

BROADCASTING

THE BUSINESS

TELEVISION AND RADIO

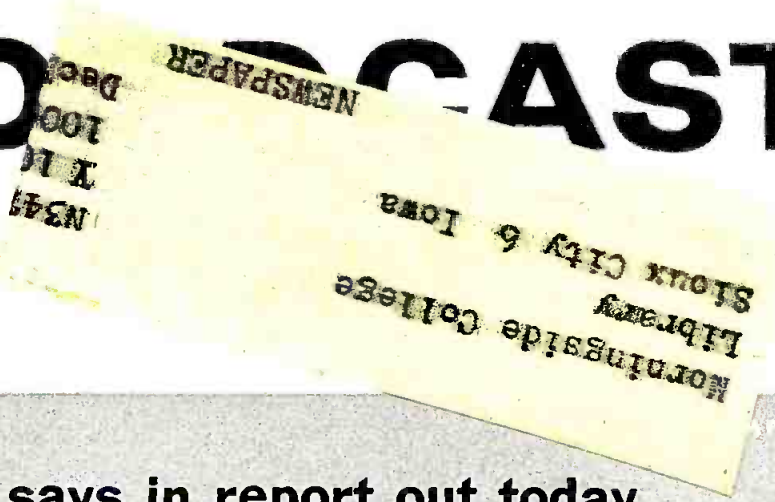

IN THIS ISSUE	COMPLETE INDEX PAGE 7
Future of uhf bleak, TASO says in report out today	Page 51
Focus on Chicago as NAB convention gets into full swing	Page 52
Y&R jumps with both feet on tv over-commercialization	Page 67
Voice of survival: how radio-tv fits into civil defense	Page 88

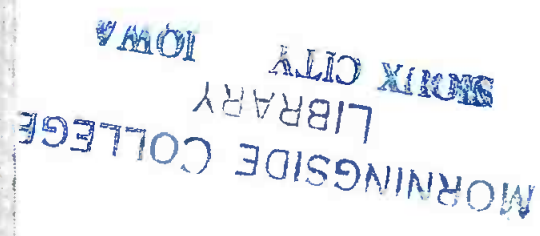
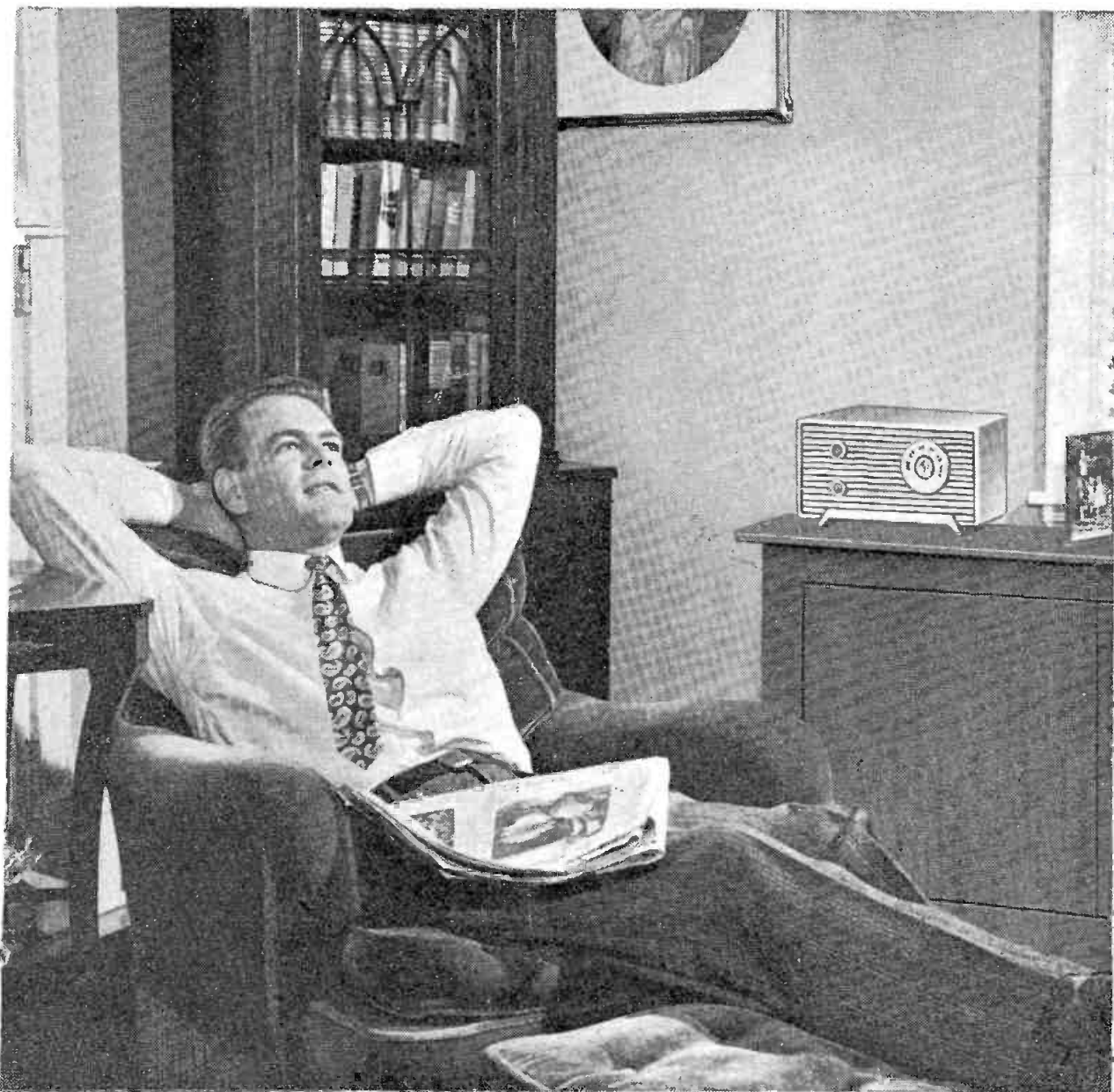

did you know that

.... Radio today is heard in over 3,200,000 MORE homes every week than it was last year* Just one more reason why

Spot Radio is such a powerful sales-maker.

- | | | |
|-----------------------------|---------------------------------|--------------------------|
| KOB Albuquerque | WINZ Miami | KCRA Sacramento |
| WSB Atlanta | WISN Milwaukee | WOAI San Antonio |
| WGN Chicago | KSTP Minneapolis-St. Paul | KFMB San Diego |
| WFAA Dallas-Ft. Worth | WTAR Norfolk | KOBY San Francisco |
| KOSI Denver | KFAB Omaha | KMA Shenandoah |
| WANE Fort Wayne | WIP Philadelphia | WNDU South Bend |
| KPRC Houston | KPOJ Portland | KREM Spokane |
| WISH Indianapolis | WJAR Providence | WGTO Tampa-Orlando |
| KARK Little Rock | WRNL Richmond | KVOO Tulsa |

*A. C. Nielsen Co.

Radio Division
EDWARD PETRY & CO., INC.
 The Original Station Representative

New York • Chicago • Atlanta • Boston • Dallas • Detroit • Los Angeles • San Francisco • St. Louis

Everybody in
Big Aggie Land
knows
Wynn
Hubler
Speece

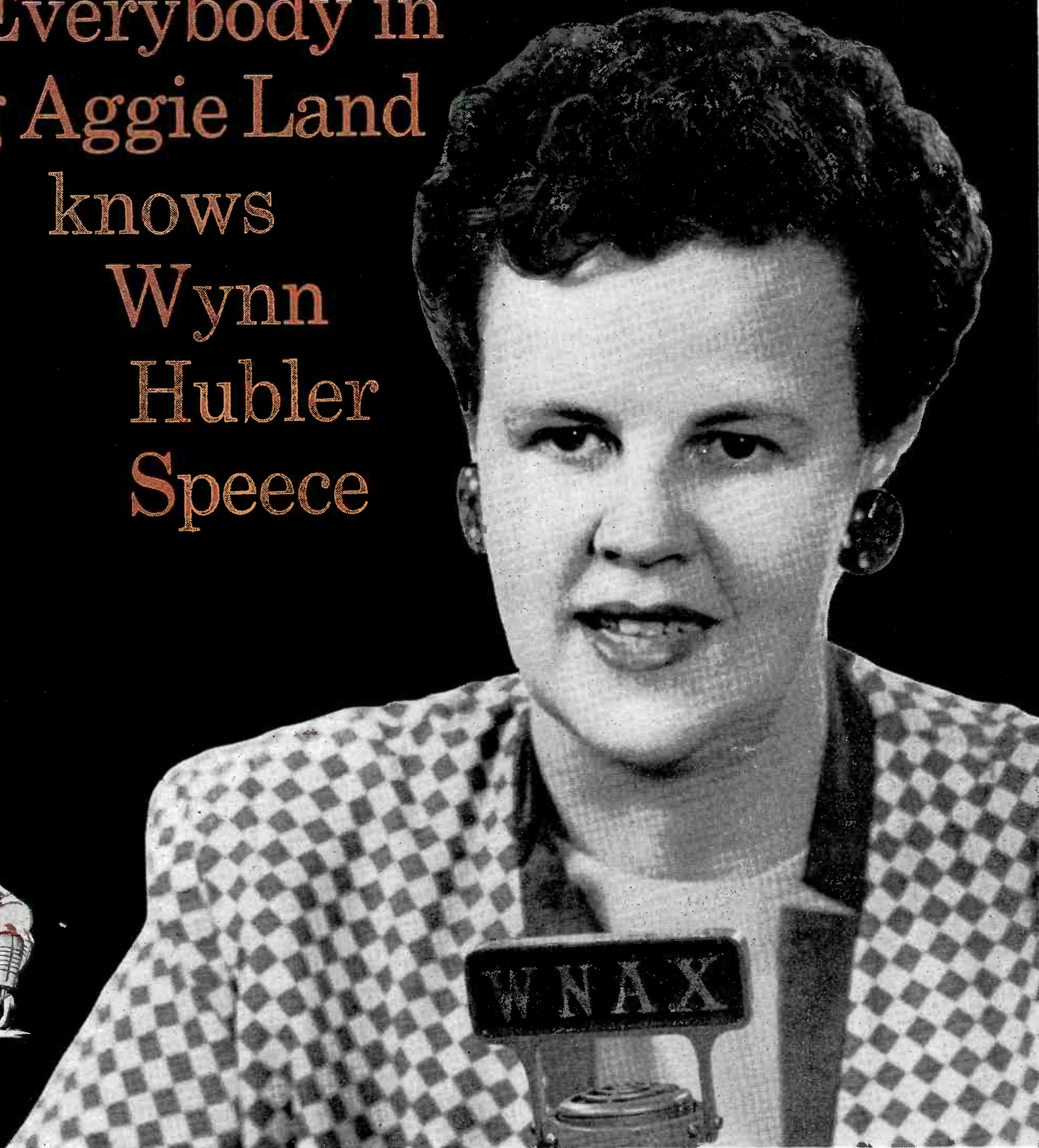

Wynn is WNAX-570's Neighbor Lady and her program is "must listening" for housewives throughout WNAX-570's 5-state, 175-county coverage area.

During her 18 years on WNAX-570, Wynn has received more than 2,000,000 letters from her listeners. She has traveled the length and breadth of Big

Aggie Land with her Neighbor Lady Kitchen Karavan. She knows her audience. They know and trust her.

The loyalties built up over the years by Wynn and other WNAX-570 personalities mean just one thing to advertisers — sales. In the Big Aggie Land market there are 2,231,800 people and

609,590 radio homes. Spendable income is over 3 billion dollars. WNAX-570 delivers 66.4% share of audience in this market.

To sell your product in the nation's 41st market — sell on the most trusted voice in Big Aggie Land, WNAX-570.

WNAX-570 CBS RADIO



PROGRAMMING FOR ADULTS OF ALL AGES

PEOPLES BROADCASTING CORPORATION
Yankton, South Dakota Sioux City, Iowa

	PEOPLES BROADCASTING CORPORATION
	WGAR, Cleveland, Ohio
	WRFD, Worthington, Ohio
	WTTM, Trenton, New Jersey
	WMMN, Fairmont, West Virginia
	WNAX, Yankton, South Dakota
KVTU, Sioux City, Iowa	

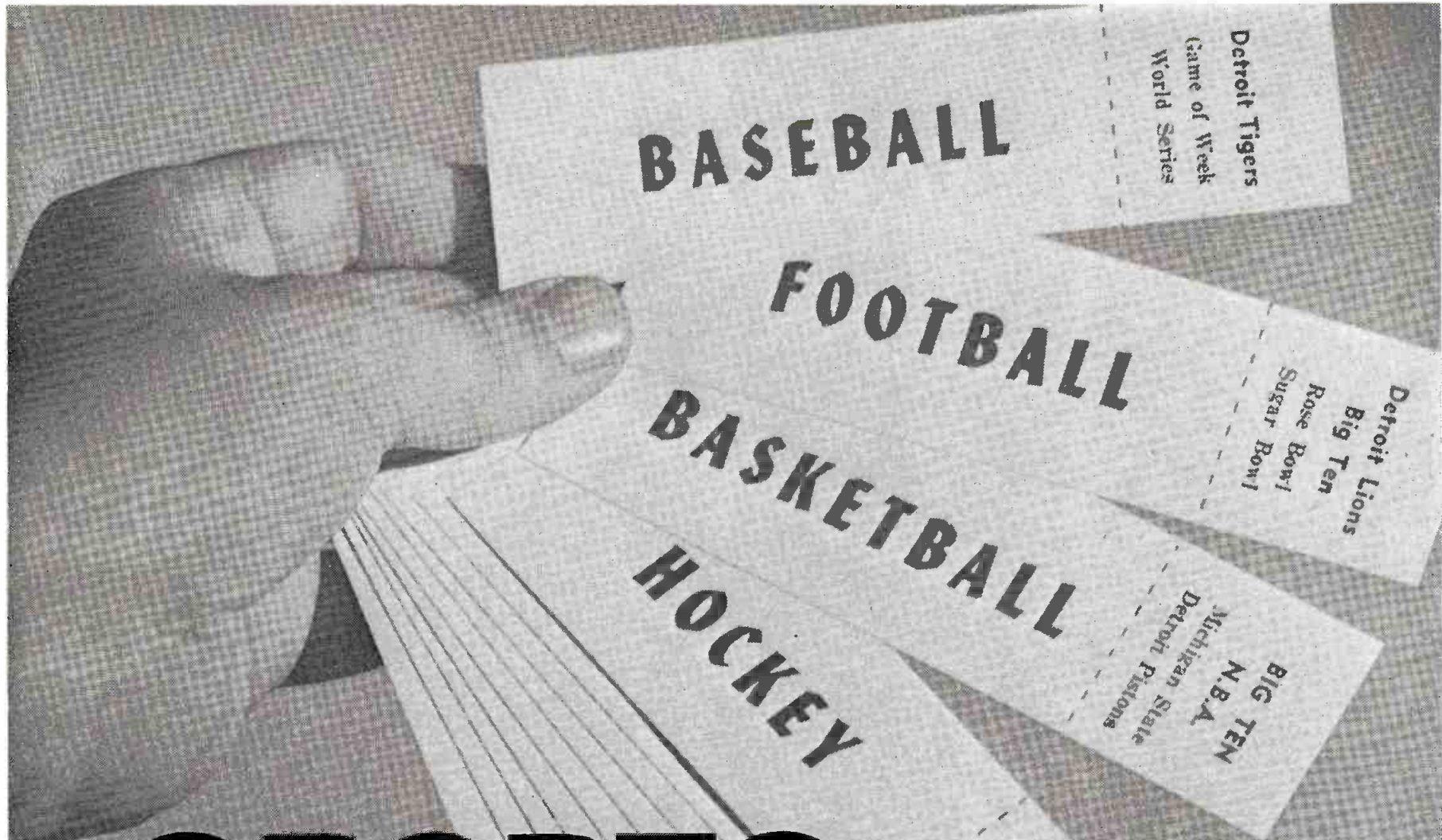

SPORTS

Coverage that Counts!

Now in our tenth year, WJIM-TV provides sports-loving mid-Michigan with the most comprehensive coverage in the nation! Fact is, fans in the populous Lansing-Flint-Jackson area see virtually every televised major championship event on the one channel.

WJIM-TV's year-round sports line-up includes NCAA Football, World Series, Big Ten Basketball and Football, Detroit Tigers, All-Star Bowling, NBA Basketball, Red Wing Hockey, Rose Bowl, Sugar Bowl, Detroit Lions, NIT Basketball, Baseball Game of the Week, golf, tennis, horse racing and more!

They're all "good sports" — including the 400,000 mid-Michigan TV families who have a habit of watching WJIM-TV.

WJIM-TV

Strategically located to exclusively serve
LANSING... FLINT... JACKSON



Represented by the **P.G.W. Colonel**

WGAL-TV

CHANNEL 8 / LANCASTER, PENNA. / NBC and CBS

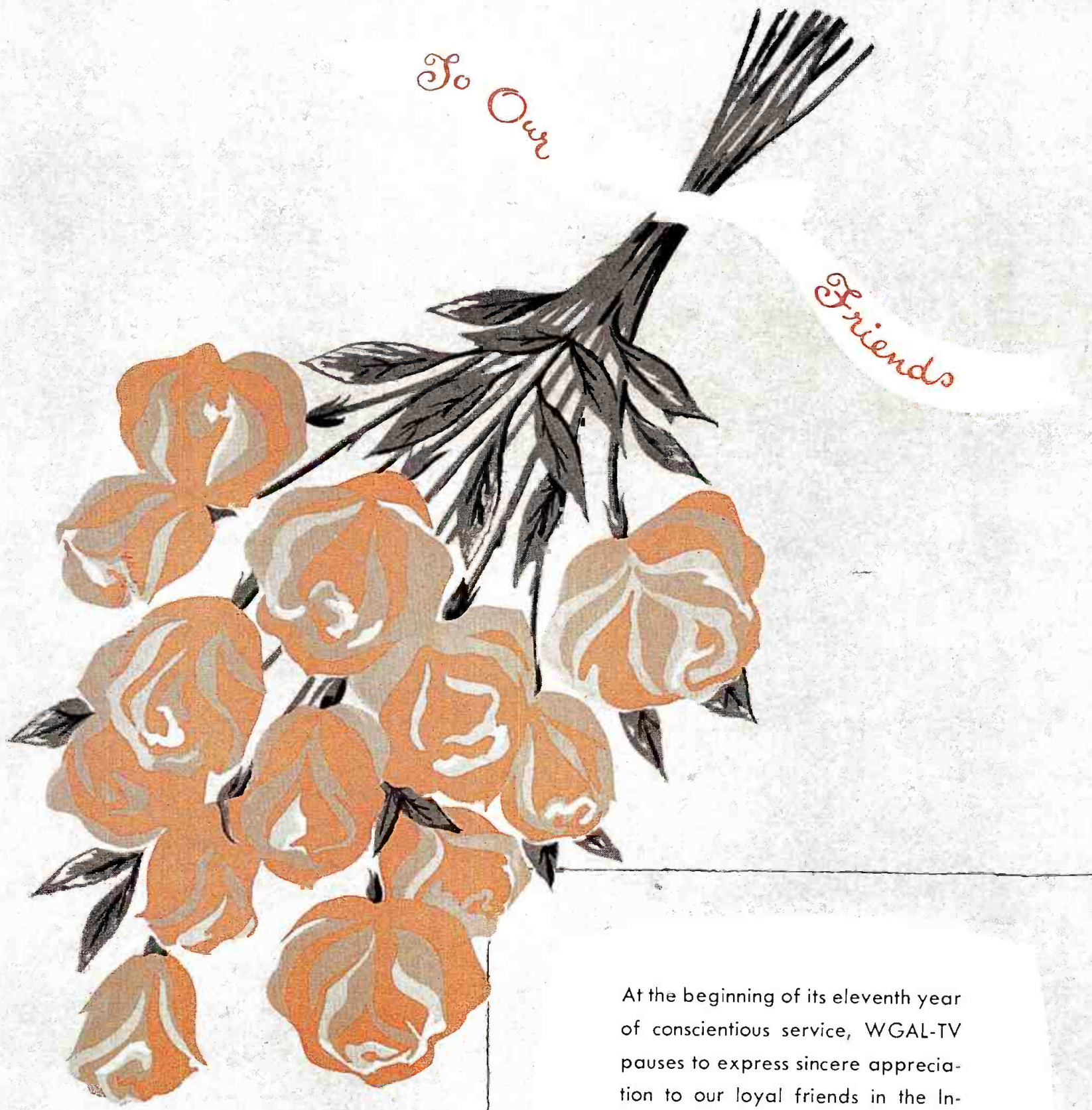

At the beginning of its eleventh year of conscientious service, WGAL-TV pauses to express sincere appreciation to our loyal friends in the Industry. We will strive to continue the best in programming, and to inform, entertain, inspire, educate, and satisfy the many communities we serve.

STEINMAN STATION
CLAIR McCOLLOUGH, PRES.



Mr. Channel 8
316,000 WATTS

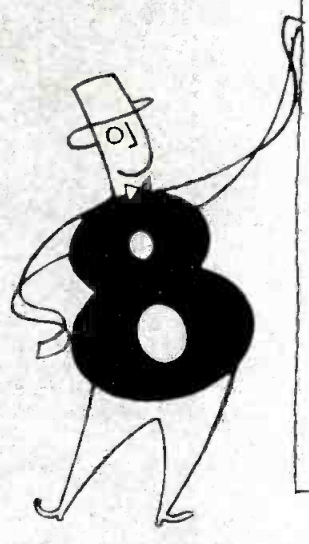

Representative:
The MEEKER Company, Inc. • New York • Chicago • Los Angeles • San Francisco

CLOSED CIRCUIT

Stanton on standby • If emergency authority over communications ever is invoked, "czar" in all likelihood will be Dr. Frank Stanton, CBS Inc. president. Dr. Stanton, who serves voluntarily on number of sensitive policy boards, for past several years has been spending average of better than one day per week in Washington. On more than one occasion, he has been asked by President to accept top-level federal appointment but has preferred to remain at CBS where he works long hours while devoting free time to Washington policy matters in cloak of complete anonymity.

No sale • Persistent rumors in financial circles that RCA will sell off NBC to get out of antitrust predicament are unequivocally denied. RCA-NBC executives believe rumors have been deliberately planted, but won't say by whom.

Big sale • WSAI-AM-FM, Cincinnati independent, moves to Consolidated Sun Ray ownership, subject to customary FCC approval, at whopping price of between \$1.5 and \$2 million under agreement signed last week by Sherwood Gordon, owner of Cincinnati property, and William B. Caskey, executive vice president of Wm. Penn Broadcasting Co., Sun Ray subsidiary. Station is second to be acquired by Sun Ray, owner of WPEN Philadelphia, in past month (it purchased WALT, Tampa daytimer, for \$300,000). It also will be applicant for new daytimer in Washington, D.C. (BROADCASTING, March 2).

WSAI-AM-FM, operating on 1360 kc with 5 kw, was established in 1923. Mr. Gordon purchased station in 1953 from Buckeye Broadcasting Co., subsidiary of Storer, for \$203,000. Mr. Gordon last week also sold KCUB, Tucson local, for \$200,000 to Ralph Bofford of New York, who has lived in South Africa for past dozen years. Mr. Gordon also owns KBUZ and KTYL-FM Mesa-Phoenix.

Uhf for pay tv • Next big development in pay tv will be pitch by Zenith (Phonevision) to acquire from CBS its uhf operation in Milwaukee (ch. 18 WXIX) scheduled to go dark April 1 when network shifts to Storer's ch. 6 WITI-TV, now independent (BROADCASTING, March 2). Zenith will seek facility to test its version of pay tv in market having established uhf audience (258,000 homes converted to uhf).

Precise circumstances under which tests would be evolved must await ac-

tion of FCC following consultation with Chairman Oren Harris (D-Ark.) of House Commerce Committee. He is author of resolution to ban pay tv (HJ Res. 130) but has suggested that limited tests be authorized under rigid supervision. FCC last year had proposed tests but this was squelched by Congress. Zenith previously had made Phonevision test in 300 homes in Chicago in 1951, but despite tidal wave of promotion, it flopped, as did Bartlesville test two years ago.

Military needs • First official military statement on future needs for spectrum space will come this week at NAB convention. Lt. Gen. Arthur G. Trudeau, Army's chief of research and development, will definitely talk about spectrum use in his convention speech at Wednesday luncheon. Speech last week went through clearances in highest Army and Dept. of Defense echelons.

Instant ratings • American Research Bureau will begin producing its Arbitron instant television ratings for Chicago on commercial basis April 1, but will preview daily reports during NAB convention in Chicago this week. For several months Arbitron New York and multi-city reports have been in commercial operation. But though Chicago is one of seven cities in multi-city ratings, sample there just now has been brought to size that justifies individual report for the market. Multi-cities include New York, Philadelphia, Baltimore, Washington, Cleveland and Detroit.

Three-way look • Liggett & Myers Tobacco, with some \$18 million at stake in network tv, at present is studying programming structure for next fall. Company is in touch with all three networks. Though Chesterfield is considering *Alaskans*, *Sugarfoot* and *Adventures in Paradise* on ABC-TV next season, agency spokesmen deny any deal has been set or that Chesterfield "pulled out" of NBC-TV where it sponsors *Black Saddle*, *Steve Canyon* and *D.A.'s Man*. Chesterfield is handled by McCann-Erickson, New York, and L&M cigarettes by Dancer-Fitzgerald-Sample, New York.

Head table • Although in retirement, Jimmy Petrillo is still haunting broadcasters. Action of Broadcast Pioneers in selecting him for special citation at its annual banquet in Chicago tomorrow (Tuesday) has brought repercussions from broadcasters who fought him tooth and nail during his free-

swinging incumbency as president of American Federation of Musicians. One head table guest, who likewise was to have received citation, asked to be excused.

Matter of time • It now appears certain that MGM-TV will enter film distribution, setting up one force for national sales and another for syndication. Should economic climate and available product favor move at that time, MGM-TV would begin distributing film as early as next fall.

More news • Although those ambitious plans ABC Radio has for its news-special events programming (see page 118) came on heels of new Intermountain Network tieup, it was not cause-effect relationship. Actually, moves are part of ABC's answer to new program like *Radio World Wide* (BROADCASTING, March 9), which may be springing up to compete with conventional radio networks.

ABC Radio reportedly has all but enticed 25-year independent station into network fold, is expected to make it official soon with formal signing. Station is KWJJ Portland, Ore., owned and managed by Rodney F. Johnson. It's 10 kw on 1080 kc, and about April 1 is slated to replace KGW Portland (620 kc, 5 kw) in ABC lineup. KGW is moving to NBC Radio.

Double reason • Why all that steam up at BBDO in behalf of tv tape? Agency makes no bones about it: not only does it believe tape is efficient and has immediacy, but Minnesota Mining & Mfg. Co. (supplies magnetic tape) is its client. BBDO is showing its tape-consciousness by encouraging all its tv clients to use tape routinely as well as experimentally; also is encouraging other advertising agencies of BBDO clients to tape live commercials.

Slow starts • Heavy slate of radio-tv matters still is facing both House and Senate Commerce Committees but discussions, particularly in Senate, have run along line of "let's not set up anything until after Easter recess (March 26-April 6)." Kenneth Cox, special counsel to Senate committee, still owes report on tv allocations but awaits FCC answers on written questions submitted last summer. Mr. Cox now wants to call Commission to Hill for face-to-face questioning before finishing his report. Inactivity also means planned (but not scheduled) ratings hearings still are weeks away.



PEOPLE WHO KNOW ATLANTA TV KNOW WAGA-TV IS THE BUY!

Up and down Peachtree (and Madison Avenue too) folks who are up-to-date on Atlanta TV are boosting their budgets on WAGA-TV, Atlanta's *live* Channel 5.

For instance, Rich's—known as the South's leading department store—has been using WAGA-TV with increasing frequency in recent months—and increasing success, too. That's because WAGA's strong local programming, featuring top Warner Brothers, RKO, United Artists, and Screen Gem Movies, is delivering a big and growing family audience at remarkably low cost.

It'll pay you to be up-to-date on Atlanta's best TV buy. See your KATZ man today.



Storer Television

WAGA-TV
Atlanta

WSPD-TV
Toledo

WJW-TV
Cleveland

WJBK-TV
Detroit

WITI-TV
Milwaukee

WEEK IN BRIEF

Chicago! Chicago! • Broadcasting industry moves to temporary headquarters at Conrad Hilton Hotel for 37th annual NAB Convention. Begins page 52.

CONVENTION LEAD STORY Page 52

OFFICIAL, UNOFFICIAL AGENDAS Page 54

"WHERE TO FIND IT" DIRECTORY Page 62



Mr. Cross

Let's promote the commercial too • Programs get plenty of publicity and fanfare. So it's about time more attention is paid to giving the commercial that extra boost it also deserves to help it do the vital job of selling. Christopher Cross, vice president and director, Publicity-Promotion Dept., Grey Adv., New York, tells how Grey performs the task in this week's **MONDAY MEMO**. Page 47.

TASO sounds knell for uhf • Two-year study finds uhf far inferior to vhf in almost all areas. Technical group holds out little hope for improvement. FCC now must face up to tv allocations problem. Page 51.

Y&R's count down • Agency grimly condemns multiple-spotting, certain other tv station practices. William E. Matthews details how Young & Rubicam deals with the situation. Page 67.

Voice of survival • A depth study of broadcasting's role as the No. 1, maybe the only connection between individuals and their communities. How CONELRAD is being revamped to meet the threat of sophisticated missiles. Page 88.

BMI renewals near 100% • All networks, all tv stations and all but 50 radio stations sign new contracts, BMI reports. CBS Radio breaks BMI precedent by taking network per-program rather than blanket license. Page 100. All-Industry group meanwhile continues ASCAP negotiations. Page 105.

Peril to journalism • Dr. Frank Stanton says Sec. 315, equal-time clause, is threat to broadcast news and even to modern democracy under latest FCC ruling. Page 112.

More about Mutual • The radio network, hanging on by its teeth, rushes to close deal for sale to Malcolm Smith and associates in time to present a solid front before affiliates at the NAB Convention in Chicago. On credit side last week: MBS was still on the air even though it has lost regional Intermountain Network to ABC and may lose Don Lee. Page 118.

Shoots for the top • ABC-TV presents its story to 1,000 advertisers and agency executives in New York and is to repeat it in Chicago. The script reads: higher ratings, greater coverage and audiences, plus new programming preview. Page 119.

Merrill Lynch rates radio-tv • . . . and finds electronics up, videotape long-range and film mixed. If you want the details of how two analysts from this top stock brokerage house appraise the broadcasting industry, read this exclusive **BROADCASTING** interview. Page 124.

DEPARTMENTS

AT DEADLINE	9	LEAD STORY	51
BROADCAST ADVERTISING	67	THE MEDIA	112
BUSINESS BRIEFLY	78	MONDAY MEMO	47
CHANGING HANDS	120	OPEN MIKE	26
CLOSED CIRCUIT	5	OUR RESPECTS	185
DATEBOOK	19	PROGRAMMING	100
EDITORIAL PAGE	186	WEEK'S HEADLINERS	10
EQUIPMENT & ENGINEERING	105		
FANFARE	152		
FATE & FORTUNES	106		
FOR THE RECORD	158		
GOVERNMENT	84		
INTERNATIONAL	149		



*

Diamonds
are ...



this girl's
best friend...
next to **KOIN-TV**.
She gets eye-power
from her baubles,
buy-power from the
favorite station in
Portland and 32
surrounding Oregon
and Washington counties.
She likes what she sees
on **KOIN-TV**, and
she buys what she likes...
just ask the astute
chaps at
CBS-TV Spot Sales.
They've got the
delightful low-down
on **KOIN-TV's**
high-up ratings
and coverage.

The Modern American Family

ONE OF THE SPECIES:

The Apron Stringed

Home Runner



A domesticated creature devoted to Bartell Family Radio for entertainment, information, shopping news. Responds quickly to attractive overtures. Sings jingles while roaming super markets, drug and department stores. She is in the 84% group of adults who comprise the dominant audience of Bartell Family Radio in five major markets.

Bartell Family Radio Reaches More Different Kinds Of People

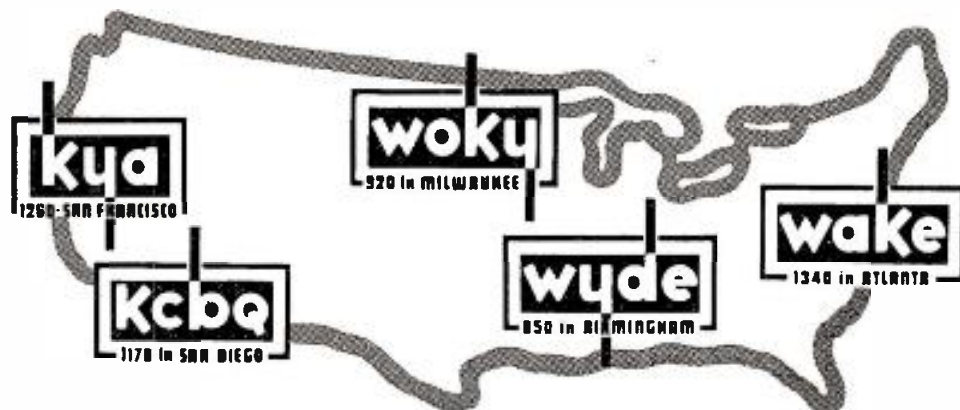

Bartell it . . . and sell it. Sold Nationally by ADAM YOUNG INC.

TvB, WBC HIT BAR REPORT

Television Bureau of Advertising and Westinghouse Broadcasting Co. last Friday (March 13) criticized sharply Broadcast Advertisers Report's survey of station practices which, Young & Rubicam said, revealed "over-commercialization" by television outlets (see page 67).

Norman E. Cash, TvB president, charged that BAR report placed tv industry in "a false and misleading light." He acknowledged that in television, as in other businesses, "some people" follow practices not accepted by others. He stressed report covers only 68 of nation's 510 tv stations and added: "Selection of these markets does not yield a sample which can be projected to measure total television."

Mr. Cash clashed with BAR's inclusion, as one example of "over-commercialization," stations' policy of placing two one-minute commercials separated by one 10-second announcement (so-called "60-10-60" formula). This practice, Mr. Cash said, has been accepted by leading advertisers and their agencies because it applies mainly to movies on tv and enables station to

interrupt a 90-minute film only six times. In summary, Mr. Cash claimed that BAR's report "certainly was no service either to its station subscribers, the industry from which it is supported, or the advertisers and agencies it is designed to serve."

Phil Edwards, publisher of BAR, took issue with TvB's statement that BAR sampling was "inadequate," since, Mr. Edwards insisted, BAR is not in sampling business and never has been. He said report was based on monitored survey in 20 cities. He added that it was noteworthy that "questionable" practices did not crop up in its monitored survey of top 25 markets.

Westinghouse made known its position in letter sent to advertising agency media vice presidents Friday in which WBC re-stated its position against triple-spotting but questioned BAR's lumping 60-10-60 second policy with other "questionable" practices. A.W. Dannenbaum Jr., vice president—sales, said it was "very unfortunate" that BAR included 60-10-60 second practice in same category with those not permitted on WBC stations.

ing projects, plus clearances with interested parties (Securities & Exchange Commission, court, among others) proved too much to be concluded in time available (see story page 118). Feeling was that final terms might be reached early this week.

Both Mr. Smith and current Mutual executive lineup will meet with affiliates at NAB Convention in Chicago over weekend to discuss their plans for network operations.

It was apparent that original one-week option could be renewed as necessary to bring negotiations to successful conclusion. Blair Walliser, Mutual executive vice president who ran network's side of negotiations last week, said Mutual would not restrict possibility of sale on grounds of "magic number like seven days."

It's also understood AT&T is satisfied with current status of sale plans and is content to hold off major demands for present. Mutual said it has money to pay current bills.

Labor has stake in station growth

Broadcasting unions "have just as much stake in a healthy, prosperous industry as broadcasting management," Charles H. Tower, NAB personnel-economics manager, said Friday (March 13) at annual meeting of American Federation of Tv & Radio Artists local in Louisville. He urged broadcast unions "to play a more active role in combating the attacks of the mischievous, misguided and misinformed."

"Management and labor have a common interest in the size of the pie," Mr. Tower said, "although they may disagree over how it should be divided. He proposed "greater realism" on part of management and labor in determining "where we are competitive and where we are not."

Miss their supper

Pity poor FCC commissioners. Looks as if they won't be able to attend NAB banquet Wednesday night. They're all due to appear Thursday morning before Senate Commerce Committee on international common carrier matters. This has to do with legislation which would permit U. S. international communications carriers to merge.

Storer buys KPOP; KVAN, KTVR sold

These station sales announced Friday, all subject to usual FCC approval:

KPOP Los Angeles • Sold by John F. Burke Sr. and family to Storer Broadcasting Co. for price understood to be in neighborhood of \$900,000. KPOP, 5 kw on 1020 kc (limited with clear channel KDKA Pittsburgh), has application pending for 50 kw daytime, specializes in Negro and Spanish programming. If purchase approved by FCC, Storer will have to dispose of one am station; it now holds maximum of seven.

KVAN Vancouver-Portland • Sold by Sheldon Sackett and associates to Don W. Burden for \$580,000, payable over 10-year period. Mr. Burden is principal owner of KOIL Omaha, Neb., and KMYR Denver, Colo. Mr. Sackett, retaining \$90,000 in KVAN net quick assets, owns KROW Oakland, Calif., and KOOS Coos Bay, Ore. He is also newspaper publisher. KVAN is 1 kw on 910 kc. Transaction handled by Norman & Norman Inc.

KTVR Denver • Half interest sold by Radio Hawaii Inc. (Founders Corp.) to other 50% owner, Gotham Broadcasting Corp. (WINS New York—J. Elroy McCaw and John D. Keating) for \$160,000. KTVR is ch. 2 independent. Gotham and Founders Corp. bought then KFEL-TV in 1955, paying \$400,000 and assuming obligations totaling \$350,000. Mr. McCaw is multiple broadcast owner, including in addition to his New York station, the following: KTVW (TV) Tacoma-Seattle, Wash.; KDAY Santa Monica, Calif.; 50% of KONA (TV) Honolulu, Hawaii; 50% of KELA Centralia, Wash., and 33 1/3 % of KALE Richland, Wash. Founders Corp. (John M. Shaheen) owns KPOA Honolulu, Hawaii; WFBL Syracuse, N.Y.; WTAC Flint, Mich., and 50% of WSMB New Orleans, La.

Mutual sale talks continue this week

Sale of Mutual network to Malcolm Smith and associates, which network had hoped to consummate Friday, could not be brought in that day. Officials said complexity of various financ-

AT DEADLINE

CONTINUED

Lar Daly won't ask parade time

Chicago tv outlets will be given chance to telecast city's St. Patrick's Day Parade tomorrow (March 17, along with Democratic and GOP nominees for mayor, without having to give equal time under Sec. 315 to potential write-in candidate Lar Daly, if they want to take his word he won't make equal time demands on them. In what appears to be, for him, magnanimous gesture, Mr. Daly promised if stations carry parade (they have no such plans so far) and Democratic and GOP nominees for mayor appear, he won't demand equal time. Mr. Daly, who ran for nomination for mayor on both tickets in Feb. 24 primaries, has not yet indicated he'll run in April 7 election.

Meanwhile, NBC joined ABC and CBS in protesting FCC's action requiring Chicago tv stations to give Mr. Daly time equal to that of Democratic and

GOP candidates for nomination in Feb. 24 primaries (BROADCASTING, Feb. 23, *et seq.*). NBC asked FCC to reverse ruling or issue declaratory ruling clarifying Sec. 315 application to station use of newsfilm of candidates in news shows.

NBC backs free access

NBC released Friday (March 13) texts of letters sent by network to New York state officials in support of bills now pending in state legislature which would permit tv, radio and motion picture coverage of hearings of legislature or its committees. David Adams, senior executive vice president of NBC, stressed that radio-tv should have equal access with other media in such coverage and pointed out that air media would not interfere with "orderliness" of proceedings. Letters went to Gov. Nelson A. Rockefeller; Republican Assembly Leader Joseph Carlino and Democratic Senate Leader Walter Mahoney.

• Business briefly

• Liggett & Myers, for L&M cigarettes, has bought complete NBC Radio *Stardust* package for 13 weeks beginning May 18, opening date of plan. Pricetag: \$525,000. *Stardust* is series of 5-minute vignettes featuring name stars (Dietrich, Hope, Bob & Ray, etc.). Broadcast at 25 minutes after hour, 17 times daily. L&M will have 60-second commercial position, local station 30-second. Agency: Dancer-Fitzgerald-Sample, N.Y.

• Corning Glass Works, Corning, N.Y., has had to apply brakes somewhat in market-by-market tv spot introduction of Corning Ware (Pyroceram cookware). Reason: demand in already-exposed markets (Northeast, California) is so far in excess of expectations that supply is not readily available for introductory markets. Plans for next fall: national nighttime network participations plus local spot in some major markets. Agency: N.W. Ayer & Son.

WEEK'S HEADLINERS



Mr. Buck

Mr. Acker

MAX E. BUCK, director of sales-marketing of WRCA-AM-TV New York, promoted to newly-created post of WRCA-TV station manager. FREDERICK E. ACKER, manager of business affairs, WRCA-AM-TV, adds duties as manager of operations for both stations. Mr. Buck joined NBC in January 1953 as director of merchandising for network's o&o stations and director of merchandising-promotion of WRCA-AM-TV. Mr. Acker acquires duties relinquished by Peter Affe, promoted last week (BROADCASTING, March 9) to NBC-TV manager of facilities planning-utilization. In related promotion, ALVIN H. PERLMUTTER, director of special events, WRCA-AM-TV, has been promoted to director of public services for both stations.

Tracey-Locke Co. Houston office will become Clay Stephenson Assoc., advertising and merchandising agency, effective April 1, according to joint announcement Friday by MORRIS HITE, president of Tracey-Locke, Dallas, and CLAY W. STEPHENSON, T-L executive v.p. in charge of Houston office. "Amicable separation" was made because of present and impending conflicts in accounts, both principals stated. Stephenson Assoc. estimated its expected first year's billings in excess of \$6 million. Mr. Stephenson formerly was with Duane Jones Co. and J. M. Mathes Inc., both New York, and joined Tracey-Locke in 1948. He was made executive v.p. in 1950. Other officers of Stephenson Assoc. will include CECIL B. PHILLIPS, Tracey-Locke account supervisor, v.p.;

THOMAS E. DALEY, T-L production manager, secretary-treasurer; SAM H. LESTER, formerly with BBDO, New York, copy director; MARGE CONNER, publicity director; JAMES B. HIGGINBOTHAM, research director; HELEN SANFORD, T-L media director will hold same title with Stephenson; ROBERT T. WOLLEBAK, production manager, and MALCOLM L. MULLEN, formerly with Hicks & Greist, New York, head of accounting department. Stephenson Assoc., headquartered at 2332 W. Holcombe Blvd., Houston, will employ staff of 43.



Mr. Snyder

FRANKLIN C. SNYDER, general manager of WTAE (TV) Pittsburgh, elected v.p. of Television City Inc., licensee of WTAE. Mr. Snyder will continue as general manager of station, which began commercial operation Sept. 14, 1958. Mr. Snyder joined WXEL (TV) (now WJW-TV) Cleveland in 1949 and rose to post of v.p. and general manager. He then became New York consultant of Westinghouse Broadcasting Co. before moving to Cleveland office of McCann-Erickson as v.p. and account service director.

IRVING FELD, v.p. and director at Guild Films, elected president of Inter-World Tv Films. Independent producer of motion pictures before joining Guild Films in 1955, Mr. Feld will direct expansion of Inter-World sales and programming abroad. Company has foreign exhibition rights to some 2,000 tv film programs owned by Guild.

• NORMAN GLUCK, formerly director of tv department of Universal Pictures Corp., N.Y., appointed to newly-created post of director of corporate operations for Screen Gems Inc., N.Y., concentrating on developing new areas of business for SG.

FOR OTHER NEWS OF PEOPLE SEE FATES & FORTUNES

AN *Incredible Achievement* WITHOUT PRECEDENT . . .

TWO ZIV SHOWS TIED FOR 1ST PLACE FOR ENTIRE YEAR!

12-MONTH
AVERAGE
FOR 22
MAJOR
MARKETS . . .

Pulse Multi-Market
Weighted Average
U. S. Pulse Spot
Film Reports,
November, 1957
thru October, 1958

VARIETY Anniversary January 7, 1959

Top 20 National Syndicated Shows

Data for this chart was taken from the U.S. Pulse Spot Film Reports covering a period from Nov., 1957, through Oct., 1958. A program to appear in this report must have appeared in four of the basic 22 Pulse markets. The national average is weighted according to the size of the market. Any program to appear in this chart must have appeared at least 6 times.

Program	No. of Appearances	Distributor	Yearly Nat'l Ave.
1. Sea Hunt	(9)	Ziv	18.3
1. Highway Patrol	(12)	Ziv	18.3

THE ONLY SHOW THAT COMPETES WITH A ZIV SHOW IS ANOTHER ZIV SHOW!

The HOT SHOWS



MACKENZIE'S RAIDERS

starring
RICHARD CARLSON

2-Station
BIRMINGHAM
WBRC-TV

55.3%

SHARE

35.3 RATING

BEATS Restless Gun, Peter Gunn, Wells Fargo, Cheyenne, Groucho Marx, Perry Como and many others.

Jan. '59



SEA HUNT

starring
LLOYD BRIDGES

4-Station
CHICAGO
WNBQ

36.0%

SHARE

25.1 RATING

BEATS Groucho Marx, Ed Sullivan, Wells Fargo, Peter Gunn, Gale Storm, GE Theatre and many others.

Jan. '59



HIGHWAY PATROL

starring
BRODERICK CRAWFORD

4-Station
SAN FRANCISCO
KRON-TV

46.3%

SHARE

21.9 RATING

BEATS Playhouse 90, Ed Sullivan, Ernie Ford, Cimarron City, Lawrence Welk, Californians and many others.

Jan. '59

come from ZIV!

3-Station
CINCINNATI
WKRC-TV

47.7%

SHARE

20.7 RATING

BEATS Ed Sullivan, Phil Silvers, Hit Parade, Restless Gun, Jackie Gleason, Bob Cummings and many others.

Dec. '58

3-Station
MIAMI
WTVJ

46.3%

SHARE

26.3 RATING

BEATS GE Theatre, Texan, Danny Thomas, Ernie Ford, Cheyenne, Groucho Marx and many others.

Dec. '58

2-Station
JOPLIN-PITTSBURG
KOAM-TV

46.7%

SHARE

31.3 RATING

BEATS Trackdown, Ed Sullivan, Bob Cummings, George Burns, Red Skelton, Texan and many others.

Dec. '59

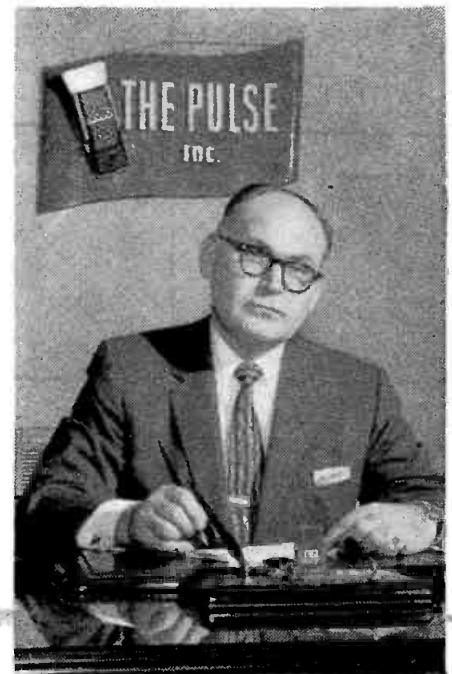

Dr. Sydney Roslow, director of Pulse, Inc., heads a nationwide staff trained to make and convert home interview reports into reliable ratings. Some of the Ziv show ratings used here are based on these authoritative findings.

4-Station
SAN FRANCISCO
KRON-TV

56.3%

SHARE

28.1 RATING

BEATS Desilu Playhouse, Ed Sullivan, Dinah Shore Chevy Show, Steve Allen, Californians and many others.

Jan. '59

4-Station
DETROIT
WJBK-TV

62.6%

SHARE

30.1 RATING

BEATS Perry Mason, Restless Gun, What's My Line, Jack Benny, Ed Sullivan, Bob Cummings and many others.

Jan. '59

3-Station
COLUMBUS
WBNS-TV

53.5%

SHARE

28.3 RATING

BEATS Ernie Ford, Danny Thomas, Groucho Marx, Lawrence Welk, Wells Fargo, Ed Sullivan and many others.

Dec. '58

3-Station
BOSTON
WBZ-TV

61.5%

SHARE

27.6 RATING

BEATS People Are Funny, Maverick, Have Gun - Will Travel, Wyatt Earp, Red Skelton, Real McCoys and many others.

Dec. '58

2-Station
BRISTOL-JOHNSON CITY
WJHL-TV

61.0%

SHARE

36.3 RATING

BEATS Wyatt Earp, Lineup, Perry Como, Maverick, Peter Gunn, Wells Fargo and many others.

Dec. '58

3-Station
ST. LOUIS
KSD-TV

48.7%

SHARE

27.5 RATING

BEATS Cheyenne, Millionaire, Ernie Ford, Alfred Hitchcock, Ed Sullivan, Wells Fargo and many others.

Dec. '58

WE'LL SEE YOU AT THE
NAB CONVENTION
ZIV HOSPITALITY SUITE
2306-A
HOTEL CONRAD HILTON—CHICAGO
MARCH 15-18



RATINGS SHOWN ARE PULSE OR ARB.

ZIV SHOWS

SEA HUNT
starring **LLOYD BRIDGES**



JAN. '59	DEC. '58	NOV. '58	OCT. '58	SEPT. '58
<p>MIAMI WTVJ</p> <p>40.1</p> <p>RATING 67.8% Share of Audience</p> <p>BEATS Wagon Train, Garry Moore, Red Skelton, Perry Como, Rifleman, Jack Benny and many others. ARB</p>	<p>NEW ORLEANS WDSU-TV</p> <p>33.6</p> <p>RATING 56.1% Share of Audience</p> <p>BEATS Have Gun Will Travel, Rifleman, Danny Thomas, Wyatt Earp, Phil Silvers, Ed Sullivan and many others. ARB</p>	<p>DETROIT WJBK-TV</p> <p>30.9</p> <p>RATING 72.7% Share of Audience</p> <p>BEATS Danny Thomas, Loretta Young, Peter Gunn, Ernie Ford, Groucho Marx, Ed Sullivan and many others. ARB</p>	<p>DES MOINES KRNT-TV</p> <p>43.5</p> <p>RATING 72.5% Share of Audience</p> <p>BEATS Desilu Playhouse, I've Got A Secret, GE Theatre, Ed Sullivan, Phil Silvers, Perry Como and many others. ARB</p>	<p>SACRAMENTO KCRA-TV</p> <p>40.1</p> <p>RATING 72.5% Share of Audience</p> <p>BEATS Restless Gun, Gunsmoke, Wagon Train, Perry Como, Steve Allen, Groucho Marx and many others. ARB</p>

TARGET
with Your Host
ADOLPHE MENJOU



<p>DETROIT WJBK-TV</p> <p>22.8</p> <p>RATING 49.1% Share of Audience</p> <p>BEATS What's My Line, Alfred Hitchcock, Groucho Marx, Ed Sullivan, Phil Silvers, Bob Cummings and many others. ARB</p>	<p>WICHITA FALLS KSYD-TV</p> <p>41.7</p> <p>RATING 70.8% Share of Audience</p> <p>BEATS People Are Funny, Wells Fargo, Ed Sullivan, Danny Thomas, Groucho Marx, Perry Como and many others. ARB</p>	<p>BUFFALO WBEN-TV</p> <p>39.2</p> <p>RATING 62.9% Share of Audience</p> <p>BEATS Wyatt Earp, Wagon Train, I Love Lucy, Maverick, Ed Sullivan, GE Theatre and many others. ARB</p>	<p>BATON ROUGE WBRZ-TV</p> <p>41.1</p> <p>RATING 68.0% Share of Audience</p> <p>BEATS Danny Thomas, People Are Funny, Jerry Lewis, Gunsmoke, Phil Silvers, Ed Sullivan and many others. ARB</p>	<p>DENVER KLZ-TV</p> <p>23.8</p> <p>RATING 46.5% Share of Audience</p> <p>BEATS Bob Cummings, Ozzie and Harriet, Dragnet, Wells Fargo, Jack Benny, Groucho Marx, and many others. ARB</p>
---	--	---	--	--

HIGHWAY PATROL
starring **BRODERICK CRAWFORD**



<p>SEATTLE-TACOMA KOMO-TV</p> <p>32.2</p> <p>RATING 38.5% Share of Audience</p> <p>BEATS Chevy Chase Show, Loretta Young, Restless Gun, Desilu Playhouse, Red Skelton, Have Gun, Will Travel and many others. ARB</p>	<p>CHARLESTON S. C. WUSN-TV</p> <p>33.1</p> <p>RATING 64.3% Share of Audience</p> <p>BEATS Steve Allen, Maverick, Danny Thomas, Walt Disney, Desilu Playhouse, Red Skelton and many others. ARB</p>	<p>CHICAGO WGN-TV</p> <p>22.9</p> <p>RATING 36.1% Share of Audience</p> <p>BEATS The Lawman, Ed Sullivan, Pat Boone, Ernie Ford, Jackie Gleason, People Are Funny and many others. ARB</p>	<p>GREENSBORO-WINSTON-SALEM WSJS-TV</p> <p>31.7</p> <p>RATING 79.3% Share of Audience</p> <p>BEATS Alfred Hitchcock, Real McCoys, George Burns, Steve Allen, Perry Como, Groucho Marx and many others. ARB</p>	<p>ATLANTA WAGA-TV</p> <p>23.6</p> <p>RATING 55.4% Share of Audience</p> <p>BEATS Ed Sullivan, Bob Cummings, Suspicion, Ozzie & Harriet, Steve Allen, Buckskin and many others. ARB</p>
--	--	---	---	--

RATE GREAT!

AUG. '58	JULY '58	JUNE '58	MAY '58	APR. '58
<p>JACKSON-VILLE WMBR-TV</p> <p>34.7</p> <p>RATING</p> <p>57.1% Share of Audience</p> <p>BEATS Phil Silvers, Wyatt Earp, Dragnet, Zorro, Bob Cummings, Burns & Allen and many others. ARB</p>	<p>NEW YORK CITY WCBS-TV</p> <p>37.5</p> <p>RATING</p> <p>72.8% Share of Audience</p> <p>BEATS What's My Line, Ed Sullivan, Wyatt Earp, Phil Silvers, I Love Lucy, \$64,000 Challenge and many others. ARB</p>	<p>EUREKA, CAL. KIEM-TV</p> <p>47.1</p> <p>RATING</p> <p>82.5% Share of Audience</p> <p>BEATS Godfrey's Talent Scouts, Burns & Allen, Jack Benny, Phil Silvers, Disneyland, Maverick and many others. ARB</p>	<p>BILLINGS KGHL-TV</p> <p>42.4</p> <p>RATING</p> <p>74.1% Share of Audience</p> <p>BEATS Gunsmoke, Phil Silvers, Zorro, Danny Thomas, Maverick, Ed Sullivan and many others. ARB</p>	<p>BATON ROUGE WBRZ-TV</p> <p>40.9</p> <p>RATING</p> <p>56.6% Share of Audience</p> <p>BEATS Disneyland, Life of Riley, Groucho Marx, Pat Boone, Wells Fargo, Dinah Shore and many others. ARB</p>
<p>JACKSON-VILLE WFGA-TV</p> <p>18.6</p> <p>RATING</p> <p>66.0% Share of Audience</p> <p>BEATS Wagon Train, Suspicion, Life of Riley, People Are Funny, Goodyear Theatre, Groucho Marx, and many others. ARB</p>	<p>NEW ORLEANS WDSU-TV</p> <p>23.5</p> <p>RATING</p> <p>56.2% Share of Audience</p> <p>BEATS Phil Silvers, Person To Person, Perry Mason, Cheyenne, Lawrence Welk, Maverick and many others. Pulse</p>	<p>EUREKA, CAL. KIEM-TV</p> <p>35.3</p> <p>RATING</p> <p>61.4% Share of Audience</p> <p>BEATS Phil Silvers, This Is Your Life, Ernie Ford, Maverick, Welk's Top Tunes, Pat Boone and many others. ARB</p>	<p>BILLINGS KGHL-TV</p> <p>33.2</p> <p>RATING</p> <p>59.8% Share of Audience</p> <p>BEATS People Are Funny, Ed Sullivan, \$64,000 Challenge, Jack Benny, I Love Lucy, Dinah Shore and many others. ARB</p>	<p>LAS VEGAS KLAS-TV</p> <p>23.5</p> <p>RATING</p> <p>42.2% Share of Audience</p> <p>BEATS Thin Man, Schlitz Playhouse, Studio One, U. S. Steel Hour, Welk's Top Tunes, Pat Boone and many others. ARB</p>
<p>BIRMINGHAM WBRC-TV</p> <p>33.3</p> <p>RATING</p> <p>64.9% Share of Audience</p> <p>BEATS Phil Silvers, Restless Gun, Wells Fargo, What's My Line, Groucho Marx, Bob Cummings and many others. Pulse</p>	<p>MEMPHIS WREC-TV</p> <p>36.9</p> <p>RATING</p> <p>72.7% Share of Audience</p> <p>BEATS Have Gun, Will Travel, Wyatt Earp, Suspicion, Alfred Hitchcock, I Love Lucy, Ed Sullivan and many others. ARB</p>	<p>DAYTON WHIO-TV</p> <p>39.7</p> <p>RATING</p> <p>59.2% Share of Audience</p> <p>BEATS Ed Sullivan, Wells Fargo, Restless Gun, Phil Silvers, Maverick, \$64,000 Question and many others. ARB</p>	<p>SHREVEPORT KTBS-TV</p> <p>36.1</p> <p>RATING</p> <p>64.2% Share of Audience</p> <p>BEATS Climax, Cheyenne, Welk's Top Tunes, \$64,000 Question, Maverick, Perry Como and many others. ARB</p>	<p>BOISE KBOI-TV</p> <p>44.2</p> <p>RATING</p> <p>60.8% Share of Audience</p> <p>BEATS Lawrence Welk, Bob Hope, This Is Your Life, Gunsmoke, Restless Gun, Maverick and many others. ARB</p>

Look at these

**CONSISTENTLY
FABULOUS RATINGS!**

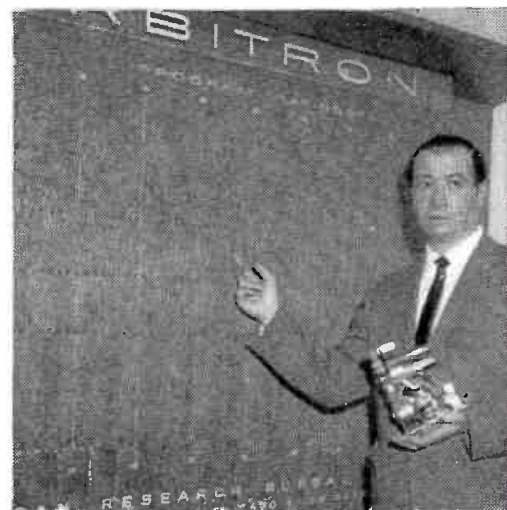

New tools of research are constantly being developed by the rating services. Here, Jack Gross, vice president of American Research Bureau, explains Arbitron, ARB's new instantaneous electronic measurement device used to provide some of the rating data given here. ARB's home diary reports are the reliable source of many other Ziv show ratings.

WE'LL SEE YOU AT THE
NAB CONVENTION
ZIV HOSPITALITY SUITE
2306-A
HOTEL CONRAD HILTON—CHICAGO
MARCH 15-18



 PUBLIC NOTICE!

All concerned are hereby notified that

LIPTON TEA AND LIPTON SOUP MIXES

Agency: YOUNG & RUBICAM, INC.



MARLBORO CIGARETTES

Agency: LEO BURNETT CO., INC.

will present

"Tombstone Territory"

for the viewing pleasure
of the citizenry!

THE BATTLE
FOR LAW
AND ORDER
IN "THE TOWN
TOO TOUGH
TO DIE"

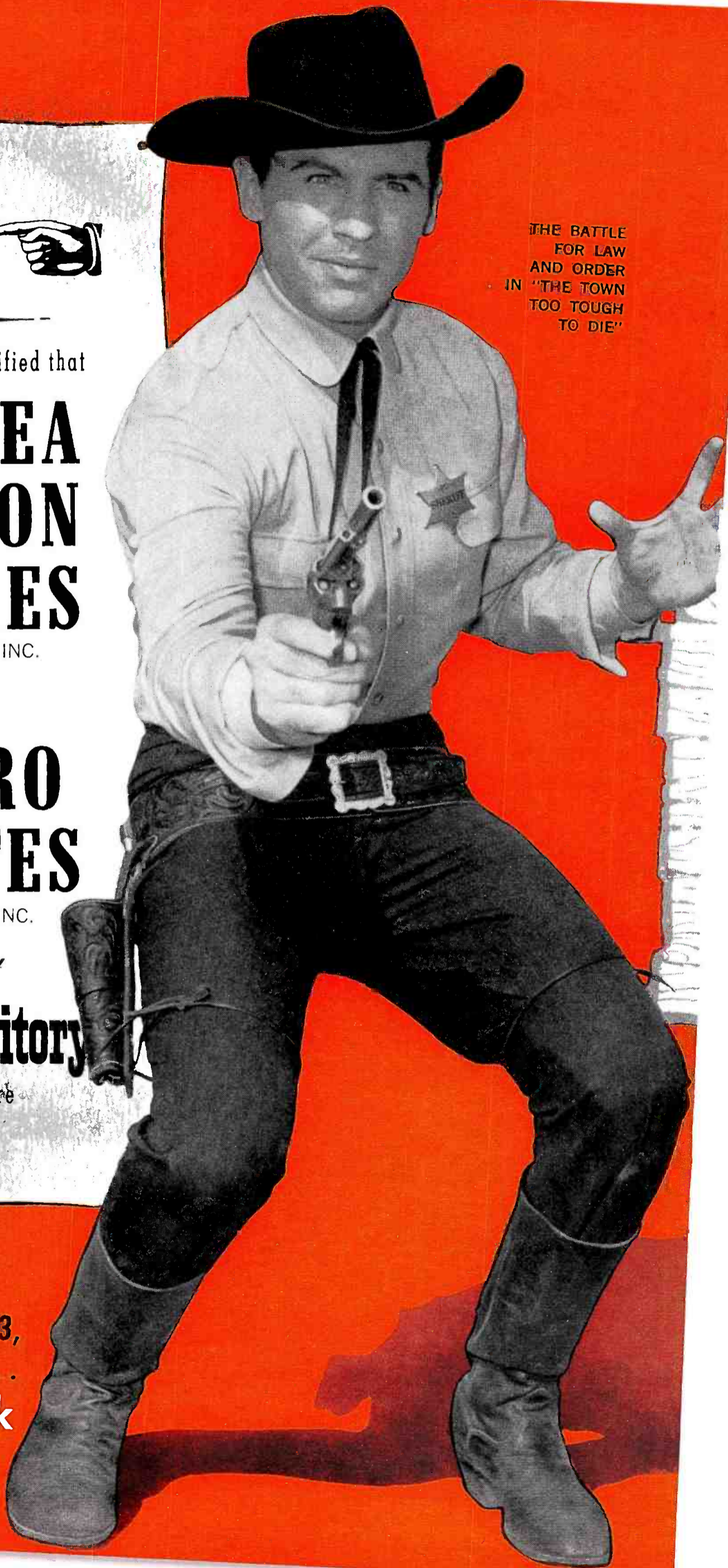

Starting Friday, March 13,
9:00 to 9:30 P.M. over ...
ABC-TV Network

starring

Pat Conway

AS SHERIFF CLAY HOLLISTER

Richard Eastham

AS EDITOR HARRIS CLAIBOURNE



TOMBSTONE TERRITORY

"BEST OF THE CROP ...!"

—Billboard

"KEPT ME AT MY SET ...!"

—San Francisco Call Bulletin

"ONE OF THE FAVORITES ..."

—Houston Chronicle

"AUTHENTICITY AND ACTION ..."

—Cincinnati Times-Star

"BIG TIME!"

—Radio Daily

"TOP-NOTCH!"

—Miami Daily News

"ABSORBING ...!"

—Variety

"THIS IS A MUST!"

—San Francisco Examiner



She's 1200 feet TALL-

and

she's a

STAINLESS!



WDAY-TV FARGO, N. D. • CHANNEL 6

Nothing beats increased tower height for more TV coverage. And WDAY-TV, with this new Stainless 1200' tower supporting a TV 6-section Superturnstile radiating 100,000 watts, now covers 96% more of the North-Dakota-Minnesota countryside!

If you are planning a new tower installation, whether she's "tall" or "short"—AM, FM, TV or STL—specify Stainless; you'll get extra years of service for your investment. Stainless tower designs are pre-tested for stresses and loads much greater than those encountered in use. That is why Stainless towers stand up . . . one reason for their enviable record of dependability. So remember, for long life at the lowest possible cost, there's no other than a Stainless. Ask today for your free booklet describing the many Stainless tower installations.

YOU CAN PUT YOUR CONFIDENCE IN A STAINLESS



Stainless, inc.

NORTH WALES • PENNSYLVANIA

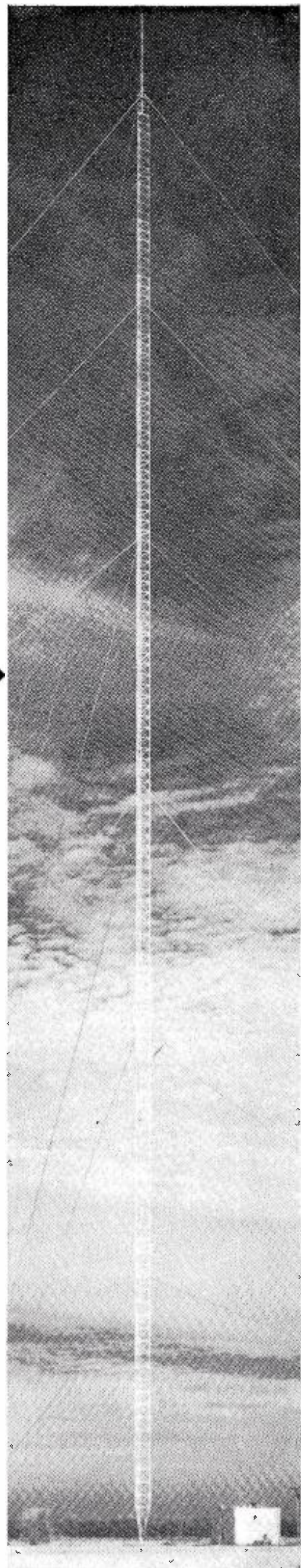

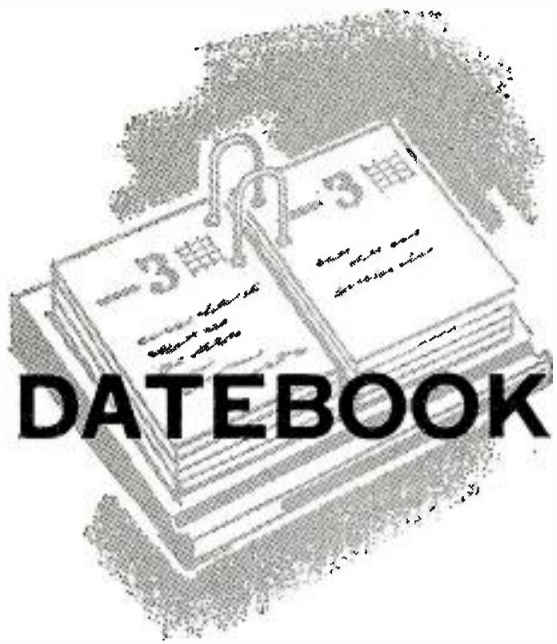

**A CALENDAR OF MEETINGS AND EVENTS
IN BROADCASTING AND RELATED FIELDS**

(*Indicates first or revised listing)

MARCH

*March 15-18—NAB Annual Convention and Broadcast Engineering Conference, Conrad Hilton Hotel, Chicago.

March 16-18—Canadian Board of Broadcast Governors, public hearings, Tariff Board Hearing Room, 70-74 Elgin St., Ottawa, Ont.

March 16 and 23—Hearing before Securities & Exchange Commission, Washington, D.C. March 16, on charges F. L. Jacobs Co. (Alexander Guterma) failed to report financial transactions. Mr. Guterma, until his troubles with SEC began, was president and chief owner of Mutual Broadcasting System. Similar Bon Ami Co. hearing March 23.

*March 17—Radio & Television Executives Society's timebuying & selling seminar luncheon, 12:15 p.m., Hawaiian Room, Lexington Hotel, New York. Jayne M. Shannon, broadcast media supervisor, J. Walter Thompson, and Richard O'Connell, president of his station rep firm, discuss the need to streamline rate cards.

March 18—Symposium on social and economic forces of advertising co-sponsored by St. Louis Council of American Assn. of Adv. Agencies and U. of Missouri School of Journalism, Sheraton-Jefferson Hotel. Dr. Earl F. English, dean of school, will moderate. Registration, \$22.50.

March 18-20—Quarterly conference, Electronic Industries Assn., Statler Hilton Hotel, Washington.

*March 19—Broadcasting Adv. Club of Chicago, luncheon at Sheraton Hotel. Matthew J. Culligan, NBC Radio executive vice president, will speak on "The New Image of Network Radio." Broadcast Pioneers will be honored. NAB officers will attend.

*March 20—Indiana Broadcasters Assn. annual meeting and election of officers, Marott Hotel, Indianapolis.

*March 21—American Women in Radio & Tv, Chicago chapter, "closed-circuit conference," Ambassador West Hotel. NAB convention delegates are invited.

March 23—Tentative date for argument before U. S. Supreme Court in *Farmers Union v WDAY Inc.* (WDAY-TV Fargo, N.D.) involving question of immunity of broadcast station when political candidate, invoking Sec. 315 of Communications Act, utters libel on air. Case No. 248.

March 23-26—Annual convention Canadian Assn. of Radio & Television Broadcasters, Royal York Hotel, Toronto, Ont.

March 23-26—National convention, Institute of Radio Engineers, Waldorf-Astoria, New York. The nation's leading electronic scientists will attend. Advances in space technology and major new electronic fields will be explored.

March 23-28—Short Course in Crime News Analysis & Reporting, Northwestern U., Fisk Hall, Evanston, Ill. Journalism and law schools, with Ford Foundation grant, will conduct intensive instruction for radio-tv, press and magazine

BROADCASTING, March 16, 1959

NOW!

A BILLION DOLLARS WORTH OF MGM MOTION PICTURES FOR ROCHESTER, N. Y. VIEWERS



11:20 P. M. NIGHTLY

(MIDNIGHT SATURDAYS)

Greatest Hollywood stars in their greatest motion pictures! 60 Academy Award Winners! 260 nominations for Academy Awards! On Channel 10 every night of the week!

Our Late Movie ratings have *always* been excellent—now they'll *zoom more than ever!*

. . . Contact the Bolling Co. (WVET-TV) or Everett-McKinney (WHEC-TV)!

NATIONAL REPRESENTATIVES • The Bolling Co. WVET-TV • Everett McKinney WHEC-TV

CHANNEL 10

WHEC-TV and WVET-TV

BASIC CBS

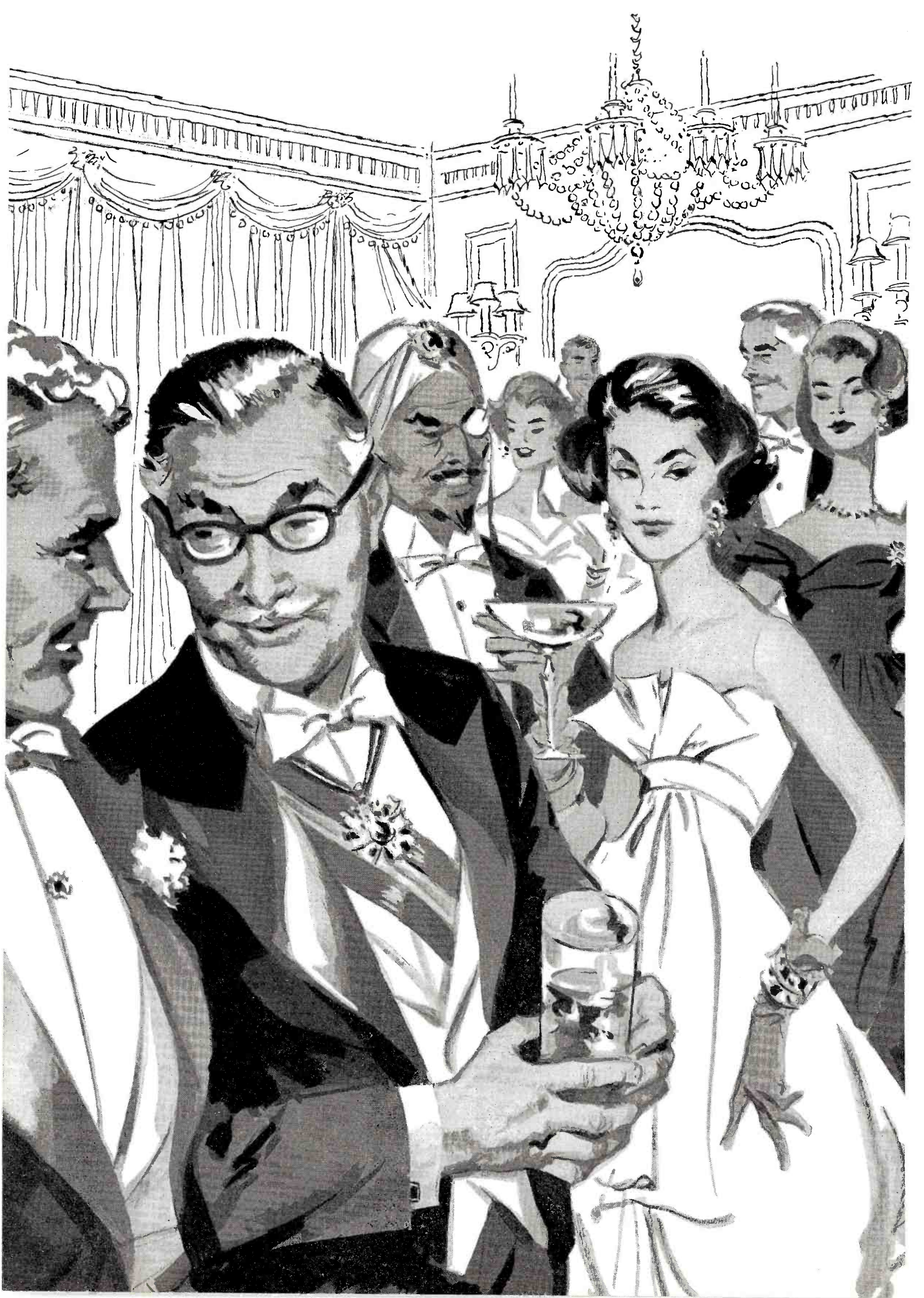

LOCAL PRODUCTS:

Embassy Parties . . . *and WMAL-TV*



ABC IN THE
NATION'S CAPITAL

Protocol regiments embassy parties, determines who sits below the salt. WMAL-TV's entire audience occupies the place of honor: in front of a tv set.

Taxi drivers, "a most reliable source," are authority for many party rumors. WMAL-TV, with on-the-spot camera-mike units, presents news as it breaks, feeds many a network newscast with authentic data.

Embassy gatherings are sometimes planned to gain the attention

of one diplomatist. WMAL-TV gains the attention of great numbers of citizens with top entertainment from ABC, plus local personalities like Louis Allen, Len Deibert, Pete Jamerson and Bill Malone.

Embassy parties are gay affairs, possibly because they offer so much for so little. WMAL-TV is nice that way too . . . its programming is arranged to give advertisers sensibly-priced one-minute spots in *all* time classifications.

Washington Means American Leadership

wmal-tv

Channel 7 Washington, D. C.

An Evening Star Station represented by H-R Television, Inc.



Jerry Austin, sidekick of "Cannonball" Mike Malone—rugged men entrusted to maintain the nation's commercial lifeline.

ADVERTISERS SNAP UP ITC'S CANNONBALL

**New Markets Sold
Each Day—Wire Now
For Your Choice
Of Availabilities!**



Dynamic action adventure and intense human interest!



BRAND-NEW by Robt. Maxwell, creator of LASSIE!

**I INDEPENDENT
T TELEVISION
C CORPORATION**

488 Madison Ave. • N.Y. 22 • PLaza 5-2100

newsmen. Courtroom broadcasting is one of topics. Attendance fee \$100. Formal registration closed today (March 16). Scholarships for needy available. Members of lecture staff will be available for interviews.

March 25—Comments due on proposed FCC rule-making to change ch. 12 Wilmington, Del., from commercial to educational or, in alternative, move ch. 12 to Atlantic City, N.J., or allocate it to Atlantic City-Wilmington. Docket No. 12,779.

*March 28-April 3—Weeklong observance of Golden Anniversary of Broadcasting and 50th Anniversary of Sigma Delta Chi, San Jose State College, San Jose, Calif. SDX "Deadline Dinner" April 2 will honor founding of broadcasting in 1909 at San Jose State.

March 30—Deadline for filing copies of direct testimony in FCC's inquiry into allocation of frequencies between 25 mc and 890 mc. Number of copies to be filed: 1 notarized original, and 20 copies.

March 30—Du Pont Awards Dinner, Mayflower Hotel, Washington.

APRIL

April 1—Assn. of National Advertisers workshop at Hotel Pierre, New York. Topic: "How to Get More Productive Advertising Through Management-Oriented Research." Henry Schachte, executive v.p., Lever Bros. Co., and chairman of ANA board of directors, will be keynote speaker.

April 3-4—Oregon Assn. of Broadcasters, U. of Oregon, Eugene.

April 3-5—Mississippi Broadcasters Assn., annual meeting, Buena Vista Hotel, Biloxi.

April 4—National Headliner Club awards luncheon, Atlantic City, N. J.

April 4—United Press Intl. Broadcasters of Minnesota Assn., Spring Meeting, Radisson Hotel, Minneapolis.

April 5-8—National Retail Merchants Assn., sales promotion division, Eden Roc Hotel, Miami Beach.

April 6-9—National Premium Buyers, 26th annual exposition, Navy Pier, Chicago. Premium Advertising Assn. of America will meet April 7, same site.

April 7—Trial of former FCC Comr. Richard A. Mack and friend, Thurman A. Whiteside, for conspiracy to defraud U.S. Presiding: Judge Burnita S. Matthews, U.S. District Court, Washington, D.C.

April 8—Deadline for comments to FCC on daytime radio stations' request to operate from 6 a.m.-6 p.m. or sunrise-sunset, whichever is longer. Docket 12,729.

April 10-11—Republican National Committee meets at Sheraton Park Hotel, Washington. Host city for the 1960 nominating convention will be picked.

April 10-11—West Virginia Broadcasters Assn. spring meeting, Press Club, Charleston.

April 12-13—Texas Assn. of Broadcasters, spring meeting, Commodore Perry Hotel, Austin. Members of Legislature will be April 13 luncheon guests.

April 12-14—Assn. of National Advertisers, annual west coast meeting, Santa Barbara Biltmore, Santa Barbara, Calif.

April 12-19—Technical symposium on aircraft and space communications sponsored by Electronic Industries Assn., McCarran Field, Las Vegas, Nev., during First World Congress of Flight.

*April 19-25—Biennial Congress, International Chamber of Commerce, Sheraton Park and Shoreham Hotels, Washington.

*April 20—Radio Advertising Bureau sales clinics at Tulsa, Okla., and Minneapolis, starting nationwide series that ends May 22. RAB will present 30 how-we-sold-it stories and exhibits.

April 20-23—American Newspaper Publishers Assn., annual meeting, Waldorf-Astoria Hotel, New York.

April 23—Oral argument before FCC en banc on Miami ch. 10 case involving charges of behind-the-scenes wirepulling. Initial decision by Examiner Horace Stern recommended grant to Public Service Television Inc. (National Airlines) be revoked and allegations of ex parte representations by applicants be weighed against them in new comparative hearing. Docket No. 9321 et al.

April 23-24—Assn. of National Advertisers two-day workshop on advertising expenditures, Westchester-Biltmore, Rye, N.Y.

April 23-25—Western States Advertising Agencies Assn., ninth annual conference, Oasis Hotel, Palm Springs, Calif.

April 23-25—American Assn. of Advertising Agencies, annual meeting at The Greenbrier in White Sulphur Springs, W. Va. Annual dinner will be held April 24.

*April 24—Ohio Assn. of Broadcasters, Sheraton Gibson Hotel, Cincinnati.

April 24-25—New Mexico Broadcasters Assn., Bishop's Lodge, Santa Fe.

April 26-29—National Assn. of Transportation Advertising convention, The Greenbrier, White Sulphur Springs, W. Va.

April 26-29—U.S. Chamber of Commerce annual meeting, chamber hdqrs., Washington.

*April 27-28—Potts-Woodbury Adv. Agency Radio-Tv Farm Clinic, Bellerive Hotel, Kansas City. Invited radio and tv farm directors and farm products manufacturers will be guests.

April 27-May 2—Journalism & Broadcasters Week, School of Journalism & Communications, U. of Florida, Gainesville. (April 27 is Broadcasters Day).

April 29—Comments due on FCC proposal to prohibit networks from representing tv stations other than their own in spot representation field. Docket No. 12,746.

April 29-30—International Advertising Assn. convention, Hotel Roosevelt, New York.

April 30-May 2—Alabama Broadcasters Assn., Buena Vista Hotel, Biloxi, Miss.

April 30-May 3—Assn. of Women in Radio & Television, annual national convention, Waldorf-Astoria Hotel, New York.

April 30-May 3—4th district, Advertising Federation of America, Tides Hotel & Bath Club, St. Petersburg, Fla.

MAY

May 1—National Radio Month opens.

May 1—National Law Day.

May 1-3—Texas Assn. of Sigma Delta Chi, Hotel Galvez, Galveston. Annual meeting.

May 4-6—Assn. of Canadian Advertisers, annual conference, Royal York Hotel, Toronto, Ont.

May 4-8—Society of Motion Picture & Tv Engineers, semi-annual convention, Fontainebleau Hotel, Miami Beach, Fla. Theme will be "Films and Television for International Communications."

May 6—National Academy of Television Arts & Sciences, 11th annual Emmy awards presentation on NBC-TV, 10-11:30 p.m. (EST).

May 7-8—Kentucky Broadcasters Assn., Sheraton-Seelbach Hotel, Louisville.

May 12—Wisconsin Fm Clinic, Center Bldg., U. of Wisconsin, Madison.

May 13-15—Pennsylvania Assn. of Broadcasters, Bedford Springs. Frank Palmer, WFBG-AM-TV Altoona will direct panel on reduction of operating costs and Ralf Brent, WIP Philadelphia, will be chairman of panel on service to local advertiser. Presidents from adjoining state associations will attend.

May 16-17—Illinois News Broadcasters Assn., spring meeting, Southern Illinois U., Carbondale; also, United Press Intl. business meeting.

May 20-22—Assn. of National Advertisers, spring meeting, Edgewater Beach Hotel, Chicago.

May 21-23—Montana Radio Stations Inc., Great Falls.

May 21-23—Electronic Industries Assn., annual convention, Sheraton Hotel, Chicago.

May 24-27—Associated Business Publications, annual meeting and management conference, Skytop Lodge, Skytop, Pa.

May 28-31—Second Annual Radio Programming Seminar and Pop Music Disc Jockey Convention, Americana Hotel, Miami, Fla. Speakers will include Matthew J. Culligan, NBC Radio executive vice president, and Gordon McLendon, head of McLendon station group. Storz stations are sponsoring seminar with Bill Stewart, Kilpatrick Bldg., Omaha, Neb., as convention coordinator.

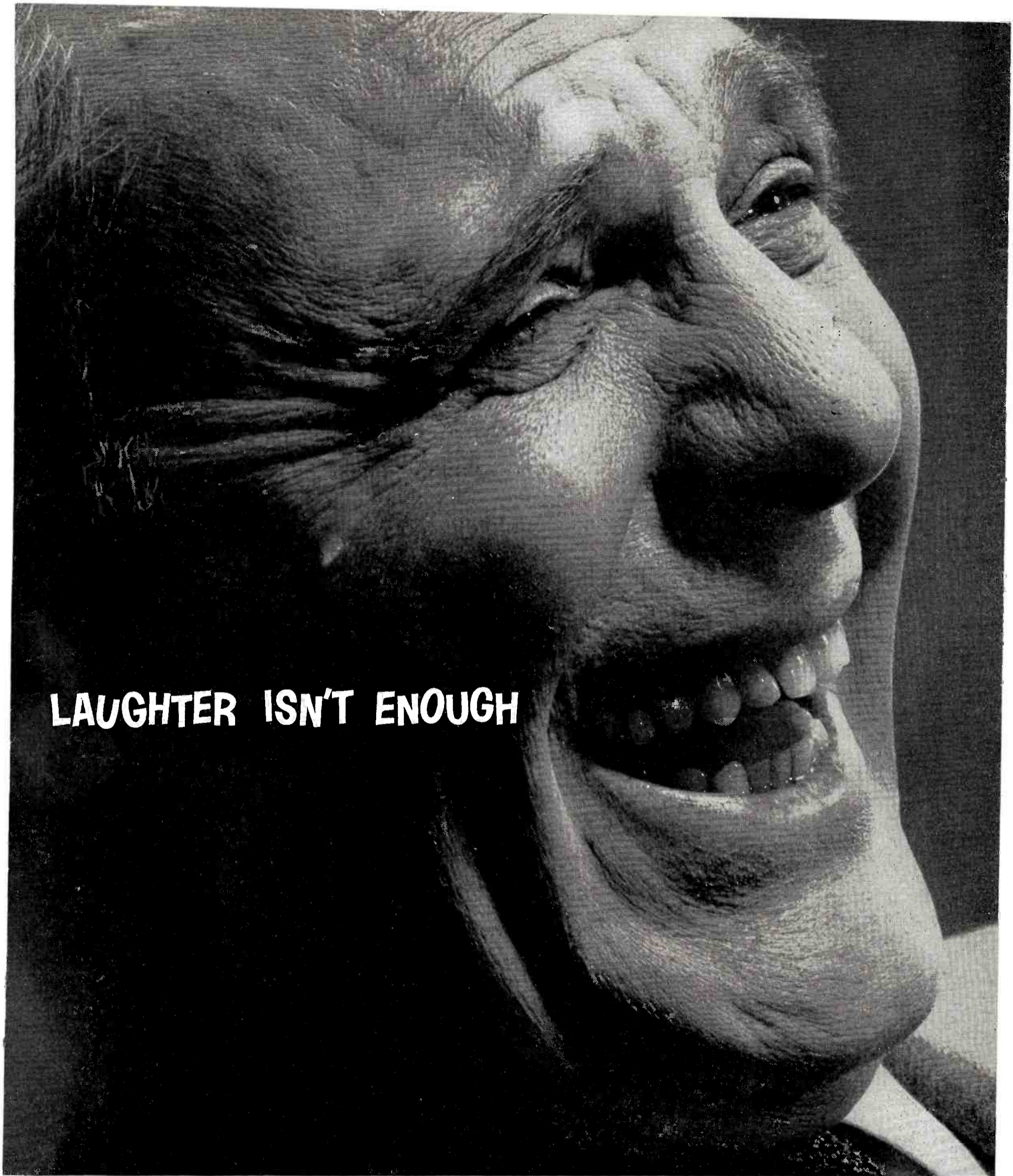

LAUGHTER ISN'T ENOUGH

Great show. A laugh a second. 27 minutes of ever-loving fun. Critics rave. Ratings swoosh upwards into orbit. Everybody shakes hands. . . . But there's a lot more to it than that. . . . For our clients' money, a TV or radio show isn't a hit until *sales and profits* are right up there with the ratings. **N. W. AYER & SON, INC.**



The commercial is the payoff

ATI

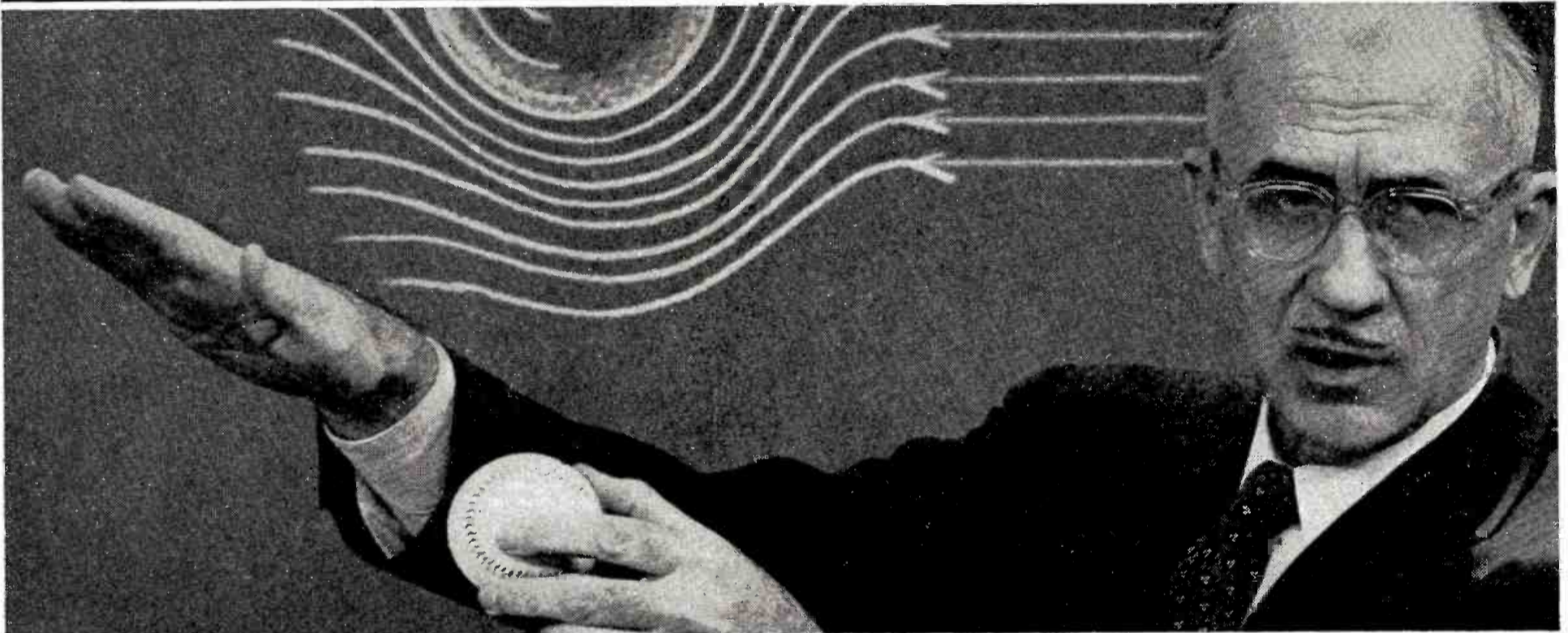

WORLD'S LARGEST CLASSROOM

It would be hard to find three programs of greater distinction — and greater diversity.

Continental Classroom, with Dr. Harvey E. White, measures its success in its ability to repair the dangerous lag in America's science education. Network television's first college-level course uniquely serves the 368,000 viewers who make it the world's largest class, and the 280 colleges and universities who offer its instruction in Atomic Age Physics for academic

credit. Within a week of the second semester's opening last month, its new textbook had boomed into a national bestseller.

Wagon Train, starring Ward Bond and Robert Horton, measures its success in entertainment that draws an estimated 55,000,000 viewers. Based on Nielsen findings (Feb. 1), this hour-long dramatic Western anthology attracts the world's largest television audience — without counting the additional millions of viewers who make it one of England's top shows.

U

at the head of their class



WORLD'S LARGEST TV AUDIENCE



WORLD'S MOST TALKED-ABOUT TV PERSONALITY

The Jack Paar Show measures its success as a delightful national nightcap and morning-after conversation piece. Spontaneous and unpredictable as only live television can be, it has made its irrepressible host Jack Paar the most talked-about TV personality in the nation, and the only one (in or out of television) to appear within the last six months on the covers of four major national magazines—Time, Life, Look and TV Guide.

No less than the distinction of these three programs, NBC prizes their diversity in meeting the different tastes and needs of all Americans. From Continental Classroom at dawn to Wagon Train at dusk to Jack Paar at midnight, America's first network strives for the true measure of network greatness — totality of program service.

NBC TELEVISION NETWORK

**This is NOT a game!
It's a FACT!**

QUESTION:

?

**What's
different
about
Buffalo, N. Y.?**

ANSWER:

**In
BUFFALO
it actually
COSTS
LESS
than HALF
to buy the
TOP
STATION
WBNY**

**See latest Pulse
figures and rate card
or call Jack Masla**

OPEN MIKE

Dispute over Sec. 315

EDITOR:

... Your editorial "Rallying Point" (page 103, Feb. 23) succinctly sums up a document which deserves the support of every broadcaster in spite of the defect regarding Section 315. The remedy for the latter lies not with the FCC, but I too would rather see the hope expressed that this impossible restriction upon political broadcasting will soon be removed by the courts or the U. S. Congress.

*Rex G. Howell
State Representative
Denver, Colo.*

[EDITOR'S NOTE: Mr. Howell is president-general manager of KREX Grand Junction, Colo.]

Don't give it away

EDITOR:

My compliments to you and to Henry B. Clay of KWKH Shreveport for the article "No Plugs for Andy" and for his letter to Lever Brothers regarding free time (page 42, Feb. 23).

I have long been concerned, as I know many, many radio station managers are, with this "free time" business. All of us are harangued with requests, bombarded by publicity, swamped by public relations firms. Less than 10% of the material comes legitimately under the public service category. The rest is out and out attempts at "chiseling."

Yet, I wonder if much of the fault doesn't lie with the station managements. . . .

Here at WWON, we do one of two things with such articles, either throw them away—or occasionally return them to the sender with the notation, "You sell perfume (or soap or what-nots) and we sell time. Enclosed is our rate card."

If every radio station manager in the country did this for a month, I think we'd slow down the flood of useless mail, and might even dramatize to the corporations who pay these public relations bills that they'll get more for their money by buying time instead of buying dubious "I'll get it for you free" stories.

*Zel Levin
Manager
WWON Woonsocket, R. I.*

Say what you think

EDITOR:

I commend you for the editorial "Faint Hearts Can't Win Freedom" in the Feb. 16 issue, particularly as it pertains to the position taken by FCC Comr. T.A.M. Craven on program questions in station application forms.

I deeply regret the decision of the

NAB to take no active stand in this matter. . .

How can the "climate of government" ever change if business men, be they broadcasters or whatever, constantly refuse to exhibit the guts to take a public stand on the issues which face this country. Must we constantly give ground to the pressure groups and other elements which appear to be able to continually influence the thinking of our elected representatives and other federal bodies? Is it not only fair, but right, that we say publicly what we believe? . . .

*C. Leslie Golliday
Partner and General Manager
WEPM Martinsburg, W. Va.*

Matson sails radio channels

EDITOR:

I just noted a story on page 32 of your Jan. 26 issue in which you state that Matson Navigation is making its first use of radio.

Matson Navigation started using adjacencies on KWG next to *Hawaii Calls* in March 1957 and has renewed through 1959.

*Bob McVay
General Manager
KWG Stockton, Calif.*

'Popeye' on KGGM-TV

EDITOR:

The March 2 front cover (advertisement) run by Edward Petry & Co. inferred KOB-TV carried *Popeye*. This is incorrect. KGGM-TV programs the *Popeye* series in Albuquerque.

*R.C. Rhoads
General Sales Manager
KGGM-TV Albuquerque, N.M.*

Education via tv

EDITOR:

We feel that the article "Tv Tolls National School Bell" in the January 12 issue . . . will be of particular value to the school administrators in Omaha as they seek to understand better the possibilities of education via television. Please send three copies.

*Chris Donaldson
Program Manager
KETV (TV) Omaha, Neb.*

EDITOR:

... I'm glad that we have this examination in depth of contributions of commercial stations for reference use.

*Garnet R. Garrison
Director of Broadcasting
U. of Michigan
Ann Arbor, Mich.*

News is no circus

EDITOR:

Between rounds in the "adult" vs.

RCA Power Tube features keep "VHF" hour meters clicking

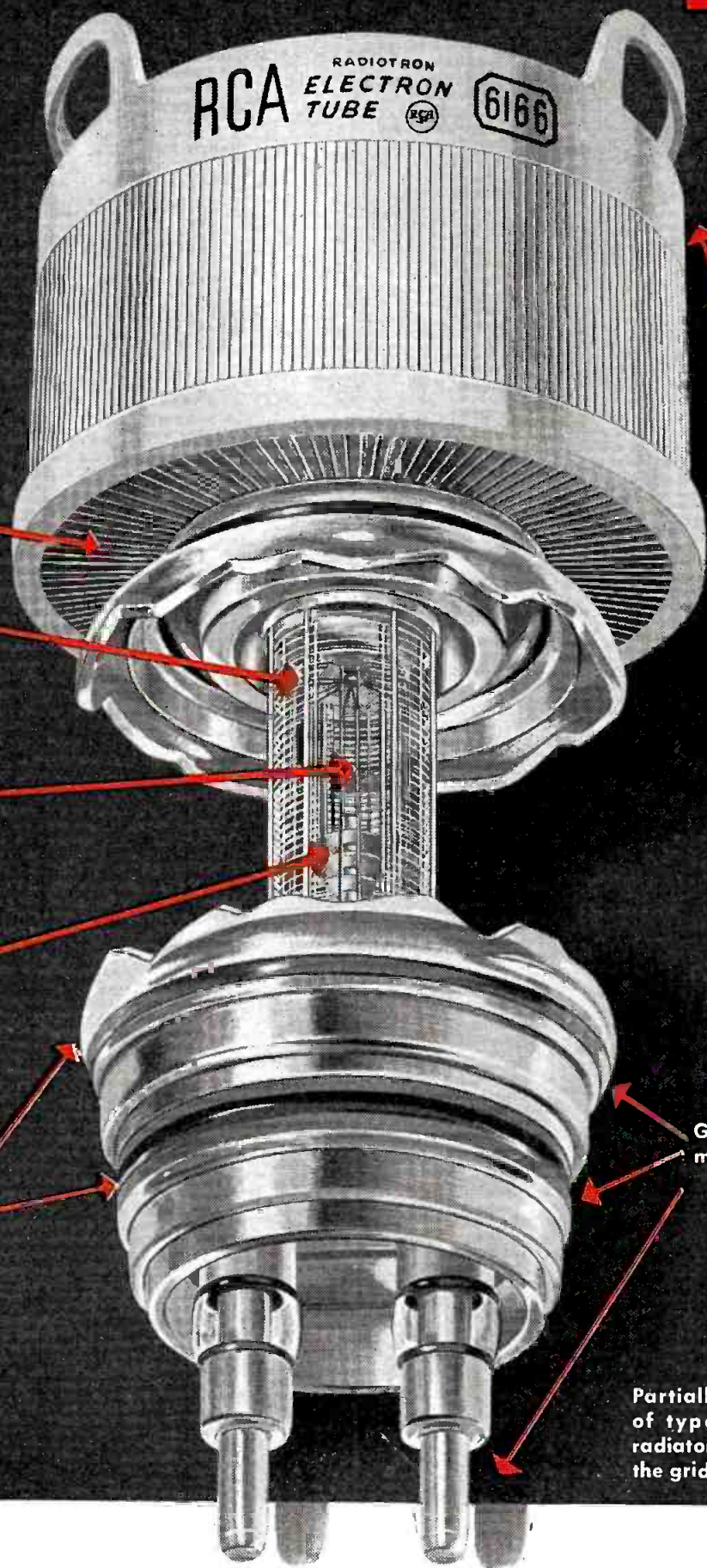

Efficient "louvered-fin" radiator design—gives improved heat radiation

Filament structural arrangement relieves stresses on filament strands and provides longer filament life

Carburized thoriated-tungsten filament for high reserve of electron emission and economical operation

"Stacked" getter—provides freedom from gas throughout life

Stress-free glass sections—individually inspected with polariscope

Glass-to-metal seals—microscopically inspected

Entire tube is "spot-knocked" at tens of thousands of volts to reduce internal leakage

Partially exploded view of type 6166 showing radiator raised to expose the grids and filament



Take the RCA-6166, for instance. "Tailored" specifically to supply the aural and visual power-amplifier requirements of medium- and high-power VHF transmitters, this RCA Power Tetrode type has been running up remarkable life-performance records.

What's back of long-term RCA power-tube reliability? First, RCA tube engineers work hand in hand with transmitter designers and station

engineers—to take measure of RCA tube performance "in the circuit". Second, RCA tube engineers never "let go" in their effort to evolve superior manufacturing techniques and design improvements to make good tubes even better.

For lower tube cost per hour of transmitter operation, always specify RCA. Your RCA Electron Tube Distributor provides "on the spot" delivery.



RADIO CORPORATION OF AMERICA

Electron Tube Division

Harrison, N. J.

DOUBLE DOUBLE

**"We had to look twice! Our figures showed
and "The Sweet 65" gave us one of our**



*65 Columbia and Universal
"want-to-see" hits with titles, stories
and stars that make it one of the
best all-around TV packages
ever offered, and ever bought!*

ALREADY SOLD IN 85 MARKETS!

**CANYON PASSAGE
THE SPOILERS
MR. DEEDS GOES TO TOWN
CORONER CREEK
SIN TOWN
FIGHTING O'FLYNN
BANK DICK**

*...and many more top-drawer titles guaranteed
to build both audience and sales!*

For availabilities in your market, contact:

SCREEN GEMS INC. TELEVISION SUBSIDIARY OF COLUMBIA PICTURES CORP.



VISIT US AT THE NAB CONVENTION,

TAKE! TAKE!

What the double-selling power of "Powerhouse"
greatest combinations of top feature hits!"

Van DeVries—WGR-TV, Buffalo, N. Y.



*78 Columbia and Universal top titles
with cast and production values to
match! TV's most diversified
power-packed package, with the
blockbusters you've been waiting for!*

ALREADY SOLD IN 61 MARKETS!

**THE KILLERS
SEVEN SINNERS
HERE COMES MR. JORDAN
NAKED CITY
MAN FROM COLORADO
A SONG TO REMEMBER
SCARLET STREET**

*...and big-league, big-name features that
spell big profits for you!*

NEW YORK

DETROIT

CHICAGO

HOUSTON

HOLLYWOOD

ATLANTA

TORONTO

CONRAD HILTON HOTEL, SUITE 2500-01-02A

They're goin'

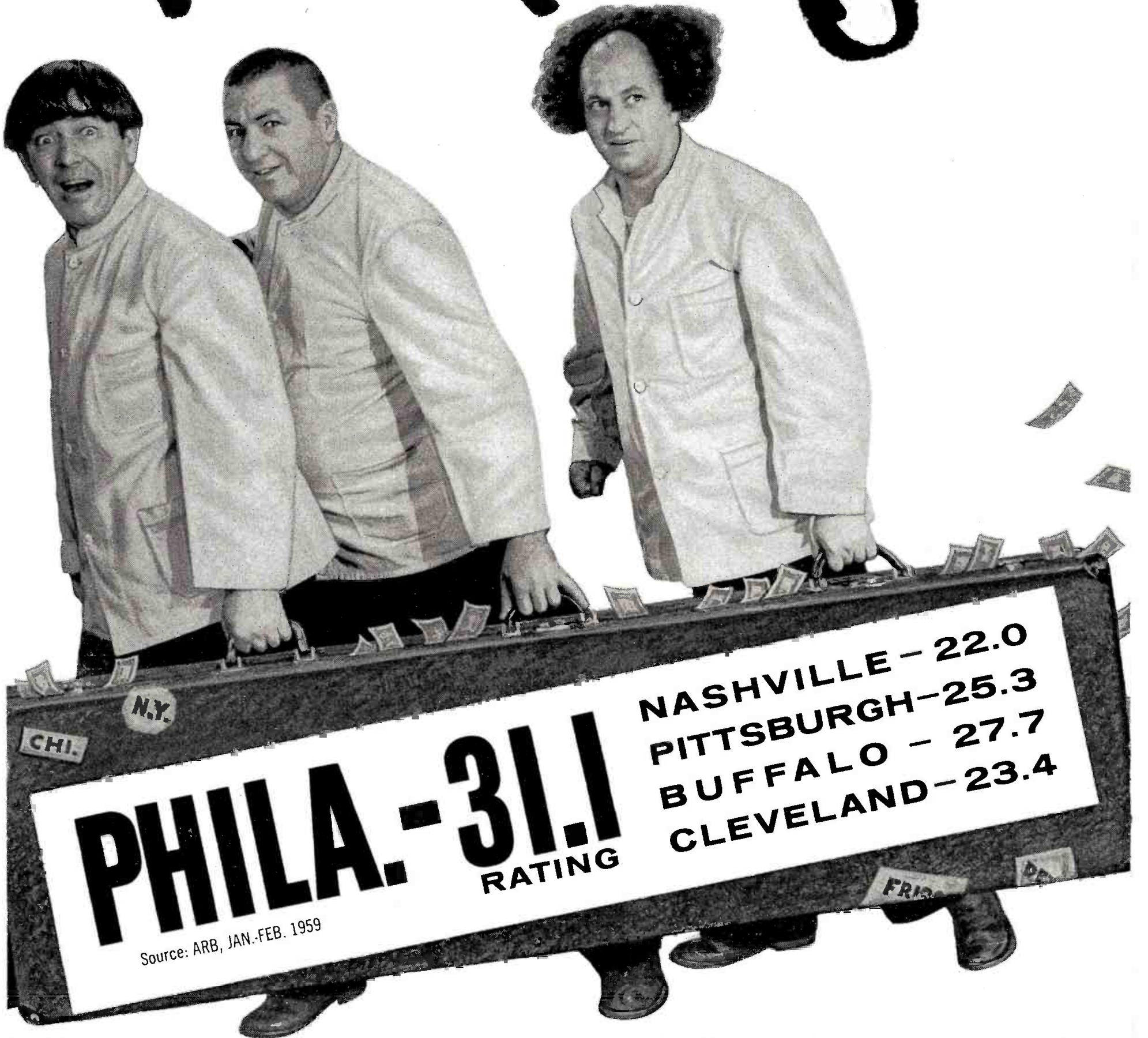

The 78 original "3 STOOGES" are setting rating records in city after city —

VISIT US AT THE NAB CONVENTION

g places!!!

"The hit show of this year"

VARIETY—Jan. 24, 1959

and now...

**BY POPULAR DEMAND
SCREEN GEMS IS ADDING
40 MORE
TERRIFIC TWO-REELERS**

**OF
"THE 3 STOOGES"**



Already sold to:

TRIANGLE STATIONS

WFIL-TV PHILADELPHIA
WFBG-TV ALTOONA
WLYH-TV LEBANON
WNHC-TV NEW HAVEN
WNBF-TV BINGHAMTON

TRANSCONTINENT STATIONS

WGR-TV BUFFALO
WROC-TV ROCHESTER
WNEP-TV SCRANTON
WSVA-TV HARRISONBURG,
VIRGINIA

Get all 118 while they're hot!

CONTACT:

SCREEN

NEW YORK

DETROIT



GEMS, INC.

CHICAGO

HOUSTON

TELEVISION SUBSIDIARY OF
COLUMBIA PICTURES CORP.

HOLLYWOOD

ATLANTA

TORONTO

CONRAD HILTON HOTEL, SUITE 2500-01-02A

The Canadian Broadcasting Corporation

*is pleased to announce
that*

McGAVREN - QUINN CORPORATION

NEW YORK—CHICAGO—LOS ANGELES
DETROIT—SAN FRANCISCO—SEATTLE

*has been appointed to
represent the*

CBC's
Trans-Canada and Dominion
Radio Networks and
16 CBC-Owned
English Radio Stations

"Top Forty" program battle, may I raise what I feel is an equally serious but neglected issue: the "modern" 5-minute every-hour newscast complete with echo chamber datelines, clanging bells, machine gun delivery and on-the-scene report of the latest fender-bender accident, by which so many stations cheapen themselves and degrade the industry's proud and legitimate service of information.

Is a straight, intelligent report of genuine news so dull a commodity or is the audience so stupid that we must turn the newscast into a news *show*? Isn't this P.T. Barnum approach incongruous with our continual (and justifiable) boast of the vital informing function we perform?

Although the hourly newscast is supposedly premised on a high audience turnover, many stations feverishly search for a new lead story for each newscast even at the cost of over-emphasizing inconsequential stories . . .

Even worse is the use of super-condensed "headline" reports of only one sentence which really tell nothing and give only the illusion of news. . . .

The net result of this irresponsible type of reporting is confusion and misunderstanding . . .

If we believe in our mission of informing the public, let's give them enough information and a sufficiently meaningful presentation of it for them to know what it is all about and discriminate between what counts and what does not.

Phil Wilson
News Director
WANE-AM-TV Fort Wayne,
Ind.

Clear channel booster

EDITOR:

If all of our clear channels are broken down and none are permitted to go super-power, our chances of ever "getting through" to people of foreign lands on a true, listenable basis are forever lost.

As a kid, I took out a patent whereby the coastal clears would radiate a nominal 50 kw inland with about 500 kw directed out to sea and to foreign countries. In this patent specification I painted what I thought was a good picture as to how the world could hear us clearly to learn better how we live. It was also pointed out that the world could be thus entertained.

I still believe it's a good idea and if done on an entertainment basis and without slanted news the world might learn to like our way of life, at least to the point of not giving us the stone and egg treatment.

Lee Hollingsworth
Hollingsworth Co. Enterprises
West Hempstead, N.Y.

**"ON YOUR WAY UP,
DROP US OFF AT SUITE 2319
IN THE CONRAD HILTON.
THE CBS FILMS SUITE.
THEIR NEW SHOWS ARE
OUT OF THIS WORLD."**

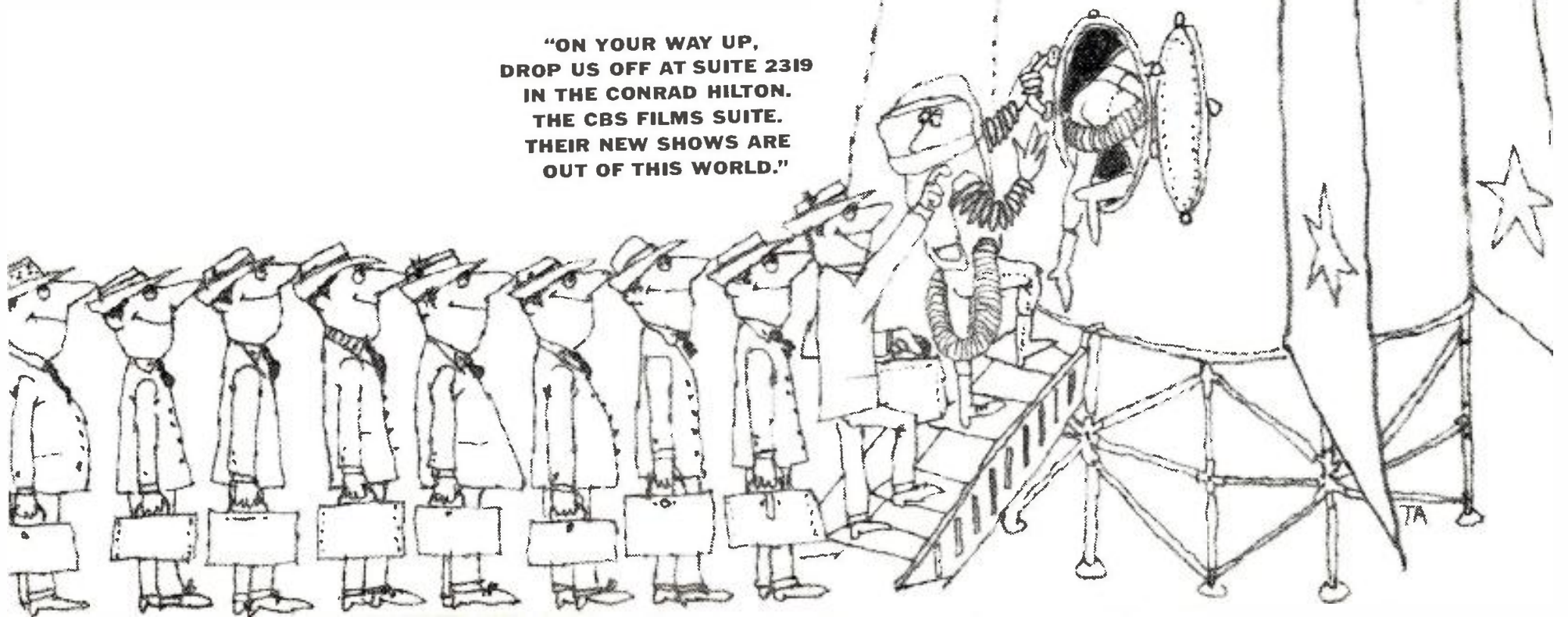

**to sell
the most
Hoosiers
be sure
your product
is cooking
in the
hottest pot!**



● **First all day** . . . "most listened to" and hottest of any as indicated by recent audience studies!*

Best news coverage . . . local, plus world-wide through exclusive Washington News Bureau.

Top personalities attracting large, loyal audiences. Every reason to place saturation spot campaigns where you reach an even greater *cumulative* audience.

Check **WFBM** first—*where every minute is a selling minute!*

*C. E. Hooper, Inc.
(7 a.m.-6 p.m.) June 19, 1958

Represented by the **KATZ Agency**

Fm, 'Perspective '59'

EDITOR:

Having struggled for five years with an 80 kw fm station in the eighth largest market, I definitely concur with the agencies who say you can't get any information out of an fm station ("Have Audience, Can Sell—Fm," page 124, Feb. 9), because we have been guilty of that same lethargy . . . mainly with background music and mediocre tapes and records.

Somehow . . . we managed to survive. We woke up one morning and found . . . we had amassed thousands of loyal listeners. . . .

Around the first of December came the revolution! We fired everybody in the place, completely re-staffed with all professional personnel and proceeded to toot our horn, featuring our new high fidelity "Colorsonic Sound."

We made a test for . . . one week in which we put a spot, public service announcement or anything else we could find, out approximately every six minutes. . . . We did not obtain . . . any complaints and three of the spots drew 492 calls on a free sample of a liquid detergent. After the test we went back to . . . a spot every 10 minutes.

We then arranged a dinner . . . to which we invited 125 of the top radio media buyers in St. Louis . . . we have added 11 accounts in the past five weeks including one national account.

*Harry Eidelman, President
KCFM (FM) St. Louis*

EDITOR:

. . . I was most interested to learn that one of our good competitors has just delivered the first of its new line of fm transmitters.

We at Gates began deliveries of our new fm transmitters during the summer of 1958 and since then 39 have been delivered. Most of these were equipped with dual channel multiplex units.

We are quite proud of the fact that we have been in continuous production on fm transmitters since right after World War II. . . .

*Larry Cervone
General Sales Manager
Gates Radio Co.
Quincy, Ill.*

EDITOR:

Please send 100 reprints . . .
*Wm. A. Hildebrand
WMHE (FM) Toledo, Ohio*

EDITOR:

This is one of the greatest fm promotion articles we have ever seen. . . .

The Pulse fm penetration of 31.7% as of October 1958 for Miami did not surprise us. However, it helps us prove our point, for WWPB(FM) can claim

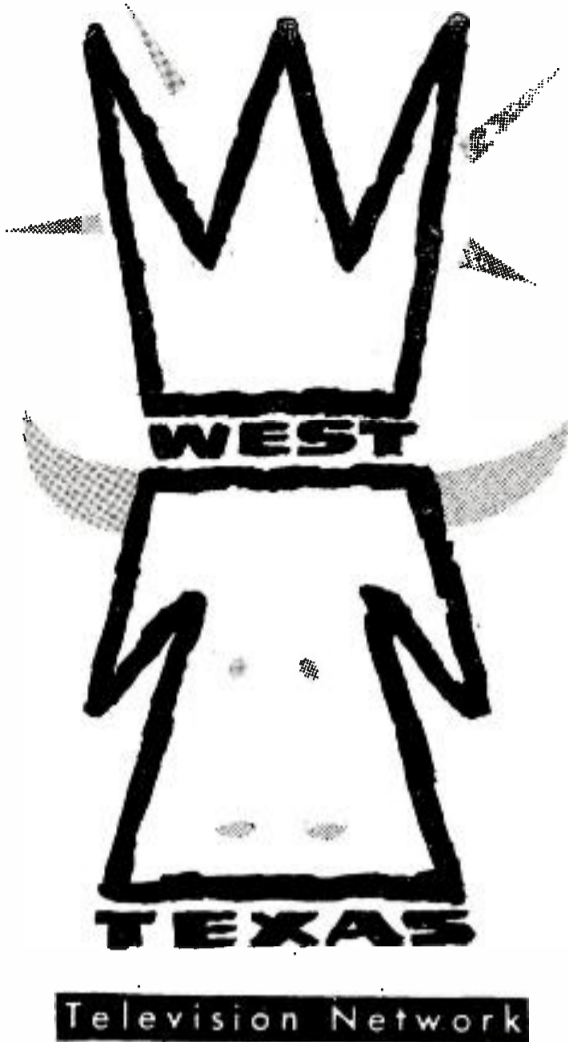

*now corraling
337,365 TVsets
into one BIG
market... yours
with one econom-
ical purchase.*



W. D. "Dub" Rogers, President and Gen. Mgr
R. S. "Bud" Nielsen, General Sales Manager
John Henry, National Sales Manager

NATIONAL REPRESENTATIVE THE BRANHAM COMPANY

How tall can you get?*

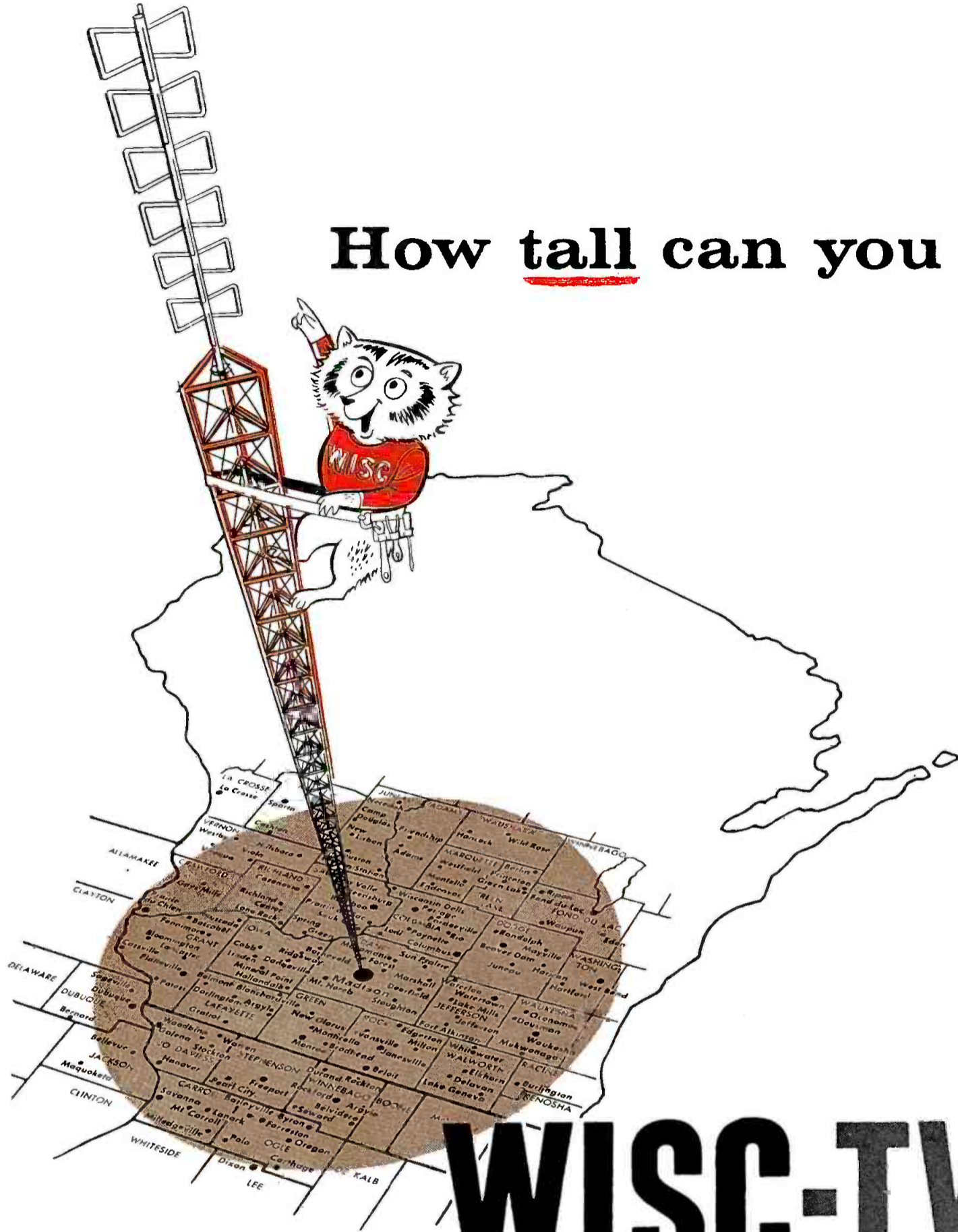

WISC-TV

CHANNEL

MADISON, WISC.



*the tallest tower in Wisconsin

The tallest man-made structure in Wisconsin now brings to WISC-TV viewers in thirty-two counties in Wisconsin, Illinois and Iowa the finest television service to 378,310 TV homes.

1200 ft. above average terrain
1107 ft. Antenna Height
2227 ft. above sea level



Represented Nationally by
Peters, Griffin, Woodward, Inc.



... and **WOC-TV**

**FOR BEST
COVERAGE
IN THE
NATION'S 47th
TV MARKET**



(Davenport, Iowa — Rock Island — Moline, Illinois)

The Largest Market between Chicago and Omaha . . . Minneapolis and St. Louis . . . the 47th TV market in the nation.

Population		Effective Buying Income*	
1957	1958	1957	1958
1,559,300	1,599,500	\$2,573,800,000	\$2,668,806,000
Increase — 40,200		Increase — \$95,006,000	
TV Homes		Retail Sales*	
422,800	438,480	\$1,855,864,000	\$1,918,167,000
Increase — 15,680		Increase — \$62,303,000	

*Sales Management's "Survey of Buying Power — 1958"



Col. B. J. Palmer
President
Ernest C. Sanders
Resident Manager
Pax Shaffer
Sales Manager
Peters, Griffin, Woodward,
Inc., Exclusive National
Representatives

THE QUINT CITIES

DAVENPORT } IOWA
BETTENDORF }

ROCK ISLAND } ILL.
MOLINE }
EAST MOLINE }



WOC-TV is No. 1 in the nation's 47th TV market—leading in TV homes (438,480), monthly coverage and weekly circulation — day and night — as reported in the Nielson Coverage Service No. 3, Spring, 1958. For further facts and latest availabilities, call your PGW Colonel . . . NOW!



WOC-TV Davenport, Iowa is part of Central Broadcasting Co., which also owns and operates WHO-TV and WHO Radio, Des Moines, Iowa

credit for building that level single handed through 11 years of "jeers" of am competition.

... send us 20 reprints . . .

John B. Cash
Assistant to the Manager
WWPB (FM) Miami, Fla.

EDITOR:

Please find enclosed \$15 . . . the cost of 100 reprints . . .

We were very sorry that the current Indianapolis fm story did not make your fine article, because we believe it to be the most outstanding one of all. One small item in this connection is that in the past 90 days three of our local am services have applied for fm facilities . . . and we are told that three additional Indianapolis applications are expected to be filed, momentarily.

Martin R. Williams
General Manager
WFMS (FM) Indianapolis

EDITOR:

... I wish to compliment you on what I believe is a generally fine job and comprehensive wrap-up of fm as it is today. . . [but] I do not believe you gave anywhere near adequate coverage of fm as it exists today in the San Francisco Bay Area. Major advertisers are now paying considerable attention to San Francisco fm, with such major accounts as Burgermeister Brewing, General Electric, James B. Lansing Speakers and Warner Bros. pictures now using KPEN with outstanding success.

James Gabbert
KPEN (FM) Atherton, Calif.

EDITOR:

Please forward 50 copies . . .

Earl A. Williams
Manager
WONO-FM Syracuse, N.Y.

EDITOR:

Please send 200 reprints . . .

Charles W. Kline
FM Unlimited, Inc.
Chicago

EDITOR:

We would appreciate . . . 15 copies . . .

Paul B. Rickard
Director of Broadcasting
Wayne State U
Detroit, Mich.

EDITOR:

Please send us 25 reprints . . .

Gardiner G. Greene
President
Browning Labs
Laconia, N. H.

EDITOR:

As a national representative of 10 fm stations we heartily concur with the need for greater information and pro-

BROADCASTING
THE BUSINESSWEEKLY OF TELEVISION AND RADIO
1735 DeSales St., N. W. Washington 6, D. C.

PLEASE START MY SUBSCRIPTION WITH THE NEXT ISSUE

52 weekly issues of BROADCASTING \$ 7.00
 52 weekly issues and Yearbook Number 11.00
 Enclosed Bill

name title/position*

company name

address

city zone state

Please send to home address — —

* Occupation Required

SEE IT AT THE NAB SHOW - BOOTH 36!

The most compact 50KW transmitter available.

As Recently Installed At —
WJR — Detroit
WOAI — San Antonio
KLIF — Dallas

SEE US AT THE NAB SHOW!

Jas. O. Weldon . . . W. M. Witty
Thomas B. Moseley . . . Mark W. Bullock
Vernon Collins . . . Richard P. Buckner
Joseph Sainton

ALSO at the show:

- Type 315B 5 KW Transmitter (shown as a part of the 50 KW unit)
- MAGNIPHASE Transmission Line Protection System
- Type TRC Remote Control for Unattended Operation



**CONTINENTAL ELECTRONICS
TYPE 317B 50,000 WATT AM
TRANSMITTER**

Continental Electronics

MANUFACTURING COMPANY

4212 S. Buckner Blvd.

Dallas 27, Texas

EVERgreen 1-1135



DESIGNERS AND BUILDERS OF SUPER POWER TRANSMITTERS



JACK STERLING

BEAT THE COMPETITION!

You no longer have to worry about getting fresh, creatively conceived script and taped material for your own personalities . . .

Be the **FIRST** in your area to use this service . . . which many of my time-buying friends and their clients have used successfully for the past ten years in New York.

Stories, anecdotes, colorful comment on current situations . . . all wrapped up in a package of 40 original featurttes for immediate use . . .

PLUS . . .

Six character voices—on tape—which can become those extra added voices to your daily schedule.

You can't help but capture agency and listener attention when you apply these new approaches to your schedule.

Get complete details NOW!

Write to:

JACK STERLING

BARBTON, INC.

485 Madison Avenue, N. Y. 22

motion for this media. Our stations have all been very successful with the national accounts they have handled and we feel that if past performance is any indication the future should indeed be a bright one.

*Joel B. Fairfax
Vice President
Fine Music Hi-Fi Broadcasters
New York*

EDITOR:

We would appreciate your forwarding one-dozen copies.

*Betty L. Hanna
WSOM (FM) Salem, Ohio*

[EDITOR'S NOTE: Reprints 15¢ each.]

RTNDA film project

EDITOR:

The Radio Television News Directors Assn. is in the process of producing a vocational film for showing to high school and college students in an effort to encourage more young men and women to enter the radio-tv news profession. . . .

RTNDA has authorized Konstantine Kalser, president of Marathon Tv Newsreel of New York City (10 E. 49th St.), to produce such a film. Any financing would be limited to the actual costs of production plus the copies. . . .

RTNDA is seeking a sponsor to finance this important project. Any firm or firms donating funds would be given credit in the film. . . .

*Julian B. Hoshal
Chairman, RTNDA Vocational
Film Committee
c/o KSTP News
3415 University Ave.
Minneapolis-St. Paul*

State tax threat

EDITOR:

Interstate taxation by the states on interstate income . . . is a very serious threat to broadcasting as you so promptly pointed out (page 104, March 2) and all the publicity you can give this now may help arouse broadcasters into an assertive action that will produce some positive effort to combat this new threat to earnings. Thank you for your foresight in publishing the editorial.

*Robert Wasdon
Vice President
WALT Tampa, Fla.*

BROADCASTING

SUBSCRIPTION PRICES: Annual subscription for 52 weekly issues \$7.00. Annual subscription including Yearbook Number \$11.00. Add \$1.00 per year for Canadian and foreign postage. Subscriber's occupation required. Regular issues 35¢ per copy; Yearbook Number \$4.00 per copy.

SUBSCRIPTION ORDERS AND ADDRESS CHANGES: Send to BROADCASTING Circulation Dept., 1735 DeSales St., N.W., Washington 6, D.C. On changes, please include both old and new addresses.



Intermountain Network Affiliate

KIMN

5000 Watts — 950 kc
in

DENVER, COLO.

Delivers

The LOWEST COST per 1,000

In the Mile High City
Ask your Avery-Knodel man

The Nation's Most Successful Regional Network
HEADQUARTERS • SALT LAKE CITY • DENVER
Contact Your Avery-Knodel Man

OUT FRONT



ALL THE WAY

RATED 1st IN NO. CALIFORNIA
by NCS #3 TV-58
and 150th MARKET IN U.S.

KHSL-TV **CHANNEL 12**

THE GOLDEN EMPIRE STATION

CHICO, CALIFORNIA CBS and ABC Affiliate

Represented nationally by Avery-Knodel
San Francisco Representative
GEORGE ROSS • National Sales Manager
Central Tower

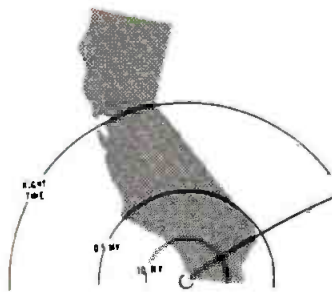

January 30, 1959

Mr. Jim Weathers, General Manager
World Broadcasting System, Inc.
Coliseum Tower Office Building
10 Columbus Circle
New York 19, New York

Dear Jim:

.... when I first heard about the World sales promotion and program service, I was skeptical and not interested. Fortunately one of your salesmen talked me into giving him thirty minutes of my time ... and now I must be one of your most satisfied clients.

Our needs here at Radio 690 require a variety of production jingles and well planned commercial sales aids I feel you have done an excellent job of producing your jingles, and our rating and revenue increases confirm that impression.

.... we are presently the number one station in our market and will stay number one by constantly adding new and better sounds. Quite frankly we will be depending on World to do this. In sales, we have sold several contracts that are presently more than paying for your service.

In summarizing, we feel that we have made a good deal and would recommend the World Library service to any radio station.

Yours truly,

James M. Harmon
President
California Broadcasters, Inc.

personalized jingles
& program signatures
exciting station
promotions
commercial jingles
and selling aids
professional production

revenue producing
musical briefs
balanced musical
selections
seasonal and
holiday shows
top artists



sound creativity . . . dollar productivity

Talk about sound investments . . . look what San Diego's Radio 690 says about World's "sound creativity!" New at XEAK, but an old story across the country, where for over 30 years World has provided stations with the constantly changing, attention-gaining sounds of modern radio . . . proven rating and revenue-wise, a sound investment. Discover for yourself the benefits of World's profitable commercial jingles, selling aids, and a host of additional revenue-producing radio tools. Write, wire or phone about World's "sound creativity". . . the dollar-producing sales promotion and program service.

VISIT THE WORLD HOSPITALITY SUITE AT THE CONRAD HILTON • MARCH 16-18 • CHICAGO



WORLD sales promotion and program service

WORLD BROADCASTING SYSTEM, INC.

COLISEUM TOWER OFFICE BUILDING • 10 COLUMBUS CIRCLE • NEW YORK 19, N.Y.
PHILADELPHIA • HOLLYWOOD • CANADIAN REPRESENTATIVES: ALL-CANADA

WORLD BROADCASTING SYSTEM, INC. VICTORY BUILDING TORONTO

There's more to Florida...

There's **WJXT** in Jacksonville, where breaking sales records is par for the course. NCS #3 revealed the handicap of the competing station in covering only 28 vs. WJXT's 66 counties in the booming Northeast Florida-South Georgia regional business center. And every ARB dramatizes the one-sided picture by showing that even where the stations are on a par, inside Jacksonville itself, WJXT scores rating leads generally between 70% and 90%! With an edge of 110,000 TV sets and a 1½ times greater weekly audience, there are more reasons than ever why there's so much more to **WJXT**

WJXT 

JACKSONVILLE, FLORIDA

*An affiliate of the CBS Television Network
Represented by CBS Television Spot Sales*

Operated by The Washington Post Broadcast Division:

WJXT Channel 4, Jacksonville, Florida **WTOP Radio** Washington, D. C. **WTOP-TV** Channel 9, Washington, D. C.



In Greensboro...
THE MOST
 listened to radio station



Greensboro's Complete Radio Service

21 YEARS
 of dynamic selling

Welcome to our
 Hospitality Suite 1900,
 Conrad Hilton Hotel
 NAB Convention
 March 15-18

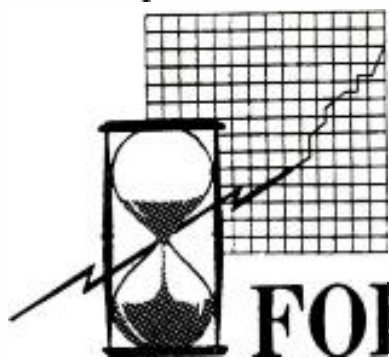

FORJOE & CO., INC.

NATIONAL STATION REPRESENTATIVES
 Sales Offices in NEW YORK • CHICAGO • LOS ANGELES
 SAN FRANCISCO • PHILADELPHIA • ATLANTA
 Headquarters - 580 5th Avenue, New York 36, N. Y.

BROADCASTING PUBLICATIONS INC.

PRESIDENT.....Sol Taishoff
 VICE PRESIDENT.....Maury Long
 VICE PRESIDENT.....Edwin H. James
 SECRETARY.....H. H. Tash
 TREASURER.....B. T. Taishoff
 COMPTROLLER.....Irving C. Miller
 ASST. SEC.-TREAS....Lawrence B. Taishoff

BROADCASTING
 THE BUSINESS WEEKLY OF TELEVISION AND RADIO

Executive and publication headquarters:
 BROADCASTING • TELECASTING Bldg., 1735
 DeSales St., N.W., Washington 6, D.C. Tele-
 phone: Metropolitan 8-1022.

EDITOR AND PUBLISHER.....Sol Taishoff
 MANAGING EDITOR.....Edwin H. James
 SENIOR EDITORS: Rufus Crater (New York),
 J. Frank Beatty, Bruce Robertson (Holly-
 wood), Fred Fitzgerald, Earl B. Abrams,
 Lawrence Christopher.
 SPECIAL PROJECTS EDITOR..David Glickman
 ASSOCIATE EDITOR.....Harold Hopkins
 ASSISTANT EDITORS: Dawson Nail, Jacque-
 line Eagle; STAFF WRITERS: George Darling-
 ton, Lee Edwards, Myron Scholnick, Jim
 Thomas; EDITORIAL ASSISTANTS: Malcolm
 Oettinger, Rita Cournoyer, Patricia Funk;
 SECRETARY TO THE PUBLISHER: Gladys L.
 Hall.

BUSINESS

V.P. & GENERAL MANAGER....Maury Long
 SALES MANAGER: Winfield Levi (New York)
 SOUTHERN SALES MANAGER....Ed Sellers
 PRODUCTION MANAGER....George L. Dant
 TRAFFIC MANAGER.....Harry Stevens
 CLASSIFIED ADVERTISING.....Doris Kelly
 ADVERTISING ASSISTANTS: Merylyn Bean,
 John Henner, Ada Michael.
 COMPTROLLER.....Irving C. Miller
 ASSISTANT AUDITOR.....Eunice Weston
 SECRETARY TO GEN. MGR....Eleanor Schadi

CIRCULATION & READER'S SERVICE

MANAGER.....John P. Cosgrove
 SUBSCRIPTION MANAGER...Frank N. Gentile
 CIRCULATION ASSISTANTS: Charles Browne,
 Gerry Cleary, David Cusick, Christine Hara-
 geones, Charles Harpod, Marilyn Peizer.

BUREAUS

New York: 444 Madison Ave., Zone 22,
 Plaza 5-8355.

Editorial

SENIOR EDITOR.....Rufus Crater
 BUREAU NEWS MANAGER...Donald V. West
 ASSOCIATE EDITOR:.....David W. Berlyn
 N. Y. FEATURES EDITOR: Rocco Famighetti
 STAFF WRITERS: Richard Erickson, Mary
 Hurley, Diane Schwartz, Benjamin Seff.

Business

SALES MANAGER.....Winfield R. Levi
 SALES SERVICE MGR....Eleanor R. Manning
 EASTERN SALES MANAGER..Kenneth Cowan
 ADVERTISING ASSISTANT....Donna Trolinger

Chicago: 360 N. Michigan Ave., Zone 1,
 Central 6-4115.

MIDWEST NEWS EDITOR.....John Osbon
 MIDWEST SALES MGR.: Warren W. Middleton
 ASSISTANT.....Barbara Kolar

Hollywood: 6253 Hollywood Blvd., Zone 28,
 Hollywood 3-3148.

SENIOR EDITOR.....Bruce Robertson
 WESTERN SALES MANAGER....Bill Merritt
 ASSISTANT.....Virginia Stricker

Toronto: 11 Burton Road, Zone 10, Hudson
 9-2694. CORRESPONDENT: James Montagnes.

BROADCASTING* Magazine was founded in 1931
 by Broadcasting Publications Inc., using the title:
 BROADCASTING*—The News Magazine of the
 Fifth Estate.

Broadcast Advertising* was acquired in 1932,
 Broadcast Reporter in 1933 and Telecast* in 1953.

* Reg. U. S. Patent Office

Copyright 1959 by Broadcasting Publications Inc.

BROADCASTING, March 16, 1959

It's a habit...

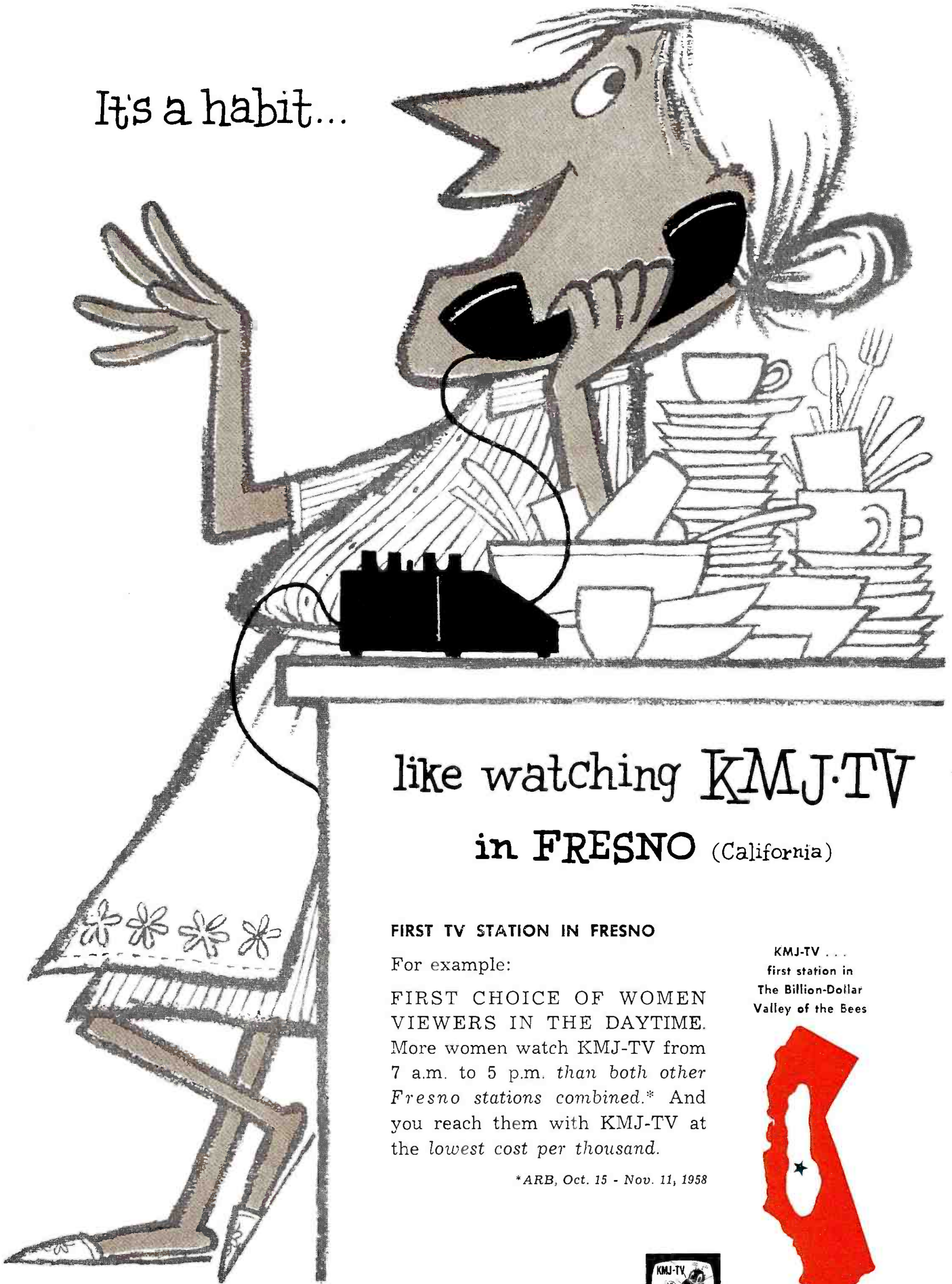

like watching **KMJ-TV**
in **FRESNO** (California)

FIRST TV STATION IN FRESNO

For example:

FIRST CHOICE OF WOMEN VIEWERS IN THE DAYTIME. More women watch KMJ-TV from 7 a.m. to 5 p.m. than both other Fresno stations combined.* And you reach them with KMJ-TV at the lowest cost per thousand.

*ARB, Oct. 15 - Nov. 11, 1958

KMJ-TV ...
first station in
The Billion-Dollar
Valley of the Bees

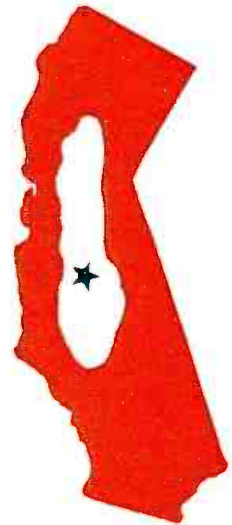

THE KATZ AGENCY, NATIONAL REPRESENTATIVE

Go right to the



TOP AUDIENCE

Tops in the Top Ten! Nielsen's First February report lists *five* ABC-TV programs in the Top Ten — as many as the other two networks combined! And ABC is the top-rated network four nights of the week — *more* nights than the other two networks combined! Over all, ABC's audience is up 1,200,000 homes per minute!*



TOP FAMILIES

You get them at the GET AGE on ABC-TV! The GET AGE is under 40. GET AGE families, as a group, spend the bulk of America's money — more dollars per household than any other age group. 40% of ABC's average audience is made up of GET AGE households! Corresponding figure for the other networks: 36%.**

TOP...go ABC-TV



TOP VALUE

You get *all* families most efficiently on ABC-TV. Average cost per minute for 1,000 homes for all Once-A-Week evening programs on ABC is \$2.78. The other two networks: \$3.13 and \$3.43. ABC has the most efficient situation comedy, variety show, and Western – in fact, 5 of the top 10 most efficient shows in all categories!***



TOP PROGRAMMING

ABC is not standing pat. Four great new series are already set to premiere this fall! Robert Taylor in *The Detectives*. A new hour-long adventure called *The Alaskans*. A brand-new series starring Gale Storm. James Michener's wonderful *Adventures in Paradise*. In the works – a hatful of other top new programs!



FREE THROW:

a two for one shot in Nebraska! No contest, really — KMTV, and only KMTV delivers Omaha AND Lincoln! Lincoln is a four station market, but a glance at the December ARB makes it look like a ONE station market—KMTV's! Nine of Lincoln's top 12 syndicated films, seven of the top 10 network shows, and Lincoln's NUMBER ONE feature film —come from Omaha—via KMTV.

REACH MAKES THE DIFFERENCE!

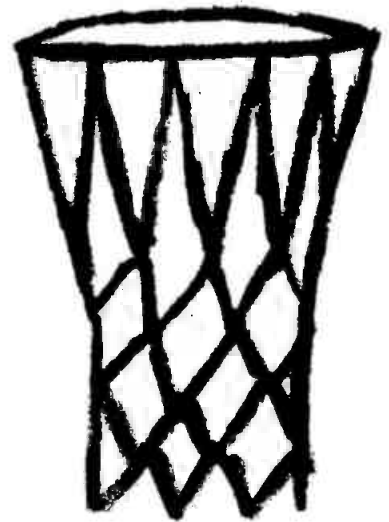

KMTV CHANNEL 3 OMAHA

LET COACH PETRY GIVE YOU THE FULL SCORE!

MONDAY MEMO

from CHRISTOPHER CROSS, vice president and director, publicity-promotion dept., Grey Adv., New York

Let's promote the commercial too

\$567 million was spent in 1958 on network television programs for time alone. The figures are higher if local expenditures are included.

Purpose of this expenditure? To sell products and services. And it's the *commercial*, of course, that bears the burden of selling. Yet, too often, the commercial is neglected.

In the beginning everyone fusses about the little commercial. There are the research and marketing reports. Then meetings with the client to develop agreement on copy strategy. Then follows the all-important period when the commercial is conceived. Creative talent struggles for the proper translation of the copy strategy into a powerful video sales message. So far, good. No neglect yet.

Then the storyboards. More meetings. More revisions. New storyboards. New meetings. New revisions. At last, the storyboards are ready for client to inspect.

Love That Soap • The client, of course, loves that commercial and has some ideas of his own. More revisions.

At last the commercial is ready for filming. The careful search for the right faces, the right voice, the right props, the right music. The rushes. The editing. The re-shooting. The commercial is born!

It has been coddled into existence to do a man-size job. Unlike the baby, it can't take time to learn. The products must be sold at once. And this is the point at which the commercial, too often, is neglected.

The poor little commercial is squeezed into star-studded programs competing with television stars, ringing phones, refrigerators with ice-cold beverages and snacks, and other natural human urges. Then there are the other little commercials on other programs valiantly calling for attention.

The commercial needs all the help it can get. Too often, in too many places, the commercial, once born, doesn't get the help it needs to do the giant job of moving merchandise and services.

Rx for Commercials • But here is what we can do for the commercial to help it do its job better. The recommendations, of course, are based on my experience at Grey where we truly love that commercial; where we don't send the commercial out into the business world without the reddest blood and strongest muscles; where we coddle that commercial throughout its entire life.

Let's look at a few examples. About two years ago, Grey recommended that its client, Greyhound Corp., invest a goodly portion of its advertising dollars in the Steve Allen show with the hope it would persuade more people to "take the bus and leave the driving to us." For this show we prepared the best commercials possible. But we didn't stop there. We examined the commercials and asked ourselves: "What can we do to help make those commercials work better?"

A Commercial's Best Friend • The answer came when a little greyhound puppy, who was named Steverino, was introduced as a lead-in to the commercials. The pup grew up on the Steve Allen show and as she grew her popularity increased. "Steverino, The Greyhound Fan Clubs" sprang up across the country. The canine began to get heavy fan mail. Television viewers complained if Steve Allen didn't seem to be as friendly as he might be to Steverino. The animal's fame rose. The dog was named Queen of National Dog Week. Then she became the canine symbol for World Day for Animals.

On to more honors. Moravian College bestowed a Degree in Animal Letters on her. Steverino the Greyhound has raised funds for March of Dimes, Cerebral Palsy, and was named Pet Director of the 1959 National Easter Seal Drive for Crippled Children.

The commercials created for Greyhound Corp. benefited from the warmth and human interest of the greyhound pup who grew up in television.

For another of our clients (GE Photo Lamp Div.) some commercials were built around Constance Bannister demonstrating how to take pictures of babies and pets. These commercials are to be seen on the Jack Paar show.

Christopher Cross, a veteran of about 20 years in the promotion-publicity business, was raised in New York and attended schools there and at the U. of California. Before he joined Grey Adv. as vice president and director of publicity-promotion four years ago, he had been with Kenyon & Eckhardt, New York, as exploitation director; public relations director for the British Broadcasting Corp. and an official of the United Nation's Public Information Dept. Previously he was with MBS in the early 1940's, serving in various capacities, including publicity director. He also is the author of three books.

Again, at Grey, we didn't create the commercial and desert it. These GE commercials were supported with (1) a booklet by-lined by Constance Bannister, "How I Photograph Babies & Pets" and (2) the star of the commercials was booked into key department stores (Strawbridge & Clothier in Philadelphia; Filene's in Boston; Mandel Bros. in Chicago, and Kann's in Washington, D.C.) to bring the commercials to life.

The Mennen Trophy • When last August The Mennen Co. sponsored the All-Star Football classic, we did not stop with the commercials. We injected an action ingredient to help make the commercials work better. For the first time, tv grid fans were invited to vote for their favorite all-star player to receive the Mennen Tv Fans All-Star Trophy. Result: Many thousands of viewers sent in their ballots. Their selection for the Mennen trophy made news on the sports pages and in tv columns. Four months later, William G. Mennen Jr. presented the trophy to the winner, a Cleveland Browns player, at Yankee Stadium before 70,000 fans.

These are but a few examples of how at Grey the commercial is fortified with an "action ingredient" to do a man-size selling job.

\$567 million is a big bank roll. But it is small when examined in light of the volume of products and services it must move. A great deal of creative publicity and promotion effort properly goes behind the tv program. Good. But it's time we put behind the little commercial the ultimate in creative publicity, promotion and public relations effort it deserves.

Who would like to join a National Society for the Support of the Commercial? No meetings. No dues. Just love that commercial.



DENVER POST

Journal NEW YORK American

The Houston Press

The San Diego Union

The Columbus Citizen

**TAKEN FROM THE
FRONT PAGES OF THE
NATION'S LEADING
NEWSPAPERS**

CHICAGO DAILY NEWS

The Call SAN FRANCISCO Bulletin

The Wyoming Eagle

**Filmed in New York
and on location**

**STORIES
THAT
SHOCK
A NATION!**

**CREATED AND PRODUCED by
Pyramid Productions, Inc.—
producers of such successful
programs as: "Treasury Men In
Action", "Decoy", "Big Story"
and "Man Behind The Badge"**

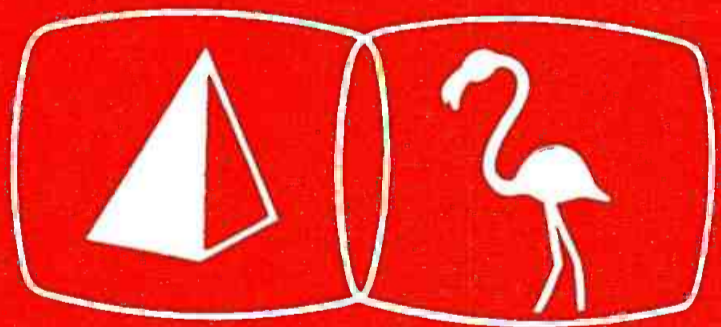

**A PYRAMID - FLAMINGO
Presentation
221 West 57th Street, N.Y.**

39 HALF HOURS

DEADLINE

STARRING PAUL STEWART
AS HOST, NARRATOR AND STAR



local advertisers
know how
to pick
a winner
in Washington

WRC-TV-4

RATE CARD NO. 14

EFFECTIVE-NOV. 1, 1958

NBC WASHINGTON, D. C.

10 SECOND
Rate of station

10
15
35

Not available
Plans or to

FAO

RE-
CIRCUIT

selected by
ARGE to the
rial to be re-

ilities - half

half hour
half hour
half hour
applies to
a remote pro-

as are required on a
dio program, the addi-
0 per camera per half
hour.

ORDING
on the air on tape or
M:

Price

\$10.00

15.00

20.00

30.00

SCOPE RECORDING
single or double system nega-
print.

Price

\$150.00

220.00

280.00

370.00

Extra Price

\$ 25.00

30.00

35.00

40.00

Services of director, announcer and perform-
ers are additional. Rates quoted upon request.

Table indicates program carrying min-
utes. Approximate announcements
may be pre-empted by pro-
gram. Contributions to the 14/50
Plan. Strip discounts may be em-
ployed.

PLANS

7/40

14/50

AA

AA

AA

AA

AA

AA

AA

AA

AA

AA

AA

AA

AA

AA

AA

AA

AA

AA

AA

AA

AA

AA

They pick WRC-TV, Washington's Number One television station! They know, from experience, WRC-TV brings them results by delivering the largest audience in Washington.* And WRC-TV reaches 90% of all Washington TV homes each week!*

National advertisers with the same objective—more sales—can take a profitable cue from these local advertisers who do big business with WRC-TV:

- Safeway Stores
- Peoples Drug Stores
- Woodward & Lothrop
- Sears, Roebuck & Company
- Drug Fair Drug Stores
- Mann's Potato Chips
- The Md. & Va. Milk Producers Assn
- Embassy Dairy
- Bergmann's Laundry
- National Bohemian Beer
- Washington Gas Light Company
- Wilkins Coffee
- Esskay Meats
- Blue Cross-Blue Shield
- Arcade-Sunshine Rug Cleaners
- The Ford Dealers of Metropolitan Washington, D.C.

WRC-TV-4

NBC Leadership Station
in Washington, D.C.
Sold by NBC SPOT SALES

*ARB, June 1958—January 1959

Use of studio re-
hearsals, three camera rehearsals
\$500 per hour, commissionable, one hour mini-
mum, prorated to the next quarter-hour if available.

TASO MEASURES UHF INADEQUACIES

- Report from industry's best engineers says vhf beats uhf
- It's final confirmation of what practical experience showed
- Allocations repair job now turns to search for more vhfs

A two-and-a-half year investigation by the high-level Television Allocations Study Organization has provided the final proof that uhf television cannot compete with vhf television.

The first copy of TASO's report will be delivered to FCC Chairman John C. Doerfer today (March 16) at the NAB convention in Chicago. It will be the subject of the first session of the NAB Broadcast Conference the same morning.

The report makes no recommendations, but its mass of facts adds up to a condemnation of a mixed uhf-vhf allocation. It describes uhf as inferior to vhf in most respects. It is expected to underscore the urgency of a search for more vhf space in which to build a nationwide, competitive television service.

Tv now occupies only 12 channels in the vhf band and 70 channels in the uhf.

There have been reports that the FCC is seeking means of swapping spectrum space with the military to permit an extension of the vhf television band above ch. 7. The goal is a continuous band of 25 or more vhf channels.

There is also speculation that a successful exchange of spectrum space between government and non-government users may entail the deletion of the low-band vhf television frequencies (chs. 2-6) as well as the uhf tv area.

Failing the addition of more vhf channels, it is presumed a drastic revision of present television engineering standards will take place.

This would take the form of reducing present mileage separations between stations on the same channels or adjacent channels. It would also mean the use of directional antennas and other technical methods for squeezing more tv stations into cities with fewer than three outlets.

Uhf Lags Behind Vhf • The gist of the TASO report, summarized by Dr. George Town, executive director, is

that uhf lags seriously behind vhf in almost all aspects of performance.

In some slight factors, it was found that uhf is better than vhf.

The impact of the TASO report cannot be underestimated. Formed in September 1956 at the behest of the FCC, the TASO group is sponsored by five organizations representing both vhf and uhf interests.

They are NAB, Electronics Industries Assn., Assn. of Maximum Service Telecasters, Committee for Competitive Tv (the uhf group), and the Joint Council on Educational Tv.

These agencies have raised almost \$200,000 to see the project through. TASO was composed of six engineering panels, and occupied the time of 271 engineers from 139 companies. The time and manpower were donated by the industry elements.

It amassed the most comprehensive

statement (for full text, see page 165):

- A uhf signal deteriorates more rapidly than a vhf signal as the distance from the transmitter increases.

- A uhf receiving antenna is less efficient than a comparable vhf antenna.

- A uhf receiver is not as good as a comparable vhf receiver.

- A uhf station costs more to operate than a comparable vhf outlet.

Dr. Town reported that in some factors uhf is superior to vhf:

- Uhf signals are almost impervious to manmade and natural interference.

- Within limits of its signal range, uhf is on a par with vhf when it is operating over a level, smooth, treeless terrain.

Critical Distance • One of the most significant of the findings was the determination of "critical distance" for vhf and uhf. This is the point, accord-

Full text of TASO's own summary begins page 165

Advance coverage of NAB convention begins page 52

data on uhf and vhf in the history of television.

Computing Coverage • One major accomplishment, acknowledged by all, was the formulation of a new method of estimating tv coverage, considered to be the nearest to actual measurements ever to be worked out.

But overall the report's most meaningful conclusions are on the relative poor showing of uhf compared with vhf.

Some of the highlights of Dr. Town's

ing to the report, where the proportion of viewers receiving "really satisfactory" pictures begins to decrease rapidly, while those receiving poorer pictures increases rapidly.

These critical distances were found to be as follows:

Chs. 2-6, 65 miles; chs. 7-13, 55 miles; low-band uhf, 40 miles; medium and high band uhf, 30 miles.

Dr. Town's report stated:

"The decrease in average service range with increasing operating fre-

quency is plainly evident. Moreover, at the critical distance, uhf service fell off more rapidly and more completely than did vhf service. Within the critical distance, service was more valuable at uhf than at vhf and was, on the average, poorer."

Basically, Dr. Town said, uhf is at a disadvantage with vhf because of inherent qualities that cannot be completely compensated by using known techniques. Other reasons stem from equipment limitations which may or may not be overcome as progress is made, Dr. Town said.

The most significant differences between uhf and vhf, Dr. Town noted, involve propagation receiving antenna performance, receiver noise, and external noise.

Of the propagation differences, Dr. Town stated:

"Propagation of television signals is a phenomenon of nature; and the differences in propagation at uhf and vhf are likely always to exist."

Improvements may be made in receiving antennas, Dr. Town said, and in receiver performance—particularly, he added, in the use of solid state parametric amplifiers (masers, etc.).

Feared Antitrust Liability • TASO was forbidden to go into equipment developments because of fear of antitrust violations. Early in its meetings, the Justice Dept. raised this question, and it was decided to forego an evaluation of possible improved equipment in the uhf and vhf television field.

Acting under Justice Dept. instructions also, all meetings of TASO panels

and committees took place under the chairmanship of an FCC official. This also was to circumvent any charge of conspiracy.

In a number of field tests, TASO engineers discovered areas where uhf was superior to vhf, where power factors were comparable.

These included single radials in the Fresno, Philadelphia, New Orleans and Buffalo areas.

In these circumstances, Dr. Town said, uhf field strengths were "consistently, appreciably higher than vhf for equal erp [effective radiated powers]."

Generally speaking, Dr. Town said, the total cost of equipping a vhf station and a uhf station is the same. However, he added, higher operating costs plague uhf stations. This relates to the costs of primary power, tubes and maintenance parts, he pointed out. He also noted that uhf stations have more problems than vhf stations do with such failures as off-frequency operation and transmitter modulation linearity.

Translators Good • Dr. Town said that the TASO researchers had found that uhf translators were performing well in bringing tv signals to viewers unable to receive direct signals. The TASO investigators found early in 1958, that more than 700,000 people lived in areas served by translators and that 45% of the homes in these areas were converted for uhf.

Translators, which pick up big city vhf signals and retransmit them on the upper uhf band frequencies, have operated at distances ranging from 43 miles to 220 miles from the stations

they were retransmitting, Dr. Town said. He added:

"Translators appear to be effective in providing television service in areas remote from regular broadcasting stations. They also appear to be effective in providing service in areas of low signal strength within the 'normal' service areas of television stations."

One of the most interesting studies undertaken by TASO was the relation of signal strength to subjective viewer attitude toward picture clarity. Dr. Town reported that viewers would tolerate more interference than might be indicated by flat signal strength measurements. Most of the observers, Dr. Town related, were middle-aged women and young men. The women, he disclosed, were much more critical of picture quality than were the young men, but, he added, they were also more variable.

By adding data on meteorological conditions (troposphere), FCC theoretical curves on vhf coverage could be used in a more correct manner, Dr. Town pointed out. In uhf, not only meteorological conditions but other corrective factors must be added to FCC curves to approach actual coverage.

Dr. Town urged that studies be continued to analyze the wealth of propagation data which has been acquired; to research the use of directional antennas in tv (already authorized under TASO auspices; BROADCASTING, Jan. 19); to study the technique of very precise offset carrier; to study the effect of circular and mixed polarization, and to undertake a study of picture quality in homes in metropolitan areas.

NAB CONVENTION IS IN ORBIT

Chicago's Conrad Hilton bulges with broadcasters

The Conrad Hilton Hotel—26 floors of auditoriums, suites, meeting rooms and assorted sleeping facilities—is the temporary control point of the broadcasting industry.

Chicago's hulk of a hostelry on lake-front Michigan Ave. has been turned into a broadcasting front-line. Network and station executives, equipment firms, engineers and hundreds of service firms are housed under one roof until Wednesday night (March 18). The meetings and influx of broadcasters started last Friday.

NAB's 1959 convention is different from any of its predecessors in two principal ways.

• Radio and tv assemblies are limited to ownership-management delegates plus designated staff executives.

• The annual carnival floor, housing all the assorted entertainment and novelty features, has been de-glamorized by scattering the film, transcription and other service exhibitors all over the vast hotel. In its place, these NAB associate members are operating hand-shaking, elbow-bending hospitality suites.

Decision to limit the 1959 convention to ownership-management delegates was made by the NAB Board at its 1958 winter meeting. The death of the immensely popular carnival floor was decreed at the same time, much to the chagrin of many participating exhibitors who had found their glittery suites teeming with delegate traffic.

Crowd May Exceed L.A. • The top-drawer formula isn't likely to make an important cut in the size of total at-

tendance, judging by signs last week. A pickup developed as registrations continued to flow into NAB convention headquarters, according to Everett E. Revercomb, NAB secretary-treasurer and convention manager. William L. Walker, assistant treasurer in charge of registration, estimated attendance might run ahead of Los Angeles but would not predict it would meet the alltime record set at Chicago in 1957. Over 1,850 had registered March 12.

The 13th annual Broadcast Engineering Conference promises to surpass those of past years both in interest and attendance. A. Prose Walker, NAB en-

Text continues on page 56

Convention agenda on next two pages

How Well Do You Know Baltimore, the Sixth City in the United States? . . .

BALTIMORE HAS . . .

- . . . the world's largest steel producing plant (Bethlehem)
- . . . the nation's largest producer of high tension insulators (General Electric)
- . . . the world's largest spice factory (McCormick)
- . . . the world's largest bichromate factory (Mutual Chem)
- . . . the world's first newspaper to use telegraph as a newsgathering agency (Baltimore Sun)
- . . . the world's first newspaper to use Hoe cylinder presses successfully (Baltimore Sun)
- . . . the world's largest producer of portable electric tools (Black & Decker)
- . . . the world's leading manufacturer of weather instruments (Bendix-Friez)
- . . . the world's largest producer of long distance telephone cable (Western Electric)
- . . . the world's first public carrier railroad (B & O)
- . . . America's first railroad depot (Pratt & Poppleton streets)
- . . . America's first monument to Christopher Columbus
- . . . America's first lodge and Grand Lodge of Odd Fellows
- . . . America's first genuine school for postgraduate study (Johns Hopkins)



Ann Mar
Versatile Hostess
of Channel Two's
"The Woman's Angle"
Monday thru Friday
1:00-1:30 P.M.

- . . . America's first Municipal Symphony Orchestra
- . . . America's first Municipal Band
- . . . the world's largest producer of superphosphates (Davison Chem)
- . . . America's first Methodist Church
- . . . America's first Roman Catholic Cathedral

*These data from the files of the Baltimore Association of Commerce .

And Baltimore is also the home of
the 1958 World's Champion COLTS!

represented by *The Katz Agency, Inc*

In Maryland MOST People WATCH
channel 2 wmar-tv
SUNPAPERS TELEVISION



ON TAP IN CHICAGO

Official agenda events
and unofficial sessions

Sunday, March 15

- 9 a.m.-5 p.m. **REGISTRATION:** Lower Lobby
All day **CBS AFFILIATES:** WBBM-TV studios
All day **FM DEVELOPMENT ASSN.** meeting. Room 19.
9:15 a.m. Buses leave south entrance of Conrad Hilton for the **BROADCASTING** golf tournament.
9:30 a.m.-12:30 p.m. **ASSN. OF MAXIMUM SERVICE TELECASTERS** membership meeting. Bel Air Room.
10 a.m. **RCA** videotape color and black-and-white videotape press preview, Exhibition Hall.
12 noon-7 p.m. **EXHIBITS:** Exhibition Hall
12:30-3 p.m. **ASSN. OF MAXIMUM SERVICE TELECASTERS** luncheon meeting. Room 9.
12:30-4 p.m. **MBS ADVISORY COMMITTEE** luncheon and meeting. Room 18.
2 p.m. **ABC-TV AFFILIATES.** Blackstone Hotel.
3 p.m. **DAYTIME BROADCASTERS ASSN.** meeting. Room 12.
4 p.m. **CLEAR CHANNEL BROADCASTING SERVICE** meeting. Room 13.
4 p.m. **MBS AFFILIATES** meeting. Waldorf Room.
5 p.m. **ABC RECEPTION.** Williford Room.
5:30 p.m. **MBS RECEPTION.** Waldorf Room.
7:30 p.m. **NAB TELEVISION CODE REVIEW BOARD** meeting. Dining Room 10.

Monday, March 16

- 7 a.m.-7 p.m. **REGISTRATION:** Lower Lobby
8 a.m. **QUALITY RADIO GROUP** breakfast meeting. Room 9.
8:45-10:45 a.m. **ENGINEERING CONFERENCE** Waldorf Room. *Presiding:* Raymond F. Guy, senior staff engineer, NBC. *Session Coordinator:* James D. Parker, director, radio frequency engineering, CBS Television.
9 a.m.-9 p.m. **EXHIBITS:** Exhibition Hall.
9-10:45 a.m. Williford Room. **"FM: FURTHER MOMENTUM"**
Participants: Ben Strouse, WWDC-FM Washington, chairman; Everett L. Dillard, WASH (FM) Washington; Merrill Lindsay, WSOY-FM, Decatur, Ill.; Fred Rabell, KITT (FM) San Diego; Michael R. Hanna, WHCU-FM Ithaca, N.Y. *Guest:* FCC Comr. Robert E. Lee.
9-10:45 a.m. Upper Tower. **LABOR CLINIC:** Closed session. *Moderator:* Charles H. Tower, manager, NAB Broadcast Personnel and Economics Dept. *Participants:* G. Maynard Smith, attorney, Atlanta; William C. Fitts, vice president for labor relations, CBS Inc., New York; Ward

L. Quaal, WGN Inc., Chicago, chairman, NAB Labor Relations Advisory Committee.

11 a.m.-12 noon. Grand Ballroom. **GENERAL ASSEMBLY** Management assemblies and Engineering Conference. *Presiding:* G. Richard Shafto, WIS-TV Columbia, S.C., 1959 Convention co-chairman. *Invocation:* The Right Rev. G. Francis Burrill, Bishop, Diocese of Chicago (Episcopal). *Presentation of the Colors:* VFW, Department of Illinois Color Guard. *The National Anthem:* Fifth U.S. Army Band. *Welcome:* The Honorable Richard J. Daley, Mayor of Chicago. *Keynote address:* Robert W. Sarnoff, chairman of the board, NBC. *Keynote award presentation to Mr. Sarnoff:* Mr. Fellows.

12:30-2 p.m. Grand Ballroom. **LUNCHEON AND GENERAL ASSEMBLY** *Presiding:* Robert T. Mason, WMRN Marion, Ohio, 1959 Convention co-chairman. *Invocation:* The Most Rev. Albert Gregory Meyer, Archbishop of Chicago. *Address:* Harold E. Fellows, president and chairman of the board, NAB. *Presentation:* National Commander John W. Mahon, Veterans of Foreign Wars.

2:30-5 p.m. Grand Ballroom. **RADIO ASSEMBLY** *Presiding:* John F. Meagher, vice president for radio, NAB. *Opening remarks:* J. Frank Jarman, WDNC Durham, N.C., chairman, NAB Radio Board of Directors. *Trends in Radio Programming:* Howard G. Barnes, CBS Radio, New York; Robert D. Enoch, WXLW Indianapolis; Frank Gaither, WSB Atlanta; Duncan Mounsey, WPTR Albany, N.Y.; Robert E. Thomas, WJAG Norfolk, Neb. *Radio's Standards of Good Practice:* Cliff Gill, KEZY Anaheim, Calif., chairman, NAB Standards of Good Practice Committee. *"The Station Representative—or What Have You Done for Us Lately?":* Lawrence Webb, director, Station Representatives Assn.; Arthur H. McCoy, vice president, John Blair & Co., chairman, Radio Trade Practices Committee, SRA. *Report of the All-Industry Radio Music License Committee:* Robert T. Mason, WMRN Marion, Ohio, chairman.

2:30-5 p.m. Williford Room. **TELEVISION ASSEMBLY** *Presiding:* Thad H. Brown Jr., vice president for television, NAB. *Welcome:* C. Howard Lane, KOIN-TV Portland, Ore., chairman, NAB Television Board of Directors. *The Television Code:* Roger W. Clipp, WFIL-TV Philadelphia, chairman, Television Code Review Board. *The New Congress—and Television:* Vincent T. Wasilewski, manager of government relations, NAB. *Your Channel and You—Tv Allocations:* (Remarks and discussion). John S. Patterson, deputy director, Office of Civil and Defense Mobilization; Rep. William G. Bray (R-Ind.).

2:30-5:30 p.m. **ENGINEERING PAPERS** Waldorf Room. *Presiding:* George W. Bartlett, assistant manager of engineering, NAB. *Session Coordinator:* Allan T. Powley, chief engineer, WMAL-AM-FM-TV Washington, D.C.

6:30 p.m. **BROADCAST MUSIC INC.** cocktails Chippendale Room, Ambassador West.

7:30 p.m. **BROADCAST MUSIC INC.** dinner. Four Georges.

Tuesday, March 17

8:45 a.m.-12:15 p.m. **ENGINEERING PAPERS** Waldorf Room. *Presiding:* James H. Butts, chief engineer, KBTW (TV) Denver. *Session Coordinator:* Julius Hetland, technical director, WDAY-AM-TV Fargo, N. D.

9 a.m.-5 p.m. **REGISTRATION:** Lower Lobby

9 a.m.-7 p.m. **EXHIBITS:** Exhibition Hall.

10 a.m.-12 noon Grand Ballroom. **RADIO ASSEMBLY** *Presiding:* Mr. Meagher. 10 a.m.—*Radio Audience Research:* E. K. Hartenbower, KCMO Kansas City, chairman, NAB Radio Research Committee; John K. Churchill, vice president, A. C. Nielsen Co., Chicago; Theodore F. Olson, Bureau of the Census, Washington; Ed Fitzgerald, J. Walter Thompson Co., Chicago; Russell Tolg, Batten, Barton, Durstine & Osborn, Chicago; Charles Harriman Smith, research consultant, Minneapolis.

11 a.m.—*Radio Advertising Bureau Presentation:* "The meeting you won't enjoy but don't dare miss if you want to stay in the radio business." Kevin B. Sweeney, president, RAB; John F. Hardesty, vice president, RAB.

10 a.m.-12 noon Williford Room. **TELEVISION MANAGEMENT AND OWNERSHIP CONFERENCE** Closed session. 10 a.m.—*Television Business Session:* The Television Board elections. *Presiding:* Mr. Fellows. 11 a.m.—*The Ownership and Management Conference:* "The Image of Television." *Presiding:* Mr. Lane.

12:30-2 p.m. Grand Ballroom. **LUNCHEON AND GENERAL ASSEMBLY** *Presiding:* Mr. Shafto. *Invocation:* The Rev. Paul M. Robinson, president, Church Federation of Greater Chicago and Bethany Biblical Seminary. *Introduction of the speaker:* Mr. Fellows. *Address:* FCC Chairman John C. Doerfer. *Special feature:* James W. Rachels Jr., Columbus, Ga., national winner, Voice of Democracy.

2:30 p.m. Projected **RADIO WORLD WIDE** program network. Closed meeting. Regency Room, Sheraton Blackstone Hotel.

7:30 p.m. **BROADCAST PIONEERS** banquet. Williford Room.

Wednesday, March 18

8:30-9:30 a.m. **TELEVISION PIONEERS** membership breakfast. Lower Tower.

9 a.m.-5 p.m. **REGISTRATION:** Lower Lobby

9 a.m.-6 p.m. **EXHIBITS:** Exhibition Hall

9:30-10:30 a.m. Grand Ballroom. **COFFEE HOUR**

10:30 a.m.-12 noon Grand Ballroom. **GENERAL ASSEMBLY** Management assemblies and Engineering Conference. *Presiding:* Mr. Mason. *FCC. Panel discussion:* FCC

Chairman John C. Doerfer and Comrs. Rosel H. Hyde, Robert T. Bartley, Robert E. Lee, T.A.M. Craven, Frederick W. Ford and John S. Cross. *Moderator:* Mr. Fellows.

12:30-2 p.m. Grand Ballroom. **LUNCHEON AND GENERAL ASSEMBLY** *Presiding:* Allan T. Powley, WMAL-AM-TV Washington, chairman, 1959 Broadcast Engineering Conference Committee. *Invocation:* Rabbi Joseph M. Strauss, Temple Menorah, Chicago. *Presentation of the first NAB Engineering Award by A. Prose Walker manager of engineering, NAB, to:* John T. Wilner, vice president and director of engineering for radio-tv, The Hearst Corp. *Introduction of the speaker:* Mr. Fellows. *Address:* "Research and Development for the Space Age" by Lt. Gen. Arthur G. Trudeau, chief of research and development, Department of the Army. *Annual NAB business session:* Mr. Fellows presiding.

2:30-5 p.m. Grand Ballroom. **RADIO ASSEMBLY** *Presiding:* Mr. Meagher. *"Editorializing on Radio":* (Radio members of the NAB Committee on Editorializing). Alex Keese, WFAA Dallas, co-chairman; Simon Goldman, WJTN Jamestown, N.Y.; Daniel W. Kops, WAVZ New Haven, Conn.; Robert L. Pratt, KGGF Coffeyville, Kan. *"Radio in 1970—A Look at the Future":* Irving Schweiger, associate professor of marketing, Graduate School of Business, U. of Chicago; Dale G. Moore, KBMN Bozeman, Mont.; Ward L. Quaal, WGN Chicago; Hyman Goldin, chief, FCC Economics Div.; Charles H. Tower, NAB. *"Trends in Automation":* A. Prose Walker, NAB Engineering Dept.

2:30-4:15 p.m. Williford Room. **TELEVISION ASSEMBLY** *Presiding:* Mr. Brown. *Television Film:* Joseph Floyd, KELO-TV Sioux Falls, S.D., chairman, NAB Tv Film Committee. *"The Future of Television Sales and Television Costs":* Panel discussion: George Storer Jr., Storer Broadcasting Corp., Miami; John W. Davis, vice president, Blair Television; Hugh M. Beville, vice president, planning and research, NBC, New York; Maxwell Ule, senior vice president, Kenyon & Eckhardt, New York.

2:30-5:25 p.m. **ENGINEERING PAPERS** Waldorf Room. *Presiding:* Clure Owen, administrative assistant, engineering dept., ABC. *Session Coordinator:* Joseph Epperson, vice president in charge of engineering, Scripps-Howard Radio Inc.

4:15 p.m. Eighth St. Theatre. **TELEVISION BUREAU OF ADVERTISING** Presentation of "Plus Over Normal." Norman (Pete) Cash, president, TvB.

7:30 p.m. Grand Ballroom. **ANNUAL CONVENTION BANQUET.**

7:30 p.m. **ACADEMY OF TV ARTS AND SCIENCES** Chicago chapter workshop seminar. Fred A. Niles Productions, 1058 W. Washington Blvd. NAB delegates invited to discuss new tv technical developments, see Ampex Corp. demonstration and take studio tour.

**Broadcast to a
CONCENTRATED
MICHIGAN
AUDIENCE**



	7:00 A.M.—12:00 Noon Monday Thru Friday	12:00 Noon—6:00 P.M. Monday Thru Friday
WPON	39	46.5
Sta. B	24.1	14.0
Sta. C	11.9	8.1
Sta. D	10.0	5.4

C. E. Hooper, Moy, 1958

The station serving



in



CONTACT

VENARD RINTOUL & McCONNELL, INC.

Associated with Lansing's



CONTINUED from page 52

gineering manager, said the conference papers will combine latest technical advances in the broadcast arts as well as practical tips on efficient station operations. Allan Powley, chief engineer of WMAL - AM - FM - TV Washington, is conference chairman. Engineering sessions open today (March 16) at 8:45 a.m. in the Waldorf Room. The morning program stops at 10:45 a.m. as engineering delegates join management in the formal convention opening and keynote address. They also will take part in the joint luncheon, to be addressed by President Harold E. Fellows.

Two management meetings precede the keynote session—concurrent labor clinic and fm panel. G. Maynard Smith, Atlanta labor consultant, heads the labor panel. FCC Comr. Robert E. Lee will join members of the NAB Fm Committee at the fm session, which is titled, "Fm, Further Momentum."

Concurrent radio and tv assemblies are scheduled this afternoon (March 16). Tuesday morning and Wednesday afternoon. FCC Chairman John C. Doerfer will be the speaker at tomorrow's joint luncheon. Tuesday afternoon is not programmed, to permit time to inspect broadcast equipment exhibits in Exhibition Hall. Several non-agenda events are scheduled that afternoon, including a meeting of the proposed Radio World Wide cooperative program network.

Government-Trade Session • The annual FCC-industry roundtable, another

joint session, will be held Wednesday morning. At the joint Wednesday luncheon, the speaker will be Lt. Gen. Arthur G. Trudeau, chief of research and development, Dept. of the Army, whose topic will be "Research and Development for the Space Age."

After the concurrent Wednesday afternoon sessions, the convention program will wind up with the annual banquet.

Delegate reaction to the 1959 convention format will be watched with interest by NAB's officers and directors. Some film and transcription firms have unofficially voiced displeasure at the abandonment of their special exhibit floor. A considerable number failed to take up NAB's offer to provide hospitality suites, contending traffic would be cut sharply. They complained, too, because they could do only token promoting and selling in a hospitality suite, where there is little chance to provide displays or exhibitions of product.

The annual equipment exposition was scheduled to open at noon Sunday. Exhibition Hall is located on the lower lobby floor of the Conrad Hilton, one of the largest hotel display facilities in the world. RCA planned a press preview Sunday morning of its new tv tape recorder for color and black-and-white. George E. Gayou is manager of the equipment show.

Sidelines • First non-agenda meetings began Friday. They included a dinner meeting of the board of Assn. of Maxi-

Fellows future pondered

A special NAB committee will meet Tuesday (March 17) at 4:30 p.m. to consider the problem of the association's presidency.

An *ad hoc* committee of eight will review the contract of Harold E. Fellows, NAB president and board chairman. Four of the members will be the respective chairman and vice-chairman of the Radio Board—J. Frank Jarman, WDNC Durham, N.C., and Robert T. Mason, WMRN Marion, Ohio, and the chairman and vice chairman of the Tv Board—C. Howard Lane, KOIN-TV Portland, Ore., and G. Richard Shafto, WIS-TV Columbia, S.C.

The two radio officers and two tv officers will each name two additional radio directors and two additional tv directors to serve on the eight-man *ad hoc* committee. This committee will review President Fellows' five-year contract which

expires in June 1960. The contract has provided a step-up salary that reaches \$75,000 annually next June, plus \$12,000 allowance for Washington expenses. A four-year consultancy arrangement starts in 1960 when Mr. Fellows' presidency expires.

Some close to President Fellows have suggested he would be willing to continue in the presidency after June 1960.

An unusual lame-duck situation exists in the NAB Radio and Tv Board chairmanships between the convention and the board's next meeting in June. The Radio Board's chairman and vice chairman apparently continue in office despite the fact their directorships expire with this week's convention. The comparable Tv Board officers hold directorships expiring at the 1960 convention so the same situation does not exist on that board.

KRON is TV in SF



San Franciscans are sold on KRON-TV

KRON/FM On the Air
Estimated A, B Contours
Approximate KRON/TV
Coverage (FCC Standards)
Call KRON/TV Sales

SAN FRANCISCO CHRONICLE • NBC AFFILIATE • CHANNEL 4 • PETERS, GRIFFIN, WOODWARD •

a message for the minority

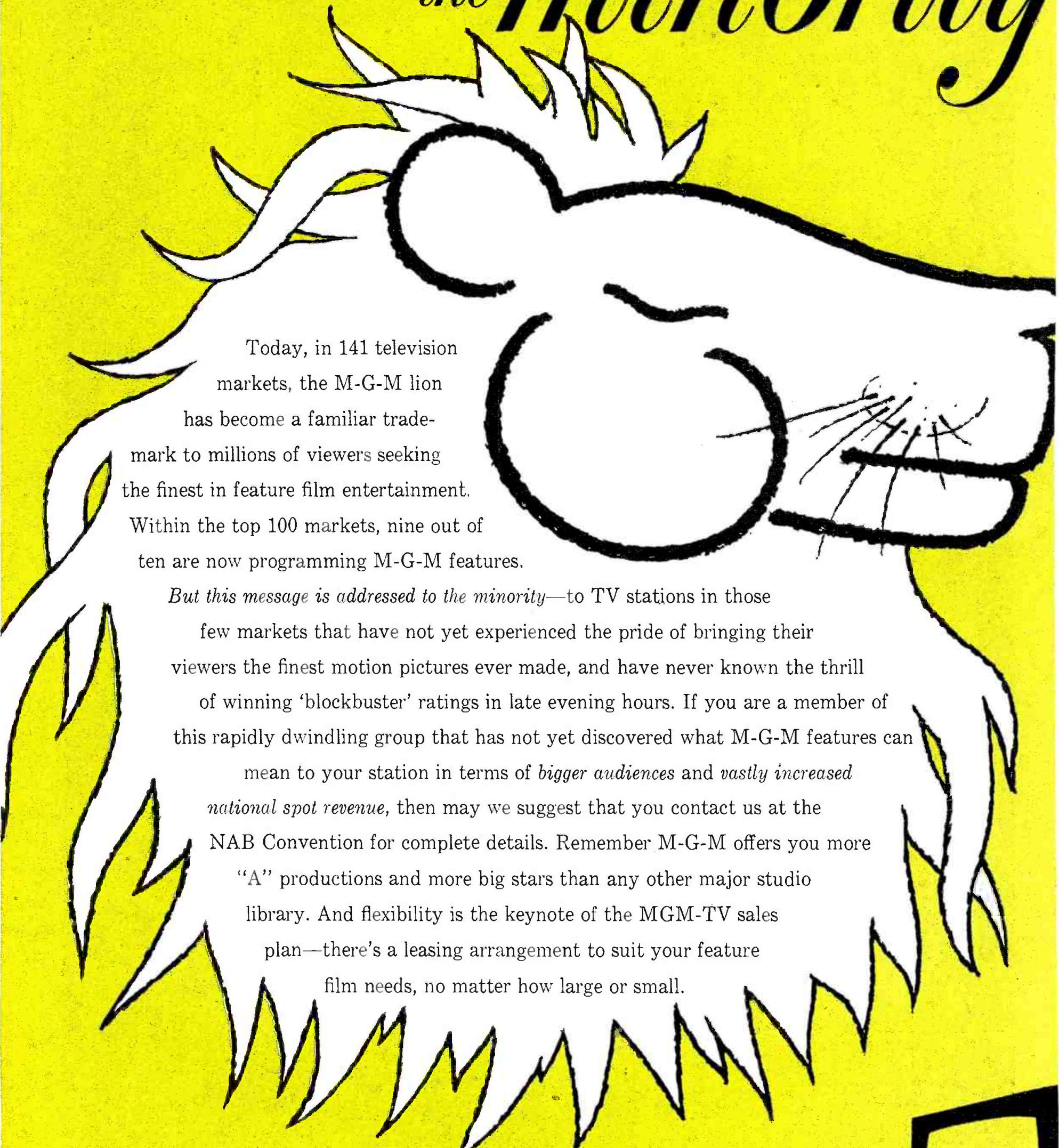

Today, in 141 television markets, the M-G-M lion has become a familiar trademark to millions of viewers seeking the finest in feature film entertainment. Within the top 100 markets, nine out of ten are now programming M-G-M features.

But this message is addressed to the minority—to TV stations in those few markets that have not yet experienced the pride of bringing their viewers the finest motion pictures ever made, and have never known the thrill of winning ‘blockbuster’ ratings in late evening hours. If you are a member of this rapidly dwindling group that has not yet discovered what M-G-M features can mean to your station in terms of *bigger audiences* and *vastly increased national spot revenue*, then may we suggest that you contact us at the NAB Convention for complete details. Remember M-G-M offers you more “A” productions and more big stars than any other major studio library. And flexibility is the keynote of the MGM-TV sales plan—there’s a leasing arrangement to suit your feature film needs, no matter how large or small.

Drop in and visit us at the NAB Convention in Chicago
Suite 2404-05-06, Conrad Hilton Hotel, March 15th-18th

MGM-TV

A Service of
Loew's Incorporated

1540 Broadway, New York 36, N.Y.

The planners assess this year's convention

Arrangements for the NAB's 37th annual convention in Chicago were directed by three key figures—NAB President Harold E. Fellows, G. Richard Shafto, WIS-TV Columbia, S.C., and Richard T. Mason, WMRN Marion, Ohio. Messrs. Shafto and Mason are co-chairmen of the 1959 NAB Convention Committee. They are respective vice-chairmen of the NAB Tv and Radio Boards.

Other members of the convention committee are Joseph E. Baudino, Westinghouse Broadcasting Co.;

John H. DeWitt, WSM Nashville, Tenn., Engineering Conference radio liaison; William Holm, WLPO LaSalle, Ill.; J. Frank Jarman, WDNC Durham, N.C., Radio Board chairman; Fred A. Knorr, WKMH Dearborn, Mich.; C. Howard Lane, KOIN-TV Portland, Ore., Tv Board chairman; C. Wrede Petersmeyer, Corinthian Broadcasting Corp.; James D. Russell, KKTU (TV) Colorado Springs, Engineering Conference tv liaison.

Here are the views of the three key figures in convention planning:



Mr. FELLOWS:

The broadcasting industry's success and vitality is the result of the individual broadcaster's ability to meet the challenge of change, his dedication to public service, and his sound sense of responsibility in management.

The best evidence that broadcasters are doing their jobs well is the continued growth and influence of both radio and television.

In a dynamic industry such as ours, certainly the ability to meet change is of prime importance.

At the NAB annual convention, broadcasters have the opportunity for the type of exchange of ideas which will most help to give the industry continued vigor and best carry forward its distinguished tradition of public service.



Mr. SHAFTO:

Television, as a growing industry, must of necessity deal with the many problems which accompany any rapid growth.

The television management sessions at the 37th annual convention provide invaluable information to broadcasters seeking answers to the many pressing questions which television broadcasting poses.

Owners and managers especially will benefit from the convention discussions of television allocations, future tv sales and tv costs, latest amendments to the television code and future use of tv film—as well as the many other facets of television operations to be spotlighted.

The road ahead for television is almost unlimited in opportunity for continued public service and acclaim.

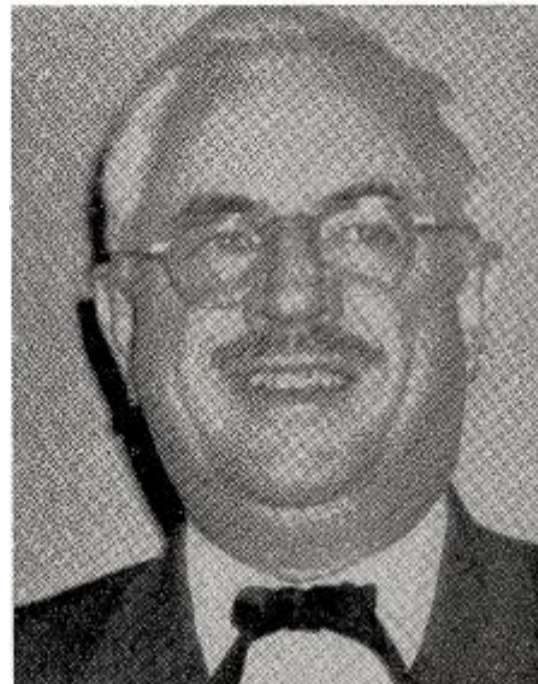

Mr. MASON:

Each year, radio broadcasting reaches new pinnacles of influence on American life through the resourcefulness of its many public services and the growing dependence of the American people on radio for news and information.

The NAB convention gives owners, managers and engineers the opportunity to keep abreast of ever-changing problems.

Discussions of current trends in radio programming, radio audience research, the Standards of Good Practice, editorializing on radio, radio advertising, the future of radio, and trends in automation—as well as such allied subjects as the role of the station representative and a report on radio music licensing—are of top interest to the industry.

num Service Telecasters, dinner meeting of Assn. for Professional Broadcasting Education and an evening get-together of Fm Development Assn. CBS-TV affiliates met Saturday at the WBBM-TV Chicago studios, winding up with a reception and banquet at the Drake Hotel.

One minor program change developed last week. NAB's Tv Code Review Board shifted its meeting from Monday morning to Sunday night. The board

has several important items on the agenda.

NAB station membership is at an all-time high as the convention opens. The roll includes 1,503 am radio members, 410 fm and 334 tv. There are 309 stations subscribing to the NAB Television Code.

Broadcast Music Inc. will provide entertainment for the Wednesday night banquet, with Russ Sanjek of BMI handling arrangements. Billed to appear

are Pee Wee Hunt and his Dixieland band, vocalists Roberta Peters and Dennis Day, Phil Ford and Mimi Hine, comedy team, and the Lou Breeze orchestra.

The Radio Side • Radio Advertising Bureau promises one of the livelier sessions. "There may be crossed swords and hurt feelings as a result of its 11 a.m. session Tuesday, but President Kevin Sweeney says 'no one can afford

FOR ALL 17 RATING PERIODS

MEASURING TOTAL CAMPAIGN

ADVERTISERS;* NBC RADIO HAS

LARGEST IN ALL NETWORK

IN JANUARY 1959, THE NBC RADIO NETWORK DELIVERED
10 OF THE 15 LARGEST CAMPAIGN AUDIENCES:

ADVERTISER	AGENCY	WEEKLY UNDUPLICATED HOMES
TIME, INC.	JOE GANS & COMPANY	7,842,000
BROWN & WILLIAMSON TOBACCO CORP.	TED BATES & COMPANY, INC.	7,299,000
LEWIS HOWE COMPANY	McCANN-ERICKSON, INC.	7,153,000
THE READER'S DIGEST ASSN., INC.	J. WALTER THOMPSON COMPANY	7,153,000
WARNER LAMBERT PHARMACEUTICAL CO. INC.	TED BATES & COMPANY, INC.	7,153,000
GROVE LABORATORIES, INC.	GARDNER ADVERTISING COMPANY	6,451,000
VICK CHEMICAL COMPANY	MORSE INTERNATIONAL, INC.	6,425,000
MOGEN DAVID WINE CORP.	EDWARD H. WEISS & CO.	6,306,000
WILLIAM WRIGLEY, JR., CO.	ARTHUR MEYERHOFF & CO.	5,564,000
LEVER BROTHERS COMPANY	FOOTE, CONE & BELDING J. WALTER THOMPSON COMPANY SULLIVAN, STAUFFER, COLWELL & BAYLES, INC.	5,087,000

*NRI, SEPTEMBER 1957-JANUARY 1959



SINCE NIELSEN BEGAN

AUDIENCES DELIVERED TO

AVERAGED 11 OF THE 15

RADIO!

NBC RADIO NETWORK

to miss it if he wants to stay in business," RAB says.

RAB queried hundreds of advertisers for views on radio in preparing the presentation, according to Mr. Sweeney. He said the study turned up patterns in broadcasting that some broadcasters don't like to admit exist but which "must be faced if radio is to grow in prestige and strength." RAB plans to unveil both long and short-term programs for sales management which it hopes will boost radio billings to the billion-dollar mark. It also will offer details of a thus-far confidential "120 play" and selling programs and present previews of three new sales presentations.

"Radio missed its sales target in 1958, winding up approximately even with 1957 instead of at least 5% ahead," Mr. Sweeney asserted. "Our presentation will explain in no uncertain terms what can be done about it in 1959 on both the national and local levels."

TvB Lineup • The Television Bureau Advertising on Wednesday will offer an hour-long presentation designed to highlight the interdependence of retailers and agencies and to offer selling tools to both. In the words of George Huntington, TvB vice president-general manager, "Any agency seeking new business, any retailer now offering items at list price, any manufacturer whose products are sold locally, should see this presentation."

Entitled "Plus Over Normal, or The Three-and-a-half-billion Dollar Account No One Really Has," the TvB presentation was first shown in New York, where it is said to have generated considerable excitement. At the meeting (4 p.m., 8th Street Theatre) TvB will also release its second annual index of retailers using tv and will report what happened to some who neglected the medium.

Open house

Headquarters of the BROADCASTING magazine staff during the NAB convention are in Suite 704-05-06A of the Conrad Hilton Hotel. A complete editorial newsroom has been set up, with a full complement of reporters covering every phase of the convention.

Attending are Sol Taishoff, Maury Long, Edwin H. James, J. Frank Beatty, Rufus Crater, Win Levi, Earl Abrams, Kenneth Cowan, Fred Fitzgerald, Warren Middleton, Bill Merritt, Ed Sellers, John Osbon, Barbara Kolar, Lawrence Taishoff.

WHERE TO FIND IT IN CHICAGO THIS WEEK



All exhibits of equipment manufacturers are in the lower lobby Exhibition Hall of the Conrad Hilton, during the NAB convention.

Exhibit space of equipment firms and the hospitality suites of these equipment exhibitors in the Conrad Hilton or other hotels are shown.

Information on networks, publications, program services, station representatives and research organizations is based on information at NAB convention headquarters as of March 12, plus checks with other hotels as well as non-member firms of NAB.

Giant directory boards in the Conrad Hilton and Sheraton Blackstone lobbies show where associate members' suites are located.

All room and suite designations are in the Conrad Hilton Hotel unless otherwise specified. (E) indicates exhibit space; (H) indicates hospitality suite.

EQUIPMENT MANUFACTURERS

Adler Electronics	(H) 923A
	(E) Space 28
Alford Mfg. Co.	(E) Space 29
Allied Radio Corp.	(H) 1133A
Ampex Corp.	(E) 2200 Space 34
Browning Labs.	(H) 823A
Century Lighting	(E) Space 22
Collins Radio Co.	(E) Space 38
Caterpillar Tractor Co.	(E) Space 26
Conrac Inc.	(E) Space 31
Continental Electronics Mfg. Co.	(H) 723A
	(E) Space 36
Dresser-Ideco Co.	(H) 723 (E) Space 37
Electronic Applications	(E) Spaces 8, 9
Foto-Video Labs.	(E) Space 23
Gates Radio Co.	(H) 1023 (E) Spaces 2, 3
General Electric Co.	(H) 1500 (E) Space 33
General Electronic Labs.	(H) 1106A
	(E) Space 35
General Precision Lab.	(E) Space 15
General Radio Co.	(E) Space 25
Harwald Co.	(E) Space 17
Hughey & Phillips	(H) 2106 (E) Space 27
Industrial Transmitters & Antennas	(E) Space 14
Kahn Research Labs	(E) Space 6
Kliegl Bros.	(E) Space 19
Kline Iron & Steel Co.	(H) 834A
Minneapolis Honeywell Regulator Co.	(E) Space 10
Phelps Dodge Copper Products Corp.	(H) 1319 (E) Space 4
RCA	(H) 605A (E) Space 24
Raytheon Mfg. Co.	(E) Space 18
Schafer Custom Engineering	(E) Space 16
Stainless Inc.	(H) 1124
Standard Electronics	(H) 1018
	(E) Space 32
Sarkes Tarzian Inc.	(E) Space 21
Telechrome Mfg. Corp.	(E) Space 30A
TelePrompTer Corp.	(E) Space 20
Telescript-CSP	(H) 1234A (E) Space 11
Tower Construction Co.	(E) Space 12
Utility Tower Co.	(E) Space 5
Visual Electronics Corp.	(H) 1218
	(E) Space 30

GOVERNMENT

U. S. Army(E) Spaces 7-11A

NAB CONVENTION OFFICES

Convention ManagerRoom 1
Everett E. Revercomb, Secretary-Treasurer
Ella Nelson, Administrative Assistant

Engineering ConferenceRoom 1
A. Prose Walker, Manager
Convention ExhibitsExhibition Hall
George E. Gayou, Exhibit Manager
Registration DeskLower Lobby
William L. Walker, Assistant Treasurer
Convention NewsRoom 3
Donald N. Martin, Assistant to the President in charge of Public Relations
Convention ProgramRoom 4
Howard H. Bell, Assistant to the President in charge of Joint Affairs

NAB STAFF OFFICES

RadioRoom 2
John F. Meagher, Vice President
TelevisionRoom 2
Thad H. Brown Jr., Vice President
Broadcast Personnel and Economics Room 4
Charles H. Tower, Manager
Government RelationsRoom 2
Vincent T. Wasilewski, Manager
LegalRoom 2
Douglas A. Anello, Chief Attorney
Organizational Services and APBE Room 4
Frederick H. Garrigus, Manager
ResearchRoom 4
Richard M. Allerton, Manager
Station RelationsLower Lobby
William Carlisle, Manager
Television Code AffairsRoom 4
Edward H. Bronson, Director

NETWORKS

ABC-Radio and ABC-TV(H) Suite 2306
CBS-Radio(H) 1806A
CBS-TV(H) 2320-25
Mutual(H) 1806
NBC(H) Sheraton Blackstone 508-10
NTA Television Network(H) 1104
Sheraton Blackstone
Keystone Broadcasting System
(H) 804-05-06

PROGRAM SERVICES

CBS Films Inc.(H) 2319
California National Productions
(H) Sheraton Blackstone
Community Club Services(H) 1218A
Governor Television Attractions
(H) 1018-19-20A

Continues on page 64

the moving finger
writes and having

WRIT moves on*
and up to number one

in milwaukee**

* Rubainat-Omar Khayyan

** Radio facts John Box

WRIT

BUY Radio when you buy media

BUY Balaban when you buy radio

BUY WRIT when you buy Milwaukee

and you BUY the people who BUY

WIL

St Louis

KBOX

Dallas

WRIT

Milwaukee

SOLD NATIONALLY BY ROBERT E. EASTMAN

THE BALABAN STATION

in tempo with the times

John F. Box, Jr., Managing Director

Bernie Strachota, General Manager

A-GAIN and **A-GAIN**
AND **A GAIN**
YEAR after **YEAR**

Radio-TV Representatives, Inc.

has consistently led U. S.
NATIONAL SPOT
AVERAGE SALES by
15% to 84.8%
AND they did it again
in 1958!

Do You Have any Rep
Problems?

Peggy Stone will be glad to
"talk them over" with you.

SHERATON-BLACKSTONE
Petite Room—Art Hall Floor



**MISSING
SOMETHING?**

You'll find IT
Right Across the Street
SHERATON-BLACKSTONE

Petite Room—Art Hall Floor

FUN FOR ALL!
SOUVENIRS—SURPRISES
NEW SHOWS—NEW IDEAS
Come On Over!

Harry S. Goodman
19 EAST 53RD STREET • NEW YORK, N.Y.

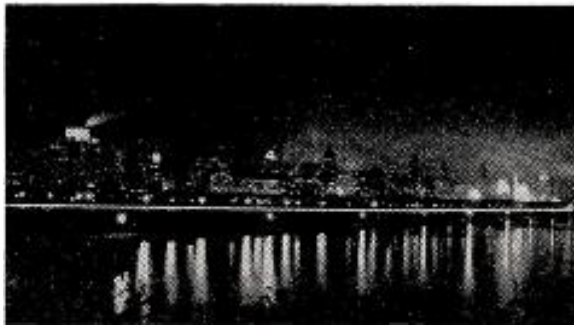

**WHERE TO FIND IT
THIS WEEK
IN CHICAGO**

Continued from page 62

Guild Films(H) Ambassador East
Independent Television Corp.(H) 2506A
Lang-Worth Feature Programs(H) 919
M & A Alexander Productions (H) 1535-36A
MCA-TV(H) 2400
MGM-TV(H) 2406
Magne-Tronics ... (H) Sheraton Blackstone
Modern Talking Picture Service(H) 823
Official Films(H) Unassigned
Programatic Broadcasting
Service (Muzak)(H) 706
RCA Recorded Program Services ..(H) 600
Roy Rogers Syndication(H) 918A
Screen Gems(H) 2500
SESAC(H) 1206A
Standard Radio Transcription Services
(H) Flower Room, Sheraton Blackstone
Trans-Lux Television Corp.
(H) 1314 S. Wabash
United Artists Associated(H) 1905-06
United Press Movietone(H) 1622A
World Broadcasting System..(H) 1822-23-24
Ziv (Economee Div.)(H) 2311A
Ziv Tv Programs (H) 2306A

RESEARCH ORGANIZATIONS

American Research Bureau(H) 800
A. C. Nielsen Co.(H) 1000
Pulse Inc.(H) 2106A

STATION BROKERS

Blackburn & Co.(H) 1322-23-24
Robert Carpenter Enterprises(H) 1218A
Paul H. Chapman Co.....(H) Unassigned
Wilt GunzendorferConrad Hilton
Hamilton, Stubblefield, Twining
(H) 1722-23-24
Allen Kander & Co.....(H) 1118-19-20A
Philip L. Kelser & Assoc....(H) Unassigned
Howard E. Stark(H) 933-34A
Jack L. Stoll & Assoc.....(H)1035-36A
William T. Stubblefield(H) 735-36A

STATION REPRESENTATIVES

Avery-Knodel(H) 718-19-20
Sheraton-Blackstone
Elisabeth M. Beckjorden
(H) Executive House
Blair Television Assoc. (H) Executive House
Blair-TV(H) 3011 Executive House
John Blair & Co...(H) 3011 Executive House
The Bolling Co.(H) 1100
Branham Co.(H) Unassigned
CBS Television Spot Sales(H) Congress
Robert E. Eastman(H) 1935A
Henry I. Christal Co.(H) 1306
Forjoe & Co.(H) 1900
Gill-Perna(H) 900-01-02A

H-R Representatives(H) 3710
Executive House
H-R Television(H) 3710
Executive House
Harrington, Righter & Parsons(H) 1705
Headley-Reed(H) 700
George P. Hollingbery Co.(H) 1600
Hal Holman Co.(H) 500-01
The Katz AgencyUnassigned
Jack Masla & Co...(H) Sheraton-Blackstone
Meeker Co.(H) 1700
McGavern-Quinn Corp.(H) 3511
Executive House
NBC Spot Sales...(H) Sheraton-Blackstone
John E. Pearson Cos.(H) Congress
Peters, Griffin, Woodward
(H) Sheraton-Blackstone
Edward Petry & Co.(H) 1400
Radio-TV RepresentativesUnassigned
Rambeau, Vance, HoppleUnassigned
Paul H. Raymer Co.(H) Executive House
Vernard, Rintoul & McConnell(H) 2100
Weed Radio Corp.(H) Congress
Weed Television Corp.(H) Congress
Adam Young Cos.(H) 2022
Prudential Plaza

TELEPHONE & TELEGRAPH COMPANIES

American Telephone & Telegraph
Unassigned

NEWS SERVICES, PUBLICATIONS

TRADE PUBLICATIONS & ASSOCIATIONS

Advertising Age(H) 1306A
Associated Press ..(H) Sheraton-Blackstone
BillboardUnassigned
Broadcast Advertisers Reports ..(H) 1534A
BROADCASTING(H) 704-05-06A
Media-Scope(H) 935A
Printers Ink(H) 1319A
Radio Advertising Bureau(H) 1524
Radio Press(H) 2506
Radio Television Daily(H) 906
Sponsor(H) 1106
Standard Rate & Data Service ..(H) 1706A
Television Age(H) 1606
Television Bureau of Advertising ..(H) 819
Television Magazine(H) 1434A
United Press Movietone News...(H) 1622A-
23A
U. S. Radio(H) 923
Variety(H) 806A

Unassigned

The following firms are listed in the official NAB convention directory as associate members not assigned Chicago convention suites as of March 12: Amperex Electronic Corp.; John F. Beasley Construction Co.; Bell & Howell Co.; Blaw-Knox Co.; Bonded Tv Film Service; Bryg Inc.; Comet Distributing Corp.; Dage Tv Div., Thompson Products; Eastman Kodak Co.; Erco Radio Labs; Flamingo Telefilm Sales; Houston-Fearless Corp.; Magnetic Sound Camera Corp.; Mohawk Business Machines Corp.; Art Moore & Assoc.; Nems-Clarke Co.; Pams Advertising Agency; Rust Industrial Co.; Stancil-Hoffman Corp.; Sterling Television Co.; Telemat; Telematics; Television Zoomar Corp.; Trans-Lux Television Corp.

Note: Individuals registered for the annual NAB Convention will be listed at the Conrad Hilton headquarters of NAB in alphabetized sheets.

Advance registrations for the convention were carried in **BROADCASTING** last issue (March 9).



HANDS

- SENSITIVE
- SKILLED

in the
CREATION
of
exciting
television
available at

CHANNEL

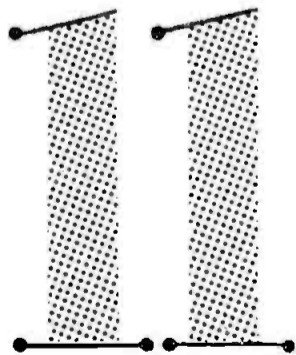

KPLR • TV VIDEO CITY

THE CHASE-PARK PLAZA HOTELS • ST. LOUIS 8, MISSOURI

HAROLD KOPLAR • PRESIDENT
JAMES L. CADDIGAN • VICE PRESIDENT
JAMES GOLDSMITH • SALES MANAGER

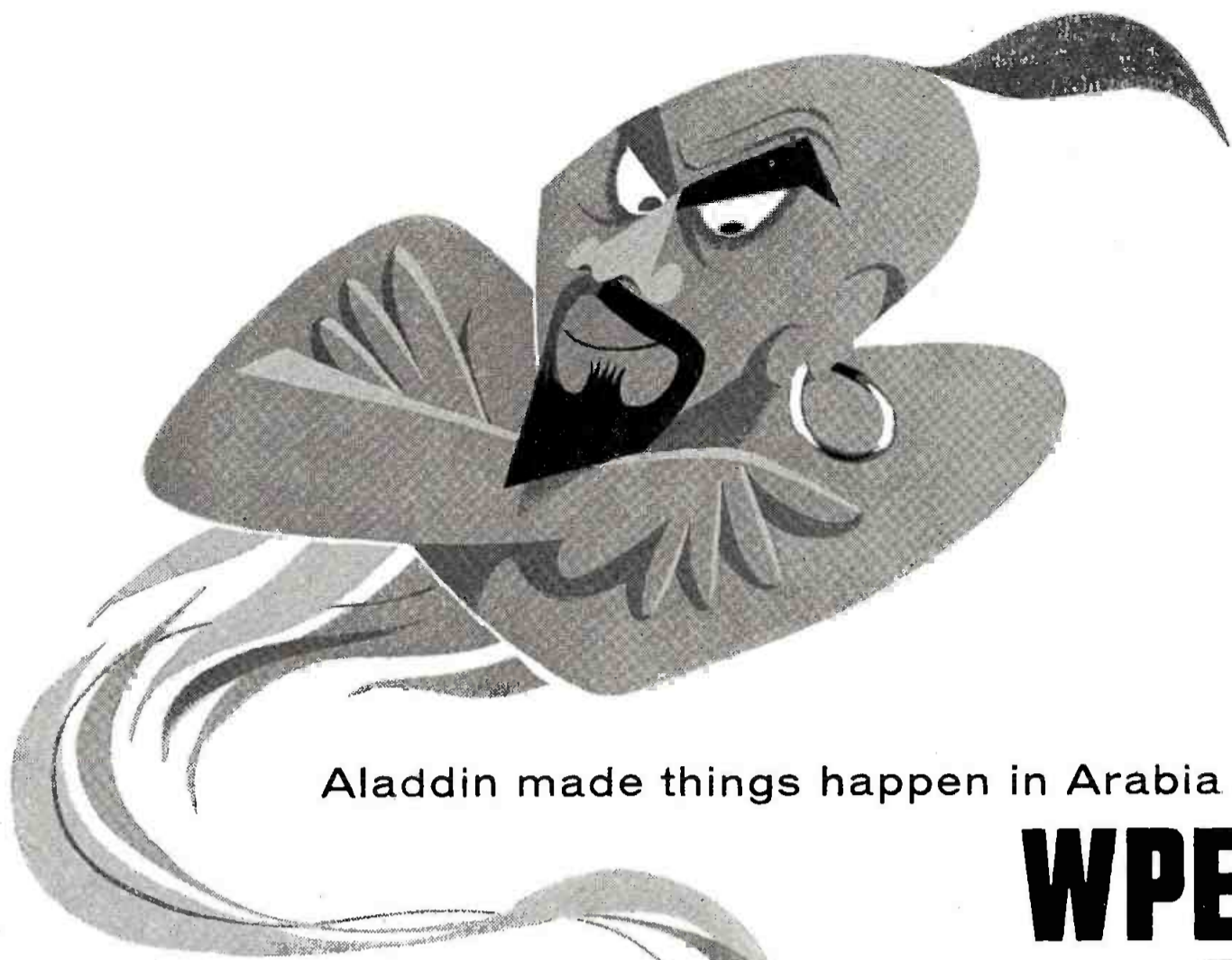

Aladdin made things happen in Arabia . . . and



WPEN
RADIO
MAKES
THINGS
HAPPEN
IN
PHILADELPHIA

WPEN is the only radio station in Philadelphia with a fighting editorial policy. As part of this grass-roots campaign, WPEN crusaded against the hoodlums with daily editorials titled "Where Did He Get The Gun?" Result: the laws are being changed in Pennsylvania. In Public Service—and in Sales—WPEN Makes Things Happen in Philadelphia.

WPEN

Represented nationally by

GILL-PERNA

New York, Chicago, Los Angeles, San Francisco, Boston, Detroit.

Y&R HITS TV TRIPLE-SPOTTING

This and other 'unethical' commercial practices at the local station level draw fire from agency officials who document their charges with BAR monitor reports

Documentation of an apparent high incidence of prime time being overcrowded with tv commercials by stations blew a fuse at Young & Rubicam last week.

Bristled the agency's media brass: "over-commercialization."

Y&R's spokesman, William E. (Pete) Matthews, vice president, media relations, called a news conference Wednesday afternoon (March 11). Issued were: (1) Y&R's "position" on what the agency called "unethical tv commercial practices at the local station level," and (2) Broadcast Advertisers Reports' "summary study" of local tv station practices in medium-sized markets (BROADCASTING, March 9). He was accompanied by Joseph F. St. Georges, associate director of the media department.

Mr. Matthews quickly set the mood of the conference by referring to a cartoon in the *Saturday Evening Post* that showed a sleepy viewer before a tv set and a caption reading, "The commercials will continue after a brief pause for entertainment."

Stations Condemned • For about an hour, Mr. Matthews elaborated on Y&R's position condemning the practices of stations shaving network time, failing to protect against competing commercials and engaging indiscriminately in multiple spotting.

Y&R's sudden pirouette in the spotlight caught other large agencies off guard and not quite sure what to make of it. In general, the pattern at these agencies was:

J. Walter Thompson (No. 1 in broadcast billing)—Agency has never made a big issue of so-called "overcommercialization" or multiple-spotting. On occasion a note or letter has been sent to a violating station or the station's representative is called in. If it is a network time shave or "clip," the network is informed and asked to "clean it up." There's nothing in JWT contracts about triple spotting.

BBDO—This agency is hesitant to outline its formal policy without necessary clearance but BBDO's spot contracts, it's known, contain clauses cautioning stations against infractions in multiple-spotting.

McCann-Erickson—Agency is known to be watching situation carefully, subscribes to BAR's reports. Its media pol-

icy makers were unavailable for comment.

Foote, Cone & Belding—FC&B in the past tried sending affidavits to stations in both its network and spot schedules and threatened non-payment to those failing to return affidavits. This scheme shredded when the agency ran into formidable resistance.

Verification Sought • According to Frank Gromer, FC&B's media manager, efforts now are concentrated on stations in network schedules only, but a way is sought to apply some method of securing affidavit verification from stations (network or spot). He cautioned, however, that the BAR monitoring service could boomerang if stations developed a way to "clean up" during monitoring periods and then slipped back to old habits when the heat was off.

Two agencies, which in the past have led the battle against multiple-spotting, are Compton Adv. and Benton & Bowles. B&B also has been pained at what it believes has been an unwarranted rise in stations chopping seconds off network time and between network programs in order to accommodate additional spots in the interval (CLOSED CIRCUIT, Jan. 26).

As does B&B, Compton expresses

itself as stamping out the multiple-spotting (or clipping) practice wherever it is found. The agency was one of the first to incorporate a proviso in contracts against triple-spotting. B&B has this, too, as does William Esty Co., still another agency with large tv billing.

Young & Rubicam's contract for General Foods with stations contains this clause, which according to Mr. Matthews has been in effect for about a year: the contract is considered "null and void in the event any triple-spotting is utilized adjacent to the spot position ordered hereby."

Young & Rubicam bills at an annual rate of more than \$100 million in network and spot tv combined. Last year it ranked third in the U.S. among all radio-tv agencies.

States Problem • Said Mr. Matthews: the problem is validating and guaranteeing the service it and the client receives from networks and broadcast stations. BAR, he thought, was a step in the right direction, he said, Y&R being the first agency to purchase the monitoring service about 4½ years ago. He noted, too, that the agency first issued a "document" on the problems of multiple or triple spotting as early as 1950.

He said the usual procedure is for the



Y&R's Matthews (l) and St. Georges document their complaint

agency to pay upon receipt of a certificate of performance from a station and that the agency in general is confident it is getting the time ordered.

But, he cautioned, there are some values which the certificate cannot indicate: "We order 30 minutes of time and get 29:40 minutes; 30-second commercial schedules and receive a cut transmission."

(Networks contacted last week on the problem of "clipping" noted that they follow the usual practice of working out grievances with affiliates as the necessity dictates. NBC, it was learned, independently—and not because of the latest BAR report—has studied the top 25 tv markets and found only a 4% "possible infringement" by affiliates in prime evening time.)

The broadcast day is limited, he commented, and stations tend to crowd schedules; he described transgressions as "certain types of intrusions or devaluations upon our advertising": occasions where the agency does not always get full time on network programs, or where placed in "close juxtaposition," to a competing advertiser.

Moving on to multiple-spotting, Mr. Matthews declared station breaks ought to be 30 seconds "possibly for a 20-second commercial and an id." But, he noted, the procedure is a closing commercial from a network show, a 20-second spot, then a 10-second commercial, another 20-second and then an opening commercial" and sometimes an additional commercial by shaving the network show—five or six commercial announcements in a row." This, he said, "injures" the advertising and entertainment value in television and places the advertiser in the position of being in "unaccepted competition."

Running Account • Mr. Matthews was armed with a sheath of papers, one pile a running account of discrepancies against Y&R accounts. "They run from improper time to network cut time to multiple spotting and time cut to . . . conflicts." He said, "Our action has been protesting. Here is a case of proper credit given. Another case where there was multiple spotting, the account is no longer on the station. Another case shows that the station has promised to make good."

Mr. Matthews also distributed to newsmen a form used by the agency in checking their schedules. The form is used when each BAR report comes into the agency. This is checked against all schedules for every station, a report made for each client and product. Verified for network and spot are: proper product, proper time, if any product conflicts, multiple spotting or network time cut. Indication is then noted on whether any action was taken in the

case of a discrepancy in the schedule.

Agency Action. Recourse for the agency follows this pattern: protest to station showing that the agency is aware of the action and a warning served not to repeat; if serious, the station or representative is contacted and an adjustment (make-good, rebate or other compensation) requested, and if very serious with no adjustment possible, the station is eliminated from schedules.

Y&R, according to Mr. Matthews, found 22% of its network and spot placements victimized in station transgressions. BAR's percentage of incidents in the report covering 25 medium-sized tv markets was about 20%, or close to Y&R's claimed average.

The 75 markets now subject to BAR monitoring represent about 85% of the national tv dollar, it was explained. This approximate percentage also holds true for Y&R's tv business now under "surveillance."

Mr. Matthews was not all fire and brimstone. He acknowledged that tv stations are under the gun when an advertiser buys a large number of spots on several hundred stations and wants them on the air; that they are then "induced" to triple-spot, a practice which perhaps they would not countenance under ordinary circumstances. Agencies then, he said, will vie with each other with considerable jockeying and stations are saddled with the chore of solving these problems.

But, he said, on the other side of the coin, when a station is not watched, it's "out of sight, out of mind."

In its formal statement, referring to efforts to seek correction of abuses,

60-10-60 or fight

One station practice that apparently won't be filed down by the agency uproar over multiple spotting is the so-called formula of 60-10-60 on the quarter hour in local programming (particularly in feature film).

Young & Rubicam privately is of the opinion that the agency can "live with this" if it continues in local programming only and the agency knows in advance "what we are buying" (and other agencies seem to agree). Trouble with most multiple-spot situations:

"We think we are purchasing one thing and find out we got into a situation about which we know nothing beforehand." The formula means a one-minute commercial followed by a 10-second ID followed by another one-minute.

Y&R said, "The response is encouraging. We have received credits and 'make goods' where violations have occurred. In the markets where monitoring has been available for some time, and where most of our efforts have been directed, the problems are much reduced and performance is much better than in non-monitored markets.

The where, who & what of BAR market study

What did Broadcast Advertisers Reports go into in its report on medium-sized tv markets?

First, the markets: Albany-Schenectady-Troy; Amarillo; Birmingham; Charleston-Huntington; Charlotte; Duluth-Superior; El Paso; Knoxville; Lansing-Flint-Bay City; Madison; Miami; New Orleans; Paducah-Cape Girardeau-Harrisburg; Peoria; Sacramento-Stockton; Salt Lake City; San Antonio; San Diego; Scranton-Wilkes-Barre; Tampa-St. Petersburg; Tulsa; Waterloo-Cedar Rapids; Wheeling-Steubenville; Wichita; Youngstown.

Advertisers affected the most times in network programs adjacent to overtime station breaks combined with the most times spot announcements affected by station practices: In the 40-50 times bracket were Adell Chemical, American Chicle, American Tobacco, J.A. Folger, Ford Motor, General Foods, Gillette, P. Lorillard, and Sterling Drug. Over 90: American Home Products; Procter & Gamble; International Latex; Lever Bros.; Warner Lambert. Highest were P&G with 192 (105 network, 87 spot), American Home with 128 and Warner Lambert with 137 (all spot). R.J. Reynolds was affected 61 times.

Shows affected (adjacent to overtime station breaks) included such a diversification as *Tales of Wells Fargo* (American Tobacco and Buick); *Pat Boone* (Chevrolet); *Lawrence Welk* (Dodge); *Ozzie & Harriet* (Eastman Kodak); *Wyatt Earp* (General Mills); *Price Is Right* (Lever); *The Rifleman* (Miles Labs); *Patti Page* (Oldsmobile); *Restless Gun*, *The Rifleman* and *Earp* all P&G; *Naked City* and *Ozzie* (Quaker Oats); *The Rifleman* (Ralston Purina); *Price* (Speidel); *Restless* (Sterling Drug) and *Perry Como* (Sunbeam). These were the shows affected the most times (more than 15 times).

In the multiple-spot bracket, the advertisers followed the pattern set in the total times (both network and spot) advertisers affected. Such advertisers as P&G, Warner-Lambert, International Latex, Robert Hall Clothes, Vick Chemical, J.A. Folger, Adell Chemical and Coca-Cola topped the national advertisers involved the greatest number of times. The report covered 71 stations (BROADCASTING, March 9).



For radio programming in the public interest, WRCV received two 1958 Freedom Foundation Awards — the only station in the nation so honored. Since 1951, WRCV has won a total of seven Foundation Awards. WRCV is grateful for these honors. Meeting its responsibility to Philadelphia constructively and imaginatively will continue to be the prime concern of WRCV.

NBC IN PHILADELPHIA



The everyday miracles of oil



FREEDOM TO FORGET THE WEATHER. Who cares if it's cold outside? This young man doesn't. Nor do any of the nine million families in America who heat their homes with oil. They take indoor comfort for granted.

But to heat this country's buildings for just one year means finding, producing, refining and delivering 18½ billion gallons of oil. A giant job, but just one of the "everyday miracles" oil men are performing for you.

Helping to build a better future . . . **Standard Oil Company (New Jersey)** 

[[One of a series of messages appearing monthly in newspapers from Maine to Louisiana—the area served by Esso Standard Oil Company.]]
[[Other Jersey Standard affiliates and their distributors market elsewhere in the United States and 134 other countries and dependencies.]]

TV TO RUN INTO MORE FLACK

Magazines plan two-page ads knocking video; Compton masterminding the print strategy

A broadside against television viewing is being fired by several leading magazines in an advertising campaign that proclaims: "Doing beats viewing." And goes on to equate "doing" with "reading."

The anti-tv viewing effort breaks on March 23 with a two-page spread in *Newsweek* and will be followed by similar insertions in *Saturday Evening Post* April 4 and *Look* April 14. A minimum of six, two-page spreads is proposed in each publication this year and other magazines will be asked to participate in the project.

Official announcement of the campaign is being made today (March 16) by Compton Adv., New York, which conceived and executed the anti-tv and pro-magazine reading crusade. Compton, which placed almost 60% of an estimated \$75 million billing in 1958 in television, is not the agency of record for the participating publications, but for this campaign is drawing "the normal 15% commission," a spokesman told BROADCASTING.

Asked if it was not "unusual" for an agency so active in tv advertising to prepare a campaign designed to hurt the television medium, a Compton spokesman replied:

"We have created and prepared a campaign just as we would for any advertiser. We feel the magazines have a story to tell and we have prepared it to the best of our ability."

Objective of the campaign is "to focus greater attention on the part of American business and advertising leaders on the dynamic power of the magazine medium as a showcase for their products and services," Compton reported.

The advertisements are addressed to "people who watch tv, but like doing things more." The ads depict reading, Compton officials said, as "one of the most rewarding forms of 'doing.'"

George Huntington, vice president and general manager of the Television Bureau of Advertising called the campaign "another step in the continuous efforts by magazines to snip at increasing television advertising." He said the campaign is "doomed to failure because it is negative, attacking another medium rather than building up its own medium."

He pointed out that the copy theme, in essence, is "calling people stupid for watching television so much." He added that he considered it "presumptuous" on the part of the magazines to tell

people that they "should read instead of doing something else."

Mr. Huntington observed that the avowed purpose of the campaign is "to get more people to read by cutting down on tv viewing." The larger purpose, he indicated, is reduce the number of tv viewers and subsequently persuade advertisers to reduce their schedules in television.

One feature of the campaign is its

unified format. The advertisements, scheduled to run only in the pages of participating magazines, will have "the same family look."

The campaign was developed over an 18-month period, during which meetings were held with publishers, editors and advertising executives from magazines. This culminated in presentations Jan. 19 and 20 to various members of the Magazine Publishers Assn. Robert Kenyon, president of MPA, said the association is not involved officially in this undertaking but added that "we nevertheless are glad to see these publishers working together in a project that has values for all magazines as well as their own."

For people who watch TV—but like DOING THINGS more...

GOOD READING

is the MOST REWARDING OF ALL!

TYPICAL REWARD FOR READERS OF NEWSWEEK

NEWS IN DEPTH

The vital news... reported in Newsweek style...not what to think, but what to think about.

Newsweek is the only magazine that gives you the news in depth. It's not just what happened, but why it happened. It's not just what to think, but what to think about.

Newsweek is the only magazine that gives you the news in depth. It's not just what happened, but why it happened. It's not just what to think, but what to think about.

Newsweek

IS ALL ABOUT AND ALL FOR DOERS!

'Newsweek' blast at viewing set March 23

Space commercials out, says Rep. Miller

Will radio-tv space satellites of the future "blare forth singing commercials?" Not if Rep. George Miller (D-Calif.) has anything to say about the matter.

Rep. Miller, member of the House Science and Astronautics Committee currently holding hearings on space communications (BROADCASTING, March 9) told testifying State Dept. officials, March 13, that any future international space code should include ban on such commercials.

Loftus Becker, State Dept. legal adviser, advised Congress to "make haste slowly" in reaching agreements on international space law. Rep. James Fulton (R-Pa.) disagreed and asked what government should tell General Electric if it wants to put network of communications satellites in orbit.

"The most practical advice to you is

to tell them to hire a lawyer," Mr. Becker replied. "I don't give advice to private citizens. I give advice to the Secretary of State."

Tv commercial library

U.S. Broadcast Checking Corp., New York, announced last week it has established a television library consisting of more than 4,300 different commercials, which will be offered for sale to companies requiring them for research purposes.

USBC monitors tv for more than 250 agencies, advertisers and public relations companies, supplying "Tv Tear Sheets," showing video action and verbatim audio copy for commercials.

The library will supply a single commercial for \$10, with cost per commercial dropping in quantity to a minimum of \$5.50 for more than 75 different ones ordered and reduced by 30% for multiple copies of the same commercial.



pause for network identification



The current television season is now at a point where the long-term achievements of the networks can be objectively measured and clearly identified.

In terms of the criteria that are most meaningful to advertisers and their agencies—size of audience and cost per thousand—this* is the CBS Television Network in March 1959:

It has the **largest average nighttime audience** of any network. *(14% bigger than the second network, 27% bigger than the third)*

It has the largest average **daytime audience** of any network. *(8% bigger than the second, 97% bigger than the third)*

It has as many of the **top ten programs** and as many of the **top forty** programs as the other two networks combined. *(5 of the top 10, 20 of the top 40)*

It has the largest audiences in more **nighttime half-hour** periods than the other two networks combined.

It has the largest audiences in more **daytime quarter-hour** periods than any other network.

It has the **lowest average cost** per thousand for all **nighttime** programs. *(3% lower than the next network)*

It has the lowest average cost per thousand for all **daytime** programs. *(12% lower than the next network)*

It is also significant that the latest Nielsen report** continues to identify the CBS Television Network with the largest average audiences, day and night, in all television.

This kind of identification perhaps explains why so many advertisers are crystallizing their program decisions earlier than ever before and are turning again to the world's largest single advertising medium. **THE CBS TELEVISION NETWORK**

NATIONAL TV CRACKS BILLION

New networks figures added to 1958 spot put U.S. tv in billion-dollar elite—TvB

National gross television time costs in the U. S. now constitute a billion-dollar business.

The Television Bureau of Advertising last week placed network television gross time billing for 1958 at \$566,509,401 (up 9.8% over 1957), as compiled by Leading National Advertisers-Broadcast Advertising Reports. Two weeks ago, TvB reported that in 1957 a total of \$511,704,000 was invested in national spot tv time (BROADCASTING, March 20), bringing national business as a whole well in the charmed billion-dollar circle.

"Network television enjoyed an increase in gross time expenditure last year that was greater than if they'd added a 13th month to the year," commented Norman E. Cash, the Bureau's president. "\$43 million was spent in network tv during the average 1957 month; 1958's annual increase was over \$50 million. Thus network tv recorded a substantial gain in a year

when other advertising media were feeling the pinch of the recession."

Mr. Cash observed that both daytime and nighttime advertising contributed to the growth in 1957 over 1958. Gross time billing in December rose to almost \$54 million, from almost \$50 million in December 1957, Mr. Cash added.

TvB reported that the leading product classification during 1958 was food and food products with \$109.2 million in gross billing, followed by toiletries and toilet goods with \$98.9 million and smoking materials with \$62.1 million.

A total of 25 advertisers spent \$25,000 or more in network tv last year, according to TvB. Six companies, who invested more than \$20 million, were: Procter & Gamble, Colgate-Palmolive, Lever Bros., General Foods, General Motors and American Home Products. In a slightly different order, these represented the leading spenders both in December and in the fourth quarter of last year.

Advertisers by product classification

	December 1958	Jan.-Dec. 1958	Fourth Quarter 1958
Agriculture & Farming	\$12,107	\$63,454	\$12,107
Apparel, Footwear & Accessories	577,688	5,408,809	1,621,792
Automotive Accessories & Equipment	3,642,336	52,500,296	12,818,756
Beer, Wine & Liquor	505,566	6,288,987	1,559,606
Building Materials, Equip. & Fixtures	251,107	2,395,117	806,661
Confectionery & Soft Drinks	1,066,213	9,324,276	2,884,295
Consumer Services	153,750	2,777,321	656,417
Entertainment & Amusement	249,989
Food & Food Products	10,808,071	109,205,706	30,804,977
Gasoline, Lubricants & Other Fuels	359,456	3,132,351	1,288,443
Horticulture	1,007,774
Household Equipment & Supplies	2,408,599	23,544,658	6,531,908
Household Furnishings	420,495	3,465,904	1,036,121
Industrial Materials	1,778,181	6,944,696	4,850,788
Insurance	378,141	17,879,698	1,748,088
Jewelry, Optical Goods & Cameras	2,185,964	12,971,333	5,554,939
Medicines & Proprietary Remedies	6,863,845	58,043,625	18,427,964
Office Equip., Stationery & Writing Supplies	540,088	6,751,311	1,767,904
Political	274,290	190,266
Publishing & Media	15,756	848,841	21,008
Radios, Tvs, Phonographs, Musical Instruments	839,036	8,515,340	2,774,837
Smoking Materials	6,030,775	62,092,208	18,750,003
Soaps, Cleansers & Polishes	5,554,059	61,475,688	15,454,860
Sporting Goods & Toys	221,515	1,762,906	805,464
Toiletries & Toilet Goods	8,544,022	98,921,152	25,479,190
Travel, Hotels & Resorts	182,070	2,590,983	681,192
Miscellaneous	599,981	8,153,688	1,946,175
TOTAL	\$53,938,821	\$566,590,401	\$158,473,761

LNA-BAR: Gross time costs only

Network television gross time billings by day parts

	December			January-December		
	1957	1958	% Change	1957	1958	% Change
Daytime	\$16,246,359	\$19,275,466	+18.6	\$156,971,125	\$172,490,627	+ 9.9
Mon.-Fri.	13,390,840	16,070,574	+20.0	132,964,283	146,139,992	+ 9.9
Sat.-Sun.	2,855,519	3,204,892	+12.2	24,006,842	26,350,635	+ 9.8
Nighttime	33,495,377	34,663,355	+ 3.5	359,230,441	394,099,774	+ 9.7
TOTAL	\$49,741,736	\$53,938,821	+ 8.4	516,201,566	566,590,401	+ 9.8

74 (BROADCAST ADVERTISING)

Top 238 in 1958

Rank	Advertiser	Billing
186.	A.S.R. Products	\$136,301
167.	Movie "Oscar" Awards	212,616
80.	Alberto Culver	1,434,882
230.	Aldon Rug Mills	31,590
137.	Aluminium Ltd.	478,638
77.	Aluminum Co. of America	1,531,362
157.	Amana Refrigeration	249,264
159.	American Bcstg.-Paramount Theatres	237,387
88.	American Can	1,253,570
213.	American Character Doll	59,164
43.	American Chiclé	2,969,625
97.	American Dairy Assn.	996,376
207.	American Express	67,940
76.	American Gas Assn.	1,549,530
6.	American Home Products	20,507,683
121.	American Machine & Foundry	720,590
237.	American Petrofina	26,156
90.	American Tel. & Tel.	1,190,176
12.	American Tobacco	11,252,180
183.	Amity Leather Products	141,026
37.	Armour	3,532,737
49.	Armstrong Cork	2,764,452
181.	Arnold Schwinn	150,490
82.	Associated Products	1,377,336
86.	Atlantis Sales	1,322,987
188.	Ballantine, P.	130,931
118.	Bayuk Cigars	743,001
54.	Beech Nut Life Savers	2,476,177
120.	Bell & Howell	730,733
225.	Beltone Hearing Aid	36,891
185.	Bird & Son	139,822
61.	Bishop, Hazel	2,112,594
85.	Block Drug	1,357,243
62.	Borden	1,860,634
95.	Breck, John H.	1,025,460
103.	Brillo Mfg.	925,190
8.	Bristol Myers	16,072,802
209.	Brown Shoe	65,397
19.	Brown & Williamson	8,250,471
70.	Bulova Watch	1,667,057
211.	Bymart Tintair	59,901
190.	California Prune	129,816
33.	Campbell Soup	4,233,743
206.	Canada Dry	68,562
151.	Canadian Breweries	268,749
52.	Carnation	2,661,252
58.	Carter Products	2,340,095
79.	Chemstrand	1,506,984
41.	Chesebrough Ponds	3,098,078
10.	Chrysler	14,341,471
153.	Church & Dwight	266,575
149.	Clairol	294,795
193.	Clinton Engines	105,847
2.	Colgate Palmolive	22,857,497
198.	Consolidated Cigar	80,151
196.	Consolidated Electron	94,623
201.	Consolidated Foods	74,500
119.	Continental Baking	740,261
202.	Coopers	74,161
29.	Corn Products	4,927,240
169.	Cracker Jack	207,372
106.	Distillers' Corp., Seagram's	876,022
222.	Dormeyer	40,831
127.	Dow Chemical	598,592
68.	Drackett	1,699,539
228.	Drexel Furniture	34,706
51.	du Pont, E.I. de Nemours	2,671,026
155.	Eastco	257,996
24.	Eastman Kodak	5,937,361
150.	Elgin National Watch	288,857
69.	Factor, Max	1,695,612
98.	Falstaff Brewing	969,879
74.	Firestone Tire & Rubber	1,597,171
102.	Florida Citrus	944,625
112.	Florists' Tel. Del.	807,468
11.	Ford Motor	12,561,121
25.	General Electric	5,295,996
4.	General Foods	20,733,118
14.	General Mills	10,790,118
5.	General Motors	20,593,366
191.	General Time	122,935
66.	Gerber Products	1,713,996
232.	Gilbert, A.C.	29,730
7.	Gillette	16,132,360
231.	Goebel Brewing	31,585
89.	Gold Seal	1,195,315
162.	Goodrich, B.F.	228,860
64.	Goodyear Tire & Rubber	1,779,195
195.	Gossard, H.W.	96,190
115.	Graham, Billy, Assn.	778,011
72.	Greyhound	1,633,818
131.	Gulf Oil	549,012
104.	Hallmark Cards	920,650

BROADCASTING, March 16, 1959

Stations on the move...
in markets on the move!

KOTV TULSA 

The *first* station in *every* rating report for the last 10 years—in the *rich* half of Oklahoma.⁽¹⁾

KGUL - TV HOUSTON 

The station (now second) with the *new look* in dynamic Houston—forecasted as the *6th largest* U.S. city by 1960.⁽²⁾

WANE - TV FORT WAYNE 

Now the *first* station in Indiana's *second* market—in retail, food and drug sales plus buying income.⁽³⁾

WISH - TV INDIANAPOLIS 

The *first* station in Indiana's *first* market (and 14th TV market) in *every* rating report for the last 4 years.⁽⁴⁾

(1) ARB, Nielsen, Federal Reserve. (2) Nielsen Area Nov.-Dec. '58. (3) ARB Nov. '58. (4) ARB, Nielsen.

THE CORINTHIAN STATIONS *Responsibility in Broadcasting*

KOTV Tulsa • KGUL-TV Houston • WANE & WANE-TV Fort Wayne • WISH & WISH-TV Indianapolis

NETWORK TOP 238 continued

Rank	Advertiser	Billing
145.	Hamm, Theodore, Brewing	366,480
187.	Hanes, P.H., Knitting	134,494
147.	Hartz Mountain Products	311,101
114.	Heinz, H.J.	795,518
46.	Helene Curtis	2,938,475
130.	Hill's Bros. Coffee	558,338
141.	Hoover Co.	404,470
217.	Hygrade Food Prod.	48,224
220.	Ideal Toy Corp.	46,325
173.	Ins. Co. of North America	184,117
176.	International Shoe	175,858
165.	Jackson Brewing	216,155
229.	Jackson & Perkins	31,711
135.	Jerclaydon	495,102
215.	Johnson, Howard D.	53,064
55.	Johnson & Johnson	2,461,026
26.	Johnson, S.C., & Son	5,242,277
39.	Kaiser Industries	3,387,268
15.	Kellogg	10,290,885
134.	Kemper Insurance	503,057
203.	Kendall	73,297
189.	Keystone Camera	129,893
44.	Kimberly Clark	2,966,771
233.	Knapp Monarch	27,180
156.	Lehn & Fink Products	251,833
3.	Lever Bros.	21,958,373
129.	Lewis Howe	562,503
73.	Libbey Owens Ford	1,623,869
81.	Libby, McNeill & Libby	1,427,411
13.	Liggett & Myers	10,849,983
18.	Lorillard, P.	9,791,226
200.	Lowe, Joe	76,505
125.	Ludens	600,325
124.	Manhattan Shirt	639,070
71.	Mars.	1,666,141
226.	Marx, Louis	36,048
136.	Mattel	492,945
56.	Mennen	2,380,733
101.	Mentholatum	957,654
30.	Miles Labs	4,785,393
113.	Miller Brewing	805,288
117.	Minnesota Mining & Mfg.	756,064
214.	Minute Maid	57,778
140.	Mogen David Wine	415,331
146.	Monsanto Chemical	316,256
177.	Murray Corp. of America	167,318
163.	Mutual Benefit Health & Accident Assn.	220,526
154.	Natl. Assn. of Ins. Agents	258,787
35.	National Biscuit	3,596,818
158.	National Brewing	240,980
223.	Natl. Citizens, Eisenhower/Nixon	39,618
20.	Natl. Dairy Products	6,709,514
238.	Natl. Fedn. of Post Off. Clerks	25,788
144.	Natl. Grape Co-op. Assn.	385,735
166.	National Presto Industries	212,999
36.	Nestle	3,537,424
218.	N.Y. State Republican Comm.	47,845
175.	Niagara Therapy Mfg.	179,689
108.	North Amer. Philips	840,729
107.	Noxzema Chemical	856,729
143.	Olin Mathieson Chem.	392,868
234.	Osrow Products	27,126
138.	Outboard Marine	470,241
96.	Pan Amer. World Airways	1,002,600
60.	Pet Milk	2,211,093
174.	Peter Paul	179,770
16.	Pharmaceuticals, Inc.	10,173,557
216.	Phila. & Reading Corp.	48,297

Rank	Advertiser	Billing
178.	Philco	162,626
28.	Philip Morris	4,967,012
122.	Phillips Van Heusen	699,234
27.	Pillsbury Mills	5,205,578
111.	Pittsburgh Plate Glass	811,189
94.	Polaroid	1,031,872
164.	Polk Miller Products	217,864
1.	Procter & Gamble	50,638,647
34.	Prudential Ins.	3,826,756
126.	Purex	599,590
31.	Quaker Oats	4,693,728
21.	RCA	6,458,126
40.	Ralston Purina	3,376,044
139.	Renault	420,028
194.	Republican Natl. Comm.	102,048
22.	Revlon	6,309,037
161.	Rexall Drug	234,455
57.	Reynolds Metals	2,358,852
9.	Reynolds, R.J.	16,002,213
148.	Ritchie, Harold F.	303,350
205.	Rock of Ages	69,397
152.	Ronson	279,595
99.	Royal McBee	965,724
109.	Rubinstein, Helena	822,346
123.	Bendura	684,315
197.	Savings & Loan Foundation	84,387
184.	Schering	140,675
65.	Schick	1,737,741
50.	Schlitz, Joseph Brewing	2,724,378
38.	Scott Paper	3,418,096
75.	Sears Roebuck	1,552,128
84.	Seven Up	1,368,282
160.	Sheaffer, W.A., Pen	236,340
110.	Shulton	812,095
59.	Singer Mfg.	2,225,091
219.	Smith Bros.	46,877
192.	Smith, Kline & French	112,990
67.	Socony Mobil Oil	1,709,593
227.	Speedway Petroleum	34,711
91.	Speidel	1,133,904
48.	Sperry Rand	2,802,210
132.	Staley, A.E.	513,850
23.	Standard Brands	6,144,983
128.	Standard Oil of Ind.	585,326
224.	Standard Oil of Ohio	38,072
172.	Star Kist Foods	184,596
142.	State Farm Mutual Auto Ins.	399,325
17.	Sterling Drug	9,919,859
182.	Sterns Nurseries	143,546
199.	Stroh Brewery	77,481
204.	Studebaker Packard	71,380
93.	Sunbeam	1,125,580
92.	Sunshine Biscuits	1,130,508
63.	Sweets Co. of Amer.	1,838,374
45.	Swift	2,953,650
53.	Sylvania Elec. Prods.	2,597,008
180.	Technical Tape	150,634
221.	Teleweather	42,756
171.	Texas Co.	200,621
116.	Time Inc.	774,563
83.	U.S. Rubber	1,372,000
42.	U.S. Steel	3,086,950
100.	U.S. Time	963,377
87.	Union Carbide Corp.	1,305,373
208.	United Republican Dinners	66,174
105.	Van Camp Sea Food	920,195
212.	Van Raalte	59,499
133.	Vick Chemical	510,621
179.	Wander	154,080
47.	Warner Lambert	2,892,606
235.	Washington, State of	26,910
32.	Westinghouse Electric	4,639,231

Rank	Advertiser	Billing
236.	White Motor	26,182
78.	Wildroot	1,509,171
170.	Williamson Dickie Mfg.	202,650
210.	Young, W.F.	62,691
168.	Zenith	211,275

Top 25 companies, 4th quarter, '58

1.	Procter & Gamble	\$13,159,952
2.	American Home Products	7,099,102
3.	Lever Bros.	6,189,832
4.	Colgate-Palmolive	6,172,037
5.	General Foods	5,737,875
6.	General Motors	5,629,348
7.	Gillette	4,818,531
8.	Bristol-Myers	3,913,440
9.	R.J. Reynolds	3,876,024
10.	P. Lorillard	3,534,440
11.	General Mills	3,347,457
12.	Sterling Drug	3,163,488
13.	Liggett & Myers	3,124,937
14.	American Tobacco	2,867,534
15.	Pharmaceuticals Inc.	2,867,174
16.	Ford Motor	2,830,651
17.	Chrysler Corp.	2,778,780
18.	Brown & Williamson	2,695,006
19.	RCA	2,130,680
20.	Pillsbury Mills	1,996,511
21.	Philip Morris	1,940,114
22.	Standard Brands	1,906,196
23.	National Dairy Products	1,758,075
24.	Kellogg	1,708,934
25.	National Biscuit	1,647,871

Top 25 brands, 4th quarter, 1958

1.	Anacin tablets	\$3,235,389
2.	Viceroy cigarettes	2,143,971
3.	Chevrolet passenger cars	2,073,918
4.	Bufferin	1,898,989
5.	Tide	1,754,713
6.	Gillette razors, blades	1,754,118
7.	Kent cigarettes	1,713,167
8.	Ford passenger cars	1,596,891
9.	Dristan tablets	1,550,835
10.	Winston cigarettes	1,500,281
11.	Colgate regular, aerosol dental creams	1,413,935
12.	Bulova watches	1,387,166
13.	Camel cigarettes	1,357,948
14.	Dodge passenger cars	1,330,923
15.	Bayer aspirin tablets	1,330,117
16.	L&M filter tips	1,323,975
17.	Plymouth passenger cars	1,199,446
18.	Old Gold cigarettes	1,184,261
19.	Gleem regular, aerosol tooth paste	1,121,872
20.	Geritol	1,038,882
21.	Chesterfield cigarettes	1,018,369
22.	Salem cigarettes	1,017,795
23.	Cheer detergent	999,656
24.	Fab detergent	958,966
25.	Crest tooth paste	938,372

Top 15 companies, December

1.	Procter & Gamble	\$4,604,609
2.	American Home Products	2,590,994
3.	Colgate-Palmolive	2,180,234
4.	Lever Bros.	2,162,013
5.	General Foods	2,144,746
6.	General Motors	1,752,903
7.	Bristol-Myers	1,474,271
8.	Gillette	1,288,494
9.	R.J. Reynolds	1,242,587
10.	Pharmaceuticals Inc.	1,175,407
11.	General Mills	1,128,620
12.	Sterling Drug	1,091,091
13.	Liggett & Myers	1,080,172
14.	P. Lorillard	967,572
15.	American Tobacco	958,848

Top 15 brands, December

1.	Anacin tablets	\$1,226,973
2.	Bufferin	745,561
3.	Viceroy cigarettes	733,597
4.	Chevrolet passenger cars	700,135
5.	Tide	611,631
6.	Ford passenger cars	533,782
7.	Winston cigarettes	522,354
8.	Dristan tablets	511,746
9.	Bayer aspirin tablets	488,479
10.	Colgate regular, aerosol dental creams	486,581
11.	Geritol	464,459
12.	Camel cigarettes	452,165
13.	Bulova watches	446,672
14.	Dodge passenger cars	433,470
15.	Plymouth passenger cars	427,776

ACTIVITY

HOW PEOPLE SPEND THEIR TIME

There were 126,403,000 people in the U.S. over 12 years of age during the week Feb. 20-26. They spent:

2,125.1 million hours	Watching Television
1,093.1 million hours	Listening to Radio
468.0 million hours	Reading Newspapers
224.7 million hours	Reading Magazines
349.2 million hours	Watching Movies on Tv
100.9 million hours	Attending Movies

These totals compiled by Sindlinger & Co., Ridley Park, Pa., and published exclusively by BROADCASTING each week, are based on a 48-state, random dispersion sample of 7,000 interviews (1,000 each day). Sindlinger's weekly "Activity" report, from which these figures are drawn, furnishes comprehensive breakdowns of these and numerous other categories, and shows the duplicated and unduplicated audiences between each specific medium. Tabulations are available from Sindlinger & Co. within two to seven days of the interviewing week.

(Copyright 1959 Sindlinger & Co.)

SINDLINGER'S SET COUNT: As of Feb. 1, Sindlinger data shows: (1) 113,686,000 people over 12 years of age have access to tv (89.9% of the people in that age group); (2) 44,272,000 households with tv; (3) 48,879,000 tv sets in use in the U.S.



JOURNALISM'S NEW FRONTIER

On February 20th, 800 high school editors and their faculty advisers filed into NBC's historic studio 8-H. The occasion was THE FIRST ANNUAL NBC BROADCAST NEWS CONFERENCE, called to inform these young editors and their teachers of the procedures and problems, the tools and techniques of electronic journalism. The establishment of this annual meeting is a contribution by the National Broadcasting Company and its

Flagship Stations to the youth of metropolitan New York, and to the broadcast industry. It was conducted to alert these future newsmen and women to the opportunities awaiting them in the broadcast media—journalism's new frontier. The annual NBC BROADCAST NEWS CONFERENCE is a stimulating new addition to the public services performed throughout the year by the Flagship Stations of the National Broadcasting Company.

WRCA & WRCA-TV-NBC IN NEW YORK

Merchandising aids retail sales

A foot-long frozen fish was thrown above the heads of an agency-station representative audience in New York last week.

It was Max Buck's way of dramatizing how old retail methods, such as selling fish in a natural state, have disappeared. Now, says Mr. Buck, newly-appointed station manager of WRCA-TV, New York (see page 10), fish is descaled, cleaned and otherwise prepared and need only be warmed up for the eating. His purpose: the retail (particularly the grocery chain) trade is changing rapidly in its selling methods, display shelves and in new products.

Mr. Buck and Hal Davis, a vice president at Grey Adv., each interpreted "merchandising" as it affects radio-tv. They appeared at the Radio & Television Executives Society's timebuying and selling seminar.

Mr. Davis entitled his particular essay "Promotion Is the Payoff." He said merchandising once was defined as what a station does when it is second in a market, but today the "squeeze" on agencies for merchandising effort has been buck-passed by agencies to stations.

It was thought that the new emphasis on promotion or "merchandising" came about with Ed Sullivan contacting Lincoln dealers in person, his "tv personality" motivating dealer tv buys. Discarded was the once-automatic impulse of the dealer to place newspapers No. 1 as his choice of media. He spoke of Grey's efforts with Steverino for Greyhound and asserted: "... Media buyers are becoming more aware of merchandising and promotion." (For more detail on Grey's views, see page 47). And not to miss a promotion bit of his own he had Steverino on leash trotted out to meet the timebuyers.

Max Buck said it was at the retail store, in the actual movement of goods at the consumer level, where an ad campaign actually "lives or dies." Sales, he said, are not made at the 50-kw transmitter or on the ad pages of a magazine, "they only start there, but the sales are made at the retailer's."

A station must seek to meet the enthusiasm and the aim of the advertiser, he thought, adding that a station merchandiser ought not to be a salesman who can't sell but "a specialist who has suffered" in the retail business. He drew attention to WRCA's "Chain Lightning" merchandising service describing it as having been "attacked and sued by everyone from the FTC to the Ku Klux Klan." Another station service



ARBITRON'S DAILY CHOICES

Listed below are the highest-ranking television network shows for each day of the week March 5-March 11 as rated by the multi-city Arbitron instant ratings of American Research Bureau.

DATE	PROGRAM and TIME	NETWORK	RATING
Thur., March 5	Zorro (8 p.m.)	ABC-TV	24.3
Fri., March 6	77 Sunset Strip (9:30 p.m.)	ABC-TV	24.3
Sat., March 7	Gunsmoke (10 p.m.)	CBS-TV	27.9
Sun., March 8	Loretta Young (10 p.m.)	NBC-TV	29.1
Mon., March 9	Danny Thomas (9 p.m.)	CBS-TV	30.0
Tues., March 10	Rifleman (9 p.m.)	ABC-TV	27.3
Wed., March 11	Wagon Train (7:30 p.m.)	NBC-TV	30.6

Copyright 1959 American Research Bureau

employs girls who telephone pharmacists on behalf of drug advertisers using the station, styling it "our 'call girl' service."

American Lines, L&N sever \$6 million tie

American Airlines Inc., New York, and Lennen & Newell, New York, its agency for the past 3½ years, are terminating their association on June 1. The company's estimated advertising budget: \$6 million.

Charles A. Rheinstrom, executive vice president of American Airlines, declined to give any reason. He said last week he had spoken to "a couple of agencies," interested in the account but refused to name them. Among those reported to have made solicitations are Compton Adv. and Young & Rubicam.

A spokesman at L&N said that for several years American has sponsored the late evening-early morning *Music 'Til Dawn* on radio in nine major markets and also has invested in spot radio. Approximately 20% of American's budget is in radio. (RAB reports that \$1 million was spent by the airline in spot radio in 1958.)

L&N billing is reported to be about \$83 million annually. The agency invests about 50% of this in radio-tv for such accounts as Reynolds Metals Co., Corn Products-Best Foods and P. Lorillard Co., among others. The American Airlines' defection is the first substantial setback suffered by L&N in several years.

Mr. Rheinstrom said late last week that he would not make a decision for several weeks. Asked if he planned to use television (not included in 1958 media plans), he replied: "Yes, if we can find a way to use the medium effectively. We are very interested in television."

• Business briefly

Time sales

• General Insurance Cos., Seattle, Wash., will debut in network radio with 26-week sponsorship of sports segments

on NBC Radio's weekend *Monitor*. General's NBC schedule (for its Safeco auto insurance, All-in-One homeowners' policies and commercial insurance) begins Aug. 29 for 13 weeks and resumes April 2, 1960, for the second half of the order. General's agency: Cole & Weber, Seattle.

• Osrow Products (Wash & Wax car-wash, Giant Whirl-a-Way window wash), Glen Cove, N.Y., will be on two tv stations in each of 25 markets this spring with one or two minute-spots, primarily late evening. Shamrock Films, Winter Park, Fla., produced films. Agency: Smith Greenland, N.Y.

• General Foods and the Borden Co., both through Benton & Bowles, N.Y., renew for 52 weeks *Fury*, starting its fifth year on NBC-TV Oct. 10. Independent Television Corp., which owns the property, noted this was the second network transaction for ITC, which recently completed the \$5 million dollar sale of *The Gale Storm Show* to ABC-TV.

• Manhattan Shirt Co., N.Y., will spearhead its pre-father's day campaign with sponsorship of ABC-TV's *Sammy Kaye Show* (moving from Thurs. 10-10:30 to Sat. at same time) beginning April 18. Satisfied with results of its pre-Christmas promotion of Mansmooth no-iron shirts via *Sammy Kaye*, the company is returning, this time to emphasize lightweight items.

• H.H. Hixson Co., Chicago, will launch a saturation radio spot announcement campaign on five local stations, plus a "strong" tv schedule, of undisclosed proportions to introduce its new Fireside egg coffee in the Chicago market next month. A similar schedule is being utilized in New York. Agency: Keyes, Madden & Jones, which has added Hixson, along with Joanna Western Mills (window shades), Revere Camera (tv only) and Dr. West's Insta-Clean denture cleaner (total: nearly \$2 million billings) to its account stable.

• Hazel Bishop Inc. (cosmetics), N.Y., through Raymond Spector Co. has con-

this is
growth

THE TAFT STATIONS . . . in only ten years, have experienced tremendous growth. At present, nine Taft Radio and television stations are reaching over 8,000,000 people in rich Mid-West and Southern markets. This growth is a result of community acceptance gained through integrity of programming and management . . . through gainful results produced for an ever increasing number of advertisers.

If you are interested in having your advertising dollars earn more . . . now is the time to invest them in growing Taft Stations.

TAFT
the radio and television stations



Sales Representatives: The Katz Agency, Inc., *The Young Television Corp. Sales Office: Radio Cincinnati

SO FAR AHEAD

in the Johnstown-Altoona Area

71.9

The leader, away out in front, is WJAC-TV ahead of its nearest competitor, WFBG-TV, by nearly 3 to 1 in station share of audience, sign-on to sign-off, all week long.

28.1

These figures, from ARB, November 19-25, 1958, prove once again, that WJAC-TV is the dominant station in its area.

.04

WJAC-TV WFBG-TV WARD-TV

The Johnstown-Altoona Coverage Area encompasses over one million television homes in 36 counties in Western Pennsylvania, 3 Maryland counties and 2 West Virginia counties.



There's no question about it . . . WJAC-TV is the station viewers prefer. And WJAC-TV is the one to buy because there are more people watching, all day, every day!



Get full details from
Harrington, Righter & Parsons, Inc.

United Press International
Facsimile Newspictures and
United Press Movietone Newsfilm
Build Ratings



tracted for alternate weeks of *Masquerade Party* (NBC-TV, Thurs. 10:30-11 p.m.) starting March 26 and three alternate week sponsorships of the *Bob Cummings Show* (NBC-TV, Tues. 9:30-10 p.m.) beginning tomorrow (March 17). P. Lorillard Co. is the other sponsor of *Masquerade Party* with R.J. Reynolds on *Bob Cummings*.

- New business placed with the NBC Radio network during the first seven selling days of March totalled \$467,720 in net revenue, according to William K. McDaniel, vice president in charge of sales. Topping the list of seven purchases was a 52-week order by Lever Bros. (Good Luck margarine) for 12 half-minute participations weekly in daytime programs starting April 6. The order was through Ogilvy, Benson and Mather Inc.

Other advertisers and their agencies: Philip Morris Inc. for *Salute to Johnny* 25th anniversary program next Thursday (March 19), through Leo Burnett Co.; Quaker Oats Co., through Wherry, Baker & Tilden Inc.; Grove Labs Inc. (No Doz tablets), through Gardner Adv.; Aldon Rug Mills, through Richard & Raymond; *Good Housekeeping* magazine, through Grey Adv., and Vick Chemical Co., through Morse International.

Agency appointments

- Pan American Coffee Bureau, with yearly billings amounting to approximately \$1 million has resigned Fuller & Smith & Ross, N.Y., and appointed BBDO, effective July 1. Bureau estimated 20% of its annual advertising budget has gone into spot radio in the past but expects to increase this 35% through its new agency. It plans to rely exclusively on spot radio in its summer ice-coffee promotion.

- Universal Pictures Co., N.Y., has named Charles Schlaifer & Co., N.Y., effective immediately. Universal's former agency, Cunningham & Walsh Inc., resigned the account, according to David A. Lipton, Universal vice president. In the past, the firm has been large radio user for its Universal-International motion pictures.

• Also in advertising

- Norman, Craig & Kummel, New York, initiated a suit for \$206,577 in damages against a former client, Pabst Brewing Co., Chicago, in U.S. District Court in New York on March 6. NC&K charged Pabst with a breach of agreement on commissions for radio programs and announcements carried on NBC Radio last spring (BROADCASTING, Feb. 9). The Pabst account now is at Kenyon & Eckhardt, New York.

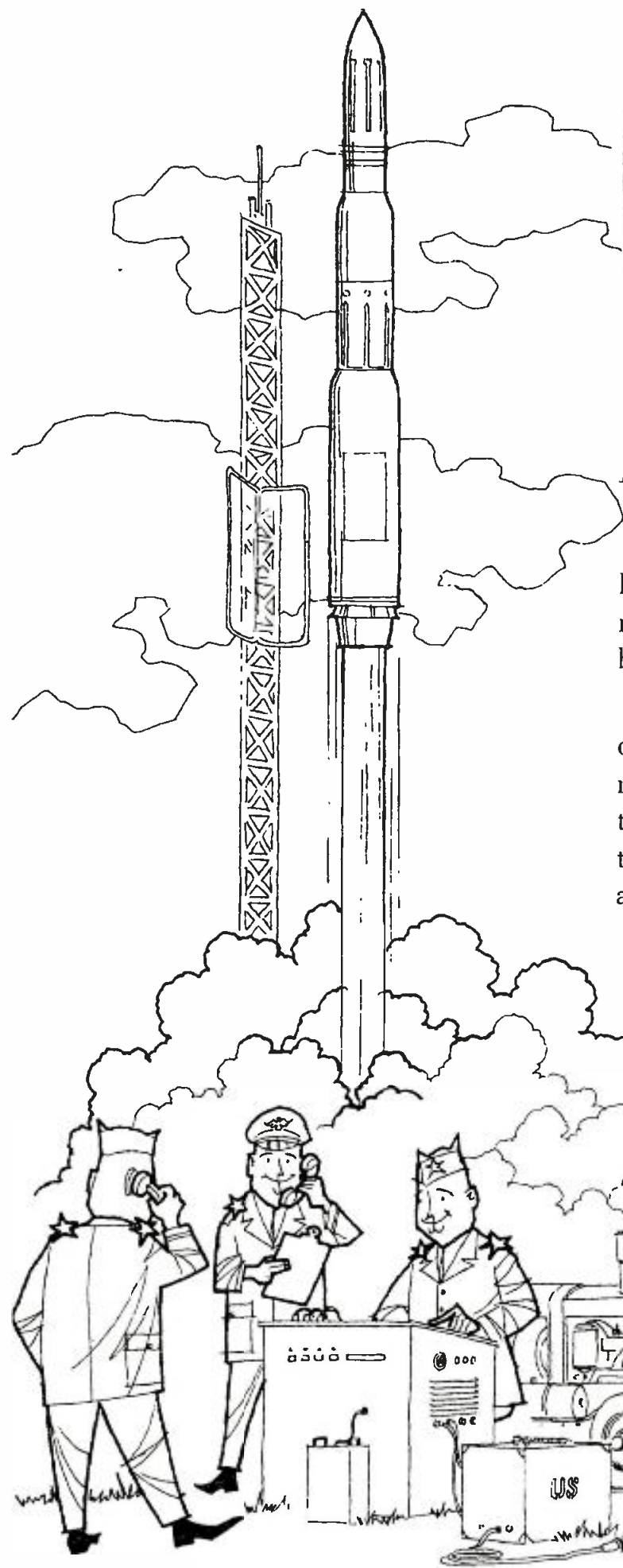

It's a matter of principals...

From the day H-R was started by a group of Working Partners, we have operated on the basis that we would represent each station *as if it were our own*; serve each buyer of time as if *we ourselves were buying time*.

As our organization has grown, it has been a matter of principle with us to continually maintain this type of representative service. That we have been able to do so through the years, is a matter of *principals* as well, for the H-R partners are still *Working Partners*, still actively and personally selling and serving every station on our list.

FRANK HEADLEY, President
 DWIGHT REED, Vice President
 FRANK PELLEGRIN, Vice President



"We always send a man to do a man's job"

- | | | |
|-----------|---------------|-------------|
| NEW YORK | SAN FRANCISCO | ATLANTA |
| CHICAGO | DALLAS | HOUSTON |
| HOLLYWOOD | DETROIT | NEW ORLEANS |

N.A.B. HEADQUARTERS; EXECUTIVE HOUSE, SUITE 3710



BASEBALL AT WGN, INC. in CHICAGO!

WGN-TV's exclusive Chicago Cubs and White Sox daytime games at home and WGN-RADIO's Chicago Cubs games—both at home and away—are SRO! Game sponsorships are gone and very few adjacencies are left. Check your WGN-TV or WGN-RADIO salesman for powerful adjacencies remaining.

S.R.O.!!



WGN-TV *Game sponsorship*—Hamm's Beer and Oklahoma Oil Co.
Lead-off Man—Walgreen Drugs *10th Inning*—Household Finance Corp.
and United Airlines

ANNOUNCEMENT ADVERTISERS INCLUDE:

Corina Cigars, Colgate Palmolive Mens Products, El Producto
Cigars, Hertz Rent A Car, Midas Mufflers, Wheaties

WGN-RADIO *Game sponsorship*—Oak Park Federal; Phillies Cigars;
Goebel Beer and Phillips Petroleum

Lead-Off Man—Howard Motors and All State Lumber Co. *Scoreboard*—Walgreen Drugs



WGN-TV and WGN-RADIO

441 North Michigan Avenue Chicago 11, Illinois

THE PUBLIC THINKS FCC IS OKAY

Pulse survey finds FCC image unscathed by scandals of 1958

The scandal that hit the FCC in 1958 made little impression on the public.

Today, nine out of ten people who know what the FCC is think it's doing an acceptable, or better, job.

But the FCC's national publicity has had one effect: more people recognize those initials than can identify TVA, BBDO, NAB and FDIC.

These are findings of a special Pulse Inc. interview ordered by BROADCASTING. The study involved 1,070 respondents in 13 cities the week of Feb. 1-8. The cities were Atlanta, Boston, Chicago, Cleveland, Dallas, Detroit, Los Angeles, Miami, New York, Philadelphia, San Francisco, St. Louis and Washington.

People interviewed were given a list of five abbreviated names—TVA (for Tennessee Valley Authority), FCC, BBDO, NAB and FDIC (Federal Deposit Insurance Corp.). The FCC was correctly identified by 41.2% of the respondents. The next best identifica-

tion was for TVA, which was known to 33.1% of those interviewed. The least known initials were BBDO, recognized by only 3.2% of the respondents.

The 41.2% of the interviewees correctly identifying the FCC were asked to describe what this agency did. General responses were correct—ranging from 25% who said the FCC "controls and regulates radio and tv," to 1.8% who said it "regulates shortwave, police and 'ham' radio."

But, surprisingly, 17.9% of these people believe the Commission also regulates the contents of programs, and 4.3% believe the FCC controls commercials and advertising on tv.

Asked what they think of the FCC, almost 50% of the respondents who showed they knew what those initials stand for voted that the Commission was doing a good-to-excellent job. Specifically, 22.9% said the FCC was doing an "excellent, important, necessary, very

good" job; 26.1% said it was doing a good-to-fine job. Only 13.6% said it was doing an adequate-to-fair job, and 9.5% said it was doing a poor-bad job.

Among the favorable mentions not listed above were such comments as "safeguards public, favorable to public, beneficial to public, controls amateur communications well, good mediator."

But among the so-called "favorable" comments were these erroneous impressions: "control on sponsor's message, good for children and teenagers, cuts down on violence, regulates quality of music."

Among so-called unfavorable impressions were the following:

"Allocates stations unfairly, too many restrictions, should have more control, narrow minded concerning pay tv, allowing poor commercials, bad political appointments, scandals."

The Pulse Inc. survey tables are printed below.

Question 1

Do you know what these initials stand for?

	Correct %	Incorrect %	Don't Know %	Total %	Total Number
TVA	33.1	3.7	63.2	100.0	1,070
FCC	41.2	1.1	57.7	100.0	1,070
BBDO	3.2	1.1	95.7	100.0	1,070
NAB	6.9	8.1	85.0	100.0	1,070
FDIC	7.5	1.5	91.0	100.0	1,070

Question 3

What do you think of the FCC? (Asked of those who correctly identified the FCC initials.)

Excellent, important, necessary, very good	22.9%
Good, fine	26.1
Adequate, fair, all right	13.6
Poor, bad	9.5
No opinion	28.0
Total	100.0%

Question 2

What does the FCC do? (Asked of those who correctly identified the FCC initials.)

Controls, regulates radio and tv	25.0%
Controls, regulates tv	5.0
Controls, regulates radio	.7
Controls, regulates communications	12.5
Controls, regulates interstate communications	2.0
Controls, regulates shortwave, police, ham radio	1.8
Controls, regulates telephone & telegraph	1.8
Licenses radio and tv stations	15.0
Assigns frequencies and wavelengths	12.0
Assigns call letters	1.1
Controls broadcasting channels and airwaves	8.1
Regulates contents of programs	17.9
Controls commercials, advertising on tv	4.3
Miscellaneous	7.5
Don't know	13.2
Total	128.4%*

*Totals over 100% because of multiple answers.

Intl. talks April 1-30

Questions involving television recording, and stereophonic broadcasting are on the agenda of the Ninth Plenary Assembly of the International Radio Consultative Committee (CCIR) which convenes at the Hotel Biltmore, Los Angeles, April 1-30. Attending this technical group's sessions will be some 600 delegates representing 50 countries and various private and international organizations.

CCIR was organized in 1927 to study problems in international radio communications. In 1947, it became a permanent organ of the International Tele-

communications Union. The Los Angeles meeting will review the results of study groups, including such questions as space frequencies and tropospheric relaying as well as tv recording and stereophonic broadcasting, and will recommend standards and positions to the ITU for its world meeting this summer in Geneva. The Los Angeles meeting is under U. S. State Dept. auspices.

The Senate Thursday (March 12) passed SJ Res 47 to authorize free communications service for official delegates at the assembly. The measure also permits alien delegates to operate amateur stations during the conference.

Libel case delayed

Argument before the U.S. Supreme Court on the equal time provision of the Communications Act, involving WDAY-TV Fargo, N.D., has been postponed to the week of March 23. The continuance from early this month was made necessary by the illness of Edward S. Greenebaum, New York attorney for the Farmers Union, petitioner in the case.

At issue is the question of libel immunity for broadcasters who are required under Sec. 315 of the Communications Act to provide equal time to political candidates running for the

This star means business . . .

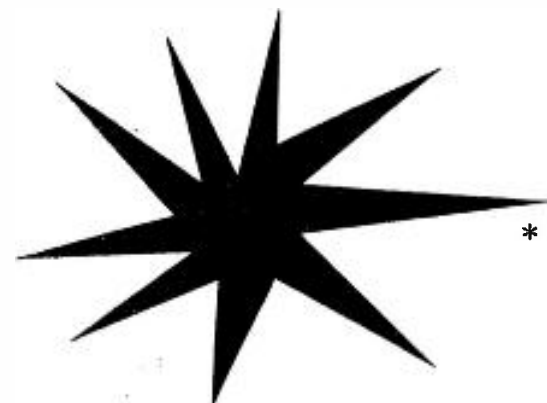

means it for you and your sponsors in these three ways:

SESAC RECORDINGS . . .

The complete transcribed service with recorded music for every need. Highly adaptable program and production aids.

"repertory recordings" . . .

SESAC's free EP service to the entire industry that has been acclaimed by over 25,000 key men in broadcasting.

Special Series Programs . . .

The smartly-built, salable packages of scripts and discs centered around important national holidays, religious celebrations, sports events and other selling entertainment ideas.

**For highlights of all three
Visit SESAC at the NAB
Suite 1205A-1206A
Conrad Hilton Hotel,
Chicago**

SESAC INC.



**THE COLISEUM TOWER
10 COLUMBUS CIRCLE NEW YORK 19,**

* Trade Mark

same office if facilities are offered to one candidate.

In the 1956 North Dakota senatorial elections, a splinter candidate implied in a film telecast that the Farmers Union was communist-dominated. WDAY-TV's immunity from libel damages was upheld by the North Dakota Supreme Court. The Farmers Union instigated the suit.

Bill filed in House to prevent Daly cases

Rep. Glenn Cunningham (R-Neb.) last week introduced a bill (HR 5389) which amends Sec. 315 of the Communications Act to spell out that the equal-time provision does not apply to candidates who appear on regularly scheduled news shows. Rep. Cunningham had announced plans to introduce the bill as a result of FCC's decision that splinter candidate Lar Daly qualified for equal time in Chicago's mayoralty race (BROADCASTING, March 9).

Sec. 315 has been described as "impossible" and "broadcasting's biggest headache," he said. "There are many good and bad things about Sec. 315 as it now stands. . . . The section is poor because it does not differentiate between a major party and a very minor party whose candidate or candidates have no possible chance for victory. It is poor because a station cannot delete libelous material but can be held liable. It is poor because it has been interpreted to apply to pure news reports."

• Government notes

- Attempts to expand the Miami ch. 10 case have been refused by the FCC. In accordance with its earlier announcement (BROADCASTING, March 2), the Commission unanimously denied a petition by North Dade Video Inc., one of the four applicants, to expand the April 23 oral argument to have the FCC also decide which applicant should receive the grant. The Commission also turned down a request by Elzey Roberts, former St. Louis broadcaster, that new applications be permitted for ch. 10 and that such new applicants be permitted in the oral argument. Chmn. John Doerfer did not participate.

- Two tv construction permits were granted by FCC last week. In Logan, Utah, Cache Valley Broadcasting Co. was granted ch. 12 with engineering conditions. In Pembina, N.D., Community Radio Corp. was granted ch. 12. Community Radio Corp. owns KNOX Grand Forks, N.D., and 71% of KNOX-TV there. Cache Valley owners include Herschel and Reed Bullen, who previously were granted this facility but allowed the permit to expire.

TWO NEW SPECTRUM BILLS

House, Senate measures ask studies

Both houses of Congress received measures proposing a study of the radio spectrum last week—but the similarity ends right there.

Sen. Warren Magnuson (D-Wash.) introduced, at the request of President Eisenhower (BROADCASTING, March 9, *et seq.*) S J Res. 76 which would establish a commission "to study and report on the U. S. telecommunication resources with special attention to the radio spectrum."

Rep. William Bray (R-Ind.) introduced H J Res 292 to investigate that portion of the spectrum allocated to the federal government.

The Senate measure calls for a five-man commission to be appointed by the President. The Bray resolution also calls for a five-man commission, but with two members appointed by the President and one each by the Vice President, Speaker of the House and the chairman of the FCC.

Sen. Magnuson put the spectrum study before the Senate to carry out recommendations made to the White House by OCDM Director Leo A. Hoegh. It is in direct conflict with the study espoused by Rep. Bray and one already authorized by Rep. Oren Harris' (D-Ark.) Communications Subcommittee of the House Interstate & Foreign Commerce Committee.

The White House proposal calls for an investigation of existing methods of allocating radio frequencies between government and non-government users and current allocations between the two users "with a view to determining whether the current division of the spectrum serves the national interest" and whether any space may be reallocated.

The commission would be required to submit a report to the President and Congress within one year after its authorization. Commissioners would receive \$75 per diem, plus expenses, while engaged in commission activities.

Rep. Bray's study would be limited to that space allocated to the federal government—all of which currently is classified as to utilization. A report would be required within six months with members to receive \$50 per diem and expenses.

Two years ago, Rep. Bray pointed out, when he first called for a spectrum study the "reaction of the executive department was such that such a report would be impossible to achieve and, if achieved, unnecessary." Now he said, the White House has proposed a study of its own and "this seems to

me a full reversal . . . [by the President]."

He said the Harris investigation is of more immediate value than the White House plan, but that he still favored a study of government-assigned space "with legislative selection of some commissioners."

Rep. Harris, meanwhile, has not as yet gotten his committee's study beyond the planning stage. A staff of spectrum experts is expected to be hired in the immediate future to conduct the study for the House body.

Communication orbs to go up this year

The timetable for military communications satellites was disclosed last week, when the House Science and Astronautics Committee released the security-cleared transcript of last February's testimony by Dept. of Defense officials. Here's the schedule:

Courier satellite—a delayed repeater, low orbit active relay, successor to last December's Project Score—tests this year and next; operational, 1961.

High orbit, 24-hour, wide-band, simultaneous relay—launchings, 1960-61; flights, 1962-63; operational, 1963.

The Courier satellite will be designed to permit 20 continuously available 100 word-per-minute teletype channels to ground stations located around the world. The transcript did not include specifications for the capacity of the active, high orbit relay.

The information was given to the House committee by Roy Johnson, director of the Defense Dept.'s Advanced Research Projects Agency.

Mr. Johnson also disclosed that television will play a significant role in the military navigation satellite program. These satellites will be designed to provide ultra-reliable radio position fixes for aircraft and ships at sea anywhere on earth. First launchings are scheduled for July or August; a second shoot will take place in February or March 1960.

Each navigation satellite will contain three television cameras. These will be used to feed pictures of cloud covers into separate magnetic tape recorders for playback when the satellite is interrogated, Mr. Johnson told the committee. He added that each tv picture will have a resolution of 500 lines per millimeter, "far more sophisticated" than present tv cameras. Every 24 hours a thousand pictures will be produced, he said.

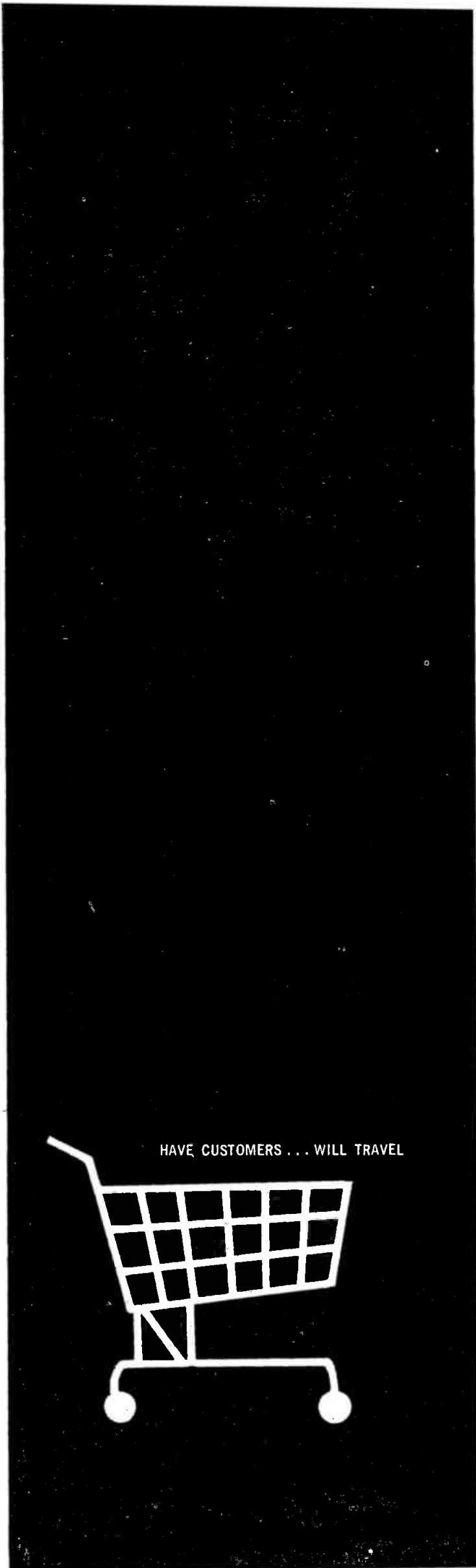
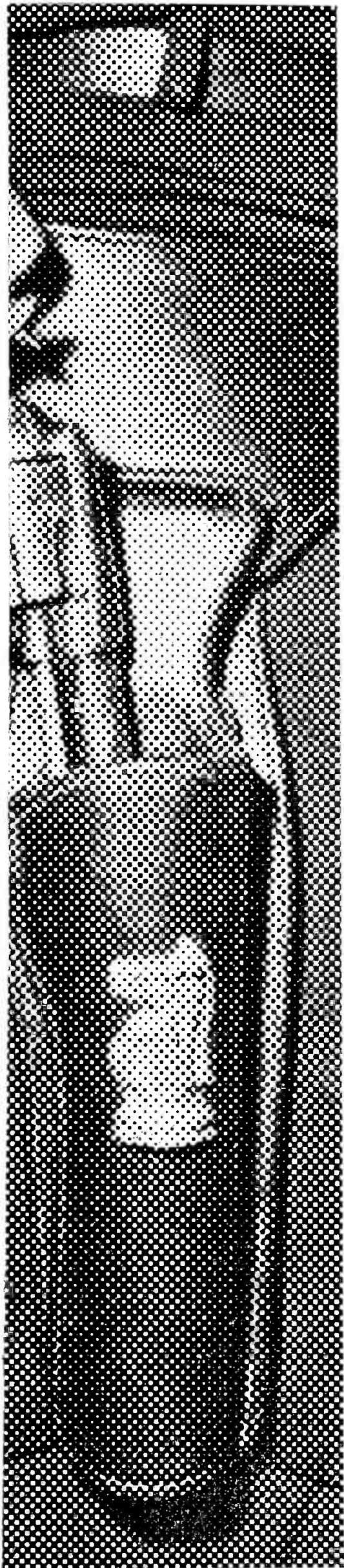

HAVE CUSTOMERS . . . WILL TRAVEL



IN
SAN DIEGO
KFMB-TV
SENDS
MORE
PEOPLE
AWAY
FROM
HOME
(TO BUY)
THAN
ANYTHING!

Most exciting western action of all is not on the TV screen . . . It's the big, exciting booming action of the San Diego TV audience of which KFMB-TV has the lion's share.

For instance, all of San Diego's top 10 TV shows are on KFMB-TV — 29 of the top 30.

If you want to send customers to a supermarket, drug store, auto or appliance showroom, be a good audience when the

Petry man calls on you. Better yet — you call him.

KFMB  **TV**
REPRESENTED BY
Edward Petry & Co., Inc. **SAN DIEGO**

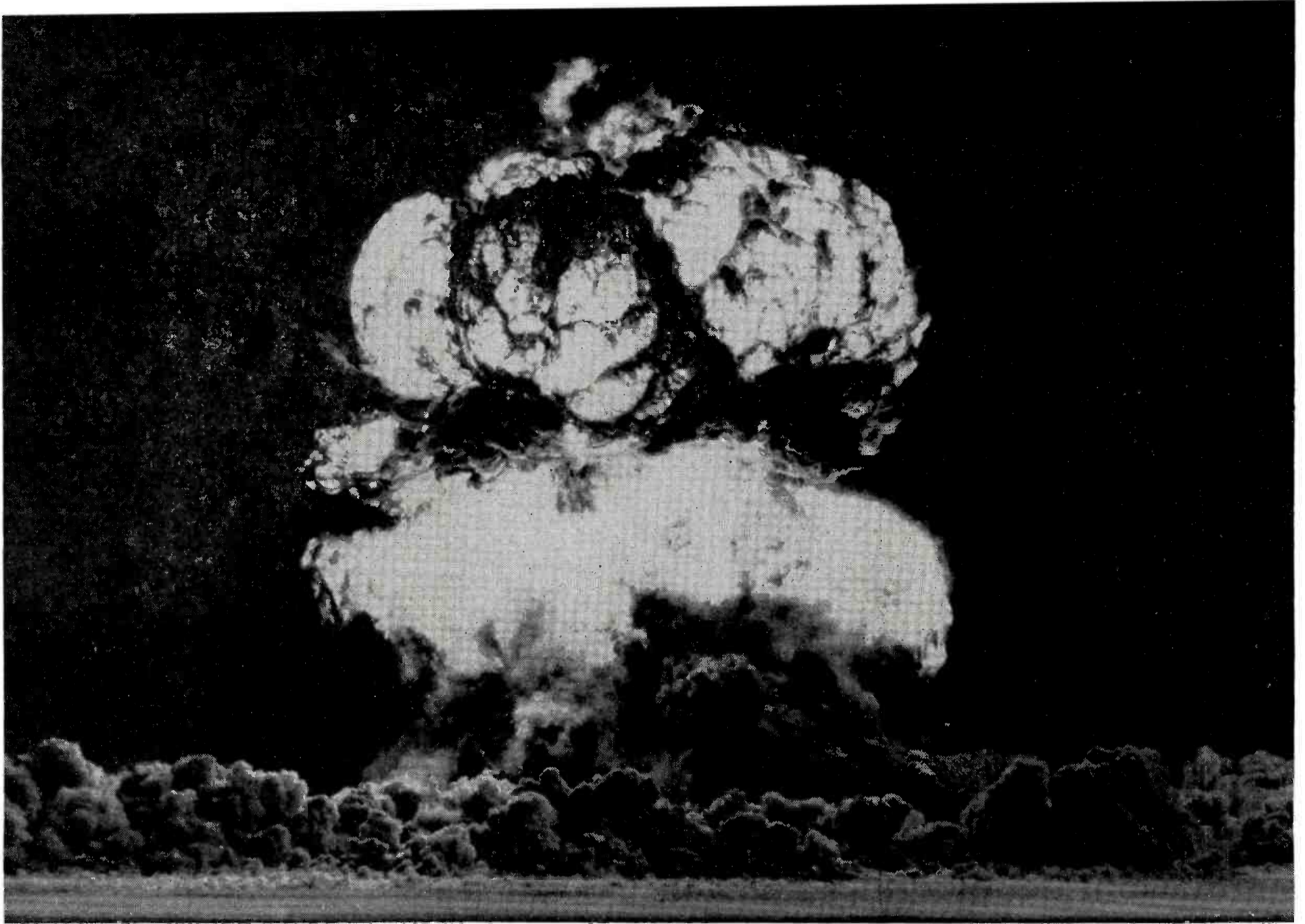

RADIO DEFENSE PLAN AT LAST?

A bumbling government begins to make sense of survival setup

The nation's only public communication link in case of a major nuclear attack is billed for a dress rehearsal April 17.

A new and powerful broadcast voice, based on the long-cussed CONELRAD, will have a preliminary test—unless there is a hitch.

CONELRAD is getting a major engineering overhaul to keep pace with war tactics. Present planning proposes a nationwide half-hour broadcast silence April 17—am (except CONELRAD stations), fm and tv.

The test, if held, will show how radio, and radio alone can, before and after a full-fledged bombardment:

- Warn the public that bombers or missiles may be approaching, and

- Tell those who survive a nuclear blast how to avoid death by fallout, modern warfare's potentially worst killer.

All this without providing homing aids to the enemy.

CONELRAD, which is the 1,300-station emergency radio structure, is being modernized and expanded as sophisticated missiles raise new defense prob-

lems. The job is a big technical task—about as big as a complete allocation of the broadcast band.

A lot is being done but there's a terribly long way to go.

The nation's broadcasters have the key role in this effort to prevent complete destruction of the land and its people—a much more critical role than most broadcasters realize.

Getting Along at Last • Working on the theory that an estimated 65 million auto and portable battery-powered radios may be the only connection among survivors of an enemy attack, FCC and Office of Civil & Defense Mobilization are finally learning how to cooperate effectively.

Not many months ago some persons in OCDM wondered if millions of broadcaster kilowatts would ever know how to emit even a beep in case of disaster. Now OCDM and FCC are sharing the belief that broadcasting is the main and perhaps only hope of national survival in case of a mass attack.

At last the radio emergency setup is starting to look encouraging. FCC and OCDM are trying to stamp out intra-

government feuding which has handicapped progress.

The real story of the radio-civil defense haggling has never been told and probably never will be. Parts of it are necessarily classified. Luckily the facts haven't been exposed to the innuendoes of scandal columnists.

Not Complicated • The radio survival formula is simple:

- If the public knows what to do, up to 85-90% of the population may be saved should the U.S. be hit with nuclear bomb or missiles.

- At worst, up to 100 million people should survive the first moments of the most devastating attack within comprehension. Then the job will be to keep them away from radioactive fallout for a fortnight or more.

That's where radio comes in, through CONELRAD and a series of intricate communications networks utilizing many of the nation's 2½-million privately operated transmitters. These plans take advantage of several built-in blessings:

- Am radio is believed effective under

*Proof of Acceptance**

NOW  WCCO RADIO
HAS MORE  LISTEN-
ERS  THAN ALL
OTHER MINNEAPOLIS-
ST. PAUL  STATIONS
 COMBINED!

WCCO Radio also delivers . . .

***LOWEST COST PER THOUSAND . . .** Exactly half of the average of all other stations

***MORE ADULTS . . .** WCCO Radio is the solid leader with a 60.1% share of the adult audience. That's 50% more than all other stations combined!

***GREATER METRO AREA DOMINANCE . . .** WCCO Radio shows its overwhelming strength with 399 quarter-hour wins. Four times more than all other stations combined!

**Nothing sells like acceptance . . .*

WCCO Radio

MINNEAPOLIS • ST. PAUL

The Northwest's Only 50,000-Watt 1-A Clear Channel Station
Represented by CBS Radio Spot Sales

Source: Nielsen Station Index, Nov.-Dec., 1958



spot
↑

SUMMER RADIO GOES

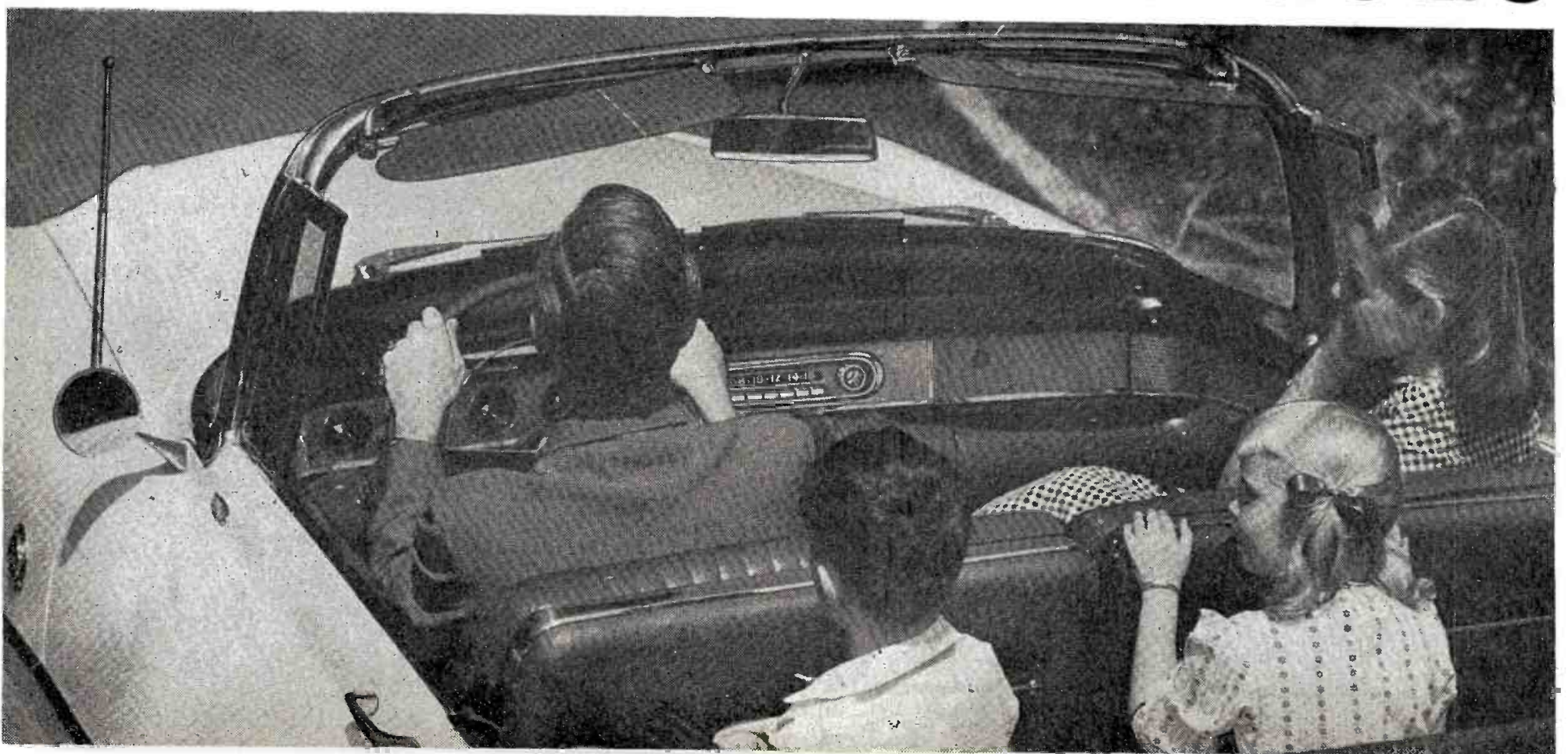



WHERE THE FAMILY GOES

You reach people—wherever they are,
at home or on vacation—with SPOT
RADIO.

SPONSORED BY MEMBER FIRMS OF



Avery-Knodel Inc. — John Blair & Company — Broadcast Time Sales
Thomas F. Clark Co. Inc. — Harry E. Cummings — Robert E. Eastman & Co. Inc.
H-R Representatives Inc. — The Katz Agency Inc. — McGavren-Quinn Company
The Meeker Company Inc. — Art Moore Associates Inc. — Richard O'Connell Inc.
Peters, Griffin, Woodward, Inc. — William J. Reilly, Inc.
Radio-TV Representatives, Inc. — Wood Radio Corporation — Adam Young & Co.

severe fallout conditions, while other parts of the spectrum may be crippled.

- Fm, too, enters the planning as a surprise package. One fm channel can carry 192 teletype or 12 voice channels under CONELRAD; half that under conditions without hurting normal programming. This is a hot new item in Washington planning—too hot for detailed discussion.

- And vhf television is part of the planning, though the work is still preliminary. Tv is less talked about, but its 6,000 kc channel is 30 times as broad as the 200 kc fm channel, offering vast communicating potentials. Uhf isn't being overlooked, either.

The April 17 CONELRAD test has gone through the bureaucratic wringer. Just last Monday (March 9) at an informal White House conference a basic agreement for this broadcast dress rehearsal was reached after weeks of uncertainty.

Its cost to broadcasters has been estimated all the way from \$250,000 to \$2 million in time and related items.

Whatever the out-of-pocket loss in am, fm and tv time, the broadcast defense maneuver April 17 is expected to be of incalculable value to the public. Insisted on originally by OCDM, the test is designed to show listeners how to use their radios in case of an enemy threat or actual attack. OCDM has prepared national network programming to originate from the emergency seat of government and also has material for station use.

Enemy-Proof • It's likely listeners will be urged to use the one communications device no enemy can ever destroy completely—radio stations using emergency power plants and feeding an estimated 65 million auto and portable battery receivers.

At this late hour the plans for the April 17 CONELRAD test are not fixed. OCDM has proposed a 11:30 a.m.-12 noon half-hour broadcast oper-



FCC's Lee: "We pray it will never happen."

ation. It suggested that all am stations go silent except about 1,300 that are tied voluntarily into the CONELRAD plan. It was willing to cut the cost to broadcasters by keeping fm and tv on.

FCC pointed out, however, that its rules plus the spirit of fair competition made an am-only operation almost impossible. Incidentally, FCC would prefer to test CONELRAD at night under worst interference conditions.

Final details of the April 17 test will be worked out March 26 at a meeting of NIAC (National Industry Advisory Committee), a broadcaster group set up by FCC to bring broadcasters into the civil-defense planning picture. It might be called off if NIAC objects.

NIAC is one of many important new aspects of civil defense. It consists of:

- National program and technical groups of broadcasters with rotating chairmen.

- White House broadcast correspondents liaison committee, with rotating chairmen.

- State groups being set up through state broadcasters associations.

- Local NIACs, just getting under way through FCC prodding and state broadcaster cooperation.

Present national NIAC chairmen (first quarter of 1959) are David M. Vorhes, technical; David Driscoll, program, and Lewis W. Shollenberger, White House, all CBS executives in line with a policy of keeping chairmen within the same network for convenient contacts. Permanent vice-chairman of the national NIAC structure is A. Prose Walker, NAB engineering manager. NAB and Electronic Industries Assn. are both active in NIAC.

Thirty state NIACs have been set up, with much of the paper work done and broadcaster members cleared for security. Most of the rest are under formation. The job of getting them started will be completed soon after the NAB Chicago convention.

At the Controls • Key figures in civil defense are taking active programming roles in the NAB convention. They are:

- FCC Comr. Robert E. Lee, designated "Defense Commissioner." With other FCC members and key staff people he is attending the convention and will take part in the Wednesday morning (March 18) FCC-Industry Roundtable. Comr. Robert T. Bartley is active as alternate Defense Commissioner.

- Director Leo A. Hoegh, of OCDM, who proposed the April 17 CONELRAD alert in letters to FCC and Dept. of Defense originally was to speak Monday afternoon. John S. Patterson, deputy director, OCDM will speak in his place.

Until recently the two government

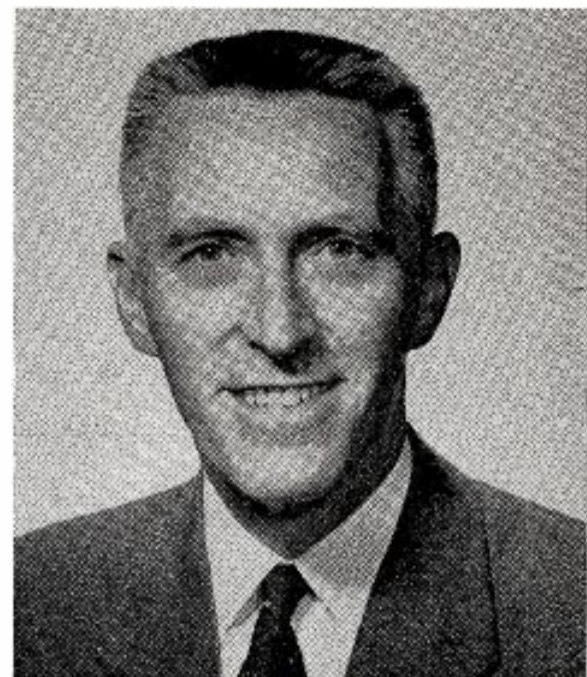

OCDM's Hoegh: "Stay on air to save lives."

agencies were having bureaucratic differences that deeply concerned some broadcasters on the inside of defense planning. Lately Comr. Lee and Director Hoegh have been resolving lower-echelon differences.

Comr. Lee has been beating a hot trail all over the U.S. telling of the horrible consequences of unpreparedness and helping local broadcasters get their NIACs formed. FCC, he explained, has one main defense job:

- Use of technical skill and federal authority to set up attack-proof communications facilities out of the 2½ million non-government transmitters, with the cooperation of their private operators.

OCDM has more complicated functions that can be roughly summarized this way:

- Operation of government radio facilities under Presidential mandate.

- Direction of non-military defenses, including protection of life and property.

- Dissemination of civil defense information through CONELRAD, a programming function that is often described as only partly finished after a decade of budget troubles and acute public indifference.

Put tersely, broadcast facilities are provided by FCC and the industry; program information by OCDM.

Tender Underbelly • There's a soft spot in this joint survival operation—getting the right information to the public.

FCC is making fast technical progress, much faster than most broadcasters generally realized.

OCDM, with its budget troubles and public indifference, has a loose national organization. This is the sort of thing that is inherent in a big government—typical chaos on the Potomac. In the case of OCDM there is a glaring flaw—state civil defense directors are paid by



**GOOD MUSIC rings up sales in Los Angeles...
and registers continuous renewals such as these:**

SLAVICK JEWELRY CO.	<i>15th year</i>	REPUBLIC VAN & STORAGE CO.	<i>6th year</i>
UNION PACIFIC RAILROAD	<i>10th year</i>	THE PRUDENTIAL INSURANCE CO.	<i>6th year</i>
BARBARA ANN BREAD	<i>10th year</i>	MARTIN MOTORS	<i>6th year</i>
HAR OMAR RESTAURANT	<i>8th year</i>	CINERAMA	<i>6th year</i>
KIP OINTMENT	<i>7th year</i>	BERLITZ SCHOOLS OF LANGUAGES	<i>5th year</i>
WALLICHS MUSIC CITY	<i>7th year</i>	PEPSI-COLA	<i>3rd year</i>
YELLOW CAB CO.	<i>6th year</i>	RCA-WHIRLPOOL	<i>3rd year</i>

...more than 40 sponsors in their 2nd to 19th year!

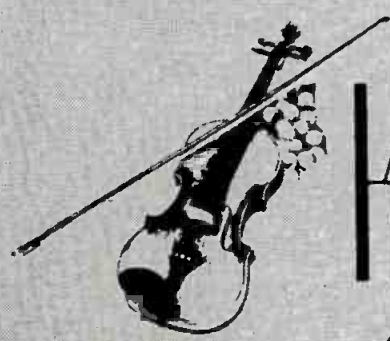

KfAC
PRUDENTIAL SQUARE • LOS ANGELES

The Music Stations for Southern California
24-hour simultaneous AM-FM at one low cost
Represented by The Bolling Co., Inc.

their states and are primarily responsible to these states.

It's worse than that. Local civil defense officials are volunteers, guided by patriotism, local interests, OCDM instructions and personal concepts. And the national OCDM in Washington is split up into a headquarters cadre a few steps from the White House and an operating headquarters at Battle Creek, Mich., 500 miles away.

The Solution • The intra-government problems are serious but there's a possible answer.

OCDM wishes it could get every broadcast station to have a volunteer staffer who would take over in case of alert or attack. But OCDM's people complain they can't reach the broadcasting industry except through their loose state and local structure.

FCC has constant regulatory and personal contact with the broadcasting industry. They've lived together for years and decades.

In an off-record way FCC people wonder what would happen if a local civil defense official got panicky and started throwing his weight around. A cooperating broadcaster might put a phony attack message on the air and find himself the target of a thousand damage suits filed by civilians claiming to have suffered valuable injury, inconvenience or loss of something valuable.

So there's the problem—FCC doesn't want to be a programmer or censor;

OCDM wants to program the heaven-sent broadcasting resource but can't set it up.

The answer becomes obvious: Link all the national, state and local NIACS (broadcaster staffed) to all the national, state and local civil defense units.

This would put a broadcaster at the headquarters point of every civil defense operation. Supporting this point is a basic argument: Broadcasters know more about programming a station than anyone else.

Comr. Lee sees a lot of merit in this plan. Director Hoegh is said to have indicated interest; he may have something to say on the subject at the NAB convention.

Director Hoegh might well ask the governor of each state to give official recognition to the state and local NIAC committees. Thus the governors could integrate NIAC and civil defense at state and local levels. The broadcaster would be the program expert for civil defense, using information supplied by civil defense agencies.

Under CONELRAD Phase I, the basic concept, highest priority goes to local programs, next to state and third to national agencies. Under Phase II, a big-station broadcast project, highest priority goes to state, next national and third local agencies.

If the worst happens, newspapers will really be in trouble unless they have emergency power plants. Even if they put out improvised news sheets and put

them on street corners, a fallout-conscious public may shun them in fear of gamma particles. Newspapers have an emergency operating plan.

Troubles Galore • CONELRAD's niche in the national scene has assumed new importance as foreign crises become more complex and hazardous. It was set up originally early in the decade, mostly by volunteer efforts and money of broadcasters, to do two main jobs—1, prevent bombers from homing in on broadcast signals, and 2, tell the public what it needs to know.

Since that time the tactics of warfare have changed but the homing hazard hasn't diminished, according to defense officials. Where once there was an hour or several hours warning that an enemy bomber was U.S. bound, the time now has been cut to minutes due to the speed of sophisticated missiles.

Suppose, one government man supposed, that a foreign missile aimed in the general direction of Washington, D.C., had a radio in its nose tuned to 1500 kc. That theoretically could guide it over Greenland right to the Wheaton, Md., transmitter of WTOP Washington.

Maybe it's not that simple. In any case, the Pentagon and other federal agencies reviewed the whole CONELRAD situation a few months ago. The conclusion—CONELRAD is needed more than ever before.

The realities of a nuclear attack are horrible to contemplate. OCDM looks for the worst. It has to in the survival business. If only the public can be told what to do, says OCDM, people can be kept in their cellars or directed to non-fallout areas. The unpleasant fact back of the survival problem is this—the human body can absorb 75 roentgens of gamma radiation from nuclear fallout. And these roentgens stay put; there's no way of getting rid of them.

Much progress in detecting the presence of fallout and the direction of its probable skyward movement has been made. OCDM's plea to broadcasters is: "Help us get this information to people."

People Indifferent • To date OCDM and its predecessor, Office of Civil Defense, have been appalled at public apathy toward survival problems and procedure.

The CONELRAD system can be put into operation instantly by the commander-in-chief, North American Air Defense Command (CINCNOAD), at Colorado Springs, Colo., or by an air command unit he designates. Instantly every broadcast station will be notified by automatic reception gear required under FCC rules. At that point all fm and tv stations go silent, after a brief announcement; am stations also go off the air except for those taking part in

What OCDM needs from broadcasters

Broadcasters have been offering important aid to Office of Civil & Defense Mobilization, according to Director Leo A. Hoegh, but much remains to be done. Mr. Hoegh last week sent this message to delegates through BROADCASTING:

"The Office of Civil & Defense Mobilization is deeply concerned with the general field of communications and the specific industry of broadcasting. Without your full cooperation we could not effectively warn the public or transmit emergency information and instructions in event of attack.

"We particularly appreciate the fine work you have accomplished in civil defense. Your cooperation in the CONELRAD program has been of special benefit to our cause. Some 1,300 am stations have spent approximately \$3,000,000 participating in this program.

"President Harold E. Fellows, of NAB, commented as recently as last

September that the government has been exceedingly vague about what the broadcaster is to do. I trust we are helping to eliminate this complaint with the creation and publication of the National Plan for Civil & Defense Mobilization.

"Representatives of your industry are working with us in preparing National Plan Annexes of prime importance to broadcasting—public information, communications, and protection of essential facilities. The National Industry Advisory Committee representing your industry is studying with the FCC and OCDM the problem of emergency programming for radio during and after attack.

"Each broadcaster should join the CONELRAD system; provide emergency power for his station; provide fallout shelter and emergency supplies at his station or transmitter, and plan for relocation sites outside of target centers."



WNBQ
WMAQ

YOUR Q FOR QUALITY In Chicago WNBQ and WMAQ mean Quality with a capital Q! And *everybody's* handing out prizes for it — the Audience *and* the Trade. ■ Chicago's *audience* votes prizes to WNBQ and WMAQ *every* day . . . from early morning to late at night. In television, WNBQ, the world's first all-color station, is the *only* network television station in Chicago to show a gain in total share of audience over the year.* ■ Jack Paar sews up late-evening television with an average rating of 16.1 between 10:15 and midnight; 28 per cent higher than the highest rated feature film during this time period!** ■ In radio, WMAQ's Henry Cooke leads off with as much as 24 per cent

of the morning audience.*** ■ Rounding out the day is Jack Eigen, the nation's most imitated interviewer, with as much as 32 per cent of the late night audience!*** ■ Chicago's *trade* votes prizes *too!* ■ The Chicago Federated Advertising Club, for instance, awarded the two stations *eight* first places in the last local competition for programming excellence. More than any other station. ■ WMAQ and WNBQ were the *only* Chicago stations cited in the Broadcasting and TV Age national promotion competitions. ■ Other national awards include citations for Alex Dreier, Clifton Utley and Len O'Connor for excellence in news coverage. ■ Take YOUR Q for success in Chicago . . . take **WNBQ-WMAQ**

NBC IN CHICAGO • SOLD BY NBC SPOT SALES

*ARB, Feb. '58 & Feb. '59 **ARB, Feb. '59 ***Nielsen, Jan. '59

we're proud of our boy!*

Jimmy Rachels, a senior at Jordan Vocational High School in Columbus, Georgia, in his winning "Voice of Democracy" essay said, in part:

"This, to me, is Democracy: To know that I am within myself socially equal to any other young person and just as important, that he stands as an equal with me. It is to live in a land where a man can hold his head up high and look at his fellow man, and be proud—proud of what he has the power to become if he is willing to work for his hopes. In my teenage world, this is Democracy."



JAMES W. RACHELS, JR. pictured in WRBL studios. He plans to use his \$1,500 first prize scholarship next year to study religious education at Mercer University.

*Sponsored in "The Voice of Democracy" competition by

W*ee* **R***e* **B***e* **L** TV CHANNEL 4
RADIO 5000 WATTS
COLUMBUS, GEORGIA
Call HOLLINGBERY

the 640 and 1240 kc CONELRAD structure, which is divided into Phase I and Phase II segments.

Important changes in CONELRAD include a new "Periphery Plan" under Phase I. This idea is simple—if a city is knocked out by the enemy, it can be covered by regional broadcast stations as far as 40 miles out.

Take an example: Assume Washington and Baltimore are knocked out. Selected stations in such outlying towns as Annapolis and Frederick, Md., and Warrenton and Fredericksburg, Va., might be among picked stations that could program an area of 100 miles or more in diameter.

FCC has a way of programming them—a key station linked by 450-455 mc relay units. And FCC has many networking projects in the works. They will be as bomb-proof and jam-proof as possible.

Jamming, incidentally, can be anticipated in case of attack. The enemy, expert at jamming broadcast service abroad, would be expected to send over planes loaded with jamming gear and high-in-the-sky missile jamming is a super-secret defense problem.

Wide Coverage • Peripheral service is based on a simple and obvious formula—the fewer the number of stations, the less interference is created permitting wide coverage. But FCC has other tricks in its kit. A microwave resource suitable for disaster networking is based on an industrial reserve—2,300 microwave stations operated by pipelines and other industries. These are fully automatic, standby-equipped and located for the most part in non-metropolitan geography.

There are, in addition, 12,000 remote broadcast transmitters. FCC has space for them in the 450-455 mc band. On top of these are the tremendous teletype and voice facilities that can be used in emergencies. Much work has been done; much is unfinished.

Phase II of CONELRAD includes selected, powerful broadcast stations that are operating 24 hours a day. These volunteer stations could blanket a substantial part of the U.S. with signals of varying effectiveness, FCC believes. Down the line at OCDM there's fear these stations would be quickly knocked out in case of attack but FCC doesn't go along with this thinking.

OCDM has its own private communications structure, entirely separate from FCC and CONELRAD. Its communications planning is based on two key projects—National Attack Warning System (NAWAS) and National Communications System (NACOM).

NAWAS is mainly a wire line system tied to the air defense command by a dial telephone routine. It reaches 276 points.

NAWAS connects the national emergency location of OCDM near Washington with its Battle Creek operation headquarters plus regional offices and state governments. It is designed to bypass damaged areas. Radio backup is planned.

NACOM is a high-frequency voice and telegraph system connecting OCDM headquarters and field offices. Hundreds of state police, fire station and other transmitters are tied into the system. OCDM is happy about this project but the point has been made that local police and fire officials would be so busy with their duties in time of disaster that they couldn't be bothered monitoring civil defense information.

OCDM also has Radio Amateur Communication Emergency Service (RACES) comprising volunteer ham operators. This includes thousands of transmitters but no provisions to keep them manned.

Buzzers and Boats • In the OCDM thinking is another idea, NEAR, which is based on the belief that every home should have a permanent 240 cycle buzzer that could be kicked on by the electric power company, warning the home of danger.

Thinking in terms of national catastrophe, OCDM figures broadcast stations could serve their areas with mobile transmitters from trucks or autos or even boats. But it's not in a position to arrange this type of service outside of making suggestions through state or regional civil defense offices.

The problems FCC, OCDM and NIAC are solving defy imagination. Recently, for example, the NIAC White House liaison group worked out the matter of getting the President on the national air immediately from the White House or an emergency location. The wiring and relays took a lot of doing though the idea seemed basic and simple.

There are such items as manning of a national programming news crew for broadcasting with network, wire service and other agencies represented. Ideally in case of emergency President and other designated federal officials would go on the air personally with official announcements. FCC has set up an executive reserve of broadcasters.

The line of authority under the Communications Act (Sec. 606c) and a series of Executive Orders has been laid out as closely as possible in recent months. There's a lot of paper-work progress—enough to keep a federal court busy a long time if anybody wants to get fussy about the niceties of interpretation. The President can authorize the FCC to take over all broadcast stations "upon just compensation to the owners." Comr. Lee has hinted recently there may be a broadcasting or communica-

tions czar—maybe the OCDM director or FCC chairman or someone else.

On His Own • With all the planning, however, it's easy to figure a nuclear holocaust that would put the President, FCC, OCDM and any czar out of business. Then it would be a case of every broadcaster for himself. Technically there are FCC rules against that sort of thing, and the Commission is considering changes to take care of any contingency.

Planning is absolutely necessary, everyone familiar with the problem believes. CONELRAD covers 117 separate radio services that must be silenced. Some parts are little known to broadcasters—SCATER for example. SCATER stands for Security Control of Air Traffic & Electromagnetic Radiation. Its purpose is to get planes out of the air and on the ground in an emergency before shutting off air navigation aids.

Comr. Lee said broader coverage will be provided in the future through judicial choice of primary and standby station operations by remote control from a single area program source. Station sequence cycles in CONELRAD have been refined. Detailed plans have been delivered to 60 areas. FCC and industry groups are working with the Air Force to find ways of giving discreet evacuation directions. CONELRAD is to be geared against submarine attack. Phase II could be put into operation in a hurry if needed.

And Comr. Lee added, "What we plan for we pray we will never do."

FCC's fm probe gets stereo issue

The FCC last week split its inquiry into possible additional uses of fm multiplexing—initiated last July 8—into two phases, (1) stereophonic broadcasting and (2) all other uses of multiplexing.

FCC recognized the "keen awareness" by broadcasters, equipment manufacturers, trade associations and the public in stereophonic broadcasting and called for comments by June 10 on six questions concerning stereo. It also said that comments filed on stereo in the rulemaking begun last July 8 need not be resubmitted, since they would be considered. The original inquiry had encompassed all forms of multiplexing, including stereo.

The FCC's questions for comments included: (a) Should stereo broadcasting be permitted on a regular basis and if so should it be a broadcast service to the general public or available only on a subscription basis? (b) What quality and performance standards, if any, should be applied to stereo multiplexing? (c) Should specific sub-carrier fre-

quencies be allocated to stereo? (d) Should present main channel quality and performance standards be relaxed beyond that already permitted for subsidiary communications (non-broadcast) operations to accommodate stereo? (e) What transmission standards should be adopted regarding cross-talk between the main channel and stereophonic sub-channel? (f) Should fm broadcast stations airing stereo be required to use a compatible system which allows listeners tuned to the main channel to hear an aurally balanced program?

IN HOME STRETCH Boston ch. 5 hearing approaches last stage

The court-remanded rehearing of the Boston ch. 5 case was tentatively concluded last week following testimony by Assistant Attorney General Victor R. Hansen, head of the Justice Dept.'s Antitrust Div.; Washington attorney Warren E. Baker, former FCC general counsel, and Maurice Simon, stockholder in the Boston *Herald Traveler* (WHDH), one of the four applicants.

Counsel for the *Herald Traveler*, the other three applicants—Massachusetts Bay Telecasters Inc., Greater Boston Tv Corp. and Allen B. DuMont Labs—and intervenor *Boston Globe* were to indicate by last weekend whether they want to call other witnesses. If not, the record was to be closed today (March 16), with proposed findings and conclusions tentatively scheduled for April 20 and oral argument May 1.

DuMont, which earlier had said it would insist on testimony by former Secretary of Commerce Sinclair Weeks on discussions of the ch. 5 case with

him by some of the parties, said last week it would forego calling Mr. Weeks if no new witnesses are called by others. Counsel for the *Globe* and the four applicants were pondering the record last week to see if they wanted additional witnesses.

The ch. 5 case is being reheard by Special Hearing Examiner Horace Stern under mandate from the U.S. Appeals Court for the District of Columbia issued last July. The court ordered a rehearing to determine if there were improper influences or *ex parte* contacts which would disqualify one or more FCC members from voting in the Commission's April 1957 grant of ch. 5 to the *Herald Traveler*.

What Hansen Said • Antitrust chief Hansen's testimony last week corroborated his proposed testimony offered in written form the week before (BROADCASTING, March 9) concerning (1) his telephone conversation on March 28, 1957, with former FCC Chairman George C. McConaughy concerning a Justice investigation of antitrust allegations against the *Herald Traveler* by the *Globe*, and (2) a meeting the day before by Mr. Hansen and former Attorney General Herbert Brownell with Robert B. Choate, publisher of the *Herald Traveler*.

Mr. Hansen said he told Mr. McConaughy in effect that while Justice did not have sufficient evidence to bring an antitrust suit against the *Herald Traveler*, the investigation would be continued. Mr. McConaughy had testified that Mr. Hansen told him Justice had closed the case and that the *Globe* charges could not be dignified as a complaint. In his testimony last week on the latter point, Mr. Hansen said he had told Mr. McConaughy no such thing.

Mr. Hansen denied that Mr. Choate was told at the meeting with Mr.

Brownell and himself that Justice had "nothing against you," as quoted by Mr. Choate in testimony last year before the House Legislative Oversight Subcommittee regarding the *Globe* charges. But Mr. Hansen (and Judge Stern) felt Mr. Choate could have misinterpreted statements by the Justice officials on the status of the Justice probe.

Mr. Hansen said Justice opened its probe Feb. 4, 1957, completed it Nov. 4, 1957, and closed the case Jan. 10, 1958, investigating not only the *Globe* charges but other information from various sources. The FBI had entered the investigation in August 1957.

Gave No Advice • The antitrust head said that he gave Mr. McConaughy no advice on what he should do or how he should vote in the ch. 5 case, but merely apprised him of the status of the Justice probe. He said he felt Justice had a right to act independently of what the FCC decided on ch. 5, pointing to the recent Supreme Court decision in the NBC-Westinghouse Broadcasting Co. case (BROADCASTING, March 2).

Mr. Hansen denied that on Feb. 12, 1957, Justice's investigation was in its "final stages." A letter from then Deputy Attorney General William P. Rogers to Sen. Leverett Saltonstall (R-Mass.) dated March 5, 1957—not yet introduced into the record as of late last week—had stated that as of Feb. 12 Justice's "preliminary inquiry" was in its "final stages."

Mr. Simon, under subpoena by DuMont, testified on his purchase of *Herald Traveler* stock between February and December 1957, saying he and an associate bought a little more than \$100,000 worth of stock during this period because the price was down and stockbrokers and friends had ad-



Judge Stern (r) greets antitrust chief Hansen



Former FCC counsel Baker: relied on chairman



Mr. Simon: he was an innocent speculator



Q:

What radio station do you listen to most of the time during the day?

A:

WWDC, said 16.7% of the Washington "day-at-homes" at whom PULSE fired the question. Our closest competition was almost a whole percentage point away.

This daylight supremacy, plus many other areas of WWDC leadership in the Washington, D.C., metropolitan market, are revealed in a special qualitative survey conducted by PULSE. For the full report, write Station WWDC or ask your Blair man for a copy of "Personality Profile of a Radio Station." It's profitable perusing!

WWDC *Radio Washington*

REPRESENTED NATIONALLY BY JOHN BLAIR & CO.

P.S. The regular PULSE for January showed WWDC in first place for the eighth consecutive month with 18.8% share of total audience, 6 A.M. to midnight — 2.5 percentage points ahead of the pack!

vised him the stock would "bounce back."

He said he shared office space in Boston with George Rabb, brother of Secretary to the Cabinet Max Rabb, but didn't discuss his purchases with either brother except to tell George Rabb he had bought *Herald Traveler* stock along with other securities. He said he didn't talk with any *Herald Traveler* officials until the summer of 1958.

Baker's Source • Mr. Baker said that as FCC general counsel it was his duty to maintain liaison with Justice and other government agencies and departments. He said he drafted for Mr. McConnaughey's signature an answer to an inquiry from Chairman Emanuel Celler (D-N.Y.) of the House Antitrust Subcommittee concerning the Boston ch. 5 case. Before writing the letter, he said, he made a routine check with Justice and was told Mr. Hansen and Mr. McConnaughey had had a telephone talk March 28, 1957. He then went to Mr. McConnaughey to get information to supply Rep. Celler and was told Justice had indicated it didn't have enough evidence to institute a suit against the *Herald Traveler*. After drafting the letter about April 5, Mr. Baker said, he left Washington for several days and thus did not talk again to Justice staff people until after the letter was signed by Mr. McConnaughey and mailed April 15, 1957.

He said he didn't discuss the *Globe*

charges with any member of the FCC, nor discuss questions of law or fact with Justice or FCC members.

The former FCC general counsel acknowledged it was his duty to prepare statements, testify and advise FCC members in Commission appearances on Capitol Hill legislation. Thus, while he performed these tasks in the FCC's presentation on a House bill to prevent FCC discrimination against newspapers in comparative cases, he did not discuss with FCC members any pending individual cases to which such a bill might be applicable, he said. (The FCC had opposed the bill on grounds the Commission did not discriminate, but merely considered newspaper ownership in weighing the media diversification factor, among others, in making grants.)

Court reverses grant to KALF (TV) Alliance

The FCC erred in dismissing petitions by KSTF (TV) Scottsbluff, Neb., to intervene in the proceeding which resulted in the June 1958 grant of ch. 13 to KALF (TV) at Alliance, Neb., the U. S. Court of Appeals for the District of Columbia said last week in reversing the FCC grant and ordering a new hearing.

The court also ordered a hearing on allegations by KSTF (ch. 10) that KALF sold stock without registering it with Securities & Exchange Commission and made false and mislead-

ing statements to the public in selling capital stock, violating state laws.

KSTF had been a competing applicant for ch. 13 but in September 1957 told the FCC it would withdraw if it received an FCC grant to enlarge KSTF facilities to cover more of the Alliance area, 40 miles away. A few days later KSTF filed to "intervene" on economic injury grounds. The FCC granted the KSTF enlargement in October 1957 and dismissed its ch. 13 application. In February 1958 the FCC denied KSTF's petition to intervene and in June 1958 granted ch. 13 to KALF, denying another petition by KSTF to intervene and dismissing KSTF's allegations about KALF's stock issues on grounds they were moot.

The court said KSTF's petition to "intervene" was a misnomer; the station was not asking to become a party but already was one and the petition merely set forth another basis for interest. "Obviously, the loss of one basis for interest [dismissal as an applicant] would not destroy the other and, despite its loss, he would remain a party to the proceeding."

In denying KSTF's first petition in February 1958 the FCC had held KSTF could not occupy the role of both applicant and party claiming economic injury and that since the station had been granted expanded facilities in October 1957 and its application for ch. 13 dismissed, it was no longer a party.

PROGRAMMING

BMI READY TO CLOSE LICENSE FILE

Only a few radio holdouts; CBS switches to per-program basis

All networks, all tv stations and all but "a handful" of radio stations have renewed their licenses with Broadcast Music Inc., BMI President Carl Haverlin announced last week.

There was one notable change, however. For the first time in BMI history, a network, CBS radio, elected to take a per-program rather than a blanket license. CBS officials said they did so because a careful study indicated "substantial" savings would result. They said the shortened programming schedule under the network's new Program Consolidation Plan did not motivate the decision, that they would have taken a per-program license in any case.

Per-program license holders pay only on periods where BMI music is used. Blanket licenses, held by all but a few

stations and by all other networks, permit a licensee to use as little or as much BMI music as he wishes, all for the same fee. Current licenses expired last Wednesday (March 11), so renewals were from that date.

Variations • There were some differences among networks as to length of the new contracts. NBC and ABC signed for five-year renewals of blanket licenses for their tv networks and three-year blanket renewals for their radio networks. Mutual, despite other problems currently facing it (see page 118), signed a five-year blanket renewal. CBS signed a three-year blanket renewal for its television network; its radio network contract, still in the drafting stage, is for five years but on the per-program basis.

All station renewals, including those of network owned-and-operated stations, were for five years, Mr. Haverlin reported.

He said all tv stations and 3,325 radio stations—all but about 50, he reported—had already renewed their old contracts, virtually all of them on a blanket basis. About 30 of the remaining 50, he said, have indicated they intend to renew.

Ranges • Blanket radio license fees range from 0.75% of net time sales for stations in lower billing classifications up to 1.2% for those billing \$100,000 and more. As a practical matter, since none of them bills less than \$100,000, radio networks pay at the 1.2% rate for blanket licenses.

Per program licenses for radio range

SPARTANBURG-GREENVILLE SUPERMARKET AS SHOWN BY U. S. CENSUS POPULATION MAP

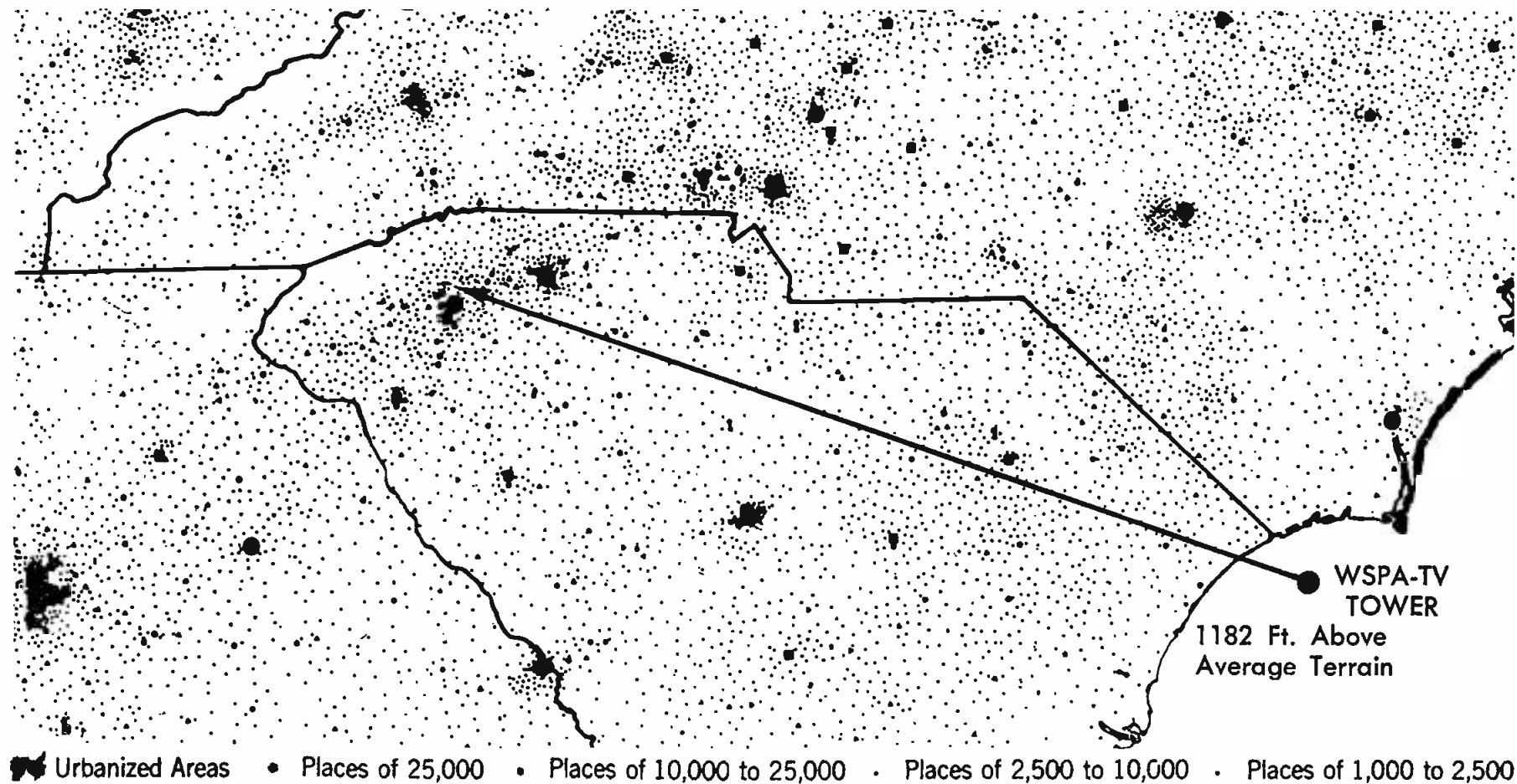

THE "Greenville-Spartanburg Metropolitan Area" now being considered in Washington for recognition by the Federal Committee on Standard Metropolitan Areas has an estimated population of 375,000. It would rank 60th in U. S. metropolitan areas. The above map shows this concentration of population. Within 75 miles of the WSPA-TV antenna on Paris Mountain, six miles from Greenville as indicated by arrow, there are 1,788,361 people. This is a larger population than in a similar area around Atlanta, Birmingham, New Orleans, Houston, Miami and other major cities.

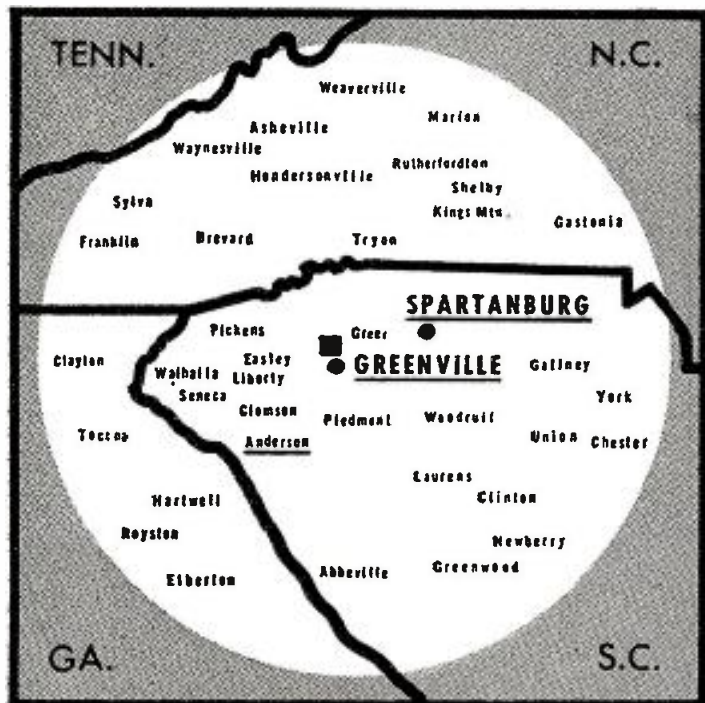

WSPA-TV IS NEAREST THE PEOPLE AND
SERVES THEM BEST WITH CBS.



WSPA-TV with its antenna on Paris Mountain is at the very core of the magic Piedmont Industrial Circle. The Channel 7 RCA 12-Bay antenna is 1182 feet above average terrain and 2209 feet above sea level. Height and location enables WSPA-TV to blanket the Spartanburg-Greenville Supermarket with the best television picture.

FOR FURTHER DETAILS, CONTACT:

GEORGE P. HOLLINGBERY COMPANY

**WSPA-TV IS THE ONLY CBS, VHF STATION
SERVING THE SPARTANBURG-GREENVILLE SUPERMARKET**

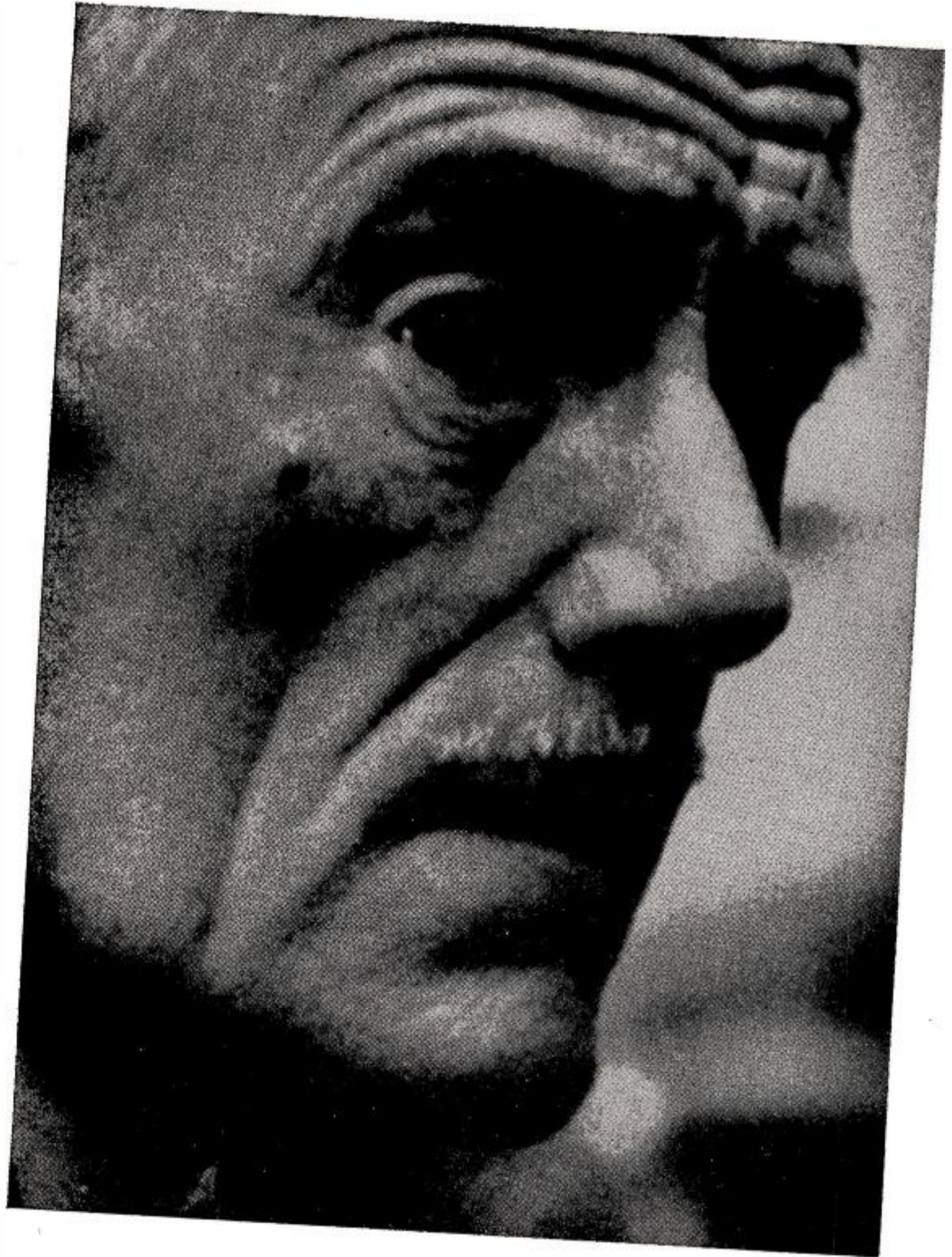



We need a new approach . . .

“Maybe the approach in that article I read might work. It has some intriguing aspects. Of course the problem that company faced isn’t exactly the same. But with a slight twist the basic idea might be adapted and it could give us just the edge we need to beat the competition.”

Today’s battle for the attention of top management is fiercely competitive . . . the constant winner is ideas. Top minds respond to ideas that provoke and demand action. This is the basic principle upon which the editorial-in-depth of Printers’ Ink is based. The principle of exploring, channeling, developing ideas that produce results. Consider the climate afforded by this kind of media, in which ideas generate immediate, intense interest, and *action*.

PRINTERS’ INK

BECAUSE IDEAS ARE AN EXECUTIVE’S MAIN BUSINESS

PRINTERS' INK

BECAUSE IDEAS ARE AN EXECUTIVE'S MAIN BUSINESS



"It's pretty obvious that the tempo in marketing has stepped up sharply in the past few years. This means that everyone in our organization must be on his toes to keep up with, and *ahead of* competition.

"Marketing information as thoroughly revealed through articles in Printers' Ink is one means of keeping in touch with these changes. Hence, I personally make it a point to include PI in my selective list of reading. Series like the recent one on distribution are required reading in the sphere that's most important to *me* and our business."

Lee H. Bristol Sr., Chairman • Bristol-Myers Company

KEY PRINTERS' INK READERS AT BRISTOL-MYERS COMPANY

Lee H. Bristol, Sr., *Chairman* • William M. Bristol, III, *President, Bristol-Myers Products Div.* • Lee H. Bristol, Jr., *PR Dir., Bristol-Myers Products Div.* • Robert B. Brown, *Exec. V.P. Bristol-Myers Company* • J. R. Burrows, *Sales* • Bruce J. Cokeley, *Product Mgr.* • John Cookson, *Product Mgr., Bristol-Myers Products Div.* • Ida B. Crawford, *Dir. Educ., Bristol-Myers Products Div.* • Michael K. Doherty, *Product Mgr., Bristol-Myers Products Div.* • John Eastman, *Product Mgr., Bristol-Myers Products Div.* • Harry Fletcher, *Dir. Sales, Bristol-Myers Products Div.* • Donald S. Frost, *V.P., Dir. of Adv., Bristol-Myers Products Div.* • Edward Gelsthorpe, *V.P., Dir. Mktg., Bristol-Myers Products Div.* • Grace Kennedy, *Adv. Mgr., Bristol-Myers Products Int'l* • John Kennedy, *Product Mgr., Bristol-Myers Products Div.* • F. R. McBrien, *President, Bristol-Myers Co., Canada, Ltd.* • James L. Macwithey, *PR Dir., Bristol-Myers Company* • Edmund W. Morris, *Product Mgr., Bristol-Myers Products Div.* • James Morrow, *Sales* • John Nicholas, *Product Mgr., Bristol-Myers Products Div.* • Clayton J. Rohrbach, *Product Mgr., Bristol-Myers Products Div.* • Frederic N. Schwartz, *President, Bristol-Myers Company* • John Tyner, *Product Mgr., Bristol-Myers Products Div.* • Richard K. Van Nostrand, *Product Mgr., Bristol-Myers Products Div.* • Roger K. Whitman, *Bristol-Myers Products Div.* • Alfred A. Whittaker, *Dir. Mkt. Res., Bristol-Myers Products Div.*

Partial Alphabetical Listing

Agency	Agency's Total Annual Billings*	Printers' Ink Readers†
BATTEN, BARTON DURSTINE & OSBORN, INC.	\$208,700,000	64.29%
BURDICK & BECKER, INC.	\$2,933,847	83%
DOHERTY, CLIFFORD. STEERS & SHENFIELD, INC.	\$23,200,000	76.92%
NOYES & SPROUL, INC.	\$5,000,000+	93%
YOUNG & RUBICAM, INC.	\$225,000,000	52.53%

AGENCIES
SERVING
BRISTOL-MYERS COMPANY

† Printers' Ink mail survey of Officers, Department Heads, Account Executives as published in Standard Advertising Register.

* As verified with agency

ASCAP treaty talks go on

All-Industry negotiators continued their discussions with ASCAP representatives last week in an effort to work out details implementing the broad agreement already reached on new ASCAP music licenses to replace those that expired Dec. 31.

The broad agreement, reached March 4 in sessions conducted under the sponsorship of Judge Sylvester J. Ryan of the U.S. Court for the Southern District of New York (BROADCASTING, March 9), is known to involve a reduction in payments as compared to the old contracts, but the exact formula must be worked out by the All-Industry and ASCAP negotiators. Spokesmen for the All-Industry Radio Music License Com-

mittee, which has the financial support of some 685 radio stations, expressed confidence that final terms would be reached amicably. When this is done, the committee will recommend acceptance, but it will be up to the stations individually to decide whether to accept or reject the terms.

The All-Industry committee, headed by Robert T. Mason of WMRN Marion, Ohio, and its counsel, Emanuel Dannett, conferred last Thursday with Herman Finkelstein, ASCAP counsel. It was not expected that further sessions would be held until after this week's NAB convention, of which Mr. Mason is co-chairman.

from 2½% of receipts from programs using BMI music up to 4% at the \$100,000-and-over level—the level at which CBS Radio will pay. In addition, the per-program license carries a charge amounting to 0.723% of card rate for sustaining programs (the blanket license has no sustaining fee).

Tv licenses with BMI are at fees 10% below the radio rates.

Committee Recommended • The All-Industry Radio Music License Committee, after negotiations with BMI earlier this year, recommended that stations accept BMI's offer of five-year renewals (BROADCASTING, Feb. 2). This committee, headed by Robert T. Mason of WMRN Marion, Ohio, also has been negotiating with ASCAP for new contracts to replace those that expired last Dec. 31 and has reached broad agreement with the society, although details remain to be worked out (see box above).

The approximately 50 BMI radio station licenses which had not been renewed as of last Thursday were described as held up, in most cases, by "mechanical" snags.

BMI officials acknowledged that some stations protested BMI's requirement that program logging be done at station expense, but they said these protests were no heavier this time than in past years and probably were fewer.

MGM-TV sells NBC-TV

In a \$2.5 million deal, MGM-TV will produce *Jeopardy* as a one-hour filmed crime anthology series for NBC-TV. The new agreement marks the second sale of an MGM-TV property to the network (*Northwest Passage* was sold last season). The new film series is set for scheduling next season.

AFM wins round one in trust fund fight

Hollywood musicians who are suing the American Federation of Musicians in an attempt to upset AFM's trust fund operations and divert royalty and wage increase payments to the working musicians have suffered a major setback. Last Tuesday (March 10) Judge Clarence L. Kincaid of the Los Angeles Superior Court knocked out the plaintiffs' claim for damages which account for some \$13 million of the \$15 million suit, filed in November 1956 on behalf of "some 6,000 musicians employed in making phonograph records.

Judge Kincaid upheld the objection of AFM attorneys that members of AFM, an incorporated association, cannot sue the association for damages, as that in effect would be suing themselves. Attorneys for the plaintiffs were granted a delay until March 24 to seek a review of the ruling by the District Court of Appeal.

Remaining in this action is some \$2 million in recording wage increases which AFM and the employers agreed were to be paid into the trust funds but which the plaintiffs are seeking to obtain for the individual working musicians. These funds were impounded by the court under control of a receiver. Similar suits, covering AFM contracts for work in films made for tv, in royalty payments for theatrical films sold for tv exhibition and for electrical transcriptions, are still awaiting trial.

Judge Kincaid also upheld a second AFM objection and ruled that when the trial resumes it will be before a judge only, without a jury.

EQUIPMENT & ENGINEERING

Tiny 'Nuvistor' tube introduced by RCA

RCA's Electronic Tube Div., Harrison, N.J., last Wednesday (March 11) displayed its "new look in electron tubes," the Nuvistor, in a presentation at the Park Sheraton Hotel in New York. Development of the thimble-sized Nuvistor was cited as a major breakthrough in tube size, performance, power drain and reliability. The advancement came about, RCA said, through the use of new materials, new processes and new techniques.

Among the demonstrations Wednesday was a completely "Nuvistorized" tuner unit of a television set in operation. The experimental tuner is reportedly the smallest ever designed for tv receivers and reduces the over-all volume of conventional tube tv tuner units by approximately one-third. In addition to the tube's advantages for entertainment equipment uses, Nuvistors will offer more compact and efficient electronic equipment for defense and industry, said D. Y. Smith, vice president-general manager, tubes.

Mr. Smith announced that developmental Nuvistor samples will be furnished within the next few months to interested electronics laboratories and equipment manufacturers. Small-signal triodes and tetrodes will be offered at first, and later it's expected beam power tubes will be provided. Limited commercial production of Nuvistors is planned to start in the first half of 1960.

Features highlighted at the preview: elimination of mica support discs or spacers through use of a strong ceramic base-wafer as a platform for erection of the tube electrode assemblies, cylindrical symmetry and cantilever construction permitting use of accurate jigs for assembly, brazing of assembly for strain-free structure, high-temperature processing resulting in super-clean structure, lugs indexed for easy insertion into tube socket, high-temperature operation and no-glass construction.

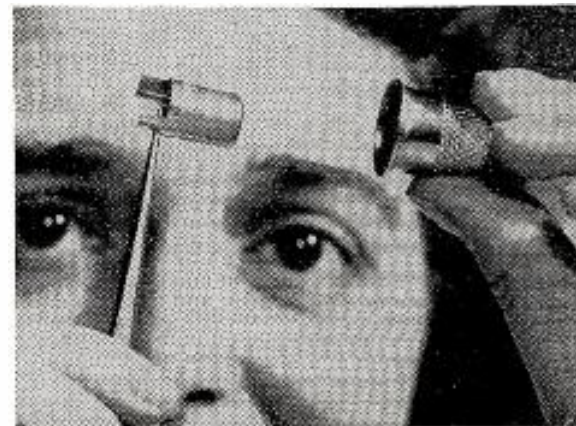

Nuvistor: fits into an ordinary thimble

FATES & FORTUNES

Advertisers

- HAROLD C. STUART, attorney and president-chairman of board, Southwestern Sales Corp., owner and operator of KVOO Tulsa, Okla., elected to board of directors of Greyhound Corp.
- JOHN J. SHAW elected v.p. in charge of marketing of Bon Ami Co., N.Y.
- WILLIAM M. STEDMAN, advertising director of American Home Products Corp. for 17 years, has retired. He will continue in consultative capacity. KENNETH R. BAUMBUSCH, Mr. Stedman's assistant, will handle major details of Mr. Stedman's job but it is understood no one will be appointed his successor.
- JOHN L. REMILLARD, formerly assistant account executive of BBDO, to Miles Products, division of Miles Labs, as product manager of One-a-Day vitamins.

Agencies



Mr. Dailey

JEROME J. COWEN, who returns to C&W's New York office.

- ROBERT W. DAILEY, formerly v.p. of McCann - Erickson, named executive v.p. of Cunningham & Walsh's west coast operations and general manager of its San Francisco office. Mr. Dailey replaces
- LEWIS H. HAPP, FREDERICK C. MAINE and DAVID J. WASKO elected v.p.'s of Geyer, Morey, Madden & Ballard Inc., N.Y. Mr. Happ formerly was media director of Geyer Adv., Mr. Wasko had been assistant to president of Morey, Humm & Warwick. Mr. Maine formerly was copy chief of MH&W.
- HAROLD J. GRAINGER, account supervisor and director of San Francisco marketing department, Compton Adv., elected v.p.
- WILLARD C. MACKAY JR., and DONALD G. GILL, account executives at Sullivan, Stauffer, Colwell & Bayles Inc., named v.p.'s.
- EMILE FRISARD, copy group head, Compton Adv., N.Y., elected v.p. and appointed assistant creative director.
- MARSHALL CLARK, v.p. of Ketchum, MacLeod & Grove, N.Y., elected director.
- RALPH W. BUGLI, special projects di-

rector of Doremus & Co.'s public relations division, N.Y., promoted to v.p.

- LINWOOD G. LESSIG, account executive of Al Paul Lefton Inc., N.Y., named v.p. in charge of technical advertising.
- CHARLES BENNETT STRAUS JR., formerly v.p. of Cunningham & Walsh, has joined Sudler & Hennessey Inc., N.Y., as executive assistant to president and director of consumer division.
- ROBERT M. HIXSON, president of Hixson & Jorgensen, L.A., for 25 years, retires from agency and as principal of company but will continue as consultant. KAI JORGENSEN, board chairman, adds duties of president.
- EARLE R. DUGAN, FRED RHODE and DANIEL J. SULLIVAN, all account supervisors in Foote, Cone & Belding's Chicago office, elected v.p.'s MRS. SHIRLEY POLYKOFF HALPERIN, New York copy supervisor, also elected v.p.
- CARL H. SIGLER, v.p. in charge of merchandising at Gordon Best Co., Chicago, announces resignation, effective May 15.
- NORMAN HEYNE, formerly partner of Wesley, Heyne & Cuca, Chicago, to Christiansen Adv., that city, as v.p. in charge of radio-tv.
- RAYMOND BROWNE, senior writer, Victor A. Bennett Co., N.Y., promoted to v.p. and creative head.
- DESMOND KENNEDY, formerly account executive in Grant Adv.'s Johannesburg (South Africa) office, to head new Grant office in Durban, South Africa. LEIGH J. BROWN, formerly assistant art director of Kenyon & Eckhardt, Detroit, to art staff of Grant's Detroit office. LEONARD E. VIS, formerly regional sales supervisor of Quaker Oats Pan American Inc., to agency's international department.
- JOSEPH H. VAAMONDE, assistant manager of Young & Rubicam's San Juan, P.R., office past two years, appointed manager of agency's Mexico City office.
- GENE DE GAINE, office manager and chief accountant of Van der Boom, Hunt, McNaughton Inc., L.A., promoted to treasurer.
- HAL DICKENS, formerly v.p. in charge of merchandising, Edward H. Weiss & Co., Chicago, to Tatham-Laird, that city, as merchandising counsellor. ART WATSON, Weiss account executive, also to T-L in similar capacity.
- HOWARD G. MYERS, formerly of Wall

Street Journal, to Boylhart, Lovett & Dean Inc., L.A., as copy chief.

- CHARLES LEE HUTCHINGS, creative director of McCann-Erickson, L.A., to copy chief at Donahue & Coe Adv., L.A. BUXTON LOWRY, who has held that position, has been given leave of absence for extended tour of Europe.
- DONALD C. ZUEHLSDORFF, formerly of Curtis & Burgis, Detroit, to Ketchum, MacLeod & Grove, Pittsburgh, as account executive.
- DONALD D. DOUGLASS to Charles F. Hutchinson Inc., Boston, as account executive.
- WILLIAM D. SAMUELS, formerly of W.S. Walker Adv., as account executive, to Pittsburgh office of Erwin Wasey, Ruthrauff & Ryan, as account executive on H.K. Porter account.
- JOHN J. MCCLEAN JR., formerly of McCann-Erickson as senior account executive, to C.J. LaRoche & Co., N.Y., as account executive on Revlon.
- JAMES E. CALHOUN, formerly account executive of KAND Corsicana, Tex., to open his own advertising firm in Corsicana April 1.
- JERRY SAMUELSON, formerly senior director of WCAU-TV Philadelphia, to Wermen & Schorr Inc., that city, as producer-director in radio-tv department.
- HOYT ALLEN, formerly executive producer in charge of all Procter & Gamble tv production at Benton & Bowles, N.Y., to Foote, Cone & Belding, N.Y., as tv commercial production supervisor.
- PAUL H. SMITH, formerly promotion director of KIRO-AM-FM-TV Seattle, Wash., to Honig-Cooper, Harrington & Miner, that city, as publicity director.
- CHARLES REICHLUM, formerly head of his own advertising art studio in Pittsburgh, named director of radio-tv of MARC & Co., that city. NORMAN SLEMENDA, with agency since last year, named art director.
- ROBERT RECHT, former owner of Rex Furniture Stores in Southern California, has re-opened his advertising agency at 1680 N. Vine St., Hollywood. Phone: Hollywood 2-1157.
- LAWRENCE D. REEDY, formerly of Abbott Kimball Co., to headquarters staff of American Assn. of Advertising Agencies for two month period.

Networks

- ROBERT CLAVER, producer and head

THE REGAL RECIPROCAL TV PLAN



YOUR UNSOLD TIME IS WORTH MONEY
When the broadcast day is done "tomorrow's" unsold time becomes "yesterday's" unsold time. Regal's Reciprocal TV Plan puts purchasing power behind "yesterday's unsold time" by contracting with stations today on a NO CASH BASIS (taking time instead of dollars). Regal stands ready to foot the bill for any film entertainment. We'll even assume the station's obligation already established for anything already purchased in exchange for "Cash Credits" for the use of time on your station spread over a three year period. This becomes possible through Regal's unique method of operation because Regal's clients can readily absorb up to ten million dollars worth of time. Presently they are on-the-air 100 times a day in nearly 200 markets. Use the REGAL RECIPROCAL TV PLAN to purchase anything of value by putting your unsold time to work with the full purchasing power of earned dollars. Regal also trades regularly on a cash basis for its many packages when stations prefer to deal this way.

REGAL CONVENTION SPECIAL

Zooming back to Chicago from somewhere in outer space and shattering sales records in major markets is the lovable, laughable and exciting COLONEL BLEEP and entourage — as timely as the Vanguard IV in orbit!

100 Fun-Packed full color outer space cartoons in combination with 390 Bleep Questions for programming **78 Half Hours**
234 Quarter Hours
390 Five-minute Segments

SPECIAL MERCHANDISING AND PROMOTION ASSISTANCE • FREE PRIZES
ADDED SELF-LIQUIDATING PRIZES WITH STRONG AUDIENCE APPEAL IF DESIRED.

Available to quality Stations on **REGAL'S NO CASH BASIS.**

Pay for this record breaking entertainment package with your unsold time.

Prepared to schedule time over two and three year period.

Meet the unearthly Oom-A-Gog, a 7-foot robot, and Colonel Bleep from outer space sharing earthly quarters with the live Stanley Grayson, Regal's Director of Station Relations, and equally live and kicking Sidney Barbet, Regal's Film V.P. They will give you all the details and set the schedules for you at the Sheraton Towers during Convention time in Chicago. Audition prints available for your Station's Staff after Convention.

SPECIALISTS IN TV AND RADIO TIME

Regal Advertising Associates Corp. concentrates its entire effort on generating desirable TV and radio time for its clients. The full impact of the entire Regal organization is placed behind this single purpose: to become specialists — experts, if you will — in this dynamic medium. Our underlying two-

fold purpose is to serve stations in their entertainment requirements and clients in their time needs. We are completely staffed with researchers, time buyers, film and station relation personnel, to render the maximum of service to station and client alike.
WRITE, WIRE OR TELEPHONE ANYTIME!

REGAL ADVERTISING ASSOCIATES CORP. *specialists in TV and radio time*

575 LEXINGTON AVENUE • NEW YORK 22, N. Y.

writer of CBS-TV's *Captain Kangaroo*, has resigned to produce forthcoming *Jimmie Rodgers Show* on NBC-TV. No replacement for Mr. Claver has been set on *Kangaroo* staff.



Mr. Corcoran

- CHARLES E. CORCORAN, since August 1957, facilities manager for RCA building, in charge of all live studio operations, appointed manager, videotape, film and kinescope operations for NBC-TV.

- CHARLES KURALT, CBS News reporter-contact, N.Y., named CBS News correspondent, assigned to New York. MARVIN KALB, currently CBS News writer, replaces Mr. Kuralt. Replacing Mr. Kalb is RICHARD RICHTER, for 3½ years assistant city editor of *New York World-Telegram & Sun*.

Stations

- ARTHUR M. TOLCHIN, v.p. of WMGM New York, elected v.p. of Loew's Theatres Inc. in charge of station.



Mr. Hix

- ROBERT S. HIX, formerly general manager of KOA Denver, to KHOW, that city, in similar capacity. Mr. Hix was previously executive v.p. and general manager of KRES St. Joseph, Mo. Other KHOW

appointments: HARKER SPENSLEY and LYNN REED, formerly salesmen of KOA, named local sales manager and account executive, respectively.

- JOSEPH T. CONWAY, national sales manager of WIBG-AM-FM Philadelphia, appointed national radio sales and merchandising manager of all seven Storer Broadcasting Co. stations. GEORGE U. LYONS, account executive of WJPK-TV Detroit, named midwest sales manager for radio-tv, Storer stations, effective March 30.

- ROBERT M. HANES, 68, banker, industrialist and director of Piedmont Publishing Co. (WSJS - AM - FM - TV Winston-Salem, N.C.), died March 10 in Winston-Salem hospital. Mr. Hanes gained prominence in many fields, was with Economic Cooperation Administration, once president of American Bankers Assn.

- JAY B. SONDEHEIM, formerly of WLYH-TV Lebanon, Pa., to KTVW (TV) Seattle-Tacoma, Wash., as sales manager.

- BILL WALKER, promotion manager of WFGA-TV Jacksonville, Fla., named

regional sales manager. JERRY ALLEN, assistant in advertising and promotion department, succeeds Mr. Walker as promotion manager.

- LOU TOROK, formerly part owner of KCAP Helena, to KMSO-TV Missoula, both Montana, as local sales manager.

- JESS LAND, formerly sales manager of KGEE Bakersfield, Calif., to KIKK, that city, as general manager.

- DANIEL DIENER, formerly v.p. of Leo M. Bernstein & Co., Washington, D.C., named v.p. and general manager of WUST-AM-FM, that city.

- R.W. (BILL) BURDEN, formerly general manager of KWIK Pocatello, to KEEP Twin Falls, both Idaho, as owner-manager. BILL ADELSTEIN, formerly sales manager, replaces Mr. Burden as general manager of KWIK.

- ROBERT J. BROWN, 49, commercial manager of WTAG Worcester, Mass., died March 11 in Fairlawn Hospital, Worcester, where he was under treatment for heart condition.

- CLAYTON KAUFMAN, director of sales promotion of WCCO Minneapolis-St. Paul, appointed director of expanded sales promotion and research department.

- ED WALTERS, sales representative of WFMF (FM) Chicago, promoted to sales manager. SY NELSON named WFMF program director.

- WILLIAM D. PABST, v.p. and general manager of KTVU (TV) Oakland-San Francisco, elected president of California Broadcasters Assn., succeeding GEORGE WHITNEY, v.p. and general manager of KFMB-AM-TV San Diego. Other CBA officers: WILLIAM E. GOETZE, KFSD-AM-FM-TV San Diego, first v.p.; ARTHUR WESTLUND, KRE-AM-FM Berkeley, v.p. for radio; CLARK GEORGE, KNXT (TV) Los Angeles, v.p. for tv, and M.F. WOODLING, KHSL-TV Chico, secretary-treasurer.

- ALLAN W. CAMERON named general manager of Dartmouth College's WDCR Hanover, N.H. Other appointments: ROGER J. SCHULZ, program director; FRANK R. GREENBERG, business manager, and DON B. KNAPP, technical director.

- ERWIN J. (TINY) MARKLE resigns as air personality and v.p. in charge of programming of WAVZ New Haven, Conn.

- W.C. (DUB) ESTES appointed commercial manager and personnel director of KBEC Waxahachie, Tex., succeeding LEON (CHUCK) JOSLIN, effective April 1. Mr. Joslin joins Paul Jones

Electric Co., Hobbs, N.M., in sales post.

- HAROLD K. CARPENTER, 58, account executive of KNX Los Angeles and Columbia Radio Pacific Network, died March 10 of cerebral hemorrhage.

- FLOYD KALBER, newscaster of KMTV (TV) Omaha, adds duties of director of public relations. JIM ROBERTS, newsman, promoted to news editor.

- KARL HAAS, founder and president of Chamber Music Society of Detroit, named director of fine arts of WJR Detroit, effective May 1.

- JUDD A. CHOLER, formerly promotion manager of WFMY-TV Greensboro, N.C., to WCAU-TV Philadelphia as sales promotion director.

- RUTH MUSSER, office manager of WMCA New York, elected to newly-created post of operations supervisor. RITA L. GARNER, formerly assistant advertising-promotion manager of Associated Artists Productions, named sales development manager.

- GUY S. HARRIS, formerly program manager of KDKA-AM-FM Pittsburgh, to WERE-AM-FM Cleveland as program director.

- JOE O'NEILL, program director of KVOO Tulsa, Okla., named director of newly-created department of production and recording.

- J. STANLEY PROBST is now assistant to THOMAS F. McNULTY, president of WWIN Baltimore, Md. BROADCASTING last week (March 9) incorrectly listed station as WINN Baltimore.

Representatives

- LON E. NELLES, formerly account executive of WGN Chicago, to Harrington, Righter & Parsons Inc., that city, in similar capacity.

- RANSOM Y. PLACE JR., formerly of WHEN-TV Syracuse, to New York sales staff of Young Television Corp. GUST J. THEODORE, formerly of Young & Rubicam as media buyer, to Young's Chicago sales staff.

Programming



Mr. Pearson

- JOHN E. PEARSON, previously sales representative of Sterling Films Ltd., Canada, named sales manager of Independent Television Corp.'s newly-created Canadian offices, to open shortly in Toronto.

- JOHN P. ROHRS, formerly v.p. and midwest sales manager of Bernard Schubert Inc., film producer-distribu-

“P” Points out proudly

A momentous occasion.

There’s a **NEW** Foreground Sound
For consumer persuasion.

In Greater Los Angeles,
hundreds of thousands
of radio dials
are tuned
to a vibrant new sound.

It’s the fresh, animated
Foreground Sound of
Radio 93, KHJ, Don Lee.

This important development
adds an entirely new dimension
to selling with radio.
Its bright, new appeal
is geared to reach
the entire adult buying population
in America’s 2nd Market
with a compelling, dynamic sound
that will keep them tuned
to Radio 93 throughout the day.

Hearing is believing.

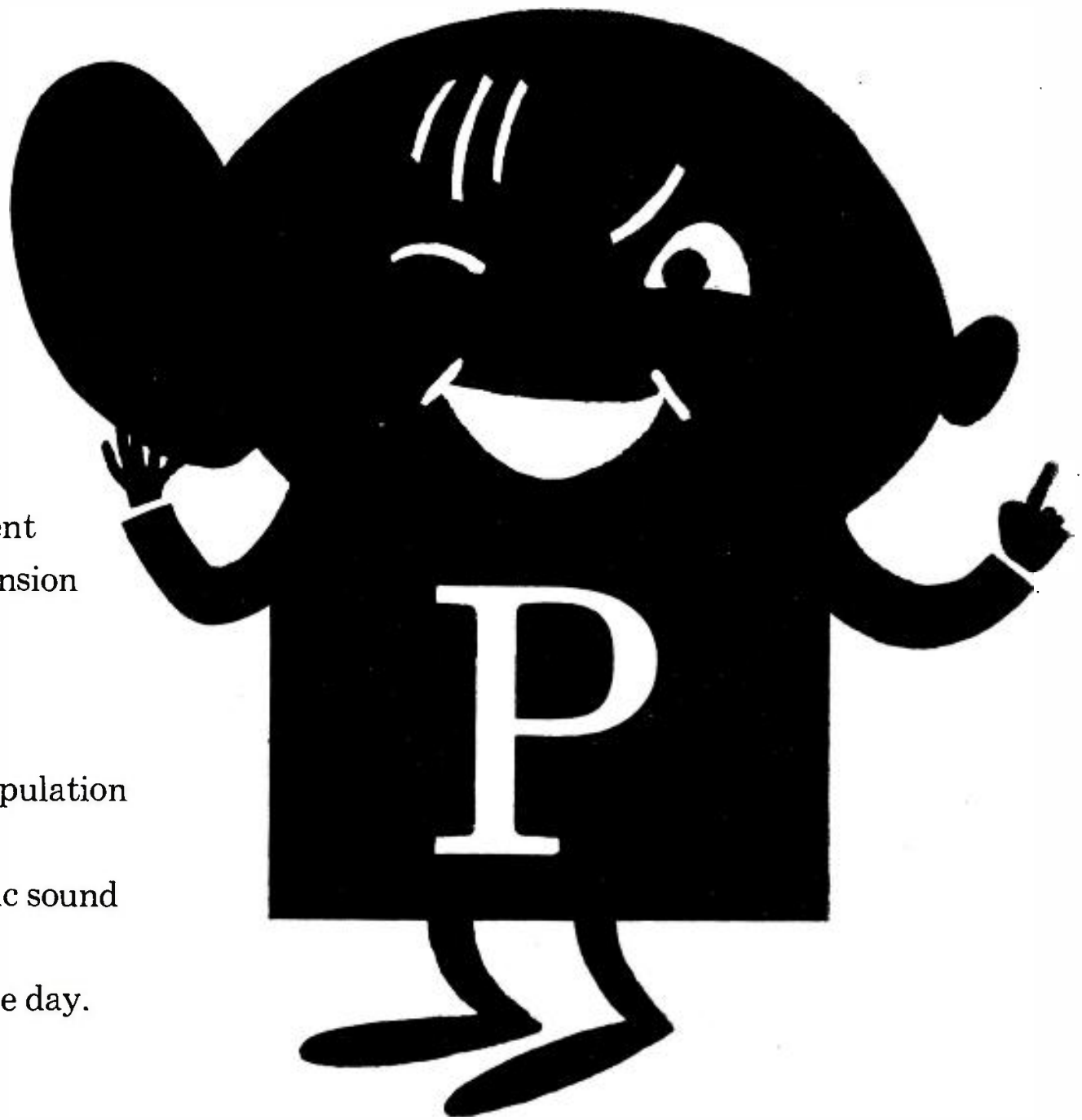

KHJ
RADIO

LOS ANGELES
1313 North Vine Street
Hollywood 28, California
Represented nationally by
H-R Representatives, Inc.



Listen to it!

tor, and v.p. of Gross-Krasne, appointed sales manager of Walter Schwimmer Inc., Chicago-based production-distribution firm.

- **ROBERT A. MONROE**, western division manager of World Broadcasting System Inc., promoted to general sales manager; **H. E. (MIKE) GURNEY**, most recently with KOFY San Mateo, Calif., replaces Mr. Monroe; **JOHN S. MURPHY**, formerly owner and president of WROD Daytona Beach, Fla., named sales manager of World and assistant to Mr. Monroe; **HAL TUNIS**, with World past two years, named spot sales manager; **DICK CRANE**, World sales executive in Memphis, promoted to southern division manager; **JIM MCKNIGHT**, formerly sales executive at WDAY Fargo, N.D., named midwestern division manager, headquartered in Minneapolis.

- **HARRY GOLDSTONE**, formerly head of Famous Pictures Film Exchange, N.Y., to sales staff of United Artists Assoc., as account executive in southern territory, covering Alabama, Georgia and Florida.

- **WILLIAM E. HUSTON**, formerly national sales manager of MPO Television Films Inc., to Filmways Inc. as director of international sales.

- **PHILIP FRANKEL**, formerly of Transfilm Inc., as unit manager and assistant director, to Klaeger Film Productions, N.Y., as assistant director.

- **LOU COSTELLO**, 52, who with retired Bud Abbott formed comedy team that was top motion picture and tv attraction for 25 years, died March 3 following heart attack in Los Angeles.

- **ROBERT BRENNEN**, formerly of Lewin, Williams & Saylor, and **JAY BERKSON**, formerly of WDSM-TV Duluth, to sales staff of California National Productions, Victory Program Sales Division, to cover New England and Minnesota-Wisconsin areas, respectively. **ROBERT SCHULTZ**, formerly of Shamus Culhane Productions and **FRANK O'DRISCOLL**, previously of Telestar Films and Guild Films, added to sales staff as eastern and midwestern representatives, respectively.

Equipment & Engineering



Mr. Krafve

Mr. Krafve will direct and coordinate activities of Raytheon divisions engaged in manufacture and distribution of commercial and industrial products.

- **RICHARD E. KRAFVE** has resigned as v.p. of Ford Motor Co., Dearborn, Mich., to become group v.p.-commercial of Raytheon Manufacturing Co., Waltham, Mass. Mr. Krafve will direct and coordinate activities of Raytheon divisions engaged in manufacture and distribution of commercial and industrial products.

- **VINCENT BARRECA** was elected executive v.p. of Admiral Corp., succeeding **JOHN B. HUARISA**, resigned. Also named: **THOMAS J. LLOYD**, v.p. in charge of government electronics; **L. H. MOOS**, president of Midwest Mfg. Corp., and **STUART D. BROWNLEE**, president of Canadian Admiral Corp., two Admiral subsidiaries.

- **STEWART EDGERTON**, formerly controller of Chicago Parts Depot, Ford Motor Co., appointed v.p. and controller of Shure Bros. (electronic components, hi-fi equipment), Evanston, Ill.

- **ANDRE G. CLAVIER**, who retired as v.p. and technical director of ITT Labs, Nutley, N.J., appointed scientific advisor to Labs' president.

- **JAMES S. KNOWLSON**, 75, board chairman of Stewart-Warner Corp. and pioneer in electronics equipment, died following heart attack March 6. Mr. Knowlson joined S-W in 1934 and served as president from 1939-54. He was co-founder of Speedway Mfg. Co. and also member of Hoover Commission as well as chairman of Commerce Dept.'s business advisory council.

Allied Fields

- **FRANKLIN H. CRAF**, v.p., A.C. Nielsen Co., N.Y., named executive v.p. and director.

- **JOHN C. GILMORE**, v.p. of Community Club Services Inc., N.Y., appointed president, succeeding **JOSEPH B. MATHEWS**. **WILLIAM M. CARPENTER**, secretary-treasurer, also named executive v.p. Messrs. Gilmore and Carpenter have acquired controlling interest in company.

- **LT. GEN. FLOYD L. PARKS** (U.S. Army, ret.), 63, formerly chief of Army Public Information Div., died of cancer March 10 in Washington, D.C. Gen. Parks, quoted as saying, "Don't forget radio and run fast to catch up with television," during his tenure as public information chief, retired from the army in 1956 to become executive director of National Rifle Assn., post he held until his death.

- **JACKSON LEE**, formerly general manager of WDBF Delray Beach, Fla., to Paul H. Chapman Co., Atlanta, Ga., media brokers, as associate.

- **ROBERT G. DODER**, legislative staff writer of United Press International, appointed manager of St. Paul (Minn.) bureau.

- **GEORGE A. WILLEY**, assistant professor of speech and drama at Stanford U., named director of university's radio-tv institute, summer session beginning its 17th season this summer.



Mr. Pelzer

& Bowles and NBC.

- **BERNARD H. PELZER**, formerly account executive of ABC Radio, to Radio Press Inc., N.Y., new "voiced" news syndicate for radio stations, as administrative director. Mr. Pelzer was also with Benton

- **KARL A. SMITH**, 55, formerly communications lawyer of Hogan & Hartson, Washington, D.C., law firm, was found shot to death in his Washington apartment March 8. Mr. Smith, who retired last year, had been in failing health. His death was ruled suicide by deputy coroner.

- **WILLIAM H. BORGESANI JR.**, formerly attorney in special radio services bureau, FCC, joins Dow, Lohnes & Albertson, Washington, D.C., law firm. Other new associates: **KEITH E. PUTBRESE**, graduate of U. of Iowa Law School; **NORMAN C. PAULSON**, graduate of George Washington Law School; **JOHN P. SULLIVAN**, and **V. BAKER SMITH**, both graduates of Georgetown Law School.

Government

- **BERNARD STRASSBURG**, with FCC since 1943 and for past year chief of telephone division of common carrier bureau, appointed assistant chief of common carrier bureau, effective upon approval by Civil Service Commission.

- **DAVID C. WILLIAMS**, 53, CONELRAD counsel and former legal assistant to FCC Comr. Robert E. Lee, died March 12 in Washington, D.C., after suffering heart attack two days previously. Mr. Williams, admitted to D.C. bar in 1935, served as Capitol Hill secretary and in U.S. District Court for D.C., and is survived by his wife, son and three daughters.

International



Mr. Sedgwick

er and past president of Canadian Assn. of Radio & Tv Broadcasters. He was also v.p. of CKLW Windsor-Detroit. He is survived by his wife, Nena Martin; daughter, Mrs. Kenneth C. Marsden; brother, Joseph, former counsel of Canadian Assn. of Broadcasters; brother, William, and two sisters.

- **HARRY SEDGWICK**, 64, who retired as president of CFRB Toronto last month due to ill health (WEEK'S HEADLINERS, Feb. 2), died March 7 in Toronto General Hospital. Mr. Sedgwick was found-



more
COVERAGE
on

CHANNEL
3

**KTBS
TV**

SHREVEPORT
LOUISIANA

Folks just naturally take cover during Shreveport's long-hot summers. You'll find them enjoying TV in their air-conditioned homes.

And Nielsen #3 Survey says more of them —1,292,550—stay tuned to Channel 3 —KTBS-TV—in this four-state market that now ranks 71st in America.

Get the complete Coverage and Ratings story from your **PETRY MAN**.

NBC-ABC

E. Newton Wray, President and General Manager

SEC. 315: JOURNALISM BODY BLOW

Dr. Stanton says FCC ruling poses threat to modern democracy

FCC's extension of the Communications Act's equal-time requirement to newscasts was branded by CBS President Frank Stanton last week as "perhaps the most severely crippling decision ever to be handed down with regard to broadcast journalism."

In a militant speech prepared for delivery Saturday at the annual conference of CBS-TV affiliates in Chicago, Dr. Stanton said the decision posed "very serious implications not only for [television] but for the whole question of the effective working of democracy under the pressure of modern life."

Promising to fight the ruling through the courts if necessary, he said:

"If upheld, the decision will have two inevitable results. One will be an immediate practical effect on news broadcasting that can abridge radically both the usefulness of radio and television to our society and their total freedom as media. The second will be to set loose a thoughtless quantitative theory governing the role of journalism in a democracy that can be described only as a wholesale negation of principles that have been safeguards and supports of our democracy from its beginnings."

The decision he attacked—and he said he attacked it only insofar as it applied Sec. 315 to newscasts, although he felt Sec. 315 in any case is "an abomination"—was one in which FCC held that Lar Daly, a perennial candidate who was seeking both Re-

publican and Democratic nominations for mayor of Chicago, was entitled to time equal to that given Mayor Richard Daley and another candidate in news broadcasts (BROADCASTING, Feb. 23).

"Make no mistake about it," Dr. Stanton declared. "The Daly decision, for all practical purposes, makes it a mathematical impossibility for broadcasting to report any political campaign in its own way and take advantage of its own technical capabilities."

To furnish all 24 Presidential and Vice Presidential candidates in the last election with time equal to that given the candidates of the two major parties, he estimated, would have required "2,238 minutes, some 38 hours, or approximately 20% more than all the time spent by all our television network newscasts on all the news."

Dr. Stanton's speech was scheduled for the Saturday luncheon of the CBS-TV affiliates annual meeting, expected to attract more than 350 affiliate and network executives. He headed a roster of speakers which was scheduled to include CBS-TV President Louis G. Cowan and other top officials during the two-day meeting at the studios of CBS-owned WBBM-TV Chicago.

Dr. Stanton said he had intended to discuss the need for more fundamental information on what the American public thinks of television and for better informing the public about television—that on this subject "we are

convinced that we are beyond the stage where talking does any further good and we are going to act." But, he said, the Daly ruling held "commanding urgency" and therefore took precedence. "We will, instead, be reporting to you in the fairly near future in closed circuit presentations and other ways, our plans more fully to inform the public," he asserted.

FCC's Daly decision, he charged, "attempts to substitute a senseless mathematical formula for the responsibility of news editors in handling the news of political campaigns. I am firmly convinced that if we are deprived of this responsibility, we have opened the door to all kinds of invasions, restrictions and harassments of our news function."

Going further, he saw the ruling as one that "spawns a monstrous idea in a democratic society—the idea that quantitative mechanics are more important than the qualitative considerations of the degree to which people are informed during the critically important period of election campaigns . . . At no time in the democratic experience is a fully informed people more important than in making their electoral decisions . . . We are now witnessing the introduction of the revolutionary idea that informing the people is a secondary matter."

Dr. Stanton held that the public clearly would "unleash a fury of protests on any station or network" that



Stanton: declares war on Section 315



Cowan: says CBS-TV still is leader



Robinson: has program aces up sleeve

Introducing

**AN EXCITING NEW STATION
DELIVERING SATURATION
COVERAGE OF
METROPOLITAN NEW ORLEANS**

WVUE

CHANNEL 13

ABC Television in New Orleans
"THE BEST VIEW IN TOWN"

Owned and Operated by

NEW ORLEANS TELEVISION CORPORATION

Represented Nationally by

WEED TELEVISION CORPORATION

New York, Chicago, Detroit, Atlanta, Dallas, Boston, San Francisco, Los Angeles

**NIELSEN
AGREES—**



**MORE PEOPLE LISTEN
TO THE 6:00 P.M. NEWS
MONDAY—FRIDAY..... WCKY...**

than to any other program on any other station in Cincinnati
Exactly **699,500*** listeners per week

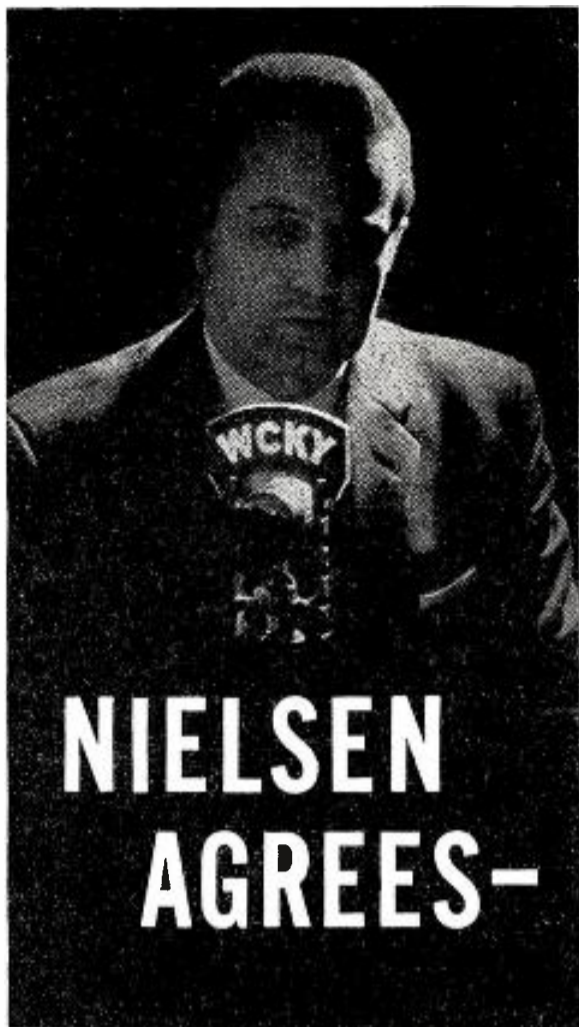

"More people listen to the 6 PM News on WCKY than to any other program on any other station in Cincinnati—699,500 people."

We didn't say it—Nielsen did in the November-December 1958 report. We've always known that Cincinnati depends on WCKY for news because WCKY is first and fast. Whenever news breaks, WCKY is there with news tapes and on-the-spot broadcasts with the WCKY News-mobile. If it's news, it's heard first on WCKY, and Cincinnati knows it!

... Your sales can make news too. Call Tom Welstead at WCKY'S New York Office, or AM Radio Sales in Chicago and on the West Coast. They'll tell you about the sales-power of WCKY'S News—33 times daily.

WCKY
50,000 WATTS
OF SELLING POWER

Cincinnati, Ohio

tried to use newscasts unfairly in a political campaign. "The Daly decision," he said, "not only distrusts the broadcasters as journalists; it distrusts them as businessmen, implying that they would not have the sense to see the fatal dangers of playing politics with the medium."

Moreover, he argued, if this ruling stands it might be extended in principle to printed journalism: "A case—utterly outrageous yet no more outrageous than the Daly ruling—could be made for the notion that if a magazine or a newspaper has a partially subsidized circulation through mailing rates, and records the words of one political candidate, then the other candidate should be entitled to equal space."

The decision, he continued, "tells the broadcasters the conditions under which they can report campaigns—indeed in a quantitative sense even the contents of the news programs. I say flatly that you cannot have any such halfway, crippling conditioned freedom of the press in America. Once the idea is established that the contents of news programs can be tampered with, restricted, harassed, controlled or regulated by a governmental agency in any medium during a political campaign, you open up a Pandora's box that can bring all kinds of harassments and restrictions.

"The idea must be knocked down now. It must be knocked down decisively. It ought to be knocked down unanimously."

More Meetings • In other sessions Saturday and Sunday the affiliates were slated to hear progress reports, plans and operations discussions by key network officials. The two-day meeting was to open Saturday morning with greetings from C. Howard Lane of KOIN-TV Portland, Ore., chairman of the affiliates association, and CBS-TV Network President Louis G. Cowan.

Mr. Cowan planned to review CBS-TV network progress generally and to assure the affiliates that "we have continued to maintain and advance for the fourth consecutive year our position of leadership in the industry."

His speech told the group that since the current season started last October "we have gathered the largest average nighttime and daytime audiences of any network," and that "of 11 new programs we have introduced this season eight have ranked first in their time periods" while "more than 50% of the new programs introduced by the other two networks ranked last in their respective time periods."

"Fundamentally," he said, "our primary concern as broadcasters must involve the quality of our program product—locally, regionally and nationwide. This, after all, is the life blood of

television. In this area I believe that we as a network have firm ground for optimism. Certainly this is indicated by the advertisers' expression of faith in the future stability of our program policy and by our continuing hold on the major attention of the television audience."

Hubbell Robinson Jr., programming vice president, was prepared to emphasize that television is "a mass medium" and that programs for the "cultivated mind," while important, represent "the peripheral job, not the main chance." CBS-TV's programming, he said, is aimed at hitting "the big bullseye right in the center."

Upcoming • While 30-60 days will be needed to complete next season's program plans, Mr. Robinson said, some of the shows will include: *The Blue Men*, story of two New York policemen, which will replace *Gale Storm* Saturdays at 9 p.m. EST. *Twilight Zone*, exploring "that area of man's experience which is startling, unpredictable and sometimes unexplainable" also will be added and is already sold, though he did not name the advertisers.

Without going into details he said a spectacular every week for 40 weeks, at the same time on the same night, was being developed as a project "which we believe can be as important, as revolutionary, as startling as *Playhouse 90* when we first launched that series."

Among other programs being planned, he said, are *Dennis the Menace*, *Peck's Bad Girl*, *The Wonderful World of Little Julius*, and *Countdown*. The last named, he said, is an hour show which will deal with the space world and will be slotted at 7:30 p.m. Tuesdays in an effort to overtake the competition in that period. Another hour-long show, which he did not disclose, is planned for Wednesdays at 7:30.

Mr. Robinson said CBS-TV currently has 103½ daytime quarter-hours sold as compared to 104 a year ago—and predicted that sales will run ahead in the next three months.

He said the biggest morning problem is *Morning Playhouse* at 10-10:30, and that this will be replaced by *On the Go*, a new program featuring Jack Linkletter, at a date to be determined. He called for greater station clearance, which he said is one of the problems of the 10 a.m. period.

He also reported that a new sales plan has been devised for *Captain Kangaroo* and urged stations to go along with this plan when its details are announced, in order to "assure the perpetuation of this very fine show."

William B. Lodge, vice president for affiliate relations and engineering, was slated to report both on affiliate and

technical matters, including conversion of two videotape recording machines in Hollywood for color use and installation of two vtr color conversions in New York. He planned to let it be known that CBS-TV is "staying in business" on color without spectacularly stepping up its regular color scheduling.

Richard D. Golden, director of sales presentation for CBS-TV, told network affiliates that westerns have been "the dominant" programming force this season and indications are they will be represented substantially on the schedules of the three television networks in 1959-60. He illustrated the "tremendous appeal" of this program form by pointing out that the average nighttime western has a "39% bigger audience than the average non-western program" (based on Nielsen figures).

To indicate that CBS-TV comes closer to achieving a "well-balanced" schedule than the other two networks,

Mr. Golden showed a chart of total nighttime tv programming. It illustrated that westerns occupied 12% of CBS-TV's schedule and 14 and 23% of NBC-TV's and ABC-TV's, respectively. Mr. Golden conceded that westerns will be replaced eventually by another type of programming but said the nature and the date of its emergence are unforeseeable.

Using Nielsen data for computation, Mr. Golden offered an array of statistics designed to show CBS-TV's superiority over the other two networks in terms of audience popularity and cost-per-thousand in the nighttime area.

Other speakers scheduled for the two-day meeting included William H. Hylan, sales administration vice president; George Bristol, operations director, advertising and sales promotion; Charles Steinberg, information services director, and—when the sessions resumed Sunday afternoon—Richard

Salant, CBS Inc. vice president, and Sig Mickelson, vice president and general manager of CBS News, followed by a panel discussion with questions by affiliates. The annual banquet was to be held Saturday night at the Drake Hotel's Gold Coast room.

Miami sale off

The proposed \$800,000 sale of WCKR-AM-FM Miami to Sun Ray Drug Co., announced in the spring of last year (BROADCASTING, May 26, 1958), has by mutual consent been cancelled, Niles Trammell, president of seller Biscayne Television Corp., announced last week. Biscayne also owns ch. 7. WCKT (TV) Miami. With the ch. 7 case tied up in the FCC on the *ex parte* issue (CLOSED CIRCUIT, Feb. 23), the sale of the radio outlets has been denied approval by the Commission.

TV IS NOW AT 86% SATURATION

Nielsen figures total television homes at 44 million

Continuing growth of television has boosted the number of tv homes in the past year to 44 million, or 86% of all U.S. homes, as against 42.4 million or 84% of all homes a year ago, according to A.C. Nielsen Co. estimates being released today (March 16).

The new figures, as of spring 1959, are described by the Nielsen company as "practical estimates . . . derived systematically by application of 'growth rates' since spring 1958 in terms of

changes in total homes and of television ownership penetrations patterns during the past year."

The estimates show total homes, tv homes and per cent of tv home coverage by state and region. Comparable updated county-by-county figures will be available starting this week.

Nielsen authorities said the new figures showed the greatest percentage gains in the regions of lowest tv ownership—notably the South Central and

Mountain areas—but pointed out that the rate of gain is slower as all regions approach the comparatively high level of 75% or better.

In percentage terms, tv penetration by major regions ranges from 78% for the South to 91% for the Northeast. In number of tv homes, the range is from 7,031,790 in the West to 13,690,930 in the North Central.

The Spring 1959 Nielsen estimates follow:

	Total Homes	TV Homes	% TV		Total Homes	TV Homes	% TV
TOTAL U. S.	51,350,000	44,000,000	86	District of Columbia	241,600	219,640	91
NORTHEAST	12,978,300	11,851,960	91	Florida	1,344,700	1,074,160	80
NEW ENGLAND	2,933,500	2,682,020	91	Georgia	1,011,600	780,990	77
Connecticut	699,900	642,330	92	Maryland	845,900	748,920	89
Maine	259,300	230,540	89	North Carolina	1,107,200	850,300	77
Massachusetts	1,455,600	1,339,770	92	South Carolina	583,700	438,780	75
New Hampshire	166,800	150,420	90	Virginia	1,016,400	816,240	80
Rhode Island	246,900	228,150	92	West Virginia	512,300	394,890	77
Vermont	105,000	90,810	86	EAST SOUTH CENTRAL	3,149,400	2,274,480	72
MIDDLE ATLANTIC	10,044,800	9,169,940	91	Alabama	831,700	616,560	74
New Jersey	1,723,600	1,587,620	92	Kentucky	824,000	603,010	73
New York	5,079,900	4,643,920	91	Mississippi	557,600	339,340	61
Pennsylvania	3,241,300	2,938,400	91	Tennessee	936,100	715,570	76
NORTH CENTRAL	15,367,200	13,690,930	89	WEST SOUTH CENTRAL	4,742,800	3,709,630	78
EAST NORTH CENTRAL	10,725,300	9,764,150	91	Arkansas	485,800	337,020	69
Illinois	3,040,500	2,760,050	91	Louisiana	855,500	661,600	77
Indiana	1,401,700	1,263,900	90	Oklahoma	678,400	545,010	80
Michigan	2,296,400	2,095,690	91	Texas	2,723,100	2,166,000	80
Ohio	2,851,800	2,635,890	92	WEST	8,320,200	7,031,790	85
Wisconsin	1,134,900	1,008,620	89	MOUNTAIN	1,904,200	1,456,380	76
WEST NORTH CENTRAL	4,641,900	3,926,780	85	Arizona	331,900	270,070	81
Iowa	843,200	753,940	89	Colorado	511,900	412,690	81
Kansas	678,100	549,630	81	Idaho	184,300	137,360	75
Minnesota	967,900	830,820	86	Montana	212,100	131,280	62
Missouri	1,342,300	1,175,110	88	Nevada	88,400	66,400	75
Nebraska	437,700	362,120	83	New Mexico	234,100	168,790	72
North Dakota	172,500	122,410	71	Utah	241,500	211,830	88
South Dakota	200,200	132,750	66	Wyoming	100,000	57,960	58
SOUTH	14,684,300	11,425,320	78	PACIFIC	6,416,000	5,575,410	87
SOUTH ATLANTIC	6,792,100	5,441,210	80	California	4,929,000	4,368,640	89
Delaware	128,700	117,290	91	Oregon	579,800	449,580	78
				Washington	907,200	757,190	83

TV'S NEW HOUSE OF ENTERTAINMENT OPENS TONIGHT ON WNTA CHANNEL 13



OPEN END WITH DAVID SUSSKIND

ONE OF THE FOREMOST CREATIVE MINDS IN THE TELEVISION INDUSTRY HAS CREATED "OPEN END"—PROVIDING VIEWERS WITH A HIGHLY WELCOME OASIS IN THE VAST DESERT OF MEDIOCRITY.

SUNDAY AT 10PM



THE MIKE WALLACE INTERVIEW SHOW

WALLACE, ONE OF THE MOST CHALLENGING REPORTERS IN TELEVISION HISTORY PROVIDES PENETRATING INTERVIEWS WITH EMPHASIS ON VITAL PEOPLE. AMONG THIS WEEK'S GUESTS: SAMMY DAVIS, JR.

MON-FRI 10:30PM

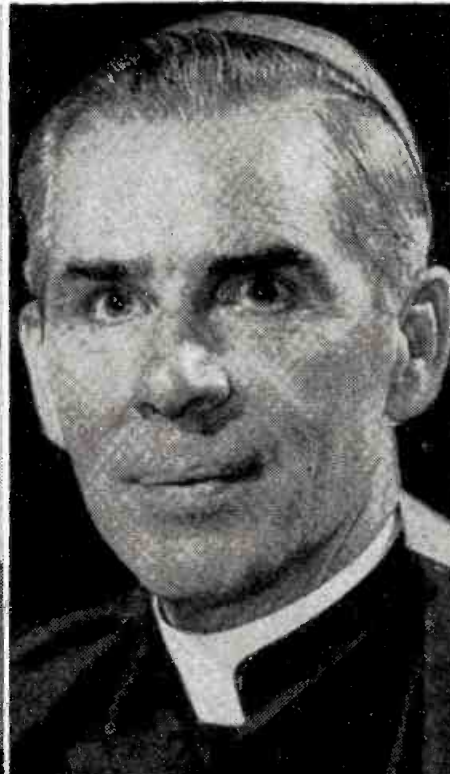

BISHOP SHEEN EDUCATOR & AUTHOR

ONE OF THE OUTSTANDING MEN OF OUR TIME DISCUSSES MODERN PROBLEMS OF THE HEART AND MIND. HIS DYNAMIC WORDS PROVIDE INSPIRING SPIRITUAL GUIDANCE FOR ALL MEN OF ALL CREEDS.

TUESDAY AT 8PM



ALEXANDER KING ALEX IN WONDERLAND

KING'S MAGNETIC PERSONALITY WILL ENTICE YOU TO FOLLOW HIM ON A MOST FASCINATING JUNKET DOWN THE RABBIT'S HOLE INTO THE REALM OF PROVOKING CONVERSATION & PROVOCATIVE PEOPLE.

WEDNESDAY 11PM



NEWSBEAT WITH MIKE WALLACE

THE MOST DEFINITIVE NEWS PROGRAM EVER TO BE TELECAST. A PENETRATING ANALYSIS OF VITAL NEWS. WALLACE REPORTS THE STORY BEHIND THE HEADLINES—THE FACTS BEHIND THE STORY.

MON-FRI 7:30PM



HENRY MORGAN AND COMPANY

MASTER WIT MORGAN HAS WON BRAVOS FROM THE CRITICS FOR HIS SPARKLING NEW COMEDY SHOW. "LAUGH-FILLED, HILARIOUS SHOW, YOU'D BETTER TUNE IN." BEN GROSS, THE NEW YORK DAILY NEWS.

FRIDAY AT 11PM



PETER POTTER JUKE BOX JURY

THE AMICABLE MR. POTTER HAS WON 2 "EMMY" AWARDS FOR CREATING ONE OF AMERICA'S MOST EXCITING STAR STUDDED PROGRAMS. A GALA ENTERTAINMENT FEATURING TOP HOLLYWOOD CELEBRITIES!

FRIDAY AT 8PM



RATE THE RECORDS FEATURING HY LIT

DANCEABLE, MUSICAL, ENJOYABLE... THIS SHOW, FAST BECOMING NEW YORK'S MOST POPULAR TEEN-AGE CRAZE, IS HOSTED BY HY LIT, THE MAN RAPIDLY BECOMING NEW YORK'S TOP-DISC JOCKEY.

THURS & SAT 6PM

JOIN US AT 'OUR HOUSE'... ENJOY A DYNAMIC NEW DIMENSION IN TV ENTERTAINMENT! REMEMBER: THERE'S ALWAYS SOMETHING INTERESTING HAPPENING ON CHANNEL 13. TV'S NEW HOUSE OF ENTERTAINMENT!

MUTUAL KEEPS WALKING TIGHTROPE

Intermountain stations depart as Smith group keeps up talks

Mutual managed to get through the week.

In an extraordinary demonstration of cliffhanging, the embattled radio network was still on the air at week's end. It hoped to be able to meet its affiliates at the NAB convention in Chicago yesterday (March 15) with assurances that it could turn last week's performance into a long run.

Key to the situation was the network's ability to land new ownership willing to take over Mutual's losses and capable of satisfying creditor demands. Negotiations with the Malcolm Smith

group, which had picked up a 7-day option to buy the network the week before (BROADCASTING, March 9), continued all last week, and both sides were hopeful final terms would be reached Friday (March 13).

But the network was having more trouble on the affiliate front. The Intermountain Network, including KALL Salt Lake City and 41 other stations, pulled out of its arrangement with Mutual in favor of a similar deal with ABC Radio (see below). Intermountain canceled MBS as of March 31. However, KALL will continue to feed Mutual to

the West Coast although it won't be carrying the network itself.

Don Lee Skittish • Other affiliates, including RKO Teleradio's Don Lee regional network, were having similar misgivings about taking a chance on Mutual being in business from one day to the next. It's known RKO Teleradio has talked with ABC Radio about possible affiliation for Don Lee.

The other entity Mutual was out to persuade was AT&T, the major creditor. Mutual owes the phone company over \$400,000, some of the obligations reaching back over a year. The phone company was given a check for \$25,000 by the Smith group last Monday, with further payments due later last week. Mr. Smith said AT&T had agreed to extend service "way beyond" last Friday, when Mr. Smith's option expired. He would not be more specific.

The other major creditors are the affiliates themselves. It's understood accounts in arrears are about \$130,000.

The Other View • Mr. Smith said his study of the Mutual situation found it "not as black as had been suggested." In fact, he felt the network was now near a break-even point in its operations, and might be able to reach that level as early as April, despite current difficulties. Further, he said Mutual had the "strongest profit potential of any radio network."

His program plans for the network, although far from firmly established, include an expansion of network service beyond the basic news service it has today. Presumably that expansion would be largely in the area of music. He remarked to an associate last week that "the last thing I want to do with Mutual is turn it into a mail order network"—this last obviously in response to trade statements that he would use MBS to sell his products on a mail order basis.

He said Mutual's current executive lineup would be retained. That includes Blair Walliser, executive vice president; Bob Hurleigh, senior vice president and head of the Washington operation, and Charles Godwin, station relations vice president. It appeared Mr. Smith would himself be chairman.

Mr. Smith estimated the various enterprises in his organizations have a total advertising budget around \$1 million annually, now split three ways among spot television, radio and print media. He estimated the combined companies as an \$8 million business.

The Smith Group • Malcolm E. Smith Jr., the man Mutual hopes to



ABC's DeGray (l), Intermountain's Hatch

Rival camp • If there was a silver lining in the clouds over Mutual last week, chances are it was labeled "ABC."

The first stations to break away from Mutual—KALL Salt Lake City and the 41-station Intermountain Network—signed an affiliation agreement with ABC Radio last week. Programming was to start yesterday (March 15).

KALL and Intermountain also cancelled their present agreement with Mutual as of the end of March. George Hatch, head of the group, said he had agreed to have further meetings with Mutual during the NAB convention this week, and that, conceivably, some new agreement might be reached to clear some of that network's time. But first call would go to ABC.

ABC Radio also stood a good chance of picking up the Don Lee Network, should that group elect to seek other affiliation arrangements

than those it now has with Mutual. Talks between ABC and Don Lee have been in progress for some weeks.

Terms of the Intermountain-ABC agreement were said to parallel the previous agreements with Mutual. That is, the regional chain would not be part of the nationwide network *per se*, but would be available to any advertisers who wanted to add it to their other ABC buys.

The new affiliations boost ABC's lineup to 330.

ABC Radio was making moves in other areas, too. It announced last week that it would increase news feeds and start a new series of "confidential" reports from its news correspondents as features of expanded programming to affiliates. Starting in April, according to Ed De Gray, vice president in charge of the radio network, ABC will provide daily reports of background material on major news events.

The exclusive reports, from both overseas and domestic correspondents, are expected to "add new authority and scope to local news programs," according to John Daly, ABC vice president in charge of news, special events and public affairs.

Other new programs planned for late March and April starts include: a daily medical report by Don Goddard; *Project Tomorrow*, twice weekly dramatic program of late developments in health, scientific, educational and other fields of public concern; a weekly 25-minute discussion from Washington between congressmen who represent opposite viewpoints on news subjects, and interview programs with the wives of Washington officials.

have as its new boss, is involved with his associates in a number of business situations, all closely intertwined.

At the top, is White House Co., a venture started 10 years ago. Below White House are Grand Award Record Corp., Waldorf Records Co., Waldorf Music Hall, Colortone Records, Audition Records, the C.C. Award Record Club and Harrison Home Products Co.

In addition there's Victor & Richards Advertising Agency, which places all advertising for the various Smith operations. All the companies and V&R share the same offices at 565 Fifth Ave. in New York. They also share officers: Mr. Smith, listed as president of Harrison Home Products, is copy chief of Victor & Richards; Richard Davimos, president of V&R, is a vice president of Harrison; Casper Pinsker, Harrison's general manager, is V&R's art director.

Mr. Davimos is one of the associates in the Mutual purchase plans. Another is Enoch Light, orchestra leader who is a vice president of Grand Award and Waldorf Records. Another is Cecil Hoge, president of Huber Hoge & Sons Inc., a now-inactive agency. Mr. Hoge also has his offices in the 565 Fifth beehive, but it could not be determined exactly where he stands in the other Smith companies.

Ade Hult, the former Mutual executive who made the original contact between Mr. Smith and the network, was still in the picture last week, but not in focus. Some reports had him slated for a top executive job under the new management, but Mr. Smith said that was undetermined. It was not known if Mr. Hult would share in the ownership.

What Smith Had to Sell • Grand Award produces albums of popular music for distribution through record and department stores. Waldorf Records does the pressing for some of the Smith labels. Audition Records are sold exclusively through F. W. Woolworth stores, and Colortone, another Waldorf label, through chain stores.

Harrison is the import-export side of the Smith businesses. It handles Adiator, an adding machine from Germany; Vivif, a fishing lure from France, and AddiPresto, another adding device from Italy.

From Bull to Broadcasting • Mr. Smith, who is 41, has a colorful ancestry. Smithtown, Long Island, where he has lived all his life, was named after an ancestor Richard (Bull) Smith. The story goes that "Bull" bought the land where Smithtown now stands from the Nisequogue Indians, giving them trinkets and the like in return for all the land he could ride around in one day on his bull.

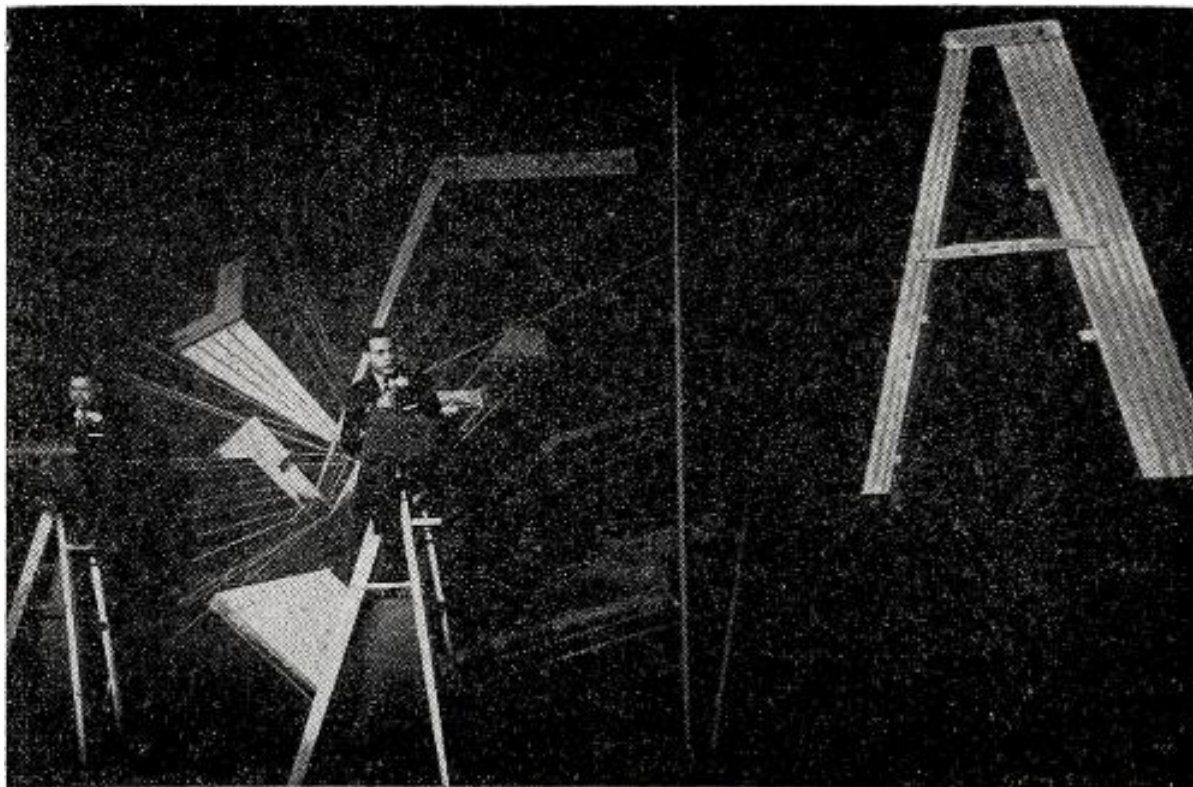

Perch-men: Mr. Briller (l) and Mr. Coyle take up their posts for ABC-TV New York presentation

ABC-TV ASSAULT ON SUMMIT

\$100,000 pitch tells tale of uplift

ABC-TV was slated today (March 16) to tell its story of shooting for "the top" in network tv for the third time in less than two weeks.

Except for a presentation scheduled yesterday (Sunday) in Chicago, two of the Cellomatic shows (today's and one in New York last Tuesday) were for advertiser and agency executives. The network reportedly budgeted about \$100,000 for total cost of the shows, which introduce the "A" ladder motif, symbolizing the climb to the top.

ABC-TV on March 10 took over the Grand Ballroom in New York's Waldorf-Astoria to underscore its claims to higher ratings and greater audiences for its programs. The audience of agency-advertiser executives was near 1,000.

The presentation in the main stressed two points:

- ABC-TV has placed itself in the running competitively on the basis of ratings and audience with the other two networks.

- The network outlined what it thinks are weak spots in current nighttime schedules and previewed what it has planned so far for the next season.

In the competitive race: Of 24 major markets in which three networks compete with "equal facilities," ABC-TV says it has raised its average evening rate 21%.

In terms of the relative positioning of the three networks on their Nielsen multi-network area ratings for January and February last year (prime evening hours), ABC-TV reported a score of 16.8% compared to 31.7 for network "X" and 22.3 for network "Y."

Now those figures are 20.3 for ABC-TV, 21.3 for network "X" and 20.7 for network "Y," it says.

On nights of the week, ABC-TV claimed that last year it had leadership in average audience only one night of the week (Tuesday) but this year added leadership on Sunday, Thursday and Friday nights and noted it had the highest-rated show on each of these four nights. (Also included was the Nielsen Top Ten, the network asserting it has four this season compared to one last season, and according to the "latest Nielsen national report," has added still a fifth.)

Half Hours • Nighttime half hour leadership has doubled this season compared to last, ABC-TV claimed and pointed to 14 of its programs topping 10 million homes. Emphasized also: It is not horse opera only on ABC-TV. The network increased its use of specials for "more balanced programming" (cited were *Art Carney Meets Peter and the Wolf* and *Bing Crosby*).

The network also said it was clearing live approximately 90% of U.S. tv homes and had opened up 14 markets to its programming in the last few years. ABC-TV asserted that its cost-per-thousand per commercial minute this season was lower than the year before—down from \$3.15 to \$2.78—and lower than any one of the other two networks.

Future Programming • ABC-TV tentatively has scheduled for the next season a flock of new shows. Schedule highlights:

Monday—New episodes of *Cheyenne*, *Adventures in Paradise* (hour-long



WBNS RADIO

COLUMBUS, OHIO

John Blair & Co., Representatives



Number One by Pulse proves our continuous conviction that quality and good taste have never gone out of style.

EAST

Major daytime independent in one of the top 15 markets.

\$400,000

SOUTHWEST

Top rated fulltime regional independent in major growth market. Highly successful operation with good profits. \$140,000 down. Part of price as long-term lease.

\$400,000

NORTHWEST

This fulltime facility available for less than annual volume if cash is paid. \$100,000 cash.

\$120,000

Visit us in our suite at the Conrad Hilton—1322-23-24.

NEGOTIATIONS • FINANCING • APPRAISALS

Blackburn & Company

WASHINGTON, D. C. OFFICE

James W. Blackburn
Jack V. Harvey
Joseph M. Strick
Washington Building
Sterling 3-4341

MIDWEST OFFICE

H. W. Cassill
William B. Ryan
333 N. Michigan Avenue
Chicago, Illinois
Financial 6-6460

SOUTHERN OFFICE

Clifford B. Marshall
Stanley Whitaker
Healey Building
Atlanta, Georgia
JAckson 5-1576

WEST COAST OFFICE

Colin M. Selph
California Bank Bldg.
9441 Wilshire Blvd.
Beverly Hills, Calif.
CRestview 4-2770

dramas), and *The Troubleshooters* (adventure). Disclosure of *Troubleshooters* on ABC-TV was first official word of the network selected for the series already purchased by Marlboro (through Leo Burnett) from United Artists Television.

Tuesday—*Sugarfoot*, alternating with *Bronco*, *Wyatt Earp* and *Riflemen*, all proven shows slated to return with addition of *Captain of Detectives* starring Robert Taylor.

Wednesday—A new series, *Bourbon Street Beat*, a Warner Bros. series.

Thursday—*Zorro*, *The Real McCoys* and *Pat Boone* returning with addition of *Dick Clark's World of Talent* and *The Fat Man* series.

Friday—*Walt Disney Presents* and *77 Sunset Strip* will be augmented by new *Gale Storm Show* episodes and *Cry Fraud* (documentary technique applied to western).

Saturday—Addition of *The War Against Crime* (Warner Bros. series of hour-long dramas).

Sunday—Addition of *The Alaskans* (also Warner Bros.).

In The Works • Other shows being developed include *Lincoln Jones* (series about a crusading lawyer), *The Confessions of Willy* (Screen Gems production); *The Big Walk* (Screen Gems) about a patrolman; *Cissie* starring recording star Molly Bee; *Doc Holliday* (Warner Bros. western) and *Where There's Smoke* (about a "wacky" fireman).

ABC-TV's daytime programming, slated to be scaled down somewhat starting in April, got scant attention in the presentation.

Elements which lent color to the network's show: the 10-foot ladder perches for the narrator (see cut), Donald W. Coyle, ABC vice president and general sales manager for tv, and Bert Briller, ABC-TV's director of sales development; the sound and visual effects of Cellomatic; a live orchestra; appearance of seven top ABC-TV stars also atop ladders; and Magician Milbourne Christopher. Hosts were Oliver Treyz, ABC-TV president, and Leonard H. Goldenson, president, American Broadcasting-Paramount Theatres.

Changing hands

ANNOUNCED • The following sales of station interests were announced last week, subject to FCC approval:

• WOLF Syracuse, N.Y.: Sold to equal owners Ellis E. Erdman, J.J. Clynes Jr., George Abbott and Allan H. Treman by T. Sherman Marshall for more than \$400,000. Mr. Marshall will continue as a consultant to the station. Mr. Erdman has under his management WBKI

Montpelier, Vt., WTKO Ithaca and WEBO Oswego, both New York, as well as an interest in WACK Newark, N.Y. Mr. Abbott, textile manufacturer, has an interest in WTKO. Messrs. Clynes and Treman are lawyers. The sale was handled by Allen Kander and Co. WOLF is on 1490 kc with 250 w.

• KANS Wichita, Kan. Sold to Lee Vaughn and Merritt Owens by Harry Patterson and William O'Connor for \$210,000 including liabilities, for two-thirds interest. The sale was handled by Blackburn & Co. KANS is on 1480 kc with 5 kw, day, 1 kw, night, directional antenna different pattern day and night, and is affiliated with NBC.

• KLIK Jefferson City, Mo.: Sold to KFEQ-AM-TV St. Joseph, Mo., principals: Jessie Fine, Isadore Fine, Oscar Fine and Theodore Nelson (who has interests in WOHP Bellefontaine, Ohio, and WILO Frankfort, Ind.), by Jerrell Shepard for \$183,750. The sale was handled by Allen Kander & Co. KLIK is on 950 kc with 5 kw, day.

• KTIP Porterville, Calif.: Sold to The Gateway Broadcasters, composed of Gareth Garlund, Dr. Henry Lindgren and Leo McClatchey, by Ralph Miller for \$107,500. The sale was handled by Hamilton, Stubblefield, Twining & Assoc. KTIP is on 1450 kc with 250 w and is affiliated with ABC.

• WERI Westerly, R.I.: Sold to Dr. Augustine L. Cavallaro of New Haven, Conn., by William Sweeney for \$100,000. The sale was handled by Blackburn & Co. WERI is on 1230 kc with 250 w and is affiliated with MBS.

• WDEW Westfield, Mass.: Sold to Harold J. Martin and other local businessmen by Albert L. Capstaff, v.p. in charge of NBC Radio network programs, for \$85,000. Mr. Capstaff said because of his NBC appointment he thought it wise to dispose of station ownership, which also include WBZY Torrington, Conn., and interest in Pioneer Network. WDEW is on 1570 kc with 1 kw, day.

• WMCP Columbia, Tenn.: Sold to B.C. Eddins and John R. Crowder by 22 stockholder selling group (J.H. Dowling, president) for \$59,500. Mr. Eddins is senior partner and general manager of WFMH-AM-FM Cullman, Ala., and Mr. Crowder is senior partner and general manager of WEKR Fayetteville, Tenn. The sale was handled by Paul H. Chapman Co. WMCP is on 1280 kc with 1 kw, day.

APPROVED • *The following transfers of station interests were approved by*

BROADCASTING, March 16, 1959

The third party in a transaction

Buyers and sellers usually meet and take action through the helpful services of some one standing by.

The broker in today's business world—whether dealing in securities—real estate—insurance—or “what not” implements decisions. He works for every one concerned.

We're doing this very thing at the NAB Convention from our headquarters suite—Room 1119 A at the Conrad Hilton.

We are proud of the results we have produced for broadcasting executives over the years. The record is one which we would like to discuss with you.

ALLEN KANDER AND COMPANY

*Negotiators for the Purchase and Sale of
Important Radio and Television Stations*

WASHINGTON	1625 Eye Street N.W.	NAtional 8-1990
NEW YORK	60 East 42nd Street	MUrray Hill 7-4242

the FCC last week (also see FOR THE RECORD, page 158):

• WPRO-AM-FM-TV Providence, R.I.: Sold to Capital Cities Television Corp. (CBS commentator Lowell Thomas, Frank M. Smith and others) by Cherry & Webb Broadcasting Co. for \$6,508,808. This grant is conditioned that John B. Poole not convert his debentures into the approximately 1% of stock in WPRO-AM-FM-TV they would receive, as per an existing agreement between him and the stations, without first notifying the FCC. Mr. Poole is a minority stockholder of Storer Broadcasting Co. and the conversion of the debentures would involve him in the ownership of more than the maximum permissible stations. Comr. Robert Bartley abstained from voting in this grant.

Capital Cities is the licensee or permittee of WROW-AM-FM, WTEN (TV) Albany, and WCDB (TV) Haganman, both New York; WCDC (TV) Adams, Mass.; and WDNC-AM-FM, WTVD (TV) Durham, N.C. WPRO is on 630 kc with 5 kw, directional antenna night, and is affiliated with CBS. WPRO-FM is on 92.3 mc with 15 kw. WPRO-TV is on ch. 12 and is primarily affiliated with CBS-TV.

• KUEQ Phoenix, Ariz.: Transferred to Dynamic Communications Inc. (Walter Hall and Carson Cowherd) in

Advertisement

WLEE-WXEX TV KICKS OFF CCA #8

In a letter to Mr. John C. Gilmore, President of Community Club Services, Mr. Harvey L. Hudson, Jr., General Manager of Radio Station WLEE WXEX TV, Richmond, Virginia, said:—

"One of the first three stations to pioneer CCA, WLEE is proud of its association with the originators of this outstanding promotion.

Several years of growing Community Club Awards cycles have proved this to be a powerful audience as sponsor satisfier.

Long live Community Club Awards!"

CAA CONVENTION HOSPITALITY SUITE
CONRAD HILTON HOTEL—SUITE 1218A

**COMMUNITY CLUB
AWARDS**

**PENTHOUSE SUITE
527 Madison Avenue
New York 22, N. Y.
Phone: PLaza 3-2842**

lease deal for 20 years with option to purchase for \$261,319 by Frank Barc, George Sorenson and Jack Caveness. KUEQ is on 740 kc with 1 kw, day, directional antenna.

• KIMN Denver, Colo.: Sold to Mile High Stations Inc. (owned by Cecil and Joyce Heftel) by KIMN Inc. (A.L. Glasmann interests) for \$175,000. Mr. and Mrs. Heftel are part of multiple-owning Glasmann family group. Mr. Heftel, specifically, has an interest in KLO Ogden, Utah, and is an officer without stock in KGEM Boise and KLIX-AM-TV Twin Falls, both Idaho. KIMN is on 950 kc with 5 kw, directional antenna same pattern day and night, and is affiliated with MBS.

• WCUM-AM-FM Cumberland, Md.: Sold to Allegheny County Broadcasting Corp. (Hollis M. Seavey and wife) by The Tower Realty Co. (Karl F. Steinmann, president) for \$125,000. WCUM is on 1230 kc with 250 w and is affiliated with CBS. WCUM-FM is on 102.9 mc with 1.25 kw.

• WKTG Thomasville, Ga.: Sold to James S. Rivers (trading as Radio Station WKTG) by John H. Phipps for \$60,000, plus assignor agreement not to engage in radio business in Thomas County for 4½ years. Mr. Rivers owns or has interests in WMJM Cordele, WTJH East Point, WDOL Athens, WJAZ Albany and WCAL Waycross, all Georgia. Comr. Robert Bartley abstained from voting in this grant. WKTG is on 730 kc with 1 kw, day.

Hoosiers get access

Hoosier radio-tv newsmen have won a clear-cut victory obtaining the right to broadcast all public hearings of administrative bodies in the state of Indiana. The victory was couched in provisions of an Indiana bill (HR 548) declaring the "public policy" of the state is opposed to secrecy in public hearings. Gov. Harold W. Handley signed the measure into law March 11.

To facilitate the policy, according to the House measure, "all administrative bodies of the state of Indiana conducting public hearings shall allow the use of either recorded or live broadcasts of such hearings, subject to such reasonable rules and regulations as may be adopted by the administrative body holding and conducting such public hearings."

The movement to get relief for broadcasters on such coverage gained momentum last year with appointment of a state group headed by Fred Heckman, WIBC Indianapolis. Among newsmen credited with helping push the proposed legislation were Larry Richardson of WFBM Indianapolis; Allan Jeffries of WISH there and Bob Hoover, WIBC.

RCA, NBC SALARIES Bob Sarnoff gets big increase over 10 years

A 10-year contract starting at \$150,000 a year and increasing by \$10,000 annually to a top of \$200,000 has been signed by Robert W. Sarnoff, NBC board chairman, according to RCA proxy statements mailed to stockholders in preparation for the May 5 stockholders meeting. In addition he may receive "such other amounts" as the NBC board may fix "in light of [his] performance and responsibilities."

The statement showed Mr. Sarnoff received \$136,743 in salary in 1958, plus \$9,100 in incentive award payments and \$36,400 incentive payments to be "earned out" over the next four years. His retirement income at age 65 was put at \$105,600 a year.

Mr. Sarnoff's new contract, executed this year, is one of three reported in the proxy statement. The others: Elmer W. Engstrom, RCA senior executive vice president, for \$135,000 a year until his retirement at age 65 in 1966 (he received \$110,000 salary last year, plus incentive payments), and Charles M. Odorizzi, RCA executive vice president for sales and services, for 10 years at \$125,000 a year (he received \$100,000 last year, plus incentive payments). Like Mr. Sarnoff, they may receive such other additional amounts as the RCA board of directors authorizes.

Mr. Sarnoff's contract is for employment by NBC; Mr. Engstrom's and Mr. Odorizzi's, for employment by RCA.

Top Salaries • Highest salaried RCA officer in 1958 was Brig. Gen. David Sarnoff, board chairman, who received \$200,000 salary but no incentive payments. Frank M. Folsom, executive committee chairman, was second with \$165,000 salary and \$11,000 incentive payments (plus \$44,000 to be "earned out"); President John Burns was third with \$160,417 salary and \$19,962 incentive (plus \$80,038 to be "earned out").

The statement also reported \$425,000 paid to Cahill, Gordon, Reindel & Ohl for legal services in 1958.

Seventeen stock options have been granted this year to officers and other key employes to purchase an aggregate of 49,500 shares of RCA common stock at the market price on the date the option was granted. These include options for 10,000 shares each to Messrs. Robert Sarnoff, Engstrom and Odorizzi.

Meanwhile, although not shown in the proxy statement (because he is not an RCA officer or director), it was reported that Robert E. Kintner, NBC president, signed a 10-year contract at an estimated \$125,000 a year.

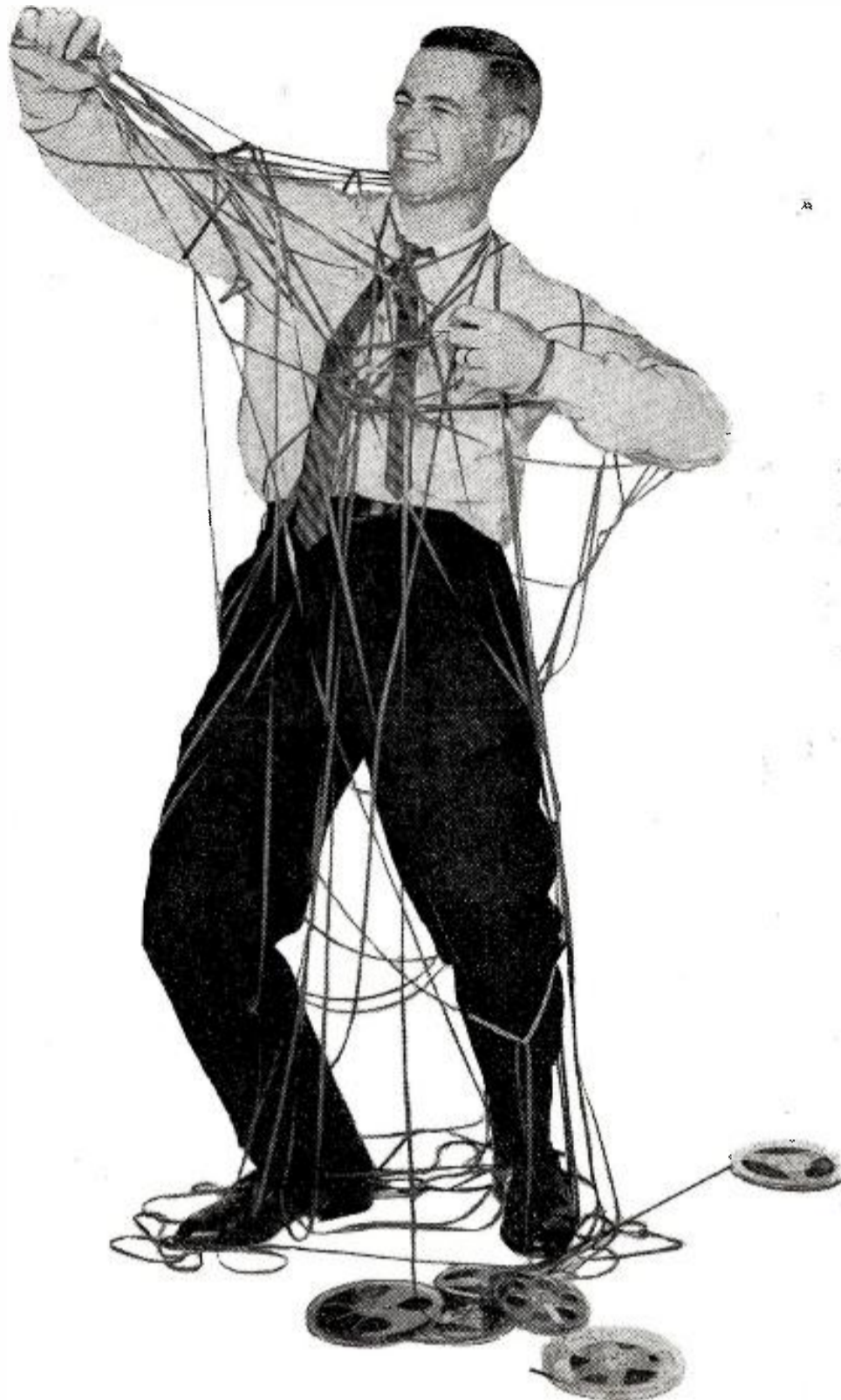

END TAPE FRUSTRATION FOREVER

with the new Collins AUTOMATIC TAPE CONTROL

It'll be the hottest item at the NAB Convention in Chicago!

All tied up in broadcast tape? Break that fumbling tape routine with the new Collins Automatic Tape Control. The touch of your finger makes you a production genius. That's all it takes for automatic, continuous programming. And you get the best high fidelity reproduction — equaled only by the finest tape equipment.

Collins Automatic Tape Control features completely automatic cueing, rewind and stopping; instantaneous no-wow starting; simplified handling and storage.

End your tape frustration. Get immediate delivery on the new Collins Automatic Tape Control. Collins will be at the NAB Convention to take your order.

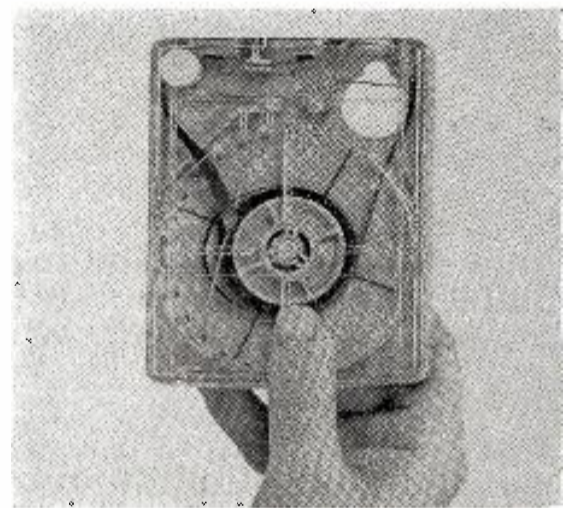

Cartridge only. Playback and record units are available for rack or console mounting.



COLLINS RADIO COMPANY • CEDAR RAPIDS • DALLAS • BURBANK



MERRILL LYNCH RATES RADIO-TV

. . . and finds electronics up, vtr long-range, film mixed

Merrill Lynch, Pierce, Fenner & Smith is the largest brokerage house in the business. A substantial share of the ownership of American industry traffics through its hands. Its opinions are sought daily by thousands of investors. There's no doubt that a Merrill Lynch opinion carries weight in the market place.

The following represents what Merrill Lynch thinks about the broadcasting industry. It was obtained in an interview recorded by BROADCASTING editors with the two industry analysts at Merrill Lynch whose particular specialities include broadcasting and amusement issues—Arch Catapano and Robert Beauvette, respectively (see biographies on opposite page). Their conclusions on the present and future prospects of the industry are of interest to all those who make their living—and those who would make money—in broadcasting.

MR. CATAPANO:

What is the economic outlook for the electronics industry in 1959?

The Dept. of Commerce forecasts sales at about \$7.9 billion, up roughly \$1 billion from 1958, which has been estimated at some \$6.9 billion. These figures do not include research and development expenditures. That's why figures from the Dept. of Commerce differ from those of the Electronics In-

dustries Assn. The EIA includes research and development and is projecting sales for 1959 at \$8.3 billion. That compares with something like \$7.7 billion for 1958. So the outlook is quite good.

This would be a record . . . ?

Right. Over-all figures are record highs.

Do you have figures which would show how 1958 compared with 1957?

Using EIA figures, 1958's roughly \$7.7 billion compared with \$7.6 billion in 1957.

What accounted for the increase?

The increase was due primarily to higher military expenditures. Consumer sales were down. The recession did hit the industry in the consumer field.

In the recently rising stock market, were electronics stocks ahead or behind other growth industries?

For the full year 1958 the electronics stocks acted better than the market, though defense shares outperformed the stocks of consumer companies.

Which companies were leaders?

Raytheon, Litton Industries, Texas Instruments, Avco and others in the defense field. These are the stocks that acted better than the market throughout the year. But, somewhere in the late summer, the consumer tv stocks, paced by Zenith, outperformed the

market, and they outperformed the market consistently in the last three or four months of the year.

Why has Zenith been so good consistently? [New high March 11, 241½.]

I think Zenith's performance is a reflection of its excellent operating results. During the recession, the company reported record sales and earnings. Zenith has also been getting a greater share of a shrinking market. That is, tv set production was down last year, and Zenith was getting a larger share of that decreased market. The company gained quite a bit of prestige in the marketplace.

How did RCA fare during the year, compared, say, with Zenith?

Zenith outperformed RCA marketwise, by a wide margin. As a matter of fact, RCA lagged behind the industry in the market. It wasn't until the last few months of the year that RCA started to act up marketwise. It's acted fairly well since. [RCA now is around 54.]

Why did RCA lag?

Well, there was the patent problem with RCA that confused some investors. Also, the losses on color tv didn't help. And their earnings for the early part of the year were down pretty sharply.

MR. BEAUDETTE:

In any discussion of electronics stocks, Ampex, of course, stands

out. My question is this: In the six months ending in October Ampex earned 36 cents. Do you feel that the earnings of this company are such that it can support the price at which the stock is selling?

Well, it's my feeling that the market does not reflect current earnings, but rather future earnings. Ampex is certainly not being valued on the earnings it showed for the first six months of the current fiscal year, but rather the company is being valued on what it can earn in '59, '60, '61 and the years thereafter. The operating outlook for the company is quite good. It reported record sales in fiscal '58, and the company just forecast a record level of activity for the current fiscal year, with sales up to around \$44 million and earnings at about \$1.40 a share. That's a pretty good gain versus last year when sales of \$30 million and earnings of 84 cents were reported. In addition, the company spends a lot of its own money on research and development, which also is taken into account by the investor. Thus, the investor is buying growth.

How much has Ampex stock advanced?

Well, there was a 2½ for 1 split during the year. Adjusted for this, the stock has had a range of about 17 to 75 during 1958-59. [Now selling about 75.]

Has videotape been the magic factor at Ampex?

Yes, definitely. Although it is in other lines, such as instrumentation, it's been primarily videotape. No question about it.

Is it correct that Minnesota Mining & Mfg. has about 50% of the tape market?

Yes—in terms of the production of magnetic tape. This includes videotape, computer tape, all kinds of magnetic tape. It's believed that Minnesota Mining has approximately 50% of the market, which probably amounted to something like \$20 million in 1958. This is not an industry statistic, it's just a guess. The other 50% is shared primarily by three companies: Audio Devices, ORRadio and Reeves Soundcraft. Audio probably has about 25% of the total market, and the remaining 25% is shared by ORRadio and Reeves.

Ampex has purchased 20% or so of ORRadio. How do you view ORRadio's future, then, with this tie-in?

Well, the ownership of ORRadio stock by Ampex unquestionably must be regarded as a favorable factor, at least to the extent that Ampex is able to persuade the users of its equipment to buy ORRadio videotape. The extent to which it is an influence, though, I really cannot say. Minnesota Mining

is, for all practical purposes, the only producer of vidotape today.

Would you comment on the other two companies, Audio and Reeves?

I think we can count all three in a group. All have reported very negligible earnings to date, and this in fact has not been a very good year for the companies. For example, Audio has gone into the production of silicon rectifiers, and the losses on these silicon rectifiers have offset about half the profits on the tape operation. As a result, the company is earning little. Neither ORRadio nor Reeves Soundcraft is reporting earnings of any significance whatsoever, either. Yet the stocks command fancy prices.

I think the person who's interested in the field is best advised to buy any two of the three, rather than to put all his money into one basket.

To what extent is the market in-

ulation on the continued success of its tv operations. Up until 1957 the theatre chain still contributed the largest single part of the company's overall revenue. In 1957 the tv and radio networks finally contributed somewhat more than the theatre operation. The assumption is that this trend continued in 1958. In any event, AB-PT's overall revenues will be up, while motion picture attendance was down and while, in fact, the company has continued to liquidate some of its theatres.

We think that the stock is basically a speculation on the success of the tv network. We do not think it is possible to say with absolute confidence that this success is assured. The company has certainly made amazing progress, relative to NBC and CBS. But ABC admits itself that this success has been based in large part on special types of programs, primarily westerns, and that

The industry is viewed by the analysts . . .



. . . from Merrill Lynch, Pierce, Fenner & Smith • The stock experts in this interview are Robert R. Beaudette (1) and Arch John Catapano. Mr. Beaudette joined Merrill Lynch in 1952, serves as industry specialist in amusements (which includes broadcasting) as well as atomic energy, office equipment, household equipment, hotel and hardware fields. He did graduate work in finance at U. of Southern California and is a Navy veteran. Mr. Catapano joined Merrill Lynch in 1950, serves as industry specialist in electronics, electrical equipment and building fields. He holds a master's degree in business administration from New York U.

interested in broadcasting stock *per se*, as distinguished from electronics?

Well, there's been some interest in ABC (AB-PT), based on the progress it has made in capturing a larger share of the television audience. The stock acted quite well in 1958, particularly during the first half of the year. The present price—around 24—compares with the 1958 low of 13 established in January.

Basically, ABC-Paramount is a spec-

the public's taste is so unpredictable that it's simply not possible to guess that the type of programming which is popular in one season will again be popular in the next.

Can you give us an estimate on growth of ABC in the coming year?

I cannot be quantitative about it. For 1958 ABC will have earned about \$1.30 a share versus \$1.10 in 1957, with tv contributing all this increase;

probably even more than that, since the theatre operation, we'll assume, was less profitable. As far as '59 is concerned, I would think further gains in earnings are logical, because the tv season extends from September into June. ABC apparently has a fairly good lineup for the current season, and we can see good earnings for the first half of the year, at least from this segment of the operation.

Theatre attendance, which is the other half of the story, is something else again. It's gone down now for I believe eight years in the past ten, and the decline in this past year was fairly substantial, amounting to about 5% in terms of paid admissions. I've been thinking that sooner or later this theatre attendance has to hit bottom, simply because of the growth in the population. But no really substantial recovery could be expected.

You said the earnings of ABC were roughly \$1.30 for the year ended Dec. 31, 1958. As of this date, what is the stock selling for? About 24.

So, based on a price-earning ratio, the stock is selling at about 16 or 17 times earnings, whereas a comparison with CBS with earnings of over \$3 a share, their stock is selling in the vicinity of \$38, as I recall. So based on a valuation standpoint, CBS is cheaper on a price-earnings ratio than is ABC. If you were going to buy one of the two stocks, would you feel that CBS would be a better purchase for long range, based first on earnings and second on growth?

If this case had existed, let's say, five years ago, the price-earnings ratios would probably be exactly the opposite that they are now, because CBS is, I would say, the better quality of these two stocks, is the larger company, the more firmly established of the two companies. I don't think ABC would argue with that too much. However, in our present market psychology, investors are willing to pay higher price-earnings ratios for smaller situations which, by virtue of the fact that they are starting from a smaller base, have got at least what investors would consider to be greater potential.

How do you feel about it?

ABC has the potential, but by no means the assured potential, of earnings considerably more than the figures which will be reported for 1958.

MR. CATAPANO:

Now that we've brought CBS into it, perhaps Mr. Catapano will want to make some observations on that stock.

Well, we consider Columbia to be a good quality stock, of higher quality

than most stocks in the—well, I guess you could call it the entertainment field. The stock sells very reasonably in relation to earnings. They probably earned around \$3.25 or a little more in 1958. The prospects are, with the economy apparently in an upward trend, that they will show even higher profits in the current year. On that basis, we consider Columbia to be an attractive situation.

In spite of the fact that I have a high regard for Columbia Broadcasting, my

Interview with the analysts:



Beaudette (l), Catapano

choice on a longer range basis would be RCA because of its diversification. RCA does work in the consumer area and is the industry leader. It has the major interest in color tv, which could grow substantially over the longer term, and is the second largest broadcasting company. It has a very important stake in another growing area, the military electronics field. The company also participates in commercial and industrial electronics. So in the case of RCA you get quite a bit of diversification. You don't get that in Columbia. Columbia is primarily a broadcasting company—and a good one. But on a longer range basis, I'd rather have more diversification in this growing electronics field.

It seems to me that in talking about broadcasting companies as such that you find the greatest amount of investor interest in those companies which have networks.

That has been our experience. Well, you have cases like Storer Broadcasting which is a very good company, has had an excellent record, but there is virtually no investor interest in Storer, at least in my experience. The same experience is felt also with local stations, local broadcasting companies.

Why?

Because the growth potential is limited by governmental restrictions on the number of stations they can operate. The only thing they can do is to upgrade their present operations, or exchange them for other stations.

How about Westinghouse, which operates Westinghouse Broadcasting?

It's such a small part of Westing-

house's over-all operation that it's virtually naught. Westinghouse is a huge company, saleswise. And while Westinghouse Broadcasting is important, as such, it's relatively small. Don't forget, Westinghouse is a \$2 billion operation, all told.

You say that Storer's growth potential, for example, is limited. However, I wonder whether from an investor's standpoint it might not be a good purchase for its 7½% return.

It's a good income situation, no question about that. But people don't seem to be interested in income nowadays. They seem more interested in capital gains. They're more interested in buying a stock at a certain price and selling it at a higher price, rather than holding it for income.

MR. BEAUDETTE:

In discussing AB-PT, you mentioned the interesting situation caused by their having both theatrical and broadcasting interests. Is this true of other firms—Loew's and Paramount and so on?

It's certainly true. In some cases more than in others. The stake of the individual motion picture producer varies as far as tv is concerned. For example, Warner Brothers produces more series for tv than any other Hollywood company. Their stake in the production of programs specifically for tv is large. Columbia is active in the field, too, through Screen Gems, which also is handling the release of their pre-'48 films to tv. So is Universal. Now, every company has sold its pre-'48 films to tv and the contracts are well spelled out. As far as production of pictures specifically for tv, this varies. Paramount is probably the weakest in the field and Warner Brothers, as I said, is the strongest.

How would you line up the other companies? Loew's, of course, is a story on its own. But just taking its tv activity, how does it stand now?

Well, Loew's has leased its pre-1948 films to tv for gross rentals which now amount to \$12-13 million a year. However, their production of films specifically for tv is small.

The *Wall Street Journal* said recently that Screen Gem's contribution to Columbia was the only factor in keeping them deeply out of the red. Do you agree?

Yes, that is apparently true.

What weight does the investing public give to television contribution to the film companies?

Let me broaden your question a bit, and review a bit. The motion picture production stocks have performed quite well this year. In fact, they have actually outperformed the market. This is

THE TALLEST TOWER IN THE WHOLE WIDE WORLD

the tallest man made structure

DESIGNED, FABRICATED

& ERECTED

by

KIMCO

ALMOST TO OUTER-SPACE-1619 FT.

In addition to the current 4 TALLEST TOWERS east of the Mississippi, Kimco will design, fabricate, and erect the tallest structure in the world at Portland, Maine for WGAN-TV.

When you want to go up, up, up or even higher than up, then write, wire or phone for full information on our one package . . . tower, lights, and erection included in one contract . . .

In all instances Kline assures on-time delivery and by all standards the top quality tower in the country.

For complete information call write or wire the ^{very, very} tall tower people—

KLINE IRON & STEEL CO.

KIMCO TOWERS FOR THE BROADCASTING INDUSTRY

Dept. T. P. O. Box 1013, Phone ALpine 4-0301 Columbia, S. C.



SOMETHING EXTRA



... has
been added
to the old
due bill!

AT THE NAB CONVENTION learn how the WORLD TRAVELERS' CLUB has brought the due bill idea up to date by adding a *new dimension* which makes sense for both station owner and advertiser.

FIND OUT just how the WORLD TRAVELERS' CLUB Pooled Advertising Exchange Plan provides:

- ... BUSINESS AND PERSONAL TRAVEL ACCOMMODATIONS in leading hotels and resorts . . . as well as airline transportation and the choice of high quality products.
- ... A BIG SELECTION OF PRIZES for listener and viewer contests.
- ... SALES INCENTIVE CONTEST PRIZES for time salesmen.

LEARN how leading radio and television stations throughout the country are now enjoying the benefits of this unique due bill plan.

DROP IN TO SEE US during the NAB convention in:

Suite 1604-5 in the SHERATON BLACKSTONE HOTEL

At the NAB: Robin Moore—Gene Fitts—Hal Wagner

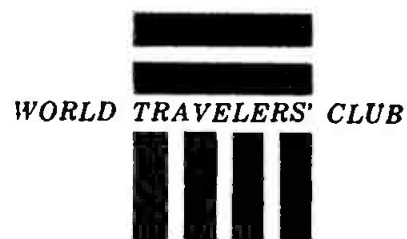

WORLD TRAVELERS' CLUB

THE WORLD TRAVELERS' CLUB, INC.

655 Madison Avenue, New York 21, N. Y. TEmpleton 8-4600

TO WORLD TRAVELERS' CLUB MEMBERS:

We look forward to welcoming you at our suite.

amazing when one looks at the over-all earnings picture. As I've already pointed out, motion picture attendance, which is the primary determinant of the producer's earnings, is down. The earnings picture in the industry is quite poor. 20th Century-Fox is having a record year, United Artists is having a record year, Paramount is having a fairly good year. Disney, if we can include this firm, has had a record year, based on Disneyland and tv earnings.

The rest of the companies are or have been sick.

Universal will show a large loss for its October fiscal year, Columbia has shown a loss for its June year, Warner Brothers showed a loss for its August fiscal year, and Loew's showed a very nominal profit for its August fiscal year. So half the companies in the industry either are not making any money or they're actually losing it.

Now, in the face of this over-all earnings picture, the stocks have done quite well, and my only explanation for it is that the industry is being appraised primarily on a liquidating basis. That is to say, investors are appraising these stocks based on underlying assets—what they could realize if they were sold. And this includes both the pre-1948 films and the post-1948 films. It includes, in some cases, the value of their real estate holdings. The fact that the stocks have done quite well also reflects the fact that some of the companies have reduced their capitalizations by buying in stock. This includes 20th, Paramount and Warner Brothers.

National Theatres' earnings are down about 70% from 1956. Now they are buying National Telefilm Assoc. and various broadcast properties. Do you feel this is a good move in the future of National Theatres?

I think they're doing what they had to do. They're attempting to buy into the industry which has been responsible for their deteriorating earnings position.

Do you think this trend will hold true with the rest of the motion picture companies? Do you think that eventually they'll be in tv more than they are now?

They'll certainly step up their production of films specifically for tv. I don't think there's the slightest doubt about this. You remember when tv first became a popular entertainment medium, it was commonly thought that the motion picture industry was aligned against it, and suddenly the motion picture interests realized that if you can't lick 'em, you join 'em. As far as the post-1948 motion pictures are concerned, the industry is now saying, at least, that they're not going to release them to tv. Mr. Skouras [of 20th Century-Fox] has

54-COUNTY COVERAGE

46TH TV MARKET

(Television Magazine Dec. '58)

26TH in LUMBER and HARDWARE SALES*

34TH in GASOLINE and SERVICE
STATION SALES*

39TH in DRUG SALES*

41ST in RETAIL SALES*

41ST in EFFECTIVE BUYING INCOME*

47TH in FOOD SALES*

including nearly 2,000 cities, towns and villages, is yours when you buy the WCIA Television Market—covering Central Illinois and Western Indiana.

WCIA, Channel 3, puts more than 1,951,900 (NCS #3) prospective customers in the palm of your hand. It places an effective buying income of \$3,504,010,000 at your fingertips.

You can reach more people in this rich area through WCIA, Champaign, Illinois, located just 128 miles from Chicago, 135 miles from St. Louis, and 124 miles from Indianapolis.

TOTAL FAMILIES

594,000 (NCS #3)

RETAIL SALES

\$2,210,444,000

TOTAL TV HOMES

370,100

TV Mag. March '59



WCIA 3
Champaign, Ill.

*Figures include only the 5 metropolitan areas and do not include the vast interurbia served by WCIA.

George P. Hollingbery, Representative

been the most vehement spokesman from that standpoint. He claims that the release of the pre-1948 films to tv was a great mistake, and I think the earnings figures of the producing companies bear him out.

Now I would not want to rule out the possibility, however, that one company, finding itself on the verge of bankruptcy, let's say, would not be forced to sell its post-'48 films to tv, and that if this happened, it might break the dike and the rest of the companies would also be forced to do so. It would be a little bit more difficult to sell the post-'48 films, however, because of the

problem of the guilds and the share of the income which they want.

Speaking hypothetically, which of the Hollywood majors are now so weak that they possibly might be liquidated and this situation might arise?

Well, one naturally would mention the companies which are operating unprofitably at the moment. Universal would be the foremost example. However, Universal has just sold and leased back its studio lot (to MCA). At least they've obtained a sum in cash to keep them going for awhile. And as you know, there's nothing so wrong with any

Interview with the analysts:



Beaudette (l), Catapano

given motion picture company that a good picture couldn't cure.

Let's go back to Disney. With a rise of almost 300% in the stock price last year, do you feel that the price position has been overextended, based on prospects, or are the earnings there to support a price of 50, having risen from 15 or so?

The earnings for the fiscal year ended September have just been released. They amounted to \$2.51 per share versus \$2.44 in 1957. The stock is selling then at about 20 times earnings.

They've had an unusually good year, and commenting on Disney it's only worthwhile pointing out that their product is of timeless value, really. You can sell it to one generation of children after another. It's a special situation within the industry. And Disneyland, too, has contributed earnings to the extent of about 35 cents a share. So Disney is entitled to sell at a little higher price-earnings ratio than the other stocks in the industry.

What about Desilu, and its public stock offering?

Well, it's hard to have an opinion on Desilu because the company has been in business for a relatively short period of time. There's little demonstrated earnings record on which to base an opinion. The earnings have not been large to date. The largest earnings were reported in the year in which they sold out *I Love Lucy*, which was undoubtedly their top show. As this development indicates, the stock is a speculation which hinges basically on the residual values of their tv series. The original offering was snapped up by investors because of the names behind it.

How do you regard the future of pay tv?

I think it's far from assured that there will ever be a pay tv system in this country of any significant importance—let's say, on a nationwide basis.

35
32

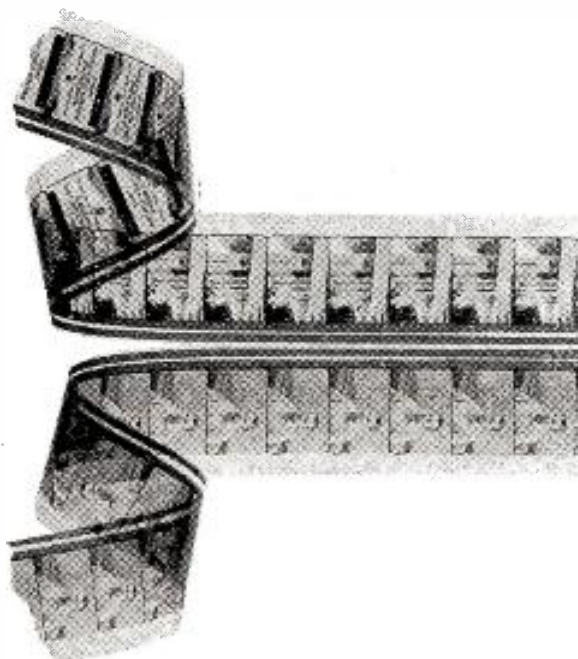

... a unique process pioneered by General Film in which a strip of 35mm film, perforated with 32mm sprocket holes, is split down the center to produce two 16mm prints of outstanding quality.

After successfully processing millions of feet of 35/32 black and white and color film we have observed many outstanding advantages and list a few: better sound quality, lack of roller abrasions in sound track area, the ability to use standard 35mm professional equipment, and the efficiency that comes from handling two prints in one operation. Negatives made on 35/32 film stand wear and handling of multiple printing much better than do 16mm negatives.

Additional information to help you apply these advantages to your own film needs is available on request. Ask for Bulletin G.

GENERAL
FILM LABORATORIES CORP.
1546 ARGYLE, HOLLYWOOD 28, CALIF., HD 2-6171

*Presented October 9, 1956 at SMPTE Convention at Los Angeles by William E. Gephart, Jr., V.P. of General Film Laboratories Corp

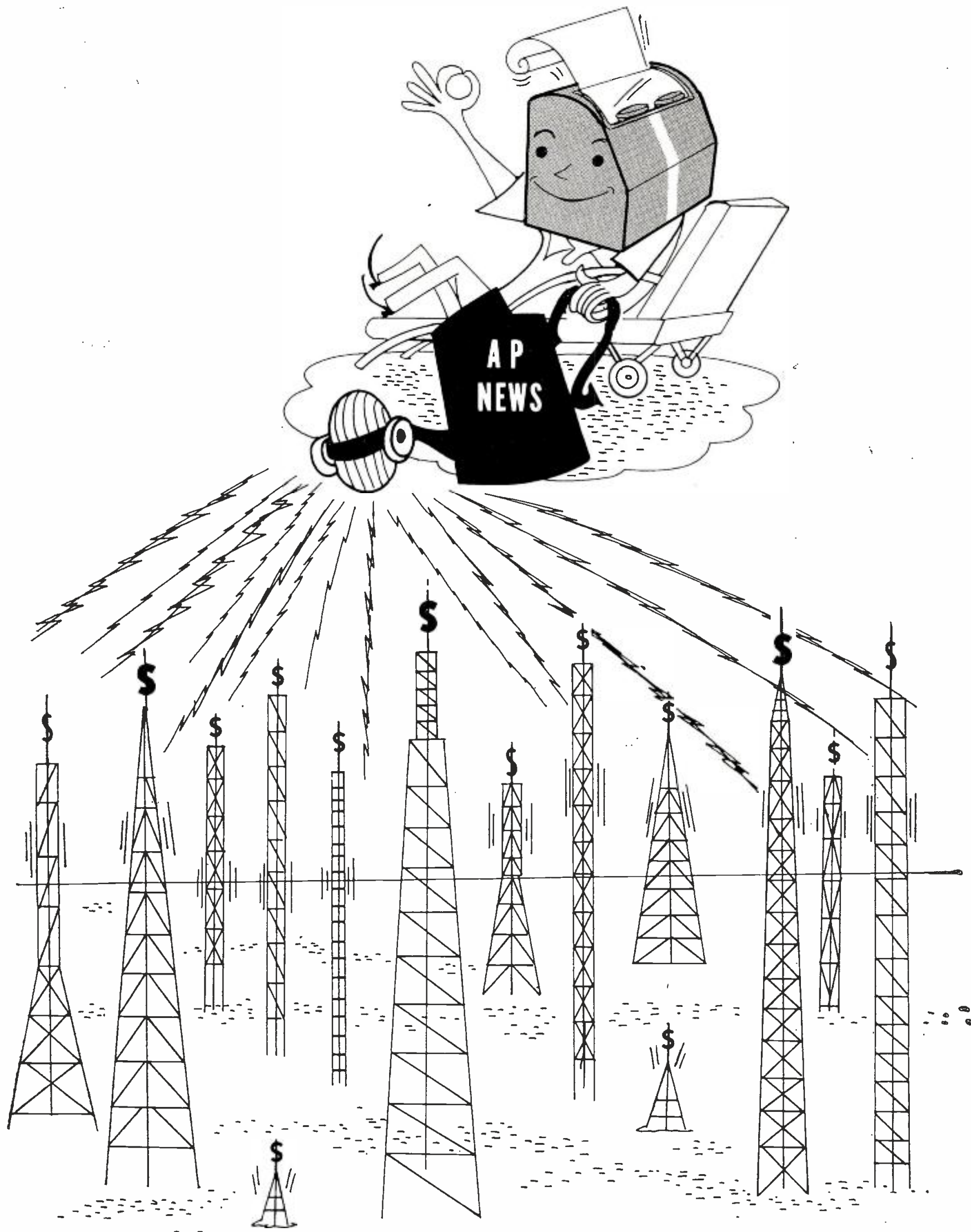

Stations Grow With **AP** *News*

**The Nation's
Foremost Manufacturer
of Multiplex Equipment
introduces
A NEW LINE OF
FM TRANSMITTERS**

**250 watts
5,000 watts
10,000 watts**

These transmitters use the same high quality Multiplex Exciters whose outstanding performance has captured the confidence of Broadcast* owners and operators from coast to coast.

*names on request

**See Our 10 Kw FM Transmitter
IRE SHOW**

N.Y.C. Coliseum March 23 to 26

Booth Nos. 3003 & 3004

G
E
L

GENERAL ELECTRONIC LABORATORIES, INC.

195 MASSACHUSETTS AVENUE, CAMBRIDGE, MASS.

Because I think it's yet to be demonstrated that there is a demand for it. The experiments which have been made to date have hardly been unqualified successes. Secondly, there is very strong opposition to pay tv, and little support for it from influential sources.

MR. CATAPANO:

What do you consider to be the future of color television?

We consider the future of color tv to be very bright. However, it's likely to be some time before we get mass acceptance. At the present time there are two schools of thought on color. One is that this will naturally evolve, that, as time progresses, more and more improvements will be made from the engineering and technical point of view. The other school feels that color will not be accepted in its present form and that we need a technical break-through to get the price down and to simplify the unit before the mass public will be interested in buying.

At the present time, color tv obviously has been very disappointing. Nobody really knows, outside of RCA, I guess, the number of sets in use, but it is very small compared with some 50 million black-and-white sets currently in use. Our feeling is that the price will have to come down, and down pretty sharply, before we get the mass purchasing by the public. That seems to be the feeling of most companies in the industry, and we'll go along with that.

From the standpoint of broadcast manufacturing, particularly receiving equipment, what do you think is the most exciting field open for the near future and perhaps the long-run future?

I think that stereo, and particularly stereo equipment, will grow very sharply in coming years. It's caught the consumer imagination, whereas color tv has not, and I don't know why. It's probably a question for psychologists. But the fact is that every company that I'm familiar with is increasing its production schedules for stereo equipment, and some companies supplying equipment to the industry are back-ordered.

Could you say which is the brightest company in stereo at the moment?

It's pretty hard to say, because a lot of it depends on taste and how the consumer goes for the product. If I were to place my money on any company in the field, I would stick with Zenith, RCA, Motorola and Sylvania.

Those are packagers, now.

Packaged sets, right.

What about the component manufacturers?

I think the big growth will come in packaged sets.

That's very interesting, because I

Announcing...

A M E R I C A N R E S E A R C H B U R E A U ' S

1959 TELEVISION COVERAGE STUDY

***Unequalled research standards . . . outdates
any existing coverage studies . . . presents
latest data on station coverage and
circulation for more than one hundred
and twenty key television markets . . .***

ARB's *new 1959 "A-to-Z"* television coverage study—just being released—surveys selected markets where *current* information is needed due to recent developments affecting:

- power or tower
- network affiliation
- number of stations
- community antenna installations
and the like

This Fifth Annual "Abilene-to-Zanesville" study shows TV and UHF saturation for each market. And, for each station: ● percent of homes able to receive ● weekly circulation ● average daytime and nighttime circulation.

Only ARB offers *new* data secured from *full* sample of respondent families by *telephone* interview. These techniques are in keeping with ARB's high research standards, unequalled throughout the industry. For descriptive folder and list of areas surveyed, contact your nearest ARB representative.

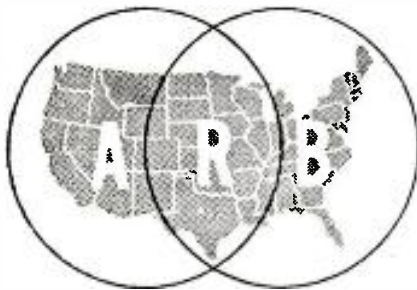

AMERICAN RESEARCH BUREAU, INC.

- WASHINGTON ● 4320 Ammendale Road, Beltsville, Md. WEbster 5-2600
NEW YORK ● 400 Park Avenue, New York 22, N. Y. PLaza 1-5577
CHICAGO ● Tribune Tower, Chicago 11, Ill. SUperior 7-3388
LOS ANGELES ● 6223 Selma Avenue, Hollywood, Calif. HOLlywood 9-1683



Now...Air Express goes

**Almost twice the speed
at the same low rates**

The giant planes that have opened the Jet Age carry both passengers *and Air Express!* As a shipper, you are entering a brand new ten-mile-a-minute world.

The whole U. S. A. is now your local market. Your shipments cross the nation in 270 minutes—just about *half* the previous time. Your goods can go on sale

thousands of miles away the same day they are shipped. Business will boom, inventories decline, duplicate warehouses disappear.

These are vast and electrifying changes. And Air Express prepared more than a year ago to help you take them in stride. Added fleets of modern trucks, many radio dispatched . . . added fast moving conveyors at airports . . . added a nationwide private wire network . . . all designed to give you jet age speed from the ground up!

CALL AIR EXPRESS  . . . division of **RAILWAY EXPRESS AGENCY**



A private wire system co-ordinates all Air Express operations throughout the country . . . keeps your shipment moving swiftly and steadily to its destination.



13,500 Air Express trucks are at your service. Many are equipped with two-way radio communication for fast pick-up, often minutes after you call up.

JET!

Yet Air Express rates are still low, still unchanged. For jet as for regular service, rates at many weights and distances cannot be beaten. And only Air Express offers you one carrier door-to-door speed to thousands of U. S. cities and towns. Explore all the facts. Call Air Express.

 **AIR EXPRESS** 

GETS THERE FIRST via U. S. SCHEDULED AIRLINES

BROADCASTING, March 16, 1959

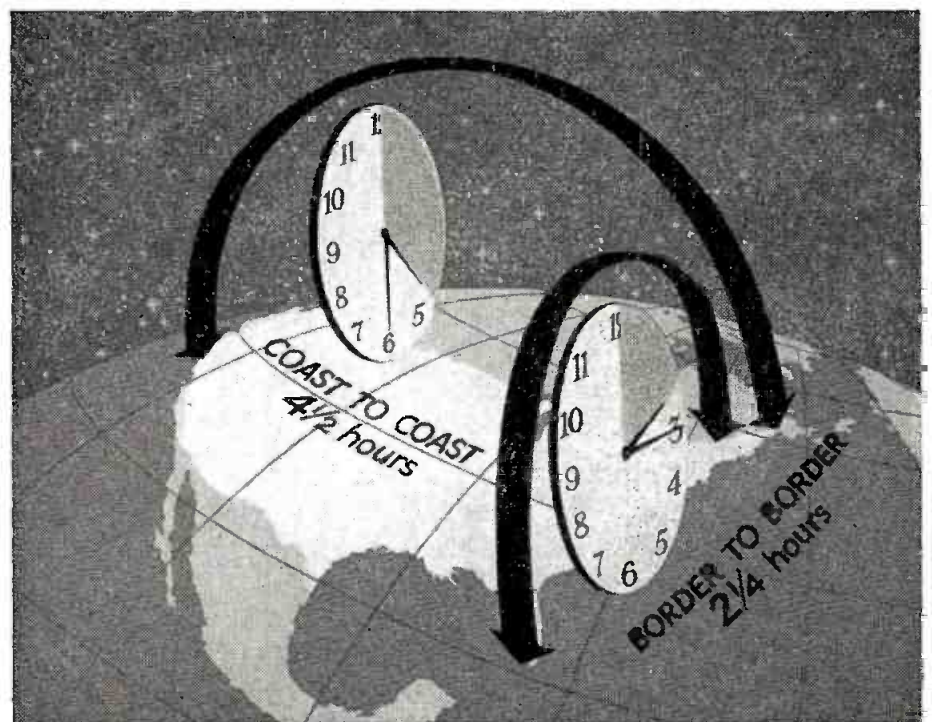

Jet-fast Air Express now flies coast to coast and border to border. New cities in every section of the country will be added to the schedule as quickly as possible.

think an article published just recently quoted the Institute of High Fidelity Manufacturers that the growth would come in component. . . .

When I say that the future here lies in the packaged sets, I'm talking about the mass public, rather than a limited public. Sure, you probably would get a better unit as far as tone fidelity is concerned if you were to package your own set. But I just don't feel that the mass public is interested or able to assemble their own units.

Let's try to put some of these points in focus. Have broadcasting stocks been ahead of the market in the past year, and do you anticipate that they would be in the coming year, or have they been behind the market in general?

It's very difficult to say whether they've been ahead of the market, because the only way of measuring it, as far as I'm concerned, is to measure Storer and Columbia and a few others, and on this basis I would say that they've been behind the market.

Why?

Lack of investor interest, primarily, in our experience. There just doesn't seem to be the interest in broadcasting as there is in electronics.

Does that mean the profit potential is not as great?

Probably that is the feeling of the investor. You would be amazed at the lack of interest in broadcasting stocks. We get very, very few inquiries on the broadcasting industry. Most of the interest seems to be in the electronics stocks—the manufacturing companies.

Do you anticipate that there will be more interest?

Unfortunately no, because there aren't many ways to participate in this growth. Many companies are privately-owned. Many have only limited markets. The only ones you can buy actively are the Big Three and maybe one or two others, like Storer. There aren't many others that you can buy to participate in the industry whereas in the manufacturing branch of the electronics industry, there are any number of stocks you can buy.

On the other hand, should broadcasting be interested in these investors?

Yes, I think they should. And you ask why, and I say the reason for doing this is that if they want to finance their growth through equity financing, then they are going to have to make certain that their stocks are valued properly in a market.

Is there a course that one takes to elicit this interest?

Yes. By making more information available to the analysts and others who are concerned with stocks.

Stations readying for baseball season

Plans for the 1959 baseball season are being finalized by broadcasters and major league clubs in preparation for next month's opener. Among reports thus far to BROADCASTING:

Joseph A. Schlitz Brewing Co., Milwaukee, through Majestic Adv. there is sponsoring a 10-game Kansas City Athletics schedule over WDAF-TV Kansas City. This marks a first for WDAF-TV and the Athletics, who formerly maintained a no-television policy.

The Phillies' games on WIP Philadelphia are being underwritten by the Atlantic Refining Co., Philadelphia; P. Ballantine & Sons, Newark; Bayuk Cigars Inc. (Phillies), Philadelphia, and Tasty Baking Co., Philadelphia. Atlantic Refining and Ballantine have one-third each. The remaining segment is divided between Phillies and Tasty Baking. Agency: N. W. Ayer.

Gunther Brewing Co., Baltimore, will sponsor the WJZ-TV telecasts of the Baltimore Orioles' games.

Miller Brewing Co., Clark Oil & Refining Co., both Milwaukee, and P. Lorillard Co., New York, will sponsor the Milwaukee Braves' schedule over WTMJ there.

The American Tobacco Co., New York, and Eastside Brewing Co. are underwriting the Los Angeles Dodgers' games over the L.A. Dodgers Radio Network. (The network includes KMPC Los Angeles, KFXM San Bernardino, KVEL San Luis Obispo, KPAL Palm Springs, KROD Brawley, KYOR Blythe, KREO Indio and KIST Santa

Barbara, all California.) Agencies: American Tobacco—Lawrence C. Gumbinner; Eastside—Young & Rubicam.

The Pittsburgh Pirates' telecasts will be on KDKA-TV, that city.

WINS New York plans to carry home games of the San Francisco Giants.

WTOP Washington has contracted to broadcast all the Senators' games and WTOP-TV will telecast 13 weekend contests. A spokesman for the Washington Club indicated that Gunther Brewing Co. will be one of the sponsors.

WPIX (TV) New York will warm up for its regular in-season Yankee baseball telecasts with four exhibition games from Florida, beginning March 14. Plans for what the station reports will be the only tv baseball coverage in the metropolitan area include all Yankee home games and a "majority" of games played on the road. P. Ballantine & Sons and R. J. Reynolds Tobacco continue as sponsors, through William Esty.

Cincinnati Reds' games will be seen on WLWT (TV) Cincinnati and WLWD (TV) Dayton, Ohio.

Onondaga sharetimer commences operation

Part educational-part commercial ch. 10 Onondaga, Mich., went on the air yesterday (March 15). And, officials of Michigan State U.'s WMSB (TV), commercial station WILX-TV and General Electric, suppliers of transmitter equipment to the stations, are predicting the operation may provide financial answers to solve the problem of financing the nation's educational tv stations. GE described it as the first educational-commercial project.

Not only are WMSB and WILX-TV sharing the same frequency (BROADCASTING, Sept. 8; Dec. 22, 1958), they also are using the same transmission equipment, with the commercial station paying the educational station for the use of its facilities.

Dr. Armand L. Hunter, director of broadcasting for the university, expects the sharetime operation will "provide the solution to two principal problems facing each type of operation." He termed the problems financial support for educational operation and better public service programs by the commercial station.

WMSB is on the air 38½ hours weekly: 9:30 a.m.-2 p.m. Monday-Saturday; 6-7:30 p.m. Monday-Friday and noon-4 p.m. Sunday. Approximately 75% of its programming will be live.

WILX-TV, an NBC-TV affiliate, has "an even longer broadcasting schedule," Dr. Hunter said.



New president. • Vice President Richard M. Nixon (c) handed a gavel to NBC's Julian Goodman (r) when Mr. Goodman was installed as president of the Radio & Tv Correspondents Assn. Retiring association president, Edward P. Morgan of ABC, looks on. The occasion was the correspondents' annual dinner March 7 in Washington.

Jan. - Feb. - '59 ARB Names . . .

KETV 1ST

in Omaha!

OMAHA METROPOLITAN AREA — ONE WEEK			
	STATION B	STATION C	KETV
MONDAY THRU FRIDAY			
Sign-on to 9 A M	60.0	46.2*	—
9:00 AM to 12:00 Noon	51.1	44.5	4.4
Sign-on to Noon	53.6	44.9*	4.4*
Noon to 3:00 PM	20.2	46.0	33.8
3:00 PM to 6:00 PM	30.5	26.2	43.3
Noon to 6:00 PM	25.9	35.0	39.1
6:00 PM to 10:00 PM	29.8	34.4	35.8
10:00 PM to Midnight	33.3	21.8	44.9
6:00 PM to Midnight	30.6	31.3	38.1
SATURDAY			
Sign-on to 6:00 PM	32.0	28.5	54.2*
6:00 PM to 10:00 PM	28.5	41.3	30.2
10:00 PM to Midnight	23.6	29.5	46.9
SUNDAY			
Sign-on to 6:00 PM	51.4*	15.2	38.2*
6:00 PM to 10:00 PM	26.4	31.2	42.4
10:00 PM to Midnight	19.5	31.1	49.4
SUNDAY THRU SATURDAY			
6:00 PM to 10:00 PM	29.1	35.0	35.9
10:00 PM to Midnight	30.0	24.2	45.8
6:00 PM to Midnight	29.3	32.3	38.4
Sign-on to Sign off	32.9	33.3	36.2

OMAHA METROPOLITAN AREA — FOUR WEEK			
	STATION B	STATION C	KETV
MONDAY THRU FRIDAY			
Sign-on to 9 A M	47.3	58.5*	—
9:00 AM to 12:00 Noon	52.5	42.8	4.7
Sign-on to Noon	50.8	47.6*	4.7*
Noon to 3:00 PM	23.1	41.7	35.2
3:00 PM to 6:00 PM	35.6	24.1	40.3
Noon to 6:00 PM	30.3	31.5	38.2
6:00 PM to 10:00 PM	30.6	34.2	35.2
10:00 PM to Midnight	33.8	25.5	40.7
6:00 PM to Midnight	31.3	32.2	36.5
SATURDAY			
Sign-on to 6:00 PM	29.1	30.8	56.3*
6:00 PM to 10:00 PM	31.4	40.3	28.3
10:00 PM to Midnight	30.8	32.8	36.4
SUNDAY			
Sign-on to 6:00 PM	40.3*	19.5	47.5*
6:00 PM to 10:00 PM	26.7	32.0	41.3
10:00 PM to Midnight	23.0	32.2	44.8
SUNDAY THRU SATURDAY			
6:00 PM to 10:00 PM	30.1	34.8	35.1
10:00 PM to Midnight	31.9	27.5	40.6
6:00 PM to Midnight	30.5	33.2	36.3
Sign-on to Sign off	33.3	33.9	35.4

Sign - on to Sign - off
36.2

KETV

Sign - on to sign - off
35.4

KETV

Buy the leader in Omaha!



Omaha World-Herald Station

Ben H. Cowdery, President
Eugene S. Thomas, V.P. & Gen. Mgr.

Call your **H-R** man today!

channel **7**

ABC TELEVISION NETWORK

VISIT US IN SUITE 600 AT THE CONRAD HILTON AND ENJOY A GLASS OF IRISH COFFEE

*pull big profits
out of the air with*

the **RCA
THESAURUS
LIBRARY
COMMERCIAL
FEATURES**

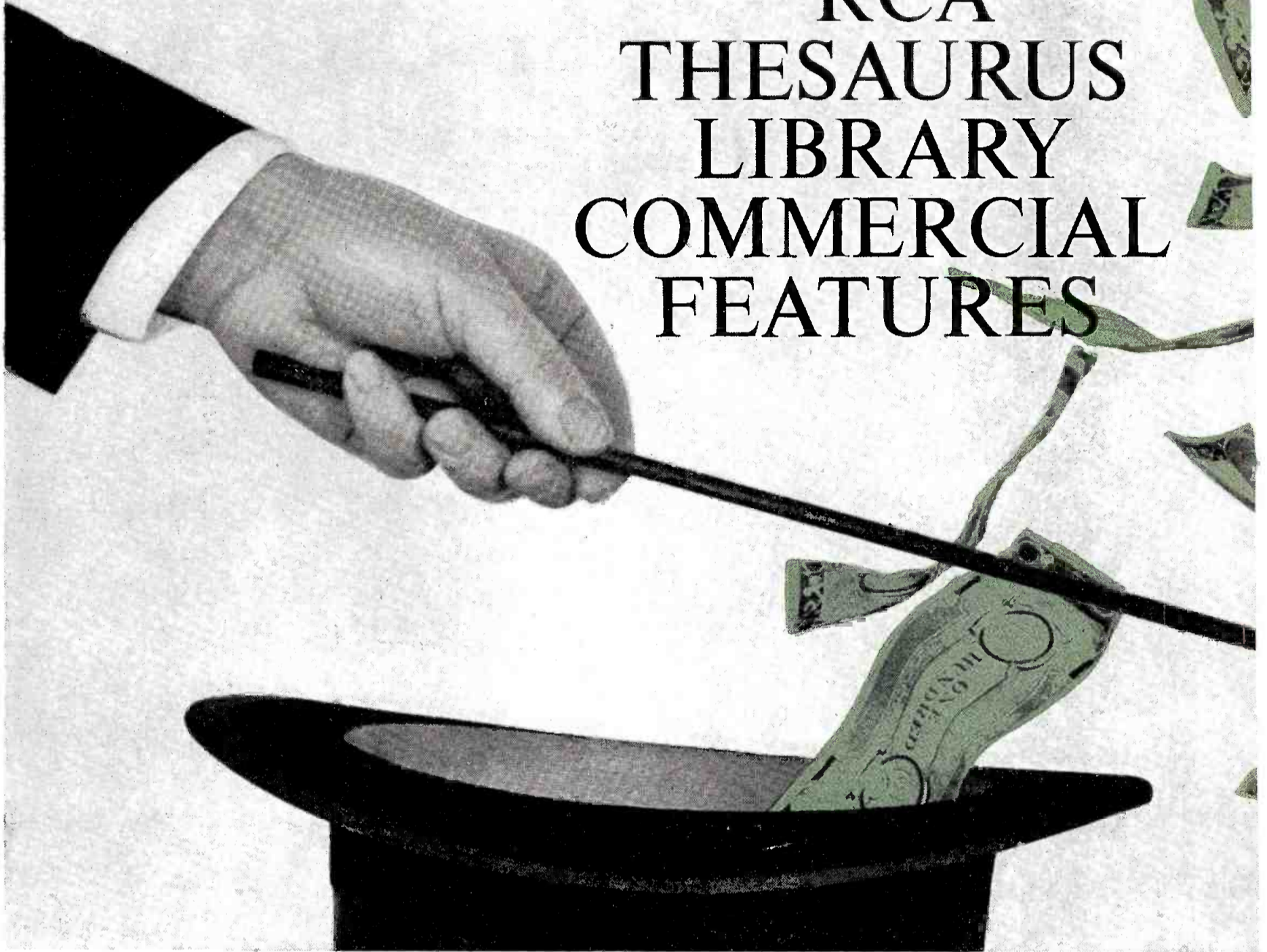

*100's of subscribers net
1000's of dollars of extra profit
with these potent sales aids.*

It's positively magic the way the RCA Thesaurus Library commercial features help subscriber radio stations make *new* sales, earn *extra* profits, with such aids as the following:

SELL-TUNES AND SUPERMARKET CAMPAIGN—"Most of the 100-odd new local accounts on KITO during past few months were sold by producing spots on speculation using Thesaurus SELL-TUNES. Such proposals resulted in sales better than 80% of the time. Stater Brothers has been using 140 Thesaurus supermarket spots per week on KITO . . . today *increased* schedule to 182 spots per week all year 'round."—Joe Klass, National & Regional Sales Manager, Station KITO, San Bernardino, Cal.

"I'm happy to report sale of 1800 announcements to the Nehi-Royal Crown Cola Bottling Company of Montgomery, using Thesaurus jingle number 603-A-2. Owner of local bottling company 'highly pleased' . . . this sale to 'R. C.' was primarily because of the excellent jingle."—Ed Morgan, General Manager, Station WETU, Wetumpka, Alabama

DEPARTMENT STORE RADIO CAMPAIGN—"Sold 40 announcements per week to Roger's Department Store . . . sponsor very pleased. Thesaurus. DEPARTMENT STORE RADIO CAMPAIGN tipped the scale in really selling them."—David M. Myers, President, Station WFGM, Fitchburg, Massachusetts

SHOP AT THE STORE WITH THE MIKE ON THE DOOR—"SHOP AT THE STORE WITH THE MIKE ON THE DOOR brought in over \$7,000.00! Over 100,000 listener registrations at sponsor stores for contest . . . best promotion we've ever had in nine years of broadcasting!"—Jim Hairgrove, General Manager, Station KFRD, Rosenberg, Texas

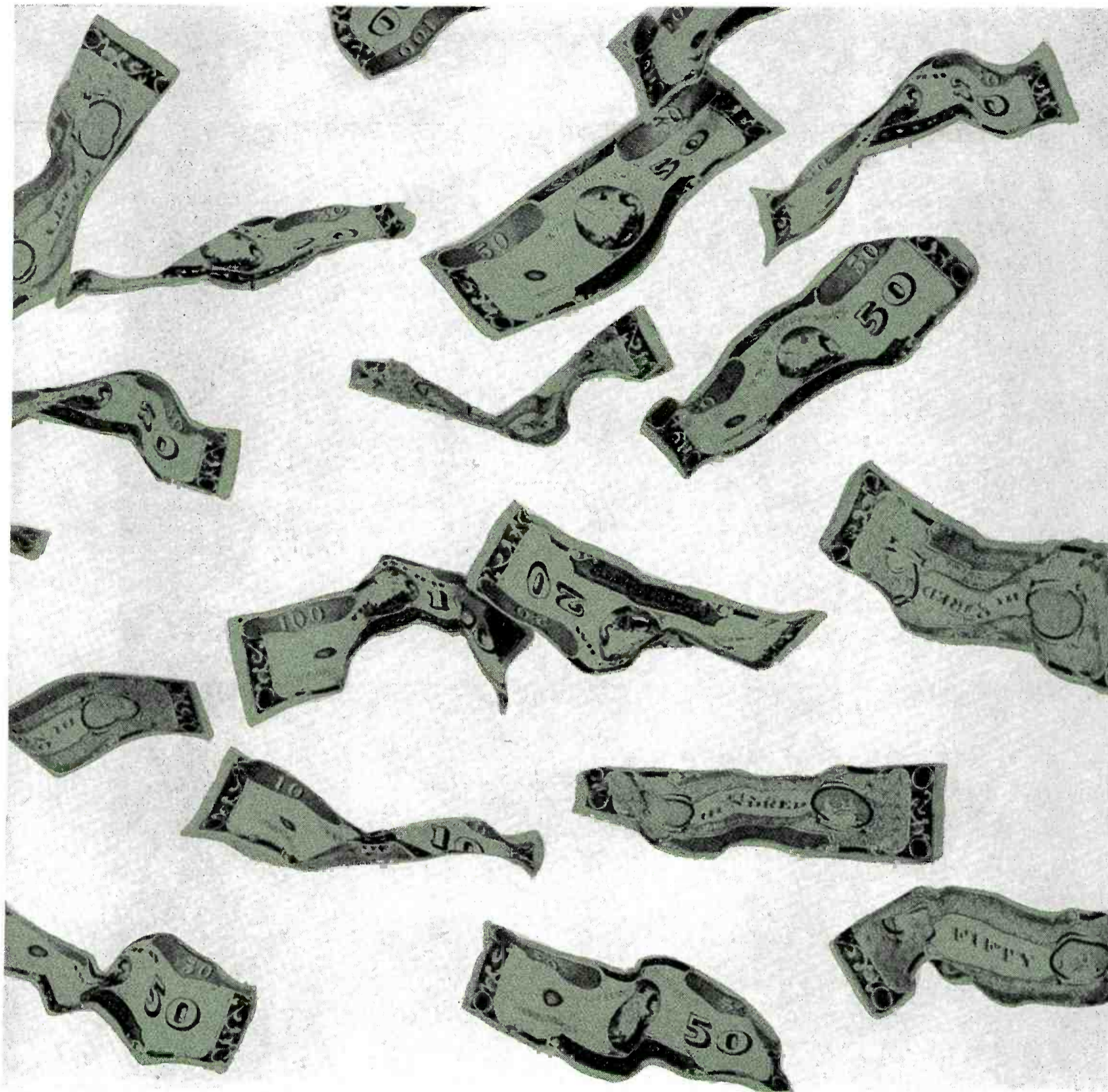

"Taking in an additional \$5,000.00 with 26-week SHOP AT THE STORE campaign." — Dave Hofer, Jr., Sales Manager, Station KRDU, Dinuba, California

HOLIDAY JINGLES AND OPEN-END SHOWS — "Twenty Thesaurus Christmas jingles and special effects were used to sell 812 announcements (527 minutes and 285 station breaks) aired between Thanksgiving and Christmas. Total income from this source amounted to \$3,221.50, including \$60 talent fees (\$3.00 per jingle)." — William Holm, General Manager, Station WLPO, La Salle, Illinois

These and many other commercial aids—like SALES BOOSTERS, SOUND EFFECTS, ECHO and ACTION ATTENTION-GETTERS, SHOPPING CENTER RADIO CAMPAIGN, SHOW STOPPERS and SHOW THEMES AND PRODUCTION AIDS, STATION IDENTIFIERS and MUSIC TO SELL BY — pay their small cost many times over at hundreds of radio stations across the country. And subscriber stations get plenty of extra sales help, too, from the exclusive

THESAURUS MONTHLY MARKETING BULLETIN and SALES PROMOTION MATERIALS supplied at no extra cost every month.

RCA Thesaurus Library commercial features are supplied on easily-handled, easily-stored 12-inch, 33 $\frac{1}{3}$ records, with a complete catalog index. Now, more than ever, time can mean money for you, with the income-earning power of the RCA Thesaurus Library commercial features. Get full details today from your nearest RCA Thesaurus representative.

RECORDED PROGRAM SERVICES

155 EAST 24TH STREET, NEW YORK 10, N. Y., MURRAY HILL 9-7200
445 N. LAKE SHORE DRIVE, CHICAGO 11, ILL., WHITEHALL 4-3530
1121 RHODES-HAVERTY BLDG., ATLANTA, GA., JACKSON 4-7703
7901 EMPIRE FREEWAY, DALLAS 35, TEXAS, FLEETWOOD 2-3911
1016 N. SYCAMORE AVE., HOLLYWOOD 38, CAL., OLDFIELD 4-1660
800 SEVENTEENTH AVE. SO., NASHVILLE, TENN., ALPINE 5-6691

NEW VOTE OF CONFIDENCE FOR TV

Most people think tv is as good as it ever was—or better

Print media hatchet throwers to the contrary, the people who watch television do not think tv programming is going to pot. For the most part, though they often have favorite program types they'd like to see more of, they think tv programmers are doing a good job.

This is the first obvious conclusion to be drawn from a special survey conducted for BROADCASTING by The Pulse Inc., covering 1,070 viewers in 13 cities* during the week of Feb. 1-8 (also see survey of the public's attitude toward the FCC, GOVERNMENT).

The findings show that the largest single block—45.5%—thinks television programming today is better than a few

*Cities were Atlanta, Boston, Chicago, Cleveland, Dallas, Detroit, Los Angeles, Miami, New York, Philadelphia, San Francisco, St. Louis and Washington.

years ago. In addition, 35% think it's "about the same," leaving 20% who consider it not as good. When the question is approached from another direction, six out of ten persons think stations are doing a good or very good job, slightly less than three out of ten think it's a "fair" job and a little more than one of ten considers the job poor or very poor.

Preferences • Almost eight out of ten persons would like to see more of certain types of programming than is now available—and the No. 1 type, mentioned by 16.2%, is educational. Next, in rank order, come dramatic, comedy, variety and western programs.

What most people are looking for in television is entertainment (52.8%) rather than information (14.1%), but

one-third of the respondents said they were looking for both.

As to specific program types, those that draw interest from the most are newscasts (mentioned by 91.9%), movies (80.7%) and variety shows (75.4%).

The viewers also were given four shows and asked to indicate which one they would watch if all four were on at the same time. This was done with two sets of programs, some viewers being asked about one set and the rest about another. One group chose *Father Knows Best*, *Omnibus*, *Bat Masterson* and *Small World*, in that order, while the other group of viewers picked *Meet the Press over Millionaire*, *Twentieth Century* and *Restless Gun*.

Here are the complete results:

WHAT THE PEOPLE THINK OF THIS SEASON

Question 1

What is your opinion of television programs you now watch compared with programs presented during the past few years? Do you think programs now on the air are better, about the same or not as good as those you watched in previous years?

	Number of Respondents	Percent of Respondents
Better	487	45.5%
About the same	370	34.6%
Not as good	213	19.9%
Total	1070	100.0%

Question 2

On the whole, do you think television stations are doing a very good, good, fair, poor or very poor job of presenting the kinds of programs you like to watch?

	Number of Respondents	Percent of Respondents
Very good	202	18.9%
Good	452	42.2%
Fair	302	28.2%
Poor	76	7.1%
Very poor	38	3.6%
Total	1070	100.0%

Question 3

A television program can serve two basic functions: to provide information or entertainment. When you watch television, are you primarily interested in programs devoted to information or entertainment?

	Number of Respondents	Percent of Respondents
Information	151	14.1%
Entertainment	565	52.8%
Both	354	33.1%
Total	1070	100.0%

More tables page 142

Question 4

Here is a list of different categories of television programs (show card). In connection with each of these types of programs, would you say that you are very interested or not at all interested in watching (type) programs on tv?

	Interested		Not interested		Total Respondents	
	No.	Pct.	No.	Pct.	No.	Pct.
News programs	983	91.9%	87	8.1%	1070	100.0%
Quiz programs	416	38.9	654	61.1	1070	100.0
Discussions & debates on current events	701	65.5	369	34.5	1070	100.0
Dramatic programs	767	71.7	303	28.3	1070	100.0
Westerns	612	57.2	458	42.8	1070	100.0
Operatic & classical music programs	526	49.2	544	50.8	1070	100.0
Situation comedy programs	761	71.1	309	28.9	1070	100.0
Popular music programs	675	63.1	395	36.9	1070	100.0
Interviews with famous people	751	70.2	319	29.8	1070	100.0
Movies	863	80.7	207	19.3	1070	100.0
Variety programs	807	75.4	263	24.6	1070	100.0
Mystery programs	752	70.3	318	29.7	1070	100.0

Question 5

In connection with your own viewing habits, do you feel there should be more (type) programs on television, there should be fewer (type); or do you feel the number of each of said programs now on television is about right?

	More		Same		Fewer		Total Who Are Interested	
	No.	Pct.	No.	Pct.	No.	Pct.	No.	Pct.
News programs	293	29.8%	661	67.2%	29	3.0%	983	100%
Quiz programs	88	21.2	289	69.4	39	9.3	416	100
Discussions & debates on current events	333	47.5	340	48.5	28	4.0	701	100
Dramatic programs	349	45.5	395	51.5	23	3.0	767	100
Westerns	123	20.1	345	56.4	144	23.5	612	100
Operatic & classical music programs	273	51.9	233	44.3	20	3.8	526	100
Situation comedy programs	251	33.0	472	62.0	38	5.0	761	100
Popular music programs	215	31.9	439	65.1	21	3.0	675	100
Interviews with famous people	342	45.4	386	51.5	23	3.1	751	100
Movies	347	40.2	493	57.1	23	2.7	863	100
Variety programs	282	34.9	500	62.0	25	3.1	807	100
Mystery programs	261	34.7	449	59.7	42	5.6	752	100

as basic as the alphabet



EGYPTIAN

Word of mouth was man's first form of communication. Therefore, the sign for mouth was one of the most common ideographs used on the papyrus the Egyptians made from reeds growing along the Nile.



PHOENICIAN

Marketing papyrus throughout the ancient world was big business with the Phoenicians. In time, the Egyptian mouth sign became their letter pei — fore-runner of the modern P.



GREEK

To papyrus and wax tablets, the Greeks added another writing material: parchment, made from animal skins and first used in the city of Pergamum. Gradually, pei was changed to pi.



ROMAN

Paper became a favorite with the Romans about the 8th Century after the Arabs had brought the Chinese invention into southern Europe. Meanwhile, scholars had transformed pi into P.

*Historical data by
Dr. Donald J. Lloyd,
Wayne State University*



Put your money where the people are

Seventy per cent of Michigan's population commanding 75 per cent of the state's buying power lives within WWJ's daytime primary coverage area.

Push up spring sales by using WWJ, Detroit's Basic Radio Station. Dealers and distributors favor WWJ because they know it moves merchandise. Listeners prefer WWJ because it entertains them with modern radio at its very best.

Personalities like Melody Paradors Hugh Roberts, Faye Elizabeth, Dick French, Bob Maxwell, and Jim DeLand — programs like WWJ News, sports, and weather, NBC's Monitor and Nightline are the talk of the town. Buy WWJ—it's the basic thing to do!

WWJ RADIO

AM and FM

Detroit's Basic Radio Station

Owned and operated by **The Detroit News**

NBC Affiliate

National Representatives: Peters, Griffin, Woodward, Inc.

Question 6

Are there any types of programs which you would like to see more of on television?

	Number of Respondents	Percent of Respondents
Yes	824	77.0%
No	246	23.0
Total	1070	100.0%

Question 6a

What types would you like to see more of?

	Number of Mentions	Percent of Mentions
Dramas	156	14.6%
Educational	173	16.2
Comedy	116	10.8
News	27	2.5
Quiz programs	23	2.2
Informative discussions	42	3.9
Westerns	66	6.7
Opera, ballet, classical music	45	4.2
Popular music	46	4.3
Movies	62	5.8
Variety	88	8.2
Mystery	52	4.9
Sports	54	5.0
Stories, soap operas	20	1.9
Religious	19	1.8
Cultural	11	1.0
Live programs	12	1.1
Travelogues	27	2.5
Science fiction	10	.9
Children's	15	1.4
Spectaculars	19	1.8
Adventure	19	1.8
Miscellaneous	12	1.1
Total responses	1114	104.1%*

*Total over 100% because of multiple responses.

Question 7

Here are four television programs scheduled during the coming week (show card). If these programs were telecast on the same evening at the same time, which one, if any, would you choose? (One set of programs was shown to about half the respondents and another set to the other half.)

	Number of Respondents	Percent of Respondents
Omnibus	165	30.5%
Small World	35	6.5
Bat Masterson	105	19.4
Father Knows Best	203	37.5
None	33	6.1
Total	541	100.0%

	Number of Respondents	Percent of Respondents
Twentieth Century	114	21.6%
Meet The Press	147	27.8
Restless Gun	112	21.2
Millionaire	115	21.7
None	41	7.7
Total	529	100.0%

KFAB forces issue

The weight of an editorial campaign by KFAB Omaha, Neb., was demonstrated when the Nebraska state legislature passed into law a bill reducing the speed limit on secondary roads from 60 to 50 miles per hour.

Lyell Bremser, vice president and general manager of the 50 kw station, devoted at least one editorial a week during the past year to the need for a lower speed law on the state's secondary roads. A KFAB editorial last October

created such public response that the Nebraska governor called a special news conference, the station reports, during which he pointed out that the majority of fatal accidents occurred on secondary roads. This admission of an unsafe speed limit for secondary roads was the opening wedge, KFAB says, in its successful drive to have the speed limit lowered.

Tv execution coverage

KRON-TV San Francisco has asked permission to televise the next execution in San Quentin's gas chamber. Earlier State Sen. Fred S. Farr, author of a bill to abolish the death penalty in California, commented, "If an execution were televised, you'd soon have an end to the death penalty." Harold P. See, general manager of KRON-TV, then wired Richard A. McGee, state director of corrections: "On ground executions in California are public proceedings done for and in behalf of the people of the state, KRON-TV wishes to use its broadcast facilities to televise the next execution at San Quentin gas chamber. If capital punishment is to deter capital crimes, it should be made a maximum deterrent. Let all the people see it."

Gov. Edmund C. Brown said that he is definitely opposed to televising executions. Mr. McGee said this is a matter which the legislature should decide.

What built this building?

- KNOWLEDGE of good programming
- ACQUIRING & KEEPING good air salesmen
- EXPERIENCE gained through 28 years of broadcasting
- AWARENESS of our obligation to serve the public and to sell merchandise
- FLEXIBILITY of thinking to keep ahead of trends
- TRAFFIC CONTROL systematic and thorough

Open our door—through your P.G.W. Colonel—and we'll open the door of sales for your product. (You'll be keeping good company, too!)



WIS RADIO
5000 W
560 KC
NBC
COLUMBIA, SOUTH CAROLINA

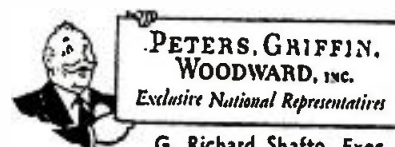

G. Richard Shafto, Exec. Vice President
W. Frank Harden, Managing Director

**Because
Local
Sponsors
Buy With That
"Critical Buck,"
They Buy
The Station
That Gets
"Next Day"
Results...**

**You've Got A Live One
When You Buy
KRNT
TOTAL RADIO
in Des Moines, Iowa**

In DES MOINES,

that result-getting station is . . .
and has always been . . .

KRNT RADIO, that "know-how,
go-now" station that keeps pace
with all that's going on in
Des Moines, Iowa's lively center of
business activity. Because KRNT
has news on the hour, total
sports, the best of music,
dramatic shows, complete weather
and complete service, local
sponsors spend nearly as much
on KRNT RADIO as on the
other 5 Des Moines

stations combined! Better See Katz Soon.

SOURCE: LATEST AVAILABLE F. C. C. FIGURES

KRNT RADIO-CBS
A Cowles Station

THE MEDIA WAR

Jones in St. Louis focuses on tv critics

A leading television executive took a look last week at the average viewer's watching habits and saw both "a remarkable figure" and a cause for concern.

While the 2½ hours that the average viewer spends with television each day is "more time than is spent on all other leisure-time activity combined," CBS TV Stations Div. President Merle S. Jones declared, this still leaves him to get his impressions about an overwhelming majority of tv programming from what he reads about it rather than from what he sees.

Mr. Jones, in a speech prepared for the St. Louis Rotary Club last Thursday (March 12), called attention to the attacks on television carried in *Newsweek*, *Life*, *Fortune* and *Esquire* in recent months. While the public's opinion of television is in "sharp contrast" to the magazines', he said, the average viewer's 2½ hours a day at the tv set covers, for example, less than 5% of the 55 hours a day programmed by the three St. Louis stations.

Reading Influence • "As a result, his impression of television as a whole is bound to be influenced, not only by what he sees himself, but also by what he reads about the programs he has not seen—which comes to 95% of the total," Mr. Jones asserted.

He showed film clips from 17 CBS-TV shows presented on KMOX-TV St. Louis on one recent Sunday—"17 programs on which close to 6,000 people labored a combined total of over 50,000 hours—the equivalent of six years—for the sole purpose of bringing you something that you would find represents time well spent." He said they add up to "an extraordinary range of entertainment and exciting information" but were "not extraordinary television in the sense of being exceptional." Moreover, he said, "similar efforts" are being made by St. Louis' two other stations, KSD-TV (NBC) and KTVI (TV) (ABC-TV).

Mr. Jones said thoughtful broadcasters "welcome constructive criticism and are quick to respond to it," but that "some of the attacks seem to be leveled simply because they represent good, juicy, circulation-building copy, while still others . . . reflect a built-in bias against a medium that is competing so successfully. . . ."

Mr. Jones appeared in St. Louis in connection with CBS-owned KMOX-TV's first birthday and dedication of the station's new transmitter and tower.



Gubernatorial oratory • Gov. Nelson A. Rockefeller of New York explains the state's interest in the broadcasting field during the second annual legislative dinner sponsored by the New York State Assn. of Broadcasters in Albany (BROADCASTING, March 9). Applauding are Robert Leder (l), president of NYSAB and vice president-general manager of WOR-AM-TV New York, FCC Comr. Robert E. Lee (r) and Dr. William Rowan, assistant to Gov. Rockefeller (extreme r). Gov. Rockefeller and Comr. Lee stressed the need for closer cooperation between the broadcasting industry and the government.

OK Group Negro study presented in New York

Buying habits of Negroes and their motivations as consumers are not the same as for white consumers, says Henry A. Bullock, professional Negro surveyor at Texas Southern U. Dr. Bullock last fortnight outlined the findings of his study in a series of New York presentations conducted by the OK Group of radio stations and the Motion Picture Advertising Service, both headquartered in New Orleans.

Speaking to representatives of more than 20 New York advertising agencies, Dr. Bullock revealed preferences, prejudices, family organization and buying motives revealed in a survey of 150 Negro families and 50 white families.

Among the findings: dominance of the Negro mother in the home; in personality development, Negro males emerge submissive, females aggressive; Negro income is more discretionary, with necessity purchases not so fixed as for whites; Negroes must identify themselves with the situation in advertisements; they are more optimistic of the future than whites.

Jules J. Paglin, president of the OK Group, which has six stations in south-

ern cities, emphasized that the Negro market is a separate one that must be reached with specialized media, different copy angles and different types of program appeal.

WFBR, AFTRA settle

A strike by the American Federation of Television & Radio Artists against WFBR Baltimore was settled March 13 with the station resuming normal operations. Robert B. Jones Jr., WFBR vice president, said the station lost only two minutes at the start of the strike Feb. 16 (BROADCASTING, March 2). The settlement was understood to have specified a five-day week for talent, a union security clause and modest raise. Vacation clause was not changed. No talent fees were included, talent working on straight salary.

Media reports

- With attention riveted on the single rate system, Ted Tostlebe, commercial manager of WOI-TV Des Moines, whipped out a news release emphasizing the station "quietly" had adopted a single rate a year ago March 1. WOI-TV, he said, combined its retail rates into saturation plans and left its "general rate structure" intact.

- Revenue of WJIM-AM-FM-TV Lansing, Mich., in 1958 was \$2,876,569. The 1957 figure was \$2,790,924. The 1958 earnings of \$1.91 a share were the highest in the company's history. Earnings in 1957 equaled \$1.68 a share.

- WAGM Presque Isle, Me., is broadcasting on a new frequency, 950 kc (with 5 kw). A directional signal from a three-tower array supplies Aroostook County with primary coverage. Secondary coverage is given to eight contiguous Canadian counties. WAGM formerly was on 1450 kc with 250 w.

- WLOS-TV Asheville, N.C., is telecasting programs originating from a studio in Greenville, S.C. via microwave transmitters and receivers. Programs are fed into WLOS-TV's coaxial cables in Greenville and transmitted 23 miles to a repeater station in Caesar's Head, S.C. From there the signal is sent 24 miles to WLOS-TV's transmitter about 18 miles from the station's studios.

- KFWB Los Angeles reports that an interview with a witness in the Elizabeth Duncan murder trial has thrown new light on the case. The witness, Barbara Jean Reed, told a staffer that she had known the suspects, Louis and Augustine Baldano, for some time. This



LEADER!

Meet George Gould, and discover a prime reason why NTA Telestudios has asserted such dynamic leadership in the field of tape for television. As head man of the burgeoning NTA Telestudios operation, Gould has built the industry's finest plant designed specifically for custom tape productions. More important, he's staffed the Telestudios operation from top to bottom with men and women who reflect George Gould's desire and ability to do it better for you with tape. At NTA Telestudios, every session moves smoothly, with the confidence born of Gould's 15 years of live network experience. At NTA Telestudios, you work with the most complete custom tape facilities available. At NTA Telestudios you work with the people who want to give you more, the experienced people who have more to give.

NTA TELESTUDIOS

Leading the field of tape with commercial productions for key agencies such as:

N.W. AYER & SON; LEO BURNETT; DANIEL & CHARLES;
D. C. S. & S.; FOOTE CONE & BELDING; KETCHUM MacLEOD & GROVE;
C. J. LaROCHE; LENNEN & NEWELL; MARSCHALK & PRATT;
MAXON; McCANN-ERICKSON; MOGUL LEWIN WILLIAMS & SAYLOR;
NORMAN CRAIG & KUMMEL; REACH McCLINTON

NTA Telestudios, 1481 Broadway, N.Y., LO 3-1122

fact previously had not come out in testimony.

- KEZY Anaheim, Calif. will broadcast from studios in the Disneyland Hotel, opposite the famed amusement park. According to Cliff Gill, station president, additional studios will also be established in nearby Fullerton.

- Lou Frankel Co., public relations, moves to 45 W. 57th St., New York; telephone Plaza 3-4636.

- Recipients of three research grants-in-aid have been announced for the National Assn. of Educational Broadcasters by Dr. Harry J. Skornia, executive director. Grants up to \$500 each will be made to Dr. Keith Engar, manager of KUED (TV) Salt Lake City (U. of Utah) to study effectiveness of a tv course for college credit; Dean Warren L. Hickman, College of Arts & Sciences of Ithaca College, to study a business and economics tv series, and Raymond T. Bedwell Jr., assistant in radio-tv, Ohio State U., Columbus, to compile history and development of U. S. radio broadcasting before 1934.

- WHK-AM-FM Cleveland and the National Assn. of Broadcast Employees & Technicians have signed a new five-year agreement, according to Mary Ellen Trottnor, union regional director, and Robert Dreyer, general counsel for Metropolitan Broadcasting Corp., representing WHK. The agreement guarantees a liberal wage increase, new severance pay compensations and a new method of computing vacation and holiday benefits.

- The farm service department of WSJS - AM - FM - TV Winston-Salem, N.C., has been given the 1958 distinguished service award of the North Carolina Farm Bureau Federation for "outstanding agricultural reporting." Also, Farm Service Director Harvey Dinkins has received a "certificate of appreciation" from the state forest industries for "his continuous presentation of forestry matters on his daily programs."

- Forty members of United Press International Broadcasters Assn. of Connecticut will fly to Omaha, Neb., this weekend (March 20) as guests of Gen. Thomas S. Power, commander-in-chief of the Strategic Air Command at Offutt Air Force Base. The group, including news directors and station managers, will acquaint itself with "the overall operation of SAC." Said Richard J. O'Brien, co-director of WCNX Middleton, "We live in a prime target state, and the better informed we are on our defenses, the more intelligently we can tell the story of SAC to the . . . listeners and viewers in our area."

- Avery-Knodel, station representative, is now operating out of new San Francisco quarters at 369 Pine St., one-half block from its old office. Phone numbers remain the same but TWX is changed to San Francisco 1345.

- Keystone Broadcasting System has signed ten new station affiliates: KUKI Ukiah, Calif.; KZIX Fort Collins, Colo.; WWCC Bremen, Ga.; KLER Orofino and KSRA Salmon, Idaho; KMCD Fairfield, Iowa; WMST Mt. Sterling, Ky.; KDOM Windom, Minn.; KUMA Pendleton, Ore., and WAVL Apollo, Pa. The additions bring KBS' total to 1,061 stations.

- WCEC Rocky Mount, N.C., has been given an award by the North Carolina Farm Bureau Federation for "the best job of agricultural broadcasting, for a station of its size, in the state."



No panic button • A new master control set-up has been installed by KMTV (TV) Omaha to eliminate any lag in switching audio, film and other broadcast phases. Developed by the station's engineering vice president, Raymond Schroeder, this panel allows pre-setting of five up-coming audio events beyond the event on the air. Switching from one audio source to the next in line is a push-button operation, whereupon the just-used event strip is automatically prepared for another pre-set event. Shown operating the device is KMTV engineer Leo Lechner.

- KPIX (TV) San Francisco has given educational KQED (TV) there 47 pieces of tv equipment. The gift, an addition to the \$4,000 previously donated by KPIX, includes a film camera, sync generator, amplifiers and a variety of test equipment.

- An all-album format has been adopted by KRKD Los Angeles, according to General Manager Jack Feldman.

- Dean Earl F. English of the U. of Missouri's School of Journalism will be the moderator of the symposium on "The Social and Economic Forces of Advertising" to be held Wednesday (March 18). The program is a feature of the school's 50th anniversary.

- Northwestern U. will run a course in crime news analysis and reporting March 23-27 for radio, tv and other media newsmen. Registration is being handled by Northwestern U. School of Law, Chicago 11.

- KHSL Chico, Calif., has revised its format to eliminate the more strident types of phonograph records and now features local and regional news, plus CBS newscasts and calls its programming "The Friendly Sound."

- WICE Providence, R.I., appoints Creamer-Trowbridge Co. there for station advertising.

- WMAQ Chicago is in the middle of a dispute between Jack Eigen, proprietor of its early morning interview show, and a client, the Chez Paree nightclub. Club owner David Halper informed Lloyd Yoder, NBC vice president and general manager of WMAQ, the club will refuse to extend its contract for the program unless Mr. Eigen is dropped. The program is virtually sold out and commands good ratings. Mr. Eigen has been airing his show on WMAQ for over seven years.

- KLX Oakland, Calif., appoints San Francisco office of Erwin Wasey, Ruthrauff & Ryan to direct its national advertising and sales promotion.

- The dept. of journalism at Memphis (Tenn.) State U. will offer a major in advertising beginning next fall.

- A campaign prepared by WTTM Trenton, N.J., for Blakely Laundry Co. there has won first prize in the American Institute of Laundering's radio advertising awards. Blakely spots are produced and recorded at the station's Custom Recording Div. Each announcement pinpoints a service of the laundry by interviewing one of the "friendly Blakely Laundry routemen." The laundry's agency: Ecoff & James Inc., Philadelphia.

• Rep appointments

- WTVC (TV) Chattanooga, Tenn., names Young Tv Corp.

- WDCR Hanover, N.H., names Walker-Rawalt, N.Y., as its New England representative, excepting New Hampshire.

- WJAC-TV Johnstown, Pa., names Harrington, Righter & Parsons, N.Y.

A "Good Buy" That Says Hello!

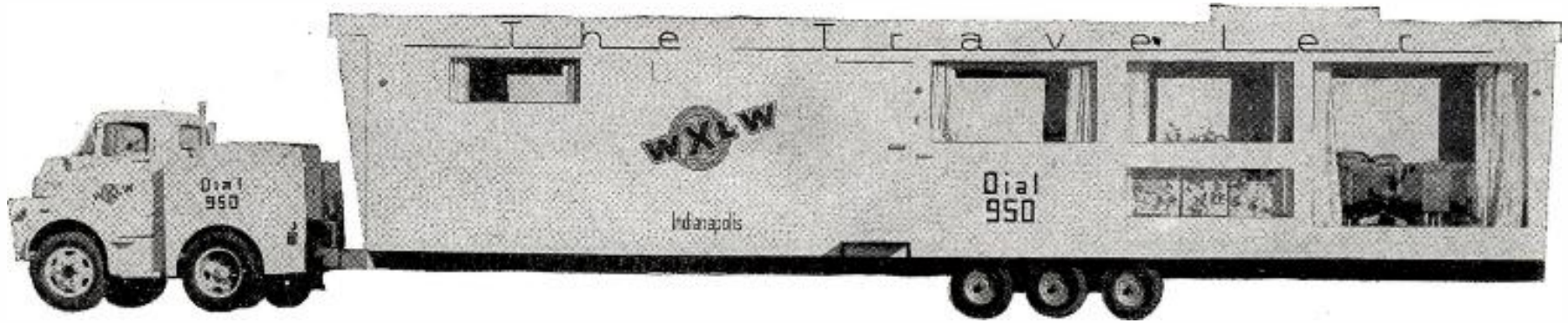

WXLW INDIANAPOLIS

Brings the "personal touch" to your sales message with

RADIO-MOBILITY

Hoosiers throughout the Indianapolis area are getting a warm, *personal* greeting from WXLW's greatest "first"—*The Traveler*—a 60-foot-long complete radio station on wheels! WXLW's *Traveler* brings the impact of RADIO-MOBILITY to its programming and to your announcements, with on-the-spot broadcasting of regular programs, interviews, and special events. Now listeners of the number one radio station in Central Indiana can see and hear their favorite WXLW personalities in action.

Send your sales messages along on these good-will tours, with *the buy* in Indianapolis radio . . . top-rated WXLW.

1st to feature true hi-fidelity sound.

1st to feature live on-the-spot news coverage.

1st to offer on-the-air editorials.

1st to offer adult programming, and now,

1st with RADIO-MOBILITY!

Enjoy the sales benefits of the personal touch only personal appearances can give . . . pull extra results from the extra effort made by WXLW to capture even more of the Indianapolis audience. Specify the good buy that says hello—WXLW!

950 ON YOUR DIAL



RADIO INDIANAPOLIS
5,000 WATTS DAYTIME



The Traveler's completely equipped studio



Interviews are conducted in The Traveler's modern lounge



The Traveler's control room features all the latest magic of advanced technical design

CONTACT YOUR NEAREST JOHN E. PEARSON REPRESENTATIVE

Good time for all!



**One little clock radio produces
over 50,000 sponsor identifications by listeners
to Atlanta's WSB Radio...**

During National Advertising Week the WSB Radio audience was invited to take part in a little game the staff cooked up. "Send in the names of WSB advertisers whose messages you hear, Monday thru Friday," they were asked. Clock radio pictured was offered the one submitting the longest correct listing.

Now this was no great shakes of an award. And therein lies the entire significance of the event. *Over 50,000 advertiser impressions were recorded* in the mail received from participants.

Advertiser identification always has been high on WSB Radio. And this is one more reason why WSB *out-produces and out-sells* competitive media in Georgia.

Affiliated with The Atlanta Journal and Constitution. NBC affiliate. Represented by Petry.

WSB Radio

The Voice of the South

ATLANTA

CELLER REVIEWS EUROPE'S TV

Wants study of British commercial tv rules

U.S. television is far ahead of the systems of Western Europe, Rep. Emanuel Celler (D-N.Y.), chairman of the House Judiciary Committee and its Antitrust Subcommittee, stated in a report scheduled for release today (March 16).

However, the outspoken foe of many network practices said Congress should take a long look at "certain regulatory features of British commercial television."

Government control, he said, tends to "eliminate evils which might otherwise beset the system. The first of these evils is the tie-in of the sale of network time to the sale of network-owned stations. . . . The second facet of the British commercial system which merits attention is the prohibition of program sponsorship by advertisers and the rigid restrictions [placed] on advertising. This tends to eliminate the omnipresent commercial which characterizes American television."

(Rep. Celler's Antitrust Subcommittee, in a spring 1957 report on tv, hit the alleged program tie-in practice of networks [BROADCASTING, June 10, 1957] and the FCC recently has started an inquiry into the matter [BROADCASTING, March 2]. The 1957 report, however, found it "desirable" for advertisers to have equal access for program sponsorship.)

Look-See Last Year • Rep. Celler's European report, based on a personal trip made by the congressman in September 1958, covers principally England, France and Italy. He said that in technical development, set distribution, area and population coverage, program quality and "particularly in variety and multiplicity of programs available to viewers, the United States is far ahead of Western Europe."

Except in the British Isles, tv still is a comparative infant in Western Europe, Rep. Celler stated. This is attributable to World War II, the high cost of sets, lack of revenue and lack of uniform technical standards, he said. However, in 1958 USIA figures show that the number of tv stations in Western Europe increased from 276 to 472 and the number of receivers from 11,345,200 to 14,684,000.

Eurovision, which joins 12 countries with live tv programming, "is an impressive accomplishment of international

cooperation," Rep. Celler said, "particularly in light of the conversion problems created by the differing transmission standards adopted by the member countries." Eurovision became operative in 1953 with a telecast of Queen Elizabeth's coronation.

Tv in England • Today, more than half the adults in the United Kingdom see tv daily, with service available to 98% of the population from 25 stations, Rep. Celler said. He discussed the operations of Britain's two separate tv systems—British Broadcasting Corp. (noncommercial) and Independent Tv Authority (commercial).

Two-thirds of the 9 million British sets are capable of receiving ITA programming, Rep. Celler said, with ad-

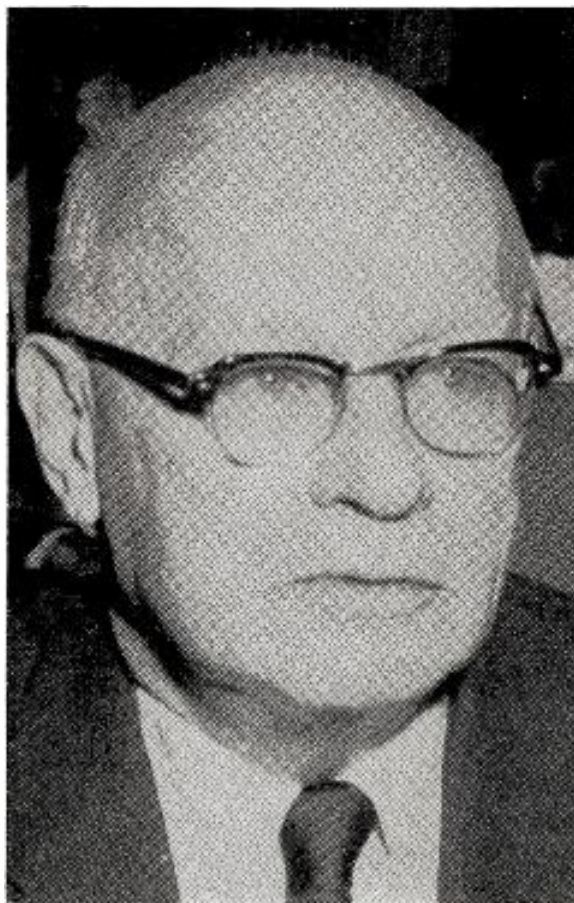

Rep. Celler: finds U.S. tv superior to Europe's

vertising revenue on the seven commercial stations amounting to \$73.5 million for the first half of 1958. Set owners must buy an annual license costing \$4 and there is a 60% "purchase tax" on a new set.

"The government has used its reserve power to censor programming most sparingly," Rep. Celler said. Three restrictions were cited which have been placed against tv programming.

Superior Reception in France • France's use of an 819-line picture

system, along with some Belgian stations, "probably gives the best reception of any in the world," Rep. Celler said. The U.S. uses a 525-line picture, England 405 lines and a majority of Western Europe, 625 lines.

A permanent tv studio was established in Paris as early as 1932, Rep. Celler said, with regular broadcasts continued until the war forced suspension. Sets today cost from \$250 to \$300 each (approximately two months salary for the average Frenchman), with annual license fees costing \$15.

French broadcasting is operated as a state monopoly on a no-concession basis. There is one central tv station with approximately 30 satellite stations in various sections of the country. "Central station control has created a tendency for information and education programs to take precedence over entertainment," Rep. Celler found. Advertising on tv has been prohibited since World War II.

By October 1958, 918,000 Frenchmen owned tv sets with the total audience estimated at 3,250,000 persons. Rep. Celler said that Teleclubs, originating in rural France in 1950, have been important in French tv development. Teleclubs also are active in Italy, Switzerland and Belgium.

Italian Monopoly • Tv began in Italy in 1947 under Radio Audisioni Italia, a state body whose directors are made up of government officials. RAI has a monopoly concession for both radio and tv broadcasting. Advertising is permitted but must be approved prior to being broadcast, as must programming, by the Minister of Post Telecommunications.

RAI also is required to place at the disposal of the government a maximum of two hours daily free of cost. As of May 1958, RAI was telecasting over 24 principal and 139 satellite stations covering all of Italy, plus Sicily and Sardinia. On the same date, sets in use totaled approximately 970,000 with private set owners paying \$22.50 annually for a license.

CBHT (TV) satellites

CBHT (TV) Halifax, N.S., ch. 3 station of the government Canadian Broadcasting Corp., has put into operation three low-power satellite stations on the southwest coast of Nova Scotia. They are located at Liverpool, on ch. 12, at Shelburne, ch. 8, and at Yarmouth, ch. 11. The equipment is operated without

any staff attendants, and inspection crews from CBHT make periodic visits. The transmitting antennas at the satellites are six-slot wavestacks mounted on towers 100 feet high.

BBG Chmn. Stewart CAB meeting keynoter

Most Canadian broadcasters will have their first meeting with the new Canadian broadcast chief next week (March 23) at the Royal York Hotel, Toronto, when Dr. Andrew Stewart, chairman of the Board of Broadcast Governors, keynotes the annual meeting of the Canadian Assn. of Broadcasters. (The organization's name has officially reverted from Canadian Assn. of Radio & Television Broadcasters to CAB.)

In the few public meetings held by the BBG since its appointment late in 1958, Dr. Stewart has stressed that Canadian broadcasters must live up to their program plans stated at the time of licensing. Thus it is not difficult to see why programming will feature the four-day CAB meeting at both open and closed sessions.

Dr. Stewart's opening address will be followed by sessions that morning on research, ratings and surveys. In the afternoon executives of advertising agencies and advertisers will join in the discussions on research and surveys. The opening day's luncheon will take the form of an annual meeting of the Bureau of Broadcast Measurement, the co-operative survey organization of the industry.

Tuesday morning will be devoted to an industry television workshop with advertiser and agency personnel invited. The session will be under chairmanship of Don Lawrie, Northern Broadcasting Ltd., Toronto. The afternoon will be devoted to a radio workshop under chairmanship of Howard Caine, CHWO Oakville, Ont. The sessions will deal to a large extent with program ideas.

Two on Tuesday • Tuesday luncheon period will have two meetings, one for the CAB Quarter Century Club at which 16 new members will be welcomed, and the second a meeting of the Central Canada Broadcasters Assn.

The 16 new members of the CAB Quarter Century Club are T. J. Allard, CAB executive vice president; E. G. Archibald, CHOV Pembroke, Ont.; John E. Baldwin, All-Canada Radio & Television Ltd., Vancouver, B. C.; R. J. Buss, manager, CHAT Medicine Hat, Alta.; H. R. Carson, president, All-Canada Radio & Television Ltd., Calgary, Alta.; Antonio Desfosses, CKAC Montreal; H. F. Dougall, president, CKPR Fort William, Ont.; Charles Edwards, general manager, Broadcast News Ltd., Toronto; M. M. Elliott, S. W. Caldwell Ltd., Toronto; David G. Hill, manager, CKDA Victoria, B. C.; M. Johnson, Radio Representatives Ltd., Toronto; Mrs. M. E. Large, CFCY Charlottetown, P. E. I.; Henri LePage, managing director, CHRC Quebec City; W. Slatter, general manager, CJOY Guelph, Ont.; F. R. Turner, CKXL Calgary, Alta.; Jack Dennett, CFRB Toronto.

Wednesday will be devoted to closed sessions for CAB members, featuring brainstorming meetings on subjects ranging from programming to promotion, with operational problems discussed at separate afternoon meetings for radio and television station members.

The annual business meeting, for CAB members only, will be on March 26, and will include election of new directors. CAB's annual dinner will be held Tuesday evening.

Canadian strike over

The strike of 74 French-language producers against the Canadian Broadcasting Corp. (BROADCASTING, Feb. 9) ended March 7 with the signing of an

agreement that gives the producers' association bargaining rights. The agreement stipulates that producers may obtain technical advice and assistance from union groups but may not join any union or group of unions.

• Abroad in brief

• March 31 is the deadline for entries in Crusade for Freedom Inc's "Radio Free Europe" (BROADCASTING, March 2) competition. Six European trips and other prizes will be awarded writers of 25-word messages on the subject, "As an American I support Radio Free Europe because. . . ." Address: Radio-Tv Participation Program, Crusade for Freedom, Box 35-A, Mount Vernon 10, New York.

• The spring survey of the co-operative Bureau of Broadcast Measurement, Toronto, is this week (March 16-22). BBM is asking that member stations do not make special promotions during that week so as to give distorted coverage figures. Stations which in the fall survey were known to have used special promotions during the survey week were so listed in the BBM survey report.

• CKSF Cornwall, Ont., has been sold to Stanley Shenkman, Montreal architect, and group of associates for an undisclosed sum, pending approval of the Canadian Board of Broadcast Governors. The station was owned by the *Cornwall Standard-Freeholder*, daily newspaper, which was recently sold to the Thomson Co., Toronto, newspaper chain. The Thomson Co., owner of a number of radio stations through subsidiaries, would not be able to own the radio station under Canadian multiple ownership limitations. Ernest Miller, manager of CFCM-TV Quebec City, will be president and general manager of CKSF upon approval of the transfer.

The new group is also applying for a television license at Cornwall, on ch. 8 with 130 kw video and 78 kw audio power.

• The number of registered tv sets in West Germany increased 163,091 last January. This brings the total to 2,292,274 tv sets in the country.

• The number of registered tv sets in France increased more than 300,000 in 1958. The total number of tv sets in the country now is approximately 988,600. About 550,000 radio sets were sold in 1958, bringing the total to 10,646,000.

• The Soviet Union will reward outstanding work in electronics with a medal commemorating the centenary of Prof. A. S. Popov, who the Russians call "the inventor of radio."

BROADCASTING, March 16, 1959

Beautiful words. Beautiful thoughts.
Thanks to my Beautiful Friends.

BERT LOWN

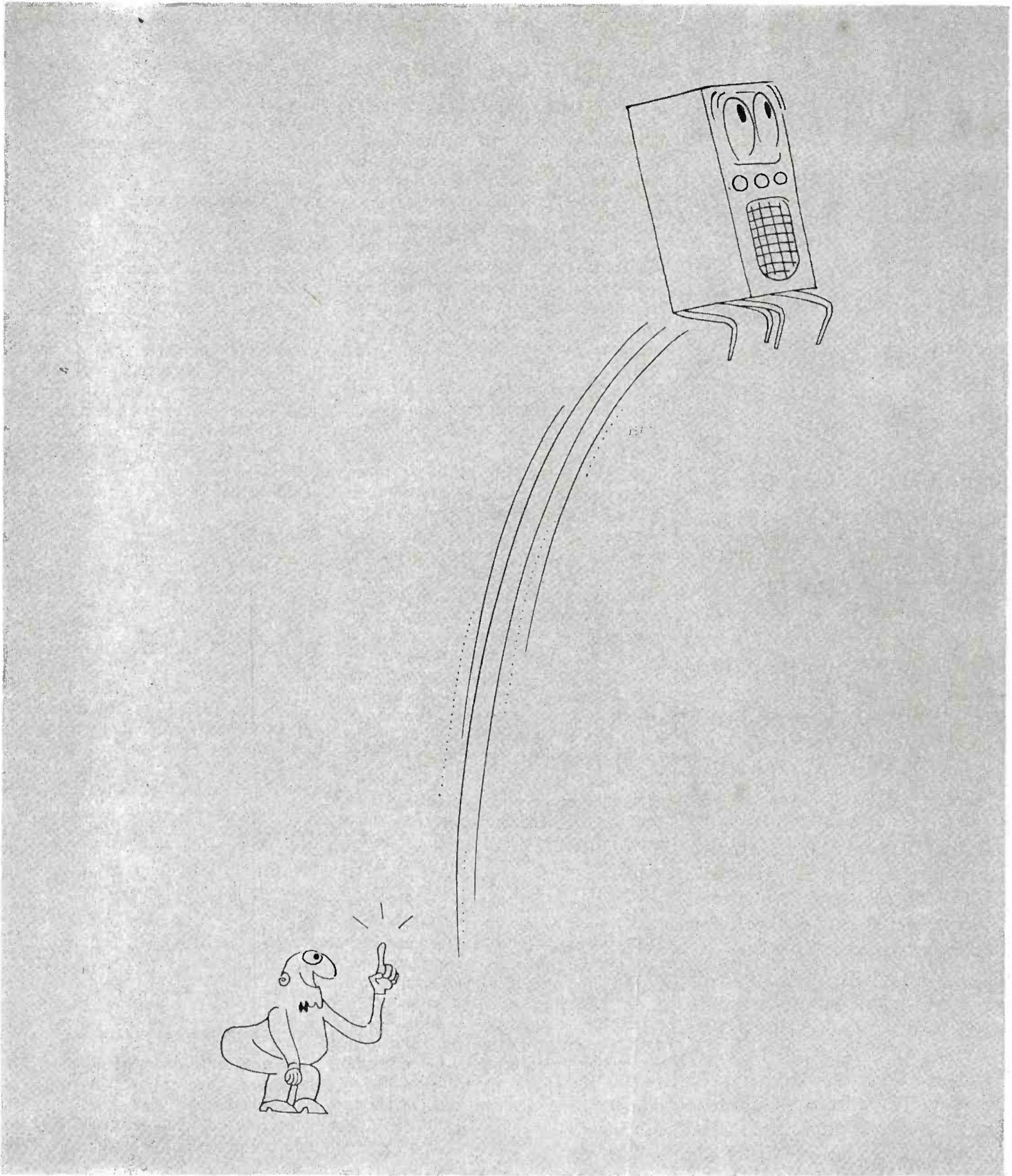

We Came In Third In Hypo
(and furthermore, hurrah.)

Dollar value of newspaper space scheduled in Cedar Rapids Gazette, Waterloo Courier, and Dubuque Telegraph Herald during last ARB rating period has WMT-TV running third. Station B used about \$300 more space; station C used about \$16,000 more.

Box score: WMT-TV's 50.8 over-all share of sets

in use is the highest ever recorded by ARB in this market. (Nov. 1-wk. -4 wk. Cedar Rapids—Waterloo.) In Dubuque: 19 of 20 top shows on WMT-TV.

WMT-TV, CBS Television for Eastern Iowa, represented by The Katz Agency, covers over half of the tv families in Iowa, and dominates three of Iowa's six largest cities.

REMA

RKAB

LE



says Joseph Dougherty, Sales Manager

WJZ-TV

BALTIMORE

The latest Pulse in Baltimore sounds a triumphant beat, beat, beat for WJZ-TV. Out of the six top-rated films four of them (including the top two) were United Artist Features telecast by WJZ-TV. As WJZ-TV's Sales Manager puts it:

"This remarkable record bears out our past experience with UA Features. We can always count on them for top ratings against competition."

The high scoring UA Pictures were: SHIELD FOR MURDER, RAIDERS OF THE SEVEN SEAS, CROSSED SWORDS, IROQUOIS TRAIL. They ran November 5-12, 1958 from 6:00 to 7:20 p.m. These features, all from United Artists "52 Award Group," captured an average of 56% of the audience in a 3 station market. *A good buy for WJZ-TV... a good buy for you, too!*

U.A.A.

UNITED ARTISTS ASSOCIATED, INC.

NEW YORK, 345 Madison Ave., MUrray Hill 6-2323
CHICAGO, 75 E. Wacker Dr., DEarborn 2-2030
DALLAS, 1511 Bryan St., RIVERSIDE 7-8553
LOS ANGELES, 9110 Sunset Blvd., CREstview 6-5886

152

FANFARE

500,000 day listeners sewed up in KBIG plan

KBIG Avalon, Calif., a daytime station, is making itself a listening post for 500,000 of the most reliable listeners to be found in the daytime crowd.

The corps is made up of area club-women who participate in the "Home-Makers' Club" merchandising-charity plan. They keep in touch with the project through KBIG, which broadcasts club news and commercials for club sponsors daily between 10 a.m. and 1:30 p.m. KBIG's tie-up with the plan not only gives the station a bread-and-butter listener list but puts it in a good position to sell the sponsors who sell the women.

In its 18-year history, the Home-Makers' Club has cleared contributions of more than \$2 million to charity. Members of parent-teacher, church and civic groups save labels of sponsoring manufacturers or sales slips of contributing merchants and turn the slips in every eight weeks for cash prizes totaling \$300 to high-scoring organizations. The group taking the top prize of \$150 begins its next eight-week cycle with a score of zero while the other groups build on the score they have. This process virtually insures every group of winning the major prize in time.

Past Performance • The Home-Makers' Club began in 1941 as a radio program with merchandising bonuses to its sponsors, on KHJ Los Angeles. Later it moved to KMPC there and with the advent of tv it became a video show on KLAC-TV Los Angeles (now KCOP [TV]). Group luncheons, the main feature of the broadcasts, were then staged in restaurants (a la *Breakfast in Hollywood*, which got started just about the same time) rather than in churches or club quarters as they are now. But these remotes proved too costly on television and the Home-Makers' Club decided to drop the broadcasts and concentrate on mainly its luncheon and label-saving operations.

After a five-year hiatus, the club went back on radio last year, on KDAY Long Beach, Calif. When KDAY changed its program format to appeal primarily to younger listeners, the club moved to KBIG whose programming seems more in keeping with the civic or charitable-minded housewife who is the typical H-MC member.

Home-Makers' Club is headed in Southern California by Grace Glasser Koopal, also president of the Los Ange-

les advertising agency, Glasser-Gailey Inc. H-M C's co-owner, Jane Holmes, is head of the San Francisco branch. Plans for expansion into other major markets are under consideration at present.

Spot salesman sells houses

Lalo Campos, account executive, KOKE Austin, Tex., is wondering whether to switch from radio to real estate after selling a spot package to a local housing development. In making the sale, a \$96 saturation package, Mr. Campos assured the realtor that he would check the results personally at the development site. The client replied with an offer of \$100 for each house the account executive sold. The following week the KOKE staffer received \$400 from the client's four sales. Commission from the \$96 spot sale: \$14.40.

Greeting the fleet

The fleet was in for a rousing greeting in Norfolk, Va., as 12,000 sailors returned from the Mediterranean area near Lebanon Thursday (March 12). WTAR-AM-TV Norfolk whooped up a big "Welcome Home" program for the returning seamen. With CBS-TV, WTAR arranged to have Ed Sullivan, Myron Cohen and Toni Arden as special greeters. The station originated parts of its Wednesday night schedule (March 11) from the ships at sea and included interviews with families awaiting the men's arrival. Early morning shows Thursday were remoted from the Naval Base. That evening, highlights of the landing were featured on Doug Edwards' CBS news program. The entire Galen Drake CBS show was brought to Norfolk for the celebration and presented on tape Friday morning.

Rating not everything

A brochure distributed by Television Bureau of Advertising to members last week emphasizes that the "important barometer" in buying a television program is not the rating but its sales effectiveness.

The mailing piece is based on a TvB interview with George Abrams, formerly vice president and advertising director of Revlon, Inc. Mr. Abrams disclosed that Revlon decided to renew CBS-TV's *Garry Moore Show* even though it ranked 52d among 124 network-sponsored programs (based on the December 1958 Nielsen). Mr. Abrams added that Revlon conducted surveys in Philadelphia, Los Angeles and Chicago and received "convincing proof" that the pro-

BROADCASTING, March 16, 1959



IF IT IS **BIG**
AND **IMPORTANT,**
IT'S ON **WHAS-TV**

Phyllis Knight
Top McCall's Winner
for 1957
hostess of "Small Talk"
6-6:15 p.m. daily

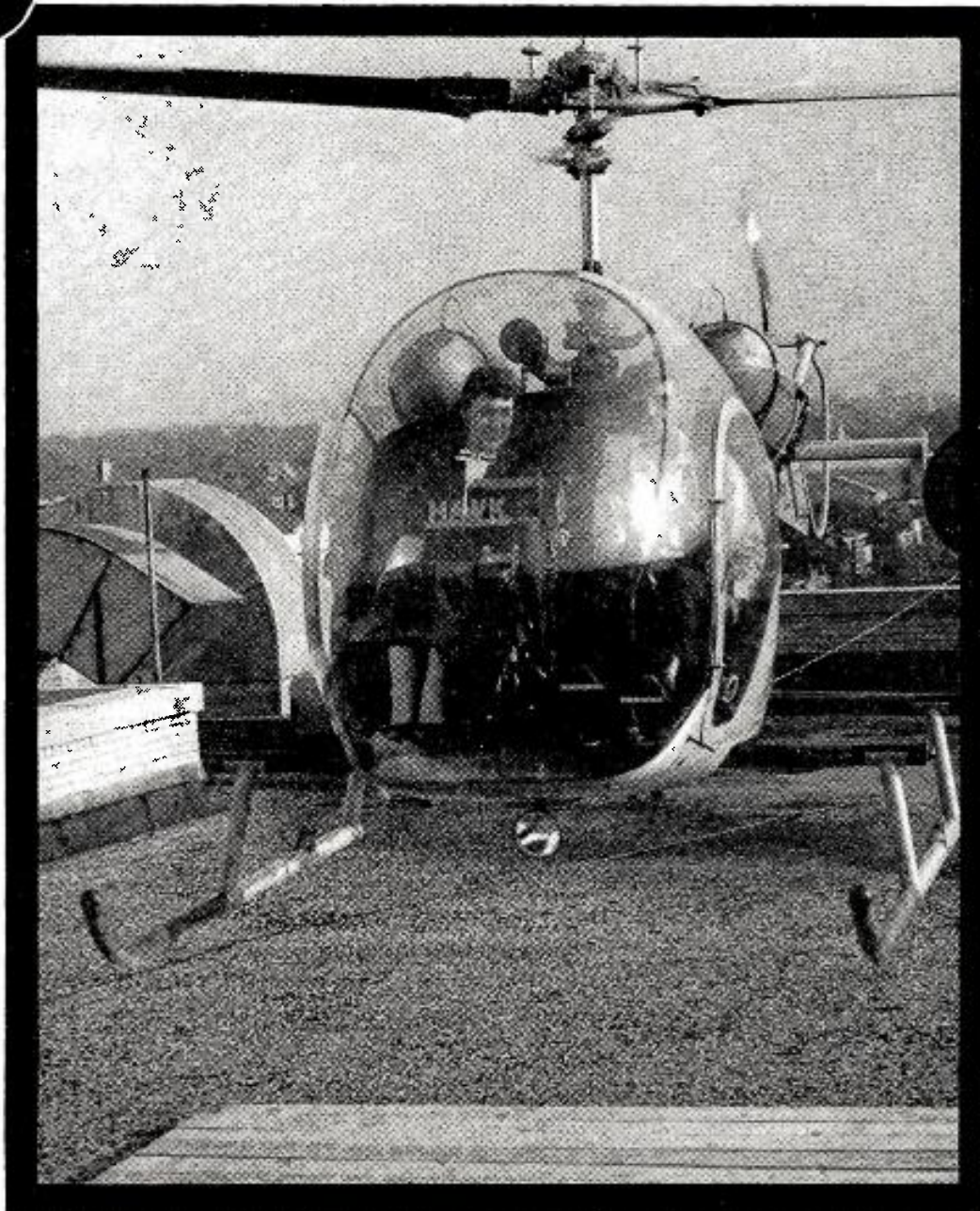

Live helicopter flights with landings on the studio roof, remotes from Churchill Downs and the state fairgrounds, a video taped jet plane ride . . . guests ranging from Billy Graham to Bourbon Beef Show winners keep Phyllis Knight's "Small Talk" show sparkling. And Phyllis won McCall's top Golden Mike Award for persuading thousands of women to submit to a cervical cancer test.

Adroitly blending community service with entertainment and information, "Small Talk" is typical of the imaginative, **IMPORTANT** programming which viewers have learned to expect from **WHAS-TV**. Advertisers such as Tetley Tea, Breast O' Chicken Tuna, FAB, VEL, Powder-ene and Zest recognize that "Small Talk" sells **BIG**.

Your Advertising Deserves WHAS-TV Attention . . .
with the ADDED IMPACT OF PROGRAMMING OF CHARACTER!



WHAS-TV
Fisbie
Foremost In Service
Best In Entertainment



WHAS-TV CHANNEL 11, LOUISVILLE
316,000 WATTS — CBS-TV NETWORK
Victor A. Sholis, Director
Represented Nationally by
HARRINGTON, RIGHTER & PARSONS, INC.



One in 5,000 • Ann Sonka, 21, beat out 4,999 other entrants contestants for the title, "Miss Ruby Lips," in a contest by KLIF Dallas. Having won the beauty title, now she will appear in "The Gila Monster," a film feature by Hollywood Pictures Corp., which is backed by KLIF owners Gordon McLendon and his father, B.R.

gram was reaching "a responsive audience . . . that bought large amounts of the products advertised on the program."

Market study is top prize

Promotion managers at 145 ABC-TV affiliated stations are competing for a station market research study and a \$500 Diners' Club expense account. Seven-Up through its agency, J. Walter Thompson Co., has asked stations to invent new ways for "Fresh Up Freddie" to promote the soda pop and *Zorro*, Seven-Up's ABC-TV program.

The market research study will be paid for by Seven-Up and provided by Seymour Smith Assoc. The contest runs March 9 through April 10.

KPLI (FM) open-air opening

KPLI (FM) Riverside, Calif., forsook its new studios on opening day to let the neighborhood know where to tune fm sets. Ceremonies were highlighted by an open air show on a stage built for the occasion outside KPLI's studios downtown.

Following a concert by an Air Force band, a fire truck, sounding its siren, brought Miss KPLI, a local model, to the dais. Miss KPLI pulled the switch that put the station officially on the air. The first voice broadcast by KPLI was that of California Gov. Edmund G. Brown declaring March 1-7 "KPLI Week." The new fm is on 99.1 mc with 1.57 kw.

WNEB stops town meeting

The broadcast of the Auburn (Mass.) High School hockey team's game at Boston over WNEB Worcester, Mass., resulted in postponement of the annual Auburn town meeting. About 600 residents turned up at the meeting but it was immediately adjourned so that they could hear the hockey broadcast.

Tornado alert from WHAS-TV

A WHAS-TV Louisville, Ky., half-hour documentary, *53 Miles From Death*, is credited with influencing the city to expand and tighten up its tornado warning service.

The documentary showed the damage to 53-mile-away Caneyville, Ky., and editorialized about the weaknesses in the Louisville schools' tornado warning systems.

As a result of the investigation that followed the program, Louisville is increasing its warning sirens from four to sixteen, installing Conelrad receivers in all schools and instituting other tornado precautions.

WPTR's 'Revolution'

Promoters at WPTR Albany, N.Y., didn't think they'd done anything really revolutionary when they put out a humorous promotional disc, "Revolution." Listener acclaim, however, has turned the promotional spot into a featured record, and the three WPTR staffers responsible for "Revolution" have had to incorporate to handle commercial distribution of the record (with local promotion edited out.)

"Revolution" satirizes events south of the border, featuring an interview with "Hi Fidel Bistro" and inserts from currently popular songs. WPTR's copy chief, Tony Visk, wrote and recorded it (with Marty Ross, program manager, and Jim Cruise, chief studio engineer) strictly as a promotional platter, plugging the station's "Fabulous Five" disc jockeys.

The disc was given routine on-and-off airing. In its first week, listeners voted it No. 1 on the regular WPTR "Parade of Hits," made up of fans' telephoned requests. Demand expanded to record shops and "Revolution" was written up in the local press. Last week sales were reported along the eastern seaboard. WPTR is still playing its original edition and pressing more copies for advertiser-agency friends.

Three-day drama show

CJON-TV Newfoundland has assessed its first televised Drama Festival and decided to make it an annual affair. The initial three-day competition for little theatres of the province is reported in a picture brochure. Three groups were

selected to present plays on consecutive nights, an understanding that involved in all some 50 amateurs working with CJON-TV personnel. The event got extensive coverage on radio and in newspapers, CJON-TV reports in the festival brochure.

KIOA stamp giveaway

Two million premium stamps were given away by KIOA Des Moines, Iowa, in a six-week give-away that elicited about 65,000 letters from listeners. Co-operating in various station stunts was Super Value, a central Iowa grocery chain.

Among the contests that earned winners the stores' stamps: listeners were asked to identify groceries described over KIOA (130 stamps); bring a baby pig dressed in a diaper to the studio (1,500 stamps); appear at KIOA in a bathing suit carrying an umbrella (1,500 stamps).

Gospel singer contest

In support of the 10th anniversary of Aunt Jemima's self-rising flour as an advertiser on WWRL Woodside, N.Y., the station has launched a "Gospel Singing Contest," which has attracted more than 1,000 contestants. Soloists, groups and choirs appear on *Gospel Caravan* (Mon.-Fri., 10:30 a.m.-1 p.m.) and *Gospel Time* (Mon.-Fri., 1-2:30 p.m.) programs. Listeners will pick winners but a label from Aunt Jemima package must accompany each selection.

The first prize winners in each of the categories will be given a recording contract and bookings at the Apollo Theatre in New York.

Ship-shape promotions

Broadcasters are making the most of boat show season around the country. Sample promotions:

WIP Philadelphia originated its evening broadcasts directly from a 30-foot cabin cruiser at the Boat and Sportsman's Show in that city (Feb. 27- March 7). The stunt paid off in time sales as well as good will. General Copper & Brass bought entire 5½-hour segments on Friday and Saturday nights. Commercial Banking Corp. bought four interviews of five minutes each, featuring WIP Sports Director Jim Leaming. These were in addition to regular evening reports. All the station's personalities appeared at the show.

A "Fishin' Derby" promotion by WGR Buffalo was credited by officials of the annual local Boat, Travel & Sports Show with increasing attendance by 30% this year. During the nine-day



**No
 Matter
 How You
 Look at
 The
 Memphis
 Market...**

It's Channel 3 First By All Surveys

At WREC-TV the finest local programming is combined with the great shows of CBS Television to constantly support our motto: "In Memphis There's More to SEE on Channel 3." Survey after survey proves it . . . so will the results of your advertising effort. See your Katz man soon.

Here are the latest Memphis Surveys showing leads in competitively rated quarter hours, sign-on to sign-off, Sunday thru Saturday:

	A.R.B. Oct. 29-Nov. 25 '58 (Metro Area)	Pulse Nov. '58 (Metro Area)	Nielsen Dec. 7-Jan. 10 '59 (Station Area)
WREC-TV	248	293	259
Sta. B	94	96	71
Sta. C	69	29	81

WREC-TV

Channel 3 Memphis



Represented Nationally by the Katz Agency

THE NATION'S
LEADING CREATORS
OF STATION
PROMOTION
JINGLES
PRESENT - - -

STEREO JINGLES

That famous CRC sound, now available in true STEREO! Even if you don't have an immediate need for this newest CRC service, send for demo tapes for a real revelation. Or better still, see Dick, or Bob, at the Palmer House during the N.A.B. for refreshments, and a sparkling audition of CRC's newest and greatest jingle sets, in Mono or Stereo. Or, catch our act in Miami at the D.J. May bash.

Any way you splice it, a set of CRC tapes on your station will place you in the company of today's radio giants, AND WE CAN PROVE IT. Experience counts.

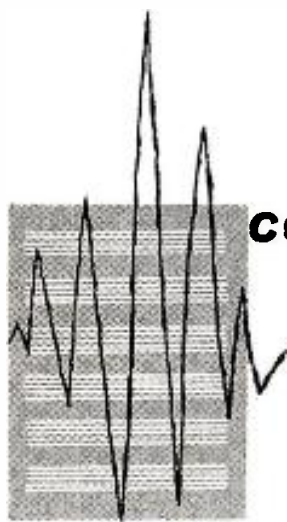

COMMERCIAL RECORDING

P.O. BOX 6726 • DALLAS 19
PHONE RI 8-8004
TOM MERRIMAN
president
BOB FARRAR
vice president
DICK MORRISON
general sales manager

event, some 45,000 came to the WGR-AM-TV exhibit alone.

Toledo Sports Arena attributes WOHO there with attracting a record (11,041) crowd to its Boat & Sports Show Feb. 15. The station, which broadcast between 2-10 p.m. from the arena, was the only broadcast medium used to promote the show. The sports promoters have asked WOHO to return for next year's show.

Feathered friends of KTTV (TV)

To mark the flight of Kellogg's *Woody Woodpecker* program to KTTV (TV) Los Angeles, the station outfitted a midget actor as the uninhibited bird and a model as "Miss Ladybird" for a tour of the area. They distributed woodpecker dolls and Kellogg cereal products to journalists and handed out the breakfast foods to pedestrians at each stop light. Producer Walter Lantz made three guest appearances as part of the all-out campaign which featured animated 30 and 60-second film spots. In addition, letters from Woody, including one pecked out on a piece of wood, were dispatched to tv editors. Similar campaigns were conducted by KTTV for *Superman* and *Wild Bill Hickok*.

No sharks wanted here

There are only six fatalities on record, since the turn of the century, of persons attacked by savage tiger sharks in the normally serene swimming areas around Honolulu, Hawaii, according to KPOA there. Thus, relates the station, the community was alarmed recently by the killing of a youngster by one of the big fish. KPOA aired daily editorials on the shark problem, offering a \$200 bounty on each shark caught within a month of the boy's death. One such shark was brought in by a Kailua fisherman, reports KPOA. The station's campaign has been commended by the governor's office and federal and territorial fish and game authorities.

• Drumbeats

• Bill Savitt, owner of WCCC Hartford, Conn., and also a local jeweler, believes in his medium. He has bought more than 250 spots on four community stations for the jewelry business.

• WHOP Hopkinsville, Ky., let 4-H Club members take over as salesmen, d.j.'s, copywriters and announcers in the station's second annual 4-H Club Broadcast Day. The young farmers grossed more than \$400.

• Ellen K. Dryer of W. B. Doner & Co., and spouse are on an expense-paid trip to Cape Canaveral, Fla., courtesy of KFWB Los Angeles. Mrs. Dryer most nearly guessed the station's Pulse rating to win KFWB's "Rocketing Ratings" competition.

• *Radio Moscow*, the WBT Charlotte, N.C., program based on Russian propaganda broadcasts (BROADCASTING, Jan. 19), is being expanded. The program, previously heard Sunday, now will be on Monday, Wednesday and Friday nights.

• KTNT Tacoma, Wash., won the Tacoma Ad Club's third annual award for the most original local radio commercial of 1958. The spot, created by KTNT's program director, Don St. Thomas, and retail sales manager, Stan Johnson, was for a local cafe.

• KMSO-TV Missoula, Mont., assessing its program, *The Pastor's Study*, reports that in a generous mail response every week, there have been no complaints in two years on the air.

• The Civil Air Patrol (77,000 volunteers) has pledged its support to California National Productions' *Flight* series, KRCA (TV) Los Angeles reports. The programs are seen on KRCA Wednesday 10:30-11 p.m. Air Force cooperation also has been enlisted.



Outdoor honors • Two broadcast properties, WRVA Richmond, Va., and KDAL-AM-TV Duluth, Minn., emerged with awards in the seventh annual contest sponsored by Outdoor Adv. Assn. of America. WRVA was cited, along with its agency, Stone-Heffner-Cook, for its outdoor campaign directed at car radio listeners. KDAL-AM-TV used billboards over a 30-day period to introduce a new sports personality. The tv station maintains a board the year around. Contest judges were agency men.

Another thriller-diller from WJRT—

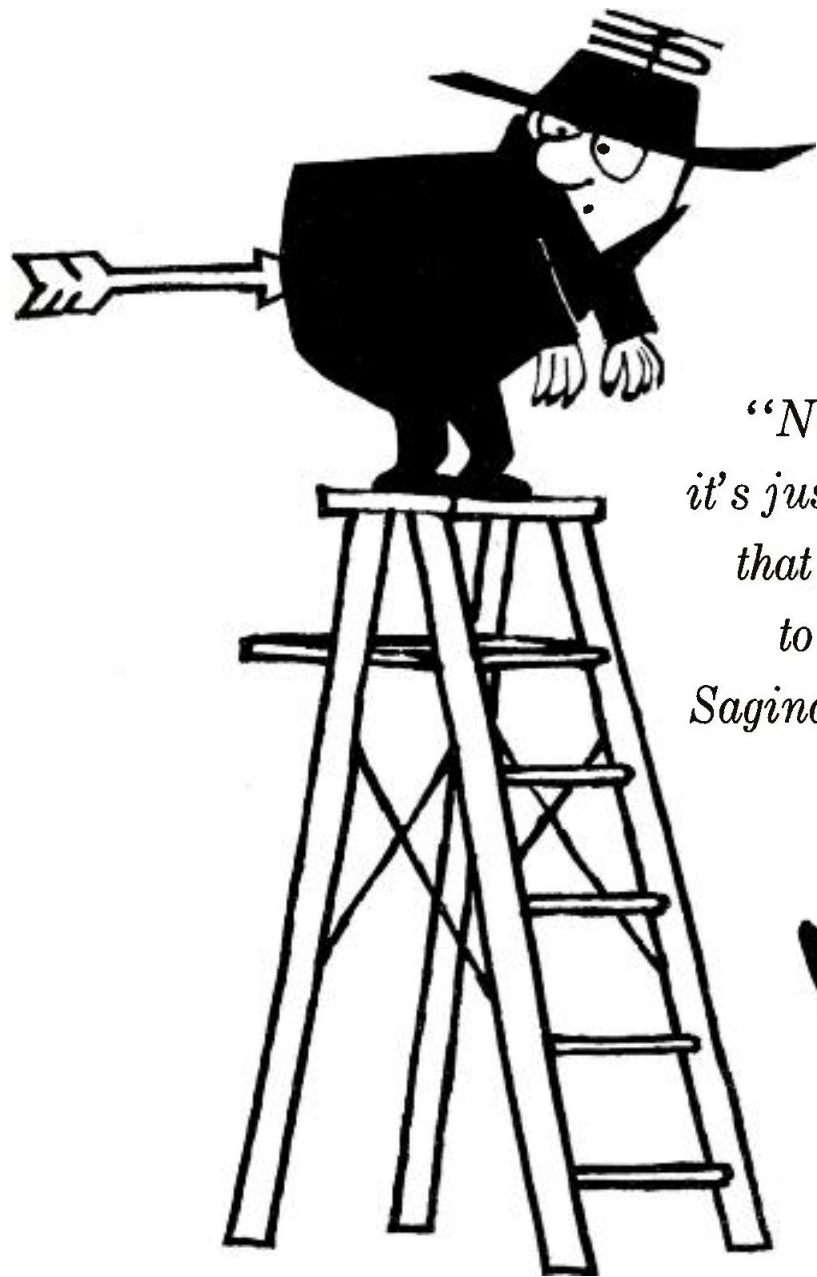

“They’re trying to pin something on me, Chief.”

“Nonsense, Ponsonby, it’s just a pointed reminder that WJRT is the efficient way to reach Flint, Lansing, Saginaw and Bay City.”

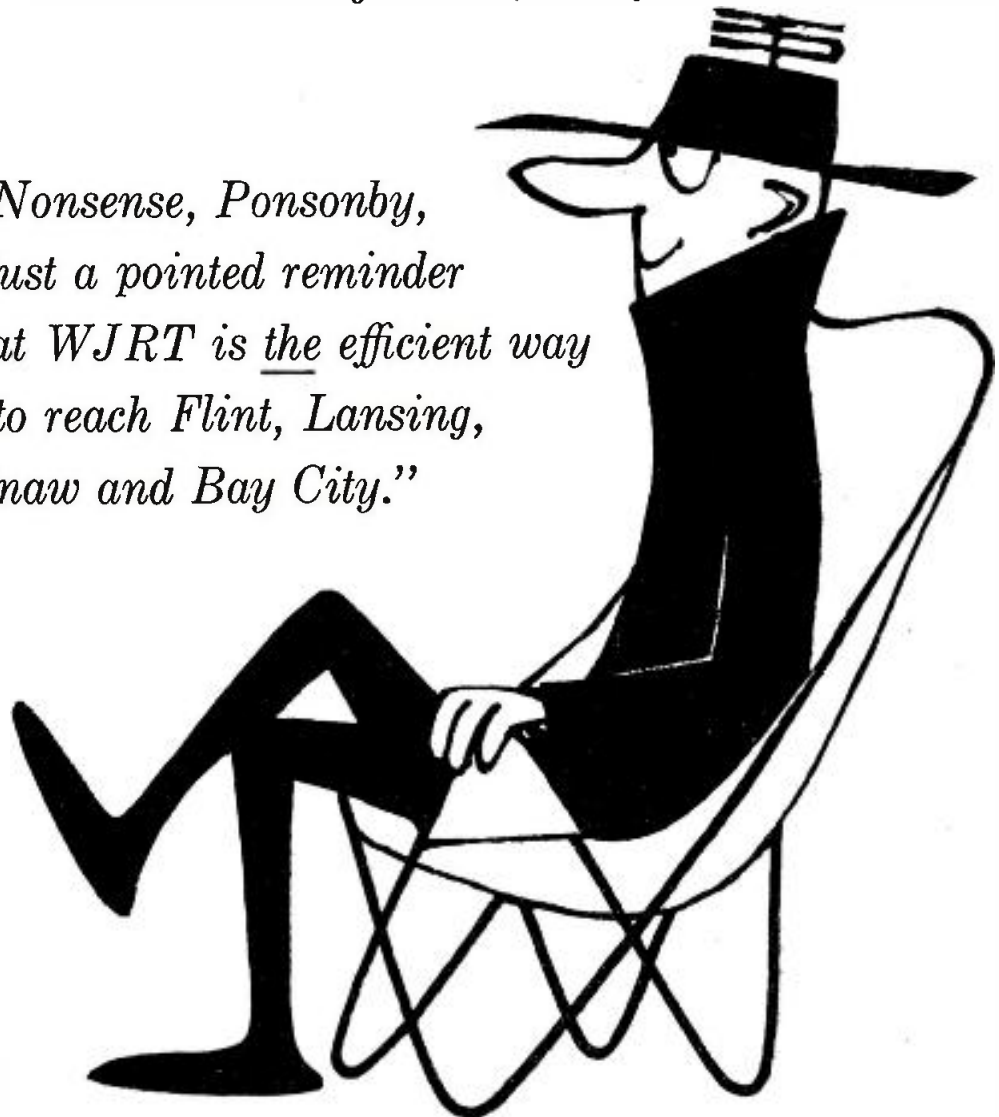

Sharpest buy in mid-Michigan TV: WJRT, the only single-station way to blanket Flint, Lansing, Saginaw and Bay City. The signal: grade “A” or better. That’s WJRT efficiency, bringing you right into the center of things, giving you penetration from within.

If you want to sell in Flint, Lansing, Saginaw, Bay City—and throughout mid-Michigan with its nearly half-million TV households—there’s no better way than WJRT, the only efficient way. And the sooner the better! You won’t avoid the rush, but the getting’s still good.

WJRT

CHANNEL **12** FLINT

ABC Primary Affiliate

Represented by HARRINGTON, RIGHTER & PARSONS, INC.

New York • Chicago • Detroit • Boston • San Francisco • Atlanta

Station Authorizations, Applications

As Compiled by BROADCASTING

March 5 through March 11: Includes data on new stations, changes in existing stations, ownership changes, hearing cases, rules & standards changes and routine roundup.

Abbreviations:

DA—directional antenna. cp—construction permit. ERP—effective radiated power. vhf—very high frequency. uhf—ultra high frequency. ant.—antenna. aur.—aural. vis.—visual. kw—kilowatts. w—watt. mc—megacycles. D—day. N—night. LS—local sunset. mod.—modification. trans.—transmitter. unl.—unlimited hours. kc—kilocycles. SCA—subsidiary communications authorization. SSA—special service authorization. STA—special temporary authorization. *—educ. Ann.—Announced.

New Am Stations

APPLICATIONS

Redwood City, Calif.—Western State Bcstg. Co. 850 kc, 500 w. P.O. address 110 Crocker Ave., Piedmont, Calif. Estimated construction cost \$40,294, first year operating cost \$102,000, revenue \$112,000. Equal owners are Roman W. Wassenberg, account executive KJBS San Francisco, and Kirk Hayes, furniture manufacturer. Ann. March 10.

Barnesville, Ga.—A. S. Riviere 1590 kc, 1 kw D. P.O. address Barnesville, Ga. Estimated construction cost \$20,962, first year operating cost \$32,000, revenue \$8,000. Mr. Riviere is pecan, cattle and cotton farmer. Ann. March 10.

Des Plaines, Ill.—Des Plaines-Arlington Bcstg. Co. 1550 kc, 10 kw D. P.O. address 720 Apple Tree Lane, Glencoe, Ill. Estimated construction cost \$68,421, first year operating cost \$84,000, revenue \$108,000. Sole owner Herbert S. Laufman owns advertising agency and tv film production firm. Ann. March 5.

Flora, Ill.—Central State Bstrs. Inc. 1550 kc, 250 w D. P.O. address 5705 North Belt-West, Belleville, Ill. Estimated construction cost \$5,722, first year operating cost \$24,000, revenue \$30,000. Applicants are John W. Lewis (40%) who has interest in WIBV Belleville; Ralph J. Bitzer (20%) who has interest in KGRN Grinnell, Iowa, and John M. Rion (40%), radio personality. Ann. March 11.

Elwood, Ind.—Stokes Gresham Jr. 1030 kc, 1 kw D. P.O. address 7525 Gypsy Hill Rd., Indianapolis, Ind. Estimated construction cost \$11,820, first year operating cost \$44,500, revenue \$57,200. Mr. Stokes is chief engineer WISH-AM-TV Indianapolis. Ann. March 11.

Newton, Mass.—Newton Bcstg. Co. 1550 kc, 10 kw D. Estimated construction cost \$56,429, first year operating cost \$83,910, revenue \$120,900. Partners are Charles A. Bell, production manager Advance Instruments Inc.; James A. Collins and George J. Helmer III, employes Socony Mobil, and Wayne H. Lewis, employe WERI Westerly, R.I. Ann. March 5.

Taos, N.M.—Art Capitol Bcstg. Co. 1340 kc, 250 w. P.O. address Box 1718, Cortez, N.M. Estimated construction cost \$16,150, first year operating cost \$30,000, revenue \$42,000. Equal owners are Donald Boston, half owner KBLT Big Lake and general manager KCMR McCamey, both Texas, and Jack M. Hawkins, who has interest in KVFC Cortez, Colo., KIUN Pecos, KFST Fort Stockton and KVLFF Alpine, all Texas. Ann. March 11.

Midwest City, Okla.—M. W. Cooper 1220 kc, 250 w D. P.O. address 412 Leonhardt Bldg., Oklahoma City, Okla. Estimated construction cost \$15,400, first year operating cost \$35,000, revenue \$75,000. Applicant is attorney. Ann. March 6.

Conway, S.C.—J. A. Gallimore 1240 kc, 250 w D. P.O. address Box 443, Seneca, S.C. Estimated construction cost \$14,700, first year operating cost \$34,080, revenue \$36,000. Mr. Gallimore has interest in WSSC Sumter, WBAW Barnwell, WBHC Hampton, WABV Abbeville, all South Carolina, and WLFA LaFayette, Ga. Ann. March 11.

Clinton, Tenn.—Clinton Bcstrs. Inc. 1380 kc, 1 kw D. P.O. address 329 W. Hillcrest Dr., Morristown, Tenn. Estimated construction cost \$15,311, first year operating cost \$30,000, revenue \$35,000. Principals include George R. Guertin (49%), one-third owner WMTN Morristown, Tenn., and John M.

Paxton (50%), owner retail music store and coin operated machines. Ann. March 5.

Kirkland, Wash.—Sealth Bcstg. Co. 1460 kc, 500 w D. P.O. address 13215 39th St. NE, Seattle 55, Wash. Estimated construction cost \$12,879, first year operating cost \$50,000, revenue \$65,000. Applicant, George W. Boucher, is commercial manager KTW Seattle. Ann. March 11.

Spencer, W.Va.—Spencer Bcstg. Co. 1400 kc, 250 w. P.O. address 901 Evanwood Rd., Charleston, W.Va. Estimated construction cost \$10,300, first year operating cost \$30,000, revenue \$40,000. Applicants are Melvin S. Burka, Gus Zaharis and Bernard A. Burka, who have interest in WTIP Charleston, W.Va. Each owns approximately one-third interest in Spencer Bcstg. Co. Ann. March 6.

Fort Atkinson, Wis.—Clarkwood Bcstg. Corp. 940 kc, 500 w D. P.O. address 1710 N. Central Ave., Marshfield, Wis. Estimated construction cost \$19,854, first year operating cost \$78,000, revenue \$85,000. Applicants are Judith S. Scofield (50%), Margery A. and Hartley L. Samuels (25% each) who have similar interest in KODY North Platte, Neb. Ann. March 11.

Madison, Wis.—Air Capitol Inc. 1550 kc, 500 w D. P.O. address Herbert L. Mount, 2040 W. Wisconsin Ave., Milwaukee. Estimated construction cost \$23,973, first year operating cost \$75,200, revenue \$88,088. Applicants are Herbert L. Mount (26.53%) attorney; Neil K. Searles (26.53%) former general manager WFOX Milwaukee; Frederick A. Wilmanns (13%); John E. Dickinson (13%), and Gordon D. Adams (20%). Ann. March 5.

Existing Am Stations

APPLICATIONS

WGWC Selma, Ala.—Mod. of license to change hours of operation from specified hours to unl. (1340 kc) Ann. March 10.

WTRR Sanford, Fla.—Cp to increase daytime power from 250 w to 1 kw and install new trans. for daytime use (2 main trans.). (1400 kc) Ann. March 11.

WSJM St. Joseph, Mich.—Cp to increase daytime power from 250 w to 1 kw and install new trans. (1400 kc) Ann. March 5.

KUDL Kansas City, Mo.—Cp to change hours of operation from D to unl., using power of 1 kw, 5 kw-LS (increase daytime power from 1 kw to 5 kw), change ant-trans. location, install DA D and N (DA-2), make changes in ground system, install new trans. and delete remote control operation of trans. Ann. March 6.

KL0S Albuquerque, N.M.—Cp to change frequency from 1450 kc to 1240 kc. Ann. March 5.

WKVA Lewistown, Pa.—Cp to change hours of operation to unl., change power to 500 w, 5 kw-LS (increase day), install DA D and N (DA-2), delete remote control, install two main trans. (N and D) and changes in ground system. (920 kc) Ann. March 10.

WBTN Bennington, Vt.—Cp to increase power from 500 w to 1 kw and make changes in trans. equipment. (1370 kc) Ann. March 11.

WAUX Waukesha, Wis.—Cp to increase power from 250 w to 10 kw, install DA D, change ant-trans. location, change ground system and install new trans. (1510 kc) Ann. March 5.

New Fm Stations

APPLICATIONS

Mt. Kisco, N.Y.—Radio Mt. Kisco Inc., 105.7 mc, 12 kw. P.O. address 494 Lexington Ave. Estimated construction cost \$32,189, first year operating cost \$10,000, revenue \$10,000. Applicant is licensee of WVIP Mt. Kisco. Requests waiver of Sec. 3.313 (c) of rules. Originally filed Dec. 30, 1958. Resubmitted March 11.

Tulsa, Okla.—Grayhill Inc., 97.5 mc, 1504 kw. P.O. address 1223 S. Harvard. Estimated construction cost \$19,700, first year operating cost \$8,000, revenue \$9,500. Applicants are Meridith R. Gray, former owner recording firm, and Claude H. Hill, chief engineer U. of Tulsa station KWGS-FM and former owner recording firm. Ann. March 11.

Ownership Changes

APPLICATIONS

WACT Tuscaloosa, Ala.—Seeks assignment of license from New South Radio to New South Radio Inc. Change to corporate form of business, no change in ownership involved. Ann. March 11.

KIFN Phoenix, Ariz.—Seeks transfer of control of Western Bcstg. Co. from H. Walker Harrison, Frank P. Redfield, Henry J. J. Steffens Jr., and Edgar B. Pool to H. Walker Harrison for \$135,000. Mr. Harrison currently owns 25% of licensee. Ann. March 6.

KGUN-TV Tucson, Ariz.—Seeks transfer of control of Tucson Television Inc. to H. U. Garrett, present 45% owner, through purchase of 8% interest owned by C. M. Peters, for \$23,520. After transfer, Mr. Garrett will own 53% of licensee. Ann. March 11.

KPER Gilroy, Calif.—Seeks assignment of cp and license from Charles W. Jobbins and James D. Bernard d/b Jobbins Bcstg. Co. to John H. Gregory and Messrs. Jobbins and Bernard d/b Radio KPER for \$25,000. After transfer, each will own one-third interest. Ann. March 6.

WBGC Chipley, Fla.—Seeks assignment of license of Tri-County Radio Bcstrs. from Edward C. Allmon to John Sanders for \$37,500. Mr. Sanders is general manager WAGC Chattanooga, Tenn. Ann. March 11.

WFEC Miami, Fla.—Seeks transfer of control from Sabeca Corp. to Florida East Coast Bcstg. Inc. for \$50,500. Florida East Coast consists of Harry Trenner (55%) and Herbert Schorr (45%) who both have current interests in WFEC and WRVM Rochester, N.Y. Ann. Feb. 26.

WTVJ (TV) Miami, Fla.—Seeks transfer of control of Wometco Television & Theatre Co. from Sidney Meyer, et al. (as family group) and Mitchell Wolfson, et al. (as family group) to Mitchell Wolfson, et al. (as family group). Each group presently owns 50% interest in station. After transfer, Wolfson group will own 55%, Meyer group will own 10%, and remaining 35% will be sold to public. Meyer principal receives \$1,500,000 for her interest. (See CLOSED CIRCUIT, March 9.) Ann. March 5.

WDCL Tarpon Springs, Fla.—Seeks transfer of one-third interest in Clearwater Bcstg. Corp. from McClain Bowman to present one-third owners William Hodding Carter Jr. and John T. Gibson for \$11,250. After transfer Messrs. Carter and Gibson will each hold one-half interest. They also hold controlling interest in Delta-Democrat Publishing Co. Ann. March 6.

WDCB Chicago, Ill.—Seeks assignment of license from Michael J. Mintern as general overseer of Christian Catholic Church, to Oscar, Gertrude, Julius and Bertha Miller, d/b Radio Station WAIT for \$132,000. WDCB currently shares time and facilities with WAIT, broadcasting on Sundays only. Ann. March 6.

WLOS-AM-FM-TV Asheville, N.C.—Seeks transfer of control of Skyway Bcstg. Co. from Sidney Meyer and family and Mitchell Wolfson and family to Mitchell Wolfson and family. Each presently owns 50%. After transfer Wolfson family will own majority control. Meyer principal will receive \$1,500,000 for interest sold (including interest in WTVJ [TV] Miami.) (See CLOSED CIRCUIT, March 9.) Ann. March 5.

WBNY (FM) Buffalo, N.Y.—Seeks assignment of license from Albertson Bcstg. Co. to Functional Bcstg. Inc. for \$65,000. Purchaser is Albert Wertheimer, who owns WDDS-FM Syracuse, N.Y. Functional currently has contract for music service with WBNY. Ann. March 10.

WRVM Rochester, N.Y.—Seeks transfer of control from Sabeca Corp. to Rochester Bcstg. Inc. for \$49,500. Rochester consists of Harry Trenner (55%) and Herbert Schorr (45%) who both have current interests in WRVM and WFEC Miami, Fla. Ann. Feb. 26.

WRSR Saratoga Springs, N.Y.—Seeks transfer of 50% negative control of WRSR Inc. from Lou Tobler to Martin Karig for \$15,000. Mr. Karig has interests in WWSR Glen Falls, and WNDR Syracuse, both New York. Ann. March 6.

KRNR Roseburg, Ore.—Seeks assignment of license from James Doyle to News-Review Inc. owner KRNR from 1935 to 1956. According to application, Mr. Doyle has defaulted on payments to News-Review Inc. for KRNR. Consideration involved—relief of Mr. Doyle of any further liability regarding KRNR. Ann. March 11.

KDDD Dumas, Tex.—Seeks transfer of control of North Plains Bcstg. Corp. from present stockholders to North Plains and assignment of license from North Plains



BIG REACH

WEEK A

WEEK B

Participation in three key 1/2 hours one week, alternating with three other key 1/2 hours the next week to give the participating advertiser exposure in six different shows (Class AA and A time) every two weeks.

3—Minutes per week, \$1200

3—CB per week \$ 900



Mon. 10:30 P. M. DIAL 999



Mon. 7:00 P. M. WHIRLYBIRDS



Tues. 7:00 P. M. HIGHWAY PATROL



Wed. 10:30 P. M. TARGET



Sat. 7:00 P. M. HONEYMOONERS



Fri. 7:00 P. M. UNION PACIFIC

The November ARB gives the six BIG 11 REACH shows a two-week cumulative rating of 85.2. This figures to a weekly average of 42.6 average rating. ARB shows non-duplicated reach for these programs of 50.2 homes one or more times.

WIIC CHANNEL 11, PITTSBURGH

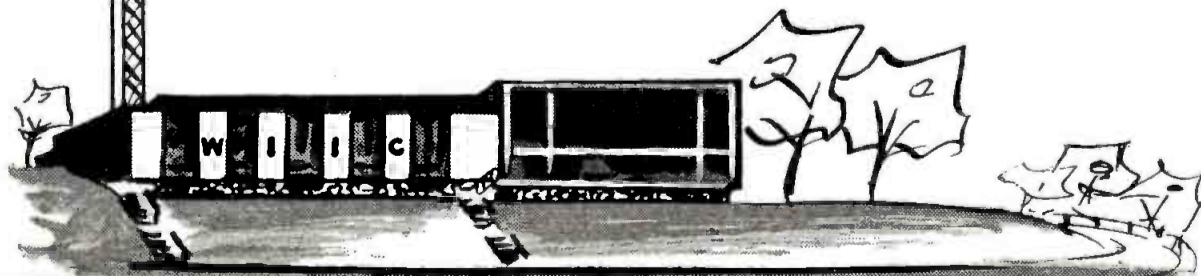

REPRESENTED NATIONALLY BY
BLAIR-TV

The station for whirl-wind

WWRL

THE FAMILY STATION

5000 WATTS

NEW YORK

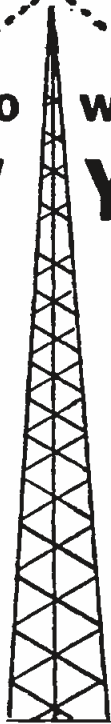

On the air 24 hours
DE 5-1600

sales action!

WWRL
beamed to sell
New York's
2,455,000
Negroes
&
Puerto Ricans

WWRL . . . puts the act in action by speaking the language of New York's ever-expanding Negro and Puerto Rican market. Top personalities sell your product 24 hours a day. Get in the sales whirl . . . buy WWRL.

MERCHANDISING PLUS: Ask about our "geared-to-sell" merchandising plan.

FREE REPORT
NEGRO MARKET IN NEW YORK
POPULATION STUDY

*More than a decade
of Constructive Service
to Broadcasters and the
Broadcasting Industry*

HOWARD E. STARK

Brokers — Consultants

50 EAST 58TH STREET NEW YORK, N. Y. ELDORADO 5-0405

NAB Convention

Conrad Hilton Hotel Suite 933A-34A For Appointments

Bestg. Corp. to Dumas Bcstrs. Inc. for \$100,835. Purchasers are Kenneth Earl Duke (70%), present KDDD manager; Eleanor Mae Duke (10%) and Alfred A. Tremble (20%) KDDD assistant manager. Ann. March 6.

KBRZ Freeport, Tex.—Seeks assignment of license from KBRZ Inc. to William D. Schueler who presently owns 100% of KBRZ Inc. No consideration involved. Ann. March 6.

Routine Roundup

Commission has incorporated in record in network study proceeding letter, with attachments, from Commission dated Jan. 14, 1959, to Victor R. Hansen, assistant attorney general, antitrust division, Dept. of Justice, requesting opinion from Attorney General on antitrust aspects of option time practice, and response of Feb. 27, 1959, from Assistant Attorney General Hansen.

Commission sent following telegram to Stephen M. Bailey, General Chairman of St. Patrick's Day Parade Assn., Chicago:

"Reference your telegram Feb. 28, 1959, which asserts that 'FCC decisions concerning equal time for political candidates have been locally interpreted to preclude the television broadcast of the annual St. Patrick's Day Parade'. You request 'that the four Chicago television stations be advised that this is a legitimate news event and therefore not affected by the reciprocal clause of the Federal Communications Act'. No reason appears from your telegram why Section 315 of the Communications Act or FCC decisions under that provision should preclude broadcasting of the St. Patrick's Day Parade. Section 315 provides that: Quote If any licensee shall permit any person who is a legally qualified candidate for any public office to use a broadcasting station, he shall afford equal opportunities to all other such candidates for that office in the use of such broadcasting station: . . . Unquote. Whether or not the St. Patrick's Day Parade will be broadcast is a matter within the control of the stations of your community not the FCC." Ann. March 5.

BROADCAST ACTIONS

By Broadcast Bureau

Actions of March 6

KUFM (FM) El Cajon, Calif.—Granted assignment of cp to Forwek & Co.

KBUN Bemidji, Minn.—Granted licenses covering changing ant.-trans. location and making changes in ant. and ground system; and to use aux. trans. at main trans. location; remote control permitted.

KRKC King City, Calif.—Granted license for am station.

KOXR-FM Oxnard, Calif.—Granted license for fm station.

KEYM (FM) Santa Maria, Calif.—Granted license for fm station.

KBIQ (FM) Los Angeles, Calif.—Granted licenses covering change of ERP, ant. height, trans. and studio location, installation new trans. and ant. type, change in ant. system; remote control permitted, and installation alternate main trans.

KBIQ (FM) Los Angeles, Calif.—Granted mod. of license to change name to KBIQ Inc.

Actions of March 5

Granted licenses for following tv stations: KCIX-TV Nampa, Idaho; WBIR-TV Knoxville, Tenn., ant. 990 ft.; WWL-TV New Orleans, La. (main trans. and ant.), and installation aux. trans.; WNEP-TV Scranton, Pa., and redescribe trans. location (not a move), ERP vis. 316 kw.

WHMS Charleston, W.Va.—Granted cp to install old main trans. at Coal Branch Heights, near Charleston, W.Va. (main trans. location) for aux. purposes; remote control permitted.

WORC Worcester, Mass.—Granted cp to install old main trans. at Pakachoag Rd., Auburn, Mass., as aux. trans.

KLIF Dallas, Tex.—Granted cp to install present licensed nighttime main trans. as aux. trans. for daytime use; remote control permitted.

WQMN Superior, Wis.—Granted mod. of cp to move ant.-trans. location 500 ft. north of present site (same description) and specify studio location.

WSWV Pennington Gap, Va.—Granted mod. of cp to change ant.-trans. location, studio location and remote control point and change type trans.

WGOG Walhalla, S.C.—Granted mod. of cp to change type trans.

Following stations were granted extensions of completion dates as shown: WGRC Green Cove Springs, Fla., to May 8; WSWV Pennington Gap, Va., to July 1, and WFAA-FM Dallas, Tex., to Sept. 23.

WYLD New Orleans, La.—Remote control

*for
music
around
the
clock*

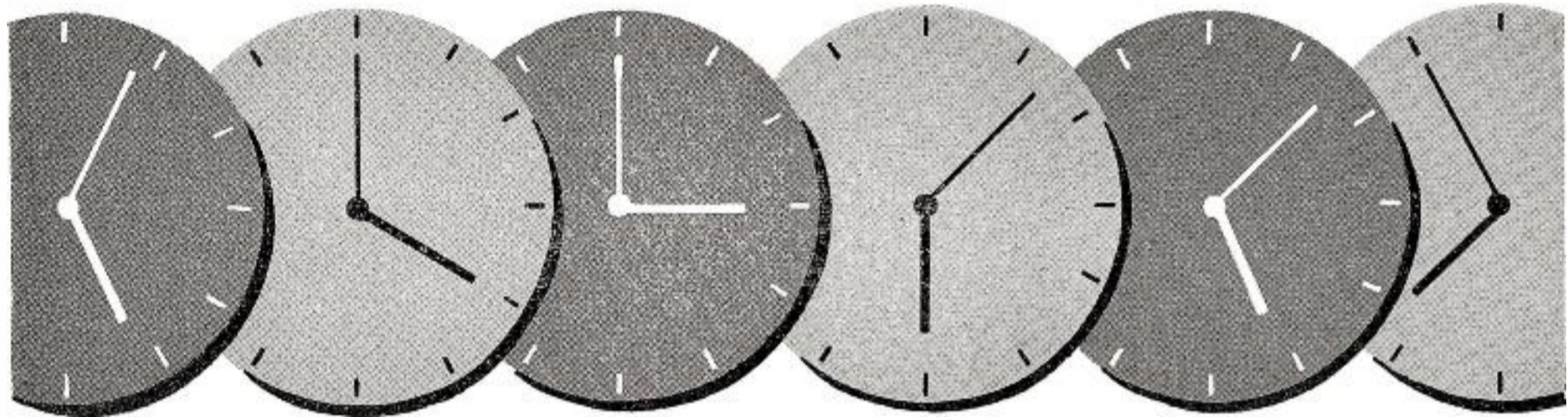

**IT'S
ALWAYS
ASCAP!**

When you want to perform the **POPULAR SONGS** of yesterday, today and tomorrow . . . When you want to perform the very finest **PRODUCTION MUSIC** of the stage or screen . . . When you want the great music of our **SYMPHONIC AND CONCERT** field, or the music of **PRIZE-WINNING AMERICAN OPERAS** . . . When you want to perform the **RELIGIOUS MUSIC** of our nation . . . Whenever you have need of the best in music, you may be sure — **IT'S ALWAYS IN THE ASCAP REPERTORY!**

AMERICAN SOCIETY OF COMPOSERS, AUTHORS AND PUBLISHERS
575 Madison Avenue, New York 22, New York



VIDEOTAPETM



Now, you say when

And how often too! For once programs and commercials are Videotape* recorded, scheduling is wide open. Playbacks can be telecast immediately—hours later—or anytime you decide. At least 100 repeats can be made from any one recording. Copies can be made. And tapes recorded on a VR-1000 Videotape Recorder can be played back on any other VR-1000, anywhere.

Never before have sponsors been able to schedule commercials to reach selected audiences so easily. Never have stations had so many "live" availabilities to offer.

Get the complete story on the many things Videotape recording can do for you. Write today.

CONVERTS TO COLOR ANYTIME • LIVE QUALITY • IMMEDIATE PLAYBACK • PRACTICAL EDITING • TAPES INTERCHANGEABLE • TAPES ERASABLE, REUSABLE • LOWEST OVERALL COST

934 CHARTER STREET, REDWOOD CITY, CALIFORNIA
Offices in Principal Cities

AMPEX
CORPORATION
*professional
products division*

*TM AMPEX CORP.

SUMMARY OF COMMERCIAL BROADCASTING

Compiled by BROADCASTING through March 11

	ON AIR		CP	TOTAL APPLICATIONS
	Lic.	Cps	Not on air	For new stations
AM	3,298	43	117	641
FM	547	44	139	69
TV	448 ¹	69	103	112

OPERATING TELEVISION STATIONS

Compiled by BROADCASTING through March 11

	VHF	UHF	TOTAL
	Commercial	437	80
Non-commercial	32	8	40 ⁴

COMMERCIAL STATION BOXSCORE

As reported by FCC through Jan. 31, 1959

	AM	FM	TV
Licensed (all on air)	3,289	543	441 ¹
CPs on air (new stations)	45	38	75 ²
CPs not on the air (new stations)	113	128	106
Total authorized stations	3,447	709	668
Applications for new stations (not in hearing)	484	45	40
Applications for new stations (in hearing)	122	26	65
Total applications for new stations	606	71	105
Applications for major changes (not in hearing)	498	34	41
Applications for major changes (in hearing)	47	0	17
Total applications for major changes	545	34	58
Licenses deleted	2	1	1
CPs deleted	0	0	0

¹There are, in addition, six tv stations which are no longer on the air, but retain their licenses.

²There are, in addition, 39 tv cp-holders which were on the air at one time but are no longer in operation and one which has not started operation.

³There have been, in addition, 211 television cps granted, but now deleted (44 vhf and 167 uhf).

⁴There has been, in addition, one uhf educational tv station granted but now deleted.

permitted while using non-directional ant.
KOFO Ottawa, Kan.—Granted authority to operate 6 a.m. to 6:30 p.m., CST, for period April through August.

WDLA Walton, N.Y.—Granted authority to sign-off at 6 p.m., EST, for period ending Sept. 30.

Actions of March 4

KIEM-TV Eureka, Calif.—Granted license covering maintenance of facilities in STA dated 12-14-55 as aux. ant.

KGBT-TV Harlingen, Tex.—Granted license covering changes in tv station; ERP vis. 100 kw, aur. 50 kw, ant. 990 ft.

WWPB (FM) Miami, Fla.—Granted cp to change trans. and studio location and increase ERP to 9.2 kw.

WSAD (FM) San Juan, P.R.—Granted mod. of cp to change name to Puerto Rico Music Services.

KCCC-TV Sacramento, Calif.—Granted mod. of cp to change trans. and studio locations; ERP vis. 20.4 kw, aur. 11 kw.

WORG - FM Orangeburg, S.C.—Granted authority to remain silent for period ending April 30.

WCRB - FM Waltham, Mass.—Granted authority to utilize additional control tones for SCA for period ending April 1.

Following stations were granted extensions of completion dates as shown: **WABG-TV Greenwood, Miss.**, to July 15; **WIS-TV Columbia, S.C.**, to April 15; **WXYZ-TV Detroit, Mich.**, to Sept. 10 (main trans. and ant.); **WSAV-TV Savannah, Ga.**, to Sept. 18; **WHAV-FM Haverhill, Mass.**, to April 15; **WLIR (FM) Hicksville, N.Y.**, to July 9; **WJHL-FM Johnson City, Tenn.**, to April 15; **KGB-FM San Diego, Calif.**, to May 20, and **KAGI Grants Pass, Ore.**, to May 30.

Actions of March 3

WRVM Rochester, N.Y.—Granted acquisition of positive control by Harry Trenner through purchase of stock from Sabeca Corp. by licensee and retirement to treasury thereof.

WFEC Miami, Fla.—Granted acquisition of positive control by Harry Trenner through purchase of stock from Sabeca Corp. by licensee and retirement to treasury thereof.

WYFE New Orleans, La.—Granted assignment of license and cp to WYFE Inc.

WJBO Baton Rouge, La.—Granted cp to change ant.-trans. location and type trans.

KIBE Palo Alto, Calif.—Granted cp to change ant.-trans. location.

ACTIONS ON MOTIONS

By Hearing Examiner James D. Cunningham on dates shown

Granted petition of Midland Bcstg. Co. and accepted pleading in excess of fifteen pages in proceeding on its application for new tv station to operate on ch. 8 in Moline, Ill. Action March 9.

Scheduled hearing for April 27 in proceeding on am application of Sussex County Bcstrs. (WNNJ), Newton, N.J. Action March 11.

By Hearing Examiner Jay A. Kyle on March 9

Continued hearing from March 20 to April 28 in proceeding on applications of Brinkley Bcstg. Co. and Tri-County Bcstg. Co., for am facilities in Brinkley, Ark.

By Hearing Examiner Basil P. Cooper on dates shown

Granted petition by Kansas Bcstrs. Inc., for leave to amend its application to reflect certain changes in stock ownership; application is in consolidated proceeding with Salina Radio Inc., both for am facilities in Salina, Kan. Action March 9.

Granted petition by Times and News Publishing Co. (WGET), Gettysburg, Pa., for extension of time from March 16 to March 30 to file proposed findings of fact and conclusions, and for reply findings from April 6 to April 20 in proceeding on its am application, et al. Action March 10.

By Hearing Examiner Herbert Sharfman on March 10

Scheduled further hearing for March 13 in proceeding on application of Jane A. Roberts (KCFI), Cedar Falls, Iowa, for station license.

By Hearing Examiner H. Gifford Irion on March 10

Scheduled further prehearing conference for March 11, at 2 p.m., in proceeding on am applications of Continental Bcstg. Corp. (WHOA), San Juan, and Jose R. Madrazo, Guynabo, both Puerto Rico.

Upon oral request of applicant, continued hearing from March 13 to March 20 on am application of Booth Bcstg. Co. (WBBC), Flint, Mich.

By Hearing Examiner J. D. Bond on March 9

Denied petition by Donald W. Huff and

"How to be in two places at once"



Mr. Joel Chaseman
 Program Manager, WJZ-TV
 Television Hill, Baltimore

"We taped a busy candidate's campaign speech. He was on the air 'live' and actively campaigning at the same time — literally in two places at one time, thanks to Videotape* recording."

AMPEX
 CORPORATION

934 CHARTER STREET, REDWOOD CITY, CALIFORNIA

professional
 products division

*TM Ampex Corporation

rejected amendment to specify different trans.-ant. site for new am station in Lansdale, Pa. which is in consolidated hearing with Equitable Pub. Co., Lansdale; reopened record, made transcript vol. 4 part of record, and hearing record closed; further ordered release date of orders to be effective date of memorandum opinion and order for purposes of appeal.

Commission on March 6 granted motion by Indiana Central U., Indianapolis, for further extension of time from March 4 to April 3 to file responses to its petition for rulemaking to reserve ch. 13 at Indianapolis for noncommercial educational use.

By Comr. John S. Cross on March 9

Granted petition by Logansport Bcstg. Corp., Aurora-Batavia, Ill., for extension of time to April 6 to file exceptions to initial decision in proceeding on its am application, et al.

By Hearing Examiner Isadore A. Honig on March 6

Upon informal request by Quad Cities Bcstg. Co., Brazil, Ind., continued indefinitely prehearing conference scheduled for March 6 and hearing scheduled for April 6 pending disposition by Commission of request by Quad Cities for reconsideration of Feb. 6 order designating its application for hearing.

By Hearing Examiner J. D. Bond on March 6

Granted motion by Naugatuck Valley Service Inc., Naugatuck, Conn., and scheduled hearing of evidence for March 24 in proceeding on its am application and that of Berkshire Bcstg. Inc. (WSBS), Great Barrington, Mass.

By Chief Hearing Examiner James D. Cunningham on March 9

Upon request by Rounsaville of Cincinnati Inc. (WCIN), Cincinnati, Ohio, dismissed its petition to enlarge issues in proceeding on its am application.

By Hearing Examiner Thomas H. Donahue on March 6

Granted petition by Lakeside Bcstrs., Sparks, Nev., for continuance of hearing

from March 6 to March 19, at 9:30 a.m., in proceeding on its am application.

Reopened record to accept supplementary exhibit filed by Vernon G. Ludwig, Benson, Ariz., in proceeding on his am application and that of Pan American Radio Corp., Tucson, Ariz., and record closed.

By Hearing Examiner Isador A. Honig on March 6

Granted motion by Old Belt Bcstg. Corp. (WJWS), South Hill, Va., for continuance of various dates now applicable to further proceedings on its am application and that of John Laurino, Scotland Neck, N.C.; continued commencement of formal hearing from March 31 to April 28.

Commission on March 5 granted request by McKenna and Wilkinson, counsel for number of stations, for extension of time to March 27 to file engineering and other pertinent supporting data relating to petitions by Wm. Penn Bcstg. Co. (WPEN), Philadelphia, Pa., and Cleveland Bcstg. Inc. (WERE), Cleveland, Ohio, looking toward amendment of Commission's rules to permit regional stations to operate with maximum power of 25 kw.

By Comr. John S. Cross on March 4

Granted petition by Richard B. Gilbert, Tempe, Ariz., for extension of time to March 13 to file opposition to petition by David V. Harman, Tempe, to enlarge issues in proceeding on their am applications, et al.

By Hearing Examiner Thomas H. Donahue on March 4

Granted motion by Liberty Television Inc., for extension of time from March 9 to March 19 to file proposed findings and for replies from March 23 to April 2 in proceeding on its application and that of KEED Inc., for new tv stations to operate on ch. 9 in Eugene, Ore.

By Hearing Examiner Annie Neal Huntting on March 4

Upon agreement reached by parties at prehearing conference March 4, continued hearing from April 6 to June 1 on am applications of Louis W. Skelly, Conneaut, Ohio, and Mon-Yough Bcstg. Co. (WMCK), McKeesport, Pa.

Upon agreement reached by parties at March 4 prehearing conference, scheduled hearing for June 15 in proceeding on applications of Telemusic Co., and Southwest Bcstg. Co. Inc., for fm facilities in San Bernardino and Redlands, Calif.

By Hearing Examiner Jay A. Kyle on dates shown

Upon request by Broadcast Bureau, re-scheduled prehearing conference scheduled for March 5 at 10 a.m., for 2 p.m., on same date, in proceeding on am applications of Brinkley Bcstg. Co. and Tri-County Bcstg. Co., for am facilities in Brinkley, Ark. Action March 3.

Granted petition by Tempe Bcstg. Co., Tempe, Ariz., for continuance of prehearing conference from March 6 to March 9 at 2 p.m., in proceeding on its am application, et al. Action March 4.

By Hearing Examiner Herbert Sharfman on March 3

Granted request by protestant Tomah-Mauston Bcstg. Inc. (WTMB), Tomah, Wis., filed with its proposed findings of fact and conclusions, for correction of transcript in proceeding on am application of Jack L. Goodsitt (WTOJ), Tomah, Wis.

By Hearing Examiner Basil P. Cooper on March 2

Granted motion by Ben S. McGlashen (KGFJ), Los Angeles, Calif., respondent, for continuance of date of evidentiary hearing from March 12 to March 20 in proceeding on am application of Intrastate Bcstrs., Pomona-C Claremont, Calif.

PETITION FOR RULEMAKING FILED

Genesee Valley Television Inc., Rochester, N.Y. (3-3-59)—Requests assignment of ch. 13 to Rochester, N.Y.

Joint Council on Educational Television, New York, N.Y. (3-3-59)—Requests assignment of ch. 10 to Appleton, Minn., and reservation of that channel for educational tv station.

WICS Springfield, Ill. (3-4-59)—Requests institution of rulemaking and issuance of notice to show cause looking toward substitution of ch. 7 for ch. 5 in Mitchell, S.D., and allocation of ch. 5 to Sioux Falls, S.D.

Servicing and Selling the Markets of America

SYMBOL OF SERVICE

TRANSCONTINENT TELEVISION CORPORATION

Offices: 70 Niagara Street, Buffalo, MOhawk 2600 • 15 East 47th Street, New York City, PLaza 1-3030

NARBA Notifications

List of changes, proposed changes and corrections in assignments of Canadian broadcast stations modifying appendix containing assignments of Canadian broadcast stations attached to recommendations of North American Regional Bcstg. Agreement Engineering Meeting.

CANADA

910 kc

CJDV Drumheller, Alba.—1 kw, DA-1, unl. Class III. Now in operation.

CFJC Kamloops, B.C.—10 kw D ND, 1 kw N, unl. Class III. Now in operation with increased daytime power.

920 kc

Woodstock, N.B.—1 kw, DA-1, unl. Class III. Mod. of mode of operation from that shown on list #120. EIO 2-15-60. (New.)

930 kc

CJCA Edmonton, Alba.—10 kw D DA-N, 5 kw N, unl. Class III. Correction of nighttime power from that shown in recapitulative list dated 12-31-58.

980 kc

CHEX Peterborough, Ont.—5 kw, DA-2, unl. Class III. Now in operation.

1050 kc

CFGP Grande Prairie, Alba.—10 kw, DA-1, unl. Class II. Now in operation with increased power.

1430 kc

CKFH Toronto, Ont.—5 kw, DA-2, unl. Class III. EIO 2-15-60. (PO: 1400 kc, 0.25 kw DA-1 TV.)

CJOY Guelph, Ont.—5 kw, DA-1, unl. Class III. Delete assignment remaining on 1450 kc.

CHEX Peterborough, Ont.—1 kw, DA-1, unl. Class III. Delete assignment vide 980 kc.

TEXT: TOWN ON TASO

The final report of the Television Allocations Study Organization is being submitted today (March 16) to the FCC (see Lead Story, page 51). The bulk of the report represents the data and analyses of the six engineering panels which did the technical work on the television allocations problem over the past two years.

Covering these documents is an explicit, objective, overall explanation of the results and findings of the TASO investigation. This was written by Dr. George Town, Iowa State engineering dean, and executive director of TASO. It is a revision of a similar statement submitted to the TASO board last January. The TASO board approved Dr. Town's statement last week. Dissenting or concurring statements from board members may also be filed, it was decided.

BROADCASTING herewith reprints Dr. Town's final summary statement of the work and findings of TASO.

1. INTRODUCTION

On August 31, 1956, the Federal Communications Commission issued its Public

Notice 35638 in which it called a meeting of representatives of the television broadcasting and manufacturing industries to be held on September 20, 1956, for the purpose of establishing an organization to conduct a study of "the technical principles which should be applied in television channel allocation." The television industry responded by establishing the Television Allocations Study Organization (TASO). This report presents the results of the work of TASO through December 31, 1958. It represents a summary of work extending over a period of two years by the 271 engineers from 139 companies who make up the six TASO engineering panels and their subsidiary committees. This report is released to the Federal Communications Commission in accord with action taken by the TASO Board of Directors at its meeting on March 9, 1959.

The report consists of six parts. Part I is a summary of the remainder of the report. In Part II, information is presented regarding the objectives and organization of TASO. Part III consists of the reports of the six TASO engineering panels, and it is the most important part of this report. In Part IV, supplementary technical information is presented as well as a consolidated discussion of some topics which were considered in more than one panel. Part V includes brief concluding remarks of a non-technical nature. Part

SERVICING AND SELLING are two key words that dominate the objectives of Transcontinent stations. Whether it's...

- **WGR-TV and WGR Radio, Buffalo**, blanketing the mighty and prosperous market of Western New York known as the Niagara Frontier, or... **WROC-TV, Rochester**, with its 26.5% coverage advantage in the thriving 13-county industrial and agricultural area in up-state New York, or... **WNEP-TV, Scranton-Wilkes-Barre**, with the most powerful transmitter serving Northeastern Pennsylvania, the state's third largest market, or... **WSVA-TV and WSVA Radio, Harrisonburg**, covering the rich and diversified Shenandoah Valley area in Virginia...

...you'll find the Transcontinent station is well-known as a symbol of service to audiences and a symbol of sales to advertisers. Experienced management, intelligent program balance, strong merchandising and promotion plans, and a genuine feeling of community responsibility are basic characteristics that advertisers profit by when they select...

A TRANSCONTINENT STATION

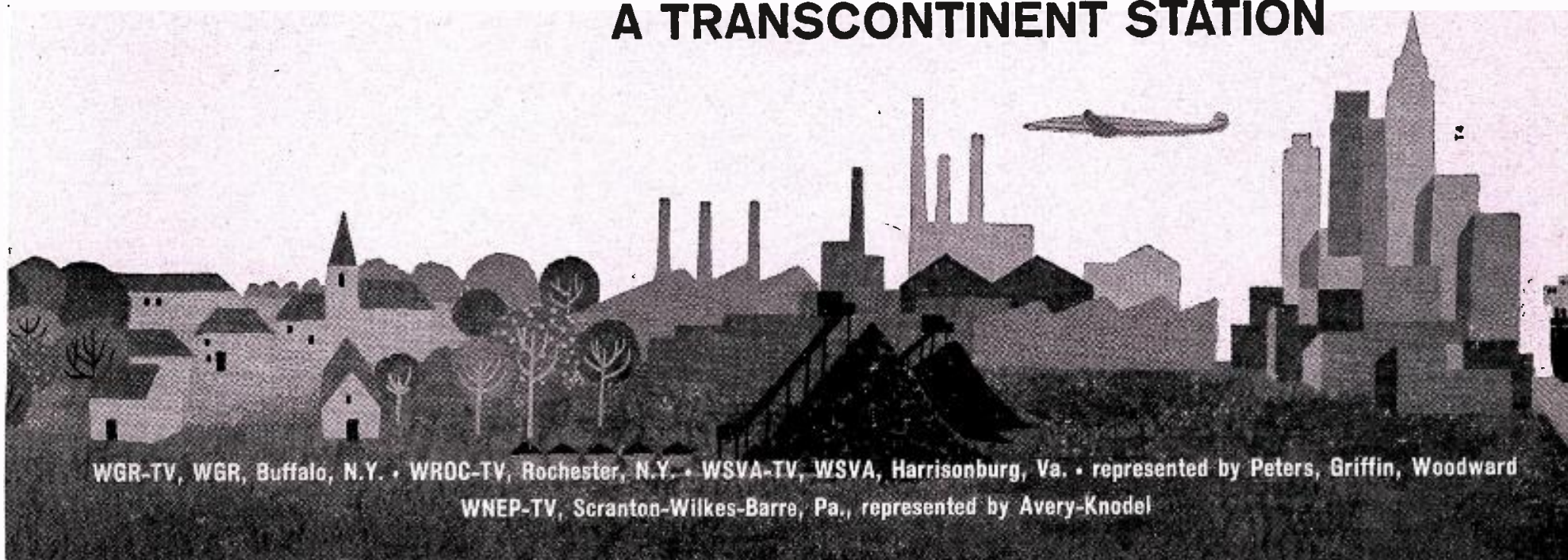

WGR-TV, WGR, Buffalo, N.Y. • WROC-TV, Rochester, N.Y. • WSVA-TV, WSVA, Harrisonburg, Va. • represented by Peters, Griffin, Woodward
WNEP-TV, Scranton-Wilkes-Barre, Pa., represented by Avery-Knodel

*The morning
after . . .*



**YOUR SALES MESSAGE
HITS THE 50,000 TV HOMES**

covered by

KMSO-channel 13

THINGS BEGIN TO HAPPEN
IN WESTERN MONTANA

BECAUSE . . .

KMSO programs the best of all 3 networks . . . plus VIP treatment for ALL commercials.

and that goes for

KGVO RADIO TOO

CBS — ABC — NBC

ask FORJOE or
KMSO-KGVO — MISSOULA, MONT.

One hundred
eleven*
national
and
regional
spot
advertisers
know
**Terre Haute
is not covered
effectively
by outside
TV**

*Basis: 1958

WTHI-TV CHANNEL **10** CBS
ABC

TERRE HAUTE, INDIANA
Represented Nationally by Bolling Co.,

Los Angeles - San Francisco - Boston - New York - Chicago - Dallas

VI consists of four attachments relating to the organization of TASO.

PART I—SUMMARY

Part I consists of one section only—a summary written by the Executive Director of the material contained in the remainder of this report and in the records of the TASO panels and committees. Three principal topics are presented: a statement regarding the major tasks accomplished by TASO, a resume of the major results of the engineering studies conducted by the TASO panels and an indication of the work which should be carried on to supplement the work of the TASO panels.

2. ABSTRACT OF REMAINDER OF THIS REPORT

2.1 Major Tasks Accomplished

The sole task of TASO is to make a comprehensive study of the engineering factors underlying the allocation of frequencies (or channels) to television broadcasting. It is natural, therefore, that its major accomplishments have been technical in nature. The more important of these will be described in general terms in this Section, with technical details being reserved for later Sections.

Before technical achievements are enumerated, however, it is worthwhile to note another significant aspect of the TASO operations. This is the fact that in its organizational structure, its financial backing and its engineering studies, all phases of the television industry were represented and worked together actively and cooperatively to achieve the specified goals. TASO panels and committees were composed of leading engineers from manufacturers of television transmitting, receiving and measuring equipment; from television networks; from independent high and low power, uhf and vhf broadcasting stations; from consulting engineering firms; from educational institutions; from governmental agencies; from community television distribution groups; from technical publishing houses; and from the television service industry. The fact that the TASO panel reports were prepared and approved by such a diversified group of highly qualified engineers lends authority to the conclusions reached in these reports.

Turning now to technical matters, one of the major accomplishments of TASO was the collection of a large body of reliable data regarding the propagation of both uhf and vhf television signals within the service range of television stations. TASO was, of course, far from the first to collect this type of information. Prior to the TASO operations, however, relatively few data had been taken at uhf; and at both uhf and vhf, measurements had been made in such a wide variety of manners that the results of different studies could not be readily compared. One of TASO's first tasks, therefore, was to draw up acceptable specifications whereby measurements of field strength would be made in a standard manner. These specifications were followed in all of the TASO studies of signal propagation within service areas, and they proved to be highly satisfactory. A second noteworthy aspect of the TASO field strength measurement program lay in the choice of measurement areas. Except in a few instances where measurements were made for special purposes, the tests were conducted where both uhf and vhf stations of comparable power output and closely adjacent transmitting antennas of

comparable height were available. A wide variety of topographical and climatic conditions were represented in the different studies. The TASO field strength measurement program, therefore, has provided the best set of propagation data yet available—data taken in a standardized manner on comparable uhf and vhf signal sources in a variety of geographical conditions.

A second major accomplishment has been the collection of invaluable information regarding the relationship between signal strength as measured in standardized manners and picture quality as observed in the home. Television allocations must be based on quantitative predictions and measurements of field strength; but the ultimate objective of a television broadcasting system is to produce satisfactory pictures in the home. The relationship between these two quantities is therefore an essential piece of information. Again, TASO was not the first to study this relationship; but TASO was the first to make a large scale field study of this problem, carrying out this study at both uhf and vhf in many areas under a wide variety of geographical conditions. The information obtained by TASO on the relationship between field strength and picture quality is of fundamental importance in this and in any future study of television allocations. One significant aspect of this TASO field work is the fact that field strength measurements were made at both 10 feet and 30 feet; and the comparison of these two sets of measurements with picture quality could have an important bearing on the techniques to be used in future field strength surveys for determining station coverage.

There has been still a third major accomplishment related to the general problem of determining service areas. An analysis of the data accumulated in the field strength measurement program has led to the development of means for predicting field strength with much greater accuracy than was possible by previous methods. The new TASO methods refer not only to the prediction of median values, but also, by taking into account meteorological and topographical conditions, permit an accurate estimate of local deviations from the median values. These methods, which apply to both uhf and vhf signals, represent a very real advance in propagation theory and practice.

Allocations studies require not only a knowledge of the propagation of desired signals within the service range of a television station, but also information regarding the propagation of interfering signals from stations located at distances much greater than their service ranges. The results of over a million hours of measurement of distant signals made by the Central Radio Propagation Laboratory of the National Bureau of Standards were made available to TASO; and curves representing the best current information on tropospheric propagation of uhf and vhf signals over distances of between 100 and 300 miles have been prepared from these and other data.

Before the information regarding the propagation of desired and interfering signals can be combined to determine the service area of a television station, certain information regarding the performance of transmitting and receiving equipment is needed. One of the most essential needs is that of knowing the amounts of interference of various types that can be tolerated and still permit the display of satisfactory television pictures. A major task of TASO was to make the detailed and exacting lab-

BMI presents another notable addition to its award-winning script series...

**THE BOOK PARADE
THE AMERICAN STORY
THE WORLD OF THE MIND**

**"THE
ABRAHAM
LINCOLN
STORY"**

1809-1959



Initial scripts have already been mailed to broadcasters. The complete series will be available only upon request.

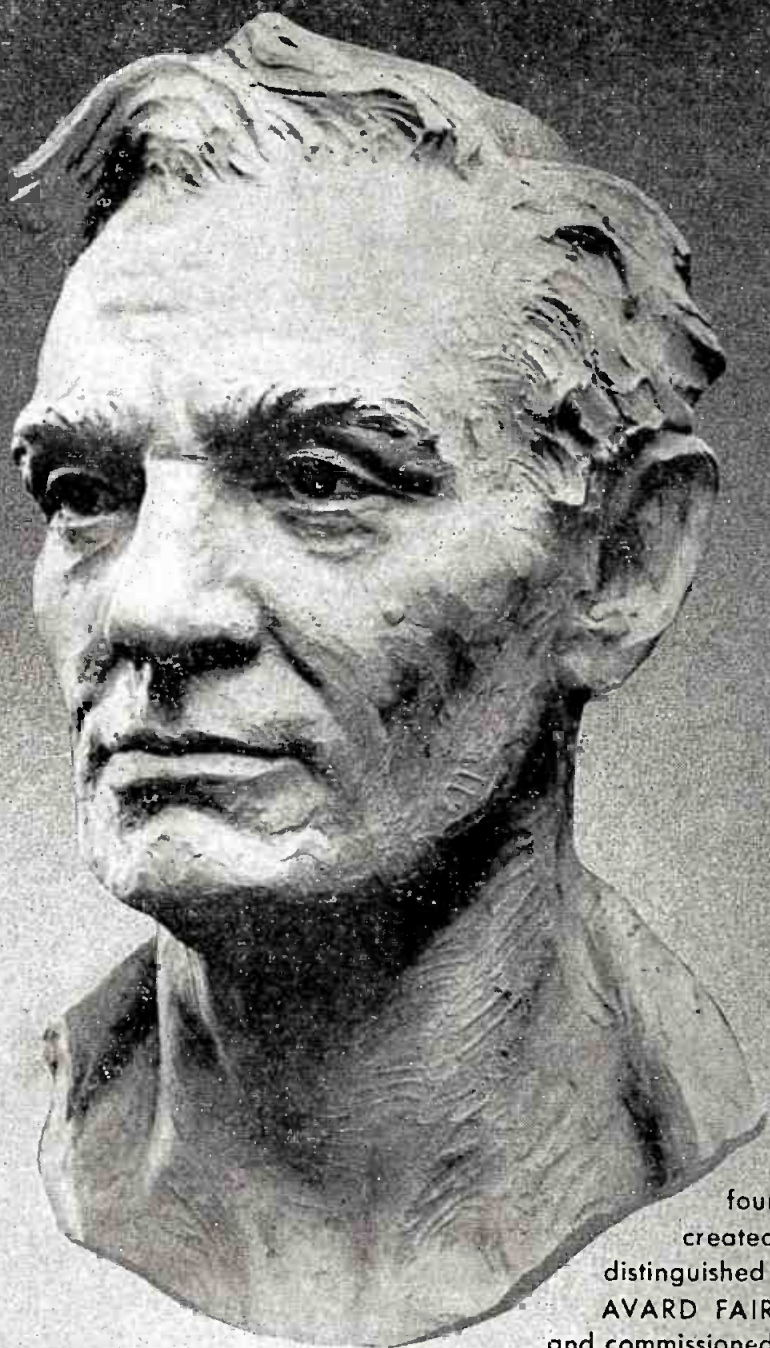

One of four studies created by the distinguished sculptor AVARD FAIRBANKS and commissioned by BMI

WRITTEN by 70 distinguished Lincoln and Civil War scholars of our time—among them Carl Sandburg, Bruce Catton, Sterling North, Earl Schenck Miers, Henry S. Commager, Roy F. Nichols, Allan Nevins, Adlai Stevenson, Gov. William G. Stratton, Sen. John Sherman Cooper, Sen. Paul H. Douglas, U. S. Grant III, Norman Corwin, Dore Schary and other eminent historians—this new segment continues BMI's series, "The American Story," now in its fifth year.

Also contributing are: Paul M. Angle, William E. Baringer, Roy P. Basier, Howard K. Beale, Richard N. Current, Irving Dilliard, Clifford Dowdey, Father Joseph Durkin, Otto Eisenschiml, Avard Fairbanks, Shelby Foote, John Hope Franklin, Dr. Richard P. Graebel, Wood Gray, Sherrill Halbert, Richard B. Harwell, Carl Haverlin, Willard King, Lloyd Lewis, Mort Lewis, E. B. Long, R. Gerald McMurtry.

Also David C. Mearns, Roy Meredith, Justin Miller, Herbert Mitgang, Jay Monaghan, Ralph G. Newman, Roy F. Nichols, David P. Potter, C. Percy Powell, Mrs. Marion D. Pratt, James G. Randall, Ruth Painter Randall, Donald Riddle, Congressman Fred Schwengel, Louis Starr, W. R. Swanberg, Wayne Temple, Benjamin P. Thomas, Walter Trohan, Randel Truitt, Philip Van Doren Stern, Clyde C. Walton, T. H. Williams, Albert Woldman.

These public service programs are available to radio and television stations and to public libraries and local boards of education for broadcast purposes.

BROADCAST MUSIC, INC.

589 Fifth Avenue, New York 17, N. Y.

New York • Chicago • Hollywood • Toronto • Montreal

oratory measurements and viewer observations to collect this information. A comprehensive series of laboratory tests, using representative groups of observers drawn from the general public, was conducted by TASO to determine the tolerable amounts of thermal noise, co-channel interference (with normal, precise and very precise carrier frequency offset) and adjacent channel interference (upper and lower) as well as tolerable amounts of certain combinations of these types of interference. Observations were made using both color and monochrome signals and both color and monochrome receivers. These tests were conducted by TASO panel members skilled in the design, conduct and interpretation of psychological tests as well as by those skilled in television engineering.

TASO panels made a critical evaluation of all performance characteristics of modern uhf and vhf television transmitting and receiving equipment which have a bearing on allocations. The types of equipment studied included receivers, receiving antennas and transmission lines, receiving tubes, transmitters, transmitting antennas and transmission lines, towers and carrier frequency control equipment. Certain critical items such as receiver noise factor and sensitivity, receiving antenna gain and transmitting antenna performance received especial attention. An important preliminary task was that of drawing up specifications for standard methods of measuring the characteristics of modern television receivers, as existing standards were seriously out of date.

TASO made intensive and detailed studies of a variety of techniques pertaining to the television allocations problem. Among the more important of these were trans-

mitters, precise and very precise carrier frequency offset operation, transmitted sound-to-picture power ratio and photographic techniques in predicting station coverage. A very important factor is that of the performance of directional transmitting antennas. TASO's work on this problem is not complete, but methods have been devised and specified for conducting performance tests of such antennas.

Last, but by no means least, was the development of the systems concept for studying television allocations. This involved essentially the preparation of a detailed outline of the various elements of a television system which are significant in allocations, together with a statement of the pertinent performance characteristics of each element and the preferred methods of presenting these performance characteristics. It was to fit into this framework of the systems concept that all the technical tasks of TASO were specified and carried out.

2.2 Resume of Major Results

TASO's work has been directed toward a thorough study of television broadcasting at all frequencies currently employed in both the uhf and the vhf regions of the spectrum. Much of the detailed technical information contained in later Sections of this report is arranged to show performance at low band vhf, high band vhf and uhf; and frequently the uhf data are further subdivided into groups relating to two or three frequency bands. Every effort has been made to collect and present data to show the technical capabilities of the various frequency bands on an absolute, rather than a comparative, basis. Now that such information has been compiled, however, it is inevitable that comparisons be-

tween bands will be made. In fact, the most significant aspects of the TASO findings can probably best be discussed in terms of such comparisons. In this Section, therefore, there will be frequent reference to comparisons between uhf and vhf operation.

2.2.1 General Comparisons of Uhf and Vhf Coverage

Speaking very generally, the field surveys conducted by TASO showed that, near a television transmitter, excellent service was provided by both uhf and vhf stations, but that as one went farther from the transmitter, uhf service deteriorated much more rapidly than did vhf service. In areas of adequately high signal strength, uhf provided both the best and the poorest pictures—the best primarily because of freedom from man-made electrical noise and the poorest primarily because of less satisfactory receiving installations. One significant factor was noted over and over again in all sections of the country. This is that there is no such thing as a "standard" receiving installation. Rather, as one goes farther and farther from a transmitter, one finds the quality of the receiver installations, and particularly the quality of the receiving antennas, improves so that the decrease in signal strength is to a considerable extent compensated. As one goes farther yet, a region is reached in which the signal strength is so low that only relatively poor pictures are obtained; and soon thereafter, it is found that no receivers are purchased. This increase in quality of receiving installations with increasing distance is, of course, to be expected; but it leads to interesting results. The effect produced is that, over a considerable range of distances from a television transmitter, picture quality, as observed in the home, remains at approximately the same satisfactory level; but that when some more or less critical distance is exceeded, the service deteriorates very rapidly. This critical distance depends upon many local factors; but the significant fact is that, in practically all cases, this critical distance is much less for uhf than for vhf. It is even markedly less for high band vhf than for low band vhf. Exceptions can, of course, always be found. For example, in the extremely flat and quite treeless San Joaquin Valley, signals from the Fresno uhf transmitters located 3300 and 4300 feet above the valley floor spread far down the valley and provide service quite comparable to that provided by the similarly located vhf transmitter. On the other hand, little uhf service is provided in the mountainous region to the east of the Fresno transmitter, although vhf service is quite adequate. In other words, the extent of uhf service is much more dependent upon the terrain than is vhf service.

Returning to the general conclusions, rather than the exceptions, and speaking in broad terms, the TASO field surveys showed that, under average conditions, with currently used effective radiated powers and transmitting antenna heights, service fell off rapidly beyond about the distances indicated in Table 2-1. In particular areas, and especially with better-than-average receiving installations, good television service was often obtained at greater distances. In other areas, or with inferior installations, poor service was sometimes obtained at lesser distances. In the usual case, service of consistently good quality was maintained out to about the distance indicated. In no case did service cease suddenly as the "critical distance" was exceeded. Rather, at about this distance, the proportion of viewers receiving really satis-

Convention Headquarters

Suites 718A-19A-20A

Conrad Hilton Hotel

R. C. CRISLER & CO., INC.

BUSINESS BROKERS SPECIALIZING IN RADIO TELEVISION STATIONS

Lincoln Dellar & Co.

Paul E. Wagner

Paul R. Fry



LET'S COUNT BACK FROM THE COUNTDOWN

This is the "moment of truth." This is the countdown. A satellite will soar into the stratosphere. A rocket will hit or encircle the moon.

But let's count *back* from the countdown.

Let's count the grueling tests, the check-outs. Let's count the months of manufacturing, the skill, precision and care that went into each of the thousands of parts.

Let's count the brain-power, the engineering talents of the brilliant men at work . . . the modifications and refinements in design . . . the "break-throughs" that had to be made.

Let's count all the way back to the first gleam of concept in a scientist's probing, inventive mind.

And let's not forget to count the administrative control, the guidance, the coordination and planning that go into these complex projects.

There's a new name for it

Such involved systems of engineering and automation demand an entirely

new concept of planning, research, specialized administration and technical coordination. It is called "system management." It places complete responsibility for every phase of a giant project in the hands of one company or group of companies.

It takes tremendous resources. In manpower. In administrative capacity. In facilities. And that is why ITT has been selected for projects of the highest importance. The ITT System operates and maintains the DEW Line, and is managing the production of a new world-wide electronic control system ingeniously conceived by the Strategic Air Command for its operations.

And ITT is deep in many other vital projects.

In industry, too, there are "countdowns"

Large industrial projects, too, need system management. Vast communication networks, for instance . . . linking continents through "over-the-horizon" microwave . . . world-wide air-navigation systems . . . the development

of automation in industrial processes.

System management has great potential. And ITT is equipped to put it to work . . . to assume full responsibility for complete system management projects anywhere in the free world. This includes not only basic concept, engineering and manufacture . . . but also installation, testing, operation and maintenance.

You can count on ITT . . . from concept to countdown.



. . . the largest American-owned world-wide electronic and telecommunication enterprise, with 80 research and manufacturing units, 14 telephone and telegraph operating companies and 128,000 employees.

INTERNATIONAL TELEPHONE AND TELEGRAPH CORPORATION 67 Broad Street, New York 4, N. Y.

FEDERAL ELECTRIC CORPORATION • ITT COMPONENTS DIVISION • ITT FEDERAL DIVISION • ITT INDUSTRIAL PRODUCTS DIVISION • ITT LABORATORIES
INTELEX SYSTEMS INCORPORATED • KELLOGG SWITCHBOARD AND SUPPLY COMPANY • ROYAL ELECTRIC CORPORATION • AIRMATIC SYSTEMS CORPORATION
AMERICAN CABLE & RADIO CORPORATION • INTERNATIONAL STANDARD ELECTRIC CORPORATION • LABORATORIES AND MANUFACTURING PLANTS IN
20 FREE-WORLD COUNTRIES

Frequency Range	Channel Range	Critical Distance—Miles
Low VHF	2 - 6	65
High VHF	7 - 13	55
Low UHF	14 - 40	40
Medium and High UHF	41 - 83	30

Table 2-1

factory pictures began to decrease rather rapidly, while those receiving poorer pictures increased correspondingly.

The decrease in average service range with increasing operating frequency is plainly evident. Moreover, at the critical distance, uhf service fell off more rapidly and more completely than did vhf service. Within the critical distance, service was more variable at uhf than at vhf and was, on the average, poorer. The TASO studies showed clearly that some of the reasons for the poorer performance at uhf are truly basic in their nature and are not susceptible to complete compensation by the application of known techniques, while other reasons stem from equipment limitations which may or may not change as the art progresses. The most significant differences between uhf and vhf performance are due to propagation effects, receiving antenna performance, receiver noise factor and external noise. Propagation of television signals is a phenomenon of nature; and the differences in propagation at uhf and vhf are likely always to exist. Uhf reception suffers in comparison with vhf reception, for one reason because of the smaller physical size of receiving antennas of the same type. Theoretically, if antennas of equal size were used, they would be equally effective in picking up signals. There are a number of sound practical reasons why this equality has not been achieved; but future, and as yet unknown, inventions might improve the effectiveness of practical uhf antennas. Referring again to reception, the noise factors of current uhf receivers are markedly poorer than those of vhf receivers. This is largely because of the lack of good reasonably priced tubes or other electron devices for use in uhf tuners, particularly r-f amplifiers. If the commercial demand existed, it might be possible to develop such tubes. This is uncertain for the present, although solid state parametric amplifiers show definite promise. These devices have not yet been used in television receivers; therefore, the limitations on the studies of the panels prohibited their consideration by Panel 2. One might suggest that the handicaps suffered by uhf could be overcome by the use of corre-

spondingly higher power transmitters. Currently available transmitters do not permit the achievement of this goal; but again, future developments might change the situation. In one respect, uhf enjoys a distinct advantage in comparison with vhf. Both man-made and natural noise—from auto ignition systems, diathermy machines, neon signs, thunder storms, galactic sources, etc.—are almost totally lacking at uhf while some of these are very bothersome at vhf. Some of the various factors affecting the comparison of uhf and vhf will now be discussed briefly.

2.2.2 Wave Propagation

Because it is not subject to control by man, the propagation of signals is of prime importance in allocation studies. As has already been mentioned, most of the TASO measurements of field strength were made in such a manner as to permit a direct comparison between uhf and vhf fields.* Generalizations drawn from such comparisons are fraught with danger as such pertinent factors as transmitting antenna height and location, exact terrain profile and exact time of measurement are never all the same for the uhf and vhf measurements which are compared. Nevertheless, overall, average comparisons of uhf and vhf field strength indicate the general nature of the differences in propagation and therefore they will be made.

A direct comparison of measurements made at some 1232 points in 8 areas across the country showed that, for the same effective radiated power, vhf field strength exceeded the uhf field strength by an average of 6.5 db. The values of field strength compared are the medians of continuous runs at least 100 feet in length taken with a measuring antenna height of 30 feet. Throughout these surveys, the average variation from maximum to minimum measured field strength within a

*The greatest disparities in conditions were in transmitting antenna heights. In the eight areas studied in detail, the vhf antenna was much higher than the uhf antenna in three areas, much lower in two areas and of essentially equal height in three areas. For details, see Table 16-1.

single run was 9.4 db at uhf and 4.5 db at vhf, a clear indication of the greater variability with location of uhf signals. It should be noted that this greater variation in field strength at uhf is not entirely disadvantageous. It results in the presence of spots of low signal strength, but it also affords an opportunity for the serviceman to search for and find spots of high signal strength when installing a receiving antenna.

The data comparing uhf and vhf fields summarized above may be subdivided to show comparative propagation phenomena at the high and low vhf bands. Such comparisons show that, for the same effective radiated powers in the areas surveyed, the low band vhf field strength exceeded the uhf field strength by an average of 7.5 db while the high band vhf field strength exceeded the uhf field strength by an average of 4.5 db. The average difference between the maximum and minimum field strengths measured along the 100 foot (or greater) runs was 3.8 db for low vhf bands and 6.2 db for high vhf bands, compared with 9.4 db at uhf. It should be mentioned that all but one set of the uhf measurements summarized in this and the preceding paragraph were made in the lower half of the uhf band.

It should be noted that these comparisons of field strength hold only out to limited distances, namely to the distance at which uhf field strength could be measured. Beyond these distances, no quantitative comparisons could be made. If comparisons at these greater distances could have been made, the difference between vhf and uhf fields would have been much greater. Moreover, in obtaining the averages, data from the atypical areas favoring uhf propagation were included. If these had been excluded, the vhf field strengths would have averaged higher in comparison with uhf fields.

Areas were found in which exceptions to the above general conditions occurred. In some extremely flat, open (or treeless) areas within line of sight from the transmitters, the uhf field strength was consistently appreciably higher than the vhf field strength for equal erp. Examples of this were along radials running generally southward from Fresno through the San Joaquin Valley, along one radial running southwest from Philadelphia across flat, sandy southern New Jersey, and along a radial running northward from New Orleans across the 22 mile long Lake Pontchartrain bridge. The last case was very striking. Considering all points on the bridge, the uhf field strength averaged 8.1 db higher than the vhf field strength. Immediately to the north of the bridge, however, the uhf field strength dropped suddenly and over the next 20 miles to the north, averaged 11.6 db lower than the vhf field strength.

Although the terrain was quite different, somewhat similar results were found along a radial running northwest from Buffalo. Here the measurements were made in such a manner as not to permit a direct one-to-one comparison of field strengths, but statistical comparisons could be made.* Also, the situation was complicated by the fact that, while the uhf transmitting antenna was 686 feet above average terrain, the vhf antenna height was only 380 feet. In the area just south of Lake Ontario, the vhf field strength averaged 2.7 db higher than the uhf field strength, for equal erp, over a distance of some 14 miles. Across Lake Ontario, at a distance of some 55

*This was the only one of the 60 radials studied in detail along which direct comparisons could not be made.

here is... modern radio

—IN SUITE 919-20 AT THE CONRAD HILTON! AS MODERN AS L-W "RADIO HUCKSTERS & AIRLIFTS" JINGLES AND OTHER L-W SERVICES . . . AS TRADITIONAL AS L-W HOSPITALITY AT N.A.B. CONVENTIONS.

LANG-WORTH

FEATURE PROGRAMS, INC.
1755 BROADWAY, N.Y. 19, N.Y.
TELEPHONE: JUDSON 6-5700

Distance Miles	Median Picture Quality		
	KFRE - Ch. 12	KMJ - Ch. 24	KJEO - Ch. 47
130	2		4
114		3	
100	3		4
98	1.8		3
92		3	
88	2	2	3
85		1.2	
80	2		2
73	2.2	2	5
60		2.5	
56	2.5	2	2.5
50	2	2.8	2.5

Table 2-2

miles from the transmitters, the terrain rises quite suddenly and for the next 40 miles, it generally continues to rise. In this area, the uhf field strength was particularly high. The profiles from the two transmitters were quite different, with the terrain favoring transmission from the uhf transmitter, so that conditions were not directly comparable. Over a distance of some 30 miles in this area, the uhf field strength averaged 17.1 db higher than the vhf field strength, although it should be emphasized that here, both transmitting antenna height and terrain favored uhf transmission.

Again, along a radial running to the south from the Fresno transmitters and under directly comparable conditions, the vhf field strength was 5.2 db higher in the foothills and rolling country near the stations. Across the next 80 miles through the flat, open valley, the uhf field averaged higher by 9.2 db. As soon as the rolling country approaching the foothills on the far side of the valley was reached, the uhf field strength dropped to an average of 6.2 db below the vhf field strength. It should be noted that, because of the extremely high location of the transmitting antennas, essentially the entire length of this radial was within line of sight from both transmitters. It should also be noted that "smooth earth" theory indicates that field strength should be proportional to frequency within line of sight. Apparently where practical conditions closely approach those postulated in this theory, uhf field strength is substantially higher than vhf field strength. However, in areas which are even moderately rolling or which contain even moderate vegetation, rocks, houses or other obstructing, scattering or absorbing objects, the vhf field strength is substantially higher than uhf field strength. These considerations indicate rather clearly the nature of the areas in which uhf operation should be most successful from the technical point of view.

As a matter of interest, a few more facts regarding the Fresno survey will be noted here. Because of the high field strengths

resulting from the very unusual geographical conditions, satisfactory television reception at both uhf and vhf was observed at remarkable distances. Pictures were classified by TASO observers as "1 - Excellent," "2 - Good," "3 - Passable," "4 - Not Quite Passable," "5 - Poor" and "6 - Unusable." Using this scale, the following observations of picture quality were made at the distances indicated in Table 2-2, in a generally southerly direction down the San Joaquin Valley.

It should be noted that both uhf and vhf signals were here received well at exceptional distances, and that the difference between uhf and vhf reception was not great.

A somewhat similar situation was observed in the Albany, N.Y., area on a survey which included observations in the Hudson and Mohawk Valleys of signals originating at WCDC, Channel 19, located at the summit of Mt. Greylock some 3500 feet above the valleys. Here, median picture ratings of 2.5 were observed at distances of 44 and 54 miles.

It must be emphasized, however, that the conditions at both Fresno and Mt. Greylock are exceptional and that the results there cannot possibly be considered typical. Nevertheless, these unusual conditions do exist in the areas cited and doubtless also elsewhere.

2.2.3 Interference

A factor which favors uhf operation is that of greater freedom from interference. Although TASO did not make quantitative measurements of interference, the observations made in the field surveys, the questionnaire survey of television servicemen and inquiries directed to service managers of leading television receiver manufacturers showed clearly that uhf television is substantially free from atmospheric interference, from such man-made interference as ignition and other impulsive electrical noise and from airplane flutter. Multi-path difficulties were not found to be a really serious factor except in large cities. In any location, multi-path was more objectionable at vhf than at uhf. Galactic noise, which may be an occasional bothersome source of interference on low vhf channels, is of no consequence at uhf. Finally, although there were frequent reports of co-channel and adjacent-channel interference at vhf in the information obtained from servicemen and others, there were practically no such reports at uhf. This, however, may well be due at least in part to the relatively small number of uhf stations on the air to cause such interference, since the curves of interfering (or troposphericly propagated) signal strength developed by TASO indicate that, at equal distances and for comparable effective radiated powers and transmitting antenna heights, interfering field strengths at uhf are only some 6 db lower than at vhf.

HOWARD E. STARK

Brokers and Financial
Consultants

Television Stations
Radio Stations

50 East 58th Street
New York 22, N. Y. ELdorado 5-0405

AVOID TOWER LIGHTING ISOLATION TRANSFORMER TROUBLES

INSTALL MODERN DESIGN

... by HUGHEY & PHILLIPS, Inc.
... your most dependable source of Obstruction Lighting Equipment
... the widest selection of Control and Alarm Apparatus in the Industry.

FEATURING:

- HIGHER EFFICIENCY
- IMPROVED REGULATION
- ADDITIONAL TAPS
- FIBER GLASS INSULATION
- EPOXY ENCASED
- VERSATILE MOUNTING



THREE SIZES . . . 750, 1750, 3500 WATTS

Essential wherever 60 cycle power must be transferred efficiently across two points with very low capacitance or at very high voltages.

"See it at our NAB Exhibit"

REQUEST DESCRIPTIVE BULLETIN
HPS-152

HUGHEY & PHILLIPS, INC.

MANUFACTURERS OF
300MM Beacons, Obstruction Lights, Photo-Electric Controls, Beacon Flashers, Special Junction Boxes, Microwave Tower Light Control and Alarm Systems, Tower Isolation Transformers, and Complete Kits for: Tower Lighting, Sleetmelter Power and Control.

3200 N. San Fernando Blvd. Burbank, Calif.



In the Radio-TV Publishing Field
only BROADCASTING is a
member of Audit Bureau of
Circulations and Associated
Business Publications

IF YOU'RE CHARGED WITH

LIBEL — SLANDER
PIRACY — PLAGIARISM
INVASION OF PRIVACY
COPYRIGHT VIOLATION

Be ready with our unique
EXCESS INSURANCE
Adequate protection against embarrassing loss
at amazingly moderate cost. Write!

EMPLOYERS REINSURANCE CORPORATION

21 W. Tenth, Kansas City, Mo.
New York, Chicago, San Francisco,
107 William St. 175 W. 100 Bush
St. Jackson St.

RELATIONSHIP BETWEEN INCIDENT FIELD STRENGTHS AND VOLTAGE AT RECEIVER INPUT TERMINALS

TV Band	Average Antenna Gain with respect to a tuned, folded dipole	Dipole Constant, K_a (1)	Ratio of Voltage at Transmission Line Input to Incident Field Strength (2)	Average Trans - mission Line Loss (30 feet)		Ratio of Voltage at Receiver Terminals to Incident Field Strength (2)	
				New, Dry	Wet Line Year Old	New Dry Line	5 Years Old, Wet
Low V	3.7 db	2.9 db	6.6 db	0.3 db	1.5 db	6.3 db	5.1 db
High V	6.8	- 6.1	0.7	0.5	2.9	0.2	-2.2
UHF	7.7	-16.7	-9.0	1.1	6.0	-10.1	-15.0

(1) Ratio, expressed in db, of antenna output voltage in volts to incident field strength in volts per meter.

(2) Voltage in volts field strength in volts per meter.

Table 2-3

REDUCTION IN RECEIVER INPUT TERMINAL VOLTAGE AND IN SIGNAL-TO-NOISE RATIOS FOR HIGH VHF AND UHF BANDS RELATIVE TO LOW VHF BAND, FOR EQUAL FIELD STRENGTHS

TV Band	Reduction in Receiver Input Terminal Voltage		Signal-to-Noise Ratio Transmission	
	Transmission Line—New, Dry	Transmission Line—5 yrs. Old, Wet	Reduction in Line—New, Dry	Transmission Line—5 yrs. Old, Wet
High VHF	6.1 db	7.3 db	8.1 db	9.3 db
UHF	16.4	20.1	23.2	26.9

Table 2-4

2.2.4 Receiving Equipment

If propagation phenomena are of first importance in allocation studies, the performance characteristics of receiving installation includes not only the receiver itself and the uhf converter (if any), but also the receiving antenna and transmission line.

The function of the receiving antenna may be regarded as that of converting field strength into voltage at the output terminals of the antenna. The gain of a receiving antenna is expressed as the ratio (in db) of the open circuit voltage delivered by that antenna to the voltage which would be delivered by a reference tuned, folded half-wave dipole at the same physical location. It is possible to build uhf antennas with substantially more gain than

vhf antennas. However, the effectiveness of the standard dipole to which the gain is referred also depends upon frequency and is, in fact, inversely proportional to frequency. As one goes from lower to higher frequencies, the gain of practical receiving antennas increases at a rate which is less than the rate of decrease of the effectiveness of the reference dipole; and the overall result is that practical uhf antennas are substantially less efficient than vhf antennas. For fields of equal strength, therefore, less voltage is delivered by the receiving antenna to the transmission line at uhf than at vhf.

This result is so important, and still so often misunderstood, that it will be explained again in other terms. Field strength is measured as so many volts per

meter or, in other words, the voltage existing between two points in space one meter apart. The length of a tuned dipole antenna is inversely proportional to frequency, being equal in meters to $300/f$ if the frequency, f , is expressed in megacycles. It follows, therefore, that in fields of equal strength, the voltage delivered by a tuned dipole antenna is inversely proportional to frequency. This basic effect, which operates to the inherent detriment of uhf, may be *partially* compensated by using complex antennas rather than a tuned dipole. Practical uhf television receiving antennas of this more complex nature can be built to have a greater efficiency (or gain) relative to tuned dipole antenna than can practical vhf television receiving antennas. This increased gain of practical uhf television antennas (as compared with practical vhf television antennas) is not, however, sufficient to overcome the basic, inherent disadvantage under which uhf television antennas operate. The result is that in fields of equal strength, uhf television receiving antennas deliver less voltage to the transmission line than do vhf television antennas.

The transmission line itself has greater losses at uhf than at vhf. This is true even with new, dry line. As the line ages, and particularly when it is wet, its transmission loss increases; and the deterioration is worse at uhf than at vhf. The overall result is that, for equal voltages at the input to the transmission line, less voltage is delivered to the receiver at uhf than at vhf.

The data collected by TASO show these effects clearly. The figures in Table 2-3 are the averages of the values furnished by the manufacturers of receiving antennas and transmission lines. (More detailed information is found in the report of Panel 2.) It should be noted that in calculating the losses, a transmission line length of 30 feet was assumed. This is less than the figure of 50 feet later furnished by Panel 3 on average home installations. If the greater length had been used, the disparity between uhf and vhf operations would have been greater. In fringe areas, antennas will be larger and higher, and transmission lines still longer. This will, in general, increase the relative efficiency of the uhf antenna, but will also increase the relative loss of the uhf transmission line.

Turning now to the receiver itself*, the most significant characteristic is the noise factor since this is the ultimate limiting factor in receiver performance. Here again, uhf shows to a disadvantage with vhf. The average noise factors as shown by the TASO data are: for low vhf, 6.5 db; for high vhf, 8.5 db; and for uhf, 13.3 db. The best noise factors reported were: for low vhf, 4.6 db; for high vhf, 6.5 db; and for uhf, 10.0 db. These data, in combination with the data given in Table 2-3 on antenna and transmission line performance, permit the calculation of Table 2-4 which shows, for the same field strength, the average reduction in receiver input terminal voltage and in signal-to-noise ratio for high band vhf and for uhf as compared with low band vhf for comparable qualities of receiver installations.

The most significant aspect of these figures is that there does not appear to be much immediate probability of an appreciable improvement in the relative performance of uhf receiving installations as compared with similar vhf installations. A major part of the difference is due to

* It should be noted that all data reported to TASO refer to commercially available receivers and that no such receivers have been designed specifically and solely for uhf operation.

**CAMART DUAL
SOUND READER**

Model SB-111

Complete with optical sound reproduction head (or choice of magnetic soundhead) base plate, amplifier-speaker. For single or double system sound. An unbeatable combination with any 16mm motion picture viewer.

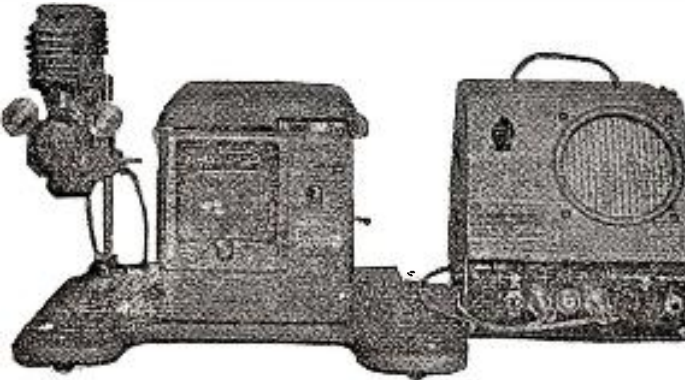

Camart Dual Reader
Model SB-111
(Less Viewer) **\$195.00**

THE CAMERA MART, INC.
1845 Broadway, New York 23, N. Y.
Plaza 7-6977

Frequency Range	Channel Range	Median Field Strength in dbu Resulting in Median Picture Quality of	
		2 - Good	3 - Passable
Low VHF	2 - 6	50 and above	40 to 45
High VHF	7 - 13	60 and above	50 to 55
Low UHF	14 - 30	65 and above	55 to 60
Medium and High UHF	41 - 83	72 and above	62 to 67

Table 2-5

the antenna and the transmission line; and it is difficult to visualize means for improving the uhf performance of these components greatly without also improving their vhf performance. Even if the noise factor of a uhf receiver were made equal to that of a low band vhf receiver, the relative performance of the uhf installation would improve only 7 db; and the overall performance of the uhf installation would still be some 16 or 20 db poorer than that of a low band vhf receiver installation and some 10 to 13 db poorer than that of a high band vhf installation.

Other receiver characteristics, as shown by the TASO data, are of interest, but not of as much significance. Image ratio, oscillator stability, tuner band width and receiver sensitivity are poorer at uhf than at vhf. Other characteristics are not significantly different and the poorer sensitivity of uhf receivers is not particularly important in view of their poorer noise factors. A matter of practical interest is that of the relatively rapid failure of a vacuum tube (Type 6AF4 oscillator) used in uhf tuners. This has been a real source of trouble in the field. Recent improvements in the design and construction of these tubes, plus care in the design of the associated circuits have improved this situation, although some difficulty will doubtless continue to be experienced.

2.2.5 Comparison of Laboratory and Field Tests of Receiving Installations

The data on receiver installations given are the results of careful laboratory measurements. It is worthwhile to compare them with the results obtained in TASO field surveys of reception in over 1,000 homes in 11 areas across the country. These observations of picture quality were made at the same time that measurements of field strengths were made in the same measurement locations.

In Table 2-5, comparisons are shown between the median picture quality in a given location and the median field strength in dbu (decibels above one microvolt per meter) as measured at a height of 30 feet in the same location.

The information contained in Tables 2-4 and 2-5 was obtained by completely independent means. If a comparison between these tables shows areas of agreement, or if differences can be explained in terms of data already presented, the reliability of the information becomes greater. Such a comparison will now be made.

From Table 2-5 it is seen that, for a given rating of picture quality, the signal strength is 10 db greater at high vhf channels than at low vhf channels, and 18 or 19 db greater at uhf channels than at low vhf. The difference of 10 db between high band and low band vhf field reception agrees remarkably well with the results of the laboratory measurements given in Table 2-4 where the difference is given as 8 or 9 db. The 18 or 19 db difference between uhf and low vhf field reception

is not greatly different from the 23 to 27 db difference in laboratory results of Table 2-4; but nevertheless, uhf reception as observed in the field appears to be significantly better in comparison with vhf reception than would be expected from the laboratory measurements of receivers, antennas and transmission lines. This discrepancy can be explained if it is remembered that the field strengths listed in Table 2-5 correspond to the minima for which the observed picture ratings occur and represent conditions in areas near the limits of satisfactory service. As noted previously, in such areas receiving installations are of significantly higher quality than in average areas. In particular, uhf antennas of somewhat greater gain than average can be used, as their physical size is still reasonable. In practice, therefore, in fringe areas uhf antennas may show to somewhat greater advantage than indicated in Table 2-3. A second very significant factor noted in the field surveys is that at uhf, the servicemen frequently, of necessity, search for antenna locations where the field strength is high, while this practice is not as common at vhf. Still another factor is one which has been noted previously, namely that electrical interference is less at uhf than at vhf. Again, in the fringe areas, it is possible that higher quality receivers having better than average noise factors are used; and as previously noted, the difference between the best uhf and vhf noise figures is about one db less than the difference between the average uhf and vhf noise figures. Finally, the data given in Table 2-4 represent conditions at the center of the uhf band, while practically all of the uhf observations summarized in Table 2-5 were made in the lower half of that band. The difference in effectiveness of the reference dipole antenna (to which antenna gains are related) in these two parts of the uhf band accounts for another one db of the discrepancy. All of these factors, and in particular the fact that receiving installations are not standard but are adapted to the necessities dictated by existing field strength, operate to decrease the difference between uhf and vhf performance that would be predicted from laboratory measurements alone; and undoubtedly these factors go far to explain, not only the results obtained by TASO, but also the technically successful operations of uhf stations.* Two points must, however, be emphasized. First, there still are very substantial differences in performance at uhf and vhf out to the limits of service, as shown in Table 2-5. Second, nothing in this discussion affects the results shown in Table 2-1. The service range of a uhf station is, as shown in that Table, far less than that of a vhf station. To put these two points in other words, current dif-

* It should be noted that a correction of only one db due to each of the factors cited would result in agreement between Tables 2-4 and 2-5.



BUY NOW FOR THE FUTURE

Monaural today—stereo tomorrow—handle both with finest quality results on Ampex Multi-Channel Recorders. May be fully remote controlled. Now sold by Ampex Professional Dealers everywhere—Write to Ampex for a copy of Bulletin B.

AMPEX CORPORATION
professional products division

934 CHARTER STREET • REDWOOD CITY, CALIFORNIA

Program Guide For FM-SCA LICENSEES

Present and Prospective

The only background music on tape that isn't also on transcriptions available to any broadcaster is



Exclusive franchise territories for this exclusive tape program service now being allocated. No franchise fees. No percentages. For franchise particulars, availabilities and audition—

NAB—Blackstone Suite

MAGNE-TRONICS, Inc.
49 West 45th Street, New York 36, N. Y.

Please rush complete particulars on exclusive franchise plan for FM-SCA and wire services.

NAME.....
STATION.....
STREET.....
CITY.....STATE.....

Nems • Clarke Type 120-D

FIELD INTENSITY METER



A portable instrument for measuring the wide range of radio signal intensities from 540 to 1600 kc. Its range is from 10 microvolts to 10 volts per meter, making it equally effective for interference studies at low signal strengths and close-in measurements on high-power directional arrays.

Accuracy is assured by a calibration method that compensates for variations in tube characteristics and for voltage variations in the self-contained battery power supply. Operation is simple—measurements made rapidly—direct reading on all ranges—requires no charts or multiplication factors—no warm-up period necessary.

NEMS • CLARKE COMPANY

A DIVISION OF VITRO CORPORATION OF AMERICA
919 JESUP-BLAIR DRIVE • SILVER SPRING, MARYLAND • JUNIPER 5-1000

Precision Electronics Since 1909



Compact
Lightweight
Direct Reading

ANTENNA SYSTEMS - COMPONENTS - AIR NAVIGATION AIDS - INSTRUMENTS

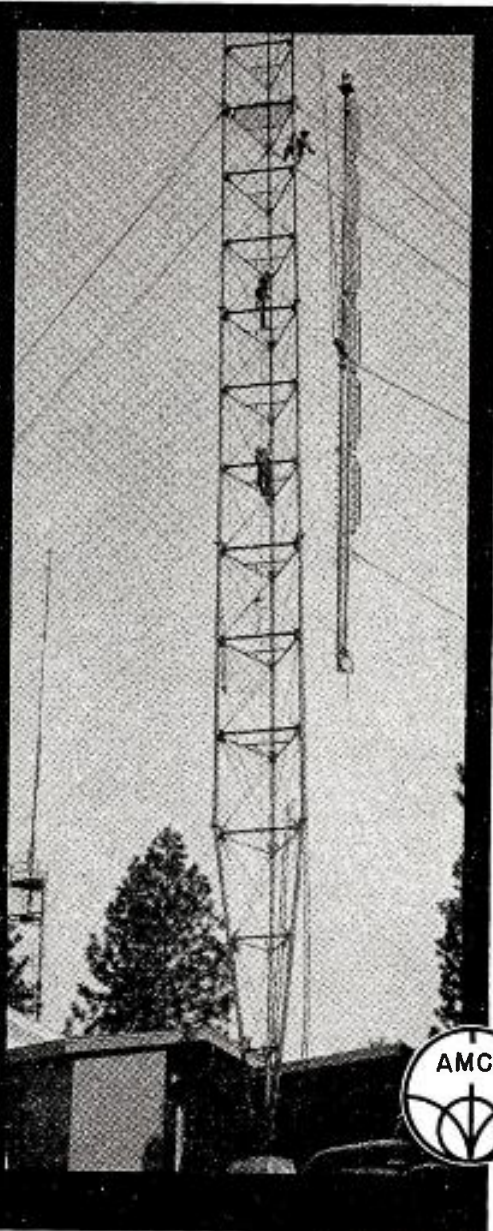

AMCI...

- Omnidirectional TV Transmitting Antennas
 - Directional TV Transmitting Antennas
 - Tower-mounted TV Transmitting Antennas
 - Standby TV Transmitting Antennas
 - Diplexers
 - Coaxial Switches
- ... have been proven in service.

Write for information and catalog.

ALFORD
Manufacturing Company
299 ATLANTIC AVE., BOSTON, MASS.



ference in the effective radiated powers used at low vhf, high vhf and uhf tend to equalize the picture quality obtainable within the service area of a transmitter (except, perhaps, for "holes" within the service area; but they do not at all equalize the size of the service areas obtainable in the three frequency ranges.

2.2.6 Transmitting Equipment

Turning next to a consideration of transmitting equipment, it is important to note that while propagation phenomena and the performance of receiving equipment set the requirements for field strength at the receiving antenna and for effective radiated power at the transmitter, it is only through a study of the characteristics of transmitting equipment that it can be learned whether or not these requirements can actually be met. TASO activities in this area were directed toward studies of (1) the characteristics, performance and reliability of currently available transmitters, (2) the characteristics of antennas, towers and transmission lines, (3) the performance of translators, and (4) the applicability of new techniques in transmitter operation.

A survey of television stations revealed that the maximum power output in all frequency bands ranged from 25 to 50 kw and that high effective radiated power is, of course, obtained through the use of high gain antennas. To obtain the higher effective radiated power permitted at uhf necessitates, of course, the use of antennas with higher gain and consequent higher vertical directivity. This, in turn, introduces greater problems in securing satisfactorily uniform coverage of the desired service area. The highest gain antennas reported had gains of 12 times in the low vhf band, 22 times in the high vhf band, approximately 50 times in the low and medium portions of the uhf band and 60 times in the high portion of the uhf band.

Since cost is an important factor in any study of transmitters, data were gathered to show both the original and operating costs of transmitting stations in the different bands. Comparing average costs of low band vhf and high band vhf transmitting plants, no significant difference was found for transmitter power outputs of 7.5 kw and higher. The average cost of a high power uhf transmitting plant (say 25 kw and above) was found to be a little less than that of the average vhf plant. At lower powers, however, uhf plants averaged substantially higher in cost than vhf plants.

It should be noted that the term "transmitting plant" as used above includes the main transmitter, the main transmitter accessories, and transmitter plant terminal facilities, plus installation and transmitter building costs. With respect to transmitters alone, for comparable power outputs, uhf transmitters were found to cost substantially more than vhf transmitters.

Transmitting antennas were shown to contribute only a relatively small amount to transmitting plant costs and their costs were relatively independent of frequency. For a given power gain, the cost of a uhf antenna is substantially less than that of a high band vhf antenna and much less than that of a low band vhf antenna. This decrease in cost with increasing operating frequency is, however, to a considerable extent offset by the necessity of using higher gains at higher frequencies to achieve maximum permitted effective radiated power. The net result is that, for typical uhf and vhf antennas, the costs are not greatly different.

By far the most significant factor in the cost of a transmitting antenna installation

is the height of the tower. If the tower height is very great, the total cost, including antenna, transmission line, tower and erection, increases more rapidly than the height. Typical low and high band vhf maximum power antenna installations of comparable tower heights were reported to cost substantially the same, with low band installations costing slightly more. The costs of typical uhf antenna installations (up to 300 kw erp) averaged less than those of comparable vhf installations, but the cost of the few high power uhf installations (500 or 1000 kw erp) was much greater.

Transmission line costs were found to be not greatly different at uhf and vhf except that at highest powers, the wave guide sometimes used at uhf costs only half as much as the nine inch transmission line used at vhf.

The total cost of a transmitting station includes the costs of the transmitting plant and the transmitting antenna installation. Because of the various manners in which transmitters, accessories, antennas, transmission lines, towers, etc., are combined in different stations, it was not felt correct simply to add average transmitting plant costs (as obtained by one group) and average transmitting antenna installation costs (as obtained by another group) to obtain average overall station costs. Rather, information on the total transmitting station costs was solicited directly from the stations. The reported data showed wide variability, but on the average, maximum power, high band vhf stations were shown to cost about 25 per cent more than maximum power, low band vhf stations. Uhf stations operating at powers up through 300 kw erp were shown to cost, on the average, about 10 per cent less than maximum power, low band vhf stations. Little information was obtained regarding 500 and 1000 kw uhf stations, but it appeared that their cost was comparable to that of maximum power, low band vhf stations.

A comparison of operating costs, including the costs of primary power, tubes and maintenance parts, shows substantial economies in vhf operations. The operating costs of high vhf band stations were found to average approximately 15 per cent higher than those of low band vhf stations. For uhf stations, the operating costs varied from 20 per cent higher than for low band vhf stations for the lowest powers, to 100 per cent higher for power outputs above 15 kw. More operating difficulties were reported at higher frequencies, the outage time in relationship to hours of

operation being 0.09 per cent at low band vhf, 0.15 per cent at high band vhf and 0.25 per cent at uhf. Also, more problems were reported at uhf than at vhf with such matters as off-frequency operation and transmitter modulation linearity.

A considerable amount of information was obtained regarding the structural aspects of antenna towers. The relative cost was shown to vary linearly with the wind pressure assumed in the design. It was recommended that in making studies of tower deflection, or bending, a value of 10 pounds per square foot* (on flat surfaces) be used as a general average of design wind pressure at a height of 1000 feet above grade. This corresponds to a wind velocity of 50 miles per hour. It is reported that at this wind velocity, the deflection of a high gain (50 times) uhf antenna on a typical 1000 foot tower is so small as to cause less than a 6 db variation in received signal strength at the worst point and less than one db variation in the fringe area.

TASO made an extensive study of the characteristics of uhf translators operating on channels 70 to 83 and of the service provided by these translators. As of the first part of 1958, it was determined that over 700,000 persons resided in areas served by these translators and that 45 per cent of the homes in these areas were equipped for uhf reception. Television signals were reported as being picked up and retransmitted from stations varying from 43 to 220 miles distant, the average distance being 110 miles. In general, service was reported to be good, with only minor difficulties in operation being experienced. Translators appear to be effective in providing television service in areas remote from regular broadcasting stations. They also appear to be effective in providing service in areas of low signal strength within the "normal" service areas of television stations.

2.2.7 Miscellaneous Transmitting Techniques

Several techniques with possible influences in allocation practices were investigated by TASO groups. One of these was the use of very precise carrier frequency control which would permit the use of precise carrier frequency offset in practical situations involving interference

* This, of course, does not refer to the higher wind pressure to be used in structural design.

Planning a Radio Station?

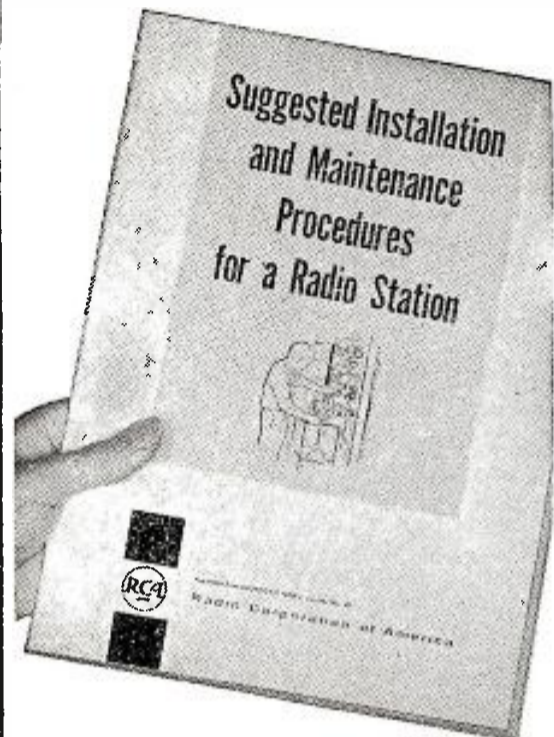

This valuable planning guide will help you realize a greater return on your equipment investment. Installation and maintenance procedures, outlined in this new brochure, will show you how to get long equipment life and top performance for your station.

For your free copy of this brochure, write to RCA, Dept. RC-22, Building 15-1, Camden, N. J. In Canada: RCA VICTOR Company Limited, Montreal.

RADIO CORPORATION of AMERICA

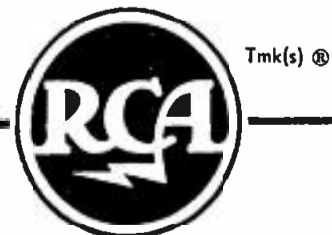

THIS IS THE JINGLE MILL RECORD

\$38

Price applies to the United States Only

PER JINGLE ON CONTRACT
COMPLETELY CUSTOM MADE

OVER 400 STATIONS SOLD
98% OF STATIONS HAVE REORDERED
OVER 7,000 JINGLES ORDERED AND WRITTEN

PUT THIS RECORD TO WORK FOR YOU

Completely custom made jingles for commercial accounts and station breaks — no open ends and no inserts.

JINGLE MILL

201 West 49th St., New York City

from so-called "second-ring" stations operating on nominally the same frequency. In such operation, carrier frequencies must be maintained constant to within about one cycle per second, a precision of one part in 10^9 at upper uhf channels. Laboratory tests involving the observations of desired and undesired pictures under controlled conditions showed that the expected benefits of very precise carrier frequency control were obtained. It was determined that no completely satisfactory and reasonably priced equipment was now available for controlling the carrier frequency to the desired accuracy; and that the necessary synchronization of studio equipment would require considerable extra expense. The question of whether or not the necessary carrier phase stability is maintained in fringe areas was studied in a preliminary manner and it was considered probable that no great difficulties of this nature would be experienced out to 60 miles. Obviously, data taken at greater distances are required. Field tests were not conducted; and therefore no conclusions regarding the practicability of very precise carrier frequency control operation were drawn. Specifications for tests were, however, drawn up.

Another technique studied by TASO was that of employing directional transmitting antennas. Again, specifications for conducting tests were developed and definite plans for tests were prepared. The results of such tests will be presented later in a supplementary report.

Still another matter investigated by TASO was that of the sound-to-picture power ratio. There was a feeling on the

part of some that the presently specified sound power is unnecessarily high; and that the reduction in lower adjacent channel sound carrier interference resulting from a decrease in sound power would outweigh the reduction in sound channel coverage in fringe areas. Others felt that it was most important to maintain a high sound signal in fringe areas because there program continuity is carried by the sound signal. Moreover, it was shown that even in areas of high sound signal, a decrease in sound power would result in a corresponding deterioration in sound quality in the presence of impulse noise. It was also felt by some that any reduction in the sound-to-picture power ratio would have an adverse effect on the performance for which television receivers could be designed. It should be emphasized that only a rather moderate decrease in sound-to-picture power ratio from the present 1:2 ratio to a ratio of 1:4 or 1:10 was considered by TASO. Although not a major factor in this study, data were collected on the original and operating costs of transmitters operating at different sound-to-picture power ratios. It was reported that if the ratio were 1:4, the original costs of vhf transmitters would average 85 per cent of the costs of current (1:2 ratio) transmitters while for uhf transmitters the figure would be 95 per cent. If a ratio of 1:10 were employed, the corresponding figures would be 75 per cent and 85 per cent. Very substantial reductions in power and tube replacement costs were reported with greater savings again being effected at vhf than at uhf. Although no general conclusions were drawn, a large amount of

factual information was compiled from laboratory and field tests which should permit decisions to be made by the FCC regarding sound-to-picture power ratio to provide maximum service.

2.2.8 Picture Quality

Another major factor in allocation studies is that of the amount of interference of various types which can be permitted and still result in the production of satisfactory pictures. The general problem has been discussed briefly in the preceding section. The results of the TASO studies are given in detail later in this report and are not easily presented in condensed form. Table 2-6 presents a brief summary of some of the more important results.

The reason for choosing a picture rating of #3 (passable) in preparing this summary is that such pictures are of a quality considered adequate, plus the fact that with such a choice, the selected points fall on portions of the curves (representing the observed data) which have reasonable slopes. The choice was made for illustrative purposes only and should not be considered as a recommendation that this quality of picture be chosen for allocations purposes.

Type of Interference	Average Ratio of Desired-to-Undesired Signal (db) Required for a #3 Picture
Thermal Noise	27
Co-channel, 360 Cycle Carrier Offset	22
Co-channel, 604 Cycle Carrier Offset	41
Co-channel, 9985 Cycle Carrier Offset	22
Co-channel, 10,010 Cycle Carrier Offset	18
Co-channel, 19,995 Cycle Carrier Offset	26
Co-channel, 20,020 Cycle Carrier Offset	18
Lower Adjacent Channel	-24
Upper Adjacent Channel	-24

It must be emphasized that the values given in Table 2-6 are overall averages and represent conditions which may or may not be directly comparable. For example, the permissible ratio of desired signal to lower adjacent channel signal may vary considerably with the level of the desired signal. The detailed analysis of the data in Section 12 of this report should be consulted for information on specific comparative and absolute results. Some general conclusions can, however be drawn from the Table. It is evident that, in the receivers tested, lower and upper adjacent channel interference were equally bothersome.* Carrier frequency offsets of 10,010 and 20,020 cycles were apparently equally ef-

*In terms of interfering signal at the picture tube grid, lower adjacent channel interference was 13 db worse than upper adjacent channel interference, but this was exactly balanced by greater lower adjacent channel rejection. The data collected by Panel 2, and presented in Section 8 of this report, indicate that in the average receiver, upper and lower adjacent channel rejections are nearly equal. In such average receivers, lower adjacent channel interference would be more bothersome than upper adjacent channel interference.

COME SEE US AT THE CONVENTION

NEGOTIATIONS
FINANCING
APPRAISALS

—ATTRACTIVE BROADCAST PROPERTIES FOR SALE IN ALL SECTIONS OF THE COUNTRY.

—WE HAVE A LONG LIST OF QUALIFIED BUYERS FOR RADIO, TELEVISION STATIONS AND NEWSPAPERS IN ALL PRICE BRACKETS.

Suite 1722-23-24 CONRAD HILTON HOTEL

HAMILTON · STUBBLEFIELD · TWINING and Associates, Inc.

BROKERS · RADIO AND TELEVISION STATIONS · NEWSPAPERS

PROFESSIONAL CARDS

JANSKY & BAILEY INC.

Executive Offices ME. 8-5411
1735 DeSales St., N. W.
Offices and Laboratories
1339 Wisconsin Ave., N. W.
Washington, D. C. FEderal 3-4800
Member AFCCE

JAMES C. McNARY

Consulting Engineer
National Press Bldg.,
Wash. 4, D. C.
Telephone District 7-1205
Member AFCCE

—Established 1926—

PAUL GODLEY CO.

Upper Montclair, N. J.
Pilgrim 6-3000
Laboratories, Great Notch, N. J.
Member AFCCE

GEORGE C. DAVIS

CONSULTING ENGINEERS
RADIO & TELEVISION
501-514 Munsey Bldg.
STerling 3-0111
Washington 4, D. C.
Member AFCCE

Commercial Radio Equip. Co.

Everett L. Dillard, Gen. Mgr.
INTERNATIONAL BLDG. DI. 7-131
WASHINGTON, D. C.
P. O. BOX 7937 JACKSON 5302
KANSAS CITY, MO.
Member AFCCE

A. D. Ring & Associates

30 Years' Experience in Radio
Engineering
Pennsylvania Bldg. Republic 7-2347
WASHINGTON 4, D. C.
Member AFCCE

GAUTNEY & JONES

CONSULTING RADIO ENGINEERS
1052 Warner Bldg. National 8-7757
Washington 4, D. C.
Member AFCCE

Lohnes & Culver

Munsey Building District 7-8215
Washington 4, D. C.
Member AFCCE

RUSSELL P. MAY

711 14th St., N. W. Sheraton Bldg.
Washington 5, D. C. REpublic 7-3984
Member AFCCE

L. H. Carr & Associates

Consulting
Radio & Television
Engineers
Washington 6, D. C. Fort Evans
1000 Conn. Ave. Leesburg, Va.
Member AFCCE

KEAR & KENNEDY

1302 18th St., N. W. Hudson 3-9000
WASHINGTON 6, D. C.
Member AFCCE

A. EARL CULLUM, JR.

CONSULTING ENGINEERS
INWOOD POST OFFICE
DALLAS 9, TEXAS
LAKESIDE 8-6108
Member AFCCE

GUY C. HUTCHESON

P. O. Box 32 CRestview 4-8721
1100 W. Abram
ARLINGTON, TEXAS

SILLIMAN, MOFFET & ROHRER

1405 G St., N. W.
Republic 7-6646
Washington 5, D. C.
Member AFCCE

LYNNE C. SMEBY

CONSULTING ENGINEER
AM-FM-TV
7615 LYNN DRIVE
WASHINGTON 15, D. C.
Oliver 2-8520

GEO. P. ADAIR ENG. CO.

CONSULTING ENGINEERS
Radio-Television
Communications-Electronics
1610 Eye St., N. W.
Washington, D. C.
Executive 3-1230 Executive 3-5851
Member AFCCE

WALTER F. KEAN

CONSULTING RADIO ENGINEERS
Associates
George M. Sklom, Robert A. Jones
19 E. Quincy St.—Riverside 7-2153
Riverside, Ill.
(A Chicago suburb)

WILLIAM E. BENNS, JR.

Consulting Radio Engineer
3802 Military Rd., N. W.,
Wash., D. C.
Phone EMerson 2-8071
Box 2468, Birmingham, Ala.
Phone STate 7-2601
Member AFCCE

HAMMETT & EDISON

CONSULTING RADIO ENGINEERS
Box 68, International Airport
San Francisco 28, California
Diamond 2-5208

JOHN B. HEFFELFINGER

8401 Cherry St. Hiland 4-7010
KANSAS CITY, MISSOURI

Vandivere & Cohen

Consulting Electronic Engineers
617 Albee Bldg. Executive 3-4616
1426 G St., N. W.
Washington 5, D. C.
Member AFCCE

CARL E. SMITH

CONSULTING RADIO ENGINEERS
8200 Snowville Road
Brecksville, Ohio
(a Cleveland Suburb)
Tel: JACkson 6-4386 P. O. Box 82
Member AFCCE

J. G. ROUNTREE

CONSULTING ENGINEER
5622 DYER STREET
EMERSON 3-3266
DALLAS 6, TEXAS

VIR N. JAMES

SPECIALTY
DIRECTIONAL ANTENNAS
1316 S. Kearney Skyline 6-1603
Denver 22, Colorado

JOHN H. MULLANEY

Consulting Radio Engineers
2000 P St., N. W.
Washington 6, D. C.
Columbia 5-4666

A. E. Towne Assocs., Inc.

TELEVISION and RADIO
ENGINEERING CONSULTANTS
420 Taylor St.
San Francisco 2, Calif.
PR. 5-3100

PETE JOHNSON

Consulting am-fm-tv Engineers
Applications—Field Engineering
Suite 601 Kanawha Hotel Bldg.
Charleston, W. Va. Dickens 2-6281

MERL SAXON

CONSULTING RADIO ENGINEER
622 Hoskins Street
Lufkin, Texas
NEptune 4-4242 NEptune 4-9550

Service Directory

COMMERCIAL RADIO

Monitoring Company
PRECISION FREQUENCY
MEASUREMENTS
A FULL TIME SERVICE
FOR AM-FM-TV
P. O. Box 7037 Kansas City, Mo.
Phone Jackson 3-5302

CAMBRIDGE CRYSTALS

PRECISION FREQUENCY
MEASURING SERVICE
SPECIALISTS FOR AM-FM-TV
445 Concord Ave.,
Cambridge 38, Mass.
Phone TRowbridge 6-2810

PAUL DEAN FORD

Broadcast Engineering Consultant
4341 South 8th Street
Terre Haute, Indiana
Crawford 4496

contact

BROADCASTING MAGAZINE
1735 DeSales St. N.W.
Washington 6, D. C.
for availabilities

SPOT YOUR FIRM'S NAME HERE,

To Be Seen by 85,000* Readers
—among them, the decision-mak-
ing station owners and manag-
ers, chief engineers and techni-
cians—applicants for am, fm, tv
and facsimile facilities.

*ARB Continuing Readership Study

fective, but the 4 db increase in interference resulting in going from 10,010 to 9,985 cycles was significantly less than the 8 db increase in going from 20,020 to 19,995 cycles. In general, it could be concluded that on the basis of a Grade 3 picture the benefits of precise carrier offset are well worth while. It was found that if results were judged on the basis of higher quality pictures, precise carrier offset was even more beneficial. The value of very precise carrier frequency control is well illustrated in the comparison of the results achieved at 360 and 604 cycle offset. The 360 cycle offset was used to produce the effects obtained when two co-channel stations are operated with carriers which are synchronized to the degree required for very precise carrier frequency control (say to within one cycle or less), while the 604 cycle offset was used to produce the worst condition that would be obtained if the carrier frequencies drifted apart from the synchronized condition. It is interesting to note that if it were possible to achieve carrier synchronization, the resulting interference (22 db) would be comparable with that obtained with normal 10 and 20 kc offset.

Other results of general interest may be stated briefly, though incompletely. In two series of otherwise identical tests of lower adjacent channel interference, sound powers of 3 db and 10 db below peak picture power were used. The reduction in interference was 7 db as would be expected for monochrome reception but was only 3 or 4 db for color reception. Incidentally, removing the modulation from the sound carrier, at the normal level of 3 db below the picture power, caused a 2 db reduction in interference. In some tests, pictures on color receivers were found to be less susceptible to interference than those on monochrome receivers, although at high levels of interference (low desired-to-undesired signal ratios), the color pictures frequently deteriorated more rapidly than monochrome pictures. The tests of combined thermal noise and co-channel interference showed that the greater interference predominated until the two levels of interference were within a few db of each other. In some cases, the presence of thermal noise appeared to lessen the disturbing effects of co-channel interference. Details of the results of the effects of these combined interferences can best be seen by reference to the curves in Section 12.

The observers used in the tests of picture quality in the presence of interference were drawn from rather diversified groups.

Many of them, however, fell into the general categories of middle aged women and young men. On the average, the middle aged women were somewhat (approximately 0.3 step on a six-point scale) more critical of picture quality than the young men. The judgments of the women were, however, much more variable than those of the men.

Still pictures rather than motion pictures were used as the subject material in front of the television camera. The reason for this was that interference is more noticeable and more annoying in still than in motion pictures and all television programs include a substantial amount of time in which there is little or no motion in the picture. A variety of scenes were used, but two scenes were used most frequently. One of these was a close-up of a girl's head and shoulders while the other was a middle-distance kitchen scene. On a statistical basis, the choice of scene appeared to produce no significant difference in the results of the tests. Such difference as did exist in some individual tests indicated that more interference (in some extreme cases as much as 3 db) could be tolerated in a close-up scene than in scenes which included more fine detail. The variability with respect to scene was less than that due to observers which itself was not considered to be great.

A number of replication tests were made to determine the reliability of the judgments reported by the observers. These showed a high degree of self-consistency, the correlation coefficient being 0.8 between the ratings of repeated pictures produced under identical conditions.

It should be noted that the results given above are largely independent of the frequency of operation. One possible exception might be the case of adjacent channel interference which depends upon the rejection ratios of the receiver for both upper and lower adjacent channels. However, the data collected by TASO indicate that uhf and vhf receivers have practically identical performance with respect to these characteristics.

2.2.9 Prediction of Field Strength

As has been stated previously, one of the most significant accomplishments of TASO has been the preparation of uhf and vhf propagation curves, together with the development of good means for predicting signal strength at specific locations. The general differences between uhf and vhf propagation, as determined from the TASO

surveys, have already been indicated. The propagation curves for service and interfering fields are found in Sections 11 and 10 respectively of this report, and cannot be adequately presented in less space than in those Sections. Likewise, the TASO methods of predicting signal strength are presented in Section 11. Since these also cannot be summarized briefly, such a summary is not attempted in this Section.

Some general observations regarding the prediction of service field strength can be made. At vhf, the data taken by TASO showed reasonably good agreement with the FCC (50,50) curves for median service field strength as a function of distance. The studies made by TASO showed clearly that these median curves can be improved materially in any specific case by taking into consideration meteorological conditions and the effect of these conditions on the effective radius of curvature of the earth. With proper attention to this factor, the shapes of curves developed on the basis of classical theory and curves drawn through the measured data checked well, but the theoretical curves were a little higher than the measured data. It was concluded that for median curves at vhf, the theoretical curves should be used, taking into account meteorological conditions, and subtracting an empirical correction factor of 1 db at low vhf channels and 4 db at high vhf channels.

At uhf, the TASO measurements agreed reasonably well with the Appendix A curve (FCC Report T.R.R. 2.4.16) for median service field strength as a function of distance. Here, however, the theoretical curves, even using meteorological data, were much higher than the observed data and the Appendix A empirical curves. An analysis of the data showed that, at uhf, the best results are obtained by using the theoretical curves, taking into account meteorological conditions, and subtracting an empirical correction factor of 22 db. Both analytical and field studies were made to attempt to learn the reason for this large correction factor. The results already discussed in this Section indicate that the roughness of the terrain, the presence of wooded areas and other ambient conditions in the neighborhood of the receiving antenna must be significant factors. Special measurements of uhf service field strength in carefully selected open and wooded areas in eastern Maryland showed clearly the depression of field strength due to forestation. Although time did not permit exhaustive tests, the measurements which were made indicated that, even in November and December, the presence of trees in the vicinity of the receiving antenna and in the line of sight toward the transmitter causes a very substantial decrease in the received signals. In typical cases, the signal strength near a wooded area was found to be 20 db less than in nearby cleared areas. It was noted that, as the receiving antenna was moved away from wooded areas, the field strength, expressed in dbu, rose more or less linearly with the logarithm of the clear distance to the wooded area. Measurements reported to TASO by Sylvania Electric Products and made at their uhf installations at Emporium, Pa., indicate that the signal strength is some two to four db lower in the summer than in the winter.

Much additional work is needed to
CONTINUES on page 183

WANTED

Promotion Manager for Group
of Well Established Radio
Stations.

Apply, Box 977H, BROADCASTING

CLASSIFIED ADVERTISEMENTS

(Payable in advance. Checks and money orders only.) (FINAL DEADLINE—Monday preceding publication date.)

- SITUATIONS WANTED 20¢ per word—\$2.00 minimum • HELP WANTED 25¢ per word—\$2.00 minimum.
- DISPLAY ads \$20.00 per inch—STATIONS FOR SALE advertising require display space.
- All other classifications 30¢ per word—\$4.00 minimum.
- No charge for blind box number. Send replies to Broadcasting, 1735 DeSales St., N.W., Washington 6, D. C.

APPLICANTS: If transcriptions or bulk packages submitted, \$1.00 charge for mailing (Forward remittance separately, please). All transcriptions, photos, etc., sent to box numbers are sent at owner's risk. BROADCASTING expressly repudiates any liability or responsibility for their custody or return.

RADIO

Help Wanted—Management

Sales manager who can produce in a depressed market; one who is interested in future ownership. Box 136K, BROADCASTING.

Sales manager—New station, central New York area, \$10,000 salary plus percentage. Box 139K, BROADCASTING.

Sales manager. Experienced. Excellent opportunity. WHTG, Asbury Park, N. J.

Sales

Maine radio station requires ambitious hard working man combining talents of live wire salesman and top announcer. We want a man who can assume responsibility. Some air work. Emphasis on sales. Guarantee over \$5,000 plus commissions. No prima donnas. Box 724H, BROADCASTING.

Michigan independent adding to sales staff. Major market over 100,000. Top job for money and climbing upstairs. Send picture and details of previous experience to Box 894H, BROADCASTING.

Radio salesman. The "Yankees" need three new additional pitchers! Why pitch in the minors when you can make big league money pitching in top ten market. Be a big leaguer and get on a real big league team. Salary, commission, bonuses, vacation, car expenses. Money making opportunity of life time for young rookies ready for majors. Work with winning team in number one place. For the best pitching job you've ever had rush photo, data. Box 935H, BROADCASTING.

Salesman—Excellent opportunity for good producer. Strong independent, major Indiana market \$6,000 plus. 144K, BROADCASTING.

Sales engineer—Leading manufacturer offers two outstanding opportunities in sales: broadcast equipment sales in Washington, D. C. area; recording tape sales nation wide. Must be aggressive with technical background, willing to travel, salary plus commission. Box 174K, BROADCASTING.

Salesman, for Tucson, Arizona. Write Manager, P.O. Box 5158.

California, KCHJ, Delano. Serves 1,300,000. Increasing sales staff.

Salesman—216,000 wealthy and progressive agricultural market. Experienced only. Must produce. First phone and board work helpful. Adult programming, local and regional. Ideal community life. Family man preferred. KWSO, Wasco, California.

Experienced radio salesman with ideas and follow through to sell for leading regional station in highly competitive market. Send resume, proven record and references to Gene Conrad, WERC, R.D. #4, Robinson Road, Erie, Pennsylvania. 9-9647.

Wanted, 2 experienced salesmen. Salary commensurate with ability. Contact Radio Station WJSO, Johnson City, Tenn.

Mass. indie wants top salesman, with sales manager potential. Good market with excellent earning prospect. Draw and commission. Open March 30th. Send resume and picture WLYN, Lynn, Massachusetts.

Announcers

New south Florida station metropolitan market needs 3 dj's. Experienced, smooth, fast paced professionals only. \$110 week to start. Send tape, references, resume! Box 251H, BROADCASTING.

Help Wanted—(Cont'd)

Announcers

Staff announcer for independent Pennsylvania station. 48-hour week, large market, excellent salary plus over-time, vacations. Desire an experienced man looking for a permanent job in a chain organization with an opportunity for advancement. Tape and resume required. Box 455H, BROADCASTING.

California station wants announcer who is unable to vent his humorous personality on air where now employed. Top pay. Box 942H, BROADCASTING.

Sparkling personality—experienced. Music-news-play-by-play. Must have new ideas and drive to execute them. Possibility pd for right man. 1st phone preferred. Ohio daytimer. Send tape, background resume, and salary expected. Box 105K, BROADCASTING.

We are looking for an experienced man capable of handling a heavy commercial morning shift. Must be a fine announcer with a working knowledge of news and sports. Married man preferred. Must be ready to settle down and become part of one of the finest small market radio families in Iowa. Send full details including tape with first letter. Box 147K, BROADCASTING.

Announcer with first phone. Good salary, excellent opportunity for advancement with top Montana station. Box 176K, BROADCASTING.

50,000 watt salary waiting for swinging afternoon man. Must run fast happy show, with just enough personality. Man we want knows his way around pop music world, can deliver potent commercial and wants outside appearances for even more money. Excellent hours. Highly competitive market of 300,000 in Great Lakes area. Rush tape. Box 183K, BROADCASTING.

Dj's it's important that you join with a winner. If you're looking for that last step before the big time consider this. We operate stations in .3 and .6 million markets . . . we're not big time, but we do pay major market salaries. We hire only the best, right now we have a prime time opening for a dj who is up on his radio and thoroughly familiar with popular music. Rush sample of your dj work on the air . . . it may be best move you'll ever make. Hurry! Box 184K, BROADCASTING.

Experienced salesman-announcer position open immediately. Must be able to handle bright morning show. Tight on production. Wire or call: Program Director, Radio Station KGFV, Kearney, Nebraska.

Washington D.C. area's number one station auditioning exceptional, fast, modern announcers. Send tape. WEAM.

Experienced dj night shift immediately. No rock. WICY, Malone, New York.

Fast growing Michigan station needs announcers with superb ability to sell on the air. Must be dependable and know production and quality. Good pay to the right men. Send tapes and resume or apply in person. WION, Ionia, Michigan.

Announcer with first phone. Engineering secondary. Contact Don C. Wirth, WNAM, Neenah, Wisconsin.

Top 40 station in major midwest market looking for dj who's hep to McLendon. Good salary to right man. Send picture, tape and resume c/o Brownstone Properties, 8 East 96th Street, N.Y. 28.

Disc jockeys boost your ratings! Order your "Deejay showmanship Kit", includes: "Book of 2400 anecdotes and one-liners"; and "Radiomanship Guide", containing proven formulas for building larger audiences. Also, "Hints for DJ Comedy". \$2.95 DeBu Features, 20 E. Huron St., Chicago, Illinois.

Help Wanted—(Cont'd)

Technical

Fulltime Florida network station looking for two young men with first phone. Prefer maintenance men but will consider all applicants who can also sell, announce or write. Must have feet on the ground and willing to settle. Send photo, resume of experience, age and other personal information plus tape if talents run to announcing. Salary will be governed by ability. Box 158K, BROADCASTING.

Capable technician for E. Pennsylvania station. Must be a man with pride in his work. Accent on maintenance and construction. No announcing. WCOJ, Coatesville, Penna.

Beginner wanted, with first phone and desire to announce. \$75.00 a week. Send tape, resume to WCRA, Effingham, Illinois.

Combination engineer-announcer immediately. \$85 per week. Send audition to WCPH, P.O. Box 85, Etowah, Tenn.

Opening beginning this summer for maintenance-supervisor engineer for radio-television studios and other electronic equipment in new quarters on college campus. Contact Donald Kleckner, Bowling Green State University, Bowling Green, Ohio.

Production-Programming, Others

We are looking for a man experienced in gathering, writing and delivering local news. This man will take over the Number 2 position in one of the top local news operations in Iowa. Must be mature, preferably married and ready to settle down in one of the top small market stations. Send full details including tape with first letter. Box 146K, BROADCASTING.

Prominent midwest advertising agency is interested in adding competent radio-television writer to its air media department. Prefer experienced male thirty or over. Please advise personal data and background, samples of recent copy, details of experience, salary requirements. All replies confidential. Write to Box 161K, BROADCASTING.

Cooking school, food editor for tv-radio and newspapers. Box 170K, BROADCASTING.

News director at radio and tv network stations medium size midwest market. Prefer journalism graduate with radio and/or tv news experience. Send complete info and picture. Box 199K, BROADCASTING.

Wanted—Really creative copywriter, able to write humorous production spots. Opening in two weeks. Leading southern New Jersey independent. Box 201K, BROADCASTING.

Writer-producer with flair for compelling commercial copy writing and radio production know-how needed by 50-kilowatt WOWO, Fort Wayne. Rush photo, copy samples and complete resume to: Cal Bollwinkel, WOWO, Fort Wayne, Indiana.

Growing Chicago area indie needs a copywriter. Good pay, fine future to the right person. Contact WRMN, Elgin, Ill.

Wanted, instructor and administrator with college training and broadcasting experience. National Academy of Broadcasting, 3338 16th Street, N.W., Washington, D.C., Decatur 2-5580.

Help Wanted—(Cont'd)

Production-Programming, Others

Copy writer—Wonderful opportunity for a creative writer. Every aid available. Plenty of talent to work with. We specialize in production commercials. Should be able to take charge of department with co-writer. Highest salary offered. Beautiful community on shores of Lake Erie. Funland summer and winter. WJET, Erie, Pa.

RADIO

Situations Wanted—Management

General manager topping industry records at several stations. Twenty-five years specializing productivity in sales and operations. Seeking new opportunity for maximum revenue expansion. Box 923H, BROADCASTING.

Production manager, 7 years, modern radio. Able to put you on top in ratings. Seeking large Florida or Carolina market. Must have complete co-operation and top pay. Write: Box 149K, BROADCASTING.

Working manager, salesman, announcer, tops. Family, college graduate, five figure income. Have youth, experience, aggressiveness. Box 166K, BROADCASTING.

Workin', sellin' manager will consider any offer. Prefer market under 50,000. Money unimportant. Now in top 10 market. Write, wire your best offer. Box 195K, BROADCASTING.

Rockin jockey, key market, desires aggressive management. Successful, stable, dynamic. Box 203K, BROADCASTING.

Manager available, experienced all phases, aggressive, capable, record of eight years of profits for owner and development of top station in competitive market. If you need manager who can sell, program, train and promote; write. But if not content to count your money with no second guessing don't waste your time and mine, west coast preferred. Write Box 211K, BROADCASTING.

Will appreciate opportunity your interview at convention. Manager, sales manager, sales. Extensive radio-television experience. My references industry best. Personally available at convention. Contact me through Box 214K, BROADCASTING.

The BIG MONEY goes to F. C. C. LICENSED MEN

F.C.C. License—the Key to Better Jobs

An F.C.C. commercial (not amateur) license is your ticket to higher pay and more interesting employment. This license is Federal Government evidence of your qualifications in electronics. Employers are eager to hire licensed technicians.

Grantham Training Prepares You

Grantham School of Electronics specializes in preparing students to pass F.C.C. examinations. We train you quickly and well. All courses begin with basic fundamentals—NO previous training required. A beginner may qualify for his first class FCC license in as little as 12 weeks.

Learn by Mail or in Residence

The Grantham F.C.C. License Course in Communications Electronics is available by correspondence or in resident classes. You may enroll for either type course at any of the three Grantham Schools—at Washington, Hollywood, or Seattle.

Write for Free Booklet

For our free booklet giving complete details concerning our F.C.C. license training, write to the Grantham School nearest you and ask for Booklet 99-C.

WASHINGTON
D. C. Grantham School of Electronics
821-19th Street, N. W.
Washington 6, D. C.

HOLLYWOOD
CALIF. Grantham School of Electronics
1505 N. Western Avenue
Hollywood 27, California

SEATTLE
WASH. Grantham School of Electronics
408 Marion Street
Seattle, Washington

Situations Wanted—(Cont'd)

Management

Have pulled three stations out of red. Ready to have capital gains of my own. If your operation not making money and you want a change will take over as manager for share of profits as interest in station. Now managing one of the best operations on west coast and have staff to do a job for you. We don't come cheap but will return biggest dollar profit you have ever had. West preferred, large or small market. If you don't want a manager but just a yes man, don't waste my time or yours. Write Box 212K, BROADCASTING.

Sales

Salesman/announcer. Love challenging sales problems. Write copy. Operate board. Box 957H, BROADCASTING.

Top man in 5 radio station market will relocate for opportunity in major market. Box 168K, BROADCASTING.

Attention midwest 250 watters! Need sales manager? I'm a salesman with 5 years in all phases radio-tv. Family, 29, B.S. Degree. Box 169K, BROADCASTING.

President of public relations and publicity firm, 30 with family now traveling coast to coast seeks cut down on travel. Desire to locate as sales director, public relations, (or both). Now earning \$10,500 yearly. Desire station needing play-by-play man. (This is a hobby, not my living.) Willing to cut income if opportunity is sufficient. Write Box 187K, BROADCASTING.

FM sales—Starting or expanding your sales force? Here is a sincere fm account executive presently employed in major fm market. Will travel to any area where potential is present. Have drive, enthusiasm and extreme confidence in fm as the media of the future. Let's discuss your fm plans and the important future you hold as potential. Box 193K, BROADCASTING.

Announcers

Girl broadcaster. Capable, versatile. Operate board. Writing, production, publicity, sales. Box 878H, BROADCASTING.

Negro deejay. Smooth patter. Efficient. Production. Controls. Audition tape. References. Box 879H, BROADCASTING.

Country/western music. My strongest suit. Capable-staff, controls, sales. Box 880H, BROADCASTING.

Female, announcer plus. Good background. Women's programs, plus. Reliable. Versatile. Box 959H, BROADCASTING.

Alert, aggressive, single, vet. 13 months' announcing experience to 5 kw network. Can write, will sell. Resume, photo, tape. Prefer medium northeast market. Box 960H, BROADCASTING.

Announcer-dj—2 years experience in all phases. Deep resonant voice. Good references. Prefer Florida or California. Box 972H, BROADCASTING.

Country dj available. For the last three years I have been program director, dj with a top ranking, money making country operation. I'd like to relocate. Worker. Know promotion, production, top dj. 29, sober, reliable, artist. Best references. Write Box 127K, BROADCASTING.

Summer work, college student, commercially experienced. Will work anywhere. Prefer D.C. Box 131K, BROADCASTING.

Attention New Jersey—eastern Pennsylvania! Announcer-dj with first phone, excellent voice, would like to relocate. No maintenance. Presently employed as dj at 5 kw. Box 135K, BROADCASTING.

Professional announcer/dj. Family. 30 years old. Fast-paced pro with commercial sell. Five years radio, three years tv. Ambitious. Major markets only. Box 138K, BROADCASTING.

Situations Wanted—(Cont'd)

Announcers

Clear-thinking, experienced, versatile announcer with best voice. Excels in knowledge of events, all music. Can adjust to any operation. Box 140K, BROADCASTING.

Announcer, 26, college grad, single, 4 years experience, veteran. Good voice, excellent diction, pleasant intelligent style. DJ, news, play-by-play. Best references. Seeks future. Box 142K, BROADCASTING.

Commercial experience all phases—college graduate. Married, versatile, reliable, tape, photo available, employed. Box 143K, BROADCASTING.

Sports minded stations: Tremendous sports-caster-announcer-salesman. First phone, 6 years experience, available April 15. California preferred, other areas considered. Box 145K, BROADCASTING.

News-special events-plus. Announcer-producer-writer. Radio and tv. Box 148K, BROADCASTING.

Country music dj. Music librarian, program director all in one. Write Box 152K, BROADCASTING.

Pacific northwest: Experience, youth, ability. DJ-copywriter for over year in Seattle station. College grad, single, third-phone. Looking for chance to grow with progressive station. Box 155K, BROADCASTING.

Friendly, relaxed style. No screaming. News, experienced. Desire medium market. Box 162K, BROADCASTING.

Versatile broadcaster. Experienced in television. Good voice and on camera appearance. Solid radio background. Includes dj, news, play-by-play, and sales. On current job two years at better than \$5,000.00 a year. Box 165K, BROADCASTING.

Professional announcer. 15 years announcing and programming. 5 years university. Music, theater background. Cheerful morning show or adult afternoon or evening show with attractive music. Prefer metropolitan station with possible tv. Box 167K, BROADCASTING.

Twelve years staff and farm news experience at 37. Ten years on 50,000. Some tv. Family man. Put me to work. Box 175K, BROADCASTING.

Dj-announcer, 3 years, seeks midwest position. Married. Excellent references. Box 177K, BROADCASTING.

Capable announcer. Can compile, edit and write news, convincing commercials, excellent interviews. Box 181K, BROADCASTING.

Staff announcer: 27, single, dependable, moderate experience, mature dignified approach (but not stuffy) authoritative news. Prefer north east. Box 185K, BROADCASTING.

Recent graduate of the Calument Broadcasting School. 20, no experience. Box 188K, BROADCASTING.

Staff announcer, experienced, dependable, good background, college degree. Box 194K, BROADCASTING.

Reliable announcer-salesman desires to settle in southern, central Florida. Box 198K, BROADCASTING.

Professional radio school graduate. Some AFRS experience. Operate board. Veteran, married, one child. Prefer southeast. Photo, tape on request. Box 205K, BROADCASTING.

Staff announcer: Require permanent position on west coast. 1st phone, married, dependable and have experience. Box 207K, BROADCASTING.

Deejay, 26 years old, married, two children. Experienced, combo, sales, 1st phone. TV trained. Box 208K, BROADCASTING.

First phone announcer. Four years announcing experience, little maintenance. Family man, 24. Employed. \$95, seek permanent position, Tenn., Ky. area. Box 213K, BROADCASTING.

Situations Wanted—(Cont'd)**Announcers**

Announcer. Professional radio school graduate, operate board. Married. Veteran. Tape, photo on request. Prefer south. Box 216K, BROADCASTING.

Look ma, no cavities! Just solid nine years experience major, medium markets including McLendon. Promotion, production, continuity. Currently pd-dj. Prefer south or west. S. Knight, WASK, Lafayette, Indiana.

Radio announcing and tv sales experience. Excellent knowledge of music and sports. Address inquiries to John O. Merki, 1008 Minnesota Ave., Gladstone, Michigan.

Announcer, 1st phone, \$85, no car. Berkshire 7-6721 after 6:00 P.M. Walter Piasecki, 2219 N. Parkside, Chicago, Illinois.

Experienced announcer-salesman. Married, excellent references. Upper midwest preferred. Charles Swenson, 2127 Alameda St., St. Paul, Minn.

Technical

First phone, experienced transmitters, remotes, equipment construction, and control rooms. Box 993H, BROADCASTING.

Chief engineer—Over twenty years experience am directional, remote, am-fm and tv transmitter and studio installation. Last ten years maintenance and supervision. Seniority prevents further advancement with present employer. Family man. Box 994H, BROADCASTING.

Supervisory or chief position. Prefer full-timer. Experienced. No unsavory habits. Good, clear voice. All inquiries answered. Box 153K, BROADCASTING.

First phone—prefer warmer climates, Single, amateur radio 25 years. Now transmitter engineer directional station. Minimum wage acceptable. Box 163K, BROADCASTING.

Engineer much experience am-fm directional wants location for tv shop and engineer for station, also good announcer. Box 173K, BROADCASTING.

Chief engineer; young, married, experienced in construction and/or operation. Box 180K, BROADCASTING.

Chief engineer—25 years experience, construction, directional, remote control. Box 191K, BROADCASTING.

Staff cut causes change in position. Engineer, 27 years old, experienced, dependable, desires secure position in television or radio. Top references, versatile, and a willing worker. Box 209K, BROADCASTING.

First phone, second telegraph, amateur general class, college, news, combo, staff. Non drinker; \$100.00 minimum. Box 215K, BROADCASTING.

5 years experienced country announcer with first ticket. Some maintenance, dependable, sober. No sign on. Making change for programming reasons. Ted Foster, WHBT, Phone 661, Harriman, Tennessee.

Engineer or combo man for new daytime directional in central Michigan. Start April with construction. Will go on air about July 1st. Send resume, photo and tape to: Justin F. Marzke, 120 No. Clinton Ave., St. Johns, Michigan.

Production-Programming, Others

Capable newsman for Florida. 27, nine years varied experience. Will provide a top quality resume and references, plus many extras. Box 137K, BROADCASTING.

News director. 12 years, all phases, Ohio. Gather, write, report. Box 159K, BROADCASTING.

Experienced continuity writer, traffic director, also fill-in announcer, or newsman. Full particulars on request. Box 197K, BROADCASTING.

Operations manager caught in shuffle, without job, ten years specializing in programming-production-inside operation. Married, 36. I know radio. Box 202K, BROADCASTING.

TELEVISION**Help Wanted—Announcers**

Wanted: Top flight news and staff announcer for Texas 100 kw network affiliate. Permanent. Good pay. Will consider experienced radio announcer. Send tape, recent photo or snapshot, full details. Box 989H, BROADCASTING.

Emcee for teenage show. Want emcee with plenty of tv experience and fresh ideas for teenage program in leading midwest city. About \$100 fee to right man with opportunity for other work and possible staff job. Write giving recent photo and full resume. Box 141K, BROADCASTING.

Experienced tv announcer, live camera, booth, production work, handle weather show, some radio. KMMT-KAUS, Austin, Minnesota.

Expanding staff wants experienced, hard-sell, on-camera announcer. Air mail special resume and photo to John Radeck, P.D., WJBF, Channel 6, Augusta, Georgia.

Technical

Transmitter engineers for combined radio-tv operation. Southeast. Good pay scale commensurate with ability and experience. Excellent working conditions in major market. Send picture and complete background information first letter. Box 828H, BROADCASTING.

Technical supervisor to handle engineering staff at mid-west television station. Only top technical men with experience on maintaining transmitters, studio control and microwave need apply. Address Box 981H, BROADCASTING.

Full power midwest vhf station needs studio and transmitter maintenance men. Experienced only. Must have first phone. Box 189K, BROADCASTING.

Vacancy for television engineer. Permanent job, good climate. Would consider competent radio engineer who wants to learn television. Send complete details, including small snapshot to Manager, KSWs-TV, Roswell, N.M.

Production-Programming, Others

Mature, experienced staff announcer with good news background. NBC basic station on eastern seaboard. Write Bob Grossman, WXEX-TV, Petersburg, Va.

TELEVISION**Situations Wanted—Management**

Experienced tv station manager available immediately. Background includes installation of two vhf stations from hiring personnel, buying film to operations. Well versed all phases programming, sales. References. Box 831H, BROADCASTING.

End the struggle. Increase profits, efficiency, prestige—permanently. Write, wire: Box 939H, BROADCASTING.

General manager, with 20 years background in radio and tv. Experienced all phases. Strong on sales—personally handle national and regional accounts. Five years in present position. Box 192K, BROADCASTING.

Sales

Dependable salesman. Excellent television experience. Top references. Write Box 190K, BROADCASTING.

Situations Wanted—(Cont'd)**Announcers**

Personality announcer, all types on-camera work, produces, directs, excellent tv background and experience. Employed, college graduate, Harvard, age 35, married. Box 999H, BROADCASTING.

Ernie Saunders, 16 years, two stations, play-by-play, daily sports commentary, news, special events. Available immediately due new owner cutback. Best references. Radio and/or tv. Reply 94 Ray Street, Manchester, New Hampshire.

Technical

Chief engineer—9 years experience. Planning, construction and operation. Past five years assistant chief engineer. Proven ability, excellent references. Box 974H, BROADCASTING.

1st phone. Experienced, major market operations. Technical school graduate. Draft deferred. Prefer north-east. Mid-west. Box 156K, BROADCASTING.

Tv engineer, experienced studio and transmitter maintenance. Southeastern location preferred. Box 164K, BROADCASTING.

Production-Programming, Others

Radio-tv program-production manager. California net, desires east. References. Box 856H, BROADCASTING.

Operations or production manager. Presently employed program director small market vhf. Family, college. Best references, proven record all phases. Flexible. Sales and organization minded. It will take more than this ad, I know, but I feel resume and personal interview will convince. Box 196K, BROADCASTING.

FOR SALE**Equipment**

Instant echo and filter for less than \$150.00! Complete plans, drawings, \$100.00. Box 910H, BROADCASTING.

Two complete DuMont type TA-188-A multi-scanners. Can be converted for color. Box 178K, BROADCASTING.

Two-230 foot Ideco self-supporting towers, transmission lines, coupling units, Austin lighting chokes, lights. Ready for shipment soon. Write KCBQ, San Diego, Calif.

Excellent Gates BC1E 1 kw transmitter. Antenna tuning equipment. Rust remote control. Package or individually priced to sell. Going 5 kw. WEEB, Southern Pines, N.C.

Westinghouse type fm-3 transmitter \$4700. Collins type 37ma antenna (tuned for 100.5 mcs) \$450. REL frequency and modulation monitor \$150. All prices quoted f.o.b. location and subject to prior sale. Contact W. E. Garrison, WFBC, P.O. Box 1140, Greenville, S. C.

16mm Bell & Howell 70 DR complete, make offer. M. Harris, 6421 Richmond, Dallas, Texas.

Several used towers in top condition, including insulated am broadcast towers. Inquire Tower Construction Co., P.O. Box 1828, Sioux City, Iowa.

In TEN years as GENERAL and SALES MANAGER of WNOR, Norfolk, Va.

- (1) Built station business from zero to \$450,000 yearly.
- (2) Made over \$800,000 profit for owner.
- (3) Increased station value over ONE MILLION DOLLARS.

Interested in management with part ownership or management with salary plus commissions or share of profits.

EARL HARPER
1000 Manchester-Norfolk, Va. Madison 2-1930

FOR SALE

Equipment—(Cont'd)

Audio equipment—professional series—used tape recorders, microphones, amplifiers, consoles. Write for list of materials available. U.S. Recording Company, 1121 Vermont Avenue, N.W., Washington 5, D.C.

WANTED TO BUY

Stations

CP or station in difficulty, sought by responsible operator. Box 902H, BROADCASTING.

250 watt or 1 kw fulltime or daytime. Small market. List price and terms. Box 979H, BROADCASTING.

Qualified and financially able party will buy station or cp with good potential. Write confidentially and in detail. Box 100K, BROADCASTING.

Reliable group \$100,000.00 cash or down for a station anywhere in eastern section. Guaranteed confidential. Box 150K, BROADCASTING.

Cash for cp or \$10- \$15M down existing station. Successful manager, financially responsible. Consider partnership. Box 160K, BROADCASTING.

Will buy tv station. Replies confidential. Box 172K, BROADCASTING.

Radio broadcaster will buy or participate in Florida east coast cp or station. Address Box 514—Delray Beach, Florida.

WANTED TO BUY

Equipment

100- to 200-ft. tower; Collins or Andrew fm antenna; fm monitor; also 44 BX or 77 D; 7/8 flexible coax. Box 179K, BROADCASTING.

DuMont video switching and mixing equipment, type TA-178-B. Box 206K, BROADCASTING.

R.C.A. 73-B recording lathe; condition and price. Bernie Koval, KQEO, Albuquerque, New Mexico.

Wanted—Proof of performance outfit including oscillator, distortion meter, gainset, diode. State make, price, condition. WCME, Brunswick, Maine.

Used Magnecord amplifier chassis, PT-63-J. Marvin S. Seimes, Chief Engineer, WKIP, Box 889, Poughkeepsie, N.Y.

Wanted—used 250-500 1 kw transmitter. Used towers mod. and freq. monitors. Rush condition, model numbers, price to Broadcast Construction Co., 1136 Villa Ave., Belmont, California.

MISCELLANEOUS

Set of western station break jingles, for all country and western radio station. K-KEY, Vancouver, Washington.

Personalized playing card bingo cards, size 3 3/4 x 5 3/4 \$2.50 per 1,000. Bingo Time U.S.A., P.O. Box 906, Denver 1, Colorado. Phone Acoma 2-7539.

INSTRUCTIONS

F.C.C. first phone preparation by correspondence or in resident classes. Our schools are located in Washington, Hollywood, and Seattle. For details, write Grantham School, Desk 2. 821—19th Street, N. W., Washington, D. C.

FCC first phone license in six weeks. Guaranteed instruction by master teacher. G.I. approved. Phone FLeetwood 2-2733. Elkins Radio License School. 3605 Regent Drive, Dallas, Texas.

Since 1946. The original course for FCC 1st phone license, 5 to 6 weeks. Reservations required. Enrolling now for classes starting June 24, Sept. 2, Oct. 28, 1959, January 6, March 2, 1960. For information, references and reservations write William B. Ogden Radio Operational Engineering School, 1150 West Olive Avenue, Burbank, California.

First phone license in six weeks. Guaranteed instruction. Next class—April 6. Elkins Radio License School of Atlanta, 1139 Spring Street, N.W., Atlanta 9, Georgia.

BUSINESS OPPORTUNITY

Representative in New York City wanted by aggressive and outstanding southern California metropolitan fm radio station. Potential greater than that offered by the average am radio station. Box 151K, BROADCASTING.

Operate area radio-tv talent search: cooking schools, special promotions. If you want permanent money-making opportunity it's yours if you can sell. Box 171K, BROADCASTING.

RADIO

Help Wanted—Management

STATION MANAGER

To direct sales and programming at 5000 watt radio station medium mid-west market. Substantial salary plus excellent commission makes exceptional, permanent position for experienced proven man. Send summary of experience and recent picture to: Box 200K, BROADCASTING

BUSINESS OPPORTUNITY

FOR LEASE

SAN DIEGO'S ONLY BACKGROUND MUSIC BUSINESS

One million population Nation's 20th market

- Will lease on minimum plus percentage basis
- Will transfer trade name "Music Unlimited"
- Will transfer better than 100 existing accounts which have been under contract for 3 to 5 years. Now grossing \$2500 a month. Fine potential.

CONTACT: Fred or Dorothy Rabell at NAB Convention, Chicago, or at KITT, U.S. Grant Hotel, San Diego, California.

STATIONS • FOR SALE

SOUTHERN CALIFORNIA FM PERMIT
WANT OFFER FOR PARTICIPATION OR TRANSFER
Box 157K BROADCASTING

THE PIONEER FIRM OF TELEVISION AND RADIO MANAGEMENT CONSULTANTS
ESTABLISHED 1946
NEGOTIATIONS MANAGEMENT APPRAISALS FINANCING
HOWARD S. FRAZIER, INC.
1736 Wisconsin Ave., N.W.
Washington 7, D. C.

Patt McDonald, Box 9322, Austin, Texas, GL 3-8080 offers southern vhf, \$1,500,000, liberal terms. Regional full timer, one of nation's top six markets, \$900,000, terms. Southwestern regional daytimer, \$100,000; half down. Southern fulltimer, \$50,000. Thirty percent down.

Established 5 kw in Pacific North West multi-station market. Owns land and equipment. Absentee ownership reason for selling. Substantial downpayment required. Box 210K, BROADCASTING

NORMAN & NORMAN INCORPORATED
Brokers — Consultants — Appraisers
RADIO-TELEVISION STATIONS

visit us during
NAB Convention in Chicago
March 15-18 Conrad Hilton Hotel

Security Bldg. Davenport, Iowa

STATIONS FOR SALE

We are expecting you.

SUITE 1035A-1036A
Conrad Hilton Hotel
JACK L. STOLL & ASSOCIATES

Texas	Single	1kw-D	\$30M	terms
Fla.	Single	250w-F	55M	terms
Ala.	Medium	1kw-D	65M	terms
Calif.	Single	500w-D	100M	terms
W.Va.	Small	250w-F	30M	cash
S.E.	Monop.	A.M. & N.P.	150M	terms
Ky.	Single	500kw-D	70M	terms
Pa.	Sm-med.	1kw-D	100M	terms
Fla.	Medium	250w-F	155M	terms
N.C.	Medium	1kw-D	200M	terms
Gulf	Medium	1kw-D	98M	terms
Va.	Metro	1kw-D	150M	terms
S.E.	Major	5kw-D	250M	cash
Fla.	Large	250-w	250M	terms
East	Large	250w-D	450M	terms
S.W.	Large	clear	325M	terms
Ga.	Large	500w-D	75M	terms
South	Medium	VHF-TV	750M	terms

N.A.B. Convention
Conrad Hilton, Chicago
PAUL H.
CHAPMAN COMPANY
INCORPORATED
MEDIA BROKERS
atlanta chicago
1182 w. peachtree 205 w. wacker
new york santa barbara
1270 ave. of americas 33 w. micheltorena

determine quantitatively the effects of forestation at both uhf and vhf. The results obtained to date, however, leave no doubt of the serious effects on uhf signal strength of even a few trees in the vicinity of the receiving antenna. The effects are, of course, of greatest significance in fringe areas where the signal strength is already low.

The calculation of curves of median service field strength versus distance is only one aspect of the problem of predicting signal strength. Of equal importance is the calculation of deviations from the median curves due to the topography of the transmission path. The analytical work sponsored by TASO which was carried on in the Bureau of Engineering Research at the University of Texas led not only to the preparation of the median curves described above, but also to methods for predicting the presence and extent of deviations from the median with surprising accuracy at both uhf and vhf. It is in this particular area that the TASO analysis of propagation data has been most fruitful, although time did not permit this analysis to be completely finished. The methods developed for calculating the deviations from the median curves are empirical in nature and depend upon a knowledge of the terrain profile between the transmitting antenna and the point under consideration. The plotting of the required sections of the profile is somewhat laborious but can be expedited through the use of judgment developed through experience. After the plots have been made, the required calculations are simple. As stated previously, the details of this work are presented in Section 11.

The accurate prediction of troposphericly propagated interfering signals has also been shown by the National Bureau of Standards to depend upon detailed knowledge of the topography of the propagation path. It was the conclusion of

TASO, however, that for use in television allocation studies, the small increase in accuracy obtainable by these methods in comparison with that obtained from the use of propagation curves would not justify the extra labor involved in the more accurate methods. It was concluded that the tropospheric propagation curves presented in Section 10 are the best practical means for representing the present knowledge regarding interfering fields and for predicting the strength of such fields.

The propagation curves permit a cross check of some of the results given in earlier parts of this Section. A comparison of field strengths as derived from data in Table 2-1 and the propagation curves, with field strengths given in Table 2-5 indicates consistency. Details of this comparison are given in Section 19 of this report.

One general conclusion, which has already been implied, should be stated here. This is that in predicting service field accurately, it is not possible to resort to the use of general, average curves or to the use of over-simplified methods. The variations encountered in different types of geographical conditions have already been pointed out. These examples are sufficient to show that detailed study of the local geography, and especially topography, is necessary if reasonably accurate predictions of field strength are to be made in any specific area. The necessity for such detailed studies increases as the roughness of the area increases. The means for making those predictions with reasonable accuracy and without an unreasonable amount of effort are given in Section 11 and constitute one of the major accomplishments of TASO.

2.3 Unfinished Work

It would be grossly misleading to suggest that TASO has done all of the work which needs to be done in the field of television engineering allocation studies. This type of work should, and in fact will, be carried on indefinitely by the television industry, by educational institutions and by the government. In this Section, several of the more important unfinished tasks will be mentioned briefly. More specific suggestions regarding some of those problems will be presented later in Section 23 of this report.

Probably the most important unfinished task is the completion of the analysis of propagation data. TASO has collected and compiled a large amount of reliable data on service field strength. The analysis of these data has resulted in the development of propagation curves and prediction methods. However, it has been physically impossible to study carefully all of the available data. This should be done in order to provide further checks of the propagation curves and prediction methods and quite possibly to make needed modifications (expected to be slight) in these curves and methods. This is a most urgent matter if maximum use is to be made of the data which have been collected at the expenditure of much time and money.

In connection with the analysis of propagation data, additional field work is needed to learn more about the reasons why uhf field strength is well below its theoretical value. In particular, more information is needed regarding the influence of its surroundings upon the performance of the receiving antenna. The work done to date indicates that ambient conditions near the

receiving antenna are most significant, but further work is needed to permit a more accurate quantitative evaluation of these factors.

Still another aspect of propagation phenomena which needs further study is that of the variation of field strength with time over short periods (several minutes), median length periods (several hours) and long periods (days and months). Information on these matters is given in Sections 10 and 11, but continued measurements over almost unlimited periods are needed in order to permit an increase in the understanding of temporal variations in field strength.

Another matter relating to propagation which should be studied further is the question of the effects of galactic noise on television reception; and in particular, why the effects of galactic noise in the low vhf band appear to be appreciably less than predicted by some measurements.

A second important unfinished task is that of conducting and analyzing reliable field tests of directional transmitting antennas. Specifications for such tests have been prepared, funds for tests have been raised, sites have been selected and tests will commence soon. The results will be presented later in a supplementary report.

Field tests of other types are also needed. One of these, which has already been discussed, is a field test of very precise carrier frequency control operation. Again, specifications for such tests have been prepared but no arrangements have been completed for conducting the tests. Other techniques which could be of importance in allocations and whose values can be determined only by field tests are the use of circular polarization in an effort to provide better coverage in shadowed areas, particularly at uhf; and the use of mixed circular, horizontal and vertical polarization in an effort to provide better discrimination against interfering signals. Again there are no current plans for such tests. Still other field tests should be conducted to determine the usefulness of the methods proposed in Section 10 for sampling the area around a television transmitter to determine its service area. It is believed that these methods are sound but, as is pointed out in Section 10, they must be tested in a number of areas before their use can be recommended.

Finally, field surveys of television picture quality in the home in very large metropolitan areas should be conducted. These should be coordinated with concurrent measurements of field strength and, of course, comparable uhf and vhf sources of television signals are needed if the surveys are to be of maximum usefulness. Unfortunately, facilities for such surveys are not readily available. Moreover, and perhaps of even more importance, is the fact that no satisfactory specifications for measuring field strength in very large metropolitan areas have been developed, and there is even a great scarcity of worthwhile ideas on the subject. Perhaps in the absence of such specifications, surveys of picture quality alone would provide significant information, although a tremendous number of observations would have to be made if the results were to be of much statistical significance. The utility of a uhf station in a canyon-like city has not been determined; quantitative data are needed. TASO has no plans for such tests, but they should be undertaken if facilities become available.

FOR SALE

Equipment

FOR SALE:

To educational Broadcasters

One 6A1 RCA 6-bay high band antenna used on Channel 11. In satisfactory service for four years in dry desert climate until September, 1958 when replaced by higher gain antenna.

Address inquiries to Leavenworth Wheeler, Chief Engineer, KIVA-TV, P.O. Box 1671, Yuma, Arizona.

WANTED TO BUY

Equipment

TV MOBILE UNIT

Will buy for cash tv mobile truck, including cameras and equipment. Must be in first class condition. Write full details immediately. Box 217K, BROADCASTING.



An Industry That Takes

“Time Out” To Be Courteous

Ever have a flat tire or run out of gas miles from a service station and have a truck driver stop to help you?

If so, you understand perfectly what is meant when it's said that the trucking industry is an industry that takes “time out” to be courteous. And it's plain to see, too, why truck drivers are often referred to as gentlemen of the highways.

Courtesy is one of a number of basic subjects

given top billing in truck driver training programs all over America. In addition to helping stranded motorists, it involves the conscientious use of signals, giving the other fellow the right of way, maintaining the proper mental attitude.

The industry's emphasis on courtesy and safe driving practices helps explain the splendid safety record of the nation's over-the-highway truck drivers.



AMERICAN TRUCKING INDUSTRY

American Trucking Associations, Inc., Washington 6, D. C.

THE WHEELS THAT GO EVERYWHERE



OUR RESPECTS TO . . .

Charles Carroll Barry

When Bud Barry was a youngster in Newton, Mass., he dreamed of playing shortstop for a major league team or acting on Broadway.

He didn't attain either of these ambitions. But he has had a varied and rewarding career as an announcer, radio and television network official, talent agency executive and tv film company vice president. Last January, Mr. Barry undertook a new assignment that he considers "the most difficult and most challenging" of his business life—the presidency of the NTA Television (formerly Film) Network.

As a network executive of long standing at both NBC and ABC, Mr. Barry is aware of the roadblocks in the path of a fourth network—station time, availability of quality programming and sponsor acceptance. But Mr. Barry is a self-styled "optimist and gambler," who believes that "provocative and imaginative programming" can establish the NTA Television Network as a competitive force in the industry.

The Personal Equation • Mr. Barry is a tall, pleasant-faced individual with a quick smile and lively manner. Associates describe him as "a highly-creative programming man and a persuasive salesman with a likable Irish blarney." He gives the impression of lightheartedness, of not taking himself too seriously; but friends say he is "hard-headed" about business with "tremendous enthusiasm" for work and people.

Charles Carroll (Bud) Barry was born in Newton on July 1, 1911, and attended the local high school (he has not had college training). He played semi-professional baseball and participated in local theatricals following graduation.

"But nobody discovered me—either for baseball or the stage," he recalls.

He began his business career as an office boy in the advertising department of the *Boston Globe* and remained there for two years until 1934 when he joined R. H. White Co. in that city as a publicity assistant and junior copywriter. In 1935 he moved to New York and worked for Montgomery Ward as a copywriter. The following year, he was appointed advertising manager of Grosner's Men's Store, Washington, D.C.

This position led to Mr. Barry's switch to the broadcasting field. Grosner's was sponsoring a sports program over WRC, the NBC owned-and-op-

erated station in Washington. Mr. Barry suggested that the format be revised, and, confidently, voiced the belief that he himself could perform the broadcasting chores. The owner of the store liked Mr. Barry's self-confidence and gave him the go-ahead signal. His on-the-air delivery caught the attention of the NBC management and he was offered—and accepted—a post on the Washington NBC announcing staff in February 1937.

Worth a Salary Cut • "I was on cloud nine when I was offered that job," Mr. Barry remembers. "I felt I was beginning to find my niche. I wanted to get



NTA's president: enthusiastic

out of the clothing business so bad that I took a cut in salary from \$240 a month to \$167."

In 1938, he became night manager of WRC, then the Red Network outlet, and WMAL, the Blue Network station, and in 1939 was appointed Presidential announcer to Franklin D. Roosevelt. NBC assigned him as its representative attached to Wendell Willkie during the latter's campaign for the Presidency in 1940. From 1939-41, NBC lend-leased Mr. Barry to the National March of Dimes during campaign periods and he is credited with having organized the "Mile o' Dimes" promotional effort, which was used in 75 cities and raised several million dollars for the undertaking.

In 1941, Mr. Barry was advanced to eastern program manager of the Blue Network and in 1942, when the network became ABC, he was named national program manager of ABC. In 1947 he was promoted to vice president in charge of radio programs and in 1948 to vice president in charge of tv.

Mr. Barry rejoined NBC in 1950, first as vice president in charge of radio programming and subsequently as program manager for the television network as well. In 1954 he resigned from NBC to join the William Morris Agency as a program executive. In 1956 Mr. Barry was asked to organize the Loew's Inc. entrance into television. As vice president in charge of MGM-TV, he supervised the leasing of MGM's library of pre-1948 feature films to tv, an operation from which Loew's grossed more than \$50 million in less than a year and a half.

Tapes and Kinescopes, too • Mr. Barry revealed that the NTA Television Network hopes to offer tape and kinescope programs as well as film shows to stations. For the fall, Mr. Barry plans to make available to network stations a group of programs in the following categories: daytime and nighttime variety, children's and service. In addition, Mr. Barry said, the network hopes to utilize some of the tape programs developed by the NTA-owned stations.

Mr. Barry believes the NTA network can be successful by "being exciting, different, getting away from pattern programming." He maintains programming must be "a mirror of the times and the people's interests." He feels viewers can be stimulated to watch "provocative shows that are not stereotyped."

Mr. Barry belongs to the Radio and Television Executives Society of New York, the Society of Television Pioneers and the New York chapter of the Academy of Television Arts & Sciences. He is a member of the New York Athletic Club and the Bel Air (Calif.) Country Club.

In 1951, Mr. Barry married the former Florence Morris of Staten Island, N.Y., formerly director of operations for the Blue Network. Mrs. Barry has created and developed a unique business enterprise in New York: she heads the Encore Shops, which re-sell expensive women's and men's clothing. Mr. Barry has a daughter, Christina, 18, by a former marriage. He maintains homes in New York and Duxbury, Mass.

Mr. Barry's one unfulfilled ambition: to produce a Broadway play or musical.

Programs: 'a mirror of the times'

It's a federation now

THE program labels it the 37th annual convention of the NAB. Actually, the sessions this week in Chicago constitute separate conventions of a score of different entities in broadcasting meeting under the aegis of the NAB.

The main tent meetings, which run Monday through Wednesday, likewise are split. The radio sessions are separate. So are the tv sessions. The engineers meet concurrently. No monumental issues will be decided. There will be informative speeches, panels and forums.

Networks will meet with their affiliates—separately for radio and television. Maximum power telecasters will parley, as will the uhf group. Clear channel stations will have a do or die session; syndicators will meet with their customers, representatives with their station owners. Tangible results will emanate from most of these assemblies because they will be dealing with their own special problems.

What has happened is that the NAB, because it cannot be all things to all segments of broadcasting, necessarily has become an innocuous hub of a federation of broadcasters. This has happened without a preordained plan but rather because of the evolution of the broadcast arts. NAB simply has outgrown its trade association breeches.

Broadcasting is now a billion-dollar-plus business.

Because competition is intense, not only with other media, but intramurally among the broadcast media, conflicts of interest inevitably have developed. These transcend the competition for the advertising dollar; they involve conflicts for facilities, conflicts between networks and their affiliates, conflicts on program availabilities, and conflicts even on regulation and legislation.

The NAB is in the middle. There is only one area in which all these warring segments have an indivisible interest. That is imbedded in the philosophy of free enterprise broadcasting. The NAB should function as the spokesman for all segments of broadcasting as the legislative and public relations umbrella under which all can be protected. It should in fact become the "federation" through a fusion of all groups who live by the microphone and camera, and who would be destroyed if free broadcasting perished.

Following this convention, an ad hoc committee of the NAB board will be named to negotiate with NAB Chairman-President Harold E. Fellows on a new arrangement upon expiration of his term June 30, 1960. The scope of this committee, or of a more representative one, should go far beyond the matter of Mr. Fellows' contract. It should consider policy as well as personnel—all-inclusive policy, looking toward the combining of forces on the one theme on which all must agree, preservation of free competitive broadcasting.

The ideal structure, as we see it, would be a single, unified organization at the top. There would be a single spokesman. The area of authority would be broad public policy, legislation and nationwide public relations. This would be a close-knit compact organization of highly competent people.

This "federation of broadcasting" would be responsible to a board representing every segment of the radio-tv arts. Each division would have its own director and staff, like networks, the TvB, RAB, AMST, Fm Assn., SRA, film syndicators, manufacturers, state associations, educators, and others having a legitimate stake in American Plan broadcasting. And each would have a place on the "federation" board.

A prerequisite to membership in any of these divisional operations would be membership in the NAB federation, which would derive its support, not necessarily in direct dues from member broadcasters or associates, but from the special

interest organizations as "federation affiliates". These separate organizations would pay their own way, and get out of the federation precisely what they are willing to put in.

State associations, which have shown commendable growth and influence, should be constituents of the "federation". Theirs is the grass roots job. With their local dealers and distributors and advertising groups, they can coordinate their battles against local ordinances and restrictions which are becoming ominous threats as municipalities seek to tap new sources of revenue. These associations, legislatively, have done well and would do infinitely better with the federation type of high level guidance from Washington.

To safeguard broadcasting's free estate and to enhance its prestige, we firmly believe that the federation idea or some similar enlightened and effective approach is essential—and soon. The alternative will be the propagation of a rash of special interest organizations, going their separate ways, to the detriment of the arts of broadcasting.

Remembrance

FOR 37 years the nation's broadcasters have held annual conventions, except when there were travel restrictions during World War II. Each year there are more new faces; fewer old ones. The second generation is taking over.

In the last month alone three veterans passed from the scene. George M. Burbach, who as head of KSD-AM-TV St. Louis long had been an elder statesman, died at 75. John J. Louis, 63, known best as the co-founder of Needham, Louis & Brorby and developer of *Fibber McGee & Molly* and *The Great Gildersleeve* of radio fame and *Robert Montgomery Presents* for tv, but also owner of several Arizona radio and tv stations, died following a stroke. Ike Lounsberry, former manager and part owner of WGR-AM-TV Buffalo, died at 60 in retirement in Florida.

Just 10 days ago, Canada's most distinguished broadcaster, Harry Sedgwick, president of CFRB Toronto, died at 64. He had retired only a few weeks earlier because of ill health. He was the man most responsible for the creation of the Canadian Assn. of Broadcasters, the counterpart of NAB, and for a dozen years had been its chairman and president.

All these men made great contributions to broadcasting and to their nations. They lived good lives. To their families go the gratitude of all broadcasters, for their friendship, guidance and selfless devotion to the art they helped pioneer.



Drawn for BROADCASTING by Sid Hix

"Remember that winning recipe . . . ?"

this is the **Piedmont Industrial Crescent . . .**

and it's Dominated by

wfmy-tv

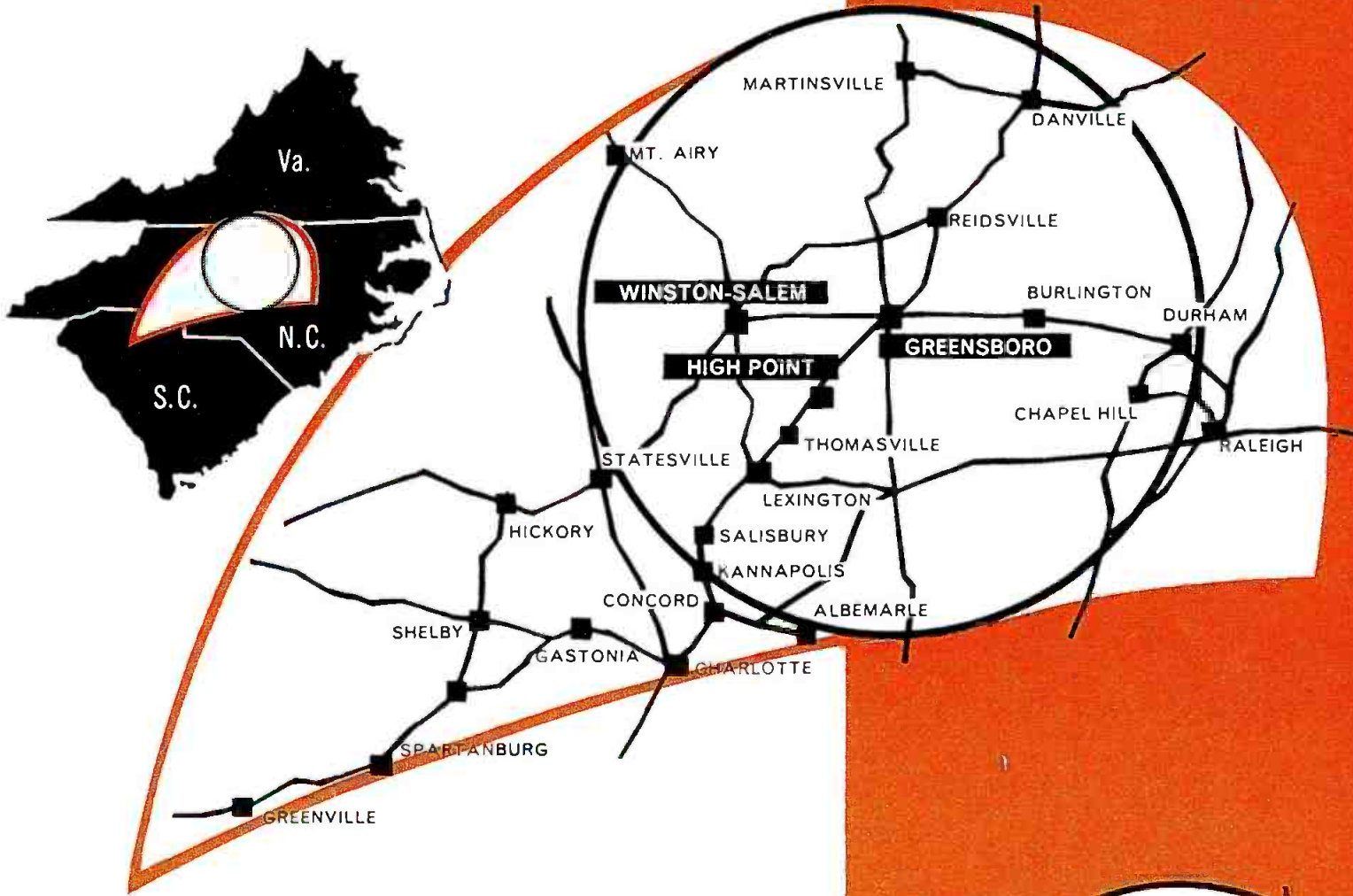

The Piedmont Industrial Crescent is a unique concentration of buying power . . . a vast "area laboratory" . . . stretching across the productive Piedmont section of North Carolina, South Carolina and Virginia.

It is a vast urban complex created by bustling cities, booming industry and big agricultural purchasing power where millions of your customers WORK, EARN, SPEND.

Strategically located at the hub of this big year-round market is WFMY-TV . . . the most powerful selling influence, by far.



This Is North Carolina's Interurbia

. . . The largest metropolitan market in the two Carolinas. Here, WFMY-TV dominates because it serves . . . sells.

GREENSBORO-HIGH POINT-WINSTON-SALEM
 (2 Stations)
 Greensboro-High Point—Guilford County—Map Location F-3
 Winston-Salem—Forsyth County—Map Location
 See SRDS consumer market map and listing of the State Area



wfmy-tv

GREENSBORO, N. C.

Represented by Harrington, Righter and Parsons, Inc., New York, Chicago, San Francisco, Atlanta, Boston, Detroit



WEED

TELEVISION

television station representatives



NEW YORK
CHICAGO
DETROIT
BOSTON
SAN FRANCISCO
ATLANTA
HOLLYWOOD
DALLAS