

Broadcasting

Yearbook 1976

ABC's of Radio & TV	A-1	Engineers	E-36	Radio: Call Letters	C-242
ADI Market Atlas	B-1	Equipment Manufacturers	E-1	Radio: Formats	D-68
Advertising Agencies	D-1	FCC	A 9	Radio: Frequencies	C-260
Associations	F-20	Group Ownership	A-33	Radio: Station Directory	C-1
Attorneys	F-6	NAB	F-20	TV: Call Letters	B-152
Brokers	F-1	Networks	D-16	TV: Channels	B-156
Buyer's Guide	E-41	Program Services	D-41	TV: Station Directory	B-89
Commercial Producers	D-41	Representatives	D-8	Complete Index—Opening Page	

More audience than other area stations combined*

WGAL TV 8



**LANCASTER-HARRISBURG
YORK-LEBANON, PA.**

*Nielsen Station Index, Nov. '75, Sun. through Sat., 7:00 AM to 1:00 AM. Audience estimates subject to limitations published by Nielsen.



for complete coverage of the PROVIDENCE ADI

WTEV 6



**PROVIDENCE, RHODE ISLAND
NEW BEDFORD-FALL RIVER, MASS.**

Steinman Television Stations



JAMES W. BLACKBURN
Washington, D. C.



JACK V. HARVEY
Washington, D.C.



JOSEPH M. SITRICK
Washington, D. C.



FRANK H. NOWACZEK
Washington, D.C.



CLIFFORD B. MARSHALL
Atlanta, Georgia

The men from Blackburn.



JAMES W. BLACKBURN, JR.
Washington, D.C.



ROBERT A. MARSHALL
Atlanta, Georgia



BLACKBURN & COMPANY, INC.

RADIO • TV • CATV • NEWSPAPER BROKERS NEGOTIATIONS • FINANCING • APPRAISALS

WASHINGTON, D. C.
20006
1725 K Street, N.W.
(202) 331-9270

CHICAGO 60601
333 N. Michigan Ave.
(312) 346-6460

ATLANTA 30361
400 Colony Square
Suite 510
(404) 892-4655

BEVERLY HILLS 90212
9465 Wilshire Blvd.
(213) 274-8151



RICHARD BLACKBURN
Washington, D.C.



HUB JACKSON
Chicago, Illinois



WENDELL W. DOSS
Chicago, Illinois



ROGER H. O'SULLIVAN
Chicago, Illinois



COLIN M. SELPH
Beverly Hills, California



ROY ROWAN
Beverly Hills, California

Broadcasting

Yearbook 1976

The 1976 BROADCASTING YEARBOOK shares with its predecessors the ambition of being the most comprehensive directory to the business of broadcasting. It continues to improve on the past, offering both new features and refinements of established ones. To acquaint YEARBOOK readers with what they can expect to find between these covers, and to assist in locating information, the editors offer this general description of the six major sections.

Section A—Titled “Broadcasting in General,” section A begins with a history of the broadcasting media and their evolution (on page A-1). The “Short Course in Broadcasting” (A-2) provides a capsule summary of the industry. There follows a major section on the Federal Communications Commission, an extract of its principal rules, a guide to station application procedure and an organization chart of the FCC on page A-8. At the close of Section A are directories of Group Ownership, Newspaper/Magazine Crossownership and a tabular record of station trading since 1956. A new feature of the Group Ownership list is the tallying of station totals for each owner.

Section B—This is the television section of the YEARBOOK. The first part, “The Television Marketplace,” which describes the commercial aspects of the medium, has as its primary feature the “ADI Market Atlas,” a 79-page section showing each of the 207 ADI’s (Areas of Dominant Influence) according to Arbitron Television, complete with coverage maps and other important market rankings. The second part, “The Facilities of Television,” adds to its detailed directory of TV stations a new item—key rates for each reporting commercial station. Additionally, there are cross-references to the appropriate ADI’s. Among the other features of this section are lists of stations by call letters and channels, and a complete history of TV station transfers.

Section C—The radio section of the YEARBOOK begins with the directory of AM and FM stations in the United States—also with key rates as a new feature—followed by stations in U.S. territories and Canada. Additionally, this year’s listings identify each station’s group owner and audio news service, if any. The

AM and FM lists by call letters and frequencies follow, along with Mexican and Caribbean coverage and statistical tables of general broadcasting interest.

Section D—This section is in two parts. The first, “Broadcast Advertising,” presents directories of advertising agencies, station representatives and similar service organizations. The second, “Networks & Programing,” contains two innovations: The major network directories now list all radio affiliates as well as television; and program and commercial producers for radio and TV have been combined, along with distributors and production services, into a single directory designed for ease in locating companies either by name or by type of service. Other program-related material includes the section on awards, the TV and Radio Codes, and an improved list of radio stations according to their formats and special programing. At the end of Section D appears a directory of international broadcasting.

Section E—This, the “Equipment & Engineering” section, begins with a list of equipment manufacturers, continues with a directory of consulting engineers and includes an expanded guide to common carriers: land lines, microwave and satellites. It concludes with the 1976 *Buyer’s Guide*, a 16-yellow-page commercial directory to both equipment and services.

Section F—Divided into three parts—professional services, associations, and miscellaneous directories—section F leads off with brokers and station financing firms, followed by consultants in several broadcasting fields. The National Association of Broadcasters listing on page F-20 opens the chapter on trade organizations, and the YEARBOOK ends with an assortment of directories on government agencies (other than the FCC), congressional committees, unions, books and educational institutions.

At the top of the first page of each section is a detailed table of contents to principal elements therein. Through each of those, and in the alphabetized editorial index that begins in the columns below, the editors hope that readers will quickly find their way to the information they most need to know about broadcasting.

Editorial Index

A

Abbreviations iv ABC’s of Radio and Television A-1 Advertisers Index xi Advertising Agency Directory D-1 Advertising Assns., Media Societies F-30 Advertising Research Foundation F-30 Advertising Services D-15 Affiliates (see appropriate network) AFRTS F-38 Agencies, Advertising D-1 Agents, Talent F-19	Allocations of TV Channels, U.S. B-162 AM Stations Authorized C-301 By Call Letters, Canada C-259 By Call Letters, U.S. C-242 By Frequencies, Bermuda Caribbean C-241 By Frequencies, Canada C-289 By Frequencies, Mexico C-237 By Provinces, Canada C-228 By Frequencies, U.S. C-260 By States, U.S. C-1 American Advertising Federation F-30 American Association of Advertising Agencies F-30 American Broadcasting Co. D-16 American Telephone & Telegraph E-39 American Women in Radio & TV F-31 Applications, TV Stations B-164 Applying for a Broadcast Station A-32	Arbitron F-16 Armed Forces Radio & TV F-38 Artists Representatives F-19 Assn. of Independent TV Stations F-31 Assn. of Maximum Service Telecasters F-32 Assn. of National Advertisers F-32 Associations, Societies F-30 Associations, State Broadcasters F-29 Assn. of Federal Communications Consulting Engineers F-31 AT&T E-39 Attorneys, Communications F-7 Audience (Radio & TV) C-300 Audience Analysis C-300 Audience in TV Markets B-1 Audience Measurement Services F-16 Authorized Broadcast Stations, 1922-1975 C-301 Awards & Citations D-60
--	--	--

BROADCASTING PUBLICATIONS INC.

Soi Teishoff, *chairman.*
 Lawrence B. Teishoff, *president.*
 Maury Long, *vice president.*
 Edwin H. James, *vice president.*
 Joanne T. Cowan, *secretary.*
 Irving C. Miller, *treasurer.*
 Lee Teishoff, *assistant treasurer.*

Broadcasting

Yearbook 1976

Executive and publication headquarters
 Broadcasting-Telecasting building
 1735 DeSales Street, N.W., Washington, D.C. 20036.
 Phone: 202-638-1022.

Soi Teishoff, *editor.*

Lawrence B. Teishoff, *publisher.*

EDITORIAL

Edwin H. James, *executive editor.*
 Donald West, *managing editor.*
 Rufus Crater (New York), *chief correspondent.*
 Leonard Zeidenberg, *senior correspondent.*
 J. Daniel Rudy, *assistant to the managing editor.*
 Frederick M. Fitzgerald, *senior editor.*
 Joseph A. Esser, Randall Moskop,
 Jonathan Tourtelot, *assistant editors.*
 Mark Harrad, Mark Miller, Jay Rubin, *staff writers.*
 Ian C. Bowen, Barbara Chase, Linda Gilmourginas
 (editor's office), Kira Gagne, *editorial assistants.*

BUSINESS

Maury Long, *vice president.*
 David N. Whitcombe, *director of marketing.*
 Doris Kelly, *secretary.*

ADVERTISING

Winfield R. Levi, *general sales manager* (New York).
 John Andre, *sales manager—equipment and engineering* (Washington).
 David Berlyn, *Eastern sales manager* (New York).
 Ruth Lindstrom, *account supervisor* (New York).
 Bill Merritt, *Western sales manager* (Hollywood).
 Lynda Dorman, *classified advertising manager.*

CIRCULATION

Bill Criger, *circulation manager.*
 Kwentin Keenan, *subscription manager.*
 Lucille Paulus, Odell Jackson, Patricia Johnson,
 Gregg Karpicky, Joanne Mieso.

PRODUCTION

Harry Stevens, *production manager.*

ADMINISTRATION

Irving C. Miller, *business manager.*
 Lynda Dorman, *secretary to the publisher.*
 Philippe E. Boucher, Gloria Nelson.

BUREAUS

New York: 75 Rockefeller Plaza, 10019
 Phone: 212-757-3260.
 Rufus Crater, *chief correspondent.*
 Rocco Famighetti, *senior editor.*
 John M. Dempsey, *assistant editor.*
 Joanne Ostrow, *staff writer.*

Winfield R. Levi, *general sales manager.*
 David Berlyn, *Eastern sales manager.*
 Ruth Lindstrom, *account supervisor.*
 Harriette Weinberg, *advertising assistant.*

Hollywood: 1880 North Vine
 Street, 90028. Phone: 213-463-3148.
 Bill Merritt, *Western sales manager.*
 Sandra Klauener, *editorial-advertising assistant.*

Broadcasting* magazine was founded in 1931 by
 Broadcasting Publications Inc., using the title Broadcasting*
 —The News Magazine of the Fifth Estate. Broadcast
 Advertising* was acquired in 1932. Broadcast Reporter in
 1933, Telecast* in 1953 and Television in 1961.
 Broadcasting-Telecasting* was introduced in 1946.



* Reg. U.S. Patent Office.
 Copyright 1976 by Broadcasting Publications Inc.

Microfilms of Broadcasting are available from University
 Microfilms, 300 North Zeeb Road, Ann Arbor, Mich. 48103.

Editorial Index

B

Bermuda, Caribbean Radio C-241
 Billings, Radio C-298
 Billings, TV B-161
 Black Programming D-69
 Books Relating to Radio-TV F-40
 Broadcast History A-1
 Broadcast Pioneers Library F-32
 Broadcast Rating Council F-22
 Broadcasters State Assns. F-29
 Broadcasting, Evolution of A-1
 Broadcasting, Short Course in A-2
 Brokers, Station and CATV F-1

TO BUY OR SELL A

**TELEVISION OR
 RADIO STATION**

HAMILTON-LANDIS & ASSOC., Inc.

WASHINGTON, D.C. CHICAGO
 1730 K St., N.W. 1429 Tribune Tower
 (202) 393-3456 (312) 337-2754
 SAN FRANCISCO DALLAS
 111 Sutter St. 6060 N. Central Expy.
 (415) 392-5671 (214) 691-2345

**NATIONWIDE • NEGOTIATIONS
 FINANCING • APPRAISALS**

Business Films D-41
 Buyer's Guide E-41
 Buying/Planning Svcs D-8

C

Call Letters
 AM Stations (U.S.) C-242
 FM Stations (U.S.) C-251
 TV Stations (U.S.) B-152
 Call Sign Allocations D-92
 Campus Stations C-301
 Canada
 AM Stations by Call Letters. C-259
 AM Stations by Frequencies. C-289
 AM-FM Station Directory C-228
 FM by Frequency C-291
 FM Stations by Call Letters. C-259
 TV by Channel B-160
 TV Station Directory B-147
 TV Stations by Call Letters. B-156
 Station Representatives D-15
 Canadian Broadcasting Corp. D-39
 Canadian Radio-Television
 Commission F-38
 Canadian Representatives D-15
 Caribbean Radio Stations C-241
 CBS Inc. D-24
 Channels, FM C-293
 Channels, TV B-156
 Citations and Awards D-60
 Closed-Circuit TV D-59
 Code, NAB Radio D-66
 Code, NAB TV D-61
 College Radio Stations C-301
 Colleges Offering Radio-TV
 Degrees F-46

Hogan - Feldmann - Inc.
 MEDIA BROKERS CONSULTANTS
 16255 Ventura Boulevard, Suite 415
 Encino, California 91436
 AREA CODE 213 986-3201

BECKERMAN ASSOCIATES

Media Brokers—Consultants

14001 MIRAMAR AVENUE
 MADEIRA BEACH, FLORIDA 33708
 TELEPHONE (813) 391-2824

Commerce Committees,
 House and Senate F-36
 Commercial Producers, Radio D-41
 Commercial Producers, TV D-41
 Common Carriers E-39
 Communications Attorneys F-7
 Communications Satellite Corp. E-40
 COMSAT E-40
 Congress, Radio-TV Galleries F-27
 Construction Services E-1
 Consultants (Management,
 Financial, Program, Sales,
 Promotion, Technical) F-4
 Consulting Engineers E-36
 Contemporary Programming D-82
 Coordinators, AT&T E-39
 Corporation for Public
 Broadcasting D-38
 Correspondents Assn., Radio-TV ... F-35
 Country & Western Programming ... D-70
 CTV Television Network D-39

D

Demographics of TV
 Markets B-1, B-80, B-83, B-84
 Distributors, Equipment E-1
 Distributors, Programs D-41

E

Editorializing, Radio-TV Stations.. C-300
 Educational Broadcasting Corp. ... D-38
 Educational FM Call Letters C-251
 Educational TV Call Letters B-152
 Employment Services F-18
 Engineers, Consulting E-36
 Equipment Buyer's Guide E-41
 Equipment Manufacturers E-1
 Experimental TV B-164

F

Farm Broadcasters,
 National Assn. of F-22
 Federal Communications
 Consulting Engineers,
 Assn. of F-31

**WANTED
 AM & FM**

*We represent
 a large public company interested in ac-
 quiring AM & FM broadcast properties.
 All market sizes considered.*

Media Brokers,
 Creative Financing
MERGER RESEARCH & ASSOC.
 11113 Springfield Pike
 Cincinnati, Ohio 45246
 (513) 771-3355

Your AmpereX distributor has the replacement tube that will restore your Plumbicon* TV camera to its original performance... ...or even better!

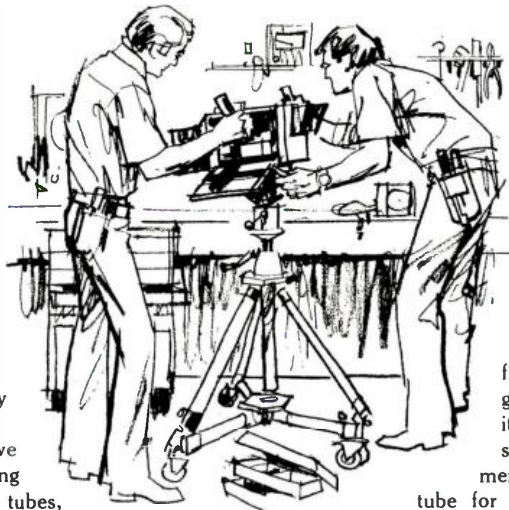

Let's face it — even Plumbicon TV camera tubes wear out and eventually have to be replaced to restore your camera's original picture quality. If we learned anything on the way to selling over 30,000 Plumbicon TV camera tubes, we learned how important Service is to the telecaster. Especially when it's related to availability! No TV camera-user can afford to shut down his operation while "waiting for parts." Plumbicon replacement tubes are instantly available, at all times, through local distributors and through AmpereX factory sales representatives. And Plumbicon tube distributors (your own local businessmen) are carefully selected for their ability to support Plumbicon TV camera systems with on-the-spot customer support and on-the-spot customer service.

No doubt it was picture quality that motivated you to select a Plumbicon CCTV camera originally. Today, when business conditions, more than ever, demand absolute peak performance



from every system, you can upgrade your camera's picture quality dramatically, simply by substituting a direct plug-in replacement, broadcast-grade Plumbicon tube for the industrial-grade Plumbicon tube now in your camera.

The broadcast-grade tube is the direct descendant of our original Plumbicon that revolutionized color TV broadcasting...and won an Emmy award from the Broadcast Industry. As a matter of fact, contemporary Plumbicon tubes outperform the original Plumbicon by a wide margin with such important improvements as Higher Resolution and Modulation Depth, Extended-Red Response and Minimum Lag.

Genuine AmpereX Plumbicon tubes are available through selected AmpereX Distributors. For the name of the Plumbicon Distributors nearest you, write: Electro-Optical Devices Division, AmpereX Electronic Corporation, Slatersville, Rhode Island 02876. Telephone: 401-762-3800.

AmpereX®

TOMORROW'S THINKING IN TODAY'S PRODUCTS

A NORTH AMERICAN PHILIPS COMPANY

*Trademark of N.V. Philips of The Netherlands

Editorial Index

Federal Communications Commission
 Executives & Staff..... A-9
 Organization Chart..... A-8
 Past Members..... A-10
Rules Regulating Radio-TV..... A-11
 Allocations..... A-11
 Censorship..... A-32
 Common antenna site..... A-25
 Fee Schedule..... A-31
 Fraudulent Billing..... A-29
 License renewals..... A-27
 Logs & Records..... A-30
 Lotteries..... A-31
 Multiple ownership..... A-15
 Network affiliation..... A-22
 Operating schedules..... A-19
 Operator requirements..... A-21
 Personal attacks..... A-22
 Political editorials..... A-22
 Political broadcasts..... A-29
 Public Notice..... A-28
 Rebroadcasts..... A-29
 Recordings..... A-29
 Reports..... A-25
 Revocations..... A-29
 Sponsored programs..... A-27
 Station identification..... A-27
 Studio origination..... A-18
Federal Radio Commission,
 Former Members..... A-10
Film Distributors for TV..... D-41
Financial Consultants..... F-4
Financing, Station..... F-3

FM Stations
 Assignments, Table of..... C-292
 Authorizations..... C-301
 By Call Letters,
 Canada..... C-259
 By Call Letters, U.S..... C-251
 By Frequency, Canadian..... C-291
 By Frequency, U.S..... C-281
 Channels..... C-293
 Directory of..... C-1
 In Northern Mexico..... C-240
Foreign Broadcasting..... D-91
Foreign Language Programing..... D-85
Foreign TV..... B-152
Formats, Radio Programing..... D-68
Frequencies
 Bermuda..... C-241
 Canadian AM..... C-289

Canadian FM..... C-291
 Mexican AM..... C-237
 Mexican FM..... C-240
 United States AM..... C-260
 United States FM..... C-281
Frequency Measuring Services..... E-39

G

Galleries, Radio-TV in Congress..... F-27
 Global Television Network..... D-39
 Government Agencies..... F-36
 Group Ownership of Stations..... A-33

H

History of Broadcasting..... A-1
 How to Apply for a Station..... A-32
 Hughes Television Network..... D-32

I

Independent Media Buying/
 Planning Svcs..... D-8
 Independent TV Stations,
 Assn. of..... F-31
 Index to Advertisers..... xi
 Information Agency, U.S..... F-37
 International Broadcasting..... D-91
 International Stations in the U.S..... C-297
 International Television..... B-152, D-91

J

Jingle Producers..... D-41

L

Labor Groups & Unions..... F-39

TO BUY OR SELL A

**TELEVISION OR
 RADIO STATION**

HAMILTON-LANDIS & ASSOC., Inc.

WASHINGTON, D.C. CHICAGO
 1730 K St., N.W. 1429 Tribune Tower
 (202) 393-3456 (312) 337-2754
SAN FRANCISCO DALLAS
 111 Sutter St. 6060 N. Central Expy.
 (415) 392-5671 (214) 691-2345

**NATIONWIDE • NEGOTIATIONS
 FINANCING • APPRAISALS**

Abbreviations Commonly Used in the 1976 YEARBOOK

actg..... acting	C&W..... country & western	lt..... Italian	opns..... operations	sep..... separate
admin..... administrative	dev..... development	khz..... kilohertz	own..... owner	sls..... sales
adv..... advertising	dir..... director	kw..... kilowatts	pckgd..... packaged	Sp..... Spanish
advertisment	dup..... duplicates	loc..... local	per..... personnel	spec..... special
affil..... affiliate	edit..... editor	lstng..... listening	Pol..... Polish	stn..... station
anncr..... announcer	educ..... educational	lw..... longwave	PR..... public relations	sub..... subscriber
ant..... antenna	enrg..... engineer	mdse..... merchandising	pres..... president	supt..... superintendent
APR..... Associated	enrg..... engineering	med..... media	prod..... production,	supvr..... supervisor
Press Radio	ERP..... effective	mfg..... manufacturing	producer	svcs..... services
assn..... association	radiated power	mgng..... managing	prog..... program	sw..... short wave
assoc..... associate	ETV..... educational	mgr..... manager	progmg..... programming	tech..... technical
asst..... assistant	television	mgt..... management	progrsv..... progressive	traf..... traffic
aur..... aural	exec..... executive	mhz..... megahertz	prom..... promotion	treas..... treasurer
bcstg..... broadcasting	gen..... general	mktg..... marketing	ptr..... partner	TWX..... Teletypewriter
bd..... board	Ger..... German	MOR..... middle of	pub affrs..... public affairs	Exchange
bdg..... building	HAAT..... height above	road	pub ser..... public service	U..... unlimited
btfl..... beautiful	average terrain	monthly	publ..... publicity	u.c..... under construction
bus..... business	horiz..... horizontal	mus..... music	quad..... quadraphonic	UPI..... United Press
cd..... ciudad	polarization	mw..... medium	rel..... relations	International
ch..... channel	hqtrs..... headquarters	wave	relg..... religion	vert..... vertical
chg..... charge	ind..... independent	natl..... national	rep..... representative	polarization
chmn..... chairman	info..... information	net..... network	rgnl..... regional	vis..... visual
coml..... commercial	instal..... installation	nwspr..... newspaper	rsch..... research	w..... watts
coord..... coordinator	instrm..... instrumental	off..... officer	sec..... secretary	wkly..... weekly

Several directories of the 1976 YEARBOOK—including the ADI Market Atlas that begins on B-1—employ the standard, two-letter state abbreviations of the U.S. Postal Service. They are shown below:

Alabama..... AL	Georgia..... GA	Maryland..... MD	New Mexico..... NM	South Dakota..... SD
Alaska..... AK	Guam..... GU	Massachusetts..... MA	New York..... NY	Tennessee..... TN
Arizona..... AZ	Hawaii..... HI	Michigan..... MI	North Carolina..... NC	Texas..... TX
Arkansas..... AR	Idaho..... ID	Minnesota..... MN	North Dakota..... ND	Utah..... UT
California..... CA	Illinois..... IL	Mississippi..... MS	Ohio..... OH	Vermont..... VT
Canal Zone..... CZ	Indiana..... IN	Missouri..... MO	Oklahoma..... OK	Virginia..... VA
Colorado..... CO	Iowa..... IA	Montana..... MT	Oregon..... OR	Virgin Islands..... VI
Connecticut..... CT	Kansas..... KS	Nebraska..... NE	Pennsylvania..... PA	Washington..... WA
Delaware..... DE	Kentucky..... KY	Nevada..... NV	Puerto Rico..... PR	West Virginia..... WV
District of Columbia..... DC	Louisiana..... LA	New Hampshire..... NH	Rhode Island..... RI	Wisconsin..... WI
Florida..... FL	Maine..... ME	New Jersey..... NJ	South Carolina..... SC	Wyoming..... WY



THE SIGN OF GOOD TELEVISION



Representing

RAI RADIOTELEVISIONE ITALIANA

and

SACIS

in the U.S.A. and Canada

1350 Avenue of the Americas

(212) 757-6987

Renato M. Pachetti
Executive Vice President
and General Manager

alcare
COMMUNICATIONS

creators,
producers and
distributors of
quality features and
programs for
TV and radio

TV

- "Mort Crim: One Moment Please"
- "One Great Moment in Sports"
- "Maintenance Ms."

RADIO

- "Mort Crim: One Moment Please"
- "Bernard Meltzer on Living Better"
- "Family Focus"
- "Update: Where are they Now" (MBS)

Call or write

ALCARE COMMUNICATIONS

130 W. Lancaster Ave., Wayne, Pa. 19087

(215) 687-5767

Editorial Index

Labs, TV Processing	D-41
Land Lines (AT&T)	E-39
Law Firms	F-6
Lawyers, Communications	F-7
Library, Broadcast Pioneers	F-32
License, How to Apply for	A-32
Licensing, Music	D-59

M

Magazine or Newspaper Ownership of Broadcast Stations	A-43
Management Consultants	F-4
Managers, Talent	F-19
Manufacturers of Equipment	E-1
Manufacturers Societies, Groups	F-30
Maps of TV Markets	B-1
Market Research Services	F-16
Marketing Guide	B-1
Markets, ADI TV	B-1
Markets, TV by Size	B-80
Markets, TV Demographics	B-83
Markets of TV (Maps)	B-1
Maximum Service Telecasters, Assn. of	F-32
Measuring Services, Frequency	E-39
Media Buying/Planning Services	D-8
Media Societies, Groups	F-30
Mexican Radio Stations	C-237
Microwave	E-39
Middle-of-the-Road Programing	D-75
Motion Picture & TV Film Associations	F-30
Multiple Station Owners	A-33
Music Licensing Groups	D-59
Mutual Black Network	D-30
Mutual Broadcasting System	D-30

N

National Advertisers, Assn. of	F-32
National Assn. of Broadcasters Committees	F-21
Officers	F-20
Radio Code	D-66
TV Code	D-61
National Assn. of Farm Broadcasters	F-22
National Assn. of Television Program Executives	F-23
National Black Network	D-32
National Broadcasting Co.	D-27
National Call Sign Allocations	D-92
National Public Affairs Center for Television	D-38
National Public Radio	D-38
Network Audience in TV Markets ..	B-84
Networks ABC Executives & Staff	D-16
CBS Executives & Staff	D-24
MBS Executives & Staff	D-30
NBC Executives & Staff	D-27
Regional Radio	D-33
Regional TV	D-33
News Directors, Radio-TV Assn.	F-25

SET MOOD AND TEMPO
AM-FM-TV

Add the final touch to your sound image
Use a custom electronic music package
created for you by:

DAVID SMITH MUSICAL PRODUCTIONS

27 Colonial Hls Pkwy., St. Louis, Mo. 63141
Logos and beds stylized to suit all formats.
Free sample tape. (314) 569-0767 collect

News Services, Radio and TV	D-39
Newspaper Ownership of Stations ..	A-43
Nielsen, A. C. Co.	F-17

O

Overseas Radio, TV	D-91
Ownership, Group Stations	A-33
Ownership, Newspaper	A-43

P

Pay TV	B-164
Placement Services	F-18
Press Services	D-39
Processing Labs, TV	D-41
Producers, TV Commercials	D-41
Product Guide	E-41
Production, Radio	D-41
Production, Television	D-41
Professional Societies	F-30
Program Buyers Guide	E-56
Program Distributors, Radio	D-41

BONNEVILLE
Adult-oriented programming
for live or automated stations.
Complete music library service
at affordable prices
CALL NOW.
201-567-8800
274 County Road
Tenafly, N.J. 07670

Program Distributors, TV	D-41
Program Producers, Radio	D-41
Program Producers, TV	D-41

Association-Sterling Films
Free-loan Public Service
Films for Television
Please see our ad on page D-42

Programing, Radio Formats	D-68
Promotion Consultants	F-4
Promotion Films	D-41
Promotion Services	F-18
Public Broadcasting	D-38
Public Broadcasting Service	D-38
Public Relations Services	F-18
Pulse Inc.	F-17

R

Radio Advertising Bureau	F-22
Attorneys	F-7
Audience	C-300

Marsh & McLennan announces a major insurance program for Broadcasters.

Up until now the information needed to create the best possible insurance package for broadcasters has been extremely diffuse and limited.

But after three years of research and surveys by experts (surveys you may have come into contact with yourself), a major insurance package for the broadcasting industry is now ready.

The Marsh & McLennan Plan for Broadcasters.

The Marsh & McLennan Plan can mean significant savings on your station's insurance.

This program should save you 25% to 40% over the rates your station currently pays.

That figure isn't wishful thinking either. It's based on surveys of hundreds of broadcast station insurance policies.

The Marsh & McLennan Plan means your tower will be insured at replacement value. Do you know if it is now?

Your station presently carries tower insurance of course, but it could be the "stated" or "fixed value" kind.

The Marsh & McLennan Plan insures your tower at the *full cost of replacement*.

The Marsh & McLennan Plan gives you short-term Broadcasters' Business Interruption Insurance.

Many stations now fail to carry adequate business interruption insurance.

That's why the Marsh & McLennan Plans offers a *short-term* business interruption policy. One that covers your net earnings for the longest period your station's business would foreseeably be interrupted—about 30 days.

You're living dangerously without at least \$5,000,000 worth of Broadcaster's Liability Insurance. The Marsh & McLennan Plan gives you up to \$10,000,000. At a reasonable cost.

Since we're dealing with the entire broadcasting industry our rates for liability insurance are computed on an industry basis. This alone can mean up to a 30% discount for your station.

Our comparative estimate is FREE.

For more information about the Marsh & McLennan Plan for Broadcasters write to:

Lawrence E. McLean
Marsh & McLennan

National Marketing Corporation
1221 Ave. of Americas, N. Y., N.Y. 10020
(212) 997-5035

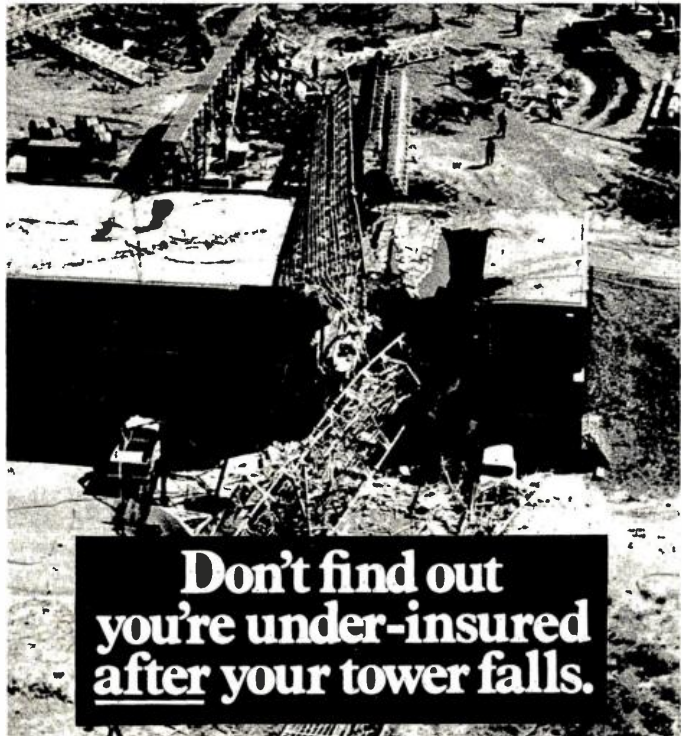

**Don't find out
you're under-insured
after your tower falls.**

This 1375 foot, 3-station transmitting tower in Minnesota collapsed and fell across the building housing the transmitter, killing seven people.

Editorial Index

Bermuda Stations C-241
 Billing 1935-1974 C-298
 Call Letters, AM C-242
 Call Letters FM C-251
 Canadian AM Call Letters C-259
 Canadian AM-FM Stations C-228
 Canadian FM Call Letters C-259
 Caribbean Stations C-241
 Channel Assignments, FM C-292
 Code of NAB D-66
 College Radio Stations C-301
 Commercial Producers D-41

AUDIBLE ADVERTISING PRODS, INC.
 663 Fifth Ave., N.Y., N.Y. 10022

RADIO  JINGLES

MARY HURT

212 873-1238

LOW BUDGET COMMERCIALS
 WITH QUALITY. IN BUSINESS 13 YEARS.

Correspondents F-27
 Country & Western Programing. D-70
 Directory, Canadian C-228
 Directory, U.S. C-1
 Editorializing C-300
 Equipment Manufacturers E-1
 Foreign Language Programs D-85
 Frequencies, AM C-260
 Frequencies, FM C-281
 Group Ownership A-33
 International D-91
 International Stations in the U.S. C-297
 Information Office F-22
 Jingle Producers D-41
 Mexican Stations C-237
 Networks, Regional D-33
 Newspaper Ownership A-43
 News Services D-39
 Pioneers Library F-32
 Program Distributors D-41
 Program Producers D-41
 Programing Formats D-68

Representatives D-8
 Set Sales—1922-1974 C-298
 Station Authorization—
 1922-1975 C-301
 Stations on Air A-2, C-301
 Time Sales—1935-1974 C-298
 Radio Advertising Bureau F-22
 Radio Free Europe F-38
 Radio Information Office F-22
 Radio Liberty F-38
 Radio-Television
 Commission of Canada F-38
 Radio-TV Correspondents Assn. F-35
 Radio-TV Galleries of Congress. F-27
 Radio-TV News Directors Assn. F-25
 Ranking of TV markets B-80
 Rating Services F-16
 RCA Corp.
 Communications Systems
 Division E-26
 Electronic Components E-27
 Executives, Staff & Divisions. E-26
 Service Co. E-27
 Recording Services D-41
 Regional Radio Networks,
 Groups D-33
 Regional TV Networks D-33
 Representatives, Canadian D-15
 Representatives of Stations, U.S. D-8
 Research Services, Radio-TV. F-16

S

Sales Consultants F-4
 Sales of Stations A-52, B-168
 Sales of TV Time B-161
 Satellites E-40
 Schools, Radio & TV F-45
 Services
 Buying/Planning D-8
 Employment F-18
 Frequency Measuring E-39
 Rating & Research F-16
 Set Sales, Radio C-298
 Short Course in Broadcasting A-2
 Societies, Professional, Radio-TV. F-30
 Spanish Programing D-90
 Special Advertising Services D-15
 Sports, Network (Hughes) D-32
 Spot Advertisers, Radio C-298
 State Broadcasters Associations. F-29
 Station Applications A-32
 Station Applications Pending, TV. B-164
 Station Brokers F-1
 Station Editorializing C-300
 Station Financing F-3

Station Trading Record A-52
 Station Transfers TV B-168
 Stations, Number C-301
 Subscription TV B-164
 Suppliers & Services E-1
 Surveys & Market Research F-16

T

Talent Agents F-19
 Technical Consultants F-4
 Television
 ADI Markets B-1
 Allocations B-162
 Applications Pending B-164
 Attorneys F-7
 Audience C-300
 Billings 1948-1974 B-161
 Bureau of Advertising F-21
 Business Films D-41
 Call Letters B-152
 Channel Allocations B-162
 Channels B-156
 Closed Circuit D-59
 Commercial Producers D-41
 Code of NAB D-61
 Correspondents F-27
 CTV Network D-39
 Dimensions A-2
 Directory, Canadian B-147
 Directory, U.S. B-89
 Editorializing C-300
 Equipment Manufacturers E-1
 Group Ownership A-33
 Information Office F-22
 International D-91
 Markets, by ADI B-1
 Market Demographics B-83
 Market Ranking B-80
 Network delivery, by market B-84
 Networks, Regional D-33
 Newspaper Ownership A-43
 News Services D-39
 Number of Stations A-2, C-301
 Processing Labs D-41
 Program Distributors (TV) D-41
 Program Production Services (TV) D-41
 Promotion Films D-41
 Regional Networks D-33
 Station Sales B-168
 Stations on air A-2, C-301
 Subscription B-164
 Time Sales 1948-1974 B-161
 Transfers of Ownership B-168
 Television Bureau of Advertising. F-21
 Television Information Office F-22
 Top-40 programing D-82
 Trade Assns, & Professional
 Groups F-20
 Transcription Services (Radio). D-41
 Transfers of TV ownership B-168
 Transmitter & Equipment Mfrs. E-1
 TVA (network) D-39
 TVS TV Network D-33

U

Unions & Labor Groups F-39
 U.S. Govt. Agencies F-36
 U.S. Information Agency F-37

V

Viewing Habits C-300
 Voice of America F-38

**Successful radio programming delivers dollars.
 We deal in success. Ask our
 clients, they know us best.**

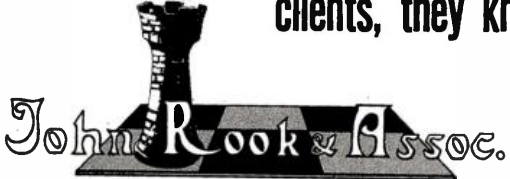

John Rook & Assoc.

19031 Marilla St. Northridge, California 91324 (213) 885-7404



..WHERE "THE SPECIALTY
OF THE HOUSE" IS DIVERSITY.

NATIONAL BROADCASTING
COMPANY

BOOKS FOR BROADCASTERS

- 304. AUDIO CONTROL HANDBOOK**—for radio and television broadcasting, 4th edition. Revised and Expanded by Robert S. Oringel. Closely following the format of the three earlier editions, the fourth has been almost entirely rewritten. Reflects changes in equipment and techniques, while digging deeper into all technical and electronic aspects of audio operation. 192 pages, illustrated index. **\$10.00.**
- 305. BROADCAST JOURNALISM, An Introduction to News Writing** by Mark W. Hall. Covers all basics of radio-television news writing style, techniques—for student and practicing professional. 160 pages, 6 1/8" x 9 1/4". **\$6.95.**
- 306. BROADCAST MANAGEMENT** by Ward L. Quaal and James A. Brown. Whether you aspire to a career in broadcasting, are a student of broadcasting or already are employed in broadcasting, this second edition—revised and enlarged—is "must" reading. 464 pages, charts & index. **\$16.50.**
- 312. THE TECHNIQUE OF TELEVISION PRODUCTION, 9th Revised Edition** by Gerald Millerson. Now revised and updated throughout to reflect the latest techniques and with a new chapter on color TV, this book consolidates its leadership as the standard in the field. 440 pages, 1,160 illustrations, bibliography. **\$14.50.**
- 313. THE FOCAL ENCYCLOPEDIA OF FILM AND TELEVISION: Techniques** edited by Raymond Spottiswoode. Major reference work of 10,000 entries—will eventually comprise three or four volumes. 1,124 pages, 6 3/4" x 9 1/2", 1,000 diagrams, index. **\$37.50.**
- 316. RADIO BROADCASTING: An Introduction to the Sound Medium, Revised Edition** by Irving E. Fang. Reset, expanded and revised throughout, this new edition includes radio news, First Amendment problems and current techniques of electronic journalism. 478 pages, 100 illustrations, notes, bibliography, appendices, glossary. **\$10.95.**
- 318. TV CAMERA OPERATION** by Gerald Millerson. Examines step by step the various principles that underlie the use of the television camera. "Clear, concise and an absolute 'must' for anyone aspiring to TV camera work, it surpasses anything I have seen on the subject."—Richard D. Hutto, Director of Broadcasting, St. Lawrence University. 160 pages, 5 1/2" x 8 1/2", 71 two-color diagrammatic illustrations, glossary. **\$10.95.**
- 327. THE WORK OF THE TELEVISION JOURNALIST** by R.W. Tyrell. Describes every job from writer and producer to that of cameraman, recordist, film editor and newscaster. Invaluable as a basic primer for all newcomers to television—student and professional. 176 pages, illustrated, glossary. **\$14.50.**
- 328. WRITING FOR TELEVISION AND RADIO, Revised and Enlarged 3rd Edition** by Robert L. Hilliard. Shows how today's successful writers prepare and produce top TV and radio programs of every type. Includes new chapters and fresh script samples and excerpts. 461 pages, index. **\$16.50.**
- 332. THE TECHNIQUE OF THE SOUND STUDIO, Radio, Television, Recording, 3rd Revised Edition** by Alec Nisbett. The basic approach of this widely-used text and guidebook emphasizing general principles rather than rule-of-thumb, has the latest technological developments. 558 pages, 5 1/2" x 8 1/2", 234 diagrams, glossary. **\$14.50.**
- 333. THE TECHNIQUE OF SPECIAL EFFECTS IN TELEVISION** by Bernard Wilkie. A unique, pioneering and astonishingly comprehensive book that covers everything one needs to know about "special effects" from popping champagne cork to bullet and bomb effects. 400 pages, 5 1/2" x 8 3/4", 200 halftones, 40 diagrams, appendix, index. **\$18.50.**
- 336. THE BROADCAST COMMUNICATIONS DICTIONARY** edited by Lincoln Diamant. Puts—at your fingertips—some 2,000 technical common and slang words in daily use on both sides of the Atlantic. . . many coined during the last decade. Includes familiar words that mean the same thing (and the same words that mean different things) in English-speaking countries everywhere. An extremely useful tool. 128 pages. **\$6.95.**
- 345. AMERICAN BROADCASTING: A Sourcebook on the History of Radio and Television** by Lawrence W. Lichty and Malachi C. Topping. A skillfully edited anthology of 93 selections, this unique source book provides a comprehensive description and analysis of broadcasting in America from its pre-history to 1975. Articles by such notables as: Edwin H. Armstrong, William L. Shirer, Edward R. Murrow, Samuel Goldwyn, Frank Stanton—to name but a few. A must for every broadcaster's library. 723 pages, notes, tables, bibliography, index, chronological table of contents. **\$26.50.**

Broadcasting Book Division

1735 DeSales Street, N.W. Washington, D.C. 20036

Send me the books whose numbers I've indicated. Payment for the full amount is enclosed.

Name _____

Address _____

H City _____ State _____ Zip _____

Book No.	Price
Total	\$ _____

Index to Advertisers

Equipment

Allied Tower Co. Inc. E-3
 American Data Corp. B-88, E-2
 American Electronic Labs Inc. E-2, E-6, E-18, E-25, E-41, E-51
 Amperex Electronic Corp. iii
 Ampro Corp. E-44, E-47
 Angenieux Service Corp. of N.Y. E-48
 Audio Designs and Manufacturing Inc. E-7
 Audio Distributors Inc. E-44
 Belar Electronics Lab Inc. E-50
 Berkey Colortran Inc. E-5
 Boston Insulated Wire & Cable Co. E-42
 Broadcast Automation Associates. E-43
 Broadcast Electronics Inc. Back E divider
 Broadcast Supply West. E-49
 Buhl Optical. E-43
 CSI Electronics Inc. throughout section C
 Cablewave Systems Inc. E-9
 Calvert Electronics Inc. E-56
 Camera Mart Inc., The. E-11
 Canon. E-13
 CeCo Communications Inc. E-56
 Collins Radio Co. Front E divider
 Colorado Video Inc. E-52
 Continental Electronics Inc. E-2, E-6, E-8, E-12, E-18, E-26
 Control Design Corp. E-15
 Control Technology Inc. E-43
 Cooke Engineering Co. E-10
 Datavision Video Products. E-46
 Delta Electronics Inc. E-17
 Dyma Engineering Inc. E-46
 Electro Impulse Inc. E-12
 Electro-Voice Inc. E-19
 English Electric Valve North America. Front F divider
 Robert Bosch Corp., Fernseh Division. Front B divider
 Fidelipac. E-45
 Fort Worth Tower Co. Inc. E-14
 Garron Electronics Inc. E-44, E-52
 Harris Corp., Broadcast Equipment Division. E-16, E-18
 Dave Hovey. E-54
 Hughey & Phillips Inc. E-18, E-54
 International Tapetronics Corp. E-50
 JVC Industries Inc. E-21
 Jamieson Film Co. E-20
 LPB Inc. E-41
 Landy Associates Inc. E-41
 C. M. Levit Electronics. E-22
 Lipsner-Smith Corp. E-22
 Marti Electronics Inc. E-23
 McKay Dymek Co. E-12, E-25
 Moseley Associates Inc. E-24, E-47, E-49
 National Audio Co. E-44
 Potomac Instruments. E-53
 Pulse Dynamics Manufacturing Corp. E-51
 Quick-Set Inc. E-49
 RCA Equipment. Back cover
 RCA Service Co. E-27
 Revox Corp. E-29
 Robins-Fairchild. E-47

Roh Corp. E-42
 Shakespeare Group. E-28
 Shallco Inc. E-43
 Sintronic Corp. E-30
 Stainless Inc. E-31
 Stanton Maganetics Inc. E-30
 Stevens Tower Service Inc. E-54
 Tektronix. E-33
 Television Technology Corp. E-55
 Thomson-CSF Labs Inc. E-35
 Unarco-Rohn. E-54
 Utility Tower Co. E-34, E-55
 Varian. E-1, E-4, E-8, E-34
 Wilkinson Electronics Inc. E-55

General

John H. Battison & Associates. E-36
 Beckerman Associates. ii, C-39, C-51
 Black Audio Network Inc. D-39
 Blackburn & Co. Inc. Second cover
 Broadcast Music Inc. Front C divider
 Columbia College. F-45
 Communications Satellite Corp. (COMSAT). Back D divider
 R. C. Crisler & Co. Inc. F-2
 Oscar Leon Cuellar. E-56
 William A. Exline Inc. B-96
 throughout section C, F-1
 Firstmark Financial Corp. F-4
 Hamilton-Landis & Associates Inc. ii, iv, throughout station directories, Back F divider
 Hogan-Feldmann Inc. ii, B-89, B-95, B-123, C-2, C-15, C-56, C-130
 The Keith W. Horton Co. Inc. F-3
 Hudson Investment Corp. F-2
 Vir James. E-37
 William Kepper Associates. F-2
 Larson/Walker & Co. F-2
 March & McLennan. vii
 Reggie Martin. C-40
 Merger Research & Associates. ii
 George Moore & Associates. F-2
 Northwest Monitoring Service. E-39
 Cecil L. Richards Inc. F-2
 Roosevelt Hotel. B-125
 Richard A. Shaheen Inc. F-3
 Howard E. Stark. B-177
 Edwin Tornberg & Co. Inc. F-3
 Twining & Co. F-3
 Western Business Brokers. F-3

Networks/Groups

ABC Broadcasting Companies. xii
 CBS Television Network. v
 Mutual Black Network. D-40
 Mutual Broadcasting

System. Third cover
 NBC Television Network. ix
 Steinman Stations. Front cover
 Storer Broadcasting Co. Back B divider, Back C divider

Program Services

Alcare Communications. vi, D-41
 Association-Sterling Films. vi, D-42
 Audible Advertising Products Inc. viii
 Bonneville Broadcast Consultants. vi, spine
 Byron Motion Pictures Inc. xi
 CnB Studios. D-44
 Command Productions. D-44
 Detroit, University of. D-57
 Dolphin Productions, Inc. D-45
 RAI Corp. (Italian Radio TV Systems). vi
 John H. Rook & Associates. viii
 Sheridan Elson Communications Inc. D-54
 David Smith Musical Productions. vi
 Travelux TV Network. D-56

Stations

KCCI-TV Des Moines. B-21
 KCMT(TV) Alexandria, Minn. B-3
 KCST(TV) San Diego. Back B Divider
 KDLO-TV Florence, S. D. B-68
 KELO-TV Sioux Falls, S.C. B-68
 KGBS Los Angeles. Back C divider
 KLIX(AM) Twin Falls, Idaho. C-55
 KMID-TV Midland, Tex. B-51
 KNMT(TV) Walker, Minn. B-3
 KPLO-TV Reliance, S.D. B-68
 KSTP-TV St. Paul. B-47
 WAGA-TV Atlanta. Back B divider
 WALA-TV Mobile, Ala. B-48
 WCVB-TV Boston. B-11
 WDAY-TV Fargo, N.D. B-25
 WDAZ-TV Devils Lake, N.D. B-25
 WESH-TV Orlando, Fla. B-52
 WGAL-TV Lancaster, Pa. Front cover
 WGBS(AM) Miami. Back C divider
 WHN(AM) New York. Back C divider
 WITI-TV Milwaukee. Back B divider
 WIVE(AM) Ashland, Va. C-209
 WJAZ(AM) Albany, Ga. C-46
 WJBK-TV Detroit. Back B divider
 WJHO(AM) Opelika, Ala. C-2
 WJLM(FM) Roanoke, Va. C-209
 WJW-AM-TV Cleveland. Backs B/C dividers
 WMNA-AM-FM Gretna, Va. C-207
 WREG-TV Memphis. B-44
 WRIS(AM) Roanoke, Va. C-209
 WSBK-TV Boston. Back B divider
 WSPD-AM-TV Toledo. Backs B, C dividers
 WTEV-TV Providence, R.I. Front cover
 WVOJ(AM) Jacksonville, Fla. C-39

You belong in Broadcasting

ABC RADIO

ABC Radio Network
ABC Owned AM Radio Stations
ABC Owned FM Radio Stations
ABC FM Spot Sales

ABC TELEVISION

ABC Television Network
ABC Entertainment
ABC Sports
ABC Owned Television Stations
ABC Television Spot Sales

ABC NEWS



A

ABC's of Radio and Television	A-1	Station Application Procedure	A-32
Short Course in Broadcasting	A-2	Group Ownership	A-33
Federal Communications Commission Staff	A-9	Newspaper/Magazine Crossownership	A-43
FCC Rules & Regulations	A-11	Station Trading Since 1956	A-52
FCC Fee Schedule	A-31		

Broadcasting:
Yearbook 1976

Broadcasting in General

The A B C's of radio and television

A description of broadcasting—how it evolved, how it works, how it is regulated—as reported by the FCC

One of the most dramatic developments of 20th Century technology has been the use of radio waves—electromagnetic radiations traveling at the speed of light—for communication. Radio communication designed for reception by the general public is known as “broadcasting.” Radio waves of different frequencies (number of cycles per second) can be “tuned.” Hence, signals from many sources can be received on a radio set without interfering with each other.

In everyday language, the term “radio” refers to aural (sound) broadcasting, which is received from amplitude-modulated (AM) or frequency-modulated (FM) stations. “Television,” another form of radio, is received from stations making both visual and aural transmissions. AM radio, sometimes called standard broadcasting, was the earliest broadcast service and operates on relatively low “medium” frequencies. FM and TV are newer and occupy considerably higher frequency bands.

Radio communications was born of many minds and developments. In the 1860's, the Scottish physicist, James Clerk Maxwell, predicted the existence of radio waves. Heinrich Rudolph Hertz, the German physicist, later demonstrated that rapid variations of electric current can be projected into space in the form of waves similar to those of light and heat. (His contributions have been honored internationally by the adoption of Hertz as a synonym for cycles per second.) In 1895, the Italian engineer, Guglielmo Marconi, transmitted radio signals for a short distance, and at the turn of the century, conducted successful trans-Atlantic tests.

The first practical application of radio was for ship-to-ship and ship-to-shore telegraphic communication. Marine disasters early demonstrated the speed and effectiveness of radiotelegraphy for saving life and property at sea.

This new communication medium was first known as “wireless.” American use of the term “radio” is traced to about 1912 when the Navy, feeling that

“wireless” was too inclusive, adopted the word “radiotelegraph.” The use of the word “broadcast” (originally a way to sow seed) stems from early U.S. naval references to “broadcast” or orders to the fleet. Now it is used to describe radio service to the public.

The origin of the first voice broadcast is a subject for debate. Claims to that distinction range from “Hello, Rainey,” said to have been transmitted by Nathan B. Stubblefield to a neighbor, Rainey T. Wells, in a demonstration near Murray, Ky., in 1892, to an impromptu program from Brant Rock, Mass., by Reginald A. Fessenden in 1906, which was picked up by nearby ships.

There were other early experimental audio transmissions. Lee De Forest put singer Enrico Caruso on the air in 1910, and there were trans-Atlantic voice tests by the Bell Telephone Co. at Arlington, Va., in 1915. But it was not until after World War I that regular broadcasting began.

The identity of the “first” broadcasting station is also a matter of conflicting claims. This is due largely to the fact that some pioneer AM broadcast stations developed from experimental operations. Although KDKA Pittsburgh did not receive a regular broadcasting license until Nov. 7, 1921, it furnished programs under a different authorization before that date. Records of the Department of Commerce, which then supervised radio, indicate that the first station issued a regular broadcasting license was WBZ Springfield, Mass. on Sept. 15, 1921. (WBZ is now assigned to Boston.)

There was experimental network operation over telephone lines as early as 1922. In that year WJZ (now WABC) New York and WGY Schenectady, N.Y., broadcast the World Series. Early in 1923 WEAF (now WNBC) New York and WNAC Boston picked up a football game from Chicago. Later that same year WEAF and WGY were connected with KDKA Pittsburgh and KYW Chicago (now Philadelphia) to carry talks made at a dinner in New York. President Coolidge's message to Congress was broadcast by six stations in 1923.

In 1926 the National Broadcasting Co., a subsidiary of RCA Corp., started the first regular network with 24 stations. For its first coast-to-coast hookup, in 1927, it broadcast a football game. In that same year, the Columbia Broadcasting System, first called the Columbia Phonograph Broadcasting System, was organized.

For some years NBC operated two networks, the Red and the Blue, but when the FCC adopted chain-broadcasting rules in the early forties, one organization was prohibited from operating two networks serving the same area at the same time. RCA sold the Blue Network to Edward J. Noble in 1943. It ultimately became the American Broadcasting Co. (In 1968, ABC itself was given a limited exception to the dual-network rule in order to operate four radio networks, each providing a specific service.)

FM and TV broadcasting emerged from their experimental stage just before U.S. entry into World War II. Wartime restrictions retarded expansion of radio facilities, although the emergency produced new techniques and apparatus that are in use today. In the decades following the war, broadcasting expanded domestically, and the development of communication satellites has opened new possibilities for international relay.

Regulation of Broadcasting

The Wireless Ship Act of 1910 applied to use of radio by ships, but the Radio Act of 1912 was the first domestic law for general control of radio. It made the Secretary of Commerce and Labor responsible for licensing radio stations and operators.

Early broadcasting was experimental and, therefore, noncommercial. In 1919 radiotelephone experiments were enabled to operate as “limited commercial stations.” In 1922 the wavelength of 360 meters (approximately 830 kilocycles per second) was assigned for the transmission of “important news items, entertainment, lectures, sermons, and similar matter.”

Recommendations of the first National Radio Conference in 1922 resulted in further regulations by the Secretary of Commerce. A new type of AM broadcast station came into being, with minimum power of 500 watts and maximum of 1000 watts (1 kilowatt). Two frequencies (750 and 833 kilocycles per second) were assigned for program transmission.

So rapid was the development of AM broadcasting that, upon recommendation of subsequent National Radio Conferences in 1923 and 1924, the Department of Commerce allocated 550 to 1500 kilocycles per second for standard broadcast and authorized operating power up to 5000 watts (5 kilowatts).

Increasing numbers of AM stations caused so much interference that, in 1925, a fourth National Radio Conference asked for a limitation on broadcast time and power. The Secretary of Commerce was unable to deal with the situation because court decisions held that the Radio Act of 1912 did not give him this authority. As a result, many broadcasters changed their frequencies and increased their power and operating time at will, regardless of the effect on other stations, producing bedlam on the air.

In 1926 President Coolidge urged Congress to remedy matters. The result was the Dill-White Radio Act of 1927.

Federal Radio Commission

The Radio Act of 1927 created a five-member Federal Radio Commission to issue station licenses, allocate frequency bands to various services, assign specific frequencies to individual stations, and control station power. The same act delegated to the Secretary

of Commerce authority to inspect radio stations, to examine and license radio operators, and to assign radio call signs.

Much of the early effort of the Federal Radio Commission was required to straighten out the confusion in the broadcast band. It was impossible to accommodate the 732 broadcast stations then operating. New regulations caused about 150 of them to surrender their licenses.

Communications Act of 1934

At the request of President Roosevelt, the Secretary of Commerce in 1933 appointed an interdepartmental committee to study electrical communications. The committee recommended that Congress establish a single agency to regulate all interstate and foreign communication by wire and radio, including telegraph, telephone and broadcast. The Communications Act of 1934 created the Federal Communications Commission for this unified regulation. This is the statute under which the FCC operates and which it enforces. Several of its provisions were taken from the earlier Radio Act.

Federal Communications Commission

The FCC began operating on July 11, 1934, as an independent federal agency headed by seven commissioners, who are appointed by the President with the advice and consent of the Senate.

FCC Broadcast Regulation

One of the FCC's major activities is the regulation of broadcasting. This has three phases.

The first is the allocation of space in the radio frequency spectrum to the broadcast services and to many nonbroadcast services which also must be accommodated. In view of the tremendously increased use of radio technology in recent decades, the competing demands for frequencies are among the commission's most pressing problems. Fortunately, as technology has advanced, frequencies higher and higher in the spectrum have become usable. Apart from the frequencies used for broadcasting, frequencies in other portions of the spectrum are allocated for "broadcast auxiliary" use by remote pickup and other transmitters auxiliary to main broadcast stations (see Auxiliary Broadcast Services).

The second phase of regulation is the assignment of stations in each service within the allocated frequency bands, with specific location, frequency and power. The chief consideration, although by no means the only one, is to avoid interference with other stations on the same channel (frequency) or channels adjacent in the spectrum. If his application is granted, an applicant for a new station or for changed facilities receives a construction permit. Later, when the station is built and it is capable of operating as proposed, a license to operate is issued.

The third phase is regulation of existing stations: inspection to see that stations are operating in accordance with FCC rules and technical provisions of their authorizations, modifying the authorizations when necessary, assigning station call letters, licensing transmitter operators, processing requests to assign the station license to another party or transfer control of the licensee corporation, and processing applications for renewal of license. At renewal time the commission reviews the station's record to see if it is operating in the public interest.

The Nature of American Broadcasting

Although educational and other noncommercial stations share the airwaves, the American broadcasting system for the most part is a commercial system. In this respect it is supported by revenues from those who advertise goods or services to the audience. Advertising messages are presented as commercial "spot announcements" before, during, and after programs, or as a part of "sponsored" programs.

Broadcast stations are licensed to serve the public interest, convenience and necessity. Because radio channels are limited and are part of the public domain, it is important to entrust them to licensees with a sense of public responsibility. By law, each license must contain a statement that the licensee does not have any right to operate the station or use the frequency beyond the term of license. The maximum term of license is three years. [Editor's note: legislation pending at press time may have lengthened license terms to five years.]

Under requirements of the Communications Act, applicants must be legally, technically and financially qualified, and they must show that their proposed

A short course in broadcasting, 1976

There were 8,034 radio stations operating in the United States at the beginning of January 1976. Of these, 4,463 were commercial AM's, 2,767 were commercial FM's and 804 were noncommercial FM's. At the same time, there were 962 operating television stations: 513 commercial VHF's, 197 commercial UHF's, 97 noncommercial VHF's and 155 noncommercial UHF's. Most commercial TV's are network-affiliated; approximately 100 operate as independents.

No single entity may own more than seven stations in each service (AM, FM or TV). In TV, no more than five may be VHF. No owner may have two stations of the same service in the same community. No owner of three VHF's in the top 50 markets may purchase other VHF's in the top 50 without a showing of compelling public interest. Newspaper owners may no longer purchase broadcast properties in the same market, nor may radio station owners acquire TV stations there, nor TV owners radio outlets. TV stations may no longer acquire cable TV franchises in the same city, and networks may not own cable systems at all.

In 1974, the last year for which official FCC figures are available, commercial broadcasting had total revenues of \$5.4 billion. Profits were \$821.2 million. Television accounted for \$3.8 billion (70.4%) of revenues and \$737.1 million (89.8%) of profits; radio, for \$1.6 billion (29.6%) and \$84.1 million (10.2%). Public broadcasting had a \$290.6 million income—23% from the federal government.

There are over 120 million TV sets in the U.S. (57 million color sets) in 71.5 million homes (97% of all homes). There are an estimated 413.1 million radio sets, 299 million (72.4%) of them in homes and 114.1 million (27.6%) out of homes. (Worldwide, TV and radio sets number more than one billion.) It is estimated that 86% of U.S. TV homes can receive UHF signals, that 45% have more than one set and that 15% are linked to cable systems.

The average American home watches TV for six hours and 56 minutes per day, according to A.C. Nielsen statistics. And, according to the latest study by The Roper Organization (commissioned by the Television Information Office), 65% of the U.S. public turns to TV as the source of most of its news, and 51% rank it as the most believable news source.

The average 30-second announcement in prime-time network television now costs \$30,300 (the highest-rated spot would cost \$50,000 or more, the lowest about \$20,000). The average successful prime-time show will reach 32 million people; a "smash" may reach 40 million or more. An estimated 73 million people watched the 1976 Super Bowl football telecast; minute announcements in that event commanded the medium's highest unit price: \$230,000. Thirty-second announcements on individual TV stations range from \$15,000 in top-rated specials in major markets to as low as \$5 in the second hundred markets. Radio spots cost from \$275 or more in major markets to less than a dollar in small towns.

operation would be in the public interest. They must be citizens of the United States. Corporations with alien officers or directors or with more than one-fifth of the capital stock controlled by foreign interests may not be licensed.

Penalties for broadcast station violations, depending upon the degree of seriousness, range from reprimands, fines up to \$10,000, and short-term probationary licenses to denial of license renewal, or even license revocation. Cease and desist orders may also be issued.

In 1965 the commission provided for public inspection of certain records of broadcast stations in the communities they serve. These are mainly duplicate copies of records in the public files of the commission in Washington, and include licenses, records of ownership, applications to the FCC and related material, network affiliation contracts and employment reports.

Under the Communications Act, it is the responsibility of each broadcast licensee to program in the public interest. The commission does not prescribe the time to be devoted to news, education, religion, music, public issues, or other subjects. Programming can vary with community needs at the discretion of the station licensee.

Licensees are expected to ascertain and meet the needs of their communities in programming. Applicants must show how community needs and interest have been determined and how they will be met. The commission periodically reviews station performance, usually in connection with the license renewal application, to determine whether the licensee has lived up to its obligations and the promises it made in obtaining permission to use the public airwaves.

The commission is forbidden by law from censoring programs. The Communications Act, Section 326, states: "Nothing in this Act shall be understood or construed to give the commission the power of censorship over the radio communications of signals transmitted by any radio station, and no regulation or condition shall be promulgated or fixed by the commission which shall interfere with the right of free speech by means of radio communication."

Fairness—The commission has held that when a station presents one viewpoint on a controversial public issue, the public interest requires that reasonable opportunity be afforded for the presentation of opposing viewpoints. This is the "Fairness Doctrine." It stems from a policy on editorializing announced in 1949, supported by a 1959 amendment to the Communications Act, which obligates broadcasters "to afford reasonable opportunity for the discussion of conflicting views of public importance." In 1967, the commission adopted specific rules requiring stations to notify persons when personal attacks were made on them in discussion of controversial public issues (with certain exceptions such as newscasts). The same requirement was also applied to station editorials endorsing or opposing a political candidate. These rules were upheld by the Supreme Court in 1969.

Section 315.—Section 315 of the Communications Act provides: (a) "If any licensee shall permit any person who is a legally qualified candidate for any public office to use a broadcasting station, he shall afford equal opportunities to all other such candidates for that office in the use of such broadcasting station; provided, that such licensee shall have no power of censorship over the material broadcast under the provisions of this section. No obligation is hereby imposed upon any licensee to allow the use of its station by any such candidate.... (b) The charges made for the use of any broadcast station for any of the purposes set forth in this section shall not exceed the charges made for comparable use of such station for other purposes...." In 1959 the act was amended to exempt from the equal-time requirement appearances by candidates on newscasts, news interviews and other news coverage.

A problem in connection with this statute is that it requires a station presenting one candidate to afford equal opportunities to all other legally qualified candidates for the same office, including, often, some who have no chance of prevailing in the election. In 1960 Congress suspended this requirement for the presidential election, thus making possible the broadcast debates between the Democratic and Republican candidates without stations having to give equal time to the numerous other presidential candidates representing small parties. A similar provision on a permanent basis is contained in legislation passed by Congress in September 1970.

Advertising.—The commission does not regulate individual commercials. In considering applications for new stations, renewals and transfers, it does consider whether overcommercialization contrary to the public interest may be involved. Radio applicants proposing

more than 18 minutes of commercials per hour must justify their policies to the commission. There is no commercial quota in FCC rules, but the 18-minute benchmark is part of the National Association of Broadcasters Radio Code. The NAB Television Code specifies a commercial maximum of 16 minutes per hour. (See section on Industry Self-Regulation).

Under a cooperative arrangement with the Federal Trade Commission, which has jurisdiction over false and misleading advertising, the FCC notifies stations of broadcast advertising cited by the FTC so that they may take any necessary action that is consistent with their obligation to operate in the public interest.

Stations and producers of advertising are expected to cooperate in controlling the sound volume (loudness) of commercials.

"Payola" and "rigged quiz shows".—Revelations about programs in the late 1950's led to amendments to the Communications Act in 1960. These made more explicit a station's obligation to make an announcement when money or other consideration is received for the presentation of broadcast material (e.g., money received by a disk jockey for playing a record). They made illegal the presentation of programs purporting to be contests of knowledge or skill where the result is in any way prearranged.

Lotteries, obscenity and fraud.—The U.S. Criminal Code prohibits broadcast of information concerning "any lottery, gift enterprise, or similar scheme," also utterance of obscene, indecent or profane language, or fraud by wire, radio or television. To be regarded as a "lottery," a giveaway arrangement must involve a prize, chance, and "consideration." A number of commission and court decisions have dealt with these concepts in particular situations, especially as to what is "consideration." (It has been held, for instance, that having to go to a particular store or listen to a particular program is not "consideration.")

Sale of time and station management.—The Communications Act declares that broadcasting is not a common carrier operation. Unlike common carriers, broadcasters are not required to sell or to give time to all who seek to go on the air, nor are they subject to regulation of rates and business affairs. Because programming is primarily the responsibility of broadcast licensees, the commission does not ordinarily monitor individual programs, or require the filing of scripts. However, stations are required to keep logs showing the programs presented and records of requests for political time.

The commission does not maintain surveillance of the day-to-day internal management of broadcast stations, or regulate time charges, profits, artists' salaries or employ relations. It licenses only stations and their transmitter operators, not announcers, disk jockeys or other personnel, except where they are employed as transmitter operators. Stations are required to keep technical and maintenance logs as well as program logs.

Industry self-regulation.—Radio and TV "codes" are administered by the National Association of Broadcasters for the guidance and voluntary compliance of stations subscribing to the codes. The codes govern programming and advertising practices.

Networks.—The commission does not license networks as such, only individual stations. Station licensees are subject to the chain broadcasting regulations adopted by the commission in 1941 to further competition in broadcasting. These rules have been supplemented by further regulations adopted from time to time.

Monopoly.—One of the commission's foremost concerns is promotion of diversification in the broadcast media, avoiding monopoly or undue concentration of control. Commission rules prohibit the same person or group from operating more than one station in the same service (AM, FM or TV) in the same locality. They also limit to seven the number of stations in the same service that may be commonly owned in the nation as a whole (only five of any group of TV stations may be VHF). Acquisition of more than three TV stations (only two of which may be VHF) in the 50 largest TV markets is permitted only upon a compelling showing that it would be in the public interest. New licensees are now also prohibited from owning more than one full-time station (AM, FM, TV) in the same locality.

Receivers.—The advent of "wireless" prompted amateurs and others interested in listening in on Morse code radiotelegraph transmissions to acquire receiving sets. Inexpensive crystal frequency detectors boomed the production of homemade and commercially manufactured receivers. Then the rise of broad-

casting aroused public interest in owning sets, battery operated at first, to receive regular programs. Receivers operated by house current came on the market about 1928. Development of the transistor in 1948 led to their use in place of tubes in sets. Successive stages in TV receiver development have taken sets from black-and-white to color, and VHF-only to all-channel (VHF and UHF) capability (see chapter on TV Broadcast).

The commission does not license receivers. However, it does require manufacturers to limit radiation that may interfere with radio or TV reception.

Call letters.—International agreement provides for national identification of a radio station by the first letter or first two letters of its assigned call signal, and for this purpose the alphabet is apportioned among nations. Broadcast stations in the United States use call letters beginning with K or W. Generally, those beginning with K are assigned to stations west of the Mississippi River and in the territories or possessions, while W is assigned east of the Mississippi.

During radio's infancy, most of the broadcast stations were in the East. As inland stations developed, the Mississippi River was made the dividing line between K and W calls. However, KDKA Pittsburgh and some other eastern stations authorized before this system went into effect have retained their K calls, and similarly some pioneer stations west of the Mississippi have kept their W calls. Most of the early broadcast call signs contained only three letters. These combinations were soon exhausted and stations were assigned four-letter calls. Since many AM licensees also operate FM and TV stations, a common practice is to use the AM call letters followed by "-FM" or "-TV."

National defense.—In cooperation with military and civil defense agencies, the commission has established the Emergency Broadcast System, based on voluntary participation by the broadcast industry. EBS facilities are for the primary purpose of giving emergency warning and advice to the public in event of attack, but they are put to peacetime use in alerting audiences to serious weather and other emergencies threatening life and property.

Broadcast Operation

Frequencies and Station Assignments.—Radio frequencies differ in characteristics, and each service is assigned to a frequency band to suit its needs.

The AM aural service, sometimes called standard broadcast, occupies the band from 535 kilocycles per second to 1605 kc/s. Radio waves travel with the same speed as light, and are of different "frequencies" (cycles per second) and "wavelengths" (distance between points in successive cycles). "Frequency" and "wavelength" vary inversely with each other. The latter term was formerly used generally to describe a particular radio wave, and still is in some other countries; but in the United States the use of "frequency" is much more common. The "medium" frequencies such as the AM band are usually referred to by their number of kilocycles (1000 cycles) per second, or, for short "kilocycles." The higher frequencies are usually referred to by the number of megacycles (1000 kilocycles or 1,000,000 cycles) per second, or "megacycles." The term "gigacycle" has come into use in more recent years, meaning 1,000,000,000 cycles per second (1,000 megacycles), to describe the much higher frequencies now being used in many services although not in broadcasting as such. The term "Hertz" as a synonym for cycle per second has recently been agreed upon internationally and domestically, along with its derivatives "kilohertz," "megahertz," etc. The usable frequency spectrum has constantly expanded upward with developing technology, so that what were once "high" frequencies are near the low end of the total spectrum used. AM stations are assigned at 10 kc/s intervals beginning at 540 kc/s, providing 107 frequencies.

FM broadcasting occupies the frequencies from 88 to 108 mhz, with 100 channels of 200 khz width each, the lowest 20 of them reserved for educational use. Both the center frequency (e.g., "93.1 mhz") and the designated channel number from 201 to 300 are used (e.g., "channel 201" is "81.1 mhz"), although channel numbers are not in popular usage since they are not on FM receivers.

In television, where wider channels are required to carry both picture and sound, each channel is 6 mhz wide. The very high frequency (VHF) portion of the television service occupies the frequencies 54 to 72 mhz (channels 2, 3 and 4), 76 to 88 mhz (channels 5 and 6) and 174 to 216 mhz (channels 7 through 13). The ultra high frequency (UHF) portion of the televi-

A B C's of Radio-TV

sion service occupies the frequencies from 470 to 890 mhz (channels 14 through 83). Designated channel numbers identify the frequency assignments (e.g., 54-60 mhz is "Channel 2"). There is no "Channel 1" in television.

Although "AM" and "FM" are often used to refer to the standard broadcast and FM broadcast services, these terms more properly apply to the methods, "amplitude modulation" and "frequency modulation," used to impress aural or visual intelligence on the carrier wave. The "AM" principle is used not only in the standard broadcast service but also in the picture portion of television and in the international "shortwave" service. The "FM" principle is used both in the FM broadcast service and in the sound portion of television.

In all the broadcast services, the same aural or visual channel can be used in different places if the stations are far enough apart not to interfere with one another or with stations on adjacent or technically related channels. A TV station may be required to "offset" 10 khz above or below its normal carrier frequency. The channel assigned to such a station is then designated "plus" or "minus" as the case may be. This makes more TV assignments possible and reduces the possibility of interference.

AM and FM Systems

Without being too technical, this is how an aural station works:

A person talks into a microphone as if it were a telephone. His voice sets up vibrations of varying intensity and frequency. The lower the pitch the slower the vibration. A cycle, or wavelength, is one complete performance of a vibration.

In the microphone these vibrations are converted into electrical impulses which are then greatly amplified at the transmitter before being put on the "carrier" wave. The intensity and frequency of the carrier wave are constant. This wave, by itself, does not transmit music or speech, so it is varied to correspond with fluctuations of the speech or music received at the microphone. This is called "modulation."

In AM broadcast the audio waves are impressed on the carrier wave in a manner to cause its amplitude (or power) to vary with the audio waves. The frequency of the carrier remains constant. This is known as amplitude modulation. In frequency modulation (FM), the amplitude remains unchanged but the frequency is varied in a manner corresponding to the voice or music to be transmitted.

These modulated waves radiate from the antenna tower at approximately 186,000 miles per second (the speed of light). Some of them follow the contour of the ground and are called "groundwaves." Others dart upward and are called "skywaves." At night the skywave portions of transmissions in the standard broadcast (AM) frequencies are reflected back to earth by electrical particles in the "ionosphere" portion of the atmosphere. This gives the listener a choice of more distant AM stations at night, but also increases interference. Daytime reception is largely dependent upon groundwaves.

Radio waves may pass through buildings and other objects but are subject to absorption or interference. As in the case of ripples on water, radio vibrations weaken with distance. Seasonal disturbances and sunspot periods can throw them off course and cause "freak" reception.

AM broadcast stations use "medium waves." That is to say, they transmit 540,000 to 1,600,000 waves a second or 540 to 1600 "kilocycles" or "kilohertz." At 540,000 waves a second, the distance between the crests is approximately 1,800 feet.

The so-called "shortwave" (international long-distance) broadcast stations transmit in the frequency range 6 mhz to 25 mhz (mhz = 1 million cycles/second). These waves are sent out one after another so rapidly that the distance between their crests (wave length) is only about 37 to 150 feet).

FM and TV stations, broadcasting in the very high and ultra high frequencies, send out even shorter, or very short, waves. (The word "shortwave" came into use before there was technology to use these other parts of the spectrum.)

The modulated radio wave from the radio station is picked up by the home receiving antenna. In other words, the wave sets up in the receiving antenna a current having the same frequency characteristics as the one transmitted. In the receiver the audio and carrier waves are separated by a device called a detector or demodulator. The carrier wave, no longer needed, is dissipated while the audio wave is relayed to the

loudspeaker where it is transformed back into the sound that is heard by the listener. (Television operation is discussed in TV Broadcast.)

Relay of Broadcasts

Simultaneous relay of broadcasting, including "networks," depends upon wire, cable, or radio connecting facilities (common carrier or private). Most live-talent radio network programs are sent over telephone circuits, many across the continent, for rebroadcast. For local broadcasts, stations usually employ wire connections between studio and transmitter, but some use radio links (see Auxiliary Broadcast Services).

Broadcast programs can also be picked out of the air for rebroadcast. TV, because of its characteristics, cannot be sent over ordinary wire lines but depends upon coaxial cable or microwave relay. Both of these methods also handle AM and FM transmission as well as telephone and telegraph communication.

Transmitting Antennas

In the AM service, antenna height above ground is not usually a matter of much importance. The entire antenna structure acts as the antenna and usually varies in height with the frequency of the transmission. Few AM antennas exceed 1,000 feet in height and most are considerably less. By contrast, in FM and TV, where transmission follows "line of sight," service depends on the location of the receiver in relation to the transmitting antenna. Here, antenna height is extremely important. While FM and TV antennas themselves are short, they are often situated atop natural or manmade structures which give greater height, such as tall buildings, mountain tops, or tall antenna towers specifically built for this purpose. TV towers extend as much as 2,000 feet above ground and higher.

In the interest of safety to air navigation, authorizations for broadcast transmitting antennas must usually be coordinated with the Federal Aviation Administration. Those over a certain height (usually 200 feet) must be painted and lighted. To further minimize the hazard to air traffic, shared use of tall towers, or location of all tall antennas of a given area on an "antenna farm" is being encouraged.

"Directional antennas" consist of more than one radiating element (the tower in AM), with phasing of the radiation from a series of towers so arranged that radiations cancel each other in some directions and reinforce each other in other directions. Sometimes they are used to increase radiation and service in a particular direction. More commonly, the purpose is to restrict radiation in one or more directions, usually to avoid interference to other stations.

As AM stations began to multiply on shared channels, it became necessary to employ directional antennas to prevent interference. Since 1937, directional antennas have helped new stations squeeze into the congested AM broadcast band. Most full-time (day and night) AM stations operate directionally at night. Directional antenna arrays can produce "figure eight" and more complicated service patterns. A complete array may include 12 towers. Directional antennas also are used in international communication and microwave relay to beam transmissions to particular points. Some FM and TV stations now use directional antennas.

AM Broadcast

Amplitude modulation is the oldest system of program transmission. The pioneer AM broadcast service started operation on the low frequencies it still uses now—535 to 1605 khz.

AM broadcast stations use power of 250 w to 50 kw (50,000 w)—the maximum power permitted by the commission.

Classes of AM Stations

These are four major AM classes:
Class I stations operating on "clear" channels and usually with 50 kw power (never less than 10 kw) to serve remote rural areas as well as large centers of population. The U.S. has Class I priority on 45 clear channels. (Other North American countries have their own Class I priorities, some shared by the U.S.) There are only one or two Class I stations on each clear channel.

A Class II station is a secondary station on a clear channel, operating with a power of 250 w to 50 kw. It serves a population center and an adjacent rural area, and is so operated as not to interfere with the extensive services rendered by major clear channel stations (both U.S. and foreign). There are 29 channels on which Class II stations may operate.

A Class III station shares a "regional" channel with numerous similar stations, using power of 500 w to 5

kw to serve a center of population and an adjacent rural area. There are 41 regional channels and more than 2,000 Class III stations.

A Class IV station operates on a "local" channel (shared by many similar stations elsewhere), employing a maximum power of 1 kw day and 250 w night. There are six local channels, each occupied by 150 or more stations.

"Clear channels" are frequencies set apart by international agreement for use primarily by high-powered stations designed to serve wide areas with groundwave and (at night) skywave service, particularly remote rural areas. Listeners living outside populous communities depend for night-time AM service on the skywave signals of distant clear-channel stations. The signals of Class I stations receive a high degree of protection from interference to make this wide service possible.

Day and Night Service.—Of the two types of signal, groundwave and skywave, groundwave service is steadier, more reliable, and is called "primary" service. Skywave or "secondary" service is available at night because skywave signals, lost in the daylight, are reflected from the ionosphere. Since skywaves cover tremendous distances, Class I stations can render skywave service across 700 miles or more. This service is subject to "fading," varying with changes in such factors as time of day, weather, latitude, atmospheric noise, and sunspot activity, hence the name "secondary." Because of the high power and extent of protection required for skywave signals to afford useful service, only Class I stations are authorized for skywave service.

Because skywave transmission is a factor in the AM frequencies at night, the number of AM stations operating at night must be limited. Therefore, slightly more than half of U.S. AM stations are licensed for daytime-only operation, sunrise to sunset, although on many frequencies most of them are also permitted to operate, usually with reduced power, starting at 6 a.m. when that is before sunrise (so-called "presunrise" operation).

In the early 1960s, the AM band was experiencing congestion and interference. At the same time, some service needs, such as night-time primary service to large portions of the country, were not being met. Therefore, in 1964, the assignment rules for new AM stations, or for more powerful facilities, were tightened to prevent interference and preserve the AM potential for more efficient use.

Facilities authorized from 1964 to 1968 involved minimal interference and provided the first local radio outlets for a number of communities. Still there were unfulfilled service needs, particularly at night, and so in July 1968, the commission stopped accepting AM applications while it studied how to utilize the limited potential for new stations in the AM band. At that time there were 4,215 AM stations on the air in this country; another hundred that had been previously authorized were expected to come on the air in succeeding months. There were more than twice as many AM as FM stations on the air.

The next year, new rules were proposed under which the commission would, to a greater extent, regard AM and FM as a single aural service. New AM stations would be authorized only where they would bring a primary service to a substantial area not receiving such service from existing AM or FM stations, and would not be granted if an FM channel were available which would bring the same service benefits. FM development would be encouraged because of technical qualities of this service, including ample night-time coverage and relative lack of interference when new stations are added.

The rules, which would be rather restrictive, are not contemplated as permanent, but rather would apply in the near future, for perhaps five years, while the commission examines what use can best be made of the limited remaining AM spectrum space.

FM Broadcast

Frequency modulation broadcast has several advantages over the older amplitude modulation. FM has higher fidelity characteristics and is freer of static, fading and background overlapping of other stations' programs.

FM's greater tonal range is due primarily to the fact that it uses a wider channel than that employed for AM broadcast. Then, too, it occupies a higher portion of the radio spectrum where there is less static and other noise than at lower frequencies. FM receivers have the particular ability to suppress weaker stations and other interference.

Since the frequencies on which FM operates do not

ordinarily reflect back to earth from ionospheric layers (in skywaves), it is possible for many scattered FM stations to use the same frequency without interference, night or day, unlike the AM band.

FM and AM broadcast do not interfere with each other since they are on widely separated bands. Because of the difference in their spectrum locations and the systems used, FM cannot be heard on AM receivers without special adapters. Likewise, AM cannot be heard on sets made to receive only FM. However, combination sets receive both systems. Legislation has been proposed to require all radio sets to have both AM and FM capability, just as TV sets are required to receive both VHF and UHF channels.

History.—The principle of frequency modulation has long been known, but its advantages for broadcasting were not realized until shortly before World War II. Largely as a result of interest evoked by extensive developmental work by Edwin H. Armstrong in the 1930's, the commission authorized increased FM experimentation, and in 1940, after extensive public hearings, provided for FM operation to start Jan. 1, 1941. It set apart 35 channels for commercial and five channels for noncommercial educational FM.

On Oct. 31, 1940, the commission granted construction permits for the first 15 FM stations. By the end of that year there were 10 more. Though all radio construction was frozen during World War II, more than 40 prewar FM stations continued to serve some 400,000 receivers.

FM stations were initially assigned call letters with numerals added, but in 1943 the present letter system was adopted. There is optional use of the suffix "FM" to distinguish these stations from jointly operated AM stations.

Because of skywave interference experienced on the original FM band of 42-50 mhz per second, the commission in 1945 moved FM to its present higher and less vulnerable position in the radio spectrum—88 to 108 mhz. At the same time it increased the number of channels to 100, providing 80 for commercial and 20 for noncommercial educational use.

FM Zones and Classes.—In 1962, the commission revised its commercial FM rules to divide the country into three zones (instead of the previous two). Zone I includes part or all of 18 northeastern states, plus the District of Columbia; Zone I-A is limited to Southern California, and Zone II includes the rest of the country.

Three classes of commercial FM stations (instead of the previous two) were created. Class A stations are assigned to all zones; Class B stations are assigned to Zones I and I-A, and Class C stations are assigned to Zone II.

Class A stations are low-powered with a maximum of 3 kw effective radiated power. The maximum power for Class B stations is 50 kw and for Class C, 100 kw.

An important factor in FM operation is the height of the antenna above surrounding terrain (see earlier section on Transmitting Antennas, line-of-sight transmission). Therefore stations have maximum antenna heights in relation to power, 300 feet above average terrain for Class A, 500 feet for Class B and 2,000 feet for Class C. If the antenna height above average terrain is greater, power must be reduced commensurately. Minimum power requirements are also prescribed.

FM reception varies with location of the receiver in relation to the transmitting antenna. With maximum power and antenna height, good service extends about 15 miles for Class A stations, 33 miles for Class B, and 64 miles for Class C. The rules also include minimum mileage separations between stations on the same or adjacent channels. This is to protect the service from interference.

In 1963, the commission adopted a table assigning commercial FM channels to states and communities. (This is similar to the TV table of channel assignments.) Nearly 3,000 FM channel assignments were made to nearly 2,000 mainland communities. Assignments in Alaska, Hawaii, Puerto Rico, and the Virgin Islands were added in 1964.

FM stations owned jointly with AM stations in cities of more than 100,000 population may not duplicate AM programming for more than half the FM station's broadcast week.

The commission has said it believes that separate ownership of AM and FM stations is a desirable long-range goal.

Subsidiary FM service.—To aid FM broadcasters, the commission in 1955 enabled them to apply for subsidiary communications authorizations for supplemental service such as background music. Sometimes called "functional music," this specialized service is offered to stores, factories and other business subscribers.

Originally, subsidiary communications were permitted on a simplex basis, the station devoting part of the time on its channel to regular broadcasting and part to this specialized service. Later, rules were adopted requiring subsidiary communications to be on a multiplex basis, that is, using one or more subchannels with the main channel used for regular broadcasting. Subsidiary communications transmissions are received on special sets in stores, offices and plants of subscribers.

Stereophonic Service.—Stereophony is not really a 20th Century innovation but dates back to experiments performed over wire lines by telephone engineers in the 1880's. Even at that time contemporary accounts spoke of being able to "localize" a singer's position on an opera stage by virtue of the signal strength in either the right or left telephone. Over the next few decades, there were other experiments in transmitting binaural sound, but the general impetus to development came only with post-World War II technology in which multiplexing techniques were applied to FM broadcasting. In 1959, the National Stereophonic Radio Committee was created to examine the many proposed systems of FM stereo and submit a final recommendation to the commission. In the summer of 1960, six systems were field tested over KDKA-FM in Pittsburgh, with receivers set up at Uniontown, Pa. The system of stereo transmission proposed by the General Electric Co. and the Zenith Corp. was adopted, with broadcasting authorized to start on June 1, 1961.

TV Broadcast

Television broadcasting is synchronous transmission of visual and aural programs. The picture phase is accomplished by sending a rapid succession of electrical impulses which the receiver transforms into scenes and images. Here is a brief explanation of a complex process.

Monochrome.—The scene to be televised is focused on a special tube in the television camera which has a small "screen" covered with about 367,000 microscopic dots of a special photo-sensitive substance. This can be likened to a tiny motion picture screen and is called a "mosaic." The varying light from each part of the scene being televised falls upon these dots and gives them an electrical charge, the strength depending upon the amount of light falling upon the individual dots. Thus each dot becomes a tiny storage battery and the scene is formed in a pattern of electrical charges on the mosaic.

The mosaic is "scanned" by a tiny beam of electrons, no larger than the head of a pin, moving from left to right and progressing downward (just as the printed page is read by the human eye). This complete process is repeated 60 times per second, and the horizontal lines of alternate scanning are interlaced so that 30 complete pictures or "frames" composed of 525 horizontal lines are produced each second.

As the electron beam strikes each dot on the mosaic, the dot is discharged through the electron beam and the electrical impulses produced are used to modulate the signals of the TV transmitter. Each time the dots are discharged by the electron beam they are recharged by the light produced by the succeeding scene falling upon them. The succession of individual "still" scenes creates the illusion of motion just as in the case of motion pictures made on film.

The reproduction by the TV receiver of the pictures transmitted is just the reverse of the transmission. The incoming succession of electrical impulses is separated from the "carrier," and after amplification is impressed on the picture tube grid. The picture tube also has an electron "gun" which shoots out a tiny beam of electrons which moves from left to right and progresses downward on the face of the picture tube.

The face of the tube is coated with a material which fluoresces or gives off light at the point where it is struck by the electron beam. In the absence of a television signal the whole face of the picture tube is illuminated equally by a series of closely spaced horizontal lines. When a TV signal is placed on the grid of the picture tube, it controls the strength of the electron beam and hence the amount of light on the face of the tube. If the scanning of the electron beam in the picture tube is kept in perfect step with the scanning of the electron beam in the TV camera, the picture tube will reproduce the lights and shadows of the subject scene, and the succession of such scenes produces the illusion of motion.

In brief, the picture seen by the viewer is actually produced by a flickering spot of light moving rapidly across and down the face of the picture tube. The viewer sees the "whole" picture because the screen

continues to glow for a tiny fraction of a second after the electron beam has passed. Coupled with the retentive ability of the eye, this creates the illusion that the picture is there all the time. The high rate of repetition of the picture produced by the beam minimizes flicker and lends smoothness to motion.

The TV transmitter is, in effect, two separate units. One sends out the picture and the other the sound. Visual transmission is by amplitude modulation. Sound transmission is by frequency modulation.

Color.—In color TV, a brightness component is transmitted in much the same manner as the black-and-white picture signal is sent. In addition, a color component is transmitted at the same time on a sub-carrier frequency located between the visual and aural carrier frequencies.

Color standards are based on a simultaneous system of color transmission. Signals representing red, blue, and green are transmitted simultaneously. These are the "primary colors," and when they are combined in various amounts, they produce all of the other colors. A magnifying-glass examination of the scene on a receiver will reveal that it is made up only of red, blue and green dots, no matter what color is being shown. Even scenes not transmitted in color and seen as varying shades of gray to white are made up of red, blue and green dots.

Only color receivers have the special picture tubes and the necessary circuitry to illuminate the colored dots. Under the "compatible color" system, color programs can be received in black-and-white on monochrome sets, and black-and-white programs can be received as they are on color sets.

TV History.—Men of many lands contributed to the development of television. Like aural radio, TV was made possible by electronic discoveries in the late 19th and early 20th centuries. In 1884 Paul Nipkow, a German, patented a scanning disk for transmitting pictures by wireless. In this country Charles F. Jenkins began his study of the subject about 1890. The English physicist, E.E. Fournier d'Albe, conducted experiments in the early 1900's. In 1915 Marconi predicted "visible telephone."

In 1923 physicist Vladimir Zworykin, a Russian-born American, applied for a patent on the iconoscope camera tube. In the years following there were experiments by E.F.W. Alexanderson and Philo T. Farnsworth in this country and John L. Baird in England. An experimental TV program, in which Secretary of Commerce Herbert Hoover participated, was sent by wire between New York and Washington by the Bell Telephone Laboratories in 1927. The next year Bell experimentally televised outdoor programs.

The Federal Radio Commission (predecessor of the Federal Communications Commission) reported that a few broadcast stations were experimenting with television in 1928. In that year, WGY Schenectady, N.Y., broadcast the first TV drama. Large-screen TV was demonstrated by Radio Corp. of America (now RCA Corp.) at a New York theater in 1930. RCA tested outdoor TV pickup at Camden, N.J., in 1936.

By 1937 there were 17 experimental TV stations operating. The first United States President seen on TV was Franklin D. Roosevelt, when he opened the New York World's Fair in 1939. That year saw the first telecast of a major league baseball game, a college football game, and a professional boxing match. In 1940 the Republican and Democratic conventions were first televised. Pioneer use of coaxial cable for long-distance relay was made for the Republican convention.

The first President's message to Congress over network TV was that of President Truman in 1950. The first TV debate between presidential candidates was in 1960 between Kennedy and Nixon. The first presidential message to Congress televised in color was that of President Johnson in 1966.

Early Commercial Operation.—The Journal Co. of Milwaukee, now licensee of WTMJ-TV, filed the first application to broadcast TV on a commercial basis. At a 1940 hearing the FCC found industry divided on technology and standards, but a committee appointed to work on the questions reached agreement on the present standards of 525 lines and 30 frames per second, and on April 30, 1941, the commission authorized commercial TV operations to start the following July 1 on 10 commercial stations which were on the air by May 1942, six continuing during the war.

In 1945 the commission allocated 13 VHF channels between 44 and 216 mhz for commercial television, but it noted that there was not enough spectrum space below 300 mhz for an adequate nationwide system.

A B C's of Radio-TV

Twelve of the VHF channels had to be shared with nonbroadcast two-way radio services. To prepare for TV expansion, the UHF frequencies between 480 and 920 mhz were made available for experimental TV and those between 1245 and 1325 mhz for TV relay.

In 1948, because of interference with commercial TV, the VHF sharing was ended. TV Channel 1 (44-50 mhz) was deleted and assigned to land mobile or two-way radio service.

TV Proceedings 1948-1951.—As the commission had foreseen, it was increasingly evident that the available channels were too few for nationwide service. On Sept. 30, 1948, the commission stopped granting new TV applications in order to study the situation. This was the so-called TV "freeze" order. On July 11, 1949, comprehensive changes were proposed to improve and extend TV service. These included engineering standards, opening UHF channels for TV, consideration of color systems, reservation of channels for noncommercial educational use, and a national assignment plan for all channels.

Color was considered first. Three competitive systems were offered for commission consideration. They were the "field sequential" system of Columbia Broadcasting System, the RCA "dot sequential" system, and the Color Television Inc. "line sequential" system. The commission found that the field sequential system was the only one that met its criteria for color operation, even though this system could not be received in monochrome on existing receivers (the others claimed theirs could.) This method of operation was adopted in 1950, but the door was left open for development of a better system.

CBS began limited color broadcasts on June 25, 1951, but ran into problems. Because of a materials shortage, the National Production Authority, on the following Nov. 20, prohibited manufacture of color TV sets for the public, and interest in the field sequential system lagged.

Thereafter new standards for "compatible color," receivable both in color and monochrome, were developed by RCA and advocated by the industry through its National Television System Committee. These standards were adopted by the commission on Dec. 17, 1953.

Freeze Lifted 1952.—On April 14, 1952, the commission reopened TV to expansion. It added 70 UHF channels (between 470 and 890 mhz) to the 12 VHF channels (54-216 mhz). It adopted a table making more than 2,000 channel assignments to nearly 1,300 communities. These included 242 assignments for noncommercial educational use.

The minimum effective radiated visual power of TV stations was set at 100 w. The maximum varies with antenna height. (No minimum height above average terrain is specified.) On VHF channels 2-6, maximum power is 100 kw; on channels 7-13 it is 316 kw; and on UHF channels 14-83 it is 5000 kw. With very high antennas the amount of power is reduced.

Separation of stations on the same channel is determined by three geographic zones. In Zone I, minimum co-channel separation is 170 miles for VHF channels and 155 for UHF. This zone covers Massachusetts, Rhode Island, Connecticut, New Jersey, Maryland, Pennsylvania, Delaware, District of Columbia, Ohio, Indiana, Illinois, and parts of Maine, New Hampshire, Vermont, New York, Virginia, West Virginia, Michigan and Wisconsin.

In Zone II, minimum co-channel separation is 190 miles for VHF and 175 miles for UHF channels. This zone includes Kentucky, Tennessee, North and South Carolina, Missouri, Iowa, Minnesota, Arkansas, Kansas, Nebraska, Oklahoma, North and South Dakota, Utah, Idaho, Arizona, New Mexico, Montana, Wyoming, Nevada, Colorado, Oregon, Washington, California, Alaska, Hawaii, and parts of the states of Maine, New Hampshire, Vermont, New York, Virginia, West Virginia, Georgia, Alabama, Mississippi, Louisiana, Michigan, Wisconsin and Texas.

In Zone III the separation is 220 miles for VHF and 205 miles for UHF channels. This zone includes Florida, parts of Georgia, Alabama, Louisiana, Mississippi, and Texas.

The first commercial TV grants after the freeze were made July 11, 1952, to three Denver stations. The first commercial UHF station to go on the air was KPTV Portland, Ore., on Sept. 20, 1952.

TV Service.—Commercial TV stations are required to broadcast at least 28 hours a week, at least two hours every day, although they are allowed a shorter schedule

when they begin operation.

TV service may be expanded to new areas through use of "satellite" stations—regular stations largely rebroadcasting the programs of parent stations—and "translators," lower power automatic installations which pick up and rebroadcast programs of parent stations on a different frequency. The rules also provide that UHF stations may use "boosters," low-power stations rebroadcasting on the same frequency, to fill in "shadow" areas within their normal service areas. These have not proved satisfactory and none are now in operation. Rebroadcasting requires the consent of the originating stations.

Unlike AM networking over ordinary telephone wires, TV networking requires special relay adjuncts. Network TV was made possible in large measure by the development of coaxial cable and microwave relay facilities. As early as 1937 motion pictures were televised and sent over the coaxial cable link between New York and Philadelphia. Network operation was begun by WNBT (now WNBC-TV) New York City; WRGB Schenectady, and WPTZ (now KYW-TV) Philadelphia in 1944.

Regular coaxial-cable relay service was inaugurated between Washington and New York in 1946. The following year microwave relay service extended as far as Boston. A Midwestern relay system, opened in 1948, was joined with the Eastern system in 1949. The first link in the transcontinental relay system was opened between New York and Chicago in 1950. It reached San Francisco the following year and on Sept. 4, 1951, it carried telecasts of the Japanese peace treaty conference.

Programs are carried between coasts now mostly by microwave, with cable used for local loops where microwave is not feasible. Although there is some private microwave TV relay, most live networking is over the facilities of common carriers. American Telephone & Telegraph Co. is the dominant carrier nationally.

Subliminal Advertising.—There have been experiments with transmission of quick visual messages, aimed below the threshold of conscious perception, but they were dropped. So-called "subliminal advertising" is frowned upon by the television industry. There is none on the air, and so the commission has not adopted any rules on the subject.

UHF Development.—Economic and technical problems have impeded full utilization of the UHF channels. Because of the large number of VHF-only receivers originally in use, advertisers have preferred VHF stations, limiting UHF revenues.

In 1956 the commission outlined plans to promote comparable TV facilities as a means of extending service throughout the nation. In the years following, it considered and rejected the idea of moving all or most of TV to the UHF band. It sought the cooperation of industry to find ways to increase the range of UHF stations. It made certain areas all-UHF and took other steps to put UHF and VHF on a more competitive basis. In 1966 it revised the table of channel assignments to make additional UHF assignments.

At the commission's request, Congress appropriated money for a test in New York City to determine the ability of UHF to provide service comparable with VHF in a locality of difficult reception because of tall buildings separated by "canyons." As a result of the tests, the commission concluded that UHF reception, generally, was equal to that of VHF.

Also at FCC request, Congress in 1962 adopted a law permitting the FCC to require that all TV receivers be made to receive UHF as well as VHF channels. Industry had to convert to all-channel production by April 30, 1964. This has given substantial impetus to UHF expansion. A lingering complaint was that VHF tuning dials, which were clicked into place, were easier to work than UHF, which worked like aural radio dials. Efforts were launched to make UHF tuning more comparable with the click-action VHF tuning, and rules were adopted in 1970 to require comparability.

Cable TV.—Cable TV is not a broadcast service. It augments broadcast service and it is regulated by the FCC, but cable TV systems are not licensed as broadcast stations are.

Cable TV systems pick up the programs of broadcast stations by a central receiving antenna or by microwave radio relay. Coaxial cable, which can carry many signals, delivers them from the reception point to the homes of subscribers.

Cable TV started in 1949-50 as a means of bringing TV service to communities outside the reach of broadcast signals. It spread to communities that had TV service but wanted to receive more stations. Other markets were found where there was already a choice of signals but where obstacles on over-the-air reception

gave cable operators an opportunity to promise a better picture.

The commission began to regulate cable TV in April 1965 when it adopted rules for microwave-served cable TV systems. It required them to carry the signals of local stations and to refrain from duplicating the programs of local commercial stations (by carrying other stations broadcasting the same programs) within 15 days of the local broadcast. In October of that year, special frequencies were made available for relaying signals to cable TV systems.

In 1966 the commission required all cable TV systems to carry local and nearby stations and to protect their programs from duplication, although the 15-day requirement was reduced to protection the day of broadcast. It also set a hearing requirement on proposals to bring distant signals into communities regularly served by TV stations in the 100 largest TV markets.

The commission proposed new cable TV rules in December 1968. Adopting some of these the following October, it required systems with more than 3,500 subscribers to originate programming as of 1971. This was designed to bring local outlets to communities without stations. The broadcast requirements of fairness and sponsor identification were extended to cable TV.

Subscription TV.—Subscription television is a special program service for viewers who pay for it. It is transmitted over the air in scrambled signals which are deciphered by devices on subscriber sets.

The commission first authorized experimentation with over-the-air pay TV in 1950. Five years later it invited comments on whether it would be in the public interest to establish a pay-TV service on a permanent basis. In 1957 it said trial demonstrations would be needed to resolve the question, but in view of resolutions by two congressional committees, it deferred action for two years. In 1959 it invited trial pay-TV applicants by commercial stations. After a hearing, an application by WHCTV (TV) Hartford, Conn., for use of UHF channel 18 was granted in 1961, and trial pay TV began in the summer of 1962. It was voluntarily ended by the station in January 1969.

Commission rulemaking began in 1966. After studying comments and the Hartford data, the commission's Subscription Television Committee proposed to authorize a new national service. The commission heard oral argument on the proposal in the fall of 1967. On Dec. 12, 1968, the commission established over-the-air pay TV as a permanent service. The beginning of service awaited approval of applications to operate pay-TV stations.

Over-the-air pay TV is designed to be a supplemental service to conventional broadcasting. Only one station in a community may be granted a pay-TV authorization and only where at least four conventional TV stations, in addition to the proposed pay-TV station, serve the community. There are safeguards in the rules to prevent pay-TV stations from siphoning programs from conventional television. For example, with some exceptions, pay TV may not show feature films more than two years old. There is also a rule that bars from pay TV any sports programs regularly shown in the community over conventional TV during the previous two years. It is proposed to extend this prohibition to a five-year period as a further protection against siphoning.

Educational Broadcasting

AM.—Educational institutions were among the pioneers in experimental broadcast, and held many early AM licenses.

By 1925, educational groups had 171 AM licenses. For various reasons, notably the increased competition from commercial broadcasting, most of these stations were off the air by 1934 when the FCC was created. However, there are still two dozen educational stations operating in the AM broadcast band, although there are no longer any educational allocations there (see section on FM below).

As directed by Section 307(c) of the Communications Act, the commission in 1934 studied a proposal that Congress allocate fixed percentages of radio facilities for nonprofit programs. On Jan. 22, 1935, the FCC recommended against such a statutory allocation but recognized the need for extending broadcasting to education. It expressed its intention "actively to assist the determination of the rightful place of broadcasting in education and to see that it is used in that place."

FM Educational Stations.—When regular FM broadcasting was authorized in 1941, five channels were authorized for noncommercial educational use as a substitution for AM allocations previously made to education.

In 1945, as part of an extensive revision of frequency allocations, the commission reserved 20 FM channels between 88 and 92 mhz for noncommercial educational FM stations. This part of the FM band is contiguous to the commercial portion, and FM receivers can tune both noncommercial and commercial stations. Since then, the number of noncommercial educational FM stations has grown slowly but steadily.

In 1948 the commission authorized 10 w operation on educational FM channels. With such low power equipment, easily installed and operated, schools may broadcast to a limited area of two to five miles for an outlay of a few thousand dollars. High power equipment may be added when desired. In 1951, as a further aid, the commission authorized remote control operation of low power educational stations. Approximately half of all educational FM stations use power of 10 w.

Educational FM stations traditionally have been assigned on an individual-application "demand" basis, as AM stations are assigned. To permit planned development of the 20 reserved channels, it is proposed to adopt a table of assignments like that adopted in 1963 for commercial FM channels to allocate specific frequencies to communities.

Stations in the educational FM service are licensed principally to school systems, colleges and universities for student-teacher programs as well as for public education and information.

TV Educational Stations.—The commission allocated TV facilities for noncommercial educational use after a lengthy study in the general television proceedings (see Broadcast). It determined that "the need for noncommercial educational stations has been amply demonstrated," that it would take longer for the educational service to be developed than for the commercial service, and that special channels should be reserved. Consequently, in 1952, channel assignments were made to 242 communities exclusively for noncommercial educational stations. Forty-six of these were made to primary educational centers. Of the total 242 channels, 80 were VHF and 162 UHF. There have been more assignments since. In 1966 a revised table of channel assignments was adopted for UHF, containing many more educational assignments than before. The new table contains altogether over 615 educational TV assignments in the mainland states, more than a third of all channel assignments.

The first educational TV station to go on the air was KUHT Houston on May 25, 1953. The first state educational TV network was established in Alabama on April 28, 1955.

The commission expects educational TV licensees to make their station facilities available to other local educational institutions, since such assignments are made to serve the educational and cultural needs of the community. Except in particular cases, educational TV eligibility is not extended to municipal authorities in places where an independent educational authority, such as a board of education, is established. Noncommercial educational stations are not required to broadcast a specific minimum number of hours, but educational and commercial TV stations are subject to the same service requirements, such as station separation, antenna height and power.

A 1962 law enabled the Department of Health, Education and Welfare to make matching federal grants of money to build educational TV stations, and a 1967 law extended these benefits to educational radio.

As an aid to educational TV, the commission in 1963 established the Instructional Television Fixed Service, a nonbroadcast service on considerably higher frequencies (2500-2690 mhz) than the broadcast service. An ITFS station at a central point such as a school district headquarters can transmit as many as four programs simultaneously to area schools, where special receivers pick up the programs. Simultaneous transmission capability eases scheduling programs for in-school educational TV, and the ITFS service frees broadcast educational TV for more general programming.

(Many schools have closed-circuit TV systems to link classrooms for instruction, but this is by cable, not broadcast, and it is not regulated by the commission.)

Several colleges, universities and community groups hold TV authorizations on channels not reserved for education, and they operate either on a profit or non-profit basis.

Other Broadcast Activity

International Broadcast.—Under international agreement, certain high-frequency bands are allocated for broadcast between nations.

Authorizations for non-government international broadcast stations in the United States are issued by

the FCC. Only three of these international stations are now authorized. A single station uses a number of frequencies between 5950 and 26100 khz, and it may need more than one transmitter because of seasonal considerations and other factors in broadcasting different programs simultaneously to different parts of the world. The three stations have a total of seven transmitters, all located in this country. The minimum power for these stations, sometimes known as short-wave stations, is 50 kw.

During World War II, international broadcast stations in the United States were taken over temporarily by the Office of War Information and the Office of Inter-American Affairs of the Department of State, which programed them in the interest of the war effort.

Under the peacetime program of the Department of State, the United States Information Agency broadcasts daily in many languages to other parts of the world through the Voice of America. VOA stations are not licensed or regulated by the FCC. There are about 30 VOA transmitters in the United States and about 70 located in foreign countries.

Broadcast Relay by Satellite.—The first live transatlantic telecast by satellite was relayed by Telstar I on July 10, 1962. The picture was of the American flag fluttering in front of the sending station at Andover, Me. More panoramic telecasts, showing life in widely distant places, were exchanged between the U.S. and Europe 13 days later. Telstar I and other experimental satellites were operated by the National Aeronautics and Space Administration, which continues to handle the rocket launching of privately operated communication satellites as well as some satellites in government communication and space programs.

The Communications Satellite Act of 1962 provided for the U.S. portion of a global system to be operated by a private corporation, the Communications Satellite Corp., subject to federal regulations. Comsat is owned partly by common carriers and partly by the general public. Early Bird (INTELSAT I) on April 2, 1965, became the first commercial satellite to be put in orbit by Comsat and its foreign partners in the International Telecommunications Satellite Consortium. During the following year, some 80 hours of television were transmitted between the U.S. and Europe. Early Bird has since been replaced and retired.

When INTELSAT II (flight 2) went up over the Pacific on Jan. 11, 1967, satellite communication was established between the U.S. mainland and Hawaii, making live network TV transmission available there for the first time. Still, television makes up only a small part of the traffic on communication satellites around the world. Telephone and teletype communications, including data transmissions, dominate the loads.

The commission is now also considering applications for satellites for domestic use within the United States.

Auxiliary Broadcast Services.—Broadcasters take

portable or mobile transmitters to the scene of events to relay aural programs back to the station for on-the-spot coverage of sporting events, parades, conventions, fairs, disasters, and other newsworthy events. These remote-broadcast pickup stations use frequencies in the 26, 153, and 450 mhz portions of the spectrum.

TV stations also use small portable transmitters operating in the 2, 7, and 13 ghz-per-second (microwave) portions of the spectrum for visual coverage of out-of-studio events.

Stations may also use transmitters to send TV and aural programs from the studio to the transmitter (studio-transmitter links) and to relay programs between broadcast stations (intercity relay stations). Aural studio-transmitter links and intercity relay stations operate in the 950 mhz portion of the spectrum and TV studio-transmitter links and intercity relay stations in the 2, 7, and 13 ghz portions.

Experimental Broadcast.—Experimental broadcast stations test new techniques and develop broadcast equipment. Information obtained helps the industry to evolve and provides the commission with information about new developments. All the broadcast services (AM, FM, TV) had their origins in experimental stations, as did UHF television, color television and subscription television. Because of their temporary nature, experimental station authorizations fluctuate in number.

—Published by the FCC

REFERENCE MATERIAL

The following material on broadcasting and regulation is obtainable from the FCC's public information officer on request.

Applications—How to Apply for a Broadcast Station.

Fairness—Applicability of the Fairness Doctrine in the Handling of Issues of Public Importance.

FCC—What You Should Know About the FCC (1968).

Lists of FCC Publications Sold by the Government Printing Office, noting that rules governing broadcasting (Volume II of FCC Rules & Regulations) can be purchased.

Lists—Radio Stations and Other Lists, noting commercial sources, since the FCC does not furnish stations, frequency or equipment lists.

Programing—FCC Report and Statement of Policy Concerning Broadcast Programing.

Publications—Publications and Services, listing business media in the broadcast field.

Sponsorship—Applicability of Sponsorship Identification Rules.

Growth of Broadcast Service

These tables show the development of broadcasting. The number of stations is as of Jan. 1 of the year noted:

Commercial radio in operation

Year	AM	FM
1945	884	46
1950	2,086	733
1955	2,669	552
1960	3,456	678
1965	4,012	1,270
1966	4,050	1,446
1967	4,117	1,631
1968	4,171	1,779
1969	4,236	1,944
1970	4,319	2,184
1971	4,323	2,196
1972	4,355	2,304
1973	4,393	2,482
1974	4,422	2,605
1975	4,432	2,636

Commercial TV stations in operation

Year	Total	VHF	UHF
1945	6	6	—
1950	97	97	—
1955	439	294	117
1960	573	441	76
1965	586	487	99
1966	598	491	107
1967	620	497	123
1968	648	504	144
1969	675	506	169
1970	690	508	182
1971	696	511	185
1972	699	510	189
1973	705	511	189
1974	705	513	192
1975	711	513	198

Noncommercial FM's in operation

Year	Number
1945	—
1950	48
1955	122
1960	162
1965	255
1966	269
1967	299
1968	326
1969	362
1970	396
1971	440
1972	479
1973	625
1974	711
1975	717

Noncommercial TV's in operation

Year	Total	VHF	UHF
1955	9	—	—
1960	44	—	—
1965	88	54	34
1966	105	61	44
1967	118	67	51
1968	146	71	75
1969	172	76	96
1970	182	77	105
1971	196	85	111
1972	206	89	117
1973	229	91	138
1974	233	91	142
1975	241	95	146

FEDERAL COMMUNICATIONS COMMISSION

Richard E. Wiley, Chairman

Robert E. Lee
Bernard L. Hoots
Absoil W. Washburn

Charlotte T. Reid
James H. Daniels
Glen G. Robinson, Jr.

As of January 1976

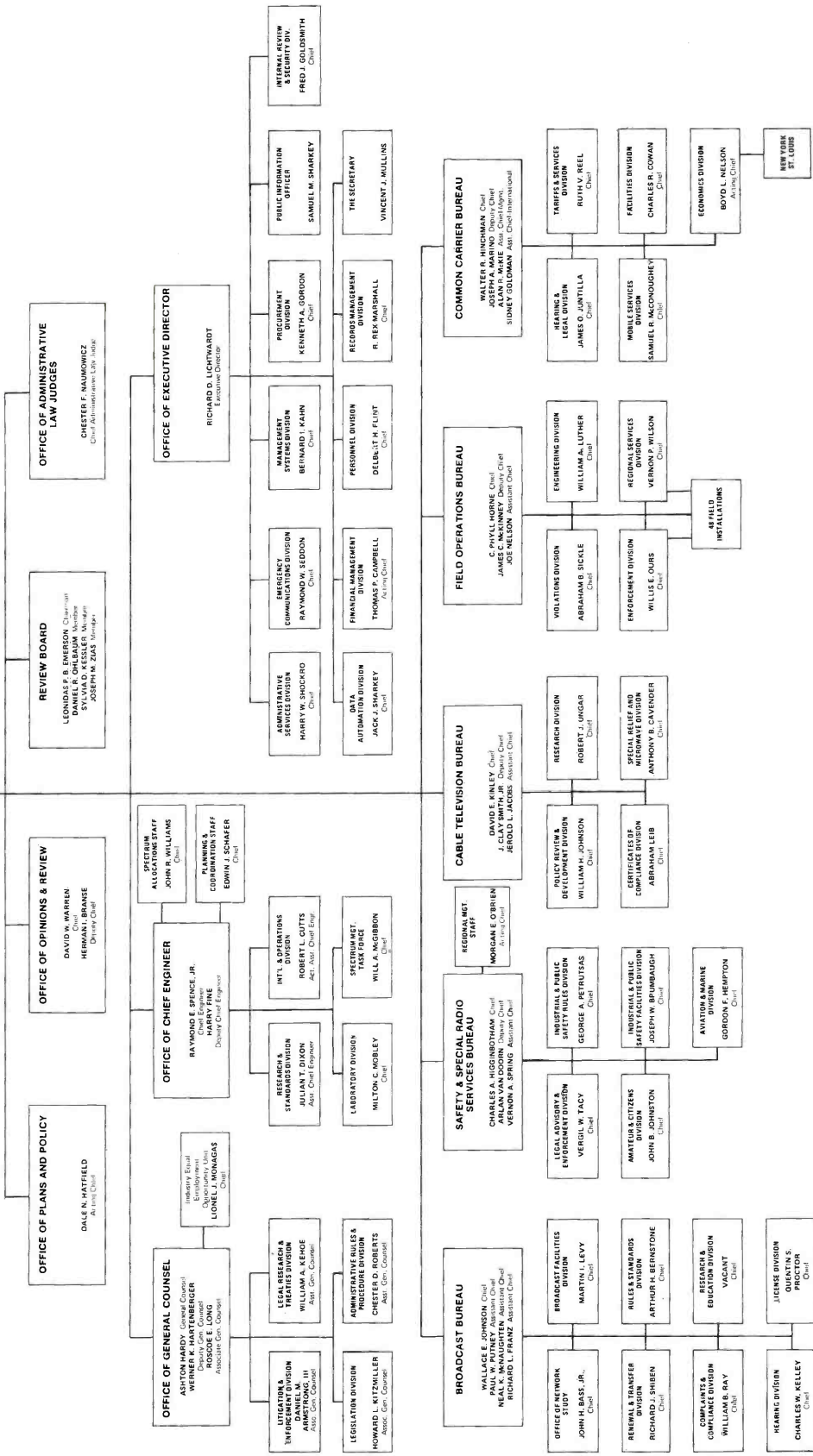

Federal Communications Commission Executives & Staff Personnel

Headquarters: 1919 M St. N.W., Washington 20554.
(202) 655-4000.

Commissioners and Assistants

Richard E. Wiley, chmn (632-6336), Room 814. Republican; assumed office Jan. 5, 1972; became chairman March 8, 1974; term expires June 30, 1977. Lawrence Secrest, admin asst (632-6366); Robert Luff, engrg asst; Dorothy Basso, confidential asst; Donald D. Wear, spec asst; R. Michael Senkowski, legal asst; Mary S. Williams, office asst; Jennifer J. Mock, receptionist; Patricia Windham, Betty Freeman, secs; Edgar Gaskins, clerk.

Robert E. Lee, comr (632-6996), Room 832. Republican; assumed office Oct. 6, 1953; term expires June 30, 1982. Marjorie S. Reed, legal asst; Lawrence Webb, engrg asst; Sharon L. Pope, confidential asst; Eileen Chaney, Linda Netro, secs.

Charlotte T. Reid, comr (632-7007), Room 808. Republican; assumed office Oct. 1, 1971; term expires June 30, 1978. John F. Sturm, legal asst; Emmett B. Kitchen, engrg asst; Delores A. Noble, confidential asst; Mary Phyllis Breen, sec.

Benjamin L. Hooks, comr (632-6446), Room 826. Democrat; assumed office July 5, 1972; term expires June 30, 1979. Norman B. Blumenthal, Albert Baxter, legal assts; Chester Higgins, special asst; Doris V. Coles, confidential asst; Bessie M. Canty, sec.

James H. Quello, comr (632-7557), Room 802. Democrat; assumed office April 30, 1974; term expires June 30, 1980. Allen Cordon, legal asst; William G. Harris, engrg asst; Ethel J. Ciulas, confidential asst; Ruby C. Odone, Ruth E. Richardson, secs.

Abbott Washburn, comr (632-7116), Room 844. Republican; assumed office July 10, 1974; term expires July 30, 1982. Edward W. Cowling, legal asst; Sebastian A. Lasher, engrg asst; Catherine L. Toms, confidential asst; Mary Ann Thompson, Barbara Glover, secs.

Glen O. Robinson, comr (632-7227), Room 822. Democrat; assumed office July 10, 1974; term expires June 30, 1976. Daniel D. Polsby, legal asst; Bonnie J. Herbert, confidential asst; Gloria Hilliard, Diane P. Menefee, secs.

Administrative Departments

Office of Executive Director Room 852.

Richard D. Lichtwardt, exec dir (632-6390). (vacant), deputy exec dir. Financial Management Div.—Thomas P. Campbell, actg chief. Personnel Div.—Delbert H. Flint, chief. Management Systems Div.—Bernard Kahn, chief. Data Automation Div.—Jack Sharkey, chief. Records Management Div.—R. Rex Marshall, chief. Administrative Services Div.—Harry W. Shockro, chief. Emergency Communications Div.—Raymond Seddon, chief. Procurement Div.—Kenneth A. Gordon, chief. Internal Review & Security Div.—Fred Goldsmith. Adm asst to exec dir—Ozella Drake.

The Secretary (Room 222) Vincent J. Mullins, sec (632-6410). Technical Assistance Div.—Gordon J. Kent, chief. Dockets Branch—Joyce C. Butler, chief; Irene J. Christopoulos, asst chief. Minutes Branch—Beulah Hylton, chief; Lorraine Schnaebel, asst chief. Library Branch—Kathleen M. Fagan, chief.

Public Information Office. (Room 202) Samuel B. Sharkey Jr. public information officer (632-7260). (vacant), asst chief; Henry Patrick, Carol Marrion, Thomas H. Otwell, Judith D. Kurtich, Maureen P. Peratino, Rosemary Kimball, writer-editors; Margaret L. White, Ann Taylor, editorial assts; Harold Watson, Alfreda Lyles, Mildred Hayes, clerk typists.

Office of Plans and Policy Room 838.

Dale N. Hatfield, actg chief (632-6312). Dawn Crutchfield, sec to chief; Thomas McKnight, John Lyons, Carlos Roberts, Richard Emerine, Robert Blau, Dr. Raymond Wilmotte, Karen Hartenberger.

Office of Opinions and Review Room 404.

David W. Warren, Jr., chief (632-7220). Herman I. Branse, deputy chief; Walter L. Reitz Jr., John I. Riffer,

Harold R. Deitrick, Jerome D. Remson, Philip A. Wells, Richard S. Martin, Robert G. Seasonwein, Nancy Strickland, Michele Cheadle, Joseph C. Vanzant, Gerald M. Goldstein, Neale T. Adams, Edward W. Hautanan, Louise Florencourt, Steven S. Fadem, attys. Jack Damelin, engr.

Review Board Room 602.

Leonidus P. Emerson, chmn (632-7180); Roberta Poindexter, office asst. Sylvia D. Kessler, Daniel R. Ohlbaum and Joseph Zias, bd members; Esther M. Iglesias, Maxine E. Mulvehill and D. Jane Haddock, secs; Irvin J. Friedland, chief for admin & law; Leland J. Blair, Bonnie H. Lea, Myra G. Kovy, Robert A. Mansbach, David M. Pritzker, Alan Sacks, June A. Schechter, Kathryn A. Schmetzler, Jonathan I. Sternberg, and Freda L. Thyder, attys.

Office of Administrative Law Judges Room 632

Chester F. Naumowicz Jr., chief admin law judge (632-7680). Dorothy Kelly, admin asst; Myrtle F. Gray, sec; Lenore G. Ehrig, asst chief admin law judge; Odessa Pradier, sec to asst chief judge. Admin law judges: John H. Conlin, Frederick W. Denniston, Thomas B. Fitzpatrick, Byron E. Harrison, David I. Kraushaar, Reuben Lozner, Walter C. Miller, Ernest Nash, Joseph Stirmer, James F. Tierney.

Office of General Counsel Room 614.

Ashton R. Hardy, gen counsel (632-7020). Werner K. Hartenberger, deputy gen counsel; Roscoe E. Long, assoc gen counsel; Susan I. West, adm asst.

Litigation and Enforcement Division. Daniel M. Armstrong III, chief (632-7112); Barbara O'Malley, asst chief; John E. Ingle, Clifford G. Pash, Julian Rush, Sheldon Guttman, Steve Sharp, Jack Smith, Diana Evans, Cal Saunders, Raymond L. Strassburger, attys; Michael Hirrel, Nancy Joyner, litigation clk.

Legislation Division Howard Kitzmiller, chief (632-6405); Edward R. Duffy, Joseph D. Hanlon, Richard J. Bodorff, Willard R. Nichols, attys.

Administrative Rules and Procedure Division Chester D. Roberts, chief (632-6444); Upton K. Guthery, asst chief; John W. Hardwick, Edward C. McKenzie, Robert A. Fossaner, Neil M. Katz, Robert C. Ware, Thomas R. King, attys.

Legal Research and Treaties Division William A. Kehoe Jr., chief (632-6990); (vacant) asst chief; John Greenspan, Lawrence Schaffner, David L. Kuhns, Henry C. Bowen, Nancy D. Carey, Charles H. Bell, Charles L. Spencer, attys.

Industry Equal Employment Opportunity Unit Lionel J. Monagas, chief (254-6530); Clarence V. McKee, dep chief.

Office of Chief Engineer Room 7002: 2025 M St. N.W., Washington

Raymond Spence, chief engr (632-7060); Harry Fine, dep.chief; Nona E. Heilmeier, admin off; Arkley Bridforth, admin asst; Romaona M. Wallace, admin clerk; Audrey L. Jones & Rebecca Dent, secs.

Spectrum Allocations Staff: John R. Williams, chief (632-7073); Kenneth R. Nichols, Donald D. Campbell, Joseph V. Cesaitis, Art Feller, engrs; Rodney Small, economist; Herbert H. Wilson Jr., Robert Perry, attys; Janis L. Perkins, analyst; Joyce M. Willis, sec.

Planning and Coordination Staff: Edwin J. Schafer, acting chief (632-7060); Mary Jane Roland, analyst.

Research and Standards Division: Julian Dixon, chief (632-7040). Space Systems Branch: Roger Herbstritt, chief. Special Projects Branch: Jules Deitz, chief. Applied Propagation Branch: Roger B. Carey, chief. Technical Standards Branch: Frank Rose, chief.

International and Operations Division: Robert L. Cutts, acting chief (632-7025); William R. Torak, acting dep. RF Devices/Experimental Branch: Herman Garlan, chief. Treaty Branch: Richard Shrum, chief. Frequency Registration & Notification Branch: Howard F. Wright, chief.

Laboratory Division: Milton C. Mobley, chief (776-3133); Michael Toia, dep. Operations Group: (vacant), chief; Project Control Unit: Sandra L. Haase, specialist. Systems Engineering Group: John J. McMahon, chief.

Spectrum Management Task Force: Will A. McGibbon, chief (632-6350); Morgan O'Brien & Don Olmstead, attys. Systems Engineering Group: John McMahon, chief. Microwave Group: Alvin Reiner, chief. Data Systems Group: Michael J. Gilbride, chief. Chicago Regional Center (312-298-7340).

Bureaus

Broadcast Bureau Room 314.

Wallace E. Johnson, chief (632-6460); Paul W. Putney, deputy chief Neal K. McNaughten, asst chief; Richard L. Franz, asst bureau chief for mgmt; Larry D. Eads, opns rsch analyst; Angie P. Smith, admin off; Gloria D. Simonetta, admin asst; Doris P. Cooper, sec to Mr. Johnson; Emma C. Mebane, sec to Mr. Putney; Elizabeth Lindsley, sec to Mr. McNaughten.

Broadcast Facilities Division (Room 302) Martin I. Levy, chief (632-6485); David S. Landis, asst chief; K. Gordon Oppenheimer, atty; Julius Kurtz, staff accountant; Margaret M. Lipske, sec to Mr. Levy; Gwendolyn J. Grier, sec to Mr. Landis. Aural Existing Facilities Branch: Dennis L. Williams, chief; Robert A. Hayne, atty; Byron Bradley, William Moore, Paul Palmer, engrs; John Sadler, electronics technician; William Cote, staff accountant; Delores Tapscoot, sec. Aural New & Changed Facilities Branch: H. John Morgan, chief; Hugh M. Reed, supervisory atty; James Faust, Robert Umland, attys; John Boursy, Nai Tam, Henry Allen, Thomas Polzin, Michael Fox, Stuart Overby, Robert Hart, Edward Lubetzky, engrs; Thomas English, electronics technician; Charles Estep, broadcast analyst; Rose M. Bettick, sec to Mr. Morgan. Technical & Allocations Branch: Lloyd R. Smith, chief; John Chambers, Steven Selwyn, Bernard Gorden, engrs; Robert Burkhardt, electronics technician; Diane F. Blair, sec to Mr. Smith. TV Applications Branch: Samuel L. Saady, chief; Clyde Gurley, supervisory electronics engr; John Bentley, Clay Pendarvis, Eric Chase, attys; William Martin, Albert Jarratt, Charles Breig, Kenneth Kidder, Philip Gieseler, James Audet, Steven Linn, engrs; Raymond Mansing, electronics technician; Lucille J. Graves, sec to Mr. Saady.

Complaints and Compliance Division (Room 332) William B. Ray, chief (632-6968); Arthur Ginsburg, asst chief; Arthur Steinberg, William J. Gay, attys; Delores C. Browder, sec to Mr. Ray; Betty Blumberg, chief, Control Section. Complaints Branch: Stephen Sewell, chief; Jack Estep, Daniel Moyer, John McDonald, Dorothy Flores, Mitchell Brecher, Lee Peitzman, attys; Carroll White, Milton Adams, broadcast specialists; Arthur Gearheart, complaints asst; Martha Dobbins, sec to Mr. Sewell. Compliance Branch: Merlin Smith, chief; Lawrence Clance, Floyd Prevost, Brian Kilbane, Alfred Tripp, Marilyn Bain, Keltner Locke, Joel Rosenberg, Aaron Shainis, Alan Gray, Charles Stanford, attys; Charles Gray, James Lyddane, investigators; Ralph Blumberg, Thomas Winkler, broadcast specialists. Fairness/Political Broadcasting Branch: Milton O. Gross, chief; Irving Gastfreund, Mark Solberg, Eduard Berlin, attys.

Hearing Division (Room 342) Charles W. Kelley, chief (632-6402); (vacant), asst chief; David Silberman, William Silva, Joseph Chackin, Jack Kelly, Michael Fitch, Charles Dziedzic, Bruce Eisen, Theodore Kramer, Keith Fagan, Norman Goldstein, Eric Kravetz, Raymond Kowalski, Barbara Kreisman, Roderick Porter, William Keane, Charles Dahquist, Robert Zauner, Lawrence Bernstein, attys; Frederic Schottland, supervisory electronics engr; Larry Olson, Hinton Richardson, Thomas Johnson, engrs; Mae Whitlock, sec to Mr. Kelley; Margaret Northrup, sec to Mr. Schottland.

License Division (Room 242) Quentin S. Proctor, chief (632-6334); Mildred Satterfield, license fee clerk; James Martin, public reference asst, reference room; William Alston, chief, files section. AM-FM Branch: David Tau, chief; Rose Mumaw, Susann Putzek, Barbara Riddick, Olga Broderick, supervisory applications examiners. Miscellaneous Services Branch: James Durst, chief. TV Branch: Paul deLeon, chief.

FCC Staff & Former Members

Office of Network Study (A-323) John H. Bass Jr., chief (632-6939); Walter T. Maguire, atty; Sarah Caplan, research asst.

Renewal and Transfer Division (Room 702) Richard J. Shiben, chief (632-6993); James Brown, asst chief; James Powers, Adam Jamin, engr; Gertrude Koenigsberg, sec to Mr. Shiben; David Weston, chief control section. **Renewal Branch:** James R. Hobson, chief; Henry Baumann, Carol Foelak, William Watson, Francis McDonough, Stuart Grozbean, Martin Blumenthal, Israel Teitelbaum, Thomas McCoy, Terrence Reideler, Stanley Wiggins, Tullio Wells, John Spencer, Arnold Spevak, Donald Crosby, Patricia Russell, Steven Jemison, Marcus Rindal, Rudolph Ennis, John Cary Jr., attys; Simon Lowen, supervisory broadcast specialist; Glenn Wolfe, equal opportunity off; Esther Martinez, equal opportunity specialist; George Eisenberger, staff accountant; Anita Thomas, sec to Mr. Hobson. **Transfer Branch:** Roy Stewart, chief; Peter Monahan, Stuart Bedell, Alan Glasser, David Blank, Robert Linthicum, Jeffrey Malickson, P. Philip Peterson, Tom Albers, Fred Bartlett, H. Taft Snowden, Jonathan Owens, Dennis Kahane, Rock Albers, Edwin Jorgensen, attys; Eula Staten, sec to Mr. Stewart.

Research and Education Division (Room 420) (vacant), chief (632-7213). **Research Branch:** Alexander Korn, chief; Nathan Epstein, supervisory industry economist; Scott Roberts, industry economist; Miriam Gang, statistician; Sharlene Lofly, sec to Mr. Korn. **Educational Broadcasting Branch:** Robert Hilliard, chief; Minnie Rainey, sec to Mr. Hilliard.

Rules and Standards Division (Room 8010-2025 M St. N.W.) Arthur H. Bernstone, chief (632-5414); John Taff, asst chief; Philip Cross, Jonathan David, Lynne Kaufman, Barry Umansky, Rudolph Luter, Joseph Ryan, John Lindsay, Andrew Rhodes, James Gross, Mark Lipp, attys; Hideyuki Noguchi, Gregory De Priest, Ralph Smith, Gordon Godfrey, Bobby Darr, engr; James Crane, Mildred Nesterak, broadcast specialists; Leslie Shapiro, sec to Mr. Bernstone.

Cable Television Bureau

2025 M St., 6th fl.

David Kinley, chief (632-6480); J. Clay Smith, dep chief (632-6483); Jerold L. Jacobs, asst chief; Joann B. Fleming, admin off.

Certificate of Compliance Division Abraham A. Leib, chief (632-7480); Gregory Weiss, chief, Processing Branch A (254-3407); Angela B. Green, chief, Processing Branch B (254-3430); Laurence Bloom, chief, Processing Branch C (254-3440).

Special Relief and Microwave Division Anthony B. Cavender, chief (632-8882). **Special Relief & Enforcement Branch:** Roger Seltzer, chief (632-9703). **Microwave Branch:** Frances Peck, chief (254-3420).

Research Division Robert J. Ungar, chief (632-9797).

Policy Review and Development Division William H. Johnson, chief (632-6468).

Safety & Special Radio Services Bureau

Room 5002

2025 M St. N.W., Washington 20036.

Charles A. Higginbotham, chief (632-6940). Arlan K. van Doorn, deputy chief; Vernon A. Spring, asst chief; Elle Jordre, admin officer. **Legal Advisory and Enforcement Div.:** Vergil Tacy, chief. **Aviation and Marine Div.:** Gordon Hempton, chief. **Industrial and Public Safety Rules Div.:** George Petrusas, chief. **Industrial and Public Safety Facilities Div.:** Joseph Brumbaugh, chief. **Amateur and Citizens Div.:** John B. Johnston, chief.

Common Carrier Bureau

Room 500.

Walter R. Hinchman, chief (632-6910); Joseph A. Marino, deputy chief; Sidney Goldman, asst chief/international; Alan R. McKie, asst chief/mgt; Philip V. Permut, spec asst to bureau chief; Mary A. O'Neil, admin asst. **Hearing & Legal Division:** James O. Juntilla, chief (632-7500). **Tariffs & Services Division:** Ruth V. Reel, chief (632-6387). **Mobile Services Division:** Samuel R. McConoughey, chief (632-6400). **Facilities Division:** Charles R. Cowan, chief (632-6415). **Economics Division:** Boyd L. Nelson, actg chief. **AT&T Task Force:** Peter M. Andersen, mgng counsel.

Field Operations Bureau

Room 734.

C. Phyll Horne, chief (632-6980); James C. McKinney, deputy chief; Sylvia B. Sternstein, atty adviser; Rose M. Crutchfield, admin off; Willis E. Ours Jr., chief, Enforcement Div.; William A. Luther, chief, Engineering Div.; Vernon P. Wilson, chief, Regional Services Div.; Abraham Sickle, chief, Violations Div.

District Offices District 1: 1600 Customhouse, Boston 02109. 223-6608. Gerard Sarno, engr in charge.

District 2: 201 Varick St., New York 10014. (212) 620-3435. Henry Paulisen, engr in charge.

District 3: 11425 James A. Byrne Federal Court-house, 601 Market St., Philadelphia 19106. 597-4410, Ennis C. Coleman, Jr., engr in charge.

District 4: 819 Federal Bldg., 31 Hopkins Plaza, Baltimore 21201. 962-2727. Benjamin Berkowitz, engr in charge.

District 5: Military Circle, 870 N. Military Highway, Norfolk, Va. 23502. (804) 441-6611. J. Jerry Freeman, engr in charge.

District 6: 1602 Gas Light Tower, 235 Peachtree Street N.E., Atlanta 30303. 526-6381. Angelo R. Ditty, Jr., engr in charge. **Sub-Office:** Room 238, Federal Bldg & Courthouse, Savannah, Ga. 31402. (912) 232-4320. Calvin W. Graves, radio engr.

District 7: 51 S.W. First Ave., Miami 33130. 350-5541. Jack J. May, engr in charge. **Sub-Office:** Room 738 Federal Bldg., 500 Zack St., Tampa, Fla. 33602. 228-2605. Ralph M. Barlow, engr in charge.

District 8: 829 F. Edward Hebert Federal Bldg, 600 South St., New Orleans 70130. 527-2094. William J. Simpson, engr in charge. **Sub-Office:** 439 U.S. Courthouse & Customhouse, Mobile, Ala. 36602. 690-2808. Wayne E. Hall, engr in charge.

District 9: Room 5636 New Federal Office Bldg., 515 Rusk Ave., Houston 77002. 226-4306. Daniel A. Cantrell, engr in charge. **Sub-Office:** Room 323 Federal Bldg., 300 Willow St., Beaumont, Tex 77701. 838-0271, ext 317. Barry L. Nadler, engr in charge.

District 10: Room 13E7, 1100 Commerce St.,

Dallas. 749-3243. Carle E. Pyron, engr in charge.

District 11: 1758 U.S. Courthouse, 312 No. Spring St., Los Angeles 90012. 688-3276. Serge Marti-Volkoff, engr in charge. **Sub-Office:** 1245 Seventh Ave., San Diego 92101. 293-5460. Clarence C. Spillman, Jr., engr in charge. **Sub-Office:** Room 2525, 300 South Ferry St., San Pedro, Calif. 90731. Phone: 548-2542. (vacant), engr in charge.

District 12: 323-A Customhouse, 555 Battery St., San Francisco 94111. 556-7700. Ney R. Landry, engr in charge.

District 13: 1782 Federal Office Bldg, 1220 S.W. Third Ave., Portland, Ore. 97204. 221-3097. George F. Wager, engr in charge.

District 14: 3256 Federal Bldg, 915 Second Ave., Seattle 98174. 442-7653. Robert C. Dietsch, engr in charge.

District 15: 504 U.S. Customhouse, Denver 80202. 837-4053. Warren D. George, engr in charge.

District 16: 691 Federal Bldg. & U.S. Courthouse, 316 N. Robert Streets, St. Paul 55101. 725-7819. Harold E. Allen, engr in charge.

District 17: Room 1703 Federal Bldg, 601 E. 12th St., Kansas City, Mo. 64106. 374-5526. James T. Crowell, engr in charge.

District 18: 230 S. Dearborn St., Room 3935, Chicago 60604. 353-5388. Ernest J. Galins, engr in charge.

District 19: 1054 Federal Bldg., Detroit 48226. 226-6077, ext 441. Edward Atems, engr in charge.

District 20: 1307 Federal Bldg, 111 W. Huron St., Buffalo, N.Y. 14202. 842-3216. John L. Theimer, engr in charge.

District 21: Room 502 Federal Bldg, Honolulu 96808. 546-5640. Melvin S. Vittum, engr in charge.

District 22: Room 322 Federal Bldg., San Juan, P.R. 00903. 722-4562. Eugene W. Klein, engr in charge.

District 23: Room G63, U.S. Post Office & Court-house Bldg. Anchorage 99510. 272-1822. John S. Phillips, engr in charge.

District 24: Room 411, 1919 M St., N.W. Washing-ton 20554. (202) 632-7000. Paul J. Harris, engr in charge.

Past Membership

Members of Former Federal Radio Commission

Feb. 23, 1927—July 10, 1934.

Colonel John F. Dillon, Calif., March 15, 1927—Oct. 8,

1927 (Deceased)

Henry A. Bellows, Minn., March 15, 1927—Oct. 31,

1927 (Deceased)

Admiral W. H. G. Bullard, Pa., March 15, 1927—Nov.

24, 1927 (Deceased)

Sam Pickard, Kan., Nov. 1, 1927—Jan. 31, 1929

Orestes H. Caldwell, New York, March 15, 1927—Feb.

23, 1929

Eugene O. Sykes, Miss., March 15, 1927—July 10,

1934 (Deceased)

Harold A. Lafount, Utah, Nov. 14, 1927—July 10, 1934

(Deceased)

Ira E. Robinson, W. Va., March 29, 1928—Jan. 15,

1932 (Deceased)

General C. McK. Saltzman, Iowa, May 2, 1929—July

19, 1932 (Deceased)

Thad H. Brown, Ohio, Jan. 21, 1932—July 10, 1934

(Deceased)

James H. Hanley, Neb., Apr. 1, 1933—July 10, 1934

(Deceased)

Past Members of Federal Communications Commission

Hampson Gary, Tex. July 11, 1934—Dec. 24, 1934

(Deceased)

Irvin Stewart, Tex. July 11, 1934—June 30, 1937

Eugene O. Sykes, Miss. July 11, 1934—Apr. 5, 1939

(Deceased)

Thad H. Brown, Ohio July 11, 1934—June 30, 1940

(Deceased)

George H. Payne, N. Y. July 11, 1934—June 30, 1943

(Deceased)

Norman S. Case, R. I. July 11, 1934—June 30, 1945

(Deceased)

Paul Atlee Walker, Okla. July 11, 1934—June 30,

1953 (Deceased)

Anning S. Prall, N.Y., Jan. 17, 1935—July 23, 1937

(Deceased)

T. A. M. Craven, D. C. Aug. 21, 1937—June 30, 1944;

July 2, 1956—Jan. 31, 1963 (Deceased)

Frank R. McNinch, N. C. Oct. 1, 1937—Aug. 31, 1939

(Deceased)

Frederick I. Thompson, Ala. Apr. 8, 1939—June 30,

1941 (Deceased)

James Lawrence Fly, Tex. Sept. 1, 1939—Nov. 13,

1944 (Deceased)

Ray C. Wakefield, Calif. Mar. 22, 1941—June 30, 1947

(Deceased)

Clifford J. Durr, Ala. Nov. 1, 1941—June 30, 1948

(Deceased)

Ewell K. Jett, Md. Feb. 15, 1944—Dec. 31, 1947

(Deceased)

Paul A. Porter, Ky. Dec. 21, 1944—Feb. 25, 1946

(Deceased)

Rosel H. Hyde, Idaho April 17, 1946—Oct. 31, 1969

Charles R. Denny Jr., D. C. Mar. 30, 1945—Oct. 31,

1947

William H. Wills, Vt. July 1, 1945—Mar. 6, 1946

(Deceased)

Edward Mount Webster, D. C. Apr. 10, 1947—June 30,

1956

Robert Franklin Jones, Ohio Sept. 5, 1947—Sept. 19,

1952 (Deceased)

Albert Wayne Coy, Ind. Dec. 29, 1947—Feb. 21, 1952

(Deceased)

George Edward Sterling, Me. Jan. 2, 1948—Sept. 30,

1954

Frieda Barkin Hennock, N. Y. July 6, 1948—June 30,

1955 (Deceased)

Eugene H. Merrill, Utah Oct. 14, 1952—Apr. 15, 1953

(Recess Appointee) (Deceased)

John C. Doerfer, Wis. Apr. 15, 1953—Mar. 21, 1960

George C. McConnaughey, Ohio Oct. 4, 1954—June 30,

1957 (Deceased)

Richard A. Mack, Fla. July 7, 1955—Mar. 3, 1958

(Deceased)

Frederick W. Ford, W. Va. Aug. 29, 1957—Dec. 31,

1964

John S. Cross, Ark. May 23, 1958—Sept. 30, 1962

Charles H. King, Mich. July 19, 1960—Mar. 2, 1961

(Recess Appointee)

Newton N. Minow, Ill. Mar. 2, 1961—June 1, 1963

E. William Henry, Tenn. Oct. 2, 1962—Apr. 30, 1966

Kenneth A. Cox, Wash., March 26, 1963—Sept. 1,

1970

Lee Loevinger, Minn. July 11, 1963—June 30, 1968

James J. Wadsworth, N. Y. May 5, 1965—Nov. 6, 1969

Thomas J. Houser, Ill. Jan. 7, 1971—Oct. 1, 1971

Robert Wells, Kan. Nov. 6, 1969—Nov. 1, 1971

Robert T. Bartley, Tex. March 6, 1952—June 30, 1973

Nicholas Johnson, Iowa, July 1, 1966—Dec. 5, 1972

H. Rex Lee, D.C. Oct. 28, 1968—Dec. 31, 1973

Dean Burch, Ariz. Oct. 31, 1969—March 8, 1974

FCC Rules and Regulations

For reader convenience, the FCC rules reported below have been organized by subject, rather than by strict sequence of paragraph and section numbers. Rules for AM, FM and TV are grouped under the following headings.

Definitions (§§73.1-.12).....	page A-11
Allocations (§§73.21-.29, 73.201-.211, 73.603-.614).....	page A-11
Multiple ownership (§§73.35, 73.240, 73.636).....	page A-15
Studio location (§§73.30, 73.210, 73.613).....	page A-18
Operating schedules (§§73.71-3, 73.79-88, 73.98-9, 73.242-2, 73.651).....	page A-19
Operator requirements (§§73.93, 73.265, 73.661).....	page A-21
Personal Attack, political (§§73.123, 73.300, 73.679).....	page A-22
Equal employment (§§73.125, 73.301, 73.680).....	page A-22
Affiliation (§§73.131-.138, 73.231-.239, 73.658).....	page A-22
Common antenna (§73.635).....	page A-25
Reports and records (§§1.611-.615, 1.526).....	page A-25
License renewals (§§1.539, 73.34, 73.218, 73.630).....	page A-27
Station identification (§73.1201).....	page A-27
Sponsored programs (§73.1212).....	page A-27
Public notice (§73.1202).....	page A-28
Fraudulent billing (§73.1205-.1206).....	page A-29
Rebroadcasts (§73.1207).....	page A-29
Recording (§73.1208).....	page A-29
Political broadcasts (§73.120).....	page A-29
License revocations (§§1.85-.92).....	page A-29
Logs (§1.6).....	page A-30
Lotteries (§73.1211).....	page A-31
Censorship (§326 [Communications Act]).....	page A-31
Fees.....	page A-31

Compiled with the cooperation of Pike & Fischer Inc., publisher of Pike & Fischer Radio Regulation. Correct to Oct. 15, 1975.

Definitions

In AM rules...

§73.1 Standard broadcast station.—The term "standard broadcast station" means a broadcasting station licensed for the transmission of radio-telephone emissions primarily intended to be received by the general public and operated on a channel in the band 535-1605 kilohertz per second (khz).

§73.2 Standard broadcast band.—The term "standard broadcast band" means the band of frequencies extending from 535-1605 khz.

§73.3 Standard broadcast channel.—The term "standard broadcast channel" means the band of frequencies occupied by the carrier and two side bands of a broadcast signal with the carrier frequencies. The 107 carrier frequencies assigned to standard broadcast stations shall begin at 540 khz and be in successive steps of 10 khz.

§73.4 Dominant station.—The term "dominant station" means a Class I station, as defined in §73.21, operating on a clear channel.

§73.5 Secondary station.—The term "secondary station" means any station, except a Class I station, operating on a clear channel.

§73.6 Daytime.—The term "daytime" means that period of time between local sunrise and local sunset.

§73.7 Nighttime.—The term "nighttime" means that period of time between local sunset and local sunrise.

§73.8 Sunrise and sunset.—The terms "sunrise" and "sunset" mean, for each particular location and during any particular month, the time of sunrise and sunset as specified in the instrument of authorization. See §73.83.

§73.9 Broadcast day.—The term "broadcast day" means that period of time between local sunrise and 12 midnight local time.

§73.10 Experimental period.—The term "experimental period" means that time between 12 midnight local time and local sunrise. This period may be used for experimental purposes in testing and maintaining apparatus by the licensee of any standard broadcast station on its assigned frequency and with its authorized power, provided no interference is caused to other stations maintaining a regular operating schedule within such period. No station licensed for "daytime" or "specified hours" of operation may broadcast any regular or scheduled program during this period.

§73.11 Service areas.—(a) The term "primary service area" of a broadcast station means the area in which the ground wave is not subject to objectionable

interference or objectionable fading.

(b) The term "secondary service area" of a broadcast station means the area served by the sky wave and not subject to objectionable interference. The signal is subject to intermittent variations in intensity.

(c) The term "intermittent service area" of a broadcast station means the area receiving service from the ground wave but beyond the primary service area and subject to some interference and fading.

§73.12 Portable transmitter.—The term "portable transmitter" means a transmitter so constructed that it may be moved about conveniently from place to place, and is in fact so moved about from time to time, but not ordinarily used while in motion. In the standard broadcast band, such a transmitter is used in making field intensity measurements for locating a transmitter site for a standard broadcast station. A portable broadcast station will not be licensed in the standard broadcast band for regular transmission of programs intended to be received by the public.

Allocations

In AM rules...

§73.21 Classes of standard broadcast channels and stations.

(a) Clear channel. A clear channel is one on which the dominant station or stations render service over wide areas, and which are cleared of objectionable interference within their primary service areas and over all or a substantial portion of their secondary service areas. Stations operating on these channels are classified as follows:

(1) Class I station. A Class I station is a dominant station operating on a clear channel and designed to render primary and secondary service over an extended area and at relatively long distances. Its primary service area is free from objectionable interference from other stations on the same and adjacent channels, and its secondary service area free from interference except from stations on adjacent channels, and from stations on the same channel in accordance with the channel designation in §73.25 or §73.182. The operating power shall not be less than 10 kilowatts nor more than 50 kilowatts. (Also see §73.25 [a] for further power limitation.)

(2) Class II station. A Class II station is a secondary station which operates on a clear channel (see §73.25) and is designated to render service over a primary service area which is limited by and subject to such interference as may be received from Class I stations. Whenever necessary a Class II station shall use a directional antenna or other means to avoid interference with Class I stations and with other Class II stations, in accordance with §73.182 (and §73.22 in the case of Class II-A stations). Class II stations are divided into three groups:

(i) Class II-A station. A Class II-A station is an unlimited time Class II station operating on one of the clear channels listed in §73.22 and assigned to a community within a state specified in the Table contained in that section. A Class II-A station shall operate with power of not less than 10 kilowatts nighttime nor more than 50 kilowatts at any time.

(ii) Class II-B station. A Class II-B station is an unlimited time Class II station other than those included in Class II-A. A Class II-B station shall operate with power not less than 0.25 kilowatts nor more than 50 kilowatts.

NOTE: The Class II station operating unlimited time on 760 khz at San Diego and the Class II station operating unlimited time on 750 khz at Anchorage, Alaska, shall be limited to a power of 10 kw. Both stations shall protect the I-A station on the same frequency to its 0.5 mv/m 50% skywave contour.

(iii) Class II-D station. A Class II-D station is a Class II station operating daytime or limited time. A Class II-D station shall operate with power not less than 0.25 kilowatts nor more than 50 kilowatts.

(b) Regional channel. A regional channel is one on which several stations may operate with powers not in excess of 5 kilowatts. The primary service area of a station operating on any such channel may be limited to a given field intensity contour as a consequence of interference.

(1) Class III station. A Class III station is a station which operates on a regional channel and is designed to render service primarily to a principal center of population and the rural area contiguous thereto. Class III stations are subdivided into two classes.

(i) Class III-A station. A Class III-A station is a Class III station which operates with power not less than 1 kilowatt nor more than 5 kilowatts and the service area of which is subject to interference in accordance with §73.182.

(ii) Class III-B station. A Class III-B station is a Class III station which operates with power not less than 0.5 kilowatt, nor more than 1 kilowatt night and 5 kilowatts daytime, and the service area of which is subject to interference in accordance with §73.182.

(c) Local channel. A local channel is one on which several stations operate with powers no greater than provided in this paragraph. The primary service area of a station operating on any such channel may be limited to a given field intensity contour as a consequence of interference. Such stations operate with power no greater than 250 watts nighttime, and no greater than 1 kilowatt daytime (except that for stations in an area in the State of Florida south of the parallel 28 degrees north latitude, and between the meridians 80 and 82 degrees west longitude, power is limited to 250 watts, daytime and nighttime).

(1) Class IV station. A Class IV station is a station operating on a local channel and designed to render service primarily to a city or town and the suburban and rural areas contiguous thereto. The power of a station of this class shall not be less than 0.25 kilowatt, and not more than 0.25 kilowatt nighttime and 1 kilowatt daytime, and its service area is subject to interference in accordance with §73.182. Stations which are licensed to operate with 100 watts day or night may continue to do so.

NOTE 1: Under NARBA, the power ceiling for Class IV stations is 250 watts daytime, as well as nighttime. The U.S./Mexican Agreement permits such stations to operate with power not in excess of 1 kilowatt daytime. Pursuant to the U.S./Mexican Agreement and informal coordination with the NARBA signatories, the Commission will consider applications for Class IV stations on local channels with daytime powers in excess of 250 watts, up to 1 kilowatt, if such stations are outside of the area specified in paragraph (c) of this section, and if no objectionable interference would be caused (under the standards set forth in the pertinent international agreement) to a duly notified station in Mexico, Haiti, or any foreign country signatory to NARBA.

NOTE 2: Class IV stations located within 100 kilometers (62 miles) of the Mexican border, and presently authorized to operate with a daytime power of 250 watts, may file applications for increases in daytime power to 1 kilowatt. However, such an application will be granted only after coordination with Mexico of the proposed increase, if required, pursuant to Annex IV to the U.S./Mexican Agreement.

NOTE 3: All authorizations of new or changed Class I-B, Class II-B, Class II-D, Class III or Class IV facilities after October 30, 1961, are subject to what-

FCC Rules

ever interference may be received from, or whatever overlap of 2.0 mv/m and 25 mv/m groundwave, contours may be involved with previously or subsequently authorized Class II-A facilities.

§73.22 Assignment of Class II-A stations.

(a) Table of assignments. One Class II-A station may be assigned on each channel listed in the following table within the designated state or states:

Channel (kHz)	Location of Existing Class I Station	State(s) in which Class II-A Assignment may be Applied for
670	Chicago	Idaho
720	Chicago	Nevada or Idaho
780	Chicago	Nevada
880	New York	No. Dakota, So. Dakota or Nebraska
890	Chicago	Utah
1020	Pittsburgh	New Mexico
1030	Boston	Wyoming
1100	Cleveland	Colorado
1120	St. Louis	California or Oregon
1180	Rochester	Montana
1210	Philadelphia	Kansas Nebraska or Oklahoma

(b) Minimum service to "white" areas. No Class II-A station shall be assigned unless at least 25% of its nighttime interference-free service area or at least 25% of the population residing therein receives no other interference-free nighttime primary service.

(c) Power. Class II-A stations shall operate with not less than 10 kw power nighttime.

(d) Protection. (1) Protection by Class II-A stations to other stations. The co-channel Class I-A station shall be protected by the Class II-A station to its 0.1 mv/m contour daytime and its 0.5 mv/m 50% skywave contour nighttime. All other stations of any class authorized on or before October 30, 1961, shall normally receive protection from objectionable interference from Class II-A stations as provided in §73.182.

(2) Protection to Class II-A stations. A Class II-A station shall normally receive daytime protection to its 0.5 mv/m groundwave contour and nighttime protection to the contour to which it is limited by the co-channel Class I-A station.

(e) Applications not complying with this section. Applications for Class II-A stations which do not meet the requirements of paragraphs (b) and (c) of this section will be returned without further consideration.

§73.23 Time of operation of the several classes of stations.—The several classes of standard broadcast stations may be licensed to operate in accordance with the following:

(a) "Unlimited time" permits operation without a maximum limit as to time.

(b) "Limited time" is applicable to Class II (secondary) stations operating on a clear channel with facilities authorized before Nov. 30, 1959. It permits operation of the secondary station during daytime, and until local sunset if located west of the dominant station on the channel, or if located east thereof, until sunset at the dominant station; and in addition during night hours, if any, not used by the dominant station or stations on the channel.

(c) Daytime permits operation during the hours between average monthly local sunrise and average monthly local sunset.

(d) "Sharing time" permits operation during hours which are so restricted by the station license as to require a division of time with one or more other stations using the same channel.

(e) Specified hours means that the exact operating hours are specified in the license. (The minimum hours that any station shall operate are specified in §73.71.) Specified hours stations operating on local channels, except those sharing time with other stations may operate at hours beyond those specified in their licenses to carry special events programming. To the extent that such operation is conducted during the nighttime hours, the station's authorized nighttime facilities must be used.

§73.24 Broadcast facilities; showing required. An authorization for a new standard broadcast

station or increase in facilities of an existing station will be issued only after a satisfactory showing has been made in regard to the following, among others:

(a) That the proposed assignment will tend to effect a fair, efficient and equitable distribution of radio service among the several states and communities.

(b) That a proposed new station (or a proposed change in the facilities of an authorized station) complies with the pertinent requirements of §73.37.

NOTE: The provisions of §73.37 shall not be applicable to new Class II-A stations or to stations for which applications were accepted for filing before July 13, 1964. With respect to such stations, the provisions of §73.28(d), and the provisions of NOTE 1 of §73.37 shall apply. Special provisions concerning interference from Class II-A to stations of other classes authorized after October 30, 1961 are contained in §73.22(d) and NOTE 3 to §73.21. The level of interference shall be computed pursuant to §573.182 and 73.186.

(c) That the applicant is financially qualified to construct and operate the proposed station.

(d) That the applicant is legally qualified. That the applicant (or the person or persons in control of an applicant corporation or other organization) is of good character and possesses other qualifications sufficient to provide a satisfactory public service.

(e) That the technical equipment proposed, the location of the transmitter, and other technical phases of operation comply with the regulations governing the same, and the requirements of good engineering practice. (See technical regulations of this subpart and §73.188.)

(f) That the facilities sought are subject to assignment as requested under existing international agreements and the rules and regulations of the Commission.

(g) That the population within the 1 m/v contour does not exceed 1.0 percent of the population within the 25 mv/m contour; Provided, however, that where the number of persons within the 1 m/v contour is 300 or less the provisions of this subparagraph are not applicable.

(h) That, in the case of an applicant for a Class II station the proposed station would radiate, during two hours following local sunrise and two hours preceding local sunset, in any direction toward the 0.1 mv/m ground-wave contour of a co-channel United States Class I station, no more than the maximum radiation values permitted under the provision of §78.187.

(i) That, in the case of an application for a Class II-A station (see §73.22), 25% or more of the area of population within the nighttime interference-free service contour of the proposed station receives no nighttime interference-free primary service from another station.

(j) That the 25mv/m contour encompasses the business district of the community to which the station is assigned, and that the 5 mv/m contour (or, at night, the interference-free contour, if of a higher value) encompasses all residential areas of such community.

(k) That the public interest, convenience and necessity will be served through the operation under the proposed assignment.

§73.25 Clear channels: Classes I and II stations.—The frequencies in the following tabulations are designated as clear channels and assigned for use by the classes of stations given:

(a) On each of the following channels, one Class I station will be assigned, operating with power of 50 kw: 640, 650, 660, 670, 700, 720, 750, 760, 780, 820, 830, 840, 870, 880, 890, 1020, 1030, 1040, 1110, 1120, 1160, 1180, 1200 and 1210 khz. In addition, on the channels listed in this paragraph, Class II stations may be assigned as follows:

(1) On 670, 720, 780, 880, 890, 1020, 1030, 1100, 1120, 1180 and 1210 khz, one Class II-A unlimited time station, assigned and located pursuant to the provisions of §73.22.

(2) On the channel 750 khz, an unlimited time Class II station located at Anchorage.

(3) On the channel 760 khz, an unlimited time Class II station located at San Diego, Calif.

(4) On any of the channels listed in this paragraph (to the extent consistent with the assignments provided in subparagraphs [1], [2], and [3] of this paragraph), unlimited time Class II stations located in Alaska, Hawaii, Virgin Islands, or Puerto Rico, which will not deliver more than 5 microvolts per meter groundwave day or night or microvolts per meter 10 percent time skywave at night at any point within the continental limits of the United States excluding Alaska.

(5) On any of the channels listed in this paragraph (to the extent consistent with the Class I, Class II-A, and Anchorage and San Diego Class II assignments

provided in this paragraph, and, in the case of limited time stations, subject to the restrictions contained in §73.38), limited time and daytime only stations, as follows:

(i) In Alaska, Hawaii, Puerto Rico and Virgin Islands.

(ii) Within the continental United States excluding Alaska, where the station would operate with facilities authorized as of October 30, 1961.

NOTE 1: In view of special circumstances arising from the provision of presunrise broadcast service on 640 khz at Ames, Iowa, applications will be accepted for broadcast operations on 640 khz between 6:00 a.m. central standard time and local sunrise at Ames, Iowa, with not to exceed 1 kw power: provided, that such applications will be acted upon only after and in light of the decision reached in Docket No. 11290.

NOTE 2: In view of special circumstances arising from the provision of a service during some nighttime hours by a Class II station operating on 830 khz at New York, N.Y., (i.e., from 6:00 a.m. to local sunrise and from sunset at Minneapolis to 10:00 p.m. E.S.T.), applications will be accepted for such operation: Provided, that they will be acted upon only after and in light of the decision reached in Docket No. 11227.

NOTE 3: The question of whether two Class I stations should be assigned to 770 khz, and if so how they should operate, has not been determined.

NOTE 4: See NARBA concerning priority for Canadian Class I-B and Cuban I-C assignments on 640 khz.

NOTE 5: NARBA concerning Cuban Class II-E assignments on 660, 670, 760, 780, 830, 1020, 1030 and 1120 khz.

NOTE 6: See U.S.-Mexican Agreement concerning Mexican use of 660, 760, 830, 1020, 1030, and 1180 khz.

(b) To each of the following channels there may be assigned Class I and Class II stations: 680, 710, 810, 850, 940, 1000, 1060, 1070, 1080, 1090, 1110, 1130, 1140, 1170, 1190, 1500, 1510, 1520, 1530, 1540, 1550 and 1560 khz.

NOTE: Class I and Class II stations on 1540 khz shall deliver not over 5 microvolts per meter groundwave or 25 microvolts per meter 10 percent time skywave at any point of land in the Bahama Islands, and such stations operating nighttime (i.e., sunset to sunrise at the location of the Class II station) shall be located not less than 650 miles from the nearest point of land in the Bahama Islands.

(c) For Class II stations which will not deliver over 5 microvolts per meter groundwave or 25 microvolts per meter 10 percent time skywave at any point on the Canadian border, and provided that such station operating nighttime (i.e., sunset to sunrise at the location of the Class II station) are located not less than 650 miles from the nearest point on the Canadian border, 690, 740, 860, 990, 1010, and 1580 khz.

NOTE: See NARBA concerning priority for Cuban Class I-B assignment on 1010 khz, Class I-C assignments on 690 and 860 khz, and Class I-D assignment on 740 khz.

(d) The frequencies 730, 800, 900, 1050, 1220 and 1570 khz, for Class II stations which operate daytime only which will not deliver at any point on the Mexican border over 5 microvolts per meter groundwave, and which operate with no more than the following powers:

(1) If not located within the areas specified in subparagraph (2) of this paragraph, 5 kilowatts.

(2) If operating on any of the following frequencies within the following specified areas, no more than one kilowatt:

(i) 800 khz: less than 1319 kilometers (820 miles) from Ciudad Juarez, Chihuahua.

(ii) 1050 khz: less than 998 kilometers (620 miles) from Monterrey, Nuevo Leon.

(iii) 1570 khz: less than 998 kilometers (620 miles) from Ciudad Acuna, Coahuila.

NOTE: See the U.S.-Mexican Agreement concerning specific U.S. unlimited time Class II assignments on each of the following channels: 730, 800, 900, 1050 and 1220 khz.

(e) The frequency 540 khz, for Class II stations which will not deliver a signal of more than 5 microvolts per meter groundwave or 25 microvolts per meter 10% skywave at any point on the Canadian border, nor more than 10 microvolts per meter daytime or 50 microvolts per meter nighttime at any point on the Mexican border; Provided, that stations operating at night shall be located:

(1) Within the continental United States including Alaska; and

(2) Not less than 650 miles from the nearest point on the Canadian border; and

(3) North of the parallel 35°N. if west of the meridian 93°W, or north of the parallel 30°N. if east of said meridian.

NOTE 1: See U.S.-Mexican Agreement concerning a specific U.S. unlimited time assignment on this channel.

NOTE 2: See 2.106(a) of this chapter with respect to use of 540 khz.

§73.26 Regional channels: Classes III-A and III-B stations.—The following frequencies are designated as regional channels and are assigned for use by class III-A and III-B stations: 550, 560, 570, 580, 500, 600, 610, 620, 630, 790, 910, 920, 930, 950, 960, 970, 980, 1150, 1250, 1260, 1270, 1280, 1290, 1300, 1310, 1320, 1330, 1350, 1360, 1370, 1380, 1390, 1410, 1420, 1430, 1440, 1460, 1470, 1480, 1590, and 1600 khz.

NOTE: See NARBA concerning Cuban Class I-C assignment on 550 khz, Class I-D assignments on 570, 590, 630, 920, 950 and 980 khz, and Class III-E assignments on 790, 910, and 1150 khz.

§73.27 Local channels: Class IV stations.—The following frequencies are designated as local channels and are assigned for use by Class IV stations: 1230, 1240, 1400, 1450, and 1490 khz.

NOTE: See NARBA concerning Cuban Class IV-E assignments on 1240 and 1340 khz.

§73.28 Assignments of stations to channels. (a) With respect to applications for new Class II-A stations, and other applications accepted for filing before July 13, 1964, the individual assignments of stations to channels which may cause interference to other United States stations only shall be made in accordance with the provisions of this part for the respective classes of stations involved. (For determining objectionable interference, see §73.22, and §73.182 through §73.186.)

(b) Except as provided in §73.21 (c) concerning Class IV stations, no U.S. assignment of a standard broadcast station will be made which would be inconsistent with the provisions of NARBA or the U.S.-Mexican Agreement. Similarly, as long as protection for U.S. assignments from Haitian assignments continues, no U.S. assignment of a standard broadcast station will be made which would cause objectionable interference (under the standards set forth in NARBA) to a duly notified Haitian station. (The Haitian stations considered to be duly notified are those notified and accepted in accordance with past agreements, and those subsequently notified in accordance with the procedures and understandings which have pertained thus far.) In all cases where an individual assignment may cause interference with, or may involve a channel assigned for priority of use by, a station in another North American country, the classifications, allocation requirements, and engineering standards set forth in NARBA and the U.S.-Mexican Agreement shall be observed.

NOTE: In general, an application for a standard broadcast station assignment, the grant of which would be consistent with the provisions of NARBA and the U.S.-Mexican Agreement and would not cause objectionable interference to a duly notified station in Haiti, will be considered and acted upon by the Commission in accordance with its rules and established procedure for action upon such applications. However, in particular cases such applications may also present considerations of an international nature which require that a different procedure be followed. In such cases the procedure to be followed will be determined by the Commission in the light of the special considerations involved.

With respect to applications for facilities which would involve conflict with NARBA only as to a country which has signed but not completed formal ratification of that agreement, and facilities which would cause objectionable interference to a duly notified Haitian station, special provisions of a procedural nature are contained in §1.352 of this chapter.

(c) Engineering standards now in force domestically differ in some respects from those specified for international purposes. The engineering standards specified for international purposes (in NARBA and the U.S.-Mexican Agreement) will be used to determine: (1) the extent to which interference might be caused by a proposed station in the United States to a station in another country of the North American Region; and (2) whether the United States should register an objection to any new or changed assignment notified by another country of the North American Region. The domestic standards in effect in the United States will be used to determine the extent to which interference exists or would exist from a foreign station where the value of such interference enters into a calculation of: (1) the service to be rendered by a proposed operation in the United States; or (2) the permissible interfering signal from one station in the United States to another United States station.

(d) With respect to applications for new Class II-A

stations, and other applications accepted for filing before July 13, 1964, the following shall apply: Upon showing that a need exists, a Class II, III, or IV station may be assigned to a channel available for such class, even though interference will be received within its normally protected contour, subject to the following conditions: (1) No objectionable interference will be caused by the proposed station to existing stations or that if interference will be caused, the need for the proposed service outweighs the need for the service which will be lost by reason of such interference; (2) Primary service will be provided to the community in which the proposed station is located; (3) The interference received does not affect more than 10 percent of the population in the proposed station's normally protected primary service area; however, in the event that the nighttime interference received by a proposed Class II or III station would exceed this amount, then an assignment may be made if the proposed station would provide either a standard broadcast nighttime facility to a community not having such a facility or if 25 percent or more of the nighttime primary service area of the proposed station is without primary nighttime service. This subparagraph (3) shall not apply to existing Class IV stations on local channels applying for an increase in power above 250 watts, nor to new Class IV stations proposing power in excess of 250 watts with respect to population in the primary service area outside the equivalent 250 watt, 0.5 mv/m contour.

§73.29 Class IV stations on regional channels.—No license will be granted for the operation of a Class IV station on a regional channel, provided, however, that Class IV stations presently authorized to operate on regional channels will not be required to change frequency or power but will not be protected against interference from Class III stations.

In FM rules...

§73.201. Numerical designation of FM broadcast channels.—The FM broadcast band consists of that portion of the radio frequency spectrum between 88 megacycles per second (mhz) and 108 mhz. It is divided into 100 channels of 200 kilocycles per second (khz) each. For convenience, the frequencies available are given numerical designations.

EDITOR'S NOTE: [See FM Table of Assignments, Section C.]

§73.202. Table of Assignments.—(a) General. The following Table of Assignments contains the channels (other than noncommercial educational channels) assigned to the listed communities in the United States, its territories and possessions.

EDITOR'S NOTE: Channel assignments by cities are reprinted in the AM-FM directory.

§73.203. Availability of channels.—(a) Subject to the provisions of paragraph (b) of this section, applications may be filed to construct FM broadcast stations only on the channels assigned in the Table of Assignments (§73.202)(b) (1) and only in communities listed therein. Applications which fail to comply with this requirement, whether or not accompanied by a petition to amend the Table, will not be accepted for filing; provided, however, that applications specifying channels which accord with publicly announced Commission orders changing the Table of Assignments will be accepted for filing even though such applications are tendered before the effective dates of such channel changes.

(b) A channel assigned to a community listed in the Table of Assignments is available upon application in any listed community which is located within 10 miles of the listed community if the channel requested is a Class A channel and 15 miles if the channel is a Class B/C channel, provided no other channel in the listed community has been similarly assigned to another community and provided further that the unlisted community has not already removed a channel from any other listed community. Where channels are assigned to two or more communities listed in combination in the Table of Assignments the provisions of this paragraph shall apply separately to each community so listed. The distance between communities shall be determined by the distance between the respective coordinates thereof as set forth in the publication of the United States Department of Commerce entitled "Air Line Distance Between Cities in the United States." (This publication may be purchased from the Superintendent of Documents, Government Printing Office, Washington, D.C. 20402). If said publication does not contain the coordinates of either or both communities, the coordinates of the main post office in either or both of the com-

munities shall be used. The method to be followed in making the measurements is set forth in §73.208(c).

§73.204. International agreements and other restrictions on use of channels.

(a) The United States has entered into agreements with Canada and the United Mexican States, respectively, dealing with the allotment and use of FM broadcast channels and facilities for a defined border area. Assignment of an FM channel, authorization for use of an FM broadcast facility, and related matters as to the use of FM facilities for the particular border area are subject to the provisions of the respective agreements. Both provide for consultation and the right to object to any particular proposal. The Commission will give notice of the filing of such an objection; if, for whatever reason, the Commission has taken action inconsistent with any such timely objection, it may take appropriate steps to rescind the action taken.

(b) The frequency 89.1 mhz (ch. 206) is reserved in the New York City metropolitan area for the use of the United Nations with the equivalent of an antenna height of 500 feet above average terrain and effective radiated power of 20 kilowatts, and the Commission will make no assignments which would cause objectionable interference with such use.

(c) In Alaska, the frequency band 88-100 mhz is allocated exclusively to government radio services and the nongovernment fixed service. The frequencies 88.1 through 99.9 mhz (chs. 201 through 260) will not be assigned in Alaska for use by FM broadcast stations.

(d) In Hawaii, the frequency band 98-108 mhz is allocated for nonbroadcast use. The frequencies 98.1 through 107.9 mhz (chs. 251 through 300) will not be assigned in Hawaii for use by FM broadcast stations.

§73.205. Zones.

For the purpose of allocation and assignment the United States is divided into three zones as follows:

(a) Zone I consists of that portion of the United States located within the confines of the following lines drawn on the United States Albers Equal Area Projection Map (based on standard parallels 29½° and 45½°; North American datum); Beginning at the most easterly point on the State boundary line between North Carolina and Virginia; thence in a straight line to a point on the Virginia, West Virginia boundary line located at North Latitude 37° 49' and West Longitude 80° 12' 30"; thence westerly along the southern boundary lines of the States of West Virginia, Ohio, Indiana, and Illinois to a point at the junction of the Illinois, Kentucky, and Missouri state boundary lines; thence northerly along the western boundary line of the State of Illinois to a point at the junction of the Illinois, Iowa, and Wisconsin state boundary lines; thence, easterly along the northern state boundary line of Illinois to the 90th meridian; thence north along this meridian to the 43.5° parallel; thence east along the parallel to the United States-Canada border; thence southerly and following that border until it again intersects the 43.5° parallel; thence east along this parallel to the 71st meridian; thence in a straight line to the intersection of the 69th meridian and the 45th parallel; thence east along the 45th parallel to the Atlantic Ocean. When any of the above lines pass through a city, the city shall be considered to be located in Zone I. (See Figure I of §73.699 [in complete copy of Rules]).

(b) Zone IA consists of Puerto Rico, the Virgin Islands, and that portion of the State of California which is located south of the 40th parallel.

(c) Zone II consists of Alaska, Hawaii and the rest of the United States which is not located in either Zone I or Zone IA.

§73.206. Classes of commercial channels, and stations operating thereon.

(a) **Class A channels and stations.**

(1) Except as provided in §73.202, the following frequencies are designated as Class A channels and are assigned for use, in all zones, by Class A stations only:

Frequency (mhz)	Channel No.	Frequency (mhz)	Channel No.
92.1	221	100.1	261
92.7	224	100.9	265
93.5	228	101.7	269
94.3	232	102.3	272
95.3	237	103.1	276
95.9	240	103.9	280
96.7	244	104.9	285
97.7	249	105.5	288
98.3	252	106.3	292
99.3	257	107.1	296

FCC Rules

(2) A Class A station is a station which operates on a Class A channel, and is designed to render service to a relatively small community, city, or town, and the surrounding rural area.

(3) A Class A station will not be authorized to operate with effective radiated power greater than 3 kilowatts (4.8 dbk), and the coverage of a Class A station shall not exceed that obtained from 3 kilowatts effective radiated power and antenna height above average terrain of 300 feet. For provisions concerning minimum facilities, and concerning reduction in power where antenna height above average terrain exceeds 300 feet, see §73.211.

(b) Class B-C channels and Class B and Class C stations.

(1) Except for the channels specified in paragraph (a) (1) of this section, all of the channels listed in §73.201 from 222 through 300 (92.3 through 107.9 mhz) are classified as Class B-C channels, and (subject to the restrictions set forth in §73.204) are assigned for use in Zones I and I-A by Class B stations only, and for use in Zone II by Class C stations only (there are no Class C stations in Zones I or I-A and no Class B stations in Zone II).

(2) A Class B station is a station which operates on a Class B-C channel in Zone I or Zone I-A, and is designed to render service to a sizeable community, city, or town, or to the principal city or cities of an urbanized area, and to the surrounding area.

(3) With respect to Class B stations authorized after September 10, 1962, no such station will be authorized with effective radiated power greater than 50 kilowatts (17 dbk), and the coverage of a Class B station authorized after that date shall not exceed that obtained from 50 kilowatts effective radiated power and 500 feet antenna height above average terrain. For provisions concerning minimum power, and concerning reduction in power where antenna height above average terrain exceeds 500 feet, see §73.211.

(4) A Class C station is a station which operates on a Class B-C channel in Zone II, and is designed to render service to a community, city, or town, and large surrounding area.

(5) With respect to Class C stations authorized after September 10, 1962, no such station will be authorized with effective radiated power greater than 100 kilowatts (20 dbk), and the coverage of a Class C station authorized after that date shall not exceed that obtained from 100 kilowatts effective radiated power and antenna height above average terrain of 2,000 feet. For provisions concerning minimum power, and reduction in power where antenna height above average terrain exceeds 2,000 feet, see §73.211.

§73.207. Minimum mileage separations between co-channel and adjacent-channel stations on commercial channels.

(a) Petitions to amend the Table of Assignments (§73.202(b) (1) (other than those expressly requesting amendment of this section or §73.205)) will be dismissed and no application for a new station, change in the channel of an existing station, or increase in antenna height or effective radiated power, or change in location of an existing station will be accepted for filing unless the proposed facilities will be located at least as far from the transmitter sites of other co-channel and adjacent-channel stations (both existing and proposed) as the distances specified in this paragraph. Proposed stations of the respective classes shown in the left-hand column of the table, [see separation table, this page] shall be located no less than the distance shown from co-channel stations and first adjacent-channel stations (200 khz removed) and second and third adjacent-channel stations (400 and 600 khz removed) of the classes shown in the remaining columns of the table. The distances shown between stations of different classes apply regardless of which is the proposed station under consideration (e.g., distances shown from a new Class A station to an existing Class C station are also the distances between a new Class C station and an existing Class A station.) The distances between Class B and Class C stations apply only across zone lines. The adjacent-channel spacings listed also apply: (1) to applications for noncommercial educational facilities on channels 218, 219, or 220, with respect to other stations on channels 221, 222, or 223; (2) to applications for facilities on channels 221, 222, or 223 with respect to noncommercial educational stations on channels 218, 219, or 220 (for classification of non-commercial educational stations, see §73.504).

(b) The zone in which the transmitter of an FM station is located or proposed to be located determines the

applicable rules with respect to minimum required spacings.

§73.209. Protection from interference.

(a) Permittees and licensees of FM broadcast stations are not protected from any interference which may be caused by the grant of a new station, or of authority to modify the facilities of an existing station, in accordance with the provisions of the subpart.

(b) The nature and extent of the protection from interference accorded to FM broadcast stations is limited solely to the protection which results from the minimum assignment and station separation require-

ments and the rules with respect to maximum powers and antenna heights set forth in this subpart.

(c) When the Commission determines that grant of an application would serve the public interest, convenience and necessity and the instrument of authorization specifies an antenna location in a designated antenna farm area which results in mileage separation less than those specified in this subpart, FM broadcast station permittees and licensees shall be afforded protection from interference equivalent to the protection afforded under the minimum mileage separations specified in this subpart.

Spacing in Miles, by Class of Station and Frequency Separation (khz)

Class of Station	Class A			Class B			Class C			10-watt educational						
	Co-ch.	200	400	600	Co-ch.	200	400	600	Co-ch.	200	400	600				
Class A	65	40	15	15	65	40	40	—	105	65	65	—	30	15	15	
Class B	—	—	—	—	150	150	40	40	170	135	65	65	—	—	40	40
Class C	—	—	—	—	—	—	—	—	180	150	65	65	—	—	65	65
10-watt educational	—	—	—	—	—	—	—	—	—	—	—	—	—	—	—	—

NOTE: Stations or assignments separated in frequency by 10.6 or 10.8 mhz (53 or 54 channels) will not be authorized unless they conform to the following separation table:

Class to class	Required spacing in Miles
A to A	5
B to A	10
B to B	15
C to A	20
C to B	25
C to C	30

§73.211. Power and antenna height requirements.

(a) Minimum requirements.
(1) Except as provided in paragraph (b) (2) of this section, the minimum effective radiated power shall be:

Class A	100 watts (-10dbk)
Class B	5 kw (7dbk)
Class C	25 kw (14dbk)

(2) No minimum antenna height above average height is specified.

(b) Maximum power and antenna height.
(1) The maximum effective radiated power in any direction, and maximum antenna height for equivalence purposes, shall be as follows for the various classes of stations:

Station class	Maximum power	Maximum antenna height (feet above average terrain)
Class A	3 kw (4.8 dbk)	300
Class B	50 kw (17.0 dbk)	500
Class C	100 kw (20.0 dbk)	2,000

(2) Antenna heights may be used as exceeding those specified in this paragraph for equivalence purposes, provided effective radiated power is reduced in the amount determined by use of the appropriate curves in Figure 3 of §73.333. Where, under Figure 3 of §73.333, effective radiated power must be reduced to an amount less than the normal minimum specified in paragraph (a) (1) of this section for the class of station involved, the effective radiated power determined by Figure 3 of §73.333 shall be the minimum for the station involved.

(3) In Puerto Rico and the Virgin Islands Class B stations may use antenna heights up to 2000 feet above average terrain with effective radiated powers up to 25 kw. For antenna heights above 2000 feet the power shall be reduced so that the station's 1 mv/m contour (located pursuant to Figure 1 of §73.333) will extend no farther from the station's transmitter than with the facilities of 25 kw and antenna height of 2000 feet. For powers above 25 kw (up to 50 kw) no antenna heights will be authorized which result in greater coverage by the 1 mv/m contour than that obtained with the facilities of 25 kw and antenna height of 2000 feet.

(c) Determination of applicable rules. The zone in which the transmitter of an FM station is located or proposed to be located determines the applicable rules with respect to the class of station, and thus the minimum and maximum requirements as to facilities.

(d) Existing stations. Stations authorized as of September 10, 1962 which do not conform to the requirements of this section, may continue to operate as

authorized. For stations operating with facilities in excess of those specified in Paragraph (b) of this section no changes in facilities will be authorized which either increases the effective radiated power or extends the location of the 1 mv/m field strength contour beyond that of its present authorization in any direction. The provisions of this section shall not apply to applications to increase facilities for those stations operating with powers less than the minimum powers specified in paragraph (a) of this section.

In TV rules...

§73.603. Numerical designation of television channels—(a)

Channel No.	Frequency band (Mega-cycles)	Channel No.	Frequency band (Mega-cycles)
2	54-60	43	844-850
3	60-66	44	850-856
4	66-72	45	856-862
5	72-78	46	862-868
6	82-88	47	868-874
7	174-180	48	874-880
8	180-186	49	880-886
9	186-192	50	886-892
10	192-198	51	892-898
11	198-204	52	898-904
12	204-210	53	904-910
13	210-216	54	910-916
14	470-476	55	916-922
15	476-482	56	922-928
16	482-488	57	928-934
17	488-494	58	934-940
18	494-500	59	940-946
19	500-506	60	946-952
20	506-512	61	952-958
21	512-518	62	958-964
22	518-524	63	964-970
23	524-530	64	970-976
24	530-536	65	976-982
25	536-542	66	982-988
26	542-548	67	988-994
27	548-554	68	994-1000
28	554-560	69	1000-1006
29	560-566	70	1006-1012
30	566-572	71	1012-1018
31	572-578	72	1018-1024
32	578-584	73	1024-1030
33	584-590	74	1030-1036
34	590-596	75	1036-1042
35	596-602	76	1042-1048
36	602-608	77	1048-1054
37	608-614	78	1054-1060
38	614-620	79	1060-1066
39	620-626	80	1066-1072
40	626-632	81	1072-1078
41	632-638	82	1078-1084
42	638-644	83	1084-1090

(b) In Alaska and Hawaii the frequency bands 76-82 mhz and 82-88 mhz are allocated for nonbroadcast use. These frequency bands (Channels 5 and 6) will not be assigned in Alaska and Hawaii for use by television broadcast stations.

(c) Channel 37, 608-614 mhz, is reserved exclusively for the radio astronomy service until the first Administrative Radio Conference after January 1, 1974, which is competent to review this provision.

§73.606. Table of Assignments.—(a) The following Table of Assignments contains the channels assigned to the listed communities in the United States, its territories, and possessions. Channels designated with an asterisk are assigned for use by noncommercial educational broadcast stations only. A station on a channel identified by a plus or a minus mark is required to operate with its carrier frequencies offset 10 khz above or below, respectively, the normal carrier frequencies.

[EDITOR'S NOTE: Channel assignments by cities are reprinted in the AM-FM directory and are not repeated here.]

§73.607. Availability of channels.—(a) Subject to the provisions of paragraphs (b) of this section, applications may be filed to construct television broadcast stations only on the channels assigned in the Table of Assignments and only in the communities listed therein. Applications which fail to comply with this requirement, whether or not accompanied by a petition to amend the Table, will not be accepted for filing provided, however, that applications specifying channels which accord with publicly announced Commission orders changing the Table of Assignments will be accepted for filing even though such applications are tendered before the effective dates of such channel changes.

(b) A channel assigned to a community listed in the Table of Assignments is available upon application in any unlisted community which is located within 15 miles of the listed community. In addition, a channel assigned to a community listed in the Table of Assignments and not designated for use by noncommercial educational stations only, is available upon application in any other community within 15 miles thereof which, although listed in the table, is assigned only a channel designated for use only by noncommercial educational stations. Where channels are assigned to two or more communities listed in combination in the Table of Assignments the provisions of this paragraph shall apply separately to each community so listed. The distance between communities shall be determined by the distance between the respective coordinates thereof as set forth in the publication of the United States Department of Commerce entitled "Air Line Distances Between Cities in the United States." (This publication may be purchased from the Government Printing Office, Washington, D.C.) If said publication does not contain the coordinates of either or both communities the coordinates of the main post office in either or both of such communities shall be used. The method to be followed in making the measurements is set forth in §73.611(d).

§73.609. Zones.—(a) For the purpose of allocation and assignment, the United States is divided into three zones as follows:

(1) Zone I consists of that portion of the United States located within the confines of the following lines drawn on the United States Albers Equal Area Projection Map (based on standard parallels 29½° and 45½°, North American datum); Beginning at the most easterly point on the state boundary line between North Carolina and Virginia; thence a straight line to a point on the Virginia-West Virginia boundary line located at North Latitude 37° 49' and West Longitude 80° 12' 30"; thence westerly along the southern boundary lines of the states of West Virginia, Ohio, Indiana and Illinois to a point at the junction of the Illinois, Kentucky, and Missouri state boundary lines; thence northerly along the western boundary line of the state of Illinois to a point at the junction of the Illinois, Iowa, and Wisconsin state boundary lines; thence easterly along the northern state boundary line of Illinois to the 90th meridian; thence north along this meridian to the 43.5° parallel; thence east along this parallel to the United States-Canada border; thence southerly and following that border until it again intersects the 43.5° parallel; thence east along this parallel to the 71st meridian; thence in a straight line to the intersection of the 69th meridian and the 45th parallel; thence east along the 45th parallel; to the Atlantic Ocean. When any of the above lines pass through a city, the city shall be considered to be located in Zone I. (See Figure 1 of §73.699).

(2) Zone II consists of that portion of the United

States which is not located in either Zone I or Zone III, and Puerto Rico, Alaska, Hawaiian Islands and the Virgin Islands.

(3) Zone III consists of that portion of the United States located south of a line, drawn on the United States Albers Equal Area Projection Map (based on standard parallels 29½° and 45½°, North American datum), beginning at a point on the east coast of Georgia and the 31st parallel and ending at the United States-Mexican border, consisting of arcs drawn with a 150 mile radius to the north from the following specified points:

North Latitude	West Longitude
a) 29°40'00"	83°24'00"
b) 30°07'00"	84°12'00"
c) 30°31'00"	86°30'00"
d) 30°48'00"	87°58'30"
e) 30°00'00"	90°38'30"
f) 30°04'30"	93°19'00"
g) 29°48'00"	95°05'00"
h) 28°43'00"	96°30'30"
i) 27°52'30"	97°32'00"

When any of the above arcs pass through a city, the city shall be considered to be located in Zone II. (See Figure 2 of §73.699.)

§73.610. Separations.—(a) The provisions of this section relate to assignment separations and station separations. Petitions to amend the Table of Assignments (§73.606 (b)) (other than those also expressly requesting amendment of this section or §73.609) will be dismissed and all applications for new television broadcast stations or for changes in the transmitter sites of existing stations will not be accepted for filing if they fail to comply with the requirements specified in paragraphs (b), (c) and (d) of this section.

NOTE: Licensees and permittees of television broadcast stations which were operating on April 14, 1952 pursuant to one or more separations below those set forth in §73.610 may continue to so operate but in no event may they further reduce the separations below the minimum. As the existing separations of such stations are increased, the new separations will become the required minimum separations until separations are reached which comply with the requirements of §73.610. Thereafter the provisions of said section shall be applicable.

(b) Minimum co-channel assignment and station separations:

(1) Zone	Channels 2-13	Channels 14-28
I	170 miles	155 miles
II	190 miles	175 miles
III	220 miles	205 miles

(2) The minimum co-channel mileage separation between a station in one zone and a station in another zone shall be that of the zone requiring the lower separation.

(c) Minimum assignment and station adjacent channel separations applicable to all zones:

(1) Channels 2-13	60 miles
Channels 14-83	55 miles

(2) Due to the frequency spacing which exists between channels 4 and 5, between channels 6 and 7, and between channels 13 and 14, the minimum adjacent channel separations specified above shall not be applicable to these pairs of channels (see §73.603).

(d) In addition to the requirements of paragraphs (a), (b) and (c) of this section, the minimum assignment and station separations between stations on channels 14-83, inclusive, as set forth in Table IV of §73.698 must be met in either rule making proceedings looking towards the amendment of the Table of Assignments (§73.606 (b)) or in licensing proceedings. No channel listed in column (1) of Table IV of §73.698 [see box, next page] will be assigned to any city, and no application for an authorization to operate on such a channel will be granted unless the mileage separations indicated at the top of the column (2)-(7), inclusive, are met with respect to each of the channels listed in those columns and parallel with the channel in column (1).

(e) The zone in which the transmitter of a television station is located or proposed to be located determines the applicable rules with respect to co-channel mileage separations where the transmitter is located in a different zone from that in which the channel to be employed is located.

§73.614. Power and antenna height requirements.—(a) Minimum requirements. Applications will not be accepted for filing if they specify less than—10 dbk (100 watts) visual effective radiated power in any horizontal direction. No minimum antenna height above average terrain is specified.

(b) Maximum power. Applications will not be accepted for filing if they specify a power in excess of that provided in this paragraph. Except as provided in subparagraph (1) below, the maximum effective radiated powers of television broadcast stations operating on the channels set forth below with antenna heights not in excess of 2000 feet above average terrain shall be as follows:

Channel Nos.	Maximum visual effective radiated power in db above one kilowatt (dbk)
2-6	20dbk (100 kw)
7-13	25 dbk (316 kw)
14-83	37 dbk (5000)

(1) In Zone I, on Channels 2-13 inclusive, the maximum powers specified above for these channels may be used only with antenna heights not in excess of 1000 feet above average terrain. Where antenna heights exceeding 1000 feet above average terrain are used on Channels 2-13, or antenna heights exceeding 2000 feet above average terrain are used on Channels 14-83, the maximum power shall be based on the chart designated as Figure 3 of §76.699.

NOTE: This limitation shall not apply to any licensee or permittee in Zone I who received an authorization after March 22, 1951, to relocate its transmitter site and construct a new tower and antenna to a height in excess of 1000 feet above average terrain and who constructed or who had substantially completed construction of said tower and antenna prior to April 14, 1952. In such case, maximum power may be utilized at the height above average terrain specified in the authorization. The limitation shall apply, however, where the tower of other principal supporting structure had been constructed prior to the date of such authorization.

(2) In Zones II and III, the maximum powers which may be used by television broadcast stations operating on the respective channels set forth in the above table with antenna heights exceeding 2000 feet above average terrain shall be based on the chart designated as Figure 4 of §73.699.

(3) The effective radiated power in any horizontal or vertical direction may not exceed the maximum values permitted by this section and Figure 3 and 4 of §73.699.

(4) The maximum effective radiated power in any direction above the horizontal plane shall be as low as the state of the art permits and may not exceed the effective radiated power in the horizontal direction in the same vertical plane.

(c) The zone in which the transmitter of a television station is located or proposed to be located determines the applicable rules with respect to maximum antenna heights and powers for VHF stations when the transmitter is located in Zone I and the channel to be employed is located in Zone II, or the transmitter is located in Zone II and the channel to be employed is located in Zone I.

[NOTE: The maximum visual effective radiated power of television broadcast stations operating on channels 14-83 within 250 miles of the Canadian-U.S. border may not be in excess of 30 dbk (1,000 kw).]

Multiple ownership

In AM rules...

§73.35. Multiple ownership.—(a) No license for a standard broadcast station shall be granted to any party (including all parties under common control) if such party directly or indirectly owns, operates, or controls: one or more standard broadcast stations and the grant of such license will result in any overlap of the predicted or measured 1 mv/m groundwave contours of the existing and proposed stations, computed in accordance with §73.183 or §73.186; or one or more television broadcast stations and the grant of such license will result in the predicted or measured 2 mv/m groundwave contour of the proposed station, computed in accordance with §73.183 or §73.186, encompassing the entire community of license of one of the television broadcast stations or will result in the Grade A contour(s) of the television broadcast station(s), computed in accordance with §73.684, encompassing

FCC Rules

the entire community of license of the proposed station; or a daily newspaper the grant of such license will result in the predicted or measured 2 mV/m contour, computed in accordance with §73.183 or §73.186, encompassing the entire community in which such newspaper is published.

(b) No license for a standard broadcast station shall be granted to any party (including all parties under common control) if such party, or any or any stockholder, officer or director of such party, directly or indirectly owns, operates, controls, or has any interest in, or is an officer or director of any other standard broadcast station if the grant of such license would result in a concentration of control of standard broadcasting in a manner inconsistent with public interest, convenience, or necessity. In determining whether there is such a concentration of control, consideration

will be given to the facts of each case with particular reference to such factors as the size, extent and location of area served, the number of people served, classes of stations involved and the extent of other competitive service to the areas in question. The Commission, however, will in any event consider that there would be such a concentration of control contrary to the public interest, convenience or necessity for any party or any of its stockholders, officers or directors to have a direct or indirect interest in, or be stockholders, officers, or directors of, more than seven standard broadcast stations.

(c) No renewal of license shall be granted for a term extending beyond January 1, 1980, to any party that as of January 1, 1975, directly or indirectly owns, operates or controls the only daily newspaper published in a community and also as of January 1, 1975, directly or indirectly owns, operates or controls the only commercial aural station or stations encompassing the entire community with a city-grade signal during daytime

hours (predicted or measured signal for AM, predicted for FM). The provisions of this paragraph shall not require divestiture of any interest not in conformity with its provisions earlier than January 1, 1980. Divestiture is not required if there is a separately owned, operated or controlled television broadcast station licensed to serve the community.

NOTE 1: The word "control" as used herein, is not limited to majority stock ownership but includes actual working control in whatever manner exercised.

NOTE 2: In applying the provisions of paragraphs (a) and (c) of this section, partial (as well as total) ownership interests in corporate broadcast licensees and corporate daily newspapers represented by ownership of voting stock of such corporations will be considered.

NOTE 3: Except as provided in NOTE 4 of this section, in applying the provisions of paragraphs (a), (b) and (c) of this section to the stockholders of a corporation which has more than 50 voting stockholders, only those stockholders need be considered who are officers or directors or who directly or indirectly own 1 percent or more of the outstanding voting stock.

NOTE 4: In applying the provisions of paragraphs (a), (b) and (c) of this section to the stockholders of a corporation which has more than 50 voting stockholders, an investment company, as defined in 15 USC §80a-3 (commonly called a mutual fund), need be considered only if it directly or indirectly owns 3 percent or more of the outstanding voting stock or if officers or directors of the corporation are representatives of the investment company. Holdings by investment companies under common managements shall be aggregated.

NOTE 5: In calculating the percentage of ownership of voting stock under the provisions of NOTE 4, if an investment company directly or indirectly owns voting stock in a company which in turn directly or indirectly owns 50% or more of the voting stock off a corporate broadcast licensee or corporate daily newspaper, the investment company shall be considered to own the same percentage of outstanding shares of the corporate broadcast station licensee or corporate daily newspaper as it owns of the outstanding voting shares of the company standing between it and the licensee corporation or corporate daily newspaper. If the intermediate company owns less than 50% of the voting stock of a corporate broadcast station licensee or corporate daily newspaper, the holding of the investment company need not be considered under the 3 percent rule, but, officer or directors of the licensee corporation or of the corporate daily newspaper who are representatives of the intermediate company shall be deemed to be representatives of the investment company.

NOTE 6: In applying the provisions of paragraphs (a), (b) and (c) of this section to the stockholders of a corporation which has more than 50 voting stockholders, a bank holding stock through its trust department in trust accounts need be considered only if such bank directly or indirectly owns 5 percent or more of the outstanding voting stock; provided, the bank files a disclaimer of intent to control the management or policies of the broadcast corporation. Holdings by banks shall be aggregated if the bank has any right to determine how the stock will be voted.

NOTE 7: In cases where record and beneficial ownership of voting stock of a corporate broadcast station licensee or corporate daily newspaper which has more than 50 voting stockholders are not identical, e.g., bank nominees holding stock as record owners for the benefit of mutual funds, brokerage houses holding stock in street names for the benefit of customers, trusts holding stock as record owners for the benefit of designated parties, the party having the right to determine how the stock will be voted will be considered to own it for the purposes of these rules.

NOTE 8: Paragraph (a) of this section will not be applied so as to require divestiture, by any licensee, of existing facilities. Said paragraph will not apply to applications for increased power for Class IV stations, to applications for assignment of license or transfer of control filed in accordance with §91.540 (b) or 1.541 (b) of this chapter, or to applications for assignment of license or transfer of control to heirs or legatees by will or intestacy if no new or increased overlap would be created between commonly owned, operated, or controlled standard broadcast stations and if no new encompassment of communities proscribed in paragraph (a) of this section as to commonly owned, operated, or controlled standard broadcast stations and television broadcast stations or daily newspapers would result. Said paragraph will apply to all applications for new stations, to all other applications for assignment or transfer, and to all applications for major changes in existing stations except major changes that will result in overlap of contours of standard broadcast stations with

Table IV of Sec. 73.698—UHF Mileage Separations

(1) Channel	(2) 20 miles (I.F. beat)	(3) 20 miles (intermodulation)	(4) 55 miles (Adjacent channel)	(5) 60 miles (Oscillator)	(6) 60 miles (Sound image)	(7) 75 miles (Picture image)
14	22	16-19	15	21	29	30
15	23	17-20	14,16	22	29	30
16	24	14,18-21	15,17	23	30	31
17	25	14-15,19-22	16,18	24	31	32
18	26	14-16,20-23	17,19	25	32	33
19	27	14-17,21-24	18,20	26	33	34
20	28	15-18,22-25	19,21	27	34	35
21	29	16-19,23-26	20,22	28,14	35	36
22	30,14	17-20,24-27	21,23	29,15	36	37
23	31,15	18-21,25-28	22,24	30,16	37	38
24	32,16	19-22,26-29	23,25	31,17	38	39
25	33,17	20-23,27-30	24,26	32,18	39	40
26	34,18	21-24,28-31	25,27	33,19	40	41
27	35,19	22-25,29-32	26,28	34,20	41	42
28	36,20	23-26,30-33	27,29	35,21	42,14	43
29	37,21	24-27,31-34	28,30	36,22	43,15	44,14
30	38,22	25-28,32-35	29,31	37,23	44,16	45,15
31	39,23	26-29,33-36	30,32	38,24	45,17	46,16
32	40,24	27-30,34-37	31,33	39,25	46,18	47,17
33	41,25	28-31,35-38	32,34	40,26	47,19	48,18
34	42,26	29-32,36-39	33,35	41,27	48,20	49,19
35	43,27	30-33,37-40	34,36	42,28	49,21	50,20
36	44,28	31-34,38-41	35,37	43,29	50,22	51,21
37	45,29	32-35,39-42	36,38	44,30	51,23	52,22
38	46,30	33-36,40-43	37,39	45,31	52,24	53,23
39	47,31	34-37,41-44	38,40	46,32	53,25	54,24
40	48,32	35-38,42-45	39,41	47,33	54,26	55,25
41	49,33	36-39,43-46	40,42	48,34	55,27	56,26
42	50,34	37-40,44-47	41,43	49,35	56,28	57,27
43	51,35	38-41,45-48	42,44	50,36	57,29	58,28
44	52,36	39-42,46-49	43,45	51,37	58,30	59,29
45	53,37	40-43,47-50	44,46	52,38	59,31	60,30
46	54,38	41-44,48-51	45,47	53,39	60,32	61,31
47	55,39	42-45,49-52	46,48	54,40	61,33	62,32
48	56,40	43-46,50-53	47,49	55,41	62,34	63,33
49	57,41	44-47,51-54	48,50	56,42	63,35	64,34
50	58,42	45-48,52-55	49,51	57,43	64,36	65,35
51	59,43	46-49,53-56	50,52	58,44	65,37	66,36
52	60,44	47-50,54-57	51,53	59,45	66,38	67,37
53	61,45	48-51,55-58	52,54	60,46	67,39	68,38
54	62,46	49-52,56-59	53,55	61,47	68,40	69,39
55	63,47	50-53,57-60	54,56	62,48	69,41	70,40
56	64,48	51-54,58-61	55,57	63,49	70,42	71,41
57	65,49	52-55,59-62	56,58	64,50	71,43	72,42
58	66,50	53-56,60-63	57,59	65,51	72,44	73,43
59	67,51	54-57,61-64	58,60	66,52	73,45	74,44
60	68,52	55-58,62-65	59,61	67,53	74,46	75,45
61	69,53	56-59,63-66	60,62	68,54	75,47	76,46
62	70,54	57-60,64-67	61,63	69,55	76,48	77,47
63	71,55	58-61,65-68	62,64	70,56	77,49	78,48
64	72,56	59-62,66-69	63,65	71,57	78,50	79,49
65	73,57	60-63,67-70	64,66	72,58	79,51	80,50
66	74,58	61-64,68-71	65,67	73,59	80,52	81,51
67	75,59	62-65,69-72	66,68	74,60	81,53	82,52
68	76,60	63-66,70-73	67,69	75,61	82,54	83,53
69	77,61	64-67,71-74	68,70	76,62	83,55	84
70	78,62	65-68,72-75	69,71	77,63	84	85
71	79,63	66-69,73-76	70,72	78,64	85	86
72	80,64	67-70,74-77	71,73	79,65	86	87
73	81,65	68-71,75-78	72,74	80,66	87	88
74	82,66	69-72,76-79	73,75	81,67	88	89
75	83,67	70-73,77-80	74,76	82,68	89	90
76	84	71-74,78-81	75,77	83,69	90	91
77	85	72-75,79-82	76,78	84	91	92
78	86	73-76,80-83	77,79	85	92	93
79	87	74-77,81-84	78,80	86	93	94
80	88	75-78,82-85	79,81	87	94	95
81	89	76-79,83	80,82	88	95	96
82	90	77-80	81,83	89	96	97
83	91	78-81	82	90	97	98

each other no greater than that already existing. (The resulting areas of overlap of contours of standard broadcast stations with each other in such major change cases may consist partly or entirely of new terrain. However, if the population in the resulting overlap areas substantially exceeds that in the previously existing overlap areas, the Commission will not grant the application if it finds that to do so would be against the public interest, convenience and necessity.) Paragraph (a) of this section will not apply to any application by a party who directly or indirectly owns, operates or controls a UHF television broadcast station where grant of such application would result in the Grade A contour of the UHF station encompassing the entire community of license of a commonly owned, operated, or controlled standard broadcast station or would result in the entire community of license of such UHF station being encompassed by the 2 mv/m contour of such standard broadcast station. Such community encompassment cases will be handled on a case-by-case basis in order to determine whether common ownership, operation or control of the stations in question would be in the public interest. Commonly owned, operated, or controlled broadcast stations with overlapping contours or with community-encompassing contours prohibited by paragraph (a) of this section may not be assigned or transferred to a single person, group, or entity, except as provided above in this note. If a commonly owned, operated or controlled standard broadcast station and daily newspaper fall within the encompassing proscription of paragraph (a) of this section, the station may not be assigned to a single person, group or entity if the newspaper is being simultaneously sold to such single person, group or entity.

NOTE 9: Paragraph (a) of this section will not be applied to cases involving television stations which are primarily "satellite" operations. Such cases will be considered on a case-by-case basis in order to determine whether common ownership, operation, or control of the stations in question would be in the public interest. Whether or not a particular television broadcast station which does not present a substantial amount of locally originated programming is primarily a "satellite" operation will be determined on the facts of the particular case. An authorized and operating "satellite" television station the Grade A contour of which completely encompasses the community of license of a commonly owned, operated, or controlled standard broadcast station, or the community of license of which is completely encompassed by the 2 mv/m contour of such a standard broadcast station may subsequently become a "nonsatellite" station with local studios and locally originated programming. However, such commonly owned, operated, or controlled standard and "non-satellite" television stations may not be transferred or assigned to a single person, group, or entity, except as provided in Note 8.

NOTE 10: For the purposes of this section a daily newspaper is one which is published four or more days per week, which is in the English language, and which is circulated generally in the community of publication. A college newspaper is not considered as being circulated generally.

In FM rules...

§73.240. Multiple ownership.—(1) (a) No license for an FM broadcast station shall be granted to any party (including all parties under common control) if such party directly or indirectly owns, operates or controls: one or more FM broadcast stations and the grant of such license will result in any overlap of the predicted 1 mv/m contours of the existing and proposed stations, computed in accordance with §73.313; or one or more television broadcast stations and the grant of such license will result in the predicted 1 mv/m contour of the proposed station, computed in accordance with §73.313, encompassing the entire community of license of one of the television broadcast stations or will result in the Grade A contour(s) of the television broadcast station(s), computed in accordance with §73.684, encompassing the entire community of license of the proposed stations; or a daily newspaper and the grant of such license will result in the predicted 1 mv/m contour, computed in accordance with §73.313, encompassing the entire community in which such newspaper is published.

(2) No license for an FM broadcast station shall be granted to any party (including all parties under common control) if such party, or any stockholder, officer or director of such party, directly or indirectly owns, operates, controls or has interest in, or is an officer or director of any other FM broadcast station if the grant of such license would result in a concentration of control of FM broadcasting in a manner inconsistent with

the public interest, convenience or necessity. In determining whether there is such a concentration of control, consideration will be given to the facts of each case with particular reference to such factors as the size, extent and location of areas served, the number of people served, classes of stations involved and the extent of other competitive service to the areas in question. The Commission, however, will in any event consider that there would be such a concentration of control contrary to the public interest, convenience or necessity for any party of any of its stockholders, officers or directors to have a direct or indirect interest in, or be stockholders, officers, or directors of, more than seven FM broadcast stations.

(b) Paragraphs (a) and (c) of this section are not applicable to non-commercial educational FM stations.

(c) No renewal of license shall be granted for a term extending beyond January 1, 1980, to any party that as of January 1, 1975, directly or indirectly owns, operates or controls the only daily newspaper published in a community and also as of January 1, 1975, directly or indirectly owns, operates or controls the only commercial aural station or stations encompassing the entire community with a city-grade signal during daytime hours (predicted or measured signal for AM, predicted for FM). The provisions of this paragraph shall not require divestiture of any interest not in conformity with its provisions earlier than January 1, 1980. Divestiture is not required if there is a separately owned, operated or controlled television broadcast station licensed to serve the community.

NOTE 1: The word "control" as used herein is not limited to majority stock ownership, but includes actual working control in whatever manner exercised.

NOTE 2: In applying the provisions of paragraph (a) (1) and (c) of this section, partial (as well as total) ownership interests in corporate broadcast licensees and corporate daily newspapers represented by ownership of voting stock of such corporations will be considered.

NOTE 3: Except as provided in NOTE 4 of this section, in applying the provisions of paragraphs (a) (1), (a) (2) and (c) of this section to the stockholders of a corporation which has more than 50 voting stockholders, only those stockholders need be considered who are officers or directors or who directly or indirectly own 1 percent or more of the outstanding voting stock.

NOTE 4: In applying the provision of paragraphs (a) (1) and (a) (2) and (c) of this section to the stockholders of a corporation which has more than 50 voting stockholders, an investment company, as defined in 15 USC §80a-3 (commonly called a mutual fund), need be considered only if it directly or indirectly owns 3 percent or more of the outstanding voting stock or if officers or directors of the corporation are representatives of the investment company. Holdings by investment companies under common management shall be aggregated.

NOTE 5: In calculating the percentage of ownership of voting stock under the provisions of NOTE 4, if an investment company directly or indirectly owns voting stock in a company which in turn directly or indirectly owns 50% or more of the voting stock of a corporate broadcast licensee or corporate daily newspaper, the investment company shall be considered to own the same percentage of outstanding shares of the corporate broadcast station licensee or corporate daily newspaper as it owns of the outstanding voting shares of the company standing between it and the licensee corporation or corporate daily newspaper. If the intermediate company owns less than 50% of the voting stock of a corporate broadcast station licensee or corporate daily newspaper, the holding of the investment company need not be considered under the 3 percent rule, but, officers or directors of the licensee corporation or corporate daily newspaper who are representatives of the intermediate company shall be deemed to be representatives of the investment company.

NOTE 6: In applying the provisions of paragraphs (a) (1), (a) (2), and (c) of this section to the stockholders of a corporation which has more than 50 voting stockholders, a bank holding stock through its trust department in trust accounts need be considered only if such bank directly or indirectly owns 5 percent or more of the outstanding voting stock; provided, the bank files a disclaimer of intent to control the management or policies of the broadcast or newspaper corporation. Holdings by banks shall be aggregated if the bank has any right to determine how the stock will be voted.

NOTE 7: In cases where record and beneficial ownership of voting stock of a corporate broadcast station licensee or corporate daily newspaper which has more than 50 voting stockholders are not identical, e.g., bank nominees holding stock as record owners for the benefit of mutual funds, brokerage houses holding

stock in street names for the benefit of customers, trusts holding stock as record owners for the benefit of designated parties, the party having the right to determine how the stock will be voted will be considered to own it for the purposes of these rules.

NOTE 8: Paragraph (a) (1) of this section will not be applied so as to require divestiture, by any licensee, of existing facilities. Said paragraph will not apply to applications for assignment of license or transfer of control filed in accordance with §§1.540(b) or 1.541 (b) of this chapter, or to applications for assignment of license or transfer of control to heirs or legatees by will or intestacy if no new or increased overlap would be created between commonly owned, operated, or controlled FM broadcast stations and if no new encompassment of communities proscribed in paragraph (a) (1) of this section as to commonly owned, operated, or controlled FM broadcast stations and standard or television broadcast stations or daily newspapers would result. Said paragraph will apply to all applications for new stations, to all other applications for assignment or transfer, and to all applications for major changes in existing stations except major changes that will result in overlap of contours of FM broadcast stations with each other no greater than that already existing. (The resulting areas of overlap of contours of FM broadcast stations with each other in such major change cases may consist partly or entirely of new terrain. However, if the population in the resulting overlap areas substantially exceeds that in the previously existing overlap areas, the Commission will not grant the application if it finds that to do so would be against the public interest, convenience, or necessity.) Paragraph (a) (1) of this section will not apply to any application by a party who directly or indirectly owns, operates or controls a UHF television broadcast station where grant of such application would result in the Grade A contour of the UHF station encompassing the entire community of license of a commonly owned, operated, or controlled FM broadcast station or would result in the entire community of license of such UHF station being encompassed by the 1 mv/m contour of such FM broadcast station. Such community encompassment cases will be handled on a case-by-case basis in order to determine whether common ownership, operation or control of the stations in question would be in the public interest. Commonly owned, operated, or controlled broadcast stations with overlapping contours or community-encompassing contours prohibited by paragraph (a) (1) of this section may not be assigned or transferred to a single person, group, or entity, except as provided above in this note. If a commonly owned, operated or controlled FM broadcast station and daily newspaper fall within the encompassing proscription of subparagraph (a) (1) of this section, the station may not be assigned to a single person, group or entity if the newspaper is being simultaneously sold to such single person, group or entity.

NOTE 9: Paragraph (a) (1) of this section will not be applied to cases involving television stations which are primarily "satellite" operations. Such cases will be considered on a case-by-case basis in order to determine whether common ownership, operation, or control of the stations in question would be in the public interest. Whether or not a particular television broadcast station which does not present a substantial amount of locally originated programming is primarily a "satellite" operation will be determined on the facts of the particular case. An authorized and operating "satellite" television station the Grade A contour of which completely encompasses the community of license of a commonly owned, operated, or controlled FM broadcast station, or the community of license of which is completely encompassed by the 1 mv/m contour of such an FM broadcast station may subsequently become a "non-satellite" station with local studios and locally originated programming. However, such commonly owned, operated, or controlled FM and "non-satellite" television stations may not be transferred or assigned to a single person, group, or entity, except as provided in Note 8.

NOTE 10: For the purposes of this section a daily newspaper is one which is published four or more days per week, which is in the English language, and which is circulated generally in the community of publication. A college newspaper is not considered as being circulated generally.

In TV rules...

§73.636. Multiple ownership.—(a) (1) No license for television broadcast station shall be granted to any party (including all parties under common con-

FCC Rules

trol) if such party directly or indirectly owns, operates, or controls: one or more television broadcast stations and the grant of such license will result in any overlap of the Grade B contours of the existing and proposed stations, computed in accordance with §73.684; or one or more standard broadcast stations and the grant of such license will result in the Grade A contour of the proposed station, computed in accordance with §73.684, encompassing the entire community of license of one of the standard broadcast stations, or will result in the predicted or measured 2 mv/m ground-wave contour(s) of the standard broadcast station(s), computed in accordance with §73.183 or §73.186, encompassing the entire community of license of the proposed station; or one or more FM broadcast stations and the grant of such license will result in the Grade A contour of the proposed station, computed in accordance with §73.684, encompassing the entire community of license of one of the FM broadcast stations, or will result in the predicted 1 mv/m contour of the FM broadcast station(s), computed in accordance with §73.313, encompassing the entire community of license of the proposed station; or a daily newspaper and the grant of such license will result in the Grade A contour, computed in accordance with §73.684, encompassing the entire community in which such newspaper is published.

(2) No such license for a television broadcast station shall be granted to any party (including all parties under common control) if such party, or any stockholder, officer, or director of such a part, directly or indirectly owns, operates, controls, or has any interest in, or is an officer or director of any other television broadcast station if the grant of such license would result in a concentration of control of television broadcasting in a manner inconsistent with public interest, convenience, or necessity. In determining whether there is such a concentration of control, consideration will be given to the facts of each case with particular reference to such factors as the size, extent and location of areas served, the number of people served, and the extent of other competitive service in the areas in question. The Commission, however, will in any event consider that there would be such a concentration of control contrary to the public interest, convenience or necessity for any party or any of its stockholders, officers or directors to have a direct or indirect interest in, or be stockholders, officers, or directors of, more than seven television broadcast station, no more than five of which may be in the VHF band.

(b) Paragraphs (a) and (c) of this section are not applicable to non-commercial educational stations.

(c) No renewal of license shall be granted for a term extending beyond January 1, 1980, to any party that as of January 1, 1975, directly or indirectly owns, operates or controls the only daily newspaper published in a community and also as of January 1, 1975, directly or indirectly owns, operates or controls the only commercial television station encompassing the entire community with a city-grade signal. The provisions of this paragraph shall not require divestiture of any interest not in conformity with its provisions earlier than January 1, 1980.

NOTE 1: The word "control" as used herein is not limited to majority stock ownership, but includes actual working control in whatever manner exercised.

NOTE 2: In applying the provisions of paragraphs (a) (1) and (c) of this section, partial (as well as total) ownership interests in corporate broadcast licensees and corporate daily newspapers represented by ownership of voting stock of such corporations will be considered.

NOTE 3: Except as provided in NOTE 4 of this section, in applying the provisions of paragraphs (a) (1) and (a) (2) and (c) of this section to the stockholders of a corporation which has more than 50 voting stockholders, only those stockholders need be considered who are officers or directors or who directly or indirectly own 1 percent or more of the outstanding voting stock.

NOTE 4: In applying the provisions of paragraphs (a) (1), (a) (2) and (c) of this section to the stockholders of a corporation which has more than 50 voting stockholders, an investment company, as defined in 15 USC §80a-3 (commonly called a mutual fund), need be considered only if it directly or indirectly owns 3 percent or more of the outstanding voting stock or if officers or directors of the corporation are representatives of the investment company. Holdings by investment companies under common management shall be aggregated.

NOTE 5: In calculating the percentage of ownership of voting stock under the provisions of NOTE 4, if an

investment company directly or indirectly owns voting stock in a company which in turn directly or indirectly owns 50% or more of the voting stock of a corporate broadcast licensee or corporate newspaper, the investment company shall be considered to own the same percentage of outstanding shares of the corporate broadcast station licensee or corporate daily newspaper as it owns of the outstanding voting shares of the company standing between it and the licensee operation or corporate newspaper. If the intermediate company owns less than 50% of the voting stock of a corporate broadcast station licensee or corporate daily newspaper, the holding of the investment company need not be considered under the 3 percent rule, but, officers or directors of the licensee corporation or corporate daily newspaper who are representatives of the intermediate company shall be deemed to be representatives of the investment company.

NOTE 6: In applying the provision of paragraphs (a) (1), (a) (2), and (3) of this section to the stockholders of a corporation which has more than 50 voting stockholders, a bank holding stock through its trust department in trust accounts need be considered only if such bank directly or indirectly owns 5 percent or more of the outstanding voting stock; provided, the bank files a disclaimer of intent to control the management or policies of the broadcast or newspaper corporation. Holdings by banks shall be aggregated if the bank has any right to determine how the stock will be voted.

NOTE 7: In cases where record and beneficial ownership of voting stock of a corporate broadcast station licensee or corporate daily newspaper which has more than 50 voting stockholders are not identical, e.g., bank nominees holding stock as record owners for the benefit of mutual funds, brokerage houses holding stock in street name for the benefit of customers, trusts holding stock as record owners for the benefit of designated parties, the party having the right to determine how the stock will be voted will be considered to own it for the purposes of these rules.

NOTE 8: Paragraph (a) (1) of this section will not be applied so as to require divestiture, by any licensee, of existing facilities. Said paragraph will not apply to applications for assignment of license or transfer of control filed in accordance with §91.540 (b) or 1.541 (b) of this chapter, or to applications for assignment of license or transfer of control to heirs or legatees by will or intestacy if no new or increased overlap would be created between commonly owned, operated, or controlled television broadcast stations and if no new encompassment of communities proscribed in paragraph (a) (1) of this section as to commonly owned, operated, or controlled television broadcast stations and standard or FM broadcast stations or daily newspapers would result. Said paragraph will apply to all applications for new stations, to all other applications for assignment or transfer, and to all applications for major changes that will result in overlap of contours of television broadcast stations with each other no greater than that already existing. (The resulting areas of overlap of contours of television broadcast stations with each other in such major change cases may consist partly or entirely of new terrain. However, if the population in the resulting overlap areas substantially exceeds that in the previously existing overlap areas, the Commission will not grant the application if it finds that to do so would be against the public interest, convenience, and necessity.) Paragraph (a) (1) of this section will not apply to major changes in UHF television broadcast stations authorized as of September 30, 1964, which will result in Grade B overlap with another television broadcast station that was commonly owned, operated, or controlled as of September 20, 1964; or to any application concerning a UHF television broadcast station which would result in the Grade A contour of the UHF station encompassing the entire community of license of a commonly owned, operated, or controlled standard or FM broadcast station or which would result in the entire community of license of such UHF station being encompassed by the 2 mv/m or 1 mv/m contours of such standard or FM broadcast stations, respectively. Such UHF overlap or community encompassment cases will be handled on a case-by-case basis in order to determine whether common ownership, operation, or control of the stations in question would be in the public interest. Commonly owned, operated, or controlled broadcast stations with overlapping contours or with community-encompassing contours prohibited by paragraph (a) (1) of this section may not be assigned or transferred to a single person, group, or entity, except as provided in this note. If a commonly owned, operated or controlled television broadcast station and daily newspaper fall within the encompassing proscription of subparagraph (a) (1) of this section, the station may not be assigned to a single person, group or entity if the newspaper is being simultaneously sold to

such single person, group or entity.

NOTE 9: Paragraph (a) (1) of this section will not be applied to cases involving television stations which are primarily "satellite" operations. Such cases will be considered on a case-by-case basis in order to determine whether common ownership, operation, or control of the stations in question would be in the public interest. Whether or not a particular television broadcast station which does not present a substantial amount of locally originated programming is primarily a "satellite" operation will be determined on the facts of the particular case. An authorized and operating "satellite" television station the Grade B contour of which overlaps that of a commonly owned, operated, or controlled "non-satellite" parent television station, or the Grade A contour of which completely encompasses the community of publication of a commonly owned, operated or controlled daily newspaper or the community of license of a commonly owned, operated or controlled standard or FM broadcast station, or the community of license of which is completely encompassed by the 2 mv/m contour of such a standard broadcast station of 1 mv/m contour of such an FM station may subsequently become a "non-satellite" station with local studios and locally originated programming. However, such commonly owned, operated or controlled "non-satellite" television stations with Grade B overlap or such commonly owned, operated or controlled non-satellite television stations and standard or FM stations with the aforementioned community encompassment, may not be transferred or assigned to a single person, group, or entity except as provided in NOTE 8. Nor shall any application for assignment or transfer concerning such non-satellite stations be granted if the assignment of transfer would be to the same person, group or entity to which the commonly owned, operated or controlled newspaper is proposed to be transferred, except as provided in NOTE 8.

NOTE 10: For the purposes of this section a daily newspaper is one which is published four or more days per week, which is in the English language and which is circulated generally in the community of publication. A college newspaper is not considered as being circulated generally.

Studio location, program originations

In AM rules...

§73.30 Station location and program origination.—(a) (1) Except as provided in paragraph (b) of this section each standard broadcast station will be licensed to serve primarily a particular city, town, political subdivision, or community which will be specified in the station license and the station will be considered to be located in such place. (2) Unless licensed as a synchronous amplifier transmitter, each station shall maintain a studio, which will be known as the main studio, in the place where the station is located provided that the main studio may be located at the transmitter site whether or not the transmitter site is in the place where the station is located. (3) A majority (computed on the basis of duration and not number) of a station's programs or in the case of a station affiliated with a network two-thirds of such station's non-network programs, whichever is smaller, shall originate from the main studio or from other studios or remote points situated in the place where the station is located.

(b) (1) Stations will be licensed to serve more than one city, town, political subdivision, or community only where a satisfactory showing is made that each such place meets all the requirements of the rules and regulations of this subpart with respect to the location of main studios; that the station can and will originate a substantial number of local live programs from each such place; and that the requirements as to origination of programs contained in paragraph (a) of this section would place an unreasonable burden on the station if it were licensed to serve only one city, town, political subdivision or community. (2) A station licensed to serve more than one place shall be considered to be located in and shall maintain main studios in each such place. With respect to such station and requirements as to origination of programs contained in paragraph (a) of this section shall be satisfied by the origination of programs from any or all of the main studios or from other studios and remote points situated in any or all of the places in which the main studios are located.

§73.31 Authority to move main studio.—The licensee of a station shall not move its main studio outside the borders of the borough or city, state, district, territory, or possession in which it is located, unless such move is to the location of the station's transmitter, without first securing a modification of construc-

tion permit or license. The licensee shall promptly notify the Commission of any other change in location of the main studio.

In FM rules...

§73.210 Station location, main studio location, and program origination.—(a) (1) Except as provided in paragraph (b) of this section, each FM broadcast station will be licensed to serve primarily a particular city, town, political subdivision, or community which will be specified in the station license and the station will be considered to be located in such place.

(2) The main studio of an FM broadcast station shall be located in the principal community to be served. Where the principal community to be served is a city, town, village or other political subdivision, the main studio shall be located within the corporate boundaries of such city, town, village or other political subdivision. Where the principal community to be served does not have specifically defined political boundaries, applications will be considered on a case by case basis in the light of the particular facts involved to determine whether the main studio is located within the principal community to be served.

(3) Where an adequate showing is made that good cause exists for locating a main studio outside the principal community to be served and that to do so would be consistent with the operation of the station in the public interest, the Commission will permit the use of a main studio location other than that specified in subparagraph (2) of this paragraph. No relocation of a main studio to a point outside the principal community to be served, or from one such point outside the community to another, may be made without first securing a modification of construction permit or license, except for relocation at the AM main studio location of a commonly-owned AM station licensed to the same community. FCC Form 301 shall be used to apply therefor. The main studio may, however, be relocated within the principal community to be served, or be moved from a location outside the community to one within it, without specific authority, but the Commission shall be notified promptly of any such relocation.

(4) A majority (computed on the basis of duration and not number) of a station's programs or, in the case of a station affiliated with a network, two-thirds of such station's non-network programs, which ever is smaller, shall originate from the main studio or from other studios or remote points situated in the place where the station is located.

(b) (1) Stations will be licensed to serve more than one city, town, political subdivision, or community only where a satisfactory showing is made that each such place meets the requirements of this subpart with respect to the location of main studios; that the station can and will originate a substantial number of local live programs from each such place, and that the requirements as to origination of programs contained in paragraph (a) of this section would place an unreasonable burden on the station if it were licensed to serve only one city, town, political subdivision, or community.

(2) A station licensed to serve more than one place shall be considered to be located in and shall maintain main studios in each such place.

(3) With respect to such station, the requirements in paragraph (a) of this section as to origination of programs shall be satisfied by the origination of programs from any or all of the main studios, other studios, or remote points situated in any or all of the places in which the main studios are located.

In TV rules...

§73.613 Main studio location.—(a) The main studio of a television broadcast station shall be located in the principal community to be served. Where the principal community to be served is a city, town, village or other political subdivision, the main studio shall be located within the corporate boundaries of such city, town, village or other political subdivision. Where the principal community to be served does not have specifically defined political boundaries, applications will be considered on a case-to-case basis in the light of the particular facts involved to determine whether the main studio is located within the principal community to be served.

(b) Where an adequate showing is made that good cause exists for locating a main studio outside the principal community to be served and that to do so would be consistent with the operation of the station in the public interest, the Commission will permit the use of a main studio location other than that specified in paragraph (a) of this section. No relocation of a main studio to a point outside the principal community to be

served, or from one such point outside the community to another, may be made without first securing a modification of construction permit or license. FCC Form 301 shall be used to apply therefor. The main studio may, however, be relocated within the principal community to be served or be moved from a location outside the community to one within it without specific authority, but the Commission shall be notified promptly of any such relocation.

Operating schedules

For AM stations...

§73.71 Minimum operating schedule.—(a) All standard broadcast stations are required to maintain an operating schedule of not less than two-thirds of the total hours they are authorized to operate between 6 a.m. and 6 p.m., local time, and two-thirds of the total hours they are authorized to operate between 6 p.m. and midnight, local time each day of the week except Sunday: Provided, however, that stations authorized for daytime operation need comply only with the minimum requirement for operation between 6 a.m. and 6 p.m.

(b) In the event that causes beyond the control of a permittee or licensee make it impossible to adhere to the operating schedule in paragraph (a) of this section or to continue operating, the station may limit or discontinue operation for a period of not more than 30 days without further authority from the Commission, provided that notification is sent to the Commission in Washington, D.C. no later than the 10th day of limited or discontinued operation. During such period, the permittee or licensee shall continue to adhere to the requirements of the station license pertaining to the lighting of antenna structures. In the event normal operation is restored prior to the expiration of the 30-day period, the permittee or licensee will so notify the Commission in Washington, D.C. of this date. If causes beyond the control of the permittee or licensee make it impossible to comply within the allowed period, informal written request shall be made to the Commission in Washington, D.C., no later than the 30th day for such additional time as may be deemed necessary.

§73.72 Operation during experimental period.—The licensee of each standard broadcast station shall operate or refrain from operating its station during the experimental period as directed by the Commission in order to facilitate frequency measurement or for the determination of interference.

§73.73 Specified hours.—If the license of a station specifies the hours of operation, the schedule so specified shall be adhered to except as provided in §§73.23 (e), 73.71, 73.72 and 73.98 (d).

§73.79 License to specify sunrise and sunset hours.—If the licensee of a broadcast station is required to commence or cease operation, or to change the mode of operation at the times of sunrise and sunset at any particular location, the controlling times of each month of the year are set forth in the station's instrument of authorization. Uniform sunrise and sunset times are specified for all of the days of each month, based upon the actual times of sunrise and sunset for the fifteenth day of that month adjusted to the nearest quarter hour. In accordance with a standardized procedure described therein, actual sunrise and sunset time are derived by interpolation in the tables of the 1946 American Nautical Almanac, issued by the Nautical Almanac Office of the United States Observatory.

§73.80 Secondary station; filing of operating schedule.—The license of a secondary station authorized to operate limited time and which may resume operation at the time the dominant station (or stations) on the same channel ceases operation shall, with each application for renewal of license, file in triplicate a copy of its regular operating schedule, bearing a signed notation by the licensee of the dominant station of its objection or lack of objection thereto. Upon approval of such operating schedule, the Commission will affix its file mark and return one copy to the licensee authorized to operate limited time, which shall be posted with the station license and considered as a part thereof. Departure from said operating schedule will be permitted in accordance with the procedure set forth in §73.77.

§73.81 Secondary station; failure to reach agreement.—If the licensee of a secondary station authorized to operate limited time and a dominant station on a channel are unable to agree upon a definite time for resumption of operation by the station

authorized limited time, the Commission shall be so notified by the licensee of the station authorized limited time. After receipt of such statement the Commission will designate for hearing the applications of both stations for renewal of license, and pending the hearing the schedule previously adhered to shall remain in full force and effect.

§73.82 Departure from schedule; material violation.—In all cases where a station licensee is required to prepare and file an operating schedule, except as herein authorized, shall be considered as a violation of a material term of the license.

§73.87 Times and modes of program transmission.—Except as provided in §73.98 and §73.99, no standard broadcast station shall operate at times, or with modes or powers, other than those specified in the basic instrument of authorization.

§73.88 Blanketing interference.—The licensee of each broadcast station is required to satisfy all reasonable complaints of blanketing interference with the 1 m/v contour.

§73.98 Operation during emergency.—(a) When necessary to the safety of life and property and in response to dangerous conditions of a general nature, standard broadcast stations may, at the discretion of the licensee and without further Commission authority, transmit emergency weather warnings and other emergency information. Examples of emergency situations which may warrant either an immediate or delayed response by the licensee are: tornadoes, hurricanes, floods, tidal waves, earthquakes, icing conditions, heavy snows, widespread fires, discharge of toxic gases, widespread power failures, industrial explosions, and civil disorders. Transmission of information concerning school closings and changes in school bus schedules resulting from any of these conditions is appropriate. In addition, and if requested by responsible public officials, emergency point-to-point messages may be transmitted for the purpose of requesting or dispatching aid and assisting in rescue operations.

(b) When emergency operation is conducted under a state-level EBS Operational Plan, the attention signal described in §73.906 may be employed.

(c) Except as provided in paragraph (d) of this section, emergency operation shall be confined to the hours, frequencies, powers, and modes of operation specified in the license documents of the stations concerned.

(d) When adequate advance warning cannot be given with the facilities or hours authorized, stations may employ their full daytime facilities during nighttime hours to carry weather warnings and other types of emergency information connected with the examples listed in paragraph (a) of this section. Because of skywave interference impact on other stations assigned to the same channel, such operation may be undertaken only if regular, unlimited-time service is nonexistent, inadequate from the standpoint of coverage, or not serving public need. All operation under this paragraph must be conducted on a noncommercial basis. Recorded music may be used to the extent necessary to provide program continuity.

(e) Any emergency operation undertaken in accordance with this section may be terminated by the Commission, if required in the public interest.

(f) Immediately upon cessation of an emergency during which broadcast facilities were used for the transmission of point-to-point messages under paragraph (a) of this section, or when daytime facilities were used during nighttime hours in accordance with paragraph (d) of this section, a report in letter form shall be forwarded to the Commission, in Washington, D.C., setting forth the nature of the emergency, the dates and hours of emergency operation; and a brief description of the material carried during the emergency period. A certification of compliance with the non-commercialization provision of paragraph (d) of this section must accompany the report where daytime facilities are used during nighttime hours, together with a detailed showing concerning the alternate service provisions of that paragraph.

(g) If the Emergency Broadcast System (EBS) is activated by the National-Level while non-EBS emergency operation under this section is in progress, the EBS shall take precedence.

§73.99 Pre-sunrise Service Authority.—(a) In order to afford the maximum uniformity in early morning operations compatible with interference con-

siderations, the following classes of standard broadcast permittees and licensees are eligible to request Pre-sunrise Service Authority (PSA):

(1) Class II stations operating on clear channels, except those operating on Canadian I-A clear channels and those located east of co-channel U.S. Class I-A stations.

(2) Class III stations.
(b) When issued, a PSA will permit:

(1) Class II stations operating on Mexican and Bahamian Class I-A clear channels to commence operation with their daytime antenna systems at 6 a.m. local time, and to continue such operation until the sunrise times specified in their basic instruments of authorization; and other Class II stations, where eligible under paragraph (a) (1) of this section, to commence operation with their daytime or critical hours antenna systems either at 6 a.m. local time, or at the time of sunrise at the westernmost Class I station located east of the Class II stations (whichever is later), and to continue such operation until the sunrise times specified in their basic instruments of authorization: Provided, that the permissible power to be specified in a PSA shall not exceed 500 watts (or the authorized daytime or critical hours power, if less than 500 watts), or such lesser power as may be determined by computations made pursuant to paragraph (c) of this section.

(2) Class III stations to commence operation with their daytime antenna systems at 6:00 a.m. local time, and to continue such operation until local sunrise: Provided, that the permissible power, to be specified in the PSA, shall not exceed 500 watts or such lesser power as may be determined on the basis of calculations made pursuant to paragraph (c) of this section.

(c) Notwithstanding the provisions of §§1.571 and 1.580 of this chapter, requests for PSA's shall be treated as proposals for minor change in existing facilities and, as such, are not subject to the procedural requirements or remedies applicable to applications for new facilities and major changes therein. PSA requests shall be submitted by letter, signed in the manner specified in §1.513 of this chapter, with the following information:

(1) Name, call letters and station location.

(2) For Class II stations operating on clear channels other than Class I-A clear channels, a showing that objectionable interference as determined by the Standard Broadcast Technical Standards (§§73.182 to 73.190), or by the engineering standards of the NARBA (whichever is controlling), will not be caused within the 0.5 mv/m 50 percent skywave contour of any domestic Class I-B Station, or of a Class I-B station in any country signatory to the NARBA, where the Class II station is located east of the Class I-B station; for Class II stations operating on Mexican Class I-A clear channels, and for Class II stations located east of co-channel Mexican Class I-B stations, a showing under the engineering standards of the United States/Mexican Agreement that the Class II station does not produce a signal in excess of 25 uv/m 10 percent skywave at any point on the co-channel Mexican Class I station's 0.5 mv/m 50 percent skywave contour which falls on Mexican territory, or more than 50 uv/m 10 percent skywave at any point on the Mexican border or boundary where the signal of the Mexican Class I station exceeds 0.5 mv/m 50 percent skywave in strength. In addition, the applicant must show that foreign Class II stations (if any) assigned to the same channel as the U.S. Class II station will receive full protection under the standards for nighttime operation set forth in the applicable agreement. If the foregoing protections cannot be achieved by the Class II station while operating with 500 watts, a showing may be submitted to establish the level to which power must be limited to preclude objectionable interference: Provided, that in relation to Canadian Class II stations, the permissible power level may be established in the manner described in paragraph (c) (3) of this section by the use of Figure 12 of §73.190.

NOTE: PSA applicants for the Bahamian I-A clear channel (1540 khz) need not submit the nighttime interference study required of other PSA applicants under this subparagraph. Instead, the commission will assign a power and time of commencement of pre-sunrise operation consistent with the provisions of the U.S.-Bahamian pre-sunrise agreement (1974) and the protection requirements of U.S. I-B and foreign Class II full-time station assignments on this frequency.

(3) For Class III stations, a showing that co-channel stations in foreign countries will receive full treaty protection. If such protection cannot be achieved on the basis of 500-watt operation, calculations may be sub-

mitted to establish the level to which power must be reduced to preclude objectionable interference: Provided, that with respect to Canadian Class III stations, such power level may be established by a showing that the radiation at the pertinent vertical angle toward co-channel Canadian stations does not exceed that defined in Figure 12 of §73.190. If the latter showing cannot be made on the basis of 500-watt operations, calculations may be submitted to establish the level to which power must be reduced in order to limit radiation at the pertinent vertical angle to the values specified in Figure 2 of §73.190.

(4) A description of the method whereby any proposed power reduction will be achieved.

(d) Calculations made under paragraph (c) of this section shall not take outstanding PSA's into account, nor shall the grant of PSA confer any degree of interference protection on the holder thereof.

(e) Operation under a PSA is not mandatory, and will not be included in determining compliance with the requirements of §73.71. To the extent actually undertaken, however, pre-sunrise operation will be considered by the Commission in determining overall compliance with past programing representations and station policy concerning commercial matter.

(f) The PSA is secondary to the basic instrument of authorization and may be suspended, modified, or withdrawn by the Commission without prior notice or right to hearing, if necessary to resolve interference conflicts, to implement agreements with foreign governments, or in other circumstances warranting such action.

(g) The PSA will be issued for a term coinciding with the current basic instrument of authorization and, unless surrendered by the holder or suspended, modified or withdrawn by the Commission, will have continuing or renewed effect under succeeding instruments.

(h) The issuance of a PSA is intended to include the waiver of §§73.45, 73.182, and 73.188 in situations where the operation might otherwise be considered as technically sub-standard. However, such special conditions as the Commission may deem appropriate may be included in the PSA to insure the operation of the transmitter and associated equipment in accordance with all phases of good engineering practice.

(i) In the event of permanent discontinuance of pre-sunrise operation, the PSA shall be forwarded to the Commission's Washington office for cancellation, and the Engineer in Charge of the radio district in which the station is located shall be notified accordingly.

For FM stations...

§73.242 Duplication of AM and FM programming.—(a) After October 15, 1965, licensees of FM stations in cities of over 100,000 population (as listed in the latest regular U.S. Census Reports) shall operate so as to devote no more than 50 percent of the average FM broadcast week to programs duplicated from an AM station owned by the same licensee in the same local area. For the purposes of this paragraph, duplication is defined to mean simultaneous broadcasting of a particular program over both the AM and FM station or the broadcast of a particular FM program within 24 hours before or after the identical program is broadcast over the AM station.

(b) Compliance with the non-duplication requirement shall be evidenced by such showing in connection with renewal applications as the Commission may require.

(c) Upon a substantial showing that continued program duplication over a particular station would better serve the public interest than immediate non-duplication, a licensee may be granted a temporary exemption from the requirements of paragraph (a) of this section. Requests for such exemption must be submitted to the Commission, accompanied by supporting data, at least 6 months prior to the time the non-duplication requirement of paragraph (a) of this section is to become effective as to a particular station. Such exemption, if granted, will ordinarily run to the end of the station's current license period, or if granted near the end of the license period, for some other reasonable period not to exceed 3 years.

§73.261 Time of operation.—(a) All FM broadcast stations will be licensed for unlimited time operation. All FM stations are required to maintain an operating schedule of not less than eight hours between 6 a.m. and 6 p.m., local time, and not less than four hours between 6 p.m. and midnight, local time, each day of the week except Sunday.

(b) In the event that causes beyond the control of a permittee or licensee make it impossible to adhere to the operating schedule in paragraph (a) of this section

or to continue operating, the station may limit or discontinue operation for a period of not more than 30 days without further authority from the Commission, provided that notification is sent to the Commission in Washington, D.C. no later than the 10th day of limited or discontinued operation. During such period, the permittee or licensee shall continue to adhere to the requirements of the station license pertaining to the lighting of antenna structures. In the event normal operation is restored prior to the expiration of the 30-day period, the permittee or licensee will so notify the Commission in Washington, D.C. of this date. If the causes beyond the control of the permittee or licensee make it impossible to comply within the allowed period, informal written request shall be made to the Commission in Washington, D.C., no later than the 30th day for such additional times as may be deemed necessary.

§73.262 Experimental operation.—(a) The period between 12 midnight and 6 a.m., prevailing local time, may be used for experimental purposes in testing and maintaining apparatus by the licensee of any FM broadcast station on its assigned frequency and not in excess of its authorized power without specific authorization from the Commission.

(b) FM broadcast stations may (with prior notification to the Commission and the Engineer in Charge of the radio district in which the station is located) test, maintain, and adjust the apparatus at the station during other time periods; and may (upon informal application) conduct technical experimentation directed to the improvement of technical phases of operation during other time periods and for such purposes may utilize a signal other than the standard FM signal, subject to the following conditions:

(1) That the licensee complies with the provisions of §73.261 with regard to the minimum number of hours of operation.

(2) That emissions outside the authorized bandwidth shall comply with §73.317 (a) and that no interference is caused to the transmissions of other FM broadcast stations.

(3) No charges either direct or indirect shall be made by the licensee of an FM broadcast station for the production or transmission of programs when conducting technical experimentation.

For TV stations...

§73.651 Time of operation.—(a) (1) All television broadcast stations will be licensed for unlimited time operation. Each such station shall maintain a regular program operating schedule as follows: not less than 2 hours daily in any five broadcast days per week and not less than a total of 12 hours per week during the first 18 months of the stations operation; not less than 2 hours daily in any 5 broadcast days per week and not less than a total of 16 hours, 20 hours and 24 hours per week for each successive 6-month period of operation, respectively; and not less than a total of 28 hours per week thereafter.

(2) "Operation" includes the period during which a station is operated pursuant to temporary authorization or during program tests, as well as during the license period. Time devoted to test patterns, or to aural presentations accompanied by the incidental use of fixed visual images which have no substantial relationship to the subject matter of such aural presentations, shall not be considered in computing periods of program service.

(3) In the event that causes beyond the control of a permittee or licensee make it impossible to adhere to the operating schedule in paragraph (a) of this section or to continue operating, the station may limit or discontinue operation for a period of not more than 30 days without further authority from the Commission, provided that notification is sent to the Commission in Washington, D.C. no later than the 10th day of limited or discontinued operation. During such period, the permittee or licensee shall continue to adhere to the requirements of the station license pertaining to the lighting of antenna structures. In the event normal operation is restored prior to the expiration of the 30-day period, the permittee or licensee will so notify the Commission in Washington, D.C. of this date. If the causes beyond the control of the permittee or licensee make it impossible to comply within the allowed period, informal written request shall be made to the Commission in Washington, D.C., no later than the 30th day for such additional time as may be deemed necessary.

(b) Noncommercial educational television broadcast stations are not required to operate on a regular schedule and no minimum number of hours or operation is specified; but the hours of actual operation during a license period shall be taken into account when

considering the renewal of noncommercial educational television broadcast licenses.

(c) (1) The aural transmitter of a television station shall not be operated separately from the visual transmitter except for the following purposes:

(i) For actual tests of station equipment or actual experimentation in accordance with §73.666; and

(ii) For emergency "fills" in case of visual equipment failure or unscheduled and unavoidable delays in presenting visual programs. In such situations the aural transmitter may be used to advise the audience of difficulties and to transmit for a short period program material of such nature that the audience will be enabled to remain tuned to the station: for example, music or news accompanying a test pattern or other visual presentation.

(2) During periods of transmission of a test pattern on the visual transmitter of a television station, aural transmission shall consist only of a single tone or series of variable tones. During periods when still pictures or slides are employed to produce visual transmissions which are accompanied by aural transmissions, the aural and visual transmission shall be integral parts of a program or announcement and shall have a substantial relationship to each other; Provided: That nothing herein shall preclude the transmission of a test pattern, still picture or slides for the following purposes and periods:

(1) To accompany aural announcements of the station's program schedule and aural news broadcasts or news commentaries, for a total period not to exceed one hour in any broadcast day.

(ii) To accompany aural transmissions for a period of time not to exceed fifteen minutes immediately prior to the commencement of a programming schedule.

Examples: (1) Duplication of AM or FM programs on the aural transmitter of a television station while the same program is broadcast on the visual transmitter (i.e., a "simulcast") is consistent with this paragraph.

(2) Duplication of AM or FM programs on the aural transmitter of a television station while a test pattern broadcast on the visual transmitter is not consistent with this paragraph, except for the specific purposes and periods specified in paragraph (c) (2).

(3) A travel lecture in which the words of the lecturer are broadcast simultaneously with still pictures or slides of scenes illustrating the lecture and a newscast in which the words of the newscaster are broadcast simultaneously with still pictures or slides of the news events, are examples of programs in which the aural and visual transmission are integral parts of the same program having a substantial relationship to each other, within the meaning of paragraph (c) (2). Mood music unrelated to the visual transmission is not consistent with this paragraph.

(4) The broadcast of a test pattern accompanied by a musical composition for the purpose of demonstration, sale, installation or orientation of television receivers, or receiving antennas is not consistent with this paragraph.

(5) Music accompanying the transmission of a test pattern upon which is visually imposed a moving test consisting of continuous program material, such as a running newscast or news commentary, is inconsistent with this paragraph.

(6) Music accompanying the transmission of a test pattern upon which is visually imposed a clock indicating the time of day, or a text that is changed at spaced intervals, is not consistent with this paragraph.

Operator requirements

In AM rules...

§73.93 Operator requirements.—(a) One or more operators holding a radio operator license or permit of a grade specified in this section shall be in actual charge of the transmitting system, and shall be on duty at the transmitter location, or at an authorized remote control point, or the position at which extension meters, as authorized pursuant to §73.70 of this Subpart are located. The transmitter and required monitors and metering equipment, or the required extension meters and monitoring equipment and other required metering equipment, or the controls and required monitoring and metering equipment in an authorized remote control operation, shall be readily accessible to the licensed operator and located sufficiently close to the normal operating location that deviations from normal indications of required instruments can be observed from that location.

(b) With the exceptions set forth in paragraph (f) of this section, adjustments of the transmitting system, and inspection, maintenance, required equipment performance measurements, and required field strength

measurements shall be performed only by a first class radiotelephone operator, or, during periods of operation when a first class radiotelephone operator is in charge of the transmitter, by or under the direction of a broadcast consultant regularly engaged in the practice of broadcast station engineering.

(c) A station using a non-directional antenna with nominal power of 10 kilowatts or less may employ first class radiotelegraph operators, second-class radiotelegraph or radiotelephone operators, or operators with third-class radiotelegraph or radiotelephone permits endorsed for broadcast station operation for routine operation of the transmitting system if the station has at least one first class radiotelephone operator readily available at all times. This operator may be in full-time employment, or, as an alternative, the licensee may contract in writing for the services, on a part-time basis, of one or more such operators. Signed contracts with part-time operators shall be kept in the files of the station and shall be made available for inspection upon request by an authorized representative of this Commission.

(d) A station using a non-directional antenna, during periods of operation with authorized power in excess of 10 kilowatts, may employ first class radiotelephone operators, second-class radiotelegraph or radiotelephone operators, or radiotelegraph or radiotelephone operators with third class permits endorsed for broadcast station operation for routine operation of the transmitting system, if the station has in full-time employment at least one first class radiotelephone operator.

(e) A station using a directional antenna system, which is required by the station authorization to maintain the ratio of the currents in the elements of the system within a tolerance which is less than 5 per cent or the relative phases of those currents within a tolerance which is less than 3 degrees shall, without exception, employ first class radiotelephone operators who shall be on duty and in actual charge of the transmitting system as specified in paragraph (a) of this section during hours of operation with a directional radiation pattern. A station whose authorization does not specifically require therein the maintenance of phase and current relationships within closer tolerances than above specified shall employ first class radiotelephone operators for routine operation of the transmitting system during periods of directional operation; provided, however, that holders of first-class radiotelegraph licenses, second-class radiotelegraph or radiotelephone licenses or third-class radiotelegraph or radiotelephone permits endorsed for broadcast station operation, may be employed for routine operation of the transmitting system if the following conditions are met:

(1) The station must have in full-time employment at least one first class radiotelephone operator.

(2) The station shall be equipped with a type-approved phase (antenna) monitor fed by a sampling system installed and maintained pursuant to accepted standards of good engineering practice (see NOTE 1 at end of this section).

(3) Within 1 year of the date on which lesser grade operators are first employed and a chief operator has been designated, pursuant to paragraph (h) of this section, the station shall complete a partial proof of performance, as defined in Note 2 at the end of this section, and shall complete subsequent proofs of performance at 3 year intervals thereafter. A skeleton proof of performance, as defined in Note 3 at the end of this section, shall be completed during each year that a partial proof of performance is not required. Not less than 10, nor more than 14 months shall elapse between the completion dates of successive proofs of performance. The results of such proofs shall be prepared and filed in the same manner as required in equipment performance measurements pursuant to paragraph (b) of §73.47.

(4) Field strength measurements shall be made at the monitoring points specified in the station authorization at least once each 30 days unless more frequent measurements are required by such authorization. The results of these measurements shall be entered in the station maintenance log. The licensee shall have readily available, and in proper working condition, field strength measuring equipment to perform these measurements.

(f) Subject to the conditions set forth in paragraphs (c), (d), and (e) of this section, the routine operation of the transmitting system may be performed by an operator holding a first-class radiotelegraph license, a second-class radiotelegraph or radiotelephone license, or a third-class radiotelegraph or radiotelephone permit endorsed for broadcast operation. Unless, however, performed under the immediate and personal

supervision of an operator holding a first-class radiotelephone license, an operator holding a first-class radiotelegraph license, second-class radiotelegraph or radiotelephone license, or third-class radiotelegraph or radiotelephone permit endorsed for broadcast station operation, may make adjustments only of external controls, as follows:

(1) Those necessary to turn the transmitter on and off;

(2) Those necessary to compensate for voltage fluctuations in the primary power supply;

(3) Those necessary to maintain modulation levels of the transmitter within prescribed limits;

(4) Those necessary to effect routine changes in operating power which are required by the station authorization;

(5) Those necessary to change between non-directional and direction or between differing radiation patterns, provided that such changes require only activation of switches and do not involve the manual tuning of the transmitter final amplifier or antenna phasor equipment. The switching equipment shall be so arranged that the failure of any relay in the directional antenna system to activate properly will cause the emissions of the station to terminate.

(g) It is the responsibility of the station licensee to insure that each operator is fully instructed in the performance of all the above adjustments, as well as in other required duties, such as reading meters and making log entries. Printed step-by-step instructions for those adjustments which the lesser grade operator is permitted to make, and a tabulation or chart of upper and lower limiting values of parameters required to be observed and logged, shall be posted at the operating position. The emissions of the station shall be terminated immediately whenever the transmitting system is observed operating beyond the posted parameters, or in any other manner inconsistent with the rules or the station authorization, and the above adjustments are ineffective in correcting the condition of improper operation, and a first class radiotelephone operator is not present.

(h) When lesser grade operators are used, in accordance with paragraph (d) or (e) of this section, for any period of operation with nominal power in excess of 10 kilowatts, or with a directional radiation pattern, the station licensee shall designate one first class radiotelephone operator in full-time employment as the chief operator who, together with the licensee, shall be responsible for the technical operation of the station. The licensee also may designate another first class radiotelephone operator as assistant chief operator, who shall assume all responsibilities of the chief operator during periods of his absence. The station licensee shall notify the engineer in charge of the radio district in which the station is located of the name(s) and license number(s) of the operator(s) so designated. Such notification shall be made within three days of the date of such designation. A copy of the notification shall be posted with the license(s) of the designated operator(s).

(1) An operator designated as chief operator for one station may not be so designated concurrently at any other standard broadcast station.

(2) The station licensee shall vest such authority in, and afford such facilities to the chief operator as may be necessary to insure that the chief operator's primary responsibility for the proper technical operation of the station may be discharged efficiently.

(3) At such time as the regularly designated chief operator is unavailable or unable to act as chief operator (e.g., vacations, sickness), and an assistant chief operator has not been designated, or, if designated, for any reason is unable to assume the duties of chief operator, the licensee shall designate another first class radiotelephone operator as acting chief operator on a temporary basis. Within three days of the date such action is taken, the engineer in charge of the radio district in which the station is located shall be notified by the licensee by letter of the name and license number of the acting chief operator, and shall be notified by letter, again within three days of the date when the regularly designated chief operator returns to duty.

(4) The designated chief operator may serve as a routine duty transmitter operator at any station only to the extent that it does not interfere with the efficient discharge of his responsibilities as listed below.

(i) The inspection and maintenance of the transmitting system including the antenna system and required monitoring equipment.

(ii) The accuracy and completeness of entries in the maintenance log.

FCC Rules

(iii) The supervision and instruction of all other station operators in the performance of their technical duties.

(iv) A review of completed operating logs to determine whether technical operation of the station has been in accordance with the rules and terms of the station authorization. After review, the chief operator shall sign the log and indicate the date and time of such review. If the review of the operating logs indicates technical operation of the station is in violation of the rules or the terms of the station authorization, he shall promptly initiate corrective action. The review of each day's operating log shall be made within 24 hours, except that, if the chief operator is not on duty during a given 24 hour period, the logs must be reviewed within two hours after his next appearance for duty. In any case, the time before review shall not exceed 72 hours.

(i) The operator on duty at the transmitter or remote control point, may, at the discretion of the licensee and the chief operator, if any, be employed for other duties or for the operation of another radio station or stations in accordance with the class of operator's license which he holds and the rules and regulations governing such other stations; provided, however, that such other duties shall not interfere with the proper operation of the standard broadcast transmitting system and keeping of required logs.

(j) At all standard broadcast stations, a complete inspection of the transmitting system and required monitoring equipment in use, shall be made by an operator holding a first class radiotelephone license at least once each calendar week. The interval between successive required inspections shall not be less than 5 days. This inspection shall include such tests, adjustments, and repairs as may be necessary to insure operation in conformance with the provisions of this subpart and the current station authorization.

NOTE 1: See §73.69, Note 2.

NOTE 2: The partial proof of performance shall consist of at least 10 field strength measurements on each of the radials established in the latest complete adjustment of the directional antenna system. These measurements shall be made at locations, all within 2 to 10 miles from the antenna, which were utilized in such adjustment, and include on each radial, the point, if any, designated as a monitoring point in the station authorization. Measurements shall be analyzed in the manner prescribed in §73.186 of the rules of this part.

NOTE 3: The skeleton proof of performance shall consist of field strength measurements at least three on each of the radials established in the latest complete adjustment of the directional antenna system, made at measurement locations utilized in such adjustment, and include, on each radial, the point, if any, designated as a monitoring point in the station authorization.

In FM rules...

§73.265 Operator requirements.

[EDITOR'S NOTE: Substantially the same as §73.93.]

In TV rules...

§73.661 Operator requirements.—One or more operators holding a valid radiotelephone first class operator license shall be on duty at the place where the transmitting apparatus is located; or where extension meters and monitoring devices for monitoring critical parameters of the transmitter are located; as provided by §73.678 of this subpart; or at an authorized remote control point established pursuant to the provisions of §73.677 of this subpart; and shall be in actual charge thereof whenever the transmitter is delivering power to the transmitting antenna. The licensed operator on duty and in charge of the television broadcast transmitter may, at the discretion of the licensee, be employed for other duties or for operation of another station or stations in accordance with the class of license which he holds and the rules and regulations governing such other stations. However, such other duties shall in nowise impair or impede the required supervision of the television broadcast transmitter. The transmitter and required monitors and metering equipment, or the required extension meters and monitoring equipment and other required metering equipment, or the controls and required monitoring and metering equipment in an authorized remote control operation, shall be readily accessible to the licensed operator and located sufficiently close to the normal operating location that deviations from normal indications of required instruments can be observed from that location.

Personal attack and political broadcasts

In AM rules...

§73.123 Personal attacks; political editorials.—(a) When, during the presentation of views on a controversial issue of public importance, an attack is made upon the honesty, character, integrity or like personal qualities of an identified person or group, the licensee shall, within a reasonable time and in no event later than one week after the attack, transmit to the person or group attacked (1) notification of the date, time and identification of the broadcast; (2) a script or tape (or an accurate summary if a script or tape is not available) of the attack; and (3) an offer of a reasonable opportunity to respond over the licensee's facilities.

(b) The provisions of paragraph (a) of this section shall not be applicable (i) to attacks on foreign groups or foreign public figures; (ii) to personal attacks which are made by legally qualified candidates, their authorized spokesmen, or those associated with them in the campaign, on other such candidates, their authorized spokesmen, or persons associated with the candidates in the campaign; and (iii) to bona fide newscasts, bona fide news interviews, and on-on-the-spot coverage of a bona fide news event (including commentary or analysis contained in the foregoing programs, but the provisions of paragraph (a) shall be applicable to editorials of the licensee).

NOTE: The fairness doctrine is applicable to situations coming within (iii), above, and, in a specific factual situation, may be applicable in the general area of political broadcasts (ii), above. See, Section 315(a) of the Act, 47 USC §315(a); Public Notice: Applicability of the Fairness Doctrine in the Handling of Controversial Issues of Public Importance, 29 Fed. Reg. 10415. The categories listed in (iii) are the same as those specified in Section 315(a) of the Act.

(c) Where a licensee, in an editorial, (i) endorses or (ii) opposes a legally qualified candidate or candidates, the licensee shall, within 24 hours after the editorial, transmit to respectively (i) the otherqualified candidate or candidates for the same office or (ii) the candidate opposed in the editorial (1) notification of the date and the time of the editorial; (2) a script or tape of the editorial; and (3) an offer of a reasonable opportunity for a candidate or spokesman of the candidate to respond over the licensee's facilities: provided, however, that where such editorials are broadcast within 72 hours prior to the day of the election, the licensee shall comply with the provisions of this subsection sufficiently far in advance of the broadcast to enable the candidate or candidates to have a reasonable opportunity to prepare a response and to present it in a timely fashion.

In FM rules...

§73.300 [EDITOR'S NOTE: Identical with §73.123 above.]

In TV rules...

§73.679 [EDITOR'S NOTE: Identical with §73.123 above.]

Equal Employment

§73.125 Equal employment opportunities.

(a) General policy: Equal opportunity in employment shall be afforded by all licensees or permittees of commercially or noncommercially operated standard, FM, television or international broadcast stations (as defined in this Part) to all qualified persons, and no person shall be discriminated against in employment because of race, color, religion, or national origin or sex.

(b) Equal employment opportunity program: Each station shall establish, maintain, and carry out, a positive continuing program of specific practices designed to assure equal opportunity in every aspect of station employment policy and practice. Under the terms of this program, a station shall:

(1) Define the responsibility of each level of management to insure a positive application and vigorous enforcement of the policy of equal opportunity, and establish a procedure to review and control managerial and supervisory performance.

(2) Inform its employees and recognized employee organizations of the positive equal employment opportunity policy and program and enlist their cooperation.

(3) Communicate the station's equal employment opportunity policy and program and its employment needs to sources of qualified applicants without regard to race, color, religion, national origin or sex, and solicit their recruitment assistance on a continuing basis.

(4) Conduct a continuing campaign to exclude every form of prejudice or discrimination based upon race, color, religion, national origin or sex, from the

station's personnel policies and practices and working conditions.

(5) Conduct continuing review of job structure and employment practices and adopt positive recruitment, training, job design and other measures needed in order to insure genuine equality of opportunity to participate fully in all organizational units, occupations and levels of responsibility in the station.

(c) Applicants for construction permit for a new facility, for assignment of license or construction permit or for transfer of control (other than pro forma or involuntary assignments and transfers), and applicants for renewal of license who have not previously done so, shall file with the Commission programs designed to provide equal employment opportunities for Negroes, orientals, American Indians, Spanish-surnamed Americans, and women, or amendments to such programs. Guidelines for the preparation of such programs are set out in Section VI of the appropriate application forms. See 32 FCC 2d 708, 831. A program need not be filed by any station having less than five full-time employees or with respect to any minority group which is represented in such insignificant numbers in the area that a program would not be meaningful. In the latter situation, a statement of explanation should be filed.

In FM rules...

§73.301—[EDITOR'S NOTE: In substance the same as §73.125 above.]

In TV rules...

§73.680—[EDITOR'S NOTE: In substance, the same as §73.125 above.]

Network Affiliation

In AM rules...

§73.131 Exclusive affiliation of station.—No license shall be granted to a standard broadcast station having any contract, arrangement, or understanding, express or implied, with a network organization under which the station is prevented or hindered from or penalized for, broadcasting the programs of any other network organization. (The term "network organization" as used herein includes national and regional network organizations. See Chapter VII, J of Report on Chain Broadcasting.)

§73.132 Territorial exclusivity.—No license shall be granted to a standard broadcast station having any contract, arrangement, or understanding, express or implied, with a network organization which prevents or hinders another station serving substantially the same area from broadcasting the network's programs not taken by the former station, or which prevents or hinders another station serving a substantially different area from broadcasting any program of the network organization. This section shall not be construed to prohibit any contract, arrangement, or understanding between a station and a network organization pursuant to which the station is granted the first call in its primary organization.

§73.133 Term of affiliation.—No license shall be granted to a standard broadcast station having any contract, arrangement, or understanding, express or implied, with a network organization which provides, by original term, provisions for renewal, or otherwise for the affiliation of the station with the network organization for a period longer than two years; provided that a contract, arrangement, or understanding for a period up to two years, may be entered into within six months prior to the commencement of such period.

§73.134 Option time.—No license shall be granted to a standard broadcast station which options for network programs any time subject to call on less than 56 days' notice, or more time than a total of 3 hours within each of four segments of the broadcast day, as herein described. The broadcast day is divided into four segments, as follows: 8 a.m. to 1 p.m.; 1 p.m. to 6 p.m.; 6 p.m. to 11 p.m.; 11 p.m. to 8 a.m. (These segments are to be determined for each station in terms of local time at the location of the station but may remain constant throughout the year regardless of shifts from nonadvanced to advanced time or vice versa.) Such option may not be exclusive, as against other network organizations and may not prevent or hinder the station from obtaining or selling any or all of the time covered by the option, or other time, to other network organizations.

NOTE 1: As used in this section, an option is any contract, arrangement, or understanding, expressed or implied, between a station and a network organization which prevents or hinders the station from scheduling programs before the network agrees to utilize the time during which such programs are scheduled, or which requires the station to clear time already scheduled

when the network organization seeks to utilize the time.

NOTE 2: All time options permitted under this section must be for specific clock hours, expressed in terms of any time system set forth in the contract agreed upon by the station and network organization. Shifts from advanced to nonadvanced time or vice versa may or may not shift the specified hours correspondingly as agreed by the station and network organization.

§73.135 Right to reject programs.—No license shall be granted to a standard broadcast station having any contract, agreement, or understanding, expressed or implied, with a network organization which (a) with respect to programs offered pursuant to an affiliation contract, prevents or hinders the station from rejecting or refusing network programs which the station reasonably believes to be unsatisfactory or unsuitable; or which (b) with respect to network programs so offered or already contracted for, prevents the station from rejecting or refusing any program which, in its opinion, is contrary to the public interest, or from substituting a program of outstanding local or national importance.

§73.136 Network ownership of stations.—No license shall be granted to a network organization, or to any person directly or indirectly controlled by or under common control with a network organization, for more than one standard broadcast station where one of the stations covers substantially the service area of the other station, or for any standard broadcast station in any locality where the existing standard broadcast stations are so few or of such unequal desirability (in terms of coverage, power, frequency, or other related matters) that competition would be substantially restrained by such licensing. (The word "control" as used herein, is not limited to full control but includes such a measure of control as would substantially affect the availability of the station to other networks.)

NOTE: Effective date of this section with respect to any station may be extended from time to time in order to permit the orderly disposition of properties; and it shall be suspended indefinitely with respect to regional network organizations.

§73.137 Dual network operation.—No license shall be granted to a standard broadcast station affiliated with a network organization which maintains more than one network; provided, that this section shall not be applicable if such networks are not operated simultaneously, or if there is no substantial overlap in the territory served by the group of stations comprising each such network.

§73.138 Control by networks of station rates.—No license shall be granted to a standard broadcast station having any contract, arrangement, or understanding, expressed or implied, with a network organization under which the station is prevented or hindered from, or penalized for, fixing or altering its rates for the sale of broadcast time for other than the network's programs.

In FM rules...

§73.231-73.238, Inclusive—

[EDITOR'S NOTE: Same as §§73.131-73.138 above, with the following exceptions; (1) references are to FM rather than standard stations and networks; and (2) the section on "Network Ownership of Stations" is changed to read as follows:†

§73.236 Network ownership of stations.—No license shall be granted to a network organization, or to any person directly or indirectly controlled by or under common control with a network organization, for an FM broadcast station in any locality where the existing FM broadcast stations are so few or of such unequal desirability (in terms of coverage, power, frequency, or other related matters) that competition would be substantially restrained by such licensing. (The word "control" as used herein, is not limited to majority stock ownership but includes actual working control in whatever manner exercised.)

In TV rules...

§73.658. Affiliation agreements.—(a) **Exclusive affiliation of station.** No license shall be granted to a television broadcast station having any contract, arrangement, or understanding, express or implied, with a network organization under which the station is prevented or hindered from, or penalized for, broadcasting the programs of any other network organization.

(The term "network organization" as used herein includes national and regional network organizations.

See chapter VII, J. of Report on Chain Broadcasting.)

(b) **Territorial exclusivity.** No license shall be granted to a television broadcast station having any contract, arrangement, or understanding, express or implied, with a network organization which prevents or hinders another broadcast station in the same community from broadcasting the network's programs not taken by the former stations, or which prevents or hinders another broadcast station located in a different community from broadcasting any program of the network organization. This regulation shall not be construed to prohibit any contract, arrangement, or understanding between a station and a network organization pursuant to which the station is granted the first call in its community upon the program of the network organization. As employed in this paragraph the term "community" is defined as the community specified in the instrument of authorization as the location of the station.

(c) **Term of affiliation.** No license shall be granted to a television broadcast station having any contract, arrangement, or understanding, express or implied, with a network organization which provides, by original terms, provisions for renewal, or otherwise for the affiliation of the station with the network organization for a period longer than 2 years: Provided that a contract, arrangement, or understanding for a period of up to two years may be entered into within 6 months prior to take commencement of such period.

(d) **Station commitment of broadcast time.** No license shall be granted to a television broadcast station having any contract, arrangement, or understanding, express or implied, with any network organization, which provides for optioning of the station's time to the network organization, or which has the same restraining effect as time optioning. As used in this section, time optioning is any contract, arrangement, or understanding, express or implied, between a station and a network organization which prevents or hinders the station from scheduling programs before the network agrees to utilize the time during which such programs are scheduled, or which requires the station to clear time already scheduled when the network organization seeks to utilize the time.

(e) **Right to reject programs.** No license shall be granted to a television broadcast station having any contract, arrangement, or understanding, express or implied, with a network organization which, with respect to programs offered or already contracted for pursuant to an affiliation contract, prevents or hinders the station from (1) rejecting or refusing network programs which the station reasonably believes to be unsatisfactory or unsuitable or contrary to the public interest, or (2) substituting a program which in the station's opinion, is of greater local or national importance.

(f) **Network ownership of stations.** No license shall be granted to a network organization, or to any person directly or indirectly controlled by or under common control of a network organization, for a television broadcast station in any locality where the existing television broadcast stations are so few or of such unequal desirability (in terms of coverage, power, frequency, or other related matters) that competition would be substantially restrained by such licensing. (The word "control" as used in this section is not limited to full control but includes such a measure of control as would substantially affect the availability of the station to other networks.)

(g) **Dual network operation.** No license shall be issued to a television broadcast station affiliated with a network organization which maintains more than one network of television broadcast stations: Provided that this section shall not be applicable, if such networks are not operated simultaneously, or if there is no substantial overlap in the territory served by the group of stations comprising each such network.

(h) **Control by networks of station rates.** No license shall be granted to a television broadcast station having any contract, arrangement, or understanding, express or implied, with a network organization under which the station is prevented or hindered from, or penalized for, fixing or altering its rates for the sale of broadcast time for other than the network's programs.

(i) No license shall be granted to a television broadcast station which is represented for the sale of non-network time by a network organization or by an organization directly or indirectly controlled by or under common control with a network organization, if the station has any contract, arrangement, or understanding, express or implied, which provides for the affiliation of the station with such network organization; provided, however, that this rule shall not be applicable to stations licensed to a network organization or to a subsidiary of a network organization.

(j) **Network syndication and program practices.** (1) Except as provided in subparagraph (3) of this paragraph, no television network shall:

(i) after June 1, 1973, sell, license, or distribute television programs to television station licensees within the United States or non-network television exhibition or otherwise engage in the business commonly known as "syndication" within the United States; or sell, license, or distribute television programs to television station licensees within the United States or non-network television exhibition or otherwise engage in the business commonly known as "syndication" within the United States; or sell, license or distribute television programs of which it is not the sole producer for exhibition outside the United States; or reserve any option or right to share in revenues or profits in connection with such domestic and/or foreign sale, license, or distribution; or

(ii) after August 1, 1972, acquire any financial or proprietary right or interest in the exhibition, distribution, or other commercial use of any television program produced wholly or in part by a person other than such television network, except the license or other exclusive right to network exhibition within the United States and on foreign stations regularly included within such television network; provided that if such network does not timely avail itself of such license or other exclusive right to network exhibition within the United States, the grantor of such license or right to network exhibition may, upon making a timely offer reasonably to compensate the network, re-acquire such license or other exclusive right to exhibition of the program.

(2) Nothing contained in subparagraph (1) and (2) of this paragraph shall prevent any television network from selling or distributing programs of which it is the sole producer for television exhibition outside the United States, or from selling or otherwise disposing of any program rights not acquired from another person, including the right to distribute programs for non-network exhibition (as in syndication) within the United States as long as it does not itself engage in such distribution within the United States or retain the right to share the revenues or profits therefrom.

(3) Nothing contained in this paragraph shall be construed to include any television network formed for the purpose of producing, distributing, or syndicating program materials for educational, non-commercial, or public broadcasting exhibitions or uses.

(k) **Prime time access rule.** Effective September 8, 1975, commercial television stations owned by or affiliated with a national television network in the 50 largest television markets (see Note 1 to this paragraph) shall devote, during the four hours of prime time (7-11 p.m. E.T. and P.T., 6-10 p.m. C.T. and M.T.), no more than three hours to the presentation of programs from a national network, programs formerly on a national network (off-network programs) other than feature films, or, on Saturdays, feature films; provided, however, that the following categories of programs need not be counted toward the three-hour limitation:

(1) On nights other than Saturdays, network or off-network programs designed for children, public affairs programs or documentary programs (see Note 2 to this paragraph for definitions).

(2) Special news programs dealing with fast-breaking news events, on-the-spot coverage of news events or other material related to such coverage, and political broadcasts by or on behalf of legally qualified candidates for public office.

(3) Regular network news broadcasts up to half hour, when immediately adjacent to a full hour of continuous locally produced news or locally produced public affairs programming.

(3) Runovers of live network broadcast of sporting events, where the event has been reasonably scheduled to conclude before prime time or occupy only a certain amount of prime time, but the event has gone beyond its expected duration due to circumstances not reasonably foreseeable by the networks or under their control. This exemption does not apply to post-game material.

(5) In the case of stations in the Mountain and Pacific time zones, on evenings when network prime time programming consists of a sports event or other program broadcast live and simultaneously throughout the contiguous 48 states, such stations may assume that the network's schedule that evening occupies no more of prime time in these time zones than it does in the Eastern and Central time zones.

(6) Network broadcasts of an international sports

FCC Rules

event (such as the Olympic Games), New Year's Day college football games, or any other network programming of a special nature other than motion pictures or other sports events, when the network devotes all of its time on the same evening to the same programming, except brief incidental fill material.

NOTE 1: The top 50 markets to which this paragraph applies are the 50 largest markets in terms of prime time audience for all stations in the market, as listed each year in the Arbitron publication *Television Market Analysis*. This publication is currently issued each November, and shortly thereafter the commission will issue a list of markets to which the rule will apply for the year starting the following September.

NOTE 2: As used in this paragraph, the term "programs designed for children" means programs primarily designed for children aged 2 through 12. The term "documentary programs" means programs which are nonfictional and educational or informational, but not including programs where the information is used as part of a contest among participants in the program, and not including programs relating to the visual entertainment arts (stage, motion pictures or television) where more than 50% of the program is devoted to the presentation of entertainment material itself. The term "public affairs programs" means talks, commentaries, discussions, speeches, editorials, political programs, documentaries, forums, panels, roundtables, and similar programs primarily concerning local, national, and international public affairs.

(1) **Broadcast of the programs of more than one network.** The provisions of this paragraph govern and limit the extent to which, after October 1, 1971, commercial television stations in the 50 States of the United States, which are regular affiliates of one of the three national television networks, may broadcast programs of another network, in markets where there are two such affiliated stations and one or more operational VHF or UHF stations having reasonably comparable facilities which are not regular affiliates of any network. Whether or not the stations in a particular market come within the provisions of this paragraph is determined by whether, as of July 1 of each year with respect to programs beginning October 1, or as of January 1 of each year with respect to programs beginning April 1, there are in the market the stations specified in the last sentence.

(1) **Definitions.** As used in this paragraph, the following terms have the meaning given:

(i) "Station" means a commercial television station in the 50 States of the United States.

(ii) "Operational station" means a station authorized and operating as of June 10 (with respect to programs beginning October 1) or as of December 10 (with respect to programs beginning April 1), or as a station authorized and which gives notice to the Commission by such June 10 or December 10 date that it will be on the air by such October 1 or April 1 date (including request for program test authority if none has previously been given), and commit itself to remain on the air for six months after such October 1 or April 1 date. Such notice shall be received at the Commission by the June 10 or December 10 date mentioned, and shall show that copies thereof have been sent to the three national networks and to the licensees of all operating television stations in the market.

(iii) "Affiliated station" means a station having a regular affiliation with one of the three national television networks, under which it serves as that network's primary outlet for the presentation of its programs in a market. It includes any arrangement under which the network looks primarily to this station rather than other stations for the presentation of its programs and the station chiefly presents the programs of this network rather than another network.

(iv) "Unaffiliated station" means a station not having an affiliation arrangement as defined in this subparagraph with a national television network, even though it may have other types of agreements or pre-program arrangements with it.

(v) "Network" means a national organization distributing programs for a substantial part of each broadcast day to television stations in all parts of the United States, generally via interconnection facilities.

(vi) "Unaffiliated network" means a network not having an affiliated station (as defined in this paragraph) in a particular market, even though it may have other types of agreements or pre-program arrangements.

(vii) "Market" means the television markets of the United States, and the stations in them, as identified in the latest publication of American Research Bureau (ARB), together with any stations which have since

become operational in the same communities.

(viii) "Evening programming" means programming (regular programs or "specials") starting and concluding on a network between the hours of 7:30 p.m. and 11 p.m. local time (except 6:30 p.m. and 10 p.m. in the Central time zone), plus all programs other than regular newscasts starting on the network between 7 and 7:30 p.m. local time (6 and 6:30 p.m. local time in the Central time zone). It does not include portions broadcast after 7 p.m. of programs starting earlier, or portions broadcast after 11 p.m. of programs starting earlier.

(ix) "Specials" means programs not carried on the network at least as often as once a week. It includes both programs scheduled very well in advance and those scheduled very shortly before broadcast on the network.

(x) "Reasonably comparable facilities" means station transmitting facilities (effective radiated power and effective antenna height above average terrain) such that the station's Grade B coverage area is at least two-thirds as large (in square miles) as the smallest of the market affiliated stations' Grade B coverage areas. Where on or both of the affiliates is licensed to a city different from that of the unaffiliated station, the term "reasonably comparable facilities" also includes the requirement that the unaffiliated station must put a predicted Grade A or better signal over all of the city of license of the other regular (non-satellite) station(s), except that where one of the affiliated stations is licensed to the same city as the unaffiliated station, and puts a Grade B but not a Grade A signal over the other city of license, the unaffiliated station will be considered as having reasonably comparable facilities if it too puts a predicted Grade B signal over all of the other city of license.

(2) Taking programs from unaffiliated networks. No affiliated station, in a market covered by this paragraph, shall take and broadcast, from an unaffiliated network, any programming of the times and types specified in this subparagraph, unless the conditions specified have first been met:

(i) Any evening programming (as defined in this paragraph), unless and until the entire schedule of such programs has been offered by the unaffiliated network to the unaffiliated station as provided in subparagraph (4) of this paragraph, and the unaffiliated station has either accepted 15 hours per week of such programs, plus additional "special" hours when part of the "special" is included in the 15 hours, or has accepted a lesser amount and indicated that it does not wish to carry any more. Such acceptance shall be governed by the provisions of subparagraph (4) of this paragraph.

(ii) Any programming beginning on the network between 12 noon and 7 p.m. on Saturdays, Sundays and holidays, and consisting of sports events (without limitation, college football and basketball, professional football, baseball, ice hockey, golf, tennis, horse racing and auto racing), unless and until the program has first been offered to the unaffiliated station and that station has indicated that it does not wish to accept it.

(iii) Any programming broadcast after 11 p.m. local time (except 10 p.m. local time in the Central time zone) which is a continuation of programs starting earlier and carried by the unaffiliated station; or any material broadcast after 7 p.m. (6 p.m. in the Central time zone) which is a continuation of sports programs beginning earlier and carried by the unaffiliated station.

(iv) Any program presented in the same week by the unaffiliated station.

(3) Carriage of programs of a network which has an affiliate. No affiliated station in a market covered by this paragraph shall broadcast, from another network which has an affiliated station in the market, any evening programming or Saturday, Sunday or holiday sports programming, unless such programming has been offered to the unaffiliated station in the market and the latter has indicated that it does not wish to carry it.

(4) Offer and acceptance. (i) The "offer" by a network referred to in this paragraph means an offer to the unaffiliated station of the programs for broadcast. Programs so offered cannot be withdrawn by the network until the following April 1 or October 1, unless the station does not in fact broadcast the program as accepted, in which case the provisions of paragraph (1) (4) (ii) shall apply, or unless the program is cancelled on the network, in which case the replacement or substitute program shall be offered to the station as a new program under paragraph (1) (2) or (1) (3). If a program accepted by the unaffiliated station is shifted in time, the station may exercise its right of "first call" either with respect to the program at its new time, or the previous time segment, at its option.

(ii) The acceptance referred to in paragraphs (1) (2) and (1) (3) means that the unaffiliated station agrees to broadcast the program accepted, at its live network time or a delayed time acceptable to the network, unless in its judgment the program is not in the public interest or it wishes to substitute a local, or other live, program for it. The provisions of §73.658(a), prohibiting agreements which hinder the presentation of the programs of other networks, shall not apply to material covered by this paragraph. If a program is not presented in a particular week or at a delayed time acceptable to the network, the network may place this particular broadcast of the program on another station; and if this occurs more than 4 times in any 13-week period the network may withdraw the program from the station without obligation to offer it any additional programming. The unaffiliated station is free to seek and obtain other terms of acceptance from the network; but the offer of programming by the network on the foregoing terms satisfies its obligations under this paragraph.

(iii) The offer by the network shall, to the extent possible, be on or before July 15 with respect to programs beginning in the fall season, and by January 15 with respect to programs presented after April 1, or otherwise as soon as possible. The unaffiliated station's acceptance or indication of non-acceptance shall be within two weeks after the date of the offer; where any negotiations between the network and the station concerning particular programs are involved, programs not accepted within 30 days of the date of the offer shall be deemed not accepted.

NOTE 1: If there are in a particular market two affiliated stations and two (or more) operational unaffiliated stations with reasonably comparable facilities, the provisions of paragraph (1) shall require an offer of programming to each; but the 15-hour-per-week "first call" provision applies to the total programming taken by all such stations.

NOTE 2: The provisions of paragraph (1) do not apply to a market in which there are two VHF affiliated U.S. stations, and a foreign VHF station to which a national U.S. television network transmits programs pursuant to authority granted under Section 325 of the Communications Act of 1934, as amended, and which serves as that network's primary affiliate in the market.

(m) **Territorial exclusivity in non-network arrangements.** No television station shall enter into any contract, arrangement or understanding, expressed or implied, with a non-network program producer, distributor, or supplier, or other person which prevents or hinders another television station located in a community over 35 miles away, as determined by the reference points contained in §76.53 of this chapter, (if reference points for a community are not listed in §76.53, the location of the main post office will be used) from broadcasting any program purchased by the former station from such non-network program producer, distributor, supplier, or other person, except that a television station may secure exclusivity against a television station licensed to another designated community in a hyphenated market specified in the market listing as contained in §76.51 of this chapter for those 100 markets listed, and for markets not listed in §76.51 of this chapter, the listing as contained in the ARB Television Market Analysis for the most recent year at the time that the exclusivity contract, arrangement, or understanding is complete under practices of the industry. As used in this subsection, the term "community" is defined as the community specified in the instrument of authorization as the location of the station.

NOTE 1: Contracts, arrangements, or understandings that are complete under the practices of the industry prior to August 7, 1973, will not be disturbed. Extensions or renewals of such agreements are not permitted because they would in effect be new agreements without competitive bidding. However, such agreements that were based on the broadcaster's advancing "seed money" for the production of a specific program or series that specify two time periods—a tryout period and a period thereafter for general exhibition—may be extended or renewed as contemplated in the basic agreement.

NOTE 2: For a two-year period beginning May 10, 1974, television stations licensed to Cleveland, Ohio, and Stockton, California, may not enter into any contract, arrangement or understanding, express or implied, with a non-network program producer, distributor, or supplier, or other person which prevents Station WAKR-TV, Akron, Ohio, and Station KLOC-TV, Modesto, California, respectively, from broadcasting programs purchased by those Cleveland, Ohio, and Stockton, California stations.

NOTE 3: It is intended that the top 100 major television markets listed in §76.51 of this chapter shall be used for the purposes of this rule and that the listing of the top 100 television markets appearing in the ARB Television Market Analysis shall not be used. The

reference in this rule to the listing of markets in the ARB Television Market Analysis refers to hyphenated markets below the top-100 markets contained in the ARB Television Market Analysis. If a community is listed in a hyphenated market in §76.51 and is also listed in one of the markets in the ARB listing, the listing in §76.51 shall govern.

NOTE 4: The provisions of this paragraph apply only to U.S. commercial television broadcast stations in the 50 states, and not to stations in Puerto Rico or the Virgin Islands, foreign stations or noncommercial educational television or "public" television stations (either by way of restrictions on their exclusivity or on exclusivity against them).

NOTE 5: New stations authorized in any community of a hyphenated market listed in §76.51 of this chapter or in any community of a hyphenated market listed in the ARB Television Market Analysis (for markets below the top-100 markets) are subject to the same rules as previously existing stations therein. New stations authorized in other communities are considered stations in separate markets unless and until §76.51 is amended by Commission action, or the ARB listing is changed.

Common antenna site

§73.635. Use of common antenna site. No television license or renewal of a television license will be granted to any person who owns, leases, or controls a particular site which is peculiarly suitable for television broadcasting in a particular area and (a) which is not available for use by other television licensees; and (b) no other comparable site is available in the area; and (c) where the exclusive use of such site by the applicant or licensee would unduly limit the number of television stations that can be authorized in a particular area or would unduly restrict competition among television stations.

Reports to be filed

All broadcast stations...

§1.611 Financial report.—Each licensee or permittee of a commercially operated standard, FM, television, or international broadcast station (as defined in Part 73 of this chapter) shall file with the Commission on or before April 1 of each year, on FCC form 324, an annual financial report.

§1.612 Annual employment report.—Each licensee or permittee of a commercially or non-commercially operated standard, FM, television, or international broadcast station (as defined in Part 73 of this chapter) with five or more fulltime employees shall file with the Commission on or before May 31 of each year, on FCC Form 395, an annual employment report.

§1.613 Filing of contracts.—Each licensee or permittee of a standard, FM, television, or international broadcast station (as defined in Part 73 of this chapter), whether operating or intending to operate on a commercial or non-commercial basis, shall file with the Commission copies of the following contracts, instruments, and documents together with amendments, supplements, and cancellations, within 30 days of execution thereof. The substance of oral contracts shall be reported in writing.

(a) Contracts relating to network service: All network affiliation contracts, agreements or understandings between a station and a national, regional or other network shall be reduced to writing and filed. Each such filing in or after May 1, 1969 initially shall consist of a written instrument containing all the terms and conditions of such contract, agreement, or understanding without reference to any other paper or document by incorporation or otherwise. Subsequent filings may simply set forth renewal, extension, amendment, or change, as the case may be, of particular contract previously filed in accordance herewith. Transcription agreements or contracts for the supplying of film for the television stations which specify option time must be filed. This section does not require the filing of transcription agreements or contracts for the supplying of film for television stations which do not specify option time, nor contracts granting the right to broadcast music such as ASCAP, BMI, or SESAC agreements.

(b) Contracts relating to ownership or control. Contracts, instruments, or documents relating to the present or future ownership or control of the licensee or permittee or of the licensee's or permittee's stock, rights, or interests therein, or relating to changes in such ownership or control. This paragraph shall include but is not limited to the following:

(1) Articles of partnership, association, and incorporation, and changes in such instruments:

(2) Bylaws, and any instruments effecting changes in such bylaws:

(3) Any agreement, document or instrument (i) providing for the assignment of a license or permit or (ii) affecting, directly or indirectly, the ownership or voting rights of the licensee's or permittee's stock (common or preferred, voting or non-voting), such as: (a) agreements for transfer of stock; (b) instruments for the issuance of new stock; or (c) agreements for the acquisition of licensee's or permittee's stock by the issuing licensee or permittee corporation. Pledges, trust agreements, options to purchase stock and other executory agreements are required to be filed: provided, however, that trust agreements or abstracts thereof are not required to be filed, unless requested specifically by the Commission. Should the Commission request an abstract of the trust agreement in lieu of the trust agreement, the licensee or permittee will submit the following information concerning the trust: (1) name of trust; (2) duration of trust; (3) number of shares of stock owned; (4) name of beneficial owner of stock; (5) name of record owner of stock; (6) name of the party or parties who have the power to vote or control the vote of the shares; and (7) any conditions on the powers of voting the stock or any unusual characteristics of the trust.

(4) Proxies with respect to the licensee's or permittee's stock running for a period in excess of one year; and all proxies, whether or not running for a period of one year, given without full and detailed instructions binding the nominee to act in a specified manner. With respect to proxies given without full and detailed instructions, a statement showing the number of such proxies, by whom given and received, and the percentage of outstanding stock represented by each proxy shall be submitted by the licensee or permittee within 30 days after the stockholders' meeting in which the stock covered by such proxies has been voted: Provided, however, that when the licensee or permittee is a corporation having more than 50 stockholders, such complete information need be filed only with respect to proxies given by stockholders who are officers or directors, or who have 1% or more of the corporation's voting stock; in cases where the licensee or permittee is a corporation having more than 50 stockholders and the stockholders giving the proxies are neither officers or directors nor hold 1% or more of the corporation's stock, the only information required to be filed is the name of any person voting 1% or more of the stock by proxy, the number of shares voted by proxy by such person, and the total number of shares voted at the particular stockholders' meeting in which the shares were voted by proxy:

(5) Mortgage or loan agreements containing provisions restricting the licensee's or permittee's freedom of operation, such as those affecting voting rights, specifying or limiting the amount of dividends payable, the purchase of new equipment, the maintenance of current assets, etc.: or

(6) Any agreement reflecting a change in the officers, directors, or stockholders of a corporation, other than the licensee or permittee, having an interest, direct or indirect, in the licensee or permittee as specified by §1.615.

(c) Contracts relating to personnel:

(1) The following contracts, agreements, or understandings shall be filed: management consultant agreements with independent contractors; contracts relating to the utilization in a management capacity of any person other than an officer, director, or regular employee of the licensee or permittee station; management contracts with any persons, whether or not officers, directors, or regular employees, which provide for both a percentage of profits and a sharing in losses; or any similar agreements.

(2) The following contracts, agreements, or understandings need not be filed: agreements with persons regularly employed as general or station managers or salesmen; contracts with program managers or program personnel; contracts with attorneys, accountants, or consulting radio engineers; contracts with performers; contracts with station representatives; contracts with labor unions; or any similar agreements.

(d) The following contracts, agreements, or understandings need not be filed, but shall be kept at the station and made available for inspection upon request: contracts relating to the sale of broadcast time to "time brokers" for resale; subchannel leasing agreements for Subsidiary Communications Authorization operation; time sales contracts with the same sponsor for more than 4 or more hours per day, except where the length of the events (such as athletic contests, musical programs, and special events) broadcast pursuant to the contract is not under control of the station; and contracts with chief operators and other engineering personnel.

§1.615 Ownership reports.—(a) Each licensee of a TV, FM or standard broadcast station (as defined

in Part 73 of this chapter), other than noncommercial educational stations, shall file an Ownership Report (FCC Form 323) at the time the applications for renewal of station license is required to be filed: Provided, however, the licensees owning more than one TV, FM, or standard broadcast station need file only one Ownership Report at 3-year intervals. Ownership Reports shall give the following information as of a date not more than 30 days prior to the filing of the Ownership Report:

(1) In the case of an individual, the name of such individual;

(2) In the case of a partnership, the names of the partners and the interest of each partner:

NOTE: Any change in partners or in their rights will require prior consent of the Commission upon an application for consent to assignment of license or permit. If such change involves less than a controlling interest, the application for Commission consent to such change may be made upon FCC Form 316 (Short Form).

(3) In the case of a corporation, association, trust, estate, or receivership, the data applicable to each:

(i) The name, residence, citizenship and stockholdings of officers, directors, stockholders, trustees, executors, administrators, receivers, and members of any association;

(ii) Full information as to family relationship of business association between two or more officials, and/or stockholders, trustees, executors, administrators, receivers, and members of any association;

(iii) Capitalization with a description of the classes and voting power of stock authorized by the corporate charter or other appropriate legal instrument and the number of shares of each class issued and outstanding; and

(iv) Full information on FCC Form 323 with respect to the interest, and identity of any person having any direct, indirect, fiduciary, or beneficiary interest in the licensee or any of its stock:

For example:

(a) Where A is the beneficial owner or votes stock held by B, the same information should be furnished for A as is required for B.

(b) Where X corporation controls the licensee, or holds 25% or more of the number of issued and outstanding shares of either voting or non-voting stock of the licensee, the same information should be furnished with respect to X corporation (its capitalization, officers, directors, and stockholders and the amount of stock [by class] in X held by each) as is required in the case of the licensee, together with full information as to the identity and citizenship of the person authorized to vote licensee's stock, in case of voting stock.

(c) The same information should be furnished as to Y corporation if it controls X corporation or holds 25% or more of the number of issued and outstanding shares of either voting or non-voting stock of X, and as to Z corporation if it controls Y corporation or holds 25% or more of the number of issued and outstanding shares of either voting or non-voting stock of Y and so on back to natural persons.

(4) In the case of licensees:

(i) A list of all contracts still in effect required to be filed with the Commission by §1.342 showing the date of execution and expiration of each contract; and

(ii) Any interest which the licensee may have in any other broadcast station.

(b) A permittee shall file an Ownership Report (FCC Form 323) within 30 days of the date of grant by the Commission of an application for original construction permit. The Ownership Report of the permittee shall give the information required by the applicable portions of paragraph (a) of this section.

(c) A supplemental Ownership Report (FCC Form 323) shall be filed by each licensee or permittee within 30 days after any change occurs in the information required by the Ownership Report from that previously reported. Such report shall include without limitation:

(1) Any change in capitalization or organization;

(2) Any change in officers and directors;

(3) Any transaction affecting the ownership, direct or indirect, or voting rights of licensee's or permittee's stock, such as:

(i) A transfer of stock;

(ii) Issuance of new stock or disposition of treasury stock; or

(iii) Acquisition of licensee's or permittee's stock by the issuing corporation; or

(4) Any change in the officers, directors, or stockholders of a corporation other than the licensee or permittee such as X, Y, or Z corporation described in the example in paragraph (a) (3) of this section.

FCC Rules

NOTE: Before any change is made in the organization, capitalization, officers, directors, or stockholders of a corporation other than licensee or permittee, which results in a change in the control of the licensee or permittee, prior Commission consent must be received under Section 310(b) of the Communications Act and § 1.329. A transfer of control takes place when an individual, or group in privacy, gains or loses affiliation or negative (50%) control. See instruction of FCC Form 323, "Ownership Report."

(d) Exception: Where information is required under paragraphs (a), (b), or (c) of this section with respect to a corporation or association having more than 50 stockholders or members, such information need be filed only with respect to stockholders or members who are officers or directors of the corporation or association, or other stockholders or members who have 1 percent or more of either the voting or nonvoting stock of the corporation or voting rights in the association regardless of whether the stockholder or member is an investment company as defined in NOTE 4 to §§ 73.35, 73.240, and 73.636 of this chapter: Provided, however, that such information with respect to stock held by stockbrokers need be filed only if the stock is held by the stockbroker in its name (either for itself or for customers) for a period exceeding 30 days.

(e) The provisions of this paragraph apply to all licensees and permittees of noncommercial educational TV, FM, or standard broadcast stations.

(1) Each licensee covered by this paragraph shall file an Ownership Report (FCC Form 323E): Provided, however, that licensees owning more than one non-commercial educational TV, FM, or standard broadcast station need file only one Ownership Report at 3-year intervals. Ownership Reports shall give the following information as of a date no more than 30 days prior to the filing of the Ownership Report:

(i) The following information as to all officers, members of governing board, and holders of 1 percent or more ownership interest (if any): Name, residence, office held, citizenship, principal profession or occupation, and by whom appointed or elected.

(ii) Full information on FCC form 323E with respect to the interest and identity of any individual, organization, corporation, association, or any other entity which has direct or indirect control over the licensee or permittee.

(iii) A list of all contracts still in effect required by § 1.342 to be filed with the Commission, showing the date of execution and expiration of each contract.

(iv) Any interest which the licensee or permittee or any of its officers, members of the governing board, and holders of 1 percent or more ownership interest (if any) hold in any other broadcast station.

(2) A permittee shall file an Ownership Report (FCC Form 323E) within 30 days of the date of grant by the Commission of an application for original construction permit. The Ownership Report of the permittee shall give the information required by the applicable portions of this paragraph.

(3) A supplemental Ownership Report (FCC Form 323E) shall be filed by each licensee or permittee within 30 days after any change occurs in the information required by Ownership Report from that previously reported. Such report should include, without limitation:

(i) Any change in organization;

(ii) Any change in officers or directors;

(iii) Any transaction affecting the ownership (direct or indirect) or voting rights with respect to the licensee or permittee (or with respect to any stock interest therein).

(f) A copy of all ownership and supplemental ownership reports and related material filed pursuant to this section shall be maintained and made available for public inspection locally as required by § 1.526.

§ 1.526 Records to be maintained locally for public inspection by applicants, permittees, and licensees.

(a) Records to be maintained. Every applicant for a construction permit for a new station in the broadcast services shall maintain for public inspection a file for such station containing the material in subparagraph (1) of this paragraph, every permittee or licensee of a station in the broadcast services shall maintain for public inspection a file for such station containing the material in subparagraphs (1), (2), (3), (4), (5), (6) and (7) of this paragraph, and every permittee or licensee of a commercial television station shall maintain for public inspection a file for such station containing the material in subparagraphs (8) and (9) of this paragraph: Provided, however, that the foregoing requirements shall not apply to applicants for or permit-

tees or licensees of television broadcast translator stations, FM broadcast translator stations, or FM broadcast booster stations. The material to be contained in the file is as follows:

(1) A copy of every application tendered for filing by the applicant for such station after May 13, 1965, pursuant to the provisions of this part, with respect to which local public notice is required to be given under the provisions of §§ 1.580 or 1.594; and all exhibits, letters and other documents tendered for filing as part thereof, all amendments thereto, copies of all documents incorporated therein by reference, all correspondence between the Commission and the applicant pertaining to the application after it has been tendered for filing, and copies of Initial Decision and Final Decisions in hearing cases pertaining thereto, which according to the provisions of § 0.417 of this chapter are open for public inspection at the offices of the Commission. Information incorporated by reference which is already in the local file need not be duplicated if the entry making the reference sufficiently identifies the information so that it may be found in the file, and if there has been no change in the document since the date of filing and the applicant, after making the reference, so states. If petitions to deny are filed against the application, and have been duly served on the applicant, a statement that such a petition has been filed shall appear in the local file together with the name and address of the party filing the petition.

NOTE: Applications tendered for filing on or before May 13, 1965, which are subsequently designated for hearing after May 13, 1965, with local notice being given pursuant to the provisions of § 1.594, and material related to such applications, need not be placed in the file required to be kept by this section. Applications tendered for filing after May 13, 1965, which contain major amendments to applications tendered for filing on or before May 13, 1965, with local notice of the amending application being given pursuant to the provisions of § 1.580, need not be placed in the file required to be kept by this section.

(2) A copy of every application tendered for filing by the licensee or permittee for such station after May 13, 1965, pursuant to the provisions of this part, which is not included in subparagraph (1) of this paragraph and which involves changes in program service, which requests an extension of time in which to complete construction of a new station, or which requests consent to involuntary assignment or transfer, or to voluntary assignment or transfer not resulting in a substantial change in ownership or control and which may be applied for on FCC Form 316; and copies of all exhibits, letters, and other documents filed as part thereof, all amendments thereto, all correspondence between the Commission and the applicant pertaining to the application after it has been tendered for filing, and copies of all documents incorporated therein by reference, which according to the provisions of § 0.417 of this chapter are open for public inspection at the offices of the Commission. Information incorporated by reference which is already in the local file need not be duplicated if the entry making the reference sufficiently identifies the information so that it may be found in the file, and there has been no change in the document since the date of filing and the licensee, after making the reference, so states. If petitions to deny are filed against the application, and have been duly served on the applicant, a statement that such a petition has been filed shall appear in the local file together with the name and address of the party filing the petition.

(3) A copy of every ownership report or supplemental ownership report filed by the licensee or permittee for such station after May 13, 1965, pursuant to the provisions of this part; and copies of all exhibits, letters, and other documents filed as part thereof, all amendments thereto, all correspondence between the permittee or licensee and the Commission pertaining to the reports after they have been filed, and all documents incorporated therein by reference, including contracts listed in such reports in accordance with the provisions of § 1.615(a) (4) (i) and which according to the provisions of § 0.417 of this chapter are open for public inspection at the offices of the Commission. Information incorporated by reference which is already in the local file need not be duplicated if the entry making the reference sufficiently identifies the information so that it may be found in the file, and if there has been no change in the document since the date of filing and the licensee or permittee, after making the reference, so states.

(4) Such records as are required to be kept by §§ 73.120(d), 73.290(d), 73.590(d), and 73.657(d) of this chapter, concerning broadcasts by candidates for public office.

(5) A copy of every annual employment report filed by the licensee or permittee for such station pursuant to the provisions of this part; and copies of all exhibits, letters and other documents filed as part thereof, all amendments thereto, all correspondence between the permittee or licensee and the Commission pertaining to the reports after they have been filed all documents incorporated therein by reference and which according to the provisions of §§ 0.451-0.461 of this chapter are open for public inspection at the offices of the Commission.

(6) The Public and Broadcasting Procedure Manual (see FCC 74-942, 39 FR 32288, September 5, 1974).

(7) Letters received from members of the public as are required to be retained by § 73.1202.

(8) A copy of the Annual Programming Report (Form 303-A) containing programming information for a composite week selected by the Commission and the licensee's or permittee's program logs for that composite week.

(9) A copy of the current annual listing of what the licensee or permittee believes to have been significant problems and needs of the area served by the station during the preceding twelve months. No more than ten problems and needs are to be included in the listing. Opposite each problem or need listed, licensees or permittees shall indicate and briefly describe typical and illustrative programs or program segments, excluding news inserts (the daily or ordinary news coverage of breaking newsworthy events), broadcast during the preceding twelve months designed to help meet that problem or need. Such description shall include source and time of broadcast. Licensees or permittees are to place these listings in the public file each year on the anniversary date on which renewal applications are due; provided, however, that upon filing a renewal application, the listings for the current license period, including the most recent listing which shall be simultaneously placed in the local file, shall be forwarded to the Commission as a part of the renewal application. The listings are not to exceed five pages but may be supplemented at any time by additional material placed in the public inspection file, identified as a continuation of the information submitted to the Commission and subject to Commission inspection.

(10) Although not part of the regular file for public inspection, program logs for television stations will be available for public inspection under the circumstances set forth in § 73.674 and discussed in the Public and Broadcasting Procedure Manual.

NOTE: The engineering section of applications mentioned in subparagraphs (1) and (2) of this paragraph, and material related to the engineering section, need not be kept in the file required to be maintained by this paragraph. If such engineering section contains service contour maps submitted with that section, copies of such maps, and information (state, county, city, street address, or other identifying information) showing main studio and transmitter location shall be kept in the file.

(b) Responsibility in case of assignment or transfer.

(1) In cases involving applications for consent to assignment of broadcast station construction permits or licenses, with respect to which public notice is required to be given under the provisions of §§ 1.580 or 1.594, the file mentioned in paragraph (a) of this section shall be maintained by the assignor. If the assignment is consented to by the Commission and consummated, the assignee shall maintain the file commencing with the date on which notice of the consummation of the assignment is filed with the Commission. The file maintained by the assignee shall cover the period both before and after the time when the notice of consummation of assignment was filed. The assignee is responsible for obtaining copies of the necessary documents from the assignor or from the Commission files.

(2) In cases involving applications for consent to transfer of control of a permittee or licensee of a broadcast station, the file mentioned in paragraph (a) of this section shall be maintained by the permittee or licensee.

(c) Station to which records pertain. The file need contain only applications, ownership reports, and related material that concern the station for which the file is kept. Applicants, permittees, and licensees need not keep in the file copies of such applications, reports, and material which pertain to other stations with regard to which they may be applicants, permittees, or licensees, except to the extent that such information is reflected in the materials required to be kept under the provisions of this section.

(d) Location of records. The file shall be maintained at the main studio of the station or at any accessible place (such as a public registry for documents or an attorney's office) in the community to which the station

is or is proposed to be licensed, and shall be available for public inspection at any time during regular business hours.

(e) Period of retention. The records specified in paragraph (a) (4) of this section shall be retained for the periods specified in §§73.120(d), 73.290(d), 73.590(d) and 73.657(d) of this chapter (2 years). The manual specified in paragraph (a) (7) of this section shall be retained for the period specified in 73.1202 (3 years). The records specified in paragraph (a) (1), (2), (3), (5), (8) and (9) of this section shall be retained as follows:

(1) The applicant for a construction permit for a new station shall maintain such a file so long as the application is pending before the Commission or any proceeding involving that application is pending before the courts. (If the application is granted, subparagraph (2) of this paragraph shall apply.)

(2) The permittee or licensee shall maintain such a file so long as an authorization to operate the station is outstanding, and shall permit public inspection of the material as long as it is retained by the licensee even though the request for inspection is made after the conclusion of the required retention period specified in this subparagraph. However, material which is voluntarily retained after the required retention time may be kept in a form and place convenient to the licensee, and shall be made available to the inquiring party, in good faith after written request, at a time and place convenient to both the party and the licensee. Applications and other material placed in the file should be retained for a period of seven years from the date the material is tendered for filing with the Commission, with two exceptions: First, engineering material pertaining to a former mode of operation need not be retained longer than 3 years after a station commences operation under a mode; and second, all of the material shall be retained for whatever longer period is necessary to comply with the following requirements: (1) material shall be retained until final Commission action on the second renewal application following the application or other material in question; and (2) material having a substantial bearing on a matter which is the subject of a claim against the licensee, or relating to a commission action of which the licensee has been advised, shall be retained until the licensee is notified in writing that the material may be discarded, or, if the matter is a private one, the claim has been satisfied or is barred by statutes of limitations. Where an application or related material incorporates by reference material in earlier applications and material concerning programming and related matters (Section IV and related material), the material so referred to shall be retained as long as the application referring to it.

(f) Copies of any material in the public file of any television station shall be available for machine reproduction upon request made in person, provided the requesting party shall pay the reasonable cost of reproduction. Requests for machine copies shall be fulfilled at a location specified by the licensee, within a reasonable period of time, which in no event shall be longer than seven days. The licensee is not required to honor requests made by mail but may do so if it chooses.

License renewals

General...

§1.539 Application for renewal of license.—(a) Unless otherwise directed by the Commission, an application for renewal of license shall be filed not later than the first day of the fourth full calendar month prior to the expiration date of the license sought to be renewed, except that applications for renewal of license of an experimental or developmental broadcast station shall be filed not later than the first day of the second full calendar month prior to the expiration date of the license sought to be renewed. If any deadline prescribed in this paragraph falls on a non-business day, the cut-off shall be the close of business of the first full business day thereafter.

(b) No application for renewal of license of any broadcast station will be considered unless there is on file with the Commission, the information, if any, currently required by §§1.622-1.615, inclusive, for the particular class of station. The renewal application shall include a reference by date and file number to such information on file.

(c) Whenever the Commission regards an application for a renewal of license as essential to the proper conduct of a hearing or investigation, and specifically directs that it be filed by a certain date, such application shall be filed within the time thus specified. If the licensee fails to file such application within the prescribed time, the hearing or investigation shall proceed as if such renewal application has been received.

(d) The following application forms shall be used: [EDITOR'S NOTE: There follows a list of forms to be used in filing for license renewals.]

In AM rules...

§73.34 Normal license period.—(a) Initial licenses for standard broadcast stations will ordinarily be issued for a period running until the dates specified in this section for the state or territory in which the station is located or, if issued after such date, to the next triennial renewal date determined in accordance with this section; and, when renewed, will normally be renewed for three years; provided, however, that if the Commission finds that the public interest, convenience or necessity will be served thereby, it may issue either an initial license or a renewal thereof for a lesser term. The time of expiration of normally issued initial and renewal licenses will be 3 a.m., local time, on the following dates, and at three year intervals thereafter:

[EDITOR'S NOTE: For list of expiration dates for licenses see TV rules below.]

NOTE: For the cutoff date for the filing of applications mutually exclusive with, and petitions to deny, renewal applications, see &1.516(e) of this chapter.

In FM rules...

§73.218 Normal license period.—(a) Initial licenses for FM broadcast stations will ordinarily be issued for a period running until the date specified in this section for the state or territory in which the station is located or, if issued after such date, to the next triennial renewal date determined in accordance with this section; and, when renewed, will normally be renewed for three years; provided, however, that, if the Commission finds that the public interest, convenience, or necessity will be served thereby, it may issue either an initial license or a renewal thereof for a lesser term. The time of expiration of normally issued initial and renewal licenses will be 3 a.m., local time, on the following dates, and at three-year intervals thereafter:

[EDITOR'S NOTE: For list of expiration dates for licenses see TV rules below.]

In TV rules...

§76.630 Normal license period.—(a) Initial licenses for television broadcast stations will ordinarily be issued for a period running until the date specified in this section for the state or territory in which the station is located or, if issued after such date, to the next triennial renewal date determined in accordance with this section; and, when renewed, will normally be renewed for three years; provided, however, that, if the Commission finds that the public interest, convenience or necessity will be served thereby, it may issue either an initial license or a renewal thereof for a lesser term. The time of expiration of normally issued initial and renewal licenses will be 3 a.m., local time, on the following dates, and at three-year intervals thereafter:

(1) For stations located in Iowa and Missouri, Feb. 1, 1974.

(2) For stations located in Minnesota, North Dakota, South Dakota, Montana, and Colorado, April 1, 1974.

(3) For stations located in Kansas, Oklahoma, and Nebraska, June 1, 1974.

(4) For stations located in Texas, Aug. 1, 1974.

(5) For stations located in Wyoming, Nevada, Arizona, Utah, New Mexico, and Idaho, October 1, 1974.

(6) For stations located in California, December 1, 1974.

(7) For stations located in Washington, Oregon, Alaska, Guam, and Hawaii, Feb. 1, 1975.

(8) For stations located in Connecticut, Maine, Massachusetts, New Hampshire, Rhode Island, and Vermont, April 1, 1975.

(9) For stations located in New Jersey and New York, June 1, 1975.

(10) For stations located in Delaware and Pennsylvania, Aug. 1, 1975.

(11) For stations located in Maryland, District of Columbia, Virginia, and West Virginia, Oct. 1, 1975.

(12) For stations located in North Carolina, and South Carolina, Dec. 1, 1975.

(13) For stations located in Florida, Puerto Rico, and Virgin Islands, Feb. 1, 1973.

(14) For stations located in Alabama and Georgia, April 1, 1973.

(15) For stations located in Arkansas, Louisiana, and Mississippi, June 1, 1973.

(16) For stations located in Tennessee, Kentucky, and Indiana, August 1, 1973.

(17) For stations located in Ohio and Michigan, Oct. 1, 1973.

(18) For stations located in Illinois and Wisconsin, Dec. 1, 1973.

NOTE: For the cutoff date for the filing of applications mutually exclusive with, and petitions to deny, renewal applications, see §1.516(e).

Station identification

All broadcast stations...

§73.1201 Station identification.—(a) When regularly required. Broadcast station identification announcements shall be made: (1) at the beginning and ending of each hour of operation, and (2) hourly, as close to the hour as feasible, at a natural break in program offerings. Television broadcast stations may make these announcements visually or aurally.

(b) Content. (1) Official station identification shall consist of the station's call letters immediately followed by the name of the community or communities specified in its license as the station's location.

(2) When given specific written authorization to do so, a station may include in its official station identification the name of an additional community or communities, but the community to which the station is licensed must be named first.

(3) A licensee shall not in any identification announcements, promotional announcements or any other broadcast matter either lead or attempt to lead the station's audience to believe that the station has been authorized to identify officially with cities other than those permitted to be included in official station identifications under subparagraphs (1) and (2) of this paragraph.

NOTE: Commission interpretations of this paragraph may be found in a separate Public Notice issued October 30, 1967, entitled "Examples of Application of Rule Regarding Broadcast of Statements Regarding a Station's Licensed Location." (FCC 67-1132; 10 FCC 2d 407.)

(c) Channel. (1) Generally. Except as provided in this paragraph, in making the identification announcement the call letters shall be given only on the channel of the station identified thereby.

(2) Simultaneous AM-FM broadcasts. If the same licensee operates an FM broadcast station and a standard broadcast station and simultaneously broadcasts the same programs over the facilities of both such stations, station identification announcements may be made jointly for both stations for periods of such simultaneous operation. If the call letters of the FM station do not clearly reveal that it is an FM station, the joint announcement shall so identify it.

(3) Satellite operation. When programming of a broadcast station is rebroadcast simultaneously over the facilities of a satellite station, the originating station may make identification announcements for the satellite station for periods of such simultaneous operation.

(i) In the case of a television broadcast station, such announcements, in addition to the information required by paragraph (b) (1) of this section, shall include the number of the channel on which each station is operating.

(ii) In the case of aural broadcast stations, such announcements, in addition to the information required by paragraph (b) (1) of this section, shall include the frequency on which each station is operating.

Announcement of sponsored programs

§73.1212 Sponsorship identification; list retention; related requirements.—(a) When a broadcast station transmits any matter for which money, service, or other valuable consideration is either directly or indirectly paid or promised to, or charged or accepted by such station, the station, at the time of the broadcast, shall announce (i) that such matter is sponsored, paid for, or furnished, either in whole or in part, and (ii) by whom or on whose behalf such consideration was supplied; provided, however, that "service or other valuable consideration" shall not include any service or property furnished either without or at a nominal charge for use on, or in connection with, a broadcast unless it is so furnished in consideration for an identification of any person, product, service, trademark, or brand name beyond an identification reasonably related to the use of such service or property on the broadcast.

(1) For the purposes of this section, the term "sponsored" shall be deemed to have the same meaning as "paid for."

(b) The licensee of each standard broadcast station

FCC Rules

shall exercise reasonable diligence to obtain from its employees, and from other persons with whom it deals directly in connection with any program matter for broadcast, information to enable such licensee to make the announcement required by this section.

(c) In any case where a report has been made to a broadcast station, as required by Section 508 of the Communications Act of 1934, as amended, of circumstances which would have required an announcement under this section had the consideration been received by such broadcast station, an appropriate announcement shall be made by such station.

(d) In the case of any political broadcast matter or any broadcast matter involving the discussion of a controversial issue of public importance for which any film, record, transcription, talent, script, or other material or service of any kind is furnished, either directly or indirectly, to a station as an inducement for broadcasting such matter, an announcement shall be made both at the beginning and conclusion of such broadcast on which such material or service is used that such film, record, transcription, talent, script, or other material or service has been furnished to such station in connection with the transmission of such broadcast matter: provided, however, that in the case of any broadcast of 5 minutes duration or less, only one such announcement need be made either at the beginning or conclusion of the broadcast.

(e) The announcement required by this section shall, in addition to stating the fact that the broadcast matter was sponsored, paid for or furnished, fully and fairly disclose the true identity of the person or persons or corporation, committee, association or other unincorporated group, or other entity by whom or on whose behalf such payment is made or promised, or from whom or on whose behalf such services or other valuable consideration is received, or by whom the material or services referred to in paragraph (d) of this section are furnished. Where an agent or other person or entity contracts or otherwise makes arrangements with a station on behalf of another, and such fact is known or by the exercise of reasonable diligence, as specified in paragraph (b) of this section, could be known to the station, the announcement shall disclose the identity of the person or persons or entity on whose behalf such agent is acting instead of the name of such agent. Where the material broadcast is political matter or matter involving the discussion of a controversial issue of public importance and a corporation, committee, association or other unincorporated group, or other entity is paying for or furnishing the broadcast matter, the station shall, in addition to making the announcement required by this section, require that a list of the chief directors of the corporation, committee, association or other unincorporated group, or other entity, shall be made available for public inspection at the location specified by the licensee under §1.526 of this chapter. If the broadcast is originated by a network, the list may, instead, be retained at the headquarters office of the network or at the location where the originating station maintains its public inspection file under §1.526 of this chapter. Such lists shall be kept and made available for a period of two years.

(f) In the case of broadcast matter advertising commercial products or services, an announcement stating the sponsor's corporate or trade name, or the name of the sponsor's product, when it is clear that the mention of the name of the product constitutes a sponsorship identification, shall be deemed sufficient for the purposes of this section and only one such announcement need be made at any time during the course of the broadcast.

(g) The announcement otherwise required by Section 317(a) of the Communications Act of 1934, as amended, is waived with respect to the broadcast of "want ad" or classified advertisements sponsored by an individual. The waiver granted in this paragraph shall not extend to a classified advertisement or want ad sponsored by any form of business enterprise, corporate or otherwise. Whenever sponsorship announcements are omitted pursuant to this paragraph the licensee shall observe the following conditions:

(1) Maintain a list showing the name, address and (where available) the telephone number of each advertiser;

(2) Attach the list to the program log for the day when such broadcast was made; and

(3) Make this list available to members of the public who have a legitimate interest in obtaining the information contained in the list.

(h) Any announcement required by Section 317(b) of the Communications Act of 1934, as amended, is waived with respect to feature motion picture film pro-

duced initially and primarily for theatre exhibition.

NOTE: The waiver heretofore granted by the commission in its report and order adopted November 16, 1960 (FCC 60-1369; 40 FCC 95), continues to apply to programs filmed or recorded on or before June 20, 1963, when §73.654, the predecessor television rule, went into effect.

(i) Commission interpretations in connection with the provisions of the sponsorship identification rules are contained in the commission's public notice, entitled "Applicability of Sponsorship Identification Rules," dated May 6, 1963 (40 FCC 141), as modified by public notice, dated April 21, 1975 (FCC 75-418). Further interpretations are printed in full in various volumes of the Federal Communications Commission reports.

[EDITOR'S NOTE: In a statement issued in 1950, the FCC warned that the sponsor or his product must be identified by a distinctive name and not by one merely descriptive of the type of business or product. The following are acceptable, the Commission said: "Henry Smith offers you..." or "Smith Stove Co. offers you..." or "Ajax Pens brings you..." The following are not acceptable: "Write to the Comb Man..." or "Send your money to Nylons, Box..." or "This program is sponsored by your Sink man..."]

Public notice

In AM, FM and TV.

§73.1202 Public notice of licensee obligations.—(a) Each licensee of a commercial AM, FM or television station except international or television translator stations, shall make an announcement informing the public of the licensee's obligation to the public and of the appropriate method for individuals to express their opinions of the station's operation. Such announcements shall be aired on the first and sixteenth day of each calendar month throughout the license period except during the period beginning on the first day of the sixth full calendar month prior to expiration and ending on the last day of the next to last full calendar month prior to expiration, during which time the renewal application notices in §1.580(d) of this chapter shall be broadcast. Such announcements shall be aired during the following time periods:

(1) For commercial television stations, the announcement broadcast on the first day of each calendar month shall be broadcast between 6 p.m. and 11 p.m. (5 p.m. and 10 p.m. Central and Mountain time). The announcement broadcast on the sixteenth day of each calendar month shall be broadcast during the following four-hour time periods in rotating order, beginning with 6 a.m. to 10 a.m.; 6 a.m. to 10 a.m.; 10 a.m. to 2 p.m.; 2 p.m. to 6 p.m.

(2) For commercial radio stations, the announcement broadcast on the first day of each calendar month shall be broadcast either between 7 a.m. and 9 a.m. or between 4 p.m. and 6 p.m. The announcement broadcast on the sixteenth day of each calendar month shall be broadcast during the following time periods in rotating order, beginning with 9 a.m. to 1 p.m.; 9 a.m. to 1 p.m.; 1 p.m. to 4 p.m.; 6 p.m. to 10 p.m. For stations which neither operate between 7 a.m. and 9 a.m. nor between 4 p.m. and 6 p.m., the announcement broadcast on the first day of each calendar month shall be broadcast during the first two hours of broadcast operation and the announcement broadcast on the sixteenth day of each month shall be broadcast during every other four-hour time period during the broadcast day in rotating order, beginning with the third to sixth hours of broadcast operation.

(b) If an emergency arises which prevents the airing of the announcement at the scheduled time, the announcement shall be aired on the day following the ending of such emergency at the identical time or during the time period which the rotating order specified above requires.

(c) In the case of commercial television broadcast stations, a sign-board with the licensee's address for receiving comments shall be shown when the announcer is giving that address.

(d) The notice shall contain the following information (stations broadcasting primarily in a foreign language should broadcast the announcements in that language):

(1) For commercial radio stations.

(i) The station's call letters.

(ii) A statement that on (give date of last renewal grant) the station was granted a license by the Federal Communications Commission to serve the public interest as a public trustee until (give date of license expiration).

(iii) A statement that the broadcaster is obligated to make a continuing, diligent effort to determine the significant problems and needs of the service area and to

provide programming to help meet those problems and needs.

(iv) A statement that the station invites any specific suggestions or comments listeners may have regarding station operation and the licensee's programming efforts.

(v) The appropriate name and address to which comments should be mailed.

(vi) A statement that unless otherwise requested, all letters received will be made available for public inspection during regular business hours.

(2) For commercial television stations.

(i) The station's call letters.

(ii) A statement that on (give date of last renewal grant) the station was granted a license by the Federal Communications Commission to serve the public interest as a public trustee until (give date of license expiration).

(iii) A statement that (give the anniversary date of the deadline for filing of the renewal application) the station places in its public inspection file a list of what the licensee considered to have been some of the significant problems and needs of the service area during the preceding twelve months and some of the programs the station aired to help meet those problems and needs.

(iv) A statement that the station invites any specific suggestions or comments viewers may have regarding station operation and the licensee's programming efforts.

(v) The appropriate name and address to which comments should be mailed.

(vi) A statement that unless otherwise requested, all letters received will be available for public inspection during regular business hours.

(e) During the period beginning the first day of the last full calendar month prior to expiration of the license and until the date of license renewal, stations shall broadcast the appropriate announcement herein, except that in lieu of (d) (1) (ii) or (d) (2) (ii) stations shall broadcast a statement that the station is licensed by the Federal Communications Commission to serve the public interest as a public trustee and shall not mention the date of the last renewal grant or the length of the license period. Following the date of renewal and commencing on the first or sixteenth day of the month (whichever comes first) the regular announcement shall be resumed and shall be broadcast in accordance with the schedule provided in paragraph (a) of this section.

(f) All written comments and suggestions received from members of the public concerning operation of the station shall be maintained in a local file available for inspection by the public, except when the person making the comment or suggestion has specifically requested that his communication not be made public or where the licensee feels that it should be excluded from availability for public inspection because of the special nature of its content, such as a defamatory or obscene letter. Letters shall be retained in the local file for three years from the date on which they are received by the licensee. Letters received by television licensees shall be placed in one of the following separated subject categories: Programming and non-programming. If comments in one letter relate to more than one subject category, the correspondence shall be filed under the category which, in the licensee's judgment, receives the most attention in the letter.

(1) Sample announcement for radio.

On (date of last renewal grant) (Station's call letters) was granted a license by the Federal Communications Commission to serve the public interest as a public trustee until (date of license expiration). We are obligated to make a continuing, diligent effort to determine the significant problems and needs of our service area and to provide programming to help meet those problems and needs.

We invite listeners to send specific suggestions or comments concerning our station operation and programming efforts to (name and mailing address). Unless otherwise requested, all letters received will be available for public inspection during regular business hours.

(2) Sample announcement for television.

On (date of last renewal grant) (Station's call letters) was granted a license by the Federal Communications Commission to serve the public interest as a public trustee until (date of license expiration). Each (anniversary date of deadline for filing renewal application) we place in our public inspection file a list of what we consider to have been some of the significant problems and needs of our service area during the preceding twelve months and some of our programming to help meet those problems and needs.

We invite viewers to send specific suggestions or comments concerning our station operation and program-

ming efforts to (name and mailing address). Unless otherwise requested, all letters received will be available for public inspection during regular business hours.

Fraudulent billing

§73.1205 Fraudulent billing practices.—No licensee of a standard, FM or television broadcast station shall knowingly issue to any local, regional or national advertiser, advertising agency, station representative, manufacturer, distributor, jobber or any other party, any bill, invoice, affidavit or other document which contains false information concerning the amount actually charged by the licensee for the broadcast advertising for which such bill, invoice, affidavit or other document is issued, or which misrepresents the quantity of advertising actually broadcast (number or length of advertising messages) or the time of day or date at which it was broadcast. Licensees shall exercise reasonable diligence to see that their agents and employees do not issue any documents which would violate this section if issued by the licensee.

NOTE: Commission interpretations in connection with this Rule may be found in a separate Public Notice issued May 18, 1970, entitled "Applicability of Fraudulent Billing Rule." (FCC 70-513), 35 FR 7906.

§73.1206 Broadcast of telephone conversations.—Before recording a telephone conversation for broadcast, or broadcasting such a conversation simultaneously with its occurrence, a licensee shall inform any party to the call of the licensee's intention to broadcast the conversation, except where such party is aware, or may be presumed to be aware from the circumstances of the conversation, that it is being or likely will be broadcast. Such awareness is presumed to exist only when the other party to the call is associated with the station (such as an employee or part-time reporter), or where the other party originates the call and it is obvious that it is in connection with a program in which the station customarily broadcasts telephone conversations.

Rebroadcasts

§73.1207 Rebroadcast.—(a) The term "rebroadcast" means reception by radio of the programs of a radio station, and the simultaneous or subsequent retransmission of such programs by a broadcast station.

NOTE 1: As used in §73.1207 "program" includes any complete program or part thereof.

NOTE 2: The transmission of a program from its point of origin to a broadcast station entirely by common carrier facilities, whether by wire line or radio, is not considered a rebroadcast.

(b) No broadcasting station shall rebroadcast the program, or any part thereof of another U.S. broadcasting station without the express authority of the originating station. A copy of the written consent of the licensee originating the program shall be kept by the licensee of the station rebroadcasting such program and shall be made available to the Commission upon request. Stations originating emergency communications under a Detailed State EBS Operational Plan, shall be deemed to have conferred rebroadcast authority on other participating stations. The rebroadcasting of a program relayed by a remote pickup broadcast station (§74.401 of this chapter) is not considered a rebroadcast.

(c) The rebroadcast of time signals originated by the Naval Observatory and the National Bureau of Standards is permitted without further Commission authorization under the conditions set forth in Note 1 to this paragraph. The rebroadcast of National Weather Service (NWS) transmissions is permitted without further Commission authorization under the conditions set forth in Note 2 to this paragraph. Programs originated by the Voice of America (VOA) and the American Forces Radio and Television Service (AFRTS) cannot, in general, be cleared for domestic rebroadcast, and may therefore be rebroadcast only by special arrangement among the parties concerned. Except as otherwise provided by international agreement, programs originated by foreign broadcasting stations may be rebroadcast without the consent of the originating station. In the case of retransmissions of subcarrier background music and other FM multiplex subscription services, permission must first be obtained from the originating station. The retransmission of point-to-point messages originated by government and privately owned non-broadcast stations must be authorized by the Commission prior to retransmission; such authority may be requested informally by telephone, to be followed within one week with a written confirmation accompanied by the written consent of the originating station.

NOTE 1: (a) Naval Observatory Time Signals.

(1) The time signal rebroadcast must be obtained by direct radio reception from a Naval radio station.

(2) Announcement of the time signal must be made without reference to any commercial activity.

(3) Identification of the Naval Observatory as the source of the time signal must be made by an announcement, substantially as follows: "With the signal, the time will be, courtesy of the United States Naval Observatory."

Schedules of time signal broadcasts may be obtained upon request from the Superintendent, United States Naval Observatory, Washington, D.C. 20390.

(b) National Bureau of Standards Time Signals.

(1) Time signals for rebroadcast must be obtained by direct radio reception from an NBS station.

(2) Use of receiving and rebroadcasting equipment must not delay the signals by more than 0.05 seconds.

(3) Signals must be rebroadcast live, not from tape or other recording.

(4) Voice or code announcements of the call letters of NBS stations are not to be rebroadcast.

(5) Identification of the origin of the service and the source of the signals must be made by an announcement substantially as follows: "At the tone, 11 hours 25 minutes Greenwich Mean Time. This is a rebroadcast of a continuous service furnished by the National Bureau of Standards, Time and Frequency Division, Boulder, Colorado." No commercial sponsorship of this announcement is permitted and none may be implied.

(6) Notice of use of NBS time signals for rebroadcast should be forwarded semi-annually to Frequency-Time Broadcast Services, Time and Frequency Division, National Bureau of Standards, Boulder, Colorado, 80302.

(7) In the rebroadcasting of NBS time signals, announcements will not state that they are standard frequency transmissions. Voice announcements of GMT are given in voice every minute. Each minute, except the first of the hour, begins with a 0.8 second long tone of 1000 Hz at WWV and 1200 Hz tone at WWVH. The first minute of every hour begins with an 0.8 second long tone of 1500 Hz at both stations. This tone is followed by a 3-second pause, then the announcement, "National Bureau of Standards Time." This is followed by another 3-second pause before station identification. This arrangement allows broadcast stations sufficient time to retransmit the hour time tone and the words "National Bureau of Standards Time" either by manual or automatic switching.

(8) Time signals or scales made up from integration of standard frequency signals broadcast from NBS stations may not be designated as National standard scales of time or attributed to NBS as originator. For example, if a broadcasting station transmits time signals obtained from a studio clock which periodically calibrated against the NBS time signals from WWV or WWVH, such signals may not be announced as NBS standard time or as having been originated by the NBS.

Schedules of time signal broadcast may be obtained upon request from Frequency-Time Broadcast Services Section, Time and Frequency Division, National Bureau of Standards, Boulder, Colorado 80302.

NOTE 2: (a) Messages must be rebroadcast within one hour of receipt from the National Weather Service (Weather Bureau).

(b) If advertisements are given in connection with a weather rebroadcast, these advertisements shall not directly convey an endorsement by the government of the products or services so advertised.

(c) Credit must be given to indicate that the rebroadcast messages originate with the National Weather Service (Weather Bureau).

Recordings, Tapes and Films

§73.1208 Broadcast of taped, filmed, or recorded material.—(a) Any taped, filmed or recorded program material in which time is of special significance, or by which an affirmative attempt is made to create the impression that it is occurring simultaneously with the broadcast, shall be announced at the beginning as taped, filmed or recorded. The language of the announcement shall be clear and in terms commonly understood by the public. For television stations, the announcement may be made visually or aurally.

(b) Taped, filmed or recorded announcements which are of a commercial, promotional or public service nature need not be identified as taped, filmed, or recorded.

Time

For AM, FM and TV...

§73.1209 References to time. Unless specifically designated as "standard (non-advanced)" or "ad-

vanced," all references to time contained in this part, and in license documents and other authorizations issued thereunder, shall be understood to mean local time; i.e., the time legally observed in the community.

Political Broadcasts

For AM, FM and TV...

§73.120 Definitions. (a) A "legally qualified candidate" means any person who has publicly announced that he is a candidate for nomination by a convention of a political party or for nomination or election in a primary, special, or general election, municipal, county, state or national, and who meets the qualifications prescribed by the applicable laws to hold the office for which he is a candidate, so that he may be voted for by the electorate directly or by means of delegates or electors, and who

(1) has qualified for a place on the ballot or
(2) is eligible under the applicable law to be voted by sticker, by writing in his name on the ballot, or other method, and (1) has been duly nominated by a political party which is commonly known and regarded as such, or (2) make a substantial showing that he is a bona fide candidate for nomination or office, as the case may be.

(b) General requirements. No station licensee is required to permit the use of its facilities by any legally qualified candidate for public office, but if any licensee shall permit any such candidate to use its facilities, it shall afford equal opportunities to all other such candidates for that office to use such facilities: provided, that such licensee shall have no power of censorship over the material broadcast by any such candidate.

(c) Rates and practices.—(1) The rates, if any, charged all such candidates for the same office shall be uniform and shall not be rebated by any means direct or indirect. A candidate shall, in each case, be charged no more than the rate the station would charge if the candidate were a commercial advertiser whose advertising was directed to promoting its business within the same area as that encompassed by the particular office for which such person is a candidate. All discount privileges otherwise offered by a station to commercial advertisers shall be available upon equal terms to all candidates for public office.

(2) In making time available to candidates for public office no licensee shall make any discrimination between candidates in charges, practices, regulations, facilities, or services for or in connection with the service rendered pursuant to this part, or make or give any preference to any candidate for public office or subject any such candidate to any prejudice or disadvantage; nor shall any licensee make any contract or other agreement which shall have the effect of permitting any legally qualified candidate for any public office to broadcast to the exclusion of other legally qualified candidates for the same public office.

(d) Records: inspections.—Every licensee shall keep and permit public inspection of a complete record of all requests for broadcast time made by or on behalf of candidates for public office, together with an appropriate notation showing the disposition made by the licensee of such request, and the charges made, if any, if request is granted. Such records shall be retained for a period of two years.

NOTE: See §1.526 of this chapter.

(e) Time of request. A request for equal opportunity must be submitted to the licensee within one week of the day on which the first prior use, giving rise to the right to equal opportunities, occurred; provided however, that where a person was not a candidate at the time of such first prior use, he shall submit his request within one week of the first subsequent use after he has become a legally qualified candidate for the office in question.

(f) A candidate requesting such equal opportunities of the licensee, or complaining of noncompliance to the Commission, shall have the burden of proving that he and his opponent are legally qualified candidates for the same public office.

[EDITOR'S NOTE: In FM this is §73.290; in TV, §73.657.]

Revocations, modifications, suspensions

All Classes of Station Licenses...

§1.85 Suspension of operator licenses.—Whenever grounds exist for suspension of an operator license, as provided in Section 303(m) of the Communications Act, the Chief of the Safety and Special Radio Services Bureau, with respect to amateur opera-

FCC Rules

for licenses, or the Chief of the Field Engineering and Monitoring Bureau, with respect to commercial operator licenses, may issue an order suspending the operator license. No order of suspension in any operators' license shall take effect until 15 days' notice in writing of the cause for the proposed suspension has been given to the operator licensee, who may make written application to the Commission at any time within said 15 days for a hearing upon such order. The notice to the operator licensee shall not be effective until actually received by him, and from that time he shall have 15 days in which to mail the said application. In the event that physical conditions prevent mailing of the application before the expiration of the 15-day period, the application shall then be mailed as soon as possible thereafter, accompanied by a satisfactory explanation of the delay. Upon receipt by the Commission of such application for hearing, said order of suspension shall be designated for hearing by the Chief, Safety and Special Radio Services Radio Bureau or the Chief, Field Engineering Bureau, as the case may be, and said order of suspension shall be held in abeyance until the conclusion of the hearing. Upon the conclusion of said hearing, the Commission may affirm, modify or revoke said order of suspension. If the license is ordered suspended, the operator shall send his operator license to the office of the Commission in Washington, D.C., on or before the effective date of the order, or, if the effective date has passed at the time notice is received, the license shall be sent to the Commission forthwith.

§1.87 Modification of license or construction permit on motion of the Commission.—

(a) Whenever it appears that a station license or construction permit should be modified, the Commission will notify the licensee or permittee in writing of the proposed action and the grounds and reasons therefor and direct him to show cause why an order modifying the license or construction permit in the manner proposed by the Commission should not be issued.

(b) Any order to show cause issued in accordance with paragraph (a) of this section will notify the licensee or permittee that he may request within a period of time to be stated in the order to show cause, that a hearing be held on the proposed modification. In case of timely request, a hearing will be held on the proposed modification, in no event less than 30 days after the receipt of the order to show cause, unless the Commission finds that safety of life or property require the fixing of a shorter period.

(c) In order to avail himself of the right to request a hearing and of the opportunity to appear and give evidence upon the matters specified in order to show cause, the licensee or permittee, in person or by his attorney shall, within the period of time as may be specified in the order to show cause, file with the Commission a written statement stating that he request a hearing and will appear at the hearing and present evidence on the matter specified in the order to show cause. Such written statement must contain a detailed response to the matter specified in the order to show cause and the permittee or licensee shall be limited in the hearing to matters fairly encompassed within the issues raised by the response.

(d) The right to request a hearing shall, unless a good cause is shown in a petition to be filed not later than 5 days before the lapse of the time specified in paragraph (c) of this section, be deemed waived:

(1) In case of failure to timely file a written statement as required by paragraph (c) of this section.

(2) In case of filing the written statement provided for in paragraph (c) of this section but failure to appear at the hearing, either in person or by counsel.

(e) Where the right to request a hearing is waived and no written statement has been filed within the period of time specified in the order to show cause, the licensee or permittee will be deemed to consent to the modification as proposed in the order to show cause and a final decision will be issued by the Commission accordingly.

(f) Where the right to request a hearing has been waived, a written statement may be filed within the period of time to be specified in the order to show cause, showing with particularity why the license or construction permit should not be modified or not so modified as proposed in the order to show cause. In this case, the Commission may, depending upon the facts alleged and proof offered, either call upon the submitting party to furnish additional information under oath, designate the proceeding for hearing, or issue without further proceedings, an order modifying the construction permit or license as proposed in the order to show cause or in said written statement. The

order to show cause will advise the person against whom it is directed of procedure set forth in this paragraph.

(g) Any order of modification issued pursuant to this section shall include a statement of the findings and the grounds and reasons therefor, shall specify the effective date of the order and shall be served on the licensee or permittee.

§1.89 Notice of violations.—(a) Except in cases of willfulness or those in which public health, interest, or safety requires otherwise, any licensee who appears to have violated any provision of the Communications Act or any provision of this chapter will, before revocation, suspension or cease and desist proceedings are instituted, be served with a written notice calling these facts to his attention and requesting a statement concerning the matter. FCC Form 793 may be used for this purpose. The notice of violation may be combined with a notice of apparent liability to monetary forfeiture. In such event, notwithstanding the notice of violation, the provisions of §1.80 apply and not those of §1.89.

(b) Within 10 days from receipt of notice or such other period as may be specified, the licensee shall send a written answer, in duplicate, direct to the office of the Commission originating the official notice. If an answer cannot be sent nor an acknowledgement made within such 10-day period by reason of illness or other unavoidable circumstances, acknowledgement and answer shall be made at the earliest practicable date with a satisfactory explanation of the delay.

(c) The answer to each notice shall be complete in itself and shall not be abbreviated by reference to other communications or answers to other notices. In every instance the answer shall contain a statement of action taken to correct the condition or omission complained of and to preclude its recurrence. In addition:

(1) If the notice relates to violations that may be due to the physical or electrical characteristics of transmitting apparatus and any new apparatus is to be installed, the answer shall state the date such apparatus was ordered, the name of the manufacturer, and the promised date of delivery. If the installation of such apparatus requires a construction permit, the file number of the application shall be given, or if a file number has not been assigned by the Commission, such identification shall be given as will permit ready identification of the application.

(2) If the notice of violation relates to lack of attention to or improper operation of the transmitter, the name and license number of the operator in charge shall be given.

§1.91 Revocation and/or cease and desist proceedings: hearings.—

(a) If it appears that a station license or construction permit should be revoked and/or that a cease and desist order should be issued, the Commission will issue an order directing the person to show cause why an order of revocation and/or a cease and desist order, as the facts may warrant, should not be issued.

(b) An order to show cause why an order of revocation and/or a cease and desist order should not be issued will contain a statement of the matters with respect to which the Commission is inquiring and will call upon the person to whom it is directed (the respondent) to appear before the Commission at a hearing, at a time and place stated in the order, but not less than thirty days after the receipt of such order, and give evidence upon the matters specified in the order to show cause. However, if safety of life or property is involved, the order to show cause may specify a hearing date less than thirty days from the receipt of such order.

(c) To avail himself of such opportunity for hearing, the respondent, personally or by his attorney, shall file with the Commission, within thirty days of the service of the order or such shorter period as may be specified therein, a written appearance stating that he will appear at the hearing and present evidence on the matters specified in the order. The Commission in its discretion may accept a late appearance. However, an appearance tendered after the specific time has expired will not be accepted unless accompanied by a petition stating with particularity the facts and reasons relied on to justify such late filing. Such petition for acceptance of late appearance will be granted only if the Commission determines that the facts and reasons stated therein constitute good cause for failure to file on time.

(d) Hearings on the matters specified in such orders to show cause shall accord with the practice and procedure prescribed in this subpart and Subpart B of this part, with the following exception: (1) In all such revocation and/or cease and desist hearings, the burden of proceeding with the introduction of evidence and the burden of proof shall be upon the Commission; and (2) the Commission may specify in a show cause order, when the circumstances of the pro-

ceeding require expedition, a time less than that prescribed in §§1.276 and 1.277 within which the initial decision in the proceeding shall become effective, exceptions to such initial decision must be filed, parties must file request for oral argument, and parties must file notice of intention to participate in oral argument.

(e) Correction or promise to correct the conditions or matters complained of in a show cause order shall not preclude the issuance of a cease and desist order. Corrections or promises to correct the conditions or matters complained of, and the past record of the licensee, may, however, be considered in determining whether a revocation and/or cease and desist order should be issued.

(f) Any order of revocation and/or cease and desist order issued after hearing pursuant to this section shall include a statement of findings and the grounds therefor, shall specify the effective date of the order, and shall be served on the person to whom such order is directed.

§1.92 Revocation and/or cease and desist proceedings: after waiver of hearing.—

(a) After the issuance of an order to show cause, pursuant to §1.91, calling upon a person to appear at a hearing before the Commission, the occurrence of any one of the following events or circumstances will constitute a waiver of such hearing and the proceeding thereafter will be conducted in accordance with the provisions of this section.

(1) The respondent fails to file a timely written appearance as prescribed in §1.91(c) indicating that he will appear at a hearing and present evidence on the matters specified in the order.

(2) The respondent, having filed a timely written appearance as prescribed in §1.91(c), fails in fact to appear in person or by his attorney at the time and place of the duly scheduled hearing.

(3) The respondent files with the Commission, within the time specified for a written appearance in §1.91(c), a written statement expressly waiving his rights to a hearing.

(b) When a hearing is waived under the provisions of paragraph (a) (1) or (3) of this section, a written statement signed by the respondent denying or seeking to mitigate or justify the circumstances or conduct complained of in the order to show cause may be submitted within the time specified in §1.91(c). The Commission in its discretion may accept a late statement. However, a statement tendered after the specified time has expired will not be accepted unless accompanied by a petition stating with particularity the facts and reasons relied on to justify such late filing. Such petitions for acceptance of a late statement will be granted only if the Commission determines that the facts and reasons stated therein constitute good cause for failure to file on time.

(c) Whenever a hearing is waived by the occurrence of any of the events or circumstances listed in paragraph (a) of this section, the Chief Hearing Examiner (or the presiding officer if one has been designated) shall, at the earliest practicable date, issue an order reciting the events or circumstances constituting a waiver of hearing, terminating the hearing proceeding, and certifying the case to the Commission. Such order shall be served upon the respondent.

(d) After a hearing has been terminated pursuant to paragraph (c) of this section, the Commission will act upon the matters specified in the order to show cause in the regular course of business. The Commission will determine on the basis of all the information available to it from any source, including such further proceedings as may be warranted, if a revocation order and/or a cease and desist order should issue, and if so, will issue such order. Otherwise, the Commission will issue an order dismissing the proceeding. All orders specified in this paragraph will include a statement of the findings of the Commission and the grounds and reasons therefor, will specify the effective date thereof, and will be served upon the respondent.

(e) Corrections or promise to correct the conditions or matters complained of in a show cause order shall not preclude the issuance of a cease and desist order. Corrections or promises to correct the conditions or matters complained of, and the past record of the licensee, may, however, be considered in determining whether a revocation and/or cease and desist order should be issued.

Logs and records

§1.6 Availability of station logs and records for Commission inspection.—(a) Station records and logs shall be made available for inspection or duplication at the request of the Commission or its representative. Such logs or records may be removed from the licensee's possession by a Commission representa-

tive or, upon request, shall be mailed by the licensee to the Commission by either registered mail, return receipt requested, or certified mail, return receipt requested. The return receipt shall be retained by the licensee as part of the station records until such records or logs are returned to the licensee. A receipt shall be furnished when the logs or records are removed from the licensee's possession by a Commission representative and this receipt shall be retained by the licensee as part of the station records until such records or logs are returned to the licensee. When the Commission has no further need for such records or logs, they shall be returned to the licensee. The provisions of this rule shall apply solely to those station logs and records which are required to be maintained by the provisions of this chapter.

(b) Where records or logs are maintained as the official records of a recognized law enforcement agency and the removal of the records from the possession of that law enforcement agency will hinder its law enforcement activities, such records will not be removed pursuant to this section if the Chief of the law enforcement agency shall promptly certify in writing to the Federal Communications Commission that the removal of the logs or records will hinder law enforcement activities of the agency, and stating insofar as feasible the basis for his decision and the date when it can reasonably be expected that such records may be released to the Federal Communications Commission.

Lotteries

§73.1211 Broadcast of lottery information.— (a) No licensee of an AM, FM or television broadcast station, except as in paragraph (c) of this section, shall

broadcast any advertisement of or information concerning any lottery, gift enterprise, or similar scheme, offering prizes dependent in whole or in part upon lot or chance, or any list of the prizes drawn or awarded by means of any such lottery, gift enterprise or scheme, whether said list contains any part or all of such prizes. (18 USC §1304, 62 Stat 763).

(b) The determination whether a particular program comes within the provisions of paragraph (a) of this section depends on the facts of each case. However, the Commission will in any event consider that a program comes within the provisions of paragraph (a) of this section if in connection with such program a prize consisting of money or thing of value is awarded, to any person whose selection is dependent in whole or in part upon lot or chance, if as a condition of winning or competing for such prize, such winner or winners, are required to furnish any money, or thing of value or are required to have in their possession any product sold, manufactured, furnished or distributed by a sponsor of a program broadcast on the station in question.

(c) The provisions of paragraphs (a) and (b) of this section shall not apply to an advertisement, list of prizes or other information concerning a lottery conducted by a state acting under authority of state law when such information is broadcast: (1) by a radio or television broadcast station licensed to a location in that state, or (2) by a radio or television broadcast station licensed to a location in an adjacent state which also conducts such a lottery.

(d) For the purposes of paragraph (c) of this section, "lottery" means the pooling of proceeds derived from the sale of tickets or chances and allotting those proceeds or parts thereof by chance to one or more

chance takers or ticket purchasers. It does not include the placing or accepting of bets or wagers on sporting events or contests.

NOTE: Pursuant to the exemption set out in paragraph (c) of this section, a broadcast station licensed to a location in a state that conducts a state lottery may broadcast advertisements of or information concerning such lottery in its state of license and advertisement of or information concerning such lotteries conducted in any adjacent state. The exemption would, for example, permit a broadcast station licensed to a location in New York, which conducts a lawful state lottery, to broadcast advertisements of or information concerning the New York state lottery as well as the lawful state lotteries of Massachusetts, Connecticut, New Jersey and Pennsylvania since these states are adjacent to New York, and also conduct a state lottery. The exemption, however, would not permit a broadcast station licensed to a location in New York to broadcast information concerning the Maine or Michigan state lotteries since those states are not adjacent to New York. Nor would the exemption permit a station licensed to a location in Virginia to broadcast information concerning the Maryland state lottery, since although Virginia is adjacent to Maryland, Virginia does not conduct a state lottery.

§1304 (of U.S. Criminal Code) Broadcasting Lottery Information.—Whoever broadcasts by means of any radio station for which a license is required by any law of the U.S. or whoever, operating any

FCC Fee Schedule

Construction permits:	Filing fee	Grant fee
VHF—top-50 markets	\$10,000	\$67,500
UHF—top-50 markets	2,500	22,500
VHF—next 50 markets	4,000	27,000
UHF—next 50 markets	1,000	9,000
VHF—balance	2,000	13,500
UHF—balance	500	4,500
FM—class A	200	1,350
FM—class B and C	400	2,700
AM—day—50 kw	1,000	6,750
AM—day—25 kw	800	5,400
AM—day—10 kw	600	4,050
AM—day—5 kw	400	2,700
AM—day—2.5 kw	300	2,025
AM—day—1 kw	200	1,350
AM—day—500 w	100	675
AM—day—250 w	50	340
AM—unlimited 50 kw	2,000	13,500
AM—unlimited 25 kw	1,600	10,800
AM—unlimited 10 kw	1,200	8,100
AM—unlimited 5 kw	800	5,400
AM—unlimited 2.5 kw	600	4,050
AM—unlimited 1 kw	400	2,700
AM—unlimited 500 w	200	1,350
AM—unlimited 250 w	100	675
AM—class IV—1 kw-D, 250 w-N	200	1,350

Other applications:	AM	FM	TV	Auxiliary
Application for construction permit to replace expired permit (Form 321)	\$250	\$250	\$250	\$ 50
Application for modification other than major change (Form 301):				
(A) Application to change antenna/transmitter site; or to increase antenna height; or to change antenna pattern	—	—	—	—
(B) All other Form 301 applications	100	100	100	—
Application for change of call sign for broadcast station	200	200	200	—
Application for authorization in auxiliary broadcast services (Form 313):				
(A) Application for modification of construction permit or license in auxiliary broadcast services	—	—	—	50
(B) Application for construction permit for remote pick-up mobile station	—	—	—	100
(C) Application for construction permit for intercity relay or for studio transmitter link or for remote pick-up base station	—	—	—	250
(D) All other Form 313 applications	—	—	—	100
Application for construction permit or license of auxiliary or alternate main transmitter	50	50	50	50
All other applications in the broadcast services	100	100	100	100

* One-half the filing fee for an application for construction permit for new station or major change in existing station but not less than \$100.

Subscription television authorizations:
Application filing fee \$700

Assignments and transfers:

Application for assignment of license or transfer of control—Form 314, Form 315 and Form 316 applications. (Where more than one broadcast station license is involved, the total amount of fees prescribed for each license so involved will be paid in the manner set forth below):

Sales of Exchanges:	Fee
Application filing fee (Forms 314 & 315)	\$200
Application filing fee (Form 316)	\$100
Grant fee to be paid immediately following consummation of the assignment or transfer:	
For AM stations, and joint assignment or transfer of AM-FM stations, with gross revenue of \$400,000 or less	0.9% of gross revenue
For AM stations, and joint assignment or transfer of AM-FM stations, with gross revenue greater than \$400,000	\$3,600 plus 1.4% of gross revenue in excess of \$400,000
For all FM stations	0.9% of gross revenue
For television stations with gross revenue of \$800,000 or less	1% of gross revenue
For television stations with gross revenue greater than \$800,000	\$8,000 plus 1.6% of gross revenue in excess of \$800,000
In all other cases and/or when gross revenue is indeterminable (See Note 2)	0.4% of consideration for assignment or transfer

Gifts:

Application filing fees and grant fees for assignments or transfers resulting from gifts are the same as those for sales or exchanges above, with the exception that no grant fee will be assessed for an assignment or transfer by gift from a person to a spouse and/or lineal descendant.

Note 1: Gross revenue will be determined by taking the average of the annual gross revenue figures reported on line 19 of FCC Form 324 for the respective station(s) for the three years immediately preceding the date of the consummation of the transfer or assignment.

Note 2: In certain situations gross revenue figures are not available for assessment of a fee on that basis—for example, assignment or transfer of an AM or FM station individually from what had been a joint AM-FM operation; assignment or transfer of a broadcast station license in which gross revenue has been either nonexistent or so intermittent as to be an improper basis upon which to establish a grant fee; assignment or transfer of religious or other stations that do not report gross revenue. In those types of cases, the grant fee will be assessed on the basis of consideration as indicated above.

Note 3: In the case of transfer of control, the transfer grant fee will be based on the percentage of interest acquired which resulted in the transfer of control (except for those situations described in note 4 below in which additional acquisitions of interest may be subject to the grant fee). Example: "A" acquires a 60% interest in an AM station with gross revenue of \$100,000. Assuming "A" holds no other interest in this station that was acquired in the preceding two years, the grant fee is \$540—\$100,000 x 0.9% x 60%.

Note 4: In the case of transfers of control that require the filing of a FCC Form 315 application, in which the transferee holds previously acquired interests in the subject broadcast station license, the grant fee will be based on the acquisition which resulted in the transfer of control and on interests acquired during the two-year period, or portion thereof, which occurs after March 1, 1975, preceding the date of the contract that necessitates the filing of FCC Form 315. As a part of such Form 315 application, the transferee (i.e. the person, party, entity, or group that is the real party in interest that is seeking to acquire control) will be fully identified and will list all prior acquisitions by the transferee, as defined herein, together with the dates of the acquisitions of interest. In addition, a grant fee will be assessed against any additional interest in the station acquired within two years following the date of the contract for transfer of control. The transferee will be required to inform the

Fees, Station Applications

such station, knowingly permits the broadcasting of any advertisement or information concerning any lottery, gift enterprise, or similar scheme, offering prizes dependent in whole or in part upon lot or chance, or any list of the prizes drawn or awarded by means of any such lottery, gift enterprise, or scheme, whether said list contains any part or all of such prizes, shall be fined not more than \$1,000 or imprisoned not more than one year, or both.

Each day's broadcasting shall constitute a separate offense.

Censorship

§326 (of Communications Act)—Nothing in this Act shall be understood to give the Commission the power of censorship over the radio communications or signals transmitted by any radio station, and no regulation or condition shall be promulgated or fixed by the Commission which shall interfere with the right of free speech by means of radio communications.

Station Application Procedure

Any qualified citizen, firm, or group may apply to the Federal Communications Commission for authority to construct a standard (AM), frequency modulation (FM), or television (TV) broadcast station.

Licensing of these facilities is prescribed by the Communications Act of 1934, as amended, which sets up certain basic requirements. In general, applicants must satisfy the commission that they are legally, technically and financially qualified, and that operation of the proposed station would be in the public interest.

The licensing procedure is detailed in Part 1 of the commission's rules, "Practice and Procedure." Station operation is covered by Part 73 (formerly Part 3), "Radio Broadcast Services." This includes technical

standards for AM, FM and TV stations, and TV and FM channel (frequency) assignments by states and communities. Copies of these rules are available from the Government Printing Office.

Most applicants employ engineering and legal services in preparing their applications. The commission does not make technical or other special studies for prospective applicants nor does it recommend individual lawyers or engineers. Names of firms and individuals practicing before the commission are listed in various trade publications.

Following is a summary of the consecutive steps to be followed in applying for authorization to build and operate a broadcast station. The application procedure is substantially the same whether the facility sought is AM, FM or TV.

Selecting a Facility

An AM applicant must make his own search for a frequency on which he can operate without causing or receiving interference from existing stations and stations proposed in pending applications. AM broadcast stations operate on "local," "regional" or "clear" channels. Stations of 250 watts power nighttime and up to 1 kilowatt daytime serve small communities; stations of 500 watts to 5 kilowatts power cover centers of population and surrounding areas; stations of 10 to 50 kilowatts power are for large area coverage, particularly at night.

An FM station applicant must request an FM channel assigned to the community in which he proposes to operate, or a place within a 10-mile radius (for Class A FM stations) or a 15-mile radius (for Class B or Class C FM stations), which has no FM channel assignment. Power, antenna height and station separation are governed by the zone in which the station is located. There are three classes of commercial FM stations and three zones. Class A stations use power from 100 watts to 3 kilowatts to cover a radius of about 15 miles; Class B stations, 5 kilowatts to 50 kilowatts for 40-mile service and Class C, 25 kilowatts to 100 kilowatts for 65-mile range. Noncommercial educational FM stations are in a separate category and may operate with power as low as 10 watts. Commercial and educational FM stations may apply for a "Subsidiary Communications Authorization" (Form 318) to furnish certain supple-

mental services. FM stations may engage in stereophonic broadcasting, for which no special application is required.

An applicant for a TV station must request a VHF (very high frequency) or a UHF (ultra high frequency) channel assignment to the community in which he proposes to operate, or a place having no channel assignment within 15 miles of that community. Power depends upon the kind of channel used (VHF or UHF) and station separation is determined by three zones. TV "translator" stations serve remote communities by picking up and rebroadcasting the programs of outside stations, with the latter's permission. They operate on any VHF channel or on any unassigned UHF channel between 55 and 69 or on any unassigned channel. Certain channels are assigned for noncommercial educational TV operation. There is a "Community Antenna Relay Service" for non-common carrier microwave facilities to relay TV signals to cable TV systems.

Applying for a Construction Permit

After a prospective broadcaster has decided upon the type of station he desires, and the place where it would be located, he should ascertain and plan to meet the programming needs of the locality he intends to serve. The next step is to apply for a construction permit. This is done on FCC Form 301, "Application for Authority to Construct a New Broadcast Station or Make Changes in an Existing Station," which covers AM, FM, or TV broadcasts, except educational applicants who use FCC Form 340, FM and TV translators (Form 346) and FM booster stations (Form 349P). These forms require information about the citizenship and character of the applicant, as well as his financial, technical and other qualifications, plus details about the transmitting apparatus to be used, antenna and studio locations, and the service proposed. Commercial broadcast applicants are required to show their financial ability to operate for one year after construction of the station. Triplicate copies are required. Non-profit education institutions apply for new or changed instructional TV fixed stations on Form 330-P.

Applicants Must Give Local Notice

Applicants for new broadcast stations, license

Commission of such additional acquisitions and make certain that the proper grant fees are paid. Such grant fee for additional acquisitions within two years subsequent to transfer of control will be computed on the basis of the same gross revenue figures used in connection with the transfer of control application and such additional fee shall be submitted at the time the supplemental Ownership Report (FCC Form 323) is filed with the Commission pursuant to § 1.615(c) of this chapter. (Example: The transferee as fully identified in the Form 315 application acquires the following interests in a station with \$100,000 gross revenue: January 1, 1974-5 percent; January 1, 1975-5 percent; March 10, 1975-35 percent; April 1, 1975 (contract date)—15 percent. The transfer grant fee is \$450—\$100,000 X 0.9 percent X 50 percent, with the 50 percent figure representing the interest that required the filing of the transfer of control application, plus interests acquired in the two years, occurring after March 1, 1975, which immediately precede the date of the contract which resulted in the transfer of control. If the transferee were to acquire any additional interest in the station prior to April 1, 1977, an additional grant fee would be incurred equivalent to the additional interest acquired times \$100,000 times 0.9 percent.

Note 5: In cases in which control, either positive or negative, is relinquished by a transferor, and no entity, person, party or group is acquiring control, either positive or negative, the grant fee will be assessed on the basis of the interest passing under the FCC Form 315 application plus all interests that the transferor passed to any entity, person, party or group occurring within two years prior to the contract date that gives rise to the filing of the application. Applicants will set forth the complete information as to all aspects of the "control relinquishing" transactions, including all interests transferred by the transferor's to any entity, person, party or group in the two-year period prior to the contract date.

Annual license fee:

Each broadcast station shall pay an annual license fee to the commission based on the station's rate card as of June 1 of each year.

For AM & FM stations:

The annual license fee will be a payment equal to 8.5 times the station's highest single one-minute spot announcement rate, but in no event shall the annual license fee for each AM and each FM station be less than \$25.

For television stations:

The annual license fee will be a payment equal to 4.25 times the station's highest 30-second spot announcement rate, but in no event shall the annual license fee be less than \$100.

Fees are not required in the following instances:

- Applications filed by tax exempt organizations for operation of stations providing noncommercial educational broadcast services, whether or not such stations operate on frequencies allocated for noncommercial, educational use.
- Applications in the standard broadcast service requesting authority to determine power of nondirectional standard broadcast stations by direct measurement.
- Applications for all FM or television translators and all FM or television translator relay stations.
- Applications by local government entities in connection with the licensing or operation of a noncommercial broadcast station.
- Applications for licenses to cover construction permits in the auxiliary broadcast services.

Satellite communications services:	Filing fee	Grant fee
Application for initial construction permit for commercial transmit/receive earth station	\$120	1/3 of 1% of construction cost as set forth in the application— not to exceed \$15,000
Application for initial construction permit for a commercial receive-only or transportable earth station	60	1/3 of 1% of construction cost as set forth in the application— not to exceed \$15,000
Application for modification of construction permit or license or for construction permit for additional equipment at an existing commercial earth station	60	1/3 of 1% of construction cost
Application for authority to operate a transportable earth station at a fixed site	180	None
Application for renewal of license for a commercial transmit/receive earth station	60	\$3,000
Application for renewal of license for a commercial receive-only earth station	330	None
Application for initial construction permit or modification of construction permit or license for an auxiliary station (boresight) to an earth station or for a telemetry, tracking and control station	30	1/3 of 1% of construction cost
Application for initial construction permit per satellite	150	\$3,000
Application for authority to launch and operate satellites, per satellite	150	1/3 of 1% of satellite construction cost (due 45 days after successful launch and operation)
Application for renewal of an auxiliary station to an earth station or for a telemetry, tracking and control station	180	None
Application for assignment of a commercial transmit/receive earth station or satellite construction permit or license or transfer of control of a licensee or permittee, per earth station or satellite	45	None
Application for assignment of a commercial receive-only or transportable earth station construction permit or license or transfer of control of a licensee or permittee, per earth station	45	None
Application for communications common carrier for authorization to own stock in the Communications Satellite Corp.	45	None
Any other application filed under the Communications Satellite Act or the Communications Act of 1934 in the Satellite Communications Services	45	None

renewals, station sales or major changes in existing stations must give local public notice of their plans and also of any subsequent designation of their applications for hearing. This is done over the applicant's local station (if any) and by advertising in the local newspaper. It affords interested persons an opportunity to comment on these applications to the commission. Applicants and stations must also maintain public reference files in their respective localities.

Application Processing

All broadcast applications (except translators) are reported twice by the commission—when first tendered (received) and, again, when formally accepted for filing. An application is not acted upon until at least 30 days after the commission gives public notice of its acceptance.

Competing AM-FM-TV applications may be filed up to a date in a notice of AM-FM-TV applications ready for processing. It usually is about 30 days following that notice. During that time objecting petitions may be filed.

Applications are, in general, processed in the order in which accepted. They are reviewed for engineering, legal and financial data by the Broadcast Bureau which, under delegated authority, acts on routine applications and reports to the commission applications involving policy or other particular considerations. If an application has no engineering or other conflicts and no valid protests have been received, the applicant is found qualified. Assuming all other requirements are met, the application may be granted without hearing and a construction permit issued. All such grants are announced by the commission. Petitions for reconsideration of grants made without hearing can be filed within 30 days but must show good cause why the objections were not raised before the grant.

Hearing Procedure

Where it appears that an application does not conform to the commission's rules and regulations, that serious interference would be caused, if there is protest of merit, or if other serious questions of a technical, legal or financial character develop, a hearing is usually required. The commission must accord a hearing to competing applications filed within specified time limits.

In designating an application for hearing, the commission gives public notice of the issues for the information of the applicant and others concerned. The hearing notice generally allows the applicant 60 days or more in which to prepare. Even after the hearing has been set, an applicant may amend his application to resolve engineering or other problems upon petition. (Commission approval is required for all mergers or situations in which a competing applicant withdraws on payment of expenses.)

Hearings on competing applications are normally held at the commission's Washington offices. Hearings on license revocations and renewals are held in the communities affected.

Hearings are customarily conducted by an Administrative Law Judge (ALJ). He has authority to administer oaths, examine witnesses and rule upon the admission of evidence. A prehearing conference is held to reach agreement on procedural matters.

Within 20 days after the close of a record by the ALJ, each party and the chief of the Broadcast Bureau of the commission can file proposed findings of fact and conclusions to support their contentions. After review of the evidence and statements, the ALJ issues an initial decision.

If he wishes to contest the initial decision, the applicant or any other party in interest has 30 days from the date on which the initial decision was issued to file exceptions. In all cases heard by an ALJ, the commission or its review board may hear oral argument on timely request of any party. After oral argument, the commission or the review board may adopt, modify or reverse the ALJ's initial decision. In cases where the review board has acted on the exceptions, an appeal from its decision may be taken to the commission within 30 days. The commission may, however, deny an appeal for review without stating reasons for such action.

Court appeals can be taken within 30 days following release of the final decision, in which case the commission's action is stayed pending court determination.

Construction Permit

When an application is granted, a construction permit is issued. The new permittee may then request call letters which, if available and conforming to the rules, are issued. A period of 60 days from date of the construction permit is provided in which construction shall begin, and a maximum of ten months (AM-FM,

FM-TV translators and ITFS) thereafter as the time for completion (or twelve months in all) and a maximum of sixteen months (commercial and educational television; UHF-VHF) thereafter as the time for completion (or eighteen months in all). Application to modify a broadcast construction authorization or to modify a license is made on Form 301-A, for remote control authority for transmitter. If the permittee is unable to build his station within the time specified, he must apply for extension of time on Form 701 ("Application for Additional Time to Construct a Radio Station"), giving reasons. Upon completion of construction the permittee conducts equipment (not program) tests.

License

The final step is to apply for the actual license on Form 302 ("Application for New Broadcast Station License"), or Form 330-L (for instructional TV fixed stations), or Form 341 (for noncommercial educational FM stations), Form 347 (for TV and FM translators), or Form 349L (for FM boosters). Applicants must show compliance with all terms, conditions and obligations set forth in the original application and the construction permit. Not until he applies for a license can the holder of a construction permit request authority to conduct program tests. The license application form provides a space for program test requests, or it can be made separately. A station license and program test authority are issued if no new cause or circumstance has come to the attention of the commission that would make operation of the station contrary to public interest.

Renewals

Applicants for renewal of station license must show that they have operated according to the terms of their authorizations and the promises they made in obtaining them. Most renewal applications are made on Form 303 ("Application for Renewal of Broadcast Station License"). Instructional TV fixed, use Form 330-R. Noncommercial educational licensees use Form 342; TV and FM translators Form 348 and FM boosters Form 349R. Pending the disposition of any commission hearing or other proceeding involving license renewal or revocation considerations, the station continues to operate even though its license term may have expired.

Sales and Transfers

If the holder of a construction permit or license desires to assign it to someone else, he makes application on Form 314 ("Application for Consent to Assignment of Radio Broadcast Station Construction Permit or License"). Should the permittee or licensee wish to transfer corporate control, he applies on Form 315 ("Application for Consent to Transfer Control of Corporation Holding Radio Broadcast Station Construction Permit or License"). Form 316 ("Application for Assignment or Transfer—Short Form") may be used when the transfer or assignment involves no substantial change in interest. Sales of stations held less than three years are subject to hearing except in case of death, hardship or other mitigating circumstances beyond the licensee's control.

Construction Changes

Applicants for authority to make construction changes in existing stations apply on the same form

Station Applications, Group Ownership

used for a construction permit for the type of station involved.

Application Fees

Since March 17, 1964, the commission has charged fees for most application filings in order to comply with government policy to charge for certain federal services. On July 1, 1970, a new fee schedule was adopted for broadcast stations, which includes three types of charges: (1) a filing fee (the only type of fee previously charged) payable when the application is tendered; (2) a grant fee, payable when the application is granted; and (3) an annual operating fee, paid by all commercial AM, FM and TV stations, in lieu of the renewal application fee previously charged. Application filing fees for construction permits, generally considerably higher than those previously charged, vary with the type of station, from \$50 for a daytime-only 250-watt non-directional AM station permit and \$200 for a class A FM, to \$10,000 for a VHF TV permit in the top-50 markets (in TV, though not in radio, fees vary with market size: top 50, next 50, and other; and there is also a VHF-UHF difference). Applications for major changes are charged the same fee as those for new stations. The grant fee is charged on the same schedule. For assignments of licenses and transfers of control (other than involuntary transfers), the filing fee is \$200 (per license) and the grant fee, based on annual revenue (with certain exceptions), is payable on consummation. The annual operating fee is based on a station's highest commercial announcement rate: in AM and FM, the highest one-minute rate multiplied by 8.5 and in TV the highest 30-second rate multiplied by 4.25, with a minimum of \$25 in radio and \$100 in television. Most "other" applications, such as for covering licenses and minor changes, entail a filing fee of \$100 and no grant fee; involuntary or voluntary assignments or transfers of control using Form 316 require a filing fee of \$100 (per station where more than one is involved) and no grant fee; and applications for subscription television authorizations entail a \$700 filing fee but no grant fee.

Translators and noncommercial education stations are exempt from fees.

March 1, 1975 was the generally effective date of the new fee schedule. The annual operating fee for broadcast stations is due each year on the anniversary of the station's license expiration date.

The fee schedule will be subject to continuing review, to determine whether changes in over-all or comparative levels are in order.

Printed Rules

FCC rules may be obtained only through the Government Printing Office, Washington, D.C. 20402. The rules of FCC practice and procedure are contained in Volume I, which is available for \$8.00 a copy; the broadcast rules are contained in Volume III, for \$18.50. Orders should be sent to the Government Printing Office direct (not through the FCC). The printed rules are sold on a subscription basis, which entitles the purchaser to receive subsequent amendments to the rule part purchased until an over-all revised issue is printed.

Group Ownership

Listed here are individuals and companies with multiple station holdings. Included are all those controlling three or more radio stations and/or two or more television stations. FCC rules limit multiple ownership to seven AM stations, seven FM stations and seven television stations of which not more than five TV stations may be VHF. Ownership of CATV systems, as reported by these stations, is also listed. Unless otherwise noted, the first station listed is group headquarters.

A

ABC Owned Stns—Stns: 6 AM, 6 FM, 5 TV. WABC(AM), WPLJ(FM), and WABC-TV New York; WLS(AM), WDAI(FM) and WLS-TV Chicago; KGO(AM), KSFX(FM) and KGO-TV San Francisco; KABC(AM), KLOS(FM) and KABC-TV Los Angeles; WXYZ(AM), WRIF(FM) and WXYZ-TV Detroit; KXYZ(AM) and KAUM(FM) Houston. For listing of ABC divisions and executives, see Index, Section D.

The A.S. Abell Co.—Stns: 1 AM, 2 FM, 2 TV. WMAR-FM-TV Baltimore and WBOC-AM-FM-TV Salisbury, Maryland. Ownership: A.S. Abell Co. Hqs: The A.S. Abell Co., WMAR-TV, 6400 York Rd., Baltimore 21212. (301) 377-2222.

Abilene Radio & TV Stns—Stns: 1 AM, 2 TV. KENM(AM) Portales, N.M.; KRBC-TV Abilene, and KACB-TV San Angelo, both Texas. Ownership: Dale Ackers, 29.17%; Sybil Ackers, 12.5%; Jack Andrews, 29.17%; Christine Ackers Cagle, 20%; Carol Cagle Trust, 9.17%.

Able Communications Inc.—Stns: 1 AM, 3 FM. KJOI(FM) Los Angeles and KOAX(FM) Dallas; minority interest in WAVO(AM) Decatur and WPCF(FM) Atlanta, both Georgia. Executives: Ed Blake, pres; Robert E. Richer, exec VP. Ownership: Owned by Noel Fund Inc. Louis Marx and Dan W. Lufkin own 50% each of Noel Fund.

Allegheny Mountain Network Stns—Stns: 5 AM, 4 FM. WBLF(AM) Bellefonte, WIYQ(FM) Ebsburg.

Group Ownership

WTRN(AM) and WGMR-FM Tyrone, all Pennsylvania; 71% of WFRM(AM) Coudersport, WNB(AM) and WGR-FM Wellsboro, both Pennsylvania; 50% of WKBI(AM) St. Marys and WKBI-FM Ridgway both Pennsylvania. Ownership: Cary H. Simpson. Hqs: Box 204, State College, Pa. 16801. (814) 238-0792.

Amaturo Group Inc.—KQTV(TV) St. Joseph and KKSS(FM) St. Louis, both Missouri; and KLYX(FM) Clear Lake City, Tex. Ownership: Owned by Joseph C. Amaturo and members of the Loeb family. Hqs: Box 533, Fort Lauderdale, Fla. 33310.

American Colonial Bcstg. Corp.—Stns: 1 AM, 1 FM, 2 TV. WKBM-TV Caguas, WSUR-TV Ponce, and WKVM(AM) and WCAD-FM San Juan, all Puerto Rico. Owned by Ralph Perez Perry. Hqs: Box 4189, San Juan, PR. 00905.

American Media—Stns: 2 AM, 3 FM. KCSJ(AM) and KDJO(FM) Pueblo, Colo.; KBL(AM) and KEYN-FM Wichita, Kan.; and KOFM(FM) Oklahoma City. Ownership: Lowell D. Denniston, 33 1/3%; Robert D. Freeman, 33 1/3%; Frank L. Carney, 33 1/3%.

Anderson Stns—Stns: 5 AM, 5 FM. KRKS and KLIR-FM Denver; KCLO-AM-FM Leavenworth, KJRG-AM-FM Newton and KFLA-AM-FM Scott City, all Kansas; KJSK-AM-FM Columbus, Neb. (68%), George Basil Anderson and family. Hqs: 6535 West Jewell, Denver 80226.

Armington-France-Gehring-Ocepek Stns—Stns: 3 AM, 2 FM. WFKY(AM) and WKYW(FM) Frankfort, Ky.; WHOK-AM-FM Lancaster and WPVL(AM) Painesville, both Ohio. Principal owners: Anthony S. Ocepek, William M. France, Richard H. Gehring, Raymond Q. Armington. Hqs: c/o WPVL Radio, 1 Radio Place, Painesville, Ohio 44077.

ASI Communications Inc.—Stns: 4 AM, 2 FM, 1 TV. KJTV(TV) Bakersfield, KFAC-AM-FM Los Angeles and KROY(AM)-KROI(FM) Sacramento, all California; WRYT(AM) Boston, and WERE(AM) Cleveland. (Note: All 100% owned, except KROI. ASI owns 76% of KROI Sacramento, Calif.) Ownership: Ralph C. Guild, George R. Fritzing, Daren F. McGavren. Hqs: 400 Park Ave., New York 10022. (212) 826-4200.

Avco Broadcasting Corp.—Stns: 3 AM, 1 FM, 1 TV. WLW(AM) Cincinnati, WLWD(TV) Dayton, all Ohio; KYA-AM-FM San Francisco; WRTH(AM) Wood River, Ill. (Note: Avco has agreed to transfer WLWD, subject to FCC approval.) Execs: John T. Murphy, pres; Walter E. Bartlett, senior VP-TV; Robert L. Goosman, senior VP-treas; Charles K. Murdock, senior VP-radio; Donald G. Middendorf, VP-administration; George J. Gray, VP-Washington affairs; Clyde G. Haehnle, VP-tech asst to the pres; Donald L. Dahliman, VP-TV sls; Howard Leppe, VP-engr. Following are VPs and/or gen mgrs of these Avco-owned stations: WLW—Charles K. Murdock; WLWD(TV)—Ray Colie; KYA-AM-FM—Clifford M. Hunter; WRTH—Joseph P. Costantino. Avco Bcstg. is a subsidiary of Avco Corp. which owns companies manufacturing electronic products, airplane engines, farm implements and other heavy machinery, and is engaged in electronic and chemical research, insurance and financial services. It also owns Avco Embassy Pictures and Carte Blanche. Avco Bcstg. owns Avco Program Sales, producers and distributors of syndicated programs; and Avco Film Productions, producers of 16mm non-theatrical films. Hqs: 1600 Provident Tower, Cincinnati 45202. (513) 241-1822.

B

(Cy N.) Bahakel Bcstg—Stns: 6 AM, 4 FM, 5 TV. WCCB(TV) Charlotte, N.C.; WKAB-TV Montgomery, Ala.; WOLO-TV Columbia, S.C.; WABG-AM-TV Greenwood, Miss.; WKIN(AM) Kingsport, WBBJ-TV Jackson and WDDO-AM-FM Chattanooga, all Tennessee; WWOD-AM-FM Lynchburg, Va.; WLBJ-AM-FM Bowling Green, Ky., and KXEL-AM-FM Waterloo, Iowa. (All 100% owned). Hqs: Box 2449, Charlotte, N.C. 28234. (704) 372-4434.

Vernon H. Baker Stns—Stns: 4 AM, 3 FM. WNNN(FM) Canton (95%) and WJIC(AM) Salem (95%), both New Jersey; WGIC(AM) and WBZI(FM) Xenia (75%), Ohio; WEOO(AM) Smithfield (100%) and WESR-AM-FM Tasley (60%), both Virginia. Principal owner: Vernon H. Baker. Hqs: Box 889, Blacksburg, Va. 24060. (703) 552-4252.

Balaban Stns—Stns: 4 TV. Owns 50% each of

WICS(TV) Springfield, WICD(TV) Champaign, both Illinois; WHNB-TV New Britain-Hartford, Conn.; owns 47% of WTVO(TV) Rockford, Ill. Ownership: Harry and Elmer Balaban, who also own chain of motion picture theaters in Midwest, CATV. Hqs: H. & E. Balaban Corp., 190 N. State St., Chicago 60601.

Baltimore Newspapers Stns—See The A.S. Abell Co.

Bartell Broadcasters Inc.—Stns: 3 AM, 3 FM. WDRQ(FM) Detroit; WMUX(FM) Miami; WOKY(AM) Milwaukee; WADO(AM) New York; KSLQ(FM) St. Louis; KCBQ(AM) San Diego. (Note: WADO has been sold, subject to FCC approval). Hqs: 205 E. 42d St., New York 10017.

Bass Bcstg Stns—Stns: 2 AM, 2 FM, 3 TV. KFDW-TV Clovis, N.M.; KFDO-TV Sayre, Okla.; KFDA-TV Amarillo and KDNT-AM-FM Denton, both Texas; WSLC(AM) and WSLO(FM) Roanoke, Va. Hqs: 8330 Engineer Rd., San Diego 92111.

Beasley Broadcast Group—Stns: 7 AM, 4 FM. WMOO(AM) and WBLX(FM) Mobile, Ala. (53.5%); WGAC(AM) Augusta, Ga. (60%); WFAI(AM) Fayetteville (60%), WFMC(AM) and WOKN(FM) Goldsboro (AM-95%, FM-90%), WHNC(AM) and WXNC(FM) Henderson (50%), and WKGX(AM) Lenoir (46%), all North Carolina; WDMT(FM) Cleveland (100%); and WASC(AM) Spartanburg, S.C. (10%). Principal owner: George G. Beasley. Hqs: Box 1355, Goldsboro, N.C. 27530. (919) 734-8003.

Beck-Ross Communications Inc.—Stns: 2 AM, 3 FM. WHCN(FM) Hartford, Conn.; WKMF(AM) and WGMZ(FM) Flint, Mich.; WGLI(AM) Babylon and WBLI(FM) Patchogue, both New York. (All 100% owned.) Principal owners: Martin F. Beck, George H. Ross. Hqs: c/o WGLI Inc., 1290 Peconic Ave., Babylon, N.Y. 11704. (516) MO 9-1290.

Beef Empire Stns—Stns: 2 AM, 2 FM. KCOL-AM-FM Fort Collins, Colo.; WJAG-AM-FM Norfolk, Neb. Ownership: E.F. Huse Jr., Huse Publishing Co., Norfolk, Neb. (majority); Bob Thomas, VP (minority). Jim Prchal & Hollis Francis have minority interest in KCOL-AM-FM only. Hqs: c/o WJAG Inc., Box 789, Norfolk, Neb. 68701. (402) 371-0780.

Charles E. Bell Stns—Stns: 3 AM, 1 FM. WTRS-AM-FM Dunnellon, Fla. (49%); WDOG(AM) Allendale (100%) and WSIB(AM) Beaufort (100%), both South Carolina. Hqs: c/o WSIB, Drawer W, Beaufort, S.C. 29902.

Belo Broadcasting Corp.—Stns: 1 AM, 1 FM, 2 TV. KFDM-TV Beaumont and WFAA-AM-TV, KZEW(FM) Dallas, both Texas. Executives: James M. Moroney Jr., chmn & chief exec off; Mike Shapiro, pres & chief operating off; Ward L. Huey Jr., VP & gen mgr; Jim W. Cooper, VP & sec; Aubrey Jenkins, VP & treas; Jeanette Greer, asst sec. Ownership: A. H. Belo Corp. Hqs: Communications Center, Dallas 75202.

BFR Stns—See Midcontinent Broadcasting Co.

Big Bend Bcstg Corp.—Stns: 2 AM, 1 FM. WCNH-AM-FM Quincy, Fla.; WBS(AM) Bennettsville, S.C. Ownership: W.S. Dodson, D.C. Dodson. Hqs: Box 630, Quincy, Fla. 32351. (904) 627-6700.

Big Country Radio Stns—Stns: 2 AM, 1 FM. KYAK(AM)-KGOT(FM) Anchorage and KIAK(AM) Fairbanks, both Alaska. Ownership: Richard C. Cruver, Glenn S. Miller, Robert W. Fleming. Hqs: 2800 E. Dowling Rd., Anchorage 99507. (907) 344-2522.

Black Hawk Broadcasting Stns—Stns: 3 AM, 1 FM, 2 TV. KLWW(AM) Cedar Rapids, KCBC(AM) Des Moines, KTIV(TV) Sioux City, KWVL-AM-TV and KFMW(FM) Waterloo, all Iowa; KAAL(TV) Austin, Minn. Robert Buckmaster, bd chmn; Harry G. Slife, pres. Hqs: E. Fourth & Franklin Sts., Waterloo, Iowa 50703.

Bluegrass Broadcasting Co.—Stns: 4 AM, 2 FM. WFFG(AM) Marathon and WHOO-AM-FM Orlando, both Florida; WVLK-AM-FM Lexington and WINN(AM) Louisville, both Kentucky. (All 100% owned.) Principal owner: G.D. Kincaid, 91%. Hqs: 610 Central Bank Bldg., Lexington, Ky. 40502. (606) 254-1572.

Bonneville International Corp.—Stns: 4 AM, 6 FM, 2 TV. KBRT(AM) Avalon and KBIG(FM) Los Angeles, both California; WCLR(FM) Skokie, Ill. (Chicago); KMBZ(AM) and KMBR(FM) Kansas City, Mo.; WRFM(FM) New York; KSL-AM-FM-TV Salt Lake City; KIRO-AM-TV and KSEA(FM) Seattle. Ownership: Bonneville International Corp., 100% owned by the Corp. of the President of the Church of Jesus Christ of Latter Day Saints. Arch L. Madsen, pres. CATV. Hqs: 136 East South Temple, Suite 2000, Salt Lake City 84111.

Booth American Co.—Wtns: 7 AM, 7 FM. WIOU(AM), WKMO(FM) Kokomo and WJVA(AM), WRBR(FM) South Bend, both Indiana; WJLB(AM) and WMZK(FM) Detroit, WIBM(AM) and WHFI(FM) Jackson, WSGW(AM) and WIOG(FM) Saginaw, all Michigan; WABQ(AM), WXEN(FM) Cleveland and WTD(AM), WKLR(FM) Toledo, both Ohio. Principal owners: John L. Booth, Mrs. John L. Booth, John L. Booth II, Ralph H. Booth II. CATV. Hqs: 2300 Buhl Bldg., Detroit 48226. (313) 965-3360.

Braden Stns—Stns: 2 AM, 3 FM. WSMJ(FM) Greenfield, Ind.; WPFB(AM)-WPBF(FM) Middletown and WPAY-AM-FM Portsmouth, both Ohio. Principal owner: Paul F. Braden. Hqs: 4505 Central Ave., Middletown, Ohio 45042.

Bride Broadcasting Inc.—Stns: 2 AM, 1 FM. WJBQ(AM) Westbrook (Portland) and WJBQ-FM Scarborough, both Maine; WMB(AM) Ambridge, Pa. Executive: John W. Bride, pres. Hqs: Box 309, Ambridge, Pa. 15003. (412) 266-1110.

Brown Broadcasting Co.—Stns: 2 AM, 1 FM. WVBS-AM-FM Burgaw and WBBS(AM) Jacksonville, both North Carolina. (All 100% owned.) Ownership: Herschel R. Brown, 50%; Norman O. Brown, 50%. Hqs: Drawer AM, Jacksonville, N.C. 28540. (919) 347-6141.

Buckley Broadcasting Corp.—Stns: 4 AM, 2 FM. WDR-AM-FM Hartford, Conn.; WWTC(AM) Minneapolis-St. Paul; KKH-AM-FM San Francisco and KGIL(AM) San Fernando, all California. Hqs: 3 E. 54th St., New York 10022. (212) 832-4044.

Buford Television Inc.—Stns: 4 TV. KFMS-TV Fort Smith, Ark.; KXON-TV Mitchell, S.D.; KTRE-TV Lufkin and KLTV(TV) Tyler, both Texas. Ownership: Robert P. Geofffrey R. Buford, 33% each. CATV. Hqs: Box 957, Tyler, Tex. 75701. (214) 592-3873.

John Burroughs Stns—Stns: 2 AM, 1 FM. KRZY(AM)-KRST(FM) Albuquerque (70%) and KRSY(AM) Roswell (100%), both New Mexico. Hqs: c/o KRSY, Box 1981, Roswell, N.M. 88201.

C

California-Oregon Bcstg Inc.—Stns: 1 AM, 4 TV. KRCR-TV Redding, Calif. (100%); KAGI(AM) Grants Pass (83%), KOTI(TV) Klamath Falls (100%), KOB(TV) Medford (100%) and KPIC(TV) Roseburg (50%), all Oregon. Ownership: John Voorhies, 19.614%; William B. Smullin, 58.69%; Earle Voorhies Estate, 9.807%. CATV (group owner). Hqs: 2000 Crater Lake Hwy, Medford, Ore. 97501. (503) 779-5555.

Camp Stations—Stns: 2 AM, 1 FM. WGN(AM) Albany, WPOW(AM) New York and WHAZ(AM) Troy, all New York. Principal owner: Ruth Camp. Hqs: Box 968, Wheaton, Ill. 60187.

Capital Cities Communications Inc.—Stns: 7 AM, 6 FM 6 TV. KFSN-TV Fresno and KPOL-AM-FM Los Angeles, both California; WTNH-TV New Haven, Conn.; WJR-AM-FM Detroit; WPAT-AM-FM Paterson, N.J.; WROW-AM-FM Albany and WKBW-AM-TV Buffalo, both New York; WTV(D) Durham, N.C.; WPVI-TV Philadelphia; WPRO-AM-FM Providence, R.I.; WBAP(AM)-KSCS(FM) Fort Worth and KTRK-TV Houston. Ownership: Edgar W. B. Fairchild, 1.1%; Lowell Thomas, 2.4%; William S. Lasdon, 1.2%; David Minikin, 1.0%; Thomas S. Murphy, 1.0%; publicly traded. Officers of Capital Cities are: Thomas S. Murphy, bd chmn; Daniel B. Burke, pres; Joseph P. Dougherty, exec VP & pres, broadcast division; John B. Fairchild, exec VP; Robert K. King, exec VP-TV, broadcast division; Willard E. Walbridge, senior VP-corporate affairs, broadcast division; Daniel H. Smith, senior VP-dir of engr; James P. Arcara, Philip R. Beuth, George R. Chamberlin, R. Thomas Cronk, William R. James, Kenneth M. Johnson, Peter C. Newell, Robert M. Peebles, Lawrence J. Pollock, Richard G. Rakovan, Melvin J. Thompson, Andrew E. Jackson, Peter K. Orne, Warren Potash, all VPs; William Kopta, VP & treas; Gerald Dickter, sec; Robert W. Gelles, ctrl, asst sec & asst treas. Capital Cities also owns Fairchild Publications Inc.; The Oakland Press Co., Pontiac, Mich.; and Belleville News-Democrat Inc., Belleville, Ill. See Nwspr Crossownership. Hqs: 24 East 51st St., New York 10022. (212) 421-9595.

Capitol Broadcasting Co.—Stns: 1 AM, 1 FM, 2 TV. KKTV(TV) Colorado Springs; WSLI(AM), WJFR(FM) and WJTV(TV) Jackson, Miss. (All 100% owned.) Ownership: Mississippi Publishers Corp., 40%; Standard Life Insurance Co., 32.4%; L. M. Sepaugh, 13.8%; T. B. Lanford, 13.8% (see listing). Hqs: Box 8887, Jackson, Miss. 39204. (601) 372-6311.

Hqs: 208 N. Elm St., Shenandoah, Iowa 51603. (712) 246-1020.

Wendell Mayes Stations—Stns: 4 AM, 1 FM. KNOW(AM) Austin (100%), KCRS(AM) Midland (100%), KSNY(AM) Snyder (32.5%), KVIC(AM) and KCWM(FM) Victoria (100%), all Texas. Principal owner: Wendell Mayes Jr. CATV. Hqs: Box 2197, Austin, Tex. 78767. (512) 477-9841.

McClatchy Bcstg Stns—Stns: 3 AM, 3 FM, 2 TV. KFBC-AM-FM Sacramento, KMJ-AM-FM-TV Fresno, KBEE-AM-FM Modesto, KOVR(TV) Stockton-Sacramento, all California; KOH(AM) Reno. Eleanor McClatchy, pres. (See also Newspaper Crossownership.) Hqs: 21st & Q, Sacramento 95813. Box 15779.

C.A. McClure Stations—Stns: 2 AM, 2 FM. WCHK-AM-FM Canton and WHYD(AM)-WCGQ(FM) Columbus, both Georgia. Ownership: C.A. McClure, 90%; F.K. Brown, 10%. Hqs: Box 1537, Columbus, Ga. 31902. (404) 323-3603.

McCormick Communications Inc.—Stns: 2 AM, 2 FM. WECZ(AM) Boston; WBNY(FM) Buffalo, N.Y.; WLKW-AM-FM Providence, R.I. Ownership: Technical Operations Inc., 80%; William M. McCormick, pres., 20%. Hqs: 1 Beacon St., Boston 02108. (617) 523-2030.

McGraw-Hill Broadcasting Co.—Stns: 4 TV. KERO-TV Bakersfield and KGTV(TV) San Diego, both California; KMGH-TV Denver; WRTV(TV) Indianapolis. Executives: Robert E. Slaughter, chmn; Norman E. Wall, pres; John Trzaska, VP-ctrlr, Robert W. Flanders, VP-engrg; Jack E. Shafer, dir progmg; Robert P. Rimes, dir of creative svcs. Ownership: McGraw-Hill Inc. Hqs: 1221 Ave. of the Americas, New York 10020. (212)997-1221.

James A. McKenna Radio Stns—Stns: 4 AM, 4 FM. KQRS-AM-FM Golden Valley, Minn. (100%); WCMB(AM) and WSMF(FM) Harrisburg, Pa. (80%); WAWA(AM) West Allis, WAWA-FM Milwaukee (32%), WMAD(AM) Madison, WMAD-FM Middleton (100%), all Wisconsin. Hqs: 1150 17th St., N.W., Washington 20036.

Lloyd C. McKenney Stns—Stns: 3 AM. KMDO(AM) Fort Scott, Kan. (25%); KBHM(AM) Branson (50%) and KRMO(AM) Monett (100%), both Missouri. Mr. McKenney's wife, Dorothy N. McKenney, also owns 25% of KMDO. Mr. McKenney's son, Lloyd James McKenney, owns 50% of KMDO. CATV: Lloyd C. and Dorothy N. McKenney each have 9.7% interest in Fort Cable Vision, Fort Scott, Kan. and Lloyd James McKenney has 16 2/3% interest in Fort Cable Vision. Lloyd C. McKenney and Joel R. McKenney (son) each have 16 2/3% interest in Branson, Mo. CATV system. Hqs: Box 503, Carthage, Mo. 64836.

McNaughton Stns—Stns: 4 AM, 4 FM. WCRA-AM-FM Effingham, WRMN-AM-FM Elgin and WKEL(AM)-WJRE(FM) Kewanee, all Illinois; WBEV-AM-FM Beaver Dam, Wis. Ownership: Joseph E. McNaughton and family and others. Hqs: 201 N. Banker, Effingham, Ill. 62401.

Media Horizons Inc.—Stns: 4 AM, 4 FM. KMEO-AM-FM Phoenix; KDEF-AM-FM Albuquerque, N.M.; WGNV(AM) and WFMN(FM) Newburgh, N.Y.; and KROD(AM)-KUOE(FM) El Paso, Kenneth Cowan, exec VP. Note: KDEF(AM) and KROD(AM)-KUOE(FM) have been sold, subject to FCC approval. Hqs: 750 Third Ave., New York 10017.

Meredith Broadcasting—Stns: 4 AM, 2 FM, 4 TV. KPHO-TV Phoenix; WGST(AM) Atlanta; WNEM-TV Bay City, Mich.; KCMO-AM-TV and KCEZ(FM) Kansas City, Mo.; WOW(AM) and KEZO(FM) Omaha; and WHEN-AM-TV Syracuse, N.Y. Executive: James Conley, pres. Meredith Broadcasting is a division of Meredith Corp., Des Moines, Iowa, which publishes, *Better Homes & Gardens, Successful Farming*, consumer books, and is a contract printer. Hqs: 747 Third Ave., New York 10017. (212)688-7300.

Metromedia Inc.—Stns: 5 AM, 7 FM, 6 TV. KLAC(AM), KMET(FM) and KTTV(TV) Los Angeles; KNEW(AM) Oakland and KSNAN(FM) San Francisco; WASH(FM) and WTTG(TV) Washington; WDHF(FM) Chicago; WXIX-TV Newport, Ky. (Cincinnati); WCBM(AM) Baltimore; WOMC(FM) Detroit; WTCN-TV Minneapolis; KMBC-TV Kansas City, Mo.; WNEW-AM-FM-TV New York; WIP(AM) and WMMR(FM) Philadelphia. Principal: John W. Kluge, 9.1%; publicly traded. John W. Kluge, chmn of bd and pres; Clemens M. Weber, exec VP; Ross Barrett, senior VP; Thomas J. Dougherty, VP, Metromedia Bcstg; George Etkin, sec; Albert P. Krivin, senior VP; Stanley Landow, VP-controller; Mary McKenna, VP (mkt rsch); Herbert G.

Klein, VP (corporate rel); Alfred L. Schwartz, senior VP-general counsel; Robert A. Maresca, treas. Metromedia Television: Albert P. Krivin, pres; Richard Woollen, VP-prog; Reavis G. Winckler, VP-adv & prom. Metromedia Radio: George Duncan, pres. Metro TV Sales: Thomas J. Tilson, pres. Metro Radio Sales: Richard J. Kelliher, senior VP & gen mgr. Metromedia Producers Corp.: A. Frank Reel, pres. Other Metromedia Divisions: Foster & Kleiser (outdoor adv); Metro Transit Advertising; Metromail; Ice Capades. Hqs: 277 Park Ave., New York 10017. (212)682-9100.

Meyer Bcstg Co. Stns—Stns: 3 AM, 3 FM, 3 TV. KOYN-AM-FM Billings and KEIN(AM) Great Falls (94%), both Montana; KFYR-AM-FM-TV Bismarck, KMOT-FM and KMOT(TV) Minot, and KUMV-TV Williston, all North Dakota. (All 100% owned except KEIN.) William A. Ekberg, pres. Principals: William A. Ekberg, 0.8%; Marietta M. Ekberg, 99.2%. CATV. Hqs: Box 1738, Bismarck, N.D. 58501. (701) 223-0900.

Mid America Media—Stns: 6 AM, 4 FM. WKAN(AM) Kankakee, WQUA(AM) Moline, WIRL(AM) and WSWT(FM) Peoria, all Illinois; WIRE(AM) and WXTZ(FM) Indianapolis; KRVR(FM) Davenport and KIOA-AM-FM Des Moines, both Iowa; WTRX(AM) Flint, Mich. Burrell L. Small, pres; Leslie H. Small, VP; Stephen B. Small, VP; G. LaVerne Flambo, exec dir of bcstg; Robert J. Hawkins, exec asst to pres. CATV: Kankakee TV Cable Co., Kankakee, Ill. Hqs: 6 Dearborn Square, Kankakee, Ill. 60901. (815) 933-6633.

Mid-America Television Co.—Stns: 3 TV. KRCG(TV) Jefferson City and KMOS(TV) Sedalia, both Missouri; WEEK-TV Peoria, Ill. (All 100% owned.) Ownership: Kansas City Southern Industries Inc., 100%. William A. Bates is pres of Mid-America Television. Hqs: 114 W. Eleventh St., Kansas City, Mo. 64105. (816) 842-0077 extension 328.

Mid Atlantic Network—Stns: 6 AM, 4 FM. WINC(AM) and WRFL(FM) Winchester, WSIG(AM) Mt. Jackson, and WFVA-AM-FM Fredericksburg (60%), all Virginia; WAYZ-AM-FM Waynesboro and WHYL-AM-FM Carlisle, both Pennsylvania; WELD(AM) Fisher, W.Va. CATV: Virginia systems, Lexington Cable Co. (80%), Winchester TV Cable and Telaco (Front Royal). Controlling ownership: John P. Lewis, David P. Lewis and Howard P. Lewis. Hqs: Box 605, Winchester, Va. 22601.

Midcontinent Broadcasting Co.—Stns: 3 AM, 4 FM, 3 TV. WL0L-AM-FM Minneapolis; KDLO-TV Florence, KPLO-TV Reliance, KELO-AM-FM-TV Sioux Falls and KDLO-FM Watertown, all South Dakota; and WTSO(AM)-WZEE(FM) Madison, Wis. CATV. Principals: Joseph L. Floyd, N.L. Bentson and Edmond R. Ruben, 33 1/3% each, Hqs: 13th & Phillips Ave., Sioux Falls, S.D. 57102. (605) 336-1100.

Mid New York Bcstg Stns—Stns: 2 TV. WMTW-TV Pold Spring, Me.; WKTY(TV) Ulica, N.Y. Ownership: Paul Harron and Family, 70%; Lawrence D. Biele, 7%, and others. CATV. Hqs: c/o WKTU, Box 2, Ulica, N.Y. 13503.

Midnight Sun Stns—Stns: 4 AM, 3 TV. KENI-AM-TV Anchorage, KFAR-AM-TV Fairbanks, KINY-AM-TV Juneau, and KTKN(AM) Ketchikan, all Alaska. Alvin O. Branstedt, pres-gen mgr; R. D. Jensen, exec VP; Charles M. Gray, VP tech dir; James C. Fletcher Jr., VP-natl sis mgr (N.Y.). Stockholders: A. O. Bramstedt, 25.47%; Charles M. Gray, 7.667%; Donald G. Andon, 3.766%; James C. Fletcher Jr., 11.8%; R. D. Jensen, 14.066%; Merriman H. Holtz Jr., 6.466%. CATV: Ketchikan and Sitka, both Alaska. Hqs: Box 1160, Anchorage 99510.

Mid-West Family Stations (formerly Walker Stations)—Stns: 6 AM, 5 FM. WYFE(AM) Rockford and WYFE-AM Winnebago, both Illinois; WITL-AM-FM Lansing, and WSJM(AM) and WIRX(FM) St. Joseph, both Michigan; WJZM(AM) La Crosse, WISM-AM-FM Madison and WYTL(AM)-WOSH(FM) Oshkosh, all Wisconsin. Ownership: William R. Walker, Joseph D. Mackin, Philip Fisher, Charles D. Mefford. Executive: William R. Walker, pres. Hqs: Box 2058, Madison, Wis. 53701. (608) 271-1481.

Midwest Television Inc.—Stns: 2 AM, 2 FM, 3 TV. WCIA(TV) Champaign and WMBD-AM-FM-TV Peoria, both Illinois; KFMB-AM-FM-TV San Diego. Stockholders: August C. Meyer and wife, 54.78%; Lindsay-Schaub Newspapers, 21.48%; estate of Helen M. Stevick & Marajen S. D. Chingio (each 10.74%). Interlocking ownership with *Champaign (Ill.) News-Gazette* (WDWS) and Lindsay-Schaub Newspapers. Hqs: 509 S. Neil St., Champaign, Ill. 61820.

Midwestern Bcstg Co. Stns—Stns: 5 AM, 3 FM, 2 TV. WTCM-AM-FM, WPBN-TV Traverse City, WTOM-

Group Ownership

TV Cheboygan, WATT(AM) Cadillac, WATC(AM) Gaylord, WATZ-AM-FM Alpena, and WMBN-AM-FM Petoskey, all Michigan. Ownership: Les Biederman, 52.5%; Drew McClay, 15%; William Kiker, 16.25%; Fred Zierle estate, 16.25%. CATV: Midwestern Cablevision Corp., Traverse City, Mich. Hqs: 314 E. Front St., Traverse City, Mich. 49684.

Minneapolis Star and Tribune Stns—Stns: 1 AM, 1 FM, 2 TV. WCCO-AM-FM-TV Minneapolis (47%); KTVH(TV) Hutchinson (Wichita), Kan. (100%). Hqs: 425 Portland Ave., Minneapolis 55415. (612) 372-4141.

Mission Broadcasting Co.—Stns: 4 AM, 2 FM. KERE(AM) Denver; WWOK(AM) and WIGL(FM) Miami; WAME(AM) Charlotte, N.C.; KONO(AM) and KITV(FM) San Antonio, Tex. Jack Roth, pres; George W. Ing, VP & dir of engrg; George Collie, VP broadcast ops. Hqs: Box 2338, San Antonio, Tex. 78298. (512) 225-5111.

Mooney Broadcasting Corp.—Stns: 4 AM, 1 FM. WERC-AM-FM Birmingham, Ala.; WBSR(AM) Pensacola, Fla.; WMAK(AM) Nashville; WUNO(AM) San Juan, P.R. (All 100% owned.) Executives: George P. Mooney, pres, 26.5%; John W. Bailey, VP; Sara D. Hickman, ctrlr. Publicly traded. Hqs: Box 1750, Knoxville, Tenn. 37901. (615) 546-7202.

Dale G. Moore Stns—Stns: 3 AM, 1 FM, 4 TV. KSEI(AM) Pocatello and KMVT(TV) Twin Falls, both Idaho; KTMV(TV) Butte, KCAP-AM-FM Helena, KCFW-TV Kalispell, and KGV0-AM-TV Missoula, all Montana. Dale G. Moore owns 100%. Hqs: Drawer M, Missoula, Mont. 59801. (406) 728-2850.

Truman A. Morris Stns—Stns: 2 AM, 1 FM. WCAI(AM) Fort Myers, Fla.; WBEX-AM-FM Chillicothe, Ohio. Hqs: c/o Shawnee Bcstg Co., Box 244, Pohlman Rd., Chillicothe, Ohio 45602.

Multimedia Broadcasting Co. (a division of Multimedia Inc.)—Stns: 4 AM, 3 FM 5 TV. WMAZ-AM-FM-TV Macon, Ga.; WNNC(AM) Asheville and WXII(TV) Winston-Salem, both North Carolina; WFBC-AM-FM-TV Greenville, S.C.; and WBIR-AM-FM-TV Knoxville, Tenn.; WLWT(TV) Cincinnati. Ownership: J. Kelly Sisk, 3%; James E. Jolley 1.5%; R.A. Jolley Jr., 1.5%; publicly traded. Executives: Wilson C. Wearn, pres; A. Bruce Buchanan, VP; John P. Hart, VP; James M. Hart, VP; James E. Jolley VP & sec-treas; Albert H. Sanders Jr., VP; Douglas A. Smith, VP. See also Newspaper Crossownership. Hqs: Box 2760, Greenville, S.C. 29602. (803) 271-8052.

Multimedia Radio Inc. (a subsidiary of Multimedia Inc.)—Stns: 3 AM, 1 FM. KAAY(AM) Little Rock, Ark.; WAKY(AM) Louisville, Ky.; and KEEL(AM) and KMBQ(FM) Shreveport, La. Executives: Wilson C. Wearn, pres; A. Bruce Buchanan, exec VP; James E. Jolley, sec-treas; Ralph A. Walsh II, VP; Marie B. Gifford, VP; Donald W. Meyers, VP. Hqs: Box 2760, Greenville, S.C. 29602. (803) 271-8053.

Morgan Murphy Stations (Evening Telegram)—Stns: 1 AM, 1 FM, 5 TV. KTHI-TV Fargo, N.D.; KVEV(TV) Kennewick, KXLY-AM-FM-TV Spokane and KAPP(TV) Yakima, all Washington; and WISC-TV Madison, Wis. Evening Telegram Co. owns 100% of KTHI-TV and KXLY-AM-FM-TV, and 86.4% of KVEV(TV) and KAPP(TV). Evening Telegram Co. owns 34.8% of WISC-TV, with an additional 15.2% of the station held by Morgan Murphy Estate (equivalent to 50% negative control). See also Newspaper Crossownership. Hqs: 1226 Ogden Ave., Superior, Wis. 54880. (715) 394-4411.

N

Nationwide Communications Inc. (Nationwide Mutual Insurance Co.)—Stns: 2 AM, 3 FM, 3 TV. WPOC(FM) Baltimore; WGAR(AM)-WKSW(FM) Cleveland and WNCI(FM) Columbus, both Ohio; WATE-TV Knoxville, Tenn.; WXEX-TV Petersburg (Richmond) and WLEE(AM) Richmond, both Virginia; WBAY-TV Green Bay, Wis. Executives: Charles Fullerton, pres; Clark Pollock, VP & gen mgr; Willard Hoyt, VP-treas. Hqs: 246 N. High St., Columbus, Ohio 43216. (614) 227-7556 or 227-7676.

NBC Owned Stns—Stns: 4 AM, 4 FM, 5 TV. WNBC-AM-TV and WNNW-FM New York; WRC-AM-TV and WKYS(FM) Washington; WMAQ-AM-TV and WNIS-FM Chicago; WKYC-TV Cleveland; KNBR(AM)-KNAI-

Group Ownership

FM San Francisco; KNBC(TV) Los Angeles. For a listing of NBC divisions and executives, see section D.

Robert F. Neathery Stns—Stns: 4 AM, 2 FM. KAMS(FM) Mammoth Spring, Ark. (95%); KBHM(AM) Branson (50%), KALM(AM) Thayer (95%), KWPM-AM-FM West Plains (100%) and KUKU(AM) Willow Springs (95%), all Missouri. Ownership: Robert F. Neathery. CATV. Hqs: Box 589, West Plains, Mo. 65775. (417) 256-3131.

Newhouse Broadcasting Corp.—Stns: 3 AM, 4 FM, 6 TV. WAPI-AM-FM-TV Birmingham, Ala. (100%); KTVI(TV) St. Louis (100%); WSYE-TV Elmira (100%) and WSYR-AM-FM-TV Syracuse (100%), both New York; KOIN-AM-FM-TV Portland, Ore. (50%); and WTPA-FM-TV Harrisburg, Pa. (100%). Executive: E.R. Vadeboncoeur, pres. Ownership: Samuel I. Newhouse, 44.44%; Donald E. Newhouse, 26.67%; Samuel I. Newhouse Jr., 26.67%; Miltzi E. Newhouse, 2.22%. CATV. See also Newspaper Crossownership. Hqs: 1030 James St., Syracuse, N.Y. 13203. (315) 474-3911.

Newport Bcstg Co.—See Sudbury Services Inc.

New South Radio Network—Stns: 6 AM, 4 FM. WBIL(AM) Tuskegee, Ala.; WVMI(AM)-WQID(FM) Biloxi, WVUN(AM) Jackson, WNSL-AM-FM Laurel, WLSM-AM-FM Louisville and WOKK(AM)-WALT(FM) Meridian, all Mississippi. Principal owners: Ed Holladay and Joseph W. Carson. Hqs: Box 5797, Meridian, Miss. 39301.

Nininger Stns—Stns: 3 AM, 3 FM. WKYX(AM) and WKYQ(FM) Paducah, Ky. (100%); WFHG(FM) Bristol, Tenn. (92%); WFHG(AM) Bristol, Va. (100%); WKAZ(AM) and WOBE(FM) Charleston, W. Va. (100%). Ownership: W.L. Nininger.

Northern TV Inc.—Stns: 2 AM, 1 FM, 2 TV. KBYR(AM), KNK(FM), KTV(A) Anchorage and KFRB(AM)-KTVF(TV) Fairbanks, all Alaska. Stockholders: A. G. Hiebert, 41.325% and others. Hqs: Box 2200, Anchorage 99510.

NTV Enterprises Inc.—Stns: 4 TV. KCNA-TV Albion, KWNB-TV Hayes Center, KHGI-TV Kearney and KSNB-TV Superior, all Nebraska. Ownership: John W. Payne, 10%; Alan M. Oldfather, 16-2/3%; Charles E. Oldfather, 16-2/3%; John M. Crowley, 10%; Richard H. Oldfather, 16-2/3%; Charles E. Payne, 5%; Payne Enterprises Inc., 25%; James D. Johnson, 1%. Payne Enterprises is owned as follows: A. E. Payne, 54%; Ruth Payne, 3%; John W. Payne, 15%; Charles E. Payne, 14%; Ronald K. Payne, 14%. Hqs: c/o KHGI-TV Kearney, Neb. 68847. (308) 743-2494.

Number One Radio Inc.—Stns: 2 AM, 2 FM. KBUZ-AM-FM Mesa and KAIR-AM-FM Tucson, both Arizona. (All 100% owned.) Ownership: Edwin G. Richter, 30%; H.L. Druckman, 30%; Frank Kalil, 15%; Howard D. Duncan, 10%. Hqs: Box 49067, Tucson, Ariz. 85717. (602) 795-1490.

The Nutmeg Broadcasting Co.—Stns: 3 AM, 1 WINY(AM) Putnam, WNTY(AM) Southington, and WLI(AM) Willimantic, all Connecticut. Ownership: Michael C. Rice, trustee, Herbert C. Rice family trust, 100%. Executive: Michael C. Rice, pres. Hqs: Box 496, Willimantic, Conn. 06226. (203) 423-1621.

O

Anthony S. Oceppek—See Armington-France-Gehring-Oceppek Stns.

J. William O'Connor Stations—Stns: 1 AM, 1 FM, 1 TV. WCIU-TV Chicago (36%); and WRKR-AM-FM Racine, Wis. (100%). Hqs: Suite 3200, Board of Trade Bldg, Chicago 60604. (312) 663-0260.

Ohio Radio Inc.—Stns: 1 AM, 4 FM. WAWR-FM Bowling Green, WKTN-FM Kenton, WLKR-AM-FM Norwalk and WRWR-FM Port Clinton, all Ohio. Executives: Robert W. Reider, pres; Clarence H. Streeter, VP-treas; Keith E. Montgomery, sec. Hqs: Drawer A, Port Clinton, Ohio 43452. (419) 734-3148

Oklahoma Quality Bcstg Stns—Stns: 3 AM, 2 TV. KRHD(AM) Duncan, KGWA(AM) Enid and KSWO-AM-TV Lawton, all Oklahoma; KMID-TV Midland, Tex. Ownership: KSWO stations, R. H. Drewry, 69%; Jack E. and James T. and Judith E. Warkentin, 5% each; Edith Scott, 16%; Kmid-TV: R. H. Drewry, 29%; Jack E. and James T. and Judith Warkentin, 6% each; J. Conrad Dunagan, 11%; E. G. Rodman and W. D. Noel, 12% each and others. KSWO principals own 100% of KRHD. Mr. Drewry and Warkentin family respectively

own 64% and 15% of KGWA. CATV. Hqs: Box 709, Lawton, Okla. 73501.

Farnell O'Quinn Stns—Stns: 4 AM, 1 FM. WUFF(AM) Baxley, WULF(AM) Alma (both 80%), and WUFF(AM) Eastman (100%), all Georgia; WOF(AM) Rockwood, Tenn. (24%). CATV: Jesup system (50%), Baxley, (33%), both Georgia. Hqs: Box 389, Baxley, Ga. 31513.

Orion Bcstg, Inc.—Stns: 2 AM, 1 FM, 5 TV. WAVE-AM-TV Louisville, Ky.; WFIE-TV Evansville, Ind.; WMT-AM-FM-TV Cedar Rapids, Iowa, and WFRV-TV Green Bay, Wis., and WJMN-TV Escanaba, Mich. Mrs. Jane Morton Norton, chmn of the bd; T. Ballard Morton, pres; Ralph S. Jackson, exec VP. Hqs: Box 1000, Louisville, Ky. 40201. (502) 585-2201.

Ostrander-Wilson Stns—Stns: 3 AM, 1 FM. KBLE-AM-FM Seattle, KARI(AM) Blaine, Both Washington; KASA(AM) Phoenix, Ariz. L. N. Ostrander and G. A. Wilson each own 50% of KBLE and KASA stations, and 33% of KARI. Hqs: 114 Lakeside Ave., Seattle 98122.

Outlet Broadcasting—Stns: 2 AM, 1 FM, 5 TV. WDBO-AM-FM-TV Orlando, Fla. (100%); WNYN-TV Syracuse, N.Y. (80%); WLWC(TV) Columbus, Ohio (100%); WJAR-AM-TV Providence, R.I. (100%); and KSAT-TV San Antonio, Tex. (100%). Ownership: The Outlet Co. Hqs: 176 Weybosset St., Providence, R.I. 02902. (401) 751-5700.

Buck Owens Stns—Stns: 2 AM, 2 FM. KTUF(AM) Tempe and KNIX(FM) Phoenix, both Arizona; KLUZ-AM-FM Bakersfield, Calif. Hqs: Box 15040, Phoenix 85018.

P

Pacifica Foundation Inc.—KPFA(FM) Berkeley, KPFB(FM) Berkeley and KPFF(FM) Los Angeles, all California; WBAI(FM) New York; KPFT(FM) Houston; and permittee of WPFW(FM) Washington. Executives: Edwin A. Goodman, chairperson; David B. Finkel, pres; Oscar Hanigbert, treas; Mary Mann, cfr; Nina Bauman, admin asst; Bill Stein, Pacifica Program Service. Pacifica Foundation also operates Pacifica Program Service and Pacifica Tape Library, Los Angeles. Hqs: Box 8455, Universal City, Calif. 91608. (213) 763-0700.

Palmer Bcstg Stns—Stns: 3 AM, 3 FM, 2 TV. WNOG(AM) and WCVU(FM) Naples, Fla.; WOC-AM-TV, KLIK(FM) Davenport and WHO-AM-TV, KLYF(FM) Des Moines, both Iowa. D. D. Palmer, 98%. CATV. Hqs: 805 Brady St., Davenport, Iowa 52803.

Park Broadcasting Inc.—Stns: 7 AM, 6 FM, 7 TV. WBMG(TV) Birmingham, Ala.; WEBC(AM) Duluth and KRSI(AM)-KFMX(FM) St. Louis Park, both Minnesota; WUTR(TV) Utica, N.Y.; WNCT-AM-FM-TV Greenville, N.C.I. KWJJ(AM) and KJIB(FM) Portland, Ore.; WNAX(AM) Yankton, S.D.; WDEF-AM-FM-TV Chattanooga and WJHL-TV Johnson City, both Tennessee; WTVR-AM-FM-TV Richmond and WLSL-TV Roanoke, both Virginia; and KEZX(FM) Seattle. Roy H. Park, pres (sole owner); John B. Babcock, exec VP; Roger R. Turner, VP-radio; John W. Conwell, treas. See also Newspaper Crossownership. Hqs: Terrace Hill, Box 550, Ithaca, N.Y. 14850. (607) 272-9020.

Plains Television Corp.—Stns: 3 TV. WHNB-TV New Britain, Conn. (100%); WICD(TV) Champaign (100%) and WICS(TV) Springfield (100%), both Illinois. Ownership: William Burger & Herbert Scheffel, voting trustees, 50%; H. & E. Balaban Corp., 50% (see Balaban Stns). Mr. Scheffel owns 20% of WXTV(TV) Paterson, N.J. CATV. Hqs: 2680 E. Cook St., Springfield, Ill. 62703.

Plough Broadcasting Co.—Stns: 6 AM, 6 FM. WPLO-AM-FM Atlanta; WCAO-AM-FM Baltimore; WCOF-AM-FM Boston; WJJD-AM-FM Chicago; WMPA-AM-FM Memphis; WQXM(FM) Clearwater and WSUN(AM) St. Petersburg, both Florida. Executives: Harold R. Krefstein, chmn; H. Wayne Hudson, pres. Ownership: Plough Broadcasting Co. is a wholly owned subsidiary of publicly traded Schering-Plough Corp. Hqs: 112 Union, Memphis 38103. (901) 525-6868.

Poole Bcstg. Stns—Stns: 3 TV. WJRT-TV Flint, Mich.; WTEN(TV) Albany, N.Y.; WPRI-TV Providence, R.I. John B. Poole, chmn and 65.5% owner; Albert J. Gillen, pres and 4.5% owner. Hqs: 2302 Lapeer Rd., Flint, Mich. 48503.

Post Corp. Stns—Stns: 2 AM, 1 FM, 4 TV. WEAU-FM-TV Eau Claire, WAXX(AM) Chippewa Falls, WLUK-TV Green Bay, all Wisconsin; KTVO(TV) Kirksville, Mo.-Ottumwa, Iowa; KBIZ(AM) Ottumwa, Iowa;

WLUC-TV Marquette, Mich. (All 100% owned.) Ownership: V.I. Minahan, 14.2%. See also Newspaper Crossownership. Hqs: 306 W. Washington St., Appleton, Wis. 54911. (414) 733-4411.

Post-Newsweek Stations Inc.—Stns: 1 AM, 4 TV. WFSB-TV Hartford, Conn.; WTOP-AM-TV Washington; WJXT(TV) Jacksonville and WPLG(TV) Miami, both Florida. Executive: Joel Chaseman, pres. Ownership: Post-Newsweek Stations is a subsidiary of the publicly traded Washington Post Co. See also Newspaper Crossownership. Hqs: 40th & Broadway Sts. N.W., Washington 20016. (202) 686-6000.

The Potter Group—Stns: 2 AM, 1 FM. WATA(AM) Boone, WDSL(AM) Mocksville and WKBC-AM-FM North Wilkesboro, all North Carolina. Roland B. and Doris B. Potter. Hqs: Radio Bldg., C St., North Wilkesboro, N.C. 28659.

Progressive Publishing Co. Stns—Stns: 2 AM, 1 FM. WCPA-AM-FM Clearfield (100%) and WDAQ(AM) and WQMU(FM) Indiana (84%), both Pennsylvania. In addition, W. K. Ulerich, pres of Progressive Publishing Co., owns 100% of WMAJ(AM) and WXLRFM) State College, Pa. See also Newspaper Crossownership. Hqs: Box 291, Clearfield, Pa. 16830.

PSB Inc.—Stns: 6 AM, 5 FM. WVLN(AM)-WSEI(FM) Olney and WTIM(AM)-WEEF(FM) Taylorville, both Illinois; WCTW(AM) and WMDH(FM) New Castle, Ind.; KROS(AM) and KSAY(FM) Clinton, Iowa; KWBE-AM-FM Rochester, Minn.; and KFIZ(AM) Fond du Lac, Wis. Executive: Donald G. Jones, pres; Jon R. Ulz, exec VP. Hqs: Box 1167, Fond du Lac, Wis. 54935. (414) 921-3778.

Pulitzer Publishing Co. Stns—Stns: 1 AM, 2 TV. KSD-AM-TV St. Louis; KOAT-TV Albuquerque, N.M. Note: Company has also purchased KETV(TV) Omaha, subject to FCC approval. Joseph Pulitzer, pres. See also Newspaper Crossownership. Hqs: 1111 Olive St., St. Louis 63101.

R

Rahall Communications Corp.—Stns: 4 AM, 2 FM, 1 TV. WLCY(AM) St. Petersburg, WLCY-FM Tampa and WLCY-TV Largo, all Florida; WND(AM) and WFBQ(FM) Indianapolis; WKAP(AM) Allentown, Pa.; and WWRN(AM) Beckley, W.Va. (All 100% owned.) Ownership: N. Joe Rahall, F.E. Rahall, S.G. Rahall. Hqs: Box 14000, St. Petersburg, Fla. 33733. (813) 577-1111.

Rau Radio Stations Inc.—Stns: 6 AM, 6 FM. WDOV(AM) and WDSD(FM) Dover, Del.; WNAV-AM-FM Annapolis and WARK-AM-FM Hagerstown, both Maryland; WBBB(AM) and WNCB(FM) Burlington, N.C.; WATO(AM) and WUUU(FM) Oak Ridge, Tenn.; and WPDV-AM-FM Clarksburg, W.Va. Henry Rau, chmn of the bd; Lloyd S. Smith, pres; Patrick H. Kelly, treas-sec. CATV: Delaware Telesevice Co., Dover, Del. Hqs: Suite 716, 2100 M St. N.W., Washington 20037. (202) 296-3900.

Reeves Telecom Corp.—Stns: 2 AM, 2 FM. WTH(AM) and WDJO(FM) Baltimore; WKEE-AM-FM Huntington, W.Va. (All 100% owned.) Ownership: Hazard E. Reeves, chmn of the bd, 14.06%; J. Drayton Hastie, pres, 2.11%. Hqs: 615 Wesley Drive, Charleston, S.C. 29407. (803) 571-1460.

Regional Broadcasters Group—Stns: 6 AM, 3 FM. WMGW(AM)-WZPR(FM) Meadville, WPIC(AM)-WYFM(FM) Sharon, both Pennsylvania; WGRD-AM-FM Grand Rapids and WTRU(AM) Muskegon, both Michigan; and WOLF(AM) Syracuse and WKNY(AM) Kingston, N.Y. Ownership: Alastair B. Martin, Robin B. Martin, and Edwin A. Bernstein. A. B. Martin, pres; E. A. Bernstein, VP-gen mgr; F. Tascone, exec VP. Hqs: 212 Fair St., Kingston, N.Y. 12401. (914) 339-5505.

Rennekamp Stns—Stns: 3 AM, 1 FM. WTRA(AM) Latrobe (25%), WKZR(AM) and WDJR(FM) Oil City (100%), WKKB(AM) St. Marys (50%), all Pennsylvania. Ownership: Olivia T. Rennekamp. Hqs: c/o Radio Station WOTR, Box 4, Corry, Pa. 16407.

Dee Rivers Stns—Stns: 5 AM, 6 FM. WSWN-AM-FM Belle Glade, WEDR(FM) Miami and WXOS(FM) Plantation Key, all Florida; WGUN(AM) Atlanta, WEAS-AM-FM Savannah and WGOV-AM-FM Valdosta, all Georgia; KWAM-AM-FM Memphis. E. D. Rivers Jr. Hqs: Box 40-2037, Miami Beach, Fla. 33140.

James Rivers Stns—Stns: 3 AM, 3 FM. WJAZ(AM)-WJIZ(FM) Albany, WDOI(AM)-WJSR(FM) Athens, WMJM(AM)-WFAV(FM) Cordele and WTJH(AM) East Point, all Georgia. James Rivers, pres; Sara J. Howell, bus mgr; Bill Goodson, natl and rgnt sls mgr. Hqs: 20th Ave. at Owens St., Cordele, Ga. 31015.

Cascade Broadcasting Corp.—Stns: 4 AM, 2 FM. KEGL(AM) Santa Clara and KUBA(AM)-KHFX(FM) Yuba City, both California; KLIO(AM) Portland, Ore.; and KUDY(AM)-KICN(FM) Spokane, Wash. (All 100% owned.) Note: Cascade has agreed to purchase KBIF(AM) Fresno, Calif., subject to FCC approval. Executive: David M. Jack, pres. Hqs: Box 02155, Portland, Ore. 97202. (503) 234-8448.

CBS Owned Stns—Stns: 7 AM, 7 FM, 5 TV. WCBS-AM-FM-TV New York, KNX-AM-FM, KNXT(TV) Los Angeles, WBMM-AM-FM-TV Chicago, WCAU-AM-FM-TV Philadelphia, KCBS-AM-FM San Francisco, KMJX-AM-FM-TV St. Louis, WEEI-AM-FM Boston. For a listing of CBS divisions and executives, see index, section D.

The Central Broadcasting Group—Stns: 4 AM, 3 FM. WBIW(AM)-WBIF(FM) Bedford, WBAT(AM) Marion, and WKBV-AM-FM Richmond, all Indiana; KTRM-AM-FM Beaumont, Tex. (All 100% owned.) Ownership: Central has 42 stockholders. Hqs: Box 1646, Richmond, Ind. 47374. (317) 962-6533.

Central California Communications Corp.—Stns: 2 TV. KSBW-TV Salinas-Monterey and KSTV-TV San Luis Obispo, both California. Ownership: The estate of John C. Cohan, The Shattuck Trust. C, TV. Hqs: Box 1651, Salinas, Calif. 93901. (408) 422-6642.

Central Minnesota Television Co.—Stns: 1 FM, 2 TV. KCMT-FM and KCMT(TV) Alexandria, and KNMT(TV) Walker, both Minnesota. (All 100% owned.) Ownership: Thomas A. Barnestube estate, 53%; Joseph O. Perino and John J. McCarten, 11% each; Glenn Flint and Kenneth C. Bechtel, 10% each; and others. Hqs: 720 Hawthorne, Alexandria, Minn. 56308. (612) 763-5166.

Century Broadcasting Corp.—Stns: 4 FM. WLOO(FM) Chicago; KSHE(FM) Crestwood, Mo.; WABX(FM) Detroit; KWST(FM) Los Angeles. Executives: Howard Grafman, pres.; George A. Collias, VP. Hqs: 875 N. Michigan Ave., Chicago 60611. (312) 922-1000.

Channel 10 Inc.—Stns: 2 TV. WDIO-TV Duluth and WIRT(TV) Hibbing, both Minnesota. (Both 100% owned.) Ownership: Frank P. Befera, pres, 13%; A. W. Hedenberg, 27%; John H. Poole, 13.1%; and others. Hqs: 10 observation Road, Duluth, Minn. 55811. (218) 727-6864.

Childress Radio—Stns: 3 AM. WMSJ(AM) Sylva (100%), WKSJ(AM) West Jefferson (100%), WKRK(AM) Murphy (5%), all North Carolina. Hqs: Box 1044, Sylva, N.C. 28779. (704) 586-2221.

Chris Craft Industries Stns—Stns: 2 TV. KCOP(TV) Los Angeles; KPTV(TV) Portland, Ore. Executives: Herbert J. Siegel, chmn & pres; Lawrence R. Barnett, exec VP; James J. Rochlis, exec VP; John H. Darby, VP-finance & ctrlr; Richard Frank, VP (pres-bcstg division); Robert B. Hunter, sec-treas. Hqs: 600 Madison Ave., New York 10022.

Christian Broadcasting Network Inc.—Stns: 6 FM, 5 TV. WXRI(FM) Norfolk and WYAH-TV Portsmouth, both Virginia, WHAE-TV Atlanta, WXNE-TV Boston, KXTX-TV Dallas, WMTU-TV Memphis, and the following FM's: WEIV Ithaca, WBIV Wethersfield, WMIV South Bristol, WOIV DeRuyter Twp., WJIV Cherry Valley Twp., all New York. Note: CBN has agreed to purchase WHCT-TV Hartford, Conn., subject to FCC approval. M. G. (Pat) Robertson, pres. Hqs: 1318 Sprattley St., Portsmouth, Va. 23704.

Christian Enterprises Inc.—Stns: 4 AM, 3 FM. KGVW-AM-FM Belgrade, KURL-AM-FM Billings, KGLE(AM)-KIVE(FM) Glendive, all Montana; KKIM(AM) Albuquerque, N.M. Harold Erickson, pres. Hqs: Box 1875, Billings, Mont. 59103.

Chronicle Broadcasting Co.—Stns: 1 FM, 2 TV. WQWT(TV) Omaha and KRON-FM-TV San Francisco. Note: KRON-FM has been sold, subject to FCC approval. Ownership: Chronicle Broadcasting Co. is subsidiary of Chronicle Publishing Co. See Nwspr Crossownership. Hqs: 1001 Van Ness Ave., San Francisco 94119.

Clay Communications Inc.—Stns: 3 TV. WWAY(TV) Wilmington, N.C. (80% owned by CCI; remaining 20% held by Lyell B. Clay, bd chmn of Clay Communications); KJAC-TV Port Arthur (100%) and KFDX-TV Wichita Falls (100%), both Texas. Ownership: Lyell B. Clay, Buckner Clay and Julie C. Alexander, 31.4168% each. Hqs: 1001 Virginia St. E., Charleston, W.Va. 25301. (304) 348-5140.

Columbia Broadcasting Corp.—Stns: 2 TV. KNDO(TV) Yakima and KNDU(TV) Richland, both

Washington. (Both 100% owned.) Ownership: Hugh E. Davis, 100%. Hqs: Box 466, Yakima, Wash. 98907. (509) 248-2300.

Columbia Pictures Industries Inc.—Stns: 3 AM, 2 FM, 4 TV. WYDE(AM) Birmingham, Ala.; WVUE(TV) New Orleans; WNUJ-TV Linden, N.J.; KCPX-AM-FM Salt Lake City; WVVA-AM-FM Wheeling, W.Va.; WOLE-TV Aquadilla and WAPA-TV San Juan, both Puerto Rico. WAPA-TV owns 33-1/3% of WCLE-TV. Hqs: 711 Fifth Ave., New York 10022. (212) 751-4400.

Combined Communications Corp.—Stns: 3 AM, 4 FM, 7 TV. KTAR(AM), KBBC(FM) Phoenix and KJAR-TV Mesa, both Arizona; KARK-TV Little Rock, Ark.; KHS-AM-FM Los Angeles and KEZL(FM) San Diego; KBTB(TV) Denver; WXIA-TV Atlanta; WPTA(TV) Roanoke, Va.; WLKY-TV Louisville, Ky.; WWDJ(AM) Hackensack, N.J.; KOCO-TV Oklahoma City; WSAI-AM-FM Cincinnati. Executives: John J. Louis, chmn of the bd; Karl Eller, pres & chief exec off; Alvin G. Flanagan, pres/broadcast division. Ownership: John J. Louis Jr. and Karl Eller and their families own approximately 40%; 60% publicly held. Hqs: Box 25518, Phoenix 85002. (602) 257-1333.

Communicana Group—Stns: 3 AM, 2 FM. WTRC(AM) and WYEZ(FM) Elkhart and WMEE(AM)-WMEF(FM) Fort Wayne, both Indiana; WCUI(AM) Grand Rapids, Mich. John F. Dille Jr., pres; John F. Dille III, exec VP. Hqs: Box 487, Elkhart, Ind. 46514.

Communications Fund Inc.—Stns: 1 AM, 2 FM. KWK(FM) Kansas City, Mo.; KADI(AM) Clayton and KADI-FM St. Louis, both Missouri. Hqs: 2735 Bompert, St. Louis 63144. (314) 961-1320.

Communications Properties Inc.—Stns: 6 AM, 3 FM. KHAK-AM-FM Cedar Rapids and WDBO(AM)-KIWI(FM) Dubuque, both Iowa; WDBC(AM) Escanaba, Mich.; KATE(AM) and KCPJ-FM Albert Lea, Minn.; KFGO(AM) Fargo, N.D.; WNFL(AM) Green Bay Wis. Ownership: Harl N. Carozzo Jr., 87.06%; Philip T. Kelly, 7.77%; Richard C. Voight, 2.64%; and James C. Zimmerman, 2.53%. Hqs: 96 Many Levels Road, Dellwood, Minn. 55110. (612) 426-2257.

Communicom—Stns: 1 AM, 2 FM. WKSS(FM) Hartford-Meriden, Conn.; KPOI(AM) and KHSS(FM) Honolulu. Executive: Frederic W. Constant, pres. Hqs: 2 Wethersfield Ave., Hartford, Conn. 06114.

Community Broadcasting Co.—Stns: 3 AM, 3 FM. KGIW-AM-FM Alamosa, Colo.; KRNS-AM-FM Los Alamos, N.M.; and KBUH-AM-FM Brigham City, Utah. Ownership: Darrel K. Burns, 100%. Hqs: Box 749, Los Alamos, N.M. 87544.

Community Broadcasting Service Inc.—Stns: 2 AM, 1 FM, 2 TV. WABI-AM-TV and WBGW(FM) Bangor, and WAGM-AM-TV Presque Isle, both Maine. Ownership: Horace A. Hildreth & family. Hqs: 35 Hildreth St., Bangor, Me. 04401.

Community Service Radio Inc.—Stns: 2 AM, 2 FM. KANO(AM) and KTWNF(FM) Anoka, Minn.; WLVE(FM) Baraboo and WIBU(AM) Poynette, both Wisconsin. (All 100% owned.) Principal owners: Thomas R. Holter, Victor M. Aime. Hqs: 1245 E. Washington Ave., Madison, Wis. 53703. (608) 251-3955.

Corinthian Broadcasting Corp.—Stns: 5 TV. KXTV(TV) Sacramento, Calif.; WANE-TV Fort Wayne and WISH-TV Indianapolis, both Indiana; KOTV(TV) Tulsa, Okla.; and KHOU-TV Houston. (All 100% owned.) Ownership: Corinthian Broadcasting Corp. is a wholly owned subsidiary of Dun & Bradstreet Companies Inc. Executives of Corinthian: C. Wrede Petersmeyer, chmn; Philip J. Lombardo, pres; Charles H. Tower, VP; Jerry L. Gabert, financial VP & sec; Bruce J. Bloom, dir of adv & PR; Betty D. Fox, dir of rsch; Lee S. Eden, dir of progms. TVS Television Network, an independent network for sports, is a division of Corinthian Broadcasting Corp. Hqs: 280 Park Ave., New York 10017. (212) 697-9400.

Cosmos Broadcasting Corp.—Stns: 1 AM, 4 TV. WIS-AM-TV Columbia, S.C.; WSPA-TV Montgomery, Ala.; WDSU-TV New Orleans; WTOL-TV Toledo, Ohio. (All 100% owned.) Executives: Charles A. Batson, pres & chief exec off; L. Brent Hill, VP administration & radio opns; Dixon C. Lovvorn, VP broadcast svcs; James G. Saunders, VP-bus affairs; Joseph P. Gill Jr., dir of engrg & purchasing; John G. Lert Jr., dir of planning & dev; Hal Von Nessen, exec asst. Ownership: The Liberty Corp., Greenville, S.C. (Francis M. Hipp, B. Calhoun Hipp, Herman N. Hipp, D. H. Gunter and families, principals). Hqs: Box 367, Columbia, S.C. 29202. (803) 799-8446.

Covenant Broadcasting—Stns: 3 AM, 2 FM. WELI(AM) New Haven, Conn.; WGSO(AM) and

WQUE(FM) New Orleans; KTOK(AM) and KAFG(FM) Oklahoma City. Covenant Broadcasting also operates the Oklahoma News Network, Oklahoma City. Ownership: Broad Street Communications Corp. (Richard L. Geismar, chairman; Fred E. Walker, president), 100%. Covenant Cable TV Inc., wholly owned by Broad Street Communications, operates CATV systems in Port Huron, Mich.; Millville, N.J.; and Greensburg, Pa. Hqs: Box 85, New Haven, Conn. 06501.

Cowles Communications Inc.—Stns: 2 TV. KCCI-TV Des Moines, Iowa; WESH-TV Daytona Beach, Fla. (Both 100% owned.) M. C. Whatmore, pres. Hqs: 488 Madison Ave., New York 10022. (212) 593-8800.

Cox Broadcasting Corp.—Stns: 5 AM, 4 FM, 5 TV. WSB-AM-FM-TV Atlanta; WSOC-AM-FM-TV Charlotte, N.C.; WHIO-AM-FM-TV Dayton, Ohio; KFI(AM) Los Angeles; WIOD(AM), WAI(AM) Miami; KTVU(TV) Oakland-San Francisco; WIIC-TV Pittsburgh. Officers: Robert W. Chambers, chmn; Garner Anthony, chmn of exec com; Clifford M. Kirklund Jr., pres; Ernest L. Adams, VP-engrg; E. William John, VP-per & PR, asst sec; Alan D. Chunka, ctrlr & asst sec; H. Stewart Corbett Jr., VP-subsidary opns, asst treas; Thomas J. Frawley, VP-news (Washington office); Michael S. Kievan, VP-progms; James A. Landon, VP; Stanley G. Mouse, group VP (broadcast division); Raymond J. Tucker, sec & treas. CATV: Cox Cable Communications Inc. Hqs: 1601 W. Peachtree St. N.E., Atlanta 30309.

Crawford Broadcasting Co.—Stns: 5 AM, 6 FM. WDJC(FM) Birmingham, Ala.; WPEO(AM) Peoria, Ill.; WYCA(FM) Hammond, Ind.; WMUZ(FM) Detroit; WDCX(FM) Buffalo and WYRD(AM) East Syracuse, both New York; KELR(AM) El Reno, Okla.; WDCJ(FM) Lancaster, Pa.; WVGW(AM) Nashville; KPBC(AM) Dallas and KFMK(FM) Houston. Ownership: WDJC is 50% owned by Kimtron Inc. and 50% by Crawford Broadcasting Co. WPEO is owned by Pinebrook Foundation Inc. (Crawford nonprofit corporation). WYCA is owned by Crawford Broadcasting Co. WMUZ is owned by WMUZ Radio Inc. WDCX is owned by Kimtron Inc. (Donald B. Crawford, pres). WYRD is owned solely by Richard T. Crawford, individually. KELR is owned by Young Peoples Church of the Air (Crawford nonprofit corporation). WDCJ is owned by WDAC Radio Co. WVGW is owned by Crawford Radio Enterprises Inc. KPBC is owned by Crawford Broadcasting Co. (Donald B. Crawford, pres). KFMK is owned by Liberty Communications Corp. Hqs: Box 86, Flourtown, Pa. 19031. (215) 836-4900.

Cummings Communications Corp.—Stns: 3 AM, 1 FM. WRRR(AM) Rockford, Illinois; KARR(AM)-KOPR-FM Great Falls, Mont.; WNAM(AM) Neenah-Menasha, Wis. Ownership: Alan H. Cummings, pres, 100%.

Curtis Radio Group—Stns: 2 AM, 1 FM. WEWO(AM)-WSTS(FM) Laurinburg and WOMX(AM) Mebane, both North Carolina. Principal owners: Donald W. Curtis, pres & gen mgr; C. Grier and Kenneth B. Beam; Aaron B. Moss. Hqs: Box 512, Laurinburg, N.C. 28352.

D

Daily Telegraph Printing Co. Stns—Stns: 1 AM, 1 FM, 2 TV. WHIS-AM-FM-TV Bluefield, W. Va.; WBTW(TV) Florence, S.C. Ownership: Hugh Shott Jr., 39.4%; estate of James H. Shott, 39.2%; Daily Telegraph Printing Co. Employees Pension Trust Fund, 20.3%, and others. Hqs: Box 208, Bluefield, W. Va. 24701. (304) 327-6171.

Dakota Broadcasting Co.—Stns: 2 TV. KIVV-TV Lead and KEVN-TV Rapid City, both South Dakota. Ownership: Theodore M. Cormaney, 33 1/3%; Gilbert D. Moyle, 33 1/3%; Sherwood L. Corner, 33 1/3%. Hqs: c/o Theodore M. Cormaney, 1116 Jackson Blvd., Rapid City, S.D. 57701.

Fredric A. Danz Stns—See Sterling Recreation Organization.

De La Hunt Group—Stns: 3 AM, 2 FM. KEHG-AM-FM Fosston, KPRM-AM-FM Park Rapids and KLLR(AM) Walker, all Minnesota. Ownership: E.P. De La Hunt. Hqs: Box 49, Park Rapids, Minn. 56470.

Dix Stns—Stns: 2 AM, 2 FM. WWSM-AM-FM Wooster, Ohio, and WRAD-AM-FM Radford, Va. R. E. Dix and family.

Dixie Stns—Stns: 2 AM, 2 FM. KREH(AM)-KCWR(FM) Oakdale, La.; KSTV(AM) and KWWW(FM) Stephenville, Tex. Cyril W. Reddoch and C. Winsett Reddoch, owners.

Group Ownership

Donrey Media Group—Stns: 4 AM, 1 FM, 3 TV. KFSA(AM) Fort Smith and KBRN(AM) Springdale, both Arkansas; KORK-AM-FM-TV Las Vegas, KOLO-AM-TV Reno; KGNS-TV Laredo, Tex. (All 100% owned.) Ownership: Donald W. Reynolds, 100%. Executives: Donald W. Reynolds, pres & chief exec off; Fred W. Smith, exec VP & chief operating off; Robert N. Ordonez, VP-broadcast division. Hqs: Donrey House, 920 Rogers Ave., Fort Smith, Ark. 72901. (501) 782-4922.

Doubleday Broadcasting Co.—Stns: 4 AM, 2 FM. KRIZ(AM) Phoenix; KHOW-AM-FM Denver; KDWB(AM) St. Paul; KITE(AM) (licensed to Terrell Hills) and KEXL(FM) San Antonio, Tex. Executives: D. G. Scribner, pres; John Vacca, senior VP; R. A. Anderson, VP & corporate bus dir. Ownership: A wholly owned subsidiary of Doubleday & Co., New York publishing company. CATV: Doubleday Broadcasting owns 25% of Community Cablevision of Odessa in Odessa, Tex. Hqs: Suite 417W, 13601 Preston Rd., Dallas 75240. (214) 233-9242.

R. H. Drewry Group—Stns: 2 AM, 1 FM, 2 TV. KRHD-AM-FM Duncan and KSWO-AM-TV Lawton, both Oklahoma; KMID-TV Midland, Tex. Ownership: R. H. Drewry owns 62.1% of KRHD, 64.5% of KGWA, 69% of KSWO-AM-TV and 27.5% of KMID-TV. Hqs: Box 708, Lawton, Okla. 73501.

Duhamel Broadcasting Enterprises Inc.—Stns: 1 AM, 3 TV. KOTA-AM-TV Rapid City, KHSD-TV Lead, all South Dakota; KDUH-TV Hay Springs, Neb. Stockholders: Mrs. Helen S. Duhamel, 53.3%, and others. Executives: Helen S. Duhamel, pres-gen mgr; William F. Duhamel, exec VP; Dan Lesmeister, natl svs & TV progmg. CATV. Hqs: Box 1760, Rapid City, S.D. 57701.

E

Eastern Broadcasting Corp.—Stns: 4 AM, 3 FM. WCVS(AM) Springfield, Ill.; WHUT(AM) and WLHN(FM) Anderson and WBOW(AM)-WBOC(FM) Terre Haute (90%), both Indiana; and WRSC(AM)-WQWK(FM) State College, Pa. (80%), Roger A. Neuhoff, pres. Ownership: Roger A. Neuhoff, Louise H. Neuhoff, John R. Neuhoff. Hqs: 1601 Connecticut Ave. N.W., Washington 20009. (202) 265-1400.

Empire Broadcasting Corp.—Stns: 3 AM. KFLN(AM) Baker, KXXL(AM) Bozeman and KWYS(AM) West Yellowstone, all Montana. (Note: Empire Broadcasting has agreed to purchase KAFF-AM-FM Flagstaff, Ariz., subject to FCC approval.) Ownership: Eldon Mengel, pres, 12.9%; Eugene L. Russell, VP-dir, 8.0%; Russell L. Culver and Gene Huntley, 6.5% each. Hqs: c/o KXXL, Box 1689, Bozeman, Mont. 59715. (406) 587-5188.

Entertainment Communications Inc. (Entercom)—Stns: 1 AM, 4 FM. KBRG(FM) San Francisco; WAYL(FM) Minneapolis; KLEF(FM) Houston; and KTAC(AM) and KBRD(FM) Tacoma, Wash. (All 100% owned.) Ownership: Joseph M. Field, 77%. Hqs: 555 City Line Ave., Bala-Cynwyd, Pa. 19004. (215) 667-1226.

Eugene Television Inc.—Stns: 3 TV. KVAL-TV Eugene, KCBY-TV Coos Bay and 50% of KPIC(TV) Roseburg, all Oregon. Hqs: Box 1313, Eugene, Ore. 97401.

Evening News Association—Stns: 1 AM, 1 FM, 4 TV. WALA-TV Mobile, Ala.; KOLD-TV Tucson, Ariz.; WWJ-AM-FM-TV Detroit; WKY-TV Oklahoma City (All 100% owned.) Note: WKY-TV will change to KTVY(TV), pending FCC approval. Group owns *Detroit News* 615 Lafayette Blvd., Detroit 48231. (313) 222-2000.

Evening Star Stns—Stns: 2 AM, 1 FM, 3 TV. WMAL-AM-FM-TV Washington; WLVA-AM-TV Lynchburg, Va.; WCIV(TV) Charleston, S.C. John W. Thompson Jr., pres; Richard S. Stakes, exec VP. Ownership: Joe L. Allbritton. See also Newspaper Crossownership.

EZ Communications Inc.—Stns: 4 FM. WEZB(FM) New Orleans; WEZC(FM) Charlotte, N.C.; WEZR(FM) Manassas and WEZS(FM) Richmond, both Virginia. (All 100% owned.) Arthur C. Keller, pres (50%); James L. Draper Jr., sec-treas (15%). Hqs: 10810 Main St., Fairfax, Va. 22030. (703) 273-8950.

F

Fairbanks Broadcasting Co.—Stns: 5 AM, 4 FM. WRMF-AM-FM Titusville, Fla.; WIBC(AM)-WNAP(FM) Indianapolis; WKOX(AM)-WVBF(FM) Framingham,

Mass.; KVIL(AM) Highland Park and KVIL-FM Highland Park-Dallas, both Texas; WIBG(AM) Philadelphia. Ownership: Richard M. Fairbanks, pres; James C. Hilliard, exec VP, gen mgr. Hqs: 2835 N. Illinois St., Indianapolis 46208.

Faith Center Inc. Board (Faith Center Global Ministries Inc.)—Stns: 1 FM, 3 TV. KHOF(FM) Los Angeles, KHOF-TV San Bernardino and KVOF-TV San Francisco, all California; WHCT-TV Hartford, Conn. Note: WHCT-TV has been sold, subject to FCC approval. Hqs: 1615 S. Glendale Ave., Glendale, Calif. 91205

J. B. Falt Jr. Stns—Stns: 4 AM. WQAB(AM) (67%) Arab, WFX(AM) (60%) Huntsville, WJF(AM) (60%) Decatur and WSHF(AM) (100%) Sheffield, all Alabama.

Family Stations Inc.—Stns: 6 FM, 1 TV. KEAR(FM) San Francisco, KEBR(FM) Sacramento, KECR(FM) El Cajon, all California; WFSI(FM) Annapolis, Md.; and WKDN-FM Camden and WFMF(FM) Newark, both New Jersey; WYFR (shortwave) Scituate, Mass. (All 100% owned.) Ownership: Nonprofit corporation. Hqs: 290 Heegenberger Road, Oakland, Calif. 94621. (415) 568-6200.

Faulkner Radio Inc.—Stns: 4 AM, 3 FM. WBFA(AM) and WWSM(FM) Bay Minette, WAOA(AM) Opelika and WRFI(FM) Auburn, all Alabama; WLBB(AM), WBTR-FM Carrollton and WGAA(AM) Cedartown, Ga. Georgia. Note: Faulkner has sold WAOA and WRFI, subject to FCC approval. James H. Faulkner and Bob Thorburn. Hqs: Box 569, Carrollton, Ga. 30117.

John E. Fetzer Stns—Stns: 2 AM, 2 FM, 6 TV. Fetzer Broadcasting Co. owns 100% of WWAM(AM), WKJF(FM) and WWTW(TV) Cadillac, WJFM(FM) Grand Rapids, WKZO(AM) Kalamazoo and WWUP-TV Sault Ste. Marie, all Michigan. Fetzer Communications Inc. owns 90.48% of KMEG(TV) Sioux City, Iowa and of WKZO-TV Kalamazoo, Mich.; and owns 100% of KGIN-TV Grand Island and KOLN-TV Lincoln, both Nebraska. Executives of Fetzer Broadcasting Co.: John E. Fetzer, chmn; Carl E. Lee, pres; Robert C. Van Horn, sec-treas. Executives of Fetzer Communications Inc.: John E. Fetzer, pres; Carl E. Lee, VP; A. James Ebel, VP; Robert C. Van Horn, sec-treas. Ownership of Fetzer Broadcasting Co.: John E. Fetzer, 49.9%; Carl E. Lee, A. James Ebel, C.E. Ellerman and others, 15.7%. Ownership of Fetzer Communications Inc.: John E. Fetzer, 100%. CATV. Hqs: 590 West Maple St., Kalamazoo, Mich. 49001.

Fisher's Blend Station Inc.—Stns: 1 AM, 2 TV. KATU(TV) Portland, Ore.; KOMO-AM-TV Seattle. (All 100% owned.) Ownership: Fisher Companies Inc., Seattle. Hqs: 100 Fourth Ave. N., Seattle 98109. (206) 223-4000.

Formby Stations—Stns: 4 AM, 2 FM. KPAN-AM-FM Hereford, KLVT(AM) Levelland, KTEM(AM)-KPLE(FM) Temple and KTBB(AM) Tyler, all Texas. Principal owners: Clint Formby, Marshall Formby. Hqs: Drawer 1757, Hereford, Tex. 79045. (806) 364-1860.

Forum Communications Inc.—Stns: 1 AM, 1 FM, 5 TV. WDAZ-TV Devils Lake and WDAY-AM-FM-TV Fargo, both North Dakota; KABY-TV Aberdeen, KPRY-TV Pierre and KSFY-TV Sioux Falls, all South Dakota. Ownership: Forum Publishing Co. (William C. Marcil, pres). Hqs: c/o WDAY Inc., 207 N. Fifth St., Fargo, N.D. 58102.

Forward Communications Corp.—Stns: 3 AM, 4 FM, 6 TV. WRAU-TV Peoria, Ill.; KCAU-TV Sioux City, Iowa; KVGB-AM-FM Great Bend, Kan.; KOSA-TV Odessa, Tex.; WTRF(FM) and WTRF-TV Wheeling, W. Va.; WKAU-AM-FM Kaukauna, WMTV(TV) Madison, WSAU-AM-TV and WIFC(FM) Wausau, all Wisconsin. Ownership: Wausau (Wis.) Record-Herald, 44.61%; Wisconsin Rapids Tribune-WFHR(AM) and WWRW(FM) Wisconsin Rapids, Wis., 18.24%; Rhinelander Publishing Co., 11.17%; Merrill Publishing Co., 11.17%; and others. See Nwspwr Ownr. Richard D. Dudley, pres. Hqs: 1114 Grand Ave., Box 1088, Wausau, Wis. 54401. (715) 845-4211.

4-K Radio Inc.—Stns: 3 AM, 1 FM. KORT(AM) Grangeville, KOZE-AM-FM Lewiston and LER(AM) Orofino, all Idaho. Eugene A. Hamblin, pres. 93.75%; Mrs. E.A. Hamblin, VP; Michael R. Ripley, sec-treas, 6.25%. Hqs: Box 936, Lewiston, Idaho 83501. (208) 743-2502.

Fox Radio Stns—Stns: 3 AM. WIZS(AM) Henderson, WRMT(AM) Rocky Mount and WYE(AM) Sanford, all North Carolina. Ownership: Stanley H. Fox, 68-1%; WIZS; 70.85% WRMT; 60%, WYE, Irvine L. Fox, 23-1%, WIZS; 20.85%, WRMT; 25%, WYE.

William M. France—See Armington-France-Gehring-Ocepek Stns.

Edward O. Fritts Stns—Stns: 2 AM, 3 FM. KCRI(FM) Helena, Ark.; KMAR-AM-FM Winnsboro, La.; and WNLA-AM-FM Indianola, Miss. Ownership: Edward O. Fritts owns 100% of KCRI and KMAR-AM-FM, and 55% of WNLA-AM-FM. Hqs: Box 667, Indianola, Miss. 38751. (601) 887-1380.

Fuqua Communications Inc.—Stns: 2 AM, 1 TV. WROZ(AM) and WTVW(TV) Evansville, Ind.; WTAC(AM) Flint, Mich. Executives: Joe Windsor, pres; Jerry Fischer, treas. Ownership: Fuqua Industries Inc., 100%. A wholly owned subsidiary of Fuqua Industries (Marketing Treaties of Georgia Inc.) owns 100% of WTVM (Market) and 100% of WTVM(TV) Columbus, Ga., and 100% of WTVC Inc., licensee of WTVCTV(CTV) Chattahoochee. Hqs: Suite 336 Martin Bldg., Columbus, Ga. 31902. (404) 323-1881.

J. W. Furr Stns—See Gulf Central Radio Network.

G

Gulf Gannett Broadcasting Services Inc.—Stns: 3 AM, 3 FM, 2 TV. WINZ(AM) Miami and WINZ-FM Miami Beach, Fla.; WGAN-AM-FM-TV Portland, Me.; and WHY-AM-FM-TV Springfield, Mass. Ownership: Privately held. Hqs: 390 Congress St., Portland, Me. 04111. (207) 772-4661.

Gannett Co. Stns—Stns: 2 AM, 1 TV. WHEC-TV Rochester, N.Y.; WBRJ(AM) Marietta and WKFI(AM) Wilmington, both Ohio. Ownership: Paul Miller, bd chmn; Allen H. Neuhart, pres; et al. CATV. See also "Newspaper Ownership." Hqs: 55 Exchange St., Rochester, N.Y. 14614. (716) 232-7100.

Garryowen Stns—Stns: 1 AM, 4 TV. KTVQ(TV) Billings, KXLF-AM-TV Butte, KRTV(TV) Great Falls and KPAX-TV Missoula, all Montana. Ownership: Joseph S. Sample, 100%. Hqs: Box 2557, Billings, Mont. 59103.

Gateway Communications Inc.—Stns: 4 TV. WBNG-TV Binghamton, N.Y.; WTAJ-TV Altoona and WLYH-TV Lancaster-Lebanon, both Pennsylvania; and WOVK-TV Huntington, W. Va. Ownership: Bergen Evening Record Corp., 80%; George A. Koehler, 13%; and others. Executives: George A. Koehler, pres; Lewis Klein, exec VP. Hqs: Suite 612, Executive Bldg., Cherry Hill, N.J. 08002. (609) 667-8100.

Gay-Bell Stns—Stns: 1 AM, 2 TV. WLEX-TV Lexington, Ky.; WCOV-AM-TV Montgomery, Ala. Ownership: J. Douglas Gay Jr., 41.9%; estate of H. Guthrie Bell, 37.43% and others. Hqs: Box 1457, Russell Cave Rd., Lexington, Ky. 40501.

Gaylord Broadcasting Co.—Stns: 2 AM, 5 TV. WTVT(TV) Tampa, Fla.; KRKE(AM) Albuquerque, N.M.; WKY(AM) Oklahoma City; KTVI(TV) Fort Worth and KHTV(TV) Houston; KSTW(TV) Tacoma, Wash.; and WWTW(TV) Milwaukee. (All 100% owned.) Ownership: Oklahoma Publishing Co., Oklahoma City, 100%. Executive: Edward L. Gaylord, chmn. See also Newspaper Crossownership. Hqs: Box 22013, Tampa, Fla. 33622. (813) 876-1313.

GCC Communications Inc.—Stns: 1 AM, 4 FM. WGKA(AM)-WZGC(FM) Atlanta, WEFM(FM) Chicago, WGCL(FM) Cleveland and WIFI(FM) Philadelphia. Ownership: Alexander M. Tanger, 100% common stock; General Cinema Corp., 100% preferred stock. Hqs: 35 Fox Lane, Newton Centre, Mass. 02159. (617) 244-9225.

Richard H. Gehring—See Armington-France-Gehring-Ocepek Stns.

General Electric Broadcasting Co.—Stns: 3 AM, 5 FM, 3 TV. KFOG(FM) San Francisco; KOA-AM-TV and KOAQ(FM) Denver; WJIB(FM) Boston; WGY(AM), WGFN(FM) and WRGB(TV) Schenectady, N.Y.; WSIX-AM-FM and WNGE(TV) Nashville. Reid L. Shaw, pres. Ownership: General Electric Co. GE is a diversified electronics and electrical firm, which makes among other things, radio and TV broadcast equipment, radio and TV receivers, record players. Hqs: 1202 Troy-Schenectady Rd., Schenectady, N.Y. 12301. (518) 370-5520.

Gilmore Broadcasting Corp.—Stns: 2 AM, 1 FM, 3 TV. WREX-TV Rockford, Ill.; WEHT(TV) Evansville, Ind.; KODE-AM-TV Joplin, Mo.; and WSAV(AM) and WQPO(FM) Harrisonburg, Va. Ownership: James S. Gilmore Jr., 100%. Executives: Richard E. Reed, exec VP, ops; Hamilton Shea, exec VP, administration/corporate dev. Hqs: 162 East Michigan, Kalamazoo, Mich. 49006. (616) 381-6744.

Globetrotter Communications Inc.—Stns: 3 AM, 2

RKO General Inc.—Stns: 6 AM, 7 FM, 4 TV. WOR-AM-TV and WXLO(FM) New York; WRKO(AM), WROR(FM) and WNAC-TV Boston; WGMS-AM-FM Bethesda, Md.-Washington; WAXY(FM) Fort Lauderdale, Fla.; WFYR(FM) Chicago; WHBO-AM-TV Memphis; KFRC-AM-FM San Francisco; KHJ-AM-TV and KRTH(FM) Los Angeles. (All 100% owned.) Ownership: RKO General Inc. is wholly owned by General Tire & Rubber Co. Officers of RKO General: Thomas F. O'Neil, chmn of exec com; John B. Poor, chmn; Frank Shakespear, pres. Officers of RKO General (in chg of bstg division): Robert L. Glaser, pres (television); Dwight Case, pres (radio). CATV: RKO General Inc. owns 74% of Cablecom-General Inc. Hqs: 1400 Broadway, New York 10018. (212) 764-7000.

Robertson-Clapp Stns—Stns: 3 AM. KXRO(AM) Aberdeen and KUEN(AM) Wenatchee, both Washington; and KFQD(AM) Anchorage. Ownership: Miller C. Robertson and Matthew N. Clapp Jr. each own 50% of KUEN and KFQD. Mr. Robertson owns 100% of KXRO. Hqs: 2108 Seattle Tower, Seattle 98101

E. O. Roden Stns—Stns: 6 AM, 4 FM. WTUG(AM) Tuscaloosa, Ala. (45%); WBOP-AM-FM Pensacola, Fla. (44%); WBIP-AM-FM Booneville (100%), WGCN(AM)-WTAM(FM) Gulfport (45%), WOKJ(AM)-WJMI(FM) Jackson (45%) and WTUP(AM) Tupelo (48%), all Mississippi.

Rodgers Group—Stns: 2 AM, 2 FM. KKZZ(AM)-KOTE(FM) Lancaster and KKEE(AM)-KWYT(FM) Salinas, both California. Ownership: David A. Rodgers, pres, 100%. Hqs: Box 2138, Salinas, Calif. 93901. (408) 424-1428.

Rollins Inc.—Stns: 5 AM, 1 FM, 3 TV. Rollins Broadcasting of Delaware Inc. (Paul H. Downs, VP): KDAY(AM) Santa Monica, Calif.; WAMS(AM) Wilmington, Del.; WBEE(AM) Harvey, Ill.; WRAP(AM) Norfolk, Va.; WCHS(AM) and WBES(FM) Charleston, W.Va. Rollins Telecasting Inc. (William P. Eaton Jr., VP): WEAR-TV Pensacola, Fla.; WPTZ(TV) North Pole, N.Y.; and WCHS-TV Charleston, W.Va. Ownership: publicly traded Rollins Inc. (parent corporation). James C. Roddey, med group VP. CATV: Rollins Cablevision Inc.: Rollins Cablevision Inc., New Castle county, Del. Hqs: Box 647, Atlanta 30301.

Rosenbaum-Smylie Stns—Stns: 2 TV, WDM-AM-TV Laurel-Hattiesburg, Miss., and WCFT-TV Tuscaloosa, Ala. S. A. Rosenbaum, 44%; William S. Smylie Jr., 10.4%; Mrs. William S. Smylie Jr., 17% and others. Mr. Rosenbaum also owns 11.5% of WTOK-TV Meridian, Miss.

R.W. Rounsaville Stations—Stns: 5 AM, 3 FM. WMBR(AM) and WAIV(FM) Jacksonville. WBJW(FM) Orlando. WDAE(AM) and WAVV(FM) Tampa, and WNB(AM) Winter Park, all Florida; WCIN(AM) Cincinnati; and WVOL(AM) Berry Hill, Tenn. Executives: R.W. Rounsaville, chmn of the bd; Ralph B. Johnson, pres. Hqs: 3220 Peachtree Rd., Atlanta 30305. (404) 261-3000.

Rowland Broadcasting Co.—Stns: 2 AM, 2 FM. WQIK-AM-FM Jacksonville and WQYK(AM) Tampa and WQYK-FM St. Petersburg, all Florida. Note: WQYK(AM) has been sold, subject to FCC approval. Ownership: Marshall W. Rowland, 50%; Carol C. Rowland, 50%. Hqs: Box 6978, Jacksonville, Fla. 32205. (904) 356-1366.

Frank J. Russell Stns—Stns: 2 AM, 1 FM. WDMJ-AM-FM Marquette, Mich.; and WMAM(AM) Marinette, Wis. Principal owner: Frank J. Russell of Marquette, Mich. Hqs: Box 700, Marquette, Mich. 49855.

Rust Communications Group—Stns: 8 AM, 4 FM. WPTR(AM) Albany, WHAM(AM)-WHFM(FM) Rochester and WFLY(FM) Troy, all New York; WAEB(AM) and WXKW(AM) Allentown, WNOV(AM)-WQXA(FM) York and WRAD(AM) Reading, all Pennsylvania; WKXL(AM) Portsmouth and WRNL(AM) and WRXL(FM) Richmond, both Virginia. Ownership: William F. Rust Jr., 80%, and others. CATV. Hqs: Box 1378, Leesburg, Va. 22075.

Rust Craft Broadcasting Co.—Stns: 6 AM, 5 FM, 6 TV. WJKS-TV Jacksonville and WSOL(AM) Tampa, both Florida; WRDW-TV Augusta, Ga.; WEYI-TV Saginaw, Mich.; WWOL-AM-FM Buffalo and WROC-AM-TV, WPXY(FM) Rochester, both New York; WSTV-AM-TV and WRKY(FM) Steubenville, Ohio; WRCP-AM-FM Philadelphia and WPIT-AM-FM Pittsburgh; WRBC-TV Chattanooga. Executives: Jack N. Berkman, vice chmn; Marshall L. Berkman, pres; Ralph E. Becker, VP-television; Andrew F. Hofmann, VP-radio; Thomas B. Shealy, mgr of engr; James C. McCreary, ctrlr; Martha Sabo, asst sec & admin asst. Owned

100% by Rust Craft Greeting Cards Inc., whose principal stockholders are Louis, Jack N., and Allen H. Berkman and others. Hqs: 700 Porter Bldg, Pittsburgh 15219. (412) 288-0920.

S

Sammons-Ruff Stations—Stns: 4 AM. KTRN(AM) Wichita Falls and KIXZ(AM) Amarillo, both Texas; KELI(AM) Tulsa, Okla.; KHOG(AM) Fayetteville, Ark. C. A. Sammons, 80%; Raymond Ruff, 20%. Mr. Sammons owns 99% of KWAT-AM-FM Waterlton, S.D.

San Juan Racing Association Inc.—See SJR Communications Inc.

Sconnix Group Broadcasting Inc.—Stns: 3 AM, 2 FM. WLNH-AM-FM Laconia, N.H.; WCVR(AM) Randolph and WCFR-AM-FM Springfield, both Vermont. (All 100% owned.) Ownership: Scott R. McQueen, Theodore E. Nixon, Randall T. Odeneal and Alfred W. Hill. Executives: Scott R. McQueen, pres; Theodore E. Nixon, exec VP; Randall T. Odeneal, VP-finance; Alfred Hill, VP-progm. Hqs: Parade Road, Laconia, N.H. 03246. (603) 524-1323.

Scripps-Howard Broadcasting Co.—Stns: 2 AM, 1 FM, 5 TV. WPTV(TV) West Palm Beach, Fla.; WCPO-TV Cincinnati and WEWS(TV) Cleveland, both Ohio; KTEW(TV) Tulsa, Okla.; WNOX(AM) Knoxville and WMC-AM-FM-TV Memphis, both Tennessee. Executives: Jack R. Howard, bd chmn; Donald L. Perris, pres; Mortimer C. Watters, chmn of exec com. Hqs: 1100 Central Trust Tower, Cincinnati 45202.

Seaton Stns—Stns: 3 AM, 1 TV. KHAS-AM-TV Hastings, Neb.; KMAN(AM) Manhattan and KGGF(AM) Coffeyville, both Kansas. Ownership: KHAS-TV, Seaton Publishing Co., 51.7%; Morrison-Quirk Grain Corp., 3.55%; D. H. Meves, 4.15%; Duane L. Watts, 1.1%, and others. Seaton Publishing Co. is owned by Richard M. Seaton and the Fred A. Seaton Estate, who also control stations listed. Hqs: Box 853, Coffeyville, Kan. 67337.

Seehafer & Johnson Broadcasting Corp.—Stns: 3 AM, 1 FM. KRBI-AM-FM St. Peter, Minn.; WOMT(AM) Manitowoc and WXCO(AM) Wausau, both Wisconsin. (All 100% owned.) Ownership: Donald W. Seehafer, pres, 50%; Robert C. Johnson, 50%. Hqs: Box 685, Manitowoc, Wis. 54220. (414) 682-0351.

Shamrock Development Corp.—Stns: 1 AM, 3 FM. WDIZ(FM) Orlando, Fla.; WEJL(AM) and WEZZ(FM) Scranton, Pa.; and WQFM(FM) Milwaukee. Principal owners: William R. Lynett, James J. Haggerty, Edward J. Lynett, George V. Lynett. Hqs: 149 Penn Ave., Scranton, Pa. 18501.

Shepard Broadcasting Corp.—Stns: 1 AM, 2 FM. KITT(FM) San Diego (60%); and WLAV-AM-FM Grand Rapids, Mich. (100%). Executive: John J. Shepard. Hqs: Waters Bldg, Grand Rapids, Mich. 49502. (616) 456-5461.

Sheridan Broadcasting Corp.—Stns: 3 AM, 1 FM. WILD(AM) Boston; WUFO(AM) Amherst, N.Y.; and WAMO-AM-FM Pittsburgh. Ownership: Ronald Davenport, chmn, chief exec off & treas, 68.42%; and others. Hqs: 1811 Blvd. of the Allies, Pittsburgh 15219. (412) 281-6747.

Sherman-Ruwitich Stns—Stns: 2 AM, 1 FM. WAVS(AM) Fort Lauderdale, WMMB(AM) and WYRL-FM Melbourne, both Florida. Gordon Sherman and Lee Ruwitich. Hqs: Box 7539, Fort Lauderdale, Fla. 33304.

Sigmar Corp.—Stns: 4 AM, 2 FM. KTON-AM-FM Belton, KRYS(AM) Corpus Christi, KXOL(AM) Fort Worth and KBUC-AM-FM San Antonio, all Texas. Ownership: Tom E. Turner Sr., Mary Turner, Tom Turner Jr. Hqs: Box 20267, San Antonio, Tex. 78220. (512) 222-9191.

J. Ardell Sink Stns (Mark Media Group)—Stns: 4 AM. WKYK(AM) Burnsville and WCSL(AM) Cherryville, both North Carolina; WKHJ(AM) Holly Hill and WKKR(AM) Pickens, both South Carolina. Ownership: J. Ardell Sink, pres & treas, 75%; Remelle K. Sink, VP & sec, 25%. Hqs: Mark Media Bldg, 715 E. Main St., Burnsville, N.C. 28714. (704) 682-6221.

Sis Radio Inc.—Stns: 2 AM, 1 FM. WAPE(AM) Jacksonville, Fla.; WAYS(AM) and WRQQ(FM) Charlotte, N.C. Ownership: Stanley N. Kaplan, pres, 30%; Harriet A. Kaplan, sec-treas, 60%. Hqs: 400 Radio Road, Charlotte, N.C. 28216. (704) 392-6191.

SJR Communications Inc.—Stns: 2 AM, 6 FM. WKLS(FM) Atlanta; WOAL(FM) Cleveland; WTMi(FM) Miami; WHOM(AM) and WKTU(FM) New York; WYSP(FM) Philadelphia; WUST(AM) Washington and

WJMD(FM) Bethesda, Md. Ownership: SJR Communications Inc. is a wholly owned subsidiary of San Juan Racing Association Inc. Hqs: 1370 Avenue of the Americas, New York 10019. (212) 765-3142.

Sonderling Broadcasting Corp.—Stns: 6 AM, 4 FM, 1 TV. KDIA(AM) Oakland, Calif.; WOL(AM) and WMO(D) Washington; WOPA(AM) and WBMX(FM) Oak Park, Ill.; WAST(TV) Albany, N.Y.; WWRL(AM) New York; WDI(AM) and WQUD(FM) Memphis; KIKK(AM) Pasadena and KIKK-FM Houston, both Texas. Note: Sonderling has purchased WVRV(FM) New York, subject to FCC approval. Executives: Egmont Sonderling, chmn of the bd & pres; Jerrold Levine, exec VP & treas; Roy Sonderling, VP & sec; John W. Doubleday, dir of radio bstg. Sonderling Broadcasting Corp. also owns SBC Theatre Group, operating 51 theaters in New England and upper New York state; Modern Teleservice Inc., commercial TV distributing company; and Bernard Howard & Co., natl radio stn rep. Hqs: 3050 Biscayne Blvd., Miami 33137. (305) 576-6688.

Southmedia Stns—Stns: 2 AM, 1 FM. WAAX(AM) and WQEN(FM) Gadsden, Ala., and WRNG(AM) North Atlanta, Ga. Ownership: Charles Smithgall. CATV: Rome, Ga. Hqs: 403 First National Bank Bldg, Gainesville, Ga. 30501.

South Central Bcstg Corp.—Stns: 1 AM, 2 FM, 1 TV. WIKY-AM-FM Evansville, Ind.; WEZK(FM) and WTVK(TV) Knoxville, Tenn. (All 100% owned.) John A. Engelbrecht and family, 100%. Hqs: Box 3848, Evansville, Ind. 47736. (812) 424-8284.

Southern Broadcasting Co.—Stns: 5 AM, 5 FM, 1 TV. WSGN(AM) Birmingham, Ala.; KOY(AM) and KRFM(FM) Phoenix; WRBQ(FM) Tampa, Fla.; WGHP-TV High Point and WKIX(AM)-WYYD(FM) Raleigh, both North Carolina; WEZI(FM) Memphis; KFWD(FM) Fort Worth, KULF(AM) Houston and KYND(FM) Pasadena, all Texas; WRVA(AM) and WRVQ(FM) Richmond, Va. Ownership: John G. Johnson, 6.99%; Earl F. Slick, 22.05%; Albert L. Butler Jr., 10.00%. Hqs: Box 5176, Winston-Salem, N.C. 27103. (919) 723-3561.

Southwestern Broadcasters Inc.—Stns: 2 AM, 2 FM. KRDS(AM) Tolleson, Ariz.; KPRI(FM) San Diego and KYMS(FM) Santa Ana, both California; KBRN(AM) Brighton, Colo. Principal owners: Edward T. Shadec, pres; Jack A. Lane, VP. Hqs: 11585 Sorrento Valley Rd., San Diego 92121. (714) 452-8181.

Southwestern Bcstg Stns—Stns: 3 AM, 3 FM. KADL-AM-FM Pine Bluff, Ark.; WMDC-AM-FM Hazlehurst and WAP(FM), WCCA(FM) McComb, both Mississippi. Ownership: Louis Alford, Philip D. Brady and Albert Mack Smith. Hqs: Box 604, McComb, Miss. 39648.

Spanish International Communications Corp.—Stns: 5 TV. KFTV(TV) Hanford, Calif.; KMEX-TV Los Angeles; WLTV(TV) Miami; WXTV(TV) Paterson, N.J.; and KWEX-TV San Antonio, Tex. Ownership: Laura M. de Azcarra, 20.00%; Fouce Amusement Enterprises Inc., 23.43%; Reynold V. Anselmo, 16.44%; James Jacobson, 8.16%. Hqs: 250 Park Ave., New York 10017. (212) 697-0585.

Springfield Television Broadcasting Corp.—Stns: 3 TV. WWLP(TV) Springfield, Mass.; WKEF(TV) Dayton, Ohio; WRPL(TV) Keene, N.H.-Brattleboro, Vt.-Greenfield, Mass. (All 100% owned.) Ownership: William L. Putnam, estate of Roger L. Putnam, Joseph Deliso. Executive: William L. Putnam, pres. Hqs: Box 2210, Springfield, Mass. 01101. (413) 786-2200.

Star Stations Inc.—Stns: 3 AM, 2 FM. WIFE-AM-FM Indianapolis; KOIL(AM)-KEFM(FM) Omaha; and KISN(AM) Vancouver, Wash. Don W. Burden, principal owner. (FCC issued order on Jan. 30, 1975, denying renewal of all Star licenses.

The Starr Broadcasting Group Inc.—Stns: 6 AM, 5 FM, 4 TV. KXLR(AM) North Little Rock, Ark.; KABL(AM) Oakland and KABL-FM San Francisco, both California; KHVO(TV) Hilo and KITV(TV) Honolulu, both Hawaii; KUDL(AM) Fairway and KUDL-FM Kansas City, both Kansas; WTVQ-TV Lexington, Ky.; WBOK(AM) New Orleans; WWWV(FM) Detroit; WNCN(FM) New York; WLOK(AM) Memphis; KDTX(FM) Dallas and KYOK(AM) Houston; WCYB-TV Bristol, Va. Ownership: No shareholder owns more than 10% of the stock. The largest shareholders are Peter H. Starr, Michael F. Starr and William F. Buckley Jr. Hqs: 3715 Williams Blvd., Kenner, La. 70062. (504) 443-5656.

Group Ownership

The State-Record Co.—See State Telecasting Co.

State Telecasting Co. Inc.—Stns: 3 TV, KSWB-TV Roswell, N.M.; WCBD-TV Charleston, S.C.; KCBD-TV Lubbock, Tex. Executives: Ben R. Morris, bd chmn; W. Frank Harden, pres. Ownership: Wholly owned subsidiary of The State-Record Co., Columbia, S.C. (Frank Hampton, Ambrose G. Hampton, Ben R. Morris, Arthur D. Cooper, and others). See also Newspaper Crossownership. Hqs: Box 1333, Columbia, S.C. 29202. (803) 771-6161.

Stauffer Publications Inc.—Stns: 5 AM, 3 FM, 1 TV. KRNT(AM)-KRNQ(FM) Des Moines, Iowa; KSOK(AM) Arkansas City and WIBW-AM-FM-TV Topeka, both Kansas; KGFF(AM) Shawnee, Okla.; KGNC-AM-FM Amarillo, Tex. Executive: Thad M. Sandstrom, VP-bcstg. Ownership: Oscar S. Stauffer, 20.6%; Stanley H. Stauffer, 2.94%; John W. Stauffer, 2.64%, and others. CATV: 25% of Total Television of Amarillo, Tex. See also Newspaper Crossownership. Hqs: Box 119, Topeka, Kan. 66601. (913) 272-3456.

Steinman Stns—Stns: 2 AM, 2 FM, 2 TV. WGAL-AM-FM-TV Lancaster, Pa.; WDEL(AM) and WSTW(FM) Wilmington, Del.; WTEV(TV) New Bedford, Mass. (Providence, R.I.). Executive: Harry J. Shaub Jr., exec VP & gen mgr. Ownership: John F. and estate of J. Hale Steinman and families. See also Newspaper Crossownership. Hqs: 8 W. King St., Lancaster, Pa. 17604.

Sterling Recreation Organization (Broadcast Division)—Stns: 5 AM, 4 FM. KJSJ(FM) San Jose, Calif.; KASH(AM) Eugene and KSNDFM Springfield-Eugene, both Oregon; KBWF(AM) Bellingham-Ferndale, KEDO(AM) and KLYK(FM) Longview, KALE(AM) Richland, KUUU(AM) and KAOK(FM) Seattle, all Washington. (All 100% owned.) Ownership: Trust of John Danz, 20.1%; Estate of Jessie Danz, 21.2%; Frederic A. Danz, 17.8%. Hqs: 5900 Wilshire Blvd., Los Angeles 90036. (213) 937-8467.

Stone Country Network—Stns: 3 AM, 1 FM. KPDK-AM-FM Colorado Springs; KZIP(AM) Amarillo and KDAV(AM) Lubbock, both Texas. (All 100% owned.) Ownership: D.P. Pinkston owns 100% of KPDK-AM-FM and KZIP. 50% of KDAV. Robert Clark owns 50% of KDAV. Hqs: Box 2440, Colorado Springs 80901. (303) 634-1503.

Stoner Broadcasting System Inc.—Stns: 3 AM, 3 FM. KSO(AM) and KGGO(FM) Des Moines, Iowa; WVEZ(FM) Louisville, Ky.; WNB(AM) and WQYT(FM) Binghamton, N.Y.; and WGN(TM) Huntington, W.Va. Executives: Thomas H. Stoner, pres; Glenn K. Bell, exec VP. Hqs: 212 Polk County Federal S & L Bldg, 7th & High St., Des Moines, Iowa 50309. (515) 244-3154.

Storer Broadcasting Co.—Stns: 5 AM, 1 FM, 7 TV. WAGA-TV Atlanta; WSBK-TV Boston; WJW-AM-TV Cleveland; WJBK-TV Detroit; KGBS-AM-FM Los Angeles; WGBS(AM) Miami; WITI-TV Milwaukee; WHN(AM) New York; KCST-TV San Diego; and WSPD-AM-TV Toledo, Ohio. Hqrs exec staff: Bill Michaels, chmn & chief exec off; Peter Storer, pres; Terry Lee, exec VP; John McCoy, VP law & sec; Arno Mueller, VP & treas; Ken Bagwell, VP West Coast ops & CATV division; A. A. Church, VP & asst sec; Bob Edell, VP adv & PR; Warren Zwicky, VP & Washington counsel; John Grubbs, VP bcst standards & compliance; Leonard Spragg, VP engrg; C. C. McClymonds, VP special svcs; Kenneth R. Mosher, asst treas; Shirley E. Conover, asst sec. Hqs: 1177 Kane Concourse, Miami Beach, Fla. 33154. (305) 866-0211.

Storz Broadcasting Co.—Stns: 6 AM. WHB(AM) Kansas City, Mo.; WQAM(AM) Miami; WDGW(AM) Minneapolis; WTX(AM) New Orleans; KOMA(AM) Oklahoma City; KXOK(AM) St. Louis. Ownership: Robert H. Storz. Hqs: 8th Floor, Kiewit Plaza, Omaha 68131. (402) 342-4700.

Stuart Broadcasting Co.—Stns: 7 AM, 6 FM. WMAY(AM) Springfield, Ill.; KOEL-AM-FM Oelwein and KMNS(AM)-KSEZ(FM) Sioux City, both Iowa; KSAL(AM)-KYEZ(FM) Salina, Kan.; KWTO-AM-FM Springfield, Mo.; KRGI-AM-FM Grand Island and KFOR-AM-FM Lincoln, both Nebraska. Ownership: Mr. & Mrs. James Stuart, 85%. Hqs: 625 Stuart Bldg., Lincoln, Neb. 68501. (402) 475-4204.

Suburban Radio Group—Stns: 6 AM, 2 FM. WCGC(AM) Belmont, WEGO(AM) and WPEG(FM) Concord, WSVN(AM) Valdese, WZKY(AM) Albemarle, all North Carolina; WJJJ(AM) Christiansburg,

WVVV(FM) Blacksburg, and WHHV(AM) Hillsville, all Virginia. Ownership: Robert R. Hilker & William R. Rollins. Hqs: Box 888, Belmont, N.C. 28012. (704) 825-8224.

Sudbrink Bcstg Stns—Stns: 2 AM, 6 FM. WLYF(FM) Miami and WFUN(AM) South Miami, both Florida; WPCH(FM) Atlanta and WAOV(AM) Decatur, both Georgia; WLAK(FM) Chicago; WLIF(FM) Baltimore; WWEZ(FM) Cincinnati; and WEZW(FM) Wauwatosa, Wis. Robert W. and Margareta S. Sudbrink. Hqs: 3081 E. Commercial Blvd., Fort Lauderdale, Fla. 33308. (305) 771-0735.

Sudbury Services Inc. & Newport Broadcasting Co.—Stns: 5 AM, 3 FM. KLCN(AM)-KHL5(FM) Blytheville, KAWW-AM-FM Heber Springs, KNBY(AM)-KOKR(FM) Newport, KTPA(AM) Prescott and KSUD(AM) West Memphis, all Arkansas. Principal owners: Harold L. Sudbury Sr., Gladys B. Sudbury and Harold L. Sudbury Jr. CATV: Blytheville TV Cable Co., Blytheville, Ark. Hqs: Box 989, Blytheville, Ark. 72315.

Susquehanna Broadcasting Co.—Stns: 6 AM, 7 FM, 1 TV. WQBA(A+I) Miami and WKIS(AM) Orlando, both Florida; WLTA(FM) Atlanta; WFMS(FM) Indianapolis; WGBB(AM) Freeport, N.Y.; WHLO(AM) Akron, WHLO(FM) Canton, WLQA(FM) Cincinnati and WLQR(FM) Toledo, all Ohio; WARM(AM) Scranton and WBSA-AM-FM-TV York, both Pennsylvania; KPLX(FM) Fort Worth. Ownership: Louis J. Appell Residuary Trust, 87% (voted by trustees Louis J. Appell Jr., George N. Appell, Helen P. Appell and Helen A. Norton, each of whom has minority interest of own). CATV. Hqs: 140 E. Market St., York, Pa. 17401. (717) 845-5626.

Swanco Broadcasting Inc.—Stns: 4 AM, 3 FM. KLEO(AM) Wichita, Kan.; WBYU(FM) New Orleans; KQEO(AM) Albuquerque, N.M.; KKNQ(FM) Oklahoma City and KRMG(AM)-KWEN(FM) Tulsa, both Oklahoma; and KKYX(AM) San Antonio, Tex. Note: Swanco has purchased KFJZ(AM)-KWXI(FM) and the Texas State Network, both Fort Worth, subject to FCC approval. Ownership: Gerock H. Swanson, 82%. Executives: Gerock H. Swanson, pres; Ron B. Blue, exec VP; Richard F. Marcellan, VP; Kenneth Baugh, VP; Sam E. Bakke, VP; Marc McLean, VP. Hqs: 1502 S. Boulder, Tulsa, Okla. 74119.

T

T/R Inc.—Stns: 3 AM, 3 FM, 1 TV. WOMP-AM-FM Bellaire, WNXT-AM-FM Portsmouth and WHIZ-AM-FM-TV Zanesville, all Ohio. T/R Inc. owns 100% of WOMP and WNXT; 60% of WHIZ and 63% of WHIZ-TV. Ownership: Clay Littick, Arthur Littick and Mrs. William O. Littick own approximately 33-1/3% each. Hqs: 421 Main St., Zanesville, Ohio 43701.

Taft Broadcasting Co.—Stns: 5 AM, 5 FM, 6 TV. WBRC-TV Birmingham, Ala.; WDAF-AM-TV and KYYS(FM) Kansas City, Mo.; WGR-AM-TV and WGRQ(FM) Buffalo, N.Y.; WKRC-AM-TV, WKRO(FM) Cincinnati and WTVN-AM-FM-TV Columbus, both Ohio; WTAF-TV Philadelphia and KQV(AM)-WDVE(FM) Pittsburgh. Executives: Charles S. Mechem Jr., bd chmn; David S. Ingalls, vice chmn; Lawrence H. Rogers II, pres; John L. McClay, exec VP-bcstg; Carlyle J. Wagner, VP-radio; Dorothy S. Murphy, treas; George E. Castrucci, VP-administration & planning; Donald L. Chapin, VP-sl; William H. Hansher, VP-engrg; Arthur L. Haack, ctrir; Martyn S. Weinberg, mgr, bus affairs; Robert C. Wiegand, VP; L. D. Bolton II, VP; Frederick H. von Stade, VP; Leon H. Lowenthal, VP; Ro Grignon, VP; Earl Beal, VP; Dudley S. Taft, exec VP-amusement park group; Samuel T. Johnston, exec VP-Hanna-Barbera Productions; Charles D. Lindberg, corporate sec. Hqs: 1906 Highland Ave., Cincinnati 45219. (513) 721-1414.

Talton Broadcasting Co.—Stns: 2 AM, 1 FM. WBIB(AM) Centerville and WHBB(AM)-WTUN(FM) Selma, both Alabama. Note: Talton has purchased WFRI(AM) Auburn and WAOA(AM) Opelika, both Alabama, subject to FCC approval. Ownership: Julius E. Talton, Pearle L. Talton, B. David Rigdon, Gary Fuller. Hqs: 505 Lauderdale St., Selma, Ala. *36701. (205) 874-8296.

Sarkes Tarzian Stns—Stns: 2 AM, 2 FM, 1 TV. WTT5(AM), WGTC(FM) and WTTV(TV) Bloomington, WPTH(FM) Fort Wayne, and WATI(AM) Indianapolis, all Indiana. Ownership: Sarkes and Mary Tarzian. Hqs: 3490 Bluff Rd., Indianapolis 46217.

Technical Operations Inc.—See McCormick Communications Inc.

Albert S. Tedesco Stns—Stns: 2 AM, 2 FM. KDUZ-AM-FM Hutchinson and KTCR-AM-FM Minneapolis,

both Minnesota. Principal owner: Albert S. Tedesco. Hqs: 3701 Winnetka Ave. N., Minneapolis 55427.

Texas Bcstg Corp.—See The LBJ Co.

Norman Thomas Stns—Stns: 3 AM, 1 FM. WDNT(AM)-WNFM(FM) Dayton, WENR(AM) Englewood and WJSO(AM) Jonesboro, all Tennessee. Principal owner: Norman A. Thomas. Hqs: Box 428, Chattanooga 37401. (615) 698-6767.

Thoms Radio & TV Enterprises—Stns: 3 AM, 1 TV. WANC-TV Asheville, WCOG(AM) Greensboro and WKLM(AM) Wilmington, all North Carolina; and WEAM(AM) Arlington, Va. Ownership: Harold H. Thoms, pres; Selene Thoms, VP; Mاتيann Thoms Gennett, sec. CATV. Hqs: 75 Elk Mtn. Scenic Hwy, Asheville, N.C. 28804. (704) 255-0111.

A. V. Tidmore Stns—Stns: 4 AM, 1 FM. WPPA(AM), WAVT-FM Pottsville, Pa.; WSB(AM) New Smyrna Beach, Fla.; 28.6% of WJUE(AM) Hagerstown, Md., and 15.5% of WAGE(AM) Leesburg, Va. Hqs: 212 S. Centre St., Pottsville, Pa. 17901. (717) 622-1380.

The Times Mirror Co.—Stns: 2 TV. KTBC-TV Austin (100%) and KDFW-TV Dallas (100%), both Texas. Executives: Dr. Franklin D. Murphy, chmn & chief exec off; Otis Chandler, vice chmn; Robert F. Erburu, pres; Philip L. Williams, group VP-nwsprts & TV; Dow W. Carpenter Jr., group VP, cable communications. The Times Mirror Co. publishes the *Orange Coast Daily Pilot*, *Costa Mesa*, and *Los Angeles Times*, Los Angeles, both California; *Newsday*, Long Island, N.Y.; and *The Dallas Times Herald*, Dallas, CATV: The TM Communications Co., Costa Mesa, Calif. and Long Island Cablevision Corp., Riverhead, N.Y. Hqs: Times Mirror Square, Los Angeles 90053.

Transamerica Corp.—See United Artists Broadcasting Inc.

Tribune Co. (Chicago Tribune) Stns—See WGN Continental Broadcasting Co.

Turner Communications Corp.—Stns: 1 AM, 1 FM, 2 TV. WTGG(TV) Atlanta; WRET-TV Charlotte, N.C.; WGOV(AM) and WYNO(FM) Chattanooga. Ownership: R. E. Turner, 61%. Hqs: 1018 W. Peachtree St. N.W., Atlanta 30309.

Turner Farrar Association—Stns: 2 TV. WSIL-TV Harrisburg, Ill.; KPOB-TV Poplar Bluff, Mo. Ownership: O. L. Turner, O. L. Turner, as trustee for Turner Trust; Ethel M. Turner. Same group owns chain of Illinois theaters. Hqs: Television Bldg., Harrisburg, Ill. 62946.

Twentieth Century-Fox Film Corp.—Stns: 3 TV. KMSP-TV Minneapolis; KMOL-TV San Antonio, Tex.; and KTVX(TV) Salt Lake City. Executive: Dennis C. Stanfill, chmn of the bd, pres & chief exec off. Hqs: Box 900, Beverly Hills, Calif. 90213. (213) 277-2211.

2588 Newport Corp.—Stns 4 AM, 4 FM. KTUC(AM) and KFMM(FM) Tucson, Ariz.; KHSJ-AM-FM Hemet and KHOT(AM)-KUUL(FM) Madera, both California; KYVA(AM) and KGLP(FM) Gallup, N.M. (All 100% owned.) Ownership: Raymond I. Kandel, 50%; John J. Cote, trustee, 50%. Hqs: Suite 2102, 2222 Avenue of the Stars, Los Angeles 90067. (213) 277-4980.

U

United Artists Broadcasting Inc.—Stns: 1 FM, 2 TV. WUAB(TV) Lorain, Ohio; WWSH(FM) Philadelphia; and WRIK-TV Ponce, P.R. Executives: Eric Pleskow, chmn of bd; Andy Albeck, pres. Ownership: United Artists Broadcasting is a unit of United Artists Corp., New York. United Artists Corp. is a subsidiary of Transamerica Corp., San Francisco. Hqs: 729 Seventh Ave., New York 10019. (212) 245-6000.

United Broadcasting Co.—Stns: 7 AM, 4 FM, 3 TV. Owns 100% of WOOK(AM) and WFAN(FM) Washington; WFAB(AM) Miami-South Miami; KIKU-TV Honolulu; WSID(AM), WLPL(FM) Baltimore and WINX(AM) Rockville, both Maryland; WMUR-TV Manchester, N.H.; WBNX(AM) New York; WJMO(AM) and WLYT(FM) Cleveland Heights, Ohio. Owns 94% of KECC-TV El Centro, KALI(AM) San Gabriel and KSOL(FM) San Mateo, all California. Ownership: Richard Eaton, pres & treas, 100%; Pierre Eaton, sec; Morton Silverman, dir. CATV: Manchester, N.H. Hqs: 4733 Bethesda Ave., Suite 808, Bethesda, Md. 20014. (301) 652-7707.

United Television Inc.—See Twentieth Century-Fox Film Corp.

Universal Bcstg Stns—Stns: 6 AM. KPCC(AM) Pasadena and KEST(AM) San Francisco, both California; KUXL(AM) Golden Valley, Minn.; WTHE(AM) Mineola, N.Y.; WARO(AM) Canonsburg, Pa.;

FM. WVON(AM) and WGCI(FM) Chicago, WIXY(AM) and WDOK(FM) Cleveland, and WDEE(AM) Detroit. (All 100% owned.) Executive: George Gillett, pres. Major stockholders: George N. Gillett Jr., Potter Palmer. Company also operates GCI Sales Inc., natl radio rep & syndication s/s company. Hqs: Suite 322, One IBM Plaza, Chicago 60611. (312) 222-1660.

Gold Coast Network—See Central California Communications Corp.

Gold Seal Stns—See Hubbard Bcstg Inc.

The Golden Pacific Group—Stns: 2 AM, 3 FM. KFIG(FM) Fresno, KCVR(AM) and KWIN(FM) Lodi and KEEN(AM) and KBAY(FM) San Jose, all California. (All 100% owned.) Ownership: George M. Mardikian, 33 1/3%; B. Floyd Farr, 33 1/3%; George D. Snell, 33 1/3%. Hqs: 1245 S. Winchester Blvd., San Jose, Calif. 95128. (408) 249-5336.

Golden West Broadcasters Stns—Stns: 4 AM, 1 TV. KMPC(AM) and KTLA(TV) Los Angeles, KSFQ(AM) San Francisco, KEX(AM) Portland, Ore. and KVI(AM) Seattle. Ownership: Gene and Ina Mae Aury, 50.1%; The Signal Cos., 49.9%. Mr. Aury, chmn & pres; Bert S. West, pres-radio division; John T. Reynolds, pres-TV division; Clair Stout, VP & sec; William D. Shaw, VP; Michael M. Schreier, VP of finance & administration & treas. Mr. Aury is also a stockholder in KOOL-AM-FM-TV Phoenix, and owns 24.48% of KOPO(AM) Tucson, Ariz. Hqs: 5858 Sunset Blvd., Los Angeles 90028. (213) 469-5341.

Goldman Group—Stns: 5 AM, 3 FM. WDOE(AM) Dunkirk and WJTN(AM)-WVWE(FM) Jamestown, both New York; WWYN(AM) and WLWU(FM) Erie, Pa.; WVMT(AM) Burlington and WSYB(AM)-WRUT(FM) Rutland, both Vermont. (All 100% owned.) Ownership: Simon Goldman. Hqs: Box 1139, Jamestown, N.Y. 14701. (716) 487-1151.

Curt Gowdy Broadcasting—Stns: 4 AM, 2 FM. WEAT-AM-FM West Palm Beach, Fla.; WCCM(AM) and WCGY(FM) Lawrence, Mass.; WBBX(AM) Portsmouth, N.H.; and KOWB(AM) Laramie, Wyo. Ownership: Curtis E. Gowdy. Hqs: 33 Franklin St., Lawrence, Mass. 01840. (617) 683-7171.

Gray Broadcast Enterprises—Stns: 4 AM, 1 FM. WRNB(AM) New Bern, N.C.; WCRE(AM) Cheraw, S.C.; WKDE-AM-FM Altavista and WTTX(AM) Appomattox, both Virginia. (All 100% owned.) Ownership: Ted J. Gray, 100%. Hqs: Box 512, Altavista, Va. 24517. (804) 369-5588.

Gray Communications Systems Inc.—Stns: 3 TV. WALB-TV Albany, Ga.; WJHG-TV Panama City, Fla., and KTVE-TV El Dorado, Ark. (Monroe, La.). (All 100% owned.) Ownership: James H. Gray Sr., 53.2%, and others. Hqs: Box 3130, Albany Ga. 31706. (912) 435-8386.

Grayson Enterprises Inc.—Stns: 2 AM, 1 FM, 4 TV. KLBK-AM-FM-TV Lubbock, KWAB(TV) Big Spring, KMOM-TV Monahans-Odessa, and KTXS-TV Sweetwater-Abiene, all Texas; and KCCN Honolulu. Ownership: Theodore Shanbaum, Dal-Tex Optical Co. Inc. and Lee Optical & Associated Companies Retirement Pension Plan Trust, each 33-1%. Dal-Tex Optical Co. Inc. is controlled by Theodore Shanbaum. Hqs: 1403 Slocum St., Dallas 75207.

Great Scott Stns—Stns: 7 AM, 4 FM. WJWL(AM) and WSEA(AM) Georgetown, Del.; WTTM(AM) and WCHR(FM) Trenton, N.J.; WTRY(AM) Troy and WHSH(FM) Albany, both New York; WTIG(AM) Massillon, Ohio; WFEM(FM) Ellwood City, WFECA(AM) Harrisburg, WKST(AM) New Castle and WPAZ(AM) Pottstown, all Pennsylvania. Note: WTIG has been sold, subject to FCC approval. Ownership: Herbert Scott, 100%. Hqs: c/o Radio Station WPAZ, Broadcast Lodge, Pottstown, Pa. 19464.

Great Trails Broadcasting Corp.—Stns: 5 AM, 4 FM. WKLO(AM) and WCSN(FM) Louisville, Ky.; WCOL-AM-FM Columbus, WING(AM) Dayton, WJAI(FM) Eaton and WIZE(AM) Springfield, all Ohio; WRIT(AM) and WBCS(FM) Milwaukee. Charles Sawyer, pres; Gerhard Joseph, VP; Alexander Williams, VP. Hqs: 2513 Central Trust Tower, Cincinnati 45202. (513) 241-4823.

Greater Media Inc.—Stns: 6 AM, 6 FM. WTCR(AM) Ashland, Ky.; WGA(AM) Silver Spring, Md. and WGA(AM) Washington; WHNE(FM) Birmingham and WHND(AM) Monroe, both Michigan; WGSN(AM) Huntington and WCTO(FM) Smithtown, both New York; WCTC(AM) and WQMR(FM) New Brunswick, N.J.; WPE(AM) and WMGK(FM) Philadelphia; WHEZ(FM) Huntington, W.Va. Peter A. Bordes, pres; Joseph L. Rosenmiller Jr., chmn of the bd. CATV. See also News-

paper Crossownership. Hqs: 96 Bayard St. New Brunswick, N.J. 08901. (201) 247-6161.

The Green Group—Stns: 2 AM, 2 FM, 1 TV. WENY-AM-FM-TV Elmira, N.Y.; WOND(AM) Pleasantville and WMGM(FM) Atlantic City, both New Jersey. Ownership: Howard L. Green, 33-1%; Donald M. Simmons, 33-1/3%; John T. Stethers, 33-1/3%. Hqs: 15 Shore Road, Linwood, N.J. 08221.

The Greentree Group—Stns: 5 AM. KMBY(AM) Monterey and KVEC(AM) San Luis Obispo, both California; KEXO(AM) Grand Junction, Colo.; KTFI(AM) Twin Falls, Idaho; and WJPF(AM) Herrin, Ill. Principal owner: Charles D. Powers, pres. Hqs: Box 68, Moraga, Calif. 94556.

Greer Stns—Stns: 2 AM, 3 FM. WAJR-AM-FM Morgantown, W.Va.; WJER-AM-FM Dover-New Philadelphia, Ohio; WJOI(FM) Pittsburgh. Agnes Jane Reeves Greer, pres. Hqs: Box 867, Morgantown, W.Va. 26505.

Merv Griffin Group Radio—Stns: 4 AM, 3 FM. WPOP(AM) Hartford and WIOF(FM) Waterbury, both Connecticut; WMID(AM) Atlantic City and WGRF(FM) Pleasantville, both New Jersey; WENE(AM) and WMRV(FM) Endicott, N.Y.; WBAX(AM) Wilkes Barre, Pa. Principal owner: Merv Griffin. Hqs: 430 Park Ave., New York 10022.

Grisham Group—Stns: 3 TV. WHNT-TV Huntsville (100%) and WSLA(TV) Selma (100%), both Alabama; WYEA-TV Columbus, Ga. (50%). Ownership: Charles F. Grisham, Aaron Aronov, Tine W. Davis, B.D. Godbold. Hqs: Box 19, Huntsville, Ala. 35804. (205) 539-5743.

Gross Telecasting Inc.—Stns: 1 AM, 1 FM, 2 TV. WJIM-AM-FM-TV Lansing, Mich.; WKBT(TV) La Crosse, Wis. Ownership: Harold F. Gross, 16.3%; Charlotte Gross, 10.6%; and others. Executives: Harold F. Gross, chmn of the bd; James H. Gross, pres, treas; Paul R. Trigg Jr., VP; Philip E. Sherck, sec. Hqs: 2820 E. Saginaw St., Lansing, Mich. 48904. (517) 372-8282.

Group One Broadcasting Co.—Stns: 4 AM, 4 FM, 1 TV. KLZ-AM-FM Denver; WAKR-AM-TV, WAEZ(FM) Akron and WONE(AM) and WTUE(FM) Dayton, both Ohio; KBOX(AM) and KTLCC(FM) Dallas. Ownership: Summit Radio Corp., 55%; Knight-Ridder Newspapers Inc., 45%. Hqs: 853 Copley Rd., Akron, Ohio 44320. (216) 535-7831.

Group W—See Westinghouse Broadcasting Co.

Gulf Central Radio Network—Stns: 3 AM, 3 FM. WMPA(AM)-WHAY(FM) Aberdeen, WMBC(AM)-WJWF(FM) Columbus and WFOR(AM)-WHER(FM) Hattiesburg, all Mississippi. Principal owner: J. W. Furr. Hqs: Box 707, Columbus, Miss. 39701.

H

Halker Group—Stns: 3 AM, 2 FM. WIKB(AM) Iron River and WJPD-AM-FM Ishpeming, both Michigan; WATW-AM-FM Ashland, Wis. (All 100% owned.) Ownership: Eugene A. Halker, 100%. Hqs: Box 269, Ashland, Wis. 54806. (715) 682-2727.

Hall Communications Inc.—Stns: 5 AM, 3 FM. WICH-AM-FM Norwich, Conn.; WNBH(AM) and WMYS(FM) New Bedford, Mass.; WUSJ(AM) Lockport, N.Y.; WBVP(AM)-WVKS(FM) Beaver Falls, Pa.; and WETE(AM) Knoxville, Tenn. Principal owners: Robert M. Hall, pres; Donald Laufer, exec VP, chief operating off. Hqs: 101 Park Ave., New York 10017.

Harris Enterprises—Stns: 5 AM, 5 FM. KFKA(FM) Greeley, Colo.; WJOL(AM)-WLLI-FM Joliet, Ill.; KBUR-AM-FM Burlington, Iowa; KIUL(AM) Garden City and KTOP-AM-FM Topeka, both Kansas; and KSEL-AM-FM Lubbock, Tex. Ownership: John P. Harris family. See also Newspaper Crossownership. Hqs: 300 W. 2d St., Hutchinson, Kan. 67501. (316) 662-0466.

Harriscorp Broadcasting Corp.—Stns: 2 AM, 6 TV. KFBB-TV Great Falls, KULR-TV Billings, both Montana; KTWO-AM-TV Casper, Wyo.; KBAK-TV Bakersfield, Calif.; WSNB-TV Chicago (50%); KGGM-TV Albuquerque (30%) and KVSF(AM) Santa Fe (30%), both New Mexico. Ownership: Burt I. Harris, Irving B. Harris and Donald P. Nathanson. CATV. Hqs: 10889 Wilshire Blvd. (Suite 1240), Los Angeles 90024. (213) 478-0118.

Paul Harron Stns—See Mid New York Bcstg Stns.

The Harte-Hanks Broadcasting Group—Stns: 2 TV. WTLV(TV) Jacksonville, Fla. and KENS-TV San Antonio, Tex. Executive: Wayne Keairl, pres. Ownership:

Group Ownership

The Harte-Hanks Broadcasting Group is a division of Harte-Hank Newspapers Inc. See also Newspaper Crossownership. Hqs: Box 269, San Antonio, Tex. 78281.

George C. and Wilda Gene Hatch Stns—Stns: 3 AM, 2 FM, 1 TV. KGEM(AM) Boise, Idaho; KGHL(AM)-KBMS(FM) Billings, Mont.; KALL-AM-FM and KUTV(TV) Salt Lake City. Principal owners: George C. and Wilda Gene Hatch. Hqs: 312 E. South Temple, Salt Lake City. 84111.

Hearst Stns—Stns: 4 AM, 3 FM, 3 TV. WBAL-AM-FM-TV Baltimore; WISN-AM-FM-TV Milwaukee; WTAE-AM-FM-TV Pittsburgh; WAPA San Juan, Puerto Rico; WBAL, WISN and WTAE licensed to Hearst Corp. WAPA licensed to Hearst Radio Inc. Hqs: 959 Eighth Ave., New York 10019.

Heart of the Black Hills Stns—Stns: 1 AM, 2 TV. KDSJ(AM) Deadwood, KDSJ-TV Lead and KRSD-TV Rapid City, all South Dakota. Eli and Harry Daniels, 50% each.

Heath Communications Inc.—Stns: 2 AM, 2 FM. WJMS(AM) and WIMM(FM) Ironwood, Mich.; and WJMT-AM-FM Merrill, Wis. (All 100% owned.) Ownership: Donald Roberts, 100%. Hqs: Route 2, Box 106 A, Lac du Flambeau, Wis. 54538. (715) 588-3852.

Hefel Broadcasting Corp.—Stns: 2 AM, 4 FM, 3 TV. WHYI(FM) Fort Lauderdale, Fla.; KPUA-TV Hilo, KGMB-AM-TV and KGMQ(FM) Honolulu and KMAU-TV Wailuku, all Hawaii; KEZK(FM) St. Louis; WKTQ(AM) and WSHH(FM) Pittsburgh. Principal owner: Cecil Hefel, pres. Hqs: 1534 Kapiolani Blvd., Honolulu 96814.

Horace Hirsch Stns—See Community Broadcasting Service Inc.

Oscar C. Hirsch Stns—Stns: 3 AM, 1 TV. KFVS-AM-TV Cape Girardeau and KFMO(AM) Flat River, all Missouri and WHCO(AM) Sparta, Ill. Hqs: 324 Broadway, Cape Girardeau, Mo. 63701.

Holt Bcstg System—Stns: 3 AM, 2 FM. WHSY-AM-FM Hattiesburg and WHNY(AM) McComb, all Mississippi; WHHY-AM-FM Montgomery, Ala. Charles W. Holt, pres & mgng dir; Robert N. Robinson, exec VP; Connie I. Holt. Hqs: Box 2178, Hattiesburg, Miss. 39401.

Hook Stns—Stns: 5 AM, 4 FM. WRAG(AM) (55%) and WAQT(FM) (100%) Carrollton, Ala.; WRUS(AM) and WAKQ(FM) Russellville, Ky. (55%); WSLG(AM) Donaldville (50%) and KRUS-AM-FM Ruston (50%), both Louisiana; WMAG(AM) and WQST(FM) Forest, Miss. (80%). Roth E. Hook and wife. CATV.

Horizons Communications Corp.—Stns: 3 AM, 2 FM, 3 TV. KRE-AM-FM Berkeley, Calif.; WALK-AM-FM Patchogue, and WRIV(AM) Riverhead, both New York; WXOW-TV La Crosse, WKOW-TV Madison and WAOW-TV Wausau, all Wisconsin. Principal owners: Edward W. Wood, Jerome R. Feniger Jr., William W. Mulvey, Tipton Huntley. Hqs: 444 Madison Ave., New York 10022. (212) 752-3840.

Hubbard Broadcasting Inc.—Stns: 3 AM, 2 FM, 3 TV. WGTO(AM) Cypress Gardens and WTOG(TV) St. Petersburg, both Florida; KSTP-AM-FM-TV St. Paul (Minneapolis); KOB-AM-FM-TV Albuquerque, N.M. Officers: Stanley E. Hubbard, chmn of the bd & chief exec off; Stanley S. Hubbard, pres & gen mgr; Gerald D. Deeney, VP & treas; Marvin L. Rosene, VP; Mary Ellen Hubbard, sec; Constance L. Sathre, asst sec; Sherry L. Sorenson, asst sec. Stockholders: Stanley E. Hubbard Trust, 62.8%; Stanley S. Hubbard Trust, 9.98%; Hubbard Foundation, 9.7%; Estate of Thomas E. & Vera S. Bragg, 17.62%; Pautette Fownes, 6.08%; Stanley S. Hubbard & family, 2.48%. Hqs: 3415 University Ave., St. Paul 55114.

Jim Hughes Stns—Stns: 3 AM. KPIN(AM) Casa Grande, Ariz. (51%); KGRO(AM) Pampa (100%) and KCAS(AM) Slaton (50%), both Texas. Hqs: c/o KGRO, Box 1779, Pampa, Tex. 79065.

I

Illinois Bcstg Co.—Stns: 2 AM, 2 FM. WSOY-AM-FM Decatur, Ill.; WLAP-AM-FM Lexington, Ky. Principal owners: F.M. Lindsay, Jr., pres; C.R. Griggs, exec VP. See also Newspaper Crossownership. Hqs: Box 2250, Decatur, Ill. 62526. (217) 877-5371.

Birney Ines Jr. Stns—Stns: 5 AM, 1 TV. WCBi(AM) (97%) and WCBi-TV (25%) Columbus, WELO(AM) Tupelo (72%), WNAG(AM) Grenada (97%).

Group Ownership

WONA(AM) Winona (20%), and WROX(AM) Clarksdale (100%), all Mississippi.

Ingstad Broadcasting Media—Stns: 7 AM, 4 FM, KKWB(FM) Breckenridge, KLOH-AM-FM Pipestone, KWAD(AM) and KKWS(FM) Wadena, all Minnesota; KXKL(AM) Grand Forks, KOVC(AM) Valley City and KBMW(AM) Wahpeton, all North Dakota; KGFX(AM) Pierre and KKLS-AM-FM Rapid City, both South Dakota. Principal owners: Mary Jean Ingstad, pres; Robert E. Ingstad Jr., VP; Thomas E. Ingstad, sec-treas. Hqs: Box 1197, Pierre, S.D. 57501.

J

Jefferson-Pilot Broadcasting Co.—Stns: 3 AM, 3 FM, 2 TV. KIMN-AM-FM Denver; WQXI(AM) Atlanta and WQXI-FM Smyrna, both Georgia; WBT-AM-FM, WBTV(TV) Charlotte, N.C.; and WWBT(TV) Richmond, Va. Ownership: Jefferson-Pilot Corp., 100%. Jefferson-Pilot Corp. also owns 100% of WBIG(AM) Greensboro, N.C. Charles Crutchfield, president, Jefferson-Pilot Broadcasting. Hqs: One Julian Price Place, Charlotte, N.C. 28208.

Myron Jones Stns—Stns: 4 AM, 3 FM, 1 TV. WHOT(AM) Campbell, WHOT-FM Youngstown, both Ohio; WEEP-AM-FM Pittsburgh, WJET-AM-FM-TV Erie and WTVI(AM) Titusville (50%), all Pennsylvania.

Journal Star Stns—Stns: 4 AM, 2 FM. KSSS(AM) Colorado Springs; WAZY-AM-FM Lafayette, Ind.; KBMY(AM) Billings, Mont.; and KNOX(AM) and KYTN(FM) Grand Forks, N.D. Ownership: Peoria Journal Star Inc., 100%. Executives: H.P. Slane, pres; F.P. Nugent, VP-gen mgr bcst division; T. Brown, Western regional mgr. See also Newspaper Crossownership. Hqs: 1 News Plaza, Peoria, Ill. 61601. (309) 688-2411.

Juniper Broadcasting Inc.—Stns: 6 AM, 1 FM. KGRL(AM)-KXIQ(FM) Bend, KGAL(AM) Lebanon, KTX(AM) Pendleton and KACI(AM) The Dalles, all Oregon. Ownership: Gary L. Capps, David N. Capps and Inland Radio Inc. Inland Radio Inc., licensee of KSRV(AM) Ontario, Ore. and KEEP(AM) Twin Falls, Idaho, is controlled by Gordon L. Capps (24.9%), David N. Capps (30.56%), Gary L. Capps (30.56%), et al. Hqs: Box 590, Bend, Ore. 97701. (503) 382-5611.

K

Kaiser Bcstg Stns—Stns: 1 AM, 7 TV. KBSC-TV Corona and KBHK-TV San Francisco, both California; WFLD-TV Chicago; WCAS(AM) and WLVI-TV Cambridge, Mass. (Boston); WKBD-TV Detroit; WKBS-TV Burlington, N.J. (Philadelphia); WUAB(TV) Lorain, Ohio (Cleveland). KBSC-TV and WCAS are owned by Kaiser Broadcasting Corp. KBHK-TV, WFLD-TV, WLVI-TV, WKBD-TV and WKBS-TV are 100% owned by Kaiser Broadcasting Co., a partnership of Kaiser Broadcasting Corp. (77.5%) and Field Communications Corp. (22.5%). WUAB is 36% owned by Kaiser Broadcasting Co. Ownership: Kaiser Broadcasting Corp. is a wholly owned subsidiary of Kaiser Industries Corp. Executives: Don B. Curran, pres; Herb Victor, exec VP; W. Martin Wingren, VP-administration & ctrlr. Hqs: One Hallidie Plaza, Seventh Floor, San Francisco 94102. (415) 885-3750.

Kansas State Network Inc.—Stns: 1 FM, 5 TV. KGLD(TV) Garden City, KCKT(TV) Great Bend, KARD(FM) and KARD-TV Wichita, all Kansas; KTVJ(TV) Joplin, Mo.; and KOMC(TV) McCook, Neb. (Oberlin, Kan.) Ownership: Estate of G.M. Brown, 6.18%; Charles L. Brown, 3.29%; and others. Executive: Frank Chappell, pres, bcstg division. CATV. Hqs: Box 333, Wichita, Kan. 67201. (316) 265-5631.

Kaye-Smith Radio—Stns: 5 AM, 4 FM. KCKN-AM-FM Kansas City, Kan.; WUBE-AM-FM Cincinnati; KXL-AM-FM Portland, Ore.; KJR(AM)-KISW(FM) Seattle and KJRB(AM) Spokane, both Washington. Ownership: Corporation owned 80% by Danny Kaye and 20% by Lester M. Smith. Hqs: Box 3010, Bellevue, Wash. 98809. (206) 455-0923.

Key Stns—Stns: 3 AM, 2 FM. KGMS(AM) Sacramento, KFAX(AM) San Francisco and KSFM(FM) Woodland, all California; KAGO(AM) and KAGM(FM) Kiamath Falls, Ore. Ownership: A.J. Krisik owns 25.4% of KFAX, 51.1% of KGMS and KSFM, 40.5% of KAGO and KAGM. Theodore J. Wolf owns 14.2% of KFAX, 29% of KGMS and KSFM, 25.5% of KAGO and KAGM. A. Judson Sturevant owns 15.2% of KFAX, 10% of KGMS and KSFM, and 10% of KAGO and KAGM. H.W. Dustin owns 6.5% of KFAX and 9% of KGMS and KSFM.

King Broadcasting Co.—Stns: 3 AM, 3 FM, 3 TV. KGW-AM-TV KINK(FM) Portland, Ore.; KING-AM-FM-

TV Seattle and KREM-AM-FM-TV Spokane, both Washington. Principal owners: Dorothy S. Bullitt, Harriet B. Rice, and Priscilla B. Collins. CATV. Hqs: 320 Aurora Ave. N., Seattle 98109. (206) 223-5000.

Kirk Broadcasting Inc.—Stns: 4 AM, 2 FM. (WGIG(AM)-WSBI-FM Brunswick (100%) and WGGA(AM) Gainesville (100%), both Georgia; KVOL(AM) Lafayette, La. (100%); and WTJS(AM)-WKIR(FM) Jackson, Tenn. (90%). Ownership: James L. Kirk II, 90%. Hqs: Box 707, Moultrie, Ga. 31768. (912) 985-5475.

Knight-Ridder Newspapers Inc.—See Group One Broadcasting Co.

Knight Quality Stns—Stns: 4 AM, 3 FM. WEIM(AM) Fitchburg, WSAR(AM) Fall River, WRSR(FM) Worcester, all Massachusetts; WGR-AM-FM Manchester and WHEB-AM-FM Portsmouth, both New Hampshire. Ownership: Norman Knight, 100%. Hqs: 390 Commonwealth Ave., Boston 02215.

Kuiper Stns—Stns: 4 AM, 3 FM. WFUR-AM-FM Grand Rapids (control), WKPR(AM) Kalamazoo, WDOV-AM-FM Dowagiac, WKJR-AM-FM Muskegon Heights, all Michigan. William and William E. Kuiper. Hqs: 399 Garfield Ave. S.W., Grand Rapids, Mich. 49504.

KWTX Broadcasting Co.—Stns: 1 AM, 1 FM, 1 TV. KWTX-AM-FM-TV Waco, Tex. Stockholders of KWTX also own KLFY-TV Lafayette, La.; KXII(TV) Ardmore, Okla.; KBTX-TV Bryan and KNAL(AM) Victoria, both Texas. Ownership: M.N. Bostick, the LBJ Co. (see listing), Ross Sams, estate of Hilton E. Howell. Hqs: Box 7528, Waco, Tex. 76710. (817) 776-1330.

L

Lackey Group—Stns: 3 AM, 3 FM. WRAJ-AM-FM Anna, Ill.; WSON(AM)-WKDO-FM Henderson and WHOP-AM-FM Hopkinsville, both Kentucky. F.E. Lackey and Donald Michel jointly own WRAJ; Hecht S. Lackey owns WSON and WKDO-FM; F.E. Lackey owns WHOP stns. Hqs: Box 418, Henderson, Ky. 42420.

La Gran Cadena—Stns: 3 AM, 3 FM, 1 TV. WORA-AM-FM-TV Mayaguez, WPRP-AM-FM Ponce and WQBS-AM-FM San Juan, all Puerto Rico. Hqs: Box 13427, Santurce, P.R. 00908.

Lamb Communications Inc.—Stns: 4 TV. KTVS(TV) Sterling, Colo.; KSTF(TV) Scottsbluff, Neb.; WICU-TV Erie, Pa.; and KYCU-TV Cheyenne, Wyo. (All 100% owned.) Executives: Edward Lamb, chmn of the bd; Arthur M. Ingram, pres; Bertram Ramlow, treas; LeRoy W. Sigler, corporate sec & gen counsel; Jame M. McCarthy, asst sec. Ownership: Lamb Enterprises Inc. 86%. CATV. Hqs: 600 Edward Lamb Bldg., Toledo, Ohio 43604. (419) 241-1254.

Landmark Communications Inc.—Stns: 1 AM, 1 FM, 2 TV. WTAR-AM-TV and WKEZ(FM) Norfolk, Va.; WPMY-TV Greensboro, N.C. (See also Newspaper Crossownership.) Executive: William A. Gietz, pres, bcstg division. Principal owner: Frank Batten, individually and as trustee. CATV.

Alf M. Landon Stns—Stns: 4 AM, 1 FM. KIIX(AM) and KTCL(FM) Fort Collins, Colo.; KEDD(AM) Dodge City, KSCB(AM) Liberal and WREN(AM) Topeka, all Kansas.

T.B. Lanford Stns—Stns: 4 AM, 2 FM, 4 TV. KKTV(TV) Colorado Springs-Pueblo (13.8%); WZST(AM) Leesburg (74%) and WYOU(AM) Tampa (74%), both Florida; KALB(AM), KSLI(FM) both 100% and KALB-TV Alexandria, La. (68%); WSLI(AM)-WJFR(FM) (11%) and WJTV(TV) Jackson, Miss. (13.8%); KCTV(TV) San Angelo, Tex. (100%). Hqs: 605-11 Washington St., Alexandria, La. 71301.

The LBJ Co.—Stns: 1 AM, 1 FM. KLBJ-AM-FM Austin, Tex. (100%); 29% of KWTX-AM-FM-TV Waco, which owns 50% of KBTX-TV Bryan, 75% of KNAL(AM) Victoria, all Texas; and 23% of KXII(TV) Ardmore, Okla. and of KLFY-TV Lafayette, La. Ownership: Mrs. Claudia T. Johnson, 49.3%; Lynda Bird Robb, 21.1%; Luci Baines Nugent, 21.1%. CATV. Hqs: Box 1209, Austin, Tex. 78767. (512) 474-6543.

Leake Television Inc.—Stns: 2 TV. KATV(TV) Little Rock, Ark.; KTUL-TV Tulsa, Okla. James C. Leake, principal owner, holds 80% interest in WSTE(TV) Fajardo, P.R. CATV: Cable TV Co., Ponca City, Okla. Hqs: Box 1887, Muskogee, Okla. 74401.

Lee Enterprises Inc.—Stns: 2 AM, 2 FM, 2 TV. WTAD(AM) and WOCY(FM) Quincy, Ill.; KGLD-AM-TV Mason City, Iowa; KEYC-AM-FM Mankato, Minn.; KHQA-TV Hannibal, Mo.-Quincy, Ill.; and WSAZ-TV

Huntington, W. Va. Lee Enterprises also owns 49.75% of *Lincoln (Neb.) Journal*, which in turn owns 48.86% of KFAB-AM-FM Omaha. Executives: Lloyd G. Schermer, pres; Lloyd D. Loers, VP broadcast divisions; James E. Burgess, VP nwsp ops; John Stenlar, VP of finance. (See also Newspaper Crossownership.) Broadcast divisions' hqs: 112 North Penn., Box 620, Mason City, Iowa 50401. Lee Enterprises Inc. hqs: 130 E. Second St., Davenport, Iowa 52801.

Liberty Communications Inc.—Stns: 2 TV. KEZI-TV Eugene and KVDO-TV Salem, both Oregon. CATV. Hqs: 2225 Coburg Road, Eugene, Ore. 97401. (503)343-3301.

LIN Broadcasting Corp.—Stns: 4 AM, 3 FM, 3 TV. WAND(TV) Decatur, Ill.; WIL-AM-FM St. Louis; WBBF(AM) and WBBF(FM) Rochester, N.Y.; WFIL(AM) Philadelphia; KXAS-TV Fort Worth and KILT-AM-FM Houston; and WAVY-TV Portsmouth, Va. Ownership: Publicly owned corporation. Executives: Donald A. Pels, pres/chmn; Morris Berkowitz, VP-finance & law; Philip D. Marella, VP-ops; Ron E. Graiff, dir of engrg; James DeCaro, VP; Dickie Rosenfeld, VP; Barrett Geoghegan, VP; David Ray, VP; Michael O'Sullivan, ctrlr. Firm is also engaged in the telephone answering and radio paging and communications business. Hqs: 1370 Avenue of the Americas, New York 100129. (212) 765-1902.

Linder Radio Group—Stns: 4 AM, 2 FM. KTOE(AM) Mankato, KMHL-AM-FM Marshall, KDMA(AM) Montevideo, KWLM(AM) and KOIC(FM) Willmar, all Minnesota. Ownership: Donald O. Linder, H. Willard Linder. Hqs: Box 838, Willmar, Minn. 56201. (612) 235-1340.

Pirallo Lopez Stns—Stns: 4 AM, 2 FM. WMIA(AM) Arecibo, WEYA(FM) Bayamon, WAEL-FM Maricao, WAEL(AM) Mayaguez, WISO(AM) Ponce and WRAI(AM) San Juan, all Puerto Rico. Carlos and Manuel Pirallo Lopez. Hqs: 74 Mayaguez St., San Juan, P.R. 00917.

Lotus Communications Corp.—Stns: 6 AM, 1 FM. KRUX(AM) Glendale (Phoenix) and KTKT(AM) Tucson, both Arizona; KOXR(AM) Oxnard, KWKW(AM) Pasadena (Los Angeles) and KFSD-FM San Diego, all California; KENO(AM) Las Vegas and KONE(AM) Reno. Executives: Howard A. Kalmenson, pres; Paul Hill, sec-treas & ctrlr. Hqs: 10850 Wilshire Blvd., Los Angeles 90024.

The Lyon Radio Stations—Stns: 3 AM. WRPL(AM) Charlotte, WKDX(AM) Hamlet and WADE(AM) Wadesboro, all North Carolina. (All 100% owned.) Principal owner: R.A. Lyon. Hqs: Drawer 886, Wadesboro, N.C. 28170. (704) 694-3969.

M

Maine Broadcasting System—Stns: 2 AM, 2 TV. WLZ-AM-TV Bangor and WCSH-AM-TV Portland, all Maine. Principal owners: Adeline B. Rines, Mary R. Thompson. Hqs: Congress Square, Portland, Me. 04101. (207) 772-0181.

Mairite Broadcasting Co.—Stns: 5 AM, 5 FM. WBRB-AM-FM Mount Clemens, Mich.; KEEY-AM-FM St. Paul; WNYR(AM) and WEZO(FM) Rochester, N.Y.; WHK(AM) and WMM5(FM) Cleveland; WZUU-AM-FM Milwaukee. Principal owner: Milton Maltz. Executives: Milton Maltz, pres; Carl Hirsch, VP; David Millan, VP; William Luchtman, VP; Charles Park Jr., VP; William Scarbrough, VP. Hqs: 5000 Euclid Ave., Cleveland 44103. (216)391-8565.

Manship Stns—Stns: 2 AM, 1 FM, 2 TV. WJBO-AM-FM and WBRZ(TV) Baton Rouge, and KRGV-AM-TV Westlake, Tex. Ownership: WJBO stations—D.L. Manship, 30.2%; C.P. Manship Jr., 35%. WBRZ—owned 96% by WJBO licensee. KRGV-TV—jointly owned by the Messrs. Manship. (See also Newspaper Crossownership.) Hqs: Box 2906, Baton Rouge 70821.

Mardikian-Farr-Snell Stns—See the Golden Pacific Group.

Mark Media Group—See J. Ardell Sink Stns.

Mathis Stns—Stns: 3 AM, 2 FM. WSJC-AM-FM Magee, WPCP-AM-FM Houston, WSAO Senatobia, and WXTN (AM) Lexington, all Mississippi. Ownership: Robin H., Ralph C., and Jeannette Mathis, J.B. Skelton Jr. Hqs: Box 426, Magee, Miss. 39111.

May Broadcasting Co.—Stns: 2 AM, 2 TV. KGUN-TV Tucson, Ariz. (100%); KMA(AM) Shenandoah, Iowa (100%); KFAB(AM)-KGOR(FM) and KMTV(TV) Omaha (AM-FM 48.4%, TV 100%). Ownership: May Bcstg Co. is a subsidiary of May Seed & Nursey Co. (Frances M. Rankin, 19.15%; Edward R. May, 9.29%).

WYLO(AM) Jackson, Wis. Ownership: Marvin B. Kosofsky, Howard Warshaw, Lawrence Brandon. Hqs: 310 Madison Ave., New York 10017. (212) 661-6096.

V

Vogel Communications—Stns: 6 AM, 5 FM. WULA-AM-FM Eufaula, WBLO(AM) Evergreen, WTCB(AM) Flomation, WHOD-AM-FM Jackson and WAMA(AM) Selma, all Alabama; WNOI(FM) Flora, Ill.; WIFN(FM) Franklin and WMPF(FM) Scottsboro, both Indiana; and WGSN(AM) Murfreesboro, Tenn. Principal owner: William R. Vogel. Hqs: Box 1439, Murfreesboro, Tenn. 37130.

W

The John Walton Stns—Stns: 5 AM, 2 FM, 2 TV. KIKX(AM) Tucson, Ariz.; KFOX(AM) Long Beach and KIDD(AM) Monterey, both California; KAVE-TV Carlsbad, N.M.; KDUW-AM-FM Amarillo, KLP-AM-TV El Paso and KBUY-FM Fort Worth, all Texas. Note: Walton group has sold KAVE-TV, KLP-TV and KBUY-FM, subject to FCC approval. Ownership: John B. Walton Jr., 100%. Hqs: c/o KLP, Box 12277, El Paso 79912.

Welcome Radio Inc.—Stns: 4 AM. KTLK(AM) Denver; KLNG(AM) Omaha; WOKO(AM) Albany, N.Y.; and WSLR(AM) Akron, Ohio. Executive: Harrison Fuerst, pres. Hqs: 369 S. Portage Path, Akron, Ohio 44320. (216) 535-6165.

Westinghouse Broadcasting Co. (Group W)—Stns: 7 AM, 2 FM, 5 TV. WJZ-TV Baltimore; WBZ-AM-FM-TV Boston; WIND(AM) Chicago; WOWO(AM) Fort Wayne, Ind.; KFWB(AM) Los Angeles; WINS(AM) New York; KYW-AM-TV Philadelphia; KDKA-AM-FM-TV Pittsburgh; and KPX(TV) San Francisco. Ownership: WBC is a wholly owned subsidiary of Westinghouse Electric Corp. Executives: Donald H. McGannon, chmn of the bd & pres; Marvin L. Shapiro, exec VP & pres-stn group; Win Baker, pres-TV stn group; Richard Harris, pres-radio stn group; Robert W. Baker, VP-ctrlr; John Burns, VP-urban affairs; Chet Collier, senior VP; Wallace Dunlap, VP-Washington; Cecil R. Forster Jr., VP-bus affairs; Robert Hoffman, VP-creative svcs; J.K. Mikita, senior VP; Richard Monroe, VP-engng; Pat Polillo, VP/exec news prod-TV stn group; James Yergin, VP-rsch; Jay Francis, dir of info svcs; David N. Lewis, mgr-adv & sls prom; Geraldine McKenna, dir of continuity acceptance; John D. Moran, dir of labor rel; George E. Moynihan, natl TV prog mgr; Joseph O. Schertler, mgr-pwr svcs; David E. Salzman, chmn-Group W Production; Jack Reilly, pres-Group W Productions; George Back, VP/gen sls mgr-Group W Productions. CATV: Clearview Cable TV, a unit of Westinghouse Broadcasting Co. based in Dublin, Ga., operates cable TV svcs in seven northern Florida and central Georgia cities, as well as a microwave service. Hqs: 90 Park Ave., New York 10016. (212) 983-6500.

WGN Continental Broadcasting Co.—Stns: 2 AM, 3 TV. WGN-AM-TV Chicago; KWGN-TV Denver; and KDAL-AM-TV Duluth, Minn. Also operates a TV production company through a division, WGN Continental Productions Co. Ownership: Tribune Co., Chicago, 100%. Interlocking ownership (Patterson families). News Syndicate Co. Inc. (*New York Daily News*) which owns WPIX Inc. (WPIX-FM-TV New York and WICC(AM) Bridgeport, Conn.) WGN Continental Broadcasting Co.: Daniel T. Pecaro, pres; Robert E. Henley, VP & gen mgr-radio; Sheldon Cooper, VP & gen mgr-TV; Donald H. Knautz, VP, asst to pres & dir of broadcast ops; Odin S. Ramsland, exec VP & gen mgr, KDAL stations; Robert A. Innes, VP & gen mgr, KWGN-TV. WPIX Inc.: Fred M. Thrower, bd chmn; Leavitt J. Pope, pres (WPIX Inc. Hqs: 220 E. 42d St., New York 10017). CATV: WGN Electronic Systems Co., a wholly owned subsidiary of WGN Continental Broadcasting Co., operates CATV systems in California and Michigan. Hqs (of WGN Continental Broadcasting Co.): 2501 Bradley Place, Chicago 60618. (312) 528-2311.

Arthur Wilkerson Stns—Stns: 3 AM, 1 FM. WLIL-AM-FM Lenoir City, WLK(AM) Newport and WLJ(AM) Shelbyville, all Tennessee. Ownership: Arthur Wilkerson, 100%. Hqs: Box 340, Lenoir City, Tenn. 37771. (615) 986-7536.

WKY Television System Inc.—See Gaylord Broadcasting Co.

Wometco Enterprises Inc.—Stns: 1 FM, 3 TV. WTJJ(TV) Miami; WLOS-FM-TV Asheville, N.C.; and KVOS-TV Bellingham, Wash. (Vancouver, B.C.). Executives: Mitchell Wolfson, pres; Richard F. Wolfson, exec VP; Louis Wolfson II, Van Myers, Stanley L. Stern, Arthur H. Hertz, senior VPs; William R. Brazzil, Michael

S. Brown, Charles Francis, Harold Funt, William Hess, Marvin J. Krantz, Jose A. Martinez, Ralph A. Renick, Cal B. Rosenbaum, Edward Stern, Phil de Tournillon, Gerald F. Whaley, VPs; Jack Mitchell, asst VP; H.B. House, treas; J. Bruce Irving, sec; Leon Thaler, asst treas. Ownership: Mitchell Wolfson, 11.17%; Mitchell Wolfson Jr., 10.4%; Frances Cary, 10.34%. CATV: Alert Cable TV Inc., Fort Benning, Ga.; Alert Cable TV of North Carolina Inc., Garner, Hillsborough, Selma and Smithfield, all North Carolina; Alert Cable TV of Oklahoma Inc., Pryor, Okla.; AuSable Communications Inc., Plattsburgh, N.Y.; Cable TV of Arcadiana Inc., Eunice, La.; Grand Bahama CATV Ltd., Freeport, Bahamas; Lafourche Communications Inc., Thibodaux, La.; Miami Communications Inc., Miami Beach, Fla.; Middlesex Cablevision Inc., East Brunswick, N.J.; Night 'N' Day TV Service Ltd., Freeport, Bahamas; Picayune Cablevision Inc., Picayune, Miss.; Plainfield Cablevision Inc., Plainfield, N.J.; St. Landry Cable TV Inc., Opelousas, La.; Sea TV Ltd., Freeport, Bahamas. Hqs: 306 N. Miami Ave., Miami 33138. (305) 374-6262.

W.D. Woodall Jr. Stations—Stns: 7 AM, 3 FM. WDSR(AM)-WTLD(FM) Lake City (33 1/3%), WPFA(AM) Pensacola (51%) and WMEN(AM) Tallahassee (40%), all Florida; WBBK(AM) Blakely (51%), WDWD-AM-FM Dawson (100%) and WWNS(AM)-WJCD(FM) Statesboro (28%), all Georgia; and WGSW(AM) Greenwood, S.C. (37 1/2%). Ownership: W.C. Woodall Jr. Hqs: c/o WDWD-AM-FM, Box 390, Dawson, Ga. 31742. (912) 995-5846.

J. W. Woodruff Jr. Stns—Stns: 2 AM, 2 FM, 1 TV.

Group Ownership, Crossownership

WRBL-AM-FM-TV Columbus (80%) and WGPC-AM-FM Albany (57.5%), both Georgia.

Woods Communication Corp.—Stns: 3 AM, 1 FM. WRUN-AM-FM Utica, N.Y.; WSSB(AM) Durham and WTOB(AM) Winston-Salem, both N.C. Ownership: John Woods, 33%; balance publicly held. Hqs: Box 5129, Winston-Salem, N.C. 27103. (919) 723-4353.

Wycom Corp.—Stns: 2 AM, 1 FM. KOJO(AM)-KIOZ(FM) Laramie and KWYO(AM) Sheridan, both Wyoming. Note: Wycom also has CP for new AM in Green River, Wyo. Ownership: William R. Sims, pres, 51%. Hqs: 409 S. Fourth St., Laramie, Wyo. 82070.

X

XYZ Television Inc.—Stns: 1 AM, 1 FM, 3 TV. KREX-AM-FM-TV Grand Junction, KREY-TV Montrose and KREZ-TV Durango, all Colorado. Ownership: Rex G. Howell, 51%; Carl Q. Anderson, 8%; Dr. J.H. Dornheggen, 8%; Forrester Realty Co., 14%. Hqs: Box 789, Grand Junction, Colo. 81501. (303) 242-5000.

Y

H. Calvin Young Stns—Stns: 3 AM, 1 FM. WENO(AM) Madison, Tenn.; WGUS(AM) North Augusta, S.C. and WGUS-FM Augusta, Ga.; WSHO(AM) New Orleans. Ownership: Mr. Young owns 100% of WENO, 84% of WGUS and 75% of WSHO.

Newspaper/Magazine Crossownership with Broadcasting Stations

The following companies have interests in both broadcasting and newspaper or magazine publishing. Minority interests are indicated where information is available. In many instances stations and publications are owned by the same interests, but operations are entirely separated. Accompanying this directory is a state-by-state cross-reference list of broadcasting stations and the publishing companies or newspapers with which they are associated.

The A.S. Abell Co.—Hqs: 6400 York Road, Baltimore 21212. The A.S. Abell Co., publisher of the *Baltimore Sunpapers*, owns 100% of WMAR-FM-TV Baltimore and WBOC-AM-FM-TV Salisbury, both Maryland.

Advance Broadcasting Corp.—Hqs: 220 First Ave. S., Wisconsin Rapids, Wis. 54494. Wisconsin Rapids Tribune Co., publisher of the *Wisconsin Rapids* (Wis.) *Tribune*, owns Advance Broadcasting Co., licensee of WFHR(AM) and WWRW(FM) Wisconsin Rapids, Wis. The *Wisconsin Rapids Tribune* also owns 18.24% of Forward Communications Corp. (see listing).

American Broadcasting Companies Inc.—Hqs: 1330 Avenue of the Americas, New York 10019. ABC Farm Publications, division of ABC Leisure Group I, American Broadcasting Companies Inc., publishes three bimonthly magazines: *Prairie Farmer*, *Wallaces Farmer* and *Wisconsin Agriculturist* and operates Homestead Book Co. ABC Leisure Magazines, division of ABC Leisure Group I, American Broadcasting Companies Inc., publishes two monthly magazines: *High Fidelity Magazine* and *Modern Photography*. Word Inc., Waco, Tex., division of ABC Leisure Group I, American Broadcasting Companies Inc., publishes *Faith at Work*, a monthly inspirational magazine for contemporary living. American Broadcasting Companies Inc. owns WLS-AM-TV and WDAI(FM) Chicago, WXYZ-AM-TV and WRIF(FM) Detroit, KXYZ(AM) and KAUM(FM) Houston, KABC-AM-TV and KLOS(FM) Los Angeles, WABC-AM-TV and WPLJ(FM) New York and KGO-AM-TV and KSFY(FM) San Francisco.

Anderson (S.C.) Independent and Mail—Hqs: 115 E. Market St., Anderson, S.C. Wilton E. Hall, publisher of the *Anderson (S.C.) Independent* (mornng/Sunday) and *Anderson (S.C.) Daily Mail* (evening), owns 100% of WAIM-AM-TV and WCAC(FM) Anderson, S.C.

Anniston (Ala.) Star—Harry Brandt Ayers and Elise Ayers Sauguinetti, who each holds a minority interest in the *Anniston Star*, each owns 40% of Anniston Broadcasting Co., licensee of WHMA-AM-FM-TV Anniston, Ala.

Asheboro Broadcasting Co.—Hqs: Box 309, Asheboro, N.C. 27203. Roy Cox Jr., owner of the *Asheboro (N.C.) Courier-Tribune*, is majority stockholder of Asheboro Broadcasting Co., licensee of

WGWR(AM) and WCSE(FM) Asheboro, N.C.

Aspen Broadcasting Co.—Hqs: Box 10910, Aspen, Colo. 81611. William R. Dunaway, publisher of weekly *Aspen Times* and weekly *Rifle Telegram*, is 50% owner of Aspen Broadcasting Co., licensee of KSNQ(AM) Aspen, Colo.

Badger Broadcasting Co.—Hqs: Box 99, Madison, Wis. 53701. The Capital Times Co., publisher of the *Madison (Wis.) Capital Times*, owns 100% of Badger Broadcasting Co., licensee of WIBA-AM-FM Madison, Wis.

Bar-B Broadcasting Inc.—Hqs: Box 1390, El Campo, Tex. 77437. Fred V. Barbee Jr., 40% owner of the weekly *El Campo (Tex.) Leader-News*, owns 40% of Bar-B Broadcasting Inc., licensee of KULP-AM-FM El Campo, Tex. A. Richard Elam Jr., 40% owner of the *Leader-News*, owns 40% of KULP-AM-FM, Charles C. Woodson Estate, 20% owner of the *Leader-News*, owns 20% of KULP-AM-FM.

Bartell Media Corp.—Hqs: 205 E. 42d St., New York 10017. Bartell Broadcasters is owned by Bartell Media Corp., publishers of, through Macfadden-Bartell Corp., *True Story*, *Photoplay*, *TV Radio Mirror*, *Sport*, *Motion Picture*, *True Confessions*, *True Romance*, *True Love*, and *True Experience*. Other trade publication is the *Discount Merchandiser*. Bartell is principally owned (38%) by Downe Communications, publisher of *Ladies Home Journal*, *Family Weekly* and *American Home* magazines. Stations: WDQR(FM) Detroit, WMJX(FM) Miami, WOKY(AM) Milwaukee, WADO(AM) New York (sold pending FCC approval), KSLQ(FM) St. Louis and KCBQ(AM) San Diego.

Beef Empire Stns—Hqs: Box 789, Norfolk, Neb. 68701. Huse Publishing Co., publisher of the *Norfolk (Neb.) Daily News*, owns 80% of KCOL-AM-FM Fort Collins, Colo. and is also associated with WJAG-AM-FM Norfolk, Neb.

Belo Broadcasting Corp.—Hqs: Communication Center, Dallas 75202. A.H. Belo Corp., publisher of the *Dallas Morning News*, owns KFDM-TV Beaumont and WFAA-AM-TV, KZEW(FM) Dallas, both Texas.

Bloomington Broadcasting Corp.—Hqs: 236 Greenwood Ave., Bloomington, Ill. 61701. Evergreen Communication Corp., which publishes the *Bloomington (Ill.) Pantagraph*, owns 66 2/3% of WJBC(AM)-WBNQ(FM) Bloomington and WROK(AM)-WZOK(FM) Rockford, both Illinois.

Crossownership

Bloomington Bcstg and WROK own Metro Radio WGBF(AM) Evansville, Ind.

Bonneville International Corp.—Hqs: 36 S. State St., Suite 2100, Salt Lake City 84111. Bonneville International Corp. is the broadcasting arm of the Mormon Church, which publishes the *Deseret News*. Stations: KBRT(AM) Avalon and KBIG(FM) Los Angeles, both California; WCLR(FM) Skokie, Ill.; KMBZ(AM) and KMBR(FM) Kansas City, Mo.; WRFM(FM) New York; KSL-AM-FM-TV Salt Lake City; KIRO-AM-TV and KSEA(FM) Seattle.

Booth American Co.—Hqs: 2300 Buhl Bldg., Detroit 48226. John L. Booth, president, personally owns 3% of Booth Newspapers Inc. (*Grand Rapids Press*, *Flint Journal*, *Muskegon Chronicle*, *Kalamazoo Gazette*, *Saginaw News*, *Bay City Times*, *Jackson Citizen-Patriot*, and *Ann Arbor News*, all Michigan) and 55.36% of the following stations: WIOU(AM), WKMO(FM) Kokomo and WJVA(AM), WRBR(FM) South Bend, both Indiana; WJLB(AM) and WMZK(FM) Detroit, WIBM(AM) and WHFI(FM) Jackson, WSGW(AM) and WIOG(FM) Saginaw, all Michigan; WABQ(AM), WXEN(FM) Cleveland and WTOD(AM), WKLR(FM) Toledo, both Ohio.

Brinkley (Ark.) Argus—Hqs: c/o Mason W. Clifton, KBRI-AM-FM, Box 711, Brinkley, Ark. 72021. Mason W. Clifton, owner of weekly *Brinkley Argus*, owns Tri-county Broadcasting Co., licensee of KBRI-AM-FM Brinkley, Ark.

The Brockway Co.—Hqs: 260 Washington St., Watertown, N.Y. 13601. The Brockway Co., publisher of the *Watertown (N.Y.) Daily Times*, is licensee of WWNY-TV Carthage, WMSA(AM) Massena and WWNY(AM) Watertown, all New York.

Bulletin Co.—Hqs: 440 Domino Lane, Philadelphia 19128. Bulletin Co. publishes the *Philadelphia Bulletin*, and the *Santa Barbara (Calif.) News-Press*. Stations: KTMS-AM-FM Santa Barbara, Calif.; WPBS(FM) Philadelphia.

California-Oregon Broadcasting Inc.—Hqs: 2000 Crater Lake Hwy, Medford, Ore. 97501. John Voorhies of the *Grants Pass (Ore.) Courier* owns 19.614% of California-Oregon Broadcasting Inc. Stations: KRCR-TV Redding, Calif.; KAGI(AM) Grants Pass, KOTI(TV) Klamath Falls, KOBI(TV) Medford and KPIC(TV) Roseburg, all Oregon.

Capital Cities Communications Inc.—Hqs: 24 E. 51st St., New York 10022. Capital Cities Communications Inc., is owner of Fairchild Publications, which publishes *Women's Wear Daily*, *Home Furnishings Daily*, *Daily News Record*, *Footwear News*, *Supermarket News*, *Electronic News*, *American Metal Market*, *W*, all newspapers, and two magazines: *Men's Wear* and *MetalCenter News*. Capital also owns a book division and publishes three daily newspapers: *The Oakland Press*, Pontiac,

Mich., the *Belleville (Ill.) News-Democrat* and the *Star-Telegram* Fort Worth. Stations: KFSN-TV Fresno and KPOL-AM-FM Los Angeles, both California; WTNH-TV New Haven, Conn.; WJR-AM-FM Detroit; WPAT-AM-FM Paterson, N.J.; WROW-AM-FM Albany and WKBW-AM-TV Buffalo, both New York; WTVD(TV) Durham, N.C.; WPVI-TV Philadelphia; WPRO-AM-FM Providence, R.I.; WBAP(AM)-KSCS(FM) Fort Worth and KTRK-TV Houston.

Capitol Broadcasting Co.—Hqs: Box 8887, Jackson, Miss. 39204. Mississippi Publishers Corp. (*Jackson Clarion-Ledger* and *Daily News*) owns 40% of Capitol Broadcasting Co., licensee of WSLI(AM), WJFR(FM), WJTV(TV) Jackson, Miss. and owner of KKTV(TV) Colton Springs. T.B. Lanford, director, holds 13.8% interest in Capitol and holds controlling interests in WZST(AM) Leesburg and WYOU(AM) Tampa, both Florida; KALB-AM-TV and KSLI(FM) Alexandria, La.; and KCTV(TV) San Angelo, Tex.

CBS Inc.—Hqs: 51 W. 52d St., New York 10019. CBS Inc., through its CBS/Publishing Group, publishes six monthly special-interest magazines: *Field & Stream*, *Road & Track*, *World Tennis*, *Cycle World*, *Sea and PV4*. (Note: *Sea* is directed to boating enthusiasts and *PV4* is directed to pickup, van and 4-wheel enthusiasts.) CBS Inc., through its CBS/Broadcast Group, owns WEEL-AM-FM Boston, WBBM-AM-FM-TV Chicago, KNX-AM-FM/KNXT(TV) Los Angeles, WCBN-AM-FM-TV New York, WCAU-AM-FM-TV Philadelphia, KMOX-AM-FM-TV St. Louis and KCBS-AM-FM San Francisco.

Cedar Rapids Television Co.—Hqs: 2nd Ave. at 5th St. S.E., Cedar Rapids, Iowa 52406. The Gazette Co., publisher of the *Cedar Rapids (Iowa) Gazette*, owns 100% of KCRG-AM-TV Cedar Rapids, Iowa.

Central City-Greenville Broadcasting Co.—Hqs: Box 31, Central City, Ky. 42330. L.L. and A.E. Stone and R.G. Utley, publisher of weekly *Central City Messenger Times-Argus*, own Central City-Greenville Broadcasting Co., licensee of WMTA(AM) Central City, Ky.

Central West Virginia Service Corp.—Hqs: Box 431, Weston, W.Va. 26452. Richard H. Ralston, owner of the weekly *Buckhannon (W.Va.) Record*, owns 50% of Central West Virginia Service Corp., licensee of WHAW-AM-FM Weston, W.Va.

C & H Broadcasting Inc.—Hqs: Box 1440, Cherokee, Iowa 51012. J. Alan Cramer, owner of the weekly *Wayne (Iowa) Herald*, owns 75% of C & H Broadcasting Inc., licensee of KCHE(AM) Cherokee, Iowa.

Champaign News Gazette Inc.—Hqs: 48-52 Main St., Champaign, Ill. 61820. Owns *Champaign News-Gazette*. Stations: WDWB-AM-FM Champaign, Ill.

Channel Two Television Co.—Hqs: Box 2222, Houston 77001. *Houston Post* owned by same interest as KPRC Radio Co., licensee of KPRC(AM) Houston, and Channel Two Television Co., licensee of KPRC-

TV Houston and WTVF(TV) Nashville.

Channel 6 Inc.—Hqs: Box 188, Temple, Tex. 76501. Frank W. Mayborn, 100% owner of the *Sherman Democrat* and the *Temple Telegram*, both Texas, and principal owner of the *Killeen (Tex.) Herald*, also owns 100% of KCEN-TV Temple, Tex.

Channel 7 Corp.—Hqs: 27th & Douglas Sts., Omaha 68131. *Omaha World Herald* has same ownership as Channel 7 Corp., licensee of KETV(TV) Omaha.

Chronicle Broadcasting Co.—Hqs: 1001 Van Ness Ave., San Francisco 94119. Chronicle Broadcasting Co. is 100% owned by The Chronicle Publishing Co., publisher of the *San Francisco Chronicle*. Stations: KRON-FM-TV San Francisco and WQWT(TV) Omaha.

Chronicle Publishing Co.—See Chronicle Broadcasting Co.

Clay Communications Inc.—Hqs: 1001 Virginia St. E., Charleston, W.Va. 25301. Clay Communications Inc., publisher of the *Charleston (W.Va.) Daily Mail*, owns 80% of WWAY(TV) Wilmington, N.C. and 100% of KJAC-TV Port Arthur and KFDX-TV Wichita Falls, both Texas.

Clay County Broadcasters—Hqs: Residence B, Nyquist Circle, Green Cove Springs, Fla. 32043. James A. Wilson, publisher of weekly *Clay County Crescent*, owns Clay County Broadcasters, licensee of WKJ(FM) Green Cove Springs, Fla.

Clearwater Broadcasting Corp.—Hqs: 988 N. Broadway, Greenville, Miss. 38701. John T. Gibson and Hodding Carter Jr., owners of the *Delta Democrat-Times*, Greenville, Miss., are principals in Clearwater Broadcasting Co., licensee of WDDT(AM) Greenville, Miss.

Columbus (Miss.) Commercial Dispatch—Hqs: 516 Main St., Columbus, Miss. 39702. Birney Iles Jr., publisher of the *Columbus (Miss.) Commercial Dispatch*, owns WROX(AM) Clarksdale (100%), WCBI(AM) (97%) and WCBI-TV (25%) Columbus, WNAJ(AM) Grenada (97%), WELO-AM-FM Tupelo (72%) and WONA-AM-FM Winona (20%), all Mississippi.

Columbus (Ohio) Dispatch—Hqs: c/o WBNS-AM-FM-TV, 770 Twin Rivers Dr., Columbus, Ohio 43216. *Columbus (Ohio) Dispatch* has same ownership as WBNS-AM-FM-TV Columbus, Ohio and WLWI(TV) Indianapolis.

The Copley Press Inc.—Hqs: 7776 Ivanhoe Ave., La Jolla, Calif. 92037. Copley Press Inc. is publisher of *San Diego Union and Tribune*, *Alhambra Post-Advocate*, *Borrego Springs Sun*, *Burbank Daily Review*, *Culver City Evening Star-News*, *Glendal News-Press*, *Monrovia Daily News-Post*, *Torrance South Bay Daily Breeze*, *San Pedro News-Pilot*, *Sacramento Union*, *Westchester Star-News*, and *Venice Evening Vanguard*, all California; *Aurora Beacon-News*, *Elgin Courier-News*, *Juliet Herald-News*, *Springfield Illinois State Journal* and *State Register*, all Illinois. Station: KGU(AM) Honolulu.

Crossownership by Stations

Note: The following stations have, in some form, interlocking ownership with newspapers of magazine publishing companies. To use this list, find the desired station, then locate the indicated company or newspaper in the accompanying directory, "Newspaper/Magazine Crossownership, for details.

Alabama

WHMA-AM-FM-TV Anniston—*Anniston Star*.
WBCA(AM) and WWSM(FM) Bay Minette—Faulkner Radio Inc.
WAPI-AM-FM-TV Birmingham—Newhouse Newspapers
WBMG(TV) Birmingham—Park Broadcasting Inc.
WAAX(AM) and WQEN(FM) Gadsden—Southland Publishing Co.
WALA-TV Mobile—Evening News Association.
WMFC-AM-FM Monroeville—*Monroe Journal*.
WAOA Opelika and WFRI(FM) Auburn—Faulkner Radio Inc.

Arizona

KPHO-TV Phoenix—Meredith Corp.
KOLD-TV Tucson—Evening News Association.

Arkansas

KBRI-AM-FM Brinkley—*Brinkley Argus*.

KAMD(AM) and KWEH(FM) Camden—WEHCO Media Inc.

KTVE(TV) El Dorado-Monroe, La.—Gray Communications Systems Inc.

KFSA(AM) Fort Smith—Donrey Media Group.

KXAR(AM) Hope—*Hope Star*.

KAAY(AM) Little Rock—Multimedia Inc.

KXLR(AM) North Little Rock—The Starr Broadcasting Group Inc.

KBRN(AM) Springdale—Donrey Media Group.

California

KBRT(AM) Avalon—Bonneville International Corp.

KERO-TV Bakersfield—McGraw-Hill Bcstg Co.

KFSN-TV Fresno—Capital Cities Communications Inc.

KMJ-AM-FM-TV Fresno—McClatchy Newspapers.

KABC-AM-TV and KLOS(FM) Los Angeles—American Broadcasting Companies Inc.

KBIG(FM) Los Angeles—Bonneville International Corp.

KFI(AM) Los Angeles—Cox Broadcasting Corp.

KNX-AM-FM/KNXT(TV) Los Angeles—CBS Inc.

KPOL-AM-FM Los Angeles—Capital Cities Communications Inc.

KBEE-AM-FM Modesto—McClatchy Newspapers.

KABI(AM) Oakland—The Starr Broadcasting Group Inc.

KTVU(TV) Oakland—Cox Broadcasting Corp.

KORV(AM) Oroville—Oroville Radio Inc.

KRCR-TV Redding—California-Oregon Broadcasting Inc.

KFBK-AM-FM Sacramento—McClatchy Newspapers.

KCBQ(AM) San Diego—Bartell Media Corp.

KFMB-AM-FM-TV San Diego—Midwest Television Inc.

KGTV(TV) San Diego—McGraw-Hill Bcstg Co.

KABL-FM San Francisco—The Starr Broadcasting Group Inc.

KBHK-TV San Francisco—Kaiser Broadcasting Co.

KCBS-AM-FM San Francisco—CBS Inc.

KGO-AM-TV and KSFJ(FM) San Francisco—American Broadcasting Companies Inc.

KRON-FM-TV San Francisco—Chronicle Broadcasting Co.

KTIM-AM-FM San Rafael—Marin Broadcasting Co.

KTMS-AM-FM Santa Barbara—Bulletin Co.

KSCO-AM-FM Santa Cruz—Radio Santa Cruz.

KSRO(AM) Santa Rosa—Finley Broadcasting Co.

KOVR(TV) Stockton/Sacramento—McClatchy Newspapers.

Colorado

KSNO(AM) Aspen—Aspen Broadcasting Co.

KKTV(TV) Colorado Springs—Capitol Broadcasting Co.

KSSS(AM) Colorado Springs—Peoria Journal Star Inc.

KIMN-AM-FM Denver—Jefferson-Pilot Corp.

KLZ-AM-FM Denver—Knight-Ridder Newspapers Inc.

KMGH-TV Denver—McGraw-Hill Bcstg Co.

KWGN-TV Denver—WGN Continental Broadcasting Co.

KCOL-AM-FM Fort Collins—Beef Empire Stns.

Corbin (Ky.) Times-Tribune—Hqs: Corbin Times-Tribune Inc., Corbin, Ky. 40701. Corbin Times-Tribune Inc., publisher of the *Corbin Times-Tribune*, is licensee of WCTT-AM-FM Corbin, Ky.

Cowles Communications Inc.—Hqs: 488 Madison Ave., New York 10022. The company's principal investment is its ownership of approximately 23% of the outstanding common stock of The New York Times Co. Stations: WESH-TV Daytona Beach, Fla.; and KCCTV-TV Des Moines, Iowa.

Cox Broadcasting Corp.—Hqs: 1601 W. Peachtree St. N.E., Atlanta 30309. Principal owners of Cox Broadcasting Corp., also control *Atlanta Journal and Constitution*; *Dayton News and Journal-Herald*; and *Springfield News and Sun*, all Ohio, and *Miami News, Palm Beach Daily News, West Palm Beach Post and Times, Palm Beach Life, Boynton Beach News-Journal and Delray Beach News Journal*, all Florida. The publishing division of Cox Broadcasting Corp. publishes *Electronic Products Magazine, Electronic Engineers Master, Off-The-Shelf, Office Products News, Office World News, Black Book Used Car Guide, Black Book Used Truck Guide, Industrial Machinery News, Floor Covering Weekly, Amphoto* (Photographic Books), retirement advisory services, college placement manuals and career magazines. Stations: WSB-AM-FM-TV Atlanta; WHIO-AM-FM-TV Dayton, Ohio; WSOC-AM-FM-TV Charlotte, N.C.; WIOD(AM) and WAIA(FM) Miami; WIIC-TV Pittsburgh; KTVU(TV) Oakland-San Francisco and KFI(AM) Los Angeles.

Cox Newspapers—See Cox Broadcasting Corp.

Cumberland Valley Broadcasting Co.—Hqs: Box 759, McMinnville, Tenn. 37110. James W.R. White, publisher of the semi-weekly *McMinnville (Tenn.) Southern Standard* and weekly *Smithville (Tenn.) Review*, and family hold majority ownership in Cumberland Valley Broadcasting Co., licensee of WBCM-AM-FM McMinnville, Tenn.

Daily News Broadcasting Co.—Hqs: Box 930, Bowling Green, Ky. 42101. Owners of the *Park City Daily News*, Bowling Green, Ky., also control Daily News Broadcasting Co., licensee of WKCT(AM) and WDNS(FM) Bowling Green, Ky.

Daily Telegraph Printing Co.—Hqs: Box 208, Bluefield, W.Va. 24701. Daily Telegraph Printing Co., publisher of the *Bluefield (W.Va.) Daily Telegraph*, is licensee of WBTW(TV) Florence, S.C. and WHIS-AM-FM-TV Bluefield, W.Va.

Dakota-North Plains Corp.—Hqs: c/o L.T. Lauston, 1216 S. Main St., Aberdeen, S.D. 57401. Dakota-North Plains Corp., a diversified printing company which publishes *Dakota Farmer* magazine as well as doing commercial printing and selling books and insurance, is licensee of KKA(AM) and KQAA(FM) Aberdeen, S.D.

The Dispatch Broadcasting Co.—Hqs: Box 746, Chester, S.C. 29706. Joe S. and Fred O. Sink, who own

the *Lexington (N.C.) Dispatch*, own WPYB(AM) Benson, N.C.; WGCD(AM) Chester and WBUG(AM) Ridgeland, both South Carolina.

Dix Stns—Hqs: c/o Wooster Republican Printing Co., 186 S. Hillcrest Dr., Wooster, Ohio 44691. Dix Newspapers: *Frankfort (Ky.) State Journal; Alliance Review; Ashland Times-Gazette; Defiance Crescent-News; Martins Ferry-Bellaire Times-Leader; Ravenna-Kent Record-Courier* and *Wooster Daily Record*, all Ohio. Interlocking ownership (R.E. Dix and family) with WWST-AM-FM Wooster, Ohio and WRAD-AM-FM Radford, Va.

The Dodge City Broadcasting Co.—Hqs: Box 1398, Dodge City, Kan. 67801. Juliet Denious and other stockholders, owners of the *Dodge City Daily Globe*, also own The Dodge City Broadcasting Co., licensee of KGNO-AM-FM Dodge City, Kan.

Donrey Media Group—Hqs: Donrey House, 920 Rogers Ave., Fort Smith, Ark. 72902. 1810 E. Sahara, Suite 201, Las Vegas 89105. Donrey Media Group, Donald W. Reynolds Sr., pres. which publishes *Boonville Democrat, Eureka Springs Times-Echo, Fort Smith Southwest Times Record, Rogers Daily News, Springdale News*, all Arkansas; *Ontario Daily Report, Pomona Progress-Bulletin, Red Bluff Daily News, Vallejo Times-Herald*, all California; *Hilo (Hawaii) Tribune-Herald, West Hawaii Today (Kaealakekua); Moberly (Mo.) Monitor-Index; Washington, Indiana Times-Herald; Carson City Nevada Appeal, Ely Daily Times, Las Vegas Review-Journal*, all Nevada; *Bartlesville Examiner-Enterprise, Blackwell Journal Tribune, Chickasha Daily Express, Frederick Daily Leader, Guthrie Daily Leader, Guymon Daily Herald, Henryetta Daily Free-Lance, Holdenville News, Okmulgee Times, Pauls Valley Daily Democrat, Pawhuska Journal-Capital, Wewoka Daily Times*, all Oklahoma; *Gainesville Daily Register, Sweetwater Reporter, Weatherford Democrat*, all Texas; *Aberdeen (Wash.) Daily World*. Stations: KFSA(AM) Fort Smith and KBRS(AM) Springdale, both Arkansas; KORK-AM-FM-TV Las Vegas; KOLO-AM-TV Reno; KGNS-TV Laredo, Tex.

Downe Communications Inc.—See Bartell Media Corp.

DuBois (Pa.) Courier-Express—Hqs: Long at High Sts., DuBois, Pa. 15801. Jason and the estate of S. and H.T. Gray, publishers of the *DuBois (Pa.) Courier-Express*, own Tri-County Broadcasting Co., licensee of WCED-AM-FM DuBois, Pa.

Durant Publishing Broadcasting Corp.—Hqs: Box 190, Durant, Okla. 74701. Durant Publishing Broadcasting Corp., publisher of the *Durant (Okla.) Democrat* (a daily newspaper) and the *Durant (Okla.) Weekly News*, is licensee of KSEO-AM-FM Durant, Okla.

Durham Radio Corp.—Hqs: Box 2126, Durham, N.C. 27702. Durham Herald Co., publisher of the *Durham (N.C.) Herald* (morning/Sunday) and *Durham (N.C.) Sun* (evening), owns 96.8% of Durham Radio Corp., licensee of WDNC(AM) and WDCG(FM)

Durham, N.C.

Easton (Pa.) Express—Hqs: c/o Easton Publishing Co., 30 N. Fourth St., Easton, Pa. 18042. Easton Publishing Co., publisher of the *The Express*, (Pa.) owns 100% of WEEX Inc., licensee of WEEX(AM) and WQQQ(FM) Easton, Pa.

Enterprise Publishing Co.—Hqs: 60 Main St., Brockton, Mass. 02403. Enterprise Publishing Co. (*Brockton Enterprise & Times*) is licensee of WBET-AM-FM Brockton, Mass.

Equitable Publishing Co.—Hqs: Box 1440, Lansdale, Pa. 19446. Equitable Publishing Co., publisher of the *North Penn Reporter*, Lansdale, Pa., is also licensee of WNPV(AM) Lansdale, Pa.

Evening News Association—Hqs: 615 Lafayette Blvd., Detroit 48231. Publishes the *Detroit News*, and owns Times Graphics Inc. and the Desert Sun Publishing Co. Stations: WALA-TV Mobile, Ala.; KOLD-TV Tucson, Ariz; WWJ-AM-FM-TV Detroit; WKY-TV Oklahoma City.

Evening Post Publishing Co.—Hqs: 134 Columbus St., Charleston, S.C. 29402. Evening Post Publishing Co., publisher of the Charleston, S.C. *News & Courier* and *Post*, owns 100% of KDBC-TV El Paso.

Evergreen Communications Corp.—See Bloomington Broadcasting Corp.

Fairchild Publications Inc.—See Capital Cities Communications Inc.

Faulkner Radio Inc.—Hqs: Box 569, Carrollton, Ga. 30117. James H. Faulkner, principal owner of Faulkner Radio Inc., owns 50% of weekly *The Baldwin (Ala.) Times, The Fairhope (Ala.) Courier* and *The Onlooker (Foley, Ala.)*. Faulkner Radio Inc. owns WBCA(AM) and WWSM(FM) Bay Minette, WAOA(AM) Opelika and WFRI(FM) Auburn, all Alabama; WLBB(AM), WBTR-FM Carrollton and WGAA(AM) Cedartown, both Georgia.

Field Enterprises Inc.—See Kaiser Broadcasting Co.

The Findlay Publishing Co.—Hqs: 101 1/2 W. Sandusky St., Findlay, Ohio 45840. The Findlay Publishing Co. publishes the *Findlay (Ohio) Courier*. Stations: The Findlay Publishing Co. owns 100% of WCSI-AM-FM Columbus, Ind.; WFIN(AM) and WHMQ(FM) Findlay, Ohio.

Finley Broadcasting Co.—Hqs: 627 College Ave., Box 1598, Santa Rosa, Calif. 95403. Evert B. Person, publisher and pres, and Ruth Finley Person, VP of *Santa Rosa Press Democrat*, are majority stockholders of Finley Broadcasting Co., licensee of KSRO(AM) Santa Rosa, Calif. KSRO is operated independently of newspaper.

Forum Communications Inc.—Hqs: Box 2466, Fargo, N.D. 58102. Forum Publishing Co., publisher of *The Fargo (N.D.) Forum*, owns WDAZ-TV Devils Lake and WDAY-AM-FM-TV Fargo, both North

KFKA(AM) Greeley—Harris Enterprises Inc.

Connecticut

WICC(AM) Bridgeport—WPX Inc.

WINE-AM-FM Brookfield—Home News Publishing Co.

WFSB-TV Hartford—Post-Newsweek Stations Inc.

WTNH-TV New Haven—Capital Cities Communications Inc.

WSTC(AM)-WYRS(FM) Stamford—Western Connecticut Broadcasting Co.

Delaware

WDEL(AM) and WSTW(FM) Wilmington—Steinman Stns.

District of Columbia

WGAY-FM Washington—Greater Media Inc.

WMAL-AM-FM-TV Washington—Washington Star Communications Inc.

WTOP-AM-TV Washington—Post-Newsweek Stations Inc.

Florida

WESH-TV Daytona Beach—Cowles Communications Inc.

WKKJ(FM) Green Cove Springs—Clay County Bcstrs.

WJXT(TV) Jacksonville—Post-Newsweek Stations Inc.

WZST(AM) Leesburg—Capitol Broadcasting Co.

WRGI(AM) Marco Island—Progressive Publishing Co.

WINZ-AM-FM Miami—Guy Gannett Broadcasting Services Inc.

WIOD(AM) and WAIA(FM) Miami—Cox Broadcasting Corp.

WMJX(FM) Miami—Bartell Media Corp.

WPLG(TV) Miami—Post-Newsweek Stations Inc.

WRGI-FM Naples—Progressive Publishing Co.

WDIZ(FM) Orlando—Shamrock Development Corp.

WJHG-TV Panama City—Gray Communications Systems Inc.

WFLA-AM-FM-TV Tampa—Media General Inc.

WTVT(TV) Tampa—Gaylord Publishing Co.

WYOU(AM) Tampa—Capitol Broadcasting Co.

WPTV(TV) West Palm Beach—Scripps-Howard Broadcasting Co.

Georgia

WALB-TV Albany—Gray Communications Systems Inc.

WGST(AM) Atlanta—Meredith Corp.

WQXI(AM) Atlanta—Jefferson-Pilot Corp.

WSB-AM-FM-TV Atlanta—Cox Broadcasting Corp.

WLBB(AM) and WBTR-FM Carrollton—Faulkner Radio Inc.

WGAA(AM) Cedartown—Faulkner Radio Inc.

WMAZ-AM-FM-TV Macon—Multimedia Inc.

WRNG(AM) North Atlanta—Southland Publishing Co.

WQXI-FM Smyrna—Jefferson-Pilot Corp.

WSFT(AM) Thomaston—Thomaston Broadcasting Co.

WTCQ(FM) Vidalia—Vidalia Broadcasting Co.

WVOP(AM) Vidalia—Vidalia Broadcasting Co.

Hawaii

KGU(AM) Honolulu—Copley Press Inc.

KHVO(TV) Hilo—The Starr Broadcasting Group Inc.

KITV(TV) Honolulu—The Starr Broadcasting Group Inc.

KOHO(AM) Honolulu—The Hawaii Times Ltd.

KMVI-AM-TV Wailuku—Maui Publishing Co.

Idaho

KGEM(AM) Boise—George C. and Wilda Gene Hatch Stns.

KBAR-AM-FM Burley—Leshner Newspapers Inc.

KVNI(AM) Coeur d'Alene—Scripps League Newspapers.

KIFI-TV Idaho Falls—The Post Co.

Illinois

WJBC(AM) and WBNQ(FM) Bloomington—Bloomington Broadcasting Corp.

WCIA(TV) Champaign—Midwest Television Inc.

WDWS-AM-FM Champaign—The Champaign News-Gazette Inc.

WBBM-AM-FM-TV Chicago—CBS Inc.

WFLD-TV Chicago—Kaiser Broadcasting Co.

WGN-AM-TV Chicago—WGN Continental Broadcasting Co.

Crossownership

Dakota; KABY-TV Aberdeen, KPRY-TV Pierre and KSFY-TV Sioux Falls, all South Dakota.

Forward Association Inc.—Hqs: 1700 Broadway, New York 10019. Forward Association Inc., a non-membership corporation which publishes the *Jewish Daily Forward*, is licensee of WEVD-AM-FM New York.

Forward Communications Corp.—Hqs: Box 1088, Wausau, Wis. 54401. Ownership of Forward Communications Corp. is as follows: R.H. Holding Co., 44.61%; *Wisconsin Rapids Tribune* WFHR(AM) and WWRW(FM) Wisconsin Rapids, Wis., 18.24%; Rhinelander Publishing Co., 11.17%; Merrill Publishing Co., 11.17%; and others. Stations: WRAU-TV Peoria, Ill.; KCAU-TV Sioux City, Iowa; KVGB-AM-FM Great Bend, Kan.; KOSA-TV Odessa, Tex.; WTRF(FM) and WTRF-TV Wheeling, W.Va.; WKAU-AM-FM Kaukauna, WMTV(TV) Madison, WSAU-AM-TV and WIFC(FM) Wausau, all Wisconsin.

Franklin (Ky.) Favorite—Hqs: The Franklin Favorite-WFKN Inc., 103 N. High St., Franklin, Ky. 42134. The Franklin Favorite-WFKN Inc. (semi-weekly *Franklin Favorite*) is licensee of WFKN(AM) Franklin, Ky.

Frontier Broadcasting Co.—Hqs: 1806 Capitol Ave., Cheyenne, Wyo. 82001. Lillian D. McCracken family and associates own 100% of Cheyenne Newspapers Inc. McCracken family also owns 25% or more of the following companies: Laramie Newspapers Inc., Laramie, Wyo.; Rawlins Newspapers Inc., Rawlins, Wyo.; Rock Springs Newspapers Inc., Rock Springs, Wyo.; and Big Horn Newspapers Inc., Worland, Wyo. Lillian D. McCracken family and associates also own a majority interest in Frontier Broadcasting Co., licensee of KFBC-AM-FM Cheyenne, Wyo.

Galesburg Broadcasting Co.—Hqs: 154 E. Simmons St., Galesburg, Ill. 61401. Galesburg Printing & Publishing Co., publisher of the *Galesburg* (Ill.) *Register-Mail*, owns 75% of WGIL(AM) and WAAG(FM) Galesburg, Ill.

Galesburg Printing & Publishing Co.—See Galesburg Broadcasting Co.

Guy Gannett Broadcasting Services Inc.—Hqs: 390 Congress St., Portland, Me. 04111. Guy Gannett Broadcasting Services is 100% owned by Guy Gannett Publishing Co., which publishes the *Augusta Kennebec Journal*, *Portland Express*, *Portland Press Herald* and the *Waterville Sentinel*, all Maine. Stations: WINZ-AM-FM Miami; WGAN-AM-FM-TV Portland, Me.; and WHYN-AM-FM-TV Springfield, Mass.

Gannett Co.—Hqs: 55 Exchange St., Rochester, N.Y. 14614. Gannett Co. is publisher of the *San Bernardino Evening Telegram* and *San Bernardino Sun*, both California; *Cocoa Today*, *Fort Myers News-Press*, *Melbourne*

Times, *Pensacola Journal*, *Pensacola News* and *Titusville Star-Advocate*, all Florida; *Pacific Daily News* and *Pacific Dateline*, both Guam; *Honolulu Star-Bulletin*; *Boise* (Idaho) *Statesman*; *Danville Commercial-News*, *Rockford Morning Star* and *Rockford Register-Republic*, all Illinois; *Lafayette Journal and Courier* and *Marion Chronicle-Tribune*, both Indiana; *Battle Creek Enquirer and News*, *Lansing State Journal* and *Port Huron Times Herald*, all Michigan; *Bridgewater Courier-News* and *Camden Courier-Post*, both New Jersey; *Binghamton Evening Press*, *Binghamton Sun-Bulletin*, *Elmira Star-Gazette* (morning & evening), *Ithaca Journal*, *Niagara Falls Gazette*, *Rochester Democrat and Chronicle*, *Rochester Times-Union*, *Saratoga Springs Saratogian*, *Utica Daily Press*, *Utica Observer-Dispatch*, all New York; Westchester Rockland newspapers: *Mamaroneck* (N.Y.) *Daily Times*, *Mount Vernon* (N.Y.) *Daily Argus*, *New Rochelle* (N.Y.) *Standard Star*, *Nyack-Rockland* (N.Y.) *Journal-News*, *Port Chester* (N.Y.) *Daily Item*, *Tarrytown* (N.Y.) *Daily News*, *White Plains* (N.Y.) *Reporter Dispatch*, *Yonkers* (N.Y.) *Herald Statesman*, *Ossining* (N.Y.) *Citizen-Register*; *The Marietta* (Ohio) *Daily Times*; the *Oregon Statesman* and *Coolidge Journal*, both in Salem, Ore.; *Chambersburg* (Pa.) *Public Opinion*; and the *Valley News Dispatch*, *New Kensington-Tarentum*, Pa.; *Nashville Banner*; *El Paso Times*; *Burlington* (Vt.) *Free Press*; *Bellingham Herald* and *Olympia Daily Olympian*, both Washington; *Huntington Herald-Dispatch* and *Huntington Advertiser*, both West Virginia. Stations: WBRJ(AM) Marietta and WKFI(AM) Wilmington, both Ohio; WHEC-TV Rochester, N.Y.

Gateway Communications Inc.—Hqs: Suite 612-Executive Bldg., Cherry Hill, N.J. 08002. Bergen Evening Record Corp. (Malcolm A. Borg, chmn & pres), publisher of the *Bergen Evening Record* in Bergen county, N.J., owns 80% of Gateway Communications Inc., licensee of WBNG-TV Binghamton, N.Y.; WTAJ-TV Altoona and WLYH-TV Lancaster-Lebanon, both Pennsylvania; WOVK-TV Huntington, W. Va. **Gaylord Broadcasting Co.**—Hqs: Box 25125, Oklahoma City 73125. Oklahoma Publishing Co. (100% owner of Gaylord Broadcasting Co.) publishes the *Oklahoma City Oklahoman* and *Times*. Stations: WTVT(TV) Tampa, Fla.; KRKE(AM) Albuquerque, N.M.; WKY(AM) Oklahoma City; KTV(TV) Fort Worth and KHTV(TV) Houston; KSTW(TV) Tacoma, Wash.; and WVTV(TV) Milwaukee.

Gazette Printing Co.—Hqs: 1 South Parker Drive, Janesville, Wis. 53545. Gazette Printing Co., publisher of the *Janesville* (Wis.) *Gazette*, owns KJIV-AM-FM Huron, S.D.; WCLO(AM)-WJVL(FM) Janesville and WBKV-AM-FM West Bend, both Wisconsin.

Gibson County Broadcasting Co.—Hqs: 2606 East End Drive, Humboldt, Tenn. 38343. *The Humboldt* (Tenn.) *Courier Chronicle*, a weekly, has interlocking ownership with Gibson County Broadcasting Co., licensee of WIRJ-AM-FM Humboldt, Tenn.

Gray Communications Systems Inc.—Hqs: Box

3130, Albany, Ga. 31706. Gray Communications publishes, through Albany Herald Publishing Co., *The Albany* (Ga.) *Herald*. Stations: WALB-TV Albany, Ga.; WJHG-TV Panama City, Fla., and KTVE(TV) El Dorado, Ark. (Monroe, La.).

Great Lakes Television Co.—Hqs: 1220 Peach St., Erie, Pa. 16501. Principals of the *Erie* (Pa.) *Morning News* and the *Erie* (Pa.) *Times* (an evening newspaper) own 41.172% of Great Lakes Television Co., licensee of WSEE(TV) Erie, Pa.

Greater Media Inc.—Hqs: 96 Bayard St., New Brunswick, N.J. 08901. Joseph L. Rosenmiller Jr., chmn of the bd of Greater Media Inc., and Peter A. Bordes, pres of Greater Media, own 80% of Sentinel Publishing Co., publisher of weekly East Brunswick (N.J.) *Sentinel-Spokesman*. Greater Media Inc. owns WTCR(AM) Ashland, Ky.; WGAY(AM) Silver Spring, Md. and WGAY-FM Washington; WHNE(FM) Birmingham and WHND(AM) Monroe, both Michigan; WCTC(AM) and WQMR(FM) New Brunswick, N.J.; WGSM(AM) Huntington and WCTO(FM) Smithtown, both New York; WPEN(AM) and WMGK(FM) Philadelphia; and WHEZ(FM) Huntington, W.Va. (Note: Also see listing for WESO Broadcasting Corp.)

Greer (S.C.) Citizen—Hqs: Edd A. Burch, Box 70, Greer, S.C. 29651. Edd A. Burch, publisher of the weekly *Greer* (S.C.) *Citizen*, is also licensee of WEAB(AM) Greer, S.C.

Hammond Newspapers—Hqs: c/o Milton James Hammond, 404 North Ave., Millvale, Pa. 15209. Milton James Hammond, owner of Hammond Newspapers, Millvale, Pa. (weekly *Liberty Ledger* and *Valley Journal*), is licensee of WNUF(FM) New Kensington, Pa.

Hampton Roads Broadcasting Corp.—Hqs: Box 98, Newport News, Va. 23607. Daily Press Inc., publisher of the *Newport News* (Va.) *Daily Press* (morning/Sunday) and the *Newport News* (Va.) *Times-Herald* (evening), owns 100% of Hampton Roads Broadcasting Corp., licensee of WGH-AM-FM Newport News, Va.

Harris Enterprises Inc.—Hqs: 300 W. Second St., Hutchinson, Kan. 67501. Estates of John P. and Sidney Harris own *Garden City Telegram*, *Hays Daily News*, *Hutchinson News*, *Ottawa Herald*, *Chanute Tribune*, *Salina Journal*, *Olathe News*, all Kansas; *Burlington* (Iowa) *Hawkeye*, and *Camarillo* (Calif.) *News*. Stations: KFKA(AM) Greeley, Colo.; WJOL(AM) and WLLI-FM Joliet, Ill.; KBUR(AM)-KGRS(FM) Burlington, Iowa; KIUL(AM) Garden City and KTOP-AM-FM Topeka, both Kansas; KSEL-AM-FM Lubbock, Tex.

Harte-Hanks Newspapers Inc.—Hqs: Box 269, San Antonio, Tex. 78291. Harte-Hanks owns the *Van/De Publishing Co.*, Orange County, Chula Vista Group, San Diego, San Diego Group, San Diego, and *San Francisco Progress*, all California; *South Middlesex Daily News*, Framingham, Mass.; *The Press*, Ypsilanti,

Crossownership by Station (cont.)

WJPC(AM) Chicago—Johnson Publishing Co.
WLS-AM-TV and WDAI(FM) Chicago—American Broadcasting Companies Inc.

WSOY-AM-FM Decatur—Illinois Broadcasting Co.
WCRA-AM-FM Effingham—McNaughton Stns.
WRMN(AM) and WJKL(FM) Elgin—McNaughton Stns.

WFRL-AM-FM Freeport—Triad Stations Inc.
WGIL(AM) and WAAG(FM) Galesburg—Galesburg Broadcasting Co.

WLDS(AM) and WEAI(FM) Jacksonville—Jacksonville Radio & Television Broadcasting Corp.
WJOL(AM)-WLLI-FM Joliet—Harris Enterprises Inc.

WKEI(AM) and WJRE(FM) Kewanee—McNaughton Stns.

WLPO-AM-FM La Salle—La Salle County Broadcasting Corp.

WKAI-AM-FM Macomb—WKAI Broadcasting Co.
WMBD-AM-FM-TV Peoria—Midwest Television Inc.
WRAU-TV Peoria—Forward Communications Corp.
WGEM-AM-FM-TV Quincy—Quincy Broadcasting Co.

WTAD(AM) and WQCY(FM) Quincy—Lee Enterprises Inc.

WROK(AM) and WZOK(FM) Rockford—Bloomington Broadcasting Corp.

WCLR(FM) Skokie—Bonneville International Corp.
WPGU(FM) Urbana—Illini Publishing Co.

WKRS(AM) Waukegan—News-Sun Broadcasting Co.

Indiana

WCSI-AM-FM Columbus—Findlay Publishing Co.

WCNB-AM-FM Connersville—News Examiner Co.

WSJV(TV) Elkhart—Truth Publishing Co.

WTRC(AM) and WYEF(FM) Elkhart—Truth Radio Corp.

WGBF(AM) Evansville—Evergreen Communications Corp.

WGL(AM) Fort Wayne—News-Sentinel Broadcasting Co.

WMEE(AM) and WMEF(FM) Fort Wayne—Truth Radio Co.

WRTV(TV) Indianapolis—McGraw-Hill Bcstg Co.

WLWI(TV) Indianapolis—Columbus (Ohio) *Dispatch*.

WIOU(AM) and WKMO(FM) Kokomo—Booth American Co.

WAZY-AM-FM Lafayette—Peoria Journal Star Inc.

WJVA(AM) and WYBR(FM) South Bend—Booth American Co.

WBSB-AM-TV and WWJY(FM) South Bend—*South Bend* (Ind.) *Tribune*.

WRSW-AM-FM Warsaw—Reub Williams & Sons Inc.

Iowa

KBUR(AM) Burlington—Harris Enterprises Inc.

KGRS(FM) Burlington—Harris Enterprises Inc.

KCRG-AM-TV Cedar Rapids—Cedar Rapids Television Co.

KCHE(AM) Cherokee—C & H Broadcasting Inc.

KRNT(AM) and KRNQ(FM) Des Moines—Stauffer Publications Inc.

KCCI-TV Des Moines—Cowles Communications Inc.

KDTH(AM) and KFMD(FM) Dubuque—Telegraph-Herald Inc.

KFJB-AM-FM Marshalltown—Marshall Electric Co.

KGLO-AM-TV Mason City—Lee Enterprises Inc.

KBIZ(AM) Ottumwa—The Post Corp.

KCAU-TV Sioux City—Forward Communications Corp.

Kansas

KSOK(AM) Arkansas City—Stauffer Publications Inc.

KGGF(AM) Coffeyville—Seaton Stns.

KGNO-AM-FM Dodge City—Dodge City Broadcasting Co.

KUDL(AM) Fairway and KUDL-FM Kansas City—The Starr Broadcasting Group Inc.

KIUL(AM) Garden City—Harris Enterprises Inc.

KVGB-AM-FM Great Bend—Forward Communications Corp.

KMAN(AM) and KMKF(FM) Manhattan—Seaton Stns.

KNEX-AM-FM McPherson—McPherson Broadcasting Inc.

KOAM-TV Pittsburg—Mid-Continent Telecasting Inc.

KTOP-AM-FM Topeka—Harris Enterprises Inc.

WIBW-AM-FM-TV Topeka—Stauffer Publications Inc.

Crossownership

Mich.; *The Daily Times*, Woodbury, N.J.; *The Journal News*, Hamilton, Ohio; *Anderson (S.C.) Independent and Daily Mail*; *Yakima (Wash.) Herald Republic*; and the following newspapers in Texas: *The Abilene Reporter-News*; *Big Spring Herald*; *The Eagle*, Bryan-College Station; *The Commerce Journal*; *The Corpus Christi Caller-Times*; *Corsicana Daily Sun*; *The Denison Herald*; *The Herald Banner*, Greenville; *The Huntsville Item*; *Marshall News Messenger*; *The Paris News*; *San Angelo Standard-Times*. Stations: WTLV(TV) Jacksonville, Fla. and KENS-TV San Antonio, Tex.

George C. and Wilda Gene Hatch Stns.—Hqs: 312 East South Temple, Salt Lake City 84111. The Standard Corp., publisher of the *Ogden (Utah) Standard-Examiner*, owns 80% of KUTV(TV) Salt Lake City. *Ogden Standard-Examiner* is owned by Glasmann family, which also has interests as follows: Mr. and Mrs. George C. Hatch (Mrs. Hatch is Mr. Glasmann's daughter) own KGEM(AM) Boise, Idaho; KGHL(AM)-KBMS(FM) Billings, Mont.; and KALL-AM-FM Salt Lake City.

The Hawaii Times Ltd.—Hqs: 916 Nuuanu Ave., Honolulu 96807. The Hawaii Times Ltd. publishes a daily newspaper, the evening *Hawaii Times*. The company also owns 50% of KOHO(AM) Honolulu.

The Hearst Corporation—Hqs: 959 8th Ave., New York 10019. Hearst Newspapers are *Baltimore (Md.) News-American*; *Albany Times-Union* and *Knickerbocker News Union-Star*, both New York; *Boston Herald-American*; *Los Angeles (Calif.) Herald-Examiner*; *San Antonio (Tex.) Light*; *San Francisco (Calif.) Sunday Examiner & Chronicle* (50%) *Seattle (Wash.) Post-Intelligencer*; and *Puck—The Comic Weekly* (newspaper supplement). Hearst magazines are *Cosmopolitan*, *Good Housekeeping*, *Harper's Bazaar*, *Town & Country*, *House Beautiful*, *Motor*, *Motor Boating and Sailing*, *Sports Afield*, *Popular Mechanics*, *Science Digest* and *American Druggist*. Hearst also owns Avon Books. Stations: WBAL-AM-FM-TV Baltimore; WISN-AM-FM-TV Milwaukee; WTAE-AM-FM-TV Pittsburgh; and WAPA(AM) San Juan, P.R.

Home News Publishing Co.—Hqs: 123 How Lane, New Brunswick, N.J. 08903. Home News Publishing Co. publishes the *New Brunswick (N.J.) Home News*. Home News Publishing Co. also owns WINE-AM-FM Brookfield, Conn.; and WKPT-AM-FM-TV Kingsport, Tenn.

Hope (Ark.) Star—Hqs: c/o Hope Broadcasting Co., Box K, Hope, Ark. 71801. A.H. Washburn, editor and publisher of *Hope Star*, owns 66 2/3% of KXAR(AM) Hope, Ark. The newspaper is operated independently of KXAR.

Huntingdon Broadcasters Inc.—Hqs: Box 404, Huntingdon, Pa. 16652. John H. Biddle, publisher of the *Huntingdon (Pa.) News*, is pres of Huntingdon Broadcasters Inc., licensee of WHUN-AM-FM Huntingdon, Pa.

Huse Publishing Co.—See Beef Empire Stns.

Illini Publishing Co.—Hqs: 620 E. John, Champaign, Ill. 61820. Illini Publishing Co. publishes the *Daily Illini*, a newspaper; *Technograph*, a magazine; and "Illio", a yearbook. Illini Publishing Co. also is licensee of WPGU(FM) Urbana, Ill.

Illinois Broadcasting Co.—Hqs: Box 2250, Decatur, Ill. 62526. Illinois Broadcasting Co. has similar ownership to Lindsay-Schaub Newspapers Inc., publisher of *Decatur Herald and Review*; *Champaign-Urbana Courier*, *Metro-East Journal* (East St. Louis), *Southern Illinoisian* (Carbondale) all Illinois; *Midland (Mich.) News*, and *Edwardsville Intelligencer* and semi-weekly *Venice Gondolier* and *New Port Richey Press*, all Florida. Illinois Broadcasting Co. owns WSOY-AM-FM Decatur, Ill. and WLAP-AM-FM Lexington, Ky. **Inquirer Printing Co.—Hqs:** Box 572, Bedford, Pa. 15522. Partners owning corporation which publishes the *Bedford (Pa.) Daily Gazette* also own Inquirer Printing Co., licensee of WBF(D) and WAKM(FM) Bedford, Pa.

International Broadcasting Corp.—Hqs: Box 1130, Shreveport, La. 71120. Times Publishing Co. Ltd. (publisher of *Shreveport (La.) Times*; same ownership as *Monroe (La.) World and News-Star*) owns 100% of the stock of International Broadcasting Corp., licensee of KWKH(AM) and KROK(FM) Shreveport, La.

Jackson Parish Broadcasters—Hqs: Box 550, Jonesboro, La. 71251. Ansley and Theodore Colvin, publishers of the weekly *Jackson Independent* in Jonesboro, La., own Jackson Parish Broadcasters, licensee of KTOC-AM-FM Jonesboro, La.

Jacksonville Radio & Television Broadcasting Corp.—Hqs: Box 477, Jacksonville, Ill. 62651. Jacksonville Journal Courier Co., publisher of the *Jacksonville Journal and Courier*, owns 100% of Jacksonville Radio & Television Broadcasting Corp., licensee of WLDS(AM) and WEAL(FM) Jacksonville, Ill.

Jefferson-Pilot Corp.—Hqs: Box 21008, Greensboro, N.C. 27420. Jefferson-Pilot Corp. publishes the *Clearwater (Fla.) Sun*; the *Altus (Okla.) Times-Democrat*; the *Beaumont Enterprise and Journal*, *The Laredo Times* and *The Texas City Daily Sun*, all Texas. The company also holds a minority interest in *The Galveston (Tex.) Daily News*. Jefferson-Pilot Corp. also owns KIMN-AM-FM Denver; WQX1(AM) Atlanta and WQX1-FM Smyrna, both Georgia; WBT-AM-FM, WBT(TV) Charlotte and WBIG(AM) Greensboro, both North Carolina; and WWBT(TV) Richmond, Va.

Johnson Publishing Co.—Hqs: 221 N. La Salle St., Chicago 60601. Johnson Publishing Co. publishes several black-oriented magazines, including *Ebony*, *Jet*, *Black Stars* and *Black World*. Johnson Publishing Co. also is licensee of WJPC(AM) Chicago.

Kaiser Broadcasting Co.—Hqs: 420 Taylor St., San Francisco 94102. Kaiser Broadcasting Co. is a co-partnership of Kaiser Broadcasting Corp. (77.5%) and

Field Enterprises Inc. (22.5%). Field Enterprises Inc., Chicago, publishes the *Chicago Sun Times* and *Daily News*. Stations: KBHK-TV San Francisco; WFLD-TV Chicago; WLVI-TV Cambridge, Mass.; WKBD-TV Detroit; WKBS-TV Burlington, N.J.

KFAB Broadcasting Co.—Hqs: 5010 Underwood Ave., Omaha 68132. Journal-Star Printing Co., printer of the *Lincoln (Neb.) Star and Journal*, owns 48.86% of the stock of KFAB Broadcasting Co., licensee of KFAB(AM) and KGOR(FM) Omaha. A minority interest in KFAB Broadcasting Co. is held by Lee Enterprises Inc. (see listing).

KFRU Inc.—Hqs: Box 718, Columbia, Mo. 65201. H.J. Waters Jr., owner of the *Columbia (Mo.) Daily Tribune*, controls KFRU Inc., licensee of KFRU(AM) Columbia, Mo.

KMIN Inc.—Hqs: Box 980, Grants, N.M. 87020. Grants Publishing Co., publisher of the *Grants (N.M.) Daily Beacon*, owns 51% of KMIN Inc., licensee of KMIN(AM) Grants, N.M.

Knight-Ridder Newspapers Inc.—Hqs: One Herald Plaza, Miami 33101. Knight-Ridder Newspapers are *Aberdeen (S.D.) American News*, *Akron (Ohio) Beacon Journal*, *Boca Raton (Fla.) News*, *Boulder (Colo.) Camera*, *Bradenton (Fla.) Herald*, *Charlotte (N.C.) News (evening)*, *Charlotte (N.C.) Observer (morning, Sunday)*, *Columbus (Ga.) Enquirer (morning)*, *Columbus (Ga.) Ledger (evening)*; *Columbus (Ga.) Ledger-Enquirer (Sunday)*, *Detroit Free Press*, *Duluth (Minn.) Herald (evening)*, *Duluth (Minn.) News Tribune (morning, Sunday)*, *Gary (Ind.) Post-Tribune*, *Grand Forks (N.D.) Herald*, *Lexington (Ky.) Herald (morning)*, *Lexington (Ky.) Leader (evening)*, *Lexington (Ky.) Herald-Leader (Sunday)*, *Long Beach (Calif.) Independent (morning)*, *Long Beach (Calif.) Press-Telegram (evening)*, *Long Beach (Calif.) Independent*, *Press-Telegram (Sunday)*, *Macon (Ga.) News (evening)*, *Macon (Ga.) Telegraph (morning)*, *Macon (Ga.) Telegraph & News (Sunday)*, *Miami Herald*, *New York Journal of Commerce*, *Niles (Mich.) Star*, *Pasadena (Calif.) Star-News*, *Philadelphia Inquirer (morning, Sunday)*, *Philadelphia Daily News (evening)*, *St. Paul Dispatch (evening)*, *St. Paul Pioneer Press (morning, Sunday)*, *San Jose (Calif.) Mercury (morning)*, *San Jose (Calif.) News (evening)*, *San Jose (Calif.) Mercury-News (Sunday)*, *Seattle Times*, *Tallahassee (Fla.) Democrat*, *Walla Walla (Wash.) Union-Bulletin*, *Wichita (Kan.) Beacon (evening)*, *Wichita (Kan.) Eagle (Morning)*, *Wichita (Kan.) Eagle & Beacon (Sunday)*. Newspapers published less than daily include the *Broward County (Fla.) Times*, the *Coral Gables (Fla.) Guide*, *Florida Keys Keynote*, *North Dade (Fla.) Journal*, and the *Union-Recorder*, Milledgeville, Ga. California papers published by Knight-Ridder are the *Buena Park News*, *Fullerton Independent*, *Hunting-*

Kentucky

WTCR(AM) Ashland—Greater Media Inc.
WKCT(AM) and WDNS(FM) Bowling Green—Daily News Broadcasting Co.

WMTA(AM) Central City—Central City-Greenville Broadcasting Co.

WCTT-AM-FM Corbin—Corbin (Ky.) *Times-Tribune*.

WPKN(AM) Franklin—Franklin (Ky.) *Favorite*.

WLAP-AM-FM Lexington—Illinois Broadcasting Co.

WTVQ-TV Lexington—The Starr Broadcasting Group Inc.

WAKY(AM) Louisville—Multimedia Inc.

WHAS-AM-TV and WNN(FM) Louisville—WHAS Inc.

WOMI(AM) and WBKR(FM) Owensboro—Owensboro Broadcasting Co.

WPSD-TV Paducah—Paducah Newspapers Inc.

Louisiana

KALB-AM-TV and KSLI(FM) Alexandria—Capitol Broadcasting Co.

WBRZ(TV) Baton Rouge—Manship Stns.

WFMF(FM) Baton Rouge—Manship Stns.

WJBO(AM) Baton Rouge—Manship Stns.

KTOC-AM-FM Jonesboro—Jackson Parish Broadcasters.

WBOK(AM) New Orleans—The Starr Broadcasting Group Inc.

KEEL(AM) and KMBQ(FM) Shreveport—Multimedia Inc.

KSLA-TV Shreveport—KSLA-TV Inc.

KWKH(AM) and KROK(FM) Shreveport—International Broadcasting Corp.

Maine

WGAN-AM-FM-TV Portland—Guy Gannett Broadcasting Services Inc.

Maryland

WBAL-AM-FM-TV Baltimore—The Hearst Corp.

WMAR-FM-TV Baltimore—The A. S. Abell Co.

WBOC-AM-FM-TV Salisbury—The A. S. Abell Co.

WGAY(AM) Silver Spring—Greater Media Inc.

Massachusetts

WEEI-AM-FM Boston—CBS Inc.

WBET-AM-FM Brockton—Enterprise Publishing Co.

WLVI-TV Cambridge—Kaiser Broadcasting Co.

WTEV(TV) New Bedford—Steinman Stns.

WHMP-AM-FM Northampton—Pioneer Valley Broadcasting Co.

WESO-AM-FM Southbridge—WESO Broadcasting Corp.

WHYN-AM-FM-TV Springfield—Guy Gannett Broadcasting Services Inc.

WTAG(AM) Worcester—Worcester Telegram and Gazette Inc.

Michigan

WALM(AM) Bay City—Triad Stations Inc.

WNEM-TV Bay City-Saginaw-Flint—Meredith Corp.

WHFB-AM-FM Benton Harbor—Palladium Publishing Co.

WHNE(FM) Birmingham—Greater Media Inc.

WDRQ(FM) Detroit—Bartell Media Corp.

WJLB(AM), WMZK(FM) Detroit—Booth American Co.

WJR-AM-FM Detroit—Capital Cities Communications Inc.

WKBD-TV Detroit—Kaiser Broadcasting Co.

WWJ-AM-FM-TV Detroit—Evening News Association.

WWWW(FM) Detroit—The Starr Broadcasting Group Inc.

WXYZ-AM-TV and WRIF(FM) Detroit—American Broadcasting Companies Inc.

WCUZ(AM) Grand Rapids—Truth Radio Corp.

WOTV(TV) Grand Rapids—Time Inc.

WIBM(AM) and WHFI(FM) Jackson—Booth American Co.

WLUC-TV Marquette—Post Corp.

WELL-FM Marshall—Triad Stations Inc.

WHND(AM) Monroe—Greater Media Inc.

WOAP-AM-FM Owosso—Owosso Broadcasting Co.

WSGW(AM) and WIOG(FM) Saginaw—Booth American Co.

Minnesota

KDAL-AM-TV Duluth—WGN Continental Broadcasting Co.

WEBC(AM) Duluth—Park Broadcasting Inc.

KEYC-FM-TV Mankato—Lee Enterprises Inc.

KNUJ-AM-FM New Ulm—KNUJ Inc.

KRSI(AM) and KFMX(FM) St. Louis Park—Park

Crossownership

ton Beach Independent, La Mirada Lamplighter and the Orange County News. Knight-Ridder owns 45% of Group One Broadcasting Co. Group One owns KJLZ-AM-FM Denver; WAKR-AM-TV, WAEZ(FM) Akron and WONE(AM) and WTUE(FM) Dayton, both Ohio; KBOX(AM) and KTLK(FM) Dallas.

KNUJ Inc.—Hqs: 510 1/2 Third St. North, New Ulm, Minn. 56073. *New Ulm Daily Journal, Fairmont Sentinel, Marshall Messenger, St. James Courier and Sleepy Eye Herald-Dispatch*, all Minnesota, are affiliated with KNUJ Inc., licensee of KNUJ-AM-FM New Ulm, Minn.

KSLA-TV Inc.—Hqs: Box 4812, Shreveport, La. 71104. *Journal Publishing Co. (Shreveport Journal)* owns 55% of KSLA-TV Inc., licensee of KSLA-TV Shreveport, La.

KVSO Broadcasting Co.—Hqs: Box 429, Ardmore, Okla. 73401. *Ardmore (Okla.) Ardmoreite* has same ownership as KVSO Broadcasting Co., licensee of KVSO(AM) Ardmore, Okla.

Lancaster Newspapers Inc.—See Steinman Stns. **Landmark Communications Inc.**—Hqs: c/o WTAR Radio-TV Corp., 720 Boush St., Norfolk, Va. 23510. *Landmark Communications Inc.* is publisher of the *Greensboro (N.C.) Daily News and Record*; the *Norfolk Ledger-Star* and *Virginian-Pilot*; and *Roanoke Times and World-News*, all Virginia. Stations: WFMV-TV Greensboro, N.C. and WTAR-AM-TV, WKEZ(FM) Norfolk, Va.

La Salle County Broadcasting Corp.—Hqs: Box 215, La Salle, Ill. 61301. *The Daily News-Tribune Inc.*, publisher of the *Daily News-Tribune*, owns La Salle County Broadcasting Corp., licensee of WLPO-AM-FM La Salle, Ill.

Lee Enterprises Inc.—Hqs: 130 E. Second St., Davenport, Iowa 52801. *Lee Enterprises Inc.* publishes the *Globe-Gazette*, *Mason City, Muscatine Journal*, *Muscatine*, and *Ottumwa Courier*, Ottumwa, all Iowa; *The Billings Gazette*, *Billings*, *The Montana Standard*, *Butte*, *The Independent Record*, *Helena*, and *The Missoulian*, *Missoula*, all Montana; *The Lincoln Star*, *Lincoln*, Neb.; *Corvallis Gazette-Times*, *Corvallis*, Ore.; *La Crosse Tribune*, *La Crosse*, *Wisconsin State Journal*, *Madison*, and *The Racine Journal-Times*, *Racine*, all Wisconsin. *Lee Enterprises* partially owns *The Star-Courier*, *Kewanee*, Ill. and *Quad-City Times*, *Davenport*, Iowa. Stations: WTAD(AM)-WQCY(FM) Quincy, Ill.; KGLQ-AM-TV *Mason City*, Iowa; KEYC-FM-TV *Mankato*, Minn.; KHQA-TV *Hannibal*, Mo.-Quincy, Ill.; and WSAZ-TV *Huntington*, W.Va. *Lee Enterprises* also owns 49.75% of *Lincoln (Neb.) Journal*, which in turn owns 48.86% of *KFAB(AM)* and *KGOR(FM)* *Omaha*.

Leshner Newspapers Inc.—Hqs: 3033 North G St., Merced, Calif. 95340. *Leshner Newspapers Inc.* publishes the *Merced (Calif.) Sun-Star*. *Dean S. Leshner* and *Stanley Leshner II*, owners of the newspaper, also own 70% of *KBAR-AM-FM* *Burley*, Idaho.

Lindsay-Schaub Newspapers Inc.—See Illinois Broadcasting Co. and *Midwest Television Inc.* **Manish Stns**—Hqs: 1650 Highland Rd., Baton Rouge 70821. *Baton Rouge Advocate* and *State-Times* have same ownership as *WJBO(AM)-WFMF(FM)* and *WBRZ(TV)* *Baton Rouge*; and *KRGV-AM-TV* *Weslaco*, Tex.

Marin Broadcasting Co.—Hqs: 1040 B St., San Rafael, Calif. 94901. *Marin Broadcasting Co.* is 100% owned by stockholders of *San Rafael Independent Journal*. Stations: *KTIM-AM-FM* *San Rafael*, Calif.

Marshall Electric Co.—Hqs: 133 E. Main St., Marshalltown, Iowa 50158. *Marshalltown (Iowa) Times-Republican* owns 100% of *Marshall Electric Co.*, licensee of *KFJB-AM-FM* *Marshalltown*, Iowa.

Maul Publishing Co.—Hqs: Box 550, Wailuku, Hawaii 96793. *Maul Publishing Co.* publishes the *Mauli (Hawaii) News*, a tri-weekly. *Maul Publishing Co.* also is licensee of *KMVI-AM-TV* *Wailuku*.

McClatchy Newspapers—Hqs: 21st & Q, Sacramento, Calif. 95816. *McClatchy Newspapers* owns the *Fresno Bee*, *Modesto Bee* and *Sacramento Bee*, all California. Stations: *KMJ-AM-FM-TV* *Fresno*, *KBEE-AM-FM* *Modesto*, *KFBK-AM-FM* *Sacramento*, and *KOVR(TV)* *Stockton*, all California, *KOH(AM)* *Reno*.

McGraw-Hill Broadcasting Co.—Hqs: 1221 Ave. of the Americas, New York 10020. *McGraw-Hill Inc.*, 100% owner of *McGraw-Hill Broadcasting Co.*, publishes *Business Week* magazine and various trade publications. *McGraw-Hill Broadcasting Co.* owns *KERO-TV* *Bakersfield* and *KGTV(TV)* *San Diego*, both California; *KMGH-TV* *Denver*; *WRTV(TV)* *Indianapolis*.

McNaughton Stns—Hqs: c/o WCRA-AM-FM, 201 N. Banker St., Effingham, Ill. 62401. Ownership (*Joseph E. McNaughton* and family) identified with *Effingham News* and *Pekin Times*, both Illinois; *Yuma (Ariz.) Sun*, and *Fairfield (Calif.) Republic*. Stations: *WCR A-AM-FM* *Effingham*, *WRMN(AM)-WJKL(FM)* *Elgin* and *WKEI(AM)-WJRE(FM)* *Kewanee*, all Illinois; and *WBEE-AM-FM* *Beaver Dam*, Wis.

McPherson Broadcasting Inc.—Hqs: Box 186, McPherson, Kan. 67460. *K.R. Krehbiel*, publisher of the *McPherson (Kan.) Sentinel*, owns *McPherson Broadcasting Inc.*, licensee of *KNEX-AM-FM* *McPherson*, Kan.

Media General Inc.—Hqs: 333 E. Grace St., Richmond, Va. 23219. *Media General Inc.* is publisher of

The Tampa (Fla.) Tribune and *The Tampa (Fla.) Times*; *Winston-Salem (N.C.) Journal* and the *Twin City Sentinel*, *Winston-Salem*, N.C.; *Richmond (Va.) Times-Dispatch* and *The Richmond (Va.) News Leader*; and *The Media General Financial Weekly*, *Richmond*, Va. Stations: *Media General Inc.* owns 100% of *WFLA-AM-FM-TV* *Tampa*, Fla.

Meredith Corp.—Hqs: 1716 Locust St., Des Moines, Iowa 50336. *Meredith Corp.* publishes *Apartment Life* magazine, *Better Homes and Gardens* magazine, and *Successful Farming* magazine. *Meredith Corp.* also publishes two groups of weekly and semi-weekly community newspapers: *Nine Hicks-Deal* papers in metropolitan Los Angeles and 15 *Herald American* papers distributed in the Los Angeles suburbs. The broadcasting division of *Meredith Corp.* operates *KPHO-TV* *Phoenix*; *WGST(AM)* *Atlanta*; *WNEM-TV* *Bay City*, Mich.; *KCMO-AM-TV* and *KCEZ(FM)* *Kansas City*, Mo.; *WOW(AM)* and *KEZO(FM)* *Omaha*; and *WHEN-AM-TV* *Syracuse*, N.Y.

Meridian (Miss.) Star—Hqs: 810 22d Ave., Meridian, Miss. 39301. *James B. Skewes* and *Mrs. Grace B. Skewes*, owners of the *Meridian (Miss.) Star*, are principals in *Lauderdale Broadcasting Co.*, licensee of *WMOX(AM)* *Meridian*, Miss. *James B. Skewes*, editor and publisher of the *Star*, also owns 11.5% of *Southern Television Corp.*, licensee of *WTOK-TV* *Meridian*, Miss.

Messenger Publishing Co.—Hqs: Route 33 North & Johnson Road, Athens, Ohio 45701. *Messenger Publishing Co.*, publisher of the *Athens (Ohio) Messenger*, owns *WNAL(AM)* *Nelsonville*, Ohio.

Mid-Continent Telecasting Inc.—Hqs: Box 659, Pittsburg, Kan. 66762. *Joplin Globe Publishing Co.*, publisher of the *Joplin (Mo.) Globe* and *News-Herald*, owns 33.23% of *Mid-Continent Telecasting Inc.*, licensee of *KOAM-TV* *Pittsburg*, Kan.

Midwest Television Inc.—Hqs: 509 S. Neil St., Champaign, Ill. 61820. *Midwest Television Inc.* is owned by *Lindsay-Schaub Newspapers*, 21.48%; estate of *Helen M. Stevick & Marajen S.D. Chinigo* (each 10.74%). Interlocking ownership with *Champaign (Ill.) News-Gazette* and *Lindsay-Schaub Newspapers*. Stations: *KFMB-AM-FM-TV* *San Diego*; *WCIA(TV)* *Champaign* and *WMBD-AM-FM-TV* *Peoria*, both Illinois.

Miles City (Mont.) Star—See *Star Printing Co.* **Milwaukee Courier**—Hqs: 2431 W. Hopkins St., Milwaukee 53209. *Jerrel W. Jones*, publisher and majority stockholder of *Courier Publishing Co.*, publisher of the weekly *Milwaukee Courier*, owns 60% of *Courier Communications Corp.*, licensee of *WNOV(AM)* *Milwaukee*.

Monroe Journal—Hqs: c/o William M. Stewart, WMFC-AM-FM, Box 645, Monroeville, Ala. 36460.

Crossownership by station (cont.)

Broadcasting Inc.

Mississippi

WROX(AM) *Clarksdale*—*Columbus (Miss.) Commercial Dispatch*.
WCBI-AM-TV *Columbus*—*Columbus (Miss.) Commercial Dispatch*.
WDDT(AM) *Greenville*—*Clearwater Broadcasting Corp.*
WNAG(AM) *Grenada*—*Columbus (Miss.) Commercial Dispatch*.
WSLI(AM), **WJFR(FM)** and **WJTV(TV)** *Jackson*—*Capitol Broadcasting Co.*
WMOX(AM) *Meridian*—*Meridian (Miss.) Star*.
WTOK-TV *Meridian*—*Meridian (Miss.) Star*.
WELQ-AM-FM *Tupelo*—*Columbus (Miss.) Commercial Dispatch*.
WTYL-AM-FM *Tylertown*—*Tylertown Broadcasting Co.*
WONA-AM-FM *Winona*—*Columbus (Miss.) Commercial Dispatch*.

Missouri

KFRU(AM) *Columbia*—*KFRU Inc.*
KHQA-TV *Hannibal*—*Lee Enterprises Inc.*
KCMO-AM-TV and **KCEZ(FM)** *Kansas City*—*Meredith Corp.*
KMBZ(AM) and **KMBR(FM)** *Kansas City*—*Bon-
 neville International Corp.*

KTVO(TV) *Kirkville*—*Post Corp.*
KMOX-AM-FM-TV *St. Louis*—*CBS Inc.*
KSD-AM-TV *St. Louis*—*Pulitzer Publishing Co.*
KSLQ(FM) *St. Louis*—*Bartell Media Corp.*
KTVI(TV) *St. Louis*—*Newhouse Newspapers*.
KG BX(AM) *Springfield*—*Springfield Newspapers Inc.*
KYTV(TV) *Springfield*—*Springfield Newspapers Inc.*

Montana

KGHL(AM)-KBMS(FM) *Billings*—*George C. and
 Wilda Gene Hatch Stns.*
KBMY(AM) *Billings*—*Peoria Journal Star Inc.*
KATL(AM) *Miles City*—*Star Printing Co.*

Nebraska

KHAS-AM-TV *Hastings*—*Seaton Stns.*
KLMS(AM) *Lincoln*—*Telegraph-Herald Inc.*
WJAG-AM-FM *Norfolk*—*Beef Empire Stns.*
KETV(TV) *Omaha*—*Channel 7 Corp.*
KFAB(AM) and **KGOR(FM)** *Omaha*—*KFAB Broad-
 casting Co.*
WOW(AM) and **KEZO(FM)** *Omaha*—*Meredith
 Corp.*
WOWT(TV) *Omaha*—*Chronicle Broadcasting Co.*

Nevada

KORK-AM-FM-TV *Las Vegas*—*Donrey Media
 Group.*
KOH(AM) *Reno*—*McClatchy Newspapers*.
KOLO-AM-TV *Reno*—*Donrey Media Group.*

New Jersey

WJLK-AM-FM *Asbury Park*—*Press Broadcasting Co.*
WKBS-TV *Burlington*—*Kaiser Broadcasting Co.*
WCTC(AM) and **WQMR(FM)** *New Brunswick*—*Greater Media Inc.*
WPAT-AM-FM *Paterson*—*Capital Cities Communi-
 cations Inc.*
WOND(AM) *Pleasantville* and **WMGM(FM)** *atlan-
 tic City*—*South Jersey Radio Inc.*

New Mexico

KOAT-TV *Albuquerque*—*Pulitzer Publishing Co.*
KRKE(AM) *Albuquerque*—*Gaylord Broadcasting Co.*
KMIN(AM) *Grants*—*KMIN Inc.*

New York

WROW-AM-FM *Albany*—*Capital Cities Communi-
 cations Inc.*
WBNG-TV *Binghamton*—*Gateway Communications
 Inc.*
WBEN-AM-FM-TV *Buffalo*—*Capital Cities Com-
 munications Inc.*
WWNY-TV *Carthage*—*The Brockway Co.*
WENY-AM-FM-TV *Elmira*—*South Jersey Radio Inc.*
WSYE-TV *Elmira*—*Newhouse Newspapers*.
WGSN(AM) *Huntington*—*Greater Media Inc.*
WMSA(AM) *Massena*—*The Brockway Co.*
WABC-AM-TV and **WPLJ(FM)** *New York*—*Ameri-
 can Broadcasting Companies Inc.*
WADO(AM) *New York*—*Bartell Media Corp.*
WCBS-AM-FM-TV *New York*—*CBS Inc.*

William M. Stewart, publisher of the weekly *Monroe Journal*, is principal stockholder in Monroe Broadcasting Co., licensee of WMFC-AM-FM Monroeville, Ala.

Multimedia Inc.—Hqs: Box 1688, Greenville, S.C. 29602. Multimedia Inc. publishes the *Montgomery Advertiser* and *Alabama Journal*, both in Montgomery, Ala.; *Asheville* (N.C.) *Citizen-Times*; *Greenville* (S.C.) *News* and *Piedmont*; and the *Clarksville* (Tenn.) *Leaf-Chronicle*. Stations: KAAV(AM) Little Rock, Ark.; WMAZ-AM-FM Macon, Ga.; WAKY(AM) Louisville, Ky.; KEEL(AM) and KMBQ(FM) Shreveport, La.; WWNC(AM) Asheville and WXII(TV) Winston-Salem, both North Carolina; WFBC-AM-FM-TV Greenville, S.C.; and WBIR-AM-FM-TV Knoxville, Tenn.

Morgan Murphy Stns—Hqs: c/o Evening Telegram, 1226 Ogden Ave., Superior, Wis. 54880. The estate of Morgan Murphy has interests in the *Virginia Mesabi News*, *Hibbing Tribune*, both Minnesota; the *Ashland Press* and *Superior Evening Telegram*, both in Wisconsin; *Dunedin Times*, *Largo Sentinel*, both Florida; West Coast Printing Co., Pinellas Park, Fla. Stations: KTHI-TV Fargo, N.D.; KVEW(TV) Kennewick, KXLY-AM-FM-TV Spokane and KAPP(TV) Yakima, all Washington; WISC-TV Madison, Wis.

Newhouse Newspapers—Hqs: c/o Newark Star-Ledger, Court & Plain Sts., Newark, N.J. 07101. Newhouse Broadcasting Corp. has same ownership (S.I. Newhouse) as *Syracuse Post-Standard* and *Herald-Journal*, *Long Island Press* and *Star-Journal*, and *Staten Island Advance*, all New York; *Newark Star-Ledger*, *Jersey City Jersey Journal*, both New Jersey; *Harrisburg Pa.* *Patriot and News*; *Portland* (Ore.) *Oregonian* and *Oregon Journal*; *St. Louis* (Mo.) *Globe-Democrat*; *Birmingham News*, *Huntsville News* and *Times*, *Mobile Register* and *Press*, all Alabama; *Cleveland* (Ohio) *Plain Dealer*, *Pascagoula* (Miss.) *Press*; 18.8% of *Denver* (Colo.) *Post*; *New Orleans Times-Picayune* and *States-Item*, both Louisiana; *Springfield* (Mass.) *Union* and *News*. Mr. Newhouse also has an interest in Conde-Nast Publications Inc. (*Vogue*, *House & Garden*, *Glamour*, *Bride*, *Mademoiselle*). Newhouse Broadcasting Corp. owns WAPI-AM-FM-TV Birmingham, Ala.; KTVI(TV) St. Louis; WSYE-TV Elmira and WSYR-AM-FM-TV Syracuse, both New York; WTPA-FM-TV Harrisburg, Pa.; and 50% of KOIN-AM-FM-TV Portland, Ore.

News-Examiner Co.—Hqs: 406 Central Ave., Connersville, Ind. 47331. News-Examiner Co., publisher of the *Connersville* (Ind.) *News-Examiner*, is licensee of WNCB-AM-FM Connersville, Ind.

News-Sentinel Broadcasting Co.—Hqs: 2000 Lower Huntington Rd., Fort Wayne, Ind. 46819. News Publishing Co. (*Fort Wayne News-Sentinel*) owns

News-Sentinel Broadcasting Co., licensee of WGL(AM) Fort Wayne, Ind.

News-Sun Broadcasting Co.—Hqs: Box 500, Waukegan, Ill. 60085. *Waukegan News-Sun* has same stockholders as News-Sun Broadcasting Co., licensee of WKRS(AM) Waukegan, Ill.

The New York Times Co.—Hqs: 229 W. 43d St., New York 10036. The New York Times Co. is publisher of the *New York Times* and the following newspapers: *Avon Park Sun*, *Fernandina Beach News-Leader*, *Marco Island Eagle*, *Sebring News*, *Gainesville Sun*, *Lake City Reporter*, *Lakeland Ledger*, *Leesburg Commercial*, *Ocala Star-Banner* and the *Palatka News*, all Florida; *Hendersonville Times-News*, *Lexington Dispatch*, *Wilmington Morning Star* and *News*, all North Carolina. The New York Times Co. owns WQXR-AM-FM New York and WREG-TV Memphis.

Niles Suburban Newspapers Inc.—See Warren Broadcasting Corp.

Oklahoma Press Publishing Co.—Hqs: Box 1608, Muskogee, Okla. 74401. Oklahoma Press Publishing Co., publisher of the *Muskogee* (Okla.) *Phoenix & Times Democrat*, is licensee of KBIX(AM) Muskogee, Okla.

Oroville Radio Inc.—Hqs: Box 1340, Oroville, Calif. 95965. Oroville Radio Inc. is owned jointly by James J. and Carol G. McGiffin. Mr. McGiffin owns Daily Record Inc., a newspaper publishing firm in Ellensburg, Wash., and also 33-1/3% of *Fairfield Daily Ledger*, *Fairfield*, Iowa. Station: KORV(AM) Oroville, Calif.

Owensboro Broadcasting Co.—Hqs: Box 1330, Owensboro, Ky. 42301. Principal stockholders of Owensboro Publishing Co., publisher of the *Owensboro Messenger and Inquirer*, own 80% of the stock of Owensboro Broadcasting Co., licensee of WOMI(AM) and WBKR(FM) Owensboro, Ky.

Owosso Broadcasting Co.—Hqs: Box E, Owosso, Mich. 48867. Argus Press Co., publisher of the *Owosso* (Mich.) *Argus Press*, is parent company of Owosso Broadcasting Co., licensee of WOAP-AM-FM Owosso, Mich.

Paducah Newspapers Inc.—Hqs: Box 1037, Paducah, Ky. 42001. Paducah Newspapers Inc., publisher of the *Paducah* (Ky.) *Sun-Democrat*, is licensee of WPSD-TV Paducah, Ky.

Palladium Publishing Co.—Hqs: Oak & Michigan, Benton Harbor, Mich. 49022. Palladium Publishing Co., publisher of the *Benton Harbor* (Mich.) *News-Palladium* and *St. Joseph* (Mich.) *Herald Press*, also is licensee of WHFB-AM-FM Benton Harbor, Mich.

Park Broadcasting Inc.—Hqs: Terrace Hill, Ithaca, N.Y. 14850. Park Newspapers Inc. owns *Brooksville* (Fla.) *Sun-Journal*; *Warner Robins* (Ga.) *Daily Sun*; *Nebraska City* (Neb.) *News-Press*; *Lockport Union-Sun*

& *Journal* and *Ogdensburg Journal*, both New York; and the *Manassas* (Va.) *Journal Messenger*. Park Broadcasting Inc. operates WBMG(TV) Birmingham, Ala.; WEBC(AM) Duluth and KRIS(AM)-KFMX(FM) St. Louis Park, both Minnesota; WUTR(TV) Utica, N.Y.; WNCU-AM-FM-TV Greenville, N.C.; KWJJ(AM) and KJIB(FM) Portland, Ore.; WNAX(AM) Yankton, S.D.; WDEF-AM-FM-TV Chattanooga and WJHL-TV Johnson City, both Tennessee; WTVR-AM-FM-TV Richmond and WLSL-TV Roanoke, both Virginia; KEZX(FM) Seattle.

Pathfinder Communications Corp.—Hqs: Box 6000, Fort Wayne, Ind. 46806. John F. Dille Jr., 52% owner of the *Elkhart* (Ind.) *Truth*, also owns 52% of Pathfinder Communications Corp., licensee of WMEE(AM)-WMEF(FM) Fort Wayne, Ind. and WCUZ(AM) Grand Rapids, Mich.

Peoria Journal Star Inc.—Hqs: One News Plaza, Peoria, Ill. 61601. Peoria Journal Star Inc., publisher of the *Peoria* (Ill.) *Journal-Star*, owns 100% of WAZY-AM-FM Lafayette, Ind.; KNOX(AM) and KYTN(FM) Grand Forks, N.D.; KBMY(AM) Billings, Mont.; KSSS(AM) Colorado Springs.

Pioneer Valley Broadcasting Co.—Hqs: 78 Main St., Northampton, Mass. 01060. Peter L. and Charles W. DeRose, owner of the *Northampton* (Mass.) *Hampshire Gazette*, own 100% of Pioneer Valley Broadcasting Co., licensee of WHMP-AM-FM Northampton, Mass.

Ponca City Publishing Co.—Hqs: Box 588, Ponca City, Okla. 74601. Ponca City Publishing Co., publisher of the *Ponca City* (Okla.) *News*, is licensee of WBBZ(AM) Ponca City, Okla.

The Post Co.—Hqs: Box 2148, Idaho Falls, Idaho 83401. The Post Co. publishes the *Idaho Falls Post Register*. The company also is licensee of KIFI-TV Idaho Falls, Idaho.

Post Corp.—Hqs: Box 59, Appleton, Wis. 54911. Post Corp. is publisher of four daily newspapers: *The Daily Transcript*, Dedham, Mass.; *The Post-Crescent*, Appleton-Neenah-Menasha, *Twin City News-Record*, Neenah-Menasha, and the *West Bend News*, West Bend, all Wisconsin. Post Corp. is publisher of weekly newspapers through *Granite City* (Ill.) *Press-Record*; *Transcript Newspapers*, Dedham, Mass.; and Post Publications, West Allis, Wis. Stations: KBIZ(AM) Ottumwa, Iowa; WLUC-TV Marquette, Mich.; KTVO(TV) Kirksville, Mo.; WAXX(AM) Chippewa Falls, WEAU-FM-TV Eau Claire and WLUC-TV Green Bay, all Wisconsin.

Post-Newsweek Stations Inc.—Hqs: 4001 Brandywine St. N.W., Washington 20016. The Washington

WEVD-AM-FM New York—Forward Association Inc. WNCN(FM) New York—The Starr Broadcasting Group Inc.

WPIX-FM-TV New York—WGN Continental Broadcasting Co.

WRFM(FM) New York—Bonneville International Corp.

WQXR-AM-FM New York—The New York Times Co.

WHDL(AM) and WEBF(FM) Olean—WHDL Inc. WHEC-TV Rochester—Gannett Co.

WCTO(FM) Smithtown—Greater Media Inc. WHEN-AM-TV Syracuse—Meredith Corp.

WSYR-AM-FM-TV Syracuse—Newhouse Newspapers.

WUTR(TV) Utica—Park Broadcasting Inc. WWNY(AM) Watertown—The Brockway Co.

North Carolina

WGWR(AM) and WCSE(FM) Asheboro—Asheboro Broadcasting Co.

WWNC(AM) Asheville—Multimedia Inc. WPYB(AM) Benson—Dispatch Broadcasting Co.

WBT-AM-FM, WBTB(TV) Charlotte—Jefferson-Pilot Corp.

WSOC-AM-FM-TV Charlotte—Cox Broadcasting Corp.

WDNC(AM) and WDCG(FM) Durham—Durham Radio Corp.

WTVD(TV) Durham—Capital Cities Communications Inc.

WIFM-AM-FM Elkin—Tri-County Broadcasting Co. WBIG(AM) Greensboro—Jefferson-Pilot Corp.

WFMY-TV Greensboro—Landmark Communications Inc.

WNCT-AM-FM-TV Greenville—Park Broadcasting Inc.

WWAY(TV) Wilmington—Clay Communications Inc. WXII(TV) Winston-Salem—Multimedia Inc.

North Dakota

WDAZ-TV Devils Lake—Forum Communications Inc.

KTHI-TV Fargo—Morgan Murphy Stns. WDAY-AM-FM-TV Fargo—Forum Communications Inc.

KNOX(AM) and KYTN(FM) Grand Forks—Peoria Journal Star Inc.

KTGO(AM) Tioga—Tioga Broadcasting Corp.

Ohio

WAKR-AM-TV and WAEZ(FM) Akron—Knight-Ridder Newspapers Inc.

WCPO-TV Cincinnati—Scripps-Howard Broadcasting Co.

WABQ(AM) and WXEN(FM) Cleveland—Booth American Co.

WEWS(TV) Cleveland—Scripps-Howard Broadcasting Co.

WBNS-AM-FM-TV Columbus—Columbus (Ohio) Dispatch.

WHIO-AM-FM-TV Dayton—Cox Broadcasting Corp.

WONE(AM) and WTUE(FM) Dayton—Knight-Ridder Newspapers Inc.

WJER-AM-FM Dover-New Philadelphia—Greer Stns. WFIN(AM) and WHMQ(FM) Findlay—Findlay Publishing Co.

WBRJ(AM) Marietta—Gannett Co. WNAL(AM) Nelsonville—Messenger Publishing Co.

WCLT-AM-FM Newark—WCLT Radio Inc. WTOD(AM) and WKLR(FM) Toledo—Booth American Co.

WHHH(AM) Warren—Radio Station WHHH Inc. WTCL(AM) Warren—Warren Broadcasting Corp.

WKFI(AM) Wilmington—Gannett Co. WWST-AM-FM Wooster—Dix Stns.

WFMJ-AM-TV Youngstown—Vindicator Printing Co.

Oklahoma

KVSO(AM) Ardmore—KVSO Broadcasting Co. KSEO-AM-FM Durant—Durant Publishing Broadcasting Corp.

KBIX(AM) Muskogee—Oklahoma Press Publishing Co.

WKY(AM) Oklahoma City—Gaylord Broadcasting Co.

WKY-TV Oklahoma City—Evening News Association.

WBBZ(AM) Ponca City—Ponca City Publishing Co. KGFF(AM) Shawnee—Stauffer Publications Inc.

KSPI-AM-FM Stillwater—Stillwater Publishing Co. KTEW(TV) Tulsa—Scripps-Howard Broadcasting Co.

Crossownership

Post Co. (parent company of Post-Newsweek Stations Inc.) publishes the *Washington Post* and *Newsweek* magazine. Post-Newsweek stations: WFSB-TV Hartford, Conn.; WTOP-AM-TV Washington; WJXT(TV) Jacksonville and WPLG(TV) Miami, both Florida.

Press Broadcasting Co.—Hqs: Press Plaza, Asbury Park, N.J. 07712. Asbury Park Press Inc., publisher of the *Asbury Park* (N.J.) *Press*, is parent company of Press Broadcasting Co., licensee of WJLK-AM-FM Asbury Park, N.J.

Press Inc.—Hqs: Box 1717, Johnson City, Tenn. 37601. Press Inc., publisher of the *Johnson City* (Tenn.) *Press-Chronicle*, is licensee of WETB(AM) Johnson City, Tenn.

Progressive Publishing Co.—Hqs: Box 291, Clearfield, Pa. 16830. Progressive Publishing Co., publisher of the *Clearfield* (Pa.) *Progress* and the *Danville* (Pa.) *News*, owns WCPA-AM-FM Clearfield and WDAD(AM) and WQMU(FM) Indiana, both Pennsylvania. In addition, W.K. Ulerich, pres of Progressive Publishing Co., owns 100% of WMAJ(AM) and WXLN(FM) State College, Pa. and holds 48 1/2% of WRGI(AM) Marco Island and WRGI-FM Naples, both Florida.

Providence (R.I.) Journal-Bulletin—Hqs: The Providence Journal Co., 75 Fountain St., Providence, R.I. 02902. The Providence Journal Co., publisher of the *Providence* (R.I.) *Journal-Bulletin*, is licensee of WEAN(AM) and WPJB-FM Providence, R.I.

Pulitzer Publishing Co.—Hqs: 1133 Franklin Ave., St. Louis 63101. Pulitzer Publishing Co., publisher of the *St. Louis Post-Dispatch* and the *Tucson* (Ariz.) *Star*, owns KSD-AM-TV St. Louis and KOAT-TV Albuquerque, N.M. Company also has purchased KETV(TV) Omaha, subject to FCC approval.

Quincy Broadcasting Co.—Hqs: Hotel Quincy, Quincy, Ill. 62301. Quincy (Ill.) *Herald Whig* owns 88% of Quincy Broadcasting Co., licensee of WGEM-AM-FM-TV Quincy, Ill.

Radio Santa Cruz—Hqs: Box 1080, Santa Cruz, Calif. 95061. Fred D. McPherson Jr., president, Santa Cruz Sentinel Publishers Inc., is a partner in Radio Santa Cruz, licensee of KSCO-AM-FM Santa Cruz.

Radio Station WHHH Inc.—Hqs: Second National Bank Bldg., Warren, Ohio 44481. Tribune Co., publisher of the *Warren* (Ohio) *Tribune-Chronicle*, owns Radio Station WHHH Inc., licensee of WHHH(AM) Warren, Ohio.

Rusk (Tex.) Cherokeean—Hqs: c/o E.H. Whitehead, Box 475, Rusk, Tex. 75785. E.H. Whitehead, publisher of the weekly *Rusk* (Tex.) *Cherokeean*, is licensee of KTLU(AM) Rusk, Tex.

Scripps-Howard Broadcasting Co.—Hqs: 1100 Central Trust Tower, Cincinnati 45202. Scripps-Howard newspapers are *Cleveland Press*, *Cincinnati Post*, *Columbus Citizen-Journal*, all Ohio; *Pittsburgh Press*; *Knoxville News-Sentinel*, *Memphis Commercial Appeal* and *Press-Scimitar*, all Tennessee; *El Paso Herald-Post*; *Albuquerque* (N.M.) *Tribune*; *Kentucky Post* (Covington, Ky.); *Denver Rocky Mountain News*; *Daily News Tribune* (Fullerton, Calif.); *Evansville* (Ind.) *Press*, *Birmingham* (Ala.) *Post-Herald*; *San Juan* (Puerto Rico) *Star*; *Hollywood* (Fla.) *Sun-Tattler*, and *Suati* (Fla.) *News*, all dailies. Stations: WPTV(TV) West Palm Beach, Fla.; WCPO-TV Cincinnati and WEWS(TV) Cleveland; KTEW(TV) Tulsa, Okla.; WNOX(AM) Knoxville and WMC-AM-FM-TV Memphis, both Tennessee.

Scripps League Newspapers—Hqs: Box 1491, San Mateo, Calif. 94401. Scripps League Newspapers are *Flagstaff* (Ariz.) *Daily Sun*; *Hanford Sentinel*, *Napa Register*, *Petaluma Argus-Courier*, *Santa Maria Times*, *Tahoe Daily Tribune*, *Grass Valley Union*, all California; *Caldwell News-Tribune*, *Coeur d'Alene Press*, *Nampa Free Press*, *Pocatello Idaho State Journal*, all Idaho; *Bozeman Chronicle*, *Havre Daily News*, *Kalispell Daily Inter Lake*, all Montana; *Klamath Falls Herald & News*, *Oregon City Enterprise-Courier*, *Roseburg News-Review*, *The Dalles Chronicle*, all Oregon; *Logan Herald Journal*, *Provo Herald*, both Utah; *Casper* (Wyo.) *Star-Tribune*; *Tucumcari* (N.M.) *News*; *Anacortes American*, *Moses Lake Columbia Basin Herald*, *Mount Vernon Skagit Valley Herald* and *Pullman Herald*, all Washington; Honolulu Hawaii Press Newspapers, *The Garden Island* (Kauai), both Hawaii; *Beloit Daily News*, *Rhineland Daily News*, both Wisconsin; *DeKalb* (Ill.) *Daily Chronicle*. Lake City Printing Co., a subsidiary of Scripps-Hagadone Newspapers (a division of Scripps League Newspapers), owns North Idaho Broadcasting Co., licensee of KVMN(AM) Coeur d'Alene, Idaho.

Seaton Stns—Hqs: Box 853, Coffeyville, Kan. 67337. Seaton Group of newspapers includes the *Hastings Tribune*, *Alliance Times-Herald*, both Nebraska; *Manhattan Mercury*, *Coffeyville Journal*, *Winfield Courier*, all Kansas; *Deadwood Pioneer-Times*, *Lead Call*, both South Dakota, and *Sheridan* (Wyo.) *Press*. Stations: KGGF(AM) Coffeyville and KMAN(AM)-KMKF(FM) Manhattan, both Kansas; KHAS-AM-TV Hastings, Neb.

Shamrock Development Corp.—Hqs: 149 Penn Ave., Scranton, Pa. 18503. Principals of Shamrock Development Corp. also publish the *Scranton Times*. Stations: WDJZ(FM) Orlando, Fla.; WEJL(AM) and WEZX(FM) Scranton, Pa.; and WQFM(FM) Milwaukee.

South Bend (Ind.) Tribune—Hqs: c/o WSBT-AM-FM-TV, 300 West Jefferson Blvd., South Bend, Ind.

46601. South Bend Tribune is publisher of *South Bend Tribune*, *Bloomington Herald-Telephone* and *Bedford Times-Mail*, all Indiana; *Hagerstown* (Md.) *Herald-Mail*; *Indio Daily News*, *Brawley News* and *El Centro Imperial Valley Press*, all California. South Bend Tribune owns WSBT-AM-TV and WWJY(FM) South Bend, Ind. and WDBJ-TV Roanoke, Va.

South Jersey Radio Inc.—Hqs: 15 Shore Road, Linwood, N.J. 08221. John T. Stethers, publisher of the weekly *Ocean City* (N.J.) *Sentinel-Ledger*, owns 33 1/3% of WOND(AM) Pleasantville and WMGM(FM) Atlantic City, both New Jersey; and WENY-AM-FM-TV Elmira, N.Y.

Southland Publishing Co.—Hqs: Box 838, 345 Green St., Gainesville, Ga. 30501. Owns *The Times*, Gainesville, Ga. Charles Smithgall, chmn of Southland Publishing Co., is controlling stockholder in WAAX(AM) and WQEN(FM) Gadsden, Ala.; and WRNG(AM) North Atlanta, Ga.

Spokane (Wash.) Chronicle—Hqs: c/o Spokane Chronicle Co., W. 926 Sprague Ave., Spokane, Wash. 99203. Spokane Chronicle Co., publisher of the *Spokane* (Wash.) *Chronicle*, owns 100% of KHQ Inc., licensee of KHQ-AM-FM-TV Spokane, Wash.

Springfield Newspapers Inc.—Hqs: 651 Boonville, Springfield, Mo. 65801. Springfield Newspapers Inc., publisher of the *Springfield* (Mo.) *News* and the *Springfield* (Mo.) *Leader & Press*, operates KHMO(AM) Hannibal and KGBX(AM) and KYTV(TV) Springfield, both Missouri.

The Standard Corp.—See George C. and Wilda Gene Hatch Stns.

Star Broadcasting Corp.—Hqs: 616 Amelia St., Fredericksburg, Va. 22401. Charles S. Rowe, pres of the *Fredericksburg* (Va.) *Free Lance-Star*, is also pres of Star Broadcasting Corp., licensee of WFLS-AM-FM Fredericksburg, Va.

Star Printing Co.—Hqs: Box 700, Miles City, Mont. 59301. Star Printing Co., publisher of the *Miles City* (Mont.) *Star*, is licensee of KATL(AM) Miles City, Mont.

The Starr Broadcasting Group Inc.—Hqs: 3715 Williams Blvd., Kenner, La. 70062. William F. Buckley, chmn of The Starr Broadcasting Group Inc., is editor and publisher of *National Review* magazine. Stations: KXLR(AM) North Little Rock, Ark.; KABL(AM) Oakland and KABL-FM San Francisco, both California; KHVO(TV) Hilo and KITV(TV) Honolulu, both Hawaii; KUDL(AM) Fairway and KUDL-FM Kansas City, both Kansas; WTVQ-TV Lexington, Ky.; WBOK(AM) New Orleans; WWW(FM) Detroit; WNCN(FM) New York; WLOK(AM) Memphis; KDTX(FM) Dallas; KYOK(AM) Houston; and WCYB-TV Bristol, Va.

State Telecasting Co.—Hqs: Box 1333, Columbia,

Crossownership by Station (cont.)

Oregon

KAGI(AM) Grants Pass—California-Oregon Broadcasting Inc.

KOTI(TV) Klamath Falls—California-Oregon Broadcasting Inc.

KOBI(TV) Medford—California-Oregon Broadcasting Inc.

KJIB(FM) Portland—Park Broadcasting Inc.

KOIN-AM-FM-TV Portland—Newhouse Newspapers.

KWJJ(AM) Portland—Park Broadcasting Inc.

KPIC(TV) Roseburg—California-Oregon Broadcasting Inc.

Pennsylvania

WTAJ-TV Altoona—Gateway Communications Inc. WFBD(AM) and WAKM(FM) Bedford—Inquirer Printing Co.

WCPA-AM-FM Clearfield—Progressive Publishing Co.

WCED-AM-FM DuBois—DuBois (Pa.) *Courier-Express*.

WEEEX(AM) and WQQQ(FM) Easton—Easton (Pa.) *Express*.

WSEE(TV) Erie—Great Lakes Television Co.

WGET-AM-FM Gettysburg—Times & News Publishing Co.

WTPA-FM-TV Harrisburg—Newhouse Newspapers.

WHUN-AM-FM Huntingdon—Huntingdon Broadcasters Inc.

WDAD(AM) and WQMU(FM) Indiana—Progressive Publishing Co.

WJAC-AM-FM-TV Johnstown—WJAC Inc.

WGAL-AM-FM-TV Lancaster—Steinman Stns.

WLYH-TV Lancaster-Lebanon—Gateway Communications Inc.

WNPV(AM) Lansdale—Equitable Publishing Co.

WNUF(FM) New Kensington—Hammond Newspapers.

WCAU-AM-FM-TV Philadelphia—CBS Inc.

WMGK(FM) Philadelphia—Greater Media Inc.

WPBS(FM) Philadelphia—Bulletin Co.

WPEN(AM) Philadelphia—Greater Media Inc.

WPVI-TV Philadelphia—Capital Cities Communications Inc.

WIIC-TV Pittsburgh—Cox Broadcasting Corp.

WTAE-AM-FM-TV Pittsburgh—The Hearst Corp.

WWSW(AM) and WPEZ(FM) Pittsburgh—WWSW Radio Inc.

WEEU(AM) Reading—WEEU Broadcasting Co.

WEJL(AM) and WEZX(FM) Scranton—Shamrock Development Corp.

WMAJ(AM) and WXLN(FM) State College—Progressive Publishing Co.

WPQR-FM Uniontown—Warman Broadcasting Inc.

Rhode Island

WEAN(AM) and WPJB-FM Providence—Providence (R.I.) *Journal-Bulletin*.

WPRO-AM-FM Providence—Capital Cities Communications Inc.

WWOX-AM-FM Woonsocket—Woonsocket (R.I.) *Call*.

South Carolina

WAIM-AM-TV, WCAC(FM) Anderson—Anderson (S.C.) *Independent and Mail*.

WCIV(TV) Charleston—Washington Star Communications Inc.

WGCD(AM) Chester—Dispatch Broadcasting Co.

WBTW(TV) Florence—Daily Telegraph Printing Co.

WFBC-AM-FM-TV Greenville—Multimedia Inc.

WEAB(AM) Greer—Greer (S.C.) *Citizen*.

WTND(AM) Orangeburg—WTND Inc.

WBUG(AM) Ridgeland—Dispatch Broadcasting Co.

South Dakota

KABY-TV Aberdeen—Forum Communications Inc.

KKAA(AM) Aberdeen—Dakota-North Plains Corp.

KQAA(FM) Aberdeen—Dakota-North Plains Corp.

KJIV-AM-FM Huron—Gazette Printing Co.

KPRY-TV Pierre—Forum Communications Inc.

KSFY-TV Sioux Falls—Forum Communications Inc.

Tennessee

WIRJ-AM-FM Humboldt—Gibson County Broadcasting Co.

WETB(AM) Johnson City—Press Inc.

WKPT-AM-FM-TV Kingsport—Home News Publishing Co.

S.C. 29202. The State-Record Co. is publisher of the *Biloxi* (Miss.) *Daily Herald* and *South Mississippi Sun*; *Columbia State and Record* and the *Myrtle Beach Sun News*, both South Carolina; and *The Alexandria* (Va.) *Gazette*. State Telecasting Co., a wholly owned subsidiary of The State-Record Co., operates KSW5-TV Roswell, N.M.; WCBD-TV Charleston, S.C.; and KCBD-TV Lubbock, Tex.

Stauffer Publications Inc.—Hqs: Box 119, Topeka, Kan. 66601. Stauffer Publications Inc. is publisher of the *Glenwood Springs* (Colo.) *Post*; *Topeka State Journal and Capital*, *Arkansas City Traveler*, *Kansas City Kansan*, *Pittsburg Morning Sun*, *Newton Kansan* and *Capper's Weekly*; all Kansas; *Hillsdale* (Mich.) *Daily News*; *Hannibal Courier-Post*, *Independence Examiner*, *Marshall Democrat-News*, *Marysville Forum*, *Nevada Mail*, all Missouri; *Beatrice Daily Sun*, *Grand Island Independent*, and *York News-Times*, all Nebraska; *Shawnee* (Okla.) *News-Star*; *Brookings* (S.D.) *Register*. Stauffer Publications Inc. owns KRNT(AM) and KRNQ(FM) Des Moines, Iowa; KSOK(AM) Arkansas City and WIBW-AM-FM-TV Topeka, both Kansas; KGGF(AM) Shawnee, Okla.; and KGNC-AM-FM Amarillo, Tex.

Steinman Stns—Hqs: 8 W. King St., Lancaster, Pa. 17604. Same ownership (Steinman) as *Lancaster Intelligence-Journal* and *New Era*. Stations (operated independently): WDEL(AM) and WSTW(FM) Wilmington, Del.; WTEV(TV) New Bedford, Mass. (Providence, R.I.); WGAL-AM-FM-TV Lancaster, Pa.

Stillwater Publishing Co.—Hqs: Box 231, Stillwater, Okla. 74074. Stillwater Publishing Co., publisher of the *Stillwater* (Okla.) *News-Press*, is licensee of KP51-AM-FM Stillwater, Okla.

Tacoma (Wash.) News-Tribune—Hqs: c/o Tribune Publishing Co., 1950 S. State St., Tacoma, Wash. 98411. Tribune Publishing Co., publisher of the *Tacoma* (Wash.) *News-Tribune*, is licensee of KTNT-AM-FM Tacoma, Wash.

Telegraph-Herald Inc.—Hqs: 8th & Bluff Sts., Dubuque, Iowa 52001. Telegraph-Herald Inc., publisher of the *Dubuque* (Iowa) *Telegraph-Herald*, is licensee of KDTH(AM) and KFMD(FM) Dubuque, Iowa; KLMS(AM) Lincoln, Neb.; WGEZ(AM) Beloit and WHBY(AM) Appleton, both Wisconsin.

Thomaston Broadcasting Co.—Hqs: Box 689, Thomaston, Ga. 30286. Thomaston Broadcasting Co. is 20% owned by S.J. Carswell, majority owner of weekly *Thomaston Times* and *Free Press*. Station: WSFT(AM) Thomaston, Ga.

Time Inc.—Hqs: Time & Life Bldg, 30 Rockefeller Center, New York 10020. Time Inc. publishes five magazines: *Time*, *Fortune*, *Sports Illustrated*, *People* and *Money*. Station: WOTV(TV) Grand Rapids, Mich.

The Times Mirror Co.—Hqs: Times Mirror Square, Los Angeles 90053. The Times Mirror Co. publishes the *Orange Coast Daily Pilot*, Costa Mesa, and *Los Angeles Times*, Los Angeles, both California; *Newsday*, Long Island, N.Y.; and *The Dallas Times Herald*, Dallas. Stations: KTBC-TV Austin and KDFW-TV Dallas, both Texas.

Times & News Publishing Co.—Hqs: Box 280, Gettysburg, Pa. 17325. Times & News Publishing Co., publisher of the *Gettysburg* (Pa.) *Times*, is licensee of WGET-AM-FM Gettysburg, Pa.

Tioga Broadcasting Corp.—Hqs: Box 456, Tioga, N.D. 58852. Pius Hornstein, publisher of the weekly *Tioga* (N.D.) *Tribune*, owns 70% of Tioga Broadcasting Corp., licensee of KTGO(AM) Tioga, N.D.

Triad Stations Inc.—Hqs: 111 W. Michigan Ave., Marshall, Mich. 49068. Jack C. Biedent, owner of the *Albion* (Mich.) *Recorder*, is 3.96% stockholder of Triad Stations Inc. Stations: WFRL-AM-FM Freeport, Ill.; WALM(AM) Albion and WELL-FM Marshall, both Michigan.

Tri-County Broadcasting Co.—Hqs: Drawer 1038, Elkin, N.C. 28621. Harvey F. Lafoon, publisher of the semi-weekly *Elkin* (N.C.) *Tribune*; Stella W. Anderson, publisher of weeklies *Brevard Transylvania Times*, *Forest City Courier*, *Sparta Alleghany News* and *West Jefferson Skyland Post*, all North Carolina; and W.P. Erwin own one-third each of Tri-County Broadcasting Co., licensee of WJFM-AM-FM Elkin, N.C.

Truth Radio Corp.—Hqs: Box 699, Elkhart, Ind. 46514. John F. Dille Jr., 52% owner of the *Elkhart* (Ind.) *Truth*, is also 52% owner of Truth Radio Corp., licensee of WTRC(AM) and WYEZ(FM) Elkhart, Ind.

Tyertown Broadcasting Co.—Hqs: Box 447, Tyertown, Miss. 39667. Paul H. Pittman, owner of *The Tyertown Times* (a weekly newspaper), holds controlling interest in Tyertown Broadcasting Co., licensee of WTYL-AM-FM Tyertown, Miss.

United States Transdynamics Corp.—Hqs: 1901 Fort Myer Drive, Arlington, Va. 22209. Arthur W. Arundel, owner of the weekly *Loudon Times-Mirror*, *Leesburg*, *Reston Times*, *Reston* and *Fauquier Democrat*, Warrenton, all Virginia, is president of United States Transdynamics Corp., licensee of WAVA-AM-FM Arlington, Va.

United Technical Publications Inc.—See Cox Broadcasting Corp.

Vidalia Broadcasting Co.—Hqs: Box 900, Vidalia, Ga. 30474. R.E. Ledford, 50% owner of WVOF(AM) and WTCQ(FM) Vidalia, Ga., is publisher of the weekly *Vidalia Advance*.

The Vindicator Printing Co.—Hqs: 101 W. Boardman St., Youngstown, Ohio 44503. The Vindicator Printing Co., publisher of the *Youngstown* (Ohio) *Vindicator*, is

licensee of WFMJ-TV Youngstown, Ohio and also owns WFMJ(AM) Youngstown, Ohio.

Warman Broadcasting Inc.—Hqs: Drawer 639, Uniontown, Pa. 15401. Edwin G. Warman, publisher and owner of E.G. Warman Publishing Co., owns 50% of Warman Broadcasting Inc., licensee of WPQR-FM Uniontown, Pa.

Warren Broadcasting Corp.—Hqs: 1295 Lane West Road S.W., Warren, Ohio 44481. Niles Publishing Co., publisher of the *Niles* (Ohio) *Times*, owns 91% of Warren Broadcasting Corp., licensee of WTCL(AM) Warren, Ohio.

Washington Star Communications Inc.—Hqs: 225 Virginia Ave. S.E., Washington 20003. Washington Star Communications (owned by Joe L. Allbritton) publishes *Washington Star-News*. Stations: WMAL-AM-FM-TV Washington; WCIV(TV) Charleston, S.C.; and WLVA-AM-TV Lynchburg, Va.

Washington Telecasters Inc.—Hqs: 2939 Fourth Ave. S., Seattle 98134. Jessica L. Longston, publisher of weekly *The Othello* (Wash.) *Outlook*, owns 52% of KSEM Inc., licensee of KSEM(AM) Moses Lake, Wash., and 56% of Washington Telecasters Inc., licensee of KAYO(AM) Seattle.

WBEN Inc.—Hqs: 2077 Elmwood Ave., Buffalo, N.Y. 14207. *Buffalo* (N.Y.) *Evening News* has same ownership as WBEN Inc., licensee of WBEN-AM-FM-TV Buffalo, N.Y.

WCLT Radio Inc.—Hqs: 25 W. Main St., Newark, Ohio 43055. Stockholders of the *Newark* (Ohio) *Advocate & American Tribune*, an evening newspaper, own 80% of WCLT Radio Inc., licensee of WCLT-AM-FM Newark, Ohio.

WEEU Broadcasting Co.—Hqs: 34 N. Fourth St., Reading, Pa. 19601. Reading Eagle Co., publisher of the *Reading* (Pa.) *Times* (morning) and *Reading* (Pa.) *Eagle* (evening & Sunday), owns 51% of WEEU Broadcasting Co., licensee of WEEU(AM) Reading, Pa.

WEHCO Media Inc.—Hqs: 113 Madison Ave., Camden, Ark. 71701. W.E. Hussman family publishes the *Camden News*, *El Dorado Times*, and *News, Hope Star* (25%), *Hot Springs Sentinel Record* and *New Era*, (Little Rock) *Arkansas Democrat*, *Magnolia Banner News* (80%) and the *Texarkana Gazette* and *News*, all Arkansas; and the *Jacksonville* (Tex.) *Daily Progress* (25%). Stations: KAMD(AM) and KWEH(FM) Camden, Ark.; KCMC(AM) and KTAL-FM-TV Texarkana, Tex.-Shreveport, La.

WESO Broadcasting Corp.—Hqs: 399 Main St., Southbridge, Mass. 01550. Principals in Greater Media Inc. (see listing), John L. Rosenmiller and Peter A.

WBIR-AM-FM-TV Knoxville—Multimedia Inc.
WNOX(AM) Knoxville—Scripps-Howard Broadcasting Co.
WBMC-AM-FM McMinnville—Cumberland Valley Broadcasting Co.
WLOK(AM) Memphis—The Starr Broadcasting Group Inc.
WMC-AM-FM-TV Memphis—Scripps-Howard Broadcasting Co.
WREG-TV Memphis—The New York Times Co.
WTVF(TV) Nashville—Channel Two TV Co.

Texas

KGNC-AM-FM Amarillo—Stauffer Publications Inc.
KTBC-TV Austin—The Times Mirror Co.
KFDM-TV Beaumont—Belo Broadcasting Corp.
KBOX(AM) and KTLG(FM) Dallas—Knight-Ridder Newspapers Inc.
KDFW-TV Dallas—The Times Mirror Co.
KDTX(FM) Dallas—The Starr Broadcasting Group Inc.
WFAA-AM-TV and KZEW(FM) Dallas—Belo Broadcasting Corp.
KULP-AM-FM El Campo—Bar-B Broadcasting Inc.
KDBC-TV El Paso—Evening Post Publishing Co.
KTVT(TV) Fort Worth-Dallas—Gaylord Broadcasting Co.
KHTV(TV) Houston—Gaylord Broadcasting Co.
KTRK-TV Houston—Capital Cities Communications Inc.

KPRC-AM-TV Houston—Channel Two Television Co.
KXYZ(AM) and KAUM(FM) Houston—American Broadcasting Companies Inc.
KYOK(AM) Houston—The Starr Broadcasting Group Inc.
WBAP(AM)-KSCS(FM) Fort Worth—Capital Cities Communications Inc.
KGNS-TV Laredo—Doney Media Group.
KSEL-AM-FM Lubbock—Harris Enterprises Inc.
KWBK(AM) Navasota—Whitten Broadcasting Co.
KOSA-TV Odessa—Forward Communications Corp.
KJAC-TV Port Arthur—Clay Communications Inc.
KTLU(AM) Rusk—Rusk (Tex.) *Cherokeean*.
KCTV(TV) San Angelo—Capitol Broadcasting Co.
KENS-TV San Antonio—Harte-Hanks Newspapers Inc.
KCEN-TV Temple—Channel 6 Inc.
KCMC(AM) and KTAL-FM-TV Texarkana-Shreveport, La.—WEHCO Media Inc.
KRGV-AM-TV Westaco—Manship Stns.
KANI(AM) Wharton—Wharton Communications Inc.
KFDX-TV Wichita Falls—Clay Communications Inc.

Utah

KALL-AM-FM Salt Lake City—George C. and Wilda Gene Hatch Stns.
KSL-AM-FM-TV Salt Lake City—Bonneville International Corp.
KUTV(TV) Salt Lake City—George C. and Wilda

Gene Hatch Stns.

Virginia

WAVA-AM-FM Arlington—United States Transdynamics Corp.
WCYB-TV Bristol—Starr Broadcasting Group Inc.
WFLS-AM-FM Fredericksburg—Star Broadcasting Corp.
WSVA-TV Harrisonburg—Worrell Newspapers Inc.
WLVA-AM-TV Lynchburg—Washington Star Communications Inc.
WGH-AM-FM Newport News—Hampton Roads Broadcasting Corp.
WTAR-AM-TV and WKEZ(FM) Norfolk—Landmark Communications Inc.
WRAD-AM-FM Radford—Dix Stns.
WWBT(TV) Richmond—Jefferson-Pilot Corp.
WDBJ-TV Roanoke—*South Bend* (Ind.) *Tribune*.

Washington

KVEW(TV) Kennewick—Morgan Murphy Stns.
KSEM(AM) Moses Lake—Washington Telecasters Inc.
KAYO(AM) Seattle—Washington Telecasters Inc.
KEZX(FM) Seattle—Park Bcsg Co.
KIRO-AM-TV and KSEA(FM) Seattle—Bonneville International Corp.
KHQ-AM-FM-TV Spokane—*Spokane* (Wash.) *Chronicle*.
KXLY-AM-FM-TV Spokane—Morgan Murphy Stns.
KSTW(TV) Tacoma—Gaylord Broadcasting Co.

Crossownership, Station Sales

Bordes, also control WESO Broadcasting Corp., licensee of WESO-AM-FM Southbridge, Mass.

Western Connecticut Broadcasting Co.—Hqs: 117 Prospect St., Stamford, Conn. 06904. Kingsley Gillespie, publisher of the *Stamford Advocate*, is president of Western Connecticut Broadcasting Co., licensee of WSTC(AM) and WYRS(FM) Stamford, Conn.

WGN Continental Broadcasting Co.—Hqs: 2501 Bradley Place, Chicago 60618. Same ownership as *Chicago Tribune*. Interlocking ownership (McCormick-Patterson family) with *New York Daily News* (WPIX-FM-TV); *Van Nuys* (Calif.) *Valley News and Green Sheet*; *Fort Lauderdale News, Orlando Sentinel Star, Osceola Sun and Pompano Beach Sun-Sentinel*, all Florida. WGN Continental Broadcasting Co.: WGN-AM-TV Chicago; KWGN-TV Denver; and KDAL-AM-TV Duluth, Minn. WPIX Inc.: WPIX-FM-TV New York and WICC(AM) Bridgeport, Conn.

Wharton Communication Inc.—Hqs: Box 111, Wharton, Tex. 77488. V.M. Preston, publisher of the weekly *Wharton* (Tex.) *Journal*, owns 60% of Wharton Communications Inc., licensee of KANI(AM) Wharton, Tex.

WHAS Inc.—Hqs: 520 W. Chestnut St., Louisville, Ky. 40202. *Louisville* (Ky.) *Courier-Journal* and *Louisville* (Ky.) *Times* have same ownership as WHAS Inc., licensee of WHAS-AM-TV and WNNS(FM) Louisville, Ky.

WHDL Inc.—Hqs: 3219 West State Road, Olean, N.Y. 14760. Olean Times-Herald Corp., publisher of the *Olean* (N.Y.) *Times-Herald*, owns 100% of WHDL Inc., licensee of WHDL(AM) and WEBF(FM) Olean, N.Y.

Whitten Broadcasting Co.—Hqs: 177 RR St., Drawer 751, Navasota, Tex. 77868. R.H. Whitten, 100% owner of the weekly *Navasota* (Tex.) *Examiner-Review*, owns Whitten Broadcasting Co., licensee of KWBC(AM) Navasota, Tex.

Reub Williams & Sons Inc.—Hqs: Box 351, Warsaw, Ind. 46580. Reub Williams & Sons Inc., publisher of the *Warsaw* (Ind.) *Times-Union*, is licensee of WRSW-AM-FM Warsaw, Ind.

WJAC Inc.—Hqs: Hickory Lane, Johnstown, Pa. 15905. Johnstown Tribune Publishing Co., publisher of the *Johnstown* (Pa.) *Tribune-Democrat*, has same ownership as WJAC Inc., licensee of WJAC-AM-FM-TV Johnstown, Pa.

WKAI Broadcasting Co.—Hqs: 119 W. Carroll St., Macomb, Ill. 61455. William H. Rudolph, publisher of the *Macomb Daily Journal*, owns 100% of WKAI Broadcasting Co., licensee of WKAI-AM-FM Macomb, Ill.

Woonsocket (R.I.) Call—Hqs: The Evening Call Publishing Co., 75 Main St., Woonsocket, R.I. 02895. The Evening Call Publishing Co., publisher of the *Woonsocket* (R.I.) *Call*, owns Woonsocket Broadcasting Co., licensee of WWOV-AM-FM Woonsocket, R.I.

Worcester Telegram & Gazette Inc.—Hqs: 20 Franklin St., Worcester, Mass. 01613. Worcester

Telegram & Gazette Inc., publisher of the *Worcester Telegram, The Evening Gazette, and The Sunday Telegram*, also is licensee of WTAG(AM) Worcester, Mass.

Worrell Newspapers Inc.—Hqs: 320 Morrison Blvd., Bristol, Va. 24201. Worrell Newspapers Inc. publishes the *Florence* (Ala.) *Times Tri-Cities Daily; Pittsburg* (Calif.) *Post-Dispatch; Sterling* (Colo.) *Journal Advocate; Greensburg* (Ind.) *Daily News; Harlan Enterprise, Madisonville Messenger and Middlesboro Daily News*, all Kentucky; *Opelousas* (La.) *World; Corinth* (Miss.) *Daily Corinthian; Las Cruces* (N.M.) *Sun-News; Lenoir* (N.C.) *News-Topic; Dyersburg* (Tenn.) *State Gazette; Bristol Herald Courier and Virginia Tennessean, Charlottesville Progress, Pulaski Southwest Times, Radford News Journal and Suffolk News-Herald*, all Virginia. Station: Worrell group has agreed to purchase WSWA-TV Harrisonburg, Va., subject to FCC approval.

WTMJ Inc.—Hqs: 720 E. Capitol Drive, Milwaukee 53212. The Journal Co., publisher of the morning *Milwaukee Sentinel* and evening *Milwaukee Journal*, owns 100% of WTMJ Inc., licensee of WTMJ-AM-TV and WTKI(FM) Milwaukee.

WTND Inc.—Hqs: Drawer 730, Orangeburg, S.C. 29115. *Orangeburg* (S.C.) *Times & Democrat* has interlocking ownership (estate of J.I. Sims) with WTND Inc., licensee of WTND(AM) Orangeburg, S.C.

WWSW Radio Inc.—Hqs: One Allegheny Sq., Pittsburgh 15212. *Pittsburgh Post-Gazette* (same ownership [Paul Block] as *Toledo* [Ohio] *Blade*) owns WWSW Radio Inc., licensee of WWSW(AM) and WPEZ(FM) Pittsburgh.

Crossownership by station (cont.)

KINT-AM-FM Tacoma—*Tacoma* (Wash.) *News-Tribune*.

KAPP(TV) Yakima—Morgan Murphy Stns.

West Virginia

WHIS-AM-FM-TV Bluefield—Daily Telegraph Printing Co.

WHEZ(FM) Huntington—Greater Media Inc.

WOWK-TV Huntington—Gateway Communications Inc.

WSAZ-TV Huntington—Lee Enterprises Inc.

WHAW-AM-FM Weston—Central West Virginia Service Corp.

WTRF-FM-TV Wheeling—Forward Communications Corp.

Wisconsin

WHBY(AM) Appleton—Telegraph-Herald Inc.

WBEV-AM-FM Beaver Dam—McNaughton Stns.

WGEZ(AM) Beloit—Telegraph-Herald Inc.

WAXX(AM) Chippewa Falls—Post Corp.

WEAU-FM-TV Eau Claire—Post Corp.

WLUK-TV Green Bay—Post Corp.

WCLO(AM), WJVL(FM) Janesville—Gazette Printing Co.

WKAU-AM-FM Kaukauna—Forward Communications Corp.

WIBA-AM-FM Madison—Badger Broadcasting Co.

WISC-TV Madison—Morgan Murphy Stns.

WMTV(TV) Madison—Forward Communications Corp.

WISN-AM-FM-TV Milwaukee—The Hearst Corp.

WNOV(AM) Milwaukee—*Milwaukee Courier*.

WOKY(AM) Milwaukee—Bartell Media Corp.

WQFM(FM) Milwaukee—Shamrock Development Corp.

WTMJ-AM-TV and WTKI(FM) Milwaukee—WTMJ Inc.

WVTV(TV) Milwaukee—Gaylord Broadcasting Co.

WSAU-AM-TV and WIFC(FM) Wausau—Forward Communications Corp.

WBKV-AM-FM West Bend—Gazette Printing Co.

WFHR(AM) and WRRW(FM) Wisconsin Rapids—Advance Broadcasting Corp.

Wyoming

KFBC-AM-FM Cheyenne—Frontier Broadcasting Co.

Puerto Rico

WAPA(AM) San Juan—The Hearst Corp.

Station Trading Since 1956

Dollar volume of transactions approved by FCC

Number of stations changing hands

	Total	Radio only	Combined Radio-TV†	TV only
1956	115,605,828	32,563,378	65,212,055	17,830,395
1957	124,187,660	48,207,470	47,490,884	28,489,206
1958	127,537,026	49,868,123	60,872,618	16,796,285
1959	123,496,581	65,544,653	42,724,727	15,227,201
1960	99,341,910	51,763,285	24,648,400	22,930,225
1961	128,804,167	55,532,516	42,103,708	31,167,943
1962	101,742,903	59,912,520	18,822,745	23,007,638
1963	105,303,078	43,457,584	25,045,726	36,799,768
1964	205,756,736	52,296,480	67,185,762	86,274,494
1965	135,123,766	55,933,300	49,756,993	29,433,473
1966	135,718,316	76,633,762	28,510,500	30,574,054
1967	172,072,573	59,670,053	32,086,297	80,316,223
1968	152,455,412	71,310,709	47,556,634	33,588,069
1969	231,697,570	108,866,538	35,037,000	87,794,032
1970	203,785,442	86,292,899	1,038,465	87,454,078
1971	393,547,924	125,501,514	750,000	267,296,410
1972	268,330,537	114,424,673	0	156,905,864
1973	227,568,701	160,933,557	2,812,444*	66,635,144
1974	307,781,474	168,998,012	19,800,000***	118,983,462
1975	259,485,961	131,065,860	0	128,420,101
Total	\$3,619,343,565	\$1,618,776,886	\$611,454,958	\$1,365,924,065

	Radio only	Combined Radio-TV†	TV only
1956	316	24	21
1957	357	28	38
1958	407	17	23
1959	436	15	21
1960	345	10	21
1961	282	13	24
1962	306	8	16
1963	305	3	16
1964	430	20	36
1965	389	15	32
1966	367	11	31
1967	316	9	30
1968	316	9	20
1969	343	5	32
1970	268	3	19
1971	270	1	27
1972	239	0	37
1973	352	2*	25
1974	369	5***	24
1975	363	0	22
Total	5,776	209	535

Note: Dollar volume figures represent total considerations reported to all transactions, with the exception of minority-interest transfers in which control of the licensee did not change hands. All sales have been approved by the FCC.

*Two acquisitions of radio-TV combinations were approved in 1973 on waiver of FCC one-to-a-customer rule that became effective in 1971.

**Figure represents merger of Pacific & Southern's combination of four radio and one television stations into Combined Communications Corp.

**Note: In computing the number of stations traded, an AM-FM facility, or an AM-only or FM-only was counted as one radio unit.

†Includes single properties consisting of radio and TV stations.

Fernseh means television.

NBC has the picture. They've fielded the Fernseh KCN into their O&O news operations.

Which gives NBC the flexibility and portability to get to where the news is.

And television means some good news, and some bad news. All of which means being there.

So you've got to be flexible. You've got to be portable. And you've got to be ready to go.

The battery operated KCN (shown with the cameraman) is completely self-contained and can be used in conjunction with a portable VTR.

Fernseh handheld camera systems are lightweight and offer the speed and portability you need for electronic journalism, plus the video quality required for television production excellence.

The KCR-40 (shown front and center) is

completely compatible with our standard KCU-40 and will operate from that system's electronics. You can roam 325 feet on a quarter-inch cable, 2600 on a half. With an additional 50 feet between the head and back pack.

Both KCR and KCN systems use the same camera head, which is the lightest in its class, weighing as little as a 16mm film camera.

Fernseh means television. Television good news.

We'd welcome the opportunity to demonstrate the superior capabilities of Fernseh television equipment. A call to your nearest office will bring any further information you require.

Saddle Brook, Headquarters (201) 797-7400
Chicago (312) 681-5000
Houston

(713) 688-9171
Los Angeles (213) 649-4330

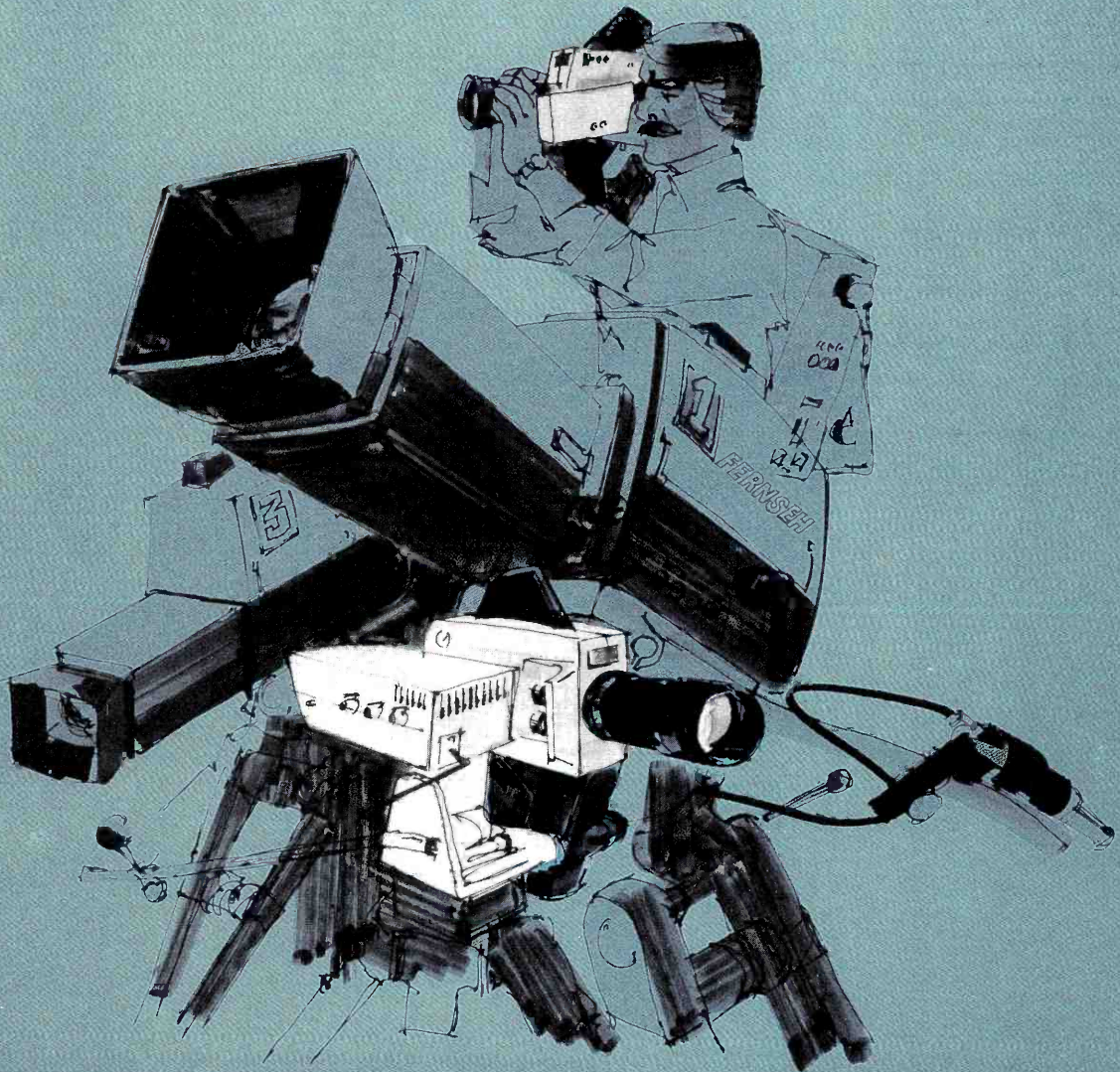

FERNSEH Robert Bosch Corporation

WAGA-TV Atlanta

WSBK-TV Boston

WJW-TV Cleveland

WJBK-TV Detroit

WITI-TV Milwaukee

KCST-TV San Diego

WSPD-TV Toledo

Broadcasting that serves.

THE

**STORER
STATIONS**

STORER BROADCASTING COMPANY

**General Offices: 1177 Kane Concourse
Bay Harbor Islands, Miami Beach, Florida**

B

The TV Marketplace

The ADI Atlas	B-1
The Markets Ranked by Size	B-80
TV Markets by Nielsen Retail Index Territory	B-83
Network Delivery Variations by Market	B-84

The Facilities of Television

Directory of Television Stations in the U.S. and Canada	B-89
Foreign TV	B-152
TV Stations by Call Letters	B-152
Canadian TV by Call Letters	B-156
U.S. TV by Channel	B-156

Canadian TV by Channel	B-160
Television Billings 1948-74	B-161
TV Allocations	B-162
Broadcast Pay TV	B-164
Experimental TV	B-164
Pending TV Applications	B-164
TV Ownership Transfers	B-168

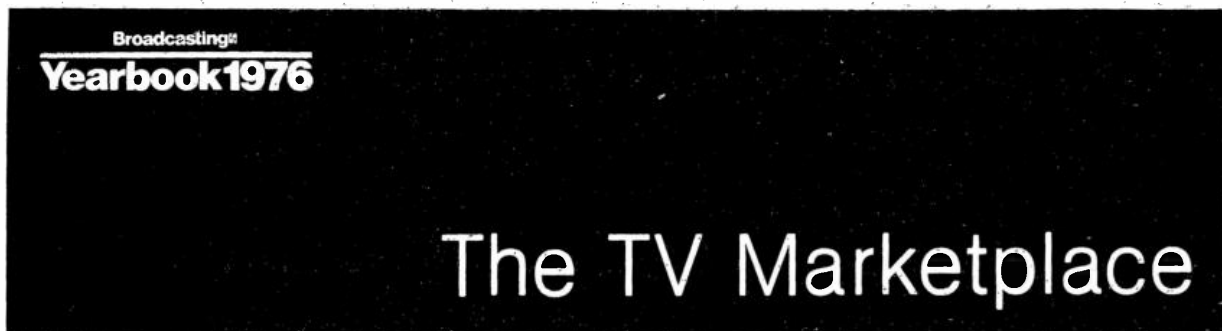

The ADI Market Atlas

The Area of Dominant Influence is a geographic market design that defines each television market exclusive of the others, based on measurable viewing patterns. Each market's ADI consists of all counties in which the home market stations receive a preponderance of viewing, and every county in the U.S. (excluding Hawaii and part of Alaska) is allocated exclusively to only one ADI—there is no overlap. The estimated television households are therefore additive, and the total of all ADI's represents the total television households in the U.S.

The ADI is a standard market definition. As a television buying tool it is a geographic and demographic means for maximum efficiency. As a station tool it has numerous applications for more effective sales efforts, and for programming and promotion planning.

Following, in alphabetical order, are Arbitron Television's 208 ADI markets for 1975, with coverage maps for each; county-by-county breakouts of TV households; and totals of women, men, teens and children in the ADI audience. Other data include the market's stations, and their cities of license, channel numbers and network affiliations. (Networks in

parentheses indicate secondary affiliations.)

Coverage maps show total survey areas in white, the ADI's themselves in light crosshatching, and Arbitron Metro Rating Areas in heavier cross-hatching. The survey areas consist of all counties in which the home market stations are viewed to any significant extent, including via cable. The Metro Areas, save for an occasional deviation caused by geographical or historical factors, conform to the U.S. Census Standard Metropolitan Statistical Areas.

Arbitron has also designated several "supplementary markets"—TV-station home counties where the stations of a different market receive the preponderance of viewing. Supplementary markets therefore do not meet Arbitron's criteria for having an ADI of their own; they are listed in this atlas next to the ADI of which they are a part. (Note—The survey area of a supplementary market usually differs from that of the neighboring ADI market.)

A complete list of the supplementary markets appears on page B-79, and a cross-reference list for cities in a multi-city ADI on B-80.

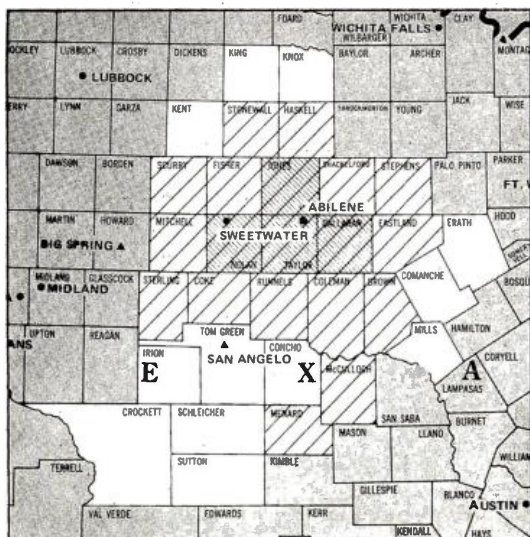

Abilene-Sweetwater, Tex. (145)

ADI TV Households	100,300
Survey Area TV Households	145,800

KRBC-TV Abilene, Tex., ch. 9 NBC
 KACB-TV San Angelo, Tex., ch. 3, satellite to
 KRBC-TV
 KTXS-TV Sweetwater, Tex., ch. 12, ABC (CBS)

ADI Counties	State	TV Households
Brown	TX	10,500
Callahan	TX	3,700
Coke	TX	1,100
Coleman	TX	4,000
Eastland	TX	7,200
Fisher	TX	2,200
Haskell	TX	2,700

Jones	TX	5,700
McCulloch	TX	2,900
Menard	TX	1,100
Mitchell	TX	2,700
Nolan	TX	5,400
Runnels	TX	4,400
Scurry	TX	6,000
Shackelford	TX	1,200
Stephens	TX	3,100
Sterling	TX	300
Stonewall	TX	900
Taylor	TX	35,200

Women	104,300
Men	93,900
Teens	30,600
Children	41,400



Albany, Ga. (139)

ADI TV Households 112,900
 Survey Area TV Households 390,000

WALB-TV Albany, Ga., ch. 10, NBC (ABC)

ADI Counties	State	TV Households
Atkinson	GA	1,300
Baker	GA	900
Ben Hill	GA	4,700
Berrien	GA	3,600
Calhoun	GA	1,600
Coffee	GA	3,100
Colquitt	GA	10,300
Cook	GA	3,900

Dougherty	GA	29,700
Irwin	GA	2,500
Lanier	GA	1,600
Lee	GA	2,300
Lowndes	GA	18,700
Mitchell	GA	5,100
Telfair	GA	3,400
Tift	GA	8,800
Turner	GA	2,500
Worth	GA	4,900

Women		124,300
Men		111,000
Teens		44,200
Children		70,800

Albany-Schenectady-Troy, N.Y. (43)

ADI TV Households 430,200
 Survey Area TV Households 1,371,600

WRGB Albany-Schenectady-Troy, N.Y., ch. 6, NBC

WTEN Albany, N.Y., ch. 10, CBS
 WCDC Adams, Mass., ch. 19, satellite to WTEN
 WAST Albany, N.Y., ch. 13, ABC
 *WMHT Schenectady, N.Y., ch. 17, ETW

ADI Counties	State	TV Households
Berkshire	MA	50,600
Albany	NY	100,200
Columbia	NY	18,700

Fulton	NY	20,400
Greene	NY	13,100
Hamilton	NY	1,700
Montgomery	NY	20,400
Rensselaer	NY	51,100
Saratoga	NY	44,900
Schenectady	NY	55,500
Schoharie	NY	9,500
Warren	NY	17,300
Washington	NY	17,000
Bennington	VT	9,800

Women		458,000
Men		403,800
Teens		139,700
Children		193,100

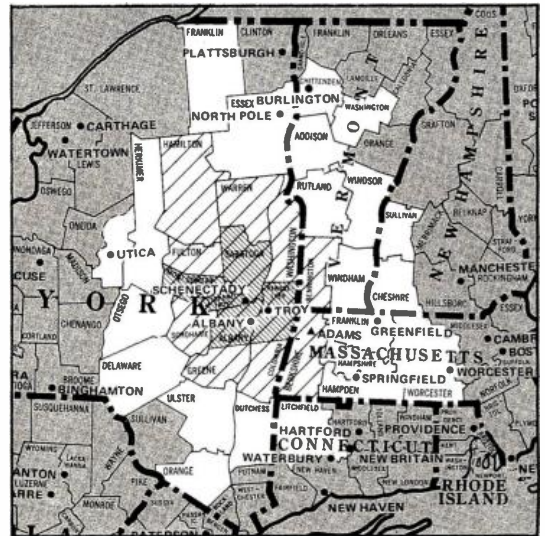

Albuquerque, N.M. (80)

ADI TV Households 238,500
 Survey Area TV Households 363,900

KOB-TV Albuquerque, N.M., ch. 4, NBC
 *KNME-TV Albuquerque, N.M., ch. 5, ETW
 KOAT-TV Albuquerque, N.M., ch. 7, ABC
 KGMX-TV Albuquerque, N.M., ch. 13, CBS
 KMXN-TV Albuquerque, N.M., ch. 23, IND

ADI Counties	State	TV Households
Apache North	AZ	6,400
Alamosa	CO	3,200
Archuleta	CO	700
Conejos	CO	1,700
Costilla	CO	700
Montezuma	CO	4,200
Rio Grande	CO	3,000
Saguache	CO	1,200
Bernalillo	NM	124,800

Colfax	NM	4,300
Guadalupe	NM	1,400
Harding	NM	300
Lincoln	NM	3,200
Los Alamos	NM	5,200
McKinley	NM	11,500
Mora	NM	1,300
Rio Arriba	NM	7,100
Sandoval	NM	5,800
San Miguel	NM	6,300
Santa Fe	NM	19,300
Sierra	NM	3,600
Socorro	NM	3,000
Taos	NM	5,300
Torrance	NM	2,000
Valencia	NM	13,200

Women		247,400
Men		225,200
Teens		99,700
Children		139,800

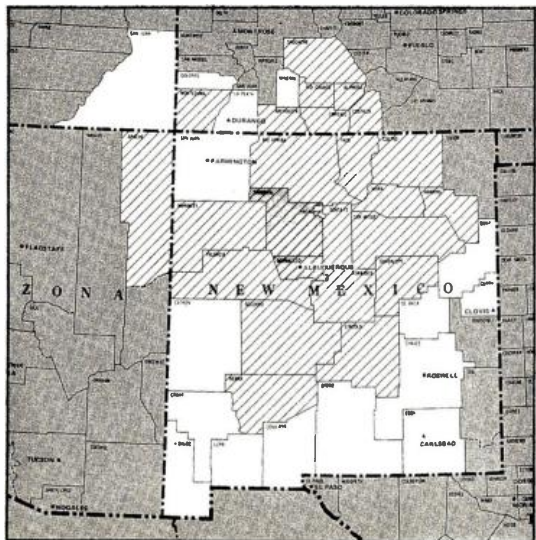



Alexandria, La. (167)

ADI TV Households	63,100	Grant	LA	4,700
Survey Area TV Households	503,800	Rapides	LA	37,900
		Vernon	LA	8,900
KALB-TV Alexandria, La., ch. 5, NBC				
ADI	State	TV	Women	67,300
Counties	LA	Households	Men	77,800
Avoyelles	LA	11,600	Teens	24,600
			Children	35,400

Alexandria, Minn. (157)

ADI TV Households	86,000
Survey Area TV Households	247,200

KCMT Alexandria, Minn., ch. 7, NBC (ABC)
 KNMT Walker, Minn., ch. 12, satellite to KCMT
 *KWCM-TV Appleton, Minn., ch. 10, ETV

ADI Counties	State	TV Households
Beltrami	MN	9,000
Cass	MN	6,600
Chippewa	MN	5,800
Crow Wing	MN	13,700
Douglas	MN	8,800

Grant	MN	2,400
Hubbard	MN	4,400
Lac qui Parle	MN	3,900
Pope	MN	4,000
Stevens	MN	3,700
Swift	MN	4,600
Todd	MN	8,100
Traverse	MN	2,000
Wadena	MN	4,300
Yeller Medicine	MN	4,700

Women	88,200
Men	84,000
Teens	31,500
Children	38,000



No Outside Station Delivers the TV Twins' Mid-Minnesota Market

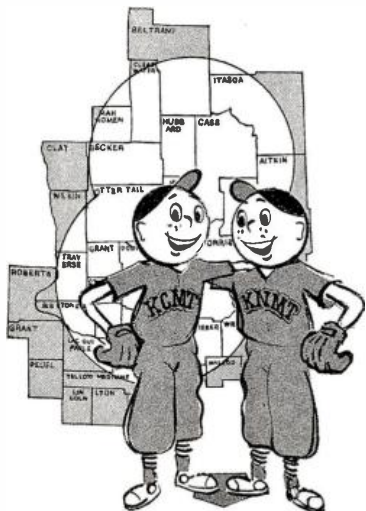

EXCLUSIVE COVERAGE

KCMT-TV, Alexandria and KNMT-TV, Walker — Minnesota's TV Twins — provide exclusive coverage in a market you can't reach from Minneapolis, Duluth, or Fargo — a market with 232,500 potential TV homes in a total of 32 Mid-Minnesota counties:

Population	689,300
CSI	2,755,552,000
TRS	1,740,621,000
Gross Farm Inc.	1,660,343,000
	(SRDS Data 1-1-75)

LEADERS IN THEIR MARKET

KCMT-KNMT clearly show up in ARB as Mid-Minnesota's hard-core leaders, with:

Sun.-Sat., 6:30-10 p.m.:

AVG RTG 43, TV Households — 54,000, Total Persons — 127,000, Total Adults — 89,000.

Sun.-Sat., 9 a.m.-Midnight:

AVG RTG 25, TV Households — 30,000, Total Persons — 50,000, Total Adults — 44,000.

	ADI	RTG	Share%	HH
M-F 6:30-10 p.m.	44	68	55,000	
Late News 10-10:30	42	71	49,000	
Early News 6-6:30	43	73	46,000	
Johnny Carson M-F 10:30-11	23	63	21,000	
Another World M-F 2-2:30	27	57	35,000	

(ARB, Alexandria, Minn., Feb./Mar., 1975. Estimates subject to qualifications in report.)

Go with Mid-Minnesota's twins . . .

KCMT / KNMT

Channel 7 Alexandria Channel 12 Walker

Represented by
AVERY-KNODEL, INC.

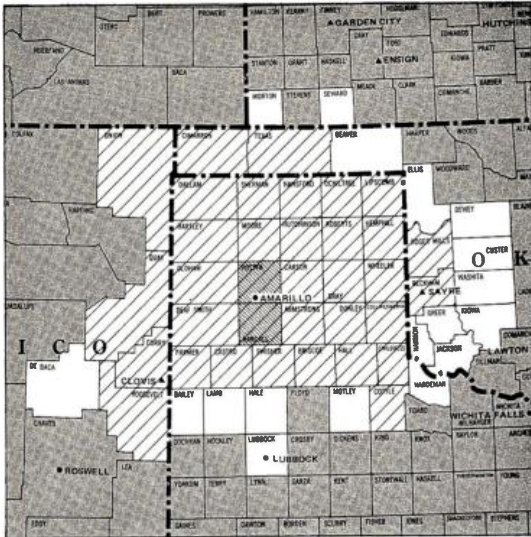

Amarillo, Tex. (109)

ADI TV Households 158,400
 Survey Area TV Households 291,800

KAMR-TV Amarillo, Tex. ch. 4, NBC
KVII Amarillo, Tex., ch. 7, ABC
KFDA-TV Amarillo, Tex., ch. 10, CBS
KFDD-TV Sayre, Okla., ch. 8, satellite to KFDA
KFDW-TV Clovis, N.M., ch. 12, satellite to KFDA
KENW-TV Portales, N.M., ch. 3, ETV

ADI Counties	State	TV Households
Curry	NM	14,800
Quay	NM	3,600
Roosavelt	NM	6,300
Union	NM	1,800
Beckham	OK	5,500
Cimarron	OK	1,300
Roger Mills	OK	1,500
Texas	OK	5,800
Armstrong	TX	800
Briscoe	TX	800
Carson	TX	2,100
Castro	TX	2,500
Childress	TX	2,700
Collingsworth	TX	1,500

Cottie	TX	1,100
Dallam	TX	1,900
Deaf Smith	TX	5,500
Donley	TX	1,200
Gray	TX	9,200
Halt	TX	2,100
Hansford	TX	1,800
Hartley	TX	800
Hemphill	TX	1,400
Hutchinson	TX	9,400
Lipscomb	TX	1,100
Moore	TX	4,200
Ochiltree	TX	2,800
Oldham	TX	600
Parmer	TX	2,700
Potter	TX	34,100
Randall	TX	20,100
Roberts	TX	800
Sherman	TX	1,100
Swisher	TX	3,000
Wheeler	TX	2,200

Women 158,900
Men 148,200
Teens 53,400
Children 76,200

Anchorage, Alaska (176)

ADI TV Households 50,700
 Survey Area TV Households 50,700

ADI Counties	State	TV Households
Anchorage	AK	45,200
Kenai-Cook Inlet	AK	2,700
Matanuska-Susitna	AK	2,200
Seward	AK	600

KENI-TV Anchorage, ch. 2, NBC
KAKM-TV Anchorage, ch. 7, ETV
KTVB-TV Anchorage, ch. 11, CBS
KIMO-TV Anchorage, ch. 13, ABC

Women 50,200
Men 57,300
Teens 22,800
Children 35,800



Anniston, Ala. (194)

ADI TV Households 32,400
 Survey Area TV Households 420,100

WHMA-TV Anniston, Ala., ch. 40, CBS

ADI Counties	State	TV Households
Calhoun	AL	32,400

Women 38,500
Men 32,300
Teens 11,200
Children 16,600



Ardmore-Ada, Okla. (173)

ADI TV Households 53,100
 Survey Area TV Households 571,400

KTEN Ada, Okla., ch. 10, ABC (NBC-CBS)
 KXII Ardmore, Okla., ch. 12, NBC (ABC-CBS)

ADI Counties	State	TV Households
Adoka	OK	3,500
Bryan	OK	9,600
Carter	OK	14,200

Coal	OK	2,200
Johnston	OK	3,200
Love	OK	2,200
Marshall	OK	3,300
Pontotoc	OK	11,400
Pushmataha	OK	3,500

Women	54,000
Men	48,500
Teens	15,400
Children	21,100

Note: Coverage maps in this special section show total survey areas in white, with Areas of Dominant Influence (ADI's), indicated by light cross-hatching where appropriate, and Arbitron Metro Rating Areas shown by heavier cross-hatching.

Atlanta (16)

ADI TV Households 836,100
 Survey Area TV Households 2,096,700

WSB-TV Atlanta, ch. 2, NBC
 WAGA-TV Atlanta, ch. 5, CBS
 *WGTV Athens, ch. 8, ETV
 WXIA-TV Atlanta, ch. 11, ABC
 WTCG Atlanta, ch. 17, IND
 *WETV Atlanta, ch. 30, ETV
 WHAE-TV Atlanta, ch. 46, IND

ADI Counties	State	TV Households
Cherokee	AL	6,000
Cleburne	AL	3,700
Randolph	AL	6,100
Banks	GA	2,100
Barrow	GA	6,200
Barrow	GA	11,500
Butts	GA	3,300
Carroll	GA	17,200
Cherokee	GA	12,000
Clarke	GA	22,200
Clayton	GA	40,300
Cobb	GA	72,200
Coweta	GA	11,100
Dawson	GA	1,500
De Kalb	GA	156,300
Douglas	GA	12,400
Fayette	GA	4,300
Floyd	GA	24,500
Forsyth	GA	6,800
Fulton	GA	202,300
Gilmer	GA	3,000
Gordon	GA	8,700

Greene	GA	3,000
Gwinnett	GA	33,000
Habersham	GA	6,900
Hall	GA	20,100
Haralson	GA	6,100
Keard	GA	2,000
Henry	GA	7,800
Jackson	GA	7,400
Jasper	GA	2,000
Lamar	GA	3,100
Lumpkin	GA	2,500
Meriwether	GA	5,500
Monroe	GA	3,300
Morgan	GA	2,700
Newton	GA	9,400
Oconee	GA	2,800
Paulding	GA	7,000
Pickens	GA	3,000
Pike	GA	2,200
Polk	GA	9,900
Putnam	GA	2,300
Rockdale	GA	7,200
Spalding	GA	13,900
Towns	GA	1,400
Troup	GA	13,400
Union	GA	2,500
Upson	GA	8,000
Walton	GA	8,900
White	GA	2,600
Clay	GA	1,700

Women	909,600
Men	815,300
Teens	296,300
Children	460,700

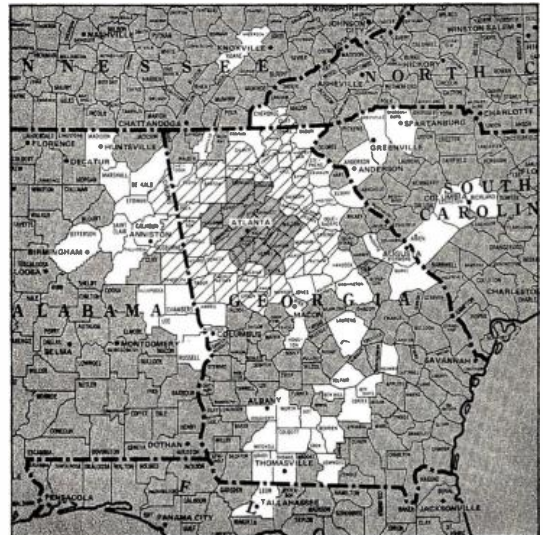

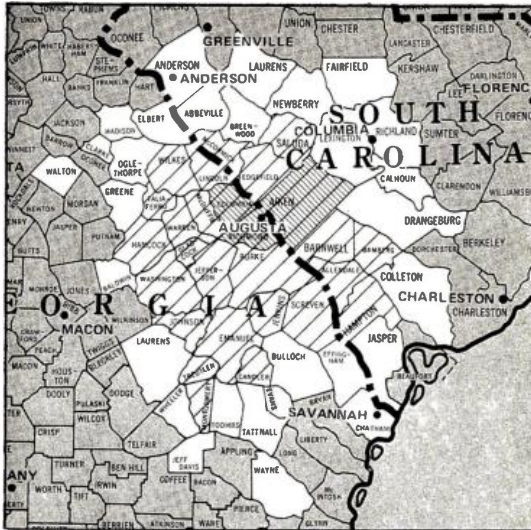

Augusta, Ga. (111)

ADI TV Households 157,800
 Survey Area TV Households 550,500

WJBF Augusta, Ga. ch. 6, ABC (NBC)
 WRDW-TV Augusta, Ga. ch. 12, CBS (NBC)
 *WEBA-TV Allendale, S.C. ch. 14, ETV
 *WCES-TV Wrens, Ga. ch. 20, ETV
 WATU-TV Augusta, Ga. ch. 26, NBC

ADI Counties	State	TV Households
Burke	GA	4,300
Candler	GA	1,900
Columbia	GA	7,700
Emanuel	GA	6,100
Glascok	GA	700
Hancock	GA	2,300
Jefferson	GA	4,200
Jenkins	GA	2,600
Johnson	GA	2,200
Lincoln	GA	1,800

McDuffie	GA	4,800
Montgomery	GA	1,600
Richmond	GA	43,300
Scriven	GA	3,500
Talbot	GA	700
Treutlen	GA	1,600
Warren	GA	1,900
Washington	GA	4,400
Wilkes	GA	3,100
Aiken	SC	30,200
Allendale	SC	3,000
Barnberg	SC	4,400
Barnwell	SC	5,400
Edgefield	SC	4,500
Hampton	SC	4,700
McCormick	SC	2,200
Saluda	SC	4,600
Women		175,900
Men		166,100
Teens		62,100
Children		91,600

Austin, Tex. (106)

ADI TV Households 163,700
 Survey Area TV Households 363,700

KTBC-TV Austin, Tex., ch. 7, CBS
 KVUE Austin, Tex., ch. 24, ABC
 KTVV Austin, Tex., ch. 36, NBC

ADI Counties	State	TV Households
Bastrop	TX	7,200
Blanco	TX	1,600

Burnett	TX	6,100
Fayette	TX	6,200
Lee	TX	3,500
Llano	TX	3,300
Mason	TX	1,200
Travis	TX	117,700
Williamson	TX	16,900
Women		173,200
Men		163,500
Teens		50,500
Children		79,000

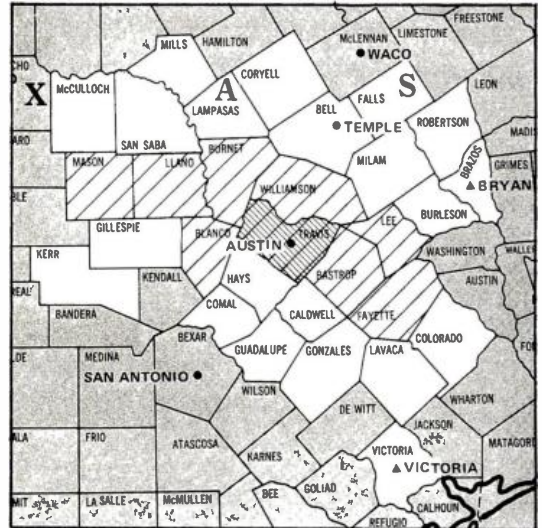

Bakersfield, Calif. (151)

ADI TV Households 95,700
 Survey Area TV Households 3,124,700

KJTV Bakersfield, Calif. ch. 17, CBS
 KERO-TV Bakersfield, Calif. ch. 23, NBC
 KBKA-TV Bakersfield, Calif. ch. 29, ABC

ADI Counties	State	TV Households
Kern West	CA	95,700

Women		97,400
Men		91,300
Teens		36,000
Children		48,600





Baltimore (19)

ADI TV Households 745,500
 Survey Area TV Households 2,800,800

WMAR-TV Baltimore, ch. 2, CBS
 WBAL-TV Baltimore, ch. 11, NBC
 WJZ-TV Baltimore, ch. 13, ABC
 *WAPB-TV Annapolis, ch. 22, ETV
 *WBFF Baltimore, ch. 45, IND
 *WMPB Baltimore, ch. 67, ETV

ADI Counties	State	TV Households
Anne Arundel	MD	99,500
Baltimore	MD	499,200

Caroline	MD	7,200
Carroll	MD	24,800
Cecil	MD	14,900
Dorchester	MD	10,200
Harford	MD	39,900
Howard	MD	27,600
Kent	MD	5,900
Queen Annes	MD	6,800
Talbot	MD	9,500

Women	823,700
Men	754,100
Teens	270,400
Children	362,400

Bangor, Me. (146)

ADI TV Households 99,400
 Survey Area TV Households 263,200

WLBZ-TV Bangor, Me., ch. 2, NBC
 WABI-TV Bangor, Me., ch. 5, CBS
 WEMT-TV Bangor, Me., ch. 7, ABC
 *WMEB-TV Orono, Me., ch. 12, ETV
 *WMED-TV Calais, Me., ch. 13, ETV

ADI Counties	State	TV Households
Hancock	ME	12,600

Knox	ME	10,800
Penobscot	ME	38,700
Piscataquis	ME	5,400
Somerset	ME	13,100
Waldo	ME	8,200
Washington	ME	10,600

Women	111,800
Men	103,800
Teens	36,400
Children	50,600

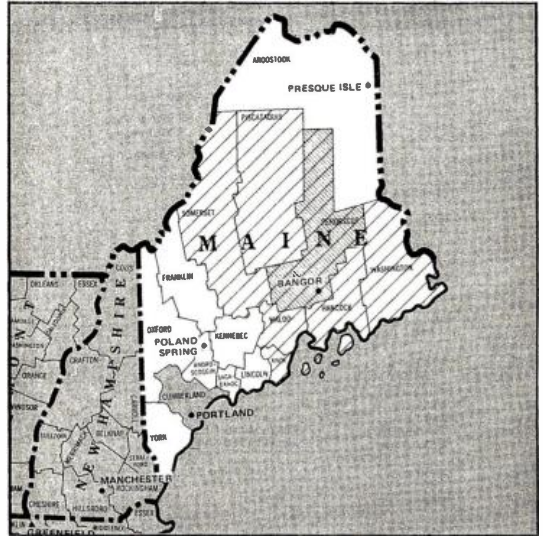

Baton Rouge (98)

ADI TV Households 176,800
 Survey Area TV Households 519,000

WBRZ Baton Rouge, ch. 2, NBC
 WAFB-TV Baton Rouge, ch. 9, CBS
 WRBT Baton Rouge, ch. 33, ABC

ADI Counties	State	TV Households
Ascension	LA	12,100
Assumption	LA	5,700
East Baton-Rouge	LA	94,800
East Feliciana	LA	3,800

Iberville	LA	8,900
Livingston	LA	12,200
Pointe Coupee	LA	6,000
St. Helena	LA	2,300
St. Mary	LA	18,100
West Baton Rouge	LA	5,100
West Feliciana	LA	1,500
Amite	MS	3,600
Wilkinson	MS	2,700

Women	199,100
Men	184,700
Teens	75,300
Children	111,700

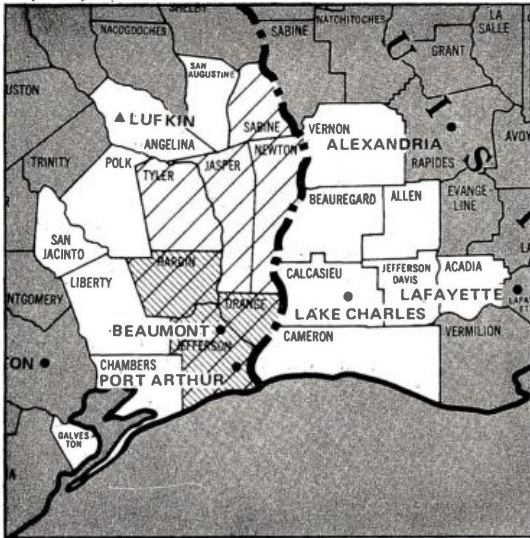

Beaumont-Port Arthur, Tex. (127)

ADI TV Households 131,400
 Survey Area TV Households 337,600

KJAC-TV Port Arthur-Beaumont, Tex., ch. 4,
 NBC
 KFDM-TV Beaumont, Tex., ch. 6, CBS
 KBMT Beaumont, Tex., ch. 12, ABC

ADI Counties	State	TV Households
Hardin	TX	10,600

Jasper	TX	7,900
Jefferson	TX	78,900
Newton	TX	3,300
Orange	TX	23,600
Sabine	TX	2,600
Tyler	TX	4,500

Women	141,200
Men	128,800
Teens	48,900
Children	64,700

Bellingham, Wash. (196)

ADI TV Households 30,200
 Survey Area TV Households 762,100

KVOS-TV Bellingham, Wash., ch. 12, CBS

ADI Counties	State	TV Households
Whatcom	WA	30,200

Women	31,500
Men	28,900
Teens	9,000
Children	12,900

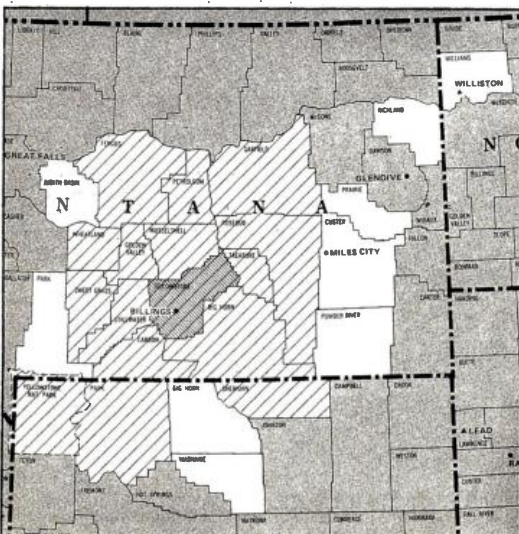

Billings, Mont. (170)

ADI TV Households 63,300
 Survey Area TV Households 87,400

KTVO-TV Billings, Mont., ch. 2, CBS (NBC-ABC)
 KULR-TV Billings, Mont., ch. 8, ABC (NBC)

ADI Counties	State	TV Households
Big Horn	MT	3,000
Carbon	MT	2,900
Fergus	MT	3,800
Garfield	MT	500
Golden Valley	MT	300
Musselshell	MT	1,500

Petroleum	MT	200
Rosebud	MT	2,100
Stillwater	MT	1,700
Sweet Grass	MT	1,000
Treasure	MT	300
Wheatland	MT	700
Yellowstone	MT	31,300
Park	WY	6,000
Sheridan	WY	6,800
Yellowstone Natl Prk	WY	200

Women	65,800
Men	61,300
Teens	22,900
Children	28,600



Biloxi-Gulfport-Pascagoula, Miss. (180)

ADI TV Households	45,000	ADI Counties	State	TV Households
Survey Area TV Households	362,400	Harrison	MS	42,700
		Stone	MS	2,300
		Women		48,900
		Men		53,400
		Teens		18,400
		Children		28,900

WLOX-TV Biloxi-Gulfport-Pascagoula, Miss., ch. 13, ABC
 *WMAH Biloxi, Miss., ch. 19, ETV

Binghamton, N.Y. (115)

ADI TV Households	149,600
Survey Area TV Households	682,000

WBNG-TV Binghamton, N.Y., ch. 12, CBS
 WBJA-TV Binghamton, N.Y., ch. 34, ABC
 WICZ-TV Binghamton, N.Y., ch. 40, NBC
 *WSKG Binghamton, N.Y., ch. 46, ETV

ADI Counties	State	TV Households
Broome	NY	72,400

Chenango	NY	14,700
Delaware	NY	14,900
Tioga	NY	14,700
Bradford	PA	18,900
Sullivan	PA	1,800
Susquehanna	PA	12,200

Women	160,100
Men	144,200
Teens	64,900
Children	73,800



Birmingham, Ala. (51)

ADI TV Households	396,300
Survey Area TV Households	794,900

WBRC-TV Birmingham, Ala., ch. 6, ABC
 *WCIO Mt. Cheaha State Park, Ala., ch. 7, ETV
 *WBIQ Birmingham, Ala., ch. 10, ETV
 WAPI-TV Birmingham, Ala., ch. 13, NBC
 WBMG Birmingham, Ala., ch. 42, CBS

ADI Counties	State	TV Households
Bibb	AL	4,200
Blount	AL	10,500
Chilton	AL	9,200
Coosa	AL	3,600
Cullman	AL	19,300

Etowah	AL	32,500
Fayette	AL	5,600
Greene	AL	2,600
Hale	AL	4,100
Jefferson	AL	219,300
Marion	AL	9,000
Perry	AL	3,800
St. Clair	AL	10,400
Shelby	AL	13,600
Talladega	AL	19,500
Walker	AL	21,800
Winston	AL	7,300

Women	430,400
Men	371,100
Teens	134,900
Children	190,200

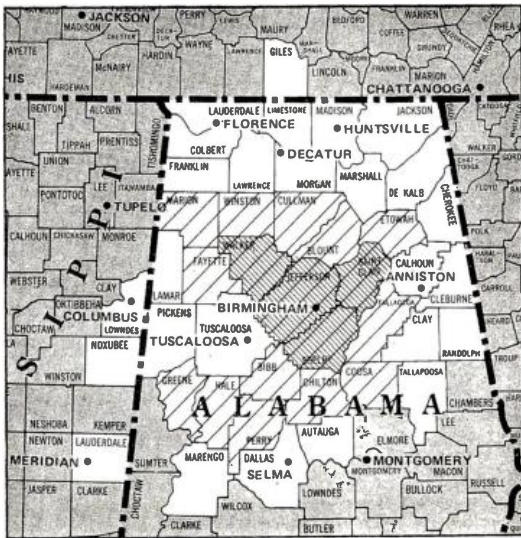

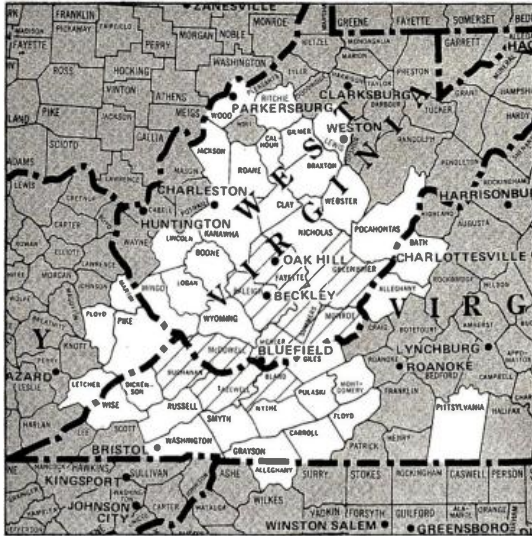

Bluefield-Beckley-Oak Hill, W. Va. (133)

ADI TV Households	123,800	Tazewell	VA	13,800
Survey Area TV Households	532,900	Fayette	WV	17,500
		Greenbrier	WV	10,600
		McDowell	WV	15,800
		Mercer	WV	22,300
		Monroe	WV	3,400
		Raleigh	WV	25,000
		Summers	WV	4,700

ADI	Counties	State	TV Households
Bland	VA	1,800
Buchanan	VA	8,900

Women	136,100
Men	120,200
Teens	42,700
Children	61,700

Boise, Idaho (144)

ADI TV Households	104,700
Survey Area TV Households	168,000

KBOI-TV Boise, Idaho, ch. 2, CBS (ABC)
***KAID** Boise, Idaho, ch. 4, ETV
KIVI Nampa-Boise-Caldwell, Idaho, ch. 6, ABC
KTVB Boise, Idaho, ch. 7, NBC (ABC)

ADI	Counties	State	TV Households
Ada	ID	44,000
Adams	ID	800
Boise	ID	700
Canyon	ID	23,400

Elmore	ID	6,000
Gem	ID	3,400
Oneida	ID	2,200
Payette	ID	5,000
Valley	ID	1,300
Washington	ID	2,500
Baker	OR	5,400
Grant	OR	2,400
Malheur	OR	7,600

Women	109,400
Men	102,900
Teens	37,500
Children	54,300



Boston (5)

ADI TV Households	1,736,300
Survey Area TV Households	2,832,200

***WGBH-TV** Boston, ch. 2, ETV
WBZ-TV Boston, ch. 4, NBC
WCVB-TV Boston, ch. 5, ABC
WNAC-TV Boston, ch. 7, CBS
***WENH-TV** Durham, N.H., ch. 11, ETV
WSBK-TV Boston, ch. 38, IND
***WGBX** Boston, ch. 44, ETV
***WEKW-TV** Keene, N.H., ch. 52, ETV
WLVI-TV Cambridge-Boston, ch. 56, IND

ADI	Counties	State	TV Households
Barnstable	MA	43,400

Essex	MA	224,300
Middlesex	MA	463,900
Norfolk	MA	197,200
Plymouth	MA	120,600
Suffolk	MA	261,500
Worcester	MA	213,700
Cheshire	NH	18,100
Hillsborough	NH	79,400
Merrimack	NH	28,700
Rockingham	NH	50,100
Strafford	NH	24,400
Sullivan	NH	11,000

Women	1,923,800
Men	1,681,200
Teens	593,700
Children	820,000

Manchester, N.H. (supplementary market)

Arbitron characterizes supplementary markets as those that do not meet its criteria for having an ADI.

WMUR-TV Manchester, N.H., ch. 9, ABC	
Home county	Hillsborough
TV Households	79,400

Worcester, Mass. (supplementary market)

Arbitron characterizes supplementary markets as those that do not meet its criteria for having an ADI.

WSMW-TV Worcester, Mass., ch. 27, IND	
Home county	Worcester
TV Households	213,700

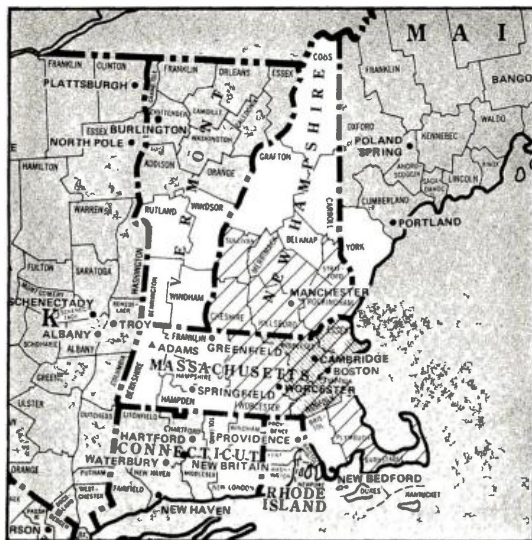

Bristol, Va.-Kingsport-Johnson City, Tenn. (86)

ADI TV Households 219,300
 Survey Area TV Households 677,500

*WSJK-TV Sneedville, Tenn., ch. 2, ETV
 WCYB-TV Bristol, Va.-Johnson City, Kingsport, Tenn., ch. 5, NBC
 WJHL-TV Johnson City-Kingsport-Bristol, Tenn., ch. 11, CBS
 WKPT-TV Kingsport-Johnson City, Tenn., Bristol, Va., ch. 19, ABC
 *WSVN-TV Norton, Va., ch. 47, ETV

ADI Counties	State	TV Households
Knott	KY	4,400
Letcher	KY	7,900
Ashe	NC	6,300
Carter	TN	16,400

Greene	TN	16,900
Hancock	TN	2,300
Hawkins	TN	12,700
Johnson	TN	4,400
Sullivan	TN	44,800
Union	TN	5,800
Washington	TN	27,400
Dickens	VA	5,300
Lee	VA	7,600
Russell	VA	7,400
Scott	VA	7,400
Smyth	VA	9,500
Washington	VA	19,500
Wise	VA	13,300

Women	238,500
Men	214,600
Teens	72,200
Children	106,700

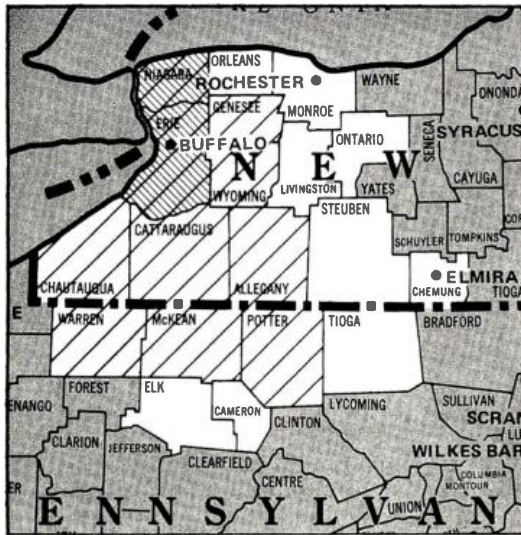
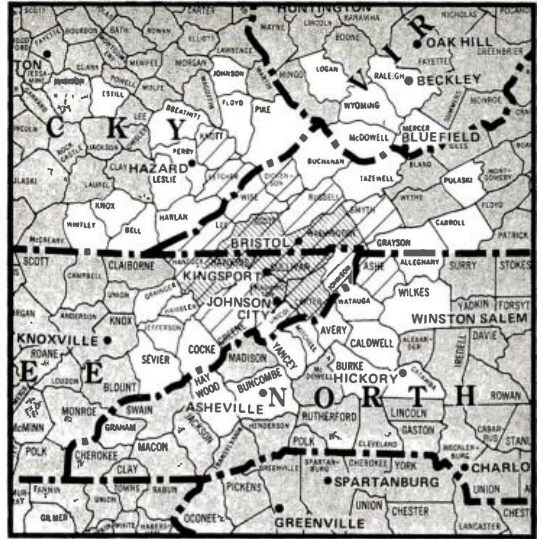

Buffalo, N.Y. (27)

ADI TV Households 611,100
 Survey Area TV Households 993,100

WGR-TV Buffalo, N.Y., ch. 2, NBC
 WBEN-TV Buffalo, N.Y., ch. 4, CBS
 WKBW-TV Buffalo, N.Y., ch. 7, ABC
 *WNED-TV Buffalo, N.Y., ch. 17, ETV
 WUTV Buffalo, N.Y., ch. 29, IND

ADI Counties	State	TV Households
Allegany	NY	15,100
Cattaraugus	NY	28,100

Chautauqua	NY	50,400
Erie	NY	369,600
Genesee	NY	19,600
Niagara	NY	77,600
Wyoming	NY	11,500
McKean	PA	17,800
Potter	PA	6,100
Warren	PA	15,300

Women	664,800
Men	585,400
Teens	213,100
Children	285,300

SETTING A NEW STANDARD



New England's first live entertainment television network. Now covering six states.



"House Call", America's pioneer prime-time medical program with Dr. Timothy Johnson.



The nation's number one station in total hours of news and public affairs programming.



More than 92 awards since we began broadcasting 46 months ago.

WCVB-TV BOSTON



represented nationally by HRP

Burlington, Vt.-Plattsburgh, N.Y. (100)

ADI TV Households 172,500
 Survey Area TV Households 339,500

WCAX-TV Burlington, Vt., ch. 3, CBS
WPTZ Plattsburgh-North Pole, N.Y., Burlington, Vt., ch. 5, NBC
***WVTB** St. Johnsbury, Vt., ch. 20, ETV
WEZF-TV Burlington, Vt., ch. 22, ABC
***WVER** Rutland, Vt., ch. 28, ETV
***WETK** Burlington, Vt., ch. 33, ETV
***WVTA** Windsor, Vt., ch. 41, ETV

ADI Counties	State	TV Households
Clinton	NY	22,000
Essex	NY	11,300
Franklin	NY	13,600

Addison	VT	7,200
Caledonia	VT	7,800
Chittenden	VT	32,000
Essex	VT	1,800
Franklin	VT	10,500
Grand Isle	VT	1,100
Lamoille	VT	4,400
Orange	VT	6,100
Orleans	VT	6,700
Rutland	VT	17,400
Washington	VT	15,100
Windsor	VT	15,500

Women	192,600
Men	179,600
Teens	68,200
Children	95,600

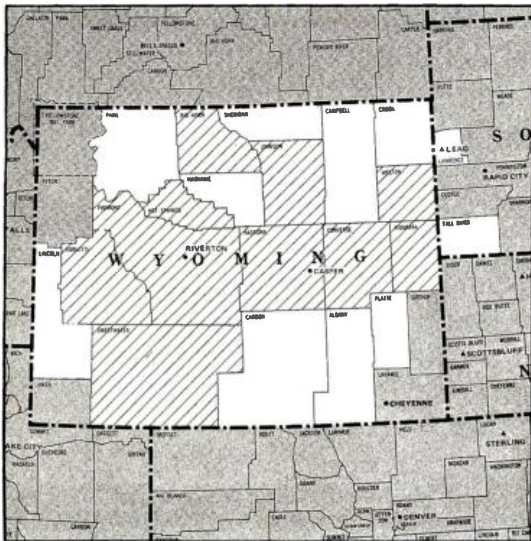

Casper-Riverton, Wyo. (185)

ADI TV Households 40,000
 Survey Area TV Households 95,400

KTWO-TV Casper, Wyo., ch. 2, NBC (ABC-CBS)
KWRB-TV Lander-Riverton-Thermopolis-Worland, Wyo., ch. 10, NBC (CBS)

ADI Counties	State	TV Households
Big Horn	WY	3,600
Converse	WY	2,200

Fremont	WY	8,900
Hot Springs	WY	1,900
Johnson	WY	1,900
Natrona	WY	17,400
Niobrara	WY	1,100
Sublett	WY	1,200
Weston	WY	1,800

Women	40,900
Men	38,900
Teens	15,300
Children	20,200

Cedar Rapids-Waterloo, Iowa (71)

ADI TV Households 288,600
 Survey Area TV Households 523,000

WMT-TV Cedar Rapids-Waterloo, Iowa, ch. 2, CBS
KWWL-TV Waterloo-Cedar Rapids, Iowa, ch. 7, NBC
KCRG-TV Cedar Rapids-Waterloo, Iowa, ch. 9, ABC
***KIIN-TV** Iowa City, Iowa, ch. 12, ETV
***KRIN-TV** Waterloo, Iowa, ch. 32, ETV

ADI Counties	State	TV Households
Allamakee	IA	5,300
Benton	IA	8,400
Black Hawk	IA	45,000
Bremer	IA	7,800
Buchanan	IA	7,100
Butler	IA	6,600

Cedar	IA	6,500
Chickasaw	IA	5,000
Clayton	IA	7,000
Delaware	IA	6,300
Dubuque	IA	28,500
Fayette	IA	9,800
Grundy	IA	5,300
Iowa	IA	5,400
Johnson	IA	25,800
Jones	IA	6,700
Keokuk	IA	5,800
Linn	IA	59,400
Tama	IA	7,600
Washington	IA	7,100
Winneshiak	IA	6,900
Grant	WI	15,300

Women	298,400
Men	272,500
Teens	102,600
Children	140,300

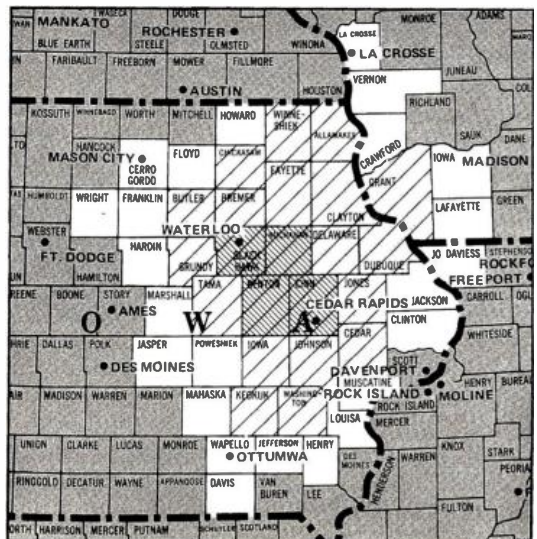

Charleston, S.C. (123)

ADI TV Households 137,600
 Survey Area TV Households 361,400

WCBD-TV Charleston, S.C., ch. 2, ABC
 WCIV Charleston, S.C., ch. 4, NBC
 WCSC-TV Charleston, S.C., ch. 5, CBS
 *WITY Charleston, S.C., ch. 7, ETV

ADI Counties	State	TV Households
Berkeley	SC	16,300

Charleston	SC	82,000
Colleton	SC	8,500
Dorchester	SC	11,700
Georgetown	SC	10,100
Williamsburg	SC	9,000

Women	149,400
Men	147,500
Teens	59,200
Children	86,800

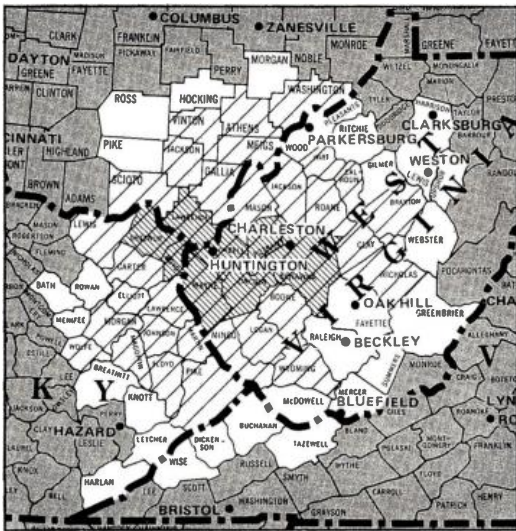

Charleston-Huntington, W. Va. (42)

ADI TV Households 434,200
 Survey Area TV Households 729,800

WSAZ-TV Huntington, Wva., ch. 3, NBC
 WCHS-TV Charleston, Wva., ch. 8, CBS
 WQWK-TV Huntington, Wva., ch. 13, ABC
 *WOUB-TV Athens, Ohio, ch. 20, ETV
 *WKPI Pikeville, Ky, ch. 22, ETV
 *WKAS Ashland, Ky, ch. 25, ETV
 *WMUL-TV Huntington, Wva., ch. 33, ETV
 *WPBO-TV Portsmouth, Ohio, ch. 42, ETV

ADI Counties	State	TV Households
Boyd	KY	17,800
Carter	KY	7,100
Elliott	KY	1,700
Floyd	KY	12,400
Greenup	KY	10,300
Johnson	KY	6,300
Lawrence	KY	3,800
Lewis	KY	3,900
Magoffin	KY	3,200
Martin	KY	2,900
Morgan	KY	3,300
Pike	KY	20,300
Wolle	KY	2,000
Athens	OH	16,000

Gallia	OH	9,100
Jackson	OH	9,600
Lawrence	OH	20,800
Meigs	OH	7,100
Scioto	OH	27,500
Vinton	OH	3,400
Washington	OH	19,100
Boone	WV	8,700
Braxton	WV	4,400
Calhoun	WV	38,200
Cabell	WV	2,400
Clay	WV	3,100
Jackson	WV	6,800
Kanawha	WV	78,900
Lincoln	WV	6,200
Logan	WV	15,000
Mason	WV	8,100
Mingo	WV	10,300
Nicholas	WV	12,300
Puimart	WV	9,700
Roane	WV	4,900
Wayne	WV	12,300
Wirt	WV	1,500
Wyoming	WV	9,300

Women	472,300
Men	423,900
Teens	149,500
Children	212,000

Charlotte, N.C. (33)

ADI TV Households 500,100
 Survey Area TV Households 1,704,200

WBTV Charlotte, N.C., ch. 3, CBS
 WSOC-TV Charlotte, N.C., ch. 9, NBC
 *WUNE-TV Linville, N.C., ch. 17, ETV
 WCCB-TV Charlotte, N.C., ch. 18, ABC
 WRET-TV Charlotte, N.C., ch. 36, IND
 *WTVI Charlotte, N.C., ch. 42, ETV
 *WUNG-TV Concord, N.C., ch. 58, ETV

ADI Counties	State	TV Households
Alexander	NC	6,800
Anson	NC	7,200
Avery	NC	3,900
Burke	NC	20,100
Cabarrus	NC	26,300
Caldwell	NC	18,600
Catawba	NC	32,100

Cleveland	NC	23,600
Gaston	NC	50,700
Iredell	NC	25,500
Lincoln	NC	11,700
Mecklenburg	NC	123,400
Richmond	NC	12,700
Rowan	NC	31,600
Stanly	NC	15,000
Union	NC	19,100
Watauga	NC	7,800
Chester	SC	9,700
Chesterfield	SC	10,500
Lancaster	SC	14,600
York	SC	29,100

Women	551,500
Men	487,000
Teens	174,700
Children	264,500

Hickory, N.C. (supplementary market)

Arbitron characterizes supplementary markets as those that do not meet its criteria for having an ADI.

WHKY-TV Hickory, N.C., ch. 14, IND	
Home county	Catawba
TV Households	32,100



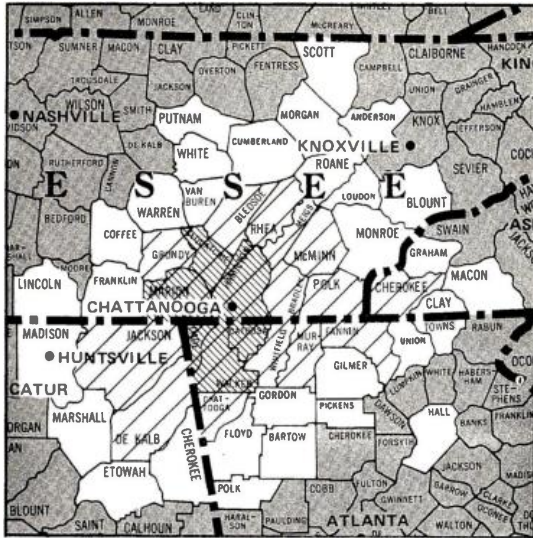

Chattanooga (76)

ADI TV Households 259,000
 Survey Area TV Households 622,300

WRCB-TV Chattanooga, Tenn., ch. 3, NBC
 WTVC Chattanooga, Tenn., ch. 9, ABC
 WDEF-TV Chattanooga, Tenn., ch. 12, CBS
 *WCLP-TV Chatsworth, Ga., ch. 18, ETV
 *WTCI Chattanooga, Tenn., ch. 45, ETV
 WRIP-TV Chattanooga, Tenn., ch. 61, IND

ADI Counties	State	TV Households
De Kalb	AL	15,600
Jackson	AL	14,700
Catoosa	GA	10,700
Chattanooga	GA	7,100
Dade	GA	3,600
Fannin	GA	4,500

Murray	GA	4,800
Walker	GA	17,100
Whitfield	GA	19,100
Cherokee	NC	5,400
Bledsoe	TN	2,600
Bradley	TN	20,000
Grundy	TN	3,900
Hamilton	TN	94,800
McMinn	TN	13,800
Marion	TN	7,000
Meigs	TN	1,700
Polk	TN	4,000
Rhea	TN	6,800
Sequatchie	TN	2,000
Women		271,600
Men		240,000
Teens		85,500
Children		129,300

Cheyenne, Wyo. (171)

ADI TV Households 56,000
 Survey Area TV Households 401,200

KYCU-TV Cheyenne, Wyo., ch. 5, CBS (ABC-NBC)
 KTVS Sterling, Colo., ch. 3, satellite to KYCU
 KSTF Scottsbluff-Gering, Neb., ch. 10, satellite to KYCU

ADI Counties	State	TV Households
Logan	CO	6,100
Phillips	CO	1,500
Sedgwick	CO	1,100

Banner	NE	300
Cheyenne	NE	3,800
Deuel	NE	1,200
Garden	NE	1,100
Kimball	NE	1,900
Morrill	NE	2,000
Scotts Bluff	NE	12,100
Goshen	WY	4,000
Laramie	WY	20,800

Women	57,700
Men	53,900
Teens	20,300
Children	26,800

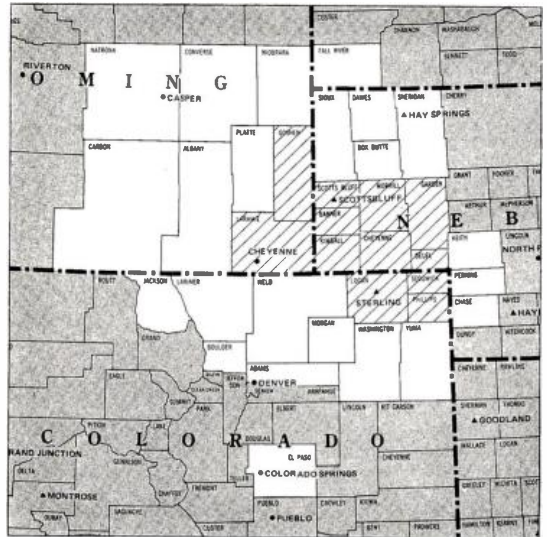

Chicago (3)

ADI TV Households 2,777,100
 Survey Area TV Households 3,927,400

WBBM-TV Chicago, ch. 2, CBS
 WMAQ-TV Chicago, ch. 5, NBC
 WLS-TV Chicago, ch. 7, ABC
 WGN-TV Chicago, ch. 9, IND
 *WTTW Chicago, ch. 11, ETV
 WCIU-TV Chicago, ch. 26, IND
 WFLD-TV Chicago, ch. 32, IND
 WSNS Chicago, ch. 44, IND
 *WCAE St. John, Ind., ch. 50, ETV

ADI Counties	State	TV Households
Cook	IL	1,874,000
De Kalb	IL	21,400
Du Page	IL	162,000
Grundy	IL	9,900
Kane	IL	86,600

Kankakee	IL	30,500
Kendall	IL	9,500
Lake	IL	116,700
La Salle	IL	37,700
Livingston	IL	13,700
Mchenry	IL	39,100
Will	IL	87,800
Jasper	IN	7,300
Lake	IN	172,700
La Porte	IN	34,100
Newton	IN	4,500
Porter	IN	28,800
Kenosha	WI	40,800



Chico-Redding, Calif. (152)

ADI TV Households 95,500
 Survey Area TV Households 1,075,400
KRCR-TV Redding, Calif., ch. 7, ABC (NBC)
***KIXE** Redding, Calif., ch. 9, ETV
KHSL-TV Chico, Calif., ch. 12, CBS (NBC)

Blenn CA 6,300
 Modoc CA 2,800
 Shasta CA 30,300
 Tehama CA 11,100
 Trinity CA 3,300

ADI Counties	State	TV Households
Butte	CA	41,700

Women 96,000
 Men 89,000
 Teens 30,300
 Children 38,200

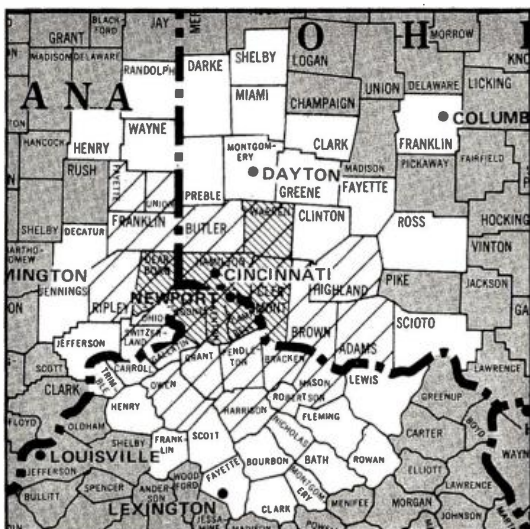
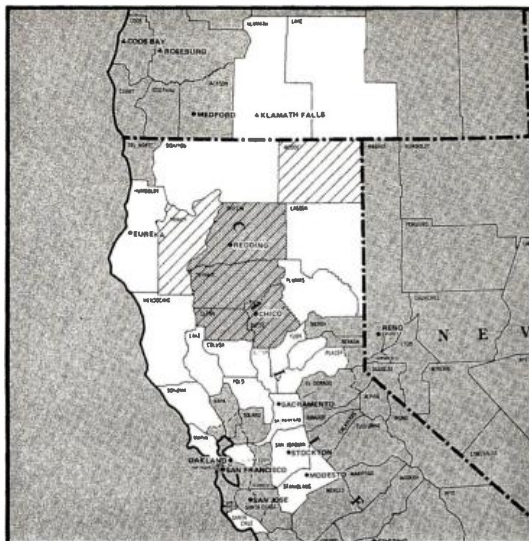

Cincinnati (26)

ADI TV Households 617,100
 Survey Area TV Households 1,543,800

WLWT Cincinnati, ch. 5, NBC
WCPO-TV Cincinnati, ch. 9, CBS
WKRC-TV Cincinnati, ch. 12, ABC
***WMUB-TV** Oxford, Ky., ch. 14, ETV
WXIS-TV Newport, Ky., Cincinnati, ch. 19, IND
***WCET** Cincinnati, ch. 48, ETV
***WKON** Owenton, Ky., ch. 52, ETV
***WCVN** Covington, Ky., ch. 54, ETV

ADI Counties	State	TV Households
Dearborn	IN	10,100
Fayette	IN	9,200
Franklin	IN	5,200
Ohio	IN	1,800
Ripley	IN	7,600
Switzerland	IN	2,100
Union	IN	2,400

Boone	KY	11,300
Braken	KY	2,700
Campbell	KY	28,700
Gallatin	KY	1,800
Grant	KY	4,500
Harrison	KY	5,100
Kenton	KY	45,700
Mason	KY	5,700
Owen	KY	3,000
Pendleton	KY	3,500
Robertson	OH	700
Adams	OH	7,200
Brown	OH	9,200
Butler	OH	77,300
Clermont	OH	31,500
Hamilton	OH	304,300
Highland	OH	10,600
Warren	OH	25,900

Women 658,200
 Men 580,300
 Teens 221,400
 Children 311,800

Clarksburg-Weston, W. Va. (161)

ADI TV Households 77,300
 Survey Area TV Households 1,275,000

WDTV Weston-Clarksburg, W. Va., ch. 5, CBS (ABC)
WBOY-TV Clarksburg, W. Va., ch. 12, NBC (ABC)

Harrison WV 28,100
 Lewis WV 6,300
 Pleasants WV 2,500
 Randolph WV 8,500
 Ritchie WV 3,800
 Taylor WV 5,300
 Tucker WV 2,600
 Upshur WV 7,200
 Webster WV 3,300

ADI Counties	State	TV Households
Barbour	WV	5,000
Doddridge	WV	2,400
Gilmer	WV	2,300

Women 82,700
 Men 73,200
 Teens 23,900
 Children 34,200





Cleveland (9)

ADI TV Households 1,308,800
 Survey Area TV Households 2,140,500

WKYC-TV Cleveland, ch. 3, NBC
 WEWS Cleveland, ch. 5, ABC
 WJW-TV Cleveland, ch. 8, CBS
 *WVIZ-TV Cleveland, ch. 25, ETV
 *WUAB Lorain-Cleveland, Ohio, ch. 43, IND
 *WNEO Alliance, Ohio, ch. 45, ETV

ADI Counties	State	TV Households
Ashtabula	OH	14,700
Carroll	OH	8,200
Coshocton	OH	12,400
Crawford	OH	17,500
Cuyahoga	OH	547,000

Erie	OH	25,200
Geauga	OH	19,400
Holmes	OH	5,900
Huron	OH	16,400
Lake	OH	61,200
Lorain	OH	81,100
Medina	OH	28,000
Portage	OH	38,400
Richland	OH	42,600
Stark	OH	122,800
Summit	OH	180,200
Tuscarawas	OH	27,300
Wayne	OH	27,800

Women 1,427,800
 Men 1,272,600
 Teens 468,400
 Children 644,200

Akron, Ohio (supplementary market)

Arbitron characterizes supplementary markets as those that do not meet its criteria for having an ADI.

WAKR-TV Akron, Ohio, ch. 23 ABC
 WCOV-TV Akron, Ohio, ch. 55, IND

Home county	Summit
TV Households	180,200

Canton, Ohio (supplementary market)

Arbitron characterizes supplementary markets as those that do not meet its criteria for having an ADI.

WJAN Canton, Ohio, ch. 17, IND

Home county	Stark
TV Households	122,800

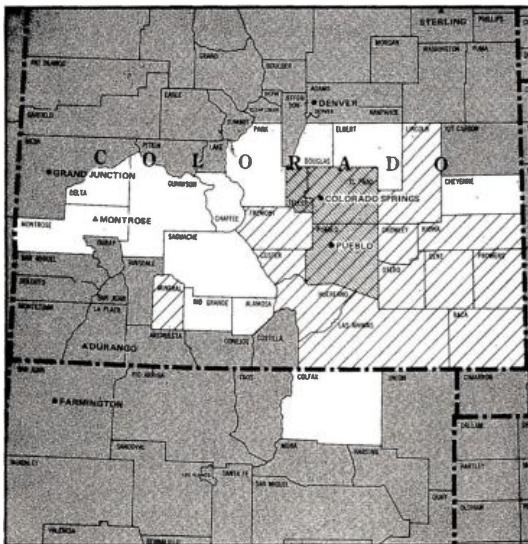

Colorado Springs-Pueblo, Colo. (103)

ADI TV Households 168,900
 Survey Area TV Households 205,600

KOAA-TV Pueblo-Colorado Springs, Colo., ch. 5, NBC
 *KTSC Pueblo, Colo., ch. 8, ETV
 KKTU-TV Colorado Springs-Pueblo, Colo. ch. 11, CBS
 KRDO-TV Colorado Springs-Pueblo, Colo., ch. 13, ABC

ADI Counties	State	TV Households
Baca	CO	1,800
Bent	CO	1,800
Crowley	CO	1,200

Custer	CO	400
El Paso	CO	90,300
Fremont	CO	8,400
Huerfano	CO	2,100
Kiowa	CO	700
Las Animas	CO	5,300
Lincoln	CO	1,600
Mineral	CO	200
Otero	CO	7,900
Prowers	CO	4,300
Pueblo	CO	40,800
Teller	CO	2,300

Women 175,400
 Men 181,700
 Teens 82,700
 Children 90,100

Columbia, S.C. (97)

ADI TV Households 177,700
 Survey Area TV Households 787,800

WIS-TV Columbia, S.C., ch. 10, NBC
 WNOK-TV Columbia, S.C., ch. 19, CBS
 WOLO-TV Columbia, S.C., ch. 25, ABC
 *WRLL-TV Columbia, S.C., ch. 35, ETV

ADI Counties	State	TV Households
Calhoun	SC	2,900
Clarendon	SC	6,800

Fairfield	SC	5,400
Kershaw	SC	11,000
Lee	SC	4,600
Lexington	SC	34,800
Orangeburg	SC	20,200
Richland	SC	67,900
Sumter	SC	24,100

Women	201,800
Men	200,500
Teens	71,500
Children	105,100

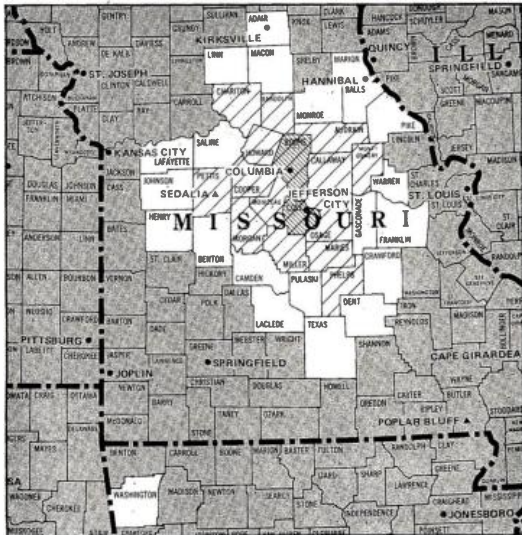

Columbia-Jefferson City, Mo. (125)

ADI TV Households 132,500
 Survey Area TV Households 316,400

KOMU-TV Columbia, Mo., ch. 8, NBC
 KRCG Jefferson City, Mo., ch. 13, CBS
 KMOS-TV Sedalia, Mo., ch. 6, satellite to KRCG
 KCBJ-TV Columbia, Mo., ch. 17, ABC

ADI Counties	State	TV Households
Audrain	MO	9,300
Boone	MO	27,600
Callaway	MO	8,900
Chariton	MO	3,800
Cole	MO	16,100
Cooper	MO	5,300

Howard	MO	3,900
Maries	MO	2,200
Miller	MO	6,300
Moniteau	MO	4,100
Montgomery	MO	4,200
Morgan	MO	4,900
Osage	MO	3,700
Pettis	MO	13,800
Phelps	MO	10,200
Randolph	MO	8,200

Women	142,900
Men	135,400
Teens	41,200
Children	58,500

Columbus, Ga. (116)

ADI TV Households 149,100
 Survey Area TV Households 692,500

WRBL-TV Columbus, Ga., ch. 3, CBS
 WTVM Columbus, Ga., ch. 9, ABC
 *WACS-TV Dawson, Ga., ch. 25, ETV
 *WJSP-TV Columbus, Ga., ch. 28, ETV
 WYEA-TV Columbus, Ga., ch. 38, NBC
 *WGIO Lousville, Ala., ch. 43, ETV

ADI Counties	State	TV Households
Barbour	AL	7,200
Chambers	AL	11,800
Lee	AL	18,700
Russell	GA	13,800
Chattahoochee	GA	4,600
Clay	GA	5,800
Dooly	GA	3,200

Harris	GA	3,300
Macon	GA	3,400
Marion	GA	1,500
Muscogee	GA	53,100
Quitman	GA	600
Randolph	GA	2,700
Schley	GA	700
Stewart	GA	1,400
Sumter	GA	7,700
Talbot	GA	1,400
Taylor	GA	2,200
Terrell	GA	3,200
Webster	GA	500

Women	165,200
Men	150,400
Teens	55,300
Children	84,100

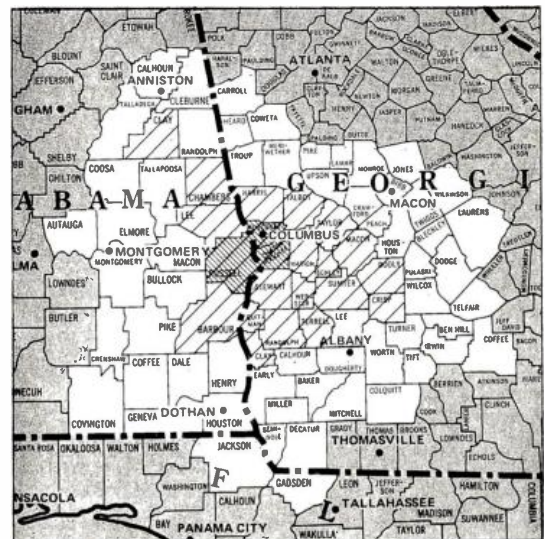

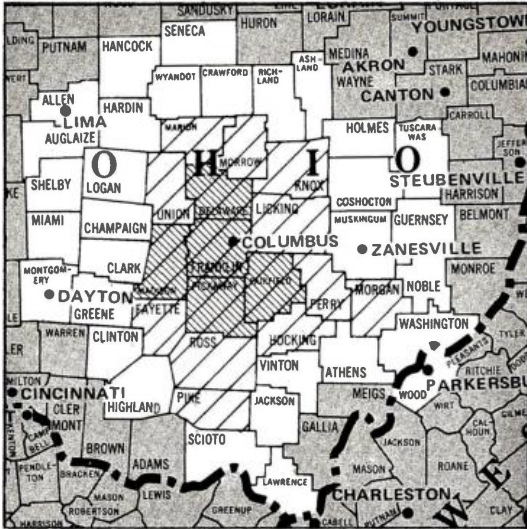

Columbus, Ohio (32)

ADI TV Households 500,600
 Survey Area TV Households 1,277,300

WLWC Columbus, Ohio, ch. 4, NBC
 WTVN-TV Columbus, Ohio, ch. 6, ABC
 WBNS-TV Columbus, Ohio, ch. 10, CBS
 *WGSF-TV Newark, Ohio, ch. 31, ETV
 *WOSU-TV Columbus, Ohio, ch. 34, ETV

ADI Counties	State	TV Households
Delaware	OH	16,000
Fairfield	OH	27,200
Fayette	OH	9,300
Franklin	OH	289,300
Hocking	OH	7,000

Knox	OH	14,200
Licking	OH	37,000
Madison	OH	9,500
Marion	OH	21,900
Morgan	OH	4,300
Morrow	OH	7,900
Perry	OH	8,900
Pickaway	OH	13,500
Pike	OH	6,400
Ross	OH	19,500
Union	OH	8,700

Women	534,700
Men	487,500
Teens	175,200
Children	254,400

Columbus-Tupelo, Miss. (143)

ADI TV Households 108,400
 Survey Area TV Households 468,000

*WMAB State College, Miss., ch. 2, ETV
 WCBI-TV Columbus, Miss., ch. 4, CBS (ABC-NBC)
 WTVV-TV Tupelo-Columbus, Miss., ch. 9, NBC
 WMAE-TV Booneville, Miss., ch. 12, ETV

ADI Counties	State	TV Households
Lamar	AL	5,600
Pickens	AL	6,500
Calhoun	MS	4,700
Chickasaw	MS	4,800
Choctaw	MS	2,600

Clay	MS	5,300
Grenada	MS	5,600
Itawamba	MS	5,300
Lee	MS	15,700
Lowndes	MS	15,400
Monroe	MS	10,400
Noxubee	MS	3,600
Oktibbeha	MS	8,100
Prenitiss	MS	6,200
Tishomingo	MS	5,500
Webster	MS	3,100

Women	122,600
Men	110,100
Teens	41,500
Children	62,500

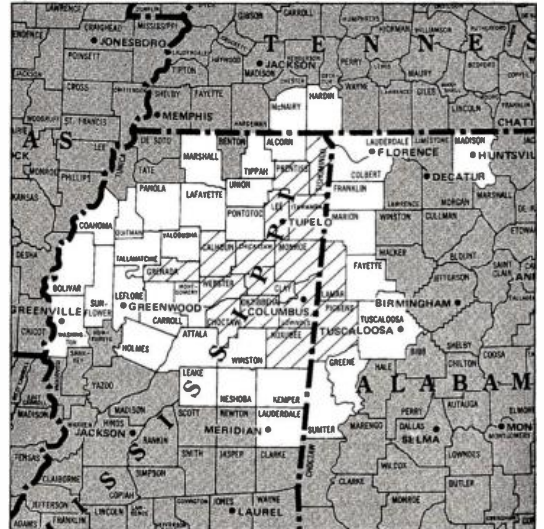

Corpus Christi, Tex. (126)

ADI TV Households 131,700
 Survey Area TV Households 280,100

KIII Corpus Christi, Tex., ch. 3, ABC
 KSIS Victoria, Tex., ch. 19, satellite to KIII
 KRIS-TV Corpus Christi, Tex., ch. 6, NBC
 KZTV Corpus Christi, Tex., ch. 10, CBS
 *KTED Corpus Christi, Tex., ch. 16, ETV

ADI Counties	State	TV Households
Aransas	TX	3,900
Bee	TX	7,300

Brooks	TX	2,300
Duval	TX	3,700
Jim Hogg	TX	1,100
Jim Wells	TX	9,100
Kennedy	TX	200
Kleberg	TX	10,000
Nueces	TX	76,800
Refugio	TX	2,900
San Patricio	TX	14,400

Women	144,900
Men	134,700
Teens	55,200
Children	83,600

Dallas-Fort Worth, Tex. (11)

ADI TV Households 1,045,400
Survey Area TV Households 2,138,700

KDFW-TV Dallas-Fort Worth, ch. 4, CBS
KXAS-TV Fort Worth-Dallas, ch. 5, NBC
WFAA-TV Dallas-Fort Worth, ch. 8, ABC
WTVT Fort Worth-Dallas, ch. 11, IND
***KERA-TV** Dallas, ch. 13, ETV
KXTX-TV Dallas, ch. 39, IND

ADI Counties	State	TV Households
Coctaw	OK	5,900
Anderson	TX	10,500
Bosque	TX	5,200
Collin	TX	28,700
Comanche	TX	4,700
Cooke	TX	8,900
Dallas	TX	471,800
Delta	TX	1,700
Denton	TX	31,600
Ellis	TX	17,500
Erath	TX	7,900
Fannin	TX	9,200
Freestone	TX	4,100

Grayson	TX	27,100
Hamilton	TX	3,700
Henderson	TX	10,600
Hill	TX	8,900
Hood	TX	3,400
Hopkins	TX	8,200
Hunt	TX	16,600
Johnson	TX	19,200
Kaufman	TX	11,700
Lamar	TX	12,800
Limestone	TX	6,400
Navarro	TX	12,300
Palo Pinto	TX	9,600
Parker	TX	11,600
Rains	TX	1,700
Rockwall	TX	2,700
Somervell	TX	1,400
Tarrant	TX	243,600
Van Zandt	TX	10,300
Wise	TX	7,700
Wood	TX	8,200

Women 1,083,600
Men 971,700
Teens 346,200
Children 520,100



Davenport, Iowa-Rock Island-Moline, Ill. (67)

ADI TV Households 295,400
Survey Area TV Households 587,600

WHBF-TV Rock Island, Ill., ch. 4, CBS
WOC-TV Davenport, Iowa, ch. 6, NBC
WQAD-TV Moline, Ill., ch. 8, ABC

ADI Counties	State	TV Households
Bureau	IL	12,400
Carroll	IL	6,800
Henderson	IL	2,900
Henry	IL	18,200
Jo Davess	IL	6,800
Knox	IL	21,600
Lee	IL	10,900
Mercer	IL	5,600

Pulnam	IL	1,900
Rock Island	IL	57,000
Stark	IL	3,000
Warren	IL	7,500
Whiteside	IL	21,200
Clinton	IA	20,800
Des Moines	IA	17,200
Henry	IA	6,500
Jackson	IA	7,300
Louisa	IA	3,900
Muscatine	IA	13,800
Scott	IA	50,100

Women 298,100
Men 271,200
Teens 101,200
Children 138,100

Dayton, Ohio (40)

ADI TV Households 446,000
Survey Area TV Households 1,152,900

WLWD Dayton, Ohio, ch. 2, NBC
WHIO-TV Dayton, Ohio, ch. 7, CBS
***WOET-TV** Kettering-Dayton, Ohio, ch. 16, ETV
WKFE Dayton, Ohio, ch. 22, ABC

ADI Counties	State	TV Households
Wayne	IN	26,600
Auglaize	OH	13,200
Champaign	OH	10,500
Clark	OH	51,100

Clinton	OH	10,500
Darke	OH	16,600
Greene	OH	36,900
Logan	OH	13,000
Mercer	OH	10,900
Miami	OH	30,400
Montgomery	OH	201,900
Preble	OH	12,000
Shelby	OH	12,400

Women 477,900
Men 431,500
Teens 160,100
Children 226,600

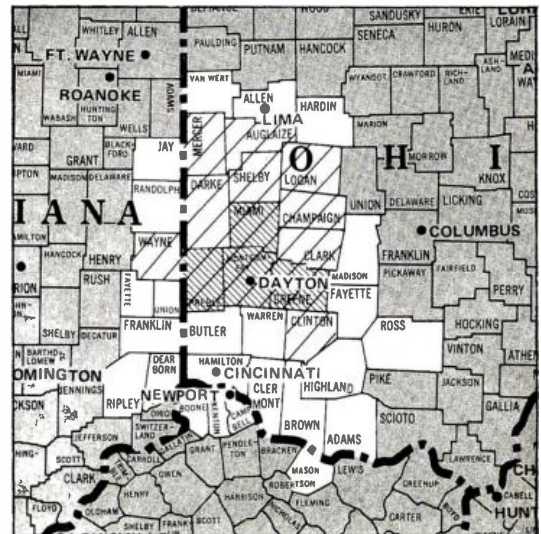

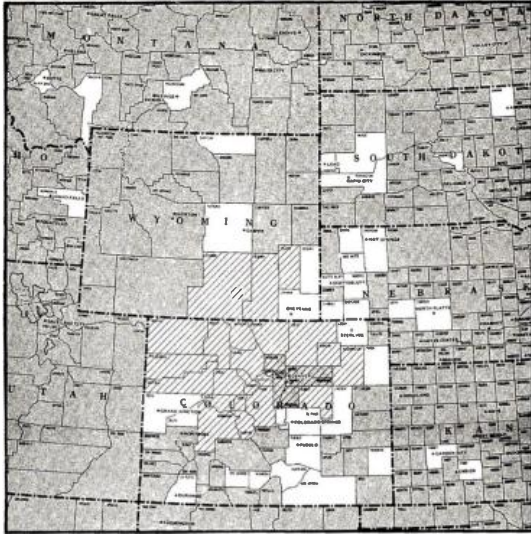

Denver (28)

ADI TV Households 598,500
 Survey Area TV Households 1,025,400

KWGN-TV Denver, ch. 2, IND
 KOA-TV Denver, ch. 4, NBC
 *KRMA-TV Denver, ch. 6, ETV
 KMGH-TV Denver, ch. 7, CBS
 KBTV Denver, ch. 9, ABC

ADI Counties	State	TV Households
Adams	CO	63,100
Arapahoe	CO	67,600
Boulder	CO	52,600
Chaffee	CO	4,100
Clear Creek	CO	1,600
Denver	CO	183,100
Douglas	CO	3,800
Eagle	CO	2,300
Elbert	CO	1,600
Garfield	CO	5,800
Gilpin	CO	800

Grand	CO	2,200
Gunnison	CO	2,100
Jackson	CO	800
Jefferson	CO	96,000
Lake	CO	2,500
Larimer	CO	38,100
Moffat	CO	2,000
Morgan	CO	7,600
Park	CO	1,400
Pitkin	CO	2,700
Rio Blanco	CO	1,600
Routt	CO	3,100
Summit	CO	1,600
Washington	CO	1,800
Weid	CO	32,500
Albany	WY	8,300
Carbon	WY	5,200
Platte	WY	2,600

Women 641,400
 Men 591,300
 Teens 217,300
 Children 301,600

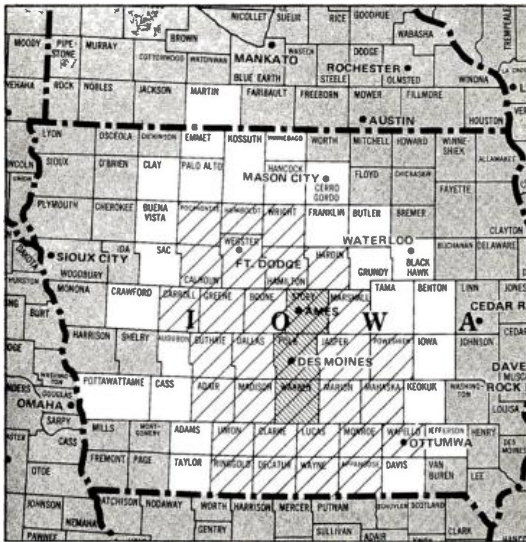

Des Moines, Iowa (59)

ADI TV Households 344,100
 Survey Area TV Households 574,000

WOI-TV Ames, Iowa, ch. 5, ABC
 KCCI-TV Des Moines, Iowa, ch. 8, CBS
 *KDIN-TV Des Moines, Iowa, ch. 11, ETV
 WHO-TV Des Moines, Iowa, ch. 13, NBC

ADI Counties	State	TV Households
Adair	IA	3,700
Appanoose	IA	6,300
Boone	IA	10,100
Calhoun	IA	5,400
Carroll	IA	7,500
Clarke	IA	3,300
Dallas	IA	9,900
Decatur	IA	3,700
Greene	IA	4,800
Guthrie	IA	5,200
Hamilton	IA	6,600
Hardin	IA	8,400
Humboldt	IA	4,800

Jasper	IA	13,700
Lucas	IA	4,400
Madison	IA	4,900
Mahaska	IA	8,800
Marion	IA	9,500
Marshall	IA	15,600
Monroe	IA	3,700
Pocahontas	IA	4,400
Polk	IA	108,700
Poneshiek	IA	7,000
Ringgold	IA	2,700
Story	IA	21,500
Union	IA	5,600
Wapello	IA	16,400
Warren	IA	10,000
Wayne	IA	3,900
Webster	IA	17,100
Wright	IA	6,500

Women 341,300
 Men 310,100
 Teens 108,100
 Children 144,100

Fort Dodge, Iowa (supplementary market)

Arbitron characterizes supplementary markets as those that do not meet its criteria for having an ADI.

KVFD-TV Fort Dodge, Iowa, ch. 21, NBC

Home county Webster
 TV Households 17,100

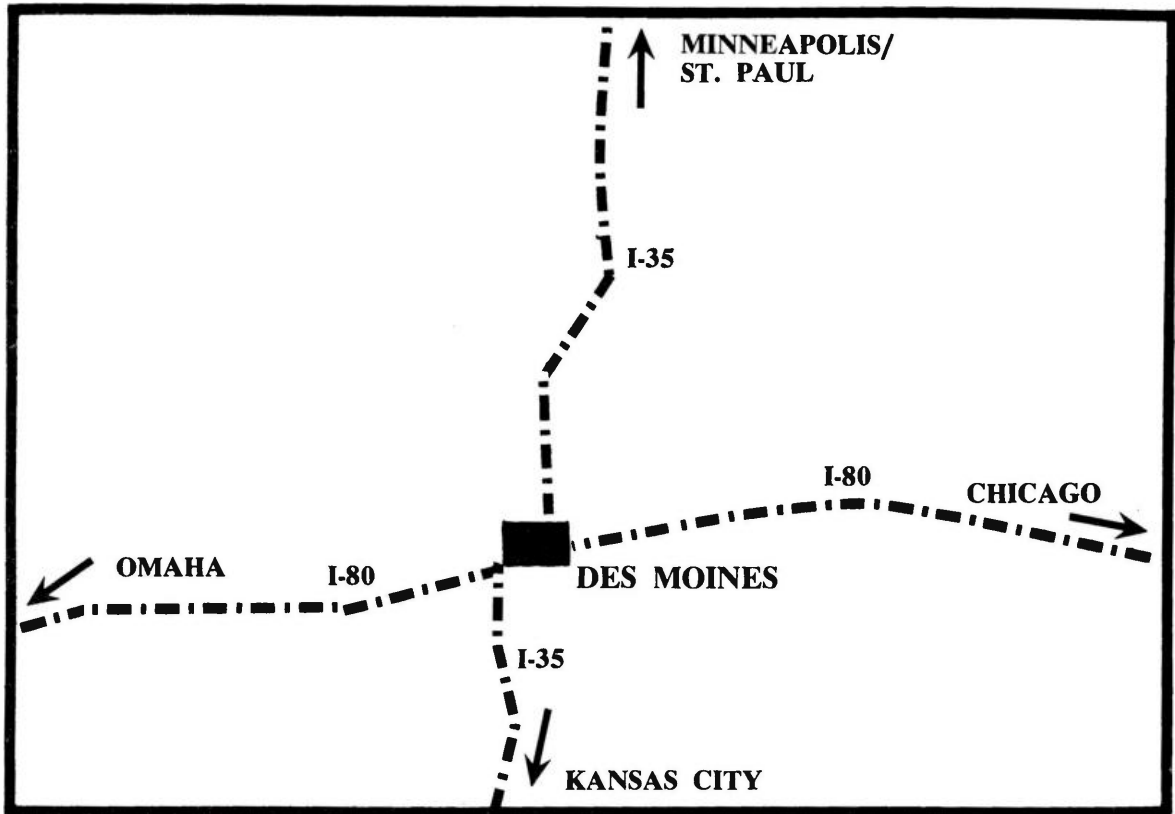

DES MOINES

THE 59TH ADI MARKET
Now 344,100 Households

- RETAIL:** "Iowa's Largest Shopping Center" because of easy Interstate access to Des Moines (see above)
- MANUFACTURING:** Largest Center in Iowa . . . over 500 products produced . . . 2nd largest tire output in the world
- DISTRIBUTION:** Major Center . . . over 700 wholesalers and jobbers
- INSURANCE:** Major Center . . . 52 home offices . . . over 100 divisional offices
- FOOD:** Greatest producing center in the world . . . over 10% of food in U.S. comes from Iowa
- GOVERNMENT:** State Capitol . . . almost 20,000 employees
- EMPLOYMENT:** Continual high rate because of such an equal distribution of labor force
- TEST MARKET:** A proven track record

KCCI-TV, DES MOINES

CBS for Central Iowa

A Broadcast Division of
COWLES COMMUNICATIONS, INC.

Represented by
THE KATZ AGENCY, INC.



Detroit (7)

ADI TV Households 1,587,500
 Survey Area TV Households 2,687,600

WJBK-TV Detroit, ch. 2, CBS
 WWJ-TV Detroit, ch. 4, NBC
 WXYZ-TV Detroit, ch. 7, ABC
 CBET-TV Windsor, Ontario, ch. 9, CBC
 WXON Detroit, ch. 20, IND
 WKBD-TV Detroit, ch. 50, IND
 *WTVS Detroit, ch. 56, ETV
 WGR-TV Detroit, ch. 62, IND

ADI Counties	State	TV Households
Lapeer	MI	17,800

Lenawee	MI	27,300
Livingston	MI	22,400
Macomb	MI	195,200
Monroe	MI	38,600
Oakland	MI	303,000
St. Clair	MI	42,200
Sanilac	MI	12,800
Washtenaw	MI	76,800
Wayne	MI	851,400

Women	1,727,200
Men	1,572,400
Teens	593,100
Children	835,600

Dothan, Ala. (159)

ADI TV Households 82,900
 Survey Area TV Households 532,200

WTVY Dothan, Ala., ch. 4, CBS (ABC)
 WDHN Dothan, Ala., ch. 18, ABC

ADI Counties	State	TV Households
Coffee	AL	11,900
Dale	AL	13,600
Geneva	AL	7,900

Henry	AL	4,200
Houston	AL	22,300
Holmes	FL	3,700
Jackson	FL	11,500
Early	GA	3,800
Miller	GA	1,700
Seminole	GA	2,500

Women	87,200
Men	84,700
Teens	28,700
Children	45,400



Duluth, Minn.-Superior, Wis. (108)

ADI TV Households 160,300
 Survey Area TV Households 232,100

KDAL-TV Duluth, Minn., ch. 3, CBS
 KBJR-TV Superior, Wis.-Duluth, Minn., ch. 6, NBC

*WDSE-TV Duluth, Minn., ch. 8, ETV
 WDIO-TV Duluth, Minn.-Superior, Wis., ch. 10, ABC

WIRT Hibbing, Minn., ch. 13, satellite to WDIO

ADI Counties	State	TV Households
Gogebic	MI	7,800
Aitkin	MN	4,800
Carlton	MN	9,600

Cook	MN	1,300
Itasca	MN	12,700
Koochiching	MN	5,900
Lake	MN	4,400
St. Louis	MN	75,100
Ashland	WI	5,700
Bayfield	WI	4,600
O Douglas	WI	17,100
Iron	WI	2,800
Sawyer	WI	4,000
Washburn	WI	4,500

Women	159,800
Men	150,900
Teens	57,000
Children	69,900

El Centro, Calif.-Yuma, Ariz. (184)

ADI TV Households 43,400
 Survey Area TV Households 88,000

ADI Counties	State	TV Households
Yuma	AZ	19,600
Imperial	CA	23,800

Women	45,500
Men	44,900
Teens	18,600
Children	28,800

KECC-TV El Centro, Calif., ch. 9, CBS
 KBLU-TV Yuma, Ariz., ch. 13, NBC



El Paso (102)

ADI TV Households 169,600
 Survey Area TV Households 218,300

KDBC-TV El Paso, ch. 4, CBS
 KTSM-TV El Paso, ch. 9, NBC
 KLP-TV El Paso, ch. 13, ABC
 KAVE-TV Carlsbad, N.M., ch. 6, satellite to KELP
 *KRWG-TV Las Cruces, N.M., ch. 22, ETV

ADI Counties	State	TV Households
Dona Ana	NM	22,800

Grant	NM	7,600
Hidalgo	NM	1,600
Luna	NM	4,500
Otero	NM	12,500
El Paso	TX	120,000
Hudspeth	TX	600

Women	185,400
Men	174,000
Teens	76,200
Children	115,600

Erie, Pa. (137)

ADI TV Households 116,900
 Survey Area TV Households 784,800

ADI Counties	State	TV Households
Crawford	PA	28,000
Erie	PA	88,900

Women	126,600
Men	111,800
Teens	40,800
Children	59,600

WICU-TV Erie, Pa., ch. 12, NBC
 WJET-TV Erie, Pa., ch. 24, ABC
 WSEE Erie, Pa., ch. 35, CBS
 *WQLN Erie, Pa., ch. 54, ETV

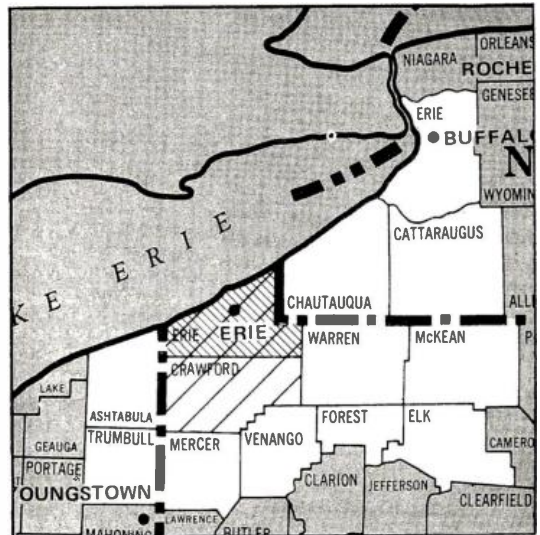

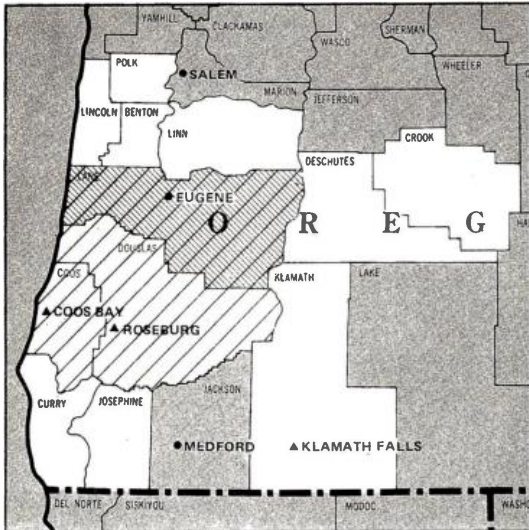

Eugene, Ore. (130)

ADI TV Households 128,300
 Survey Area TV Households 259,200

KEZI-TV Eugene, Ore., ch. 9, ABC
 KVAL-TV Eugene, Ore., ch. 13, NBC
 KPIC Roseburg, Ore., ch. 4, satellite to KVAL
 KCBY-TV Coos Bay, Ore., ch. 11, satellite to KVAL

ADI Counties	State	TV Households
Coos	OR	19,400
Douglas	OR	26,600
Lane	OR	82,300
Women		127,900
Men		122,500
Teens		43,000
Children		57,400

Eureka, Calif. (181)

ADI TV Households 44,700
 Survey Area TV Households 77,900

KIEM-TV Eureka, Calif., ch. 3, CBS (NBC-ABC)
 KVIQ-TV Eureka, Calif., ch. 6, ABC (NBC)
 *KEET Eureka, Calif., ch. 13, ETV

ADI Counties	State	TV Households
Del Norte	CA	5,000
Humboldt	CA	35,100
Curry	OR	4,600
Women		43,900
Men		44,000
Teens		14,800
Children		19,200

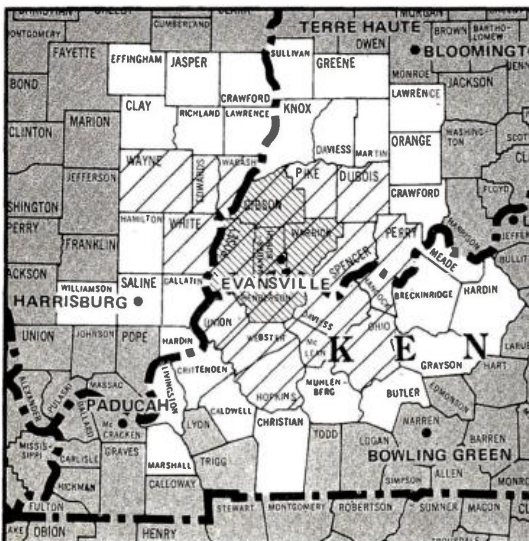
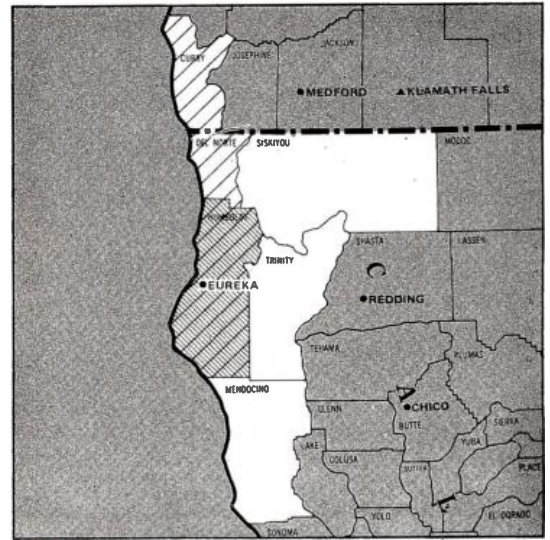

Evansville, Ind. (87)

ADI TV Households 209,100
 Survey Area TV Households 440,200

WTVW Evansville, Ind., ch. 7, ABC
 *WNIN Evansville, Ind., ch. 9, ETV
 WFIE-TV Evansville, Ind., ch. 14, NBC
 WEHT Evansville, Ind., ch. 25, CBS
 *WKMA Madisonville, Ky., ch. 35, ETV

ADI Counties	State	TV Households
Edwards	IL	2,700
Wabash	IL	4,800
Wayne	IL	6,500
White	IL	5,800
Dubois	IN	9,200
Gibson	IN	11,000
Perry	IN	5,900

Pike	IN	4,700
Posey	IN	7,500
Spencer	IN	5,700
Vanderburgh	IN	57,700
Warrick	IN	10,500
Daviess	KY	27,100
Hancock	KY	2,400
Henderson	KY	12,300
Hopkins	KY	14,600
McLean	KY	3,400
Ohio	KY	7,400
Union	KY	4,600
Webster	KY	5,300
Women		218,500
Men		196,400
Teens		71,300
Children		95,800



Fargo, N.D. (92)

ADI TV Households 194,800
 Survey Area TV Households 240,100

KGFE-TV Grand Forks, N.D., ch. 4, CBS
 KXJB-TV Valley City, N.D., ch. 4, CBS
 WDAY-TV Fargo, N.D., ch. 6, NBC
 WDAZ-TV Devils Lake-Grand Forks, N.D., ch. 8,
 satellite to WDAY
 KTHI-TV Fargo-Grand Forks, N.D., ch. 11, ABC
 *KFME Fargo, N.D., ch. 13, ETV

ADI Counties	State	TV Households
Becker	MN	8,700
Clay	MN	14,800
Clearwater	MN	2,800
Kitson	MN	2,300
Lake of the Woods	MN	1,400
Mahomen	MN	1,000
Marshall	MN	4,800
Norman	MN	3,400
Otter Tail	MN	16,800
Pennington	MN	5,400
Polk	MN	11,500
Red Lake	MN	1,600
Roseau	MN	3,900
Wilkin	MN	3,000

Barnes	ND	5,100
Benson	ND	2,500
Cass	ND	27,800
Cavalier	ND	3,500
Dickey	ND	2,300
Eddy	ND	1,400
Foster	ND	1,400
Grand Forks	ND	21,300
Griggs	ND	1,500
La Moure	ND	2,600
Nelson	ND	2,000
Pembina	ND	3,800
Ransom	ND	4,500
Richland	ND	6,900
Sargent	ND	1,800
Steele	ND	1,300
Stutsman	ND	8,000
Towner	ND	1,500
Trail	ND	3,000
Walsh	ND	5,400
Wells	ND	2,500

Women	202,700
Men	199,100
Teens	71,700
Children	92,200

1ST IN 1953 : **1ST IN 1958** : **1ST IN 1963** : **1ST IN 1968** : **1ST IN 1973**

IN 1954 : IN 1959 : IN 1964 : IN 1969 : IN 1974

IN 1955 : IN 1960 : IN 1965 : IN 1970 : IN 1975

IN 1956 : IN 1961 : IN 1966 : IN 1971 : IN 1972

IN 1957 : IN 1962 : IN 1967 : IN 1972

1ST IN 1976

WDAY **NBC** WDAZ

FARGO, NORTH DAKOTA TELEVISION THE 'PARIS OF THE PLAINS'

PETERS, GRIFFIN, WOODWARD, INC.

SIGN-ON TO SIGN-OFF

Farmington, N.M. (204)

ADI TV Households 16,700
 Survey Area TV Households 45,400

KIVA-TV Farmington, N.M., ch. 12, NBC

ADI Counties	State	TV Households
San Juan	NM	16,700

Women	17,800
Men	16,500
Teens	8,900
Children	12,300

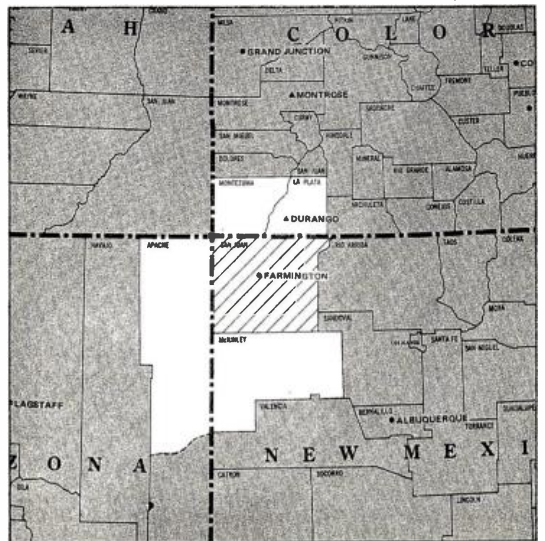



Flagstaff, Ariz. (206)

ADI TV Households 16,100
 Survey Area TV Households 475,200

Women 19,000
 Men 18,100
 Teens 7,300
 Children 12,500

KOAI-TV Flagstaff, Ariz. ch. 2, NBC

ADI Counties	State	TV Households
Coconino	AZ	16,100

Flint-Saginaw-Bay City, Mich. (52)

ADI TV Households 380,800
 Survey Area TV Households 1,087,700

WNEM-TV Bay City-Saginaw-Flint, Mich., ch. 5, NBC

WJRT-TV Flint, Mich., ch. 12, ABC

*WCMU-TV Mt. Pleasant, Mich., ch. 14, ETV

*WUCM-TV University Center, Mich., ch. 19, ETV

WEYI-TV Saginaw, Mich., ch. 25, CBS

ADI Counties	State	TV Households
Alcona	MI	3,300
Arenac	MI	4,300
Bay	MI	37,400

Clare	MI	7,000
Genesee	MI	142,200
Gladwin	MI	5,300
Gratiot	MI	12,700
Huron	MI	11,800
Iosco	MI	9,400
Isabella	MI	13,200
Midland	MI	20,800
Ogemaw	MI	4,700
Saginaw	MI	71,700
Shiawassee	MI	21,700
Tuscola	MI	15,800

Women	409,500
Men	378,200
Teens	157,400
Children	223,100

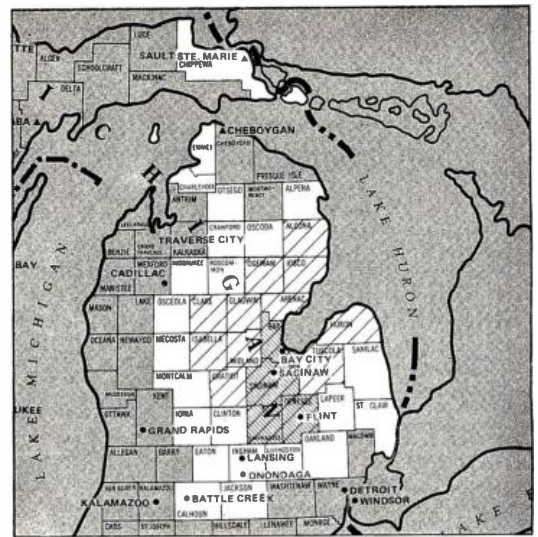

Florence, S.C. (160)

ADI TV Households 78,500
 Survey Area TV Households 495,400

Darlington SC 15,900
 Dillon SC 7,700
 Florence SC 28,600
 Marion SC 9,700
 Marlboro SC 8,300

WBTW Florence, S.C., ch. 13, CBS (ABC)

*WJPM-TV Florence, S.C. ch. 33, ETV

ADI Counties	State	TV Households
Scotland	NC	8,300

Women	86,500
Men	75,700
Teens	32,500
Children	47,500



Fort Myers, Fla. (153)

ADI TV Households 94,600
 Survey Area TV Households 1,335,900

ADI Counties	State	TV Households
Charlotte	FL	17,900
Collier	FL	21,100
Lee	FL	55,600

WINK-TV Fort Myers, Fla., ch. 11, CBS
 WBBH-TV Fort Myers, Fla., ch. 20, NBC
 WEVU Naples, Fla., ch. 26, ABC

Women	95,400
Men	84,700
Teens	24,400
Children	36,300

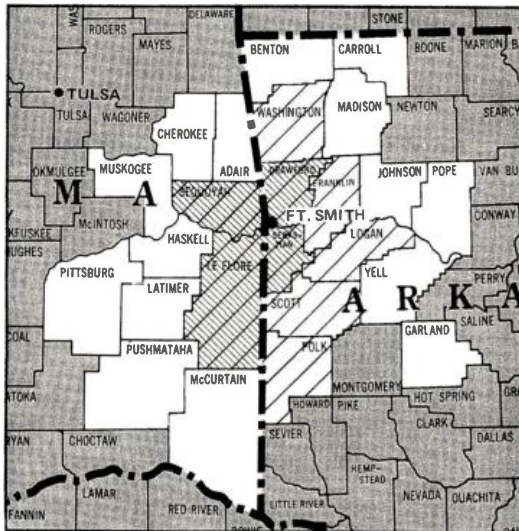

Fort Smith, Ark. (142)

ADI TV Households 109,200
 Survey Area TV Households 247,400

KFSM-TV Fort Smith, Ark., ch. 5, NBC (ABC)
 KFPW-TV Fort Smith, Ark., ch. 40, CBS (ABC)

ADI Counties	State	TV Households
Crawford	AR	9,900
Franklin	AR	4,100
Logan	AR	6,300

Polk	AR	5,500
Scott	AR	3,500
Sebastian	AR	31,100
Washington	AR	29,400
Le Flore	OK	11,700
Sequoyah	OK	7,700

Women	110,500
Men	101,400
Teens	34,000
Children	49,900

Fort Wayne, Ind. (89)

ADI TV Households 198,800
 Survey Area TV Households 375,600

WANE-TV Fort Wayne, Ind., ch. 15, CBS
 WPTA Roanoke-Fort Wayne, Ind., ch. 21, ABC
 WKJG-TV Fort Wayne, Ind., ch. 33, NBC

ADI Counties	State	TV Households
Adams	IN	8,100
Allen	IN	96,100
De Kalb	IN	10,400
Huntington	IN	12,200

Jay	IN	8,400
Noble	IN	10,800
Steuben	IN	7,500
Wabash	IN	11,700
Wells	IN	8,400
Whitley	IN	8,400
Pauding	OH	6,300
Van Wert	OH	10,500

Women	207,100
Men	187,400
Teens	71,000
Children	103,500

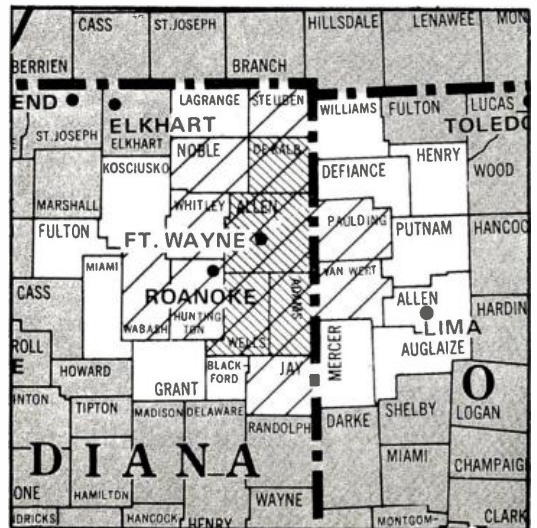



Fresno, Calif. (74)

ADI TV Households	281,000	Kings	CA	20,500
Survey Area TV Households	548,700	Madera	CA	14,200
		Merced	CA	2,700
		Tulare	CA	63,900

KFTV Hanford-Fresno, Calif., ch. 21, IND
 KMJ-TV Fresno, Calif., ch. 24, NBC
 KFSN-TV Fresno, Calif., ch. 30, CBS
 KJEO Fresno, Calif., ch. 47, ABC

ADI	TV	
Counties	Households	
Fresno	CA	143,900

Women	291,800
Men	273,900
Teens	105,100
Children	147,500

Tulare, Calif. (supplementary market)

Arbitron characterizes supplementary markets as those that do not meet its criteria for having an ADI.

KMPH-TV Visalia, Calif., ch. 26, NBC (CBS)

Home county	Tulare
TV Households	63,900

Gainesville, Fla. (182)

ADI TV Households	44,500
Survey Area TV Households	162,500

*WUFT Gainesville, Fla., ch. 5, ETV
 WCJB Gainesville, Fla., ch. 20, ABC

ADI	TV	
Counties	Households	
Alachua	FL	38,100

Gilchrist	FL	1,600
Levy	FL	4,800

Women	50,400
Men	48,400
Teens	14,900
Children	23,200

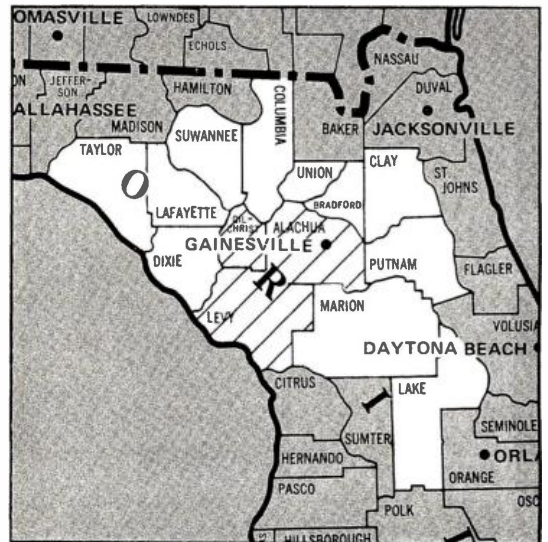

Grand Junction, Colo. (186)

ADI TV Households	38,600
Survey Area TV Households	72,400

KREX-TV Grand Junction, Colo., ch. 5, CBS
 (ABC-NBC)
 KREZ-TV Durango, Colo., ch. 6, satellite to
 KREX
 KREY-TV Montrose, Colo., ch. 10, satellite to
 KREX

ADI	TV	
Counties	Households	
Delta	CO	5,700

Hinsdale	CO	200
La Plata	CO	6,600
Mesa	CO	19,300
Montrose	CO	5,600
Ourray	CO	400
San Juan	CO	300
San Miguel	CO	500

Women	41,500
Men	38,900
Teens	14,000
Children	17,000

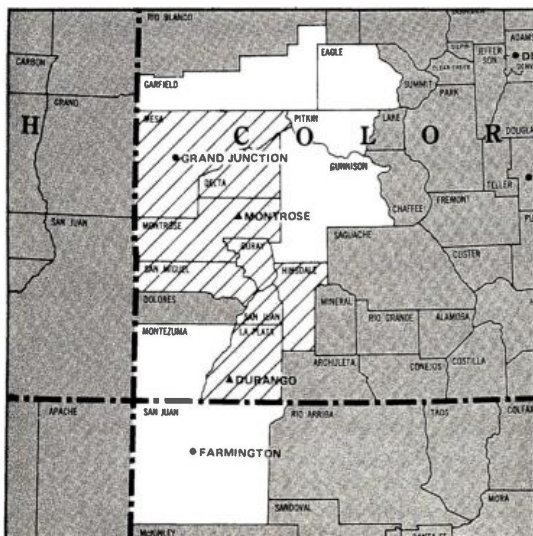

Grand Rapids-Kalamazoo, Mich. (39)

ADI TV Households 450,900
 Survey Area TV Households 938,000

WKZO-TV Kalamazoo, Mich., ch. 3, CBS
WOTV Grand Rapids, Mich., ch. 8, NBC
WZZM-TV Grand Rapids, Mich., ch. 13, ABC
***WGVC** Grand Rapids, Mich., ch. 35 ETV

ADI Counties	State	TV Households
Allegan	MI	21,900
Barry	MI	13,300
Branch	MI	12,500
Calhoun	MI	47,000

Ionia	MI	14,600
Kalamazoo	MI	63,700
Kent	MI	134,600
Montcalm	MI	14,500
Muskegon	MI	50,300
Newaygo	MI	9,300
Oceana	MI	6,500
Ottawa	MI	42,100
Van Buren	MI	20,600

Women 489,400
Men 444,000
Teens 175,400
Children 238,300

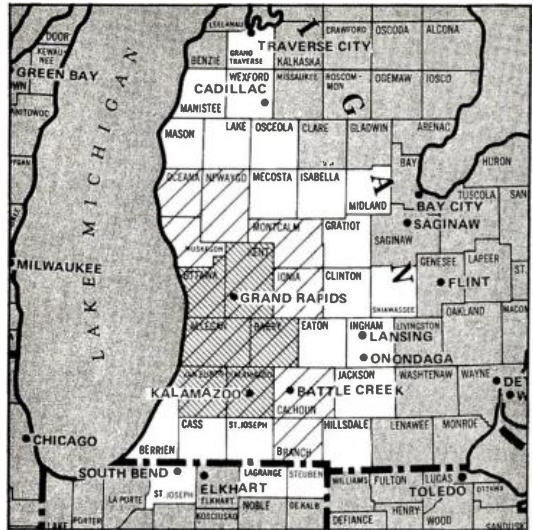

Battle Creek, Mich (supplementary market)

Arbitron characterizes supplementary markets as those that do not meet its criteria for having an ADI.

WUHQ-TV Battle Creek, Mich., ch. 41, ABC

Home county	Calhoun
TV Households	47,000

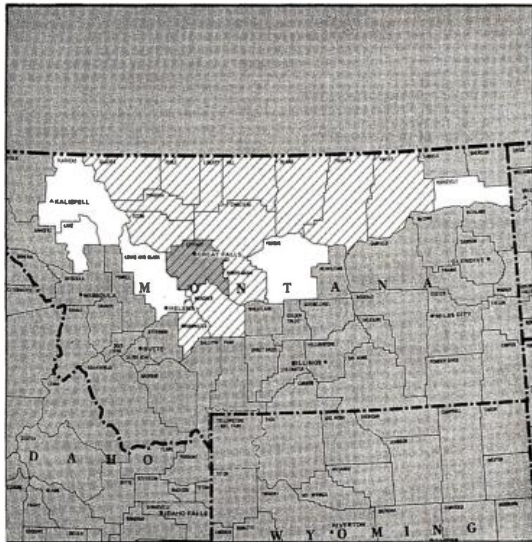

Great Falls, Mont. (172)

ADI TV Households 54,000
 Survey Area TV Households 90,700

KRTV Great Falls, Mont., ch. 3, CBS-NBC
KFBB-TV Great Falls, Mont., ch. 5, ABC (CBS)

ADI Counties	State	TV Households
Blaine	MT	1,900
Broadwater	MT	900
Cascade	MT	27,100
Chouteau	MT	2,100
Glacier	MT	2,800

Hill	MT	5,300
Judith Basin	MT	800
Liberty	MT	700
Meagher	MT	600
Phillips	MT	1,500
Pondera	MT	2,000
Teton	MT	2,200
Toole	MT	2,000
Valley	MT	4,100

Women 56,700
Men 55,300
Teens 22,600
Children 29,600

Green Bay, Wis. (66)

ADI TV Households 302,400
 Survey Area TV Households 677,800

WBAY-TV Green Bay, Wis., ch. 2, CBS
WFRV-TV Green Bay, Wis., ch. 5, NBC
WJMN Escanaba, Mich., ch. 3, satellite to WFRV
WLUK-TV Green Bay, Wis., ch. 11, ABC
***WPNE** Green Bay, Wis., ch. 38, ETV

ADI Counties	State	TV Households
Delta	MI	12,300
Dickinson	MI	8,700
Menominee	MI	8,500
Brown	WI	52,100
Cadumet	WI	8,300
Door	WI	8,100

Fond du Lac	WI	27,500
Green Lake	MI	6,500
Kewaunee	WI	6,500
Manitowoc	WI	28,000
Marquette	WI	13,000
Menominee	WI	600
Oconto	WI	9,600
Outagamie	WI	38,500
Shawano	WI	11,500
Waupeca	WI	14,100
Wauzara	WI	5,600
Winnebago	WI	43,000

Women 324,500
Men 300,200
Teens 119,600
Children 155,400



Greensboro-Winston Salem-High Point, N.C. (55)

ADI TV Households 321,900
 Survey Area TV Households 1,212,200

WFMY-TV Greensboro, N.C., ch. 2, CBS
 WGHP-TV High Point-Greensboro-Winston Salem, N.C., ch. 8, ABC
 WXII Winston-Salem-Greensboro-High Point, N.C., ch. 12, NBC
 *WUNL-TV Winston-Salem, N.C., ch. 26, ETV

ADI Counties	State	TV Households
Alamance	NC	34,200
Alleghany	NC	3,100
Caswell	NC	5,800
Davidson	NC	33,200

Davie	NC	6,300
Forsyth	NC	75,700
Guilford	NC	98,500
Montgomery	NC	8,100
Randolph	NC	27,000
Rockingham	NC	25,000
Stokes	NC	8,500
Surry	NC	17,700
Wilkes	NC	17,000
Yadkin	NC	9,000
Patrick	VA	5,000

Women	409,800
Men	362,300
Teens	126,400
Children	183,200

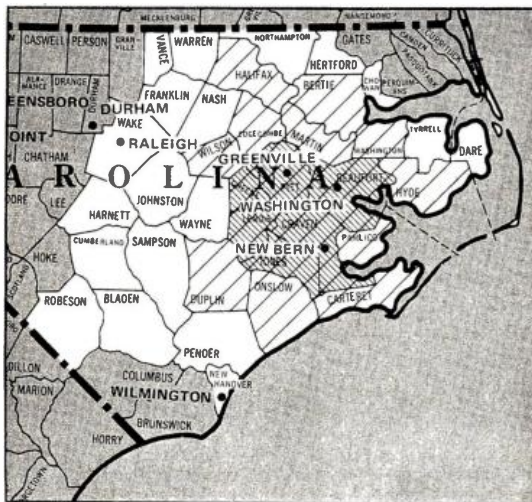
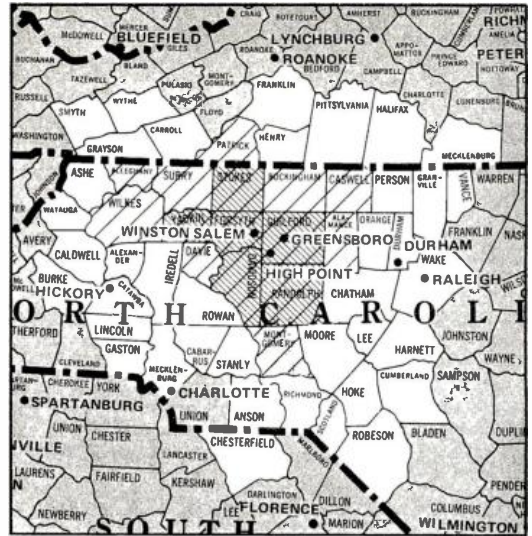

Greenville-New Bern-Washington, N.C. (91)

ADI TV Households 195,600
 Survey Area TV Households 544,200

WUNC-TV Columbia, N.C., ch. 2, ETV
 WITN-TV Washington, N.C., ch. 7, NBC
 WNCN-TV Greenville, N.C., ch. 9, CBS
 WCTI-TV New Bern, N.C., ch. 12, ABC
 *WUNK-TV Greenville, N.C., ch. 25, ETV

ADI Counties	State	TV Households
Beaufort	NC	11,500
Bertie	NC	5,900
Carteret	NC	11,300
Craven	NC	20,100
Dupin	NC	11,800

Edgecombe	NC	15,900
Greene	NC	4,200
Halifax	NC	15,300
Hyde	NC	1,800
Jones	NC	2,800
Lenoir	NC	17,900
Martin	NC	7,400
Onslow	NC	22,800
Pamlico	NC	3,300
Pitt	NC	22,300
Washington	NC	4,000
Wilson	NC	17,300

Women	219,700
Men	220,000
Teens	75,600
Children	112,400

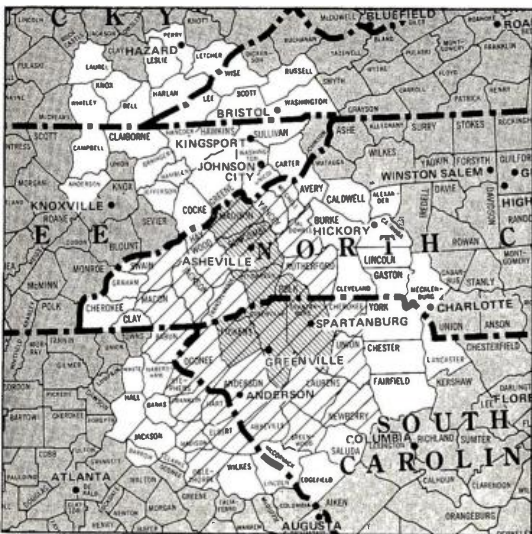

Greenville-Spartanburg, S.C.-Asheville, N.C. (36)

ADI TV Households 481,800
 Survey Area TV Households 1,252,000

WFBC-TV Greenville, S.C., ch. 4, NBC
 WSPA-TV Spartanburg, S.C., ch. 7, CBS
 WLOS-TV Asheville, N.C., ch. 13, ABC
 WGGS-TV Greenville, S.C., ch. 16, IND
 WANC-TV Asheville, N.C., ch. 21, IND
 *WNTV Greenville, S.C., ch. 29, ETV
 *WUNF-TV Asheville, N.C., ch. 33, ETV

ADI Counties	State	TV Households
Elbert	GA	5,800
Franklin	GA	4,400
Hart	GA	5,200
Madison	GA	5,000
Oglethorpe	GA	2,200
Rabun	GA	2,900
Stephens	GA	7,800
Buncombe	NC	50,500
Haywood	NC	14,100
Henderson	NC	15,500
Jackson	NC	6,400

McDowell	NC	10,400
Macon	NC	5,800
Madison	NC	4,800
Mitchell	NC	4,400
Polk	NC	4,100
Rutherford	NC	16,600
Swain	NC	2,800
Transylvania	NC	6,000
Yancey	NC	4,100
Abbeville	SC	6,700
Anderson	SC	39,600
Cherokee	SC	13,500
Greenville	SC	89,800
Greenwood	SC	17,200
Laurens	SC	14,800
Newberry	SC	9,800
Oconee	SC	15,900
Pickens	SC	21,100
Spartanburg	SC	64,400
Union	SC	10,700

Women	517,600
Men	482,400
Teens	156,000
Children	235,000

Anderson, S.C. (supplementary market)

Arbitron characterizes supplementary markets as those that do not meet its criteria for having an ADI.

WAIM-TV Anderson, S.C., ch. 40, ABC (CBS)

Home county	Anderson
TV Households	39,600

Greenwood-Greenville, Miss. (189)

ADI TV Households 38,000
 Survey Area TV Households 324,300

WABG-TV Greenwood-Greenville, Miss., ch. 6,
 ABC

***WMAO** Iverness, Miss., ch. 23, ETV

ADI Counties	State	TV Households
Bolivar	MS	12,300

Carroll	MS	2,300
LeFlore	MS	11,200
Montgomery	MS	3,700
Sunflower	MS	8,500

Women	45,300
Men	39,000
Teens	18,400
Children	29,100

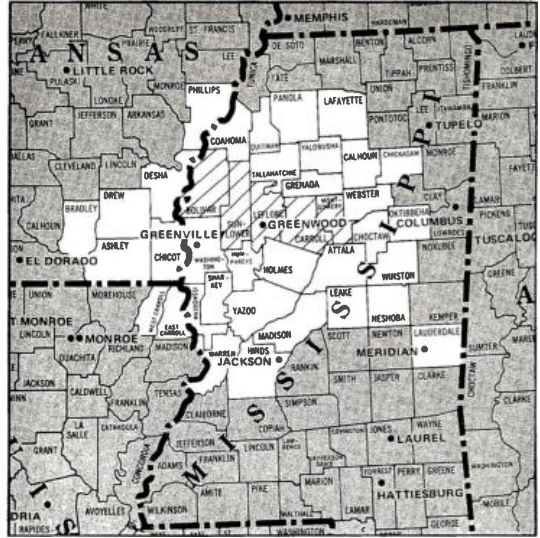

Harrisburg-York-Lancaster-Lebanon, Pa. (46)

ADI TV Households 419,100
 Survey Area TV Households 2,815,700

WGAL-TV Lancaster, Pa., ch. 8, NBC
WLYH-TV Lebanon-Lancaster, Pa., ch. 15, CBS
WHP-TV Harrisburg, Pa., ch. 21, CBS
WTPA Harrisburg-York-Lebanon, Pa., ch. 27,
 ABC

***WITF-TV** Hershey, Pa., ch. 33, ETV
WSBA-TV York, Pa., ch. 43, CBS

ADI Counties	State	TV Households
Adams	PA	19,100

Cumberland	PA	55,300
Dauphin	PA	80,500
Juniauta	PA	5,300
Lancaster	PA	107,600
Lebanon	PA	34,000
Perry	PA	10,700
Snyder	PA	8,700
York	PA	97,900

Women	444,200
Men	397,800
Teens	137,300
Children	192,100

Harrisonburg, Va. (197)

ADI TV Households 29,300
 Survey Area TV Households 708,100

WSVA-TV Harrisonburg, Va., ch. 3, ABC

ADI Counties	State	TV Households
Rockingham	VA	21,300

Grant	WV	2,600
Hardy	WV	2,900
Pendleton	WV	2,500

Women	35,700
Men	30,100
Teens	10,000
Children	14,400





Hartford-New Haven, Conn. (21)

ADI TV Households 653,500
 Survey Area TV Households 4,678,000

WFSB-TV	Hartford, Conn., ch. 3, CBS
WTNH-TV	New Haven, Conn., ch. 8, ABC
WHCT	Hartford, Conn., ch. 18, IND
WATR-TV	Waterbury, Conn., ch. 20, NBC
*WEDH	Hartford, Conn., ch. 24, ETV
*WHNB-TV	New Britain-Hartford, Conn., ch. 30, NBC
WEDY-TV	New Haven, Conn., ch. 65, ETV

ADI Counties	State	TV Households
Hartford	CT	274,900
Litchfield	CT	51,200
Middlesex	CT	39,300
New Haven	CT	255,500
Tolland	CT	32,800
Women		715,900
Men		642,500
Teens		222,200
Children		303,300

Helena, Mont. (207)

ADI TV Households 11,800
 Survey Area TV Households 73,200

KTCM Helena, Mont., ch. 12, NBC (ABC)

ADI Counties	State	TV Households
Lewis & Clark	MT	11,800

Women 12,400
 Men 10,900
 Teens 4,200
 Children 5,700

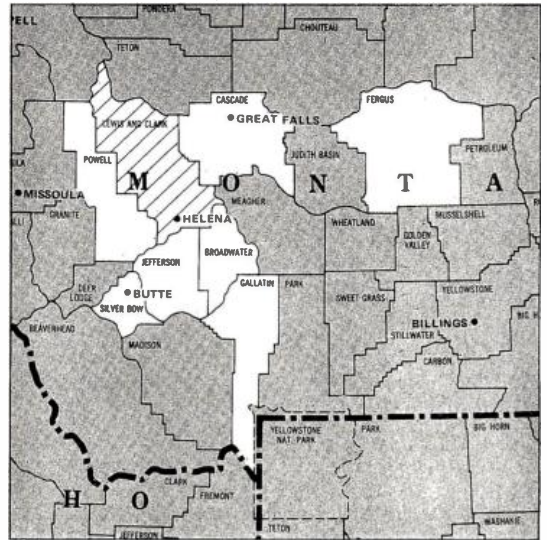

Houston (14)

ADI TV Households 882,300
 Survey Area TV Households 1,188,800

KPRC-TV Houston, ch. 2, NBC
 *KUHT Houston, ch. 8, ETV
 KHOU-TV Houston-Galveston, Tex., ch. 11, CBS
 KTRK-TV Houston, ch. 13, ABC
 KDOG-TV Houston, ch. 26, IND
 KHTV Houston, ch. 39, IND

ADI Counties	State	TV Households
Austin	TX	5,200
Brazoria	TX	34,900
Calhoun	TX	5,000
Chambers	TX	4,400
Colorado	TX	5,400
Fort Bend	TX	19,600
Galveston	TX	60,800

Grimes	TX	4,200
Harris	TX	645,800
Jackson	TX	4,300
Liberty	TX	13,300
Madison	TX	2,600
Matagorda	TX	8,900
Montgomery	TX	26,400
Polk	TX	5,400
San Jacinto	TX	2,400
Trinity	TX	2,700
Walker	TX	9,100
Waller	TX	4,100
Washington	TX	6,600
Wharton	TX	11,200

Women 916,600
 Men 853,600
 Teens 324,000
 Children 479,800

Huntsville-Decatur-Florence, Ala. (99)

ADI TV Households 173,900
 Survey Area TV Households 387,800

WQWL-TV Florence, Ala., ch. 15, NBC
WHNT-TV Huntsville, Ala., ch. 19, CBS
***WHIQ** Huntsville, Ala., ch. 25, ETV
***WAAY-TV** Huntsville, Ala., ch. 31, NBC
***WFIQ** Florence, Ala., ch. 36, ETV
WYUR-TV Huntsville-Decatur, Ala., ch. 48, ABC

Franklin	AL	9,100
Lauderdale	AL	23,300
Lawrence	AL	8,000
Limestone	AL	13,600
Madison	AL	57,400
Marshall	AL	19,200
Morgan	TN	27,400

Women	187,400
Men	171,200
Teens	67,200
Children	94,600

ADI	Counties	State	TV Households
Colbert	AL		15,900

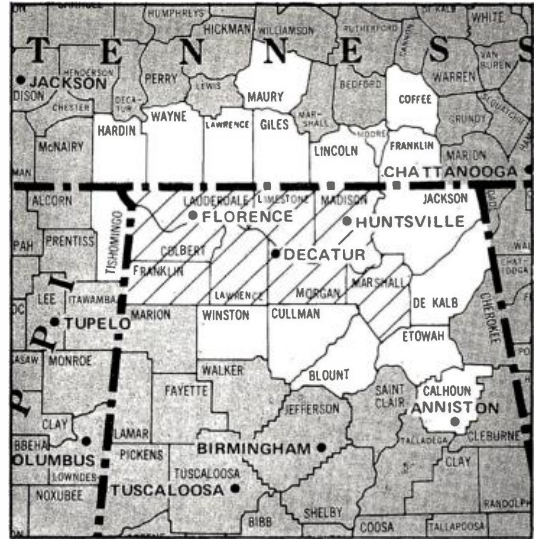

Idaho Falls-Pocatello, Idaho (169)

ADI TV Households 62,400
 Survey Area TV Households 122,000

KID-TV Idaho Falls-Pocatello, Idaho, ch. 3, CBS (ABC)
KPVI Pocatello, Idaho, ch. 6, ABC
KIFI-TV Idaho Falls-Pocatello, Idaho, ch. 8, NBC (ABC)
***KQGL-TV** Pocatello, Idaho, ch. 10, ETV

ADI	Counties	State	TV Households
Bannock	ID		16,900
Bingham	ID		8,400
Bonneville	ID		16,300
Butte	ID		800

Clark	ID	300
Custer	ID	1,000
Fremont	ID	2,900
Jefferson	ID	3,800
Lemhi	ID	1,800
Madison	ID	3,500
Power	ID	1,500
Teton	ID	600
Lincoln	WY	2,700
Teton	WY	1,900

Women	69,300
Men	65,800
Teens	27,500
Children	40,900

Indianapolis (20)

ADI TV Households 738,100
 Survey Area TV Households 1,186,800

WTTV Bloomington-Indianapolis, Ind., ch. 4, IND
WRTV Indianapolis, Ind., ch. 6, NBC
WISH-TV Indianapolis, Ind., ch. 8, CBS
WTHR Indianapolis, Ind., ch. 13, ABC
***WFTU** Indianapolis, Ind., ch. 20, ETV
***WTIU** Indianapolis, Ind., ch. 30, ETV
WHMB-TV Indianapolis, Ind., ch. 40, IND
***WIPB** Muncie, Ind., ch. 49, ETV

Grant	IN	27,800
Hamilton	IN	20,900
Hancock	IN	13,200
Hendricks	IN	19,200
Henry	IN	18,100
Howard	IN	29,600
Jennings	IN	6,200
Johnson	IN	21,200
Madison	IN	48,700
Marion	IN	271,700
Miami	IN	13,000
Monroe	IN	29,500
Montgomery	IN	12,100
Morgan	IN	15,200
Owen	IN	4,500
Putnam	IN	9,900
Randolph	IN	10,800
Rush	IN	7,200
Shelby	IN	13,900
Tipton	IN	5,300
White	IN	7,300

Women	768,900
Men	695,200
Teens	258,800
Children	372,200

ADI	Counties	State	TV Households
Bartholomew	IN		19,900
Benton	IN		3,900
Blackford	IN		5,500
Boone	IN		11,300
Brown	IN		3,200
Carroll	IN		6,400
Cass	IN		14,200
Clinton	IN		11,500
Decatur	IN		7,900
Delaware	IN		43,200
Fountain	IN		6,700



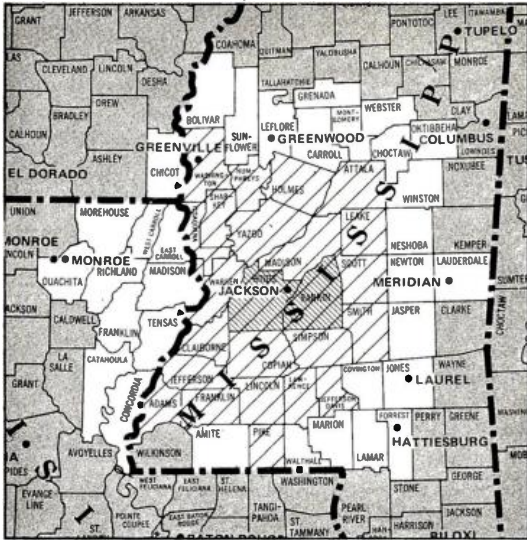

Jackson, Miss. (85)

ADI TV Households 219,800
 Survey Area TV Households 477,600

- WLBT** Jackson, Miss., ch. 3, NBC
- WJTV** Jackson, Miss., ch. 12, CBS
- WAPT** Jackson, Miss., ch. 16, ABC
- WMAU** Bude, Miss., ch. 17, ETV
- WMAA** Jackson, Miss., ch. 29, ETV

ADI Counties	State	TV Households
Adams	MS	10,900
Attala	MS	5,700
Claiborne	MS	2,700
Copiah	MS	7,100
Franklin	MS	2,200
Hinds	MS	67,500
Holmes	MS	6,000
Humphreys	MS	3,300
Issaquena	MS	600

Jefferson	MS	2,200
Jefferson Davis	MS	3,700
Lawrence	MS	3,300
Leake	MS	5,400
Lincoln	MS	8,100
Madison	MS	8,300
Pike	MS	9,900
Rankin	MS	13,700
Scott	MS	6,300
Sharkey	MS	2,100
Simpson	MS	6,200
Smith	MS	4,000
Warren	MS	13,800
Washington	MS	18,900
Yazoo	MS	7,600

Women 259,900
Men 222,700
Teens 94,200
Children 138,300

Jackson, Tenn. (188)

ADI TV Households 38,500
 Survey Area TV Households 290,600

- WBBJ-TV** Jackson, Tenn., ch. 7, ABC
- WLJT-TV** Lexington, Tenn., ch. 11, ETV

ADI Counties	State	TV Households
Hardin	TN	6,600

Henderson TN 6,800
 Madison TN 25,100

Women 41,100
Men 35,400
Teens 12,100
Children 18,000

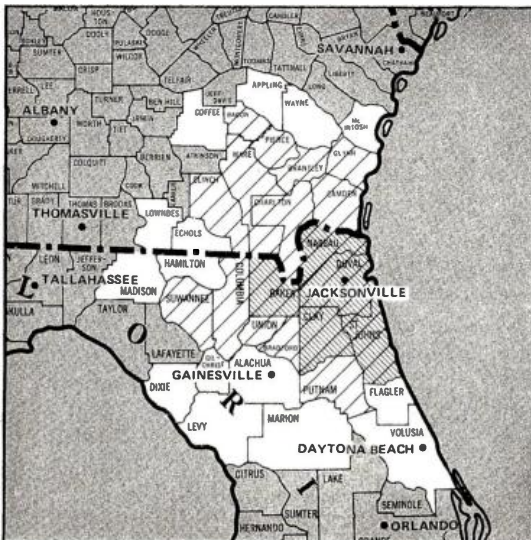
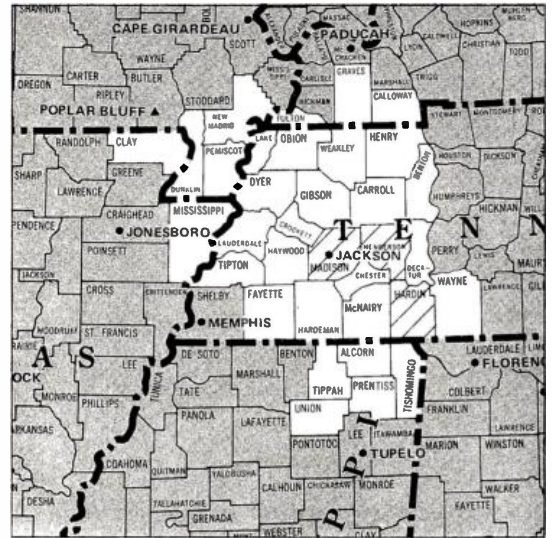

Jacksonville, Fla. (69)

ADI TV Households 294,500
 Survey Area TV Households 499,300

- WJXT** Jacksonville, Fla., ch. 4, CBS
- WJCT** Jacksonville, Fla., ch. 7, ETV
- WXGA-TV** Waycross, Ga., ch. 8, ETV
- WTLV** Jacksonville, Fla., ch. 12, NBC
- WJKS-TV** Jacksonville, Fla., ch. 17, ABC

ADI Counties	State	TV Households
Baker	FL	3,000
Bradford	FL	4,600
Clay	FL	13,700
Columbia	FL	8,900
Duval	FL	182,400
Nassau	FL	7,800

Putnam	FL	14,100
St. Johns	FL	12,300
Suwannee	FL	5,200
Union	FL	2,000
Bacon	GA	2,600
Brantley	GA	2,200
Camden	GA	3,400
Charlton	GA	1,600
Clinch	GA	1,800
Glynn	GA	14,900
Pierce	GA	2,700
Ware	GA	11,300

Women 318,800
Men 297,300
Teens 110,000
Children 160,700

Johnstown-Altoona, Pa. (73)

ADI TV Households 284,500
 Survey Area TV Households 1,819,700

*WPSX-TV Clearfield, Pa., ch. 3&ETV
 WJAC-TV Johnstown, Pa., ch. 6, NBC (ABC)
 WTAJ-TV Altoona, Pa., ch. 10, CBS
 WJNL Johnstown, Pa., ch. 19, CBS (ABC)
 WOPC-TV Altoona, Pa., ch. 38, ABC

ADI Counties	State	TV Households
Bedford	PA	14,700
Blair	PA	47,600
Cambria	PA	62,100
Cameron	PA	2,500

Centre	PA	30,500
Clearfield	PA	26,200
Clinton	PA	12,800
Elk	PA	11,900
Forest	PA	1,700
Fulton	PA	3,400
Huntingdon	PA	12,900
Jefferson	PA	15,900
Millin	PA	15,700
Somerset	PA	26,600

Women	307,400
Men	278,400
Teens	93,100
Children	132,200

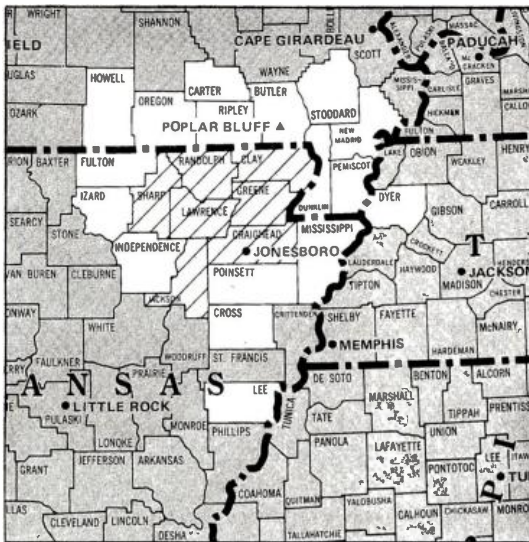
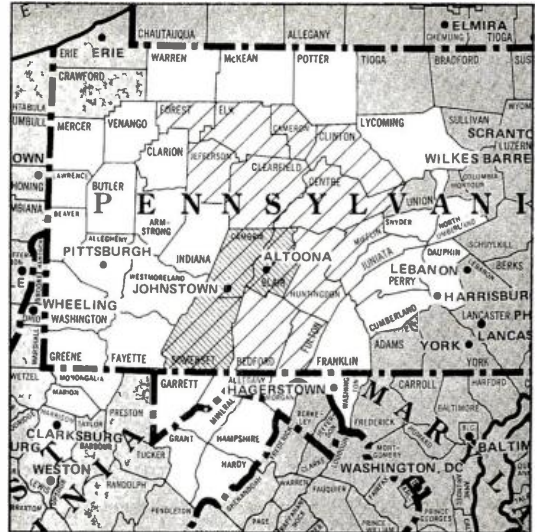

Jonesboro, Ark. (168)

ADI TV Households 62,600
 Survey Area TV Households 200,700

KAIT-TV Jonesboro, Ark., ch. 8, ABC

ADI Counties	State	TV Households
Clay	AR	7,600
Craighead	AR	20,700

Greene	AR	10,700
Jackson	AR	7,600
Lawrence	AR	6,800
Randolph	AR	5,200
Sharp	AR	4,000

Women	63,800
Men	57,500
Teens	18,900
Children	25,300

Joplin, Mo.-Pittsburg, Kan. (114)

ADI TV Households 150,200
 Survey Area TV Households 366,400

KOAM-TV Pittsburg Kan., ch. 7, NBC
 KODE-TV Joplin, Mo., ch. 12, ABC
 KTVJ Joplin, Mo., ch. 16, CBS

ADI Counties	State	TV Households
Benton	AR	20,700
Allen	KS	5,900
Bourbon	KS	6,600
Cherokee	KS	8,600
Crawford	KS	14,600

Labelle	KS	9,600
Neosho	KS	6,800
Wilson	KS	4,600
Woodson	KS	1,800
Barton	MO	4,400
Jasper	MO	31,200
McDonald	MO	5,300
Newton	MO	12,600
Vernon	MO	6,700
Ottawa	OK	10,800

Women	151,400
Men	132,100
Teens	41,600
Children	57,900

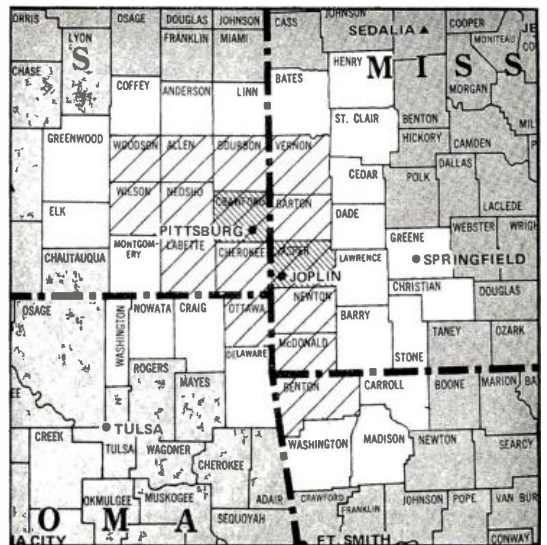

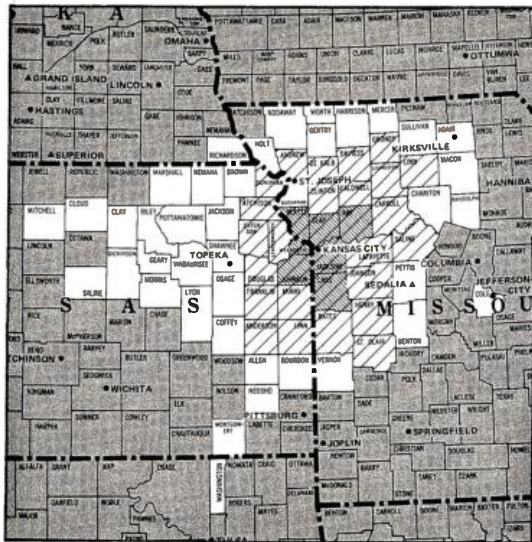

Kansas City, Mo. (23)

ADI TV Households 633,000
 Survey Area TV Households 979,800

WDAF-TV Kansas City, Mo., ch. 4, NBC
KCMO-TV Kansas City, Mo., ch. 5, CBS
KMBC-TV Kansas City, Mo., ch. 19, ET
***KCPT-TV** Kansas City, Mo., ch. 19, ET
KBMA-TV Kansas City, Mo., ch. 41, IND

ADI Counties	State	TV Households
Anderson	KS	3,300
Atchison	KS	6,700
Douglas	KS	20,500
Franklin	KS	7,700
Jefferson	KS	4,200
Johnson	KS	77,400
Leavenworth	KS	17,500
Linn	KS	3,600
Miami	KS	7,500
Wyandotte	KS	64,800
Andrew	MO	4,900

Bates	MO	6,000
Caldwell	MO	3,700
Carroll	MO	4,600
Cass	MO	15,600
Clay	MO	44,800
Clinton	MO	5,200
Daviess	MO	3,500
deKalb	MO	2,600
Grundy	MO	4,400
Henry	MO	8,100
Jackson	MO	247,500
Johnson	MO	11,000
Lafayette	MO	10,400
Linn	MO	6,400
Livingston	MO	6,200
Platte	MO	11,900
Ray	MO	7,100
St. Clair	MO	3,500
Saline	MO	8,100
Women		639,800
Men		575,800
Teens		207,600
Children		280,900

Knoxville, Tenn. (58)

ADI TV Households 350,300
 Survey Area TV Households 687,300

WATE-TV Knoxville, Tenn., ch. 6, NBC
WBIR-TV Knoxville, Tenn., ch. 10, CBS
WTVK Knoxville, Tenn., ch. 26, ABC
***WKSO** Somerset, Ky., ch. 29, ET

ADI Counties	State	TV Households
Bell	KY	10,400
Harlan	KY	13,200
Jackson	KY	3,100
Knox	KY	8,200
Laurel	KY	9,000
Leslie	KY	3,300
McCreary	KY	4,100
Pulaski	KY	13,700
Russell	KY	4,100
Wayne	KY	4,800
Whitley	KY	9,100
Graham	NC	1,700

Anderson	TN	21,300
Blount	TN	23,300
Campbell	TN	9,000
Claiborne	TN	7,900
Cocke	TN	8,800
Cumberland	TN	7,400
Grainger	TN	5,300
Hamblen	TN	14,600
Jefferson	TN	9,800
Knox	TN	102,300
Loudon	TN	9,100
Monroe	TN	8,200
Morgan	TN	4,400
Roane	TN	14,400
Scott	TN	4,900
Sevier	TN	11,600
Union	TN	3,300

Women	373,500
Men	332,100
Teens	115,000
Children	166,400

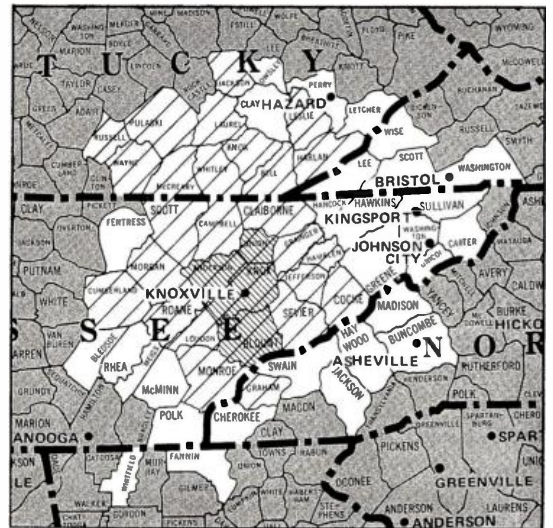

La Crosse-Eau Claire, Wis. (117)

ADI TV Households 146,900
 Survey Area TV Households 412,100

WKBT La Crosse, Wis., ch. 8, CBS
WEAU-TV Eau Claire, Wis., ch. 13, NBC
WXOW-TV La Crosse, Wis., ch. 19, ABC
***WHLA-TV** La Crosse, Wis., ch. 31, ET

ADI Counties	State	TV Households
Houston	MN	5,500
Winona	MN	14,800
Buffalo	WI	4,700
Chippewa	WI	15,900

Crawford	WI	5,500
Eau Claire	WI	24,900
Jackson	WI	5,400
Juneau	WI	6,700
La Crosse	WI	28,400
Monroe	WI	10,700
Pepin	WI	2,500
Rusk	WI	5,100
Templeau	WI	8,300
Vernon	WI	8,600

Women	158,900
Men	145,100
Teens	53,400
Children	70,300

Lafayette, Ind. (192)

ADI TV Households 35,900
 Survey Area TV Households 555,200

WLFJ-TV Lafayette-Kokomo, Ind., ch. 18, CBS

ADI Counties State TV Households
 Tippecanoe IN 35,900

Women 39,400
 Men 40,800
 Teens 10,500
 Children 18,300

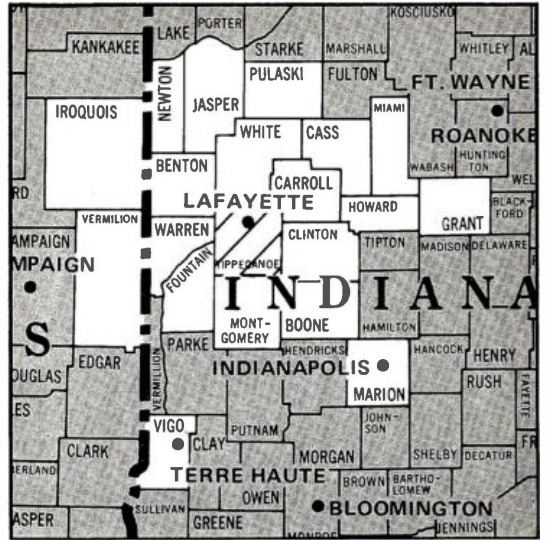

Lafayette, La. (113)

ADI TV Households 152,500
 Survey Area TV Households 470,600

KATC Lafayette, La., ch. 3 ABC
 KLFY-TV Lafayette, La., ch. 10, CBS

ADI Counties State TV Households
 Acadia LA 16,000
 Allen LA 6,000
 Beauregard LA 8,100
 Evangeline LA 10,500

Iberia LA 18,200
 Jefferson Davis LA 8,900
 Lafayette LA 36,900
 St. Landry LA 23,800
 St. Martin LA 9,800
 Vermilion LA 14,300

Women 162,200
 Men 146,000
 Teens 65,100
 Children 93,000

Lake Charles, La. (175)

ADI TV Households 51,300
 Survey Area TV Households 376,700

KPLC-TV Lake Charles, La., ch. 7, NBC

ADI Counties State TV Households
 Calcasieu LA 48,300

Cameron LA 3,000
 Women 53,400
 Men 49,000
 Teens 20,800
 Children 28,700

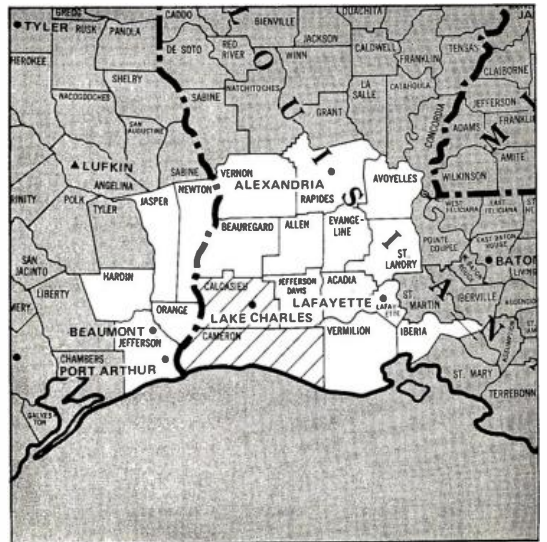

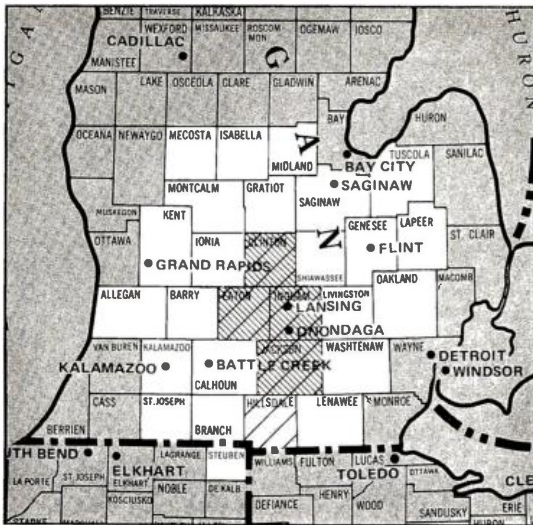

Lansing, Mich. (96)

ADI TV Households 179,800
 Survey Area TV Households 1,282,300

WJIM-TV Lansing, Mich., ch. 6, CBS
 WILX-TV Onondaga, Mich., ch. 10, NBC
 *WKAR E. Lansing, Mich., ch. 23, ETV

ADI Counties	State	TV Households
Clinton	MI	14,600

Eaton	MI	23,300
Hillsdale	MI	12,800
Ingham	MI	83,700
Jackson	MI	45,400

Women	197,700
Men	187,700
Teens	66,100
Children	98,300

Laredo, Tex. (202)

ADI TV Households 21,200
 Survey Area TV Households 142,700

KGNS-TV Laredo, Tex., ch. 8, NBC (ABC)
 KVTV Laredo, Tex., ch. 13, CBS

ADI Counties	State	TV Households
Webb	TX	19,700

Zapala TX 1,500

Women	24,800
Men	21,700
Teens	10,600
Children	18,200

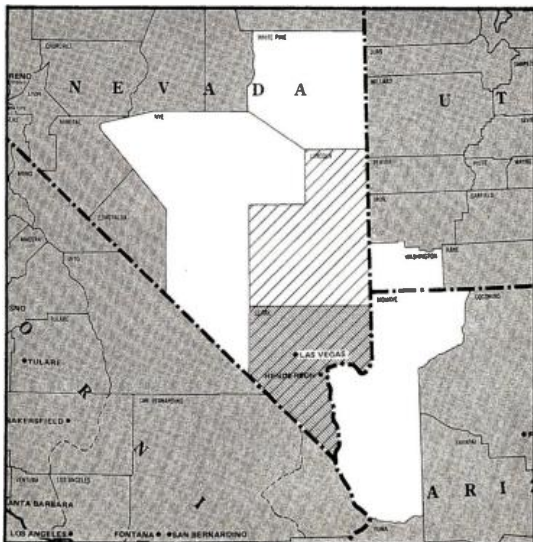
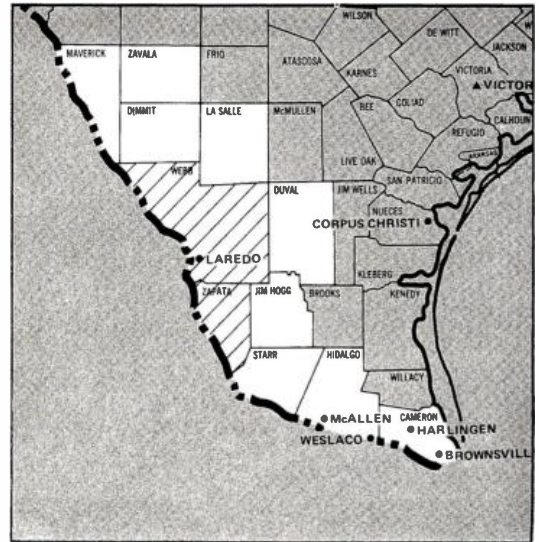

Las Vegas (140)

ADI TV Households 110,900
 Survey Area TV Households 132,100

KORK-TV Las Vegas, ch. 3, NBC
 KVUU Henderson-Las Vegas, Nev., ch. 5, IND
 KLAS-TV Las Vegas, ch. 8, CBS
 *KLVS Las Vegas, ch. 10, ETV
 KSHO-TV Las Vegas, ch. 13, ABC

ADI Counties	State	TV Households
Clark	NV	110,300
Lincoln	NV	600

Women	107,200
Men	104,400
Teens	39,100
Children	59,100

Laurel-Hattiesburg, Miss. (163)

ADI TV Households 65,400
 Survey Area TV Households 259,600

WDAM-TV Laurel-Hattiesburg, Miss. ch 7.
 NBC

ADI Counties	State	TV Households
Covington	MS	4,000
Forrest	MS	19,000
Jasper	MS	4,500

Jones	MS	18,500
Lamar	MS	5,200
Marion	MS	7,100
Perry	MS	2,400
Wayne	MS	4,700

Women	75,300
Men	66,800
Teens	25,000
Children	37,000



Lexington, Ky. (93)

ADI TV Households 189,100
 Survey Area TV Households 443,900

WLEX-TV Lexington, Ky. ch 18, NBC
WKYT-TV Lexington, Ky. ch 27, CBS
WKHA-TV Hazard, Ky. ch 35, ETV
WKMR-TV Morehead, Ky. ch 38, ETV
***WKLE** Lexington, Ky. ch 46, ETV
WTVQ-TV Lexington, Ky. ch 62, ABC

ADI Counties	State	TV Households
Bath	KY	3,300
Bourbon	KY	6,700
Boyle	KY	7,900
Breathitt	KY	4,000
Casey	KY	4,300
Clark	KY	9,100
Clay	KY	5,300
Estill	KY	4,000
Fayette	KY	63,900
Fleming	KY	3,900

Gerrard	KY	3,200
Jessamine	KY	6,400
Lee	KY	2,200
Lincoln	KY	5,700
Madison	KY	13,100
Menifee	KY	1,200
Mercer	KY	6,100
Montgomery	KY	5,500
Nicholas	KY	2,200
Owsley	KY	1,400
Perry	KY	7,700
Powell	KY	2,400
Rockcastle	KY	3,700
Rowan	KY	4,600
Scott	KY	6,000
Woodford	KY	5,300

Women	203,800
Men	184,500
Teens	82,800
Children	97,600

Hazard, Ky. (supplementary market)

Arbitron characterizes supplementary markets as those that do not meet its criteria for having an ADI.

***WKHA** Hazard, Ky. ch 35, ETV
WKYH-TV Hazard, Ky. ch 57, NBC

Home county	Perry
TV Households	7,700

Lima, Ohio (193)

ADI TV Households 34,800
 Survey Area TV Households 291,800

WLIO Lima, Ohio, ch 35, NBC (ABC)
***WBGU-TV** Lima-Bowling Green, Ohio, ch 57, ETV

ADI Counties	State	TV Households
Allen	OH	34,800
Women	36,900	
Men	33,600	
Teens	12,800	
Children	18,200	

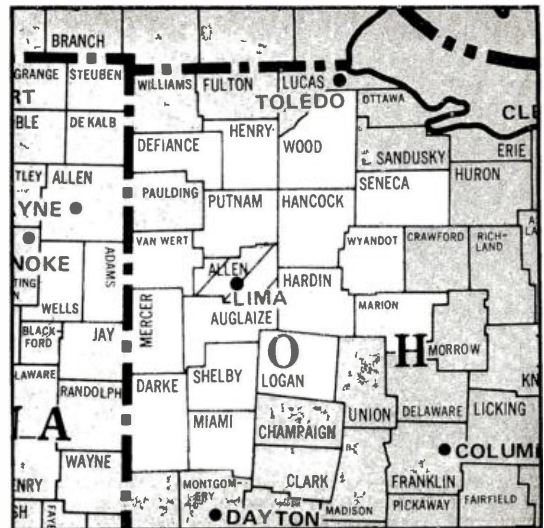



Lincoln-Hastings-Kearney, Neb. (81)

ADI TV Households	238,300	Frontier	NE	1,300
Survey Area TV Households	580,800	Furnas	NE	2,500
		Gage	NE	8,400
		Garfield	NE	1,000
		Gosper	NE	700
		Greeley	NE	1,300
		Hall	NE	15,700
		Hamilton	NE	3,100
		Harlan	NE	1,900
		Hayes	NE	500
		Holt	NE	4,200
		Howard	NE	2,500
		Jefferson	NE	4,200
		Kearney	NE	2,500
		Lancaster	NE	66,500
		Loup	NE	300
		Merrick	NE	3,000
		Nance	NE	1,900
		Nuckolls	NE	2,500
		Pawnee	NE	1,400
		Perkins	NE	1,200
		Phelps	NE	3,500
		Platte	NE	9,000
		Polk	NE	2,300
		Rock	NE	700
		Saline	NE	5,000
		Seward	NE	5,400
		Sherman	NE	1,600
		Thayer	NE	3,100
		Valley	NE	2,000
		Webster	NE	2,200
		Wheeler	NE	300
		York	NE	4,900
		Women		243,000
		Men		225,600
		Teens		73,600
		Children		99,400

Little Rock, Ark. (57)

ADI TV Households 353,800
 Survey Area TV Households 604,000

*KETS Little Rock, Ark. ch. 2, ETV
 KARK-TV Little Rock, Ark., ch. 4, NBC
 KATV Little Rock, Ark., ch. 7, ABC
 KTHV Little Rock, Ark., ch. 11, CBS

ADI Counties	State	TV Households
Arkansas	AR	7,800
Bradley	AR	4,500
Calhoun	AR	1,900
Clark	AR	7,300
Cleburne	AR	4,900
Cleveland	AR	2,300
Conway	AR	7,300
Dallas	AR	3,300
Desha	AR	5,400
Drew	AR	4,900
Faulkner	AR	10,800
Garland	AR	24,300
Grant	AR	4,200
Hot Spring	AR	6,400

Independence	AR	9,000
Jefferson	AR	27,200
Johnson	AR	5,600
Lincoln	AR	3,500
Lonoke	AR	10,000
Monroe	AR	4,400
Montgomery	AR	2,300
Nevada	AR	3,900
Ouachita	AR	10,100
Perry	AR	2,200
Pike	AR	3,200
Pope	AR	11,200
Prairie	AR	3,900
Pulaski	AR	111,200
Saline	AR	14,000
Stone	AR	2,400
Van Buren	AR	3,500
White	AR	15,900
Woodruff	AR	3,600
Yell	AR	6,000
Women		363,300
Men		324,700
Teens		113,700
Children		165,600



You belong in Broadcasting

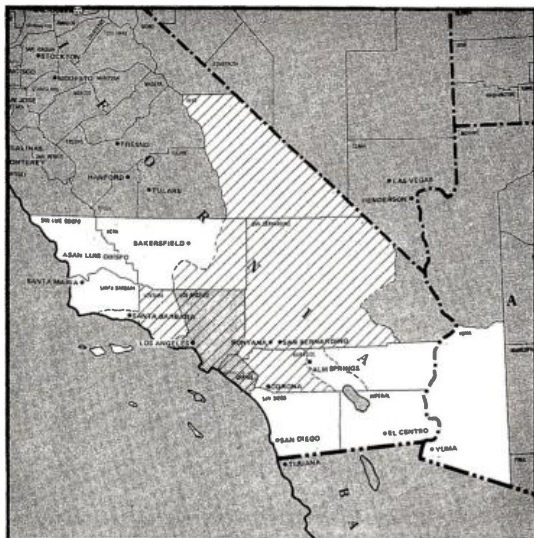

Los Angeles (2)

ADI TV Households 3,647,200
 Survey Area TV Households 4,506,300

KBCS-TV Corona-Los Angeles, Calif. ch. 52, IND

KNXT Los Angeles, ch. 2, CBS
KNBC Los Angeles, ch. 4, NBC
KTLA Los Angeles, ch. 5, IND
KABC-TV Los Angeles, ch. 7, ABC
KHJ-TV Los Angeles, ch. 9, IND
KTTV Los Angeles, ch. 11, IND
KCOP Los Angeles, ch. 13, IND
KWHY-TV Los Angeles, ch. 22, IND
***KVCB-TV** San Bernardino, Calif., ch. 24, ETV
***KCET** Los Angeles, ch. 28, ETV
KHOF-TV San Bernardino, Calif., ch. 30, IND
KMEX-TV Los Angeles, ch. 34, IND
KLXA-TV Fontana, Calif., ch. 40, IND
***KOCE-TV** Huntington Beach, Calif., ch. 50, ETV

ADI Counties	State	TV Households
Inyo	CA	5,900
Kern East	CA	17,500
Los Angeles	CA	2,551,700
Orange North	CA	378,000
Orange South	CA	189,800
Riverside West	CA	136,800
San Bernardino West	CA	231,500
Ventura	CA	136,200
Women		3,614,600
Men		3,289,100
Teens		1,130,400
Children		1,620,000

Louisville, Ky. (38)

ADI TV Households 469,100
 Survey Area TV Households 782,900

WAVE-TV Louisville, Ky. ch. 3, NBC
WHAS-TV Louisville, Ky. ch. 11, CBS
***WKPC-TV** Louisville, Ky. ch. 15, ETV
***WKZT** Elizabethtown, Ky. ch. 23, ETV
WLKY-TV Louisville, Ky. ch. 32, ABC
WDRB-TV Louisville, Ky. ch. 41, IND
***WKMJ** Louisville, Ky. ch. 68, ETV

ADI Counties	State	TV Households
Clark	IN	27,000
Crawford	IN	2,700
Floyd	IN	19,900
Harrison	IN	7,800
Jackson	IN	11,500
Jefferson	IN	9,000
Lawrence	IN	14,700
Orange	IN	6,000
Scott	IN	5,700
Washington	IN	6,400
Adair	KY	4,700
Anderson	KY	3,600

Breckinridge	KY	5,400
Bullitt	KY	9,700
Carroll	KY	3,200
Franklin	KY	12,900
Grayson	KY	6,100
Green	KY	3,300
Hardin	KY	16,800
Hart	KY	5,800
Henry	KY	4,400
Jefferson	KY	238,900
Larue	KY	4,000
Marion	KY	4,700
Meade	KY	6,900
Neelson	KY	6,900
Oldham	KY	4,400
Shelby	KY	6,700
Spencer	KY	2,000
Taylor	KY	6,100
Trimble	KY	1,700
Washington	KY	3,300

Women 496,400
Men 459,100
Teens 189,700
Children 237,100

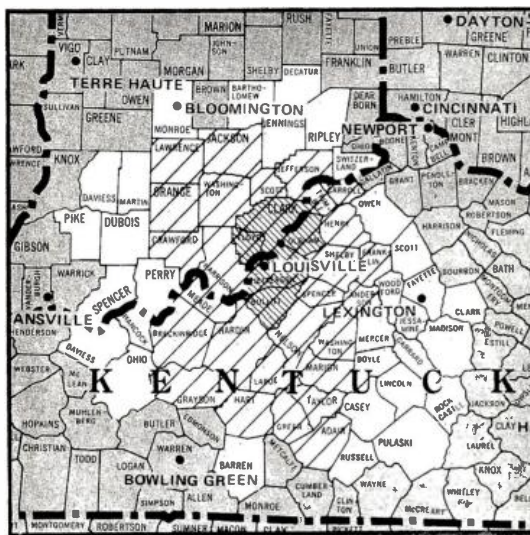

Lubbock, Tex. (134)

ADI TV Households 122,600
 Survey Area TV Households 215,800

***KTXT-TV** Lubbock, Tex. ch. 5, ETV
KCBD-TV Lubbock, Tex. ch. 11, NBC
KWSB-TV Roswell, N.M., ch. 8, satellite to KCBD
KLBB-TV Lubbock, Tex., ch. 13, CBS
KMCC Lubbock, Tex. ch. 28, ABC

ADI Counties	State	TV Households
De Baca	NM	900
Bailey	TX	2,500
Borden	TX	300
Cochran	TX	1,400
Crosby	TX	2,600
Dawson	TX	5,470

Dickens	TX	1,300
Floyd	TX	3,800
Gaines	TX	3,300
Garza	TX	2,100
Hale	TX	11,300
Hockley	TX	6,800
Kent	TX	500
Lamb	TX	5,800
Lubbock	TX	64,100
Lynn	TX	2,000
Motley	TX	500
Terry	TX	4,400
Yoakum	TX	2,600

Women 129,300
Men 119,800
Teens 48,400
Children 69,100

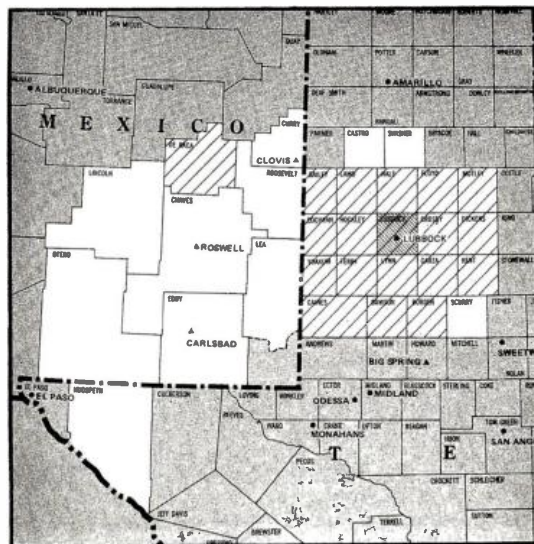

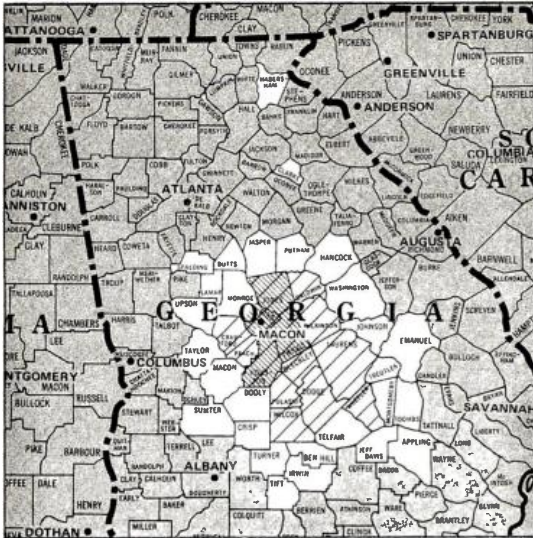

Macon, Ga. (136)

ADI TV Households 117,200
 Survey Area TV Households 259,100

WMAZ-TV Macon, Ga., ch. 13, CBS (ABC)
***WDCO-TV** Cochran, Ga., ch. 15, ETV
WCWB-TV Macon, Ga., ch. 41, NBC (CBS-ABC)

ADI Counties	State	TV Households
Baldwin	GA	6,900
Bibb	GA	47,400
Bleckley	GA	3,400
Crawford	GA	1,500
Dodge	GA	5,300

Houston	GA	21,200
Jones	GA	4,300
Laurens	GA	10,500
Peach	GA	5,500
Pulaski	GA	2,500
Twiggs	GA	2,000
Wheeler	GA	1,400
Wilcox	GA	2,200
Wilkinson	GA	3,000

Women	137,400
Men	119,000
Teens	46,100
Children	66,500

Madison, Wis. (105)

ADI TV Households 164,400
 Survey Area TV Households 632,500

WISC-TV Madison, Wis., ch. 3, CBS
WMTV Madison, Wis., ch. 15, NBC
***WHA-TV** Madison, Wis., ch. 21, ETV
WKOW-TV Madison, Wis., ch. 27, ABC

ADI Counties	State	TV Households
Columbia	WI	14,800

Dane	WI	104,900
Green	WI	9,900
Iowa	WI	6,400
Lafayette	WI	5,800
Marquette	WI	3,300
Richland	WI	5,300
Sauk	WI	14,000

Women	170,600
Men	158,800
Teens	55,900
Children	76,900



Mankato, Minn. (179)

ADI TV Households 46,300
 Survey Area TV Households 214,100

KEYC-TV Mankato, Minn., ch. 12, CBS

ADI Counties	State	TV Households
Emmet	IA	5,100
Blue Earth	MN	17,400

Cottonwood	MN	5,000
Jackson	MN	4,800
Martin	MN	9,300
Watwan	MN	4,700

Women	50,500
Men	45,900
Teens	15,500
Children	19,900

Marquette, Mich. (174)

ADI TV Households 52,800
 Survey Area TV Households 129,900

WLUC-TV Marquette, Mich., ch. 6, CBS (ABC-NBC)
***WNMU-TV** Marquette, Mich., ch. 13, ETV

ADI Counties	State	TV Households
Alger	MI	2,700
Baraga	MI	2,400

Houghton	MI	12,700
Iron	MI	5,100
Keweenaw	MI	800
Marquette	MI	21,300
Ontonagon	MI	3,800
Schoolcraft	MI	3,000
Florence	WI	1,000

Women	55,100
Men	57,700
Teens	18,000
Children	25,200

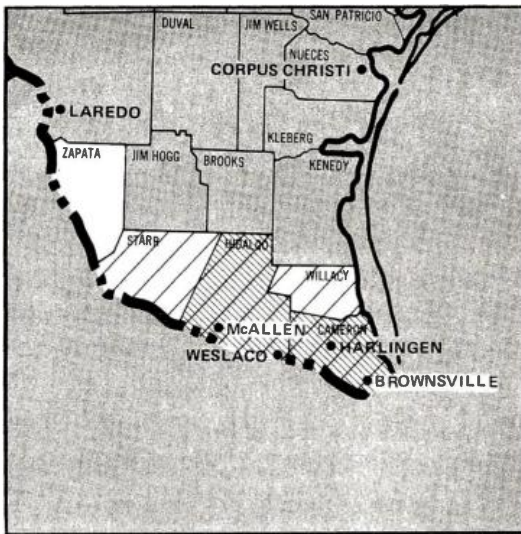

McAllen-Brownsville, Tex. (141)

ADI TV Households 109,900
 Survey Area TV Households 111,400

KGFT-TV Harlingen, Tex., ch. 4, CBS (ABC)
KRGV-TV Weslaco, Tex., ch. 5, NBC (ABC)

ADI Counties	State	TV Households
Cameron	TX	45,000

Hidalgo	TX	56,400
Starr	TX	4,400
Willacy	TX	4,100

Women	132,700
Men	113,200
Teens	56,100
Children	93,400

Medford, Ore. (155)

ADI TV Households 90,500
 Survey Area TV Households 271,000

KOBI Medford, Ore., ch. 5, CBS (ABC)
KOTI Klamath Falls, Ore., ch. 2, satellite to KOBI
KMED-TV Medford, Ore., ch. 10, NBC (ABC)

ADI Counties	State	TV Households
Siskiyou	CA	11,800

Jackson	OR	40,100
Josephine	OR	17,800
Klamath	OR	18,700
Lake	OR	2,100

Women	88,200
Men	83,400
Teens	27,900
Children	37,400

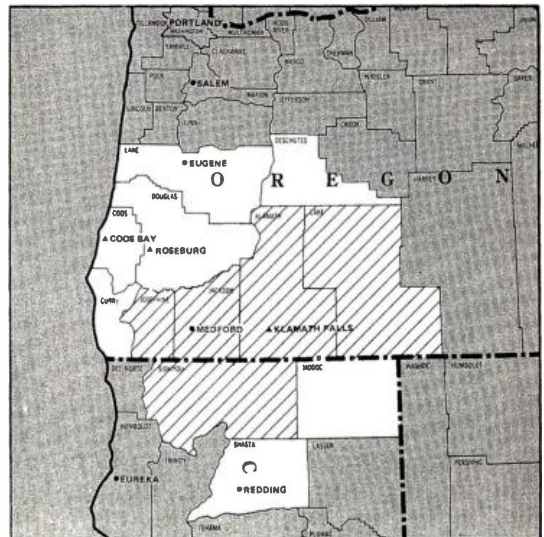

Producing Commercials? We'll make it easy for you!

The Mississippi River, the Memphis skyline and its bridges, a landscaped patio, or a grassy slope . . . they're all a part of our new studios. We're right on the river bank and we move outside with our cameras as easily as we shoot inside our two (50' x 70' and 40' x 40') completely independently equipped studios. Thus you go

right on tape with your outside shots just like you were in the studio. There's even a 14-foot lift for high angle work . . . and every other modern aid you'd expect in an all-new facility. Give our production manager, Cal Crowell, a call and let him show you how we can really make it easy for you! That number is (901) 525-3333.



MEMPHIS, TENNESSEE

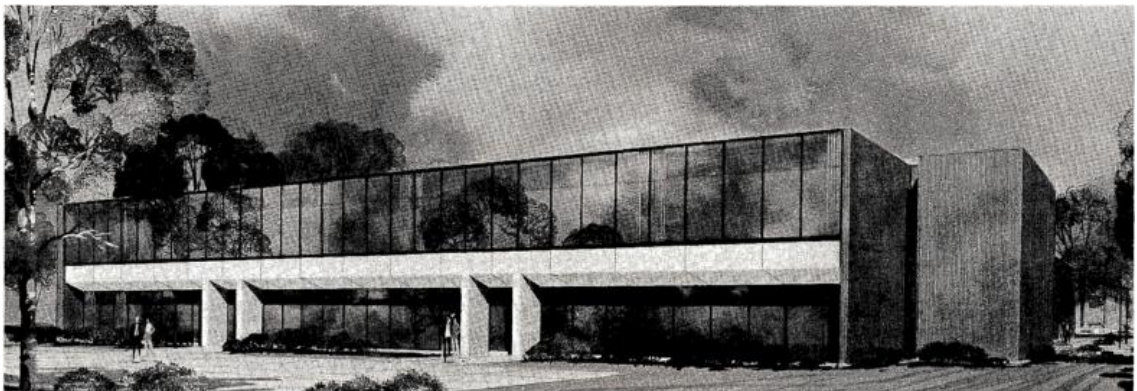

THE NEW YORK TIMES BROADCASTING SERVICE, INC. AFFILIATED WITH CBS. REPRESENTED BY THE KATZ AGENCY.

A NEW YORK TIMES COMPANY

Memphis (34)

ADI TV Households 493,200
 Survey Area TV Households 780,500

WREG-TV Memphis, ch. 3, CBS
WMC Memphis, ch. 5, NBC
***WKNO-TV** Memphis, ch. 10, ETV
WHBO-TV Memphis, ch. 13, ABC
***WMAV** Oxford, Miss., ch. 18, ETV

ADI Counties	State	TV Households
Crittenden	AR	14,400
Cross	AR	5,700
Lee	AR	4,800
Mississippi	AR	19,400
Phillips	AR	11,200
Pointsett	AR	9,300
St. Francis	AR	8,400
Alcorn	MS	9,800
Benton	MS	1,800
Coahoma	MS	10,400
De Soto	MS	11,400
Lafayette	MS	7,000
Marshall	MS	6,000
Panola	MS	6,700

Pontotoc	MS	5,400
Quitman	MS	3,800
Tallahatchie	MS	4,700
Tate	MS	4,900
Tippah	MS	5,300
Tunica	MS	2,600
Union	MS	6,800
Yalobusha	MS	4,000
Pemiscot	MO	9,000
Chester	TN	3,600
Crockett	TN	5,300
Dyer	TN	11,600
Fayette	TN	5,800
Gibson	TN	17,600
Hardeman	TN	6,100
Haywood	TN	6,600
Lauderdale	TN	6,900
McNairy	TN	7,800
Shelby	TN	240,300
Tipton	TN	8,800

Women 541,200
Men 478,000
Teens 191,900
Children 275,200

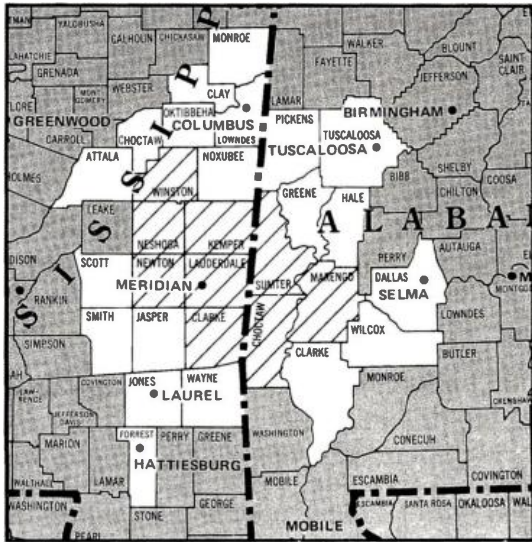
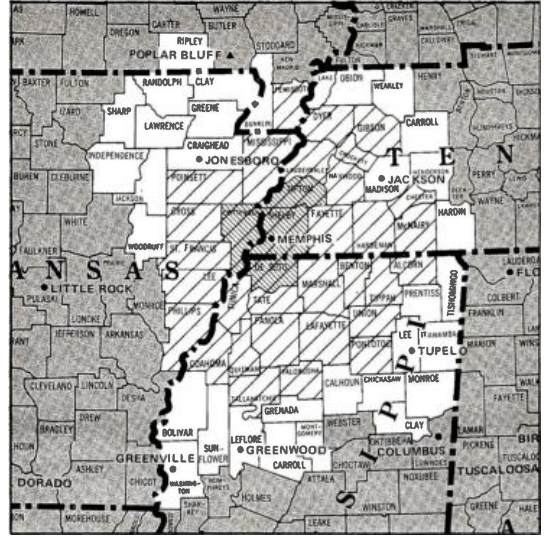

Meridian, Miss. (164)

ADI TV Households 64,400
 Survey Area TV Households 251,300

WTOK-TV Meridian, Miss., ch. 11, CBS (ABC-NBC)
***WMAW** Meridian, Miss., ch. 14, ETV
WHTV-TV Meridian, Miss., ch. 24, NBC
***WIIQ** Demopolis, Ala., ch. 41, ETV

ADI Counties	State	TV Households
Choctaw	AL	5,000

Marengo	AL	6,900
Sumter	AL	4,500
Clarke	MS	4,700
Kemper	MS	2,700
Lauderdale	MS	22,700
Neshoba	MS	6,600
Newton	MS	5,800
Winston	MS	5,500

Women 72,800
Men 63,800
Teens 23,800
Children 37,300

Miami (15)

ADI TV Households 842,600
 Survey Area TV Households 1,145,800

***WPBT** Miami, ch. 2, ETV
***WTHS-TV** Miami, ch. 2, ETV
WTVJ Miami, ch. 4, CBS
WCIX-TV Miami, ch. 6, IND
WCKT Miami, ch. 7, NBC
WPLQ-TV Miami, ch. 10, ABC
***WLRN-TV** Miami, ch. 17, ETV
WLTU Miami, ch. 23, IND
WFCB-TV Miami, Fla., ch. 45, IND

ADI Counties	State	TV Households
Broward	FL	310,100
Dade	FL	513,300
Henry	FL	4,200
Monroe	FL	15,000

Women 905,000
Men 777,100
Teens 236,600
Children 328,700

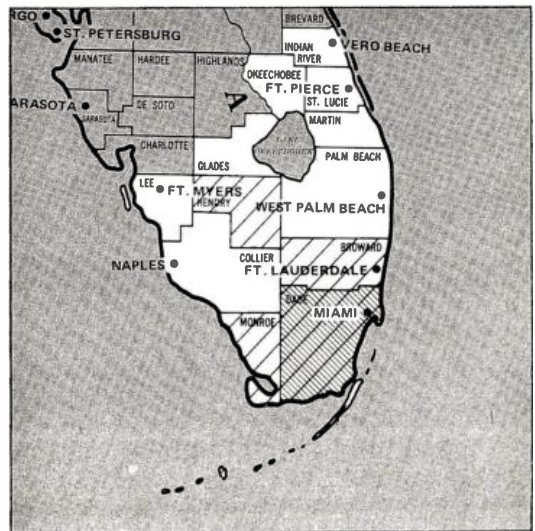

Fort Lauderdale, Fla. (supplementary market)

Arbitron characterizes supplementary markets as those that do not meet its criteria for having an ADI.

WKID Fort Lauderdale, Fla., ch. 51, IND	
Home county	Broward
TV Households	310,100

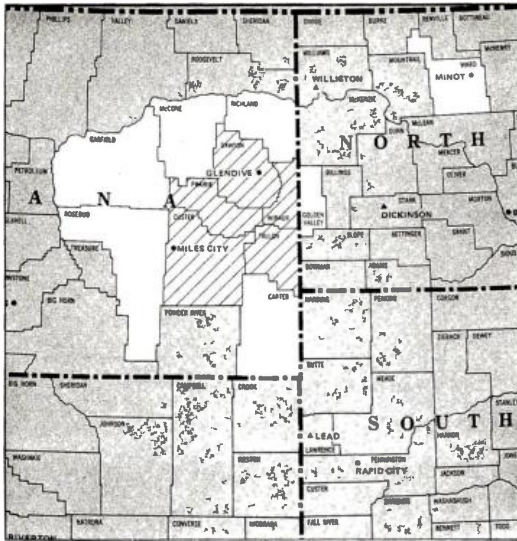

Miles City-Glendive, Mont. (208)

ADI TV Households	8,600	Dawson	MT	3,100
Survey Area TV Households	35,900	Fallon	MT	1,100
		Prairie	MT	500
		Wibaux	MT	400
KYUS-TV Miles City, Mont. ch. 3, NBC				
KXGN-TV Glendive, Mont. ch. 5, CBS (ABC-NBC)				
ADI Counties	State	TV Households	Women	9,100
Custer	MT	3,500	Men	8,600
			Teens	3,700
			Children	4,400

Milwaukee (22)

ADI TV Households	639,900	Jefferson	WI	20,300
Survey Area TV Households	1,234,600	Milwaukee	WI	368,100
		Ozaukee	WI	19,300
		Racine	WI	55,500
		Sheboygan	WI	34,900
		Walworth	WI	22,400
		Washington	WI	22,400
		Waukesha	WI	73,600
				673,000
ADI Counties	State	TV Households	Women	609,000
Dodge	WI	23,400	Men	231,400
			Teens	234,000
			Children	307,300

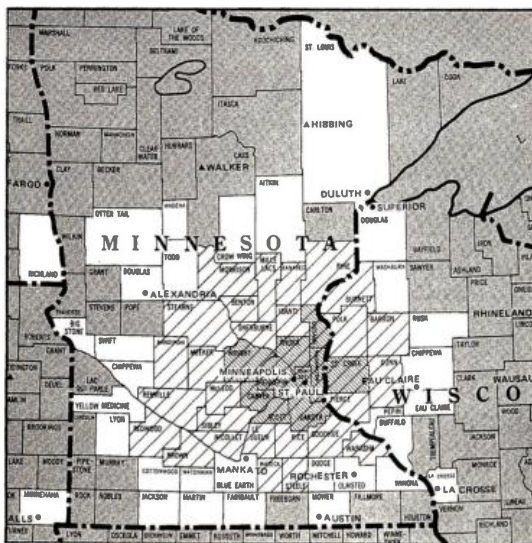
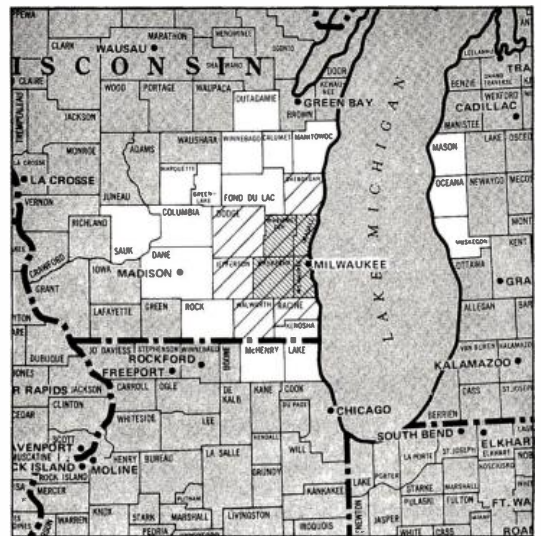

Minneapolis-St. Paul (13)

ADI TV Households	908,700	Morrison	MN	8,300
Survey Area TV Households	1,321,600	Nicollet	MN	7,000
		Pine	MN	6,400
		Ramsey	MN	157,800
		Redwood	MN	6,500
		Renville	MN	7,300
		Rice	MN	13,200
		Scott	MN	11,000
		Shelburne	MN	7,400
		Sibley	MN	5,400
		Stearns	MN	27,100
		Steele	MN	10,300
		Wabasha	MN	6,400
		Waseca	MN	5,600
		Washington	MN	28,500
		Wright	MN	14,500
		Barron	WI	13,200
		Burnett	WI	4,100
		Dunn	WI	10,100
		Pierce	WI	9,400
		Polk	WI	10,400
		St. Croix	WI	12,000
ADI Counties	State	TV Households	Women	962,800
Anoka	MN	51,200	Men	875,900
Benton	MN	6,600	Teens	341,800
Brown	MN	9,800	Children	471,600
Carver	MN	10,200		
Chisago	MN	7,100		
Dakota	MN	48,000		
Goodhue	MN	13,400		
Hennepin	MN	327,500		
Isanti	MN	6,700		
Kanabec	MN	4,500		
Kandiyohi	MN	10,100		
Le Sueur	MN	7,800		
McLeod	MN	9,700		
Meeker	MN	7,200		
Mille Lacs	MN	6,000		

Minot-Bismarck-Dickinson, N.D. (138)

ADI TV Households 115,100
 Survey Area TV Households 140,800

KFVR-TV Bismarck, N.D., ch. 5, NBC (ABC)
KUMV-TV Williston, N.D., ch. 8, satellite to KFVR
KMOT Minot, N.D., ch. 10, satellite to KFVR
KXMC-TV Minot, N.D., ch. 13, CBS (ABC)
KDIX-TV Dickinson, N.D., ch. 2, satellite to KXMC
KXMB-TV Williston, N.D., ch. 11, satellite to KXMC
KXMB-TV Bismarck, N.D., ch. 12, satellite to KXMC
KPSD-TV Eagle Butte, S.D., ch. 13, ETV

Counties	State	TV Households
Daniels	MT	1,200
McCone	MT	700
Richland	MT	3,100
Roosevelt	MT	2,900
Sheridan	MT	1,900
Adams	ND	1,200
Billings	ND	300
Butlineau	ND	2,800
Bowman	ND	1,200
Burke	ND	1,500
Burleigh	ND	14,700
Divide	ND	1,800
Dunn	ND	1,100
Emmons	ND	1,900

Golden Valley ND 500
 Grant ND 1,500
 Hettinger ND 1,800
 Kidder ND 1,300
 Logan ND 1,300
 McHenry ND 1,900
 McIntosh ND 2,000
 McKenzie ND 1,900
 McLean ND 4,400
 Mercer ND 1,800
 Morton ND 6,800
 Mountain ND 3,000
 Oliver ND 600
 Pierce ND 2,000
 Renville ND 1,200
 Rolette ND 3,200
 Sheridan ND 1,000
 Sioux ND 800
 Slope ND 400
 Stark ND 5,800
 Ward ND 19,500
 Williams ND 6,500
 Campbell SD 900
 Corson SD 1,200
 Dewey SD 1,700
 Perkins SD 1,500
 Watworth SD 2,900

Women 122,200
 Men 116,200
 Teens 48,700
 Children 62,800

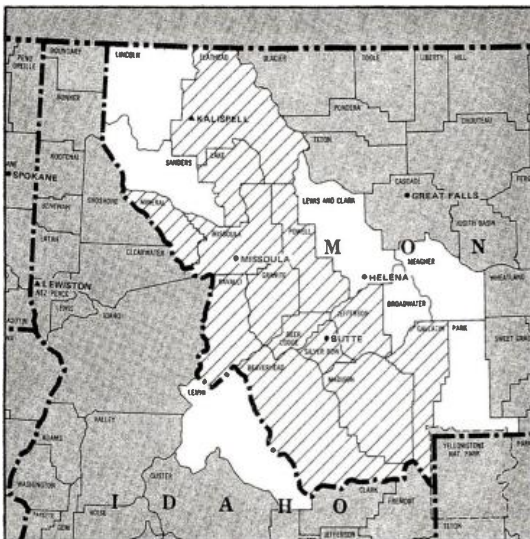

Missoula-Butte, Mont. (158)

ADI TV Households 84,100
 Survey Area TV Households 111,200

KXLF-TV Butte, Mont., ch. 4, CBS (ABC-NBC)
KPAX-TV Missoula, Mont., ch. 8, satellite to KXLF
KGVO-TV Missoula, Mont., ch. 13, NBC (ABC-CBS)
KTVM Butte, Mont., ch. 6, satellite to KGVO
KCFW-TV Kalispell, Mont., ch. 9, satellite to KGVO

Counties	State	TV Households
Beaverhead	MT	2,600
Deer Lodge	MT	4,900

Flathead MT 13,000
 Gallatin MT 11,400
 Granite MT 900
 Jefferson MT 1,800
 Lake MT 5,200
 Madison MT 1,900
 Mineral MT 1,200
 Missoula MT 19,100
 Powell MT 2,000
 Ravalli MT 5,700
 Silver Bow MT 14,400

Women 90,200
 Men 88,200
 Teens 30,600
 Children 40,900

If it happens at 10:24 p.m....



viewers see it at 10:24 p.m.



LIVE "ACTION-CAM!" ONLY ON KSTP-TV IN THE TWIN CITIES, THE NO. 1 NEWS AT 10 O'CLOCK.

EYEWITNESS NEWS - KSTP-TV 5

MINNEAPOLIS • ST. PAUL

*Source: Arbitron, May, 1975. 10 p.m. news, 5-day program averages. TSA Estimates subject to limitations in said report.



Mobile, Ala.-Pensacola, Fla. (65)

ADI TV Households 310,700
 Survey Area TV Households 508,800

WEAR-TV Pensacola, Fla., ch. 3, ABC
WKRG-TV Mobile, Ala., ch. 5, CBS
WALA-TV Mobile, Ala., ch. 10, CBS
***WSRE** Pensacola, Fla., ch. 23, ETV
***WEIQ** Mobile, Ala., ch. 42, ETV

ADI Counties	State	TV Households
Baldwin	AL	21,100
Clarke	AL	7,800
Conecuh	AL	4,800

Escambia	AL	10,800
Mobile	AL	101,100
Monroe	AL	5,600
Washington	AL	4,800
Escambia	FL	72,300
Ocalaosa	FL	30,600
Santa Rosa	FL	15,100
George	MS	3,900
Greene	MS	2,600
Jackson	MS	30,400

Women	340,200
Men	318,700
Teens	128,200
Children	186,000

**"MAKE IT
 KNOWN ON
 THE GULF COAST"**
 ONE OF THE HOTTEST GROWTH AREAS
 IN THE COUNTRY! THE ALABAMA,
 FLORIDA & MISSISSIPPI
 GULF COAST.

NEWSBEAT

The Dominant Influence In This Market

... November '75

ARB/ADI SHARE	6PM-41%	10PM-35%
NSI/DMA SHARE	6PM-39%	10PM-35%

Only Newsbeat Beats All Other Local
 Newscasts as Well as NBC Nightly News.
 CBS Evening News and ABC News!

WALA-TV

Mobile, Alabama

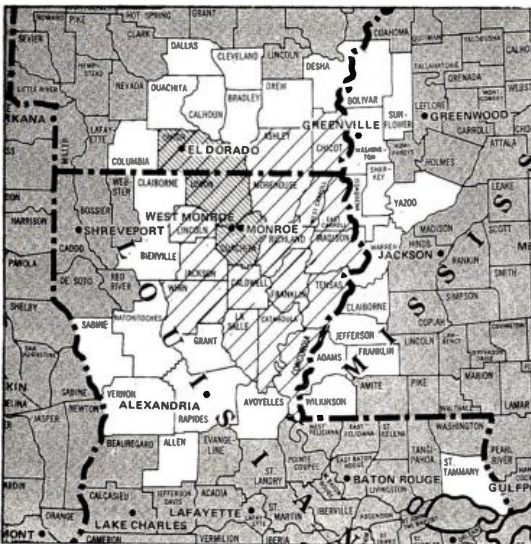

Monroe, La.-El Dorado, Ark. (112)

ADI TV Households 154,500
 Survey Area TV Households 396,900

KNOE-TV Monroe, La., ch. 8, CBS (ABC)
KTVE El Dorado, Ark.-Monroe, La., ch. 10, ABC
 (NBC)
KLAA-TV West Monroe, La., ch. 14, NBC

ADI Counties	State	TV Households
Ashley	AR	8,000
Chicot	AR	5,300
Union	AR	15,800
Caldwell	LA	2,700
Catahoula	LA	3,600
Concordia	LA	6,100
East Carroll	LA	3,400

Franklin	LA	7,000
Jackson	LA	5,300
La Salle	LA	5,300
Lincoln	LA	11,000
Madison	LA	4,500
Morehouse	LA	10,000
Ouachita	LA	41,000
Richland	LA	6,700
Tensas	LA	2,700
Union	LA	6,000
West Carroll	LA	4,100
Winn	LA	6,000

Women	163,400
Men	143,000
Teens	56,800
Children	82,900

Montgomery, Ala. (121)

ADI TV Households 138,200
 Survey Area TV Households 423,200

***WDIQ** Dozier, Ala., ch. 2 ETV
WFSB-TV Montgomery, Ala., ch. 12, NBC
WCOV-TV Montgomery, Ala., ch. 20, CBS
WAIQ Montgomery, Ala., ch. 26, ETV
WKAB-TV Montgomery, Ala., ch. 32, ABC

ADI Counties	State	TV Households
Autauga	AL	8,000
Bullock	AL	3,200
Butter	AL	6,200

Covington	AL	12,400
Crenshaw	AL	5,200
Elmore	AL	11,400
Lowndes	AL	3,400
Macon	AL	7,200
Montgomery	AL	58,100
Pike	AL	8,000
Tallapoosa	AL	11,200
Wilcox	AL	3,900

Women 153,400
 Men 131,900
 Teens 51,700
 Children 75,300



Note: Coverage maps in this special section show total survey areas in white, with Areas of Dominant Influence (ADI's), indicated by light cross-hatching where appropriate, and Arbitron Metro Rating Areas shown by heavier cross-hatching.

Nashville (30)

ADI TV Households 579,900
 Survey Area TV Households 919,100

WNGE Nashville, ch. 2, ABC
WSM-TV Nashville, ch. 4, NBC
WTVF Nashville, ch. 5, CBS
WDCN-TV Nashville, ch. 8, ETV
WKGB Bowling Green, Ky., ch. 53, ETV

ADI Counties	State	TV Households
Allen	KY	4,500
Barron	KY	10,400
Butler	KY	3,600
Christian	KY	19,200
Clinton	KY	2,800
Cumberland	KY	2,100
Edmonson	KY	3,000
Logan	KY	7,800
Meigs	KY	3,100
Monroe	KY	4,600
Muhlenberg	KY	10,800
Simpson	KY	5,100
Todd	KY	3,600
Trigg	KY	2,600
Warren	KY	21,300
Bedford	TN	9,000
Benton	TN	4,400
Cannon	TN	3,700
Carroll	TN	9,600
Cheatham	TN	5,200
Clay	TN	2,500
Coffee	TN	11,500
Davidson	TN	156,800
Decatur	TN	3,300
De Kalb	TN	4,100
Dickson	TN	9,400

Fentress	TN	4,100
Franklin	TN	9,400
Giles	TN	7,800
Henry	TN	9,600
Hickman	TN	4,700
Houston	TN	2,100
Humphreys	TN	5,100
Jackson	TN	2,900
Lawrence	TN	10,600
Lewis	TN	3,000
Lincoln	TN	9,400
Macon	TN	4,500
Marshall	TN	6,500
Mauzy	TN	15,300
Montgomery	TN	19,400
Moore	TN	1,500
Overtown	TN	5,500
Perry	TN	2,200
Pickett	TN	1,400
Putnam	TN	13,800
Robertson	TN	11,600
Rutherford	TN	21,500
Smith	TN	5,200
Stewart	TN	3,200
Sumner	TN	23,000
Trousdale	TN	1,800
Van Buren	TN	1,100
Warren	TN	10,400
Wayne	TN	1,000
White	TN	5,800
Williamson	TN	14,000
Wilson	TN	15,300

Women 603,800
 Men 559,800
 Teens 188,800
 Children 268,100

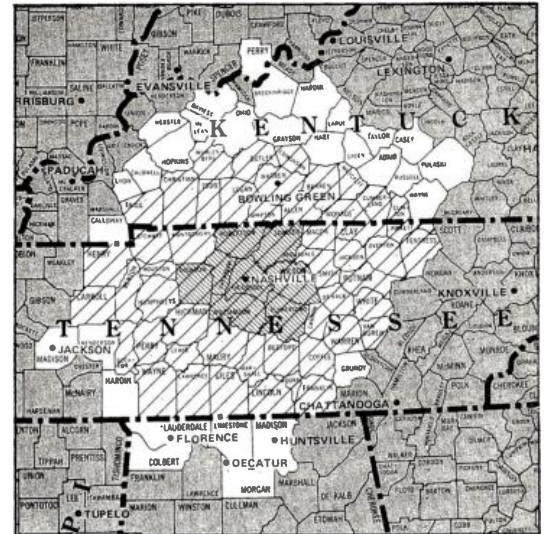

Bowling Green, Ky. (supplementary market)

Arbitron characterizes supplementary markets as those that do not meet its criteria for having an ADI.

WBKO Bowling Green, Ky., ch. 13, ABC
WKGB Bowling Green, Ky., ch. 53, ETV

Home county	Warren
TV Households	21,300

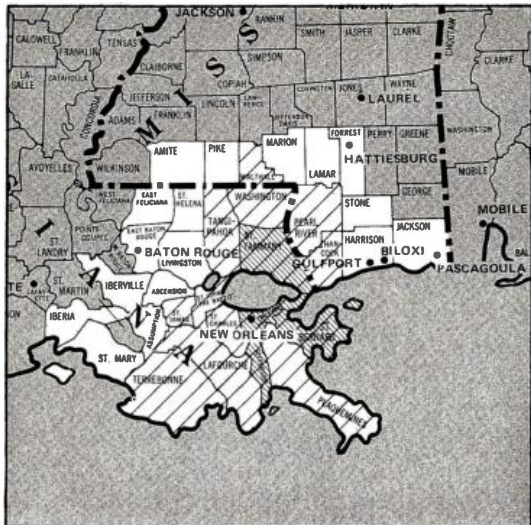

New Orleans (35)

ADI TV Households 492,200
 Survey Area TV Households 788,500

WWL-TV New Orleans, ch. 4, CBS
WDSU-TV New Orleans, ch. 6, NBC
WVUE New Orleans, ch. 8, ABC
***WYES-TV** New Orleans, ch. 12, ETV
WGNO New Orleans, ch. 26, IND

Counties	State	TV Households
Jefferson	LA	125,800
Lafourche	LA	20,700
Orleans	LA	5,200
Plaquemines	LA	6,400

St. Bernard	LA	17,400
St. Charles	LA	8,700
St. James	LA	4,700
St. John the Baptist	LA	6,200
St. Tammany	LA	21,500
Tangipahoa	LA	20,900
Terrebonne	LA	22,700
Washington	LA	14,500
Hancock	MS	5,600
Pearl River	MS	8,000
Walthall	MS	3,500

Women 517,900
Men 456,000
Teens 187,600
Children 275,300

New York (1)

ADI TV Households 6,410,600
 Survey Area TV Households 8,338,500

WCBS-TV New York, ch. 2, CBS
WNBC-TV New York, ch. 4, NBC
WNEW-TV New York, ch. 5, IND
WABC-TV New York, ch. 7, ABC
WOR-TV New York, ch. 9, IND
WPIX New York, ch. 11, IND
***WNET** Newark, N.J., ch. 13, ETV
***WLIW** Garden City, N.Y., ch. 21, ETV
***WNYE-TV** New York, ch. 25, ETV
***WNYC-TV** New York, ch. 31, ETV
WXTV Paterson, N.J., ch. 41, IND
WNJU-TV Linden-Newark, N.J., ch. 47, IND
WEDW-TV Bridgeport, Conn., ch. 49, ETV
***WNJM** Montclair, N.J., ch. 50, ETV
***WNJB** New Brunswick, N.J., ch. 58, ETV

Counties	State	TV Households
Fairfield	CT	268,200
Bergen	NJ	304,600
Essex	NJ	322,100
Hudson	NJ	222,700
Hunterdon	NJ	24,400
Middlesex	NJ	188,500
Monmouth	NJ	153,200

Morris	NJ	123,800
Ocean	NJ	96,400
Passaic	NJ	159,500
Somerset	NJ	63,100
Sussex	NJ	28,200
Union	NJ	187,400
Bronx	NY	510,800
Dutchess	NY	68,000
Kings	NY	876,600
Nassau	NY	434,600
New York	NY	601,900
Orange	NY	74,800
Putnam	NY	21,100
Queens	NY	732,900
Richmond	NY	101,400
Rockland	NY	73,500
Suffolk East	NY	108,200
Suffolk West	NY	262,500
Sullivan	NY	19,800
Ulster	NY	49,500
Westchester	NY	310,200
Monroe	PA	17,700
Pike	PA	5,000

Women 6,896,600
Men 5,960,600
Teens 1,978,800
Children 2,754,200

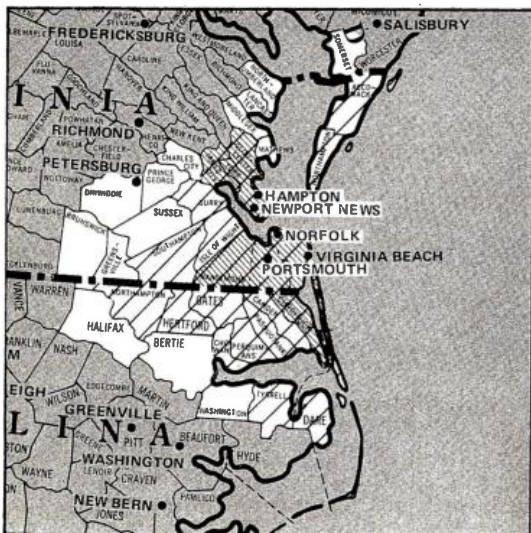

Norfolk-Portsmouth-Newport News-Hampton, Va. (48)

ADI TV Households 397,800
 Survey Area TV Households 488,200

WTAR-TV Norfolk, Va., ch. 3, CBS
WAVY-TV Portsmouth-Norfolk-Newport News, Va., ch. 10, NBC
WVEC-TV Hampton-Norfolk, Va., ch. 13, ABC
***WHRO-TV** Hampton-Norfolk, Va., ch. 15, ETV
WYAH-TV Portsmouth, Va., ch. 27, IND

Counties	State	TV Households
Camden	NC	1,700
Chowan	NC	3,500
Currituck	NC	2,800
Dare	NC	2,700
Gates	NC	2,400
Hertford	NC	6,800
Northampton	NC	5,900
Pasquotank	NC	8,800

Perquimans	NC	2,500
Tyrell	NC	1,100
Accomack	VA	10,000
Gloucester	VA	5,500
Hampton-Newport News	VA	81,600
Isle of Wight	VA	5,400
James City	VA	8,000
Mathews	VA	3,200
Nansemond	VA	14,000
Norfolk	VA	146,900
Northampton	VA	4,900
Southampton	VA	6,900
Surry	VA	1,700
Virginia Beach	VA	60,500
York	VA	11,000

Women 435,000
Men 449,000
Teens 156,000
Children 220,300

North Platte, Neb. (203)

ADI TV Households 17,300
 Survey Area TV Households 42,500

KNOP-TV North Platte, Neb., ch. 2, NBC
***KPNE** Green Bay, Wis. ch. 9, ETV

ADI Counties	State	TV Households
Arthur	NE	200
Blaine	NE	200

Hooker	NE	300
Keith	NE	3,300
Lincoln	NE	12,400
Logan	NE	300
McPherson	NE	200
Thomas	NE	400

Women	18,100
Men	16,000
Teens	5,700
Children	7,200

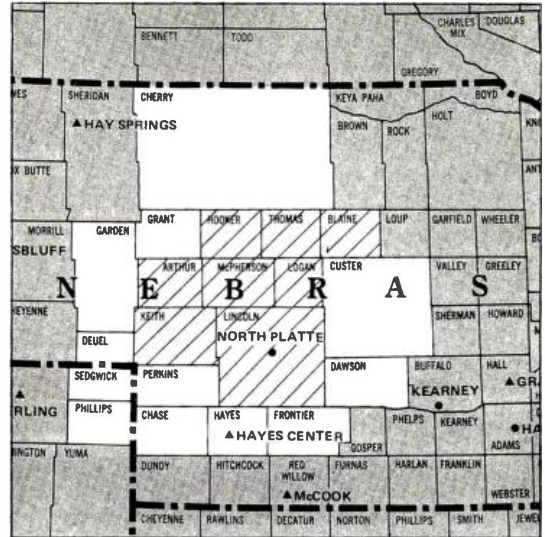

The DOMINANT MEDIA

Serving the largest petroleum energy producing area in the United States . . .

The PERMIAN BASIN of West Texas and Southeast New Mexico.

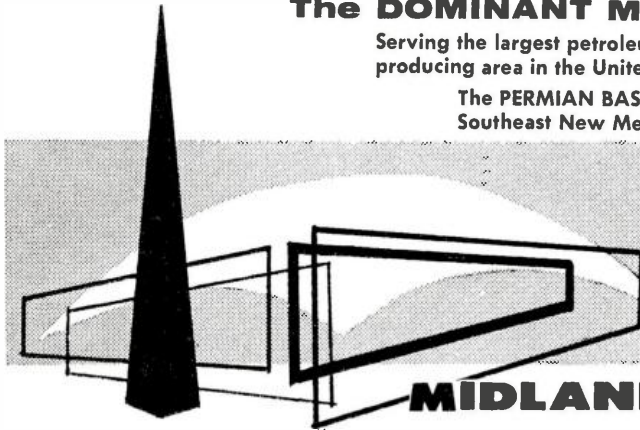

KMID-TV
channel 2 NBC

MIDLAND-ODESSA, TEXAS

Odessa-Midland, Tex. (148)

ADI TV Households 99,100
 Survey Area TV Households 127,600

KMID-TV Midland-Odessa, Tex. ch. 2, NBC
KOSA-TV Odessa-Midland, Tex. ch. 7, CBS
KMOM-TV Monahan's-Odessa, Tex. ch. 9, ABC
KWAB Big Spring, Tex. ch. 4, satellite to KMOM

ADI Counties	State	TV Households
Lea South	NM	2,200
Andrews	TX	3,600
Brewster	TX	2,400
Crane	TX	1,300
Crockett	TX	1,100
Culberson	TX	800
Ector	TX	30,600
Glasscock	TX	300

Howard	TX	12,700
Jeff Davis	TX	400
Loving	TX	100
Martin	TX	1,500
Midland	TX	21,900
Pecos	TX	4,100
Presidio	TX	1,400
Reagan	TX	1,000
Reeves	TX	4,000
Terrell	TX	400
Upton	TX	1,700
Ward	TX	3,900
Winkler	TX	3,100

Women	105,400
Men	90,000
Teens	39,200
Children	54,500

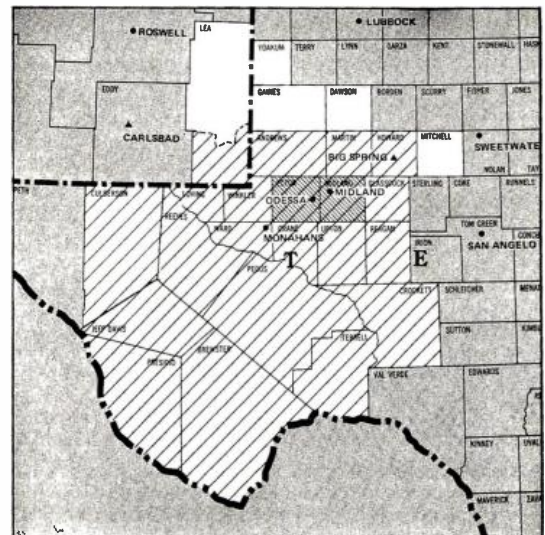

WESH-TV

CONSISTENTLY NO. 1*
ORLANDO - DAYTONA BEACH MARKET
AMERICA'S 44th ADI**

Key Viewing Areas Share of ADI HH

	WESH-TV	WDBO-TV	WFTV (TV)
● EARLY FRINGE 5-7:30 p.m. M-F	35	33	19
● LATE NEWS 11-11:30 p.m. M-F	39	30	26
● TOTAL WEEK Sign On-Sign Off, 7 Days	35	33	27

*10-REPORT AVERAGE, ARBITRON, MAY, 1972 - MAY, 1975

**BASED ON ARBITRON ESTIMATES OF U.S. TELEVISION HOUSEHOLDS (428,600) AS OF JANUARY 1, 1976.

WESH-TV

DAYTONA BEACH/ORLANDO

A Cowles Communication Station



Represented Nationally by KATZ TELEVISION



Oklahoma City (41)

ADI TV Households 443,600
 Survey Area TV Households 580,900

KTVY Oklahoma City, ch. 4, NBC
KOCO-TV Oklahoma City, ch. 5, ABC
KWTV Oklahoma City, ch. 9, CBS
***KETA** Oklahoma City, ch. 13, ETV
***KOKH-TV** Oklahoma City, ch. 25, ETV

ADI Counties	State	TV Households
Allfala	OK	3,000
Blaine	OK	4,300
Caddo	OK	10,600
Canadian	OK	13,900
Cleveland	OK	33,500
Custer	OK	8,400
Dewey	OK	2,000
Ellis	OK	1,800
Garfield	OK	21,400
Garvin	OK	10,200
Grady	OK	12,900

Grant	OK	2,800
Harper	OK	1,500
Hughes	OK	5,500
Kay	OK	17,700
Kingfisher	OK	4,300
Lincoln	OK	7,900
Logan	OK	8,100
McClain	OK	6,800
Major	OK	2,600
Murray	OK	3,800
Noble	OK	3,900
Oklahoma	OK	196,400
Payne	OK	19,100
Pottawatomie	OK	18,100
Seminole	OK	10,000
Washita	OK	4,300
Woods	OK	4,000
Woodward	OK	4,800
Women		459,100
Men		411,300
Teens		138,300
Children		196,000

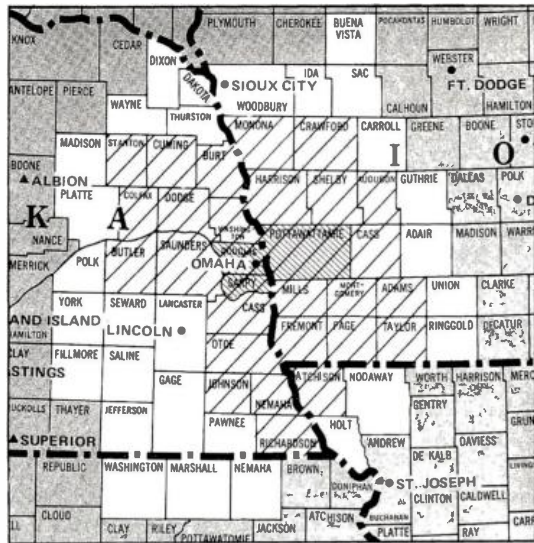

Omaha (63)

ADI TV Households 326,400
 Survey Area TV Households 562,700

KMTV Omaha, ch. 3, NBC
WOW-TV Omaha, ch. 6, CBS
KETV Omaha, ch. 7, ABC
***KYNE-TV** Omaha, ch. 26, ETV

ADI Counties	State	TV Households
Adams	IA	2,600
Audubon	IA	3,300
Cass	IA	7,100
Crawford	IA	6,800
Fremont	IA	3,900
Harrison	IA	6,400
Mills	IA	4,600
Monona	IA	4,900
Montgomery	IA	5,800
Page	IA	7,900
Pottawattamie	IA	30,900
Shelby	IA	5,200

Taylor	IA	3,600
Atchison	MO	3,500
Burt	NE	3,200
Butler	NE	3,100
Cass	NE	7,200
Collax	NE	3,700
Cuming	NE	4,100
Dodge	NE	12,900
Douglas	NE	145,300
Johnson	NE	2,000
Nemaha	NE	3,300
Otoe	NE	6,000
Richardson	NE	4,700
Saipy	NE	20,900
Saunders	NE	6,100
Stanton	NE	2,100
Washington	NE	5,500
Women		330,500
Men		298,900
Teens		116,300
Children		157,100

Orlando-Daytona Beach, Fla. (44)

ADI TV Households 428,600
 Survey Area TV Households 987,900

WESH-TV Orlando-Daytona Beach, Fla., ch. 2, NBC
WDBO-TV Orlando, Fla., ch. 6, CBS
WFTV Orlando, Fla., ch. 9, ABC
***WMFE-TV** Orlando, Fla., ch. 24, ETV
***WSWB-TV** Orlando, Fla., ch. 35, INTV

ADI Counties	State	TV Households
Brevard	FL	77,600

Flagler	FL	2,000
Lake	FL	31,400
Marion	FL	30,800
Orange	FL	140,600
Osceola	FL	14,200
Seminole	FL	45,900
Sumter	FL	6,200
Volusia	FL	79,900
Women		455,500
Men		410,400
Teens		148,200
Children		200,500

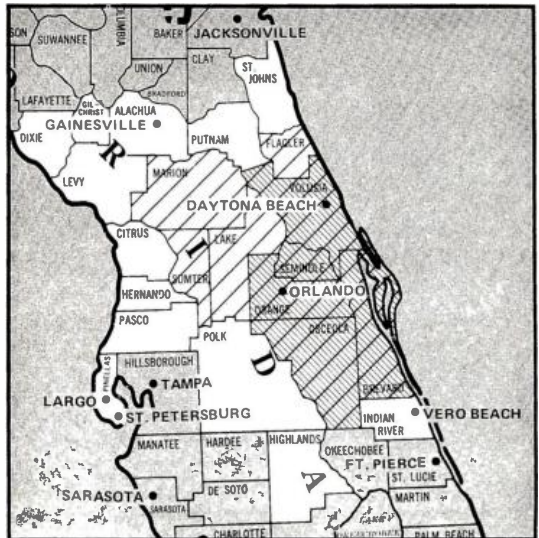

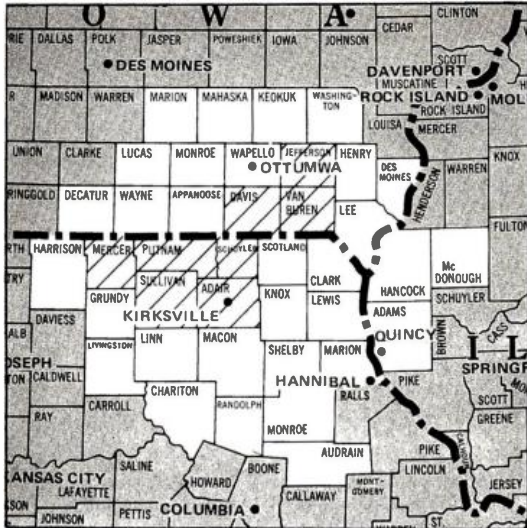

Ottumwa, Iowa-Kirksville, Mo. (195)

ADI TV Households 30,400
 Survey Area TV Households 260,400

KTVO Kirksville, Mo.-Ottumwa, Iowa, ch. 3, ABC
 (NBC-CBS)

Counties	State	TV Households
Davis	IA	3,100
Jefferson	IA	5,800

Van Buren	IA	3,500
Adair	MO	8,400
Mercer	MO	1,900
Putnam	MO	2,600
Schuyler	MO	2,000
Sullivan	MO	3,100

Women	30,400
Men	28,800
Teens	8,200
Children	11,300

Paducah, Ky.-Cape Girardeau, Mo.-Harrisburg, Ill. (68)

ADI TV Households 294,800
 Survey Area TV Households 578,300

WSIL-TV Harrisburg, Ill., ch. 3, ABC
KPOB-TV Poplar Bluff, Mo., ch. 15, satellite to WSIL
WPSD-TV Paducah, Ky., ch. 6, NBC
WFSU-TV Carbondale, Ill., ch. 8, ETV
KFVS-TV Cape Girardeau, Mo., ch. 12, CBS
WKMU Murray, Ky., ch. 21, ETV
WDXR-TV Paducah, Ky., ch. 29, IND

Counties	State	TV Households
Alexander	IL	4,500
Franklin	IL	16,700
Gallatin	IL	2,700
Hamilton	IL	3,300
Hardin	IL	1,900
Jackson	IL	17,300
Johnson	IL	2,900
Massac	IL	4,700
Pope	IL	1,700
Pulaski	IL	3,300
Saline	IL	10,900
Union	IL	6,100
Williamson	IL	19,000
Ballard	KY	3,300
Caldwell	KY	4,800

Calloway	KY	9,900
Carlisle	KY	2,100
Crittenden	KY	3,600
Fulton	KY	3,300
Graves	KY	12,100
Hickman	KY	2,400
Livingston	KY	3,300
Lyon	KY	2,100
McCracken	KY	22,400
Marshall	KY	8,200
Bolinger	MO	3,200
Butler	MO	13,400
Cape Girardeau	MO	17,400
Carter	MO	1,300
Dunklin	MO	13,000
Mississippi	MO	5,800
New Madrid	MO	8,000
Perry	MO	5,000
Ripley	MO	4,400
Scott	MO	11,700
Stoddard	MO	9,400
Wayne	MO	3,700
Lake	TN	2,600
Obion	TN	12,400
Weakley	TN	11,200
Women	303,400	
Men	273,400	
Teens	86,500	
Children	118,500	

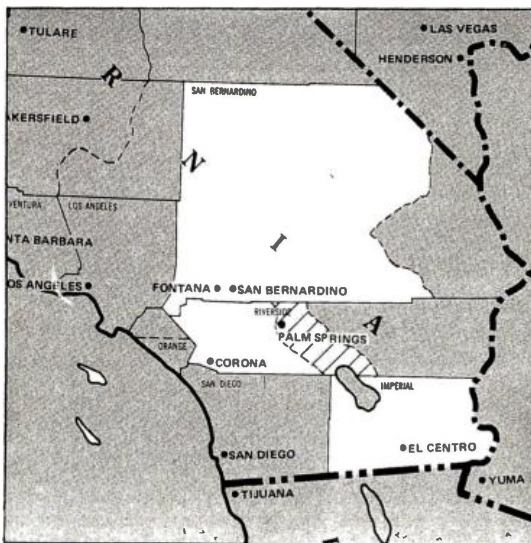
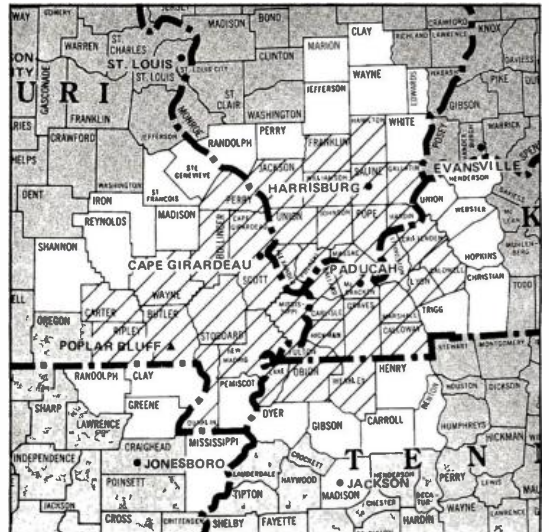

Palm Springs, Calif. (191)

ADI TV Households 36,600
 Survey Area TV Households 428,700

KMIR-TV Palm Springs, Calif., ch. 36, NBC
KPLM-TV Palm Springs, Calif., ch. 42, ABC

Counties	State	TV Households
Riverside Central	CA	36,600

Women	36,300
Men	33,300
Teens	12,000
Children	16,400

Panama City, Fla. (178)

ADI TV Households 47,200
 Survey Area TV Households 263,300

WJHG-TV Panama City, Fla., ch. 7, ABC
 WDTB Panama City, Fla., ch. 13, NBC

ADI Counties	State	TV Households
Bay	FL	28,500
Calhoun	FL	2,200

Franklin	FL	2,500
Gulf	FL	2,800
Liberty	FL	1,400
Walton	FL	5,800
Washington	FL	4,000

Women	52,000
Men	46,800
Teens	18,400
Children	25,200

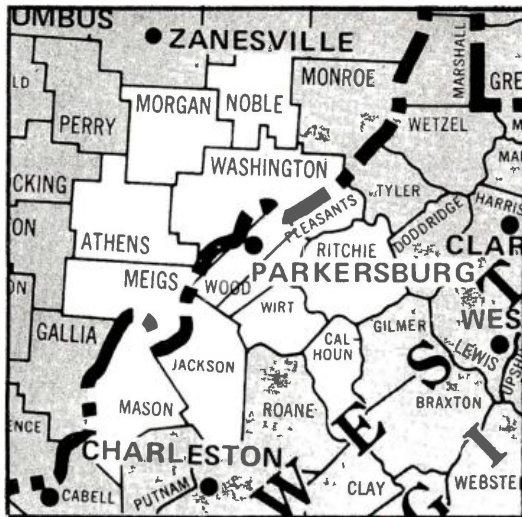
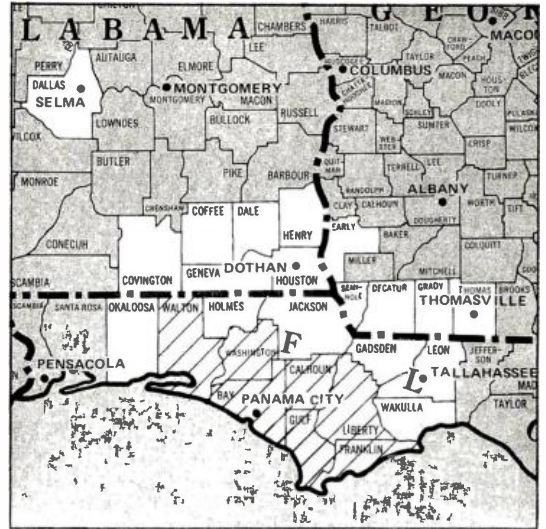

Parkersburg, W. Va. (198)

ADI TV Households 29,100
 Survey Area TV Households 104,600

WTAP-TV Parkersburg, W Va.-Marietta, Oho.,
 ch. 15, NBC

ADI Counties	State	TV Households
Wood	WV	29,100

Women	30,400
Men	26,500
Teens	9,800
Children	14,300

Peoria, Ill. (90)

ADI TV Households 198,400
 Survey Area TV Households 407,300

WRAU Peoria, Ill., ch. 19, ABC
 WEEK-TV Peoria, Ill., ch. 25, NBC
 WMBD-TV Peoria, Ill., ch. 31, CBS
 *WTVP Peoria, Ill., ch. 47, ETV

ADI Counties	State	TV Households
Fulton	IL	16,200

Logan	IL	10,100
McLean	IL	38,800
Marshall	IL	4,600
Mason	IL	6,500
Peoria	IL	71,400
Tazewell	IL	41,700
Woodford	IL	9,100

Women	209,700
Men	188,800
Teens	65,700
Children	91,900

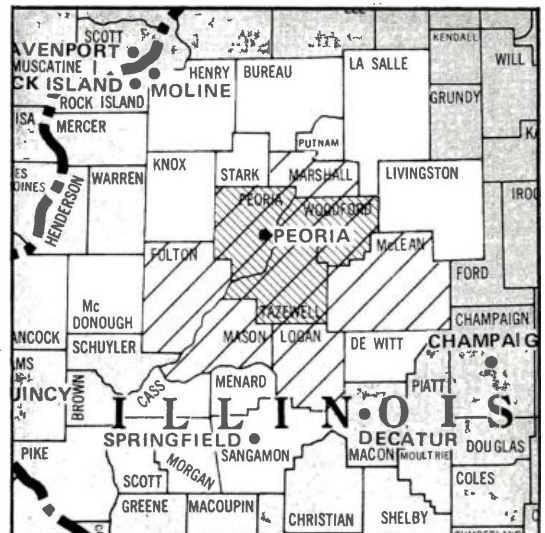



Philadelphia (4)

ADI TV Households 2,295,500
 Survey Area TV Households 3,342,000

- KYW-TV Philadelphia, ch. 3, NBC
- WPVI Philadelphia, ch. 6, ABC
- WCAU-TV Philadelphia, ch. 10, CBS
- WHYY-TV Wilmington, Del., ch. 12, ET
- WPHL-TV Philadelphia, ch. 17, IND
- *WNJS Camden, N.J., ch. 23, ET
- *WTF-TV Philadelphia, ch. 29, IND
- *WLVT-TV Allentown-Bethlehem, Pa., ch. 39, ET
- WKBW-TV Burlington, N.J.-Philadelphia, ch. 48, IND
- *WNJT Trenton, N.J., ch. 52, ET

Counties	State	TV Households
Kent	DE	27,300
New Castle	DE	135,100
Atlantic	NJ	66,500

Burlington	NJ	91,200
Cape May	NJ	158,400
Cape May	NJ	25,200
Cumberland	NJ	42,400
Gloucester	NJ	57,600
Mercer	NJ	107,200
Salem	NJ	21,000
Warren	NJ	26,000
Berks	PA	107,700
Bucks	PA	138,600
Chester	PA	88,100
Delaware	PA	191,400
Lehigh	PA	92,000
Montgomery	PA	205,400
Northampton	PA	76,000
Philadelphia	PA	638,400

Women	2,503,300
Men	2,225,400
Teens	773,700
Children	1,054,200

Wildwood, N.J. (supplementary market)

Arbitron characterizes supplementary markets as those that do not meet its criteria for having an ADI.

WCMC-TV Wildwood, N.J., ch. 40, NBC

Home county	Cape May
TV Households	25,200

Phoenix (37)

ADI TV Households 475,800
 Survey Area TV Households 722,800

- KTVK Phoenix, ch. 3, ABC
- KPHO-TV Phoenix, ch. 5, IND
- KAET Phoenix, ch. 8, ET
- KOOL-TV Phoenix, ch. 10, CBS
- KTAR-TV Phoenix-Mesa, ch. 12, NBC
- KPAZ-TV Phoenix, ch. 21, IND

Counties	State	TV Households
Gila	AZ	9,800

Greenlee	AZ	3,600
Maricopa	AZ	392,000
Mohave	AZ	11,500
Navajo	AZ	11,900
Pinal	AZ	22,300
Yavapai	AZ	16,700
Riverside East	CA	5,900
San Bernardino East	CA	2,100

Women	512,800
Men	469,500
Teens	179,100
Children	263,400

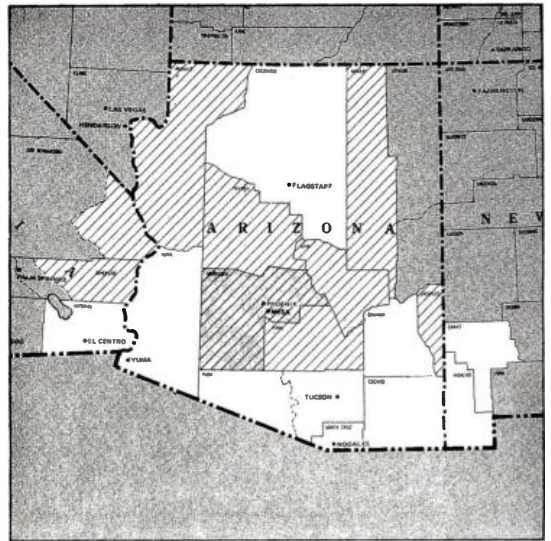

Pittsburgh (10)

ADI TV Households 1,082,900
 Survey Area TV Households 1,741,600

- KDKA-TV Pittsburgh, ch. 2, CBS
- WTAE-TV Pittsburgh, ch. 4, ABC
- WJIC-TV Pittsburgh, ch. 11, NBC
- *WQED Pittsburgh, ch. 13, ET
- *WQEX Pittsburgh, ch. 16, ET
- *WVWU Morgantown, W.Va., ch. 24, ET
- WPQH-TV Pittsburgh, ch. 53, IND

Counties	State	TV Households
Garrett	MD	7,000
Columbiana	OH	37,900
Allegheny	PA	522,200
Armstrong	PA	26,500

Beaver	PA	69,700
Butler	PA	43,400
Clarion	PA	12,800
Fayette	PA	52,100
Greene	PA	12,900
Indiana	PA	26,400
Venango	PA	19,900
Washington	PA	72,200
Westmoreland	PA	125,200
Marion	WV	23,700
Monongalia	WV	22,400
Preston	WV	8,800

Women	1,198,500
Men	1,047,900
Teens	351,200
Children	459,700

Portland, Ore. (24)

ADI TV Households 630,300
 Survey Area TV Households 871,700

KATU Portland, ch. 2, ABC
KOIN-TV Portland, ch. 6, CBS
***KOAC-TV** Corvallis, ch. 7, ETV
KGW-TV Portland, ch. 8, NBC
***KOAP-TV** Portland, ch. 10, ETV
KPTV Portland, ch. 12, IND

ADI Counties	State	TV Households
Benton	OR	19,300
Clackamas	OR	67,300
Clatsop	OR	11,100
Columbia	OR	10,900
Crook	OR	4,400
Deschutes	OR	14,500
Gilliam	OR	600
Harney	OR	2,200
Hood River	OR	4,800

Jefferson	OR	2,900
Lincoln	OR	9,800
Linn	OR	27,500
Marion	OR	56,800
Multnomah	OR	204,800
Polk	OR	14,300
Sherman	OR	700
Tillamook	OR	6,500
Wasco	OR	6,700
Washington	OR	67,300
Wheeler	OR	500
Yamhill	OR	15,000
Clark	WA	50,500
Cowlitz	WA	24,300
Klickitat	WA	4,200
Skamania	WA	2,000
Wahkiakum	WA	1,400
Women		636,200
Men		575,800
Teens		197,600
Children		267,200

Salem, Ore. (supplementary market)

Arbitron characterizes supplementary markets as those that do not meet its criteria for having an ADI.

KVDO-TV Salem, Ore., ch. 3, IND

Home county	Marion, Polk
TV Households	71,100

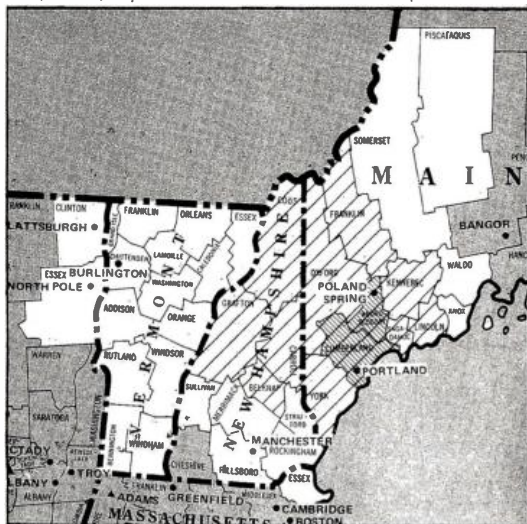
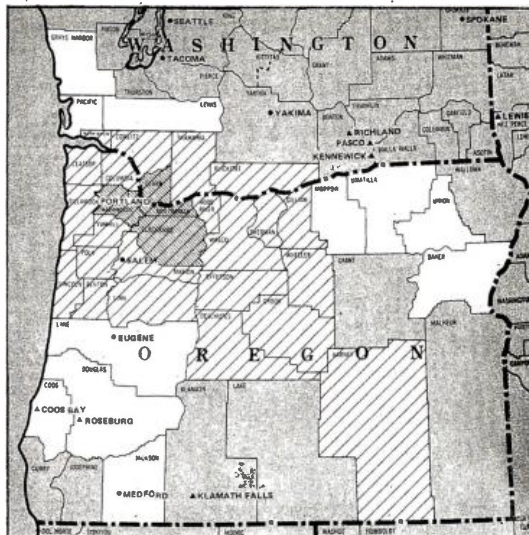

Portland-Poland Spring, Me. (78)

ADI TV Households 252,100
 Survey Area TV Households 888,000

WCSH-TV Portland, Me., ch. 6, NBC
WMTW-TV Poland Spring, Me., ch. 8, ABC
***WCBB** Augusta, Me., ch. 10, ETV
WGAN-TV Portland, Me., ch. 13, CBS
***WHED-TV** Hanover, N.H., ch. 15, ETV
***WMEG-TV** Bidelord, Me., ch. 26, ETV
WHCH Lebanon, N.H., ch. 31, ABC
***WEDB-TV** Berlin, N.J., ch. 40, ETV
***WLED** Littleton, H.H., ch. 49, ETV

ADI Counties	State	TV Households
Androscoggin	ME	30,400

Cumberland	ME	65,100
Franklin	ME	7,100
Kennebec	ME	30,100
Lincoln	ME	7,600
Oxford	ME	14,800
Sagadahoc	ME	8,500
York	ME	39,000
Belknap	NH	12,100
Carroll	NH	7,900
Cook	NH	11,000
Grafton	NH	18,500

Women		280,700
Men		253,000
Teens		89,400
Children		127,100

Presque Isle, Me. (201)

ADI TV Households 26,300
 Survey Area TV Households 107,700

WAGM-TV Presque Isle, Me., ch. 8, CBS-ABC (NBC)
***WMEM-TV** Presque Isle, Me., ch. 10, ETV

ADI Counties	State	TV Households
Aroostook	ME	26,300
Women		30,700
Men		29,100
Teens		12,400
Children		16,800

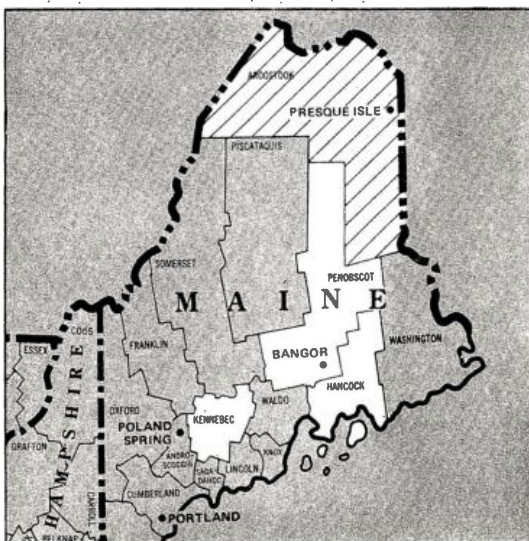



Providence, R.I. (29)

ADI TV Households 597,100
 Survey Area TV Households 2,351,900

WETV New Bedford, Mass.-Providence, R.I., ch. 6, ABC
 WJAR-TV Providence, R.I., ch. 10, NBC
 WPRI-TV Providence, R.I., ch. 12, CBS
 *WSBE-TV Providence, R.I., ch. 36, ETV
 *WEDN Norwch, Conn., ch. 53, ETV

ADI Counties	State	TV Households
New London	CT	75,600

Windham	CT	31,000
Bristol	MA	162,900
Dukes	MA	3,000
Nantucket	MA	1,800
Bristol	RI	14,800
Kent	RI	49,100
Newport	RI	22,900
Providence	RI	212,000
Washington	RI	24,000

Women	638,200
Men	564,500
Teens	192,900
Children	275,400

Quincy, Ill.-Hannibal, Mo. (132)

ADI TV Households 124,000
 Survey Area TV Households 318,800

KHOA-TV Hannibal, Mo.-Quincy, Ill., ch. 7, CBS
 WGEM-TV Quincy, Ill., ch. 10, NBC

ADI Counties	State	TV Households
Adams	IL	25,300
Brown	IL	2,300
Cass	IL	5,100
Hancock	IL	7,700
McDonough	IL	11,900
Pike	IL	7,500
Schuyler	IL	3,100
Scott	IL	2,400

Lee	IA	15,900
Clark	MO	3,100
Knox	MO	2,100
Lewis	MO	3,600
Macon	MO	5,700
Marion	MO	10,700
Monroe	MO	3,300
Pike	MO	6,100
Ralls	MO	2,900
Scotland	MO	3,300
Shelby	MO	3,000

Women	129,500
Men	115,800
Teens	37,400
Children	51,500



Raleigh-Durham, N.C. (53)

ADI TV Households 380,300
 Survey Area TV Households 897,600

*WUNC-TV Chapel Hill, N.C., ch. 4, ETV
 WRAL-TV Raleigh, N.C., ch. 5, ABC
 WTVD Durham, N.C., ch. 11, CBS
 WRDU-TV Durham, N.C., ch. 28, NBC

ADI Counties	State	TV Households
Chatham	NC	9,300
Cumberland	NC	58,200
Durham	NC	48,300
Cumberland	NC	58,200
Durham	NC	48,300
Franklin	NC	8,300
Granville	NC	8,900
Harnett	NC	16,400

Hoke	NC	4,300
Johnston	NC	20,800
Lee	NC	10,000
Moore	NC	13,000
Nash	NC	19,000
Orange	NC	20,100
Person	NC	8,300
Sampson	NC	13,900
Vance	NC	9,700
Wake	NC	82,900
Warren	NC	5,200
Wayne	NC	25,900

Women	427,400
Men	417,900
Teens	138,800
Children	207,700

Rapid City, S.D. (164)

ADI TV Households 64,400
 Survey Area TV Households 144,300

KOTA-TV Rapid City, S.D., ch. 3, NBC (ABC)
KHSD-TV Lead, S.D., ch. 11, satellite to KOTA
KDUH-TV Hay Springs, Neb., ch. 4, satellite to KOTA
KRSD-TV Rapid City, S.D., ch. 7, CBS (ABC)
KDSJ-TV Lead, S.D., ch. 5, satellite to KRSD
***KBHE-TV** Rapid City, S.D., ch. 9, ETV
***KTNE-TV** Alliance, Neb., ch. 13, ETV

ADI Counties	State	TV Households
Carter	MT	500
Powder River	MT	700
Box Butte	NE	3,400
Dawes	NE	3,200
Grant	NE	700
Sheridan	NE	2,500

Sioux	NE	800
Bennett	SD	1,000
Butte	SD	3,100
Custer	SD	1,900
Fall River	SD	2,900
Haskell	SD	1,300
Harding	SD	600
Jackson	SD	600
Lawrence	SD	5,700
Meade	SD	5,100
Pennington	SD	22,200
Shannon	SD	2,000
Washabaugh	SD	300
Ziebach	SD	800
Campbell	WY	3,800
Crook	WY	1,300

Women 65,000
Men 64,200
Teens 24,200
Children 35,200

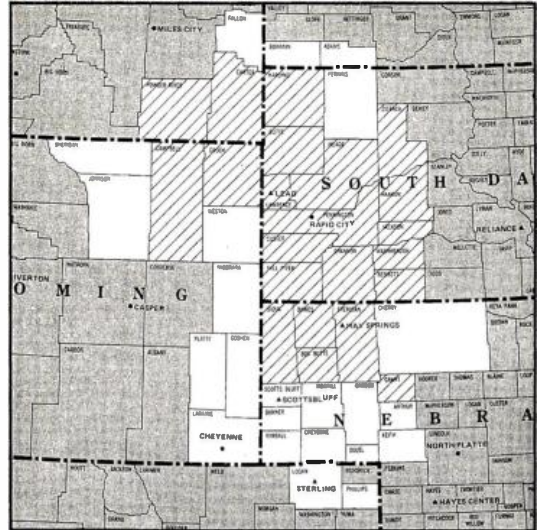

You belong in Broadcasting

Reno (150)

ADI TV Households 96,000
 Survey Area TV Households 120,300

KTVN Reno, ch. 2, CBS
KCRL Reno, ch. 4, NBC
KOLO-TV Reno, ch. 8, ABC

ADI Counties	State	TV Households
Alpine	CA	300
El Dorado East	CA	6,800
Lassen	CA	5,800
Placer East	CA	2,500
Sierra	CA	800
Carson City	NV	8,600

Churchill	NV	4,400
Douglas	NV	3,700
Esmeralda	NV	300
Humboldt	NV	2,100
Lander	NV	800
Lyon	NV	3,600
Mineral	NV	2,500
Nye	NV	1,200
Pershing	NV	900
Storey	NV	300
Washoe	NV	51,600

Women 94,000
Men 92,700
Teens 30,400
Children 41,100

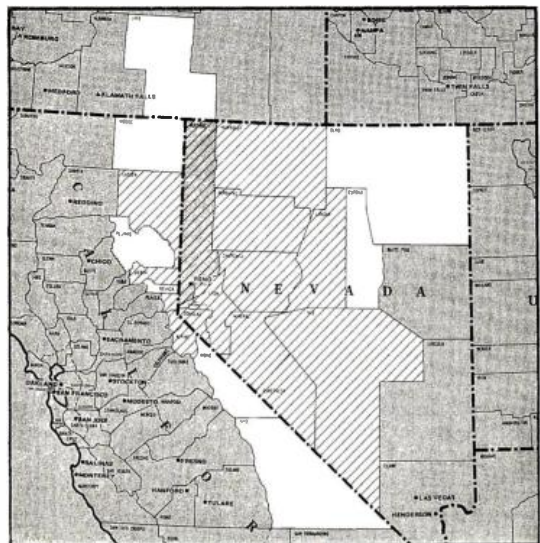

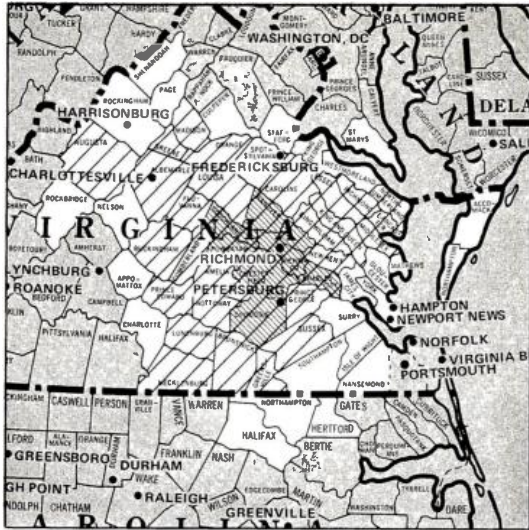

Richmond, Va. (56)

ADI TV Households 358,800
 Survey Area TV Households 640,900

WTVR-TV Richmond, Va., ch. 6, CBS
 WXEX-TV Petersburg-Richmond, Va., ch. 8, ABC
 WWBT Richmond, Va., ch. 12, NBC
 *WCVE-TV Richmond, Va., ch. 23, ETV
 *WVPT Staunton, Va., ch. 51, ETV
 *WCVV Richmond, Va., ch. 57, ETV

Counties	State	TV Households
Albemarle	VA	27,200
Amelia	VA	2,400
Augusta	VA	27,800
Brunswick	VA	4,300
Buckingham	VA	3,300
Caroline	VA	4,100
Charles City	VA	1,700
Chesterfield	VA	30,500
Cumberland	VA	1,900
Dinwiddie	VA	26,000
Essex	VA	2,300
Fluvanna	VA	2,700

Goochland	VA	2,600
Greene	VA	1,300
Greensville	VA	4,400
Hanover	VA	14,100
Henrico	VA	136,000
King and Queen	VA	1,500
King William	VA	2,100
Lancaster	VA	3,000
Louisa	VA	4,400
Lunenburg	VA	3,700
Madison	VA	2,900
Mecklenburg	VA	9,100
Middlesex	VA	2,100
New Kent	VA	1,800
Northumberland	VA	3,200
Nottoway	VA	4,100
Orange	VA	5,000
Powhatan	VA	2,600
Prince Edward	VA	4,300
Prince George	VA	11,300
Richmond	VA	2,000
Sussex	VA	3,100
Women		405,800
Men		368,800
Teens		127,400
Children		177,500

Charlottesville, Va. (supplementary market)

Arbitron characterizes supplementary markets as those that do not meet its criteria for having an ADI.

WVIR-TV Charlottesville, Va., ch. 29, NBC

Home county	Albemarle
TV Households	27,200



Roanoke-Lynchburg, Va. (70)

ADI TV Households 292,900
 Survey Area TV Households 793,100

WDBJ-TV Roanoke, Va., ch. 7, CBS
 WSLS-TV Roanoke, Va., ch. 10, NBC
 WLVA-TV Lynchburg, Va., ch. 13, ABC
 *WBRA-TV Roanoke, Va., ch. 15, ETV

Counties	State	TV Households
Allegheny	VA	9,800
Amherst	VA	7,200
Appomattox	VA	3,300
Bath	VA	1,800
Bedford	VA	11,100
Botetourt	VA	6,600
Campbell	VA	33,900
Carroll	VA	8,700
Charlotte	VA	3,500
Craig	VA	1,400

Floyd	VA	3,300
Franklin	VA	9,000
Giles	VA	5,400
Grayson	VA	5,200
Halifax	VA	10,800
Henry	VA	21,900
Highland	VA	800
Montgomery	VA	19,300
Nelson	VA	3,400
Pittsylvania	VA	33,500
Pulaski	VA	9,500
Roanoke	VA	65,300
Rockbridge	VA	8,800
Wythe	VA	6,600
Pocahontas	VA	2,800

Women		329,300
Men		298,000
Teens		100,800
Children		147,100

Rochester, Minn.-Mason City, Iowa- Austin, Minn. (120)

ADI TV Households 139,000
 Survey Area TV Households 464,700

KGLO-TV Mason City, Iowa, ch. 3, CBS
KAAL-TV Austin-Albert Lea, Minn., ch. 6, ABC
KROC-TV Rochester, Minn., ch. 10, NBC
***KAVT-TV** Austin, Minn., ch. 15, ETV

ADI Counties	State	TV Households
Cerro Gordo	IA	18,700
Floyd	IA	7,600
Franklin	IA	5,100
Hancock	IA	5,400
Howard	IA	3,900

Kossuth	IA	6,100
Mitchell	IA	3,600
Winnebago	IA	5,300
Worth	IA	3,300
Dodge	MN	4,400
Faribault	MN	7,300
Fillmore	MN	8,100
Freeborn	MN	13,400
Homer	MN	14,800
Olmsted	MN	29,800

Women	142,100
Men	129,600
Teens	50,500
Children	62,900



Rochester, N.Y. (64)

ADI TV Households 316,800
 Survey Area TV Households 531,800

WROC-TV Rochester, N.Y., ch. 8, NBC
WHEC-TV Rochester, N.Y., ch. 10, CBS
WOKR Rochester, N.Y., ch. 13, ABC
***WXXI** Rochester, N.Y., ch. 21, ETV

ADI Counties	State	TV Households
Livingston	NY	16,900

Monroe	NY	234,300
Ontario	NY	27,100
Orleans	NY	12,500
Wayne	NY	26,000

Women	340,800
Men	304,000
Teens	110,900
Children	159,100

Rockford, Ill. (104)

ADI TV Households 165,200
 Survey Area TV Households 628,900

WREX-TV Rockford, Ill., ch. 13, ABC
WTVO Rockford, Ill., ch. 17, NBC
WCEE-TV Freeport-Rockford, Ill., ch. 23, CBS

ADI Counties	State	TV Households
Boone	IL	9,100

Ogle	IL	14,100
Stephenson	IL	17,000
Winnebago	IL	80,900
Rock	WI	44,100

Women	167,900
Men	153,300
Teens	60,500
Children	85,100

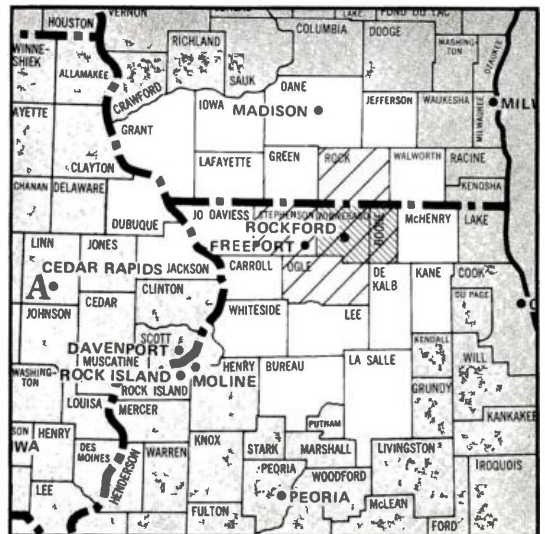

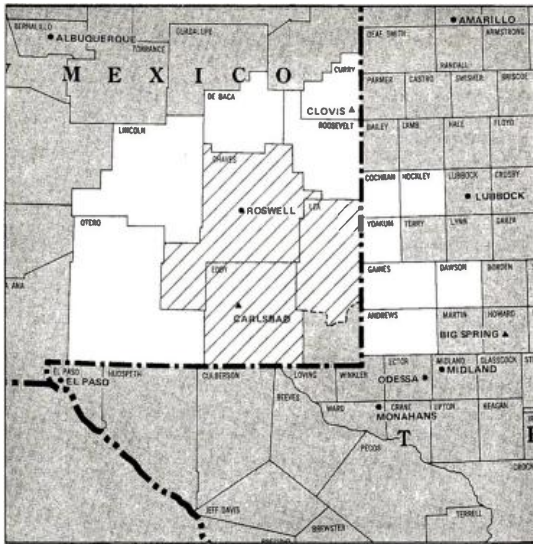

Roswell, N.M. (183)

ADI TV Households 44,300
 Survey Area TV Households 105,100

Women 44,100
 Men 40,800
 Teens 16,800
 Children 21,800

KBIM-TV Roswell, N.M., ch. 10, CBS

ADI Counties	State	TV Households
Chaves	NM	16,000
Eddy	NM	13,800
Lea North	NM	14,500

Sacramento-Stockton, Calif. (25)

ADI TV Households 627,700
 Survey Area TV Households 2,480,400

KCRA-TV Sacramento, Calif., ch. 3, NBC
 KVIE Sacramento-Stockton, Calif., ch. 6, ETW
 KXTV Sacramento-Stockton, Calif., ch. 10, CBS
 KQVR Stockton-Sacramento, Calif., ch. 13, ABC
 KMUV-TV Sacramento, Calif., ch. 31, IND
 KTXL Sacramento-Stockton, Calif., ch. 40, IND

ADI Counties	State	TV Households
Amador	CA	5,300
Calaveras	CA	5,500
Colusa	CA	4,500
Contra Costa East	CA	29,300
El Dorado West	CA	12,700
Lake	CA	10,200

Mono	CA	2,300
Nevada East	CA	1,100
Nevada West	CA	10,700
Placer West	CA	27,800
Plumas	CA	4,700
Sacramento	CA	238,500
San Joaquin	CA	101,800
Solano East	CA	31,100
Stanislaus	CA	70,200
Sutter	CA	15,000
Tuolumne	CA	9,400
Yolo	CA	34,800
Yuba	CA	12,900

Women 638,200
 Men 602,900
 Teens 214,600
 Children 281,100

Modesto, Calif. (supplementary market)

Arbitron characterizes supplementary markets as those that do not meet its criteria for having an ADI.

KLOC-TV Modesto, Calif., ch. 19, IND

Home county	Stanislaus
TV Households	70,200

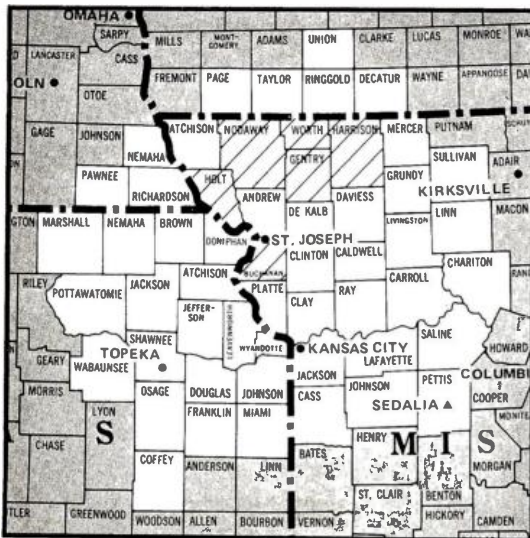
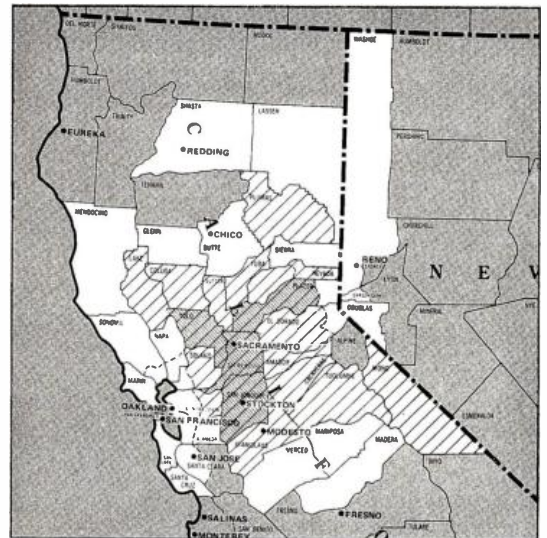

St. Joseph, Mo. (177)

ADI TV Households 50,600
 Survey Area TV Households 808,600

Gentry MO 3,200
 Harrison MO 3,800
 Holt MO 2,800
 Nodaway MO 8,100
 Worth MO 1,200

KQTV St. Joseph, Mo. ch. 2, ABC

ADI Counties	State	TV Households
Buchanan	MO	31,500

Women 53,300
 Men 46,800
 Teens 15,100
 Children 20,700

St. Louis (12)

ADI TV Households 928,900
 Survey Area TV Households 1,302,500

KTVI St. Louis, ch. 2, ABC
KMOX-TV St. Louis, ch. 4, CBS
KSD-TV St. Louis, ch. 5, NBC
***KETC** St. Louis, ch. 9, ETV
KPLR-TV St. Louis, ch. 11, IND
KDNL-TV St. Louis, ch. 30, IND

ADI Counties	State	TV Households
Bond	IL	5,100
Calhoun	IL	1,900
Clinton	IL	9,000
Fayette	IL	7,200
Green	IL	5,900
Jefferson	IL	12,200
Jersey	IL	6,300
Maccoupin	IL	16,100
Madison	IL	85,600
Marion	IL	15,000
Monroe	IL	6,300
Montgomery	IL	11,200

Perry	IL	7,600
Randolph	IL	10,700
St. Clair	IL	92,900
Washington	IL	5,500
Crawford	MO	5,800
Dent	MO	4,300
Franklin	MO	20,400
Gasconade	MO	5,100
Iron	MO	5,500
Jefferson	MO	35,800
Lincoln	MO	6,700
Madison	MO	3,400
Reynolds	MO	2,000
St. Charles	MO	32,500
St. Francois	MO	13,800
St. Louis	MO	483,400
St. Genevieve	MO	4,300
Warren	MO	4,200
Washington	MO	5,200
Women		1,003,600
Men		877,700
Teens		336,100
Children		480,700

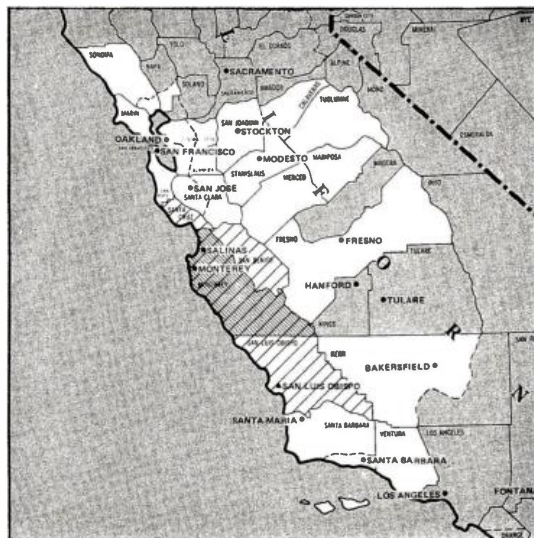

Salinas-Monterey, Calif. (94) (including San Jose, Calif., stations)

ADI TV Households 182,700
 Survey Area TV Households 2,535,900

ADI Counties	State	TV Households
Monterey	CA	79,800
San Benito	CA	6,000
San Luis Obispo	CA	41,500
Santa Cruz	CA	55,400

KSBW-TV Salinas-Monterey, Calif., ch. 8, NBC
KSBY-TV San Luis Obispo, Calif., ch. 6, satellite to KSBW
KNTV San Jose, Calif., ch. 11, ABC
KMST Monterey-Salinas, Calif., ch. 46, CBS

Women	182,600
Men	195,100
Teens	55,100
Children	81,500

Salisbury, Md. (166)

ADI TV Households 63,200
 Survey Area TV Households 617,100

WBQC-TV Salisbury, Md., ch. 16, CBS (ABC-NBC)
***WCPB** Salisbury, Md., ch. 28, ETV

ADI Counties	State	TV Households
Sussex	DE	28,400

Somerset	MD	6,100
Wicomico	MD	19,700
Worcester	MD	9,000
Women		66,100
Men		58,700
Teens		21,300
Children		20,700





Salt Lake City (50)

ADI TV Households 396,500
 Survey Area TV Households 653,400

KUTV Salt Lake City, ch. 2, NBC
KTVX-TV Salt Lake City, ch. 4, ABC
KSL-TV Salt Lake City, ch. 5, CBS
***KUED** Salt Lake City, ch. 7, ETV
***KBVU-TV** Salt Lake City-Provo, Utah, ch. 11, ETV

ADI Counties	State	TV Households
Dolores	CO	300
Bear Lake	ID	1,700
Caribo	ID	1,800
Franklin	ID	2,400
Oneida	ID	1,000
Park	MT	4,000
Eiko	NV	5,200
Eureka	NV	200
White Pine	NV	3,600
Beaver	UT	1,200
Box Elder	UT	9,300
Cache	UT	14,300
Carbon	UT	6,300
Daggett	UT	100
Davis	UT	29,800
Duchesne	UT	3,500
Emery	UT	2,000

Garfield	UT	800
Grand	UT	1,600
Iron	UT	4,100
Juab	UT	1,700
Kane	UT	700
Millard	UT	2,600
Morgan	UT	1,400
Plute	UT	300
Rich	UT	400
Salt Lake	UT	162,200
San Juan	UT	2,500
Sanpete	UT	4,300
Sevier	UT	4,100
Summit	UT	2,200
Todele	UT	7,300
Uintah	UT	4,800
Utah	UT	45,200
Wasatch	UT	2,000
Washington	UT	4,900
Wayne	UT	500
Weber	UT	44,000
Sweetwater	WY	7,700
Uinta	WY	2,100
Washakie	WY	2,400

Women 414,000
Men 387,000
Teens 159,200
Children 258,200

San Angelo, Tex. (200)

ADI TV Households 26,700
 Survey Area TV Households 78,100

KCTV San Angelo, Tex., ch. 8, CBS-ABC

ADI Counties	State	TV Households
Concho	TX	1,000

Irion TX 400
 Schleicher TX 800
 Tom Green TX 24,500

Women 28,500
Men 28,000
Teens 8,700
Children 12,500

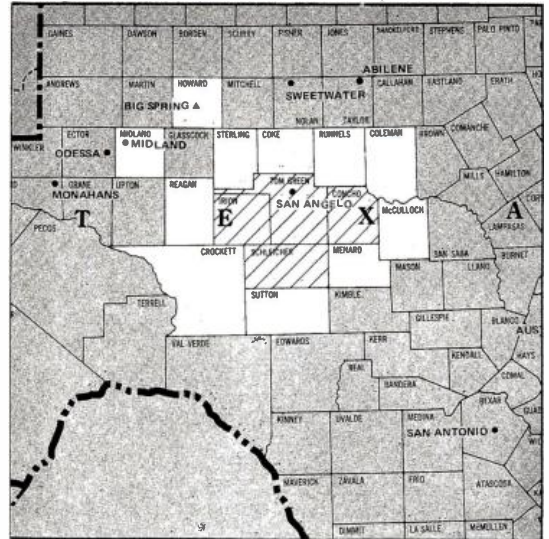

San Antonio, Tex. (45)

ADI TV Households 419,500
 Survey Area TV Households 743,400

KMOL-TV San Antonio, Tex., ch. 4, NBC
KENS-TV San Antonio, Tex., ch. 5, CBS
***KLRN** San Antonio, Tex., ch. 9, ETV
KSAT-TV San Antonio, Tex., ch. 12, ABC
KWEX-TV San Antonio, Tex., ch. 41, IND

ADI Counties	State	TV Households
Atascosa	TX	5,800
Bandera	TX	2,300
Bexar	TX	274,600
Caldwell	TX	5,500
Cornal	TX	9,900
De Witt	TX	6,700
Dimmit	TX	2,400
Edwards	TX	900
Frio	TX	3,000
Gillespie	TX	3,600
Goliad	TX	1,600
Gonzales	TX	5,800
Guadalupe	TX	12,500

Hays	TX	9,800
Karnes	TX	3,300
Kendall	TX	3,000
Kerr	TX	7,000
Kimble	TX	1,300
Kinney	TX	500
La Salle	TX	1,400
Lavaca	TX	6,100
Live Oak	TX	2,000
McMullen	TX	300
Maverick	TX	4,500
Medina	TX	6,300
Real	TX	700
Sutton	TX	900
Uvalde	TX	5,200
Val Verde	TX	8,000
Victoria	TX	17,200
Wilson	TX	4,200
Zavala	TX	2,600

Women 464,100
Men 428,200
Teens 185,800
Children 250,200

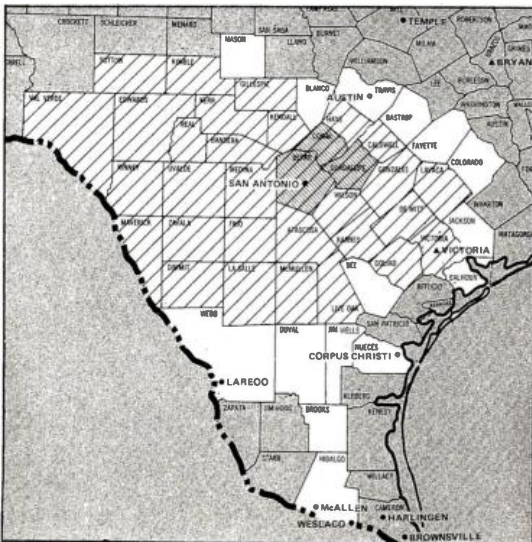

San Diego (31)

ADI TV Households 542,200
 Survey Area TV Households 3,806,000

ADI Counties State TV Households
 San Diego CA 542,200

XETV Tijuana, Mex., ch. 6, IND
 KFMB-TV San Diego, ch. 8, CBS
 KGTV San Diego, ch. 10, NBC
 *KPBS-TV San Diego, ch. 15, ETV
 KCST San Diego, ch. 39, ABC

Women 521,200
 Men 560,900
 Teens 184,900
 Children 239,500

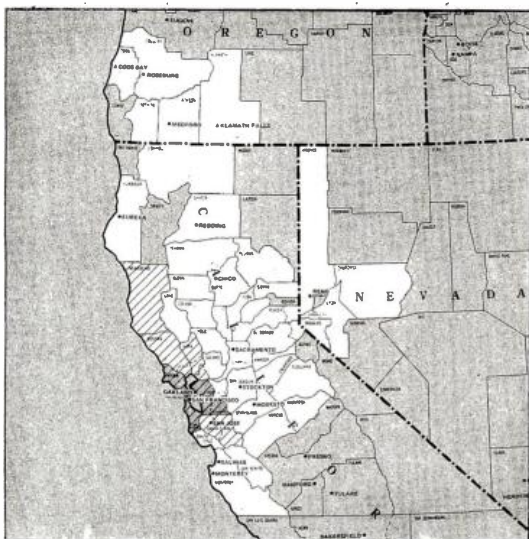

San Francisco (6)

ADI TV Households 1,682,400
 Survey Area TV Households 2,827,100

KTVU Oakland-San Francisco, Calif., ch. 2, IND
 KRON-TV San Francisco, ch. 4, NBC
 KPIX San Francisco, ch. 5, CBS
 KGO-TV San Francisco, ch. 7, ABC
 *KQED San Francisco, ch. 9, ETV
 *KCSM-TV San Mateo, Calif., ch. 14, ETV
 KEMO-TV San Francisco, ch. 20, IND
 KGSC-TV San Jose, Calif., ch. 36, IND
 KVOF-TV San Francisco, Calif., ch. 38, IND
 KBHK-TV San Francisco, ch. 44, IND
 *KTEH San Jose, Calif., ch. 54, ETV
 KDTV-TV San Francisco, Calif., ch. 60, IND

Alameda West CA 375,200
 Contra Costa West CA 171,100
 Marin CA 75,000
 Mendocino CA 18,100
 Napa North CA 5,400
 Napa South CA 25,200
 San Francisco CA 274,300
 San Mateo CA 203,900
 Santa Clara East CA 11,400
 Santa Clara West CA 380,000
 Soland West CA 30,000
 Sonoma North CA 55,700
 Sonoma South CA 28,000

ADI Counties State TV Households
 Alameda East CA 29,100

Women 1,688,600
 Men 1,564,600
 Teens 509,000
 Children 698,600

Santa Barbara-Santa Maria, Calif. (154)

ADI TV Households 93,800
 Survey Area TV Households 3,767,100

Women 98,600
 Men 92,700
 Teens 30,900
 Children 40,900

KEYT Santa Barbara, Calif., ch. 3, ABC
 KCOY-TV Santa Maria, Calif., ch. 12, CBS

ADI Counties State TV Households
 Santa Barbara North CA 40,400
 Santa Barbara South CA 53,400

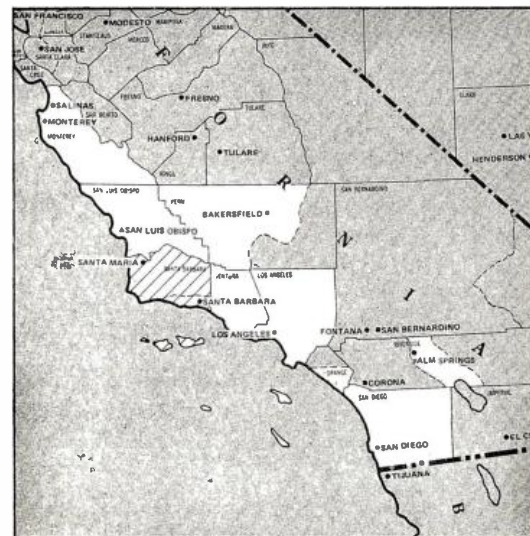



Savannah, Ga. (131)

ADI TV Households 127,900
 Survey Area TV Households 204,400

WSAV-TV Savannah, Ga., ch. 3, NBC
 *WVAN-TV Savannah, Ga., ch. 9, ETV
 WTOG-TV Savannah, Ga., ch. 11, CBS
 WJCL Savannah, Ga., ch. 22, ABC

ADI Counties	State	TV Households
Appling	GA	4,200
Bryan	GA	2,400
Bulloch	GA	10,600
Chatham	GA	58,600
Effingham	GA	4,400

Evans	GA	2,600
Jeff Davis	GA	3,100
Liberly	GA	4,800
Long	GA	1,000
McIntosh	GA	2,600
Tatnall	GA	3,600
Toombs	GA	6,200
Wayne	GA	5,700
Beaufort	SC	15,000
Jasper	SC	3,200

Women	138,400
Men	136,200
Teens	49,100
Children	74,500

Seattle-Tacoma, Wash. (18)

ADI TV Households 783,300
 Survey Area TV Households 906,400

KOMO-TV Seattle, ch. 4, ABC
 KING-TV Seattle, ch. 5, NBC
 KIRO-TV Seattle, ch. 7, CBS
 *KCTS-TV Seattle, ch. 9, ETV
 *KSTW Tacoma, Seattle, ch. 11, IND
 *KPEC-TV Lakewood Center, Wash., ch. 56, ETV
 *KTSP Tacoma, Wash., ch. 62, ETV

ADI Counties	State	TV Households
Ciallam	WA	13,300
Grays Harbor	WA	20,500
Island	WA	10,400

Jefferson	WA	4,100
King	WA	402,200
Kitsap	WA	36,000
Kittitas West	WA	1,600
Lewis	WA	16,500
Mason	WA	7,600
Pacific	WA	5,600
Pierce	WA	129,100
San Juan	WA	1,900
Skagit	WA	18,300
Snohomish	WA	85,800
Thurston	WA	30,500

Women	781,900
Men	752,700
Teens	252,700
Children	341,300

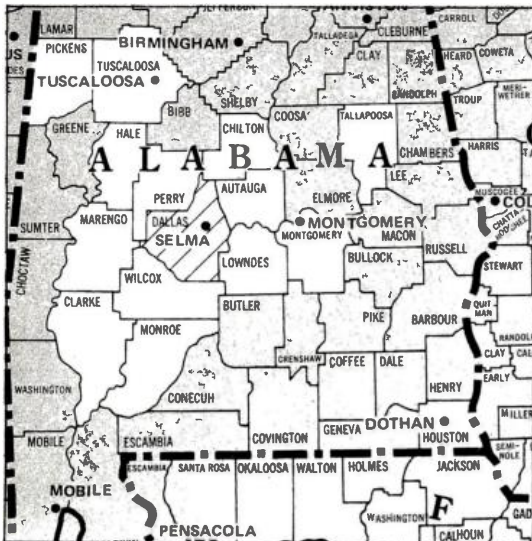

Selma, Ala. (205)

ADI TV Households 16,500
 Survey Area TV Households 182,400

WSLA-TV Selma, Ala., ch. 8, CBS

ADI Counties	State	TV Households
Dallas	AL	16,500

Women	18,100
Men	15,500
Teens	7,000
Children	10,900

Shreveport, La.-Texarkana, Tex. (61)

ADI TV Households 341,800
 Survey Area TV Households 578,100

KTBS-TV Shreveport, La., ch. 3, ABC
KTAL-TV Texarkana, Tex.-Shreveport, La., ch. 6, NBC
KSLA-TV Shreveport, La., ch. 12, CBS

ADI Counties	State	TV Households
Columbia	AR	8,400
Hempstead	AR	6,600
Howard	AR	4,900
Lafayette	AR	3,000
Little River	AR	3,600
Miller	AR	12,300
Sevier	AR	4,900
Bienville	LA	5,100
Bossier	LA	20,900
Caddo	LA	83,200
Claiborne	LA	5,400
De Soto	LA	7,100
Natchitoches	LA	10,400

Red River	LA	2,900
Sabine	LA	5,800
Webster	LA	14,100
McCurain	OK	11,300
Bowie	TX	23,200
Camp	TX	2,700
Cass	TX	8,600
Franklin	TX	2,000
Gregg	TX	28,400
Harrison	TX	14,600
Marion	TX	2,700
Morris	TX	4,200
Panola	TX	8,100
Red River	TX	5,000
Rusk	TX	12,800
Shelby	TX	7,300
Titus	TX	6,500
Upshur	TX	8,000
Women		355,300
Men		310,400
Teens		114,000
Children		163,400

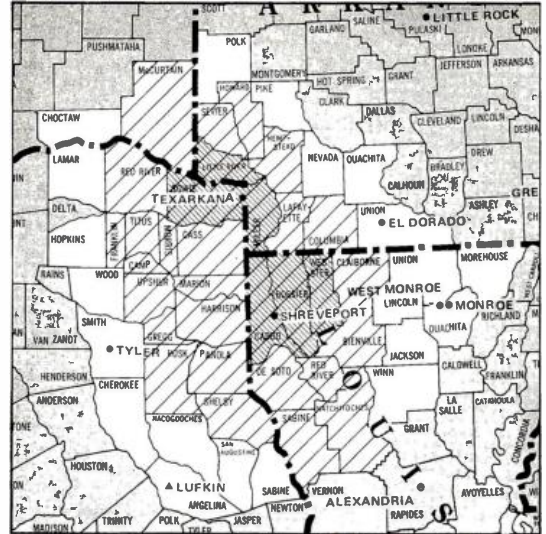

Sioux City, Iowa (119)

ADI TV Households 146,300
 Survey Area TV Households 331,200

***KUSD-TV** Vermillion, S.D., ch. 2, ETV
KTIV Sioux City, Iowa, ch. 4, NBC
KCAU-TV Sioux City, Iowa, ch. 9, ABC
KMEG Sioux City, Iowa, ch. 14, CBS
***KXNE-TV** Norfolk, Neb., ch. 19, ETV
KSIN-TV Sioux City, Iowa, ch. 27, ETV

ADI Counties	State	TV Households
Buena Vista	IA	7,800
Cherokee	IA	6,300
Clay	IA	6,900
Dickinson	IA	5,100
Ia	IA	3,500
O'Brien	IA	6,600
Osceola	IA	3,000

Palo Alto	IA	4,900
Plymouth	IA	8,000
Sac	IA	6,000
Sioux	IA	9,100
Woodbury	IA	37,700
Cedar	NE	3,600
Dakota	NE	5,100
Dixon	NE	2,500
Knox	NE	3,700
Madison	NE	10,100
Pierce	NE	3,100
Thurston	NE	2,200
Wayne	NE	3,100
Clay	SD	4,200
Union	SD	3,800
Women		151,100
Men		137,100
Teens		50,700
Children		64,200



You belong in Broadcasting

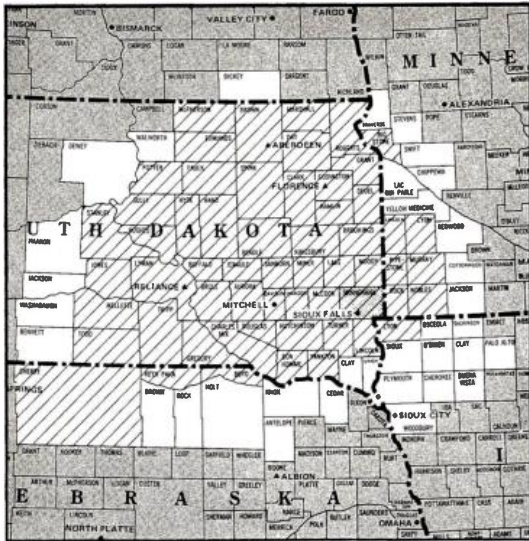

Sioux Falls-Mitchell, S.D. (88)

ADI TV Households 208,100
 Survey Area TV Households 379,700

KXON-TV Mitchell, S.D., ch. 5, ABC
***KESD-TV** Brookings, S.D., ch. 8, ETV
***KTSB-TV** Pierre, S.D., ch. 10, ETV
KELO-TV Sioux Falls, S.D., ch. 11, CBS
KDLO-TV Florence, S.D., ch. 3, satellite to KELO
KPLO-TV Reliance, S.D., ch. 6, satellite to KELO
***KRNE-TV** Merriman, Neb., ch. 12, ETV
KSFY-TV Sioux Falls, S.D., ch. 13, NBC
KABY-TV Aberdeen, S.D., ch. 9, satellite to KSFY
***KDSD-TV** Aberdeen, S.D., ch. 16, ETV

Deuel	SD	2,000
Douglas	SD	1,300
Edmunds	SD	1,800
Faulk	SD	1,300
Grant	SD	2,900
Gregory	SD	2,600
Hamlin	SD	2,300
Hand	SD	1,700
Hanson	SD	1,300
Hughes	SD	4,400
Hutchinson	SD	3,400
Hyde	SD	700
Jerauld	SD	1,100
Jones	SD	800
Kingsbury	SD	2,500
Lake	SD	3,900
Lincoln	SD	4,600
Lyman	SD	1,700
McCook	SD	2,600
McPherson	SD	1,400
Marshall	SD	1,800
Mellette	SD	700
Miner	SD	1,500
Minnehaha	SD	33,300
Moody	SD	2,300
Potter	SD	1,300
Roberts	SD	3,500
Sanborn	SD	1,100
Spink	SD	3,500
Stanley	SD	800
Sully	SD	800
Todd	SD	1,800
Tripp	SD	2,500
Turner	SD	3,800
Yankton	SD	6,300

ADI Counties	State	TV Households
Lyon	IA	4,800
Big Stone	MN	3,000
Lincoln	MN	2,700
Lyon	MN	7,700
Murray	MN	3,700
Nobles	MN	7,900
Pipestone	MN	4,200
Rock	MN	4,100
Boyd	NE	1,200
Cherry	NE	2,300
Keya Paha	NE	400
Aurora	SD	1,600
Beadle	SD	7,000
Bon Homme	SD	3,000
Brookings	SD	7,100
Brown	SD	13,600
Brule	SD	2,200
Buffalo	SD	400
Charles Mix	SD	3,400
Clark	SD	2,200
Codington	SD	7,000
Davison	SD	6,300
Day	SD	3,200

Women 219,600
Men 203,800
Teens 78,900
Children 97,300

Note: Coverage maps in this special section show total survey areas in white, with Areas of Dominant Influence (ADI's), indicated by light cross-hatching where appropriate, and Arbitron Metro Rating Areas shown by heavier cross-hatching.

in a class by itself

If ever a market were made-to-order for the tv advertiser, that market is KELO-LAND. It is uniquely television-oriented. Its one-third million families live in 92 counties, embracing 74,000 square miles of four states. Yet its total

coverage television facility, KELO-LAND TV, enables you to display your product to its entire population—as easily as though you had every man, woman and child assembled in one room. With the doors locked. By that, we mean

the KELO-LAND market is virtually unpenetrable from the outside. Minneapolis stations can't get in. Omaha stations can't get in. KELO-LAND is a market apart. In a class by itself. No advertising campaign is a national campaign without it.



kelo-land tv

KELO-TV Sioux Falls, S.D. and satellites KDLO-TV and KPLO-TV

Represented nationally by **HR** in Minneapolis by WAYNE EVANS

A CBS **☉** AFFILIATE

South Bend-Elkhart, Ind. (75)

ADI TV Households 267,300
 Survey Area TV Households 2,617,600

WNDU-TV South Bend, Ind., ch. 16, NBC
WSBT-TV South Bend, Ind., ch. 22, CBS
WSJV Elkhart-South Bend, Ind., ch. 28, ABC
***WNIT-TV** South Bend, Ind., ch. 34, ETV
WMSH-TV South Bend, Ind., ch. 46, IND

ADI Counties	State	TV Households
Elkhart	IN	43,500
Fulton	IN	6,300

Kosciusko	IN	17,600
La Grange	IN	6,300
Marshall	IN	12,200
Pulaski	IN	4,300
St. Joseph	IN	81,000
Starke	IN	7,200
Berrien	MI	56,700
Cass	MI	14,400
St. Joseph	MI	17,800

Women	279,000
Men	254,100
Teens	92,900
Children	135,300

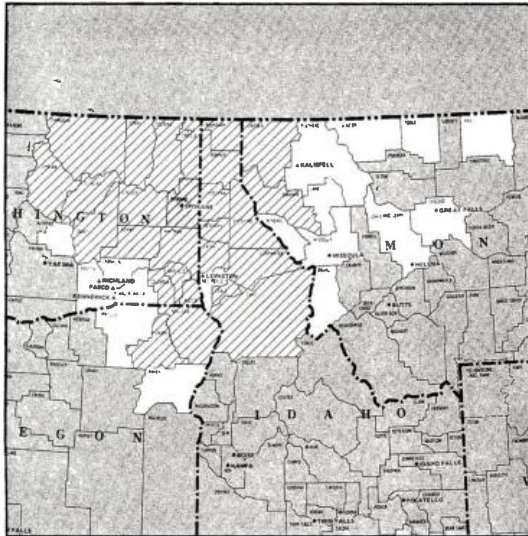

Spokane, Wash. (79)

ADI TV Households 248,700
 Survey Area TV Households 425,600

KREM-TV Spokane, Wash., ch. 2, ABC
KXLY-TV Spokane, Wash., ch. 4, CBS
KHO-TV Spokane, Wash., ch. 6, NBC
***KSPS-TV** Spokane, Wash., ch. 7, ETV
***KWSU-TV** Pullman, Wash., ch. 10, ETV
***KUID-TV** Moscow, Idaho, ch. 12, ETV

ADI Counties	State	TV Households
Behewah	IN	2,300
Bonner	IN	6,300
Boundary	IN	2,100
Clearwater	IN	3,200
Idaho	ID	3,800
Kootenai	ID	14,900
Latah	ID	8,600
Lewis	ID	1,500
Shoshone	ID	6,300
Lincoln	MT	5,200

Sanders	MT	2,800
Union	OR	7,600
Wallowa	OR	2,300
Adams	WA	3,900
Asotin	WA	5,000
Chelan	WA	14,300
Columbia	WA	1,500
Douglas	WA	5,700
Ferry	WA	1,300
Garfield	WA	700
Grant	WA	12,900
Lincoln	WA	3,400
Okanogan	WA	8,900
Pend Oreille	WA	2,500
Spokane	WA	103,900
Stevens	WA	6,400
Whitman	WA	11,400

Women	255,400
Men	241,100
Teens	83,300
Children	112,900

Springfield, Mass. (82)

ADI TV Households 228,900
 Survey Area TV Households 1,140,100

WWLP Springfield, Mass.-Hartford, Conn., ch. 22, NBC
WRLP Keene, N.H.-Brattleboro, Vt.-Greenfield, Mass., ch. 32
WHYH-TV Springfield, Mass.-Hartford, Conn., ch. 40, ABC
***WGBY-TV** Springfield, Mass., ch. 57, ETV

ADI Counties	State	TV Households
Franklin	MA	22,100
Hampden	MA	154,200
Hampshire	MA	40,800
Windham	VT	11,800

Women	257,400
Men	227,100
Teens	75,800
Children	101,800

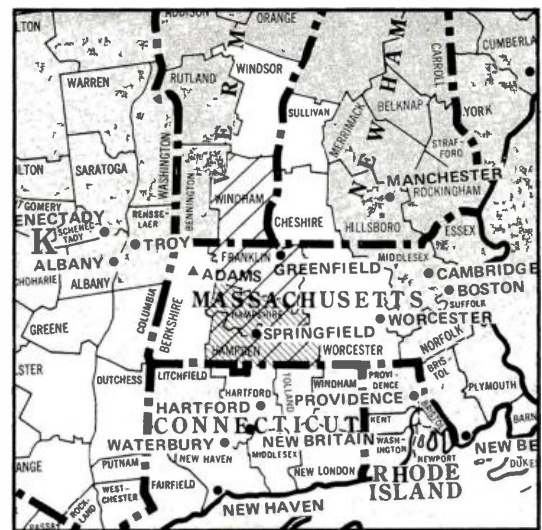

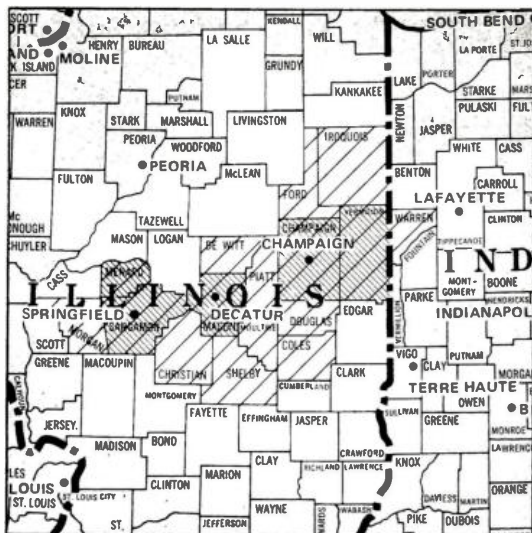

Springfield-Decatur-Champaign, Ill. (72)

ADI TV Households 285,500
 Survey Area TV Households 682,700

WCIA Champaign, Ill., ch. 3, CBS
 *WILL-TV Urbana-Champaign, Ill., ch. 12, ETV
 WAND Decatur, Ill., ch. 17, ABC
 WICS Springfield, Ill., ch. 20, NBC
 WICD Champaign-Danville, Ill., ch. 15, satellite to WICS

ADI Counties	State	TV Households
Champaign	IL	50,200
Christian	IL	13,200
Coles	IL	16,400
De Witt	IL	6,400

Douglas	IL	6,700
Ford	IL	5,100
Iroquois	IL	12,100
Macon	IL	43,000
Menard	IL	3,800
Morgan	IL	12,400
Moultrie	IL	4,600
Piatt	IL	5,800
Sangamon	IL	60,800
Shelby	IL	8,200
Vermilion	IL	34,200
Warren	IN	2,600

Women	298,300
Men	269,300
Teens	91,100
Children	126,200

Springfield, Mo. (84)

ADI TV Households 222,700
 Survey Area TV Households 402,000

KYTV Springfield, Mo., ch. 3, NBC
 KOLR Springfield, Mo., ch. 10, CBS
 KOZK-TV Springfield, Mo., ch. 21, ETV
 KMTC Springfield, Mo., ch. 27, ABC

ADI Counties	State	TV Households
Baxter	AR	7,900
Boone	AR	8,000
Carroll	AR	5,800
Fulton	AR	3,000
Izard	AR	3,700
Madison	AR	3,300
Marion	AR	3,800
Newton	AR	2,200
Barry	MO	8,100
Benton	MO	5,200
Camden	MO	6,000
Cedar	MO	4,000
Christian	MO	7,200

Dade	MO	2,900
Dallas	MO	4,100
Douglas	MO	4,000
Greene	MO	59,800
Hickory	MO	2,200
Howell	MO	9,500
Laclede	MO	7,600
Lawrence	MO	10,500
Oregon	MO	3,600
Ozark	MO	2,800
Polk	MO	6,500
Pulaski	MO	7,400
Shannon	MO	2,300
Stone	MO	4,800
Taney	MO	7,000
Texas	MO	7,400
Webster	MO	6,600
Wright	MO	5,700

Women	226,300
Men	218,200
Teens	64,300
Children	90,400

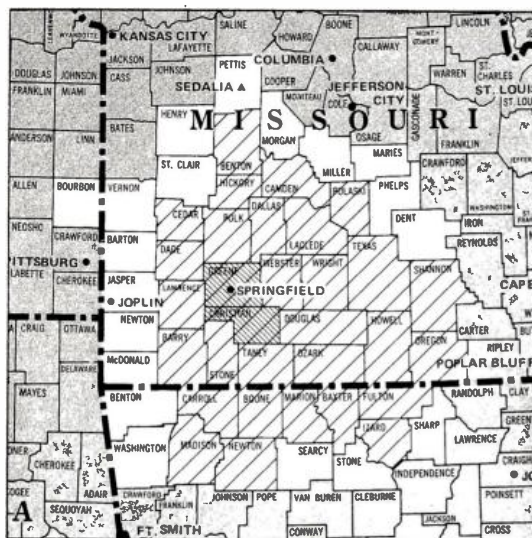

Syracuse-Elmira, N.Y. (49)

ADI TV Households 396,200
 Survey Area TV Households 1,436,300

WSYR-TV Syracuse, N.Y., ch. 3, NBC
 WSYE-TV Elmira-Corning, N.Y., ch. 18, satellite to WSYR
 WHEN-TV Syracuse, N.Y., ch. 5, CBS
 WNY5-TV Syracuse, N.Y., ch. 9, ABC
 *WCNY-TV Syracuse, N.Y., ch. 24, ETV
 WENY-TV Elmira, N.Y., ch. 36, ABC

ADI Counties	State	TV Households
Cayuga	NY	24,500
Chemung	NY	31,900

Cortland	NY	14,400
Madison	NY	19,700
Oneida West	NY	28,400
Onondaga	NY	152,600
Oswego	NY	33,500
Schuyler	NY	5,900
Seneca	NY	10,400
Steuben	NY	32,100
Tompkins	NY	23,900
Yates	NY	6,600
Tioga	PA	12,800

Women	429,800
Men	391,300
Teens	141,800
Children	198,100



Tallahassee, Fla. (149)

ADI TV Households 97,000
 Survey Area TV Households 359,600

WCTV Tallahassee, Fla., ch. 6, CBS (ABC)
 *WFSU-TV Tallahassee, Fla., ch. 11, ETV
 *WABW-TV Pelham, Ga., ch. 14, ETV

Counties	State	TV Households
Dixie	FL	1,800
Gadsden	FL	9,300
Hamilton	FL	2,700
Jefferson	FL	2,600
Lafayette	FL	1,000

Leon	FL	40,000
Madison	FL	4,300
Taylor	FL	4,500
Wakulla	FL	2,400
Brooks	GA	4,200
Decatur	GA	6,400
Echols	GA	500
Grady	GA	5,700
Thomas	GA	11,600

Women	111,700
Men	98,500
Teens	36,300
Children	54,900

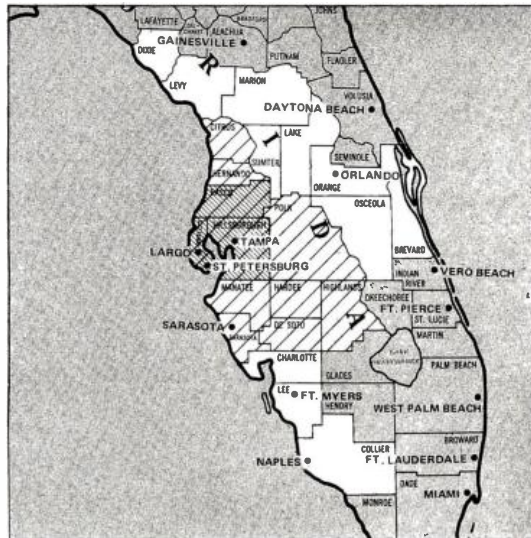

Tampa-St. Petersburg, Fla. (17)

ADI TV Households 791,700
 Survey Area TV Households 1,193,700

*WEDV Tampa-St. Petersburg, Fla., ch. 3, ETV
 WFLA-TV Tampa-St. Petersburg, Fla., ch. 8, NBC
 WLCY-TV Largo, Fla., ch. 10 ABC
 WTVT Tampa-St. Petersburg, Fla., ch. 13, CBS
 *WUSF-TV Tampa, Fla., ch. 18, ETV
 WTOG St. Petersburg, Fla., ch. 44, IND

Counties	State	TV Households
Citrus	FL	14,600

De Soto	FL	4,600
Hardee	FL	5,400
Hernando	FL	10,400
Highlands	FL	13,900
Hillsborough	FL	196,700
Manatee	FL	47,600
Pasco	FL	54,900
Pinellas	FL	287,700
Polk	FL	88,800
Sarasota	FL	67,100

Women	814,100
Men	689,200
Teens	247,000
Children	289,900

Sarasota, Fla. (supplementary market)

Arbitron characterizes supplementary markets as those that do not meet its criteria for having an ADI.

WXLT-TV Sarasota, Fla., ch. 40, ABC

Home county	Sarasota
TV Households	67,100

Terre Haute, Ind. (107)

ADI TV Households 160,700
 Survey Area TV Households 517,700

WTWO Terre Haute, Ind., ch. 2, NBC (ABC)
 WTHI-TV Terre Haute, Ind., ch. 10, CBS (ABC)
 *WVUI-TV Olney, Ill., ch. 16, ETV
 *WVUT-TV Vincennes, Ind., ch. 22, ETV
 WIIL-TV Terre Haute, Ind., ch. 38, ABC

Counties	State	TV Households
Clark	IL	6,100
Clay	IL	5,100
Crawford	IL	7,800
Cumberland	IL	3,700
Edgar	IL	7,900
Efingham	IL	8,900

Jasper	IL	3,700
Lawrence	IL	6,700
Richtland	IL	6,100
Clay	IN	8,900
Daviess	IN	8,700
Greene	IN	10,300
Knox	IN	14,800
Marlin	IN	3,600
Parke	IN	5,400
Sullivan	IN	7,400
Vermilion	IN	6,800
Vigo	IN	38,800

Women	166,300
Men	148,100
Teens	48,600
Children	66,400

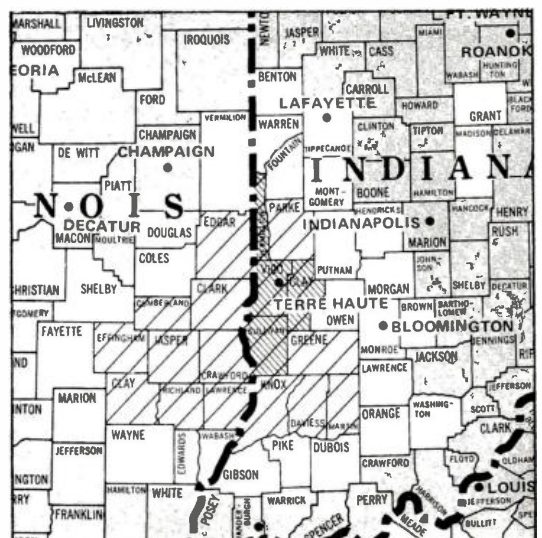

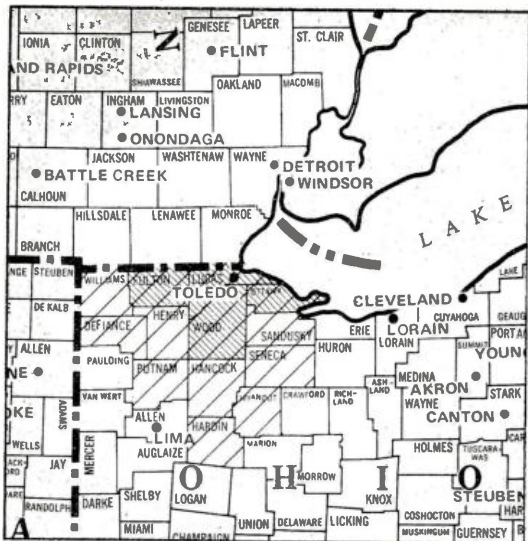

Toledo, Ohio (60)

ADI TV Households 343,400
 Survey Area TV Households 2,183,200

WTOL-TV Toledo, Ohio, ch. 11, CBS
 WSPD-TV Toledo, Ohio, ch. 13, NBC
 WDHO-TV Toledo, Ohio, ch. 24, ABC
 *WGTE-TV Toledo, Ohio, ch. 30, ETV

ADI Counties	State	TV Households
Defiance	OH	11,300
Fulton	OH	11,800
Hancock	OH	21,800
Hardin	OH	12,200

Henry	OH	9,200
Lucas	OH	165,400
Ottawa	OH	13,700
Pulham	OH	9,400
Sandusky	OH	21,000
Seneca	OH	18,700
Williams	OH	11,500
Wood	OH	30,400
Wyandot	OH	7,000

Women	365,300
Men	328,100
Teens	122,100
Children	177,700

Topeka, Kan. (124)

ADI TV Households 136,500
 Survey Area TV Households 783,100

*KTWU Topeka, Kan., ch. 11, ETV
 WIBW-TV Topeka, Kan., ch. 13, CBS (ABC)
 KTSB Topeka, Kan., ch. 27, NBC

ADI Counties	State	TV Households
Brown	KS	4,800
Clay	KS	3,900
Cofey	KS	3,500
Geary	KS	10,000
Jackson	KS	4,400

Lyon	KS	11,900
Marshall	KS	5,300
Morris	KS	2,700
Nemaha	KS	3,800
Osage	KS	5,300
Pottawatomie	KS	4,500
Riley	KS	16,500
Shawnee	KS	57,700
Wabanssee	KS	2,200

Women	135,100
Men	138,600
Teens	41,000
Children	61,300

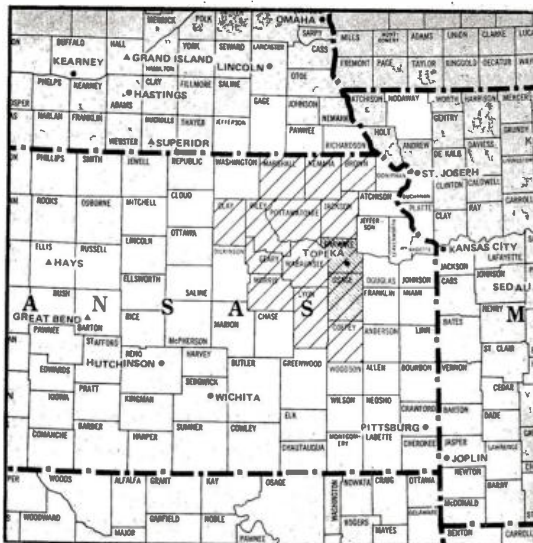

Traverse City-Cadillac, Mich. (122)

ADI TV Households 137,700
 Survey Area TV Households 747,300

WPBN-TV Traverse City, Mich., ch. 7, NBC
 WTOM-TV Cheboygan, Mich., ch. 4, satellite to WPBN
 WWTV-Cadillac-Traverse City, Mich., ch. 9, CBS
 WWUP-TV Sault Ste. Marie, Mich., ch. 10, satellite to WWTV
 WGTU Traverse City, Mich., ch. 29, ABC

ADI Counties	State	TV Households
Alpena	MI	10,000
Antrim	MI	4,900
Benzie	MI	3,000
Charlevoix	MI	5,900
Cheboygan	MI	6,000
Chippewa	MI	10,900
Crawford	MI	2,500
Emmet	MI	6,400
Grand Traverse	MI	13,700

Kalkaska	MI	2,300
Lake	MI	2,400
Leelanau	MI	4,200
Luce	MI	2,200
Mackinac	MI	3,800
Manistee	MI	7,500
Mason	MI	8,400
Mecosta	MI	10,200
Missaukee	MI	2,700
Montmorency	MI	2,300
Oscoda	MI	5,700
Oscoda	MI	1,900
Otsego	MI	4,100
Presque Isle	MI	4,100
Roscommon	MI	5,300
Wextford	MI	7,300

Women	144,300
Men	138,000
Teens	52,500
Children	69,400

Tucson, Ariz. (95)

ADI TV Households 180,400
 Survey Area TV Households 237,200

KVOA-TV Tucson, Ariz., ch. 4, NBC
 *KUAT-TV Tucson, Ariz., ch. 6, ETV
 KGUN-TV Tucson, Ariz., ch. 9, ABC
 KZAZ Tucson-Nogales, Ariz., ch. 11, IND
 KOLD-TV Tucson, Ariz., ch. 13, CBS

ADI Counties	State	TV Households
Apache South	AZ	1,300

Cochise	AZ	21,800
Graham	AZ	5,000
Pine East	AZ	141,900
Pine West	AZ	4,700
Santa Cruz	AZ	4,900
Catron	NM	800

Women	196,400
Men	182,800
Teens	66,200
Children	98,000



Tulsa, Okla. (62)

ADI TV Households 331,300
 Survey Area TV Households 643,500

KTEW Tulsa, Okla., ch. 2, NBC
 KOTV Tulsa, Okla., ch. 6, CBS
 KTUL-TV Tulsa, Okla., ch. 8, ABC
 *KOED-TV Tulsa, Okla., ch. 11 ETV

ADI Counties	State	TV Households
Chataqua	KS	2,100
Montgomery	KS	16,800
Adair	OK	5,100
Cherokee	OK	8,500
Craig	OK	5,100
Creek	OK	16,100
Delaware	OK	7,000
Haskell	OK	3,200

Latimer	OK	2,900
McIntosh	OK	4,700
Mayer	OK	9,200
Muskogee	OK	21,300
Nowata	OK	3,900
Okfuskee	OK	3,900
Okmulgee	OK	12,800
Osage	OK	10,200
Pawnee	OK	4,900
Pittsburg	OK	12,500
Rogers	OK	11,100
Tulsa	OK	146,500
Wagoner	OK	9,100
Washington	OK	14,600

Women	342,200
Men	303,500
Teens	104,800
Children	144,200

Tuscaloosa, Ala. (190)

ADI TV Households 37,400
 Survey Area TV Households 341,200

WCFT-TV Tuscaloosa, Ala., ch. 33, CBS

ADI Counties	State	TV Households
Tuscaloosa	AL	37,400

Women	44,900
Men	41,400
Teens	12,400
Children	19,300

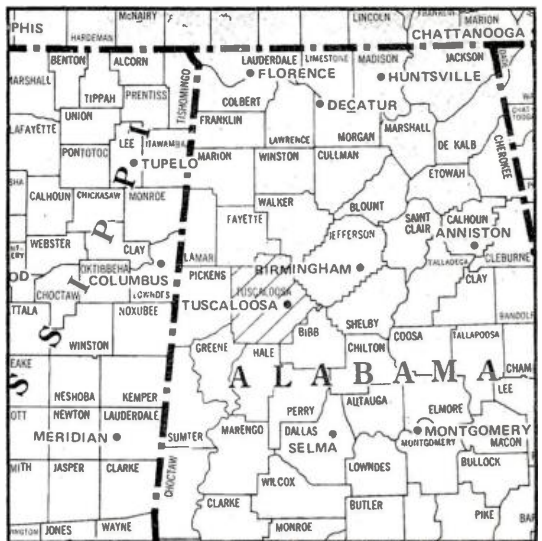

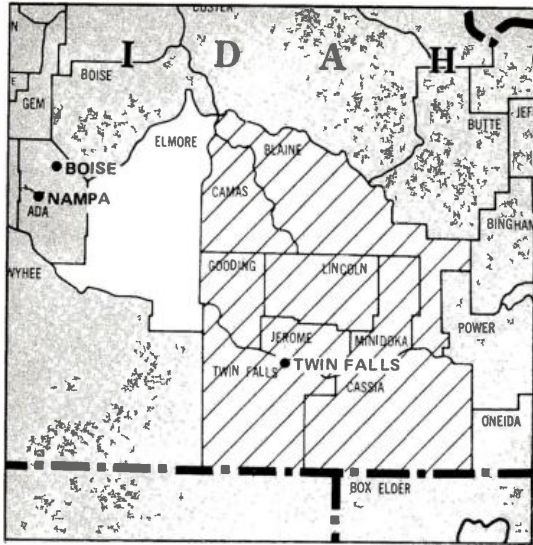

Twin Falls, Idaho (186)

ADI TV Households	38,600	Cassia	ID	5,300
Survey Area TV Households	44,800	Gooding	ID	3,200
		Jerome	ID	4,500
		Lincoln	ID	1,300
		Minidoka	ID	5,500
		Twin Falls	ID	16,100
ADI Counties	State	TV Households	Women	40,100
Blaine	ID	2,600	Men	37,400
Camas	ID	200	Teens	14,100
			Children	20,300

Tyler, Tex. (156)

ADI TV Households	86,200
Survey Area TV Households	1,655,000
KLTV Tyler, Tex., ch. 7, ABC (NBC)	
KTRE-TV Lufkin, Tex., ch. 9, satellite to KLTV	

ADI Counties	State	TV Households
Angelina	TX	16,000

Cherokee	TX	11,600
Houston	TX	5,400
Nacogdoches	TX	13,100
San Augustine	TX	2,700
Smith	TX	35,400
Women		93,100
Men		83,300
Teens		27,300
Children		41,800

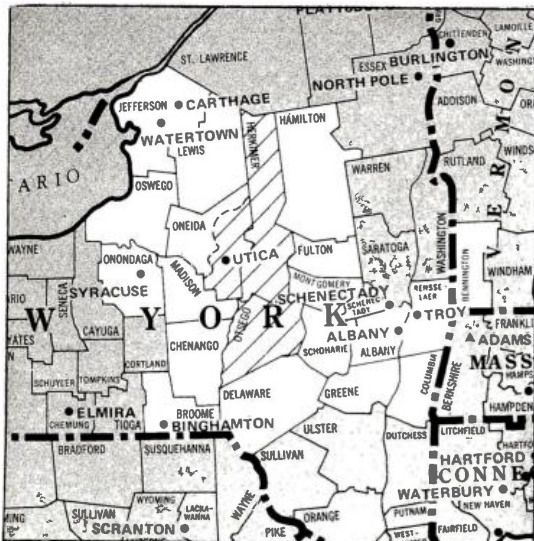

Utica, N.Y. (147)

ADI TV Households	99,200	Oneida East	NY	58,100
Survey Area TV Households	773,800	Otsego	NY	17,900
WKTV Utica, N.Y., ch. 2, NBC				
WUTR Utica, N.Y., ch. 20, ABC				
ADI Counties	State	TV Households	Women	109,400
Herkimer	NY	23,200	Men	97,500
			Teens	34,100
			Children	47,200

Waco-Temple, Tex. (101)

ADI TV Households 171,300
 Survey Area TV Households 458,400

KCEN-TV Temple-Waco, Tex., ch. 6, NBC
KWTX-TV Waco, Tex., ch. 10, CBS (ABC)
KBTX-TV Bryan, Tex., ch. 3, satellite to KWTX
***KAMU** College Station, Tex., ch. 15, ETV
***KNCT** Belton, Tex., ch. 46, ETV

ADI Counties	State	TV Households
Bell	TX	51,100
Brazos	TX	20,700
Burleson	TX	3,600

Corvell	TX	11,800
Falls	TX	6,100
Lampasas	TX	4,700
Leon	TX	3,400
McLennan	TX	53,600
Milam	TX	7,300
Mills	TX	1,500
Robertson	TX	5,200
San Saba	TX	2,300

Women	170,900
Men	189,900
Teens	51,300
Children	87,000



Washington, D.C. (8)

ADI TV Households 1,322,900
 Survey Area TV Households 2,548,700

WRC-TV Washington, ch. 4, NBC
WTTG Washington, ch. 5, IND
WMAL-TV Washington, ch. 7, ABC
WTOP-TV Washington, ch. 9, CBS
WDCA-TV Washington, ch. 20, IND
***WETA-TV** Washington, ch. 26, ETV
***WPWB-TV** Hagerstown, Md., ch. 31, ETV
***WVNT** Goldvein, Va., ch. 53, ETV

ADI Counties	State	TV Households
District of Columbia	DC	285,900
Allegany	MD	29,600
Calvert	MD	7,200
Charles	MD	15,800
Frederick	MD	29,900
Montgomery	MD	193,100
Prince Georges	MD	229,400
St. Marys	MD	14,400
Washington	MD	36,500
Franklin	PA	32,900

Arlington	VA	109,000
Clarke	VA	2,900
Culpeper	VA	5,900
Fairfax	VA	172,700
Fauquier	VA	8,000
Frederick	VA	15,700
King George	VA	2,300
Loudoun	VA	13,300
Page	VA	6,300
Prince William	VA	35,200
Rappahannock	VA	1,400
Shenandoah	VA	8,300
Spotsylvania	VA	11,700
Stafford	VA	8,100
Warren	VA	5,900
Westmoreland	VA	4,600
Berkeley	VA	13,500
Hampshire	WV	4,500
Jefferson	WV	7,900
Mineral	WV	8,200
Morgan	WV	2,900

Women	1,386,700
Men	1,258,800
Teens	454,200
Children	855,400

Fredericksburg, Va. (supplementary market)

Arbitron characterizes supplementary markets as those that do not meet its criteria for having an ADI.

WHFV Fredericksburg, Va., ch. 69, NBC	Spotsylvania
Home county	Spotsylvania
TV Households	11,700

Hagerstown, Md. (supplementary market)

WHAG-TV Hagerstown, Md., ch. 25, NBC	Washington
*WPWB-TV Owings Mills, Md., ch. 31, ETV	Washington
Home county	Washington
TV Households	36,500



Watertown-Carthage, N.Y. (162)

ADI TV Households 71,600
 Survey Area TV Households 418,500

WWNY-TV Carthage-Watertown, N.Y., ch. 7, CBS (ABC)
***WNPE-TV** Watertown, N.Y., ch. 16, ETV
***WNPI-TV** Norwood, N.Y., ch. 18, ETV

ADI Counties	State	TV Households
Jefferson	NY	30,500
Lewis	NY	7,500
St. Lawrence	NY	33,600

Women	79,400
Men	72,700
Teens	28,200
Children	38,400





Wausau-Rhinelander, Wis. (128)

ADI TV Households	131,100	Lincoln	WI	9,100
Survey Area TV Households	442,500	Marathon	WI	33,700
WSAU-TV Wausau, Wis., ch. 7, CBS		Oneida	WI	10,200
WAOW-TV Wausau, Wis., ch. 9, ABC		Portage	WI	15,200
WAEQ-TV Rhinelander, Wis., ch. 12, NBC		Taylor	WI	5,500
WHRM-TV Wausau, Wis., ch. 20, ETV		Vilas	WI	5,900
		Wood	WI	22,500

ADI Counties	State	TV Households	Women	Men	Teens	Children
Adams	WI	3,800	138,200	130,000	51,500	86,100
Clark	WI	10,500				
Forest	WI	2,700				
Langlade	WI	6,900				

West Palm Beach, Fla. (83)

ADI TV Households	226,500	Indian River	FL	16,300
Survey Area TV Households	1,152,800	Martin	FL	15,700
WPTV West Palm Beach, Fla., ch. 5, NBC		Okeechobee	FL	4,800
WPEC West Palm Beach, Fla., ch. 12, ABC		Palm Beach	FL	165,000
		St. Lucie	FL	23,200

ADI Counties	State	TV Households	Women	Men	Teens	Children
Glades	FL	1,500	233,700	203,800	65,900	96,400



Fort Pierce-Vero Beach, Fla. (supplementary market)

Arbitron characterizes supplementary markets as those that do not meet its criteria for having an ADL

WTVX Fort Pierce, Fla., ch. 34, CBS	
Home county	St. Lucie
TV Households	23,200



Wheeling, W. Va.-Steubenville, Ohio (110)

ADI TV Households	158,300	Jefferson	OH	30,900
Survey Area TV Households	1,898,100	Monroe	OH	5,400
WTRF-TV Wheeling, W. Va.-Steubenville, Ohio, ch. 7, NBC (ABC)		Noble	OH	3,800
WSTV-TV Steubenville, Ohio-Wheeling, W. Va., ch. 9, CBS (ABC)		Brooke	WV	10,200
*WOUC-TV Cambridge, Ohio, ch. 44, ETV		Hancock	WV	13,300
		Marshall	WV	13,200
		Ohio	WV	22,200
		Tyler	WV	3,400
		Wetzel	WV	6,800

ADI Counties	State	TV Households	Women	Men	Teens	Children
Belmont	OH	29,300	170,600	151,400	51,200	70,300
Guernsey	OH	13,900				
Harrison	OH	5,900				

Wichita-Hutchinson, Kan. (54)

ADI TV Households 377,800
 Survey Area TV Households 475,900

KARD-TV Wichita, Kan., ch. 3, NBC
KCKT Great Bend, Kan., ch. 2, satellite to KARD
KOMC McCook-Oberlin, Neb., ch. 8, satellite to KARD
KGLD Garden City, Kan., ch. 11, satellite to KARD
***KPTS** Hutchinson, Kan., ch. 8, ETV
KAKE-TV Wichita, Kan., ch. 10, ABC
KUPK-TV Garden City, Kan., ch. 13, satellite to KAKE
KTVH Hutchinson-Wichita, Kan., ch. 12, CBS
KTVC Ensign, Kan., ch. 6, satellite to KTVH
KAYS-TV Hays, Kan., ch. 7, satellite to KTVH
KLOE-TV Goodland, Kan., ch. 10, satellite to KAYS

ADI Counties	State	TV Households
Cheyenne	CO	700
Kit Carson	CO	2,300
Yuma	CO	2,900
Barber	KS	2,700
Barton	KS	10,800
Butler	KS	14,000
Chase	KS	1,500
Cheyenne	KS	1,600
Clark	KS	1,100
Comanche	KS	12,800
Cowley	KS	1,900
Decatur	KS	9,000
Dickinson	KS	1,700
Edwards	KS	1,500
Elk	KS	8,100
Ellis	KS	2,300
Ellsworth	KS	7,100
Finney	KS	8,200
Ford	KS	1,300
Gove	KS	1,700
Graham	KS	2,000
Grant	KS	1,800
Gray	KS	600
Greeley	KS	3,900
Greenwood	KS	1,300
Hamilton	KS	3,500
Harper	KS	

Harvey	KS	9,800
Haskell	KS	1,600
Hodgeman	KS	900
Kearny	KS	1,200
Kingman	KS	3,600
Kiowa	KS	1,500
Lane	KS	1,100
Lincoln	KS	1,700
Logan	KS	1,200
McPherson	KS	9,000
Marion	KS	5,200
Meade	KS	1,800
Mitchell	KS	2,700
Morton	KS	1,000
Ness	KS	1,700
Norton	KS	2,500
Osborne	KS	2,600
Ottawa	KS	2,500
Pawnee	KS	3,000
Pratt	KS	3,700
Rawlins	KS	1,500
Reno	KS	23,100
Rice	KS	4,600
Rooks	KS	2,900
Rush	KS	1,900
Russell	KS	3,600
Saline	KS	16,100
Scott	KS	2,000
Sedgwick	KS	115,900
Seward	KS	6,000
Sheridan	KS	1,200
Sherman	KS	2,800
Stafford	KS	2,700
Stanton	KS	700
Stevens	KS	1,300
Sumner	KS	8,900
Thomas	KS	3,200
Trego	KS	1,700
Wallace	KS	700
Wichita	KS	1,000
Dundy	NE	1,100
Hitchcock	NE	1,900
Red Willow	NE	4,900
Beaver	OK	2,400
Women		381,900
Men		345,200
Teens		123,600
Children		158,700



Wichita Falls, Tex.-Lawton, Okla. (118)

ADI TV Households 146,800
 Survey Area TV Households 262,900

KFDX-TV Wichita Falls, Tex., ch. 3, NBC
KAUZ-TV Wichita Falls, Tex., ch. 6, CBS
KSWO-TV Lawton, Okla., ch. 7, ABC
***KIDZ-TV** Wichita Falls, Tex., ch. 24, ETV

ADI Counties	State	TV Households
Comanche	OK	27,300
Cotton	OK	2,400
Greer	OK	2,800
Harmon	OK	1,700
Jackson	OK	10,800
Jefferson	OK	3,400
Kiowa	OK	4,700
Stephens	OK	14,600

Tillman	OK	4,400
Archer	TX	2,100
Baylor	TX	2,000
Clay	TX	3,200
Foard	TX	800
Hardeman	TX	2,400
Jack	TX	2,500
King	TX	200
Knox	TX	2,000
Montague	TX	6,100
Throckmorton	TX	900
Wichita	TX	40,800
Wilbarger	TX	5,800
Young	TX	6,100
Women		148,600
Men		149,400
Teens		46,300
Children		65,600

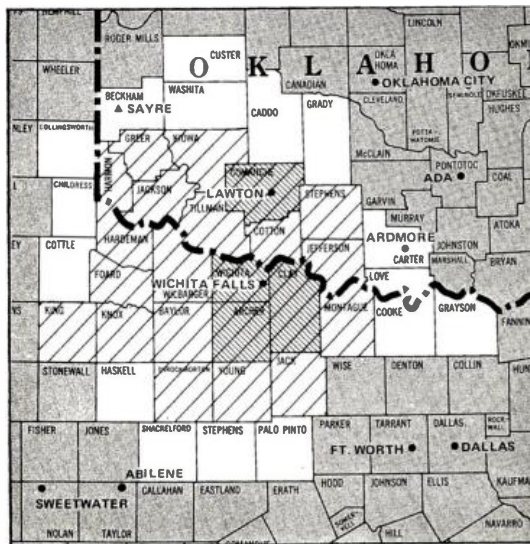



Wilkes Barre-Scranton, Pa. (47)

ADI TV Households 406,300
 Survey Area TV Households 1,121,900

WNEP-TV Scranton-Wilkes Barre, Pa., ch. 16, ABC
WDAU-TV Scranton-Wilkes Barre, Pa., ch. 22, CBS
WBRE-TV Wilkes Barre-Scranton, Pa., ch. 28, NBC
***WVIA-TV** Scranton-Wilkes Barre-Hazleton, Pa., ch. 44, ETV

Columbia	PA	19,800
Lackawanna	PA	83,700
Luzerne	PA	121,500
Lycoming	PA	38,400
Montour	PA	5,100
Northumberland	PA	35,800
Schuykill	PA	57,100
Union	PA	8,400
Wayne	PA	10,500
Wyoming	PA	7,700

ADI Counties	State	TV Households
Carbon	PA	18,500

Women	444,800
Men	381,400
Teens	117,300
Children	162,900

Wilmington, N.C. (135)

ADI TV Households 117,700
 Survey Area TV Households 442,000

WWAY Wilmington, N.C., ch. 3, ABC
WECT Wilmington, N.C., ch. 6, NBC (CBS)
***WUNJ-TV** Wilmington, N.C., ch. 39, ETV

Brunswick	NC	9,600
Columbus	NC	14,300
New Hanover	NC	31,400
Pender	NC	5,500
Robeson	NC	23,900
Horry	SC	25,300

ADI Counties	State	TV Households
Bladen	NC	7,700

Women	129,500
Men	117,200
Teens	45,700
Children	69,000



Yakima, Wash. (129)

ADI TV Households 130,400
 Survey Area TV Households 202,800

KNDO Yakima, Wash., ch. 23, NBC
KNDO Richland-Pasco-Kennewick, Wash., ch. 25, satellite to KNDO
KIMA-TV Yakima, Wash., ch. 29, CBS (ABC)
KLEW-TV Lewiston, Idaho, ch. 3, satellite to KIMA
KEPR-TV Pasco, Wash., ch. 19, satellite to KIMA
KAPP Yakima, Wash., ch. 35, ABC
KVEV Kennewick-Pasco-Richland, Wash., ch. 42, satellite to KAPP
***KYVE-TV** Yakima, Wash., ch. 47, ETV

ADI Counties	State	TV Households
Nez Perce	ID	10,700
Morrow	OR	1,500
Umatilla	OR	15,900
Benton	WA	22,800
Franklin	WA	8,500
Kittitas East	WA	6,800
Walla Walla	WA	13,600
Yakima	WA	50,600

Women	134,400
Men	126,000
Teens	44,800
Children	59,600

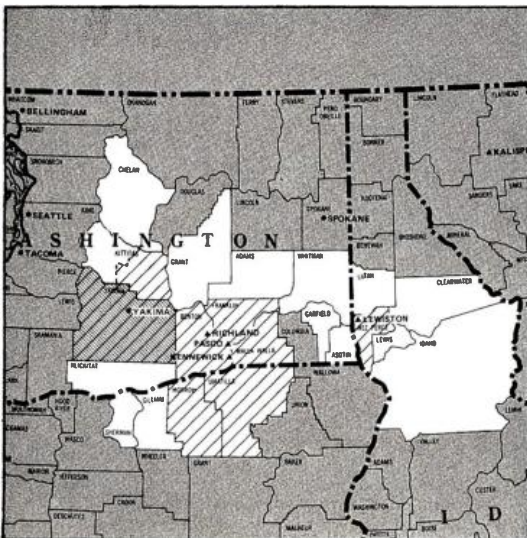

Youngstown, Ohio (77)

ADI TV Households 256,500
 Survey Area TV Households 1,610,400

WFMJ-TV Youngstown, Ohio, ch. 21, NBC
 WKBN-TV Youngstown, Ohio, ch. 27, CBS
 WYTV Youngstown, Ohio, ch. 33, ABC

ADI Counties	State	TV Households
Mahoning	OH	100,700

Trumbull	OH	78,800
Lawrence	PA	35,300
Mercer	PA	41,700

Women	286,700
Men	257,900
Teens	98,500
Children	120,900

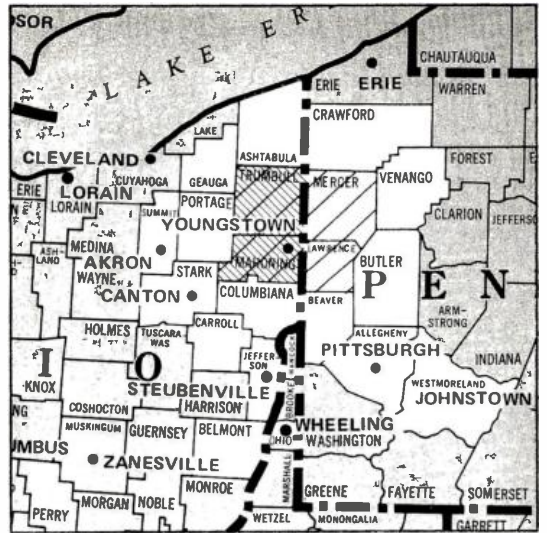

Zanesville, Ohio (199)

ADI TV Households 28,100
 Survey Area TV Households 213,000

WHIZ-TV Zanesville, Ohio, ch. 18, NBC (ABC-CBS)

ADI Counties	State	TV Households
Muskingum	OH	28,100

Women	29,800
Men	25,900
Teens	9,600
Children	14,200

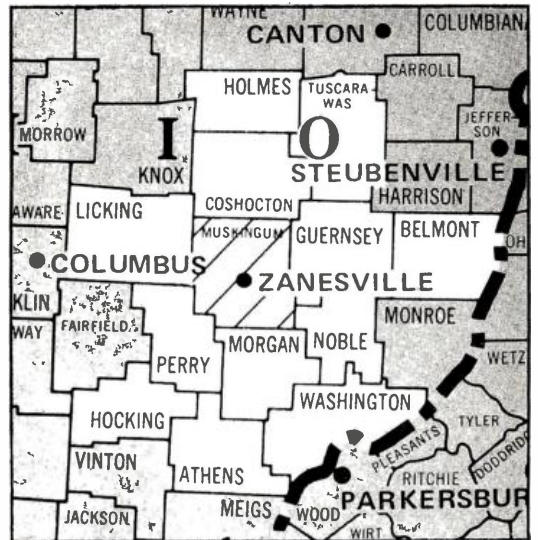

Supplementary markets

The following supplementary markets have no ADI. Reports for these non-ADI markets may be produced in the November, February and/or May surveys. Data on each market is listed in the preceding atlas adjacent to the ADI in which it falls (third column, below). TV household estimates for supplementary markets are nonadditive, since these markets are composed of counties which are a part of other markets' ADI's.

Supplementary market

Akron, Ohio
 Anderson, S.C.
 Battle Creek, Mich.
 Bowling Green, Ky.

Home county

Summit
 Anderson
 Calhoun
 Warren

ADI where located

Cleveland
 Greenville-Spartanburg-Asheville
 Grand Rapids-Kalamazoo
 Nashville

Supplementary market

Canton, Ohio
 Charlottesville, Va.
 Fort Dodge, Iowa
 Fort Lauderdale, Fla.
 Fort Pierce-Vero Beach, Fla.
 Fredericksburg, Va.
 Hagerstown, Md.
 Hazard, Ky.
 Hickory, N.C.
 Manchester, N.H.
 Modesto, Calif.
 Salem, Ore.
 Sarasota, Fla.
 Tulare, Calif.
 Wildwood, N.J.
 Worcester, Mass.

Home county

Stark
 Albemarle
 Webster
 Broward
 St. Lucie
 Spotsylvania
 Washington
 Perry
 Catawba
 Hillsborough
 Stanislaus
 Marion; Polk
 Sarasota
 Tulare
 Cape May
 Worcester

ADI where located

Cleveland
 Richmond
 Des Moines
 Miami
 West Palm Beach
 Richmond
 Washington, D.C.
 Lexington
 Charlotte
 Boston
 Sacramento-Stockton
 Portland
 Tampa, St. Petersburg
 Fresno
 Philadelphia
 Boston

Multi-city ADI cross-reference. The following cities are in hyphenated markets, but are not the first city given in such a market; i.e., Troy in Albany-Schenectady-Troy, N.Y. They are listed alphabetically.

- Ada, Okla. See Ardmore-Ada, Okla.
- Altoona, Pa. See Johnstown-Altoona, Pa.
- Asheville, N.C. See Greenville-Spartanburg, S.C.-Asheville, N.C.
- Austin, Minn. See Rochester, Minn.-Mason City, Iowa-Austin, Minn.
- Bay City, Mich. See Flint-Saginaw-Bay City, Mich.
- Beckley, W. Va. See Bluefield-Beckley-Oak Hill, W. Va.
- Bismarck, N.D. See Minot-Bismarck-Dickinson, N.D.
- Brownsville, Tex. See McAllen-Brownsville, Tex.
- Butte, Mont. See Missoula-Butte, Mont.
- Cadillac, Mich. See Traverse City-Cadillac, Mich.
- Cape Girardeau, Mo. See Paducah, Ky.-Cape Girardeau, Mo.-Harrisburg, Ill.
- Carthage, N.Y. See Watertown-Carthage, N.Y.
- Champaign, Ill. See Springfield-Decatur-Champaign, Ill.
- Daytona Beach, Fla. See Orlando-Daytona Beach, Fla.
- Decatur, Ala. See Huntsville-Decatur-Florence, Ala.
- Decatur, Ill. See Springfield-Decatur-Champaign, Ill.
- Dickinson, N.D. See Minot-Bismarck-Dickinson, N.D.
- Durham, N.C. See Raleigh-Durham, N.C.
- Eau Claire, Wis. See La Crosse-Eau Claire, Wis.
- El Dorado, Ark. See Monroe, La.-El Dorado, Ark.
- Elkhart, Ind. See South Bend-Elkhart, Ind.
- Elmira, N.Y. See Syracuse-Elmira, N.Y.
- Florence, Ala. See Huntsville-Decatur-Florence, Ala.
- Fort Worth, Tex. See Dallas-Fort Worth, Tex.
- Glendive, Mont. See Miles City-Glendive, Mont.
- Greenville, Miss. See Greenwood-Greenville, Miss.
- Gulfport, Miss. See Biloxi-Gulfport-Pascagoula, Miss.
- Hampton, Va. See Norfolk-Portsmouth-Newport News-Hampton, Va.
- Hannibal, Mo. See Quincy, Ill.-Hannibal, Mo.
- Harrisburg, Ill. See Paducah, Ky.-Cape Girardeau, Mo.-Harrisburg, Ill.
- Hastings, Neb. See Lincoln-Hastings-Kearney, Neb.
- Hattiesburg, Miss. See Laurel-Hattiesburg, Miss.
- High Point, N.C. See Greensboro-Winston-Salem-High Point, N.C.
- Huntington, W. Va. See Charleston-Huntington, W. Va.
- Hutchinson, Kan. See Wichita-Hutchinson, Kan.
- Jefferson City, Mo. See Columbia-Jefferson City, Mo.
- Johnson City, Tenn. See Bristol, Va.-Kingsport-Johnson City, Tenn.
- Kalamazoo, Mich. See Grand Rapids-Kalamazoo, Mich.
- Kearney, Neb. See Lincoln-Hastings-Kearney, Neb.
- Kingsport, Tenn. See Bristol, Va.-Kingsport-Johnson City, Tenn.
- Kirkville, Mo. See Ottumwa, Iowa-Kirkville, Mo.
- Lancaster, Pa. See Harrisburg-York-Lancaster-Lebanon, Pa.
- Lawton, Okla. See Wichita Falls, Tex.-Lawton, Okla.
- Lebanon, Pa. See Harrisburg-York-Lancaster-Lebanon, Pa.
- Lynchburg, Va. See Roanoke-Lynchburg, Va.
- Mason City, Iowa. See Rochester, Minn.-Mason City, Iowa-Austin, Minn.
- Midland, Tex. See Odessa-Midland, Tex.
- Mitchell, S.D. See Sioux Falls-Mitchell, S.D.
- Moline, Ill. See Davenport-Rock Island, Iowa, Moline, Ill. (Quad City)
- Monterey, Calif. See Salinas-Monterey, Calif.
- New Bern, N.C. See Greenville-New Bern-Washington, N.C.
- New Haven, Conn. See Hartford-New Haven, Conn.
- Newport News, Va. See Norfolk-Portsmouth-Newport News-Hampton, Va.
- Oak Hill, W. Va. See Bluefield-Beckley-Oak Hill, W. Va.
- Pascagoula, Miss. See Biloxi-Gulfport-Pascagoula, Miss.
- Pensacola, Fla. See Mobile, Ala.-Pensacola, Fla.
- Pittsburg, Kan. See Joplin, Mo.-Pittsburg, Kan.
- Plattsburgh, N.Y. See Burlington, Vt.-Plattsburgh, N.Y.
- Pocatello, Idaho. See Idaho Falls-Pocatello, Idaho.
- Poland Spring, Me. See Portland-Poland Spring, Me.
- Port Arthur, Tex. See Beaumont-Port Arthur, Tex.
- Portsmouth, Va. See Norfolk-Portsmouth-Newport News-Hampton, Va.
- Pueblo, Colo. See Colorado Springs-Pueblo, Colo.
- Redding, Calif. See Chico-Redding, Calif.
- Rhineland, Wis. See Wausau-Rhineland, Wis.
- Riverton, Wyo. See Casper-Riverton, Wyo.
- Rock Island, Ill. See Davenport-Rock Island, Iowa, Moline, Ill. (Quad City)
- Saginaw, Mich. See Flint-Saginaw-Bay City, Mich.
- Santa Maria, Calif. See Santa Barbara-Santa Maria, Calif.
- St. Petersburg, Fla. See Tampa-St. Petersburg, Fla.
- Schenectady, N.Y. See Albany-Schenectady-Troy, N.Y.
- Scranton, Pa. See Wilkes Barre-Scranton, Pa.
- Spartanburg, S.C. See Greenville-Spartanburg, S.C.-Asheville, N.C.
- Steubenville, Ohio. See Wheeling, W. Va.-Steubenville, Ohio.
- Superior, Wis. See Duluth, Minn.-Superior, Wis.
- Stockton, Calif. See Sacramento-Stockton, Calif.
- Sweetwater, Tex. See Abilene-Sweetwater, Tex.
- Tacoma, Wash. See Seattle-Tacoma, Wash.
- Temple, Tex. See Waco-Temple, Tex.
- Texarkana, Tex. See Shreveport, La.-Texarkana, Tex.
- Troy, N.Y. See Albany-Schenectady-Troy, N.Y.
- Washington, N.C. See Greenville-New Bern-Washington, N.C.
- Waterloo, Iowa. See Cedar Rapids-Waterloo, Iowa.
- Weston, W. Va. See Clarksburg-Weston, W. Va.
- Winston-Salem, N.C. See Greensboro-Winston-Salem-High Point, N.C.
- York, Pa. See Harrisburg-York-Lancaster-Lebanon, Pa.
- Yuma, Ariz. See El Centro, Calif.-Yuma, Ariz.

The Markets Ranked by Size

Here are the television markets of the U.S. ranked in descending order by the number of television homes they contain. Also shown are the numbers of women, men, teenagers and children in each market and the percentage of the total U.S. population each represents.

All data is from American Research Bureau, and represents the Arbitron Television household and population estimates for the 1975-1976 season.

	ADI TV Households		ADI Women		ADI Men		ADI Teen-Agers		ADI Children	
Total U.S.	70,573,300	100%	74,874,800	100%	67,817,400	100%	24,132,900	100%	34,038,100	100%
1. New York	6,410,600	9.08%	6,896,600	9.21%	5,960,600	8.79%	1,978,800	8.20%	2,754,200	8.09%
2. Los Angeles	3,647,200	5.17	3,614,800	4.83	3,289,100	4.85	1,130,400	4.68	1,620,000	4.76
3. Chicago	2,777,100	3.94	2,916,300	3.89	2,631,600	3.88	966,500	4.00	1,363,100	4.00
4. Philadelphia	2,295,500	3.25	2,503,300	3.34	2,225,400	3.28	773,700	3.21	1,054,200	3.10
5. Boston	1,736,300	2.46	1,923,800	2.57	1,681,200	2.48	593,700	2.46	820,000	2.41
6. San Francisco	1,682,400	2.38	1,688,600	2.26	1,564,600	2.31	509,000	2.11	698,600	2.05
7. Detroit	1,587,500	2.25	1,727,200	2.31	1,572,400	2.32	593,100	2.46	835,600	2.45
8. Washington, DC	1,322,900	1.87	1,386,700	1.85	1,258,800	1.86	454,200	1.88	655,400	1.93
9. Cleveland	1,308,800	1.85	1,427,800	1.91	1,272,600	1.88	466,400	1.93	644,200	1.89
10. Pittsburgh	1,082,900	1.53	1,198,500	1.60	1,047,900	1.55	351,200	1.46	459,700	1.35
Markets 1-10	23,851,200	33.80%	25,283,400	33.77%	22,504,200	33.18%	7,817,000	32.39%	10,905,000	32.04%
Cumulative Total	23,851,200	33.80%	25,283,400	33.77%	22,504,200	33.18%	7,817,000	32.39%	10,905,000	32.04%
11. Dallas-Ft. Worth	1,045,400	1.48%	1,083,600	1.45%	971,700	1.43%	346,200	1.43%	520,100	1.53%
12. St. Louis	928,900	1.32	1,003,600	1.34	877,700	1.29	336,100	1.39	480,700	1.41
13. Minneapolis-St. Paul	908,700	1.29	962,800	1.29	875,900	1.29	348,800	1.45	471,600	1.39
14. Houston	882,300	1.25	916,600	1.22	853,600	1.26	324,000	1.34	479,800	1.41
15. Miami	842,600	1.19	905,000	1.21	777,100	1.15	236,600	.98	328,700	.97
16. Atlanta	836,100	1.18	909,600	1.21	815,300	1.20	296,300	1.23	460,700	1.35
17. Tampa-St. Petersburg	791,700	1.12	814,100	1.09	689,200	1.02	202,000	.84	289,900	.85
18. Seattle-Tacoma	783,300	1.11	781,900	1.04	752,700	1.11	252,700	1.05	341,300	1.00
19. Baltimore	745,500	1.06	823,700	1.10	754,100	1.11	270,400	1.12	362,400	1.06
20. Indianapolis	738,100	1.05	768,900	1.03	695,200	1.03	258,800	1.07	372,200	1.09
Markets 11-20	8,502,600	12.05%	8,969,800	11.98%	8,062,500	11.89%	2,871,900	11.90%	4,107,400	12.07%
Cumulative Total	32,353,800	45.84%	34,253,200	45.75%	30,566,700	45.07%	10,688,900	44.29%	15,012,400	44.10%
21. Hartford-New Haven	653,500	.93%	715,900	.96%	642,500	.95%	222,200	.92%	303,300	.89%
22. Milwaukee	639,900	.91	673,000	.90	609,000	.90	231,400	.96	307,300	.90
23. Kansas City	632,000	.90	639,800	.85	575,800	.85	207,600	.86	280,900	.83
24. Portland, Or.	630,300	.89	636,200	.85	575,800	.85	197,600	.82	267,200	.79
25. Sacramento-Stockton	627,700	.89	638,200	.85	602,900	.89	214,600	.89	281,100	.83
26. Cincinnati	617,100	.87	658,200	.88	580,300	.86	221,400	.92	311,800	.92
27. Buffalo	611,100	.87	664,600	.89	585,400	.86	213,100	.88	285,300	.84
28. Denver	598,500	.85	641,400	.86	591,300	.87	217,300	.90	301,600	.89
29. Providence	597,100	.85	638,200	.85	564,500	.83	192,900	.80	275,400	.81
30. Nashville	579,900	.82	603,600	.81	559,600	.83	186,800	.77	268,100	.79
Markets 21-30	6,187,100	8.77%	6,509,100	8.69%	5,887,100	8.68%	2,104,900	8.72%	2,882,000	8.47%
Cumulative Total	38,540,900	54.61%	40,762,300	54.44%	36,453,800	53.75%	12,793,800	53.01%	17,894,400	52.57%

	ADI TV Households		ADI Women		ADI Men		ADI Teen-Agers		ADI Children	
182. Gainesville	44,500	.06	50,400	.07	48,400	.07	14,900	.06	23,200	.07
183. Roswell	44,300	.06	44,100	.06	40,800	.06	16,600	.07	21,800	.06
184. El Centro-Yuma	43,400	.06	45,500	.06	44,900	.07	18,600	.08	26,800	.08
185. Casper-Riverton	40,000	.06	40,900	.05	38,800	.06	15,300	.06	20,200	.06
186. Grand Junction	38,600	.05	41,500	.06	38,900	.06	14,000	.06	17,000	.05
187. Twin Falls	38,600	.05	40,100	.05	37,400	.06	14,100	.06	20,300	.06
188. Jackson, Tn	38,500	.05	41,100	.05	35,400	.05	12,100	.05	18,000	.05
189. Greenwood-Greenville	38,000	.05	45,300	.06	39,000	.06	18,400	.08	29,100	.09
190. Tuscaloosa	37,400	.05	44,900	.06	41,400	.06	12,400	.05	19,300	.06
Markets 181-190	408,000	.58%	437,700	.58%	409,000	.60%	151,200	.63%	214,900	.63%
Cumulative Total	70,125,300	99.37%	74,389,400	99.35%	67,375,000	99.35%	23,971,300	99.33%	33,801,000	99.30%
191. Palm Springs	36,600	.05%	36,300	.05%	33,300	.05%	12,000	.05%	16,400	.05%
192. Lafayette, In	35,900	.05	39,400	.05	40,600	.06	10,500	.04	18,300	.05
193. Lima	34,800	.05	36,900	.05	33,600	.05	12,800	.05	18,200	.05
194. Anniston	32,400	.05	36,500	.05	32,300	.05	11,200	.05	16,600	.05
195. Ottumwa-Kirksville	30,400	.04	30,400	.04	28,800	.04	8,200	.03	11,300	.03
196. Bellingham	30,200	.04	31,500	.04	28,900	.04	9,000	.04	12,900	.04
197. Harrisonburg	29,300	.04	35,700	.05	30,100	.04	10,000	.04	14,400	.04
198. Parkersburg	29,100	.04	30,400	.04	26,500	.04	9,800	.04	14,300	.04
199. Zanesville	28,100	.04	29,800	.04	25,900	.04	9,600	.04	14,200	.04
200. San Angelo	26,700	.04	28,500	.04	26,000	.04	8,700	.04	12,500	.04
Markets 191-200	313,500	.44%	335,400	.45%	306,000	.45%	101,800	.42%	149,100	.44%
Cumulative Total	70,438,800	99.81%	74,724,800	99.80%	67,681,000	99.80%	24,073,100	99.75%	33,950,100	99.74%
201. Presque Isle	26,300	.04%	30,700	.04%	29,100	.04%	12,400	.05%	16,800	.05%
202. Laredo	21,200	.03	24,800	.03	21,700	.03	10,600	.04	18,200	.05
203. North Platte	17,300	.02	18,100	.02	16,000	.02	5,700	.02	7,200	.02
204. Farmington	16,700	.02	17,800	.02	16,500	.02	8,900	.04	12,300	.04
205. Selma	16,500	.02	18,100	.02	15,500	.02	7,000	.03	10,900	.03
206. Flagstaff	16,100	.02	19,000	.03	18,100	.03	7,300	.03	12,500	.04
207. Helena	11,800	.02	12,400	.02	10,900	.02	4,200	.02	5,700	.02
208. Miles City-Glendive	8,600	.01	9,100	.01	8,600	.01	3,700	.02	4,400	.01
Markets 201-208	134,500	.19%	150,000	.20%	136,400	.20%	59,800	.25%	88,000	.26%
Cumulative Total	70,573,300	100%	74,874,800	100%	67,817,400	100%	24,132,900	100%	34,038,100	100%

TV Markets by Nielsen Retail Index Territory

Nielsen Retail Index territory groupings are another standard way of reporting sales data. The following table ranks TV markets within each Nielsen Territory. This provides a yardstick for determining the number of spot markets needed to achieve a given coverage of a territory. For example, if the national media are not delivering sufficient advertising weight in New England, the planner will find that three TV markets

(Boston, Hartford and Providence) contain more than 80% of the New England territory households. Or, he can use the table to get a better idea of how and what TV markets are needed to cover all of New England. Data is from a special Nielsen Station Index tabulation based on a September 1975 estimate.

Designated Market Area	TV Households	% Territory	% Total U.S.	Rank	Designated Market Area	TV Households	% Territory	% Total U.S.	Rank
Total U.S. (excluding Alaska, Hawaii)	69,644,300	100	100		Raleigh-Durham	330,570	2.9	.473	62
Metro New York					Mobile-Pensacola	304,740	2.7	.436	65
New York	6,337,510	100	9.069	1	Roanoke-Lynchburg	299,560	2.6	.429	68
Metro Los Angeles					Chattanooga	255,210	2.2	.365	77
Los Angeles, Palm Springs	3,638,680	100	5.207	2	West Palm Beach, Ft. Pierce-Vero Beach	222,760	1.9	.319	82
Metro Chicago					Tri Cities: Tenn.-Va.	220,500	1.9	.315	83
Chicago	2,718,100	100	3.890	3	Greenville-New Bern-Washington	220,440	1.9	.315	84
New England Territory					Jackson, Miss.	211,020	1.8	.302	87
Boston, Manchester, Worcester	1,734,090	46.6	2.482	5	Columbia, S.C.	177,820	1.6	.254	96
Hartford & New Haven	646,280	17.4	.925	21	Huntsville-Decatur, Florence	173,900	1.5	.249	99
Providence	588,990	15.8	.843	29	Augusta, Ga.	157,480	1.4	.225	111
Portland-Poland Spring	240,300	6.5	.344	78	Montgomery	153,630	1.3	.220	112
Springfield-Holyoke	210,060	5.8	.306	86	Charleston, S.C.	151,970	1.3	.217	114
Burlington-Plattsburgh	169,530	4.6	.243	102	Columbus, Ga.	141,900	1.2	.203	118
Bangor	99,220	2.7	.142	144	Wilmington	128,710	1.1	.184	130
Presque Isle	26,490	.7	.038	195	Macon	120,300	1.0	.172	134
Middle Atlantic					Tallahassee-Thomasville	114,440	1.0	.164	137
Philadelphia	2,278,100	30.1	3.260	4	Savannah	114,400	1.0	.164	138
Washington, D.C., Hagerstown	1,287,850	17.0	1.843	8	Columbus-Tupelo	100,450	.9	.144	142
Baltimore	731,460	9.7	1.047	20	Albany, Ga.	93,660	.8	.134	149
Buffalo	620,620	8.2	.888	25	Dothan	84,590	.7	.121	155
Albany-Schenectady-Troy	429,970	5.7	.615	42	Fl. Myers	80,100	.7	.115	157
Wilkes Barre-Scranton	426,850	5.6	.609	44	Florence, S.C.	78,490	.7	.112	158
Harrisburg-Lancaster-Lebanon-York	418,100	5.5	.598	47	Hattiesburg-Laurel	64,860	.6	.093	163
Syracuse, Elmira	417,750	5.5	.598	48	Meridian	64,180	.6	.092	164
Rochester	303,790	4.0	.435	67	Biloxi	44,120	.4	.063	182
Johnstown-Altoona	284,380	3.8	.407	70	Panama City	43,400	.4	.062	185
Binghamton	135,020	1.8	.193	125	Greenwood, Miss.	38,490	.3	.055	187
Utica	94,430	1.2	.135	148	Harrisonburg, Va.	37,050	.3	.053	189
Watertown	71,990	1.0	.103	161	East Central	10,451,960	100	15.010	-
Salisbury	62,940	.8	.090	165	Detroit	1,559,890	14.9	2.232	7
Southeast	11,457,870	100	16.45	-	Cleveland-Akron	1,280,570	12.3	1.833	9
Atlanta	827,240	7.2	1.184	15	Pittsburgh	1,118,180	10.7	1.600	10
Miami-Ft. Lauderdale	820,820	7.2	1.175	16	Indianapolis, Lafayette	771,760	7.4	1.104	19
Tampa-St. Petersburg-Sarasota	794,470	6.9	1.137	18	Cincinnati	625,580	6.0	.895	24
Nashville, Bowling Green	573,520	5.0	.821	30	Columbus, Ohio	493,580	4.7	.706	34
Memphis, Jackson	554,680	4.8	.794	31	Louisville	449,170	4.3	.643	39
Charlotte	504,790	4.4	.722	33	Grand Rapids-Kalamazoo	444,570	4.3	.636	41
Greenville-Spartanburg-Asheville	473,040	4.1	.667	37	Dayton	429,190	4.1	.614	43
Birmingham, Anniston	463,890	4.0	.664	38	Charleston-Huntington	420,180	4.0	.601	46
Orlando-Daytona Beach	421,980	3.7	.604	45	Flint-Saginaw-Bay City	375,830	3.6	.538	53
Norfolk-Portsmouth-Newport News	392,180	3.4	.561	51	Toledo	338,400	3.2	.484	60
Greensboro-High Point-Winston Salem	376,660	3.3	.539	52	South Bend-Elkhart	263,260	2.5	.377	76
Richmond-Petersburg	352,350	3.1	.504	57	Youngstown	218,380	2.1	.313	85
Jacksonville, Florida	339,460	3.0	.468	59	Evansville	201,880	1.9	.289	90
Knoxville	334,250	2.9	.478	61	Lexington	192,130	1.8	.275	92
					Fort Wayne	187,770	1.8	.269	94
					Lansing	176,580	1.7	.253	97

Designated Market Area	TV				Rank	Designated Market Area	TV			
	Households	% Territory	% U.S.	Total			Households	% Territory	% U.S.	Total
Wheeling-Steubenville	165,010	1.6	.236	107	Dallas-Ft. Worth	1,035,740	14.8	1.482	11	
Terre Haute	150,830	1.4	.216	115	Houston	860,840	12.3	1.207	14	
Traverse City-Cadillac	137,360	1.3	.197	122	New Orleans	485,540	6.9	.695	35	
Erie	116,700	1.1	.167	136	Oklahoma City	446,440	6.4	.639	40	
Beckley-Bluefield-Oak Hill	106,510	1.0	.152	140	San Antonio	415,220	5.9	.594	49	
Clarksburg-Weston	71,820	.7	.103	162	Little Rock-Pine Bluff	362,470	5.2	.519	55	
Parkersburg	48,140	.5	.069	178	Tulsa	357,910	5.1	.512	56	
Marquette	46,350	.4	.066	179	Shreveport	346,990	5.0	.497	58	
Lima	34,520	.3	.049	191	Albuquerque	235,950	3.4	.338	81	
Zanesville	27,820	.3	.040	194	Baton Rouge	176,180	2.5	.252	98	
West Central	9,620,200	100	13.810	-	Waco-Temple	169,530	2.4	.243	102	
St. Louis	921,240	9.6	1.318	12	El Paso	167,090	2.4	.239	105	
Minneapolis-St. Paul	886,940	9.2	1.269	13	Monroe-El Dorado	165,940	2.4	.237	106	
Milwaukee	628,530	6.5	.899	23	Austin	158,760	2.3	.227	110	
Kansas City	616,100	6.4	.882	26	Amarillo	152,110	2.2	.218	113	
Denver	591,020	6.1	.846	28	Lafayette, La.	144,440	2.1	.207	117	
Wichita-Hutchinson-Plus	370,600	3.9	.530	54	Wichita Falls-Lawton	139,940	2.0	.200	119	
Des Moines-Ames, Ft. Dodge	325,150	3.4	.465	63	Beaumont-Port Arthur	138,250	2.0	.198	121	
Omaha	311,240	3.2	.445	64	Corpus Christi	129,600	1.9	.185	127	
Green Bay	304,040	3.2	.435	66	Lubbock	126,980	1.8	.182	132	
Davenport-Rock Island-Moline	287,660	3.0	.412	69	Harlingen-Weslaco	105,430	1.5	.151	141	
Cedar Rapids-Waterloo	282,730	2.9	.405	71	Odessa-Midland-Monahans	97,250	1.4	.139	146	
Champaign & Springfield-Decatur	276,090	2.9	.395	73	Abilene-Sweetwater	88,250	1.3	.126	154	
Paducah-Cape Girardeau-Harrisburg	274,470	2.9	.393	74	Tyler	82,780	1.2	.118	156	
Lincoln & Hastings-Kearney, Hayes	236,200	2.5	.341	79	Ft. Smith	73,060	1.0	.105	160	
Sioux Falls	210,330	2.2	.301	88	Alexandria, La.	62,280	.9	.089	166	
Springfield, Mo	209,850	2.2	.300	89	Ada-Ardmore	56,220	.8	.126	154	
Peoria	198,250	2.1	.284	91	Jonesboro	54,230	.8	.078	174	
Fargo-Valley City, Pembina	188,930	2.0	.270	93	Lake Charles	50,740	.7	.073	176	
Colorado Springs-Pueblo	170,100	1.8	.243	101	Roswell	43,860	.6	.063	183	
Madison	168,240	1.7	.241	104	San Angelo	26,150	.4	.037	196	
Duluth-Superior	163,290	1.7	.234	108	Laredo	20,980	.3	.030	197	
Rockford	162,930	1.7	.233	109	Farmington	16,170	.2	.023	199	
Joplin-Pittsburg	147,910	1.5	.212	116	Remaining Pacific Territory	7,162,700	100	10.250	-	
Quincy-Hannibal-Keokuk	138,340	1.4	.198	120	San Francisco-Oakland	1,679,490	23.4	2.403	6	
Mason City-Austin-Rochester	137,090	1.4	.196	123	Seattle-Tacoma, Bellingham	807,000	11.3	1.155	17	
Sioux City	136,770	1.4	.196	124	Portland, Oregon	631,820	8.8	.904	22	
Columbia-Jefferson City	130,900	1.4	.187	126	Sacramento-Stockton	601,500	8.4	.861	27	
Wausau, Rhinelander	129,350	1.3	.185	128	San Diego	529,620	7.4	.758	32	
Topeka	129,190	1.3	.185	129	Phoenix	482,210	6.7	.690	36	
Minot-Bismarck, Dickinson	117,070	1.2	.168	135	Salt Lake City	412,090	5.8	.590	50	
La Crosse	90,890	.9	.130	152	Fresno (Visalia)	281,000	3.9	.402	72	
Alexandria, Minn.	78,300	.8	.112	159	Spokane	273,580	3.8	.391	75	
St. Joseph	61,070	.6	.087	167	Monterey-Satinas	180,080	2.5	.258	95	
Rapid City	59,300	.6	.085	168	Tucson (Nogales)	172,650	2.4	.247	100	
Cheyenne-Scottsbluff-Sterling	56,320	.6	.081	170	Eugene	127,940	1.8	.183	131	
Billings	55,510	.6	.079	172	Yakima	121,870	1.7	.174	133	
Great Falls	54,640	.6	.078	173	Las Vegas	109,470	1.5	.157	139	
Butte	52,270	.5	.075	175	Boise	100,280	1.4	.144	143	
Mankato	50,690	.5	.073	177	Bakersfield	97,430	1.4	.139	145	
Eau Claire	45,000	.5	.064	180	Chico-Redding	94,530	1.3	.135	147	
Ottumwa	42,350	.4	.061	186	Santa Barbara-Santa Maria	92,750	1.3	.133	150	
Casper-Riverton	36,880	.4	.053	190	Reno	92,570	1.3	.132	151	
Grand Junction-Montrose	32,490	.3	.046	192	Medford-Klamath Falls	89,630	1.3	.128	153	
Missoula	30,190	.3	.043	193	Idaho Falls-Pocatello	59,210	.8	.085	169	
North Platte	16,840	.2	.024	198	Eureka	44,210	.6	.063	181	
Glendive	4,910	.1	.007	200	Yuma, El Centro	43,730	.6	.063	184	
Southwest	6,993,320	100	10.040	-	Twin Falls	38,040	.5	.054	188	

How Network Delivery Varies by Market

National advertisers use spot television to increase network advertising weight in specific markets to achieve a predetermined level. These market goals are derived from the advertising budget and the market's share of the brand's projected sales. Thus, a spot schedule is usually indicated where a market has an unusually high brand-sales potential, or where the network weight delivered for the brand is below the national average used in planning, or both.

The first factor, market brand potential, varies by product and is difficult to generalize. The second factor, local-market network audiences, must be generalized because planning is based upon next season's *anticipated* network performance. The prevalence of network "package" buys, which tend to deliver average audience levels, supports

the use of average data.

The following tabulation, chosen especially for the BROADCASTING Yearbook, shows Arbitron Television's Areas of Dominant Influence (ADI) in terms of percent of the total number of U.S. TV households. Also given, in like percentage terms, are the network audiences in each ADI market during prime-time hours. It is this market audience figure, when compared to the market's share of population, that indicates whether the network commitment will perform above or below the national plan average in that market.

The figures are based on Arbitron Television's May 1975 Network Program Group Analysis.

ADI TV Households Rank	Market	ADI TV Households	ADI % of U.S. TV Households	-ABC- % of U.S. Index	-CBS- % of U.S. Index	-NBC- % of U.S. Index	
1.	New York	6,192,900	9.01	8.53	95	8.48	94
2.	Los Angeles	3,545,700	5.16	5.24	102	5.09	99
3.	Chicago	2,772,100	4.03	4.39	109	3.83	95
4.	Philadelphia	2,239,000	3.26	3.39	104	2.93	90
5.	Boston	1,673,700	2.43	2.79	115	2.33	96
6.	San Francisco	1,635,600	2.38	2.40	101	1.87	79
7.	Detroit	1,504,900	2.19	2.46	112	2.22	101
8.	Washington, DC	1,282,400	1.86	1.98	106	1.37	74
9.	Cleveland	1,274,700	1.85	2.15	116	1.86	101
10.	Pittsburgh	1,069,800	1.56	1.68	108	1.98	127
1-10 Market Group Total		23,190,800	33.72	35.02	104	31.60	94
Cumulative Total		23,190,800	33.72	35.02	104	31.60	94
11.	Dallas-Ft. Worth	1,045,800	1.52	1.49	98	1.43	94
12.	St. Louis	917,200	1.33	1.23	92	1.54	116
13.	Minneapolis-St. Paul	874,200	1.27	1.09	86	1.22	96
14.	Houston	857,500	1.25	1.47	118	1.21	97
15.	Miami	838,900	1.22	1.19	98	1.26	103

<i>ADI TV Households Rank Market</i>	<i>ADI TV Households</i>	<i>ADI % of U.S. TV Households</i>	<i>-ABC- % of U.S. Index</i>		<i>-CBS- % of U.S. Index</i>		<i>-NBC- % of U.S. Index</i>	
16. Atlanta	818,500	1.19	1.00	84	1.12	94	1.14	96
17. Tampa-St. Petersburg	801,200	1.17	.90	77	1.30	111	1.20	103
18. Seattle-Tacoma	768,400	1.12	1.33	119	.78	70	1.19	106
19. Baltimore	735,700	1.07	1.01	94	1.10	103	.99	93
20. Indianapolis	721,700	1.05	.89	85	1.07	102	.97	92
11-20 Market Group Total	8,379,100	12.18	11.62	95	12.04	99	11.93	98
Cumulative Total	31,569,900	45.91	46.63	102	43.64	95	43.48	95
21. Hartford-New Haven	637,500	.93	1.08	116	1.09	117	.83	89
22. Cincinnati	628,300	.91	.94	103	.99	109	.73	80
23. Kansas City	627,700	.91	.93	102	.85	93	.70	77
24. Milwaukee	620,200	.90	.88	98	.78	87	.91	101
25. Portland, Ore.	607,900	.88	.89	101	.82	93	.86	98
26. Sacramento-Stockton	604,700	.88	.99	113	.79	90	.88	100
27. Denver	594,900	.87	.86	99	.68	78	.83	95
28. Buffalo	578,400	.84	.77	92	.77	92	.78	93
29. Providence	576,800	.84	.93	111	.99	118	.86	102
30. Nashville	542,500	.79	.70	89	.81	103	.79	100
21-30 Market Group Total	6,018,900	8.75	8.97	103	8.57	98	8.17	93
Cumulative Total	37,588,800	54.66	55.60	102	52.21	96	51.66	95
31. San Diego	517,300	.75	.58	77	.60	80	.78	104
32. Memphis	507,400	.74	.74	100	.81	109	.74	100
33. Columbus, Ohio	507,000	.74	.70	95	.82	111	.64	86
34. Charlotte	502,400	.73	.47	64	.89	122	.62	85
35. Phoenix	496,900	.72	.72	100	.70	97	.72	100
36. New Orleans	476,400	.69	.77	112	.84	122	.77	112
37. Louisville	465,300	.68	.48	71	.65	96	.68	100
38. Oklahoma City	458,000	.67	.65	97	.56	84	.71	106
39. Greenville-Spartanburg-Asheville	454,600	.66	.46	70	.67	102	.77	117
40. Charleston-Huntington	442,600	.64	.60	94	.54	84	.96	150
31-40 Market Group Total	4,827,900	7.02	6.17	88	7.10	101	7.38	105
Cumulative Total	42,416,700	61.68	61.77	100	59.30	96	59.04	96
41. Dayton	431,700	.63	.54	86	.73	116	.52	83
42. Albany-Schenectady-Troy	430,800	.63	.63	100	.68	108	.80	127
43. Grand Rapids-Kalamazoo	426,100	.62	.65	105	.60	97	.67	108
44. Orlando-Daytona Beach	425,500	.62	.62	100	.59	95	.68	110
45. Wilkes Barre-Scranton	406,900	.59	.71	120	.68	115	.75	127
46. Harrisburg-York-Lancaster-Lebanon	399,900	.58	.48	83	.51	88	.68	117
47. San Antonio	396,300	.58	.69	119	.64	110	.54	93
48. Birmingham	395,500	.58	.78	134	.35	60	.54	93
49. Norfolk-Portsmouth-Newport News-Hampton	389,200	.57	.62	109	.71	125	.51	89
50. Toledo	389,100	.57	.48	84	.59	104	.67	118
41-50 Market Group Total	4,091,000	5.95	6.21	104	6.08	102	6.35	107
Cumulative Total	47,507,700	67.63	67.98	101	65.38	97	65.40	97
51. Salt Lake City	386,000	.56	.72	129	.50	89	.53	95
52. Greensboro-Winston Salem-High Pt.	381,400	.55	.57	104	.70	127	.54	98
53. Flint-Saginaw-Bay City	371,300	.54	.59	109	.45	83	.72	133
54. Syracuse-Elmira	368,300	.54	.45	83	.56	104	.63	117
55. Tulsa	365,400	.53	.61	115	.53	100	.55	104
56. Wichita-Hutchinson	361,300	.53	.48	91	.57	108	.52	98
57. Richmond	357,700	.52	.59	113	.64	123	.48	92
58. Little Rock	357,600	.52	.64	123	.49	94	.62	119
59. Shreveport-Texarkana	348,400	.51	.64	125	.56	110	.47	92
60. Knoxville	338,200	.49	.24	49	.52	106	.62	127
51-60 Market Group Total	3,635,600	5.29	5.53	105	5.53	105	5.68	107
Cumulative Total	50,143,300	72.91	73.51	101	70.91	97	71.08	97
61. Raleigh-Durham	317,800	.46	.61	133	.60	130	.23	50
62. Des Moines	317,200	.46	.38	83	.53	115	.47	102
63. Mobile-Pensacola	310,100	.45	.56	124	.47	104	.52	116
64. Rochester, NY	304,600	.44	.56	127	.47	107	.48	109
65. Omaha	303,400	.44	.39	89	.43	98	.44	100
66. Jacksonville	299,000	.43	.36	84	.49	114	.46	107
67. Roanoke-Lynchburg	290,500	.42	.29	69	.54	129	.47	112
68. Davenport-Rock Island-Moline (quad CY)	288,400	.42	.43	102	.37	88	.44	105
69. Green Bay	288,800	.42	.44	105	.54	129	.48	114
70. Cedar Rapids-Waterloo	279,100	.41	.43	105	.43	105	.42	102
61-70 Market Group Total	2,998,900	4.36	4.44	102	4.86	111	4.42	101
Cumulative Total	53,142,200	77.27	77.94	101	75.77	90	75.50	98
71. Paducah-Cape Girardeau-Harrisburg	277,900	.40	.28	70	.48	120	.44	110
72. Johnstown-Altoona	276,800	.40	.27	68	.51	128	.47	118
73. Fresno	270,500	.39	.44	113	.37	95	.46	118
74. Springfield-Decatur-Champaign	269,400	.39	.36	92	.39	100	.40	103
75. Portland-Poland Spring	252,900	.37	.31	84	.29	78	.40	108
76. Chattanooga	248,300	.36	.34	94	.38	106	.37	103
77. Spokane	242,200	.35	.37	106	.31	89	.35	100
78. Greenville-New Bern-Washington	240,700	.35	.33	94	.43	123	.33	94
79. Lincoln-Hastings-Kearney	231,600	.34	.31	91	.43	126	.25	74
80. Albuquerque	228,200	.33	.43	130	.30	91	.38	115
71-80 Market Group Total	2,538,500	3.69	3.42	93	3.90	106	3.85	104
Cumulative Total	55,680,700	80.97	81.36	100	79.67	98	79.35	98

ADI TV Households		ADI TV	ADI %	-ABC-		-CBS-		-NBC-	
Rank	Market	Households	of U.S. TV Households	% of U.S. Index		% of U.S. Index		% of U.S. Index	
81.	Jackson, MS	222,800	.32	.25	78	.31	97	.38	119
82.	Youngstown	215,000	.31	.37	119	.37	119	.37	119
83.	Springfield, MA	214,000	.31	.44	142	.34	110	.35	113
84.	West Palm Beach	213,900	.31	.33	106	.29	65	.37	119
85.	Springfield, MO	206,700	.30	.17	57	.29	97	.38	127
86.	South Bend-Elkhart	206,500	.30	.31	103	.31	103	.31	103
87.	Evansville	204,000	.30	.36	120	.33	110	.25	83
88.	Peoria	203,300	.30	.34	113	.28	93	.27	90
89.	Bristol-Kingsport-Johnson City	201,800	.29	.15	52	.34	117	.37	128
90.	Sioux Falls-Mitchell	200,800	.29	.12	41	.45	155	.22	76
81-90	Market Group Total	2,088,800	3.04	2.83	93	3.22	106	3.27	108
	Cumulative Total	57,769,500	84.00	84.20	100	82.89	99	82.62	98
91.	Ft. Wayne	193,100	.28	.27	96	.28	100	.32	114
92.	Lansing	191,900	.28	.19	68	.32	114	.31	111
93.	Huntsville-Decatur-Florence	180,900	.26	.20	77	.29	112	.26	100
94.	Wheeling-Steubenville	176,100	.26	.22	85	.29	112	.34	131
95.	Fargo	175,400	.26	.20	77	.27	104	.30	115
96.	Tucson	175,400	.26	.31	119	.25	96	.26	100
97.	Colorado Springs-Pueblo	172,100	.25	.36	144	.26	104	.26	104
98.	Salinas-Monterey	171,100	.25	.25	100	.18	72	.27	108
99.	Columbia, SC	170,400	.25	.20	80	.21	84	.36	144
100.	Baton Rouge	169,500	.25	.26	104	.32	128	.35	140
91-100	Market Group Total	1,775,900	2.58	2.44	95	2.68	104	3.01	117
	Cumulative Total	59,545,400	86.59	86.64	100	85.57	99	85.63	99
101.	Lexington	167,300	.24	.19	79	.25	104	.24	100
102.	Monroe-El Dorado	163,700	.24	.23	96	.45	188	.13	54
103.	Austin, TX	162,000	.24	.23	96	.27	113	.20	83
104.	Burlington-Plattsburgh	161,500	.23	.14	61	.26	113	.19	83
105.	Waco-Temple	161,100	.23	.44	191	.29	126	.26	113
106.	Rockford	159,700	.23	.26	113	.23	100	.21	91
107.	Terre Haute	158,400	.23	.13	57	.31	135	.27	117
108.	Augusta	157,900	.23	.33	143	.27	117	.12	52
109.	El Paso	157,400	.23	.23	100	.20	87	.24	104
110.	Binghamton	155,600	.23	.19	83	.26	113	.23	100
101-110	Market Group Total	1,604,600	2.33	2.35	101	2.79	120	2.09	90
	Cumulative Total	61,150,000	88.92	88.99	100	88.36	99	87.72	99
111.	Madison	155,500	.23	.19	83	.26	113	.16	70
112.	Amarillo	153,600	.22	.28	127	.21	95	.21	95
113.	Duluth-Superior	152,700	.22	.25	114	.25	114	.25	114
114.	Montgomery	150,700	.22	.19	86	.20	91	.34	155
115.	LaFayette, LA	149,200	.22	.26	118	.35	159	.17	77
116.	Joplin-Pittsburg	148,800	.22	.25	114	.17	77	.27	123
117.	Sioux City	146,400	.21	.25	119	.17	81	.24	114
118.	Wichita Falls-Lawton	143,300	.21	.22	105	.20	95	.22	105
119.	Columbus, GA	140,900	.20	.28	140	.25	125	.16	80
120.	Beaumont-Port Arthur	137,900	.20	.20	100	.25	125	.25	125
111-120	Market Group Total	1,479,000	2.15	3.38	110	2.31	107	2.27	106
	Cumulative Total	62,629,000	91.07	91.36	100	90.67	100	89.99	99
121.	Columbia-Jefferson City	136,700	.20	.13	65	.24	120	.25	125
122.	Topeka	132,700	.19	.10	53	.23	121	.16	84
223.	La Crosse-Eau Claire	132,000	.19	.10	53	.28	147	.22	116
124.	Rochester-Mason City-Austin	131,100	.19	.21	111	.21	111	.17	89
125.	Savannah	130,400	.19	.20	115	.22	116	.19	100
126.	Traverse City-Cadillac	130,100	.19	.13	68	.19	100	.20	105
127.	Corpus Christi	128,500	.19	.23	121	.20	105	.20	105
128.	Charleston, SC	127,700	.19	.19	100	.27	142	.18	95
129.	Yakima	127,700	.19	.21	111	.18	95	.19	100
130.	Eugene	123,300	.18	.17	94	.10	56	.26	144
121-130	Market Group Total	1,300,200	1.89	1.66	88	2.13	113	2.02	107
	Cumulative Total	63,929,200	92.96	93.01	100	92.80	100	92.01	99
131.	Wausau-Rhineland	122,300	.18	.20	111	.26	144	.16	89
132.	Quincy-Hannibal	120,300	.17	.08	47	.21	124	.21	124
133.	Macon	120,000	.17	.08	47	.23	135	.13	76
134.	Minot-Bismarck-Dickinson	115,100	.17	.16	94	.19	112	.26	153
135.	Lubbock	114,800	.17	.12	71	.19	112	.18	106
136.	Wilmington	113,000	.16	.22	138	.08	50	.22	138
137.	Erie	111,100	.16	.20	125	.12	75	.22	138
138.	Albany, GA	110,800	.16	.05	31	.14	88	.27	169
139.	Bluefield-Beckley-Oak Hill	108,400	.16	.14	88	.11	69	.22	138
140.	Las Vegas	107,300	.16	.19	119	.16	100	.18	113
131-140	Market Group Total	1,143,100	1.66	1.43	86	1.70	102	2.05	123
	Cumulative Total	65,072,300	94.62	94.44	100	94.50	100	94.06	99
141.	McAllen-Brownsville (Lower Rio Grande)	104,100	.15	.11	73	.18	120	.18	120
142.	Boise	103,300	.15	.17	113	.15	100	.17	113
143.	Odessa-Midland	100,600	.15	.12	80	.18	120	.17	113
144.	Abilene-Sweetwater	100,500	.15	.20	133	.09	60	.22	147

<i>ADI TV</i> <i>Households</i> <i>Rank Market</i>	<i>ADI TV</i> <i>Households</i>	<i>ADI %</i> <i>of U.S. TV</i> <i>Households</i>	<i>-ABC-</i> <i>% of U.S. Index</i>		<i>-CBS-</i> <i>% of U.S. Index</i>		<i>-NBC-</i> <i>% of U.S. Index</i>	
145. Tallahassee	99,800	.15	.05	33	.24	160	.11	73
146. Bangor	99,000	.14	.12	86	.16	114	.14	100
147. Clarksburg-Weston	96,400	.14	.11	79	.17	121	.16	114
148. Utica	95,000	.14	.12	86	.10	71	.19	136
149. Bakersfield	94,200	.14	.16	114	.10	71	.17	121
150. Reno	92,600	.13	.16	123	.11	85	.14	108
141-150 Market Group Total	985,500	1.43	1.33	93	1.47	103	1.65	115
Cumulative Total	66,057,800	96.05	95.77	100	95.97	100	95.72	100
151. Santa Barbara-Santa Maria	90,200	.13	.16	123	.10	77	.10	77
152. Chico-Redding	89,500	.13	.19	146	.12	92	.11	85
153. Dothan	88,400	.13	.14	108	.18	138	.09	69
154. Missoula-Butte	86,100	.13	.19	146	.12	92	.17	131
155. Medford	84,000	.12	.23	108	.16	133	.14	117
156. Alexandria, MN	78,300	.11	.03	27	.06	55	.22	200
157. Florence, SC	75,200	.11	.03	27	.18	164	.10	91
158. Ft. Myers	74,100	.11	.09	82	.12	109	.11	100
159. Tyler	72,300	.11	.24	218	.07	64	.22	200
160. Ft. Smith	71,800	.10	.11	110	.09	90	.12	120
151-160 Market Group Total	809,900	1.18	1.31	111	1.19	101	1.37	116
Cumulative Total	66,867,700	97.23	97.08	100	97.17	100	97.09	100
161. Columbus, MS	70,400	.10	.04	40	.14	140	.12	120
162. Laurel-Hattiesburg	67,500	.10	.07	70	.06	60	.18	180
163. Watertown-Carthage	66,500	.10	.03	30	.12	120	.07	70
164. Meridian	65,800	.10	.02	20	.18	180	.07	70
165. Idaho Falls-Pocatello	64,000	.09	.09	100	.10	111	.11	122
166. Rapid City	62,900	.09	.14	156	.05	56	.17	189
167. Salisbury	62,500	.09	.04	44	.15	167	.07	78
168. Alexandria, LA	60,700	.09	.04	44	.09	100	.15	167
169. Billings	60,400	.09	.13	144	.10	111	.12	133
170. Great Falls	54,800	.08	.11	138	.07	88	.10	125
161-170 Market Group Total	635,500	.92	.72	78	1.05	114	1.16	128
Cumulative Total	67,503,200	98.16	97.80	100	98.22	100	98.25	100
171. Cheyenne	53,900	.08	.14	175	.13	163	.05	63
172. Ardmore-Ada	53,600	.08	.07	88	.07	88	.07	88
173. St. Joseph	50,200	.07	.12	171	.06	86	.05	71
174. Lake Charles	49,900	.07	.05	71	.07	100	.11	157
175. Marquette	48,600	.07	.04	57	.13	186	.06	86
176. Casper-Riverton	46,900	.07	.11	157	.06	86	.10	143
177. Biloxi-Gulfport-Pascagoula	45,300	.07	.13	186	.06	86	.07	100
178. Mankato	45,200	.07	.04	57	.11	157	.03	43
179. Tupelo	43,600	.06	.04	67	.06	100	.10	167
180. Eureka	43,000	.06	.11	183	.09	150	.04	67
171-180 Market Group Total	480,200	.70	.86	123	.84	120	.67	98
Cumulative Total	67,983,400	98.85	98.66	100	99.05	100	98.92	100
181. El Centro-Yuma	42,900	.06	.04	67	.06	100	.09	150
182. Jonesboro	41,900	.06	.10	167	.04	67	.02	33
183. Roswell	41,800	.06	.03	50	.07	117	.07	117
184. Twin Falls	38,600	.06	.12	200	.04	67	.04	67
185. Gainesville	37,100	.05	.15	100	.05	100	.04	80
186. Panama City	36,900	.05	.08	160	.03	60	.06	120
187. Tuscaloosa	36,500	.05	.07	140	.04	80	.04	80
188. Jackson, TN	36,400	.05	.08	160	.04	80	.02	40
189. Greenwood-Greenville	36,200	.05	.10	200	.03	60	.04	80
190. Palm Springs	34,900	.05	.03	60	.03	60	.05	100
181-190 Market Group Total	383,200	.56	.70	125	.43	77	.48	86
Cumulative Total	68,366,600	99.41	99.36	100	99.48	100	99.40	100
191. Lafayette, IN	34,800	.05	.04	80	.04	80	.05	100
192. Lima	34,300	.05	.04	80	.05	100	.06	120
193. Grand Junction	33,500	.05	.12	240	.09	180	.08	160
194. Anniston	31,900	.05	.05	100	.04	80	.03	60
195. Ottumwa-Kirkville	29,900	.04	.08	200	.03	75	.02	50
196. Bellingham	29,800	.04	.03	75	.02	50	.02	50
197. Parkersburg	27,800	.04	.03	75	.03	75	.06	150
198. Presque Isle	26,600	.14	.02	50	.05	125	.03	75
199. Harrisonburg	25,700	.04	.07	175	.02	50	.02	50
200. Zanesville	25,600	.04	.04	100	.03	75	.05	125
191-200 Market Group Total	299,900	.44	.53	120	.41	93	.43	98
Cumulative Total	68,666,500	99.85	99.89	100	99.89	100	99.83	100
201. San Angelo	25,100	.04	.02	50	.05	125	.03	75
202. Laredo	22,100	.03	.02	67	.02	67	.02	67
203. Farmington	16,000	.02	.02	100	.01	50	.02	100
204. North Platte	13,300	.02	.01	50	.02	100	.03	150
205. Helena	11,900	.02	.02	100	.01	50	.02	100
206. Miles City-Glendive	8,400	.01	.01	100	.01	100	.02	200
206. Pembina	8,400	.01					.01	100
201-207 Market Group Total	105,200	.15	.11	73	.11	73	.17	113
Cumulative Total	68,771,700	100.00	100.00	100	100.00	100	100.00	100

WE OFFER MORE (*)

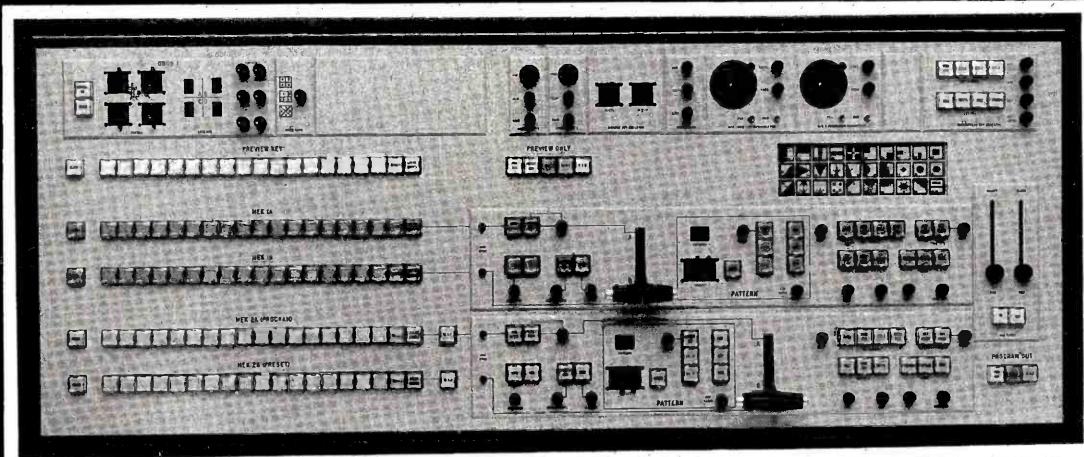

WITH THE AMERICAN DATA 558

(*) WHICH FEATURES THE ONLY FOUR CHANNEL MIX EFFECTS SYSTEM AVAILABLE — ALLOWING ALL OF THESE PRODUCTION FUNCTIONS TO BE DONE ON A SINGLE MIX EFFECTS AMPLIFIER.

- A-B Mix or Dissolve
- A-B Wipe
- A-B Wipe with Border
- A-B Wipe through 100% Border
- Mix or Dissolve to a Preset Wipe
- Wipe to a Preset Wipe
- Bordered Wipe to a Preset Wipe
- Mix or Dissolve to a Key
- Wipe to a Key or Wipe Key
- Mix to a Bordered Key
- A-B Mix Behind a Chroma Key
- A-B Wipe Behind a Chroma Key
- A-B Wipe with Borders Behind a Chroma Key
- Mix-Wipe or Bordered Wipe to a Preset Wipe Behind a Chroma Key
- Mix or Dissolve to a Luminance Key Over a Chroma Key
- Wipe to a Luminance Key over a Chroma Key
- Mix, Wipe or Dissolve to an Electronic Spotlight Behind a Chroma Key
- Mix or Wipe to a Quad Split, with or without Borders, Behind a Chroma Key
- Luminance Key over a Quad Split behind a Chroma Key
- And More —

SEE FOR YOURSELF
NAB BOOTH 403

AND JUST THINK — THE 558 HAS TWO!



AMERICAN DATA DIVISION

AIRPAX ELECTRONICS INC.

Cambridge Division
Cambridge, Md.
Circuit Breakers & Switches

Controls Division
Ft. Lauderdale, Fla.
Tachometry & Control Instrumentation

401 WYNN DRIVE • P. O. BOX 5228 • HUNTSVILLE, ALABAMA 35805 USA • TELEPHONE 205 837 5180 • TWX 810 726-2125

1729 WILMONT DRIVE
ATLANTA, GA. 30329
404 633-2100

5504 WATERWAY
ROCKVILLE, MD. 20853
301 460-1454

3250 WILSHIRE BL. STE900
LOS ANGELES, CA. 90010
213 387-7756

2908 MULBERRY
PASADENA, TX. 77502
713 941-7272

733 W. HILL AVE.
GLENN ELLYN, IL. 60137
312 469-6200

Facilities of Television

Directory of Television Stations in the United States and Canada

Key to the Listings

Listed in this directory are all TV stations in the U.S., its territories and Canada. Information received as late as Dec. 1, 1975, has been included in the listings. The following is a sample listing, with explanation of information keyed to the boldface numbers.

WOF-TV—(1) ch 2,200 kw vis, 20 kw aur, ant 500t/300g. (CP: ant 750t/550g.) (2) April 13, 1952. (3) Box 100, 99999. (909) 555-1000. TWX 909-999-9999. (4) Licensee: WOF Bcstg Co. (acq 7-20-69). (5) Ownership: See Acme Stns, also Nwspr. ■ (6) CBS, NBC. Sp 2 hrs wkly. Rep: Jones; Tri-State. Wash atty: Goltz & Stick. ■ (7) Jud Jones, pres & gen mgr; D. Spark, chief engr. ■ (8) On 6 CATV's—20,000 subs. On 10 trans. (9) Co-owned: WOF-AM-FM. ■ (10) Rates: \$100; 83; 70.

- (1) Channel, power and antenna. WOF-TV operates with 200 kilowatts (effective radiated power) visual and 20 kilowatts aural. Its antenna is 500 feet above average terrain and 300 feet above the ground; it holds a construction permit for a height increase.
 (2) Date station first went, on air (regardless of subsequent ownership changes).
 (3) Address and zip code, telephone, Teletype Writer Exchange number.
 (4) Licensee name and date of acquisition (if not original owner).

(5) Ownership. Acme Stations owns WOF-TV and several other broadcast properties, all detailed in the Group Ownership directory in section A. The station additionally has print media connections, explained in the Newspaper directory (also in section A). Principal stockholders are listed for independently owned stations.

(6) Network, foreign language, rep and Washington attorney. The primary WOF-TV national affiliate is CBS, the secondary is NBC. The station broadcasts two hours of Spanish a week. Sales representatives are listed with national rep first, then regional.

(7) Personnel.

(8) Cable and translators. WOF-TV is carried on six cable TV systems with a total of 20,000 subscribers, and on 10 rebroadcasting translators.

(9) Co-owned radio. WOF-TV has the same licensee as WOF-AM-FM.

(10) Advertising rates. The prices the station charges national advertisers for a 30-second spot are shown for each of three day-parts:

Prime time; early fringe; daytime

in that order. If a day-part is inapplicable a dash (—) replaces the rate.

* An asterisk indicates noncommercial stations.

ADI. Immediately beneath every city heading is the ranked market Area of Dominant Influence into which the city falls. ADI details are presented in the preceding ADI Atlas.

See introductory pages of the Yearbook for other abbreviations used in the listings.

Alabama

Anniston

ADI No. 194; see page B-4

WHMA-TV
 "THE BUY THAT SELLS"



WHMA-TV—ch 40, 724 kw vis, 93.3 kw aur, ant 880t/243g, Oct. 26, 1969. Box 40, 36201. (205) 237-8651. Licensee: Anniston Bcstg Co. Ownership: H. Brandt Ayers, Elise Ayers Sanguinetti, each 40%, and others. See Nwspr. ■ CBS. Rep: Savalli/Gates. Wash atty: Daly, Joyce, Borsari and George. ■ Malcolm B. Street, pres; Harry Mabry, gen mgr; Bill Hagler, nat sls mgr & news dir; Jim Vice, reg sls mgr;

TO BUY OR SELL A TELEVISION OR RADIO STATION

HAMILTON-LANDIS & ASSOC., Inc.

WASHINGTON, D.C.

1730 K St., N.W.
 (202) 393-3456

SAN FRANCISCO

111 Sutter St.
 (415) 392-5671

CHICAGO

1429 Tribune Tower
 (312) 337-2754

DALLAS

6060 N. Central Expy.
 (214) 691-2345

**NATIONWIDE • NEGOTIATIONS
 FINANCING • APPRAISALS**

Larry Sharpton, prog dir; Mimi Butler, prom mgr; James A. Hudson, chief engr. ■ On 14 CATV's—21,807 subs. Co-owned: WHMA-AM-FM. ■ Rates: \$54; 35; 21.

Birmingham

ADI No. 51; see page B-9

WAPI-TV—ch 13, 302 kw vis, 24.8 kw aur, ant

1,130t/833g. May 1949. Box 10502, 35202. (205) 933-2720. TWX 810-733-4465. Licensee: Newhouse Bcstg Corp. Ownership: See Newhouse Stns, also Nwspr. ■ NBC. Rep: Harrington, Righter & Parsons. Wash atty: Dow, Lohnes & Albertson. ■ Donald D. Wear, VP & gen mgr; Robert L. Williams, sls mgr; Everett H. Holle, prog dir; James Chenoweth, prom mgr; Wendell Harris, news dir; Paul D. Gross, chief engr. ■ Co-owned: WAPI-AM-FM.

***WBIQ**—ch 10, 316 kw vis, 25 kw aur, ant 1,050t/795g. April 28, 1955. 2101 Magnolia Ave., 35205. (205) 328-8756. Special interim authority: Ala. ETV Commission. ■ PBS. ■ Execs: See *WAIQ(TV) Montgomery.

WBMG—ch 42, 891 kw vis, 174 kw aur, ant 1,150t/903g. Oct. 17, 1965. Box 6146, 35209. (205) 252-9821. TWX 810-733-4466.

Hogan-Feldmann, Inc.
 MEDIA BROKERS • CONSULTANTS
 16255 Ventura Boulevard, Suite 415
 Encino, California 91436
 AREA CODE 213 986-3201

Alabama TV

See page B-89 for explanation of listings.

Licensee: Birmingham TV Corp. (acq 7-17-73).
Ownership: Roy H. Park 100%. See Park Bcstg.
■ CBS. Rep: Blair TV. ■ Roy H. Park, pres; Hugh M. Smith, exec VP and gen mgr; Charles Rountree, prog dir; Ray White, news dir; Fred Vinson, chief engr. ■ On 18 CATV's—50,000 subs. On 1 trans. ■ Rates: \$150; 60; 30.

WBRC-TV—ch 6, 100 kw vis, 20 kw aur, ant 1,110t/795.2g. July 1, 1949. Box 6, 35201. (205) 322-4701. TWX 810-733-3650. Licensee: Taft Bcstg Co. Ownership: See Taft Stns. ■ ABC. Rep: Telerep. Wash atty: Koteen & Burt. ■ Lawrence H. Rogers II, pres; Nick Bolton, VP & gen mgr; Richard S. Stephen, gen sls mgr; Ann Bryant, prom mgr; Chet Falzerano, opns mgr; Jerry Levin, news dir; Harry L. Lawson, chief engr. ■ On 53 CATV's—109,649 subs.

Decatur

WYUR—See Huntsville.

Demopolis

ADI No. 164; see page B-45.

***WIIQ**—ch 41, 447 kw vis, 26.5 kw aur, ant 1,082t/999g. Sept. 13, 1971. 2101 Magnolia Ave., Birmingham 35205. Special interim authority: Ala. ETV Commission. ■ PBS. ■ Execs: See *WAIQ(TV) Montgomery.

Dothan

ADI No. 159; see page B-22.



WDHN—ch 18, 1,080.4 kw vis, 216 kw aur, ant 730t/796.2g. Aug. 7, 1970. Box 2228, 36301. (205) 794-2651. Licensee: Southeast Alabama Bcstg Inc. Ownership: Sam Blumberg Jr., 10.718%; Jay B. Bragg, 12.076%. ■ ABC. Rep: Savalli/Gates. Wash atty: Morgan, Lewis & Bockius. ■ Betts Slingluff Jr., dir; Emery McCullough, gen mgr; Robert Haden, sls mgr; Glenn Daniels, news dir; Richard Blanton, chief engr. ■ On 24 CATV's—48,605 subs. ■ Rates: \$40; 26; 17.

WTVY—ch 4, 100 kw vis, 20 kw aur, ant 1,670t/1,709g. Feb. 12, 1955. Box 1089, 36301. (205) 792-3195. TWX 810-744-3070. Licensee: WTVY Inc. Ownership: Charles Woods 100%. See WTVY Stns. ■ CBS. Rep: Meeker. Wash atty: Miller, Schroeder & Bankson. ■ Charles Woods, pres & gen mgr; John Gause, sls mgr; Bob Howell, news dir; Rebecca Ledensham, prom mgr; Charles Woods, film buyer; Ellis N. Anderson, chief engr. ■ On 12 CATV's. Co-owned: WTVY-FM. ■ Rates: \$150; 130; 50.

Dozier

ADI No. 121; see page B-49

***WDIQ**—ch 2, 100 kw vis, 10 kw aur, ant 695t/571g. Aug. 8, 1956. 2101 Magnolia Ave., Birmingham, 35205. Permittee: Ala. ETV Commission. ■ PBS. ■ Execs: See *WAIQ(TV) Montgomery.

Florence

ADI No. 99; see page B-33

***WFIQ**—ch 36, 589 kw vis, 58.9 kw aur, ant

760t/538g. Aug. 16, 1967. 2101 Magnolia Ave., Birmingham, 35205. Permittee: Ala. ETV Commission. ■ PBS. ■ Execs: See *WAIQ(TV) Montgomery.

WOWL-TV—ch 15, 230 kw vis, 23.6 kw aur, ant 400t/358g. Oct. 27, 1957. Box 2220, 35630. (205) 764-7711. Licensee: TV Muscle Shoals Inc. Ownership: Richard B. Biddle, 76%; Frederick A. Biddle, 10%; Barbara Biddle, 10%; Jack A. Worley 4%. ■ NBC. Rep: Savalli/Gates, Southern TV. ■ Richard B. Biddle, pres & natl sls mgr; Jack A. Worley, VP & film buyer; Tom D. Pepper, opns mgr; John Halbert, news dir; Patsy Johnson, traf mgr; Larry Rohling, chief engr. ■ On 16 CATV's—30,000 subs. Co-owned: WOWL(AM).

Huntsville

ADI No. 99; see page B-33

WAAY-TV—ch 31, 1,255 kw vis, 125 kw aur, ant 1,290t/455g. Aug. 1, 1959. 1000 Monte Sano Blvd. S.E., 35801. (205) 539-1783. Licensee: Rocket City TV Inc. Ownership: M. Davidson Smith III. ■ NBC. Rep: Young-VTM. Wash atty: Cohn & Marks. ■ M. D. Smith IV, pres & gen mgr; Daniel Whitsett, VP & sls mgr; Tony Worley, prog dir; Adrian Gibson, news dir; Robert Gay, chief engr. ■ On 26 CATV's—90,000 subs. Co-owned: WAAY(AM).

***WHIQ**—ch 25, 631 kw vis, 126 kw aur, ant 1,170t/342g. November 1965. 2101 Magnolia Ave., Birmingham, 35205. Permittee: Ala. ETV Commission. ■ PBS. ■ Execs: See *WAIQ(TV) Montgomery.

WHNT-TV—ch 19, 1,279 kw vis, 254 kw aur, ant 1,750t/944g. Nov. 28, 1963. Box 19, 35804. (205) 539-5743. TWX 810-726-2221. Licensee: N. Ala. Bcstrs Inc. Ownership: See Grisham, Davis, Godbold, Aronov Stns. ■ CBS. Rep: Katz. Wash atty: Fly, Shuebruk, Blume & Gaguine. ■ Charles F. Grisham, pres; Tom Percer, exec VP & gen mgr; Ralph Stanley, VP & sls mgr; Dick Wright, prom mgr; opns mgr; Jerome M. Hall, chief engr. ■ On 33 CATV's—90,000 subs.

WYUR—ch 48, 1,790 kw vis, 360 kw aur, ant 1,195t/818g. July 4, 1954. 4848 Governor Dr., 35801. (205) 533-4848. TWX 810-726-2192. Licensee: Tenn. Valley Radio & TV Corp. Ownership: International Television Corp. (acq 10-74). Gerald V. Bull, Donald G. Martin 36.8% each. ■ ABC. Rep: Spot Masters Inc. Wash atty: Fowler and Myers. ■ Donald G. Martin, pres; William G. Evans, gen mgr; Howard Trickey, sls mgr; Becky Bean, prog dir & prom mgr; Paul Buxton, news dir; Mack Bramlett, film buyer & chief engr. ■ On 32 CATV's. ■ Rates: \$110; 65; 20.

Louisville

ADI No. 116; see page B-17

***WGIQ**—ch 43, 708 kw vis, 70.8 kw aur; ant 940t/795g. Sept. 9, 1968. 2101 Magnolia Ave., Birmingham, 35205. Permittee: Ala. ETV Commission. ■ PBS. ■ Execs: See *WAIQ(TV) Montgomery.

Mobile

ADI No. 65; see page B-48

WALA-TV—ch 10, 316 kw vis, 47 kw aur, ant 1,246t/1,200g. Jan. 14, 1953. Box 1548, 36601. (205) 433-3754. TWX 810-741-2642. Licensee: Universal Communications Corp. Ownership: See Evening News Assn Stn. ■ NBC. Rep: Blair. Wash atty: Pierson, Ball & Dowd. ■ H. Ray McGuire, VP & gen mgr & film buyer; Pete Williams, sls mgr; Claude Evans, prog dir; Alan Batten, bs mgr; Carlton Cordell, news dir; Betty Griffen, prom dir; Grady Jackson, chief engr. ■ On 19 CATV's—80,000 subs. ■ Rates: \$155; 100; 30.

WEAR-TV—(Pensacola, Fla.) ch 3, 100 kw vis, 20 kw aur, ant 1,220t/1,257g. Jan. 13, 1954. Box 12278, Pensacola, Fla. 32581. (904) 455-7311. TWX 510-737-7952. Licensee: Rollins Telecasting Inc. Ownership: See Rollins Bcstg Co. Stns. ■ ABC. Rep: H-R Television Inc. Wash atty: Smith & Pepper. ■ O. Wayne Rollins, pres; Mill De Reyna Jr., film buyer & gen mgr; Jim Grimes, sls mgr; Mike Carey, prom mgr; Jim Harper, opns dir; Jim Pennington, news dir; Harry Babb, chief engr. ■ On 5 CATV's.

***WEIQ**—ch 42, 234 kw vis, 23.4 kw aur, ant 600t/543g. Nov. 6, 1964. 2101 Magnolia Ave., Birmingham, 35205. Permittee: Ala. ETV Commission. ■ PBS. ■ Execs: See *WAIQ(TV) Montgomery.

WKRG-TV—ch 5, 100 kw vis, 20 kw aur, ant 1,050t/999g. Sept. 5, 1955. Box 2367, 36601. (205) 432-5501. TWX 810-741-4263. Licensee: WKRG Inc. Ownership: Kenneth R. Giddens, 100%. ■ CBS. Rep: Katz. Wash atty: McKenna, Wilkinson & Kittner. ■ Mrs. Kenneth R. Giddens, pres & treas; C. P. Persons Jr., exec VP gen mgr & film buyer; D. H. Long, VP & sls mgr; Bob Lee, news dir; T. Wesley Diamond, prom mgr; Curtis B. Willard, chief engr. ■ On 32 CATV's—80,000 subs. Co-owned: WKRG-AM-FM.

Montgomery

ADI No. 121; see page B-49

***WAIQ**—ch 26, 229 kw vis, 23.6 kw aur, ant 590t/553g. Dec. 18, 1962. 2101 Magnolia Ave., Birmingham, 35205. (205) 328-8756 (Birmingham). Special interim authority: Ala. ETV Commission. ■ PBS. Wash atty: Hogan & Hartson. ■ Ned Butler, pres; Denis N. Stork, gen sls mgr; Henry L. Bonner, dir of progmg; Al Renfro, net engr dir. Studios & exec: Auburn Sts., Ed Wegener, dir; Jim Stone, chief engr; Birmingham Area ETV Assn., 2316 7th Ave. N., Frank Martin, dir; Tom Arledge, chief engr; U. Of Ala., Bud Russell, dir; Joe Stuckey, chief engr; Montgomery ETV Ctr, 1302 Upper Wetumpka Rd., Wilbur H. Hinton, dir; Ed Mastin, chief engr; Huntsville, David Maixer, dir; Danny Bramlett, chief engr; Montealla U. Karl Perkins, dir; Ray Sosa, chief engr; A & M Univ., Normal, Ala., Neil Traugh, dir. ■ On 80 CATV's—200,000 subs.

WCOV-TV—ch 20, 550 kw vis, 112 kw aur, ant 740t/793g. April 23, 1953. Box 2505, 36105. (205) 288-7020. TWX 810-728-3204. Licensee: WCOV Inc. (acq 10-64). Ownership: See Gay-Bell Stns. ■ CBS. Rep: Meeker; Busby, Finch & Woods. Wash atty: Smith, Pepper, Shack & L'Heureux. ■ Harry Barfield, pres; Karl Richards, VP & gen mgr; Ed White, VP, reg & natl sls; Sonny Strassburger, loc sls; Jim Hall, opns dir & film buyer; Fred Thompson, news dir; Phil Witt, chief engr. ■ On 17 CATV's—23,825 subs. Co-owned: WCOV(AM).

WKAB-TV—ch 32, 1,133 kw vis, 83.2 kw aur, ant 830t/762g. March 12, 1964. Box 3236, 36109. (205) 272-5331. Licensee: Montgomery Ind Telecasters Inc. Ownership: See Bahakel Stns. ■ ABC. Rep: Savalli/Gates. Wash atty: Wilmer, Cutler & Pickering. ■ Cy Bahakel, pres; Ed Johnson, gen mgr; Richard J. Peluso, gen sls and stn mgr; Judy Motowicki, prog dir; George Tee, news dir; Terry Hattaway, prod mgr; Pat Hartman, prom mgr; William E. Taylor, chief engr. ■ On 20 CATV's—30,194 subs. ■ Rates: \$70; 30; 5.

WSFA-TV—ch 12, 316 kw vis, 47.4 kw aur, ant 1,040t/823g. (CP: 288 kw vis, 24.6 kw aur, ant 2,000t/1951g. Dec. 25, 1954. Box 2566, 36105. (205) 281-2900. TWX 205-272-4194. Licensee: Cosmos Bcstg Corp. Ownership: Liberty Corp. ■ NBC. Rep: Peters, Griffin, Woodward. Wash atty: Dow, Lohnes & Albertson. ■ Charles A. Batson, pres; Thomas Josephsen, gen mgr; Frank G. Potts, sls mgr; John T. Schmuhl, asst gen mgr, prog-prom mgr & film buyer; Clark Edwards, news dir; Dick

Payne, chief engr. ■ On 19 CATV's—25,900 subs. ■ Rates: \$195; 125; 70.

Mount Cheaha State Park

ADI No. 51; see page B-9

***WCIO**—ch 7, 316 kw vis, 31.6 kw aur, ant 2,000/581g. Jan. 7, 1955. 2101 Magnolia Ave., Birmingham, 35205. Permittee: Ala. ETV Commission. ■ PBS. ■ Execs: See *WAIQ(TV) Montgomery.

Selma

ADI No. 205; see page B-66

WSLA—ch 8, 53.7 kw vis, 10.7 kw aur, ant 360/387g. Nov. 1, 1973. Box 1888, 36701. (205) 875-2240. Licensee: Central Alabama Bcstrs Inc. Ownership: See Grisham-Davis-Aronov-Godbold Stations. ■ CBS. Rep: Devney; Busby, Finch, Lathom and Widman. Wash atty: Fly, Schuebruk, Blume, Gaguine. ■ Thomas G. Bond, gen and sls mgr; George Singleton, opns mgr; Earl Johnson, chief engr. ■ On 8 CATV's.

Tuscaloosa

ADI No. 190; see page B-73

WCFT-TV—ch 33, 596 kw vis, 108 kw aur, ant 550/442g. Oct. 27, 1965. Box 5239, 35401. (205) 553-1333. TWX 205-460-1645. Licensee: Chapman TV of Tuscaloosa Inc. Ownership: See Rosenbaum-Smylie Stns. ■ CBS. Rep: Young-VTM. Wash atty: McKenna, Wilkinson & Kittner. ■ W. S. Smylie, pres; Stan Siegal, VP, gen & sls mgr; Jim Caruthers, local sls mgr; Tommy Ray, prog dir; Bob Crawford, news dir; Marvin Reuben, film buyer; Gail Garretson, prom mgr; Don Langford, chief engr. ■ On 19 CATV's—34,000 subs. ■ Rates: \$50; 25; 15.

Alaska

HAMILTON-LANDIS & ASSOCIATES, Inc.
NATIONWIDE MEDIA BROKERS
WASHINGTON, D. C., CHICAGO, DALLAS,
SAN FRANCISCO
SELL **MORE**
RADIO & TELEVISION STATIONS
IN THE WEST—NEAREST OFFICE IS—
111 SUTTER ST., SAN FRANCISCO 94104
(415) 392-5671

Anchorage

ADI No. 176; see page B-4

***KAKM**—ch 7, 105 kw vis, 22.9 kw aur, ant 186/230g. 1975. 2530 Providence Drive, 99504. (907) 277-7772. Licensee: Alaska Public Television Inc. ■ PBS. Wash atty: McKenna, Wilkinson & Kittner. ■ William Mack, bd chmn; William Jackson, exec dir & gen mgr; Ed Smith, vice chmn; Mrs. Wade Jackinsky, treas; Beverly Isenson, sec. ■ On 2 trans.

KENI-TV

Midnight Sun Broadcasters, Inc.



KENI-TV—ch 2, 28.8 kw vis, 5.74 kw aur, ant

180/291g. December 1953. Box 1160, 99510. (907) 279-7477. TWX: (090) 25186. Licensee: Midnight Sun Bcstrs Inc. Ownership: See Midnight Sun Stns. ■ NBC. Rep: Avery-Knodel; Simpson-Reilly. Wash atty: Fisher, Wayland, Southmayd & Cooper. ■ Alvin O. Bramstedt, pres & gen mgr; Jhan Hiber, stn mgr; Paul Wonder, news dir; Charles M. Gray, VP & tech dir; Sandra Moore, prog coord; Elizabeth Berg, Seattle film buyer. ■ Rates: \$50; 34; 14.

KIMO—ch 13, 30.9 kw vis, 6.17 kw aur, ant 90/350g. Oct. 31, 1967. 3910 Seward Highway, 99503. (907) 279-9437. Licensee: Central Alaska Bcstg. (acq 6-1-71). Ownership: Carl A. Bracale, 21%; Duane L. Triplett, 17%; Richard M. Zook, 15%; Robert L. Lewis, 11%, and others. ■ ABC; Hughes. Rep: Masla; Tacher. Wash atty: Haley, Bader & Potts. ■ Carl Bracale, pres & gen mgr; Richard Mystrom, sls mgr; Mary Lou Lauer, prom mgr; Richard Zook, chief engr.

KTVB—ch 11, 26.3 kw vis, 5.25 kw aur, ant 300/392g. Dec. 11, 1953. 1007 West 32d Ave., 99503. (907) 272-3456. Licensee: Northern TV Inc. Ownership: See Northern TV Stns. ■ CBS. Rep: Young; Moore (Seattle, Portland). Wash atty: Booth & Freret. ■ A. G. Hiebert, pres; Ron L. Moore, VP, gen & sls mgr; James Koonce, opns mgr & buyer; Nancy Bergh, prom mgr; Jerry Rose, news dir; George Howard, chief engr. ■ Co-owned: KBYR(AM)-KNIK(FM).

Bethel

***KYUK-TV**—ch 4, 4.68 kw vis, 933 w aur, ant 205.65/253g. August 1973. Box 468, 99559. (907) 543-2644. Permittee: Bethel Bcstg Inc. ■ PBS. Wash atty: McKenna, Wilkinson & Kittner. ■ Jim Croll, gen mgr; Henry Ivanoff, prom mgr; Rosie Porter, prog dir; Bob Tinkle, chief engr. ■ On 15 trans. Co-owned: KYUK(AM).

Fairbanks

KFAR-TV—ch 2, 5.37 kw vis, 676 w aur, ant 45/200g. March 1, 1955. 516 Second Ave., 99701. (907) 452-2125. Licensee: Midnight Sun Bcstrs Inc. Ownership: See Midnight Sun Stns. ■ ABC, NBC. Rep: Fletcher; Simpson-Reilly. Wash atty: Fisher, Wayland, Southmayd & Cooper. ■ Alvin O. Bramstedt, gen mgr; Don Andon, stn mgr; Lee Russell, prog dir; Bob Parsons, coml mgr; Maury Smith, news dir; Don Garrett, chief engr. ■ On 7 trans. Co-owned: KFAR(AM).

KTVF

Northern Television, Inc.



KTVF—ch 11, 27.5 kw vis, 5.5 kw aur, ant 50/168g. Feb 17, 1955. Box 950, 99707. (907) 452-5121. Licensee: Northern TV Inc. Ownership: See Northern TV Stns. ■ CBS, ABC. Rep: Young-VTM; Alaska Radio-TV Sales; Art Moore. Wash atty: Booth & Freret. ■ A. G. Hiebert, pres; Theodore Lehne, VP & gen mgr; Mrs. Jan Taylor, gen sls mgr; Mimi McKinney, Jeff Phillips, opns mgrs; George Sample, news dir. ■ On 24 trans. Co-owned: KFRB(AM). ■ Rates: \$35; 24; 12.

***KUAC-TV**—ch 9, 56.2 kw vis, 10 kw aur, ant 500/151g. Dec. 22, 1971. University of Alaska, 99701. (907) 479-7491. Telex: 090-35311. Licensee: U. of Alaska. ■ PBS. Wash atty: McKenna, Wilkinson & Kittner. ■ Don M. Dafoe, exec VP; Donald B. Upham, gen mgr; Paul E. Hartman, prog dir; Myron A. Tisdell, prod mgr; Henry H. Howe, chief engr. ■ On 4 trans. Co-owned: *KUAC(FM).

Alabama, Alaska, Arizona TV

See page B-89 for explanation of listings.

Juneau

KINY-TV—ch 8, 239 w vis, 47 w aur, ant 1,160/69g. Feb. 19, 1956. 231 S. Franklin St., 99801. (907) 586-1800. Licensee: Midnight Sun Bcstrs Inc. Ownership: See Midnight Sun Stns. ■ NBC. Rep: Fletcher; Simpson/Reilly. Wash atty: Fisher, Wayland, Southmayd & Cooper. ■ A. O. Bramstedt, pres; Kenneth Wiley, stn mgr; Paul Rider, prog & news dir; Dave Moore, chief engr. ■ On 1 CATV—8,000 subs. On 1 trans. Co-owned: KINY(AM). ■ Rates: \$18; 14; 8.

Sitka

KIFW-TV—ch 13, 199 w vis, 30 w aur, 150/157g. Sept. 1, 1966. Box 299, 99835. (907) 747-6626, -6627. Licensee: Sitka Bcstg Co. Ownership: Roy Paschal, 72.29%; Steve Rhyner, 10.13%. ■ CBS, ABC. Rep: Young; Alaska Radio TV Sls. Wash atty: Haley, Bader & Potts. ■ Roy Paschal, pres & gen mgr; Steven L. Rhyner, stn & sls mgr & news dir; Martin Strand, prog dir; Harry Lanz, prom mgr; Steve Goodwin, consulting engr. ■ On 1 CATV—1000 subs. Co-owned: KIFW(AM). ■ Rates: \$12.50; 10.50; 7.50.

Arizona

Flagstaff

ADI No. 205; see page B-26

KOAI—ch 2, 24.5 kw vis, 4.9 kw aur, ant 1,597/284g. May 2, 1970. Box 1843, 86001. (602) 774-1818. TWX 910-972-0968. Licensee: Grand Canyon TV Co. Ownership: Wendell Elliott Jr., 30.8%; Charles J. Saunders, 14.8%, et al. ■ NBC. Wash atty: Wilkinson, Cragun & Barker. ■ Wendell Elliott Jr., pres, gen & sls mgr; Greg Crosman, prog dir; Kenneth H. Karr, chief engr. ■ On 5 trans. On 7 CATV's—14,151 subs. ■ Rates: \$29; 19; 13.

Mesa

KTAR-TV—Licensed to Mesa. See Phoenix.

Nogales

KZAZ—Licensed to Nogales. See Tucson.

Phoenix

ADI No. 37; see page B-56

***KAET**—ch 8, 117 kw vis, 16.2 kw aur, ant 1,620/177g. Jan. 30, 1961. Arizona State U., Tempe, 85281. (602) 965-3506. Licensee: Ariz. Bd of Regents. ■ PBS. ■ Robert H. Ellis, dir of bcstg & gen mgr; Joseph Zesbaugh, stn mgr & prog dir; Frank Blythe, opns mgr; Richard Peterson, prod mgr; Steve Smith, comm svc dir; Carolyn Kowalski, info dir; Victor R. Turner, chief engr. ■ On 5 CATV's—8,550 subs.

KNXV-TV—ch 15, 285 kw vis, 28.5 kw aur, ant 1753 ft. Not on air, target date unknown. 3033 N. Central Ave., Suite 209, 85012. Licensee:

Arizona, Arkansas TV

See page B-89 for explanation of listings.

New Television Corp. Ownership: Edward Cooperstein, 50.5%; Thomas H. Brodeur, 36.4% et al. ■ Wash atty: Fly, Shuebruk, Blume & Gaguine.

KOOL-TV—ch 10, 316 kw vis, 46.8 kw aur, ant 1,700t/264g. Oct. 24, 1953. 511 W. Adams, 85016. (602) 257-1234. TWX 910-951-1343. Licensee: KOOL Radio-TV Inc. Ownership: Gene Autry, 48.11%; Tom Chauncey, 49.89%; Homer Lane, 2.00%. See Golden West Stns. ■ CBS. Rep: H-R. Wash atty: Dow, Lohnes & Albertson. ■ Gene Autry, chmn of bd; Tom Chauncey, pres; Homer Lane, exec VP & gen mgr; Les Lindvig, VP TV & gen sls mgr; Bob Davies, VP spec proj, sppts; William J. Close, VP, news; Bob Martin, VP & asst mgr, prog; Marge Injasoulain, VP inform svcs, prom; Alvin R. Hillstrom, VP engineering. ■ On 16 trans. On 15 CATV's—66,300 subs. Co-owned: KOOL-AM-FM. ■ Rates: \$450; 375; 100.

KPAZ-TV—ch 21, 646 kw vis, 247 kw aur, ant 2,143t/178g. Sept. 16, 1967. 3847 E. Thomas Rd., 85018. (602) 273-1477. Licensee and owner: Glad Tidings Church of America. (acq 11-15-70). ■ Wash atty: Booth & Freret. ■ L. A. Edmonds, gen mgr; Keith A. Houser, prom mgr, film buyer, & prog & news dir; Fred Falduti, sls mgr; Ted Turner, chief engr. ■ On 10 CATV's—30,000 subs. On 2 trans.

KPHO-TV—ch 5, 100 kw vis, 15 kw aur, ant 1,770t/387g. Dec. 4, 1949. 4016 N. Black Canyon, 85017. (602) 248-7474. TWX 910-951-1519. Licensee: Meredith Corp. (acq 1952). Ownership: See Meredith Stns, also Nwspr. ■ Rep: MMT. Wash atty: Haley, Bader & Potts. ■ W. C. McReynolds, VP & gen mgr; Norris Reichel, gen sls mgr; Ed Aiken, prog dir; Ken Robinson, news dir; Linda Stone, prom mgr; Glenn Thompson, dir engr. ■ On 24 CATV's—49,557 subs. On 10 trans.

KTAR-TV (Mesa)—ch 12, 316 kw vis, 46.8 kw aur, ant 1,780t/350g. April 23, 1953. Box 711, Phoenix, 85001. (602) 258-7333. TWX 910-951-4214. Licensee: KTAR Bcstg Co. Ownership: See Combined Communications Stns. ■ NBC. Rep: Peters, Griffin, Woodward. Wash atty: Pierson, Ball & Dowd. ■ John J. Louis, bd chmn; Robert L. Brown, pres & gen mgr; Randy Cantrell, VP & gen sls mgr; Bob Allingham, VP prog & stn mgr; Bill Tucker, news director; Cliff Stevens, VP engr. ■ On 15 CATV's—20,000 subs. Co-owned: KTAR(AM)-KBBC(FM). ■ Rates: \$450; 195; 60.

KTVK—ch 3, 100 kw vis, 15.1 kw aur, ant 1,670t/231g. Feb. 28, 1955. 3435 N. 16th St., 85010. (602) 266-5691. TWX 602-255-0544. Licensee: Ariz. TV Co. Ownership: Ernest W. McFarland, 41.07%; Leon W. Nowell, 19.71%; Delbert R. Lewis, 12.40% & others. ■ ABC. Rep: Petry. ■ Ernest W. McFarland, pres; Burton B. LaDow, gen mgr & film buyer; Charles Glance, prog dir; Earl Mehaffey, chief engr. ■ On 24 CATV's. On 8 trans.

Tucson

ADI No. 95; see page B-73

KGUN-TV—ch 9, 110 kw vis, 21.9 kw aur, ant 3,660t/237g. June 3, 1956. Box 5707, 85703. (602) 792-9933. TWX 910-952-1265. Licensee: May Bcstg Co. Ownership: See May Bcstg Stns. ■ ABC. Sp 3 hrs wkly. Rep: Petry. Wash atty: McKenna, Wilkinson & Kittner. ■ Edward W. May, pres; Owen L. Saddler, exec VP; George Wallace, VP & gen mgr; Scott Vaughan, gen sls mgr; Jack Jacobson, prog dir; Pat Stevens, news dir; Glen Hills, chief engr; Paul J. Falvey, compt. ■ On 6 CATV's—20,000 subs. On 9 trans. ■ Rates: \$220; 60; 20.

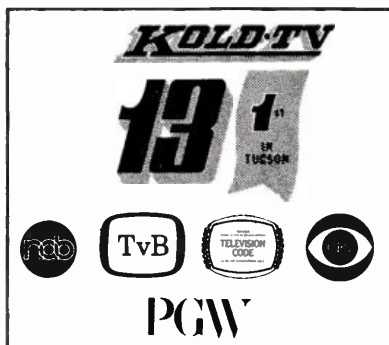

KOLD-TV—ch 13, 107 kw vis, 15.6 kw aur, ant 3,610t/201.8g. Jan 13, 1953. 115 W. Drachman St., 85705. (602) 624-2511. TWX 602-792-2701. Licensee: Universal Communications Corp. Ownership: See Evening News Assn Stns. ■ CBS. Sp 2½ hrs wkly. Rep: Peters, Griffin, Woodward. Wash atty: Pierson, Ball & Dowd. ■ Peter B. Clark, pres; Paul Plunkett, VP, gen mgr; Charles Olson, sls mgr; Dave Reaban, opns mgr, prog dir & film buyer; Karl Kindberg, news dir; Howard Smith, chief engr. ■ On 11 CATV's—8,554 subs. On 15 trans. ■ Rates: \$225; 90; 25.

***KUAT-TV**—ch 6, 35.5 kw vis, 3.5 kw aur, ant 3,630t/196g. March 8, 1959. U. of Ariz., 85721. (602) 884-1434. Licensee: Ariz. Bd of Regents, U. of Arizona. ■ PBS. ■ Frank Barreca, gen mgr; Wesley Marshall, stn mgr; Marvin Smith II, prod mgr; Robert Hendrickson, chief engr. ■ On 4 CATV's. On 1 trans. Co-owned: *KUAT-AM-FM.

KVOA-TV—ch 4, 35 kw vis, 18 kw aur, ant 3,610t/223g. Sept. 15, 1953. Box 5188, 85703. (602) 623-2555. TWX 910-952-1100. Licensee: Channel 4-TV (acq 1-1-73). Ownership: Donald R. Diamond, 30%; Donald Pitt, 30%; Richard L. Bloch, 30%; Jack M. Gumbin, 10%. See Donrey Media Group. ■ NBC. Rep: Blair. Wash atty: Smith & Pepper. ■ Jon F. Ruby, gen mgr; Holland Williams, opns mgr; Gary Anderson, news dir; Dick Daggett, gen sls mgr; Ray Holsclaw, chief engr. ■ On 11 CATV's—16,000 subs. On 15 trans.

KZAZ (Nogales)—ch 11, 150 kw vis, 15 kw aur, ant 1,570t/110g. Feb. 1, 1967. Box 6026, Tucson, 85716. (602) 795-0311. Licensee: IBC (limited partnership). Ownership: Danny Thomas, 53.03%; Ziffren & Ziffren, 17.677%; Carlotta Kirkeby, 17.929% & others. ■ Rep: Avco. Wash atty: Mallyck & Bernton. ■ Gene Adelstein, gen mgr, gen sls mgr & film buyer; Harry West, prog dir; Anne Rigg, prom mgr; George Borozan & John Scott, news dirs; Richard Heatley, chief engr. ■ On 1 CATV—10,000 subs.

Yuma

ADI No. 184; see page B-23

KBLU-TV—ch 13, 316 kw vis, 31.6 kw aur, ant 1,420t/203g. Dec. 1, 1963. Box 1501, 85364. (602) 782-3881. TWX 910-953-1650. Licensee: KBLU Bcstg Co. (acq 8-7-3). Ownership: Robert W. Crites, 20%; Horace G. Murfin, 13%; Victor A. Root, 13%, et al. ■ NBC. Rep: Avery-Knodel. Wash atty: Mark E. Fields. ■ Robert W. Crites, pres & gen mgr; Jim Evans, sls mgr; Charlie Bartell, prog dir; Lou Dobbs, news dir; Richard Nix, chief engr. ■ On 10 CATV's—23,100 subs. On 2 trans. Co-owned: KBLU(AM). ■ Rates: \$35; 30; 12.

Arkansas

Arkadelphia

*KETG—ch 9, 300 kw vis, 60 kw aur, ant

1,086t/116g. Not on air, target date unknown. 350 S. Donaghey St., Conway, 72032. Arkansas Educ Television Commission. ■ Lee Reaves, dir.

El Dorado

ADI No. 112; see page B-48

KNOE-TV—see Monroe, La.

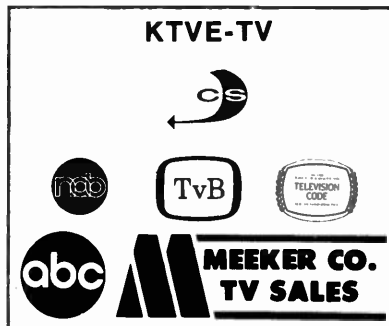

KTVE-TV—ch 10, 316 kw vis, 63.1 kw aur, ant 1,320t/1,348g. Dec. 3, 1955. Box 791, 400 W. Main, 71730. (501) 862-3488. In Monroe, La: 206 Catalpa, 71203. (318) 323-7716. TWX 910-720-7881. Licensee: KTVE Inc. Ownership: See Gray Communications Stns. ■ ABC. Rep: Meeker. Wash atty: Kirkland, Ellis & Rowe. ■ James H. Gray, pres; James S. Tighe, VP, gen mgr, sls mgr & film buyer; Mike Dumas, news dir; Pete Sparks, chief engr. ■ On 33 CATV's—64,500 subs. On 1 trans.

Fayetteville

ADI No. 82; see page B-73

*KAFT—ch 13, 297.5 kw vis, 59.5 aur, ant 1,687t/1,348g. Not on air, target date unknown. 350 S. Donaghey St., Conway, 72032. Arkansas Educl Television Commission. ■ Lee Reaves, dir.

KGTO-TV—ch 36, 1,450 kw vis, 148 kw aur, ant 820t/450g. Feb. 9, 1969. Box 4097, 72701. (501) 521-4111. Licensee: Noark Investment Co. (acq 4-30-75). Ownership: George T. Herrreich. ■ NBC, ABC. Rep: Savalli/Gates. Wash atty: Dow, Lohnes & Albertson. ■ Paul W. Milam Jr, VP, gen mgr & prog dir; Don McKinney, chief engr. ■ On 9 CATV's—30,000 subs.

Fort Smith

ADI No. 142; see page B-27

KFPW-TV—ch 40, 811 kw vis, 162 kw aur, ant 424t/496g. July 28, 1971. 2415 N. Albert Pike, 72901. (501) 783-4105. TWX 910-723-7661. Permittee: KFPW Bcstg Co. Ownership: George T. Herrreich. ■ CBS, ABC. Rep: Meeker. Wash atty: Hamel, Park, McCabe & Saunders. ■ George Herrreich, pres; John Whitt, gen mgr; Pat Porta, prog dir. ■ On 20 CATV's—24,000 subs. Co-owned: KFPW(AM).

KFSM-TV—ch 5, 100 kw vis, 12.7 kw aur, ant 1,260t/1,173g. Dec. 3, 1956. 318 N. 13th St., 72901. (501) 783-3131. TWX 910-723-7672. Licensee: Buford Television Inc. (acq 6-1-73). Ownership: Robert P. Buford, Geoffrey Buford, Gerald Buford. ■ NBC, ABC. Rep: Avery-Knodel. Wash atty: McKenna, Wilkinson & Kittner. ■ Robert P. Buford, pres; Robert Browning, gen mgr; Gordon Brown, sls mgr; Ralph Coleman, news dir; Jim Anhalt, chief engr. ■ On 35 CATV's—70,000 subs.

KLMM—ch 24, 513 kw vis, 102 kw aur, ant 920.6t/541.3g. Not on air, target date unknown. c/o Melvin B. Caldwell, 2201 Mississippi Ave., Joplin, Mo., 64801. MCM Bcstg Co. ■ David C. McClinton, 26%; Clark C. McClinton, 25%; Melvin B. Caldwell, 20%, et al.

Jonesboro

ADI No. 188; see page B-35

KAIT-TV—ch 8, 141 kw vis, 28.2 kw aur, ant 420t/342g. July 15, 1963. Box 790, 72401. (501) 932-4288. TWX 910-728-6503. Licensee: George T. Herrreich. Ownership: Mr. Herrreich, 100%. ■ ABC. Rep: Meeker; Gray. Wash atty: Hamel, Park, McCabe and Saunders. ■ Robert Herrreich, pres & gen mgr; Darrel Cunningham, stn mgr; Al Blanks, sls mgr; Mary Smith, prog dir; Jack Hill, news dir; Don Vest, chief engr. ■ On 24 CATV's—26,000 subs. ■ Rates: \$56; 38; 20.

***KTEJ**—ch 19, 933 kw vis, 186 kw aur, ant 1,020t/949g. Not on air, target date March 1976. 350 S. Donaghey, Conway, 72032. (501) 329-3887. Permitee: Arkansas ETV Commission. ■ PBS. Wash atty: Pierson, Ball & Dowd. ■ Mrs. O. P. Hammons, chmn; Lee Reaves, gen mgr; Herbert H. Lawrence, instructional administrator; Fred H. Schmutz, prog dir; Vernon L. Dillaplain, chief engr.

Little Rock

ADI No. 57; see page B-40

KARK-TV—ch 4, 100 kw vis, 20 kw aur, ant 1,650t/1,175g. April 15, 1954. 10th & Spring Sts., 72203. (501) 376-2481. TWX 910-722-7417. Licensee: Combined Communications Corp. (acq 2-1-72). Ownership: See Combined Communications Corp. ■ NBC. Rep: Peters, Griffin, Woodward. Wash atty: Pierson, Ball & Dowd. ■ David J. Jones, pres, gen mgr & film buyer; Ray Brown, sls mgr; Jim Tuley, prog dir; Sue Gibson, prom mgr; John Reeder, news dir; Dean Howard, chief engr. ■ On 45 CATV's—55,150 subs.

KATV—ch 7, 240 kw vis, 47.9 kw aur, ant 1,940t/2,000g. Dec. 18, 1953. 401 Main, Box 77, 72203. (501) 374-1691. TWX 501-721-8372. Licensee: Leake TV Inc. Ownership: See Leake TV Inc. ■ ABC. Rep: Peetry. Wash atty: Fletcher, Heald, Rowell, Kenehan & Hildreth. ■ Robert Doubleday, pres; Eric Nelson, gen mgr; Ed Hunt, sls mgr; Kathy McClanahan, prom mgr; Jim Pitcock, news dir; Rudy Garrett, chief engr. ■ On 30 CATV's—31,125 subs.

***KETS**—ch 2, 100 kw vis, 20 kw aur, ant 1,780t/2,000g. Dec. 4, 1966. 350 S. Donaghey, Conway, 72032. (501) 375-2431. TWX 501-327-1878. Licensee: Arkansas ETV Commission. ■ PBS. Wash atty: Pierson, Ball & Dowd. ■ Mrs. O. P. Hammons, chmn; Herbert H. Lawrence, instructional admin; Lee Reaves, gen mgr; Fred H. Schmutz, prog dir; Vernon L. Dillaplain, chief engr. ■ On 35 CATV's.

KTHV—ch 11, 316 kw vis, 38 kw aur, ant 1,760t/1,175g. Nov. 28, 1955. Box 269, 72203. (501) 374-3764. TWX 910-722-7486. Licensee: Ark. TV Co. Ownership: Radio Bcstg Inc. 42%; Ark. Democrat Co. (Arkansas Democrat), 32%; C. W. Lowry, 16%; K. A. Engel estate, 10%. See Nwspr. ■ CBS. Rep: H-R. Wash atty: Dempsey & Koplovitz. ■ C. E. Lowry, pres; B. G. Robertson, VP & gen mgr; Mack S. Walker, sls mgr; Jack Bomar, prog dir; Charles Kelly, news dir; G. Blair Robertson, prom mgr; Cecil Suitt, chief engr.

California

Anaheim

ADI No. 2; see page B-41

New TV—ch 56, 5 kw vis, 1 kw aur, ant 1,865t/182g. Not on air yet; target date unknown. 125 S. Claudina, 92805. Licensee: Golden Orange Bcstg Co. Wash atty: Marcus Chohn.

**HAMILTON-LANDIS
& ASSOCIATES, Inc.**
NATIONWIDE MEDIA BROKERS
WASHINGTON, D. C., CHICAGO, DALLAS,
SAN FRANCISCO
SELL **MORE**
RADIO & TELEVISION STATIONS
IN THE WEST—NEAREST OFFICE IS—
111 SUTTER ST., SAN FRANCISCO 94104
(415) 392-5671

Bakersfield

ADI No. 151; see page B-6

KBAK-TV—ch 29, 77.6 kw vis, 8.9 kw aur, ant 3,730t/230g. Aug. 23, 1953. Box 2929, 93303. (805) 327-7955. TWX 910-327-1109. Licensee: Harriscop Broadcasting Corp. (acq 5-24-64). Ownership: See Harriscop Stns. ■ CBS. Rep: H-R Television. Wash atty: Cohn & Marks. ■ Burt I. Harris, pres; Robert Curry, VP, gen mgr & film buyer; Patti Morgan, natl sls mgr; Fred Wells, lcl/rgr sls mgr; Dave Moore, prod & prom mgr; Vince Fleming, news dir; Al Ruch, chief engr. ■ On 18 CATV's—82,811 subs. On 1 trans.

KERO-TV—ch 23, 323 kw vis, 14.4 kw aur, ant 3,700t/183g. Sept. 26, 1953. Box 2367, 93303. (805) 327-1441. TWX 510-843-2113. Licensee: McGraw-Hill Bcstg Co. (acq 6-1-72). Ownership: See McGraw-Hill Stations, also Nwspr. ■ NBC. Rep: Harrington, Righter and Parsons Inc. Wash atty: Koteen & Burt. ■ Raymond A. Watson, VP & gen mgr; Don Rinker, prog dir & prom mgr; Rod O'Harra, gen sls mgr; John E. Barrett, lcl sls mgr; Ron Moore, news dir; Norman E. Hall, dir of engr. ■ On 11 CATV's—72,000 subs. ■ Rates: \$165; 75; 25.



KJTV—ch 17, 316 kw vis, 62.8 kw aur, ant 1,391t/271g. Nov. 8, 1959. 2831 Eye St., 93301. (805) 327-7511. TWX 910-327-1120. Licensee: Kern County Bcstg Co. (acq 10-6-69). Ownership: ASI Communications. See Atlantic States Industries Stns. ■ CBS. Rep: Avco. Wash atty: Haley, Bader & Potts. ■ Ralph C. Guild, pres; Joe Niccoli, VP & gen mgr; Jim Hayden, loc sls mgr; Don Vann, news dir; Ted Warner, opns dir; Bruce Smith, chief engr. ■ On 2 CATV's—24,500 subs. ■ Rates: \$125; 75; 20.

Chico

ADI No. 152; see page B-15

KHSL-TV—ch 12, 316 kw vis, 38 kw aur, ant 1,300t/287g. Aug. 29, 1953. Box 489, 95926. (916) 342-0141. TWX 916-348-2134. Licensee: Golden Empire Bcstg Co. Ownership: Mrs. Hugh McClung, 95%; Hugh McClung Jr., 5%. ■ CBS, NBC. Rep: Avery-Knodel. Wash atty: Haley, Bader & Potts. ■ C. H. Kinsley Jr., exec VP; Lawrence Pavilionis, prod mgr; Russel Pope, dir of engr; George Wussow, chief engr. ■ On 34 CATV's—55,000 subs. On 16 trans. Co-owned: KHSL(AM).

Corona

KBSC-TV—Licensed to Corona. See Los Angeles.

El Centro

ADI No. 184; see page B-23

KECC-TV—ch 9, 120 kw vis, 24 kw aur, ant

Arkansas, California TV

See page B-89 for explanation of listings.

1,720t/460g. Dec. 11, 1968. Box 29, 92243. (714) 352-9670. Licensee: KECC-TV Inc. Ownership: See United Bcstg Stns. ■ CBS. Sp 5 hrs wkly. Rep: UBC Sts; Potter. Wash atty: Smith & Pepper. ■ Richard Eaton, pres; Rhoberly Bright, prog dir; James Driscoll, prom mgr; Connie Delahoussaye, news dir; Richard Sampson, gen and sls mgr, film buyer; Ralph Melanson, chief engr. ■ On 3 CATV's—26,000 subs. On 3 trans. ■ Rates: \$22.50; 20; 20.

Eureka

ADI No. 181; see page B-24

***KEET**—ch 13, 66.1 kw vis, 13.2 kw aur, ant 1510t/107g. (CP: ant 1460t). April 14, 1969. Box 13, 95501. (707) 445-0813. TWX 707-443-4420. Licensee: Redwood Empire Pub TV Inc. ■ PBS. ■ Wendell Adams, pres; Lawrence Marston, prog dir; Michael Feist, chief engr. ■ On 4 CATV's.

KIEM-TV—ch 3, 100 kw vis, 20 kw aur, ant 1,650t/249g. Oct. 25, 1953. Box 3E, 95501. (707) 443-3123. TWX 510-742-6014. Licensee: Calif. Oreg. Radio Co. Ownership: Harvey Ingham, 50%; Richard S. Ingham, 50%. ■ CBS, NBC. Rep: Avery-Knodel; Moore. Wash atty: Haley, Bader & Potts. ■ Harvey Ingham, pres; Newton L. Steward, VP & mgr; Elmer Haskin, sls mgr; Bob Miller, opns mgr & prog dir; Carol Olson, news dir; Donald R. King, chief engr. ■ On 2 CATV's—8,000 subs. On 5 trans. ■ Rates: \$35; 20; 15.

KVIQ-TV—ch 6, 100 kw vis, 16 kw aur, ant 1,740t/377g. April 1, 1958. Box 1019, 95501. (707) 443-3061. TWX 510-742-6265. Licensee: Calif. Northwest Bcstg Co. Ownership: Carl & Leah McConnell, 100%. ■ ABC, NBC. Rep: H-R Television; Simpson/Reilly. Wash atty: Greeley, Bernard & Tierney. ■ Carl R. McConnell, pres; Allen Jones, VP & gen mgr; Dennis Eagan, sls mgr; Robert Turner, prog dir & film buyer; St. Clair Adams, prom mgr; Jerry Yarberry, news dir; Lynn Olsen, chief engr. ■ On 4 CATV's—34,400 subs. On 6 trans. ■ Rates: \$55; 25; 12.

Fontana

KLXA-TV—Licensed to Fontana. See Los Angeles.

Fresno

ADI No. 74; see page B-28

KAIL—ch 53, 16.1 kw vis, 2.1 kw aur, ant 350t/395g. Dec. 18, 1961. Box 5160, 93755. (209) 299-2104. Licensee: Tel-America Corp. Ownership: Albert J. Williams, 100%. ■ Wash atty: Pierson, Ball & Dowd. ■ Albert J. Williams, pres; Victor D. Sanders, gen mgr & film buyer; Charles Griggs, stn mgr; John Lockhart, chief engr.

KFSN-TV—ch 30, 347 kw vis, 35.5 kw aur, ant 2,020t/276g. May 10, 1956. 1777 G st., 93706. (209) 442-1170. TWX 910-362-3911. Licensee: Capital Cities Communications Inc. (acq 2-24-71). Ownership: See Capital Cities, also Nwspr. ■ CBS. Rep: Blair. Wash atty: Wilmer, Cutler & Pickering. ■ Walter Liss, gen mgr; Lee Jason, prog dir; Paul Stone, prom

Hogan-Feldmann, Inc.
MEDIA BROKERS CONSULTANTS
16255 Ventura Boulevard, Suite 415
Encino, California 91436
AREA CODE 213 986-3201

California TV

See page B-89 for explanation of listings.

mgr; Roger Rocca, news dir; Stephen Weber, chief engr. ■ On 5 CATV's—3,000 subs. On 3 trans.

KFTV—See Hanford.

KJEO—ch 47, 200 kw vis, 20 kw aur, ant 1,790t/138g. Oct. 1, 1953. Box 5455, 93755. (209) 222-2411. TWX 910-362-3181. Licensee: Retlaw Enterprises Inc. Ownership: Sharon Disney Lund, 30%; Diane Disney Miller, 24%; Lillian Disney Truynens, 30%, and others. ■ ABC. Rep: PGW-TV. Wash atty: McKenna, Wilkinson & Kittner. ■ Joseph C. Drilling, pres; William A. Sawyers, VP & gen mgr; Walter B. Davis, sls mgr; Gary Vautin, prog dir & film buyer; James Myers, prom mgr; Dan Cullen, news dir; Colin Dougherty, pub aff dir; Jay Hill, chief engr. ■ On 11 CATV's—17,700 subs. On 1 trans. ■ Rates: \$175; 60; 35.

KMJ-TV—ch 24, 191 kw vis, 22.8 kw aur, ant 2,350t/321g. June 1, 1953. Box 12907, 93779. (209) 268-6666. TWX 910-362-2403. Licensee: McClatchy Nwspr. Ownership: See McClatchy Stns, also Nwspr. ■ NBC. Rep: Katz. Wash atty: Dow, Lohnes & Albertson. ■ Eleanor McClatchy, pres; Jim C. Thompson, VP and stn mgr; Edgar L. Deatherage, sls mgr; Allen Buch, news edit; Kenneth Waligorski, prog dir; Don LaMont, prom mgr; Gordon C. Lee, chief engr. ■ On 4 CATV's—1,724 subs. On 1 trans. Co-owned: KMJ-AM-FM. ■ Rates: \$250; 120; 50.

***KMTF**—ch 18, 513 kw vis, 51.3 kw aur, ant 245g. Not on air yet; target date unknown. 2314 Mariposa St., 93721. Licensee: Fresno County Board of Education.

Guasti

KBSA—Licensed to Guasti. See Los Angeles.

Hanford

ADI No. 74; see page B-28

KFTV—ch 21, 132 kw vis, 23.8 kw aur, ant 1,840t/160g. July 1972. 8515 E. Lacey Blvd., 93230. (209) 584-3362. Licensee: Spanish Intl Bcstg Co. Ownership: See Span Intl Communications. ■ Rep: Span Intl Net. Wash atty: Norman Leventhal. ■ Ernesto Balleste, gen mgr; Armando Corral, sls mgr; Pedro D. Santos, prog & mus dir; Lawrence M. Beckman, chief engr.

Huntington Beach

ADI No. 2; see page B-41

***KOCE-TV**—ch 50, 290 kw vis, 29 kw aur, ant 1,090t/254g. November 1972. 15744 Golden West St., 92647. (714) 897-0302. Licensee: Board of Trustees, Coast Community College District. Ownership: Coast Community College District. ■ PBS. Wash atty: Greeley, Bernard & Tierney. ■ William A. Furniss, exec VP & gen mgr; James L. Cooper, dir of commun svc; C. Paul Corbin, dir of progmg; Donald D. Gerdtis, dir of opns & prod; Robert C. Moffett, dir of engr. ■ On 8 CATV's—35,000 subs.

Los Angeles

ADI No. 2; see page B-41

KABC-TV—ch 7, 166 kw vis, 25.7 kw aur, ant 2,970t/234g. (CP: 159 kw vis, 31.7 kw aur). Sept. 16, 1949. 4151 Prospect Ave., 90027. (213) 663-3311. TWX 213-666-1240. Licensee: ABC Inc. Ownership: See ABC-owned Stns. ■ ABC. Rep: ABC TV Spot Sales. Wash atty: McKenna, Wilkinson & Kittner. ■ John C. Severino, VP & gen mgr; Tom Van Amburg, gen sls mgr; Jerry Minnucci, prom & pub dir; Paul Coss, prog dir; James Taylor, asst prog

dir; William Fyffe, news dir; William Dryer, chief engr. ■ Co-owned: KABC-AM-FM.

KBSA—(Guasti) ch 46, 219 kw vis, 22.4 kw aur, ant 2,878t/138g. August 16, 1972. 1401 E. Ball Rd., Anaheim, Calif., 92805. (714) 636-4455. Licensee: Berean Bible Ministries Inc. (acq 5-9-75). ■ Wash atty: George Rodda Jr. ■ W. Kenneth Connolly, pres; Norman Carl, gen mgr; G. N. Hartwell, chief engr.

KBSC-TV—(Corona) ch 52, 813 kw vis, 69.2 kw aur, ant 2,780t/82g. June 29, 1966. 5752 Sunset Blvd., 90028. (213) 461-3611. TWX 910-321-3740. Licensee: Kaiser Bcstg Corp. Ownership: See Kaiser Bcstg Corp. ■ Rep: Kaiser Spot Sls. Wash atty: Wilmer, Cutler & Pickering. ■ Jay Bruce Johansen, gen mgr; Greg Gordon, opns mgr; James S. Parent, engr supvr. ■ On 78 CATV's—300,000 subs. ■ Rates: \$100; 80; 70.

***KCET**—ch 28, 45.7 kw vis, 9.12 kw aur, ant 3,050t/363g. Sept. 28, 1964. 4400 Sunset Drive, 90027. (213) 666-6500. TWX 910-321-4396. Licensee: Community TV of Southern Calif. ■ PBS, Western Educl Net. Wash atty: Covington & Burling. ■ James L. Loper, pres & gen mgr; Charles Allen, VP progs; Bert Snow, dir of pub rel; Evert Anderson, dir of engr. ■ On 70 CATV's—150,000 subs. On 1 trans.

KCOP—ch 13, 162 kw vis, 32.4 kw aur, ant 2,920t/203g. Sept. 17, 1948. 915 N. La Brea Ave., 90038. (213) 851-1000. TWX 910-321-4197. Licensee: KCOP TV Inc. Ownership: See Chris-Craft Industries Stns. ■ Rep: Tele-Rep. Wash atty: Hogan & Hartson. ■ Rich Frank, pres; Evan Thompson, stn mgr; Bill Frank, loc cis mgr; Randy Reiss, natl sls mgr; Pete Schlesinger, prog dir; Gary Davis, prom mgr; Dan Tompkins, news dir; John L. Grasse, chief engr. ■ On 95 CATV's.

KHJ-TV—ch 9, 162 kw vis, 22.9 kw aur, ant 2,960t/199g. Oct. 6, 1948. 5515 Melrose Ave., 90038. (213) 462-2133. TWX 910-321-2345. Licensee: RKO General Inc. Ownership: See RKO General Stns. ■ Rep: RTVR. Wash atty: Pierson, Ball & Dowd. ■ Lionel L. Schaan, VP & gen mgr & film buyer; Allan Royster, gen sls mgr; Walt Baker, prog dir; Stephanie Rank, news dir; David Pina, adv & prom mgr; George Tokar, chief engr. ■ On 350 CATV's—450,000 subs. Co-owned: KHJ(AM)-KRTH(FM).

***KLCS**—ch 58, 550 kw vis, 110 kw aur, ant 3,050t/180g. Nov. 5, 1973. Box 3307, 90051. (213) 625-8958. Permittee: Los Angeles Unified School District. Ownership: Los Angeles Board of Education. ■ PBS. Wash atty: Cohn & Marks. ■ J.C. Kenaston, stn mgr; Elinor Richardson, prog dir; Tom Mossman, dir prod/opns; Mike Takacs, chief engr. ■ On 3 CATV's.

KLXA-TV—(Fontana) ch 40, 631 kw vis, 126 kw aur, ant 2,890t/202g. Jan. 5, 1967. Box A, 111 W. Dyer Rd., Santa Ana, Calif., 92711. (714) 556-0830. Licensee: Intl Panorama TV Inc. Ownership: Trinity Broadcasting Network (acq 1974). ■ Wash atty: James A. Gammon. ■ Paul F. Crouch, pres & gen mgr; Vince M. Sanada, net sls mgr. ■ On 18 CATV's—50,000 subs.

KMEX-TV—ch 34, 251 kw vis, 50.1 kw aur, ant 2,930t/170g. Sept. 30, 1962. 721 N. Bronson, 90038. (213) 466-8131. Telex 67-4024. Licensee: Spanish Intl Communications Corp. Ownership: See Span Intl Stns. ■ Rep: Spanish Intl Net. Wash atty: McKenna, Wilkinson & Kittner. ■ Daniel Villanueva, VP & gen mgr; Louis Sweeney, sls mgr; Gerardo Pallares, Robert Porter, dir engr.

KNBC—ch 4, 42.7 kw vis, 7.4 kw aur, ant 3,200t/492g. Jan. 16, 1949. 3000 W. Alameda Ave., Burbank, Calif. 91523. (213) 845-7000. TWX 910-498-2752. Telex 67-7237. Licensee: NBC Inc. Ownership: See NBC-owned Stns. ■ NBC. Rep: NBC-TV Spot Sales. ■ Raymond J. Timothy, VP & gen mgr; Thomas Straszewski, stn mgr; Phil Mayer, prog mgr; John Rohrbeck, gen sls mgr; Robert Kennedy, adv & prom mgr;

Robert Eaton, news dir, West coast; James Brooks, chief engr.

KNXT—ch 2, 46.8 kw vis, 9.33 kw aur, ant 3,140t/466g. May 6, 1948. 6121 Sunset Blvd., 90028. (213) 469-1212. TWX 213-655-7546. Licensee: CBS Inc. Ownership: See CBS-owned Stns. ■ CBS. Rep: CBS TV Stns Natl Sls. ■ W. Russel Barry, VP & gen mgr; Marvin Shapiro, dir sls; Joseph Sands, dir bcstg; Garth Hintz, admin asst to gen mgr; Alberta Hackett, dir planning & admin; Allen Ludlum, film dir; Richard Bell, dir prom; James Topping, news dir. ■ Co-owned: KNX-AM-FM.

KTLA—ch 5, 50 kw vis, 25 kw aur, ant 2,990t/240g. Jan. 22, 1947. 5800 Sunset Blvd., 90028. (213) 469-3181. TWX 910-321-2417. Licensee: Golden West Bcstrs (acq 5-13-64). Ownership: See Golden West Stns. ■ Rep: Peetry. Wash atty: Dow, Lohnes & Albertson. ■ John T. Reynolds, pres TV div GWB & gen mgr; Anthony B. Cassara, gen sls mgr; Jerry Birdwell, dir prog admin; Don Searle, dir of rsch and prom; Lew Rothbart, news dir; Edward Herlihy, dir of engr. ■ On 154 CATV's—729,210 subs. ■ Co-owned: KMPC(AM). ■ Rates: \$200; 500; 50.

KTTV—ch 11, 166 kw vis, 20 kw aur, ant 2,940t/237g. Jan. 1, 1949. 5746 Sunset Blvd., 90028. (213) 462-7111. TWX 910-321-4222. Licensee: Metromedia Inc. (acq 5-28-63). Ownership: See Metromedia Stns. ■ Rep: Metro TV Sales. Wash atty: Thomas J. Dougherty. ■ Albert Krivin, pres; Charles D. Young, VP & gen mgr; Martin Bergman, VP & gen sls mgr; Robert O'Connor, VP & prog dir; Janet Fede, VP & prom dir; Ray Green, prod mgr; Charles M. Riley, VP & news dir; Lee Pardee, chief engr. ■ Co-owned: KLAC(AM)-KMET(FM).

***KVST-TV**—ch 68, 55 kw vis, 11 kw aur, ant 2,870t/126g. May 5, 1974. 1136 N. Highland Ave., 90038. (213) 461-3911. Permittee: Viewer Sponsored TV Foundation. ■ PBS. Wash atty: Arent, Fox, Kintner, Plotkin & Kahn. ■ Leslie Parrish, pres; Hy Freedman, gen mgr; Charles Mellone, chief engr.

KWHY-TV—ch 22, 64.6 kw vis, 9.1 kw aur, ant 2,930t/132g. March 25, 1963. Authorization for pay TV bcstg (not operational). 5545 Sunset Blvd., 90028. (213) 466-5441. Licensee: Coast TV Bcstg Corp. Ownership: Thomas S. Bunn family, 55%; Fredrick D. Custer, 15%; Straub family, 15% & others. ■ Sp 40 hrs, Jap 7 hrs, Korean 3 hrs, Chinese, Ger, It 1 hr wkly. ■ Wash atty: Fletcher, Heald, Rowell, Kenehan & Hildreth. ■ Wiley D. Bunn, pres; Robert W. Bunn, gen mgr; John Nelson, Mike Wagner, acct execs; Steven Weiner, prog dir; David Zulli, chief engr. ■ On 50 CATV's. ■ Rates: \$70; 45; 56.

Modesto

ADI No. 25; see page B-62

KLOC-TV—ch 19, 182 kw max, 25.7 kw horizontal vis, 15 kw max & 3.39 kw horiz aur, ant 1,320t/163g. Aug. 26, 1966. Box 3689, 95352. (209) 529-2024. Licensee: KLOC Bcstg Co. Ownership: Chester Smith 51%; Melvin Querio, 12% & others. ■ Net: Spanish Int. Rep: Spanish Int Sls. Wash atty: Fletcher, Heald, Rowell, Kenehan & Hildreth. ■ Chester Smith, pres; Bert Chance, sls mgr; Wilbert Ruiz, news dir; Dave Metts, chief engr. ■ On 26 CATV's—55,000 subs. Co-owned: KLOC(AM) Ceres, Calif. ■ Rates: \$50; 40; 30.

KMUV-TV—Licensed to Sacramento. See Sacramento.

Monterey

KMST—Licensed to Monterey-Salinas. See Salinas.

KSBW-TV—Licensed to Salinas. See Salinas.

Oakland

KTVU—Licensed to Oakland-San Francisco. See San Francisco.

Oxnard

ADI No. 2; see page B-41

***KTIE**—ch 63, 20 kw vis, 3.55 kw aur, ant 1741/59g. Not on air, target date unknown. Box 274, Malibu, 90265. Permittee: Lola Goelet Yoakem.

Palm Springs

ADI No. 191; see page B-54

KMIR-TV—ch 36, 164 kw vis, 32.8 kw aur, ant 6801/124g. Oct. 26, 1968. Box 1506, 400 Tachevah Drive, 92262. (714) 325-7121. Licensee: Desert Empire TV Corp. Ownership: John & Sirpuhe Conte, 100%. ■ NBC. Sp 2 hrs wkly. Rep: Savalli/Gates. Wash atty: Koteen & Burt. ■ John Conte, pres & gen mgr; Ted Conway, sls mgr; Suzanne Albert, prog dir; Sirpuhe Conte, film buyer; John Weston, news dir; Bill Lorin, prom mgr; A. W. Kuykendall, chief engr. ■ On 4 CATV's—18,000 subs. ■ Rates: \$85; 55; 27.

KPLM-TV—ch 42, 316 kw vis, 45.8 kw aur, ant 6301/130g. Oct. 5, 1968. Drawer 4200, 92262. (714) 328-8881. Licensee: Pacific Media Corp. ■ ABC. Sp 2½ hrs wkly. ■ Jack Latham, VP, gen mgr & film buyer; Tom Moore, VP & sls mgr; Max Kirkland, opns mgr and chief engr. ■ On 8 CATV's—23,034 subs. On 1 trans. ■ Rates: \$70; 40; 18.

Redding

ADI No. 152; see page B-15

***KIXE-TV**—ch 9, 115 kw vis, 12 kw aur, ant 3,590t/99g. Oct. 5, 1964. 825 Industrial St., 96001. (916) 241-7900. Licensee: Northern Calif. Educ TV Assn Inc. ■ PBS. ■ Henry Saunders, pres; Robert P. Casey, exec VP and gen mgr; Sandy McCaleb, film buyer; Robert Buchanan, dev dir; Brantley Hunter, chief engr. ■ On 10 CATV's. On 14 trans.

KRCR-TV—ch 7, 115 kw vis, 22.4 kw aur, ant 3,620t/126g. Aug. 1, 1956. Box 7R, 96001. (916) 243-7777. TWX 916-243-6721. Licensee: Sacramento Valley TV Inc. Ownership: Southern Oregon Bcstg Co., 80.94%, Calif. Oregon Bcstg Co., 19.06%. See California Oregon Bcstg, also Nwspr. ■ ABC, NBC. Rep: Meeker; Moore; McDermott. Wash atty: Dempsey & Kopolovitz. ■ Richard Green, pres & gen mgr; William B. Smullin, VP dir of opns & film buyer; Ken King, ntl sls mgr; Charles Hess, lcl sls mgr; Doreeta Domke, prog dir; Darlene Gilmore, prom mgr; Norm Hoatson, chief engr; Dean Reeter, news dir. ■ On 26 CATV's—62,230 subs. On 26 trans. ■ Rates: \$115; 80; 40.

Sacramento

ADI No. 25; see page B-62

KCRA-TV—ch 3, 100 kw vis, 20 kw aur, ant 1,490t/1,549g. Sept. 2, 1955. 370 10th St., 95814. (916) 444-7300. TWX 916-444-7429. Licensee: Kelly Bcstg Co. Ownership: Nina N. Kelly, Robert E. Kelly and Jon S. Kelly, equal partners. ■ NBC. Rep: Storer TV Sls. Wash atty: Koteen & Burt. ■ Robert E. Kelly & Jon S. Kelly, ptrns; Robert C. Grant, gen sls mgr; Harvey S. Fisher, lcl sls mgr; Dean Gull, prog mgr; Paul Thompson, news & pub affairs dir; Bill Karpisek, chief engr. ■ On 48 CATV's—204,650 subs. On 8 trans. Co-owned: KCRA(AM)-KCTC(FM).

KMUV-TV—ch 31, 706 kw vis, 141 kw aur, ant 1,060t/508g. Oct. 5, 1974. 500 Media Pl., 95815. (916) 929-0300. Licensee: Grayson

Television Inc. Ownership: Andrew C. Bartalini, pres, 16%; Dain Domich, 19%; George Artz, 10.5%; Samuel Klor, VP 15% and others. ■ Sp full time. Rep: Adam Young. Wash atty: Smith & Pepper. ■ Andrew C. Bartalini, pres; Frank M. Lokey, gen mgr and film buyer; Mike C. Lee, gen sls mgr; Carlotta Herd, prom mgr; Johnny Hyde, prog dir; Don Gomez, news dir; Michael Welte, chief engr. ■ On 76 CATV's—478,982 subs. ■ Rates: \$45; 40; 30.

KOVR—(Stockton) ch 13, 281 kw vis, 42.7 kw aur, ant 1,490t/1,548g. September 1954. 1216 Arden Way, Sacramento 95815. 225 East Miner Ave., Stockton 95202. (916) 927-1313. TWX 910-367-2396. Licensee: McClatchy Nwsprs. Ownership: See McClatchy Stns, also Nwspr. ■ ABC. Rep: Katz. Wash atty: Dow, Lohnes & Albertson. ■ Eleanor McClatchy, pres; Ramsey Elliott, VP and gen mgr; Wilson Lefler, sls mgr; Bel Lange, prog mgr; Norm Hartman, news edit; David Wortman, chief engr. ■ On 78 CATV's—506,780 subs. Co-owned: KFBK-AM-FM.

KTXL—ch 40, 622 kw vis, 124.5 kw aur, ant 970t/996g. Oct. 26, 1968. 4655 Fruitridge Rd., 95820. (916) 452-8221. TWX 910-367-3522. Licensee: Camellia City Telecasters Inc. Ownership: Business Men's Assurance Co., 65%; Jack F. Matranga, 35%. ■ ABC, CBS, NBC. Rep: Avco. Wash atty: Arent, Fox, Kintner, Plotkin & Kahn. ■ Jack F. Matranga, pres, gen mgr & film buyer; William Morrison, sls mgr; Melvin Quierio, opns mgr; William Kline, prog dir & prom mgr; David Preston, news dir; Robert Nelson, chief engr. ■ On 298 CATV's—448,000 subs. On 5 trans.

***KVIE**—ch 6, 55 kw vis, 11 kw aur, ant 1,120t/1,549g. Feb. 23, 1959. Box 6, 95801. (916) 922-6563. Licensee: Central Calif. Educl TV. ■ PBS. Wash atty: Schwartz & Woods. ■ Henry Steinmetz Jr., pres; Arthur A. Paul, exec VP & gen mgr; Donald John Coney, prog dir; Walter T. Carter, dir of devel; Suzie Nissan, pub info mgr; Gorman K. Brown, chief engr. ■ On 71 CATV's.

KXTV—ch 10, 309 kw vis, 61.7 kw aur, ant 1,490t/1,549g. March 20, 1955. Box 10, 95801. (916) 441-4041. TWX 910-367-2099. Licensee: Great Western Bcstg Corp. Ownership: See Corinthian Stns. ■ CBS. Rep: Tele Rep. Wash atty: Covington & Burling. ■ Philip J. Lombardo, pres; Joseph E. Lake, VP & gen mgr; Justin A. Cassidy, sls mgr; Cal Bollwinkel, prog dir & film buyer; William T. Raney, prom mgr; James Drennan, news dir; Donald Ferguson, chief engr.

Salinas

ADI No. 94; see page B-63

KMST—(Monterey-Salinas) ch 46, 443 kw vis, 88.6 kw aur, ant 2,530t/226g. Feb. 2, 1969. Box 1938, Monterey, 93940. (408) 373-4326. Licensee: Monterey-Salinas TV Inc. Ownership: Stoddard P. Johnston, 50.05%; William D. Pabst, Ward D. Ingram, each 22.5%; William H. Schuyler, 4.95%. ■ CBS. Rep: Avery-Knodel. Wash atty: Cohn & Marks. ■ Stoddard P. Johnston, pres; William H. Schuyler, VP & gen mgr; Jim Dooley, news dir; Lori Marvin, prom mgr; Judy Law, prod mgr; Kenneth F. Warren, chief engr. ■ On 25 CATV's—83,000 subs. Co-owned: KWAV(FM).

KSBW-TV—ch 8, 234 kw vis, 44.7 kw aur, ant 2,330t/148g (CP: 46.8 kw aur). Sept. 11, 1953. Box 1651, Salinas, 93901. (408) 422-6422. TWX 910-368-7058. Licensee: Ctrl Calif. Communications Corp. Ownership: See John C. Cohan Stns. ■ NBC. Rep: Blair. Wash atty: Sells & Gregory. ■ Will Spraggins, pres; Boyd Lawlor, gen mgr, TV dir; Keith Moon, stn & gen sls mgr; Dwight Wheeler, prog dir; Roy Stearns, news dir; Byington Colvig, prom & res dir; Earl Corby, chief engr. ■ On 30 CATV's—160,000 subs. On 4 trans. Co-owned: KSBY-TV. ■ Rates: \$275; 110; 25.

California TV

See page B-89 for explanation of listings.

San Bernardino

ADI No. 2; see page B-41

KHOF-TV—ch 30, 269 kw vis, 53.7 kw aur, ant 2,340t/308g. Oct. 12, 1969. 1615 S. Glendale Ave., Glendale, 91205. (714) 245-7575. Licensee: Faith Ctr Inc. Ownership: Faith Ctr Board, 100%. ■ Wash atty: Cohen & Berfield. ■ Dr. W. Eugene Scott, pres; Paul Calentine, gen sls mgr; Joe Snelson, prog dir; W. Bernard Marston, gen mgr. ■ Co-owned: KHOF-FM Los Angeles. ■ Rates: \$34.50; 23; 23.

KSCI—ch 18, 3319 kw vis, 664.3 kw aur, ant 2,380t/201g. Not on air, target date March 1976. 1950 Cotner Ave., West Los Angeles, 90025. (213) 479-8081. Licensee: Global Television Inc. (nonprofit corp). ■ Wash atty: Ralph W. Hardy. ■ Mark Fleischer, pres and gen mgr; Gary Nalley, sls mgr; Rollin Olson, news dir; Cecil Flucker, chief engr. ■ Rates: \$34; 34; 34.

***KVCR-TV**—ch 24, 5.6 kw vis, 1.12 kw aur, ant minus 290t/120g. Sept. 11, 1962. 701 S. Mt. Vernon Ave., 92403. (714) 885-0231. Licensee: San Bernardino Community College District. ■ PBS, Western Educational Network. ■ Raymond F. Ellerman, chancellor; Thomas Little, gen mgr; Lew Warren, opns and prog dir; Don Leiffer, prom mgr; Al Gondos, film buyer; Gordon Madson, news dir; Carmelo Cacciola, chief engr. ■ On 25 CATV's—25,000 subs. On 6 trans. Co-owned: KVCR-FM.

San Diego

ADI No. 31; see page B-65

KCST-TV—ch 39, 813 kw vis, 148 kw aur, ant 1,910t/180g. Nov. 14, 1965. 8330 Engineer Rd., 92111. (714) 279-3939. TWX 910-335-1507. Licensee: Western Telecasters Inc. Ownership: See Storer Bcstg Co. ■ ABC. Rep: Storer TV Sls. Wash atty: Warren C. Zwicky. ■ Peter Storer, pres; Bill Fox, gen mgr; Bob Mahlman, sls mgr; Bill Fouch, prog dir; Bill Peterson, news dir; Bill Stevens, chief engr. ■ On 18 CATV's—147,000 subs. On 1 trans.

KFMB-TV—ch 8, 316 kw vis, 63.2 kw aur, ant 760t/284g. May 16, 1949. 1405 Fifth Ave., 92101. (714) 232-2114. TWX 910-335-1245. Licensee: Midwest TV Inc. Ownership: See Midwest TV Stns, also Nwspr. ■ CBS. Rep: Peters, Griffin, Woodward. Wash atty: Covington & Burling. ■ August C. Meyer, pres, Midwest TV; Clara R. Meyer, VP, Midwest TV; Jack B. Everette, asst to the pres; Robert L. Myers, pres, Western Div, gen mgr—KFMB; William R. Moylan, VP, Western Div, opns/sls; J. M. Bradley, asst gen mgr and bus mgr; Jules Moreland, prog dir and film buyer; Peter R. Noyes, exec news dir; Ray Wilson, news dir; Fred Bornstein, prom mgr; Charles Abel, mgr of engr. ■ Co-owned: KFMB-AM-FM. ■ Rates: \$500; 175; 70.

KGTV—ch 10, 214 kw vis, 31.6 kw aur, ant 750t/252g. Sept. 9, 1953. Box 81047, 92138. (714) 262-2421. TWX 910-335-1247. Licensee: McGraw-Hill Bcstg Co. (acq 6-1-72). Ownership: See McGraw-Hill Stns. ■ NBC. Rep: Katz. Wash atty: Koteen & Burt. ■ Norm Walt, pres; Clayton Brace, VP & gen mgr; Jay Grill, stn mgr; Mike Sobel, ntl sls mgr; A. Philip Corvo, prog dir; Robert P. Rimes, adv & prom mgr; Ronald E. Mires, news dir; LeRoy Bellwood, chief engr. ■ On 14 CATV's—70,000 subs.

KJOG-TV—ch 51, 309 kw vis, 55 kw aur, ant 1,940t/197g. Not on air, target date unknown. 2810 Talbot St., 92106. Permittee: Gross Bcstg Co. Ownership: Jack O. Gross, 100%. ■ Wash atty: Norman E. Jorgensen.

California TV

See page B-89 for explanation of listings.

***KPBS-TV**—ch 15, 219 kw vis, 23.4 kw aur, ant 1,880/168g. June 25, 1967. San Diego State U., 92182. (714) 286-6415. Licensee: Bd. of Trustees, The California State U. and Colleges. ■ PBS. Wash atty: Norman E. Jorgensen. ■ Robert Myers, dir of develop; Paul J. Steen, gen mgr; Bradford B. Warner, prog dir; Paul Marshall, prod mgr; Gloria Penner, dir TV prog devel; Paul Marshall, dir of prod; C. Christopher Rager, dir engrg. ■ On 16 CATV's—157,730 subs. On 2 trans. Co-owned: *KPBS(FM).

XETV—(Tijuana, Mexico) ch 6, 100 kw vis, 50 kw aur, ant 1,000/550g. Jan. 29, 1953. 1430 7th Ave., San Diego, 92101. (714) 234-8431. TWX 910-335-2017. Licensee: Radio TV S. A. Ownership: Emilio Azcarraga Milmo, chief owner. ■ Rep: Blair Wash atty: Haley, Bader & Potts. ■ Julian M. Kaufman, VP, gen mgr & film buyer; Lou Meiers, treas & bus mgr; Carol Healy, prog dir; Felipe Fernandez, chief engr; Marty Colby, stn mgr; Joannie O'Laughlin, ntl sls coord. ■ On 5 CATV's—25,000 subs. On 1 trans. ■ Rates: \$300; 200; 50.

XEWTV-TV—(Tijuana, Mexico) ch 12, 64 kw vis, 32 kw aur, ant 1,000/200g. July 12, 1960. Box 44-K, San Ysidro, 92073. (714) 385-9201. Telex: 0566833. Licensee: Televisora de Calimes, S. A. Ownership: Televisora de Calimes S. A. ■ Rep: Spanish International Network Sls. ■ Jose Marquez, gen mgr; Carlos H. Luna, prog mgr; Roberto Expinoza, bus mgr; Mario Acosta, traf mgr; Max Duenas, chief engr.

San Francisco

ADI No. 6; see page B-65

KBHK-TV—ch 44, 2000 kw vis, 230.12 kw aur, ant 1,610/977g. Jan. 2, 1968. 420 Taylor St., 94102. (415) 885-3750. Telex: 34-0691. Licensee: Kaiser Bcstg Corp. Ownership: See Kaiser Stns. ■ Rep: Kaiser Bcstg Spot Sls. Wash atty: Wilmer, Cutler & Pickering. ■ Herb Victor, VP & gen mgr; Manny Brooks, gen sis mgr; C. D. Zimmerman, prog mgr; Norman Andrus, sis mgr; Kim Rowley, prom mgr; Frank A. Philpot, news & pub affairs dir; Eugene R. Hill, chief engr. ■ On 83 CATV's—466,099 subs.

KDVT—ch 60, 1550 kw vis, 229 kw aur, ant 1,240/226g. 1975. c/o Revnold V. Anselmo, 250 Park Ave., New York, 10017. Permittee: Bahia de San Francisco Television Co. Ownership: Reynold V. Anselmo, 21%; Frank Fouce Jr., 10%; James Jacobson, 15%; Daniel Villanueva, 10%; Lawrence B. Alexander, 30%; and others. ■ Wash atty: McKenna, Wilkinson & Kittner.

KEMO-TV—ch 20, 1,700 kw vis, 240 kw aur, ant 1,270/256g. April 1, 1968. 2500 Marin St., 94124. (415) 285-6420. Licensee: Leon A. Crosby. (acq 1-72). Ownership: Leon A. Crosby. ■ Rep: Spanish Int Net; Creed. Wash atty: Lauren A. Colby. ■ Leon Crosby, pres & gen mgr; Whitney Harris, gen sis mgr; Michael Moeller, sis mgr; Don Humphrey, prog dir; Roy Cosda, Span prog dir; Richard O'Hearn, chief engr. ■ On 30 CATV's—300,000 subs.

KGO-TV—ch 7, 316 kw vis, 63.2 kw aur, ant 1,670/977g. May 5, 1949. 277 Golden Gate Ave., 94102. (415) 863-0077. TWX 415-393-7317. Telex: 34-0250. Licensee: ABC Inc. Ownership: See ABC-owned Stns. ■ ABC. Rep: ABC-TV Spot Sls. Wash atty: McKenna, Wilkinson & Kittner. ■ Russ C. Coughlan, VP & gen mgr; Mark Mandala, gen sis mgr; Len Spagnoletti, ntl sls mgr; Robert Young, local sls mgr; Jim Tuvsoren, prog dir; Dennis Fitch, prom mgr; Pete Jacobus, news dir; James Von Striver, chief engr. ■ On 131 CATV's—450,000 subs. On 1 trans. Co-owned: KGO(AM)-KSF(X)(FM).

KPIX—ch 5, 100 kw vis, 10 kw aur, ant 1,660/980g. Dec. 22, 1948. 2655 Van Ness Ave., 94109. (415) 776-5100. TWX 415-393-7334. Licensee: Westinghouse Bcstg Co. Ownership: See Westinghouse Stns. ■ CBS. Rep: TVAR. Wash atty: Hedrick & Lane. ■ Donald H. McGannon, pres; Louis S. Simon, VP, West Coast; George E. Resing Jr., gen mgr; Herbert Farber, gen sis mgr; William Hillier, prog mgr; Dick Newton, creative services mgr; Jim Van Messel, news dir; Charles Coane, pub rel dir; Ray Holtz, chief engr. ■ On 32 CATV's—40,000 subs. On 8 trans.

***KQEC**—ch 32, 1,334 kw vis, 267 kw aur, ant 783/885g. June 17, 1968. 1011 Bryant St., 94103. (415) 334-5470. TWX 910-372-6609. Licensee: KQED Inc. (acq 9-9-70). (See KQED TV). ■ PBS. Wash atty: Covington and Burling. ■ Execs: see *KQED.

***KQED**—ch 9, 316 kw vis, 37 kw aur, ant 1,670/980g. June 10, 1954. 1011 Bryant St., 94103. (415) 334-5470. TWX 910-372-6609. Licensee: KQED Inc. ■ PBS, Western Educl Net. Wash atty: Covington & Burling. ■ William E. Osterhaus, pres & gen mgr; Jonathan C. Rice, prog mgr; Jeanne Alexander, prom mgr; Joseph Russin, news dir; Gerald Plemmons, chief engr. ■ On 120 CATV's—375,000 subs. Co-owned: *KQED-FM. *KQEC(TV).

KRON-TV—ch 4, 100 kw vis, 15.1 kw aur, ant 1,680/977g. Nov. 15, 1949. Box 3412, 1001 Van Ness Ave., 94119. (415) 441-4444. TWX 910-372-6644. Licensee: Chronicle Bcstg Co. Ownership: San Francisco Chronicle. See Nwspr. ■ NBC. Rep: Peters, Griffin, Woodward. Wash atty: Robert L. Heald. ■ Aldo H. Constant, pres; C. E. Cooney, VP and gen mgr; George Davidson, gen sis mgr; Bill Row, adv dir; Jim Reiman, news dir; Joe Seaver, ctrlr; Richard Behrendt, stn, prog and prod mgr; F. A. Martin, stn mgr; J. L. Berryhill, chief engr. ■ On 68 CATV's—180,000 subs. On 7 trans. Co-owned: KRON-FM. ■ Rates: \$2,000; 400; 200.

KTSF-TV—ch 26, 245 kw vis, 46.8 kw aur, ant 1,580/980g. Not on air, target date unknown. c/o Vista Grande, Greenbrae, 94901. Permittee: Lincoln TV Inc. Ownership: Lillian L. Banta, 100%.

KTUV—(Oakland) ch 2, 100 kw vis, 20 kw aur, ant 1,571/977.5g. March 3, 1958. 1 Jack London Sq., Oakland, 94607. (415) 834-2000. TWX 910-366-7030. Licensee: Miami Valley Bcstg Corp. Ownership: See Cox Bcstg Stns, also Nwspr. ■ Rep: Tele-Rep. Wash atty: Dow, Lohnes & Albertson. ■ Clifford M. Kirtland Jr., pres; William A. Schwartz, VP & gen mgr; Robert I. Mart, gen sis mgr; Thomas A. Breen, prog mgr & film buyer; Sherm Bazell, news dir; Ivan Ladizinsky, prom mgr; John Swanson, chief engr. ■ On 150 CATV's—500,123 subs. On 7 trans.

KVOF-TV—ch 38, 895 kw vis, 145 kw aur, ant 1,310/184g. Dec. 28, 1968. 601 Taraval, 94116. (415) 665-5410. Licensee: Faith Center Inc. (acq 6-6-73). Ownership: See Faith Center Stns. ■ Wash atty: Cohen & Berfield. ■ Paul C. Schoch, gen mgr; W. Bernard Marston, chief engr.

San Jose

ADI No. 6; see page B-65

KGSC-TV—ch 36, 2,735 kw vis, 273.5 kw aur, ant 2,000/202g. Oct. 3, 1967. 1536 Kerley Dr., 95112. (408) 298-6676. Licensee: Continental Urban TV Corp. Ownership: Vincent B. Welch, 25.09%; Edward P. Morgan, 17.61%; H. Leslie Atlas Jr., 18.41%; Richard E. Curtis, 25%. ■ Rep: Savalli/Gates; Pearse. Wash atty: Welch & Morgan. ■ Vincent B. Welch, chmn; Edwin D. Jones Jr., pres; Sid Connolly, VP & gen mgr; Hal Grant, opns mgr; Frank Foge, chief engr. ■ On 38 CATV's—607,334 subs. On 1 trans. ■ Rates: \$55; 55; 30.

KNTV—ch 11, 80 kw vis, 8 kw aur, ant 2,770/291g. Sept. 12, 1955. 645 Park Ave., 95110. (408) 286-1111. TWX 910-338-0157. Licensee: Gill Industries. Ownership: Wholly owned by Allen T. Gilliland, 72.18% & A. T. Gilliland estate, 27.82%. ■ ABC. Rep: Katz. Wash atty: Fletcher, Heald, Rowell, Kenehan & Hildreth. ■ Allen T. Gilliland, pres; Bob Hosfeldt, VP, gen mgr; John Yearwood, gen sis mgr; Stew Park, prog dir & film buyer; Trudy Allyson, pub aff dir; Lee Schell, news dir; Linda Jay, pub serv dir; Lou Bell, chief engr. ■ On 47 CATV's—419,012 subs. On 1 trans. ■ Rates: \$310; 115; 55.

***KTEH**—ch 54, 305.5 kw vis, 61.1 kw aur, ant 301/92g. October 1964. 100 Skyport Dr., 95110. (408) 299-2754. Licensee: Santa Clara County Board of Education. ■ PBS. Wash atty: Schwartz & Woods. ■ Dr. Glenn W. Hoffman, gen mgr; Maynard E. Orme, stn mgr; William E. Glaeser, prog dir; Dr. Peter Craske, learning svcs dir; Bob Whalley, chief engr. ■ On 42 CATV's. On 6 trans.

San Luis Obispo

ADI No. 94; see page B-63

KSBY-TV—ch 6, 100 kw vis, 12 kw aur, ant 1,570/459g. May 1953. Box 1368, 93406. (805) 543-0920. Licensee: Ctrl Calif. Communications Corp. Ownership: See John C. Cohan Stns. ■ NBC. Rep: Blair Wash atty: Greg & Mendenhall. ■ Will Spraggins, pres; Boyd Lawlor, gen mgr, TV dir; Larry Fischer, stn & gen sis mgr; Ken Bruce, sis mgr; Dick McIntyre, prog dir; Stan Lambert, news dir; Ken Reid, chief engr. ■ On 11 CATV's—55,000 subs. Co-owned: KSBY-FM.

William A. Exline, Inc.
31 CARROLL COURT
SAN RAFAEL, CALIFORNIA 94903
(415) 479-0717
MEDIA BROKERS - CONSULTANTS

San Mateo

ADI No. 6; see page B-65

***KCSM-TV**—ch 14, 13.8 kw vis, 2.8 kw aur, ant 380/143g. Oct. 12, 1964. 1700 W. Hillisdale Blvd., 94402. (415) 574-6586. Licensee: San Mateo Community College District. ■ PBS. ■ Douglas B. Montgomery, gen & prog mgr; Daniel Odum, dir, mus programs; Joe Morgan, chief engr. ■ On 32 CATV's—194,000 subs. Co-owned: *KCSM-FM.

Santa Barbara

ADI No. 154; see page B-65

KEYT—ch 3, 50 kw vis, 5.9 kw aur, ant 3,010/210g. July 24, 1953. Drawer X, 93102. (805) 965-8533. TWX 910-334-1183. Licensee: Key TV Inc. (acq 12-56). Ownership: William F. Luton, 29.81%; Nancy Luton, 32.61%; Richard C. D. Bell (through trust), 32.89%; Luton children trust, 4.02%. ■ ABC. Rep: Young; Moore. Wash atty: Fly, Shuebruk, Blume & Gaguine. ■ William F. Luton, pres; Hal O'Donnell, gen mgr; Gene Forssell, prom mgr; William P. Huddy, VP & dir news & pub affrs; Ted Froming, chief engr. ■ On 25 CATV's—100,000 subs. On 1 trans. ■ Rates: \$140; 50; 30.

Santa Maria

ADI No. 154; see page B-65

KCOY-TV—ch 12, 115 kw vis, 22.9 kw aur, ant 1,940/140g. March 16, 1964. Box 1217, 1503

N. McClelland, 93454. (805) 922-1943. TWX 910-351-5875. Licensee: Ctrl Coast Bcstrs Inc. (acq 8-1-63). Ownership: Helen L. Pedotti, 69.24%; Mili Acquistapace, 22.04%; Burns Rick, 8.72%. ■ CBS. Rep: Meeker; Simpson/Reilly. Wash atty: Fletcher, Heald, Rowell, Kenehan & Hildreth. ■ Helen Pedotti, pres; Robert L. Burris, gen mgr; Jim Carey, sls mgr; Phyllis Trombeta, prog dir; Ken Kopec, news dir; John Wiegand, chief engr. ■ On 9 CATV's—70,000 subs. On 5 trans.

Santa Rosa

ADI No. 6; see page B-65

KFTY—ch 50, 269 kw vis, 32.4 kw aur, ant 3,090t/170g. Aug. 12, 1972. (off the air). Licensee: William B. Grover, trustee in bankruptcy. ■ Wash atty: Farrand, Malti, Spillane & Walsh.

Stockton

ADI No. 25; see page B-62

KAJC-TV—ch 58, 270 kw vis, 53.3 kw aur, ant 1,510t/1,537g. Not on air, target date unknown. 1103 Valley Center, San Dimas, 91773. Permittee: Andrew J. Crevolin. Ownership: Andrew J. Crevolin, 100%. ■ Wash atty: Seymour M. Chase.

KMUV-TV—Licensed to Sacramento. See Sacramento.

KOVR—Licensed to Stockton. See Sacramento.

Tulare

ADI No. 74; see page B-28

KMPH—ch 26, 363 kw vis, 406.4 w aur, ant 2,730t/252g. Oct. 11, 1971. 2600 S. Mooney Blvd., Visalia, 93277. (209) 733-2600. TWX 910-377-3496. Licensee: Pappas Television Inc. Ownership: Mike J. Pappas, 10.5%; others, 69.5%. ■ NBC, CBS. Rep: Savalli/Gates. Wash atty: Fletcher, Heald, Rowell, Kenehan & Hildreth. ■ Mike J. Pappas, pres; Harry J. Pappas, VP gen mgr & film buyer; Joseph Shaffer, prog & news dir; Sam Horel, sls mgr; John Zauher, prom mgr; Herschel McKenzie, chief engr. ■ On 10 CATV's—46,500 subs. Co-owned: KGEN(AM)-KBOS(FM).

Colorado

HAMILTON-LANDIS

& ASSOCIATES, Inc.
NATIONWIDE MEDIA BROKERS
WASHINGTON, D.C., CHICAGO, DALLAS,
SAN FRANCISCO

SELL **MORE**

RADIO & TELEVISION STATIONS
IN THE SOUTHWEST—NEAREST OFFICE IS—
6060 N. CENTRAL EXPY., DALLAS 75206
(214) 691-2345

Colorado Springs

ADI No. 103; see page B-16

KKTU—ch 11, 85.1 kw vis, 42.7 kw aur, ant 2,380t/351g. Dec. 7, 1952. Box 2110, 3100 N. Nevada Ave., 80901. (303) 634-2844. TWX 303-473-1264. Licensee: Capitol of Colorado Corp. Ownership: See Capitol Bcstg Co. ■

CBS. Rep: Katz; Hix. Wash atty: Kirkland, Ellis & Rowe. ■ T. M. Hederman, pres; George W. Jeffrey, VP gen mgr & film buyer; Hal Kennedy, news dir; Robert Blauvelt, chief engr. ■ On 6 CATV's—35,000 subs. On 5 trans.

KOAA-TV—(Pueblo) ch 5, 100 kw vis, 15.1 kw aur, ant 1,310t/977g. June 13, 1953. Box 876, Pueblo, 81002. (303) 544-5782. TWX 910-939-9565. Licensee: Sangre De Cristo Bcstg Corp. Ownership: William Grant, 20%; Helen T. White, 28.2%; Mahlon T. White, 28.2%; & others. ■ NBC. Rep: Avery-Knodel; Mountain Media. Wash atty: McKenna, Wilkinson & Kittner. ■ Robert J. McMahan, pres, gen mgr & film buyer; Jack Sinclair, prog dir; James Schaeffer, natl sls mgr; Larry Keenan, loc sls mgr; Hazel Provenza, prom mgr; David W. Sears, news dir; Ken Renfrow, chief engr. ■ On 10 CATV's—38,700 subs. On 29 trans. ■ Rates: \$120; 60; 30.

KRDO-TV—ch 13, 75.9 kw vis, 11.2 kw aur, ant 2,080t/153g. Sept. 21, 1953. Box 1457, 80901. (303) 632-1515. Licensee: Pikes Peak Bcstg Co. Ownership: Harry W. Hoth Jr. & wife, 76.8%; Estate of William J. Gregory, 21%; others. ■ ABC. Rep: Peters, Griffin, Woodward. Wash atty: Fletcher, Heald, Rowell, Kenehan & Hildreth. ■ Harry W. Hoth, pres; Jay E. Gardner, gen mgr & film buyer; Don Long, prog dir; Ron Headley, news dir; Chas. Upton, chief engr. ■ On 6 CATV's—5,000 subs. On 9 trans. Co-owned: KRDO-AM-FM. ■ Rates: \$150; 35; 30.

Denver

ADI No. 28; see page B-20

KBTU—ch 9, 316 kw vis, 45.3 kw aur, ant 950t/277g. Oct. 12, 1952. 1089 Bannock St., 80217. (303) 825-5288. TWX 303-825-5288. Telex 910-931-2648. Licensee: Combined Communications Co. (acq 9-19-72). Ownership: See Combined Communications Stns. ■ ABC. Rep: Peters, Griffin, Woodward. Wash atty: Pierson, Ball & Dowd. ■ Alvin G. Flanagan, pres & gen mgr; Joe Franzgrote, VP & gen sls mgr; Charles T. Leasure, VP & stn mgr; Cecil L. Walker, VP & bus mgr; David DiManna, prod mgr; Carl Akers, news dir; Marjorie Schmidt, prom mgr; Mrs. Mardee McKinlay, dir pub affrs; Herb Schubarth, VP & chief engr. ■ On CATV's—152,000 subs. On 40 trans.

KMGH-TV

McGraw-Hill Broadcasting Co.

hrp HARRINGTON, RIGHTER
& PARSONS, INC.



KMGH-TV—ch 7, 316 kw vis, 50 kw aur, ant 1,010t/285g. Nov. 1, 1953. 123 Speer Blvd., 80217. (303) 832-7777. TWX 910-931-2615. Licensee: McGraw Hill Bcstg Co. (acq 6-1-72). Ownership: See McGraw Hill Stns, also Nwsp. ■ CBS. Rep: H.R.P. Wash atty: Koteen & Burt. ■ Arthur D. Glenn, VP & gen mgr; Bob Hart, sls mgr; Bob Jones, prog dir & film buyer; Letitia Matson, prom mgr; Bob Burton, news dir; Eugene Jenkins, chief engr. ■ On 7 trans.

KOA-TV—ch 4, 100 kw vis, 35.1 kw aur, ant 1,480t/833g. Dec. 24, 1953. 1044 Lincoln St., 80217. (303) 861-8111. TWX 910-931-0439. Licensee: General Electric Bcstg Co. of Colo. Inc. Ownership: See GE Stns. ■ NBC. Navajo ½ hr wkly. Rep: Blair. Wash atty: McKenna, Wilkinson & Kittner. ■ Richard M. Schafback, VP & gen mgr; Dick Harris, mktg mgr; Becky Averyt, prog dir; Joel Day, sls mgr; Terry Simerly, news dir; Bob Rubin, opns mgr. ■ On 38 CATV's—42,000 subs. On 25 trans. Co-owned: KOA-AM-FM. ■ Rates: \$1,000; 600; 100.

California, Colorado TV

See page B-89 for explanation of listings.

***KRMA-TV**—ch 6, 100 kw vis, 15.1 kw aur, ant 880t/213g. Jan. 30, 1956. 1261 Glenarm Pl., 80204. (303) 572-8218. Licensee: School Dist. No 1, City & County of Denver. ■ PBS. Wash atty: Norman E. Jorgensen. ■ Paul Blue, exec dir; Donald D. Johnson, supvr; John G. Cullen, dir engrg; David Thomsen, prog mgr & film buyer.

KWGN-TV—ch 2, 100 kw vis, 20 kw aur, ant 1,050t/448.5g. July 18, 1952. 550 Lincoln St., 80203. (303) 832-2222. TWX 910-931-2544. Licensee: WGN of Colo. Inc. Ownership: See Tribune Co. Stns, also Nwsp. ■ Sp 2 hrs wkly. Rep: Petry; WGN Continental Sls; Hyett; Creed. Wash atty: Kirkland, Ellis & Rowe. ■ Robert A. Innes; VP & gen mgr; Peter Rosella, gen sls mgr; E. Leroy Olliger, VP & prog dir, film buyer; Tom Smidt, adv & prom mgr; Wayne Vriesman, VP in charge of news; John J. Brennan, VP dir. of opns & sls; Don Raydon, VP & chief engr. ■ On 86 CATV's—212,334 subs. On 3 trans. ■ Rates: \$100; 140; 35.

Durango

ADI No. 80; see page B-2

KREZ-TV—ch 6, 3.16 kw vis, 500 w aur, ant 460t/186g. Sept. 4, 1965. Box 789, Grand Junction, 81501. Licensee: XYZ TV Inc. Co-owned satellite of KREX-TV Grand Junction. ■ ABC, CBS, NBC. ■ Carl Q. Anderson, gen mgr; Ron Nott, chief engr. ■ On 3 CATV's—5,000 subs.

Grand Junction

ADI No. 186; see page B-28

KREX-TV—ch 5, 12.9 kw vis, 2.5 kw aur, ant 10t/343g. May 22, 1954. Box 789, 81501. (303) 242-5000. TWX 910-929-6992. Licensee: XYZ TV Inc. Ownership: See XYZ Stns. ■ CBS, ABC, NBC. Rep: H-R. Wash atty: Lois Siegal Schwartz. ■ Rex G. Howell, chmn; Carl Q. Anderson, pres & gen mgr; Harley Terril, prog dir & film buyer; Tom Lundstrum, news dir; Al LaDage, chief engr. ■ On 5 CATV's—6,000 subs. On 51 trans. Co-owned: KREX-AM-FM. ■ Rates: \$72; 64; 45.

Montrose

ADI No. 186; see page B-28

KREY-TV—ch 10, 3.09 kw vis, 617 w aur, ant 80t/112.5g. Aug. 26, 1956. Box 49, 81401. (303) 249-9601. Licensee: XYZ TV Inc. Co-owned satellite of KREX-TV Grand Junction. ■ CBS, ABC, NBC. ■ Carl Q. Anderson, gen mgr; Gordon Carson, stn mgr. ■ On 2 CATV's—1,100 subs. On 12 trans. ■ Rates: \$22; 18.25; 15.60.

Pueblo

ADI No. 103; see page B-16

KKTU—Licensed to Colorado Springs. See Colorado Springs.

KOAA-TV—See Colorado Springs.

KRDO-TV—Licensed to Colorado Springs. See Colorado Springs.

***KTSC**—ch 8, 316 kw vis, 63.2 kw aur, ant 1,224t/972g. Feb 3, 1971. 900 W. Orman, 81004. (303) 549-3220. Licensee: University of Southern Colo. ■ PBS. ■ Marshall E. Allen, gen mgr; Clayton Roehl, opns mgr; Marie Masimer, prom mgr; Oliver F. Kendall, chief engr. ■ 4 CATV's—24,000 subs. On 2 trans.

Sterling

ADI No. 171; see page B-14

KTVS—ch 3, 60.6 kw vis, 6 kw aur, ant

Connecticut, Delaware, D.C. TV

See page B-89 for explanation of listings.

760t/604g. Jan 1, 1964. 204 1/2 Main St., 80751. (303) 522-5743. Licensee: Wyneco Communications Inc. (acq 9-15-72) Ownership: See Lamb Communications Inc. ■ CBS, ABC. Rep: Avery-Knodel. Wash atty: Fly, Shuebruk, Blume & Gaguine. ■ Gene L. Huston, res mgr; Gary McDuffie, chief engr. ■ On 15 CATV's—14,375 subs.

Connecticut

HAMILTON-LANDIS & ASSOCIATES, Inc.
NATIONWIDE MEDIA BROKERS
WASHINGTON, D. C., CHICAGO, DALLAS,
SAN FRANCISCO
SELL **MORE**
RADIO & TELEVISION STATIONS
IN THE EAST—NEAREST OFFICE IS—
1730 K ST., N.W., WASHINGTON 20006
(202) 393-3456

Bridgeport

ADI No. 1; see page B-50

***WEDW**—ch 49, 380 kw vis, 38.0 kw aur, ant 610t/376g. Dec. 17, 1967. Box 449, 06601. Licensee: Conn. ETV Corp. ■ PBS, Eastern Educl TV Net. ■ Exec: See *WEDH(TV) Hartford.

Hartford

ADI No. 21; see page B-32

***WEDH**—ch 24, 680 kw vis, 69 kw aur, ant 860t/455g. Oct. 1, 1962. 24 Summit St., 06106. (203) 278-5310. TWX 710-425-4039. Licensee: Conn. ETV Corp. ■ PBS, Eastern Educl TV Net. Wash atty: Dow, Lohnes & Albertson. ■ Paul K. Taff, pres & gen mgr; Christine Fitzpatrick, VP prom; Al Binford, VP prog; John C. Lennhoff, VP bus affrs; John Kean, VP engr; Stan Levy, prod mgr; Fran Abramowicz, chief engr. ■ On 1 trans.

WFSB-TV—ch 3, 100 kw vis, 13.8 kw aur, ant 910t/542g. Sept. 23, 1957. Broadcast House, 3 Constitution Plaza, 06115. (203) 525-0801. TWX 203-278-0330. Licensee: Post-Newsweek Stations, Connecticut Inc. (acq 3-8-74). Ownership: See Post-Newsweek, also Nwspr. ■ CBS. Rep: Top Market TV. Wash atty: Covington & Burling. ■ Daniel E. Gold, sr VP & gen mgr; Amy McCombs, prod dir & film buyer; Henry J. O'Neill, sls mgr; Michael Von Ende, news dir; Stephen J. Myers, chief engr. ■ On 32 CATV's—75,000 subs. ■ Rates: \$1,180; 200; 105.

WHCT-TV—ch 18, 158 kw vis, 31.6 kw aur, ant 6,405/291g. Jan. 24, 1959. 555 Asylum St., 06105. (203) 525-2611. TWX 710-425-6258. Licensee: Faith Center Inc. Ownership: See Faith Center Inc. Stns. ■ Rep: Savalli/Gates. Wash atty: Cohen & Berfield. ■ E. L. Cole, gen mgr; Thomas McCarsky, dir of opns; Fred Tucker, dir of engr. ■ On 3 CATV's.

WHNB-TV—(New Britain) ch 30, 790 kw vis, 78 kw aur, ant 930t/1,288g. Feb. 11, 1953. 1422 New Britain Ave., W. Hartford, 06110. (203) 521-3030. TWX 203-278-0378. Licensee: Conn. TV Inc. Ownership: Plains TV Corp., 100%. See Transcontinental Stns and Balaban Stns. ■ NBC. Rep: Young; Kettell-Carter. Wash atty: McKenna, Wilkinson & Kitner. ■ Herbert Scheffel, pres; Elmer Balaban, VP; Robert W. Bray, VP & gen mgr; Jack Fox, sls dir; John Palmer, prod dir; Phillip B. Hale,

film buyer; Howard Wry, prom mgr. ■ On 2 trans.

WTNH-TV—See New Haven.

New Britain

WHNB-TV—Licensed to New Britain. See Hartford, Conn.

New Haven

ADI No. 21; see page B-32

***WEDY**—ch 65, 443 kw vis, 500 w aur, ant 270t/101.6g. November 1974. 24 Summit Street, 06106. (203) 278-5310. Permittee: Conn. ETV Corp. ■ PBS. ■ Exec: See *WEDH(TV) Hartford.

WTNH-TV—ch 8, 115 kw vis, 22.9 kw aur, ant 1,210t/909g. June 15, 1948. Box 1859, 06508. (203) 777-3611. TWX 710-465-0083. Licensee: Capital Cities Communications Inc. (acq 4-28-71). Ownership: See Capital Cities, also Nwspr. ■ ABC. Rep: Blair. Wash atty: Wilmer, Cutler & Pickering. ■ Peter K. Orne, VP & gen mgr; William Mallery, gen sls mgr; Nat Tucker, dir of bcst opns; Bruce Lawrence, loc & rgl sls mgr; James Chirumbolo, prom mgr; Bill Lawlor, news dir; Carmine Iannucci, chief engr. ■ On 20 CATV's—50,000 subs.

WTVU—ch 59, 19.5 kw vis, 10.2 kw aur, ant 560t/334g. Not on air, target date unknown. Box 85, 06501. Permittee: Impart Systems Inc. Ownership: See Victor Muscat Stns. ■ Wash atty: Fly, Shuebruk, Blume & Gaguine.

Norwich

ADI No. 29; see page B-58

***WEDN**—ch 53, 316 kw vis, 31.6 kw aur, ant 681t/481g. March 5, 1967. 24 Summit St., Hartford, 06106. Licensee: Conn. ETV Corp. ■ PBS, ETV. ■ Exec: See *WEDH(TV) Hartford. ■ On 1 CATV.

Waterbury

ADI No. 21; see page B-32

WATR-TV—ch 20, 200 kw vis, 20 kw aur, ant 510t/255g. Sept. 4, 1953. (203) 755-1121. Licensee: Thomas Television Inc. 79 Baldwin Ave., 06706. Ownership: Estate of Harold Thomas, 99%; Lillian Thomas, 1%. ■ NBC. Sp 2 hrs wkly. Rep: Devney; Kettell-Carter. Wash atty: Finklestein & Firestone. ■ B. Preston Gilmore, exec VP; Robert S. Holczer, gen mgr & film buyer; Trisha Torrello, prom mgr; Fred Schilling, news dir; Charles Allen, chief engr. ■ On 10 CATV's—68,200 subs. Co-owned: WATR(AM)-WWYZ-FM. ■ Rates: \$50; 45; 35.

Delaware

Wilmington

ADI No. 4; see page B-56

***WHYY-TV**—ch 12, 309 kw vis, 30.9 kw aur, 960t/1148g. Sept. 12, 1963. 5th & Scott St., 19805. (302) 654-6255. TWX 710-670-5983. 4548 Market St., Philadelphia, 19139. (215) 382-9300. Licensee: WHYY Inc. Ownership: WHYY Inc. ■ PBS, Eastern Educl TV Net, Penna. Public TV Net. Wash atty: Schwartz & Woods. ■ Elkins Wetherill, chmn; Warren A. Kraetzer, pres & gen mgr; Norman Marcus, VP prog & prod; Karl A. Peckman, VP devel; Michael Cascio, news dir; Mrs. Shellie Karabell, dir of PR; Michael A. Prescott, VP fin & admin; Robert Hall, VP & chief engr. ■ On 45 CATV's—225,000 subs. On 1 trans.

District of Columbia

HAMILTON-LANDIS & ASSOCIATES, Inc.
NATIONWIDE MEDIA BROKERS
WASHINGTON, D. C., CHICAGO, DALLAS,
SAN FRANCISCO
SELL **MORE**
RADIO & TELEVISION STATIONS
IN THE EAST—NEAREST OFFICE IS—
1730 K ST., N.W., WASHINGTON 20006
(202) 393-3456

Washington

ADI No. 8; see page B-75

WDCA-TV—ch 20, 4,000 kw vis, 400 kw aur, ant 770t/809g. April 20, 1966. 5202 River Rd., 20016. (301) 654-2600. TWX 710-824-9608. Licensee: Ch. 20 Inc. Ownership: Superior Tube Co. ■ Rep: Peters, Griffin, Woodward. Wash atty: Pierson, Ball & Dowd. ■ Warren Stone, pres; Milton Grant, VP & gen mgr; Joe Girard, sls mgr; Jim Reid, prod dir & film buyer; Dan O'Brien, prom mgr; Don Doughty, dir engr. ■ On 39 CATV's—99,328 subs.

***WETA-TV**—ch 26, 1,074 kw vis, 107.4 kw aur, ant 777t/817g. Oct. 2, 1961. 3620 27th St. South, Arlington, Va., 22206. (703) 820-4500. TWX 710-955-9846. Licensee: Greater Washington Educl Telecommunications Assn Inc. ■ PBS, Eastern Educl TV Net. Wash atty: Norman E. Jorgensen. ■ Ward B. Chamberlin Jr., pres and gen mgr; Gerald Slater, exec VP; Richard Hiner, prod dir; Fred Flaxman, prod dir; William Gladmon, dev dir; King Harrison, dir of engr. ■ On 13 CATV's—38,747 subs. On 1 trans. Co-owned: *WETA-FM.

WGSP-TV—ch 50, 813 kw vis, 162 kw aur, ant 480t/492g. Not on air, target date unknown. 1120 Connecticut Ave., 20036. Permittee: Lee W. Cowan, trustee in bankruptcy.

***WHMM**—ch 32, 784 kw vis, 155.2 kw aur, ant 771t/809g. Not on air, target date Dec. 25, 1976. 2600 Fourth St. N.W., 20059. (202) 265-9494. Permittee: Howard University. ■ Wash atty: Arnold & Porter. ■ Dr. James E. Cheek, pres; Millard J. Watkins, chief engr. ■ Co-owned: WHUR-FM.

WMAL-TV—ch 7, 316 kw vis, 48 kw aur, ant 780t/640g. Oct. 3, 1947. 4461 Connecticut Ave. N.W., 20008. (202) 686-3000. TWX 710-822-9505. Licensee: Evening Star Bcstg Co. Ownership: See Evening Star Stns, also Nwspr. (Joe L. Allbritton, 100%). ■ ABC. Rep: Petry. Wash atty: Hogan & Hartson. ■ Richard S. Stakes, pres; Andrew M. Ockershausen, VP; Thomas B. Cookerly, gen mgr; Fred Barber, stn mgr; Wayne Spracklin, gen sls mgr; Stan Pederson, prom mgr; Irwin Starr, prod dir; Sam Zelman, exec news dir; Ed Hippe, chief engr. ■ Co-owned: WMAL-AM-FM.

WRC-TV—ch 4, 100 kw vis, 15.1 kw aur, ant 570t/457.9g. June 27, 1947. 4001 Nebraska Ave. N.W., 20016. (202) 686-4000. TWX 202-965-0804. Licensee: NBC Inc. Ownership: See NBC-Owned Stns. ■ NBC. Rep: NBC Spot Sales. ■ Tom E. Paro, VP & gen mgr; J. Taber Bolden, stn mgr; Jane Cohen, prod mgr; Bruce MacDonell, news mgr; Michael Artist, adv prom; James E. Martz, gen sls mgr; Allan Aebig, dir tech opns; Sherman Hildreth, dir of engr & facil; Bryson Rash, mgr edit svcs; Sandra Wingfield, mgr community rel, press & pub. ■ Co-owned: WRC(AM) and WKYS(FM).

WTOP-TV—ch 9, 316 kw vis, 44.7 kw aur, ant 770t/640g. Jan. 16, 1949. 40th & Brandywine Sts. N.W., 20016. (202) 686-6000. TWX 710-822-9776. Licensee: Post-Newsweek Stns, Capital Area Inc. Ownership: See Post-Newsweek Stns, also Nwspr. ■ CBS. Rep: Top Market Television. Wash atty: Covington & Burling. ■ Joel Chaseman, pres; James E. Allen,

exec VP; Ray Hubbard, VP progmg; James T. Lynagh, VP & gen mgr; James L. Snyder, VP news; Leonard Giarraputo, exec VP sls; James D. Bodz, natl sls mgr; Ben Wolfe, VP engr; Charles Horich, prog dir; Helen Dudman, PR dir; Gene Davis, prom mgr; Ralph Miaska, chief engr. ■ On 16 CATV's—36,600 subs. On 6 trans. Co-owned: WTOF(AM).

WTWG—ch 5, 100 kw vis, 15 kw aur, ant 770t/705g, Jan. 1, 1947. 5151 Wisconsin Ave., N.W., 20016. (202) 244-5151. TWX (710) 822-9363. Licensee: Metromedia Inc. Ownership: See Metromedia Stns. ■ Rep: Metro TV Slc. Wash atty: Thomas J. Dougherty. ■ John W. Kluge, chmn of bd & pres Metromedia Inc.; Albert P. Krivin, pres TV; William Carpenter, VP & gen mgr; Jerry Marcus, VP & gen sls mgr; Albert Mazzoni, natl sls mgr; Stanley Rudick, VP & prog dir; Harold Levenson, news dir; Tim McDonald, asst prog dir & prom mgr; Albert L. Harmon, VP & chief engr. ■ On 100+ CATV's. On 2 trans. Co-owned: WASH(FM).

Florida

HAMILTON-LANDIS & ASSOCIATES, Inc.
NATIONWIDE MEDIA BROKERS
WASHINGTON, D. C., CHICAGO, DALLAS,
SAN FRANCISCO
SELL **MORE**
RADIO & TELEVISION STATIONS
IN THE EAST—NEAREST OFFICE IS—
1730 K ST., N.W., WASHINGTON 20006
(202) 393-3456

Boynton Beach

ADI No. 83; see page B-76

***WHRS-TV**—ch 42.44.2 kw vis, 8.8 kw aur, ant 500t/503g. Not on air, target date 1976. 505 S. Congress Ave., 33435. (305) 737-7300. Permittee: School Board of Palm Beach County. ■ Net: PBS. ■ Dr. Joseph Carroll, supt; John H. Burger, gen mgr; Sam J. Barbaro, prog dir; Pat E. O'Meara, prom mgr; Melvin Cohen, chief engr. ■ Co-owned: *WHRS-FM.

Daytona Beach

WESH-TV—Licensed to Daytona Beach-Orlando, See Orlando.

Fort Lauderdale

ADI No. 15; see page B-45

WKID—ch 51, 355 kw vis, 70.8 kw aur, ant 1020t/1034g, Dec. 6, 1968. 605 Sheridan St. Dania, 33004. (305) 920-7804. TWX 510-954-0303. Licensee: Ch. 51 Inc. Debtor in Possession. ■ Rep: Young. Wash atty: Everett Johnstone. ■ William Johns, pres, gen mgr; Don S. Sundquist, dir of opns; Craig Fearing, chief engr. ■ On 5 CATV's.

Fort Myers

ADI No. 153; see page B-27

WBBH-TV—ch 20, 524 kw vis, 52 kw aur, ant 930t/995g, Dec. 19, 1968. 3719 Central Ave., 33901. (813) 936-0195. TWX 510-951-7370. Licensee: Bcstg-Telecting Svcs Inc. Ownership: Thomas E. Mitchell, 23.96%; Jackson Burgess, 19.17%; William N. Dakos, 13.06%; Rex Stubbs, 11.38%; and others. ■ NBC. Sp 2½ hrs wkly. Rep: Avery-Knodel. Wash atty: Hogan & Hartson. ■ Howard Hoffman, pres & gen mgr; Warren T. Roof, lcl sls mgr; Steve Smith, news

dir; Jo Corey, prog adm; Edie Reno, prom mgr; David McKelvey, chief engr. ■ On 20 CATV's—80,000 subs. ■ Rates: \$80; 50; 20.

WINK-TV

MEEKER CO. TV SALES

WINK-TV—ch 11, 316 kw vis, 55 kw aur, ant 960t/995g, March 18, 1954. Box 1060, 33902. (813) 334-1131. TWX 510-951-7371. Licensee: Ft. Myers Bcstg Co. Ownership: Arthur B. McBride, 50%; Edward J. McBride, 50%. ■ CBS. Rep: Meeker; Busby, Finch, Latham, Widman. Wash atty: Dempsey & Koplovitz. ■ Edward McBride, pres; Robert L. Rausch, VP & gen mgr; Joyce T. Dority, dir of sls; Jan Icyda, prom mgr; Lee Phillips, news dir; Clarence Mosley, chief engr. ■ On 21 CATV's—81,000 subs. Co-owned: WINK-AM-FM. ■ Rates: \$70; 55; 20.

Fort Pierce

ADI No. 83; see page B-76

WTVX—ch 34, 5.25 kw vis, 1.1 kw aur, ant 490t/478g, April 5, 1966. Rt 1, Box 313, 33450. (305) 464-5220. Licensee: Indian River TV Co. Ownership: Ruhl W. Koblegard, 10%; Alto Adams Jr., 23%; Chistine Haynes, 16%, & others. ■ CBS. Wash atty: Fly, Shuebruk, Blume & Gaguine. ■ Ruhl W. Koblegard, pres; Marian "Skeet" Talley, gen mgr; Jack Tallcott, sls mgr; Ed Trent, news dir; Charles Castle, chief engr. ■ On 3 CATV's—45,000 subs.

Gainesville

ADI No. 182; see page B-28

WCJB—ch 20, 427 kw vis, 87.1 kw aur, ant 680t/669g, April 7, 1971. Drawer 13414, 32601. (904) 372-3545. Licensee: Minshall Bcstg Co. Ownership: W. E. Minshall, 100%. ■ ABC. Rep: Busby, Finch, Woods. Wash atty: Fly, Shuebruk, Blume & Gaguine. ■ W. E. Minshall, pres & gen mgr; Marc Orgera, prog dir; Otto Goetz, chief engr. ■ On 9 CATV's—45,000 subs.

***WUFT**—ch 5, 100 kw vis, 20 kw aur, ant 860t/896g, Nov. 10, 1958. 234 Stadium Bldg., 32611. (904) 392-0471. Licensee: Fla. Bd. of Regents. ■ PBS. Wash atty: Jorgensen & Baron. ■ Jesse Cripe, gen mgr; Susan M. Whitaker, prog dir; Sunny Fader, prom mgr; Donald A. Grooms, news dir. ■ On 12 CATV's—40,000 subs.

Jacksonville

ADI No. 69; see page B-34

***WJCT**—ch 7, 302 kw vis, 36.9 kw aur, ant 840t/996g, Sept. 10, 1958. 2037 N. Main St., 32206. (904) 354-2806. Licensee: Community TV Inc. ■ PBS, Fla. ETV. Wash atty: Schwartz & Woods. ■ Fred Reban, pres & gen mgr; Dan Kossoff, dir of spec projects; Vic Digente, dir of info svcs; Eric Sass, devel dir; Richard A. Heuer, prog dir; Kent Taylor, prod dir; T. A. Gaylon, bus mgr; Gene Napier, chief engr. ■ On 12 CATV's.

WJKS-TV—ch 17, 2,450 kw vis, 25.5 kw aur, ant 980t/1,015g, Feb 19, 1966. Box 17000, 32216. (904) 641-1700. TWX 810-827-0284. Licensee: Rust Craft Bcstg Co. Ownership: See Rust Craft Stns. ■ ABC. Rep: Petry. Wash atty: Kirkland, Ellis & Rowe. ■ Marshall Berkman, pres; Gary Adler, VP & gen mgr; Robert A.

D.C., Florida TV

See page B-89 for explanation of listings.

Craig, sls mgr; Herb Gold, prog dir & film buyer; Mary Jo Trenkler, prom mgr; Larry Lyle, news dir. ■ On 23 CATV's—52,569 subs. On 1 trans. ■ Rates: \$300; 160; 40.

WJXT—ch 4, 100 kw vis, 20 kw aur, ant 930t/996g, Sept. 15, 1949. Box 5270, 32207. (904) 399-4000. TWX 810-827-1605. Licensee: Post-Newsweek Stns, Fla. Inc. (acq 2-25-53). Ownership: See Post-Newsweek Stns, also Nwspr. ■ CBS. Rep: Top Market Television. Wash atty: Covington & Burling. ■ Larry Israel, chmn; Joel Chaseman, pres; Robert W. Schellenberg, VP & gen mgr; Harry Kalkines, sls mgr; Lon Lee, prog dir & prom mgr; William Grove, VP for news; Ernie Mastroianni, news dir; Ralph Thompson, engr mgr. ■ On 28 CATV's—90,000 subs.

WTLV—ch 12, 316 kw vis, 60.3 kw aur, ant 940t/996g, Sept. 1, 1957. Box 1212, 32201. (904) 354-1212. TWX 904-733-3310. Licensee: TV 12 of Jacksonville Inc. (acq 5-12-75). Ownership: Harte-Hanks Nwsprs, 100%. ■ NBC. Rep: Blair. Wash atty: Arnold & Porter. ■ Gert H. W. Schmidt, pres & gen mgr & film buyer; Robert M. Reuschle, gen sls mgr; John Fuller, prog dir; Roy Lang, prom mgr; Harold Baker, news dir; Nile M. Hunt, chief engr. ■ On 14 CATV's—52,960 subs. ■ Rates: \$595; 280; 60.

Largo

WLCY-TV—Licensed to Largo. See Tampa.

Miami

ADI No. 15; see page B-45

WCIX-TV—ch 6, 77.6 kw vis, 13.2 kw aur, ant 1,049t/1,049g, Sept. 20, 1967. 1111 Brickell Ave., 33131. (305) 377-0811. TWX 810-848-8208. Licensee: Coral TV Corp. Ownership: General Cinema Corp, 95%. ■ Sp 2 hrs wkly. Rep: Petry TV Inc. Wash atty: Wilner & Scheiner. ■ Alexander M. Tanger, pres; Edward Q. Adams, gen mgr, prog dir & film buyer; Harvey Cohen, gen sls mgr; Gail Blanchard, prom mgr; Richard Descutner, opns & news dir; Jack R. Cowart, chief engr. ■ On 44 CATV's—323,710 subs. On 4 trans.

WCKT—ch 7, 316 kw vis, 63.2 kw aur, ant 950t/994g, July 29, 1956. 1401 79th St., Causeway, 33141. (305) 751-6692. TWX 810-848-6151. Licensee: Sunbeam TV Corp. Ownership: Edmund N. Ansin, 45.8%, & others. ■ NBC. Rep: Harrington, Righter & Parsons. Wash atty: Koteen & Burt. ■ Edmund N. Ansin, pres & gen mgr; John Fenwick, gen sls mgr; Allen Sternberg, opns mgr; Frank Struzzi, film buyer; Gene Strul, news dir; George White, prom mgr; Robert Paasch, chief engr. ■ On 3 CATV's—20,000 subs. On 2 trans.

WFCB-TV—ch 45, 447 kw vis, 89.1 kw aur, 1,020t/1,040g, March 16, 1975. Box 21218, Ft. Lauderdale 33315. (305) 524-8352. Licensee: Florida Christian Broadcasting Inc. Ownership: T. I. Monroe, pres, et al. Non-profit-non-stock corporation. ■ Wash atty: Fisher, Wayland, Southmayd & Cooper. ■ Thomas I. Monroe, pres & gen mgr; Raymond Ostendorf, sls mgr; James Darin, film buyer; Judson Murray, chief engr.

***WLRR-TV**—ch 17, 16.6 kw vis, 3.2 kw aur, ant 600t/724g, June 26, 1962. 1410 N. E. Second Ave., 33132. School Board of Dade County. ■ PBS. ■ See *WPBT(TV) Miami.

WLTW—ch 23, 468 kw vis, 77.6 kw aur, ant 920t/941g, Nov. 15, 1967. 695 N.W. 199th St., 33169. (305) 625-1301. Licensee: Spanish Int. Communications Corp. (acq 1-71). Ownership: See Spanish Communications Corp Stns. ■ Span Int. Rep: Petry; Span Int. Net. ■ Frank L.

Florida TV

See page B-89 for explanation of listings.

Fouce, chmn; Reynold V. Anselmo, pres; Humberto Estevez, gen mgr; Joaquin Blaya, sls mgr.

***WPBT**—ch 2, 81.3 kw vis, 16.2 kw aur, ant 6701/724g. ST WTHS—TV, Aug. 12, 1955. Box 610001, 33161. (305) 949-8321. Licensee: Comm TV Foundation of S. Fla. Inc. ■ PBS. Wash atty: Wilmer, Cutler & Pickering. ■ George Dooley, pres & gen mgr; John Felton, VP for progmg; Thomas Sanberg, VP for devel; N. Joseph Potts, controller; Taffy Beber, mgr of pub info; Steve L. Rogers, VP for engrg.

10
wplg-miami
the one to watch

WPLG-TV—ch 10, 316 kw vis, 47.9 kw aur, ant 1,000/1,045g. Nov 20, 1961. 3900 Biscayne Blvd., 33137. (305) 573-7111. TWX 810-848-6032. Licensee: Post-Newsweek Stns, Fla. Inc. (acq 1969) Ownership: See Post-Newsweek Stns, also Nwsprs. ■ ABC. Rep: Top Market Television. Wash atty: Covington & Burling. ■ Larry Israel, chmn; Joel Chaseman, pres; James T. Lynch, VP & gen mgr; Norman Davis, dep gen mgr; Lewis I. Freifeld, sls mgr; Robert T. Sulton, prog dir; Hans Petersen, prom mgr; Gregory Favre, news dir; William Latham, engr mgr. ■ On 22 CATV's—88,400 subs.

***WTHS-TV**—ch 2, 81.3 kw vis, 16.2 kw aur, ant 6801/728g. (CP: 85.1 kw vis, 17 kw aur, ant 920 ft.) ST WPBT. 1410 N.E. 2nd Ave., 33132. School Board of Dade County.

WTVJ—ch 4, 100 kw vis, 20 kw aur, ant 9521/995g. March 21, 1949. 316 N. Miami Ave., 33128. (305) 377-8241. TWX 810-848-5932. Licensee: Wometco Enterprises Inc. Ownership: See Wometco Enterprises Stns. ■ CBS. Sp 1 hr wkly. Rep: MMT Sls Inc. Wash atty: Cohn & Marks. ■ Mitchell Wolfson, pres; William Brazzil, VP & gen mgr; Dick Hollands, asst gen mgr; Frank Miller, stn mgr; Tom Fraioli, gen sls mgr; Doug Barker, natl sls mgr; Tay Voye, dir of prog opns; Sheryl Gold, prom mgr; Ralph A. Renick, VP, news dir; Joe Kline, dir of tech opns. ■ On 29 CATV's—64,000 subs. ■ Rates: \$1600; 720; 270.

Naples

ADI No. 153; see page B-27

WEVU-TV—ch 26, 1000 kw vis, 100 kw aur, 7101/732g. August 21, 1974. Box N, Bonita Springs, 33923. (813) 597-5555. TWX 510-951-7343. Licensee: Gulfshore Television Corp. Ownership: Richard G. Simpson Jr., pres, 25%; Robert S. Dean, VP, 25%; Sam Johnson Jr., sec, 25%. ■ ABC. Rep: Savalli-Gates. Wash atty: Smith & Pepper. ■ Richard G. Simpson Jr., pres; Harold S. Taylor, gen mgr, prog dir & film buyer; Dan Harlacher, gen sls mgr; David Howell, prom mgr; Thad Osenkowski, chief engr. ■ On 12 CATV's. ■ Rates: \$46; 42; 14.

Ocala

ADI No. 44; see page B-53

WOCA-TV—ch 51, 1127.2 kw vis, 225.42 kw aur, ant 9271/932.5g. Not on air, target date September 1976. 1516 SW Third Ave., 32670. (904) 373-3693. Permittee: Marion Communications Corp. Ownership: Thomas P. Hicks, R. Joseph Zeigler. ■ Wash atty: Fletcher, Heald, Rowell, Kenehan & Hildreth. ■ Thomas P. Hicks, pres.

Orlando

ADI No. 44; see page B-53

WDBO-TV—ch 6, 74.1 kw vis, 14.8 kw aur, ant 1,465/1,484g. (CP: 100 kw vis, 20 kw aur, ant 1,835 ft.) July 1, 1954. Box 1833, 32802. (305) 843-0006. TWX 810-850-0141. Licensee: The Outlet Co. Ownership: See Outlet Co. Stns. ■ CBS. Rep: Petry. Wash atty: Sundlun, Tirana & Scher. ■ J. S. Sinclair, chmn; Kenneth Logowitz, pres; David E. Henderson, pres Outlet Bcst Div; Arnold F. Schoen Jr., VP & gen mgr; Joseph S. Haller, gen sls mgr; Everett H. Hughes, prog dir; Benjamin Aycrigg, news dir; Chalmers S. Stromberg, chief engr. ■ Co-owned: WDBO-AM—FM.

WESH-TV—(Daytona Beach) ch 2, 100 kw vis, 20 kw aur, ant 9401/998g. May 29, 1956. Box 1551, Daytona Beach, 32015. (904) 253-7616. TWX 810-853-0255. Licensee: Cowles Fla. Bcstg Inc. Ownership: See Cowles Stns, also Nwspr. ■ NBC. Rep: Katz. Wash atty: Marmet Professional Corp. ■ John Haberman, pres & gen mgr; Walter M. Strouse, exec VP, stn mgr; Jack Hitchcock, VP & asst stn mgr; Ken Brown, news dir; Kenneth Smith, VP & ops mgr; Bev Barton, prom mgr; Morrison Gable, chief engr. ■ On 34 CATV's—136,742 subs. ■ Rates: \$500; 200; 90.

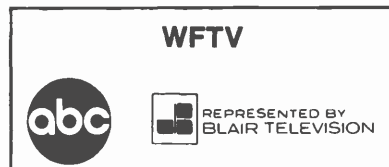

WFTV—ch 9 (interim opn eff. 4/1/69), 316 kw vis, 31.6 kw aur, 15701/1543g. (CP: Ant 1943 ft.) Feb. 1, 1958. Box 999, 32802. (305) 841-9000. TWX 810-850-0179. Licensee: Ch. 9 of Orlando. Ownership: Mid-Fla. TV Corp.; Central 9 Corp.; TV-9 Inc.; Comint Corp.; Fla. Heartland TV Inc., equally. ■ ABC. Rep: Blair. Wash atty: Mullin, Connor & Rhyne. ■ Walter M. Windsor, gen mgr; Clifton L. Conley, gen sls mgr; Clifford S. Pine, ops mgr; Richard P. Flynn, bus mgr; Harry Handley, prom mgr; Warren B. Croke, news dir; James Hammond, chief engr. ■ On 41 CATV's—166,500 subs. ■ Rates: \$260; 130; 35.

***WMFE-TV**—ch 24, 1,202 kw vis, 240 kw aur, ant 1,254/1,228g. March 25, 1965. 2908 W. Oak Ridge Rd., 32809. (305) 855-3691. Licensee: Fla. Cent. E. Coast Educl TV Inc. ■ PBS. Wash atty: Schwartz & Woods. ■ Stephen M. Steck, exec VP & gen mgr; Gary Yeomans, prog mgr; Thomas Landin, prog dir; Linda Mayfield, prom mgr; Aldo Vivona, admin svcs coord; John C. Newsome, dev dir; Joseph S. Hearn, ops mgr; Lee Watkins, chief engr. ■ On 6 CATV's—32,165 subs. On 3 trans. Co-owned: *WMFE-FM.

WSWB-TV—ch 35, 646 kw vis, 12.6 kw aur, ant 14701/1482g. March 31, 1974. 11510 E. Colonial Dr., 32807. (305) 273-2300. Telex 567423. Licensee: Sun World Bcstrs. Ownership: Earl L. Boyles, 28%; Lopatka & McQuaig, 10%; Geraldine Nobles, 6.5%; Wayne Boyles, 5.2% and others. ■ Rep: Young. Wash atty: Welch & Morgan. ■ Earl L. Boyles, chmn & pres; Joseph E. Everett, Robert G. Martins, dir of eng. ■ On 83 CATV's—100,000 subs.

Panama City

ADI No. 178; see page B-55

WDTB—ch 13, 316 kw vis, 63 kw aur, ant 14021/1464g. Oct 3, 1973. Box 1340, 32401. (904) 769-2313. TWX 510-738-7536. Licensee: Panhandle Bcstg Co. Ownership: Eugenia Brannen, 40%; Luther Edwin Thomas, 26%; Ralph J. Bennett, 10%; and others. ■ NBC. Rep: Avery-Knodel. Wash atty: Smith & Pepper. ■ Luther E. Thomas, pres; F. E. Busby,

gen mgr & film buyer; Jerry Blair, natl sls mgr; Thomas J. Sabiston, ops & prom mgr; Barry Shanley, news dir; Larry Young, chief engr. ■ On 15 CATV's—80,000 subs. ■ Rates: \$60; 35; 25.

WJHG-TV—ch 7, 316 kw vis, 34 kw aur, 8701/887g. Dec. 15, 1953. Box 2349, 32401. (904) 234-2125. Licensee: WJHG-TV Inc. Ownership: See Gray Communications Stns, also Nwspr. ■ ABC. Rep: Meeker. Wash atty: Kirkland, Ellis & Rowe. ■ James H. Gray, pres; Raymond E. Carow, VP; Ray H. Holloway, VP & gen mgr; Hugh V. Roche, sls mgr; James Bates, chief engr. ■ On 12 CATV's.

Pensacola

ADI No. 65; see page B-48

WEAR-TV—Licensed to Pensacola. See Mobile, Ala.

***WSRE**—ch 23, 38 kw vis, 5.87 kw aur, ant 4901/469g. Sept. 11, 1967. 1000 College Blvd., 32504. (904) 476-5418, ext 333. Licensee: Dist Bd of Trustees of Pensacola Jr. College (acq 8-31-71). ■ PBS. ■ Eric C. Smith Jr., gen mgr; James Stasko, prog dir; Tom Kearley, prom mgr; Eric E. Wallace, community affairs dir; Harry Flynn, chief engr. ■ On 7 CATV's—27,709 subs.

St. Petersburg

See Tampa-St. Petersburg

Sarasota

ADI No. 17; see page B-71

WXLT-TV—ch 40, 589 kw vis, 120 kw aur, ant 721.1/747g. Oct 23, 1971. Box 940, 33578. (813) 922-0777. Licensee: Sarasota-Bradenton, Fla. TV Co. Ownership: Robert R. Nelson, 51%; Roger Clipp, Clifford Beal, John H. Waltz, Rudolph C. Schonek, Wilbur E. Schonek, each approx. 10%. ■ ABC. Rep: HR-TV; Adv Reps. Wash atty: Daly, Joyce & Borsari. ■ Robert R. Nelson, pres, gen mgr & film buyer; Ted Eleston, sls mgr; Lin Rickard, prog dir; Michael Simmons, news dir; Dan Lunin, chief engr. ■ On 15 CATV's—50,000 subs.

Tallahassee

ADI No. 149; see page B-71

WCTV—(Thomasville, Ga.) ch 6, 100 kw vis, 19.5 kw aur, ant 1,030/1,010g. Sept. 15, 1955. Box 3048, Tallahassee, 32303. (904) 385-2121. TWX 810-931-3773. Licensee: John H. Phipps Bcstg Stns Inc. Ownership: John H. Phipps. ■ CBS, ABC. Rep: Blair. Wash atty: McKenna, Wilkinson & Kittner. ■ Colin S. Phipps, pres; Joseph E. Hosford, VP & gen mgr; Frank Flynn, natl sls mgr; Jerry Williams, prog dir; Charles Clifton, chief engr.

WFSU-TV



***WFSU-TV**—ch 11, 316 kw vis, 31.6 kw aur, ant 7771/774g. Sept 20, 1960. 202 Dodd Hall, Fla. State U., 32306. (904) 644-1736. Licensee: Fla. Bd. of Regents & Fla. State U. ■ PBS. ■ Edward Herp, dir; Wayne Godwin, prog dir & prom mgr; Woodfin O. Walker, chief engr. ■ Co-owned: *WFSU-FM.

WSCT—ch 27, 566.2 kw vis, 113.2 kw aur, ant 8671/900g. Not on air, target date unknown. 3303 Louisiana St., Houston, 77006. Permittee: Allen Communications (acq 1975). Ownership: E.C. Allen, 100%. ■ Wash atty: Finkelstein & Firestone.

Tampa-St. Petersburg

ADI No. 17; see page B-71

***WEDU**—ch 3, 100 kw vis, 12.6 kw aur, ant 935t/1024g. Oct. 27, 1958, 908 S. 20th St., Tampa, 33605. (813) 248-5751. Licensee: Fla. West Coast Pub Bcstg Inc. ■ PBS. Wash atty: Schwartz & Woods. ■ R. LeRoy Lastering, pres; Steve Tyrrell, dir progmg; Orbra Harrell, chief engr. ■ On 45 CATV's.

WFLA-TV—ch 8, 302 kw vis, 60.3 kw aur, ant 1,040t/1,055g. Feb 14, 1955. Box 1410, Tampa, 33601. (813) 229-7781. TWX 810-876-0602. Licensee: WFLA Inc. Ownership: Media General Inc. See Nwspr. ■ NBC. Rep: Blair. Wash atty: Cohn & Marks. ■ George W. Harvey, chmn; William B. Faber, pres; C. Wesley Quinn, gen mgr; Harry Smith, gen sls mgr; Doug Duperrault, film buyer & prog dir; Frank Stringer, opns dir; Joe Mannion, news dir; Larry Kellogg, prom mgr; Patrick McLaughlin, chief engr. ■ On 22 CATV's. Co-owned: WFLA-AM-FM.

WLCY-TV—(Largo) ch 10, 316 kw vis, 50 kw aur, ant 500t/539g. July 17, 1965. Box 14000, St. Petersburg, 33733. (813) 577-1111. TWX 810-863-0371. Licensee: WLCY-TV Inc. Ownership: See Rahall Stns. ■ ABC. Rep: RTVR. Wash atty: Kirkland, Ellis & Rowe. ■ N. Joe Rahall, pres; Jeff Evans, exec VP, gen mgr & film buyer; Ray Shouse, gen sls mgr; Sid Perry, prog & prod mgr; Marshall Cleaver, news dir; Giff Eager, lcl & reg sls mgr; Bruce Singleton, VP & chief engr. ■ On 25 CATV's—125,000 subs. Co-owned: WLCY-AM-FM. ■ Rates: \$450; 175; 50.



A Division of
Hubbard Broadcasting, Inc.

WTOG—ch 44, 828 kw vis, 148 kw aur, ant 1,434t/1,474g. Nov 4, 1968. Box 365, 105th Terrace NE St., St. Petersburg, 33702. (813) 576-4444. TWX 810-863-0379. Licensee: Hubbard Bcstg Inc. Ownership: See Hubbard Stns. ■ Rep: Petry. Wash atty: Fletcher, Heald, Rowell, Kenehan & Hildreth. ■ Stanley S. Hubbard, pres; James C. Dowdle, film buyer & gen mgr; James Tomlin, sls mgr; Ed Moser, prom mgr; Bruce Micek, news dir; Gary L. Simcox, opns mgr; George Orgera, chief engr. ■ On 106 CATV's—176,000 subs. Co-owned: WGTO(AM). ■ Rates: \$70; 150; 35.

WTVT—ch 13, 316 kw vis, 47.4 kw aur, ant 1,416t/1,549g. April 1, 1955. Box 22013, Tampa, 33622. (813) 876-1313. TWX 810-876-0618. Licensee: Gaylord Bcstg Co. (acq 7-19-56). Ownership: See Oklahoma Publishing Co. ■ CBS. Rep: Katz. Wash atty: Pierson, Ball & Dowd. ■ Edward L. Gaylord, chmn of the bd; Eugene B. Dodson, pres & gen mgr; Lawrence T. Whitney, gen sls mgr; Robert M. Olson, asst mgr; Walter K. Rhoads, prom mgr; Ray Dantzier, news, prog & pub affrs dir; Frank Rankel, chief engr. ■ On 42 CATV's—167,065 subs. ■ Rates: \$1,050; 100; 175.

***WUSF-TV**—ch 16, 603 kw vis, 120 kw aur, ant 1,010t/1,024g. Sept. 12, 1966. U. of S. Fla., 4202 Fowler Ave., Tampa, 33620. (813) 974-2341. Licensee: U. of S. Fla. ■ PBS. Wash atty: Cohn & Marks. ■ Dr. William Mitchell, gen mgr; J.D. Hershberger, stn mgr; W.M. Brady, prog dir; Dick Brown, prod mgr; Ted Sullivan, prom mgr; John Ralle, chief engr. ■ On 26 CATV's—250,000 subs. Co-owned: *WUSF-FM.

Vero Beach

WTVX—Licensed to Fort Pierce—Vero Beach. See Fort Pierce.

West Palm Beach

ADI No. 83; see page B-76

WPEC—ch 12, 288 kw vis, 56.2 kw aur, ant 980t/1,027g. Jan 1, 1955. Fairfield Dr., 33407. (305) 848-7211. TWX 510-952-7639. Licensee: PEC Communications Inc. (acq 12-1-73). Ownership: Photo Electronics Corp. ■ ABC. Rep: Katz. Wash atty: Cohn & Marks. ■ Alex W. Dreyfoos, pres & gen mgr; Gary Dean, gen sls mgr; Norma Amick, prog dir; June Aiken, prom mgr; Bill Markham, news dir; Warren Weisheit, film buyer; George Danner, chief engr. ■ On 9 CATV's—65,135 subs. ■ Rates: \$220; 100; 40.

WPTV—ch 5, 100 kw vis, 10 kw aur, ant 990t/1,031g. Aug. 22, 1954. Box 510, Palm Beach, 33480. (305) 655-5455. TWX 510-952-7606. Licensee: Scripps—Howard Bcstg Co. (acq 12-28-61). Ownership: See Scripps-Howard Stns, also Nwspr. ■ NBC. Rep: Blair. Wash atty: Dempsey & Klopovitz. ■ Jack R. Howard, bd chmn; Donald L. Perris, chief exec off; M. C. Watters, chmn, exec comm; Bob Regalbuto, gen mgr & gen sls mgr; Nory LeBrun, sls mgr; Arvo Katajisto, opns dir; Bill Gordon, news dir; Lew Evenden, dir of engr. ■ On 49 CATV's—108,000 subs. ■ Rates: \$400; 250; 90.

Georgia

Albany

ADI No. 139; see page B-2

WALB-TV—ch 10, 275 kw vis, 43.7 kw aur, ant 960t/1,000g. April 7, 1954. Box 3130, 31706. (912) 435-8386. TWX 810-781-5104. Licensee: WALB-TV Inc. Ownership: See Gray Communications Stns, also Nwspr. ■ NBC, ABC. Rep: Meeker, Ayers. Wash atty: Kirkland, Ellis, & Rowe. ■ James H. Gray, pres; Raymond E. Carow, VP & gen mgr; R. Douglas Oliver, sls mgr & film buyer; Lucille Russell, traf dir; G. Donovan Cox, opns dir; James Davis, news dir; Perley E. Eppley, dir of engr. ■ On 36 CATV's—83,000 subs.

Athens

ADI No. 16; see page B-5

***WGTV**—ch 8, 288 kw vis, 56.2 kw aur, ant 1,200t/420g. May 23, 1960. Ga. Ctr for Continuing Educ., U. of Ga., 30601. (404) 542-3554. TWX 404-548-6516. Licensee: Regents of U. System of Ga. ■ PBS, SEN, GETN. Wash atty: Norman E. Jorgensen. ■ Dr. W. H. Hale, Jr., assoc dir communications; Hill Belmont, prog dir; James F. Shehane, prod mgr; Jann Wagner, admin asst; Edward Graham Jr., chief engr. ■ On 29 CATV's—58,886 subs.

Atlanta

ADI No. 16; see page B-5

WAGA-TV—ch 5, 100 kw vis, 10 kw aur, ant 1,076t/1,103g. April, 1949. Box 4207, 30302. (404) 875-5551. TWX 810-751-8265. Licensee: Storer Bcstg Co. Ownership: See Storer Bcstg Co. Stns. ■ CBS. Sp ½ hr wkly. Rep: Storer TV Sls. Wash atty: Warren C. Zwicky. ■ Paul Raymon, VP & gen mgr; Terry McGuirk, stn mgr; Peter Murray, natl sls mgr; James Ferguson, prog dir; Dick Goss, prom mgr; Dale Clark, pub svcs dir; J. Marc Doyle, news dir; Hugo Bondy, chief engr. ■ On 65 CATV's—200,000 subs. ■ Rates: \$1550; 350; 150.

WATL-TV—ch 36, 2,030 kw vis, 304 kw aur, ant 1,090t/1,174g. Aug 16, 1969. (Off the air.) Permittee: Briarcliff Communications (acq 7-74).

Florida, Georgia TV

See page B-89 for explanation of listings.

***WETV**—ch 30, 776 kw vis, 77.6 kw aur, ant 1,090t/1,070g. Feb. 17, 1958, 740 Bismarck Rd., N.E., 30324. (404) 873-4471. TWX 810-751-8164. Licensee: Atlanta Bd of Educ. ■ PBS. Wash atty: McHugh, Steptoe & Johnson. ■ Benjamin E. Mays, pres; Richard B. Holcomb, gen mgr; Larry Watkins, asst gen mgr; William E. Scott, prog dir; Augustine Dempsey, comnty rel coord; Don Gilpin, prod mgr; Jack R. Curry, chief engr. ■ On 7 CATV's—25,200 subs. Co-owned: *WABE(FM).

WHAETV—ch 46, 1860 kw vis, 370 kw aur, ant 1,170t/1,174g. (CP: 1,762 kw vis, 176 kw aur, ant 1088 ft.) June 6, 1971. 1810 Briarcliff Rd., N.E., 30329. (404) 325-3103. TWX 810-751-3597. Licensee: Christian Bcstg Network Inc., nonprofit organization. See Christian Bcstg Net Stns. ■ Rep: Adam-Young. Wash atty: Fisher, Wayland, Southmayd & Cooper. ■ M. G. Robertson, pres; Robert E. Johnson, gen mgr; John Pauza, gen sls mgr; Don Barney, prog dir; Ada Fuller, film buyer; Kathi Neal, prom mgr; Carl Meeks, chief engr. ■ Rates: \$40; 30; 20.

WSB-TV

Cox Broadcasting Corporation

WSB-TV—ch 2, 100 kw vis, 20 kw aur, ant 1,037t/1,076g. Sept. 29, 1948. 1601 W. Peachtree St., N.E., 30309. (404) 897-7000. TWX 810-751-3532. Licensee: Cox Bcstg Corp. Ownership: See Cox Bcstg Stns, also Nwspr. ■ NBC. Rep: Tele-Rep. Wash atty: Dow, Lohnes & Albertson. ■ Clifford M. Kirtland Jr., pres; Stanley Mouse, group VP & gen mgr; bcst div; Don Elliot Heald, VP & gen mgr; Dale A. Smith, stn mgr; John Carpenter, gen sls mgr; A. R. Van Cantfort, film buyer & prog mgr; Skip Haley, news dir; Jean Hendrix, dir of prom & pub; William Powers, dir of engr. ■ On 1 trans. Co-owned: WSB-AM-FM.

WTGG—ch 17, 2,224 kw vis, 224 kw aur, ant 1,093t/1,042g. Sept. 1, 1967. 1018 W. Peachtree St., N.W., 30309. (404) 873-2242. TWX 810-751-8568. Licensee: Turner Comm Corp. (acq 1-70). Ownership: R. E. Turner III, 85%; & others. ■ Rep: RKO TV Reps. Wash atty: Smith & Pepper. ■ R. E. Turner, pres & gen mgr; Don Lachowski, VP & gen sls mgr; Sidney Pike, stn mgr, prog dir & film buyer; Ned Jay, prom mgr; Eugene B. Wright, chief engr. ■ On 88 CATV's—353,158 subs. ■ Rates: \$150; 275; 60.

WXIA-TV—ch 11, 316 kw vis, 63.2 kw aur, ant 1,040t/1,042g. Sept. 30, 1951. 1611 W. Peachtree St., N.E., 30309. (404) 892-1611. TWX 810-751-8360. Licensee: Combined Communications Corp. (acq 1-4-68) Ownership: See Combined Communication Corp. Stns. ■ ABC. Rep: PGW. Wash atty: Pierson, Ball & Dowd. ■ Jack Clifford, pres & gen mgr; Elliott Bass, gen sls mgr; Neil Kevin, prog dir & film buyer; Virgil Dominick, news dir; Larry Lowenstein, prom mgr; Russ Artz, chief engr. ■ On 89 CATV's—185,000 subs. ■ Rates: \$900; 225; 75.

Augusta

ADI No. 111; see page B-6

WATU-TV—ch 26, 340 kw vis, 30 kw aur, ant 1,580t/1,546g. (CP: 295 kw vis, 29.5 kw aur, ant 1600 ft.) Dec. 24, 1968. 7th & Reynolds St., 30902. (404) 824-5527. Licensee: Augusta Telecasters Inc. Ownership: Francis Hanks Robertson, 45%; Harold W. Twisdale, 12.43%; David L. Steel Sr., 9.88%; and others. ■ Net: NBC. Rep: Young. Wash atty: Finkelstein & Firestone. ■ A. Richard Vance, VP & gen mgr; Bruce Baker, sls mgr; Lynn Evans, opns mgr; James Luttrell, chief engr.

Georgia, Hawaii TV

See page B-89 for explanation of listings.

WJBF—ch 6, 100 kw vis, 20 kw aur, ant 1,370t/1,292g. Nov. 23, 1953. Box 1404, 30903. (404) 722-6664. TWX 810-755-4023. Licensee: Fuqua Television Inc. Ownership: J. B. Fuqua, 62%. ■ ABC. Rep: H-R. Wash atty: Wilner & Scheiner. ■ John Radeck, pres & gen mgr; Walter Campbell Jr., VP sls; Gerry Levy, prod mgr; Terry Sams, VP & prog dir; James Davis, VP & news dir; John P. Jopling, VP & chief engr.

WRDW-TV—ch 12, 316 kw vis, 30.2 kw aur, ant 1,590t/1,506g. Feb. 15, 1954. Drawer 1212, 30903. (803) 278-1212. TWX 810-771-4860. Licensee: Rust Craft Bcstg Co. Ownership: See Rust Craft Bcstg Stns. ■ CBS. Rep: Katz. Wash atty: Kirkland, Ellis & Rowe. ■ Marshall Berkman, pres; James N. Armistead, VP, gen mgr & film buyer; H. Dean Hinson, sls mgr; Lee Sheridan, prog dir; Mary Cashon, prom mgr; Dave Kesler, news dir; Don Smith, chief engr. ■ On 21 CATV's—44,450 subs. ■ Rates: \$190; 60; 40.

Chatsworth

ADI No. 76; see page B-14

***WCLP-TV**—ch 18, 447 kw vis, 44.7 kw aur, ant 1,850t/333g. Feb. 1, 1967. Box 400, 30705. (404) 695-2422. Licensee: Ga. State Bd of Educ. ■ PBS; Ga. Ed TV Net. Wash atty: Arent, Fox, Kintner, Plotkin & Kahn. ■ Jack P. Nix, supt of schools; John R. Haney, prog dev admin; Robert E. Ware, dir of engr; Wilfred D. Weatherly, chief engr.

Cochran

ADI No. 136; see page B-42

***WDCO-TV**—ch 15, 363 kw vis, 36.3 kw aur, ant 1,150t/1,169g. Jan. 1, 1968. Box 269, 31014. (912) 934-2220. Licensee: Ga. State Bd of Educ. See *WCLP-TV Chatsworth. ■ PBS. ■ Wallace Lynch, chief engr.

Columbus

ADI No. 116; see page B-17

***WJSP-TV**—ch 28, 144 kw vis, 21.9 kw aur (CP: 921 kw vis, 92.1 kw aur), ant 1,510t/1,103g. Aug. 10, 1964. Box 5, Warm Springs, 31830. (404) 655-2145. Licensee: Ga. State Bd of Educ. See *WCLP-TV Chatsworth. ■ PBS. ■ Donald Thomas, chief engr.

WRBL-TV—ch 3, 100 kw vis, 12 kw aur, ant 1,780t/1,749g. Nov. 15, 1953. Box 270, 31902. (404) 322-0601. TWX 810-758-4335. Licensee: Columbus Bcstg Co. (acq 2-17-73). Ownership: J. W. Woodruff Jr., 81.22%; Barnett Woodruff, 18.78%. See J. W. Woodruff Jr. Stns, also Nwspr. ■ CBS. Rep: Katz. Wash atty: Dow, Lohnes & Albertson. ■ J. W. Woodruff Jr., pres & gen mgr; Paul Berry, VP, prog dir & film buyer; Jesse Woodward, prod mgr; George A. Gingell, VP, dir pub affrs; Dick McMichael, VP, news dir; Bob Walton, VP & gen sls mgr; Eleanor Whitelaw, prom dir; Joe A. Gamble, VP, dir of engr. ■ On 46 CATV's—105,508 subs. Co-owned: WRBL-AM-FM. ■ Rates: \$250; 70; 40.

WTVM—ch 9, 284 kw vis, 52.5 kw aur, ant 1,650t/1,749g. Oct. 6, 1953. Box 1848, 31902. (404) 324-6471. TWX 810-758-4326. Licensee: WTVM Inc. (acq 2-7-69). Ownership: Martin Theatres of Ga. Inc. See Fuqua Communications Inc. ■ ABC. Rep: Blair. Wash atty: Wilner & Scheiner. ■ Joe Windsor, pres; Lynn F. Avery, VP, gen mgr; Charles Hitchins, gen sls mgr; Carroll Ward, prog dir; Griff Godwin, news dir; Bob King, chief engr. ■ On 51 CATV's—115,000 subs. ■ Rates: \$225; 80; 50.



WYEA-TV—ch 38, 1,070 kw vis, 209 kw aur, ant 1,310t/1,319g. Oct. 29, 1970. Box 6389, 31907. (404) 561-3838. TWX 810-758-4312. Licensee: Eagle Bcstg Co. Ownership: Inland Broadcasting, Gala Broadcasting, each 50%. For Gala interests, see Grisham, Davis, Gobold, Aronov Stn. Inland is owned by John Swift, 15%; Kyle Spencer & David Rothschild, each 40%; & Douglas Smith, 5%. ■ NBC; TVS & Hughes. Rep: Meeker. Wash atty: Fly, Shuebruk, Blume & Gaguine. ■ Charles Grisham, pres; Maury Farrell, gen mgr & film buyer; Ken Gerdes, sls mgr; Al Fleming, news dir; Warren Clemmons, prom mgr; Frank Hardman, chief engr. ■ On 37 CATV's—231,000 subs. ■ Rates: \$65; 20; 10.

Dawson

ADI No. 116; see page B-17

***WACS-TV**—ch 25, 363 kw vis, 36.3 kw aur, ant 1,080t/1,096g. March 6, 1967. Rt. 1, Box 75A, Parrott, 31777. (912) 623-4883. Licensee: Ga. State Bd of Educ. See *WCLP-TV Chatsworth. ■ PBS. ■ Ralph E. Gnann, chief engr.

Macon

ADI No. 136; see page B-42

WCWB-TV—ch 41, 760 kw vis, 154 kw aur, ant 893t/837g. Aug. 26, 1968. Box 4328, 31208. (912) 746-1455. Licensee: Bibb Television Inc. (acq 8-74). Ownership: F. E. Busby, 64%; R. A. Birgel, 12%; E. L. Finch, 10%; and others. ■ NBC. Rep: Avery-Knodel; Busby, Finch, Latham & Widman. Wash atty: Miller, Schroeder. ■ Lanny Finch, pres; Lorán Nesmith, stn mgr; Ed Starr, news dir; Joe Spears, chief engr. ■ On 14 CATV's—45,000 subs. ■ Rates: \$75; 25; 15.

WMAZ-TV—ch 13, 316 kw vis, 63.1 kw aur, ant 780t/895g. Sept. 27, 1953. Box 5008, 31208. (912) 746-7311. TWX 912-788-3713. Licensee: Multimedia Inc. Ownership: See Multimedia Stns, also Nwspr. ■ CBS, ABC. Rep: Katz. Wash atty: Dow, Lohnes & Albertson. ■ Wilson C. Wearn, pres; Albert Sanders, VP & gen mgr; James C. Elrod, dir opns; Don McGouirk, admin co-ord; William Tribble, news dir; Jim Lawhon, chief engr; Elmo Simmons, gen sls mgr. ■ On 24 CATV's—32,000 subs. Co-owned: WMAZ-AM-FM. ■ Rates: \$325; 125; 50.

Pelham

ADI No. 149; see page B-71

***WABW-TV**—ch 14, 363 kw vis, 36.3 kw aur; ant 1,240t/1,224g. Jan. 1, 1967. Box 249, 31779. (912) 294-8313. Licensee: Ga. State Bd of Educ. See *WCLP-TV Chatsworth. ■ PBS. ■ Guy Cochran, chief engr.

Savannah

ADI No. 131; see page B-66

WJCL—ch 22, 891 kw vis, 53.7 kw aur, ant 1,430t/1,478g. July 18, 1970. Box 13646, 31406. (912) 352-2022. TWX 810-784-5679. Licensee: Lewis Bcstg Co. Ownership: J. C. Lewis Jr. ■ ABC. Rep: Meeker; Busby, Finch & Woods. Wash atty: Pierson, Ball & Dowd. ■ J. C. Lewis, pres; J. Fred Pierce, exec VP & gen mgr; Christopher A. Barbieri, VP sls & progmg;

E. F. Bigbie, VP opns & engr; Douglas Weathers, news dir; Don Addington, chief engr. ■ On 50 CATV's. Co-owned: WJCL-FM. ■ Rates: \$85; 55; 20.

WSAV-TV—ch 3, 100 kw vis, 15.1 kw aur (CP: 20 kw aur), ant 480t/521g. Feb. 1, 1956. Box 2429, 31402. (912) 236-0303. TWX 810-784-5661. Licensee: WSAV Inc. Ownership: Harben Daniel, 52.78%; William K. Jenkins estate, 19.83%; Arthur Lucas Estate, 19.83%; & others. ■ NBC. Rep: H-R Inc. Wash atty: McKenna, Wilkinson & Kittner. ■ Harben Daniel, pres & gen mgr; M. E. Thompson, VP & opns mgr; H. M. (Mack) Humpidge, coml mgr & film buyer; Camille Kurtz, prom mgr; Stanley Bowman, news dir; Bryon Stong, chief engr. ■ On 24 CATV's—32,000 subs. Co-owned: WSAV(AM). ■ Rates: \$68; 40; 26.

WTOC-TV—ch 11, 316 kw vis, 31.6 kw aur, ant 480t/501g. Feb. 14, 1954. Box 8086, 31402. (912) 232-0127. TWX 810-784-5619. Licensee: Savannah Bcstg Co. Ownership: William T. Knight Jr., 17.5%; F. Schley Knight, 17.8%; Stuart G. Knight, 17.8%; William T. Knight III, 17.7%; Courtney S. Gaines, 17.7%; and others. ■ CBS. Rep: Avery-Knodel. Wash atty: Hamel, Park, McCabe & Saunders. ■ F. Schley Knight, pres & gen mgr; Dwight J. Bruce, VP, prog dir & film buyer; Jess Mooney, sls mgr; Dick Lantz, news dir; Wade Randall, prom mgr; Kyle E. Goodman, chief engr. ■ Co-owned: WTOC-AM-FM.

***WVAN-TV**—ch 9, 316 kw vis, 34.7 kw aur; ant 1,050t/1,086g. Sept. 16, 1963. Box 367, Pembroke, 31321. (912) 653-4996. Licensee: Ga. State Bd of Educ. ■ PBS, Georgia ETV Net. ■ Execs see *WCLP-TV Chatsworth. A. Frank Darsey, chief engr.

Thomasville

ADI No. 149; see page B-71

WCTV—Licensed to Thomasville. See Tallahassee, Fla.

Waycross

ADI No. 69; see page B-34

***WXGA-TV**—ch 8, 316 kw vis, 47.9 kw aur, ant 1,030t/1,089g. Dec. 4, 1961. Box 842, 31501. (912) 283-4838. Licensee: Ga. State Bd of Educ. ■ PBS, Ga. ETV, Net. ■ Execs see *WCLP-TV Chatsworth. Knox Carreker, chief engr.

Wrens

ADI No. 111; see page B-6

***WCES-TV**—ch 20, 331 kw vis, 33.6 kw aur, ant 1,480t/1,465g. Sept. 12, 1966. Box 525, 30833. (404) 547-2107. Licensee: Ga. State Bd of Educ. ■ Execs see *WCLP-TV Chatsworth. Rabun F. Bobo, chief engr.

Hawaii

Hilo

KHAW-TV—ch 11, 209 kw vis, 275 w aur, ant -620t/139g. Nov. 27, 1961. Licensee: KHON-TV Inc. (acq 1-26-73). Co-owned satellite of KHON-TV Honolulu.

KHYO—ch 13, 468 kw vis, 1.59 kw aur, ant minus 823t/80g. May 15, 1960. Licensee: Western Telestations Inc. Ownership: See Starr Bcstg Group.

KPUA-TV—ch 9, 1 kw vis, 500 w aur, ant minus 290t/258g. May 15, 1955. 58 Manaolana Place, 96720. (808) 935-5461. Licensee: Hefel Television—Hilo Inc. (acq 1973). Owner-

ship: Heftel Bcstg Corp., 90%; Lani G. & James Donohoe Jr., 10%. Partially co-owned satellite of KGMB-TV, Honolulu. ■ Co-owned: KPUA(AM).

Honolulu

KGMB-TV—ch 9, 208 kw vis, 29.5 kw aur, ant minus 50g/436g. Dec. 1, 1962. Box 581, 96809. (808) 941-3011. Telex RCA 723-363 ITT 743-0020. Licensee: Heftel Bcstg-Honolulu Inc. Ownership: See Heftel Bcstg Corp. ■ CBS, Rep: RTVR. Wash atty: Arnold & Porter. ■ Cecil L. Heftel, pres; Gene Erger, exec VP-Hawaii & gen mgr; Richard Cramer, sls mgr; Phil Arnone, prog dir; Robert W. Sevey, VP news; Sid Cohen, film buyer; Alvin Chang, chief engr. Co-owned: KGMB(AM) and KGMQ(FM).

***KHET**—ch 11, 149 kw vis, 29.5 kw aur, ant minus 80t/436g. April 15, 1966. 2350 Dole St., 96822. (808) 955-7878. Telex 723-8553. Licensee: Hawaii Public Bcstg Authority. ■ PBS. Wash atty: Cohn & Marks. ■ Mary G. F. Bitterman, exec dir; Douglas Green, prod mgr; Cliff Eblen, prom mgr; Charles H. E. Stubbiefield, prog mgr; Akio Sakata, chief engr.

KHON-TV—ch 2, 60.3 kw vis, 12.6 aur, ant minus 150t/350g. Dec. 15, 1952. 1170 Auahi St., 96814. (808) 531-8585. Telex 723-340. Licensee: KHON-TV Inc. (acq 1-26-73). Ownership: See McCoy Bcstg Co. Sns. ■ NBC. Rep: Peters, Griffin, Woodward. Wash atty: Lois Siegel Schwartz. ■ George Hagar, pres & gen mgr; Richard Schaller, sls mgr; Dan Kawakami, prog dir; David Beggin, prom mgr; B. J. Sams, news dir; Alfred Ono, chief engr. ■ On 6 CATV's. On 2 trans. ■ Rates: \$210; 45; 18.

KIKU-TV—ch 13, 30.7 kw vis, 6.2 kw aur, ant minus 100t/371g. July 4, 1962. 150 B. Puuhale Rd., 96819. (808) 847-1178. Licensee: KIKU Television Corp. Ownership: See United Bcstg Sns. ■ Rep: U.B.C. Sales. Wash atty: Cohn & Marks. ■ Richard Eaton, pres; Joanne Ninomiya, gen mgr & prog dir; Edna Oba, sls mgr; Robert Tomosawa, news dir; Jim Bowen, chief engr.

KITV—ch 4, 100 kw vis, 20 kw aur, ant minus 140t/368g. 1290 Ala Moana Blvd., 96814. (808) 537-3991. TWX: WU163258. Licensee: Western Telestations Inc. (acq 8-1-73). Ownership: See Starr Broadcasting Group. ■ ABC. Rep: Katz. Wash atty: Fly, Shuebruk, Blume & Gaguine. ■ Peter Starr, pres; Dick Grimm, VP, gen mgr & film buyer; Bob Hoffman, sls mgr; Don Robbs, prog dir; Charles W. Riley, prod mgr; Don Rockwell, news dir; Charles J. Hartman, chief engr. ■ On 11 CATV's—28,000 subs. On 5 trans.

Wailuku

KAI-TV—ch 7, 29.8 kw vis, 5.9 kw aur, ant 5,940t/75g. Nov. 17, 1958. Licensee: KHON-TV Inc. Co-owned satellite of KHON-TV, Honolulu.

KMAU-TV—ch 3, 14.1 kw vis, 2.69 kw aur, ant 5,950t/60g. April 24, 1955. Box 1574, Kahului, 96732. (808) 244-5348. Licensee: Heftel Bcstg—Maui Inc. (acq 5-74). Ownership: Cecil Heftel, 40%; Joyce Heftel, 40%; Robert Park, 10%; Margaret Park, 10%. Partially co-owned satellite of KGMB-TV, Honolulu. ■ Robert Park, pres; Julius M. Vetter, stn mgr & chief engr. ■ On 2 CATV's.

***KMEB**—ch 10, 30.9 kw vis, 6 kw aur, ant 5,940t/47g. Sept. 22, 1966. TWX 723-8553. Licensee: Hawaii Public Bcstg Authority. Co-owned satellite of *KHET, Honolulu. ■ Mary G. F. Bitterman, exec dir; Cliff Eblen, prom mgr; Douglas Green, prod mgr.

KMVI-TV—ch 12, 27.5 kw vis, 4.36 kw aur, ant 5,910t/70g. Nov. 28, 1955. Box 550, 96793. Licensee: Maui Publishing Co. Ownership: J. Walter Cameron, 94.4%, & others. See Nwspr. Separately-owned satellite of KITV Honolulu. ■ ABC. Wash atty: Dow, Lohnes & Albertson. Co-owned: KMVI(AM).

Idaho

**HAMILTON-LANDIS
& ASSOCIATES, Inc.**
NATIONWIDE MEDIA BROKERS
WASHINGTON, D. C. CHICAGO, DALLAS,
SAN FRANCISCO
SELL MORE
RADIO & TELEVISION STATIONS
IN THE WEST—NEAREST OFFICE IS—
111 SUTTER ST., SAN FRANCISCO 94104
(415) 392-5671

Blackfoot

KPVI—Licensed to Pocatello. See Idaho Falls.

Boise

ADI No. 144; see page B-10

***KAID**—ch 4, 28.2 kw vis, 5.62 kw aur, ant 2474t/1426g. Dec. 31, 1971. 1910 College Blvd., Boise State College, 83725. (208) 385-3344. Licensee: Idaho State Bd of Ed. ■ PBS. ■ Jack A. Schlaefle, dir ETV; Vaun J. McArthur, chief engr.

KBCI-TV—ch 2, 65 kw vis, 7.0t kw aur, ant 2,550t/149g. Nov. 26, 1953. Box 2600, 83701. (208) 342-9331. TWX 910-970-5790. Licensee: Boise Valley Bcstrs Inc. Ownership: Robert W. Howell, 12%; and others. ■ CBS. Rep: Peters, Griffin, Woodward; Moore. Wash atty: Wilkinson, Cragan & Barker. ■ James A. Johnz, Jr. pres & gen mgr; Britt Bowden, VP sls; Dena Howell, prog dir; Pauli Crooke, actg news dir; R. W. Howell, film buyer; Larry Chase, prod mgr; Manson McClure, VP engrg. ■ On 7 CATV's—4,500 subs. On 33 trans. ■ Rates: \$80-140; 65; 30.

KIVI television, inc.

KIVI—(Nampa)—ch 6, 60.3 kw vis, 12.0 kw aur, ant 2,660t/210g. Feb. 1, 1974. 1866 E. Chisholm Dr., Nampa, 83651. (208) 467-3301. TWX 910-970-5945. Licensee: Idaho Television Corp. Ownership: M. Walker Wallace, 38.2%; James U. Lavenstein, 12.80%; R.V. Hamsberger, 20.50%; and others. ■ ABC. Rep: H-R Television; Tacher; Bournstein Co. Wash atty: McKenna, Wilkinson & Kittner. ■ James U. Lavenstein, pres & gen mgr & film buyer; Charles McCabe, loc & natl sls mgr; Robert Peters, news dir; Raymond Barp, prom mgr and prog dir; Kenneth Manley, chief engr. ■ On 3 CATV's—1,372 subs. On 4 trans. ■ Rates: \$93; 47; 17.

KTVB—ch 7, 166 kw vis, 26.9 kw aur, ant 2,560t/223g. July 12, 1953. Box 7778, 83701. (208) 375-7277. TWX 910-970-5779. Licensee: KTVB Inc. Ownership: Mrs. Georgia M. Davidson and family 100%. ■ NBC. Rep: Avery-Knode; Hix; Reilly (Seattle). Wash atty: Fisher, Wayland, Southmayd & Cooper. ■ Robert E. Krueger, pres, gen mgr & film buyer; Rex McArthur, sls mgr; Anne Pearson, prog dir; Clint Bellows, prom mgr; Sal Celeski, news dir; Harold Toedemeier, dir of engrg. ■ On 18 CATV's—14,800 subs. On 25 trans. ■ Rates: \$100; 65; 25.

Hawaii, Idaho TV

See page B-89 for explanation of listings.

Idaho Falls

ADI No. 169; see page B-33

KID-TV—ch 3, 100 kw vis, 14.4 kw aur, ant 1,600t/201g. Dec. 20, 1953. Box 2008, Idaho Falls, 83401. (208) 522-5100. Licensee: KID Bcstg Corp. Ownership: LaVere A. & Lucille J. Ricks, 15.6%; A. W. Schwieder, 14.4%; Warren Wright, 10.7%. ■ CBS. Rep: PGW; Moore; McDermott (Canada). Wash atty: Wilkinson, Cragan & Barker. ■ J. Allen Jensen, pres & gen mgr; Claude Cain, stn mgr & sls mgr; Arthur Reid, opns dir; Neil Hansen, prom mgr; Ron Barker, news dir; Carroll Secrist, chief engr. ■ On 8 CATV's—20,000 subs. On 21 trans. Co-owned: KID-AM-FM. ■ Rates: \$60; 45; 30.

KIFI-TV—ch 8, 316 kw vis, 63.1 kw aur, ant 1,520t/180g. Jan. 21, 1961. Box 2148, Idaho Falls, 83401. (208) 523-1171. TWX 910-977-5726. Licensee: The Post Co. Ownership: J. Robb Brady Trust Co., 81.25%; Edwin F. McDermott, 18.75%. See Nwspr. ■ NBC. Rep: Avery-Knode; Hix; Simpson/Reilly. Wash atty: Midlen & Reddy. ■ James M. Brady, pres, gen mgr & sls mgr; E. F. McDermott, VP; Herman G. Haeffe, chief engr & prog mgr; Arnie Augustin, news dir; Lloyd Lindsay Young, prom mgr. ■ On 12 CATV's—20,000 subs. On 12 trans. ■ Rates: \$45; 36; 12.

KPVI television, inc.

KPVI—(Pocatello) ch 6, 100 kw vis, 17.4 kw aur, ant 1530t/619g. April 26, 1974. 421 Fredregill Road, Box 4909, Pocatello, 83201. (208) 233-6667. TWX 910-977-5756. Licensee: Eastern Idaho Television Corp. Ownership: M. Walker Wallace, 38.2%; James U. Lavenstein, 12.80%; R.V. Hamsberger, 20.50%; and others. ■ ABC. Rep: H-R Television; Tacher; Aaron Bournstein. Wash atty: McKenna, Wilkinson & Kittner. ■ James U. Lavenstein, pres, gen mgr and film buyer; Archie Edmondson, lcl sls mgr; Raymond Barp, prom mgr and prog dir; Jeff Kingery, news dir; John Morand, chief engr. ■ On 9 CATV's—22,944 subs. ■ Rates: \$51; 24; 14.

Lewiston

ADI No. 129; see page B-78

KLEW-TV—ch 3, 13.8 kw vis, 1.38 kw aur, ant 1,260t/303.5g. December, 1956. (208) 746-2636. Licensee: NWSG Bcstg Co. ■ Co-owned satellite of KIMA-TV Yakima, Wash.

Moscow

ADI No. 79; see page B-66

***KUID-TV**—ch 12, 115 kw vis, 57.5 kw aur, ant 1,050t/154g. July 1, 1965. Radio-TV Ctr. U. of Idaho, 83843. (208) 885-6723. Licensee: Regents of U. of Idaho. ■ PBS. ■ Peter Haggart, gen mgr; Joyce Campbell, prog dir; Ric Glaub, prom mgr; Linda Carter, traffic mgr; Dick Carroll, chief engr. ■ On 14 CATV's—23,000 subs. On 4 trans. Co-owned: *KUID-FM.

Nampa

KIVI—Licensed to Nampa. See Boise.

Idaho, Illinois.TV

See page B-89 for explanation of listings.

Pocatello

ADI No. 169; see page B-33

***KBGL-TV**—ch 10, 66.1 kw vis, 12.9 kw aur, ant 1,450t/87g. July 7, 1951. Idaho State University, 83209. (208) 236-2857. Licensee: State Board of Education, acting as trustees for Idaho State University ■ PBS. ■ Herbert Everitt, dir, radio-TV service, & gen mgr; Elmo Sackett, stn mgr; Don Rogers, prog dir; Jim Alexander, prod dir; Janet House, traf dir & prom mgr; Dick Siebe, chief engr. ■ Co-owned: *KBGL(FM).

KID-TV—Licensed to Idaho Falls. See Idaho Falls.

KIFI-TV—Licensed to Idaho Falls. See Idaho Falls.

KPVI—Licensed to Pocatello. See Idaho Falls.

Twin Falls

ADI No. 186; see page B-74

KMVT—ch 11, 316 kw vis, 31.6 kw aur, ant 1190t/690g. May 30, 1955. Box 547, 83301. (208) 733-1280. TWX 910-977-5716. Licensee: KLIX Corp. (acq 1-1-71). Ownership: Dale G. Moore 100%. See Dale G. Moore stns. ■ ABC, CBS, NBC. Rep: Avery-Knodel. Wash atty: Haley, Bader & Potts. ■ Earl Morgenroth, pres; Harold O. Hirtle, exec VP & gen mgr; Mel Oppliger, sls mgr; George Brown, prog dir; Jeff Rounce, news dir; Dick Christopherson, prom mgr; Gilbert Anderson, chief engr. ■ On 4 CATV's—30,000 subs. On 5 trans. ■ Rates: \$50; 40; 15.

Illinois

**HAMILTON-LANDIS
& ASSOCIATES, Inc.**
NATIONWIDE MEDIA BROKERS
WASHINGTON, D. C. CHICAGO, DALLAS,
SAN FRANCISCO
SELL **MORE**
RADIO & TELEVISION STATIONS
IN THE MIDWEST—NEAREST OFFICE IS—
1429 TRIBUNE TOWER, CHICAGO 60611
(312) 337-2754

Carbondale

ADI No. 68; see page B-54

***WSIU-TV**—ch 8, 316 kw vis, 40.7 kw aur, ant 890t/903g. November 1961. Southern Ill. U., 62901. (618) 453-4343. Licensee: Bd of Trustees of Southern Ill. U. ■ PBS. Wash atty: Mallyck & Bernton. ■ Charles T. Lynch, chmn; David B. Rochelle, stn & gen mgr; Virginia Mampre, prog dir; Erv Coppi, prom mgr; Ed Brown, news dir; William E. Dixon, chief engr. ■ On 30 CATV's. Co-owned: *WSIU(FM).

Champaign

ADI No. 72; see page B-70

WCIA—ch 3, 100 kw vis, 20 kw aur, ant 940t/981g. Nov. 14, 1953. 509 S. Neil, 61820. (217) 356-8333. Licensee: Midwest TV Inc. Ownership: See Midwest TV Stns, also Nwspr. ■ CBS. Rep: Peters, Griffin, Woodward. Wash atty: Covington & Burling. ■ August C. Meyer, pres; Clara R. Meyer, VP; Guy F. Main, exec VP; Jack Everette, asst to pres & engr dir; Dale

Fleming, chief engr; Gerald J. Johnson, sls mgr; Darrell Blue, prod mgr; Dick Adams, mgr, informational prog; William J. Helms, prog dir; Paul Davis, news dir.

WICD—ch 15, 647 kw vis, 64.6 kw aur, ant 1,300t/1,338g. April 24, 1959. 17 E. University Ave., Champaign, 61820. (217) 352-7673. Licensee: Plains TV Corp. Ownership: See Plains Television Corp. ■ NBC. Rep: Katz. Wash atty: McKenna, Wilkinson & Kittner. ■ Elmer Balaban, pres; Milton Friedland, VP & gen mgr; Joe Norris, sls mgr; Vince Daube, prog mgr; Wally Gair, prom mgr; Len Prazak, news dir; David Boyer, chief engr. ■ On 13 CATV's. Co-owned satellite of WICS Springfield, Illinois.

Chicago

ADI No. 3; see page B-14

WBBM-TV—ch 2, 35.4 kw vis, 7.08 kw aur, ant 1350t/1456g. August 1940. 630 N. McClurg Court, 60611. (312) 944-6000. TWX 312-222-0698. Licensee: CBS Inc. Ownership: See CBS-Owned Stns. ■ CBS. Rep: CBS-TV Natl Sales. ■ Neil E. Derrough, VP & gen mgr; Steven Orr, dir of sls; Arnold Brustin, dir of bcstg; Jay Feldman, news dir; Alice Necker, film buyer; Hal Biard, dir of prom & info svcs; Luther A. Pierce, tech opns dir. ■ Co-owned: WBBM-AM-FM.

WCFL-TV—ch 38, 1,260 kw vis, 25.1 kw aur, ant 1,210t/1453g. Not on air, target date unknown. 300 N. State St., 60610. (312) 222-1000. Permittee: Chicago Federation of Labor & Industrial Union Council. ■ Wash atty: Greeley, Bernard & Tierney. William A. Lee, pres; T. E. Haviland Sr., gen mgr; A. P. Young, stn mgr. ■ Co-owned: WCFL (AM).

WCJU-TV—ch 26, 961 kw vis, 194 kw aur, ant 650t/684g. Feb. 6, 1964. 141 W. Jackson Blvd., 60604. (312) 663-0260. Licensee: Weigel Bcstg Co. Ownership: J. William O'Connor & Howard Shapiro, 71.2%. See O'Connor Stns. ■ Rep: Spanish International Network. Wash atty: McKenna, Wilkinson & Kittner. ■ J. William O'Connor, chmn board; Howard Shapiro, pres; J. Herman Sitrick, VP & gen mgr; Robert Ward, VP & gen sls mgr; Peter Zomaya, asst mgr; Syl Friedman, dir bus; Ben Larson, news dir; Glenn Stewart, film buyer; Dick Ashenfelter, chief engr. ■ Rates: \$100; 90; 60.

WFLD-TV—ch 32, 2,500 kw vis, 500 kw aur, ant 1,415t/1,456g. Jan. 4, 1966. 300 N. State St., 60610. (312) 645-0300. Telex 25-5273. Licensee: Kaiser Broadcasting Co. (acq 7-1-73). Ownership: See Kaiser Broadcasting Co., also Nwspr. ■ Rep: Kaiser Spot Sls. Wash atty: Wilmer, Cutler & Pickering. ■ James C. Warner, gen mgr; Joe Girard, gen sls mgr; Albert B. Sturges, stn mgr, prog dir & film buyer; Maurice Roberts, news dir; William P. Kusack, chief engr. ■ On 55 CATV's—159,792 subs.

WGN-TV—ch 9, 110 kw vis, 22 kw aur, ant 1,360t/1,453g. April 5, 1948. 2501 Bradley Pl., 60618. (312) 528-2311. TWX 910-221-1324. Licensee: WGN Continental Bcstg Co. Ownership: See Tribune Co. Stns, also Nwspr. ■ Rep: Petry; WGN Continental Sls; Creed; Hyett; Glen-Warren. Wash atty: Kirkland, Ellis & Rowe. ■ Daniel T. Pecaro, exec VP & gen mgr; John Brennan, VP & natl sales mgr; Charles Harrison, VP & mgr news; Sheldon Cooper, VP & stn mgr; Jack Jacobson, VP & prog mgr, group stns; Harry Trigg, prog mgr; William H. Wills, PR mgr; E. Boyd Seghers Jr., VP & mgr sls prom, rsch & adv; Woodrow R. Crane, chief engr. ■ On 190 CATV's—300,000 subs. Co-owned: WGN(AM)

WLS-TV—ch 7, 275 kw vis, 55 kw aur, ant 890t/969g. (CP: 81.3 kw vis, 6.94 kw aur, ant 1,500 ft). Sept. 17, 1948. 190 N. State St., 60601. (312) 263-0800. TWX 312-222-9530. Licensee: ABC Inc. Ownership: See ABC Owned Stns. ■ ABC. Rep: ABC-TV Spot Sales.

Wash atty: McKenna, Wilkinson & Kittner. ■ Richard A. O'Leary, pres; Lewis H. Erlicht, gen mgr; Peter B. Desnoes, gen sls mgr; David H. McLaughlin, sls mgr; Chris Duffy, prog dir; Edward P. Weber, prom mgr; John Mies, news dir; Jim Tuverson, film buyer; J.J. Kresnicka, engr dir. ■ Co-owned: WLS(AM)-WDAI(FM).

WMAQ-TV—ch 5, 41.1 kw vis, 8.0 kw aur, ant 1,307t/1,307g. January 1948. Merchandise Mart, 60654. (312) 644-8300 (after 3-76: 861-5555). TWX 312-222-9441. Licensee: NBC Inc. Ownership: See NBC-Owned Stns. ■ NBC. Rep: NBC-TV Spot Sales; Bomar Lawrence. ■ Lee Schulman, VP & gen mgr; Robert S. Walsh, stn mgr; Al Jerome, 'natl' sls mgr; Charles Gerber, gen sls mgr; Jim Hoel, loc sls mgr; Ziv Shoubin, prog mgr; Ed Planer, news dir; Jay Ojeda, mgr pub affrs; Betty Lewis, mgr community relations; Jo Ellen Webster, personnel mgr; Ella G'sell, mgr, adv, prom & press; William Marshall, dir tech opns. ■ Co-owned: WMAQ(AM) and WNIS(FM). ■ Rates: \$2,000 to 4,500; 600; 500.

WSNS—ch 44, 610 kw vis, 122 kw aur, ant 1,420t/1,456g. April 5, 1970. 430 West Grant Pl., 60614. (312) 929-1200. Licensee: Video 44. Ownership: Harriscope of Chicago Inc., 50%; Woods Amusement, Rivergrove Drive Ins, dba Video 44., 50%. See Harriscope Stns. ■ Rep: HR Television Inc. Wash atty: Cohn & Marks. ■ Edward L. Morris, VP & gen mgr; Mal Wyman, asst gen mgr; Nat Gershman, sls mgr; Peter Strand, prog dir; Kevin Murphy, chief engr. ■ On 77 CATV's—200,000 subs.

***WTTW**—ch 11, 22.7 kw vis, 5.09 kw aur, ant 1,470t/1,519g. Sept. 5, 1955. 5400 N. St. Louis Ave., 60625. (312) 583-5000. TWX 910-221-5459. Licensee: Chicago Educl TV Assn. ■ PBS. Wash atty: Schwartz & Woods. ■ Irving B. Harris, chmn; William J. McCarter, exec VP & gen mgr; John C. Rahmann, stn mgr; Dick Bowman, dir of bcstg; David Wilson, dir of prog prod; John R. Modisett, dir of dev & mktg; John D. Callaway, dir of news; Larry Ocker, chief engr.

***WXXW**—ch 20, 25 kw vis, 5.2 kw aur, ant 770t/800g. Sept. 20, 1965. Licensee: Chicago Educl TV Assn. ■ Exec: see *WTTW Chicago.

Decatur

ADI No. 72; see page B-70

WAND—ch 17, 1,977 kw vis, 197.7 kw aur, ant 1,030t/1,063g. Aug. 16, 1953. Box 631 Southside Dr., 62525. (217) 428-4304. TWX 910-243-0458. Licensee: WFIL Inc. Ownership: See LIN Bcstg Stns. ■ ABC. Rep: Blair. Wash atty: Wilmer, Cutler & Pickering. ■ Barrett H. Geoghegan, pres & gen mgr; T. J. Vaughan, prog dir; Calvin E. Coleman, gen sls mgr; Richard E. Westbrook, news dir; Michael Cheever, prom dir; Wayne J. Semple, chief engr. ■ On 19 CATV's—60,755 subs. On 1 trans. ■ Rates: \$250; 80; 50.

Freeport

WCÉE-TV—Licensed to Freeport. See Rockford.

Harrisburg

ADI No. 68; see page B-54

WSIL-TV—ch 3, 100 kw vis, 20 kw aur, ant 880t/859.5g. December 1953. 21 W. Poplar St., 62946. (618) 253-7837. Licensee: Turner-Farrar Assn. Ownership: See Turner-Farrar Stns. ■ ABC. Rep: Adam Young. Wash atty: McKenna, Wilkinson & Kittner. ■ O. L. Turner, gen mgr & film buyer; Charles Gilliam, chief engr. ■ Rates: \$75; 50; 36.

Moline

ADI No. 67; see page B-19

WHBF-TV—See Rock Island.

WOC-TV—See Davenport, Iowa.

WQAD-TV—ch 8, 282 kw vis, 56.2 kw aur, ant 1,010t/1,058g, Aug 1, 1963. 3003 Park 16th St., 61265. (309) 764-9694. TWX 910-225-1481. Licensee: Moline TV Corp. Ownership: Francis J. Coyle, 11.28%; Arthur M. Swift, 9.92%; & others. ■ ABC. Rep: Katz. Wash atty: Pierson, Ball & Dowd. ■ Francis J. Coyle, pres; Arthur M. Swift, exec VP & gen mgr; William L. Snyder, sls mgr; Ron Klayman, prog & prom dir; Jim King, dir of news; Ray Krueger, chief engr. ■ On 14 CATV's—12,000 subs. ■ Rates: \$250; 90; 40.

Olney

ADI No. 107; see page B-71

***WUSI-TV**—ch 16, 977 kw vis, 195 kw aur, ant 930t/976g, Aug 19, 1968. Box 430, 62450. Licensee: Bd of Trustees, Southern Ill. U. (See WSJU, Carbondale). ■ PBS. Wash atty: Mallick & Bernton. ■ Charles T. Lynch, chmn; David B. Rochelle, strn & gen mgr; William E. Dixon, chief engr. ■ On 30 CATV's.

Peoria

ADI No. 90; see page B-55

WEEK-TV—ch 25, 562 kw vis, 112 kw aur, ant 680t/604.9g, Feb. 1, 1953. 2907 Springfield Rd., 61611. (309) 699-3961. TWX 910-652-4455. Licensee: Mid-America TV Co. Ownership: See Mid-America TV Stns. ■ NBC. Rep: Katz. Wash atty: Dow, Lohnes & Albertson. ■ William A. Bates, pres; Philip Mergener, VP & gen mgr; Bill Adams, sls mgr; Tom Connor, news dir; Roger Ottenbach, audience dev mgr & film buyer. ■ On 8 CATV's—30,000 subs. ■ Rates: \$200; 85; 40.

WMBD-TV—ch 31, 2050 kw vis, 406 kw aur, ant 635t/548g, Jan. 1, 1958. 212 SW Jefferson Ave., 61602. (309) 676-0711. TWX 910-652-3954. Licensee: Midwest TV Inc. Ownership: See Midwest TV Stns, also Nwsp. ■ CBS. Rep: Peters, Griffin, Woodward. Wash atty: Covington & Burling. ■ August C. Meyer, pres; Guy Main, exec VP; William L. Brown, VP & gen mgr; Gene Robinson, mgr; Duane Wallace, news dir; Chris Benjamin, prog dir; Wm. K. Zeithammer, opns mgr; Neil Burk, chief engr. ■ On 1 trans. Co-owned: WMBD-AM-FM.

WRAU-TV—ch 19, 2,090 kw vis max, 813 kw horiz, 200 kw aur max, 81.3 kw horiz, ant 1,426t/656g, Oct. 20, 1953. 500 N. Stewart St., Creve Coeur, Ill., 61611. (309) 694-4351. TWX 910-652-3955. Licensee: Forward of Ill. (acq 5-1-71) Ownership: See Forward Communications Stns, also Nwsp. ■ ABC. Rep: Meeker; Schneider (St. Louis); Hyett (Minneapolis); CCI (Indianapolis). Wash atty: McKenna, Wilkinson & Kittner. ■ Robert E. Rice, pres & gen mgr; Bill Thorson, VP & sls dir; Henry Osborn, asst to the pres; Bob Moss, prom mgr; Bill Carson, loc sls mgr; Eugene Holmes, news dir; George Litz, chief engr. ■ On 17 CATV's—75,000 subs. ■ Rates: \$140; 80; 35.

***WTPV**—ch 47, 1,260 kw vis, 251 kw aur, ant 337t/352g, June 23 1971. 1501 West Bradley Ave., 61625. (309) 676-4747. Licensee: Illinois Valley Public Telecom. Corp. ■ PBS. Wash atty: Wiiner, Scheiner & Greeley. ■ Philip Weinberg, pres; Elwin L. Basquin, gen mgr; Joel Hartman, opns mgr; David Dzurak, prom mgr & prog dir; Steve Connert, chief engr. ■ On 8 CATV's—40,000 subs.

Quincy

ADI No. 132; see page B-58

KHQA-TV—(Hannibal, Mo.) ch 7, 269 kw vis, 45 kw aur, ant 890t/804g, Sept 23, 1953. 510 Main St., Quincy, 62301. (217) 222-6200. TWX 910-246-3204. Licensee: Lee Enterprises Inc. Ownership: See Lee Stns, also Nwsp. ■ CBS. Rep: Katz. Wash atty: Pierson, Ball & Dowd. ■

Lloyd Loers, VP, bcst div; John Phillips, gen mgr & film buyer; Jack Rose, gen sls mgr; Robert Fruehe, natl sls mgr; Gary Schmedding, prog dir; Gene Terry, news dir; Lee Ellis, tech dir. ■ On 19 CATV's. On 2 trans. Co-owned: WTAD-AM; WQCY-FM. ■ Rates: \$90; 55; 30.

WGEM-TV—ch 10, 316 kw vis, 31.6 kw aur, ant 780t/673g, Sept 4, 1953. 513 Hampshire, Box 769, 62301. (217) 222-6840. TWX 910-246-3209. Licensee: Quincy Bcstg Co. Ownership: Quincy Newspapers Inc., 88%, to others. See nwsp. ■ NBC, ABC. Rep: Avery-Knodel. Wash atty: Dow, Lohnes & Albertson. ■ T. A. Oakley, pres; Dave Oakley, VP & gen mgr; J. Ben Stewart, coml mgr; Fred Colgan, prog dir; Robert Meyer, adv dir; Leo Henning, prom mgr; Charlie Griffith, news dir; Jim Martens, chief engr. ■ On 19 CATV's. Co-owned: WGEM-AM-FM. ■ Rates: \$95; 55; 25.

Rockford

ADI No. 104; see page B-61

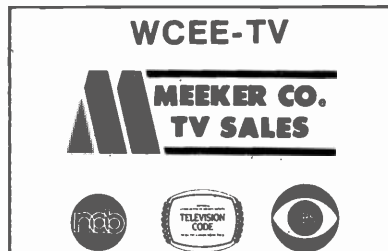

WCEE-TV—(Freeport) ch 23, 562 kw vis, 85.2 kw aur, ant 720t/731g, Sept 12, 1965. Box 957, 61105. (815) 965-0523. TWX 910-631-0746. Licensee: WCEE-TV Inc. Ownership: General Media Corp. ■ CBS. Rep: Meeker. Wash atty: Fletcher, Heald, Rowell, Kenehan & Hildreth. ■ Edward B. Holt, chmn of the bd; Earl W. Hicker-son, pres & chief exec off; Dean Ward, gen & strn mgr; Chuck Faber, news dir; Ken Staaf, prog dir; Dean Turman, chief engr. ■ On 8 CATV's—50,000 subs. ■ Rates: \$120; 60; 30.

WREX-TV—ch 13, 316 kw vis, 39.8 kw aur, ant 710t/652g, Oct. 1, 1953. Auburn & Winnebago Rds., 61105. (815) 968-1813. TWX 910-642-0770. Licensee: Gilmore Bcstg. Ownership: See Gilmore Stns. ■ ABC. Rep: H-R. Wash atty: Kirkland, Ellis, & Rowe. ■ James S. Gilmore Jr., pres; Jack Mazzie, VP & gen mgr; Richard E. Reed, exec VP, opns; Hamilton Shea, exec VP, admin/corp dev; John P. Mc-Weeny, gen sls mgr; Frank Graham, news dir; Bob Pofetski, engrg supv. ■ On 24 CATV's—57,000 subs. ■ Rates: \$144; 80; 35.

WTVO—ch 17, 759 vis, 79.4 kw aur, ant 674t/710g, May 3, 1953. 1917 N. Meridian Rd., 61105. (815) 963-5413. TWX 815-398-0165. Licensee: Winnebago TV Corp. Ownership: H. & E. Balaban Corp., 47.5%; Irwin & H. W. Dubinsky, 47.5%; Harold Froelich, 5%. See Balaban Stns. ■ NBC. Rep: Young. Wash atty: McKenna, Wilkinson & Kittner. ■ Harry Balaban, pres; Harold Froelich, gen mgr; Tom Anderson, gen sls mgr; Dick McDaniel, prog dir; Bruce Richardson, news dir; Al Petzke, chief engr.

Rock Island

ADI No. 67; see page B-19

WHBF-TV—ch 4, 100 kw vis, 14.1 kw aur, ant 1,000t/993g, July 1, 1950. 231 18th St., 61201. (309) 786-5441. TWX 910-653-1508. Licensee: Rock Island Bcstg Co. Ownership: Marguerite F. Potter, 33.32%; Marguerite F. Potter, trustee of estate of Ben H. Potter, 33.31%; Rock Island Bank & Trust Co., executor of estate of John W. Potter, 22.2%; Anne Potter DeLong, 11.11%. ■ CBS. Rep: Petry; Hyett (Minneapolis). ■ Marguerite F. Potter, pres; Ed-

Illinois, Indiana TV

See page B-89 for explanation of listings.

ward E. DeLong III, exec VP; Robert J. Sinnen, VP & gen mgr; Dewey L. Neisen, sls mgr; George Koplow, prog dir & film buyer; Louis Plaisance, news dir; Paul Liggitt, prom mgr; Wesley C. Hoots, chief engr. ■ On 12 CATV's—45,000 subs. Co-owned: WHBF-AM-FM. ■ Rates: \$160; —; —.

WOC-TV—see Davenport, Iowa.

WQAD-TV—see Moline.

Springfield

ADI No. 72; see page B-70

WICS—ch 20, 676 kw vis, 67.6 kw aur, ant 1,430t/1,458g, Sept 30, 1953. Box 3920, 62708. (217) 528-0465. TWX 217-546-0349. Licensee: Plains TV Corp. Ownership: See Plains Television Corp. ■ NBC. Rep: Katz. Wash atty: McKenna, Wilkinson & Kittner. ■ Elmer Balaban, pres; Milton D. Friedland, VP & gen mgr; Robert B. Farrow, gen sls mgr; Gary Spears, prog mgr & film buyer; Don Hickman, news dir; Jerry Merritt, chief engr. ■ On 16 CATV's. ■ Rates: \$220; 110; 40.

Urbana

ADI No. 72; see page B-70

***WILL-TV**—ch 12, 316 kw vis, 63.1 kw aur, ant 990t/1,047g, Aug. 1, 1955. 228 Gregory Hall, 61803. (217) 333-1070. Licensee: U. of Ill. Bd. of Trustees. ■ PBS. ■ John E. Corbally, pres; Donald P. Mullally, dir of bcstg & gen mgr; Mike H. Mottler, asst mgr; Dave Otto, film buyer; Rob R. Beldon, chief engr. ■ Co-owned: *WILL-AM-FM.

Indiana

Bloomington

ADI No. 20; see page B-33

***WTIU-TV**—ch 30, 200 kw vis, 39.8 kw aur, ant 710t/647g, March 1969. Radio-TV Bldg., Indiana U., 47401. (812) 337-8000. Licensee: Trustees of Indiana U. ■ PBS. ■ Donley F. Feddersen, gen mgr; Herbert Seltz, prog dir; Marijyn Curry, prom mgr; Emmet Beeker, chief engr. ■ On 10 CATV's—15,000 subs. Co-owned: *WFIU(FM).

WTTV—Licensed to Bloomington. See Indianapolis.

Elkhart

***WNIT-TV**—Licensed to South Bend. See South Bend.

WSJV—Licensed to Elkhart. See South Bend.

Evansville

ADI No. 87; see page B-24

WEHT—ch 25, 162 kw vis, 32.4 kw aur, ant 1,030t/988g, Sept. 11, 1953. Box 395, 47703. (812) 424-9215. TWX 510-540-1063. Licensee: Gilmore Bcstg Corp. Ownership: See James S. Gilmore Jr. Stns. ■ CBS. Rep: Meeker. Wash atty: Kirkland, Ellis, & Rowe. ■ James S. Gilmore Jr., pres & treas; Richard E. Reed, exec VP opns; Hamilton Shea, exec VP, admin/corp dev; Ernest D. Madden, VP & gen mgr; Frank DeTillio, gen sls mgr; Brod Seymour, prog dir; Jon Esther, news dir; Elmer Chancellor, chief engr. ■ On 6 CATV's. ■ Rates: \$185; 75; 20.

WFIE-TV—ch 14, 178 kw vis, 35.5 kw aur, ant

Indiana TV

See page B-89 for explanation of listings.

560t/533g. Nov. 9, 1953. 1115 Mt. Auburn Rd., 47712. (812) 425-6201. TWX 810-353-0507. Licensee: WFIE Inc. Ownership: See Orion Bcstg Inc. ■ NBC. Rep: Katz. Wash atty: Covington & Burling. ■ Ralph S. Jackson, pres; Kelly Atherton, VP & gen mgr; Jerry Eastham, natl sls mgr; Chester Behrman, prog mgr & film buyer; Larry Pond, news dir; Marion B. Paul, chief engr. ■ On 12 CATV's. ■ Rates: \$135; 45; 18.

***WNIN**—ch 9, 282 kw vis, 56.2 kw aur, ant 570t/570g. March 16, 1970. 9201 Petersburg Rd., 47711. (812) 867-8471. Licensee: SW Ind. Public Television Inc. (acq 9-12-73). ■ PBS. Wash atty: Stambler & Shrinisky. ■ Vincent F. Saele, pres & gen mgr; Constance Julius, prog dir and film buyer; Dan Agan, prom mgr; David Wilson, prod mgr. ■ On 9 CATV's.

WTWV—ch 7, 316 kw vis, 63.1 kw aur, ant 1,000t/991g. Aug. 21, 1956. 477 Carpenter St., 47736. (812) 422-1121. TWX 810-353-0594. Licensee: Evansville TV Inc. (acq 10-6-66). Ownership: See Fuqua Stns. ■ ABC. Rep: H-R. Wash atty: Winer & Scheiner. ■ Joe Windsor, chmn; E. Berry Smith, pres & gen mgr; Al Saucier, VP & sls mgr; Jim Abbott, prog dir; John Schuta, chief engr. ■ On 25 CATV's. ■ Rates: \$220; 90; 30.

Fort Wayne

ADI No. 89; see page B-27

WANE-TV—ch 15, 144 kw vis, 28.2 kw aur, ant 830t/839g. Sept. 26, 1954. 2915 W. State Blvd., 46808. (219) 742-9411. TWX 810-332-1508. Licensee: Indiana Bcstg Corp. Ownership: See Corinthian Stns. ■ CBS. Rep: Harrington, Righter & Parsons. Wash atty: Covington & Burling. ■ Philip J. Lombardo, pres; Reid G. Chapman, VP & gen mgr & film buyer; Francis Conway, gen sls mgr; Harry Michaels, prog dir; Ann Colone, prom mgr; Roger Mann, news dir; Walter H. Jones, chief engr. ■ On 5 CATV's.

WKJG-TV—ch 33, 295 kw vis, 49 kw aur, ant 770t/793g. Nov. 21, 1953. 2633 W. State Blvd., 46808. (219) 422-7474. TWX 219-241-2083. Licensee: Thirty-Three Inc. (acq 8-7-4). Ownership: Wabash Valley Bcstg Corp. ■ Anton Hulman Jr., 73.1%; Joseph Cloutier, 23%; and others. ■ NBC. Rep: Blair. Wash atty: Haley, Bader & Potts. ■ Anton Hulman Jr., pres; Joseph Cloutier, exec VP & treas; Hilliard Gates, VP & gen mgr; William Kline, coml mgr; Calo O. Mahlock, asst gen mgr; Richard Florea, news dir; William B. Nichols, opns mgr; Eugene A. Chase, chief engr. ■ On 15 CATV's—40,911 subs.

WPTA—(Roanoke) ch 21, 110 kw vis, 22 kw aur, ant 760t/770g. Oct. 27, 1957. 3401 Butler Rd., Fort Wayne, 46808. (219) 483-0584. TWX 810-332-1549. Licensee: WPTA-TV Inc. (acq 4-30-73). Ownership: See Combined Communications Corp. ■ ABC. Rep: PGW. Wash atty: Pierson, Ball & Dowd. ■ Edwin Metcalfe, pres & gen mgr; Marv Gottlieb, VP & gen sls mgr; Barbara Wigham, prog dir and prom mgr; Harry Gallagher, news dir; John Carroll, chief engr. ■ On 19 CATV's—59,860 subs. ■ Rates: \$180; 90; 45.

Indianapolis

ADI No. 20; see page B-33

***WFYI**—ch 20, 562 kw vis, 112 kw aur, ant 847t/867g. Oct. 4, 1970. 1440 North Meridian, 46202. (317) 639-5591. Licensee: Metro Indianapolis TV Assn Inc. ■ PBS. ■ Luke Lanford, pres; Frank Meek Jr., gen mgr; Alan Cloe, prog dir; Frank Sorrentino, chief engr. ■ On 16 CATV's—30,000 subs.

WHMB-TV—ch 40, 933 kw vis, 933 kw aur, ant 470t/500g. January 25, 1971. Box 50250,

46250. (317) 773-5050. Licensee: LeSea Bcstg Corp. (acq 8-15-72). Ownership: LeSea Bcstg Corp., non-profit corporation with Lester Sumrall, pres; Louise Sumrall, sec and Leona Murphy treas, trustees of Lester Sumrall Evangelistic Assn, licensee of *WHME(FM) South Bend. Wash atty: Mallick & Benton. ■ Rev. Lester Sumrall, pres; Rev. Neal Hail, VP and gen mgr; Peter Sumrall, prod dir; Charles Huffman, dir cable opns; Wanda Linville, traffic mgr; Evelyn Haws, prom mgr; Larry Vehorn, chief engr. ■ On 90 CATV's—150,000 subs.

WISH-TV—ch 8, 316 kw vis, 42.7 kw aur, ant 990t/997g. July 1, 1954. 1950 N. Meridian St., 46202. (317) 924-4381. TWX 810-341-3208. Licensee: Indiana Bcstg Corp. (acq 12-1-56). Ownership: See Corinthian Stns. ■ CBS. Rep: Tele-Rep. Wash atty: Covington & Burling. ■ Philip J. Lombardo, pres; Robert B. McConnell, VP & gen mgr; William B. Stough, sls mgr; Larry O. Cazavan, prog dir; R. Lee Giles, news dir; James Langford, prom mgr; Joseph F. Missick, chief engr. ■ On 40 CATV's—176,000 subs. ■ Rates: \$525; 155; 92.

WRTV—ch 6, 100 kw vis, 20 kw aur, ant 990t/1,019g. May 30, 1949. 1330 N. Meridian St., 46206. (317) 635-9788. TWX 810-341-3339. Licensee: McGraw-Hill Bcstg (acq 6-1-72). Ownership: See McGraw-Hill Bcstg. See Nwspr. ■ NBC. Rep: HR&P. Wash atty: Koteen & Burt. ■ Norman E. Walt, pres; Jerry Chapman, VP & gen mgr; James Mathis, gen sls mgr; Earl Johnson, prog dir & film buyer; Loren Neuharth, natl sls mgr; Charles Rogers, prom mgr; Robert Gamble, news dir; Robert Flanders, dir of engr. ■ On 49 CATV's—184,487 subs. ■ Rates: \$975; 300; 120.



WTHR—ch 13, 316 kw vis, 31.6 kw aur, ant 976t/1,024g. Oct. 30, 1957. 1401 N. Meridian St., 46202. (317) 639-2311. TWX 810-341-3350. Licensee: Videoinc Indiana Inc. (acq 10-1-75). Ownership: See Dispatch Printing. ■ ABC. Rep: Blair TV Slis. Wash atty: Dow, Lohnes & Albertson. ■ Richard M. Wolfe, pres; Chris Duffy, gen mgr; Mel Grossman, gen sls mgr; Tom Rose, prog dir and film buyer; Doug Mallory, prom mgr; Bill Dean, news dir; Norm Nixon, chief engr. ■ On 41 CATV's 91,000 subs. ■ Rates: \$900; 100; 85.

WTTV (Bloomington)—ch 4, 56.2 kw vis, 11.2 kw aur, ant 1,190t/1,225g. Nov. 11, 1949. 3490 Bluff Rd., Indianapolis, 46217. (317) 787-2211. TWX 810-341-3177. Licensee: Sarkes Tarzian Inc. Ownership: See Sarkes Tarzian Stns. ■ Rep: RTVR. Wash atty: Cohn & Marks. ■ Sarkes Tarzian, pres; Elmer Snow, gen mgr; Don Tillman, prog mgr; Clyde Dutton, gen sls mgr; Terrence Simpson, prom mgr; Jim Lockwood, news dir; James Hair, opns mgr; Donald Morgan, chief engr. ■ Rates: \$175; 175; 75.

Kokomo

WLFI-TV—Licensed to Lafayette. See Lafayette.

Lafayette

ADI No. 192; see page B-37



WLFI-TV—ch 18, 1,490 kw vis, 298 kw aur, ant

778t/755.99g. June 15, 1953. Box 18, 47902. (317) 463-3516. Licensee: RJN Bcstg Co. Ownership: Richard F. Shively, 100% (acq 11-16-67). ■ CBS. Rep: Devney; Walton; Messina; Oakes. Wash atty: James E. Greeley. ■ Richard Shively, pres; Harold Shively, VP & gen mgr; Jane Wallace, prog dir; Bill McCormick, news dir; Robert Hardie, chief engr. ■ On 22 CATV's—50,000 subs.

Muncie

ADI No. 20; see page B-33

***WIPB**—ch 49, 142 kw vis, 28.2 kw aur, ant 500t/542g. May 8, 1953. 246 Minnestrista Blvd., 47303. (317) 285-4771. Licensee: Ball State U. (acq 10-31-71). ■ PBS. Wash atty: Schwartz & Woods. ■ Robert W. Faulk, gen mgr; Ronald P. Wolf, prog dir; Richard J. Stawicki, news dir; James Miller, chief engr. ■ On 10 CATV's—25,000 subs.

Roanoke

WPTA—Licensed to Roanoke. See Fort Wayne.

St. John

ADI No. 3; see page B-14

***WCAE**—ch 50, 603 kw vis, 120 kw aur, ant 417t/448g. Sept. 20, 1967. 123 Sesame St., 46373. (219) 365-4041. Licensee: Lake Central School Corp. ■ PBS. ■ Lou Iaconetti, gen mgr; Ernest Rueter, prom mgr; Bud Rudy, pres, lay bd of dirs; John Gerrard, prog dir; Scott Markley, news dir; Harry Garba, chief engr. ■ On 2 CATV's.

South Bend

ADI No. 75; see page B-69

WMSH-TV—ch 46, 891 kw vis, 178 kw aur, ant 1,000t/883g. 1974. Box 1901, 46634. (219) 284-9510. Permittee: G & E Religious and Educational Broadcasting Corp. ■ David M. Kelley, gen mgr.

WNDU-TV—ch 16, 3,770 kw vis, 754 kw aur, ant 1,070t/1,046g. July 15, 1955. Box 1616, 46634. (219) 233-7111. TWX 810-229-2594. Licensee: Michiana Telecasting Corp. Ownership: U. of Notre Dame du Lac, 100%. ■ NBC. Rep: Young. Andy McDermott. Wash atty: Dempsey & Kopolovitz. ■ Rev. T. M. Hesburgh, pres; W. Thomas Hamilton, exec VP & gen mgr; Basil O'Hagan, VP, bcst opns; Dave O'Shea, sls mgr; P. E. Walton Jr., prog dir; Harry Kevoorkian, news dir; Dave Williams, prom mgr; Ray Jackson, chief engr. ■ On 13 CATV's. Co-owned WNDU-AM-FM. ■ Rates: \$250; 80; 30.

***WNIT-TV**—ch 34, 700 kw vis, 77 kw aur, 564t/549g. May 1974. Box 34, 46624. Licensee: Michiana Public Bcstg Corp. (219) 234-3434. ■ PBS. ■ Ms. E. Blair Warner, pres; Thomas E. Brubaker, exec dir & gen mgr; Gary Weinstein, prog dir; Nick Kiernan, prom mgr; K. Clem Kuespert, chief engr.

WSBT-TV—ch 22, 586.5 kw vis, 117.3 kw aur, ant 1,070t/1,047g. Dec. 21, 1952. 300 W. Jefferson Blvd., 46601. (219) 233-3141. TWX 219-282-8154. Licensee: South Bend Tribune. Ownership: South Bend Tribune. See Nwspr. ■ CBS. Rep: Katz. Wash atty: Hogan & Hartson. ■ Warren G. Wheeler Jr., pres; Jack E. Douglas, gen mgr; Jerome Bleck, natl sls mgr; James D. Freeman, loc & rgnl sls mgr; Justin R. Meacham, prom mgr; Roderick Johnson, comm aff dir; Norbert J. Gassensmith, prog dir & film buyer; Jack Bowe, news dir; Robert W. Bell, chief engr; Walter A. Sweitzer, pub svc dir. ■ On 27 CATV's. Co-owned: WSBT-AM; WWJY(FM). ■ Rates: \$175; 85; 35.

WSJV (Elkhart)—ch 28, 1,510 kw vis, 27.4 kw aur, ant 1,086t/1,045g. March 15, 1954. Box

700, Elkhart, 46514. (219) 293-8616. TWX 810-294-2242. Licensee: WSJV Television Inc. (acq 4-1-75). Ownership: See Quincy Newspapers. ■ ABC. Rep: Blair. Wash atty: Dow, Lohnes & Albertson. ■ Thomas A. Oakley, pres; Don Fuller, VP & gen mgr; Larry G. Alt, admin asst; Andy Rinaldi, sls mgr; Phil Lengyel, news dir; Craig Brines, prom mgr; Wayne Lovely, chief engr. ■ On 11 CATV's. ■ Rates: \$175; 75; 30.

Terre Haute

ADI No. 107; see page B-71

WILL-TV—ch 38, 2310 kw vis, 191 kw aur, 976t/1,004g. April 3, 1973. Box 719, 47808. (812) 238-1515. Licensee: Alpha Bcstg Corp. Ownership: John M. House, 23.37%; Jessie M. House, 16.23%; and others. ■ ABC. Rep: Young. Wash atty: Booth & Freret. ■ John House, pres; Ben Falber, Jr., exec VP, gen mgr & film buyer; George Allen Jr., gen sls mgr; Gerald Badaeux, opns mgr; John Lawrence, chief engr. ■ On 14 CATV's—44,675 subs. ■ Rates: \$55; 28; 18.



WTHI-TV—ch 10, 316 kw vis, 31.6 kw aur, ant 960t/993g. July 22, 1954. 918 Ohio St., 47808. (812) 232-9481. TWX 810-356-2137. Licensee: Wabash Valley Bcstg Corp. Ownership: Anton Hulman Jr., 80.7%; J. R. Cloutier, 14.1%; and others. ■ CBS. Rep: Avery-Knodel. Wash atty: Haley, Bader & Potts. ■ Anton Hulman Jr., pres; Robert K. Larr, VP & stn mgr; Ruth Ann Madesitt, prom dir; Russ Arnold, VP & chief engr. ■ On 28 CATV's—70,970 subs. Co-owned: WTHI-AM-FM. ■ Rates: \$140; 65; 40.

WTWO—ch 2, 100 kw vis, 19.5 kw aur, ant 950t/999g. Sept. 1, 1965. Box 299, 47808. (812) 232-9504. TWX 810-350-2470. Licensee: Iliana Telecasting Corp. Ownership: Malcolm I. Glazer. (acq 7-18-75). ■ NBC. Rep: Peters, Griffin, Woodward. Wash atty: Dow, Lohnes & Albertson. ■ James E. Sauter, pres; John T. Gelder Jr., exec VP & gen mgr; Robert Beall, asst gen mgr & sls mgr; James Underwood, opns mgr; Scott Blumenthal, prod mgr; John Palmer, news dir; Richard Poole, prom mgr; Arden Ramsey, chief engr. ■ On 32 CATV's—62,000 subs.

Vincennes

ADI No. 107; see page B-71

***WVUT**—ch 22, 1,150 kw vis, 115 kw aur, ant 570t/560g. Feb. 15, 1968. 1029 N. Fourth St., 47591. (812) 822-6525. Licensee: Vincennes U. trustees. ■ PBS, CEN. Wash atty: Fletcher, Heald, Rowell, Kenahan & Hildreth. ■ Robert Stevens, gen mgr; Jack Hanes, prod dir; T. Mack Seed, prod dir & chief engr. ■ On 9 CATV's—20,000 subs. Co-owned: *WVUB(FM).

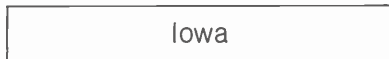

Ames

WOI-TV—Licensed to Ames. See Des Moines.

Cedar Rapids

ADI No. 71; see page B-12

KCRG-TV—ch 9, 295 kw vis, 58.9 kw aur, ant 2,000t/1,926g. Oct. 15, 1953. Second Ave. at 5th St. S.E., 52406. (319) 398-8422. TWX 910-525-1341. Licensee: Cedar Rapids TV Co. Ownership: The Gazette Co. (Cedar Rapids

HAMILTON-LANDIS
& ASSOCIATES, Inc.
NATIONWIDE MEDIA BROKERS
WASHINGTON, D. C. CHICAGO, DALLAS,
SAN FRANCISCO
SELL **MORE**
RADIO & TELEVISION STATIONS
IN THE MIDWEST—NEAREST OFFICE IS—
1429 TRIBUNE TOWER, CHICAGO 60611
(312) 337-2754

Gazette), 100%. See Nwspr. ■ ABC. Rep: H-R. Wash atty: Kirkland, Ellis & Rowe. ■ Joseph F. Hladky Jr., pres; Edwin J. Lasko, VP & gen mgr; Ronald Stack, sls mgr; Paul Dicker, opns mgr & prod dir; Sid Hayman, news dir; Edna A. Herbst, VP & dir prom, publ & pub affs; Walter Alliss, chief engr. ■ Co-owned: KCRG(AM).

KWWL-TV—(Waterloo) ch 7, 316 kw vis, 27 kw aur, ant 1,980t/2,000g. November 1953. 500 E. 4th, Waterloo, 50703. (319) 234-4401. TWX 910-525-1271. Licensee: Black Hawk Bcstg Co. Ownership: See Black Hawk Stns. ■ NBC. Rep: Blair TV. Wash atty: Arent, Fox, Kintner, Plotkin & Kahn. ■ Robert Buckmaster, pres; James Bradley, exec VP & gen mgr; John A. MacGregor, sls mgr; Jim Noonan, prod dir; Rick Stone, prom mgr; Grant Price, dir of news svcs; Tom Peterson, news dir; Edward M. Tink, dir of engr. ■ On 8 CATV's—15,000 subs. On 1 trans. Co-owned: KWWL(AM)-KFMW(FM).

WMT-TV—ch 2, 100 kw vis, 20 kw aur, ant 1,450t/1,355g. Sept. 30, 1953. Broadcast Park, 52406. (319) 393-8200. TWX 910-525-1326. Licensee: WMT Inc. Ownership: See Orion Bcstg Inc. ■ CBS. Rep: Katz. Wash atty: Covington & Burling. ■ Ralph S. Jackson, pres; Lew Van Nostrand, exec VP & gen mgr; James B. Oetken, stn mgr; DeWayne Browning, sls mgr; Bill Logan, prod dir; Dan Udvig, prom mgr; Roy Karon, news dir; Bob Kucera, chief. ■ On 13 CATV's—20,500 subs. On 4 trans. Co-owned: WMT-AM-FM. ■ Rates: \$260; 130; 65.

Council Bluffs

ADI No. 63; see page B-53

***KBIN**—ch 32, 245 kw vis, 24.5 kw aur, 316.5t/320g. Sept. 7, 1975. Box 1758, Des Moines, Iowa 50306. Licensee: State Educational Radio and Television Facility Board. ■ PBS. Wash atty: Pierson, Ball & Dowd. ■ Dr. Robert F. Ray, chmn.

Davenport

ADI No. 67; see page B-19

WHBF-TV—see Rock Island, Ill.

WOC-TV—ch 6, 100 kw vis, 15.1 kw aur, ant 940t/978g. Oct. 31, 1949. 805 Brady St., 52808. (319) 324-1661. TWX 910-525-1189. Licensee: WOC Bcstg Co. Ownership: See Palmer Broadcasting Stns. ■ NBC. Rep: Peters, Griffin, Woodward. ■ David D. Palmer, pres & treas; Lee Marts, gen mgr; Harold R. Heath, sls mgr; Ed Zack, prod dir; Jack Thomsen, news dir; Dorothy Boyd, prom dir; Coy Bullard, dir engr. ■ On 4 CATV's—17,200 subs. On 1 trans. Co-owned: WOC(AM)-KLIK(FM).

WQAD-TV—see Moline, Ill.

Des Moines

ADI No. 59; see page B-50

KCCI-TV—ch 8, 316 kw vis, 63.1 kw aur, ant 610t/709g. 9th & Pleasant, 50308. (515) 243-4141. TWX 910-520-2818. Licensee: Cowles Communications Inc. Ownership: See Cowles Stns. ■ CBS. Rep: Katz. ■ William H. Hippee, pres & gen mgr; Joe Hudgens, prod dir & film buyer; Guy Koenigsberger, adv & prom mgr; Russ Van Dyke, news dir; Nolan Quam,

Indiana, Iowa TV

See page B-89 for explanation of listings.

gen sls mgr; Jake Sneller, chief engr. ■ On 29 CATV's. On 2 trans.

***KDIN-TV**—ch 11, 316 kw max vis, 31.6 kw max aur, ant 1,973t/2,000g. April 14, 1959. Box 1758, 50306. (515) 280-1120. TWX 910-520-2656. Licensee: State Educl Radio-TV Facility Bd. ■ PBS. Wash atty: Pierson, Ball & Dowd. ■ Dr. Thomas M. Ditzel, exec dir; David J. Brugger, dir admin; Michael Labonia, dir progs; Mark Douglas, prom super; Don Saveraid, dir engr. ■ On 8 CATV's—6,158 subs. On 2 trans.

WHO-TV—ch 13, 316 kw vis, 47.9 kw aur, ant 2,030t/2,000g. April 15, 1954. 1100 Walnut St., 50308. (515) 288-6511. TWX 910-520-2549. Licensee: Palmer Bcstg Co. Ownership: See Palmer Stns. ■ NBC. Rep: Peters, Griffin, Woodward. Wash atty: Dow, Lohnes & Albertson. ■ David D. Palmer, pres & treas; Robert H. Harter, exec VP & gen mgr; W. J. Blick, sec; George Carpenter III, TV stn mgr; Alvin H. Barcheski, prod dir & film buyer; Robert K. Wilbanks, news dir; Robert Engelhardt, chief engr. ■ On 7 CATV's—3,370 subs. On 3 trans. Co-owned: WHO(AM)-KLYF(FM). ■ Rates: \$360; 100; 55.

WOI-TV—(Ames) ch 5, 100 kw vis, 20 kw aur, ant 1,854t/1,995g. Feb. 21, 1950. WOI Bldg, Ames, 50010. (515) 294-5555. TWX 910-520-1152. Licensee: Iowa State University of Science & Tech. ■ ABC. Rep: H-R. Wash atty: Cohn & Marks. ■ Robert W. Parks, pres; Robert C. Mulhall, gen mgr, prod dir & film buyer; Ted Tostlebe, coml mgr; Kirk Winkler, news dir; Bob Helmers, prom mgr; Keith Ketcham, chief engr. ■ On 23 CATV's. On 2 trans. Co-owned: WOI-AM-FM. ■ Rates: \$190; 70; 27.

Dubuque

ADI No. 71; see page B-12

KDUB-TV—ch 40, 538 kw vis, 108 kw aur, ant 793t/786g. May 31, 1970. Box 1166, Evergreen Park, 52001. (319) 556-4040. Licensee: Dubuque Communications Corp. Ownership: Gerald J. & Timothy M. Green, each 30.5%. ■ ABC. Rep: Meeker. Wash atty: Mallyck & Bernton. ■ Gerald J. Green, pres & gen mgr; Claren Schroeder, admin dir; Charles Cybersk, dir of opns; Earl Goodrick, prod mgr; James Esmoil, news dir. ■ On 23 CATV's—25,000 subs.

Fort Dodge

ADI No. 59; see page B-20

KVFD-TV—ch 21, 414 kw vis, 41.4 kw aur, 1,160t/1,206g. Nov. 23, 1953. Television Square, 50501. (515) 576-7606. Licensee: Northwest TV Co. Ownership: Edward Breen 18%; Northwest Bcstg Co., 31% & others. ■ NBC, PBS. Rep: Savail-Gates. Wash atty: Fisher, Wayland, Southmayd & Cooper. ■ Edward Breen, pres, gen mgr & film buyer; Eve Rubenstein, stn mgr; Gordon DeKoster, sls mgr; Lyle Bartlett, prod dir; Robert Tarbox, news dir; Dave Sinclair, chief engr. ■ On 21 CATV's—21,607 subs.

***New TV**—ch 46, 561 kw vis, 56 kw aur, ant 1,024t/1,206g. Not on air target date unknown. Box 1578, 50306. Permittee: State Educl Radio-TV Facility Board.

Iowa City

ADI No. 71; see page B-12

***KIIN-TV**—ch 12, 316 kw vis, 31.6 kw aur, ant 1,440t/1,449g. Feb. 8, 1970. Licensee: State Educl Radio-TV Facility Board. ■ Execs: See *KDIN-TV Des Moines ■ On 9 CATV's—24,950 subs. On 2 trans.

Iowa, Kansas TV

See page B-89 for explanation of listings.

Mason City

ADI No. 120; see page B-81

KGLO-TV—ch 3, 100 kw vis, 20 kw aur, (CP: 5 kw aur) ant 1,510/1,525g. May 15, 1954. 112 N. Pennsylvania Ave., 50401. (515) 423-2540. TWX 910-523-6966. Licensee: Lee Enterprises Inc. Ownership: See Lee Stns, also Nwspr. ■ CBS. Rep: Katz. Wash atty: Pierson, Ball & Dowd. ■ Lloyd D. Loers, VP-broadcast divs & gen mgr; Earl L. Schoborg, gen sis mgr; Howard Kennedy, opns mgr & film buyer; Max Lee Smith, news dir; David Sappenfield, chief engr. ■ On 21 CATV's—44,634 subs. On 1 trans. Co-owned: KGLO(AM). ■ Rates: \$100; 65; 25.

***KYIN**—ch 24, 531 kw vis, 53 kw aur, ant 1,386/1,524g. Not on air, target date unknown. c/o Don D. Saverid, 2801 Bell Ave., Des Moines, 50306. ■ Wash atty: Pierson, Ball & Dowd. Permittee: State Educl Radio-TV Facility Board.

Ottumwa

ADI No. 195; see page B-54

KTVO—(Kirksville, Mo.) ch 3, 100 kw vis, 14.3 kw aur, ant 1,080/1,101g. Nov. 21, 1955. 211 E. Second St., Ottumwa, 52501. (515) 682-4535. TWX 910-520-1455. Licensee: KTVO Inc. Ownership: See Post Corp Stns, also Nwspr. ■ ABC. Rep: H-R. Wash atty: Chadbourne, Parke, Whiteside & Wolff. ■ V. I. Minahan, pres; David L. Nelson, VP-treas; Alvina M. Britz, gen mgr; Jack Paris, stn & gen sis mgr; Gary Cunningham, film buyer; Ron Heller, news dir; Joe Galvan, prog & prom dir; Chuck Conger, farm dir; John Canny, prod dir; Gerald Dreger, chief engr. ■ On 23 CATV's—40,040 subs. Co-owned: KBIZ(AM). ■ Rates: \$72; 65; 31.

Red Oak

ADI No. 63; see page B-53

***KHIN**—ch 36, 490 kw vis, 49 kw aur, ant 1,561/1,560g. September, 1975. Box 1758, Des Moines, Iowa, 50306. Licensee: State Educational Radio and Television Facility Board. ■ PBS. Wash atty: Pierson, Ball & Dowd. ■ Execs: See *KDIN-TV Des Moines. ■ On 30 CATV's—308,000 subs. On 2 trans.

Sioux City

ADI No. 119; see page B-67

KCAU-TV—ch 9, 245 kw vis, 49 kw aur, ant 2,020/2,000g. March 28, 1953. 7th & Douglas Sts., 51101. (712) 277-2345. Licensee: Forward of Iowa Inc. Ownership: See Forward Communications Stns, also Nwspr. ■ ABC. Rep: Meeker, Hyett; BFW; Hix. Wash atty: McKenna, Wilkinson & Kittner. ■ Richard D. Dudley, corp pres; William F. Turner, div pres & gen mgr; Jack Gilbert, stn mgr; Clair W. Giles, bus mgr; Paul J. O'Bryan Jr., asst gen mgr & gen sis mgr; David L. Slater, opns mgr; Jim Henry, prom mgr; Glen Larsen, tech dir. ■ On 15 CATV's—9,500 subs. On 5 trans. ■ Rates: \$125; 88; 27.

KMEG—ch 14, 380 kw vis, 75.9 kw aur, ant 1,152/1,000g. Sept. 5, 1967. Seventh & Floyd Blvd, 51102. (712) 277-3554. TWX 910-968-1742. Licensee: Medallion Bcstrs Inc. Ownership: See Fetzer Stns. ■ CBS. Rep: Avery-Knodel. Wash atty: Dow, Lohnes & Albertson. ■ A. James Ebel, pres; Robert B. Donovan, gen & sis mgr; Jack Parris, stn mgr; Andy Kokas, prom mgr; Don Keeler, news dir; Bernie Sasek, chief engr. ■ On 11 CATV's—12,000 subs. On 1 trans. ■ Rates: \$70; 30; 15.

***KSIN**—ch 27, 933 kw vis, 186 kw aur, ant 1073.2/1000g. Not on air, target date unknown. Box 1758, Des Moines, Iowa, 50306. Permittee: State Educational Radio and Television Facility Board. ■ PBS. Wash atty: Pierson, Ball & Dowd. ■ Execs: See *KDIN-TV Des Moines.

KTIV—ch 4, 100 kw vis, 20 kw aur, ant 1,920/2,000g. Oct 9, 1954. Box 87, 51102. (712) 258-0545. TWX 910-976-2064. Licensee KTIV TV Co. (acq 4-10-74). Ownership: See Black Hawk Bcstg Co. Stns. ■ NBC. Rep: Katz TV. Wash atty: Arent, Fox, Kintner, Plotkin & Kahn. ■ Robert Buckmaster, pres; Lyn P. Stoyer, gen mgr; Raymond P. Maselli, local sis mgr; Roger Mansfield, stn mgr, prod dir & film buyer; Dick Wait, news dir; Al Smith, chief engr. ■ On 8 CATV's. On 5 trans. ■ Rates: \$135; 100; 45.

Waterloo

ADI No. 71; see page B-12

***KRIN**—ch 32, 912 kw vis, 182 kw aur, ant 1,820/1,923g. Dec 15, 1974. Box 1758, Des Moines, 50306. Permittee: State Educational Radio & Television Facility Bd. ■ PBS. Wash atty: Pierson, Ball & Dowd. ■ Execs: See *KDIN-TV Des Moines.

KWWL-TV—Licensed to Waterloo. See Cedar Rapids.

WMT-TV—Licensed to Cedar Rapids. See Cedar Rapids.

Kansas

HAMILTON-LANDIS
& ASSOCIATES, Inc.
NATIONWIDE MEDIA BROKERS
WASHINGTON, D. C., CHICAGO, DALLAS,
SAN FRANCISCO
SELL MORE
RADIO & TELEVISION STATIONS
IN THE MIDWEST—NEAREST OFFICE IS—
1429 TRIBUNE TOWER, CHICAGO 60611
(312) 337-2754

Ensign

ADI No. 54; see page B-77

KTVC—ch 6, 100 kw vis, 10 kw aur, ant 720/686g. July 24, 1957. Box 157, Dodge City, 67801. (316) 227-3121. Licensee: Southwest Kansas TV Co. Ownership: Leigh Warner, 55.32%; Sidney Warner, 5%; Diana Janoff, 12%, and others. ■ CBS, Kansas Bcstg System. Rep: Avery-Knodel. Wash atty: Wilner & Scheiner. ■ Leigh Warner, pres; W. H. Bailey, gen mgr; ■ On 6 CATV's—8,000 subs. On 1 trans.

Garden City

ADI No. 54; see page B-77

KGLD—ch 11, 200 kw vis, 24.5 kw aur, ant 800/837g. Nov. 5, 1958. Box 1076, 67846. (316) 276-2311. Licensee: Kansas State Network Inc. Co-owned satellite of KARD-TV, Wichita. ■ NBC. ■ Jim Austin, gen mgr. ■ On 10 CATV's—7,938 subs. ■ Rates: \$42; 34; 24.

KUPK-TV—ch 13, 87.1 kw vis, 17.4 kw aur, ant 870/881g. Nov. 8 1964. Box 216, Copeland, 67837. Licensee: KAKE-TV & Radio Inc. Co-owned satellite of KAKE-TV, Wichita. ■ Wash atty: Cohn & Marks. ■ Martin Umansky, pres; Bob Surber, VP & gen mgr; John Strauss,

prog dir; Bryce Baker, sis mgr; Paul Hinderliter, chief engr. ■ On 6 CATV's. ■ Rates: \$30; 24; 18.

Goodland

ADI No. 54; see page B-77

KLOE-TV—ch 10, 316 kw vis, 45.7 kw aur, ant 770/778.5g. April 28, 1959. Box 817, Hays, 67601. Licensee: KAYS Inc. Co-owned satellite of KAYS-TV, Hays.

Great Bend

ADI No. 54; see page B-77

KCKT—ch 2, 100 kw vis, 17.8 kw aur, ant 970/1,005g. Nov. 28, 1954. Box 689, 67530. (316) 793-7868. Licensee: Kansas State Network Inc. Co-owned satellite of KARD-TV, Wichita. ■ Bill Ranker, stn mgr. ■ On 18 CATV's—23,337 subs. On 1 trans.

Hays

ADI No. 54; see page B-77

KAYS-TV—ch 7, 316 kw vis, 33.6 kw aur, ant 710/812g. Sept 1, 1958. Box 817, 67601. (913) 625-2578. Licensee: KAYS Inc. Ownership: Ross Beach Jr., 50-2/3%; Robert E. Schmidt, 49-1/3%. ■ CBS, ABC, Kansas Bcstg System. Rep: Avery-Knodel. Wash atty: A. L. Stein ■ Ross Beach, pres; Robert E. Schmidt, gen mgr; Bernie Brown, stn mgr & film buyer; Errol Weurtz, prod dir; Don Coen, chief engr. ■ On 8 CATV's—7,100 subs. On 1 trans. Co-owned KAYS(AM). ■ Rates: \$45; 33; 20.

Hutchinson

ADI No. 54; see page B-77

***KPTS**—ch 8, 229 kw vis, 22.9 kw aur, ant 800/785g. Jan 5, 1970. 309 East 3d, Wichita, 67202. (316) 262-4161. Licensee: Sunflower Educl TV Corp. ■ PBS. Wash atty: Dow, Lohnes & Albertson. ■ Zoel Parenteau, pres & gen mgr; Torey Southwick, dir progmg; Robert Nelson, dir of dev; Robert Wine, asst treas & dir of adm; Bob Fulkerson, dir of engrg. ■ On 33 CATV's—30,000 subs.

KTVH—Licensed to Hutchinson. See Wichita.

Pittsburg

ADI No. 114; see page B-35

KOAM-TV—ch 7, 316 kw vis, 63.1 kw aur; ant 1,090/1,159g. Dec. 13, 1953. Box 659, Pittsburg, 66762. (316) 231-0400. TWX 316-952-8230. Licensee: Mid-Continent Telecasting Inc. Ownership: Pittsburg Bcstg Co. (KOAM), 66 2/3%, and Joplin Globe (Mo). Pub Co. (Globe and News Herald), 33-1/3%. See Nwspr. ■ NBC. Rep: Katz. Wash atty: Fisher, Wayland, Southmayd & Cooper. ■ Bill Bengtson, VP, gen mgr & film buyer; Glenn Harold, coml mgr; Louis R. Martin, VP, prog dir & film buyer; Rich Hendry, prom mgr; Jack Lawrence, chief engr. ■ On 22 CATV's—40,000 subs. Co-owned: KOAM(AM). ■ Rates: \$95; 40; 30.

KODE-TV—See Joplin, Mo.

Topeka

ADI No. 124; see page B-72

KTSB—ch 27, 912 kw vis, 138 kw aur, ant 1,050/1,149g. Dec. 28, 1967. Box 2700, 66601. (913) 582-4000. TWX 910-749-6600. Licensee: Studio Broadcasting System Division, Highwood Svc Inc. Ownership: Motorcar

Transport Co., 100%. ■ NBC, ABC. Rep: H-R. Wash atty: McKenna, Wilkinson & Kittner. ■ Ralph C. Wilson Jr., pres; William R. Hirshey, gen mgr; Herbert L. Brown, dir of sls; Harry L. Strader, asst mgr; George Davis, news dir; William Keegan, chief engr. ■ On 27 CATV's—74,108 subs. On 3 trans. ■ Rates: \$75; 50; 20.

***KTWU**—ch 11, 316 kw vis, 316 kw aur; ant 1,000/952g. Oct. 21, 1965. 301 N. Wandmaker Rd., 66604. (913) 272-8181. Licensee: Washburn U. of Topeka. ■ PBS. ■ Dr. John W. Henderson, pres; Dr. Dale N. Anderson, gen mgr & film buyer; David Pomeroy, prog dir; Jody Hankammer, prom mgr; Ernie Hedges, chief engr. ■ On 40 CATV's.

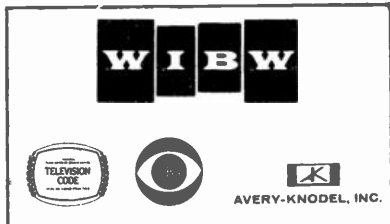

WIBW-TV—ch 13, 204 kw vis, 40.7 kw aur, ant 1,380/1,255.2g. Nov. 15, 1953. Box 119, 66601. (913) 272-3456. TWX 913-323-6151. Licensee: Stauffer Publications Inc. Ownership: See Stauffer Publications Stns, also Nwspr. ■ CBS, ABC. Rep: Avery-Knodel; Hix. Wash atty: Dow, Lohnes & Albertson. ■ Thad M. Sandstrom, VP, bcstg; Jerry Holley, gen mgr; Ray Senate, natl sls mgr; Bob Kearns, sls mgr; Dick Siley, prog dir; Don Morgan, prom dir; Tom Parmley, news dir; Paul Winders, dir of engr. ■ On 67 CATV's—112,000 subs. On 7 trans. Co-owned: WIBW-AM-FM. ■ Rates: \$125; 85; 30.

Wichita

ADI No. 54; see page B-77

KAKE-TV—ch 10, 316 kw vis, 42.7 kw aur, ant 1,030/1,079g. Oct. 19, 1954. Box 10, 67201. (316) 943-4221. TWX 910-741-6926. Licensee: KAKE-TV & Radio Inc. Ownership: Tom Palmer Testamentary Trusts, 19.6% & others. ■ ABC. Rep: Katz. Wash atty: Cohn & Marks. ■ Martin Umansky, pres & gen mgr; Bryce Benedict, VP & gen sls mgr; John Froome, VP and asst gen mgr; Ed Brady, prom mgr; Paul Threlfall, VP & news mgr; Harold Newby, VP & chief engr. ■ On 38 CATV's—68,448 subs. On 7 trans. Co-owned: KAKE(AM). ■ Rates: \$170; 115; 35.

KARD-TV—ch 3, 100 kw vis, 20 kw aur, ant 1,000/1,071g. Sept. 1, 1955. Box 333, 833 N. Main, 67201. (316) 265-5631. TWX 910-741-6976. Licensee: Kansas State Network Inc. Ownership: See Kansas State Network Stns. ■ NBC. Rep: Tele-Rep. Wash atty: Koteen & Burt. ■ Frank Chappell, pres & gen mgr; Larry Proffitt, natl sls mgr; Bob Traeger, local & rgnl sls mgr; Bill Sikes, prog dir & film buyer; Jerryanne Hadley, prom mgr; Greg Gamer, news dir; Glenn Bell, chief engr. ■ On 59 CATV's—87,325 subs. On 1 trans. Co-owned: KARD-FM.

KTVH (Hutchinson)—ch 12, 316 kw vis, 63.1 kw aur, ant 1,522/1,504g. July 1, 1953. Box 12, Wichita, 67201. (316) 838-1411. TWX 316-554-9473. Licensee: Wichita-Hutchinson Co. Ownership: Minneapolis Star and Tribune, 100%. See Minneapolis Star & Tribune Stns, also Nwspr. ■ CBS, Kansas Bcstg System. Rep: Blair. Wash atty: Marmet & Webster. ■ M. Dale Larsen, pres & gen mgr; Gerald W. Carr, VP, stn & natl sls mgr; Julius Efland, dir of prog & film buyer; John S. Mileham, adv & prom dir; Jon Poston, news dir; Dale Heckel, dir of engr. ■ On 25 CATV's—52,547 subs. ■ Rates: \$175; 70; 30.

Kentucky

HAMILTON-LANDIS & ASSOCIATES, Inc.
NATIONWIDE MEDIA BROKERS
WASHINGTON, D. C., CHICAGO, DALLAS, SAN FRANCISCO
SELL **MORE**
RADIO & TELEVISION STATIONS
IN THE MIDWEST—NEAREST OFFICE IS—
1429 TRIBUNE TOWER, CHICAGO 60611
(312) 337-2754

Ashland

ADI No. 42; see page B-13

***WKAS**—ch 25, 9.6 kw vis, 1.92 kw aur, ant 500/400 g. Sept. 23, 1968. Licensee: Ky Bd of Educ. ■ Execs: See *WKLE Lexington.

Bowling Green

ADI No. 30; see page B-49

WBKO—ch 13, 316 kw vis, 30.2 kw aur, ant 740/603g. June 3, 1962. Box 1198, 42101. (502) 781-1313. Licensee: Professional Telecasting Systems Inc. (acq 7-24-70). Ownership: Lincoln International Corp. ■ ABC. Rep: Avery-Knodel. Wash atty: Jones, Day, Reavis & Pogue. ■ D.C. Combs, pres; Clyde G. Payne, exec VP, gen mgr & film buyer; Randy Odil, gen sls & stn mgr; Mrs. Gene Prather, prog dir; Larry Bailey, news dir; Allan Korn, prod mgr; David Chumley, dir of engr. ■ On 35 CATV's—39,000 subs. ■ Rates: \$60; 45; 18.

***WKGB**—ch 53, 562 kw vis, 112 kw aur, ant 810/618g. Sept. 23, 1968. Licensee: Ky. Bd of Educ. ■ Execs: See *WKLE Lexington.

Covington

ADI No. 26; see page B-15

***WCVN**—ch 54, 8.7 kw vis, 1.7 kw aur, ant 400/312g. Sept. 9, 1969. Licensee: Ky Bd of Educ. ■ Execs: See *WKLE Lexington.

Elizabethtown

ADI No. 38; See page B-41

***WKZT**—ch 23, 575 kw vis, 115 kw aur, ant 650/655g. Sept. 23, 1968. Licensee: Ky. Bd. of Educ. ■ Execs: See *WKLE Lexington.

Hazard

ADI No. 86; see page B-11

***WKHA**—ch 35, 417 kw vis, 83.2 kw aur, ant 1,260/608g. June 6, 1968. Licensee: Ky. Bd of Educ. ■ Execs: See *WKLE Lexington.

WKYH-TV—ch 57, 15 kw vis, 2.9 kw aur, ant 800/442.2g. Oct. 20, 1969. Box 929, 41701. (606) 436-4444. TWX 510-474-7198. Licensee: Hazard TV Co. Ownership: William D. Gorman, 91%. ■ NBC. Rep: Max Goldfarb (Detroit). Wash atty: Fly, Shuebruk, Blume & Gaguine. ■ William D. Gorman, pres; William D. Gorman Jr., stn mgr; William R. Helton, sls mgr; Vaughn Ogrosky, prog dir; Randell Combs, film buyer. ■ On 15 CATV's—10,000 subs.

Lexington

ADI No. 93; see page B-39

***WKLE**—ch 46, 525 kw vis, 105 kw aur (CP: 1,050 kw horiz vis, 105 kw hor aur), ant 870/858g. Sept. 23, 1968. 600 Cooper Dr., 40502. (606) 233-0666. TWX 510-476-8879. Wash atty: Miller, Schroeder & Bankston. ■ O. Leonard Press, exec dir; Ronald B. Stewart, dep dir; Robert J. Klein, acting dir of engr; Virginia Fox, dir of ed; Donna Turner, dir of progmg.

WKYT-TV—ch 27, 2,360 kw vis, 1,382 kw aur,

Kansas, Kentucky TV

See page B-89 for explanation of listings.

ant 984.7/1,000 Sept 30, 1957. Box 5037, 40505. (606) 299-0411. TWX 510-476-8850. Licensee: Ky. Central TV Inc. Ownership: Ky. Central Life Ins. Co. Garvice Kincaid, principal stockholder. For Kincaid interests see Bluegrass Bcst Stns. ■ CBS. Rep: Avery-Knodel. Wash atty: Arent, Fox, Kintner, Plotkin & Kahn. ■ G. D. Kincaid, pres; Raymond P. Holbrook, exec VP; Ralph W. Gabbard, VP & gen mgr; Jere Pigue, gen sls mgr; Al Taylor, prom mgr & prog dir; Ken Kurtz, news dir; Harold Schumacher, chief engr. ■ On 66 CATV's—72,000 subs. On 1 trans. Co-owned: WVLC-AM-FM. ■ Rates: \$175; 85; 40.

WLEX-TV—ch 18, 1,104 kw max, 1,000 kw horiz vis; 221 kw max, 200 kw horiz aur, ant 640/670g. March 15, 1955. Box 1457, 40501. (606) 255-4404. TWX 510-476-8896. Licensee: WLEX-TV Inc. Ownership: See Gay-Bell Stns. ■ NBC. Rep: Meeker. Wash atty: Fletcher, Heald, Rowell, Kenehan & Hildredth. ■ Harry C. Barfield, pres & gen mgr; Ed White, VP natl-rgnl sls; Bob Davidson, VP-loc sls; Bob Jones, opns mgr & film buyer; Bill Thompson, news dir; Sue Wylie, dir of pub affrs & prom; A. W. Scheer, chief engr. ■ On 43 CATV's—44,130 subs. ■ Rates: \$239; 57; 79.

WTVQ-TV—ch 62, 492 kw vis; 49.2 kw aur, ant 1,029/996g. June 2, 1968. Box 5590, 40505. (606) 299-6262. TWX 510-476-8806. Licensee: Starr, WTVQ Inc. (acq 12-22-73). Ownership: See Starr Bcstg Group Stns, also Nwspr. ■ ABC. Rep: Katz. Wash atty: Fly, Shuebruk, Blume & Gaguine. ■ Clark Davis, VP, gen mgr & film buyer; Charles P. Harper Jr., gen mgr; Kenlyn Zschunke, gen sls mgr; Jerry Fox, prog dir; Butch Armstrong, prom mgr; Rich Gimmel, news dir; William F. Bratton Jr., chief engr. ■ On 46 CATV's—77,000 subs. On 1 trans. ■ Rates: \$200; 60; 25.

Louisville

ADI No. 38; see page B-41

WAVE-TV—ch 3, 100 kw vis, 20 kw aur, ant-910/600g. Nov. 24, 1948. Box 1000, 40201. (502) 585-2201. TWX 502-589-2328. Licensee: Orion Bcstg Inc. Ownership: See Orion Bcstg. ■ NBC. Rep: Katz. Wash atty: Covington & Burling. ■ T. Ballard Morton, pres; Ralph S. Jackson, exec VP; Lee Browning, VP & gen mgr; Houston Jones, natl sls mgr; S. Wheeler Rudd, loc sls mgr; Peppy Martin, prom mgr; Conrad Cagle, opns dir; Jim Keeler, news dir; H. B. Holtman, chief engr. ■ On 38 CATV's—61,488 subs. Co-owned: WAVE(AM).

WDRB-TV—ch 41, 303 kw vis, 30.3 kw aur, ant 1,280/1,000g. Feb. 28, 1971. 1051 E. Main St., 40206. (502) 584-9701. TWX 810-535-3328. Licensee: Consolidated Bcstg. Ownership: Arlie Howard, 16%; Owsley Welch, 14%; J. P. Morgan, 16%; Edgerton Welch, 16%, and others. ■ Rep: Bolton/Burchill. Wash atty: Welch, Morgan & Kleindienst. ■ Arlie Howard, pres; Elmer F. Jaspas, exec VP, gen mgr & film buyer; James P. Riggs, sls mgr; Robert Cleveland, chief engr. ■ On 36 CATV's—65,000 subs.

WHAS-TV—ch 11, 135 kw vis, 26.3 kw aur,

Kentucky, Louisiana TV

See page B-89 for explanation of listings.

ant 1,290t/973g. March 27, 1950. Box 1084, 520 W. Chestnut St., 40201. (502) 582-7840. TWX 810-535-3326. Licensee: WHAS Inc. Ownership: Barry Bingham & family. See Nwspr. ■ CBS. Rep: Harrington, Righter & Parsons. Wash atty: Sidley & Austin. ■ Barry Bingham Jr., pres; Frederic B. Osler Jr., exec VP & gen mgr; Biggs Tabler, gen sls mgr; Dick Sweeney, prog dir & film buyer; Robert B. Taylor, opns mgr; George Ellis prom mgr; Tom Dorsey, news dir; William C. Hunter, dir of engr. ■ On 35 CATV's. Co-owned: WHAS(AM) & WNNF(AM).

***WKMJ**—ch 68, 794 kw vis, 159 kw aur, ant 820t/549.6g. Aug 31, 1970. Licensee: Ky. Bd of Educ. ■ Execs: See *WKLE Lexington. ■ On 3 CATV's—2,500 subs.

***WKPC-TV**—ch 15, 263 kw vis, 46.8 kw aur, ant 860t/549g. Sept 5, 1958. Box 1515, 40201. (502) 456-3286. TWX 502-458-2455. Licensee: Jefferson County Bd. of Educ. ■ PBS. Wash atty: Schwartz & Woods. ■ Richard VanHoose, pres; Jerry D. Weaver, exec VP & gen mgr; Gordon C. Whiteley, prod dir; Kenneth Lam, dir of ITV & opns mgr; Charles T. Landers, dir of engr. ■ On 1 CATV.

WLKY-TV
Combined Communications Corp.





WLKY-TV—ch 32, 1290 kw vis, 257 kw aur, ant 1260t/989g. Sept 18, 1961. 1918 Mellwood Ave., 40206. (502) 893-3671. TWX 810-535-3212. Licensee: Combined Communications of Kentucky Inc. (acq 5-10-73) Ownership: See Combined Communications Corp. ■ ABC. Rep: Peters, Griffin, Woodward. Wash atty: Pierson, Ball & Dowd. ■ Jeff Davidson, pres & gen mgr; John Dorkin, prog dir & film buyer; William Campbell, gen sls mgr; Lois Hinkle, prom mgr; Rick Moore, news dir; Paul Kelley, chief engr. ■ On 31 CATV's—50,441 subs. ■ Rates: \$195; 95; 35.

Madisonville

ADI No. 87; see page B-24

***WKMA**—ch 35, 513 kw vis, 102 kw aur, ant 1,040t/998g. Sept 23, 1968. Licensee: Ky. Bd of Educ. ■ Execs: See *WKLE Lexington.

Morehead

ADI No. 42; see page B-13

***WKMR**—ch 38, 575 kw vis, 115 kw aur, ant 960t/607g. Sept 23, 1968. Licensee: Ky. Bd of Educ. ■ Execs: See *WKLE Lexington.

Murray

ADI No. 88; see page B-54

***WKMU**—ch 21, 575 kw vis, 115 kw aur, ant 660t/655g. Oct 9, 1968. Licensee: Ky. Bd of Educ. ■ Execs: See *WKLE Lexington.

Newport

WXIX-TV—Licensed to Newport. See Cincinnati, Ohio.

Owenton

ADI No. 26; see page B-15

***WKON**—ch 52, 562 kw vis, 115 kw aur, ant 710t/602g. Sept 23, 1968. Licensee: Ky. Bd of Educ. ■ Execs: See *WKLE Lexington

Paducah

ADI No. 88; see page B-54

WDXR-TV—ch 29, 759 kw vis, 110 kw aur, ant 710t/653g. May 31, 1971. Box 298, 42001. (502) 443-1737. Licensee: WDXR-TV Inc. Ownership: Lady Sarah McKinney-Smith, 100%. ■ Rep: Savalli/Gates, Regional Reps. Wash atty: Miller, Schroeder & Bankson. ■ Lady Sarah McKinney-Smith, pres; Larry Weatherford, stn mgr & prog dir; Roger Chesser, prom mgr; John Stewart, news dir; Richard O'Dell, prog mgr; Tom Wimberly, chief engr. ■ On 42 CATV's—110,219 subs. Co-owned: WDXR(AM).

WPSD-TV—ch 6, 100 kw vis, 13.8 kw aur, ant 1,600t/1,638g. May 28, 1957. Box 1037, 42001. (502) 442-8214. TWX 502-591-7604. Licensee: Paducah Nwspr Inc. Ownership: Paxton family substantially, 100%. See Nwspr. ■ NBC. Rep: H-R. Wash atty: Arthur Stambler. ■ Fred Paxton, pres; Sam Livingston, gen mgr; John Williams, asst gen mgr; James E. English III, prog dir; Tom Butler, news dir; Don Brown, chief engr. ■ On 61 CATV's. On 1 trans. ■ Rates: \$162; 110; 40.

Pikesville

ADI No. 42; see page B-13

***WKPI**—ch 22, 468 kw vis, 93.3 kw aur, ant 1,410t/153g. April 8, 1968. Licensee: Ky. Bd of Educ. ■ Execs: See *WKLE Lexington.

Somerset

ADI No. 93; see page B-39

***WKSO**—ch 29, 378 kw vis, 75.6 kw aur, ant 1,460t/1,000g. Sept 23, 1968. Licensee: Ky. Bd of Educ. ■ Execs: See *WKLE Lexington.

Louisiana

HAMILTON-LANDIS

& ASSOCIATES, Inc.

NATIONWIDE MEDIA BROKERS
WASHINGTON, D.C., CHICAGO, DALLAS,
SAN FRANCISCO

SELL **MORE**

RADIO & TELEVISION STATIONS
IN THE SOUTHWEST—NEAREST OFFICE IS—
6060 N. CENTRAL EXPY., DALLAS 75206
(214) 691-2345

Alexandria

ADI No. 167; see page B-3

KALB-TV—ch 5, 100 kw vis, 20 kw aur, ant 1,590t/1,586g. Sept. 29, 1954. 605-11 Washington St., 71301. (318) 445-2456. TWX 510-976-5709. Licensee: Lanford Telecasting Co. Ownership: T. B. Lanford, 68%; William L. Fox, 32%. For Lanford interests see T. B. Lanford Stns. ■ NBC, ABC. Rep: Katz. Wash atty: Kirkland, Ellis & Rowe. ■ T. B. Lanford, pres & film buyer; Robert E. Miller, VP & gen mgr; Dowell Bushnell, sls mgr; Berton Chaudrier, natl sls mgr; Ron Saunders, prog dir; Tom Webb, news dir; William T. Holt, chief engr. ■ On 31 CATV's—31,000 subs. Co-owned: KALB-AM-FM.

Baton Rouge

ADI No. 98; see page B-7

WAFB-TV—ch 9, 316 kw vis, 63 kw aur, ant 1,670t/1,729g. April 19, 1953. 929 Government St., 70821. (504) 348-4921. TWX 510-993-3406. Licensee: Guaranty Bcstg Corp. Ownership: Guaranty, 100%. ■ CBS. Rep: Katz. Wash atty: McKenna, Wilkinson & Kittner. ■ George A. Foster Jr., chmn; Tom E. Gibbens, pres & gen mgr; Mervyn E. Rhys, coml mgr; Ed Lamy, prog dir & film buyer; Grace McElveen, prom mgr; Donald K. Allan, chief engr. ■ On 13 CATV's—25,000 subs. Co-owned: WAFB-FM.

WRBZ—ch 2, 100 kw vis, 19.5 kw aur, ant 1,676t/1,724g. April 14, 1955. Box 2906, 70821. (504) 344-2641. TWX 510-993-3576. Licensee: La. TV Bcstg Corp. Ownership: Baton Rouge Bcstg Co. (WJBO), 96%; Charles P. Manship Jr., 1%; Douglas L. Manship, less than 1%; and others. See Manship Stns, also Nwspr. ■ NBC. Rep: Avco Radio TV Sls. Wash atty: Cohn & Marks. ■ Douglas Manship Sr., pres; Jules L. Mayeux, gen mgr; Robert J. Headlee, sls mgr; Ray Alexander, prog dir; Pat Patton, news dir; Ildo Corkern, chief engr. ■ On 21 CATV's—31,000 subs. Co-owned: WJBO-AM-FM.

***WLBP-TV**—ch 27, 1,143 kw vis, 226 kw aur, ant 961t/981g. Sept. 6, 1975. Box 44064, 70804. (504) 389-2131. Louisiana Educational Television Authority. ■ PBS. Wash atty: Charles O. Verrill Jr. ■ Ed Prendergast, chmn; A. Fred Frey, acting exec dir; O. Pat Morgan, prog dir; Albert Wright, prom mgr; Billy G. Porter, chief engr.

WRBT—ch 33, 871 kw vis, 174 kw aur; ant 1000t/1,030g. Oct 16, 1971. Essen Lane, Box 14685, 70808. (504) 766-3233. TWX 510-993-3493. Licensee: Rush Bcstg Corp. Ownership: Richard O. Rush, 50%; Ramon V. Jarrell, 50%. ■ ABC. Rep: Meeker; Busby, Finch & Woods. Wash atty: Mallyck & Bernton. ■ Ramon V. Jarrell, pres; Al Crouch, gen mgr; William M. Hathorn, gen sls mgr; Joyce Harvey, prog dir; Robert Faulk, prom mgr; Maurice Cockerham, news dir; C.G. Hambrick, chief engr. ■ On 10 CATV's—25,606 subs. ■ Rates: \$115; 95; 25.

Lafayette

ADI No. 113; see page B-37

KATC—ch 3, 100 kw vis, 20 kw aur, ant 1,200t/1,239g. Sept 1, 1962. Box 3347, 70501. (318) 232-6111. TWX 510-972-5043. Licensee: Acadian TV Corp. Ownership: Washington Life Insurance Co. of America, 10%; Mrs. Shirley Kurzweg Gouaux, 19.8%; and others. ■ ABC. Rep: Meeker. Wash atty: Leo Resnick. ■ Mrs. Frances T. Kurzweg, pres; William Patton, gen mgr; Paul Brown, stn mgr; Roy Rhodes, gen sls mgr; Roy LeJeune, chief engr. ■ On 20 CATV's—30,000 subs. ■ Rates: \$118; 71; 29.

KLFY-TV—ch 10, 302 kw vis, 44.7 kw aur, ant 1,240t/1,269g. June 3, 1955. Box 3687, 70501. (318) 233-2152. TWX 510-975-5052. Licensee: Texoma Bcstns Inc. Ownership: KWTX Bcstg Co., 80%; M. N. Bostick, 20%. See KWTX Stns & Texoma Bcstg Stns. ■ CBS. Rep: H-R. Wash atty: Cordon & Jacob. ■ M. N. Bostick, pres; Thomas G. Pears, gen & sls mgr; Dan Coleman, prod supvr; Terry Dover, opns mgr & film buyer; Jim Baronet, news dir; Keith Townsden, chief engr. ■ On 28 CATV's—47,404 subs.

KLNI-TV—ch 15, 832 kw vis; 147 kw aur; ant 490t/529g. Sept 16, 1968. Box 52409, 70501. (318) 837-1139. Licensee: Southwestern La. Communications Inc. Ownership: Charles Castille, 47.3%, and others. ■ NBC. Rep: Devney; Messina. Wash atty: Miller, Schroeder & Bankson. ■ Charles Castille, pres; Gene Griffin, gen mgr; Dustie Griffin, sls mgr; Bill McGoffin, prog & news dir & film buyer; Marti

Evans, prom mgr; Clyde Sylvester, chief engr. ■ On 14 CATV's—20,000 subs.

Lake Charles

ADI No. 175; see page B-37

KPLC-TV—ch 7, 316 kw vis, 63.1 kw aur, ant 1,480t/1,519g. September 1954. Box 1488, 70601. (318) 439-9071. TWX 510-971-7570. Licensee: Calcasieu Television & Radio. (acq 2-71). Ownership: G. Russell Chambers, 100%. ■ NBC. Rep: Avery Knodel. Wash atty: Cohn & Marks. ■ G. Russell Chambers, pres & gen mgr; Albert H. Smith, VP, asst gen mgr & film buyer; Jeb Roberts, natl sls & prom mgr; Bill Davis, loc sls mgr; Tom Weiser, news dir; Rick Craddock, chief engr. ■ On 18 CATV's—30,000 subs.

Monroe

ADI No. 112; see page B-48

KLAA—See West Monroe.

***KLTM**—ch 13, 316 kw vis, 31.6 kw aur, ant 1,777t/1,986g. 1975. Box 44064, Capitol Station, Baton Rouge, 70804. Licensee: La. Educational TV Authority. ■ PBS. Wash atty: Patton, Boggs & Blow. ■ A. Fred Frey, acting exec dir.

KNOE-TV—ch 8, 316 kw vis, 63.2 kw aur, ant 1,890t/1,985g. Sept. 27, 1953. Box 4067, 71201. (318) 322-8155. Licensee: Noe Enterprises Inc. Ownership: James A. Noe Sr., 100%. ■ CBS. Rep: H-R. Wash atty: Cohn & Marks. ■ James A. Noe Sr., chmn of bd & treas; James A. Noe Jr., pres; Paul H. Goldman, exec VP, gen mgr & film buyer; Jack McCall, VP & prog dir; Earl Casey, VP, news dir; Ray Boyd, VP & dir of engr. ■ On 19 CATV's—On 1 trans. Co-owned: KNOE-AM-FM. ■ Rates: \$190; 150; 50.

KTVE—See El Dorado, Ark.

New Orleans

ADI No. 35; see page B-50

WDSU-TV—ch 6, 100 kw vis, 20 kw aur, ant 930t/975g. Dec 18, 1948. 520 Royal St., 70130. (504) 588-9378. TWX 810-951-6077. Licensee: Cosmos Bcstg of Louisiana Inc. (acq 1-1-73). Ownership: See Cosmos Bcstg Stns. ■ NBC. Rep: Blair. Wash atty: Dow, Lohnes & Albertson. ■ A. Louis Read, chmn; James K. Yager, exec VP & gen mgr; Richard O. Wexo, gen sls mgr; Robert Wisniewski, asst gen mgr & prog dir; Ben Waters, news dir; Don Hess, dir of prom & prog planning; Ronnie Catoo, bus mgr; Edward Tong, chief engr. ■ On 15 CATV's—15,000 subs. ■ Rates: \$390; 150; 80.

WGNO-TV—ch 26, 501 kw vis, 50.1 kw aur, ant 490t/495g. Oct. 16, 1967. 2912 ITM Bldg, 2 Canal St., 70130. (504) 522-6211. Licensee: Communications Corp. of the South (acq 3-9-72). Ownership: Cascade Development Corp., 70%; Raymond C. Abercrombe, 10%; Morris L. Trahan Sr., 10%; Paul J. Yasich, 10%. ■ ABC, CBS, Sp 2 hrs wkly. Rep: Bolton-Burchill. Wash atty: Smith & Pepper. ■ Seymour Smith, pres & gen mgr; Rick Oringel, sls mgr; Xavier DeSoto, prog dir & film buyer; Farrell Meisel, prom mgr; Dan Gilbert, news dir; Bill Brister, chief engr. ■ On 15 CATV's—250,000 subs. ■ Rates: \$30; 40; 10.

WVUE—ch 8, 316 kw vis, 31.6 kw aur, ant 990t/1,046g. Feb 1, 1959. Box 13847, 70185. (504) 486-6161. TWX 801-951-6090. Licensee: Screen Gems Stns Inc. Ownership: See Columbia Pictures Industries Inc. ■ ABC, Sp ½ hr wkly. Rep: Pety TV. Wash atty: Fletcher, Heald, Rowell, Kenehan, & Hildreth. ■ Norman Louvau, pres; Douglas J. Elleson, gen mgr; Jack Long, gen sls mgr; Mal Potter, prog dir, prom mgr & film buyer; Alec Gifford, news

dir; Allen L. Gunderson, chief engr. ■ Rates: \$475; 220; 35.

WWL-TV—ch 4, 100 kw vis, 10 kw aur, ant 1,000t/1,049g. Sept 7, 1957. 1024 N. Rampart St., 70116. (504) 529-4444. TWX 810-951-5097. Licensee: Loyola U. of the South. ■ CBS. Rep: Katz. Wash atty: Marmet & Webster. ■ Rev. James Carter, S. J., pres; J. Michael Early, gen mgr; Maurice Guillerman, asst gen mgr & gen sls mgr; Mickey Wellman, prom mgr; Phil Johnson, news dir; Hugh Burney, chief engr. ■ On 9 CATV's—20,000 subs. On 2 trans. Co-owned: WWL-AM-FM.

***WYES**—ch 12, 316 kw vis, 31.6 kw aur, ant 1,0108t/1,046g. April 1, 1957. 916 Navarre Ave., 70124. (504) 486-5511. TWX 810-951-5279. Licensee: Greater New Orleans Educl TV Foundation. ■ PBS. Wash atty: Sevaritz & Woods. ■ William S. Hart, pres; William G. Koonce, bus mgr; Jack M. Sawyer, prog mgr; Elizabeth Curren, dir of prom & adv; William D. Hess, pub aff dir; Julian Craggs, prod mgr; A. E. Maurin Jr., chief engr. ■ On 12 CATV's. Co-owned: WNPS(AM).

Shreveport

ADI No. 61; see page B-67

KSLS-TV—ch 12, 316 kw vis, 38 kw aur, ant 1,800t/1,794g. Jan 1, 1954. Box 4812, 71104. (318) 424-8101. TWX 510-973-4013. Licensee: KSLS-TV Inc. (acq 1960) Ownership: Journal Publishing Co. (Shreveport Journal), 55%; Winston B. Linam, 10%; Mrs. Dolores Lavigne, 20%; and others. See Nwspr. ■ CBS. Rep: Harrington, Righter & Parsons. Wash atty: Cordon & Jacob. ■ D. F. Attaway, chmn; Winston B. Linam, pres & gen mgr; Ben B. McLaughlin, VP & sls mgr; John C. Renshaw, VP, progs & prom; Robert Weimar, VP prod; Don Owen, news dir; John Hitt, VP engr. ■ On 44 CATV's—57,450 subs. ■ Rates: \$220; 110; 55.

KTAL-TV—(Texarkana, Tex.) ch 6, 100 kw vis, 10 kw aur, ant 1,580t/1,552g. August 16, 1953. 3150 N. Market St., Shreveport, 71107. (318) 425-2422. TWX 510-973-4169. Licensee: KCMC Inc. Ownership: Camden News Pub. Co. (Walter E. and Betty P. Hussman), 50%; Bettie M. Palmer, 17%; W. E. & Betty Hussman, 13%; Alden P. Mooney, 10%; J. Q. Mahaffey, 4%; and W. D. Palmer, 3%. See Nwspr. ■ NBC. Rep: Blair. Wash atty: Covington & Burling. ■ Walter E. Hussman, pres; H. Lee Bryant, VP & gen mgr; Stephen McDonald, sls mgr; Jean Byrd, prog dir; Sharon Porter, prom mgr; Stan Wyatt, news dir; Dave Hendricks, chief engr. ■ On 11 CATV's. Co-owned: KCMC(AM) Texarkana, Tex.—KTAL-FM Shreveport.

KTBS-TV—ch 3, 100 kw vis, 20 kw aur, ant 1,780t/1,800.5g. Sept 3, 1955. 312 E. Kings Highway, Box 4367, 71104. (318) 868-3644. TWX 510-973-4076. Licensee: KTBS Inc. Ownership: E. Newton Wray, 43%; George D. Wray Jr., Charles W. Wray, each 26.4%; Evelyn Wray Smith, 4.2%. ■ ABC. Rep: Katz. Wash atty: Fletcher, Heald, Rowell, Kenehan & Hildreth. ■ E. Newton Wray, pres & gen mgr; Edwin N. Wray, stn mgr; Marvin Perry, prog dir; Miles Resnick, news dir; Allan Stoll, natl sls mgr; Clyde Baldwin, loc sls mgr; Claude Scott, chief engr. ■ On 40 CATV's—52,000 subs. ■ Rates: \$240; 115; 40.

West Monroe

ADI No. 112; see page B-48

KLAA—ch 14, 457 kw vis, 69.2 kw aur; 630t/677.4g. Oct. 6, 1974. 701 Parkwood Dr., 71291. (318) 388-0114. Permittee: Monroe TV Inc. Ownership: K.E. Meyer, Morris Burks, Steve Ball and H.C. Wattner, 12% each. ■ NBC. Rep: Savalli/Gates. Wash atty: John Wilner. ■ Kenneth E. Meyer, pres; David Padburg, gen mgr; Mona Brooks, prog dir; Urso George, chief engr.

KNOE-TV—See Monroe.

Louisiana, Maine TV

See page B-89 for explanation of listings.

Maine

Augusta

ADI No. 78; see page B-57

***WCBB**—ch 10, 309 kw vis, 63 kw aur, ant 1,000t/641g. Nov. 13, 1961. 1450 Lisbon St., Lewiston, 04240. (207) 783-9101. TWX 710-223-1538. Telex 1-800-638-0974. Licensee: Colby-Bates-Bowdoin Educl Telecasting Corp. Ownership: Colby College, Bates College, Bowdoin College, each 33-1/3%. ■ PBS, EEN (regional). Wash atty: Greeley, Bernard & Tierney. ■ Roger Howell Jr., pres; H. Odell Skinner, gen mgr; Harry J. Wiest, prog dir; Roland A. Desjardins, chief engr. ■ On 13 CATV's—21,380 subs.

Bangor

ADI No. 146; see page B-7

WABI-TV—ch 5, 38.9 kw vis, 7.76 kw aur, ant 1,310t/529g. Jan. 25, 1953. 35 Hildreth St., 04401. (207) 947-8321. TWX 207-989-4550. Licensee: Community Broadcasting Service. Ownership: See Community Broadcasting Service Inc. ■ CBS. Rep: H-R; Kettell-Carter. Wash atty: Fly, Shuebruk, Blume & Gaguine. ■ Horace Hildreth, chmn of bd; Walter L. Dickson, pres; George Gonyar, mgr of opns; George Spring, dir of sls & natl sls mgr; William Whitten, sls mgr; Ralph Lowe, news dir; Dale Carter, chief engr. ■ On 16 CATV's. On 2 trans. Co-owned: WABI (AM)—WBGW (FM). ■ Rates: \$120; 30; 20.

WEMT—ch 7, 316 kw vis, 31.6 kw aur, ant 820t/187g. Oct. 15, 1965. 41 Farm Rd., 04401. (207) 945-6457. Licensee: Downeast TV Inc. Ownership: Herbert S. Hoffman, 21.43%; Howard E. Alpert, 12.39%; Martin H. Alpert, 12.39%; Murray Candib, 12.39%; Aaron O. Cohen, 12.39%. ■ ABC. Rep: Savalli/Gates. Wash atty: Cohn & Marks. ■ Robert Gilbertson, pres & gen mgr; Robert Gray, gen sls mgr; Daniel Osgood, prog dir; Don Perry, news dir; Henry Mattson, film buyer & prom mgr; Raymond Philbrook, chief engr. ■ On 16 CATV's—41,000 subs. ■ Rates: \$50; 35; 10.

WLBZ-TV—ch 2, 51.3 kw vis, 10.2 kw aur, ant 640t/99g. Sept. 12, 1954. Box 934, 04401. (207) 942-4822. TWX 207-989-4658. Licensee: WLBZ TV Inc. (acq 5-14-58). Ownership: See Maine Bcstg System Stns. ■ NBC. Rep: Katz. ■ Mary Rines Thompson, pres; Don Powers, gen mgr; Edward E. Guernsey, stn mgr; Mike Trudel, news dir; Bruce Scott, chief engr. ■ On 27 CATV's—75,000 subs. On 1 trans. Co-owned: WLBZ(AM).

Biddeford

ADI No. 78; see page B-57

***WMEG-TV**—ch 26, 589 kw vis, 117 kw aur, 800t/550g. March, 1975. Alumni Hall, Orono, 04473. Licensee: U of Maine. ■ Execs: See *WMEB-TV Orono.

Calais

ADI No. 146; see page B-7

***WMED-TV**—ch 13, 31.6 kw vis, 6.2 kw aur, ant 430t/190g. September 1965. Licensee: U. of Maine. ■ Execs: See *WMEB-TV Orono.

Orono

ADI No. 146; see page B-7

***WMEB-TV**—ch 12, 299 kw vis, 30 kw aur, ant

Maine, Maryland, Mass. TV

See page B-89 for explanation of listings.

990t/369g. Sept. 23, 1963. Alumni Hall, U. of Maine, 04473. (207) 866-4493. TWX 710-229-1091. Licensee: U. of Maine. ■ PBS, EEN (regional). Wash atty: Dow, Lohnes & Albertson. ■ Erik Van De Bogart, dir of prog svcs; Kenneth B. Krall, actg dir pub svc & prog dev; Edward E. Winchester, actg gen mgr & dir engr. ■ On 20' CATV's—10,000 subs. On 3 trans.

Poland Spring

ADI No. 78; see page B-57

WMTW-TV—Licensed to Poland Spring. See Portland.

Portland

ADI No. 78; see page B-57

WCSH-TV—ch 6, 100 kw vis, 20 kw aur, ant 2,000t/1,292g. Dec. 1, 1953. 579 Congress St., 04101. (207) 772-0181. TWX 710-221-1988. Licensee: Maine Radio & TV Co. Ownership: See Maine Bcstg System Stns. ■ NBC. Rep: Katz. Wash atty: Wilkinson, Cragun & Barker. ■ Mary Rines Thompson, pres; Donald K. Powers, VP & gen mgr; Bob Burtt, natl sls mgr; Ben Hubley, local sls mgr; Bruce C. McGorill, stn mgr & film buyer; Lewis Colby, prod mgr; Peg Maloney, prom mgr; Larry Geraghty, news dir; Clem Payeur, chief engr. ■ On 10 CATV's. On 1 trans. Co-owned: WCSH (AM).

WGAN-TV—ch 13, 295 kw vis, 29.5 kw aur, ant 1,610t/1,619g. May 16, 1954. 390 Congress St., 04111. (207) 772-4461. TWX 710-221-1674. Licensee: Guy Gannett Bcstg Svcs. Ownership: See Guy Gannett Stns, also Nwspr. ■ CBS. Rep: Blair; Mulvihill (Canada). Wash atty: Dow, Lohnes & Albertson. ■ George H. Anderson, exec VP; Charles R. Sanford, VP & gen mgr; Raymond A. Gilvard, stn mgr; David G. King, sls mgr; Mike Craig, news dir; Lyman Brewer, chief engr. ■ On 15 CATV's—17,400 subs. Co-owned: WGAN-AM-FM. ■ Rates: \$130; 60; 30.

WMTW-TV(Poland Spring)—ch 8, 105 kw vis, 21 kw aur, ant 3,850t/120g. Aug. 31, 1954. Lafayette Towne House, 638 Congress St., Portland, 04101. (207) 773-5664. TWX 207-781-5539. Licensee: Mt. Washington TV Inc. Ownership: See Mid New York Bcstg Stns. ■ ABC. Rep: H-R; Stephens & Towndrow. Wash atty: Hogan & Hartson. ■ Paul Harron, pres; John Flynn, VP & gen mgr; Robert M. Joyce, asst gen mgr & film buyer; Jack Martin, sls mgr; Jim Aikman, news dir; Parker H. Vincent, chief engr; Richard L. Gove, prom dir. ■ On 53 U.S. CATV's—84,393 subs. On 76 Canadian CATV's—176,000 subs. On 4 trans.

Presque Isle

ADI No. 201; see page B-57

WAGM-TV—ch 8, 27.5 kw vis, 5.37 kw aur, ant 350t/290g. Oct. 13, 1956. Box 1149, 04769. (207) 764-4461. TWX 710-229-1631. Licensee: Aroostook Bcstg Corp. (acq 1958). Ownership: See Community Broadcasting Service Inc. ■ CBS, ABC, NBC. Rep: H-R; Kettell-Carter. Wash atty: Fly, Shuebruk, Blume & Gaguine. ■ Walter L. Dickson, pres; Keith H. Fowles, opns mgr & film buyer; Ronald Madore, sls mgr; Mike Dunn, prom mgr; Pete Hilton, news dir; Norman Johnson, chief engr. ■ On 13 CATV's—9,000 subs. On 3 trans. Co-owned: WAGM(AM). ■ Rates: \$45; 33; 22.

***WMEM-TV**—ch 10, 299 kw vis, 30 kw aur, ant 1,090t/158g. Feb. 17, 1964. Licensee: U. of Maine. ■ Execs: See *WMEB-TV Orono.

Maryland

TO BUY OR SELL A TELEVISION OR RADIO STATION

HAMILTON-LANDIS & ASSOC., Inc.

WASHINGTON, D.C.

1730 K St., N.W.
(202) 393-3456

SAN FRANCISCO

111 Sutter St.
(415) 392-5671

CHICAGO

1429 Tribune Tower
(312) 337-2754

DALLAS

6060 N. Central Expy.
(214) 691-2345

NATIONWIDE • NEGOTIATIONS FINANCING • APPRAISALS

Annapolis

ADI No. 19; see page B-7

***WAPB**—ch 22, 3890 kw vis, 389 kw aur, ant 874t/852g. July 16, 1975. Owings Mills, 21117. (301) 356-5600. Licensee: Maryland Public Bcstg Commission. ■ Execs: See *WMPB Baltimore.

Baltimore

ADI No. 19; see page B-7

WBAL-TV—ch 11, 316 kw vis, 31.6 kw aur, ant 1,000t/998g. March 11, 1948. Maryland Bcst Ctr., 21211. (301) 467-3000. TWX 710-234-1086; 710-234-1087. Licensee: The Hearst Corp. Ownership: See Hearst Stns, also Nwspr. ■ NBC. Rep: Blair TV. Wash atty: Dempsey & Kopolovitz. ■ Jack F. Beauchamp, VP & gen mgr; John P. Frankfield, asst stn mgr & prod dir; William J. Katsafanas, gen sls mgr; Kerry Richards, dir of adv & prom; Ron Kershaw, news dir; Otto R. Claus Jr., chief engr. ■ On 196 CATV's—85,178 subs. Co-owned: WBAL-AM-FM. ■ Rates: \$1,500; 750; 400.

WBFF—ch 45, 1,590 kw vis, 180 kw aur, ant 900t/668g. April 11, 1971. 3500 Parkdale Ave., 21211. (301) 462-4500. Licensee: Chesapeake Television Inc. Ownership: Julian S. Smith, 36.51%; Commercial Radio Institute, 26.67%, & others. ■ Rep: Avco. Wash atty: Fisher, Wayland, Southmayd & Cooper. ■ Julian S. Smith, pres & gen mgr; William Le Fevre, prod dir; Frederick M. Himes Jr., VP; Robert Simmons, gen sls mgr; George Lewis, prod mgr; Augustine Levero, mktg mgr; Anthony Richardson, chief engr.

WJZ-TV—ch 13, 288 kw vis, 31.6 kw aur, ant 990t/998g. Nov. 2, 1948. TV Hill, 21211. (301) 466-0013. TWX 701-234-1951; 710-234-1672. Licensee: Westinghouse Bcstg Co. Ownership: See Westinghouse Bcstg Co. Stns. ■ ABC. Rep: TVAR; McDermott (Canada). Wash atty: Hedrick & Lane. ■ Marvin L. Shapiro, exec VP pres-stn group; Winthrop Baker, pres, TV stn group; Joel A. Segall, gen mgr; Arnold J. Kleiner, gen sls mgr; Alan W. Frank, prod mgr; Lou Zaccaro, creative svcs mgr; Ron Holden, news dir; Irene Morganstein, film dir; Robert O. Donahue, chief engr. ■ On 81 CATV's—341,000 subs. ■ Rates: \$1,650; 400; 200.

WMAR-TV—ch 2, 100 kw vis, 11 kw aur, ant 1,000t/999g. Oct. 27, 1947. 6400 York Rd., 21212. (301) 377-2222. TWX 710-232-1804. Licensee: The A. S. Abell Co. Ownership: See The A. S. Abell Co., also Nwspr. ■ CBS. Rep: Katz; Stephens & Towndrow (Canada). Wash atty: Hogan & Hartson. ■ Gary Black, chmn of bd; Wm. F. Schmick Jr., pres; Donald P. Campbell, VP & gen mgr; Janet Covington, dir

pub affrs; George F. Rogers Jr., news dir; Reynard Corley, sls mgr; Anton G. Picha, prom dir; Dale Wright, prod dir; Carlton G. Nopper, dir of engr. ■ On 65 CATV's. Co-owned: WMAR-FM. ■ Rates: \$1050; 160; 135.

***WMPB**—ch 67, 646 kw vis, 129 kw aur, ant 820t/693g. Oct. 6, 1969. Owings Mills, 21117. (301) 356-5600. Licensee: Maryland Public Broadcasting Commission. ■ PBS. Wash atty: Schwartz & Woods. ■ Dr. Frederick Breitenfeld Jr., exec dir; Warren S. Park Jr., dir progmg & opns; David L. Graham, dir engr. ■ On 1 trans.

Hagerstown

ADI No. 8; see page B-75

WHAG-TV—ch 25, 436 kw vis, 43.6 kw aur, ant 1,230t/453.5g. Jan. 3, 1970. On The Square, 21740. (301) 797-4400. Licensee: WHAG-TV Inc. (acq 9-18-72) Ownership: Sheldon Magazine, 50%, Samuel Magazine, 50%. ■ NBC. Rep: Avery-Knodel. Wash atty: Fletcher, Heald, Rowell, Kenehan & Hildreth. ■ Sheldon Magazine, pres; Arch McDonald, VP & gen mgr; John McCollum, sls mgr; Dennis Wright, prod dir; Edward Lott, news dir; Wilbur Kelly, chief engr. ■ On 33 CATV's—80,730 subs. ■ Rates: \$90; 40; 30.

***WWPB-TV**—ch 31, 436 kw vis, 79.4 kw aur, ant 1,230t/415g. Oct. 5, 1974. Bonita Avenue, Owings Mills, 21117. Licensee: Maryland Public Bcstg Commission. ■ PBS. ■ Execs: See *WMPB Baltimore.

Salisbury

ADI No. 166; see page B-63

WBOC-TV—ch 16, 225 kw vis, 38.1 kw aur, ant 620t/647g. July 15, 1954. Radio-TV Park, 21801. (301) 749-1111. TWX 710-864-9672. Licensee: WBOC Inc. (acq 10-1-61). Ownership: See The A. S. Abell Co., also Nwspr. ■ CBS, ABC, NBC. Rep: Young. Wash atty: Hogan & Hartson. ■ Samuel S. Carey, pres, gen & sls mgr & film buyer; John W. Downing Jr., prod dir; Jack W. Ward, VP, opns mgr; Alan Landay, news dir; Bernard F. Sparks, chief engr. ■ On 12 CATV's—39,801 subs. Co-owned: WBOC-AM-FM. ■ Rates: \$112.50; 62.50; 37.50.

***WCPB**—ch 28, 708 kw vis, 141 kw aur, ant 510t/551g. March 21, 1971. c/o Frederick Breitenfeld Jr., Owings Mills, 21117. Licensee: Maryland Public Bcstg Commission. ■ PBS. ■ Execs: See *WMPB Baltimore.

Massachusetts

Adams

ADI No. 43; see page B-2

WCDC—ch 19, 116 kw vis, 22.9 kw aur, ant 2,100t/248g. (CP: 538 kw vis, 108 kw aur). Feb. 5, 1954. 341 Northern Blvd., Albany, N.Y., 12204. (518) 436-4822. TWX 710-441-8203. Licensee: Poole Bcstg Co. Inc. Co-owned satellite of WTEN Albany, N.Y. (acq 4-27-71). ■ CBS. Rep: Tele Rep. Wash atty: Wilmer, Cutler & Pickering. ■ Albert J. Gillen, pres; Paul M. Hughes, VP & gen mgr; Vince DeLuca, sls mgr; Gene Collins, prod dir & prom mgr; Tom Bryson, news dir; Thomas Johnson, chief engr. ■ On 64 CATV's—237,233 subs. On 3 trans.

Boston

ADI No. 5; see page B-10

WBZ-TV—ch 4, 60.3 kw vis, 9.75 kw aur, ant 1,160t/1,199g. June 9, 1948. 1170 Soldiers Field Rd., 02134. (617) 254-5670. TWX

710-330-0283. Licensee: Westinghouse Bcstg Co. Ownership: See Westinghouse Bcstg Co. Stns. ■ NBC. Rep: TVAR; McDermott (Canada). Wash atty: Hedrick & Lane. ■ Donald H. McGannon, chmn & pres; Sy Yanoff, gen mgr; John Davison, sls mgr; Jeff Schiffman, prog mgr; Bill Aber, news dir; Alex Dusek, prom mgr; Bill Gregory, chief engr. ■ Co-owned: WBZ-AM-FM.



WCVB-TV—ch 5, 100 kw vis, 10 kw aur, ant 980t/1194g. Nov. 26, 1957. 5 TV Place, Needham, 02192. (617) 449-0400. TWX 710-325-0773. Licensee: Boston Broadcasters Inc. (acq 3-19-72). Ownership: Leo L. Beranek, 6.17%; Matthew Brown, 5.88%; Robert M. Bennett, 2.78%; Richard S. Burdick, 2.75%; Thomas G. Maney, 1.26%; William J. Poorvu, 6.22%; Charles Marrañ, 5.70%; and others. ■ ABC. Rep: Harrington, Righter & Parsons. Wash atty: Fly, Shuebruk, Blumé & Gaguine. ■ Leo L. Beranek, pres & chief exec officer; Robert M. Bennett, VP & gen mgr; Richard S. Burdick, VP, corporate dev; Thomas G. Maney, VP & asst gen mgr & dir of sls; James P. Miller, bus mgr & ctrlr; Lew Barlow, actg prog mgr; Lawrence Pickard, dir pub affrs; James Thistle, dir of news; John Lisanti, dir adv & prom; Steve deSatinck, dir engr; Joseph A. Ryan, asst VP & dir community svcs; Eunice West, dir women's issues & involvement; Valdo Conte, coml opns mgr; William Mockbee, dir rsch. ■ Rates: \$2700; 500; 200.

***WGBH-TV**—ch 2, 50 kw vis, 5 kw aur, ant 1,040t/1,199g. May 2, 1955. 125 Western Ave., 02134. (617) 868-3800. TWX 710-330-6887. Licensee: WGBH Educl Foundation. ■ PBS, EEN (regional). Wash atty: Covington & Burling. ■ David O. Ives, pres; Michael S. Rice, VP & mgr; Peter Downey, mgr opns; Sylvia Davis, prom mgr; Robert E. Ferrante, news dir; Thomas B. Keller Jr., chief engr. ■ On 20 CATV's—45,000 subs. On 1 trans. Co-owned: *WGBH-FM.

***WGBX-TV**—ch 44, 251 kw vis, 50.1 kw aur, ant 1,080t/1,074g. Sept. 25, 1967. Licensee: WGBH Educl Foundation. ■ Execs: See *WGBH-TV Boston.

WLVI-TV—(Cambridge) ch 56, 1,660 kw vis, 166 kw aur, ant 1,186t/1,201g. Aug. 31, 1953. 75 Morrissey Blvd., Boston, 02125. (617) 288-3200. TWX 710-333-6631. Licensee: Kaiser Broadcasting Co. Ownership: Kaiser Bcstg, 100%. See Kaiser Bcstg Stns. ■ Rep: Kaiser Bcstg Spot Sls. Wash atty: Wilmer, Cutler & Pickering. ■ Steven A. Bell, VP & gen mgr; George Babick, gen sls mgr; Lucie Salhany, prog mgr; Rick Weidner, prom mgr; Gwen Dillard, news mgr; Richard Lipson, engr mgr. ■ On 50 CATV's—150,000 subs. Co-owned: WCAS(AM).

WNAC-TV—ch 7, 316 kw vis, 63.2 kw aur, ant 1,000t/1,069g. June 21, 1948. Government Ctr., 02114. (617) 742-9000. Telex 710-321-0361. Licensee: RKO General Inc. Ownership: See RKO General Stns. ■ CBS. Rep: RTVR. Wash atty: Pierson, Ball & Dowd. ■ Robert Glaser,

pres; S. James Coppersmith, VP & gen mgr; Peter LaBruzzo, VP & dir of sls; John Quinlan, local sls mgr; Earl Davis, adv & prom mgr; Mel Bernstein, news dir; John Atkinson, prog dir; Ladislav Hlavaty, chief engr. ■ Co-owned: WRKO(AM)-WROR(FM).

WQTV—ch 68, 398 kw vis, 79.4 kw aur, 720t/807g. Not on air, target date unknown. c/o Edward H. Mank, treas. 239 Lewis Wharf, Boston, 02110. (617) 742-3200. Permittee: Boston Heritage Bcstg Inc. Authorized for pay-TV operation.

WSBK-TV—ch 38, 1,170 kw vis, 117 kw aur, 1180t/1201g. Oct. 12, 1964. 83 Leo Birmingham Pkwy, 02135. (617) 783-3838. TWX 710-330-1356. Licensee: New Boston TV Inc. (acq 6-66). Ownership: See Storer Stns. ■ Secondary affiliation with ABC, CBS, NBC. Rep: Storer TV Sls. Wash atty: Warren Zwicky. ■ William J. Flynn, VP & gen mgr; Richard D. Beach, prog adm; Joseph C. Dimino, gen sls mgr; John F. Anderson, dir of rsch; Gene Harris, opns mgr; Gayton N. Masters, prom mgr; William B. Knight, comptlr; Douglas Henderson, chief engr. ■ On 52 CATV's—283,000 subs.

WXNE-TV—ch 25, 741 kw vis, 148.9 kw aur, ant 1,160t/1,201g. Not on air, target date unknown. 1318 Spratley St., Portsmouth, Va., 23074. Permittee: Christian Bcstg Network Inc. Ownership: See Christian Bcstg Network Stns. ■ Wash atty: Fisher, Wayland, Southmayd & Cooper. ■ M. G. Robertson, pres; Adelia E. Robertson, sec.

Cambridge

WLVI-TV—Licensed to Cambridge. See Boston.

Greenfield

ADI No. 82; see page B-69

WRLP—ch 32, 468 kw vis, 46.8 kw aur, ant 918t/663g. July 1, 1957. Box 2210, Springfield, Mass., 01101. (413) 786-2200. TWX 710-350-1421. Licensee: Springfield TV Bcstg Corp. ■ NBC. Rep: H-R Television; Kettell-Carter. Wash atty: Finkelstein & Firestone. ■ William L. Putnam, pres and gen mgr; William Pepin, stn mgr; Holland Low, gen sls mgr; W. (Buzz) Sawyer, film buyer; Robert F. Donahue, prom mgr; Jordan St. John, news dir; Ralph Jay, chief engr. ■ On 25 CATV's—54,000 subs. On 1 trans. ■ Rates: \$34; 18; 9.

New Bedford

WTEV—Licensed to New Bedford. See Providence, R. I.

Springfield

ADI No. 82; see page B-69

***WGBY-TV**—ch 57, 776 kw vis, 155 kw aur, ant 1,000t/142g. September 26, 1971. One Army Square, 01105. (413) 781-2801. Licensee: WGBH Educational Foundation. ■ PBS, EEN (regional). Wash atty: Covington & Burling. ■ David O. Ives, pres; Jack Caldwell, gen mgr; Michael Hurley, dir of dev; Dan Kain, prog dir; Midge Ramsey, prom mgr; Dennis Dunbar, engr. ■ On 11 CATV's—25,000 subs.

WHYN-TV—ch 40, 3,680 kw vis, 368 kw aur, ant 1,004t/152g. April 14, 1953. 1300 Liberty St., 01101. (413) 785-1911. TWX 710-350-1369. Licensee: WHYN Stns Corp. Ownership: See Guy Gannett Bcstg Stns, also Nwspr. ■ ABC. Rep: Katz. Wash atty: Dow, Lohnes & Albertson. ■ George W. Anderson, exec VP; James A. Kontoleon, VP & gen mgr; Richard E. Wylie, natl sls mgr; Gilbert M. Lefkovich, stn & prom mgr, prog dir, film buyer; Durham Caldwell, news dir; Theodore

Massachusetts, Michigan TV

See page B-89 for explanation of listings.

Gratkowski, chief engr. ■ On 12 CATV's. Co-owned: WHYN-AM-FM. ■ Rates: \$300; 70; 35.

WWLP—ch 22, 933 kw vis, 93.3 kw aur, ant 750t/400g. (CP: 4,305 kw vis, 430.5 kw aur, ant 876.6t/530g). March 17, 1953. (413) 786-2200. TWX 710-350-1421. Licensee: Springfield TV Bcstg Corp. Ownership: See Springfield TV Bcstg Co. Stns. ■ NBC. Rep: H-R; Kettell-Carter. Wash atty: Finkelstein & Firestone. ■ William L. Putnam, pres & gen mgr; Kitty Broman, VP & asst to pres; James H. Ferguson Jr., exec VP; E. Holland Low, sls mgr; W. (Buzz) Sawyer, VP, stn mgr & film buyer; Robert F. Donahue, prom mgr; Keith Silver, news dir; Louis Chenevert, chief engr. ■ On 28 CATV's—69,000 subs. ■ Rates: \$400-200; 150-50; 50-25.

Worcester

ADI No. 5; see page B-10



WSMW-TV

WSMW-TV—ch 27, 513 kw vis, 102 kw aur, ant 1,531t/1,349g. Jan. 2, 1970. 127 Beverly Road, 01605. (617) 852-0027. TWX 710-340-7687. Licensee: America Group Management Corp. Ownership: State Mutual Insurance Corp. 100%. ■ Wash atty: Cohn & Marks. ■ Brian A. Higgins, VP, gen mgr & film buyer; Robert E. Fouracre, gen sls mgr; Donald J. Reilly, asst gen mgr & bus mgr; Ray Conlon, prod mgr; Mario Finocchio, creative svcs dir; Kathleen Fryer, prog supvsr; Beth Burrows, traf mgr; Donald Rutana, film dir; Mike McCarty, news dir; L. Wittenberg, chief engr. ■ On 74 CATV's—182,000 subs.

Michigan

Alpena

ADI No. 122; see page B-72



WBKB-TV—ch 11, 316 kw vis, 63.2 kw aur, ant 665t/500g. Sept. 22, 1975. Box 35, 49707. (517) 354-8216. Licensee: Thunder Bay Broadcasting Corp. Ownership: Thomas Scanlan, 21.2%; and others. ■ CBS. Wash atty: McKenna, Wilkinson and Kiltner. ■ Thomas Scanlan, pres; gen mgr, prog dir & film buyer; Gayle Wismer, prom mgr; Don Pettenger, gen sls mgr; S. Peter Neumann, news & spec pro-

Michigan TV

See page B-89 for explanation of listings.

TO BUY OR SELL A TELEVISION OR RADIO STATION

HAMILTON-LANDIS & ASSOC., Inc.

WASHINGTON, D.C.

1730 K St., N.W.
(202) 393-3456

SAN FRANCISCO

111 Sutter St.
(415) 392-5671

CHICAGO

1429 Tribune Tower
(312) 337-2754

DALLAS

6060 N. Central Expy.
(214) 691-2345

NATIONWIDE • NEGOTIATIONS FINANCING • APPRAISALS

jects dir; Thomas M. Disinger, chief engr. ■ On 4 CATV's—12,000 subs. ■ Rates: \$40; 23; 16.

***WCML-TV**—ch 6, 100 kw vis, 15.1 kw aur, 1472t/1349g. 1975. Central Michigan University.

Ann Arbor

New TV—ch 31, 1096 kw vis, 217 kw aur, 1085t/1044g. Not on air, target date unknown. 2997 Lakeview Dr., 48103. Permittee: Wolverine-Morningstar Bcstg. Ownership: Gershon Clark Morningstar, 35%; James L. Mullison, 14%; Gin Sing Lum, 9%; and others. ■ Wash atty: Welch, Morgan & Kleindienst.

Battle Creek

ADI No. 39; see page B-29

WUHQ-TV



WUHQ-TV—ch 41, 1,380 kw vis, 138 kw aur, ant 1,076t/963g. July 24, 1971. 5200 Dickman Rd., 49016. (616) 968-9341. TWX 810-276-2201. Licensee: Channel 41 Inc. Ownership: John W. Lawrence, pres 29.29%; William J. Lawrence, 29.23%; Carl A. Gardner, 11.1%; Borgia M. Lawrence, 29.7%. ■ ABC. Rep: Meeker. Wash atty: Bilger & Blair. ■ John W. Lawrence, pres; Lee G. Stevens, gen mgr; Ernest W. Hill, sls mgr; Charles Alvey, prod dir, film buyer & news director; Debbie Bennett, prom mgr; Michael J. Laemers, chief engr. ■ On 20 CATV's—80,000 subs. ■ Rates: \$150; 40; 20.

Bay City

WNEM-TV—Licensed to Bay City. See Flint.

Cadillac

ADI No. 122; see page B-72

WPBN-TV—Licensed to Traverse City. See Traverse City.

WWTV—ch 9, 316 kw vis, 51.3 kw aur, ant 1,630t/1295g. Jan. 1, 1954. Box 627, 49601. (616) 775-3478. Licensee: Fetzer Bcstg Co. Ownership: See Fetzer Stns. ■ CBS. Rep: Avery-Knodel. Wash atty: Dow, Lohnes & Albertson. ■ John E. Fetzer, pres; Gene Ellerman, VP & gen mgr; John Wheat, prod dir & film buyer; Bob Lee, news dir; Murray Tucker, chief engr. ■ Co-owned: WWAM(AM)-WKJF(FM).

Cheboygan

ADI No. 122; see page B-72

WTOM-TV—ch 4, 100 kw vis, 20 kw aur, ant 620t/590g. May 16, 1959. Paul Bunyan Bldg., Traverse City, 49684. (616) 947-7675. Licensee: Midwestern Bcstg Co. Co-owned satellite of WPBN-TV, Traverse City. ■ NBC. Rep: Young; McDermott (Canada). Wash atty: Cordon & Jacob.

Detroit

ADI No. 7; see page B-22

CBET—(Licensed to Windsor, Ont.) ch 9, 325 kw vis, 65 kw aur, 655t/626g. Sept. 16, 1954. Box 9, Detroit, 48226. (313) 961-7200. TWX 810-221-9590. Telex 610-362-0763. Licensee: Canadian Bcstg Corp. (acq 7-23-75). Ownership: CBC 100%. ■ CBC. Rep: Young; Canadian Bcst Sts; Neil Group. ■ H.L. Hacknes, gen mgr; D. E. West, prod dir; N. T. Addison, asst prod dir; Don Sharon, film buyer; W. M. Wrye, news dir; R. J. Kryger, chief engr.

WGPR-TV—ch 62, 759 kw vis, 75.9 kw aur, 974t/1070g. 1975. 2101 Gratiot Ave., 48207. WGPR Inc. International Free and Accepted Black Masons Inc., principal. ■ Wash atty: Dow, Lohnes & Albertson. ■ Dr. William V. Banks, pres.

WJBK-TV—ch 2, 100 kw vis, 10 kw aur, ant 1,000t/1,057g. Oct. 24, 1948. Number Two Storer Place, 48075. (313) 557-9000. TWX 810-224-4876. Licensee: Storer Bcstg Co. Ownership: See Storer Bcstg Stns. ■ CBS. Rep: Storer TV Sales. Wash atty: Warren C. Zwicky. ■ Jay Watson, VP & gen mgr; Bob McBride, stn mgr; Hap Eaton, gen sls mgr; Ron Kaufman, ntl sls mgr; George A. Crandall, loc sls mgr; James Major, prod dir; Dick Graf, news dir; Thomas O. Fox, dir of cmnty affairs; Henry R. Owen, chief engr. ■ On 27 CATV's—252,000 subs. ■ Rates: \$2200; 550; 180.

WKBD-TV—ch 50, 2090 kw vis, 209 kw aur, ant 960t/1,053g. Jan. 10, 1965. Box 359, Southfield, 48075. (313) 444-8500. TWX 810-224-4897. Telex 23-0330. Licensee: Kaiser Bcstg Co. Ownership: See Kaiser Stns. ■ Rep: Kaiser Bcstg Spot Slis. Wash atty: Wilmer, Cutler & Pickering. ■ Lee C. Hanson, VP & gen mgr; George Sperry, prod mgr; George J. Kapel, gen sls mgr; Al Martin, engr mgr. ■ On 157 CATV's—238,000 subs.

***WTVS**—ch 56, 617 kw vis, 61.7 kw aur, ant 960t/1,049g. Oct. 3, 1955. 7441 Second Blvd., 48202. (313) 873-7200. Licensee: Detroit Educl TV Foundation. ■ PBS, CEN (regional). Wash atty: Schwartz & Woods. ■ Irving Bluestone, pres; James N. Christianson, gen mgr; Jerome K. Trainor, film buyer & prog-ops dir; Agnes Scott, dev dir; Jack Costello, prod dir; Rosetta Gadson, PR & prom dir; Edgar B. Hendry, chief engr. ■ On 17 CATV's.

WWJ-TV—ch 4, 97.7 kw vis, 9.7 kw aur, ant 1,010t/1,063g. March 4, 1947. 622 Lafayette Blvd., 48231. (313) 222-2000. TWX 810-221-1623. Licensee: The Evening News Assn. Ownership: See Evening News Assn Stns, also Nwspr. ■ NBC. Rep: Peters, Griffin, Woodward; McDermott. Wash atty: Pierson, Ball & Dowd. ■ Don F. De Groot, VP & gen mgr; Franklin G. Sisson, stn mgr; James S. Morgan, sls mgr; W. R. Williams, prom mgr & film buyer; Thomas P. Becherer, news dir; Donald L. Balcom, chief engr. ■ Co-owned: WWJ-AM-FM.

WXON—ch 20, 501 kw vis, 50.1 kw aur, ant 960t/1,050g. Sept. 15, 1968. 100 Decker Rd., Walled Lake, 48088. (313) 851-3444. Licensee: WXON-TV Inc. Ownership: Aben E. Johnson Jr., 57%; John E. Danaher, 43%. ■ Wash atty: Fletcher, Heald, Rowell, Kenehan & Hildreth. ■ Aben E. Johnson Jr., pres & gen mgr; Thomas R. Winters, sls mgr; A. J. Sch-

weizer, opns mgr; Alan L. Evans, chief engr. ■ On 7 CATV's—40,000 subs.

WXYZ-TV—ch 7, 316 kw vis, 31.6 kw aur, ant 1,000t/1,073g. Oct. 9, 1948. 20777 W. Ten Mile Rd., Southfield, 48075. (313) 444-1111. TWX 313-357-4605. Licensee: WXYZ Inc. Ownership: See ABC-Owned Stns. ■ ABC. Rep: ABC-TV Spot Slis. Wash atty: McKenna, Wilkinson & Kittner. ■ James R. Osborn, VP & gen mgr; Jack Allen, gen sls mgr; Jeanne Findlater, prod dir; Dave Kenworthy, prom mgr; Michael Berman, ntl sls mgr; Keith McClellan, loc sls mgr; Jon K. Gluck, dir of rsch and dev; Charles Kocher, chief engr. ■ On 24 CATV's—151,916 subs. Co-owned: WXYZ(AM)-WRIF(FM).

East Lansing

ADI No. 96; see page B-38

***WKAR-TV**—ch 23, 1,100 kw vis, 219 kw aur, ant 975t/1,038g. Sept. 10, 1972. 600 Kalamazoo St., 48824. (517) 355-2300. Licensee: Mich State U. ■ PBS. ■ Robert D. Page, gen mgr; Kay Ingram, prod dir; Daniel Alpert, prom mgr; J. Raymond Wilson, chief engr. ■ On 12 CATV's—64,000 subs. Co-owned: *WKAR-AM-FM.

Escanaba

ADI No. 66; see page B-29

WJMN-TV—ch 3, 100 kw vis, 20 kw aur, ant 1,192t/1,048g. Oct. 7, 1969. Licensee: WFRV Inc. ■ NBC. Co-owned satellite of WFRV-TV, Green Bay, Wis. ■ Rates: \$160; 40; 50.

Flint

ADI No. 52; see page B-26

WEYI-TV—(Saginaw) ch 25, 1,350 kw vis, 135 kw aur, ant 1,320t/1,359g. April 5, 1953. Box 3265, Saginaw, 48605. (517) 755-0525. TWX 810-235-1132. Licensee: Rust Craft Bcstg Co. (acq 3-23-72). Ownership: See Rust Craft Bcstg Co. ■ CBS. Rep: Katz. Wash atty: Wilkinson, Cragun & Barker. ■ Marshall Berkman, pres; Allen S. Feuer, gen mgr; Robert Kreighoff Jr., sls mgr; Michael Seagly, prom mgr, prod dir & film buyer; Mary E. Marty, bus mgr; Bob Volz, chief engr; Richard Fabian, news dir. ■ On 14 CATV's—51,000 subs.

WJRT-TV—ch 12, 316 kw vis, 31.6 kw aur, ant 940t/999g. Oct. 12, 1958. 2302 Lapeer Rd., 48503. (313) 239-6611. TWX 810-235-1183. Licensee: Poole Bcstg Co. Ownership: See John B. Poole Stns. ■ ABC. Rep: TeleRep. Wash atty: Wilmer, Cutler & Pickering. ■ Albert J. Gillen, pres; William E. Wuerch, VP & gen mgr; Thomas F. Hartman, gen sls mgr; Richard A. Stark, news mgr; George Leh, prom mgr; Robert E. Swayze, chief engr. ■ On 13 CATV's—40,605 subs. ■ Rates: \$390; 140; 90.

WNEM-TV—(Bay City) ch 5, 100 kw vis, 20 kw aur, ant 1,036t/1,056g. Feb. 16, 1954. 5700 Becker Rd., Saginaw, 48606. (517) 755-8191. TWX 810-265-1203. Licensee: Meredith Corp. Ownership: See Meredith Stns, also Nwspr. ■ NBC. Rep: MMT Sales. Wash atty: Haley, Bader & Potts. ■ Richard De Angelis, VP & gen mgr; M. T. Holmes, gen sls mgr; Erwin Parthe, prod dir; David Course, prom mgr; Thomas Crane, news dir; Ed Brennenstuhl, prod dir; David Grover, chief engr. ■ On 18 CATV's—95,105 subs. ■ Rates: \$480; 260; 120.

Grand Rapids

ADI No. 39; see page B-29

***WGVC**—ch 35, 1000 kw vis, 200 kw aur, ant 857.5t/859g. Dec. 17, 1972. 301 Manitow Hall, Allendale, 49401. (616) 895-6691. Licensee: Board of Control, Grand Valley State College. ■ PBS. Sp 1½ hrs wkly. Wash atty: Cohn & Marks.

■ Gordon Lawrence, gen mgr; Charles Furman, prog dir; Cindy Sharp, prom mgr; Paul Bock, chief engr. ■ On 16 CATV's—30,000 subs.

WOTV—ch 8, 282 kw vis, 56.2 kw aur, ant 970t/1,015g. Aug. 15, 1949. Box B, 49501. (616) 459-4125. TWX 810-273-6920. Licensee: Manhattan Cable Television Inc. Ownership: Time Inc. See Nwspr. ■ NBC. Rep: Katz. Wash atty: Pierson, Ball & Dowd. ■ Willard Schroeder, pres; Thomas Girocco, VP & gen mgr; Robert Kirby, sls mgr; Marv Chauvin, stn mgr; William Gill, news dir; Andy Amyx, community rel dir; Philip Bandy, dir aud dev; R. C. Smith, engrg mgr; Leonard Bridge, bus mgr. ■ On 32 CATV's—98,656 subs. ■ Rates: \$375; 228; 68.

WZZM-TV—ch 13, 295 kw vis, 63 kw aur, ant 1,000t/991g. Nov. 1, 1962. Box Z, 49501. (616) 364-9551. TWX 616-949-2260. Licensee: W. Mich. Telecasters Inc. Ownership: Lewis V. Chamberlin, 3.64%; Paul A. Johnson, 3.58%; Robert C. Pew, 3.72%; Nancy S. Dempsey, 10.45%; and others. ■ ABC. Rep: Peters, Griffin, Woodward. Wash atty: Arnold & Porter. ■ Lewis V. Chamberlin, pres; George Lyons, VP & gen mgr; Bill Smith, gen sls mgr; Jack Hogan, news dir; Mike Seagly, prog dir and film buyer; Dale Wolters, chief engr. ■ On 1 trans. Co-owned: WZZM-FM.

Jackson

ADI No. 96; see page B-38

WWLD-TV—ch 18, 1,084 kw vis, 214 kw aur, ant 1,053t/1,079g. Not on air, target date unknown. 911 McCandless, Sault Ste. Marie, 49783. (517) 635-1160. Permittee: Jackson TV Corp. Ownership: Jackson TV Corp. c/o Mrs. Walter Patterson. ■ Wash atty: Booth & Freret.

Kalamazoo

ADI No. 39; see page B-29

WKZO-TV
A Fetzer Station

WKZO-TV—ch 3, 100 kw vis, 20 kw aur, ant 1,000t/1,130g. June 1, 1950. 590 W. Maple St., Kalamazoo, 49001. (616) 345-2101. Licensee: Fetzer Television Corp. Ownership: See John E. Fetzer Stns. ■ CBS. Rep: Avery-Knodel. Wash atty: Dow, Lohnes & Albertson. ■ John E. Fetzer, chmn; Carl E. Lee, pres & gen mgr; Donald DeSmit, VP sls; Gordon Anderson, adm VP; Fred Douglas, news & sp events dir; Daryl Sebastian, pub affrs dir; Arthur Covell, chief engr. ■ Co-owned: WKZO(AM). ■ Rates: \$500; 200; 75.

WUHQ-TV—See Battle Creek.

Lansing

ADI No. 96; see page B-38

WILX-TV—See Onondaga.

WJIM-TV—ch 6, 100 kw vis, 20 kw aur, ant 1,000t/1,023g. May 1, 1950. 2820 E. Saginaw, 48904. (517) 372-8282. TWX 810-251-0805. Licensee: Gross Telecasting Inc. Ownership: Harold F. Gross, 16.3%; Charlotte Gross, 10.6%; & others. ■ CBS. Rep: Harrington, Righter & Parsons. Wash atty: Arent, Fox, Kintner, Plotkin & Kahn. ■ James H. Gross, pres & gen mgr; Phil Sherck, VP, gen sls mgr; Carl Onken, chief engr. ■ On 11 CATV's—44,000 subs. Co-owned: WJIM-AM-FM. ■ Rates: \$350; 175; 55.

Marquette

ADI No. 174; see page B-43

WLUC-TV—ch 6, 100 kw vis, 20 kw aur, ant 978t/1,018g. April 29, 1956. Box 460, 49855. (906) 475-4161. TWX 810-278-4880. Licensee: WLUC Inc. (acq 4-29-65). Ownership: See Post Corp. Stns, also Nwspr. ■ CBS, ABC. Rep: Peters, Griffin, Woodward. Wash atty: Chadbourne, Park, Whiteside & Wolff. ■ V. I. Minahan, pres; David Nelson, VP & treas, Post Corp Stns; Thomas L. Gagnon, gen mgr & film buyer; Ken Bauder, sls mgr; Jack R. LaForest, prog dir & prom mgr; John Williams, news dir; John Truitt, chief engr. ■ On 19 CATV's—30,000 subs. On 4 trans. ■ Rates: \$125; 95; 20.

***WNPB**—ch 13, 316 kw vis, 63.1 kw aur, ant 1,090t/1,101g. Dec. 28, 1972. Northern Michigan U., 49855. (906) 227-3950. Licensee: Board of Control of Northern Michigan U. ■ PBS. Wash atty: Cohn & Marks. ■ Dr. George E. Lott Jr., dir of Learning Resources; Bruce Turner, stn mgr; James D. Steffy, chief engr. ■ On 20 CATV's—110,000 subs.

Mount Pleasant

ADI No. 52; see page B-26

***WCMU-TV**—ch 14, 39.8 kw vis, 7.9 kw aur, ant 520t/547g. March 29, 1967. Ctr Mich. U., 48859. (517) 774-3105. Licensee: Ctr Mich. U. ■ PBS. Sp 3½ hrs wkly. Wash atty: Dow, Lohnes & Albertson. ■ William J. Grigaliunas, dir; Monte Higgins, prog dir; Peter Collinson, prom mgr; Paul Baumgartner, chief engr. ■ On 5 CATV's—28,000 subs. Co-owned: *WCMU-FM.

Onondaga

ADI No. 96; see page B-38

WILX-TV—ch 10, 309 kw vis, 61.7 kw aur, ant 970t/983g. March 15, 1959. Box 380, Jackson, 49204. (517) 783-2621. TWX 810-253-1941. Licensee: TV Corp. of Mich. Inc. Ownership: Edward E. Wilson 50.002%; members of Mr. Wilson's immediate family, 6.998%; Lansing Bcstg Co. (WILS-AM-FM Lansing), 40%; William J. Hart, 3%. ■ NBC. Rep: Avco Radio TV Slis. Wash atty: Leo Resnick. ■ Edward E. Wilson, pres; William J. Hart, gen mgr & film buyer; John F. Cundiff, gen sls mgr; Stuart S. Hazard, prog dir; John Tallero, news dir; Renwood C. Flagg, chief engr. ■ On 7 CATV's—15,000 subs. Co-owned: WJCO(AM) Jackson. ■ Rates: \$300; 140; 75.

Saginaw

WEYI-TV—Licensed to Saginaw. See Flint.

WNEM-TV—Licensed to Bay City. See Flint.

Sault Ste. Marie

ADI No. 122; see page B-72

WWUP-TV—ch 10, 253 kw vis, 50.5 kw aur, ant 1,210t/1,126g. June 15, 1962. Licensee: Fetzer Bcstg Co. Co-owned satellite of WWTV Cadillac. ■ CBS, ABC. Wash atty: Dow, Lohnes & Albertson.

Traverse City

ADI No. 122; see page B-72

WGTV—ch 29, 1,000 kw vis, 200 kw aur, ant 1,300t/1,243g. Aug. 23, 1971. 201 East Front St., 49684. (616) 946-2900. TWX 810-291-1972. Licensee: Northern Entertainment Inc. Ownership: Thomas W. Kiple, pres, 6.57%; and others. ■ ABC. Rep: H-R Television. Wash atty: Booth & Freret. ■ Thomas W. Kiple, pres; James J. Matthews, VP & sls mgr; Daryle Harris, prog dir; Barry Harrand, prod dir; Robert Pincumbe, chief engr. ■ On 29 CATV's—60,000 subs. On 1 trans.

Michigan, Minnesota TV

See page B-89 for explanation of listings.

WPBN-TV—ch 7, 316 kw vis, 63.2 kw aur, ant 1,348t/1,130g. Sept. 13, 1954. (616) 947-7675. Licensee: Midwestern Bcstg Co. Ownership: See Midwestern Bcstg Co. Stns. ■ NBC. Rep: Young; McDermott (Canada). Wash atty: Cordon & Jacob. ■ Les Biederman, pres; Harry R. Lipson, gen mgr; Robert L. Dreher, sls mgr; William Kiker, VP & chief engr. ■ Co-owned: WTCM-AM-FM. ■ Rates: \$68; 35; 24.

WWTV—Licensed to Cadillac. See Cadillac.

University Center

ADI No. 52; see page B-26

***WUCM-TV**—ch 19, 562 kw vis, 56.2 kw aur, ant 470t/496g. Oct. 12, 1964. University Ctr, 48710. (517) 686-0400, ext. 318. Licensee: Delta College. ■ PBS, CEN (regional). Wash atty: Cohn & Marks. ■ Donald J. Carlyon, pres; William J. Ballard, gen mgr; Thomas E. Haskell, prog dir; Nancy K. Rogers, prom mgr; Raymond A. Woods, asst stn mgr & chief engr. ■ On 9 CATV's—63,000 subs.

Minnesota

HAMILTON-LANDIS
& ASSOCIATES, Inc.
NATIONWIDE MEDIA BROKERS
WASHINGTON, D. C. CHICAGO, DALLAS,
SAN FRANCISCO

SELL **MORE**
RADIO & TELEVISION STATIONS
IN THE MIDWEST—NEAREST OFFICE IS—
1429 TRIBUNE TOWER, CHICAGO 60611
(312) 337 2754

Alexandria

ADI No. 157; see page B-3

KCMT—ch 7, 316 kw vis, 63.1 kw aur, ant 1,120t/1,133g. Oct. 8, 1958. 720 Hawthorne St., 56308. (808) 763-5166. TWX 910-578-0003. Licensee: Ctr Minn. TV Co. Ownership: See Ctr Minn. TV Stns. ■ NBC, ABC. Rep: Avery-Knodel; Hyett. Wash atty: Marmet Professional Corp. ■ Joseph O. Perino, chmn; Tom Barnes Jr, pres; Glenn W. Flint, gen mgr; James Syrdal, sls mgr; John Froyd, news dir; John Perino, prom mgr; Carl Iverson, chief engr. ■ On 22 CATV's—24,000 subs. On 4 trans. Co-owned: KCMT-FM. ■ Rates: \$130; 80; 35.

Appleton

ADI No. 157; see page B-3

***KWCM-TV**—ch 10, 316 kw vis, 37.1 kw aur, ant 484t/499g. Feb. 7, 1966. 128 W. Sorenson, 56208. (612) 289-1640. Licensee: Twin City Area Educl TV Corp. and W. Ctr Minn. Educl TV Co. ■ PBS. ■ Ralph Schmidt, pres; Elmer Goetsch, chief engr. ■ On 12 CATV's.

Austin

ADI No. 120; see page B-61

KAAL—ch 6, 100 kw vis, 10 kw aur, ant 1,031t/1,000g. Aug. 17, 1953. Box 577, 55912. (507) 433-8836. TWX 910-565-2104. Licensee: Minn.-Iowa TV Co. Ownership: See Black Hawk Bcstg Stns. (acq 11-3-58). ■ ABC. Rep: Blair. Wash atty: Arent, Fox, Kintner, Plotkin & Kahn. ■ Harry Siife, pres; Richard V. Taber, VP & gen mgr; Terry Dolan, prog dir &

Minnesota, Mississippi, TV

See page B-89 for explanation of listings.

film buyer; Darrell Larson, news dir; Jerald Jones, VP & chief engr. ■ On 6 CATV's—35,000 subs.

***KAVT-TV**—ch 15, 10.5 kw vis, 2.1 kw aur, ant 190t/215g, Oct. 17, 1972. 1900 8th Ave., N.W., 55912. (507) 433-6000. TWX 507-433-7880. Licensee: Independent School District 492. ■ PBS. ■ Donald A. Welch, stn mgr and chief engr; Morton A. Cerney, gen mgr; Virginia Holder, dir; John O'Rourke, prog & news dir, prom mgr; Shonti Elder, asst dir; Mary Whalen, coord.

Duluth

ADI No. 108; see page B-22

KBJR-TV—(Superior, Wis.), ch 6, 100 kw vis, 20 kw aur, ant 1010t/804g, March 11, 1954. 230 E. Superior St., Duluth, 55802. (218) 727-8484. TWX 218-820-0275. Licensee: RJR Communications Inc. (acq 10-1-74). Ownership: Robert J. Rich, 60%; Benits Gaguine, 30%; Richard Pearson, 10%. ■ NBC. Rep: PGW; Hurley; McDermott (Canada). Wash atty: Fly, Shuebruk, Blume & Gaguine. ■ Robert J. Rich, pres; Richard W. Pearson, stn mgr and film buyer; Chuck Cervasio, prom mgr; Dick Wallack, news dir; Norman Gill, chief engr. ■ On 7 CATV's—30,000 subs. On 16 trans. ■ Rates: \$135; 50; 25.

KDAL-TV—ch 3, 100 kw vis, 20 kw aur, ant 990t/816.5g, March 14, 1954. 425 W. Superior St., 55802. (218) 727-8911. TWX 910-561-2522. Licensee: KDAL Inc. Ownership: See WGN Continental Stns, also Nwspr. ■ CBS. Rep: Petry; Hyett; Hix; Creed. Wash atty: Kirkland, Ellis & Rowe. ■ Odin S. Ramsland, pres & gen mgr; John J. Golden, VP & sls mgr; Earl Henton, VP, prog dir & film buyer; Gordon Paymar, prom mgr; William Krueger, edit dir; William Cortez, news dir; Rudy Luukinen, VP & chief engr. ■ On 18 CATV's. On 20 trans. Co-owned: KDAL(AM).

WDIO-TV—ch 10, 316 kw vis, 31.6 kw aur, ant 1,010t/859g, Jan. 24, 1966. 10 Observation Rd., 55811. (218) 727-6864. TWX 910-561-2539. Licensee: Channel 10 Inc. Ownership: A. W. Hedenberg, 27%; John H. Poole 14.33%; Frank P. Befera, 13.91%; & others. ■ ABC. Rep: Avery-Knodel. Wash atty: McKenna, Wilkinson & Kitzner. ■ Frank Befera, pres & gen mgr; Michael C. Daley, sls mgr; David Poirier, prog dir; Jim Schwinn, news dir; George Woody, chief engr. ■ On 19 CATV's—26,300 subs. On 7 trans. ■ Rates: \$100; 40; 20.

***WDSE-TV**—ch 8, 316 kw vis, 47.9 kw aur, ant 880t/805g, Sept. 1, 1964. 210 Bradley Bldg., 55802. (218) 727-8734. Licensee: Duluth-Superior Area Educl TV Corp. ■ PBS, Minn. Educl TV. Wash atty: Fly, Shuebruk, Blume & Gaguine. ■ John Oltmanns, pres; George A. Beck, gen mgr; Ronald Anderson, prog dir, prom mgr & film buyer; Theodore Helgeson, chief engr. ■ On 16 CATV's. On 3 trans.

Hibbing

ADI No. 108; see page B-22

WIRT—ch 13, 125 kw vis, 21.6 kw aur, ant 670t/476g, Sept. 1, 1967. Licensee: Ch 10 Inc. Co-owned satellite of WDIO-TV Duluth. ■ ABC.

Mankato

ADI No. 179; see page B-42

KEYC-TV—ch 12, 316 kw vis, 63 kw aur, ant 1,045t/1,116g, Oct. 5, 1960. Box 128, 56001. (507) 387-7905. TWX 507-890-8128. Licensee: Lee Enterprises Inc. Ownership: See Lee Bcstg Stns, also Nwspr. ■ CBS. Rep: Katz.

Wash atty: Pierson, Ball & Dowd. ■ Donald G. Harter, gen mgr; Hap Halligan, sls & prom mgr. ■ On 5 CATV's—12,700 subs. On 2 trans. Co-owned: KEYC-FM. ■ Rates: \$80; 50; 30.

Minneapolis-St. Paul

ADI No. 13; see page B-48

KMSM-TV—ch 9, 187.26 kw vis, 191.76 kw aur, ant 1,440t/1,475g, Jan 5, 1955. 6975 York Ave South, 55435. (612) 925-3300. TWX 910-576-2926. Licensee: United TV Group. Ownership: 20th Century Fox Film Corp. ■ ABC. Rep: Blair. Wash atty: Dow, Lohnes & Albertson. ■ Donald Swartz, pres & gen mgr; Roland King, sls mgr; Joseph Carney, prog dir; Jerry Bronston, prom mgr; Jerry Smith, news dir. ■ On 74 CATV's—122,200 subs. On 7 trans. ■ Rates: \$750; 150; 80.



KSTP-TV—ch 5, 100 kw vis, 15.1 kw aur, ant 1,430t/1,370g, April 23, 1948. 3415 University Ave., St. Paul, 55114. (612) 645-2724. TWX 612-551-0918; Telex 029-685. Licensee: Hubbard Bcstg Inc. Ownership: See Hubbard Bcstg Inc. ■ NBC. Rep: Petry. Wash atty: Fletcher, Heald, Rowell, Kenehan & Hildreth. ■ Stanley E. Hubbard, chmn; Stanley S. Hubbard, pres & gen mgr; James E. Blake, TV sls mgr; David Garvin, natl sls mgr; Ron Magers, dir news opns; Ralph J. Dolan, opns & prog dir; Kay Greaser, prom mgr; George Merrill, chief engr; John Degan, prod mgr. ■ On 51 CATV's—111,500 subs. On 6 trans. Co-owned: KSTP-AM-FM. ■ Rates: \$700; 350; 100.

***KTCA-TV**—ch 2, 100 kw vis, 20 kw aur, ant 1,336t/1,372g, Sept. 3, 1957. 1640 Como Ave., St. Paul, 55108. (612) 645-0471. Licensee: Twin City Area Educl TV Corp. ■ PBS. ■ George H. Gruenwald, pres; Dr. John C. Schwarzwalder, exec VP & gen mgr; Chris Donaldson, asst gen mgr; L. T. Morrisette, asst mgr prod; Wayne A. Mayer, dir of engr. ■ On 63 CATV's—120,000 subs. On 7 trans.

***KTCl-TV**—ch 17, 28.8 kw vis, 5.75 kw aur, ant 1,300t/1,342g, May 3, 1965. Licensee: Twin City Area Educl TV Corp. ■ PBS. ■ Execs: See *KTCA-TV.

KTMA-TV—ch 23, 316 kw vis, 63.1 kw aur, ant 1,400t/1,490g. Not on air, target date unknown. c/o Laura Beaudoin, 450 Southview Blvd., S. St. Paul, 55075. Permittee: Viking TV Inc. Ownership: Harold W. Bargert, 25%; Irving W. Beaudoin, 34%; Morton H. Henkin, 10%; Barbara D. Marmet, 25%; and others.

WCCO-TV—ch 4, 100 kw vis, 15.1 kw aur, ant 1,430t/1,375g, July 1, 1949. 50 S. 9th St., Minneapolis, 55402. (612) 338-0552. Licensee: Midwest Radio-TV Inc. Ownership: Mid-Continent Radio-TV Inc., 53%; Minneapolis Star & Tribune Co. (Cowles), 47%. See Minneapolis Star & Tribune Stns. ■ CBS. Rep: Peters, Griffin, Woodward. Wash atty: Fly, Shuebruk, Blume & Gaguine. ■ Lawrence F. Haeg, pres; Sherman K. Headley, gen mgr; Jack Hansen, gen sls mgr; Chuck Sorlien, prog dir; Ron Handberg, news dir; Harry Jones, film dir; Tom Cousins, prom dir; Henry Sheppard, chief engr. ■ On 71 CATV's—115,000 subs. On 6 trans. Co-owned: WCCO-AM-FM. ■ Rates: \$700; 300; 100.

WTCN-TV—ch 11, 316 kw vis, 45.7 kw aur, ant 1,440t/1,375g, Sept. 1, 1953. 441 Boone Ave. N., Minneapolis, 55427. (612) 546-1111. TWX 910-576-2825. Licensee: WTCN Television Inc., a service of Metromedia Inc. (acq 7-29-71). Ownership: See Metromedia Stns. ■

Rep: Metro TV Sls. Wash atty: Hogan & Hartson. ■ Albert P. Krivin, pres; Robert C. Fransen, VP & gen mgr; Kevin O'Brien, gen sls mgr; Art Ludwig, prog dir & film buyer; Jay Scafione, prom mgr; Gil Amundson, news dir; Leo Domeier, chief engr. ■ On 85 CATV's—132,589 subs. On 8 trans.

Rochester

ADI No. 120; see page B-61

KROC-TV—ch 10, 316 kw vis, 46.8 kw aur, ant 1,260t/1,314g, July 16, 1953. 601 First Ave., S.W., 55901. (507) 288-4444. TWX 507-840-8232. Licensee: Southern Minn. Bcstg Co. Ownership: G. David Gentling, 100%. ■ NBC. Rep: Avery-Knodel; Hyett. Wash atty: Cordon & Jacob. ■ G. David Gentling, pres, gen mgr & film buyer; Joseph P. St. George, gen sls mgr; Ron Gruber, prog dir & prom mgr; Mike Morgan, news dir; Robert W. Cross, chief engr. ■ On 42 CATV's—84,700 subs. On 4 translators. Co-owned: KROC-AM-FM.

St. Cloud

***New TV**—ch 25, 575 kw vis, 115 kw aur, 560t/609g. Not on air, target date unknown. 13th Ave. & 7th St. S., 56301. Permittee: Minnesota Independent School District.

Walker

ADI No. 157; see page B-3

KNMT—ch 12, 31 kw vis, 6.17 kw aur, ant 930t/999g, Jan. 1, 1964. Box 550, Hackensack, Minn., 56452. (218) 675-6115. Licensee: Central Minn. TV Co. Co-owned satellite of KCMI(TV) Alexandria. ■ NBC, ABC. ■ On 4 CATV's—4,740 subs. ■ Rates: \$130; 80; 35.

Mississippi

Biloxi

ADI No. 180; see page B-9

WLOX-TV—ch 13, 316 kw vis, 57.5 kw aur, ant 1,340t/1,319g, Sept. 15, 1962. Box 4596, Biloxi, 39531. (601) 896-1313. TWX 510-997-1090. Licensee: WLOX Bcstg Co. Ownership: J. S. Love Jr., estate, 44.45%; Mrs. J. S. Love Jr., 42.10%; & others. ■ ABC. Rep: Savalli/Gates. Wash atty: Pittman, Lovett, Ford & Hennessey. ■ J. S. Love III, pres; Ray Butterfield, gen mgr; Earl Blessey, sls mgr; William Stinski, prog dir, film buyer & prom mgr; Dale Robinson, news dir; Thomas B. Majure, chief engr. ■ On 14 CATV's—3,361 subs. On 1 trans. Co-owned: WLOX(AM). ■ Rates: \$97; 55; 25.

***WMAH**—ch 19, 631 kw vis, 120 kw aur, ant 1,560t/1,539g, Jan. 14, 1972. Drawer 1101, Jackson, 39205. Licensee: Miss. Authority for Educational TV. See *WMAA Jackson.

Booneville

ADI No. 143; see page B-18

***WMAE**—ch 12, 44.7 kw vis, 8.91 kw aur, ant 750t/578g, Aug. 11, 1974. Licensee: Mississippi Authority for Educational Television. See *WMAA, Jackson

Bude

ADI No. 85; see page B-34

***WMAU**—ch 17, 550 kw vis, 110 kw aur, ant 1,121t/1,065.75g, Jan. 14, 1972. Drawer 1101, Jackson, 39205. Licensee: Miss. Authority for Educational TV. See *WMAA Jackson.

Columbus

ADI No. 143; see page B-18

WCBI-TV—ch 4, 100 kw vis, 100 kw aud, ant 450/1500g. July 13, 1956. Box 271, 39701. (601) 328-5631. TWX 510-982-9481. Licensee: Columbus TV Inc. Ownership: See Birney Ives Jr. Stns, also Nwspr. ■ CBS, ABC. Rep: Meeker; Ayers. Wash atty: Arent, Fox, Kintner, Plotkin & Kahn. ■ Birney Ives Jr., pres; W. W. Whitfield, gen mgr & film buyer; J. D. Reed, prog dir; Shirley Ray, prom mgr. ■ On 40 CATV's—55,500 subs. Co-owned: WCBI(AM). ■ Rates: \$80; 50; 25.

WTWV—See Tupelo.

Greenville

ADI No. 189; see page B-31

WABG-TV—ch 6, 100 kw vis, 14.7 kw aud, ant 1090/1,134g. Oct. 20, 1959. Drawer 720, 38930. (601) 453-4001. Licensee: Miss. Telecasting Co. Ownership: See Cy N. Bahakel Stns. ■ ABC. Rep: Savalli/Gates. Wash atty: Wilmer, Cutler & Pickering. ■ Cy N. Bahakel, pres; Henry W. Hughes, VP & gen mgr; Hugh (Mike) O'Reilly, news dir; Dorothy Porter, prom mgr; Robert Taylor, chief engr. ■ On 30 CATV's—60,000 subs. Co-owned: WABG(AM).

***WMAO**—ch 23, 537 kw vis, 107 kw aud, ant 1,040/1,061g. Sept. 15, 1972. Drawer 1101, Jackson, 39205. Licensee: Miss. Authority for Educational TV. See *WMAA Jackson.

Greenwood

WABG-TV—Licensed to Greenwood. See Greenville.

WMAO—Licensed to Greenwood. See Greenville.

Gulfport

WLOX-TV—Licensed to Biloxi. See Biloxi.

Hattiesburg

ADI No. 163; see page B-39

WDAM-TV (Laurel)—ch 7, 316 kw vis, 47 kw aud, ant 510/1575g. June 8, 1956. Box 1978, Hattiesburg, 39402. (601) 544-4730. Licensee: Chapman TV of Tuscaloosa Inc. Ownership: S. A. Rosenbaum, 43.75%; William S. Smylie Jr., 10.4%; Mrs. William S. Smylie Jr., 16.67%; & others. ■ NBC. Rep: Young-VTM. Wash atty: McKenna, Wilkinson & Kittner. ■ William S. Smylie Jr., pres; Marvin Reuben, VP & gen mgr; Frank Pilgrim, sales mgr; Neil Sumrall, prog mgr; Bobby Smith, chief engr & ops mgr. ■ On 18 CATV's—36,086 subs. ■ Rates: \$90; 85; 25.

Jackson

ADI No. 85; see page B-34

WAPT—ch 16, 794 kw vis, 158 kw aud, ant 1,166/1,072g. Oct. 3, 1970. Box 10297, 39209. (601) 922-1607. TWX 810-966-2734. Licensee: Amer. Pub. Life Bcstg Co. Ownership: American Public Life Ins. Co., 100% (acq July 30, 1970). ■ ABC. Rep: Meeker. Wash atty: Mallyck & Bernton. ■ Ralph B. Edwards, pres; Jerry Colvin, gen & gen sls mgr, film buyer; Jack L. Rea, prog mgr; Craig Potter, prom mgr; Cal Adams, news dir; Gary Jones, chief engr. ■ On 16 CATV's—48,750 subs. ■ Rates: \$85; 60; 25.

WJTV—ch 12, 316 kw vis, 63.1 kw aud, ant 1,630/1,615g. Jan. 28, 1953. Box 8887, 39204. 372-6311. TWX 810-966-2735. Licensee: Capitol Bcstg Co. (acq 6-55). Ownership: Miss. Publishers Corp., 40%; Standard Life Ins Co., 32.4%; L. M. Sepaugh, 13.8%; T. B. Lanford,

13.8%. See T. B. Lanford Stns, also Nwspr. ■ CBS. Rep: Katz. Wash atty: Kirkland, Ellis & Rowe. ■ L. M. Sepaugh, exec VP & gen mgr; Owens Alexander, stn mgr & film buyer; Alan Axtell, sls coord & natl sls mgr; Phyllis Qualls, prom mgr; Wydett Hawkins, dir of pub affrs; C. A. Perkins, chief engr. ■ On 40 CATV's—84,800 subs. Co-owned: WSLI-AM-FM.

WLBT—ch 3, 95.5 kw vis, 19.1 kw aud, ant 2,050/1,999g. Dec. 28, 1953. Box 1712, 39205. (601) 948-3333. TWX 810-966-2616. Licensee: Communications Improvement Inc. (Interim authority). ■ NBC. Rep: H-R. ■ Kenneth Dean, pres; William H. Dilday Jr., gen mgr; Harry L. Bickelhaupt, gen sls mgr; Hewitt Griffin, prog mgr & film buyer; Bert Case, news dir; Dorothy Terry, prom mgr; Floyd Kinard, chief engr. ■ On 26 CATV's—42,292 subs. ■ Rates: \$159; 40-129; 23-76.

***WMAA**—ch 29, 307 kw vis, 90.4 kw aud, 1,960/1,999g. Feb. 1, 1970. Drawer 1101, 39205. (601) 982-6555. Licensee: Miss. Authority for ETV. ■ PBS. Wash atty: Schwartz & Woods. ■ William R. Smith Jr., exec dir; Malcolm Wall, prog dir; B. F. Lucroy, educ dir; F. L. Morris, dir of engr. ■ On 10 CATV's—18,616 subs.

Laurel

WDAM-TV—Licensed to Laurel. See Hattiesburg.

Meridian

ADI No. 184; see page B-45

WHTV—ch 24, 245 kw vis, 2.45 kw aud, ant 1,001/301g. June 10, 1968. Box 5185, 39301. (601) 693-2933. Licensee: Central Television Inc. (acq 11-72). Ownership: Frank K. Spain, 70%; Ronald E. Hale, 10%. ■ NBC, ABC. Rep: Young, Busby, Finch, Latham, Widman. Wash atty: Haley, Bader & Potts. ■ Frank K. Spain, pres; Ronald E. Hale, exec VP & gen mgr; Mike Glass, lcl sls mgr; Ray Denton, prog dir; Videt Carmichael, asst mgr; Brad Sykes, prom mgr; Carol Perkins, news dir; Max Berryhill, chief engr. ■ On 5 CATV's—15,000 subs. ■ Rates: \$30; 20; 12.

***WMAW**—ch 14, 550 kw vis, 110 kw aud, ant 1,207/1,065g. Jan. 14, 1972. Licensee: Miss. Authority for Educational TV. See *WMAA Jackson.

WTOK-TV—ch 11, 316 kw vis, 47.9 kw aud, ant 560/315g. Sept. 27, 1953. Southern Bldg, 39302. (601) 483-1441. TWX 601-483-6851. Licensee: Southern TV Corp. Ownership: Robert F. Wright, 25.5%; W. B. Crooks Jr., 16.5%; S. A. Rosenbaum, I. A. Rosenbaum, James B. Skewes, each 11.5%; & others. See Nwspr. ■ CBS, ABC. Rep: Avery-Knodel. Wash atty: McKenna, Wilkinson & Kittner. ■ Robert F. Wright, pres, gen mgr & film buyer; W. B. Crooks Jr., VP & coml mgr; George Shannon, prod dir; Cecil Germany, prog mgr; Bob Holland, news dir; Joe Saxon, chief engr. ■ On 12 CATV's.

Mississippi State

***WMAB**—ch 2, 100 kw vis, 15.1 kw aud, ant 1,250/1,093g. Licensee: Miss. Authority for ETV. See *WMAA, Jackson.

Oxford

ADI No. 34; see page B-45

***WMAV**—ch 18, 347 kw vis, 63.1 kw aud, ant 1,389/1,304g. May 19, 1972. Licensee: Authority for Educational TV. See *WMAA Jackson.

Pascagoula

WLOX-TV—Licensed to Biloxi. See Biloxi.

Mississippi, Missouri TV

See page B-89 for explanation of listings.

Tupelo

ADI No. 143; see page B-18

WTWV—ch 9, 316 kw vis, 31.6 kw aud, ant 1,786/1,590g. March 18, 1957. Box 350, 38801. (901) 842-7620. Licensee: WTWV Inc. Ownership: F. K. Spain, 35%; Margaret H. Spain, 35%; Letha M. Spain, 20%; Perrin Purvis, 10%. ■ NBC, ABC. Rep: Katz. Wash atty: Haley, Bader & Potts. ■ Frank K. Spain, pres; Paul A. Moore, exec VP; Charlie H. Hicks Jr., stn & sls mgr; Ed Bishop, prog dir; Gerald Stanford, ops mgr; Mark Ledbetter, news dir; Jim Stenbridge, chief engr. ■ On 67 CATV's—80,000 subs.

Missouri

HAMILTON-LANDIS
& ASSOCIATES, Inc.
NATIONWIDE MEDIA BROKERS
WASHINGTON, D. C. CHICAGO, DALLAS,
SAN FRANCISCO
SELL **MORE**
RADIO & TELEVISION STATIONS
IN THE MIDWEST—NEAREST OFFICE IS—
1429 TRIBUNE TOWER, CHICAGO 60611
(312) 337-2754

Cape Girardeau

ADI No. 68; see page B-54

KFVS-TV—ch 12, 288 kw vis, 57.5 kw aud, ant 2,000/1,677g. Oct. 3, 1954. 324 Broadway, 63701. (314) 335-5511. TWX 910-760-1564. Licensee: Hirsch Bcstg Co. Ownership: See Oscar C. Hirsch Stns. ■ CBS. Rep: Meeker. ■ Oscar C. Hirsch, pres & gen mgr; Robert O. Hirsch, ops mgr; Donald T. McNeely, prog dir; Byron Mercer, sls mgr; James F. Hirsch, chief engr. ■ Co-owned: KFVS(AM).

Columbia

ADI No. 125; see page B-17

KCBJ-TV—ch 17, 750 kw vis, 150 kw aud, ant 1,144/1,057g. Dec 5, 1971. 114 S. 7th St., 65201. (314) 449-0917. Licensee: Ch 17 Inc. Ownership: Richard E. Koenig, 55% and Robert H. Koenig, 45%. ■ ABC. Rep: Devney, Gray. Wash atty: Bilger & Blair. ■ Richard E. Koenig, pres, gen mgr & film buyer; Craig Miller, gen sls mgr; Elaine Thompson, prog dir & prom mgr; Mary Kaye, news dir; Tom Johns, chief engr. ■ On 25 CATV's. ■ Rates: \$40; 20; 15.

KOMU-TV—ch 8, 288 kw vis, 30.2 kw aud, ant 790/774g. Dec 21, 1953. Highway 63 S, 65201. (314) 442-1122. TWX 910-760-1444. Licensee: Curators of U. of Mo. ■ NBC. Rep: Avery-Knodel. Wash atty: Fisher, Wayland, Southmayd & Cooper. ■ Thomas R. Gray, gen mgr; Don Ruggles, sls mgr; Monte Gurwit, prog dir & film buyer; Charlyn Law, prom mgr; Leigh Wilson, news dir; William Reagan, chief engr. ■ On 26 CATV's—58,200 subs. On 2 trans. ■ Rates: \$80; 50; 20.

KRCG—See Jefferson City.

Hannibal

KHQA-TV Licensed to Hannibal. See Quincy, Ill.

Missouri TV

See page B-89 for explanation of listings.

Jefferson City

ADI No. 125; see page B-17

KOMU-TV—See Columbia.

KRCG—ch 13, 214 kw vis, 47.4 kw aur, ant 1,010t/929g. Feb 13, 1955. Box 659, 65101. (314) 636-6188. TWX 910-760-2923. Licensee: Mid-America TV Co. Ownership: See Mid-America TV Stns. ■ CBS. Rep: Blair Wash atty: Dow, Lohnes & Albertson. ■ William A. Bates, pres; Edward J. Schuelein, VP & gen mgr; Otis Jarrett, rgnl & loc sls mgr; Don Shinkle, news dir; Lee Gordon Jr., prog dir; Warren A. Polmanteer, chief engr. ■ On 37 CATV's—57,621 subs. ■ Rates: \$115; 40; 25.

Joplin

ADI No. 114; see page B-35

KOAM-TV—See Pittsburg, Kan.

KODE-TV—ch 12, 316 kw vis, 63.2 kw aur, ant 1,020t/999g. Sept. 26, 1954. 1928 W. 13th St., 64801. (417) 623-7260. TWX 910-774-4516. Licensee: Gilmore Bcstg Corp. Ownership: See James S. Gilmore Jr. Stns. ■ ABC. Rep: H-R TV. Wash atty: Kirkland, Ellis & Rowe. ■ James S. Gilmore Jr., pres; Bob Lee, VP & gen mgr; Richard E. Reed, exec VP opns; Hamilton Shea, exec VP admin/corp dev; John Holmes, sls mgr; Ed Wilson, prog dir; Jim Lobby, dir of comm affrs; Gary Cooper, prom mgr; Larry Meacham, news dir; Morris Sweet, chief engr. ■ On 23 CATV's—34,600 subs. Co-owned. KODE(AM). ■ Rates: \$100; 50; 20.

KTVJ—ch 16, 852 kw vis, 171 kw aur, ant 1060t/1,014g. Sept. 2, 1967. Box 1393, 64801. (417) 781-2345. TWX 910-774-4520. Licensee: Mid-America Bcstg Inc. Ownership: Kansas State Network, 99.45%. ■ CBS. Rep: Avery-Knodel. Wash atty: Koteen & Burt. ■ Frank Chappel, pres KSN bcstg div; Bill Clarke, gen mgr; Hoop Morgan, sls mgr; Bill Sikes, film buyer; Dave Richardson, news dir; Lloyd Frazer, dir engr; Melvin Brooks, chief engr. ■ On 36 CATV's—59,505 subs. ■ Rates: \$80; 25; 30.

Kansas City

ADI No. 23; see page B-36

KBMA-TV—ch 41, 1,000 kw vis, 100 kw aur, ant 1,060t/1,163g. Sept. 28, 1970. BMA Tower, 1 Penn Valley Park, 64108. (816) 756-1441. TWX 910-771-3003. Licensee: Westport TV Inc. Ownership: Benno Schmidt, 61%; Paul Willson, 29%; Wesley J. Barta, 10% & others. ■ ABC, CBS, NBC. Rep: H.R. Wash atty: Fly, Shuebruk, Blume & Gaguine. ■ Bob J. Wormington, pres, gen mgr & film buyer; Stuart Powell, sls mgr; G. Mel House, prog dir; John Sylvester, prom mgr; Harold De Good, chief engr. ■ On 120 CATV's—295,000 subs.



KCMO-TV—ch 5, 100 kw vis, 15.1 kw aur, ant 1,130t/1,042g. Sept. 27, 1953. 125 E. 31st St., 64108. (816) 531-6789. TWX 910-771-3112. Licensee: Meredith Corp. (acq 10-1-53). Ownership: See Meredith Stns, also Nwspr. ■ CBS. Rep: MMT Sales, Inc. Wash atty: Haley, Bader & Potts. ■ Charles M. McAbee, Jr., VP & gen mgr; Gerald P. Noonan, gen sls mgr; John Proffitt, prog dir & film buyer; Owen Uridge, prom mgr; Joe Kramer, news dir; Steven Smith,

chief engr. ■ On 80 CATV's—148,835 subs. Co-owned: KCMO(AM)—KCEZ(FM).

***KCPT**—ch 19, 868 kw vis, 170 kw aur, ant 1,164t/1,220g. March 29, 1961. 2100 Stark, 64126. (816) 461-8100. Licensee: Community Service Bcstg of Mid-America Inc. (acq 1-1-72). ■ PBS. Wash atty: Dow, Lohnes & Albertson. ■ John H. Kreamer, pres; Robert F. Fuzy, gen mgr; David Welsh, film buyer & prog dir; Jane Ann Breuer, prom mgr; Clyde A. Howe Jr., chief engr. ■ On 15 CATV's.

KMBC-TV—ch 9, 316 kw vis, 47.4 kw aur, ant 1,070t/1,023g. Aug. 1, 1952. 11th & Central Sts., 64105. (816) 421-2650. TWX 816-556-0470. Telex 42-559. Licensee: Metromedia Inc. Ownership: See Metromedia Stns. ■ ABC. Rep: Metro TV Sales. Wash atty: Thomas J. Dougherty. ■ R. Kent Replogle, VP & gen mgr; Robert Harris, gen sls mgr; Gene Cless, prog dir; Art Parks, prom mgr; Ray Markoff, exec producer; Claude Dorsey, VP & news dir; Wally Wurz, VP & chief engr. ■ On 59 CATV's—165,000 subs. ■ Rates: \$900; 200; 40.

WDAF-TV—ch 4, 100 kw vis, 10 kw aur, ant 1,130t/1,163g. Oct. 16, 1949. Signal Hill, 64108. (816) 753-4567. TWX 910-771-2047. Licensee: Taft Bcstg Co. Ownership: See Taft Stns. ■ NBC. Rep: TeleRep. Wash atty: Koteen & Burt. ■ Lawrence Rogers II, pres; Ro Grignon, VP & gen mgr; Carl Flickinger, gen sls mgr; Clayton Turner, opns mgr; Sue Sampson, prom mgr; Ken Keller, news dir; James P. Schmidt, chief engr. ■ On 51 CATV's—57,000 subs. Co-owned: WDAF-AM-FM.

Kirksville

KTVO—Licensed to Kirksville. See Ottumwa, Iowa.

Poplar Bluff

ADI No. 68; see page B-54

***KPOB-TV**—ch 15, 15.1 kw vis, 1.58 kw aur, ant 620t/546g. Sept. 15, 1967. Television Bldg, Harrisburg, Ill, 62946. (314) 257-7837. Licensee: Turner-Farrar Assn. Co-owned satellite of WSIL-TV Harrisburg, Ill. ■ Wash atty: McKenna, Wilkinson & Kittner.

St. Joseph

ADI No. 177; see page B-62

KQTV—ch 2, 100 kw vis, 20 kw aur, ant 810t/750g. Sept. 27, 1953. 40th & Faraon Sts., 64506. (816) 233-2528. TWX 910-777-7872. Licensee: Amatoro Group Inc. (acq 12-1-73). Ownership: See Amatoro Group Stns. ■ ABC. Rep: Avery-Knodel. Wash atty: Koteen & Burt. ■ Joseph Amatoro, pres; Tom Matthews, VP & gen mgr; Carleton Schirmer, sls mgr; Ken Henson, news dir; Larry Beauchamp, prog dir & film buyer; Ken Lux, chief engr. ■ On 14 CATV's—23,750 subs. On 1 trans.

St. Louis

ADI No. 12; see page B-63

KDNL-TV—ch 30, 1,160 kw vis, 212 kw aur, ant 1,100t/1,148g. June 8, 1969. 1215 Cole St., 63106. (314) 436-3030. TWX 910-761-0538. Licensee: Evans Bcstg Corp. Ownership: Thomas M. Evans, 100%. ■ Rep: Evans. Wash atty: Arnold & Porter. ■ Edward P. Evans, pres; Jack P. Petrik, VP, gen mgr & film buyer; B. Thomas Koon Jr., gen sls mgr; Bill Jackson, prom mgr; Wayne E. Anderson, chief engr. ■ On 27 CATV's—41,000 subs. ■ Rates: \$80; 100; 25.

***KETC-TV**—ch 9, 295 kw vis, 58.9 kw aur, ant 1,070t/1,073g. Sept. 20, 1954. 6996 Millbrook Blvd., 63130. (314) 725-2460. Licensee: St. Louis Educl TV Commission. ■ PBS. Wash atty: Dan Toohey. ■ William L. Davis, pres; Robert C.

Glazier, gen mgr, news dir & film buyer; Don Jeffries, prog dir; Jim Barnes, prom mgr; Andrew R. McMaster, dir opns; John Muench, chief engr. ■ On 36 CATV's—On 6 trans.

KMOX-TV—ch 4, 100 kw vis, 15 kw aur, ant 1,110t/1,214g. July 8, 1954. 1 Memorial Dr., 63102. (314) 621-2345. Telex: TT 7250-03. Licensee: CBS Inc. Ownership: See CBS-Owned Stns. ■ CBS. Rep: CBS-TV Stns Natl Sls. ■ Chris Desmond, VP & gen mgr; Thoren Schroeck, sls dir; Don Merl, prog dir; Vivian Hunt, dir of info svcs; Robert Schaefer, news dir; Wally Wesley, dir of tech opns. ■ Co-owned: KMOX-AM-FM. ■ Rates: \$800; 250; 150.

KPLR-TV—ch 11, 316 kw vis, 55 kw aur, ant 1,010t/1,214g. April 28, 1959. 4935 Lindell Blvd., 63108. (314) 367-7211. TWX 910-761-1093. Licensee: 220 TV Inc. Ownership: 220 N. Kingshighway Inc., 100%. ■ Rep: Kaiser. Wash atty: Koteen & Burt. ■ Harold Koplar, pres; Harold E. Protter, VP & gen mgr; Doug Johnston, gen sls mgr; Ted Koplar, prog dir; Bill Thomas, news dir; Greg Smith, chief engr. ■ On 15 CATV's—22,000 subs. ■ Rates: \$100; 180; 30.

KSD-TV—ch 5, 100 kw vis, 20 kw aur, ant 1,090t/1,148g. Feb 8, 1947. 1111 Olive St., 63101. (314) 421-5055. TWX 910-761-1037. Telex: 44-7480. Licensee: KSD/KSD-TV Inc. Ownership: See Pulitzer Stns, also Nwspr. ■ NBC. Rep: Blair Wash atty: Marmet & Webster. ■ Joseph Pulitzer Jr., chmn; Harold Grooms, pres; Ray Karpowicz, VP & gen mgr; A. E. Bello, gen sls mgr; Mike Duffy, loc sls mgr; Gary Chapman, natl sales mgr; Keith Gunther, prog mgr & film buyer; Austin Bridgman, dir news admin; Pete Vesey, dir news and opns; Harry Honig, dir creative svcs; Fred J. Mueller, prom mgr; Don Burnes, dir of info svcs; Don Schomburg, bus mgr; Monte Walpole, engr mgr—TV; J. E. Risk, dir of engr. ■ On 30 CATV's—75,893 subs. Co-owned: KSD(AM). ■ Rates: \$1400; 225; 100.

KTVI—ch 2, 100 kw vis, 20 kw aur, ant 1,085t/1,049g. April 15, 1957. 5915 Berthold Ave., 63110. (314) 647-7777. TWX 314-556-0082. Licensee: Newhouse Bcstg Corp. (acq 6-10-64). Ownership: See Newhouse Stns, also Nwspr. ■ ABC. Rep: MMT Sales Inc. Wash atty: Monroe Oppenheimer. ■ Ralph M. Hansen, VP & gen mgr; E. Manne Russo, dir sales; Vic Skaggs, dir prog & film buyer; Don McMullin, dir news & publ affairs; Clark Grant, dir adv & prom; Richard Trompeter, dir engr. ■ On 17 CATV's—43,861 subs.

Sedalia

ADI No. 125; see page B-17

KMOS-TV—ch 6, 16.2 kw vis, 3.28 kw aur, ant 360t/321g. July 6, 1954. Box 149, 65302. (816) 826-1651. Licensee: Mid-American TV Co. Co-owned satellite of KRCG(TV) Jefferson City, Mo.

Springfield

ADI No. 84; see page B-70

KMTC—ch 27, 240 kw vis, 48 kw aur, ant 1,690t/1,621g. Sept. 22, 1968. 3000 Cherry St., 65804. (417) 862-7091. Licensee: Midland TV Corp. Ownership: K. E. Meyer, 25.6%; Steve W. Ball, 10.7%; Burks Dev Co., 10.7%; G. F. Doran, 10.7%; John Noennig, 10.2%; Herb C. Wattner, 10.7%; and others. ■ ABC. Rep: Gray. Wash atty: Wilner & Scheiner. ■ K. E. Meyer, pres & gen mgr; Bob Burke, sls mgr; Ben Kuehnel, prom mgr; Betty Alley, prog dir; Don Weiser, news dir; Bob DeForrest, opns mgr; Dale Blankenship, chief engr.

KOLR—ch 10, 282 kw vis, 28.2 kw aur, ant 2,070t/2,000g. March 14, 1953. Box 1716, 65805. (417) 862-7474. TWX 910-775-4718.

Missouri, Montana, Neb. TV

See page B-89 for explanation of listings.

Miles City

ADI No. 208; see page B-48

KYUS-TV—ch 3, 10 kw vis, 1 kw aur, ant 1251/65g. Aug. 29, 1969. Box 760, 59301. (406) 232-3540. Licensee: Custer Bcstg Corp. Ownership: David G. Rivenes, 41%; L.B. Foster, 41%; Charles D. Vick, 12%; Peter G. Sieler, 5%; Donald P. Miller, 1%. ■ NBC. Rep: Savalli/Gates. Wash atty: McKenna, Wilkinson & Kittner. ■ David G. Rivenes, pres, gen & sls mgr; Ella M. Rivenes, prog & news dir & film buyer; Terry Kowalkowski, chief engr. ■ On 1 CATV—2,200 subs. On 6 trans.

Missoula

ADI No. 158; see page B-47

KGVO-TV—ch 13, 231 kw vis, 23.2 kw aur, ant 2,003t/289g. July 1, 1954. Drawer M, 59801. (406) 543-8313. TWX 910-963-2490. Licensee: KMSO-TV Inc. Ownership: See Dale Moore Stns. ■ NBC, ABC. Rep: H-R; Simpson/Reilly; Hyett; Hix. Wash atty: Fisher, Wayland, Southmayd & Cooper. ■ Dale G. Moore, pres; Wayne Killmer, gen mgr; Lynn Koch, natl and rgnl sls mgr; C. Kirk Buls, sls mgr; Duane Barr, prog dir; Larry Cooper, news dir; Doug Drader, chief engr. ■ On 10 CATV's—17,500 subs. On 23 trans. Co-owned: KGVO(AM). ■ Rates: \$70; 50; 20.

KPAX-TV—ch 8, 257 kw vis, 49 kw aur, ant 2,150t/284g. June 5, 1970. c/o Joseph S. Sample, Box 3500, Butte, 59701. Licensee: Garryowen Corp. Co-owned satellite of KXLF-TV Butte. ■ On 3 trans.

Nebraska

HAMILTON-LANDIS
G ASSOCIATES, Inc.
NATIONWIDE MEDIA BROKERS
WASHINGTON, D. C., CHICAGO, DALLAS,
SAN FRANCISCO
SELL **MORE**
RADIO & TELEVISION STATIONS
IN THE MIDWEST—NEAREST OFFICE IS—
1429 TRIBUNE TOWER, CHICAGO 60611
(312) 337-2754

Albion

ADI No. 81; see page B-40

KCNA-TV—ch 8, 316 kw vis, 63.2 kw aur, ant 1,142t/1,134g. Dec. 3, 1964. NTV Network, Kearney, Neb., 68847. (308) 743-2494. Licensee: NTV Enterprises Inc. (acq 6-1-74). Co-owned satellite of KHGI-TV, Kearney. ■ ABC. ■ Denny Reeves, stn mgr. ■ Rates: \$39; 32; 19.

Alliance

ADI No. 164; see page B-59

KDUH-TV—Licensed to Hay Springs. See Hay Springs.

***KTNE-TV**—ch 13, 288 kw vis, 57.5 kw aur, ant 1,550t/1,499g. Sept. 7, 1966. Box 83111, Lincoln, 68501. Licensee: Neb. ETV Commission. Co-owned satellite of *KUON-TV Lincoln. ■ PBS. ■ On 16 CATV's—17,655 subs. On 1 trans.

Licensee: Independent Bcstg Co. Ownership: J. H. G. Cooper, 25%; J. H. Cooper, 26%; J. O. Cooper, 26%. ■ CBS. Rep: H-R. Wash atty: Dempsey & Koplovitz. ■ Jerry Sweaney, VP, gen mgr & film buyer; Jack Lloyd, sls mgr; Kevin McAndrews, prog dir; Sherlu Walpole, prom mgr; Ron Arnold, news dir; Walter Stansbury, chief engr. ■ On 31 CATV's—34,400 subs. On 3 trans.

***KOZK**—ch 21, 537 kw vis, 53.7 kw aur, ant 1790t/2000g. Jan 21, 1975. M.P.O. Box 21, 65801. (417) 865-2100. Licensee: Springfield Community Television Inc. ■ PBS. Wash atty: Midlen & Reddy. ■ William T. Maynard, exec dir; William F. Curry, chief engr.

KYTV—ch 3, 100 kw vis, 20 kw aur, ant 2,040t/2,000g. Oct. 1, 1953. 999 W. Sunshine, 65804. (417) 866-2766. TWX 910-775-4714. Licensee: Springfield TV Inc. Ownership: Grand Prairie Investment Co., 50%; Springfield Newspapers Inc., 49.866%. See Nwspr. ■ NBC. Rep: Blair. Wash atty: Fisher, Wayland, Southmayd & Cooper. ■ Lester L. Cox, pres; Donald S. Moeller, VP & gen mgr; Carl Fox, VP progmg; Tom Flanagan, sls mgr; Clarence Martin, prom mgr; E. Dennis White, chief engr. ■ On 47 CATV's—43,000 subs. On 2 trans.

Montana

Billings

ADI No. 170; see page B-8

KTVQ—ch 2, 100 kw vis, 10.2 kw aur, ant 670t/383g. Nov. 9, 1953. Box 2557, 59103. (406) 252-5611. TWX 910-975-1925. Licensee: The Mont. Network. Ownership: See Garryowen Stns. ■ CBS, NBC. Rep: Avery-Knodel. Wash atty: Midlen & Reddy. ■ Joseph S. Sample, pres; Victor Miller, gen mgr; Pete Friden, natl sls mgr; Lee Lareva, opns dir; Duane Crants, prod mgr; Barry Wirth, news dir; Donald Bradley, film buyer; J. R. Middleton, chief engr. ■ On 12 CATV's. On 62 trans.

KULR-TV—ch 8, 316 kw vis, 38.9 kw aur, 750t/531g. March 15, 1958. Box 2512, 59103. (406) 252-4676. TWX 910-975-1020. Licensee: Harriscope Bcstg Corp. Ownership: Harriscope Stns. ■ ABC, NBC, CBS. Rep: H-R; Hyett; Simpson/Reilly; McGuire. Wash atty: Cohn & Marks. ■ E.D. Merrill, VP gen & natl sls mgr; Tom Ehrman, loc sls mgr; Ron Olson, opns mgr; Don Hardy, news dir; Dean Jansma, chief engr. ■ On 15 CATV's—46,500 subs. On 42 trans. ■ Rates: \$55; 30; 15.

Butte

ADI No. 158; see page B-47

***KMPT**—ch 7, 316 kw vis, 63 kw aur, ant 1870t/203g. Not on air, target date unknown. c/o Curt Wheeling, Box 195, Capitol Station, Helena, 59601. Licensee: Educl Bcstg Commission.

KTVM—ch 6, 100 kw vis, 12.6 kw aur, ant 1,936t/234g. May 12, 1970. Drawer M, Missoula, 59801. (406) 728-9318. TWX 910-963-2490. Licensee: KMSO-TV Inc. Ownership: Dale G. Moore, 100%. See Dale G. Moore Stns. Co-owned satellite of KGVO-TV, Missoula. ■ NBC, ABC. Rep: H-R; Simpson/Reilly; Hyett; Hix. Wash atty: Fisher, Wayland, Southmayd & Cooper. ■ Dale G. Moore, pres; Lynn H. Koch, natl and rgnl sls mgr; Wayne E. Killmer, gen mgr; Kirk Buls, sls mgr; Duane Barr, prog dir; Larry Cooper, news dir; Doug Drader, chief engr. ■ On 5 CATV's—9,100 subs. On 5 trans. ■ Rates: \$70; 50; 20.

KXLF-TV—ch 4, 100 kw vis, 20 kw aur, ant 1,890t/202g. Aug 14, 1953. Box 3500, 59701. (406) 792-9111. TWX 910-975-1939.

Licensee: Garryowen Butte TV Inc. Ownership: See Garryowen Stns. ■ CBS, ABC. Rep: Avery-Knodel; Art Moore. Wash atty: Midlen & Reddy. ■ Paul Simitzes, gen mgr; Jim Manning, sls mgr; Pete Friden, natl sls mgr; Don Bradley, film buyer; Ken Woosley, news dir; Weldon Paulsen, chief engr. ■ On 5 CATV's—9,100 subs. On 19 trans. ■ Rates: \$65; 45; 16.

Glendive

ADI No. 208; see page B-48

KXGN-TV—ch 5, 14.8 kw vis, 2.9 kw aur, ant 500t/146g. Nov 1, 1957. 210 South Douglas, 59330. (406) 365-3377. Licensee: Glendive Bcstg Corp. Ownership: Lewis Moore & family, 100%. ■ CBS, NBC. Rep: Devney; Hix. Wash atty: Daly, Joyce & Borsari. ■ Lewis W. Moore, pres; Winnifred Norton, prog dir, sls & office mgr; Donald Powers, chief engr. ■ On 3 CATV's—3,400 subs. On 6 trans. Co-owned: KXGN(AM).

Great Falls

ADI No. 172; see page B-29

KFBB-TV—ch 5, 100 kw vis, 20 kw aur, ant 590t/694g. March 21, 1954. Box 1139, 59403. (406) 453-4377. TWX 910-975-1917. Licensee: Harriscope Bcstg Corp. Ownership: See Harriscope Stns. ■ Net: ABC, CBS, NBC. Rep: H-R; McGuire; Simpson/Reilly; Hyett. Wash atty: Cohn & Marks. ■ Donald E. McClin-tock, VP & gen mgr; Jack Olson, gen sls mgr; Stan Whitman, prog dir; Dick Monaco, opns mgr; Ken Dunham, news dir; Earl Crowder, chief engr. ■ On 7 CATV's—16,600 subs. On 40 trans.

KRTV—ch 3, 87.1 kw vis, 10 kw aur, ant 590t/550g. Oct. 5, 1958. Box 1331, 59403. (406) 453-2433. TWX 910-975-1915. Licensee: Garryowen Corp. (acq 6-1-69). Ownership: See Garryowen Stns. ■ NBC, CBS. Rep: Avery-Knodel; Moore; Mountain Media; Montana TV Network; McDermott (Canada). Wash atty: Midlen & Reddy. ■ Joseph S. Sample, pres; Clifford Ewing, gen mgr; Pete Friden, natl sls mgr; Ed Kolman, sls mgr; Glenn Lockwood, opns dir & prom mgr; Ed Coghlan, news dir; Don Bradley, film buyer; Karl Black, chief engr. ■ On 8 CATV's—18,000 subs. On 37 trans. ■ Rates: \$50; 35; 10.

Helena

ADI No. 207; see page B-32

KTCM—ch 12, 214 kw vis, 21.4 kw aur, ant 2250t/176g. Jan 1, 1958. 2433 N. Montana Ave., 59601. (406) 443-5050. Licensee: Capital City TV Inc. Ownership: Tim Babcock, 56.6%; Bob Magness, 43.3%. ■ NBC, ABC. Rep: Savalli/Gates; McGuire. Wash atty: Kirkland, Ellis & Rowe. ■ Tim Babcock, pres; Steve Ralls, gen sls & prom mgr; Gary Tyree, prog dir; Sharon Aldridge, film buyer; Rod Grams, news dir; Tom Jenkins, chief engr. ■ On 1 CATV—4,500 subs. On 1 trans. ■ Rates: \$50; 42; 30.

Kalispell

ADI No. 158; see page B-47

KCFW-TV—ch 9, 26.5 kw vis, 5.3 kw aur, ant 2,794t/240g. June 10, 1968. Box 857, 59901. (406) 756-9051. Licensee: KMSO-TV Inc. Ownership: See Dale Moore Stns. Co-owned semi-satellite of KGVO-TV, Missoula. ■ NBC, ABC. Rep: Meeker; Simpson/Reilly; Hyett; Busby, Finch & Woods. Wash atty: Fisher, Wayland, Southmayd & Cooper. ■ Earl Morgenroth, pres; Scott Graber, gen mgr; Steve Felteit, prog dir; Mike Stocklin, prom mgr & film buyer; Phil Dunton, chief engr. ■ On 3 CATV's—6,000 subs. On 3 trans.

Nebraska TV

See page B-89 for explanation of listings.

Bassett

ADI No. 81; see page B-40

***KMNE-TV**—ch 7, 275 kw vis, 27.5 kw aur, ant 1,480/1,524g. Sept. 1, 1967. Box 83111, Lincoln, 68501. Licensee: Neb. ETV Commission. Co-owned satellite of *KUON-TV Lincoln. ■ PBS. ■ On 1 CATV—252 subs.

Columbus

KNCA-TV—Licensed to Albion. See Albion.

Gering

KSTF—Licensed to Scottsbluff. See Scottsbluff.

Grand Island

ADI No. 81; see page B-40

KGIN-TV—ch 11, 316 kw vis, 55 kw aur, ant 1,010/1,069g. Oct. 1, 1961. Box 1069, 68801. (308) 382-6100. TWX 910-621-8114. Licensee: Cornhusker TV Corp. Ownership: See John E. Fetzer Stns. Co-owned satellite of KOLN-TV Lincoln. ■ CBS. Rep: Avery-Knodel. Wash atty: Dow, Lohnes & Albertson. ■ Robert Schueler, stn mgr; Al Panec, news dir. ■ On 32 CATV's. On 19 trans. ■ Rates: \$190; 175; 50.

KHGI-TV—Licensed to Kearney. See Kearney.

Hastings

ADI No. 81; see page B-40

KHAS-TV—ch 5, 100 kw vis, 16.2 kw aur, ant 730/767g. Jan. 1, 1956. Box 578, 68901. (402) 463-1321. TWX 910-624-8123. Licensee: Nebraska Television Corp. Ownership: Seaton Pub Co., 51.6%; and others. See Seaton Stns, also Nwspr. ■ NBC. Rep: Young. Wash atty: Dow, Lohnes & Albertson. ■ Gladys D. Seaton, pres; Duane L. Watts, exec VP, chief operating off & film buyer; Bob Booe, asst gen mgr & news dir; Anthony Day, sls mgr; Anne Stout, prom mgr; Duane B. Allison, chief engr. ■ On 30 CATV's—40,000 subs. Co-owned: KHAS(AM).

KHGI-TV Licensed to Kearney. See Kearney.

***KHNE-TV**—ch 29, 383 kw vis, 76.6 kw aur, ant 1,220/1,238g. Nov 17, 1968. Licensee: Neb. ETV Commission. Co-owned satellite of *KUON-TV Lincoln. ■ PBS. ■ On 6 CATV's—4,799 subs.

Hayes Center

ADI No. 81; see page B-40

KWNB-TV—ch 6, 100 kw vis, 11.2 kw aur, ant 710/586g. Feb. 9, 1956. NTV Network, Kearney, 68847. (308) 743-2494. TWX: 910-960-3746. Licensee: NTV Enterprises Inc. (acq 6-1-74). Co-owned satellite of KHGI-TV, Kearney. ■ Rates: \$39; 32; 19.

Hay Springs

ADI No. 164; see page B-59

KDUH-TV—ch 4, 100 kw vis, 20 kw aur, ant 2,000/1,965g. March 5, 1958. Box 250, 69347. (308) 638-2741. Licensee: Duhamel Bcstg Enterprises. Ownership: Helen S. Duhamel, 66.7%; & others. See Duhamel Bcstg Stns. ■ NBC, ABC. Rep: H-R; Soderlund; Evans; McGuire. Wash atty: Fisher, Wayland, Southmayd & Cooper. ■ Helen S. Duhamel, pres; Jerry Dishong, gen mgr and news dir; Dan Lesmeister, gen sls mgr, prog dir and film

buyer; Irene Hale, prom mgr; Tom Reminiskey, chief engr. ■ On 21 CATV's. On 25 trans.

Kearney

ADI No. 81; see page B-40

KHGI-TV—ch 13, 316 kw vis, 63.2 kw aur, ant 1,115/1,163g. Dec. 24, 1953. NTV Network, 68847. (308) 743-2494. TWX 910-960-3746. Licensee: NTV Enterprises Inc. (acq 6-1-74). Ownership: Payne Enterprises Inc., 25%; Alan M. Oldfather, 16-2/3%; Richard H. Oldfather, 16-2/3%; Charles E. Oldfather, 16-2/3%; John W. Payne, 10%; John M. Crowley, 10%. ■ ABC. Rep: H-R; Soderlund; Gray; Hix. Wash atty: Fisher, Wayland, Southmayd & Cooper. ■ John W. Payne, pres; James D. Johnson, exec VP & gen mgr; John T. Benson, sls mgr; Don Welch, prod mgr; Linda Johnson, prom mgr; James D. Johnson, film buyer; Walker Merryman, news dir; Lloyd Mintzmyer, chief engr. ■ On 52 CATV's—44,000 subs. On 21 trans. ■ Rates: \$85; 50; 35.

Lexington

ADI No. 81; see page B-40

***KLNE-TV**—ch 3, 100 kw vis, 15.1 kw aur, ant 1,062/1,065g. Sept 6, 1965. Box 514, Holdrege, Neb., 68949. (308) 337-2311. Licensee: Neb. ETV Commission. Co-owned satellite of *KUON-TV, Lincoln. ■ Stan Sjol, trans supvr.

Lincoln

ADI No. 81; see page B-40



KOLN-TV—ch 10, 316 kw vis, 60.3 kw aur, ant 1,530/1,500g. Feb 18, 1953. Box 30350, 68503. (402) 467-4321. TWX 910-621-8114. Licensee: Cornhusker TV Corp. Ownership: See John E. Fetzer Stns. ■ CBS. Rep: Avery-Knodel. Wash atty: Dow, Lohnes & Albertson. ■ John E. Fetzer, chmn; A. James Ebel, pres & gen mgr; Wes Maser, gen sls mgr; Paul Jensen, mgr, prog dir & film buyer; Lynne Grasz, prom mgr & PR mgr; Bob Taylor, news dir; D. Ray Taylor, chief engr. ■ On 32 CATV's—13,600 subs. On 19 trans. ■ Rates: \$190; 175; 50.

***KUON-TV**—ch 12, 310 kw vis, 31 kw aur, ant 830/874g. Nov. 1, 1954. Box 83111, 68501. (402) 472-3611. TWX 910-621-8110. Licensee: U. of Neb. ■ PBS. Wash atty: Dow, Lohnes & Albertson. ■ Durward B. Varner, pres; Jack G. McBride, dir of TV & gen mgr; Ron Hull, prog mgr & film buyer; Ruthanna Russel, dir of info; William R. Ramsay, dir of engr. ■ On 20 CATV's—37,613 subs. On 1 trans.

McCook

ADI No. 54; see page B-77

KOMC—ch 8, 100.8 kw vis, 20 kw aur, ant 710/677g. Nov. 28, 1959. Box 184, Oberlin, Kan., 67749. Licensee: Kansas State Network Inc. Co-owned satellite of KARD-TV, Wichita, Kan. ■ NBC. ■ Robert Berkheimer, stn mgr. ■ On 9 CATV's—5,698 subs.

Merriman

ADI No. 88; see page B-68

***KRNE-TV**—ch 12, 182 kw vis, 16.9 kw aur, ant 1,066/1,029g. Dec. 9, 1968. Box 83111, Lincoln, 68501. Licensee: Neb. ETV Commission. Co-owned satellite of *KUON-TV Lincoln. ■ PBS. ■ On 1 CATV—747 subs.

Norfolk

ADI No. 119; see page B-67

KNCA-TV—Licensed to Albion. See Albion.

***KXNE-TV**—ch 19, 308 kw vis, 61.6 kw aur, ant 1,042/1,071g. Nov. 10, 1967. Box 83111, Lincoln, 68501. Licensee: Neb. ETV Commission. Co-owned satellite of *KUON-TV Lincoln. ■ PBS. ■ On 1 CATV—820 subs.

North Platte

ADI No. 203; see page B-51

KNOP-TV—ch 2, 56.9 kw vis, 11.2 kw aur, ant 630/609g. Dec. 2, 1958. Box 749, 69101. (308) 532-2222. Licensee: North Platte Television Inc. Ownership: Fer-Rich Bcstg Co., 93%. ■ NBC. Rep: Masla; Hix. Wash atty: Wilner & Scheiner. ■ Richard F. Shively, pres; Ulysses A. Carlini, gen & sls mgr; Don Feldman, news dir; Ross Hutcherson, chief engr. ■ On 2 CATV's—1,500 subs. On 5 trans. Co-owned: KNOP(AM).

***KPNE-TV**—ch 9, 316 kw vis, 31.6 kw aur, ant 1,020/1,006g. Sept. 12, 1966. Licensee: Neb. ETV Commission. Co-owned satellite of *KUON-TV Lincoln. ■ PBS. ■ On 4 CATV's. On 1 trans.

Omaha

ADI No. 63; see page B-53

KETV—ch 7, 316 kw vis, 60.3 kw aur, ant 1,356/1,362g. Sept. 17, 1957. 27th & Douglas Sts., 68131. (402) 345-7777. TWX 910-622-0710. Licensee: Channel 7 Corp. Ownership: Peter Kiewit Sons' Inc., 91.7%. See Nwspr. ■ ABC. Rep: Peters, Griffin, Woodward. Wash atty: Kirkland, Ellis & Rowe. ■ Kenneth H. James, pres & gen mgr; Ken J. Elkins, gen sls mgr; Dan R. Thompson, reg & lcl sls mgr; Al Dullnig, prog, pub affrs & film buyer; Lee Terry, mgng edit, news; Russell V. Goyette, chief engr. ■ On 37 CATV's. On 3 trans.

KMTV



KMTV—ch 3, 100 kw vis, 20 kw aur, ant 1,370/1,345g. Sept. 1, 1949. 2615 Farnam St., 68131. (402) 345-3333. TWX 910-622-0337. Licensee: May Bcstg Co. Ownership: See May Bcstg Stns. ■ NBC. Rep: Petry. Wash atty: McKenna, Wilkinson & Kittner. ■ Owen L. Sadtler, exec VP & gen mgr; Norman W. Williams, VP & asst gen mgr; Joe H. Baker, prog dir; Kay Rediger, prom dir; Art Jacobson, prog opns dir; Mark O. Gautier Jr., news dir; Gale A. Totten, dir of engr. ■ On 25 CATV's. On 4 trans.

***KYNE-TV**—ch 26, 33.9 kw vis, 6.76 kw aur, ant 430/409g. Oct. 25, 1965. Box 688, 68101. (402) 554-2516. Licensee: Neb. ETV Commission. ■ PBS; Neb. ETV. Wash atty: Dow, Lohnes & Albertson. ■ Philip Heckman, chmn; Paul Borge, gen mgr; John Evans, asst mgr & prog dir; Norman Herzog, chief engr. ■ On 3 CATV's—15,000 subs. Co-owned: KVNO(FM).

WOWT—ch 6, 100 kw vis, 20 kw aur, ant 1,380/1,358g. Aug. 29, 1949. 3501 Farnam St., 68131. (402) 346-6666. TWX 910-622-0488. Licensee: Chronicle Bcstg Co. (acq 7-9-75). Ownership: See nwspr. ■ CBS. Rep: Peters, Griffin, Woodward. Wash atty: Fletcher, Heald, Rowell, Kenahan and Hildreth. ■ Paul Wischmeyer, VP and gen mgr; Ed Zachary, gen sls mgr; Ken Ladage, prog dir and film buyer; Judy Horan, prom mgr; Steve Murphy, news dir; Bill Sturbe, chief engr. ■ On 28 CATV's—28,000 subs. On 2 trans. ■ Rates: \$650; 250; 125.

Scottsbluff

ADI No. 171; see page B-14

KDUH-TV—Licensed to Hay Springs. See Hay Springs.

KSTF—ch 10, 240 kw vis, 24 kw aur, ant 840t/674g. Aug. 7, 1955. Box 731, 69361. (308) 692-6107. Licensee: Wyneco Communications (acq 10-72). Ownership: See Lamb Communications. ■ CBS, ABC. Rep: Avery-Knodel; Soderlund; Hix. Wash atty: Fly, Shuebruk, Blume & Gaguine. ■ On 6 CATV's—8,500 subs. On 4 trans.

Superior

ADI No. 81; see page B-40

KSNB-TV—ch 4, 100 kw vis, 19.1 kw aur, ant 1,130t/1,086g. Oct. 1, 1965. NTV Network, Kearney, 68847. (308) 743-2494. Licensee: NTV Enterprises, Inc. (acq 6-1-74). Co-owned satellite of KHGI-TV, Kearney. ■ ABC. ■ Tom Nuss, stn mgr. ■ Rates: \$ 68; 40; 29.

Nevada

Elko

ADI No. 50; see page B-64

KEKO—ch 10, 26.38 kw vis, 5.276 kw aur, ant 1,885t/71g. April 1973. 4925 Energy Way, Reno, 89505. Licensee: Washoe Empire. Co-owned satellite of KTVN Reno. ■ CBS.

Henderson

KVVU-TV—Licensed to Henderson. See Las Vegas.

Las Vegas

ADI No. 140; see page B-38

KLAS-TV—ch 8, 291 kw vis, 57.6 kw aur, ant 1,200t/271g. July 8, 1953. Box 15047, 89114. (702) 735-7511. TWX 910-397-6968. Telex: 80-8328. Licensee: Summa Corp. (acq 3-24-68). Ownership: Howard R. Hughes, 100%. ■ CBS. Sp ½ hr wkly. Rep: Katz. Wash atty: Hogan & Hartson. ■ Nadine Henley, sr VP; Mark Smith, gen mgr; Edward R. Tabor, gen sls mgr; Fred Lewis, news edit; Allyn C. Cutler, controller; Sam Bowler, news dir; Tom Franklin, chief engr. ■ On 13 trans. ■ Rates: \$400; 135; 30.

***KLVX**—ch 10, 295 kw vis, 25 kw aur, ant 1,220t/176g. March 25, 1968. 5700 Mountain Vista St., 89120. (702) 451-1026. TWX 702-451-4730. Licensee: Clark County School District. ■ PBS. Wash atty: McKenna, Wilkinson & Kittner. ■ Dr. Ronald D. Hawley, gen mgr; William Haught, opns supvr; Ruth Uhls, prog & prom supvr; John K. Hill, ITV spec; Hank Tester, pub affairs supv. ■ On 5 trans.

KORK-TV—ch 3, 100 kw vis, 17.4 kw aur, ant 275t/513g. Jan. 23, 1955. Box 550, 89101. (702) 451-7600. TWX 910-397-6997. Licensee: Western Communications Inc. Ownership: See Donrey Media Group Stns, also Nwspr. ■ NBC. Rep: Peters, Griffin, Woodward. Wash atty: Covington & Burling. ■ Donald W. Reynolds, pres; Gene Spry, VP & gen mgr & film buyer; Rick Richardson, sls mgr; Walter Hopper, prog dir; Kathie Milone, comm affrs dir; Don Stubbs, news dir; James M. Garner, chief engr. ■ On 15 trans. Co-owned: KORK-AM-FM.

KSHO-TV—ch 13, 204 kw vis, 40.7 kw aur, ant 290t/440g. 1957. 3355 Valley View Blvd., 89102. (702) 876-1313. TWX 910-397-6984. Telex: 599-3211. Licensee: Ch 13 of Las Vegas Inc. Ownership: Arthur P. Williams and

family, 100%. ■ ABC. Rep: Avery-Knodel. Wash atty: Mullin, Connor & Rhyne. ■ Arthur P. Williams, pres; John Coco, VP & film buyer; Red Gilson, VP & gen sls mgr; Larry Massoli, prog dir; John Utley, prom mgr; David Cooper, news dir; Frank Anderson, chief engr. ■ On 5 trans. ■ Rates: \$150-300; 60-90; 25-40.

KVVU-TV (Henderson)—ch 5, 64.6 kw vis, 12.9 kw aur, ant 1,190t/139g. Sept. 10, 1967. 1800 Boulder Hwy, Henderson, 89015. (702) 565-9755. TWX 910-398-6922. Licensee: Nevada Independent Bcstg Corp. (acq 9-10-67). Ownership: William H. Hernstadt, 97%. ■ Rep: Avco. Wash atty: Gordon & Healy. ■ William H. Hernstadt, pres; Gary J. Walker, VP & gen mgr; John Locke, gen sls mgr; Rusty Durante, prog dir & film buyer; Thomas Purney, prom mgr; Ralph Menard, news dir; Jack Smith, chief engr. ■ On 6 trans. ■ Rates: \$60; 75; 30.

Reno

ADI No. 150; see page B-59

KCRL-TV—ch 4, 17.4 kw vis, 3.4 kw aur, ant 420t/92g. Sept. 30, 1962. Box 7160, 89510. (702) 322-9145. TWX 910-395-7080. Licensee: Circle L Inc. Ownership: E. L. Cord, 90%; C. E. Cord, 10%. ■ NBC. Rep: Avery-Knodel; Tacher. Wash atty: Pierson, Ball & Dowd. ■ Charles E. Cord, pres & gen mgr; Jim Elliott, stn- & gen sls mgr; Dick De Witt, news dir; Ron Oakley, chief engr. ■ On 9 CATV's—24,000 subs. On 15 trans. Co-owned: KCRL(AM). ■ Rates: \$90; 45; 20.

KOLO-TV—ch 8, 151 kw vis, 30.2 kw aur, ant 2,930t/120g. Sept. 27, 1953. Box 2610, 89505. (702) 786-8880. TWX 910-395-7051. Licensee: Nevada Radio-TV Inc. Ownership: See Donrey Media Group Stns, also Nwspr. ■ ABC. Rep: Peters, Griffin, Woodward. Wash atty: Covington & Burling. ■ Donald W. Reynolds, pres; James C. Herzig, VP & gen mgr; John Glenn, sls mgr; Ron Rash, prod mgr; R. J. Carothers, prog dir; Dave Nicholas, news dir; Jim Bull, chief engr. ■ On 19 CATV's—14,041 subs. On 19 trans. Co-owned: KOLO(AM).

KTVN—ch 2, 34.7 kw vis, 6.9 kw aur, ant 490t/151g. June 4, 1967. Box 2111, 89505. (702) 786-2212. Licensee: Washoe Empire. Ownership: Lee D. Hirshland, 24%; H. G. Wells, Robert A. Pairley, David McKay, each 16%, & others. ■ CBS. Rep: H-R. Wash atty: Cohn & Marks. ■ Lee D. Hirshland, pres & gen mgr; Jackson Fleming, sls mgr; Will Chism, opns dir; Ed Pearce, news dir; Pam Judge, prom mgr; Al Richards, chief engr. ■ On 10 CATV's—18,000 subs. On 18 trans.

New Hampshire

HAMILTON-LANDIS
G & ASSOCIATES, Inc.
NATIONWIDE MEDIA BROKERS
WASHINGTON, D. C. CHICAGO, DALLAS,
SAN FRANCISCO
SELL MORE
RADIO & TELEVISION STATIONS
IN THE EAST—NEAREST OFFICE IS—
1730 K ST., N.W., WASHINGTON 20006
(202) 393 3456

Berlin

ADI No. 78; see page B-57

***WEDB-TV**—ch 40, 10.5 kw vis, 2.1 kw aur, ant 300t/180g. April 30, 1969. Box Z, Durham, 03824. Licensee: U. of N.H. ■ PBS.

Neb., Nev., N.H., N.J. TV

See page B-89 for explanation of listings.

Durham

ADI No. 5; see page B-10

***WENH-TV**—ch 11, 316 kw vis, 63.1 kw aur, ant 980t/436g. July 6, 1959. Box Z, 03824. (603) 862-1047. TWX 510-297-4440. Licensee: U. of N.H. ■ PBS. Wash atty: Covington & Burling. ■ Dr. Eugéné S. Mills, pres; Keith J. Nighbert, gen mgr; Alton Hotaling, prog dir; Lyn Sawyer, prom mgr; Charles Tamm, dir of engr. ■ On 2 trans.

Hanover

ADI No. 78; see page B-57

***WHED-TV**—ch 15, 37.2 kw vis, 7.44 kw aur, ant 1,300t/455g. April 11, 1968. Box Z, Durham, 03824. Licensee: U. of N.H. ■ See *WENH-TV Durham.

Keene

ADI No. 5; see page B-10

***WEKW-TV**—ch 52, 37.5 kw vis, 7.5 kw aur, ant 1,080t/500g. May 21, 1968. Box Z, Durham, N.H., 03824. Licensee: U. of N.H. ■ Execs: See *WENH-TV Durham.

WRLP—Licensed to Greenfield, Mass. See Greenfield.

Lebanon

ADI No. 78; see page B-57

WRLH—ch 31, 10.48 kw vis, 3.08 kw aur, ant 270t/158g. July 26, 1966. The Mall, 03766. (603) 448-4550. Licensee: Upper Valley Television Bcstrs Inc. (acq 6-30-71). Ownership: Page & Baker, 79%; Stephen W. & Gretchen S. Taylor, 19%. ■ NBC. Rep: Kettell-Carter. Wash atty: Fly, Shuebruk, Blume & Gaguine. ■ Stephen H. Taylor, pres; Ridley W. Page, VP; Mark A. McGarhan, sls mgr; William Crangle, prog dir & news dir; George A. Cerbostias, chief engr. ■ On 4 CATV's—4,300 subs. On 2 trans.

Littleton

ADI No. 78; see page B-57

***WLED-TV**—ch 49, 36.7 kw vis, 7.35 kw aur, ant 1,285t/443g. Feb. 7, 1968. Box Z, Durham, N.H., 03824. Licensee: U. of N.H. ■ Execs: See *WENH-TV Durham.

Manchester

ADI No. 5; see page B-10

WMUR-TV—ch 9, 282 kw vis, 33.5 kw aur, ant 1,030t/227g. March 9, 1954. 1819 Elm St., 03105. (603) 623-8061. Licensee: United TV Co. of N.H. Ownership: See United Bcstg Co. Stns. ■ ABC. Rep: UBC Sls; Eckels & Queen. Wash atty: Smith & Pepper. ■ Richard Eaton, pres; S. E. Phillips, VP & gen mgr; Ray Harris, prog dir; Gus Bernier, prom mgr; Maurice Wynne, chief engr. ■ On 38 CATV's—85,000 subs. ■ Rates: \$77; 64; 38.

New Jersey

Burlington

WKBS-TV—Licensed to Burlington. See Philadelphia.

Camden

ADI No. 4; see page B-56

***WNJS**—ch 23, 809.1 kw vis, 125 kw aur, ant

New Jersey, New Mexico TV

See page B-89 for explanation of listings.

890t/937g. Oct. 23, 1972. 1573 Parkside Ave., Trenton, N.J., 08638. Licensee: New Jersey Public Bcstg Authority. ■ Execs: See *WNJT Trenton.

Linden

WNJU-TV—Licensed to Linden. See Newark.

Montclair

ADI No. 1; see page B-50

***WNJM**—ch 50, 882.9 kw vis, 132.4 kw aur, ant 800t/656g. June 5, 1973. 1573 Parkside Ave., Trenton, N.J., 08638. Licensee: New Jersey Public Bcstg Auth. ■ Execs: See *WNJT Trenton.

Newark

ADI No. 1; see page B-50

WBTB-TV—ch 68, 795.25 kw vis, 799.75 kw aur, ant 968t/347g. Sept. 29, 1974. Box 296, West Orange, 07052. (201) 731-9024. Licensee: Blonder-Tongue Corp. Ownership: Isaac Blonder, 77%; Ben H. Tongue, 23%. ■ Jap 3 hrs wkly. Rep: Savalli/Gates. Wash atty: Fly, Shuebruk, Blume & Gaguine. ■ Isaac S. Blonder, pres; Eugene E. Inger, gen mgr; John Myers, gen sls mgr; Victor Longtin, prog dir; Keith A. House, stn mgr; Robert Fasbender, news dir; Craig Ferring, chief engr. ■ On 45 CATV's—280,000 subs. ■ Rates: \$75; 65; 55. ■ **WNET**—Licensed to Newark. See New York.

WNJU-TV(Linden)—ch 47, 12.1 kw vis, 2.42 kw aur, ant 1,180t/1,465g. May 16, 1965. 1020 Broad St., Newark, 07102. (201) 643-9100. Telex 13-8891. Licensee: WNJU-TV Bcstg Corp. (acq 12-23-70). Ownership: See Columbia Pictures Industries Stns. ■ Sp full time. Wash atty: Fletcher, Heald, Rowell, Kenahan & Hildreth. ■ Carlos Barba, VP gen mgr; Jerry Mac Farland, sls mgr; Monolo Iglesias, news dir; Daniel Rutman, chief engr. ■ Rates: \$105; 50; —.

New Brunswick

ADI No. 1; see page B-50

***WNJB**—ch 58, 1,000 kw vis, 198 kw aur, ant 730t/401g. June 5, 1973. 1573 Parkside Ave., Trenton, 08638. Licensee: New Jersey Public Bcstg Authority. ■ Execs: See *WNJT Trenton.

Paterson

ADI No. 1; see page B-50

WXTV—ch 41, 1,020 kw vis, 204 kw aur, ant 890t/955g. Aug. 4, 1968. 641 Main St., 07503. (201) 345-0041. Telex 130-421. Licensee: Spanish International Communications Corp. Ownership: See Spanish Intl Communications Stns. ■ Sp full time. Rep: Spanish Intl Net Sls. Wash atty: McKenna, Wilkinson & Kittner. ■ Rene Anselmo, pres; Sally Segal, gen mgr; Ivan Egas, gen sls mgr; Leandro Blanco, stn mgr; Guillermo Restrepo, news dir; Edward McDonnell, chief engr. ■ On 20 CATV's—150,000 subs.

Trenton

ADI No. 4; see page B-58

***WNJT**—ch 52, 813 kw vis, 126 kw aur, ant 890t/975g. April 5, 1971. 1573 Parkside Ave., 08638. (609) 882-5252. TWX 510-685-9576. Licensee: New Jersey Public Bcstg Authority. ■ PBS; EEN (regional). Wash atty: Welch, Morgan & Kleindienst. ■ Dr. Lawrence T. Frymire, exec dir and gen mgr; Douglas Leonard,

dir of progmg; Geo. Perkins, news dir; John Wilner, chief engr. ■ On 30 CATV's.

Wildwood

ADI No. 4; see page B-58

WCMT-TV—ch 40, 16.6 kw vis, 1.66 kw aur, ant 200t/223g. Jan. 25, 1966. 3010 New Jersey Ave., 08260. (609) 522-1416. Licensee: Jersey Cape Bcstg Corp. Ownership: William C. Wotring Jr., Carlton S. Owen, Frank W. Strohm, each 33.3%; Francis J. Matrangola, 0.1%. ■ NBC. Rep: Dome. Wash atty: Daly, Joyce & Borsari. ■ William C. Wotring Jr., pres & gen mgr; Frank Strohm, sls mgr & film buyer; Ed McDonough, prog dir; Carlton S. Owen, opns mgr & chief engr; Jack Weigand, news dir. ■ On 9 CATV's—39,200 subs. Co-owned: WCMC-AM-FM. ■ Rates: \$18; 18; 12.

New Mexico

Albuquerque

ADI No. 80; see page B-2

KGGM-TV—ch 13, 89.1 kw vis, 9 kw aur, ant 4,180t/143g. Oct. 3, 1953. Box 1294, 87103. (505) 243-2285. TWX 910-989-1676. Licensee: N. M. Bcstg Co. Ownership: Goldie Hebenstreit, 56.6%; Harriscope Bcstg, 30%; & others. See Harriscope Stns. ■ CBS. Rep: Katz. Wash atty: Dow, Lohnes & Albertson. ■ Bruce Hebenstreit, pres & gen mgr; W. Q. Edholm, VP sls mgr & prog dir; Linda Thorne, prom dir; Jim Hussin, news dir; Richard Doyle, chief engr. ■ On 20 CATV's—25,000 subs. On 50 trans.

KMXN-TV—ch 23, 11.7 kw vis, 2.2 kw aur, ant minus 25t/291g. 1975. 7221 N. Hills Blvd., N.E., 87109. Licensee: Spanish TV of New Mexico. Ownership: Odís L. Echols Jr., 44.2%; Clarence L. Holgerson, & Herbert J. Taylor, both 13.4%, et al. ■ Wash atty: Daly, Joyce, Borsari & George.

***KNME-TV**—ch 5, 27 kw vis, 5.6 kw aur, ant 4,150t/123g. May 5, 1958. 1130 University Blvd N., 87106. (505) 277-2121. DACS 505-247-2996. Licensee: Albuquerque Public School System and U. of N.M. ■ PBS. ■ Robert M. Gordon, acting gen mgr & chief engr; Carlos Molina, prog dir; David Canleer, prod mgr. ■ On 16 CATV's—47,984 subs. On 13 trans.

KOAT-TV—ch 7, 73.5 kw vis, 14.6 kw aur, ant 4,240t/257g. Sept. 28, 1953. 1377 University Blvd. N.E., 87106. (505) 247-0101. TWX 505-243-8364. Licensee: KOAT-TV Inc. Ownership: See Pulitzer Stns, also Nwspr. ■ ABC. Rep: Blair. Wash atty: Marmet Professional Corp. ■ Joseph Pulitzer Jr., pres; Max A. Sklower, gen mgr; Arthur Pinson, sls mgr; Elvin Smith, opns mgr & film buyer; Miles Resnick, news dir; Dan Ricker, prod mgr; James H. Sharman, chief engr. ■ On 21 CATV's—31,800 subs. On 46 trans.



KOB-TV—ch 4, 27 kw vis, 5.4 kw aur, ant 4,203t/183g. Nov. 29, 1948. Box 1351, 87103. (505) 243-4411. TWX 910-989-1682. Licensee: Hubbard Bcstg Inc. Ownership:

Hubbard Bcstg Stns. ■ NBC. Rep: Petry, Wash atty: Fletcher, Heald, Rowell, Kenahan & Hildreth. ■ Stanley E. Hubbard, chmn; Stanley S. Hubbard, pres; Jerry Danziger, gen mgr, prog dir & film buyer; David Herman, sls mgr; Ray Davenport, prom mgr; Gordon Sanders, news dir; Fern Bibeau, chief engr. ■ On 37 CATV's—70,000 subs. On 65 trans. Co-owned: KOB-AM-FM. ■ Rates: \$210; 60; 35.

Carlsbad

ADI No. 183; see page B-82

KAVE-TV—ch 6, 26.3 kw vis, 5.3 kw aur, ant 1,200t/1,047g. August 1959. Box 219, 88220. (505) 885-3931. Licensee: John B. Walton Jr. (acq 10-66). Co-owned satellite of KELP-TV, El Paso. ■ ABC. ■ Edwin W. Booth, gen mgr & chief engr. ■ On 4 CATV's. On 2 trans.

Clovis

ADI No. 109; see page B-4

KFDW-TV—ch 12, 178 kw vis, 35.3 kw aur, ant 670t/719g. December 1957. Box 922, Portales, 88130. (505) 276-8444. Licensee: Bass Bcstg Co. Ownership: See Bass Bcstg Stns. ■ CBS. Rep: H-R. Wash atty: Miller & Schroeder. ■ Melvin L. Wheeler, pres; Earle H. Rast Jr., gen mgr; Dave Coons, chief engr.

Farmington

ADI No. 204; see page B-25

KIVA-TV—ch 12, 158 kw vis, 15.8 kw aur; ant 410t/210g. 1972. Box 1620, 87401. (505) 327-9881. TWX 910-980-0604. Licensee: Four States TV Inc. Ownership: Gerald R. Proctor, 50%; Jerry Johnson, 20%; Allen Theaters Inc., 15%; Charles Martin Ball, 15%. ■ NBC. Rep: Savalli/Gates; Hix. ■ Gerald R. Proctor, pres & gen mgr; Charles M. Ball, sls mgr; Jerry Lee, opns mgr; John A. Parker, chief engr. ■ On 3 CATV's—8,000 subs. On 2 trans.

Las Cruces

ADI No. 102; see page B-23

***KRWG-TV**—ch 22, 1,620 kw vis, 350 kw aur, ant 450t/403g. June 29, 1973. Drawer 3J, 88003. (505) 646-2212. Licensee: Regents of New Mexico State U. ■ PBS. ■ Frank F. Hash, dir; James A. Dryden, gen mgr; Joachim DeBlasi, prog dir; James Ficklin, prod dir; Sandra Steinberg, news dir; James Doiron, chief engr. ■ On 7 CATV's—20,000 subs. Co-owned: KRWG(FM).

Portales

ADI No. 109; see page B-4

***KENW**—ch 3, 100 kw vis, 20 kw aur; ant 1,150t/1,085g. Sept. 1, 1974. Eastern New Mexico University, 88130. (505) 562-3112. Licensee: Regents of Eastern N. M. Univ. ■ PBS; Rocky Mountain Public Bcst Net. ■ Warren B. Armstrong, pres; Duane W. Ryan, gen mgr; Larry Ahlstrom, chief engr. ■ Co-owned: KENW-FM.

Roswell

ADI No. 183; see page B-82

KBIM-TV—ch 10, 316 kw vis, 40.7 kw aur, ant 1,999t/1,839g. Feb. 26, 1966. Box 910, 88201. (505) 622-2120. TWX 910-986-0072. Licensee: Holsum Inc. Ownership: Gene Reichman, 47.7%; J. Kenneth Smith, 26.4%; W. C. Taylor, 14.5% & others. ■ CBS. Rep: Avery Knodel, Hix. Wash atty: Dow, Lohnes & Albertson. ■ W.C. Taylor, pres; Joe Carriere, VP & gen mgr; Gene Rader, chief engr. ■ On 24 CATV's Co-owned: KBIM-AM-FM. ■ Rates: \$45; 35; 12.

KSWs-TV—ch 8, 316 kw vis, 52.5 kw aur, ant 1,760t/1,610g. June 24, 1953. Box 2190, Lubbock, Tex., 79408. (806) 744-1414. TWX 910-896-4306. Licensee: State Telecasting Inc. (acq 6-17-71). ■ NBC. ■ Co-owned satellite of KCBT-TV, Lubbock, Tex. ■ Rates: \$150; 40; 30.

New York

Hogan-Feldmann, Inc.
MEDIA BROKERS • CONSULTANTS
16255 Ventura Boulevard, Suite 415
Encino, California 91436
AREA CODE 213 986-3201

Albany

ADI No. 43; see page B-2

WAST—ch 13, 110 kw vis, 11 kw aur, ant 1,210t/765g. Feb. 19, 1954. Box 4035, 12204. (518) 436-4791. TWX 710-441-8282. Licensee: Sonderling Broadcasting Corp. (acq 1-1-69). Ownership: See Sonderling Stns. ■ ABC. Rep: Peters, Griffin, Woodward. Wash atty: Fly, Shuebruk, Blume & Gaguine. ■ Egmont Sonderling, pres; Michael J. Corken, VP & gen mgr; Richard L. Herd, natl sls mgr; James Hill, loc sls mgr; John R. Lease, prog dir & film buyer; Charles Burnell, prom mgr; Terry Connelly, news dir; Daniel Fiorillo, chief engr. ■ On 46 CATV's—137, 587 subs. On 4 trans.

WRGB (Schenectady)—ch 6, 93.3 kw vis, 11 kw aur, ant 1,020t/314g. Nov. 6, 1939. 1400 Balltown Rd., Schenectady, 12309. (518) 377-2261. TWX 518-556-2092. Licensee: General Electric Bcstg Co. Ownership: General Electric Bcstg Co., 100%. See General Electric Stns. ■ NBC. Rep: Blair. Wash atty: McKenna, Wilkinson & Kittner. ■ Reid Shaw, pres; James Delmonico, gen mgr; Dave Martin, sls mgr; Arthur Garland, prog dir & film buyer; Walter McDowell, prom mgr; Donald Decker, news dir; Charles King, opns mgr. ■ On 32 CATV's—47,000 subs. Co-owned: WGY(AM)-WGFM(FM), Schenectady.

WTEN—ch 10, 200 kw vis, 30 kw aur, ant 1,000t/275.5g. Oct. 14, 1953. 341 Northern Blvd., 12204. (518) 436-4822. TWX 710-441-8203. Licensee: Poole Bcstg Co. Inc. (acq 4-27-71). Ownership: See Poole Bcstg Co. ■ CBS. Rep: TeleRep. Wash atty: Wilmer, Cutler & Pickering. ■ Albert J. Gillen, pres; Paul M. Hughes, VP & gen mgr; Vince DeLuca, gen sls mgr; Gene Collins, prog dir & prom mgr; Tom Bryson, news dir; Thomas Johnson, chief

enr. ■ On 64 CATV's—237,233 subs. On 3 trans. ■ Rates: \$540; 105; 80.

Binghamton

ADI No. 115; see page B-9

WBJA-TV—ch 34, 204 kw vis, 39.8 kw aur, ant 900t/544.74g. Nov. 25, 1962. Box 813, 13902. (607) 798-7111. Licensee: WBJA-TV Inc. Ownership: Empire Television & Radio Inc. ■ ABC. Rep: Devney. Wash atty: Fly, Shuebruk, Blume & Gaguine. ■ O. Lazare, sec-treas; J. J. L. Hessen, VP; Ralph Fabrizio, VP & gen mgr; George Rydos, sls mgr; Lowell Nelson, chief engr. ■ On 23 CATV's.

WBNG-TV—ch 12, 166 kw vis, 18.2 kw aur, ant 1,200t/785g. Dec. 1, 1949. 50 Front St., 13905. (607) 723-7311. TWX 510-252-1991. Licensee: Gateway Communications Inc. Ownership: Bergen Evening Record, 80%; George A. Koehler, 13%. See Gateway Communications. ■ CBS. Rep: Blair. Wash atty: Wiener & Scheiner. ■ George A. Koehler, pres; Robert W. Harkness, gen mgr; LeRoy V. Bertin, gen sls mgr; Judy Girard, prog dir; Michael A. LaMonia, chief engr. ■ Rates: \$300; 140; 80.

WICZ-TV—ch 40, 501 kw vis, 50.1 kw aur, ant 1,230t/934g. Nov. 1, 1957. 70 Henry St., 13902. (607) 723-8251. TWX 607-772-0240. Licensee: Stainless Inc. (acq 4-7-71). Ownership: Henry J. Guzewicz, 60%; Richard J. Eberle, 38%. ■ NBC. Rep: H-R; McDermott (Canada). Wash atty: Dow, Lohnes & Albertson. ■ Henry J. Guzewicz, pres; Joseph J. Kilcullen, gen & sls mgr; Marty Owens, natl sls mgr; Robert Dunn, prog dir & film buyer; Gino Ricciardelli, chief engr. ■ On 41 CATV's—23,000 subs.

***WSKG**—ch 46, 505 kw vis, 101 kw aur, ant 1,227t/924g. May 12, 1968. Box 97, Endwell, 13760. (607) 754-4777. Licensee: Southern Tier ETV Assn Inc. ■ PBS. Net: New York Net; Eastern Educl Net. Wash atty: Norman Jorgensen. ■ David W. Allen, chmn; Arthur F. Dees, pres & gen mgr; Mary L. Doolittle, bus mgr; Timothy B. Conroy, dev mgr; Robert L. Owens, prog mgr; Wayne H. Olsen, ITV mgr; Phillip P. Jackson, stn proj mgr; Gordon Burdo Jr., news prod; Edward Y. Wright, chief engr. ■ On 31 CATV's—123,780 subs. On 1 trans. Co-owned: WSKG-FM.

Buffalo

ADI No. 27; see page B-11

WBEN-TV—ch 4, 100 kw vis, 20 kw aur, ant 1,200t/1,059g. May 14, 1948. 2077 Elmwood Ave., 14207. (716) 876-0930. TWX 710-522-1719. Licensee: WBEN Inc. Ownership: Buffalo Evening News. See Nwspr. ■ CBS. Rep: Harrington, Righter & Parsons; Stephens & Towndrow (Canada). Wash atty: Fletcher, Heald, Rowell, Kenahan & Hildreth. ■ Leslie G. Arries Jr., pres; George R. Torge, VP; George D. Lilly, sls mgr; Quintin E. Renner, prog dir & film buyer; Margit L. Clark, prom mgr; Raymond

New Mexico, New York TV

See page B-89 for explanation of listings.

Hasson, news dir; Joseph W. Koral, cmnty svcs dir; Frank A. Maser, dir engr. ■ On 107 CATV's—435,000 subs. Co-owned WBEN-AM-FM. ■ Rates: \$925; 325; 180.

WGR-TV—ch 2, 100 kw vis, 20 kw aur, ant 1,000t/961.9g. Aug. 14, 1954. 259 Delaware Ave., 14202. (716) 856-1414. TWX 710-522-1729. Licensee: Taft Bcstg Co. Ownership: See Taft Stns. ■ NBC. Rep: MMT; Television Mktg Svcs (Canada). Wash atty: Koeten & Burt. ■ Lawrence H. Rogers II, pres; Earl Beall, VP & gen mgr; Mike Fisher, gen sls mgr; Edward Herbert, opns mgr & film buyer; Kurt Eichsteadt, prom mgr; Stewart Dan, news dir; Hal Higgins, mgr of engr. ■ On 33 CATV's—124,976 subs. Co-owned WGR(AM)-WGRQ(FM).

WKBW-TV—ch 7, 91.2 kw vis, 18.2 kw aur, ant 1,420t/1,076g. Nov. 30, 1958. 1420 Main St., 14209. (716) 883-0770. TWX 710-522-1846. Licensee: Capital Cities Communications Inc. Ownership: See Capital Cities Stns. ■ ABC. Rep: Blair; OPEX. Wash atty: Wilmer, Cutler & Pickering. ■ Robert King, sr VP; Philip R. Beuth, VP & gen mgr; Richard C. Shepard, gen sls mgr; Marc Edwards, loc sls mgr; Alan B. Bennett, prog dir; Irv Weinstein, news dir; Barry Barth, prom mgr; Don Holland, chief engr. ■ On 125 CATV's—150,000 subs. Co-owned: WKBW(AM).

***WNED-TV**—ch 17, 1150 kw vis, 115 kw aur, ant 720t/742g. March 30, 1959. Box 1263, 14240. (716) 881-5000. TWX 710-522-1166. Licensee: Western N.Y. Educl TV Assn. ■ PBS. Eastern Educl Net. Wash atty: Schwartz & Woods. ■ J. Michael Collins, pres & gen mgr; John L. Hutchinson Jr., dir progmg; John Reynolds, dir dev; Harry Wyman, dir engr. ■ On 20 CATV's—140,000 subs.

WUTV—ch 29, 1,050 kw vis, 105 kw aur, 920t/959g. Dec. 21, 1970. 951 Whitehaven Rd., 14072. (716) 773-7531. TWX 710-260-1359. Licensee: Ultravision Bcstg Co. Ownership: Florian R. Burczynski, 58.1%; Stanley J. Jasinski, 13.6%, and others. ■ Rep: AVCO; Radio-TV Reps Ltd. (Canada). Wash atty: Pierson, Ball & Dowd. ■ Stanley Jasinski, pres; Herman Pease, gen mgr & film buyer; Arthur R. Zweig, gen sls mgr; Denise Krumm, prog coord; Ellen Goldstein, prom mgr; John Clemens, news dir; Phillip Popp, chief engr. ■ Rates: \$80; 120; 65.

Carthage

WWNY-TV—Licensed to Carthage. See Watertown.

Corning

WSYE-TV—Licensed to Elmira. See Elmira.

You belong in Broadcasting

New York TV

See page B-89 for explanation of listings.

Elmira

ADI No. 49; see page B-70

WENY-TV—ch 36, 427 kw vis, 85.4 kw aur, 1,050/840g. Nov. 19, 1969. Box 208, 14902. (607) 739-3636. Licensee: WENY Inc. Ownership: See Green Stns, also Nwspr. ■ ABC. Wash atty: Jacob & Cordon. ■ Howard L. Green, exec VP; C. Robert Edwards, stn mgr; John Herrick, prog dir; Hazel Riedell, prom mgr; Vince Murphy, news dir; Howard L. Green, film buyer; Larry Taylor, chief engr. ■ On 33 CATV's—80,000 subs. Co-owned: WENY-AM-FM.

WSYE-TV—ch 18, 113 kw vis, 22.4 kw aur, ant 1,220/843g. Sept. 10, 1956. 1030 James St., Syracuse, 13203. (315) 474-3911. Licensee: Newhouse Bcstg Corp. Co-owned semisatellite of WSYR-TV, Syracuse. ■ NBC. Rep: Harrington, Righter & Parsons. Wash atty: Dow, Lohnes & Albertson. ■ E. R. Vadeboncoeur, pres; Don Buies, gen. sls & prom mgr; Bruce E. Flaherty, news dir; T. A. Greene, chief engr. ■ On 21 CATV's—40,000 subs.

Garden City

ADI No. 1; see page B-50

***WLIW**—ch 21, 1220 kw vis, 122 kw aur, ant 3801/409g. Jan. 6, 1969. Ellington Ave. W., 11530. (516) 248-2140. Licensee: Long Island ETV Council Inc. ■ PBS. Wash atty: Norman E. Jorgensen. ■ Dr. Alexander Schure, pres; Charles R. Bell, gen mgr; Geraldine Carmody, prog dir & film buyer; Edith C. Ialleggio, dir crmnty rel; Samuel Edsall, chief engr. ■ On 21 CATV's—110,000 subs.

New York

ADI No. 1; see page B-50

TO BUY OR SELL A TELEVISION OR RADIO STATION

HAMILTON-LANDIS & ASSOC., Inc.

WASHINGTON, D.C.

1730 K St., N.W.
(202) 393-3456

SAN FRANCISCO

111 Sutter St.
(415) 392-5671

CHICAGO

1429 Tribune Tower
(312) 337-2754

DALLAS

6060 N. Central Expwy.
(214) 691-2345

NATIONWIDE • NEGOTIATIONS FINANCING • APPRAISALS

WABC-TV—ch 7, 110 kw vis, 11 kw aur, ant 1,380/1,465g. Aug. 10, 1948. 1330 Ave. of Americas, 10019. (212) LT 1-7777. TWX 212-640-4540. Licensee: ABC Inc. Ownership: See ABC-Owned Stns. ■ ABC. Rep: ABC TV Spot Sales. Wash atty: McKenna, Wilkinson & Kittner. ■ Richard A. O'Leary, pres; Kenneth H. MacQueen, VP & gen mgr; John S. Bonanni, gen sls mgr; Seymour Horowitz, prog dir; Jonathan Olken, dir adv & press info; Phil Nye, news dir; James Baker, chief engr. ■ Co-owned: WABC(AM)-WPLJ(FM).

WBTB-TV—Licensed to Newark, N.J. See Newark, N.J.

WCBS-TV—ch 2, 42 kw vis, 21 kw aur, ant 1,300/1,465g. July 1, 1941. 51 W. 52d St., 10019. (212) 765-4321. TWX 212-867-7987.

Licensee: CBS Inc. Ownership: See CBS Owned Stns. ■ CBS. Rep: CBS-TV Stns Natl Sls. ■ Thomas F. Leahy, VP & gen mgr; Marvin B. Shapiro, dir of sls; Gail Trell, gen sls mgr; Tom Smith, prog mgr; Robert E. Shay, dir of bcstg; Ed Joyce, news dir; Chris Ridley, mgr of adv; Linda Goldman, opns mgr. ■ Co-owned: WCBS-AM-FM.

WNBC-TV—ch 4, 25.7 kw vis, 12.9 kw aur, ant 1,440/1,465g. July 1, 1941. 30 Rockefeller Plaza, 10020. (212) 247-8300. TWX 212-640-5788. Licensee: NBC. Ownership: See NBC Owned Stns. ■ NBC. Rep: NBC Spot Sls. ■ Arthur A. Watson, exec VP & gen mgr; Lawrence E. Gershman, stn mgr; Diran Demirian, sls mgr; Dick Gold, natl sls mgr; Stan Levy, loc sls mgr; Ann Berk, adv & prom mgr; Roger Lefkon, prog mgr; Earl Ubell, news dir; Lawrence C. Johnson, mgr crmnty affairs; Alvin Slep, mgr press & publ; William Ryden, prog mgr; Jack Hughes, mgr stn engrg. ■ Co-owned: WNBC-AM-FM.

***WNED** (Newark, N.J.)—ch 13, 178 kw vis, 34.7 kw aur, ant 1,190/1,200g. Jan. 2, 1948. 304 W. 58th St., New York, 10019. (212) 262-4200. Licensee: Educl Bcstg Corp. ■ PBS, Eastern Educl Net. Wash atty: McKenna, Wilkinson & Kittner. ■ John Jay Iselin, pres; Curtis Messinger, VP finance; Frank Leicht, VP & dir prod svcs; Mal Albaum, dir of engrg; Angela Solomon, dir of publ; Robert Kattawitz, prog dir.

WNEW-TV—ch 5, 37.1 kw vis, 5.5 kw aur, ant 1,330/1,465g. May 2, 1944. 205 E. 67th St., 10021. (212) 535-1000. TWX 212-867-4835. Licensee: Metromedia Inc. Ownership: See Metromedia Stns. ■ Rep: Metro TV Sales. Wash atty: Thomas J. Dougherty. ■ John W. Kluge, chmn & pres, Metromedia Inc.; Albert P. Krivin, pres TV; Lawrence P. Fraiberg, VP gen mgr; Charles T. (Budd) Meehan, gen sls mgr; Lennart Ringquist, prog mgr; Joanna Dymond, dir of adv & prom; Mark Monsky, news dir; William D. Kelly, VP & chief engr. ■ Co-owned: WNEW-AM-FM.

WNJU-TV—See Newark, N.J.

***WNYC-TV**—ch 31, 25.1 kw vis, 2.51 kw aur, ant 1,290/1,470g. Nov. 1, 1962. 2500 Municipal Bldg, 10007. (212) 566-2118. Licensee: City of N.Y. ■ PBS. Wash atty: Rhyne & Rhyne. ■ Arnold Labaton, dir; Matt Biberfeld, exec off; Bernard Buck, prog mgr; Morris K. Kunins, chief engr. ■ On 8 CATV's—75,000 subs. Co-owned: *WNYC-AM-FM.

***WNYE-TV**—ch 25, 589 kw vis, 117 kw aur, ant 577/597g. April 3, 1967. 112 Tillary St., Brooklyn, 11201. (212) 596-5064. Licensee: New York City Bd of Educ. ■ PBS; Eastern Educl Net. Wash atty: Cohn & Marks. ■ Cecil H. Sufferin, dir of bcstg; Florence Monroe, asst dir of bcstg; Jerome Silverstein, prod supvr; Benjamin Linder, chief supvr TV. ■ On 2 CATV's. Co-owned: *WNYE-FM.

WOR-TV—ch 9, 155 kw vis, 31 kw aur, ant 1,240/1,231g. Oct. 5, 1949. 1440 Broadway, 10018. (212) 764-7000. TWX 212-640-5160. Licensee: RKO General Inc. Ownership: See RKO Gnl Stns. ■ Rep: RKO TV Reps. Wash atty: Pierson, Ball & Dowd. ■ Robert J. Williamson, VP gen mgr; Robert T. Fennimore, gen sls mgr; Peter Mitchell, natl sls mgr; George W. Snowden, VP prog & opns; Alan Zimmerman, news dir; Andrew Duca, prom mgr; John Murray, VP pub affrs; Richard Quodomine, chief engr. ■ Co-owned: WOR-AM-FM.

WPIX—ch 11, 58.35 kw vis, 11.67 kw aur, ant 1,663/1,464g. June 15, 1948. 220 E. 42d St., 10017. (212) 883-1100. TWX 710-581-2768. Licensee: WPIX Inc. Ownership: See NY News (Tribune Co.) 52% and others. ■ Rep: Peters, Griffin, Woodward. Wash atty: Kirkland, Ellis & Rowe. ■ L. J. Pope, pres; Richard N. Hughes, senior VP; T. E. Mitchell, senior VP finance & administration; Hendrick Booraem, VP progmg; William Cooper, VP film; Otis Freeman, VP engrg; Gerard Mulderg, VP sls; F. X.

Tuoti, VP mktg; John Corporan, VP news. ■ On 240 CATV's—1,357,000 subs. Co-owned: WPIX-FM.

North Pole

WPTZ—Licensed to North Pole. See Plattsburgh.

Norwood

ADI No. 162; see page B-75

***WNPI-TV**—ch 18, 556 kw vis, 83.4 kw aur, ant 797/1758g. Aug. 30, 1971. c/o Richard A. Jones, Box 114, Watertown, 13601. (315) 782-3142. Licensee: St. Lawrence Valley ETV Council. ■ PBS. Wash atty: Schwartz & Woods. ■ Richard A. Jones, pres & gen mgr; William J. Saiff Jr., opns mgr, prog dir & film buyer; Donna D. Kelley, news dir; James W. Edwards, chief engr. ■ On 14 CATV's.

Patchogue

ADI No. 1; see page B-50

WSNL-TV—ch 67, 1280 kw vis, 208 kw aur, ant 440/1450g. November 1973. Central Islip, 11722. (512) 582-6700. Licensee: Suburban Bcstg Corp. (acq 4-75). ■ Wash atty: Gordon & Healy.

Plattsburgh

ADI No. 100; see page B-12

***WCFE-TV**—ch 57, 513 kw vis, 102 kw aur, ant 1,645/1440g. Not on air, target date 8-1-76. c/o State University College, 12901. Permittee: Northeast N.Y. ETV Assoc. ■ Wash atty: Dow, Lohnes & Albertson. ■ Paul C. Hassenplug, gen mgr; William F. Slook Jr., prog mgr; Newton D. Dunn, chief engr.

WPTZ (North Pole)—ch 5, 25.1 kw vis, 4.3 kw aur, ant 1,990/977g. Dec. 8, 1954. 357 Cornelia St., 12901. (518) 561-5555. TWX 510-251-6707. Licensee: Rollins Telecasting Inc. (acq 3-28-56). Ownership: See Rollins Stns. ■ NBC. Rep: Blair. Wash atty: Smith & Pepper. ■ J. C. Roddey, group VP; W. P. Eaton Jr., VP TV; Robert O. Paxson, gen mgr; Bob Groothand, gen sls mgr; Carl Leahy, opns mgr; Tom Bradshaw, chief engr. ■ On 80 CATV's—269,565 subs. ■ Rates: \$135; 25; 20.

Rochester

ADI No. 64; see page B-61

WHEC-TV—ch 10, 316 kw vis, 39.8 kw aur, ant 500/353g. Nov. 1, 1953. 191 East Ave., 14604. (716) 546-5670. TWX 716-235-8699. Licensee: WHEC Inc. Ownership: See Gannett Co. Stns, also Nwspr. ■ CBS. Rep: Katz. Wash atty: Dow, Lohnes & Albertson. ■ Jack Decker, gen mgr & film buyer; Steve Kronquest, sls mgr; Bill Carroll, prog dir; Robert Yeager, prom mgr; James Reiley, news dir; Howard Huff, chief engr. ■ On 17 CATV's—25,700 subs.

WOKR-TV



REPRESENTED BY
BLAIR TELEVISION

WOKR—ch 13, 316 kw vis, 47.9 kw aur, ant 500/3635g. Sept. 15, 1962. 4225 West Henrietta Rd., 14623. (716) 334-8700. TWX 510-253-6740. Licensee: Flower City TV Corp. (acq 3-1-70). Ownership: John L. Wehle, 14.2%; G. B. Larson, 10%; and others. ■ ABC. Rep: Blair. Wash atty: Pierson, Ball & Dowd. ■ James P. Wilmot, pres; G. Bennett Larson, exec VP & gen mgr; Frank DiProsa, VP & sls mgr; Jerry Carr, VP & prog dir & film buyer; Gordon Sclar, prom dir; Dick Burt, news dir; Clyde Parker, chief engr; Gerry Walker, dir pub affrs. ■

New York TV

See page B-89 for explanation of listings.

On 36 CATV's—70,430 subs.

WROC-TV—ch 8, 316 kw vis, 48.5 kw aur, ant 5001/346g. June 14, 1949. 201 Humboldt St., 14601. (716) 288-8400. TWX 716-235-9136. Licensee: Rust Craft Bcstg of N.Y. Inc. Ownership: See Rust Craft Stns. ■ NBC. Rep: Petry. Wash atty: Kirkland, Ellis & Rowe. ■ Albert C. Lucero, gen mgr; F Chase Taylor Jr., prog mgr; Steven Engles, gen sls mgr; Don Keough, news dir; K. Gerald Evans, chief engr. ■ On 34 CATV's—70,000 subs. Co-owned: WROC(AM)-WPXY(FM). ■ Rates: \$350; 160; 60.

***WXXI**—ch 21, 832 kw vis, 166 kw aur, ant 453t/343g. September 1966. Box 21, 14601. (716) 325-7500. TWX 510-253-6588. Licensee: Rochester Area ETV Assn Inc. ■ PBS, Eastern Educl Net. Wash atty: Schwartz & Woods. ■ William J. Pearce, pres & gen mgr; William E. Haley Jr., prog mgr; James H. Bryant Jr., dev dir; John W. Owen, pub affs dir; John R. Bell, dir of engr. ■ On 14 CATV's—20,000 subs. Co-owned: WXXI-FM.

Schenectady

ADI No. 43; see page B-2

***WMHT**—ch 17, 2,000 kw vis, 398 kw aur, ant 983t/271g. May 2, 1962. Box 17, 12301. 356-1700. TWX 710-442-2993. Licensee: Mohawk-Hudson Council on ETV. ■ PBS, Eastern Educl Net. Wash atty: Schwartz & Woods. ■ Donald E. Schein, pres & gen mgr; Caleb Paine, VP; Charles A. Maday Jr., prog mgr; Willard J. Stone, opns mgr; Arthur J. Singer, dev mgr; Richard A. Hill, chief engr. ■ On 18 CATV's—40,000 subs. On 16 trans. Co-owned: WHMT-FM.

WRGB—Licensed to Schenectady. See Albany.

Syracuse

ADI No. 49; see page B-70

***WCNY-TV**—ch 24, 347 kw vis, 69.2 kw aur, ant 1,380t/964g. Dec. 20, 1965. Old Liverpool Rd., Liverpool, 13088. (315) 457-0440. Telex: 710-541-0430. Licensee: Public Bcstg Council of Ctrl N.Y. ■ PBS; NYN. Wash atty: Haley, Bader & Potts. ■ Richard W. Russell, pres & gen mgr; Theodore J. Weinheimer, prog mgr; Thomas E. Fanella, dir of dev; S. Paul Barron, dir engr. ■ On 19 CATV's—88,493 subs. Co-owned: WCNY-FM.

WHEN-TV—ch 5, 84 kw vis, 16.6 kw aur, ant 950t/556.3g. Dec. 1, 1948. 980 James St. (13203). (315) 474-8511. TWX 710-541-0443. Licensee: Meredith Corp. Ownership: See Meredith Publishing Stns, also Newpr. ■ CBS. Rep: MMT; Mulvihill (Canada). Wash atty: Haley, Bader & Potts. ■ Lawrence Rhodes, VP & gen mgr; Robert Delehanty, gen sls mgr; Andy Brigham, news dir; George Walsh, prog dir; Betty Kram, prom mgr; Albert H. Chismark, chief engr. ■ On 38 CATV's—91,900 subs. Co-owned: WHEN(AM). ■ Rates: \$400; 90; 50.

WNYS-TV—ch 9, 79.6 kw vis, 11.8 kw aur, ant 1,520t/964g. Sept. 9, 1962. Box 9, 13214. (315) 446-4780. TWX 710-541-0565. Licensee: WNYS-TV Inc. (acq 9-1-72). Ownership: The Outlet Co., 80%; Syracuse TV, 20%. See Outlet Co. Stns. ■ ABC. Rep: Petry. Wash atty: Sundlun, Tirana & Scher. ■ J. S. Sinclair, chmn; Ken Logowitz, vice-chmn; David E. Henderson, pres; Charles F. Kennedy, gen mgr; Carl D. Jaquint, asst gen mgr, prog dir and prom mgr; Kenneth F. Rothrum, loc sls mgr; W. Thomas Peschel, natl sls mgr; Richard Townley, news dir; Charles Mulvey, chief engr. ■ On 55

Our guests love us for our view.



How many New York hotels can boast an unobstructed view of Union Carbide? Pan Am? Grand Central Station?

We don't catch a whole lot of sunsets. But that's okay. Because our guests don't want sunsets.

Our guests want zip! Dash! Service! They're here to get jobs done. So they can get home fast and enjoy sunsets.

They pick the Roosevelt. In the middle of mid-town. They can get up later, get to work earlier.

If the view looks good to you, you ought to see it in person. At the Roosevelt, Madison at 45th, New York City.

THE ROOSEVELT

What we are is where we are.

(800) 221-2690. In New York State, call (800) 522-6449. In the city 661-1717. Call your corporate travel office or travel agent.

New York, North Carolina TV

See page B-89 for explanation of listings.

CATV's—167,723 subs. On 2 trans. ■ Rates: \$300; 90; 50.

WONH—ch 43, 200 kw vis, 36.6 kw aur, ant 8701/540g. Not on air, target date unknown. 345 Peat St., 13210. Permittee: Onondaga HUF TV Inc.

WSYR-TV—ch 3, 100 kw vis, 20 kw aur, ant 1,0001/594g. Feb. 15, 1950. 1030 James St., 13203. (315) 474-3911. TWX 710-541-0428. Licensee: Newhouse Bcstg Corp. Ownership: See Newhouse Bcstg Stns, also Nwspr. ■ NBC. Rep: Harrington, Righter, Parsons; McDermott (Canada). Wash atty: Dow, Lohnes & Albertson. ■ E. R. Vadeboncoeur, pres; David J. Shurtleff, VP & gen mgr; Norman R. Cissna, sis mgr; E. James McDonald, prog dir & film buyer; Louis Switzer, prom mgr; Richard J. Hoffman, news dir; A. J. Eicholzer, chief engr. ■ On 43 CATV's—188,809 subs. Co-owned: WSYR-AM-FM.

Utica

ADI No. 146; see page B-7

WKTV—ch 2, 34.7 kw vis, 5.2 kw (CP 6.9 kw) aur, ant 1,380t/1,065g. Dec. 1, 1949. Box 2, 13503. (315) 733-0404. TWX 315-797-1832. Licensee: Mid-New York Bcstg Corp. Ownership: See Mid New York Bcstg Stns. ■ NBC. Rep: PGW. Wash atty: Hogan & Hartson. ■ Paul F. Harron Sr., pres; Sheldon Storrer, VP, gen mgr & sis mgr; Daniel Germain, prog dir, film buyer & prom mgr; Jack Durant, news edit. ■ On 23 CATV's—132,000 subs. ■ Rates: \$200; 160; 75.

WUTR—ch 20, 813 kw vis, 123 kw aur, ant 800t/427g. Feb. 28, 1970. Box 20, 13503. (315) 797-5220. TWX 510-242-1994. Licensee: Roy H. Park Bcstg of Utica-Rome Inc. Ownership: See Roy H. Park Stns. ■ ABC. Rep: Blair. Wash atty: Midlen & Reddy. ■ Roy H. Park, pres; Floyd Eckerson, exec VP, gen & sis mgr & film buyer; Hoyle S. Broom, VP opns; Robert Phillips, news dir; Gerald E. Devine, chief engr. ■ On 19 CATV's—92,000 subs. On 4 trans. ■ Rates: \$60; 25; 15.

Watertown

ADI No. 162; see page B-75

WWNY-TV (Carthage)—ch 7, 316 kw vis, 47 kw aur, ant 720t/574g. Oct. 22, 1954. Box 211, 13601. (315) 788-3800. TWX 510-257-4650. Licensee: The Brockway Co. Ownership: John B. Johnson, 100%. Also Nwspr. ■ CBS, ABC, NBC. Rep: Avery-Knodel. Wash atty: Fisher, Wayland, Southmayd & Cooper. ■ John B. Johnson, pres; Tony C. Malara, gen mgr; David G. Propeck, sis mgr; David M. Graves, prog mgr & film buyer; Glenn H. Hall, opns dir; Lois Dempster, prom mgr; Robert Tompkins, news dir; Michael R. Yonkovic, dir of engr. ■ On 13 CATV's—45,000 subs. (10 CATV's in Canada). Co-owned: WWNY(AM). ■ Rates: \$115; 45; 45.

***WNPE-TV**—ch 16, 525 kw vis, 105 kw aur, ant 1,214t/943g. Aug. 5, 1971. c/o Richard A. Jones, Box 114, 13601. (315) 782-3142. Licensee: St. Lawrence Valley TV Council. ■ PBS. Wash atty: Schwartz & Woods. ■ Richard A. Jones, pres & gen mgr; William J. Saiff Jr., opns mgr, prog mgr and film buyer; Donna D. Kelley, news dir; James W. Edwards, chief engr.

North Carolina

HAMILTON-LANDIS
& ASSOCIATES, Inc.
NATIONWIDE MEDIA BROKERS
WASHINGTON, D. C. CHICAGO, DALLAS,
SAN FRANCISCO
SELL MORE
RADIO & TELEVISION STATIONS
IN THE EAST—NEAREST OFFICE IS—
1730 K ST., N.W., WASHINGTON 20006
(202) 393-3456

Asheville

ADI No. 36; see page B-30

WANC-TV—ch 21, 17.2 kw vis, 1.49 kw aur, ant 432t/137g. July 5, 1953. 75 Elk Mtn. Scenic Hwy, 28804. (704) 255-0111. Licensee: WISE-TV Inc. Ownership: See Harold H. Thoms Stns. ■ Wash atty: Norman E. Jorgensen. ■ Harold H. Thoms, pres; Kenneth P. Lovelace, admin asst; John Randolph, chief engr.

WLOS-TV—Licensed to Asheville. See Greenville, S.C.

***WUNF-TV**—ch 33, 3.63 kw vis, .724 kw aur, ant 2,620t/338.5g. Sept 11, 1967. 910 Raleigh Rd., Chapel Hill, 27514. Licensee: U. of N.C. ■ Execs: See *WUNC-TV Chapel Hill. ■ On 6 CATV's—10,514 subs.

Chapel Hill

ADI No. 53; see page B-58

***WUNC-TV**—ch 4, 100 kw vis, 20 kw aur, ant 990t/799g. Jan 8, 1955. UNC Television Network, 202 Univ. Sq. W., 27514. (919) 933-8191. Licensee: U. of N.C. ■ PBS. Wash atty: Schwartz & Woods. ■ George E. Bair, dir of ETV; Robert E. Miss, assoc dir of ETV; Hugh R. Fisher, net prog coord; Dale M. Rhodes, dir of audience svcs; Alan B. MacIntyre, dir of engr. ■ On 40 CATV's—80,000 subs.

Charlotte

ADI No. 33; see page B-13

WBTV—ch 3, 100 kw vis, 10 kw aur, ant 1,090t/562g. July 15, 1949. One Julian Price Pl., 28208. (704) 374-3500. TWX 810-621-0449. Licensee: Jefferson Pilot Bcstg Co. Ownership: See Jefferson-Pilot Stns. ■ CBS. Rep: Petry. Wash atty: Kirkland, Ellis & Rowe. ■ Charles H. Crutchfield, pres; Wallace J. Jorgensen, exec VP; James G. Babb Jr., VP & mgng dir; Wyatt H. Coggins, gen sis mgr; John A. Edgerton, prog opns mgr & film buyer; William T. Ballard, news & info mgr; O.E. Simerly, tech opns mgr; Charles Pittman, prom spvsr. ■ On 42 CATV's. Co-owned: WBT-AM-FM. ■ Rates: \$600; 125; 85.

WCCB—ch 18, 518 kw vis, 51.8 kw aur, ant 1,295t/1,249g. Dec 7, 1953. 1 TV Pl., 28205. (704) 372-1800. Licensee: WCCB-TV Inc. (acq 11-1-64). Ownership: See Cy N. Bahakel Stns. ■ ABC. Rep: HR. Wash atty: Wilmer, Cutler & Pickering. ■ Cy N. Bahakel, pres; Douglas G. Bell, gen mgr & film buyer; Gil Stamper, news dir; Don E. Kassner, VP engrng; Guy Titman, chief engr. ■ On 30 CATV's—45,000 subs.

WRET-TV—ch 36, 603 kw vis, 60 kw aur, ant 1,355t/1,404g. July 9, 1967. Box 12665, 28205. (704) 536-3636. TWX 810-621-7888. Licensee: Turner Comm. Corp. (acq 5-75). Ownership: See Turner Comm. Corp. ■ Rep: RTVR. Wash atty: Smith & Pepper. ■ James Thrash, pres & gen mgr; Robert L. Schuessler, VP & gen sis mgr; Kathy Uhrich, prom mgr; Dave J. Uhrich, prog dir & film buyer; Jack Barr, chief engr. ■ On 65 CATV's—150,628 subs.

WSOC-TV—ch 9, 316 kw vis, 63.1 kw aur, ant 1,190t/1,073g. April 28, 1957. Box 2536, 28234. (704) 372-0930. TWX 810-621-0437. Licensee: Carolina Bcstg Co. (acq 4-13-59).

Ownership: See Cox Bcstg Stns, also Nwspr. ■ NBC. Rep: Telerep. Wash atty: Dow, Lohnes & Albertson. ■ Clifford M. Kirtland Jr., pres; Freeman R. Jones, VP & gen mgr; John E. Callaghan, opns mgr; Robert McCourt, prog dir; Marvin S. Pridgen, dir of s/c; Charles Andrew, prom mgr; Lewis Brooks, news dir; Charles W. Whitley, chief engr. ■ On 26 CATV's. Co-owned: WSOC-AM-FM.

***WTVI**—ch 42, 214 kw vis, 42 kw aur, ant 450t/497g. Aug 27, 1965. 42 Coliseum Dr., 28205. (704) 372-2442. Licensee: Charlotte-Mecklenburg Bd. of Educ. ■ PBS. ■ Dona Lee Davenport, gen mgr; Shelia Tucker, prog opns mgr; Dolores Richards, prom mgr; Elliot Sanderson, prod mgr; Jack Phillips, chief engr. ■ On 6 CATV's—22,488 subs.

Columbia

ADI No. 91; see page B-30

***WUND-TV**—ch 2, 100 kw vis, 15 kw aur, ant 1,290t/1,041g. Sept 10, 1965. 910 Raleigh Rd., Chapel Hill, 27514. Licensee: U. of N.C. ■ Execs: See *WUNC-TV Chapel Hill.

Concord

ADI No. 33; see page B-13

***WUNG-TV**—ch 58, 191 kw vis, 29 kw aur, ant 1,290t/1,305g. Sept 11, 1967. 910 Raleigh Rd., Chapel Hill, 27514. Licensee: U. of N.C. ■ Execs: See *WUNC-TV Chapel Hill.

Durham

See Raleigh-Durham

Greensboro

ADI No. 55; see page B-30

WFMY-TV—ch 2, 100 kw vis, 20 kw aur, ant 720t/759g. Sept 22, 1949. Drawer 22047, 27420. (919)274-0113. TWX 510-925-1193. Licensee: WFMY-TV Corp. (acq 2-25-64). Ownership: See Landmark Communications stns, also Nwspr. ■ CBS. Rep: Harrington, Righter & Parsons. Wash atty: Hogan & Hartson. ■ Charles A. Whitehurst, VP & gen mgr; William M. Alexander, sis mgr; T. Jack Markham, prog dir & film buyer; Bailey W. Hobgood, prom mgr; A. Rabun Matthews, news dir; Doyle D. Thompson, chief engr. ■ On 22 CATV's. ■ Rates: \$450; 240; 50.

WGHP-TV—Licensed to High Point-Greensboro-Winston-Salem. See High Point.

WXII—See Winston-Salem.

Greenville

ADI No. 91; see page B-30

WCTI—(New Bern) ch 12, 316 kw vis, 31 kw aur, ant 940t/1,004g. Sept 1, 1963. Box 2325, New Bern, 28560. (919) 637-2111. TWX 510-924-2230. Licensee: Continental TV Inc. (acq 6-69). Ownership: Continental Communications, 100%. ■ ABC. Rep: Avery-Knodel. Wash atty: Midlen & Reddy. ■ Harold Timken, pres; Robert G. Bolyard, VP & gen mgr; Ray Horn, prog dir; Shelton Pogue, sis mgr; Judy Larson, prom mgr; Jack Six, news dir; Catherine Sumaro, film buyer; James Cason & Edgar Hathaway, chief engr. ■ On 2 CATV's—12,000 subs. ■ Rates: \$80; 30; 15.

WITN—(Washington) ch 7, 316 kw vis, 31.6 kw aur, ant 1,470t/1,523g. Sept 28, 1955. Box 468, Washington, 27889. (919) 946-3131. TWX 510-924-1834. Licensee: N.C. TV Inc. Ownership: W. R. Roberson Jr. & family, 62.5%; William S. Page, 25.2%; William E. Barnes, 10.99% & others. ■ NBC. Rep: Katz. Wash atty: Everett D. Johnston. ■ W. R. Roberson Jr., pres & CEO; Dick Paul, exec VP & COO; G. Earl Broome, VP-sls; Paul Oughton, VP-opns, prom mgr & film buyer; W.E. Bass Jr., VP-regnl lcl sls; Roy Hardee, VP-news; Harvey Mason, VP

enrg. ■ On 18 CATV's—75,000 subs. Co-owned: WITN-AM-FM. ■ Rates: \$215; 115; 40.

WNCT-TV—ch 9, 316 kw vis, 31.6 kw aur, ant 8601/873g. Dec 22, 1953. Box 898, 27834. (919) 756-3180. TWX 510-929-1616. Licensee: Roy H. Park Bcstg Inc. Ownership: See Roy H. Park Stns, also Nwspr. ■ CBS. Rep: Blair. Wash atty: McKenna, Wilkinson & Kittner. ■ Roy H. Park, pres; Hank Tribbley, VP & gen mgr; John G. Clark Jr., gen sis mgr; Ed Fields, prog dir, prom mgr & film buyer; Vance Morris, news dir; Heber Adams, chief engr. ■ On 7 CATV's—43,387 subs. On 1 trans. Co-owned: WNCN-AM-FM. ■ Rates: \$180; 90; 35.

***WUNC-TV**—ch 25, 562 kw vis, 112 kw aur, ant 1,150t/1,169g. 1972. 910 Raleigh Rd., Chapel Hill, 27514. Licensee: U. of N.C. ■ Execs: See *WUNC-TV Chapel Hill.

Hickory

ADI No. 33; see page B-13

WHKY-TV—ch 14, 8.9 kw vis, 1.8 kw aur, ant 6001/487g. Feb 14, 1968. Box 1059, 28601. (704) 322-5726. Licensee: Catawba Valley Bcstg Inc. Ownership: E. S. Long, 19.5%; Mrs. Mildred J. Gifford, 27.8% & others. ■ Rep: WHKY-TV. Wash atty: Miller & Fields. ■ Thomas E. Long, stn, sis mgr & chief engr; James O. Carr, news dir. ■ On 2 CATV's. Co-owned: WHKY-AM-FM. ■ Rates: \$15.75; 11.80; 11.80.

High Point

ADI No. 55; see page B-30

WFMY-TV—see Greensboro.

WGHP-TV—(Greensboro-Winston-Salem) ch 8, 316 kw vis, 63.1 kw aur, ant 1,270t/1,255.5g. Oct. 14, 1963. 400 N. Main St., High Point, 27260. (919) 883-7131. TWX 510-926-1640. Licensee: Southern Bcstg Co. Ownership: See Southern Bcstg Stns. ■ ABC. Rep: Storer TV Sls. Wash atty: Welch & Morgan. ■ Eugene H. Bohi, VP gen mgr; Dave Whitaker, gen sis mgr; Gary Robinson, prog mgr; Fred Blackman, news dir; Jerry Blankenbeker, chief engr. ■ On 35 CATV's—150,000 subs. On 1 trans. ■ Rates: \$300; 130; 35.

WXII—See Winston-Salem.

Linville

ADI No. 33; see page B-13

***WUNE-TV**—ch 17, 38 kw vis, 270 kw max, 7.59 kw aur, ant 1,540t/265g. Sept. 11, 1967. 910 Raleigh Rd., Chapel Hill, 27514. Licensee: U. of N.C. ■ Execs: See *WUNC-TV Chapel Hill.

New Bern

WCTI—Licensed to New Bern. See Greenville.

Raleigh, Durham

ADI No. 53; see page B-58

WRAL-TV—ch 5, 100 kw vis, 10 kw aur, ant 1,170t/156g. Dec. 15, 1956. Box 12000, Raleigh, 27605. (919) 828-2511. TWX 510-928-1833. Licensee: Capitol Bcstg Co. Ownership: A. J. Fletcher, 67.53%, James F. Goodman, 20.60% & others. ■ ABC. Rep: Katz. Wash atty: Fletcher, Heald, Rowell, Kenehan & Hildreth. ■ A. J. Fletcher, chief exec off; James F. Goodman, pres & gen mgr; William R. Murray, gen sis mgr; Joel Lawhon, news dir; Gene Walsh, opns mgr; Bob Caudie, prog dir & film buyer; Whit Neville, bus mgr; David H. Witherspoon, VP-prom; Lee Poole, chief engr. ■ On 16 CATV's—50,000 subs. On 1 trans. Co-owned: WRAL-FM. ■ Rates: \$400; 85; 50.

WRDU-TV—ch 28, 1,080 kw vis, 214 kw aur, ant 1,040t/838g. Nov. 4, 1968. Box 8706, Durham, 27707. (919) 544-1786. TWX

510-927-1818. Licensee: Triangle Telecasters Inc. Ownership: Robinson O. Everett & Katherine R. Everett, jointly 81.34%; John B. Wilson, 6.7%; Emanue J. Evans, 5.8% & others. ■ NBC. Rep: Devney. ■ Robinson O. Everett, pres; John B. Wilson, VP; Tom McCaffrey, gen mgr & film buyer; Carroll M. Ogle, sis mgr; Coke Ariali, prog dir; Paul Crawley, news dir; Greg Precioppo, chief engr. ■ On 14 CATV's—62,000 subs. On 2 trans. ■ Rates: \$120; 90; 90.

WTVD—ch 11, 316 kw vis, 46.8 kw aur, ant 1,490t/1,503g. Sept. 2, 1954. Box 2009, Durham, 27702. (919) 477-2131. TWX 510-927-1810. Licensee: Capital Cities Communications Inc. (acq 1958). Ownership: See Capital Cities Stns. ■ CBS. Rep: Blair. Wash atty: Wilmer, Cutler & Pickering. ■ M. J. Thompson, VP & gen mgr; Jack West, gen sis mgr; Jim Duncan, prog dir & film buyer; Allen Jones, news dir; Willie H. Mebane Jr., prom mgr; Ed Wall, chief engr. ■ On 18 CATV's. On 1 trans. ■ Rates: \$390; 90; 80.

Washington

WITN-TV—Licensed to Washington. See Greenville.

Wilmington

ADI No. 135; see page B-78

WECT—ch 6, 100 kw vis, 10 kw aur, ant 1,940t/1,994g. April 9, 1954. 322 Shipyard Blvd., 28401. (919) 791-8070. TWX 510-937-0314. Licensee: Atlantic Bcstg Corp. (acq 10-57). Ownership: Dan D. Cameron, 42.86%; J. S. Brody, 21.51%; Leo Brody, 11.93%; Port & Co., 14.29%. ■ NBC, CBS. Rep: Young-VTM. Wash atty: Wilner & Scheiner. ■ Dan D. Cameron, pres; Paul A. Brissette Jr., exec VP & gen mgr; C. D. Martin Jr., sis mgr; Bill Elks, opns mgr; Wayne Jackson, stn mgr; Ken Murphy, news dir. ■ On 17 CATV's—50,000 subs. ■ Rates: \$180; 100; 40.

WWAY-TV—ch 3, 100 kw vis, 20 kw aur, ant 1,170t/1,190g. Oct. 1, 1964. Box 2068, 28401. (919) 762-8581. TWX 510-937-0333. Licensee: Clay Bcstg Corp. (acq 9-1-68). Ownership: See Clay Communications Inc. See also Nwspr. ■ ABC, CBS. Rep: H-R; Ayers. Wash atty: Fletcher, Heald, Rowell, Kenehan & Hildreth. ■ George Diab, pres, Clay Bcstg & film buyer; Mitchell L. Saieed, stn mgr; Henry Sullivan, sis mgr; Art Bannon, prom mgr; George Allen, prog dir; Gene Hodges, news dir; Arthur Madeley, chief engr. ■ On 6 CATV's—13,000 subs. ■ Rates: \$60; 50; 15.

WUNJ-TV—ch 39, 525 kw vis, 105 kw aur, ant 930t/963g. 1971. 910 Raleigh Rd., Chapel Hill, 27514. Licensee: U. of N.C. ■ Execs: See *WUNC-TV Chapel Hill.

Winston-Salem

ADI No. 55; see page B-30

WFMY-TV—See Greensboro.

WGHP-TV—Licensed to High Point-Greensboro-Winston-Salem. See High Point.

WXII—ch 12, 316 kw vis, 63.5 kw aur, ant 1,980t/680g. Sept. 30, 1953. Box 11847, 27106. (919) 723-9241. TWX 510-931-3676. Licensee: Multimedia Inc. (acq 10-1-72). Ownership: See Multimedia Stns. ■ NBC. Rep: Katz. Wash atty: Dow, Lohnes & Albertson. ■ Wilson C. Wearn, pres; Jim Hart, VP & gen mgr; Zack Manning, sis mgr; John Comas, prog dir; Wayne Ashworth, news dir; Douglas Bales, prom mgr; Charles Timmons, chief engr. ■ On 25 CATV's—70,887 subs. ■ Rates: \$275; 120; 40.

***WUNL-TV**—ch 26, 302 kw vis, 60.3 kw aur, ant 1,670t/363g. Feb. 22, 1973. 910 Raleigh Rd., Chapel Hill, 27514. Licensee: U. of N.C. ■ Execs: See *WUNC-TV Chapel Hill.

North Carolina, North Dakota TV

See page B-89 for explanation of listings.

North Dakota

Bismarck

ADI No. 138; see page B-47

KFYR-TV—ch 5, 100 kw vis, 13.5 kw aur, ant 1,400t/1,101g. Dec. 19, 1953. Box 1738, 58501. (701) 223-0900. TWX 701-241-9434. Licensee: Meyer Bcstg Co. Ownership: See Meyer Bcstg Stns. ■ NBC, ABC. Rep: Blair. Wash atty: Hogan & Hartson. ■ William A. Ekberg, pres; Claire Anne Holmberg, stn mgr; Dave Stuart, natl-rgrnl sis mgr; Merton Johnsrud, prog dir; Dewey Heggen, news dir; Carl Zeller, dir of engr. ■ On 3 CATV's—3,000 subs. On 18 trans. Co-owned: KFYR-AM-FM.

KXMB-TV—ch 12, 27.8 kw vis, 27.8 kw aur, ant 1,530t/1,204g. Nov. 19, 1955. Box 1617, 58501. (701) 223-9197. Licensee: Bismarck Television Inc. (acq 1-27-71). ■ CBS, ABC. Rep: H-R. Wash atty: Fisher, Wayland, Southmayd & Cooper. ■ Chester Reiten, pres; John Von Rueden, gen & sis mgr; Steve Skjelvik, prog dir & film buyer; Dave Allan, prom mgr; Dave Goss, news dir; John Krance, chief engr. ■ On 3 CATV's—2,000 subs. ■ Rates: \$29; 19; 14.

Devils Lake

ADI No. 92; see page B-25

WDAZ-TV—ch 8, 316 kw vis, 50 kw aur, ant 1,480t/1,461g. Jan. 29, 1967. Box 638, Grand Forks, 58201. (701) 775-2511. TWX 910-673-8380. Box 775, Devils Lake, 58301. (701) 662-8188. TWX 910-673-8450. Licensee: WDAY Inc. Co-owned satellite of WDAY-TV Fargo. ■ On 12 CATV's.

Dickinson

ADI No. 138; see page B-47

KDIX-TV—ch 2, 100 kw vis, 10 kw aur, ant 840t/621g. October, 1956. Box 1368, 58601. (701) 225-5133. Licensee: Dickinson Bcstg Corp. Ownership: Stanley Deck, 98%; June Deck, Lauren Haacke, each 1%. ■ CBS, ABC, NBC. Rep: H-R; Hurley. Wash atty: Wilner & Scheiner. ■ S. T. Deck, pres, gen mgr & film buyer; Lauren Haacke, stn mgr & prom mgr; Warren Vranna, sis mgr; Tom Nelson, news dir; William Kohler, chief engr. ■ On 2 CATV's. On 12 trans. Co-owned: KDIX(AM).

Fargo

ADI No. 92; see page B-25

***KFME**—ch 13, 264 kw vis, 47.5 kw aur, ant 390t/426g. Jan. 19, 1964. 4500 S. University Dr., 58102. (701) 232-8921. Licensee: N. Ctr Educl TV inc. ■ PBS. Wash atty: Marmet Professional Corp. ■ William Koerner, pres; Dennis Falk, gen mgr; Cheryl Heller, prog dir; Donald Geiken, dir engr. ■ On 39 CATV's—180,000. On 2 trans.

KTHI-TV—ch 11, 304 kw vis, 45.7 kw aur, ant 2,000t/2,063g. Oct. 11, 1959. Box 1878, Fargo, 58102. (701) 237-5211. TWX 910-674-2365. Licensee: Spokane TV Inc. Ownership: See Morgan Murphy Stns, also Nwspr. ■ ABC. Rep: Avery-Knodel; Hyett; Tacher. Wash atty: Stambler & Shrinsky. ■ Paul M. Wickre, sis mgr; David Knudtson, opns mgr; Roger Johnson, chief engr. ■ On 6 CATV's. On 1 trans. ■ Rates: \$120; 60; 20.

KXJB-TV—(Valley City) ch 4, 97.7 kw vis, 10 kw aur, ant 2,030t/2060g. Sept. 11, 1954. Box 2926, 4000 W. Main Ave., Fargo, 58102. (701) 282-0444. TWX 701-221-6020. Licensee:

North Dakota, Ohio TV

See page B-89 for explanation of listings.

North American Communications Corp. Ownership: North Dakota Bcstg Corp., 100%. CBS. Rep: H-R; Hurley. Wash atty: Fisher, Wayland, Southmayd & Cooper. ■ John W. Bolter, pres; Mel J. Kampmann, gen mgr; Harold Michaels, gen sls mgr & film buyer; Linda McGuire, prog dir; Lloyd Erickson, chief engr. ■ On 9 CATV's—17,200 subs. On 4 trans.

WDAY-TV—ch 6, 100 kw vis, 20 kw aur, ant 1,150t/1,206g. June 1, 1953. 207 N. 5th St., 58102. (701) 237-6500. TWX 910-673-8301. Licensee: WDAY Inc. Ownership: See WDAY Stns, also Nwspr. ■ NBC. Rep: Peters, Griffin, Woodward. Wash atty: Marmet Professional Corp. ■ William Marcil, pres; Jack Dunn, exec VP; Jack Lester, VP & gen mgr; Lee Stewart, sls mgr; Ken Kennedy, prog dir; Jack Lester, film buyer; Roy Pedersen, prom mgr; Norm Schrader, news dir; Sumner Rasmussen, chief engr. ■ On 12 CATV's—60,000 subs. On 10 trans. Co-owned WDAY-AM-FM. ■ Rates: \$120; 90; 30.

Grand Forks

ADI No. 92; see page B-25

***KGFE**—ch 2, 100 kw vis, 10 kw aur, ant 1,340t/1,461g. Sept. 9, 1974. 4500 S. University Dr., Fargo, N.D. 58102. (701) 232-8921. Licensee: North Central ETV Inc. Co-owned satellite of *KFME, Fargo.

KTHI-TV—Licensed to Fargo. See Fargo.

WDAZ-TV—Licensed to Devils Lake. See Devils Lake.

Minot

ADI No. 138; see page B-47

KMOT—ch 10, 214 kw vis, 42.7 kw aur, ant 680t/690g. Jan. 21, 1958. Box 1738, Bismarck, 58501. (701) 852-4101. Licensee: Meyer Bcstg Co. Co-owned satellite of KFVR-TV, Bismarck. ■ NBC. Wash atty: Hogan & Hartson. ■ Stan Wilson, stn mgr; Mary Beth Huber, prog dir; Norm Buckner, sls mgr; Paul R. Jwinin, news dir; Linda Schuler, prom mgr; Ray Swenson, chief engr. ■ On 5 CATV's—7,000 subs. On 3 trans. Co-owned: KMOT-FM. ■ Rates: \$35; 28; 15.

KXMC-TV—ch 13, 245 kw vis, 24.5 kw aur, ant 1,120t/1,053g. April 1, 1953. Box 1686, KXMC-TV Bldg., 58701. (701) 838-2104. TWX 910-675-2496. Licensee: KXMC-TV. Ownership: Chester Reiten, 55%; and others. ■ CBS, ABC. Rep: H-R; Hurley. Wash atty: Fisher, Wayland, Southmayd & Cooper. ■ Chester Reiten, pres; Henry F. Beuchler, gen & coml mgr & film buyer; Rodney Romine; prog dir; John Williams, news dir; Jerry Romine, prom mgr; Henry Beuchler, film buyer; Duane Aase, chief engr. ■ On 6 CATV's. On 6 trans. Co-owned KCJB-AM-FM.

Valley City

KXJB-TV—Licensed to Valley City. See Fargo.

Williston

ADI No. 138; see page B-47

KUMV-TV—ch 8, 166 kw vis, 33.1 kw aur, ant 1,060t/874g. Feb. 11, 1957. Box 1287, 58801. (701) 875-4311. Licensee: Meyer Bcstg Co. Co-owned semi-satellite of KFVR-TV, Bismarck. ■ NBC, ABC. ■ William Ekberg, pres; Roger Rien, gen mgr & prog dir; Arvin Grove, sls mgr; Ed Bazer, news dir; David Pederson, chief engr. ■ On 3 CATV's. On 10 trans.

KXMD-TV—ch 11, 174 kw vis, 17.4 kw aur, ant 980t/840g. Oct. 25, 1969. KXMC-TV Building, 58707. Licensee: Williston Enterprises. Co-owned satellite of KXMC-TV, Minot. ■ CBS, ABC. Rep: H-R; Hurley. Wash atty: Fisher, Wayland, Southmayd & Cooper. ■ Chester Reiten, pres; Henry F. Beuchler, gen mgr; Robert Wilkens, sls & prom mgr; Rodney Romine, prog dir; Dave Peterson, chief engr.

Ohio

Akron

ADI No. 9; see page B-16

WAKR-TV—ch 23, 1,280 kw vis, 175 kw aur, ant 960t/925g. July 19, 1953. 853 Copley Rd., 44320. (216) 535-7831. Licensee: Summit Radio Corp. Ownership: See Group One Bcstg, also Nwspr. ■ ABC. Rep: Savalli/Gates. Wash atty: McKenna, Wilkinson & Kittner. ■ Roger G. Berk, VP & gen mgr; Robert Bostian, stn mgr; William O'Neil Jr., opns mgr; Ben Maidenburg Jr., gen sls mgr; Fred Anthony, news dir; Irwin L. Knopp, chief engr. ■ On 25 CATV's—157,000 subs. Co-owned: WAKR(AM), WAEZ(FM).

***WEAO**—ch 49, 112 kw vis, 11.2 kw aur, ant 378t/492g. September 1975. 1640 Franklin Ave., Kent 44240. Northeastern Educl TV of Ohio. Wash atty: Dow, Lohnes & Albertson.

Alliance

ADI No. 9; see page B-16

***WNEO-TV**—ch 45, 1,260 kw vis, 251 kw aur, ant 830t/770g. May 1973. 1640 Franklin Ave., Kent, 44240. (216) 678-1656. Licensee: Ohio Educational Network Commission. ■ PBS, Ohio ETV. Wash atty: Cohn & Marks. ■ Phillip English, gen mgr.

Athens

ADI No. 42; see page B-13

***WOUB-TV**—ch 20, 479 kw vis, 95 kw aur, ant 810t/871g. Jan 3, 1963. College St., 45701. (614) 594-6171. TWX 810-239-2992. Licensee: Ohio U. ■ PBS; Ohio Net. Wash atty: Cohn & Marks. ■ Joseph Welling, dir & gen mgr; Richard H. Madden, asst dir for opns; David Liroff, prog dir; John Chalfant, news dir; Jean Mezza, pub info dir; Don Smith, chief engr. ■ On 70 CATV's—70,000 subs. Co-owned: *WOUB-AM-FM.

Bowling Green

ADI No. 60; see page B-72

***WBGU-TV** (Lima)—ch 57, 479 kw vis, 95.5 kw aur, ant 1,060t/1,094g. Feb. 10, 1964. Bowling Green State U., 43403. (419) 372-0121. Licensee: Ohio ETV Network Commission. ■ PBS, Ohio Educl Bcstg. Wash atty: Cohn & Marks. ■ Duane E. Tucker, dir bcstg & gen mgr; Ronald J. Gargasz, prog dir; Joan Gordon, prom mgr; Steven Brash, news dir; William Leutz, chief engr. ■ On 26 CATV's. On 1 trans. Co-owned: *WBGU(FM).

Cambridge

ADI No. 110; see page B-76

***WOUC-TV**—ch 44, 436 kw vis, 87.1 kw aur, ant 1,290t/1,214g. 9 S. College St., Athens, 45701. (614) 594-2166. Licensee: Ohio Educational Television Network Commission. ■ PBS, Ohio Educl Bcstg. Wash atty: Cohn & Marks. ■ N. Joseph Welling, gen mgr.

Canton

ADI No. 9; see page B-16

WJAN—ch 17, 230 kw vis, 42 kw aur, ant 450t/450g. Jan 3, 1967. Box 8080, 44711. (216) 875-5542. Licensee: Janson Industries. Ownership: Richard W. Janson, 45%; Raymond K. Janson, 32.5%; Russell C. Janson, 22.5%. ■ Wash atty: Fletcher, Heald, Rowell, Kenehan & Hildreth. ■ Raymond Janson, pres; Robert M. Carano, gen mgr & film buyer; Herb Burke, gen sls mgr; Jim Stegner, prog dir & prom mgr; Scott Davis, news dir; Dale Lamm, chief engr. ■ On 18 CATV's—120,000 subs. ■ Rates: \$28; 24; 24.

Cincinnati

ADI No. 26; see page B-15

WCET-TV



***WCET**—ch 48, 473 kw vis, 47.9 kw aur, ant 870t/909g. July 26, 1954. 2222 Chickasaw St., 45219. After 3-1-76: 1223 Central Pkwy, 45214. (513) 381-4033. Licensee: Greater Cincinnati TV Educl Foundation. ■ PBS. ■ Charles W. Vaughan, pres & gen mgr; Marjorie McKinney, dir of TV; Ronald L. Wilson, dir progmg; Veda Schalk, dir of bus administration; Sharon Wead, dir of cmnty rel; Earl (Bud) Gillis, dir of dev; Ed Middleton, dir of engr. ■ On 9 CATV's.

WCPO-TV—ch 9, 282 kw vis, 58.9 kw aur, ant 1,000t/909g. July 26, 1949. 500 Central Ave., 45202. (513) 721-9900. TWX 810-461-2690. Licensee: Scripps-Howard Bcstg Co. Ownership: See Scripps-Howard Stns, also Nwspr. ■ CBS. Rep: Blair. Wash atty: Dempsey & Koplovitz. ■ Robert Gordon, VP & gen mgr; Ben Hevel, asst gen mgr; Don Howe, gen sls mgr; J. B. Chase, sls mgr; Al Schottekotte, VP, news; W. Earl Corbett, coml mgr; Archie Miller, chief engr. ■ On 47 CATV's—100,000 subs. ■ Rates: \$650; 300; 95.

WKRC-TV

Taft Broadcasting

WKRC-TV—ch 12, 303 kw vis, 30.3 kw aur, ant 1,000t/971g. 1906 Highland Ave., 45219. (513) 651-1200. TWX 810-461-2606. Licensee: Taft Bcstg Co. Ownership: See Taft Stns. ■ ABC, NBC. Rep: HRP; Taft. Wash atty: Koteen & Burt. ■ L. H. Rogers II, pres; Robert C. Wiegand, VP & gen mgr; G. Kent Smith, sls mgr; Gus Bailey Jr., prog/opns mgr; Linda Staff, prom mgr; Robert Gilmartin, news dir; Ray Owen, chief engr. ■ Co-owned: WKRC(AM)—WKRC(FM). ■ Rates: \$650; 350; 130.

WLWT—ch 5, 100 kw vis, 10 kw aur, ant 685t/583g. Feb. 9, 1948. 140 W. Ninth St., 45202. (513) 241-1822. TWX 810-461-2610. Telex 21-4470. Licensee: Avco Bcstg Corp. Ownership: See Avco Stns. ■ NBC. Rep: Avco Radio TV Sis. Wash atty: Hogan & Hartson. ■ John T. Murphy, pres; Walter E. Bartlett, senior VP, TV & gen mgr; Barry Hersh, gen sls mgr; William H. Spiegel, prog mgr; Louis J. Rainone, prod mgr; Robert W. McCall, news dir; Steve Fisher, prom mgr; Ed Dooley, chief engr. ■ On 33 CATV's—115,781 subs. Co-owned: WLW(AM). ■ Rates: \$400; 105; 70.

WXIX-TV—(Newport, Ky.) ch 19, 1900 kw vis, 285 kw aur, ant 990t/1,022g. 10490 Taconic Terrace 45215. (513) 772-1919. Telex 21-4364. Licensee: WXIX Inc. (acq 8-72). Ownership: See Metromedia Inc. ■ Rep: Metro Sis. Wash atty: Lohnes & Culver. ■ Allan Ginsberg, VP & gen mgr; Joseph Mazza, natl sls mgr; Douglas Faulkner, lcl sls mgr; Sandra

Pastor, prog dir; Patricia Stiphout, prom mgr; James Parker, chief engr. ■ On 50 CATV's—95,000 subs. ■ Rates: \$50; 100; 20.

Cleveland

ADI No. 9; see page B-16

WCTF—ch 19, 553 kw vis, 110 kw aur, ant 1,140/1,029g. Not on air, target date unknown. Penthouse, One Erieview Plaza, 44114. (216) 781-8000. Permittee: Community Telecasters of Cleveland Inc. ■ Wash atty: Finkelstein & Firestone. ■ Charles W. Steadman, pres; John M. Kinsellagn, exec VP; Homer H. Marshman, VP.

WEWS—ch 5, 93.3 kw vis, 10 kw aur, ant 1,020/851g. Dec. 17, 1947. 3001 Euclid Ave., 44115. (216) 432-1500. TWX 810-421-8593. Licensee: Scripps-Howard Bcstg Co. Ownership: See Scripps-Howard Stns, also Nwspr. ■ ABC. Rep: Blair. Wash atty: Dempsey & Koplovitz. ■ Jack R. Howard, chmn; M. C. Walters, chmn, exec com; Donald L. Peris, pres; Edward D. Cervenak, gen mgr; Joseph B. Epperson, VP engrg; James E. Smith, asst gen mgr s/s; Peter Hinka, Ohio adv mgr; William F. Baker, prog dir; Patrick J. Kenney, natl sls mgr; Ernest E. Sindelar, stn mgr; James J. Lowe Jr., pub dir; Edward D. Cervenak, asst gen mgr prog, news; Garry H. Ritchie, news dir; James E. Bloyd, VP, chief engr.

WJW-TV—ch 8, 302 kw vis, 30.2 w aur, ant 1,000/1775g. Dec. 19, 1949. 5800 S. Marginal Rd., 44103. (216) 431-8888. TWX 810-421-8406. Licensee: Storer Bcstg Co. Ownership: See Storer Bcstg Co. Stns. ■ CBS. Rep: Storer TV Sales. Wash atty: Warren C. Zwicky. ■ Charles W. Bergeson, VP & gen mgr; Joseph T. Conway, stn mgr; Francis P. Brady, gen sls mgr; Herman Stern, ntl sls mgr; Robert E. Huber, prog mgr; William J. Feest, news dir; Rod Warner, prom mgr; Arthur MacColl, film buyer; Jim Perkins, chief engr. ■ On 71 CATV's—207,600 subs. Co-owned: WJW(AM). ■ Rates: \$2,100; 550; 170.

WKYC-TV—ch 3, 100 kw vis, 20 kw aur, ant 1,000/1906g. October 1948. 1403 E. 6th St., 44114. (216) 696-1000. TWX 810-421-8133. Licensee: NBC Inc. Ownership: See NBC TV Stns. ■ NBC. Rep: NBC Spot Sls. ■ Neal Van Ells, VP & gen mgr; Joe Varholy, stn mgr; Clifford Ford, sls mgr; Richard Lobo, news dir; Joseph E. Ondrick, prom mgr; Raymond Smith, mgr tech ops.

WUAB—(Lorain) ch 43, 1,239 kw vis, 248 kw aur, ant 1,074/1919g. Sept. 15, 1968. 8443 Day Dr., 44129. (216) 845-6043. TWX 810-427-9153. Licensee: United Artists Bcst. Ownership: See United Artists Stns. ■ Rep: Peetry. Wash atty: Pierson, Ball & Dowd. ■ A. Albeck, pres, UAB; Jack J. Moffitt, gen mgr; Robert Hartman, sls mgr; Ronald St. Charles, prog dir; Mel Smith, prom mgr; Harry Sykora, mgr engrg. ■ Rates: \$200; 300; 175.

***WVIZ-TV**—ch 25, 646 kw vis, 129 kw aur, ant 1,000/1818g. Feb. 7, 1965. 4300 Brookpark Rd., 44134. (216) 398-2800. TWX 810-421-8875. Licensee: Educl TV Assn of Metro Cleveland. ■ PBS. ■ Betty Cope, gen mgr; Edward L. Stopke, chief engr. ■ On 22 CATV's.

Columbus

ADI No. 32; see page B-18

WBNS-TV—ch 10, 316 kw vis, 52.5 kw aur, ant 710/839g. Oct. 5, 1949. 62 E. Broad St., 43215. (614) 224-7121. TWX 810-482-1619. Licensee: WBNS TV Inc. Ownership: Wolfe Family, which owns Columbus Dispatch. See Nwspr. ■ CBS. Rep: Blair. Wash atty: Dow, Lohnes & Albertson. ■ Richard Wolfe, pres; Gene D'Angelo, gen mgr; Arnold Routson, gen sls mgr; John A. Haldi, VP progmg; Betty Dixon, film buyer; Bill Vance, news dir; William Orr, chief engr. ■ Co-owned: WBNS-AM-FM.

WLWC—ch 4, 100 kw vis, 10 kw aur, ant 440/576g. April 3, 1949. Box 4, 43216. (614) 263-5441. TWX 614-759-0373. Licensee: Avco Bcstg Corp. Ownership: See Avco Stns. ■ NBC. Rep: Avco Radio TV Sls. Wash atty: Hogan & Hartson. ■ John T. Murphy, pres; Walter E. Bartlett, senior VP TV; Benjamin D. McKeel, VP & gen mgr; Richard P. Levy, gen sls mgr; Charles A. Larsen, prog dir; Hugh DeMoss, news dir; Robert Dye, chief engr. ■ On 65 CATV's—178,260 subs.

***WOSU-TV**—ch 34, 931 kw vis, 186 kw aur, ant 1,080/1,120g. Feb. 20, 1956. 2400 Olen-tangy River Rd., 43210. (614) 421-2540. Licensee: Ohio State U. ■ PBS, CEN (regional). ■ Harold L. Enarson, pres; Mervin A. Durea, actg dir bcstg & prod mgr; Dr. John Malcolm, assoc dir; Martha Hauelsen, bus mgr; Kent W. Creswell, bcst mgr; Jody Asbury, prom mgr; Don Davis, news dir; R.L. Arendall, chief engr. ■ On 3 CATV's. On 1 trans. Co-owned: *WOSU-AM-FM.

WTVN-TV—ch 6, 100 kw vis, 10 kw aur, ant 570/643g. (CP: 20 kw aur, ant 535.46 ft.). Aug. 30, 1949. Box 718, 753 Harmon Ave., 43216. (614) 228-5801. TWX 810-482-1616. Licensee: Taft Bcstg Co. Ownership: See Taft Stns. ■ ABC. Rep: Harrington, Righter & Parsons. Wash atty: Koteen & Burt. ■ Lawrence H. Rogers II, pres; Fred von Stade, VP & gen mgr & film buyer; George Coles, gen sls mgr; Patricia Cramer, prom mgr; Earl Green, news dir; Glade Grable, chief engr. ■ Co-owned: WTVN-AM-FM.

Dayton

ADI No. 40; see page B-19



WHIO-TV—ch 7, 200 kw vis, 39.8 kw aur, ant 1,170/1,096g. Jan. 26, 1949. 1414 Wilmington Ave., 45401. (513) 254-5311. TWX 810-459-1760. Licensee: Miami Valley Bcstg Corp. Ownership: See Cox Bcstg Stns, also Nwspr. ■ CBS. Rep: TeleRep. Wash atty: Dow, Lohnes & Albertson. ■ Clifford Kirtland, pres; Neil Pugh, gen sls mgr; John E. Clark, prog dir; Jack McCarthy, gen mgr; Jack Hurley, news dir; Roy Whitaker, prom mgr; Al Higgins, chief engr. ■ On 711 CATV's—122,894 subs. Co-owned: WHIO-AM-FM. ■ Rates: \$512; 204; 94.

WKEF—ch 22, 1,081 kw vis, 108.1 kw aur, ant 700/650g. Sept. 13, 1964. 1731 Soldiers Home Rd., 45418. (513) 263-2662. TWX 810-459-1661. Licensee: Springfield TV Bcstg Corp. Ownership: See Springfield TV Stns. ■ ABC. Rep: H-R. Kettell-Carter; Mulvihill. Wash atty: Finkelstein & Firestone. ■ William L. Putnam, pres; George J. Mitchell, VP & gen mgr; Lon Mirolli, gen sls mgr; Berl Golub, prog mgr & film buyer; Johnny Walker, cmnty affairs & sp events dir; Sandy Patton, prom dir; Darrell Hunter, chief engr. ■ On 25 CATV's—50,000 subs.

WLWD—ch 2, 100 kw vis, 20 kw aur, ant 510/459g. March 15, 1949. 4590 Avco Dr., 45401. (513) 293-2101. TWX 513-944-0194. Licensee: Avco Bcstg Corp. Ownership: See Avco Stns. ■ NBC. Rep: Avco Radio TV Sls. Wash atty: Hogan & Hartson. ■ Ray W. Colie, VP & gen mgr; Donald E. Meineke, gen sls mgr; Don Prijatelj, prog dir; Ron Niess, prom mgr; Ed Hart, news dir; Harold Thompson, chief engr. ■ On 16 CATV's—48,000 subs.

***WOET-TV**—(Kettering) ch 16, 724 kw vis, 72.4 kw aur, ant 531/500g. March 20, 1967.

Ohio TV

See page B-89 for explanation of listings.

3131 S. Dixie Dr., Dayton, 45439. (513) 298-9500. Licensee: Univ. Rgnl. Bcstg Inc. (acq 7-1-75). ■ PBS, CEN, OEB. Wash atty: Cohn & Marks. ■ Dr. Clair R. Tettemer, exec dir & gen mgr; Richard O. Hackney, prog dir & film buyer; Phyllis Lloyd, dev dir; Robert L. Cheesman, chief engr. ■ On 9 CATV's—15,000 subs.

Kettering

***WOET-TV**—Licensed to Kettering. See Dayton.

Lima

ADI No. 193; see page B-39

***WBGU-TV**—See Bowling Green.

WLIO—ch 35, 202 kw vis, 40 kw aur, ant 540/549g. March 1953. 1424 Rice Ave., Box 1689, 45805. (419) 225-3010. TWX 810-447-2720. Licensee: Lima Communications Corp. (acq 2-1-72). Ownership: Toledo Blade Co., 75% (Toledo Blade, WWSW Inc. Buckeye Cablevision); Midwestern Bcstg Co., 25% (WOHO [AM] Toledo and WXEZ [FM] Sylvania). See Nwspr. ■ NBC, ABC. Rep: Meeker; Pearse, Busby, Finch & Woods. Wash atty: Dow, Lohnes & Albertson. ■ Wayne Current, pres; Charles E. Osburn, gen mgr & prog dir, prom mgr & film buyer; Robert B. Chorpensing, sls mgr; George Dunster, news dir; M.J. Lamb, chief engr. ■ On 19 CATV's—71,881 subs.

Lorain

WUAB—Licensed to Lorain. See Cleveland.

Marietta

WTAP-TV—Licensed to Parkersburg, W. Va. See Parkersburg, W. Va.

Newark

ADI No. 32; see page B-18

***WGSF**—ch 31, 4.68 kw vis, 933 w aur, 500/425g. March 18, 1963. 9. N. 5th St., 43055. (614) 345-9891. TWX 810-489-2717. Licensee: Newark Public School District. ■ PBS, Ohio ETV Net. Wash atty: Cohn & Marks. ■ Loren H. Briggs, supt school; Leland Hubbell, gen mgr & chief engr; John Hall, prom mgr & film buyer; Vicki Miller, news dir. ■ On 7 CATV's.

Oxford

ADI No. 26; see page B-15

***WMUB-TV**—ch 14, 204 kw vis, 40.7 kw aur, ant 332/342g. Oct. 14, 1959. 3131 S. Dixie Dr., Dayton, 45439. (513) 298-9500. Licensee: Univ. Rgnl. Bcstg Inc. (acq 11-11-75). ■ PBS, OEB, CEN (regional). ■ Dr. Clair Tettemer, exec dir & gen mgr; Richard O. Hackney, prog dir & film buyer; Phyllis Lloyd, dev dir; Robert L. Cheesman, chief engr. ■ On 7 CATV's—7,500 subs.

Portsmouth

ADI No. 110; see page B-76

WPBO-TV—ch 42, 398 kw vis, 79.4 kw aur, ant 1,240/1950g. October, 1973. 2470 N. Start Rd., Columbus, 43221. Licensee: Ohio Educational TV Network Commission.

Steubenville

ADI No. 110; see page B-76

WSTV-TV—ch 9, 316 kw vis, 31.6 kw aur, ant

Ohio, Oklahoma TV

See page B-89 for explanation of listings.

9501/884g. Dec. 10, 1953. Bcst Ctr, 43952. (614) 282-0911. TWX 614-283-4061. Licensee: Rust Craft Bcstg Co. Ownership: See Rust Craft Stns. ■ CBS, ABC. Rep: Petry. Wash atty: Kirkland, Ellis & Rowe. ■ Marshall Berkman, pres; Rust Craft, VP; Ray J. Chumley, gen mgr; M. Macaluso, sls mgr; Georgianna Hasley, prom mgr; Tom Peterson, news dir; Terry Walden, prog mgr & film buyer; Wm Chesnes, chief engr. ■ On 200 CATV's—100,000 subs. Co-owned: WSTV-AM-FM.

WTRF-TV—Licensed to Wheeling, W. Va. See Wheeling, W. Va.

Toledo

ADI No. 60; see B-72

WDHO-TV—ch 24, 363.9 kw vis, 72.8 kw aur, (CP: 36.3 kw aur), ant 1,413t/1,470g. May 3, 1966. 300 S. Byrne Rd., 43615. (419) 535-0024. TWX 810-442-1646. Licensee: D. H. Overmyer Telecasting Inc. Ownership: D. H. Overmyer Telecasting Co. Inc. ■ ABC. Rep: Katz. Wash atty: Fly, Shuebruk, Blume & Gaguine. ■ Arthur M. Dorfner, pres & gen mgr; James Steele, VP sls; James Garner, prog svcs sup; Shirley Webb, bus affrs; Liz Alexander, prom supvr; Bill Yeager, news dir; Ernest Retz, VP engr. ■ On 30 CATV's—124,000 subs. ■ Rates: \$215; 95; 35.

***WGTE-TV**—ch 30, 1,170 kw vis, 234 kw aur, ant 1,017t/1,034g. Oct. 10, 1960. 415 N. St. Clair, 43604. (419) 255-3330. Licensee: Greater Toledo Educl TV Foundation. ■ PBS, Ohio ETV. Wash atty: Schwartz & Woods. ■ Mrs. Stephen Stranahan, pres; Robert D. Smith, VP & gen mgr; Tobe Snow, dir, school TV; Peg Emerson, prog dir; Keith Darby, prod dir; James Hill, public info dir; William Crounse, dev dir; Kathleen Sieve, auction/voluntæer coord; Arthur C. Hafer, dir of engr. ■ On 20 CATV's. Co-owned: *WGTE-FM.

WSPD-TV—ch 13, 316 kw vis, 18.2 kw aur, ant 1,000t/1,049g. July 21, 1948. 136 Huron St., 43604. (419) 255-1313. TWX 810-442-1748. Licensee: Storer Bcstg Co. Ownership: See Storer Bcstg Co. Stns. ■ NBC. Rep: Storer TV Sls. Wash atty: Warren C. Zwicky. ■ Keith T. McKenney, VP & gen mgr; H. W. Ray, asst gen mgr; Robert H. Baker, gen sls mgr; Arthur B. Regenold III, prom mgr; Douglas W. Knight, prod, prog coord; George Fulop, chief engr. ■ On 36 CATV's.

WTOL-TV—ch 11, 316 kw vis, 38 kw aur, ant 1,000t/1,045.5g. Dec. 5, 1958. 604 Jackson St., 43604. (419) 244-7411. TWX 810-442-1609. Licensee: Cosmos Bcstg Corp. Ownership: See Cosmos Stns. ■ CBS. Rep: Peters, Griffin, Woodward. Wash atty: Dow, Lohnes & Albertson. ■ Charles A. Batson, pres; Law Epps, Sr. VP & gen mgr; Jack Sander, gen sls mgr; William J. Shock, prog/prom mgr; Larry Maisel, news dir; Hans Schippel, dir film svcs; Wyatt McDaniel, chief engr. ■ On 31 CATV's—90,450. ■ Rates: \$300; 140; 60.

Youngstown

ADI No. 77; see page B-79

WFMJ-TV—ch 21, 1,000 kw vis, 200 kw aur, ant 990t/1085g. March 8, 1953. 101 W. Boardman St., 44503. (216) 744-8611. TWX 810-435-2909. Licensee: Vindicator Printing Co. Ownership: Licensee publishes Youngstown Vindicator. See Nwspr. ■ NBC. Rep: Blair. Wash atty: Fisher, Wayland, Southmayd & Cooper. ■ William J. Brown, pres; Mitchell F. Stanley, stn mgr & sls mgr; Eugene Donahay, prog dir; Ed Baron, news dir; Frank A. Dieringer, chief engr. ■ Co-owned: WFMJ(AM).

WKBN-TV—ch 27, 1,000 kw vis, 46.8 kw aur,

(CP: 865 kw vis, 86.5 kw aur), ant 630t/663g. Jan 6, 1953. 3930 Sunset Blvd., 44501. (216) 782-1144. TWX 216-736-0108. Licensee: WKBN Bcstg Corp. Ownership: Warren P. Williamson Jr., 74.95% & family. ■ CBS. Rep: Katz. Wash atty: Wilner & Scheiner. ■ W. P. Williamson Jr., chmn; W. P. Williamson III, pres & gen mgr; David V. Stewart, coml mgr; Norman Berger, prog dir; Ted Conner, PR dir; P. J. Ford, dir of engr. ■ On 61 CATV's—213,196 subs. Co-owned: WKBN-AM-FM. ■ Rates: \$285; 85; 35.

WYTV—ch 33, 550 kw vis, 110 kw aur, ant 557t/638g. Oct. 30, 1957. 3800 Shady Run Rd., 44502. (216) 783-2930. TWX 810-435-2816. Licensee: WYTV Inc. (acq 11-13-70). Ownership: Adams-Russell Co., 100%. ■ ABC. Rep: Young. Wash atty: Smith & Pepper. ■ Geoffrey Pearce, pres & gen mgr; Gary Bolton, gen sls mgr; Stan Marinoff, prog dir; Tom Peterson, news dir; Arthur W. Taylor, chief engr. ■ On 58 CATV's. ■ Rates: \$225; 80; 35.

Zanesville

ADI No. 199; see page B-79

WHIZ-TV—ch 18, 186 kw vis, 37.2 kw aur, ant 540t/508g. May 23, 1953. Lind Arcade Bldg., 43701. (614) 452-5431. Licensee: Southeastern Ohio TV System. Ownership: T/R Inc., 63%; Southeastern Ohio Bcstg Sys., 20%; Ernest B. Graham, 11%; Ernest B. Graham Jr., 2%; James F. Graham, 2%; John C. Graham, 2%. ■ NBC. Rep: Savalli/Gates; Rgnl Reps; McDermott (Canada). Wash atty: Sells & Gregory. ■ Clay Littick, pres; Allan Land, group mgr & film buyer; Robert F. Hodous, gen mgr; Reed K. Mellon, prog dir; C. E. Hartmeyer, chief engr. ■ On 10 CATV's—15,000 subs. Co-owned: WHIZ-AM-FM.

Oklahoma

HAMILTON-LANDIS & ASSOCIATES, Inc.

NATIONWIDE MEDIA BROKERS
WASHINGTON, D.C., CHICAGO, DALLAS,
SAN FRANCISCO

SELL MORE

RADIO & TELEVISION STATIONS
IN THE SOUTHWEST—NEAREST OFFICE IS—
6060 N. CENTRAL EXPY., DALLAS 75206
(214) 691-2345

Ada

ADI No. 173; see page B-5

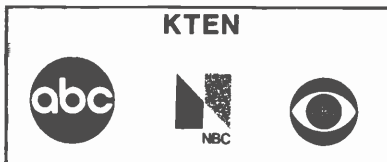

KTEN—ch 10, 316 kw vis, 47.9 kw aur, ant 760t/725g. May 3, 1954. Box 10, 74820. (405) 332-3311. TWX 405-332-1141. Licensee: Eastern Okla. TV Co. Ownership: Bill Hoover, 78%; & others. ■ ABC, NBC. Rep: Savalli/Gates. Wash atty: Fletcher, Heald, Rowell, Kenehan & Hildreth. ■ Bill Hoover, pres & gen mgr; R. Jack Hoover, VP, prod coord; Dan Hoover, prog dir; Charles Stacy, news dir; James Lollar, chief engr. ■ On 21 CATV's—20,000 subs. Co-owned: KTEN-FM. ■ Rates: \$60; 32; 24.

Ardmore

ADI No. 173; see page B-5

KXII—(Sherman-Denison, Tex.) ch 12, 214 kw vis, 32.4 kw aur, ant 1,030t/978g. July 1956. Box 1175, Sherman, Tex., 75090. (214) 892-8123. TWX 910-860-5226. Licensee: Tex-

oma Bcstrs Inc. Ownership: KWTX Bcstg Co., 80%; M. N. Bostick, 20%. See KWTX Stns & Texas Bcstg Stns. ■ NBC, CBS. Rep: H-R. Wash atty: Dow, Lohnes & Albertson. ■ M. N. Bostick, pres; C. H. Balding, gen mgr; Gil Lee, prog dir; Phil Ransom, prom mgr; Dave Floyd, news dir; Rubin Masters, chief engr. ■ On 16 CATV's. ■ Rates: \$65; 60; 20.

Lawton

ADI No. 118; see page B-77

KAUZ-TV—See Wichita Falls, Tex.

KFDX-TV—See Wichita Falls, Tex.

KSWO-TV—ch 7, 316 kw vis, 63.1 kw aur, ant 1,050t/1,059g. March 8, 1953. Box 708, 73501. (405) 355-7000. TWX 910-836-3600. Licensee: KSWO TV Inc. Ownership: R. H. Drewry, 69%; T.R. Warkenten estate, Edith Scott, each 15.5%. See R. H. Drewry Stns. ■ ABC. Rep: Avery-Knodel. Wash atty: James E. Greeley. ■ R. H. Drewry, pres; William B. Fort, gen mgr & news sls mgr; Larry Patton, prog dir; Bill Riley, gen sls mgr; Shannan Conway, prom mgr; Jim Locker, chief engr. ■ On 18 CATV's—15,300 subs. Co-owned: KSWO(AM).

Oklahoma City

ADI No. 41; see page B-53

***KETA**—ch 13, 260 kw vis, 37.1 kw aur, ant 1,450t/1,427g. April 13, 1956. 1700 Asp Ave., Norman, 73069. (405) 364-2100. Licensee: Okla. Educl TV Authority. ■ PBS. Wash atty: Cohn & Marks. ■ Mrs. Juanita Kidd, chmn; Bob Allen, dir; Ken Clark, asst dir; Don Singleton, prog dir; Bill P. Key, chief engr. ■ On 45 CATV's.

KOCO-TV—ch 5, 83.2 kw vis, 7.5 kw aur, ant 1,520t/1,563g. July 15, 1954. Box 32325, 73132. (405) 848-3311. TWX 910-830-6854. Licensee: Combined Communications Corp. of Oklahoma. (acq 9-70). Ownership: See Combined Communications Stns. ■ ABC. Rep: Peters, Griffin, Woodward. Wash atty: James A. Gammon. ■ Kenneth R. Croes, pres & gen mgr; Al Parsons, VP, stn & sls mgr; Mike Palmer, prog dir & film buyer; Anne Coleman, prom mgr; Foster Morgan, news dir; John D. Harrison, dir of pub affairs; Ted Newcomb, VP & chief engr. ■ On 19 CATV's—12,200 subs. On 1 trans. ■ Rates: \$260; 110; 60.

***KOKH-TV**—ch 25, 296 kw vis, 55 kw aur, ant 460t/500g. Jan. 26, 1959. 1801 N. Ellison St., 73106. (405) 236-2661. Licensee: Independent School District 89. ■ PBS. ■ Paul Ringle, gen mgr; Richard Newton, opns mgr; Fred Daniel, acquisitions mgr; Jim Stacy, film buyer; Kaye Teall, coord of progmg & instr svcs; John Gordon, chief engr.

KTVY

(Formerly WKY-TV)

KTVY—ch 4, 97.7 kw vis, 19.5 kw aur, ant 1,540t/1,602. June 6, 1949. Box 14068, 73114. (405) 478-1212. TWX 910-830-6866. Licensee: KTVY Inc. (acq 1-5-76). Ownership: See Evening News Assoc., also Nwspr. ■ NBC. Rep: Katz. Wash atty: Pierson, Ball & Dowd. ■ Peter B. Clark, pres; Norman P. Bagwell, VP & gen mgr; Joe T. Jerkins, asst gen mgr; Tom Parrington, stn & sls mgr; Bill Thrash, prog mgr & film buyer; Jack Sherry, prom mgr; Ernie Schultz, dir info progs; John Bushnell Jr., chief engr. ■ On 50 CATV's—70,000 subs. ■ Rates: \$385; 175; 65.

KWTV—ch 9, 316 kw vis, 33.9 kw aur, ant 1,520t/1,572g. Dec. 20, 1953. Box 14159, 73114. (405) 843-6641. TWX 910-830-6852. Licensee: Griffin TV Inc. ■ CBS. Rep: Blair. Wash atty: Fletcher, Heald, Rowell, Kenehan & Hildreth. ■ John T. Griffin, pres; Jacques DeLier, exec VP & gen mgr; Jack Sallaska admin asst & film buyer; Michael J. De Lier, gen sls mgr;

David Whaley, natl sls mgr; Charles Unger, prom mgr; Roy Charles, news dir; William A. Green, chief engr. ■ On 35 CATV's. ■ Rates: \$525; 200; 70.

Sayre

ADI No. 41; see page B-53

KFDO-TV—ch 8, 26.3 kw vis, 5.25 kw aur, ant 580t/650g. May 17, 1966. Box 1400, Amarillo, Tex., 79105. (405) 928-3233. Licensee: Bass Bcstg Co. Co-owned satellite of KFDA-TV Amarillo, Tex. ■ Rep: H-R. Wash atty: Miller & Schroeder. ■ Melvin L. Wheeler, pres; Earle H. Rast, Jr., mgr; Dave Coons, chief engr.

Tulsa

ADI No. 62; see page B-73

***KOED-TV**—ch 11, 259 kw vis, 37 kw aur, ant 1,270t/1,133g. Jan. 12, 1959. Box 14190, Oklahoma City, 73114. (405) 848-8501. Licensee: Okla. Educl TV Authority. ■ PBS. ■ Execs: See *KETA Oklahoma City.

KOTV—ch 6, 100 kw vis, 20 kw aur, ant 1,310t/1,135g. Nov. 30, 1949. 302 S. Frankfort, 74120. (918) 583-9223. TWX 918-923-3356. Licensee: KOTV Inc. Ownership: See Corinthian Stns. ■ CBS. Rep: Harrington, Righter & Parsons. Wash atty: Covington & Burling. ■ Philip J. Lombardo, pres; Duane R. Harm, VP & gen mgr; David E. Michels, gen sls mgr; Steve McCleaster, opns & prod mgr; J. Clyde Parker, prom mgr; Clayton Vaughn, news dir; C. E. Allen, chief engr. ■ On 34 CATV's—75,500 subs. On 2 trans.

KTEW—ch 2, 100 kw vis, 10 kw aur, ant 1,330t/1,176g. Dec. 5, 1954. 3701 S. Peoria, 74105. (918) 742-5561. TWX 910-845-2134. Licensee: Scripps-Howard Bcstg Co. (acq 1-1-71). Ownership: See Scripps-Howard Stns, also Nwspr. ■ NBC. Rep: Blair. Wash atty: Dempsey & Koplovitz. ■ Donald L. Perris, pres; William S. Ritchie, VP & gen mgr; M. C. Watters, exec VP; Wallace Dunham, asst gen mgr; Tom Belcher, gen sls mgr; Jack Morris, news dir; Bruce Washburn, prod mgr; Allen Cox, prom mgr; John D. Barth, chief engr. ■ On 41 CATV's—80,000 subs. On 3 trans.

KTUL-TV—ch 8, 316 kw vis, 63 kw aur, ant 1,880t/1,909g. Sept. 18, 1954. Box 8, 74101. (918) 446-3351. TWX 910-845-2181. Licensee: Leake Industries Inc. Ownership: See Leake TV Inc. Stns. ■ ABC. Rep: Petry. Wash atty: Fletcher, Heald, Rowell, Kenehan & Hildreth. ■ James C. Leake, bd chmn; Bob Doubleday, pres; Tom Goodgame, VP & gen mgr; Ed Hunt, gen sls mgr; Eric Nelson, prod mgr; Betty Boyd, prom mgr; Bob Gregory, VP news dir; Lewis Brown, chief engr. ■ On 52 CATV's—150,000 subs.

Oregon

Coos Bay

ADI No. 130; see page B-24

KCBY-TV—ch 11, 11.5 kw vis, 1.1 kw aur, ant 680t/200g. Oct. 1, 1960. Box 1156, 97420. (503) 269-1111. TWX 503-431-0350. Licensee: Eugene TV Inc. Ownership: See Eugene TV. ■ NBC. Rep: Hollingbery; Moore. Wash atty: Dow, Lohnes & Albertson. ■ Robert P. Booth, pres; Mary Miller, gen mgr; Gordon Shaw, opns mgr & news dir; Glynn McCready, chief engr. ■ On 4 CATV's—7,000 subs. On 5 trans.

Corvallis

ADI No. 24; see page B-57

***KOAC-TV**—ch 7, 263 kw vis, 26.3 kw aur, ant

1,230t/276g. Oct. 7, 1957. Oregon State U, 97331. (503) 754-1311. Licensee: Oregon State Bd of Higher Educ. ■ PBS. Wash atty: Fisher, Wayland, Southmayd & Cooper. ■ Donald Bryant, exec dir; Bob Hinz, dir of opns & engrg; Tom Doggett, dir of prog & prod; Marion Billings, prom mgr; Ben J. Ballard, chief engr. ■ On 44 CATV's—67,000 subs. Co-owned: *KOAC(AM).

Eugene

ADI No. 130; see page B-24

KEZI-TV—ch 9, 316 kw vis, 47.4 kw aur, ant 1,570t/255g. Dec. 19, 1960. 2225 Coburg Rd., 97401. (503) 343-3301. TWX 503-485-0488. Licensee: Liberty Communications Inc. (acq 8-16-72). Ownership: Durward L. Boyles, 16.1%; Donald E. Tykeson, 11.6%; & others. ■ ABC. Rep: Avco. Wash atty: Fly, Shuebruk, Blume and Gaguine. ■ Donald E. Tykeson, pres & gen mgr; Jim Magnuson, stn & sls mgr; James Putney, asst stn mgr; Shirley Shepherd, prod mgr; David Weinkauff, opns mgr; Charles Cookson, chief engr. ■ On 29 CATV's—69,242 subs. On 24 trans.

KVAL-TV—ch 13, 316 kw vis, 63.1 kw aur, ant 1,480t/850.5g. April 16, 1954. Box 1313, 97401. (503) 342-4961. TWX 510-597-0365. Licensee: Eugene TV Inc. Ownership: See Eugene TV Stns. ■ NBC. Rep: H-R; Moore. Wash atty: Dow, Lohnes & Albertson. ■ Robert P. Booth, pres; S. W. McCready, VP; Glenn E. Nickell, gen & sls mgr; Don Flinders, opns mgr; John Doyle, news dir; Gordon Bussey, prod mgr; Jim Bowen, chief engr. ■ On 24 CATV's—49,897 subs. On 17 trans.

Klamath Falls

ADI No. 155; see page B-43

KOTI—ch 2, 13.5 kw vis, 2.5 kw aur, ant 1,050t/109g. Aug. 12, 1956. Box 2K, 97601. (503) 884-8131. Licensee: Oregon Bcstg Co. Ownership: See California-Oregon Stns, also Nwspr. ■ CBS, ABC. Rep: Meeker; Moore; McDermott (Canadian). Wash atty: Dempsey & Koplovitz. ■ William B. Smullin, pres; Daniel Markham, stn mgr; Ken King, natl sls mgr; Larry Baker, news dir; Steve Douglas, chief engr. ■ On 3 CATV's—9,000 subs. On 4 trans. Co-owned: KAGI(AM). ■ Rates: \$59; 26; 19.

Medford

ADI No. 155; see page B-43

KMED-TV—ch 10, 132 kw vis, 26.3 kw aur, ant 3,310t/151g. Oct. 3, 1961. Box 10, 97501. (503) 773-7373. TWX 510-757-0606. Licensee: Radio Medford Inc. Ownership: J. L. DeArmond, George R. Johnson, John R. Dellenback, each 33-1/3%. ■ NBC, ABC. Rep: H-R; Simpson/Reilly. Wash atty: Dow, Lohnes & Albertson. ■ J. L. DeArmond, pres; Ray Johnson, exec VP & gen mgr; John Larkin, stn mgr; Hank Henry, news dir; Ellis Feinstein, dir of engrg; Art Chipman, natl sls mgr. ■ On 19 CATV's—18,000 subs. On 21 trans. Co-owned: KMED(AM)-KTMT(FM). ■ Rates: \$100; 50; 27.

KOBI—ch 5, 60 kw vis, 8.1 kw aur, ant 2,700t/313g. Aug. 1, 1953. Box 5M, 97501. (503) 779-5555. TWX 510-757-0607. Licensee: Oregon Bcstg Co. Ownership: California-Oregon Stns, also Nwspr. ■ CBS, ABC. Rep: Young; Moore. Wash atty: Dempsey & Koplovitz. ■ Wm. B. Smullin, pres; Jerold R. Poulos, VP & gen mgr; Art Knoles, prod mgr; John Darling, news dir; Bill Kirk, chief engr. ■ On 19 CATV's—48,000 subs. On 18 trans.

***KSYS**—ch 8, 131.8 kw vis, 26.36 kw aur, ant 3,340t/140g. Not on air, target date unknown. Box 518, 97501. Licensee: Southern Oregon Education Co.

Oklahoma, Oregon TV

See page B-89 for explanation of listings.

Portland

ADI No. 24; see page B-57

KATU—ch 2, 100 kw vis, 20 kw aur, ant 1,560t/918g. March 15, 1962. 2153 N. E. Sandy Blvd., 97208. (503) 233-2422. TWX 910-464-4700. Licensee: Fisher's Blend Stns Inc. Ownership: Fisher's Blend Stns, 100%. See Fisher's Blend Stns. ■ ABC. Rep: Katz; Simpson/Reilly. Wash atty: Fisher, Wayland, Southmayd & Cooper. ■ William W. Warren, pres; Thomas R. Dargan, exec VP & gen mgr; Charles Gingold, dir of progmg; Richard Ross, news dir; Skip Hinman, sls mgr; William Vandermyer, chief engr. ■ On 61 CATV's—90,000 subs. On 9 trans. ■ Rates: \$875; 325; 90.

KGW-TV—ch 8, 302 kw vis, 60.3 kw aur, ant 1,770t/926g. Dec. 15, 1956. 1501 S. W. Jefferson St., 97201. (503) 224-8620. TWX 910-464-6150. Licensee: King Bcstg Co. Ownership: See King Bcstg Co. Stns. ■ NBC. Rep: Blair; Paul Mulvihill (Canada). Wash atty: Fletcher, Heald, Rowell, Kenehan & Hildreth. ■ Ancil H. Payne, pres; Forest W. Amsden, VP & gen mgr; Richard A. Morgans, gen sls mgr; Robert Lewis, prod dir & film buyer; Judith Spannagel, prom mgr; Ed Godfrey, news dir; Claire Hanawalt, chief engr. ■ On 56 CATV's—67,000 subs. On 21 trans. Co-owned: KGW(AM)-KINK(FM). ■ Rates: \$750; 300; 65.

***KOAP-TV**—ch 10, 60.3 kw vis, 12 kw aur, ant 950t/203g. Feb. 6, 1961. 2828 S. W. Front Ave., 97201. (503) 229-4892. Licensee: Oregon State Bd of Higher Educ. ■ PBS. ■ Donald S. Bryant, exec dir; Robert Hinz, dir opns & engrg; Thomas M. Doggett, prod & prod dir; Marion Billings, prom mgr; Harold Hepler, chief engr. ■ Co-owned: *KOAP-FM.

KOIN-TV—ch 6, 100 kw vis, 15.1 kw aur, ant 1,760t/989g. Oct. 15, 1953. 140 S. W. Columbia St, 97201. (503) 228-3333. TWX 503-7251-67; Telex 910-464-1520. Licensee: Mount Hood Radio & TV Bcstg Corp. Ownership: Newhouse Bcstg Corp., 50%; Theodore R. Gamble, 11%; Joan Hering, 11%; Susan G. Behrendt, 11%; & others. See Newhouse Stns, also Nwspr. ■ CBS. Rep: Harrington, Righter & Parsons. Wash atty: Dow, Lohnes & Albertson. ■ Richard J. Butterfield, gen mgr; Lee Carlson, gen sls mgr; John McGhie, prod dir & film buyer; Larry Hogan, prom mgr; Ted Bryant, news dir; Albert R. Bishop, dir of engrg. ■ On 117 CATV's—142,675 subs. On 27 trans. Co-owned: KOIN-AM-FM. ■ Rates: \$825; 130; 55.

KPTV

TELE-REP

KPTV—ch 12, 316 kw vis, 61.7 kw aur, ant 1,780t/1,055g. Sept. 20, 1952. Box 3401, 97208. (503) 222-9921. TWX 910-464-6136. Licensee: Oregon TV Inc. Ownership: See Chris Craft Industries Stns. ■ Rep: Tele-Rep. Wash atty: Hogan & Hartson. ■ John S. Hansen, pres & gen mgr; Martin Brantley, gen sls mgr; Gordon White, prod dir; Karen Malmsten, prom mgr; Donald Stelges, news dir; Gene Phelps, chief engr. ■ On 41 CATV's. On 10 trans. ■ Rates: \$120; 190; 35.

Roseburg

ADI No. 130; see page B-24

KPIC—ch 4, 5.37 kw vis, 55 kw aur, ant 1,000t/173g. April 1, 1956. Box 1345, 655 N. Umpqua, 97470. (503) 672-4481. TWX 510-758-0258. Licensee: South West Oregon

Oregon, Pennsylvania TV

See page B-89 for explanation of listings.

TV Bcstg Corp. Ownership: See California-Oregon Stns & Eugene TV Stns, also Nwsp. ■ Wash atty: Dow, Lohnes & Albertson. ■ S. W. McCreedy, gen mgr; Glenn Nickell, sls mgr; Dave Coplin, opns mgr; Don Clithero, chief engr. ■ On 1 CATV—2,200 subs. On 5 trans.

Salem

ADI No. 24; see page B-57

KVDO-TV—ch 3, 18.6 kw vis, 3.7 kw aur, ant 1,070t/296g, Feb. 24, 1970. 3000 Portland Rd., N. E., 97303. (503) 581-6300. Licensee: Corvallis Cable Co. (acq 10-72). Ownership: Liberty Communications Inc. ■ Rep: Savalli-Gates; Tacher. Wash atty: Fly, Shuebruk, Blume & Gaguine. ■ Jim Magnuson, gen mgr; Dick Walker, stn mgr; Ken Christensen, news dir; Robert N. Ridgway, chief engr. ■ On 24 CATV's—52,063 subs. On 4 trans.

Pennsylvania

**HAMILTON-LANDIS
& ASSOCIATES, Inc.**
NATIONWIDE MEDIA BROKERS
WASHINGTON, D. C., CHICAGO, DALLAS,
SAN FRANCISCO
SELL **MORE**
RADIO & TELEVISION STATIONS
IN THE EAST—NEAREST OFFICE IS—
1730 K ST., N.W., WASHINGTON 20006
(202) 393-3456

Allentown

ADI No. 4; see page B-56

***WLVT-TV**—ch 39, 617 kw vis, 123 kw aur, ant 990t/516g, September, 1965. South Mountain Dr., W. Bethlehem, 18015. (215) 867-4677. TWX 510-651-2345. Licensee: Lehigh Valley Educl TV Corp. ■ PBS, EETN, PPTN. Wash atty: Dow, Lohnes & Albertson. ■ Philip I. Berman, pres; Sheldon P. Siegel, exec VP & gen mgr; Donald L. Robert, prog dir; Jerry Richards, dir engr. ■ On 40 CATV's—175,000 subs.

New TV—ch 69, 18.25 kw vis, 4.79 kw aur, 898t/471g. Not on air, target date 7-76. E. Rock Rd., 18103. Permittee: Maranatha Bcstg Co.

Altoona

ADI No. 73; see page B-35

WOPC—ch 38, 62.7 kw vis, 11.33 kw aur, ant 940t/140.6g, November 1974. Box 609, 16603. (814) 943-2607. Licensee: John R. Powley. Ownership: John R. Powley, 100%. ■ ABC. Rep: Savalli/Gates; Regional Reps. ■ John R. Powley, gen mgr. ■ Co-owned: WHGM(FM) Bellwood. ■ Rates: \$30; 17; 14.

WTAJ-TV—ch 10, 214 kw vis, 21.9 kw aur, ant 1,110t/277g, March 1, 1953. Commerce Park, 16603. (814) 944-2031. TWX 510-691-4841. Licensee: Gateway Communications Inc. (acq 10-72). Ownership: Bergen Evening Record Corp., 80%; George A. Koehler, 13%; and others. See Gateway Communications Stns, also Nwsp. ■ CBS. Rep: Blair; Dome. Wash atty: Wilner & Scheiner. ■ George A. Koehler, pres; Ian K. Harrower, VP & gen mgr; Joe Lastort, gen sls mgr; Jeff Hark, prog dir; Jan Gray, prom mgr; Tim Fritz, news dir; Dick Kline, chief engr. ■ On 202 CATV's—218,148 subs.

Clearfield

ADI No. 73; see page B-35

***WPSX-TV**—ch 3, 100 kw vis, 20 kw aur, ant 880t/539g, March 1, 1965. 201 Wagner Bldg., University Park, 16802. (814) 865-9531. TWX 510-691-2674. Licensee: Penn State Univ. ■ PBS, EEN, PPTN. Wash atty: Norman E. Jorgensen. ■ David L. Phillips, dir of bcstg & gen mgr; Robert Dudley, asst dir, prog dev; William Miller, asst dir progmg; Gary Miller, info spec; Lloyd Niemann, chief electronics svcs. ■ On 87 CATV's—206,633 subs. On 1 trans. Co-owned: *WDFM(FM).

Erie

ADI No. 137; see page B-23

WICU-TV—ch 12, 316 kw vis, 32.9 kw aur, ant 1,000t/792g, March 14, 1949. 3514 State St., 16508. (814) 454-5201. TWX 814-696-6878. Licensee: Great Lakes Communications Inc. Ownership: Edward Lamb & family, 87%; & others. See Lamb Communications Inc. ■ NBC. Rep: Avery-Knodel. Wash atty: Fly, Shuebruk, Blume & Gaguine. ■ Bob Lunquist, gen mgr & film buyer; Clarence Paoletta, sls mgr; Eric Johnson, opns mgr; Michael Csp, chief engr. ■ On 72 CATV's—155,000 subs.

WJET-TV—ch 24, 589 kw vis, 58.9 kw aur, ant 740t/600g, April 2, 1966. 8700 Waterford Pike Rd., 16509. (814) 864-4902. Licensee: Jet Bcstg Co. Ownership: See Myron Jones Stns. ■ ABC. Rep: Natl TV Sls. Wash atty: Midlen & Reddy. ■ Myron Jones, pres; Pete Coticchia, gen mgr & natl sls mgr; Ken Franizini, prog dir & film buyer; John Kanzius, chief engr. ■ Co-owned: WJET(AM).

***WQLN**—ch 54, 276 kw vis, 27.8 kw aur, ant 877t/717g, Aug. 13, 1967. Waterford Pike, 16509. (814) 868-4654. TWX 510-696-6854. Licensee: Public Bcstg of Northwest Pa. Inc. ■ PBS. ■ Robert J. Chitester, pres; David Roland, dir bcst opns; Art Martinucci, VP, comm relations; Donald Hain, VP, engr.

WSEE—ch 35, 602 kw vis, 60.2 kw aur, ant 960t/760g, April 24, 1954. 1220 Peach St., 16501. (814) 455-7575. TWX 510-696-6806. Licensee: Great Lakes TV Co. Ownership: George J. Mead Estate, 17.13%; A. R. Minadeo, 13.824%; Grace F. Mead Estate, 13.824%; J. Jacob Young Estate, 11.946%; and others. ■ CBS. Rep: Meeker; Dome; Pearse. Wash atty: Haley, Bader & Potts. ■ John W. English, pres; Edward G. Zellefor, gen mgr & film buyer; Melvin Kofod, sls mgr; David Tung, prog dir; James De Santis, news dir; James J. Penna, chief engr. ■ On 42 CATV's—222,581 subs. ■ Rates: \$60; 45; 17.

Greensburg

New TV—ch 40, 1488 kw vis, 157 kw aur, 950t/909g. Not on air, target date unknown. 3500 Parkdale Ave., Baltimore, Md., 21211. Licensee: Commercial Radio Institute.

Harrisburg

ADI No. 46; see page B-31

WHP-TV—ch 21, 1,250 kw vis, 245 kw aur, ant 1220t/496g, April 15, 1953. 3300 N. 6th St., 17110. (717) 238-2100. TWX 510-650-4925. Licensee: WHP Inc. Ownership: Commonwealth Communications Services. ■ CBS. Rep: HR TV. Wash atty: Dow, Lohnes & Albertson. ■ Joseph M. Higgins, pres & gen mgr; Donald C. Yeiser, gen sls mgr; John Sebastian, news dir; Carol Haigh, prom & prod mgr; Juanita Hostetter, prog dir; Maurice Gannaway, dir of engr. ■ On 35 CATV's—77,000 subs. Co-owned: WHP-AM-FM. ■ Rates: \$245; 70; 30.

WTPA (York-Lebanon)—ch 27, 1,000 kw vis, 100 kw aur, ant 1,120t/609g, June 19, 1953. Box 2775, Harrisburg, 17105. (717) 238-7171.

TWX 510-650-0803. Licensee: Newhouse Bcstg Corp. Ownership: See Newhouse Stns, also Nwsp. ■ ABC. Rep: Harrington, Righter & Parsons. Wash atty: Dow, Lohnes & Albertson. ■ E. R. Vadeboncoeur, pres; Paul S. Abbott, gen mgr & film buyer; Jack L. Thornsley, sls mgr; Paul J. Baker, prog dir; Mike Ross, news dir; Charles W. Baker, chief engr. ■ On 31 CATV's. On 3 trans. Co-owned: WTPA-FM.

Hershey

ADI No. 46; see page B-31

***WITF-TV**—ch 33, 513 kw vis, 51.3 kw aur, ant 867t/195g, Nov. 22, 1964. Box Z, 17033. (717) 534-3333. TWX 510-567-4010. Licensee: South Central Educational Bcstg Council. ■ PBS, EEN, PPTN. Wash atty: Dow, Lohnes & Albertson. ■ Andrew M. Bradley, pres; Robert F. Larson, gen mgr; Michael J. Ziegler, asst gen mgr; Richard L. Hair, mgr educ svcs; Michael L. Greenwald, prom & dev mgr; Bill Varney, prog dir; John Bosak, chief engr. ■ On 31 CATV's—127,481 subs. On 1 trans. Co-owned: *WITF-FM.

Johnstown

ADI No. 72; see page B-70

WJAC-TV—ch 6, 70.8 kw vis, 10.6 kw aur, ant 1,120t/175g, Sept. 15, 1949. Hickory Lane, 15905. (814) 255-5831. TWX 510-698-3274. Licensee: WJAC Inc. Ownership: Johnstown Tribune Publishing Co., 100%. See Nwsp. ■ NBC. Rep: Harrington, Righter & Parsons. Wash atty: Dow, Lohnes & Albertson. ■ Alvin D. Schrott, pres; John B. Rogers, coml mgr; James M. Edwards Sr., prog dir; Ronald Stephenson, news dir; Theodore Campbell, chief engr. ■ On 141 CATV's—378,441 subs. On 3 trans. Co-owned WJAC-AM-FM. ■ Rates: \$250; 130; 75.

WJNL-TV—ch 19, 95.6 kw vis, 10.47 kw aur, ant 640t/561g, Oct. 15, 1953. 341 Lincoln St., 15901. (814) 536-0761. Licensee: Cover Bcstg Inc. Debtor in possession. (acq 8-11-75). ■ CBS, ABC. ■ John E. Gelormino, pres & gen mgr; Wm L. Santoro, asst to pres; J. J. Kershkey, chief engr. ■ On 16 CATV's—85,000 subs. On 6 trans. ■ Rates: \$55; —; —.

Lancaster

ADI No. 46; see page B-31

WGAL-TV—ch 8, 316 kw vis, 63.1 kw aur, ant 1,000t/480g, March 18, 1949. Lincoln Highway W., 17604. (717) 393-5851. Licensee: WGAL-TV Inc. Ownership: See Steinman Stns, also Nwsp. ■ NBC. Rep: Meeker; Kettell-Carter; Pearse; Hix; Busby, Finch & Woods. Wash atty: Hogan & Hartson. ■ Harry J. Shaub Jr., exec VP & gen mgr; Harold E. Miller, stn mgr; Leroy K. Strine, natl sls mgr; Nelson Sears, prog mgr; Thomas E. McCarty, rgnl sls mgr; Robert F. Walther, prod mgr; Robert H. Zima, sls service mgr; Paul I. Woodland, prom mgr; J. Jude Schlager, sls dev mgr; Wayne Seacat, tech dir. ■ On 90 CATV's—426,500 subs. Co-owned WGAL-AM-FM.

WLYH-TV—ch 15, 129 kw vis, 24 kw aur, ant 880t/572g, Oct. 15, 1953. 1126 Park City Center, 17601. (717) 273-4551. TWX: 510-650-4953. Licensee: Gateway Communications Inc. (acq 10-72). Ownership: Bergen Evening Record Corp., 80%; George A. Koehler, 13%; and others. See Gateway Communications Stns. ■ CBS. Rep: Blair. Wash atty: Wilner & Scheiner. ■ George A. Koehler, pres; Donald F. Snyder, gen mgr; Steve Petrich, gen sls mgr; Henry Urlick, prog dir; Wes Maley, news dir; Robert Good, chief engr. ■ On 75 CATV's—250,000 subs. ■ Rates: \$65; 40; 15.

Lebanon

WLYH-TV Licensed to Lancaster. See Lancaster.

ADI No. 10; see page B-56

Philadelphia

ADI No. 4; see page B-56

KYW-TV—ch 3, 95.5 kw vis, 9.5 kw aur, ant 1,000T/1,166g. Sept. 3, 1941. Independence Mail East, 19106. (215) 238-4700. TWX 710-670-0255. Licensee: Westinghouse Bcstg Co. Ownership: See Westinghouse Stns. █ NBC. Rep: TVAR; McDermott (Canada). Wash atty: Hedrick & Lane. █ Donald H. McGannon, chmn & pres; Wm Baker, pres, TV group; Alan J. Bell, VP & gen mgr; Arthur Kern, gen sls mgr; Michael Lape, local sls mgr; Robert T. Sutton, prog dir; Paul A. Bissonette, creative svcs dir; Kenneth D. Tiven, news dir; Charles Blair, chief engr. █ Co-owned: KYW(AM). █ Rates: \$4,000; 1200; 500.

WCAU-TV—ch 10, 191 kw vis, 19.1 kw aur, ant 1,160T/1,139g. March 15, 1948. City Line & Monument Aves., 19131. (215) 839-7000. TWX 510-662-5997. Telex 84-5279. Licensee: CBS Inc. Ownership: See CBS-owned Stns. █ CBS. Rep: CBS TV Stns Natl Sis. █ D. Thomas Miller, pres; Robert L. Hosking, gen mgr; Richard Goldstein, sls mgr; Noble V. Blackwell, dir of bcst; Bruce A. Weiner, prom mgr; Robert Morse, dir of news; Gordon W. West, film buyer; Robert Gross, dir of engr. █ Co-owned; WCAU-AM-FM.

WKBS-TV (Burlington, N.J.)—ch 48, 2,140 kw vis, 214 kw aur, ant 1,107T/1,105g. Sept. 1, 1965. 3201 S. 26th St., Philadelphia, 19145. (215) 336-6400. Licensee: Kaiser Bcstg Co. Ownership: See Kaiser Bcstg Stns. █ Rep: Kaiser Bcstg Spot Sls. Wash atty: Wilmer, Cutler & Pickering. █ Robert L. Bryan, gen mgr; Jack Kline, gen sls mgr; Sam Feinberg, sls mgr; Elbert Sampson, prog dir; James A. Capone, prom mgr; Martin S. Jacobs, news dir; Glenn H. Romsos, engr mgr. █ On 90 CATV's—516,000 subs. On 1 trans.

WPHL-TV—ch 17, 2,450 kw vis, 368 kw aur, ant 1,080T/1,140g. Sept. 17, 1965. 5001 Wynnefield Ave., 19131. (215) 878-1700. TWX 710-670-0476. Telex 845-400. Licensee: WPHL-TV Inc. Ownership: AVC Corp. █ Rep: Avco TV Sls. Wash atty: Covington & Burling. █ Eugene McCurdy, pres & gen mgr; Charles McFadden, gen sls mgr; Ted Baze, stn mgr & film buyer; Walter Bundy, chief engr. █ On 90 CATV's—400,000 subs. █ Rates: \$200; 125; 75.

WPVI-TV—ch 6, 74.1 kw vis, 14.8 kw aur, ant 1,094T/1,111g. Sept. 13, 1947. 4100 City Line Ave., 19131. (215) 878-9700. TWX 215-569-9730. Licensee: Capital Cities Communications Inc. (acq 4-27-71). Ownership: See Capital Cities Stations. █ ABC. Rep: Blair; Mulvihill (Canada). Wash atty: Wilmer, Cutler & Pickering. █ Lawrence Pollock, VP & gen mgr; Henry Chadwick, gen sls mgr; Charles Bradley, prog dir; Richard F. Appleton, dir of sls; David Elmore, prom dir; Ronald Tindiglia, news dir; Irwin Ross, chief engr.

WTAF-TV—ch 29, 825 kw vis, 82.5 kw aur, ant 1,100T/1,140g. (CP: 5,000 kw max, 3,740 kw horiz vis, 500 kw max, 347 kw horiz aur, ant 1,140T/1,190g.) May 18, 1965. 330 Market St., 19106. (215) WA5-2929. TWX 710-670-1979. Licensee: Taft Bcstg Co. of Pa. Ownership: See Taft Stns. █ Rep: Bolton/Burchill. Wash atty: Koteen & Burt. █ Carlo Anneke, gen mgr; Philip A. Jones, sls mgr; Richard N. Owens, chief engr.

*WUHY-TV—ch 35, 141 kw vis, 14.1 kw aur, ant 500T/585g. April 25, 1957. 4548 Market St., 19139. (215) 382-9300. TWX 710-670-5983. Licensee: WHYI Inc. █ PBS, EEN. Wash atty: Schwartz & Woods. █ Warren A. Kraetzer, pres & gen mgr; Karl A. Peckmann, VP & dev mgr; Norman Marcus, VP prog & prod; Robert Hall, VP & chief engr. █ On 40 CATV's—200,000 subs. On 1 trans. Co-owned: *WUHY-FM.

KDKA-TV—ch 2, 100 kw vis, 10 kw aur, ant 995T/683g. January 1949. 1 Gateway Ctr, 15222. (412) 391-3000. TWX 710-644-4380. Licensee: Westinghouse Bcstg Co. Ownership: See Westinghouse Stns. █ CBS. Rep: TVAR. Wash atty: Hedrick & Lane. █ Jonathan S. Hayes, gen mgr; William C. Strong, sls mgr; Richard Kurlander, prog mgr; Joe Houston, prom mgr; David Beddow, news dir; Glenn Lahman, engr mgr. █ On 122 CATV's—169,000 subs. Co-owned: KDKA-AM-FM.

WIIIC-TV—ch 11, 295 kw vis, 29.5 kw aur, ant 990T/848g. Sept. 1, 1957. 341 Rising Main Ave., 15214. (412) 321-8700. TWX 710-664-2099. Licensee: WIIIC-TV Corp. (acq 1-1-65). Ownership: See Cox Bcstg Stns, also Nwspr. █ NBC Rep: Telerep. Wash atty: Dow, Lohnes & Albertson. █ Clifford Kirtland, pres; Stanley G. Mouse, VP & gen mgr bcst dir; Leonard A. Swanson, VP & gen mgr WIIIC-TV; Merritt Rose, sls mgr; Alexander H. Gordon, adv mgr; David Chase, stn mgr; By Williams, prog dir; Al Mann, news dir; Ray M. Swenson, dir of engr. █ On 145 CATV's—458,368 subs.

WPCB-TV—ch 22, 1100 kw vis, 110 kw aur, 966T/839g. Not on air, target date unknown. Licensee: Western Pa. Christian Bcstg.

Advertisement for WPGH-TV/Pittsburgh featuring the slogan 'We play favorites!' and logos for 88 BOLTON BURCHILL INTERNATIONAL LTD, NTV, and TELEVISION CODE.

WPGH-TV—ch 53, 2,338 kw vis, 191 kw aur; ant 1024T/736g. July 14, 1953. 750 Ivory Ave., 15214. (412) 931-8600. TWX: 710-664-2088. Licensee: Pittsburgh Telecasting Inc. (acq 12-12-73). Ownership: Stip Realty, 100%. █ Rep: Bolton/Burchill. Wash atty: Pierson, Ball & Dowd. █ Albert M. Holtz, gen mgr; John J. Baggio, sls mgr; George Pienderleith, opns mgr and film buyer; Ed Stankay, prom mgr; Robert R. Boyd, chief engr. █ Rates: \$300; 200; 50.

*WQED—ch 13, 316 kw vis, 63.1 kw aur, ant 690T/600g. April 1, 1954. 4802 Fifth Ave., 15213. (412) 683-1300. TWX 710-664-2097. Licensee: Metro Pittsburgh Public Bcstg Inc. █ PBS. Wash atty: Covington & Burling. █ Lloyd Kaiser, pres & gen mgr; Samuel J. Francis, controller; Jay Rayvid, VP; Tom Skinner, VP; Sam Silberman, prog dir; Sara Harvey, ed svcs dir; Cal Thomas, dev dir; Jerry Jones, chief engr. █ On 145 CATV's.

*WQEX—ch 16, 171 kw vis, 34.2 kw aur, ant 700T/600g. Sept. 14, 1959. Licensee: Metro Pittsburgh Public Bcstg Inc. See *WQED(TV). █ On 55 CATV's.

WTAE-TV—ch 4, 100 kw vis, 20 kw aur, ant 960T/1,066g. Sept. 14, 1958. 400 Ardmore Blvd., 15230. (412) 242-4300. TWX 710-664-4266. Licensee: Hearst Corp. Ownership: See Hearst Stns, also Nwspr. █ ABC. Rep: Katz. Wash atty: Dempsey & Koplovitz. █ Franklin C. Snyder, VP & gen mgr; John G. Conomikes, VP & stn mgr; Jack A. W. Shenkan, gen sls mgr; Mickey Hooten, prog dir; David M. Crantz, prom mgr; Fred Young, news dir; Estelle Gould, cmnty affairs dir; James Hurley, dir of engr. █ On 168 CATV's—597,533 subs. On 4 trans. Co-owned WTAE-AM-FM.

Scranton

ADI No. 47; see page B-78

WBRE-TV (Wilkes-Barre)—ch 28, 4,120 kw max vis, 820.4 kw max aur, ant 1,645T/845g. Jan. 1, 1953. 62 S. Franklin St., Wilkes-Barre, 18703. (717) 823-3101. TWX 717-480-0510. Licensee: WBRE-TV Inc. Ownership: David M. Baltimore family, 100%. █ NBC. Rep: Petry. Wash atty: Hogan & Hartson. █ David M. Baltimore, pres, gen mgr & film buyer; Franklin D. Coslett, VP loc sls mgr, personnel dir; Terry Baltimore, natl sls & prom mgr; Don Miller, prod dir; Tom Bigler, news dir. █ On 120 CATV's—300,000 subs. On 5 trans. Co-owned: WBRE-AM-FM.

WDAU-TV—ch 22, 750 kw vis, 137 kw aur, ant 1,560T/618g. June 7, 1953. 1000 Wyoming Ave., 18509. (717) 342-7634. TWX 510-671-4607. Licensee: Scranton Bcstrs Inc. Ownership: Mrs. M. E. Megargee & family, 100%. █ CBS. Rep: Spotmasters. Wash atty: Dow, Lohnes & Albertson. █ Mrs. M. E. Megargee, pres; Madge M. Holcomb, gen mgr; Jack White, natl sls mgr; Mort Rosenthal, prog dir & film buyer; Doug Holcomb, prom & adv dir; Tom Powell, news & pub affrs dir; Robert Leach, chief engr. █ On 101 CATV's—405,265 subs. On 3 trans. Co-owned: WGBI-AM-FM. █ Rates: \$300; 110; 40.

WNEP-TV—ch 16, 1,268 kw vis, 127 kw aur, ant 1,666T/829g. Feb. 9, 1954. Wilkes-Barre Scranton Airport, Avoca, 18641. (717) 655-2821. TWX 710-671-4532. Licensee: NEP Communications Inc. (acq 12-1-73). Ownership: Thomas P. Shelburne, 32.94%; Catherine W. Shelburne, 21.96%; Frank Henry, 21.64%. █ ABC. Rep: Katz. Wash atty: Koteen & Burt. █ Thomas P. Shelburne, pres; Thomas P. Shelburne III, stn mgr & film buyer; Jesse Pevear, sls mgr; Elden A. Hale Jr., news dir; Chester F. Sawicki, chief engr. █ On 130 CATV's—150,000 subs. █ Rates: \$225; 100; 50.

*WVIA-TV—ch 44, 1,200 kw vis, 120 kw aur, ant 1,674T/845g. September 1966. Public Bcstg Center, Pittston, 18640. (717) 655-4561. TWX 510-656-5273. Licensee: Northeastern Pa. Educl TV Assn. █ PBS, EETN, PPTN. Wash atty: Dow, Lohnes & Albertson. █ George H. Strimel Jr., pres & gen mgr; Gerald Schumacher, prog dir; Jack Lewis, prom mgr; Paul Evanosky, chief engr. █ On 60 CATV's—90,000 subs. On 12 trans. Co-owned: WVIA-FM.

Wilkes-Barre

WBRE-TV—Licensed to Wilkes-Barre. See Scranton.

York

ADI No. 46; see page B-31

WSBA-TV—ch 43, 1,000 kw vis, 100 kw aur, ant 530T/419g. Dec. 22, 1952. Box 1868, 17405. (717) 843-0043. Licensee: Susquehanna Bcstg Co. Ownership: See Susquehanna Bcstg Stns. █ CBS. Rep: Blair. Wash atty: Cohn & Marks. █ Louis J. Appell Jr., pres; Robert M. Stough, stn mgr & natl sls mgr; H. David Berlin, sls mgr; Robert H. Bruetsch, news dir; Jack M. Schuster, chief engr & dir prod. █ On 22 CATV's—123,785 subs. Co-owned: WSBA-AM-FM.

WTPA—Licensed to Harrisburg. See Harrisburg.

Rhode Island, South Carolina TV

See page B-89 for explanation of listings.

Rhode Island

Providence

ADI No. 29; see page B-58

WJAR-TV—ch 10, 316 kw vis, 50 kw aur, ant 1,000t/940g. July 10, 1949. 176 Weybosset St., 02902. (401) 751-5700. TWX 710-381-1749. Licensee: The Outlet Co. Ownership: See Outlet Co. Stns. ■ NBC. Sp 1 hr monthly. Rep: Petry. Wash atty: Sundlun, Tirana & Scher. ■ David E. Henderson, pres; Leonard S. Davey Jr., gen mgr; Raymond Janz, gen sls mgr; Gary Dreispul, prom mgr & film buyer; Arthur Alpert, news dir; George St. Andre, chief engr. ■ Co-owned: WJAR(AM).

WPRI-TV—ch 12, 316 kw vis, 31.6 kw aur, ant 910t/981g. March 27, 1955. 25 Catamore Blvd., E. Providence, 02914. (401) 438-7200. TWX 710-381-1606. Licensee: Poole Bcstg Co. Inc. (acq 7-18-67). Ownership: See John B. Poole Stns. ■ CBS. Rep: TeleRep. Wash atty: Wilmer, Cutler & Pickering. ■ Edwin W. Pfeiffer, VP, gen mgr & film buyer; Paul Arznen, gen sls mgr; Robert Kinkead, prom dir; Walter Cryan, news dir; T. Arthur Bone, chief engr.

***WSBE-TV**—ch 36, 479 kw vis, 95.5 kw aur, ant 600t/502g. June 5, 1967. 24 Mason St., 02903. (401) 831-2900. Licensee: Board of Regents for Education, State of Rhode Island & Providence Plantations. ■ PBS, EEN. Wash atty: Norman E. Jorgensen. ■ Robert P. Danilowicz, gen mgr; Walter Covell, prog dir; Thomas K. Prior, chief engr. ■ On 1 CATV—1,100 subs.

WTEV (New Bedford, Mass.)—ch 6, 100 kw vis, 22.4 kw aur, ant 940t/996g. Jan 1, 1963. TV Center, New Bedford, 02741. (617) 993-2651. TWX 617-993-6255. Licensee: WGAL TV Inc. Ownership: See Steinman Stns, also Nwspr. ■ ABC. Rep: Meeker; Busby, Finch & Woods; Kettell-Carter; Pearse. Wash atty: Hogan & Hartson. ■ Harry J. Shaub Jr., exec VP; Vance L. Eckersley, stn mgr; John H. Candioto, sls mgr; Mann Reed, rgnl sls mgr; John Robinson, prog mgr; Truman Taylor, news dir; Lee W. Tanner, opns & engrg mgr; Donald E. Norris, prom mgr; Maurice P. Wynne, chief engr. ■ On 15 CATV's—38,034 subs.

New TV—ch 64, 1000 kw vis, 200 kw aur, ant 1,000t/867g. Not on air, target date unknown. 514 Industrial Bank Bldg., 02903. Permittee: Channel 16 of Rhode Island. Ownership: Harold C. Arcaro, 92%; TV Assoc. 8%. ■ Atty: Cottone & Fanelli.

South Carolina

HAMILTON-LANDIS

& ASSOCIATES, Inc.
NATIONWIDE MEDIA BROKERS
WASHINGTON, D. C., CHICAGO, DALLAS,
SAN FRANCISCO

SELL **MORE**

RADIO & TELEVISION STATIONS
IN THE EAST—NEAREST OFFICE IS—
1730 K ST., N.W., WASHINGTON 20006
(202) 393-3456

Allendale

ADI No. 111; see page B-6

***WEBA-TV**—ch 14, 557 kw vis, 114.4 kw aur; ant 800t/809g. Sept. 5, 1967. 2712 Millwood Ave., Columbia, S.C., 21205. Licensee: South Carolina ETV Commission. ■ Charles E. Cortez, stn supr. See *WRLK-TV Columbia.

Anderson

ADI No. 36; see page B-30

WAIM-TV—ch 40, 135 kw vis, 26.9 kw aur; ant 380t/418g. Dec. 1, 1953. 321 Kingsley Rd, 29621. (803) 226-1511. Licensee: Wilton E. Hall. Ownership: See Nwspr. ■ ABC, CBS. Rep: Devney; Dora-Clayton. Wash atty: Benedict Cottone. ■ Wilton E. Hall, pres; Betty K. Black, gen mgr & prog dir; John F. McCallum, sls mgr; Marshall H. Gaillard, prom mgr; Jerry C. Garett, film buyer; T. Franklin Aiken, news dir; Robert K. Baldwin, chief engr. ■ Co-owned: WAIM(AM)-WCAC(FM).

Beaufort

ADI No. 131; see page B-66

***WJWJ-TV**—ch 16, 852 kw vis, 169 kw aur, ant 1,277t/1,318g. Sept. 19, 1975. 2712 Millwood Ave., Columbia, 29205. Licensee: South Carolina ETV Commission. ■ Clyde H. Jones, stn supr. See *WRLK-TV Columbia.

Charleston

ADI No. 123; see page B-13

WCBD-TV—ch 2, 100 kw vis, 19.5 kw aur, ant 790t/842g. Sept. 25, 1954. Box 879, 29402. (803) 884-4141. TWX 803-884-9612. Licensee: State Telecasting Co. (acq 9-1-71). Ownership: See State Telecasting Stns, also Nwspr. ■ ABC. Rep: Blair. Wash atty: Dow, Lohnes & Albertson. ■ W. Frank Harden, pres; Carter C. Hardwick Jr., VP & gen mgr; Grange S. Cuthbert, sls mgr; A. W. Evans, news dir; C. Stephen Currie, dir of bcstg & film buyer; Cil Frazier, prom mgr; Walter M. Neilson, engrg dir. ■ On 8 CATV's—22,000 subs.

WCIV—ch 4, 100 kw vis, 20 kw aur, ant 1,955t/2,000g. Oct. 23, 1962. Hwy 703, Mt. Pleasant, 29464. (803) 884-8513. Licensee: First Charleston Corp. (acq 11-6-66). Ownership: See Evening Star Stns, also Nwspr. ■ NBC. Rep: Petry; Ayers. Wash atty: Hogan & Hartson. ■ Richard S. Stakes, pres; Wm. E. Lucas, VP, gen mgr & film buyer; James Edwards, sls mgr; Celia Shaw, stn mgr; Betty Hudson, prom mgr; Don Shelby, news dir; Charles Shaw, chief engr. ■ On 10 CATV's—15,000 subs. ■ Rates: \$250; 35; 15.

WCSC-TV—ch 5, 100 kw vis, 20 kw aur, ant 1,000t/1,044g. June 19, 1953. Box 186, 29402. (803) 723-8371. TWX 810-881-1876. Licensee: WCSC Inc. Ownership: John M. Rivers, 59.59%; & others. ■ CBS. Rep: Peters, Griffin & Woodward. Wash atty: Dow, Lohnes & Albertson. ■ John M. Rivers, chmn; John M. Rivers Jr., pres; Virgil V. Evans Jr, VP & gen mgr; Frank Brosseau, VP, sls mgr; Gloria Wilson, prom mgr; Rick Ray, stn mgr & film buyer; Ray Clune, news dir; Jack Becknell, dir of engrg. ■ On 16 CATV's—31,682 subs. Co-owned: WCSC(AM), WXTG(FM). ■ Rates: \$250; 125; 65.

***WITV**—ch 7, 310 kw vis, 62 kw aur, ant 848t/1,044g. Oct. 20, 1963. 2712 Millwood Ave., Columbia, 29250. Licensee: South Carolina ETV Commission. ■ Walter L. Moring, stn supr. See *WRLK-TV Columbia.

Columbia

ADI No. 97; see page B-17

WIS-TV
COLUMBIA

PGW

NBC

WIS-TV—ch 10, 316 kw vis, 63.2 kw aur, ant

Broadcasting Yearbook 1976

B-134

1,546t/1,526g. Nov. 7, 1953. 1111 Bull St., 29202. (803) 799-1010. TWX 803-733-1184. Licensee: Cosmos Bcstg Corp. Ownership: See Cosmos Bcstg Stns. ■ NBC. Rep: Peters, Griffin, Woodward. Wash atty: Dow, Lohnes & Albertson. ■ Charles A. Batson, pres; Todd A. Spoerl, gen mgr; Richard M. Coulter, asst gen mgr & sls mgr; David J. Miller, prog dir & film buyer; Joseph Petty; news dir; Carl Miller, prom mgr; Tom Bradford, asst chief engr. ■ On 21 CATV's—32,200 subs. Co-owned: WIS(AM). ■ Rates: \$215; 90; 70.

WNOK-TV—ch 19, 1,046 kw vis, 104.6 kw aur, ant 640t/556g. Sept. 1, 1953. Drawer M, 29250. (803) 776-3600. TWX 803-733-1131. Licensee: Palmetto Radio Corp. Ownership: Irwin Kahn, 32.1%; J. W. Lindau III, 10.3%; W. Croft Jennings; & others. ■ CBS. Rep: Avery-Knodel. Wash atty: Covington & Burling. ■ H. Moody McElveen Jr., exec VP; Richard Laughridge, VP sls; Donald Bryant, prog dir; Allard Dial, prod mgr; Jack Cook, news dir; Donald Bryant, film buyer; Jim Kelly III, tech dir. ■ On 4 CATV's. Co-owned: WNOK-AM-FM.

WOLO-TV—ch 25, 871 kw vis, 96 kw aur, ant 620t/531g. Oct. 1, 1961. Box 4217, 29204. (803) 754-7525. TWX 810-666-2100. Licensee: Columbia TV Bcstrs Inc. Ownership: See Bahakel Stns. ■ ABC. Rep: Savalli/Gates. Wash atty: Wilmer, Cutler & Pickering. ■ Cy N. Bahakel, pres; Donald H. Krauss, gen & sls mgr; David Aiken, prog dir & prom mgr; Mackie Quave, news dir; Jim Martinson, film buyer; Brian Baker, chief engr. ■ On 16 CATV's—41,559 subs. ■ Rates: \$85; 50; 30.

***WRLK-TV**—ch 35, 513 kw vis, 102 kw aur, ant 1,030t/999g. Sept. 5, 1966. 2712 Millwood Ave, 29205. Licensee: South Carolina ETV Commission. ■ Robert K. Baldwin, stn supr; Henry J. Cauthen, gen mgr; Charles S. Morris, dir div of opns; Charlon W. Bowers, chief engr; Robert E. Wood, dir of education; Gene Upright, prog dir; Dick Phipps, dir of info.

Florence

ADI No. 160; see page B-26

WBTW—ch 13, 316 kw vis, 39.8 kw aur, ant 790t/827g. Oct. 18, 1954. TV Road, 29501. (803) 622-1565. TWX 803-662-2212. Licensee: Daily Telegraph Printing Co. Ownership: See Daily Telegraph Stns, also Nwspr. ■ CBS, ABC. Rep: Avery-Knodel. Wash atty: Dow, Lohnes & Albertson. ■ Joseph B. Foster, stn mgr; George L. Sansbury, sls mgr; Jim Griffin, news dir; Bernard E. Moore, chief engr. ■ On 19 CATV's.

***WJPM-TV**—ch 33, 537 kw vis, 107 kw aur, ant 790t/797g. Sept. 3, 1967. 2712 Millwood Ave., Columbia, 29205. Licensee: South Carolina ETV Commission. See *WRLK-TV Columbia, S.C. ■ Frank Jenne, stn supr.

Greenville

ADI No. 36; see page B-30

WANC-TV—See Asheville, N.C.

WFBC-TV—ch 4, 100 kw vis, 20 kw aur, ant 2,000t/892g. Dec. 31, 1953. Box 788, 29602. (803) 233-4601. TWX 810-281-2182. Licensee: Multimedia Inc. Ownership: See Multimedia Stns, also Nwspr. ■ NBC. Rep: Katz. Wash atty: Dow, Lohnes & Albertson. ■ Wilson C. Wearn, pres; Douglas A. Smith, VP & gen mgr; Mark Conrad, sls mgr; Tom Todd, prog dir, prom mgr & film buyer; Dave Partridge, news dir; Jim Lynn, engrg supr. ■ On 35 CATV's—45,000 subs. On 13 trans. Co-owned: WFBC-AM-FM. ■ Rates: \$850; 300; 160.

WGGS-TV—ch 16, 186 kw vis, 37.2 kw aur, ant 1,150t/196g. Box 4157, 29608. (803) 242-1616. Licensee: Carolina Christian Bcstg Inc. Ownership: James H. Thompson, 51%; J. Dan Lynn, 16%; Harold N. Pettit, 16%. ■ Rep:

Savalli-Gates. Wash atty: Fisher, Wayland, Southmayd & Cooper. ■ James H. Thompson, pres; Jim McManus, gen & s/s mgr; Dianne Wright, prog dir; Tom Hinton, prom mgr; Tom Taylor, news dir; Joanne Thompson, film buyer. ■ On 7 CATV's.

WLOS-TV (Asheville, N.C.)—ch 13, 170 kw vis, 26.3 kw aur, ant 2,835/1338.5g. Sept. 18, 1954. Box 2150, 288 Macon Ave, Asheville, N.C., 28802. (704) 255-0013. TWX 510-933-0166. Licensee: Wometco Skyway Bcstg Co. Ownership: See Wometco Enterprises Stns. ■ ABC. Rep: Peters, Griffin, Woodward. Wash atty: Cohn & Marks. ■ Mitchell Wolfson, bd chmn; Morton S. Cohn, pres & gen mgr; Dave DeArmond, VP & gen s/s mgr; William Pfeiffer, VP progmg; Walt Dondaville, news dir; Dave Guthrie, prom mgr; C. Lee Davis, chief engr. ■ On 71 CATV's—150,000 subs. On 27 trans. Co-owned: WLOS(FM) Asheville. ■ Rates: \$300; 200; 70.

***WNTV**—ch 29, 347 kw vis, 67.6 kw aur, ant 1,142/151g. Sept. 15, 1963. 2712 Millwood Ave., 29205. Licensee: South Carolina ETV Commission. See *WRLK-TV Columbia. ■ J. B. Cothran, stn supvr.

WSPA-TV (Spartanburg)—ch 7, 294.4 kw vis, ant 2,000/1257g. (CP 44.5 kw aur). April 29, 1956. Box 1717, Spartanburg, 29304. (803) 585-7777. TWX 810-282-2591. Licensee: Spartan Radiocasting Co. Ownership: Walter J. Brown & family, 60%; & others. ■ CBS. Rep: H-R. Wash atty: Covington & Burling. ■ Walter J. Brown, pres; David Abbott, gen mgr; Ray Johnson, gen s/s mgr; Louis Miller, prom mgr; Dave Handy, stn & prog mgr; Tom Crosby, news dir; Glynn Rogers, dir of engr. ■ On 38 CATV's. On 19 trans. Co-owned: WSPA-AM-FM (Spartanburg). ■ Rates: \$425; 100; 60.

Spartanburg

WNTV—Licensed to Greenville. See Greenville.

WSPA-TV Licensed to Spartanburg. See Greenville.

Sumter

ADI No. 97; see page B-17

***WRJA-TV**—ch 27, 794 kw vis, 157 kw aur, ant 1,163/1,200g. Sept. 7, 1975. 2712 Millwood Ave., Columbia, 29205. Licensee: South Carolina ETV Commission. See *WRLK-TV Columbia. ■ Willam H. Jones, stn supvr.

South Dakota

Aberdeen

ADI No. 88; see page B-68

KABY-TV—ch 9, 295 kw vis, 47.5 kw aur, ant 1,390/1,288g. Nov. 28, 1958. Box 1520, 57401. (605) 225-4350. Licensee: Forum Communications Inc. (acq 1973). Co-owned: satellite of KSFY-TV Sioux Falls.

***KDSD-TV**—ch 16, 537 kw vis, 81.3 kw aur, ant 1,171/1,062g. Jan. 1, 1972. 310 E. Clark St., Vermillion, 57069. Licensee: State Board of Directors for Educational TV. See *KUSD-TV Vermillion. ■ On 1 CATV—1,200 subs.

Brookings

ADI No. 88; see page B-68

***KESD-TV**—ch 8, 257 kw vis, 51.3 kw aur, ant 1,750/800g. Feb. 6, 1968. Solberg Hall, S. D. State U., 57006. (605) 688-4191. Licensee: S. D. State U. ■ PBS. Wash atty: Dow, Lohnes &

Albertson. ■ Eric Brown, dir of educ med; W. P. Wentzy, gen mgr; Dennis Pack, prog dir; Mrs. Lonnie Johnson, asst prog mgr; Wilbur V. Kraft, chief engr. ■ On 8 CATV's. On 1 trans. Co-owned: *KESD-FM.

Deadwood

KHSD-TV—Licensed to Lead. See Lead.

Eagle Butte

ADI No. 138; see page B-47

***KPSD-TV**—ch 13, 316 kw vis, 31.6 kw aur, ant 1,700/1,696g. September 1973. 310 E. Clark St., Vermillion, 57069. Licensee: State Board of Directors for Educational TV. See *KUSD-TV Vermillion.

Florence

ADI No. 88; see page B-68

KDLO-TV—ch 3, 100 kw vis, 20 kw aur, ant 1,390/1,408.5g. September 1955. Licensee: Midcontinent Bcstg Co. Co-owned satellite of KELO-TV Sioux Falls. ■ Wash atty: Dow, Lohnes & Albertson. ■ Co-owned: KDLO-FM.

Lead

ADI No. 88; see page B-68

KDSJ-TV—ch 5, 100 kw vis, 10 kw aur, ant 1,900/1,539g. January 1960. c/o Theodore M. Cormaney, 1116 Jackson Blvd., Rapid City, 57701. Permittee: Dakota Bcstg Co. (acq 7-3-75). Co-owned satellite of KRSD-TV Rapid City. ■ Wash atty: Bilger & Blair.

KHSD-TV—ch 11, 316 kw vis, 31.6 kw aur, ant 1,890/1,605g. Nov. 2, 1966. Box 1760, Rapid City, 57701. (605) 342-2000. Licensee: Duhamel Bcstg Enterprises. Co-owned satellite of KOTA-TV Rapid City. ■ NBC, ABC. Wash atty: Fisher, Wayland, Southmayd & Cooper. ■ W. Duhamel, gen mgr; D. Lesmeister, prog dir; Sherry Waldron, prom mgr; Gene Carlson, news dir; Fred Wuenschel, chief engr. ■ Rates: \$96; 45; 24.

Lowry

ADI No. 138; see page B-47

***KQSD-TV**—ch 11, 316 kw vis, 32 kw aur, ant 1040/1,875g. (CP: 234 kw vis, 28.2 kw aur, ant 1040 ft.). Not on air, target date unknown. c/o Martin P. Busch, University of South Dakota, Vermillion, 57069. Permittee: State Board of Directors for Educational Television.

Mitchell

ADI No. 88; see page B-68

KXON-TV—ch 5, 100 kw vis, 11.5 kw aur, ant 1,510/1,599g. June 12, 1960. Box 1049, 57301. (605) 996-7501. TWX 910-668-0598. Licensee: Buford Television Inc. (acq 11-10-72). Ownership: See Buford Television Stns. ■ ABC. Rep: Katz. Wash atty: McKenna, Wilkinson & Kittner. ■ Robert P. Buford, pres; Joe Shields, gen mgr mktg; Errol Kapellusch, gen mgr resources, film buyer; Gary L. Hanson, news dir; Arnold Monday, chief engr. ■ On 3 CATV's. On 2 trans. ■ Rates: \$50; 30; 15.

Pierre

ADI No. 88; see page B-68

KPRY-TV—ch 4, 100 kw vis, 20 kw aur, ant 1240/1,089g. Not on air, target date unknown. Courthouse Plaza, 6th & Dakota, Sioux Falls, 57102. Permittee: Forum Communications Co. Ownership: see Forum Communications Stns. Satellite of KSFY-TV, Sioux Falls. ■ NBC. Wash

South Carolina. South Dakota TV

See page B-89 for explanation of listings.

atty: Marmet Prof. Corp. ■ William Marcil, pres.

***KTSD-TV**—ch 10, 269 kw vis, 31.6 kw aur, ant 1,600/1,326g. Aug. 1, 1970. 310 E. Clark St., Vermillion, 57069. Licensee: S.D. ETV Bd. See *KUSD-TV Vermillion. ■ On 2 CATV's.

Rapid City

ADI No. 164; see page B-59

***KBHE-TV**—ch 9, 38.4 kw vis, 7.2 kw aur, ant 650/470g. July 1967. Keystone Route, Box 126, 57701. (605) 343-1930. 310 E. Clark St., Vermillion, 57069. Licensee: S.D. ETV Bd. See *KUSD-TV Vermillion.

KOTA-TV—ch 3, 100 kw vis, 20 kw aur, ant 660/1,607g. July 1, 1955. Box 1760, 57701. (605) 342-2000. TWX 910-668-0244. Licensee: Duhamel Bcstg Enterprises. Ownership: See Duhamel Bcstg Stns. ■ NBC, ABC. Rep: H-R. Wash atty: Fisher, Wayland, Southmayd & Cooper. ■ Helen S. Duhamel, pres & gen mgr; William F. Duhamel, exec VP & stn mgr; Dan Lesmeister, s/s mgr, prog dir & film buyer; Gene Carlson, news dir; Mrs. Sherry Waldron, prom mgr; Fred Wuenschel, chief engr. ■ On 8 CATV's—10,000 subs. On 40 trans. Co-owned: KOTA(AM). ■ Rates: \$96; 45; 24.

KRSD-TV—ch 7, 196 kw vis, 19.6 kw aur, ant 744t. Jan. 22, 1958. 1116 Jackson Blvd., 57701. (605) 342-6050. Permittee: Dakota Bcstg Co. (acq 7-3-75). Ownership: Theodore M. Cormaney, Gilbert Moyle & Sherwood Corner, 33 1/3% each. ■ CBS, ABC. Rep: Savalli/Gates. Wash atty: Bilger & Blair. ■ Pete G. Sieler, prog dir & stn mgr; Marty Wilcox, news dir. ■ On 8 CATV's—20,000 subs.

Reliance

ADI No. 88; see page B-68

KPLO-TV—ch 6, 100 kw vis, 20 kw aur, ant 1,110/1,711g. July 1957. Licensee: Midcontinent Bcstg Co. Co-owned satellite of KELO-TV Sioux Falls. ■ Wash atty: Dow, Lohnes & Albertson.

Sioux Falls

ADI No. 88; see page B-68



KELO-TV—ch 11, 288 kw vis, 28.8 kw aur, ant 2,000/1,985g. May 1953. Phillips at 13th, 57102. (605) 336-1100. TWX 910-660-0552. Licensee: Midcontinent Bcstg Co. Ownership: See Midcontinent Bcstg Stns. ■ CBS. Rep: H-R; Evans. Wash atty: Dow, Lohnes & Albertson. ■ Joe Floyd, pres; Evans Nord, exec VP & gen mgr; Tom Sheeley, VP opns; Vince Davi, prom mgr; Lee Heisel, dir engr. ■ On 5 CATV's—2,000 subs. On 19 trans. Co-owned: KELO-AM-FM.

KSFY-TV—ch 13, 316 kw vis, 39.8 kw aur, ant 2,000/1,985g. July 31, 1960. Sixth & Dakota, 57102. (605) 336-1300. TWX 910-660-0569. Licensee: Forum Communications Inc. (acq 12-11-73). Ownership: See Forum Communications Stns. ■ NBC. Rep: PG&W; Hyett;

South Dakota, Tennessee TV

See page B-89 for explanation of listings.

Soderlund, Wash atty: Marmet Prof. Corp. ■ William Marcil, pres; Scott Park, VP gen mgr & film buyer; James Dunham, gen sls mgr; Marge Hokenstad, prog dir; Al Edel, news dir; John Dunicliff, prom mgr; Max E. Pierce, chief engr. ■ On 17 CATV's—28,800 subs. ■ Rates: \$110; 60; 35.

KXON-TV—See Mitchell.

Vermillion

ADI No. 119; see page B-67

***KUSD-TV**—ch 2, 100 kw vis, 20 kw aur, ant 760t/656g, July 5, 1961. Old Union Bldg., University of South Dakota, 57069. (605) 677-5277. Licensee: U. of S.D. ■ PBS, MET, CEN. Wash atty: Cohn & Marks. ■ Martin P. Busch, telecommunications dir; Douglas Barstow, prog & news dir; James Prusha, chief engr. ■ On 6 CATV's—24,233 subs. On 21 trans. Co-owned: *KUSD-AM-FM.

Tennessee

HAMILTON-LANDIS & ASSOCIATES, Inc.
NATIONWIDE MEDIA BROKERS
WASHINGTON, D. C. CHICAGO, DALLAS, SAN FRANCISCO
SELL **MORE**
RADIO & TELEVISION STATIONS
IN THE EAST—NEAREST OFFICE IS—
1730 K ST., N.W., WASHINGTON 20006
(202) 393-3456

Bristol

WCYB-TV—See Bristol, Va.

Chattanooga

ADI No. 76; see page B-14

WDEF-TV—ch 12, 316 kw vis, 37.1 kw aur, ant 1,260t/461g, April 25, 1954. 3300 Broad St., 37408. (615) 267-3392. TWX 810-573-5207. Licensee: Roy H. Park Bcstg of Tenn. Inc. Ownership: See Park Bcstg Inc. ■ CBS. Rep: Blair. Wash atty: Pierson, Ball & Dowd. ■ Roy H. Park, pres; William M. Dunaway, VP gen mgr; Joe Killebrew, gen sls mgr; Cecil Ruffin, prog dir; Emory Williamson, prom mgr; Ray White, news dir; Gene Landau, chief engr. ■ On 8 CATV's. On 2 trans. Co-owned: WDEF-AM-FM.

WRCB-TV—ch 3, 100 kw vis, 19.5 kw aur (CP: 10 kw aur), ant 1,070t/301g, May 6, 1956. 900 Whitehall Rd., 37405. (615) 267-5412. TWX 810-873-5240. Licensee: Rust Craft Bcstg of Tenn. Inc. Ownership: See Rust Craft Bcstg Stns. ■ NBC. Rep: Katz. Wash atty: Fisher, Wayland, Duvall & Southmayd. ■ Marshall Berkman, pres; Ralph E. Becker, VP TV; George A. Stevens, gen mgr; Hal Siegel, sls mgr; Lem Schofield, prog dir; Ronald Conner, prom mgr; Allen Jones, news dir; Bob Glenn, chief engr. ■ On 20 CATV's. On 1 trans.

WRIP-TV—ch 61, 457 kw vis, 91.2 kw aur, ant 980t/348g, Jan. 24, 1972. Ellis Rd., Rossville, Ga., 30741. (404) 866-3855. Licensee: WRIP TV Inc. Ownership: Col. Jay Sadow, 100%. ■ Rep: Devney. Wash atty: Finkelstein & Firestone. ■ Col. Jay Sadow, pres, gen & sls mgr; Gerry Sadow, prog dir; Ron Lone, prom mgr; Bob Broome, news dir; Marvin Glass, film buyer; Terry Howard, chief engr. ■ On 42 CATV's—359,000 subs. On 12 trans. Co-owned: WRIP(AM)-WOWE(FM) Rossville, Ga.

***WTCl**—ch 45, 617 kw vis, 117 kw aur, ant

950t/296g, March 8, 1970. 4411 Amnicola Hwy, 37406. (615) 629-4368. Licensee: Tenn. State Bd of Educ. ■ PBS. ■ Walter Alley, gen mgr; Robert Briscoe, chief engr.

WTVC—ch 9, 316 kw vis, 31.6 kw aur, ant 1,040t/278g, Feb. 11, 1958. Box 1150, 37401. (615) 756-5500. TWX 810-537-5269. Licensee: WTVC Inc. Ownership: See Fuqua Stns. ■ ABC. Rep: H-R. Wash atty: Cohn & Marks. ■ Joe Windsor, pres; Reeve Owen, VP gen mgr; & film buyer; Leon Webb, VP-ops & stn mgr; Jack Sausman, VP, sls mgr; Tommy Reynolds, prog dir; Charles Stephenson, chief engr; Gil Norwood, news dir. ■ On 12 CATV's. 1 trans.

Cookeville

ADI No. 30; see page B-49

***WCTE**—ch 22, 427 kw vis, 77.6 kw aur, ant 1,395t/805g. Not on air, target date unknown. 100 Cordell Hull Bldg, Nashville, 37219. Licensee: Tennessee State Bd of Educ. Co-owned satellite of *WSJK-TV, Sneedville.

Crossville

New TV—ch 55, 18.6 kw vis, 3.71 kw aur, ant 1,180t/230g. Not on air, target date unknown: Box 591, 38555. Permittee: Cumberland Television Co. Ownership: Edward M. Johnson (100%). ■ Edward M. Johnson, pres.

Jackson

ADI No. 188; see page B-34

WBBJ-TV—ch 7, 316 kw vis, 31.6 kw aur, ant 1,060t/1065g, March 5, 1955. Box 2387, 38301. (901) 424-4515. Licensee: Jackson Telecasters Inc. (acq 9-1-66). Ownership: See Cy Bahakel Stns. ■ ABC. Rep: Savalli-Gates. Wash atty: Wilmer, Cutler & Pickering. ■ Cy Bahakel, pres; Gerry Quick, gen mgr, sls mgr & film buyer; Don Hill, prog dir; Dave O'Brien, news dir; Ed Ward, chief engr. ■ On 15 CATV's—22,000 subs. ■ Rates: \$112; 60; 35.

Johnson City

ADI No. 188; see page B-34

WCYB-TV—Licensed to Bristol, Va.-Johnson City-Kingsport, Tenn. See Bristol, Va.

WJHL-TV(Johnson City-Kingsport-Bristol)—ch 11, 245 kw vis, 30 kw aur, ant 2,320t/228g, Oct. 26, 1953. Box 1130, Johnson City, 37601. (615) 926-2151. TWX 810-575-8551. Licensee: Roy H. Park Bcstg of the Tri-Cities Inc. (acq 6-64). Ownership: See Park Bcstg Inc. ■ CBS. Rep: Blair. Wash atty: McKenna, Wilkinson & Kittner. ■ Roy H. Park, pres; W. H. Lancaster Jr., exec VP & gen mgr; J. Will Hall, coml mgr; Al Gregory, prog dir & film buyer; Bob Lewis, news dir; Larry Coleman, prom mgr; Carl Dickenson, chief engr. ■ On 72 CATV's. On 2 trans.

Kingsport

ADI No. 86; see page B-11

WCYB-TV—See Bristol, Va.

WJHL-TV—See Johnson City.

WKPT-TV—ch 19, 447 kw vis, 89.1 kw aur, ant 2,320t/225g, Aug. 20, 1969. 222 Commerce St., 37662. (615) 245-4161. TWX: 810-574-5180. Licensee: Holston Valley Bcstg Corp. Ownership: Home News Pub Co., 97%; et al. ■ ABC. Wash atty: Welch & Morgan. Rep: Meeker; Busby, Finch & Woods. ■ William M. Boyd, pres; Robert I. Ratcliff, exec VP & gen mgr; Raymond Walker, sls mgr; George E. DeVault Jr., VP for ops; William Freehoff, news dir; Harold T. Dougherty, VP engr. ■ On 75

CATV's—65,000 subs. On 1 trans. Co-owned: WKPT-AM-FM.

Knoxville

ADI No. 58; see page B-36

WATE-TV—ch 6, 100 kw vis, 15 kw aur, ant 1,490t/1,153g, Oct. 1, 1953. 1306 N.E. Broadway, 37901. (615) 637-9666. TWX 615-546-0023. Licensee: Nationwide Communications Inc. Ownership: See Nationwide Communications Stns. ■ NBC. Rep: Harrington, Righter & Parsons. Wash atty: Fly, Shuebruk, Blume & Gaguine. ■ Clark Pollock, exec VP; John T. McCLOUD, VP & gen mgr; John H. Reese, prog dir & film buyer; Bill Linebaugh, sls mgr; Russ Hillis, prom mgr; Don E. Watkins, chief engr. ■ On 86 CATV's—110,000 subs. On 3 trans. ■ Rates: \$300; 175; 60.

WBIR-TV—ch 10, 300 kw vis, 59 kw aur, ant 1,870t/1,751g, Aug. 13, 1956. 1513 Hutchison Ave., 37917. (615) 637-1010. TWX 810-583-0172. Licensee: Multimedia Inc. Ownership: See Multimedia Stns, also Nwspr. ■ CBS. Rep: Katz. Wash atty: Dow, Lohnes & Albertson. ■ Wilson C. Wearn, pres, Neal Branch, gen mgr; R. Lynn Leopper, sls mgr; Peter N. Fennelly, prog dir & film buyer; Walter H. Martin, prom mgr; Tom Poe, news dir; Robert E. Horton, chief engr. ■ On 42 CATV's. On 17 trans. Co-owned: WBIR-AM-FM. ■ Rates: \$225; 125; 40.

WTVK—ch 26, 813 kw vis, 162 kw aur, ant 1,290t/1,073g, Oct. 18, 1953. Box 1388, 37901. (615) 687-2312. TWX 810-583-2178. Licensee: South Central Bcstg Corp. Ownership: See South Central Bcstg Stns. ■ ABC. Rep: Avery-Knodel. Wash atty: Wilner & Scheiner. ■ John A. Engelbrecht, pres; Duane V. Eastvold, gen mgr & film buyer; Jerry Whitener, sls mgr; William E. Eckstein, prog dir; Johnny Mountain, prom mgr; Carl Lawson, chief engr. ■ On 24 CATV's—43,000 subs. On 2 trans. Co-owned: WEZK(FM). ■ Rates: \$77; 37; 13.

Lexington

ADI No. 93; see page B-39

***WLJT-TV**—ch 11, 316 kw vis, 63.1 kw aur, ant 640t/496g, Feb. 1, 1968. 117 Cordell Hull Bldg, Nashville, 37219. Licensee: Tenn. Bd of Educ. ■ PBS. ■ Eugene Dietz, dir of ETV; George Griffin, prog dir; Herman Williams, asst chief engr.

Memphis

ADI No. 34; see page B-45

WHBQ-TV—ch 13, 316 kw vis, 63.2 kw aur, ant 1,110t/1,073g, Sept. 27, 1953. 485 S. Highland Ave., 38111. (901) 323-7661. TWX 901-278-1314. Licensee: RKO Gnl Inc. Ownership: See RKO Gnl Stns. ■ ABC. Rep: RKO Gnl Bcstg Natl Sls. Wash atty: Pierson, Ball & Dowd. ■ D. A. Noel, VP & gen mgr; Alex Bonner, sls mgr; Lance Russell, prog dir; Sam McCullough, prom mgr; Welton Roy, chief engr. ■ On 42 CATV's—50,000 subs. Co-owned: WHBQ(AM). ■ Rates: \$200-600; 100-280; 30-60.

***WKNO-TV**—ch 10, 282 kw vis, 56.2 kw aur, ant 1,080t/1,114g, June 25, 1956. Memphis State U., Box 80,000, 38152. (901) 458-2521. Licensee: Memphis Community TV Foundation. ■ PBS. ■ Wm. S. Pollard Jr., bd chmn; Howard D. Holst, mgng dir; A. Fred Willis, prog dir; A. Price Broughton, prod mgr; Emileigh Latham, comm rel dir; Robert Nollner, chief engr. ■ On 18 CATV's. Co-owned: WKNO-FM.

WMC-TV—ch 5, 100 kw vis, 20 kw aur, ant 1,010t/1,088g, Dec. 11, 1948. 1960 Union Ave., 38104. (901) 274-8515. TWX 810-591-1710. Licensee: Scripps-Howard Bcstg Co. Ownership: Scripps-Howard Bcstg Stns, also Nwspr.

■ NBC. Rep: Blair. Wash atty: Dempsey & Koplovitz. ■ Donald L. Perris, pres; M. E. Greiner Jr., VP & gen mgr; J. P. Tucker, gen sls mgr; Ray B. Gill Jr., natl sls mgr; Philip Slavick, prog dir & film buyer; Barton Lamb, prom mgr; Edward F. Greaney, asst gen mgr in chg of news & pub affrs; Robert A. Frase, chief engr. ■ On 61 CATV's. Co-owned: WMC-AM-FM.

WMTU-TV—ch 30, 676 kw vis, 66.1 kw aur, ant¹ 1,190/1,179g. Not on air, target date unknown. 4421 Central Ave., Charlotte, N.C., 28205. Permittee: Christian Bcstg Net. (acq 7-75). Ownership: See Christian Bcstg Net. ■ Wash atty: Finkelstein & Firestone.

WREG-TV—ch 3, 100 kw vis, 20 kw aur, ant 1,000/1,077g. Jan. 1, 1956. Hotel Peabody, 38103 (901) 525-1313. TWX 810-591-1365. Licensee: New York Times Co. (acq 8-71). Ownership: New York Times Co. See Nwspr. ■ CBS. Rep: Katz. Wash atty: Koteen & Burt. ■ Charles B. Brakefield, pres & gen mgr; Frank Roberts, natl sls mgr; Jack Michael, VP & prog dir; Olin Morris, prom mgr & dir pub affrs; John Powell, news dir; Leroy Knight, chief engr. ■ On 46 CATV's—71,000 subs.

Nashville

ADI No. 30; see page B-49



***WDCN-TV**—ch 8, 295 kw vis, 29.5 kw aur, ant 1,280/942g. Sept. 10, 1962. Box 12555, 37212. (615) 292-6605. Licensee: Metro Bd of Educ. ■ PBS. Wash atty: Schwartz & Woods. ■ Robert L. Shepherd, exec VP & gen mgr; Gaylord L. Ayers, prog dir; Linda A. Nix, prom mgr; Louis C. Steinman, film dir; Carl C. Shirley, chief engr. ■ On 14 CATV's.

WNGE—ch 2, 100 kw vis, 10 kw aur, ant 1,350/942g. Nov. 29, 1953. 441 Murfreesboro Rd., 37210. (615) 259-2200. TWX 810-371-1943. Licensee: General Electric Bcstg Co. (acq 5-19-66). Ownership: See General Electric Stns. ■ ABC. Rep: Blair. Wash atty: McKenna, Wilkinson & Kittner. ■ Charles Duke, VP & gen mgr; Buddy Ragan, prom mgr; Brian Cobb, sls mgr; James Travis, news dir; Gene Parker, chief engr. ■ On 48 CATV's—90,000 subs. Co-owned: WSIX-AM-FM. ■ Rates: \$240; 70; 50.

WSM-TV—ch 4, 97.7 kw vis, 10 kw aur, ant 1,410/1368.5g (CP: 93.63 kw vis, 19.68 kw aur). Sept. 30, 1950. Box 100, 37202. (615) 749-2244. TWX 810-371-1148. Licensee: WSM Inc. Ownership: NLT Corp., 100%. ■ NBC. Rep: Petry. Wash atty: Kirkland, Ellis & Rowe. ■ William C. Weaver, chmn; Irving C. Waugh, pres; Tom Griscom Jr., gen mgr; Tom Elmer Alley, prog dir; Mike Kettering, news dir; Raymond Tichenor, chief engr; Lee Whitehurst, tech dir. ■ On 30 CATV's—26,800 subs. Co-owned: WSM-AM-FM. ■ Rates: \$275; 200; 75.

WTVF—ch 5, 100 kw vis, 10 kw aur, ant 1,370/1,179g. Aug. 6, 1954. 474 James Robertson Pkwy, 37219. (615) 244-5000. TWX 810-371-1168. Licensee: WLAC-TV Inc. Ownership: Channel Two TV Co. (acq 12-1-75). ■ CBS. Rep: Katz. Wash atty: Dow, Lohnes & Albertson. ■ Jack Harris, pres; Ruth C. Talley, VP & sec-treas; Harold C. Crump, exec VP & gen mgr; Dave Hart, prom mgr; Ralph L. Hucaby, VP & dir engr; Thomas E. Ervin, VP, stn mgr & sls dir; Bill Jay Bumpus, VP & opns mgr; Chris Clark, VP & news dir. ■ Rates: \$400; 190; 130.

WZTV—ch 17, 1,028 kw vis, 195 kw aur, ant 685/574g. Aug. 5, 1968 (dark since 1971). Box

90764, 37209. (615) 385-1717. Licensee: Reel Bcstg Co. (acq 11-6-75). Ownership: Robert K. Zelle, 62%; Jeffery Buntin, 10%; Michael P. Thompson, 20%. Rep: Bolton/Burchill Intl. Wash atty: Finkelstein & Firestone. ■ Robert K. Zelle, pres; Ian N. Wheeler, stn mgr, film buyer & prog dir; Michael Thompson, gen sls mgr; Ray McInturff, chief engr. ■ Rates: \$45; 55; 30.

Sneedville

ADI No. 58; see page B-36

***WSJK-TV**—ch 2, 100 kw vis, 20 kw aur, ant 1,760/499g. March 15, 1967. 209 Communications Extension, U. of Tennessee, Knoxville, 37916. (615) 974-5281. Licensee: Tenn. State Bd of Educ. ■ PBS; SECA. ■ Al Curtis, gen mgr; Hop Edwards, prog dir; Dick Renner, prog mgr; Nancy Brooks, prom mgr; Mike Knight, chief engr.

Texas

TO BUY OR SELL A

TELEVISION OR RADIO STATION

HAMILTON-LANDIS & ASSOC., Inc.

WASHINGTON, D.C.	CHICAGO
1730 K St., N.W. (202) 393-3456	1429 Tribune Tower (312) 373-2754
SAN FRANCISCO	DALLAS
111 Sutter St. (415) 392-5671	6060 N. Central Expy. (214) 691-2345

NATIONWIDE • NEGOTIATIONS FINANCING • APPRAISALS

Abilene

ADI No. 145; see page B-1

KRBC-TV—ch 9, 316 kw vis, 31.6 kw aur, ant 851/543g. Aug. 31, 1953. 4510 S. 14th St., 79604. (915) 692-4242. TWX 910-897-5414. Licensee: Abilene Radio & TV Co. Ownership: See Abilene Radio & TV Stns. ■ NBC. Rep: Blair. Wash atty: Miller, Schroeder & Bankson. ■ Dale Ackers, pres & gen mgr; William Terry, stn & coml mgr; Normand Mann, prog dir; Larry Fitzgerald, news dir; Gene Smith, chief engr. ■ On 17 CATV's. On 2 trans. Co-owned: KRBC(AM).

KTXS-TV(Sweetwater)—ch 12, 257 kw vis, 25.7 kw aur, ant 1,400/1,069g. Jan. 30, 1956. Box 2997, 79604. (915) 677-2281. TWX 910-896-4321. Licensee: Texas Key Bcstrs (acq 1966). Ownership: See Grayson Stns. ■ ABC, CBS. Rep: HR. Wash atty: Koteen & Burt. ■ Theodore Shanbaum, pres; Bob Jackson, gen mgr & film buyer; Hal Kemp, sls mgr; Shirley Seim, prog dir & opns mgr; James Parromore, news dir; J. T. Allen, chief engr. ■ On 19 CATV's—37,000 subs.

Amarillo

ADI No. 109; see page B-4

KAMR-TV—ch 4, 100 kw vis, 10 kw aur, ant 1,420/1,440g. March 18, 1953. Box 751, 79105. (806) 383-3321. TWX 910-898-4146. Licensee: Cannan Communications Inc. (acq 1974). ■ NBC. Rep: Blair. Wash atty: Hogan & Hartson. ■ Darrod A. Cannan, pres; Ray Poin-dexter, VP & gen mgr; Gil Schneider, asst mgr & gen sls mgr; Paul Roberts, news dir; Dale Scarberry, opns mgr; Alan Nuzum, chief engr. ■ On 36 CATV's—36,546 subs. On 19 trans.

KFDA-TV—ch 10, 302 kw vis, 30.2 kw aur, ant

Tennessee, Texas TV

See page B-89 for explanation of listings.

800/725g. April 4, 1953. Box 1400, 79105. (806) 383-2226. TWX 910-898-4124. Licensee: Bass Bcstg Co. Ownership: See Bass Bcstg Stns. ■ CBS. Rep: H-R. Wash atty: Miller & Schroeder. ■ Melvin L. Wheeler, pres & film buyer; Earle H. Rast Jr., VP & gen mgr; Larry Faler, sls mgr; Jack Byrd, opns mgr; Lynn Barry, prom mgr; Ron Scover, news dir; Dave Coons, chief engr. ■ On 54 CATV's—42,000 subs. On 20 trans.

KVII-TV—ch 7, 316 kw vis, 31.6 kw aur, ant 1,703/1,626g. Nov. 1, 1957. Box 13000, 79101. (806) 373-1787. TWX 910-898-4106. Licensee: Marsh Media Ltd. (acq 2-1-68). Ownership: Stanley Marsh III, 37.5%; Tom Marsh, 12.5%; Michael March, 25%; Estelle Marsh Watlington, 25%. ■ ABC. Sp 1 1/4 hrs wkly. Rep: Katz. Wash atty: Kirkland, Ellis & Rowe. ■ James R. McCormick, gen mgr; Wayne Roy, sls mgr; Jim Currie, prog dir; Bill Tell Zortman, news dir; John Martin, prom mgr; Bill Canady, chief engr. ■ On 39 CATV's—93,200 subs. On 19 trans. ■ Rates: \$100; 85; 20.

Austin

ADI No. 106; see page B-6

KTBC-TV—ch 7, 316 kw vis, 29.5 kw aur, ant 1,280/1,137g. Nov. 27, 1952. Box 2223, 78767. (512) 472-2424. TWX 910-874-1301. Licensee: Times Mirror Co. (acq 9-6-73). Ownership: See Times Mirror Stns. ■ CBS. Rep: Katz. Wash atty: Wilmer, Cutler & Pickering. ■ Rush K. Evans Jr., pres & gen mgr; Al Mustin, natl/regl sls mgr; Gus Stewart, local sls mgr; Joe Roddy, news edit; Arthur Riley, chief engr. ■ On 15 CATV's—59,800 subs. On 2 trans. ■ Rates: \$160-260; 140-160; 20-50.

KTVV—ch 36, 1,380 kw vis, 138 kw aur, ant 1,290/1,199g. Feb. 12, 1965. Box 490, 78767. (512) 476-3636. TWX 910-874-1370. Licensee: Kingstrip Communications Inc. Ownership: Kingstrip Inc. 100%. ■ NBC. Rep: H-R. Wash atty: Wilner & Schneider. ■ Henry Tippie, chmn; Al Howard, VP & gen mgr; Ed Hutchings, stn mgr; Jim Batson, gen sls mgr; Doug Matthews, news dir; William R. Yordy, VP engr. ■ On 21 CATV's—49,645 subs. Co-owned: KHFI-FM. ■ Rates: \$130; 50; 25.

KVUE—ch 24, 708 kw vis, 141 kw aur, ant 2,190/1,184g. Sept. 12, 1971. Box 9927, 78766. (512) 459-6521. TWX 910-874-1346. Licensee: Ch. 24 Corp. Ownership: Tolbert Foster, Allan Shivers, W. E. Dyché Jr. and Edgar B. Younger Sr. ■ ABC. Rep: Avery-Knodel. ■ Tolbert Foster, pres & gen mgr; Hal Wallace, gen sls mgr; Al Helton, prog dir & film buyer; Jim Barber, loc sls mgr; Gayle Shipp, news dir; Elmo Brown, pub affairs dir; Mike Wengler, chief engr. ■ On 32 CATV's—45,600 subs. On 1 trans. ■ Rates: \$150; 45; 30.

Beaumont

ADI No. 127; see page B-8

KBMT—ch 12, 316 kw vis, 31.6 kw aur, ant 1,000/1,022g. June 18, 1961. Box 1550, 77704. (713) 833-7512. TWX 910-884-5113. Licensee: Harbour Television Systems Inc. ■ ABC. Rep: Blair. Wash atty: Fly, Shuebruk, Blume & Gaguine. ■ Doug Thompson, gen mgr; John Ross, gen sls mgr; Mike Murphy, prom mgr; Bill Patton, news dir; Art Giddings, chief engr. ■ On 15 CATV's—51,085 subs. ■ Rates: \$90; 40; 20.

KFDM-TV—ch 6, 100 kw vis, 20 kw aur, ant 960/1,031g. April 24, 1955. (713) 892-6622. TWX 910-884-5121. Licensee: Belo Bcstg Corp. (acq 6-15-69). Ownership: See Belo Corp. stns, also Nwspr. ■ CBS. Rep: Petry. Wash atty: Dempsey & Koplovitz. ■ Mike Shapiro, pres; Terrence S. Ford, VP & stn mgr; George Gould, sls mgr; Ron Alexander, prog

Texas TV

See page B-89 for explanation of listings.

dir; Bill Huston, news dir; H. W. Bartlett, chief engr. ■ On 3 CATV's.

KJAC-TV (Port Arthur)—ch 4, 100 kw vis, 20 kw aur, ant 1,184t/1,225g. Oct. 22, 1957. Box 3257, Port Arthur, 77640. (713) 985-5557. TWX 910-886-5307. Licensee: Southeast Texas Television Corp. (acq 7-1-73). Ownership: See Clay Communications. ■ NBC. Rep: PG.W. Wash atty: Fletcher, Heald, Rowell, Kenehan & Hildreth. ■ George Diab, pres & film buyer; Roy Shotts, VP, gen mgr; Jack Dahmer, sls mgr; Bob Schnarr, prog dir; Wilson Yancey, prom mgr; Dave Wilson, news dir; Arthur Skipper, chief engr. ■ On 16 CATV's—33,137 subs. ■ Rates: \$175; 55; 40.

Belton

ADI No. 101; see page B-75

***KNCT**—ch 46, 479 kw vis, 67.6 kw aur, ant 1,261t/1,126g. Nov. 23, 1970. Central Texas College, Hwy 190W, Killeen, 76541. (817) 526-1268. Licensee: Ctr. Tex. College. ■ PBS. ■ Richard D. Wilson, gen mgr; Edward B. Jasuta Jr., stn mgr; P. Anthony Zeiss, dir of bcst svcs; Steve Rabberman, prog dir; Catherine Mason, coord of special projects; Mona Lane, prom mgr; Lee Roy Franklin, chief engr. ■ On 15 CATV's—64,389 subs. Co-owned *KNCT-FM.

Big Spring

ADI No. 148; see page B-51

KWAB—ch 4, 12.9 kw vis, 1.5 kw aur, ant 380t/497g. Jan. 15, 1956. 2700 Kentucky Way, 79720. (915) 267-6325. TWX 806-747-3811. Licensee: Grayson Enterprises Inc. Co-owned satellite of KMOM-TV Monahans. ■ ABC. ■ Clyde Benjamin, chief engr.

Brownsville

ADI No. 141; see page B-43

KGBT-TV—See Harlingen.

KPSA-TV—ch 23, 295 kw vis, 13.2 kw aur, ant 1,432t/1,494g. Not on air, target date unknown. Box 3841, 78520. (512) 546-3777. Permittee: Pan American Broadcasting Corp. Ownership: Charles E. H. Haywood, 100%. ■ Wash atty: Mullin, Connor & Rhyne. ■ Charles E. Haywood, pres.

KRGB-TV—See Weslaco.

Bryan

ADI No. 101; see page B-75

KBTX-TV—ch 3, 60.3 kw vis, 8.1 kw aur, ant 410t/482g. May 22, 1957. Drawer 3730, 77801. (713) 846-7777. Licensee: Brazos Bcstg Co. Ownership: KWTX Bcstg Co. (KWTX-AM-TV Waco), 50%; Mrs. W. W. Callan, W. C. Mitchell, M. N. Bostick, and B. Varisco, estate, each 10%; John M. Lawrence III and Harry L. Gillam, each 5%. For KWTX holdings see KWTX Stns and Tex. Bcstg Stns. ■ ABC, CBS. Rep: H-R. ■ M. N. (Buddy) Bostick, pres, gen mgr & film buyer; Harry L. Gilliam VP & stn mgr; Ulman McMullen, prog dir; Ted Montgomery, prom mgr; Martin Sebastian, news dir; W.B. Cox, chief engr. ■ On 11 CATV's—21,759 subs. ■ Rates: \$48; 28; 28.

College Station

ADI No. 101; see page B-75

***KAMU-TV**—ch 15, 22.9 kw vis, 2.29 kw aur, ant 390t/379g. Feb. 15, 1970. 77843. (713) 845-1526. TWX 910-880-4425. Licensee: Texas A&M U. ■ PBS. ■ Dr. Mel Chastain, stn mgr; Rod Zent, prog dir; Mark Holcomb, news

dir; John Gray, chief engr. ■ On 6 CATV's—20,500 subs.

Corpus Christi

ADI No. 126; see page B-18

***KEDT**—ch 16, 975 kw vis, 164 kw aur, ant 970t/996g. Oct. 15, 1972. Box 416, 78403. (512) 855-2213. Licensee: South Texas Educational Bcstg Council. ■ PBS. ■ Terrell L. Cass, stn mgr; Susan Castor, community coord; Mike Neibauer, chief engr.

KIII—ch 3, 100 kw vis, 10 kw aur, ant 860t/899g. May 4, 1964. Box 6669, 78411. (512) 854-4733. TWX 910-876-1470. Licensee: S. Tex. Telecasting Co. Ownership: Michael D. McKinnon, 28.3%; Dan McKinnon, 24%; C. D. McKinnon, 24%; C. D. McKinnon, 24.25%; Bernard Weinberg, Estate of Harold Garfield, each 16%, et al. ■ ABC. Sp 3 hrs wkly. Rep: Blair Wash atty: Cohn & Marks. ■ Michael D. McKinnon, pres & gen mgr; Bob White, VP, stn mgr & film buyer; Bill McDonald, news dir; Billy Brotherton, prog dir; Dale Taylor, chief engr. ■ On 12 CATV's. ■ Rates: \$150; 60; 30.

KORO—ch 28, 283 kw vis, 56.7 kw aur, ant 325t/328.8g. Not on air, target date unknown. c/o Jose de Leon Jr., 1801 S. Staples St., 78404. Permittee: Telecorpus Inc.

KRIS-TV—ch 6, 100 kw vis, 10 kw aur, ant 650t/683g. May 22, 1956. Box 840, 78403. (512) 883-6511. TWX 910-876-1442. Licensee: Gulf Coast Bcstg Co. Ownership: T. Frank Smith, 52.5%; Mrs. T. Frank Smith, 47.5%. ■ NBC. Sp 1 hr wkly. Rep: Peters, Griffin, Woodward. Wash atty: Finkelstein & Firestone. ■ T. Frank Smith Jr., pres & gen mgr; Hal Atkins Jr., sls mgr; Charles Nethery, prog VP; van Johnson, VP natl sls & film buyer; Jim Pratt, news dir; Buck Johnston, chief engr. ■ On 5 CATV's. ■ Rates: \$100; 70; 25.

KZTV—ch 10, 316 kw vis, 47.9 kw aur, ant 940t/982g. Sept. 30, 1956. Show Room Bldg., 78401. (512) 884-1616. TWX (910) 876-1480. Licensee: KSIX Television Inc. Ownership: Corpus Christi Bcstg Co. (KSIX), 54.266%; Guy I. Warren, 13.333%; Vann M. Kennedy, 12.46% & others. ■ CBS. Sp 6 hrs wkly. Rep: H-R. Wash atty: McKenna, Wilkinson & Kither. ■ Vann M. Kennedy, pres, gen mgr & film buyer; Bob Payne, gen sls mgr; Eugene M. Looper, prog dir; Alice Benson, prom mgr; Kenneth D. Cessna, news dir; William J. Carter, opns mgr; Eric Beals, dir of engr. ■ Co-owned: KSIX-AM-FM. ■ Rates: \$113; 55; 27.

Dallas

ADI No. 11; see page B-19

KDFW-TV—ch 4, 100 kw vis, 20 kw aur, ant 1,680t/1,521g. Dec. 3, 1949. 400 N. Griffin, 75202. (214) 742-5711. TWX 910-861-4104. Licensee: Times Herald Printing Co. Ownership: Times Herald Printing Co. (acq 5-15-70). See Nwspr. ■ CBS. Rep: Harrington, Righter & Parsons. Wash atty: Wilmer, Cutler & Pickering. ■ John J. McCrory, VP & gen mgr; I. W. Baker, VP & dir of sls; Gene Cuny, prog mgr & film buyer; Jack Harrison, prom mgr; Wayne Thomas, news dir; B. B. Honeycutt, chief engr. ■ On 78 CATV's—168,307 subs.

***KERA-TV**—ch 13, 316 kw vis, 31.6 kw aur, ant 1,540t/1,347g. Sept. 14, 1960. 3000 Harry Hines Blvd., 75201. (214) 744-1300. TWX 910-861-4118. Licensee: Public Communication Foundation for North Texas. ■ PBS. Wash atty: Wilmer, Cutler & Pickering. ■ Ralph B. Rogers, pres; Ed Pfister, gen mgr; Ron Devillier, prog dir; Lee Clark, news dir; Pat Perini, prom mgr; Daniel Owen, sp project dir; Renate Cole, traf; Clyde Miller, chief engr. ■ On 41 CATV's—100,000 subs.

KTVT—Licensed to Fort Worth. See Ft. Worth.

KXAS-TV—Licensed to Fort Worth. See Fort Worth.

KXTX-TV—ch 39, 1410 kw vis, 141 kw aur, ant 1,681t/1535g. Feb. 5, 1968. 3900 Harry Hines Blvd., 75219 (214) 521-3900. TWX 910-861-4282. Licensee: Christian Bcstg Network (acq 1974). Ownership: See Christian Bcstg Stns. ■ Rep: Young; Williams. Wash atty: Fisher, Wayland, Southmayd & Cooper. ■ M. G. Robertson, pres; Roger Baerwolf, gen mgr; Robert Johnson, VP & film buyer; Richard J. Bove, sls mgr; Harold D. Wheat, prog dir; Mrs. Lana Ensrud, prom mgr; Michael Eastes, news dir; Arthur L. Runyon Jr., chief engr. ■ On 120 CATV's—410,000 subs. ■ Rates: \$—; 85; 35.

WFAA-TV—ch 8, 316 kw vis, 31.6 kw aur, ant 1,680t/1,521g. Sept. 17, 1949. Communications Ctr., 75202. (214) 748-9631. TWX 910-861-4139. Licensee: Belo Bcstg Corp. Ownership: See Belo Corp Stns, also Nwspr. ■ ABC. Rep: Petry. Wash atty: Dempsey & Koplovitz. ■ J. M. Moroney Jr., chmn; Mike Shapiro, pres; Ward L. Huey, VP & gen mgr; David T. Lane, VP & stn mgr; Jim Pratt, prog dir; Mike Howe, gen sls mgr; George Gould, sls mgr; Paul Keller, ntl sls mgr; Bob Turner, prod mgr; Marty Haag, exec news dir; Joan Johnson, film buyer; Jim W. Cooper, VP & sec; Aubrey Jenkins, VP & treas; J. C. Irby, chief engr. ■ On 77 CATV's—160,510 subs. On 1 trans. Co-owned: WFAA (AM)-KZEW (FM).

Denison

KXII—See Ardmore, Okla.

El Paso

ADI No. 102; see page B-23

***KCOS**—ch 7, 302 kw vis, 47.4 aur, ant 743t/293g. Not on air, target date unknown. Box 146, 79942. Permittee: El Paso Public TV Foundation.

KDBC-TV—ch 4, 61.7 kw vis, 6.8 kw aur, ant 1,150t/285g. Dec. 14, 1952. Box 1799, 79999. (915) 532-6551. TWX 910-964-1323. Licensee: Portal Communications Inc. (acq 10-16-74). Ownership: Evening Post Publishing Co., 100%. Evening Post Publishing Co. is publisher of Charleston, S.C., *News & Courier* and *Post*. ■ CBS. Rep: H-R. Wash atty: Dow, Lohnes & Albertson. ■ Edward M. Sleighel, pres & gen mgr; Sam Kobren, gen sls mgr; Bill Mitchell, news dir; Charles Maly, prog mgr & film buyer; Howell Eurich, prom mgr; Frank Jordan, chief engr. ■ On 8 CATV's—3,500 subs. On 6 trans. ■ Rates: \$90; 75; 21.

KELP-TV—ch 13, 209 kw vis, 20.9 kw aur, ant 820t/296g. (CP) 275 kw vis, 27.5 kw aur, ant 2,000/397g. Sept. 1, 1956. Box 12277, 79912. (915) 533-5911. Licensee: Walton Enterprises Inc. Ownership: See John B. Walton Jr. Stns. ■ ABC. Rep: Bolton/Burchill; Hix. Wash atty: Cohn & Marks. ■ John B. Walton Jr., pres; Bob Galbraith, stn mgr; Fred Witt, gen sls mgr; John Chapman, news dir; Ribin Masters, dir of engr. ■ On 5 CATV's. On 2 trans. Co-owned: KELP(AM).

KTSM-TV—ch 9, 316 kw vis, 42.7 kw aur, ant 1,910t/370g. Jan. 4, 1953. 801 N. Oregon St., 79902. (915) 532-5423. TWX 915-544-1963. Licensee: Tri-State Bcstg Co. Ownership: Karl O. Wyler Sr., 55%; Karl O. Wyler Jr., 30%; F. L. Koons, 10% & others. ■ NBC. Rep: Avery-Knodel. Wash atty: Wilner & Scheiner. ■ Karl O. Wyler Sr., pres & gen mgr; Jack Rye, exec VP, prog dir & film buyer; John Phelan, VP & sls mgr; Jeff Gates, news dir; W. T. McGill, VP & chief engr. ■ On 9 CATV's. On 4 trans. Co-owned: KTSM-AM-FM. ■ Rates: \$100; 60; 30.

Fort Worth

ADI No. 11; see page B-19

KDFW-TV Licensed to Dallas. See Dallas.

KTVT—ch 11, 316 kw vis, 31.6 kw aur, ant 1,670t/1,549g. Sept. 11, 1955. Box 2495,

76101. (817) 738-1951. TWX 817-891-8076. Licensee: Gaylor Bcstg Co. Ownership: See Gaylor Bcstg Co., also Nwspr. ■ Rep: Katz. Wash atty: Pierson, Ball & Dowd. ■ Edward L. Gaylor, chmn of the bd; Eugene B. Dodson, pres; Jim Terrell, exec VP, gen mgr & film buyer; Jack Berning, asst gen mgr & gen sls mgr; Clem Candelaria, prog mgr; John Whitson, news dir; Bill Kessel, chief engr; Dave Ford, prom mgr. ■ On 144 CATV's—525,000 subs. ■ Rates: \$155; 250; 40.

KXAS-TV—ch 5, 100 kw vis, 20 kw aur, ant 1,680/1,521g. Sept. 29, 1948. Box 1780, 76101. (817) 429-1550. TWX 910-893-5070. Licensee: North Texas Bcstg Corp. (acq 5-74). Ownership: See LIN Bcstg Stns. ■ NBC. Rep: Blair. Wash atty: Haley, Bader & Potts. ■ Blake Byrne, pres & gen mgr; Jett F. Jamison, gen sls mgr; John Kendall, natl sls mgr; Robert Gould, prog dir & film buyer; Paul Witengier, prom dir; Russ Thornton, news mgr; Tom Beford, chief engr. ■ Rates: \$950; 250; 90.

KXTX-TV Licensed to Dallas. See Dallas.

WFAA-TV Licensed to Dallas. See Dallas.

Harlingen

ADI No. 141; see page B-43

KGBT-TV—ch 4, 100 kw vis, 18.7 kw aur, ant 990/1,944g. October 1953. Box 711, 78550. (512) 423-3910. TWX 910-870-1504. Licensee: Harbenito Bcstg Co. Ownership: J. C. Looney, 21%; Rogers Kelley, 21%; McHenry Tichenor, 57%; & others. ■ CBS, ABC. Rep: Avery-Knodel. Wash atty: Cohn & Marks. ■ McHenry Tichenor, chmn; McHenry T. Tichenor, pres; Mal Kasanoff, exec VP & gen mgr; David Lykes, VP, stn mgr; L. W. Heyman, sls mgr; Larry Brook, ops dir; Ray Norton, news dir; Jim Mattison, chief engr; Alex Giese, dir of engr. ■ On 12 CATV's—25,000 subs. Co-owned: KGBT (AM)—KELT (FM).

KRGV-TV See Weslaco.

Houston

ADI No. 14; see page B-32

KDOG-TV—ch 26, 1,660 kw vis, 331 kw aur, ant 940/1,995g. Aug. 15, 1971. Box 22810, 3935 Westheimer Rd., 77027. (713) 626-2610. TWX 910-881-6212. Licensee: Crest Bcstg Co. Ownership: Raymond G. Schindler, 43.08%; Frank W. Head Jr., 11.63%; Leroy J. Gloger, 6.98%; Warner F. Brock, 5.82%; Leon A. Schindler, 5.82%; William A. Schindler, 5.82%; and others. ■ Sp 6½ hrs wkly. Rep: Avco. Wash atty: Benedict P. Cottone. ■ Leroy J. Gloger, pres & gen mgr; Jo Edgell, natl sls mgr; Jim Monahan, prog dir; Wendell Wyborny, chief engr. ■ On 35 CATV's—180,000 subs.

KHOU-TV

A Corinthian Station

KHOU-TV—ch 11, 316 kw vis, 47.9 kw aur, ant 1,440/1,473g. March 22, 1953. Box 11, 77001. (713) 526-8811. TWX 910-881-1705. Licensee: Gulf TV Corp. Ownership: See Corinthian Stns. ■ CBS. Rep: Harrington, Righter & Parsons. Wash atty: Covington & Burling. ■ James M. King, VP & gen mgr; Bob Finke, gen sls mgr; John Nottingham, natl sls mgr; Tom Kenney, prog mgr & film buyer; Milt Weiss, news dir; Craig Bland, prom mgr; Art Biggs, chief engr. ■ On 40 CATV's—40,000 subs. ■ Rates: \$1500; 300; 200.

KHTV—ch 39, 1170 kw vis, 117 kw aur, ant 1,579/1,473g. Jan. 6, 1967. Box 1439, 77001. (713) 781-3930. TWX 910-881-3664. Licensee: Gaylor Bcstg Co. Ownership: See Gaylor Bcstg Co., also Nwspr. ■ Rep: Katz. Wash atty: Pierson, Ball & Dowd. ■ E.B. Dodson, pres; Gene R. Jacobsen, gen mgr; Harry Apel, asst gen mgr & gen sls mgr; Don

Houglund, prom mgr; Clyde Formby, opns mgr & film buyer; Chuck Scott, news dir; Jack H. Tudor, chief engr. ■ On 48 CATV's—121,000 subs. ■ Rates: \$135; 165; 50.

KPRC-TV—ch 2, 100 kw vis, 10 kw aur, ant 1,430/1,473g. Jan. 1, 1949. Box 2222, 77001. (713) 771-4631. TWX 910-881-2587. Licensee: Channel Two Television Co. Ownership: Oveta Culp Hobby & family. ■ NBC. Rep: Petry. Wash atty: Miller & Schroeder. ■ Mrs. Oveta Culp Hobby, chmn; W. P. Hobby Jr., vice chmn bd; Jack Harris, pres, bcst div & gen mgr; Jack McGrew, exec VP, stn & coml mgr; Paul Huhndorf, VP, opns; Tom Reiff, prog. dir; Kirt Harris, prom mgr; Ray Miller, VP, news & pub affairs. ■ Co-owned: KPRC (AM).

KTRK-TV—ch 13, 316 kw vis, 39.8 kw aur, ant 960/1,978g. Nov. 20, 1954. Box 13, 77001. (713) 666-0713. TWX 910-881-1511. Licensee: Capital Cities Communications Inc. (acq 7-17-67). Ownership: See Capital Cities Stns. ■ ABC. Rep: Blair. Wash atty: Wilmer, Cutler & Pickering. ■ Kenneth M. Johnson, VP & gen mgr; Paul L. Bures Jr., sls mgr; James Masucci, opns mgr; Charles Wolf, prom dir; Larry Autry, prod dir; Walter Hawver, news dir; Jess Mitchell, chief studio engr; Robert Sutton, chief trans engr. ■ On 30 CATV's—63,730 subs.

***KUHT**—ch 8, 302 kw vis, 30.2 kw aur, ant 1,160/1,199g. May 12, 1953. 4513 Cullen Blvd., 77004. (713) 748-6814. TWX 910-881-3687. Licensee: U. of Houston. ■ PBS. ■ James L. Bauer, mgr; Sharon Blair, prog dir; Judy Ryan, prom mgr; George L. Collins, opns mgr; Al Leverick, chief engr. ■ On 36 CATV's. Co-owned: *KUHF (FM).

Laredo

ADI No. 202; see page B-38

KGNS-TV—ch 8, 316 kw vis, 42.2 kw aur, ant 1,021/1,049g. Jan. 6, 1956. Box 1378, 78040. (512) 723-7457. TWX 910-870-1794. Licensee: Western Comm Inc. Ownership: See Donrey Media Group Stns, also Nwspr. ■ NBC, ABC. Sp 5 hrs wkly. Rep: Meeker. Wash atty: Covington & Burling. ■ Donald W. Reynolds, pres; Sam Spivey, VP & gen mgr; Jack Poray, gen sls mgr; Carl F. Floyd, prog dir; George Causey, chief engr. ■ On 5 CATV's—13,000 subs. On 1 trans. ■ Rates: \$65; 55; 30.

KVTV—ch 13, 87.5 kw vis, 17.4 kw aur, ant 920/1,035g. Dec. 29, 1973. Box 735, 78040. (512) 723-2923. Licensee: K-Six TV Inc. Ownership: Same as KZTV(TV) Corpus Christi. ■ CBS. Rep: H-R. ■ Vann M. Kennedy, pres & gen mgr; Neil Gilligan Jr., stn mgr; Hector Garcia, prod mgr; Sam Houston Allred, prog dir; William R. Lamb, news dir; Wayne Johnston, resident engr. ■ Rates: \$55; 27; 14.

Lubbock

ADI No. 134; see page B-41

KCBD-TV—ch 11, 316 kw vis, 60 kw aur, ant 760/1,814g. May 10, 1953. Box 2190, 79408. (806) 744-1414. TWX 910-896-4306. Licensee: State Telecasting Co. (acq 6-17-71). Ownership: State-Record Co., Columbus, S.C. 100%. See State-Record Co. Stns, also Nwspr. ■ NBC. Rep: Blair. Wash atty: Dow, Lohnes & Albertson. ■ W. Frank Harden, pres; W. Robert McKinsey, VP & gen mgr; Carl Minor, sls mgr; Henry Taylor, prog dir; Richard Benedict, news dir; Frank Lee, dir of engr. ■ On 30 CATV's—27,700 subs. On 3 trans. ■ Rates: \$150; 40; 30.

KLBK-TV—ch 13, 251 kw vis, 25.1 kw aur, ant 880/1,923g. Nov. 13, 1952. 7400 University Ave., 79408. (806) 744-2345. TWX 910-896-4321. Licensee: Grayson Enterprises Inc. Ownership: See Grayson Enterprises Stns. ■ CBS. Rep: H-R; Hix. Wash atty: Koteen & Burt. ■ Theodore Shanbaum, chmn; Dr. Ellis Carp, pres; W. F. de Tournillon, VP, film buyer, natl sls mgr & gen mgr; Ford Robertson, loc sls mgr; Pat Hales, prog dir; Sammy Smith, news dir; B. J. Latta,

Texas TV

See page B-89 for explanation of listings.

engr. ■ On 21 CATV's—86,421 subs. Co-owned: KLBK-AM-FM.

KMCC—ch 28, 788 kw vis, 153 kw aur, ant 840/1,871g. Nov. 12, 1968. Box 2805, 79408. (806) 745-2828. TWX 910-896-4357. Licensee: McAlister TV Enterprises Inc. Ownership: B. B. McAlister, R. B. McAlister, 50% each. ■ ABC. Rep: Avery-Knodel. Wash atty: Leo Resnick. ■ Bill B. McAlister, pres & gen mgr; A. C. Wimberly, prog dir & film buyer; Jo Kidd, gen sls mgr; John McCoy, prom mgr; Rusty Jones, news dir; Bill Baker, chief engr. ■ On 18 CATV's—20,000 subs. Co-owned: KSEL-AM-FM. ■ Rates: \$90; 70; 35.

***KTXT-TV**—ch 5, 25.7 kw vis, 5.1 kw aur, ant 440/1,452g. Oct. 16, 1962. Box 4359, Tech Station, 79409. (806) 742-2200. Licensee: Texas Tech College. ■ PBS. ■ D. M. McElroy, dir; John Henson, stn mgr; John C. Lacy, prog dir; Barbara Haley, instructional coord; Pat Pattillo, chief engr. ■ On 9 CATV's—17,157 subs. Co-owned: *KTXT-FM.

Lufkin

ADI No. 156; see page B-74

KTRE-TV—ch 9, 27.5 kw vis, 5.4 kw aur, ant 650/1,540g. Aug. 31, 1955. Drawer 729, 75901. (713) 634-7771. Licensee: Buford Television Inc. Ownership: See Buford Stns. ■ NBC, ABC. Rep: H-R TV. Wash atty: McKenna, Wilkinson & Kittner. ■ Bob Buford, pres. ■ On 10 CATV's—14,000 subs. ■ Rates: \$82; 45; 22.

McAllen

ADI No. 141; see page B-43

KVEO-TV—ch 48, 229 kw vis, 339 kw aur, ant 1494/1,460g. Not on air, target date unknown. Box 3588, 78501. Permittee: Delta Rio Broadcasting Co. Ownership: Edward L. Gomez, 10%; Darrell Davis, 10%; Eduardo Izaguirre, 10%; and others. ■ Darrell Davis, exec VP.

Midland

ADI No. 148; see page B-51

KDCD-TV—ch 18, 6.76 kw vis, 852 w aur, ant 390/1,413g. Jan. 15, 1961. 3201 West Wall St., 79701. (915) 694-1213. Licensee: Midland Telecasting Co. Ownership: Luther T. Fair, 39%; Chet Darwin, 41%; Louis McCracken, 10%; and others. ■ Rep: Savalli-Gates. ■ Chet Darwin, pres, gen & sls mgr; Bart Darwin, stn mgr; E. E. Burney, chief engr. ■ On 2 CATV's—18,000 subs.

KMID-TV—ch 2, 100 kw vis, 10 kw aur, ant 1,060/1,147g. Dec. 18, 1953. Drawer B, 79701. (915) 563-2222. TWX 910-897-8682. Licensee: Midessa TV Co. Ownership: See R. H. Drewry Stns. ■ NBC. Rep: Avery-Knodel. Wash atty: Greeley, Bernard & Tierney. ■ J. Conrad Dunagan, pres; R. F. Herndon Jr., VP, gen mgr & film buyer; J. L. Foster, sls mgr; Harry Neuhardt, news dir; George Wright, chief engr. ■ On 27 CATV's—64,416 subs. On 4 trans.

KMOM-TV See Monahans.

KOSA-TV Licensed to Odessa. See Odessa.

Monahans

ADI No. 148; see page B-51

KMID-TV See Midland.

KMOM-TV—ch 9, 240 kw vis, 45.7 kw aur, ant 1,270/1,080g. Dec. 1, 1958. Drawer N, Monahans 79756. (915) 943-3231. Box 4677, Odessa, 79760. (915) 563-1803. TWX 910-897-5642. Licensee: Grayson Enterprises. Ownership: See Grayson Enterprises Stns. ■ ABC, CBS. Rep: Hull. Wash atty: Koteen & Burt.

Texas, Utah TV

See page B-89 for explanation of listings.

■ Ted Shambaum, pres; Pat Hales, gen mgr; Joe Hull, natl sls mgr; Tony Radican, prod dir; Joe Connally, chief engr. ■ On 35 CATV's—71,873 subs. On 4 trans.

KOSA-TV See Odessa.

Odessa

ADI No. 148; see page B-51

KMID-TV Licensed to Midland. See Midland.

KMOM-TV Licensed to Monahans. See Monahans.

KOSA-TV—ch 7, 316 kw vis, 39.8 kw aur, ant 740t/726g. Jan. 1, 1956. Box 4186, 1211 N. Whitaker, 79760. (915) 337-8301. TWX 910-897-5504. Licensee: Forward Communications of Texas Inc. (acq 9-12-73). Ownership: See Forward Communications. ■ CBS. Rep: Meeker. Wash atty: McKenna, Wilkinson & Kittner. ■ Richard D. Dudley, pres; Doyce Elliott, pres & gen mgr; Bob Spielmann, natl sls mgr; Ed Costello, lcl sls mgr; Tom Hughes, opns mgr & film buyer; Robert Rosas, news dir; Clyde Aly, prod mgr; Mike Gazzella, prom mgr; Dave Williams, chief engr. ■ On 24 CATV's—52,712 subs. On 8 trans. ■ Rates: \$85; 29; 21.

Port Arthur

KJAC-TV Licensed to Port Arthur. See Beaumont.

San Angelo

ADI No. 200; see page B-64

KACB-TV—ch 3, 17.8 kw vis, 3.5 kw aur, ant 600t/469g. Feb. 8, 1962. Licensee: Abilene Radio & TV Co. Co-owned satellite of KRBC-TV Abilene. ■ NBC. Wash atty: Miller & Schroeder. ■ Bill Terry, stn mgr. ■ On 4 CATV's. ■ Rates: \$150; 85; 25.

KCTV—ch 8, 25.1 kw vis, 5 kw aur, ant 420t/443g. June 23, 1953. Box 1941, 76901. (915) 655-7383. TWX 510-871-3905. Licensee: Jewell Television (acq 2-1-71). Ownership: See T. B. Lanford Stns. ■ CBS. Rep: Young. Wash atty: Kirkland, Ellis & Rowe. ■ T. B. Lanford, pres; Harry Mooradian, gen mgr & prod dir; Harry Abbott, sls mgr; Pat Attebery, prom mgr; Edward Mateo, opns mgr. ■ On 11 CATV's—38,917 subs. On 1 trans.

San Antonio

ADI No. 45; see page B-64

KENS-TV—ch 5, 100 kw vis, 20 kw aur, ant 1,390t/1,531g. Feb. 15, 1950. Box TV5, 78299. (512) 225-5211. TWX 512-571-0951. Licensee: Harte-Hanks Television Inc. Ownership: See Harte-Hanks Nwspr. ■ CBS. Rep: Peters, Griffin, Woodward. Wash atty: Arnold & Porter. ■ Wayne Kearl, pres; William G. Moll, VP & gen mgr; Bill Lydle, natl sls mgr; Elliott Kleeman, gen sls mgr; Bill Shomette, prod mgr; Bob Rogers, news dir; Linda Rios, prom mgr; R. McMillan, chief engr. ■ Rates: \$305; 160; 61.

***KLRN**—ch 9, 298 kw vis, 43.2 kw aur, ant 1,110t/1,019g. Sept. 10, 1962. Box 7158, Austin, 78712. (512) 471-1631. DACS 512-472-3033. Licensee: Southwest Texas Public Broadcasting Council. ■ PBS. Wash atty: Cohn & Marks. ■ Robert F. Schenkan, pres & gen mgr; Harvey Herbst, VP, stn mgr; Myrtle Boyce, instructional coord; Howard Chalmers Jr., dir of dev; Noyes W. Willett, chief engr; Bill Arhos, prod dir; Larry Miller, news dir; Melody Davison, pub dir. ■ On 52 CATV's. On 2 trans.

KMOL-TV—ch 4, 100 kw vis, 11.2 kw aur, ant

1,476t/1,531g. Dec. 11, 1949. Box 2641, 78299. (512) 226-4251. TWX 910-871-1030. Licensee: United TV Inc. (acq 11-5-75). Ownership: See Twentieth Century Fox. ■ NBC. Rep: Blair. Wash atty: Dow, Lohnes & Albertson. ■ Edward V. Cheviot, VP & gen mgr; Morton A. Barrett, gen sls mgr; Jack Carroll, prod dir; Don McMullin, news dir; Cheri Bedford, prom mgr; Dave Karbach, chief engr. ■ On 34 CATV's—82,000 subs.

KSAT-TV—ch 12, 316 kw vis, 63.2 kw aur, ant 1,480t/1,505g. Jan. 21, 1957. Box 2478, 78298. (512) 226-7611. TWX 910-871-1022. Licensee: Outlet Co. Ownership: See Outlet Co. Stns. ■ ABC. Rep: Petry. Wash atty: Sundlun, Tirana & Scher. ■ J. S. Sinclair, chmn; Kenneth Logowitz, pres; David E. Henderson, pres, bcst dir; James Schiavone, VP & gen mgr; Sam Rocco, prod dir; Jack Dix, gen sls mgr; Dennis Siewert, natl sls mgr; Doug Ramsey, news dir; Bruce Laughlin, chief engr. ■ On 24 CATV's—86,844 subs. On 4 trans. ■ Rates: \$350; 80; 60.

KWEX-TV—ch 41, 129 kw vis, 25.7 kw aur, ant 500t/598g. June 10, 1955. Box 9225, 78204. (512) 227-4141. Telex 767-4300. Licensee: Spanish Intl Bcstg Corp. Ownership: See Spanish Intl Bcstg Stns. ■ Rep: Spanish Intl Net. Wash atty: McKenna, Wilkinson & Kittner. ■ Reynold V. Anselmo, pres; Emilio Nicolas, VP & gen mgr; Bill Hicks, gen sls mgr; James Meek, VP & dir of engr. ■ Rates: \$70; 60; 35.

Sherman

KXII Licensed to Ardmore, Okla. See Ardmore, Okla.

Sweetwater

KTXS-TV Licensed to Sweetwater. See Abilene.

Temple

ADI No. 101; see page B-75

KCEN-TV—ch 6, 100 kw vis, 14.1 kw aur, ant 830t/833g. Nov. 1, 1953. Box 188, 87601. (817) 773-6868. TWX 817-467-5429. Licensee: Ch 6 Inc. Ownership: Frank W. Mayborn, 100%; see Nwspr. ■ NBC, ABC. Rep: Blair. Wash atty: Fisher, Wayland, Duvall, Southmayd & Cooper. ■ Frank W. Mayborn, pres; Jack Hauser, VP, gen mgr & film buyer; Bob Good, gen sls mgr; Raymond Britton, opns mgr; Max Tooker, news dir; Jinx Dennis, prom mgr; Earl Hill, chief engr. ■ On 24 CATV's—72,500 subs. On 1 trans.

KWTX-TV Licensed to Waco. See Waco.

Texarkana

KTAL-TV Licensed to Texarkana. See Shreveport, La.

Tyler

ADI No. 158; see page B-74

KLTV—ch 7, 316 kw vis, 50 kw aur, ant 520t/495g. Oct. 15, 1954. Box 957, 75701. (214) 592-3873. TWX 910-860-5810. Licensee: Buford Television Inc. Ownership: Robert P. Buford, 32.8573%; Gerald Barber Buford, 32.9192%; Geoffrey Ross Buford, 32.9192%; and others. See Buford Stns. ■ ABC, NBC, CBS. Rep: Avery Knodel. Wash atty: McKenna, Wilkinson & Kittner. ■ Robert P. Buford, pres; Larry Harris, gen mgr & film buyer; Gayle Helms, traf mgr; Bobby Perdue, news dir; Hudson C. Collins, chief engr. ■ On 15 CATV's. ■ Rates: \$270; 115; 70.

Victoria

ADI No. 45; see page B-64

KAVU—ch 25, 5.4 kw vis, 1.02 kw aur, ant 271t/265g. Not on air, target date unknown. Box 2525, 77901. Permittee: John J. Tibiletti.

KXIX—ch 19, 14.8 kw vis, 2.9 kw aur, ant 490t/495g. Nov. 21, 1969. Box 6669, Corpus Christi, 78411. Licensee: Guadalupe Valley Telecasting Co. Co-owned satellite of KIII(TV) Corpus Christi. ■ ABC. ■ On 6 CATV's—10,000 subs.

Waco

ADI No. 101; see page B-75

KCEN-TV Licensed to Temple. See Temple.

KWTX-TV—ch 10, 257 kw vis, 51.4 kw aur, ant 1,140t/1,080g. April 1955. Box 7528, 76710. (817) 776-1330. TWX 910-894-5206. Licensee: KWTX Bcstg Co. Ownership: See KWTX Stns. ■ CBS, ABC. Rep: H-R. ■ M. N. (Buddy) Bostick, pres & gen mgr; J. M. Brinegar, loc sls mgr; Barbara Havins, natl/rngl sls contact; Ralph Webb, prod mgr; Ron Hall, news dir; Jesse Doye, chief engr. ■ On 9 CATV's. Co-owned: KWTX-AM-FM.

Weslaco

ADI No. 141; see page B-43

KGBT-TV Licensed to Harlingen. See Harlingen.

KRGV-TV—ch 5, 100 kw vis, 19.1 kw aur, ant 950t/995g. April 10, 1954. Box 626, 78596. (512) 968-3131. TWX 910-870-1850. Licensee: Mobile Video Tapes Inc. Ownership: See Manship Stns. ■ NBC, ABC. Rep: H-R. Wash atty: Cohn & Marks. ■ Douglas Manship, pres; Earl Noel, gen mgr; Jim Cook, loc sls mgr; Julian Adame, opns mgr; Bob Richardson, news dir. ■ On 1 CATV. Co-owned: KRGV (AM).

Wichita Falls

ADI No. 118; see page B-77

KAUZ-TV—ch 6, 100 kw vis, 20 kw aur, ant 1,020t/1,028g. March 1, 1953. Box 2130, 76307. (817) 322-6957. TWX 910-890-5836. Licensee: Wichita Falls Telecasters (acq 11-1-74). Ownership: Wichita Falls Television, 80%; White Fuel Corp., 20%. ■ CBS. Rep: Blair. Wash atty: Hamel, Park, McCabe & Saunders. ■ William E. Hobbs, pres, gen mgr & film buyer; Jay Harmon, prod dir; Jack Britton, loc sls mgr; Mary Norwood, prom mgr; Lynn Walker, news dir; Leon Hoeffner, chief engr. ■ On 24 CATV's—42,880 subs. ■ Rates: \$115; 80; 30.

KFDX-TV—ch 3, 100 kw vis, 20 kw aur, ant 1,000t/1,045g. April 12, 1953. Box 4000, 76308. (817) 692-4530. TWX 910-890-5825. Licensee: Clay Bcstg Corp. of Texas (acq 4-1-71). Ownership: Clay Communications 100%. See Nwspr. ■ NBC. Rep: Peters, Griffin, Woodward. Wash atty: Fletcher, Heald, Rowell, Kenehan & Hildreth. ■ George Diab, pres & film buyer; Warren W. Silver, VP, gen mgr; Charles C. Howard, gen sls mgr; Tom Witherspoon, opns & prom mgr; Don Alexander, news dir; Bill Enloe, chief engr. ■ On 24 CATV's—35,000 subs.

***KIDZ-TV** ch 24, 2.82 kw vis, 282 w aur, ant 530t/1036g. Nov. 15, 1973. 816 Seventh St., Box 5147, 76307. (817) 723-0981. Licensee: Wichita Falls Educational Translator Inc. ■ Wash atty: Miller & Schroeder. ■ Ray Farabee, pres.

KSWO-TV Licensed to Lawton, Okla. See Lawton, Okla.

Utah

Provo

ADI No. 50; See page B-84

***KBYU-TV**—ch 11, 49 kw vis, 9.8 kw aur, ant 2,890t/96g. Nov. 15, 1965. C-306, HFAC, Brigham Young U, 84602. (801) 374-1211, ext

3551. Licensee: Brigham Young U. ■ PBS. Wash atty: Wilkinson, Cragun & Barker. ■ Dr. Dallin H. Oakes, pres B.Y.U.; Bruce L. Christensen, gen mgr; Joseph White, prog dir & film buyer; Val Kendall, prom mgr; Thomas A. Griffiths, news dir; Ralph Silver, chief engr. ■ On 8 CATV's—50,000 subs. Co-owned: *KBYU-FM.

Salt Lake City

ADI No. 50; see page B-64

*KBYU-TV—See Provo.

KSL-TV—ch 5, 33.9 kw vis, 6.8 kw aur, ant 3,660/90g. June 1, 1949. 145 Social Hall Ave., 84111. (801) 524-2500. TWX 910-925-5822. Licensee: KSL Inc. Ownership: See Bonneville Intl Stns. ■ CBS. Rep: Peters, Griffin, Woodward. Wash atty: Wilkinson, Cragun & Barker. ■ L. H. Curtis, pres & gen mgr; Jay Lloyd, senior VP & stn mgr; James E. Schultz, gen sls mgr; Scott R. Clawson, dir of progmg & opns; Clifton B. Thomas, dir adv & prom; J. Spencer Kinard, news dir; Howard Smith, studio chief engr. On 36 CATV's—24,400 subs. On 104 trans. Co-owned: KSL-AM-FM. ■ Rates: \$275; 120; 35.

KTVX—ch 4, 50.1 kw vis, 8.7 kw aur, ant 3,000/189g. April 15, 1948. 1760 Fremont Dr., 84104. (801) 486-3392. TWX 910-925-5685. Licensee: United Television Inc. (acq 10-75). Ownership: See 20th Century Fox Film Corp. ■ ABC. Rep: Blair TV. Wash atty: Dow, Lohnes & Albertson. ■ Donald Swartz, pres; Harold (Hack) Woolley, VP & gen mgr; L. Boyd Mullins, sls mgr; Dan Rainger, prog dir; Dennis Shiner, prod mgr; Michael Snarr, prom mgr; Arthur Kent Jr., news dir; Gary W. Horrocks, dir of engr. ■ On 42 CATV's—136,841 subs. On 115 trans.

***KUED**—ch 7, 138 kw vis, 25.1 kw aur, ant 3,050/205g. Jan. 20, 1958. 101 Music Hall, U. of Utah, 84112. (801) 581-6336. Licensee: U. of Utah. ■ PBS. ■ David P. Gardner, pres; Milton L. Davis, dir; Byron J. Openshaw, prog & news dir & film buyer; Paula McQuown, prom mgr; Herbert Holtshouser, chief engr. ■ On 53 CATV's—304,875 subs. On 54 trans. Co-owned: *KUER(FM).

KUTV—ch 2, 45.7 kw vis, 9.1 kw aur, ant 3,060/233g. Sept. 26, 1954. 179 Social Hall Ave., 84111. (801) 322-2505. TWX 910-925-5620. Licensee: KUTV Inc. (acq 3-7-56). Ownership: See George C. and Wilda Gene Hatch Stns. ■ NBC. Rep: Katz. Wash atty: Haley, Bader & Potts. ■ George C. Hatch, pres; Robert H. Temple, VP & gen mgr; LaMar Smith, prog dir; Dick Crookston, prod dir; Rick Spratligh, news dir; Mrs. Pat Kirk, natl sls mgr; Albin Seethaler, gen sls mgr; Keith Hill, prom mgr; Reid Carpenter, chief engr. ■ On 38 CATV's—83,064 subs. On 101 trans. Co-owned: KALL(AM)-KGMU(FM).

Vermont

Brattleboro

WRLP—Licensed to Greenfield, Mass. See Greenfield, Mass.

Burlington

ADI No. 100; see page B-12

WCAX-TV—ch 3, 37.6 kw vis, 7.25 kw aur, ant 2,740/132g. Sept. 26, 1954. Box 608, 05401. (802) 862-5761. TWX 510-299-0026. Licensee: Mt. Mansfield TV Inc. Ownership: S. T. Martin, 55.42%; C. P. Hasbrook, 23.3%; J. A. Dobson, 12.5%; & others. ■ CBS. Rep: Avery-Knodel. Wash atty: Wilmer, Cutler & Pickering. ■ Stuart T. Martin, pres, gen mgr & prog dir; Philip Waterman, VP sls; Stuart Hall, VP prod;

Ken Greene, dir pub affrs; Richard Gallagher, news dir; Charles Liese, chief engr. ■ Rates: \$160; 125; 50.

***WETK**—ch 33, 251 kw vis, 50.1 kw aur, ant 2,680/96g. Oct. 16, 1967. Ethan Allen Ave., Winooski, 05404. (802) 656-3311. TWX 510-299-0017. Licensee: U. of Vt. ■ PBS, EETN. Wash atty: Covington & Burling. ■ John W. Dunlop, gen mgr; Gary Simpson, prog dir; Wallace Edwards, chief engr.

WEZF-TV—ch 22, 501 kw vis, 75.9 kw aur, ant 2,753/324g. Aug. 19, 1968. Box 22, 05401. (802) 655-3663. TWX 510-299-0022. Licensee: International Television Corp. Ownership: Donald G. Martin, 47.5%; Gerald V. Bull, 47.5%; John R. Hughes, 5%. ■ ABC. Rep: Young, Kettel-Carter. Wash atty: Fowler & Myers. ■ Donald G. Martin, pres; John R. Hughes, VP & gen mgr; Nelson Trotter, sls mgr; George Rousseau, prog dir, prom mgr & film buyer; George Como, news dir; Sargent Cathrall, chief engr. ■ On 42 CATV's—73,000 subs. Co-owned: WEZF(FM).

Rutland

***WVER**—ch 28, 40.7 kw vis, 7.4 kw aur, ant 1,400/297g. March 18, 1968. Licensee: U. of Vt. ■ Execs: see *WETK Burlington.

St. Johnsbury

***WVTB**—ch 20, 42.7 kw vis, 7.76 kw aur, ant 1,940/131g. Feb. 26, 1968. Licensee: U. of Vt. ■ Execs: see *WETK Burlington.

Windsor

***WVTA**—ch 41, 589 kw vis, 112 kw aur, ant 2,260/426g. March 18, 1968. Licensee: U. of Vt. ■ Execs: see *WETK Burlington.

Virginia

HAMILTON-LANDIS & ASSOCIATES, Inc.
NATIONWIDE MEDIA BROKERS
WASHINGTON, D. C., CHICAGO, DALLAS, SAN FRANCISCO
SELL **MORE**
RADIO & TELEVISION STATIONS
IN THE EAST—NEAREST OFFICE IS—
1730 K ST., N.W., WASHINGTON 20006
(202) 393-3456

Bristol

ADI No. 86; see page B-11

WCYB-TV—ch 5, 85.1 kw vis, 10.25 kw aur, ant 2,220/125.6g. August 1956. Box 1009, 24201. (703)699-4161. TWX 510-580-4523. Licensee: Appalachian Bcstg Corp. (acq 11-23-70). Ownership: See Starr Bcstg Group. ■ NBC. Rep: Katz. Wash atty: Fly, Shuebruk, Blume and Gaguine. ■ Robert G. Smith, pres, gen mgr & film buyer; J. Fey Rogers, VP & sls mgr; Walter Crockett, news dir; Charles Lineburger, prog dir; Russell Robinson, chief engr.

WJHL-TV—Licensed to Johnson City, Tenn. See Johnson City, Tenn.

Charlottesville

ADI No. 56; see page B-60

WVIR-TV—ch 29, 438 kw vis, 130 kw aur, ant 1,200/302g. March 11, 1973. Box 751, 22902.

Utah, Vt., Va. TV

See page B-89 for explanation of listings.

(804)977-7082. Licensee: Virginia Bcstg Corp. Ownership: Harold B. Wright Jr., 7.36%; George H. Haslam, 14.64%; Charles E. Echols, 14.19%; E. Gerald Tremblay, 8.79%; and others. ■ NBC. Rep: Savalli/Gates. Wash atty: Arnold & Porter. ■ Lloyd T. Smith, pres; Harold B. Wright Jr., gen & sales mgr; Howard Meagle, prog dir & film buyer; Angel A. Husted, news dir; Richard C. Comeau, chief engr. ■ On 7 CATV's—30,000 subs. On 1 trans.

Fredericksburg

ADI No. 8; see page B-75

WHFV—ch 69, 219 kw vis, 20 kw aur, ant 542/499g. Oct. 4, 1973. Box 728, 22401. (703)371-9960. Licensee: Television Fredericksburg Inc. Ownership: Charles B. McDaniel, 10.2%; Keith E. Angstadt, 10.2%; John L. Fenlon, 10.2%; Jerry W. Leonard, 10.2%; Edward Z. Angstadt, 10.2%. ■ NBC. Rep: Dome. Wash atty: Cole, Zylstra and Raywid. ■ Keith E. Angstadt, VP & gen mgr; Mel Browning, sls mgr; Monty Smith, prog dir & film buyer; Sue Phelan, prom mgr; Ken McNulty, news dir; Ray McIntruff, chief engr. ■ On 9 CATV's.

Goldvein

***WNVT**—ch 53, 1440 kw vis, 144 kw aur, ant 750/650.3g. March 1, 1972. 8325 Little River Turnpike, Annandale, 22003. (703)323-7000. Licensee: Central Virginia Educational Television Corp. (acq 7-3-74). ■ PBS, EEN. Wash atty: Fisher, Wayland, Southmayd & Cooper. ■ B.W. Spiller, pres; Daniel P. Ward, gen mgr; Steve White, prom mgr; Howard Frost, chief engr.

Hampton

***WHRO-TV**—Licensed to Hampton. See Norfolk.

WVEC-TV—Licensed to Hampton. See Norfolk.

Harrisonburg

ADI No. 197; see page B-31

WSVA-TV—ch 3, 8.32 kw vis, 1.7 kw aur, ant 2,130/332g. Oct. 19, 1953. Box 752, 22801. (703)434-0331. TWX 710-839-1394. Licensee: Gilmore Bcstg Corp. Ownership: See James S. Gilmore Jr. Stns. ■ ABC, NBC. Rep: H-R. Wash atty: Kirkland, Ellis & Rowe. ■ James S. Gilmore Jr., pres; Arthur Hamilton, VP & gen mgr; Richard E. Reed, exec VP opns; Hamilton Shea, exec VP admin/corp dev; Sammy Bland, stn & sls mgr; Larry Nelson, opns mgr; Tom Lewis, news dir; Vincent O'Connell, dir of engr. ■ On 29 CATV's—68,000 subs. Co-owned: WSAV(AM)-WQPO(FM). ■ Rates: \$60; 40; 15.

Lynchburg

ADI No. 70; see page B-60

WLVA-TV—ch 13, 316 kw vis, 50 kw aur, ant 1,110/574g. Feb. 8, 1953. Box 238, 24505. (804) 845-1242. Licensee: WLVA Inc. (acq 10-1-65). Ownership: See Evening Star Stns, also Nwspr, ■ ABC. Rep: Avco. Wash atty: Hogan & Hartson. ■ Richard S. Stakes, pres; Andrew Ockershausen, VP; Rodger Divens, gen mgr; Howard Satterwhite, bus mgr; Alvin B. Tackett, gen sls mgr; Ed Harvey, prog dir; Dorothy Ballagh, opns mgr; Anthony Fuller, prom mgr; Warren Ashmore, news dir; Willis A. Little, chief engr. ■ On 16 CATV's—59,463 subs. Co-owned: WLVA(AM). ■ Rates: \$110; 50; 10.

Newport News

WAVY-TV—Licensed to Portsmouth. See Norfolk.

Virginia, Washington TV

See page B-89 for explanation of listings.

Norfolk

ADI No. 48; see page B-50

WAVY-TV (Portsmouth)—ch 10, 316 kw vis, 38.9 kw aur, ant 990/1,026g. Sept. 1, 1957. 801 Wavy St., Portsmouth, 23704. (804)397-3441. TWX 710-882-3271. Licensee: LIN Bcstg Stns. ■ NBC. Rep: Blair. Wash atty: Wilmer, Cutler & Pickering. ■ Donald A. Pels, pres LIN; Ed J. Frech, pres & gen mgr; Harold Soldingier, VP & asst gen mgr; Edward J. Hennessy, gen sls mgr; Gary Smart, natl sls mgr; Charles N. Moyer, prog dir; Bob Trent, news dir; Carol Schell, prom mgr; Waverly Foster, chief engr. ■ On 7 CATV's—5,400 subs. ■ Rates: \$380; 70; 40.

***WHRO-TV** (Hampton)—ch 15, 110 kw vis, 22 kw aur, ant 1027/1027g. Oct. 2, 1961. 5200 Hampton Blvd., Norfolk, 23508. (804)489-9476. Licensee: Hampton Roads ETV Assn Inc. ■ PBS. Wash atty: Cohn & Marks. ■ John Morison, gen mgr; Patrick Arnoux, prog dir; Jerry Wareham, prom mgr; Al Van Dinteren, chief engr.

WTAR-TV—ch 3, 100 kw vis, 20 kw aur, ant 980/1,029g. April 2, 1950. 720 Boush St., 23510. (804)625-6711. TWX 710-881-1195. Licensee: WTAR Radio-TV Corp. Ownership: See Landmark Communications Stns, also Nwspr. ■ CBS. Rep: Harrington, Righter & Parsons. Wash atty: Hogan & Hartson. ■ William Gietz, pres; Ron Phillips, gen sls mgr; Joe Perkins, prog dir; Tom Roland, dir cmnty affrs; James Mays, news dir; Jim Bangley, dir engr. ■ On 2 CATV's. Co-owned: WTAR(AM)-WKEZ(FM). ■ Rates: \$500; 175; 70.

WVEC-TV (Hampton)—ch 13, 316 kw vis, 31.6 kw aur, ant 980/1,028g. Sept. 15, 1953. Box 400, Hampton, 23669. (804)722-6331. 110 Third St., Norfolk, 23510. (804)622-4674. TWX 710-882-0072. Licensee: Peninsula Bcstg Corp. Ownership: T.P. Chisman, 23%; J.W. Chisman, 21.5%; & others. ■ ABC. Rep: Katz. Wash atty: Cohn & Marks. ■ Thomas P. Chisman, pres, gen mgr & film buyer; Harrol A. Brauer Jr., VP, sls; Lawrence W. Kliever, VP, ops; James O. Gray, prom mgr; George Hillier, chief engr. ■ On 15 CATV's—23,000 subs. Co-owned: WVEC(AM)-WVHR(FM). ■ Rates: \$350; 130; 55.

Norton

ADI No. 86; see page B-11

***WSVN-TV**—ch 47, 690 kw vis, 61.7 kw aur, ant 1,940/242g. March 29, 1971. Box 13246, Roanoke, 24032. (703)679-3638. Licensee: Blue Ridge ETV Association Inc. ■ PBS. Wash atty: Cohn & Marks. ■ Samuel P. McNeil, pres; E.V. Rexrode Jr., VP & gen mgr; Jon Boettcher, prod mgr; Burt Mahone, prom mgr; Ronald Smith, chief engr. ■ On 20 CATV's—33,496 subs. On 1 trans.

Petersburg

WXEX-TV—Licensed to Petersburg. See Richmond.

Portsmouth

ADI No. 48; see page B-50

WAVY-TV—Licensed to Portsmouth. See Norfolk.

WYAH-TV—ch 27, 462 kw vis, 288 kw aur, ant 970/1,025g. Oct. 1, 1961. 1318 Spratley St., 23704. (804) 393-2503. TWX 710-882-3276. Licensee: Christian Bcstg Network Inc. (acq 10-1-61). Ownership: See Christian Bcstg Stns. ■ Rep: Adam-Young. Wash atty: Fisher, Wayland, Southmavd & Cooper. ■ Pat

Robertson, pres; Robert E. Johnson, VP, film buyer & gen mgr; Ray Davis, sls mgr; John Gilman, prog dir; Scott P. Hessick, prom mgr; Mike Little, news dir; Sam Tolbert, chief engr. ■ On 9 CATV's—6,400 subs. Co-owned: WXR(FM). ■ Rates: \$70; 65; 30.

Richmond

ADI No. 56; see page B-60

***WCVE-TV** ch 23, 617 kw vis, 123 kw aur, ant 770/669g. Sept. 14, 1964. 23 Sesame St., 23235. (804)320-1301. Licensee: Central Virginia Educational TV Corp. ■ PBS. Wash atty: Fisher, Wayland, Southmavd & Cooper. ■ W. Brooks George, chmn; B.W. Spiller, pres & gen mgr; Dick Hall, stn mgr; Walter McGhee, public prog dir; Ida Hill, instructional prog dir; Bruce Twyman, news dir; Pauline A. Mitchell, corp dir pub rel; Bob Jones, prod mgr; John Prather, chief engr. ■ On 9 CATV's—100,000 subs. On 10 trans.

***WCWV**—ch 57, 513 kw vis, 102 kw aur, ant 650/699g. Dec. 22, 1966. Licensee: Central Virginia Educational TV Corp. See *WCVE-TV. ■ On 9 CATV's—11,000 subs. On 9 trans.

WTVR-TV—ch 6, 100 kw vis, 15.1 kw aur, ant 840/844g. April 22, 1948. 3301 W. Broad St., 23230. (804)355-8611. TWX 710-756-0178. Licensee: Roy H. Park Bcstg of Va. Inc. (acq 11-65). Ownership: See Park Broadcasting Inc. ■ CBS. Rep: Blair. Wash atty: Midlen & Reddy. ■ Roy H. Park, pres; Ed J. French, exec VP & gen mgr; William J. Kemple, natl sls mgr; John V. Shand, ops dir; James W. Kyle, chief engr. ■ On 20 CATV's—42,000 subs. Co-owned: WTVR-AM-FM.

WWBT—ch 12, 316 kw vis, 63.1 kw aur, ant 790/790g. April 29, 1956. 5710 Midlothian Tpke., 23201. (804)233-5461. TWX 703-232-7021. Licensee: Jefferson Pilot Bcstg Co. of Va. Ownership: See Jefferson Pilot Stns. ■ NBC. Rep: Petry. Wash atty: Kirkland, Ellis & Rowe. ■ Charles H. Crutchfield, pres; Robert L. McRaney, gen mgr; Grady Pridgen, sls mgr; John L. Greene, prog & news dir; Bailey Dwiggins, prom mgr; Sanford Terry, chief engr. ■ On 10 CATV's—19,000 subs.

WXEX-TV—(Petersburg) ch 8, 316 kw vis, 43.6 kw aur, ant 940/971g. Aug. 15, 1955. Box 888, Richmond, 23207. (804)643-0166. TWX 710-957-2329. Licensee: Nationwide Communications Inc. Ownership: See Nationwide Communications Stns. ■ ABC. Rep: Harrington, Righter & Parsons. Wash atty: Fly, Shuebruk, Blume & Gaguine. ■ Clark Pollack, corp VP; John T. Mackin, gen mgr; Larry Slon, gen sls mgr; Ed Davis, ops mgr; Frank Richardson, news dir; George McGuigan, chief engr. ■ On 14 CATV's—32,960 subs. Co-owned: WLEE(AM).

Roanoke

ADI No. 70; see page B-60

***WBRA-TV**—ch 15, 616 kw vis, 92 kw aur, ant 2,050/265g. Aug. 1, 1967. Box 13246, 24032. (703)344-0991. DACS 703-344-8327. Licensee: Blue Ridge ETV Assn. ■ PBS. Wash atty: Cohn & Marks. ■ Samuel P. McNeil, pres; E.V. Rexrode Jr., VP & gen mgr; Jon Boettcher, prod mgr; Burt Mahone, prom mgr; Ronald Smith, chief engr. ■ On 21 CATV's—44,804 subs. On 1 trans.

WDBJ-TV—ch 7, 316 kw vis, 61.7 kw aur, ant 2,000/146g. Oct. 3, 1955. Box 7, 24022. (703)343-8031. TWX 710-870-0437. Licensee: WDBJ-TV Inc. (acq 11-1-69). Ownership: *South Bend* (Ind.) *Tribune*. ■ CBS. Rep: Peters, Griffin, Woodward. Wash atty: Stambler & Shinsky. ■ Franklin D. Schurz Jr., pres; John Harkrader, VP & gen mgr; C.H. McKeever, sls mgr; Kay Hall, prog mgr; Mel Mayfield, prom mgr; Ron Miller, news dir; Paul Reynolds, film buyer; J.E. Newman, chief engr. ■ On 67 CATV's. On 1 trans.

WRLU-TV—ch 27, 589 kw vis, 117 kw aur, ant 2,040/243.3g. March 3, 1966. Box 27, 24001. (703)342-7863. Licensee: Roanoke Telecasting Corp. Ownership: Alexander Apostolou, 52.2%; and others. ■ ABC. Wash atty: Philip M. Baker. ■ Andrew Petersen, gen & sls mgr; Adrian Cronauer, prog dir & opns mgr; Paul Paulin, film dir; Dewey Anderson, traf mgr; Bill Davis, chief engr. ■ On 4 CATV's.

WLSL-TV—ch 10, 316 kw vis, 43.6 kw aur, ant 1,970/174g. Dec. 10, 1952. Box 2161, 24009. (703) 344-9226. TWX 710-870-0428. Licensee: Roy H. Park Bcstg Inc. Ownership: See Park Broadcasting Inc. ■ NBC. Rep: Blair. Wash atty: Midlen & Reddy. ■ Roy H. Park, pres; Robert H. Teter, exec VP, gen mgr & film buyer; Louis J. Rocke, gen sls mgr; Lee Garrett, news dir; Melvin Linkous, prog dir; J.P. Briggs, chief engr. ■ On 50 CATV's—59,539 subs. On 1 trans.

Staunton

ADI No. 56; see page B-60

***WVPT**—ch 51, 89.3 kw vis, 13.4 kw aur, ant 2,230/46g. Sept. 9, 1968. Port Republic Rd., Harrisonburg, 22801. (703)434-5391. Licensee: Shenandoah Valley ETV Corp. ■ PBS. Wash atty: Covington & Burling. ■ Dr. G. Tyler Miller, pres; Richard L. Parker, gen mgr; Edwin L. Kaufman, dir of instructional TV; Tom Watkins, dir of dev; James S. Jones, prod mgr; Robert Privott, art dir; David K. Barnes, chief engr. ■ On 10 CATV's—45,010 subs. On 3 trans.

Washington

HAMILTON-LANDIS
& ASSOCIATES, Inc.
NATIONWIDE MEDIA BROKERS
WASHINGTON, D. C., CHICAGO, DALLAS,
SAN FRANCISCO
SELL **MORE**
RADIO & TELEVISION STATIONS
IN THE WEST—NEAREST OFFICE IS—
111 SUTTER ST., SAN FRANCISCO 94104
(415) 392-5671

Bellingham

ADI No. 196; see page B-8

KVOS-TV—ch 12, 229 kw vis, 45.7 kw aur, ant 2,370/141g. June 3, 1953. 115 Ellis St., 98225. (206)734-4101. Telex: 32-8812. Licensee: KVOS TV Corp. (acq 6-61). Ownership: See Wometco Stns. ■ CBS. Rep: Bolton-Burchill; Alexander; Pearson-Dawson. Wash atty: Cohn & Marks. ■ Mitchell Wolfson, pres; David Mintz, VP, gen mgr & film buyer; Fred Elsethagen, sls mgr; Frank Jank, ops dir; Tom Haverman, prom mgr; Jim Walker, news dir; John Price, chief engr. ■ On 21 CATV's.

Kennewick

ADI No. 129; see page B-78

KNDU—Licensed to Richland. See Richland.

KVEW—ch 42, 102 kw vis, 18.7 kw aur, ant 1,280/205g. Oct. 30, 1970. Licensee: Apple Valley Bcstg Inc. Co-owned satellite of KAPP, Yakima.

Lakewood Center

***KPEC-TV**—ch 56, 21.4 kw vis, 4.3 kw aur, ant 210/200g. April 2, 1960. 4400 Steilacoom Blvd., 98499. (206)552-5431. Licensee: Clover Park School District, No. 400. ■ PBS. ■ R.L. Chisholm, supt schools; J. Albert Brevik, gen mgr; John Watson, prog mgr; Paul Herlinger, prod mgr; C.W. Evans, chief engr. ■ On 11

CATV's. On 6 trans. Co-owned: *KPEC-FM Tacoma.

Pasco

ADI No. 129; see page B-78

KEPR-TV—ch 19, 97.7 kw vis, 9.8 kw aur, ant 1,250/351g. Dec. 28, 1954. Licensee: NWG Bcstg Co. Co-owned satellite of KIMA-TV Yakima.

KNDU—Licensed to Richland. See Richland.

Pullman

ADI No. 79; see page B-89

***KWSU-TV**—ch 10, 117 kw vis, 11.7 kw aur, ant 1,350/300g. Sept. 24, 1962. Edward R. Murrow Communications Center, Wash. State U., 99163. (509)335-2681. Licensee: Wash. State U. ■ PBS. ■ Gordon Tuell, gen mgr; Lyle Mettler, mgr & prog dir; Suzy Franko, prom mgr; Frank Coile, chief engr. ■ On 5 CATV's—10,000 subs. On 7 trans. Co-owned: *KWSU(AM).

Richland

ADI No. 129; see page B-78

KNDU—ch 25, 163 kw vis, 16.3 kw aur, ant 1,271/142g. July 1, 1961. Box 2523, Pasco, 99302. (509)582-2137. Licensee: Columbia Empire Bcstg Corp. Ownership: Hugh E. Davis. Co-owned satellite of KNDU Yakima. ■ NBC. Rep: Avery-Knodel, Simpson Reilly. Wash atty: Haley, Bader & Potts. ■ Hugh E. Davis, pres; Bob Gray, opns mgr; Scott Hayner, stn & sls mgr; Elaine Malone, prog dir; Linda Avery, prom mgr; Ed Evans, news dir; Fred Bartell, chief engr. ■ On 14 CATV's—55,510 subs. On 3 trans. ■ Rates: \$45; 25; 12.

Seattle

ADI No. 18; see page B-86

***KCTS-TV**—ch 9, 275 kw vis, 55 kw aur, ant 830/590g. Dec. 7, 1954. Drama-TV Bldg. U. of Wash., 98195. (206)543-2000. Licensee: U. of Wash. ■ PBS. ■ Richard Meyer, gen mgr; Bur-nill Clark, prog dir; Hope Green, prom mgr; Patti Parson, news dir; Richard C. Oldham, chief engr.

KING-TV—ch 5, 100 kw vis, 50 kw aur, ant 820/570g. Nov. 25, 1948. 320 Aurora Ave. N., 98109. (206)223-5000. TWX 910-444-2010. Telex 032-251. Licensee: King Bcstg Co. (acq 8-49). Ownership: See King Bcstg Co. Stns. ■ NBC. Rep: Blair, Paul Mulvihill (Canada). Wash atty: Fletcher, Heald, Rowell, Kenehan, Hildreth. ■ Ancil H. Payne, pres; Eric S. Bremner, VP & gen mgr; Tim Moore, sls mgr; Robert Guy, prog dir & film buyer; Ronald B. Lorentzen, prom dir; Norm Heffron, news dir; John J. Shawcroft, chief engr. ■ On 89 CATV's—523,400 subs. On 8 trans. Co-owned: KING-AM-FM. ■ Rates: \$1,100; 340; 150.

KIRO-TV—ch 7, 316 kw vis, 63.2 kw aur, ant 820/598.7g. Feb. 8, 1958. 3d & Broad, 98121. (206)624-7077. TWX 910-444-2233. Licensee: KIRO Inc. Ownership: See Bonneville Intl Stns. ■ CBS. Rep: Peters, Griffin, Woodward. Wash atty: Wilkinson, Cragun & Barker. ■ Lloyd Cooney, pres & gen mgr; Kenneth Hatch, senior VP, stn & sls mgr; Nick Freeman, prog dir; Don Brice, news dir; Cindy Salazar, prom supvr; Charles R. Morris, chief engr. ■ On 59 CATV's—212,200 subs. On 8 trans. Co-owned: KIRO-AM-FM. ■ Rates: \$800; 275; 125.

KOMO-TV—ch 4, 100 kw vis, 15 kw aur, ant 810/550g. Dec. 10, 1953. 100 4th Ave. N., 98109. (206)223-4000. TWX 206-998-0751. Licensee: Fisher's Blend Stn Inc. Ownership: See Fisher's Blend Stns. ■ ABC. Rep: Katz; Simpson. Wash atty: Fisher, Wayland,

Southmayd & Cooper. ■ W.W. Warren, pres & gen mgr; John Benhke, VP & asst gen mgr; Dave Crockett, senior VP & film buyer; Phelps Fisher, local sls mgr; Roy Albertson, natl sls mgr; Ed Lackner, prog dir; Dan Tutt, rsch & dev asst; Ralph Miffilin, dir of engr. Howard Scott, news dir. ■ On 94 CATV's—603,448 subs. On 10 trans. Co-owned: KOMO(AM). ■ Rates: \$850; 300; 120.

KSTW—(Tacoma) ch 11, 316 kw vis, 47.9 aur, ant 800/580g. March 1, 1953. Box 11411, Tacoma 98411. (206)572-5789. TWX 910-441-2622. Licensee: Gaylor Bcstg Co. (acq 3-1-74). Ownership: Oklahoma Publishing Co., 100%. See Gaylor Bcstg Co., also Nwspr. ■ Rep: Tele Rep. Wash atty: Pierson, Ball & Dowd. ■ Edward L. Gaylor, chmn; E. B. Dodson, pres; Crawford P. Rice, exec VP & gen mgr; Charles L. Edwards, asst mgr & sls mgr; Donald M. Lacy, opns mgr; William R. McLain, prom mgr; Robert A. Cleland, news dir; M.B. (Bud) Johnson, prog mgr & film buyer; Paul C. Crittenden, chief engr. ■ On 78 CATV's—312,077 subs. On 1 trans. ■ Rates: \$80; 155; 25.

***KTVW**—(Tacoma) ch 13, 214 kw vis, 31.6 kw aur, ant 780/536g. 1954. 4400 Steilacoom Blvd., S.W., Tacoma, 98499. (206) 552-5431. Licensee: Clover Park School Dist. No. 400 (acq 10-17-75). ■ PBS. Wash atty: Haley, Bader & Potts. ■ J. Albert Brevik, gen mgr; John D. Watson, prog dir; Paul Herlinger, prod mgr; C. W. Evans, chief engr. ■ On 51 CATV's—200,000 subs. On 3 trans. Co-owned: KPEC-FM.

Spokane

ADI No. 79; see page B-89

KHQ-TV—ch 6, 87.1 kw vis, 17.4 wk aur, ant 2,150/904g. Dec. 20, 1952. 4202 S. Regal St., 99203. (509) KEystone 4-0511. TWX 610-773-1830. Licensee: KHQ Inc. Ownership: Spokane Chronicle Co., 100%. See Nwspr. ■ NBC. Rep: Katz; Moore. Wash atty: Kirkland, Ellis & Rowe. ■ J. Birney Blair, pres & gen mgr; Rich Alegria, loc sls mgr; Jack Reber, natl sls mgr; Homer Mason, prog dir; Larry Gants, prom mgr; Dean Mell, news dir; Dee Waymire, chief engr. ■ On 84 CATV's—97,700 subs. On 62 trans. Co-owned: KHQ-AM-FM.

KREM-TV—ch 2, 84.7 kw vis, 15.5 kw aur, ant 2,200/969g. Oct. 31, 1954. 4103 S. Regal St., 99203. (509)534-0423. TWX 509-328-0848. Licensee: King Bcstg Co. Ownership: See King Bcstg Stns. ■ ABC. Rep: Blair. Wash atty: Wilmer, Cutler & Pickering. ■ Ancil H. Payne, pres; Dean H. Woodring, VP & gen mgr; Jack Harris, sls mgr; Robert Lewis, prog dir & film buyer; Wes Lynch, news dir; Gloria Snyder, prom mgr; Warren Pritchard, chief engr. ■ On 95 CATV's—93,900 subs. On 45 trans. ■ Rates: \$205; 100; 45.

***KSPP-TV**—ch 7, 195 kw vis, 22.45 kw aur, ant 1,830/595g. April 26, 1967. 3911 S. Regal St., 99203. (509)455-3790. Licensee: Spokane School District No. 81. ■ PBS. Wash atty: Robert G. Seaks. ■ Walter A. Hitchcock, supt of schools; Walter J. Schaar, gen mgr; Claude Kistler, opns mgr; Sally Gerimonte, prog & traf mgr; Carol Kabat, news dir; Ronald Valley, chief engr. ■ On 40 CATV's—210,000 subs. On 20 trans.

KXLY-TV—ch 4, 48 kw vis, 9.55 kw aur, ant 3,060/153g. Jan. 16, 1953. 500 W. Boone Ave., 99201. (509) Fairfax 8-9084. TWX 509-328-4083. Licensee: Spokane TV Inc. Ownership: See Morgan Murphy Stns, also Nwspr. ■ CBS. Rep: Peters, Griffin, Woodward; Simpson. Wash atty: Stambler & Shrinky. ■ Mrs. Elizabeth B. Murphy, pres; Wayne F. McNulty, VP & dir; T.O. Jorgenson, chief engr. ■ On 107 CATV's—107,000 subs. On 70 trans. Co-owned: KXLY-AM-FM.

Tacoma

ADI No. 18; see page B-86

KSTW—Licensed to Tacoma. See Seattle.

Washington, West Virginia TV

See page B-89 for explanation of listings.

***KTSP**—ch 62, 338 kw vis, 50 kw aur, ant 420/351g. Sept 25, 1961. 1101 S. Yakima Ave., 98405. (206) 572-6262. Licensee: Tacoma School District No. 10. ■ PBS. ■ Bob Slingland, dir of TV; Tom Rogstad, prog mgr; Alex Crewdson, prom mgr; Robert W. Meers, chief engr. ■ On 20 CATV's—16,500 subs. Co-owned: *KTOY(FM).

KTVW—Licensed to Tacoma. See Seattle.

Yakima

ADI No. 129; see page B-78

KAPP—ch 35, 255 kw vis, 25.5 kw aur, ant 960/175g. Sept 21, 1970. 35 S. First St., 98901. (509)453-0351. Licensee: Apple Valley Bcstg Inc. Ownership: Morgan Murphy estate. See Morgan Murphy Stns, also Nwspr. ■ ABC. Rep: PGW; Tacher. Wash atty: Stambler & Shrinky. ■ Mrs. Elizabeth Murphy, pres; Wayne McNulty, VP; Frank Schutz, stn mgr; David Pugsley, chief engr; T. O. Jorgenson, engrg supr. ■ On 5 CATV's. On 3 trans.

KIMA-TV—ch 29, 105 kw vis, 10.5 kw aur, ant 970/66g. July 19, 1953. Box 702, 98907. (509)452-9111. TWX 510-777-5356. Licensee: NWG Bcstg Co. Ownership: John Noel Jr., 50%; Seattle First Natl Bank, executor of estate of Harrell Whitney, 50%. ■ CBS. Rep: H-R; Moore; McDermott (Canada). Wash atty: Smith & Pepper. ■ John Noel Jr., pres; Dale Hazen, gen & sls mgr; Jim Nolan, prog dir & film buyer; Dale Robinson, prom mgr; T.J. Close, news dir; Mike Rastovich, chief engr.

KNDU—ch 23, 500 kw vis, 61 kw aur, ant 960/160g. Oct. 15, 1959. Box 466, 98907. (509)248-2300. Licensee: Columbia Empire Bcstg Corp. (acq 2-15-61). Ownership: Hugh E. Davis, 100%; see Columbia Empire Stns. ■ NBC. Rep: Avery-Knodel; Simpson/Reilly. Wash atty: Haley, Bader & Potts. ■ Hugh E. Davis, pres & film buyer; Ben Shropshire, gen sls mgr; Opal Laurent, off mgr; Elaine Malone, prog dir; Linda Avery, prom mgr; Les Thompson, opns mgr; Jim Lewis, news dir; Ron Krous, chief engr. ■ On 17 CATV's—36,600 subs. On 3 trans. ■ Rates: \$55; 25; 15.

***KYVE-TV**—ch 47, 19.1 kw vis, 3.8 kw aur, ant 860/78g. Nov. 1, 1962. 1105 S. 15th Ave., 98902. (206)248-2447. Licensee: Yakima School Dist. No. 7. ■ PBS. ■ Frank E. Roberts, gen mgr, prog dir & film buyer; Stephen Bronson, prom mgr; Don Meighan, news dir; Hugh Wetmore, chief engr. ■ On 5 CATV's—5,000 subs.

West Virginia

HAMILTON-LANDIS
& ASSOCIATES, Inc.
NATIONWIDE MEDIA BROKERS
WASHINGTON, D. C. CHICAGO, DALLAS,
SAN FRANCISCO
SELL MORE
RADIO & TELEVISION STATIONS
IN THE EAST—NEAREST OFFICE IS—
1730 K ST., N.W., WASHINGTON 20006
(202) 393-3456

Beckley

WOAY-TV—See Oak Hill.

***WSWP-TV**—See Grandview.

Bluefield

ADI No. 133; see page B-10

WHIS-TV—ch 6, 50 kw vis, 6-kw aur, ant 1,220/185g. July 31, 1955. Broadcast Center,

West Virginia, Wisconsin TV

See page B-89 for explanation of listings.

E. Cumberland Rd., 24701. (304) 327-7114. TWX 710-938-8380. Licensee: Daily Telegraph Printing Co. Ownership: See Daily Telegraph Stns, also Nwspr. ■ NBC. Rep: Avery-Knodel. Wash atty: Dow, Lohnes & Albertson. ■ Ned Shott, pres; John C. Shott, gen mgr & film buyer; Robert W. Moore, sls mgr; Jean Ball, prog dir; Erleen Branch, prom mgr; Mike Stater, news dir; Kenneth Dick, chief engr. ■ On 94 CATV's—96,284 subs. Co-owned: WHIS-AM-FM. ■ Rates: \$80; 40; 20.

Charleston

ADI No. 42; see page B-13

WCHS-TV—ch 8, 158 kw vis, 19.9 kw aur, ant 1,240/1999g. Aug. 15, 1954. 1111 Virginia St. E., 25324. (304) 342-8131. TWX 304-666-8839. Licensee: Rollins Telecasting Inc. Ownership: See Rollins Stns. ■ CBS. Rep: Blair. Wash atty: Smith & Pepper. ■ O. Wayne Rollins, pres; Curtis W. Butler, gen mgr; William K. McAllister, opns mgr; Jack Robinette, sls mgr; Charles Ryan, news dir; Genè Brick, chief engr. ■ On 53 CATV's—89,000 subs. Co-owned: WCHS(AM), WBES(FM).

WOWK-TV—Licensed to Huntington. See Huntington.

WSAZ-TV—Licensed to Huntington. See Huntington.

Clarksburg

ADI No. 181; see page B-15

WBOY-TV—ch 12, 129 kw vis; 24 kw aur, ant 860/1593g. Nov. 17, 1957. 912 W. Pike St., 26301. (304) 624-7573. TWX 304-366-2376. Licensee: Northern W. Va. TV Bcstg Co. Ownership: Marion R. Ascoli, 80%; Max Ascoli, 10%; Nathan W. Levin, 10%. ■ NBC, ABC. Rep: Young; Regional Reps (Cleveland, Cincinnati); Dome-Messervy (Pittsburgh). Wash atty: Smith & Pepper. ■ Nathan W. Levin, pres; John J. Borghi, exec VP & gen mgr; Roger Garrett, mngn dir & film buyer; Robert W. Toothman, prog dir; John Pratt, prom mgr & news dir; Joe Wright, chief engr. ■ On 75 CATV's—100,000 subs. ■ Rates: \$45; 35; 20.

Grandview

***WSWP-TV**—ch 9, 316 kw vis, 63.2 kw aur, ant 1,000/1498g. Nov. 1, 1970. Box A.H., Beckley, 25801. (304) 255-1501. Licensee: W. Va. Educ Bcstg Authority. ■ PBS. Wash atty: Bilger & Blair. ■ Arthur E. Albrecht, gen mgr; Bill Campbell, prog dir; Jim Bakken, prom mgr; Rita Ray, school svcs dir; Marsha Bragg, traf mgr; Leon Drye, chief engr. ■ On 31 CATV's—50,000 subs. Co-owned: *WVPB(FM), Beckley.

Huntington

ADI No. 42; see page B-13

WCHS-TV—Licensed to Charleston. See Charleston.

***WMUL-TV**—ch 33, 398 kw vis, 79.4 kw aur, ant 1,280/1,071g. July 14, 1969. Third Ave., 25701. (304) 696-6630. TWX 710-931-8070. Licensee: W. Va. Educl Bcstg Authority. ■ PBS, EETN. Wash atty: Bilger & Blair. ■ Terry Holinger, gen mgr; Carol Brodrick, prog mgr; George Parnieza, chief engr. ■ On 68 CATV's—100,000 subs.

WOWK-TV—ch 13, 132 kw vis, 26.3 kw aur, ant 1,267.5/1,109g. Oct. 2, 1955. 625 Fourth Ave., 25701. (304) 525-7661. TWX 710-931-8076. Licensee: Gateway Communications Inc. (acq 10-23-74). Ownership: See Gateway Communications Stns. ■ ABC. Rep: Blair. ■ George Koehler, pres; Leo M.

MacCourtney, VP & gen mgr; Tom Conners, gen sls mgr; Don Cunningham, prog dir & film buyer; Robert D. Willis, prom mgr; Jim Morgan, news dir; Ed Gordon, chief engr. ■ On 92 CATV's—176,000 subs. On 2 trans. ■ Rates: \$300; 100; 60.



WSAZ-TV—ch 3, 46.8 kw vis, 7 kw aur, ant 1,250/1,069g. Nov. 15, 1949. 645 Fifth Ave., 25721. (304) 697-4780. TWX 710-931-8034. Licensee: Lee Enterprises Inc. (acq 4-28-71). Ownership: See Lee Stns, also Nwspr. ■ NBC. Rep: Katz. Wash atty: Pierson, Ball & Dowd. ■ Lloyd G. Schermer, pres; George R. Andrick, gen mgr; Harold Hall, sls mgr; C. William Watts, mktg mgr; George Curry, prog dir; Jim Battin, prom mgr; C. Bosworth Johnson, news dir; John Clay, chief engr. ■ On 204 CATV's—215,184 subs. ■ Rates: \$350; 140; 150.

Morgantown

ADI No. 10; see page B-56

***WVVU-TV**—ch 24, 400 kw vis, 80 kw aur, ant 1,502/1518g. Feb. 23, 1969. W. Va. U., c/o Hotel Morgan, 26505. (304) 293-6511. TWX 710-921-0307. Licensee: W. Va. Bd of Regents. ■ PBS, EEN. Wash atty: Bilger & Blair. ■ C. Gregory Van Camp, gen mgr; Sarah L. Kirk, asst to gen mgr; R. Gregory Ruff, prod mgr; Robert J. Sestili, prog mgr; Wilda Ridgway, opns mgr; Judith A. Parker, sch svcs mgr; Keith L. Massie, engrg opns mgr; Gary L. Watts, cmnty rel dir; Michael C. Helmantoler, instr media mgr. ■ On 115 CATV's. On 5 trans.

Oak Hill

ADI No. 133; see page B-10

WOAY-TV—ch 4, 100 kw vis, 20 kw aur, ant 740/688g. Dec. 14, 1954. Box 251, 25901. (304) HObar 9-3361. Licensee: Robert R. Thomas Jr. Ownership: Robert R. Thomas Jr., 100%. ■ ABC. Rep: Savalli/Gates. Wash atty: Barnes & Neilson. ■ Robert R. Thomas Jr., ownr & gen mgr; Robert R. Brown, stn mgr & film buyer; Shirley Love, sls mgr; Robert R. Thomas III, opns dir; Arnell Church, news dir; Thomas Phillips, chief engr. ■ On 35 CATV's—75,000 subs.

Parkersburg

ADI No. 198; see page B-55

WTAP-TV—ch 15, 208 kw vis, 41.1 kw aur, ant 620/439g. Oct. 8, 1953. 123 W. 7th St., 26101. (304) 485-4588. Licensee: PMA Communications, Inc. (acq 11-75). Ownership: George R. Abels, Sherman A. Grimm, 8 others, 10% each. ■ NBC. Rep: Savalli/Gates; Rgnl Reps (Ohio, Ky.); Dome-Messervy (Pittsburgh, Baltimore). Wash atty: Kirkland, Ellis & Rowe. ■ Sherman A. Grimm, gen mgr & film buyer; Glen Wilson, prog dir; Charles Helmick, chief engr. ■ On 32 CATV's—36,168 subs. On 1 trans.

Weston

ADI No. 161; see page B-15

WDTV—ch 5, 100 kw vis, 20 kw aur, ant 885/1509g. June 1, 1960. Box 480, Bridgeport, W. Va. 26330. (304) 842-3558. TWX 710-935-1142. Licensee: Withers Broadcast-

ing Co. of West Virginia (acq 5-8-73). Ownership: W. Russell Withers Jr., 90%. ■ CBS, ABC. Rep: Savalli/Gates. Wash atty: Mallyck & Bernton. ■ W. Russell Withers Jr., pres & gen mgr; John Peters, stn mgr; Tom Steyer, news dir; Kermit Wendt, chief engr. ■ On 104 CATV's—130,640 subs.

Wheeling

ADI No. 110; see page B-78

WSTV-TV—Licensed to Steubenville, Ohio. See Steubenville, Ohio.

WTRF-TV—ch 7, 316 kw vis, 30.9 kw aur, ant 960/1740g. Oct. 23, 1953. 96-16th St., 26003. (304) 232-7777. TWX 304-232-6897. Licensee: Forward Tele-Production Inc. Ownership: See Forward Communications Stns. ■ NBC. Rep: Blair. Wash atty: McKenna, Wilkinson & Kittner. ■ Robert W. Ferguson, exec VP & gen mgr; Frank Curtis, gen sls mgr; Garry Vorhees, opns mgr; George Carroll, prog mgr; Mary Neal, prom mgr; Mark Davis, news dir; Robert McFarland, chief engr; Doug Stone, pub affrs dir. ■ On 160 CATV's—263,000 subs. On 2 trans. Co-owned: WTRF-FM.

Wisconsin

HAMILTON-LANDIS

G & ASSOCIATES, Inc.
NATIONWIDE MEDIA BROKERS
WASHINGTON, D. C., CHICAGO, DALLAS,
SAN FRANCISCO

SELL **MORE**
RADIO & TELEVISION STATIONS
IN THE MIDWEST—NEAREST OFFICE IS—
1429 TRIBUNE TOWER, CHICAGO 60611
(312) 337-2754

Colfax

ADI No. 13; see page B-46

***WHWC-TV**—ch 28, 871 kw vis, 174 kw aur, ant 1150/1200g. Nov. 18, 1973. Wheeler, 54730. (715) 232-2279. Licensee: Educational Communications Board. ■ PBS. Wash atty: Dow, Lohnes & Albertson. ■ Anton J. Moe, exec dir; Paul M. Norton, dir, administration & opns; Robert E. Bell, net prog dir; James W. Kissinger, stn prog dir; William P. Estes, prom mgr; William C. Woods, chief engr. ■ On 7 CATV's.

Eau Claire

ADI No. 117; see page B-36

WEAU-TV—ch 13, 195 kw vis, 28.8 kw aur, ant 1,990/2,000g. Dec. 17, 1953. Box 47, 54701. (715) 832-3474. TWX 910-282-1633. Licensee: WEAU Inc. (acq 1962). Ownership: See Post Corp. Stns, also Nwspr. ■ NBC. Rep: H-R; Hurley. Wash atty: Chadbourn, Parke & Whiteside. ■ Victor I. Minahan, pres; Lawrence A. Busse, gen mgr; Clark Wideman, stn mgr; Denise Noonan, prog dir; Aldy Swanson, news dir; Robert Fallis, chief engr. ■ On 41 CATV's—67,581 subs. Co-owned: WAXX(AM)-WEAU-FM. ■ Rates: \$94; 70; 28.

Green Bay

ADI No. 86; see page B-29

WBAY-TV—ch 2, 100 kw vis, 20 kw aur, ant 1,250/1,140g. March 17, 1953. 115 S. Jefferson, 54301. (414) 432-3331. TWX 910-263-1260. Licensee: Nationwide Communications (acq 1974). Ownership: See Nationwide Communications Stns. ■ CBS. Rep: Blair. Wash atty: Fly, Shuebruk & Gaguine. ■ Robert C. Nelson, gen mgr; C. R. Burnton, gen sls mgr; Greg McElrone, stn mgr & film buyer; Esther Stange, prom mgr; Jim Marshall, news

dir; W. J. Stangel, chief engr. ■ On 3 trans. ■ Rates: \$200; 140; 40.

WFRV-TV—ch 5, 93.3 kw vis, 18.6 kw aur, ant 1,120/999g. May 21, 1955. 1181 E. Mason St., Box 1128, 54305. (414) 437-5411. TWX 910-263-1258. Licensee: WFRV Inc. Ownership: See Orion Stns. ■ NBC. Rep: Katz; McDermott (Canada). Wash atty: Covington & Burling. ■ Ralph S. Jackson, pres; Robert O. Southard, gen mgr; Jerry Montgomery, gen sls mgr; Harold Riegert, prog dir, prom mgr & film buyer; Bob McMullen, news dir; Harry Hill, chief engr. ■ On 20 CATV's—58,000 subs. On 4 trans. ■ Rates: \$160; 55; 60.

WLUK-TV—ch 11, 316 kw vis, 47.4 kw aur, ant 1,260/1,159g. Sept 10, 1954. Box 7711, 54303. (414) 494-8711. TWX 910-263-1267. Licensee: WLUK Inc. Ownership: See Post Corp. Stns, also Nwspr. ■ ABC. Rep: Peters, Griffin, Woodward. ■ Victor I. Minihan, pres; David L. Neilson, VP & mgr, Post Corp stns; Thomas A. Hutchison, gen mgr; Lowell Johnson, gen sls mgr; Monty Stock, natl sls mgr; Thomas R. Torinus, news dir; Marshall Williamson, chief engr. ■ On 19 CATV's—On 5 trans.

***WPNE**—ch 38, 912 kw vis, 182 kw aur, ant 1,180/1,149g. Licensee: Educational Communications Board. ■ PBS. Wash atty: Dow, Lohnes & Albertson. ■ Anton J. Moe, exec dir; Paul M. Norton, asst dir ECB; Don Kates, rgnl rep; Robert E. Bell, prog dir; William C. Woods, dir of engr. ■ Co-owned: *WPNE-FM.

La Crosse

ADI No. 117; see page B-36

***WHLA-TV**—ch 31, 955 kw vis, 191 kw aur, ant 1,140/831g. Dec. 3, 1973. Route 1, Box 190-B, La Crescent, Minn. 55947. (507) 895-2026. Licensee: Educational Communications Board. ■ PBS. ■ Execs: See *WPNE Green Bay; Daniel F. Smith, chief engr. ■ On 9 CATV's.

WKBT—ch 8, 316 kw vis, 57.5 kw aur, ant 1,540/1,625g. Aug. 8, 1954. 141 S. 6th St., 54601. (608) 782-4678. TWX 910-287-2572. Licensee: Gross Telecasting of Wis. Inc. (acq 1-15-70). Ownership: See Gross Telecasting Inc. ■ CBS. Rep: Avery-Knodel; Hyett/Ramsland. Wash atty: Arent, Fox, Kintner, Plotkin & Kahn. ■ Peter S. Good, gen mgr; Edith S. Harris, natl sls mgr; Larry Johnson, prom mgr; Mark J. Quade, news dir; Al Leeman, chief engr. ■ On 65 CATV's—65,011 subs. On 1 trans. ■ Rates: \$140; 80; 35.

WXOW-TV—ch 19, 132.1 vis, 26.4 aur, ant 930/605g. March 7, 1970. Box 198, 54601. (507) 895-4433. Licensee: Horizons Comm. Corp. of Wis. (acq 9-9-70). Co-owned satellite of WKOW-TV Madison. ■ ABC. Rep: H-R Television; Wayne Evans. Wash atty: Marmet. ■ Terry K. Shockley, exec VP; John Schermerhorn, mgr; Arthur Osborn, chief engr. ■ On 10 CATV's—25,170 subs.

Madison

ADI No. 105; see page B-42

***WHA-TV**—ch 21, 339 kw vis, 67.6 kw aur, ant 1,250/1,200g. May 3, 1954. 821 University Ave., 53706. (608) 263-2121. DACS 608-233-3664. Licensee: U of Wis. ■ PBS. Wash atty: Dow, Lohnes & Albertson. ■ Ronald C. Bornstein, dir & gen mgr; Anthony S. Tiano, stn mgr; Mark Smukler, opns mgr; Hayward Allen, prom mgr; Larry Dickerson, prog mgr; Boris Frank, mgr, special projects; Donald Borchert, dir engr. ■ On 20 CATV's. Co-owned: *WHA(AM).

WISC-TV—ch 3, 56.2 kw vis, 11 kw aur, ant 1,190/1,107g. June 24, 1956. 4801 W. Bellline Hwy, 53711. (608) 271-4321. TWX 608-654-8212. Licensee: TV Wis. Inc. Owner-

ship: See Morgan Murphy Stns, also Nwspr. ■ CBS. Rep: Peters, Griffin, Woodward. Wash atty: Arthur Stambler. ■ Mrs. Elizabeth B. Murphy, pres; George Stantis, gen mgr; Richard Nickerson, sls mgr; R. Roy Miller, dir-viewer affairs; Steve Herling, opns dir; Helen Slauson, prog dir; Rick Fetherston, news dir; Walter Hariu, chief engr. ■ On 37 CATV's—60,400 subs. ■ Rates: \$175; 50; 35.

WKOW-TV—ch 27, 871 kw vis, 174 kw aur, ant 1,250/1,182g. July 1953. Box 100, 53701. (608) 274-1234. TWX 910-286-2718. Licensee: Horizons Comm. Corp. of Wis. (acq 9-9-70). Ownership: See WAOW-TV Wausau, below. ■ ABC. Rep: Katz. Wash atty: Marmet. ■ Terry K. Shockley, pres & gen mgr; Jack Brennan, gen sls mgr; Debbi Johnson, prom mgr; John Lindgren, news dir; Marshal Shapiro, sports dir; Bruce R. Liljegren, film buyer; Robert J. Wickhem, VP opns & engr. ■ On 27 CATV's—33,700 subs. On 1 trans. ■ Rates: \$130; 75; 36.

WMTV—ch 15, 794 kw vis, 79.4 kw aur, ant 1,160/1,100g. July 1953. 615 Forward Dr., 53711. (608) 274-1515. TWX 608-654-8214. Licensee: Forward TV Inc. Ownership: See Forward Communications Stns, also Nwspr. ■ NBC. Rep: Meecker. Wash atty: McKenna, Wilkinson & Kittner. ■ Richard D. Dudley, pres; Thomas E. Bolger, exec VP, gen mgr & film buyer; Addison Sprague, coml mgr; Richard Flanigan, prog dir; Don Schmitt, news dir; Elmer Wiesensel, chief engr. ■ On 20 CATV's.

Milwaukee

ADI No. 22; see page B-46

WCGV—ch 24, 2,000 kw vis, 400 kw aur, ant 1,028/1,085g. Not on air, target date unknown. Authorized for pay-TV operation. 777 West Glencoe Place, 53217. (414) 351-1680. Permittee: B&F Broadcasting Inc. Ownership: Robert S. Block, 48%; Marvin L. Fishman, 40%; and others. ■ Wash atty: Dow, Lohnes & Albertson. ■ Robert S. Block, pres.

WISN-TV—ch 12, 316 kw vis, 31.6 kw aur, ant 1,000/1,105g. Oct. 27, 1954. Box 402, 53201. (414) 342-TV12. TWX 910-262-3417. Licensee: Hearst Corp. Ownership: See Hearst Stns, also Nwspr. ■ CBS. Rep: Blair. Wash atty: Dempsey & Kopolovitz. ■ James T. Butler, VP & gen mgr; James Norton, gen sls mgr; Fred W. Koestering, loc sls mgr; Ron Scott, news dir; Ralph T. Kuehn, prod dir; Ron Anderson, pub affrs dir; D. Wayne Barrington, prog dir; Thomas Nedwek, personnel & PR dir; Gary Sherman, com dir; Gerald Robinson, chief engr. ■ On 4 CATV's—31,600 subs. On 1 trans. Co-owned: WISN-AM-FM. ■ Rates: \$550; 180; 70.

WITI-TV—ch 6, 100 kw vis, 10 kw aur, ant 1,000/1,078g. May 21, 1956. 5445 N. 27th St., 53209. (414) 462-6666. TWX 910-262-3425. Licensee: WITI-TV Inc. (acq 12-22-58). Ownership: See Storer Stns. ■ ABC. Rep: Storer TV Sls. Wash atty: Warren C. Zwicky. ■ Henry J. Davis, VP & gen mgr; James P. Behling, prog dir; Allen L. Haushalter, film buyer; Daniel J. Berkery, gen sls mgr; Timothy J. Bennett, prom mgr; Carl Zimmermann, news dir; Robert Truscott, chief engr. ■ On 9 CATV's—31,500 subs. ■ Rates: \$525; 200; 80.

***WMVS**—ch 10, 316 kw vis, 49 kw aur, ant 750/1,079g. Oct. 28, 1957. 1015 N. Sixth St., 53203. (414) 271-1036. TWX 414-273-4538. Licensee: Milwaukee Area Bd of Vocational, Technical & Adult Educ. ■ PBS, CEN (regional). ■ Otto Schlaack, mgr; Don Burgess, prom mgr; John Lemke, film supvr; Harold G. Wagner, chief engr. ■ On 6 CATV's.

***WMVT**—ch 36, 182 kw vis, 21.9 kw aur, ant 750/1,080g. Jan. 23, 1963. Licensee: Milwaukee Area Bd of Vocational, Technical & Adult Educ. ■ Execs: See *WMVS(TV).

Wisconsin TV

See page B-89 for explanation of listings.



WTMJ-TV—ch 4, 100 kw vis, 20 kw aur, ant 1,000/1,096g. Dec. 1947. 720 E. Capitol Dr., 53211. (414) 332-9611. TWX 910-262-3141. Licensee: WTMJ Inc. Ownership: The Journal Co., 100%. See Nwspr. ■ NBC. Rep: Harrington, Righter & Parsons. Wash atty: Hogan & Hartson. ■ Michael McCormick, pres; Richard Herbst, VP; Edward Quinn, gen sls mgr; Gerald McGrath, prog dir; Don Loose, mgr news ops; Kenneth Taishoff, dir of adv, prom & publ; Jim Willman, chief engr. ■ On 12 CATV's. Co-owned: WTMJ-AM, WKTI-FM. ■ Rates: \$500; 70; 45.

WVTV—ch 18, 1,100 kw vis, 110 kw aur, ant 530/663g. July 1, 1959. Box 1818, 53201. (414) 442-7050. TWX 910-262-3466. Licensee: Gaylord Bcstg (acq 4-1-66). Ownership: See Gaylord Bcstg Stns. ■ Rep: Katz. Wash atty: Pierson, Ball & Dowd. ■ Edward L. Gaylord, pres; Joseph Loughlin, mgr; William Franks, prog dir & film buyer; Michael Schuch, gen sls mgr; Stephanie Netzel, prom mgr; William U. Witt, dir of engr. ■ On 36 CATV's—102,461 subs.

Rhineland

ADI NO. 128; see page B-76

WAOE-TV—ch 12, 316 kw vis, 57 kw aur, ant 1,650/1,683g. Oct. 6, 1966. Box 858, 54501. (715) 369-4700. Licensee: Northland TV Inc. Ownership: Alvin E. O'Konski, 94%; Veronica O'Konski, 4%; & others. ■ NBC. Rep: Savalli/Gates. Wash atty: Frank Fletcher. ■ Alvin E. O'Konski, pres, gen & prom mgr & film buyer; Carl Hilstrom, sls mgr; Julia Roberts, prog dir; Bob Hamilton, news dir; Dave Gigure, chief engr. ■ On 40 CATV's—10,000 subs. On 4 trans.

Superior

KBJR-TV—Licensed to Superior. See Duluth, Minn.

Wausau

ADI No. 128; see page B-76

WAOW-TV—ch 9, 204 kw vis, 20.4 kw aur, ant 990/647g. May 7, 1965. 1908 Grand Ave., 54401. (715) 842-2251. TWX 715-331-0887. Licensee: Horizons Comm. Corp. of Wis. (acq 9-9-70). Ownership: See Horizons Communications Corp. ■ ABC. Rep: Katz. Wash atty: Marmet. ■ Terry K. Shockley, pres & gen mgr; Bruce R. Liljegren, mgr; Robert D. Knapp, loc & rgnl sls mgr; Larry Entner, chief engr. ■ On 12 CATV's—13,150 subs. On 2 trans.

***WHRM-TV**—ch 20, 724 kw vis, 144 kw aur, ant 987/980g. 1975. 732 N. Midvale Blvd., Madison, 53705. Licensee: Educational Communications Board. ■ PBS. Wash atty: Dow, Lohnes & Albertson. ■ Execs: see *WPNE, Green Bay.

WSAU-TV—ch 7, 316 kw vis, 53.7 kw aur, ant 1,210/647.3g. Oct. 23, 1954. 1114 Grand Ave., 54401. (715) 845-4211. Licensee: Forward Communications Corp. Ownership: See Forward Communications Stns, also Nwspr. ■

Wyoming, Guam, P.R., V.I. TV

See page B-89 for explanation of listings.

CBS, Rep: Meeker; Hyett. Wash atty: McKenna, Wilkinson & Kittner. ■ Richard D. Dudley, pres & gen mgr; Bart F. Kellinhauser, exec VP & stn mgr; John T. Crowley, prog & prom mgr; Mark Zelich, news dir; James W. Frey, sls mgr; Donald Cochart, chief engr. ■ On 14 CATV's—26,000 subs. On 3 trans. Co-owned: WSAU(AM)-WIFC(FM).

Wyoming

Casper

ADI No. 185; see page B-12

KTWO-TV—ch 2, 100 kw vis, 10.2 kw aur, ant 2,000t/375g. March 1, 1957. Box 2720, 82602. (307) 237-3711. TWX 910-949-4462. Licensee: Harriscope Bcstg Corp. (acq 3-1-57). Ownership: See Harriscope Stns. ■ NBC, ABC, CBS, Rep: Meeker, Hyett-Ramland, Simpson-Reilly. Wash atty: Cohn & Marks. ■ Burt I. Harris, pres; Bob Dallas Price, VP, gen mgr; Jack Rosenthal, exec VP; Dave Borino, prog dir; Bob Horner, news dir; Gary Teddy, admin mgr. ■ On 24 CATV's—47,000 subs. On 39 trans. Co-owned: KTWO(AM). ■ Rates: \$70; 80; 20.

Cheyenne

ADI No. 171; see page B-14

KYCU-TV—ch 5, 100 kw vis, 10 kw aur, ant 620t/483g. March 22, 1954. 2923 E. Lincolnway, 82001. (307) 634-7755. TWX 910-949-4067. Licensee: Wyneco Communications Inc. (acq 9-7-72). Ownership: See Lamb Communications Inc. ■ CBS, ABC, NBC, Rep: Avery-Knodel; Hix (Denver); Soderlund (Omaha). Wash atty: Fly, Shuebruk, Blume & Gaguine. ■ Arthur Ingram, pres; Carl J. Occhipinti, gen mgr; Stu Seibel, prog dir; Margie O'Brien, dir natl sls; Scott Tipton, chief engr. ■ On 11 CATV's—30,697 subs. On 13 trans. ■ Rates: \$90-130; 20-35; 20-35.

Riverton

ADI No. 185; see page B-12

KWRB-TV—ch 10, 58.9 kw vis, 8.7 kw aur, ant 1,630t/79g. Dec. 22, 1957. 500 Arapahoe, Thermopolis, 82443. (307) 864-2351. Licensee: Chief Washakie TV. Ownership: Joseph P. & Mildred V. Ernst, 100%. ■ NBC, CBS, ABC, Rep: Savalli-Gates. Wash atty: McKenna, Wilkinson & Kittner. ■ Mildred V. Ernst, gen mgr & sls mgr, & film buyer; Cindy De Vries, prog dir; Karl V. Kertson, news dir & chief engr. ■ On 7 CATV's. Co-owned: KRTR(AM) Thermopolis.

Guam

Agaña

***KGTF**—ch 12, 27.4 kw vis, 5.47 kw aur, ant 199t/187g. Oct. 30, 1970. Box 3615, 96910. 734-2207. Licensee: Guam Educational Telecommunications Corp. ■ PBS. ■ Ursula I. Muna, stn mgr. ■ On 1 CATV—11,500 subs.

KUAM-TV—ch 8, 25.1 kw vis, 2.57 kw aur, ant 140t/320g. Aug. 5, 1956. Box 368, 96910. 777-9861. TLX 721-142. Licensee: Pacific Bcstg Corp. Ownership: H. Scott Killgore, 65%; Samuel N. Rubin, 35%. ■ CBS, ABC, NBC, Rep: Intercontinental. Wash atty: Cohn & Marks. ■ H. Scott Killgore, pres; William B. Neilsen, exec VP; Russell A. Greer Jr., gen mgr; Patricia Clymer, prog mgr; Laling Camacho, pub affrs mgr; Richard Carlson, dir of engr. ■ On 1 CATV. On 5 trans. Co-owned: KUAM—AM—FM.

Puerto Rico

HAMILTON-LANDIS & ASSOCIATES, Inc.
NATIONWIDE MEDIA BROKERS
WASHINGTON, D. C. CHICAGO, DALLAS, SAN FRANCISCO
SELL MORE
RADIO & TELEVISION STATIONS
IN THE EAST—NEAREST OFFICE IS—
1730 K ST., N.W., WASHINGTON 20006
(202) 393-3456

Aguadilla

WOLE-TV—ch 12, 17.8 kw vis, 5 kw aur, ant 1,010t/60g. May 13, 1960. Box 1194, Mayaguez, 00708. (809) 832-4160. Licensee: Western Bcstg Corp of PR. Ownership: WAPA-TV Bcstg Corp. (WAPA—TV San Juan) and DuArt Film Labs Inc., each 33-1%; Jose Bechara, 16-2%; Rynalda Barletta, 8-1%; Alfonso Gimenez-Aquayo, 8-1/3%. See Columbia Pictures Industries. ■ Wash atty: Fletcher, Heald, Rowell, Kenehan & Hildreth. ■ Irwin Young, pres; Amadeo Nazario, gen, sales & prom mgr & film buyer; Santiago Hernandez, prog dir; Gilberto Rodriguez, news dir; Maximino Perez, chief engr. On 1 trans. ■ Rates: \$35; 20; 20.

WVEO—ch 44, 995 kw vis, 100 kw aur, ant 1,220t/235g. October 1974. Box W-GPO, Aguadilla, 00603. Licensee: Video Empresas Del Oeste Inc. Ownership: Dr. Pablo Guardiola, 42%; Abacoa Radio Corp., 42%; Hector Nicolau, 16%. ■ Net: Perez Perry. Sp full time. ■ Dr. Pablo Guardiola, pres; Hector Nicolau, chief engr. ■ Rates: \$30; 20; 20.

Caguas

WKBM-TV—(San Juan) ch 11, 200 kw vis, 39.8 kw aur, ant 1,178t/243g. May 23, 1960. Box 4189, San Juan, 00905. Licensee: American Colonial Bcstg Corp. Ownership: See American Colonial Stns. ■ Rep: Cadena Perez-Perry. Wash atty: Mallyck & Bernton. ■ Ralph Perez Perry, pres; Carmen Juncos, gen mgr & film buyer; Jose Ribas, coml mgr; Efraim Rivera, chief engr. ■ Co-owned: WKVM(AM)—WCAD—FM.

Fajardo

WSTE—ch 13, 31.6 kw vis, ant 2,900t/338g. Not on air, target date unknown. 105 Padre Las Casas, 00648. Permittee: WSTE-TV Inc. Ownership: James C. Leake, 80%; Carmina Mendez, 20%. See Leake TV Stns. ■ Wash atty: Frank Mullins.

Mayaguez

***WIPM-TV**—ch 3, 35 kw vis, 3.5 kw aur, ant 440t/159g (CP: 77.6 kw vis, ant 2,280t/383g). April 28, 1961. Box 449, 00708. (809) 832-0164. Telex: 385-401. Licensee: Dept. of Educ. of PR. ■ PBS. Wash atty: Steptoe & Johnson. ■ Salvador Suau, mgr.

WOLE-TV—Licensed to Aguadilla. See Aguadilla.

WORA-TV—ch 5, 95.5 kw vis, 19.1 kw aur, ant 2,000t/240g. Oct. 1, 1955. Box 43, 00708. (809) 832-1150. Licensee: Quality Telecasting Corp. Ownership: Radio Americas Corp., 99%. Radio Americas is owned by Alfredo R. deArellano Jr. & family. See Quality Bcstg System. ■ Ricavision Network. Rep: Island. Wash atty: Wilner & Scheiner. ■ Alfredo R. deArellano Jr., pres; Maureen Justiniano de Mendez, mgr; G. A. Bonet, dir of engr. ■ Co-owned: WORA—AM—FM.

Ponce

WRIK-TV—ch 7, 166 kw vis, 22.4 kw aur, ant 2,710t/440g. Feb. 2, 1958. Box A, San Juan, 00902. (809) 724-7575. TWX 809-345-3074. Licensee: Ponce TV Corp. Ownership: United Artists Bcstg of PR. Inc., 80.1%; Alfredo Ramirez deArellano III, 19.9%; (acq 4-23-70). See United Artists Stns. ■ Sp full time. Wash atty: Pierson, Ball & Dowd. ■ Andy Albeck, pres; Peter L. Moreno, VP & gen mgr; William Sochuk, prog dir; Adolfo Flores, gen sls mgr; Manuel Morales Flores, news dir; Robert Beurket, chief engr. ■ Rates: \$275; 140; 80.

WSUR-TV—ch 9, 57.5 kw vis, 7.2 kw aur, ant 2,775t/276g. February 1958. Box 471, 00732. (809) 842-4178. Licensee: American Colonial Bcstg Corp. Ownership: See American Colonial Stns. ■ Rep: Cadena Perez-Perry. Wash atty: Mallyck & Bernton. ■ Ralph Perez Perry, pres & mgr; Luis-Felipe Rodriguez, prod mgr.

San Juan

WAPA-TV—ch 4, 53.7 kw vis, 8.1 kw aur, ant 2,865t/1,094g. April, 1954. G.P.O. Box 2050, 00936. (809) 783-4440. Telex: 3450245. Licensee: WAPA-TV Bcstg Corp. Ownership: Screen Gems Bcstg Co. See Columbia Pictures Industries. ■ Wash atty: Fletcher, Heald, Rowell, Kenehan & Hildreth. ■ Norman Louvau, pres & film buyer; Hector Modestti, VP & gen mgr; Eduardo R. Arellano, sls mgr; Rafael Duany, prog mgr; Miguel Angel Negron, prom mgr; Carles Ruben Ortiz, news dir; Julio Brito, chief engr.

***WIPR-TV**—ch 6, 53.7 kw vis, 5.37 kw aur, ant 2,860t/1,094g. Jan. 6, 1958. Box 909, Baldrich, Rio Piedras, 00919. (809) 763-3666. Licensee: Dept. of Educ. of PR. ■ PBS. Sp 39½ hrs wky. Wash atty: Steptoe & Johnson. ■ Alberto Cordero, gen mgr; Hector V. Suarez, prog dir & prom mgr; José M. Alvarez, news dir; Manuel Collazo, chief engr. ■ Co-owned: *WIPR—AM—FM.

WKAQ-TV—ch 2, 53.7 kw vis, 10 kw aur, ant 2,830t/1,100g. March 28, 1954. Box W, 00936. (809) 764-0202. Licensee: Telemundo Inc. Ownership: Angel Ramos Foundation. ■ Rep: Inter-American. Wash atty: Dempsey & Koplovitz. ■ Argentina S. Hills, pres; Rafael Ruiz, VP & gen mgr; Roberto L. Prohías, sls mgr; Enrique Valdes Pages, chief engr. ■ On 5 trans. Co-owned: WKAQ—AM—FM.

Virgin Islands

Charlotte Amalie

WBNB-TV—ch 10, 52.5 kw vis, 5.2 kw aur, ant 2,610t/203g. July 22, 1961. Box 1947, 00801. (809) 744-0300/0400. Licensee: Island Teleradio Service Inc. Ownership: District Communications Inc., 100%. ■ CBS, NBC, Rep: Intercontinental Services; Schellenberg & Kirwan. Wash atty: Arnold & Porter. ■ Ruth H. Jones, pres; Shirlee Taylor Haizlip, gen & prom mgr, prog dir; Susan Sikora, news dir; Sam James, chief engr. ■ On 2 CATV's—11,000 subs. ■ Rates: \$30; 22.50; 22.50.

***WTJX-TV**—ch 12, 16.6 kw vis, 3.31 kw aur, ant 1,490t/130g. Aug. 29, 1972. Box 5077, 00801. (809) 774-6255. Telex 3470009. Licensee: Virgin Islands Public Television System. ■ Wash atty: Schwartz & Woods. ■ Calvin F. Bastian, gen mgr; Milton Davis, Jr., prog mgr; Marjorie Beimer, prom mgr; John Lovatt, film dir; Albert O. Peck, chief engr. ■ On 1 CATV-1,000 subs.

Christiansted

WSVI—ch 8, 58.5 kw vis, 7.2 kw aur, ant

7421/80g. January 1966. Box Y, 00820. (809) 773-1899. Licensee: People's Bcstg Corp. (acq 11-23-73). Ownership: Albert A. Sheen & others. ■ ABC. Rep: TIE States. Wash atty: Mullin, Conner & Rhyne. ■ Albert A. Sheen, pres; Arthur L. Swanson, gen & sls mgr & film buyer; James L. Bearden, prod mgr; Richard J. Costello, opns mgr; John H. Koch, chief engr. ■ On 2 CATV's—13,000 subs. On 2 trans. ■ Rates: \$44; 36; 22.

American Samoa

Pago Pago

The government of American Samoa, Dept. of Education, 96799, operates the following stations:

***KVZK-2**—ch 2, 40 kw vis.

***KVZK-4**—ch 4, 40 kw vis.
***KVZK-5**—ch 5, 40 kw vis.
***KVZK-8**—ch 8, 100 kw vis.
***KVZK-10**—ch 10, 100 kw vis.

Micronesia

(Trust Territory of the Pacific)

Saipan

WSZE-TV—ch 8, 500 w vis (1.5 kw vis planned). October 1967. c/o KUAM, Box 268, Agana, Guam 96910. Licensee: Micronesia Broadcasting Corp. Ownership: Pacific Broadcasting Corp. ■ CBS, ABC, NBC. Rep: Intercontinental Services Ltd. Wash atty: Cohn & Marks. ■ H. Scott Kilgore, pres; Oly Olson, gen mgr. ■ On 2 trans.

Am. Samoa, Micronesia, Can. TV

See page B-89 for explanation of listings.

Medicine Hat

CHAT-TV—ch 6, 5.7 kw vis, 3 kw aur, ant 3151/270g. 1956. Box 1270. (403) 548-3911. Telex: 038-4824. Licensee: Monarch Bcstg Co. Ltd. ■ CBC. ■ W. H. Yuill, pres; Orv Kope, gen mgr.

Peace River

CFRN-TV-2—ch 3, 2.4 kw vis, .24 kw aur. Rebroadcasts CFRN-TV Edmonton.

Pivot

CHAT-TV-1—ch 4, 2.75 kw vis, 1.37 kw aur. Rebroadcasts CHAT-TV Medicine Hat.

Red Deer

CFRN-TV-6—ch 8, 2.4 kw vis. Rebroadcasts CFRN-TV Edmonton.

CKRD-TV—ch 6, 13.2 kw vis, 6.6 kw aur, ant 7141/321g. Box 5555, T4N-5H6. (403) 347-6681. Telex: 038-316. Licensee: CHCA-TV Ltd. ■ CBC. ■ H. L. Flock, pres; M. G. Phillips, gen mgr.

Whitecourt

CBXT-2—ch 9, 9.4 kw vis, 4.7 kw aur. Rebroadcasts CBXT Edmonton.

British Columbia

Canal Flats

CBUBT-1—ch 12, 5.4 kw vis, 1 kw aur. Rebroadcasts CBUBT Cranbrook.

Dawson Creek

CJDC-TV—ch 5, 10 kw vis, 5 kw aur. 1958. 901-102d Ave. (604) 782-3341. Telex: 036-77127. Licensee: Radio Stn CJDC Ltd. ■ CBC. ■ H. L. Michaud, pres; W. R. Duncan, gen mgr.

Kamloops

CFJC-TV—ch 4, 4 kw vis, 2 kw aur, ant 5011/114g. 1957. 460 Pemberton Terr. (604) 762-3322. Telex: 048-8148. Licensee: Inland Bcstrs (1969) Ltd. (acq 1-10-70). ■ CBC. ■ David Clark, pres; Jack Pollard, gen mgr.

CHKM—ch 6, 4 kw vis, 1 kw aur. Rebroadcasts CHAN-TV Vancouver.

Kelowna

CHBC-TV—ch 2, 3.7 kw vis, .46 kw aur, ant 27041/77g. 1957. 342 Leon Ave. (604) 762-4535. Telex: 048-5119. Licensee: Okanagan Valley Television Co. Ltd. ■ CBC. ■ R.L. Sharp, VP & gen mgr. ■ On 26 trans.

CHKL-TV—ch 5, 4 kw vis, 8 kw aur. Rebroadcasts CHAN-TV Vancouver.

Prince George

CIFG-TV—ch 12, 1.9 kw. Licensee: British Columbia Bcstg System Ltd.

CKPG-TV—ch 2, 778 w vis, 389 w aur. 1961. 1220 6th Ave. (604) 564-8861. Telex: 047-8698. Licensee: Q Bcstg Ltd. (acq 1-74). ■ CBC. ■ J. E. Stark, pres; G. M. Leighton, stn mgr.

Canada

Note—Repeaters, satellites or rebroadcasting stations in Canada with a power less than 1 kw are not listed.

Alberta

Ashmont

CFRN-TV-4—ch 12, 14.6 kw vis, 7.3 kw aur. Rebroadcasts CFRN-TV Edmonton.

Athabasca

CBXT-1—ch 8, 25.7 kw vis, 12.8 kw aur. Rebroadcasts CBXT Edmonton.

Bonnyville

CKSA-TV-2—ch 9, 20.75 kw vis, 4.15 kw aur. Rebroadcasts CKSA-TV Lloydminster.

Calgary

CBRT—ch 9, 178 kw vis, 36 kw aur, 1975. 1724 Westmount Blvd., Box 2640, T2P-2M7. (403) 283-8361. Telex 038-21604. Licensee: CBC. ■ CBC. ■ D. Carroll, gen mgr; P. LeGrave, gen sls mgr.

CFAC-TV—ch 2, 100 kw vis, 20 kw aur, ant 9891/633g. October 1954. 955 Rideau Rd. S. W. T2S 0S4. (403) 243-3491. Telex 038-22549. Licensee: Calgary TV Ltd. Ownership: Selkirk Holdings Ltd., 100%. ■ Rep: All Canada Radio & TV. ■ Dave Penn, pres & gen mgr; N. Wagner, opns mgr.

CFCN-TV—ch 4, 55 kw vis, 27.5 kw aur, ant 6691/426g. 1960. Bcst House, Postal Station E, T3C 3L9. (403) 249-9101. Telex 038-21637. Licensee: CFCN TV Ltd. ■ CTV. ■ E. W. Chapman, pres; H. G. Marshall, gen mgr; Alex I. Pestes, gen sls mgr; Bruce Nelson, prog dir; Ron Nordquist, chief engr. ■ On 9 CATV's—60,000 subs. On 15 trans. Co-owned: CFCN.

Coronation

CKRD-TV-1—ch 10, 12.4 kw vis, 6.2 kw aur. Rebroadcasts CKRD-TV Red Deer.

Drumheller

CFCN-TV-1—ch 12, 14.1 kw vis, 7 kw aur. Rebroadcasts CFCN-TV Calgary.

Edmonton

CBXFT—(Fr) ch 11, 90 kw vis, 9 kw aur. 1970. Box 555, T5J-2P4. (403) 469-2321. Licensee: CBC. ■ CBC. ■ L. Wallace, dir of TV.

CBXT—ch 5, 318 kw vis, 34.3 kw aur. 1961. Box 555, T5J 2P4. (403) 469-2321. Telex 0372-287. Licensee: CBC. ■ W. Porth, dir Alberta; L. Wallace, dir of TV.

CFRN-TV—ch 3, 250 kw vis, 20 kw aur. 1954. Box 5030, Stn E, T5P 4C2. (403) 484-3311. Telex 037-2257. Licensee: Sunwapta Bcstg Co. Ltd. ■ CTV. Rep: Radio-TV Reps, Canada; Bolton Burchill, Harlan Oakes, U.S. ■ G. R. A. Rice, pres; B. Alloway, gen mgr. ■ On 8 CATV's—80,000 subs. On 8 trans. Co-owned: CFRN-AM-FM.

CITY-TV—ch 13, 325 kw vis, 32.5 kw aur. 1974. 5325-104th St., T6H 5B8. (403) 436-1250. Telex: 037-3780. Licensee: Edmonton Video Ltd. ■ C. A. Allard, pres.

Grande Prairie

CBXAT—ch 10, 36 kw vis, 18 kw aur. Box 639. (403) 774-3780. Licensee: CBC.

CFRN-TV-1—ch 13, 32 kw vis, 6.4 kw aur. Rebroadcasts CFRN-TV Edmonton.

High Prairie

CBXAT-2—ch 2, 6.2 kw vis, 3.1 kw aur. Rebroadcasts CBXAT Grand Prairie.

Lethbridge

CFCN-TV-5—ch 13, 47 kw vis, 7.34 kw aur. Rebroadcasts CFCN-TV Calgary.

CJOC-TV—ch 7, 96 kw vis, 19 kw aur, ant 6621/600g. 1955. Box 1120. (403) 327-1521. Telex 038-49130. Licensee: Lethbridge TV Ltd. ■ CBC. ■ N. Botterill, pres; R. C. Johnson, gen mgr.

Lloydminster

CITL-TV—ch 4, 82 kw vis.

CKSA-TV—ch 2, 116 kw vis, 23.2 kw aur. 1960. 5026 50th St., S9V 0Z1. (403) 875-3321. Telex: 037-32511. Licensee: CKSA-TV Ltd. ■ CBC. ■ A. F. Shortell, pres; L. A. Wildman, gen mgr; Peter Senchuk, coml mgr.

Manning

CBXAT-3—ch 12, 1.77 kw vis, .177 kw aur. Rebroadcasts CBXAT Grande Prairie.

B.C., Man., N.B., Nfld., N.S. TV

See page B-89 for explanation of listings.

Terrace

CFTK-TV—ch 3, 4.1 kw vis, 2.1 kw aur, ant 17831/70g. 1962. 4625 Lazelle Ave., V8G 1S4. (604) 635-6316. Telex: 047-85529. Licensee: Skeena Bcstrs Ltd. ■ CBC. ■ J. Fred Weber, mgng dir; R. A. Parfitt, gen sls mgr.

Trail

CBUAT—ch 11, 3.34 kw vis, .668 kw aur, ant 7621/203g. Licensee: CBC.

Vancouver

CBUT—ch 2, 47.6 kw vis, 7.6 kw aur, ant 2400t/190g. 1953. Box 4600, 747 Bute St., V6B 4A2. (604) 684-0246. Telex: 045-1207. Licensee: CBC. ■ CBC. ■ R. W. McGall, dir for province of B.C.; Hugh Palmer, dir of TV.

CHAN-TV—ch 8, 164 kw vis, 81 kw aur, ant 1171t/338g. Oct. 31, 1960. Box 4700, V6B 4A3. (604) 299-7272. Telex: 043-54784. Licensee: British Columbia Television Bcstg System Ltd. ■ CTV. ■ J. R. Peters, pres & gen mgr; D. M. Smith, VP sales.

Victoria

CHEK-TV—ch 6, 100 kw vis, 50 kw aur, ant 1555t/298g. 1956. 3693 Epsom Dr. (604) 477-1821. Telex: 043-54784. Licensee: CHEK-TV Ltd. ■ CBC & CTV. ■ J. R. Peters, pres & gen mgr; Frank Bond, stn mgr.

Manitoba**Brandon**

CJAY-TV—ch 4, 55 kw vis. Rebroadcasts CKY-TV Winnipeg.

CKX-TV—ch 5, 44 kw vis, 27 kw aur, ant 511t/525g. Box 1150. (204) 728-1150. Telex: 03-5016. Licensee: Western Man. Bcstrs Ltd. ■ CBC. ■ John B. Craig, pres; A. S. Craig, gen mgr.

Dauphin

CBWST—ch 8, 120 kw vis.

Fisher Branch

CBWGT—ch 10, 27.4 kw vis, 5.48 kw aur, ant 559t/548g. Licensee: CBC.

Flin Flon

CBWBT—ch 10, 7.8 kw vis, .16 kw aur. Licensee: CBC.

Foxwarren

CKX-TV-1—ch 11, 6.64 kw vis, 3.48 kw aur. Rebroadcasts CKX-TV Brandon.

Lac du Bonnet

CBWT-2—ch 4, 9.7 kw vis, 1.9 kw aur. Rebroadcasts CBWT Winnipeg.

Winnipeg

CBWFT (Fr)—ch 3, 59 kw vis, 7.3 kw aur, ant 930t/923g. 1960. Box 160, 541 Portage Ave., R3C 2H1. (204) 774-2541. Telex: 035-435. Licensee: CBC. ■ CBC. ■ D. L. Bennett, Prairie rgnl dir; William Morgan, dir of TV; L. Paul Du-maine, prog dir.

CBWT—ch 6, 100 kw vis, 12 kw aur, ant 1027t/1020g. 1954. Box 160, R3C 2H1. (204) 774-2541. Telex: 07-57780. Licensee: CBC. ■ CBC. ■ William Morgan, dir of TV; Al Johnson, (Ottawa), pres; Frank Stanley, rgnl sls mgr; Norm Cowan, pub relations mgr; Bill Terry, prog dir; Herb Nixon, rgnl news dir; Jake Marks, prod mgr; Zella Vermeulen, film buyer; R. D. Fairley, rgnl chief engr. ■ On 4 CATV's—123,000 subs. On 4 trans.

CKND—ch 9, 325 kw vis, 25 kw aur. 1975. 603 St. Mary's Rd., R2M 4A5. (204) 233-3304. Telex 07-55270. Licensee: Canwest Bcstg. ■ Reps: P. Forscutt; TV Mktng Svc; Bolton/Burchill. ■ PG. Morton, pres; D.C. Brinton, gen & prom mgr; W.J. Elliott, chief engr.

CKY-TV—ch 7, 325 kw vis, 65 kw aur, Polo Park, R3G OL7. 1960. (204) 775-0371. Telex: 07-57745. Licensee: MTV Ltd. ■ CTV. ■ J. R. Mitchell, pres; J. S. Purvis, gen mgr; J. M. Lillie, gen sls mgr; J. C. Armstrong, prog mgr; R. J. Webb, prod mgr; J. S. Gibson, opns mgr; B. W. Graham, dir of news & current affairs; T. Milan, engr mgr.

New Brunswick**Bon Accord**

CHSJ-TV-1—ch 6, 54.7 kw vis, 27.3 kw aur. Rebroadcasts CHSJ-TV St. John.

Campbellton

CKCD-TV—ch 7, 1.4 kw vis, .288 kw aur. Box 5004, Moncton. Licensee: Moncton Bcstg Ltd.

Edmundston

CJBR-TV-1—ch 13, 1.43 kw vis, .714 kw aur. Rebroadcasts CJBR-TV Rimouski, Que.

Moncton

CBAFT (Fr)—ch 11, 163 kw vis, 33 kw aur, ant 781t/394g. 1969. Box 950, 250 Archibald St., E1C 8N8. (506) 855-3370. Telex: 014-2284. Licensee: CBC. ■ CBC. ■ Guy Theriault, gen mgr; A. Landry, sls rep.

CHMT-TV—ch 7, 182 kw vis, 36.4 kw aur. N.B. Bcstg Co. Ltd.

CKCW-TV—ch 2, 25 kw vis, 3.74 kw aur. 1954. Box 5004. (506) 855-1224. Telex: 014-2250. Licensee: Moncton Bcstg Ltd. ■ CTV. ■ F. S. Sherratt, pres; J. S. Irvine, gen mgr.

Saint John

CHSJ-TV—ch 4, 54.2 kw vis, 7.8 kw aur, ant 1263t/144g. 1954. 335 Union St. (506) 657-3410. Telex: 014-47218. Licensee: New Brunswick Bcstg Co. Ltd. ■ CBC. ■ G. A. Cromwell, gen mgr; H. Sullivan, chief engr.

CKLT-TV—ch 9, 162 kw vis, 32 kw aur, ant 1361t/241g. Licensee: Moncton Bcstg Ltd.

Upsalquitch Lake

CKAM-TV—ch 12, 141 kw vis, 28.2 kw aur. Knights of Pythias Bldg., Moncton. Licensee: Moncton Bcstg Ltd. ■ F. S. Sherratt, pres; J. S. Irvine, gen mgr.

Newfoundland**Argentia**

CJOX-TV—ch 3, 6.7 kw vis, 3.4 kw aur. Rebroadcasts CJON-TV St. John's.

Baie Verte

CBNAT-1—ch 3, 3.4 kw vis. Rebroadcasts CBNAT Grand Falls.

Bonne Bay

CBYT-3—ch 2, 6.2 kw vis, 1.2 kw aur. Rebroadcasts CBYT Corner Brook.

Corner Brook

CBYT-TV—ch 5, 10.6 kw vis, 2.1 kw aur. Box 610, A2H 6G1. (709) 634-3141. Telex: 016-44222. Licensee: CBC. ■ R. G. O'Brien, gen mgr.

Grand Bank

CJOX-TV-1—ch 2, 7.4 kw vis. Rebroadcasts CJON-TV St. John's.

Grand Falls

CBNAT—ch 11, 317 kw vis, 64 kw aur. Licensee: CBC.

CJCN-TV—ch 4, 26 kw vis, 13 kw aur. Bot-wood Highway. (709) 489-6601. Telex: 016-4237. Licensee: Newfoundland Bcstg Corp. ■ Jerry Peet, stn mgr.

Marystown

CBNT-3—ch 5, 22.5 kw vis, 11.25 kw aur. Rebroadcasts CBNT St. John's.

Mount St. Margaret

CBNAT-9—ch 9, 29 kw vis. Rebroadcasts CBNAT Grand Falls.

Placentia

CBNT-2—ch 12, 1.58 kw vis, .79 kw aur. Rebroadcasts CBNT St. John's.

Port Rexton

CBNT-1—ch 13, 16 kw vis, 8 kw aur. Rebroadcasts CBNT St. John's.

St. Anthony

CBNAT-4—ch 6, 6.54 kw vis, .65 kw aur. Rebroadcasts CBNAT Grand Falls.

St. John's

CBNT—ch 8, 196 kw vis, 39 kw aur. 1964. Box 5490, 95 University Ave., A1C 5W5. (709) 753-1300. Telex: 016-4590. Licensee: CBC. ■ A. K. Morrow, rgnl dir; D. Fardy, dir of TV.

CJON-TV—ch 6, 62 kw vis, 33 kw aur. Box 2020. (709) 579-5015. Telex: 016-355. Licensee: Newfoundland Bcstg Co. Ltd. ■ Colin Jamieson, pres & gen mgr; W. G. Coffen, sls mgr; Helen Byrne, prom mgr; Ted Bartlett, news dir; Bob Zeidler, chief engr.

Stephenville

CBYT-1—ch 8, 11.6 kw vis, 2.32 kw aur. Rebroadcasts CBYT Corner Brook.

Nova Scotia**Antigonish**

CJCB-TV-2—ch 9, 140 kw vis. Rebroadcasts CJCB-TV Sydney.

Caledonia

CJCH-TV-6—ch 6, 51.5 kw vis, 10.3 kw aur. Rebroadcasts CJCH-TV Halifax.

Canning

CJCH-TV-1—ch 10, 9.05 kw vis, 4.53 kw aur. Rebroadcasts CJCH-TV Halifax.

Cheticamp

CBHFT-4—ch 10, 7.9 kw vis, 4 kw aur. Rebroadcasts CBHFT Halifax.

CBIT-2—ch 2, 2.7 kw vis. Rebroadcasts CBIT Sydney.

Halifax

CBHFT (Fr.)—ch 13, 135 kw vis, .0135 kw aur. 1971. Box 3000, B3J 3E9. (902) 422-8311. Licensee: CBC.

CBHT—ch 3, 56 kw vis, 11.2 kw aur, ant 866t/1620g. 1954. Box 3000, 5600 Sackville St., B3J 3E9. (902) 422-8311. Telex: 019-21618. Licensee: CBC. ■ CBC. ■ A. K. Morrow, dir for Maritime provinces; G. J. Fardy, gen mgr.

CJCH-TV—ch 5, 60 kw vis, 6 kw aur, ant 822t/575g. 1961. 2885 Robie St. (902) 453-2524. Telex: 019-21826. Licensee: CJCH Ltd. ■ CTV. ■ Fred Sherratt, pres & gen mgr.

Inverness

CJCB-TV-1—ch 6, 9.4 kw vis, 4.7 kw aur. Rebroadcasts CJCB-TV Sydney.

Mulgrave

CBHFT-2—ch 7, 106 kw vis. Rebroadcasts CBHFT Halifax.

CBIT-1—ch 12, 129 kw vis. Rebroadcasts CBIT Sydney.

Sheet Harbour

CBHT-4—ch 11, 9.07 kw vis, 1.814 kw aur. Rebroadcasts CBHT Halifax.

Sydney

CBHFT-3—ch 13, 4.5 kw vis. Rebroadcasts CBHFT Halifax.

CBIT—ch 5, 100 kw vis, 10.8 kw aur. 1972. Box 700, 285 Alexandra St., B1P 6H7. (902) 539-5050. Telex: 019-35109. Licensee: CBC. ■ CBC. ■ A. W. Wilson, loc mgr; H. Tobin, sls mgr.

CJCB-TV—ch 4, 100 kw vis, 60 kw aur. 1954. Box 469, B1P 6H5. (902) 562-5511. Telex: 019-35195. Licensee: Cape Breton Bcstrs Ltd. ■ CTV. ■ F.G. Sherratt, pres; Kenneth M. Boyce, gen mgr.

Yarmouth

CBHFT-1—ch 3, 1.9 kw vis, .19 kw aur. Rebroadcasts CBHFT Halifax.

CBHT-3—ch 11, 15.7 kw vis, 3.3 kw aur. Rebroadcasts CBHT Halifax.

Ontario

Bancroft

CKGN-TV-2—ch 2, 40.5 kw vis.

Barrie

CKVR-TV—ch 3, 100 kw vis, 12.5 kw aur, ant 820t/651g. 1955. Box 519, L4M 4T9. (705) 726-9711. Telex 0687-5520. Licensee: CKVR Ch 3 Ltd. ■ Allan Waters, pres; Jack Mattenley, VP & gen mgr.

Cornwall

CJOH-TV-8—ch 8, 130 kw vis, 78 kw aur. Rebroadcasts CJOH-TV Ottawa.

Deseronto

CJOH-TV-6—ch 6, 55 kw vis, 5.5 kw aur. Rebroadcasts CJOH-TV Ottawa.

Dryden

CBWDT—ch 9, 8.9 kw vis, 4.45 kw aur. Rebroadcasts CBWDT Winnipeg, Man.

Elliott Lake

CBFST-3—ch 12, 18.6 kw vis, 3.72 kw aur. Rebroadcasts CBFST Sturgeon Falls.

CKNC-TV-1—ch 7, 12.5 kw vis, 1.3 kw aur. Rebroadcasts CKNC-TV Sudbury.

CKSO-TV-1—ch 3, 19 kw vis, 3.8 kw aur. Rebroadcasts CKSO-TV Sudbury.

Fort Frances

CBWCT—ch 5, 20.2 kw vis, 10.1 kw aur.

Geraldton

CBLAT—ch 13, 22 kw vis, 4.4 kw aur, ant 598t/540g. Licensee: CBC.

Hamilton

CHCH-TV—ch 11, 230 kw vis, 23 kw aur, ant 1173t/1054g. June 4, 1954. 163 Jackson St. W., L8N 3A6. (416) 522-1101. Telex: 021-8312. Licensee: Niagara Television Ltd. ■ S. J. Bibby, pres; Douglas C. Gale, VP & gen mgr; Gary Buss, VP & sls mgr; F. P. Denardis, VP & prog dir. ■ On 78 CATV's.

Hearst

CBFOT-2—ch 7, 8.4 kw vis, 1.68 kw aur. Rebroadcasts CBFOT Timmins.

Kapuskasing

CBFOT-1—ch 12, 17.4 kw vis, 3.4 kw aur. Rebroadcasts CBFOT Timmins.

Kearns

CFCL-TV-2—ch 2, 38.5 kw vis. Rebroadcasts CFCL-TV Timmins.

CKSO-TV-3—ch 11, 162 kw vis, 13 kw aur. Rebroadcasts CKSO-TV Sudbury.

Kenora

CBWAT—ch 8, 9.3 kw vis, 5.5 kw aur. Rebroadcasts CBWAT Winnipeg, Man.

Kingston

CKWS-TV—ch 11, 130 kw vis, 26 kw aur, ant 851t/785g. 1954. 170 Queen St. (613) 544-2340. Telex 066-3256. Licensee: Frontenac Bcstg Co. Ltd. ■ Arthur Daves, pres; Allan J. Brooks, gen mgr.

Nova Scotia, Ontario TV

See page B-89 for explanation of listings.

Kitchener

CKCO-TV—ch 13, 325 kw vis, 65 kw aur, ant 954t/653g. March 1, 1954. 864 King St. W. N2G 1E8. (519) 578-1313. Kitchener. (416) 366-0852, Toronto. Telex: 069-5432. Licensee: CtrI Ont. TV Ltd. Ownership: Electrohome Comm. Inc. 100%. ■ Howard W. Main, chmn of bd; W. D. McGregor, pres. ■ On 95 CATV's—850,000 subs. Co-owned CKKW (AM), CFCA-FM.

London

CFPL-TV—ch 10, 325 kw vis, 43.2 kw aur, ant 1,000t/975g. Nov. 28, 1953. Box 2880, N6A 4H9. (519) 434-2115. Telex: 024-846. Licensee: CFPL Bcstg Ltd. ■ CBC. Rep: All-Canada. ■ Murray T. Brown, pres; W. Cliff Wingrove, gen mgr; Robert V. Eidsen, sls mgr; James A. Plant, prog dir & prom mgr; Ronald Laidlaw, news dir; Robert White, film buyer; Glenn A. Robitaille, chief engr. ■ On 18 CATV's—229,200 subs. Co-owned: CFPL-AM-FM.

Manitouwadge

CBLAT-1—ch 8, 22 kw vis, 4.4 kw aur. Rebroadcasts CBLAT Geraldton.

Marathon

CBLAT-4—ch 11, 7.66 kw vis, 1.532 kw aur. Rebroadcasts CBLAT Geraldton.

North Bay

CHNB-TV—ch 4, 60.9 kw vis, 6.1 kw aur, ant 730t/523g. 751 Main St. E. (705) 472-2221. Licensee: J. Conrad Lavigne Enterprises. ■ J. Conrad Lavigne, pres.

CKNY-TV—ch 10, 119 kw vis, 24 kw aur, ant 420t/340g. 1950. Box 1050. (705) 752-3000. Telex 027-76287. Licensee: Tel-Ad Co. Ltd. ■ W.B. Plaunt, pres; E.W. (Bud) Guilfoyle, gen & sls mgr.

Ottawa

CBOT (Fr)—ch 9, 128 kw vis, 25.6 kw aur, ant 1394t/702g. Box 3220, Stn C, K1Y 1E4. (613) 725-3511. Telex: 013-4260. Licensee: CBC. ■ CBC. ■ G. Bruce, dir, Ottawa area; L. M. O'Neill, area sls mgr.

CBOT—ch 4, 100 kw vis, 15 kw aur, ant 1310t/618g. 1953. Box 3220, Stn C, K1Y 1E4. (613) 725-3511. Telex: 013-4260. Licensee: CBC. ■ CBC. ■ G. Bruce, dir, Ottawa area; L. M. O'Neill, area sls mgr.

CJOH-TV—ch 13, 178 kw vis, 35.6 kw aur, ant 1225t/533g. 1961. 1500 Merivale Rd., Box 5813, Stn. F, K2C 3G6. (613) 224-1313. Telex: 013-294. Licensee: Ottawa-Cornwall Bcstg Ltd. ■ CTV. ■ W. Griffiths, pres & mgng dir; Roy Faibish, exec VP.

CKGN-TV-6—ch 6, 2.8 kw vis.

Paris

CKGN-TV—ch 6, 100 kw vis, 10 kw aur. 1974. 81 Barber Greene Rd., Don Mills, M3C 2A3. (416) 446-5311. Licensee: Global Communications Ltd. ■ Reps: Mulvihill; Radio-TV Reps; Sumner. ■ J.A. Slaight, pres; P. Viner, gen sls mgr.

Pembroke

CHOV-TV—ch 5, 19.1 kw vis, 9.5 kw aur, ant 496t/520g. 1961. 319 Pembroke St. E., (613)

Ont., P.E.I., Quebec TV

See page B-89 for explanation of listings.

735-6811. Telex: 013-34515. Licensee: Ot-tawa Valley TV Co. Ltd. ■ E. Gordon Archibald, pres & gen mgr; Brooke Duval, prog & opns mgr.

Peterborough

CHEX-TV—ch 12, 139 kw vis, 83.4 kw aur, ant 7721/753g. 1955. Box 659. (705) 742-0451. Telex: 06-962810. Licensee: Kawartha Bcstg. Co. Ltd. ■ Robertson Davies, pres; Wally Rewegan, gen mgr.

Sarnia

CKGN-TV-29—ch 29, 162 kw vis. Rebroad-casts CKGN-TV Paris.

Sault Ste. Marie

CJIC-TV—ch 2, 28 kw vis, 15 kw aur, ant minus 19t/225g. 1954. 119 East St. (705) 256-7494. Telex: 027-7716. Licensee: Hyland Radio-TV Ltd. ■ R. H. Ramsay, pres.

Sturgeon Falls

CBFST—ch 7, 9.75 kw vis, 1.95 kw aur.

Sudbury

CBFST-1—ch 13, 8.6 kw vis, 1.72 kw aur. Rebroadcasts CBFST Sturgeon Falls.

CKNK-TV—ch 9, 293 kw vis, 29.3 kw aur, ant 6271/539g. Oct. 4, 1971. 699 Froot Road, P3C 5A3. (705) 674-8301. Telex: 027-81539. Licensee: J. Conrad Lavigne, Ltd. ■ CBC. Rep: Canadian Standard Bcst Sls. ■ J. Conrad Lavigne, pres; Terry Coles, gen mgr; Harry Charbonneau, sls mgr; Bill Nadeau, stn mgr; All Brooks, prog dir; Bill Catalano, news dir; Detlef Krumbacher, chief engr.

CKSO-TV—ch 5, 100 kw vis, 13.7 kw aur, ant 1049t/975g. 1953. Box 400. (705) 674-0711. Telex: 027-7584. Licensee: Cambrian Bcstg Ltd. ■ W. B. Plaunt, pres & gen mgr.

Thunder Bay

CHFD-TV—ch 4, 56 kw vis, 30 kw aur, ant 1,202t/634g. 1972. 87 N. Hill St, P7A 5V6. (807) 344-9685. Telex 073-4521. Licensee: Thunder Bay Electronics Ltd.

CKPR-TV—ch 2, 55 kw vis, 30 kw aur, ant 1202t/643g. 1954. 87 N. Hill St, P7A 5V6. (807) 344-9685. Telex: 073-4521. Licensee: Thunder Bay Electronics Ltd. ■ H. Fraser Dougall, pres; Garnet N. Conger, gen mgr.

Timmins

CBFOT—(Fr) ch 9, 16 kw vis, 3.2 kw aur, ant 706t/525g. Licensee: CBC.

CFCL-TV—ch 6, 100 kw vis, 10 kw aur, ant 562t/508g. July 1, 1956. Box 620, P4N 7G3. (705) 264-4211. Telex: 027-81539. Licensee: J. Conrad Lavigne Ltd. ■ CBC. Rep: Canadian Standard Bcst Sls. ■ J. Conrad Lavigne, pres; Terry Coles, gen mgr; Zella Dawkins, sls mgr; Al Brooks, prog dir; Roger Reid, prom mgr; Jim Prince, news dir; Rudy Fauteux, chief engr. ■ Co-owned CFCL(AM).

CKSO-TV-2—ch 3, 55 kw vis, 11 kw aur. Rebroadcasts CKSO-TV Sudbury.

Toronto

CBLFT (Fr)—ch 25, 234 kw vis, 46.8 kw aur, ant 350t/380g. 1973. Box 500, Terminal A, 354 Jarvis St., M5W 1E6. (416) 925-3311. Telex:

022-763. Licensee: CBC. ■ CBC. ■ P. LaRose, rgnt dir; L. Forestier, stn mgr.

CBLT—ch 5, 77 kw vis, 7 kw aur, ant 444t/541g. Box 500, Terminal A, 354 Jarvis St., M5W 1E6. (416) 925-3311. Telex: 06-23195. Licensee: CBC. ■ CBC. ■ A.W. Johnson, Ot-tawa dir; L. Lauk, gen mgr.

CFTO-TV—ch 9, 325 kw vis, 162 kw aur, ant 925t/889.5g. Jan. 1, 1961. Box 9, M4A 2M9. (416) 291-9111. Telex: 02-2674. Licensee: CFTO-TV Ltd. Ownership: Baton Broadcasting Inc., 100%. ■ CTV. Rep: Bolton/Burchill (US); Glen-Warren; Messner (Canada). ■ J. W. Bassett, chmn; D. H. Davis, VP prods; I. J. Hall, gen sls mgr; E. J. Billo, prog dir; P.F. Reesor, prom mgr; E. J. Stuebling, VP news & pub affrs; G. Malcolm, dir of engr. ■ On 55 CATV's—727,152 subs.

***CICA-TV**—ch 19, 600 kw vis, 120 kw aur, ant 476t/521g. 2180 Yonge St., M4S 2C1. (416) 484-2600. Telex 06-23547. Licensee: Ontario Educational Communications Authority. ■ T. Ran Ide, chmn & chief exec; Peter Bowers, gen mgr, opns.

CITY-TV—ch 79, 64 kw vis, 12.8 kw aur, ant 420t/342g. 1972. 99 Queen St. E., M5C 2M1. (416) 867-7979. Telex 06-217678. Licensee: Channel Seventy-Nine Ltd. ■ Reps: Alexander Pearson & Dawson; Radio-TV Reps; Sumner. ■ Moses Znaimer, pres & gen mgr; R. Reid, chief engr.

CKGN-TV—See Paris.

Uxbridge

CKGN-TV-22—ch 22, 3,120 kw vis.

Wawa

CBLAT-3—ch 9, 16 kw vis, 3.2 kw aur. Rebroadcasts CBLAT Geraldton.

Warton

CKCO-TV-2—ch 2, 100 kw vis, 13.5 kw aur. Rebroadcasts CKCO-TV Kitchener.

Windsor

CKGN-TV-1—ch 26, 218 kw vis. Rebroad-casts CKGN-TV Paris.

CBET—Licensed to Windsor. See Detroit.

Wingham

CKNX-TV—ch 8, 180 kw vis, 100 kw aur, ant 793t/623g. 1955. Wingham, NOG 2W0. (519) 357-1310. Telex: 069-5461. Licensee: CKNX Bcstg Ltd. ■ M. T. Brown, pres; R. Hamilton, gen mgr.

Prince Edward Island

Charlottetown

CBCT—ch 13, 62 kw vis, 12.4 kw aur, ant 771t/540g. 1968. Box 515, 430 Univer. Ave., C1A 7L1. (902) 892-3591. Telex: 014-44176. Licensee: CBC. ■ D. Gunn, gen mgr.

CKCW-TV-1—ch 8, 14.5 kw vis.

Quebec

Carleton

CHAU-TV—ch 5, 52.2 kw vis, 26.25 kw aur, ant 1543t/151g. 1959. CP 100, G0C 1J0. (418)

364-3344. Telex: 014-43126. Licensee: TV de la Baie des Chaleurs Inc. ■ Andre Lecomte, dir-gen; M. Chabot, asst dir gen & mgr.

Chicoutimi

CJPM-TV—ch 6, 61 kw vis, 6.7 kw aur, ant 440t/190g. April 14, 1963. Box 600. (418) 549-2576. Telex: 011-36132. Licensee: CJPM-TV Inc. Ownership: Paul Murdock, 50%; Tele Metropole, 50%. ■ TVA. Rep: Paul L'Anglais (Canada); E. Sumner (US). ■ Paul Murdock, pres; Claude Blain, gen & sls mgr; Roger Hudon, prog dir; G. Goulet, news & sports dir; Yves Champagne, chief engr. ■ On 6 CATV's—7,000 subs.

Hull

CFVO-TV—ch 30, 727 kw vis, 145 kw aur. 1974. 259 Boul. St. Joseph. (819) 778-2380. Telex 053-3629. Licensee: Cooperative de Television de L'Outaouais. ■ J. Desbiens, pres.

Iles-de-la-Madeleine

CBIMT—ch 12, 1.48 kw vis, .74 kw aur. Rebroadcasts CBHFT Halifax, N.S.

Jonquiere

CKRS-TV—ch 12, 20 kw vis, 10 kw aur, ant 311t/228g. 1955. 175 Sir Wilfrid Laurier St., G7X 7X3 (418) 542-4551. Telex: 011-36117. Licensee: Radio Saguenay Ltée. ■ CBC. Rep: Tele-Capitale/Unicom Ltd. ■ Herv'e Baribeau, pres; Tom Burham, gen mgr; Guy Gaudreault, gen sls mgr; Eugene Michaud, prog dir; Yvon Perron, stn mgr; Jean-Paul Tremblay, news dir; Gaetan Boivin, chief engr. ■ On 4 trans. Co-owned: CKRS(AM).

La Tuque

CBVT-2—ch 3, 15.4 kw vis, 1.54 kw aur. Rebroadcasts CBVT Quebec City.

Lithiums Mines

CJDG-TV—ch 8, 48.9 kw vis. Rebroadcasts CKRN-TV Rouyn.

Malartic

CFCL-TV-5—ch 5, 9.35 kw vis, 4.675 kw aur. Rebroadcasts CFCL-TV-2 Kearns, Ont.

Matane

CBGAT—ch 9, 153 kw vis, 92 kw aur, ant 2336t/114g. 155 St. Sacrement St. Box 218, G4W 3P7. (418) 562-0291. Telex: 0118-370. Licensee: CBC. ■ A. Giroux, loc mgr; J. Senecal, sls rep.

Mont-Laurier

CBFT-2—ch 3, 5.54 kw vis, 2.8 kw aur. Rebroadcasts CBFT Montreal.

Montreal

CBFT—ch 2, 100 kw vis, 10 kw aur, ant 905t/252g. 1952. Box 6000, 1400 Dorchester Blvd. E., H3C 3A8. (514) 285-3211. Telex: 052-67417. Licensee: CBC. ■ CBC. ■ J. M. Dugas, dir of TV; G. Fontaine, TV opns dir.

CBMT (Eng)—ch 6, 100 kw vis, 15 kw aur, ant 820t/167g. 1945. 1400 Dorchester Blvd. E., H3C 3A8. (514) 285-3211. Telex: 052-67417. Licensee: CBC. ■ CBC. ■ E. Koch, dir; D. Smith, dir of TV.

CFCF-TV(Eng)—ch 12, 325 kw vis, 160 kw aur, ant 9701/330g. January 1961. 405 Ogilvy Ave., H3N 1M4. (514) 273-6311. Telex: 05-826638. Licensee: Multiple Access Ltd. (acq 7-28-72). ■ CTV. Rep: Alexander, Pearson, Dawson (Canada); All-Canada (US). ■ D.W.G. Martz, stn mgr & senior VP; Lee Hambleton, VP bcstg & sls mgr; Bill Callender, prog dir & film buyer; Gail Morrell, prom mgr; Mike Donegan, news dir; J. E. Thompson, dir tech svcs. ■ Co-owned: CFCF(AM)-CFQR-FM.

CFTM-TV—ch 10, 325 kw vis, 160 kw aur, ant 9721/328g. 1405 Rue Alexandre-DeSeve, H2L 2V4. (514) 526-9251. Telex: 05-267329. Licensee: Tele-Metropole Corp. ■ TVA. ■ Robert L'Herbier, VP progs; Gaston W. Belanger, VP sls.

***CIVM-TV**—ch 17, 1,212 kw vis, 242 kw aur. 1975. 1000 Rue Fullum, H2K 3L7. (514) 893-4611. Licensee: Radio Quebec. ■ Y. Labonte, pres.

Quebec City

CBVT—ch 11, 173 kw vis, 34.6 kw aur, ant 6411/525g. 1964. Box 10400, G1V 2X2. (418) 656-9440. Telex: 011-286. Licensee: CBC. ■ CBC. ■ A.W. Johnson, pres; Jacques-Henri Gagnon, gen mgr; Bertrand Messely, sls mgr.

CFCM-TV—ch 4, 100 kw vis, 15 kw aur, ant 4601/407g. July 1954. Box 2026, G1K 7N2. (418) 688-9330. Telex: 011-234. Licensee: Tele-Capitale Ltee. ■ TVA. ■ Jean A. Pouliot, pres & mgng dir; France Fortin, exec VP; Rudy Stefanik, gen sls mgr; Paul Chamberland, prog dir & film buyer; Geraldine Ranger, publ & prom mgr; Louis Langlois, news dir; Gerald Fortin, chief engr.

***CIVQ-TV**—ch 15, 1,298 kw vis, 259 kw aur. 1975. See *CIVM-TV Montreal.

CKMI-TV—(Eng) ch 5, 1,385 kw vis, 6.77 kw aur, ant 4601/407g. 1957. Box 2026. (418) 688-9330. Telex: 011-234. Licensee: Tele-Capitale Ltee. ■ CBC. ■ Jean A. Pouliot, pres & mgng dir; Franz Fortin, exec VP.

Rimouski

CJBR-TV—ch 3, 49.3 kw vis, 9.9 kw aur, ant 9861/124g. 273 St. Jean Baptiste, Ouest. (418) 723-2217. Telex: 011-86343. Licensee: CJBR-TV Ltee. ■ Andre Mercier, pres; Walter Ruest, gen mgr; Roma Pelletier, sls mgr; Robert Theriault, chief engr.

Riviere-du-Loup

CKRT-TV—ch 7, 49 kw vis, 24.5 kw aur, ant 11561/200g. 1961. 1 Frontenac, G5R 1R7. (418) 862-8241. Telex: 011-3915. Licensee: CKRT-TV Ltee. ■ Luc Simard, pres & gen mgr.

Roberval

CKRS-TV-3—ch 8, 236 kw vis, .354 kw aur. Rebroadcasts CKRS-TV Jonquiere.

Rouyn

CKRN-TV—ch 4, 115 kw vis, 57.5 kw aur. 68 Gamble West, J9X 5A5. (819) 762-0741. Telex: 057-46526. Licensee: Northern Radio-Radio Nord Inc. ■ Rep: Tele-Capitale. ■ Alain Gourd, pres & gen mgr. ■ On 1 CATV.

Sept-Iles

CBST—ch 13, 8.4 kw. Licensee: CBC.

Sherbrooke

CHLT-TV—ch 7, 316 kw vis, 100 kw aur, ant 19201/106g. Aug. 12, 1956. 3330 ouest rue

King, J1L 1C9. (819) 569-9331. Telex: 05-836129. Licensee: CHLT Tele-7 Ltee. Ownership: Telemedia Comm Ltee. (acq 1970). ■ TVA. Rep: Opex; Paul L'Anglais. ■ Andre Mercier, pres; Gilles David, gen mgr; Normand Beauchamp, natl sts mgr; Jacques Marechal, local sls mgr; Denis Langlois, opns dir; Laurette Larocque, traffic mgr; Andre DeSeve, news & pub affrs dir; Pierre St. Marie, prog dir; Robert Theriault, chief engr.

CKSH-TV—ch 9, 325 kw vis, 57.9 kw aur. 1974. 2295 King West, J1J 3W7. (819) 563-9890. Telex: 05-836133. Licensee: Television St. Francois Inc. ■ H. Audet, pres; G. DeGagne, opns mgr.

Temiscaming

CBFST-2—ch 12, 7.08 kw vis, 1.416 kw aur. Rebroadcasts CBFST Sturgeon Falls, Ont.

Trois-Rivieres

CKTM-TV—ch 13, 325 kw vis, 65 kw aur, ant 16601/1085g. April 15, 1958; Box 277. (819) 375-7311. Telex: 05-837-137. Licensee: Television St. Maurice Inc. ■ CBC. Rep: All Canada. ■ Henri Audet, pres; Robert Bonneau, gen mgr; Gilles Dussault, sls mgr; Jean Brousseau, prog dir; Andre Duguet, news dir; Albert Aubichan, film buyer; Robert Bonneau, chief engr.

Saskatchewan

Carlyle Lake

CFSS-TV—ch 7, 55 kw vis, 8.8 kw aur.

Colgate

CKCK-TV-1—ch 12, 15.1 kw vis, 3.02 kw aur. Rebroadcasts CKCK-TV Regina.

Greenwater Lake

CKBI-TV-3—ch 4, 3 kw vis, 1.6 kw aur. Rebroadcasts CKBI-TV Prince Albert.

Marquis

CKMJ-TV—ch 7, 55.4 kw vis, 11.08 kw aur.

Melfort

CKBQ-TV—ch 2, 11.5 kw vis. Rebroadcasts CFQC-TV Saskatoon, and CKBI-TV Prince Albert.

Moose Jaw

CBKMT—ch 4, 48 kw vis, 25 kw aur, ant 7931/563g. 1969. 127 Main St. N. S6H 0V9. (306) 693-4683. Telex: 071-21190. Licensee: CBC. ■ G. Hurren, loc mgr; F. Sidwell, opns mgr.

North Battleford

CFQC-TV-2—ch 6, 5.6 kw vis, 1.1 kw aur. Rebroadcasts CFQC-TV Saskatoon.

Prince Albert

CKBI-TV—ch 5, 61 kw vis, 12.2 kw aur. 1958. 10th St. W. (306) 763-7421. Telex: 034-29132. Licensee: Ctr'l Bcstg Co. Ltd. ■ E. A. Rawlinson, pres & gen mgr; Ian Robertson, sls mgr.

Regina

CBKRT—ch 9, 140 kw vis, 75 kw aur, ant 6801/697.5g. 1969. 1840 McIntyre St., S4P 2R1.

Quebec, Saskatchewan TV

See page B-89 for explanation of listings.

(306) 523-6641. Telex: 071-2289. Licensee: CBC. ■ A.W. Johnson, pres; G. Hurren, mgr; W. Hudema, salesman; D. Browne-Wilkinson, prog dir; A. Small, PR off; W. Cameron, news dir; G. Goudie, chief engr. ■ Co-owned: CBK(AM).

CKCK-TV—ch 2, 100 kw vis, 20 kw aur, ant 5881/670g. 1971. Box 2000, S4P 3E5. (306) 523-6671. Telex: 071-2433. ■ Michael C. Sifton, pres; H. A. Crittenden, VP & mgng dir; Bruce Cowie, gen mgr; Gayle Robinson, sls mgr; Mel Friesen, prog mgr; Dorothy Donne, prom mgr; Frank Flegel, news dir; L. Westmoreland, asst mgr & programmer, Lorne McBride, chief engr. ■ Co-owned: CKCK(AM).

Saskatoon

CBKST—ch 11, 325 kw vis, 65 kw aur, ant 7861/600g. 503 CN Towers, S7K 1J5. (306) 244-1911. Telex: 074-2227. Licensee: CBC. ■ H. Garmen, stn mgr; D. Holtzman, sls mgr; D. Walder, opns mgr; A. Pressman, news dir; D. Walder, chief engr.

CFQC-TV—ch 8, 180 kw vis, 27 kw aur, ant minus 291/105g. 1954. 216 First Ave. N., S7K 3W3. (306) 242-6611. Telex: 074-2228. Licensee: CFQC Broadcasting Ltd. (acq 1972). ■ G. Blair Nelson, pres; E.W. Eadinger, gen mgr. ■ On 2 trans. Co-owned CFQC(AM).

Shaunavon

CBCP-TV-1—ch 7, 1,488 kw vis, .1488 kw aur. Rebroadcasts CJFB-TV Swift Current.

Stranraer

CBKST-1—ch 9, 35.2 kw vis, 7.05 kw aur.

CFQC-TV-1—ch 3, 6.8 kw vis, 1.02 kw aur. Rebroadcasts CFQC-TV Saskatoon.

Swift Current

CJFB-TV—ch 5, 13.3 kw vis, 6.65 kw aur, ant 5111/343g. 1957. Box 160. (306) 773-7266. Telex: 031-2119. Licensee: Swift Current Telecasting Co. Ltd. ■ William D. Forst, pres & gen mgr; Walter S. Buffam, sls mgr.

Willow Bunch

CBKMT-1—ch 10, 22.1 kw vis, 2.2 kw aur. Rebroadcasts CBKMT Moose Jaw.

CKCK-TV-2—ch 6, 9 kw vis, 1.8 kw aur. Rebroadcasts CKCK-TV Regina.

Wynyard

CHSS-TV—ch 6, 11 kw vis, 1.8 kw aur.

CICC-TV-1—ch 12, 25 kw vis. Rebroadcasts CICC-TV Yorkton.

Yorkton

CICC-TV—ch 10, 39.24 kw aur. 1974. Box 280, 95 E. Broadway, (306) 783-3688. Telex 074-21512. ■ R.L. Skinner, pres & gen mgr.

CKOS-TV—ch 3, 15 kw vis, 2.6 kw aur, ant 5341/525g. 1974. 95 E. Broadway, (306) 783-3688. Telex: 034-21512. Licensee: Yorkton TV Co. Ltd. ■ Ronal L. Skinner, pres & gen mgr; George Skinner, VP & asst gen mgr.

NWT, Yukon, Foreign TV U.S. TV Calls

Northwest Territories

Inuvik

CHAK-TV—ch 6, 3 kw vis, 300 w aur, ant 394t/303g, Box 1220. Licensee: CBC. ■ A.W. Johnson, pres; Nellie Cournoyea, gen mgr.

Pine Point

CBEET—ch 4, 7.9 kw vis, 1.4 kw aur. Licensee: CBC.

Foreign TV near the U.S.

Bermuda

ZFB-TV (ch. 8), Capitol Broadcasting Co., Box 652, Hamilton, 32.5 kw, Net.: ABC.
ZBM-TV (ch. 10), Bermuda Broadcasting Co. Ltd., Box 452, Hamilton, 20 kw, Net.: CBS.

British Virgin Islands

ZBTV (ch. 5) Tortola, West Indies Television Network, Television House, Philipsburg, St. Maarten, Neth. Antilles. 5 kw. Satellite of PJF-TV (ch. 3) St. Maarten.

Cuba

Cuba operates channels 2 (110 kw) and 6 (100 kw) from Havana.

Yellowknife

CFYK-TV—ch 8, 59.5 kw vis, 5.95 kw aur. Box 160, XOE 1H0 (403) 873-3464. Telex: 034-45517. Licensee: CBC. ■ Patrick Reilly, area mgr. ■ On 1 CATV.

Yukon Territory

Keno Hill

CBKHT—ch 13, 248 w. Licensee: CBC.

Whitehorse

CFWH-TV—ch 6, 300 w vis, 30 w aur, ant 1248t/100g. Licensee: CBC.

XHJMA Hidalgo del Parral, Chihuahua, 0.8 kw, ant. 98 ft.
XEFB Monterrey, Nuevo Leon, 100 kw, ant 956 ft.

Channel 4

XELN Torreon, Coahuila, 3.6 kw, ant. 128 ft.
XHIT Chihuahua, Chihuahua, 42.7 kw, ant. 89 ft.

Channel 5

XHAQ Mexicali, Baja Calif., 54.2 kw, ant. 304 ft.
XHFI Chihuahua, Chihuahua, 23.3 kw, ant. minus 254 ft.
XEJ Cd. Juarez, Chihuahua, 9.9 kw, ant 205 ft.
XHAE Saltillo, Coahuila, 3.6 kw, ant. 229 ft.

Channel 6

XETV Tijuana, Baja Calif., 100 kw, ant. 1163 ft.
XET Monterrey, Nuevo Leon, 80 kw, ant. 3204 ft.
XEWB Hermosillo, Sonora, 6.6 kw, ant. 170 ft.

Channel 7

XHAD Saltillo, Coahuila, 10.6 kw, ant. minus 506 ft.

Channel 8

XHBU Cd. Jimenez, Chihuahua, 800w.
XHUS Hermosillo, Sonora, 1 kw.

Channel 10

XHX Monterrey, Nuevo Leon, 329.5 kw, ant 196 ft.

Channel 11

XETT Chihuahua, Chihuahua, 0.2 kw, ant 121 ft.
XEDI Cd. Juarez, Chihuahua, 5 kw.
XHO Torreon, Coahuila, 10.9 kw, ant 303 ft.
XHBR Nuevo Laredo, Tamaulipas, 3.5 kw, ant 187 ft.

Channel 12

XEWT Tijuana, Baja Calif., 31.6 kw, ant 395 ft.
XHAW Monterrey, Nuevo Leon, 99.7 kw, ant minus 145 ft.
XHAK Hermosillo, Sonora, 8.2 kw, ant 85 ft.

Channel 23

XHS-TV Ensenada, Baja Calif., 2.8 kw.

The following Mexican TV stations, listed by channel, are located within 200 miles of the U.S. border.

Channel 2

XHCH Chihuahua, Chihuahua, 5.4 kw, ant 164 ft.
XEPM Cd. Juarez, Chihuahua, 9.4 kw, ant. 95 ft.
XHIA Torreon, Coahuila, 13.5 kw, ant. 567 ft.
XHIA Torreon, Coahuila, 13.5 kw, ant. 567 ft.
XHFA Nogales, Sonora, 0.8 kw, ant. minus 175 ft.
XHCR Matamoros, Tamaulipas, 3.6 kw, ant. 328 ft.
XEFE Nuevo Laredo, Tamaulipas, 21.4 kw, ant. 186 ft.

Channel 3

XHBC Mexicali, Baja Calif., 83.8 kw, ant. 525 ft.

Mexico

U.S. Television Stations by Call Letters

KAAL Austin, Minn.
KABC-TV Los Angeles, Calif.
KABY-TV Aberdeen, S.D.
KACB-TV San Angelo, Tex.
*KAET Phoenix, Ariz.
*KAFT Fayetteville, Ark.
*KAID Boise, Idaho
KAIJ-TV Wailuku, Hawaii
KAIL Fresno, Calif.
KAIT-TV Jonesboro, Ark.
KAJC-TV Stockton, Calif.
KAKE-TV Wichita, Kan.
*KAKM Anchorage, Alaska
KALB-TV Alexandria, La.
KAMR-TV Amarillo, Tex.
*KAMU-TV College Station, Tex.
KAPP Yakima, Wash.
KARD-TV Wichita, Kan.
KARK-TV Little Rock, Ark.
KATC Lafayette, La.
KATU Portland, Ore.
KATV Little Rock, Ark.
KAUZ-TV Wichita Falls, Tex.
KAVE-TV Carlsbad, N.M.
*KAVT-TV Austin, Minn.
KAVU Victoria, Tex.
KAYS-TV Hays, Kan.

KBAK-TV Bakersfield, Calif.
KBCI-TV Boise, Idaho
*KBGL-TV Pocatello, Idaho
*KBHE-TV Rapid City, S.D.
KBHK-TV San Francisco, Calif.
KBIM-TV Roswell, N.M.
KBIN Council Bluffs, Iowa
KBJR-TV Superior, Wis.
KBLU-TV Yuma, Ariz.
KBMA-TV Kansas City, Mo.
KBMT Beaumont, Tex.
KBSA Guasti, Calif.

KBSC-TV Corona, Calif.
KBTV Denver, Colo.
KBTX-TV Bryan, Tex.
*KBYU-TV Provo, Utah

KCAU-TV Sioux City, Iowa
KCBD-TV Lubbock, Tex.
KCBJ-TV Columbia, Mo.
KCBY-TV Coos Bay, Ore.
KCCI-TV Des Moines, Iowa
KCCN-TV Temple, Tex.
*KCET Los Angeles, Calif.
KCFW-TV Kalispell, Mont.
KCKT Great Bend, Kan.
KCMO-TV Kansas City, Mo.
KCOM-TV Santa Maria, Minn.
KCNB-TV Albion, Neb.
KCOP Los Angeles, Calif.
*KCOS El Paso, Tex.
KCOY-TV Santa Maria, Calif.
*KCRP Kansas City, Mo.
KCRB-TV Sacramento, Calif.
KCRG-TV Cedar Rapids, Iowa
KCRL-TV Reno, Nev.
*KCSM-TV San Mateo, Calif.
KCST-TV San Diego, Calif.
*KCTS-TV Seattle, Wash.
KCTV San Angelo, Tex.

KDAL-TV Duluth, Minn.
KDDB-TV El Paso, Tex.
KDCC-TV Midland, Tex.
KDFW-TV Dallas, Tex.
*KDIN-TV Des Moines, Iowa
KDIX-TV Dickinson, N.D.
KDKA-TV Pittsburgh, Pa.
KDLO-TV Florence, S.D.
KDNL-TV St. Louis, Mo.

KDOG-TV Houston, Tex.
*KDSD-TV Aberdeen, S.D.
KDSJ-TV Lead, S.D.
KDTV San Francisco, Calif.
KDUH-TV Dubuque, Iowa
KDUU-TV Hay Springs, Neb.

KECC-TV El Centro, Calif.
*KEDT Corpus Christi, Tex.
*KEET Eureka, Calif.
KEKO Okla, Nev.
KELO-TV Sioux Falls, S.D.
KELP-TV El Paso, Tex.
KEMO-TV San Francisco, Calif.
KENI-TV Anchorage, Alaska
KENS-TV San Antonio, Tex.
*KENW Portales, N.M.
KEPR-TV Pasco, Wash.
*KERA-TV Dallas, Tex.
KERO-TV Bakersfield, Calif.
*KESD-TV Brookings, S.D.
*KETA Oklahoma City, Okla.
*KETC-TV St. Louis, Mo.
*KETG Arkadelphia, Ark.
*KETS Little Rock, Ark.
KETV Omaha, Neb.
KEYC-TV Mankato, Minn.
KEYT Santa Barbara, Calif.
KEZI-TV Eugene, Ore.

KFAR-TV Fairbanks, Alaska
KFBB-TV Great Falls, Mont.
KFDA-TV Amarillo, Tex.
KFDH-TV Beaumont, Tex.
KFDO-TV Sayre, Okla.
KFDW-TV Clovis, N.M.
KFDX-TV Wichita Falls, Tex.
KFMB-TV San Diego, Calif.
*KFME Fargo, N.D.
KFPW-TV Fort Smith, Ark.

KFSM-TV Fort Smith, Ark.
KFSN-TV Fresno, Calif.
KFTV Hanford, Calif.
KFTY Santa Rosa, Calif.
KFVS-TV Cape Girardeau, Mo.
KFYR-TV Bismarck, N.D.

KGBT-TV Harlingen, Tex.
*KGFE Grand Forks, N.D.
KGGM-TV Albuquerque, N.M.
KGIN-TV Grand Island, Neb.
KGLD Garden City, Kan.
KGLO-TV Mason City, Iowa
KGNB-TV Honolulu, Hawaii
KGNB-TV Laredo, Tex.
KGO-TV San Francisco, Calif.
KGSC-TV San Jose, Calif.
*KGTG Agana, Guam
KGTU-TV Fayetteville, Ark.
KGTU San Diego, Calif.
KGUN-TV Tucson, Ariz.
KGVU-TV Missoula, Mont.
KGVU-TV Portland, Ore.

KHAS-TV Hastings, Neb.
KHAW-TV Hilo, Hawaii
*KHET Honolulu, Hawaii
KHGI-TV Kearney, Neb.
*KHIN Red Oak, Iowa
KHJ-TV Los Angeles, Calif.
*KHNE-TV Hastings, Neb.
KHOF-TV San Bernardino, Calif.
KHON-TV Honolulu, Hawaii
KHOU-TV Houston, Tex.
KHQ-TV Spokane, Wash.
KHQA-TV Hannibal, Mo.
KHSD-TV Lead, S.D.
KHSL-TV Chico, Calif.

KHTV Houston, Tex.
KHVO Hilo, Hawaii

KID-TV Idaho Falls, Idaho
*KIDZ-TV Wichita Falls, Tex.
KIEM-TV Eureka, Calif.
KIFI-TV Idaho Falls, Idaho
KIFW-TV Sitka, Alaska
KIII Corpus Christi, Tex.
*KIIN-TV Iowa City, Iowa
KIKU-TV Honolulu, Hawaii
KIMA-TV Yakima, Wash.
KIMO Anchorage, Alaska
KING-TV Seattle, Wash.
KINY-TV Juneau, Alaska
KIRO-TV Seattle, Wash.
KIRT-TV Honolulu, Hawaii
KIVA-TV Farmington, N.M.
KIVI Nampa, Idaho
*KIXE-TV Redding, Calif.

KJAC-TV Port Arthur, Tex.
KJEO Fresno, Calif.
KJOG-TV San Diego, Calif.
KJTV Bakersfield, Calif.

KKTU Colorado Springs, Colo.
KLA West Monroe, La.
KLAS-TV Las Vegas, Nev.
KLBK-TV Lubbock, Tex.
*KLCB-TV Los Angeles, Calif.
KLEW-TV Lewiston, Idaho
KLFY-TV Lafayette, La.
KLMN Fort Smith, Ark.
*KLINE-TV Lexington, Neb.
KLNI-TV Lafayette, La.
KLOC-TV Modesto, Calif.
KLOE-TV Goodland, Kan.
*KLRN San Antonio, Tex.
*KLTM Monroe, La.
KLVY Tyler, Tex.
*KLVX Las Vegas, Nev.
KLXA-TV Fontana, Calif.



1976 BROADCASTING Cable Sourcebook. Complete...Comprehensive...Most Up-to-Date Cable Source Available Anywhere. Completely redesigned and reset in modern, easy-to-read type faces, the **1976 Cable Sourcebook** contains a wealth of information—some of which cannot be found in any other publication. Exhaustively gleaned from FCC sources and mail questionnaires, the **1976 Cable Sourcebook** puts at your fingertips complete information on every operating system in the US and Canada. Here, for example, is just some of the important data you'll find for **one** operating system:
 —City, name of system, address, telephone number, name of local manager and chief technician, name of attorney and city location, service area, county TV market size, number of subscribers and homes passed, total homes in franchised area, start date, length of system, installation charges, monthly payment, franchise fee.
 —Also: total channel capacity, channel usage—broadcast TV, automated, access, other

local, technically unavailable and unused channels—and number of radio stations carried.
 —For TV stations carried: calls and city location, channel of broadcast, channel of carriage on cable with network, independent, ETV and foreign language stations also shown.
 —Origination: automated and non-automated with full description, including type of service, background FM radio calls with city of location, number of service hours.

Full Ownership Data—
 The **1976 BROADCASTING Cable Sourcebook** will contain two up-to-date ownership directories:
 —The MSO Directory lists all groups...the systems each group owns in full or part...names of corporate officers and directors.
 —The Broadcasters in Cable Directory shows those radio-TV companies or individual's owning cable systems in whole or in part, with ownership percentages...and includes addresses of both corporations and individuals.

A wealth of valuable data—

Whenever applicable, the **1976 Cable Sourcebook** shows, for each system:
 —Whether pay cable offered...with description of: channel of carriage, program supplier, type of program and hours per week, total current and potential pay subscribers, and monthly cost.
 —Type of local origination...access channels...and much more.
 —Advertising volume.

—Two-way capability.
 —Microwave common carrier.
 —Time, weather, news, sports, stock market and similar automated programming.

Additional Directories—

The **1976 Cable Sourcebook** will be a complete one-stop source of all available cable information. For in addition to all the above data, the **1976 Cable Sourcebook** will contain a cable equipment and

programming buyers guide, plus listings of: automated channel suppliers...billing services...brokers...consultants...financial services...pay cable services...PR and promotion firms...FCC rules...cable association...state and federal regulatory agencies.
 To obtain your own copy of the most complete and comprehensive cable guide now available, fill in the coupon and mail it today.

1976 BROADCASTING Cable Sourcebook

Please send _____ copies at \$10.00 each.
 (If payment with order: \$8.50 each)
 My \$_____ payment is enclosed Bill me later.

Name: two initials and last name
 1 2 3-16

Company Name
 17-35

Address
 36-53

City 54-66 State Zip Code 67-71

Home?
 Yes
 No

Title/Position

Broadcasting 1735 DeSales St., N.W., Washington, D.C. 20036

U.S. TV by Call Letters

KMAU-TV Wailuku, Hawaii
 KMBC-TV Kansas City, Mo.
 KMCC Lubbock, Tex.
 *KMEB Wailuku, Hawaii
 KMED-TV Medford, Ore.
 KMEG Sioux City, Iowa
 KMEX-TV Los Angeles, Calif.
 KMGH-TV Denver, Colo.
 KMID-TV Midland, Tex.
 KMIR-TV Palm Springs, Calif.
 KMJ-TV Fresno, Calif.
 *KMNE-TV Bassett, Neb.
 KMOL-TV San Antonio, Tex.
 KMOM-TV Monahans, Tex.
 KMOS-TV Sedalia, Mo.
 KMOT Minot, N.D.
 KMOX-TV St. Louis, Mo.
 KMPH Tulare, Calif.
 *KMPT Butte, Mont.
 KMSP-TV Minneapolis, Minn.
 KMST Monterey, Calif.
 KMTC Springfield, Mo.
 *KMTF Fresno, Calif.
 KMTV Omaha, Neb.
 KMUV-TV Sacramento, Calif.
 KMVI-TV Wailuku, Hawaii
 KMVT Twin Falls, Idaho
 KMXN-TV Albuquerque, N.M.

KNBC Los Angeles, Calif.
 *KNCT Belton, Tex.
 KNDO Yakima, Wash.
 KNDU Richland, Wash.
 *KNME-TV Albuquerque, N.M.
 KNMT Walker, Minn.
 KNOE-TV Monroe, La.
 KNOP-TV North Platte, Neb.
 KNTV San Jose, Calif.
 KNXT Los Angeles, Calif.
 KXNV-TV Phoenix, Ariz.

KOA-TV Denver, Colo.
 KOAA-TV Pueblo, Colo.
 *KOAC-TV Corvallis, Ore.
 KOAI Flagstaff, Ariz.
 KOAM-TV Pittsburg, Kan.
 *KOAP-TV Portland, Ore.
 KOAT-TV Albuquerque, N.M.
 KOB-TV Albuquerque, N.M.
 KOB Medford, Ore.
 *KOCE-TV Huntington Beach, Calif.
 KOCO-TV Oklahoma City, Okla.
 KODE-TV Joplin, Mo.
 *KOED-TV Tulsa, Okla.
 KOIN-TV Portland, Ore.
 *KOKH-TV Oklahoma City, Okla.
 KOLD-TV Tucson, Ariz.
 KOLN-TV Lincoln, Neb.
 KOLO-TV Reno, Nev.
 KOLR Springfield, Mo.
 KOMC McCook, Neb.
 KOMO-TV Seattle, Wash.
 KOMU-TV Columbia, Mo.
 KOOL-TV Phoenix, Ariz.
 KORK-TV Las Vegas, Nev.
 KORO Corpus Christi, Tex.
 KOSA-TV Odessa, Tex.
 KOTA-TV Rapid City, S.D.
 KOTI Klamath Falls, Ore.
 KOTV Tulsa, Okla.
 KOVR Stockton, Calif.
 *KOZK Springfield, Mo.

KPAX-TV Missoula, Mont.
 KPZ-TV Phoenix, Ariz.
 *KPBS-TV San Diego, Calif.
 *KPEC-TV Lakewood Center, Wash.
 KPHO-TV Phoenix, Ariz.
 KPIC Roseburg, Ore.
 KPXI San Francisco, Calif.

KPLC-TV Lake Charles, La.
 KPLM-TV Palm Springs, Calif.
 KPLO-TV Reliance, S.D.
 KPLR-TV St. Louis, Mo.
 *KPNE-TV North Platte, Neb.
 *KPOB-TV Poplar Bluff, Mo.
 KPRC-TV Houston, Tex.
 KPRY-TV Pierre, S.D.
 KPSA-TV Brownsville, Tex.
 *KPSD-TV Eagle Butte, S.D.
 *KPTS Hutchinson, Kan.
 KPTV Portland, Ore.
 KPUA-TV Hilo, Hawaii
 KPVI Pocatello, Idaho

*KQEC San Francisco, Calif.
 *KQED San Francisco, Calif.
 *KQSD-TV Lowry, S.D.
 KQTV St. Joseph, Mo.

KRBC-TV Abilene, Tex.
 KRCC Jefferson City, Mo.
 KRCR-TV Redding, Calif.
 KRDO-TV Colorado Springs, Colo.
 KREM-TV Spokane, Wash.
 KREX-TV Grand Junction, Colo.
 KREY-TV Montrose, Colo.
 KREZ-TV Durango, Colo.
 KRGV-TV Westlake, Tex.
 *KRIN Waterloo, Iowa
 KRIS-TV Corpus Christi, Tex.
 *KRMA-TV Denver, Colo.
 *KRNE-TV Merriman, Neb.
 KROC-TV Rochester, Minn.
 KRON-TV San Francisco, Calif.
 KRSD-TV Rapid City, S.D.
 KRTV Great Falls, Mont.
 *KRWG-TV Las Cruces, N.M.

KSAT-TV San Antonio, Tex.
 KSBW-TV Salinas, Calif.
 KSBY-TV San Luis Obispo, Calif.
 KSCI San Bernardino, Calif.
 KSD-TV St. Louis, Mo.
 KSFY-TV Sioux Falls, S.D.
 KSHO-TV Las Vegas, Nev.
 *KSN Sioux City, Iowa
 KSL-TV Salt Lake City, Utah
 KSLA-TV Shreveport, La.
 KSNB-TV Superior, Neb.
 *KSPS-TV Spokane, Wash.
 KSTF Scottsbluff, Neb.
 KSTP-TV St. Paul, Minn.
 KSTW Tacoma, Wash.
 KSWO-TV Lawton, Okla.
 KSW5-TV Roswell, N.M.
 *KSYS Medford, Ore.

KTAL-TV Texarkana, Tex.
 KTAR-TV Mesa, Ariz.
 KTBC-TV Austin, Tex.
 KTBS-TV Shreveport, La.
 *KTCA-TV St. Paul, Minn.
 *KTCT-TV St. Paul, Minn.
 KTCM Helena, Mont.
 *KTEH San Jose, Calif.
 *KTEJ Jonesboro, Ark.
 KTEW Tulsa, Okla.
 KTHI-TV Fargo, N.D.
 KTHV Little Rock, Ark.

KTIE Oxnard, Calif.
 KTIV Sioux City, Iowa
 KTLA Los Angeles, Calif.
 KTMA-TV Minneapolis, Minn.
 *KTNE-TV Alliance, Neb.
 *KTPS Tacoma, Wash.
 KTRF-TV Lufkin, Tex.
 KTRK-TV Houston, Tex.
 KTSB Topeka, Kan.
 *KTSC Pueblo, Colo.
 *KTSU-TV Pierre, S.D.
 KTSF-TV San Francisco, Calif.
 KTSM-TV El Paso, Tex.
 KTTV Los Angeles, Calif.
 KTUL-TV Tulsa, Okla.
 KTV Anchorage, Alaska
 KTVB Boise, Idaho
 KTVN Reno, Nev.
 KTVF Fairbanks, Alaska
 KTVH Hutchinson, Kan.
 KTVI St. Louis, Mo.
 KTVJ Joplin, Mo.
 KTVK Phoenix, Ariz.
 KTVM Butte, Mont.
 KTVN Reno, Nev.
 KTVQ Kirksville, Mo.
 KTVQ Billings, Mont.
 KTVS Sterling, Colo.
 KTVT Fort Worth, Tex.
 KTVU Oakland, Calif.
 KTVV Austin, Tex.
 KTVW Tacoma, Wash.
 KTVX Salt Lake City, Utah
 KTVY Oklahoma City, Okla.
 KTW-TV Casper, Wyo.
 *KTWU Topeka, Kan.
 KTXL Sacramento, Calif.
 KTXS-TV Sweetwater, Tex.
 *KTXT-TV Lubbock, Tex.

*KUAC-TV Fairbanks, Alaska
 KUAM-TV Agana, Guam
 *KUAT-TV Tucson, Ariz.
 *KUED Salt Lake City, Utah
 *KUHT Houston, Tex.
 *KUID-TV Moscow, Idaho
 KULR-TV Billings, Mont.
 KUMV-TV Williston, N.D.
 *KUON-TV Lincoln, Neb.
 KUPK-TV Garden City, Kan.
 *KUSD-TV Vermillion, S.D.
 KUTV Salt Lake City, Utah

KVAL-TV Eugene, Ore.
 *KVCN-TV San Bernardino, Calif.
 KVDO-TV Salem, Ore.
 KVEO-TV McAllen, Tex.
 KVEV Kennewick, Wash.
 KVFD-TV Fort Dodge, Iowa
 *KVIE Sacramento, Calif.
 KVII-TV Amarillo, Tex.
 KVIO-TV Eureka, Calif.
 KVOA-TV Tucson, Ariz.
 KVOF-TV San Francisco, Calif.
 KVOS-TV Bellingham, Wash.
 *KVST-TV Los Angeles, Calif.
 KVTV Laredo, Tex.
 KVUE Austin, Tex.
 KVVU-TV Henderson, Nev.

KWAB Big Spring, Tex.
 *KWCM-TV Appleton, Minn.
 KWEX-TV San Antonio, Tex.
 KWGN-TV Denver, Colo.
 KWHY-TV Los Angeles, Calif.
 KWNB-TV Hayes Center, Neb.

KWRB-TV Riverton, Wyo.
 *KWSU-TV Pullman, Wash.
 KWTV Oklahoma City, Okla.
 KWTX-TV Waco, Tex.
 KWWL-TV Waterloo, Iowa

KXAS-TV Fort Worth, Tex.
 KXGN-TV Glendive, Mont.
 KXII Ardmore, Okla.
 KXIX Victoria, Tex.
 KXJB-TV Valley City, N.D.
 KXLF-TV Butte, Mont.
 KXLY-TV Spokane, Wash.
 KXMB-TV Bismarck, N.D.
 KXMC-TV Minot, N.D.
 KXMD-TV Williston, N.D.
 *KXNE-TV Norfolk, Neb.
 KXON-TV Mitchell, S.D.
 KXTV Sacramento, Calif.
 KXTX-TV Dallas, Tex.

KYCU-TV Cheyenne, Wyo.
 *KYIN Mason City, Iowa
 *KYNE-TV Omaha, Neb.
 KYTV Springfield, Mo.
 *KYUK-TV Bethel, Alaska
 KYUS-TV Miles City, Mont.
 *KYVE-TV Yakima, Wash.
 KYW-TV Philadelphia, Pa.

KZAZ Nogales, Ariz.
 KZTV Corpus Christi, Tex.

WAAY-TV Huntsville, Ala.
 WABC-TV New York, N.Y.
 WABG-TV Greenwood, Miss.
 WABI-TV Bangor, Me.
 *WABW-TV Pelham, Ga.
 *WACS-TV Dawson, Ga.
 WAEO-TV Rhinelander, Wis.
 WAFB-TV Baton Rouge, La.
 WAGA-TV Atlanta, Ga.
 WAGM-TV Presque Isle, Me.
 WAIM-TV Anderson, S.C.
 *WAIQ Montgomery, Ala.
 WAKR-TV Akron, Ohio
 WALA-TV Mobile, Ala.
 WALB-TV Albany, Ga.
 WANC-TV Asheville, N.C.
 WAND Decatur, Ill.
 WANE-TV Fort Wayne, Ind.
 WAOW-TV Wausau, Wis.
 WAPA-TV San Juan, P.R.
 *WAPB Annapolis, Md.
 WAPI-TV Birmingham, Ala.
 WAPT Jackson, Miss.
 WAST Albany, N.Y.
 WATE-TV Knoxville, Tenn.
 WATL-TV Atlanta, Ga.
 WATR-TV Waterbury, Conn.
 WATU-TV Augusta, Ga.
 WAVE-TV Louisville, Ky.
 WAVY-TV Portsmouth, Va.

WBAL-TV Baltimore, Md.
 WBAY-TV Green Bay, Wis.
 WBBH-TV Fort Myers, Fla.
 WBBJ-TV Jackson, Tenn.
 WBBM-TV Chicago, Ill.
 WBEN-TV Buffalo, N.Y.
 WBFF Baltimore, Md.
 *WBGU-TV Bowling Green, Ohio
 *WBIQ Birmingham, Ala.
 WBIR-TV Knoxville, Tenn.
 WBJA-TV Binghamton, N.Y.
 WBKB-TV Alpena, Mich.
 WBKO Bowling Green, Ky.
 WBKG Birmingham, Ala.
 WBNB-TV Charlotte Amalie, V.I.
 WBNG-TV Binghamton, N.Y.

WBNS-TV Columbus, Ohio
 WBOC-TV Salisbury, Md.
 WBOY-TV Clarksburg, W. Va.
 *WBRA-TV Roanoke, Va.
 WBRC-TV Birmingham, Ala.
 WBRE-TV Wilkes-Barre, Pa.
 WBZ-TV Boston, Mass.

*WCAE St. John, Ind.
 WCAU-TV Philadelphia, Pa.
 WCAZ-TV Burlington, Vt.
 *WCCB Augusta, Me.
 WCBF-TV Charleston, S.C.
 WCBT-TV Columbus, Miss.
 WCBS-TV New York, N.Y.
 WCCB Charlotte, N.C.
 WCCO-TV Minneapolis, Minn.
 WDCD Adams, Mass.
 WCEE-TV Freeport, Ill.
 *WCES-TV Wrens, Ga.
 *WCET Cincinnati, Ohio
 *WCFE-TV Plattsburgh, N.Y.
 WCFL-TV Chicago, Ill.
 WCFT-TV Tuscaloosa, Ala.
 WCGV-TV Milwaukee, Wis.
 WCHS-TV Charleston, W. Va.

WCIA Champaign, Ill.
 *WCIQ Mt. Cheaha State Park, Ala.
 WCIU-TV Chicago, Ill.
 WCIV Charleston, S.C.
 WCIX-TV Miami, Fla.
 WCJB Gainesville, Fla.
 WCKT Miami, Fla.
 *WCLP-TV Chatsworth, Ga.
 WCMC-TV Wildwood, N.J.
 *WCML-TV Alpena, Mich.
 *WCMU-TV Mount Pleasant, Mich.
 *WCNY-TV Syracuse, N.Y.
 WCOV-TV Montgomery, Ala.
 *WCPB Salisbury, Md.
 WCPO-TV Cincinnati, Ohio
 WCSC-TV Charleston, S.C.
 WCSH-TV Portland, Me.
 *WCTE Cookeville, Tenn.
 WCTF Cleveland, Ohio
 WCTI-TV New Bern, N.C.
 WCTV Thomasville, Ga.
 WCVB-TV Boston, Mass.
 *WCVF-TV Richmond, Va.
 *WCVN Covington, Ky.
 *WCVW Richmond, Va.
 WCWB-TV Macon, Ga.
 WCYB-TV Bristol, Va.

WDAF-TV Kansas City, Mo.
 WDAM-TV Laurel, Miss.
 WDAU-TV Scranton, Pa.
 WDAY-TV Fargo, N.D.
 WDAZ-TV Devils Lake, N.D.
 WDBJ-TV Roanoke, Va.
 WDBO-TV Orlando, Fla.
 WDCA-TV Washington, D.C.
 *WDCN-TV Nashville, Tenn.
 *WDCO-TV Cochran, Ga.
 WDEF-TV Chattanooga, Tenn.
 WDHN Dothan, Ala.
 WDHO-TV Toledo, Ohio
 WDIO-TV Duluth, Minn.
 *WDIO Dozier, Ala.
 WDRB-TV Louisville, Ky.
 *WDSE-TV Duluth, Minn.
 WDSU-TV New Orleans, La.
 WDTB Panama City, Fla.

U.S. TV by Call Letters

WDTV Weston, W. Va.
WDXR-TV Paducah, Ky.

*WEAD Akron, Ohio
WEAR-TV Pensacola, Fla.
WEAU-TV Eau Claire, Wis.
*WEBA-TV Allendale, S.C.
WECT Wilmington, N.C.
*WEDB-TV Berlin, N.H.
*WEDH Hartford, Conn.
*WEDN Norwich, Conn.
*WEDU Tampa, Fla.
*WEDW Bridgeport, Conn.
*WEDY New Haven, Conn.
WEEK-TV Peoria, Ill.
WEHT Evansville, Ind.
*WEIQ Mobile, Ala.
*WEKW-TV Keene, N.H.
WEMT Bangor, Me.
*WENH-TV Durham, N.H.
WENY-TV Elmira, N.Y.
WESH-TV Daytona Beach, Fla.
*WETA-TV Washington, D.C.
*WETK Burlington, Vt.
*WETV Atlanta, Ga.
WEVU-TV Naples, Fla.
WEWS Cleveland, Ohio
WEYI-TV Saginaw, Mich.
WEZF-TV Burlington, Vt.

WFAA-TV Dallas, Tex.
WFBC-TV Greenville, S.C.
WFCB-TV Miami, Fla.
WFIE-TV Evansville, Ind.
*WFIQ Florence, Ala.
WFLA-TV Tampa, Fla.
WFLD-TV Chicago, Ill.
WFMJ-TV Youngstown, Ohio
WFMY-TV Greensboro, N.C.
WFRV-TV Green Bay, Wis.
WFSB-TV Hartford, Conn.
*WFSU-TV Tallahassee, Fla.
WFTV Orlando, Fla.
*WFIY Indianapolis, Ind.

WGAL-TV Lancaster, Pa.
WGAN-TV Portland, Me.
*WGBH-TV Boston, Mass.
*WGBX-TV Boston, Mass.
*WGBY-TV Springfield, Mass.
WGEM-TV Quincy, Ill.
WGS-TV Greenville, S.C.
WGHP-TV High Point, N.C.
*WGIQ Louisville, Ala.
WGN-TV Chicago, Ill.
WGNQ-TV New Orleans, La.
WGPR-TV Detroit, Mich.
WGR-TV Buffalo, N.Y.
*WGSF Newark, Ohio
WGSP-TV Washington, D.C.
*WGTE-TV Toledo, Ohio
WGTV Traverse City, Mich.
*WGTW Athens, Ga.
*WGVC Grand Rapids, Mich.

*WHA-TV Madison, Wis.
WHA-TV Atlanta, Ga.
WHAG-TV Hagerstown, Md.
WHAS-TV Louisville, Ky.
WHBF-TV Rock Island, Ill.
WHBO-TV Memphis, Tenn.
WHCT-TV Hartford, Conn.
WHCC-TV Rochester, N.Y.
*WHED-TV Hanover, N.H.
WHEN-TV Syracuse, N.Y.
WHFV Fredericksburg, Va.

WHIO-TV Dayton, Ohio
*WHIQ Huntsville, Ala.
WHIS-TV Bluefield, W. Va.
WHIZ-TV Zanesville, Ohio
WHKY-TV Hickory, N.C.
*WHLA-TV La Crosse, Wis.
WHMA-TV Annniston, Ala.
WHMB-TV Indianapolis, Ind.
*WHMM Washington, D.C.
WHNB-TV New Britain, Conn.
WHNT-TV Huntsville, Ala.
WHO-TV Des Moines, Iowa
WHP-TV Harrisburg, Pa.
*WHRM-TV Wausau, Wis.
*WHRO-TV Hampton, Va.
*WHRS-TV Boynton Beach, Fla.
WHTV Meridian, Miss.
*WHWC-TV Colfax, Wis.
WHYN-TV Springfield, Mass.
*WHYY-TV Wilmington, Del.

WIBW-TV Topeka, Kan.
WICD Champaign, Ill.
WICS Springfield, Ill.
WICU-TV Erie, Pa.
WICZ-TV Binghamton, N.Y.
WIIC-TV Pittsburgh, Pa.
WILL-TV Terre Haute, Ind.
*WIIQ Demopolis, Ala.
*WILL-TV Urbana, Ill.
WILX-TV Onondaga, Mich.
WINK-TV Fort Myers, Fla.
*WIPB Muncie, Ind.
*WIPM-TV Mayaguez, P.R.
*WIPR-TV San Juan, P.R.
WIRT Hibbing, Minn.
WIS-TV Columbia, S.C.
WISC-TV Madison, Wis.
WISH-TV Indianapolis, Ind.
WISN-TV Milwaukee, Wis.
*WITF-TV Hershey, Pa.
WITI-TV Milwaukee, Wis.
WITN Washington, N.C.
*WITV Charleston, S.C.

WJAC-TV Johnstown, Pa.
WJAN Canton, Ohio
WJAR-TV Providence, R.I.
WJBF Augusta, Ga.
WJBK-TV Detroit, Mich.
WJCL Savannah, Ga.
*WJCT Jacksonville, Fla.
WJET-TV Erie, Pa.
WJHG-TV Panama City, Fla.
WJHL-TV Johnson City, Tenn.
WJIM-TV Lansing, Mich.
WJKS-TV Jacksonville, Fla.
WJMN-TV Escanaba, Mich.
WJNL-TV Johnstown, Pa.
*WJPM-TV Florence, S.C.
WJRT-TV Flint, Mich.
*WJSP-TV Columbus, Ga.
WJTV Jackson, Miss.
WJW-TV Cleveland, Ohio
*WJWJ-TV Beaufort, S.C.
WJXT Jacksonville, Fla.
WJZ-TV Baltimore, Md.

WKAB-TV Montgomery, Ala.
WKAQ-TV San Juan, P.R.
*WKAR-TV East Lansing, Mich.
*WKAS Ashland, Ky.
WKBD-TV Detroit, Mich.
WKBM-TV Caguas, P.R.
WKBN-TV Youngstown, Ohio
WKBS-TV Burlington, N.J.

WKBT La Crosse, Wis.
WKBW-TV Buffalo, N.Y.
WKEF Dayton, Ohio
*WKGB Bowling Green, Ky.
*WKHA Hazard, Ky.
WKID Fort Lauderdale, Fla.
WKJG-TV Fort Wayne, Ind.
*WKLE Lexington, Ky.
*WKMA Madisonville, Ky.
*WKMJ Louisville, Ky.
*WKMR Morehead, Ky.
*WKMU Murray, Ky.
*WKNO-TV Memphis, Tenn.
*WKON Owenton, Ky.
WKOW-TV Madison, Wis.
*WKPC-TV Louisville, Ky.
*WKPI Pikeville, Ky.
WKPT-TV Kingsport, Tenn.
WKRC-TV Cincinnati, Ohio
WKRG-TV Mobile, Ala.
*WKSQ Somerset, Ky.
WKTU Utica, N.Y.
WKYC-TV Cleveland, Ohio
WKYH-TV Hazard, Ky.
WKYT-TV Lexington, Ky.
WKZO-TV Kalamazoo, Mich.
*WKZT Elizabethtown, Ky.

WLBTV Jackson, Miss.
WLBZ-TV Bangor, Me.
WLCY-TV Largo, Fla.
*WLED-TV Littleton, N.H.
WLEX-TV Lexington, Ky.
WLF1-TV Lafayette, Ind.
WLIO Lima, Ohio
*WLIW Garden City, N.Y.
*WLJT-TV Lexington, Tenn.
WLYK-TV Louisville, Ky.
WLOS-TV Asheville, N.C.
WLOX-TV Biloxi, Miss.
*WLPB-TV Baton Rouge, La.
*WLRN-TV Miami, Fla.
WLS-TV Chicago, Ill.
WLTV Miami, Fla.
WLUC-TV Marquette, Mich.
WLUK-TV Green Bay, Wis.
WLVA-TV Lynchburg, Va.
WLVI-TV Cambridge, Mass.
*WLVTV Allentown, Pa.
WLWC Columbus, Ohio
WLWD Dayton, Ohio
WLWT Cincinnati, Ohio
WLYH-TV Lancaster, Pa.

*WMAA Jackson, Miss.
*WMAA Mississippi State, Miss.
*WMAE Booneville, Miss.
*WMAH Biloxi, Miss.
WMAJ-TV Washington, D.C.
*WMAO Greenwood, Miss.
WMAQ-TV Chicago, Ill.
WMAR-TV Baltimore, Md.
*WMAU Bude, Miss.
*WMAV Oxford, Miss.
*WMAW Meridian, Miss.
WMAZ-TV Macon, Ga.
WMBD-TV Peoria, Ill.
WMC-TV Memphis, Tenn.
*WMEB-TV Orono, Me.
*WMED-TV Calais, Me.
*WMEG-TV Biddeford, Me.
*WMEM-TV Presque Isle, Me.
*WMFE-TV Orlando, Fla.
*WMHT Schenectady, N.Y.
*WMPB Baltimore, Md.
WMSH-TV South Bend, Ind.
WMT-TV Cedar Rapids, Iowa
WMTU-TV Memphis, Tenn.
WMTV Madison, Wis.
WMTW-TV Poland Spring, Me.
*WMUB-TV Oxford, Ohio
*WMUL-TV Huntington, W. Va.

WMUR-TV Manchester, N.H.
*WMVS Milwaukee, Wis.
*WMTV Milwaukee, Wis.

WNAC-TV Boston, Mass.
WNBC-TV New York, N.Y.
WNCT-TV Greenville, N.C.
WNBU-TV South Bend, Ind.
*WNED-TV Buffalo, N.Y.
WNEM-TV Bay City, Mich.
*WNEO-TV Alliance, Ohio
WNEP-TV Scranton, Pa.
*WNET Newark, N.J.
WNEW-TV New York, N.Y.
WNGE Nashville, Tenn.
*WNIN Evansville, Ind.
*WNIT-TV South Bend, Ind.
*WNJB New Brunswick, N.J.
*WNJM Montclair, N.J.
*WNJS Camden, N.J.
*WNJT Trenton, N.J.
WNJU-TV Linden, N.J.
WNOK-TV Columbia, S.C.
*WNPB Marquette, Mich.
*WNPE-TV Watertown, N.Y.
*WNPI-TV Norwood, N.Y.
*WNTV Greenville, S.C.
*WNVTV Goldvein, Va.
*WNYC-TV New York, N.Y.
*WNYE-TV New York, N.Y.
WNYSTV Syracuse, N.Y.

WOAY-TV Oak Hill, W. Va.
WOC-TV Davenport, Iowa
WOCA-TV Ocala, Fla.
*WOET-TV Kettering, Ohio
WOI-TV Ames, Iowa
WOKR Rochester, N.Y.
WOLE-TV Aguadilla, P.R.
WOLO-TV Columbia, S.C.
WONH Syracuse, N.Y.
WOPC Altoona, Pa.
WOR-TV New York, N.Y.
WORA-TV Mayaguez, P.R.
*WOSU-TV Columbus, Ohio
WOTV Grand Rapids, Mich.
*WOUB-TV Athens, Ohio
*WOUC-TV Cambridge, Ohio
WOWK-TV Huntington, W. Va.
WOWL-TV Florence, Ala.
WOWT Omaha, Neb.

WPBN-TV Traverse City, Mich.
*WPBO-TV Portsmouth, Ohio
*WPBT Miami, Fla.
WPCB-TV Pittsburgh, Pa.
WPEC West Palm Beach, Fla.
WPGH-TV Pittsburgh, Pa.
WPHL-TV Philadelphia, Pa.
WPIX New York, N.Y.
WPLG-TV Miami, Fla.
*WPNE Green Bay, Wis.
WPRI-TV Providence, R.I.
WPSD-TV Paducah, Ky.
*WPSX-TV Clearfield, Pa.
WPTA Roanoke, Ind.
WPTV West Palm Beach, Fla.
WPTZ North Pole, N.Y.
WPVI-TV Philadelphia, Pa.

WQAD-TV Moline, Ill.
*WQED Pittsburgh, Pa.
*WQEX Pittsburgh, Pa.
*WQLN Erie, Pa.
WQTV Boston, Mass.

WRAL-TV Raleigh, N.C.
WRAU-TV Peoria, Ill.
WRBL-TV Columbus, Ga.
WRBT Baton Rouge, La.

WRC-TV Washington, D.C.
WRCB-TV Chattanooga, Tenn.
WRDU-TV Durham, N.C.
WRDW-TV Augusta, Ga.
WREG-TV Memphis, Tenn.
WRET-TV Charlotte, N.C.
WREX-TV Rockford, Ill.
WREG-Schenectady, N.Y.
WRIK-TV Ponce, PR.
WRIP-TV Chattanooga, Tenn.
*WRJA-TV Sumter, S.C.
WRLH Lebanon, N.H.
*WRLK-TV Columbia, S.C.
WRLP Greenfield, Mass.
WRLU-TV Roanoke, Va.
WROC-TV Rochester, N.Y.
WRTV Indianapolis, Ind.

WSAU-TV Wausau, Wis.
WSAV-TV Savannah, Ga.
WSAZ-TV Huntington, W. Va.
WSB-TV Atlanta, Ga.
WSBA-TV York, Pa.
*WSBE-TV Providence R.I.
WSBK-TV Boston, Mass.
WSBT-TV South Bend, Ind.
WSTC Tallahassee, Fla.
WSEE Erie, Pa.
WSFA-TV Montgomery, Ala.
WSIL-TV Harrisburg, Ill.
*WSIU-TV Carbondale, Ill.
*WSJK-TV Sneedville, Tenn.
WSJW Elkhardt, Ind.
*WSKG Binghamton, N.Y.
WSLA Selma, Ala.
WSSL-TV Roanoke, Va.
WSM-TV Nashville, Tenn.
WSMW-TV Worcester, Mass.
WSNL-TV Patchogue, N.Y.
WSNS Chicago, Ill.
WSOC-TV Charlotte, N.C.
WSPA-TV Spartanburg, S.C.
WSPD-TV Toledo, Ohio
WSPRE Pensacola, Fla.
WSTE Fajardo, P.R.
WSTV-TV Sealeville, Ohio
WSUR-TV Ponce, PR.
WSVA-TV Harrisonburg, Va.
WSVI Christiansted, V.I.
*WSVN-TV Norton, Va.
WSWB-TV Orlando, Fla.
*WSWP-TV Grandview, W. Va.
WSYE-TV Elmira, N.Y.
WSYR-TV Syracuse, N.Y.

WTAE-TV Pittsburgh, Pa.
WTAF-TV Philadelphia, Pa.
WTAJ-TV Altoona, Pa.
WTAP-TV Parkersburg, W. Va.
WTAR-TV Norfolk, Va.
WTCC Atlanta, Ga.
*WTCL Chattanooga, Tenn.
WTCN-TV Minneapolis, Minn.
WTEN Albany, N.Y.
WTEV New Bedford, Mass.
WTHI-TV Terre Haute, Ind.
WTHR Indianapolis, Ind.
*WTHS-TV Miami, Fla.
*WTIU-TV Bloomington, Ind.
*WTJX-TV Charlotte Amalie, V.I.
WTLV Jacksonville, Fla.
WTMJ-TV Milwaukee, Wis.
WTNH-TV New Haven, Conn.
WTOC-TV Savannah, Ga.
WTOG St. Petersburg, Fla.
WTKO-TV Meridian, Miss.
WTLV-TV Toledo, Ohio
WTOM-TV Cheboygan, Mich.
WTOP-TV Washington, D.C.
WTPA Harrisburg, Pa.
WTRF-TV Wheeling, W. Va.
WTTG Washington, D.C.
WTTV Bloomington, Ind.
*WTTW Chicago, Ill.
WTVG Chattanooga, Tenn.
WTVY Durham, N.C.
WTVF Nashville, Tenn.

U.S., Canadian TV Calls; U.S. Channels

*WTVI Charlotte, N.C.
WTVJ Miami, Fla.
WTVK Knoxville, Tenn.
WTVM Columbus, Ga.
WTVN-TV Columbus, Ohio
WTVQ Rockford, Ill.
*WTVP Peoria, Ill.
WTVQ-TV Lexington, Ky.
WTVR Richmond, Va.
*WTVS Detroit, Mich.
WTVT Tampa, Fla.
WTVU New Haven, Conn.
WTVW Evansville, Ind.
WTVX Fort Pierce, Fla.
WTVY Dothan, Ala.
WTVU Terre Haute, Ind.
WTVW Tupelo, Miss.
WUAB Lorain, Ohio
*WUCM-TV University Center, Mich.
*WUFT Gainesville, Fla.
WUHQ-TV Battle Creek, Mich.
*WUHY-TV Philadelphia, Pa.
*WUNC-TV Chapel Hill, N.C.
*WUND-TV Columbia, N.C.
*WUNE-TV Linville, N.C.
*WUNF-TV Asheville, N.C.
*WUNG-TV Concord, N.C.
*WUNJ-TV Wilmington, N.C.
*WUNK-TV Greenville, N.C.
*WUNL-TV Winston-Salem, N.C.
*WUSF-TV Tampa, Fla.
*WUSI-TV Olney, Ill.
WUTR Utica, N.Y.
WUTV Buffalo, N.Y.
*WVAN-TV Savannah, Ga.
WVEC-TV Hampton, Va.
WVEO Aguadilla, PR.
*WVER Rutland, Vt.
*WVIA-TV Scranton, Pa.
WVIR-TV Charlottesville, Va.
*WVIZ-TV Cleveland, Ohio
*WVPT Staunton, Va.
*WVTA Windsor, Vt.
*WVTB St. Johnsbury, Vt.
WVTV Milwaukee, Wis.
WVUE New Orleans, La.
*WVUT Vincennes, Ind.
WVAY-TV Wilmington, N.C.
WVBT Richmond, Va.
WVJ-TV Detroit, Mich.
WVLT-TV New Orleans, La.
WVLD-TV Jackson, Mich.
WVLP Springfield, Mass.
WVNY-TV Carthage, N.Y.

*WWPB-TV Hagerstown, Md.
WVTV Cadillac, Mich.
WVUP-TV Sault Ste. Marie, Mich.
*WVVU-TV Morgantown, W. Va.
WXEX-TV Petersburg, Va.

*WXGA-TV Waycross, Ga.
WXIA-TV Atlanta, Ga.
WXII Winston-Salem, N.C.
WXIX-TV Newport, Ky.
WXLTV Sarasota, Fla.
WXNE-TV Boston, Mass.
WXON Detroit, Mich.
WXOW La Crosse, Wis.
WXTV Paterson, N.J.
*WXXI Rochester, N.Y.
*WXXW Chicago, Ill.
WXYZ-TV Detroit, Mich.

WYAH-TV Portsmouth, Va.
WYEA-TV Columbus, Ga.
*WYES New Orleans, La.
WYTV Youngstown, Ohio
WYUR Huntsville, Ala.
WZTV Nashville, Tenn.
WZZM-TV Grand Rapids, Mich.

*Noncommercial

CJCH-TV-1 Canning, N.S.
CJCH-TV-6 Caledonia, N.S.
CJCN-TV Grand Falls, Nfld.
CJDC-TV Dawson Creek, B.C.
CJDG-TV Lithium Mines, Que.
CJFB-TV Swift Current, Sask.
CJIC-TV Sault Ste. Marie, Ont.
CJOC-TV Lethbridge, Alta.
CJOH-TV Ottawa, Ont.
CJOH-TV-6 Deseronto, Ont.
CJOH-TV-8 Cornwall, Ont.
CJON-TV St. John's, Nfld.
CJOX-TV Argentina, Nfld.
CJOX-TV-1 Grand Bank, Nfld.
CJPM-TV Chicoutimi, Que.
CKAM-TV Upsalquitch Lake, N.B.

CKBI-TV Prince Albert, Sask.
CKBI-TV-3 Greenwater Lake, Sask.

CKBQ-TV Melfort, Sask.
CKCD-TV Campbellton, N.B.
CKCK-TV Regina, Sask.
CKCK-TV-1 Colgate, Sask.
CKCK-TV-2 Willow Bunch, Sask.

CKCO-TV Kitchener, Ont.
CKCO-TV-2 Warton, Ont.
CKCW-TV Moncton, N.B.
CKCW-TV-1 Charlottetown, P.E.I.

CKGN-TV Paris, Ont.
CKGN-TV-1 Windsor, Ont.
CKGN-TV-2 Bancroft, Ont.
CKGN-TV-6 Ottawa, Ont.
CKGN-TV-22 Uxbridge, Ont.
CKGN-TV-29 Sarnia, Ont.
CKLT-TV St. John, N.B.
CKMI-TV Quebec City, Que.
CKMJ-TV Marquis, Sask.
CKNC-TV Sudbury, Ont.
CKNC-TV-1 Elliott Lake, Ont.
CKND Winnipeg, Man.

CKNX-TV Wingham, Ont.
CKNY-TV North Bay, Ont.
CKOS-TV Yorkton, Sask.
CKPG-TV Prince George, B.C.
CKPR-TV Thunder Bay, Ont.
CKRD-TV Red Deer, Alta.
CKRD-TV-1 Coronation, Alta.
CKRN-TV Rouyn, Que.

CKRS-TV Jonquiere, Que.
CKRS-TV-3 Roberval, Que.
CKRT-TV Riviere du Loup, Que.
CKSA-TV Lloydminster, Alta.
CKSA-TV-2 Bonnyville, Alta.
CKSH-TV Sherbrooke, Que.
CKSO-TV Sudbury, Ont.
CKSO-TV-1 Elliott Lake, Ont.
CKSO-TV-2 Timmins, Ont.
CKSO-TV-3 Kearns, Ont.
CKTM-TV Trois Rivieres, Que.
CKVR-TV Barrie, Ont.
CKWS-TV Kingston, Ont.
CKX-TV Brandon, Man.
CKX-TV-1 Foxwarren, Man.
CKY-TV Winnipeg, Man.

Canadian TV by Calls

CBAT Moncton, N.B.
CBCP-TV-1 Shaunavon, Sask.
CBCT Charlottetown, P.E.I.
CBEST Pine Point, NWT
CBET Windsor, Ont.
CBFT Timmins, Ont.
CBFOT-1 Kapuskasing, Ont.
CBFOT-2 Hearst, Ont.
CBFST Sturgeon Falls, Ont.
CBFST-1 Sudbury, Ont.
CBFST-2 Temiscaming, Que.
CBFT Montreal, Que.
CBFT-2 Mont-Laurier, Que.
CBGAT Matane, Que.
CBHFT-1 Yarmouth, N.S.
CBHFT-2 Mulgrave, N.S.
CBHFT-3 Sydney, N.S.
CBHFT-4 Cheticamp, N.S.
CBHT Halifax, N.S.
CBHT-3 Yarmouth, N.S.
CBHT-4 Sheet Harbour, N.S.
CBIMT Iles-de-la-Madeleine, Que.

CBIT Sydney, N.S.
CBIT-1 Mulgrave, N.S.
CBIT-2 Halifax, N.S.
CBKHT Keno Hill, Yukon
CBKM-TV Moose Jaw, Sask.
CBKMT-1 Willow Bunch, Sask.
CBKRT Regina, Sask.
CBKST Saskatoon, Sask.
CBKST-1 Stranraer, Sask.
CBLAT Geraldton, Ont.
CBLAT-1 Manitowadge, Ont.
CBLAT-3 Wawa, Ont.
CBLAT-4 Marathon, Ont.
CBLFT Toronto, Ont.
CBLT Toronto, Ont.
CBMT Montreal, Que.
CBNAT Grand Falls, Nfld.
CBNAT-1 Baie Verte, Nfld.
CBNAT-4 St. Anthony, Nfld.
CBNAT-9 Mount St. Margaret, Nfld.
CBNT St. John's, Nfld.
CBNT-1 Port Rexton, Nfld.

CBNT-2 Placentia, Nfld.
CBNT-3 Marystown, Nfld.
CBOT Ottawa, Ont.
CBOT Ottawa, Ont.
CBRT Calgary, Alta.
CBST Sept Iles, Que.
CBUAT Trail, B.C.
CBUBT-1 Canal Flats, B.C.
CBUT Vancouver, B.C.
CBVT Quebec City, Que.
CBVT-2 La Tuque, Que.
CBWAT Kenora, Ont.
CBWBT Fin Flon, Man.
CBWCT Fort Frances, Ont.
CBWDT Dryden, Ont.
CBWFT Winnipeg, Man.
CBWGT Fisher Branch, Man.
CBWST Dauphin, Man.
CBWT Winnipeg, Man.
CBWT-2 Lac Du Bonnet, Man.
CBXAT Grande Prairie, Alta.
CBXAT-2 High Prairie, Alta.
CBXAT-3 Manning, Alta.
CBXFT Edmonton, Alta.
CBXT Edmonton, Alta.
CBXT-1 Athabasca, Alta.
CBXT-2 Whitecourt, Alta.
CBYT Corner Brook, Nfld.
CBYT-1 Stephenville, Nfld.
CBYT-3 Bonne Bay, Nfld.
CFAC-TV Calgary, Alta.
CFCF-TV Montreal, Que.
CFCL-TV Timmins, Ont.
CFCL-TV-2 Kearns, Ont.
CFCL-TV-5 Malaric, Que.
CFCM-TV Quebec City, Que.
CFCN-TV Calgary, Alta.
CFCN-TV-1 Drumheller, Alta.
CFCN-TV-5 Lethbridge, Alta.
CFJC-TV Kamloops, B.C.
CFNR-TV-1 Grande Prairie, Alta.
CFPL-TV London, Ont.
CFQC-TV Saskatoon, Sask.
CFQC-TV-1 Stranraer, Sask.
CFQC-TV-2 North Battleford, Sask.

CFRN-TV Edmonton, Alta.
CFRN-TV-2 Peace River, Alta.
CFRN-TV-3 Whitecourt, Alta.
CFRN-TV-4 Ashmont, Alta.
CFRN-TV-6 Red Deer, Alta.
CFSS-TV Carlyle Lake, Sask.
CFTK-TV Terrace, B.C.
CFMT-TV Montreal, Que.
CFTO-TV Toronto, Ont.
CFVO-TV Hull, Que.
CFWH-TV Whitehorse, Yukon
CFYK-TV Yellowknife, NWT
CHAK-TV Inuvik, NWT
CHAN-TV Vancouver, B.C.
CHAT-TV Medicine Hat, Alta.
CHAT-TV-1 Pivot, Alta.
CHAU-TV Carleton, Que.
CHCB-TV Kelowna, B.C.
CHCH-TV Hamilton, Ont.
CHEK-TV Victoria, B.C.
CHEX-TV Peterborough, Ont.
CHFC-TV Churchill, Man.
CHFD-TV Thunder Bay, Ont.
CHKM-TV Kamloops, B.C.
CHLT-TV Sherbrooke, Que.
CHMT-TV Moncton, N.B.
CHNB-TV North Bay, Ont.
CHOV-TV Pembroke, Ont.
CHSJ-TV St. John, N.B.
CHSJ-TV-1 Bon Accord, N.B.
CHSS-TV Wynyard, Sask.
*CICA-TV Toronto, Ont.
CICC-TV Yorkton, Sask.
CIFG-TV Prince George, B.C.
CISST-TV-1 Wynyard, Sask.
CITL-TV Lloydminster, Alta.
CITV-TV Edmonton, Alta.
CITY-TV Toronto, Ont.
CIVM-TV Montreal, Que.
CIVQ-TV Quebec City, Que.
CJAY-TV Brandon, Man.
CJBR-TV Rimouski, Que.
CJBR-TV-1 Edmundston, N.B.
CJCB-TV Sydney, N.S.
CJCB-TV-1 Inverness, N.S.
CJCB-TV-2 Antigonish, N.S.
CJCH-TV Halifax, N.S.

U.S. TV by Channel

Asterisk (*) indicates non-commercial.

Channel 2 (54-60 mhz)

*WDIQ Dozier, Ala.
KENI-TV Anchorage, Alaska
KFAR-TV Fairbanks, Alaska
KQAI Flagstaff, Ariz.
*KETS Little Rock, Ark.
KNXT Los Angeles, Calif.
KTUV Oakland, Calif.
KWGN-TV Denver, Colo.
WESH-TV Daytona Beach, Fla.
*WPBT Miami, Fla.
*WTHS-TV Miami, Fla.
WSB-TV Atlanta, Ga.
KHON-TV Honolulu, Hawaii
KBCI-TV Boise, Idaho
WBBM-TV Chicago, Ill.
WTVU Terre Haute, Ind.

WMT-TV Cedar Rapids, Iowa
KCKT Great Bend, Kan.
WBRZ Baton Rouge, La.
WLBZ-TV Bangor, Me.
WMAR-TV Baltimore, Md.
*WGBH-TV Boston, Mass.
WJBK-TV Detroit, Mich.
*KCTA-TV St. Paul, Minn.
*WMAB Mississippi State, Miss.
KQTV St. Joseph, Mo.
KTVI St. Louis, Mo.
KTVO Billings, Mont.
KNOP-TV North Platte, Neb.
KTVN Reno, Nev.
WGR-TV Buffalo, N.Y.
WCBS-TV New York, N.Y.
WKTV Utica, N.Y.
*WUND-TV Columbia, N.C.
WFMV-TV Greensboro, N.C.
KDX-TV Dickinson, N.D.

*KGFV Grand Forks, N.D.
WLWD Dayton, Ohio
KTEW Tulsa, Okla.
KOTI Klamath Falls, Ore.
KATU Portland, Ore.
KDKA-TV Pittsburgh, Pa.
WCBD-TV Charleston, S.C.
*KUSD-TV Vermillion, S.D.
*WSJK-TV Sneedville, Tenn.
WNGE Nashville, Tenn.
KPRC-TV Houston, Tex.
KMID-TV Midland, Tex.
KUTV Salt Lake City, Utah
KREM-TV Spokane, Wash.
WBAV-TV Green Bay, Wis.
KTWO-TV Casper, Wyo.
WKAQ-TV San Juan, PR.

Channel 3 (60-66 mhz)

KTVK Phoenix, Ariz.

KIEM-TV Eureka, Calif.
KCRA-TV Sacramento, Calif.
KEYT Santa Barbara, Calif.
KTVS Sterling, Colo.
WFSB-TV Hartford, Conn.
WEAR-TV Pensacola, Fla.
*WEDU Tampa, Fla.
WRBL-TV Columbus, Ga.
WSAV-TV Savannah, Ga.
KMAU-TV Wailuku, Hawaii
KID-TV Idaho Falls, Idaho
KLEW-TV Lewiston, Idaho
WCIA Champaign, Ill.
WSIL-TV Harrisburg, Ill.
KGLO-TV Mason City, Iowa
KARD-TV Wichita, Kan.
WAVE-TV Louisville, Ky.
KATC Lafayette, La.
KTBS-TV Shreveport, La.
WJMN-TV Escanaba, Mich.
WKZO-TV Kalamazoo, Mich.

KDAL-TV Duluth, Minn.
WLBT Jackson, Miss.
KTVO Kirksville, Mo.
KRTV Springfield, Mo.
KRTV Great Falls, Mont.
KYUS-TV Miles City, Mont.
*KLNE-TV Lexington, Neb.
KMTV Omaha, Neb.
KORK-TV Las Vegas, Nev.
*KENW Portales, N.M.
WSYR-TV Syracuse, N.Y.
WBTV Charlotte, N.C.
WVAY-TV Wilmington, N.C.
WKYC-TV Cleveland, Ohio
KVDO-TV Salem, Ore.
*WPSX-TV Clearfield, Pa.
KYW-TV Philadelphia, Pa.
KDLO-TV Florence, S.D.
KOTA-TV Rapid City, S.D.
WRCB-TV Chattanooga, Tenn.
WREG-TV Memphis, Tenn.

BOOKS FOR BROADCASTERS

500. Crosby, P: THE ART OF GETTING YOUR OWN SWEET WAY. Here is a book written for the person who realizes that we are all "managers of situations" and that how well we manage situations—including overcoming roadblocks set up by others—determines our success in business and personal life. Explains what situations are, how they affect us individually, and why it is important to resolve them according to the author's "Laws of Situation Management."
1972 192 pp. \$10.00

501. Sampson, R: HOW TO SURVIVE THE BUSINESS RAT RACE. The author offers a total program for the total man, showing the reader (1) how to survive in the business rat race, (2) how to reduce it where possible, and (3) how to survive beyond the business rat race. The book is solidly based on the findings of the behavioral sciences but written in a readable, down-to-earth manner.
1970 288 pp. \$6.50

502. Humble, J: MANAGEMENT BY OBJECTIVES IN ACTION. This practical source book of case material shows how Management By Objectives works in reality, and how it is evolving. Discusses difficulties in applying MBO in marketing and selling, and in research and development.
1970 320 pp. \$9.95

503. Blake, R and Mouton, J: THE GRID FOR SALES EXCELLENCE: Benchmarks for Effective Salesmanship. The "sales grid" is a set of theories about human relationships between salesmen and customers, and the authors demonstrate specifically how these theories apply to every step in the selling process: prospecting, the sales presentation, objections and complaints, maintaining and strengthening established accounts.
1970 256 pp. \$11.50

504. Koontz, H: APPRAISING MANAGERS AS MANAGERS. Here, from a leading practitioner, is a system of appraising managers as managers. It supplements the present programs of appraising managers by their performance against verifiable objectives. Effective managers must be able not only to perform in setting and achieving objectives, but also for their assurance of effectiveness over the long run, must be appraised on their quality of managing.
1971 200 pp. \$13.00

505. Levitt, T: MARKETING FOR BUSINESS GROWTH, 2nd Ed. In this new edition of *Marketing for Business Growth* (formerly titled *The Marketing Mode*) the author presents a money-making view of the whole business operation. Included are many ingeniously practical schemes that show how to foresee important trends, how to influence them, and how to make them yield the greatest gains.
1974 288 pp. \$11.50

506. Lewis, H: THE BUSINESSMAN'S GUIDE TO ADVERTISING AND SALES PROMOTION. This six-chapter "how-to" book emphasizes the practical application of professional advertising rules by the retailer or small businessman who must prepare an advertising campaign without the benefit of an agency. There is no other manual available which looks at advertising, sales promotion, and positive communications from the small businessman's vantage point of cost control, budget, media selection, and production problems.
1974 224 pp. \$6.95

507. Margerison, C: MANAGERIAL PROBLEM SOLVING. This down-to-earth approach to managerial problem-solving; the process of talking with others in groups of varying size in order to resolve difficulties, outlines the principles of the process and the nature and content of problem-solving sessions. Case studies included illustrate problem-solving in the worlds of production, marketing, finance, and many others.
1975 176 pp. \$9.95

508. Keefe, W: LISTEN, MANAGEMENT! Creative Listening for Better Managing. Dedicated to better communication and more profitable enterprise, this book shows how to communicate well so that the business of the organization will get done more quickly, more efficiently, with less problems and difficulty.
1971 224 pp. \$11.50

509. Jennings, E: ROUTES TO THE EXECUTIVE SUITE. Based on first-hand research into the changing patterns of executive advancement in industry, and drawing on experience in the nation's 100 largest corporations, Dr. Jennings shows that the routes to the top are many and that the last decade has produced new avenues of advancement and a new breed of executive.
1971 288 pp. \$9.95

Broadcasting Book Division

1735 DeSales Street, N.W. Washington, D.C. 20036

Send me the books whose numbers I've indicated. Payment for the full amount is enclosed.

Name _____

Address _____

MT City _____ State _____ Zip _____

Book No. Price

Postage and Handling 75¢

Total \$ _____

U.S. TV by Channel

KBTX-TV Bryan, Tex.
 KIII Corpus Christi, Tex.
 KACB-TV San Angelo, Tex.
 KFDX-TV Wichita Falls, Tex.
 WCAX-TV Burlington, Vt.
 WSWA-TV Harrisonburg, Va.
 WTAR-TV Norfolk, Va.
 WSAZ-TV Huntington, W. Va.
 WISC-TV Madison, Wis.
 *WIPM-TV Mayaguez, PR.

Channel 4 (66-72 mhz)

WTVY Dothan, Ala.
 *KYUK-TV Bethel, Ark.
 KVOA-TV Tucson, Ariz.
 KARK-TV Little Rock, Ark.
 KNBC Los Angeles, Calif.
 KRON-TV San Francisco, Calif.
 KOA-TV Denver, Colo.
 WRC-TV Washington, D.C.
 WJXT Jacksonville, Fla.
 WTVJ Miami, Fla.
 KITV Honolulu, Hawaii
 *KAID Boise, Idaho
 WHBF-TV Rock Island, Ill.
 WTTV Bloomington, Ind.
 KTIV Sioux City, Iowa
 WWL-TV New Orleans, La.
 WBZ-TV Boston, Mass.
 WTOM-TV Cheboygan, Mich.
 WWJ-TV Detroit, Mich.
 WCCO-TV Minneapolis, Minn.
 WCBI-TV Columbus, Miss.
 WDAF-TV Kansas City, Mo.
 KMOX-TV St. Louis, Mo.
 KXLF-TV Butte, Mont.
 KDUH-TV Hay Springs, Neb.
 KSNB-TV Superior, Neb.
 KCRL-TV Reno, Nev.
 KOB-TV Albuquerque, N.M.
 WBEN-TV Buffalo, N.Y.
 WNBC-TV New York, N.Y.
 *WUNC-TV Chapel Hill, N.C.
 KXJB-TV Valley City, N.D.
 WLWC Columbus, Ohio
 KTVY Oklahoma City, Okla.
 KPIC Roseburg, Ore.
 WTAE-TV Pittsburgh, Pa.
 WCIV Charleston, S.C.
 WFBC-TV Greenville, S.C.
 KRPY-TV Pierre, S.D.
 WSM-TV Nashville, Tenn.
 KAMR-TV Amarillo, Tex.
 KWAB Big Spring, Tex.
 KDFW-TV Dallas, Tex.
 KDBC-TV El Paso, Tex.
 KGBT-TV Harlingen, Tex.
 KJAC-TV Port Arthur, Tex.
 KMOL-TV San Antonio, Tex.
 KTVX Salt Lake City, Utah
 KOMO-TV Seattle, Wash.
 KXLY-TV Spokane, Wash.
 WOAY-TV Oak Hill, W. Va.
 WTMJ-TV Milwaukee, Wis.
 WAPA-TV San Juan, PR.

Channel 5 (76-82 mhz)

WKRQ-TV Mobile, Ala.
 KPHO-TV Phoenix, Ariz.
 KFSM-TV Fort Smith, Ark.
 KTLA Los Angeles, Calif.
 KPX San Francisco, Calif.
 KREX-TV Grand Junction, Colo.
 KOAA-TV Pueblo, Colo.
 WTTG Washington, D.C.
 *WUFT Gainesville, Fla.
 WPTV West Palm Beach, Fla.
 WAGA-TV Atlanta, Ga.
 WMAQ-TV Chicago, Ill.
 WOI-TV Ames, Iowa
 KALB-TV Alexandria, La.
 WABI-TV Bangor, Me.

WCVB-TV Boston, Mass.
 WNEM-TV Bay City, Mich.
 KSTP-TV St. Paul, Minn.
 KCMO-TV Kansas City, Mo.
 KSD-TV St. Louis, Mo.
 KXGN-TV Glendive, Mont.
 KFBB-TV Great Falls, Mont.
 KHAS-TV Hastings, Neb.
 KVVU-TV Henderson, Nev.
 *KNME-TV Albuquerque, N.M.
 WNEW-TV New York, N.Y.
 WPTZ North Pole, N.Y.
 WHEN-TV Syracuse, N.Y.
 WRAL-TV Raleigh, N.C.
 KFYY-TV Bismarck, N.D.
 WLWT Cincinnati, Ohio
 WEWS Cleveland, Ohio
 KOCO-TV Oklahoma City, Okla.
 KOBI Medford, Ore.
 WCSC-TV Charleston, S.C.
 KDSJ-TV Lead, S.D.
 KXON-TV Mitchell, S.D.
 WMC-TV Memphis, Tenn.
 WTVF Nashville, Tenn.
 KXAS-TV Fort Worth, Tex.
 *KTXI-TV Lubbock, Tex.
 KENS-TV San Antonio, Tex.
 KRGV-TV Westaco, Tex.
 KSL-TV Salt Lake City, Utah
 WCYB-TV Bristol, Va.
 KING-TV Seattle, Wash.
 WDTV Weston, W. Va.
 WFRV-TV Green Bay, Wis.
 KYCU-TV Cheyenne, Wyo.
 WORA-TV Mayaguez, PR.

Channel 6 (82-88 mhz)

WBRC-TV Birmingham, Ala.
 *KUAT-TV Tucson, Ariz.
 KVIQ-TV Eureka, Calif.
 *KVIE Sacramento, Calif.
 KSBY-TV San Luis Obispo, Calif.
 *KRMA-TV Denver, Colo.
 KREZ-TV Durango, Colo.
 WCIX-TV Miami, Fla.
 WDBO-TV Orlando, Fla.
 WJBF Augusta, Ga.
 WCTV Thomasville, Ga.
 KIVI Nampa, Idaho
 KPVI Pocatello, Idaho
 WRTV Indianapolis, Ind.
 WOC-TV Davenport, Iowa
 KTVX Ensign, Kan.
 WPSD-TV Paducah, Ky.
 WDSU-TV New Orleans, La.
 WCSH-TV Portland, Me.
 WTEV New Bedford, Mass.
 *WCML-TV Alpena, Mich.
 WJIM-TV Lansing, Mich.
 WLUC-TV Marquette, Mich.
 KAAL Austin, Minn.
 WABG-TV Greenwood, Miss.
 KMOS-TV Sedalia, Mo.
 KTVM Butte, Mont.
 KWNB-TV Hayes Center, Neb.
 WOWT Omaha, Neb.
 KAVE-TV Carlsbad, N.M.
 WRGB Schenectady, N.Y.
 WECT Wilmington, N.C.
 WDAY-TV Fargo, N.D.
 WTVN-TV Columbus, Ohio
 KOTV Tulsa, Okla.
 KOIN-TV Portland, Ore.
 WJAC-TV Johnstown, Pa.
 WPVI-TV Philadelphia, Pa.
 KPLO-TV Reliance, S.D.
 WATE-TV Knoxville, Tenn.
 KFDM-TV Beaumont, Tex.
 KRIS-TV Corpus Christi, Tex.
 KCEN-TV Temple, Tex.
 KTAJ-TV Texarkana, Tex.
 KAUZ-TV Wichita Falls, Tex.
 WTVR Richmond, Va.
 KHQ-TV Spokane, Wash.
 WHIS-TV Bluefield, W. Va.
 WITI-TV Milwaukee, Wis.
 KBJR-TV Superior, Wis.
 *WIPR-TV San Juan, PR.

Channel 7 (174-180 mhz)

*WCIQ Mount Cheaha State Park, Ala.
 *KAKM Anchorage, Alaska
 KATV Little Rock, Ark.
 KABC-TV Los Angeles, Calif.
 KRCR-TV Redding, Calif.
 KGO-TV San Francisco, Calif.
 KMGH-TV Denver, Colo.
 WMAL-TV Washington, D.C.
 *WJCT Jacksonville, Fla.
 WCKT Miami, Fla.
 WJHG-TV Panama City, Fla.
 KAH-TV Wailuku, Hawaii
 KTVB Boise, Idaho
 WLS-TV Chicago, Ill.
 WTVW Evansville, Ind.
 KWVL-TV Waterloo, Iowa
 KKYV-TV Hays, Kan.
 KOAM-TV Pittsburg, Kan.
 KPLC-TV Lake Charles, La.
 WEMT Bangor, Me.
 WNAC-TV Boston, Mass.
 WXYZ-TV Detroit, Mich.
 WPBN-TV Traverse City, Mich.
 KCMT Alexandria, Minn.
 WDMAM-TV Laurel, Miss.
 KHQA-TV Hannibal, Mo.
 *KMPT Butte, Mont.
 *KMNE-TV Bassett, Neb.
 KETV Omaha, Neb.
 KOAT-TV Albuquerque, N.M.
 WKBW-TV Buffalo, N.Y.
 WNNY-TV Carthage, N.Y.
 WABC-TV New York, N.Y.
 WITN Washington, N.C.
 WHIO-TV Dayton, Ohio
 KSWO-TV Lawton, Okla.
 *KOAC-TV Corvallis, Ore.
 *WITV Charleston, S.C.
 WSPA-TV Spartanburg, S.C.
 KRSD-TV Rapid City, S.D.
 WBBJ-TV Jackson, Tenn.
 KVII-TV Amarillo, Tex.
 KTBC-TV Austin, Tex.
 KCOS El Paso, Tex.
 KOSA-TV Odessa, Tex.
 KLTV Tyler, Tex.
 *KUED Salt Lake City, Utah
 WDBJ-TV Roanoke, Va.
 KIRO-TV Seattle, Wash.
 *KSPS-TV Spokane, Wash.
 WTRF-TV Wheeling, W. Va.
 WSAU-TV Wausau, Wis.
 WRIR-TV Ponce, PR.

Channel 8 (180-186 mhz)

WLSA Selma, Ala.
 KINY-TV Juneau, Alaska
 *KAET Phoenix, Ariz.
 KAIT-TV Jonesboro, Ark.
 KSBW-TV Salinas, Calif.
 KFMB-TV San Diego, Calif.
 *KTSC Pueblo, Colo.
 WTNH-TV New Haven, Conn.
 WFLA-TV Tampa, Fla.
 *WGTV Athens, Ga.
 *WXGA-TV Waycross, Ga.
 KIFI-TV Idaho Falls, Idaho
 *WSIU-TV Carbondale, Ill.
 WQAD-TV Moline, Ill.
 WISH-TV Indianapolis, Ind.
 KCCI-TV Des Moines, Iowa
 *KPTS Hutchinson, Kan.
 KNOE-TV Monroe, La.
 WVUE New Orleans, La.
 WMTW-TV Poland Spring, Me.
 WAGM-TV Presque Isle, Me.
 WOTV Grand Rapids, Mich.
 *WDESE-TV Duluth, Minn.
 KOMU-TV Columbia, Mo.
 KULR-TV Billings, Mont.
 KPAX-TV Missoula, Mont.
 KCNA-TV Albion, Neb.
 KOMC McCook, Neb.
 KLAS-TV Las Vegas, Nev.
 KOLQ-TV Reno, Nev.
 KSWL-TV Roswell, N.M.
 WROC-TV Rochester, N.Y.
 WGHPT-TV High Point, N.C.
 WDAZ-TV Devils Lake, N.D.
 KUMV-TV Williston, N.D.

WJW-TV Cleveland, Ohio
 KFDO-TV Sayre, Okla.
 KTUL-TV Tulsa, Okla.
 KSYS Medford, Ore.
 KGW-TV Portland, Ore.
 WGAL-TV Lancaster, Pa.
 *KESD-TV Brookings, S.D.
 *WDCN-TV Nashville, Tenn.
 WFAA-TV Dallas, Tex.
 *KUHT Houston, Tex.
 KGNS-TV Laredo, Tex.
 KCTV San Angelo, Tex.
 WXEX-TV Petersburg, Va.
 WCHS-TV Charleston, W. Va.
 WKBT La Crosse, Wis.
 KUAM-TV Agana, Guam
 WSVI Christiansted, VI.

Channel 9 (186-192 mhz)

*KUAC-TV Fairbanks, Alaska
 KGUN-TV Tucson, Ariz.
 *KETG Arkadelphia, Ark.
 KECC-TV El Centro, Calif.
 KHJ-TV Los Angeles, Calif.
 *KIXE-TV Redding, Calif.
 *KQED San Francisco, Calif.
 KBTU Denver, Colo.
 WTOP-TV Washington, D.C.
 WFTV Orlando, Fla.
 WTVM Columbus, Ga.
 *WVAN-TV Savannah, Ga.
 KPUA-TV Hilo, Hawaii
 KGMB-TV Honolulu, Hawaii
 WGN-TV Chicago, Ill.
 *WNIN Evansville, Ind.
 KCRG-TV Cedar Rapids, Iowa
 KCAU-TV Sioux City, Iowa
 WAFB-TV Baton Rouge, La.
 WWTW Cadillac, Mich.
 CBET Windsor, Ontario
 KMSP-TV Minneapolis, Minn.
 WTWV Tupelo, Miss.
 KMBC-TV Kansas City, Mo.
 *KETC-TV St. Louis, Mo.
 KCFW-TV Kalispell, Mont.
 *KPNE-TV North Platte, Neb.
 WMUR-TV Manchester, N.H.
 WOR-TV New York, N.Y.
 WNYX-TV Syracuse, N.Y.
 WSOCT-TV Charlotte, N.C.
 WNCT-TV Greenville, N.C.
 WCPO-TV Cincinnati, Ohio
 WSTV-TV Steubenville, Ohio
 KWTV Oklahoma City, Okla.
 KEZI-TV Eugene, Ore.
 KABY-TV Aberdeen, S.D.
 *KBHE-TV Rapid City, S.D.
 WTVX Chattanooga, Tenn.
 KRBC-TV Abilene, Tex.
 KTSM-TV El Paso, Tex.
 KTRE-TV Lufkin, Tex.
 KMOM-TV Monahans, Tex.
 *KLRM San Antonio, Tex.
 *KCTS-TV Seattle, Wash.
 *WSWP-TV Grandview, W. Va.
 WAOW-TV Wausau, Wis.
 WSUR-TV Ponce, PR.

Channel 10 (192-198 mhz)

*WBIQ Birmingham, Ala.
 WALA-TV Mobile, Ala.
 KOOL-TV Phoenix, Ariz.
 KTYE El Dorado, Ark.
 KXTV Sacramento, Calif.
 KGTV San Diego, Calif.
 KREY-TV Montrose, Colo.
 WLCY-TV Largo, Fla.
 WPLG-TV Miami, Fla.
 WALB-TV Albany, Ga.
 *KMEB Wailuku, Hawaii
 *KBAJ-TV Pocatello, Idaho
 WGEN-TV Quincy, Ill.
 WTHI-TV Terre Haute, Ind.
 KLOE-TV Goodland, Kan.
 KAKE-TV Wichita, Kan.
 KLFY-TV Lafayette, La.
 *WCBB Augusta, Me.

*WMEM-TV Presque Isle, Me.
 WILX-TV Onondaga, Mich.
 WWUP-TV Sault Ste. Marie, Mich.
 *KWCM-TV Appleton, Minn.
 WDOI-TV Duluth, Minn.
 KROC-TV Rochester, Minn.
 KOLR Springfield, Mo.
 KOLN-TV Lincoln, Neb.
 KSTF Scottsbluff, Neb.
 KEKO Elk, Nev.
 *KLVX Las Vegas, Nev.
 KBIM-TV Roswell, N.M.
 WEN Albany, N.Y.
 WHEC-TV Rochester, N.Y.
 KMOT Minot, N.D.
 WBNS-TV Columbus, Ohio
 KTEN Ada, Okla.
 KMED-TV Medford, Ore.
 *KOAP-TV Portland, Ore.
 WTAJ-TV Altoona, Pa.
 WCAU-TV Philadelphia, Pa.
 WJAR-TV Providence, R.I.
 WIS-TV Columbia, S.C.
 *KTSJ-TV Pierre, S.D.
 WBIR-TV Knoxville, Tenn.
 *WKNO-TV Memphis, Tenn.
 KFDA-TV Amarillo, Tex.
 KZTV Corpus Christi, Tex.
 KWTV-TV Waco, Tex.
 WAVY-TV Portsmouth, Va.
 WSLV-TV Roanoke, Va.
 *KWSU-TV Pullman, Wash.
 *WMVS Milwaukee, Wis.
 KWRB-TV Riverton, Wyo.
 WBNB-TV Charlotte Amalie, VI.

Channel 11 (198-204 mhz)

KTVK Anchorage, Alaska
 KTVF Fairbanks, Alaska
 KZAZ Nogales, Ariz.
 KTHV Little Rock, Ark.
 KTTV Los Angeles, Calif.
 KNTV San Jose, Calif.
 KKTU Colorado Springs, Colo.
 WINK-TV Fort Myers, Fla.
 *WFSU-TV Tallahassee, Fla.
 WXA-TV Atlanta, Ga.
 WTOG-TV Savannah, Ga.
 KHAW-TV Hilo, Hawaii
 *KHET Honolulu, Hawaii
 KMVT Twin Falls, Idaho
 *WTTW Chicago, Ill.
 *KDIN-TV Des Moines, Iowa
 KGLD Garden City, Kan.
 *KTWU Topeka, Kan.
 WHAS-TV Louisville, Ky.
 WBAL-TV Baltimore, Md.
 KRBC-TV Alpena, Mich.
 WTCN-TV Minneapolis, Minn.
 WTKO-TV Meridian, Miss.
 KPLR-TV St. Louis, Mo.
 KGIN-TV Grand Island, Neb.
 *WENH-TV Durham, N.H.
 WPX New York, N.Y.
 WTVD Durham, N.C.
 KTHI-TV Fargo, N.D.
 KXMD-TV Williston, N.D.
 WTLQ-TV Toledo, Ohio
 *KOED-TV Tulsa, Okla.
 KCBY-TV Coos Bay, Ore.
 WIIC-TV Pittsburgh, Pa.
 KHSD-TV Lead, S.D.
 *KQSD-TV Lowry, S.D.
 KELO-TV Sioux Falls, S.D.
 WJHL-TV Johnson City, Tenn.
 *WJLT-TV Lexington, Tenn.
 KTVT Fort Worth, Tex.
 KHOU-TV Houston, Tex.
 KCBD-TV Lubbock, Tex.
 *KBYU-TV Provo, Utah
 KSTV Tacoma, Wash.
 WLUK-TV Green Bay, Wis.
 WKBM-TV Caguas, PR.

Channel 12 (204-210 mhz)

WFAA-TV Montgomery, Ala.
 KTRAR-TV Mesa, Ariz.
 KHSL-TV Chico, Calif.

U.S. TV by Channel

KCOY-TV Santa Maria, Calif.
 *WHYY-TV Wilmington, Del.
 WTLV Jacksonville, Fla.
 WPEC West Palm Beach, Fla.
 WRDQ-TV Augusta, Ga.
 KMVI-TV Wailuku, Hawaii
 *KUID-TV Moscow, Idaho
 *WILL-TV Urbana, Ill.
 *KINN-TV Iowa City, Iowa
 KTVH Hutchinson, Kan.
 *WYES New Orleans, La.
 KSLA-TV Shreveport, La.
 *WMEB-TV Orono, Me.
 WJRT-TV Flint, Mich.
 KEYC-TV Mankato, Minn.
 KNMT Walker, Minn.
 *WMAE Booneville, Miss.
 WJTV Jackson, Miss.
 KFVS-TV Cape Girardeau, Mo.
 KODE-TV Joplin, Mo.
 KTCM Helena, Mont.
 *KUON-TV Lincoln, Neb.
 *KRNE-TV Merriman, Neb.
 KFDW-TV Clovis, N.M.
 KIVA-TV Farmington, N.M.
 WBNG-TV Binghamton, N.Y.
 WCTI-TV New Bern, N.C.
 WXII Winston-Salem, N.C.
 KXMB-TV Bismarck, N.D.
 WKRC-TV Cincinnati, Ohio
 KXII Ardmore, Okla.
 KPTV Portland, Ore.
 WICU-TV Erie, Pa.
 WPRI-TV Providence, R.I.
 WDEF-TV Chattanooga, Tenn.
 KBMT Beaumont, Tex.
 KSAT-TV San Antonio, Tex.
 KTXS-TV Sweetwater, Tex.
 WWBT Richmond, Va.
 KVO5-TV Bellingham, Wash.
 WBOY-TV Clarksburg, W. Va.
 WISN-TV Milwaukee, Wis.
 WAEO-TV Rhinelander, Wis.
 *KGTG Agaña, Guam
 WOLE-TV Aguadilla, PR.
 *WTJX-TV Charlotte Amalie, VI.

Channel 13 (210-216 mhz)

WAPI-TV Birmingham, Ala.
 KIMO Anchorage, Alaska
 KIFW-TV Sitka, Alaska
 KOLD-TV Tucson, Ariz.
 KBLU-TV Yuma, Ariz.
 *KAFT Fayetteville, Ark.
 *KEET Eureka, Calif.
 KCOP Los Angeles, Calif.
 KOVR Stockton, Calif.
 KRDO-TV Colorado Springs, Colo.
 WDTB Panama City, Fla.
 WTVT Tampa, Fla.
 WMAZ-TV Macon, Ga.
 KHVO Hilo, Hawaii
 KIKU-TV Honolulu, Hawaii
 WREX-TV Rockford, Ill.
 WTHR Indianapolis, Ind.
 WHO-TV Des Moines, Iowa
 KUPK-TV Garden City, Kan.
 WIBW-TV Topeka, Kan.
 WBKO Bowling Green, Ky.
 *KLTM Monroe, La.
 *WMED-TV Calais, Me.
 WGAN-TV Portland, Me.
 WJZ-TV Baltimore, Md.
 WZZM-TV Grand Rapids, Mich.
 *WNPB Marquette, Mich.
 WIRT Hibbing, Minn.
 WLOX-TV Biloxi, Miss.
 KRCG Jefferson City, Mo.
 KGOV-TV Missoula, Mont.
 *KTNE-TV Alliance, Neb.
 KHGI-TV Kearney, Neb.
 KSHO-TV Las Vegas, Nev.
 KGMG-TV Albuquerque, N.M.
 WAST Albany, N.Y.
 *WNET Newark, N.J.
 WOKR Rochester, N.Y.
 *KFME Fargo, N.D.
 KXMC-TV Minot, N.D.
 WSPD-TV Toledo, Ohio

*KETA Oklahoma City, Okla.
 KVAL-TV Eugene, Ore.
 *WQED Pittsburgh, Pa.
 WLOS-TV Asheville, N.C.
 WBTV Florence, S.C.
 *KPSD-TV Eagle Butte, S.D.
 KSFY-TV Sioux Falls, S.D.
 WHBQ-TV Memphis, Tenn.
 *KERA-TV Dallas, Tex.
 KELP-TV El Paso, Tex.
 KTRK-TV Houston, Tex.
 KTVT Laredo, Tex.
 KLBK-TV Lubbock, Tex.
 WVEC-TV Hampton, Va.
 WLVA-TV Lynchburg, Va.
 KTVW Tacoma, Wash.
 WOVK-TV Huntington, W.Va.
 WEAU-TV Eau Claire, Wis.
 WSTE Fajardo, PR.

UHF Stations

Channel 14 (470-476 mhz)

*KCSM-TV San Mateo, Calif.
 *WABW-TV Pelham, Ga.
 WFIE-TV Evansville, Ind.
 KMEG-TV Sioux City, Iowa
 KLA4 West Monroe, La.
 *WCMU-TV Mount Pleasant, Mich.
 *WMAW Meridian, Miss.
 WKYK-TV Hickory, N.C.
 *WMUB-TV Oxford, Ohio
 *WEBB-TV Allendale, S.C.

Channel 15 (476-482 mhz)

WOWL-TV Florence, Ala.
 KNXV-TV Phoenix, Ariz.
 *KPBS-TV San Diego, Calif.
 *WDCCO-TV Cochran, Ga.
 WICD Champaign, Ill.
 WANE-TV Fort Wayne, Ind.
 *WKPC-TV Louisville, Ky.
 KLNLI-TV Lafayette, La.
 *KAVT-TV Austin, Minn.
 KPOB-TV Poplar Bluff, Mo.
 *WHED-TV Hanover, N.H.
 WLYH-TV Lancaster, Pa.
 *KAMU-TV College Station, Tex.
 *WHRO-TV Hampton, Va.
 *WBRA-TV Roanoke, Va.
 WTAP-TV Parkersburg, W.Va.
 WMTV Madison, Wis.

Channel 16 (482-488 mhz)

*WUSF-TV Tampa, Fla.
 *WUSI-TV Olney, Ill.
 WNDU-TV South Bend, Ind.
 WBOC-TV Salisbury, Md.
 WAPT Jackson, Miss.
 KTVJ Joplin, Mo.
 *WNPE-TV Watertown, N.Y.
 *WOET-TV Kettering, Ohio
 *WQEX Pittsburgh, Pa.
 WNEP-TV Scranton, Pa.
 *WJWJ-TV Beaufort, S.C.
 WGG5-TV Greenville, S.C.
 *KDSO-TV Aberdeen, S.D.
 *KEDT Corpus Christi, Tex.

Channel 17 (488-494 mhz)

KJTV Bakersfield, Calif.
 WJKS-TV Jacksonville, Fla.
 *WLRN-TV Miami, Fla.
 WTCG Atlanta, Ga.
 WAND Decatur, Ill.
 WTVO Rockford, Ill.
 *KTCL-TV St. Paul, Minn.
 *WMAU Bude, Miss.
 KCBJ-TV Columbia, Mo.

*WNED-TV Buffalo, N.Y.
 *WMHT Schenectady, N.Y.
 *WUNE-TV Linville, N.C.
 WJAN Canton, Ohio
 WPHL-TV Philadelphia, Pa.
 WZTV Nashville, Tenn.

Channel 18 (494-500 mhz)

WDHN Dothan, Ala.
 *KMTF Fresno, Calif.
 KSCI San Bernardino, Calif.
 WHCT-TV Hartford, Conn.
 *WCLP-TV Chatsworth, Ga.
 WLFI-TV Lafayette, Ind.
 WLEX-TV Lexington, Ky.
 WWLD-TV Jackson, Mich.
 *WMAV Oxford, Miss.
 WSYE-TV Elmira, N.Y.
 *WNPI-TV Norwood, N.Y.
 WCCB Charlotte, N.C.
 WHIZ-TV Zanesville, Ohio
 KDCC-TV Midland, Tex.
 WVTW Milwaukee, Wis.

Channel 19 (500-506 mhz)

WHNT-TV Huntsville, Ala.
 *KTEJ Jonesboro, Ark.
 KLOC-TV Modesto, Calif.
 WRAU-TV Peoria, Ill.
 WXIX-TV Newport, Ky.
 WDCD Adams, Mass.
 *WUCM-TV University Center, Mich.
 *WMAH Biloxi, Miss.
 *KCPT Kansas City, Mo.
 *KXNE-TV Norfolk, Neb.
 WCTF Cleveland, Ohio
 WJNL-TV Johnstown, Pa.
 WNOK-TV Columbia, S.C.
 WKPT-TV Kingsport, Tenn.
 KXIX Victoria, Tex.
 KEPR-TV Pasco, Wash.
 WXOW-TV La Crosse, Wis.

Channel 20 (506-512 mhz)

WCOV-TV Montgomery, Ala.
 KEMO-TV San Francisco, Calif.
 WATR-TV Waterbury, Conn.
 WDCA-TV Washington, D.C.
 WBBH-TV Fort Myers, Fla.
 WCBJ Gainesville, Fla.
 *WCES-TV Wrens, Ga.
 *WXXW Chicago, Ill.
 WICS Springfield, Ill.
 *WFIY Indianapolis, Ind.
 WXON Detroit, Mich.
 WUTR Utica, N.Y.
 *WOBU-TV Athens, Ohio
 *WVTB St. Johnsbury, VT
 *WHRM-TV Wausau, Wis.

Channel 21 (512-518 mhz)

KPAZ-TV Phoenix, Ariz.
 KFTV Hanford, Calif.
 WPTA Roanoke, Ind.
 KVFD-TV Fort Dodge, Iowa
 *WKMU Murray, Ky.
 *KOZK Springfield, Mo.
 *WLIW Garden City, N.Y.
 *WXXI Rochester, N.Y.
 WANC-TV Asheville, N.C.
 WFMJ-TV Youngstown, Ohio
 WHP-TV Harrisburg, Pa.
 *WHA-TV Madison, Wis.

Channel 22 (518-524 mhz)

KWHY-TV Los Angeles, Calif.
 WJCL Savannah, Ga.
 WSBTV South Bend, Ind.
 *WVUT Vincennes, Ind.
 *WKPI Pikeville, Ky.

*WAPB Annapolis, Md.
 WWLP Springfield, Mass.
 *KRWG-TV Las Cruces, N.M.
 WKEF Dayton, Ohio
 WPCB-TV Pittsburgh, Pa.
 WDAU-TV Scranton, Pa.
 *WCTE Cookeville, Tenn.
 WEZF-TV Burlington, VT.

Channel 23 (524-530 mhz)

KERO-TV Bakersfield, Calif.
 WLTU Miami, Fla.
 *WSRE Pensacola, Fla.
 WCEE-TV Freeport, Ill.
 *WKZT Elizabethtown, Ky.
 *WKAR-TV East Lansing, Mich.
 KTMA-TV Minneapolis, Minn.
 *WMAO Greenwood, Miss.
 *WNJS Camden, N.J.
 KMXN-TV Albuquerque, N.M.
 WAKR-TV Akron, Ohio
 KPSA-TV Brownsville, Tex.
 *WCVE-TV Richmond, Va.
 KNDO Yakima, Wash.

Channel 24 (530-536 mhz)

KLMN Fort Smith, Ark.
 KMJ-TV Fresno, Calif.
 *KVCB-TV San Bernardino, Calif.
 *WEDH Hartford, Conn.
 *WMFE-TV Orlando, Fla.
 *KYIN Mason City, Iowa
 WHTV Meridian, Miss.
 *WCNY-TV Syracuse, N.Y.
 WDHO-TV Toledo, Ohio
 WJET-TV Erie, Pa.
 KVUE Austin, Tex.
 *KIDZ-TV Wichita Falls, Tex.
 *WVVU-TV Morgantown, W.Va.
 WCGV-TV Milwaukee, Wis.

Channel 25 (536-542 mhz)

*WHIQ Huntsville, Ala.
 *WACS-TV Dawson, Ga.
 WEEK-TV Peoria, Ill.
 WEHT Evansville, Ind.
 *WKAS Ashland, Ky.
 WHAG-TV Hagerstown, Md.
 WXNE-TV Boston, Mass.
 WEYI-TV Saginaw, Mich.
 *NEW TV St. Cloud, Minn.
 *WNYE-TV New York, N.Y.
 *WUNK-TV Greenville, N.C.
 *WVIZ-TV Cleveland, Ohio
 *KOKH-TV Oklahoma City, Okla.
 WOLO-TV Columbia, S.C.
 KAVU Victoria, Tex.
 KNDU Richland, Wash.

Channel 26 (542-548 mhz)

*WAIQ Montgomery, Ala.
 KTSF-TV San Francisco, Calif.
 KMPH Tulare, Calif.
 *WETA-TV Washington, D.C.
 WEVU-TV Naples, Fla.
 WATU-TV Augusta, Ga.
 WCUI-TV Chicago, Ill.
 WGNO-TV New Orleans, La.
 *WMEG-TV Bidddeford, Me.
 *KYNE-TV Omaha, Neb.
 *WUNL-TV Winston-Salem, N.C.
 WTVK Knoxville, Tenn.
 KDOO-TV Houston, Tex.

Channel 27 (548-554 mhz)

WSTC Tallahassee, Fla.

*KSN Sioux City, Iowa
 KTSB Topeka, Kan.
 WKYT-TV Lexington, Ky.
 *WLPB-TV Baton Rouge, La.
 WSMW-TV Worcester, Mass.
 KMTC Springfield, Mo.
 WKBN-TV Youngstown, Ohio
 WTPA Harrisburg, Pa.
 *WRAJ-TV Sumter, S.C.
 WYAH-TV Portsmouth, Va.
 WRLU-TV Roanoke, Va.
 WKOW-TV Madison, Wis.

Channel 28 (554-560 mhz)

*KCTE Los Angeles, Calif.
 *WJSP-TV Columbus, Ga.
 WSJV Elkhart, Ind.
 *WCPB Salisbury, Md.
 WRDU-TV Durham, N.C.
 WREB-TV Wilkes-Barre, Pa.
 KORO Corpus Christi, Tex.
 KMCC Lubbock, Tex.
 *WVER Rutland, Vt.
 *WHWC-TV Colfax, Wis.

Channel 29 (560-566 mhz)

KBAK-TV Bakersfield, Calif.
 WDXR-TV Paducah, Ky.
 *WKSO Somerset, Ky.
 WGTU Traverse City, Mich.
 *WMAA Jackson, Miss.
 *KJNE-TV Hastings, Neb.
 WUTV Buffalo, N.Y.
 WTAFF-TV Philadelphia, Pa.
 *WNTV Greenville, S.C.
 WVIR-TV Charlottesville, Va.
 KIMA-TV Yakima, Wash.

Channel 30 (566-572 mhz)

KFSN-TV Fresno, Calif.
 KHOF-TV San Bernardino, Calif.
 WHNB-TV New Britain, Conn.
 *WETV Atlanta, Ga.
 *WTIU-TV Bloomington, Ind.
 KDNL-TV St. Louis, Mo.
 *WGTE-TV Toledo, Ohio
 WMTU-TV Memphis, Tenn.

Channel 31 (572-578 mhz)

WAAY-TV Huntsville, Ala.
 KMUV-TV Sacramento, Calif.
 WMBD-TV Peoria, Ill.
 *WWPB-TV Hagerstown, Md.
 NEW TV Ann Arbor, Mich.
 WRLH Lebanon, N.H.
 *WNYC-TV New York, N.Y.
 *WGSF Newark, Ohio
 *WHLA-TV La Crosse, Wis.

Channel 32 (578-584 mhz)

WKAB-TV Montgomery, Ala.
 *KQEC San Francisco, Calif.
 *WHMM Washington, D.C.
 WFLD-TV Chicago, Ill.
 *KBIN Council Bluffs, Iowa
 *KRIN Waterloo, Iowa
 WLKY-TV Louisville, Ky.
 WRLP Greenfield, Mass.

Channel 33 (584-590 mhz)

WCFT-TV Tuscaloosa, Ala.
 WKJG-TV Fort Wayne, Ind.
 WRBT Baton Rouge, La.

U.S., Canadian TV by Channel

*WUNF-TV Asheville, N.C.
WYTV Youngstown, Ohio
*WITF-TV Hershey, Pa.
*WJPM-TV Florence, S.C.
*WETK Burlington, Vt.
*WMUL-TV Huntington, W.Va.

Channel 34 (590-596 mhz)

KMEX-TV Los Angeles, Calif.
WTVX Fort Pierce, Fla.
*WNIT-TV South Bend, Ind.
WBJA-TV Binghamton, N.Y.
*WOSU-TV Columbus, Ohio

Channel 35 (596-602 mhz)

WSWB-TV Orlando, Fla.
*WKHA Hazard, Ky.
*WKMA Madisonville, Ky.
*WGVG Grand Rapids, Mich.
WLIO Lima, Ohio
WSEE Erie, Pa.
*WUHY-TV Philadelphia, Pa.
*WRLK-TV Columbia, S.C.
KAPP Yakima, Wash.

Channel 36 (602-608 mhz)

*WFIO Florence, Ala.
KGTO-TV Fayetteville, Ark.
KMIR-TV Palm Springs, Calif.
KGSC-TV San Jose, Calif.
WATL-TV Atlanta, Ga.
*KHIN Red Oak, Iowa
WENY-TV Elmira, N.Y.
WRET-TV Charlotte, N.C.
*WSBE-TV Providence, R.I.
KTVV Austin, Tex.
*WMVT Milwaukee, Wis.

Channel 38 (614-620 mhz)

KVOF-TV San Francisco, Calif.
WYEA-TV Columbus, Ga.
WCFL-TV Chicago, Ill.
WIL-TV Terre Haute, Ind.
*WKMR Morehead, Ky.
WSBK-TV Boston, Mass.
WOPC Altoona, Pa.
*WPNE Green Bay, Wis.

Channel 39 (620-626 mhz)

KCST-TV San Diego, Calif.
*WUNJ-TV Wilmington, N.C.
*WLTV-TV Allentown, Pa.
KXTX-TV Dallas, Tex.
KHTV Houston, Tex.

Channel 40 (626-632 mhz)

WHMA-TV Aniston, Ala.
KFPW-TV Fort Smith, Ark.
KLXA-TV Fontana, Calif.
KTXL Sacramento, Calif.
WXLTV Sarasota, Fla.
WHMB-TV Indianapolis, Ind.
KDUB-TV Dubuque, Iowa
WHYN-TV Springfield, Mass.
*WEDB-TV Berlin, N.H.
WCMC-TV Wildwood, N.J.
WICZ-TV Binghamton, N.Y.
NEW TV Greensburg, Pa.
WAIM-TV Anderson, S.C.

Channel 41 (632-638 mhz)

*WIIQ Demopolis, Ala.
WCWB-TV Macon, Ga.

WDRB-TV Louisville, Ky.
WUHQ-TV Battle Creek, Mich.
KBMA-TV Kansas City, Mo.
WXTV Paterson, N.J.
KWEX-TV San Antonio, Tex.
*WVTA Windsor, Vt.

Channel 42 (638-644 mhz)

WBMG Birmingham, Ala.
*WEIQ Mobile, Ala.
KPLM-TV Palm Springs, Calif.
*WHRB-TV Boynton Beach, Fla.
*WTVI Charlotte, N.C.
*WPBO-TV Portsmouth, Ohio
KVEV Kennewick, Wash.

Channel 43 (644-650 mhz)

*WGIQ Louisville, Ala.
WONH Syracuse, N.Y.
WUAB Lorain, Ohio
WSBA-TV York, Pa.

Channel 44 (650-656 mhz)

KBHK-TV San Francisco, Calif.
WTOG St. Petersburg, Fla.
WSNS Chicago, Ill.
*WGBX-TV Boston, Mass.
*WOUC-TV Cambridge, Ohio
*WVIA-TV Scranton, Pa.
WVEO Aguadilla, P.R.

Channel 45 (656-662 mhz)

WFCB-TV Miami, Fla.
WBFF Baltimore, Md.
*WNEO-TV Alliance, Ohio
*WTCI Chattanooga, Tenn.

Channel 46 (662-668 mhz)

KBSA Guasti, Calif.
KMST Monterey, Calif.
WHAE-TV Atlanta, Ga.
WMSH-TV South Bend, Ind.
*NEW TV Fort Dodge, Iowa
*WKLE Lexington, Ky.
*WSKG Binghamton, N.Y.
*KNCT Belton, Tex.

Channel 47 (668-674 mhz)

KJEO Fresno, Calif.
*WTVP Peoria, Ill.
WNJU-TV Linden, N.J.
*WSVN-TV Norton, Va.
*KYVE-TV Yakima, Wash.

Channel 48 (674-680 mhz)

WYUR Huntsville, Ala.
WKBS-TV Burlington, N.J.
*WCET Cincinnati, Ohio
KVEO-TV McAllen, Tex.

Channel 49 (680-686 mhz)

*WEDW Bridgeport, Conn.
*WIPB Muncie, Ind.
*WLED-TV Littleton, N.H.
*WEAO Akron, Ohio

Channel 50 (686-692 mhz)

*KOCE-TV Huntington Beach, Calif.

KFTY Santa Rosa, Calif.
WGSP-TV Washington, D.C.
*WCAE St. John, Ind.
WKBD-TV Detroit, Mich.
*WNJM Montclair, N.J.

Channel 51 (692-698 mhz)

KJOG-TV San Diego, Calif.
WKID Fort Lauderdale, Fla.
WOCA-TV Ocala, Fla.
*WVPT Staunton, Va.

Channel 52 (698-704 mhz)

KBSC-TV Corona, Calif.
*WKON Owenton, Ky.
*WEKW-TV Keene, N.H.
*WNJT Trenton, N.J.

Channel 53 (704-710 mhz)

KAIL Fresno, Calif.
*WEDN Norwich, Conn.
*WKGB Bowling Green, Ky.
WPGH-TV Pittsburgh, Pa.
*WNVT Goldvein, Va.

Channel 54 (710-716 mhz)

KTEH San Jose, Calif.
*WCVN Covington, Ky.
*WQLN Erie, Pa.

Channel 55 (716-722 mhz)

NEW TV Crossville, Tenn.

Channel 56 (722-728 mhz)

NEW TV Anaheim, Calif.
WLVI-TV Cambridge, Mass.
*WTVS Detroit, Mich.
*KPEC-TV Lakewood Center, Wash.

Channel 57 (728-734 mhz)

WKYH-TV Hazard, Ky.
*WGBY-TV Springfield, Mass.
*WCFE-TV Plattsburgh, N.Y.
*WBGU-TV Bowling Green, Ohio
*WCVW Richmond, Va.

Channel 58 (734-740 mhz)

*KLCS Los Angeles, Calif.
KAJC-TV Stockton, Calif.
*WNJB New Brunswick, N.J.
*WUNG-TV Concord, N.C.

Channel 59 (740-746 mhz)

WTVU New Haven, Conn.

Channel 60 (746-752 mhz)

KDTV San Francisco, Calif.

Channel 61 (752-758 mhz)

WRIP-TV Chattanooga, Tenn.

Channel 62 (758-764 mhz)

WTVQ-TV Lexington, Ky.
WGPR-TV Detroit, Mich.
*KTPS Tacoma, Wash.

Channel 63 (764-770 mhz)

KTIE Oxnard, Calif.

Channel 64 (770-776 mhz)

NEW TV Providence, R.I.

Channel 65 (776-782 mhz)

*WEDY New Haven, Conn.

Channel 67 (788-794 mhz)

*WMPB Baltimore, Md.
WSNL-TV Patchogue, N.Y.

Channel 68 (794-800 mhz)

*KVST-TV Los Angeles, Calif.
*WKMJ Louisville, Ky.
WQTV Boston, Mass.
WBTB-TV Newark, N.J.

Channel 69 (800-806 mhz)

NEW TV Allentown, Pa.
WHFV Fredericksburg, Va.

Canadian TV by Channel

Channel 2

CFAC-TV Calgary, Alta.
CBXAT-2 High Prairie, Alta.
CKSA-TV Lloydminster, Alta.
CHBC-TV Kelowna, B.C.
CKPG-TV Prince George, B.C.
CBUT Vancouver, B.C.
CKCW-TV Moncton, N.B.
CBYT-3 Bonne Bay, Nfld.
CJOX-TV-1 Grand Bank, Nfld.
CBIT-2 Halifax, N.S.
CKGN-TV-2 Bancroft, Ont.
CFCL-TV-2 Kearns, Ont.
CKIC-TV Sault Ste. Marie, Ont.
CKPR-TV Thunder Bay, Ont.
CKCO-TV-2 Wiarton, Ont.
CBFT Montreal, Que.
CKGO-TV Melfort, Sask.
CKCK-TV Regina, Sask.

Channel 3

CFRN-TV Edmonton, Alta.
CFRN-TV-2 Peace River, Alta.
CFTK-TV Terrace, B.C.
CBWFT Winnipeg, Man.
CJOX-TV Argentina, Nfld.
CBNAT-1 Baie Verte, Nfld.
CBHT Halifax, N.S.
CBHT-1 Yarmouth, N.S.
CKVR-TV Barrie, Ont.
CKSO-TV-1 Elliott Lake, Ont.
CKSO-TV-2 Timmins, Ont.
CBVT-2 La Tuque, Que.
CBFT-2 Mont-Laurier, Que.
CJBR-TV Rimouski, Que.
CFQC-TV-1 Stranraer, Sask.
CKOS-TV Yorkton, Sask.

Channel 4

CFCN-TV Calgary, Alta.
CITL-TV Lloydminster, Alta.

CHAT-TV-1 Pivot, Alta.
CFJC-TV Kamloops, B.C.
CJAY-TV Brandon, Man.
CBWT-2 Lac du Bonnet, Man.
CHSJ-TV Sydney, N.S.
CJCN-TV Grand Falls, Nfld.
CUCB-TV Sydney, N.S.
CHNB-TV North Bay, Ont.
CBOT Ottawa, Ont.
CHFD-TV Thunder Bay, Ont.
CFCM-TV Quebec City, Que.
CKRN-TV Rouyn, Que.
CKBI-TV-3 Greenwater Lake, Sask.
CBKM-TV Moose Jaw, Sask.
CBEBT Pine Point, NWT

Channel 5

CBXT Edmonton, Alta.
CJDC-TV Dawson Creek, B.C.
CKX-TV Brandon, Man.
CBYT Corner Brook, Nfld.
CBNT-3 Marystown, Nfld.
CJCH-TV Halifax, N.S.
CBIT Sydney, N.S.
CBWFT Fort Frances, Ont.
CHOV-TV Pembroke, Ont.
CKSO-TV Sudbury, Ont.
CBLT Toronto, Ont.
CHAU-TV Carleton, Que.
CFCL-TV-5 Malartic, Que.
CKMI-TV Quebec City, Que.
CKBI-TV Prince Albert, Sask.
CJFB-TV Swift Current, Sask.

Channel 6

CHAT-TV Medicine Hat, Alta.
CKRD-TV Red Deer, Alta.
CHKM-TV Kamloops, B.C.
CHEK-TV Victoria, B.C.
CBWT Winnipeg, Man.
CHSJ-TV-1 Bon Accord, N.B.

CBNAT-4 St. Anthony, Nfld.
CJON-TV St. John's, Nfld.
CJCH-TV-6 Caledonia, N.S.
CJCB-TV-1 Inverness, N.S.
CJOH-TV-6 Deseronto, Ont.
CKGN-TV-6 Ottawa, Ont.
CKGN-TV Paris, Ont.
CFCL-TV Timmins, Ont.
CJPM-TV Chicoutimi, Que.
CBMT Montreal, Que.
CFQC-TV-2 North Battleford, Sask.
CKCK-TV-2 Willow Bunch, Sask.
CHSS-TV Wynyard, Sask.
CHAK-TV Inuvik, NWT
CFWH-TV Whitehorse, Yukon

Channel 7

CJOC-TV Lethbridge, Alta.
CKY-TV Winnipeg, Man.
CKCD-TV Campbellton, N.B.
CHMT-TV Moncton, N.S.
CBHFT-2 Mulgrave, N.B.
CKNC-TV-1 Elliott Lake, Ont.
CBFOT-2 Hearst, Ont.
CBFST Sturgeon Falls, Ont.
CKRT-TV Riviere du Loup, Que.
CHLT-TV Sherbrooke, Que.
CFSS-TV Carlyle Lake, Sask.
CKMJ-TV Marquis, Sask.
CBCP-TV-1 Shaunavon, Sask.

Channel 8

CBXT-1 Athabasca, Alta.
CFRN-TV-6 Red Deer, Alta.
CHAN-TV Vancouver, B.C.
CHFC-TV Churchill, Man.
CBWST Dauphin, Man.
CBNT St. John's, Nfld.
CBY1-1 Stephenville, Nfld.
CJOH-TV-8 Cornwall, Ont.

Canadian Channels, TV Billings

CBWAT Kenora, Ont.
 CBLAT-1 Manitowadge, Ont.
 CKNX-TV Wingham, Ont.
 CKCW-TV-1 Charlottetown, P.E.I.
 CJDG-TV Lithiums Mines, Que.
 CKRS-TV-3 Roberval, Que.
 CFQC-TV Saskatoon, Sask.
 CFYK-TV Yellowknife, NWT

Channel 9

CKSA-TV-2 Bonnyville, Alta.
 CBRT Calgary, Alta.
 CBXT-2 Whitecourt, Alta.
 CKND Winnipeg, Man.
 CKLT-TV St. John, N.B.
 CBNAT-9 Mount St. Margaret, Nfld.
 CJCB-TV-2 Antigonish, N.S.
 CBWDT Dryden, Ont.
 CBOFT Ottawa, Ont.
 CKNC-TV Sudbury, Ont.
 CBFOT Timmins, Ont.
 CFTO-TV Toronto, Ont.
 CSLAT-3 Wawa, Ont.
 CBET Windsor, Ont.

CBGAT Matane, Que.
 CKSH-TV Sherbrooke, Que.
 CBKRT Regina, Sask.
 CBKST-1 Stranraer, Sask.

Channel 10

CKRD-TV-1 Coronation, Alta.
 CBXAT Grande Prairie, Alta.
 CBWGT Fisher Branch, Man.
 CBWBT Flin Flon, Man.
 CJCH-TV-1 Canning, N.S.
 CBHFT-4 Cheticamp, N.S.
 CFPL-TV London, Ont.
 CKNY-TV North Bay, Ont.
 CFTM-TV Montreal, Que.
 CBKMT-1 Willow Bunch, Sask.
 CICC-TV Yorkton, Sask.

Channel 11

CBXFT Edmonton, Alta.
 CBUAT Trail, B.C.
 CKX-TV-1 Foxwarren, Man.
 CBAFT Moncton, N.B.
 CBNAT Grand Falls, Nfld.
 CBHT-4 Sheet Harbour, N.S.

CBHT-3 Yarmouth, N.S.
 CHCH-TV Hamilton, Ont.
 CKSO-TV-3 Kearns, Ont.
 CKWS-TV Kingston, Ont.
 CBLAT-4 Marathon, Ont.
 CBVT Quebec City, Que.
 CBKST Saskatoon, Sask.

Channel 12

CFRN-TV-4 Ashmont, Alta.
 CFCN-TV-1 Drumheller, Alta.
 CBXAT-3 Manning, Alta.
 CFRN-TV-3 Whitecourt, Alta.
 CBUBT-1 Canal Flats, B.C.
 CIFG-TV Prince George, B.C.
 CKAM-TV Upsalquitch Lake, N.B.
 CBNT-2 Placentia, Nfld.
 CBIT-1 Mulgrave, N.S.
 CBFST-3 Elliott Lake, Ont.
 CBFOT-1 Kapuskasing, Ont.
 CHEX-TV Peterborough, Ont.
 CBIMT Iles-de-la-Madeleine, Que.
 CKRS-TV Jonquiere, Que.
 CFCF-TV Montreal, Que.
 CBFST-2 Temiscaming, Que.

CKCK-TV-1 Colgate, Sask.
 CISS-TV-1 Wynyard, Sask.

Channel 13

CITV-TV Edmonton, Alta.
 CFNR-TV-1 Grande Prairie, Alta.
 CFCN-TV-5 Lethbridge, Alta.
 CJBR-TV-1 Edmundston, N.B.
 CBNT-1 Port Rexton, Nfld.
 CBHFT-3 Sydney, N.S.
 CBLAT Geraldton, Ont.
 CKCO-TV Kitchener, Ont.
 CJOH-TV Ottawa, Ont.
 CBFST-1 Sudbury, Ont.
 CBCT Charlottetown, P.E.I.
 CBST Sept Iles, Que.
 CKTM-TV Trois Rivières, Que.
 CBKHT Keno Hill, Yukon

Channel 15

CIVQ-TV Quebec City, Que.

Channel 17

CIVM-TV Montreal, Que.

Channel 19

*CICA-TV Toronto, Ont.

Channel 22

CKGN-TV-22 Uxbridge, Ont.

Channel 25

CBLFT Toronto, Ont.

Channel 26

CKGN-TV-1 Windsor, Ont.

Channel 29

CKGN-TV-29 Sarnia, Ont.

Channel 30

CFVO-TV Hull, Que.

Channel 79

CITY-TV Toronto, Ont.

Television Billings 1948-1974

Figures for the years 1949 through 1967 are net time sales by stations and networks after all frequency and promotional discounts but before deduction of commissions to agencies and representatives. Figures for 1968 through 1974 were computed under a new formula and represent total amounts paid by advertisers for

the use of broadcast facilities. They include commissions paid to advertising agencies and representatives and payments for broadcast time and programs, materials, facilities and services supplied by broadcast stations and networks in connection with the sale of time. Figures are based on FCC data.

Year	National network	% change	National non-network	% change	Local	% change	Total	% change
1948*	\$ 2,500,000	\$ 6,200,000	\$ 8,700,000
1949	10,796,000	\$ 7,275,000	9,460,000	27,530,000
1950	35,210,000	+226.1%	25,034,000	+244.1%	30,385,000	+221.2%	90,629,000	+229.2%
1951	97,558,000	+177.1%	59,733,000	+138.6%	51,304,000	+ 68.8	208,595,000	+130.2
1952	137,664,000	+ 41.1	80,235,000	+ 34.3	65,171,000	+ 27.0	283,070,000	+ 35.7
1953	171,900,000	+ 24.9	124,318,000	+ 54.9	88,474,000	+ 35.8	384,692,000	+ 35.9
1954	241,224,000	+ 40.3	176,766,000	+ 42.2	120,131,000	+ 35.8	538,122,000	+ 39.9
1955	308,900,000	+ 28.1	222,400,000	+ 25.8	149,800,000	+ 24.7	681,100,000	+ 26.6
1956	367,700,000	+ 19.0	281,200,000	+ 26.4	174,200,000	+ 16.3	823,100,000	+ 20.8
1957	394,200,000	+ 7.7	300,500,000	+ 6.9	174,000,000	- 0.1	868,700,000	+ 5.5
1958	424,500,000	+ 7.7	345,200,000	+ 14.9	181,300,000	+ 4.2	951,000,000	+ 9.5
1959	445,800,000	+ 5.0	424,200,000	+ 22.9	200,600,000	+ 10.6	1,070,600,000	+ 12.6
1960	471,600,000	+ 5.8	459,200,000	+ 8.3	215,800,000	+ 7.6	1,146,600,000	+ 6.5
1961	480,300,000	+ 1.8	480,100,000	+ 4.6	199,600,000	- 7.5	1,160,000,000	+ 1.1
1962	521,500,000	+ 8.5	554,100,000	+ 15.4	227,900,000	+ 14.2	1,303,500,000	+ 10.2
1963	537,900,000	+ 3.1	616,000,000	+ 11.2	240,800,000	+ 5.7	1,394,000,000	+ 6.9
1964	562,800,000	+ 4.6	710,800,000	+ 15.4	275,700,000	+ 14.5	1,549,300,000	+ 11.0
1965	585,100,000	+ 3.9	785,700,000	+ 10.5	302,900,000	+ 9.9	1,673,700,000	+ 8.0
1966	616,700,000	+ 3.8	871,700,000	+ 10.9	346,400,000	+ 14.4	1,834,800,000	+ 9.1
1967	609,600,000	- 1.2	871,700,000	0	365,300,000	+ 5.5	1,846,600,000	+ 0.6
1968	1,424,300,000	1,009,800,000	482,100,000	2,916,300,000
1969	1,569,600,000	+ 10.2	1,119,100,000	+ 10.8	546,800,000	+ 13.4	3,235,500,000	+ 10.9
1970	1,551,100,000	- 1.2	1,102,600,000	- 1.5	589,100,000	+ 7.7	3,242,800,000	+ 0.2
1971	1,490,400,000	- 4.2	1,022,800,000	- 7.2	665,600,000	+ 13.0	3,178,800,000	- 2.0
1972	1,687,500,000	+ 13.2	1,177,400,000	+ 15.1	810,100,000	+ 21.7	3,675,000,000	+ 15.6
1973	1,839,700,000	+ 9.0	1,230,200,000	+ 4.5	932,200,000	+ 15.1	4,002,000,000	+ 9.0
1974	2,005,300,000	+ 9.0	1,336,100,000	+ 8.6	1,012,400,000	+ 8.6	4,353,800,000	+ 8.8

*In 1948 FCC reported only "total revenues" (from time, talent and services) from "network programs" and from business "sold directly by stations." Hence figures for that first year of financial reporting are not comparable with time sales in ensuing years.

TV Channel Allocations

TV Allocations

Note—UHF and VHF TV allocations have been made by the FCC to the following cities. A plus or minus after a channel indicates that a station occupying the channel must operate with its carrier frequencies offset 10 kilohertz above or below, respectively, the normal carrier frequencies.

Asterisks (*) indicate channels reserved for non-commercial use. Footnotes: 1) Following the decision in Docket 18261 (amendment of rules regarding geographic reallocation of channels 14-20 to land mobile radio in the 25 largest urbanized areas of the U.S.) channels so indicated will not be available for use until further action by the FCC. 2) This channel is not available for Elgin, Ill., unless FCC determines it is not needed at Joliet, Ill. 3) This channel is not available for Asbury Park, N.J., unless FCC determines it is not needed at New Brunswick, N.J. 4) Channel 15 will not be available for television use until further action by the FCC. 5) Stations using these assignments shall limit radiation toward stations on the same channel in Puerto Rico. 6) Operation on this channel is subject to the conditions, terms, and requirements set out in the report and order in docket 19075, RM-1645, adopted Jan. 5, 1972, released Jan. 7, 1972. FCC-72-19. (As of Aug. 1, 1975)

Alabama

Andalusia—*2-
Anniston—40-
Birmingham—6-, *10-,
13-, 21, 42, *62+,
68+
Decatur—23-
Demopolis—*41
Dothan—4, 18, *39+,
60-
Florence—15, 26, *36-
Gadsden—44+, 60
Huntsville—19, *25+,
31, 48-
Louisville—*43+
Mobile—5+, 10+, 15+,
21+, *31, *42
Montgomery—12, 2-,
*26+, 32, 45-
Munford—*7-, *16-
Selma—8-, 29
Tuscaloosa—17, 33,
*39-

Tuscumbia—47-

Alaska

Anchorage—2-, *7-,
11, 13-
Bethel—*4
Fairbanks—2+, 4+, 7+,
*9+, 11+, 13+
Juneau—*3, 8, 10
Ketchikan—2, 4, *9
Seward—4-, 9-
Sitka—13

Arizona

Ajo—*23-
Coolidge—*43
Douglas—3, *28
Flagstaff—2, 13, *16
Globe—*14+
Holbrook—*18+
Kingman—6-, *14-
McNary—*22+
Anchorage—*9+
Batesville—*17
El Dorado—10-, 18-,
*30+
Fayetteville—*13-, 36
Fort Smith—5-, 24+,
40-
Harrison—*14
Hot Springs—*20, 26
Jonesboro—8-, *19+
Little Rock—*2-, 4, 7-,
11+, 16-, *29-
Pine Bluff—25-, 38-
Russellville—*28+

California

Alturas—13+
Anaheim—56-
Bakersfield—17, 23-,
29, *39-
Barstow—*35+
Bishop—*14-
Blythe—*22-
Brawley—*26
Chico—12-, *18¹ 24+,
*30-
Coalinga—*27-
Concord—42
Corona—52
Cotati—*22-
El Centro—7+, 9+
Eureka—3-, 6-, *13-
Fort Bragg—*17¹
Fresno—*18+, 24, 30+,
47, 53
Hanford—21
Indio—*19+¹
Los Angeles—2, 4, 5, 7,
9, 11, 13, 22, *28, 34,
*58-, *68-
Modesto—19-, *23+
Oxnard—63+
Palm Springs—36-, 42
Redding—7-, *9, 16¹
Ridgecrest—*25
Riverside—40, 46
Sacramento—3, *6, 10,
15, 31-, 40-
Salinas—Monterey—8+,
46-, *56, 67-
San Bernadino—18-,
*24-, 30
San Diego—8, 10, *15,
39, 51
San Francisco—2+, 4-,
5+, 7-, *9+, 20-,
26+, *32+, 38, 44-,
60
San Jose—11+, 36,
48-, *54
San Luis Obispo—6+,
*15+
San Mateo—*14+
Santa Ana—*50-
Santa Barbara—3-, 14,
*20², *32
Santa Cruz—*16-¹
Santa Maria—12+
Santa Rosa—50-, *62
Stockton—13+, 58, 64
Susanville—*14
Tulare—26+
Vallejo-Fairfield—66
Ventura—16+
Visalia—43
Watsonville—*25+
Yreka City—*20+

Colorado

Alamosa—3-, *16
Boulder—*12, 14
Colorado Springs—11,
13, 21
Craig—*16+
Denver—2, 4-, *6-, 7,
9-, 20, 31, *41

Arkansas

Arkadelphia—*9+
Batesville—*17
El Dorado—10-, 18-,
*30+
Fayetteville—*13-, 36
Fort Smith—5-, 24+,
40-
Harrison—*14
Hot Springs—*20, 26
Jonesboro—8-, *19+
Little Rock—*2-, 4, 7-,
11+, 16-, *29-
Pine Bluff—25-, 38-
Russellville—*28+

California

Alturas—13+
Anaheim—56-
Bakersfield—17, 23-,
29, *39-
Barstow—*35+
Bishop—*14-
Blythe—*22-
Brawley—*26
Chico—12-, *18¹ 24+,
*30-
Coalinga—*27-
Concord—42
Corona—52
Cotati—*22-
El Centro—7+, 9+
Eureka—3-, 6-, *13-
Fort Bragg—*17¹
Fresno—*18+, 24, 30+,
47, 53
Hanford—21
Indio—*19+¹
Los Angeles—2, 4, 5, 7,
9, 11, 13, 22, *28, 34,
*58-, *68-
Modesto—19-, *23+
Oxnard—63+
Palm Springs—36-, 42
Redding—7-, *9, 16¹
Ridgecrest—*25
Riverside—40, 46
Sacramento—3, *6, 10,
15, 31-, 40-
Salinas—Monterey—8+,
46-, *56, 67-
San Bernadino—18-,
*24-, 30
San Diego—8, 10, *15,
39, 51
San Francisco—2+, 4-,
5+, 7-, *9+, 20-,
26+, *32+, 38, 44-,
60
San Jose—11+, 36,
48-, *54
San Luis Obispo—6+,
*15+
San Mateo—*14+
Santa Ana—*50-
Santa Barbara—3-, 14,
*20², *32
Santa Cruz—*16-¹
Santa Maria—12+
Santa Rosa—50-, *62
Stockton—13+, 58, 64
Susanville—*14
Tulare—26+
Vallejo-Fairfield—66
Ventura—16+
Visalia—43
Watsonville—*25+
Yreka City—*20+

Colorado

Alamosa—3-, *16
Boulder—*12, 14
Colorado Springs—11,
13, 21
Craig—*16+
Denver—2, 4-, *6-, 7,
9-, 20, 31, *41

Mesa—12-
Nogales—*16+
Page—*17
Parker—*17-
Phoenix—3+, 5-, *8+,
10-, 15-, 21, 33, *39
Prescott—7, *19
Safford—*23+
Tucson—4-, *6+, 9-,
13-, 18-, *27-, 40
Tucson-Nogales—11⁶
Yuma—11-, 13+, *16-

Connecticut

Bridgeport—43-, *49-
Hartford—3+, 18-, *24,
61+
New Britain—30+
New Haven—8+, 59+,
*65
New London—26+
Norwich—*53
Waterbury—20

Delaware

Dover—*34
Seaford—*38
Wilmington—*12, 61

District of Columbia

Washington—4-, 5-,
7+, 9, 14-, 20+,
*26-, *32+, 50

Florida

Boca Raton—*14
Bradenton—*19
Clearwater—22
Cocoa—*18-, 52
Daytona Beach—2-,
26
Fort Lauderdale—51
Fort Myers—11+,
20+, *30
Fort Pierce—*21-,
34
Gainesville—*5-, 20
Jacksonville—4+, *7,
12+, 17, 30+, 47-,
*59
Key West—16+, 22+
Lake City—*41
Lakeland—32
Leesburg—*45-, 55
Madison—*36-
Marianna—*16+
Melbourne—43+, 56
Miami—*2, 4, 6, 7-,
10+, *17-, 23-,
33, 39, 45+
Naples—26-
New Smyrna Beach—
*15+
Ocala—*29, 51-
Orlando—6-, 9,
*24-, 35+
Palatka—*42
Panama City—7+, 13,
*22+, 28-
Pensacola—3-, *23,
33+, 44+
St. Petersburg—10-,
38, 44+
Sarasota—40
Sebring—*27
Tallahassee—*11-,
27+, 40+
Tampa—*3, 8-, 13-,
*16, 28
West Palm Beach—5,
12, 25+, *42+, 53

Georgia

Albany—10, 19-, 31-
Ashburn—*23+
Athens—*8, 34
Atlanta—2, 5-, 11+,
17-, *30, 36, 46-,
*57+
Augusta—6+, 12-, 26,
54
Carnesville—*52
Carrollton—*49-
Cedartown—*65-
Chatsworth—*18-

Cochran—*15
Columbus—3, 9+, *28,
36+, *48, 54+
Dawson—*25
Draketown—*27-
Elberton—*60+
Flintstone—*51-
Lafayette—*35
Macon—13+, 24, 41+,
*47+
Pelham—*14-
Rome—14+
Savannah—3+, *9-, 11,
22
Thomasville—6
Toccoa—32-, *68-
Valdosta—*33, 44-
Vidalia—*18+
Warm Springs—*22-
Waycross—*8+
Wrens—*20-
Young Harris—*50+

Hawaii

Hilo—2, *4, 9, 11, 13,
14+, 26+, 26+, *32+,
*38+
Honolulu—2+, 4-, 9-,
*11+, 13-, 14, 20, 26,
32, *38, *44
Lihue—3+, *8-, 10+,
12-, 15-, *21-, *27-
Wailuku—3, 7, *10, 12,
15, 21, *27, *33

Idaho

Burley—*17+
Caldwell—9-
Coeur d'Alene—*26+
Grangeville—*15-
Idaho Falls—3, 8+, 20,
*33+
Filer—*19-
Lewiston—3-
Moscow—*12-
Nampa—6, 12+
Preston—*28
Pocatello—6-, *10, 15,
25+, 31-
Sandpoint—*16+
Twin Falls—11, *13-
Weiser—*17

Illinois

Aurora—60
Bloomington—43
Carbondale—*8
Champaign—*3, 15-
Pocatiello—6-, *10, 15,
25+, 31-
Sandpoint—*16+
Twin Falls—11, *13-
Weiser—*17
Danville—68
Decatur—17, 23-
De Kalb—*48-
Edwardsville—*18-
Elgin—66+2
Freeport—23, *65-
Galesburg—63
Harrisburg—3
Jacksonville—14
Joliet—14-1, 66+
Kankakee—*54-
La Salle—35
Macomb—*22+
Moline—8-, *24-
Mount Vernon—13
Olney—*16-
Peoria—19, 25+, 31+,
47-, 59+
Quincy—10-, 16+,
*27+
Rockford—13, 17-, 39
Rock Island—4+
Springfield—20+, 49-,
55+, *65+
Streator—*64+
Urbana—*12-, 27
Vandalia—*21

Indiana

Anderson—67+
Bloomington—4, *30-,
63+
Elkhart—28+
Evansville—7, *9+, 14-,
25-, 44-
Fort Wayne—15+, 21+,
33-, *39-, 55

Gary—*50, 56+
Hammond—62+
Indianapolis—6, 8-,
13-, *20-, 40, 59-,
*69
Kokomo—29-
Lafayette—18, *24
Madison—*60+
Marion—23
Muncie—49, *61-
Richmond—43+
South Bend—16, 22,
*34-, 46
Terre Haute—2+, 10,
*26-, 38
Vincennes—*22-

Iowa

Ames—5, 23-, *34+
Burlington—26+, *58-
Carroll—*18-
Cedar Rapids—2, 9-,
28+
Council Bluffs—*32
Davenport—6+, 18+,
30-, *36+
Decorah—*14+
Des Moines—8-, *11+,
13-, 17+, *43-, 63-,
69
Dubuque—16-, *29-,
40-
Estherville—*49+
Fort Dodge—21, *46
Iowa City—*12+, 20-
Mason City—3+, *24+
Ottumwa—15+, *33-
Red Oak—*36
Sioux City—4-, 9, 14,
*27-
Waterloo—7+, 22-,
*32-

Kansas

Chanute—*30+
Colby—4
Columbus—*34+
Dodge City—6+, *21-
Emporia—*25+
Garden City—11+, 13-
Goodland—10
Great Bend—2
Hays—7-, *14
Hutchinson—*8, 12,
36+
Lakin—*3
Lincoln Center—*9
Manhattan—*21
Parker—*15-
Pawnee—*39
Phillipsburg—*22-
Pittsburg—7+
Pratt—*32+
Salina—18+, 34-, 44
Sedan—*28
Topeka—*11, 13+, 27,
43, 49
Wichita—3-, 10-,
*15+, 24-, 33, *42

Kentucky

Ashland—*25-, 61+
Bowling Green—13,
40+, *53-
Covington—*54+
Elizabethtown—*23+
Hazard—*35+, 57-
Hopkinsville—51
Lexington—18+, 27-,
*46, 62
Louisville—3-, 11+,
*15, 21-, 32-, 41+,
*68+
Morehead—*35-
Morehead—*38+
Murray—*21+
Owensboro—19-, 31-
Paducah—6+, 29
Pikesville—*22-, 51+
Somerset—16, *29+

Louisiana

Alexandria—5, 25+,
31+, *41+
Baton Rouge—2, 9-,
*27+, 33-
De Ridder—*23-
Houma—11
Lafayette—3, 10, 15, *24

Every week
in *Broadcasting*

The good news
and bad news
that makes
Broadcasting
all news
all year long

Lake Charles-7-, *18, 29-
Monroe-8+, *13, 14-, 39+
Morgan City-*14+
Natchitoches-*28-
New Iberia-36-
New Orleans-4+, 6+, 8, *12, 20-, 26, *32+, 38+
Shreveport-3-, 12, *24-, 33
Tallulah-19

Maine

Augusta-*10-
Bangor-2-, 5+, 7-
Calais-*13-
Fort Kent-*46+
Fryeburg-*18+
Houlton-*25+
Kittery-*34
Lewiston-8-, 35-
Millinocket-*44-
Orono-*12-
Portland-6-, 13+, *26-, 51
Presque Isle-8, *10+
Rumford-*43+

Maryland

Annapolis-*22
Baltimore-2+, 11-, 13+, 24+, 45, 54, *67-
Cumberland-*36+, 52+, 65
Frederick-*62
Hagerstown-25-, *31
Salisbury-16+, *28-
Waldorf-*56-

Massachusetts

Boston-*2+, 4-, 5-, 7+, 25+, 38, *44+, 56, 68+
Greenfield-32+
New Bedford-6+, 28-, *47-
North Adams-19, *35
Pittsfield-51+
Springfield-22, 40, *57+
Worcester-14, 27, *48+, 66

Michigan

Alpena-*6, 11
Ann Arbor-31+, *58+
Bad Axe-*15-1
Battle Creek-41+
Bay City-5-, *19+, 61+
Cadillac-9, *27
Calumet-5-, *22-
Cheboygan-4+
Detroit-2+, 4, 7-, 20+, 50-, *56, 62
East Lansing-*23-, *69-
Escabana-3+
Flint-12-, *28-, 66-
Grand Rapids-8+, 13+, 17, *35+
Iron Mountain-8-, *14-
Ironwood-*15-, 24+
Jackson-18+
Kalamazoo-3-, *52+
Lansing-6-, 36+, 53-
Manistee-*21
Marquette-6-, *13, 19
Mount Clemens-38+
Mount Pleasant-*14
Muskegon-54+
Parma-10-
Petoskey-*23+
Pontiac-*22
Port Huron-46+
Saginaw-25-, 45-
Sault Ste Marie-8, 10+, *32-
Traverse City-7+, 29-
West Branch-*24

Minnesota

Alexandria-7, *24
Appleton-*10-

Austin-6-, *15-
Bemidji-*9, 26+
Brainerd-*22
Crookston-*33
Duluth-3, *8, 10+, 21, 27-
Ely-*17-
Fairmont-*16+
Hibbing-13-, *18-
International Falls-11, *35+
Mankato-12, *26-
Marshall-*30-
Minneapolis-St. Paul-2-, 4, 5-, 9+, 11-, *17, 23+, 29+
Rochester-10, 47-
St. Cloud-19, *25-, 41
St. James-38
Thief River Falls-10
Wadena-*20
Walker-12-
Willmar-14-
Winona-*35+, 44+
Worthington-*20

Mississippi

Biloxi-13+, *19+, 25-
Booneville-*12-
Bude-*17+
Clarksdale-*22-
Cleveland-*31-
Columbia-*45
Columbus-4-, 27, *43
Greenville-15-, 21+
Greenwood-6, *23+
Hattiesburg-22, *47
Houston-45+
Jackson-3+, 12+, 16, *29+, 40+
Laurel-17, 18+
Meridian-11-, *14, 24-, 30-
Miss. State-*2+
Natchez-*42+
Oxford-*18
Senatobia-*34-
Tupelo-9-
Vicksburg-35-
Yazoo City-*32-

Missouri

Birchtree-*20-
Bowling Green-*35+
Cape Girardeau-12, 23, *39-
Carrollton-*18
Columbia-8+, 17-
Flat River-*22
Hannibal-7-
Jefferson City-13, 25, *36-
Joplin-12+, 16, *22-
Kansas City-4, 5+, 9+, *19+, 41-, 50-, 62+, *68-
King City-*28-
Kirksville-3-
La Plata-*21+
Lowry City-15-
Poplar Bluff-15+, *26+
Rolla-*28
St. Joseph-2-, 16-, 22
St. Louis-2, 4-, 5-, *9, 11-, 24+, 30+, *40-
Sedalia-6-
Springfield-3+, 10, *21-, 27-

Montana

Anaconda-2+
Billings-2, 8, *11, 14, 20+
Bozeman-*9
Butte-4, 6+, *7-, 18, 24
Cut Bank-*14-
Dillon-*14+
Glendive-5+, 9+, *16-
Great Falls-3+, 5+, 16, 26, *32
Hardin-4+
Have-9+, 11+, *18-
Helena-10+, 12, *15+
Kalispell-9-, *29-
Lewistown-13
Miles City-3-, *6, 10
Missoula-8-, *11-, 13-, 17-, 23-
Wolf Point-*17+

Nebraska

Albion-8+, *21+
Alliance-*13-
Bassett-*7-
Grand Island-11-, 17-
Hastings-5-, *29+
Hayes Center-6-
Hay Springs-4+
Kearney-13
Lexington-*3+
Lincoln-10+, *12-, 45, 51
McCook-8-
Merriman-*12
Norfolk-*19+
North Platte-2-, *9+
Omaha-3, 6+, 7, 15, *26, 42+, *48-
Scottsbluff-10+
Superior-4+

Nevada

Boulder City-5+
Elko-10-, *14+
Ely-3-, 6+
Fallon-*25
Goldfield-2-
Las Vegas-3, 8-, *10+, 13-, 21+
McGill-*13
Reno-2, 4, *5, 8, 21+, 27+
Tonopah-9-, *17+
Winne-mucca-7+, *15-
Yerington-*16+

New Hampshire

Berlin-*40-
Concord-21+
Durham-*11
Hanover-*15+, 31
Keene-*52+
Littleton-*49+
Manchester-9-, 50-, 60+
Portsmouth-17-1

New Jersey

Asbury Park-583
Atlantic City-*181, *36, 53+
Burlington-48-
Camden-*23+
Little Falls-*50+
Newark-13-, 68
New Brunswick-19-1, 47+, *58
Paterson-41-
Trenton-*52-
Vineland-65-
Wildwood-40

New Mexico

Alamogordo-*18-
Albuquerque-4+, *5+, 7+, 13+, 14-, 23-, *32+
Carlsbad-6-, *15+, 25-
Clayton-*17
Clovis-12+
Deming-*16
Farmington-12+, *15+
Gallup-3, *8-, 10
Hatch-*12
Hobbs-29+
Las Cruces-*22-, 48+
Lovington-*19
Portales-*3+
Raton-*18-
Roswell-8, 10-, 21-, 27-, *33+
Santa Fe-2+, 9+, 11-, 19-
Silver City-6, *10+
Socorro-*15-
Tucumari-*15

New York

Albany-Schenectady-6, 10-, 13, *17+, 23-, *29+, 45
Amsterdam-*39+, 55
Binghamton-12-, 34, 40-, *46+
Buffalo-2, 4-, 7+, 17, *23, 29-, 49-

Carthage-7-
Corning-*30
Elmira-18+, 36-
Glens Falls-*58-
Ithaca-52, *65+
Jamestown-26+, *46
Kingston-63
Lake Placid-5, *34+
Levittown-*21-
Massena-*18
New York-2, 4, 5+, 7, 9+, 11+, *25, 31-
Oneonta-151, *42
Patchogue-67
Plattsburg-*57
Poughkeepsie-54+
Riverhead-55+
Rochester-8, 10+, 13-, *21, 31+, *61+
Syracuse-3-, 5-, 9-, *24+, 43+, 62+
Utica-2-, 20+, 33, *59
Watertown-*16, 50+

North Carolina

Asheville-13-, 21+, *33, 62+
Burlington-16
Chapel Hill-*4+
Charlotte-3, 9+, 18, 36, *42+
Columbia-*2
Concord-*58
Curham-11+, 28+
Fayetteville-40+, 62
Franklin-*56+
Goldsboro-17-
Greensboro-2-, 48-, 61
Greenville-9-, 14, *25
Hickory-14-
High Point-8-, *32+
Jacksonville-19
Kannapolis-64-
Lexington-20
Linville-*17
Morganton-23-
New Bern-12+
Raleigh-5, 22, *34-
Rocky Mount-47-
Washington-7
Waynesville-59
Wilmington-3-, 6, 29+, *39-
Wilson-30-
Winston-Salem-12, *26+, 45

North Dakota

Bismarck-*3, 5, 12-, 17-, 26+
Devils Lake-8+, 22+
Dickinson-2+, 4-, 7
Ellendale-19-
 Fargo-6, 11+, 13, 15, 16-
Grand Forks-2, 14+, 27+
Jamestown-7-, 23
Minot-6+, 10-, 13-, 14, 24
Pembina-12
Valley City-4-
Williston-8-, 11-, 15-

Ohio

Akron-23+, *49+, 55-
Alliance-45+
Ashtabula-151
Athens-20-
Bowling Green-*27+
Cambridge-*44-
Canton-17-, 67
Chillicothe-53
Cincinnati-5-, 9, 12, 19+, 48-, 64-
Cleveland-3, 5+, 8, 19, 25+, 61
Columbus-4-, 6+, 10+, 28-, *34, *56-
Dayton-2, 7+, 16+, 22+, *45
Defiance-65+
Hillsboro-*24+
Lima-35-, 44+, *57+
Lorain-43
Mansfield-*47+
Marion-68-
Newark-*31-, 52
Oxford-*14+
Portsmouth-30, 36, *42-

TV Allocations

Sandusky-51-
Springfield-26+, *66
Steubenville-9+, *62+
Toledo-11-, 13, 24-, *30+, 54, 60-
Youngstown-21-, 27, 33, *58
Zanesville-18-

Oklahoma

Ada-10+, *22
Altus-*19-
Armore-12-, *17
Bartlesville-17+
Elk City-8+, *15-
Enid-20-, *26+
Guymon-*16
Hugo-Paris (Tex.)-7, *15+, 42+
Lawton-7+, 16-, *36-
McAlester-*32-
Miami-*18-
Muskogee-19
Oklahoma City-4-, 5, 9-, *13, 14-, 25-, 34-, 43+
Tulsa-2+, 6, 8-, *11-, 23, 29, *35-, 41+
Woodward-*17-

Oregon

Astoria-*21
Bend-*15, 21+
Brookings-*14-
Burns-18
Corvallis-*7-
Eugene-9+, 13, 16+, *28-
Klamath Falls-2-, *22+
La Grande-13+, *16
Medford-5, 8+, 10+, *18+
North Bend-11, *17+
Portland-2, 6+, 8-, *10, 12, 24+, *30
Roseburg-4+
Salem-3+, *22, 32
The Dalles-*17-

Pennsylvania

Allentown-*39, 69
Altoona-10-, 38-, 47, *57+
Bethlehem-60-
Clearfield-*3+
Erie-12, 24, 35+, *54+, 66+
Greensburg-40+
Harrisburg-21+, 27-, *33+
Hazleton-56
Johnstown-6, 19+, *28+
Lancaster-8-, 15+
Lebanon-59-
Philadelphia-3, 6-, 10, 17-, 29, *35, *57
Pittsburgh-2-, 4+, 11, *13-, *16, 22, 53+
Reading-51
Scranton-16-, 22-, 38+, *44-, 64
State College-29+, *55+
Wilkes-Barre-28
Williamsport-20-1
York-43, 49+

Rhode Island

Providence-10+, 12+, 161, *36, 64+

South Carolina

Aiken-*44
Allendale-*14
Anderson-40
Beaufort-*16-
Charleston-2+, 4, 5+, *7-
Columbia-10-, 19+, 25-, *35+, 57-
Conway-*23+
Florence-13+, 15-, 21, *33+
Georgetown-*41-

Greenville-4-, 16+, *29
Greenwood-*38
Myrtle Beach-43+
Rock Hill-30+, *55-
Spartanburg-7+, 49
Sumter-*27-

South Dakota

Aberdeen-9-, *16-
Brookings-*8
Eagle Butte-*13
Huron-12+
Lead-5-, 11+
Lowry-*11-
Martin-*8-
Mitchell-5+
Pierre-4, *10+
Rapid City-3+, 7+, *9, 15-, 21-
Reliance-6-
Seneca-*2-
Sioux Falls-11, 13+, 17-, *23, 36+
Vermillion-*2+
Watertown-3-

Tennessee

Athens-*24
Chattanooga-3+, 9-, 12+, *45, 61-
Cookeville-*22
Crosville-*20, 55+
Fayetteville-*28-
Greeneville-39-
Jackson-7+, 16+, *32+
Johnson City-11-, *41
Kingsport-19
Knoxville-6, 10+, *15-, 26-, 43+
Lexington-*11
Memphis-3-, 5+, *10+, 13+, *14+, 24, 30
Murfreesboro-39+
Nashville-2-, 4+, 5, *8+, 17+, 30+, *42
Sneedville-*2+

Texas

Abilene-9+, 15, *26+, 32+
Alpine-12-
Amarillo-*2-, 4, 7, 10, 14+
Austin-7+, *18+, 24, 36, 42-
Bay City-*43+
Beaumont-6-, 12-, 21, *34-
Big Spring-4-, *14
Boquillas-8-
Brady-13
Brownsville-23
Bryan-3+, *21
Childress-*15
Corpus Christi-3-, 6+, 10-, *16, 28-, 38+
Dallas-4+, 8, *13+, 27-, 33+, 39
Del Rio-10, *24+
El Paso-4, *7, 9, 13, 14, 26+, *38-
Fort Stockton-5+
Fort Worth-5+, 11-, 21-, *31+
Galveston-*22, 47+
Haringen-4+, *44, 60
Houston-2-, *8, 11+, 13-, *14, 20, 26, 39-
Laredo-8, 13, 27-, *39
Longview-16+
Lubbock-*5-, 11, 13-, 28, 34-
Lufkin-9
McAllen-48
Marfa-3
Marshall-*22-, 35+
Midland-2+, 18
Monahans-9-
Nacogdoches-19-, *32
Odessa-7-, 24-, 30, *36
Paris-Hugo (Okla.)-42+

Allocations; Experimental, Pay TV; Applications

Port Arthur—4—
 Presidio—7+
 Richardson—23
 Rosenberg—45
 San Angelo—3-, 6+, 8+, *21+
 San Antonio—4, 5, *9-, 12+, *23-, 29+, 41+
 Sherman—20—, *26—
 Sonora—11+
 Sweetwater—12
 Temple—6, 46—
 Texarkana—6+, 17-, *34
 Tyler—7, 14+, *38
 Victoria—19+, 25
 Waco—10+, 25+, *34+, 44—
 Weslaco—5—
 Wichita Falls—3, 6-, 18-, *24

Utah

Cedar City—4, *16+
 Logan—12-, *22
 Moab—*14+
 Monticello—*16—
 Ogden—*9+, *18-, 24, 30
 Price—6, *15
 Provo—*11+, 16
 Richfield—8+, *19
 Salt Lake City—2-, 4-, 5+, *7-, 14-, 20+, *26—
 St. George—*18—
 Vernal—3+, *17+

Vermont

Burlington—3, 22+, *33—
 Rutland—*28+
 St. Johnsbury—*20—
 Windsor—*41

Virginia

Blacksburg—*43
 Bluefield—*63+
 Bristol—5+, *28—
 Charlottesville—29-, *41-, 64+
 Courtland—*52
 Danville—24-, 44+, *56
 Fredericksburg—*53, 69+
 Front Royal—*42
 Hampton—13-, *15
 Harrisonburg—3—
 Kenbridge—*31—
 Lynchburg—13, 21-, *54+
 Norfolk-Portsmouth-Newport News—3+, 10+, 27, 33, 49-, *55+
 Norton—*47—
 Onancock—*25+
 Petersburg—8
 Richmond—6+, 12-, *23, 35+, *57-, 63
 Roanoke—7-, 10, *15, 27+
 Staunton—*51—
 West Point—*46

Washington

Bellingham—12+, 24, *34, 64
 Centralia—*15+
 Everett—16—
 Kennewick—42+
 Pasco—19—
 Pullman—*10—
 Richland—25, *31
 Seattle—4, 5+, 7, *9, 22+, *28+
 Spokane—2-, 4-, 6-, *7+, 22, 28—
 Tacoma—11+, 13-, 20, *56, *62
 Vancouver—*14
 Walla Walla—14—
 Wenatchee—*18+, 27
 Yakima—23+, 29+, 35, *47

West Virginia

Beckley—4
 Bluefield—6-, 40—
 Charleston—8+, 23, 29, *49—
 Clarksburg—12+, 46—
 Fairmont—66—
 Grandview—*9—
 Huntington—3+, 13+, *33+
 Keyser—*48+
 Martinsburg—*44
 Morgantown—*24—
 Parkersburg—15-, 39+, *57
 Weirton—*50+
 Weston—5
 Wheeling—7, 14, *41
 Williamson—*31+

Wisconsin

Appleton—32+
 Colfax—*28—
 Eau Claire—13+, 18
 Fond du Lac—34+
 Green Bay—2+, 5+, 11+, 26+, *38
 Janesville—57+
 Kenosha—55—
 La Crosse—8+, 19+, 25, *31
 Madison—3, 15, *21-, 27-, 47+
 Manitowoc—16+
 Milwaukee—4-, 6-, *10+, 12, 18-, 24+, 30, *36
 Oshkosh—22+
 Racine—49+
 Rhinelander—12+
 Sheboygan—28
 Superior—6+, 40
 Wausau—7-, 9, *20+, 33—

Wyoming

Casper—2+, *6+, 14-, 20—
 Cheyenne—5+, *17, 27-, 33—
 Lander—4
 Laramie—*8+
 Rawlins—11—
 Riverton—10+
 Rock Springs—13
 Sheridan—7, 12+

U.S. Territories and Possessions

Guam

Agana—*4, 8, 10, *12

Puerto Rico

Aguadilla—*32, 44
 Arecibo-Aguadilla—12+
 Arecibo—54, 80
 Bayamon—36
 Caguas—11-, *58
 Carolina—52
 Cayey—76
 Fajardo—13+, *40
 Guayama—46
 Humacao—68
 Mayaguez—3+, 5-, 16, 22
 Ponce—7+, 9-, 14, 20, *26, 48
 San Juan—2+, 4-, *6+, 18, 24, 30, *74
 San Sebastian—38
 Utuado—*70
 Vega Baja—64
 Yauco—42

Virgin Islands

Charlotte Amalie—10-, 17, *23, 43
 Christiansted—8+, 15, *21, 27
 Charlotte Amalie Christiansted—*3b, *12

Broadcast Pay TV

American Subscription Television. 777 W. Glencoe Pl., Milwaukee 53217. (414) 351-1680. Robert S. Block, pres; George V. Stein, VP-gen mgr; Kenneth Penchos, VP-finance, planning; Ray Boyle, VP.
 Pay TV franchisee for KWHY-TV (ch 22) Los Angeles, WDCA-TV (ch 20) Washington, KTMA-TV (ch 23) Minneapolis, ch 57 Philadelphia, ch 21 Fort Worth, and WCGV (ch 24) Milwaukee.

Athena Communications Corp. 54 Denver Technological Center, Box 10727, Denver 80210. Dr. John Malone, chmn & VP; Alvin Cooperman, chief exec officer & dir. Subs TV System EnDe-Code.
 Telemeter Pay TV system.

B & F Broadcasting Inc. 777 W. Glencoe Pl., Milwaukee 53217. (414) 351-1680. Robert S. Block, pres.
 Permittee for WCGV(TV) (ch 24) Milwaukee, authorized for pay TV operation.

Blonder-Tongue Labs Inc. One Jake Brown Rd., Old Bridge, N.J. 08857. (201) 679-4000. Isaac S. Blonder, chmn; Ben H. Tongue, pres; Samuel M. Stone, mktg mgr.
 Licensee of WBTV-TV (ch 68) Newark, N.J. and Boston station, authorized for pay TV operation. Over-the-air STV systems 4745 advance approved by FCC.

Boston Heritage Broadcasting Inc. c/o Edward H. Mank, 239 Lewis Wharf, Boston 02110. (617) 742-3200.
 Permittee for WQTV(TV) (ch 68) Boston, authorized for pay TV operation.

Coast Television Broadcasting Corp. 5545 Sunset Blvd., Los Angeles 90028. (213) 466-5441. Wiley D. Bunn, pres; Robert W. Bunnigen, gen mgr; Steven D. Weiner, prog dir.
 Licensee for KWHY-TV (ch 22) Los Angeles; authorized for pay TV operation.

Midwest St. Louis Inc. c/o W.T. Doar Jr., 50 S. 9th St., Minneapolis 55402. Owned by Midwest Radio-Television Inc., Minneapolis. Robert B. Ridder, pres; Lawrence F. Haeg, VP; Sherman K. Headley, VP; Henry W. Dornseif, treas; W.T. Doar Jr., sec.
 Applicant for new TV (ch 24) in St. Louis and pay TV installation.

Pay Television Corp. 680 Fifth Ave., New York 10019. (212) 765-8387. George F. Wiemann, pres;

E.W. Morris Jr., VP; George E. Howell, sec; Rose V. Roberts, asst sec.

Equipment for scrambling, unscrambling and billing pay TV progs for over-the-air and cable systems. Mgt svcs and progmg for operation of pay TV system.

Skialtron Electronics & Television Corp. 30 E. 42nd St., New York 10017. (212) 697-2990. Arthur Levey, pres & founder; Philip A. Levey, VP; Kurt Widder, gen counsel; Stephen J. Feldman, sec-treas.
 Pay TV systems, both broadcast and cable, with two-way communications capability. Television International Inc. is Skialtron's licensee outside U.S.A.

Telesis Inc. 777 W. Glencoe Pl., Milwaukee 53217. (414) 351-1680. Robert S. Block, pres.

Holds licensing rights—with exception of three markets—for FCC approved Teleglobe 410 Pay-TV System.

Teleglobe Pay-TV System Inc. 97-45 Queens Blvd., New York 11374. (212) 897-5300. Solomon Sagall, pres; John R. Poppele, VP & treas; Murray Salit, VP; Joel Sagall, sec.

FCC approved '410' Pay-TV System for over-the-air and cable operations; diversified billing methods, including centralized "metering and billing."

Video 44. Chicago. Joint venture of Harriscope of Chicago Inc., Woods Amusement Corp. and Riverdale Drive-In Inc.

Applicant to install pay TV equipment for WSNS (ch 44) Chicago.

Experimental TV Stations

Following is a list of the experimental television stations authorized by the FCC as of December 1975.

RCA Corp.—KE2XNY Cherry Hill Township, N.J. Chs. 2 through 6 with ERP of 100 kw; chs 7 through 13 with 316 kw, and chs. 14 through 83 with 1,000 kw.

Translator Sales & Service (Bob Bradford)—KB2XKQ Various locations in Washington, Oregon, Idaho and Montana. Ch 3, 60-66 mhz, 1 w; ch 69, 800-806 mhz, 20 w. To set up a temporary VHF and/or UHF translator at a site proposed for a permanent translator installation.

Zenith Radio Corp.—KS2XBR Chicago. Ch. 38, 614-620 mhz, 1 kw.

Pending Television Station Applications

Through Nov 30, 1975

Abbreviations: ann.—announced. ch—channel. CP—construction permit. ERP—effective radiated power. VHF—very high frequency. UHF—ultra high frequency. ant.—antenna. aur—aural. vis—visual. kw—kilowatts. w—watts. mhz—megahertz. *—non-commercial. trans—transmitter. lat—latitude. long—longitude. HAAT—height of antenna above average terrain.

Alabama

Birmingham—Alabama Citizens for Responsive Public Television. VHF ch 10 (192-198 mhz); ERP 316 kw vis., 31.6 kw aur., HAAT 1,046 ft.; ant. height above ground 795 ft. P.O. address: Box 642, Auburn, Ala. 36830. Estimated construction cost \$234,421; first-year operating cost \$300,000 (for all three stations, see Demopolis and Montgomery). Legal counsel Stein & Plesser, Washington; consulting engineer Steve Lewis. Principal: Alabama Citizens for Responsive Public Television is nonprofit corporation. Nancy Spears, director. Ann. Sept 3, 1975.

***Birmingham—Alabama Educational Television Commission.** VHF ch 10 (192-198 mhz); ERP 316 kw vis., 31.6 kw aur., HAAT 1,046 ft.; ant height above ground 795 ft. P.O. address: 2101 Magnolia Ave., Birmingham, Ala. 35205. First-year operating cost \$1,605,000. Legal counsel Hogan and Hartson, Washington. Principal: Robert E. Dod, general manager. Ann. April 8, 1975.

***Demopolis—Alabama Citizens for Responsive Public Television.** UHF ch. 41 (632-638 mhz); ERP 447 kw vis., 44.7 kw aur., HAAT 1,082 ft.; ant height

above ground 100 ft. P.O. address: Box 642, Auburn, Ala. 36830. Estimated construction cost: \$93,651; first-year operating cost \$300,000 (for all three stations, see Birmingham and Montgomery). Legal counsel Stein & Plesser, Washington; consulting engineer Steve Lewis. Principal: (see Birmingham, Ala., above). Ann. Sept 3, 1975.

***Demopolis—Alabama Educational Television Commission.** UHF ch. 41 (632-638 mhz); ERP 447 kw vis., 44.7 kw aur., HAAT 1,082 ft. P.O. address: 2101 Magnolia Ave., Birmingham, Ala. 35205. First-year operating cost \$1,605,000. Legal counsel Hogan and Hartson, Washington. Principal: Robert E. Dod, general manager. Ann. April 8, 1975.

Homewood—Chapman Radio & Television Co. UHF ch. 21 (512-518 mhz); ERP 21.53 kw vis., 10.05 kw aur., HAAT 673.1 ft., above ground 292 ft. P.O. address: c/o W.A. Chapman, Box 3297, Birmingham, Ala. Estimated construction cost \$93,250; first year operating cost \$50,000; revenue \$50,000. Studio location Homewood, trans. location Birmingham, Ala. Geographic coordinates 33°29'11" north latitude, 86°48'18" west longitude. Type trans. RCA TTU-1B, type ant. GE TY-25B. Principals: William A. and George K. Chapman (each 50%). Applicant is licensee of WCRT-AM-FM Birmingham and WCFT-TV Tuscaloosa, both Alabama.

***Homewood—Alabama Citizens for Responsive Public Television.** UHF ch. 26 (542-548 mhz); ERP 229 kw vis., 33.9 kw aur., HAAT 590 ft.; ant. height above ground 563 ft. P.O. address: Box 642, Auburn, Ala., 36830. Estimated construction cost \$93,600; first-year operating cost \$300,000 (for all three stations, see Birmingham and Demopolis). Legal counsel

Stein & Plesser, Washington; consulting engineer Steve Lewis. Principals: (see Birmingham, Ala., above). Ann. Sept. 3, 1975.

***Montgomery—Alabama Educational Television Commission.** UHF ch. 26 (542-548 mhz); ERP 229 kw vis., 22.9 kw aur., HAAT 590 ft.; ant. height above ground 553 ft. PO. address: 2101 Magnolia Ave., Birmingham, Ala. 35205. First-year operating cost \$1,605,000. Legal counsel Hogan and Hartson, Washington. Principal: Robert E. Dod, general manager. Ann. April 8, 1975.

Arkansas

***Craighead—Arkansas Educational Television Commission.** UHF ch. 19 (500-506 mhz); ERP 890 kw vis., 178 kw aur., HAAT 1,220 ft.; ant. height above ground 1,145 ft. (proposed satellite of KETS(TV) Little Rock, Ark.) PO. address: 350 South Donaghey, Conway, Ark. 72032. Estimated construction cost \$1 million; first-year operating cost \$55,600; revenue none. Geographic coordinates 35° 54' 14" north lat.; 90° 46' 39" west long. Type trans. RCA TTU-60B. Type ant. RCA TFU-36J(L). Legal counsel Pierson, Ball & Dowd, Washington; consulting engineer Jansky & Bailey, Washington. Principals: Evelyn Pierce Hammons is chairman and Lee Reaves is director of Arkansas Educational Television Commission.

California

***Fresno—Fresno County Board of Education.** UHF ch. 18 (494-500 mhz); ERP 1040 kw vis., 104 kw aur., HAAT 2,223 ft.; ant. height above ground 245 ft. PO. address: 2314 Mariposa Street, Fresno 93721. Estimated construction cost \$574,113. First-year operating cost \$220,321; revenue none. Geographic coordinates 36°44'45" north lat.; 119°16'54" west long. Type trans. CCA TA-30BT. Type ant. CCA BR-30. Consulting engineer Jacob H. Wiens, Woodside, Calif. Principals: Ernest A. Poore is superintendent of Fresno County Board of Education.

Fresno, Calif.—San Joaquin Communications Corp. UHF ch. 24 (530-536 mhz); ERP 828 kw vis., 166 kw aur., HAAT 2,360 ft.; ant. height above ground 318 ft. PO. address: Box 87, Fresno 93707. Estimated construction cost \$2,585,400; first three months operating cost \$1,703,984; revenue \$2,000,000. Legal counsel Pittman, Lovett, Ford and Hennessey, Washington; consulting engineer Jules Cohen & Associates. Principals: Paul E. Diener, George T. Ellithorpe, John M. Garabedian, R.J. Giddings, Jack A. Harris, James K. Herbert, Michael S. Mathiesen, N. Sumner Peck Jr., Charles A. Sorenson (9.95% each), et al. California farmers and businessmen, request facilities of KJU-TV Fresno.

***Los Gatos—Reginald A. Fessenden Education Fund.** UHF ch. 48 (674-680 mhz); ERP 9.4 kw vis., 2.4 kw aur., HAAT 911 ft.; ant. height above ground 113 ft. PO. address: 222 University Ave., Los Gatos 95030. Estimated construction cost \$49,700; first-year operating cost \$25,300. Legal counsel Haley, Bader and Potts, Washington; consulting engineer Hatfield & Dawson. Principal: Cese McGowan, executive vice president.

***Salinas—Monterey County Superintendent of Schools.** UHF ch. 67 (788-794 mhz); ERP 23.48 kw vis., 4.67 kw aur., HAAT 2,145 ft.; ant. height above ground 29 ft. PO. address: 132 West Market St., Salinas 93901. Estimated construction cost \$92,575; first-year operating cost \$18,000; revenue none. Geographic coordinates 36°32'08" north lat.; 121°37'18" west long. Type trans. RCA TTV-1BLA. Type ant. Bogner slot B8UA. Legal counsel Monterey (Calif.) county counsel; consulting engineer Ken Warren, Monterey. Principal: Ray Charlson is superintendent of Monterey County Schools.

San Jose—National Group Television. UHF ch. 48 (674-680 mhz); ERP 450 kw vis., 264 kw aur., HAAT 2,614 ft.; ant. height above ground 4,079 ft. PO. address: 1666 The Alameda, San Jose 95126. Estimated construction cost \$1,039,000; first-year operating cost \$680,690; revenue \$1,032,800. Legal counsel Mullin, Connor & Rhyne, Washington; consulting engineer Silliman, Moffet & Kowalski. Principals: Nathaniel J. Douglas Jr. et al. Mr. Douglas is financial analyst. There are nine other stockholders. Ann. Oct. 3, 1975.

Florida

Daytona Beach—Central Florida Enterprises Inc. VHF ch. 2; ERP 100 kw vis., 20 kw aur., HAAT 940 ft.; ant. height above ground not indicated. PO. address: c/o E. William Crotty, 444 North Beach Street,

Daytona Beach 32015. Applicant proposes to negotiate with existing licensee and make reasonable offer to latter for use of all physical facilities associated with WESH-TV Daytona Beach. Geographic coordinates 28°56'25" north lat.; 81°18'33" west long. Type trans. RCA TT-26CL Type ant. RCA TF-6AL. Legal counsel Pittman, Lovett, Ford, Hennessey and White, Washington; consulting engineer Jules Cohn. Principals: E. Williams Crotty, president (15.5%), James R. Stephen, treasurer (15.55%), Jeanne M. Goddard, executive vice president, G.P. Schanck Jr., vice president, Thomas W. Staed, secretary, W.J. Taylor Jr., vice president (each 3.5%), et al. Mr. Crotty is attorney and owns 25% of motel firm. Mr. Stephen owns 50% of car rental agency, 50% of used car sales firm, 50% of real estate firm and 10% of amusement park. Dr. Schanck Jr. is physician and owns 6.5% of low rent housing. Mr. Staed operates motel, owns 25% of motel firm and 27% of oil company. Mr. Taylor Jr. owns pharmacy, 50% of real estate investment firm and 15% of another.

Lakeland—Channel 51 Inc. UHF ch. 32 (578-584 mhz); ERP 206.34 kw vis., 41.3 kw aur., HAAT 742 ft.; ant. height above ground 796 ft. PO. address: c/o William F. Johns Jr., 605 East Sheridan Street, Dania, Fla. 33004. Estimated construction cost \$429,000; first-year operating cost \$300,000; revenue \$300,000. Geographic coordinates 23°00'29" north lat.; 81°53'18" west long. Type trans. RCA TTU-10A. Type ant. RCA TFU30J. Legal counsel Everett D. Johnston, Washington. Principals: Recreation Corp. of America Inc. (80%), William F. Johns Jr., president (8%), et al. Recreation Corp. of America Inc. is owner of Pirates World Amusement Center, Film World Studios and children's film distribution firm, all in Dania. Mr. Johns owns Everglades Yacht & Tennis Club, and has majority interest in Wm. Johns & Associates, advertising firm, both in Ft. Lauderdale, Fla. Channel 51 Inc. is licensee of WKID(TV) firm, both in Ft. Lauderdale, Fla. Channel 51 Inc. is licensee of WKID(TV) Ft. Lauderdale.

Miami—Tropical Florida Broadcasting Co. VHF ch. 10 (192-198 mhz); ERP 316 kw vis., 47.9 kw aur., HAAT 1,002 ft.; ant. height above ground 1,042 ft. Mutually exclusive with license-renewal application of WPLG(TV) Miami. PO. address: c/o Cromwell A. Anderson, 169 East Flagler Street, Miami 33131. Estimated construction cost \$3,169,800; first-year operating cost \$3,650,000; revenue \$5,110,000. Geographic coordinates 25°57'59" north lat.; 80°12'44" west long. Type trans. RCA TT-50FH. Type ant. RCA TW-12A 10-P. Legal counsel Welch & Morgan, Washington; consulting engineer Gaultney & Jones, Falls Church, Va. Principals: Cromwell A. Anderson, president (10.8%), R. Leslie Cizek Jr., vice president (10.8%), et al. Mr. Anderson is proprietary partner in Smathers & Thompson, Miami law firm. Mr. Cizek is vice president of Parker & Co. of Florida Inc., insurance brokerage in Coral Gables, Fla.

Note—Orlando: Interim operating authority of ch. 9 granted by FCC on Jan. 9, 1969 to Ch. 9 of Orlando, consolidation of contestants in proceeding. Review board granted CP to Mid-Florida TV Corp. on Jan. 10, 1972, but interim operation continues pending court review of grant.

Orlando—Mid-Florida TV Corp. VHF ch. 9 (186-192 mhz); ERP 316 kw vis., 43.6 kw aur., HAAT 610 ft., ant. height above ground 651 ft. Counsel Cohen & Marks; consulting engineer A.D. Ring & Assoc., both Washington. Principals: Joseph L. Brechner, pres. (50.8%), Marion B. Brechner, asst. sec-treas. (11.8%), Harris H. Thompson (14.1%), et al. Mid-Florida was previous licensee of WFTV, operating Feb. 1, 1958.

Orlando—TV 9 Inc. VHF ch. 9 (186-192 mhz); ERP 316 kw vis., 41.23 kw aur., ant. height above average terrain 1,378 ft.; above ground 1,479 ft. PO. address: c/o George W. Johnson, 100 E. Robinson St., Orlando 32801. Estimated construction cost \$1,766,984; first-year operating cost \$1,030,150; revenue \$1,510,000. Studio located in Orlando, trans. near Chulota. Geographic coordinates 28°36'08" N. lat.; 81°05'38" W. long. Type trans. RCA TT-25DH, type ant. RCA TW 18A9P. Legal counsel Arnold & Porter, consulting engineers Raymond F. Rohrer & Associates, both Washington. Principals: Gordon Gray, Lincoln W. Miller (each 14%), Thompson K. Cassel (11%), John C. McKellar Jr., George W. Johnson, James Thomas Gurney Jr., Willoughby T. Cox Jr. (each 7%) and others. Mr. Gray is communications consultant to Time-Life Broadcast Division and Roy Park Broadcasting Co. Mr. Miller is assistant to pres. of KIRO Inc., Seattle. Mr. Cassel is 56% owner of WKIS Orlando and 12% owner of WCOA Pensacola, Fla. M.

McKellar is owner of Cadillac dealership. Messrs. Johnson and Gurney are lawyers. Mr. Cox is mortgage banker.

Orlando—Florida 9 Broadcasting Co. VHF ch. 9 (186-192 mhz); 279 kw vis., 27.9 kw aur. Ant. height above average terrain 1,443 ft., above ground 650 ft. PO. address: c/o W. Carden Meers, Suite 213 Rutland Bldg., Orlando 32802. Estimated construction cost \$527,000; first-year operating cost \$1,000,000; revenue \$1,400,000. Studio located in Orlando, trans. near Orlovista. Geographic coordinates 28°32'10" N. lat., 81°26'59" W. long. Type trans. RCA TT-25-DH(LA), type ant. RCA TW-18A9-P. Legal counsel Philipson, Lyon & Chase, Washington. Principals: W. Carden Meers, Troy B. Hewett, Bright McConnell Jr., Louis P. Brady, Harry H. Ferran, Joseph J. Bryant (each 12%) and others. Mr. Meers has filling station ownership. Mr. Hewett is real estate investor. Drs. McConnell, Brady, Ferran and Nixon are physicians. Mr. Bryant is realtor.

Orlando—Florida Heartland Television Inc. VHF ch. 9 (186-192 mhz); ERP 316 kw vis., 41.23 kw aur. Ant. height above average terrain, 1,378 ft., above ground 1,479 ft. PO. address: c/o Henry C. Amerson, 170 East Washington St., Orlando 32801. Estimated construction cost \$1,468,746; first-year operating cost \$1,270,994; revenue \$1,350,000. Geographic coordinates 28°36'08" N. lat., 81°53'38" W. long. Type trans. RCA TT-25DH(LA), type ant. RCA TW-18A9-P. Legal counsel Smith & Pepper, consulting engineers Jules Cohen & Associates, both Washington. Principals: J. Douglas Gay Jr., H. Guthrie Bell (each 12.5%), Thomas C. Butt (11%), Florence Fishback (10.4%), Thomas J. Eaton, William K. Brown (each 9%), and others. Mr. Gay is agricultural investor. Mr. Bell is soft drink bottler, farm and real estate investor. Dr. Butt is physician. Mrs. Fishback is real estate investor. Mr. Eaton is drug firm and race horse investor. Mr. Brown is real estate investor.

Orlando—Comint Corp. VHF ch. 9 (186-192 mhz); ERP 316 kw vis., 41.23 kw aur. Ant. height above average terrain 1,378 ft., above ground 1,479 ft. PO. address: c/o David W. Hedrick, Suite 301, First Federal Bldg., Orlando 32802. Estimated construction cost \$1,845,000; first-year operating cost \$1,040,000; revenue \$1,405,000. Studio located in Orlando, trans. located in NE. Type trans. RCA TT-25DH, type ant. RCA TW-15A9-P. Geographic coordinates 28°36'08" N. lat., 81°05'38" W. long. Legal counsel Keith F. Putbrese, consulting engineers Jansky & Bailey, both Washington. Principals: Wallace Mercer, Thomas K. Matthews (each 10%), James C. Robinson, David W. Hedrick (each 8.33%), Avrum N. Abramowitz, Donald S. Evans, Ralph Melitt, Paul C. Perkins (each 7.71%), Loomis C. Leedy Jr., Thomas O. Quinby, James R. Smith, Chris J. Witting (each 7%), F. Cleveland Hedrick Jr. (6.66%). Mr. Mercer is commissioner on Orlando Utilities Commission. Mr. Matthews is regional manager of KFCE-AM-FM St. Joseph and KLIK Jefferson City, both Missouri. Mr. Robinson and Mr. Hedrick are Orlando lawyers. Mr. Abramowitz is officer of life insurance company. Mr. Evans is Orange County commissioner and director of Citizens National Bank. Mr. Melitt is citrus investor. Mr. Perkins is attorney. Mr. Leedy is investment banker. Mr. Quinby is citrus processing investor. Dr. Smith is general practitioner. Mr. Witting is president and director of Crouse-Hinds Co. Mr. Hedrick Jr. is Washington attorney.

Orlando—Central Nine Corp. VHF ch. 9 (186-192 mhz); ERP 316 kw vis., 41.23 kw aur. Ant. height above average terrain 1,378 ft., above ground 1,479 ft. PO. address: c/o Benjamin F. Smathers, 369 North Orange Ave., Orlando 32802. Estimated construction cost \$1,716,500; first-year operating cost \$1,322,000; revenue \$1,326,000. Studio located in Orlando, trans. located SW of town. RCA TT25-DH LA, type ant. RCA TW18A9-P. Legal counsel Welch & Morgan; consulting engineer George C. Davis, both Washington. Principals: Richard G. Danner, (18%), J. Rolfe Davis, Robert F. Lilley, Austin A. Caruso, Grover C. Bryan (each 10%), Benjamin F. Smathers (12%), and others (each 10%). Mr. Danner is lawyer. Mr. Davis is real estate investor. Mr. Lilley is lawyer. Mr. Caruso is citrus grower. Mr. Bryan is insurance executive. Mr. Smathers is lawyer and banker.

Illinois

***Macomb—Western Illinois University.** UHF ch. 22 (518-524 mhz); ERP 354.8 kw vis., 35.5 kw aur.

TV Applications

HAAT 1,218 ft.; ant. height above ground 1,259. PO. address: 900 W. Adams St., Macomb 61455. Estimated construction cost \$1,908,000; first-year operating cost \$640,000. Legal counsel Dow, Lohnes & Albertson, Washington; consulting engineer Steel, Andrus & Adair. Principal: Dr. Robert L. Milkman, director of office of instructional technology.

***Moline—Western Illinois University.** UHF ch. 24 (530-536 mhz); ERP 446.7 kw vis., 55.8 kw aur. HAAT 586 ft.; PO. address: 900 W. Adams St., Macomb 61455. Estimated construction cost \$459,000; first-year operating cost \$640,000. Legal counsel, consulting engineer and principal same as above.

Rockford—Lloyd Hearing Aid Corp. UHF ch. 39 (620-626 mhz); ERP 741 kw vis., 148 kw aur., HAAT 170 ft. PO. address: c/o Marvin Palmquist, 128 Kishwaukee St., Rockford 61110. Estimated construction cost \$258,000; first-year operating cost \$105,000; revenue \$90,000. Legal counsel Cohn and Marks, Washington; consulting engineer Jules Cohen & Associates. Principals: **Marvin E. and Elizabeth L. (50%), Christine (16.67%), Mary (16.66%), and Andrew (16.67%) Palmquist.** Principals own same percentages of hearing aid corporation. Ann. Nov. 13, 1975.

Louisiana

***Shreveport—Louisiana Educational Television Authority.** UHF ch. 24 (520-536 mhz); ERP 1726 kw vis., 173 kw aur. HAAT 1,070 ft.; ant. height above ground 1,080 ft. PO. address: State Department of Education, Box 44064, Baton Rouge 70804. Estimated construction cost \$1,155,572; first-year operating cost \$254,064. Legal counsel, consulting engineer and principal same as above.

Massachusetts

Boston—Community Broadcasting of Boston Inc. VHF ch. 7 (174-180 mhz); ERP 190 kw vis., 39 kw aur., HAAT 1,165 ft.; ant. height above ground 1,215 ft. Mutually exclusive with license renewal application of WNAC-TV. PO. address: c/o David C. Mungan, 480 Boylston Street, Boston 02116. Estimated construction cost \$4,102,000; first-year operating cost \$7,000,000; revenue \$9,000,000. Geographic coordinates 42°18'15" north lat.; 71°13'10" west long. Type trans. GE TT515-D. Type ant. GE TY-53-B. Legal counsel Welch & Morgan, consulting engineer Raymond E. Rohrer, both Washington. Principals: **Thomas J. White,** president, **John P. Chase,** vice president (each 11%), **David Mugar,** treasurer (27.8%), et al. Mr. White owns general contracting firm and 60% of another, 70% of equipment rental and investment firm, 75% of real estate investment company and less than 25% of insurance, real estate and sand and gravel companies. Mr. Chase owns 50.14% of investment counsel firm. Mr. Mugar owns investment firm, 50% of real estate companies and has interests in motel, shopping center, gasoline stations and tomato importing firms.

Boston—Dudley Station Corp. VHF ch. 7 (174-180 mhz); ERP 308 kw vis., 61.5 kw aur., HAAT 1,000 ft.; ant. height above ground 1,025.5 ft. Mutually exclusive with license renewal application of WNAC-TV. PO. address: 47 Hutchings Street, Boston 02121. Estimated construction cost \$2,200,200; first-year operating cost \$4,870,000; revenue \$7,400,000. Geographic coordinates 42°18'12" north lat.; 71°13'08" west long. Type trans. RCA TT-25/25EH. Type ant. RCA TBF-12AH. Legal counsel Arent, Fox, Kintner, Plotkin & Kahn; consulting engineer Jules Cohen & Associates, both Washington. Principals: **Bertram M. Lee,** president (47%), **Henry E. Hampton Jr.,** treasurer (20%), **Ruth M. Batson,** **Charles T. Grigsby** (each 6%), **Henry M. Morgan,** **Thomas J. Brown** and **Jerome B. Wiesner** (each 7%). Mr. Lee is Boston industrial consultant. Mr. Morgan is manager, human relations department, Polaroid Corp., Cambridge, Mass., and has interest in several Cambridge electronics companies and in Cambridge bank. Mr. Hampton owns 60% of Blackside Inc., Boston film production-audio/visual materials firm. Ruth Batson is executive director of Metropolitan Council for Educational Opportunity, Roxbury, Mass. Mr. Grigsby is president-treasurer and will acquire a majority of the stock of Transcom Lines Inc., Boston bus leasing and charter company. Mr. Brown is assistant to president of Polaroid and has less than 1% interest in that company. Mr. Wiesner is provost of Massachusetts Institute of Technology and has minority interests in electronics firms, chemical products company and electric power company.

Michigan

Sault Ste. Marie—Northern Entertainment Inc. VHF ch. 8 (180-186 mhz); ERP 224 kw vis., 44.8 kw aur. HAAT 959 ft.; ant. height above ground 873 ft.; proposed satellite of WGTV(TV) Traverse City, Mich. PO. address: 201 East Front St., Traverse City 49684. Equipment to be leased for \$60,000 per year; first-year operating cost (not including leased equipment) \$66,800; revenue \$83,200. Geographic coordinates 46°03'22" north lat.; 84°06'18" west long. Type trans. RCA TT-25BH. Type ant. RCA TF-12AH. Legal counsel Booth and Freret, Washington; consulting engineer Smith and Powstenko, Washington. Principal: **Thomas W. Kiple** is president of Northern Entertainment, licensee of WGTV(TV) Traverse City.

Minnesota

St. Cloud—Northwest Theater Corp. UHF ch. 4 (632-638 mhz); ERP 1000 kw vis., 200 kw aur., HAAT 757 ft.; ant. height above ground 800 ft. PO. address: Central Ave., Chippewa Falls, Wis. 56301. Estimated construction cost \$1,153,000; first-year operating cost \$350,000; revenue \$480,000. Legal counsel not given; consulting engineer John B. Heffelfinger. Principals: **Merle Harberts (52%) et al.** will build dinner theatre to finance construction of station. Ann. July 16, 1975.

Mississippi

Jackson—Channel 3 Inc. VHF ch. 3 (60-66 mhz); ERP 100 kw vis., 20 kw aur., HAAT 1,938 ft.; ant. height above ground 1,995 ft. PO. address: c/o Robert C. Travis, 925 Electric Building, Jackson 39201. Estimated construction cost \$1,651,500; first-year operating cost \$800,000; revenue \$1,100,000. Geographic coordinates 32°15'30" north lat.; 90°24'16" west long. Type trans. Ampex TA-8218. Type ant. Ampex BR-6L. Legal counsel Bilger, Blair & Glaser, Washington; consulting engineer Serge Bergen, Fairfax, Virginia. Principals: **James E. Fowler,** president, **John A. Peoples Jr.,** vice-president-chairman executive committee, **Cornelius Turner,** treasurer, **Robert C. Travis,** secretary (each 6.66%) et al. Mr. Fowler owns Buick dealership, 75% of insurance company, 50% of real estate development firm and 75% of shopping center. Mr. Peoples is president of Jackson (Miss.) State College. Mr. Turner is general contractor. Mr. Travis is partner in law firm. Principals request facilities of WLBT(TV) Jackson, ch. 3.

Jackson—Civic Communications Corp. VHF ch. 3 (60-66 mhz); ERP 95.7 kw vis., 19.1 kw aur., HAAT 2,051 ft.; ant. height above ground 1,993 ft. PO. address: c/o Stephen Kurzman, 1616 H Street, N.W., Washington. Estimated construction cost \$1,622,500; first-year operating cost \$648,240; revenue \$1,000,000. Geographic coordinates 32°12'46" north lat.; 90°22'54" west long. Type trans. RCA TT-25BL. Type ant. RCA TF-6AL. Legal counsel Kurzman & Goldfarb; consulting engineer Jules Cohen & Associates, both Washington. Principals: **Weyman H.D. Walker,** president (40%), et al. Mr. Walker owns 25% of WNFA-TV Tallahassee, Fla., and 11.6% of WHTV(TV) Meridian, Miss.

Jackson—Dixie National Broadcasting Corp. VHF ch. 3 (60-66 mhz); ERP 100 kw vis., 20 kw aur., HAAT 1,972 ft.; ant. height above ground 1,944.5 ft. PO. address: c/o Rubel L. Phillips, 717 Deposit Guaranty National Bank Building, Jackson 39205. Estimated construction cost \$2,682,500; first-year operating cost \$795,820; revenue \$1,300,000. Geographic coordinates 32°11'57" north lat.; 90°23'03" west long. Type trans. RCA TT-30FL. Type ant. RCA TF-5CL. Legal counsel Keller & Heckman; consulting engineer Silliman, Moffet & Kowalski, both Washington. Principals: **William D. Mounger,** president (40%), **Rubel L. Phillips,** chairman of board (5%), **Dixie National Life Insurance Co.** (40%), et al. Dixie National Life: Charles J. Jackson, chairman of board, et al. Mr. Mounger is independent oil producer and owns 50% of real estate firm. Mr. Phillips is partner in law firm and owns 10% each of common carrier company and motor vehicle leasing firm. Principals seek facilities of WLBT(TV) Jackson, ch. 3.

Jackson—Jackson Television Inc. VHF ch. 3 (60-66 mhz); ERP 100 kw vis., 20 kw aur., HAAT 2,000 ft.; ant. height above ground 1,939 ft. PO. address: c/o Alvin P. Fiannes, 903 Deposit Guaranty Building, Jackson 39301. Estimated construction cost \$1,585,070; first-year operating cost \$1,200,000; revenue \$1,740,000. Geographic coordinates 32°13'49" north lat.; 90°22'10" west long. Type trans. Ampex TA-8225. Type ant. RCA TF-6AL. Legal counsel Mallick & Berntson; consulting engineer John H. Mullaney & As-

sociates, both Washington. Principals: **Alvin P. Fiannes,** president-chairman of board (14%), **Theodore M. Wrobel,** executive vice president (10%), **Earl W. Banks,** **Mrs. Joan N. Geiger** and **Mrs. Rose E. McCoy,** all vice presidents, **Dr. Robert Smith,** secretary, **Robert P. Guyton,** treasurer, **Burwell Beeman McClendon, Jr.,** assistant secretary (each 6%), et al. Mr. Fiannes owns 51% of wholesale supplier. Mr. Wrobel is assistant to President of LIN Broadcasting Corp., New York. Mr. Banks owns 50% of one funeral home and 12½% of another and 50% of two burial insurance firms. Mrs. Geiger owns 10% of steel fabrication company. Mr. Smith is doctor and owns 60% of grocery store and 51% of restaurant. Mr. Guyton is executive vice president and owns less than 1% of First National Bank of New Albany, Miss. Mr. McClendon, Jr. is partner in law firm and owns 30% of one real estate investment firm and 25% of another. Principals seek facilities of WLBT(TV) Jackson.

Jackson—Lamar Life Broadcasting. VHF ch. 3 (60-66 mhz); ERP 95.7 kw vis., 19.1 kw aur., HAAT 2,051 ft.; ant. height above ground 1,993 ft. PO. address: Box 2171, Jackson 39201. Estimated construction cost \$1,770,000; first-year operating cost \$1,545,000; revenue \$2,048,000. Geographic coordinates 32°12'46" north lat.; 90°22'54" west long. Type trans. RCA TT-25BL. Type ant. RCA TF6AL. Legal counsel Arnold & Porter, Washington; consulting engineer A. Earl Cullum Jr., Dallas. Principals: **Lamar Life Insurance,** 100%, **Harland L. Knight,** president (0.79%), **Robert M. Hearin,** chairman of executive committee (6.79%), **John D. Murchison (31.68%), Clint W. Murchison Jr. (13.94%),** et al. Mr. Knight owns less than 25% of two investment firms. Mr. Hearin is chairman of board and owns less than 25% of First National Bank of Jackson and owns less than 25% of oil and gas concerns, telephone company, chemical business, life insurance and bank holding company. Messrs. Murchison own investment firms, 82% jointly of Dallas Cowboys Football Club and interests in over 100 other business enterprises. Lamar Life was owner of WLBT(TV) Jackson, ch. 3, but hearing was set to decide on new licensee. It owns WJDX(AM)-WZZQ(FM) Jackson.

Meridian—American Public Life Broadcasting Co. UHF ch. 30 (566-572 mhz); ERP 234 kw vis., 46.7 kw aur. HAAT 553 ft.; ant. height above ground 315 ft. PO. address: Box 10297, Jackson, Miss. 39209. Estimated construction cost \$256,600; first-year operating cost \$284,600; revenue not indicated. Geographic coordinates 32°19'40" north lat.; 88°41'27" west long. Type trans. RCA TTU-12A. Type ant. RCA TFU-30JA. Legal counsel Mallick & Berntson, Washington; consulting engineer Willis C. Beecher, Washington. American Public Life Broadcasting Co. owns WAPT(TV) Jackson, Miss., and proposes to operate TV in Meridian as satellite to WAPT. Principal: **American Public Life Insurance Co.** (100%).

Missouri

***St. Louis—Double Helix Corp.** UHF ch. 40 (626-632 mhz); ERP 62.1 kw vis., 10.3 kw aur., HAAT 372 ft.; ant. height above ground 328 ft. PO. address: Box 8187, Pierre Laded Station, St. Louis 63156. Estimated construction cost \$29,388; first-year operating cost \$25,000. Geographic coordinates 38°38'20" north 94°14'00" west. Type trans. TTV-12. Ant. type TFU-6D. Legal counsel Haley, Bader & Potts, Washington. Principal: **Thomas J. Thomas,** general manager.

St. Louis—New Life Evangelistic Center. UHF ch. 24 (530-536 mhz); ERP 1447 kw vis., 289 kw aur., HAAT 997.6 ft.; ant. height above ground 727.6 ft. PO. address: Box 473, St. Louis 63104. Estimated construction cost \$797,100; first-year operating cost \$200,000; revenue \$400,000. Legal counsel Midlen C. Reddy, Washington; consulting engineer John Patrick Suchan. Principals: **Rev. Lawrence W. Rice Jr.** and **Patrick Flotorn** are respectively president and vice president of nonprofit New Life. Ann. Jan. 21, 1975.

***St. Louis—St. Louis Educational Television Commission.** UHF ch. 40 (626-632 mhz); ERP 500 kw vis., 100 kw aur., HAAT 1,473 ft.; ant. height above ground 1,068 ft. PO. address: 6996 Milbrook Blvd., St. Louis 63130. Estimated construction cost \$446,987; first-year operating cost \$189,000. Consulting engineer Andrew R. McMaster. Principal: **Robert C. Glazier,** executive director.

Montana

***Billings—Montana Educational Broadcasting Commission.** VHF ch. 11 (198-204 mhz); ERP 316 kw vis., 63 kw aur., HAAT 563 ft. PO. address: 923 N. Seventh, Bozeman 59715. Estimated construction

cost \$772,000; first-year operating cost \$750,000. Consulting engineer: Thomas Jenkins. Principals: Kenneth R. Clark, executive director. Ann. Feb. 26, 1975.

Nevada

Las Vegas—Las Vegas Valley Bcstg Co. VHF ch. 3 (60-66 mhz); ERP 100 kw vis., 10 kw aur; HAAT 2,000 ft.; ant. height above ground 308 ft. PO. address: Suite 402, 401 S. 3rd St., Las Vegas 89101. Estimated construction cost \$3,086,000; first-year operating cost \$1,320,000. Legal counsel Welch & Morgan, Washington; consulting engineer Serge Bergen, Principals: **James E. Rogers**, pres. (10%), **Meyer Gold**, vice pres. (12.5%), **W. Irving Haul**, treas. (12.5%), et al. Mr. Gold has negative control of KLOM-AM-FM Lompoc, Calif. Applicants are contesting licensee of KORK-TV Las Vegas.

***Reno—Nevada Educational Communications Commission.** VHF ch. 5 (76-82 mhz); ERP 50 kw vis., 5 kw aur, HAAT 2,900 ft.; ant. height above ground 95 ft. PO. address: 320 North Plaza, Carson City, Nev. 89701. Estimated construction cost \$908,050; first-year operating cost \$117,040; revenue none. Geographic coordinates 38°18'49" north lat.; 119°52'58" west long. Type trans. Ampex TA-8212. Type ant. Ampex BR41. Legal counsel Nevada attorney general; consulting engineer Jack A. Rickel Associates Inc. Principals: Hugh Smith, executive director, et al.

New Mexico

Gallup—New Mexico Broadcasting Co. VHF ch. 3 (60-66 mhz); ERP 100 kw vis., 10 kw aur, HAAT 2000 ft.; ant. height above ground 477 ft. PO. address: Box 1294, Albuquerque, N.M. 87103. Estimated construction cost \$338,500; first-year operating cost \$24,000; revenue none. Geographic coordinates 35°55'16" north lat.; 108°47'24" west long. Type trans. Gates BT-18L. Type ant. Gates TYP50-F. Legal counsel Dow, Lohnes & Albertson, Washington; consulting engineer A. Earl Cullum Jr. & Associates, Dallas. Principals: **Goidie Hebenstreit**, as executrix estate of A.R. Hebenstreit (56.2%), **Harriscope Broadcasting Corp.**, represented by Burt I. Harris (30.01%), et al. New Mexico Broadcasting owns KRKE(AM)-KGGM-TV Albuquerque and KV5F(AM) Santa Fe, all New Mexico. Harriscope is licensee of KBAK-TV Bakersfield, Calif., KTWO-AM-TV Casper, Wyo., KULR-TV Billings and KFBB-TV Great Falls, both Montana. Harriscope also has 50% interest in WSNS-TV Chicago. New VHF at Gallup is proposed satellite of KGGM-TV Albuquerque.

New York

New York—Forum Communications. VHF ch. 11 (198-204 mhz); ERP 100 kw vis., 19.6 kw aur, HAAT 1,410 ft.; ant. height above ground 1,464 ft. (facilities of WPJX [TV]). PO. address: 122 East 42 Street, New York 10017. Estimated construction cost \$2,400,000; first-year operating cost \$9,886,900; revenue \$1,000,000. Geographic coordinates 40°42'43" north lat., 74°0'49" west long. Type trans. RCA TT-25EH. Type ant. RCA custom-built. Legal counsel Michael Finkelshtein; consulting engineer Jules Cohen & Associates, both Washington. Principals: **Lawrence L. Grossman**, president (18.9%), **Irwin Sonny Fox**, vice president (12.4%), **Paul Roebing**, (18.9%), **Ronnie Eldridge**, vice president-secretary (7.5%), **Oppenheimer & Co.**, (17.6%), et al. Mr. Grossman owns New York advertising agency and Mr. Fox is TV producer. Mr. Roebing is partner in Denver mining company and is majority owner of New York film and theatrical production company Oppenheimer & Co. is New York stockbroker.

New York—Multi-State Communications Inc. VHF ch. 9 (186-192 mhz); ERP 155 kw vis., 31 kw aur. HAAT 1,237 ft.; ant. height above ground 1,470 ft. Mutually exclusive with license renewal application of WOR-TV. PO. address: c/o Charles O. Blaisdell, 230 Park Avenue, New York 10017. Estimated construction cost \$3,712,000; first-year operating cost \$10,870,000; revenue \$15,255,000. Geographic coordinates 40°49'50" north lat.; 73°59'10" west long. Type trans. RCA TT-35 FM. Legal counsel Welch and Morgan, Washington; consulting engineer Walter L. Davis, Cohen & Dippell, Washington. Principals: **Thompson Shea** (10%), **John J. Deering** (10%), et al. Mr. Shea is president and 8% owner of Parker Co. International, Inc., insurance brokerage firm. Mr. Deering is retired.

He was formerly partner in Arthur Young & Co., certified public accountants in New York.

Riverhead—Suburban Broadcasting Corp. UHF ch. 55 (716-722 mhz); ERP 371.1 kw vis., 92.7 kw aur, HAAT 378.6 ft.; ant. height above ground 200 ft. PO. address: 425 Broadhollow Road, Melville, N.Y. 11746. Estimated construction cost \$163,700; first-year operating cost \$30,000; revenue: facility will be satellite station of WSNL-TV Patchogue, N.Y. Geographic coordinates 40°51'10" north lat.; 72°45'58" west long. Type trans. RCA TTU-12ALA. Type ant. JZZ-2D1B, Jampro Antenna Co. Legal counsel Robert Healey, Miller, Gordon & Healey; consulting engineer Steel, Andrus & Adair, both Washington. Principals: **Robert A. Rosen**, board chairman (20.5%) and **David H. Polinger**, president (15.8%). Suburban is licensee of WSNL-TV Patchogue. Mr. Rosen has numerous real estate and small business interests in New York, New Jersey and elsewhere.

Pennsylvania

Allentown—Marantha Broadcasting Co. UHF ch. 69 (800-806 mhz); ERP 18.25 kw vis., 4.79 kw aur, HAAT 898 ft.; ant. height above ground 471 ft. PO. address: E. Rock Rd., Allentown 18103. Estimated construction cost \$91,790; first-year operating cost \$45,730; revenue \$60,470. Principals: **Richard C. Dean** (55%) **Robert Reichard** (30%), et al. Mr. Dean is president of radio communications company. Mr. Reichard is chemical engineer for plastics company. Marantha Broadcasting is also licensee of WFMZ(FM) Allentown. Ann. June 12, 1975.

Bethlehem—WBRE-TV Inc. UHF ch. 60 (746-752 mhz); ERP 3.5 kw vis., 35 kw aur, HAAT 898 ft.; ant. height above ground 512 ft. PO. address: 65 S. Franklin St., Wilkes-Barre, Pa. 18703. Estimated construction cost \$293,429; first-year operating cost \$259,000; revenue \$125,000. Consulting engineer Silliman, Moffet & Kowalski. Principals: **Louis G. Baltimore**, (49.9%), son and daughter-in-law **David M.** (14.5%) and **Muriel B. Baltimore** (11.9%), et al. own WBRE-TV Wilkes-Barre, of which Bethlehem station will be satellite.

Philadelphia—First Delaware Valley Citizen Television Inc. VHF ch. 10 (192-198 mhz); ERP 182 kw vis., 27.4 kw aur, HAAT 1,155 ft.; ant. height above ground 1,136 ft. PO. address: c/o Harold E. Kohn, 1214 IVB Building, 1700 Market Street, Philadelphia 19103. Estimated construction cost \$9,200,000; revenue \$12,800,000. Geographic coordinates 40°02'31" north lat.; 75°14'11" west long. Type trans. RCA TT-35 FH-(PC). Type ant. RCA TW-9A10R. Legal counsel Welch and Morgan, Washington; consulting engineer Walter L. Davis, Cohen and Dippell, Washington. Principals: **Solomon Katz** (34%), **Harold E. Kohn** (35%), et al. Mr. Katz is chairman of board and 20% owner of Strick Corp., truck trailer manufacturer in Fairless Hills, Pa. Mr. Kohn is attorney. Applicants are contesting license of WCAU-TV Philadelphia.

Philadelphia—Radio Broadcasting Co. UHF ch. 57; ERP 1640 kw max. & 1540 kw horizontal vis., 325 kw max & 225 kw horizontal aur, HAAT 289 ft.; ant. height above ground 273 ft. PO. address: c/o Leon S. Gross, 1711 Vine St., Philadelphia 19103. First-year operating cost \$300,000. Geographic coordinates 40°00'17" north lat.; 75°12'10" west long. Legal counsel Schwartz & Woods; consulting engineer Steel, Andrus & Adair. Principals: **Rose L. Gross**, president (50%); **Leon S. Gross**, secretary-treasurer (50%). Radio Broadcasting is licensee of KGB-874, Philadelphia, radio common carrier, and owns Micro TV Inc., common carrier applicant in Philadelphia.

Philadelphia—Vue Metrics Inc. UHF ch. 57; ERP 1805 kw vis., 357 kw aur, HAAT 960 ft.; ant. height above ground 1,148 ft. PO. address: 1405 Locust St., Philadelphia. Estimated construction cost \$159,000; first-year operating cost \$530,000; revenue \$640,000. Geographic coordinates 40°02'30" north lat.; 75°14'24" west long. Type trans. RCA TTU-60A. Type ant. RCA TFU-45J. Legal counsel Seymour M. Chase; consulting engineer Raymond E. Rohrer. Principals: **Sanford C. Curcie**, president (82%), et al. Mr. Curcie is former staff engineer with electronic systems firm.

Red Lion—Red Lion Broadcasting Co. UHF ch. 49 (680-686 mhz); ERP 4.48 kw vis., 2.42 kw aur, HAAT 454.5 ft.; above ground 208 ft. PO. address: c/o John H. Norris, Box 88, Red Lion 17356. Estimated construction cost \$97,826; first-year operating cost \$45,500; revenue \$75,000. Studio and trans. locations both Red Lion. Geographic coordinates 39°54'17"

TV Applications

north lat.; 76°34'48" west long. Type trans. RCA TTU-19; type ant. RCA TFU-6B. Consulting engineer Fred W. Wise, Windsor, Pa.; legal counsel Coltone and Fanelli, Washington. Principals: **John M. Norris** (80%), **John H. Norris** (10%), **Dorothy C. Norris** (10%). Rev. John M. Norris is pastor of Bible Presbyterian Church, York, Pa., and is majority owner of WGCB-AM-FM and WINB (shortwave) Red Lion. John H. Norris has minority interest of WABH(AM) Deerfield, Va., and 26 2/3% owner of WGS-AM-FM Ephrata, Pa. Dorothy C. Norris is housewife and 10% stockholder of WGCB-AM-FM.

State College—Nittany Communications. UHF ch. 29 (560-566 mhz); ERP 630 kw vis., 107 kw aur, HAAT 1,109 ft.; ant. height above ground 499 ft. PO. address: 750 S. Atherton St., State College 16801. Estimated construction cost \$690,480; first-year operating cost \$440,000; revenue \$500,000. Legal counsel Forbes W. Blair, esq., Washington; consulting engineer Willis Beecher. Principals: **Wolfram J. Dochtermann et al.** are area businessmen and doctors. Mr. Dochtermann is shareholder in corporation which has applied for TV station construction permit in State College. Ann. March 28, 1975.

South Dakota

***Martin—State Board of Directors for Educational Television.** VHF ch. 8 (180-186 mhz); ERP 316 kw vis., 320 kw aur, HAAT 1170 ft.; ant. height above ground 872 ft. PO. address: University of South Dakota, Vermillion, S.D. 57069. Estimated construction cost \$620,000; first-year operating cost \$475,000. Legal counsel Cohn & Marks, Washington; consulting engineer James Prusha. Principal: **Martin P. Busch**, University of South Dakota.

Tennessee

Cumberland—Cumberland Television Co. UHF ch. 33 (716-722 mhz); ERP 16.6 kw vis., 3.7 kw aur, HAAT 1,148 ft.; ant. height above ground 230 ft. PO. address: Box 591, Crossville 38555. Estimated construction cost \$28,500; first-year operating cost \$40,000; revenue \$52,000. Legal counsel none; consulting engineer none. Principal: **Edward M. Johnson** (100%) is general manager and 49% stockholder of WCSV(AM) Crossville. Ann. Feb. 4, 1975.

Texas

Abilene—Pictronics Inc. UHF ch. 15 (476-482 mhz); ERP 1875 kw vis., 375 kw aur, HAAT 1,472 ft.; ant. height above ground 1,332 ft. PO. address: 3201 W. Wall Street, Midland, Tex. 79701. Estimated construction cost \$508,896; first-year operating cost \$214,400; revenue \$278,400. Geographic coordinates 32°13'11" north; 100°03'37" west. Type trans. TTU-30A. Ant. type TFU-45JDA. Principal: **Henry L. Seale** (100%) has business interests in Dallas.

Corpus Christi—Telecorp Inc. UHF ch. 28 (554-560 mhz); ERP 318 kw vis., 64 kw aur, HAAT 325 ft.; ant. height above ground 308 ft. PO. address: 1801 S. Staples St., Corpus Christi 78404. Estimated construction cost \$19,500; first-year operating cost \$234,000; revenue \$140,000. Legal counsel McKenna, Wilkinson & Kittner, Washington; consulting engineer Jules Cohen & Associates. Principals: **Daniel Villanueva**, **Emilio Nicolas**, **Jerome Feldman** (10% each), et al. Messrs. Villanueva and Nicolas have interest in WLTV(TV) Miami; KWEX-TV San Antonio, Tex.; KMEX-TV Los Angeles and KFTV(TV) Hanford, Calif.

Corpus Christi—U-Anchor Broadcasting Division of U-Anchor Advertising Inc. UHF ch. 28 (554-560 mhz); ERP 220 kw vis., 44.8 kw aur, HAAT 327.5 ft.; ant. height above ground 302.1 ft. PO. address: c/o Robert W. Manley Jr., Box 190, Amarillo, Tex. 79105. Estimated construction cost \$27,000 (equipment to be leased); first-year operating cost \$290,191; revenue \$350,000. Geographic coordinates 27°47'46" north lat.; 97°23'47" west longitude \$350,000. Geographic coordinates 27°47'46" north lat.; 97°23'47" west long. Type trans. GE TT25A. Type ant. RCA TFY-24DL. Legal counsel Daly, Joyce and Borsari, 1830 Jefferson Place, N.W., Washington; consulting engineer none. Principals: **U-Anchor Enterprises** (80%), et al. Eugene J. McCart III and Joseph Robert

TV Applications, TV Transfers

McCart each own 25% of U-Anchor Enterprises, cattle and oil firm in Amarillo, and are officers of that company.

Dallas—Liberty STV Inc. UHF ch. 27 (548-554 mhz); ERP 500 kw vis., 50 kw aur. HAAT 1670 ft.; ant. height above ground 1569 ft. (subscription television service.) PO. address: 225 Coburg Road, Eugene, Ore. 97401. Estimated construction cost \$200,000 (equipment to be leased); first-year operating cost estimated \$840,000; revenue \$800,000. Geographic coordinates 32°34'14" north lat.; 96°55'54" west long. Type trans. RCA TTU-30C. Type ant. RCA TFU-30JDA. Legal counsel Fly, Shuebruk, Blume and Gaguine, Washington; consulting engineer Silliman, Moflet & Kowalski, Washington. Principals: **Donald E. Tykeson** (11.7%), **Durward L. Boyles** (16.2%), **Carolyn S. Chambers** (12.8%), et al. Liberty Communications is licensee of KEZI-TV Eugene and KVDO-TV Salem, both Oregon. Liberty also owns CATV franchises on West Coast and elsewhere.

Dallas—National Business Network-Foundation for Free Enterprise. UHF ch. 33 (584-590 mhz); ERP 300 kw vis., 300 kw aur. HAAT 1,633 ft.; ant. height above ground 1,555 ft. PO. address: Box 20005, Dallas 75221. Estimated construction cost \$406,000; first-year operating cost \$493,200; revenue \$398,400. Legal counsel Finkelstein & Firestone, Washington; consulting engineer C.P. Crossno. Principals: **Sheldon K. Turner**, former general manager of KDTV(TV) Dallas; **Nolanda Sue Turrier**, editor of National Directory for Performing Arts and Civic Center; **Nolan R. Butler**, realtor. National Business Network is non-profit corporation.

Dallas—United Television Broadcasting Corp. UHF ch. 27 (548-554 mhz); ERP 1,122 kw vis., 224 kw aur., HAAT 1,668 ft.; ant. height above ground 1,553 ft. PO. address: 4100 1st National Bank Bldg., Dallas 75201. Estimated construction cost \$893,500; first-year operating cost \$480,000; revenue \$750,000. Legal counsel Cole, Zylstra & Raywid, Washington; consulting engineer Robert L. Purcell. Principals: **T.L. Wynne Jr.**, **John P. Thompson** and **David B. Burton Jr.** (each 16-2/3%) and **United Cable Television Corp.** (50%). Messrs. Wynne, Thompson and Burton are Texas investors. United Cable owns cable systems throughout the United States. Ann. Oct. 3, 1975.

Dallas—WADECO Inc. VHF ch. 8 (180-186 mhz); ERP 296 kw vis., 29.6 kw aur. HAAT 1,680 ft.; ant. height above ground 1,521 ft. Mutually exclusive with license renewal application of WFAA-TV. PO. address: 4229 N. Central Expressway, Dallas 75219. Estimated construction cost \$7,367,000; first-year operating cost \$4,500,000. Legal counsel Welch & Morgan; consulting engineer Cohen & Dippell, both Washington. Principals: **James K. Wade**, pres (10%), **Charles E. Lattimore Jr.**, VP (17.3%), **Paul W. Eggers**, **Madeleine H. Wade** (both 10%), et al.

Fort Worth—Channel 21 Inc. UHF ch. 21 (512-518 mhz); ERP 1803 kw vis., 951 kw aur., HAAT 1,668 ft.; ant. height above ground 1,569 ft. PO. address: 777 W. Glencoe Place, Milwaukee, Wis. 53217. Estimated construction \$1,958,401; first-year operating cost \$581,551; revenue \$550,000. Legal counsel Dow, Lohnes & Albertson, Washington; consulting engineer Raymond E. Rohrer. Principals: **Robert S. Block** (100%) owns advertising agencies, market research and product development firms and subscription television operations in Wisconsin, California, Florida, Michigan, District of Columbia, Minnesota, Kansas City and Philadelphia. He is also applicant for TV stations in Milwaukee and Philadelphia. Channel 12 also requests authority to install subscription television equipment in Fort Worth. Ann. Oct. 3, 1975.

Longview—Channel 16 Inc. UHF ch. 16 (482-488 mhz); ERP 400 kw vis., 71,285 kw aur., HAAT 737 ft.; ant. height above ground 498 ft. PO. address: c/o Aubrey E. Irby, Box 3367, Tyler, Tex. 75701. Estimated construction cost \$1,065,900; first-year operating cost \$400,000; revenue \$275,000. Legal counsel Bilger & Blair, Washington; consulting engineer Guy C. Hutcheson. Principals: **Aubrey E. Irby**, **Robert Cargill**, **Jerry S. Harris**, **Clint C. Blackman Jr.**, **Bill R. Foster**, **Mayo M. Murphey**, **Joseph G. Stineciper**, **William P. Stoudt** (all 12.5%). Principals are involved in various businesses in Texas. Mr. Irby is president, general manager and majority stockholder of KZAK-AM-FM Tyler. Mr. Stineciper is employe at KLTV(TV) Tyler. Ann. Oct. 24, 1975.

Nacogdoches—Texan Broadcasting Co. UHF ch. 19 (500-506 mhz); ERP 5.5 kw vis., 1.1 kw aur., HAAT 260 ft.; ant. height above ground 260 ft. PO. address: 3007 Martinsville St. at KSFA Road 75961. Estimated construction cost \$43,150; first-year operating cost \$23,500; revenue \$100,000. Legal counsel Pierson, Ball & Dowd, Washington; consulting engineer Howard E. Griffith. Principals: **B.M. Raborn** (50%), **Bob Dunn** (30%) and **Nancy Dunn** (20%) also own KSFA-AM-FM Nacogdoches. Ann. Feb. 14, 1975.

Virginia

Norfolk—Hampton Roads Television Corp. VHF ch. 3 (60-66 mhz); ERP 100 kw vis., 20 kw aur., HAAT 986 ft.; above ground 1,023 ft. Mutually exclusive with license renewal application of WTAR-TV. PO. address: Box 1340, Virginia National Bank Building, 1 Commercial Place, Norfolk 23510. Estimated construction cost \$1,722,000; first-year operating cost \$2,750,000; revenue \$3,000,000. Geographic coordinates 36°49'07" north lat., 76°27'07" west long. Type trans. RCA TT-25 EL. Type ant. RCA TF-5CL. Legal counsel Welch & Morgan, Washington; consulting engineer Serge Bergen, Fairfax, Va. Principals: **Gordon E. Campbell**, president (70%), and **Wayne Lustig**, secretary-treasurer (30%). Messrs. Campbell and Lustig are attorneys and own 55% and 30%, respectively, of Campbell, Lustig & Hancock, law firm. Mr. Campbell owns building supply firm, building materials firm, two real estate companies and camp site real estate. Mr. Lustig owns 20% of three quick food drive-ins, 25% of another, 10% of beauty salons and 33½% of military exchange suppliers.

Wisconsin

***Colfax—Educational Communications Board.** UHF ch. 28 (554-560 mhz); ERP 1382 kw vis., 276.4 kw aur., HAAT 1,142.6 ft.; ant. height above ground 1,196 ft. PO. address: c/o William C. Woods, 732 North

Midvale Boulevard, Madison, Wis. 53705. Estimated construction cost \$1,035,779; first-year operating cost \$348,600; revenue none. Geographic coordinates 54° 02' 47" north lat.; 91° 51' 42" west long. Type trans. RCA TTU-60B. Type ant. RCA TFU-36J. Consulting engineer W.J. Kessler. Principals: **Anton J. Moe**, executive director, et al. Ann. Nov. 14, 1975.

Wyoming

Sheridan—Duhamel Broadcasting Enterprises. VHF ch. 12 (204-210 mhz); ERP 316 kw vis., 63.2 kw aur., HAAT 1,216.3 ft. PO. address: Box 1760, Rapid City, S.D. 57701. Estimated construction cost \$567,873; first-year operating cost \$57,000; revenue \$35,000. Legal counsel Fisher, Wayland, Southmayd & Cooper, Washington; consulting engineer Vir James. Principals: **Helen S.** (53.3%) and **William F. Sr.** (26.7%) **Duhamel**, et al. Duhamels each own 25% of Rapid City, S.D. cable system. Duhamel Broadcasting Enterprises owns KOTA-AM-TV Rapid City, KDUI-TV Hay Springs, Neb., and KHSD-TV Lead, S.D. Ann. Nov. 17, 1975.

Puerto Rico

San Juan—Suburban Broadcasting Corp. UHF ch. 18 (494-500 mhz); ERP 1080 kw vis., 108 kw aur., HAAT 1,160 ft.; ant. height above ground 273 ft. PO. address: Long Island Expressway and Blydenburg Road, Central Islip, N.Y. 11722. Estimated construction cost \$801,568; first-year operating cost \$203,700; revenue \$360,000. Geographic coordinates 18°16'51" north lat.; 66°06'38" west long. Type trans. RCA TTU-60C. Type ant. RCA TFU-25G. Legal counsel Gordon & Healy, Washington; consulting engineer Steel, Andrus & Adair, Washington. Principals: **Robert A. Rosen** (20.5%), **David H. Polinger** (15.8%) et al. Suburban is licensee of WSNL-TV Patchogue, N.Y. and has pending application for satellite of WSNL on ch. 55 at Riverhead, N.Y.

TV Ownership Transfers

Note: The following directory presents a comprehensive history of television station transfers from the inception of authorized commercial service through November 1975.

**TO BUY OR SELL A
TELEVISION OR
RADIO STATION**

HAMILTON-LANDIS & ASSOC., Inc.

<p>WASHINGTON, D.C.</p> <p>1730 K St., N.W. (202) 393-3456</p> <p>SAN FRANCISCO</p> <p>111 Sutter St. (415) 392-5671</p>	<p>CHICAGO</p> <p>1429 Tribune Tower (312) 337-2754</p> <p>DALLAS</p> <p>6060 N. Central Expy. (214) 691-2345</p>
--	---

**NATIONWIDE • NEGOTIATIONS
FINANCING • APPRAISALS**

Alabama

WAPI-TV Birmingham(ch 13)Licensed to Newhouse Bcstg. Corp. (see Group Ownership). Original owners: The Television Co. (Ed Norton, 75%; Thad Holt, 25%). Original call letters: WAFM-TV. Sales price: \$2.4 million (with WAPI and WAFM (FM)). FCC approved: June 10, 1953, on condition Birmingham News Co. relinquish WSGN-AM-FM-TV Birmingham. [For the Record, June 22, 1953]. Note: On Jan. 25, 1956, FCC approved \$18.7 million purchase of Birmingham News Co. by S.I. Newhouse [For the Record, Jan. 30, 1956].

WBMG(TV) Birmingham(ch 42)Licensed to Roy H. Park Broadcasting of Birmingham Inc. (see Park Broadcasting Inc. under Group Ownership). Original owner: Birmingham Television Corp. (see Southern Bcstg Co. under Group Ownership). Sales price: \$4,750,000. FCC approved: June 13, 1973 [For the Record, June 25, 1973].

WBRC-TV Birmingham(ch 6)Licensed to Taft Bcstg. (see Group Ownership). Former owner: Storer

Bcstg. Co. (see Group Ownership). Sales price: \$6,350,000 (with WBRC-AM). FCC approved: May 8, 1957 [For the Record, May 13, 1957]. Note: Storer purchased WBRC-AM-TV for \$2.4 million from Eloise S. Hanna in May 1953 [For the Record, June 1, 1953] and was required to sell stations with FCC approval of purchase of WBFH (TV) Wilmington-WIBG-AM-FM Philadelphia.

WSGN-TV Birmingham(ch 42, now deleted)Licensed to Jemison Bcstg. Co. Original owners: Birmingham News Co. Sales price: \$300,000 (with WSGN-AM-FM) FCC approved: June 26, 1953 [For the Record, July 6, 1953]. Note: This was part of condition imposed by FCC in granting Birmingham News Co. purchase of WAPI(AM)-WAFM(FM), and WAFM-TV (now WAPI-AM-FM-TV).

WMSL-TV Huntsville(ch 48)Licensed to Tennessee Valley Radio and Television Corp., 76.8% owned by International Television Corp. (Gerald V. Bull, 47.9%; Donald G. Martin, 47.9%; et al.). Original owner: Tennessee Valley Radio and Television Corp., 76.8% owned by Frank Whisenant, Benny Digesu and Ned Frazier. Sales price: \$891,111. FCC approved: Oct. 24, 1974 [For the Record, Nov. 11, 1974].

WALA-TV Mobile(ch 10)Licensed to Universal Communications Corp. (see Evening News Association stations in Group Ownership). Former owner: Roywood Corp. (Royal Street Corp., 41%, and others. Royal Street is controlled by Edgar B. Stern and family and owns WDSU-AM-FM-TV New Orleans). Sales price: \$4,750,000. FCC approved: Oct. 29, 1969 [For the Record, Nov. 10, 1969]. Note: Founded in 1953. Sold by W.O. Pape to Roywood Corp. for \$3 million in 1964 with WALA(AM) Mobile. Subsequently Roywood sold WALA(AM) to Stone Representatives for \$250,000.

WKRG-TV Mobile(ch 5)Licensed to WKRG Inc. (Kenneth H. Giddens). Previous owners: Mr. Giddens and *Mobile Press-Register* for 50%. Sales price: \$2,250,000 for 50% (with WKRG-AM-FM). FCC approved: Sept. 28, 1966 [For the Record, Oct. 10, 1966]. Note: Founded in 1955 by Mr. Giddens, Shirley Rester Conrad and others. Sold in 1958 to Mr. Giddens and *Mobile Press-Register* for \$1,179,915 (with WKRG-AM-FM).

WCOV-TV Montgomery(ch 20)Licensed to WCOV

Inc. (see Gay-Bell Stns. in Group Ownership). Former owners: Oscar P. Covington, 26.23%; Clara R. Covington, 20.83%; High M. Smith, 15.07%; Ethel Covington, 13.87%; Mary R. Covington, 2.78%. Sales price: \$1,275,000. FCC approved: Oct. 2, 1964 [For the Record, Oct. 12, 1964].

WSFA-TV Montgomery(ch 12)Licensed to Cosmos Bcstg. Co. (see Group Ownership). Former owner: WKY Television System Inc. Sales price: \$2,225,000. FCC approved: Sept. 2, 1959 [For the Record, Sept. 14, 1959]. Note: Founded by David E. Dunn and associates and sold to WKY Television System Inc. in 1955 for \$568,589 (with WSFA) [For the Record, Feb. 28, 1955].

WSLA(TV) Selma(ch 8)Licensee: WCQV Inc. (see Gay-Bell Stns in Group Ownership). Former owner: Selma Television Inc. (Francis U. Brennan, president, et al.) Sales price: \$115,000. FCC approved: Jan. 6, 1971 [For the Record, Jan. 25, 1971].

WCFT-TV Tuscaloosa(ch 35)Licensed to Chapman TV of Tuscaloosa Inc. (S.A. Rosenbaum, 43.75%; W.S. Smylie, 18.75%; Marvin Reuben, 8.33%; Jerry P. Keith, 4.17%; Margaret G. Smylie, 16.67% and W.S. Smylie III, 8.33%). Former owners: Lewis N. Manderson Jr., R.S. Holifield, C.H. Armstrong, Edwin L. Minges, C.J. Hartley and James D. Kincaid. Sales price: assumption of \$121,294 debt. FCC approved: Aug. 23, 1957 [For the Record, Sept. 4, 1967].

Alaska

KENI-TV Anchorage(ch 2)Licensed to Midnight Sun Bcstrs. Inc. (Alvin O. Bramstedt and wife, 20%; Ketchikan Alaska TV Inc., 13.33%; and others). Former owner: Lathrop Co. and others. Sales price: \$1.2 million (with KENI and KFAR-AM-TV Fairbanks and KTKN Ketchikan, all Alaska). FCC approved: March 17, 1960 [For the Record, March 28, 1960]. Note: Station founded by Richard R. Rollins and Keith Kiggins as KFIA(TV). Sold to Midnight Sun Broadcasting Co. (Lathrop Co. and others) for \$100,000 interest in Midnight Sun. FCC approved: Dec. 29, 1954 [For the Record, Jan. 10, 1955].

KIMO(TV) Anchorage(ch 13)Licensed to Central Alaska Broadcasting Inc. (Carl A. Bracale Jr., 21%; Duane L. Triplett, 17%; Robert L. Lewis, 11%, and Richard M. Zook, 15%). Former owner: Sourdough Broadcasters Inc. (Patricia E. Harpel, sole owner). Original call letters: KHAR-TV. Sales price: \$343,000. FCC approved: May 28, 1971 [For the Record, June 21, 1971]. Note: original owner was Willis R. Harpel. Sold to Sourdough Broadcasters Inc. (Mr. Harpel, 82%; Patricia Harpel, 3%, and Sourdough Broadcasters, 15%) for assumption of \$250,359.20 plus reimbursement for out of pocket expenses in amount of \$83,610.06, with KHAR-FM. FCC approved: Nov. 9, 1967 for TV, Oct. 31, 1967 for FM [For the Record, Nov. 13, 1967].

KFAR-TV Fairbanks(ch 2)See KENI-TV Anchorage, above.

KINY-TV Juneau(ch 8)Licensed to Midnight Sun Broadcasters Inc. (see Group Ownership). Sold by: William J. Wagner. Sales price: \$52,250. FCC approved: March 27, 1959 [For the Record, April 6, 1959]. Note: Founded by Alaska Broadcasting System Inc. in 1956.

Arizona

KOOL-TV Phoenix(ch 10)Licensed to KOOL Radio-Television Inc. 19.4% sold by Anne Kerney to licensee, KOOL Radio-TV Inc., for \$572,970; 7.66% sold by Gene Autry to Tom Chauncey for \$484,200. Messrs. Autry and Chauncey are both stockholders in the KOOL stations. After the transaction, which included KOOL-AM-FM as well as KOOL-TV, Mr. Chauncey now holds 47.78% of the stock, and Mr. Autry, 46.07%. The remaining 6.15% of the stock is held by Frank Beer. FCC approved: January 1972 [BROADCASTING, Jan. 31, 1972].

KOY-TV Phoenix (ch 10, now deleted)Licensed to Maricopa Bcstrs. (KOOL-AM-TV with which it shared time on ch. 10). Original owners: KOY Bcstg. Co. Sales price: \$200,000. FCC approved: May 5, 1954 [For the Record, May 10, 1954].

KPHO-TV Phoenix(ch 5)Licensed to Meredith Corp. (see Group Ownership). Original owners: Phoenix TV Inc. Sales price: \$1.5 million (with KPHO). FCC approved: June 25, 1952 [For the Record, June 30, 1952]. Note: Station, originally KTLX, first owned by W.L. Pickens, R.L. Wheelock and H.H. Coffield, then ownership broadened to include some KPHO

stockholders, finally (in 1949) taken over by John C. Mullins and associates.

KTAR-TV Phoenix-Mesa(ch 12)Licensed to KTAR Broadcasting Co. (see Combined Communications Corp. in Group Ownership). Previous owner: John J. Louir and family. Sales price: About \$15 million in CCC stock. Transfer involved merger of KTAR Broadcasting stations (which also included KTAR-AM-FM Phoenix; KYUM[AM] Yuma and KYCA[AM] Prescott, all Arizona) with properties owned by Karl Eller and others to form CCC. See KBLU-TV Yuma. Note: Founded in 1953 by Harkins Broadcasting Co. (Dwight Harkins, Lorenzo K. Lisonbee and Harry L. Nace estate). Sold as KTYL-TV in 1954 to KTAR Broadcasting Co. for \$251,242 in liabilities. Previous call letters: KVAR(TV).

KGUN-TV Tucson(ch 9)Licensed to May Bcstg. Co. (see Group Ownership). Sold by: Gilmore Bcstg. Corp. of Arizona (James S. Gilmore). Sales price: \$2,910,000. FCC approved: July 31, 1968 [For the Record, Aug. 12, 1968]. Note: Founded by D.W. and Kathleen Ingram in 1955 as KDWI-TV and sold to H.U. Garrett and associates for \$533,000 in 1956. Garrett group sold station to Henry S. Hilberg and others for \$1.44 million in 1960. Gilmore Bcstg. bought station in 1964 for \$4.2 million with WEHT(TV) Evansville, Ind.

KOLD-TV Tucson(ch 13)Licensed to Universal Communications Corp. (Evening News Association—*Detroit News* and WWJ-AM-FM-TV Detroit). Sold by Old Pueblo Broadcasting Co. (Gene Autry and others—see Golden West Broadcaster Stns. in Group Ownership). Sales price: \$4.1 million. FCC approved: May 21, 1969 [For the Record, June 9, 1969]. Note: Founded by Old Pueblo Broadcasting in January 1953.

KVOA-TV Tucson(ch 4)Licensed to Channel 4-TV. Previous owner: KVOA Television Inc. (Pulitzer Publishing Co.). Sales price: \$2,725,000. FCC approved: Nov. 24, 1972 [For the Record, Dec. 11, 1972]. Note: Founded by John J. Louis and family. Bought by Clinton D. McKinnon and associates in 1955 for \$288,904 plus assumption of obligations amounting to \$225,000 (with KVOA). Sold to WGAL Inc. in 1963 for \$3,250,000 (with KOAT-TV Albuquerque, N.M.). Sold by WGAL Television Inc. (Steinman stations) to KVOA Television Inc. in 1968 for \$3 million. FCC approved: July 31, 1968 [For the Record, Aug. 12, 1968].

KBLU-TV Yuma(ch 13)Licensed to Eller Telecasting Co. of Arizona (see Combined Communications stations in Group Ownership). Previous owner: Karl Eller and others. Sales price: Estimated \$15 million in CCC stock. Transaction, merger of Eller group's KBLU-AM-TV and KTAR stations into CCC, was approved in 1968 (BROADCASTING, Oct. 21, 1968). Second step, merger of Eller group's properties, was completed following year (BROADCASTING, Oct. 27, 1969) and at same time FCC approved donation of KBLU to Arizona Western College in Yuma. CCC is controlled by Mrs. Henrietta J. Louis and family. Mr. Eller is president of CCC. Note: KBLU-TV founded in 1963 by Robert and Patricia Crites and John and Helen Noga. Mr. Crites acquired his wife's 25% interest in 1965 for \$50,000. In 1966 one-third was sold to Paul Morgan and Herman Newhouse for \$140,000 (including KBLU[AM]). The group, Desert Telecasting Inc., sold KBLU-AM-TV to Eller Telecasting in 1967 for \$500,000. KBLU[AM] is now KAWC[AM]; KYUM[AM] is KBLU[AM].

KIVA(TV) Yuma(ch 11, now deleted)Licensed to Valley Telecasting Co. (Bruce Merrill). Previous owners: Floyd B. Odlum and Harry Butcher. Sales price: \$550,000. FCC approved: Feb. 1, 1961 [For the Record, Feb. 13, 1961]. Station went dark Jan. 31, 1970 and returned license to FCC. Note: Odlum group took over control in 1959 by assuming indebtedness of \$241,000. Mr. Butcher bought 25% for \$150,000. Mr. Butcher originally bought the station from Donald Ellsworth and associates in 1957 for \$241,000.

KYAT(TV) Yuma(ch 8, now deleted)Licensed to Marietta Investment Corp. (See KFMB-TV San Diego).

Arkansas

KTVE(TV) El Dorado, Ark.-Monroe, La.(ch 10)Licensed to Gray Communications Systems Inc. (see Group Ownership). Sold by KTVE Inc. (see Fuqua Stns in Group Ownership). Sales price: \$3,250,000. FCC approved: Dec. 4, 1967 [For the Record, Dec. 11, 1967]. Note: Founded in 1955 by Joe F. Rushton and associates. Former Representative Oren Harris (D-Ark.) bought 25% interest in 1957 for \$5,000 but sold back interest in 1958 for return of his \$5,000 note. Bought by William H. Simon in 1960 for reported \$1.1 million, with Mr. Simon selling 80% to Veterans Broad-

casting Co. later that year for \$282,000. Sold in 1963 to KTVE Inc. for \$650,000 plus assumption of \$1.5 million in obligations.

KGTO(TV) Fayetteville(ch 36)Licensed to Noark Investment Co., 100% owned by George T. Henreich. Original owner: Noark Investment Co., 100% owned by Paul W. Milam Sr., Paul W. Milam Jr. and Jane R. Horne. Sales price: \$215,000. FCC approved April 30, 1975 [For the Record, May 19, 1975].

KFSM-TV Fort Smith(ch 5)Licensed to Buford Television Inc. (see Group Ownership). Previous owner: KFSA-TV Inc. (see Donrey Media Group under Group Ownership). Former call letters: KFSA-TV. Sales price: \$4.16 million. FCC approved: April 4, 1973 [For the Record, April 16, 1973]. Note: Donald W. Reynolds, 100% owner of KFSA-TV Inc., had acquired 49% of station and then the remaining 51% from Harry Pollock in 1959 for \$565,000. FCC approved: Jan. 8, 1959 [For the Record, Jan. 19, 1959]. Mr. Pollock (16.6% owner) purchased 50% of American TV Co. from George T. Henreich and Harry Newton Co. for \$175,000. FCC approved: March 5, 1958 [For the Record, March 10, 1958]. Mr. Henreich bought 50% from the estate of Hiram S. Nakdimen in 1957 for obligations in excess of \$150,000.

KARK-TV Little Rock(ch 4)Licensed to Combined Communications Corp. (see Group Ownership). Previous owner: Mullins Broadcasting Co. Sales price (including KBTV(TV) Denver): \$13.1 million in cash and assumption of \$9.4 million in debts. FCC approved: Jan. 28, 1972 [For the Record, Feb. 14, 1972]. Note: Madeline M. Barton, C.N. Barton, and TK. Barton sold station to Mullins in 1966 for \$3,750,000 (with KARK-AM-FM). FCC approved: Jan. 19, 1966 [For the Record, Jan. 24, 1966].

KRTV(TV) Little Rock(ch 16, now deleted)Licensed to Little Rock Telecasters Inc. (Rowley-Brown Bcstg. Co.). Original owners: Rowley-Brown Bcstg. Co. and Donald W. Reynolds. Sales price: \$52,500 and assumption of \$300,000 in liabilities. FCC approved: Aug. 26, 1953 [For the Record, Aug. 31, 1953]. Note: Station facilities sold to Central South Sales Co., owners of KATV(TV) Pine Bluff, Ark., for \$400,000 in March 1954 [For the Record, March 8, 1954].

California

KBAK-TV Bakersfield(ch 29)Licensed to Hariscope Broadcasting Corp. (see Group Ownership). Previous owner: Reeves Broadcasting Corp. Sales price: \$1,635,147. FCC approved: April 24, 1964 [For the Record, May 4, 1964]. Note: Founded by Sheldon Anderson as KAFY-TV; sold to *San Francisco Chronicle* in 1953 for \$85,000 (with KAFY[AM]), with remainder of stock purchased by newspaper in 1954. Sold to Reeves Bcstg. Corp. for \$1.25 million in 1960.

KERO-TV Bakersfield(ch 23)Licensed to McGraw-Hill Broadcasting Co. (see Group Ownership). Previous owner: Time-Life Bcst Inc. Sales price (including KGTV(TV) San Diego, KMGH-TV Denver and WRTV(TV) Indianapolis): \$57,180,000. FCC approved: March 8, 1972 [BROADCASTING, March 13, 1972; May 15, 1972]. Note: Time-Life bought station from Transcontinent TV Inc. in 1964 for \$1.5 million. FCC approved: Feb. 19, 1964. See KFMB-TV San Diego.

KJTV(TV) Bakersfield(ch 17)Licensed to Kern County Broadcasting Corp. (see ASI Communications Inc. in Group Ownership). Sold by Kern County Broadcasting Co. (Lincoln and Sylvia Dellar). Sales price: \$1,150,000. FCC approved: Sept. 11, 1969 [For the Record, Sept. 22, 1969]. Note: Founded by Mr. and Mrs. Dellar, Edward E. Urner, Bryan J. Coleman and Maurice St. Clair in November 1959. Mr. and Mrs. Dellar, owners of 41.18%, bought 23% from Mr. Urner (who acquired KLYD[AM] for his interest), and 17.64% each from Messrs. Coleman and St. Clair for \$117,720 in December 1962. Former call letters: KLYD-TV.

KCFT-TV Concord(ch 42, now deleted)Licensed to T.V. Hill Inc. (joint venture of Television Communications Inc. [Lindsey H. Spight] and Watson Comm. Syst. [Herbert M. Watson]). Sold by: John M. England, trustee of estate of Jerry Basset Inc. Price: \$13,500. FCC approved Sept. 20, 1968 [For the Record, Oct. 7, 1968]. CP only.

KECC-TV El Centro(ch 9)Licensed to Tele-Broadcasters of California Inc. (United Bcstg. Co.). Former

TV Transfers

owners: Tele-Broadcasters Inc. (H. Scott Kilgore and others.) Sales price: \$1.9 million with KALI(AM) San Gabriel and KUFY(FM) San Mateo, both California. FCC approved: April 25, 1967 [Changing Hands, May 1, 1967].

KIEM-TV Eureka(ch 3)Licensed to California Oregon Radio Co., Harvey and Richard S. Ingham (50% each). Original owner: California Oregon Radio Co., Wayne Vickers, et al. Sales price: \$400,000 plus assumption of liabilities of \$300,000. FCC approved July 29, 1975 [For the Record, Aug 19, 1975].

KVIO-TV Eureka(ch 6)Licensed to California Northwest Bcstg. Corp. (Carl R. and Leah McConnell). Former owners: Carroll R. Hauser, 50%; Shasta Telecasting Corp. (KVIP-AM-TV Redding, Calif.), 50%. Sales price: \$83,472. FCC approved: May 18, 1960 [For the Record, May 23, 1960]. Note: Founded by Carroll R. Hauser as KHUM-TV. Sold 50% to Shasta Telecasting Corp. for out-of-pocket expenses. FCC approved: August 2, 1957 [For the Record, August 5, 1957].

KLXA-TV Fontana(ch 40)Licensed to International Panorama TV Inc., 100% owned by Trinity Broadcasting Network (nonstock, nonprofit; Paul F. Couch, pres). Original owner: International Panorama TV Inc., 100% owned by Angel Lerma Maler. Sales price: \$1,266,419. FCC approved: Aug. 2, 1974 [For the Record, Aug. 19, 1974].

KAIL-TV Fresno(ch 53)Licensed to Tel-America Corp. (A.J. Williams, 100%). Former owners: B.L. Golden and L.W. Fawns. Sales price: \$236,500. FCC approved: Dec. 23, 1966 [For the Record, Dec. 26, 1966].

KFSN-TV Fresno(ch 30)Licensed to Capital Cities Communications Inc. (see Group Ownership). Former owner: Triangle Publications Inc. (owned by Walter H. Annenberg and family). Original call letters: KFRE-TV. Sales price: \$110 million (with WFIL(AM), WIOQ(FM), and WPVI-TV Philadelphia; WNHC(AM), WPLR(FM) and WTNH-TV New Haven, Conn.; KFRE(AM) and KYFE(FM) Fresno; and television program syndication business). Contingent on sale was Capital Cities "spin-off" of WFIL(AM) and WIOQ(FM) (formerly WFIL-FM) Philadelphia; WNHC(AM) and WPLR(FM) (formerly WNHC-FM) New Haven; and KFRE(AM) and KYFE(FM) (formerly KFRE-FM) Fresno, Calif. to separate buyers for an aggregate of \$14,455,000. FCC approved: Feb. 24, 1971 [BROADCASTING, March 1, 1971]. Note: Triangle purchased station from original owner, California Inland Bcstg. Co. (Paul R. Bartlett, et al), for \$3 million (with KFRE-AM-FM). FCC approved: Dec. 30, 1958 [For the Record, Jan. 5, 1959].

KJEO-TV Fresno(ch 47)Licensed to Retlaw Enterprises Inc., (Mrs. Walter E. Disney, Sharon Disney Brown, Diane Disney Miller and others). Sold by Shasta Telecasting Corp. (see Group Ownership). Sales price: \$3,654,000. FCC approved: April 17, 1968 [For the Record, April 29, 1968]. Note: Founded by J.E. O'Neill and associates. Bought by Shasta Telecasting in 1961 for \$3 million.

KBSA-TV Guastli(ch 46)Licensed to Broadcasting Service of America, 100% owned by Berean Bible Ministries. Original owner: Broadcasting Service of America, William A. And Ethel J. Myers (51%) and Berean Bible Ministries (49%). Sales price: \$602,578. FCC approved March 12, 1975 [For the Record, March 24, 1975].

KSVJ-TV Hanford(ch 21, now deleted)Licensed to Spanish International Broadcasting Co. (Reynold V. Aselmo, 50%, Emilio Azcarraga, 20%, and others). Sold by KSVJ Television Inc. (Cy Newman, 41.1%, and others). Sales price: \$40,000 plus assumption of liabilities of \$73,000. FCC approved: March 19, 1969 [For the Record, March 31, 1969]. Former owners: George L. Naron and C.B. Sweeney. Former call letters: KDAS-TV. CP sold in February 1966 to KSVJ Television Inc. for \$90,750.

KABC-TV Los Angeles(ch 7)Licensed to ABC Inc. (see Group Ownership). Original owner: American Bcstg. Co. Original call letters: KECA-TV. Note: This was change of ownership when ABC merged with United Paramount Theaters Inc. FCC approved: Feb. 2, 1953. [For the Record, Feb. 16, 1953].

KCOP-TV Los Angeles(ch 13)Licensed to KCOP TV Inc. (See Chris Craft Industries in Group Ownership). Former owners: Kenyon Brown, Harry L. (Bing)

Crosby, George L. Coleman, Joseph A. Thomas and Alvin G. Flanagan. Sales price: \$1.5 million in the aggregate. FCC approved: Jan. 28, 1960 [For the Record, Feb. 8, 1960]. Note: Founded by Mrs. Dorothy Schiff Sonneborn as KLAC-TV. Sold to Copley Press for \$1,375,000 in December 1953. [For the Record, Jan. 4, 1954]. Messrs. Brown, Crosby, Coleman, Thomas and Flanagan bought station from Copley Press Inc. for \$4 million. FCC approved: Dec. 11, 1957. [For the Record, Dec. 16, 1957].

KHJ-TV Los Angeles(ch 9)Licensed to RKO General Inc. (see Group Ownership). Original owner: Earle C. Anthony Inc. Original call letters: KFI-TV. Sales price: \$2.5 million. FCC approved: August 8, 1951. [For the Record, Aug. 13, 1951].

KNXT-TV Los Angeles(ch 2)Licensed to CBS Inc. (see Group Ownership). Original owner: Thomas S. Lee Enterprises Inc. (General Tire & Rubber Co.). Original call letters: KTLN. Sales price: \$3.6 million. FCC approved: Dec. 27, 1950 [For the Record, Jan. 1, 1951]. Note: Licensee sold to General Tire & Rubber Co. from estate of Thomas S. Lee in 1950, with other Don Lee properties for \$12,320,000. [For the Record, Jan. 1, 1951].

KTLA-TV Los Angeles(ch 5)Licensed to Golden West Bcstrs. (Gene Autry, Robert O. Reynolds, Lloyd Sigmon and others. (see Group Ownership). Sold by: Paramount Pictures Corp. Sales price: \$12 million. FCC approved: May 13, 1964. [For the Record, May 18, 1964].

KTTV-TV Los Angeles(ch 11)Licensed to Metromedia Inc. (John W. Kluge, chairman and president, see Group Ownership). Original owners: Los Angeles Times-Mirror. Sales price: \$10,390,000. FCC approved: May 28, 1963 [For the Record, June 10, 1963].

KWHY-TV Los Angeles(ch 22)Licensed to Coast TV Broadcasting Corp. (Thomas S. Bunn, 24.4%; Frederick D. Custer, 15%; Straub Family Foundation, 10.9%; Suzanne A. Springer, Hugh R. Murchison Jr., each 10% and others). Former owners: Messrs Bunn, Custer, Hugh Murchison Jr. and others. Former call letters: KPOL-TV. Sales price: \$400,000. FCC approved: June 17, 1966 [For the Record, June 27, 1966]. Note: Founded in 1952 as KBIC-TV by John Poole. Sold in 1963 to H. Calvin Young, Martha White Mills & others as KIXX-TV for \$180,000. FCC approved: Jan. 23, 1963 [For the Record, Jan. 28, 1963]. Sold to Messrs. Murchison, Straub and others in 1964 for \$150,000 and assumption of \$205,377 in obligations.

KTRB-TV Modesto(ch 14, now deleted)Licensed to O'Neill Bcstg. Co. (J.E.O'Neill). Former owners: William H. Bates Jr. and Margie W. Cleary. Sales price: \$5,000 (assignment of CP). FCC approved: Sept. 5, 1957 [For the Record, Sept. 16, 1957].

KTVU-TV Oakland-San Francisco(ch 2)Licensed to Miami Valley Bcstg. Corp. (see Cox Broadcasting Corp. in Group Ownership). Original owners: Ward D. Ingram, William D. Pabst, Edwin W. Pauley, each 25%, and others. Sales price: \$12,360,000. FCC approved: Oct. 16, 1963 [For the Record, Oct. 21, 1963].

KRCR-TV Redding(ch 7)Licensed to Sacramento Valley TV Inc. (William B. Smullin and others). Sold by: George A. and Mary Margaret Schmidbauer Jr., William Glenn Crawford and Lois Elizabeth Tracy. Sales price: \$185,000 for 46%. FCC approved: Feb. 9, 1968 [For the Record, Feb. 19, 1968]. Note: Founded by George Fiehart, Laurence W. Carr, Carl R. McConnell and others. Original call letters: KVIP-TV. Bought by Sacramento Valley TV Inc. (William B. Smullin, George A. and Mary Margaret Schmidbauer Jr., William Glenn Crawford and Lois Elizabeth Tracy) in 1963 for \$1,280,000.

KCCC-TV Sacramento(ch 40, now deleted)Licensed to Capital TV Co. (Melvin Lord, 16.8%; Melvin Lucas, Clarence A. Halien, Henry P. Deane, 11.1%, and others). Original owners: Melvin Lucas and group. Sales price: \$70,548. FCC approved: Oct. 7, 1959 [For the Record, Oct. 19, 1959].

KCRA-TV Sacramento(ch 3)Licensed to Kelly Bcstg. Co. (Gerald and C. Vernon Hansen and family). Original owners: 50% owned by the family of the late Ewing C. Kelley. Sales price: \$2.8 million for 50% (with KCRA-AM-FM). FCC approved: April 8, 1962 [For the Record, April 23, 1962].

KMUV-TV Sacramento(ch 31)Licensed to Grayson Television Inc. (Hugh A. Evans, 10%; Morris Lavine, 25%; Della G. Grayson, 15%; Norman Kauffman, 15%, et al.). Original owner: Hercules Broadcast-

ing Co. (Manning Slater, et al). Original call letters: KRAQ-TV. Sales price: \$26,800. FCC approved: Dec. 9, 1970 [For the Record, Dec. 21, 1970].

KXTL-TV Sacramento(ch 40)Licensed to Camellia City Telecasters Inc. (Cypress Communications Corp., 71%; Jack F. Matraga, 24%, and others). 60% sold by Electronics Capital Corp. (Richard C. Memhard, W. Randolph Tucker, Leon N. Papernow, Richard Burns and others). Sales price: stock transfer. FCC approved: Jan. 5, 1968. (CP).

KXTV-TV Sacramento(ch 10)Licensed to Great Western Broadcasting Corp. (see Corinthian Broadcasting Corp. in Group Ownership). Station was merged with Corinthian Broadcasting into Dun & Bradstreet Companies Inc. for stock valued at \$137 million (with KOTV [TV] Tulsa, Okla.; KHOU-TV Houston; WISH-TV Indianapolis; and WANE-TV Fort Wayne, Ind.). FCC approved: April 14, 1971 [BROADCASTING, April 19, 1971]. Note: Corinthian purchased station from original owner in 1958. Original owner: Sacramento Telecasters Inc. (William Wright and sons, 20.55%; John H. Schachte, 15.48% and others). Sales price: \$4.5 million. FCC approved: Dec. 23, 1958 [For the Record, Dec. 29, 1958]. Originally KBET-TV.

KCHU-TV San Bernardino(ch 18, now deleted)Licensed to Sun Co. of San Bernardino (James A. Guthrie, pres). Original owner: Norman H. Rogers. Sales price: \$180,109. FCC approved: Jan. 30, 1963. [For the Record, Feb. 4, 1963].

KCST-TV San Diego(ch 39)Licensed to Western Telecasters Inc., 100% owned by KCST-TV Inc. (a wholly owned subsidiary of Storer Broadcasting Co. See Storer Broadcasting Co. under Group Ownership). Previous owner: Western Telecasters Inc., 100% owned by Bass Brothers Enterprises Inc. (see Group Ownership). Sales price: \$12 million and adjustments. FCC approved: Sept. 26, 1974 [For the Record, Oct. 14, 1974]. Note: Original call letters: KAARTV. San Diego Telecasters Inc. (Paul Corriere, 44%; Town & Country Development Inc. and Sample-Brown Enterprises, 56%) sold KAAR to Bass Brothers Enterprises in 1967 for \$1,108,000. FCC approved: Aug. 3, 1967 [For the Record, Sept. 11, 1967].

KFMB-TV San Diego(ch 8)Licensed to Midwest TV Inc. (see Group Ownership). Previous owner: Transcontinent TV Corp. Sales price: \$10,085,000 (with KFMB-AM-FM). FCC approved: Feb. 19, 1964. Note: TTC acquired KFMB stations and KERO-TV Bakersfield, Calif. through merger with Marietta Bcstg. Inc. (Jack D. Wrather and Edward Petry Inc.) in 1959. Marietta Bcstg. took over stations from Wrather-Alvarez Bcstg. Inc. for \$2.9 million for Mrs. Alvarez's 38.9% in 1958. Petry Co. bought 22.2% of Wrather-Alvarez for \$633,333 in 1953. Wrather-Alvarez bought KFMB stations from John A. Kennedy for \$3 million in 1953. Mr. Kennedy bought KFMB stations from Jack Gross for \$925,000 in 1951. Wrather-Alvarez bought KERO-TV from Albert E. DeYoung & assoc. for \$2.15 million in 1957.

KGTV-TV San Diego(ch 10)Licensed to McGraw-Hill Broadcasting Co. (see Group Ownership). Previous owner: Time-Life Bcst Inc. Former call letters: KOGO-TV. Sales price (including KERO-TV Bakersfield, Calif.; KMGH-TV Denver and WRTV-TV Indianapolis): \$57,180,000. FCC approved: March 8, 1972 [BROADCASTING, March 13, 1972; May 15, 1972]. Note: Founded as KFSD-TV in 1953 by Thomas E. Sharpe and associates. Sold in 1954 to Fox, Wells & Rogers, 42.55% and Newsweek Magazine (Washington Post Co.), 46.22% for \$2.2 million. Sold in 1962 to Time-Life Bcst. Inc. for \$6,125,000 (with KOGO-AM-FM). FCC approved: March 21, 1962 [For the Record, March 26, 1962].

KBHK-TV San Francisco(ch 44)Licensed to Kaiser Broadcasting Co., 77.5% owned by Kaiser Broadcasting Corp. (see Group Ownership) and 22.5% by Field Communications Corp. (owned by Field Enterprises Inc., Chicago). Original owner: Kaiser Broadcasting Corp. (100%). Sales price: no consideration. FCC approved merger of Kaiser Broadcasting Corp.'s five independent UHF's (including KBHK-TV) and Field Communications Corp.'s one independent UHF in May 1973 [BROADCASTING, May 14, 1973].

KEMO-TV San Francisco(ch 20)Licensed to Leon A. Crosby. Previous owner: U.S. Communications of California Inc. Sales price: assumption of liabilities to \$278,820 per year plus assumption of promissory notes totalling \$11,058. FCC approved: Jan. 19, 1972 [For the Record, Feb. 7, 1972]. Note: CP secured by Lawrence A. Harvey. Sold to Leonard and Lily Averett in

1954 (no consideration). Former call letters: KBAY-TV. Purchased by Sherrill C. Corwin in 1957 for \$1,750. CP sold by Mr. Corwin to D.H. Overmyer Communications in 1965 for \$6,000. 80% of CP sold by D.H. Overmyer Communications to U.S. Communications Corp. in 1967 (with 80% of CPs for WMBO-TV Atlanta; WSCO-TV Newport, Ky.; WECO-TV Pittsburgh and KJDO-TV Rosenberg, Tex.). Sales price: Aggregate of \$1 million. FCC approved: Dec. 8, 1967 [For the Record, Dec. 18, 1967].

KGO-TV San Francisco (ch 7)—Licensed to ABC Inc. (see Group Ownership). Note: This was change of ownership when ABC merged with United Paramount Theaters Inc. FCC approved: Feb. 9, 1953 [For the Record, Feb. 16, 1953].

KPIX (TV) San Francisco (ch 5)—Licensed to Westinghouse Broadcasting Co. (see Group Ownership). Original owners: KPIX Inc. (Wesley I. Dumm and associates). Sales price: \$7.5 million. FCC approved: July 2, 1954 [For the Record, July 12, 1954].

***KQEC (TV) San Francisco (ch 32)**—Licensed to Bay Area Educational TV Association. Previous owner: Metromedia Inc. (see Group Ownership). Former call letters: KNEW-TV. Donated as gift to Bay Area. FCC approved: Sept. 9, 1970 [BROADCASTING, Sept. 14, 1970]. Note: Founded by S.H. Patterson in 1954. Original call letters: KSAN-TV. Went dark in 1958. Returned to air as satellite of KICU-TV Visalia-Fresno, Calif. in 1966. Sold to Metromedia in 1968 for \$1 million. FCC approved: March 20, 1968 [For the Record, April 1, 1968].

KVOF-TV San Francisco (ch 38)—Licensed to Faith Center (see Group Ownership). Previous owner: John M. England, trustee in bankruptcy. Original call letters: KUDO (TV). Sales price: \$10,200. FCC approved: May 29, 1973 [For the Record, June 18, 1973].

KNTV (TV) San Jose (ch 11)—Licensed to Gill Industries. (Allen T. Gilliland Jr., 73.1% and others). Former owners: estate of Allen T. Gilliland Sr. Sales price: \$957,825. FCC approved: Aug. 4, 1966 [For the Record, Aug. 15, 1966].

KSBY-TV San Luis Obispo (ch 6)—Licensed to Central California Communications Corp. (see Group Ownership). Original owners: Christina M. Jacobson and Leslie H. Hacker. Original call letters: KVCC-TV. Sales price: \$450,000 (with KVEC(AM)). FCC approved: June 13, 1956 [For the Record, June 25, 1956].

KEYT (TV) Santa Barbara (ch 3)—Licensed to Key TV Inc. (William F. and Nancy Lutton). Original owner: Santa Barbara Bcstg. & TV Corp. Sales price: \$1.4 million. FCC approved: March 27, 1957 [For the Record, April 1, 1957].

KCOY-TV Santa Maria (ch 12)—Licensed to Central Coast Broadcasters Inc. (see Dale G. Moore stations in Group Ownership). Sold by: Helen L. Pedotti and others. Sales price: \$75,000 for 50%. FCC approved: July 9, 1968 [For the Record, July 15, 1968]. Note: Founded by Central Coast Bcstrs Inc. (formerly Central Coast TV—Helen L. Pedotti and others) in 1964.

KFTY (TV) Santa Rosa (ch 50)—Licensed to William B. Grover, trustee in bankruptcy. Original owner: Redwood Empire Broadcasting Co. (Sonoma Productions, gen plnr, 50%; and others). Sales price: No consideration. FCC approved: July 22, 1974 [For the Record, Aug. 12, 1974].

KOVR (TV) Stockton-Sacramento (ch 13)—Licensed to McClatchy Newspapers (see Group Ownership). Sold by: Metromedia Inc. Sales price: \$7.8 million. FCC approved: July 30, 1964 [For the Record, Aug. 10, 1964]. Note: Founded by H.L. Hoffman in 1954. Sold to Gannett Co. in 1958 for \$1,477,239. Bought by Metromedia Inc. in 1959 for \$1,391,000 plus assumption of \$2.1 million in debts.

KVVG (TV) Tulare (ch 27, now deleted)—Licensed to James Stacy. Former owner: UHF Telecasting Corp. (M.B. Scott and Joseph Justman). Sales price: \$10,000 and assumption of liabilities. FCC approved: Jan. 30, 1957 [For the Record, Feb. 4, 1957]. Note: Messrs. Scott and Justman purchased station in March 1955 from Sheldon Anderson for \$350,000 in obligations [For the Record, March 28, 1955].

Colorado

KKTV (TV) Colorado Springs (Pueblo) (ch 11)—Licensed to Capital of Colorado Corp. (see T.B. Lanford stations in Group Ownership). Previous owner: Willard Garvey. Sales price: \$2,575,000. FCC approved: June

4, 1969 [For the Record, June 16, 1969]. Note: Founded in 1952. Sold to Mr. Garvey in 1963 by Gifford Phillips, James D. and Betty Z. Russell and Robert D. Ellis for \$885,000 with KFHM(FM) Colorado Springs and KGHF(AM) Pueblo, Colo.

KBTV (TV) Denver (ch 9)—Licensed to Combined Communications Corp. (see Group Ownership). Previous owner: Mullins Broadcasting Co. Sales price (including KARK-TV Little Rock, Ark.): \$13.1 million in cash and assumption of \$9.4 million in debts. FCC approved: Jan. 28, 1972 [For the Record, Feb. 14, 1972]. Note: John C. Mullins and Frank Leu bought KBTV from Colorado TV Corp. (W.D. Pyle and others) for \$900,000 in 1955. Webb & Knapp Inc. bought its 50% interest from Frank Leu for \$850,000 in 1956. Webb & Knapp Inc. sold its 50% interest to John C. Mullins in 1961 for \$2.4 million. FCC approved: Sept. 22, 1961.

KHBC (TV) Denver (ch 20)—Permittee: Denver Post Inc. (Newhouse Newspapers, 18.8%, and others). 50% of CP sold by: Harcourt, Brace & World Inc. (William J. Javanovich and others). Sales price: \$6,160. FCC approved: Nov. 22, 1967. Note: Founded in 1966 by Harcourt, Brace & World. Fifty percent of CP sold to Denver Post in 1967 for about \$6,000.

KMGH-TV Denver (ch 7)—Licensed to McGraw-Hill Broadcasting Co. (see Group Ownership). Previous owner: Time-Life Bcst. Inc. Former call letters: KLZ-TV. Sales price (including KERO-TV Bakersfield and KGTV(TV) San Diego, both California; and WRTV(TV) Indianapolis): \$57,180,000. FCC approved: March 8, 1972 [BROADCASTING, March 13, 1972; May 15, 1972]. Note: Original owner: Aladdin Radio and TV Inc., sold KLZ-TV (with KLZ-AM-FM) to Time-Life in 1954 for \$3.5 million. FCC approved: June 25, 1954 [For the Record, July 5, 1954].

KOA-TV Denver (ch 4)—Licensed to General Electric Bcstg. Co. (see Group Ownership). Sold by: Metropolitan Television Co. (William Grant and others). Sales price: \$10 million in GE stock plus adjustments (with KOA-AM-FM Denver and KOAA-TV Pueblo). FCC approved: June 5, 1968 [For the Record, June 10, 1968]. Note: Founded by Bob Hope, James L. Saphier, William Grant and others in 1953. In 1964, 52.5% sold by Messrs. Hope, Saphier and group to Mr. Grant and "Denver" group for \$6.3 million including KOA-AM-FM and KOAA-TV.

KWGN-TV Denver (ch 2)—Licensed to WGN of Colorado Inc. (see WGN Continental Broadcasting Co. in Group Ownership). Former owner: J. Elroy McCaw. Former calls: KCTO(TV). Sales price: \$3.5 million. FCC approved: March 3, 1966. Original owner: O'Fallon Inc. Original call letters: KFEL-TV later KTVR(TV). Transferred to Eugene P. O'Fallon Trust, Sept. 1953. Transferred to Gotham Bcstg. for \$400,000 and assumption of \$300,000 in obligations. FCC approved: July 27, 1955 [For the Record, August 1, 1955]. Fifty percent transferred to Radio Hawaii for payment of half of purchase price and half of obligations. FCC approved: Nov. 16, 1955. Gotham repurchased 50% from Radio Hawaii. Sales price: \$150,000. FCC approved: March 25, 1959 [For the Record, April 6, 1959].

KREZ-TV Durango (ch 6)—Licensed to XYZ Television Inc. (see Group Ownership). For details see KREX-TV Grand Junction below. Note: Founded by Floyd and Liesolette Jeter: sold to Mr. Howell in 1964 for \$2,000.

KREX-TV Grand Junction (ch 5)—Licensed to XYZ Television Inc. (Rex G. Howell). Previous owner: XYZ Television Inc. (Forestville Realty Corp., et al.). Sales price (including KREZ-TV Durango, KREX-AM-FM Grand Junction and KREY-TV Montrose): \$954,119. FCC approved: Aug. 11, 1972 [For the Record, Oct. 23, 1972]. Note: Mr. Howell, former owner of stations, transferred control while retaining a minority interest for \$2,092,000 plus assumption of \$75,000 in liabilities, plus \$500,000 for 10-year consultant's fee to Mr. Howell (with KREY-TV Montrose and KREZ-TV Durango, both Colorado). FCC approved: Sept. 21, 1966 [For the Record, Oct. 3, 1966].

KREY-TV Montrose (ch 10)—Licensed to XYZ Television Inc. (see Group Ownership). Previous owner: Rex Howell. Sales price: see KREX-TV Grand Junction above. Note: Originally owned 51% by Mr. Howell and 49% by Carl Q. Anderson. Mr. Howell paid Mr. Anderson \$75,000 for the latter's 49% in 1966. FCC approved: May 19, 1966 [For the Record, May 30, 1966].

KOAA-TV Pueblo (ch 5)—Licensed to Sangre de Cristo Broadcasting Corp. (William Grant, 33%; William M. White, Mahlon T. White, each 25.6%, and

others). Sold by Metropolitan Television Co. (William Grant and others). Sales price: \$1.5 million. FCC approved: June 18, 1968. Note: Founded by Douglas D. Kahle and Robert L. Clinton in 1953. Original call letters: KSCJ-TV. Sold in 1954 to Star Broadcasting (Bankers Life & Casualty Co.) for assumption of obligations amounting to \$823,000 (with KCSJ(AM) Pueblo). KOAA-TV sold in 1961 to Metropolitan Television for \$1,250,000.

KHOL-TV Sterling (ch 3, now deleted)—Licensed to Richard B. Steuer. Original owner: Bi-States Co. Sales price: \$2,185 (for CP). FCC approved: Feb. 1, 1961 [For the Record, Feb. 6, 1961].

KTVS (TV) Sterling (ch 3)—Licensed to Wyneco Communications Inc. (a wholly owned subsidiary of Lamb Communications; see Lamb Communications Inc. in Group Ownership). Previous owner: Frontier Broadcasting Co. Sales price (including KSTF(TV) Scottsbluff, Neb; KYCU-TV Cheyenne, Wyo. and a CP for KVRW(TV) Rawlins, Wyo.): \$3 million. FCC approved: July 6, 1972 [BROADCASTING, July 10, 1972].

Connecticut

WICC-TV Bridgeport (ch 43, now deleted)—Licensed to Bridgeport Bcstg. Co. (original owner). Connecticut-New York Bcstrs Inc. purchased 80% from Phillip Merryman and Manning Slater. Sales price: \$1,228,400 (with WICC-AM) and \$275,000 to not compete for 10 years. FCC approved: Feb. 25, 1959 [For the Record, March 2, 1959].

WFSB-TV Hartford (ch 3)—Licensed to Post-Newsweek Stations, Connecticut Inc. (see Post-Newsweek Stations Inc. under Group Ownership). Original owner: Broadcast Plaza Inc. (100% owned by Traveler's Corp., Hartford, Conn.). Original call letters: WTIC-TV. Sales price: \$33.9 million. FCC approved: Jan. 30, 1974 [For the Record, Feb. 11, 1974].

WHCT-TV Hartford (ch 18)—Licensed to Faith Center Inc. (see Group Ownership). Previous owner: RKO General Inc. (see Group Ownership). Former call letters: WHCT(TV). Given to Faith Center by RKO in 1972. FCC approved: Feb. 16, 1972 [BROADCASTING, Feb. 21, 1972]. Note: Founded as WGTH-TV, 55% owned by RKO General Inc. and 45% owned by Hartford Times. Sold to CBS in 1956 for \$650,000. FCC approved: Feb. 23, 1956. Edward D. Taddei and group bought station from CBS for \$250,000. FCC approved: Dec. 23, 1958 [For the Record, Dec. 29, 1958]. Mr. Taddei and associates sold station in 1960 to RKO General Inc. for \$150,000 plus \$245,200 for 10-year lease (and option to purchase for \$570,000 at end of four years). FCC approved: June 1, 1960 [For the Record, June 6, 1960].

WUHF-TV Hartford (ch 61)—Permittee: Evans Broadcasting Corp. (Thomas M. Evans). Former owner: Albert G. Hartigan. Sales price: \$48,821 for CP. FCC approved: April 24, 1970 [For the Record, May 11, 1970].

WHNB-TV New Britain-Hartford (ch 30)—Licensed to Connecticut TV Inc. (Transcontinental Properties Inc. and H & E Balaban Corp.—see Group Ownership). Former owner: NBC. Former call letters: WNBC(TV). Sales price: \$750,000 (with WKNB(AM), later resold). FCC approved: Sept. 23, 1959 [For the Record, Oct. 5, 1959]. Note: Founded by Julian Gross and associates as WKNB-TV and sold to NBC in 1956 for \$600,000 (with WKNB(AM)). [For the Record, Dec. 17, 1966].

WTNH-TV New Haven (ch 8)—Licensed to Capital Cities Communications Inc. (see Group Ownership). Former owner: Triangle Publications Inc. (owned by Walter H. Annenberg and family). Original call letters: WNHC-TV. Sales price: \$110 million (with WFIL(AM), WIOQ(FM) and WPVI-TV Philadelphia; WNHC(AM) and WPLR(FM) New Haven, Conn.; KFRE(AM), KFYE(FM) and KFNSN-TV Fresno, Calif.; and television program syndication business). Contingent on sale was Capital Cities "spin-off" of WFIL(AM) and WIOQ(FM) (formerly WFIL-FM) Philadelphia; WNHC(AM) and WPLR(FM) (formerly WNHC-TV New Haven, Conn.; and KFRE(AM) and KFYE(FM) (formerly KFRE-FM) Fresno, Calif. to separate buyers for an aggregate of \$14,455,000. FCC approved: Feb. 24, 1971 [BROADCASTING, March 1, 1971]. Note: Triangle purchased station from original owners (Aldo DeDominicis, Patrick J. Goode and associates) for \$5.4 million (with WNHC-AM-FM). FCC approved: June 20, 1956 [For the Record, July 2, 1956].

TV Transfers

WTVU(TV) New Haven(ch 59)—Permittee: Impart Systems Inc. (Victor Muscat, owner). Former permittee: Conn Radio Foundation (Richard W. Davis and others). Sales price: \$27,500 plus payment of debts. FCC approved: Aug. 18, 1967 [For the Record, Aug. 28, 1967].

Delaware

WVUE(TV) Wilmington(ch 12, now deleted)—Licensed to Storer Bcstg. Co. Former owner: Paul F. Harron and associates. Sales price: \$5.6 million (including WBG-AM-FM Philadelphia). Former call letters: WPFH(TV). FCC approved (conditioned on Storer disposal of WBRC-AM-FM-TV Birmingham, Ala.): March 28, 1957 [For the Record, April 1, 1957]. Note: Mr. Harron and associates purchased stations in March 1955 for \$3.7 million from J.F. Steinman interests [For the Record, April 4, 1955]. TV call letters were WDEL-TV at that time.

District of Columbia

WDCA-TV Washington(ch 20)—Licensed to Superior Tube Co. (Clarence A. Warden Jr., 21.5%; Paul E. Kelly, 1.4%; Richard H. Gavel, 20%, and others). Sold by: Capitol Broadcasting Co. (Milton Grant, A. Dana Hodgdon, Edward Mernone, Alan I. Kay and others). Sales price: \$4,864,527 including liabilities and agreement not to compete. FCC approved: May 7, 1969 [For the Record, May 19, 1969]. Note: Founded by Capitol Broadcasting in April 1966.

WTOP-TV Washington(ch 9)—Licensed to Post-Newsweek Stations, Capital Area Inc. (see Group Ownership). Original owner: Bamberger Bcstg. Service Inc. Original call letters: WOIC. Sales price: \$1.4 million. FCC approved: July 26, 1950 [For the Record, July 31, 1950]. CBS, 45% owner of WTOP Inc., sold its interest to Washington Post Co., 55% stockholder, for \$3.5 million in Oct. 1954.

Florida

WESH-TV Daytona Beach-Orlando (ch 2) Licensed to Cowles Florida Bcstg. Inc. (see Group Ownership). Previous owner: Tetrad Inc. (John H. Perry Jr.). Sales price: \$1 million plus stock, aggregating between \$5 and \$6 million. FCC approved: April 20, 1966. Note: Founded in 1955 by W. Wright Esch, A.B. Esch and Louis Ossinsky Sr. Sold to Perry interests in 1956 for \$5,000 plus \$150,000 loan. FCC approved: April 25, 1956 [For the Record, May 7, 1956].

WTVI(TV) Fort Pierce(ch 19, now deleted)—Licensed to Atlantic Bcstg. Co. (Isadore J. Fine and associates). Previous owner: Gene T. Dyer. Sales price: \$175,795 for CP FCC approved: July 6, 1961 [For the Record, July 17, 1961].

WDUV-TV Jacksonville(ch 30, now deleted)—Licensed to Canasta Broadcasting Co. (Al. Jérôme and Irving Lapin, 20% each; Alex and Corine Finkel, 25%, et al). Former owners: Scott I. Peek (20%), Alvin Leitman, Henry Kramer, David A. Watts, H. George Carison, each 13.35%; Norman P. Freeman, Gilbert C. Palmer, each 13.33%. Sales price: \$24,646 for CP FCC approved: June 22, 1966 [For the Record, June 27, 1966].

WJXT(TV) Jacksonville(ch 4)—Licensed to Post-Newsweek Stations, Florida Inc. (see Group Ownership). Original owner: Florida Bcstg. Co. Original call letters: WMBR-TV. Sales price: \$2.47 million (with WMBR-AM-FM). FCC approved: Jan. 28, 1953 [For the Record, Feb. 2, 1953]. Note: Sale of WMBR-AM-FM to WWDC Inc. (WWDC Washington, D.C.) for \$375,000. FCC approved: July 31, 1958. [For the Record, Aug. 11, 1958].

WQIK-TV Jacksonville(ch 30, now deleted)—Licensed to Southern Radio & Equipment Co. (Carmen Macri). Original owner: E.D. Rivers Sr., majority stockholder. Original call letters: WOBS-TV. Sales price: \$90,000 (with WOBS[AM] for additional 60% interest (Mr. Macri already owned 21%). FCC approved: July 27, 1955 [For the Record, August 1, 1955].

WTLV(TV) Jacksonville(ch 12)—Licensed to Television 12 of Jacksonville, 100% owned by Harte-Hanks Newspapers. Original owner: Television 12 of Jacksonville. Thomas McGehee, Frank S. McGehee, Frank E. Pellegrini, et al (51%). Sales price: \$11,401,

217. FCC approved: March 27, 1975 [For the Record, April 14, 1975].

WCKT(TV) Miami(ch 7)—Licensed to Sunbeam TV Corp. (Sidney D. Edmund N. Ansin and others). Former owner: Catchings Therrel. Messrs. Ansin will vote 64% of stock. Sales price: \$185,000. FCC approved: Oct. 4, 1967 [For the Record, Oct. 16, 1967].

WLTV(TV) Miami(ch 23)—Licensed to Spanish International Communications Corp. (Fouce Amusement Enterprises Inc.: Frank L. Fouce, 51%; Emilio Ascarraga, 20%; Reynolds V. Anselmo, 15%, et al). Former owner: Coastal Broadcasting System Inc. (Al Lapin Jr., 94.4%). Former call letters: WAJA-TV. Sales price: \$1,440,000. FCC approved: Jan. 6, 1971 [For the Record, Jan. 18, 1971]. Note: Coastal Broadcasting System Inc. purchased station from Storer Broadcasting Co. (see Group Ownership) in 1967. Former call letters: KGBS-TV. Sales price: \$250,000. FCC approved: Oct. 25, 1967 [For the Record, Oct. 30, 1967]. Former Storer purchase was a combination purchase of a construction permit for ch. 23 WMIE-TV Miami for \$35,410 and of facilities of ch. 23 WFTL-TV Fort Lauderdale for \$300,000. Original owners: WMIE-TV, E.D. Rivers Sr. and associates; WFTL-TV, Gore Pub. Co., principal owner. FCC approved: Dec. 16, 1954 [For the Record, Dec. 27, 1954].

WPLG-TV Miami(ch 10)—Licensed to Post-Newsweek Stations, Florida Inc. (see Post-Newsweek Stns. in Group Ownership). Sold by: L.B. Wilson Inc. (Charles H. Topmiller, Thomas A. Welstead, Jeannette Heinze, William C. Ittman, Jolar Corp. and Essie Rupp). Sales price: \$19.6 million (with WCKY[AM] Cincinnati). FCC approved: Sept. 27, 1969 [For the Record, Oct. 6, 1969]. Note: Founded by L.B. Wilson Inc. in November 1961. Former call letters: WLBW-TV.

WDBO-TV Orlando(ch 6)—Licensed to Outlet Co. (see Group Ownership). Original owners: estate of William S. Cherry Jr. Sales price: \$6.1 million (with WBDQ-AM-FM). FCC approved: July 17, 1963 [For the Record, July 29, 1963]. Note: Founded by Harold P. Danforth Sr. and associates. Bought by William S. Cherry Jr. and associates in 1957 for \$3 million (with WDBO-AM-FM).

WEAL-TV Orlando(ch 18, now deleted)—Licensed to Orange County Broadcasters Inc. Original owner: Carmén Macri, 40% stockholder. Sales price: \$29,000 (with WABR[AM]). R.H. Gunckel, 40% stockholder, increased holdings to 80% and James H. Sawyer, 20% stockholder, increased holdings to 40%. FCC approved: Nov. 3, 1955 [For the Record, Nov. 14, 1955].

WFTV(TV) Orlando(ch 9)—Licensed to Channel 9 of Orlando Inc. (joint venture of Mid-Florida TV Corp., Channel 9 Inc., TV-9 Inc., Comint Corp., Florida Heartland TV Inc.) Interim operation began April 1, 1969. Parties are involved in comparative hearing. Note: Founded in 1958 by Mid-Florida Inc. (John W. Kluge, Joseph L. Brechner and others). Mr. Brechner boosted holdings from 17% to 41.67% in 1959 when he bought stock from Mr. Kluge for \$350,000. Former call letters: WLOF-TV.

WJHG-TV Panama City(ch 7)—Licensed to WJHG-TV Inc. (see Gray Communications stations in Group Ownership). Former owners: Mel Wheeler and wife. Former call letters: WJDM-TV. Sales price: \$340,000. FCC approved: June 29, 1960 [For the Record, July 4, 1960]. Note: Founded by J.D. Manley as WJDM(TV). Sold to Mr. Wheeler in 1957 for \$60,000. FCC approved: Nov. 21, 1957 [For the Record, Dec. 2, 1957].

WSUN-TV St. Petersburg(ch 38, now deleted)—Licensed to WSUN Inc. (controlled by H.Y. Levinson, 52.6%; and Celia D. Levinson, 23.58%). Former owner: City of St. Petersburg. Sales price: \$1,315,500 (with WSUN). FCC approved: Feb. 23, 1966 [For the Record, March 7, 1966].

WTVT(TV) Tampa-St. Petersburg(ch 13)—Licensed to WKY TV System Inc. (see Group Ownership). Original owners: W. Walter Tison and associates. Sales price: \$3.5 million. FCC approved: July 19, 1956 [For the Record, July 30, 1956].

WPEC(TV) West Palm Beach(ch 12)—Licensed to PEC Communications Inc. Former owner: Gardens Bcstg. Co. (Royal American Industries Inc., 66 2/3% owned by Bankers Life & Casualty Co.). Original call letters: WEAT-TV. Sales price: \$3,535,000. FCC approved: Oct. 26, 1973 [For the Record, Nov. 12, 1973]. Note: Founded by James R. and June H. Meacham in 1954. Sold to RKO General in 1955 for \$301,000 (with WEAT[AM]). Sold to Rex Rand and associates in 1957

for \$600,000. Rex Rand, 80%, and Bertram Lebar, 20%, sold station to Gardens Bcstg. Co. for \$2.1 million (with WEAT[AM]) in 1964. FCC approved: Feb. 25, 1964 [For the Record, March 2, 1964].

WPVT(TV) West Palm Beach(ch 5)—Licensed to Scripps-Howard Bcstg. Co. (see Group Ownership). Original owner: John H. Phipps. Sales price: \$2 million. FCC approved: Dec. 13, 1961 [For the Record, Dec. 25, 1961]. Note: Founded by Theodore Granik and William H. Cook as WJNO-TV. Sold in 1956 to John H. Phipps for \$642,500.

Georgia

WATL-TV Atlanta(ch 36)—Licensed to Briarcliff Communications Group (Don Kennedy, 30.5%; D.R. Jones, 30.5%; and others). Former owner: U.S. Communications of Georgia Inc. (80% owned by U.S. Communications Corp., controlled by A.V.C. Corp.). Sales price (for CP): \$23,500. FCC approved: July 17, 1974 [For the Record, July 29, 1974]. Note: Original owner, Robert W. Rounsaville, sold CP (as WATL-TV) to D.H. Overmyer in 1965 for \$100,000. D.H. Overmyer Communications Co. sold CP (as WMBO-TV) in 1967 to U.S. Communications of Georgia Inc. for \$1 million (with CP's for KEMO-TV San Francisco; WSCO-TV Newport, Ky.; WECO-TV Pittsburgh and WJDO-TV Rosenberg, Tex.). FCC approved: Dec. 8, 1967 [For the Record, Dec. 18, 1967].

WXIA-TV Atlanta(ch 11)—Licensed to Combined Communications Corp. (see Group Ownership). Previous owner: Pacific & Southern Broadcasting Co. (Fox, Wells & Rogers, 24.4%; Paulette B. Godfrey, 10.8%; DeSales Harrison Jr., 8.0%). Former call letters: WQXI-TV. Sales price: Combined Communications Corp. and Pacific & Southern Broadcasting Co. merged in an exchange of stock (valued in January 1973 at about \$38.6 million). FCC approved: Jan. 9, 1974 [BROADCASTING, Jan. 14, 1974]. Note: Founded by Atlanta Journal as WSB-TV. When Journal merged with Atlanta Constitution in 1950, it sold station to Broadcasting Inc. for \$525,000. In 1953, Broadcasting Inc. sold facilities (WLTV [TV]) to Crosley Broadcasting Corp. for \$1.5 million. Crosley sold station (WALT-TV) in 1962 to Richard M. Fairbanks and associates for \$2,251,000. Richard M. Fairbanks and others sold station to Pacific & Southern Broadcasting Co. in 1967 for \$12,892,000. FCC approved: Nov. 15, 1967 [For the Record, Nov. 27, 1967].

WRDW-TV Augusta(ch 12)—Licensed to Rust Craft Broadcasting Co. (see Group Ownership). Original owners: Southeastern Newspapers Inc. (Augusta Chronicle and Herald). Sales price: \$1,575,000. FCC approved: April 20, 1960 [For the Record, April 25, 1960]. Note: Founded by Grover C. Maxwell Sr., Harry W. Jernigan Sr., Judge F. Frederick Kennedy, Allen M. Woodall and W.R. Ringston. Sold to Southeastern Newspapers in 1956 for \$1 million (with WRDW[AM]) [For the Record, Feb. 27, 1956].

WTVM(TV) Columbus(ch 9)—Licensed to Fuqua Industries Inc. (see Group Ownership). Sold by: Martin Theaters of Georgia Inc. (E.D. Martin and Roy E. Martin Jr.). Sales price: Exchange of stock valued at about \$19 million (with WTVG[TV] Chattanooga). FCC approved: Feb. 7, 1969 [For the Record, Feb. 17, 1969]. Note: Went on air Oct. 6, 1953, on ch. 28. Switched to ch. 9 Nov. 3, 1960. See WTVG(TV).

WCWB-TV Macon(ch 41)—Licensed to Bibb Television Inc. (FE. Busby, 64%; R.A. Biegel, 12%). Original owner: WTVY Inc. (Charles E. Woods, 100%). Sales price: \$800,000. FCC approved: Aug. 9, 1974 [For the Record, Aug. 26, 1974].

WMAZ-TV Macon(ch 13)—Licensed to Multimedia Inc. (see Group Ownership). Original owners: George P. Rankin Jr., Wilton E. Cobb, and Mr. and Mrs. Wallace Miller. Sales price: \$2,094,750 (with WMAZ-AM-FM). FCC approved: March 13, 1963 [For the Record, March 18, 1963].

WOKA(TV) Macon(ch 47, now deleted)—Licensed to Macon TV Co. (J.C. Barnes and E.K. Cargill). Original owners: W.A. Fickling and WNEX(AM) Macon. Sales price: \$1 million and assumption of \$260,000 in obligations. FCC approved: April 19, 1955 [For the Record, April 25, 1955].

WCTV(TV) Thomasville, Ga.-Tallahassee, Fla.(ch 6)—Licensed to John H. Phipps Broadcasting Stations Inc. (John H. Phipps). Original owner: E.D. Rivers Sr. Sales price: \$887,000 for expenses and equipment plus assumption of \$331,464 in obligations. FCC approved: May 11, 1955 [For the Record, May 23, 1955].

Hawaii

KHAW-TV Hilo(ch 11)—See KHON-TV Honolulu below.

KHVO-TV Hilo(ch 13)—See KITV(TV) Honolulu below.

KPUA-TV Hilo(ch 9)—Licensed to Heftel Television-Hilo Inc. (owned 90% by Heftel Broadcasting Corp. and 10% by Lani G. and James Donohoe Jr., daughter and son-in-law of Cecil and Joyce Heftel, principals of Heftel Broadcasting Corp.). Previous owner: Heftel Broadcasting Corp. Note: Station operates as a satellite of KGMB-TV Honolulu (see below).

KGMB-TV Honolulu(ch 9)—Licensed to Heftel Broadcasting-Honolulu Inc., 100% owned by Heftel Broadcasting Corp. (see Group Ownership). Previous owner: Pacific Bcstg Inc. (80% owned by The Standard Corp.). Mr. and Mrs. Heftel gained control of KGMB-AM-FM-TV Honolulu and KPUA-AM-TV Hilo, both Hawaii, by exchanging all of their stock in Standard Corp. (25%) for all of Standard's stock (80%) in Pacific. Transfer of control involved no cash consideration. The Standard Corp. owns 80% of KUTV(TV) Salt Lake City. FCC approved: September 1972 [BROADCASTING, Sept. 25, 1972]. Note: Founded by Consolidated Amusement Corp. in 1952. Bought by Hialand Development Corp. in 1958 for \$8.7 million including real estate. Honolulu Star-Bulletin became 24.5% owner in 1959 and later that year became 100% owner by paying \$2.35 million for 75.5% interest. Honolulu Star-Bulletin sold station (with KGMB(AM), KHBC-AM-TV Hilo and KMAU-TV Wailuku, Hawaii) to Pacific Bcstg. in 1965 for \$2.5 million. FCC approved: May 5, 1965 [For the Record, May 10, 1965].

KHON-TV Honolulu(ch 2)—Licensed to Pacific & Southern Broadcasting Inc. (see Group Ownership). Previous owners: Honolulu Advertiser and John D. Keating, jointly. Previous call letters: KONATV. Sales price: \$2,597,840 (with KHAW-TV Hilo and KAIT-TV Wailuku, Hawaii). FCC approved: April 28, 1956 [For the Record, May 10, 1956]. Note: Founded in 1952 by Herbert M. Richards. Bought by Honolulu Advertiser and J. Elroy McCaw-John D. Keating in 1952 for \$60,500 and \$200,000 stock subscription by Honolulu Advertiser. Mr. McCaw subsequently sold out his interest to Mr. Keating.

KITV(TV) Honolulu(ch 4)—Licensed to Western Telestations Inc., owned 100% by Starr Broadcasting Group Inc. (see Group Ownership). Previous owner: Western Telestations Inc. (Lawrence S. Berger, 51%; Mrs. Fred Goodstein, 29% and others). Former call letters: KHVH-TV. Sales price: \$4 million (with KHVO(TV)). FCC approved: June 15, 1973 [For the Record, July 2, 1973]. Note: Founded in 1954 as KULA-TV by Dolph-Petty group. Sold to Albert Zugsmith, Arthur Hogan and others in 1956 for \$600,825 (with KULA). Sold to Kaiser Bcstg. in 1958 for \$685,000 (with KULA) and call letters changed to KHVH-TV. Sold to Western Telestations (Lawrence S. Berger, et al) for \$4.25 million (with KHVH-AM-FM and KHVO(TV)) in 1964. FCC approved: Dec. 16, 1964 [For the Record, Dec. 28, 1964].

KAIT-TV Wailuku(ch 7)—See KHON-TV Honolulu above.

KMAU-TV Wailuku(ch 3)—Licensed to Heftel Broadcasting-Maui Inc. (see Heftel Broadcasting Corp. under Group Ownership). Previous owner: John S. Young Associates Inc. (John S. Young, 100%). Sales price: \$95,000 with grant fee of \$1,900. FCC approved: March 7, 1974 [For the Record, March 25, 1974]. Note: Honolulu Star-Bulletin (see KGMB-TV above) sold station (with KHBC-AM-TV Hilo and KGMB-AM-TV Honolulu, both Hawaii) to Pacific Broadcasting Inc. (A.L. Glasmann group) in 1965 for \$2.5 million. FCC approved: May 5, 1965 [For the Record, May 10, 1965]. Then Pacific Broadcasting sold station to John S. Young Associates Inc. Sales price: \$1,500 per month rent for 10 years, with Pacific Broadcasting paying KMAU-TV for period of two years. FCC approved: May 5, 1965 [For the Record, May 10, 1965].

Idaho

KLEW-TV Lewiston(ch 3)—See KIMA-TV Yakima, Wash.

KBYN(TV) Twin Falls(ch 13)—Licensed to Boise Valley Broadcasters Inc. (H. Westerman Willcock). Former permittee: Samuel H. Bennion. Sales price: \$3,000. FCC approved: May 17, 1967 [For the Record, May 29, 1967].

KMVT(TV) Twin Falls(ch 11)—Licensed to KLIX Corp. (See Glasmann Sins. in Group Ownership). Original owners: J. Robb Brady Trust Co., Frank C. Carman and Grant R. Wrathall. Original call letters: KLIX-TV. Sales price: \$95,598 (with KLIX). FCC approved: March 7, 1956 [For the Record, March 12, 1956].

Illinois

WBLN(TV) Bloomington(ch 15, now deleted)—Licensed to WBLN TV Inc. (Worth S. Rought). Original owner: Cecil W. Roberts. Sales price: \$1 plus assumption of \$199,961 in obligations. FCC approved: July 13, 1955 [For the Record, July 18, 1955].

WICD(TV) Champaign-Danville(ch 15)—Licensed to Plains TV Corp. (see Group Ownership). Original owners: Gannett Pub. Corp. Sales Price: \$75,000. FCC approved: July 27, 1960 [For the Record, August 8, 1960]. Original call letters: W DAN-TV.

WBBM-TV Chicago(ch 2)—Licensed to CBS Inc. Original owner: Balaban & Katz Inc. (subsidiary of United Paramount Theaters Inc.). Original call letters: WBKB. Sales price: \$6 million. FCC approved: Feb. 9, 1953 [For the Record, Feb. 16, 1953].

WFLD-TV Chicago(ch 32)—Licensed to Kaiser Broadcasting Co., 77.5% owned by Kaiser Broadcasting Corp. (see Group Ownership) and 22.5% by Field Communications Corp. (owned by Field Enterprises Inc., Chicago). Previous owner: Field Communications Corp. Sales price: no consideration. FCC approved merger of Kaiser Broadcasting Corp.'s five independent UHF's and Field Communications Corp.'s one independent UHF (WFLD-TV) in May 1973 [BROADCASTING, May 14, 1973]. Note: Founded as WOGO-TV by Television Chicago (Winnebago Television Corp., Transcontinental Properties Inc. and Froelich & Friedland). Sold Jan. 18, 1965 to New Television Chicago group for \$2 million with Froelich & Friedland retaining interest and Field, 50% owner, obtaining option to purchase remaining 50% for \$2.5 million. In 1970 Field bought the remaining 50% from Harry and Elmer Balaban et al for \$2.5 million. FCC approved: April 1, 1970 [For the Record, April 13, 1970].

WIND-TV Chicago(ch 20, now deleted)—Licensed to Westinghouse Broadcasting Co. (see Group Ownership). Original owner: WIND Inc. (Chicago Daily News-Ralph L. Atlas and family). Sales price: \$5.3 million (with WIND). FCC approved: Nov. 8, 1956 [For the Record, Nov. 12, 1956].

WLS-TV Chicago(ch 7)—Licensed to ABC Inc. Original owner: American Bcstg. Co. Original call letters: WENR-TV. Note: This was change of ownership when ABC merged with United Paramount Theaters Inc. FCC approved: Feb. 9, 1953 [For the Record, Feb. 16, 1953]. Previous call letters: WBKB-TV.

WSNS(TV) Chicago(ch 44)—Licensed to Video 44, joint venture. (River Grove Theater Corp., Velma Entertainment Corp. and Riverdale Drive-In, Inc., all 50% and Harriscop of Chicago Inc., 50-2/3). Original owner, Essaness Television Associates terminates its existence and transfers rights to Essaness TV Corp., which is to be merged into River Grove Theater. Sales price: \$500,000 for 50-2/3, Harriscop, and \$485,830 other group. FCC approved: Jan. 5, 1967 [For the Record, Jan. 16, 1967].

WAND(TV) Decatur(ch 17)—Licensed to WAND TV Inc. (LIN Broadcasting Co., see Group Ownership). Former owner: Metromedia Inc. Former call letters: WTVP(TV). Sales price: \$2 million. FCC approved: Dec. 22, 1965 [For the Record, Jan. 3, 1966]. Note: Founded by William A. Schellabarger and associates. Bought by George A. Bolas and associates in 1958 for \$200,000 plus \$20,000 yearly lease of premises for five years. Metromedia bought station in 1960 for \$570,000.

WCEE-TV Freeport(ch 23)—Licensed to WCEE-TV Inc. (owned by General Media Corp.). Original owner: Rock River Television Corp. Sales price: none. Rock River and WCEE Inc., both subsidiaries of General Media, have merged. FCC approved: Feb. 11, 1975 [For the Record, Feb. 24, 1975].

WSIL-TV Harrisburg(ch 3)—Licensed to Turner-Farrar Association (partnership of O.L. Turner, O.L. Turner, trustee of Turner trust; and Ethel M. Turner). Previous owner: Turner-Farrar Association (partnership of O.L. Turner, O.L. Turner, trustee of Turner trust; Ethel M. Turner; and Bernice Horning, executrix of estate of Harry R. Horning). Sales price: none. FCC approved: Nov. 7, 1974 [For the Record, Nov. 25, 1974]. Note: Earlier

in 1974 FCC granted involuntary transfer of control of Turner-Farrar Association (partnership) from Harry R. Horning to Bernice Horning, executrix of estate of Mr. Horning. FCC approved: Aug. 30, 1974 [For the Record, Sept. 16, 1974].

WEEQ-TV LaSalle(ch 35)—Licensed to Mid-America Television Co. (see WEEK-TV Peoria, Ill., below).

WEEK-TV Peoria(ch 25)—Licensed to Mid-America Television Co. (Kansas City Southern Industries Inc., see Group Ownership). Former owners: estate of late Senator Robert S. Kerr and Dale McGee. Sales price: \$3,088,650 (with satellite WEEQ-TV LaSalle, Ill.). FCC approved: July 13, 1966 [For the Record, July 18, 1966].

WBMD-TV Peoria(ch 31)—Licensed to Midwest TV Inc. (see Group Ownership). Original owners: Charles C. Caley, 51%; John E. Feltzer, 49%. Sales price: \$1,850,000 (with WBMD-AM-FM). FCC approved: June 15, 1960 [For the Record, June 20, 1960].

WRAU-TV Peoria(ch 19)—Licensed to Forward of Illinois Inc. (see Forward Communications Corp., under Group Ownership). Former owner: Mid-America Media Inc. (see Group Ownership). Former call letters: WIRL-TV. Sales price: \$2.75 million. FCC approved: March 24, 1971 [BROADCASTING, March 29, 1971]. Note: Founded in 1953 by Hugh R. Norman and Edward C. Schoede. Sold to Hilltop Bcstg. Co. (55-2/3% owned by Peoria Star-Journal) in 1954 for \$210,000. Bought by Metromedia Inc. (see Group Ownership) in 1959 for \$610,000. Previous call letters: WTVH(TV). Purchased by Mid-America Media Inc. in 1965 for \$2.2 million. FCC approved: July 21, 1965 [For the Record, July 26, 1965].

WREX-TV Rockford(ch 13)—Licensed to Gilmore Broadcasting Corp. (see Group Ownership). Sold by WREX-TV Inc. (see Gannett Co. stations in Group Ownership). Sales price: \$6,850,000. FCC approved: Aug. 29, 1969. [For the Record, Sept. 8, 1969]. Note: Founded in September, 1953 by Swan Hillman and associates. Sold to WREX-TV Inc. in June, 1963 for \$3,420,000.

Indiana

WSJV(TV) Elkhart (ch 28)—Licensed to WSJV Television Inc., owned by Quincy Newspapers (see Newspaper Crossownership under Quincy Broadcasting Co.). Original owner: Truth Publishing Co. (see Newspaper Crossownership under Truth Radio Corp.). Sales price: \$3,200,000. FCC approved: March 31, 1975 [For the Record, April 14, 1975].

WEHT(TV) Evansville (ch 25)—Licensed to Gilmore Bcstg. Corp. (see Group Ownership). Sold by Henry S. Hilberg, 17.3% personally and 17.3% as trustee; Edwin G. Richter, 20.7% and others. Sales price: \$4.2 million with KGUN-TV Tucson, Ariz. FCC approved: July 20, 1964 [For the Record, July 27, 1964]. Note: Founded in 1953 by Malco Theaters Inc. Sold to Hilbert group in 1956 for \$820,000.

WFIE-TV Evansville (ch 14)—Licensed to WFIE Inc. (see Norton Stns. in Group Ownership). Original owners: Grand Carlton Corp. (Jesse D. Fine and family). Sales price: \$586,937. FCC approved: July 19, 1956 [For the Record, July 30, 1956].

WTVW(TV) Evansville (ch 7)—Licensed to Evansville Television Inc. (see Fuqua Industries stations in Group Ownership). Previous owner: Polaris Corp. Sales price: Stock exchange valued at about \$3.8 million plus assumption of \$3 million in obligations (with KTHI-TV Fargo, N.D.; KXOA-AM-FM Sacramento, Calif.). FCC approved: Sept. 23, 1966 [For the Record, Oct. 3, 1966].

WANE-TV Fort Wayne (ch 15)—Licensed to Indiana Broadcasting Corp. (see Corinthian Broadcasting Corp. in Group Ownership). Station was merged with Corinthian Broadcasting into Dun & Bradstreet Companies Inc. for stock valued at \$137 million (with KXTV(TV) Sacramento, Calif.; KOTV(TV) Tulsa, Okla.; KHOU-TV Houston; and WISH-TV Indianapolis). FCC approved: April 14, 1971 [BROADCASTING, April 19, 1971]. Note: Universal Bcstg. Co. (C. Bruce McConnell and associates) purchased Fort Wayne stations in June 1956 from R. Morris Pierce, Frederick W. Wolf, John F. Patt and associates for \$800,000 [For the Record, June 25, 1956]. Original call letters: WINT(TV). Indiana Bcstg. Co. purchased WANE-TV from Universal in October 1956 for \$10 million (with

TV Transfers

WANE and WISH-AM-TV Indianapolis (FCC approved: Oct. 10, 1956 [For the Record, Oct. 15, 1956].)

WKJG-TV Fort Wayne (ch 33)—Licensed to Thirty-Three Inc. (Anton Hulman Jr., pres, 73.1%; Joseph R. Cloutier, VP, 23%; Henry P. Smith, dir, 3.9%). Former owner: Federated Media Inc. (Paul E. Van Hook, pres, & John Dille Jr., chmn of bd). Sales price: \$4 million. FCC approved: July 29, 1974 [For the Record, Aug. 19, 1974]. Note: WKJG Inc. purchased station from original owners (Walter L. Thomas and associates) in 1957. Sales price: \$1,925,000 (with WKJG). FCC approved: March 13, 1957 [For the Record, March 18, 1957]. WKJG Inc. (John F. Dille, 15%; Truth Publishing Co., controlled by Mr. Dille and his family and publisher of the *Elkhart* [Ind.] *Truth*, 60%; Walter R. Beardsley, 25%) sold station to Television Communications Corp. in 1971 for \$6,072,445. FCC approved: March 10, 1971 [BROADCASTING, March 29, 1971]. Spun off to Federated Media when Television Communications Corp. was sold to Warner Communications Inc. [BROADCASTING, Feb. 7, 1972].

WGMI-TV Gary (ch 56)—Permittee: Family Stations Inc. (see Group Ownership). Previous owner: General Media Television Inc. (Earl B. Glickman, et al). Sales price: \$20,000 for CP. FCC approved: Feb. 24, 1971 [For the Record, March 8, 1971].

WHMB-TV Indianapolis (ch 40)—Licensed to LeSea Broadcasting Corp. (nonprofit corporation). Previous owner: White River Radio Corp. Former call letters: WURD(TV). Sales price: \$354,618. FCC approved: Aug. 15, 1972 [For the Record, Sept. 4, 1972].

WISH-TV Indianapolis (ch 8)—Licensed to Indiana Broadcasting Corp. (see Corinthian Broadcasting Corp. in Group Ownership). Station was merged with Corinthian Broadcasting into Dun & Bradstreet Companies Inc., for stock valued at \$137 million (with KXTV(TV) Sacramento, Calif.; KOTV(TV) Tulsa, Okla.; KHOU-TV Houston; and WANE-TV Fort Wayne, Ind.). FCC approved: April 14, 1971 [BROADCASTING, April 19, 1971]. Note: Indiana Bcstg. Corp. purchased WISH-TV from original owner, Universal Bcstg. Co. (C. Bruce McConnell and associates), in October 1956. Sales price: \$10 million (with WISH and WANE-AM-TV Fort Wayne). FCC approved: Oct. 10, 1956 [For the Record, Oct. 15, 1956].

WLWI-TV Indianapolis (ch 13)—Licensed to Video Indiana, subsidiary of The Dispatch Printing Co. (see Newspaper Crossownership under *Columbus* (Ohio) *Dispatch*). Original owner: AVCO Broadcasting Corp. Sales price: \$17,650,000. FCC approved: Aug. 11, 1975 [For the Record, Sept. 1, 1975].

WRTV(TV) Indianapolis (ch 6)—Licensed to McGraw-Hill Broadcasting Co. (see Group Ownership). Previous owner: Time-Life Bcst. Inc. Former call letters: WFBM-TV. Sales price (including KERO-TV Bakersfield and KGTV(TV) San Diego, both California; and KMGH-TV Denver): \$57,180,000. FCC approved: March 8, 1972 [BROADCASTING, March 13, 1972; May 15, 1972]. Note: Original owner, Consolidated TV & Radio Bcstrs Inc. (Harry M. Bitner interests) sold station to Time-Life in 1957 as part of a package deal including WFBM(AM), WOOD-AM-TV Grand Rapids, Mich., and WTCN-AM-TV Minneapolis for \$15,750,000. FCC approved: April 17, 1957 [For the Record, April 22, 1957].

WFLI-TV Lafayette (ch 18)—Licensed to RJN Broadcasting Inc. (Richard F. Shively; see Shively Stations in Group Ownership). Former owners: Sarkes Tarzian Inc. (see Group Ownership). Former call letters: WFAM-TV. Sales price: \$250,000. FCC approved: Nov. 3, 1967 [For the Record, Nov. 13, 1967]. Former owner: Lafayette Bcstg. Inc. Sales price: \$65,000. FCC approved: May 15, 1959 [For the Record, May 25, 1959]. Original owner: Olney E. Richardson. Sales price: \$330,000 (with WASK(AM) Lafayette). FCC approved: Feb. 21, 1957 [For the Record, Feb. 25, 1957].

WSPD-TV Marion (ch 31)—Licensed to R. David Boyer, trustee in bankruptcy. Transferred by: Geneco Broadcasting Inc. (Anthony R. Martin-Trigona, 81%, and others). Sales price: no consideration. FCC approved: May 8, 1969 [For the Record, May 19, 1969]. Note: Founded in 1962 by Eugene C. Thompson. Original call letters: WTAFTV. Controlling interest sold to Northern Indiana Broadcasters (William N. Udell and others) in 1963. Northern Indiana sold 76% to Geneco, Oct. 31, 1968 for \$157,000.

WPB(TV) Muncie (ch 49)—Licensed to Ball State University. Original owner: Tri-City Radio Corp.

(Donald A. Burton, 51%; William F. Craig estate, 46.5%, and others). Original call letters: WLBC-TV. Sales price: \$125,000. FCC approved: Oct. 26, 1971 [For the Record, Dec. 6, 1971].

WPTA(TV) Roanoke (ch 21)—Licensed to WPTA-TV Inc., a wholly owned subsidiary of Combined Communications Corp. (see Group Ownership). Original owner: Sarkes Tarzian Inc. (see Group Ownership). Sales price: \$3,625,000. FCC approved: April 4, 1973 [For the Record, April 23, 1973].

WTWO(TV) Terre Haute (ch 2)—Licensed to Illiana Telecasting Corp., subsidiary of Fabri Development Co., 100% owned by Malcolm I. Glazer. Previous owner: Illiana Telecasting Corp. (James E. Sauter, Gordon Craig, Stephen F. Booth, James A. Beresford, George Hadden, John L. Booth, Richard L. Lindland, William D. Vogel and James F. Winter, trustees; see Both American Co. in Group Ownership) forced to sell station because of common ownership rules. Sales price: \$4,650,000. FCC approved: July 18, 1975 [For the Record, Aug. 4, 1975]. Note: James E. Sauter, et al., purchased station from James Raymond Livesay, 25%, et al., in 1971. Sales price: \$5,000,000. FCC approved: Jan. 6, 1971 [For the Record, Jan. 18, 1971].

Iowa

KCRG-TV Cedar Rapids (ch 9)—Licensed to Cedar Rapids TV Co. (*Cedar Rapids Gazette*). Original owners: Myron N. Blank, Harrison E. Spangler and associates, 70-2/3%; *Cedar Rapids Gazette*, 30%. Original call letters: KCRI-TV. Sales price: \$101,500 by *Cedar Rapids Gazette* of remaining 70% interest (with KCRG). FCC approved: Aug. 12, 1954 [For the Record, Aug. 23, 1954].

WMT-TV Cedar Rapids (ch 2)—Licensed to WMT Inc. (see Norton Stns. in Group Ownership). Sold by American Broadcasting Stns. Inc. (Mrs. Helen Marks and family). Sales price: \$7,500,000 (with WMT-AM-FM). FCC approved: June 12, 1968 [For the Record, June 24, 1968]. Note: Founded by Mrs. Helen Marks and others in 1953.

KCAU-TV Sioux City (ch 9)—Licensed to Forward of Iowa (see Forward Communications Stns. in Group Ownership). Sold by People's Broadcasting Corp. (Nationwide Mutual Insurance Co.). Sales price: \$3,500,000. FCC approved: Oct. 27, 1965. Former owners: Cowles Broadcasting Co. (see Group Ownership). Sold by Cowles in 1957 to People's for \$3 million with WNAX(AM) Yankton, S.D. Previous call letters: KVTV(AM).

KMEG(TV) Sioux City (ch 14)—Licensed to Medallion Broadcasters Inc. (see Felzer Broadcasting Stns. in Group Ownership). Sold by: Robert B. Donovan and others. Sales price: \$930,065. FCC approved: Aug. 13, 1969 [For the Record, Aug. 25, 1969]. Note: Founded in September 1967.

KTIV(TV) Sioux City (ch 4)—Licensed to KTIV Television Co. (see Black Hawk Broadcasting Stns. in Group Ownership). Previous owner: KTIV Television Co. (100% owned by Perkins Brothers Co.). Sales price: \$3.3 million. FCC approved: March 28, 1974 [For the Record, April 15, 1974]. Note: Original owners, KTIV Television Co. (Perkins Brothers Co. [*Sioux City Journal* and *Journal-Tribune-KSCJ*], 50%; Dietrich Dirks, 36.75%; and others), sold 50% to Perkins Brothers Co. in 1965, giving Perkins Brothers 100% control. Sales price: \$2.2 million for 50%. FCC approved: May 26, 1965 [For the Record, May 31, 1965].

Kansas

KGLD(TV) Garden City (ch 11)—See KCKT(TV) Great Bend below.

KLOE-TV Goodland (ch 10)—Licensed to KAYS Inc. (Ross Beach Jr., Robert E. Schmidt, and others, see Group Ownership under Kansas State Network). Original owner: Standard Electronics Corp. Sales price: \$152,500. FCC approved: July 13, 1962 [For the Record, July 23, 1962]. Original call letters: KWKT-TV.

KCKT(TV) Great Bend (ch 2)—Licensed to Kansas State Network Inc. (see Group Ownership). Original owners: Elmer C. Wedell and group. Sales price: \$1,037,500 (with KGLD(TV) Garden City, Kan., and KOMC(TV) McCook, Neb.). FCC approved: June 13, 1962 [For the Record, June 18, 1962].

KTVH(TV) Hutchinson (ch 12)—Licensed to Wichita-Hutchinson Co. (93% owned by Minneapolis Star-Tribune Co.). Original owners: Hutchinson TV Inc. (John P. and Sidney F. Harris, R.J. Laubengayer, Howard O. Peterson and others). Sales price: \$1 million. FCC

approved: Oct. 19, 1955 [For the Record, Oct. 24, 1955].

KSLN-TV Salina (ch 34)—Licensed to Mid-America Bcstg. Corp. (James P. Sunderland, 50%; Ralph L. Weir Jr., 25%; Robert K. Weary, 25%). Sold by: Melvin L. Gleason and family. Sales price: \$43,000. FCC approved: Feb. 26, 1964 [For the Record, March 2, 1964].

WIBW-TV Topeka (ch 13)—Licensed to Stauffer Publications Inc. (see Group Ownership). Original owner: Capper Pub. Sales price: \$7 million (including Capper Pubs' WIBW(AM) and KCKN(AM) Kansas City, Kan. KCKN in turn was sold to Cy Blumenthal for \$110,000). FCC approved: Dec. 20, 1956 [For the Record, Dec. 24, 1956].

Kentucky

WBKO(TV) Bowling Green (ch 13)—Licensed to Professional Telecasting Systems Inc. (Lincoln International Corp., 100%). Principals of Lincoln are D.C. Combs, 35%; John M. Berry Sr., 30%; and Frank J. Hildebrand estate, 15%, and others). Former owner: George A. Brown Jr. and J.M. Walters. Original call letters: WLTV(TV). Sales price: \$1 million. FCC approved: June 11, 1970 [For the Record, June 22, 1970]. Note: Founded in 1962 by Argus Broadcasting Co. (Messrs. Brown and Walters).

WKYT-TV Lexington (ch 27)—Licensed to Kentucky Central Television Inc. (100% owned by Mid-Central Investment Co., which is 100% owned by Kentucky Central Life Insurance Co. (Garvice D. Kincaid, 52.5% owner of Kentucky Central Life Insurance Co. Theodore T. Grizzard, J. Paul Warnece et al). Former owner: Taft Broadcasting Co. (see Group Ownership). Sales price: \$2.5 million. FCC approved: April 26, 1967 [For the Record, May 8, 1967]. Note: Taft Broadcasting bought station from Frederic Gregg Jr., Harry C. Feingold and Charles H. Wright for \$100,000 of which \$35,000 was paid in agreement not to compete for five years. Original call letters: WLAF-TV, later WKXP-TV. Messrs. Gregg, Feingold and Wright bought WKYT from Gilmore N. Nunn for \$350,000 (with WLAP-AM-FM) in January 1957.

WTVO-TV Lexington (ch 62)—Licensed to Starr VTVO Inc. (see Starr Broadcasting Group Inc. in Group Ownership). Original owner: WBLG-TV Inc., 50% owned by Roy B. White Jr. and 50% by Reeves Telecom Corp. (see Group Ownership). Original call letters: WBLG-TV. Sales price: \$1.5 million. FCC approved: Nov. 14, 1973 [For the Record, Nov. 26, 1973].

WEZI(TV) Louisville (ch 21)—Permittee: South Central Broadcasting Corp. (group owner). Previous owner: Mid-America Broadcasting Corp. (Charles Sawyer). Sales price: \$25,000 for CP. FCC approved: Oct. 11, 1965 [For the Record, Oct. 18, 1965]. Note: Founded in 1954 by James F. Brownlee, Milton S. Trost, Harold Plunkett, Emmanuel Levi and group as WKLO-TV. Sold to Mr. Sawyer in 1955 for \$350,000 with WKLO.

WLKY-TV Louisville (ch 32)—Licensed to WLKY-TV Inc., 100% owned by Combined Communications of Kentucky Inc., a wholly owned subsidiary of Combined Communications Corp. (see Group Ownership). Previous owner: WLKY-TV Inc., 100% owned by Sonderling Broadcasting Corp. (see Group Ownership). Sales price: \$8,330,000. FCC approved: April 4, 1973 [For the Record, April 23, 1973]. Note: Founded by Kentuckiana TV Inc. in 1961. Kentuckiana TV Inc. (George E. and Helen Egger and others) sold station to Sonderling Corp. in 1967 for \$6,860,000. FCC approved: Dec. 13, 1967 [BROADCASTING, Dec. 18, 1967].

WXIX-TV Newport-Cincinnati—Licensed to Metromedia Inc. (see Group Ownership). Previous owner: U.S. Communications of Ohio Inc. Sales price: \$3 million. FCC approved: Aug. 9, 1972 [BROADCASTING, Aug. 14, 1972]. Note: Previous owners: James G. Lang and Dean Stuhlmueller. Previous call letters: WNOP-TV. Messrs. Lang and Stuhlmueller sold CP in 1965 to D.H. Overmyer Communications Co. for \$100,000 and covenant not to compete. D.H. Overmyer Communications sold 80% of CP to U.S. Communications Corp. (a subsidiary of AVC Corp.) in 1967 for \$1 million (with 80% of CPs for KEMO-TV San Francisco; WBMO-TV Atlanta; WECO-TV Pittsburgh; and KJDD-TV Rosenberg, Tex.). Former call letters: WSCO-TV.

WDXR-TV Paducah (ch 29)—Licensed to WDXR-TV Inc. (100% owned by Lady Sarah McKinney-Smith). Previous owner: WDXR-TV Inc. (George T. Bailly, 50%; Lady Sarah McKinney-Smith, 50%). FCC approved: Dec. 19, 1974 [For the Record, Jan. 13, 1975]. Note:

FCC approved involuntary transfer of control to Mrs. McKinney-Smith as executrix of estate of E. Weaks McKinney-Smith, May 22, 1974 [For the Record, June 10, 1974].

Louisiana

KALB-TV Alexandria (ch 5)—Licensed to Lanford Telecasting Co. (see Lanford Stations in Group Ownership). Former owner: TB. Lanford 99.2%. Sales price: \$333,155. FCC approved: Jan. 10, 1957 [For the Record, Jan. 14, 1957]. Note: Mr. Lanford originally owned 47.2% of station; purchased 52% from WH. Allen for \$200,000 (with KALB-AM-FM). FCC approved: Aug. 31, 1955 [For the Record, Sept. 5, 1955].

WAFB-TV Baton Rouge (ch 9)—Licensed to Guaranty Bcstg. Corp. (Guaranty Bond & Finance Inc. and Guaranty Income Life Insurance Co., principally owned by George A. Foster Trust, 27%; George A. Foster Jr., 10%, and others). Sold by: Royal Street Corp. (WDSU-AM-FM-TV New Orleans). Price: \$2,970,000. FCC approved: Jan. 14, 1964 [For the Record, Jan. 20, 1964]. Note: Royal Street Corp. acquired control of WAFB Stns. in 1956 from Louis S. Prejean and associates by paying \$148,600 for 31.1% of the stock. It previously had owned 26.7%.

KLFY-TV Lafayette (ch 10)—Licensed to Texoma Broadcasters Inc. (see KWTX Stns. in Group Ownership). Previous owners: Paul H. DeClouet, Thomas A. DeClouet, Harold Delhommer, J.W. Mitchell, each 18.75% and others. Sales price: \$2,693,311. FCC approved: Jan. 27, 1965 [For the Record, Feb. 1, 1965].

KLPC-TV Lake Charles (ch 7)—Licensed to Calcasieu Television and Radio Inc. (Lake Charles Television Inc., 100% owned by G. Russell Chambers). Former owner: Calcasieu Television and Radio Inc. (Harry W. Chesley Jr., Ray Eder, et al.). Sales price: \$2,050,000. FCC approved: Feb. 18, 1971 [For the Record, March 1, 1971]. Note: Station was sold by TB. Lanford, 66-2/3%; Lewis M. Sepaugh Sr. and Jr., 33-1/3%; to Calcasieu Television Inc. (Henry W. Chesley Jr., 19.8%; Mary Ann Stein, 7.2%; Stan Musial, and 12 other stockholders with 4.7% each) in 1964. Sales price: \$2 million (with KLPC[AM]). FCC approved: June 27, 1964 [For the Record, July 13, 1964].

WDSU-TV New Orleans (ch 6)—Licensed to Cosmos Bcstg. of Louisiana Inc. (see Cosmos Bcstg. in Group Ownership). Original owner: WDSU-TV Inc. (wholly owned by Royal Street Corp.). Sales price: \$16 million. FCC approved: Nov. 29, 1972 [For the Record, Dec. 11, 1972].

WGNO-TV New Orleans (ch 26)—Licensed to Communications Corp. of the South Inc. (Raymond C. Abercrombe, 10%; Morris L. Trahan Sr., 10%; Paul J. Yasich, 10%; Cascade Development Corp., 70%). Previous owner: Receiver in Bankruptcy Dorothy R. Cowen. Sales price: \$300,000 (for CP). FCC approved: Dec. 29, 1971. Note: Founded in 1967 as WWOM-TV. Original owner was David W. Wagenvoor.

WJMR-TV New Orleans (ch 20, now deleted)—Permittee: Summit Broadcasting Corp. (George A. Mayoral, 85%; Richard L. Voelker, 15%). CP sold by: Supreme Broadcasting Co. (Mr. & Mrs. Roy A. Nelson and others). Sales price: \$393,000 (with WNNR-AM-FM New Orleans). FCC approved: Nov. 20, 1968 [For the Record, Dec. 2, 1968].

WVUE-TV New Orleans (ch 8)—Licensed to Screen Gems Broadcasting of Louisiana Inc. (see Group Ownership). Previous owners: Craft Bcstg. Co., 40%. Sales price: \$8 million. FCC approved: June 2, 1965 [For the Record, June 14, 1965]. Note: Founded in 1958 as merger of Supreme Bcstg. Co. (ch. 20 WJMR-TV) 40%, and Coastal Television, 60%. Rust Craft bought Supreme Bcstg's 40% in 1962 for \$855,100.

KSLA-TV Shreveport (ch 12)—Licensed to KSLA-TV Inc. (*Shreveport Journal*, 61.3% and others). Former owners: Henry E. Linam and associates. Sales price: \$3.4 million. FCC approved: May 25, 1960 [For the Record, May 30, 1960].

Maine

***WCBB(TV) Augusta (ch 10)**—Licensed to Colby-Bates-Bowdoin Educational Telecasting Corp. (Colby, Bates and Bowdoin colleges). Original owner: Richard S. Robie. Sales price: \$6,000. FCC approved: July 27, 1960 [For the Record, August 8, 1960].

WABI-TV Bangor (ch 5)—Licensed to Community Broadcasting Service (see Group Ownership). Sales

price: \$125,000 for Murray Carpenter's 50% interest (with WABI[AM]). FCC approved: Oct. 7, 1953 [For the Record, Oct. 12, 1953].

WLBZ-TV Bangor (ch 2)—Licensed to WLBZ TV Inc. (see Maine Bcstg. System Stns in Group Ownership). Former owners: Murray Carpenter and wife. Sales price: \$600,000. Former call letters: WTWO(TV). FCC approved: May 15, 1958 [For the Record, May 26, 1958].

WMTW-TV Poland Spring (Portland) (ch 8)—Licensed to Mid New York Bcstg Corp. (see Harron stations in Group Ownership). Sales price: \$3,620,469 with WMTW-FM Mt. Washington, N.H. FCC approved: Nov. 8, 1967 [For the Record, Nov. 20, 1967]. Previous owner: Dolphin Enterprises Inc. (Jack and Miriam Paar). Sold by John W. Guider, Horace A. Hildreth, Peter Anderson and others. Sales price: \$3,075,000 (with WMTW-FM). FCC approved: April 15, 1964 [For the Record, April 27, 1964].

WAGM-TV Presque Isle (ch 8)—Licensed to Aroostook Bcstg. Corp. (see Community Broadcasting Service in Group Ownership). Former owner: Harold D. Glidden. Sales price: \$525,000 (with WAGM and WABM Houlton, Me.). FCC approved: Sept. 26, 1957 [For the Record, Sept. 30, 1957].

Maryland

WJZ-TV Baltimore (ch 13)—Licensed to Westinghouse Broadcasting Co. (see Group Ownership). Original owners: Ben Cohen, Herman Cohen and associates. Former call letters: WAAM-TV. Sales price: \$4.4 million. FCC approved: June 28, 1957 [For the Record, July 1, 1957].

WTBO-TV Cumberland (ch 17, now deleted)—Licensed to Tennessee Valley Bcstg. Corp. Original owners: Maryland Radio Corp. (Howard L. Chernoff and associates). Sales price: \$110,000 (with WTBO[AM]). FCC approved: Sept. 1, 1954 [For the Record, Sept. 16, 1954].

WHAG-TV Hagerstown (ch 25)—Licensed to WHAG TV Inc. (Samuel Magazine, 50%; Sheldon Magazine, 50%). Previous owner: WHAG TV Inc. (Adler Communications Corp., 51.2%). Sales price: \$101,350. FCC approved: Sept. 18, 1972 [For the Record, Oct. 30, 1972].

WBOC-TV Salisbury (ch 16)—Licensed to WBOC Inc. (see Baltimore Sunpapers Stns. in Group Ownership). Previous owner: John W. Downing and associates. Sales price: \$1,211,246 with WBOC(AM). FCC approved: July 26, 1961 [For the Record, August 7, 1961].

Massachusetts

WCDC(TV) Adams (ch 19)—Licensed to Albany Television Inc. (see Poole Broadcasting in Group Ownership). Former owner: Capital Cities Broadcasting Corp. (see Capital Cities Communications Inc. in Group Ownership). Sales price: \$19 million (with WTE[TV] Albany, N.Y.). FCC approved: Feb. 24, 1971 [BROADCASTING, March 1, 1971]. Note: Capital Cities purchased station from original owner, Greylock Bcstg. Co., in 1957. Former call letters: WMG-TV. Sales price: \$379,206. FCC approved: Feb. 7, 1957 [For the Record, Feb. 11, 1957].

WSBK-TV Boston (ch 38)—Licensed to New Boston Television Inc. (Storer Broadcasting Co., see Group Ownership). Former owners: Boston Catholic Television Center, 50%, and Austin A. Harrison, 10%. Former call letters: WIHS-TV. Sales price: \$2,276,513.16. FCC approved: July 27, 1966 [For the Record, Aug. 8, 1966].

WLVI-TV Cambridge (ch 56)—Licensed to Kaiser Broadcasting of Massachusetts Inc., 100% owned by Kaiser Broadcasting Co. (see Kaiser Stns in Group Ownership). Former owner: Kaiser-Globe Broadcasting Corp. (90% owned by Kaiser Broadcasting Corp. and 10% by Globe Publishing Co.). Former call letters: WKBG-TV. Sales price: no consideration. FCC approved merger of Kaiser Broadcasting Corp.'s five independent UHF's (including WKBG-TV) and Field Communications Corp.'s one independent UHF in May 1973 [BROADCASTING, May 14, 1973]. Note: Former call letters: WHXR-TV. Sold by Harvey Radio Laboratories Inc. to WKBG Inc. (Kaiser Broadcasting Corp., 50%; Globe Newspaper Co., 50%) in 1966 for \$1,750,000 (with WXHR-AM-FM). FCC approved: Oct. 22, 1966 [For the Record, Oct. 31, 1966]. Kaiser bought 40% of Globe's holdings in 1968. Kaiser Broadcasting Co. acquired the remaining 10% from Globe in 1974 [BROADCASTING, Jan. 28, 1974].

WTEV(TV) New Bedford (Providence, R.I.) (ch 6)—Licensed to WGAL Television Inc. (Steinman Stations, see Group Ownership). Former owners: E. Anthony & Sons, 55%; New England Television Co., 45%. Sales price: \$5,775,000. FCC approved: April 6, 1966 [For the Record, April 11, 1966].

WHYN-TV Springfield (ch 40)—Licensed to The WHYNS Stations Corp. (see Guy Gannett Broadcasting Services in Group Ownership). Former owners: Hampden-Hampshire Corp. (William Dwight and Charles N. DeRose and families, 50%; Republican TV Inc. [employe and beneficial funds of *Springfield Republican News and Union*], 50%). Sales price: \$3,850,000 with WHYN-AM-FM plus agreement not to compete. FCC approved: June 7, 1967 [For the Record, June 19, 1967]. Note: Dwight DeRose group originally sold station to Hampden-Hampshire for \$250,000 for 50% interest by Republican TV Inc. (with WHYN-AM-FM). FCC approved: July 21, 1954 [For the Record, July 26, 1954].

WJZB-TV Worcester (ch 14)—Licensed to Capital Communications Corp. (see Springfield TV Broadcasting Corp. in Group Ownership). Original owner: Salisbury Broadcasting Corp. (Fox, Wells & Rogers, 30.4%; Kenneth P. and Milton P. Higgins, 9.9% and others). Original call letters: WWOR-TV. Sales price: 20% stock interest in Springfield TV. FCC approved: Oct. 15, 1958 [For the Record, Oct. 20, 1958].

Michigan

WXON(TV) Allen Park (Detroit) (ch 20)—Licensed to WXON-TV Inc. (principally owned by Aben Johnson). Previous owner: United Bcstg. Inc. Original call letters: WJMY(TV). Sales price: \$233,952. FCC approved: June 1972 [BROADCASTING, June 5, 1972]. Note: Founded by Robert M. Paar in 1962. CP sold to Triangle Bcstg. Co. (Robert P. Sanos, 20% and others) in 1962 for \$45,000. Sold to United Bcstg. in 1964 for \$115,000. FCC approved: July 8, 1964 [For the Record, July 13, 1964].

WUHO-TV Battle Creek (ch 41)—Licensed to Channel 41 Inc. (John W. and William Lawrence, as family group, 53%). Original owner: Channel 41 Inc. (John W. and William Lawrence, as family group, 47%; and others). Acquisition of positive control of licensee through purchase of stock from William Betts, Robert Braun, et al. approved by FCC, May 30, 1974 [For the Record, June 17, 1974].

WNEM-TV Bay City-Saginaw-Flint (ch 5)—Licensed to Meredith Corp. (see Group Ownership). Sold by Gerity Broadcasting Co. (James Gerity Jr.). Sales price: \$11.5 million. FCC approved: April 16, 1969 [For the Record, April 21, 1969]. Note: Founded by Gerity Broadcasting in February 1954.

WWTV(TV) Cadillac (ch 9)—Licensed to Fetzer Broadcasting Co. (John E. Fetzer, 49.99%; Carl E. Lee, A. James Ebel, C.E. Ellerman, et al., 15.7%). Previous owner: Fetzer Broadcasting Co. (John E. Fetzer, 53.39%; Carl E. Lee, A. James Ebel, C.E. Ellerman, et al., 12.2%). Sales price: \$240,084 (with WWAM[AM] and WKJIFM) Cadillac, WJFM[FM] Grand Rapids, WKZO[AM] Kalamazoo and WWUP-TV Sault Ste. Marie, all Michigan). FCC approved: May 24, 1974 [For the Record, June 17, 1974]. Note: Original owner, Sparton Broadcasting Co. (owned by Sparton Corp., formerly Sparks-Withington Co.), sold station to Fetzer Television Inc. in 1958 for \$1 million. FCC approved: July 24, 1958 [For the Record, Aug. 4, 1958].

WKBD-TV Detroit (ch 50)—Licensed to Kaiser Broadcasting Co., 77.5% owned by Kaiser Broadcasting Corp. (see Group Ownership) and 22.5% by Field Communications Corp. (owned by Field Enterprises Inc., Chicago). Original owner: Kaiser Broadcasting Corp. (100%). Sales price: no consideration. FCC approved merger of Kaiser Broadcasting Corp.'s five independent UHF's (including WKBD-TV) and Field Communications Corp.'s one independent UHF in May 1973 [BROADCASTING, May 14, 1973].

WXYZ-TV Detroit (ch 7)—Licensed to WXYZ Inc. (see ABC Stns. in Group Ownership). Original owner: American Bcstg. Co. Note: This was change of ownership when ABC merged with United Paramount Theaters Inc. FCC approved: Feb. 9, 1953 [For the Record, Feb. 16, 1953].

WJRT-TV Flint (ch 12)—Licensed to Poole Broadcasting Co. (see John Poole Stns. in Group Ownership). Sold by: Goodwill Stns. Inc. (G.A. Richards

TV Transfers

trusts, John F. Patt, Worth Kramer and others). Sales price: \$6 million. FCC approved: July 29, 1964 [For the Record, Aug. 10, 1964].

WMCN(TV) Grand Rapids (ch 23, now deleted)—Licensed to Peninsular Bcstg. Co. (H&B Balaban Corp., 50%; John D. Loeks, 33 1/3%; Howard W. Freck, 16 2/3%. Note: H&B Balaban purchased interest from E.A. McCready and present minority stockholders. Sales price: \$7,500. FCC approved: Sept. 12, 1956 [For the Record, Sept. 17, 1956].

WOTV(TV) Grand Rapids (ch 8)—Licensed to Manhattan Cable Television (owned by Time Inc.). Original owner: Consolidated TV & Radio Bcstrs. Inc. (Harry M. Bitner interests). Former call letters: WOOD-TV. Sales price: Part of a package deal, including WOOD-AM-TV, WTCN-AM-TV Minneapolis and WFBN-AM-TV Indianapolis, for \$15,750,000. FCC approved: April 17, 1957 [For the Record, April 22, 1957]. Note: Mr. Bitner's interests purchased WOOD-TV in September 1951 for \$1,382,086 from Leonard A. Versluis (call letters then WLAV-TV) [For the Record, Sept. 24, 1951].

WZZM-TV Grand Rapids (ch 13)—Licensed to Synergistic Communications Corp. (West Michigan Telecasters stockholders, 55%; Henry M. Hogan Jr., Paul Neal Averill and Elinor Bunin, 45% as a group). Sold by: West Michigan Telecasters Inc. (William C. Dempsey and others). Sales price: stock transaction aggregating estimated \$10 million (with WZZM-FM). FCC approved: Sept. 17, 1969 [For the Record, Sept. 29, 1969]. Note: Began operation Nov. 1, 1962, on interim basis whereby all four applicants operated on a cooperative basis. West Michigan Telecasters began operating station Jan. 25, 1965.

WIRN(TV) Ironwood (ch 12, now deleted)—Licensed to Lake Superior Bcstg. Co. (*Marquette* [Mich.] *Mining Journal*). Former owners: William J. Johnson and wife and others. Former call letters: WJMS-TV. Sales price: \$10,000 (for construction permit). FCC approved: Jan. 8, 1958 [For the Record, Jan. 13, 1958].

WTOM-TV Lansing (ch 54, now deleted)—Licensed to Inland Bcstg. Co. Original owner: Lansing Bcstg. Co. (John C. Pomeroy and associates). Original call letters: WILS-TV. Sales price: Lease with option to purchase at \$166,254. FCC approved: Sept. 21, 1954 [For the Record, Sept. 27, 1954].

WLUC-TV Marquette (ch 6)—Licensed to WLUC Inc. (see Post Corp. Stns. in Group Ownership). Previous owner: Morgan Murphy. Sales price: \$3.1 million (with WLUK-TV Green Bay, Wis.). FCC approved: Jan. 6, 1965 [For the Record, Jan. 11, 1965]. Note: Founded in 1954 as WAGE-TV by Jerome Sill and H.R. Herzberg. Sold in 1955 to *Mining Journal*-Frank Russell group for \$20,000 and call letters changed to WDMJ-TV. Control sold in 1959 to Morgan Murphy in stock transaction for overall consideration of \$250,000 plus assumption by buying corporation of obligations totaling \$102,000 and securing of notes totaling \$160,000, with call letters changed to WLUC-TV.

WEYI-TV Saginaw (ch 25)—Licensed to Rust Craft Bcstg. Co. (see Group Ownership). Previous owner: Lake Huron Bcstg. Corp. Former call letters: WKNX-TV. Sales price: \$1.6 million. FCC approved: Feb. 17, 1972 [For the Record, March 13, 1972].

FWUP-TV Sault Ste. Marie (ch 10)—Licensed to Fetzer Broadcasting Co. (John E. Fetzer, 49.99%; Carl E. Lee, A. James Ebel, C.E. Ellerman, et al., 15.7%). Previous owner: Fetzer Broadcasting Co. (John E. Fetzer, 53.39%; Carl E. Lee, A. James Ebel, C.E. Ellerman, et al., 12.2%). Sales price: \$240,084 (with WWAM[AM]-WKJF[FM] and WWTV[TV] Cadillac, WJFM[FM] Grand Rapids, WKZO[AM] Kalamazoo, all Michigan). FCC approved: May 24, 1974 [For the Record, June 17, 1974].

Minnesota

KCMT(TV) Alexandria(ch 7)—Licensed to Central Minnesota Television Co. (Thomas Barnstable Jr., Bruce Barnstable, Harris Widmer, Philip Vogel and Rozel Barnstable, trustees). Previous owner: Central Minnesota Television Co. (Thomas Barnstable Jr., Bruce Barnstable, Harris Widmer, Philip Vogel and Rozel Barnstable, executors). Sales price: no consideration. FCC approved: Nov. 18, 1974 [For the Record, Dec. 2, 1974]. Note: Earlier in 1974, FCC granted involuntary transfer of control of licensee from

Thomas K. Barnstable to Rozel Barnstable, Thomas K. Barnstable Jr., Bruce Barnstable, Philip Vogel and Harris W. Widmer, executors of estate of Mr. Barnstable. FCC approved: Aug. 26, 1974 [For the Record, Sept. 16, 1974].

KAAL(TV) Austin(ch 6)—Licensed to Minnesota-Iowa TV Co. (see Black Hawk stations in Group Ownership). Former call letters: KAUS-TV. Original owner: Minnesota-Iowa Television Co. (Chester A. Weseman, George Wilson, Martin Bustad, Harold Westby and Albert W. Smith). Former call letters: KMMT(TV). Sales price: \$41,000 (with KAUS[AM] Austin). FCC approved: Oct. 29, 1958 [For the Record, Nov. 3, 1958].

KDAL-TV Duluth(ch 3)—Licensed to KDAL Inc. (see Tribune Stns. in Group Ownership). Previous owner: estate of Dalton LeMasurier. Sales price: \$3.3 million with KDAL[AM]. FCC approved: Dec. 7, 1960 [For the Record, Dec. 19, 1960].

KEYC-TV Mankato(ch 12)—Licensed to Lee Enterprises Inc. (see Group Ownership). Original owner: Walter K. Mickelson and associates. Sales price: \$400,000 in aggregate. FCC approved: Feb. 24, 1960 [For the Record, Feb. 29, 1960].

KMSP-TV Minneapolis-St. Paul(ch 9)—Licensed to United TV Inc. (20th Century-Fox Film Corp.). Former owner: National Theaters. Sales price: \$3.5 million. FCC approved: Oct. 29, 1959 [For the Record, Nov. 9, 1959]. Note: Founded as KETD-TV by Lee L. Whiting and group. Morris T. Baker and associates bought 75% for \$300,000 in 1954 [For the Record, Sept. 20, 1954]. Thomas P. Johnson, Seymour Weintraub and associates bought 100% for \$1.14 million plus assumption of obligations amounting to \$315,452 (with KEYD[AM], later sold) in 1956 [For the Record, June 4, 1956]. Call letters changed to KMGM-TV when Loew's Inc. bought 25% interest. National Telefilm Assoc. bought 75% interest for \$650,000 in 1957 [For the Record, Dec. 2, 1957]; remaining 25% from Loew's Inc. for \$130,000 in 1958 [For the Record, Feb. 10, 1958]. National Theaters bought KMGM-TV for \$11 million (with WNTA-AM-FM-TV Newark, N.J. [New York City area] in 1959 [For the Record, March 9, 1959].

WCCO-TV Minneapolis-St. Paul(ch 4)—Licensed to Midwest Radio-TV Inc. (53% owned by Mid-Continent Radio-TV Inc., and 47% by Minneapolis Star & Tribune Co.). Acquired in November 1954 from CBS for \$3,950,000 (including 47% WCCO-AM). Mid-Continent is 50% owned by Northwest Pub. Inc.-Ridder newspapers and 50% by Minnesota Tribune Co. Minneapolis Star & Tribune Co. is a Cowles property. Original owner: Mid-Continent Radio-TV Inc. Original call letters: WTCN-TV. Sales price: This was an exchange of properties in which CBS turned over WCCO Minneapolis to new licensee in exchange for 4% interest. FCC approved: July 31, 1952 [For the Record, Aug. 4, 1952].

WTCN-TV Minneapolis-St. Paul(ch 11)—Licensed to WTCN Television Inc. (see Metromedia Inc. in Group Ownership). Previous owner: WTCN Television Inc. (100% owned by Chris-Craft Industries Inc.). FCC approved: June 1972 [BROADCASTING, June 26, 1972]. Note: Founded by Robert Butler and associates in 1953. Sold to Harry M. Bitner interests in 1959 for \$1,815,000. Bought by Time-Life Broadcast Inc. in package transaction including WTCN, WOOD-AM-FM-TV Grand Rapids and WFBN-AM-TV Indianapolis in 1957 for \$15,750,000. Purchased by Chris-Craft in 1964 for \$3.9 million. FCC approved: Aug. 24, 1964 [For the Record, Aug. 31, 1964].

KNMT(TV) Walker(ch 12)—Licensed to Central Minnesota Television Co. (Thomas Barnstable Jr., Bruce Barnstable, Harris Widmer, Philip Vogel and Rozel Barnstable, trustees). Previous owner: Central Minnesota Television Co. (Thomas Barnstable Jr., Bruce Barnstable, Harris Widmer, Philip Vogel and Rozel Barnstable, executors). Sales price: no consideration. FCC approved: Nov. 18, 1974 [For the Record, Dec. 2, 1974]. Note: Earlier in 1974, FCC granted involuntary transfer of control of licensee from Thomas K. Barnstable to Rozel Barnstable, Thomas K. Barnstable Jr., Bruce Barnstable, Philip Vogel and Harris W. Widmer, executors of estate of Mr. Barnstable. FCC approved: Aug. 26, 1974 [For the Record, Sept. 16, 1974].

Mississippi

WDAM-TV Hattiesburg(ch 9, now deleted)—Licensed to Lion TV Corp. WDSU Bcstg. Corp. (WDSU-AM-FM-TV New Orleans) purchased 51% of station from Dave A. Matison Jr., Harold M. Matison and

Milton J. Fine. Sales price: \$51,000. FCC approved: Sept. 19, 1956 [For the Record, Sept. 24, 1956].

WHTV(TV) Meridian(ch 24)—Licensed to Central Television Inc. (Frank K. Spain, 80% et al.). Previous owner: Delta Communications Corp. (F. Carrington Weems, pres, et al.). Sales price: \$30,000. FCC approved: March 23, 1972 [For the Record, April 17, 1972].

Missouri

KHOA-TV Hannibal, Mo.-Quincy, Ill.(ch 7)—Licensed to Lee Enterprises Inc. (see Group Ownership). Original owners: Courier Post Pub. Co. acquired 20% interest in Lee Bcstg. Inc. FCC approved: July 1, 1953 [For the Record, July 13, 1953].

KRCQ(TV) Jefferson City(ch 13)—Licensed to Mid-America Television Co. (Kansas City Southern Industries Inc., see Group Ownership). Former owner: William H. Weldon. Sales price: \$3,150,000 (with KWOS Jefferson City, and KMOS-TV Sedalia, both Missouri). FCC approved: July 13, 1966 [For the Record, July 18, 1966].

KODE-TV Joplin(ch 12)—Licensed to Gilmore Bcstg. Corp. (see Gilmore Stns. in Group Ownership). Original owner: WSTV Inc. (Jack Berman and associates). Sales price: \$1.85 million (with KODE). FCC approved: May 23, 1962 [For the Record, May 28, 1962]. Note: Founded by Austin Harrison and associates as KSWM-TV. Sold in 1956 to WSTV Inc. for \$591,000 (with KSWM).

KTVJ(TV) Joplin(ch 16)—Licensed to Mid America Broadcasting, (98% controlled by Kansas State Network, see Group Ownership). Original owner: Mid America Broadcasting (Virginia S. Hickey, William Burton, et al.). Former call letters: KUHI-TV. Sales price: \$1,111,732. FCC approved: April 29, 1975 [For the Record, May 12, 1975].

KCMO-TV Kansas City(ch 5)—Licensed to Meredith Corp. (see Group Ownership). Original owners: KCMO Bcstg. Co. (T.L. Evans and Lester E. Cox). Sales price: \$2 million (with KCMO-AM-FM). FCC approved: Nov. 12, 1953 [For the Record, Nov. 23, 1953].

***KCP(TV) Kansas City(ch 19)**—Licensed to Community Service Broadcasting of Mid-America Inc. Original owner: School District of Kansas City, Mo. Former call letters: *KCS-D-TV. Sales price: \$22,226. FCC approved: Dec. 10, 1971 [For the Record, Feb. 14, 1972].

KCTV(TV) Kansas City(ch 25, now deleted)—Licensed to Allen B. DuMont Labs Inc. Original owner: Empire Coil Co. Sales price: \$1 and assumption of certain obligations. FCC approved: Dec. 31, 1953 [For the Record, Jan. 11, 1954].

KMBC-TV Kansas City(ch 9)—Licensed to Metromedia Inc. (see Group Ownership). Previous owner: Cook Paint & Varnish Co. Sales price: \$9.56 million with KMBC, KMOS-TV Sedalia, Mo., and KFRM Concordia, Kan. FCC approved: July 26, 1961 [For the Record, August 7, 1961]. Note: Metromedia has sold KMOS-TV and KFRM to other parties. KMBC stations were founded by Arthur B. Church and sold to Cook in 1954 for \$1.75 million. Cook which at that time owned WHB-TV Kansas City, sharing time on ch. 9 with KMBC-TV, sold WHB to Mid-Continent Bcstg. Co. for \$400,000 and surrendered the license for WHB-TV.

WDAF-TV Kansas City(ch 4)—Licensed to Taft Bcstg. Co. (see Group Ownership). Previous owner: Transcontinent TV Corp. Sales price: \$26.9 million (with WDAF-AM-FM and WGR-AM-FM-TV Buffalo, N.Y. and WNEP-TV Scranton, Pa.). FCC approved: Feb. 19, 1964. Note: Founded by *Kansas City Star* and *Times*. Sold to National Theaters for \$7.6 million (with WDAF-AM-FM) in 1958 under divestiture order following consent judgment in 1957 in civil antitrust suit brought by the Department of Justice against the Kansas City Star Co. National Theaters sold stations to TTC for \$9 3/4 million in 1960.

KPOB-TV Kirksville(ch 3)—Licensed to Turner-Farrar Association (partnership of O.L. Turner; O.L. Turner, trustee of Turner trust; and Ethel M. Turner). Previous owner: Turner-Farrar Association (partnership of O.L. Turner; O.L. Turner, trustee of Turner trust; Ethel M. Turner; and Bernice Horning, executrix of estate of Harry B. Horning). Sales price: none. FCC approved: Nov. 7, 1974 [For the Record, Nov. 25, 1974]. Note: Earlier in 1974 FCC granted involuntary transfer of control of Turner-Farrar Association (partnership) from Harry B. Horning to Bernice Horning, executrix of estate of Mr. Horning. FCC approved: Aug. 30, 1974 [For the

KQTV(TV) St. Joseph(ch 2)—Licensed to Amaturo Group Inc. (Joseph C. Amaturo, pres & chmn, et al). Previous owner: Intermedia Inc. (a wholly owned subsidiary of ISC Industries). Sales price: \$4,677,500, with KLYX(FM) Clear Lake City, Tex. and KGRV(FM) St. Louis. FCC approved: July 3, 1973 [For the Record, July 16, 1973]. Note: Founded by Barton Pitts in September 1953. Sold to Kenyon Brown-Bing Crosby group in December 1955 for \$550,000 and \$200,000 in liabilities. Sold to Jesse D. Fine family in 1957 for \$841,091 with KFEQ(AM) St. Joseph. Sold in 1963 to Mid-States Broadcasting Corp. for \$1,750,000 with KFEQ(AM) and KLIK(AM) Jefferson City, Mo. Panax Corp. (formerly Mid-States Broadcasting) sold station as KFEQ-TV in 1969 for \$3,150,000 to Intermedia Inc.

KDNL-TV St. Louis(ch 30)—Licensed to Evans Broadcasting Corp. (Thomas M. Evans). Sold by Greater St. Louis Television Corp. (Boyd W. Fellows and others). Sales price: \$40,500. FCC approved: July 19, 1968 [For the Record, July 29, 1968].

KMOX-TV St. Louis(ch 4)—Licensed to CBS Inc. (see Group Ownership). Former owners: Robert T. Convey and associates, *St. Louis Globe-Democrat* (Newhouse interests), 800 N. 12th Inc. (Elzey Roberts), KSTP Inc., and others. Sales price: \$4 million. Original call letters: KWK-TV. FCC approved: Oct. 23, 1957 [For the Record, Oct. 28, 1957]. Note: Conditioned on CBS disposal of permit for ch. 11 in St. Louis.

KTVI(TV) St. Louis(ch 2)—Licensed to Newhouse Broadcasting Corp. (see Group Ownership). Sold by Paul E. Peltason, 34.1%; Harry Tenenbaum, 34.1%, and others, 5.8% (Newhouse already owned 26%). Sales price: \$7,576,778 for 74%. FCC approved: June 10, 1964 [For the Record, June 22, 1964].

KMOS-TV Sedalia(ch 6)—Licensed to Mid-America Television Co. (Kansas City Southern Industries Inc., see Group Ownership). See KRCG(TV) Jefferson City, above. Note: Founded by Milton J. Hintein and others; sold to Cook Paint & Varnish Co. in 1958 for \$50,000. Purchased by Metromedia Inc., and then sold to Jefferson TV Co. in 1961 for \$200,000.

KOLR(TV) Springfield(ch 10)—Licensed to Independent Broadcasting Co. (J.H.G. Cooper, 25%; John O. Cooper, 26%; James H. Cooper, 26%). Previous owner: Independent Broadcasting Co. (J.H.G. Cooper 77%). FCC granted relinquishment of positive control of licensee through transfer of stock. FCC approved: Aug. 30, 1974 [For the Record, Sept. 16, 1974].

KYTV(TV) Springfield(ch 3)—Licensed to Springfield Television Inc. 50% of voting stock of licensee, Springfield Television Inc., transferred from Lester L. Cox (749 shares) and wife, Claudine B. Cox (1 share), and Lynn E. Bussey (749 shares) and wife, Virginia Cox Bussey (1 share), to same person d/b as Grand Prairie Investment Co. of which they are sole owners, in same proportion. No consideration. FCC approved: Oct. 29, 1970 [For the Record, Nov. 16, 1970].

Montana

KTVQ(TV) Billings(ch 2)—Licensed to the Montana Network (see Garryowen Stns. in Group Ownership). Original owners: Joseph S. Sample, J. Carter Johnson, C.L. Crist and others. Former call letters: KOOK-TV. Sales price: \$540,075 (with KOOK). FCC approved: Dec. 13, 1956 [For the Record, Dec. 24, 1956].

KULR-TV Billings(ch 8)—Licensed to Harriscope Broadcasting Corp. (see Group Ownership). Former owners: Rex H. Baker, Arthur Miller and Thor Myhre. Sales price: \$350,000. FCC approved: March 8, 1967 [For the Record, March 13, 1967]. Note: Original owners were Paul Crain, Dan Snyder and associates under call letter KGHL-TV. Sold station to Messrs. Baker, Miller and Myhre for \$745,000 in 1962.

KXLF-TV Butte(ch 4)—Licensed to Garryowen Butte TV Inc. (see Garryowen Stns. in Group Ownership). Previous owner: Ed Craney and group. Sales price: \$1,750,000 with KXLF and KXLJ-AM-TV, Helena, Mont. FCC approved: Jan. 18, 1961 [For the Record, Jan. 30, 1961]. Note: Mr. Sample immediately sold the Helena stations to Helena TV Inc. for \$400,000 (see KBLL-TV Helena below).

KFBB-TV Great Falls(ch 5)—Licensed to Harriscope Bcstg. Corp. (see Group Ownership). Original owners: David E. Bright, Ernest L. Scanlon, Daniel T. O'Shea. Sales price: \$610,000 (with KFBB). FCC approved: May 23, 1962 [For the Record, June 4, 1962]. Note: KFBB-TV was founded by Joseph P. Wilkins and associates and sold to Messrs. Bright, Scanlon and

O'Shea in 1960 for \$616,000.

KRTV(TV) Great Falls(ch 3)—Licensed to Garryowen-Cascade TV. Inc. (see Garryowen stations in Group Ownership). Previous owner: Snyder & Associates (Dan Snyder, estate of Paul Crain and others). Sales price: \$1,070,000 and liabilities. FCC approved: Feb. 28, 1969 [For the Record, March 3, 1969]. Note: Founded in 1958. Construction permit sold that year by Francis N. and Robert R. Laird to Snyder & Associates for \$59,680 and cancellation of \$19,000 debt owed Snyder by Lairds. Former call letters: KCTL(TV).

KTCM(TV) Helena(ch 12)—Licensed to Capital City Television Inc. (Tim Babcock, 56.67%, Bob Magness, 43.33%). Former call letters: KBLL-TV. 56.677% sold to Mr. Babcock by: Paul McAdam and A.W. Scribner. Sales price: \$201,421.45 (with 56.677% of KBLL Helena). FCC approved: Dec. 18, 1968 [For the Record, Dec. 23, 1968]. Note: Founded by Ed Craney and associates in 1958. Original call letters: KXLJ-TV. Bought by Joseph S. Sample for \$1,700,000 in 1961 (with KXLJ-AM-TV Butte, and KBLL Helena, both Montana). Mr. Sample immediately sold the KBLL stations to W.L. Piehl and associates for \$400,000. Mr. Piehl and associates sold KBLL stations to Capital Cities Television (Paul McAdam, A.W. Scribner and Bob Magness) for \$5,000 plus \$255,000 in obligations in 1963.

KQVO-TV Missoula(ch 13)—Licensed to KMSO-TV Inc. (see Dale Moore Stns. in Group Ownership). Former owners: A.J. Mosby, 78.8%; Aline Mosby, 10.1%; Mary Jane Bader, 10.1%. Former call letters: KMSO-TV. Sales price: \$818,841. FCC approved: Sept. 10, 1964 [For the Record, Sept. 21, 1964].

Nebraska

KCNA-TV Albion(ch 8)—Licensed to Bi-States Co. (see NTV Enterprises Inc. in Group Ownership). Original owner: Bi-States Co. (F. Wayne Brewster, et al, 100%). Original call letters: KHQL-TV. Sales price: \$1.9 million (with KPHL-TV Hayes Center, KHOL-TV Kearney and KHTL-TV Superior, all Nebraska). FCC approved: April 29, 1974 [For the Record, May 13, 1974].

KGIN-TV Grand Island(ch 11)—Licensed to Cornhusker TV Corp. (see Fetzer Stns. in Group Ownership). Original owner: Electron Corp. Sales price: \$2,500 for out of pocket expenses (for CP). FCC approved: Feb. 8, 1961 [For the Record, Feb. 13, 1961].

KHAS-TV Hastings(ch 5)—Licensed to Nebraska Television Corp. (see Seaton Stns in Group Ownership). Original owner: Nebraska Television Corp. (Seaton Publishing Co., 51.67%). Sales price: no consideration. FCC approved: June 19, 1974 [For the Record, July 15, 1974].

KWNB-TV Hayes Center(ch 6)—Licensed to Bi-States Co. (see NTV Enterprises Inc. in Group Ownership). Original owner: Bi-States Co. (F. Wayne Brewster, et al, 100%). Original call letters: KHPL-TV. Sales price: \$1.9 million (with KHQL-TV Albion, KHOL-TV Kearney and KHTL-TV Superior, all Nebraska). FCC approved: April 29, 1974 [For the Record, May 13, 1974].

KHQI-TV Kearney(ch 13)—Licensed to Bi-States Co. (see NTV Enterprises Inc. in Group Ownership). Original owner: Bi-States Co. (F. Wayne Brewster, et al, 100%). Original call letters: KHOL-TV. Sales price:

TV Transfers

\$1.9 million (with KHQL-TV Albion, KHPL-TV Hayes Center and KHTL-TV Superior, all Nebraska). FCC approved: April 29, 1974 [For the Record, May 13, 1974].

KOLN-TV Lincoln(ch 10)—Licensed to Cornhusker Radio TV Corp. (see Fetzer Stns. in Group Ownership). Original owners: Edward M. O'Shea, Bennett S. Martin and Harold E. Anderson. Sales price: \$650,000 (with KOLN-AM). FCC approved: Aug. 19, 1953 [For the Record, Aug. 24, 1953].

***KUON-TV Lincoln(ch 12)**—Licensed to U. of Nebraska. Original owners: Cornhusker Radio & TV Corp. (John E. Fetzer). Original call letters: KOLN-TV (now being used on ch. 10 Lincoln). Sales price: no consideration. FCC approved: July 28, 1954 [For the Record, Aug. 2, 1954]. Note: Mr. Fetzer bought KOLN-TV Lincoln on ch. 12 in 1953 (see above). His purchase of KFOR-TV Lincoln on ch. 10 for \$300,000 from Cornbelt Bcstg. Corp. (Stuart Investment Co.) was approved by FCC March 24, 1954 [For the Record, March 29, 1954]. The ch. 12 facility is now KUON-TV; the ch. 10 facility is now KOLN-TV.

KOMC(TV) McCook(ch 8)—See KCKT(TV) Great Bend, Kan.

KNOP-TV North Platte(ch 2)—Licensed to North Platte Television Inc. (owned 93% by FerRich Broadcasting Co., Richard F. Shively, voting trustee). Previous owner: FerRich Broadcasting Co. (Ferris E. Traylor and Richard F. Shively). Sales price: no consideration involved (with KNOP). FCC approved: Oct. 28, 1970 [For the Record, Nov. 16, 1970]. Note: Original owners: Ray J. Williams, Franklin R. Stewart and Alvin E. Larsen Jr. under call letters KWSL-TV. Sold station in 1958 to North Platte for \$5,000 for CP plus ownership in permittee by Mr. Williams. North Platte Television Inc. (Rush C. Clark and associates) sold station (along with KNOP) to FerRich Broadcasting Co. (Ferris E. Traylor, 83.33%; Richard F. Shively, 16.67%) in 1967. Sales price: \$216,810 with KNOP(AM). FCC approved: June 16, 1967 [For the Record, June 26, 1967].

KETV(TV) Omaha(ch 7)—Licensed to Herald Corp. (Peter Kiewit Sons' Inc.). Original owners: World Pub. Co. (*Omaha World Herald*). Sales price: \$41.4 million for publishing firm, with about \$5 million allocated to the TV station. FCC approved: June 5, 1963 [For the Record, June 10, 1963].

WOWT(TV) Omaha(ch 6)—Licensed to Chronicle Broadcasting Co. (see Newspaper Crossownership). Previous owner: Meredith Corp. (see Group Ownership). Former call letters: WOW-TV. Sales price: \$9,158,500. FCC approved: May 27, 1975 [Changing Hands, June 2, 1975; For the Record, June 9, 1975]. Note: Original owner: Radio Station WOW Inc. (Francis P. Matthews and associates) sold station with WOW(AM) in 1951. Sales price: \$2,525,000. FCC approved: Sept. 26, 1951 [For the Record, Oct. 1, 1951].

KSTF(TV) Scottsbluff(ch 10)—Licensed to Wyneco Communications Inc. (a wholly owned subsidiary of Lamb Communications; see Lamb Communications Inc. in Group Ownership). Previous owner: Frontier Broadcasting Co. Sales price (including KTVS [TV] Sterling, Colo.; KYCU-TV Cheyenne,

*More than a decade of Constructive Service
to Broadcasters and the Broadcasting Industry*

HOWARD E. STARK

Brokers—Consultants

445 PARK AVENUE

NEW YORK, N. Y. 10022

(212) 355-0405

TV Transfers

Wyo. and a CP for KVRW [TV] Rawlins, Wyo.): \$3 million. FCC approved: July 6, 1972 [BROADCASTING, July 10, 1972].

KSNB-TV Superior(ch 4)—Licensed to Bi-States Co. (see NTV Enterprises Inc. in Group Ownership). Original owner: Bi-States Co. (F. Wayne Brewster, et al, 100%). Original call letters: KHKL-TV. Sales price: \$1.9 million (with KHQL-TV Albion, KHPL-TV Hayes Center and KHOL-TV Kearney, all Nebraska). FCC approved: April 29, 1974 [For the Record, May 13, 1974].

Nevada

KVVU-TV Henderson(ch 5)—Licensed to Nevada Independent Broadcasting Corp. (William H. Herntstadt, sole owner). Former owner: Levin-Townsend Enterprises Inc. (Levin-Townsend Computer Corp.—Howard S. Levin, James E. Townsend and others). Original call letters: KHBV-TV. Sales price: \$250,000, plus assumption of liabilities (not to exceed \$707,735). FCC approved: Sept. 1, 1971 [For the Record, Sept. 27, 1971]. Note: Founded in September 1967 by Nevada Communications Inc. (Charles Vanda). Nevada Communications Inc. sold CP in 1969 to Levin-Townsend Enterprises Inc. Sales price: \$850,000. FCC approved: May 1, 1969 [For the Record, May 12, 1969].

KLAS-TV Las Vegas(ch 8)—Licensed to Hughes Tool Co. (Howard R. Hughes). Sold by: Las Vegas Television Inc. (H.M. Greenspun and others). Sales price: \$3,650,000. FCC approved: Feb. 14, 1968 [For the Record, March 4, 1968]. Note: Founded by H.M. Greenspun and others in 1953.

KSHO-TV Las Vegas(ch 13)—Licensed to Channel 13 of Las Vegas Inc. (Arthur Powell Williams Family Group, 100%). Previous owner: Channel 13 of Las Vegas Inc. (Arthur Powell Williams Family Group, 50%; Ettlinger Group, 50%). Sales price: \$1,157,481. FCC approved: July 1974 [For the Record, July 29, 1974]. Note: Founded by Moritz Zenoff. Mr. Zenoff sold station (with KBMI [AM] Henderson, Nev.) to Television Co. of America Inc. (Frank Oxarart, Albert Zugsmith, Arthur B. Hogan and John Feldmann) in 1956 for \$200,000. FCC approved: Nov. 29, 1956 [For the Record, Dec. 10, 1956]. In 1957, Frank Oxarart and associates sold station to Nathan and Mervyn L. Adelson for \$70,000. FCC approved: Nov. 21, 1957 [For the Record, Dec. 2, 1957]. In 1959 Messrs. Adelson sold station to Nevada Broadcasters Fund Inc. for \$137,500. FCC approved: Nov. 4, 1959 [For the Record, Nov. 16, 1959]. In 1961 station was transferred to Harry Wallerstein, receiver in bankruptcy. In 1965 the station was denied a license renewal by the FCC. In 1967 Channel 13 of Las Vegas Inc. (Arthur Powell Williams, 20%; Desert Broadcasting Inc., 20%; Ettlinger Broadcasting Corp., 20%; Clark County Communications Inc., 20%; Talmac Inc., 20%) was granted interim operating authority [BROADCASTING, Aug. 14, 1967]. In 1969 Talmac Inc. (now Channel 13 of Las Vegas Inc.) was granted a CP for channel 13 in Las Vegas. FCC approved: April 16, 1969 [For the Record, April 28, 1969].

KCLR(TV) Reno(ch 4, now deleted)—Permittee: Nevada Telecasting Corp. (Robert C. Fish). Note: Sales of control of permittee corporation to Ervin V. Willat for \$500 [For the Record, April 21, 1958].

New Hampshire

WMUR-TV Manchester(ch 9)—Licensed to United TV Co. of New Hampshire (Richard Eaton, 100%). Original owner: Radio Voice of New Hampshire Inc. (Francis P. Murphy). Sales price: \$450,000. FCC approved: Feb. 3, 1959 [For the Record, Feb. 9, 1959].

New Jersey

WCOC(TV) Atlantic City(ch 52, now deleted)—Licensed to David E. Mackay. Original owners: Matta Enterprises. Sales price: \$10,446 (covering cost of securing CP). FCC approved: April 14, 1954 [For the Record, April 19, 1954].

WKBS-TV Burlington(ch 48)—Licensed to Kaiser Broadcasting Co., 77.5% owned by Kaiser Broadcasting Corp. (see Group Ownership) and 22.5% by Field Communications Corp. (owned by Field Enterprises Inc., Chicago). Original owner: Kaiser Broadcasting Corp. (100%). Sales price: no consideration. FCC approved merger of Kaiser Broadcasting Corp.'s five independent UHF's (including WKBS-TV) and Field Communications Corp.'s one independent UHF in May 1973 [BROADCASTING, May 14, 1973].

WNJU-TV Linden-Newark(ch 47)—Licensed to New Jersey Television Broadcasting Corp. (Screen Gems Broadcasting Corp., 100%. See Group Ownership). Previous owners: Henry P. Becton, Fairleigh S. Dickinson Jr. and others. Sales price: \$8.1 million. FCC approved: Sept. 9, 1970 [For the Record, Sept. 21, 1970]. Note: Founded in 1965.

WBTV-TV Newark(ch 68)—Permittee: Blonder-Tongue Broadcasting Corp. (Isaac S. Blonder, 80%; Ben H. Tongue, 20%). Former owner: Blonder-Tongue Broadcasting Corp. (Isaac S. Blonder, 50%; Ben H. Tongue, 50%). Sales price: \$60,000 (for CP). FCC approved: Aug. 12, 1974 [For the Record, Sept. 2, 1974]. Note: Original call letters: WWRO(TV). Atlantic Video Corp. sold the CP for WWRO to Blonder-Tongue in 1972 for \$252,099 [BROADCASTING, July 31, 1972].

***WNET(TV) Newark, N.J.-New York(ch 13)**—Licensed to Educational Bcstg. Corp. The National Educational Television (NET) network merged with the licensee, Educational Bcstg. Corp., in 1970 [BROADCASTING, July 6, 1970]. Former call letters: WNDT(TV). Note: Founded in 1945 by Irving R. Rosenhaus and Frank Bremer as WATV(TV). Sold in 1958 to National Telefilm Assoc. (Ely Landau and associates) for \$2.5 million stock transaction plus \$988,000 in consultant fees and agreement not to compete (including WAAT-AM-FM). Sold in 1959 to National Theaters Inc. for \$1.1 million in stock (including WNAT-AM-FM). Sold in 1961 as WNAT-TV to Educational Bcstg. Corp. for \$6.2 million. FCC approved: Oct. 25, 1961 [For the Record, Nov. 6, 1961].

WCNC-TV Wildwood(ch 40)—Permittee: Jersey Cape Broadcasting Corp. (William C. Woltring Jr., Carlton S. Owen, Frank W. Strom, 33 1/3% each). Former owner: Francis J. Matrangola. Sales price: \$590,000 for CP and WCNC-AM-FM. FCC approved: July 14, 1965 [For the Record, July 19, 1965].

New Mexico

KOAT-TV Albuquerque(ch 7)—Licensed to KOAT Television Inc. (see Pulitzer Publishing Co. stations in Group Ownership). Previous owner: WGAL Television Inc. (see Steinman stations in Group Ownership). Sales price: \$5 million. FCC approved: May 7, 1969 [For the Record, May 19, 1969]. Note: Founded in 1953. Sold by A.M. Caldwell, Walter Stiles and others in 1957 for \$718,500 to Clinton D. McKinnon. In 1959 KOAT-TV and KVOA-TV Tucson, Ariz., merged and Mr. McKinnon became 40% owner of both stations. Both stations sold by Alvarado Television Co. in 1962 to Steinman for \$3,250,000.

KOB-TV Albuquerque(ch 4)—Licensed to Hubbard Broadcasting Inc. (see Group Ownership). Former owners: Time Inc. and Wayne Coy, each 50%. Sales price: \$1.5 million (with KOB). FCC approved: March 13, 1957 [For the Record, March 18, 1957]. Note: Time Inc. and Mr. Coy purchased stations in May 1952 from T.M. Pepperyard. *Albuquerque Journal* for \$900,000 [For the Record, July 2, 1952].

KAVE-TV Carlsbad(ch 6)—Licensed to John B. Walton Jr. (see Group Ownership). Previous owners: John Deme and associates. Sales price: \$326,425. FCC approved: Sept. 7, 1966 [For the Record, Sept. 19, 1969]. Note: KAVE-TV was founded by Val Lawrence and associates. Bought by Edward P. Talbott, Nancy and John H. Battison in 1955 for \$150,000. Mr. Talbott acquired full ownership in 1958 paying \$43,500 for the Battisons' interests. Mr. Deme and group bought the station in 1963 from the estate of Mr. Talbott for \$168,000.

KFDW-TV Clovis(ch 12)—Licensed to Bass Bcstg. Co. (see Group Ownership). Sold by: John H. Marshall and family. Price: \$350,000. FCC approved: Jan. 22, 1964 [For the Record, Feb. 3, 1964]. Note: Founded by Frank Lesley and Mae Strauss as KICA-TV in 1957. 50% sold to Texas Telecasting in 1959 for \$10,000 and assumption of \$170,000 in obligations. Bought by John H. Marshall and family in 1961 as KVER-TV for \$295,600.

KRNM-TV Roswell(ch 10, now deleted)—Licensed to New Mexico Telecasting Co. (Perry C. Maxwell, Penrod Toles and Clarence E. Hinkle). Original owner: William Sam Evans. Sales price: \$10,000 plus assumption of obligations (for CP). FCC approved: Feb. 15, 1961 [For the Record, Feb. 27, 1961].

KSWB-TV Roswell(ch 8)—Licensed to State Telecasting Co. (see Group Ownership). Previous owner: Bryant Radio and Television Inc. (Joe H. Bryant and others). Sales price (including KCBD-TV Lubbock, Tex.): \$6 million. FCC approved: May 26, 1971

[BROADCASTING, May 31, 1971]. Note: Founded by John A. Barnett in 1953. Sold by John A. Barnett estate (Frances Maye Barnett, Paul B. McEvoy and John A. Barnett Jr., executors) in 1968 for \$250,000 plus \$234,375 in obligations. FCC approved: May 13, 1968 [For the Record, May 20, 1968].

KFUR-TV Santa Fe(ch 11, now deleted)—Licensed to K&H TV Station (Milford Kay and Raymond F. Hayes). Original owner: Harrison M. Fuerst. Sales price: \$2,700 for out of pocket expenses (for CP). FCC approved: March 1, 1961 [For the Record, March 6, 1961].

New York

WAST(TV) Albany(ch 13)—Licensed to Sonderling Broadcasting Corp. (see Group Ownership). Sold by: Van Curler Broadcasting Corp. (Glen Alden Corp.). Sales price: \$8 million. FCC approved: Nov. 6, 1968 [For the Record, Nov. 11, 1968]. Note: Founded in 1954 by Stanley Warner Corp. and Colonel Harry Wilder and others. Former call letters: WTRI(TV). Left air in 1955 and resumed operation in 1956, when Stanley Warner Corp. bought 50% held by Wilder group for \$425,000. Stanley Warner Corp. merged with Glen Alden Corp. in 1967.

WTEN(TV) Albany(ch 10)—Licensed to Albany Television Inc. (see Poole Broadcasting in Group Ownership). Former owner: Capital Cities Broadcasting Corp. (see Capital Cities Communications Inc. in Group Ownership). Sales price: \$19 million (with WCDC(TV) Adams, Mass.). FCC approved: Feb. 24, 1971 [BROADCASTING, March 1, 1971]. Note: Capital Cities purchased station from original owners, Hyman Rosenblum and associates, in 1954. Former call letters: WROW-TV, WCDA(TV). Sales price: \$298,800 (with WROW). FCC approved: Nov. 3, 1954 [For the Record, Nov. 8, 1954].

WBJA-TV Binghamton(ch 34)—Licensed to WBJA Inc. (see Lazare-Arthur-Hessen Stns. in Group Ownership). Previous owner: Alfred E. Ancombe and associates. Sales price: \$35,000 in cash, assumption of \$656,000 in obligations (including WEPA-TV Erie, Pa.). FCC approved: Aug. 17, 1966 [For the Record, Aug. 29, 1966].

WBNG-TV Binghamton(ch 12)—Licensed to Gateway Communications Inc. (see Newspaper Crossownership; 80% owned by the Bergen Evening Record Corp. of Hackensack, N.J.). Previous owner: Triangle Publications Inc. (owned by Walter Annenberg). Former call letters: WBNF-TV. Sales price (including WTAJ-TV Altoona and WLYH-TV Lancaster, both Pennsylvania): \$14.4 million. FCC approved: September 1972 [BROADCASTING, Sept. 25, 1972]. Note: Original owner, Clark Associates Inc. (John C. Clark) sold station (with WBNF) to Triangle in 1955 for \$3 million. FCC approved: May 4, 1955 [For the Record, May 9, 1955].

WICZ-TV Binghamton(ch 40)—Licensed to Stainless Inc. (Henry J. Guzewicz, 38.41%, et al). Former owner: Binghamton Press Co. (Gannett Co. Inc., Rochester, N.Y.). Original call letters: WINR-TV. Sales price: \$780,000. FCC approved: Feb. 22, 1971 [For the Record, March 8, 1971]. Note: Binghamton Press Co. purchased station from original owner, Southern Tier Radio Service Inc., in 1957. Sales price: \$165,000 (with WINR). FCC approved: Jan. 10, 1957 [For the Record, Jan. 14, 1957].

WBUF(TV) Buffalo(ch 17, now deleted)—Licensed to NBC. Original owner: WBUF-TV Inc. (Sherwin Grossman, Gary L. Cohen and others). Sales price: \$312,500. FCC approved: Sept. 21, 1955 [For the Record, Sept. 29, 1955].

WGR-TV Buffalo(ch 2)—Licensed to Taft Bcstg. Co. (see Group Ownership). Previous owner: Transcontinent TV Corp. Sales price: \$26.9 million (including WGR-AM-FM and WDAF-AM-FM-TV Kansas City and WNEP-TV Scranton, Pa.). FCC approved: Feb. 19, 1964.

WKBW-TV Buffalo(ch 7)—Licensed to Capital Cities Communications Inc. (see Group Ownership). Previous owner: Rev. Clinton H. Churchill and group. Sales price: \$14 million with WKBW-AM-FM. FCC approved: August 1, 1961 [For the Record, August 14, 1961].

WABC-TV New York(ch 7)—Licensed to ABC Inc. (see Group Ownership). Original owner: American Broadcasting Co. Inc. Note: This was change of ownership when ABC merged with United Paramount Theaters Inc. FCC approved: Feb. 9, 1953 [For the Record, Feb. 16, 1953].

WOR-TV New York (ch 9)—Licensed to RKO General Inc. (see Group Ownership). Original owner: Bamberger Bcstg. Service Inc. (R.H. Macy Co.). Sales price: \$4.5 million (with WOR-AM-FM) plus \$315,000 per year for 25-year lease on studio and transmitter properties plus 10% interest in General Teleradio Inc. by R.H. Macy Co. FCC approved: Jan. 17, 1952 [For the Record, Jan. 21, 1952].

WSNL-TV Patchogue (ch 67)—Licensed to Suburban Broadcasting Corp. (Stanley R. Yarmuth, Burlon I. Koffman and Christian Yegen, 80%; Robert A. Rosen, David H. Polinger, et al., 13%). Previous owner: Suburban Broadcasting Corp. (Robert A. Rosen, David H. Polinger, et al., 66%). Sales price: no consideration. FCC approved: Feb. 24, 1975 [For the Record, March 10, 1975].

WPTZ(TV) Plattsburgh (ch 57)—Licensed to Rollins Telecasting Inc. (see Group Ownership). Original owner: Carl F. Stohn Sr., Vincent S. Jerry, Joel H. Schier, Harry Schulman, Martin L. Schulman, Cyril Schulman and others. Sales price: \$500,000. Original call letters: WIRI(TV). FCC approved: March 28, 1956 [For the Record, April 2, 1956].

WROC-TV Rochester (ch 8)—Licensed to Rust Craft Bcstg. of New York Inc. (see Group Ownership). Previous owners: Veterans Bcstg. Co. (Ervin F. Lyke, 8.5% and others). Sales price: \$7 million (with WROC-AM-FM). FCC approved: Feb. 10, 1965 [For the Record, Feb. 15, 1965]. Founded as WHAM-TV in 1949 by Stromberg-Carlson Co. Bought by Transcontinent TV Corp. for \$5.6 million in 1956. Bought by Veterans Bcstg. Co. and WHEC Inc. for \$6.5 million in 1961 (WHEC received full occupancy of channel 10, which it had shared with the then WNET-TV, and in return, Veterans Bcstg. became full owner of WROC-TV on channel 8).

WNYS(TV) Syracuse (ch 9)—Licensed to W.R.G. Baker TV Corp. (see Outlet Co. Stns. in Group Ownership). Previous owner: W.R.G. Baker TV Corp. (W.R.G. Baker Inc., 40%; Six Nations Bcstg. Co., 20%; Onondaga Bcstg. Co., 18%; Salt City Bcstg. Co., 2%). Sales price: \$4.8 million. FCC approved: July 1972 [BROADCASTING, July 24, 1972].

WKTV(TV) Utica (ch 2)—Licensed to Mid-New York Bcstg. Corp. (see Paul Harron Stns. in Group Ownership). Original owners: Copper City Bcstg. Corp. (Myron J. Kalfet, Penn-State Realty Co. and others). Sales price: \$4 million (with WKAL Rome, N.Y.) plus \$100,000 for real estate and \$300,000 over 10-year period as salary to W.T. McNeilly, one of transferors, as consultant. FCC approved: Dec. 30, 1958 [For the Record, Jan. 5, 1959].

North Carolina

WLOS-TV Asheville-Greenville, S.C. (ch 13)—Licensed to Wometco Skyway Bcstg. Co. (see Wometco Enterprises Stns. in Group Ownership). Sales price: \$277,940 for additional 35.2% interest from Charles A., Henry J. and Joe H. Britt, Julia L. Stamberger, and Harold K. Bennett. FCC approved: July 24, 1958 [For the Record, July 28, 1958].

WCCB(TV) Charlotte (ch 18)—Licensed to WCCB-TV Inc. (see Bahakel Stns. in Group Ownership). Sold by: Century Advertising Inc. (Dwight L. Phillips, Cecil J. Haines, Leonard Wilson Coppala and others). Sales price: \$175,000. FCC approved: Aug. 20, 1964 [For the Record, Aug. 31, 1964]. Note: Founded by George W. Dowdy, Hugh Deadwyler and associates as WOMC(TV) in 1954. Transferred to Mr. Deadwyler for \$4 and assumption of obligations totaling \$150,000 in 1954. Transferred to receiver and back to Mr. Deadwyler in 1956. Sold by Mr. Deadwyler to Century Advertising in 1957 for \$130,000 as WAYS-TV.

WRET-TV Charlotte (ch 38)—Licensed to Turner Communications Inc. (see Group Ownership). Previous owner: Harold W. Twisdale, David L. Steel Sr. and others. Sales price: \$1,225,000 in liabilities. FCC approved: July 27, 1970 [For the Record, Aug. 3, 1970]. Note: Founded in 1967. Former call letters: WCTU-TV.

WSOC-TV Charlotte (ch 9)—Licensed to Carolina Bcstg. (see Cox Broadcasting Corp. in Group Ownership). Original owner: WSOC Broadcasting Co. (E.E. Jones, 45%; R.S. Morris, 21%; Hunter Marshall, 20%; and others). Sales price: \$5.6 million (with WSOC-AM-FM). FCC approved: April 9, 1959 [For the Record, April 13, 1959].

WTVD(TV) Durham (ch 11)—Licensed to Capital Cities Communications Inc. (see Group Ownership). Original owner: Durham Bcstg. Enterprises Inc. Sales

price: \$1,417,800. FCC approved: May 24, 1957 [For the Record, June 3, 1957].

WFMY-TV Greensboro (ch 2)—Licensed to WFMY Television Corp. (see Landmark Communications Stns. in Group Ownership). Former owners: Mrs. Margaret A. Godbey, 19.9%; Jefferson Standard Life Insurance Co., 19.9% and others. Sales price: \$17,168,875 (including *Greensboro News and Record*). FCC approved: Dec. 16, 1964 [For the Record, Dec. 28, 1964].

WNCT-TV Greenville (ch 9)—Licensed to Roy H. Park Bcstg. Inc. (see Group Ownership). Original owner: Carolina Bcstg. System Inc. (Earl McD. Westbrook and associates). Sales price: \$2,557,458. FCC approved: Feb. 6, 1962 [For the Record, Feb. 12, 1962].

WCTI-TV New Bern (Greenville) (ch 12)—Licensed to Continental TV Inc. (see Continental stations in Group Ownership). Previous owner: Piedmont Television Corp. (Harold H. Thomas and Nathan Frank. See Thomas stations in Group Ownership). Sales price: \$960,000. FCC approved: April 15, 1969 [For the Record, May 5, 1969]. Previous call letters: WNBE-TV. Note: Founded in 1963 by Mr. Frank. He sold 50% to Mr. Thomas that year for \$60,000.

WJHF(TV) Raleigh (ch 22, now deleted)—Licensed to Springfield Television Broadcasting Corp. (see Group Ownership). Former owners: William H. White, Terry Sanford and Hugh Cannon, owned 50% with Springfield Television holding remaining 50%. Sales price: between \$100,000 and \$150,000 in stock. FCC approved: Dec. 27, 1966 [For the Record, Jan. 2, 1967].

WITN-TV Washington-Greenville (ch 7)—Licensed to North Carolina TV Inc. (Robertson family, 62.5%; William S. Page, 25%; others). Original owners: H.W. Anderson and R.M. Fountain. Sales price: \$121,840. FCC approved: Sept. 23, 1955 [For the Record, Oct. 3, 1955].

WECT(TV) Wilmington (ch 6)—Licensed to Atlantic Telecasting Corp. (Dan D. Cameron, 42.86%; J.S. Brody, 21.51%; Leo Brody, 11.93%; Estate of J.W. Jackson, 14.29%, and others). Former owners: Richard A. Dunlea and Louise M. Dunlea. Original call letters: WMFD-TV. Sales price: \$153,850 for 60%. Mr. Cameron retained 40%. FCC approved: Dec. 11, 1957 [For the Record, Dec. 16, 1957].

WWAY-TV Wilmington (ch 3)—Licensed to Clay Bcstg. Corp. (Lylell B. and Buckner Clay and others). Sold by: Cape Fear Telecasting Inc. (William G. Broadfoot Jr., Charles B. Britt and others). Sales price: \$1,353,572.52. FCC approved: Aug. 28, 1968 [For the Record, Sept. 9, 1968]. Note: Founded by Cape Fear Telecasting Inc. in 1964.

WXII(TV) Winston-Salem (ch 12)—Licensed to Multimedia Inc. (see Group Ownership). Previous owner: Triangle Bcstg. Corp. (Gordon Gray & family, 100%). Former call letters: WSJS-TV. Sales price: \$7,312,500. FCC approved: Sept. 7, 1972 [For the Record, Oct. 23, 1972].

North Dakota

KXMB-TV Bismarck (ch 12)—Licensed to Bismarck Television Inc. Former owner: KXMB-TV Inc. (John Boler, pres.). Sales price: \$1.2 million. FCC approved: Jan. 27, 1971 [For the Record, Feb. 8, 1971].

KTHI-TV Fargo-Grand Forks (ch 11)—Licensed to Spokane Television Inc. (Evening Telegram Co.). Sold by: Pembina Broadcasting Co. (see Fuqua Industries Stations in Group Ownership). Sales price: \$1,491,000. FCC approved: Jan. 22, 1969 [For the Record, Feb. 3, 1969]. Previous owner: Polaris Corp. See WTVW(TV) Evansville, Ind. for details.

WDAY-TV Fargo (ch 6)—Licensed to WDAY Inc. (*Fargo Forum*). Original owner: E.C. Reineke and wife, 55.6%; N.D. Black Jr. and family *Fargo Forum*, 35% and others. Sales price: \$900,000 for 55.6%. FCC approved: July 20, 1960 [For the Record, July 25, 1960].

KNOX-TV Grand Forks (ch 10, now deleted)—Licensed to Pembina Broadcasting Inc. (see Fuqua Industries stations in Group Ownership). 94.34% sold by Community Radio Corp. in 1962 for \$225,000.

KXMC-TV Minot (ch 13)—Licensed to KXMC-TV Inc. (Chester M. Reiten, 55%). Former owner: KXMC-TV Inc. (Chester M. Reiten, 40%; Lloyd R. Amoo, 30%; W.L. Hurley, 30%). Sales price: Transfer involved acquisition of stock from Security Pacific National Bank, executor of estate of Lloyd R. Amoo. FCC approved: July 31, 1974 [For the Record, Aug. 19, 1974]. Note:

Original owner, North Dakota Broadcasting Co., sold 52.5% of KXMC-TV to KXMC-TV Inc. (Chester M. Reiten, Lloyd R. Amoo and W.L. Hurley) in 1959 for \$1,040,000. FCC approved: Oct. 21, 1959 [For the Record, Nov. 2, 1959].

KCND-TV Pembina (ch 12)—Licensed to McLendon Corp. (see Group Ownership). Previous owner: Polaris Corp. Sales price: \$850,000 for 68 months lease, with option to buy for additional \$500,000. FCC approved: Aug. 24, 1966. Note: Founded (with KTHI-TV Fargo) in 1959 by Harry Rice, Harry C. Lukkason and associates. Sold to Polaris in 1962 for \$675,200 (with KTHI-TV and KNOX-TV Grand Forks, N.D.).

Ohio

WCTF(TV) Cleveland (ch 19)—Permittee: Zingale Broadcasting Co. (100% owned by Joseph T. Zingale). Previous owner: Community Telecasters of Cleveland Inc. (Charles W. Steadman, pres, et al.). Sales price (for CP): \$180,976. FCC approved: Oct. 25, 1973 [For the Record, Nov. 5, 1973].

WHK-TV Cleveland (ch 19, now deleted)—Licensed to Metropolitan Bcstg. Corp. (formerly DuMont Bcstg. Corp.). Former owner: *Cleveland Plain Dealer and News*. Sales price: \$700,000 (with WHK-AM-FM). FCC approved: April 16, 1958 [For the Record, April 21, 1958].

WJW-TV Cleveland (ch 8)—Licensed to Storer Bcstg. Co. (see Group Ownership). Original owner: Herbert Mayer. Original call letters: WXEL(TV). Sales price: \$8.5 million (with KPTV(TV) Portland, Ore., and Empire Coil Co., New Rochelle, N.Y.). FCC approved: Oct. 27, 1954 [For the Record, Nov. 1, 1954].

WKBF-TV Cleveland (ch 61, now deleted)—Licensed to Kaiser Broadcasting Co., 77.5% owned by Kaiser Broadcasting Corp. (see Group Ownership) and 22.5% by Field Communications Corp. (owned by Field Enterprises Inc., Chicago). Previous owner: Kaiser Broadcasting Corp. (100%). Sales price: no consideration. FCC approved merger of Kaiser Broadcasting Corp.'s five independent UHF's (including WKBF-TV) and Field Communications Corp.'s one independent UHF in May 1973 [BROADCASTING, May 14, 1973]. Note: Former owner, Superior Bcstg. Corp., sold 50% of CP to Kaiser Bcstg. Corp. for \$200,000 less expenses not to exceed \$50,000 already incurred by Superior. Kaiser obtained the option to purchase 50% interest of Superior on certain terms and conditions. Former call letters: WAFT-TV. FCC approved: Sept. 19, 1967 [For the Record, Sept. 25, 1967]. Kaiser purchased the remaining 50% from Superior Bcstg. for \$280,000 in 1972. FCC approved: Aug. 14, 1972 [For the Record, Sept. 4, 1972].

WKYC-TV Cleveland (ch 3)—Licensed to NBC (see Group Ownership). Previous owner: Westinghouse Broadcasting Co. (see Group Ownership). Previous call letters: KYW-TV. Consideration: in exchange for NBC's Philadelphia stations (with KYW-AM-FM) under FCC order: FCC approved: Feb. 17, 1965 [For the Record, March 1, 1965]. Note: Founded as WNBK(TV) by NBC in 1948. Exchanged for Westinghouse's Philadelphia stations in 1955 plus \$3 million to Westinghouse.

WTVN-TV Columbus (ch 6)—Licensed to Taft Bcstg. Co. (see Group Ownership). Original owners: Picture Waves Inc. (Edward Lamb). Sales price: \$1.5 million. FCC approved: Feb. 25, 1953 [For the Record, March 2, 1953].

WKEF(TV) Dayton (ch 22)—Licensed to Springfield Television Broadcasting Co. (group owner). Previous owner: WONE-TV Inc. (Brush-Moore Newspapers). Sales price: \$153,000 for CP. FCC approved: Dec. 6, 1963. (For the Record, Dec. 16, 1963). Note: Brush-Moore Newspapers bought CP for then WONE-TV and WONE and WFIE(FM) in 1961 for \$1,650,000. Stations were owned by Ronald Woodyard and associates.

***WOET-TV Kettering (ch 16)**—Licensed to University Regional Broadcasting. Previous owners: Ohio Educational Television Network Commission. Sales price: no consideration. FCC approved: April 22, 1975 [For the Record, May 5, 1975].

WLIO(TV) Lima (ch 35)—Licensed to Lima Communications Corp. (Toledo Blade Co., 75%; Midwestern Bcstg. Co., 25%). Previous owner: WLOK Inc. (owned by Northwestern Ohio Bcstg. Corp.). Sales price: \$1.5 million. FCC approved: Jan. 19, 1972 [BROADCASTING, Jan. 24, 1972].

TV Transfers

WSWO-TV Springfield(ch 28, now deleted)—Licensed to Lester W. White. Previous owner: Thomas T. Taggart, trustee in bankruptcy. Sales price: \$452,184. FCC approved: June 1972 [BROADCASTING, June 26, 1972].

WTOL-TV Toledo(ch 11)—Licensed to Cosmos Bcstg. Co. (see Group Ownership). Previous owners: Frazier Reams, 60%; Morton Niapp, 15%; Thomas S. Bretherton, 15%; Glenn Reams, 10%. Sales price: \$12.35 million (with WTOL-AM-FM sold back to Reams group for \$500,000). FCC approved: March 10, 1965 [For the Record, March 15, 1965].

WYTV(TV) Youngstown(ch 33)—Licensed to WYTN Inc. (Adam Young Inc., 30%; Edgewood Investment Co., 25%; Edwin G. Richter Jr., 25%; Howard D. Duncan Jr., 20%). Previous owner: Communications Industries Inc. (Lazar Emanuel). Sales price: \$1.05 million plus \$325,000 covenant not to complete plus \$200,000 consulting services. FCC approved: Feb. 5, 1965 [For the Record, Feb. 15, 1965]. Founded in 1957 by S.W. Townsend. Bought by Communications Industries Inc. in 1961 for \$975,000 for 81.2% interest plus options.

Oklahoma

KXII(TV) Ardmore (Sherman-Denson, Tex.)(ch 12)—Licensed to Texoma Bcstr. Inc. (KWTX-AM-TV Waco and 50% of KBTX Bryan, both Texas). Original owner: John F. Easley estate. Sales price: \$141,666. FCC approved: June 17, 1959 [For the Record, June 22, 1959].

KSBW(TV) Elk City(ch 8, now deleted)—Licensed to Bass Broadcasting Co. (see Group Ownership). Former owner: Lonnie J. and Alice Preston. Sales price: \$275,000. FCC approved: Nov. 17, 1965 [For the Record, Nov. 29, 1965].

KOCO-TV Oklahoma City(ch 5)—Licensed to Combined Communications Corp. (see Group Ownership). Former owners: John E. Kirkpatrick, Dean A. McGee, Grayce B. Flynn estate, Leonard H. Savage and others. Sales price: \$6.5 million. FCC approved: July 17, 1970 [For the Record, July 27, 1970]. Note: Founded in 1954. Cimarron TV Corp. (L.E. Caster and Ashley L. Robison) acquired station (then WGEO-TV) in 1957 from Streets Electronics Inc. (PR. Banta and others) for \$2.5 million. Mr. Banta acquired 10% interest from Mr. Caster after transfer. Cimarron sold station in 1961 to Capital City Investment Co. for \$2.5 million. Capital City subsequently became Cimarron Television (Kirkpatrick group).

KWTV(TV) Oklahoma City(ch 9)—Licensed to Century Communications Co. (see Griffin-Leake stations in Group Ownership). Sold by: Luther T. Dulaney and Ray J. Turner sold their 50% interest to Griffin-Leake interests which already owned 50%. Price: \$200,000 plus ownership of all equipment owned by KWTV, KATV(TV) Little Rock, Ark., and KTUL-TV Tulsa, (all owned by Griffin-Leake) which they in turn sold to Oklahoma City bankers for \$3 million. FCC approved: Jan. 20, 1964 [For the Record, Jan. 27, 1964].

KOTV(TV) Tulsa(ch 8)—Licensed to KOTV Inc. (see Corinthian Broadcasting Corp. in Group Ownership). Station was merged with Corinthian Broadcasting into Dun & Bradstreet Companies Inc. for stock valued at \$137 million (with KXTV(TV) Sacramento, Calif.; KHOU-TV Houston; WANE-TV Fort Wayne, Ind., and WISH-TV Indianapolis). FCC approved: April 14, 1971 [BROADCASTING, April 19, 1971]. Note: KOTV(TV) originally owned by Cameron TV Inc. (George Cameron), sold to Wrather-Alvarez interests for \$2.5 million after FCC approval July 30, 1952 [For the Record, Aug. 4, 1952]. Wrather-Alvarez Inc. (J.D. Wrather, Mrs. Maizie Wrather and M.H. Alvarez) sold station to Corinthian Television Corp. in 1954. Sales price: \$4 million. FCC approved: May 14, 1954 [For the Record, May 24, 1954].

Oregon

KOTI(TV) Klamath Falls(ch 2)—Licensed to Oregon Bcstg Co. (see Group Ownership). Original owner: W.D. Miller. Original call letters: KFJI-TV. Sales price: \$30,000. FCC approved: May 16, 1956 [For the Record, May 28, 1956].

KSYS(TV) Medford(ch 8)—Permittee: Southern Oregon Education Co. (W. Boyce Stanard, pres. et al). Previous owner: Liberty Television, a joint venture of Liberty Communications Inc. and Siskiyou Broad-

casters Inc. Sales price: \$48,000. FCC approved: July 20, 1973 [For the Record, Aug. 6, 1973].

KLOR(TV) Portland(ch 12, now deleted)—Licensed to Oregon TV Inc. George Haggarty purchased station for \$1,794,865 and combined its facilities with KPTV(TV) Portland. FCC approved: April 18, 1957 [For the Record, April 22, 1957].

KPTV(TV) Portland(ch 12)—Licensed to Oregon TV Inc. (see Chris Craft Stns in Group Ownership). Former owner: George Haggarty. Sales price: \$3.75 million. FCC approved: July 22, 1959 [For the Record, July 27, 1959]. Note: Founded by Herbert Mayer in 1952, sold to Storer Bcstg. Co. in 1954 in \$8.5 million package deal which included WXEL(TV) Cleveland (now WJW-TV) and Empire Coil Co., New Rochelle, N.Y. Storer sold station to Mr. Haggarty in 1957 for \$1.89 million.

KVDO-TV Salem(ch 3)—Licensed to Corvallis TV Cable Co. (a wholly owned subsidiary of Liberty Communications Inc.). Previous owner: Channel 3 Inc. (Harry E. Godsil, et al). Sales price: Sold for stock in Liberty equal to value of stockholders' investment in Channel 3 (\$411,000) and to certain liabilities (\$190,000), to be retired. FCC approved: Sept. 27, 1972 [BROADCASTING, Oct. 2, 1972].

Pennsylvania

WTAJ-TV Altoona(ch 10)—Licensed to Gateway Communications Inc. (80% owned by the Bergen Evening Record Corp. of Hackensack, N.J.). Previous owner: Triangle Publications Inc. (owned by Walter Annenberg). Former call letters: WFBG-TV. Sales price (including WBNG-TV Binghamton, N.Y. and WLYH-TV Lancaster-Lebanon, Pa.): \$14.4 million. FCC approved: September 1972 [BROADCASTING, Sept. 25, 1972]. Note: Original owner: Gable Bcstg. Co., sold station (with WFBG) in 1956 to Triangle for \$3.5 million. FCC approved: Jan. 11, 1956 [For the Record, Jan. 16, 1956].

WEPA-TV Erie(ch 68, now deleted)—Licensed to Empire Television and Radio Inc. (see WBJA-TV Binghamton, N.Y.).

WTPA(TV) Harrisburg (York-Lebanon)(ch 27)—Licensed to Newhouse Bcstg. Corp. (see Group Ownership). Original owner: Donald E. Newhouse. Sales price: \$250,000. FCC approved: Nov. 17, 1954 [For the Record, Nov. 22, 1954].

WJAC-TV Johnstown(ch 6)—Licensed to WJAC Inc. (owned 100% by Johnstown Tribune Publishing Co.; Alvin D. Schrott, Richard H. Mayer and Louis A. Pradt, 60.2% jointly). Former owner: WJAC Inc. (owned 100% by Johnstown Tribune Publishing Co.; Walter W. Krebs, special trustee of A.H. Walters estate, 60.2%). FCC approved involuntary transfer of control: Aug. 16, 1974 [For the Record, Sept. 2, 1974].

WJNL-TV Johnstown(ch 19)—Licensed to Cover Broadcasting Inc. (owned 100% by John E. Gelormino), debtor in possession. FCC approved: Aug. 11, 1975 [For the Record, Sept. 1, 1975]. Previous owner: Cover Broadcasting Inc. (Ben C. Werk, Norman W. Sponseller, and Dustin C. Lewis). Former call letters: WARD-TV. Sales price (with WARD(AM)): \$886,593. FCC approved: July 19, 1972 [For the Record, Aug. 21, 1972]. Note: Former owner, Rivoli Realty Co. (Margaret E. Gartland, 38.7%; George D. Gartland, 18%; Walter M. Thomas, 14.3% and others), sold station in 1971 to Ben Werk Group of Canton, Ohio for \$575,000. FCC approved: March 17, 1971 [BROADCASTING, March 22, 1971].

WLYH-TV Lancaster-Lebanon(ch 15)—Licensed to Gateway Communications Inc. (80% owned by the Bergen Evening Record Corp. of Hackensack, N.J.). Previous owner: Triangle Publications Inc. (owned by Walter Annenberg). Sales price (including WBNG-TV Binghamton, N.Y. and WTaj-TV Altoona, Pa.): \$14.4 million. FCC approved: September 1972 [BROADCASTING, Sept. 25, 1972]. Note: Original owners, WLBR-AM-FM, 52%, and Lebanon News, 36%, sold station to Triangle for \$115,000. FCC approved: Nov. 2, 1955 [For the Record, Nov. 7, 1955] and May 2, 1957 [For the Record, May 6, 1957].

KYW-TV Philadelphia(ch 3)—Licensed to Westinghouse Broadcasting Co. (see Group Ownership). Previous owner: NBC. Previous call letters: WRCV-TV. Consideration: In exchange for Westinghouse's Cleveland stations (with KYW) under FCC order. FCC approved: Feb. 17, 1965 [For the Record, March 1, 1965]. Note: Founded in 1948 as WPTZ by Philco Corp. Bought by Westinghouse in 1953 for \$8.5 million. Exchanged for NBC's Cleveland

stations and \$3 million in 1955.

WCAU-TV Philadelphia(ch 10)—Licensed to CBS Inc. (see Group Ownership). Former owner: WCAU Inc. (*Philadelphia Bulletin*). Sales price: \$15.6 million plus \$4.4 million for land and real estate (with WCAU-AM-FM). FCC approved: July 31, 1958 [For the Record, Aug. 4, 1958].

WGTI(TV) Philadelphia(ch 23, now deleted)—Licensed to Seven Arts Broadcasting Inc. Seven Arts Associated Corp. [100%]. Former owner: Bernard Rapaport. Sales price: \$14,202.66 for CP. FCC approved: July 5, 1967 [For the Record, July 17, 1967].

WPHL-TV Philadelphia(ch 17)—Licensed to WPHL-TV Inc. (owned by AVC Corp.). Previous owner: D.H. Overmyer Communications Co. Sales price: \$1 million with 80% of Overmyer's construction permits for KEMO-TV San Francisco; WATL-TV Atlanta; WXIX-TV Newport, Ky.-Cincinnati; WPGH-TV Pittsburgh and KJDO-TV Rosenberg (Houston), Tex. FCC approved: Dec. 6, 1967. Transaction was merger with Overmyer. Note: Founded in 1960 by Young People's Church of the Air (Donald B. Crawford). Left air in 1962. Sold to Philadelphia Television Broadcasting Co. (Aaron J. Katz and Leonard Stevens) in 1964 for \$219,000 and returned to air in 1966. Former call letters: WPCA-TV.

WPVI-TV Philadelphia(ch 6)—Licensed to Capital Cities Communications Inc. (see Group Ownership). Former owner: Triangle Publications Inc. (owned by Walter H. Annenberg and family). Original call letters: WFIL-TV. Sales price: \$110 million (with WFIL(AM) and WIOQ(FM) Philadelphia; WNHC(AM), WPLR(FM) and WTNH-TV New Haven, Conn.; KFRE(AM), KFYE(FM) and KFSN-TV Fresno, Calif.; and television program syndication business). Contingent on sale was Capital Cities "spin-off" of WFIL(AM) and WIOQ(FM) (formerly WFIL-FM) Philadelphia; WNHC(AM) and WPLR(FM) (formerly WNHC-FM) New Haven, Conn.; and KFRE(AM) and KFYE(FM) (formerly KFRE-FM) Fresno, Calif. to separate buyers for an aggregate of \$14,455,000. FCC approved: Feb. 24, 1971 [BROADCASTING, March 1, 1971].

WTAF-TV Philadelphia(ch 29)—Licensed to Taft Bcstg. Co. of Pennsylvania (see Group Ownership). Sold by: William L. and Irwin C. Fox and Dorothy Kotin. Former call letters: WIBF-TV. Sales price: \$1.4 million plus adjustments and assumptions of liabilities bringing price to estimated \$4.5 million. FCC approved: May 7, 1969 [For the Record, June 2, 1969]. Note: Founded by WIBF Broadcasting (Fox group) in May 1965.

KDKA-TV Pittsburgh(ch 2)—Licensed to Westinghouse Broadcasting Co. (see Group Ownership). Original owner: Allen B. DuMont Labs Inc. Original call letters: WDTV(TV). Sales price: \$9.75 million. FCC approved: Jan. 5, 1955 [For the Record, Jan. 10, 1955].

WENS(TV) Pittsburgh(ch 22, now deleted)—Licensed to Capital Communications Corp., wholly owned subsidiary of Springfield TV Bcstg. Corp. (William L. Putnam; see Group Ownership). Previous owners: Thomas P. Johnson and others. Sales price: 5,000 shares of Springfield TV Bcstg. Corp. (estimated value, \$110,000) for CP. FCC approved: July 28, 1965 [For the Record, Aug. 2, 1965].

WIC(TV) Pittsburgh(ch 11)—Licensed to WIC-TV Corp. (see Cox Broadcasting Corp. in Group Ownership). Former owners: P-G Publishing Co. (*Pittsburgh Post-Gazette* and *Toledo Blade*) and H. Kenneth Brennan family. Sales price: \$20.5 million. FCC approved: Nov. 20, 1964 [For the Record, Nov. 30, 1964].

WPGH-TV Pittsburgh(ch 53)—Licensed to Pittsburgh Telecasting Inc. (Leon A. Crosby, 20%; Stip Realty Inc., 80%). Former owner: Vincent M. Casey, receiver for U.S. Communications of Pittsburgh Inc. Sales price: \$100,000. FCC approved: Dec. 12, 1973 [For the Record, Dec. 31, 1973]. Note: Original call letters: WKJF-TV. Original owner, Agnes Jane Reeves Greer, sold CP (as WAND-TV) to D.H. Overmyer Communications Co. in 1965 for \$28,000. FCC approved: July 28, 1965 [For the Record, Aug. 2, 1965]. In 1967, 80% of CP (WECO-TV) was sold by D.H. Overmyer Communications Co. to U.S. Communications Corp. for \$1 million (with CP's KEMO-TV San Francisco; WMBO-TV Atlanta; WSCO-TV Newport, Ky.; and KJDO-TV Rosenberg, Tex.). FCC approved: Dec. 8, 1967 [For the Record, Dec. 18, 1967].

WTAE-TV Pittsburgh(ch 4)—Licensed to Hearst Corp. (see Group Ownership). Original owners: 50% interest owned by Earl F. Reed and Irwin D. Wolf Jr. and group. Sales price: \$10.6 million for 50%. FCC approved: Aug. 1, 1962 [For the Record, Aug. 6, 1962].

WDAU-TV Scranton(ch 22)—Licensed to Scranton Bcstrs. Inc. WCAU Inc., former 75% owner sold interest to minority owner (Scranton Bcstg. Inc.). Sales price: \$700,000. FCC approved: May 27, 1959 [For the Record, June 8, 1959]. WCAU Inc. (Philadelphia Bulletin, and former licensee WCAU-AM-TV Philadelphia) purchased 75% from Scranton Bcstg. Inc. (Mrs. M.E. Megargee and family) in 1956. Sales price: \$650,000. Former call letters: WGBI-TV. FCC approved: Oct. 18, 1956 [For the Record, Oct. 22, 1956].

WNEP-TV Scranton(ch 16)—Licensed to NEP Communications Inc. (Thomas P. Shelburne, 32.9%; Frank M. Henry, 21.6%; Catherine W. Shelburne, 21.9%, et al.). Previous owner: Taft Broadcasting Co. (see Group Ownership). Sales price: \$3.9 million. FCC approved: Nov. 1, 1973 [For the Record, Nov. 26, 1973]. Note: WNEP-TV formed by merger of WARM-TV Scranton and WILK-TV Wilkes-Barre, both Pennsylvania. Transcontinent TV Corp. bought 60% interest in 1958, with William M. Scranton and associates and Mitchell Jenkins and associates with 20% each, in stock transaction considered to total \$1.5 million. Transcontinent sold station in 1964 to Taft Bcstg. Co. for \$26.9 million (with WGR-AM-FM-TV Buffalo, N.Y. and WDAF-AM-FM-TV Kansas City, Mo.).

WRAK-TV Williamsport(ch 36, now deleted)—Licensed to WGAL Inc. (WGAL-AM-FM-TV Lancaster, Pa.—Steinman Stns.). Original owner: WRAK Inc. (Margaretta Steele and associates). Sales price: \$125,000 (with WRAK-AM-FM). FCC approved: Feb. 7, 1957 [For the Record, Feb. 11, 1957].

WNOW-TV York(ch 49, now deleted)—Licensed to WNOW Inc. (William F. Rust Jr. and associates). Original owner: Helm Coal Co. Sales price: \$255,000. FCC approved: Aug. 2, 1957 [For the Record, Aug. 5, 1957].

Rhode Island

WPRI-TV Providence(ch 12)—Licensed to Providence Television Inc. (Poole Broadcasting Co. [100%]. John B. Poole, Albert J. Gillen and others). Former owners: Capital Cities Broadcasting Corp. (see Capital Cities Communications Inc. in Group Ownership). Former call letters: WPRO-TV. Sales price: \$16.5 million. FCC approved: June 16, 1967 [For the Record, June 26, 1967]. Note: Original owner, Cherry & Webb Broadcasting Co., sold station with WPRO-AM-FM to Capital Cities for \$6.5 million in 1959.

South Carolina

WCBD-TV Charleston(ch 2)—Licensed to State Telecasting Co. (see Group Ownership). Previous owner: Reeves Telecom Corp. Former call letters: WUSN-TV. Sales price: \$2 million. FCC approved: May 26, 1971 [BROADCASTING, May 31, 1971].

WCIV-TV Charleston(ch 4)—Licensed to First Charleston Corp. (see Evening Star Stations in Group Ownership). Previous owners: WTMA-TV Inc. (Calhoun Life Insurance Co. and others). Sales price: \$2,210,147 plus assumption of \$400,000 in obligations. FCC approved: Oct. 5, 1966 [For the Record, Oct. 10, 1966].

WOLO-TV Columbia(ch 25)—Licensed to Columbia TV Bcstrs. Inc. (see Bahakel Stns. in Group Ownership). Sold by: First Carolina Corp. (Philip E. Pearce, Henry Sherrill, Edwin H. Cooper, Geddings H. Crawford, Richard deG. Kennan and others). Sales price: \$240,000. FCC approved: May 5, 1964 [For the Record, May 11, 1964].

WBTW-TV Florence(ch 13)—Licensed to Daily Telegraph Printing Co. (Hugh I. Shott Jr. and others). Sold by: Jefferson Standard Bcstg. Co. (see Group Ownership). Sales price: \$4.5 million. FCC approved: Feb. 28, 1968 [For the Record, March 11, 1968]. Note: Founded by Jefferson Standard Life Insurance Co. in 1954.

South Dakota

KABY-TV Aberdeen(ch 9)—Licensed to Forum Communications Inc. (see Group Ownership). Previous owner: KSOO-TV Inc. (Gordon H. Ritz, bd chmn, et al.). Former call letters: KCOO-TV. Sales price: \$2,250,000 (with KSOO-TV Sioux Falls, S.D.). FCC approved: Nov. 14, 1973 [For the Record, Nov. 26, 1973]. Note: Founded as KDHS-TV by Aberdeen TV Co. Construction permit sold June 21, 1957 to South Dakota Television Inc. (North Dakota Broadcasting Co., voted by John W. Boler; John W. Boler individually; Constance Blackstead; Stanley Voas, and Helga M. Sjuve) for \$2,447. Sold as KXAB-TV on Dec. 23, 1969 to KSOO-TV Inc. for \$700,000 (for construction permit).

KXON-TV Mitchell(ch 5)—Licensed to Buford Television Inc. (see Group Ownership). Previous owner: Mitchell Bcstg Assn (Raymond V. Eppel and others). Former call letters: KORN-TV. Sales price: \$875,000. FCC approved: Oct. 4, 1972 [For the Record, Oct. 30, 1972].

KSFY-TV Sioux Falls(ch 13)—Licensed to Forum Communications Inc. (see Group Ownership). Previous owner: KSOO-TV Inc. (Gordon H. Ritz, bd chmn, et al.). Former call letters: KSOO-TV. Sales price: \$2,250,000 (with KCOO-TV Aberdeen, S.D.). FCC approved: Nov. 14, 1973 [For the Record, Nov. 26, 1973]. Note: Morton H. Henkin, Thomas Barnstable, Julius Hetland and others transferred 70% interest (with KSOO) to Gordon Ritz, Wheelock Whitney, Mr. Henkin and others for \$770,000 in 1965. FCC approved: Aug. 23, 1965 [For the Record, Aug. 30, 1965].

Tennessee

WDEF-TV Chattanooga(ch 12)—Licensed to Roy H. Park Bcstg of Tenn. Inc. (see Group Ownership). Sold by Carter M. Parham and others. Price: \$2,780,080 with WDEF FCC approved: Feb. 12, 1964 [For the Record, Feb. 24, 1964].

WRCB-TV Chattanooga(ch 3)—Licensed to Rust Craft Bcstg. Co. (see Group Ownership). Former owners: Ramon G. and Helen H. Patterson, 70%; Follansbee Steel Co. (Jack and Louis Berkman), 30%. Sales price: \$1,675,000 for 70%. FCC approved: Nov. 27, 1959 [For the Record, Dec. 7, 1959]. Note: Founded by Ramon G. and Helen H. Patterson and Will Cummings. The Pattersons bought Mr. Cummings' 50% in 1956 for \$87,000 plus assumption of \$32,000 in obligations [For the Record, Dec. 3, 1956]. Follansbee Steel Co. bought 30% interest in 1959 for \$325,000.

WTVC-TV Chattanooga(ch 9)—Licensed to Fuqua Industries Inc. (see Group Ownership). See WTVM-TV Columbus, Ga., for details. Note: Went on the air June 15, 1953, as WROM-TV Rome, Ga. Sold to Dean Covington and associates Oct. 31, 1957, for \$722,500. Went dark Dec. 5, 1957, moved to Chattanooga and resume operation as WTVC-TV Feb. 11, 1958.

WDXI-TV Jackson(ch 7, now deleted)—Licensed to Kosklusko Broadcasting Co. (Cy N. Bahakel—Group Ownership). Former owners: estate of Aaron B. Robinson and others. Sales price: \$900,000. FCC approved: Aug. 17, 1966 [For the Record, Aug. 22, 1966].

WJHL-TV Johnson City (Bristol, Va.—Kingsport, Tenn.)(ch 11)—Licensed to Roy H. Park Bcstg of Tri-Cities Inc. (see Group Ownership). Sold by: W.H. Lancaster, Sr. and J. Sales price: \$2.5 million. FCC approved: June 8, 1964 [For the Record, June 15, 1964].

WATE-TV Knoxville(ch 6)—Licensed to Nationwide Communications Inc. (see Group Ownership). Previous owners: Paul Mountcastle, W.H. Linebaugh and John A. Ayers, trustees, 50% and others. Sales price: \$6.8 million (with WATE[AM]). FCC approved: April 8, 1965 [For the Record, April 19, 1965].

WBIR-TV Knoxville(ch 10)—Licensed to Multimedia Inc. (see Multimedia Bcstg. Co. in Group Ownership). Former owner: Taft Bcstg. Co. Sales price: \$3¼ million (with WBIR-AM-FM). FCC approved: Nov. 16, 1960 [For the Record, Nov. 21, 1960]. Note: Taft Bcstg owned 30% of original station, bought remaining 70% for \$2.1 million in 1959 from Gilmore Nunn, Robert L. Ashe and John P. Hart.

WTVK-TV Knoxville(ch 26)—Licensed to South Central Bcstg Co. (WIKY-AM-FM Evansville, Ind.). Original owners: TV Service of Knoxville Inc. Sales price: Assumption of obligations not exceeding \$216,500. FCC approved: July 28, 1954 [For the Record, Aug. 2, 1954].

WHBQ-TV Memphis(ch 13)—Licensed to RKO General Inc. (see Group Ownership). Original owner: Harding College. Sales price: \$2.88 million (with WHBQ). FCC approved: July 1, 1954 [For the Record, July 12, 1954].

WREG-TV Memphis(ch 3)—Licensed to New York Times Co. Former owner: Cowles Broadcasting Service Inc. (see Cowles Communications Inc. in Group Ownership). Original call letters: WREC-TV. Sales price: \$10,966,410. FCC approved: Aug. 18, 1971 [BROADCASTING, Aug. 23, 1971]. Note: Cowles purchased station from original owner, Hoyt Wooten, in 1963. Sales price: \$8 million (with WREC). FCC approved: April 23, 1963 [For the Record, May 6, 1963].

WNGE(TV) Nashville(ch 2)—Licensed to General Electric Broadcasting Co. (see Group Ownership). Former owners: Louis R. Draughon, 59.3% and as trustee, 14.8%; George J. Hearn Jr., 18.5%; John D. Sprouse, 7.4%. Former call letters: WSIX-TV. Sales price: \$9.7 million (with WSIX-AM-FM). FCC approved: April 6, 1966 [For the Record, April 18, 1966]. Note: Mr. Draughon purchased 33-1/3% owned by W.H. Criswell in 1956 for \$250,000.

WTLT(TV) Nashville(ch 17)—Licensed to Hudson Broadcasting (Robert D. Hudson Jr., 43%; J.T. Lovell, 22%; Don J. Massey, 22%; and others). Former owner: Charles H. White, trustee in bankruptcy. Original call letters: WMCV-TV. FCC approved: July 31, 1974 [For the Record, Aug. 12, 1974]. Note: WMCV began operation Aug. 5, 1968, and went off the air March 14, 1971 [BROADCASTING, March 29, 1971]. Charles H. White, atty, became owner of WMCV by commission grant of June 18, 1973.

Texas

KRBC-TV Abilene(ch 9)—Licensed to Abilene Radio & TV Co. (see Group Ownership). Original owner: Mrs. Eva May Hanks. Sales price: \$500,000 (with KRBC[AM]). FCC approved: Sept. 16, 1953 [For the Record, Sept. 28, 1953].

KAMR-TV Amarillo(ch 4)—Licensed to Canaan Communications Inc. (D.A. Canaan and Darrold A. Canaan Jr. together 95%). Former owner: Stauffer Publications Inc. (see Group Ownership). Original call letters: KGNC-TV. Sales price: \$2.5 million. FCC approved: July 31, 1974 sFor the Record, Aug. 12, 1974]. Note: Began operation in March 1953. Original owner, Globe-News Publishing Co., sold station, along with KGNC(AM) Amarillo and KFYO(AM) Lubbock, both Texas, to the Roy N. Whittenburg family in 1955 for \$3.9 million [BROADCASTING, June 27, 1955]. In 1966 station (with KGNC-AM-FM) was sold to Stauffer Publications for \$5.9 million. FCC approved: Jan. 14, 1966 [For the Record, Jan. 24, 1966].

KFDA-TV Amarillo(ch 10)—Licensed to Bass Broadcasting Co. (see Group Ownership). Former owners: R.R. Bass, 16%; Sid W. Richardson Foundation, 62.1%; Gene L. Cagle, 19.6%. Sales price: \$2,295,000 for 81.7%. FCC approved: Feb. 2, 1966 [For the Record, Feb. 7, 1966]. Note: Founded by Wendell Mayes, C.C. Woodson, Gene Cagle and Charles B. Jordan. Sold to Texas State Network in 1954 for \$525,000 (with KFDA).

KVII-TV Amarillo(ch 7)—Licensed to Marsh Media Ltd. License was transferred from partnership of Stanley Marsh III, Tom F. Marsh, Michael Marsh, John S. Tyler and Estelle Marsh Wallington dba Marsh Media Ltd. to partnership of Stanley Marsh III, Tom F. Marsh, Michael Marsh and Estelle Marsh Wallington dba Marsh Media Ltd. for \$60,000. FCC approved: Nov. 8, 1972 [For the Record, Dec. 4, 1972]. Note: Founded by John L. McCarty and associates in 1957. Sold to Southwest States Inc. (Trigg-Vaughn group) in 1958 for \$136,052. Sold to John B. Walton Jr. (see Group Ownership) in 1963 for \$1,125,000. Sold to Marsh Media in 1968 for \$1.5 million. FCC approved: Jan. 31, 1968 [For the Record, Feb. 12, 1968].

KTBC-TV Austin(ch 7)—Licensed to Times Mirror Co. (see Group Ownership). Original owner: Texas Broadcasting Corp. (Lady Bird Johnson, et al.). Sales price: \$9 million. FCC approved: Sept. 6, 1973 [For the Record, Sept. 24, 1973].

KVUE(TV) Austin(ch 24)—Licensed to Channel Twenty-Four Corp. (Tolbert Foster, Allan Shivers, W.E. Dyche Jr. and Edgar B. Younger, as a group 54.4%; R.B. and Bill B. McAlister and others, as a group 45.6%). Former owners: Roy A. and Ann S. Butler. Sales price: \$44,138 for CP.FCC approved: June 10, 1970 [For the Record, July 6, 1970]. Note: Mr. Butler acquired station in 1965 from Willard Deason for \$500,000.

KBMT(TV) Beaumont(ch 12)—Licensed to Harbour Television Systems Inc. (A.O. Banning, 56%; William G. Hill Jr., 27%, et al.). Former owner: Sabine Broadcasting Co. (John Nichols, pres, et al.). Sales price: \$3 million. FCC approved: Sept. 28, 1973 [For the Record, Oct. 15, 1973].

KWAB(TV) Big Spring(ch 4)—See KLBK-TV Lubbock, Tex., below.

KIII(TV) Corpus Christi(ch 3)—Licensed to South Texas Telecasting Co. (Clinton D. McKinnon, 80%, and others). Previous owners: Dr. J.A. Garcia and associates 74%; Mr. McKinnon, 3.8%; and others. Previous

TV Transfers

call letters: KVDO-TV. Sales price: \$48,000 for 74%. FCC approved: Jan. 17, 1964 [For the Record, Jan. 27, 1964]. Note: Founded in 1956 by Gabriel Lazano and others. Sold to Dr. Garcia and associates in 1957 for \$194,000 including obligations not to exceed \$100,000.

KTLG(TV) Corpus Christi(ch 43, now deleted)—Licensed to Trinity Bcstg. Corp. (Barton R. and Gordon B. McLendon). Original owner: H.L. Hunt. Sales price: \$5,608.21 (cost of securing CP). FCC approved: April 7, 1954 [For the Record, April 12, 1954].

KDFW-TV Dallas-Fort Worth(ch 4)—Licensed to Times Herald Printing Co. (Owned 100% by Times Mirror Co., Los Angeles). Former owner: Times Herald Printing Co. Former call letters: KRLD-TV. Sales price (with KRLD-AM-FM): Stock transaction valued at \$30 million. FCC approved: May 15, 1970 [BROADCASTING, May 18, 1970].

KXTX(TV) Dallas(ch 39)—Licensed to KDTV Broadcasting Co., 100% owned by Christian Broadcasting Network Inc. (see Group Ownership). Previous owner: KDTV Broadcasting Co., 100% owned by Doubleday Broadcasting Co. (see Group Ownership). Original call letters: KDTV(TV). Sales price: Donated by gift of stock valued at \$2 million. FCC approved: Nov. 9, 1973 [For the Record, Dec. 3, 1973]. Note: Trigg-Vaughn Stations Inc. (Cecil L. Trigg and Jack C. Vaughn) sold station to Doubleday Broadcasting in 1967 for \$14,125,018 with KOSA-TV Odessa-Midland, KROD-AM-TV El Paso and KITE-AM-FM Terrell Hills-San Antonio, all Texas; KRNO San Bernardino, Calif.; KHOW Denver, and KDEF-AM-FM Albuquerque, N.M. FCC approved: Feb. 1, 1967 [For the Record, Feb. 6, 1967].

KXTX-TV Dallas(ch 33)—Off air since Dec. 20, 1973. Permittee: Christian Broadcasting Network Inc. (see Group Ownership). Previous owner: Berean Fellowship Foundation Inc. (Marvin Colwill, VP & sec. et al.). Former call letters: KBFI-TV. Sales price: \$205,000. FCC approved: March 21, 1973 [For the Record, April 2, 1973]. Note: Founded as KMEC-TV in October 1967 by Maxwell Electronics Corp. (James T. and C.H. Maxwell, Carroll Maxwell Jr. and others). Left air October 1968. Sold to Evans Broadcasting of Texas (T.M. Evans, sole owner) in 1969 for \$40,000 plus liabilities totaling \$171,530. FCC approved: April 2, 1969 [For the Record, April 14, 1969]. Evans Broadcasting sold the construction permit to Berean Fellowship Foundation in 1971 for \$23,000. FCC approved: Sept. 1, 1971 [For the Record, Oct. 11, 1971]. Resumed operation from Feb. 21, 1972 until Dec. 16, 1972. Operating under the call letters KXTX-TV, the station returned to the air on April 16, 1973.

WFAA-TV Dallas(ch 8)—Licensed to A.H. Belo Corp. Original owner: Lacy-Potter TV Bcstg. Co. (Rogers Lacy and Tom Potter). Original call letters: KBTV(TV). Sales price: \$575,000. FCC approved: March 6, 1950 [For the Record, March 13, 1950].

KDBC-TV El Paso(ch 4)—Licensed to Doubleday Broadcasting Inc. (see Group Ownership). Former owners: Trigg-Vaughn Stns Inc. Former call letters: KROD-TV. Sales price: \$14,125,018 with KROD El Paso, KOSA-TV Odessa-Midland, KITE-AM-FM Terrell Hills-San Antonio and KDTV(TV) Dallas, all Texas; KRNO San Bernardino, Calif.; KHOW Denver, and KDEF-AM-FM Albuquerque, N.M. FCC approved: Feb. 1, 1967 [For the Record, Feb. 6, 1967]. Note: Original owner, El Paso Times, sold station to Trigg-Vaughn for \$3.45 million (with KROD-AM-FM) in 1959.

KELP-TV El Paso(ch 13)—Licensed to John B. Walton Jr. (see Group Ownership). Former owners: Norman E. Alexander and Joseph Harris. Sales price: \$2,375,000 (with KELP-AM-FM). FCC approved: Jan. 19, 1966 [For the Record, Jan. 24, 1966]. Note: Founded by McLendon Investment Corp. as KILT-TV. Sold in 1957 to Messrs. Alexander and Harris for \$750,000 (with KELP-AM-FM).

KTVT(TV) Fort Worth(ch 11)—Licensed to WKY-TV System Inc. (see Group Ownership). Original owner: Nafi Telecasting Corp. Sales price: \$800,000 plus assumption of \$3 million in liabilities. FCC approved: Aug. 1, 1962 [For the Record, Aug. 6, 1962]. Note: Founded by Texas State Network as KFJZ-TV. Sold in 1960 to Nafi Telecasting Corp. for \$4 million.

KXAS-TV Fort Worth(ch 5)—Licensed to North Texas Broadcasting Corp., 100% owned by LIN Broadcasting Corp. (see Group Ownership). Original owner: Carter Publications Inc. (Amon G. Carter Foundation, and others). Original call letters: WBAP-TV. Sales

price: \$35 million. FCC approved: May 13, 1974 [For the Record, May 27, 1974].

KHOU-TV Houston(ch 11)—Licensed to Gulf Television Corp. (see Corinthian Broadcasting Corp. in Group Ownership). Station was merged with Corinthian Broadcasting into Dun & Bradstreet Companies Inc. for stock valued at \$137 million (with KXTV(TV) Sacramento, Calif.; KOTV(TV) Tulsa, Okla.; WANE-TV Fort Wayne, Ind., and WISH-TV Indianapolis). FCC approved: April 14, 1971 [BROADCASTING, April 19, 1971]. Note: Gulf Television Corp. purchased station from original owner, Paul Taft and associates, in 1956. Sales price: \$4.25 million. FCC approved: July 11, 1956 [For the Record, July 16, 1956].

KHTV(TV) Houston(ch 39)—Licensed to WKY Television System Inc. (see Group Ownership). Former owners: Max Jacob and Irvin Schlenker, 40% each; David Morris, 20%. Sales price: \$240,000 for 80% of CP (KNUZ-TV) FCC approved: Oct. 13, 1965.

KPRC-TV Houston(ch 2)—Licensed to Houston Post Co. Original owner: W. Albert Lee. Original call letters: KLEE-TV. Sales price: \$740,000. FCC approved: May 23, 1950 [For the Record, May 29, 1950].

KTRK-TV Houston(ch 13)—Licensed to Capital Cities Communications Inc. (see Group Ownership). Former owner: Houston Consolidated Television Co. Sales price: \$21.3 million. FCC approved: June 16, 1967 [For the Record, June 26, 1967].

KXYZ-TV Houston(ch 29, now deleted)—Licensed to Houston Bcstg. Corp. (Milton R. Underwood and Philip R. Neuhaus). Original owner: Glenn R. McCarthy. Sales price: \$600,000 (with KXYZ-AM). FCC approved: March 28, 1957 [For the Record, April 1, 1957].

KGNS-TV Laredo(ch 8)—Licensed to Western Communications Inc. (see Donrey Media in Group Ownership). Former owner: Vidicon Industries of America (H.C. Avery Jr. and David H. Cole). Sales price: \$190,000 (for CP). FCC approved: July 31, 1958 [For the Record, Aug. 11, 1958].

KCBD-TV Lubbock(ch 11)—Licensed to State Telecasting Co. (see Group Ownership). Previous owner: Bryant Radio and Television Inc. (Joe H. Bryant and others). Sales price (including KWSW-TV Roswell, N.M.): \$6 million. FCC approved: May 26, 1971 [BROADCASTING May 31, 1971].

KLBK-TV Lubbock(ch 13)—Licensed to Grayson Enterprises Inc. (see Group Ownership). Original owner: Texas Telecasting Inc. (W.D. Rogers and associates). Original call letters: KDUB-TV. Sales price: \$38 million (with KEDY-TV [now KWAB(TV)] Big Spring, Tex.). FCC approved: Oct. 18, 1961 [For the Record, Oct. 23, 1961].

KMCC(TV) Lubbock(ch 28)—Licensed to McAlister Television Enterprises (Bill B. and R.B. McAlister, 100%). Former owner: McAlister Television Enterprises (Tolbert Foster, Allan Shivers, et al.). Sales price: McAlisters' 41.6% interest in KVUE-TV Austin, Tex. FCC approved: March 24, 1975 [For the Record, April 14, 1975]. Note: Station founded in 1968 by McAlister group (R.B. and Bill B. McAlister, et al.). Former call letters: KSEL-TV. Control transferred through issuance of new stock to Tolbert Foster, Allan Shivers, et al. in 1970. Sales price: \$200,000 for 54.4%. FCC approved: June 10, 1970 [For the Record, July 6, 1970].

KMXN-TV Lubbock(ch 34, now deleted)—Licensed to Double B Co. Corp. (W.B. Rushing and others). Sold by: K B Co. (Chester H. and Clarence L. Kissell). Sales price: \$55,000. FCC approved: Aug. 30, 1968 [For the Record, Sept. 16, 1968]. Note: CP only. Founded by K B Co. in 1967.

KTRE-TV Lufkin(ch 9)—Licensed to Forest Capital Communications Corp. (see Buford Television Inc. in Group Ownership). Original owners: R.W. Wortham Jr. and associates. Sales price: \$750,000 (with KTRF). FCC approved: July 18, 1962 [For the Record, July 23, 1962].

KMOM-TV Monahans-Odessa(ch 9)—Licensed to Grayson Enterprises Inc. (see Group Ownership). Sold by: John B. Walton Jr. (see Group Ownership). Former call letters: KVKM-TV. Sales price: \$530,000. FCC approved: Feb. 12, 1969 [For the Record, Feb. 17, 1969]. Note: Went on air Dec. 1, 1958.

KAEC(TV) Nacogdoches-Lufkin(ch 19)—Licensed to Fredonia Bcstg. Corp. (Mrs. Jessie P. Cudlipp, 40.3%; Albert E. Cudlipp, 32.25% and others). Previous owner: G.P. Scoggins. Sales price: \$4,500 for

CP. FCC approved: Aug. 20, 1965 [For the Record, Aug. 30, 1965]. Note: Founded by Lee Scarborough in 1958. Sold to Mr. Scoggins in 1960 for \$5,000 for CP. Former call letters: KTES(TV).

KOSA-TV Odessa(ch 7)—Licensed to Forward Communications of Texas Inc. (see Forward Communications Corp. under Group Ownership). Previous owner: Doubleday Broadcasting Co. (see Group Ownership). Sales price: \$2.25 million. FCC approved: Sept. 11, 1973 [For the Record, Sept. 24, 1973]. Note: Brothers Jack C. and Grady H. Vaughn bought 50% of station from C.L. Trigg (retaining 40%), W.B. Stowe and Brooks L. Harman (each retained 5%). Sales price was \$20,000 plus assumption of approximately \$85,000 in liabilities. FCC approved: Jan. 23, 1957 [For the Record, Jan. 28, 1957]. Trigg-Vaughn Stations Inc. sold station to Doubleday Broadcasting in 1967 for \$14,125,018 with KROD El Paso, KITE-AM-FM Terrell Hills-San Antonio and KDTV(TV) Dallas, all Texas; KRNO San Bernardino, Calif.; KHOW Denver and KDEF-AM-FM Albuquerque, N.M. FCC approved: Feb. 1, 1967 [For the Record, Feb. 6, 1967].

KJAC-TV Port Arthur(ch 4)—Licensed to Texas Goldcoast Television Inc., 100% owned by Clay Communications Inc. (see Group Ownership). Previous owner: Texas Goldcoast Television Inc. (Janet Gordon Jack, Gayle A. Gordon Brannon, Lynn G. Jones, Valerie G. Tucker and Robert H. Park). Sales price: \$3 million. FCC approved: May 31, 1973 [For the Record, July 2, 1973]. Note: Began operation Oct. 22, 1957 as KPAC-TV, jointly owned by Jefferson Amusement Co. and Port Arthur College. Port Arthur College sold its 50% to Jefferson Amusement Co. in 1965 for \$1.5 million. FCC approved: Nov. 15, 1965 [for the Record, Nov. 22, 1965].

KCTV(TV) San Angelo(ch 8)—Licensed to Jewell Television (see T.B. Lanford Stns in Group Ownership). Previous owner: Westex Television Co. (Big Spring Broadcasting Co., 88.8%; Houston H. and Edward H. Harte, 0.58% each; Bruce B. Meador, 10%. Big Spring Broadcasting is owned 48.32% each by the Messrs. Harte, plus 3.36% by A.L. Hall). Note: Founded in 1953 as KTXL-TV by A.D. Rust and B.P. Bludworth. Lewis O. Seibert acquired 25% from the founders in 1957 for \$32,288 and obligations. Mr. Rust sold his remaining 25% to Roy H. Simmons in 1957 for \$50,000. Big Spring Broadcasting Co. acquired 50% in 1959 for \$31,487. Roy H. Simmons and B.P. Bludworth, 25% each; and Big Spring Broadcasting Co., 50%, sold station to Westex Television Co. in 1962. Sales price: \$226,000 for 50%. FCC approved: Dec. 5, 1962 [For the Record, Dec. 10, 1962].

KENS-TV San Antonio(ch 5)—Licensed to Harte-Hanks Television Inc. (see Harte-Hanks Stns in Group Ownership). Original owners: 63.17% owned by Frank G. Hunte Jr. and family and estate of late George W. Brackenridge. Sales price: \$6,256,000 for 63.17% (with KENS). FCC approved: July 3, 1962 [For the Record, July 23, 1962]. Note: Founded as KEYL(TV) by W.L. Pickens, R.L. Wheelock and H.H. Coffield. Sold in 1951 to Storer Bcstg. Co. for \$1.05 million. Storer in 1954 sold these facilities to Express Pub Co. for \$3.5 million.

KMOL-TV San Antonio(ch 4)—Licensed to United Television Inc., subsidiary of Twentieth Century Fox. Previous owner: Avco Broadcasting Corp. (see Group ownership). Sales price: \$9,300,000. FCC approved: Sept. 17, 1975 [For the Record, Oct. 6, 1975]. Note: National Jewish Hospital, Denver, originally held 24% interest; sold to Southland Industries in 1958. Original call letters: WOAI-TV. Sales price: \$1,145,000. Southland Industries Inc. (Hugh Haiff and family) sold to Avco Broadcasting in 1965. Sales price: \$12,000,000 (with WOAI(AM)). FCC approved: Sept. 15, 1965 [For the Record, Sept. 20, 1965].

KSAT-TV San Antonio(ch 12)—Licensed to Outlet Co. (see Group Ownership). Previous owner: Mission Telecasting Corp. (Jack and Bob Roth). Sales price: \$10.5 million. FCC approved: Nov. 22, 1967. Note: Founded in 1957. Mission Broadcasting Co. increased holdings from 50% to 100% in 1964 when it purchased stock held by James Calvert, L.A. Douglas and others for \$1,624,593. Former call letters: KONO-TV.

KWEX-TV San Antonio(ch 41)—Licensed to Spanish International Bcstg. Corp. (see Group Ownership). Original owner: Raoul Cortez and associates. Original call letters: KUAL-TV. Sales price: \$200,000. FCC approved: Dec. 6, 1961 [For the Record, Dec. 11, 1961].

KTXS-TV Sweetwater (Abilene)(ch 12)—Licensed to Texas Key Broadcasters Inc. (see Grayson

Entérprises in Group Ownership). Previous owners: A.R. Elam Jr. and associates. Sales price: \$625,000. FCC approved: June 20, 1966 [For the Record, June 27, 1966]. Note: Founded in 1956 by W.D. Rogers. Sold in 1960 to Mr. Elam and group for \$799,440 plus 10-year lease of facilities with option to purchase. Former call letters: KPAR-TV.

KLTV(TV) Tyler(ch 7)—Licensed to Buford Television Inc. (see Group Ownership). Original owner: Lucille R. Lansing (who retained a 49% interest in station). Sales price: \$7,460.32 for 51%. FCC approved: March 20, 1957 [For the Record, March 25, 1957].

KANG-TV Waco(ch 34, now deleted)—Licensed to Texas Bcstg. Co. (LBJ Co.-KTBC-AM-TV Austin). Original owners: Central Texas TV Co. (Clyde Weatherly and associates). Sales price: \$115,000 and assumption of \$19,000 in obligations. FCC approved: Dec. 2, 1954 [For the Record, Dec. 13, 1954]. Note: CP canceled in 1955 with physical facilities turned over to KWTX-TV Waco in return for 29% of that station.

WACO-TV Waco—Permittee: WACO Radio Inc. (McHenry Tichenor, 57%; James Cullen Looney, 21%, and others). Former owner: R.E. Lee Glasgow. Sales price: \$825,000 for television CP and WACO-AM-FM Waco. FCC approved: May 6, 1970 [For the Record, May 18, 1970].

KRGV-TV Wesslaco(ch 5)—Licensed to Mobil Video Tapes Inc. (see Manship Stns in Group Ownership). Sold by: Kenco Enterprises Inc. (Bruce L. and John A. Kennedy). Price: \$1,375,000 (with KRGV). FCC approved: Jan. 28, 1964 [For the Record, Feb. 3, 1964]. Note: Founded by O.L. Taylor in 1954. 50% sold to LBJ Co. (now Texas Bcstg. Co.) in 1956 for \$5,000 plus loan of \$140,000. LBJ Co. purchased remaining 50% in 1958 for \$100,000. Sold to Kenco Enterprises in 1961 for \$1.4 million (with KRGV).

KAUZ-TV Wichita Falls(ch 6)—Licensed to Wichita Falls Telecasters (Wichita Falls Television, 80%; White Fuel Corp., 20%). Previous owner: Bass Brothers Telecasters Inc. (see Bass Bcstg Stns in Group Ownership). Sales price: \$4.25 million. FCC approved: Sept. 19, 1974 [For the Record, Oct. 7, 1974]. Note: Founded in 1953. Sold in 1956 as KWFT-TV by E.H. Rowley and Kenyon Brown to Sidney A. Grayson, Nat Levine and others for \$825,000 with KWFT(AM) Wichita Falls (with proviso that Mr. Brown buy back KWFT for \$75,000). Grayson group sold station (then KSYD-TV) to Paul Harron for \$2.35 million in 1963. Mr. Harron sold KAUZ-TV to Bass Brothers Telecasters Inc. in 1968 for \$3.1 million. FCC approved: April 12, 1968 [BROADCASTING, April 15, 1968].

KFDX-TV Wichita Falls(ch 3)—Licensed to Clay Broadcasting Corp. of Texas (owned by the Charleston Mail Association, publisher of the *Charleston (W.Va.) Daily Mail*). Original owner: Wichtex Radio & Television Co. (Darrold A. Cannan, 44.97%; D.A. Cannan Jr., 15.5%; Howard H. Fry, 8.6% and others). Sales price: \$5,050,000. FCC approved: Jan. 27, 1971 [For the Record, Feb. 8, 1971].

Utah

***KUSU-TV Logan(ch 12)**—Licensed to Utah State U. of Agriculture and Applied Sciences. Original owner: Herschell and Reed Bullen and others. Sales price: \$6,331 for expenses. FCC approved: Nov. 8, 1960 [For the Record, Nov. 14, 1960].

KCPX-TV Salt Lake City(ch 4)—Licensed to United Television, subsidiary of Twentieth Century Film Corp. Previous owners: Screen Gems Bcstg of Utah, subsidiary of Screen Gems Stations. Sales price: \$11 million. FCC approved: Aug. 12 Changing Hands, Aug. 25, 1975; [For the Record, Sept. 1, 1975]. Note: Founded by S.S. Fox and associates as KDYL-TV. Sold to Intermountain Bcstg & TV Corp. (Time Inc., 80%; G. Bennet Larson, 20%) in 1953 for \$2.1 million (with KDYL-AM-FM). Sold to Columbia Pictures in 1959 for \$3.1 million (with KCPX-AM-FM). Sold to Screen Gems Stations in 1963 for \$2.4 million (with KCPX-AM-FM). FCC approved: Jan. 23, 1963 [For the Record, Jan. 28, 1963].

KUTV(TV) Salt Lake City(ch 2)—Licensed to KUTV Inc., owned 80% by Ogden Standard Examiner and 20% by Communications Investment Corp. (see Hatch Stns in Group Ownership). Original owners: *Salt Lake Tribune* and Frank Carmen-Grant Wrathall interests. Sales price: \$683,333. FCC approved: March 7, 1956 [For the Record, March 12, 1956].

Vermont

WEZF-TV Burlington(ch 22)—Licensed to Ver-

mont-New York Television Inc. (owned by International Television Corp.). Original owner: Vermont-New York Television Inc. (Jack L. Siegal, 30%; and others). Original call letters: WVNY-TV. Sales price (with WEZF-FM Burlington, VT): \$1,238,055. FCC approved: April 17, 1974 [For the Record, May 6, 1974]. Note: Began operation in 1968. Station went off air April 2, 1971, and went on air again Sept. 17, 1971.

Virginia

WCYB-TV Bristol(ch 5)—Licensed to Appalachian Broadcasting Corp. (a wholly owned subsidiary of Starr Broadcasting Group Inc.; see Starr Broadcasting in Group Ownership). Original owner: Appalachian Broadcasting Corp. (Robert H. Smith, J. Fey Rogers, Charles M. Gore and Harry M. Daniel). Sales price: \$5.2 million. FCC approved: Nov. 12, 1970 [BROADCASTING, Nov. 23, 1970].

***WNVT(TV) Goldvein(ch 53)**—Licensed to Central Virginia Educational Television Corp. (B.W. Spiller, pres). Original owner: Northern Virginia Educational Telecommunications Association (Robert D. Smith, VP & gen mgr). Sales price: \$550,000. FCC approved: July 3, 1974 [For the Record, July 22, 1974]. Note: Began operation in 1972.

WSVA-TV Harrisonburg(ch 3)—Licensed to Gilmore Bcstg Corp. of Virginia (see Group Ownership). Previous owner: *Washington Evening Star*, 51%; Hamilton Shea, 49%. Sales price: \$1,694,308 (with WSAV-AM-FM). FCC approved: Aug. 9, 1965 [For the Record, Aug. 16, 1965]. Note: Founded by Frederick L. Allman in 1953. Sold to Transcontinent TV Corp. and Hamilton Shea jointly in 1956 for \$560,000. *Washington Evening Star* bought 51% interest in 1959 for \$700,000.

WLVA-TV Lynchburg(ch 13)—Licensed to WLVA Inc. (see Evening Star Stns in Group Ownership). Previous owners: Philip P. Allen, 25.56%; Chame C. Allen, 25.56% and others. Sales price: \$25 million (with WLVA-AM-FM). FCC approved: Aug. 23, 1965 [For the Record, Aug. 30, 1965].

WACH-TV Newport News(ch 33, now deleted)—Licensed to United Bcstg. Co. of Eastern Virginia Inc. (see Group Ownership). Original owners: Eastern Bcstg. Corp. (Russell A. Collins, receiver for John Doley and others). Sales price: \$54,000 (with WACH). FCC approved: July 19, 1956 [For the Record, July 30, 1956].

WTOV-TV Norfolk(ch 27, now deleted)—Licensed to Tim Brite Inc. (Temus R. Bright). Original owner: Commonwealth Bcstg. Corp. (E.L. Scott, Robert Wasdon, Jack Siegel). Sales price: \$17,500 plus assumption of \$78,000 in obligations. FCC approved: March 9, 1955 [For the Record, March 14, 1955].

WXEX-TV Petersburg-Richmond(ch 8)—Licensed to Nationwide Communications Inc. (Bowman Doss, Wendell Weller and George Campbell et al.; see Group Ownership). Former owner: Petersburg Television Corp. Sales price: \$7,150,000. FCC approved: Nov. 3, 1967 [For the Record, Nov. 13, 1967].

WAVY-TV Portsmouth-Norfolk-Newport News(ch 10)—Licensed to WAVY TV Inc. (see LIN Stns. in Group Ownership). Sold by: Tidewater Teleradio Inc. (J. Glen Taylor and others). Sales price: \$8 million. FCC approved: March 27, 1968 [For the Record, April 11, 1968]. Note: Founded in 1957 by Tidewater Teleradio Inc.

WTVR-TV Richmond(ch 6)—Licensed to Roy H. Park Broadcasting of Virginia Inc. (see Group Ownership). Previous owner: Wilbur M. Havens and associates. Sales price: \$5,017,185 (with WMBG and WCOD(FM)). FCC approved: Oct. 13, 1965 [For the Record, Oct. 25, 1965].

WDBJ-TV Roanoke(ch 7)—Licensed to WDBJ Television Inc. (South Bend [Ind.]) *Tribune*—WSBT-AM-FM-TV South Bend). Sold by: Times-World Corp. *Roanoke Times* and *World News*. Sales price: \$8.2 million. FCC approved: Oct. 29, 1969 [For the Record, Nov. 10, 1969]. Note: Founded by Times-World Corp. in October 1955.

WSLS-TV Roanoke(ch 10)—Licensed to Roy H. Park Broadcasting of Roanoke Inc. (see Park Broadcasting Stns. in Group Ownership). Sold by: Shenandoah Life Stations Inc. (Shenandoah Life Insurance Co.—G. Frank Clement and others). Sales price: \$7,050,000 (with WSLS-AM-FM). FCC approved: Sept. 10, 1969 [For the Record, Sept. 22, 1969]. Note: Founded in December 1952 by Shenandoah Life Insurance Co.

Washington

KVOS-TV Bellingham (Vancouver, B.C.)(ch 12)—Licensed to KVOS TV Corp. (see Wometco Stns. in Group Ownership). Original owner: Rogan Jones and associates. Sales price: \$3 million. FCC approved: March 29, 1961 [For the Record, April 3, 1961].

KEPR-TV Pasco-Kennewick-Richland(ch 19)—See KIMA-TV Yakima, Wash.

KING-TV Seattle(ch 5)—Licensed to King Bcstg. Co. (see Group Ownership). Original owner: Radio Sales Corp. (PK. Leberman). Original call letters: KRSC-TV. Sales price: \$375,000. FCC approved: July 20, 1949 [For the Record, July 25, 1949]. Note: Hearst Corp. bought 25% interest in King Bcstg. Co. in 1951 which was repurchased by licensee in 1953.

KIRO-TV Seattle(ch 7)—Licensed to KIRO Inc. (see Bonneville International Stns. in Group Ownership). Sold by: Saul Haas and others. Sales price: \$5 million (with KIRO-AM-FM). FCC approved: Dec. 17, 1963 [For the Record, Dec. 23, 1963].

KREM-TV Spokane(ch 2)—Licensed to King Bcstg. Co. (see Group Ownership). Former owner: Louis Wasmer. Sales price: \$2 million (with KREM-AM-FM). FCC approved: Sept. 26, 1957 [For the Record, Oct. 7, 1957].

KXLY-TV Spokane(ch 4)—Licensed to Spokane TV Inc. (Morgan Murphy). Original owner: KELP TV Corp. (Joseph Harris and Norman Alexander). Sales price: \$3.25 million (with KXLY-AM-FM). FCC approved: Jan. 17, 1963 [For the Record, Jan. 22, 1963]. Note: Founded by E.B. Craney and Harry L. (Bing) Crosby. Sold in 1954 to KELP TV Inc. for \$1.7 million.

KSTW(TV) Tacoma(ch 11)—Licensed to WKY Television System Inc. (see Group Ownership). Original owner: Tribune Publishing Co. (James Bellamy, VP and others). Original call letters: KNTN-TV. Sales price: \$4.5 million. FCC approved: Jan. 23, 1974 [For the Record, Feb. 11, 1974]. Note: Began operation in 1953.

KTVW(TV) Tacoma(ch 13)—Licensed to Clover Park School District No. 400 (Harold J. Mulholland, president). Previous owner: KTVW Inc. (Robert A. Banks, trustee in bankruptcy). Sales price: \$378,000. FCC approved: Sept. 9, 1975 [For the Record, Sept. 29, 1975]. Note: Original owners: Carl E. and C.D. Haymond. Original call letters: KMO-TV. Sold to estate of J. Elroy McCaw in 1954 for \$300,000. FCC approved: Sept. 15, 1954 [For the Record, Sept. 20, 1954]. Sold to KTVW Inc. (Blaidon Mutual Investors Corp.) in 1972 for \$863,407. FCC approved: June 21, 1972 [For the Record, July 17, 1972].

KIMA-TV Yakima(ch 29)—Licensed to NWG Broadcasting Co. (John Noel Jr. and Helen Mae Noel, 33-1/3%; Harrell B. Whiteny, 33-1/3%; R. Richard Gassaway and Sally Gassaway, 33-1/3%). Previous owner: Cascade Broadcasting Co. (Filmways Inc.—Martin Ranshoff and others). Sales price (with KLEW-TV Lewiston, Idaho and KEPR-TV Pasco, Wash.): \$1 million. FCC approved: Aug. 30, 1972 [For the Record, Sept. 18, 1972]. Note: Founded in July 1953 by Thomas C. Bostic, A.W. Talbot and Ralph Sundquist. KEPR-TV founded in December 1954 and KLEW-TV founded in December 1955. Haltom Corp. (Mr. Bostic) purchased 80% from Messrs. Talbot and Sundquist in 1962 for \$900,000 with KIMA(AM), KEPR(AM) and KEPR-TV Pasco, KBAS-TV Ephrata, both Washington, and KLEW-TV Lewiston, Idaho. Later Haltom changed name to Cascade. Sold by Mr. Bostic, John H. Reber and others in 1969 for about \$3 million worth of Filmways stock with KEPR-TV Pasco-Kennewick-Richland, Wash. and KLEW-TV Lewiston, Idaho. FCC approved: July 3, 1969 [For the Record, Aug. 4, 1969].

KNDOTV) Yakima(ch 23)—Licensed to Columbia Empire Bcstg. Co. (see Group Ownership). Original owner: Ralph Tronsrud. Sales price: \$194,229 (including purchase price of leased property). FCC approved: Feb. 1, 1961 [For the Record, Feb. 6, 1961].

West Virginia

WCHS-TV Charleston(ch 8)—Licensed to WCHS-AM-TV Corp. (see Rollins Stns in Group Ownership). Previous owner: Tierney Co. Sales price: \$3 million with WCHS. FCC approved: Sept. 28, 1960 [For the Record, Oct. 10, 1960].

TV Transfers

WBOY-TV Clarksburg (ch 12)—Licensed to Northern West Virginia TV Bcstg. Co. (Marion R. Ascoli, principal stockholder, wife of Max Ascoli, ex-publisher of *Reporter Magazine*). Sold by: Rust Craft Bcstg. Co. Sales price: \$825,000 (with WBOY). FCC approved: March 13, 1964 [For the Record, March 23, 1964]. Note: Founded by News Pub. Co. in 1956 as WBLK-TV. Sold to Rust Craft Bcstg. (then Friendly Stations Group) in 1957 for \$250,000 (with WBLK and WPAR-AM-TV Parkersburg, W. Va.).

WOWK-TV Huntington (ch 13)—Licensed to Gateway Communications Inc. (see Group Ownership). Previous owner: WHTN-TV Inc. (owned by Reeves Telecom Corp. See Reeves Telecom Corp. in Group Ownership). Former call letters: V-HTN-TV. Sales price: \$7,424,000. FCC approved: Sept. 23, 1974 [For the Record, Oct. 7, 1974]. Note: Initially owned by Greater Huntington Theaters Corp. (S.J. Hyman and family). Sold to Cowles Broadcasting Co. in 1956 for \$535,000 plus assumption of \$100,000 in debts (with WHTN-AM-FM). Cowles Broadcasting sold station to Reeves Telecom Corp. in 1960 for \$1,925,000. FCC approved: Dec. 22, 1960 [For the Record, Jan. 2, 1961].

WSAZ-TV Huntington (ch 3)—Licensed to Lee Enterprises Inc. (see Group Ownership). Previous owner: Capital Cities Broadcasting Corp. (see Capital Cities Communications Inc. in Group Ownership). Sales price: \$18 million. FCC approved: Feb. 24, 1971 [BROADCASTING, March 1, 1971]. Note: Founded by Huntington Publishing Co. in 1949. Sold to Goodwill Stations Inc. (G.A. Richards trusts, John F. Platt, Worth Kramer and others) in 1961 for \$6.1 million (with WSAZ). Sold to Capital Cities Broadcasting Corp. in 1964 for \$15,141,330 (with WSAZ and WJR-AM-FM Detroit). FCC approved: July 29, 1964 [For the Record, Aug. 10, 1964].

WTAP-TV Parkersburg (ch 15)—Licensed to PMA Communications (George R. Abels, Sherman A. Grimm, et al.). Previous owner: Broadcasting Services Inc. (R.L. Drake, 100%). Sales price: \$300,000 FCC approved: Nov. 15, 1974 [For the Record, Dec. 2, 1974]. Note: Founded in 1953. Sold in 1955 by Frank Baer-Howard Chernoff group to Zanesville Publishing for \$124,609. Sold in 1967 by Zanesville Publishing Co. to Broadcasting Services Inc. for \$579,000 (with WTAP-AM-FM). FCC approved: Nov. 2, 1967.

WDTV (TV) Weston (ch 5)—Licensed to Withers Broadcasting Co. of West Virginia (W. Russell Withers Jr. and William P. Brenton). Previous owner: Broadcast Industries of West Virginia Inc. (Broadcast Industries of New York Inc., 100%. William Grossman is president of parent company). Sales price: \$600,000 [BROADCASTING, April 16, 1973]. Note: Founded as WJPB-TV in 1960 by J.P. Beacom, who sold 50% for \$100,000 in same year to Thomas P. Johnson and George W. Eiby, Messrs. Beacom, Johnson and Eiby sold station to Broadcast Industries of West Virginia Inc. in 1966 for \$571,720. FCC approved: Aug. 24, 1966 [For the Record, Aug. 29, 1966].

WTRF-TV Wheeling (ch 7)—Licensed to Forward Tele-Productions Inc. (Forward Communications Corp.—see Group Ownership). Sold by WTRF-TV Inc. (Robert W. Ferguson, Albert V. Robert C., Raymond E. and Gordon C. Dix—see Dix Stns. under Group Ownership). Sales price: \$7,250,000 (with WTRF-FM). FCC approved: Feb. 28, 1969 [For the Record, March 10, 1969]. Original owner: Tri-City Bcstg. Co. (Thomas M. Bloch and W.L. Harris families, News Pub. Co.). 56.13% sold Dec. 17, 1958, to Dix family for \$1.684 million. Note: Dix family already owned 30.96% of Tri-City Bcstg.

Wisconsin

WEAU-TV Eau Claire (ch 13)—Licensed to WEAU Inc. (see Post Corp. Stns. in Group Ownership). Original owner: Morgan Murphy. [For the Record, May 21, 1962].

WBAY-TV Green Bay (ch 2)—Licensed to Nationwide Communications, subsidiary of Nationwide Mutual Insurance Co. Original owners: Nobertine Fathers, religious community. Sales price: \$5,737,121. FCC approved: Dec. 27, 1974 [For the Record, Jan. 13, 1975].

WFRV-TV Green Bay (ch 5)—Licensed to WFRV Inc. (see Norton Stns. in Group Ownership). Previous owners: S.N. Pickard and associates. Sales price: \$1.6 million. FCC approved: Jan. 4, 1961 [For the Record, Jan. 16, 1961].

WLUK-TV Green Bay (ch 11)—Licensed to WLUK Inc. (see Post Corp. Stns. in Group Ownership). Former owner: Morgan Murphy. Sales price: \$3.1 million (with WLUK-TV Marquette, Mich.). FCC approved: Jan. 6, 1965 [For the Record, Jan. 11, 1965]. Note: Founded in 1957 as WMB-TV Marinette, Wis., by William Walker and associates. Sold to Mr. Murphy and others in 1958 for \$211,764 for 75% (with WMAA).

WXOW-TV La Crosse (ch 19)—See WKOW-TV Madison.

WKOW-TV Madison (ch 27)—Licensed to Horizons Communications Corp. (William Mulvey, Ed Wood and Jerry Feniger). Previous owner: Midcontinent Broadcasting Co. of Wisconsin Inc. (see BFR stations in Group Ownership). Sales price: \$3 million with WAOW-TV Wausau and WXOW-TV La Crosse, both Wisconsin. FCC approved: Sept. 9, 1970 [For the Record, Sept. 28, 1970]. Note: WKOW-TV, founded in 1953, was acquired by Midcontinent in 1960 for \$925,000 from Stewart Watson, George W. Icke, E.C. Severson, B.W. Huiskamp and others. WAOW-TV was purchased by Midcontinent in 1964 for \$34,439 from Walter A. Barnard and others, and went on the air in 1965. Midcontinent put WXOW-TV on the air in March 1970.

WMTV (TV) Madison (ch 15)—Licensed to Forward TV Inc. (see Forward Communications Stns in Group Ownership). Original owners: Lee Radio group. Sales price: \$563,000. FCC approved: May 15, 1963 [For the Record, May 27, 1963]. Note: Founded by Bartell TV Corp. Bought by Lee Ruwitch, Gordon Sherman, Mitchell Wolfson and Sidney Meyer in 1957 for \$350,000. Bought by Lee group in 1958 for \$339,333.

WCAN-TV Milwaukee (ch 24, now deleted)—Licensed to Field Communications Corp. (Field Enterprises Inc. [see Group Ownership]). Former owner: Lou Poller. Sales price: \$35,000. FCC approved: Dec. 21, 1966. Note: WCAN-TV has been dark since 1955. Lou Poller operated station from 1953-1955 when he sold physical plant to CBS, which operated ch. 18 Milwaukee with those facilities. See WVTV (TV) Milwaukee.

WISN-TV Milwaukee (ch 12)—Licensed to Hearst Corp. (see Group Ownership). Original owner: Milwaukee Area Telecasting Corp. (permit granted to MATC after merger agreement among four applicants; other three were WEMP and WFOX Milwaukee and Kolora Telecasting Inc.). Original call letters: WTVW (TV). Sales price: \$2 million. FCC approved: March 2, 1955 [For the Record, March 14, 1955].

WITI-TV Milwaukee (ch 6)—Licensed to WITI-TV Inc. (see Storer Stns. in Group Ownership). Original owner: Independent TV Inc. (Sol J. Kahn). Sales price: \$4.4 million. FCC approved: Nov. 12, 1958 [BROADCASTING, Nov. 17, 1958].

WVTV (TV) Milwaukee (ch 18)—Licensed to WKY Television System Inc. (see Group Ownership). Former owner: Harold Sampson, 43%; Bernard J. Sampson, 43%; Herbert Wilk, 9%, and Lawrence M. Turet, 5%. Sales price: \$500,000 plus \$150,000 for agreement not to compete. FCC approved: March 23, 1966. Note: Founded in 1953 as WOKY-TV by Gerald Bartell and family. Sold to CBS in 1954 for \$350,000 and call letters changed to WXIX (TV). Sold to Genie Posner, Harold and Bernard J. Sampson and others in 1959 for \$50,000 and call letters changed to WUHF (TV). Messrs. Sampson bought out Mr. Posner's 51% interest in 1962 for \$1 and other valuable considerations.

WBJR-TV Superior (ch 6)—Licensed to RJR Communications Inc. (Robert J. Rich, 60%; Richard W. Pearson, 10%). Original owner: Northwest Publications Inc. (owned by Ridder Publications Inc.). Original call letters: WDSM-TV. Sales price: \$1,864,000. FCC approved: Sept. 5, 1974 [For the Record, Sept. 23, 1974]. Note: Founded in 1954.

WAOW-TV Wausau (ch 9)—See WKOW-TV Madison.

Wyoming

KYCU-TV Cheyenne (ch 5)—Licensed to Wyneco Communications Inc. (a wholly owned subsidiary of Lamb Communications; see Lamb Communications Inc. in Group Ownership). Previous owner: Frontier Broadcasting Co. Former call letters: KFBC-TV. Sales price (including KTVS (TV) Sterling, Colo.; KSTF (TV) Scottsbluff, Neb.; and a CP for KVRW (TV) Rawlins, Wyo.): \$3 million. FCC approved: July 6, 1972 [BROADCASTING, July 10, 1972].

KVRW (TV) Rawlins (ch 11, now deleted)—Permittee: Wyneco Communications Inc. (a wholly owned

subsidiary of Lamb Communications). Previous owner: Frontier Broadcasting Co. Sales price (including KTVS (TV) Sterling, Colo.; KSTF (TV) Scottsbluff, Neb.; and KYCU-TV Cheyenne, Wyo.): \$3 million. FCC approved: July 6, 1972 [BROADCASTING, July 10, 1972].

Guam

KUAM-TV Agaña (ch 8)—Licensed to Pacific Broadcasting Corp. (H. Scott Kilgore, 65%; Samuel N. Rubin, 35%). Sold by Philip Berg. Sales price: \$650,000 (with KUAM). FCC approved: April 9, 1964 [For the Record, April 20, 1964].

Puerto Rico

WSTE (TV) Fajardo (ch 13)—Permittee: WSTE-TV Inc. (James C. Leake and Carmina Mendea. See Griffin-Leake Stns. in Group Ownership). Origin owner: Continental Broadcasting Corp. (William I. Anthony and others). Sales price: \$60,000. FCC approved: March 26, 1959.

WMGZ (TV) Mayaguez (ch 16, now deleted)—Permittee: Tele San Juan Inc. See WTSJ (TV) San Juan

WUHM-TV Mayaguez (ch 22, now deleted)—Permittee: United Hemisphere TV of Puerto Rico Inc. See WUHT-TV San Juan.

WPSJ (TV) Ponce (ch 14, now deleted)—Permittee: Tele San Juan Inc. See WTSJ (TV) San Juan.

WRIK-TV Ponce (ch 7)—Licensed to Ponce Television Corp. (see United Artists Stns in Group Ownership). Former owner: Alfredo A. de Arellano III. Sales price: \$6.1 million for 80.1% (Mr. de Arellano, owner of 82.23%, acquired 17.77% from other stockholders and sold 80.1% to United Artists, retaining 19.9%. UA has four-year option to buy remaining interest for \$1.5 million or certain multiple of station profits. FCC approved: March 11, 1970 [For the Record, April 13, 1970]. Note: Founded in 1958. Alfredo C. Ramirez de Arellano del Valle acquired 61.67% for \$338,919 in 1964, later increasing his holdings to 82.23%.

WUHP-TV Ponce (ch 20, now deleted)—See WUHT-TV San Juan.







WAPA-TV San Juan (ch 4)—Licensed to WAPA Broadcasting Corp. (see Screen Gems Stns. in Group Ownership). Original owners: Winston-Salem Bcstg. Co., Goar Mestre and family. Sales price: \$1.5 million (including one-third interest in WOLE Aquadilla, PR.). FCC approved: April 25, 1962 [For the Record, April 30, 1962]. Note: Founded by Jose Ramon Quinones and associates. Sold in 1957 to Winston-Salem Bcstg. Co. and others for \$320,000.

WTSJ (TV) San Juan (ch 8, now deleted)—Licensed to Tele San Juan Inc. (O. Roy Chalk Stns. in Group Ownership). Previous owners: Julio Morales Ortiz and Clement L. Littauer. Sales price: \$669,825 plus 27,000 shares of Trans-Caribbean Airways stock and assumption of \$245,372 in obligations (with WMGZ (TV) Mayaguez and WPSJ (TV) Ponce, both Puerto Rico).

WUHT-TV San Juan (ch 30, now deleted)—Permittee: United Hemisphere TV of Puerto Rico Inc. (United Hemisphere Productions Inc., 100%. Principals of United Hemisphere Productions include Harry W. Bank, Sidney Pink and Art Merrill). Former owner: Iris Mieres Ayuso. Sales price: \$200,000 for CP with CP's for WUHM-TV Mayaguez and WUHP-TV Ponce, both Puerto Rico. FCC approved: June 29, 1970 [For the Record, July 13, 1970]. Note: Former call letters WUHT-TV, WUHM-TV and WUHP-TV were WITA-TV, WITB-TV and WITP-TV, respectively.

Virgin Islands

WBNB-TV Charlotte Amalie (ch 10)—Licensed to Island Teleradio Service Inc. (owned by District Communications: Theodore Ledbetter Jr., 9%; Cleveland L. Dennard, 21.2%; Jeanus B. Parks Jr., 18.2%; Samuel C. Jackson, 15.2%). Previous owner: Island Teleradio Service Inc. (owned by Federated Media Inc.). Sales price: \$991,127. FCC approved: Sept. 6, 1974 [For the Record, Sept. 30, 1974]. Note: Began operation in 1961. Original owners (Robert Moss, Robert Noble, Faye Russell and Kenneth Granger) sold station to Television Communications Corp. in 1970 for \$750,100 [BROADCASTING, May 11, 1970]. When Television Communications Corp. sold its cable TV business to Warner Communications Inc. in 1972, individual stockholders of Television Communications Corp. (formed into a company known as Federated Media Inc.) acquired WBNB-TV (BROADCASTING, Feb. 7, 1972).

<p>LOVE WILL KEEP US TOGETHER Neil Sedaka. Howard Greenfield. Don Kirshner Music. Inc.</p> 	<p>HAVE YOU NEVER BEEN MELLOW John Farrar (PRS). ATV Music Corp.</p> 	<p>THE HUSTLE Van McCoy. Van McCoy Music. Warner-Tamerlane Publishing Corp.</p> 	<p>JIVE TALKIN' Barry Gibb (PRS). Maurice Gibb (PRS). Robin Gibb (PRS). Casserole Music Corp. Flamm Music</p> 	<p>MANDY Scott English. Richard Kerr (PRS). Screen Gems-Columbia Music, Inc. Wren Music Co., Inc.</p> 	<p>LISTEN TO WHAT THE MAN SAID Paul McCartney (PRS). Linda McCartney (PRS). McCartney Music. Inc. ATV Music Corp.</p>			
<p>BAD BLOOD Neil Sedaka. Phil Cody (ASCAP). Don Kirshner Music, Inc.</p> 	<p>MY EYES ADORED YOU Bob Crewe. Kenny Nolan (ASCAP). Stone Diamond Music Corp. Tannyboy Music Co.</p>	<p>GET DOWN TONITE Harry Casey, Richard Finch. Sherlyn Publishing Co.</p>	<p>MAGIC David Paton (PRS). William Lyall (PRS). Al Gallico Music Corp.</p> 	<p>PLEASE MR. POSTMAN Brian Holland Robert Bateman. Freddie Gorman (ASCAP). Stone Agate Music Div.</p>	<p>(THEY JUST CAN'T STOP IT) THE GAMES PEOPLE PLAY Joe Jefferson. Charles Simmons. Bruce Hawes. Mighty Three Music</p>	<p>FAME John Lennon (PRS). David Bowie (PRS). Carlos Alomar (ASCAP). Lennon Music. ATV Music Corp.</p>		
<p>(HEY WON'T YOU PLAY) ANOTHER SOMEBODY DONE SOMEBODY WRONG SONG Chips Moman. Larry Butler. Screen Gems- Columbia Music, Inc.. Tree Publishing Co., Inc.</p> 	<p>FALLIN' IN LOVE Dan Hamilton. Ann Hamilton. Spittire Music</p>	<p>LOVIN' YOU Richard Rudolph. Minnie Riperton. Dickiebird Music</p>	<p>WILDFIRE Michael Murphey. Larry Canster</p>	<p>T'M NOT IN LOVE Graham Gouldman (PRS). Eric Stewart (PRS). Man-Ken Music</p>	<p>LAUGHTER IN THE RAIN Neil Sedaka. Phil Cody (ASCAP). Don Kirshner Music, Inc.</p> 	<p>HE DON'T LOVE YOU LIKE I LOVE YOU Curtis Mayfield. Calvin Carter. Jerry Butler (ASCAP). Conrad Music</p>		
<p>MIRACLES Marty Balin. Diamondback Music</p> 	<p>BMI BY A LANDSLIDE According to the "Broadcasting" Playlist, 60 out of the 100 most played records on American radio during 1975 were licensed by BMI.</p> <p>BMI BROADCAST MUSIC INCORPORATED The world's largest performing rights organization.</p>					<p>DANCE WITH ME Jo Hall. Johanna Hall. Hall Music. Mojoanna Music</p> 		
<p>WHEN WILL I BE LOVED Phil Everly. Acuff-Rose Publications, Inc.</p>	<p>FIRE Clarence Satchell. Raymond Middlebrook. Marvin Pierce. Marshall Jones. Leroy Bonner. James Williams. William Beck. Unichappell Music, Inc.</p>	<p>BMI BROADCAST MUSIC INCORPORATED The world's largest performing rights organization.</p>					<p>SWEARING TO GOD Bob Crewe. Denny Randell. Caseyem Music. Hearts Delight Music</p>	<p>PINBALL WIZARD Peter Townshend (PRS). Track Music</p>
<p>WHEN WILL I SEE YOU AGAIN Leon Huff. Kenneth Gamble. Mighty Three Music</p> 	<p>BMI BROADCAST MUSIC INCORPORATED The world's largest performing rights organization.</p>					<p>COULD IT BE MAGIC Barry Manilow. Adrienne Anderson. Kamikazi Music. Angeldust Music</p> 		
<p>THE WAY I WANT TO TOUCH YOU Toni Tennille. Moonlight Music. Magnolia Publishing Co.</p>	<p>THAT'S THE WAY I LIKE IT Harry Casey. Richard Finch. Sherlyn Publishing Co.</p>	<p>MIDNIGHT BLUE Melissa Manchester. Carole Sager. The New York Times Music Corp. Rumanian Pickleworks</p>	<p>THE NO-NO SONG Hoyt Axton. David Jackson. Lady Jane Music</p>	<p>YOU'RE THE FIRST, THE LAST, MY EVERYTHING Bryan White. Sa-Vette Music. January Music Corp.</p>	<p>LOVE WON'T LET ME WAIT Vinnie Barrett. Bobby Elk. Mighty Three Music. Friday's Child Music. Wimot Music</p>	<p>SHINING STAR Maurice White. Philip Bailey. Larry Dunn. Saggfire Music</p> 		
<p>BAD TIME Mark Farner. Gram-Renratt Music</p> 	<p>NEVER CAN SAY GOODBYE Clifton Davis. Portable Music Co. Inc.</p> 	<p>CHEVY VAN Sami Johns. Act One Music</p>	<p>SOME KIND OF WONDERFUL Jesse Ellison. Crash Music. Dandelion Music. Ateresgo Music</p> 	<p>HEAT WAVE Brian Holland. Eddie Holland. Lamont Dozier. Stone Agate Music Div.</p>				
<p>YOU ARE SO BEAUTIFUL Billy Preston. Bruce Fisher (ASCAP). Irving Music, Inc.. WEP Music, Inc.</p>	<p>HOW SWEET IT IS (TO BE LOVED BY YOU) Brian Holland. Eddie Holland. Lamont Dozier. Stone Agate Music Div.</p>	<p>BEFORE THE NEXT TEARDROP FALLS Vivian Keith. Ben Peters. Shelby Singleton Music, Inc.</p>	<p>IT'S A MIRACLE Barry Manilow. Marty Panzer. Kamikazi Music</p> 	<p>IT ONLY TAKES A MINUTE Dennis Lambert. Brian Potter. ABC Dunhill Music. Inc. One of a Kind Music</p>	<p>ROCKIN' CHAIR Willie Clark. Clarence Reid. Sherlyn Publishing Co., Inc.</p> 			
<p>I CAN HELP Billy Swan. Combine Music Corp.</p>	<p>EXPRESS Louis Risbrook. Barbara Lomas. William Risbrook. Olando Woods. Richard Thompson. Carlos Ward. Dennis Rowe. Triple O Songs. Jeff Mar Music.</p> 	<p>NIGHTS ON BROADWAY Barry Gibb (PRS). Maurice Gibb (PRS). Robin Gibb (PRS). Casserole Music Corp.</p>	<p>TAKE ME IN YOUR ARMS (ROCK ME) Brian Holland. Eddie Holland. Lamont Dozier. Stone Agate Music Div.</p>	<p>BALLROOM BLITZ Nicky Chin. Mike Chapman. Chinnichap Music. Rak Music</p>	<p>JUNIORS FARM RHYTHM Paul McCartney (PRS). Linda McCartney (PRS). McCartney Music. Inc. ATV Music Corp.</p> 			
<p>SKY HIGH Des Dyer. Clive Scott. Duchess Music Corp.</p> 	<p>ONLY WOMEN Vincent Furnier. Dick Wagner. Ezra Music Corp. Early Frost Music Corp.</p> 	<p>LET'S DO IT AGAIN Curtis Mayfield. Warner-Tamerlane Publishing Corp.</p> 	<p>MY LITTLE TOWN Paul Simon. Paul Simon Music</p>					

WGBS Miami
WHN New York
WJW Cleveland
KGBS Los Angeles
WSPD Toledo

Broadcasting that serves.

THE
**STORER
STATIONS**

STORER BROADCASTING COMPANY
**General Offices: 1177 Kane Concourse
Bay Harbor Islands, Miami Beach, Florida**

C

Directory of AM and FM Radio Stations in the U.S. and Canada	C-1	U.S. FM Stations by Call Letters	C-251	Table of FM Assignments	C-292
AM Radio in Mexico	C-237	Canadian AM by Call Letters	C-259	U.S. International Radio	C-297
FM Radio in Northern Mexico	C-240	Canadian FM by Call Letters	C-259	Radio Billings 1935-74	C-298
Radio in Bermuda and the Caribbean Area	C-241	U.S. AM Stations by Frequencies	C-260	Radio Set Sales 1922-74	C-298
U.S. AM Stations by Call Letters	C-242	U.S. FM Stations by Frequencies	C-281	Radio-TV Audiences	C-300
		Canadian AM by Frequencies	C-289	Broadcast Editorializing	C-300
		Canadian FM by Frequencies	C-291	Camplus-Limited Radio	C-301

Broadcasting
Yearbook 1976

Facilities of Radio

Directory of Radio Stations in the United States and Canada

Key to the listings

Listed in this directory are all AM (amplitude modulation) and FM (frequency modulation) radio stations in the U.S., its territories and Canada. Information received as late as Dec. 1, 1975, has been included in the listings. The following is a sample listing with explanation of information keyed to the boldface numbers.

WOF— (1) Oct 8, 1946; (2) 1000 khz; 1 kw-D, 250 w-N, DA-D. (L-KQSL) (CP: 5 kw-U). (3) Box 100 (99999). (909) 555-1000. TWX 909-999-9999. (4) General Broadcasting Corp. (group owner; acq 7-20-69). (5) Net: ABC/E. Mountain State Network. Audio news: APR. Rep: Jones, Penn State. Format: MOR, C&W. Spec progs: Sp 3 hrs wkly. (6) John Jones, stn mgr; David Smith, chief engr. (7) Rates: \$14; 13.50; 14; 12.50.

WOF-FM— (1) October 1969; (8) 101.1 mhz; 3 kw. Ant 300 ft. Stereo. (9) Dups AM 50%. Format: C&W. (10) WOF-TV affil. (7) Rates: \$8.50; 7; 8.50; 7.

- (1) Date station first went on air (regardless of subsequent ownership changes).
- (2) Frequency in kilohertz; power and hours of operation. WOF operates with one kilowatt in daytime hours, 250 watts at night, and uses a directional antenna in daytime. Nighttime operation is limited to hours when dominant station KQSL is operating in daylight. WOF holds a construction permit for five kilowatts power day and night.

Operational abbreviations:

CH—critical hours
CP—construction permit
CR—Canadian restricted
D—day
DA-D—directional antenna
daytime only
DA-N—directional antenna
nighttime only

DA-1—directional antenna
day and night
DA-2—directional antenna
with changing patterns, day
and night
DA-3—same as DA-2, with
an additional pattern change
kw—kilowatt

N—night
SH—specified hours of operation

ST—shares time with . . .
U—unlimited time
w—watt

(3) Address and zip code, telephone, Teletype Writer Exchange number.

(4) Licensee name and date of acquisition (if not original owner). If the licensee is a group owner—a company with several broadcast properties—it is so identified, as is a group owner of which the licensee is a subsidiary. Details on group owners are listed in section A.

(5) Network, audio news service, rep and programing. The WOF national affiliate is ABC Entertainment Network, regional is Mountain State. The station subscribes to an audio news feed from Associated Press Radio. Sales representatives are also listed—national rep first, then regional. The WOF program format is part middle-of-the-road, part country and western, with three hours weekly of special programing in Spanish.

(6) Personnel.

(7) Advertising rates. The prices the station charges for a 12-times-a-week, one-minute spot are shown for each of four day-parts:

6 a.m.-10 a.m.; 10 a.m.-3 p.m.; 3 p.m.-7 p.m.; 7 p.m.-midnight in that order. If a day-part is inapplicable, a dash (—) replaces the rate.

Co-owned FM. WOF-FM has the same ownership as WOF(AM), and the FM listing contains only information different from the AM. Co-owned AM and FM stations are always listed together, even when they have dissimilar call letters.

(8) Frequency in megahertz, effective radiated power, and antenna height above average terrain. WOF-FM broadcasts in stereo.

(9) Programing. WOF-FM duplicates WOF programs 50% of the time and has a C&W format.

(10) Co-owned TV. WOF-TV has the same licensee as WOF-AM-FM.

Listings for independent FM stations follow the format of AM station entries.

An asterisk (*) indicates noncommercial stations.

Alabama

TO BUY OR SELL A TELEVISION OR RADIO STATION HAMILTON-LANDIS & ASSOC., Inc.

WASHINGTON, D.C. CHICAGO
1730 K St., N.W. 1429 Tribune Tower
(202) 393-3456 (312) 337-2754

SAN FRANCISCO DALLAS
111 Sutter St. 6060 N. Central Expy.
(415) 392-5671 (214) 691-2345

NATIONWIDE • NEGOTIATIONS FINANCING • APPRAISALS

Abbeville

WARI—August 31, 1961: 1480 khz; 1 kw-D. Box 577 (36310). (205)585-2274. Abbeville Radio Inc. Net: ABC/E. Rep: Ind. Format: Diversified Country Rock. ■ A.L. Harris, pres; William W. Bryant, gen mgr & coml mgr; Bruce Futrell, prog dir & news dir; Aubrey Tomlin, chief engr.

WARI-FM—Feb. 22, 1968: 94.3 mc; 3 kw. Ant 195 ft. horiz; 280 ft. vert. Dups AM 75%. Rep: Beaver.

Albertville

WAVU—1948: 630 khz; 1 kw-D. Box 190 (35950). (205)878-1311. Sand Mountain Bcstg Service. Net: Alabama Community. Format: Variety. Spec progs: C&W 18 hrs, Gospel 7 hrs, both wkly. ■ Pat. M. Courington, ptrn & gen mgr; Tony Giles, asst mgr; Henry Hoffman, chief engr.

WQSB(FM)—Co-owned with WAVU. 1949: 105.1 mhz; 20 kw. Ant. 320 ft. Stereo. Prog sep from AM. Format: Contemp.

Alexander City

WRFS—May 31, 1947: 1050 khz; 1 kw-D. 138 Main St. (35010). (205) ADams 4-2566. Piedmont Service Corp.

WRFS-FM—Sept 30, 1949: 106.1 mhz; 4.6 kw. Ant 240 ft. Dups AM.

Aliceville

WAQT(FM)—See Carrollton.

Andalusia

WAOA—September 1966: 1530 khz; 1 kw-D. Box 987 (36420). (205)222-1166. Companion Broadcasting Service Inc. Format: C&W. Spec progs: Black, 1 hr weekly. ■ Jim Williams, pres & gen mgr; Bill Smith, coml mgr; Charles Grantham, prog. mus and news dir; Dan Pope, chief engr; Betty Williams, women's dir.

WCTA—Aug 12, 1946: 920 khz; 5 kw-D, 500 w-N, DA-N. Box 8 (36420). (205)222-1144. Andalusia Bcstg Co. Net: ABC/C. Audio news: AF Spec prog: Farm, 2 hrs. wkly Format: C&W. ■ J. Dige Bishop, pres, gen mgr & chief engr; Bob Morris, coml mgr; Gene Cooper, news dir.

WCTA-FM—July 7, 1950: 98.1 mhz; 26 kw. Ant 215 ft. Stereo. Dups AM 100%.

Anniston

WANA—August 1954: 1490 khz; 1 kw-D, 250 w-N, Box 609 (36201). (205) ADams 7-1627. Anniston Radio Co. Rep: Media South Sales. Format: C&W. ■ Cary Lee Graham, pres; Joe Burney, gen & coml mgr, prog dir, chief engr. ■ Rates: \$4.25;4.25;4.25;4.25.

WDNG—July 1, 1957: 1450 khz; 1 kw-D, 250 w-N, Box 1450 (36201). (205) 236-8291. Potts Bcstg Co. (acq 7-27-59). Rep: PRO Times Sls; Busby, Finch & Woods. ■ Thomas S. Potts, pres & gen mgr; Robt. M. Price Jr., asst mgr; Bill Gliddens, opns dir; Jim Knight, prog dir; Art Vuley, news dir; Robert Crandall, chief engr.

WHMA—1938: 1390 khz; 5 kw-D, 1 kw-N, DA-N, 1330 Noble St. (36201). (205)236-7545. Anniston Bcstg. Co. Net: ABC/I. Rep: Devney; Carpenter. Format: Contemp. ■ Malcolm B. Street, pres & gen mgr; Ted Allen, coml mgr; Rex Gardner, prog dir; George Salmon, news dir; Robert Street, mus dir; James A. Hudson, chief engr. WHMA-TV affil. ■ Rates: \$7.12;6.28;7.12;6.48.

WHMA-FM—1947: 100.5 mhz; 25.5 kw. Ant. 800 ft. Prog sep from AM. Stereo. Net: ABC/FM. Rep: Devney. Format: Good mus. ■ Ed Rayfield, gen & coml mgr; Mary Jean Sirkorski, prog dir. ■ Rates: \$3;3;3.

Arab

WRAB—Oct 25, 1961: 1380 khz; 1 kw-D. Drawer D (35016). (205)586-3139. Marshall County Bcstg Inc. Group Owner: Fall. Rep: Busby, Finch & Woods. Spec progs: C&W 40 hrs. wkly. ■ J.B. Fall Jr., pres; Brian Roberts, gen mgr; Walter B. Leonard, chief engr.

Athens

WJMW—Nov 8, 1948: 730 khz; 1 kw-D. Box 386 (35611). (205)232-3911. Athens Bcstg Co. Rep: Carpenter. Format: C&W. Spec progs: Gospel 7 hrs wkly. ■ H.F. Dunnivant, pres & gen mgr; Mrs. W. Clinton Brown, coml mgr; Robert V. Dunnivant, prog & news dir; William G. Mitchell, chief engr.

WJOF(FM)—Co-owned with WJMW. Oct 1, 1958: 104.3 mhz; 50 kw. Ant 245 ft. Prog sep from AM. Format: Golden melodies. ■ Robert V. Dunnivant, dir of opns.

WKAC—September 1964: 1080 khz; 5 kw-D (1 kw-CH). Box 847 (35611). (205)232-6827. Limestone Bcstg Co. Net: Tobacco Radio. Format: Contemp, MOR. ■ Kenneth A. Casey, pres & chief engr; Ron Mathis, gen & coml mgr; Kenneth Casey, prom mgr; Lou Horton, prog & mus dir; Don Kembrough, news dir.

Atmore

WATM—Dec 17, 1949: 1590 khz; 5 kw-D. Box 7 (36502). (205) 368-2128. Southland Bcstg Co. (acq 12-1-51). Format: Block. ■ Tom C. Miniard, gen mgr and chief engr; Julia Miniard, coml mgr and prog dir; Donald Miniard, mus & news dir, prom mgr.

WATM-FM—May 19, 1966: 104.1 mhz; 29 kw. Ant 195 ft. Dups AM 10%. Format: Big band.

Auburn

WAOA—See Opelika, Ala.

WAUD

David Carpenter
& Fred W. Smith

WAUD—Dec 22, 1947: 1230 khz; 1 kw-D, 250 w-N, Box 391 (36830). (205) 887-3401. Auburn Bcstg Co. Net: ABC/I. Rep: Smith, Carpenter. Format: Variety. ■ Elmer G. Salter, pres, gen & coml mgr; Betsy McLure, mus dir; Bill Cameron, prom mgr; Bob Sanders, prog dir; Don Phelps, news dir; Terry Harper, chief engr. ■ Rates: \$4.25;4.25;4.25;4.25.

***WEGL(FM)**—April 25, 1971: 91.1 mhz; 10 w. Ant 138 ft. (CP 38 kw; ant 190 ft.) 1239 Haley Center (36830). (205) 826-5184. Board of Trustees, Auburn U. Format: prosv, diversified Spec progs: Classcl 6 3/4 hrs; Black 2 1/4 hrs; Jazz 13 3/4 hrs; C&W 2 hrs wkly. ■ Ned Browning, gen mgr.

WFRI(FM)—Co-owned with WAOA Opelika, Ala. July 8, 1968: 97.7 mhz; 3 kw, Ant 160 ft. Box 2329, Opelika, Ala. (36801). (202) 745-4657. Faulkner Radio Inc. (group owner). Format: Solid Gold. Prog sep from AM. Stereo. ■ James H. Faulkner Sr., pres; Glenn Buxton, gen mgr; Chris Hicks, coml mgr & mus dir; Gerry King, prog dir; Margie Pillatt, prom mgr; John McGibney,

Hogan - Feldmann, Inc.
MEDIA BROKERS • CONSULTANTS
16255 Ventura Boulevard, Suite 415
Encino, California 91436
AREA CODE 213 986-3201

news dir; Terry W. Harper, chief engr.

WJHO—See Opelika, Ala.

WJHO 14

Serving **AUBURN-OPELIKA, ALA.**

NO. 1 Since 1940

Bay Minette

WBCA—April 14, 1957: 1110 khz; 10 kw-D, DA-CH. Box 426 (36507). (205) 937-5596. Faulkner Radio Inc. (group owner: acq 12-58). Rep: Bernard. Format: C&W 100%. ■ James H. Faulkner Sr., pres; James B. Talley Jr., gen mgr; & prog dir; Mary Ann Smith, coml mgr; Tom Tyler mus dir; Steve Mitchell, news dir; Rod Thornton, chief engr.

WWSM(FM)—Co-owned with WBCA. Oct 1, 1964: 105.5 mhz; 2.3 kw. Ant 340 ft. Stereo. Prog sep from AM. Format: Soul. Spec progs: Gospel 8 hrs wkly. ■ James B. Talley Jr, coml mgr; Terry Leslie, mus dir; Sonny Love, news dir.

Bessamer

WYAM—June 1, 1960: 1450 khz; 1 kw-D, 250 w-N. Box 730 (35020). (205) 428-0146. Brandon-Robison Bcstg Corp. (acq 10-72). Net: MBS. Rep: Universal Bcstg. Format: C&W, religion. ■ Lawrence Brandon, pres; Anthony S. Brandon, gen mgr; Leland Childs, sls mgr; Don Lovett, mus dir; Joni Mueller, opns mgr; Ralph Parsons, chief engr.

Birmingham

WAPI—1922 1070 khz; 50 kw-D, 5 kw-N, DA-N. Box 10502 (35202). (205) 933-2720. TWX BH 160. Newhouse Bcstg Corp. (group owner). Net: NBC. Rep: Christal. ■ Donald D. Wear, VP & gen mgr; Jack Warren, coml mgr; James B. Chenoweth, prom mgr; Wendell Harris, news dir; Paul D. Gross, chief engr.

WAPI-FM—1947: 94.5 khz, 100 kw. Ant 980 ft. Stereo. ■ WAPI-TV affil.

WATV—May 20, 1946: 900 khz; 1 kw-D. Cabana Motel (35203) (205) 324-2541. Crescendo Bcstg. (acq 1-8-72). Net: CBS. Rep: Walter. Format: News. ■ Tom Whitley, VP & gen mgr; Davenport Smith, sls mgr.

***WBHM(FM)**—Not on air, target date unknown: 90.3 mhz; 25 kw. Ant 740 ft. University Station (35294). The Board of Trustees of the University of Alabama. ■ Dr. John B. Dunbar, VP for administration.

WBUL—Aug 1, 1972: 1220 khz; 1 kw-D. Box 3800-E (35208). (205) 786-4303. Radio Bcstg Co. of Birmingham Inc. Rep: Selcom. Format: Black. ■ Hal Hodgens, pres & gen mgr; Clinton Harris, coml mgr, mus dir; Bill Coleman, prog dir; Victor Boykin, news dir; Jimmy Jones, chief engr. ■ Rates: \$9;8;9;8.

WCRT—March 25, 1953: 1260 khz; 5 kw-D. Box 1922 (35201). (205) 251-5117. Magic City Communications Corp. (acq 5-73). Net: MBS. Audio news: Ala News. Rep: Blair. Format: Oldies, btlf mus. ■ Hal Fredericks, pres; Jack Bivans, VP & gen mgr; Dale McWhorter, gen sls mgr; Jan Jeffries, prog & mus dir; Gene Meyle, prom mgr; Bill Cairns, chief engr. ■ Rates: \$17;11;17;11.

WQEZ(FM)—Co-owned with WCRT. June 1, 1961: 96.5 mhz; 50 kw-U. Ant 760 ft. Stereo. (CP Ant 860 ft). Prog sep from AM. Format: Btlf mus.

WDJC(FM)—May 11, 1958: 93.7 mhz; 90 kw horiz, 30 kw vert. Ant 540 ft. Box 58021 (35209). (205) 879-3324. WDJC Radio Co. (acq 1967). Group owner: Crawford. Format: Relig/news/talk. Rep: Bunchez. ■ Donald B. Crawford, pres; Larry Adcock, gen mgr; Mike Moody, prog dir; Benton White, mus & news dir; Les Kline, sls mgr; Jimmy Long, chief engr.

WENN—1950: 1320 khz; 5 kw-D, DA. Box 1874 (35201). (205) 324-1026. Frank S. Blackford, Receiver. Rep: Howard. Format: Black 100%. ■ Joseph M. Lackey, gen mgr; E. R. Faush, prog dir; Carl Martens, chief engr.

WENN-FM—Sept 15, 1969: 107.7 mhz; 58 kw. Ant 600 ft. (CP 69 kw. Ant 660 ft.) Dups AM.

WERC—May 25, 1925: 960 khz; 5 kw. DA-N. Box 10904 (35202). (205) 252-3171. Mooney Bcstg Corp. (group owner; acq 1-72). Net: ABC/E. Rep: McGavren-Guild. Format: Contemp. ■ George P. Mooney, pres; John A. Bomer, gen mgr; Tom Hopson, coml mgr; Frank Lewis, prog dir; Michael St. John, mus dir; John Strickling, news dir; Dave Hultsman, chief engr.

WERC-FM—June 1959: 106.9 mhz; 2.5 kw. Ant. 110 ft. Stereo. (CP: 100 kw; Ant 970 ft.) Dups AM 50%. Format: Rock.

WJLD—1942: 1400 khz; 1 kw-D, 250 w-N. Box 58065 (35209). (205) 324-3468. Johnson Bcstg Co. Net: ABC/C. Rep: GCI; Ochs. Format: Black. ■ Rose Hood Johnson, pres; George Johnston III, gen mgr; Dave Davis, coml mgr; Ron Allen, prog dir; Willie McKinstry, news dir; Chester Alexander, chief engr.

WZZK(FM)—Co-owned with WJLD. 1948: 104.7 mhz; 100 kw. Ant 640 ft. Dups AM 14%. Net: ABC/FM. Rep: H/R Stone. Format: C&W ■ Dave Davis, coml mgr, prog and mus dir.

WLPH—See Irondale, Ala.

WQEZ(FM)—Listing follows WCRT.

WSGN—Feb 3, 1926: 610 khz; 5 kw-D, 1 kw-N. DA-N. Penthouse City Federal Bldg. (35203). (205) 322-3434. Southern Bcstg Co. (group owner; acq 12-55). Rep: Eastman. Format: Contemp. Spec progs: Relig 4 hrs, Pub affrs 5½ hrs, both weekly. ■ John G. Johnson, pres; Ben K. McKinnon, VP & gen mgr; Warren Merrin, sis mgr; Bob Burton, prog dir; Penny Johnson, mktg mgr; Chris Love, mus dir; Pete Taylor, news dir.

WVOK—Oct 15, 1947: 690 khz; 50 kw-D. Box 1926 (35201). (205) 785-5111. Voice of Dixie Inc. Net: ABC/E. Rep: Buckley Radio. Format: Contemp. ■ Mrs. Iratee W. Bennis, pres and gen mgr; Dan M. Brennan, coml and opns mgr, mus, prog and news dir; Don Keith, news dir; David Hunter, chief engr. ■ Rates: \$26; 24; 26;—.

WVOK-FM—Not on air, target date March 1976. 99.5 mhz, 100 kw. Ant 852 ft. Box 2468 (35201).

***WVSU-FM**—April 6, 1967: 91.1 mhz; 10 w. Samford University, 800 Lakeshore Drive (35209). (205) 870-2934. Samford University. Format: non coml diversified. ■ Dr. Leslie S. Wright, pres (Samford University); Ronald P. Stroop stn mgr.

WYAM—See Bessemer, Ala.

WYDE—April 1, 1953: 850 khz; 50 kw-D, 1 kw-N. DA-2. Suite 410, 2112 11th Ave. South (32505). (205) 322-4511. Screen Gems Radio Stations Inc. (acq 9-72). Group owner: Columbia Pictures Industries. Net: ABC/E. Rep: Katz. Format: C&W. ■ Emil Mogul, exec VP; Wynn Alby asst; Larry V. Davidson, gen mgr; Johnny Gray, prog dir; Robert Harper, news dir; James E. Gray, chief engr.

WZZK(FM)—Listing follows WJLN.

Boaz

WBSA—Oct. 1, 1959: 1300 khz; 1 kw-D. Box 597 (35957). (205) 593-4264. Radio Send Mountain Inc. ■ Glen M. Cornelius, pres & gen mgr.

Brewton

WEBJ—Aug 1, 1947: 1240 khz; 1 kw-D, 250 w-N(SH). Box 736 (36426). (205) 867-5717. Brewton Bcstg Co. (acq 1-7-59). Format: Contemp/oldies. M.O. Spec progs: C&W 12 hrs; farm 2 hrs wkly. ■ J.W. Gardner, pres, gen mgr, chief engr; Gene Cashman, station, prom mgr & news dir; Sonny Laeson, mus dir; Rachel Brooks, prog dir. ■ Rates: \$2.30; 2.30; 2.30; 2.30.

WKNU(FM)—August 19, 1974: 106.3 mhz; 3 kw. Ant. 300 ft. Box 1001 (36426). (205) 867-4824. John E. Shipp, Jr. Format: C&W/Rock/Top 40. Spec prog: Relig 8 hrs wkly. ■ John E. Shipp Jr., gen mgr & chief engr; Francis B. Shipp, coml & prom mgr & prog dir; Rollin C. Reetz, mus dir; J. Mark Bolton, news dir.

Bridgeport

WBTS—Sept 19, 1961: 1480 khz; 1 kw-D. Box U (35740). Bridgeport Bcstg Co. Rep: Beaver. Format: C&W/Gosp. ■ Roy C. McCloud, gen mgr & chief engr; Mrs. Roy C. McCloud, stn mgr; James D. Lambert, Sr., prog dir; Dale McCloud, asst stn mgr, news dir; Roy C. McCloud, chief engr. ■ Rates: \$1.75; 1.75; 1.75;—.

Butler

WPRN—July 1, 1959: 1240 khz; 1 kw-D, 250 w-N. Box 566 (36904). (205) 459-3222. Butler Bcstg Co (acq 1/75). Net: ABC. Rep: Beaver. Format: C&W, Variety. ■ Julian A. Watters III; Debra W. Jackson, co-owner; Darryl Jackson, gen mgr; Patsy Lindsey, coml mgr; Pete Wallace, prog dir; George Vice, prom mgr; Henry Tyson, chief engr. ■ Rates: \$2.75; 2.75; 2.75; 2.50.

Calera

WBYE—Jan 12, 1958: 1370 khz; 1 kw-D. Box E (35040). (205) 668-0872. Shelby County Advertising Corp. (acq 1-16-59). Net: MBS. ■ Ralph W. Sears, pres; Marion P. Jones, gen mgr & chief engr; Mrs. Stella Jones, prog dir; Marcia M. Sears, VP & prom mgr.

Camden

WCOX—Dec 11, 1968: 1540 khz; 1 kw-D. Box 620 (36726). (205) 682-4677. Black Belt Bcstg Co. Rep: Keystone; C. K. Beaver. Format: Diversified. Spec prog: Farm 1¼ hrs; Black 16 hrs; C&W 10 hrs, all weekly. ■ Virgil Moore, pres, gen mgr & chief engr; James Kelley, coml mgr; John Fendley, mus dir; Robbie Moore; prog dir; Allen F. Hurt news dir. ■ Rates: \$2.20; 2.20; 2.20; 2.20.

Carrollton

WAQT(FM)—Listing follows WRAG.

WRAG—1951: 590 khz, 1 kw-D. Box 71 (35447). (205) 367-8136. Pickens County Bcstg Co. Group owner: Hook Stations. ■ R.E. Hook, pres; ■ Rates: \$2.25; 2.25; 2.25; 2.25.

WAQT(FM)—Co-owned with WRAG. February 1970: 94.1 mhz; 30 kw. Ant 505 ft. Stereo. Sep from AM. ■ Rates same as AM.

Centre

WAGC—Nov 9, 1962: 1560 khz; 1 kw-D. Box O (35960). (205) 927-5353. Radio Centre Inc. Format: C&W. ■ F.H. Boney, pres; Ralph A. Meade, gen & coml mgr; Martha Rogers, prog dir; Kerry Rich, prom mgr & news dir; Roland Wall, chief engr.

WEIS—Sept 30, 1961: 990 khz, 250 w-D. Box 297 (35960). (205) 927-5152. Cherokee County Bcstg Co. Inc. (acq 2-24-72). Net: Alabama Community. Rep: KBS, Beaver. Format: C&W; Top 40. Spec progs: Farm, 4 hrs wkly. ■ James M. Davis, pres; Jim Davis, gen and coml mgr and news dir; Marie Owens, prog dir; Neil Davis, mus dir. ■ Rates: \$2.50; 2.50; 2.50; 2.50.

Centreville

WBIB—Dec 14, 1964: 1110 khz; 1 kw-D. Box 217 (35042). (205) 926-5691. WBIB Radio Inc. (acq 12-1-69). Group owner: Talton Bcstg Co. Net: ABC/C. Format: C&W, Gosp. ■ Julius E. Talton, pres & gen mgr; Sammy George, stn mgr; Fred Chesser Jr., mus dir; Nancy Lightsey, traf dir; John Sides, opns mgr.

Clanton

WEZZ(FM)—See listing following WKLF.

WKLF—Nov 2, 1947: 980 khz; 1 kw-D. Box 110 (35045). (205) 926-0980. Southeastern Bcstg Co. (acq 5-15-61). Net: Ala Radio. Rep: Keystone; Beaver. Format: C&W/Gosp. Spec progs: Black 4 hrs wkly. ■ James H. Dennis, pres & gen mgr; Mary C. Culp, coml mgr; Al Headley, prog dir; Morgan Reynolds II, prom mgr; Craig Rogers, mus dir; Bruce Mims, news dir; Morgan (Skip) Reynolds II, chief engr. ■ Rates: \$43.20; 43.20; 43.20; 43.20.

WEZZ(FM)—Co-owned with WKLF. May 15, 1953: 97.7 mhz; 3 kw. Ant 245 ft. (205) 755-0966. Dups AM 17%. Format: oldies. Spec prog: Black 6 hrs; C&W 18 hrs, both weekly. ■ Rates same as AM.

Cullman

WFMH—March 25, 1950: 1460 khz; 5 kw-D, 500-N, DA-N. Box 265 (35055). (205) 734-3271. TWX 205-734-7296. Voice of Cullman.

WFMH-FM—Aug 6, 1949: 101.1 mhz; 87 kw. Ant 330 ft. Dups AM.

WKLN(FM)—September 1967: 92.1 mhz; 3 kw. Ant 155 ft. Box 61, 214 First Ave. E. (35055). (205) 734-0183. Kenneth E. Lawrence. Rep: McGinley. Format:

Alabama Radio

See page C-1 for explanation of listings.

Good mus. ■ Kenneth E. Lawrence, pres & gen mgr.

WKUL—October 1946: 1340 khz; 1 kw-D, 250 w-N. Drawer 968 (35055). (205) 734-3171. Cullman Bcstg Inc. (acq 3-4-9). Rep: Admiral. Format: Contemp; Top 40. ■ Jerdan Bullard, pres, gen & coml mgr; Neil Jeffries, prog dir; Arthur Bachmann, chief engr; Melvin Smith, asst mgr.

Decatur

WAJF—Oct 3, 1953: 1490 khz; 1 kw-D, 250 w-N. Box 1009 (35601). (205) 353-9230. Falt Bcstg Co. Group owner: Falt. Net: CBS. Rep: Meeker; Busby, Finch Latham & Woods. Format: Top 40. Spec prog: Farm 1 hr wkly; Black 2 hrs wkly. ■ J.B. Falt Jr., pres; Bob Gord, gen mgr; Greg Stevens, coml, prom mgr; Mark Morehouse, mus dir; Winford Turner, news dir; Gary Wright, chief engr. ■ Rates: \$3.80; 3.40; 3.80; 2.20.

***WBQM(FM)**—May 7, 1975: 91.7 mhz; 3 kw. Ant 300 ft. Stereo. 1312 Riverview Ave, SE. (35601). (205) 353-1795. Grace Baptist Schools Inc. Audio news: AP. Format: Religious. ■ L.C. Klopfenstein, gen mgr; William E. Chapple III, chief engr.

WDRM(FM)—See listing following WHOS.

WHOS

Modern Country Music

WHOS—October 1948: 800 khz; 1 kw-D. 406 Bank St. Box 789 (35601). (205) 353-1810. Dixie Bcstg Inc. (acq 4-16-70). Net: ABC/E. Rep: Devney; Crane. Format: C&W 100%. ■ John H. Jones, pres; Louis C. Blizzard, VP, gen & coml mgr; Doug Faulk, prog dir & prom mgr; Chris Bell, news dir; Mack Bramblet, chief engr.

WDRM



WDRM(FM)—Co-owned with WHOS. September 1951: 102.1 mhz; 100 kw. Ant 165 ft. Stereo. (205) 353-1750. Net: ABC/FM. Prog sep from AM. Format: Contemp. ■ Doug Falk, prog dir.

WMSL—May 1935: 1400 khz; 1 kw-D, 250 w-N. Box 248 (35601). (205) 353-0361. New Decatur Radio Inc. (acq 9-30-1971). Group: Slatton Quick Sis. Net: MBS, Ala. Radio. Rep: PRO Meeker, Southern Spot Sis. Format: Contemp, Top 40. ■ C.H. Quick, pres & gen mgr; Ron Walker, coml mgr; Steve Mooney, prog & prom dir; Ken Casey, chief engr; J. Michael Pruet, mus dir; Chris Bell, news dir.

WNAN(FM)—See listing following WXAL.

WRSA(FM)—Nov 23, 1965: 96.9 mhz; 25 kw (CP 50 kw). Ant 830 ft. Box 1222 (35601). (205) 498-2634. Paul R. Nielsen. Format: MOR. Stereo. ■ Paul R. Nielsen, pres & gen mgr; Joe Hill, prog dir; Mack Bramlett, chief engr.

Demopolis

WXAL—Nov 9, 1947: 1400 khz; 1 kw-D, 250 w-N. Box X (36732). (205) 289-1400. Demopolis Bcstg Co. Net: MBS. Rep: Beavers. Format: Black MOR. Spec progs: Farm 6 hrs wkly. ■ William M. Jordan, pres & gen mgr; Jody Ferris, coml mgr; Grover C. Huckabee, III, stn mgr, chief engr; Roy Eisinger, mus dir. ■ Rates: \$3; 3; 3; 3.

WNAN(FM)—Co-owned with WXAL. 1975: 106.3 mhz; 3 kw. Ant 200 ft. (205) 289-2156. Format: Btlf mus. ■ Nan Jordan, gen mgr; Chuck Bethea, coml mgr. ■ Rates same as AM.

Dothan

WAGF—Sept 29, 1932: 1320 khz; 1 kw-U, DA-N. Drawer 639 (36302). (205) 792-1101. Dothan Bcstg Co. Rep: Walton. ■ Julian C. Smith, co-owner, gen mgr & chief engr; Fred C. Moseley, co-owner & coml mgr; Marvin Edwards, prog dir; Lamar Trammell, news dir.

WDIG—April 30, 1947: 1450 khz; 1 kw-D, 250 w-N.

Alabama Radio

See page C-1 for explanation of listings.

Box 1828 (36301). (205) 792-2161. WDIG Inc. (acq 2-1-70). Net: ABC/C. Rep: Bernard Ochs. Format: Contemp, black. ■ Margaret L. Wein, pres; Edward Wein, VP, gen mgr; Tony Scott, prog dir; Robert Price, news dir; Tom Kingsley, chief engr. ■ Rates: \$6.20;4.96;6.20;4.96.

WOOF—Feb 17, 1947: 560 khz; 5 kw-D. Box 1427 (36301). (205) 792-1149. WOOF Inc. (acq 1953). Net: MBS. Rep: Avery-Knodel. Format: MOR. ■ Mrs. Agnes W. Simpson, pres & gen mgr; Max McGowan, sec-treas, coml mgr; Rick Brown, prog & news dir; Sara McGowan, mgr; Art Mitchell, mus dir; Sammy Faulk, prom mgr; Oscar Lemmon, chief engr. ■ Rates: \$9.9;9.9.

WOOF-FM—Sept 18, 1964: 99.7 mhz; 100 kw, horiz; 97 kw vert. Ant 340 ft. Stereo. Prog sep from AM. Format: Btlf mus. ■ Dan Deason, mus dir; Dennis Lathen, news dir; Steve McGowan, prog dir. ■ Rates: \$6;6;6.

WTYY-FM—Sept 20, 1968: 95.5 mhz; 100 kw. Ant 1060 ft. Box 1089 (36301). (205) 792-0048. TWX 205-620-2447. WTYY Inc. Format: MOR. ■ F.E. Busby, pres & gen mgr; Eldon A. Klupal, asst mgr; Larry H. Williams, coml & prom mgr; Rex Roach Jr., news dir; Ellis N. Anderson, chief engr.

Elba

WELB—Nov 16, 1958: 1350 khz; 1 kw-D. Box 467 (36323). (205) 347-897-2216. Elda Radio Co. (acq 7-1-69). Format: C&W 100%. ■ William D. Holderfield, gen & coml mgr; Jim Brackin, prog & news dir; Michael Holderfield, prom mgr; Marvin Jones, chief engr.

Enterprise

WIRB—1948: 600 khz; 1 kw-D. Box 1136 (36330). (205) 347-8600. Wiregrass Bcstg Co. Format: C&W. ■ R.E. James, owner & gen mgr; Howard Quattlebaum, coml mgr; Ray Estes, prog dir; H. T. Rawlinson, chief engr.

WIRB-FM—July 1, 1968: 96.9 mhz; 100 kw. Ant 295 ft. Stereo. Prog sep from AM. Format: Contemp & Rock. ■ Larry Bishop, prog mgr.

WKMX(FM)—Nov 27, 1974: 106.7 mhz; 100 kw. Ant 432 ft. Stereo. Box 840 (36330). (205) 347-2278. Jones Wallace Miller. Audio news: APR. Format: MOR. ■ Wallace Miller, pres, gen mgr; Jimmy Stanley, coml mgr; David Swaim, prog & mus dir; Larry Wilkins, news dir; opns mgr & chief engr. ■ Rates: \$3.85;3.20;3.85;3.20.

Eufaula

WULA—1948: 1240 khz; 1 kw-D, 250 w-N. Box 531 (36027). (205) 687-2006. Vogel-Miligian Corp. (acq 10-1-70). Group owner: Vogel Communications. Net: MBS. Format: C&W, Top 40. ■ William R. Vogel, pres; Robert A. Ellington, gen & coml mgr; Don Jones, prog & mus dir; Steve Vann, news dir; Tom Fortune, chief engr.

WULA-FM—92.7 mhz; 3 kw. Ant 79 ft. Dups AM 100%.

Evergreen

WBLO—July 1, 1957: 1470 khz; 1 kw-D. Box 350 (36401). (205) 478-2780. Vogel-Moody Corp. Group owner: Vogel Communications.

Fairhope

WABF—Aug 12, 1961: 1220 khz; 1 kw-D, DA. Box AS (36532). (205) 928-2384. Eastern Shore Bcstrs Inc. Net: MBS. Format: MOR. Spec progs: Talk 10 hrs weekly. ■ J. Russell Kilgore Sr., pres, gen mgr & news dir; David Davis, coml mgr; Ned Perne, prog dir; Bettie Charles, prom mgr & mus dir; David Camp, chief engr. ■ Rates: \$4; 3.25; 4; —.

WGOK-FM—Co-owned with WGOK Mobile. August 28, 1966: 92.1 mhz; 3 kw. Ant 300 ft. W.G.O.K. Inc. (acq 12-73). ■ Rates: \$10.90;10.90;10.90;10.90.

Fayette

WVEL-FM—1975: 98.1 mhz; 50 kw. Ant 360 ft. Jesse Willard Shirley.

WWWF—Sept 3, 1949: 990 khz; 1 kw-D. Box 189 (35555). (205) 932-3311. Bankhead Bcstg Fayette Inc. Format: C&W/Rock/Talk. ■ Marion B. Grant, pres; Jack Black, gen mgr; Eddy Campbell, coml mgr; Eloise Thomley, prog dir.

Floamat

WTCB—December 1955: 990 khz; 500 w-D. Box 490 (36641). (205) 296-5366. Vogel Floamat Corp. (acq 12-73). Group owner: Vogel Communications. Format: C&W/Rock. ■ John R. Johnson, gen mgr; Earnie White, asst. mgr; Charles Johns, chief engr.

Florence

WOWL—1945: 1240 khz; 1 kw-D, 250 w-N. Box 756 (35630). (205) 764-8170. Hammell Bcstg Inc. (acq 1-1-73). Net: ABC/C. Rep: Savalli-Gates. Format: Rock. ■ Richard N. Hammell, pres; Mitch Faulkner, VP & gen mgr; Rick Shayne, prog dir; Carol Staggs, news dir; Paul Kelley, chief engr.

WXOR—March 29, 1946: 1340 khz; 1 kw-D, 250 w-N. Box B (35630). (205) 764-8121. JOI Radio Inc. & Big River Bcstg (acq 2-21-73). Net: MBS. Rep: Carpenter; Dora-Clayton. ■ Sam C. Phillips, pres.

WQLT(FM)—Co-owned with WXOR. May 29, 1967: 107.3 mhz; 25 kw. Ant 170 ft. Prog sep from AM.

Foley

WHEP—May 31, 1953: 1310 khz; 1 kw-D. Box F (36535). (205) 943-7131. Stewart Bcstg Co. (acq 5-1-61). Net: MBS. Format: MOR. Spec progs: Sp 7 hrs; Czech ½ hr, both wkly. ■ James E. Stewart, owner & gen mgr; Bette Baldwin, women's dir; Robert Kruger, chief engr. ■ Rates: \$3.60;3.60;3.60;—.

Fort Payne

WFPA—December 1949: 1400 khz; 1 kw-D, 250 w-N. Box 155 (35967). (205) 845-2620. WFPA Inc. (acq 9-24-62). Net: ABC/C. Rep: Carpenter. Format: Contemp rock. ■ Robert H. Johnson, pres & gen mgr; Dave Williams, coml, prom mgr & news dir; Roy McBryar, mus dir; F.L. Pierce, chief engr.

WZOB—July 2, 1950: 1250 khz; 1 kw-D. Box 148 (35967). (205) 845-2810. Central Bcstg Co. (acq 12-1-70). Rep: Dora-Clayton. Format: C&W. Spec prog: Gospel 2½ hrs wkly. ■ C. Theodore Kirby, pres; Terry D. Patty, gen mgr; Roland Wallis, coml mgr & chief engr; Glenn Shankles, mus dir.

Gadsden

WAAX Modern Country Music

WAAX—1947: 570 khz; 5 kw-D, 500 w-N, DA-N. Box 570 (35901). (205) 543-9229. Etowah Bcstrs Inc. (acq 10-18-55). Group owner: Southmedia Stns. Net: ABC/E. Rep: PRO-Meeker, Busby, Finch, Lathom & Widman, Format: C&W. ■ Michael H. McDougald, pres & gen mgr; Ron Livengood, station mgr; Mrs. Sybil Kirby, prom mgr; Dave Fitz, news dir; Jim Stevens, mus & prog dir; Palmer Boland, chief engr. ■ Rates: \$9.50;8.75;9.50;8.05.

WQEN

Beautiful Music

WQEN(FM)—Co-owned with WAAX. Oct 7, 1966: 103.7 mhz; 100 kw. Ant 1110 ft. (205) 543-9564. (acq 10-10-74). Prog sep from AM. Format: Beautfl mus. ■ Rates: \$7.50;9.25;9.25;5.75.

***WEXP(FM)**—Feb 11, 1975: 91.5 mhz; 3.5 kw. Ant 75 ft. 100 Wallace Dr. (35903). (205) 546-0484, ext 224. Gadsden State Junior College. Format: MOR, educ. Spec progs: Classical, Black, both 12 hrs wkly. ■ Donald R. Smith, gen mgr.

WGAD

Contemporary Popular Music

WGAD—May 26, 1947: 1350 khz; 5 kw-D, 1 kw-N, DA-N. Box 770(35901). (205) 546-1611. Coosa Bcstg Co. (acq 9-10-57). Group owner: Rains-Carrel-Jackson Stns. Rep: Messina. Dora-Clayton. Format:

Contemp. ■ Ed Z. Carrell, pres, gen mgr & coml mgr; Ron Burton, prog & mus dir & prom mgr; Jim Green, news dir; Troy Pennington, chief engr. ■ Rates: \$8.10; 7.50; 8.10; 7.50.

WJBY—Nov 13, 1963: 930 khz; 1 kw-D. Box 1370 (35902). (205) 546-9201. Boman Bcstg Inc. Net: MBS. Rep: Keystone. Format: MOR. Spec progs: Black 1.5 hr wkly. ■ Charles Boman, pres, gen & coml mgr; Al Bailey, opns mgr, prog & mus dir; Jeffie Mielke, women's prog mgr; Calvin Williamson, chief engr.

WQEN(FM)—See listing following WAAX.

Geneva

WGEA—March 17, 1953: 1150 khz; 1 kw-D. Box 337 (36340). (205) 684-2271. Geneva County Bcstg Inc. (acq 12-20-62). Net: Keystone, Tobacco Radio. Format: C&W. ■ Olin Johnson, pres; James C. Helms, gen mgr; Joan S. Helms, coml mgr; Cullen Whisnant, chief engr.

WGEA-FM—Sept 12, 1969: 93.5 mhz; 3 kw. Ant 200 ft. Dups AM 25%.

Greenville

WGYV—Aug 18, 1948: 1380 khz; 1 kw-D. Box 585. (36037). (205) 382-5444. Greenville Bcstg Corp. Format: Contemp/C&W/Variety. ■ W.H. Miller, gen mgr. ■ Rates: \$2.25;2.25;2.25.—.

Guntersville

WGSV—April 16, 1950: 1270 khz; 1 kw-D. Box 220 (35976). (205) 582-8131. Guntersville Bcstg Co. Group owner: Rains-Carrell-Jackson Stns. Net: ABC. ■ Lavell Jackson, pres & gen mgr; Bill Yancy, sports dir; Kerry Jackson, mus dir. ■ Rates: \$3.55;3.55;3.55;3.55.

WTWX(FM)—Co-owned with WGSV. Aug 1, 1969: 95.9 mhz; 3 kw. Ant 300 ft. ■ Rates: \$3.70;3.70;3.70;3.70.

Haleyville

WJBB—April 1, 1949: 1230 khz; 1 kw-D, 250 w-N. Drawer 370 (35565). (205) 486-2277. Haleyville Bcstg Co. Inc. (acq 1951). Net: MBS. Rep: Southern Spot Sales. Format: Contemp; C&W. ■ John L. Slatton, pres & gen mgr; J. Otis Williams, coml mgr; Mrs. Pat Slatton, prog dir; Jim Mayhall, mus dir; Judy Fulford, prom mgr & news dir; James Suttles, chief engr. ■ Rates: \$3; 3; 3;—.

Hamilton

WERH—Aug 22, 1975: 970 khz; 5 kw-D. Box 187 (35570). (205) 921-3481. Kate F. File (acq 4-1-58). Net: Keystone. ■ Kate F. File, owner; James B. Fowler, gen mgr; Kermit Minga, coml mgr; Edgar Clayton, chief engr.

WERH-FM—April 1968: 92.1 mhz; 3 kw. Ant 120 ft. Prog sep from AM.

Hartselle

WHRT—Oct 1, 1956: 860 khz; 250 w-D. (35640). (205) 773-2558. Dorsey Eugene Newman. Net: CBS. ■ Gene Newman, pres & gen mgr; George Schmidt, prog & news dir; Robert Cameron, chief engr.

Homewood

WJLD—Licensed to Homewood. See Birmingham.

Huntsville

WAAY—June 1948: 1550 khz; 5 kw-D, 500 w-N, DA-N. Box 2041 (35804). (205) 534-8471. Smith Bcstg Inc. (acq 6-58). Format: Top 40. ■ M. D. Smith III, pres; Wayne B. Johnson, gen mgr. Stew Robb, prog dir. ■ WAAY-TV affil. ■ Rates: \$10;9.05;10;8.25.

WAHR(FM)—July 28, 1959: 99.1 mhz; 3.2 kw. Ant 45 ft. Stereo. Top of the Times Bldg. (35801). (205) 536-1568. WAHR Inc. (acq 8-24-62). ■ William R. Lane, VP & gen mgr.

WBHP—May 23, 1937: 1230 khz; 1 kw-D, 250 w-N. Box 547 (35804). (205) 534-3521. Radio WPHB Inc. Net: ABC/I. Rep: PRO Time Sales. Format: C&W. Spec progs: Ger 1 hr wkly. ■ W.H. Pollard Jr., gen mgr; Donna Haynes, coml mgr; Carl Swafford, prog dir; George Parker, mus dir; Billy Watts, news dir; Bill Wilkes, chief engr.

WEUP—March 20, 1958: 1600 khz; 5 kw-D. 2609 Jordan Lane, N.W. (35806). (205) 837-1600. Garrett Bcstg Serv. Format: Black. ■ Leroy Garrett, pres and gen mgr; Mildred T. Crutcher, coml mgr; Mrs. Viola Garrett, prog and mus dir; Bruce H. Garrett, prom mgr; Emanuel Garrett, news dir; Betye C. Jones, chief engr.

WFIX—November 1946: 1450 khz; 1 kw-D. 250 w-N. Box 7 (35804). (205) 534-5641. Huntsville Bcstg Inc. (acq 5-8-48). Group owner: Falt. Net: ABC/E. Rep: Meeker; Busby Finch & Woods. ■ J. B. Falt Jr, pres & gen mgr; Peter Barber, stn mgr; J. B. Falt III, natl & rgnl s/s mgr; Beri Moore, prog dir.

***WLRH(FM)**—Not on air, target date unknown: 89.3 khz; 100 kw. Ant 75.4 ft. Box 443 (35804). The Library Board, Huntsville Public Library.

WNDA(FM)—Oct 6, 1960: 95.1 mhz; 50 kw. Ant 310 ft. 2409-9th Ave., SW. (35805). (205) 534-2433. Wells Bcstg Co. (acq 5-1-70). Stereo. Format: Sacred music, sps, classc. ■ Frederic E. Wells, pres, gen & coml mgr; Mike Pawlowicz, prog & prom mgr; Jerome Hall, chief engr.

***WOCG(FM)**—Not on air, target date unknown: 90.1 khz; Ant 230 ft. Oakwood Rd., N.W. (35806). Oakwood College.

WRSa(FM)—See Decatur, Ala.

WVOV—Oct 1, 1968: 1000 khz; 10 kw-D, DA. Box 5188 (35805). (205) 859-2441. Powell Broadcasting Co. (acq 9-74). Net: ABC/C. Audio news: AP. Rep: Devney Organization; Dora-Clayton. Format: Contemp. ■ Edwin Powell, pres, gen mgr; John Garrison Jr, s/s mgr & chief engr; Ken Maynor, prog dir.

Irondale

WLPH—Dec 5, 1960: 1480 khz; 5 kw-D. Box 6787, Birmingham (35210). (205) 592-9697. Alabama Religious Bcstg Co. (acq 9-8-64). Format: Gospel. ■ Jim Lang, pres & gen mgr; Alice Barnes, prod dir; Bill Frink, coml & prom mgr; Don Johnson, news dir; Wade Guthrie, chief engr.

Jackson

WHOD—June 1, 1950: 1230 khz; 1 kw-D, 250w-N. Box 546 (36545). (205) 246-2413. Vogel-Ellington Corp. Group owner: Vogel Communications.

WHOD-FM—Aug 1, 1964: 104.9 mhz; 3 kw. Ant 297 ft.

Jacksonville

***WLJS-FM**—1975: 91.9 mhz; 10w. Ant 246 ft. Box 124 (36265). Bd of Trustees-Jacksonville State Univ.

Jasper

WARF—March 1, 1957: 1240 khz; 1 kw-D, 250 w-N. 400 3rd Ave. (35501). (205) 221-2222. Radio South Inc. (acq 6-1-65). Net: MBS. Rep: Beaver. Format: C&W. ■ Houston Pearce, pres; Sonny Posey, gen & coml mgr; Joe Cooke, prod dir.

WWWB—Nov 2, 1946: 1360 khz; 1 kw-D. W. 20th St. Box 622 (35501). (205) 384-3461. Tri W Bcstg Co. Net: Keystone. Rep: Carpenter. Format: MOR. ■ Walter W. Bankhead, chmn of bd; Marion B. Grant, pres & prog dir; William C. Edgemon, gen mgr; Leon Wilcutt, coml mgr; J. L. Sartian, Jr, mus dir; Fred Norris, news dir; James Daughdrill, chief engr.

WWWB-FM—March 28, 1962: 102.5 mhz; 27 kw. Ant 155 ft. (CP: 39 kw; Ant 140 ft). Dups AM 30%.

Lanett

WRLD—July 1943: 1490 khz; 1 kw-D, 250 w-N. Box 312, West Point, Ga. (31833). (205) 644-1179. Valley Bcstg Co. (acq 12-59). Net: ABC/C. Rep: Thompson. Format: Contemp. ■ E.L. Pearce Jr, pres & gen mgr; James E. Fincher, s/s mgr; Alieen Love, prog dir; Don Hinkle, news dir; FP Strother, chief engr. ■ Rates: \$3.50; 3.50; 3.50; 2.75.

Lineville

WANL—1967: 1540 khz; 1 kw-D. Box 143, Talladega, Ala. (35160). Clay County Bcstrs.

Livingston

WYLS—See York.

Luverne

WLVN—September 1970: 1080 khz; 500 w-D. Box 72 (36049). Joe R. Sport. Format: C&W.

Marion

WJAM—Dec 8, 1951: 1310 khz; 5 kw-D. Drawer 930 (36756). (205) 683-2071. Radio Marion Inc. (acq 7-8-64). Rep: Keystone. Format: Top 40, Black. Spec prog: Farm 14 wkly.

Mobile

WABB—November 1948: 1480 khz; 5 kw-U. Box 2148 (36601). (205) 432-5572. WABB Inc. (acq 9-14-59). Net: ABC/C. Rep: Eastman. Format: Top 40. ■ Bernard Dittman, pres, gen, prom & coml mgr; Gary Mitchell, prog dir; Mike Sloan, news dir; Jim Cassidy, mus dir; John D. Rabon, chief engr.

WABB-FM—Feb 5, 1973: 97.5 mhz; 100 kw. Ant 450 ft. Stereo. Dups AM 50%. Format: Contemp. Rock. ■ Lee Stamp, mus dir.

WBLX(FM)—See listing following WMOO.

WGOK—Nov 21, 1958: 900 khz; 1 kw-D, DA. 800 Gum St. Box 1425 (36601). (205) 432-8661. WGOK Inc. Net: Mutual black. Rep: Robert Dore. Format: Black. ■ Jules J. Paglin, pres; Gene Tibbett, exec gen mgr, s/s mgr; A. J. Crawford, prog dir; Jordan Ray, news dir; Sam Moore, mus dir; Elza McGadney, chief engr. ■ Rates: \$10.90; 10.90; 10.90; 10.90.

WGOK-FM—See Fairhope.

***WHIL-FM**—Aug 29, 1974: 91.3 mhz; 10 W. Ant 28 ft. 4307 Old Shell Rd. (36608). (205) 460-2395. Spring Hill College. Format: non coml diversified. Spec progs: Classical 20 hrs, Jazz 10 hrs. both wkly.

WKRG—1946: 710 khz; 1 kw-D, 500 w-N, DA-N. Box 2367 (36601). (205) 432-5501. TWX 810-741-4263. WKRG-TV Inc. (acq 1956). Net: CBS. Rep: Katz. Format: MOR. ■ Mrs. Kenneth R. Giddens, pres; Carl Haug, gen mgr; Jim Scott, prog dir; Curtis Willard, chief engr; Jim Sands, news dir.

WKRG-FM—Oct 16, 1947: 99.9 mhz; 96 kw. Ant 800 ft. Stereo. Prog sep from AM. Net: ABC/FM. Format: MOR. ■ Ken Holiday, prog dir; Jim Sandss news dir. ■ WKRG-TV affil.

WKSJ—See Prichard, Ala.

WKSJ-FM—Co-owned with WKSJ Prichard, Ala. April 12, 1971: 94.9 mhz; 100 kw. Ant 410 ft. Box 1444 (36601). Capitol Bcstg Corp. (acq 11-1-70). Dups AM 50%. Format: C&W. ■ Walter A. and Anna A. Duke, own.

WLIQ—Jan 25, 1961: 1360 khz; 5 kw-D, DA. Box 2723 (36601). (205) 476-1360. Southland of Alabama Inc. (acq 7-26-71). Net: ABC/I. Rep: Devney. Format: C&W. ■ Holton Turnbough, pres; Ed Jenkins, gen mgr & mus dir; Sonny Summers, prog dir; W. D. Folks, coml mgr; Robert Savell, chief engr.

WLPR(FM)—Dec 5, 1964: 96.1 mhz; 38 kw. Ant 420 ft. Box 1944 (36601). (205) 432-0401. Sound Bcstg Corp. (acq 3-74). Format: Btfl mus. Spec prog: Classc 3 hrs wkly. ■ Nicholas C. Panayiotou, gen mgr; Gary L. Kohler, coml mgr; Roger Dendinger, prog news dir; Lorraine Folger, prom mgr; Anne Mirabella, continuity dir; Steve S. Riggs, chief engr.

WMOB—Dec 7, 1947: 840 khz; 1 kw-D. 1020 First Federal Tower (36606). (205) 478-6345. Bay Bcstg Corp. (acq 7-29-75). Net: ABC/E. Rep: Bernard. Format: MOR, talk. ■ Wayne Martin, gen mgr; Max Wise, coml mgr; Ron Meyer, prog mgr; Jim Bailey, mus dir; Robert Savell, chief engr; Dick Darby, news dir.

WMOO—1964: 1550 khz; 50 kw-D, DA. Box 1967 (36601). (205) 432-0595. Trio Broadcasters Inc. (acq 12-17-69). Group owner: Beasley. Format: Gosp. ■ George Beasley, pres; Angie Hatcher, women's edit; Ricky Barnes, news dir; Wilber H. Goforth, gen mgr, prog dir; Phillip Waite, chief engr. ■ Rates: \$8.50; 8.50; 8.50; 8.50.

WBLX(FM)—Co-owned with WMOO. 92.9 mhz; 100 kw. Ant 470 ft. Stereo. (205) 432-7609. Net: National Black. Format: Black. ■ Larry Williams, gen mgr; Harry Palmer, chief engr. ■ Rates: \$14; 12; 10; 10.

WUNI—Feb 7, 1930: 1410 khz; 5 kw-U, DA-N. 1257 Springhill Ave. (36604). (205) 438-4514. WUNI Inc.

(acq 12-3-64). Net: NBC. Rep: H-R Stone. Format: C&W. ■ Peggy S. Gilbert, pres; Don (Rocky) Reich, VP & gen mgr; Mike Malone, prog dir & prom mgr; Les Coleman, news dir; James C. Burns, chief engr.

Monroeville

WMFC—April 1952: 1360 khz; 1 kw-D. Box 645 (36460). (205) 743-3281. Monroe Bcstg Co. Rep: Keystone. Net: ABC/C. ■ W.M. Stewart, pres; Harold Harris, stn mgr & chief engr; Wayne Caylor, coml mgr.

WMFC-FM—Nov 1965: 99.3 mhz; 3 kw. Ant 275 ft. Stereo. Prog sep from AM.

Montgomery

WAPX—May 1947: 1600 khz; 1 kw-U, DA-N. Box 2028 (36103). (205) 263-3459. Spurling of Ala. Inc. (acq 12-65). Rep: Howard. ■ Judd Spurling, pres & gen mgr.

WBAM—1953: 740 khz; 50 kw-D, DA. 4740 Radio Rd. (36111). (205) 288-0150. Deep South Bcstg Co. Rep: Buckley. Format: Modern Country. ■ Frances U. Brennan, pres; Cyril G. Brennann, gen mgr & prog dir; Charles Jennings, news dir; Diane Brennan, mus dir; Robert Brennan, coml mgr; Charlie Casmus, sports dir; Taze Tisdale, chief engr. ■ Rates: \$15; 14; 15; —.

WCOV—Jan 16, 1939: 1170 khz; 10 kw-D, 1 kw-N, DA-2. Box 2505 (36105). (205) 288-7020. TWX 810-728-6246. WCOV Inc. (acq 11-10-64). Group owner: Gay-Bell Stns. Net: NBC. Rep: PRO-Meeker. Format: MOR. ■ Harry Barfield, pres; Karl Richards, VP & gen mgr; Madison Davis, opns dir; Jim Colley, s/s mgr; Fred Thompson, news dir; Phil Witt, chief engr. ■ WCOV-TV affil. ■ Rates: \$14; 10; 11; 14.

WETU—See Wetumpka.

WFMI(FM)—See listing following WQTY.

***WHCR(FM)**—Not on air, target date unknown: 90.7 khz; 10 w. Ant 100 ft. 1500 East Fairview Ave. Huntingdon College.

WHHY—April 30, 1930: 1440 khz; 5 kw-D, 1 kw-N, DA-N. Box 2744 (36105). (205) 264-2288. Broadcast Service of Montgomery Inc. (acq 1-10-57). Group owner: Holt Bcstg System. Net: ABC/C. Format: Contemp. Spec prog: Black 1 hr wkly. ■ Robert N. Robinson, pres, gen & coml mgr; Ann Colliester, stn mgr; Larry Stevens, prog dir; Robert Charles, news dir; Joe Cook, mus dir; Gerald Wilson, chief engr.

WHHY-FM—Sept 15, 1964: 101.9 mhz; 32 kw. Ant 120 ft. Stereo. CP: 100 kw; Ant 830 ft.) Progs sep from AM. Net: ABC/I. Format: C&W. ■ W. Ross Neely, stn mgr.

WKLH(FM)—July 15, 1969: 92.3 mhz; 50 kw. Ant 409 ft. Stereo. CP: 25 kw; Ant 760 ft.) 516 S. Perry St. (36104). (205) 264-7392. Griffin Bcstg. Corp. (acq 4-73). Net: ABC/FM. Rep: H.R. Stone. Format: MOR. ■ S. Wayne Griffin, pres; Glenn Griffin, gen mgr; Wayne Daughtry, coml mgr; Edgar McNeese, chief engr & opns mgr. ■ Rates: \$9.75; 9.75; 7.75.

WMGY—March, 1944: 800 khz; 1 kw-D. Box 2271 (36103). (205) 262-5245. George H. Buck Jr. Group owner: McClure. Net: ABC/E. Rep: Dora-Clayton. Format: C&W. ■ Rollis D. Carlton, gen & s/s mgr; Robert D. McKinnon, asst gen mgr; June N. Phelps, prog dir.

WMGZ(FM)—July 9, 1961: 103.3 mhz; 27.5 kw. Ant 290 ft.

WQTY—Oct 1, 1963: 1000 khz; 5 kw-D. Box 748 (36102). (205) 264-2218. Alabama Radio Corp (acq 9-8-72). Net: CBS. Rep: Savalli-Gates. Format: MOR, talk. ■ Carl M. Adams, pres; Harilyn M. Fisher, VP & gen mgr & coml mgr; Don Markwell, opns and prom mgr; Noah Sheppard, mus dir; Liz Toppins, news dir; John McLemore, chief engr. ■ Rates: \$8; 8; 8; 6.40.

WFMI(FM)—Co-owned with WQTY. Jan 1, 1961: 98.9 mhz; 10 kw. Ant 155 ft. Stereo. Prog sep from AM 50%. Format: Btfl Music. ■ Rates: same as AM.

WRMA—May 8, 1953: 950 khz; 1 kw-D. Box 2228 (36103). (205) 264-6449. WRMA Inc. (acq 1969). Net: MBS/Black. Rep: Alan Torbet. Format: Black. ■ William O. Jones, pres; Lee Lunston, gen mgr; Tracy Larkin, prog dir; Ronald Allen, mus dir; Harold Turner, news dir; Tom Jones, chief engr.

Alabama Radio

See page C-1 for explanation of listings.

Moulton

WHIY—Dec 11, 1963: 1530 khz; 1 kw-D, 250 w CH. Box 307 (35650). (205) 974-0681. Moulton Bcstg Co. Inc. (acq 1-27-68). Net: ABC/I. Format: C&W. Contemp. ■ Hiram Goodman, pres & gen mgr; Ray Wallace, stn mgr; Bill Mobbs prog, news dir; & chief engr; Ray Wallace, prom mgr.

Muscle Shoals

WLAY—Jan 15, 1933: 1450 khz; 1 kw-D, 250 w-N. Box 220, Sheffield, Ala. (35660). (205) 383-2525. Slatton-Quick Co. (acq 4-21-59). Rep: PRO Times Sls; Beaver. Format: Contemp. ■ D. Mitchell Self, pres, gen mgr & natl sls mgr; Ronald E. Hale, VP & gen sls mgr; Jim Smith, asst mgr & prog dir; John Wise, mus dir; Bill Erwin, news dir; James Suttles, chief engr.

WLAY-FM—Oct 28, 1964: 105.5 mhz; 3 kw. Ant 300 ft. Stereo. Prog sep from AM. Format: Pop. ■ James E. Smith Jr., FM dir.

Oneonta

WCRL—July 29, 1952: 1570 khz; 1 kw-D. Box 490 (35121). (205) 625-3333. Blount County Bcstg Service (acq 3-55). Net: MBS. ■ L. D. Bentley Jr., owner & gen mgr; Jerry E. Hudson, asst mgr & prog dir; Max G. Bynum, mgr; Thomas E. Baty, chief engr.

WKLD (FM)—Co-owned with WCRL. July 12, 1968: 97.7 mhz; 990 w. Ant 480 ft. Dups AM 50%.

Opelika

WAOA—Aug 12, 1968: 1520 khz; 5 kw-D, DA. Box 2329 (36801). (205) 745-4656. Faulkner Radio Inc. (group owner). Net: ABC/E. Rep: Bernard. Format: C&W. ■ James H. Faulkner Sr., pres; Glenn Buxton, gen mgr; Robert M. Thornburn, VP; Gerry King, prog dir; John McGiboney, news dir; Chris Hicks, mus dir; Margie Piliatt, prom mgr; Terry W. Harper, chief engr.

WFRI (FM)—See Auburn, Ala.

WJHO—June 3, 1940: 1400 khz; 1 kw-D, 250 w-N. Box 710 (36801). (205) 745-6484. Opelika Auburn Bcstg Co. Net: MBS. Rep: Walton, Jones. Format: Top 40/C&W/MOR/Black. ■ Jack Smolton, gen mgr & chief engr; Ken Rigsby, prog dir; Ed Mathews, office mgr; Terry Duffie, coml mgr; Billie Ann Smolton, prom mgr; L. N. Smith, news dir; Michael Jones mus dir. ■ Rates: \$6;5.50;6;5.50.

Opp

WAMI—Dec 12, 1952: 860 khz; 1 kw-D. Box 169 (36467). (205) 493-3588. Opp Bcstg Inc. Format: Block programming of MOR, Top 40 & C&W. ■ Joseph Breedlove, pres; Donald Cooke, gen & coml mgr; Chuck Eiland, prom mgr; James Heath, prog & news dir; Robert Page, chief engr. ■ Rates: \$3;3;3;3.

WAMI-FM—Nov 9, 1973: 102.3 mhz; 3 kw. Ant 280 ft. Stereo. Dups AM 70%. ■ Rates same as AM.

Ozark

WAYD—Oct 5, 1968: 1190 khz; 1 kw-D. Drawer 1259 (36360). (205) 774-3000. Wade B. Sullivan. Format: C&W. ■ Wade B. Sullivan, pres & gen mgr; Aubrey Tomlin, chief engr.

WAYD-FM—1974: 103.9 mhz; 3 kw. Ant 190 ft.

WOAB (FM)—See listing following WOZK.

WOZK—May 3, 1953: 900 khz; 1 kw-D. Box 910 (36360). (205) 774-5600. Ozark Bcstg Corp. Format: Adult. ■ Howard Parrish Jr., gen, mgr & chief engr; Miriam B. Miller, prog dir. ■ Rates: \$2.50;2.50;2.50;2.50.

WOAB (FM)—Co-owned with WOZK. July 9, 1967: 104.9 mhz; 2.85 kw. Ant 180 ft. Prog sep from AM. Format: C&W. ■ Rates: \$1.60;1.60;1.60;1.60.

Pell City

WFHK—Jan 7, 1956: 1430 khz; 1 kw-D. Box 606 (35125). (205) 338-2238. St. Clair Bcstg System (acq 5-2-56). Net: Keystone. Rep: Continental Radio Sales. Format: MOR. ■ Fate L. Gossett Sr., pres and gen mgr; Georgia Gossett, coml mgr; Fred L. Kelley, prog dir;

Leland Gossett, prom mgr; James C. Seales, news dir; C.C. McRae, chief engr.

Phenix City

WDAK—See Columbus, Ga.

WEIZ—See Columbus, Ga.

WPNX—See Columbus, Ga.

Piedmont

WPID—1953: 1280 khz; 1 kw-D. Box 223 (36272). (205) 447-2231. WPID Radio Station. (acq 6-24-65). Rep: Keystone. Format: Contemp, C&W, Gospel. ■ Terrance J. Gladden, gen mgr & chief engr; Frances Gladden, coml mgr; Brent Morrison, prog & asst mgr.

Prattville

WPXC—March 10, 1969: 1410 khz; 5 kw-D, 1 kw-N, DA-2. Box 548 (36067). (205) 365-6727. Prattville Radio Inc. Net: ABC/I. Format: C&W. ■ Joe Hagler, pres & gen mgr; Bill Stewart, coml mgr; Larry Pate, prog & news dir; Gerald W. Wilson, chief engr.

Prichard

WKSJ-FM—See Mobile, Ala.

WKSJ—June 13, 1966: 1270 khz; 1 kw-D. Box 1444, Mobile, Ala. (36601). (205) 456-6547. Broadcast Enterprises Inc. (acq 11-1-70). Format: C&W. ■ E.M. Johnson, pres; Kenneth S. Johnson, gen mgr.

Rainsville

WVSM—May 16, 1967: 1500 khz; 1 kw-D. Box 238 (35986). (205) 638-2137. Sand Mountain Advertising Co. Inc. Rep: Beaver. Format: C&W. ■ L. E. Kennamer, pres; Bill Hubert, gen mgr & prog dir; Bill Prickett, prom mgr; Robert A. Gay, chief engr. ■ Rates: \$1.90;1.90;1.90;—.

Red Bay

WRMG—June 29, 1968: 1430 khz; 1 kw-D. Box 508 (35582). (205) 356-4458. Redmont Bcstg Corp. Format: C&W. ■ E. E. Stuart, pres, gen mgr & chief engr; F. N. Grubbs, coml mgr; Robert Landers, prog dir; Keith Ledbetter, news dir.

Roanoke

WELR—April 1954: 1360 khz; 1 kw-D. Box 709 (36274). (205) 863-4139. Earl E. Manning Jr. (acq 11-4-64). Format: C&W. ■ Earl Manning, gen mgr.

WELR-FM—Feb 14, 1969: 95.3 mhz; 2.5 kw, horiz. 1:25 kw vert. Ant 320 ft. Dups AM 80%.

Russellville

WKAX—April 3, 1974: 1500 khz; 1 kw-D, DA. (205) 332-6300. Box 1117 (35653). Russellville Bcstg Co. Inc. ■ Kenneth A. Casey, pres & chief engr; Gary Sherrod, mus dir; Buz King, gen mgr.

WWWR—May 29, 1949: 920 khz; 1 kw-D. Drawer 518 (35653). (205) 332-0214. Franklin Bcstg Inc. (acq 7-6-65). Net: Tr-W. Rep: Carpenter. Format: C&W. ■ Marion Grant, pres, Hal Kirby, gen mgr, prog dir & chief engr; Mickey Davis, mus and news dir. ■ Rates: \$2.25;2.25;2.25;—.

Scottsboro

WCNA-FM—Nov 3, 1965: 98.3 mhz; 1.5 kw. Ant 400 ft. Box 699 (35768). (205) 574-2341. Mellow Sound Bcstg. Rep: Beaver. Format: C&W. ■ Ralph M. Shepard, pres; Ben Kitchens, gen & coml mgr; Ray Estes, prog & music dir; Madge Wilbanks, prom mgr; Charles Cruce, news dir; Robert A. Gay, chief engr.

WCRI—June 13, 1950: 1050 khz; 250 w-D. Box 727 (35768). (205) 574-1050. Jackson County Bcstg Service. ■ R. W. Kennamer, gen mgr.

WROS—June 11, 1952: 1330 khz; 1 kw-D. Box 966 (35768). (205) 574-2156. Scottsboro Bcstg Co. Net: Keystone. Rep: Carpenter. Format: MOR/C&W/Rock. ■ Mrs. Rose M. Kirby, pres; Hugh T. Kirby Jr., gen mgr & prog dir; Jess R. Moore, chief engr.

Selma

WALX (FM)—1974: 100.9 mhz; 3 kw. Ant. 300 ft. I5 Par-

due St. (36701). Alexander Bcstg Co.

WAMA—Dec 19, 1946: 1340 khz; 1 kw-D, 250w-N. Box 305 (36701). (205) 874-4608. Vogel-Hendrix Corp. (acq 2-1-69). Group owner: Vogel Communications. Net: CBS. Rep: Jones. Format: Contemp. Spec prog: Black 5 hrs wkly. ■ William R. Vogel, pres; Phil Taylor, gen mgr; Guy Polley, coml mgr; Joe Bolton, prog dir; Bill Gomel, sports dir; Dan Hughes, news dir; Lamar Manham, chief engr.

WHBB—Nov 11, 1935: 1490 khz; 1 kw-D. 250 w-N. Box 1055 (36701). (205) 874-8296. Talton Bcstg. (group owner; acq 3-21-62). Net: ABC/C. Rep: Keystone; Busby, Finch & Woods. Format: Contemp. Spec progs: Black 18 hrs; Farm 6 hrs; Gospel 6 hrs wkly. ■ Julius E. Talton, pres & gen mgr; Jamie Wallace, news dir; Bill Sellier, prog dir; Dave Rigdon, coml mgr; Jim Lumpkin, chief engr. ■ Rates: \$4.47;4.47;4.47;4.47.

WTUN (FM)—Co-owned with WHBB. September 1965: 100.1 mhz; 3 kw. Ant 125 ft. Stereo. Prog sep from AM. Net: ABC/I. Format: C&W. ■ Gary Fuller, coml mgr. ■ Rates: \$4.04;4.04;4.04;4.04.

WTQX—May 19, 1956: 1570 khz; 5 kw-D. Box 1307 (36701). (205) 874-9062. Kathleen E. Stutts (acq 10-9-66). Net: Mutual Black. Rep: Beaver. Format: Black. ■ Samuel S. Everette Jr., gen mgr; M. J. Anderson, prog dir; Herb Connellan, chief engr.

WTUN (FM)—See listing following WHBB.

Sheffield

WRCK-FM—Co-owned with WZZA Tusculumbia, Ala. July 2, 1969: 106.3 mhz; 3 kw. Ant 86 ft. Box 517, Tusculumbia (35674). (205) 381-1862. (acq 6-1-74). Prog sep from AM. Net: MBS Format: Rock.

WSHF—Nov 6, 1963: 1290 khz; 1 kw-D. Box 606 (35660). (205) 383-1290. J. B. Falt Jr. (group owner). Net: ABC/E. Rep: Meeker, Busby, Finch & Woods. Format: C&W. ■ J.B. Falt Jr., owner; Gary Wright, gen mgr & chief engr; Harold Clemons, prog dir; Danny Haynes, mus dir; Chet Rumore, news dir. ■ Rates: \$3.75;3.75;3.75;3.75.

Sylacauga

WFEB—March 1945: 1340 khz; 1 kw-D, 250 w-N. Box 358 (35150). (205) 245-3281. Alabama Bcstg Inc. Net: MBS. Rep: Carpenter. Format: MOR. ■ George W. Carr, pres, gen & coml mgr; Wendell Scroggins, chief engr.

WMLS—May 16, 1948: 1290 khz; 1 kw-D. Box 538 (35150). (205) 245-4354. Marble City Bcstg Co. Format: Contemp. C&W. ■ Curtis O. Liles, pres & gen mgr; Glen A. Davis, chief engr. ■ Rates: \$2;2;2;2.

WMLS-FM—Dec 20, 1959: 98.3 mhz; 630 w. Ant 83 ft. Dups AM 35%.

Talladega

WEYY—April 1956: 1580 khz; 1 kw-D. Drawer E (35160). (205) 362-9041. Tallabama Bcstg Inc. (acq 5-6-22). Net: ABC/C. Format: C&W/Black. ■ Jimmy E. Woodard, pres, gen mgr; Don Stephens Jr., prog & news dir; Bryan Townsend, coml mgr; Don Stephens Jr., prom mgr; Hugh O'Neal, chief engr.

WHTB (FM)—Co-owned with WEYY. Nov 10, 1972: 92.7 mhz; 250 w. Ant 870 ft. Stereo. Box 994 (35160). (205) 362-8890. Format: Pop contemp. Spec prog: Black 1 hr wkly.

WNUZ—1945: 1230 khz; 1 kw-D, 250 w-N. Box 998 (35160). (205) 362-1230. Radio Alabama Inc. (acq 6-1-59). Format: MOR. Spec prog: Black 6 hrs wkly. ■ J.L. Coley, pres; Royce Faulkner, gen mgr; Randall Lowley, coml mgr; Van Gable, mus dir; Charles Osborne, stn mgr & news dir; Tyril Johns, chief engr.

Tallasse

WTLS—Oct 19, 1957: 1300 khz; 1 kw-D. 1702 Gilmer Ave. (36078). (205) 283-3789. The Ne-Ler Co. (acq 5-6-59). ■ Ned Butler, owner, gen & coml mgr & chief engr.

Thomasville

WJDB—July 16, 1956: 630 khz; 1 kw-D. Box 757 (36784). (205) 363-4438. WJDB Radio Inc. Net: Keystone. Spec progs: Black 8 hrs wkly. ■ Cecil Goodreau, pres & gen mgr; Gene Vinson, chief engr.

WJDB-FM—Nov 2, 1972: 95.3 mhz; 3 kw. Ant 300 ft.

Troy

WTBF—Feb 25, 1947: 970 khz; 5 kw-D, 500 w-N, DA-N. College Dr. (36081). (205)566-0300. Troy Bcstg Corp. Net: MBS. ■ Jess Jordan, gen mgr; Robert M. Tolbert, coml mgr; Asa Dudley, prog dir; Joe Gilchrist, chief engr.

WTUB(FM)—Feb 28, 1973: 105.7 mhz; 100 kw. Ant 410 ft. Box 516 (36081). (205)566-5545. Troy Radio Inc. Format: C&W, Relig, Rock. ■ Albert G. Goree, pres, gen & coml mgr; Robert Booth, prom mgr & prog, mus & news dir; Marvin Jones, chief engr.

Tuscaloosa

WACT—September 1958: 1420 khz; 5 kw-D. Box 126 (35401). (205)759-5786. New South Radio Inc. (acq 11-67). Rep: Alan Torbet. Format: C&W. ■ Clyde Price, pres & gen mgr; Mike Travis, coml mgr; Norman Bassett Jr., prog dir; Jerry Voyles, prom mgr & mus dir; Mike Dale, news dir; Argie Johnson, chief engr.

WACT-FM—June 1, 1966: 105.5 mhz; 1.5 kw. Ant 400 ft. Stereo. Dups AM 60%. Format: C&W.

WJRD—Oct 10, 1936: 1150 khz; 5 kw-D, 1 kw-N, DA-N. Drawer 4 (35401). (205)345-2244. Tidmore & Harrison, receiver (acq 10-75). Net: CBS. Rep: Bernard Ochs. Format: C&W. ■ Robert J. Martin, pres & gen mgr; Robert Martin Jr., coml & prom mgr; Courtney Haden, prog & mus dir; Joe Affholter, news dir; John Scott, chief engr. ■ Rates: \$12;12;12,12.

WNPT—Dec 10, 1951: 1280 khz; 5 kw-D, 500 w-N, DA-N. Box 2787 (35401). (205) 758-3311. West Alabama Bcstg Co. Net: ABC/I. Rep: Dora-Clayton. Format: MOR. ■ Edna Ruth Harris, pres & own; Gordon Campbell, sls mgr; Hush Rushing, news dir; Ed Folts, chief engr.

WTBC—Dec 23, 1946: 1230 khz; 1 kw-D, 250 w-N. Box 2000 (35401). (205) 758-5523. Tuscaloosa Bcstg Co. Net: ABC/C. Format: Contemp rock. Net: MBS. ■ Bert Bank, pres; Ralph Bank, gen mgr; Alan Burns, prog dir; Tommy Roberts, news dir; R. M. Jones Jr., chief engr.

WUOA(FM)—Co-owned with WTBC. 1952: 95.7 mhz; 17.5 kw. Ant 320 ft. Prog sep from AM. Stereo. Format: Easy Istng. ■ Tommy Roberts, prog dir.

WTUG—February 1958: 790 khz; 1 kw-D. Box 1896 (35401). (205) 345-7200. Tri Cities Bcstg Co. (acq 10-57). Group owner: E.O. Roden Sns. Rep: Howard. Format: Black. ■ E.O. Roden, pres; Edmond E. Payne, gen mgr.

***WUAL(FM)**—Sept 7, 1972: 91.7 mhz; 10 w. Ant 200 ft. Box 6155, Univ of Ala. (35486). (205) 348-6082. Board of Trustees of the U. of Alabama. Stereo. Format: Progressive, Rock. Spec progs: Black 15 hrs, Classcl 6 hrs, both wkly. ■ Knox Hagwood, gen mgr; Scott Chramer, stn mgr; Frank Pettit, chief engr.

WUOA(FM)—See listing following WTBC.

Tuscumbia

WRCK(FM)—See Sheffield, Ala.

WVNA—April 5, 1955: 1590 khz; 5 kw-D, 1 kw-N, DA-N. 509 N. Main St. (35674). (205) 383-2727. Elton H. Darby (acq 1956). Net: CBS. Rep: Walton. Crane. Format: MOR. ■ Elton H. Darby, owner; James A. Hall, gen mgr; Billy Banks, coml mgr; Mary Ann Franck, prog dir; Jack Voorhies, prom mgr; Nelle Bigbee, news dir; Duane Hoisington, chief engr.

WVNA-FM—May 2, 1962: 100.3 mhz; 3.1 kw. Ant 275 ft. (CP: 100 kw horiz, 84 kw vert; Ant 245 ft). Dups AM 25%. Format: C&W.

WZZA—Co-owned with WRCK-FM, Sheffield, Ala. April 17, 1960: 1410 khz; 500 w-D, Box 2562, Muscle Shoals, Ala. (35660). (205) 383-5810. Wein Bcstg Corp. (acq 6-1-74). Net: Mutual Black. Rep: Ochs. Format: Black. ■ Margaret L. Wein, pres; Edward Wein, VP; Paul S. Slatton, gen mgr & chief engr; Bob Tracy, prog dir.

Tuskegee

WBIL—July 1, 1952: 580 khz; 500 w-D. Box 666 (36083). (205) 727-2100. All Channel TV Service Inc. (acq 1975). Net: MBS/Black. Rep: Savalli Gates. Format: Black. ■ George H. Clay, owner; J. Nicholls, opns mgr; Tracy Larkin, prog dir; Terry Harper, chief engr.

WVNS
Progressive Black
A New South Broadcasting Station
National Black Network

N A F M B

R A B

Radio Code

WVNS(FM)—July 12, 1975: 95.9 mhz; 2.45 kw. Ant 323 ft. Stereo. Box 1245, Tuskegee Institute (36088). (205) 727-1284. New South Bcstg Corp. Net: Natl Black. Format: Black, Jazz, progs. ■ William A. Gordon, Jr., pres; gen mgr & chief engr; Candy Capel, coml mgr; Tracy Larkin, prog dir; Julian Wright, mus dir; Abdul Hafiz, news dir. ■ Rates: \$2.55;2.55;2.55.

Union Springs

WQSI(FM)—Oct 16, 1975: 100.9 mhz; 3 kw. Ant 275 ft. 2137 Campbell Rd, Montgomery, Ala. 36111. Onion Springs Broadcasting. Format: Contemporary.

Vernon

WVSA—July 4, 1966: 1380 khz; 1 kw-D. Box 630 (35592). (205) 695-9191. Lamar County Bcstg Co. Inc. Rep: Keystone; Beaver. Format: C&W, Gosp. ■ Olivie E. Sisk, pres; Joel Comp, gen & coml mgr; Billy Ray Adams, prog & news dir; Edward Hunnicutt, chief engr.

Wetumpka

WETU—Oct 2, 1954: 1250 khz; 5 kw-D. Box 60 (36092). (205) 567-4351. Elmore Service Corp. Rep: Walton. ■ Lem Coley, pres; Bob McKinnon, gen & prom mgr, prog & news dir; Frank Warren, coml mgr; Dave Conley, chief engr.

Winfield

WEZO—Aug 23, 1965: 1300 khz; 1 kw-D. Box 608 (35570). (205) 487-3261. John Self. Audio news: UPI. Rep: Beaver. Format: C&W. ■ John Self, owner; Hewitt Addison, gen mgr; C.D. Self, Jr., prom mgr; Bobby Cantrell, chief engr. ■ Rates: \$3;3;3.3.

York

WSLY(FM)—follows WYLS.

WYLS—Nov 1970: 1350 khz; 5 kw-D. 687 (36925). (205) 392-7193. Grantell Bcstg Co. Rep: Keystone. Format: Black/s/MOR. Spec progs: C&W 16 hrs, rock 10 hrs wkly. ■ William B. Grant, own, gen mgr & chief engr; Charles J. Ezell, own coml mgr & prog dir. ■ Rates: \$2.45; 2.45; 2.45;—.

WSLY(FM)—Co-owned with WYLS. Not on air, target date March 1976: 99.3 mhz; 3 kw. Ant 300 ft. Stereo. Box 993, Livingston, Ala. (35470). (205) 392-7193. Format: MOR. ■ Rates same as AM.

CSI ELECTRONICS INC.

2607 River Road
Cinnaminon, New Jersey, 08077
Telephone: (609) 786-1060

Alaska

Anchorage

KANC—May 10, 1975: 1080 khz; 10 kw-U. Box 4-2287 (99509) (907) 272-4522. Mt. Susitna-Broadcasting Corp. Format: Progs country ■ H. Von Gemmingen, coml mgr; Chuck Roberts, mus dir; John R. Garland, gen mgr; Bruce Parker, prog dir; Don French, opns mgr; Larry Stiger, chief engr. ■ Rates: \$13.45; 10.10; 13.45; 6.70.

Alabama, Alaska Radio

See page C-1 for explanation of listings.

KBYR—1948: 700 khz; 1 kw-D, 500 w-N. Box 2200. (99501). (907) 272-3456. Northern TV Inc. (group owner; acq 8-16-65). Net: ABC/E; CBS; Alaska Bcstg System. Rep: Masla/Young; Alaska Radio & TV Sls. Format: MOR. ■ A. G. Hiebert, pres; Ron L. Moore, gen & coml mgr; Bruce Kier, mus dir; Eugene Miner, opns mgr; Jerry Rose, news dir; George Howard, chief engr. ■ Rates: \$13; 11.50; 13; 8.

KNIK-FM—Co-owned with KBYR. Sept 15, 1960: 105.5 mhz; 3 kw. Ant 265 ft. Dups AM 80%. Stereo. ■ KTVA(TV) affil. ■ Rates same as AM.

KENI—May 2 1948: 550 khz; 5 kw-U. Box 1160 (99510). (907) 272-7461. Telex 25-186. Midnight Sun Bcstrs Inc. (group owner; acq 1-1-60). Net: ABC/I, NBC. Rep: Avery-Knodel; Simpson/Reilly. Format: Top-40. ■ Alvin O. Bramstedt, pres & gen mgr; Hank Mann, sls mgr; Harv Allen prod dir; Ron Berry, mus dir; Charles M. Gray, chief engr. ■ KENI-TV affil. ■ Rates: \$20.50; 17.50; 20.50; 12.50.

KFQD
Contemporary/Golden



KFQD—1924: 750 khz; 50 kw-D, 10 kw-N. 9200 Lake Otis Parkway (99507). (907) 344-9622. KFQD Inc. (acq 8-1-62). Group owner: Robertson-Clapp Sns. Rep: Torbet. Format: Contemp/golden. ■ Miller C. Robertson, pres; Roy Robinson, gen mgr; David Schmidt, coml mgr; Art Lewis, prom dir; Mark Lewis; prog dir; Robert Melton, mus dir; Peter Carren, news dir; Gale Allred, chief engr. ■ Rates: \$18; 14.50; 18; 9.

KGOT(FM)—Listing follows KYAK.

KHAR—Jan 7, 1961: 590 khz; 5 kw-U. 3900 Seward Highway (99503). (907) 272-9591. Sourdough Bcstrs. Rep: Savalli/Gates; Tacher. Format: Good mus/MOR. ■ Patricia E. Harpel, pres; William B. Allen, gen mgr; Robert Pale, coml mgr; Ken Flynn, prog dir, mus dir, prom mgr; Mario Holmes chief engr. ■ Rates: \$19.50; 16.50; 19.50; 10.50.

KHAR-FM—November 1966: 103.9 mhz; 2.8 kw. Ant 54 ft. Dups KHAR 100%. Stereo. ■ Rates same as AM.

KJZZ(FM)—102.1 mhz; 3.5 kw. Ant 75 ft. 338 Denali St. (99501). (907) 279-2213. Cook Inlet Bcstrs. (acq Feb. 1973). Stereo. ■ Joseph Perry.

KNIK-FM—Listing follows KBYR.

KYAK—July 15, 1967: 650 khz; 60 kw-D, 25 kw-N. DA-2. 2800 East Dowling Rd. (99507). (907) 344-2522. Big Country Radio Inc. (group owner). Rep: H-R/Stone; The Tacher Co. Format: Country. ■ Richard C. Cruver, pres; Glenn S. Miller, VP; Robert W. Fleming, exec VP & gen mgr; Jack Arnold, coml mgr; William S. Brink, opns mgr; Jim Robbins, prog dir; Steve LaMar, news dir; Wayne Lowe, mus dir; Norm Fish, chief engr. ■ Rates: \$19; 16; 19; 11.

KGOT(FM)—Co-owned with KYAK. Sept 15, 1975: 101.3 mhz; 26 kw. Ant minus 66 ft. Format: Contemporary Rock. Stereo. ■ Larry Wayne, prog mgr. ■ Rates: \$7; 6.50; 7; 5.50.

Bethel

***KYUK**—May 13, 1971: 580 khz; 5 kw-U. Box 468 (99559). (907) 543-2644. Bethel Bcstg Co. Format: MOR. Spec progs: Eskimo-Upik, 50 hrs wkly. ■ Martin Moore, pres; Jim Coll, gen mgr; Rosie Porter, prog dir; Liz Howard, mus dir; Bob Tinkle, chief engr; Buster Richardson, news dir. ■ KYUK-TV affil.

College

***KUAC(FM)**—Sept 20, 1962: 104.7 mhz; 10.5 kw. Ant 440 ft. Stereo. U. of Alaska. Box 95003, Fairbanks (99701). (907) 479-7491. U. of Alaska. Net: NPR. Audio News: AP Radio. Format: Classical. Spec progs: Jazz 2 hrs wkly; East Indian 1 hr wkly. ■ Donald B. Upham, gen mgr; David L. Geesin, stn mgr & prog dir; Louise Kowalski, mus dir; Hank Hove, chief engr.

Alaska, Arizona Radio

See page C-1 for explanation of listings.

Cordova

KLAM—May 1953: 1450 khz; 250 w-SH. Box 278 (99574). (907) 424-3222. Northern Light Bcstg Corp. Net: CBS, Alaska Bcstg System. Rep: Young; Alaska Radio/TV Sales. Format: Contemp. ■ William D. Bechtel, owner (acq. Nov. 1973), pres, gen mgr, dir, & chief eng.

Dillingham

***KDLG**—July 22, 1975: 670 khz; 5 kw-D, 1 kw-N. Box 202 (99576). (907) 842-3183. Dillingham City School District. Format: Diversified. ■ Ethel J. Nelson, pres; Paul Ilutsk, news dir; Leo Lutchansky, gen mgr & prog dir; Paul Davis, chief eng.

Fairbanks

KFAR—1939: 660 khz; 10 kw. Box 910 (99701). (907) 452-2125. Midnight Sun Bcstrs Inc. (group owner; acq 1960). Net: ABC/I, NBC. Rep: James C. Fletcher, NYC; Simpson/Reilly. Format: Contemp. ■ A.O. Bramstedt, pres; R.D. Jensen, exec VP; Don Anderson, VP & stn mgr; Charles Sandburg, prog dir; Candy Holliday, off mgr; Don Garrett, chief eng; Jerry Fears, news dir. ■ KRAR-TV affil.

KFRB—1948: 900 khz; 10 kw. Box 950 (99701). (907) 452-5121. Northern Television Inc. (group owner; acq 8-15-65). Net: CBS; Alaska Bcst System. Rep: Young-VTM; Alaska Radio-TV Sls. ■ A. G. Hiebert, pres; Theodore Lehne, gen mgr; Bob Hamme, ops mgr; Larry Carpenter, news dir.

KIAK—Sept 18, 1972: 970 khz; 5 kw-U. Box 2828 (99707). (907) 452-1931. Big Country Radio Inc. (group owner). Rep: HR/Stone. ■ Richard C. Cruver, pres; Robert W. Fleming, VP & gen mgr; Glen Miller, VP sec-treas; Richard W. Lobdell Jr. stn mgr; Larry Stephens, news dir; Thomas A. Busch, chief eng.

Giennallen

KCAM—April 16, 1964: 790 khz; 5 kw-U. Box 125 (99588). (907) 822-3306. Central Alaska Missions Inc. Format: Easy Listening & Religious. ■ Leander Rempel, Alaska dir; Carlyle Callis, gen mgr; Fred D. Lambert, asst mgr; Ethel Bloom, office mgr; Dave Buchanan, chief eng.

Juneau

KINY—May 28, 1935: 800 khz; 5 kw-U. 231 S. Franklin St. (99801). (907) 586-1800. Midnight Sun Bcstrs Inc. (group owner; acq 6-1-68). Net: ABC, NBC, Midnight Sun. Rep: Fletcher; Simpson. ■ Al Bramstedt, pres; Jack A. Foley Sr., gen & s/s mgr; Chuck Benson, prog mgr; William Hartley Jr., mus dir; Marvin R. Weatherly, net chief eng. ■ KINY-TV affil.

KJNO—Oct 19, 1952: 630 khz; 1 kw-D, 500 w-N. Box 929 (99802). (907) 586-3630. Southeastern Alaska Broadcasters (acq. 1968). Net: CBS. Rep: Alaska Radio and TV Sales. Format: MOR. ■ Roy Paschal, pres; Dennis Egan, gen mgr; Don Erisman, chief eng.

***KT00(FM)**—Jan 27, 1974: 104.3 mhz; 10 w. Box 1487 (99801). (907) 586-1567. Capital Community Broadcasting Inc. Net: Northwest Public Radio Network. Format: Educational, varied, public affairs. ■ Dennis P. Harris, pres; John Mentli, Frederick Hoskinson, coordinators.

Ketchikan

KTKN—1942: 930 khz; 5 kw-D, 1 kw-N. Box 2347 (99901). (907) 225-2191. Midnight Sun Broadcasters Inc. (group owner; acq 1960).

Kodiak

KVOK—November 1975: 560 khz; 1 kw-U. Box 53 (99615). (907) 486-5159. Loren F. Bridges. Net: CBS, ABC/E, Alaska Bcstg System. Format: Diversified MOR. Spec progs: Classical 3 hrs; Aleut, ½ hr, wkly. ■ Loren F. Bridges, own, coml mgr, mus dir; Robert L. Bridges, news dir, chief eng; Martha W. Bridges, prog dir & sec.

***New FM**—Not on air, target date unknown: 100.1 mhz; 3 kw. Box 484 (99615). Kodiak Public Broadcasting Corp. ■ Samuel A. Ward, VP, bd of dir.

Kotzebue

***KOTZ**—April 1973: 720 khz; 5 kw-U. Box 78 (99752). (907) 442-3267. Kotzebue Bcstg. Net: NPR. Format: Educl & MOR. Spec progs: Eskimo, 10 hrs wkly. ■ June Nelson, pres; Alex Hills, chief eng; Nellie Ward, gen mgr.

Nome

KICY—April 17, 1960: 850 khz; 5 kw-U. Box 820 (99762). (907) 443-2213. Arctic Bcstg Assn. Net: CBS; Alaska Bcstg Sys. Rep: Masla-Young; Alaska Bcstg Sys. Spec progs: Eskimo 4 hrs, Russian 5 hrs, both wkly. ■ Charles F. Sebastian, pres; David DeVries, asst mgr in chg of s/s; James Engwall, bus mgr & news dir; Stanley R. Summers, prog dir & mus dir; Earl Swanson, chief eng. ■ Rates: \$4.75; 4.50; 4.75; 4.50.

***KNOM**—July 14, 1971: 780 khz; 10 kw-D, 5 kw-N. Box 988 (99762). (907) 443-5221. Catholic Bishop of Northern Alaska. Format: Contemp, C&W. Net: MBS. ■ Very Rev. Robert Whelan, S.J., pres; James E. Poole S.J., dir; Thomas A. Busch, gen mgr; Therese Burik, bus mgr; Richard D. Barton, mus dir; Ed Guiragosa, prog dir; Mark A. Hoelsken chief eng.

Northpole

KJNP—Oct 11, 1967: 1170 khz; 50 kw-U, DA-N. Box 0 (99705). (907) 448-2216. Evangelistic Missionary Fellowship. Format: C&W, Religious. ■ Donald L. Nelson, pres; Genevieve Nelson, VP; Richard Olson, mgr; Beverly Olson, prog dir; Yvonne Carrier, gen mgr; Neil Cook, chief announcer; Richard Steegstra, chief eng.

KRKM—Not on air, target date unknown: 600 khz; 1 kw-U, DA-1. 6 Mile Badger Road, Fairbanks (99701). Cassidy Broadcasting.

Seward

KRXA—November 1948: 950 khz; 1 kw-SH. Box 276 (99664). (907) 224-3456. Radio Seward Inc. (acq 12-30-70). Rep: Alaska Radio TV Sales. Format: MOR; C&W. ■ W.E. Fletcher, pres & gen mgr; Brent Whitmore, news dir & chief eng; Mark J. Goodwin, coml mgr, prog dir & prom mgr; Jim McCurdy, mus dir. ■ Rates: \$5; 5; 5; 4.40.

Sitka

KIFW—Sept. 1949: 1230 khz; 250 w. Box 299 (99835). (907) 747-3244. Sitka Bcstg Co. (acq July 1965). Net: CBS; Alaska Bcstg System. Rep: Adam Young; Alaska Radio-TV Sales. Format: Contemp, rock, talk. ■ Roy Pachal, pres & gen mgr; Steven L. Rhyner, comm/prom mgr to prog/news dir; Bob Barger, music dir; Steve Godwin, chief eng. ■ KIFW-TV affil.

***KMTE(FM)**—May 1974: 100.1 mhz; 10 w. Mt. Edgcombe High School (99835). (907) 966-2203. Department of the Interior, Bureau of Indian Affairs. Format: Educational, diversified.

Soldotna

KSRM—Sept 27, 1967: 920 khz; 5 kw. Box 950 (99669). 262-4425. KSRM Inc. (acq 4-1-70). Net: Alaska Bcstg System. Rep: Adam Young—VTN; Wellington; Alaska Radio-TV Sls. Format: MOR. ■ Walter H. Stephan, pres; John C. Davis, gen mgr; Rol

AFRTS stations

The U.S. Armed Forces Radio and Television Service operates radio stations over 200 watts in Alaska at the following locations:

Atak—890 khz; 250 w.
Adak (FM)—101.1 mhz; 250 w.
Ft. Greeley—980 khz; 250 w.
Galena—570 khz; 250 w.
King Salmon—970 khz; 250 w.
Kodiak—960 khz; 250 w.
Shemya (FM)—101.8 mhz; 1.3 kw.
Shemya—1240 khz; 250 w.
Tatalino—1450 khz; 250 w.

William A. Exline, Inc.

31 CARROLL COURT
SAN RAFAEL, CALIFORNIA 94903
(415) 479-0717
MEDIA BROKERS - CONSULTANTS

Davis, coml mgr; Bert McAlister, news dir; Jeff Bowden, chief eng.

Arizona

Apache Junction

KSTM(FM)—July 1, 1973: 107.1 mhz; 3 kw. Ant minus 115 ft. Box N (85220). (602) 982-5786. Harold R. Harkins. Format: Variety. ■ Harold R. Harkins, gen mgr & chief eng; Ron Harkins, coml & prom mgr; Joan Harkins, prog & news dir; Brett Oden mus dir. ■ Rates: \$7; 7; 7.

Bisbee

KBAZ(FM)—Not on air, target date January 1976: 92.1 mhz; 50w. Ant. 2199 ft. Box 1818 (85603). (602) 432-5441. Wrye Assoc. Format: Diversified. ■ William F. Wrye, co-owner, gen mgr & chief eng; Rose D. Wrye, co-owner & prog dir.

KSun—October 1933: 1230 khz; 1 kw-D, 250 w-N. Drawer CC (85603). (602) 432-2277. Bisbee Bcstrs Inc. (acq 12-1-68). Net: NBC. Format: MOR. ■ Howard Waterhouse, pres, gen mgr, prog dir, prom mgr & chief eng; Steve King, coml mgr & news dir.

Casa Grande

KBFE(FM)—Not on air, target date unknown: 105.5 mhz; 3 kw. Ant. 70 ft. ■ Bret F. Eisele.

KPIN—Dec 6, 1956: 1260 khz; 1 kw-D. Box 499 (85222). (602) 836-7427. Santa Cruz Valley Communication System. (acq 6-10-73). Group owner: Jim Hughes Stns. Net: Ariz. Rep: Lucas. Format: MOR. Spec progs: Sp 3½ hrs wkly. ■ James B. Hughes, pres; Dean Weatherly, gen mgr; Jack Jakeway, coml mgr; Scottie Allen, prog & mus dir; David B. Munsey, news dir; George Tunning, chief eng.

Chinle

***KCSO(FM)**—Not on air, target date unknown: 89.1 mhz; 620 w. Ant minus 281 ft. Box 587 (86503). Chinle Elementary School District.

Clifton

KCUZ—July 31, 1969: 1490 khz; 1 kw-D, 250 w-N. Box 1118 (85533). (602) 864-9982. Ira Q. Toler. Format: C&W, rock, MOR. Spec progs: Sp 10 hrs wkly. ■ Steve Warren, gen mgr; Alfredo Valdez Sr., coml mgr; Don Troy, prom mgr & news dir; John Wiles, prog & mus dir; Frank C. Hancock, chief eng.

Coolidge

KCKY—Nov 19, 1964: 1150 khz; 1 kw-U, DA-N. Box 200, Casa Grande (85228). (602) 723-5448. Pinal County Bcstg System. Format: C&W 100%. ■ Craig E. Davids, pres, gen mgr & news dir; Ken Welch, coml mgr; Tom R. Smith, prog dir; Kathleen E. Davids, prom mgr; Don Michaels, chief eng.

Cottonwood

KVIO—Dec 20, 1964: 1600 khz; 1 kw-D. Box 187 (86326). (602) 634-5921. Duane D. Kirby (acq 9-1-66). Net: Arizona. Rep: Lucas. Format: Variety. Spec progs: C&W 13½ hrs wkly. ■ Duane D. Kirby, pres, gen mgr & news dir; Sam Blessing, coml mgr; Charlene Kirby, prog dir; Ben White, chief eng.

Douglas

KAPR
Modern Country
Savalli/Gates Rep.



American
Information
Radio Network

KAPR—March 8, 1958: 930 khz; 1 kw-D. Rte. 1, Box 243 (85607). (602) 364-8403. KAPR Inc. (acq 8-29-73). Net: ABC/I. Rep: Savalli/Gates. Format: C&W. Spec progs: Sp 2 hrs, Farm 3 hrs, wkly. ■ Paul W. Knowles, pres & gen mgr; Jerry Frandsen, sta mgr; Jerry Frandsen, sta mgr; George Gatley, farm dir. ■

Rates: \$4.50; 4.50; 4.50; 4.50.

KAWT—1946: 1450 khz; 1 kw-D, 250 w-N, Drawer 1179 (85607). (602) 364-3484. Russwal Corp. (acq 5-31-75). Net: NBC. Rep: Pro/Meeker Radio. Format: MOR. Spec progs: Easy lstrng 7 hrs, Spanish 20 hrs, both wkly ■ Russ Walker, pres & gen mgr; Bob Boysen, stn mgr & chief engr; Roberta Walker, VP & prog dir; Grant Gailey, mus dir. ■ Rates: \$5.15; 5.15; 5.15; 5.15.

Flagstaff

KAFF—Oct 15, 1962: 930 khz; 5 kw-D, Box 1930 (86001). (602) 774-5231. KAFF Bcstg (acq 5-4-63). Group owner: Empire. Net: ABC. Rep: Dahlsen, PRO/Meeker. Format: C&W. ■ Guy Christian, pres & gen mgr; Ann Christian, traf mgr; Barry Hathaway, prog dir; Rich Boyd, mus dir; Clay La Count, news dir; John Swet, chief engr.

KAFF-FM—Oct 24, 1968: 92.9 mhz; 30 kw. Ant minus 200 ft. Dups AM 5%. Stereo. Format: MOR, C&W.

KAXR(FM)—November 1969: 88.5 mhz; 16 w. Ant. 82 ft. Bx 5783 (86001). (602) 523-2182. Northern Arizona University. Format: Ed/ent. ■ John S. Kincaid, gen mgr; Bill Emschwiler, chief engr.

KCLS—Aug 8, 1950: 600 khz; 5 kw-D, 500 w-N, DA-N, Box 640 (86001). (602) 779-0336. Saunders Bcstg Co. Net: NBC. Format: MOR. Spec progs: Navajo 14 hrs wkly. ■ Charles J. Saunders, pres; Ken Brown, gen & coml mgr; Cheryl Brown, off mgr; Miles Shepard, chief engr; Ed Mack, mus dir; Jack Penland news dir. ■ Rates: \$6; 4.75; 6.4.

KCTB-FM—Not on air, target date unknown: 93.9 mhz; 100 kw. Ant 1510 ft. Stereo. Box 2489, Prescott (86301). (602) 526-23804. Christian Towers Broadcasting Inc. Format: Religious. Spec progs: Classical 3 hrs; Spanish 2 hrs; Navajo, 2 hrs, v.kly. ■ Thomas J. Machamer, pres & gen mgr; Randall Sutter, prog dir; Jeff Prior, ass mgr.

KEOS—Jan 6, 1959: 690 khz; 1 kw-D, 500 w-N. (CP 1 kw-D, 500 w-N, DA-2). Box 100 (86001). (602) 774-1456. Thunderbird Bcstg Co. (acq 7-62). Rep: Hopewell. Format: Contemp. ■ Jack P. Bird, owner & pres; Russell D. Huntington, gen & coml mgr; Robert Polk, news dir; Eric Michael, prog & mus dir; Jon Swett, chief engr.

Glendale

KRUX—1946: 1360 khz; 5 kw-D, 500 w-N, DA-N, 4726 N. Central (85021). (602) 248-8128. Lotus Communications (Group owner; acq 7-72). Net: NBC/NIS. Rep: Lotus. Format: All news. ■ Howard Kalmenson, pres; Dave L. Cline, gen mgr; Gary Johnson news dir; Martin Walker, chief engr. ■ Rates: \$22; 18; 20; 12.

KXTC(FM)—Dec 19, 1970: 92.3 mhz. 100 kw. Ant 285 ft. Stereo. Hotel Westward Ho, Phoenix (85004). (602) 258-1218. Ariz. Communications Corp. Net: ABC/FM. Rep: Herbert E. Groskin. Format: Diversfd, jazz. Spec progs: Sp 19 hrs wkly. ■ Dick Gilbert, pres & gen mgr; George Wendell, coml mgr; Alma Gilbert, prog dir; Herb Johnson, mus dir; Larry Glazman, community rel dir; Gary Gilbert, chief engr. ■ Rates: \$14.25; 14.25; 14.25; 14.25.

Globe

KIKO—See Miami, Ariz.

KIKO-FM—Co-owned with KIKO Miami, Ariz. Not on air, target date Spring, 1975: 100.3 mhz; 14 kw. Ant 3,529 ft. Route 1, Box 25 (85501). Willard Shoecraft. ■ Willard Shoecraft, pres.

KPPR—1974: 1240 khz; 1 kw-D, 250 w-N. Broadcasters Inc. (acq 4-17-75).

Holbrook

KDJI—October 1955: 1270 khz; 5 kw-D, Box 430 (86025). (602) 542-3994. Navajo Bcstg Co. Inc. (acq 2-8-64). Net: ABC, Arizona. Rep: Tracy Moore. Format: Town & Country. Spec prog: Navajo 15 hrs wkly. ■ Walter V. Lowe, pres, gen & coml mgr.

Kingman

KAAA—Oct 7, 1949: 1230 khz; 1 kw-D, 250 w-N, 2534 Margaret Ave. (86401). (602) 753-2537. Sun/Mountain Bcstg. (acq 12-21-71). Net: Cactus. Rep: Pro/Meeker. Format: MOR. Spec prog: Sp 2 hrs wkly. ■ Charles D. Langerveld, pres; Jack Roland, gen mgr; Phil Tuttle,

prog dir; Doug Wood, mus dir; Lyle Henry, chief engr.

KZZZ(FM)—Co-owned with KAAA. November 1974: 92.7 mhz; 29 kw. Ant minus 81 ft. Stereo. Format: Beautiful mus.

Lake Havasu City

KBAS(FM)—Listing follows KFWJ.

KFWJ—Sept 23, 1970: 980 khz; 500 w-D, 2102 McCulloch Blvd. (86403). (602) 855-4098. Shoblom Bcstg Inc. Format: MOR. ■ Lee Shoblom, pres, gen mgr, prog & mus dir; Nancy Burke, coml mgr; Chuck Nunemacher, chief engr. ■ Rates: \$5.33; 5.33; 5.33; 5.33.

KBAS(FM)—Co-owned with KFWJ. Sept 9, 1974: 95.9 mhz; 1.45 kw. Ant minus 285 ft. Audio news: APR. Format: C&W, D; Top 40, N. ■ Rates same as AM.

Mesa

KBUZ—1946: 1310 khz; 5 kw-D, 500 w-N, DA-N, 4513 E. Thomas Rd., Phoenix (85018). (602) 959-6111. KBUZ Inc. (acq 10-12-70). Group owner: Number One Radio. Rep: H. R. Stone. Format: Beautfl mus. ■ Edwin Richter, pres; Harry Reith, gen mgr; Howard Duncun, exec VP; Fred Matthews, sls mgr; Frank Kalil, VP; Gerald Thomas, chief engr. ■ Rates: \$15.50; 13.50; 15.50; 13.50.

KBUZ-FM—1950: 104.7 mhz; 100 kw. Ant 1,550 ft. KBUZ Inc. (acq 10-12-70). Dups AM 100%. ■ Rates same as AM.

KDKB—November 1962: 1510 khz; 10 kw-D, Box 4227 (85201). (602) 833-8888 Dwight-Karma Bcstg Co. (acq 7-71). Audio news: UPI. Rep: Selcom. Format: Progs. Spec prog: Black 3 hrs wkly. ■ Dwight Tindle, pres; Eric Hauenstein VP & gen mgr; Daniel Muth, gen sls mgr; William E. Compton, prog dir; Connie Bertley, prom mgr; Linda Thompson, mus dir; Bob Dunn, news dir; Ray Thomson, chief engr. ■ Rates: \$29; 23; 23; 23.

KDKB-FM—April 20, 1968: 93.3 mhz; 100 kw. Ant 1,550 ft. Dups AM 100%. Stereo. ■ Rates same as AM.

Miami

KIKO—June 13, 1958: 1340 khz; 1 kw-D, 250 w-N, Box 1543, Globe (85501). (602) 425-4471, Globe; (602) 473-4471, Miami. Willard Shoecraft. Net: NBC; Ariz. Bcstg Syst. Format: MOR. Variety, news. Spec progs: Sp 8 hrs, Apache 3 hrs, wkly. ■ Willard Shoecraft, own & gen mgr; Gene Pearsall, prog dir; Ted Lake, news dir; Rudy Petracci, chief engr.

KIKO-FM—See Globe.

Nogales

KFBR—Sept 29, 1967: 1340 khz; 250 w-U, Box 340 (85621). (602) 287-5675. L. Walter Baranowski (9-22-75). Net: ABC/I, Arizona Bcstg System. Rep: Keystone; Simpson-Reilly (Portland, Seattle). Format: MOR & news. Spec prog: Sp 18 hrs wkly. ■ L. Walter Baranowski, own & pres; Bernard Wilson, VP & gen mgr & chief engr; John Bradford, news dir. ■ Rates: \$2.60; 2.50; 2.60; 2.50.

Page

KPGE—May 15, 1971: 1340 khz; 1 kw-D, 250 w-N, Box CC (86040). (602) 645-2262. Robert D. Holmes (acq 9-9-75). Net: ABC/I; IMN. Rep: Intermountain. Format: Contemp, C&W. ■ Dale Holmes, gen mgr & chief engr; Charlie Walters, stn mgr & coml mgr; Patric Chambers, prog dir; Willa-Don Holmes, prom mgr; Terry L. Tobinon, news dir.

Parker

KZUL—Sept 7, 1974: 1380 khz; 2.5 kw-D, Box BN (85344). (602) 669-9274. O.M. Bcstg. Net: ABC/E. Format: MOR. Spec progs: 1½ hrs Mohave, 1 hr farm, wkly. ■ Rick L. Murphy, pres & gen mgr; Jo Ann Boal, coml mgr; Mike Del Rosso, prog dir; Art Bentley, mus dir; David L. Murphy, prom mgr; Morgan Jones, news dir; Bob Nichol, chief engr. ■ Rates: \$4.65; 4.65; 4.65;

Phoenix

KASA—Jan 6, 1967: 1540 khz; 10 kw-D, DA, 1445 W. Baseline Rd. (85009). (602) 276-4241. KASA Inc (acq 4-1-73). Group owner: Ostrander, Wilson Stns. Format: Reliq. ■ George A. Wilson, pres & gen mgr; Betty Von

Arizona Radio

See page C-1 for explanation of listings.

Blomberg, stn mgr & prog dir; Jim Clark, chief engr. ■ Rates: \$6; 5; 6; —.

KBBC(FM)—See listing following KJAR.

KBUZ—See Mesa.

KDKB—See Mesa.

KHCS—Dec 12, 1962: 1010 khz; 500 w-D, 9827 North 32nd St. (85028). (602) 996-4400. Prairie Ave. Gospel Center (acq 11-71). Net: Continental Radio. Format: Relig. ■ Dr. Carl Pike, pres; William Ledbetter, gen mgr; John L. Pauley II, coml mgr; Richard A. Kerr, prog dir; Robert J. Pape, news dir; Louis Burke, chief engr.

KHEP—1956: 1280 khz; 1 kw-D, 3883 N. 38th Ave. (85019). (602) 278-5555. Grand Canyon Bcstrs Inc (acq 1957). Audio news: UPI. Format: Religious. ■ Jack Willis, VP & gen mgr; John Ballance, prog dir; Bill Fickett, chief engr. ■ Rates: \$4.50; 4.50; 4.50; 4.50.

KHEP-FM—July 5, 1964: 101.5 mhz; 100 kw. Ant 1740 ft. Stereo. Dups AM 10%. Format: Classical. ■ John Mohler, prog dir. ■ Rates: \$9; 9; 9; 9.

KIFN—Nov 23, 1949: 860 khz; 1 kw-D, Drawer 20644 (85036). (602) 258-4991. TWX 910-951-4267. KIFN Radio Inc. (acq 12-66). Net: Amigo Spanish Group. Rep: Savalli-Gates. Format: Spanish. ■ McHenry T. Tichenor, pres; Willie Harris Jr, exec VP, gen mgr; Bill Aguilar, stn mgr; Joe D. Alvarado, prog dir; Daniel C. Park, natl sls; Fabio Roderiguez, news dir; Bill Parish, chief engr.

KJJJ—1940: 910 khz; 5 kw-U, DA-N, 631 N. 1st Ave. (85003). (602) 254-7177. TWX 910-951-4253. Dairyland Mgrs Inc. (10-3-72). Net: ABC/E. Audio news: APR. Rep: Buckley. Format: C&W. ■ Ray Odum, gen mgr & natl sls mgr; Jack Block, coml mgr; Cliff Haynes, prog dir; Lou Burke, chief engr. ■ Rates: \$26; 24; 26; 22.

***KMCR-FM**—1951: 91.5 mhz; 180 w. Ant 1,510 ft. 524 W. Wash. (85003). (602) 253-6108. Maricopa County Junior College District. Net: NPR. Format: Diversified, MOR. ■ Charles E. Buzzard, gen mgr; Karol Woern, prog dir; Stephen Edwards, mus dir; Kathy Hill, prom mgr; Carl Mathusen, opns; Ralph Dodson, chief engr.

KMEO—Feb 1, 1958: 740 khz; 1 kw-D, DA, 3719 N. 32nd Ave. (85017). (602) 279-5577. Southwestern Horizons Inc. (acq 8-23-68). Group owner: Media Horizons Inc. Rep: McGavern/ Guild. Format: Beautfl mus. ■ M. Kenneth Cowan, pres; Robert J. Zimmerman, gen mgr & coml mgr; J. B. Stephens Jr, prog dir; Jim Kelly, news dir; Jim Clark, chief engr.

KMEO-FM—October 1964: 96.9 mhz; 100 kw. Ant 1,560 ft. Dups AM 100% Stereo.

KNIX(FM)—Dec 25, 1961: 102.5 mhz; 100 kw. Ant 1,620 ft. Box 15040 (85018). (602) 966-6236. Aztec Radio Inc. (acq 6-68). Group owner: Owens. Rep: Avco Radio Sls. Format: C&W 100%. ■ Buck Owens, pres; Vic Mariami, gen mgr; Charlie Ochs, mus dir; J. D. Freeman, coml mgr; Larry Daniels, prog dir; Charlie Ochs, mus dir; Burt Goodman, news dir; Elliott Klein, chief engr.

KOOL—June 1947: 960 khz; 5 kw-D, 511 W. Adams (85003). (602) 257-1234. TWX 602-255-0308. KOOL Radio-Television Inc. (acq 4-30-48). Net: CBS. Rep: Katz Radio. Format: MOR/strong personalities/heavy news. ■ Tom Chauncey, pres; Homer Lane, VP & gen mgr; Bill Lester, VP & stn mgr; Joe McNamara, prog dir; Jim Murdock, news dir; Marge Injasoutian, prom mgr; Morris Puzzi, natl sls mgr; John Redfield, loc sls mgr; Al Hillström, chief engr.

KOOL-FM—May 1956: 94.5 mhz; 100 kw. Ant 1,620 ft. Stereo. Format: Contemp. ■ Guy King, prog dir; E. Morgan Skinner, mgr; Dave Cline, loc sls mgr; Roy Stingley, opns mgr. ■ KOOL-TV affil.

KOY—October 1921: 550 khz; 5 kw-D, 1 kw-N, 84C N. Central Ave. (85004). (602) 258-8181. Southern Bcstg Co. (Group owner; acq 5-6-77). Rep: Eastman. Format: MOR. ■ John G. Johnson, pres; Gary C. Edens, gen mgr; Nat Stevens, prog dir; Pat K. McNeela, prog dir; Robert S. Scott, news dir; Roger E. Johnson, chief engr. ■ KPHO-TV affil.

KPHX—June 10, 1958: 1480 khz; 500 w-D, 2714 W. McDowell Rd. (85009). (602) 269-2311. Riverside

Arizona Radio

See page C-1 for explanation of listings.

Amusement Park Co. (acq 1-8-74). Rep: Howard Forman; News: C.L. Fite, pres; John Bonnett, gen mgr; Olaf Thorvaldsen, news dir.

KRDS—See Tolleson.

KRFM(FM)—Oct 31, 1963: 95.5 mhz; 100 kw. Ant 1,550 ft. 3501 N. 16th St., Box 10098 (85064). (602) 264-0123. Arizona FM Inc. (acq 7-3-73). Group owner: Southern Stereo. Rep: Eastman. Format: Btfl mus. John G. Johnson, pres; Gary D. Edens, VP & gen mgr; Thomas Churchill, VP & mus dir; Ed Groppo, sls mgr; Chuck Spencer, chief engr. ■ Rates: \$34; 34; 34; 22.



KRIZ—May 1949: 1230 khz; 1 kw-D, 250 w-N. 2345 W. Buckeye Rd. (85009). (602) 258-6717. TWX 910-951-1320. Doubleday Bcstg Co. Inc. (Group owner; acq 3-24-71). Rep: Radio Adv Reps. Format: Contemp Top 40; Rock. ■ David G. Scribner, pres; William G. Smith, gen mgr; Alan Neil Sargent, gen svcs mgr; Richard Haines, local sls; Jay Stone, prog dir; Lon Abernathy, news dir; Steve Casey, mus dir; Hugh Beavers, chief engr. ■ Rates: \$30; 30; 35; 35.

KRPS-FM—Not on air, target date unknown: 89.5 mhz; 88 w. Ant 1218 ft. 524 W. Washington (850U3). Maricopa County Community College District.

KRUX—See Glendale.

KTAR—June 21, 1922: 620 khz; 5 kw-U DA-N. Box 711 (85001). (602) 258-7333. TWX 602-255-0465. KTAR Bcstg Co. (acq 8-44). Group owner: Combined Communications Corp. Net: ABC/1; Arizona Bcstg Sys; Audio News: APR. Rep: Blair. Format: News/sports. Spec prog: Farm 6 hrs wkly. ■ Karl Eller, pres; Ralph Beaudin, gen mgr; John Bonnett, stn mgr; Steve Glueck, gen sls mgr; Roger Downey, news dir; William Green, chief engr.

KBBC(FM)—Co-owned with KTAR. July 1960: 98.7 mhz; 115 kw. Ant 1,680 ft. Prog sep from AM. Net: ABC/C. Rep: Blair Radio. Format: Contemp. ■ Tony Booth, prog dir; Art Webb, mus dir. ■ KTAR-TV affil.

KTUF—See Tempe.

KUPD—See Tempe.

KXIV—Aug 27, 1954: 1400 khz; 1 kw-D, 250 w-N. 3003 N. Central Ave., Suite 704 (85012). (602) 264-9001. KXIV Inc. (acq 10-1-65). Net: NBC. Rep: Masla/Young. Format: MOR/personality; talk. ■ Dick Van Dyke, pres; Ira L. Lavin, exec VP & gen mgr; Clifford Lavin, prom mgr; Frank Pollack, prog dir; Preston Westmorland, mus dir; Paul B. Munt, news dir; Elliott Klein, chief engr. ■ Rates: \$19.50; 12.50; 14.50; 9.

KXTC(FM)—See Glendale.

Prescott

KNOT—June 22, 1957: 1450 khz; 1 kw-D, 250 w-N. Box 151 (86301). (602) 445-6880. Parkell Bcstg Inc. (acq 7-26-63). Net: MBS. Rep: Savalli/Gates. Format: MOR, Good music. ■ Boyd J. Browning, pres, gen, coml & prom mgr; Bruce Hendrickson, prog & mus dir; Carol Wargo, news dir; Tom Machamer, chief engr.

KEZH(FM)—Co-owned with KNOT. Not on air, target date unknown: 98.3 mhz; 3 kw. Ant 174 ft.

KYCA—August 1940: 1490 khz; 1 kw-D, 250 w-N. Box 1631 (86301). (602) 445-1700. Southwest Bcstg Corp. (acq 9-25-70). Net: NBC; Arizona Bcstg. Rep: Oakes, Messina, Hix (Denver); Gene Bolles Co. (N.Y.). Format: MOR. Spec progs: Sp 1 hr, C&W 12 hrs, wkly. ■ Lou Silverstein, pres, gen & coml mgr; Nancy Silverstein, prog & mus dir; Gail Westrup, news dir; Don Harrison, chief engr. ■ Rates: \$4.50; 3; 4.50; 3.

Safford

KATO—May 5, 1961: 1230 khz; 1 kw-D, 250 w-N.

Drawer L (85546). (602) 428-1230. KSIL Inc. (acq 10-31-73). Net: NBC; Arizona Bcstg System. Rep: Messina. Format: MOR. Spec prog: Sp 5 hrs wkly. ■ Dennis Behan, pres; William G. Arnold, gen mgr, coml mgr & prog dir; Jeff Brown, mus dir; Bob Trent, news dir; Ward Belliston, chief engr.

Scottsdale

KDOT—1956: 1440 khz; 5 kw-D. Box 1827, 4601 N. Scottsdale Rd. (85251). (602) 947-7355. Central Ariz. Bcstg Inc. (acq 8-2-68). Format: Instrumental/easy lstrg. ■ Fred Hervey, pres; Sam E. Pendleton, exec VP & gen mgr; Rick Orick, coml mgr; John Rowlinson, news dir & opns mgr; John Horton, chief engr.

KDOT-FM—Aug 1, 1969: 100.7 mhz; 50 kw. Ant 170 ft. Dups AM 100%. Stereo.

Sedona

KAZM—Nov 1, 1974: 1470 khz; 5 kw-D. Box 1525 (86336). (602) 282-4154. Tabback Bcstg Co. Format: Oldies, btfl mus. Spec progs: Classical 10 hrs; foreign mus, 1 hr, wkly. ■ Joseph P. Tabback, owner; T. A. Tabback, gen mgr; R.J. Conway Jr., prog dir; J.P. Tabback, chief engr. ■ Rates: \$3.70; 3.70; 3.70; —.

Show Low

KVSL—July 6, 1968: 1450 khz; 1 kw-D, 250 w-N. Box 940 (85901). (602) 537-2222. KBW Assoc Inc. (acq 9-1-74). Rep: Savalli/Gates. Format: MOR. Spec prog: Apache 3½ hrs wkly. ■ Hugh Williams, pres & chief engr; Carl C. Kuehn II, gen, coml & prom mgr; Jerry Dobbs, prog & mus dir; Chip Stanley, news dir.

KVVM—May 17, 1957: 970 khz; 5 kw-D. Box 660 (85901). (602)537-2345. Peak Bcstg Co. ■ Searcy J. Woodworth, own, mgr & chief engr; Dorothy L. Woodworth, prog dir.

KVVM-FM—Sept 13, 1964: 93.5 mhz; 3 kw. Ant 150 ft. Dups AM 75%.

Sierra Vista

KTAN—March 1957: 1420 khz; 1 kw-D, 500 w-N, DA-N. Box 1566 (85635). (602) 458-4313. Huachuta Bcstg Co. (acq 1-66). Net: NBC; Arizona. Format: MOR. Spec prog: C&W 7 hrs wkly. ■ Kenneth Ferguson, pres & gen mgr; Norm Fiore, coml mgr; John McGovern, prog dir; Betty Ferguson, prom mgr; Bob Melvin, mus dir; Jon Brown, news dir; Jim Young, chief engr.

KTAN-FM—September 1973: 100.9 mhz 3 kw. Ant minus 46 ft. Dups AM 10% Stereo.

Sun City

KWAO(FM)—March 7, 1975: 106.3 mhz 3 kw. Ant: 97 ft. Stereo. 10820 Oakmont Dr. (85351). Sun City Bcstg Corp. Format: Oldies, easy listening. Spec prog: Religious, 12 hrs wkly. ■ Russell C. Lash, pres; Edwin R. White, gen mgr, prog dir & chief engr. ■ Rates: \$6.75; 6.75; 6.75; 6.75.

Tempe

KNIX(FM)—See Phoenix.

KTUF—June 23, 1967: 1580 khz; 50 kw-D, 10 kw-N, CH. Box 15040, Phoenix (85018). (602) 966-6236. Buck Owens Bcstg Inc. (Group owner; acq 4-18-67). Rep: Avco. Format: C&W. ■ Buck Owens, pres; Vic Meriane, gen mgr; Larry Daniels, prog dir; J. D. Freeman, coml mgr; Charlie Ochs, mus dir; Burt Goodman, news dir; Elliott Klein, chief engr.

KUPD—April 16, 1960: 1060 khz; 500 w-U, DA-1. 417 N. First St., Phoenix (85004). (602) 258-3434. Tri-State Broadcasting Co. (acq 12-23-74). Rep: Torbet. Format: Contemp, rock, top 40. ■ Berry Leverant, gen mgr; Lloyd Melton, stn & sls mgr; Chuck Browning, prog dir; Jimi Fox, mus dir; Chuck Britton, news dir.

KUPD-FM—July 1, 1960: 97.9 mhz; 100 kw. Ant 1,620 ft. Dups AM 100%. Stereo.

Tolleson

KRDS—Jan 23, 1961: 1190 khz; 250 w, DA-1. Penthouse Suite, 9809 N. Metro Pkwy. West Phoenix (85021). (602) 944-3367. Southwestern Bcstrs. Inc. (group owner). Net: MBS; Mutual Black. Rep: Potter; Messina. Format: Sp MOR, talk. Spec prog: French 6 hrs wkly. ■ Edward Shadak, pres; H. George Carroll, gen & coml

mgr; Martin Tallberg, prog dir; Michael Dixon, prom dir; Reggie Buckingham, news dir; Hank Warren, chief engr. ■ Rates: \$15; 11.45; 15; 7.85.

Tsaie

***KNCC(FM)**—Not on air, target date unknown: 91.9 mhz; 10 w. c John L. Bray (86503). Board of Regents, Navajo Community College. Format: Educ. ■ Guy Gorman St., chairman.

Tucson

KAIR—January 1957: 1490 khz; 250 w. (CP 1 kw-D, 250 w-N). Box 49067 (85717). (602) 795-1490. Number one Radio (Group owner; acq 12-16-67). Rep: McGovern-Guild. Format: Beautifl music. ■ Edwin Richter, pres; Howard D. Duncan, exec VP & gen mgr; Frank Kalil, VP; Ray Tenpenny, sls mgr; Larry Noyce, prog dir; Jack Baty, prom mgr; Michael Goodrich, chief engr. ■ Rates: \$13.50; 11.50; 13.50; 11.50.

KAIR-FM—April 11, 1973: 94.9 mhz; 50 kw horiz, 15 kw vert. Ant 188 ft. Stereo. Prog sep from AM. ■ Marty Ross, gen mgr; Tom Moore, coml mgr. ■ Rates: \$10.75; 11.75; 11.75; 10.75.

KCEE—Oct 1, 1958: 790 khz; 5 kw-D, 500 w-N, DA-2. Box 5803, 2100 N. Silverbell (85703). (602) 622-7788. Strauss Bcstg Co. (acq 9-1-66). Net: NBC. Rep: Avery-Knodel. Format: MOR. ■ Robert A. Strauss, pres & gen mgr; Phyllis Ehlinger, coml mgr; David Graham, prog dir & mus dir; Claire Coffman, news dir; Harry Charles, chief engr. ■ Rates: \$14; 12; 14; 12.

KCEE-FM—June 1, 1967: 96.1 mhz; 25.5 kw. Ant 77 ft. Prog sep from AM. Stereo. Format: Goooi mus. ■ Rates: \$7; 7; 7; 7.

KCUB—Aug 1929: 1290 khz; 1 kw. Box 50006 (85703). (602) 887-1000. Rex Bcstg Corp. (acq 6-68). Rep: Eastman. Format: C&W. ■ Jim Stone, pres & gen mgr; Phil Richardson, sls mgr; Jim Arnold, opns dir; Bob English, prog dir; Jay Price, prom mgr; Mel Ballinger, news dir; Lyn Holclaw, chief engr. ■ Rates: \$13; 10; 11; 10.

KEVT—Sept 23, 1953: 690 khz; 250 w-D. Box 101 (85702). (602) 624-5588. Tucson Radio Inc. (acq 5-4-66). Net: All-Spanish. Rep: Savalli-Gates. Format: Sp. ■ Alvin L. Korngold, pres; Joe Crystall, VP & gen mgr; Manuel Ornelas, opns mgr; Roberto San Martin, prog dir; Josie Velarde, traf mgr; Peter Troubridge, chief engr. ■ Rates: \$8.50; 8.50; 8.50; —.

KWFM(FM)—Co-owned with KEVT. May 18, 1970: 92.9 mhz; 28 kw. Ant 86 ft. Box 13 (85702). Stereo. Net: ABC-FM. Format: Rock, prog-s. ■ Aileen McGhie, opns mgr; Allan Browning, prog dir; Lee Dombrowski, sls mgr; Dave Gordon, mus dir; Peggy Leary, traf mgr. ■ Rates: \$16; 16; 20; 20.

KFMM(FM)—See listing following KTUC.

KHOS—August 10, 1963: 940 khz; 1 kw-D, 250 w-N, DA-2. Box 5946 (85703). (602) 624-2341. Grabet Inc. Radio Enterprises. (acq 5-1-73). Net: ABC/1. Rep: Masla, Masla/Young. Format: C&W. ■ William R. Phalen, pres & gen mgr; Charles Stretton, coml mgr; Thomas Wright, prog dir. ■ Rates: \$9.75; 8.75; 9.75; 8.75.

KHYT—1957: 1330 khz; 500 w-D. Box 26040. (85726). (602) 623-7501. Golden State Bcstg Corp. (acq 4-1-66). Net: MBS. Format: MOR, talk. ■ Robert H. Scholz, pres; Ken Byrnes, gen mgr; Dennis Lyon, coml mgr; Robert Morgan, prog dir; Karl Newkirk, mus dir; Jim Scopac, prom mgr; Mike Cassett, news dir; William Youdelamm, chief engr. ■ Rates: \$15; 9; 9; —.

KIKX—1946: 580 khz; 5 kw-D, 500 w-N, DA-1. 4701 N. Swan, Box 5566 (85703). (602) 299-9711. Walton Bcstg (Group owner; acq 1965). Net: ABC/C. Rep: Selcom. Format: Top 40. ■ John Walton, pres; Bill Mitchell, VP & gen mgr; Loyal Clark, coml mgr; Rick Morales, prog dir; Dennis DeWolf, mus dir; Dave Sommer, prog mgr; Dave Ulmer, news dir; Tom Tompkins, chief engr. ■ Rates: \$17.50; 15.30; 17.50; 15.30.

KOPO—Feb 27, 1947: 1450 khz; 500 w-D, 250 w-N. 120 West Broadway (85701). (602) 882-8511. KOPO Bcstg Co. Inc. Net: CBS, Arizona Bcstg Network. Rep: Katz. Format: MOR. ■ Tom Chauncey, pres; Jay L. Spurgeon, gen & coml mgr; Mike Mitchell, prog dir; Ron Perkins, news dir; Don Jackson, chief engr. ■ Rates: \$10; 7; 10; 7.

KTKT—December 1949: 990 khz; 10 kw-D, 1 kw-N. DA-2. Box 5585 (85703). (602) 622-6711. Lotus Com-

munication Corp. (Group owner: acq 8-1-72). Audio news: UPI. Rep: McGavren-Guild. Format: Top 40, rock. Spec prog: Black 2 hrs; religious 2½ hrs, weekly. ■ Howard A. Kalmenson, pres; Mark G. Schwartz, gen mgr; Roger Collins, prog dir; Ed Alexander, mus dir; Toni Stanton, news dir; Marshall P. Brown, chief engr. ■ Rates: \$19; 15; 5.19; 15.50.

KTUC—July 10, 1926: 1400 khz; 1 kw-D, 250 w-N. Box 4009 (85717). (602) 622-3344. KTUC Inc. (acq 7-15-64). Group owner: 2588 Newport. Net: ABC/I. Rep: Messina. Format: News, inform, sports. ■ Raymond I. Kandel, pres; Thomas A. Maples, gen mgr; Gene Kelly, coml mgr. ■ Rates: \$7; 7; 7.

KFMM(FM)—CO-owned with KTUC. March 1954: 99.5 mhz; 30 kw. Ant minus 73 ft. Prog sep from AM. Format: Relig. ■ Thelma Sees, stn mgr.

***KUAT**—Oct 7, 1968: 1550 khz; 50 kw-D. U of Ariz. (85721). (602) 884-1434. Ariz. Board of Regents. (acq 6-9-67). Format: talk, jazz. Audio news: UPI. ■ Frank Barreca, gen mgr; Wes Marshall, stn mgr; Patricia McQuown, prog mgr; Marvin Smith II, prod mgr; Robert Ritter, news editor; Robert Hendrickson, chief engr.

***KUAT-FM**—May 19, 1975: 90.5 mhz; 12.5 kw. Ant 3,580 ft. Stereo. Radio-TV-Film Bureau, Univ of Ariz (85721). (602) 884-1434. Net: NPR. Audio news: UPI. Format: Clsci. ■ Edward Garza, mus coord. ■ *KUAT-TV Affil.

KWFM(FM)—Listing follows KEVT.



KXEW—May 10, 1963: 1600 khz; 1 kw-D, DA. (CP I kw-D). Box 2284 (85702). (602) 623-3625. Radio Fiesta Inc. (acq 1972). Rep: Lotus Reps (West Coast); Caballero Spanish Media (East Coast); Riley Reps (South). Format: Spanish. ■ Ernesto Portillo, pres & gen mgr; Arnulfo Palma, prog dir; Claudio Jimenez, news dir; Lynden Holslaw, chief engr. ■ Rates: \$8; 7.50; 8; —.

KXEW-FM—Feb 1, 1971: 93.7 mhz; 29 kw. Ant minus 38 ft. Prog sep from AM. Format: Spanish popular music. ■ Rates: \$6.50; 6.50; 7; 7.

Wickenburg

KSWW—Jan 27, 1968: 1250 khz; 500 w-D. Box Y (85358). (602) 684-2162. The Wickenburg Radio Co. Inc. Rep: Jalco. Format: Contemp, C&W. Spec prog: Relig 10 hrs wkly. ■ Joyce Stirling, pres; Jack E. Hughes, VP & gen mgr; Richard Haskey, chief engr.

Willcox

KHIL—Dec 2, 1959: 1250 khz; 5 kw-D, Box 880 (85643). (602) 384-4424. Coppertone Communications (acq 3-18-75). Net: ABC/I, AP Radio Wire Service. Rep: Bill Dahlsten & Assoc. Format: Top 40 mod country. Spec prog: Farm, 4 hrs; Spanish 1½ hrs, wkly. Burkett H. Wamsley, pres & gen mgr; John P. McPartlin, coml mgr; Cody D. Wamsley, prog dir; Harry Vose, chief engr.

Williams

KNYN—June 7, 1968: 1240 khz; 1 kw-D, 250 w-N. Box 66 (86046). (602) 635-4488. Bruce Danic Owens (acq 7-30-74) Rep: Bill Dahlsten & Assoc. Format: MOR. btlf mus. Spec progs: Sp 4 hrs wkly. ■ Bruce D. Owens, pres & gen mgr; Sandy Wallingford, coml & prom mgr; Wes Tyra, prog dir; Cindy Thorson, mus dir; Timothy Hunt, chief engr.

Window Rock

KHAC—Mar 21, 1967: 1300 khz; 1 kw-D. Navajo Bible School (86515). (505)371-4387. Navajo Bible School & Mission. Net: UPI Audio. Format: Variety, MOR, rel Navajo. ■ Laurence Harper, gen mgr; Paul Lierman, prog dir; Allen Barrett, chief engr.

Winslow

KINO—Dec 18, 1962: 1230 khz; 1 kw-D, 250 w-N. Drawer K (86047). (602) 289-3364. Winslow Communications (acq 2-1-68). Net: ABC/E. Rep: Jalco. Format: CEW. Spec prog: Hopi Indian 6 hrs wkly. ■ M.J. O'Hacco, pres; E. James Brady, gen & coml mgr; Jimmy

St. James, prog dir; Diane King, news dir; Frank Kramer, chief engr.

Yuma

KALJ(FM)—Nov 6, 1970: 95.1 mhz 25 kw. Ant 76 ft. Box 4457, 841 Ave. G (85364). (602) 782-4355. Lan Jol Enterprises. Rep: Savalli/Gates. Format: Easy lting, personality. ■ Joel E. Pollard, pres & gen mgr; Robert H. Langill, VP; Neil "Bud" O'Neill, coml mgr; Richard Davis, prog dir; Michael Riley, ops & mus dir; Robert Miller, news dir; Leavenworth Wheeler, chief engr.

***KAWC**—July 11, 1970: 1320 khz; 500 w-D. Box 929 (85364). (602) 726-1000. Arizona Western College (acq 7-11-70). Net: NPR. Format: Variety. Spec prog: Sp 16 hrs wkly. ■ Dr. Robert Garin, pres; Robert E. Hardy, gen mgr; Annette Lewis, asst bcst d'r; Paul Riley, ops dir; James Haskins, prod coord; Doug MacDuff, mus dir; Ron Whitworth, prom mgr; Dennis Gilliam, chief engr.

KBLU—March 1940: 560 khz; 1 kw-U. DA-N. Box 1501 (85364). (602) 782-3881. KBLU Bcstg Co. (acq Aug 1973). Net: NBC. Rep: Avery-Knodel. Format: Contemp. ■ Robert W. Crites, gen mgr; Lee Poole, prog dir; George Corneal, news dir; Richard Nix, chief engr. ■ KBLU-TV affil. ■ Rates: \$6; 4.60; 7; 3.

KJOK—See listing following KVOY.

KVOY—Dec 11, 1950: 1400 khz; 1 kw-D, 250 w-N. Box 228 (85364). (602) 782-4321. Magnamedia Inc. (acq 3-1-71). Net: ABC/I, Golden West. Rep: PRO Time Sales; Dalsten (West). Format: MOR, C&W. Spec prog: Farm 5 hrs wkly. ■ Robert Casey Meyers, pres; Jim Stowe, VP & gen mgr; Ray Wanty, coml mgr; John Gaboury, chief engr. ■ Rates: \$8.75; 7; 8.75; 5.75.

KJOK(FM)—Co-owned with KVOY. Aug 20, 1972: 93.1 mhz; 30 kw. Ant 74 ft. (602) 782-3544. Prog sep from AM. Stereo. Format: Contemp. ■ Rates: \$6.75; 6; 6.75; 4.74.

Arkansas

HAMILTON-LANDIS & ASSOCIATES, Inc.
NATIONWIDE MEDIA BROKERS
WASHINGTON, D.C., CHICAGO, DALLAS,
SAN FRANCISCO
SELL MORE
RADIO & TELEVISION STATIONS
IN THE SOUTHWEST—NEAREST OFFICE IS—
6060 N. CENTRAL EXPY., DALLAS 75206
(214) 691-2345

Arkadelphia

***KSWH(FM)**—Sept 5, 1969: 91.1 mhz; 10 w. Ant 70 ft. HSC Box 2961 (71923). (501) 246-5511, ext. 231. (71923). Henderson State Univ. Format: Diversified. Spec progs: Pub affrs 10 hrs. ■ Edwin H. Ryland, gen mgr; Gary Brewer, chief engr.

KVRC—Sept 25, 1947: 1240 khz; 1 kw-D, 250 w-N. Box 40 (71923). (501) 246-4651. Arkadelphia Bcstg Co. ■ Bill Deaton, gen mgr; John M. Riggie, chief engr.

New FM—Co-owned with KVRC. Not on air, target date unknown: 100.9 mhz; 3 kw. Ant 96 ft.

Ashdown

KMLA(FM)—May 19, 1972: 103.9 khz; 3 kw. Ant 210 ft. Box 17 (71822). (501) 898-2774. Ashdown Broadcasters, Inc. Net: Ark Radio. Format: C&W, Contemp. ■ Jim McCollum, pres; Steve Pearce, gen mgr; Terry Snead, prog dir; Sarah Ward, bus mgr; Arthur Wright, chief engr. ■ Rates: \$26.40; 26.40; 26.40.

Augusta

KMCW—Sept 6, 1968: 1190 khz; 250 w-D. Box Z (70026). (501) 347-2671. Service Communications Inc. Net: Ark Radio. Format: C&W. ■ Carlton Garner, VP & gen mgr; Wayne Wright, coml mgr; Doris Hazelwood, prog dir; Jack Holder, prom mgr; Donny Cox, chief engr.

Arizona, Arkansas Radio

See page C-1 for explanation of listings.

Batesville

KBTA—June 30, 1950: 1340 khz; 1 kw-D, 250 w-N. Box 2077 (72501). (501) 793-3861. White River Valley Bcstrs Inc. Format: C&W, MOR, Variety. ■ J. F. Higginbottom, pres & gen mgr; Roy Henderson, stn & coml mgr.

***KGED(FM)**—Not on air, target date unknown: 88.1 mhz; 10 w. 2190 Case St. (72501). Arkansas College. ■ Dan C. West, pres.

Benton

KBBA—June 26, 1953: 690 khz; 250 w-D. Box 49 (72015). (501) 778-2690. Benton Bcstg Service. Format: C&W. Net: Keystone. ■ Winston Riddle, own/mgr; John W. Riddle, prog dir; Wilson B. Hurst, coml mgr; Richard H. Sanders, mus dir; Bill J. Wood, news dir; W. L. James, chief engr.

KGKO—May 5, 1963: 850 khz; 1 kw-D. Box 369 (72015). (501) 778-8257. Bridges Bcstg Service. (acq 1-10-67). Format: Hits of 40's & 50's. ■ Preston Bridges, owner, gen mgr & chief engr; Erma Bridges, news dir.

Berryville

KAAM(FM)—Listing follows KTHS.

KT:HS-AM/KAAM-FM

KTHS—February 1958: 1480 khz; 1 kw-D. Box 191 (72616). (501) 423-2148. KTHS Inc. (acq 2-1-66). Net: Ark Radio. Rep: Paul Miller Co. Format: C&W, MOR, Top 40. ■ Maurice F. Dunne Jr., pres; Charles C. Earls, gen mgr; William C. Autry, stn mgr; Sidney J. Burch, prog dir; Gary Usery, sls mgr; Les Hadley, mus dir; Paul J. Wilhelm, news dir; Dan Patterson, chief engr.

KAAM(FM)—Co-owned with KTHS. Dec 19, 1974: 107.1 mhz; 1 kw. Ant 450 ft. Stereo. Net: ABC/I, Brownfield. Format: C&W, MOR. Progs sep from AM.

Blytheville

KHLS(FM)—Listing follows KLCN.

KLCN—1922: 910 khz; 5 kw-D. Box 989 (72315). (501) 762-2093. Sudbury Services Inc. Group owner: Sudbury. Net: ABC/E; Ark Radio; U. of Ark Spots; Cardinal Net. Format: C&W. ■ Harold L. Sudbury, Sr., pres & gen mgr; Harold L. Sudbury, Jr., coml & prom mgr & chief engr; Wayne Toombs, prog & mus dir.

KHLS(FM)—Co-owned with KLCN. 1948: 96.1 mhz; 100 kw. Ant 350 (CP-450 ft.). Prog sep from AM. Stereo.

Brinkley

KBRI—Oct 25, 1959: 1570 khz; 250 w-D. Box 711 (72021). (501) 734-1570. Tri-County Bcstg Co. Net: Arkansas. ■ W. G. Elledge, gen mgr.

KBRI-FM—April 15, 1969: 102.3 mhz; 3 kw. Ant 190 ft. Dups AM 70%.

Camden

KAMD—June 19, 1946: 910 khz; 5 kw-D, 500 w-N. DA-2. Box 957 (71701). (501) 836-5091. Camden Radio Inc. Net: MBS. Format: C&W. ■ Walter E. Hussman, pres; Donald Cathey, gen mgr; Max Parker, coml mgr; Cal Carter, prog, mus & news dir & prom mgr; Mike Curtis, chief engr.

KWEH(FM)—Co-owned with KAMD. Dec 1, 1968: 97.1 mhz; 39 kw. Ant 185 ft. 113 Madison (71701). (501) 836-8196. Prog sep from AM. Format: MOR.

KJWH—Aug 8, 1963: 1450 khz; 1 kw-D, 250 w-N. Box 606 (71701). (501) 836-9393. Ouachita Valley Radio Corp. Net: Ark Radio. Rep: Beavers. ■ J. W. Harrell, pres, gen mgr & prog dir; Alice Harrell, coml mgr & news dir; Pat McNulty, chief engr.

KWEH(FM)—Listing follows KAMD.

Arkansas Radio

See page C-1 for explanation of listings.

Clarksville

KLYR—March 18, 1957; 1360 khz; 500 w-D. Box 188 (72830). (501) 754-3092. Roy Forrester, Net: Ark Radio. Format: Contemp; MOR. ■ Roy Forrester, pres.

KLYR-FM—1974; 92.7 mhz; 3 kw. Ant minus 73 ft. Dups AM 10%. Format: C&W; relig-Sunday.

Conway

KCON—Nov 13, 1950; 1230 khz; 1 kw-D, 250 w-N. Box 1406 (72032). (501) 327-7701. Conway Bcstg Co. Net: MBS. Rep: Beaver. Format: MOR. ■ Madge W. Clayton, pres; Bill F. Johnson, gen mgr; Paul Price, news dir; Robert Kay, mus dir; Adair Shock, coml mgr. ■ Rates: \$3; 2.50; 2.50; 2.50.

***KHDX(FM)**—May 1973; 89.1 mhz; 10 w. Ant 25 ft. Stereo. Hendrix College (72032). (501) 327-2600. Hendrix College. Net: Arkansas Radio Network. Format: noncoml diversified. Spec progs: Ger, Sp, 3 hrs wkly each. ■ John Arms, faculty advisor; Richard Duncan, chief engr.

***KUCA(FM)**—Oct 10, 1966; 91.5 mhz; 10 w. Ant 95 ft. Box A, State College of Arkansas (72032). (501) 729-2931. University of Central Arkansas. Format: Noncoml diversified. Spec progs: Black, classical, 10 hrs. wkly each; jazz, 3 hrs wkly. ■ James Napier, fac adv; Hollis Duncan, chief engr.

KVEE—May 26, 1961; 1330 khz; 500 w-D. Box 1266 (72032). (501) 329-3819. Communications Media Corp. (acq 1974). Format: C&W. Spec prog: Farm, 6 hrs wkly. ■ Lloyd V. Ston Jr, pres & gen mgr; Ronald Marable, sls mgr; Herb Baker, mus dir; Richard Lantrip, news dir; Bill S. Pledger, prog dir; Wayne Dunçan, chief engr. ■ Rates: \$60; 42; 60.

KVEE-FM—June 1, 1967; 105.1 mhz; 28.5 kw. Ant 320 ft. Dups AM 100%.

Corning

KCCB—Feb 19, 1959; 1260 khz; 1 kw-D. Box 393 (72422). (501) 857-9261. Eulis W. Cochran. Net: Keystone. Rep: Continental. ■ Eulis W. Cochran, owner; Doll Cochran, coml mgr & prog dir; Bob Cochran, gen mgr; Ray Dawson, prom mgr; Fred Martin news dir & chief engr.

Crossett

KAGH—Jan 1951; 800 khz; 250 w-D. Box 697 (71635). (501) 364-2181. Ashley County Bcstrs Inc. (acq 8-1-69). Net: Ark Radio. Rep: Beaver. Format: C&W, Variety, MOR, Rock, Top 40. ■ W. Barry Medlin, pres & gen mgr; Dee Smith & Mark Self, coml mgrs; Marsha Roan, prog dir; Russ Miller, mus dir; Mark Self, news dir; Jack Reynolds, chief engr.

KAGH-FM—March 16, 1967; 104.9 mhz; 3 kw. Ant 275 ft. Dups AM 80%.

Dardanelle

KCAB—March 24, 1964; 980 khz; 1 kw-D. Box 89 (72834). (501) 968-4949. Central Arkansas Bcstg Co. Inc. (acq 7-72) Net: ABC/C. Format: C&W. ■ G. Ronald Rye, pres; Harold Nichols, coml mgr; David Tucker, prog dir; Bill Shell, news dir; Bill McKenney, chief engr.

KWKK(FM)—Co-owned with KCAB. Jan 26, 1966; 102.3 mhz; 3 kw. Ant 260 ft. Drawer K (72834). Net: ABC/I. Progs sep from AM. Format: Contemp. ■ Ed Thompson, prog dir. ■ Rates: \$96; 60; 84; 60.

DeQueen

KDON—Aug 1, 1956; 1390 khz; 500 w-D. Box 311 (71832). (501) 584-2446. Radio DeQueen (acq 9-11-75). Net: Ark Radio. Format: MOR, Gosp, C&W, Top 40. ■ Haskell Jones, Verlaïne Jones, owners.

DeWitt

KDEW—March 1, 1968; 1470 khz; 500 w-D. Box 326 (72042). (501) 946-1470. DeWitt Bcstg Inc. Net: Ark Radio. Format: C&W/Easy Istng. ■ Edward Moory, pres & gen mgr; Mary Clemons, asst mgr; Maxie Davis, prog dir; Darryl Vansandt, chief engr.

KDEW-FM—Sept 1, 1970; 96.7 mhz; 3 kw. Ant 145 ft. Dups AM 75%. Format: Easy Istng after AM signoff.

Dumas

KDDA—April 21, 1966; 1560 khz; 500 w-D. Box 720 (71639). (501) 382-5600. Alan W. Eastham, Mrs. T. W. Eastham & Thomas O. Graves. Net: Ark. Format: Variety-Block. Spec progs: Black 13 hrs; Gospel Music 8 hrs, both wkly. ■ Alan W. Eastham, pres & gen mgr; Randy Moore, coml mgr & prog dir; Tom Graves, chief engr. ■ Rates: \$36; 36; 36; 24.

El Dorado

KDMS—May 8, 1950; 1290 khz; 5 kw-D. (CP chg in ant sys) Box 1565 (71730). (501) 863-9573. J. A. West. El Dorado Bcstg Co. (acq. 4-54). Net: ABC/C; Arkansas Radio Network. Format: Contemp. ■ J.A. West, pres; Paul Meacham, VP & gen mgr; Carl Conner-ton, news dir; Jim Nowicki, coml mgr; Lonnie Hutto, chief engr. ■ Rates: \$7.65; 6.50; 7.65; —.

KRIL(FM)—Co-owned with KDMS. Dec 23, 1963; 99.3 mhz 2.95 kw. Ant 300 ft. Stereo. Prog sep from AM. (501) 863-6872. Net: ABC/FM. Format: C&W. ■ Cecil McBryde, coml mgr. ■ Rates: \$3.20; 2.80; 3.20; 2.80.

KELD—Oct 17, 1935; 1400 khz; 1 kw-D, 250 w-N. 210 N. Washington (71730). (501) 863-6126. Noalmark Bcstg Corp. (acq 7-73). Net: NBC. Rep: Beaver/Riley. Format: MOR. ■ Jerome Orr, VP & gen mgr; Sarah Durrett, asst mgr; Mike Langley, mus dir; Bill Young, news dir; Troy Eddins, chief engr.

KEZU(FM)—Co-owned with KELD. Dec 9, 1963; 103.1 mhz; 3 kw. Ant 200 ft. Stereo. Format: Easy Istng. Progs sep from AM.

KRIL(FM)—Listing follows KDMS.

Fayetteville

KFAY—June 30, 1957; 1250 khz; 1 kw-D. Box 1121 (72701). (501) 442-9859. Big Chief Bcstg Co. of Fayetteville (acq 9-15-66). Rep: Savalli-Gates. Format: Mod country. ■ Jack Beasley, pres; Pat Demaree, stn mgr; Ray Plack, sls mgr.

KKEG(FM)—Co-owned with KFAY. Oct 16, 1964; 92.1 mhz; 3 kw. Ant 190 ft. Format: Top 40.

KHOG—Dec 15, 1946; 1440 khz; 1 kw-D. 103 West Mountain (72701). (501) 442-2322. Broadcasting Associates Inc. (acq 5-5-61). Prog owner: Sammons-Ruff. Rep: Devney. ■ Raymond Ruff, pres; Ed Gideon, gen mgr.

KKEG(FM)—Listing follows KFAY.

KNWA(FM)—Oct 1, 1966; 103.9 mhz; 800 w. Ant 510 ft. Stereo. Box 1192, 501 E. Maple St. (72701). (501) 442-4215. Kessler Mt. Bcstg Corp. Net: Ark Radio. Format: Good mus. ■ E. H. Froning, pres & gen mgr; Jerry Barnett, coml dir; Harold R. Linsey, chief engr.

***KUAF(FM)**—Jan 15, 1973; 88.9 mhz; 10 w. Ant 255 ft. 103 N. Duncan (72101). (501) 575-2556. Board of Trustees, U. of Arkansas. Format: Progs. Spec progs: Fr 2½ hrs, Sp 2½ hrs, Black 12 hrs, C&W 3 hrs, Classical 9 hrs, R&B 6 hrs wkly. ■ David R. Johnson, gen mgr.

Fordyce

KBJT—Aug 1, 1959; 1570 khz; 250 w-D. Box 659 (71742). (501) 352-2170. KBJT Inc. (acq 1-3-62). Net: Keystone. Spec progs: Black 2 hrs wkly. ■ Mack R. Smith, pres; Jay Bagwell, gen mgr; Jesse Smith, coml mgr; Melrose Bagwell, prog dir; Bob Schuler, news dir & chief engr.

Forrest City

KBFC(FM)—Listing follows KXJK.

KXJK—April 29, 1949; 950 khz; 5 kw-D. Box 707 (72335). (501) MEIrose 3-1252. Forrest City Bcstg Co. Net: Keystone. Rep: Devney; Beaver. Spec progs: C&W 15 hrs wkly. ■ William Fogg, gen mgr; Earl Black Jr, coml mgr; Joe Henderson, prog dir; David Adamson, chief engr.

KBFC(FM)—Co-owned with KXJK. Sept 22, 1960; 93.5 mhz; 3 kw. Ant 225 ft. Stereo. Format: C&W, MOR.

Fort Smith

KFPW—July 27, 1930; 1230 khz; 1 kw-D, 250 w-N.

(C.P. incr ant hght) Box 4150 (72901). (501) 783-4105. TWX 910-723-7661. KFPW Bcstg Co. Net: CBS. Format: MOR. ■ George T. Herreich, owner; John Whitt, gen mgr; Joe Roppolo, prog dir; Ron Wilson, mus dir; Jerry B. Davis, opns mgr; Calvin Smith, chief engr. ■ KFPW-TV affil.

KFSA—Feb 13, 1947; 950 khz; 1 kw-D, 500 w-N, DA-N. Box 488 (72901). (501) 782-9125. Fort Smith Bcstg Co. Group owner: Donrey. Net: ABC/I. Rep: Meeker; Busby, Finch & Woods; Crane. Format: Contemporary. ■ Joe McMurray, pres; George Glover, gen mgr; Tom Boling, coml mgr; Jim Carter, prog dir; Bill Shell, news dir; Jerry Tucker, chief engr.

KISR

The Area Leader

KISR(FM)—Aug 16, 1972; 93.7 mhz; 61 kw. Ant 19 ft. Quad Stereo. Box 3100 (72901). (501) 785-2526. Negamedia. Format: Contemp. ■ Fred H. Baker, pres; Rick Pope, stn & coml mgr; Ed G. Hopkins III, prog dir; David Hopkins, mus dir; Rick Lepper, prom mgr; Lon Schultz, chief engr. ■ Rates: \$7; 6; 7; 6.

KMAG(FM)—Dec 31, 1964; 99.1 mhz; 100 kw. Ant 2,000 ft. Box 1602 (72901). (501) 782-8888. The Valley Corp. Net: ABC. Rep: Smith. Format: MOR. ■ Lee Kelone, pres; Calvin L. Collier, gen mgr; Mike Grant, coml & prom mgr; Mike David, prog dir; Tom Cameron, news dir; Rance Rhodes, chief engr.

KTCS—March 1956; 1410 khz; 1 kw-D. Box 1017, Holiday Inn South (72902). (501) 785-2559. Big Chief Bcstg Co. (acq 1961). Rep: Bernard; Schneider St. Louis. Format: C&W. ■ Jack Beasley, pres; Bill Harper, gen mgr; Pat Demaree, coml mgr & chief engr; Jim Carter, prog dir; Joe B. Steel, news dir.

KTCS-FM—Aug 15, 1964; 99.9 mhz; 36 kw. Ant 225 ft. Dups AM.

KWHN—Nov 22, 1947; 1320 khz; 5 kw-U, DA-N. Box 143 (72901). (501) 783-8967. KWHN Bcstg Co. Inc. (acq 9-69). Rep: PRO Time Sls; Dora Clayton. Format: Contemp. Spec progs: Sp 12 hr, C&W 1 hr wkly. ■ Horace C. Boren, pres; James Inman, coml mgr; Lee Stollard, prog mgr; Bob Britton, prog dir; Bill Agler, news dir; Glen O'Neal, gen mgr; Raymond Armstrong, chief engr.

Harrison

KHOZ—Sept 28, 1946; 900 khz; 1 kw-D. Box 670 (72601). (501) 365-2302. Harrison Bcstg Corp. Net: ABC/E, Ark Radio. Rep: Carpenter. Format: C&W; Top 40. Spec progs: Talk 12 hrs wkly. ■ Robert S. Wheeler Jr, pres; W. J. Wheeler, gen mgr; Everett Horton, coml mgr; Marc Williams, prog dir; Don Horn, wkly news dir; Ralph Skaggs, prom mgr; Charles Bushong, mus dir; John Saxton, chief engr.

KHOZ-FM—March 25, 1963; 102.9 mhz; 12.5 kw. Ant 630 ft. Prog sep from AM. Net ABC/FM. Format: Easy Istng; Contemp. ■ Elvis Moody, coml mgr.

Heber Springs

KAWW—July 15, 1967; 1370 khz; 1 kw-D. 422 W. Main St. (72543). (501) 362-5863. Newport Bcstg Co. Group owner: Newport. Net: Ark Radio. Audio news: UPI. Format: Contemp. ■ Harold L. Sudbury, pres; Rick Jones, gen mgr.

KAWW-FM—Sept 1, 1972; 96.7 mhz; 3 kw. Ant minus 145 ft. Dups AM 65%.

Helena

KCRI



KCRI(FM)—1972; 103.1 mhz; 3 kw. Ant 260 ft. Stereo. Box 506 (72342). (501) 338-8331. Twin Cities Broadcasting Inc. Group Owner: Edw. O. Fritts Stations (acq 9-1-75). Net: ABC/E; Arkansas Radio, Agric. News Serv. Reps: Bonchez; Southern Spt Sls. Format: MOR, C&W. Spec prog: Farm 14 hrs wkly. ■ Edw. O. Fritts, pres; Robin Ewing, gen mgr & chief engr; Dennis Post, prog mgr. ■ Rates: \$5; 5; 5; 5.

KFFA—Nov 19, 1941: 1360 khz; 1 kw-U, DA-N. Helena National Bank Bldg. (72342). (501) 338-8361. Helena Bcstg Co. Net: MBS; Keystone; Mid South. Rep: Hopewell, Beaver. Format: C&W 50%, MOR 50%. Spec progs: Black 10 hrs wkly. ■ Sam W. Anderson, owner; Wendell Atchison, gen mgr & coml mgr; Bill Holland, prog dir; Sylvester Huling, chief eng. ■ Rates: \$6;6;6.

Hope

KXAR—Dec 12, 1947: 1490 khz; 1 kw-D, 250 w-N SH. Box K (71801). (501) 777-3601. Hope Bcstg Co. Net: Arkansas Radio & Univ. Ark Sports Net. Rep: Melville; C.K. Beaver. Format: Diversified. Spec progs: Farm 5 hrs, Black 12 hrs wkly. ■ A. H. Washburn, pres; Haskell Jones, gen mgr & prom dir; Jane Whitehead, coml mgr; Norman Bradford, chief eng. ■ Rates: \$2.40; 2.40; 2.00; 1.75.

Hot Springs

KBHS
Modern Country Music

KBHS—Feb 9, 1953: 590 khz; 5 kw-D. 113 Third St. (71901). (501) 623-6661. KBHS Bcstg Co. (acq. 12-15-71). Net: ABC/I. Rep: Avery-Knodel. Format: C&W. ■ David Mackey, pres; Bill Maddox, gen mgr; Bill Baker, coml mgr; Bob Roberts, prog dir; Ted Mullenix, mus dir; William E. Ott II, news dir; John Tatum, chief eng. ■ Rates: \$14;12;14;10.

KBHS-FM—June 18, 1965: 96.7 mhz; 2.6 kw. Ant 320 ft. Dups AM 100%. ■ Rates: \$—;—;—;8.50.

KGUS
Frederick W. Smith



KGUS(FM)—Feb 7, 1969: 97.5 mhz; 36 kw horiz, 16 kw vert. Ant 480 ft. Quad stereo. Box 1089 (71901). (501) 624-5425. Radio Hot Springs Co. Inc. Net: Razorback. Audio news: AP Repts: Frederick W. Smith; Miller. Format: Easy lstrng. Spec progs: Farm, black, C&W, Greek, 1 hr wkly each; classical 2 hrs wkly. ■ C.J. Dickson, VP, gen & coml mgr; Doyle Hawkins, prog & mus dir; Lisa Harper, prom mgr; Frances G. Forsberg, news dir; Robert King, chief eng. ■ Rates: \$10; 8.50; 7.50; 6.50.

KXOW—Oct 6, 1966: 1420 khz; 5 kw-D. Box 1739 (71901). (501) 525-1301. Noalmark Bcstg Corp. Net: MBS. Rep: Keystone, Crane. Format: Modern Country ■ Bob Gipson, gen & coml mgr; Wayne Brock, prog dir; Allen Lee Johnson, news dir; Buddy McLelland, chief eng.

KXOW-FM—October 1971: 106.3 mhz; 310 W. Ant 790 ft. Progs sep from AM. Format: Religious.

KZNG—1953: 1340 khz; 1 kw-D, 250 w-N. Radio Plaza, Box Q (71901). (501) 624-3313; George T. Herneich (acq 11-81). Net: CBS. Rep: Meeker, PRO Time Sls. Format: MOR. Spec prog: Farm 12 hrs wkly. ■ George T. Herneich, pres; Tom Nichols, gen mgr; Evelyn Goslee, coml mgr; Ron Trull, mus dir; Mark Phillips, news dir; Edward Powers, chief eng. ■ Rates: \$3.65; 2.95; 3.65; 2.95.

Jacksonville

KGMR—Aug. 24, 1963: 1500 khz; 1 kw-D. Box 311 (72076). (501) 982-5551. Radio Jacksonville Inc. (acq 1-24-68). Rep: Miller; Beaver. Format: C&W, Gospel. ■ John J. Shields, pres; Lloyd Millwood, coml mgr; Ken Powers, prog dir; Joe Griffith, news dir; Johnny Towell, stn mgr & chief eng.

KGMR-FM—Sept 29, 1969: 100.3 mhz; 25 kw. Ant 195 ft. Dups AM 25%.

Jonesboro

***KASU(FM)**—1956: 91.9 mhz; 100 kw. Ant 510 ft. Box 4B, State University, Ark. (72467). (501) 972-3070. Arkansas State Univ. ■ Charles L. Rasberry, dir bcstg & gen mgr; Richard Carvell, opns mgr; Richard Holler, news dir; Roy E. Barnhill, chief eng.

KBTM—1930: 1230 khz; 1 kw-D, 250 w-N. Box 400 (72401). (501) 935-5597. Patteson Brothers. (acq 1-58). Net: MBS. Rep: Denney; Eugene Gray. Format: MOR. Spec progs: Farm, 5 hrs wkly, classical, jazz 2 hrs wkly each. ■ Alan Patteson, Jr., gen mgr; W. Clarence Adams, stn mgr & news dir; Paul Hoffman, coml mgr; Paul Boden, prom mgr; Mike Doyle, prog & mus dir; Norman Bowman, chief eng. ■ Rates: \$4.50; 4.50; 4.50; 4.

KBTM-FM—1947: 101.9 mhz; 100 kw. Ant 200 ft. Stereo. Madison at Jackson Sts (72401). (501) 935-5598. Format: Contemp Rock. ■ Bill Little, coml mgr; Dennis Rogers, prog & mus dir; Jack Harris, news dir. ■ Rates: \$3.77; 3.77; 3.77; 3.77.

KFIN(FM)—Dec 31, 1973: 107.9 mhz 98 kw. Ant 600 ft. Stereo. Box 1691 (72401). (501) 932-1079. Snider Bcstg Co. Net: Arkansas Radio. Format: Uptempo btfl music. Spec prog: Farm, 2 hrs wkly. ■ Richard Lynn Farr, gen mgr; Dennis Robins, news dir. ■ Rates: \$5.30; 5.30; 5.30; 5.30.

KNEA—Sept 20, 1950: 970 khz; 1 kw-D. Box 8 (72401). (501) WEbster 2-8381. Radio Jonesboro Inc. Rep: PRO Time Sls, Beaner. Format: Mod C&W. ■ H. L. Baker, gen mgr.

Little Rock

KAAY—Dec 20, 1924: 1090 khz; 50 kw-U, DA-N. Box 1790 (72203). (501) 375-5311. Multimedia Radio Inc (acq 5-15-75). Group owner: Multimedia. Audio news: UPI. Rep: Katz. Format: Top 40; Relig. Spec progs: Farm 6 hrs wkly. ■ Ralph A. Walsh II, pres, gen & coml mgr; Wayne Moss, prog dir; Carolyn Metheny, prom mgr; Sonny Martin, mus dir; Mitch Michaels, news dir; Felix McDonald, chief eng. ■ Rates: \$27;23;27;23.

KALO—1927: 1250 khz; 1 kw-D, 500 w-N, DA-N. Box 5127, 1211 Rebsamen Pk Rd. (72205). (501) 664-2525. Ark. Bcstg Corp. (acq 2-8-71). Net: ABC/C. Rep: McGavren-Guild. Format: Black. ■ Bernard Mann, pres; Larry Hayes, gen mgr; Bob Shivers, prog dir; Dave Donnell, mus dir; Chuck Hollis, news dir; Dave Phillips, chief eng.

KEZQ(FM)—Oct 26, 1960: 94.1 mhz; 60 kw. Ant 310 ft. (501) 664-6666. Radio Station KEZQ Inc. (acq 3-2-73). McGavren-Guild. Format: Btfl music. ■ Richard Brady, gen mgr; Terry Bill, prog dir; Mariin Taylor, mus dir; Ben Firsell, news dir.

KARN—1928: 920 khz; 5 kw-U, DA-N. 1001 Spring St. (72202). (501) 376-9292. Snider Corp (acq 2-10-72). Net: NBC, Arkansas Radio. Rep: Blair. Format: Easy listening. ■ Ted L. Snider, pres; Harris Owen, opns mgr; Louis Seymore, admin VP; Fred Gooding, prog & mus dir; Larry Duke, gen & coml mgr; Don Corbet, news dir; Charles Akins, chief eng. ■ Rates: \$15.40;11.40;13.40;10.40.

KKYK(FM)—Co-owned with KARN. Dec 17, 1973: 103.7 mhz; 95 kw. Ant 1,510 ft. Stereo. (501) 376-8444. Net: Arkansas Radio. Format: Rock. Spec progs: Farm 2½ hrs wkly. ■ Rusty Gold, gen mgr; Cal Arnold, coml mgr; Progs sep from AM. ■ Rates: \$20; 25; 30; 30.

KBHS—See Hot Springs.

KDXE—See North Little Rock.

KEZQ(FM)—Listing follows KALO.

KKYK(FM)—Listing follows KARN.

KLAZ



KLAZ(FM)—July 7, 1972: 98.5 mhz; 100 kw. Ant 880 ft. Stereo. Box 7208 (72207). (501) 661-9850. Curtis Communications Group. (acq 7-11-75). Rep: ABC FM Spot Sls; Riley. Format: Top 40. Spec prog: Jazz, 1 hr wkly. ■ John Gorby, VP; Don Overton, gen mgr; Gregory G. Fadick, prom mgr; David B. Treadway, mus dir; Dale Seidenschwarz, chief eng. ■ Rates: \$16; 16; 18; 18.

KLRA—1925: 1010 khz; 10 kw-D, 5 kw-N, DA-N. 1755 Union National Plaza (72201). (501) 375-7319. KLRA Inc. (acq. 4-9-58). Net: CBS. Rep: Buckley. Format: C&W. ■ Leonard Coe, pres & gen mgr; Marv Heffington, prog dir; Anne Lumpkin, admin asst to pres; Herbie Byrd, news dir; Kathy Evans, prom mgr; Jay Smith, mus dir; Blande Perry, chief eng.

***KLRE(FM)**—February 1973: 90.5 mhz; 3.6 kw. Ant 265 ft. 7701 Scott Hamilton Dr (72209). (501) 568-2347. Little Rock School District. Format: Educl. ■ Ruth S. Steele, stn dir; Robert Kreimeyer, chief eng.

KMYO-FM—Listing follows KSOH.

KOKY—Oct 1956: 1440 khz; 5 kw-D. 723 W. 14th St. (72202). (501) 372-0259. Brien-KOKY Inc. (acq 12-1-72). Net: MBS/Black. Rep: Globetrotter. Format: Black. ■ Cleve J. Brien, pres; Gene Moorhead, gen mgr; J. D. Black, prog dir; Ira Hatchett, coml mgr; Clarence Guy, mus dir; Mickey Cade, news dir; Ray Loewy, chief eng.

KSOH—February 1948: 1050 khz; 1 kw-U. Box 2659 (72203). (501) 666-2821. Victor Bcstg Inc. (acq 6-1-62). Rep: Eastman. ■ R.B. Triveris, pres; Cliff B. Ford, gen mgr; Chester Pierce, coml mgr; Ken Knight, prog dir & prom mgr; Bob Davis, chief eng.

KMYO-FM—Co-owned with KSOH. 95.7 mhz; 26.4 kw. Ant 297.5 ft. Dups AM.

KXLR—See North Little Rock.

Magnolia

KFMV(FM)—Listing follows KVMA.

KVMA—April 1948: 630 khz; 1 kw-D. Box 430 (71753). (501) CEntral 4-5862. Magnolia Bcstg Co. Format: Contemp. Rep: Savalli-Gates. ■ Dr. John Wilson, pres; Bill Bigley, gen mgr; Bill Merrill, coml mgr; I. Daugherty, traffic & prom mgr; Charles Price chief eng.

KFMV(FM)—Co-owned with KVMA. 1968: 107.9 mhz; 53 kw. Ant 290 ft. William Bigley. Format: Black; Top 40; Sports.

Malvern

KBOK—August 1951: 1310 khz; 1 kw-D. Route 5, Box 5 (72104). (501) 332-6981. Malvern Bcstg Co. (acq 6-1-58). Net: Ark Radio & Razorback. Format: MOR, Variety. ■ Kermit L. Richardson, pres & gen mgr; Garrell Doggett, coml mgr; Peggy Daven, prog dir; Carole Toler, mus dir; Bob Clements, news dir; Robert Padgett, chief eng.

Mammoth Spring

KAMS(FM)—Co-owned with KALM Thayer, Mo. Jan 1, 1956: 95.1 mhz; 75 kw. Ant 97 ft. Box 15, Thayer, Mo. (65791). (417) 264-7211. Radio Station KALM. Group owner: Neathery. Rep: Keystone; Magic Circle. Format: C&W. Dups AM 100%. ■ Robert Neathery, pres; Carrie Hamilton, gen mgr; Robert Hamilton, coml & prom mgr; Marie Kisse, prog dir; Robert Hamilton, news dir; Sam Beatty, chief eng.

Marianna

KZOT—Sept 25, 1961: 1460 khz; 500 w-D, DA. Willey Bldg. (72360). (501) 295-2195. Delta Bcstg (acq 7-1-74). Net: Ark Radio. Format: C&W. Spec progs: Black 12 hrs wkly. ■ Dixie Lewis, gen & prom mgr; Harold Baker, prog, mus & news dir & chief eng. ■ Rates: \$2.25;2.25;2.25;2.25.

Marked Tree

KPCA—June 16, 1956: 1580 khz; 250 w-D. Box 550 (72365). (501) 358-2921. Poinsett County Bcstg Co. (acq 1-57). Net: Arkansas Radio. Rep: Beaver. Format: C&W. ■ Dewitt Waits, gen mgr; Gary Stidem, prog dir; Melenda Lindly, prom mgr; Stuart Brunner, mus dir; James Lawrence, news dir; Mack Howerton, chief eng. ■ Rates: \$2.25; 2.25; 2.20—.

Marshall

KCGS—May 24, 1975: 1600 khz; 1 kw-D. Box 178 (76250). (501) 448-3612. Marshall Broadcasting Co. Net: Arkansas Radio. Format: C&W. ■ Rex Elliott, pres & coml mgr; Bob Nelson, gen mgr, prog dir & news dir; David Flinker, chief eng.

McGehee

KVSA—June 29, 1953: 1220 khz; 1 kw-D. (71654). (501) 222-4200. Southeast Arkansas Bcstrs Inc. Net: Keystone; Razorback. Rep: Hopewell. ■ Abbott F. Kin

Arkansas Radio

See page C-1 for explanation of listings.

ney, pres & gen mgr; Mrs. Dorothy J. Kinney, coml mgr; James S. Hunt, chief engr.

Mena

KENA—February 1950: 1450 khz; 1 kw-D, 250 w-N. Box 1450 (71953). (501) 394-1450. Mena Bcstg Co. (acq 7-27-67). Net: Arkansas; Razorback. Rep: Keystone. Format: Variety; MOR. ■ Jack R. Reeves, owner & general mgr; Dwight L. Douglas, coml mgr; Bob Biggs, chief engr.

KSKR(FM)—Co-owned with KENA. Nov 25, 1969: 101.7 mhz; 3 kw. Ant 62 ft. Dups AM 30%. Format: C&W.

Monette

KBIB—Sept 1964: 1560 khz; 250 w-D. Box B (72447). (501) 486-5496. Craighead County Bcstg Co. (acq 10-74). Rep: Beaver. Format: C&W. ■ Margarete Reed, coml mgr; Charles Campfield, chief engr.

Monticello

KHBM—April 1955: 1430 khz; 1 kw-D. Box 446 (71655). (501) Empire 7-5136. Baker Bcstg Co. (acq 2-59). Net: Arkansas Radio, Razorback Sports. Spec prog: C&W 14 hrs; Gospel 18 hrs, both wkly. ■ Keith Baker, gen & coml mgr; Evelyn H. Baker, prog dir; George Hughes, news dir; Ray Dawson, chief engr. ■ Rates: \$3.50; 3.50; 3.50; —.

KHBM-FM—Sept 1, 1967: 93.5 mhz; 3 kw. Ant 205 ft. Dups AM 90%.

Morrilton

KVOM—Dec 25, 1951: 800 khz; 250 w-D. Box 541 (72110). (501) 354-2484. Morrilton Bcstg Co. Format: C&W. ■ J.C. Willis, owner & mgr; Stanton Willis, coml mgr; Loretta Jackson, prog dir; David Alexander, mus dir; Chris Meyer, news dir; George Underwood, chief engr.

Mountain Home

KTLO—May 30, 1953: 1240 khz; 1 kw-D, 250 w-N. Box C (72653). (501) 425-3101. Mountain Home Bcstg Corp. (acq 6-1-54). Net: ABC/E. Format: MOR. ■ Bob Knight, coml mgr; Arthur C. Hill, news dir.

KTLO-FM—Jan 11, 1971: 98.3 mhz; 1.40 kw. Ant 420 ft. Stereo. Prog sep from AM. Net: ABC/FM. Format: MOR.

Nashville

KBHC—May 1959: 1260 khz; 500 w-D. 1513 S. Fourth St (71852). (501) 845-3601. Annie Nell Gathright. (acq 5-1-73). Net: Ark Radio. Format: C&W. ■ Annie Nell Gathright, gen mgr; Pete Gathright, coml mgr; Leah Arnold, prog dir; Kris Kurtis, mus dir; R.G. McKeever, chief engr.

Newport

KNBY—Oct 12, 1949: 1280 khz; 1 kw-D. Highway 67 N. Box 218 (72112). (501) Jackson 3-5891. Newport Bcstg Co. Group owner: Newport. ■ Harold Sudbury, pres; Gene Howe, gen & coml mgr; Rex Raspberry, news dir; Joe Long, chief engr.

KOKR(FM)—Co-owned with KNBY. Sept 1, 1966: 105.5 mhz; 3 kw. Ant 220 ft. Dups AM 50%.

North Little Rock

KDXE—May 9, 1957: 1380 khz; 1 kw-D. Box 1380 Little Rock (72203). (501) 376-7266. Dixie Bcstg Co. (acq 2-6-75). Rep: Webb. Format: MOR. ■ Harvey Fritts, Kenneth W. Powers, owners; Edward Phelan, gen mgr; Jay Stone, prog dir; Dave Philipps, chief engr.

KXLR—April 15, 1946: 1150 khz; 5 kw-D, 1 kw-N. DA-N. Box 3014, Little Rock (72203). (501) 945-4501. KXLR Inc. (acq 7-1-69). Group owner: Starr. Net: ABC/E. Rep: Torbet. Format: Country. ■ Peter H. Starr, pres; Robert A. Manning, gen mgr; Larry Dean, prog dir; Elmer O. Hurst Jr., opns mgr; Ray Loewy, chief engr. ■ Rates: \$16;14;14;11.

Osceola

KHFO(FM)—Listing follows KOSE.

KOSE—Oct 11, 1949: 860 khz; 1 kw-D. Box 249 (72370). (501) 563-2641. Osceola Bcstg Corp. Net: Arkansas Radio. Rep: Crane. Format: MOR & C&W. Spec progs: Black 4 hrs wkly. ■ Don Whitney, exec VP, gen, coml & prom mgr & news dir; Mrs. Edythe Bandy, prog dir; Mary Jo Gibson, mus dir; H. M. Jones, chief engr.

KHFO(FM)—Co-owned with KOSE. April 12, 1960: 98.1 mhz 14.5 kw. Ant 285 ft. (CP 50 kw; Ant 230 ft.). Dups AM 10%.

Ozark

KZRK—Feb 5, 1969: 1540 khz; 500 w-D. Box 527 (72949). (501) 667-2863. Ozark Bcstg Co. Net: Ark Radio. Format: C&W. Spec prog: Farm, 3 hrs wkly. ■ Leo J. Weiderkehr, VP; Paul Coates, gen mgr; Randy Johnson, coml mgr; Robin Spurling, news dir; Carl Jones, chief engr.

Paragould

KDRS—Jan 1, 1947: 1490 khz; 1 kw-D, 250 w-N. Box 117 (72450). (501) 236-7627. KDRS Inc. Rep: Keystone; Beaver. Format: MOR; Rock. ■ Macine Rand, pres; Wilma Wheelis, gen mgr; Joe Long, coml mgr; Vernon Neal, news dir; Chuck Campfield, chief engr.

KHIG(FM)—Oct 4, 1971: 104.9 mhz; 3 kw. Ant 255 ft. Stereo. Box 1106 (72450). (501) 239-8588. Progressive Broadcasters of Arkansas. Net: ABC/C. Rep: Southern Spot; Bcst Repts. Format: Contemp. Spec progs: Farm 10 hrs wkly. ■ G. I. Higgins, pres; Bruce Higgins, exec VP & gen mgr; Bob Howe, coml mgr; Ron Roe, prog & mus dir; Terry Wood, prom mgr & news dir; John Abbott, chief engr.

Paris

KCCL—Aug 18, 1959: 1460 khz; 500 w-D. 24 S. Express St. (72855). (501) 963-3100. Logan County Bcstg Co. (acq 4-9-60).

Pine Bluff

KADL—Aug 19, 1960: 1270 khz; 5 kw-D. Box 8216 (71601). (501) 535-1270. Jefferson County Bcstg Co. Group owner: Southwestern Bcstg. Rep: Devney. Format: C&W. ■ Albert M. Smith, gen mgr; Chester Pierce, stn & coml mgr & chief engr; Pat McKinney, local sts mgr.

KADL-FM—1971: 94.9 mhz; 25 kw. Ant 145 ft. Dups AM 50%.

KCAT—May 2, 1963: 1340 khz; 1 kw-D, 250 w-N. Box 5201 (71601). (501) Jefferson 4-5000. J.B. Scanton. Rep: Bunchez. Format: Black. ■ J. B. Scanton, pres; William E. Kraut, chief engr.

KCLA

Real People Top 40

KCLA—Jan 16, 1947: 1400 khz; 1 kw-D, 250 w-N. 3601 Apple (71601). (501) 535-1241. KCLA Inc. (acq 6-21-68). Rep: Riley (Southwest); Jones (Southeast). Format: Top 40. Spec progs: Black, farm. ■ Johnnie K. Hill, pres; A. J. Lindsey, gen mgr; Larry Monk, prog dir; Roger Breedlove, coml mgr; Lynn James, prom mgr; Rick Burrow, mus dir; Charles Cromwell, news dir; Earl Ayres, chief engr; Wanda Shingleur, office mgr. ■ Rates: \$4.75;4.50;4.75;3.50.

KOTN—March 12, 1934: 1490 khz; 1 kw-D, 250 w-N. 920 Commerce Rd. (71601). (501) 534-8732. Joellen Bcstg Corp (acq 1-1-61). Rep: Walton, Messina. Format: Top 40. ■ Winston J. (Buddy) Deane, pres, gen & prom mgr; Guy J. Wilcox, coml mgr; J. Larry Hart, prog dir; Mike Nail, news dir; Arthur G. Kesterson, chief engr.

KOTN-FM—March 1959: 92.3 mhz; 27 kw. Ant 115 ft. Prog sep from AM. Format: Contemp pop.

KPBA—Oct 16, 1957: 1590 khz; 1 kw-D. Box 5086 (71601). (501) Jefferson 4-1523. KPBA Inc. Rep: PRO Time Sls. ■ J.C. Noble, pres; Ralph Taylor, stn & coml mgr; Levelle Langley, prog & news dir; Jerry Kesterson, chief engr.

Pocahontas

KPOC—Nov 15, 1950: 1420 khz; 1 kw-D. Box 508 (72455). (501) 892-5234. Adrian L. White Inc. Net: Ark Radio. Rep: Nome. Format: Adult. ■ Adrian L. White, pres, gen & coml mgr; Tom Arnold, prog dir & prom mgr; Jack Wilson, news dir & chief engr.

KPOC-FM—April 25, 1969: 103.9 mhz; 3 kw. Ant 145 ft. Dups AM 100%.

Prescott

KTPA—Dec 1, 1959: 1370 khz; 500 w-D. Box 734 (71857). (501) 887-2638. Newport Bcstg Co. (acq 5-14-66). Group owner: Newport. Net: Ark Radio. ■ Harold Sudbury, pres; Rob Hill, gen mgr; Joyce Westmoreland, prog dir; Tom Hill, news dir & chief engr.

Rogers

KAMO—Sept 16, 1954: 1390 khz; 1 kw-D. Route Two (72756). (501) 636-4611. KAMO Inc. Net: Ark Radio. Rep: Devney. Format: MOR. ■ Leon McAuliffie, pres; Bill Bentley, gen mgr; Clarence Beaver, coml mgr; Chuck Jones, prog, mus & news dir; Kenneth Mason, chief engr. ■ Rates: \$3.50;3.50;3.50;3.50.

KAMO-FM—1971: 94.3 mhz; 2.8 kw. Ant 310 ft. Dups AM 79%. ■ Rates same as AM.

Russellville

KARV—Feb 25, 1947: 1490 khz; 1 kw-D, 250 w-N. Box 190 (72801). (501) 968-1490. Horne Industries Inc. (acq 9-69). Format: Talk, news & info. ■ Michael Horne, pres; Alan Risener, prog dir; Ron Evans, news dir; Kermit Womack, coml mgr; Jim Alexander, chief engr.

KCAB—See Dardanelle.

Searcy

KSER(FM)—Listing follows KWCK.

KWCK—Aug 25, 1951: 1300 khz; 1 kw-D. Drawer 708 (72143). (501) 268-7123. KWCK, Inc. (acq 12-1-72). Format: MOR; Talk. ■ Michael Horne, pres; John Paul Capps, VP & gen mgr; Dudley Williams, prog dir; Don Shores, news dir; E. J. Alexander, chief engr.

KSER(FM)—Co-owned with KWCK. Oct 26, 1973: 99.3 mhz; 3 kw. Ant 170 ft. Stereo. Progs sep from AM.

Siloam Springs

KUOA—April 12, 1923: 1290 khz; 5 kw-D, DA. Box 3145 (72761). (501) 534-3154. KUOA Inc. (acq 3-15-33). Audio news: AP. Format: C&W. ■ John E. Brown Jr., pres; Carl McQuay, gen mgr; Cecil E. Smith, chief engr. ■ Rates: \$2.85; 2.85; 2.85; —.

KUOA-FM—1947: 105.7 mhz; 34 kw. Ant 410 ft. Stereo. Dups AM 15%. ■ Rates same as AM.

Springdale

KBRS—Sept 7, 1949: 1340 khz; 1 kw-D, 250 w-N. Box 47 (72764). (501) 751-4675. Northwest Arkansas Bcstg & Telecasting Co. Group owner: Donrey. Net: ABC/I. Rep: McGavren-Guild. ■ Donald W. Reynolds, pres; H. Phil Phillips, gen mgr; C. C. Hornor Jr., coml mgr; Bill Bohart, prog dir; Charles Fiss, news dir; Larry Powell, chief engr. ■ Rates: \$3.30;3.30;3.30;3.30.

KSPR—July 15, 1966: 1590 khz; 500 w-D. Box 168 (72764). (501) 756-6121. Johnson Communications Inc. Audio News: UPI. Format: MOR. ■ Dewey Johnson, pres, gen & prom mgr; Larry Barnes, coml mgr; Dan Hentschell, prog dir; Keith Osterman, chief engr.

KCIZ(FM)—Co-owned with KSPR. Sept 19, 1968: 104.9 mhz; 3 kw. Ant 130 ft. Dups AM 100%.

Stuttgart

KWAK—May 14, 1948: 1240 khz; 1 kw-D, 250 w-N. Box 907 (72160). (501) 673-1595. Stuttgart Bcstg Corp. Net: Ark Radio. Format: C&W, MOR, Top 40. ■ Melvin P. Spann, pres & gen mgr; June S. Spann, sec-treas; C. R. Sandine, VP stn mgr & chief engr; M. T. Spann, VP & coml mgr; Patty L. Blann, prog dir; Jim Sluder, mus dir.

Texarkana

KADO—See Texarkana, Tex.

KADO-FM—June 11, 1968: 107.1 mhz; 3 kw. Ant 160 ft. 303 W. Broad (75501). (501) 773-5791. KATQ Radio Inc. Net: Mutual Back. Rep: Beaver. Format: Black. ■ Floyd Bell, pres & gen mgr; Andrew Griffin, stn & coml mgr; John H. Bell, chief engr; Desmond E. Smith, mus dir; Dorian T. Cox, news dir. ■ Rates: \$5;4.50;5;4.50.

KCMC—See Texarkana, Tex.

KOSY—Nov 15, 1951: 790 khz; 1 kw-D, 500 w-N, DA-N. Box 2018 (75501). (501) 772-3771. Gateway Bcstg Co. Rep: Savalli/Gates. Format: Contemp; Top 40. ■ W. Decker Smith, pres; James K. Smith, gen & coml mgr; Paul Brown prog dir; J. Norm Mason, chief engr.

KOSY-FM—See Texarkana, Tex.

KTFS—See Texarkana, Tex.

Trumann

KTMN—Oct 1, 1963: 1530 khz; 250 w-D. Box 141 (72472). (501) 483-6314. Trumann Bcstg Inc. (acq 6-10-67). Net: Arkansas Radio. Rep: Beaver. Format: C&W. ■ Carlton Garner, gen mgr; Kathy DeLoach, prog dir; Jack Hollis, prog mgr; Hayden Sadler, news dir; Mack Howerton, chief engr.

Van Buren

KDFD—Nov 24, 1958: 1580 khz; 1 kw-D. Box 550 (72956). (501) GRanite 4-6811. Bcstrs Inc.

Walnut Ridge

KRLW—June 29, 1951: 1320 khz; 1 kw-D. Box 30 (72476). (501) 886-5460. Lawrence County Bcstg (acq 1955). Net: ABC/I; Ark Radio. Rep: Beaver. Format: C&W. Spec prog: Farm 5 hrs wkly. ■ N.H. Cate, pres; Dan Coker, gen mgr; Shirley Turbyville, coml mgr; prog & news dir; Gregg Evans, mus dir; Leonard Ringle, chief engr.

Warren

KWRF—August 1953: 860 khz; 250 w-D. Box 480 (71671). (501) 226-2653. Pines Bcstg Co. (acq 3-59). Rep: Keystone; Beaver. Format: Contemp. Spec progs: Black 6 hrs, C&W 8 hrs wkly. ■ Weldon Sledge, pres & gen mgr; Allen Weise, coml mgr & chief engr. ■ Rates: \$5;5;5;—.

West Memphis

KSUD—Dec 1, 1961: 730 khz; 250 w-D. 104 N. Fifth St., Memphis, Tenn. (72301). (501) 735-6622. Newport Bcstg Co. Group owner: Newport. Net: Ark Radio. Format: Relig & Gospel. ■ Harold L. Sudbury, pres; Harold Penn, gen. prom & coml mgr & news dir; Bob Faulkner, mus & prog dir; Charles Hood, chief engr.

Wynne

KWYN—Sept 28, 1956: 1400 khz; 1 kw-D, 250 w-N. Box 789 (72396). (501) 238-8141. East Arkansas Bcstrs Inc. Net: Razorback & Indian Net. Format: MOR, C&W, Rock, Talk. ■ Mrs. Hanna Bean, pres; Bob Caldwell, gen mgr; Ken Bock, coml mgr; Onalee Brawner, prog dir; Art Rogers, news dir & chief engr.

KWYN-FM—May 15, 1969: 92.7 mhz; 3 kw. Ant 300 ft. Stereo. Dups AM 10%.



CSI ELECTRONICS INC.
2607 River Road
Cinnaminson, New Jersey, 08077
Telephone: (609) 786-1060

California



HAMILTON-LANDIS & ASSOCIATES, Inc.
NATIONWIDE MEDIA BROKERS
WASHINGTON, D. C., CHICAGO, DALLAS, SAN FRANCISCO
SELL MORE
RADIO & TELEVISION STATIONS
IN THE WEST—NEAREST OFFICE IS—
111 SUTTER ST., SAN FRANCISCO 94104
(415) 392-5671

Alameda

KJAZ(FM)—Aug 1, 1959: 92.7 mhz; 1.85 kw. Ant 370 ft. 1509½ Webster St. (94501). (415) 523-9300. Patrick Henry. Format: Jazz. ■ Patrick Henry, gen mgr; Catherine Henry, coml mgr; Phil Brooks, prog dir; Jerry Dean, opns mgr; Jacques Verdier, chief engr. ■ Rates: \$19;19;28;28.

Alisal

KRSA-AM-FM—See Salinas.

Alturas

KCNO—June 4, 1951: 570 khz; 5 kw-D. Box 1650 (96101). (408) 233-2713. R. W. Hansen (acq 5-16-59). Rep: Savalli/Gates, Morin. ■ R. W. Hansen, own; Fred Hepler, mgr; coml & prom mgr; Ralph V. Baird, chief engr.

Anaheim

KEZY—May 18, 1959: 1190 khz; 5 kw-D, 1 kw-N, DA-N. 1190 E. Ball Rd. (92802). (714) 776-1191. KEZY Radio Inc. (acq 8-1-64). Rep: Avery-Knodel. Format: Top 40. ■ Harris H. Tomson, pres; Daniel P. Mitchell, III, exec VP & gen mgr; Peter L. Townsend, VP, regional & natl sls mgr; Scott Morgan, mus dir and prog mgr; Oliver Wilson, prom mgr; Adam J. Demorais, news dir; James Stanley, chief engr; Mark Dennis, coml mgr.

KEZY-FM—April 16, 1961: 95.9 mhz; 2.5 kw. Ant 330 ft. (714) 776-FM96. Progs sep from KEZY. Stereo. Format: Progs. ■ Tom Milner, prog dir; Caren Allen, mus dir; Mark Mocerri, chief engr.

Angwin

***KANG(FM)**—May 20, 1961: 89.9 mhz; 20 kw. Ant 800 ft. Pacific Union College. Box 89 (94508). (707) 965-6500. Pacific Union College Assn for Educational Bcstg. Stereo. Net: ABC/FM, Adventist Radio. Format: MOR. Spec progs: Relig 25 hrs wkly. ■ Don Coles, pres; John M. Rice, gen mgr; John Letcher, prom mgr; Scott Moseley, prog dir; Leanne Tillay, mus dir; Wilton Helm, chief engr.

Apple Valley

KAVR—June 5, 1954: 960 khz; 5 kw-D. Box 960 (92307). (714) 247-7251. BHA Enterprises Inc. (acq 8-1-62). Rep: Savalli-Gates. Format: MOR. ■ Gerald Hicks, pres; Benny Strong, gen mgr; Chuck Parnell, prog dir; Mark Farrell, news dir; Wayne Dillard, chief engr.

KAVR-FM—May 17, 1968: 102.3 mhz; 1.3 kw. Ant 53 ft. Dups AM 50%.

Arcadia

KMAX(FM)—Dec. 3, 1960: 107.1 mhz; 3 kw. Ant minus 240 ft. 37 W. Huntington Drive (91006). (213) 446-2030. KPCC Inc. (acq 1975). Spec progs: Ger 1 hr; Ital 2 hrs; C&W 4 hrs; Dutch 6 hrs; Greek 1 hr wkly. ■ Howard Warshaw, pres.

Arcata

***KAHS(FM)**—Jan 10, 1973: 91.5 mhz; 10 w. Ant 30 ft. 1720 M St. (95521). (707) 822-1734. Arcata Union High School Dist. Format: Top 40. Gerald Davies, pres; Robert Berkowitz, gen mgr.

KATA—Nov 15, 1957: 1340 khz; 1 kw-D, 250 w-N. Drawer I (95521). (707) 822-4814. Martin Bcstg Corp. (acq 1974). Rep: Torbet, Tacher (Portland, Ore.) Format: Top 40. ■ Dale D. Andreasen, gen mgr; Victor Massad, sls mgr; John Price, prog dir & chief engr;

Arkansas, California Radio

See page C-1 for explanation of listings.

Dennis Clay, prod dir; Len Jaruela, music dir; Bill Haigwood, news dir.

***KHSU-FM**—June 1, 1950: 90.5 mhz; 10 w. Ant 130 ft. Humboldt State University (95521). (707) 826-3560. California. Net: NPR (tape only), Pacifica. Format: Variety. Spec prog: Classical 15 hrs wkly. ■ Brian Prows, stn mgr.

KXGO(FM)—Jan 18, 1972: 93.5 mhz; 220 w. Ant 920 ft. Drawer QQ (95521). (707) 822-3666. D. A. Plank Broadcasting Co. Net: Calif. Farm. Stereo. Format: Easy Istng, religious. Spec progs: Classical 15 hrs; farm 2½ hrs, both wkly. ■ D. A. Plank, pres; Phillip Plank, gen mgr & chief engr; Bob Jacobs, coml mgr; prog & mus dir; Al Fennigott, news dir. ■ Rates: \$4.85;4.85;4.85;4.85.

Arroyo Grande

KFYV—June 29, 1962: 1280 khz; 1 kw-U, DA-N. Box 220 (93420). (805) 489-4201. Charles R. Scott (acq 10-1-71). Net: Golden West Sports. Rep: Dahlsten. Format: C&W. ■ Charles R. Scott, gen mgr; Doug Szymanski, prom mgr; John Collins, coml mgr; Jack Connors, news dir; Charles R. Scott, chief engr; Gary Michaels, prog dir; John Klassen, mus dir. ■ Rates: \$5.75;5.75;5.75;5.75.

Auburn

KAFI(FM)—Listing follows KAH1.

KAH1—Nov. 13, 1957: 950 khz; 5 kw-D, DA. Box 950. (95603). (916) 885-5636. Auburn Bcstg Inc. (acq 6-28-73). Rep: Sandberg-Glenn of Calif. Format: MOR, variety. ■ Donald J. Inglett, pres & gen mgr; Jim Huggins, prog & mus dir; Jim Johnson, chief engr; Lorna Dayen, news dir. ■ Rates: \$7.50;5.50;5.50;4.

KAFI(FM)—Co-owned with KAH1. Dec 21, 1961: 101.1 mhz; 3.2 kw. Ant 450 ft. Dups AM 95%. ■ Same as AM.

Avalon

KBIG-FM—Listing follows KBRT.

KBRT—June 1, 1952: 740 khz; 10 kw-D, DA. 7755 Sunset Blvd., Los Angeles (90046). (213) 874-7700. Bonneville Int. Corp. (group owner: acq 3-11-69). Rep: Avco. Format: Bfl mus. ■ Joseph L. Dorton, VP and gen mgr; Bill King, coml mgr; Fred Seiden, dir of opns; Joyce L. Bose, prom mgr; Charles Casterline, chief engr. ■ Rates: \$95;105;95;65.

KBIG-FM—Co-owned with KBRT. See Los Angeles.

Bakersfield

KAFY—October 1946: 550 khz; 1 kw-U, DA-N. Box 6128 (93306). (805) 366-4411. Sunset Bcstg Corp. (acq 3-74). Group owner: General Bcstg Corp. Rep: McGavren Guild. Format: Top 40. ■ Ozzie Knudson, VP & gen mgr; Jack Igo, coml mgr; Chiz Conner, mus and prog dir, prom mgr; Ron Foster, news dir; Vernon G. Tucker, chief engr. ■ Rates: \$25;22;25;22.

KBIS

Great American Country

PRO/Weeker Radio
A UNIT OF THE ARKADIA GROUP

KBIS—March 1951: 970 khz; 1 kw-U, DA-2. 225 N. Chester Ave. (93302). (805) 324-6093. Westco Media Inc. (acq 3-9-73). Net: ABC/I. Format: C&W. ■ Edward Atsinger, pres; Al Crocker, VP and gen mgr; Lee Jensen, sls mgr; Carol Cummings, coml mgr; Bob Stevens, mus and news dir; Johnny Kaye, prog dir, prom mgr; Ken Aitken, chief engr. ■ Rates: \$9;8;9;7.

Hogan-Feldmann, Inc.
MEDIA BROKERS CONSULTANTS
1625 Ventura Boulevard, Suite 415
Encino, California 91436
AREA CODE 213 986-3201

California Radio

See page C-1 for explanation of listings.

KERN—Jan 3, 1932: 1410 khz; 1 kw-U. Box 2700 (93303) (805) 832-1410. Brandon-Robison Communications Inc. (acq 5-1-75). Net: ABC/C. Rep: Katz. Format: Top 40. ■ Anthony S. Brandon, pres; Joe Scott, coml mgr; Terry Dorsey, gen mgr; Johnny Mitchell, prog dir; Bob Harlow, mus dir; John Barcroft, chief engr.

KGEE—Jan 1, 1956: 1230 khz; 1 kw-D, 250 w-N. Box 937 (93302). (805) 327-3587. KGEE Inc. (acq 10-1-70). Net: NBC. Rep: Howard. Format: Talk. Spec progs: Sp 13 hrs; Black 5 hrs; It 1 hr, all wkly. ■ John Jacquemine, pres; Dan B. Speare, gen mgr; Al Picinni, coml mgr; Chris Edwards, prom mgr & prog dir; William Galbreath, mus dir; Lou Richards, news dir; Steve Mull, chief engr.

KGFM(FM)—Co-owned with KGEE. Oct 1, 1964: 101.5 mhz; 4.8 kw. Ant 1,280 ft. Prog sep from AM. Stereo. Format: Contemp. Spec progs: It 1 hr wkly.

KIFM(FM)—Aug 24, 1963: 96.5 mhz; 39 kw. Ant 550 ft. 521 H St. (93304). (805) 327-0631. Intl Church of the Four Square Gospel (acq 9-75). Format: Relig. Coy Edwards, gen mgr & prog dir; Eugene Faulkner, chief engr; Bill Ehrman, news dir.

KLYD—February 1958: 1350 khz; 1 kw-D, 2831 Eye St. (93301). (805) 327-5772. Reliable Bcstg (acq 10-18-69). Net: ABC/E. Rep: Selcom. Format: MOR, farm. ■ Ralph Edwards, pres; Jim Treanor, VP, gen mgr; John Rodinson, prog dir; Ron Kilgore, news dir; Jim Nelson, chief engr. ■ Rates: \$8.91;8.10;8.91.5.

KLYD-FM—1948: 94.1 mhz; 4.5 kw. Ant 1,312 ft. Dup AM 100%. (acq 6-13-70). Stereo. ■ Rates same as AM.

KPMC—1933: 1560 khz; 10 kw-U, DA-1. Box 1709 (93302). (805) 327-5121. Pioneer Mercantile Co. Net: CBS, MBS, Golden West. Audio news: UPI. Format: MOR, C&W, news. Spec progs: Farm 11 hrs, sports 15 hrs, both wkly. ■ L. A. Schamblin, pres and gen mgr; Paul R. Bierman, coml mgr & prog dir; George Patterson, chief engr. ■ Rates: \$7.5;25;7.3.

KUZZ—Dec 15, 1958: 800 khz; 250 w-D. 1209 N. Chester Ave. (93308). (805) 393-1500. Thunderbird Bcstg Co. (acq 4-29-64). Group owner: Owens. Rep: Avco. Format: C&W. ■ Buck Owens, pres; Mike Owens, gen mgr; Tommy Wright, mus & prog dir; Hal Laffoon, news dir; Terry Geiser, chief engr.

KUZZ-FM—1968: 107.9 mhz; 4.3 kw. Ant 1340 ft. Dups AM 100%.

KWAC—Nov 1, 1961: 1490 khz; 1 kw-D, 250 w-N. 5200 Standard St. (93308). (805) 327-9711. KMAP Inc. (acq 9-30-61). Rep: Lotus. Format: Sp. Spec progs: Black 6 hrs wkly. ■ Edwards R. Hoppie, pres; Robert J. Duffy, gen mgr; Mike Ramirez, coml mgr; Alfredo Rodriguez, prog dir; Gloria Rodriguez, prom mgr; Jose Santos, mus dir; Miquel Franco, news dir; Ken Aitken, chief engr. ■ Rates: \$7.50;7.50;7.50;4.50.

Banning

KPAS—1975: 1490 khz; 250 w-U. Banning Bcstg Co.

Barstow

KIOT—Sept 29, 1960: 1310 khz; 5 kw-D, DA. Box 1000 (92311). (714) 256-2175. Prudential Bcstg Co. (acq 3-11-68). Rep: Savalli/Gates. Format: C&W. Spec progs: Sp 4 hrs wkly. ■ John Parker, pres & gen mgr. ■ Rates: \$37.80;37.80;37.80;—.

KWTC—Sept 19, 1947: 1230 khz; 1 kw-D, 250 w-N. Box 1230 (92311). (714) 256-8484. Mojave Valley Bcstg Inc. Net: Golden West. Rep: Lucas. Format: C&W, MOR. ■ W. T. Brown, pres & gen mgr; Fred Mull, chief engr; Bob Rightsell, coml mgr; George Jenkins, prog dir, Roy Hamilton, mus dir.

Berkeley

***KALX(FM)**—July 1967: 90.7 mhz; 10 w. Ant 150 ft. Eshleman Hall, U. of Calif. (94720). (415) 642-1111. The Regents of the U. of Calif. Format: Progs, educ, variety. Spec progs: Black 20 hrs; classical 15 hrs; jazz 20 hrs; public affairs 20 hrs wkly. ■ Andrew F. Reimer, gen mgr.

***KPFA(FM)**—April 1949: 94.1 mhz; 59 kw. Ant 1330 ft. 2207 Shattuck Ave. (94704). (415) 848-6767.

Pacific Foundation (group owner). Format: Variety. Spec progs: Black 12 hrs; Sp 10 hrs; Chinese 2 hrs; jazz 10 hrs; women 10 hrs; classical 20 hrs, all wkly. ■ David Finkel, pres; Larry Beusky, gen mgr.

***KPFB(FM)**—February 1954: 89.3 mhz; 150 w. Ant minus 100 ft. Same licensee and staff as KPFA(FM).

KRE—June 11, 1922: 1400 khz; 1 kw-D, 250 w-N. 601 Ashby Ave. (94710). (415) 848-7713. Horizons Communications Corp. (group owner; acq 10-29-70). Net: ABC/E. Format: Contemp/Jazz. ■ Jerome Feniger, pres; Alice Potter, gen & coml mgr, ops mgr; Rob Singleton, prog and mus dir; Art Lebermann, chief engr; Rick Vaill, news and pub affrs dir. ■ Rates: \$20;16;22;21.

KRE-FM—April 29, 1949: 102.9 mhz; 50 kw horiz; 3.5 kw vert. Ant 170 ft horiz; 120 ft vert. Stereo. Dups AM 50%. ■ Rates same as AM.

Big Bear Lake

KBBV—Nov 1, 1964: 1050 khz; 250 w-D, DA. Box 2810 (92315). (714) 866-3434. Mountain Bcstg Co. Inc. (acq 6-67). Format: Adult Easy Listening/MOR, C&W. ■ Vernon E. Thompson, pres, gen mgr & chief engr. ■ Rates: \$4.80;4.80;4.80;—.

KTOT-FM—May 1, 1975: 101.7 mhz; 90 w. Ant 1,500 ft. Dups AM 10%. Stereo. ■ Rates: \$5.80;5.80;5.80;5.80.

Bijou

KOWL—1975: 1490 khz; 1 kw-D, 250 w-N. KOWL Inc.

Bishop

KIBS—April 1, 1953: 1230 khz; 1 kw-D, 250 w-N. Box 757 (93514). (714) 873-6324. Bishop Bcstg Corp. Format: MOR, C&W. ■ Frank Oxlerat, pres; John Drozd, gen & coml mgr; John A. Helmer Sr, news dir; John Deardon, prog dir; Dorothy Morgan, prom mgr; Bill Ferman, mus dir; Jim Rieger, chief engr.

KIOQ-FM—November 1974: 100.7 mhz; 5 kw. Ant minus 880 ft. 157 Short St. (93514). Inyo-Mono Bcstg Co.

Blythe

KYOR—1946: 1450 khz; 1 kw-D, 250 w-N, DA-D. Drawer K (92225). (714) 922-7144. Blythe Bcstg Inc. (KYOR Inc.) (acq 6-1-65). Audio news: UPI. Rep: Lucas. Format: MOR. Spec progs: Sp 2 hrs wkly; C&W 12 hrs; both wkly. ■ Robert Roddy, pres & gen mgr; Al Guthrie, coml mgr; Vern Suiter, prog dir; Fred Hertenstein, mus dir. ■ Rates: \$4.90;4.90;4.90;3.65.

KYOR-FM—April 1975: 100.3 mhz; 35.1 kw. Ant 278 ft. Programming separate from AM. Format: Btfl mus. ■ Rates same as AM.

Brawley

KROP—November 1946: 1300 khz; 1 kw-D, 500 w-N. Box 238 (92227). (714) 344-1300. Ronke Inc. (acq 9-1-75). Net: MBS. Rep: Sandeberg-Glenn. Format: C&W. Spec progs: Sp 10 hrs wkly. ■ John B. Stodelle, pres, gen mgr and coml mgr; Eddie Edwards, prog dir; Ernest Henry, mus dir; Jessie Ruiz, prom mgr; Skip Clark, news dir; Ralph Melanson, chief engr. ■ Rates: \$6.50;4.75;6.50;4.75.

Buena Park

***KBPK(FM)**—July 6, 1970: 90.1 mhz; 10 w. (CP: 19 w. Ant 9 ft). 6885 Orangethorpe Ave. (90620). (714) 522-8412. Buena Park School District. Net: NPR. Format: Educl. ■ Glen C. Nicholson, chief exec off; Jack Townsend, gen mgr.

Burbank

KBBQ—1975: 1500 khz; 10 kw-D, 1 kw-N, DA-2. George E. Cameron Jr. Communications Inc.

Burney

KAVA—Aug 13, 1967: 1450 khz; 1 kw-D, 250 w-N. 1450 Park Ave. (96013). (916) 335-4515. Hermiston Bcstg Co. Rep: Sandeberg-Glenn. ■ Robert Chopping, pres; H. Keith Jones, gen & coml mgr; Dave Woods, prog & news director; Randy Wells, mus dir & chief engr.

Calexico

KICO—April 6, 1946: 1490 khz; 1 kw-D, 250 w-N. Box 861, El Centro (92243). (714) 352-1490. KICO Inc. (acq 8-1-73). Net: ABC/MC, Agri-business. Rep: Pro-Meeker. Format: Variety. Spec progs: Religious 7½ hrs; Farm 4 hrs; Chinese ½ hr; Sp 7½ hrs all wkly. ■ W. L. Gleeson, pres, gen & stn mgr; Mary Gleeson, mus dir; Frank Ellsworth, news dir; Wm. Harvey, chief engr.

Camarillo-Oxnard

KEWE(FM) Estereo Espanol

KEWE(FM)—Aug 15, 1972: 95.9 mhz; 3 kw. Ant 155 ft. 2195 Ventura Blvd. (93010). (805) 482-8844. Hot Air Radio. Rep: Bill Dahlsten. Format: Spanish MOR, Top 40. ■ Chester P. Coleman, pres and gen mgr; Manuel Palma, stn mgr; Henry C. Palomino, sls mgr; William Dukenfield, prog dir; Seymour Schafer, mus dir; Earl Jive, prom mgr; Remington Noble, news dir; Julio Haskey, chief engr. ■ Rates: \$12;12;12;12.

Carlsbad

KKOS(FM)—Aug 22, 1965: 95.9 mhz; 3 kw. Ant 94 ft. horiz, 74 ft. vert. Box 949 (92008). (714) 729-7955. Stereo. Tri-Cities Bcstg (acq 7-75). Format: Contemp. Spec progs: Sp 3 hrs; C&W 17 hrs, wkly. ■ Bob J. Gage, VP, gen, coml & prom mgr; Frank Mangio, prog, mus, & news dir; Marvin Vosper, chief engr.

Carmel

KLRB(FM)—April 29, 1971: 101.7 mhz; 630 w. Ant 590 ft. Box 3904 (93921). (408) 624-3859. Monterey Bay Area Media. Format: Progressive. ■ L. E. Johnson Jr., pres & gen mgr; C. R. Gardiner, coml mgr; Steve Seagrave, prog dir; Michael Fox, news dir; Richard W. Adler, chief engr.

KRML—Dec 25, 1957: 1410 khz; 500 w-D. Drawer 6478 (93921). (408) 624-6431. KRML Inc. Rep: Sandeberg-Glenn. ■ Sam Salerno, own, gen mgr.

Cathedral City

KWXY—Oct 4, 1964: 1340 khz; 1 kw-D, 250 w-N. 68700 Ave. 34, Palm Springs (92262). (714) 328-1104. Glen Barnett. Rep: John Andy Potter. Format: Btfl mus. ■ Glen Barnett, own, mgr; prog dir; chief engr; Alyce Walker, asst to own; Dick Donofrio, sls mgr; Garland Sutch, news dir; prod Ralph Kiner, sports dir. ■ Rates: \$7;5;60;7;5.60.

KWXY-FM—Jan 19, 1969: 103.1 mhz; 3 kw (CP 98.5 mhz; 50 kw). Ant minus 690 ft. Dups AM 100%. Stereo. ■ Rates same as AM.

Ceres

KLOC—Sept 15, 1963: 920 khz; 500 w-D, DA. Box 3689, Modesto (95352). (209) 529-2024. KLOC Bcstg Inc. (acq 1965). Rep: Radio Time Sales Inc., J. A. Lucas. Format: C&W. ■ Chester Smith, pres & gen mgr; Warren Stone, news dir; Cecil Lynch, chief engr. ■ Rates: \$9;7.50;7.50;—.

Chico

***KCHO(FM)**—April 22, 1969: 91.1 mhz; 10 w. Ant 100 ft. (CP 2 kw. Ant 29 ft) Calif. State Univ. (95929). (916) 895-5896. Calif. State Univ. (Chico) Foundation. Format: Ed, variety. Spec progs: Farm 6 hrs; black 2 hrs; Spanish 2 hrs, all wkly. ■ George Benson, fac adv; Thomas O'Donnell, gen mgr.

KEWQ—See Paradise.

KFMF(FM)—1968: 93.7 mhz; 14 kw. Ant 215 ft. Stereo. Box 266 (95926) (916) 343-8467. Kragwood Bcstg Inc. Net: ABC/FM. Rep: Savalli-Gates. Format: Progs. ■ William Frasier, pres; Jeff Kragel, gen mgr; Ron Woodward, prog dir; Mike Bell, mus dir; Denise Liberati, news dir; Scott Roberts, chief engr. ■ Rates: \$6.75;6.75;6.75;6.75.

KHSL—April 17, 1935: 1290 khz; 5 kw-U, DA-N. Box 489 (95926). (916) 342-0141. TWX: 910-536-0336. Golden Empire Bcstg Co. (acq 1939). Net: CBS, Golden West. Rep: Torbet. Format: MOR. ■ Mickey McClung, pres & gen mgr; Charles Kingsley, exec VP; Robert Gheller, stn & coml mgr; Gary Avey, prog dir; Leon Washburn, mus dir; Lawrence Martz, news dir; Russell B. Pope, chief engr. ■ KHSL-TV affil.

KPAY—September 1949: 1060 khz; 10 kw-U, DA-N. Box 1060 (95926). (916) 345-0021. Richardson Bcstg Co. (acq 3-1-71). Group owner: Pacific Northwest Bcstg Co. Rep: Buckley, Tacher. Format: MOR. ■ Charles H. Wilson, pres; Frank J. Mertz, VP & gen mgr; Art Douglas, prog and mus dir; Morgan C. Morgan, news dir; Dan Butner, chief engr. ■ Rates: \$10;8;10;6.

KPAY-FM—Nov 16, 1972: 95.1 mhz; 6 kw. Ant 1170 ft. Prog sep from AM. Stereo. Net: ABC/C. Format: Btlf mus. ■ Timothy E. Armstrong, prog dir. ■ Rates: \$5;5;4.

Clairemont

***KSPC(FM)**—February 1956: 88.7 mhz; 3 kw. Ant minus 265 ft. 4th & college (91711). (714) 626-4747. Pomona College. Stereo. Format: Classical, progsv, ed, jazz. ■ Michael K. Heron, gen mgr.

Clovis

KQPD—Not on air, target date 1-1-76: 790 khz; 500 w-D, DA. Clovis Broadcasters.

Coachella

KCHV—1954: 970 khz; 5 kw-D, 1 kw-N, DA-2. Box 11, Indio (92201). (714) 347-2333. Coachella Valley Bcstg Co. Net: NBC, Golden West. Rep: RTX, Duard. Format: Contemp, Variety, MOR. Spec prog: Sp 14 hrs wkly. ■ Edward E. Gorges, pres; Robert P. Osterberg, gen mgr; Betty Feisen, coml mgr; George David, mus dir; Don Bish, news dir; James Shaw, chief engr.

KVIM(FM)—Co-owned with KCHV. Sept 1, 1960: 93.7 mhz; 50 kw. Ant minus 255 ft. Drawer 401, Indio (92201). (714) 347-2333. Format: Spanish. Prog sep from AM. ■ Gil Esquivel, prog dir & prom mgr; Ben Saiz, mus dir; Ray Elias, news dir.

Compton

KJLH(FM)—1965: 102.3 mhz; 3 kw. Ant 300 ft. 3847 Crenshaw Blvd., Los Angeles (90008). (213) 299-2992. John Lamar Hill. Format: Black. ■ John L. Hill, pres; Earl Hoskinson, gen mgr; Arthur Adams, stn mgr.

Concord

***KVHS(FM)**—May 16, 1969: 90.5 mhz; 5.2 kw. Ant minus 145 ft. 1101 Alberta Way (94521). (415) 687-4721. Clayton Valley High School. Stereo. Format: Educl, diversified. ■ Ernest G. Wilson, faculty adv; Doug M. Smith, instructional aide; Stephen A. Miller, prog dir.

KWUN—Nov 17, 1961: 1480 khz; 500 w-D, DA. Box 21-1480 (94521). (415) 685-1480. Adler Communications. (acq 2-1-71). Net: MBS. Rep: Radio Time Sis. Format: oldies. Spec progs: Farm 2 hrs; Sp 4 hrs wkly. ■ William D. Adler, pres, gen and coml mgr; John Hawkins, prog and mus dir; Don DeFesi, prom mgr and news dir; Tom Wilson, chief engr. ■ Rates: \$8;8;8;—.

Corona

KQLH(FM)—Listing follows KREL.

KREL

Popular & Inspirational

KREL—1948: 1370 khz; 5 kw-D, 500 w-N, DA-2. Box 100 (91720). (714) 737-1370. Major Market Stns Inc. (acq 1965). Rep: Adv Sls West. Format: Best of mus worlds. Spec progs: Sp 17 hrs, Portuguese 4½ hrs; Italian 1 hr; Hungarian 2½ hrs, all wkly. ■ William J. Roberts, pres; William N. Babcock, gen and coml mgr, prog and news dir; Jeanne T. Babcock, mus dir; Dennis Gibson, chief engr. ■ Rates: \$8.50;7;8.50;6.50.

KQLH(FM)—Co-owned with KREL. August, 1974: 95.1 mhz; 15 kw. Ant 2000 ft. Prog sep from AM. Stereo. Box 5640, San Bernardino (92401). (714) 825-9525. Audio news: APR, Format: Religious. ■ Donald Painter, stn and coml mgr, prog and news dir; Marilyn Painter, mus dir. ■ Rates: \$8.50;7.50;8.50;6.50.

Crescent City

KPLY—July 1950: 1240 khz; 250 w-U. Box 248 (95531). (707) 464-5900. William E. Stamps (acq 9-75). Rep: Adv Sls West.

KPOD—Dec 5, 1959: 1310 khz; 1 kw-D. 267 I St.

(95531). (707) 464-3183. William E. Stamps (acq 12-10-65). Rep: Sandeberg-Glenn. Spec progs: C&W 2 hrs wkly. ■ William E. Stamps, pres & gen mgr; Steve Spaulding, prog dir & chief engr; Dave Angell, news dir.

***KVXJ(FM)**—Not on air; target date 5-76: 90.1 mhz; 10 w. Ant 100 ft. 306 36th St. Richmond (94611). Corp for Community Radio. Net: CRN Radio. Audio news: APR. Format: Diversified. ■ Tim O'Malley, chmn of the bd and gen mgr; Morris Lyons Jr, VP, treas and prom mgr; Janet L. Smith, sec; Meyer Gottesman, chief engr.

Cupertino

***KKUP(FM)**—May 15, 1972: 91.5 mhz; 42 w. Ant 2294 ft. Box 547 (95014). (408) 253-0303. Assurance Science Foundation Inc. Format: Progressive. Spec progs: Pol 2 hrs; C&W 6 hrs wkly. ■ Dana Jang, pres & gen mgr; Mike Danberger, prog dir; Diana Parham, bus mgr; Chris Bradford, mus dir; June Miller, news dir; Mike Emery, chief engr; Jean Phileen, pub svc dir.

Davis

***KDVS(FM)**—Jan 1, 1968: 91.5 mhz; 10 w. Ant. 149 ft. 14 Lower Freeborn (95616). (916) 752-2777. Regents of the U. of Calif. Net: PCRN. Stereo. Format: Prog, rock. Spec progs: Black 6 hrs; classical 10 hrs; jazz 12 hrs, all wkly. ■ James B. Musslewhite, gen mgr.

Delano

KCHJ—Dec 1, 1951: 1010 khz; 5 kw-D, 1 kw-N, DA-2. Box 1000 (93215). (805) 725-8676. Jean Goss Johns. Rep: Oakes. Format: MOR, variety, C&W. Spec progs: Sp 4 hrs; Filipino 12½ hrs, Religious 7 hrs wkly. ■ Jean G. Johns, stn mgr; Charles H. Johns, gen mgr & chief engr; Bill Lambert, news dir; Cindy Colo, women's dir; John Matthews, sports dir; Tom Dexter, prom mgr.

KDNO(FM)—November 1968: 98.5 mhz; 12.5 kw-U. Ant 630 ft. Box 489 (93215). (805) 725-2599. Tape Networks Inc. (acq 9-74). Format: Religious. ■ Dick Palmquist, pres, coml mgr, mus and news dir; Real Peloquin, prog mgr; Dan Gonseth, chief engr. ■ Rates: \$5.76;5.76;5.76;5.76.

Dimuba

KLTA(FM)—Listing follows KRDU.

KRDU—Dec 26, 1946: 1130 khz; 1 kw-U, DA-1. 597 N. Alta Ave. (93618). (290) 591-1130. Radio Dimuba Co. Rep: Keystone. Format: MOR, relig. Spec progs: Sp 10 hrs; Japanese 2½ hrs, Armenian ½ hr wkly. ■ Dave Jofar Jr, pres, gen, coml mgr & prog dir; Jim Melban, news dir; Warren Nystrom, chief engr.

KLTA(FM)—Co-owned with KRDU. June 5, 1975: 98.9 mhz; 1.5 kw. Ant 240 ft. Prog sep from AM. Format: MOR. Spec prog: SP 12 hrs wkly. Stereo.

El Cajon

KDEO—1955: 910 khz; 1 kw-U, DA-2. Box 2908, San Diego (92112). (714) 583-9100. Metro Communications Inc. (acq 1973). Rep: H-R/Stone. Format: MOR. ■ Thomas Sidley, VP & gen mgr; Morton Sidley, gen sls mgr; Mike McGregor, prog dir; John Lawrence, mus dir; Ed Murphee, chief engr. ■ Rates: \$14;10;14;10.

***KECR(FM)**—May 10, 1959: 93.3 mhz; 2 kw. Ant 1,850 ft. 312 W. Douglas (92020). (714) 442-4414. Family Stns Inc. (group owner; acq 1-1-63). Format: Relig. ■ Harold Camping, pres; Richard Kerr, gen mgr & prog dir; John Ehde, chief engr; Fred Whitman, prom mgr.

El Centro

KAMP—June 21, 1958: 1430 khz; 1 kw-D. Box 1018 (92243). (714) 352-2277. El Centro Radio Inc. Rep: Oakes, Devney. Format: Contemp, Top-40. ■ A. E. Andreatti, pres; Bob Weaver, gen mgr; Bob Holland,

William A. Exline, Inc.
31 CARROLL COURT
SAN RAFAEL, CALIFORNIA 94903
(415) 479-0717
MEDIA BROKERS - CONSULTANTS

coml mgr; Tom Turner, prog mgr; Dan Watkins, prom mgr; Steve Kessler, news dir; Ralph Melanson, chief engr.

KNEU(FM)—April 11, 1970: 107.5 mhz; 25 kw. Ant 155 ft. 207 E. Gillett Rd. (92243). (714) 353-1640. Schaefer-Wade Bcstg Co. (acq 8-24-73). Format: MOR. Stereo. ■ William C. Wade, pres; Thomas Schaefer, coml mgr; Bill Master, gen mgr; Phil Edwards, prog dir; Ralph Melanson, chief engr.

KXO—January 1927: 1250 khz; 1 kw-D, 250 w-N. Box 140 (92243). (714) 352-1230. KXO Inc. (acq 1961). Net: NBC, Calif. Farm, Golden West. Rep: Jalco. Format: MOR. ■ Gordon Belson, pres & gen mgr; Ed Muzy, sls mgr; Gene Brister, prog dir; Steve Gonzales, mus dir; Carroll Buckley, news dir; Fred Gizowski, chief engr.

Elk Grove

***KEGH-FM**—Not on air, target date unknown: 90.1 mhz; 10 w. Ant 102 ft. Elk Grove Blvd. (95624). Elk Grove Unified School District. ■ Jordan W. Montano, pres.

Escondido

KOWN—May 1, 1958: 1450 khz; 1 kw-D, 250 w-N. Vineyard Shopping Center (92027). (714) 745-8511. Palomar Bcstrs Corp. (acq 5-15-73). Net: MBS. Format: MOR. Spec progs: Sp 2 hrs wkly. ■ John D. Feldmann, pres; Lyle Davis, VP & gen mgr; Clip Helps, mus, news and prog dir; Gary Culland, chief engr. ■ Rates: \$16;14;16;14.

KOWN-FM—July 1966: 92.1 mhz; 3 kw. Ant 155 ft. Progs sep from AM. Stereo. Format: Btlf mus. ■ Rates: \$4.50;4.50;4.50;4.50.

Eureka

KATA—See Arcata.

KFMI(FM)—Co-owned with KNCR Fortuna. 1973: 96.3 mhz; 30 kw. Ant 1580 ft. 1800 Broadway (95501). (707) 443-8688. C&M Broadcasting Inc. (acq 10-18-74). Format: Btlf mus, MOR. Stereo. ■ Rates: \$6;6;6;6.

KHUM—Not on air, target date unknown: 790 khz; 5 kw. Carroll R. Hauser

KINS—January 1946: 980 khz; 5 kw-D, 500 w-N, DA-N. Box "O" (95501). (707) 442-5744. Eureka Bcstg Co. (acq 3-1-58). Net: CBS, Golden West. Rep: Howard. Format: MOR. ■ Wendell Adams, pres & gen mgr; Hugo Papstein, coml mgr; Norman Lee, news dir; Dean Elliott, chief engr.

KNCR—See Fortuna.

KRED—May 12, 1933: 1480 khz; 5 kw-U, DA-N. Box 1480 (95501). (707) 443-1621. Paudion Inc. (acq 11-74). Net: ABC/I. Rep: Avery-Knodel; Art Moore. Format: Contemp, C&W. ■ Paul Hoff, operating VP; Bob Barnett, gen mgr; Newton L. Steward, VP news & pub affrs; Alan Gordon, mus dir; Walter Noon, news dir; Donald R. King, chief engr. ■ KIEM-TV affil.

Fort Bragg

KDAC—June 1948: 1230 khz; 1 kw-D, 250 w-N. Box 1164 (95437). (707) 964-3250. Charles & Josephine Stone (acq 11-60). Net: ABC/C. Format: MOR, C&W, Top 40. ■ Charles Stone, gen mgr; Ron Phillips, prog dir & chief engr; Faye E. Keller, news dir.

Fortuna

KNCR—Co-owned with KFMI(FM) Eureka. Oct 31, 1966: 1090 khz; 10 kw-D. Suite 600C, 1800 Broadway, Eureka, Calif. (95501). (707) 443-8688. C&M Broadcasting Inc. (acq 10-18-74). Format: MOR. ■ Roger J. Locke, pres; Richard G. Meyer, gen mgr; Douglas K. Lyon, prog dir; J. Michael Jenkins, news dir; Ken Cummings, chief engr. ■ Rates: \$6;6;6;6.

Fowler

KLIP—July 1, 1962: 1220 khz; 250 w-D. Box 573 (93625). Morris Mindel. Format: Black-Sp. Spec progs: Japanese 4 hrs wkly. ■ Morris Mindel, gen mgr; Woody Miller, coml mgr; Kevin Eldings, news dir.

California Radio

See page C-1 for explanation of listings.

Fremont

***KAHR(FM)**—Not on air, target date unknown: 90.1 mhz; 10 w. 40775 Fremont Blvd. (94538). Fremont Unified School District. J. Tranchina, principal.

KFMR(FM)—March 1961: 104.9 mhz; 3 kw. Ant 115 ft. Box Q (94536). (415) 792-2555. Alameda Bcstg Inc. (acq Dec. 1971). Format: Relig. Sp. Spec progs: Portugese 11 hrs wkly. ■ Robert F. Bell, pres; Dennis King Jr, VP, gen coml, & prom mgr, prog dir; William Rogers, news & opns dir; William Hausburg, mus dir; Alan Groft, chief engr.

***KOHL(FM)**—Sept 23, 1974: 89.3 mhz; 10 w. Ant 60 ft. 43,600 Mission Blvd. (94538). (415) 657-2100. Fremont-Newark Community College Dist. Format: Educational. ■ Chet Gould, gen mgr.

Fresno

KARM—January 1938: 1430 khz; 5 kw-U, DA-1. (CP chng ant-trans-loc). Box 669 (93709). (209) 222-2425. KACY Inc. Net: CBS. Audio news: NIS/UPI. Rep: Buckley. Format: News. Spec prog: Farm 5 hrs wkly. ■ Ethan P. Bernstein, gen mgr; Manuel Gonzales, bus mgr; Pat Davis, news dir; Scott Dean, chief engr. ■ Rates: \$10;9;10;7.

KBIF—Nov. 17, 1947: 900 khz; 1 kw-D. 261 N. Broadway (93701). (209) 266-0791. KBIF Inc. (acq 6-1-57). ■ Norwood J. Patterson, pres; Norwood J. Patterson Jr, gen mgr; Bill Sterling, prog & news dir; R. Stover, chief engr. ■ KICU-TV affil.

KEAP—Oct. 14, 1957: 980 khz; 500 w-D. 305 N. Valentine (93706). (209) 486-2980. H. B. C. Bcstrs Inc. (acq 3-16-67). Net: MBS. Rep: Sandberg-Glenn, Oakes. Format: C&W. ■ John M. Hooker, pres & gen mgr; Don Hillman, mus dir; Steve Le Bel, chief engr.

***KFCF(FM)**—June 4, 1975: 88.1 mhz; 15 w. Ant 1940 ft. Box 4364 (93744). Fresno Free College Foundation.

KFIG(FM)—Jan. 21, 1961: 101.1 mhz; 50 kw. Ant 310 ft. Stereo. Fresno Townhouse, Suite 625 (93721). (209) 485-7762. Universal Bcstg Co. (acq Jan. 1968). Group owner: Golden Pacific. Net: ABC/FM. Rep: ABC-FM Spot Sales. Format: Adult Stereo Rock. ■ Géorgé M. Mardikian, pres; Thomas L. Jones, gen mgr; Ray Appleton, prog dir; Joe Reiling, news dir; Randy Stover, chief engr. ■ Rates: \$13;14;17;17.

KFRE/KFRY



KFRE—1937: 940 khz; 50 kw-U, DA-2. T. 4011 E. Ashlan Ave. (93726). (209) 224-7150. KFRE Bcstg Inc. (acq 4-28-71). Net: ABC/I. Rep: McGavren-Guild-PGW. Format: MOR. ■ Walter B. Lake, pres; Tal Jonz, VP, gen mgr; Nick Ryan, prog dir; Dick Jamison, news dir; Mike Webb, mus dir; Hal Torosian, chief engr. ■ Rates: \$34;29;34;29.

KFRY(FM)—Co-owned with KFRE. March 15, 1948: 101.9 mhz; 1.8 kw. Ant 1,870 ft. Lake Enterprises (acq 7-15-75). (209) 225-1511. Format: Btfl mus. ■ Rates: \$14;16;16;14.

KFYE(FM)—1946: 93.7 mhz; 68 kw horiz, 65 kw vert. Ant 1950 ft. Stereo. Fresno's Townhouse, Suite 535 (93721). (209) 486-5294. Stereo Bcstg Corp. (acq 1971). Net: ABC/C. Rep: Torbet. Format: Soft rock. ■ Richard A. Ingraham, pres. Miles Sexton prom mgr; Bob Treadway, stn mgr; Dick Wagner, chief engr; Greg Elliot, prog dir. ■ Rates: \$19; 16.60; 19; 16.60.

KGST—1949: 1600 khz; 5 kw-D. Box 11777 (93775). (209) 266-9901. International Radio Inc. (acq 10-1-61). Rep: Savalli/Gates; Oakes; Pickens. Format: Sp. ■ Richard E. Ryan, pres; Ben Gutierrez, gen mgr; Jim Polian, coml mgr; Rand Stover, chief engr.

KIRV—Oct. 1, 1962: 1510 khz; 500 w-D. Box 2373 (93723). (209) 233-0786. New Life Enterprises Inc. (acq 1-9-75). Net: ABC/I, E. Format: Good music. ■ Bill Dallas, gen mgr; Ruby Nagel, coml mgr; Dick Dra-

gavon, prog & mus dir; Randy Stover, chief engr.

KKNU(FM)—Jan. 6, 1962: 102.7 mhz; 50 kw. Ant 1,500 ft. Box 4261 (93744). (209) 485-2722. East-West FM Group Inc. (acq 11-16-73). Rep: Avco. Format: Beautiful music. ■ John Q. Tison III, pres; Robert E. Darling, gen mgr & prog dir; Dino R. Fulvio, sls mgr; Fred Missman, prom mgr; Ron Mussleman, mus dir; John Johnson, news dir; Douglas Howland, chief engr. ■ Rates: \$22;25;22;12.

KMAK—June 26, 1953: 1340 khz; 1 kw-D, 250 w-N. 2020 E. McKinley Ave. (93703). (209) 266-9448. McCarthy Bcstg Co. (acq 2-72). Net: ABC. Rep: Blair. ■ John McCarty, co-own; Peter E. Tracy, co-own.

KMJ—June 1925: 580 khz; 5 kw-U. 1515 Van Ness Ave. (93786). (209) 268-5771. TWX 910-362-3193. McClatchy Nwsprcs (acq 6-12-25). Group owner: McClatchy Bcstg. Net: NBC, Golden West. Rep: Katz. Format: MOR. ■ Eleanor McClatchy, pres; Dick Sheppard, gen mgr; Jim Wilson, prog dir, mus dir; Bob Hiller, prom mgr; Carl DeWing, news dir; Al Schneider, chief engr. ■ Rates: \$38;18;26;11.

KMJ-FM—1949: 97.9 mhz; 48 kw. Ant 290 ft. Prog sep from AM. Stereo. Format: Classical. ■ KMJ-TV affil. ■ Rates: \$10;10;10;10.

KPHD(FM)—Listing follows KYNO.

KXEX—October 1962: 1550 khz; 500 w-D. Box 1613 (93717). (209) 233-8803. Atlas Bcstg Co. Rep: Bernhard Howard. Format: Sp. ■ John W. Sonder, pres & gen mgr; Andres Hinojosa, prog & news dir; Leon Baraza, mus dir; Steve Weber Jr, chief engr. ■ Rates: \$9.50;9.50;9.50;9.50.

KYNO—October 1947: 1300 khz; 5 kw-D, 1 kw-N, DA-N. Box 6029 (93703). (209) 255-8383. Radio KYNO Inc. Audio news: APR. Rep: Eastman. Format: Contemp. Spec prog: Farm 2½ hrs wkly. ■ L. E. "Gene" Chenault, pres; Wayne Decker, VP & gen mgr; Ron Vaughn, coml mgr; Mike Novak, prog dir; Bill Turner, news dir; Don Hobson, chief engr. ■ Rates: \$32;28;32;28.

KPHD(FM)—Co-owned with KYNO. May 15, 1970: 95.5 mhz; 50 kw. Ant 320 ft. Progs sep from AM. Stereo. Format: C&W, Spec prog: Farm ½ hr wkly. ■ Chuck Carson, stn and coml mgr, prog dir; Bob Coffee, prom mgr. ■ Rates: \$10;8;10;10.

Garden Grove

KORJ(FM)—June 21, 1961: 94.3 mhz; 3 kw. Ant 245 ft. Stereo. 1 City Blvd West, Suite 1437, Orange, Calif. (92668). (714) 997-0700. West Coast Media Inc. (acq 11-6-70). Format: Contemp, nostalgia. Spec prog: German 1 hr wkly. ■ Donald B. McCann, pres; Reg Streeter, gen & coml mgr; Ross W. Forbes, prog dir; Richard K. Corrigan, mus dir; Travis A. Williams, news dir; Robert O. Royster, chief engr.

Glory

KAZA—September 1957: 1290 khz; 5 kw-D, DA. Box 1290, San Jose (95108). (408) 998-1290. Radio Fiesta Corp. (acq 5-14-73). Rep: Spanish Media Consultants, Lotus Reps. Format: Spanish. ■ Ines Castillo, pres and gen mgr; Robert Colunga Jr, prog dir; Bernie Devereaux, chief engr. ■ Rates: \$15;15;15;15.

KFAT(FM)—Jan. 1, 1970: 94.5 mhz; 4.5 kw. Ant 1,320 ft. 7459 N. Monterey St. (95020). (408) 842-3155. Entertainment Radio (acq 4-1-75). Format: C&W. ■ Jeremy Lansman, pres; Enid Wingate, gen mgr.

Glendale

KIEV—1931: 870 khz, 5 kw-D. 106 N. Glendale Ave. (91206). (213) 245-2388. Southern Calif. Bcstg Co. (acq 6-1-61). Format: Golden Oldies. ■ W. J. Beaton, pres & gen mgr; Ed Perry, prog & news dir; Ron W. Beaton, coml mgr; Allan McKee, prom mgr; Steve Knight, mus dir; Harold Williams, chief engr. ■ Rates: \$32.50;32.50;32.50;32.50.

KUTE(FM)—March 22, 1952: 101.9 mhz; 640 w. Ant 2,860 ft. 30th floor, Occidental Center, Los Angeles (90015). (213) 749-1441. Progress Radio Network. (acq 11-8-72). Rep: Howard, Groskin (N.Y.). ■ Richard B. Stevens, pres; Arnold Schorr, VP & gen mgr; Robert Reich, gen sls mgr; Shirley Fell, bus mgr.

Hanford

KNGS—Feb. 1, 1948: 620 khz; 1 kw-U, DA-N. Box 49 (93230). (209) 582-0361. Kings Broadcasters (acq

8-72). Net: ABC/E. Rep: PRO/Meeker. Format: C&W. Spec progs: Sp 3 hrs; Port 3 hrs, both wkly. ■ Lee Smith, gen mgr; John Gray, mus dir; Dean Johnson news dir; Marv Sawyer, chief engr; Gary Brown, coml mgr. ■ Rates: \$11;10;11;9.

KIOY(FM)—103.7 mhz; 50 kw. Ant 500 ft. Willson Bcstg Co.

KKYS(FM)—107.5 mhz; 50 kw. Ant 275 ft. 1615 E. Lacey Blvd. (93230). Kings Broadcasters Ltd.

Hemet

KHSJ—April 10, 1959: 1320 khz; 500 w-D, DA. Box 1076 (92343). (714) 658-3208. KHSJ Inc. (acq 11-21-74). Group owner: 2588 Newport. Net: ABC/E. Format: MOR. Spec progs: C&W 6 hrs wkly. ■ Pete Parsons, prog dir; Wynona Richards, mus dir; Luther Pillow, chief engr.

KHSJ-FM—Nov. 9, 1963: 105.5 mhz; 700 w. Ant minus 265 ft. Progs sep from AM. Format: Easy Istng.

Hollister

KMPG—Jan. 24, 1966: 1520 khz; 500 w-D. Box 1414 (95023). (408) 637-7476. Milo Communications Corp. Net: ABC. Rep: Radio Time Slis. Spec progs: Sp 21 hrs wkly. ■ Richard Logan, pres, gen, coml & prom mgr, prog dir & chief engr; Roger Powers, news dir.

Independence

KINC—Dec. 4, 1974: 600 khz; 500 w-D. Box 811, Simi Valley, Calif. (93065). (714) 876-5557. Mt. Whitney Broadcasters. Format: MOR, btfl mus, religious, C&W. ■ Israel Sinofsky, pres, gen mgr, prog dir and chief engr; Sal Leroy, coml mgr. ■ Rates: \$42;42;42;—.

Indio

KCHV—See Coachella.

KREO—1946: 1400 khz; 1 kw-D, 250 w-N. Drawer K (92201). (714) 347-3403. The Bounty Broadcasting Corp. (acq 6-1-73). Net: ABC/I. Rep: Torbet. Format: Contemporary. Spec progs: Sp 1½ hrs wkly. ■ D. Keith Larkin, gen mgr; Robert C. Mehl, prog dir; Gerald W. Adams, prod mgr; Wayne C. Goff, chief engr.

KVIM(FM)—See Coachella.

Inglewood

KAGB-FM—Feb. 14, 1958: 103.9 mhz; 1.65 kw. Ant 390 ft. horiz, 370 ft. vert. 9920 La Cienega Blvd. (90301). (213) 641-3222. Avant Garde Bcstg Corp. (acq 1-23-73). Format: Black. ■ Clarence Avant, pres & treas.

KTYM—Feb. 14, 1958: 1460 khz; 5 kw-D, DA. 6803 West Blvd. (90302). (213) 678-3731. Trans America Bcstg. Format: Talk, religious. Spec progs: Ger 2½ hrs; Ital 2½ hrs; Sp 1 hr; Black 15 hrs; Polish ½ hr, assorted 1 languages 7½ hrs all wkly. ■ A. J. Williams, pres; E. L. Brooks, sls dir; J. Schaffer, prog dir; Gerardo Borrego, VP and gen mgr; Gary Wayne, news dir; John Honovich, chief engr. ■ KAIL-TV affil. ■ Rates: \$15;14;15;14.

Irvine

***KUCI(FM)**—Oct 16, 1969: 89.9 mhz; 10 w. Ant 104 ft. c/o Associated Students U C I. (92664). (714) 833-6868. Regents of the University of Calif. Net: PCRN. Format: Progressive. Spec progs: Black 3 hrs; C&W 6 hrs; classical 12 hrs; jazz 6 hrs wkly. ■ Dane Stone, gen mgr.

Jackson

KNGT(FM)—1973: 94.3 mhz; 165 w. Ant 1,090 ft. Box 625 (93930). (408) 385-5421. Gold Country Radio. Net: MBS. Format: Standard pops/contemp C&W, rock. ■ Vern C. Hatfield, gen mgr; Bob Peters, prog, mus, and news dir. ■ Rates: \$3.50;3.50;3.50;3.50.

King City

KRKC—Sept 21, 1958: 1490 khz; 1 kw-D, 250 w-N. Box 625 (93930). (408) 385-5421. KRKC Inc. (acq 9-6-59). Net: MBS. Rep: Sandberg/Glenn. Format: MOR. Spec progs: Sp 7 hrs; Relig 3 hrs; Gospel 1 hr, all wkly. ■ Robert T. McVay, pres and gen mgr; Roger Carroll, stn mgr and prog dir; Ken Lang, mus dir and

prod mgr; Mark Kochman, farm and news dir; Steve McVay, sports dir; Sharon McVay, prom mgr; Ken McVay, rsch dir; Kathy McVay, records librn; Clark Williams, chief engr. ■ Rates: \$3.80;3.80;3.80;3.80.

La Canada

***KUNF(FM)**—88.3 mhz; 10 w. La Canada Unified School District. La Canada High School (91011). (213) 790-1641. Format: Progressive, variety ■ John Murphy, Fred Lyle, pres.

La Jolla

KDIG(FM)—See San Diego.

Lakeport

KBLC—June 15, 1966: 1270 khz; 500 w-D. 405 N. Main St. (95453). (707) 263-6113. Lake County Bcstg Co. (acq 11-30-71). Rep: Sandeberg-Glenn. Format: MOR. Spec progs: Sp 1 hr; Talk 4 1/2 hrs wkly. ■ Noel Knight, gen, coml & prom mgr; Doug Rhoades, mus dir & prog dir; Paul Reading, news dir; Dave Williams, chief engr.

Lancaster

KA VL—Sept 8, 1950: 610 khz; 1 kw-D. 500 w-N, DA-2. 2501 West Ave "I" (93534). (805) 942-1121. Antelope Bcstg Co. Net: MBS, Golden West Bcstrs. Rep: Savalli-Gates. ■ Whitford B. Carter, pres; Herbert L. Comstock, gen mgr; D. Dean Roper, sls mgr; John H. Isles, chief operator

KKZZ—August 1956: 1380 khz; 1 kw-D. DA. 44748 N. Elm Ave. Box 1152 (93534). (805) 948-1208. Lancaster Palmdale Bcstg Corp. (acq 6-1-74). Group owner: Rodgers. Format: C&W. ■ David Rodgers, pres; Glodean Kent, VP & gen mgr; Joseph Thompson, VP; Andrew Key, prog dir; Claude Blacker, chief engr. ■ Rates: \$5.50;5.50;5.50;5.50.

KOTE(FM)—Co-owned with KKZZ. Oct 28, 1970: 106.3 mhz; 3 kw. Ant 135 ft. 44748 N. Elm Ave. (93534). (805) 948-7521. Prog sep from AM. Format: Good music. Stereo. ■ Rates same as AM.

Lemoore

KLAN—Aug 21, 1960: 1320 khz; 1 kw-D. DA. Box 1130, Hanford, Calif. (93230). (209) 584-4466. Sadler and Fischer Ent. (acq 2-1-69). Format: Contemp MOR. ■ W. H. Sadler Jr, pres & gen mgr; Joseph P. Fischer, VP & coml mgr; Rod Ferguson, prog & mus dir; George Eddy, news dir. ■ Rates: \$7.25;6.25;7.25;6.25.

KOAD—Dec 23, 1963: 1240 khz; 250 w. Box 1289, Hanford (93230). (209) 582-9825. Golden Bcstg. (acq 5-6-69). Format: Rock. Spec prog: Portuguese 1 hr wkly. ■ Clark E. Parker, pres; Dave Anderson, opns mgr; Paul St. Jon, prog & mus dir; Dave Anderson, coml mgr; Peter Elliot, prom mgr; Marvin Sawyer, chief engr.

Livermore

KKIQ(FM)—May 1969: 101.7 mhz; 3 kw. Ant minus 150 ft. Stereo. 1603 Barcelona St. (94550). (415) 445-4500. General Bcstg Co. (acq 1-74). Audio news: APR. Format: Top 40. ■ Jerry McLevis, pres; Jerry Havel, gen mgr, coml mgr; Tom McKenzie, prog dir; Jay Coffee, mus dir; Bob Smith, prom mgr; James Rogers, chief engr.

Lodi

KCVR—1946: 1570 khz; 5 kw-D. DA. Box 600 (95240). (209) 368-0626. KCVR Radio (acq 7-60). Group owner: Golden Pacific. Rep: Lotus, Edwardo Cabellero. Format: Relig. Sp. ■ George M. Mardikian, pres; George L. Sampson, gen, coml, prom mgr & prog dir; C. Castro, coml & Sp prog dir; Orson Laam, chief engr. ■ Rates: \$8.60;8.60;8.60;8.60.

KWIN(FM)—Co-owned with KCVR. Dec 24, 1959: 97.7 mhz; 3 kw. Ant 185 ft. Prog sep from AM. Stereo. Format: MOR. ■ Orson Laam, mus dir; Keith Farr, sls mgr. ■ Rates: \$5.20;5.20;5.20;5.20.

Loma Linda

***KEMR(FM)**—Sept 8, 1961: 88.3 mhz; 10 w. 4700 Pierce St. Riverside, Calif. (92505). (714) 785-2288. Loma Linda U. Bcstg Co. (acq 11-5-70). Net: ABC/I. Format: Relig. Spec progs: Classical 4 hrs; children 2 hrs wkly. ■ David J. Bieber, pres; Lee A. McIntyre, gen

mgr; Bruce E. Potterton, prog dir; Ken Freeman, chief engr.

***KLLU(FM)**—See Riverside.

Lompoc

KKOK
Good Country Music

Market 4 Radio

KKOK—May 25, 1963: 1400 khz; 500 w-D, DA. 3460 Buellton Rd. (93436). (805) 736-5656. Straw Bcstg Co. (acq 3-74). Rep: Market 4 Radio. Format: C&W ■ Rates: \$5;4.80;5;4.80.

KLOM—Nov 2, 1962: 1330 khz; 1 kw-D, DA. Box 697 (93436). (805) 736-3429. Communications Corp. of America. (acq 2-15-67). Net: MBS. Rep: Radio Time Sis, O'Connell (Los Angeles). Format: Contemp, Top-40. Spec prog: Sp 1 1/2 hrs wkly. ■ Mike Gold, pres; Dave Jacob, gen & coml mgr; Kurt Knight mus dir; Al Slaght, chief engr

KLOM-FM—Dec 24, 1968: 92.7 mhz; 2.5 kw. Ant minus 270 ft. Dup. AM 100%.

KNEZ—Aug 8, 1958: 960 khz; 500 w-U, DA-N. 322 N. H St. (93436). (805) 736-3496. KNEZ Inc. (acq 10-1-70). Format: MOR, talk. ■ Alan F. Beach, owner; Brian McSorley, stn mgr; Robert Rightsell, coml mgr; G. Anthony, prog dir; Pat Hennessy, mus dir; Kit Balok, news dir; Larry Miller, chief engr.

Long Beach

KFOX—March 1924: 1280 khz; 1 kw-D. Box 1280 (90801). (213) 436-7281. Waiton Communications Inc. (group owner; acq 2-1-73). Rep: PRO Time Sales. Format: C&W. ■ John B. Waiton, Jr, pres; Paul Hull, VP & gen mgr; Dave Sweeney, stn mgr; Chris Collier, prog dir; Greg Carpenter, chief engr.

KGER—1926: 1390 khz; 5 kw-U, DA-N. Box 7126 (90807). (213) 427-7907. John Brown Schools of California Inc. (acq 1-49). Format: Religious, black. ■ Dr. John E. Brown, pres; Clinton H. Fowler, gen, coml & prom mgr; Ruth Talbot, prog dir; Nora Staten, mus dir; Jay Davis, news dir; Luke Crumbaugh, chief engr.

KJLH(FM)—Sept 16, 1965: 102.3 mhz; 3 kw. Ant 300 ft. 3847 S. Crenshaw Blvd., Los Angeles 90008. (213) 299-2992. John Lamar Hill (acq 9-65). Format: Black, contemp. ■ John L. Hill, owner; Rod McGrew, gen mgr; Earl Hoskinson, chief engr.

***KLON(FM)**—Jan 2, 1950: 88.1 mhz; 1.20 kw. Ant 425 ft. 1305 E. Pacific Coast Hwy (90806). (213) 436-9931 ex. 459. TWX: 213-591-5818. Long Beach Unified School District. Net: NPR, S. Calif. Community Radio Net. Format: Educ. ■ Dr. Frank B. George, gen mgr; Robert W. Huber, prog dir; Richard E. Morse, chief engr.

KNAC(FM)—August 1961: 105.5 mhz; 1.6 kw. Ant 400 ft. Stereo. Suite 1000, 320 Pine Ave. (90802). (213) 437-0366. Harden Bcstg Co. (acq 8-69). Rep: Radio Time Sis, Herion. Format: Rock. ■ James Harden, pres & gen mgr; Harvey Levitt, sls mgr; Paul Sullivan, prog & mus dir; Claudia Harden, prom mgr; Steve Milner, news dir; Ace Simpson, chief engr. ■ Rates: \$15;15-23;23;23.

KNOB(FM)—April 22, 1949: 97.9 mhz; 79 kw. Ant 410 ft. Stereo. 505 N. Euclid Ave. Anaheim, Calif. (92802). (213) 772-5662. Pennino Music Co. Rep: PRO/Meeker. ■ Jeanette B. Banocci, pres; John R. Banocci, gen mgr; L. Grannis, opns dir; Robert L. Banocci, chief engr. ■ Rates: \$29;27;29;24.

***KSUL(FM)**—May 1973: 90.1 mhz; 10 w. 6101 E. 7th St. (90840). (213) 498-5295. California State University. Format: Variety. ■ Sandra McMillan, faculty adv; Isaac de la Rocha, chief engr.

Los Altos

***KJFC(FM)**—Dec 4, 1959: 89.7 mhz; 39 w. Ant 1830 ft. 12345 El Monte Rd. (94022). (415) 948-8590 ex 260. Foothill Jr. College District. Format: Progs. ■ Jona Denz, gen mgr.

KPEN(FM)—Oct 17, 1960: 97.7 mhz; 3 kw. Ant minus 175 ft. San Antonio Center, 2550 W. El Camino

Real, Mountain View (94040). (415) 948-0555. Los Altos Bcstg Inc. (acq 11-73). Stereo. Format: MOR.

Los Angeles

KABC—Nov 15, 1929: 790 khz; 5 kw-U, DA-N. 3321 S. La Cienega Blvd. (90016). (213) 663-3311. TWX (910) 321-4316. Telex 673-127. American Broadcasting Companies Inc. (group owner; acq 8-1-44). Net: ABC/I. Rep: Katz. Format: Talk. ■ Ben Hoberman, VP & gen mgr; George Green, gen sls mgr; Jack Meyers, opns mgr; Jim Simon, news & prog dir; Bruce Marr, prom mgr; Art Sterman, chief engr.

KLOS(FM)—Co-owned with KABC. Dec 30, 1947: 95.5 mhz; 68 kw. Ant 2920 ft. Progs sep from AM. Stereo. Net: ABC/FM. Rep: ABC FM Spot Format: Rock'n stereo. ■ John Winnaman, VP & gen mgr; Tom Yates, prog dir; Bill Sommers, sls mgr; Paula Porter, prog mgr; David Heller, news dir.

KALI—See San Gabriel.

KBCA(FM)—Feb 18, 1959: 105.1 mhz; 18 kw. Ant 2900 ft. 10880 Wilshire Blvd. (90024). (213) 475-9494. Mt. Wilson FM Bcstrs Inc. Format: Jazz. ■ Saul Levine, pres. ■ Rates: \$30;30;30;30.

KBIG(FM)—Co-owned with KBRT. Feb 15, 1959: 104.3 mhz, 105 kw. Ant 5800 ft. 7755 Sunset Blvd. (90046). (213) 874-7700. Bonneville Int. (group owner; acq 3-11-69). Stereo. Progs sep from AM. Audio news: UPI. Format: Btlf mus. ■ Comb rate: 95;105;95;65.

KBRT—See Avalon.

KDAY—See Santa Monica.

KFAC—April 14, 1931: 1330 khz; 5 kw-U, DA-N. 5773 Wilshire Blvd. (90036). (213) 938-0161. TWX 910-321-2808. KFAC Inc. (acq 1-1-70). Group owner: ASI Communications. Net: MBS. Format: Classical. ■ George R. Fritzing, pres & gen mgr; Carl Princi, prog dir; Clyde Allen, mus dir; Bill Carlson, news dir; Bob Conger, chief engr; Ed Argow, VP, gen sls mgr; Larry Chambers, local sls mgr. ■ Rates: \$85;65;85;65.

KFAC-FM—Dec 29, 1948: 92.3 mhz; 39 kw. Ant 2910 ft. Dupls less than 50%. Stereo. Format: Classical. ■ Rates Same as AM.

KFI—April 16, 1922: 640 khz; 50 kw-U. Box 74607 (90004). (213) 382-2121. TWX 910-321-3570. Cox Bcstg Corp. (group owner; acq 6/1/73). Net: NBC. Rep: Christal. Format: MOR. ■ Cliff Kirtland, pres; James Wesley Jr, VP, gen mgr; Elliot "Biggie" Nevins, prog dir; Larry Vanderueen, natl sls mgr; Lee Larsen, local sls mgr; Gladys Christman, prom mgr; Rudy Magueri, mus dir; Mike Parker, news dir; Bernard Koval, chief engr

KFSG(FM)—1949: 96.3 mhz; 54 kw. Ant 480 ft. 1100 Glendale Blvd. (90026). (213) 484-1100. International Church of the Foursquare Gospel. Format: Gospel music. ■ Rolf K. McPherson, pres; Alan Bowles, stn mgr; Bert Bringas, prom mgr; George Riggs, Arthur Larson, chief engns.

KFWB—March 25, 1925: 980 khz; 5 kw-D. 6419 Hollywood Blvd. (90028). (213) 463-5151. TWX 910-321-4046. Westinghouse Bcstg Co. (group owner; acq 12-28-66). Rep: Radio Adv Reps. Format: All news. ■ Donald H. McGannon, chmn & pres; Peter E. Schrueth, rgnl VP; Gordon Davis, VP; Arthur A. Schreiber, gen mgr; Dick Newton, prom mgr; Reginald Laite, exec ed & news dir; Donald Parker, chief engr.

KGBS—1925: 1020 khz; 50 kw-U, DA-1 (L-KDKA). 338 S. Western Ave. (90020). (213) 388-2345. TWX 910-321-2895. Storer Bcstg Co. (group owner; acq 6-30-59). Rep: Masia. Format: Gentle country ■ Paul J. Cassidy, gen mgr; Ron Martin, prog dir; Mark Sayatovic sls mgr. ■ Rates: \$46;36;46;—

KGBS-FM—1954: 97.1 mhz; 58 kw. Ant 750 ft. Dupls AM 100%. Stereo. ■ Rates: \$46;36;46;21.

KGFJ—1926: 1230 khz; 1 kw-D, 250 w-N. (100 w. when KPPC opns). 5900 Wilshire Blvd. (90036). (213) 937-5900. Tracy Bcstg Co. (acq 1964). Rep: Howard. Format: Black. ■ Arnold Schorj, VP & gen mgr; Robert E. Reich, sls mgr; Shirley Fell, bus mgr; Cal Milner, prog dir; Jim Randolph, prom mgr; Ray Williams, news dir; Homer Obuchon, chief engr.

California Radio

See page C-1 for explanation of listings.

KHJ—April 13, 1922: 930 khz; 5 kw-U, DA-N. 5515 Melrose Ave. (90038). (213) 462-2133. TWX 910-321-3920. Telex 674824. RKO General Inc. (KHJ Radio div). Group owner: RKO. Rep: RKO Radio Reps. Format: Contemp. Top 40. ■ Dwight Case, pres; Tim Sullivan, gen mgr; Charlie Van Duke, prog dir; Suzanne Wallace, traf mgr; Michele Sandusky, prom mgr; Rosie Guevara, mus dir; Lyle Kilgore, news dir; Ed Dela Pena, chief engr. ■ Rates: \$130;95;130;85.

KRTH(FM)—Co-owned with KHJ. 1941: 101.1 mhz; 58.8 kw. Ant 2,930 ft. 5901 Venice Blvd. (90034). (213) 937-5230. TWX: 910-321-4491. Prog sep from AM. Stereo. Format: Oldies. ■ Allan D. Chlowitz, gen mgr; Dick Bozzi, prog dir; Vickie Burns, prom mgr; Phil Jennrich, news dir. ■ KHJ-TV affil.

KHOF(FM)—Nov 13, 1956: 99.5 mhz; 100 kw. Ant 240 ft. 1615 S. Glendale Ave., Glendale, Calif. (91205). (213) 245-7575. Faith Center Inc. (group owner; acq 11-13-56). Format: Religious. ■ R. A. Schoch, pres; W. Bernard Marston, gen mgr; Ron Myers, prog dir; Jack Acuff, news dir; Joe Snelson, chief engr; Ray Wilson, exec dir; Dan Williams, sls mgr. ■ Rates: \$18; 13; 18; 13.

KIIS—1927: 1150 khz; 5 kw-D, 1 kw-N. 4015 Wilshire Blvd. (90010). (213) 385-2101. Eleven-Fifty Corp. (acq 4-10-70). Group owner: Combined Communications. Net: ABC/C, ABC News. Rep: Eastman. Format: Contemp. ■ John E. Palmer, pres; John Wolfe, snt mgr; Charles Martin, gen sls mgr; Chuck Biore, prog supv; Patrick McGarry, bus mgr; Marc Ray, creative dir; Charley Wright, news dir; George Riggs, chief engr.

KIIS-FM—1948: 102.7 mhz; 8 kw. Ant 2960 ft. 6255 Sunset Blvd. (90028). (213) 466-8381. Pacific & Southern Co. (acq 4-15-71). Rep: Meeker. Format: Top 40. ■ John Tyler, pres; Edward R. Boyd, gen mgr; Rich Carroll, prog dir; Chris Blase, mus dir; Paul Weiman, chief engr.

KIQQ(FM)—April 1, 1965: 100.3 mhz; 58 kw. Ant 1130 ft. 6430 Sunset Blvd. Suite 1102 (90028). (213) 469-1631. Cosmic Communications (acq 1973). Rep: Century. Format: contemp. ■ L. E. Chenauff, pres; Bill Drake, VP; Pat Shaughnessy, gen mgr; Bert Kleinman, prog dir; Richard Gorman, mus dir; B.R. Bradbury, news dir; Don Neil, chief engr. ■ Rates: \$62;46;62;46.

KJOI(FM)—June 30, 1954: 98.7 mhz; 75 kw. Ant 1180 ft. 2555 Briarcrest Road, Beverly Hills, Calif. (90210). (213) 278-5990. Able Communications of Calif. (acq 10-19-70). Group owner: Able. Stereo. Rep: Bolton/Burchill. Format: Btfl mus. ■ Gordon F. Mason, VP & gen mgr; Robert Bochicchio, sls mgr; Kenneth Lamb, prog dir; Richard Vogel, prom mgr; Stan Gold, chief engr. ■ Rates: \$60;77;77;44.

KLAC—1924: 570 khz; 5 kw-U, DA-N. 5828 Wilshire Blvd. (90036). (213) 937-0110. Metromedia Inc. (group owner; acq 7-1-63). Rep: Metro Radio Sls. Format: C&W. ■ John Kluge, pres; Bill Ward, gen mgr; J. Ray Padden, coml mgr; Hal Smith, prog dir; Sam Benson, prom mgr; Carson Schreiber, mus dir; Dean Sander, news dir; Glyn Covington, chief engr.

KMET(FM)—Co-owned with KLAC. March 7, 1961: 94.7 mhz; 58 kw. Ant 2830 ft. (213) 937-0117. Prog sep from AM. Stereo. Format: Progressive. ■ George Duncan, pres; L. David Moorhead, VP & gen mgr; Howard Bloom, gen sls mgr; Shadoc Stevens, prog dir; Joe Collins, mus dir; Christine O'Connor, prom mgr; John Rydgren, news dir; Bill Fuhrer, chief engr.

KLOS(FM)—Listing follows KABC.

KLVE(FM)—May 2, 1959: 107.5 mhz; 34 kw. Ant 2800 ft. 7919 Sunset Blvd. (90046). (213) 874-5772. K-Love Bcstg Inc. (acq. 9-75). Rep: Potter. Format: Soft rock. ■ Stan Byrnes, gen mgr; Duke Norton, prog dir; Norval J. Stockness, bus mgr; Tom Polino, chief engr. ■ Rates: \$46;41;46;35.

KMET(FM)—Listing follows KLAC.

KMPC—1928: 710 khz; 50 kw-D, 10 kw-N, DA-N. 5858 Sunset Blvd. (90028). (213) 469-5341. TWX 213-465-4428. Golden West Bcstrs (group owner; 12-52). Rep: Major Market Radio. Format: MOR. ■ Gene Autry, chmn of bd; Bert West, pres, radio dir; Stanley L. Spero, VP & gen mgr; Steve Bailey, opns dir; Ken Miller, gen sls mgr; Steve Bailey, opns dir; Mark

Blinoff, prog dir; John Asher, VP in chg of adv; Jim Johnson, natl sls mgr; Val Clenard, news dir; Alene McKinney, mus dir; Warren Turnbull, pub dir; Tom Crosnoe, VP in chg of engr. ■ KTLA(TV) affil.

KNX—Sept 10, 1920: 1070 khz; 50 kw-U. 6121 Sunset Blvd. (90028). (213) Hollywood 9-1212. CBS Inc. (group owner; acq 9-36). Net: CBS. Rep: CBS. Radio Spot Sales. Format: All news. ■ George Nicholas, VP & gen mgr; Ray Barnett, sls mgr; Mike Bolen, natl sls mgr; Fred Bergendorff, prom mgr; Jim Zaillian, news dir; Ric Hammond, mgr of tech opns. ■ Rates: \$172;75;115;55.

KNX-FM—1947: 93.1 mhz; 54 kw. Ant 3040 ft. Prog sep from AM. ■ KNXT(TV) affil.

KOST(FM)—Oct 9, 1957: 103.5 mhz; 12.5 kw. Ant 3100 ft. Stereo. Suite 940, 5670 Wilshire Blvd. (90036). (213) 937-1035. Coronado Communications (acq 7-66). Group owner: McLendon. Rep: Eastman Radio, Simpson-Reilly. Format: Btfl music. ■ B. R. McLendon, chmn of bd; Gordon B. McLendon, pres; Bill Hillinck, gen mgr; Rob Edwards, prog dir. ■ Rates: \$51;53;51;32.

***KPFK(FM)**—July 26, 1959: 90.7 mhz; 110 kw. Ant 2830 ft. Stereo. 3729 Cahenga Blvd. W., N. Hollywood, Calif. (91604). (213) 877-2711. Pacifica Foundation (group owner). Format: Ed. ■ Ed Goodman, pres; Will Lewis, gen mgr; Ruth Hirschman, prog dir; Barbara Spark, prom dir; David Cloud, mus dir; Donald Wilson, chief engr.

KPOL—Sept 22, 1952: 1540 khz; 50 kw-D, 10 kw-N, DA-2. 5700 Sunset Blvd. (90028). (213) 466-4123. TWX 910-321-4202. Capital Cities Communications Inc. (group owner; acq 7-28-66). Rep: Blair. Format: Adult/Good mus. ■ Joseph Dougherty, pres; Peter C. Newell, gen mgr; Paul LaGasse, gen sls mgr; Al Herskowitz, prog dir; Tony Kent, news dir; Franz Cherry, chief engr. ■ Rates: \$97;97;97;42.

KPOL-FM—August 1957: 93.9 mhz; 100 kw. Ant 530 ft. Progs sep from AM. Stereo. ■ Rates same as AM.

KRTH(FM)—Listing follows KHJ.

***KUSC(FM)**—1946: 91.5 mhz; 29.5 kw. Ant 140 ft. U. of Southern California, University Park (90007). (213) 746-7808. U. of Southern California. Net: ABC/FM, NPR. Format: Classical and Info. Spec progs: Sp 6 hrs wkly. Stereo. ■ Dr. Wallace Smith, gen mgr; Peter Moskowitz, prog dir; Hugh R. Paul, chief engr.

KWST(FM)—Dec 20, 1956: 105.9 mhz; 72 kw. Ant 770 ft. 8833 Sunset Blvd. (90069). (213) 657-6130. Century Bcstg Corp. (group owner; acq 9-1-67). Rep: Century Ntl Sls. Format: Progs. Stereo. ■ Howard Grafman, pres; John Detz, VP, gen mgr; Monte Gast, sls mgr; Jim McKeon, prog dir; David Perry, mus dir; Mary Strand, prom mgr; Brent Seltzer, news dir; Milan Leggett, chief engr. ■ Rates: \$35;45;55;55.

***KXLU(FM)**—March 3, 1957: 88.9 mhz; 2.9 kw. Ant 10 ft. 7101 W. 80th St. (90045). (213) 642-2866. Loyola Marymount Univ. Stereo. Format: Classical & Fine Arts. Spec progs: C&W 2 hrs; Sp 8 hrs wkly. ■ Larry Caringer, gen mgr.

Los Banos

KLBS—May 1, 1961: 1330 khz; 500 w-D. Box 1428 (93635). (209) 826-4996. Los Banos Bcstg. (acq 1964). Net: Calif. Farm. Format: Variety. Spec progs: Sp 12 hrs; Port 20½ hrs; black 5 hrs; Farm 5 hrs, wkly. ■ John R. McAdam, pres & gen, coml mgr; Michael McAdam, prog dir; Gloria McAdam, mus dir; Miguel Castro, language; Paul Brown, chief engr. ■ Rates: \$6.60;6.60;5.50;4.00.

KLBS-FM—August 1966: 95.9 mhz; 2.6 kw. Ant 125 ft. Dup AM 75%. Stereo. ■ Rates same as AM.

Los Gatos

KRVE(FM)—July 9, 1966: 95.3 mhz; 250 w. Ant 860 ft. 5 University Ave. (95030). (408) 354-6622. Ethnic

William A. Exline, Inc.
31 CARROLL COURT
SAN RAFAEL, CALIFORNIA 94903
(415) 479-0717
MEDIA BROKERS - CONSULTANTS

Radio Inc. (acq. 7-6-74). Stereo. Format: Variety, Top 40, MOR, Sp. Spec progs: Portugese 18 hrs; It 2 hrs wkly. ■ Joaquin Esteves, gen mgr; John Higdon, chief engr.

Madera

KHOT—Dec. 31, 1956: 1250 khz; 500 w-D. Box 67 (93637). (209) 674-8888. KHOT Inc. (acq. 7-7-74). Group owner: 2588 Newport. Net: MBS. Rep: Mario Messina. Format: C&W. Spec prog: Sp 7 hrs wkly. ■ Ray Kandel, pres; Bob Entley, gen mgr.

KUUL(FM)—Co-owned with KHOT. Sept 30, 1974: 92.1 mhz; 3 kw. Ant 185 ft. (209) 674-8887. Progs sep from AM. Format: Contemp.

Mammoth Lakes

KMMT(FM)—March 30, 1973: 106.3 mhz; 3 kw. Ant 155 ft. Box 1284 (93546). Mammoth Mountain FM Associates Inc. ■ David A. Digerness, pres.

Manteca

***KNBS(FM)**—January 1974: 90.3 mhz; 10 w. Ant 65 ft. Manteca Unified School Dist.

Marysville

KMYC—1940: 1410 khz; 5 kw-D, 1 kw-N, DA-2. Box 631 (95901). (916) 742-2396. California First Corp. (acq 9-1-65). Net: ABC/C. Rep: JALCO. Format: Contemp. Spec progs; Sp 9½ hrs wkly. ■ Frank Oxarat, pres; Lloyd "Dutch" Klemm, gen mgr; Bob Lueper, coml & prom mgr; Tom Conrad, prog & mus dir; Larry Maneely, loc news dir; Carl Pendergraft, chief engr.

KRFN(FM)—Co-owned with KMYC. 1947: 99.9 mhz; 4.9 kw. Ant 150 ft. Format: MOR. Dups AM 14%. Stereo. Spec prog: Tele talk 5 hrs wkly.

McFarland

KXEM—Sept 1, 1970: 1590 khz; 500 w-D. Box 326 (93250). (805) 792-2128. Rep: Sandeberg-Glenn. Format: Spanish. ■ Jack O. Koonce, pres, gen mgr & chief engr; Doug Welch, coml mgr; Ignacio Peinado, prog & news dir.

Mendocino

KMFB—Nov 16, 1966: 1300 khz; 1 kw-D. Box 666 (95460). (707) 964-5306. Mathew V. & Maria J. Huber. Format: MOR, contemp. ■ Mathew V. Huber, pres & gen mgr; Tom Holmes, prog dir; Jack Walsh, chief engr.

KMFB-FM—June 26, 1967: 92.7 mhz; 3 kw. Ant 165 ft. Dup AM 70%.

Merced

KAMB(FM)—November 1967: 101.5 mhz; 50 kw horiz, 28 kw vert. Ant. 390 ft. horiz, 310 ft. vert. 90 E. 16th St. (95340). (209) 723-1015. Central Valley Bcstg Inc. Net: Family. Format: Relig. ■ Ken Holgate, pres; Richard L. Grant, gen mgr; Jim Ludwigen, opns mgr & news dir; Paul Brown, chief engr.

***KBDR(FM)**—Jan 4, 1972: 89.1 mhz; 10 w. Ant 37 ft. 3600 M St. (95340). (209) 723-4321. Merced Community College. Format: Variety. ■ Lowell F. Barker, pres; Ralph R. Donald, adv & gen mgr.

KLBS—See Los Banos.

KMYT(FM)—Listing follows KYOS.

KWIP—Feb 26, 1956: 1580 khz; 1 kw-D. Box 1109 (95340). (209) 722-3838. KWIP Bcstg (acq 2-2-68). Net: MBS. Rep: Webb. ■ Glenn H. Himer, pres & prog dir; Keith L. Stine, gen & coml mgr; Eugene Conlogue, prom mgr; Elaine Whitworth, news dir; Mal Beavers, chief engr.

KYOS—Oct 1936: 1480 khz; 5 kw-U, DA-N. Box 717 (95340). (209) 723-2191. Radio One Inc. (acq 1-1-66). Format: Contemp/Top-40. Spec progs: Sp 2 hrs; Port 1 hr wkly. ■ Maurice Hill, pres & gen mgr, mus and prog dir; Con Stefani, coml and prom mgr; Ron Sandilands, news dir; Doc Hill, chief engr. ■ Rates: \$9.25;7.25;9.25;7.25.

KMYT(FM)—Co-owned with KYOS. Not on air; target date November 1975: 97.5 mhz; 50 kw. Ant 490 ft. Prog separate from AM. Format: Btfl mus. Stereo. ■ Rates: \$6;6;6;6.

Mission Viejo

***KSBF(FM)**—September 1975: 88.5 mhz; 10 w. Ant minus 20 ft. 28000 Marguerite Pkwy (92675). (714) 495-4950. Saddleback Community College District. Format: Educ. ■ R.A. Lombardi, pres; James A. Lane, gen mgr.

Modesto

KBEE—1951: 970 khz; 1 kw-U, DA-2. Box 3131 (95353). (209) 523-7756. TWX 209-397-5149. McClatchy Newspapers (acq 8-31-56). Group owner: McClatchy Bcstg. Rep: Katz. ■ Eleanor McClatchy, pres; Jerold Rosenthal, stn mgr, prog & mus dir, prom and coml mgr; R. J. Dickman, news dir; Jack Stevenson, chief engr.

KBEE-FM—April 3, 1948: 103.3 mhz; 10.5 kw. Ant 150 ft. Progs sep from KBEE

***KBHI-FM**—September 1974: 89.9 mhz; 10 w. 1717 Sylvan Ave. (95355). Fred C. Beyer High School. Format: Top 40, school activities.

***KDHS(FM)**—Sept 7, 1969: 90.5 mhz; 10 w. 1000 Coffee Rd. (95355). (209) 526-3685. Thomas Downey High School. Format: Educ. MOR, oldies. Spec progs: Classical 3 hrs; jazz 6 hrs, both wkly. ■ Burt Vasche, advisor; Kent Randle, gen mgr.

KFIV—1950: 1360 khz; 5 kw-D, 1 kw-N, DA-2. Box 1360 (95350). (209) 529-0228. Kilibro Bcstg Corp. (acq 11-1-66). Net: ABC/C. Rep: McGavren-Guild, PGW. Format: Top 40. Spec prog: Farm ½ hr; black 1 hr; Sp 11 hrs, wkly. ■ F. Robert Fenton, pres; Ron Posey, gen mgr; Gerry Hanson, VP; Larry Maher, prog dir, prom mgr; Fred James, mus dir; Don Shannon, news dir; Mel Freedman, chief engr. ■ Rates: \$13.50;11;13.50;10.

KITA(FM)—Co-owned with KFIV. October 1975: 102.3 mhz; 3 kw. Ant 300 ft. Box 3408 (95353). (209) 529-1672. Rep: Lotus. Format: Sp. Spec prog: Religious 14 hrs wkly. ■ Adelita R. Morales, gen mgr; Lupe G. Hernandez, prog dir; Leo Lopez, sis mgr; Mel Freedman, chief engr. ■ Rates: \$10;10;10;10.

KHOP(FM)—Listing follows KTRB.

KTRB



KTRB—June 18, 1933: 860 khz; 10 kw-D, 1 kw-N, DA-2. Box 3839 (95352). (209) 523-0737. Big Valley Bcstg Inc. (acq 6-10-74). Net: MBS. Rep: Torbet. Format: Talk. Spec progs: Sp 1 hr; Port 1½ hrs wkly. ■ Mike Pappas, pres; Dick Brown, stn and natl sis mgr; Cal Puinace, opns & prog mgr; Tim St. Martin, news dir; Cliff Price, chief engr. ■ 7:6;25;8:25;6:25.

KHOP(FM)—Co-owned with KTRB. 1949: 104.1 mhz; 4.7 kw. Ant 260 ft. Dup AM 45%. (Acq 6-10-74). Spec progs: Farm 2½ hrs; black 6 hrs; It 6 hrs; Sp 1 hr; Port 1½ hrs; Greek 6 hrs; Hindustan 4 hrs; Assyrian 6 hrs wkly. ■ Mike Sturtevant, relig dir. ■ Rates: \$4.50;4.50;4.50;4.50.

Mojave

KDOL—May 1, 1961: 1340 khz; 1 kw-D, 250 w-N. Box 968 (93501). (805) 824-4221. Golden Desert Bcstg Corp. (acq 6-1-66). Net: ABC/E, Rep: Lotus. Format: C&W. Spec prog: Relig 4 hrs wkly. ■ Joe F. Means, pres; Al Kennedy, gen mgr; Ken Blakey, news dir; Ben Ferrin, chief engr. ■ Rates: \$7.25;7.25;7.25;6.

KDOL-FM—Aug 1, 1967: 97.7 mhz; 3 kw. Ant minus 120 ft. horiz, minus 125 ft. vert. Dup AM 100%. ■ Rates same as AM.

Monterey

KIDD—1955: 630 khz; 1 kw-U, DA-2. Box KIDD (93940). (408) 372-8154. Walton Radio Inc. (acq 12-1-72). Group owner: Walton. Net: MBS. Rep: Selcom. Format: MOR. ■ John B. Walton, Jr, pres; Claude Barnett, gen mgr; Vince Williams, coml mgr. ■ Rates: \$8.50;6.80;8.50;5.20.

KMBY—1935: 1,240 khz; 1 kw-D, 250 w-N. Box KMBY (93940). (408) 373-1234. Century Bcstg Co. (acq 5-75). Group owner: Greentree. Rep: Eastman. Format: Top 40. ■ Charles Powers, pres; Galy N. Hammond, gen mgr; Frank Colbourn, prog & mus dir; Bob Allen, news dir. ■ Rates: \$10;9;10;7.

KWAV(FM)—Oct 14, 1961: 96.9 mhz; 18 kw. Ant 2570 ft. Stereo. Box 1271, 46 Garden Court (93940). (408) 373-0969. TWX 910-360-7106. A.B. Chemical Corp. (acq 1-1-75). Net: ABC/FM. Rep: Torbet. Format: MOR, classical. ■ Stoddard P. Johnston, gen mgr; Ralph B. Reid, coml mgr; Chuck Leary, prog dir; Scott MacClelland, classical mus dir; Kenneth F. Warren, chief engr. ■ Rates: \$10;8;10;8.

KZEN(FM)—See Seaside.

Moraga

***KSMC(FM)**—Sept 22, 1974: 89.5 mhz; 55 w. Ant 95 ft. Box 223, St. Mary's College (94575). (415) 376-7014. Associated Students of St. Mary's College of Calif. Format: Progressive, rock, jazz, R&B. Spec progs; Black 3 hrs, It ½ hr, Ger ½ hr wkly. ■ Bob Laubacher, stn mgr; Tom McInally, gen mgr.

Morro Bay

KBAI—February 4, 1974: 1150 khz; 500 w. Box 464 (93442). (805) 772-2263. Morro Bay Investment Corp. (acq 1-21-74). Net: ABC/C. Rep: Bunchez. Format: MOR. Spec progs: Big band 8 hrs wkly. ■ J. Sherman Anderson, pres; Robert W. Souza, gen mgr & prog dir; Roy Sueda, mus dir; Harold Hallikainen, chief engr.

Mt. Shasta

KEDY(FM)—See listing following KWSD.

KWSD—June 12, 1947: 620 khz; 1 kw-D. Box 448 (96067). (916) 926-2124. Shasta Cascade Bcstg Corp. Net: Golden West. Rep: Pacific Broadcast Sis. Format: MOR. ■ David H. Rees, owner-mgr, chief engr; Iola Huntingdon, prog dir.

KEDY(FM)—Co-owned with KWSD. Not on air, target date unknown: 95.3 mhz; 3 kw. Ant minus 1297 ft. Box 448, E. Alma St. (96067).

Mountain View

***KSFH(FM)**—1974: 90.5 mhz; 10 w. (94040). St. Francis High School.

Napa

KVON—Nov 17, 1947: 1440 khz; 5 kw-D, 1 kw-N, DA-2. 1124 Foster Rd. (94558). (707) 252-1440. Young Radio Inc. (acq 9-1-70). Net: ABC/E. Audio news: APR. Format: MOR. Spec progs: Sp 5 hrs; farm 2 hrs wkly. ■ Thomas L. Young, pres & gen mgr; George Carl, coml mgr; George Waters, prog dir; Milt Cook, mus dir; Mike Piper, chief engr; Pat Stanley, news dir. ■ Rates: \$14;9;12;6.

Needles

KSFE—October 1952: 1340 khz; 1 kw-SH. Box 738 (92363). (714) 326-2101. James J. Parr (acq 4-22-71). Net: MBS, Golden West. Rep: Lucas. Format: MOR. ■ James Parr, pres.

Newport Beach

KOCM(FM)—Jan 8, 1962: 103.1 mhz; 2 kw. Ant 300 ft. 57 Fashion Island (92660). (714) 644-2727. Success Bcstg Co. (12-31-63). Stereo. Format: MOR. ■ Gary W. Burrill, pres & gen mgr; Lee Riley, stn mgr; Ed Arnold, prog dir; Barney Dewey, chief engr.

Northridge

***KCSN(FM)**—November 1963: 88.5 mhz; 3 kw. Ant minus 235 ft. KCSN (91324). (213) 885-3090. Calif State Univ. Net: NPR. Format: Variety. Spec progs: Ger 4 hr; Ital 1 hr; Pol 2 hrs; Dutch 3 hr; Black 2 hrs; jazz 4 hrs; Scandinavian and Hungarian 1 hr each; Classical 22 hrs; Jewish 2 hrs wkly. ■ Robert Bishop, gen mgr.

Oakland

KABL—1925: 960 khz; 5 kw-U, DA-1. 632 Commercial St., San Francisco (94111). (415) 982-9586. TWX 910-372-7489. Starr-KABL Inc. (acq 4-72). Group owner: Starr. Rep: Torbet, Simpson. Format: Good music. ■ Peter H. Starr, pres; Knowles L. Hall, gen mgr; David L. McKinsey, pro dir; Jacques Verdier, chief engr; R. Louis Davis, news dir. ■ Rates: \$75;70;75;40.

KABL-FM—See San Francisco.

KDIA—July 1922: 1310 khz; 5 kw-U, DA-1. Box 8432 (94662). (415) 834-4262. Sonderling Bcstg Corp. (group owner; acq 6-59). Audio news: UPI, Black

California Radio

See page C-1 for explanation of listings.

Audio. Rep: Howard. Format: Black. ■ Egmont Sonderling, pres; J. Walter Carroll, gen mgr; Willard Morrison, coml mgr; Keith Adams, prom mgr, prog dir; John Arnett Jr, mus dir; Furaha Hiyati, news dir; John Rohl, chief engr. ■ Rates: \$28;24;30;50;24.

KNEW—1922: 910 khz; 5 kw-U, DA-N. Box 910 (94604). (415) 836-0910. Metromedia Inc. (group owner; acq 4-30-66). Net: ABC/E, MBS. Audio news: APR. Rep: Metro. Format: C&W. ■ Harvey B. Levin, VP gen mgr; Jerrold Klein, gen sls mgr; Mikel Hunter-Herrington, opns mgr; Steve Leader, mus dir; Ben Glazer, bus mgr; Gil Haar, news dir; Clifford Foote, chief engr. ■ Rates: \$52;41;48;25.

KSAN(FM)—Co-owned with KNEW. See San Francisco. KNEW-TV affil.

Oceanside

KUDE—July 4, 1956: 1320 khz; 500 w-U, DA-1. Box K1320 (92054). (714) 757-1320. Dolph-Petty Bcstg Co. (acq 4-29-59). Rep: Savalli-Gates. Format: MOR. Spec Prog: Sp 2 hrs wkly. ■ Lyle R. Richardson, VP & gen mgr. ■ Rates: \$12;12;12;12.

KUDE-FM—Jan 20, 1962: 102.1 mhz; 10 kw. Ant 950 ft. (CP 9.5 kw. Ant 980 ft.). Stereo. Prog sep from AM. Format: Beautiful music. ■ Rates same as AM.

Ojai

KOVA(FM)—Jan 4, 1972: 105.5 mhz; 130 w. Ant 1180 ft. 1205-A Maricopa Rd. (93023). (805) 646-1434. Radio Ojai Inc. Format: Variety, Classical. ■ Fred M. Hall, pres, gen mgr, news dir & chief engr; Ralph Guerrero, coml & prom mgr; David Meyer, prog & mus dir.

Ontario

KSOM—1946: 1510 khz; 10 kw-D, 1 kw-N, DA-2. Box 1510 (91762). (714) 982-8888. J. Gordon Campbell, receiver. Rep: Jalco. Format: Adult easy lstrng. ■

KSOM-FM—Sept 11, 1967: 93.5 mhz; 3 kw. Ant minus 400 ft. Dups AM 100%.

Oroville

KORV—Aug 4, 1962: 1340 khz; 1 kw-D, 250 w-N. Box 1340 (95965). (916) 533-1340. Oroville Radio Inc. (acq 4/1/73). Net: ABC/I, ACB/G; Golden Pacific Sports. Rep: Sandeberg-Glenn. Format: MOR, talk. Spec progs: Relig 1½ hrs; farm 3 hrs; Sp 2 hrs wkly. ■ Vernon H. Uecker, gen mgr; David Kindig, prog dir; James Moll, news dir; James E. Walley, chief engr. ■ Rates: \$7.70;7;7.70;7.

Oxnard

KAAP—See Santa Paula.

KACY—See Port Hueneane.

KDAR(FM)—Oct 28, 1974: 98.3 mhz; 3 kw. Ant 72 ft. Financial Plaza Tower Suite 1510, 500 Esplanade Dr. (93030). (805) 485-8881. Edward G. Atsinger III. Format: Inspirational. ■ Edward G. Atsinger III, pres & gen mgr; Rod Henke, stn mgr; Gene Taylor, news and pub aff dir; Mark Pallock, chief engr. ■ Rates: \$6;5.50;6;4.

KEWE(FM)—See Camarillo.

KOXR—June 11, 1955: 910 khz; 5 kw-D, 1 kw-N, DA-2. Box 1186 (93030). (805) 487-0444. Lotus Oxnard Corp. (acq 12-1-70). Group owner: Lotus. Rep: Lotus. Format: Spanish. ■ Howard A. Kalmenson, pres; Everett Kunin, gen mgr; Marco Antonio del Castillo, prog and mus dir; Cal Norman, news dir; Robert Dahlquist, chief engr. ■ Rates: \$16;16;16;16.

KPMJ(FM)—Sept 27, 1958: 104.7 mhz; 2.85 kw. Ant 1580 ft. 1280 S. Oxnard Blvd. (93030). (805) 483-2303. Oxnard Bcstg Corp. Net: MBS. Rep: Lucas, Jalco. Format: MOR easy lstrng. Spec progs: Ger 4 hrs wkly. Stereo. ■ Paul R. Schneider, pres, gen mgr, chief engr; Jim Sumbler, coml mgr; Richard Schneider, prog dir; Brad S. Davis, news dir. ■ Rates: \$4.50;4.50;4.50;4.50.

KQIQ—See Santa Paula.

KUDU—See Ventura.

California Radio

See page C-1 for explanation of listings.

KVEN—See Ventura.

Pacific Grove

KOCN(FM)—October 1970: 104.9 mhz; 1 kw Ant 50 ft. Box 579 (93950). (408) 373-7721. Pacific Ocean Bcstrs. Format: News, clascl, jazz. ■ Jack Tobin, pres; Rick Smith, gen mgr; Chuck Gatling, sls mgr; Donna Frantz, prog dir; Bob Bewersdorf, bus mgr; John Jennings, news dir; Dick Adler, chief engr.

Palmdale

KUTY—August 1957: 1470 khz; 5 kw-D. Drawer K (93550). (805) 947-3107. Mende Inc. (acq 9-22-67). Format: Adult contemp. Spec progs: Sp 1 hr, black 1 hr, wkly. ■ Kay Mende, pres; Art Furtado, gen & coml mgr; B. Jacobson, prog dir; Wes Gibson, mus dir; Claude A. Blacker, chief engr.

Palm Desert

KGOL—Dec 7, 1963: 1270 khz; 1 kw-D, DA. Box 1270 (92260). (714) 345-1270. Duggay Corp. (acq 11-1-70). Net: MBS. Rep: McGavern Guild, PGW. Format: C&W.

Palm Springs

KCMJ—Feb 12, 1946: 1010 khz; 1 kw-D, 500 w-N, DA-2. Box KK (92263). (714) 325-2253. Westminster Bcstg Corp. (acq 9-1-61). Net: CBS. Rep: Lucas. ■ Morris Bergreen, pres; William Hesson, gen mgr; Jerry London, prog dir; Phil Stone, news dir; Edward Grossman, asst & sls mgr; Edward Puchalski, chief engr.

KDES—Oct 29, 1956: 920 khz; 5 kw-D, 500 w-N, DA-2. 821 N. Palm Canyon Drive (92262). (714) 325-1211. Tourtelot Bcstg Co. (acq. 11-9-71). Net: ABC/C. Format: Contemp. Spec progs: Sp ½ hr wkly. ■ Joseph L. Tourtelot, pres; Joseph V. Tourtelot, gen & coml mgr; Ty Stevens, prog and mus dir; Bob Lawrence news dir; Lee McGowan, chief engr. ■ Rates: \$6.75;6.75;6.75;3.75.

KDES(FM)—Feb 10, 1963: 104.7 mhz; 20 kw horiz, 120 kw vert. Ant minus 60 ft horiz, minus 640 ft vert. Stereo. Dup AM 4%. Format: MOR. Spec prog: Sp ½ hr wkly. ■ Rates: \$5;5;5;5.

KPSI—1954: 1450 khz; 1 kw-D, 250 w-N. 174 N. Palm Canyon Drive, Suite 145 (92262). (714) 325-2582. KPSI Radio Corp. (acq 6-69). Rep: Dahlsten. Format: MOR. Spec prog: Talk 5 hrs wkly. ■ Rozene R. Supple, pres; Elliot Field, gen mgr; Stanton B. Layne, prog dir; A. H. (Chris) Christensen, coml mgr. ■ Rates: \$8;8;8;7.

KWXY—See Cathedral City.

Palo Alto

KIBE—1947: 1220 khz; 5 kw-D, 495 Beach St., San Francisco (94133). (415) 776-4720. Sundial Bcstg Corp. (acq 1953). Rep: Groskin, Oakes (Los Angeles). Format: Classical. ■ William R. Crocker, pres; Edward Davis, VP; Michael Weakley, prog dir. ■ Comb rate: \$226;226;226;226.

KDFC(FM)—See San Francisco.

Paradise

KEWQ—Sept 1960: 930 khz; 500 w-D. Box KEWQ (95969). (916) 877-3872. Butte Bcstg Co. (acq 12-21-66). Rep: Sandeberg-Glenn. Format: Religious. ■ Carl J. Auel, pres; Daniel L. Barnett, stn mgr; Scott L. Smith, sec-treas & sls mgr. ■ Rates: \$43.20;43.20;43.20;43.20.

Pasadena

KALI—See San Gabriel.

***KPCS(FM)**—September 1957: 89.3 mhz; 3.8 kw. Ant minus 510 ft. 1570 E. Colorado (91106). (213) Sycamore 5-6961. Pasadena City Junior College Dist. Format: Contemp, variety. Stereo. Net: NER. ■ Dr. Harold E. Salisbury, gen mgr; John F. Gregory, stn mgr & prog dir; A. Kenneth Johnson, chief engr.

KPPC—December 1924: 1240 khz; 100 w-SH. 3884 E. Foothill Blvd. (91107). (213) 681-2486. KPPC Inc. (acq 10-73). Rep: Universal Bcstg. (group owner). Far-

mat: Variety. Spec prog: Black 11 hrs wkly. ■ Howard Warshaw, pres; Erik North, gen & coml mgr; Michael Callahan, chief engr.

KRLA—1942: 1110 khz; 50 kw-D, 10 kw-N, DA-2. 1401 S. Oak Knoll. (213) 681-2591. TWX 213-449-3351. Oak Knoll Bcstg Corp. (acq 1964). Rep: Bassett. Format: Contemp. ■ Lawrence Webb, exec VP & gen mgr; Harold Mathews, stn mgr; Leo McElroy, news dir; Jack Reeder, chief engr.

KWKW—Sept 12, 1942: 1300 khz; 5 kw-D, 1 kw-N, DA-2. 6777 Hollywood Blvd., Box 3969 (90028). (213) 466-8111. Lotus Communications Corp. (group owner; acq 6-1-62). Rep: Masia. Format: Spanish, variety. ■ Howard A. Kalmenson, pres; Larry Mazursky, VP & gen mgr; Everett Kunin, gen sls mgr; Paul Hill, ctrlr; Jaime Jarrin, news dir; Xavier Navarro, prog dir; A. V. Noto, chief engr.

Paso Robles

KPRA(FM)—Listing Follows KPRL.

KPRL—Oct 1, 1946: 1230 khz; 1 kw-D, 250 w-N. Box 96 (93446). (805) 238-1230. F. Ray Bryant (acq 1-1-67). Net: ABC/I. Rep: Howard. Format: MOR. ■ F. Ray Bryant, owner-mgr; Doris Hopper, coml mgr; Phil Dirx, news dir; Steve Martin, prog dir. ■ Rates: \$3.15;3.15;3.15;—.

KPRA(FM)—Co-owned with KPRL. Nov 20, 1972: 94.3 mhz; 3 kw. Ant 53 ft. Progs sep from AM. Stereo. Format: C&W. ■ Rates: \$3;3;3;3.

Patterson

KOSO(FM)—June 8, 1966: 93.1 mhz; 1.10 kw. Ant 1790 ft. Box 171, Modesto, Calif. (95353). (209) 529-7740. Sierra-Pacific Radio Corp. (acq 12-65). Stereo. Net: ABC/I. Rep: Savalli/Gates. Format: MOR, easy listening. ■ John Markovitch, pres; Roy D. Swanson, gen mgr. ■ Rates: \$5.50;5.50;5.50;5.50.

Petaluma

KTOB—Jan 10, 1950: 1490 khz; 1 kw-D, 250 w-N. 21 Washington St. (94952). (707) 763-1505. KTOB Inc. (acq 3-72). Spec progs: Ger ½ hr; C&W 10 hrs wkly. Format: Adult-day, Contemp-night. ■ Robert S. Lipman, co-own; David F. Devoto, co-own; Jack R. Garrison, co-own.

Pismo Beach

KPGA(FM)—Dec 7, 1974: 95.3 mhz; 1.70 kw. Ant 390 ft. 333 Five Cities Dr. (93449). (805) 773-1895. Jack and Lois Gale. Stereo. Net: ABC/FM. Format: MOR. Spec prog: Classical 2 hrs wkly. ■ Rates: \$2.60;2.60;2.60;2.60.

Pittsburg

KKIS—September 1949: 990 khz; 5 kw-U, DA-2. Box 552, 230 E. 4th St. (94565). (415) 432-3700. Schofield Bcstg Corp. (acq 8-72). Rep: Savalli/Gates. ■ Dick Schofield, co-own; Wayne Hoffman, co-own.

Pomona

KKAR—Dec 23, 1960: 1220 khz; 250 w-D, DA. 1430 E. Phillips Blvd., Box 1220 (91769). (714) 623-3434. Basset Bcstg Co. (acq 1973). Rep: Savalli/Gates. Format: C&W. Spec progs: Sp 7 hrs, Black 4 hrs wkly.

KWOW—May 12, 1947: 1600 khz; 5 kw-D, 500 w-N. South Mills & Olive (91766). (714) 628-5541. Valley Bcstg Co. Audio news: UPL. Rep: Jon Broc. Format: Oldies. ■ Dean H. Wickstrom, gen mgr; D. Thomas Wickstrom Jr., coml mgr; Jon Wickstrom, prog mgr and mus dir; Tony St. James, news dir; Cathie Minnock, prom mgr; Glenn K. Shaw, chief engr. ■ Rates: \$31;24;31;17.

Port Hueneme

KACY—July 1958: 1520 khz; 50 kw-D, 1 kw-N, DA-3. Box 1520 (93034). (805) 488-3551. KACY Inc. (acq 5-1-60). Rep: Katz. Format: Contemp. Net: ABC/C. ■ Lincoln Dellar, pres; Ron Thompson, VP & exec dir; Donald Davis, VP & gen mgr; Lou Murray, sls mgr.

Porterville

KIOO(FM)—See listing following KTIP.

KTIP—1947: 1450 khz; 1 kw-D, 250 w-N. Box 1450 (93257). (209) 784-1450. Gateway Bcstrs Inc. (acq 5-1-59). Rep: Radiotime Slis. Format: MOR. Spec progs: Sp 18 hrs wkly. ■ Gareth F. Garlund, pres & gen mgr; Lawrence D. Cotta, VP & stn mgr; Steve La Mar, prog dir; Edd Lamb, chief engr.

KIOO(FM)—Co-owned with KTIP Aug 1, 1972: 99.7 mhz; 15 kw. Ant 690 ft. Box 100 (93257). (209) 784-1452. Stereo. Progs sep from AM. Format: Variety.

Quincy

KPCO—Aug 16, 1963: 1370 khz; 500 w-D. Box 1370 (95971). (916) 283-1370. Ralph W. Hick, Dan DeMiglio. (acq. 12-12-74). Rep: Sandeberg-Glenn Co. Format: MOR. Spec Progs: C&W 12 hrs wkly. ■ Charles Kelly, gen mgr; George Sepulveda, prog dir.

Red Bluff

KBLF—1936: 1490 khz; 1 kw-D, 250 w-N. Box 1010 (96080). (916) 527-3511. Concerned Communications Corp. (acq. 9-73). Format: MOR, rock, C&W. ■ Charles A. Lawton, pres.

Redding

KCLM—June 1958: 1330 khz; 5 kw-D. Box 2378 (96001). (916) 246-1330. California Northwest Bcstg. Net: MBS. Rep: Savalli/Gates. Format: C&W. ■ Ray E. Grant, gen & coml mgr. ■ Rates: \$5;5;5;—.

KQMS—1954: 1400 khz; 1 kw-D, 250 w-N. Box 1400 (96001). (916) 246-1400. TWX (510) 768-6705. Radio Redding Inc. (acq 8-67). Rep: Buckley, Simpson-Reilly. Net: NBC. Format: MOR. ■ J. L. DeArmond, pres; Ray Johnson, VP; Harry Barker, gen mgr; Irwin Fust, chief engr; Alan Taylor, new dir; Gerry Kelly, prog dir.

KRDG—August 1956: 1230 1 kw-D, 255 w-N. Box 1917 (96001). (916) 243-0343. Redding Bcstg Co. Net: ABC/C. Format: Contemp, Top 40. ■ Howard N. Martineau, pres & gen mgr; Dolores Hall, prog dir; Terry Teeters, coml mgr; Jerry McGee, mus dir; Bob Pasero, news dir; Jean Smith, chief engr. ■ Rates: \$4.95;4.30;4.95;3.15.

KVCV—Nov 26, 1936: 600 khz; 1 kw-U, DA-1. Box 1918 (96001). (916) 243-1515. Golden Empire Bcstg Co. (acq 1939). Net: CBS, Golden West. Rep: Torbet. Format: MOR. ■ Mickey McClung, pres; Betty Saver-cool, coml mgr; Lyle Mathys, prog dir & opns mgr; John Smith, chief engr & mus dir; Howard Rucker, news dir.

KVIP—Jan. 4, 1970: 540 khz; 1 kw-D. 1139 Hartnell Ave. (96001). (916) 241-4455. North California Communications Corp. (acq 12-69). Net: Family Stns. Format: Inspirational/Relig. ■ Mrs. Arta B. Nead, pres; Eddie W. Hash, gen mgr; Jack Drake, chief engr.

KVIP-FM—Co-owned with KVIP Oct 17, 1975: 98.1 mhz; 30 kw. Ant 1,710 ft.

Redlands

KCAL—April 1954: 1410 khz; 5 kw-D, 500 w-N, DA-2, Box 390 (92373). (714) 862-4041. Southwest Bcstg Co. Rep: Dore & Miller, Clayton. Format: Sp. ■ Andy James, pres; Sterling Zimmerman, gen mgr; Alfred Gonzales, prog dir.

KCAL-FM—1965: 96.7 mhz; 2.9 kw. Ant minus 1,150 ft. (CP 3 kw. Ant 300 ft.) Prog sep from AM.

***KUOR-FM**—September 1966: 89.1 mhz; 700 w. Ant minus 500 ft. 1200 E. Cotton Ave. (92373). (714) 792-6131. Univer. of Redlands. Format: Variety, progressive. Spec progs: Black 12 hrs; jazz 16 hrs, blues and folk 5 hrs wkly. ■ Eugene E. Dawson, pres; Mark Lundahl, gen mgr.

Redondo Beach

KKOP(FM)—Aug. 4, 1961: 93.5 mhz; 3 kw. Ant 175 ft. 1617 S. Pacific Coast Highway (90277). (213) 540-5567. Stereo. Jack Barry (acq 10-23-68). Rep: Fullford. Format: Contemp. ■ Jack Barry, pres; David R. Greene, VP, gen mgr; Jeanie Fox, mus & prog dir, prom mgr; John Lindquist, chief engr; Robert L. Eames, sls mgr. ■ Rates: \$14;14;14;14.

Ridgecrest

KLOA—Dec. 11, 1956; 1240 khz; 250 w-U. (CP 1 kw) Box 938 (93555). (714) 375-8888. John J. and Eleanor Beth Quigley (acq 10-27-75). Audio news: UPI. Rep: Lucas, Jalco. Format: Contemp, MOR; Eleanor Beth Quigley, pres; John Quigley, gen mgr; West Owens, prog dir; Robert Pinney, news dir; Sam McMullen, coml mgr; Richard Clark, mus dir.

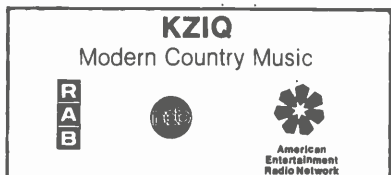

KZIQ—April 7, 1974; 1360 khz; 1 kw-D, DA. 121 W. Ridgecrest Blvd. (93555). (714) 375-2811. Space/Time Bcstg Co. Net: ABC/E. Rep: Dahlsten. Format: C&W. Spec prog: Farm 1 hr wkly; John T. Murray, pres and gen mgr; Martin D. Garbus, coml mgr; Gordon Perkal, prog and mus dir; Ernie George, news dir; Forrest W. Ogan, chief engr. ■ Rates: \$6.10; 6.10; 6.10; 6.10.

Rio Vista

***KRVH(FM)**—Nov. 7, 1972; 90.9 mhz; 10 w. Ant 60 ft. 410 S. 4th (94571). (707) 374-2121. River Delta Unified School District. Format: Educational, MOR, Top 40, diversified. Spec progs: Black 1 hr; jazz 1 hr; Sp 1 hr wkly. ■ Jerry L. Rubier, gen mgr.

Riverside

KACE—June 22, 1957; 1570 khz; 5 kw-D, DA. 7351 Lincoln Ave. (92504). (714) 688-1570. Riverside County Broadcasters. Net: MBS. Format: Modern Country. ■ Ray Lapica, owner; Al Gordon, gen mgr; J. Mike Noonan, sls mgr; Mike Moysé, opns mgr. ■ Rates: \$10; 8; 10; —.

KCNW(FM)—Co-owned with KACE. 1959; 92.7 mhz; 1.7 kw. Ant minus 88 ft. (CP: Ant 1620 ft.) Stereo. Dups AM 50% Format: Modern country ■ Rates: \$10; 8; 10; 8.

KBBL(FM)—Jan. 23, 1965; 99.1 mhz; 49 kw. Ant 165 ft. 4324 Lime St. (92501). (714) 686-8991. C. Edwin Goad. Format: Relig. ■ C. Edwin Goad, gen coml & prom mgr; Russ Hoffman, prog dir; Charles R. Brown, chief engr.

KCNW(FM)—Listing follows KACE.

KDUO(FM)—March 17, 1959; 97.5 mhz; 75 kw horiz. 2.3 kw vert. Ant 1630 ft horiz, 1616 ft vert. Stereo. 666 Fairway Drive, Suite 590 (92408). (714) 825-5555. KFYM Bcstg Co. (acq 1-1-62). Rep: Eastman. Format: MOR. Spec progs: Relig 6 hrs, community 30 min, wkly. ■ Howard Tullis, pres; Al Anthony, exec VP; Bob Bunnell, sls mgr; Larry Shields, prog dir; Jack Fuseier, chief engr.

***KLLU(FM)**—January 1970; 89.7 mhz; 1.4 kw. Ant 73 ft. 4700 Pierce St (92505). (714) 785-2288. Loma Linda U. Net: ABC/I. Format: Relig. Spec prog: Classical 3 hrs; children 2 hrs wkly. ■ David J. Bieber, pres; Lee A. McIntyre, gen mgr; Bruce Potterton, prog dir; Ken Freeman, chief engr.

KPRO—Nov. 15, 1941; 1440 khz; 1 kw-U. Box 1440 (92502). (714) 683-1440. KPRO Inc. (acq 6-1-65). Net: ABC/I. Golden West. Rep: Torbet. Format: Variety, MOR. ■ Dick Clark, pres; Howard Fisher, gen mgr; Linda Dombady, mus dir; Dave Dunbar, news dir; Bob Haley, chief engr.

***KUCR(FM)**—October 1966; 88.1 mhz; 10 w. 691 Linden St. (92507). (714) 787-3421. Regents of Univ. of California. Net: Pacific Coast. Format: Variety, educ. ■ Jeffrey Shaffer, gen mgr

Roseville

KPIP(FM)—Listing follows KPOP.

KPOP—April 1, 1968; 1110 khz; 500 w-U, DA-N. Box 1110 (95678). (916) 791-4111. KPOP Radio. Net: ABC/I, MBS. Rep: Pro Time Slis. Format: MOR & Black. Spec prog: Sp 4 hrs wkly. ■ Donnelly C. Reeves, pres; Gene Ragle, ptnr & gen mgr; Henry E. Gonzales, ptnr &

coml mgr; Kenneth A. Shuper, prog dir; Becky Fogle, prom mgr; George Prokop, chief engr.

KPIP(FM)—Co-owned with KPOP Sept. 10, 1969; 93.5 mhz; 3 kw. Ant 130 ft. Format: Sp. Dups AM 37%. ■ David Jiminez, prog dir; Armando Searey, mus dir; Salvador Sanchez, prom mgr; Jose Ramirez, news dir.

Sacramento

KCRA—April 1945; 1320 khz; 5 kw-D, 1 kw-N, DA-2. 310 10th St (95814). (916) 441-5272. TWX 916-367-2433. Kelly Bcstg Co. Net: NBC; ABC/I, E. Audio news: UPI. Format: MOR, News. ■ Virgil Clemons, gen mgr; Dick Covey, local sls mgr; Dave Darin, prog dir; Larry Page, asst mgr & news dir; Bill Karpisek, chief engr; Lee Kirk, mus dir; Bud Zumwalt, prod mgr. ■ Rates: \$70; 45; 60; 36.

KCTC(FM)—Co-owned with KCRA. 1947; 96.1 mhz; 45 kw. Ant 520 ft 1235 Fee Drive (95815). (916) 927-2706. Net: ABC/I. Rep: Blair. Format: MOR. Prog sep from AM. Stereo. ■ Stan Weisberger, gen mgr; Dick Burgess, coml mgr; Carol Dains, prom mgr; Gil Boucher, opns dir; James Balcom, chief engr. ■ KCRA-TV affil.

KÉBR(FM)—October 1958; 100.5 mhz; 115 kw. horiz, 105 kw vert. Ant 380 ft. 3108 Fulton Ave. (95821). (916) IVanhoee 3-8191. Family Stns Inc. (group owner; acq 1-1-60). Net: Family Radio. Format: Relig. ■ Harold Camping, pres; Scott Smith, VP; Carl Auel, sln mgr; Carl Gluck, prod dir; Marvin B. Clapp, chief engr; Peggy Renschler, pub affrs dir.

***KERS(FM)**—October 1964; 90.7 mhz; 5.4 kw. Ant 69 ft. 6000 J. St. (95819). (916) 454-6505. California State Univ. Format: Variety, educ, black, Sp. Spec progs: Classical 10 hrs; jazz 9 hrs; C&W 3 hrs; Greek 1 hr; native American studies 1 hr; Chinese 1 hr; women 3 hrs, all wkly. ■ Roger C. Walters, fac adv; Mark L. Decker, gen mgr.

KEWT(FM)—Listed after KRAK.

KPBK—1922; 1530 khz; 50 kw-U, DA-1. 21st & O (95813). (916) 442-0476. TWX 916-444-7335. McClatchy Newspapers (acq 1922). Group owner: McClatchy Bcstg Net: CBS, Golden West Sports. Audio news: NIS. Rep: Katz. Format: All news. Spec prog: Farm 7 hrs wkly. ■ Eleanor McClatchy, pres; Arthur C. Williams, sln mgr; Eleanor Estlick, coml mgr; Richard Garcia, prog mgr; Mike Pulsipher, news dir; Ray Rodgers, farm ed; Dale Harry, chief engr; Ron Lyons, prom mgr. ■ Rates: \$33; 20; 31; 18.

KFBK-FM—1946; 92.5 mhz; 115 kw. Ant 240 ft. Prog sep from AM. Stereo. Format: Classcl. ■ Steve Riddell, coml mgr. ■ KOVR-TV affil. ■ Rates: \$8; 8; 8; 8.

KGMS—1952; 1380 khz; 1 kw-U, DA-2. 1235 H St. (95814). (916) 441-3133. KULA Bcstg Co. (acq 6-1-62). Group owner: Key. Rep: Torbet, Moore. Format: MOR. Spec prog: Sp 2 hrs wkly. ■ Theodore J. Wolf, pres & gen mgr; Glenn Johnson, opns mgr; Gerald P. Fuetz, chief engr; Bill Stukaloff, coml mgr. ■ Rates: \$25; 19; 25; 19.

KJAY—May 23, 1963; 1430 khz; 500 w-D, DA. Rt. 1, Box 1300, W. Sacramento (95691). (916) 371-5101. Jack L. Powell (acq 12/1/65). Net: MBS. Rep: Dahlsten. Format: MOR. Spec progs: Sp 6 hrs; black 10 hrs, both wkly. ■ Jack L. Powell, pres, gen & coml mgr; Teresa Powell, prog & news & mus dir. ■ Rates: \$6.70; 6.70; 6.70; —.

KNDE—Aug. 1, 1945; 1470 khz; 5 kw-D, 1 kw-N, DA-2. 355 Commerce Circle (95815). (916) 922-8851. Mediastac (acq 1-1-71). Audio news: APR. Rep: Howard Dahlsten. Format: Top 40. ■ Scott Elrod, pres and gen mgr; Daniel Ohse, prog dir; Donovan Blue, mus dir; Steve Moore, prom mgr; Rick Comstock, news dir; Dick Hanseth, chief engr.

KPOP—See Roseville.

KRAK—November 1926; 1140 khz; 50 kw-U, DA-1. Box 6347 (95860). (916) 482-7100. Hercules Bcstg Co. (acq 1-20-60). Rep: H-R/Stone. Format: C&W. ■ Manning Slater, pres & gen mgr; John McRae, VP, sls; Jay Hoffer, VP, prog; Walt Shaw, prog dir; Bill Jones, news dir; Robert Stefan, VP, engrgr.

KEWT(FM)—Co-owned with KRAK. Feb. 21, 1960; 105.1 mhz; 50 kw. Ant 420 ft. Stereo. Box 6347 (95860). (916) 488-8300. (Acq 3-1-72). Format: Btfl music. ■ LeGrand Rogers, prog dir; James M. Pierce, coml mgr.

California Radio

See page C-1 for explanation of listings.



KROI(FM)—1959; 96.9 mhz; 64 kw. Ant 280 ft. 5831 Rosebud Lane (95841). 331-5772. KEZS Inc. (acq 8-18-75). Group owner: ASI. Rep: McGavren Guild-PGW. Format: Progs. ■ George Fritzing, pres; Michael Scheuble, gen mgr; Alice Daneri, coml mgr; Hank Swartz, chief engr. ■ Rates: \$15; 13; 15; 13.

KROY—1937; 1240 khz; 1 kw-D, 250 w-N. Box 15557 (95813). (916) 927-4274. Sacramento Bcstrs (acq 4-1-68). Group owner: ASI. Net: ABC/C. Format: Contemp. ■ George Fritzing, pres; Barry Potter, gen mgr; Jack Daniels, prog dir; Steve Randall, mus dir; Lloyd Lagace, chief engr.

KSFM(FM)—See Woodland.

KWOD(FM)—Not on air, target date unknown: 106.5 mhz; 50 kw. Ant 120 ft. Stereo. 5770 Freeport Blvd. (95822). (916) 392-5300. Royce Intl Bcstg Corp. Net: ABC/FM. Rep: Buckley. Format: Adult contemp, personality. ■ Edward R. Stolz II, pres and gen mgr. ■ Rates: \$32; 28; 32; 24.

KXOA(FM)—Aug. 1, 1945; 107.9 mhz; 49 kw. Ant. 140 ft. Box 4864 (95825). (916) 483-5083. Don Lee Motors Corp. (acq 4-30-75). Stereo. Net: ABC/FM. Rep: Selcom. Format: Adult Stereo, soft rock. ■ Willet Brown, pres; Phil Melrose, gen mgr; Ed Hamlin, prog dir; Bob Venditti, chief engr. ■ Rates: \$13; 13; 16; 13.



KZAP(FM)—Nov. 1, 1959; 98.5 mhz; 50 kw. Ant 250 ft. Stereo. Box 511 (95803). (916) 444-2806. The New Day Bcstg Co. Inc. (acq. 4-10-73). Format: Contemp. rock. ■ Edward Beimlohr, pres and gen mgr; Robert Williams, prog dir; Scott McConnel, mus dir; Maria Grady, prom mgr; J. Church, news dir; Robert B. Venditti, chief engr. ■ Rates: \$17; 17; 20; 20.

St. Helena

KVYN(FM)—Not on air, target date unknown: 101.7 mhz; 3 kw. Ant minus 520 ft. 1124 Foster Rd., Napa, Calif. (94558). Young Radio. Format: Standard pops.

Salinas

***KAUG(FM)**—90.9 mhz; 10 w. Ant 152 ft Box 147 (93901). (406) 424-0654. Salinas Union High School. Format: Top 40 ■ James Costello, gen mgr.

KBEZ(FM)—See listing following KDON.

KCTY—July 17, 1963; 980 khz; 1 kw-D, DA. Box 1939 (93901). (408) 449-2421. JECO Inc. (acq 2-16-69). Rep: Savalli/Gates. Format: Spanish, variety. ■ James Coyle, pres & gen mgr; Marty Kline, asst to pres; Ed Cook, chief engr.

KCTY-FM—Dec. 5, 1966; 103.9 mhz; 2.65 kw. (CP: 3 kw.). Ant 300 ft. Dups AM 60%.

KDON—1947; 1460 khz; 5 kw-U, DA-1. 933 North Main St. (93901). (408) 422-5363. Forrest Cal-Central Corp. (acq 6-1-73). Net: ABC/C. Rep: Katz. Format: Contemp. ■ Robert A. Forrest, pres; Jack Perk, VP & gen mgr; Johnny Morgan, prog dir; Robert Dahlstrom, coml mgr; Derek Ryan, mus dir; George Bryant, prom mgr; Bill Wise, news dir; Jerry Lewine, chief engr; Bill Sigel, asst gen mgr. ■ Rates: \$10; 8.80; 10; 8.80.

KBEZ(FM)—Co-owned with KDON. December 1959; 102.5 khz; 18.5 kw. Ant 2270 ft. Stereo. Prog separate from AM. Format: Omnibus rock. ■ Walter Tschumperlin, prog dir; George Bryant, creative dir. ■ Rates: \$9.40; 8.20; 9.40; 8.20.

KKEE—July 4, 1963; 1570 khz; 250 w-D. Box 2138

California Radio

See page C-1 for explanation of listings.

(93901). (408) 424-1428. Mt. Toro Bcstg Corp. (acq 5-1-72). Group owner, Rodgers. Net: ABC/I. Format: Btl music. ■ David Rodgers, pres; Skip Vose, VP, gen mgr.

KWYT(FM)—Co-owned with KKEE. Sept. 16, 1964. 100.7 mhz; 910 w. Ant 2,420 ft. (408) 424-4141. Stereo. Format: Btl mus.

KTOM—Sept. 25, 1947: 1380 khz; 5 kw-U, DA-2. Box 1380 (93901). (408) 422-7484. Monterey Peninsula Communications Inc. (acq 2-73). Group owner: Kilibro Bcstg Corp. Net: ABC/E. Rep: McGavren-Guild. Format: Modern country. ■ F. Robert Fenton, pres; Harry Miller, exec VP, gen mgr; Lloyd Carr, coml mgr and prog dir; Bobby Kane, mus dir; John Boren, chief engr. ■ Rates: \$10;9;10,8.

San Bernardino

KBON—August 1947: 1240 khz; 1 kw-D, 250 w-N, 990 Inland Center Dr. (92412). (714) 885-6555. San Bernardino Bcstg Corp. (acq 10-15-70). Net: ABC/E. Rep: Petry. Format: Good mus. ■ Thomas M. Jones, pres & prog dir; Donald J. Caruso, gen mgr; D. David Bolick, prom mgr; Jay Bradbury, news dir; Lavern Gar-ton, chief engr; Don Folsom, pub aff dir.

KCKC—Oct. 15, 1947: 1350 khz; 5 kw-D, 500 w-N, DA-2. Box 2565 (92406). (714) 882-2575. Dimarc Bcstg Co. (acq 2-18-66). Net: CBS. Rep: McGavren-Guild. Format: Contemp. C&W. ■ Douglas Trenner, pres; Walter D. Detweiler, VP & gen mgr; Jim Markham, gen sls mgr; Ken Thompson, local sls mgr; Mark Williams, prog dir; Bob Harvey, news dir.

KDUO(FM)—See Riverside.

KFXM—1929: 580 khz; 1 kw-U, DA-2. 666 Fairway Dr. (92408). (714) 825-5555. KFXM Bcstg Co. (acq 10-5-6). Group owner: Tullis & Hearne Stns. Rep: Blair. Format: Top 40. ■ Howard L. Tullis, pres; Al Anthony, exec VP; Bob Bunnell, gen and sls mgr; Ted Brown, prog dir; Larry Morton, chief engr.

KMEN—1947: 1290 khz; 5 kw-U, DA-2. Box 1290 (92402). (714) 889-2651. Lincoln Delar (acq 7-1-73). Net: ABC/C. Rep: Katz. Format: Contemp. ■ Lincoln Delar, pres; Ron Thompson, gen mgr; Buddy Scott, VP, prog; John Stolzenburg, VP sls.

KOLA(FM)—June 15, 1959: 99.9 mhz; 31 kw. Ant 1,630 ft. 3622 Main St, Riverside (92501). (714) 684-9992. (714) 852-9952. Frederick R. Cole (acq 12-22-65). Net: ABC. Rep: Katz. Format: Adult contemp. ■ Frederick R. Cole, pres & gen mgr; Tim Cuccia, coml mgr; George Wetherby, prog dir; Bill Farmer, prom mgr; Bruce Anderson, news dir; Dennis Howard, mus dir; Dennis Martin, chief engr.

KQLH(FM)—August 1974: 95.1 mhz; 15 kw. Ant 320 ft. Box 5640 (92412). (714) 888-2287. Channel Two Thirty Six Inc. (acq 3-74). Format: Religious. Spec progs: Black 5 hrs; Sp 1 hr, both wkly. ■ Donald Painter, mgr.

***KVCR(FM)**—December 1953: 91.9 mhz; 24.5 kw. Ant minus 320 ft. 701 S. Mt. Vernon Ave. (92403). (714) 885-0231. San Bernardino Comm. Col. Dist. Net: NPR. Format: Classical. Spec prog: Sp 3 hrs; black 11 hrs, both wkly. ■ Raymond F. Ellerman, supt; Thomas Little chmn and gen mgr. ■ *KVCR-TV affil.

San Clemente

KAPX(FM)—Nov. 16, 1971: 107.9 mhz; 28.5 kw. Ant 490 ft. 800 S. El Camino Real (92572). (714) 492-9800. El Camino Bcstg Co. Net: ABC/FM. Format: MOR. Stereo. ■ Kirk Munroe, pres; Michael Cantoni, gen and coml mgr; Michael Gordon, prog and mus dir; Michael Chamberlin, news dir; Glen Kippel, chief engr; David Mathews, VP. ■ Rates: \$10;10;10,7.

San Diego

KCBQ—1946: 1170 mhz; 50 kw-D, 5 kw-N, DA-2. 9416 Mission Gorge Rd. (92071). (714) 286-1170. KCBQ Inc. of Calif. (acq 1-20-75). Group owner: Charter Communications. Audio news: UPI. Rep: Metro Radio Sales. Format: Top 40. ■ George Wilson, pres; Russell Wittberger, gen mgr; Mike Stafford, coml mgr; Chuck Roberts, prog dir; Biran White, mus dir;

Reid Carroll, news dir; Bill Grazier, chief engr. ■ Rates: \$59;53;62;62.

KDIG(FM)—Feb 4, 1960: 98.1 mhz; 28 kw. Ant 640 ft. Box 22207 (92122). (714) 453-3962. West Coast Media Inc. (acq 5-3-71). Net: Golden West Radio. Rep: ABC FM Spot Sales. Format: MOR. ■ Donald B. McCann, pres; Reg Streeter, gen mgr; Pat Walden, coml mgr; Ross W. Forbes, prog and mus dir; Rick Corrigan, sports dir; Bob Royster, chief engr. ■ Rates: \$10;13;13;10.

KEZL(FM)—May 20, 1963: 102.9 mhz; 1.95 kw. Ant. 1850 ft. Box 0182, College Grove Center (92115). (714) 286-0103. Stereo. Combined Communications Corp. (group owner; acq 8-20-75). Rep: Selcom. Format: Btl mus. ■ Stephen O. Jacobs, gen mgr; Scott Gregory, prog dir; Carter Clements, news dir; Brenda Pina, coml mgr. ■ Rates: \$17;19;19;15.

KFMB Bright MOR



KFMB—May 19, 1941: 760 khz; 5 kw-U, DA-N. 1405 Fifth Ave. (92120). (714) 232-2114. TWX 910-335-1210. Midwest TV Inc. (group owner, acq 4-1-64). Net: ABC/E. Rep: McGavren Guild. Format: Contemp/MOR. ■ August C. Meyer, pres; Robert L. Myers, VP, gen mgr; Paul E. Palmer, stn mgr; John Lynch, gen sls mgr; Peter Hallissy, local sls mgr; Anna Kowlurt, prom mgr; Clark Anthony, mus dir; Ron Reina, news dir; Charles Abel, chief engr. ■ Rates: \$55;32;36;22.

KFMB-FM—Sept. 21, 1959: 100.7 mhz; 30 kw horiz, 26.5 vert. Ant 620 ft. Prog sep from AM. Stereo. Format: Top 40. ■ Bobby Rich, prog dir; Jimmy Fox, mus dir; Terri Lynn, news dir. ■ KFMB-TV affil. ■ Rates: \$18;15;21;21.

KFSD-FM—1949: 94.1 mhz; 100 kw. Ant 640 ft. 1540 6th Ave. (92101). (714) 239-9091. Lotus Communications (group owner; acq 2-28-74). Rep: Lotus, GCT. Format: Classical, jazz. ■ Howard Kalmenson, pres; Hal Rosenberg, gen mgr; Terry Brennen, sls mgr; Sharon Wienzueg, prom mgr; Francis Box, mus dir; Joel Saxberg, Bob Gossett, chief engns.

KGB—July 14, 1922: 1360 khz; 5 kw-D, 1 kw-N. 4141 Pacific Coast Hwy. (92138). (714) 297-2201. KGB Inc. (acq 11-30-62). Rep: Eastman. Format: Rock, news. ■ Willet Brown, pres; Jim Price, gen mgr; Bob Lafrate, coml mgr; Ron Jacobs, prog dir; Art Schroeder, mus dir; Brad Messer, news dir; Richard Rudman, chief engr.

KGB-FM—May 11, 1959: 101.5 mhz; 50 kw. Ant 500 ft. Dup AM news only. Stereo. Format: Progs rock & news.

KITT(FM)—1954: 105.3 mhz; 120 kw horiz, 31 kw vert. Ant 180 ft. Suite 525, 325 Broadway (92101). (714) 232-0144. Shepard Bcstg Corp. of Calif. Group owner: Shepard. Rep: Torbet. Format: Btl mus. ■ Herbert J. Weber, pres; Jerry Izenberg, gen mgr.

KLRO(FM)—March 6, 1960: 94.9 mhz; 40 kw. Ant 52 ft. (CP 2.15 kw Ant 1760 ft). 233 A. St., Suite 205 (92101). (714) 239-1217. James C. Gates (acq 11-15-70). Stereo. Format: Inspiration, talk. Spec prog: Black, 2 1/2 hrs; Ger 4 hrs; Sp 3 hrs; Port 1 hr wkly. ■ James C. Gates, pres & gen mgr; V. C. (Chuck) Wheeler, prog coord and chief anncr; Bob Roister, chief engr; Jann Maddock, prom mgr. ■ Rates: \$10;10;10,10.

KOGO—1926: 600 khz; 5 kw-U, DA-1. Box 545 (92112). (714) 263-6191. TWX 910-335-2099. Retlaw Bcstg Co. (acq 1-15-72). Net: NBC. Rep: Major Market Radio. Format: MOR. ■ Joseph C. Drilling, pres; Nancy Haddock, traffic mgr; Scotty Day, prog dir; Rowena Paley, mus dir; Ken Graue, news dir; Ralph Evans, chief engr; Jerry Jackson, stn mgr; Jack Heye, prom mgr. ■ Rates: \$55;37;45;27.

KOZN-FM—1965: 103.7 mhz; 36 kw. Ant 580 ft. 630 Ash St. (92101). (714) 238-1037. KOZN Inc. Rep: Webb. Format: C&W. ■ Rich Tyson, opns mgr; Steve Gordon, prog & prom mgr.

***KPBS-FM**—Sept. 12, 1960: 89.5 mhz; 2 kw. Ant

1,820 ft. San Diego State U. (92182). (714) 286-6431. State of Calif., San Diego U. Net: NPR. Format: Pub affrs, cultural. ■ Paul J. Steen, gen mgr; Tom McManus, prog dir; Ken Kramers, prod dir; Lindsay Passmore, mus dir; Jerry Zullo, news dir.

KPRI Contemporary Adult Rock

KPRI(FM)—June 26, 1960: 106.5 mhz; 50 kw. Ant 230 ft. 11585 Sorrento Valley Rd. (92121). (714) 452-8181. Southwestern Bcstr Inc. (group owner; acq 7-1-68). Stereo. Rep: Century. Format: Contemp adult rock. ■ Edward T. Shadok, pres; Jack Lane, VP & gen mgr; Keith Allen, prog dir; Monk Evans, mus dir; Linda Smith, coml mgr; Scott Thomas, news dir; Dick Warren, chief engr. ■ Rates: \$30;33;36;36.

KSDO—October 1947: 1130 khz. 5 kw-D, 1 kw-N, DA-2. 1450 7th Ave. (92101). (714) 234-8361. Generation II Radio of San Diego (acq 2-1-71). Net: CBS, MBS. Audio news: UPI. Rep: CBS Radio. Format: News. ■ Jack M. Sabella, VP, gen mgr; Keith Newby, opns mgr; Sandra Holley, prom mgr; Joe Heiser, chief engr; Donald Budd, news dir. ■ Rates: \$44;25;38;20.

***KSDS(FM)**—September 1952: 88.3 mhz; 830 w. Ant 170 ft. 1425 Russ Blvd. (92101). (714) 234-1062. San Diego Community College District. Format: Jazz. ■ James Dark, gen mgr; Hope Shaw, prog & news dir; Mary Williams, prom mgr; Richard Upton, opns mgr; Ronald C. Worloy, trans engr; Robert Wiel, chief engr.

KSON—1946: 1240 khz; 1 kw-D, 250 w-N. College Grove Center (92115). (714) 286-1240. Broadmorr Bcstg Corp. (acq 2-1-62). Net: ABC/I. Audio news: UPI. Rep: Blair. Format: C&W. ■ Dan McKinnon, pres & gen mgr; Allan Steimach, coml mgr; Ed Chandler, prog dir; Frank Lee, mus dir; Dick Warren, chief engr; Joan Reed, natl sls. ■ Rates: \$38;33;38;23.

KSON-FM—Jan. 15, 1964: 97.3 mhz; 50 kw. Ant 215 ft. Format: Easy country. Prog sep from AM. Stereo.

KYXY(FM)—1960: 96.5 mhz; 30 kw. Ant 540 ft. (CP 1.80 kw. Ant 1860 ft.). Stereo. 1414 Eighth Ave. (92101). (714) 235-6595. KYXY Inc. Net: ABC/FM. Rep: HR/Stone. Format: Better mus. ■ Wally Nelskog, pres; Wallace K. Reid, VP & gen mgr; Gordon Benson, prog & new dir.

San Fernando

KGIL—October 1947: 1260 khz; 5 kw-U, DA-2. 14800 Lassen St. (91343). (213) 894-9191. Buckley Bcstg Corp. (group owner, acq 1960). Rep: Buckley. Format: MOR. ■ Richard D. Buckley, pres; Stanley G. Warwick, gen mgr; Bill Smith, news dir; Dave Mandelbaum, chief engr; James F. Mergen, gen sls mgr.

KVFM(FM)—Nov. 14, 1958: 94.3 mhz; 3 kw. Ant minus 72 ft. Stereo. 8155 Van Nuys Blvd., Panorama City, Calif. (91402). (213) 787-6000. Pacific Western Bcstg Inc. (acq 5-74). Net: ABC/E. Rep: Radio Time Sls. Format: MOR. ■ John Shepard, pres; Jerry Izenberg, VP, gen mgr; Jack Roth, prom mgr.

San Francisco

KABL—See Oakland.

KABL-FM—July 17, 1958: 98.1 mhz; 100 kw horiz, 67 kw vert. Ant 940 ft. Stereo. 632 Commercial St. (94111). (415) 982-9586. TWX 910-366-7013. Starr-KABL Inc. (acq 4-72). Group owner: Starr. Dups KABL 25%. Rep: Torbet, Simpson. Format: Good mus. ■ Peter H. Starr, pres; Knowles L. Hall, gen mgr; David L. McKinsey, prog dir; R. Louis Davis, news dir; Jacques Verdier, chief engr.

***KALW(FM)**—1940: 91.7 mhz; 3.3 kw. Ant 70 ft. (CP 2.5 kw. Ant 800 ft.) 2905 21st St. (94110). (415) 648-1177. San Francisco Unified School District. Net: NPR. Format: Ed. Spec progs; Ger 1 1/2 hrs; It 1 hr; Sp 1 1/2 hrs; black 1 hr; classical 20 hrs; jazz 2 hrs; Chinese 9 1/2 hrs, all wkly. ■ Leon Del Grande, gen mgr; T. R. Samuel, prog dir; Mary Ann Harvey, prog coord; Jack Phillips, chief engr.

KBRG(FM)—June 1, 1964: 105.3 mhz; 15 kw. Ant 1200 ft. Stereo. 133 Geary St. (94108). (415) 421-1053. Entertainment Communications Inc. (group owner; acq 6-6-69). Rep: Fred Smith (NY), Hooper Jones (Chi.), Harlan Oaks (La.). Format: Sp. Spec progs: 20 languages. ■ Kenneth R. Carey, VP & gen mgr.

KCBS—April 1909: 740 khz; 50 kw-U, DA-2, One Embarcadero Center (94111). (415) 982-7000. CBS Inc. (group owner; acq 2-16-49). Net: CBS. Rep: CBS Radio Spot Sales. ■ Peter M. McCoy, VP-CBS Radio div & gen mgr; Wally Hutchinson, gen sls mgr; Norm Woodruff, news dir; Jack Sampson, prom mgr; Howard Immeky, chief engr.

KCBS-FM—Feb. 1, 1948: 98.9 mhz; 35 kw. Ant 640 ft. Prog sep from AM. Stereo. ■ Roger Layng, gen mgr; Dave Murphy, sls mgr.

KDFC(FM)—Sept 1, 1947: 102.1 mhz; 33 kw. Ant 1050 ft. 495 Beach St. (94133). (415) 776-4720. Sundial Bcstg Corp. Dup KIBE Palo Alto 100%. Rep: Groskin, Harlan Oakes. Format: Classical. ■ Wm. A. Crocker, pres; Edward Davis, gen mgr; Michael Weakley, prog dir. ■ Rates: \$228;228;228;2-9.

KDIA—See Oakland.

KEAR(FM)—1947: 97.3 mhz; 82 kw. Ant 1100 ft. 1234 Mariposa St. (94107). (415) 468-3500. Family Stns Inc. (group owner; acq 1958). Net: Family Radio. Format: Relig. ■ Harold Camping, pres; Thad McKinney, ssn mgr; Robert Lyon, chief engr; Dave Deno, prod dir.

KEST—June 7, 1922: 1450 khz; 1 kw-D, 250 w-N. 1231 Market St. (94103). (415) 626-5585. KEST Inc. (acq 7-3-64). Net: MBS. Rep: Webb. Format: MOR. ■ John F. (Les) Malloy, pres; Alan P. Schultz, VP & gen mgr; Charlene Perrone, coml mgr; Tom Johnson, prog dir; Jan Kelly, pub ser dir; Alan P. Schultz, mus dir; Ed Knight, news dir; Tom Johnson, chief engr.

KFAX—1926: 1100 khz; 50 kw-D, DA-D (L-WWWE). 1470 Pine St. (94109). (415) 673-4148. Argonaut Bcstg Co. (acq 5-13-60). Group owner: Key. Format: Relig/Inspirational. ■ Judd Sturtevant, pres & gen mgr; David Crosatto, opns mgr; Alfred Covaia, editorial dir; Roger L. Roberts, chief engr & asst to pres. ■ Rates: \$25;25;25;25.

KFOG(FM)—March 1, 1963: 104.5 mhz; 7.9 kw. Ant 1450 ft. Stereo. Ghirardelli Sq., 900 North Point (94109). (415) 885-1045. TWX 910-362-6651. General Electric Bcstg Co. (group owner, acq 7-9-74). Rep: Katz. Format: Easy Listening, MOR. Spec prog: Black 1/2 hr wkly. ■ Peter V. Taylor, VP & gen mgr; Wilson Van Alst III, news dir, opns mgr; Howard C. Vose, sls mgr; Cynthia Kersey, traffic; John L. McCarthy Jr., chief engr.

KFRC—Sept. 24, 1924: 610 khz; 5 kw-U. 415 Bush St. (94108). (415) 982-9200. TWX 910-372-7756. RKO General Inc. (group owner; acq 1949). Rep: RKO Radio Rep. Format: Contemp, Top 40. ■ Patrick W. Norman, VP & gen mgr; Michael Spears, prog dir; Dave Sholin, mus dir; Dave Cooke, news dir; Robert M. Kanner, chief engr.

KFRC-FM—Nov. 30, 1960: 106.1 mhz; 69 kw. Ant 1290 ft. 425 Bush St. (94108). Progs sep from AM. Stereo. Format: Nostalgia rock. ■ Paul Ward, prog dir; Dave Sholin, mus dir.

KGO—Jan. 8, 1924: 810 khz; 50 kw-U, DA-1. 277 Golden Gate Ave. (94102). (415) 863-0077. TWX 415-393-7317. ABC Inc. (group owner; acq 1944). Net: ABC/IL. Rep: Blair. Format: News, talk. ■ Michael Luckoff, VP & gen mgr; Roland Galli, gen sls mgr; Jerry Johnson, opns dir; Karylyn von Moren, prom mgr; Dick Leonard, news dir; Veldon Leverich, chief engr.

KSFX(FM)—Co-owned with KGO. Nov. 3, 1947: 103.7 mhz; 7 kw. Ant 1450 ft. 1177 Polk St. (94109). (415) 928-0104. ABC Inc. (acq 1944). Net: ABC/FM. Rep: ABC-FM Spot Sales. Audio news: APR. Format: Disco rock. Prog sep from AM. ■ Donald H. Platt, gen mgr; Marbeth Richmond, gen sls mgr; Sean Conrad, prog dir; William Abbott, news dir; Steve Roberts, chief engr. ■ KGO-TV Affil.

KIOI(FM)—Listing follows KIQI.

KIQI—Oct 27, 1957: 1010 khz; 10 kw-D, DA. San Francisco Wireless Talking Machine Co. Inc. (acq 2-22-74). Dups KIOI 100%.

KIOI(FM)—Co-owned with KIQI. Oct. 27, 1957: 101.3 mhz; 125 kw. Ant. 1,160 ft. 700 Montgomery St. (94108). (415) 956-5101. Pacific FM Inc. Net: ABC/IC. Rep: Masia. Format: Adult contemp. ■ James J. Gabbert, pres & gen mgr; Frank Kasper, coml mgr; Leora Johnson, prom mgr; Laverne Drake, mus dir; Charles Seraphin, news dir; Michael Lincoln, chief engr.

KKHI—1947: 1550 khz; 10 kw-U, DA-2. Suite 1410,

St. Francis Hotel (94119). (415) 986-2151. Buckley Enterprises (acq 3-1-64). Group owner: Buckley Bcstg. Rep: Buckley. Format: Classical. ■ James P. Hickey, Jr. VP & gen mgr; Lee Whiting, opns mgr; Leonard Mattson, local sls mgr; John Hoffman, natl sls mgr; Fred Krock, chief engr. ■ Rates: \$51;45;51;45.

KKHI-FM—1959: 95.7 mhz; 5.6 kw. Ant 1190 ft. Dup AM. Stereo. ■ Rates same as AM.

KMPX(FM)—Dec. 10, 1959: 106.9 mhz; 80 kw. Ant 1120 ft. Stereo. 7 Adelaide Pl. (94102). (415) 771-8500. National Science Network (acq 11-69). Format: Swing-Big Bands. ■ Stan Guell, sr VP; John E. Jensen, gen & prom-mgr & prog dir; Michael Pflaum, coml mgr; Kathryn Beck, mus dir; Keith Davidson, chief engr.

KNAI-FM—Listed after KNBR

KNBR—April 17, 1922: 680 khz; 50 kw-U. Grosvenor Plaza (94102). (415) 626-6700. National Broadcasting Co. (group owner). Net: NBC. Rep: McGavren-Guild/PGW. Format: MOR. ■ William W. Dwyer, gen mgr; George Moody, gen sls mgr; Allan Holtlen, prog dir; Isabelle Lemon, prom mgr; Gene D'Accardo, news dir; Ron Reynolds, mus dir; John Cameron, chief engr. ■ Rates: \$105;70;90;38.

KNAI-FM—Oct. 12, 1949: 99.7 mhz; 45 kw. Ant 1240 ft. Progs sep from AM. Stereo. Format: All news. ■ Rates same as AM.

KNEW—See Oakland.

***KPOO(FM)**—89.5 mhz; 245 w. Ant 410 ft. Box 11008 (94101). (415) 864-7474. Poor Peoples' Radio Inc. Audio news: UPI. Format: Third World communities, diversified. Spec prog: Jazz 6.5 hrs; Sp 14 hrs; C&W 4 hrs; North American, Latin American 2.5 hrs; Asian 2.5 hrs wkly. ■ George Kelsey, pres and gen mgr; Joseph J. Rudolph, opns mgr; Jahid Ashley, ssn mgr; Renee Montagne, prog dir; Karl Marx Yeagans and Jose Castellari, mus dirs; Barbara Lubinski and Terry Collins, news dirs; Odus Evans, chief engr.

***KOED-FM**—June 1969: 88.5 mhz; 110 kw. Ant 1270 ft. 1011 Bryant St. (94103). (415) 864-2051. TWX 910-373-6609. KOED Inc. Stereo. Net: NPR. Format: Contemp, talk, R&B, cultural. Spec prog: Ger 1 hr; It ½ hr; Pol 1 hr; black 3 hrs; C&W 1 hr wkly. ■ Bill Oslerhaus, pres; Jay Agustin, gen mgr; Marilyn Butters, prom mgr; Gene Parrish, prog dir; Mel Ford, chief engr. ■ KOED(TV) affil.

KRON-FM—Feb. 16, 1959: 96.5 mhz; 33 kw. Ant 1410 ft. 1001 Van Ness Ave. (94119). (415) 441-4444. Chronicle Bcstg Co. Stereo. Format: Easy Listening. ■ A. H. Constant, pres; Pep Cooney, gen mgr; Lee Noble, opns mgr; James Kuchan, mus librarian; Lee Berryhill, chief engr.

KSAN-FM—Co-owned with KNEW Oakland, Calif. March 12, 1958: 94.9 mhz; 35 kw. Ant 1140 ft. horiz. 1130 ft. vert. (CP 30 kw. Ant 1210 ft.) 354 Sansome St. (94104). (415) 986-2825. Metromedia Inc. (group owner; acq 1967). Audio news: APR. Rep: Metro Radio Sls. Format: Prog rock. ■ George Duncan, pres; Jerry Graham, gen mgr; Jeff Nemerovskii, natl sls mgr; Bonnie Simmons, prog and mus dir; Vicky Cunningham, prom mgr; Danice Bordett, news dir; Ed Ely, chief engr. ■ Rates: \$47;47;68;68.

KSFO



KSFO—Aug. 10, 1925: 560 khz; 5 kw-D, 1 kw-N. 950 California St. (94108). (415) 982-5500. TWX 916-372-7954. Golden West Bcstrs (group owner; acq 8-56). Audio news: UPI. Format: MOR. ■ Bert S. West, pres; Herbert S. Briggins, sls mgr; Victor Ives, prog dir; Elma Greer, mus dir; Jeffrey Skov, news dir; William D. Shaw, gen mgr. ■ Rates: \$100;55;85;23.

KSFX(FM)—Listing follows KGO.

***KUSF(FM)**—April 1964: 90.3 mhz; 1.45 kw. Ant 105 ft. 2130 Fulton St. (94117). (415) 387-3803 or 666-6667. University of San Francisco. ■ Steve Ruyon, gen mgr.

KYA Contemporary Rock

KYA—1926: 1260 khz; 5 kw-D, 1 kw-N. One Nob Hill Circle (94108). (415) 397-2500. TWX 910-372-6585. Avco Bcstg Corp. (group owner; acq 6-10-65). Audio news: APR. Rep: Avco Radio & TV Sls. Format: Top 40. ■ John T. Murphy, pres; Clifford Hunter, VP, gen mgr; Mark Taylor, prog dir; Larry Brownell, news dir; Ron Smith, chief engr; Fred Schumacher, coml mgr; Steve Jordan, mus dir; Bonita Williams, prom mgr. ■ (Comb rate): ■ Rates: \$55;45;65;55.

KYA-FM—February 1959: 93.3 mhz; 25 kw. Ant 660 ft. Dups AM 50%. Stereo.

San Gabriel

KALI—1942: 1430 khz; 5 kw-U, DA-2. 5723 Melrose Ave., Hollywood (90038). (213) HOLLYWOOD 6-6161. Tele Bcstrs of California Inc. (acq 2-57). Format: Spanish. ■ Richard Eaton, pres; Philip A. Malkin, gen mgr; Juan Rafael Meono, prog & news dir; Mike Mullins, sls mgr; Charles McKee, chief engr.

San Jose

KARA(FM)—See Santa Clara.

KBAY(FM)—Listing follows KEEN.

KEEN—June 21, 1947: 1370 khz; 5 kw-U, DA-2. 1245 S. Winchester Blvd. (92128). (408) 249-5336. United Bcstg Co. Group owner: Golden Pacific. Rep: Selcom. Net: Golden Pacific Sports. Format: Contemp. ■ George M. Mardikian, pres; B. Floyd Farr, gen mgr; Len C. Smith, ssn mgr; Steve Snell, prog dir; Al Dougherty, natl sls; Bill Spendlove, sls mgr; George D. Snell, chief engr. ■ Rates: \$17;15;17;15.

KBAY(FM)—Co-owned with KEEN. March 4, 1963: 100.3 khz; 14.5 kw. Ant 2,580 ft. horiz, 2,540 ft. vert. (408) 249-5229. Rep: HR/Stone. Format: Btlf mus. Prog sep from AM. Stereo. ■ Ray Hollingsworth, ssn mgr; Monty Hall, prog dir; Bill Holmberg, natl sls mgr. ■ Rates: \$24;26;24;21.

KEZR(FM)—July 3, 1967: 106.5 mhz; 50 kw. Ant 430 ft. 111 W. St. John St. (95113). (408) 287-5775. PSA Bcstg Inc. (group owner; acq 1971). Net: PSA. Rep: AVCO. Format: Easy listening. Spec prog: News 4 3/4 hrs; pub affrs 1 3/4 hrs; relig 2 hrs, wkly. ■ George Moody Jr., gen mgr; Dick Winiacki, opns dir; Tom Vigor, chief engr.

KLIV—1946: 1590 khz; 5 kw-U, DA-N. Box 995 (95108). (408) 293-8030. KLIV Inc. (acq 7-1-67). Rep: Avery-Knodel. Format: Top 40. ■ Robert S. Kieve, pres & gen mgr; Max Reeder, sls mgr; Alan Wald, news dir; John Bettencourt, mus dir; Vicent Loppolo, chief engr.

KLOK—Oct 19, 1946: 1170 khz; 50 kw-D, 1 kw-N, DA-2. Box 6177 (95150). (408) 274-1170. TWX: 910-338-0233. P&T Investment/Weaver Bcstg. (acq 12-5-66). Audio news: UPI. Rep: KATZ. Format: MOR/Personality Spec prog: Farm 1/2 hr wkly. ■ Philip C. Davis, pres; Bill Weaver, exec VP; gen mgr; Don Welsh, prog dir; Judy Currier, local sls mgr; Ray Hasha, news dir; Steve Martinez, mus lib; Patricia Meier, prom mgr and pub aff dir; Dave Evans Elster, chief engr. ■ Rates: \$48;41;48;24.

KOME(FM)—July 1, 1959: 98.5 mhz; 12.5 kw. Ant 880 ft. Stereo. 1245 S. Winchester Blvd. (95128). (408) 246-6811. The Audio House Inc. (acq 5-1-73). Rep: Century. Format: Progressive. ■ Michael Weiner, pres; Dan Tapson, gen mgr; Ed Romig, plog dir; Dana Jang, mus dir; Lynn Raskis, news dir; John Higdon, chief engr; Armand Plato, prom mgr. ■ Rates: \$26;31;35;35.

KSJO(FM)—December 1946: 92.3 mhz; 20 kw. Ant nrms 57 ft. Stereo. 3003 Moorpark (95128). (408) 246-6060. Sterling Recreation Org. (acq 5-74). Audio news: UPI. Rep: GCI. Format: Progressive. ■ Bruce Johnson, pres; Steve Rosetta, gen mgr; Dennis Newhall, coml mgr; Don Wright, prog dir, prom mgr; Burt Baumgartner, mus dir; Victory Vaughn, news dir; Bruce Earl, chief engr. ■ Rates: \$18;20;20;20.

***KSJS(FM)**—Feb 4, 1963: 90.7 mhz; 85 w (cp lkw).

California Radio

See page C-1 for explanation of listings.

Ant minus 170 ft. Cal. State Univ.-San Jose (95114). (408) 277-2766. State of California—Cal. State Univ.-San Jose. Format: Educl. Spec progs: Classical 5 hrs; Sp 5 hrs; council mtgs 4 hrs, wkly. ■ Rod Flores, gen mgr; William Matolyak, chief engr.

KXRX—June 24, 1948: 1500 khz; 10 kw-D, 5 kw-N, DA-2. Box 167 (95103). (408) 292-5080. San Jose Bcstg Co. Rep: Torbet. Format: News. ■ Joe E. Levitt, pres & gen mgr; Chuck Christianson, coml mgr; David Smith, opns dir; Alice Schokley, prom mgr; Herm Staiberg, mus dir; Ken Blase, news dir; James E. Levitt, research dir.

San Luis Obispo

KATY—Dec 13, 1949: 1340 khz; 1 kw-D, 250 w-N. Box 841 (93401). (805) 543-1340. Hill Radio Inc. (acq 6-7-73). Net: CBS, Golden West. Rep: Masla/Young, Hyett. Format: MOR. ■ Duane E. Hill, pres.

***KCBX(FM)**—July 27, 1975: 90.1 mhz; 76 w. Ant 1440 ft. 846 Higuera St., Suite 2 (93401). (805) 541-1295. Community Bcstg Inc. Net: NPR. Format: Classical, jazz, variety. Spec progs: Ger 1 hr; It 2 hrs; Sp 2 hrs; C&W 3 hrs; Amer 1 hr; religious 4 hrs, wkly. ■ Stephen Urbani, pres and prog dir; Steve Burrell, gen mgr; Patty Jones, mus dir; Ralph Waldo, news dir; Frank Calabrese, chief engr.

***KCPR(FM)**—1968: 91.3 mhz; 2 kw. Ant minus 350 ft. California State Polytechnic College (93401). (805) 544-4640. Calif Polytechnic State University. Format: Progs. Spec prog: Classical 20 hrs wkly. ■ Cheryl Wright, gen mgr.

KSLY—Feb 6, 1960: 1400 khz; 1 kw-D, 250 w-N. Box 1400 (93601). (805) 543-9400. KSLY Bcstg Co. (acq 10-16-69). Rep: McGavren-Guild/PGW Radio. Format: Contemp. Spec progs: Fr 1 1/4 hrs wkly. ■ Homer H. Odum, pres & gen mgr; Guy Paul, prog dir; Fred Peterson, news dir; Ken Burk, mus dir; Phil Acampora, coml mgr; Harold Hallikainen, chief engr.

KUNA(FM)—Co-owned with KSLY. December 1959: 96.1 mhz; 3.8 kw. Ant 1410 ft. Box 1400 (93601). (805) 543-9400. KSLY Bcst Co. (acq 8-1-72). Format: Good music. Prog sep from AM. ■ Steve LaMont, prog dir.

KVEC—May 1937: 920 khz; 1 kw-D, 500 w-N. Box 787 (93401). (805) 543-8830. Century Bcstg Co. (acq 3-13-75). Group owner: Greentree. Net: ABC/J. Rep: Eastman. Format: Utempo, MOR. ■ Charlie D. Powers, pres; Bob Brown, gen mgr; Danny Clarkson, sls & prom mgr; Gary Christianson, prog and mus dir; Keith Eldridge, news and sports dir; Rick Smith, chief engr. ■ Rates: \$12;9;12;7.

KZOZ(FM)—1962: 93.3 mhz; 29.5 kw. Ant 1430 ft. Forrest Communications Corp. Co-owned with KDON, Salinas, Calif. Format: Progs. ■ Michael Stallings, prog dir.

San Mateo

***KCSM(FM)**—October 1964: 91.1 mhz; 14 kw. Ant 330 ft. 1700 W. Hillsdale Blvd. (94402). (415) 574-6427. San Mateo Community College District. Net: NPR. Format: MOR. ■ Douglas B. Montgomery, gen mgr; Daniel C. Odum, prog dir; Mike Davidson, mus dir; Frank Lanzzone, prom mgr; Francis (Joe) Morgan, chief engr. ■ *KCSM-TV affil.

KOFY—1946: 1050 khz; 1 kw-D. 1818 Gilbreth Rd., Burlingame (94010). (415) 692-2433. Spanish Bcstg System. (acq 7-1-67). Rep: AAA Reps, Tracy Moore, Radio Time Sls. Format: Spanish. ■ H. Scott Killgore, pres; F. T. Crennan, gen mgr; Jess Carlos, stn mgr.

KSOL(FM)—April 1, 1963: 107.7 mhz; 3.8 kw. Ant 1590 ft. (CP 6.2 kw. Ant 1160 ft.) 600 S. Bayshore Blvd. (94402). (415) 347-6638. Intercontinental Radio Inc. (acq 1966). Group owner: United Bcstg. Stereo. Net: National Black. Rep: UBC Sales. Format: Black, rock. ■ Richard Eaton, pres; John Darin, gen mgr; Carol Caokowsky, coml mgr; Harry Jeffery, prog dir; Buddy Lowe, prom mgr; Ed Anderson, news dir; Lee Grundland, chief engr.

San Rafael

KTIM—May 1947: 1510 khz; 1 kw-D. 1040 B St. (94901). (415) 456-1510. Marin Bcstg Co. Net: MBS.

Format: Progs. ■ Ollie Hayden, gen mgr; Clint Weyrauch, prog dir; Bill Richison, news dir; Rick Marshall, chief engr. ■ Rates: \$12;9;12;7.

KTIM-FM—June 1, 1961: 100.9 mhz; 1.9 kw. Ant 360 ft. Dup AM 28%. Stereo. Format: Prog. ■ Rates: \$10;12;15;15.

Santa Ana

KWIZ Better Music—Better News

KWIZ—November 1926: 1480 khz; 5 kw-D, 1 kw-N, DA-2. 3101 W. 5th St. (92703). (714) 839-4220. Voice of the Orange Empire Inc. Ltd. (acq 1965). Group owner: Davis Bcstg. Audio news; APR, UPI. Rep: Masla. Format: Oldies, variety. ■ Philip C. Davis, pres; William Weaver, VP & gen mgr; Pat Michaels, stn mgr; news dir; Steve Colley, chief engr; Verna Greathouse, mus lib. ■ Rates: \$504;372;504;204.

KWIZ-FM—1947: 96.7 mhz; 3 kw. Ant 120 ft. horiz, 115 ft. vert. Prog sep from AM. Stereo. Format: Contemp. ■ Rates: \$84;84;84;84.

KYMS(FM)—Feb 6, 1960: 106.3 mhz; 3 kw. Ant 130 ft. Stereo. 1601 N. Bristol Ave. (92706). (714) 835-1063. Southwestern Bcstrs Inc. (group owner; acq 10-1-68). Format: Contemp Christian mus. ■ Edward T. Shadck, pres; Arnie McClatchey, gen mgr.

Santa Barbara

***KCSB-FM**—November 1964: 91.5 mhz; 185 w. Ant 2,910 ft. Box 13401 (93107). (805) 961-3757. Regents of the U. of Calif. Net: ABC/FM. Audio news; APR. Format: Block. ■ David Kiehn, gen mgr.

KDB—April 1, 1926: 1490 khz; 1 kw-D, 250 w-N. 23 West Micheltonena (93101). (805) 966-4131. Pacific Bcstg Co. (acq 4-21-71). Audio news: UPI. Rep: McGavren-Guild. Format: Adult mus. ■ Richard E. Marsh, pres; Robertson C. Scott, gen mgr; Richard Lane, chief engr. ■ Rates: \$15;20;15;20;7.60.

KDB-FM—Oct 14, 1960: 93.7 mhz; 5 kw. Ant minus 1,000 ft. (CP 12.5 kw. Ant 870 ft) Prog separate from AM. Stereo. Format: Btfl mus. ■ Rates same as AM.

KIST—1947: 1340 khz; 1 kw-D, 250 w-N. Box 1169 (93102). (805) 966-3981. Radio Santa Barbara Inc. Rep: Buckley. Format: Contemp. Spec progs: It 1 hr; free speech 1/2 hr, wkly. ■ J. P. Wardlow Jr, pres; Bob Jones, gen mgr; Hal Bates, prog dir; Patrick C. Riley, news dir; Cherie Welty, coml mgr; Dick Williams, mus dir; Douglas A. Wedel, chief engr.

KKIO—March 2, 1962: 1290 khz; 500 w-D. 5386 Hollister Ave. (93111). (805) 964-8661. KACL Radio Inc. (acq 5-1-74). Net: ABC/J. Rep: Torbet. Format: C&W. Spec prog: Sp 2 hrs, wkly. ■ Guy S. Erway, pres, gen & coml mgr; Joyce C. Erway, prog dir; Nick Peirce, news dir; F. W. Carr, chief engr.

KRUZ(FM)—April 18, 1961: 103.3 mhz; 105 kw. Ant 2980 ft. Carillo Hotel (93101). (805) 963-1831. The Schuele Org. (acq 5-21-71). Net: ABC/E. Format: Talk, beautiful mus. Spec prog: Classical 14 hrs wkly. Stereo. ■ Carl L. Schuele, pres and gen mgr; Randall Chase, prog & mus dir; Fred Holub, chief engr; Ed Foley, news dir; Patricia Drake, prom mgr. ■ Rates: \$13;17;17;13.

KTMS—Oct 31, 1973: 1250 khz; 1 kw-U, DA-1. Drawer NN (93102). (805) 963-1975. News-Press Pub Co. Net: NBC. Rep: Howard. Format: Contemp, news. Spec progs: Sp 2 1/2 hrs wkly. ■ Stuart S. Taylor, pres; Robert Senn, prog dir; Mary Rueh, mus dir; Gary Clark, news dir; John Stadler, chief engr. ■ Rates: \$11;7;9;7.

KTMS-FM—Sept 1, 1957: 97.5 mhz; 17.5 kw. Ant 2900 ft. Dup AM 15%. ■ Rates same as AM.

KTYD—Aug 11, 1962: 990 khz; 1 kw-D, DA. 1216 State St. (93101). (805) 963-1601. Antares Bcstg Co. (acq 6-14-75). Rep: Selcom. Format: Progressive; free form. ■ G. D. Gentling Jr, pres and gen mgr; Gerry DeWitt, news dir; Fred Holub, chief engr; Larry Johnson, prog dir; Laurie Cobb, mus dir. ■ Rates: \$13;10;50;13;9.

KTYD-FM—Aug 11, 1962: 99.9 mhz; 34 kw. Ant 550 ft. Dup AM daytime. Stereo.

Santa Clara

KARA(FM)—Sept 25, 1964: 105.7 mhz; 50 kw. Ant 500 ft. 2775 Park Ave. (95050). (408) 243-4252. Santa Clara Broadcasters Inc. (acq 7/1/72). Net: ABC/FM. Format: MOR. ■ Robert S. Kieve, pres, gen mgr; Max Reeder, sls mgr; Dan Schow, opns dir; John Betten-court, mus dir; Vincent A. Lopopolo, chief engr. ■ Rates: \$21;21;21;21.

KEGL—Dec 18, 1964: 1430 khz; 1 kw-U, DA-1. Box 631 (95052). (408) 244-2430. Cascade Bcstg Corp. (group owner, acq 4-1-72). Rep: Savalli/Gates, Mario Messina, Dallas, AAA Reps (N.Y., Chicago). Format: Relig, Sp. ■ David M. Jack, pres; June Swanson, mgr; Ruben Valentin, Sp prog dir; Gary Rodriguez, sls mgr; Jim Woodward, chief engr.

KLIV—See San Jose.

Santa Cruz

KSCO—Sept 21, 1947: 1080 khz; 10 kw-D, 5 kw-N, DA-N. Box 1080 (95061). (408) 475-1080. Radio Santa Cruz. Rep: Pro Radio Sls, Dahlsten. Format: MOR. ■ Charles V. Berlin, mngng ptrn; gen mgr & chief engr; Dick Little, news dir. ■ Rates: \$8;6;8;6.

KSCO-FM—Sept 2, 1961: 99.1 mhz; 24 kw. Ant minus 250 ft. Dup AM 50%. Stereo.

***KUSP(FM)**—1972: 88.9 mhz; 860 w. Ant 2530 ft. Box 423 (95061). (408) 476-2800. Pataphysical Bcstg Found. Inc. Spec progs: Black 15 hrs, C&W 6 hrs, Sp 2 hrs, County Bd of Supervisors 7 hrs, wkly. ■ David Freedman, gen mgr; Ronna Wallace, coml & prom mgr; Jeb Henley, prog dir; Peter Kuhn, mus dir; George Martin III, Raoul Bellerjeau, news dirs; Don Mussell, chief engr.

***KZSC(FM)**—1974: 88.1 mhz; 10 w. Ant 95 ft. 485 University Hall, 2200 University Ave. (94720). Regents of U of Calif. ■ John O. Oliphant, telecommunications coord.

Santa Maria

KSEE—Sept 1, 1961: 1480 khz; 1 kw-D. Box 442 (93454). (805) 922-1777. Cal Coast Bcstrs. (acq 4-1-75). Rep: Lucas. Format: Top 40. ■ Buddy Black, pres; James C. Mouyoes, gen mgr; Larry R. Watts, prog & news dir; Tim Scott, mus dir. ■ Rates: \$4.90;3.80;4.90;3.80.

KSMA—1945: 1240 khz; 1 kw-D, 250 w-N. Box 1240 (93454). (805) 925-2582. James W. Hagerman and John I. Groom (acq 4-1-51). Net: Golden-West. Rep: Howard. Spec progs: Sp 4 hrs wkly. ■ John I. Groom, James M. Hagerman, co-mgrs; Henry J. Neiggeman, coml mgr; T. T. Tourtilot, pub affrs mgr; Steve Southwick, mus dir; Dave Jones, prom mgr; Geoff Braslow, news dir; Dennis Bornhaft, chief engr.

KSMA-FM—1960: 102.5 mhz; 27.5 kw. Ant 12 ft. Dup AM. Stereo.

KUHL—1946: 1440 khz; 1 kw-U, DA-N. Box 166 (93454). (805) 922-7727. KUHL Bcstg. Net: ABC/J. Rep: Torbet. Format: Upbeat MOR. Spec progs: Sp 8 hrs, Portugese 1 1/2 hrs, wkly. ■ James H. Rander, pres & gen mgr; Tom Morrissey, coml mgr; Jerry Brandie, mus dir; Phil Leonard, news dir; Gary Belzman, chief engr; Steve Stagnaro, prog dir, prom mgr.

KXFM(FM)—Listing follows KZON.

KZON—June 10, 1962: 1600 khz; 500 w-D. Box 1116 (93454). (805) WAlnut 2-2181. Calif. Best Media (acq 1-22-75). Net: ABC/E. Rep: Selcom. Format: C&W. Spec prog: Sp 2 hrs wkly. ■ Jack McCarty, coml mgr; Chuck B. Wesley, prog dir; Paul Hayzlett, news dir; Bryon Gale, chief engr.

KXFM(FM)—Co-owned with KZON. July 19, 1974: 99.1 mhz; 1.8 kw. Ant 1900 ft. 325 N. Lincoln. (805) 922-7884. (Acq 4-10-73). Format: Pop-progressive. Stereo. ■ Leonard Kesselman, pres; Jim LaFawn, gen mgr; R. Diaz, coml mgr; Bill A. Brill, prog dir; Joe Nanini, mus dir; Karen Petersen, prom mgr; Tony Tokem, news dir; Richard Smith, chief engr.

Santa Monica

***KCRW(FM)**—Jan 1, 1946: 89.9 mhz; 26 kw. Ant minus 100 ft. 2425 16th St. (90405). (213) 396-5267. Santa Monica Unified School District. Net: NPR. Format: Variety. Spec progs: Fr 3 hrs; Ger 3 hrs; Ital 3 hrs; Sp 3 hrs; Japns 3 hrs, wkly. ■ Dr. Alfred A. Artuso, pres;

Earl Dible, gen mgr; Betty Kostiner, prog dir; David Steinmeyer, prom dir; Lou Riggs, sports dir; John Copps, prod dir; Alan Goulding, chief eng.

KDAY—1947: 1580 khz; 50 kw-U, DA-2, 1700 N. Alvarado, Los Angeles (90026). (213) 665-1105. Rollins Bcstg of Delaware Inc. (group owner). Rep: HR/Stone. Net: Natl Black. Format: Black, Top 40. ■ O. Wayne Rollins, pres; James C. Roddy, group VP; Gary Price, gen mgr; Jim Maddox, prog dir; Paul Battisti, sls mgr; Don Mac, mus dir; Andy Laird, chief eng.

KSRF(FM)—Dec 22, 1960: 103.1 mhz; 1.85 kw. Ant minus 95 ft. Stereo. Box 5218 (90405). (213) 393-9681. Santa Monica Bcstg Inc. (acq 8-1-65). Format: MOR. ■ George A. Baron, pres & gen mgr; Bob Dobson, prog dir; Tony Mollica, chief eng.

Santa Paula

KAAP—1948: 1400 khz; 1 kw-D, 250w-N. Box 1400, Saticoy Branch, Ventura (93401). (707) 545-1400. Rancho Bcstg Inc. (acq 11-1-65). Net: ABC/J. Audio news: NIS. Rep: Savalli/Gates. Format: All news. ■ W.F. Wallace, pres; Brian D. Wilson, news dir; Larry King, chief eng.

KAAP-FM—Not an air, target date unknown: 96.7 mhz; 87 w. Ant 1500 ft.

Santa Rosa

***KBBF(FM)**—May 30, 1973: 89.1 mhz; 420 w. Ant 2,770 ft. 4010 Finley Ave. (95401). (707) 545-8833. Bilingual Bcstg Foundation Inc. Net: NPR. Rep: Mahler. Format: Bilingual (Sp-Eng), educ, Chicano. Spec progs: Classical 2 1/2 hrs; jazz 3 hrs; C&W 2 hrs, wkly. ■ Eugenio Mijares, pres; Hector Molina, gen mgr; Ambrosio Vigil, mus dir; Jeff Collins, news dir; Juan Rivera, chief eng; Joseph McMurray, prog dir; Zeke Velazquez, prom mgr; Richard Mahler, dev dir.

KHUM—Dec 3, 1961: 1580 khz; 500 w-D. Box M (95401). (707) Liberty 5-1881. Bay Area Electronics Inc. (acq 10-1-65).



KPLS—Dec 7, 1958: 1150 khz; 5 kw-D, 500 w-N, DA-2. Box 6004 (95406). (707) 544-1150. Radio 1150 Inc. (acq 10-7-74). Net: MBS. Audio news: UPI. Rep: Howard. Format: MOR, news, sports. Spec prog: Sp 1/2 hr wkly. ■ Hugh Turner, pres, prog dir; Richard Turner, gen mgr; Willima Randles, coml mgr; William Miller, news dir; Tom Reinecke, chief eng. ■ Rates: \$9.03;8.27;9.03;5.39.

KSRO—May 1937: 1350 khz; 5 kw-U, DA-N. Box 1598 (95403). (707) 545-3313. Finley Bcstg Co. Audio news: UPI. Rep: Torbet. Format: MOR. ■ Evert B. Person, pres; Frank McLaurin, VP & gen mgr; Gordon Lofgren, coml mgr; Merle Ross, prog dir; John Levar, prom mgr; Jerry Johnson, mus dir; John Maynard, news dir; Dan Ethen, chief eng.

KVRE—April 1, 1962: 1460 khz; 1 kw-D, DA. Box 1712 (95403). (707) 544-5873. KVRE Inc. (acq 12-1-65). Net: ABC/E. Rep: Savalli/Gates. Format: C&W. Spec progs: Sp 3 hrs; Black 1/2 hr, wkly. ■ William H. Colclough, pres; Edward LaFrace, gen mgr & prog dir; Brian Dahle, news dir; Alan Carner, mus dir; Larry Trotter, chief eng; Brian Mooney, coml mgr. ■ Rates: \$9.25;9.25;9.25;9.25.

KVRE-FM—Dec 23, 1974: 99.3 mhz; 135 w. Ant 1,102 ft. Dups AM 100%. ■ Rates same as AM.

KZST(FM)—April 18, 1971: 100.1 mhz; 3 kw. Ant 240 ft. Box 2755 (95405). (707) 528-4434. Redwood Empire Stereocasters. Net: ABC/FM. Rep: Selcom. Format: Btlf music, classical. Stereo. ■ Gordon Zlot, gen & natl sls mgr, & chief eng; Ron Brown, loc sls mgr; Moorti Newmark, mus dir; Susan Zlot, prog dir; Neal Reynolds, news dir. ■ Rates: \$10.25;10.25;10.25;8.25.

Seaside

KZEN(FM)—Nov 22, 1972: 107.1 mhz; 680 w. Ant 570 ft. 1998 Fremont Blvd. (93955). (408) 394-8525. Big Sur Broadcasting Corp. Net: Natl Black. Format: Black, gospel & soul. Stereo. ■ Leonard N. Kesselman, pres and gen mgr; Vega Roecker, opns mgr, mus & news dir; Robert Perry, chief eng. ■ Rates: \$5;5;5;5.

Sierra Madre

KMAX(FM)—See Arcadia.

Sonora

KROG(FM)—Listing follows KVML.

KVML—1948: 1450 khz; 1 kw-D, 250 w-N. Box 906 (95370). (209) 532-7426. Herold Bcstg Co. (acq 11-30-68). Net: Golden West. Rep: Sandeberg-Gienn. Format: MOR. ■ Joseph L. Herold, gen mgr; John B. Whitman, stn mgr.

KROG(FM)—Co-owned with KVML. Oct 1, 1971: 92.7 mhz; 3 kw. Ant 300 ft. Stereo. Dups AM 40%. Net: ABC/FM.

South Lake Tahoe

KOWL—November 1956: 1490 khz; 1 kw-D, 250 w-N. Box 4100 (95729). (702) 588-6681. KOWL Inc. (acq 6-1-63). Rep: R/T International. Format: MOR. Spec prog: C&W 14 hrs wkly. ■ Ken Hildebrandt, pres & gen mgr; Jack G. Gregory, VP & stn mgr; Nancy Law, coml mgr; Frank Dubree, prog dir; Rahls Hemmes, news dir; Curtis Sylvestre, chief eng.

KRLT(FM)—Not an air, target date unknown: 100.1 mhz; 3 kw. Ant minus 230 ft. Entertainment Enterprises.

KTHO—March 17, 1963: 590 khz; 1 kw-D, 500 w-N, DA-N. Box AM (95705). (916) 544-6471. Emerald Bcstg Co. (acq 6-1-65). Net: ABC/E. Format: Adult MOR. ■ Robert W. Brackner, pres; Norm Henkoff, gen & coml mgr; Bill Kingman, prog, mus dir & chief eng; Terry Moore, news dir. ■ Rates: \$10;10;10;10.

KTHO-FM—April 12, 1966: 103.1 mhz; 3 kw. Ant minus 490 ft. Dups AM 10%. Format: Soft MOR. ■ Rates: \$4.75;4.75;4.75;4.75.

Stanford

***KZSU(FM)**—Oct 10, 1964: 90.1 mhz; 10 w. Box 5788 (94305). (415) 328-2000. Leland Stanford Junior U. Audio news: UPI. Format: Educl, diversified rock. Spec progs: pub affrs & svcs 2 hrs; classical 6 hrs; jazz 6 hrs; C&W 4 hrs, all wkly. ■ Sanford Feldman, stn mgr.

Stockton

***KCJH(FM)**—Feb 12, 1975: 90.5 mhz, 10 w. Ant 172 ft. 1981 Cherokee Rd. (95205). Western Apostolic Bible College of Stockton.

KJAX(FM)—Listing follows KJOY.

KJOY—1947: 1280 khz; 1 kw-U, DA-N. Drawer Y (95201). (209) 466-2844. Joseph Gamble Sns Inc. (acq 9-5-53). Net: ABC/E. Rep: McGavren-Guild. ■ Ort J. Lofthus, pres & gen prom mgr; Peter Bradley, sls mgr; Don Hoffman, prog dir.

KJAX(FM)—Co-owned with KJOY. June 15, 1968: 99.3 mhz, 3 kw. Ant 185 ft (CP 2.35 kw. Ant 330 ft) Stereo. Net: ABC/FM. Prog sep from AM.

***KSJC-FM**—March 1, 1971: 89.5 mhz; 10 w. 5151 Pacific Ave. (95207). (209) 951-6023. San Joaquin Delta Jr. College District. Format: Variety. Spec progs: Black 2 hrs; classical 10 hrs; Sp 1 hr; Greek 1 hr, wkly. ■ David Steele, dir of bcst & gen mgr.

KSTN—November 1949: 1420 khz; 5 kw-D, 1 kw-N, DA-2. 2171 Ralph Ave. (95206). (209) 948-KSTN. San Joaquin Bcstg Co. Net: ABC/C. Rep: Howard. Format: Contemp. Spec prog: Sp 14 hrs wkly. ■ Knox LaRue, pres; Dave Morgan, prog & mus dir; Robert Minor, news dir. ■ Rates: \$13;11;13;11.

KSTN-FM—1962: 107.3 mhz; 8.1 kw. Ant 1610 ft. Valley Bcstrs Inc. Format: Sp, C&W. Spec prog: Portuguese 16 1/2 hrs, Japanese 4 hrs wkly. ■ Rates: \$7.50;7.50;7.50;7.50.

***KUOP(FM)**—1947: 91.3 mhz; 30 kw. Ant 215 ft. 3601 Pacific Ave. (95211). (209) 946-2330. U. of the Pacific. Stereo. Net: NPR. Format: Educl, classical, prog. Spec progs: Sp 5 hrs; Black 6 hrs; jazz 16 hrs, all. ■ Stanley E. McCaffrey, pres; Richard N. Lyness, gen mgr; Robert Greenspan, opns mgr; Sandra Henwood, traf mgr; Ross Moerman, prom and dev dir; Ron Streeter, prod mgr; Dave Harris, chief eng.

KWG—Nov 21, 1921: 1230 khz; 1 kw-D, 250 w-N. 5635 Stratford Circle (95207). (209) 478-6397.

California Radio

See page C-1 for explanation of listings.

Barnes Enterprises. (acq 1-1-73). Net: MBS. Audio news: APR. Format: MOR, Big band. Spec prog: Farm 3 hrs wkly. ■ John Jacobs, pres; Dave Williams, VP & gen mgr; Denny Kirwan, prog dir; Bert Hardcastle, news dir.

Susanville

KSUE—April 22, 1948: 1240 khz; 1 kw-D, 250 w-N, 999 Chestnut St. (96130). (916) 257-2121. Radio Lassen. (acq 2-1-71). Audio news: APR. Rep: Rad Time Sls. Format: MOR, C&W. Spec progs: Farm 1 hr wkly. ■ Cecil Webb, own & mgr; Jerry Moffitt, coml mgr; Linda Kennedy, news dir; Harold C. Houston, chief eng; Dayne Webb, mus dir. ■ Rates: \$4.75;4.75;4.75;4.75.

KSUE-FM—Not an air, target date March 1976: 92.7 mhz; 2.7 kw. Ant minus 750 ft. Dups AM 30%. Stereo. Format: Btlf mus. ■ Rates: \$2.50;2.50;2.50;2.50.

Taft

KTKR—March 16, 1948: 1310 khz; 1 kw-D. Bin WW (93268). (805) 785-6101. Louise E. & Gerald K. Mann (acq 4-8-59). Spec progs: C&W 14 hrs wkly. ■ Louise E. & Gerald K. Mann, co-owners; Louise E. Mann, coml & prom mgr; Jerry Mann, prog & news dir; Jon S. Rier-son, chief eng.

Thousand Oaks

KGOE—Sept 20, 1971: 850 khz; 500 w-D, DA. 2524 Townsgate Rd. (91361). (805) 497-8511. General Bcstg (acq 5-15-74). Format: Contemp. ■ Gerald McLevis, pres; Jay Raymond, gen mgr; John Dain, prog dir; Jerry Nyrud, coml mgr; James Rogers, chief eng; Pete Cuelt, news dir. ■ Rates: \$10.50;9.75;10.50;—.

KNJO(FM)—April 1, 1963: 92.7 mhz; 3 kw. Ant minus 20 ft. Box 1348 (91360). (805) 495-2124. KNJO Inc. (acq 6-22-70). Stereo. Rep: Selcom. Format: Easy Istng. MOR. ■ Alan Fischler, pres & gen mgr; Jerry Connelly, news dir; Ed Lylle, coml mgr; Larry King, chief eng. ■ Rates: \$8;8;8;8.

Torrance

***KNHS(FM)**—March 9, 1966: 89.7 mhz; 10 w. 3620 W. 182nd St. (90504). (213) 323-8080, ext 405. Torrance Unified School District. Format: Rock. Spec prog: C&W 2 hrs wkly. ■ John Reynolds, stn mgr; Keith Vars, prog dir; Alan Matza, mus dir; Jerry Snowbell, chief eng.

Tracy

KSRT(FM)—Dec 14, 1966: 100.9 mhz; 2.5 kw. Ant 300 ft. horiz, 295 ft. vert. Stereo. 346 S. El Dorado St., Stockton (95203). (209) 463-9663. KSRT Bcstg. Format: Sp. ■ Augustin Soto Sr., pres & gen mgr; Adrian Soto, coml & prom mgr, mus dir; Augustin Soto Jr., prog dir & chief eng.

Travis A.F.B.

***KVIK(FM)**—June 4, 1973: 91.5 mhz; 10 w. Markley Rd and Deronde Drive (94535). (707) 437-3731. Travis Unified Schools. ■ Charles W. Juhl, principal; Len Meuer, tech adv.

Truckee

KSML(FM)—Nov 10, 1970: 101.7 mhz; 940 w. Ant 480 ft. Box 88, King's Beach, Calif. (95719). (916) 546-5936. Secret Mountain Lab Inc. (acq 10-7-74). Format: Progs. Spec progs: Classical 2 hrs, jazz 3 hrs wkly. ■ C. Dwight Tindle, pres and gen mgr; Jack Towle, coml mgr; Bill Ashford, prog and mus dir; Chandler Laughlin, news dir; Jerry Chamkis, chief eng. ■ Rates: \$7;7;7;7.

KTRT—May 1959: 1400 khz; 1 kw-D, 250 w-N. Box 1400 (95734). (916) 587-3332. Trans-Sierra Bcstrs. (acq 3-1-72). Format: Contemp. MOR. ■ Herbert G. Crenshaw, pres, gen mgr & chief eng; Martin Flynn, news dir.

Tulare

KBOS(FM)—Listing following KGEN.

KCOK—Aug 1, 1946: 1270 khz; 5 kw-D, 1 kw-N, DA-

California Radio

See page C-1 for explanation of listings.

N. Box 119 (93274). (209) 686-2866. KCOK Inc. (acq 8-1-57). Net: MBS. Rep: Sandeberg-Glen Oakes. Format: Block. Spec progs: Sp 21 hrs; Port 11 hrs wkly. ■ Keith Munger, pres; Bob Staley, mgr, prom mgr, prog dir; Dene Simpson, coml mgr; Russ Vestal, chief engr.

KWSM(FM)—Co-owned with KCOK. May 6, 1965: 106.7 mhz; 870 w. Ant 2550 ft. Box 119 (93274). (209) 686-2866.

KGEN—1957: 1370 khz; 1 kw-D. Box 444 (93274). (209) 686-3406. Pappas Electronics Inc. (acq 9-5-64). Rep: Savalli/Gates. Format: C&W. Spec progs: Sp 3 hrs; Port 8 hrs wkly. ■ Mike J. Pappas, pres; Pete Pappas, VP & gen mgr; Jack Alpers, prog & news dir; Casey Santos, stn mgr; John Moline, chief engr.

KBOS(FM)—Co-owned with KGEN. Sept 1, 1965: 94.9 mhz; 770 w. Ant 2650 ft. Prog sep from AM. Stereo.

KWSM(FM)—Listing follows KCOK.

Turlock

KCEY—October 1949: 1390 khz; 5 kw-U, DA-2. Box 170 (95380). (209) 632-2428. Central California Bcstrs Inc. (acq 3-16-73). Net: ABC/E. Rep: Selcom. Format: Modern country. Spec progs: Port 8 hrs Farm 2½ hrs; Sp ½ hr wkly. ■ J. M. Milt Hall, pres & gen mgr; Rex Hall, stn, coml mgr; Keith Allgood, prog dir; Marty Mitchell, news dir; Gary Shriver, chief engr; Craig Damon, mus dir. ■ Rates: \$10.70; 9.10; 10.70; 5.50.

***KCSS(FM)**—Aug 13, 1975: 91.9 mhz; 10 w. 800 Monte Vista Ave. (95380). Calif. State College, Stanislaus.

Twentynine Palms

KDHI—April 3, 1961: 1250 khz; 1 kw-D. Box 908 (92277). (714) 367-3535. Hi-Desert Bcstg Corp. Net: ABC/IL. ■ Art Sipherd, pres, gen & coml mgr & prog dir; Adeline F. Sipherd, prom mgr. ■ Rates: \$4.99; 4.99; 4.99; —.

KQYN(FM)—Co-owned with KDHI. April 1, 1965: 95.7 mhz; 5 kw horiz, 93 w vert. Ant minus 89 ft horiz, minus 130 ft vert.

Ukiah

KKTU(FM)—Listing follows KUKI.

KLIL(FM)—July 30, 1968: 94.5 mhz; 6.7 kw. Ant 1,120 ft. Box 389. (707) 462-1451. K-LIL Inc. Rep: Radio Time Sis, Chance. Format: MOR. Spec progs: Sp 1 hr; C&W 2 hrs wkly. ■ Woodrow W. White, pres & gen mgr; Lee Uran, prog dir & chief engr; Eleanor Clements, office mgr; Rod Pacini, sls mgr & news dir.

KUKI—Dec 1, 1950: 1400 khz; 1 kw-D, 250 w-N. Box 638 (95482). (707) 462-4771. Concerned Communications Corp. (acq 9-16-74). Format: MOR. Spec prog: Sp 2 hrs wkly. ■ Jimm Seaney, gen mgr.

KKTU(FM)—Co-owned with KUKI. Oct 16, 1974: 103.3 mhz; 1.9 kw. Ant 1840 ft. Format: Contemp. ■ Stu Ganz, stn mgr.

Vacaville-Fairfield

KUIC(FM)—Nov 1, 1968: 95.3 mhz; 2.85 kw. Ant 205 ft. 406 Main (95688). (707) 446-0200. KPPOP Radio Inc. (acq 1/23/73). Net: MBS. Format: MOR. Top 40. ■ Donnelly C. Reeves, pres; Gene Ragle, gen mgr; John Hart stn & sls mgr; Richard B. Johnson, chief engr; Jane LoPolito, news dir; Leo Roberts, mus dir; Larry Gaver, prog dir.

Vallejo

KNBA—Aug 1, 1947: 1190 khz; 1 kw-D. 3267 Sonoma Blvd. (94590). (707) 644-8944. KNBA Inc. Net: MBS. Rep: Savalli/Gates. Format: MOR. ■ Louis J. Ripa, pres, gen & coml mgr; Ed McMillian, prog dir; Bob Melrose, news dir; Joe Gibson, chief engr; Walt Jamond, mus dir.

Ventura-Oxnard

KAAP—See Santa Paula.

KACY—See Port Hueneme.

KBBO—June 1, 1947: 1590 khz; 5 kw-U, DA-2. Box 5151 (93003). (805) 642-3239. Tri-Counties Public Service Inc. (acq 3-13-75). Net: NBC, MBS, Golden West Bcstrs. Rep: Eastman. Format: C&W, sports. Spec prog: Farm 1 hr wkly. ■ Wm. Rea Jr., pres; Mike Thomas, gen mgr; Andy Corliss, sls mgr; Earl Spencer, prog dir, chief engr; Ron West, mus dir; Chris Pappas, prom mgr; Jerry Lund, news and sports dir. ■ Rates: \$18; 14; 18; 12.

KBBY(FM)—Co-owned with KBBO. Dec. 27, 1962: 95.1 mhz; 28 kw horiz, 6.9 kw vert. Ant 79 ft horiz, 84 ft vert. Net: ABC/FM. Format: Top 40. ■ Ron West, prog dir; Tony London, mus dir; Joe Costello, prom mgr. ■ Rates: \$7; 7; 9; 7.

KHAY(FM)—Listing follow KVEN.

KPMJ(FM)—See Oxnard.

KVEN—March 1948: 1450 khz; 1 kw-D, 250 w-N, DA-D. Box 699 (93001). (805) 642-8595. KVEN Bcstg Corp. (acq 10-6-5). Net: ABC/E. Rep: PRO Time Sis. Format: MOR. ■ Robert L. Fox, pres & gen mgr; Ira E. Laufer, stn mgr; Robert Jacobson, coml mgr; Bob Adams, prog & mus dir; Rick Wallace, news dir; Lindy Williams, chief engr.

KHAY(FM)—Co-owned with KVEN. Jan 1, 1962: 100.7 mhz; 39 kw. Ant 1210 ft. Prog sep from AM. Format: C&W. Stereo.

Victorville

KAVR—See Apple Valley.

KCIN—Sept 1, 1961: 1590 khz; 500 w-D. Box AF (92392). (714) 245-8635. Top Dial Bcstrs. Net: ABC/E. Rep: Dahlsten. Format: C&W. ■ Cliff Paxson, pres; Galen George, coml & gen mgr; Billy Montana, prog dir; Dan Harley, chief engr. ■ Rates: \$3.30; 3.30; 3.30; —.

Visalia

KONG—January 1948: 1400 khz; 1 kw-D, 250 w-N. Box 3329 (93277). (209) 734-5811. Air Waves Inc. (acq 6-1-57). Net: ABC/IL. Rep: Lucas. Format: Btfl mus. Spec progs: Farm 2 hrs; Sp 10 hrs wkly. ■ Harry E. Layman, pres & gen mgr; Carl Switzer, coml mgr; Bill Schweitzer, news dir; Russ Swamb, chief engr. ■ Rates: \$6; 6; 4.80.

KONG-FM—Sept 1, 1961: 92.9 mhz; 10 kw. Ant 960 ft. Prog sep from AM. Stereo. Net: ABC/FM. Format: Btfl mus. ■ Rates: \$5; 5; 5; 5.

Vista

KMLO—Nov 3, 1967: 1000 khz; 1 kw-D, DA. Box 1000 (92083). (714) 724-8333. North County Bcstg Co. Format: Contemp. Spec progs: Sp 2 hrs wkly. ■ Gene Alfred, pres & gen mgr; Fred W. Volken, tech dir; Bill Craig, prog dir; Steve Christopher, news dir.

Walnut

***KSAK(FM)**—Jan 10, 1974: 90.1 mhz; 3.5 w. Ant 460 ft. 1100 North Grand Ave. (91789). (714) 595-3318. Mount San Antonio Community College District. Format: Rock. ■ Howard A. Peth, dir of bcstg; Eldon E. Pearce, pres.

Walnut Creek

KDFM(FM)—Dec 10, 1959: 92.1 mhz; 3 kw. Ant 89 ft. Box 4888 (94596). (415) 934-5300. Schofield Bcstrs Inc. (acq 8-2-73). Stereo. Format: Easy Istng. ■ Richard Schofield, pres & gen mgr.

Wasco

KWSO—May 17, 1950: 1050 khz; 1 kw-D. Bin E (93280). (805) 758-2145. KWSO Inc. Format: Pop, class, relig. ■ Robert T. Bann, gen & coml mgr & chief engr; Art Carey, prog & news dir; Katherine Crosby, traf dir; R. T. Bann, chief engr.

Watsonville

KOMY—1937: 1340 khz; 1 kw-D, 250 w-N. Box 778

(95076). (408) 724-5641. Frontier Bcstg Co. of California (acq 6-16-63). Net: MBS, Calif Farm. Rep: Radio Time Sales. Spec progs: Sp 32 hrs; Yugoslavian 1 hr; Portugese 2 hrs wkly. ■ Phillip E. Ruter, pres & gen mgr; Jim Workman, coml mgr; Bill Moody, prog dir; Gordon Brown, news dir; John Boren, chief engr. ■ Rates: \$5; 5; 5; 5.

West Covina

KBOB(FM)—Listing follows KGRB.

KGRB—Sept 25, 1963: 900 khz; 250 w-D, DA. 751 Echelon Ave., City of Industry (91744). (213) 330-5211. Robert Burdette & Assoc. ■ Robert Burdette, pres, gen, coml & prom mgr; Gloria Burdette, prog dir; Rahn Harris, news dir; Doug Nelson, chief engr.

KBOB(FM)—Co-owned with KGRB. Nov 18, 1957: 98.3 mhz; 810 w. Ant minus 265 ft. Robert Burdette Investments Inc. Dups AM 80%.

West Sacramento

***KWHS(FM)**—May 14, 1975: 91.7 mhz; 10 w. 930 W. Acres Rd. (95691). Washington Unified School District.

Willows

KIOS—Dec 29, 1961: 1560 khz; 250 w-D. Box 7 (95988). (916) 934-4654. Charles W. Stone, Josephine Stone, Anthony F. Rusnak. (acq 9-7-72). Net: Keystone. Rep: Chance. Format: Variety. Spec progs: C&W 6 hrs wkly. ■ Anthony F. Rusnak, pres & gen mgr.

Woodland

KGMS—See Sacramento.

KFSM(FM)—Co-owned with KGMS Sacramento. Feb 4, 1961: 102.5 mhz; 50 kw. Ant 500 ft. Box 526 (95695). (916) 622-1047. Kula Bcstg Corp. (acq 4-1-72). Group owner: Key. Rep: Torbet, Moore. Format: Rock. Spec prog: Sp 1 hrs wkly. ■ Theodore J. Wolf, pres & gen mgr; Ken Beck, opns dir; Tom Mix, mus dir; Patrick Moore, news dir; Gerald P. Feutz, chief engr; Bill Stukaloff, coml mgr. ■ Rates: \$14; 14; 16; 16.

Yreka

KSYC—July 27, 1947: 1490 khz; 1 kw-D, 250 w-N. Box 1490 (96097). (916) 842-4158. Daimation Enterprises Inc. (acq 4-1-74). Net: Golden West Sports. Format: MOR. ■ Gary L. Hawke, gen mgr; Martin W. Hawke, prog dir.

Yuba City

KHEX(FM)—Listing follows KUBA.

KOBO—June 1953: 1450 khz; 100 w. 463 Polara Ave. (95991). (916) 673-7677. Concerned Communications Corp. (acq 10-74). Rep: Webb. Format: Contemp.

KUBA—January 1948: 1600 khz; 5 kw-D, 500 w-N, DA-N. Box 309 (95991). (916) 673-7344. Cascade Bcstg Corp. (group owner; acq 1-1-71). Net: ABC/E. Rep: Savalli Gates. Format: MOR. Spec progs: Sp 15 hrs, Punjabi 2½ hrs wkly. ■ David M. Jack, pres; Clair G. Halverson, gen mgr; Bob Cain, coml mgr; Cliff Gordy, prog & mus dir; Gene Norman, news dir; Byron Ray, chief engr.

KHEX(FM)—Co-owned with KUBA. Nov 8, 1974: 103.9 mhz; 3 kw. Ant 110 ft. Dups AM 100%.



CSI ELECTRONICS INC.
2607 River Road
Cinnaminson, New Jersey, 08077
Telephone: (609) 786-1060

Colorado

HAMILTON-LANDIS

& ASSOCIATES, Inc.

NATIONWIDE MEDIA BROKERS
WASHINGTON, D.C., CHICAGO, DALLAS,
SAN FRANCISCO

SELL **MORE**

RADIO & TELEVISION STATIONS
IN THE SOUTHWEST—NEAREST OFFICE IS—
6066 N. CENTRAL EXPY., DALLAS 75206
(214) 691-2345

Alamosa

***KASF(FM)**—Jan 1970: 90.9 mhz; 10 w. Adams State College (81101). (303) 589-7154. Adams State College. Format: free form prog. ■ Kathy Spaulding, gen mgr; Dan Davis, prog dir; Mike Vinson, mus dir; Charles Williams, news dir; Robert Crow, chief engr.

KGIW—Feb 27, 1929: 1450 khz; 1 kw-D, 250 w-N. Box 179 (81101). (303) 589-6644. Darrel K. Burns (acq 1964). Group: Community Net: ABC, Intermountain. Format: MOR. Spec. progs: Sp 6 hrs, farm 8 hrs, wkly. ■ J. Kelly Schofield, gen mgr; Neil J. Hammer, coml mgr; Steve Simmons, prog dir; George Kettle, chief engr.

KGIW-FM—June 26, 1969: 93.5 mhz; 2.8 kw. Ant 130 ft. Stereo. Dups AM 20%.

Arvada

KOXI—Jan 9, 1962: 1550 khz; 10 kw-D. Box 506 (80001). (303) 761-1550. Media Enterprises Inc. Format: Religious/gospel. ■ Harold Schwartz, pres; Larry Green, gen & coml mgr; Ramona Harris, prog dir; Lloyd Allen, chief engr. ■ Rates: \$60;60;60;60.

Aspen

KSN0—March 4, 1964: 1260 khz; 5 kw-D. Box 10910 (81611). (303) 925-7383. Aspen Bcstg Co. Net: Intermountain. Rep: RKO, Intermountain. Format: MOR. Spec progs: Interview 2 hrs, Phone Talk 2 hrs wkly. ■ William Dunaway, pres; David Chamberlain, gen mgr; Barbara Allen, traf mgr; Susan Michael, news dir; Michael Gordon, coml mgr; Chuck Mai, prog dir; David Wright, chief engr.

KSPN(FM)—Feb 14, 1970: 97.7 mhz; 3 kw. Ant minus 84 ft. Stereo. 330 E. Main St. (81611). (303) 925-5776. Recreation Bcstg of Aspen Inc. Net: ABC/FM. Rep: Century Natl Sls, McGuire Inc. Format: Light contemp. Spec prog: Classical 14 hrs wkly. ■ Stephen A. Heater, pres; Dale A. Tucker, coml & gen mgr; Bob Schulte, mus dir; Pat Miles, news dir. ■ Rates: \$8.50;7;8.50;7.

Aurora

KOSI—1954: 1430 khz; 5 kw-U, DA-2. Box 98 (80010). 343-1430. Armstrong Bcstg Corp. (acq 8-28-59). Audio news: APR. Rep: Torbet. Format: Beautifl mus. ■ William Armstrong, pres; Al Perry, gen mgr; Lee Stewart, prog dir; Tony Larson, news dir; Ray F. Doane, chief engr. ■ Rates: \$37;26;25;10.

KOSI-FM—See Denver.

Boulder

KADE—Nov 14, 1973: 1190 khz; 1 kw-D, 1900 Folsom (80302). (303) 444-5600. Centennial Wireless (acq 11-1-75). Audio news: UPI. Format: Top 40, progressive. ■ Robert D. Greenlee, pres & gen mgr; Randy Morrison, prog & mus dir; Ray Skibitsky, coml mgr; Tom DeBacker, chief engr. ■ Rates: \$6.75;5.75;6.75;5.75.

KBOL—Feb 15, 1947: 1490 khz; 1 kw-D, 250 w-N. Box 146 (80302). (303) 444-1490. Boulder Radio KBOL Inc. Net: ABC/Int. Intermountain. Rep: RKO. Format: MOR. ■ Russel Shaffer, pres & gen mgr & prog dir; Bill McBride, coml mgr; Adrian Hise, news dir; Lauren Betteencouty, chief engr. ■ Rates: \$9.90; 7.90; 9.90; 7.90.

KBVL(FM)—March 15, 1971: 94.7 mhz; 30 kw. Ant minus 180 ft. Format: Classical, btl mus. ■ Bill McBride, opns mgr; Dave Howe, prog dir; Jeff Michael, coml mgr & mus dir. ■ Rates: \$6;6;6;6.

KRNW(FM)—Oct 1, 1955: 97.3 mhz; 2 kw. Ant minus 750 ft. 1426 Pearl St. (80302). (303) 444-1444. Colorado Recording Co. Format: Classical, jazz, progs. ■ Robert N. Wilkinson, owner, gen mgr & chief engr. ■ Rates: \$6;6;6;6.

Breckenridge

KLGT(FM)—1975: 102.3 mhz; 3 kw. Ant minus 230 ft. Box 37 (80424). (303) 453-2234. Breckenridge Bcstg Co. Audio news: APR. Format: Progs; Robin G. Theobald, gen mgr. ■ Rates: \$5.50;4.50;4.50;5.50.

Brighton

KBRN—April 26, 1956: 800 khz; 500 w-D. Box 428 (80601). (303) 659-5800. Southwestern Bcstrs (group owner; acq 7-1-69). Format: MOR. Spec progs: Ger 1 hr; Sp 5 hrs; polka 5 hrs wkly. ■ Edward T. Shadek, pres; Wayne H. Thomas, gen mgr.

Burlington

KNAB—July 11, 1967: 1140 khz; 1 kw-D. Box 516 (80807). (303) 346-8600. KNAB Inc. (acq. July 1974). Net: ABC/Int. Intermountain. Rep: RKO; Intermountain. Format: C&W, MOR. ■ Ray H. Lockhart, Marvin A. Ronig and E. Charles Robacker, owners.

Canon City

KRLN—Aug 15, 1947: 1400 khz; 1 kw-D, 250 w-N. Box 511 (81212). (303) 275-2002. KRLN Inc. (acq 1-1-65). Net: ABC; MBS. Rep: Hix; Masla. Format: MOR. ■ Norton Warner, pres; Martin Nonhof, gen and coml mgr; Bob Stevenson, prog and mus dir, prom mgr; Dan Hasulak, news dir; Ivan Rymes, chief engr. ■ Rates: \$6.70;6.70;6.70;4.20.

KRLN-FM—June 1, 1975: 103.9 mhz; 3 kw. Ant minus 520 ft. Stereo. Dups AM 100%. ■ Rates same as AM.

Colorado Springs

***KEPC(FM)**—Feb 15, 1957: 90.5 mhz; 610 w. (CP 3.7 kw). Ant minus 1180 ft. Stereo. 2200 Bott St. (80904). (303) 471-7546 X 388. El Paso Community College. Net: ABC/FM. Format: Educational, variety. Spec progs: Black 14 hrs; classical 12 hrs; jazz 14 hrs; C&W 12 hrs wkly. ■ Dr. Donald W. McInnis, pres.

KIIQ—See Manitou Springs.

KKFM(FM)—May 2, 1959: 96.5 mhz; 23 kw. Ant 2300 ft. Stereo. Garden Valley Center, Suite 411 (80906). (303) 576-9292. Ski-Hi Inc. (acq 2-10-71). Rep: Sandeberg-Glenn. Format: Progs. Spec progs: Black 10 hrs wkly; classical. ■ Richard Sucher, pres; John J. Leehy, gen mgr; Richard C. Baker, coml & prom mgr; Ken Barrett, mus dir; Michael Birdsong, prog dir; Russell Ruggieri, chief engr.

KPIK—June 22, 1957: 1580 khz; 5 kw-D. Box 2440 (80901). (303) 634-1503. Western Bcstg Co. Group: David Pinkston. Net: ABC/C, Intermtn. Rep: Eastman; Intermountain. Format: C&W. ■ Dave (Stone) Pinkston, owner & pres; Bonnie Paris, gen mgr; Everett Murray, coml mgr; Tom Nimmernann, news dir; Dave Stone, mus dir; George James, chief engr; Charles Brown, prog dir.

KPIK-FM—Jan 21, 1966: 93.9 mhz; 30 kw. Ant 340 ft. Stereo. Dups AM 50%.

***KRCC(FM)**—1951: 91.5 mhz, 1.4 kw. Ant minus 590 ft. Colorado College (80903). (303) 473-2233. Ext. 335. Colorado College. Net: NPR. Format: Variety. Spec progs: Ger 1 hr; C&W 1 hr; sports 4 hrs wkly. ■ Jon Goldman, gen mgr.

KRDO—March 1947: 1240 khz; 1 kw-D, 250 w-N. Box 1457 (80901). (303) 632-1515. TWX 303-473-0437. Pikes Peak Bcstg Co. Net: ABC. Spec prog: Sp 1 hr wkly. ■ Harry Hoth Jr., pres; Jay Gardner, gen mgr; Ed Wittrock, stn mgr; Dick Eaton, prog dir; Bill Yeager, news dir; Charles Upton, chief engr.

KRDO-FM—Oct 1, 1969: 95.1 mhz; 96 kw. Ant 2,010 ft. Stereo. Prog sep from KRDO. Rep: Torbet; McGuire. ■ KRDO-TV affil.

KRYT—Feb 9, 1964: 1530 khz; 1 kw-D, 847 South Circle Drive (80910). (303) 634-4118. Silver West Bcstg Co. (acq 6-14-75). Net: ABC/C. Format: MOR. ■ William S. Cook, pres & chief engr; Robt. J. Adams, exec VP, coml & gen mgr; Lee Mozley, news dir. ■ Rates: \$9.50;7.50;9.50;5.50.

KRYT-FM—Jan 28, 1967: 101.9 mhz; 28 kw. Ant

Colorado Radio

See page C-1 for explanation of listings.

minus 310 ft. Stereo. Dups AM 100%. ■ Rates same as AM.

KSSS-AM

A Journal Star Station

KSSS—March 1955: 740 khz; 1 kw-D, 250 w-N, DA-2. Box 2589 (80901). (303) 596-5000. Radio Colorado Springs Inc. (acq 10-1-75). Group owner: Peoria Journal Star Inc. Net: MBS. Format: Modern Country. ■ Wes Bradley, gen mgr; Gary Barkley, news dir; Robert V. Powell, chief engr; Herb James, sls mgr. ■ Rates: \$11.65;8.85;11.65;8.85.

KVOR—Sept 22, 1922: 1300 khz; 5 kw-D, 1 kw-N. Box 966 (80901). (303) 632-3536. Wolverine Bcstg Corp. (acq 2-1-64). Net: CBS. Rep: Hix. Format: MOR. ■ James W. Vinall, pres & gen mgr; Bus Oaks, VP; Fred Von Pingel, loc sls mgr; Mark Radtke, news dir; William H. Finch, prom mgr; Ray Dewitt, mus dir; William Weber, chief engr.

KVOR-FM—Feb 1, 1960: 92.9 mhz; 25 kw. Ant 2130 ft. Stereo. Dups AM 40%. Format: MOR.

KWYD-FM—See Security.

KYSN—Dec 15, 1956: 1460 khz; 1 kw-D, 500 w-N, DA-N. Box 1715, 146 W. Arvada (80901). 634-1511. KYSN Bcstg Co. (acq 11-16-60). ■ Donald T. Harding Jr., pres; John H. Lambert, VP & gen mgr; Hal Tatal, news dir; Tom Turcotte, prog dir; Bud Curtis, chief engr.

Cortez

KVFC—Feb 27, 1955: 740 khz; 1 kw-D, 250 w-N, DA-N. Box 740 (81321). (303) 565-3463. Sound 74, Inc. (acq 3-1-72). Audio news: APR. Rep: John McGuire Inc. Format: Pop-rock with mod country. ■ Richard F. Hamilton Jr., pres; Sharon Burton, stn mgr. ■ Rates: \$5.98;4.77;5.98;4.77.

Craig

KRAI—1948: 550 khz; 5 kw-D, 500 w-N, DA-N. Box 665, 125 W. Victory Way (81625). (303) 824-6574. Northwestern Colorado Bcstg Co. (acq 1950). Rep: Masla; Hix. Format: MOR. Spec prog: C&W 20 hrs wkly. ■ George Cory, pres; Richard Bonderud, VP & gen mgr; Royal Maxwell, chief engr.

KRAI-FM—Not on air, target date unknown: 93.7 mhz; 100 kw. Ant 980 ft.

Delta

KDTA—Jan 14, 1955: 1400 khz; 1 kw-D, 250 w-N. Box 452 (81416). (303) 874-4544. Monarch Bcstg Co. Net: MBS. Rep: Hopwell; Adv. Sls. Format: MOR, good mus. ■ D. E. Towne, pres, gen mgr, news dir & chief engr; Rosemary Diane Fister, prog dir & prom mgr; James Fister, sls mgr.

Denver

KAAT—Dec 12, 1972: 1090 khz; 50 kw-U, 1790 Grant St. (80203). (303) 573-1090. Radio Colorado Corp. Net: NBS, MBS/Black. Rep: Savalli/Gates. Format: MOR. Spec progs: Black 2 hrs wkly. ■ John H. Gayer, pres; Ben Avery, gen mgr.

KADX(FM)—Dec 1, 1956: 105.1 mhz; 100 kw. Ant 175 ft. 9805 E. Iliff (80231). (303) 755-1213. Columbia Broadcasting Co. (acq 3-23-73). Net: ABC/FM. Audio news: UPI. Format: Jazz. ■ Kenneth B. Lange, pres and gen mgr. ■ Rates: \$20;20;20;20.

KBPI

Young Adult Contemporary

KBPI(FM)—June 21, 1965: 105.9 mhz; 100 kw. Ant 57 ft. 4460 Morrison Rd. (80219). (203) 936-2313. Progressive Bcstrs Inc. (acq 4-7-71). Rep: ABC/FM Spot Sls. Format: Progs. ■ Marvin Spector, pres; Kenneth L. Spector, VP; Donald Zucker, coml mgr; Frank Felix, prom mgr & mus dir; Jim Pettigrew, chief engr. ■ Rates: \$37; 43; 46; 46.

***KCFR(FM)**—November 1970: 90.1 mhz; 26.5 kw. Ant 910 ft. 2056 S. York St. (80210). (303) 753-2691.

Colorado Radio

See page C-1 for explanation of listings.

University of Denver. Net: NPR. Format: Free form. Spec progs: Sp 2 hrs, Black 4 hrs wkly. ■ WC. Roth, gen mgr; Max Wycisk, prog dir; Bob Stecker, mus dir; John Stark, news dir; David L. DeFord, chief engr; Jane Fisher, prom mgr; Genevieve Freeman, traffic mgr; James Falconer, prog guide edit.

KDEN—March 4, 1956: 1340 khz; 1 kw-D, 250 w-N. 1601 West Jewell Ave. (80223). (303) 935-3525. KDEN Bcstg Co. (acq 5-21-71). Rep: Avery-Knodel. Format: Contemp, MOR, news. ■ Douglas C. Stephens, pres & gen mgr; Raymond A. Mineo, sls mgr; Kenneth R. Galey, news dir.

KERE—1941: 710 khz; 5 kw-U, DA-1. 1500 Grant, Box 2097 (80201). (303) 534-5373. Mission Denver Co. (group owner; acq 9-73). Rep: Metro Radio. Format: Modern country. ■ Jack Roth, pres; Ed Hardy mgr; Jack Duane, news dir; Art Harlow, chief engr; Doug Dillon, prog dir; Bob Barwich, mus dir; George W. Ing, dir of engr.

KFML—Jan 1, 1954: 1390 khz; 5 kw-D. 290 Fillmore St. (80206). (303) 399-1390. Radio Denver Corp. (acq 3-75). Rep: Century Natl Sls. Format: Free form prog. Spec prog: Ger 1 hr wkly. ■ Don Zucker, gen mgr; Jane Steinberg, sls mgr; Craig Applequist, prog dir.

KFSC

Spanish Language Radio

KFSC—June 5, 1954: 1220 khz; 1 kw-D. 2185 Broadway (80205). (303) 623-1220. Francisco V. (Paco) Sanchez. Net: MBS. Rep: Caballero Sp Network. Format: Sp. Spec progs: Bi-lingual 5 hrs wkly. ■ George M. Sandoval, gen, prom, mus and coml mgr, prog dir; Pablo Rodolfo Gonzales, news dir; James Brown, chief engr. ■ Rates: \$12; 11.50; 12.—

KGMC—See Englewood.

KHOW—1925: 630 khz; 5 kw-U, DA-N. 255 Petroleum Club Bldg. (80202). (303) 266-2611. TWX 910-931-2503. Doubleday Bcstg Co Inc. (group owner; acq 3-31-68). Net: ABC/E. Rep: RAR. Format: Personality, progressive, MOR. ■ John R. Lego, VP & gen mgr; Lindsey English, coml mgr; Hal Moore, opns mgr; Charley Martin, mus dir; Lynn Woods, prog dir; George Vogel, chief engr; Jim Hinton, news dir.

KHOW-FM—March 31, 1968: 95.7 mhz; 51 kw. Ant 730 ft. Dups AM 50%. Format: Contemp.

KIMN—July 4, 1922: 950 khz; 5 kw-U, DA-1. Box 14008 (80214). (303) 234-9500. Jefferson Pilot Broadcasting Co. (group owner; acq 3-1-74). Audio news: UPI. Rep: Metro. Format: MOR. ■ Charles H. Crutchfield, pres; John J. McGuiness, gen mgr; David LaFrance, sls mgr; James Davis, prog dir; Debbie Locke, prom mgr; Scott Kenyon, mus dir; Robert M. Maxwell, chief engr; John McCabe, news dir. ■ Rates: \$57; 53; 57; 47.

KIMN-FM—Dec 1, 1953: 98.5 mhz; 10 kw. Ant 720 ft. (CP 25 kw). Stereo. (Acq 10-8-74). Prog sep from AM. ■ Rates: \$20; 20; 20; 20.

KLAK—See Lakewood.

KLIR-FM—Listing follows KRKS.

KLZ—March 10, 1922: 560 khz; 5 kw-U, DA-1. 2149 S. Holly St. (80222). (303) 759-5600. Group One Bcstg Co-West (group owner; acq 2-12-72). Net: CBS. Rep: McGavren-Guild-PGW. Format: MOR. ■ Roger G. Berk, pres; Dino Ianni, gen mgr; James Murphy, coml mgr; Russ Knight, prog & mus dir; Bob Butz, news dir; Gordon Vaughn, chief engr. ■ Rates: \$68; 53; 68; 38.

KLZ-FM—June 19, 1962: 106.7 mhz; 100 kw. Ant 960 ft. Stereo. Prog sep from AM. Format: Rock. ■ Bill Struck, prog dir. ■ Rates: \$36; 27; 36; 20.

KOA—Dec 15, 1924: 850 khz; 50 kw-U. Box 5012 (80217). (303) 861-8111. TWX 910-931-0439. General Electric Bcstg Co. of Colo. Inc. (group owner; 7-31-68). Net: NBC; Intermountain. Rep: Avco. Format: MOR (emphasis news, sports). ■ Reid L. Shaw, pres; Mike Schabach, VP & gen mgr; Robert C. Prangley, sls mgr; Terry Simerly, news dir; Bob Rubin, prog dir; Lee Edelman, chief engr. ■ Rates: \$90; 63; 68; 53.

KOAO(FM)—Co-owned with KOA. June 1, 1961: 103.5 mhz; 100 kw. Ant 1045 ft. Stereo. Prog sep from AM. Format: Adult rock. ■ KOA-TV affil. ■ Rates: \$23; 23; 29; 29.

KOSI—See Aurora.

KOSI-FM—March 3, 1968: 101.1 mhz; 86 kw. Ant 780 ft. Prog sep from AM. Stereo. ■ Rates: \$33; 44; 34; 13.

***KPOF**—Mar 9, 1928: 910 khz; 5 kw-D, 1 kw-N. 3455 W. 83rd Ave. (80030). (303) 428-0910. Pillar of Fire Corp. Format: Relig, ed, classcl, pub affrs. Spec progs: Ger 1 hr; Black ½ hr; Sp 2 hrs; Korean & Arabic ¼ hr; wkly. ■ Dr. Arthur K. White, pres; Robert B. Dallenbach, gen mgr; Warren Wilson, prog & mus dir; Dr. Donald Wolfram, news dir; Richard Derbyshire, chief engr.

KQXI—See Arvada.

KRKS—Aug 1, 1953: 990 khz; 1 kw-D. 6535 W. Jewell Ave. (80226). (303) 573-1189. KLIR Inc. (acq 5-22-54). Group owner: Anderson. Net: Keystone. Rep: Q.M.I. ■ George Basil Anderson, pres; Roger P. Anderson, gen mgr & prog dir; L.L. Bert Tracy, coml mgr; H.G. Kincaid, bus mgr; Van Orrick, news dir; Robert L. Snyder, chief engr.

KLIR-FM—Co-owned with KRKS. Aug 1, 1959: 100.3 mhz; 100 kw. Ant 330 ft. Stereo. Prog sep from AM.

KTLK—May 15, 1948: 1280 khz; 5 kw-U, DA-2. 1165 Delaware St. (80204). (303) 573-1280. Action Radio Inc. (acq 5-27-69). Group owner: Welcome Radio. Net: ABC/C. Rep: Avco Radio Sales. Format: Contemp. ■ Harrison Fuerst, pres; Frank Scott, gen mgr; John Nagle, coml mgr; Bobby Rivers, prog dir; Dennis Constantine, mus dir; Ron Kashner, chief engr; Dave Smith, news dir.

KVOD(FM)—Oct 2, 1958: 99.5 mhz; 100 kw. Ant 280 ft. Stereo. 1601 W. Jewell Ave. (80223). (303) 936-3428. Capitol City Bcstg. Format: Classical. ■ E.E. Koepke, pres & coml mgr; F.E. Amole, VP & gen mgr; John Wolfe, prog dir; Ted Mann, prom dir; Dick Brehm, mus dir; Gene Amole, news dir; Robert Blanchard, chief engr. ■ Rates: \$17; 11.50; 14.50; 14.50.

Durango

KDGO—April 1, 1958: 1240 khz; 1 kw-D, 250 w-N. Box 3390 (81301). (303) 247-1407. Basin Bcstg Co. (acq 3-24-64). Net: CBS. Rep: Masla/Young, Hix. ■ Jerry Hitch, pres, gen and coml mgr; Marcie Fitch, asst mgr; Barry Birr, news dir; George Norvell, chief engr. ■ Rates: \$3.60; 3.10; 3.60; 3.10.

***KDUR(FM)**—1975: 91.9 mhz; 10 w. Ant minus 100 ft. College Heights (81301). Fort Lewis College.

KIUP—1935: 930 khz; 5 kw-D, 1 kw-N, DA-N. Box 641 (81301). (303) 247-4464. Radio San Juan Inc. (acq 11-1-64). Net: MBS. Rep: Savalli/Gates, Mountain Media. Format: MOR. Spec progs: Sp 5 hrs; Southern Ute ½ hr; classical 3 hrs; farm 2½ hrs wkly. ■ W. Douglas Morrison, pres; Ted Foster, gen mgr; John Mackley, prog & mus dir; Karen Maas, coml and prom mgr; Richard Houston, chief engr; Wray Guye, news dir. ■ Rates: \$4.80; 4.80; 4.80.

KRSJ(FM)—Co-owned with KIUP. Dec 4, 1972: 100.5 mhz; 100 kw. Ant 260 ft. Stereo. Prog sep from KIUP. Format: C&W. ■ Rates same as AM.

Englewood

KWBZ—1952: 1150 khz; 5 kw-D, 3 W. Princeton (80210). (303) 761-1150. Western Bcstg (acq 5-1-75). Audio news: UPI. Format: Talk. ■ E.L. Cartwright, pres and gen mgr; Charles Rogers, prog dir, prom mgr; Joe Sutton, coml mgr; Marvin Gatch, news dir; Art Harlow, chief engr. ■ Rates: \$17; 13; 13; 13.

Estes Park

KSIR—Aug 19, 1967: 1470 khz; 500 w-D. Box 677 (80517). (303) 586-3333. Estes Park Broadcasting Co. (acq April 1974). ■ Stanley J. Pratt, owner & gen mgr; Charles K. Frodsham, gen sls mgr; Robert Gaines, prog dir; Brett Brough, news dir; Robert Suarez, chief engr.

Fort Collins

KCOL—March 1, 1947: 1410 khz; 1 kw-U, DA-N. Box 1339 (80522). (303) 482-5991. Beef Empire Bcstg Co. (group owner; acq 12-1-64). Net: ABC/IL, Inter-

mountain. Rep: Eastman, Intermountain. Format: MOR. Spec progs: Sp ½ hr wkly. ■ Jerry Huse, pres; John J. Miller, gen mgr; Don R. Grant, coml mgr; Wil Huelst, prog dir; Mike Flewelling, prom mgr; Tom Charles, mus dir; John DeHaes, news dir; Dave Julian, chief engr.

KCOL-FM—July 27, 1975: 107.9 mhz; 100 kw. Ant 470 ft. Stereo. Prog sep from AM. Format: Btfl mus.

***KCSU-FM**—Sept 20, 1964: 90.9 mhz; 2 kw. Ant minus 360 ft. Student Center, Colorado State U. (80523). (303) 484-3525. State Board of Agriculture. Net: ABC/FM; Pacifica; IMN. Format: Variety. Spec progs: Black 3 hrs; classical 15 hrs; German ½ hr; Italian ½ hr; jazz 3 hrs; C&W ½ hr; folk 3 hrs; community affairs 2 hrs; Dutch ½ hr; children 1 hr, all wkly. ■ Denise Mongeau, gen mgr.

KIIX—Jan 12, 1959: 600 khz; 1 kw-D, DA. Box 2204 (80522). (303) 484-5449. WREN Bcstg Co (acq 1-1-74). Group owner: Landon Stns. Audio news: APR. Rep: Masla/Young; Hix (mtn states). Format: Top 40. ■ Alf M. Landon, pres; Vern C. Milton, gen mgr; Lyle A. Butler, coml mgr; Scott Thielen, mus dir; Jim Harmon, news dir; Ron Krob chief engr. ■ Rates: \$7; 6; 7; 6.

KTCL(FM)—Co-owned with KIIX. September 1965: 93.3 mhz; 25 kw. Ant 37 ft. Stereo. Prog separate from AM. Format: Progressive rock. Spec prog: Spanish 3 hrs wkly. ■ Rates: \$7; 6; 6; 7.

Fort Morgan

KFTM—May 22, 1949: 1400 khz 1 kw-D, 250 w-N. Box 430 (80701). (303) 867-5674. Western Sun Broadcasting Co. (acq 9-20-74). Net: ABC/I; IMN. Rep: IMN. Format: MOR, C&W. Spec progs: Sp 3 hrs wkly.

KFTM-FM—May 1, 1968: 101.7 mhz; 3 kw. Ant 135 ft. Stereo. Dups AM 20%.

Glenwood Springs

KCMK(FM)—Not on air, target date unknown: 92.7 mhz; 3 kw. Ant minus 301 ft.

KGLN—May 14, 1950: 980 khz; 1 kw-D. Box 70 (81601). (303) 945-6501. Glenwood Bcstg. (acq 2-1-71). Rep: Mountain States; Hix. Format: MOR. Spec progs: Sp ¼ hr wkly. ■ Jack Waxenthal, pres & gen mgr; Ken Duprey, prog & mus dir; Jim Lukehart, news dir; John MCPearson, chief engr.

***New FM**—Not on air; target date unknown: 90.5 mhz, 10 w. Ant 80 ft. Route 1, Box 56B, Carbondale (81623). Colorado Mountain College. ■ Thad J. Engler.

Grand Junction

KEXO—Feb 29, 1948: 1230 khz; 1 kw-D, 250 w-N. Box 1448 (81501). (303) 243-1230. Century Bcstg Co. (acq 9-1-68). Group owner: Greentree. Net: ABC/I; Intermountain. Format: Contemp. Spec prog: Sp ½ hr wkly. ■ Charles D. Powers, pres; Richard Elliott, gen mgr; Darrel Carlson, prog dir. ■ Rates: \$6.75; 6.75; 6.75; 5.75.

***KMSA(FM)**—Feb 20, 1975: 91.3 mhz; 10 w. Ant 80 ft. Stereo. Box 2647 (81501). (303) 248-1240. Mesa College. Format: Educl, progrv. Spec progs: Classical 9 hrs; jazz 4 hrs; blues 1 hr; Christian 4 hrs; bluegrass 4 hrs wkly. ■ Coke DeBruin, gen mgr; Chuck Hendrickson, advisor.

KQIL—May 13, 1961: 1340 khz; 1 kw-D, 250 w-N. Box 340 (81501). (303) 242-7800. Mesa Bcstg Co. (acq 1-1-71). Net: MBS. Rep: Masla, Hix. Format: C&W. ■ Barry Turner, gen mgr; Phil Jensen, prog dir; Mark Bonan, news dir; Bob Goodrich, chief engr; John Langeliers, coml mgr. ■ Rates: \$4.80; 4.80; 4.80; 4.15.

KQIX-FM—Co-owned with KQIL. Nov 1, 1973: 93.1 mhz; 25 kw. Ant minus 170 ft. Stereo. (303) 243-7666. Mesa Bcstg Co. Prog sep from AM. Format: MOR. ■ Jim Ter Louw, stn mgr. ■ Rates: \$4.60; 4.60; 4.60; 2.80.

KREX—May 1, 1926: 1100 khz; 50 kw-D, 10 kw-N. DA-N. Box 789 (81501). (303) 242-5000. TWX 910-929-6992. XYZ Television, Inc. (group owner; acq 11-1-66). Net: CBS. Rep: Torbet, McDermott (Canada), McGuire. Format: MOR, Contemp. ■ Carl O. Anderson, pres & gen mgr; William G. Walters, stn mgr; Al LaDage, chief engr; Jim Huska, news dir. ■ Rates: \$9.40; 7.50; 7.50; 5.65.

KREX-FM—May 1, 1960: 92.3 mhz; 30 kw. Ant minus

42 ft. Stereo. Prog sep from AM. ■ KREX-TV affil. ■ Rates: \$2.50;2.50;2.50;2.50.

KSTR—June 19, 1957: 620 khz; 5 kw-D. Box 1120 (81501). (303) 243-1722. Lincomm Inc. (acq 12-31-68). Net: NBC. Rep: Savalli/Gates. Format: C&W. Spec prog: Sp 1 hr wkly. ■ Roy H. Adamson, pres & gen mgr; Robert A. Collins, exec VP & coml mgr, prog & news dir.

Greeley

KFKA



KFKA—May 21, 1921: 1310 khz; 5 kw-D, 1 kw-N, DA-N. Box K (80631). (303) 356-1310. RG Inc. (acq 10-5-66). Group owner: Harris. Rep: Masla, Hix. Net: MBS. Audio news: UPI. Format: Contemp, MOR. Spec progs: Sp 6 hrs, farm 18 hrs wkly. ■ Joseph J. Tennesen, pres & gen mgr; Donna Adams, coml mgr; Jim Keeton, news dir, Dave Sawyer, mus dir & chief engr. ■ Rates: \$7.50;7.50;7.50;5.50.

KFKZ

Inspirational Music

KFKZ(FM)—Co-owned with KFKA. Not on air; target date late 1975: 96.1 mhz; 100 kw. Ant 660 ft. Stereo. 1025 9th St. (80631). Format: Relg. ■ Gail Holmes, prog dir; Jeff Hancock, coml mgr. ■ Rates: \$7.50;7.50;7.50;7.50.

KGRE(FM)—Listing follows KYOU.

***KUNC-FM**—Jan 1, 1967: 91.5 mhz; 3 kw. Ant 360 ft. Stereo. Carter 201, U. of Colo. (80639). (303) 351-2915. Associated Students of U. of Northern Colo. Net: NPR. Format: noncoml diversified. Spec progs: Folk. Sp 4 hrs wkly; SCA svcs for handicapped 18 hrs wkly. ■ William E. Hurt stn mgr; Ronald S. Camp, gen mgr; Thomas Martin, prog & mus dir; Linda Bauer, opns mgr; Neil Best, pub affairs dir; Kevin Pash, prod mgr; Estel Haning, chief engr.

KYOU—Aug 24, 1948: 1450 khz; 1 kw-D, 250 w-N. 816 9th St. (80631). (303) 356-1450. Meroco Bcstg Co. Net: ABC; Intermountain. Rep: RKO. Spec progs: Sp 9 hrs wkly. ■ Elwood Meyer, pres & gen mgr; George Drew, coml mgr; Bill Obermier, prog dir; Bob Bernd, news dir; Andy Loomis, chief engr.

KGRE(FM)—Co-owned with KYOU. June 1967: 92.3 mhz; 25 kw. Ant 470 ft. Stereo. Progs sep from AM. Format: MOR.

Gunnison

KGUC—Aug 23, 1960: 1490 khz; 1 kw-D, 250 w-N. 113 E. Georgia (81230). (303) 642-1780. Gunnison Bcstg. Net: ABC; Intermountain. Format: MOR. ■ Roger W. Peppard, gen & sls mgr; Enid C. Peppard, prog dir; Fred Henry, chief engr. ■ Rates: \$3.50;3.50;3.50;3.50.

***KWSB-FM**—Jan 26, 1968: 91.9 mhz; 10 w. Ant 115 ft. Box 928 (81230). (303) 641-2131. Western State College of Colorado. Net: ABC/FM; ABC/C; NPR. Format: Free Form, Ed, C&W. Spec progs: Black 9 hrs wkly. ■ Karl F. Crass, gen & prod mgr.

Ignacio

***New FM**—Not on air; target date unknown: 91.3 mhz; 10 w. Ant 55 ft. Southern Ute Tribal Affairs Bldg. (81137). Kute Inc. ■ Leonard C. Burch.

KBLJ(FM)—Listing follows KBZZ.

KBZZ—1937: 1400 khz; 1 kw-D, 250 w-N. Box 485 (81050). (303) 384-5456. La Junta Bcstrs Inc. (acq 11-59). Net: ABC/I, Intermountain. Format: MOR, Top 40. ■ Grady Franklin Maples, pres; C. A. Denney VP & gen mgr; Don Rizzuto, stn mgr; Larry Hubbard, mus dir; John Doenges, news dir; Paul Widlund, chief engr.

KBLJ(FM)—Co-owned with KBZZ. September 1974: 92.1 mhz; 3 kw. Ant 300 ft. Net: ABC/FM. Format: C&W. ■ Paul Widlund, stn mgr.

Lakewood

KLAK—Jan 8, 1955: 1600 khz; 5 kw-U, DA-2. 7075 W. Hampden Ave., Denver (80227). (303) 985-8771.

Lakewood Bcstg Inc. (acq 8-1-61). Net: ABC/C//E/FM, Intermountain. Audio news: UPI. Rep: Eastman. Format: C&W. ■ Edward S. Scott, pres and prog dir; Mike Jorgenson, gen & prom mgr; Jim Wayne, lcl sis mgr; Peter Gardner, news dir; Con Schader, mus dir; Jan Chadwell, chief engr. ■ Rates: \$4.34;4.34;2.4.

KLAK-FM—July 9, 1966: 107.5 mhz; 56 kw. Ant 80 ft. Dups AM 100%. Stereo. ■ Rates same as AM.

Lamar

KLMR—1948: 920 khz; 5 kw-D, 500 w-N, DA-N. Box 890 (81052). (303) 336-2206. KLMR Inc. (acq 12-61). Rep: Masla; Hix. Format: Contemp, C&W. Spec progs: Sp 3 hrs wkly. Dennis Behan, pres; Gordon Stafford, gen & coml mgr; Jim Wilkinson, prog & mus dir; Ed Lang, prom mgr; Mike Birdsill, chief engr; Claire Stafford, news dir.

Leadville

KBRF—Nov 4, 1960: 1230 khz; 1 kw-D, 250 w-N. Box 968 (80461). (303) 486-1526. Zap Communications. (acq 1975). Rep: Hix. Format: MOR. ■ Ben Sleeper, prog dir; Rick Johnson, mus dir; Darwin Arnold, coml mgr; Mike Zimmerman, prom mgr & news dir; Don Youmans, chief engr.

Littleton

KDKO—Aug 22, 1957: 1510 khz; 1 kw-D, 5 kw-N, DA-2. Box 418 (80120). (303) 794-4211. KDKO Inc. (acq 4-1-65). Group owner: Segal. Rep: Dore. Net: Mutual Black. Format: Black Disco/Soul. ■ David M. Segal, pres & gen mgr; James Walker, coml mgr; Bob Moore, mus dir; Don Mueller, news dir; Robert Blanchard, chief engr. ■ Rates: \$26;26;26;26.

Longmont

***KCDC(FM)**—Sept 1975: 90.7 mhz; 10 w. Ant 100 ft. 1200 S. Sunset St. (80501). (303) 772-3333. St. Vrain Valley School District. Format: Educl. ■ George N. Baskos, gen mgr; Bob Suarez, chief engr.

KLMO—December 1949: 1060 khz; 1 kw-D, Box 799 (80501). (303) 776-2323. Radio Longmont Inc. (acq 7-1-59). Net: ABC/C. Audio news: APR. Format: MOR/Contemp. Spec progs: Sp 1 hr; Ger 1 hr; C&W 2 hrs; farm 5 hrs wkly. ■ William G. Stewart, pres & gen mgr; Les Marcus, coml mgr; King Hamilton, prom mgr; Jim Boynton, mus dir; Bob Suarez, chief engr; Steve Wheeler, news dir; Gloria Armistead, prog dir. ■ Rates: \$7;5.10;7;5.10.

KLMO-FM—Sept 1964: 104.3 mhz; 28 kw. Ant 88 ft. Stereo. Prog sep from AM. Net: ABC/FM. Format: Blf mus, Top 40. Lila J. Stewart, prog dir; Mike Alz, prom mgr. ■ Rates: \$4.40; 4.40; 4.40; 4.40.

Loveland

KLOV—1955: 1570 khz; 1 kw-D, 1440 E. 6th, Box 597 (80537). (303) 667-1570. KLOV AM/FM Inc. (acq 4-10-70). ■ Daryl W. Klassen, pres & gen mgr; Marly Wicoff, coml mgr; Rex Stephenson, prog & mus dir; Rob Turner, prom mgr; George Mason, news dir; Paul Thomas, chief engr.

KLOV-FM—Feb 5, 1966: 102.3 mhz; 3 kw. Ant 145 ft. Stereo. Dups AM 80%.

Manitou Springs

KIIQ—Nov 1956: 1490 khz; 500 w-D, 250 w-N. Box 111 (80829). (303) 685-5678. Mountain States Communications (acq 8-15-74). Net: ABC/I. Rep: Selcom. Format: Contemp, Rock. ■ Dan Lacy, pres; Charles L. Oliver, VP, sls; Lee Michaels, prog dir; Jack Bullet, mus dir; Dana Bolles, news dir. ■ Rates: \$10.50; 9.50; 10.50; 5.25.

KIIQ-FM—Oct 14, 1974: 102.7 mhz; 50 kw. Ant 2000 ft. Stereo. Dups AM 100%. ■ Rates same as AM.

Monte Vista

KSLV—February 1954: 1240 khz; 1 kw-D, 250 w-N. Box 631 (81144). (303) 852-3581 or 589-3101. George O. Cory. Audio news: UPI. Format: Diversified. Spec prog: C&W 7 hrs wkly. ■ Ted Bush, gen mgr; Jerry Salazar, prog dir. ■ Rates: \$3.25;3.25;3.25;3.25.

Montrose

KUBC—Sept 25, 1947: 580 khz; 5 kw-D, 1 kw-N, DA-N. Box 970 (81401). (303) 249-4546. Woodland

Colorado Radio

See page C-1 for explanation of listings.

Bcstg. (acq 1-30-73). Rep: Masla; Hix. Format: MOR, C&W. ■ Jack T. McCulliffe, pres; L. R. Hale, gen mgr; Garth T. Walker, coml mgr; Alvin Tessitore, prog dir; Robert Evans, chief engr.

Morrison

***KWBI(FM)**—Mar 27, 1971: 91.1 mhz; 26 kw. Ant minus 250 ft. 16075 W. Bellevue Ave. (80465). (303) 697-8700. Western Bible College. Net: ABC/E. Format: Relg, educ. Spec progs: Sp ¼ hr wkly. ■ Adrian L. House, pres; Gary D. Herr, stn mgr; Vance R. Harwood, chief engr.

Oak Creek

KFMU(FM)—Sept 22, 1975: 103.9 mhz; 165 w. Ant 1030 ft. Stereo. Box 66 (80467). (303) 736-8240. Elliot J. Bayly. Format: L C&W, MOR. Spec progs: Jazz 12 hrs; classical 12 hrs wkly. ■ Elliot J. Bayly, owner, mgr and chief engr. ■ Rates: \$2;2;2;2.

Pagosa Springs

KPAG—Aug 27, 1975: 1400 khz; 1 kw-D, 250 w-N. Box 561 (81147). (303) 968-2590. KYOR Inc. Group owner: Blythe Bcstg. Audio news: UPI. Format: Top 40. Spec progs: Farm 1 hr; Sp 2 hrs wkly. ■ Robert B. Roddy, pres and gen mgr; Larry Orr, coml mgr, news dir; Scott Williams, prog dir; Vern Sulier, chief engr.

Pueblo

KAPI—Jan 1, 1961: 690 khz; 250 w-D. 2829 Lowell Blvd. (81003). (303) 545-2883. KAPI Inc. (acq 9-18-70). Rep: Savalli/Gates. Format: Spanish. ■ George M. Sandoval, co-owner, gen mgr.

KCSJ—1947: 590 khz; 1 kw-U, DA-2. Box 1799 (81002). (303) 543-2490. American Radio Corp. (acq 5-15-73). Group owner: American Media. Net: MBS. Audio news: APR. Rep: Avery-Knodel; Moutain Media. Format: MOR. Spec progs: Farm 10 hrs wkly. ■ Robert D. Freeman, pres; Gene A. Koehn, gen mgr; Chuck Thomas, prog dir; Steve Henson, news dir; Ray Klutz, chief engr. ■ KOAA-TV Affil. ■ Rates: \$9;7.50;9;7.50.

KDJO(FM)—Co-owned with KCSJ. Aug 23, 1975: 97.9 mhz; 100 w. Ant 320 ft. Stereo (303) 545-9801. Format: Stereo rock. ■ Tim Turner, gen mgr; Lee Fields, prog dir. ■ Rates: \$7;8.25;8.25;8.25.

KDZA—Dec 29, 1947: 1230 khz; 1 kw-D, 250 w-N. Box 93 (81002). (303) 544-5646. Gayberry Bcstg Co. Inc. (acq 8-7-75). Audio news: APR. Format: Top 40. ■ Michael M. Galer, pres and gen mgr; Tony Spicola, sls mgr; Frank Provenza, prog dir; J. Ralph Carter, stn mgr; Harvey Smith, chief engr.

KZLO(FM)—Not on air, target date 1-1-76. 100.7, hz; 100 kw. Ant 640 ft. Stereo. Prog sep from AM. Format: MOR.

KFEL—Aug 1956: 970 khz; 1 kw-D, 4411 Goodnight Ave. (81005). (303) 542-6884. KFEL Inc. (acq 1-1-64). Format: Mus, relig. ■ Joseph M. Clifton, pres; Willis Baldrige, prog dir; Jim Widmar, spts dir; Larry F. Lewis, chief engr.

KKAM—Feb 1928: 1350 khz; 5 kw-D, 1 kw-N. Box 293 (81002). (303) 542-5570. KKAM Inc. (acq 1-1-72). Rep: Savalli/Gates. Format: Rock. ■ Thomas T. Farley, pres; Dwight B. Shaw II, gen mgr; Reginald Martinez, coml mgr; Paul Vann Ehls, prog & mus dir; Zoe McCrea, news dir; Tony Mejia, chief engr. ■ Rates: \$5.80;4.80;5.80;4.80.

KPUB—April 1, 1963: 1480 khz; 1 kw-D, DA. Box 831 (81002). (303) 545-5970. Ouixote Bcstg Co. (acq 2-13-69). Net: ABC/I, IMN. Rep: IMN. Format: C&W. ■ Rex R. Miller, pres & gen mgr; William J. Engler, sls mgr; Bruce Ster, prog dir.

KPUB-FM—1975: 99.9 mhz; 68w. Ant 2000 ft.

***KTSK-FM**—October 1970: 89.5 mhz; 10 w. Ant 165 ft. (CP 9.8 kw). U. of Southern Colorado, 2200 Bonforte Blvd. (81001). (303) 549-2198. U. of Southern Colorado. Format: noncoml diversified. Spec prog: Classical 2 hrs; C&W 2 hrs; jazz 1 hr, wkly. ■ Dr Harry P. Bowes, pres; Donald Wayne, gen mgr and chief engr.

KVMN(FM)—Jan 1, 1967: 98.9 mhz; 44 kw. Ant 61 ft. 2828 W. Northern (81005). (303) 564-5450. Recrea-

Colorado, Connecticut Radio

See page C-1 for explanation of listings.

tion Broadcasting of Pueblo, (acq 9-1-74). Audio news: UPI. Rep: Century, McGuire. Format: Btl mus. ■ Stephen Heater, pres; Dennis Linsin, gen mgr; Penny Thomas, coml mgr; David Olson, mus and prog dir; Diane See, news dir; David Tanin, chief engr. ■ Rates: \$6;5;5.

Rifle

KWSR—June 9, 1967: 810 khz; 1 kw-D. Box 1210 (81650). (303) 625-2299. Oil Shale Bcstg Co. Net: ABC/I, IMN. Rep: Eastman, IMN. Format: MOR, pop, C&W. ■ Charles Price, pres, gen mgr, prog dir & chief engr; Marjorie Price, prom mgr; Mary Lu Davis, coml mgr. ■ Rates: \$3.90;3.90;3.90;—

Rocky Ford

KAVI—Oct 16, 1956: 1320 khz; 1 kw-D. Box 632 (81067). (303) 254-7427. Western Sun Bcstg Co. (acq 7-16-69). Audio news: APR. Rep: Hix. Format: MOR. Spec progs: C&W 9 hrs; Sp 7½ hrs, farm 3 hrs wkly ■ George R. Gregg, pres & gen mgr; Donald D. Teets, VP; Gary W. Sharp, sls mgr; Jerry Lucher, prog dir; Sandra Gallegos, traf mgr; Roland Smith, news dir; Fred Fleishacker, chief engr. ■ Rates: \$15.50; 4.50;4.50;250.

KAVI-FM—May 1966: 95.9 mhz; 2.6 kw. Ant 96 ft. Dups AM 80%. ■ Rates same as AM.

Salida

KVRH—Dec 10, 1948: 1340 khz; 1 kw-D, 250 w-N-SH. 7600 County Rd 120 (81201). (303) 539-2575. William J. Murphy (acq 9-23-59). Net: ABC/I, IMN. Rep: Eastman, IMN. Format: Variety, MOR. ■ Wm. J. Murphy, gen mgr; Bill Cook, sls mgr; Charles Darwin, mus dir; G.G. Mills, news dir & chief engr; Mick Rose, weekend news dir. ■ Rates: \$4.40;3.50;4.40;3.50.

KVRH-FM—1971: 92.1 mhz; 3 kw. Ant minus 1200 ft. (CP 2.95 kw. Ant minus 1120 ft). Dups AM 100%. ■ Rates same as AM.

Security

KWYD(FM)—April 8, 1973: 105.5 mhz; 3 kw. Ant minus 58 ft. Stereo. Box 5668 (80911). (303) 392-4219. Edward J. Patrick. Rep: Select Religious Broadcasters. Format: Relgs. ■ Edward J. Patrick, owner, gen mgr & prog dir; Rick Martin, opns and coml mgr; John Boies, news dir; Bob Torbit, chief engr.

Steamboat Springs

KBCR—July 24, 1974: 96.7 mhz; 60 w. Ant 1880 ft. Big Country Radio. ■ Rates: \$5;5;5.5.

Sterling

KGEK—Jan 3, 1925: 1230 khz; 1 kw-D, 250 w-N. Box 830 (80751). (303) 522-1607. Sterling Radio & TV Inc. (acq 12-1-66). Net: ABC/I, IMN. Rep: Eastman; Intermountain. Format: C&W. Spec prog: Sp 1 hr wkly. ■ William Whitlock, pres; Marvin G. Rivenburgh, VP, gen mgr & chief engr; Betty Carlson, stn mgr; Harlan Gronseth, prog dir; Susan Robertson, mus dir; Ralph Canary, news dir.

KYOT(FM)—Co-owned with KGEK. Feb 8, 1974: 96.7 mhz; 940 w. Ant 500 ft. (303) 522-1609.

Telluride

***KOTO(FM)**—1975: 91.7 mhz; 100 w. 107 W. Columbia Ave. (81435). (303) 728-4333. San Miguel Educational Fund. Format: Diversified. Spec progs: Farm 10 hrs; black 10 hrs; classical 10 hrs; jazz 10 hrs; Sp 10 hrs; C&W 10 hrs, all wkly. ■ Ken Mondlin, exec dir; Jerry Greene, gen mgr.

Trinidad

KCRT—May 21, 1946: 1240 khz; 250 w-SH. Box 772 (81082). (303) 846-3347. Trinidad KCRT Inc. Hed. (acq 6-1-71). Net: ABC/I, Intermountain. Format: MOR. Spec progs: Sp 9 hrs; C&W 7 hrs, wkly. ■ James P. Platt, pres & gen mgr; John Steele, coml mgr; Richard Padilla, prog dir; Althea Platt, prom mgr; Carol Echols, news dir; John H. Bailey Jr., mus dir; Hermon Corley, chief engr.

Vail

KVMT(FM)—1975: 104.7 mhz; 80 kw. Ant 1,186 ft. Box 1047 (81657). (303)476-5868. Radio Vail. ■ John H. Gayer, pres; Nathaniel B. Harris, exec VP & gen mgr; James Chabin, prom mgr; Norm Smith, chief engr.

Walsenburg

KFLJ—July 20, 1957: 1380 khz; 1 kw-D. Box 593 (81089). (303) 738-1700. Floyd and Lieselotte Jeter. Format: MOR, C&W. Spec prog: Sp 10 hrs wkly. ■ Floyd Jeter, gen mgr & chief engr; Lee Jeter, asst & coml mgr; Beulah Read, news & mus dir.

Windsor

KUAD—April 12, 1969: 1170 khz; 1 kw-D. Box 117 (80550). (303) 686-2791. KUAD-AM Inc. Brewer Bcstg (group owner). Rep: Mountain Media. Format: C&W. Spec prog: Sp 2 hrs wkly. ■ Philip L. Brewer, pres & gen mgr. ■ Rates: \$5.50;4.60;5.50;4.60.

KUAD-FM—May 31, 1975: 99.1 mhz; 100 kw. Ant 657 ft. Format: Top 40. ■ Rates: \$4.50;4.4;5.0;4.50.

Connecticut

HAMILTON-LANDIS & ASSOCIATES, Inc.
NATIONWIDE MEDIA BROKERS
WASHINGTON, D. C., CHICAGO, DALLAS,
SAN FRANCISCO
SELL MORE
RADIO & TELEVISION STATIONS
IN THE EAST—NEAREST OFFICE IS—
1730 K ST., N.W., WASHINGTON 20006
(202) 393-3456

Ansonia

WADS—May 8, 1956: 690 khz; 500 w-D, DA. 366 Main St. (06401). (203) 735-4606. Valley Bcstg Co. Net: MBS. Rep: New England Spot Sales. Format: Contemp. Spec progs: It 1 hr; Pol 4 hrs; Jewish 1 hr, all wkly. ■ Arthur Schroder, pres; Donald Richeson, gen & prom mgr; Brad Harris, prog & mus dir.

Bridgeport

WDJZ—Not on air, target date unknown: 1530 khz; 10 kw-D, DA. Dr. Daniel J. Ferricola, 402 Mt. Prospect Ave., Newark, N.J. (07104). Connecticut Coast Bcstg Co.

WEZN

Beautiful Music

WEZN(FM)—Oct 24, 1960: 99.9 mhz; 25 kw. Ant 660 ft. Park City Plaza (06604). (203)366-9321. Robert L. Williams Bcstg Co. Inc. (acq 6-23-73). Rep: Buckley Radio Sls, Northeastern Spot Sales. Format: Btl mus. Stereo. ■ Robert L. Williams, pres; Richard A. Ferguson, VP & gen mgr; Paul Roger, opns dir; Ernest Kirschner, chief engr; Dennis Jackson, pub aff dir. ■ Rates: \$20; 25; 25; 20.

WICC—1926: 600 khz; 1 kw-D, 500 w-N, DA-1. 177 State St. (06604). (203)366-9383. Connecticut Bcstg Co. Inc. (acq 3-16-67). Rep: Eastman, Creed. Format: Contemp. ■ Ray Colonari, VP & gen mgr; Jerry Knight, prog dir; Robert Pieger, chief engr; Mark Sullivan, news dir. ■ Rates: \$36; 28; 32; 20.

WNAB—September 1941: 1450 khz; 1 kw-D, 250 w-N. Broadcast Centre (06608). (203)333-5551. WNAB Inc. Net: ABC/I. Rep: Avery Knodel. Format: MOR, talk. Spec progs: Sp 8 hrs wkly. ■ Preston Gilmore, exec VP; Thomas Kennedy, mgr; Phil Cutting, prog dir; Tom Hughes, news dir; Norman Howard, chief engr. ■ Rates: \$25; 20; 25; 10.

***WPKN(FM)**—Oct 10, 1963: 89.5 mhz; 2.4 kw. Ant 550 ft. 244 University Ave. (06602). (203) 576-4895. U of Bridgeport. Net: ABC/E. Format: progressive talk, jazz. ■ Jeffrey N. Tellis, gen mgr; Kevin Gallagher, prog dir.

Bristol

WBIS—October 1948: 1440 khz; 500 w-D. Box 1440 (06010). (203) 583-9265. Bristol Bcstg Corp. (acq 4-

1-54). Rep: Bob Dore, Eckles & Queen. Format: MOR, C&W. Spec progs: Pol 2 hrs wkly. ■ Constance Hatch, pres; James L. Sullivan Jr., gen mgr; Jack Roberts, coml mgr; Peter Lis, prog dir; Lee Steele, chief engr. ■ Rates: \$14; 12; 12; 14.

Brookfield

WINE—December 2, 1963: 940 khz; 1 kw-D. Box 11 (06804). (203) 775-1212. Housa tonic Valley Bcstg. (acq 5-9-66). Net: MBS. Rep: Bob Dore, Northeast Spot Sales. Format: Top 40. Spec progs: Ital ½ wkly, Port 2 hrs wkly. ■ Chris Caggiano, gen mgr; Jim Principi, coml mgr; Ron Tarsi, news dir; Patrick Carone, chief engr. ■ Rates: \$11; 10; 11; 10.

WINE-FM—July 14, 1957: 95.1 mhz; 29 kw. Ant 470 ft. Dups AM 65%.

Danbury

WINE—See Brookfield, Conn.

WLAD—October 1947: 800 khz; 1 kw-D. 198 Main St. (06810). (203) 744-4800. Berkshire Bcstg Corp. Rep: Pro/Meeker Radio; Eckles & Queen. Format: MOR. ■ Edward J. Raleigh, pres; Patrick Crafton, gen mgr; Paul Baker, prog dir; George Repko, mus dir; Jim Grehan, news dir; Rudi Cehak, chief engr. ■ Rates: \$12; 11; 12; 11.

WLAD-FM—December 1953: 98.3 mhz; 2.5 kw. Ant 328 ft. Prog sep from WLAD. Stereo. Format: Btl mus. ■ Rates: \$7.50; 9; 9; 7.50.

***WXCI(FM)**—Feb 27, 1973: 91.7 mhz; 1.2 kw. Ant 79 ft. 181 White St. (06810). (203) 744-5402. Western Connecticut State College. Net: MBS, NPR. Format: Rock, progressive contemporary. Spec progs: Jazz 7 hrs wkly; classical 7 hrs wkly. ■ Peter Faass, gen mgr; John Forguites, prog dir.

Fairfield

***WSHU(FM)**—Sept 1, 1964: 91.1 mhz; 1 kw. Ant 371 ft. Box 6460 (06606). (203) 374-6191. Sacred Heart U Inc. Net: ABC/FM. Format: Variety. Spec progs: Jazz 6 hrs wkly; Sp 1 hr wkly. ■ Donald E. Coonley, gen mgr; James MacDonald, prog dir.

***WVOF(FM)**—April 17, 1974: 88.5 mhz; 13.5 w. Ant 100 ft. Box R Fairfield Univ. (06430). (203) 259-8020. William P. Schimpf. Format: Progressive. Spec prog: Jazz 6 hrs wkly. ■ Mick McCullough, gen mgr.

Greenwich

WGCH—Sept 14, 1964: 1490 khz; 1 kw-D, 250 w-N. Box 1490 (06830). (203) 869-1490. Greenwich Bcstg Corp. Audio news: UPI. Rep: Masla. Format: MOR. Spec progs: It 2 hrs; Pol 1 hr; jazz 2 hrs; black, all wkly. ■ George C. Stevens, pres & gen mgr; Neil E. MacMillan Jr., prog and mus dir; Steven Downes, coml mgr; Eleanor Charles, news dir; Norman Wolfson, chief engr. ■ Rates: \$14.50; 11.75; 13.75; 11.

Groton

WSUB—July 26, 1958: 980 khz; 1 kw-D. 1064 Poquonock Rd. (06340). (203) 446-1980. Southeastern Conn. Bcstg Co. (acq 7-17-70). Net: ABC/E. Audio news: APR. Rep: Market 4 Radio, Kettel-Carter. Format: MOR. Spec progs: Black 2 hrs wkly, Ital 1 hr wkly; Pol 2 hrs wkly. ■ William Crawford, pres, gen & coml mgr; Don Turner, mus dir; Mike Mansfield, prog dir & prom mgr; Phil Hubbard, news dir.

WSUB-FM—1971: 105.5 mhz; 3 kw. Ant 275 ft. Dups WSUB 66%. Format: Top 40. Stereo.

Hamden

WCDQ—July 17, 1960: 1220 khz; 1 kw-D, DA. 473 Denslow Hill Rd. (06514). (203) 288-3561. Southern New England Bcstg Corp. (acq 8-14-67). Net: ABC/C, ABC/E. Audio news: UPI. Format: Solid Gold, rock. Spec progs: Sp 4 hrs wkly, black 4 hrs wkly. ■ Ted Quala, pres & gen mgr; Frank Bass, chief engr; Julian Brownstein, VP/gen sls mgr; Harley Saresky, loc sls mgr. ■ Rates: \$23; 19; 23; —.

WKCI(FM)—Co-owned with WAVZ New Haven. Prog sep from AM. Feb 10, 1969: 101.3 mhz; 12 kw. Ant 870 ft. Box 4313 (06514). (203) 787-5807. Kops-Monahan Communications Inc. (acq 9-13-66). Stereo. Rep: Eastman, Eckles & Queen. Format: Beautiful music. ■ Daniel W. Kops, pres; Richard J. Monahan, exec VP; Stanley P. Puzycycki, VP & gen mgr; Conrad Wicks, coml mgr; Jake Stern, mus dir; Brian Mancinelli, prog dir. ■ Rates: \$21; 28; 28; 21.

***WQAO(FM)**—Feb. 1973: 88.3 mhz; 10 w. Ant 200 ft. Box 59 c/o Quinnipiac College (06518). (203) 281-0011. Quinnipiac College. Format: Progressive, jazz rock. Spec prog: classical 15 hrs wkly. ■ Steve Ritchie, gen mgr; Dreama Claytor, prog dir.

Hartford

WCCC—1947: 1290 khz; 500 w-D. II Asylum St. (06103). (203) 549-3456. Greater Hartford Communications Corp. (acq 4-1-70). Net: ABC/E. Rep: Masla, New England Spot. Format: Top 40. Spec progs: Fr 1 hr; Ital 1 hr, Pol 1½ hr, all wkly. ■ Sy Dresner, pres, gen mgr & chief engr; Rusty Potz, prog dir; Mill Aninger, coml dir; Cynthia Davis, prom mgr; John Michaels, news dir.

WCCC-FM—June 7, 1960: 106.9 mhz; 20.5 kw. Ant 720 ft. Stereo. Dup WCCC 100%.

WDRG—Dec 10, 1922: 1360 khz; 5 kw-U, DA-N. 750 Main St. (06103). (203) 278-1115. Buckley Bcstg Corp. (acq 8-1-59). Group owner: Buckley Rep: Buckley Radio. Format: Contemp, Top 40. ■ Richard D. Buckley Jr., pres; Richard S. Korsen, exec VP & gen mgr; Dick Robinson, VP, stn mgr; Charles R. Parker, VP, prog dir; Philip Steben, coml mgr; Walt Dibble, news dir; James English, mus dir; Charles R. Parker, prom mgr; Wayne Mulligan, chief engr; Rick Alix, local sls mgr.

WDRG-FM—1936: 102.9 mhz; 15 kw. Ant 810 ft. Dup WDRG 50%. Stereo.

WHCN(FM)—1939: 105.9 mhz; 19 kw horiz, 12 kw vert. Ant 740 ft. (203) 247-9426. WHCN Inc. (acq 8-7-4). Rep: Masla; New England Spot Sales. Format: Progs. ■ Martin F. Beck, pres; Dick Paisley, VP & gen mgr; Joseph DiPietro, coml mgr; George Taylor Morris, prog dir; Larry Titus, chief engr; James Champaign, natl sls mgr.

WINF—See Manchester, Conn.

***WJM(FM)**—Not on air, target date unknown: 88.9 mhz; 8 kw. Ant 560 ft. St. Thomas Seminary.

WKND—Licensed to Windsor. See Windsor.

WKSS(FM)—See Hartford-Meriden.

WLWH(FM)—April 22, 1965: 93.7 mhz; 18 kw. Ant 760 ft. 750 Main St. (06108). (203) 525-3131. WLWH Inc. Format: Spanish. ■ Jose Grimalt, Alton J. Leno, stn mgrs; Ernest Kerschner, chief engr.

WPQP—1935: 1410 khz; 5 kw-U, DA-2. Box 11-1410 Newington Branch (06111). (203) 666-1411. Greater Connecticut Bcstg Inc. (acq 3-7-3). Group owner: Griffin. Net: NBC/NIS. Rep: Eastman, Knight. Format: All news. ■ Al Pellegrino, gen mgr; Augustine Santana, chief engr; Dick Springfield, prom and oper mgr. ■ Rates: \$38; 28; 33; 28.

***WQTQ(FM)**—November 1974: 88.3 mhz; 10 w. 415 Granby St. Weaver High School (06112). (203) 243-9761. Hartford Board of Education. Format: Variety. Spec progs: Black, Sp, jazz all 10 hrs wkly. ■ Joseph L. Grant, gen mgr.

***WRTC-FM**—February 1958: 89.3 mhz; 350 w. Ant 63 ft. Trinity College (06106). (203) 527-0447. Corp. of Trinity College. Audio news: UPI. Format: Black, educ. Spec progs: Sp 5 hrs; French 1 hr, Port 10 hrs, Ital 1 hr wkly. ■ Jeffrey Mandler, stn mgr.

WTIC—Feb 10, 1925: 1080 khz; 50 kw-U, DA-N. One Financial Plaza (60103). (203) 522-1080. TWX 710-425-0133. Ten Eighty Corp. (acq 3-8-74). Net: NBC. Rep: Christal. Format: Variety. Spec progs: Sp 1 hr wkly. Black. 5 hrs wkly. ■ Leonard J. Patricelli, pres; Robert S. Tyrod, VP & gen mgr; Donald MacGovern, coml mgr; Ross Miller, prog dir; Virginia Jesionka, mus dir; H. A. Dorschug, VP chief engr; Paul Kuntz, news dir.

WTIC-FM—Feb 5, 1940: 96.5 mhz; 15 kw horiz, 13 kw vert. Ant 810 ft. Dup AM 30%. Format: Classical Stereo.

***WUWH(FM)**—See West Hartford.

Hartford-Meriden

WKSS(FM)—June 1947: 95.7 mhz; 14.5 kw. Ant 820 ft. Stereo. Two Wethersfield Ave., Hartford (06114). (203) 243-9577. Communico Inc. (acq 5-1-71). Group owner: Communico. Rep: Blair. Format: MOR. ■ Frederic W. Constant, pres; Perry S. Ury, VP & gen mgr; William P. Hinds, sls mgr; James A. Schulke, prog &

mus dir; Barbara A. Magora, traf mgr; Richard Kerr, prom mgr; Eugene J. Chruscial, news dir; Tom Horesco, chief engr.

Manchester

WINF—May 18, 1958: 1230 khz; 1 kw-D, 250 w-N. 257 E. Center St. (06040). (203) 646-1230. Natl Media Corp. (acq 7-70). Net: CBS. Format: MOR. ■ Robert D. Charnas, pres; Jeff Jacobs, VP & gen mgr; Bob Hart, news dir; Rick Meizig, chief engr.

Meriden

WMMW—June 1947: 1470 khz; 1 kw-D. I Church St. (06450). (203) 235-5747. WMMW Inc. (acq 10-19-72). Rep: Creed. Format: MOR. ■ John Ellinger, gen mgr; Al Henry, prog dir; Richard Ellis, mus dir; Jim Richards, news dir.

Middletown

WCNX—Dec 12, 1948: 1150 khz; 1 kw-D. River Rd. (06457). (203) 347-2565. Middlesex Bcstg Co. Rep: Devney, Kirby. Format: MOR. Spec progs: Pol 1 hr, black 1 hr, both wkly. ■ Richard J. O'Brien, pres & mng dir; William J. Glynn, prog dir; Peter M. O'Brien, news dir; Roger Holt chief engr

WESU(FM)—Feb 25, 1961: 88.1 mhz; 1.85 kw. Ant minus 48 ft. Stereo. Box 2300. Wesleyan Station (06457). (203) 347-0050. Wesleyan Bcstg Assn. Audio news: UPI. Format: Variety. ■ Hal Garneau, gen mgr; Peter Lipton, pres.

***WIHS(FM)**—Oct 11, 1969: 104.9 mhz; 2.90 kw. Ant 300 ft. Box 117 (06457). (203) 346-3846. Connecticut Radio Fellowship. Audio news: APR. Format: Relig/Ed. ■ Alfred C. Thyberg, pres & gen mgr; James Pelley, prog dir; Ronald Habegger, chief engr; Gordon Kehrein, news dir.

Milford

WFIF—Sept 4, 1965: 1500 khz; 5 kw-D, DA. 1201 Post Rd. (06460). (203) 878-5915. Colonial Bcstg Co. Net: MBS. Audio news: APR. Rep: Marvin Roslin, Eckels and Queen. Format: C&W. Spec progs: Ital 6 hrs; Pol 1½ hrs; Black 3 hrs all wkly. ■ Blair Walliser, pres; Vinnie Roberts, gen mgr; Jeannette Forbes, prog dir; Robert Golda, news dir; Galle Anderson, pub aff. ■ Rates: \$16; 14; 16; 16.

Monroe

WMNR(FM)—Nov 30, 1973: 88.1 mhz; 330 w. Ant 200 ft. 1014 Monroe Turnpike (06468). (203) 268-9667. Monroe Board of Educ. Format: Educ/Community. ■ Douglas S. Taylor, stn mgr; Mike McCarthy, advisor.

Naugatuck

WOWW—Feb 26, 1961: 1380 khz; 5 kw-D, 500 w-N, DA-2. Red Carpet Rd. (06770). (203) 729-2291. Sound Communications Corp. (acq 9-15-72). Rep: Meeker, Kirby. Format: Solid gold. ■ Frank G. Stisser, pres; Albert J. Auclair, gen mgr.

New Britain

***WFCS(FM)**—Oct 17, 1972: 90.1 mhz; 14 w. Ant 140 ft. 1615 Stanley St. (06053). (203) 223-6767. Trustees of Conn. State College. Format: Progressive. Top 40. Spec progs: Black 4 hrs; classical 3 hrs; jazz 4 hrs; Port 10 hrs wkly. ■ David J. Salonia, gen mgr; David W. Smith, chief engr.

WRCH-FM—Listing follows WRCCQ.

WRCCQ—May 20, 1949: 910 khz; 5 kw-U, DA-2. Box 910 Radio Park, Farmington (06032). (203) 677-8521. TWX 710-423-0036. Central Conn. Bcstg Co. (acq 12-1-59). Audio news: UPI. Rep: Katz; Creed. Format: Golden. ■ Aldo DeDominicis, pres; Enzo DeDominicis, gen mgr; Erwin (Win) Needles, sls mgr; Lee Manson, prog-opns mgr; Win Sutor, chief engr. ■ Rates: \$24; 24; 24; 19.

WRCH-FM—Co-owned with WRCCQ. July 1, 1968: 100.5 mhz; 19.5 kw. Ant 720 ft. Stereo. Prog sep from AM. Format: Btlf mus.

WRYM—August 1946: 840 khz; 1 kw-D, 1056 Willard Ave., Newington (06111). (203) 666-5646. Hartford County Bcstg Corp. (acq 8-6-11). Net: ABC/I ABC/E. Format: Ethnic/relig. Spec progs: Ital 12 hrs; Polish, 12 hrs; Span 18 hrs all wkly. ■ Louis A. Sodokoff, pres; Ralph H. Klein, gen mgr, coml mgr; Dan Dorfneid, chief engr.

Connecticut Radio

See page C-1 for explanation of listings.

New Canaan

WLSX(FM)—1975: 91.9 mhz; 10 w. 5 N. Wilton Rd. (06840). St. Luke's Foundation.

New Haven

WAVZ-AM & WKCI-FM



KOPS-MONAHAN
Communications, Inc.

WAVZ—September 1947: 1300 khz; 1 kw-U, DA-N. 152 Temple St. (06510). (203) 777-4761. Kops-Monahan Communications Inc. (acq 7-20-49). Rep: Eastman, Kettel-Carter. Format: Top 40. ■ Daniel W. Kops, pres; Dick Monahan, exec VP; Stanley Puzycy, gen mgr; Chuck Martin, prog dir; Gerry Brooks, news dir; Dick Schumeyer, chief engr; Mike West, mus dir; Conrad Wicks, sls mgr. ■ Rates: \$28; 21; 28; 21.

WKCI(FM)—Co-owned with WAVZ. See Hamden.

WELI—October 1935: 960 khz; 5 kw-U, DA-N. Box 85 (06510). (203) 281-9600. Covenant Bcstg Corp. (acq 11-22-71). Group owner: Covenant. Rep: Blair. Format: MOR. Spec progs: Mystery Theater, 7 hrs wkly; Teie Talk 34 hrs wkly. ■ Fred E. Walker, pres; Frank N. Moore, VP & gen mgr; Tom Whalen, prog dir; Les Thimmig, prom mgr; Bill O'Sullivan, news dir; Judi Gabrielli, traf mgr; Bob Antonio, chief engr. ■ Rates: \$65; 40; 50; 26.

WKCI(FM)—See listing following WAVZ.

WNHC—1944: 1340 khz; 1 kw-D, 250 w-N. Box 1340 (06510). (203) 787-1217. TWX: 203-772-0459. Westerly Bcstg Co. (acq 4-7-71). Rep: Katz. Format: Contemp. Spec progs: Sp 1 hr wkly. ■ Carl Grande, VP & gen mgr; John Ellinger, natl sls mgr; George Grande, prog dir; George Grande, local sls mgr; Art Dinicholas, mus dir; Vincent DelaurRentis, chief engr.

WPLR(FM)—1944: 99.1 mhz; 10 kw. Ant 950 ft. 1294 Chapel St. (06510). (203) 777-6617. Stereo. Metro Connecticut Media Corp. (acq 5-28-71). Rep: Buckley. Format: prog rock. Spec progs: Black ½ hr wkly. ■ Robert G. Herpe, pres and gen mgr; Ronnie Berger, prog dir; S. Richard Kalt, stn mgr; Tom Michaels, news dir; John Russell, retail sls; Gordon Weingarh, mus dir; Thomas Horesco, chief engr.

WYBC-FM—March 9, 1959: 94.3 mhz; 1.20 kw. Ant 203 ft. Stereo. Box WYBC, Yale Station (06520). (203) 865-3451. Yale Bcstg Co. Net: ABC/FM. Rep: Ivy Neas. Format: Progressive, jazz. Spec progs: Black 10 hrs; classical 11 hrs, both wkly. ■ Antony Talalay, chmn; Eric Eichhorn, stn mgr; David Fisher, treas; Peyton Mays, prog dir; Ed O'Connell, mus dir; Peter Dennant, opns mgr; Mark Flescher, news dir; John Koerber, chief engr. ■ Rates: \$9.50; 9.50; 9.50; 9.50.

New London

***WCNI(FM)**—1974: 91.5 mhz; 10 w. Connecticut lege. Box 1333 (06320). Connecticut College Broadcast Association Inc. ■ Mary Ann Sill, pres.

WNLC—Sept 13, 1936: 1510 khz; 10 kw-D, 5 kw-N; DA-2. Box 1031 (06320). (203) 442-5328. Thames Bcstg Corp. Net: ABC/C. Rep: McGavren-Guild, North-east Spot Sales. Format: Contemp. Spec progs: It 1 hr, SP ½ hr, Black ½ hr wkly. ■ Gerald J. Morey, pres; Paul R. Morey, gen mgr; Paul S. Bernardo, colim mgr; Jim Buchanan, prog dir; David A. Connors Jr., news dir; Randolph Barret, chief engr. ■ Rates: \$18; 13; 18; 9.

WTYD(FM)—Co-owned with WNLC. Jan 1, 1970: 100.9 mhz; 3 kw. Ant 300 ft. Prog sep from AM. Format: Beautiful music. Spec progs: Symphony, 3 hrs wkly Stereo. ■ Paul Bernardo, coml mgr; Paul R. Morey, gen mgr; Gerald J. Morrey, pres. ■ Rates: \$7.20; 9; 9; 7.20.

WSUB-AM-FM—See Groton, Conn.

Norwalk

WNLK—1948: 1350 khz; 1 kw-D, 500 w-N, DA-N. Box 549 Belden Station (06852). (203) 838-5566. Hanson

Connecticut, Delaware Radio

See page C-1 for explanation of listings.

Communications (acq 1975). Format: MOR. Spec progs: Ger 1 hr; It 2 1/2 hrs; Pol 1 hr; Black 2 hrs; Sp 8 1/2 hrs; Hungarian 1 hr, all wkly. ■ Fred Grossman, pres; Richard Buonerba, prog dir; E. Sanford Arnn, A. Napoleon, news dir; Frank Montgomery, chief engr.

WNLK-FM—1965: 95.9 mhz; 3 kw. Ant 130 ft. Dup AM 100%.

Norwich

WCTY(FM)—Listing follows WICH.

WICH—September 1946: 1310 khz; 5 kw-D, 1 kw-N, DA-2. Box 551 (06360). (203) 887-1613. WICH Inc. (acq 7-1-65). Rep: Masla. Format: MOR, talk. ■ Robert M. Hall, pres; Donald Lawler, exec VP; Richard P Reed, gen & coml mgr; John London, prog dir; Bruce McDonald, news dir; A Dubenetsky, chief engr.

WCTY(FM)—Co-owned with WICH. May 1968: 97.7 mhz; 3 kw horiz, 2.95 kw vert. Ant 300 ft. Prog sep from WICH. Net: ABC/FM. Rep: PRO/Meeker. Format: Good music.

Old Saybrook

WLIS—Sept 27, 1956: 1420 khz; 500 w-D, Drawer W (06475). (203) 388-3546. Radio Conn. Inc. (acq 3-11-70). Net: MBS. Format: MOR. ■ John M. Powers, pres, gen & coml mgr; Ann C. Powers, asst mgr; Ken Griffin, news dir; Ron Allen, chief engr. ■ Rates: \$7.20; 6.70; 7.20; 6.70.

Putnam

WINY—May 3, 1953: 1350 khz; 1 kw-D, 237 Kennedy Dr. (06260). (203) 928-2721. Nutmeg Bcstg Co. (acq 9-60). Group owner: Nutmeg. Net: MBS, Connecticut Public Information Network. Format: Top 40 Pacesetter. Spec progs: Talk 2 1/2 hrs; C&W 3 hrs, both wkly. ■ Michael Rice, pres; Herbert C. Rice, chmn; Michael Gerardi, gen mgr; Peter Walsh, sls mgr; David Melendy, news dir; Frank Carroll, mus dir; Ernest A. Brochu, chief engr. ■ Rates: \$12; 10; 12; 8.

Southington

WNTY—990 khz; 500 w-D, DA. Sept 2, 1969. Box 990, Old Turnpike Rd. (06489). (203) 628-0311. Nutmeg Bcstg Co. Group owner: Nutmeg. Net: MBS. Rep: McGavren-Guild, Northeastern Spot Sales. Format: Golden contemp. Spec progs: Ital 4 hrs; Pol 3 hrs; talk 2 1/2 hrs, all wkly. ■ Michael C. Rice, pres; Craig Caragan, gen mgr; Lee F. Manilla, news dir; George Bernoski, prog & mus dir; Thomas Cawett, chief engr; James B. Coffey, com; mgr. ■ Rates: \$10.50; 8.50; 10.50; 8.50.

Stamford

WSTC—Sept 18, 1941: 1400 khz; 1 kw-D, 250 w-N, 117 Prospect St. (06901). (203) 327-1400. Western Connecticut Bcstg Co. (acq 1-1-46). Net: ABC/I, E & FM. Suburban. Rep: Torbet; New England Sls. Spec progs: It 1 hr; Pol 1 1/2 hrs; black 1 hr, all wkly. ■ Lingsley Gillespie, pres; Robert McCullough, gen mgr; Lisle Dorrian, chief engr.

WYRS(FM)—Co-owned with WSTC. Oct 18, 1947: 96.7 mhz; 3 kw. Ant 280 ft. Dup AM 78%.

Stockbridge

***WCWL(FM)**—1975: 91.3 mhz; 1.45 kw. Ant 4 ft. Berkshire Christian College.

Storrs

***WHUS(FM)**—1956: 91.7 mhz; 3.16 kw. Ant 360 ft. Box U-8 (06268). (203) 429-3100. Board of Trustees, U of Conn. Net: ABC/I. Format: Progressive, jazz. Spec progs: record review 1 hr; talk 1 hr, wkly. ■ Robert N. Markle, pres and gen mgr.

Torrington

WSNG—Jan 29, 1948: 610 khz; 1 kw-D, 500 w-N, DA-2, 365 Prospect St. (06790). (203) 489-4181. Torrington Bcstg Co. (acq 4-55). Net: MBS. Format: MOR, talk. ■ Edmund Waller, pres; Alfred G. Eyre, VP; Paul Pagano, gen mgr; Stuart LeLand, chief engr. ■ Rates: \$11; 9; 11; 9.

Waterbury

WATR—June 15, 1934: 1320 khz; 5 kw-D, 1 kw-N, DA-2. Broadcast Centre (06702). (203) 755-1121. WATR Inc. Net: MBS. Rep: Dore; Kettell-Carter. Format: MOR. Spec progs: Pol 2 hrs; talk 20 hrs, both wkly. ■ B. Preston Gilmore, exec VP; Fred Erwin, stn mgr; Lou Morton, prog dir; Robert Gillespie, news dir; Tony Tary, chief engr.

WIOF(FM)—Dec 25, 1967: 104.1 mhz; 12.5 kw. Ant 600 ft. Box 2719 (06720). (203) 758-4459. WIOF, a division of January Enterprises Inc. Group owner: Griffin. Net: ABC/E. Rep: Eastman Radio, Knight Sales. Format: C&W ■ Merv Griffin, pres; Stephen B. Labunski, Group VP; Robert C. Ardrey, Group FM VP and gen mgr; Rich Shae, prog dir; Tom Reynolds, news dir.

WQQW—November 1934: 1590 khz; 5 kw-U, DA-1, 499 Boyden St. (06704). (203) 753-2121. Waterbury Radio Inc. (acq 5-21-72). Net: CBS. Rep: Creed. Format: Contemporary, progressive. Spec progs: Black 4 1/2 hrs, Lithuanian 1 hr, both wkly. ■ Marshall Pite, pres & gen mgr; Tom Coffey, stn dir; Tony Autuore, mus dir; Fred Santore, chief engr; Jay Crawford, prog dir; Ben Freidland, VP. ■ Rates: \$18; 15; 18; 13.

WWCO—1946: 1240 khz; 1 kw-D, 250 w-N, Box 2777 (06720). (203) 758-2468. Winnepeg Corp. (acq 3-21-73). Audio news; APR. Rep: Masla, Northeastern Spot Sales. Format: Contemp. Spec progs: Dis-co 8 hrs wkly. ■ Peter Marcus, pres; William Raymond, gen mgr; Joe McCory, prog dir; Steve Thomas, news dir; Danny Loyns, mus dir; John Tomasiwicz, chief engr; Ed Maglio, coml mgr. ■ Rates: \$19; 16.50; 19; 14.10.

WWYZ(FM)—Aug 1, 1961: 92.5 mhz; 16 kw. Ant 790 ft. Broadcast Centre (06702). (203) 755-1121. WNAB Inc. Net: ABC. Format: Good mus.

West Hartford

WEXT—Feb 1946: 1550 khz; 1 kw-D, 630 Oakwood Ave. (06110). (203) 527-1878. WEXT Inc. (acq 8-72). Net: ABC/I. Rep: Natl Time Sales. Format: Modern Country. Spec progs: Talk 1 hr wkly, Ethnic (all day Sunday). ■ Harold Reiner, pres; Mike Blumberg, VP & gen mgr; Mort Roberts, asst gen mgr & opns mgr; Lee Kaplan, sls mgr; John Parks, prog dir; Bill Albert, news dir.

WRYM—See New Britain, Conn.

***WVUH(FM)**—July 15, 1968: 91.3 mhz; 1 kw. Ant 520 ft. Stereo. 200 Bloomfield Ave. (06117). (203) 243-4703. Archibald Woodruff. Format: Progs. Spec progs: Black 8 1/2 hrs; jazz 12 hrs; Czech 1 hr, all wkly. ■ Mel Yates, gen mgr.

West Haven

***WNHU(FM)**—1973: 88.7 mhz; 1.7 kw. Ant 150 ft. 300 Orange Ave. (06516). (203) 934-9296. University of New Haven Inc. Format: Progressive, black. Spec progs: Classical 6 hrs; jazz 6 hrs; Natl pub radio 4 hrs, all wkly. Richard L. Gelgauda, gen mgr; Thomas G. Kuser, stn mgr; Donald G. Fertman, prog dir; Robert Russo, chief engr; Thomas Sabellico, mus dir.

Westport

WDJF(FM)—See listing following WMMM.

WMMM—April 15, 1959: 1260 khz; 1 kw-D, DA. Box 511 (06880). (203) 227-5133. Westport Bcstg Co. (acq 2-15-60). Rep: Market 4. Format: Easy lstng. Spec prog: Ital 3 hrs wkly. ■ Gary Flamm, gen mgr; Terry Smith, prog dir; Gary Zenobia, news dir; Larry Cohen, chief engr.

WDJF(FM)—Co-owned with WMMM. Sept 1, 1962: 107.9 mhz; 50 kw. Ant 245 ft. Stereo. Format: Adult contemporary.

***WWPT(FM)**—1975: 90.3 mhz; 330 w. Ant 110 ft. Staples High School, 70 North Ave. (06880). (203) 226-9772. Board of Education, Town of Westport. Format: Variety, progressive. Spec progs: classical 15 hrs; jazz 8 hrs; pub aff 3 hrs, all wkly. ■ Michael Barzelay, gen mgr; Mark Lamb, prog dir; Andy Henderickson, chief engr.

Willimantic

WILI—October 1957: 1400 khz; 1 kw-D, 250 w N, Box 496 (06226). (203) 423-1621. Nutmeg Bcstg Co. (acq 5-59). Net: ABC/C; Conn. Public Information. For-

mat: Progressive. Spec progs: Fr 1 hr; farm 1/2 hr; Pol 2 hrs; Sp 1 hr; Ukrainian 1 hr, all wkly. ■ Herbert C. Rice, chmn; Michael C. Rice, pres; David M. Evan, gen & coml mgr; David Evan, prog dir; Mark Roy, news dir; Wayne Norman, mus dir. Colin K. Rice, chief engr. ■ Rates: \$12; 10; 12; 8.

WXLS-FM

Young and Beautiful

WXLS(FM)—June 16, 1975: 98.3 mhz; 3 kw. Ant 300 ft. Box 98 (06226). (203) 456-2251. Windham Broadcasting Group. Format: MOR, beautiful music. ■ Kenneth Dawson, pres; Peter R. Aucoin, gen mgr; James Esposito, coml mgr; Bob Scott, prog dir; Jason McCarter, mus dir; Bob Summers, prom mgr; Corey Chapin, news dir; Peter Gowen, chief engr. ■ Rates: \$15; 12; 15; 12.

Windsor

WKND

Total Black Experience

WKND—May 4, 1961: 1480 khz; 500 w-D, DA. Box 1480 (06095). (203) 688-6221. KND Corp. (acq 8-20-69). Format: Black. ■ Kenneth Dawson, pres & gen mgr; Phyllis J. Segalman, coml mgr; Rick Foy, prog dir; Louis Brown, news dir; Marion Thornton, prom mgr; Peter Gowen, chief engr; Gregory Dixon, mus dir. ■ Rates: \$20; 19; 20; 19.



Delaware

Bethany Beach

WWTR-FM—June 20, 1974: 95.9 mhz; 3 kw. Ant 300 ft. Box 366 (19930). (302) 539-4046. Connor Bcstg Co. Audio news: APR. Format: MOR. Spec progs: Farm 1 hr wkly. ■ J. Parker Connor, pres & gen mgr; Susan C. Connor, asst gen mgr; Mason Stone, mus dir; Ronald Jones, coml mgr; J. Parker Connor Jr., chief engr.

Dover

WDOV—1948: 1410 khz; 5 kw-U DA-N, Drawer "B," (19901). (302) 674-1410. Dover Bcstg Co. (acq 1956). Group owner: Rau Radio. Net: MBS. Rep: Carpenter. Format: Contemp. Spec progs: Black 3 hrs wkly. ■ Henry Rau, chmn; Lloyd Smith, pres; Thomas J. Miles, gen mgr; Donald Culver, coml mgr; Ernest Colburn, prog dir; Les Daffin, mus dir; Gary Laing, news dir; George Rond, chief engr. ■ Rates: \$12.94; 8.24; 10.59; 8.24.

WDSO(FM)—Co-owned with WDOV. 1956: 94.7 mhz; 50 kw. Ant 360 ft. (302) 734-5816. Progs sep from AM. Stereo. Format: MOR. ■ Pete Adlam, mus dir. ■ Rates: \$10.59; 10.59; 10.59; 10.59.

WKEN—Aug 2, 1957: 1600 khz; 500 w-D, 1 kw-N, DA-N, Box 553 (19901). (302) 674-1234. Capitol Bcstg Corp. (acq 1-22-63). Net: ABC/E. Format: MOR. Spec prog: Farm 1 hr wkly. Philip G. Adams, pres; Jin Stayton, coml mgr; Joan Adams, prom mgr; Howard Redman, chief engr. ■ Rates: \$7.70; 5.50; 7.70; 5.

Georgetown

WJWL—June 23, 1961: 900 khz; 1 kw-D, Box III (19947). (302) 856-2567. Scott Bcstg Corp. (acq 4-1-61). Group owner: Great Scott Stns. Format: MOR. ■ Herbert Scott, pres; Edward Marzosa, gen mgr; Robert Smith, prog & mus dir; Jeff Pringle, news dir; Steve Wallace, chief engr. ■ Rates: \$7.50; 7.50; 7.50; 7.50.

WSEA(FM)—Co-owned with WJWL. July 4, 1969:

93.5 mhz; 2.10 kw. Ant 350 ft. Prog sep from AM. Format: Contemp. ■ Edward Marzoga gen mgr; Tom Webb, prog & mus dir. ■ Rates: \$7;6;7;6.

Hockessin

***WZEE(FM)**—May 20, 1975: 88.7 mhz; 10 w. Ant 70 ft. Lancaster Pike (19707). (302) 239-5263 or 239-2618. Format: Top 40. ■ Terence N. Mills, dir of communications; Michael Wood, stn mgr.

Milford

WAFL(FM)—See listing following WTHD.

WTHD—1953: 930 khz; 500 w-D, DA. Box 324 (19963). (302) 422-7575. Broadcasters Inc. (acq 9-3-67). Audio news: APR. Format: MOR, C&W. ■ Thomas H. Draper, pres; Larry Sharp, gen & coml mgr; Dennis Hazzard, prog dir; Joe Scott, news dir; Mark Crouch, chief engr.

WAFL(FM)—Co-owned with WTHD. May 19, 1973. 97.7 mhz; 3 kw. Ant 240 ft. Dups AM afternoons. Format: C&W.

Newark

WNRK—Aug 17, 1964: 1260 khz; 500 w-D, DA. Box 425 (19711). (302) 737-5200. Radio Newark Inc. Net: ABC/C. Rep: Devney Organization; Dome Assoc. Format: Talk, oldies, contemp, C&W. Spec progs: Classical ½ hr wkly. ■ Wm. S. Cook, pres & gen mgr; John Patrick, prog & mus dir; Charles Breza, chief engr; James R. Lindley, news dir. ■ Rates: \$8;7;8;—.

Rehoboth Beach

WLRB(FM)—1975: 92.7 mhz; 3 kw. Ant 300 ft. County Rd. 288 (19971). Melvin Gollub.

Seaford

WSUX—1955: 1280 khz; 1 kw-D. Box 1280 (19973). (302) 629-6636. Beach Broadcasting Inc. (acq 8-16-74). Net MBS. Rep: Walton, Dome. Format: contemp. Spec prog: Farm 3 hrs. ■ Don Crisp, pres; Bill Crisp, gen mgr & chief engr; Al Frazier, prog & mus dir; Naomi Price, news dir. ■ Rates \$4;4;4;4.

WSUX(FM)—Feb 1972: 98.3 mhz; 3 kw. Ant 230 ft. Dups AM 100%. ■ Rates same as AM.

Wilmington

WAMS—1947: 1380 khz; 5 kw-D, 1 kw-N, DA-3. Box 3677 (19807). (302) 654-8881. Rollins Bcstg of Delaware Inc. Group owner: Rollins. Net: ABC/C. Format: Contemp. ■ James C. Roddey, group VP; Paul H. Downs, VP radio; Phil Schweinfurth, gen mgr; Ray Quinn, prog dir; Jay Christian, mus dir; Steve Downs, chief engr; Matt L. Kovich, news dir. ■ Rates: \$22; 16; 22; 12.

WDEL—1922: 1150 khz; 5 kw-U, DA-2. 2727 Shipley Road (19899). (302) 478-2700. Delmarva Bcstg Co. (acq 1931). Group owner: Steinman Stns. Net: NBC. Rep: Pro/meeker, Steinman. Spec prog: Farm 1 hr wkly. ■ Harry J. Shaub Jr, exec VP & gen mgr; Harvey C. Smith, stn mgr; C. Robert Taylor, coml mgr; Harold E. Miller Jr, natl sls mgr; Manning Kimmel, news dir; Richard V. Ayselotte, prom mgr; Alan Parker, prog dir; George Moyer, chief engr.

WSTW(FM)—Co-owned with WDEL. 1950: 93.7 mhz; 50 kw. Ant 490 ft. Prog sep from AM. Stereo. Format: Btl mus. ■ Mike Connor, coml mgr.

WILM—Oct 1, 1923: 1450 khz; 1 kw-D, 250 w-N. 1215 French Street (19801). (307) 656-9800. Delaware Bcstg Co. (acq 1949). Rep: Mastia. Format: Contemporary, black. ■ Sally V. Hawkins, pres & gen mgr; Carl Jones, coml mgr; James Reilly, prog dir; John C. Hawkins, prom mgr; E. Brandt Boylan, chief engr; Art Curley, news dir.

WJBR(FM)—January 1957: 99.5 mhz; 50 kw. Ant 500 ft. Stereo. 2617 Ebright Rd. (19810). (302) 475-4000. Radio Station WJBR. Rep: Torbet. Format: Btl mus. ■ John B. Reynolds, gen & coml mgr; John B. Reynolds Jr, stn mgr; Howard Gesner, prom mgr; Del Parks, sps dir; Karl Leatherman, chief engr. ■ Rates: \$18;22;21.8.

***WMPH(FM)**—April 23, 1970: 91.7 mhz; 28 w. Ant 74 ft. 5201 Washington St. Ext. (19809). (302) 764-5888. Board of Education of the Mount Pleasant School District. Net: ABC/FM. Format: Rock, top 40. ■ Stephen D.

Streiker, stn mgr.

WSTW(FM)—Listing follows WDEL.

WTUX—April 21, 1947: 1290 khz; 1 kw-D. Box 1830 (19899). (302) 655-8821. Port Frere Bcstg Inc. Network: MBS. Rep: Savalli/Gates. Format: MOR. ■ Gordon K. MacIntosh, pres & gen mgr; William S. Ewing, coml mgr; Richard Holmes, prog & news dir; Henry M. Cook, prom mgr; Charles Breza, chief engr. ■ Rates: \$10.50;10.50;10.50;10.50.



District of Columbia

TO BUY OR SELL A TELEVISION OR RADIO STATION

HAMILTON-LANDIS & ASSOC., Inc.

WASHINGTON, D.C. 1730 K St., N.W. (202) 393-3456	CHICAGO 1429 Tribune Tower (312) 337-2754
SAN FRANCISCO 111 Sutter St. (415) 392-5671	DALLAS 6060 N. Central Expy. (214) 691-2345

NATIONWIDE • NEGOTIATIONS FINANCING • APPRAISALS

Washington

***WAMU-FM**—Oct 23, 1961: 88.5 mhz; 50 kw. Ant 500 ft. American U. (20016). (202) 686-2690. American U. Stereo. Net: NPR; Eastern Public. Format: Noncoml diversified. Spec progs: Black 10 hrs, Jazz 12 hrs, Sp & C&W 2 hrs each, Bluegrass 13 hrs wkly. ■ Susan Harmon, gen mgr; William Brown, prog dir; David Ecleston, bus mgr; Craig Oliver, prod mgr; David Garner, chief engr.

WASH(FM)—1948: 97.1 mhz; 22.5 kw. Ant 690 ft. 5151 Wisconsin Ave., N.W. (20016). (202) 244-9700. Metromedia (acq 7-19-68). Group owner: Metromedia. Rep: Metro Radio Sis. ■ William Dalton, VP & gen mgr; Susan Breakerfield, gen sls mgr; Bob Hughes, prog dir; Bob Duckman, mus dir; Ed Tobias, news dir; Mike Byrnes, chief engr. ■ WTTG(TV) affil. ■ Rates: \$46;40;44;29.

WAVA-AM-FM—See Arlington, Va.

WCTN—See Potomac-Cabin John, Md.

WDON—See Wheaton, Md.

WEAM—See Arlington, Va.

WEEL—See Fairfax, Va.

***WETA-FM**—April 19, 1970: 90.9 mhz; 75 kw. Ant 610 ft. Stereo. 5217 19th Rd. North, Arlington, Va. (22207). (703) 536-6900. TWX 703-536-9421. Greater Washington Educational Telecommunications Assn. Inc. Net: NPR. Format: Classical. Spec progs: five coverage, talk, jazz, folk. ■ Ward Chamlerlain, pres; Michael Hardgrove, dir of radio; Bill Cerrri, opns mgr & mus dir; Kay Corcoran, prom mgr; Sam Johnson, news dir; Fred Klimes, chief engr. ■ WETA-TV affil.

WFAN(FM)—See listing following WOOK.

WFAX—See Falls Church, Va.

WGAY—See Silver Spring, Md.

WGAY-FM—June 1, 1959: 99.5 mhz; 17 kw. Ant 770 ft. Stereo. 8121 Georgia Ave., Silver Spring, Md. (20910). (301) 587-4900. TWX 710-825-0427. Greater Media

Delaware, D.C. Radio

See page C-1 for explanation of listings.

Inc. (acq 5-7-71). Rep: Katz. Format: Btl mus. Dups AM 100%. ■ Peter A. Bordes, pres; Theodore R. Dorf, gen mgr; Bob Chandler, opns mgr; John Dougan, prog dir; Charles Guy, coml mgr; Delbert Keeling, chief engr. ■ Rates: \$53;60;53;35.

WGMS—See Bethesda, Md.

WGMS-FM—1946: 103.5 mhz; 47 kw. Ant 510 ft. RKO General Inc. (group owner). Dups Bethesda, Md., 100% Stereo. TWX 710-822-9298. Rep: RKO. Radio Format: Classcl. ■ John B. Poor, pres; Jerry R. Lyman, VP & gen mgr; Martin Conn, gen sls mgr; Michael Cuthbert, prog dir; Eileen Donigan, mus dir; H. K. Leyh, chief engr.

***WGTB-FM**—Nov 7, 1960: 90.1 mhz; 6.7 kw. Ant 440 ft. Stereo. Georgetown U., 37th & O Sts, NW (20057). (202) 625-3018. The pres & board of dir of Georgetown U. Format: Progs. Spec progs: women's prog 9 hrs; alternative news, 13 hrs; quadrasonic mus, 2 hrs; Black 6 hrs all wkly. ■ Kenneth K. Sleeman, gen mgr; Geraldine Calkins, admin aide; Ken Rothschild, prog dir; Skip Pizzi, mus dir; Jude Franco, news dir; Fred Cresce, chief engr.

WGTS-FM—See Takoma Park, Md.

WHFS(FM)—See Bethesda, Md.

WHUR-FM—1971: 96.3 mhz; 24 kw. Ant 669 ft. 2600 Fourth St., N.W. (20059). (202) 265-9494. Howard University Radio. Format: Black, Contemp. Spec prog: Sp 4 hrs wkly. ■ James E. Cheek, pres; John Paul Simpkins, gen mgr; Catherine Liggins, sls mgr; Thomas E. Jones, prod dir; Jesse Fax, mus dir; Millard James Watkins, chief engr.

WINX—See Rockville, Md.

WJMD(FM)—See Bethesda, Md.

WKYS(FM)—Listing follows WRC.

WMAL—1925: 630 khz; 5 kw-U, DA-2. 4400 Jenifer St. N.W. (20015). (202) 686-3000. Evening Star Bcstg Co. (acq 5-1-38). Group owner: Evening Star. Net: ABC/I. Rep: Major Market Radio. Format: MOR. ■ Richard S. Stakes, pres; Andrew M. Ockershausen, VP; Charles A. Macatee, gen mgr; Jonathan Klein, gen sls mgr; James H. Gallant, opns mgr; Earl E. Murton, mktg svcs mgr; Terry Hourigan, prog mgr; Theodore Landphair, news & pub affrs mgr; J. B. McPherson, chief engr.

WMAL-FM—May 15, 1948: 107.3 mhz; 50 kw. Ant 410 ft. Stereo. Prog sep from WMAL. Net: ABC/FM. Contemp. ■ Vincent Genson, stn mgr; Lynn McIntosh, mgr of bcst opns; Jeffrey Greenhawt, gen sls mgr; Mike Selman, mus dir; Martha Newman, pub ser dir; Bunny Hoffberg, coml mgr; Phil DeMarne, prog dir; Tony Renaud, prom mgr. ■ WMAL-TV affil.

WMOD(FM)—See listing following WOL.

WOL—July 10 1965: 1450 khz; 1 kw-D, 250 w-N. 1680 Wisconsin Ave. N.W. (20007). (202) 338-5600. Sondersling Bcstg Corp. (7-10-65). Group owner: Sondersling. Net: MBS/Black. Rep: Howard. Format: Soul. ■ Edmond Sondersling, pres; James L. Kelsey, VP & gen mgr; Timothy O'Sullivan, gen sls mgr.

WMOD(FM)—Co-owned with WOL. September 1968: 98.7 mhz; 50 kw. Ant 490 ft. Stereo. Prog sep from AM. Rep: Buckley. Format: classic rock 'n' roll. ■ Mike Cohen, gen mgr; Steve Shulman, opns mgr.

WOOK—1940: 1340 khz; 1 kw-D, 250 w-N. 5321 First Place, N.E. (20011). (202) 722-1000. United Bcstg Co. (acq 1951). Group owner: United Bcstg. Rep: UBC Stns. Format: Black. ■ Richard Eaton, pres; E. Carlton Myers Jr, gen mgr & VP; Cliff Holland, VP opns; Harry Jeffrey, prog dir; Steve Pott, chief engr; Carl Ferguson, news dir.

WFAN(FM)—Co-owned with WOOK. 1948: 100.3 mhz; 16 kw. Ant 280 ft. Prog sep from AM. Format: Sp.

***WPWF(FM)**—Not on air, target date Jan 22, 1976: 89.3 mhz; 44.7 kw. Ant 643 ft. Rm. 868, National Press Bldg. (20045). (202) 628-0219. Pacifica Foundation. Group owner: Pacifica. ■ Greg Millard, stn mgr; Denise Oliver, prog dir; Pam Peabody, dev dir.

WPGC-AM-FM—See Morningside, Md.

WPIK—See Alexandria, Va.

D.C., Florida Radio

See page C-1 for explanation of listings.

WRC—Aug 1, 1923: 980 khz; 5 kw-U, DA-N. 4001 Nebraska Ave. (20016). (202) 686-4000. TWX 202-965-0804. National Broadcasting Co. Group owner: NBC. Net: NBC/NIS. Rep: Blair. Format: All news. ■ Jack G. Thayer, pres; Harold L. Green, gen mgr; Jeff Hedges, sls mgr; Gordon M. Peil, prog dir; Marilyn Hayden, prom mgr; Candy Wessling, mus dir; Martin Enghauser, chief engr; Frank Barnako, news mgr.

WKYS(FM)—Co-owned with WRC. Aug 1, 1947: 93.9 mhz; 50 kw. Ant 480 ft. Prog sep from AM. Rep: Eastman Radio. Format: Disco stereo. ■ WRC-TV affil.

WTOP—Sept 25, 1926: 1500 khz; 50 kw-U, DA-2. Bdcst House (20016). 686-6000. Post-Newsweek Stns Capitol Area Inc. (acq 2-9-49). Group owner: Post Newsweek. Net: CBS. Audio news: AP. Rep: CBS Radio Spot Sales. Format: All news. ■ Joel Chaseman, chmn of bd; Peter Alund, VP & gen mgr; Orrin McDaniels, gen sls mgr; Morry Alter, news dir; Granville Klink, chief engr. ■ WTOP-TV affil. ■ Rates: \$105;65;65;30.

WUST—1949 1120 khz; 1 kw-D. 815 V St. N.W. (20001). 462-0011. S.J.R. Communications Inc. (acq 3-4-70). Group owner S.J.R. Format: Gospel. ■ Edward Cosman, pres; Daniel Diener, gen mgr; Perry Walders, gen sls mgr; Eugene Forest, prog dir; John Hammond, news dir; Gary Mess, chief engr.

WWDC—1941: 1260 khz; 5 kw-U, DA-2. Box 4068 (20015). (301) 589-7100. TWX 710-825-0078. Capitol Broadcasting Co. (acq 1975). Net: ABC/E. Rep: Balir Radio. Format: Contemp. ■ Laurence H. Kirby Jr, gen mgr; Robert L. Canada, prog dir; Karen Klass, prom mgr; Jack Bennett, news dir; Don Culp, chief engr; Charles Warren, news dir.

WWDC-FM—1947: 101.1 mhz; 50 kw. Ant 500 ft. Buds WWDC 49%. Stereo.

Florida

HAMILTON-LANDIS & ASSOCIATES, Inc.
NATIONWIDE MEDIA BROKERS
WASHINGTON, D. C., CHICAGO, DALLAS, SAN FRANCISCO
SELL **MORE**
RADIO & TELEVISION STATIONS
IN THE EAST—NEAREST OFFICE IS
1730 K ST., N.W., WASHINGTON 20006
(202) 393-3456

Apopka

WTLN—May 4, 1964: 1520 khz; 5 kw-D, DA. Box 2448, Orlando, Fla. (32802). (305) 889-2505. Alton Rainbow Corp. Net: ABC/C. Format: Relig, MOR. ■ Thomas H. Moffit, pres; Tom Moffit Jr, gen mgr; Ken Crowder, news dir; Fred Wise, chief engr. ■ Rates: \$8;8;8.

WTLN-FM—Sept 1, 1968: 95.3 mhz; 3 kw. Ant 140 ft. Orange County Bcstrs. Prog dups AM 100%. ■ Rates same as AM.

Arcadia

WAPG—September 1955: 1480 khz; 1 kw-D. Box 632 (33821). (813) 494-2525 or 494-2426. Arcadia-Punta Gorda Bcstg Co. Inc. (acq 2-3-59). Rep: KBS. Format: Free style. ■ Murray Benton, pres, gen & prom mgr & chief engr; Jim Vaughan, coml mgr; Ruth Benton, prog dir; Charles Burkhart, mus dir.

Atlantic Beach

WJNJ-FM—See listing following WKTX.

WKTX—Jan. 30, 1958: 1600 khz; 1 kw-U. Box 808 (32233). (904) 246-6459. WKTX Inc. (acq 10-1-70). Rep: Bunchez. Audio news: APR. Format: MOR. ■ William H. Bivens, pres, coml mgr & chief engr; Jack Donnell, gen mgr & news dir; Gerald Brown, prog dir; William Harper, coml mgr; Walli Wade prom mgr. ■ Rates: \$6.50;5.25;6.50;5.25.

WJNJ-FM—Co-owned with WKTX. July 1967: 104.9 mhz; 3 kw. Ant 285 ft. Dups AM 66%. Format: MOR.

Auburndale

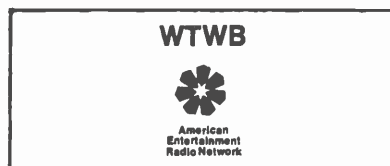

WTWB—Oct. 10, 1956: 1570 khz; 5 kw-D. Box 7 (33823). (813) 967-1570. L. M. Hughey (acq 2-57). Net: ABC/E. ■ L. M. Hughey, pres; Richard W. Boyce, gen & coml mgr & prog dir; Paul Garber, chief engr. ■ Rates: \$2.80;2.80;2.80;2.80.

Avon Park

WAPR—Oct. 1, 1970: 1390 khz; 1 kw-D. Box 1390 (33825). (813) 453-3139. Avon Electronics Services. Net: ABC/E. Format: C&W, religious. Spec prog: Farm 6 hrs wkly. ■ Charles A. Esposito, pres & chief engr; Chuck Shane, gen mgr; Louis M. Neale, coml mgr; Bruce Strenth, prog dir; Charlie O. Coffman, news dir. ■ Rates: \$2.50;2.50;2.50,—.

Bartow

WBAR—Sept. 28, 1953: 1460 khz; 1 kw-D. Box 820 (33830). (813) 533-8021. Polk County Broadcasters Inc. (acq 4-18-72). Format: C&W. ■ Michael Freeland, pres; Jim Miles, gen & coml mgr; Dick Goleno, prog & mus dir & prom mgr; Terry Parker, news dir; Frank Berry, chief engr.

WPUL—Sept. 16, 1969: 1130 khz; 1 kw-D. Box 1433 (33830). (813) 533-9093. Trans-Florida Radio Inc. (acq 7-24-72). Rep: Admiral. Audio news: UPI. Format: C&W. Spec prog: Farm 2 hrs wkly. ■ Robert D. Morris, pres; LeRoy Bradley, gen mgr & news dir; Don Goolsby, prog dir; George E. Turner IV, chief engr. ■ Rates: \$69;60;69;60.

Belle Glade

WSWN—Oct. 5, 1947: 900 khz; 1 kw-D. Box 786 (33430). (305) 996-2063. Seminole Bcstg Co. Group owner: Dee Rivers. Net: MBS. Rep: Gill-Perna. Spec progs: Black 2 hrs wkly. ■ E. D. Rivers Jr, chmn of bd; Marvin M. Smith, gen mgr; Philip T. Haire, coml mgr; James C. Sims, prog dir; Simon Train, mus dir; Dave Edwards, news dir; Ned Smith, sps dir; C. C. Turner Jr, chief engr; Don Garner, prom mgr; Diana Scott, traf mgr.

WSWN-FM—May 31, 1965: 93.5 mhz; 3 kw. Ant 255 ft. Stereo. Format: MOR. Spec progs: Black 16 hrs wkly.

Blountstown

WKMK—Sept. 8, 1962: 1000 khz; 1 kw-D. 419 N. Main St. (32424). (904) 674-5403. Calhoun Bcstg Corp. (acq 5-74). Format: Contemp, variety. Spec progs: Black 2 hrs wkly. ■ Peter L. Anderson, gen mgr; James Grantham, prog dir; James A. Maupin, chief engr.

WRTM(FM)—Dec. 18, 1968: 102.3 mhz; 3 kw. Ant 145 ft. Maupin Bcstg Co.

Boca Raton

WSBR—April 1965: 740 khz; 1 kw, DA-D. Box WSBR (33432). (305) 391-7400. Burbach Radio Inc. (acq 1968). Rep: Dora-Clayton. Format: MOR. Spec prog: Sp 1 hr wkly. ■ John Laubach, pres; George V. Liddy, gen mgr; Don Smith, prog dir; Audrey Fox, office & traffic mgr; Walt MacTommany, chief engr.

WVOG(FM)—Oct. 17, 1965: 99.9 mhz; 100 kw. Ant 280 ft. Stereo. (CP: Ant 930 ft.). Box 1297 (33432). (305) 395-7515. WVOG Inc. Format: Easy Istng. ■ Homer Akers, pres, gen mgr & chief engr; Herman A. Youngman, prog dir; Bob Williams, news dir.

Bonita Springs

WLEQ(FM)—Co-owned with WKEM, Immokalee, Fla. Sept. 1, 1974: 95.9 mhz; 3 kw Ant 310 ft. Suite 202, Scott Bldg., Ft. Meyers (33901). (813) 334-1996.

Jerome Bcstg. Net: ABC/C. Rep: Mario Messina. Format: Top 40, rock. ■ C.J. Jones, pres & gen mgr; Harry Rome, sls mgr; Rick Allen, prog & mus dir; Jerry Heckerman, chief engr. ■ Rates: \$11.50;10.50;11.50;10.50.

Boynton Beach

***WHRS(FM)**—Nov. 24, 1969: 91.7 mhz; 3 kw. Ant 200 ft. 505 S. Congress Ave. (33435). (305) 732-7850. TWX 305-732-8238. School Bd. of Palm Beach County. Net: NPR. Format: Fine Arts, classical, Sp. Spec progs: Ger 2 hrs, Black 6 hrs wkly. ■ John H. Burger, gen mgr; Sam Barbaro, prog mgr; Pat O'Meara, pub affrs dir; Melvin Cohen, chief engr.

WKAO—January 25, 1973: 1510 khz; 1kw-D. Box 1510 (33435). (305) 737-5000. N. Am Bcstg Co. Net: MBS. Format: Btfl music. ■ Mark C. Prichard Jr, pres, sls mgr; John H. Sowers, prod, opns mgr; Jim Johnson, chief engr.

Bradenton

WBRD—October 1957: 1420 khz; 1 kw, DA-D. Box 1038 (33506). (813) 746-2183. Sunshine State Bcstg Co. Net: ABC/L. Rep: Savalli/Gates. Format: Modern C&W. ■ Robert R. Nelson, pres; R. W. Nelson, gen mgr & chief engr; Edward C. Hyers, coml mgr; Maggie Chance, prom mgr; Bob Barnes, prog dir; Mike Simions, news dir. ■ Rates: \$13;10;11;11.

WUV(FM)—Co-owned with WBRD. 1963: 103.3 mhz; 100 kw. Ant 450 ft. Stereo. Box 240 (33505). (813) 746-9173. Format: Btfl music. ■ Robert W. Nelson, prog & mus dir; G. Douglas Pidgeon, coml mgr. ■ Rates: \$17.50;17.50;17.50;17.50.

WTRL—1946: 1490 khz; 1 kw-D, 250 w-N. Box 1490 (33505). (813) 746-1107. WTRL Bcstg (acq 7-74). Net: MBS. Rep: Avery-Knodel. Format: MOR. ■ Bo Mitchell, pres & gen mgr; Morgan Stinemetz, coml mgr; Dave Barker, prog dir; Dean Edwards, news dir; Gerald McGougan, chief engr.

Brooksville

WJWB—Oct. 11, 1958: 1450 khz; 1 kw-D, 250 w-N. Box 1507 (33512). (904) 796-7272. Hunter-Knight Bcstg Inc. (acq 2-8-71). Audio news: UPI. Rep: Dora-Clayton. Format: MOR. Spec prog: Talk 14 hrs wkly. ■ Philip M. Knight, pres, gen mgr & chief engr; Bill Perry, prog & mus dir, coml mgr. ■ Rates: \$4.50;4.50;4.50;3.50.

Cape Coral

WRCC(FM)—1975: 103.9 mhz; 3kw. Ant 300ft. Dr. E. Paul Eder.

Chattahoochee

WSBP—Nov. 1, 1963: 1580 khz; 1 kw-D. Radio Road (32324). (904) 663-2323. Radio Station WSBP (acq 5-1-68). Rep: Carpenter. Format: C&W. ■ Roscoe Fleetwood, pres, gen & coml mgr; Bill Parker, prog dir; Doris DeVane, chief engr.

Chiefland

WLOH—June 6, 1968: 940 khz; 500 w-D. Box 98 (32626). (904) 493-4940. White Construction Co. Inc. Format: C&W 60%, MOR 10%, Rock 30%. Spec progs: Relig 8½ hrs wkly. ■ Luther White, pres; Norma W. Schosler, gen & coml mgr; Allan Johns, prog dir; Evelyn Schosler, mus dir; Mike Sherrell, chief engr.

Chipley

WBGC—April 10, 1956: 1240 khz; 1 kw-D, 250 w-N. South Blvd Extension (32428). (904) 638-0234. Sunny Hills of Chipley (acq 12-12-72). Format: C&W. ■ William A. Masi, pres & gen mgr; Stephen D. Smith, coml & prom mgr & news dir; Phillip C. Faulkner, prog & mus dir; G. D. McKechnie, chief engr.

Clearwater

WAZE—Nov. 21, 1959: 860 khz; 500 w-D, DA. Box 930 (33517). (813) 446-8575. Three Rivers Communications Inc. (acq 1-74). Rep: Piano. Format: Contemp, MOR. ■ Carl J. Marocco, pres & gen mgr; Duane Lemley, station mgr; Dave Rhodes, opns mgr, prog & mus dir; C. L. Boyer, chief engr.

CLEARWATER/ST. PETERSBURG
WQXM
 Beautiful Music
 Plough Broadcasting Co., Inc.



WQXM(FM)—December 1967: 97.9 mhz; 100 kw. Ant 505 ft. Stereo. Box 4809 (33518). (813) 391-9988. Plough Bcstg Inc. (group owner: acq 2-1-75). Net: ABC/I. Rep: H.R. Stone. Format: Btfl mus. ■ H. Wayne Hudson, pres; Jim Johnson, gen mgr; John Mocsary, news dir; David McKay, prog dir; Carr MacCormack, chief engr. ■ Rates: \$19;20;19;18.

WTAN—June 1948: 1340 khz; 1 kw-D, 250 w-N. Box 1109, 200 Pierce St. (33517). (813) 446-3084. Clearwater Radio Inc. (acq 1-58). Net: ABC/I. Format: MOR. ■ H. Dennison Parker, pres & gen mgr; James J. Short, coml mgr; Frank L. Reid, asst mgr & chief engr.

WTAN-FM—Aug. 19, 1963: 95.7 mhz; 18 kw. Ant 130 ft. Stereo. Dup AM 14%. Format: Stand pop.

Clermont

WWFL—Sept. 30, 1962: 1340 khz; 250 w-SH. Box 948 (32711). (904) 394-2177. WWFL, Inc. Leisure Time Comm. (acq 4/75). Format: MOR. Spec prog: Sp 1 hr wkly. ■ George D. Williams, pres & gen mgr. ■ Rates: \$5.60;5.60;5.60;5.60.

Cocoa

WEZY—Oct. 4, 1957: 1350 khz; 1 kw-U, DA-N. Box 2029 (32922). (305) 636-4411. WEZY Inc. (acq 12-27-70). Net: ABC/C. Rep: Carpenter. Format: Contemp. ■ Ted H. Taylor, pres & gen mgr; Duane Hartung, coml mgr; Dale Wright, ops mgr; Tom Hutchinson, news dir; Chuck Cole, chief engr.

WEZY-FM—June 15, 1967: 99.3 mhz; 3 kw. Ant 285 ft. Stereo. Dup AM 100%.

WKKO—January 1952: 860 khz; 1 kw-U. Box 3188 (32922). (305) 636-2411. ECOM Assoc. (acq 8-1-75). Rep: PRO/Meeker. Format: Top 40, Cross-overs & old gold. ■ H.W. (Bill) Maschmeier, pres, gen & coml mgr; Kris Kelly, mus dir; Tom Collins, news, prog, prom dir & chief engr. ■ Rates: \$8.80;7.70;8.80;7.70.

WWBC—July 11, 1964: 1510 khz; 250 w-D. Box 493 (32922). (305) 632-1400. Astro Enterprises (acq 9-29-66). Rep: Bernard. Format: C&W. ■ John Fox, pres & gen mgr; Bill Diamond, coml mgr; Stan Anderson, prog dir & chief engr; Mercer Livermore, news dir.

Cocoa Beach

WCKS(FM)—July 19, 1962: 101.1 mhz; 100 kw. Ant 440 ft. Stereo. Box 520 (32931). (305) 783-9257. Southland Bcstg. (acq 9-11-71). Audio news: UPI. Format: MOR. ■ William R. Corkum, pres; Les Roberson, gen mgr; Tom Morley, coml mgr; Fred King, prog dir; Michael W. Lowe, mus dir; Bill Baker, chief engr. ■ Rates: \$5.50;5.50;5.50;5.50.

WRKT—June 22, 1959: 1300 khz; 5 kw-D, 1 kw-N, DA-2. Box 3845, Cocoa, Fla. (32922). (305) 632-1300. Bucks County Radio News (acq 6-1-68). Net: NBC. Rep: Torbet. Format: MOR, Top 40. ■ Chester E. Pike Jr., pres & gen mgr; Sandy Gambelin, coml mgr; Ben Hill, prog dir; Jim Sumpter, mus dir; Jim Pierce, prom mgr; Gary Henderson, news dir; Ron Schrader, chief engr.

WRKT-FM—May 8, 1962: 104.1 mhz; 30 kw. Ant 165 ft. Stereo. Format: Btfl mus, MOR.

Coral Gables

WRHC—June 20, 1969: 1550 khz; 10 kw-D, DA. 220 Miracle Mile, Suite 201 (33134). (305) 445-1488. Radiocentro Broadcasting Co. (acq 11-27-73). Format: Relig. Sp. Spec progs: Greek 1½ hrs wkly; Hungarian 1 hr wkly. ■ Salvador Lew, pres, gen mgr & news dir; Tomas Garcia Fuste, coml & prom mgr; Alberto Villalobos, (Sp), Liz Shea (relig), prog dirs;

Ricardo Jorge, mus dir; Donald V. Gause, chief engr. ■ Rates: \$114;144;144;144.

WVCG Radio 1080
 Stereo 105 FM

WVCG—Feb. 18, 1949: 1080 khz; 10 kw-D, 500 w-N, DA-2. 377 Alhambra Circle (33134). (305) 445-5411. TWX 810-848-8151. Independent Music Bcstrs Inc. (acq 6-67). Net: NBC. Rep: McGavren-Guild. Format: Btfl music. ■ Ted Niarhos, pres; Lynn A. Christian, gen mgr; Bud Melton, coml mgr; Betty Niarhos, prom dir; Les Smith, news dir; Earl Miller, chief engr. ■ Rates: \$60;48;57;34.

WYOR(FM)—Co-owned with WVCG. Nov. 15, 1958: 105.1 mhz; 160 kw. Ant 190 ft. Stereo. Prog sep from AM. ■ Rates same as AM.

***WVUM(FM)**—May 1968: 90.5 mhz; 35.4 w. Ant 175 ft. Stereo. Box 248191 (33124). (305) 284-6706. Men's Residence Halls Assoc. Audio news: UPI. Format: Progs. Spec progs: Black 3 hrs wkly; classical & jazz, 4 hrs wkly; intl 4 hrs wkly. ■ Brenda Sulick, gen mgr; Lon Blake, prog dir; Chuck Bortnick, prom mgr; Larry Wallenstein, news dir; Joe Poersnick, chief engr.

WYOR(FM)—See listing following WVCG

Crestview

WAAZ-FM—See listing following WJSB.

WCNU—April 8, 1948: 1010 khz; 1 kw-D. Box 518 (32536). (904) 682-2330. Gulf Shores Bcstg Co. (acq 5-1-74). Format: C&W. Spec prog: Gospel 12 hrs wkly. ■ Sam F. Townsend, pres; Jerry W. Milligan, Sr, gen mgr & news dir; W.A. Chestnut, mus dir; Leonard Lindsay, chief engr. ■ Rates: \$3.75;3;3;-.

WJSB—Sept. 15, 1954: 1050 khz; 1 kw-D. Box 267 (32536). (904) 682-3040 or 682-4623. TWX 904-682-3040. Crestview Bcstg Co. (acq 8-1-70). Net: CBS. Format: C&W, MOR. ■ James T. Whitaker, pres, gen mgr & chief engr; Betty Whitaker, prom mgr; George L. Cain, prog & mus dir; Jimmy Hugh Howell, coml mgr; Brad McDuffie, news dir.

WAAZ-FM—Co-owned with WJSB. July 15, 1965: 104.9 mhz; 3 kw. Ant 275 ft. Dups AM 30%. Format: C&W.

Crestview

WRYO(FM)—Not on air, target date unknown: 98.5 mhz; 100 kw. Ant 430 ft. Box 419A, Rte. 1, Leesburg, Va. (22075). Electra Bcstg Corp. of Florida.

Cypress Gardens

WGTO
 Adult-Contemporary
 Hubbard Broadcasting, Inc.

WGTO—Sept. 9, 1955: 540 khz; 50 kw-D, 10 kw-N (CH), DA-2. Box 123 (33880). (813) 324-5400. Hubbard Bcstg Inc. (group owner: acq 5-1-58). Net: ABC/C. Rep: Petry. Format: MOR, Top 40. Spec prog: Farm 1 hr wkly. ■ Stanley S. Hubbard, pres; Robert Artabasy, gen mgr; Terry Vani coml mgr; John Terry, news & prog dir; Dick Bennick, prom mgr; Joe Patrick, mus dir; Paul Titchenal, chief engr. ■ Rates: \$12;12;12;12.

Dade City

WDCF
 FAB

WDCF—December 1954: 1350 khz; 1 kw-D. Box 1077 (33525). (904) 567-5683. Dade City Radio Inc. (acq 11-70). Format: C&W. ■ R. Duane Anderson, pres; Patricia Webb, VP; Bert Pardun, stn mgr; Ray Webb, gen mgr; Jay Perry, mus dir; Jeff Williams, news dir; Jim Johnson, chief engr. ■ Rates: \$3.28;2.85;3.28;2.85.

Florida Radio

See page C-1 for explanation of listings.

Daytona Beach

WDAT—Aug. 1, 1957: 1380 khz; 1 kw-U, DA-N. Box 5038 (32020). (904) 677-4122. National Communications Industries Inc. (acq 2-15-71). Net: NBC. Rep: Masia. Format: Top 40. ■ William P. Hunter, pres; Richard R. Lange, gen mgr; Jim Dunaway, prod dir; Mark Windsor, mus dir; Mike Jay, news dir.

WDNJ(FM)—See listing following WDNB.

WELE—See South Daytona.

WMFJ—April 16, 1935: 1450 khz; 1 kw-D, 250 w-N. Box 5806 (32020). (904) 255-1456. Walter-Weeks Bcstg Inc. (acq 2-5-65). Net: ABC/C. Rep: Torbet; Don Bonestell. Format: Top 40. Spec progs: Farm, black, 5 hrs wkly. ■ Robert M. Weeks, pres; Dick Clark, exec VP; Bill Kirk, gen mgr; Dain Eric, prog dir; Russ Morley, prom & mus dir; Dave Archard, sis mgr; Danny Watts, chief engr. ■ Rates: \$13;11;12;9.

WMFJ-FM—Nov. 1, 1967: 101.9 mhz; 25 kw horiz, 7.4 kw vert. Ant 110 ft. Stereo. Format: Btfl music. ■ Ron Kleinstiver, coml mgr. ■ Rates: \$13;12;13;10.

WNDB—April 1948: 1150 khz; 1 kw-U, DA-N. Box 712 (32017). (904) 253-1150. Quality Bcstg Corp. (acq 11-6-72). Net: CBS. Format: MOR. Spec prog: Classl 14 hrs wkly. ■ Victor M. Knight, pres; Elliot W. Harris Jr, VP & gen mgr; John Ferree, prog dir & prom mgr; Copeland Guice, coml mgr; Ron Kay, mus dir; Bill Bowser, news dir; Bill Lemmon, chief engr. ■ Rates: \$9.50;8;9;50;8.

WDNJ(FM)—Co-owned with WDNB. March 1947: 94.5 mhz; 54 kw. Ant 330 ft. Stereo. Prog sep from AM. Format: Btfl mus. Spec prog: Classl 17 hrs wkly.

WOGO—See New Smyrna Beach.

WROD—1947: 1340 khz; 1 kw-D, 250 w-N. Box 991 (32015). (904) 252-4626. WROD, Div of Elyria-Lorain Corp. (acq 4-67). Net: ABC/E. Rep: David Carpenter. Format: MOR, Oldies. ■ Otto B. Schoepfle, pres; William A. Stipits, gen mgr; Paul Nakel, VP-group ops; Mickey Puleo, coml mgr; Bob Suess, prog dir; Bob Edwards, news dir; Jon Apfeld, chief engr. ■ Rates: \$6.20;5.45;6.20;4.40.

DeFuniak Springs

WGTX—March 1, 1956: 1280 khz; 5 kw-D, DA. Drawer 627 (32433). (904) 892-3158. Eueche Valley Bcstg Co. Inc. (acq 10-14-69). Rep: Beaver, Keystone. Format: MOR 75%, rel 10%, C&W 15%. Spec prog: Farm 2 hrs wkly. ■ E. F. Robinson, Jr, pres & gen mgr.

WQUH(FM)—Co-owned with WGTX. November 1974: 103.1 mhz; 3 kw. Ant 180 ft. Dups AM 100%.

WZEP—1955: 1460 khz; 1 kw-D. Box 387 (32433). (904) 892-5231. Leonard S. Zepp (acq 3-1-59). Format: Variety. Spec prog: C&W 2 hrs wkly. ■ Leonard S. Zepp, pres, gen mgr & chief engr; DeLois Padgett, news dir & prog dir; Linda Zepp, mus dir.

Deland

WELE-FM—July 10, 1967: 105.9 mhz; 76 kw. Ant 245 ft. Drawer F (32027). (904) 734-3100. WELE Radio Inc. (acq 5-1-74). Net: MBS. Rep: Media/Sales South. Format: C&W ■ Sidney Frazer & Sheldon Katz, co-owners; Gene McMahon, VP & gen mgr; John Milner, stn mgr; Jim King, mus dir; J. D. Tillis, chief engr.

WETO—Sept. 10, 1948: 1490 khz; 1 kw-D, 250 w-N. Box 877 (32720). (904) 734-9386. WETO Inc. (acq 8-74). Net: ABC/C/E. Format: Contemp. MOR. ■ Jon C. Peterson, pres; G. Nolan Kenner, gen mgr & news dir; Dahlon G. Ritchey, prog dir; Steven G. Prickett, prom mgr; Andreas C. Thomsen, chief engr.

WKKX—Dec 7, 1956: 1310 khz; 5 kw-D. Box 727 (32720). (904) 736-3700. Deland Bcstg Inc. (acq 5-1-73). Rep: Southern Spot Sis. Format: C&W. ■ David R. Hill & Gene N. Stuart, co-owners; Tom Joyner, pres & gen mgr; Brian Taylor, coml mgr; Fred West, prog & mus dir; Dave Kennedy, prom mgr; Tammie Williams, news dir; Bruce Kuckert, chief engr.

Delray Beach

WDBF—February 1952: 1420 khz; 5 kw-D, 500 w-N, DA-2. Box 1420 (33444). (305) 278-1420. Quality

Florida Radio

See page C-1 for explanation of listings.

Bcstg Corp. (acq 8-13-65). Net: CBS. Format: MOR. Spec prog: Black 8 hrs, classcl 7 hrs wkly ■ Victor M. Knight, pres & gen mgr; Bruce Hamilton, opns mgr; Terry Sullivan, coml mgr

Dunedin

WDCL—1955: 1470 khz; 5 kw-D. Box 1470 (33528). (813) 784-1480. Dunedin Bcstg Co. (acq 4-73). Format: Music from 40's, 50's & 60's. Spec prog: Ital 1 hr, Greek 2 hrs wkly ■ Ross Charles, gen mgr; Ray Dunphy, coml mgr; R. Flinn, prog & news dir; Manly St. Jean, chief engr. ■ Rates: \$6.40;6.40;6.40;—.

Dunnellon

WTRS—March 2, 1970: 920 khz; 500 w-D. Rt. 1, Box 7 (32630). (904) 489-2800. Rainbow Comm Svc. (acq 1975). Group owner: Chas. E. Bell. Net: ABC/E. Format: Contemp. ■ Charles E. Bell, pres; David S. Arthurs, stn mgr.

WTRS-FM—March 3, 1969: 102.3 mhz; 3 kw. Ant 300 ft. Dups AM 90%.

Eau Gallie

WMEL—See Melbourne.

WMMB—See Melbourne.

WTAI—See Melbourne.

WYRL(FM)—See Melbourne.

Englewood

WENG—Feb. 20, 1964: 1530 khz; 1 kw-D. Box 908 (33533). (813) 474-3231. Sarasota Charlotte Bcstg Corp. (acq 2-20-64). Rep: Admiral. Format: MOR. ■ Edward J. Ewing, pres; James R. Stephenson, gen mgr & news dir; Jeffrey E. Barber, mus, prom & prog dir; Michael R. Jolty, coml mgr; Geddes Kujaneck, chief engr. ■ Rates: \$4.60;4.60;4.60;4.60.

Eustis

WLCO—June 1955: 1240 khz; 1 kw-D, 250 w-N. Box 1905 (32726). (904) 357-4191 or 357-1240. Barringer Bcstg Corp. (acq 10-24-64). Format: Top 40, C&W. Spec prog: Talk show 10 hrs wkly ■ Davis H. Barringer, pres, gen mgr & chief engr; Cullen K. Zethmay, opns, news & prog dir; Jack Casey, mus dir; Davis H. Barringer, chief engr. Artimesa Barringer, sec/tres. ■ Rates: \$10.50;9.50;10.50;9.50.

Fernandina Beach

WYHI—Sept. 1, 1955: 1570 khz; 1 kw-D. Drawer 496 (32034). (904) 261-6158. Northeast Florida Radio Inc. (acq 10-1-69). Net: Keystone. Spec prog: Black 3 hrs wkly. Format: Mod country. ■ W. W. Harrell Jr., pres; Harry P. Hancock, gen mgr; W. A. Smith, VP; Irene A. Barnes, sec; Carl Barnes, stn & prog mgr; Edward Hardee, news dir; William Alexander, chief engr.

Fort Lauderdale

***WAFG(FM)**—90.3 mhz; 3 kw. Ant 280 ft. Westminster Academy.

WAVS—Aug. 21, 1970: 1190 khz; 5 kw-D, DA. Box 7539 (33304). (305) 561-1190. Radio WAVS, Inc. (acq 5-24-75). Group owner: Sherman-Ruwitich. Net: MBS. Audio news: AP/UPI. Rep: PRO Meeker, Carpenter (Southeast). Format: All news. ■ Lowell Bud Paxson, pres & gen mgr; Robert E. Brown, coml mgr; Bob Roberts, prog dir. Howard Browne, news dir. ■ Rates: \$16;14;16;—.

WAXY(FM)—July 1960: 105.9 mhz; 100 kw horiz, 97.5 kw vert. Ant 1020 ft. Stereo. 419 S. Andrews Ave. (33301). (305) 525-6351. RKO General Inc. (group owner: acq 1-26-73). Rep: RKO Radio. Format: All oldies. ■ Bruce Johnson, pres; Michael Scheuble, gen mgr; Sam Hennings, sls mgr; John Cambling, prog dir; B. J. Bakken, prom mgr; Quincy McCoy, mus dir; Wayne DeLucente, chief engr.

WCKO-FM—See Pompano Beach.

WEXY—See Oakland Park.

WFTL—September 1946: 1400 khz; 1 kw-D, 250 w-

N. Box 5333 (33310). (305) 566-9621. WFTL Bcstg Co. (acq 8-1-58). Net: ABC/I. Audio news: APR. Rep: H.R. Stone. Format: MOR. ■ Joseph C. Amato, pres; William F. Sherry, gen mgr; Charlie Warron, prog dir; Terry Gross, mus dir; Ken Cameron, chief engr. ■ Rates: \$25;21;25;14.

WGLO(FM)—Co-owned with WFTL. Aug 15, 1962: 106.7 mhz; 100 kw. Ant 900 ft. Stereo. Format: Btlf mus. Lew Krone, gen mgr; John Corrigan, mus dir, prom mgr; Bob Boyd, news dir. ■ Rates: \$21;23;23;17.

WYHI(FM)—July 31, 1960: 100.7 mhz; 100 kw. Ant 930 ft. Stereo. 2741 N. 29th Ave, Hollywood, Fla. (33020). (305) 931-1107 or 925-7117. Heftel Bcstg. (group owner: acq 4-73). Audio news: UPI. Rep: Torbet. Format: Rock, top 40. Spec prog: Sp ½ hr wkly. ■ Cec Heftel, pres; Darby Cunningham, gen mgr; Craig Wicker, sls mgr; Bob Mazur, prom mgr; Robert W. Walker, prog dir; Quincy McCoy, mus dir; Jim Reihle, news dir; John Bailie, chief engr. ■ Rates: \$66;64;66;64.

WSHE-FM—Listing Follows WSRF

WSRF—1955: 1580 khz; 10 kw-D, 5 kw-N, DA-2. 3000 SW 60th Ave. (33314). (305) 581-1580. Van Patrick Bcstg Inc. (acq 12-66). Net: MBS. Audio news: APR. Rep: Jack Masla. Format: Live, solid gold. ■ Gene Milner, pres & gen mgr; Jackie Milner, sls mgr; Gary Granger, prom mgr; Tommy Judge, prog & mus dir; Buzz Kilman, news dir; Don Powers, chief engr. ■ Rates: \$23;21;23;19.

WSHE-FM—Co-owned with WSRF. Oct. 17, 1959: 103.5 mhz; 100 kw. Ant 570 ft. Quad stereo. Format: Adult rock. ■ Dennis Lane, mus dir; Gary Granger, prog dir. ■ Rates: \$45;50;55;55.

Fort Myers

WCAI—Aug. 22, 1964: 1350 khz; 1 kw-D. Box 2121 (33902). (813) 334-1350. Lee Bcstg inc. (acq 3-23-64). Group owner: Truman A. Morris. Net: MBS. Rep: Carpenter. Cohen. Format: MOR. ■ Truman A. Morris, pres; Ron Pierce, VP & gen mgr; Bob Jones, prog dir; Tim Corey, mus dir; Bob Hays, prom dir; Patrick Kelly, news dir; Edmund Lipecki, chief engr. ■ Rates: \$7;7;7;—.

WHEW(FM)—See listing following WMYR.

WINK—June 15, 1945: 1240 khz; 1 kw-D, 250 w-N, DA-D. Box 1080 (33902). (813) 334-1131. TWX 510-951-7371. Fort Myers Bcstg Co. Net: CBS Keystone. Rep: Meeker, Busby, Finch & Woods. Format: MOR. Spec prog: Sp ½ hr wkly. ■ Edward McBride, pres; Robert L. Rausch, VP & gen mgr; Harold Taylor, stn mgr; James Jenkins, prog dir; David Howell, prom mgr; Harve Bradley, news dir; Laverne Bawinkel, chief engr.

WINK-FM—Oct. 10, 1964: 96.9 mhz; 44 kw. Ant 250 ft. Prog sep from AM. ■ WINK-TV affil.



WLEQ(FM)—See Bonita Springs.



WMYR—Nov. 11, 1952: 1410 khz; 5 kw-U, DA-N. Box 216 (33902). (813) 332-1410. Robert Hecksher. Format: Contemp. ■ Robert Hecksher, owner, gen mgr & chief engr. ■ Rates: \$16;16;16;16.



WHEW(FM)—Co-owned with WMYR. Dec. 2, 1969: 101.9 mhz; 71 kw. Ant 175 ft. Stereo. Prog sep from AM. Format: C&W. ■ Rates same as AM.

***WSOR(FM)**—Sept. 30, 1969: 95.3 mhz; 1.5 kw. Ant 185 ft. 940 Tarpon St. (33901). (813) 334-1393. Riverside Baptist Church of Ft. Myers Inc. Audio news: UPI. Format: Christian education, gospel & religious. ■ E. S. Anderson, pres; Bill Simon, gen mgr & prog dir; Bob Favre, prod mgr; Don Howden chief engr.

Fort Pierce

WFTP—Dec. 24, 1952: 1330 khz; 1 kw-D, 500 w-N, DA-N. Box 1330 (33450). (305) 464-1330. Gulfstream Bcstg Co. (acq 4-74). Net: ABC. Rep: Gill-Perra, Messervey, Messina, Advertising Repls, Carpenter. ■ Stu Wayne, gen mgr; Robert Lyons, coml mgr; Keith Kline, prog dir; Joan Adams, prom mgr; Keith Kline, news dir; R. Stuart Money, engr.

WLQY-FM—Co-owned with WFTP. May 1, 1961: 98.7 mhz; 1.3 kw. Ant 200 ft. (CP: 40 kw. Ant 340 ft.) Dups AM 100%.

WIRA—May 18, 1946: 1400 khz; 1 kw-D, 250 w-N. Box 3032 (33450). (305) 464-1400; sls: 464-6746. Indian River Bcstg (acq 9-15-67). Group owner: Air-media. Audio news: UPI. Rep: Admiral. Format: MOR. Spec progs: Farm 1½ hrs; black 1 hr. wkly ■ Hudson C. Millar Jr., pres & gen mgr; Jim Ackerman, farm dir; Jim Lord, mus dir; Ron Landy, news dir; Fran L. Sherwood chief engr. ■ Rates: \$9;8.20;9;6.10.

WLQY-FM—Follows WFTP

WOVV(FM)—Co-owned with WIRA. Oct. 30, 1969: 95.5 mhz; 100 kw. Ant 518 ft. Stereo. Prog sep from AM. Stereo. Box 3192 (33450). (305) 464-6812. Format: Top 40. Spec progs: Farm 1 hr; black 9 hrs wkly ■ Rick Abel, mus dir. ■ Rates: \$10;9.50;10;7.

Fort Walton Beach

WFTW—Nov. 20, 1953: 1260 khz; 3 kw-D, DA. Box 10 (32548). (904) 243-7676. Vacationland Bcstg Co. Audio news: APR. Format: MOR. ■ Wilbur R. Powell, pres; Zola M. Rowley, gen & coml mgr; Carl Shelenberger, tech dir & chief engr; Al Aplin, mus & prog dir; Dick Emmons, news dir; Bill Borthwick, sls mgr.

WFTW-FM—May 28, 1965: 99.3 mhz; 3 kw. Ant 170 ft. Stereo. Dup AM 100%.

WNUE—1956: 1400 khz; 1 kw-D, 250 w-N. Drawer 400 (32548). (904) 243-6188. Smith Radio Inc. (acq 6-1-60). Rep: Torbet. Format: Top 40. Spec progs: Black 13 hrs, C&W 3 hrs wkly ■ M. D. Smith III, pres; Holley Rogers, gen mgr; Harmon Van Buskirk, coml mgr; Gabby Bruce/Art Smeeton, prog dirs; Scot Gordon/Gabby Bruce, prom mgrs; Bill Collins/Bill Thomas, mus dirs; Bill Thomas/Scot Gordon, news dirs; Jerry Ryan, chief engr.

Gainesville

WAKA—May 31, 1961: 1390 khz; 5 kw-D. Box 1024 (32601). (904) 376-2688. Oliva Bcstg Corp. (acq 11-71). Format: Btlf mus. ■ Royce D. Plummer, gen mgr; Iottis Adams, chief engr. ■ Rates: \$6;6;6;—

WDVH—October 1954: 980 khz; 5 kw-D. Box 1068 (32602). (904) 372-2528. Dae Bcstg Co. (acq 12-22-69). Net: ABC/I. Reps: Ochs, Messina. Format: C&W. ■ Larry Edwards, gen mgr; Bob Cunningham, sls mgr & chief engr; Steve Sullivan, prog dir; Jim Williams, mus dir; Don Dorenberg, news dir.

WGGG—February 1948: 1230 khz; 1 kw-D, 250 w-N. Drawer G (32602). (904) 376-1230. Quality Bcstg Corp. (acq 9-30-72). Audio news: UPI. Format: Top 40, black. ■ Victor M. Knight, pres; Elsie Mercer, gen mgr; Kent Whipple, prom mgr; Phil Williams, mus dir; Don Reid, news dir; Terry Hesters, chief engr. ■ Rates: \$9;8.40;9;5.

WGVF(FM)—May 4, 1970: 105.5 mhz; 3 kw. Ant 265 ft. Quad. Box 14585, University Station (32604). (904) 378-3806. Gerler Bcstg Co. Rep: Dora-Clayton. Format: Progs, rock, underground. ■ Irving A. Uram, pres, gen mgr & chief engr; Gertrude Koppel, coml mgr; Sarah K. Uram, sls mgr; Sylvia McCulloch, mus dir; Jackson Whitehurst, chief anncr. ■ Rates: \$.750; 7.50;7.85;7.85.

WRUF—1928: 850 khz, 5 kw-U, DA-N. Box 14-444, University Station (32604). (904) 392-0771. State of Florida. Net: NBC. Rep: W. O. Jones. Format: Rock. Spec prog: Black 4 hrs wkly. ■ Robert W. Leach, gen mgr; Whitey McMullen, coml mgr; Jim Camp, prom mgr; Lisa Stewart, prog & mus dir; Jim Finch, news dir; E. A. Siimak, chief engr.

WRUF-FM—1948: 103.7 mhz; 27 kw. Ant 360 ft. Stereo. Prog sep from AM. Format: Btlf mus.

Goulds

WGLY(FM)—Not on air, target date unknown. 98.3 mhz; 1.1 kw. Ant 460 ft. Fine Arts Broadcasting Co.

Green Cove Springs

WKKJ(FM)—Not on air; target date unknown: 92.7 mhz; 3 kw. Ant 272 ft. Residence B, Nyquist Circle (32043). James A. Wilson, Clay County Broadcasters.

Haines City

WHAN—Sept. 9, 1960: 930 khz; 500 w-D, DA. Rt. 1, Box 110 (33844). (813) 422-7502. Radio Central Inc. (acq 10-1-69). Net: ABC/I. Format: C&W, gospel. ■ John H. Everbach, pres; Paul Hershey, gen mgr, news dir & chief engr; Glen Kirkland, coml & prom mgr; Vance Ross, prog dir; Stacy Howard, mus dir.

Hialeah

WCMQ-FM—Co-owned with WCMQ Miami. Dec. 22, 1969: 92.1 mhz; 3 kw. Ant 280 ft. 478 W, 28th St. (33011). (305) 885-0321. Herbert S. Dolgoff (acq 1974). Prog sep from AM. Rep: Crane. Format: Spanish MOR. ■ Herbert S. Dolgoff, pres; Jack Hogan, gen mgr; Tony Rivas, prog dir; Betty Pino, mus dir; Eugenio Bueno, news dir; Carl Taylor, chief engr.

Hollywood

WGMA—April 1953: 1320 khz; 5 kw-U, DA-2. Box WGMA (33023). (305) 961-6200. TWX 510-954-9800. WGMA Radio Inc. (acq 11-1-71). Net: ABC/E. Rep: Masla. Format: Mod country. ■ McHenry T. Tichenor, pres; Robert J. Eicholz, VP & gen mgr; Dudley Tichenor, VP & natl sls mgr; Sharon Carnahan, prom mgr; David Hutchinson, coml mgr; Jim Harper, prog dir; Gary Joe Conway, mus dir; Clarke Porterfield, news dir; Lynn Willoughby, chief engr. ■ Rates: \$22;18;22;13.

Homestead

WQDI—Nov. 4, 1957: 1430 khz; 500 w-D. 507 N.W. Second St. (33934). (305) 247-9444. Radio South Dade Inc. (acq 4-7-74). Format: C&W. Spec progs: Farm 2 hrs, black 1 hr wkly. ■ James L. Wiggins, owner; David L. Hussong, VP & gen mgr; Michael St. John, mus dir; Rick Damon, news dir; Bill Ray, prog & prom dir; William A. Coppage, chief engr. ■ Rates: \$7.50;6.50;7.50;—

Immokalee

WKEM—Oct. 14, 1964: 1490 khz; 1 kw-D, 250 w-N. Box 520 (33934). (813) 657-3651. Jerome Bcstg Corp. (acq 11-8-74). Net: MBS. Rep: Mario Messina. Format: C&W. Spec prog: Sp 18 hrs wkly. ■ C. J. Jones Jr, pres; Nick Nichol, stn mgr; Dave Owens, prog dir; Rick Allen, group prog dir; Jerry Heckerman, chief engr. ■ Rates: \$5.25;5.25;5.25;5.25.

Indian Rocks Beach

WGNB—May 11, 1963: 1520 khz; 1 kw-D, DA. Box 8888, St. Petersburg (33708). (813) 391-9994. Southern Keswick Inc. ■ C. W. Caldwell, pres; Manly St. Jean, chief engr.

WKES(FM)—See St. Petersburg.

Inverness

WYSE—Sept. 1, 1965: 1560 khz; 1 kw-D. Box 335 (32650). (904) 726-1560. Fleet & Fleet Inc. (acq 4-23-73). Net: ABC/I. Format: C&W. ■ John H. Fleet, pres, gen mgr & chief engr; Nellie M. Fleet, coml mgr & prog dir.

Jacksonville

WAPE—Oct. 23, 1958: 690 khz; 50 kw-D, 10 kw-N, DA-N. Box 486, Orange Park (32073). (904) 264-4523. Sis Radio Inc. (group owner: acq 4-9-70). Audio news: APR. Format: Top 40. ■ Stan Kaplan, pres; Joseph J. McCluskey, gen mgr; Ray McCreanor sls mgr; John Long, prog dir; Terrence Ledbetter, news dir; Art Dellinger, chief engr. ■ Rates: \$42;32;42;32.

WAYR—See Orange Park.

WBIX—See Jacksonville Beach.

WCGL—1948: 1360 khz; 5 kw-D. Box 7848 (32210). (904) 388-3521. WWBA, Inc. (acq 1975). Net: Natl Black. Rep: Howard. Format: Black. ■ Myer Feldman & Edward Winton, co-owners; Willie J. Martin, VP & gen mgr; Perry Oliver, coml mgr; Mark Picus, prog dir; Oscar Williams, prom mgr; Joe Baily, news dir; Ari M. Thomas, chief engr.

WERD Mutual Black Network

WERD—July 4, 1950: 1400 khz; 1 kw-D, 250 w-N. Box 2467, WERD Radio Drive (32203). (904) 389-1111. Radio Station WERD Inc. Net: MBS/Black. Rep: GCI Sls. Format: Black, R&B. ■ Harold S. Cohn II, VP; Ronald H. Cohn, VP. ■ Rates: \$14;14;14;11.

***WFAM(FM)**—Feb. 8, 1973: 91.1 mhz; 37 kw. Ant 460 ft. Jones College (32211). (904) 744-2800. Net: ABC/E. Format: Educl, Contemp. ■ Jack H. Jones, pres; Peter M. Trenkler, gen mgr; Richard Jones, chief engr.

WIAD—Not on air, target date unknown: 1530 khz. Integrated Bcstg Co.

WIVY—August 1948: 1280 khz; 5 kw-D. GulfLife Center (32207). (904) 396-2505. Jacksonville Bcstg Corp. (acq 4-1-71). Rep: Katz. Format: Contemp. ■ Y. Thomas Kirby, pres & gen mgr; Patrick F. Hayes, VP & stn mgr; Lee R. Fowler, prog dir; Christopher J. Hall, chief engr.

WIVY-FM—November 1965: 102.9 mhz; 29 kw. Ant 205 ft. (CP: 55 kw). Stereo. Dups AM 50%.

BECKERMAN ASSOCIATES
Media Brokers—Consultants
14001 MIRAMAR AVENUE
MADEIRA BEACH, FLORIDA 33708
TELEPHONE (813) 391 2824

WJAX—November 1925: 930 khz; 5 kw-U, DA-N. Box 1740 (32201). (904) 354-1681. City of Jacksonville. Net: NBC. Rep: H-R/Stone. Format: Contemp. ■ Tommy Tucker, gen mgr; Lamar Lynn, asst mgr; Mrs. Joyce Hendrick, traf mgr; Tandy Swink, pub serv dir; Margarete Scott, ops dir; Ernie Harelson, chief engr.

WJAX-FM—April 1949: 95.1 mhz; 100 kw. Ant 460 ft. Stereo. Progs sep from AM.

***WJCT-FM**—April 17, 1972: 89.9 mhz; 100 kw. Ant 460 ft. Stereo. 2037 Main St. (32206). (904) 354-2806 or 354-4737. Community TV Inc. Net: NPR, Florida Public Radio. Format: Noncoml diversified. ■ Fred Reberman, pres; Norm Vincent, gen mgr; Vic DiGenti, dir inf svcs; Alan Campbell, ops mgr & prog dir; Ellen Frank, cultural affairs & news dir; Robert Baxter, studio mgr; Madge Bruner, mus dir; Gene Napier, dir of engrg. ■ WJCT-TV affil.

WJEE(FM)—Not on air, target date unknown: 107.3 mhz; 100 kw. Ant 574 ft. Bold City Bcstg.

WKTZ-AM/WKTZ-FM Beautiful Music

WKTZ—Feb. 3, 1958: 1220 khz; 1 kw-D. Arlington Expressway (32211). (904) 743-2400. Jones College (acq 10-20-63). Net: ABC/E. Format: Btlf mus. ■ Ed Bell Oberle, pres & gen mgr; Lawrence Wayne Mashburn, coml mgr; Alan Munro, prog dir; Larry Beavers, chief engr. ■ Rates: \$14;13;14;—

WKTZ-FM—1949: 96.1 mhz; 90 kw. Ant 830 ft. Stereo. Dups AM. ■ Rates: \$32;28;32;15.

WMBR—Dec. 9, 1933: 600 khz; 5kw-U, DA-N. (CP: change DA pattern). Box 6877 (32205). (904) 786-1131. Rounsaville of Jacksonville Inc. (acq 7-18-75). Group owner: Rounsaville Radio. Net: ABC/I. Rep: McGavren-Guild. Format: MOR. ■ Robert W. Rounsaville, chmn; Ralph B. Johnson, pres; Arnold C. Kaufman, VP; Tom Daren, prog & mus dir; Tom Kennington, prom dir; Lee Pearce, news dir; Bob Dillehay, chief engr. ■ Rates: \$44;39;44;39.

WAIV(FM)—Co-owned with WMBR. July 1, 1969:

Florida Radio

See page C-1 for explanation of listings.

96.9 mhz; 100 kw. Ant 230 ft. Stereo. Prog sep from AM. (904) 783-3697. Format: Progs. ■ Bill Bartlett, prog dir; Ron Carey, sls mgr. ■ Rates Same as AM.

WOZN—Jan 1, 1969: 970 khz; 1 kw-D, DA. Box 9450-A (32208). (904) 355-9970. WBOM Inc. (acq 7-1-74). Format: Gospel. ■ B.F.J. Timm, pres; Jim Atkins, gen & coml mgr; James Free, chief engr. ■ Rates: \$8;8;8;—

WPDQ—August 1942: 1460 khz; 5 kw, DA-N. Box 6877 (32205). (904) 786-1131. Mel-Lin Inc. (acq 1975). Net: ABC/I, Rep: McGavren-Guild. Format: Bright MOR Personality. ■ Ralph B. Johnson, pres; Arnold C. Kaufman, gen & coml mgr; Tom Darrah, prog & mus dir; Lee Pearce, news dir; Mike Lee, chief engr.

WQIK—July 1955: 1090 khz; 10 kw-D, DA. Box 6978 (32205). (904) 356-1366. Rowland Bcst Co. (group owner: acq 7-57). Rep: Torbet. Format: C&W. ■ Marshall W. Rowland, pres & gen mgr; Bill Mize, coml mgr; Ken Kirby, prog & mus dir; Donovan Jones, chief engr. ■ Rates: \$14;12;14;—

WQIK-FM—September 1964: 99.1 mhz; 100 kw. Ant 390 ft. Dups AM 25%. Format: C&W Stereo. ■ Rates: \$14;12;14;7.

Jacksonville's Top Station
WVOJ is Jacksonville, the top station in the market almost any way you want to figure it!

WVOJ FIRSTS

Share & Avg. 1/2 Hr. Men, Women & Adults, 1AM-MID, M-F

Avg. 1/2 Hr. & Cumulative, during Combined Drive Times, M-F

Avg. 1/2 Hr. Women, during Housewife Time (11AM-1PM), M-F

Cumulative Men, Women & Adults, 6AM-MID, M-F & 24 hours, Mon.-Sun.

When you think of Jacksonville, you think of... **WVOJ** / DIAL 1320
24 hours

The Voice of Jacksonville

BLAIR RADIO

1435 Ellis Rd., S., Jacksonville, Fla. 32205

WVOJ—1945: 1320 khz; 5 kw-U, DA-N. 1435 S. Ellis Rd. (32205). (904) 388-0766. Victory Bcstg Corp. (acq 6-10-68). Rep: Blair Audio news: UPI. Format: Modern country. ■ Malcolm MacDonald, pres; R. T. Oldenburk, gen & prom mgr; Frances Maxam, coml mgr; John Harmon, prog dir; Jay St. John mus dir; Al Morgan, news dir; Jerry Yacuzzi, chief engr.

Jacksonville Beach

WBIX—1947: 1010 khz; 10 kw-D, DA. Box 16656 (32216). (904) 641-1010. Twin-Ten Radio Inc. (acq 5-1-66). Rep: Fredrick Smith, Harland Oaks. Format: Gospel & religion. ■ Carman Macri, pres; Steve Macri, gen & coml mgr; Rick Hlubek, chief engr. ■ Rates: \$10;10;10;10.

Jupiter

WRYZ—Feb. 4, 1968: 1000 khz; 1 kw-D, DA. Radio Park (33458). (305) 746-5191. Lighthouse Broadcasting (acq 5-1-71). Net: MBS. Rep: Dora-Clayton. Format: MOR. ■ P. B. Ramsdell, pres; John C. Hooker Jr, gen mgr; Jan Davisson, coml mgr; Les Crawley, prog dir; Joe Burnham, chief engr.

WRYZ-FM—Dec. 30, 1971: 96.7 mhz; 3 kw. Ant 300 ft. Progs sep from AM. Format: Progs, fine mus, talk. ■ Joe Burnham, prog dir.

Key West

WFYN-FM—See listing following WKIZ.

WKIZ—March 27, 1959: 1500 khz; 250 w-U, DA-1. Box 2515 (33040). (305) 294-2523. Florida Keys Bcstg Corp. Format: Top 40. ■ Gayle Swofford, pres & gen mgr; Tim Swofford, prog dir; Greg Artman, news dir; Dick Farkas, chief engr. ■ Rates: \$5.30; 4.40;5.30;4.40.

WFYN-FM—Co-owned with WKIZ. Feb. 20, 1967: 92.5 mhz; 25 kw horiz, 23.5 kw vert. Ant 135 ft. horiz, 130 ft. vert. Stereo. Format: Easy Istng. ■ Rates: \$3.75;3.75;3.75;3.75.

Florida Radio

See page C-1 for explanation of listings.

WKWF—October 1945: 1600 kHz; 500 w. Box 1300 (32040). (305) 296-2222. John M. Spottswood, Net: CBS. Format: C&W, MOR. ■ John Spottswood, pres & gen mgr; R. Stephen Merrill, asst gen mgr; Charles R. Lowe, chief engr.

Kissimmee

WACY—Sept. 3, 1968: 1220 kHz; 1 kw-D. Drawer X (32741). (305) 847-5147. Opportunity Broadcasters Inc. (acq 9-3-68). Rep: Bill Mapes. Format: Progs, rock. ■ James Ludiam, pres; Rick Reynolds, gen, coml, & prom mgr, prog dir; Bob Scott, mus dir; Clay Matthews, news dir; V. E. Ziegenbein, chief engr.

WFIV—April 1964: 1080 kHz; 5 kw-D. Drawer 5519, Orlando, Fla. (32805). (305) 425-0623. Radio Florida Bcstrs. Rep: PRO Time Sls, Carpenter. Format: C&W. Spec progs: Sp 2 hrs wkly, Ger 1 1/2 hrs wkly. ■ Edward C. Allmon, pres; William J. Burgess, coml mgr; Carolyn Missroon, wom dir; R.E. Hanna, chief engr. ■ Rates: \$8;8;8.

Lake City

WDSR—May 6, 1946: 1340 kHz; 1 kw-D, 250 w-N. Box 1570 (32055). (904) 752-1340. Deep South Radioways Inc. (acq 9-1-67). Group owner: W.C. Woodall Jr. Stns. Net: CBS, Tobacco Radio Net. Format: Modern country. ■ Joe L. Duckett, pres & chief engr; Clay Brinker, gen, coml & prom mgr; Bill Thomas, prog & news dir; Jim Godbold, mus dir. ■ Rates: \$6;5;6;3.

WTLD-FM—Co-owned with WDSR. May 28, 1969: 94.3 mhz; 3 kw. Ant 300 ft. Stereo. Dups AM 15%. Format: MOR. ■ Rates same as AM.

WGRO—Nov. 14, 1958: 960 kHz; 500 w-D. Box 2005 (32055). (904) 752-0960. Columbia County Bcstg Co. Rep: Bernard, W. O. Jones. Format: C&W, Top 40. Spec progs: Farm 1 1/2 hrs; black 5 hrs wkly. ■ Robert E. Dobelstein, pres; Dean Blackwell, gen & prom mgr, coml & news dir; Gary Whitehead, mus & prog dir; Richard E. Deese, chief engr. ■ Rates: \$4;4;4.

WTLD-FM—See listing following WDSR.

Lakeland

***New FM**—Not on air; target date unknown: 91.3 mhz; 50 kw. Ant 403 ft. 360 E. Main St. (33801). Evangel Christian School Inc. ■ Karl D. Strader, pres.

WGTO—See Cypress Gardens, Fla.

WONN—Sept. 15, 1949: 1230 kHz; 1 kw-D, 250 w-N. Box 2038 (33802). (813) 682-8184. Tellafan Inc. (acq 8-7-1). Net: NBC. Rep: PRO Time Sales, Busby, Finch, Woods. Format: Contemp. Spec progs: Black 12 hrs; C&W 12 hrs; discussion 1 1/2 hrs wkly. ■ Joe Garagiola, pres & gen mgr; Joyce Robbins, stn mgr; E. C. Pat Morgan, coml mgr; Marji Bedgood, prog dir; Dan Sanborn, news dir; Roy Riley, mus dir; Frank Berry, chief engr.

WQPD—1936: 1430 kHz; 5 kw-D, 1 kw-N. Box 827 (33801). (813) 682-3142. Hugh Holder Enterprises Inc. (acq 11-7-1). Net: ABC/E. Format: Contemp, rock, Top 40. ■ Hugh Holder, pres & gen mgr; Les Howard, opns mgr; George McGovern, prog dir; Gary Knight, mus dir; Rick White, news dir; Robert Ottinger, chief engr.

WVFM(FM)—Sept. 11, 1967: 94.1 mhz; 100 kw. Ant 500 ft. Stereo. Box 2655 (33803). (813) 682-4191. Lakeland FM Bcstg Inc. (acq 8-20-67). Rep: Torbet. Format: Btfl mus, pub affrs. Spec prog: Point of View 1/2 hr wkly. ■ Bud Kurtz, pres, gen mgr; Duane McConnell, VP; John Taylor, opns mgr; Murray Goldsborough, coml mgr; Ken Simmons, news dir. ■ Rates: \$7.25; 6.50;7.25;5.75.

WWAB—September 1957: 1330 kHz; 1 kw-D. Box 65 (33802). (813) 688-2358. WWAB Inc. (acq 1-16-73). Net: Mutual Black. Format: Black ■ Hugh Hughes, pres & gen mgr; J.R. Hughes, coml mgr; Sam Martin, prog dir & mus dir; Frank Clark, news dir. ■ Rates: \$5.65;5.65;5.65;5.65.

Lake Wales

WIPC—July 1951: 1280 kHz; 1 kw-D. Box 712 (33853). (813) 676-1486. Oliva Bcstg Co. (acq

12-20-70). Net: ABC/C. Rep: Admiral. Format: Contemp. ■ George Oliva Jr, pres; Thomas N. Thornburg, gen, coml & prom mgr; Dan O'Day, prog, mus & news dir; Frank L. Berry, chief engr.

Lake Worth

WLIZ—May, 1, 1959: 1380 kHz; 1 kw-D. Box 1689 (33460). (305) 585-5533. Gold Coast Bcstg Co. Rep: Keystone. Format: Religious. Spec prog: Finnish 1/2 hr wkly. ■ Sam Phillips, pres; Tony DeLaney, gen & coml mgr; Mark Dabney, prom mgr; Doug De Vos, prog & mus dir; John Levesque, news dir; Jim Johnson, chief engr. ■ Rates: \$8;8;8.

Largo

WSST Happy Family Gospel



WSST—May 29, 1972: 800 kHz; 250 w-D, DA. Box 800 (33540). (813) 581-9424. Largo Bcstg Co. Format: Talk, religious, gospel. Spec progs: Farm 1/2 hr; Ital 1/4 hr wkly. ■ E. W. Bie, pres; Robert J. Hensler, stn mgr; Agnete S. Rose, asst stn mgr; Jan Prior, service dir; David Dapper, chief engr. ■ Rates: \$8.50; 8.50;8.50;8.50.

**Specializing
FLORIDA
and the Southeast
REGGIE MARTIN
Media Broker**

(305) 731 S. Mashta Dr.
361-2181 Key Biscayne, Fla.
33149

Leesburg

WDGM(FM)—Feb. 12, 1969: 106.7 mhz; 50 kw. Ant 210 ft. Stereo. Heard Bcstg Co. Format: MOR.

WLBE—1947: 790 kHz; 5 kw-D, 1 kw-N, DA-N. Box 799 (32748). (904) 787-2790. WLBE Radio Inc. (acq 6-20-75). Net: MBS. Format: MOR. Spec prog: farm 5 hrs wkly. ■ H. James Sharp, pres & gen mgr; Ester M. White, coml mgr; Charles Grant, prom mgr; Richard Ravenhill, prog dir; Robert Dunn, mus dir; James Hartley, news dir; Marjory Stone, loc news edit; Ronald Potaczala, chief engr.

WZST—1965: 1410 kHz; 5 kw-D. Drawer K (32748). (904) 787-2313. WYOU Radio (Box 1988, Tampa) (acq 11-68). Group owner: T.B. Lanford Stns. Rep: Carpenter. Format: Mod country ■ Arthur Rueben, pres; Gary Larsen, gen mgr; Edward Brown, prog & news dir & chief engr.

Lehigh Acres

WAYK—April 29, 1970: 1440 kHz; 5 kw-D, 1 kw-N, DA-2. Box 835 (33936). (813) 369-2118. Broadcast Management Inc. Net: ABC/E. Rep: H-R Stone. Format: Btfl mus. ■ Roger W. Clipp, pres; Lou L. Garris Jr, gen mgr; Jean Simon, opns mgr; Melvin S. Hoppe, chief engr.

WAYK-FM—Not on air; target date unknown: 107.1 mhz; 3 kw. Ant 300 ft. Format: btfl mus.

Live Oak

WNER—June 16, 1949: 1250 kHz; 1 kw-D. Box 130 (32060). (904) 362-1250. WNER Radio Inc. ■ Norman O. Protsman, pres; George R. Day Jr, VP & gen mgr; William M. Savitz, coml mgr; Elaine Lea, mus dir; Tan Fletcher, news dir; Clarence S. Parker, chief engr. ■ Rates: \$2.50;2.50;2.50;2.50.

WOHL(FM)—Co-owned with WNER. October 1973: 98.1 mhz; 31 kw. Ant 175 ft. Stereo. Prog sep from AM. Net: ABC/I. Format: Btfl mus. ■ Rates: \$3;3;3;3.

Madison

WMAF—Dec. 6, 1956: 1230 kHz; 1 kw-D. SH 250 w-N. Box 621 (32340). (904) 973-6333. Billy G. Walker (acq 12-6-72). Net: ABC/E, Tobacco Radio. Rep: Keystone. Format: Block, C&W, MOR, Progs, Top 40. Spec prog: Black 10 hrs wkly. ■ Billy G. Walker, owner; Lonnie Cecil Carter, gen, coml & prom mgr; Steve Karpik, prog, mus & news dir; Michael Lepper, sis mgr.

Marathon

**WFFG
MOR
Bluegrass Broadcasting Co., Inc.**

ABC RADIO

WFFG—April 7, 1962: 1300 kHz; 500 w-D, 250 w-N, DA-2. Box 488 (33050). (305) 743-5563. WHO Radio Inc. (acq May, 1964). Group owner: Bluegrass Bcstg Co. Net: ABC/I. Buckley Radio Sls. Format: MOR. Spec prog: Talk Show 5 hrs wkly. ■ H. Hart Hagan Jr, pres; David W. Albright, gen mgr; Milt Collins, prog dir. ■ Rates: \$3.40;3.40;3.40;3.40.

WMUM(FM)—Not on air; target date November 75: 94.3 mhz; 3 kw. Ant 107 ft. Stereo. Box 1017 (33050). Breeze 94 Inc. Format: MOR, btfl mus. Spec prog: Classical 2 hrs wkly. ■ John F. Thacker, pres, gen mgr & chief engr.

Marco Island

WALJ(FM)—See Naples.

WRGI—January 1975: 1510 kHz; 1 kw-D, DA. (1191 8th St. S., (33940). (813) 649-9104. Collier Bcstg Co. Net: ABC/I. Rep: Glidewell Rep. Format: Top 40. Spec Progs: Black, Sp, both 1/2 hrs wkly. ■ Bob Michael, gen & coml mgr; Suds Coleman, prog & mus dir; Al Corbett, chief engr. ■ Rates: \$6.20;6.20;6.20;6.20.

Marianna

WTOT—Sept. 24, 1958: 980 kHz; 1 kw-D. Box 569 (32446). (904) 482-3046. The Chipola Corp. Rep: Meeker. Spec progs: C&W 12 hrs wkly. ■ Jerome F. Turner, pres; Nick McLure, gen mgr; Lloyd Hart, prog dir; Bart W. Lincoln, news dir; Roy Dancy, chief engr.

WTOT-FM—Sept. 1, 1964: 100.9 mhz; 2.5 kw. Ant 330 ft. Stereo. Prog sep from AM.

WTYS—1948: 1340 kHz; 1 kw-D, 250 w-N. Box 777 (32446). (904) 482-2131. Jackson Bcstg Corp. (acq 11-7-74). Net: ABC/I. Format: C&W. Spec prog: Farm 1 hr; black 5 1/2 hrs; religious 19 hrs wkly. ■ William Dunkle III, pres & gen mgr; Grady Watson, prog dir; Bill Collins, mus dir; M. Westmoreland, news dir; G. D. McKechnie, chief engr. ■ Rates: \$2.40;2.20;2.20;2.20.

Melbourne

***WFIT(FM)**—April 4, 1975: 91.5 mhz; 41 w. Ant 131 ft. Campus Box 5067 (32901). (305) 724-0915 or 723-3701. Florida Institute of Technology. Format: Noncoml diversified. Spec progs: C&W & jazz 1 hr wkly each; classical 1 1/2 hrs wkly. ■ Gary J. Bowie, gen mgr; Jeffrey A. Fleming, prog dir; Richard P. Kapushinski, chief engr.

WMEL—Jan. 4, 1956: 920 kHz; 1 kw-U, DA-N. Box 1318 (32935). (305) 254-2282. Elyria-Lorain Bcstg Co. (acq 10-7-74). Net: CBS. Rep: Masla Media Sls South, New England Spot Sls. Format: MOR. ■ Otto B. Schoepfle, pres; William L. Humphries, gen mgr; Pat Yaturo, coml mgr; Bill Early, prog dir; Charles Weiler, prom mgr; Keith Alien, mus dir; Bill Harris, news dir.

WMMB—1946: 1240 kHz; 1 kw-D, 250 w-N. Box 908 (32901). (305) 723-1661. Bcst Enterprises Inc. (acq 1965). Group owner: Sherman—Ruwitich. Net: MBS. Rep: PRO Meeker, Adv. Repts, Miami. Format: MOR. ■ Gordon Sherman, pres; John Gilman, gen mgr; Sandra Mattley, admin asst; Don Gould, mus dir; George Tomlinson, news dir; Chuck Cole, chief engr.

WYRL(FM)—Co-owned with WMMB. Dec. 25, 1966:

102.3 mhz; 3 kw horiz, 2.95 kw vert. Ant 210 ft horiz, 205 ft vert. Stereo. (305) 727-8662. Prog sep from AM. Format: C&W. ■ Bud Lucas, WYRL dir; Allen Jackson, mus dir.

WTAI—March 8, 1968: 1560 khz; 5 kw-D. Box 1560 (32935). (305) 254-1771. Cape Canaveral Bcstrs Inc. Net: ABC/E. Rep: Walton, Robinson. Format: Mod country. ■ Thomas R. Hanssen, pres, gen mgr & chief engr; John W. Donahay Jr, coml mgr; Bill Austin, opns mgr & mus dir; Elaine M. Stone, gen mgr; Debbie Conner, news dir.

WTAI-FM—Nov. 9, 1972: 107.1 mhz; 3 kw. Ant 300 ft. Stereo. Prog sep from AM. Net: ABC/FM. Format: Contemp. ■ Jim Day, prom mgr; Pam Gera, news dir.

WYRL(FM)—See listing following WMMB.

Miami

WIAI(FM)—See listing following WIOD.

WAXY—See Ft. Lauderdale.

WCMQ—May 18, 1958: 1220 khz; 250 w-D. 478 W. 28th St, Hialeah (33011). (305) 885-0321. Herbert S. Dolgoff (acq 11-1-72). Rep: Century Natl, Jack Riley, Atlanta Spot Sls. Format: Latin contemp mus. ■ Herbert S. Dolgoff, pres; Jack Hogan, gen mgr; Tony Rivas, prog dir; Betty Pino, mus dir; Eugenio Bueno, news dir.

WCMQ-FM—See Hialeah.

***WDNA(FM)**—Not on air; target date unknown: 88.9 mhz; 1.7 kw. Ant 830 ft. Bascomb Mem. Bcstg Foundation. 150 Southeast 2nd Ave., Suite 1300 (33301). ■ Holt Maness, pres.

WEDR(FM)—May 18, 1963: 99.1 mhz; 70 kw horiz, 47 kw vert. Ant 165 ft. 1437 N.W. 35th St. (33142). (305) 633-1487. WEDR Inc. Group owner: Dee Rivers. Net: Natl. Black. Rep: Southern Spot Sls. Format: Black. ■ M. S. Wigley, pres; Dewitt Ingraham, gen mgr; Gary Rogers, prog dir; G. Walden, chief engr.

WFAB—Feb. 15, 1962: 990 khz; 5 kw-U, DA-1. 1779 W. Flagler St. (33125). (305) 649-2946. United Broadcasting (group owner). Rep: UBC Sls. Format: Sp. ■ Richard Eaton, pres; Leopoldo Justo, gen, coml & prom mgr; Humberto Estevez, Ana Teresa Napoles, mus dir; Antonio Arias, news dir; G. Harold Brewer, chief engr.

WFUN—See South Miami.

WGBS—1939: 710 khz; 50 kw-U, DA-2. 710 Brickell Ave. (33131). (305) 377-8811. Storer Bcstg Co. (group owner: acq 3-4-44). Net: ABC/I. Rep: CBS Radio Spot Sales. Format: Play favorites. ■ Donald R. Hamlin, gen mgr; Lee Rodgers, prog dir; Bill Liappas, mus dir; Ken Taylor, news dir; Robert H. Walton, chief engr.

WHYI(FM)—See Ft. Lauderdale.

WIGL(FM)—See listing following WWOK.

WINZ—1946: 940 khz; 50 kw-D, 10 kw-N, DA-2. 100 Biscayne Blvd. (33132). (305) 371-6641. WINZ Inc. (acq 3-7-73). Group: Guy Gannett Bcstg Svcs. Audio news: NBC/NIS. Rep: KATZ Radio. Format: All news. ■ Jean Gannett Hawley, pres; Richard D. Casper, VP & gen mgr; Jack Wiley, gen sls mgr; John Emm, news dir; Michael Gable, prom mgr; Edw. Reid, chief engr. ■ Rates: \$35;22;30;14.

WINZ-FM—See Miami Beach.

WIOD—Jan. 19, 1926: 610 khz; 5 kw-U, DA-2. Box 1177 (33138). (305) 759-4311. TWX 305-696-3450. Miami Valley Bcstg Corp. (acq 1-1-63). Group owner: Cox. Net: NBC. Rep: The Christal Co. Format: MOR. ■ Clifford M. Kirtland Jr, pres; Phillip D. Costin, gen mgr; Dan Dioreto, coml mgr; Don Reed, prog dir; Mike Gable, prom mgr; Yolanda Parapar, mus dir; Chuck Dent, News dir; Gene Rider, chief engr.

WIAI(FM)—Co-owned with WIOD. Dec. 6, 1971: 97.3 mhz; 98 kw. Ant 790 ft. Stereo. Group owner: Cox. Prog sep from AM. Format: Contemp, MOR. ■ Herb Hirsch, gen mgr; Bob Poller, coml mgr; Ken Roth, opns mgr.

***WLRN-FM**—February 1959: 91.3 mhz; 8.4 kw. Ant 400 ft. (CP: 92kw), 1410 N.E. Second Ave. (33123). (305) 350-3228. Dade County School Board. Net: NPR, Fla. Pub. Radio. Format: noncoml diversified. Spec progs: Black 1 hr; jazz 3 hrs; Sp 1 hr; Ger 12 hrs; Ital 4 hrs; Swedish 1 hr; Finnish 1 hr wkly. ■ Roger R. Kobzina, gen mgr; William Chesser, prog dir; Leonard

M. Pace, mus dir; Joseph E. Cooper, Jr, news dir; Henry C. Cronin, chief engr. ■ *WLRN-TV affil.

WLYF(FM)—Dec. 23, 1970: 101.5 mhz, 100 kw. Ant 810 ft. Stereo. Box 3456 (33169). (305) 653-0040. Sudbrink Bcstg (group owner: acq 12-23-70). Rep: Bolton-Burchill. Format: Btlf mus. ■ Woody Sudbrink, pres; Norman Feuer, gen mgr; Kathy Seipp, stn mgr; Peter Irmiler, prog dir, mus dir, news dir; Tom Middleton, chief engr. ■ Rates: \$50;60;60;40.

***WMCU(FM)**—Aug. 24, 1970: 89.7 mhz; 100 kw. Ant 850 ft. Stereo. 2300 NW 135 St. (33167). (305) 681-4689. Miami Christian College. Audio news: Mutagl. Format: Educl, Christian. ■ Dr. Ken Gangel, pres; George Anderson, gen mgr; Glen Velker, prog dir.

WMBM—See Miami Beach.

WMJX(FM)—1948: 96.3 mhz; 98 kw. Ant 790 ft. 825 41st St. Miami Beach (33140). (305) 538-5321. Bartell Bcstg of Florida Inc. (group owner). Rep: Metro Radio Sls. Format: Contemp. ■ Edward Downe Jr, pres; Carl Como Tuter, VP & gen mgr; George Wilson, exec VP; Dave Laskey, sis mgr; Gary Allyn, prog dir; Bette Woods, mus dir; Ron Hill, news dir; Bill Walsh, chief engr.

WOCN—Dec. 22, 1956: 1450 khz; 1 kw-D, 250 w-N. Sheraton-Four Ambassadors Hotel (33130). (305) 377-9505. WOCN Inc. (acq 5-6-66). Net: ABC/E. Rep: Petry. Format: Mod good mus. ■ Ed Winton, pres & gen mgr; Roger Deutsch, gen sls mgr; Kernie Anderson, stn mgr; Robert Fouts, news dir; John Fleet, chief engr.

WQAM—May 1921: 560 khz; 5 kw-D, 1 kw-N. 767 41st St. Miami Beach (33140). (305) 531-6651. Storz Bcstg Co. (group owner: acq 8-5-66). Rep: Blair. Format: Contemp. ■ Robert H. Storz, pres; Ron L. Ruth, gen mgr; James A. Dunlap, prog dir; Harrison Wilder, loc sls mgr; Ted Green, chief engr. ■ Rates: \$66;50;66;50.

WQBA—1947: 1140 khz; 10 kw-D, 5 kw-N, DA-2. WQBA Radio, 1301 SW 1st St. (33135). (305) 643-5000. Susquehanna Bcstg Co. (group owner: acq 6-1-66). Rep: Torbet, Jones. Format: Sp. ■ A. W. Carlson, VP; Herbert M. Levin, mng dir; Jack Nobles, natl sis mgr; Tony Segredo, coml mgr; Emilio Millian, news dir.

WRHC—See Coral Gables.

WSHE(FM)—See Ft. Lauderdale.

WTMI(FM)—Nov. 1, 1960: 93.1 mhz; 100 kw horiz, 93 kw vert. Ant 390 ft. 2951 S. Bay Shore Dr. (33133). (305) 443-5251. SJR Communications (group owner: acq 3-18-71). Rep: SJR Reps. Format: Classical. ■ Ray McFadden, pres & gen mgr; David Conner, prog dir; Lynda Marino, mus dir; Meyer Gottesman, chief engr.

WVCG—See Coral Gables.

***WVUM(FM)**—See Coral Gables.

WWOK—June 20, 1969: 1260 khz; 5 kw-U, DA-2. Box 450577, Shenandoah Station (33145). (305) 856-1260. Mission East Co. (group owner: acq 6-20-69). Net: MBS. Rep: Metro Radio Sls. Format: C&W. ■ Jack Roth, pres; Cyrus Russell, VP & gen mgr; Richard W. Kelsey, coml mgr; Ted Cramer, prog dir & prom mgr; Ron Tatar, mus dir; Jack McCoy, news dir; Peter Dohm, chief engr.

WIGL(FM)—Co-owned with WWOK. June 7, 1974. 107.5 mhz; 100 kw horiz, 92 kw vert. Ant 460 ft. Stereo. Format: Country. Prog sep from AM.

Miami Beach

***WBUS-FM**—See listing following WMBM.

WINZ-FM—Co-owned with WINZ Miami. 1961: 94.9 mhz; 81 kw. Ant 214 ft. Stereo. Prog sep from AM. Format: Mellow rock. ■ Hal Frank, sis mgr; Bill Stedman, prog dir; David Sousa, mus dir; Ben Johnson, chief engr. ■ Rates: \$19;19;19;19.

WKAT—November 1937: 1360 khz; 5 kw-D, 1 kw-N. 1759 N. Bay Rd. (33139). (305) 531-8181. WKAT Inc. Net: CBS. Rep: Masla. Format: Talk. ■ Mrs. A. Frank Katzentine, pres; Sidney Levin, VP & gen mgr; Robert W. "Bob" Allen, coml mgr; Joseph Fried, news dir; Arthur P. Smith Jr, chief engr. ■ Rates: \$31;25;28;22.

WMBM—1949: 1490 khz; 1 kw-D, 250 w-N. 814 First St. (33009). (305) 672-6347. Community Service Bcstrs Inc. (acq 4-6-62). Rep: Howard. Format: Black/R&B. ■ Allan B. Margolis, pres, gen mgr; China Vallis,

coml mgr & prog dir; Les Goldberg, chief engr.

WBUS(FM)—Co-owned with WMBM. July 1, 1968: 93.9 mhz; 38 kw. Ant 175 ft. Stereo. Prog sep from AM. Format: Progressive. ■ Joe Ricco, coml mgr; Jack La-Mont, prog, news dir; Sandy Thompson, mus dir.

WMJX(FM)—See Miami.

Milton

WKCK—Dec. 18, 1957: 1490 khz; 1 kw-D, 250 w-N. 703 Berryhill St. (32570). (904) 623-4691. Millard F. Adams Jr. (acq 5-11-74). Audio news: UPL. Rep: Hopewell Jones. Format: MOR, C&W. ■ Millard F. Adams Jr, owner, gen mgr & news & prog dir; Ms. Helen Christian, sis mgr; David Waldrop, prom mgr; George K. Gibb, mus dir & chief engr. ■ Rates: \$5;4;5;3.

WXBM-FM—April 28, 1964: 102.7 mhz; 100 kw. Ant 500 ft. Stereo. Box 588 (32570). (904) 994-5357. Mapoles Bcstg. Net: ABC/I. Rep: Carpenter. Format: Farm, C&W. Spec prog: Religious 10 hrs wkly. ■ H. Byrd Mapoles, pres, gen & coml mgr & chief engr; Robert Rogers, prog & mus dir.

Monticello

WTBJ—Jan. 1, 1969: 1090 khz; 1 kw-DA. Box 519 (32344). (904) 997-2572. Townsend Bcstg Corp. (acq 6-1-74). Audio news: UPL. Rep: Admiral. Format: MOR. Spec progs: Farm 4 hrs wkly; black 5 hrs wkly. ■ H. L. Townsend Jr, pres; Jim Broadudd, gen mgr; Woodly Pelt, prog dir; Gloria Yaun, coml mgr; Donald Sirmans, chief engr. ■ Rates: \$2.15;2.15;2.15;2.15.

Mount Dora

WGTW—July 31, 1974: 1580 khz; 5 kw-D. 1445 Old Hwy. 441 (32757). (904) 383-5636. Community Bcstg. Rep: Dora-Clayton. Format: MOR. ■ Matthew G. Byrne, Richard J. & Stephen G. Aicher & Walter J. Kaufman, Jr, owners. Ellis Stewart, stn mgr; Anthony Swindle, adv mgr; Bob Andrews, chief engr.

WORJ-FM—Co-owned with WORL Orlando. 1966: 107.7 mhz; 100 kw. Ant 380 ft. Stereo. Box 133 (32757) (305) 298-5510. Orlando Radio & TV Corp. (acq 10-69). Group: Osceola Bcstg. Rgnt net: Assoc. Press. Rep: ABC-FM Spot Sls. Format: Progs. ■ Emil Corona, pres & gen mgr; Lee Arnold, prog dir; Richard E. Namey, coml mgr; William W. McGaffey, prom mgr; Mike Lyons, mus dir; Thomas B. Webb, news dir; Michael Ziegenbein, chief engr. ■ Rates: \$32; 32;37;37.

Naples

WCVU(FM)—See listing following WNOG.

WNOG—Oct. 14, 1954: 1270 khz; 500 w, DA-N. 333 8th St. South (33940). (813) 262-1000. Palmer Bcstg Co. (group owner: acq 6-6-69). Net: NBC. Rep: Cohen. Format: MOR. ■ William J. Ryan, VP & gen mgr; Homer L. Dixon, dir of sls; Tom Pry, prom mgr; Ken Collier, prog dir; Gene Hebert, news dir; Paul Martin, chief engr. ■ Rates: \$6.95;6.20;6.95;6.20.

WCVU(FM)—Co-owned with WNOG. May 8, 1962: 94.5 mhz; 100 kw. Ant 739 ft. Progs sep from AM. Stereo. Format: Beautiful Music. ■ Homer L. Dixon; coml mgr. ■ Rates: \$6.75;6.75;6.75;6.75.

WRGI-FM—Co-owned with WRGI Marco Island. December 1971: 93.5 mhz; 3 kw. Ant 300 ft. Stereo. Collier Bcstg Co. ■ Rates: \$6.20;6.20;6.20;6.20.

New Port Richey

WGUL—Oct. 31, 1963: 1500 khz; 250 w-D. Box 1500 (33552). (813) 842-8425. Richey Airwaves Inc. (acq 1964). Rep: Carpenter. Format: MOR, talk. ■ Don Armstrong Sr, pres; Thad Lowrey, gen mgr; Joe Jankowski, coml mgr; Don Armstrong Jr, prog dir; Rick Adkins, mus dir; Steve McClure, news dir; William Rossini, chief engr.

WGUL-FM—Sept. 19, 1969. 105.5 mhz. 3 kw. Ant 255 ft. Stereo. Progs sep from AM. Format: C&W.

New Smyrna Beach

WOGO—Feb. 1, 1962: 1550 khz; 250 w-D. Box 340 (32069). (904) 427-1550. Astro Enterprises. (acq

Florida Radio

See page C-1 for explanation of listings.

11-27-74) Audio news: UPI. Format: MOR. Spec prog: C&W 15 hrs w/ky. ■ John Fox, pres; Walter N. (Pat) Patterson, gen mgr; Joyce Johnson, prom mgr; Hank Morgan, prog dir; Stan Anderson, chief engr. ■ Rates: \$2.80; —; —; —.

WSBB—1950: 1230 khz; 1 kw-D, 250 w-N. Box 130 (32069). (904) 428-9091. Bcstrs Inc. (acq 5-30-54). Group owner: A.V. Tidmore. Net: MBS. Format: MOR. ■ A. V. Tidmore, owner & pres; A. L. Pruitt, gen. coml & prom mgr; Murray Pendleton, prog dir; S. Philip Burton, mus dir; Lucille Irick, news dir; Sim S. Eagleson Sr, chief engr.

Niceville

WFSH—See Valparaiso-Niceville.

Oakland Park

WAXY(FM)—See Fort Lauderdale.

WEXY—June 1963: 1520 khz; 1 kw-D. 539 E. Oakland Park Blvd. (33308). (305) 565-1841. Broward County Bcstg Inc. Group owner: Albert S. Tedesco. Net: ABC/E. Format: Modern country. Spec prog: Black 4 hrs w/ky. ■ Albert S. Tedesco, pres; William J. Wheatley, gen mgr; Mike Moore, prog dir & chief engr; Shirley Durdin, mus dir.

Ocala

WFUZ(FM)—See listing following WMOP

WMOP—Dec. 18, 1953: 900 khz; 5 kw-D. Box 1136 (32670). (904) 732-2010. WMOP Inc. (acq 4-14-64). Rep: Keystone, Southern Spt Sls. Format: C&W. Spec progs: Black 1 hr w/ky. ■ Jim Kirk, pres; Tom Catalno, gen mgr; Carol Carpenter, coml mgr; Stan White, prog dir; Bob Paxton, mus dir; Al Lee, news dir; Terry Reeves, chief engr.

WFUZ(FM)—Co-owned with WMOP. Nov. 7, 1960: 93.7 mhz; 100 kw vert, 78 kw horiz. Ant 190 ft. Prog sep from AM. Box 1973 (32670). (904) 732-3368. Format: Easy lstdg. ■ Wesley Unold, prog & mus dir.

WTMC

PRO/Meeker Radio

WTMC—1938: 1290 khz; 5 kw-D, 1 kw-N, DA-N. Box 897 (32670). (904) 629-8008. Hunter-Arnette Bcstg (acq 1973). Net: MBS. Rep: Pro-Meeker, Busby, Finch & Woods. Format: Top 40, MOR. ■ Bill Hunter, pres; Vernon Arnette, VP gen mgr; E. V. Arnette, coml mgr; Chuck Morgan, prog dir; Bill Mansfield, opns mgr; Charles Agnano, mus dir; William C. Mansfield, news dir; Clyde Moller, chief engr. ■ Rates: \$6;6;6;5.

WWKE—May 1958: 1370 khz; 5 kw-D. Box 1056 (32670). (904) 732-8000. Greater Ocala Bcstg Corp. (acq 8-1-65). Net: ABC/C. Rep: Buckley, Atlanta. Format: Modern MOR. ■ Robert Hauck, pres & gen mgr; W. N. Duncan, coml & prom mgr; Ken Steele, prog dir; Kris Van Dyke, mus dir; Mike South, news dir; James Carrier, chief engr. ■ Rates: \$7.50;5.50;7.50;3.50.

Okeechobee

WLMC(FM)—See listing following WOKC.

WOKC—Feb. 6, 1962: 1570 khz; 1 kw-D. Box 1247 (32073). (813) 763-3181. Okeechobee Bcstrs Inc. (acq 1-1-64). Net: ABC. Rep: Beaver, Cohen. Format: C&W. ■ Charles C. Castle, pres; William A. Stokes, VP, gen mgr & chief engr; Miss S. Anderson, coml mgr; Ron Hayes, prog dir; Al Stokes, prom mgr & chief engr.

WLMC(FM)—Co-owned with WOKC. July 4, 1965: 103.1 mhz; 2.6 kw. Ant 150 ft. Prog sep from AM.

Orange Park

WAYR—May 28, 1960: 550 khz; 1 kw-D. Box 398 (32073). (904) 264-6655. Dan Richardson. Format: Relig. ■ Dan Richardson, owner & dir; Donald McIntosh, traf mgr; James Richardson, prog dir.

Orlando

WBJW—See Winter Park.

WBJW-FM—Co-owned with WBJW, Winter Park Fla. August 15, 1967: 105.1 mhz; 100 kw. Ant 350 ft. Box 7475 (32804). (305) 425-6631. Rounsaville of Tampa Inc. (group owner: acq 7-73). Stereo. Prog sep from AM. Format: Contemp. Spec prog: Point of view 3 hrs w/ky.

WBDO—May 24, 1924: 580 khz; 5 kw-U, DA-N. 58 S. Ivanhoe Blvd. (32802). (305) 241-1491. TWX 810-850-0141. The Outlet Co. (group owner: acq 8-20-63). Net: CBS. Rep: Blair Format: MOR, Contemp. ■ David E. Henderson, pres; Carl F. Hallberg, VP & gen mgr; Alan Ecklund, coml mgr; Glenn C. Lewis Sr, prog dir; Perry Moore, mus dir; Jim Martin, news dir; Chalmers Stromberg, chief engr.

WBDO-FM—April 24, 1949: 92.3 mhz; 96 kw. Ant 1,110 ft. (CP 80 kw. Ant 1,320 ft). Stereo. Prog sep from AM. Format: Good music. ■ WBDO-TV affil.

WDIZ(FM)—July 1, 1971: 100.3 mhz; 100 kw. Ant 840 ft. Suite 840, Hartford Bldg., 200 E. Robinson Ave. (32801). (305) 843-3520. Shamrock Development Corp. (group owner: acq 3-71). Net: ABC/C. Rep: Torbet, Media Sls. Format: Adult stereo rock. ■ James Haggarty, pres; Robert E. French, gen mgr; Thom Sherwood, coml mgr; Ken Stevens, prog & news dir; Bob Sweat, chief engr.

WHOO

Modern Country



Buckley Radio Sales, Inc.

WHOO—Dec. 5, 1947: 990 khz; 10 kw-D, 5 kw-N, DA-N (CP: 50 kw-D, 5 kw-DA-2, 10 kw, non-DA-CH). Box 15310 (32808). (305) 295-3990. WHOO Radio Inc. (acq 8-18-58). Group owner: Bluegrass Bcstg Co. Net: ABC/I. Rep: Buckley. Format: Mod Country. ■ H. Hart Hagan Jr, pres; William L. Stakelin, gen mgr; Mike Burger, prog dir; Andy Wilson, prom mgr; Adrian Charles, news dir; Tim Sawyer, chief engr. ■ Rates: \$38;32;35;37.

WHOO-FM—1952: 96.5 mhz; 100 kw. Ant 460 Ft. Stereo. Prog sep from AM. Format: Contemp bitfl mus. ■ Rates: \$11;14;14;11.

WKIS—1947: 740 khz; 5 kw-D, 1 kw-N, DA-N. Box 740 (32802). (305) 295-0740. Susquehanna Bcstg Co. (group owner: acq 3-1-71). Rep: McGavren-Guild. Format: Pop/Standard MOR. ■ Dale Moudy, VP & gen mgr; Gene Burns, asst to the mgr; Jim Tillery, sls mgr; Dick Riley, prog & mus dir; Rod Hemphill, news dir; Stan Savran, sps dir; John Loving, chief engr.

WL0F—April 1, 1940: 950 khz; 5 kw-U, DA-N. Box 15746 (32808). (305) 293-2431. Home Security Bcstg Co. (acq 4-1-72). Rep: Katz. Format: Contemp. ■ Carl Glickens, pres, gen mgr; Jerry Frericks, coml mgr; Bill Dennis, prog dir; Blue Christy, mus dir; Dave Elliott, news dir; Luke Beasley, chief engr.

WL0Q(FM)—See Winter Park.

WORJ-FM—See Mount Dora.

WORL—1957: 1270 khz; 5 kw-D. 2001 Mercy Dr. (32808). (305) 298-5510. Orlando Radio & TV Corp. (acq 10-69). Group: Ocala Bcstg. Net: Mutual Black; Assoc. Press. Rep: GCI. Format: Black. ■ Emil Corona, pres & gen mgr; Richard E. Namey, coml mgr; Stephen Crumbley, mus & prog dir; Michael Ziegenbein, chief engr. ■ Rates: \$18;13;18;13.

WOKB—See Winter Garden.

WTRR—See Sanford.

WVCF—See Windermere.

Ormond Beach

WDAT—See Daytona Beach.

Palatka

WIYD-FM—See listing following WWPF.

WSUZ—1957: 800 khz; 1 kw-D. Box 668 (32077). (904) 328-1434. WSUZ Radio Station (acq 1966). Net: MBS. Format: C&W. Spec prog: Religion 8 hrs

w/ky. ■ Wayne E. Bullock, own, gen mgr; Elliott Bullock, prog dir; Dave Ewing, mus dir; Dennis Brown, news dir; George Duck, chief engr.

WWPF—Feb. 14, 1947: 1260 khz; 1 kw-D, 500 w-N, DA-N. Box 640 (32077). (904) 325-4555. Half Bcstg Co. (acq 9-68). Net: MBS. Rep: Carpenter. Format: Top 40. Spec prog: Black 1½ hrs w/ky. ■ Mrs. Georgia Williams, pres; Ronald G. Tumlin, gen & coml mgr; Larry Castle, prog dir; Bob Henry, mus dir; Don Wolfe, news dir; Robert Castellanos, chief engr. ■ Rates: \$3.50;3.50;3.50;3.50.

WIYD-FM—Co-owned with WWPF. Dec. 14, 1972: 99.9 mhz; 100 kw horiz, 25 kw vert. Ant 180 ft. (904) 325-4556. Progs sep from AM. Format: Beautiful mus. ■ Richard Harnage, coml mgr; Jim Hart, prom mgr. ■ Rates: same as AM.

Palm Beach

WJNO—See West Palm Beach.

WJNO-FM—1957: 97.9 mhz; 100 kw. Ant 340 ft. Box 189, West Palm Beach (33402). (305) 832-3638. Walter-Weeks Bcstg Inc. (acq 11-71). Rep: Torbet. Format: Good music. ■ Robert M. Weeks, pres; Robert L. Hoffer, gen mgr; Larry Baronoff, gen sls mgr; Ray Edwards, opns mgr; Robert Young, sls mgr; Robert Hundley, reg sls mgr; Steve Armstrong, news dir; Curtis Brinson, chief engr.

WPBR

News-Talk

WPBR—1940: 1340 khz; 1kw-D, 250 w-N. 3000 S. Ocean Blvd. (33408). (305) 582-7401. GR Group Inc. (acq 10-21-72). Net: NBC. Rep: Atlanta Spot Sls. Format: Talk. Spec progs: Classical 10 hrs; Finnish 1 hr w/ky. ■ Everett H. Aspinwall Jr, gen mgr & news dir; William Dix, sls mgr; Valerie R. Aspinwall, prog dir; Jim Johnson, chief engr. ■ Rates: \$14;12;14;12.

Panama City

WDLF—April 1940: 590 khz; 1 kw-U, DA-N. Box 759 (32401). (904) 763-1777. Dae Bcstg Co. (acq 5-1-72). Rep: Meeker, Ochs. Format: Contemp, rock. ■ Larry Edwards, gen mgr; Ken Winstanley, sls mgr; Rick Mauldin, prog dir; Alan Dean, mus dir; Bill Battieger, chief engr; J. Pat Dority, news dir.

WGNE-FM—Co-owned with WGNE, Panama City Beach. October 1971: 98.5 mhz; 100 kw. Ant 120 ft. Stereo. Prog sep from AM. Net: ABC/FM. Format: Btlf mus. ■ Rates: \$9.85;9.10;9.85;9.10.

***WKGC-FM**—October 1974: 90.7 mhz; 40 w. Ant 65 ft. Stereo. (CP 100 kw Ant 205 ft). 5230 W. Hwy. 98 (32401). (904) 769-1557. Gulf Coast Community College. Net: NPR; Fla. Pub. Radio. Audio news: AP. Format: Noncoml diversified. ■ Dr. Richard Morley, pres; Charles T. Wooten, gen mgr; Ron Johnson, prog dir; Jean Taylor, prom dir; Ian Barker, news dir; Bill Turman, chief engr.

WPAP-FM—92.5 mhz; 95 kw. Ant 1230 Ft. Box 2288 (32401). (904) 769-1409. Deltona Bcstg Co. Inc. (acq 6-1-74). Format: Modern country. ■ Frank Mackle Jr, pres; James H. Bozeman, gen mgr; Bill Underwood, coml mgr; Steve Smith, prom mgr; Carrol (Smokey) King, prog & mus dir; Gail White, news dir; Bill Battieger, chief engr.

WPCF—Dec. 11, 1949: 1430 khz; 5 kw-U, DA-2. Box 1430 (32401). (904) 785-6176. Magnasonics Inc. (acq 9-74). Net: ABC/I. Rep: Devney, Southern Spot Sls. Format: MOR. ■ Berkley L. Fraser, pres, gen & coml mgr; Laurence DuKate, prod dir & prom mgr; Rex Ogburn, mus dir; John McMullen, news dir; Reed Kinney, chief engr.

WPFM(FM)—Co-owned with WPCF. September 1963: 107.9 mhz; 89.3 kw. Ant 740 ft. Prog sep from AM. Net: ABC/E. Format: Contemp.

Panama City Beach

WGNE—June 25, 1965: 1480 khz; 500 w-D. Drawer Y (32401). (904) 234-6622. Janus Bcstg Co. (acq 12-1-72). Net: ABC/C. Rep: Media Sls/South. Format: Contemp. ■ Frederick L. Lindholm, pres & gen mgr; Donald G. McCoy, exec VP & gen sls mgr; Chet Smith, prog dir; Mike McCormick, news dir. ■ Rates: \$8.50;7.75;8.50;7.75.

WGNE-FM—See Panama City.

WSCM

Modern Country Music

WSCM—Sept. 23, 1958: 1290 khz; 500 w-D. Box 4398 (32401). (904) 234-3128. Community Service Bcstg (acq 1-21-71). Net: MBC. Rep: Carter-Jones. Format: C&W. ■ Ken Winstanley, pres, gen & coml mgr; Rick Mauldin, prog dir; Fran Winstanley prom mgr; Bill Batteiger, chief engr. ■ Rates: \$5.75;5.50;5.75;5.50.

Pensacola

WBOP—November 1957: 980 khz; 1 kw-D. Box 12764 (32575). (904) 438-7543. Tri-Cities Bcstg Co. Inc. (acq 3-58). Group owner: E.O. Roden Stns. Net: MBS, Mutual Black, Rep: Howard. Format: Black, R&B. ■ E. O. Roden, pres; Wayne Coleman, gen mgr; John Williams, asst mgr; Tom Wilson, prog dir; Jim Golden, mus dir; Robert Morgan, news dir; Harry Babb, chief engr.

WBOP-FM—1971: 101.5 mhz; 100 kw. Ant 400 ft. Stereo. Dups AM 90%. Format: Black, R&B.

WBSR—Sept. 1, 1946: 1450 khz; 1 kw-D, 250 w-N. B0x 5668 (32505). (904) 432-6172. Mooney-WRSR Inc. (acq 1969). Group owner: Mooney Bcstg Corp. Net: ABC/C. Rep: McGavren-Guild-PGW. Format: Contemp. ■ George Mooney, pres; Sam C. Trent, gen mgr; Ben Larson, coml mgr; Chris Hampton, prog dir; T. J. Duke, mus dir; Jim Wesley, news dir; John Powell, chief engr.

WCOA—1926: 1370 khz; 5 kw-U, DA-N. Box 12487 (32573). (904) 456-5751. Summit Communications. (acq 1-6-75). Net: CBS. Audio news: AP. Rep: McGavren-Guild. Format: MOR. Spec prog: Farm ½ hr wkly. ■ Lee Wallenhaupt, pres; Gordon Towne, gen & coml mgr; Byrn Bennick, prog dir; Jerry Ray, mus dir; Don Priest, news dir; David Kiker, chief engr. ■ Rates: \$23;15;19;15.

WJLQ(FM)—Co-owned with WCOA. Sept. 1, 1965: 100.7 mhz; 25 kw. Ant 300 ft. Stereo. Prog sep from AM. Format: Top 40. ■ Don Lynch, prom mgr. ■ Rates: \$8.50;8.50;11.50;9.50.

WMEZ(FM)—Nov. 11, 1960: 94.1 mhz; 100 kw horiz, 56 kw vert. Ant 320 ft. Stereo. Box 8057, Town & Country Plaza (32505). (904) 432-4775. Frederic T. C. Brewer (acq 7-1-65). Net: ABC/FM. Rep: Devney. Format: Btlf mus. ■ Frederic T. C. Brewer, own, gen mgr & chief engr; Gene Pfaltzer, coml mgr.

WNVY—1947: 1230 khz; 1 kw-D, 250 w-N. 2070 N. Palafox St. (32501). (904) 433-5666. Pensacola Bcstg Corp. Rep: HR/Stone. Format: Mod country. ■ Cleve J. Brien, pres; Thom Smith, VP, gen & coml mgr; Jerry Ray, prog dir & prom mgr; Greg Edwards, mus dir; Steve Remel, news dir; John Milner, chief engr.

***WPCS(FM)**—June 22, 1971: 89.3 mhz; 100 kw. Ant 510 ft. 125 John St. (32503). (904) 434-0687. Pensacola Christian School. Net: ABC/FM. Format: Sacred Music & Relig Talk prog. Spec prog: Metropolitan Opera. ■ Dr. A. R. Horton, gen mgr; A. A. Baker, prog dir; Paul Baker, mus dir; R. D. Bowman, chief engr.

WPFA—October 1956: 790 khz; 1 kw-D. Box 8127 (32505). (904) 433-1141. Miracle Radio (acq 4-1-71). Net: ABC/E. Rep: Busby Finch, Lathom & Widman. Cohen. Format: C&W, gospel. Spec prog: farm ½ hr wkly. ■ Billy Woodall, pres; Don Griffith, gen & coml mgr; Charlie Dillard, prog, news & mus dir & prom mgr; Harry Babb, chief engr. ■ Rates: \$8;8;8;8.

WVIX—Nov. 1, 1959: 610 khz; 500 w-D, 604 New Warrington Rd. (32506). (904) 456-7475. The Wonder Corp. (acq 9-1-71). Net: ABC/I. Rep: Savalli-Gatas. Format: Contemp, rock. ■ Roy L. Hess, pres; Jim Smith, gen mgr; Paul Burch, sls mgr; Dave Johnson, prog dir; Gary P. Martin III, prom dir; Steve Edwards, mus dir; Craig Sanders, news dir; Harry Babb, chief engr.

WXBM-FM—See Milton.

Perry

WGKR—July 25, 1963: 1310 khz; 1 kw-D, Box 779 (32347). (904) 457-1310. K&R Bcstrs. ■ Eugene Ketring, pres, mgr & chief engr; C. E. Roye, gen mgr & coml mgr; Betty J. Roye, prog dir.

Pine Castle-Sky Lake

WHHL—Not on air, target date unknown: 1190 khz; 250 w-D. 7388 Chamery Lane (32809). Hyman Lake.

Pinellas Park

WFSO—March 12, 1966: 570 khz; 500 w DA-D. Box 570 (33565). (813) 392-2215. Pinellas Radio Corp. Format: Prog rock/Top 40. Spec progs: Greek 2 hrs wkly. ■ Dan L. Johnson, pres & gen mgr; Joseph F. Gingrich, coml mgr; Glenn Scott, prog & mus dir & prom mgr; Ted Webb, news dir; William D. Mangold, chief engr.

Plantation Key

WXOS(FM)—July 1969: 100.3 mhz; 100 kw. Ant 440 ft. Stereo. Box 223 Tavernier (33070). (305) 852-5030. Sounds of Service Radio. Group owner: Dee Rivers. Net: MBS. Format: MOR, C&W. ■ M. B. Rivers, pres; E. D. Rivers, chrm bd; Hank Cutshall, VP, gen, coml & prom mgr; Roy Facemyer, prog, mus & news dir; Bill Zammit, chief engr. ■ Rates: \$5.50;5.50;5.50;5.50.

Plant City

WPLA—July 1949: 910 khz; 1 kw-D. Drawer J (33566). (813) 752-3123. WPLA Bcstg Co. Inc. (acq 11-74). Rep: Hopewell, Carpenter. Format: C&W, farm, talk. ■ Eccelle Smith, pres & coml mgr; Al Berry, gen mgr; B. Mason Dean, mus & prog dir; Jack Rushing, news dir; Al Berry, chief engr. ■ Rates: \$5.45; 5.45;5.45;5.45.

Pompano Beach

WCKO(FM)—See listing following WRDB.

WL0D—April 13, 1959: 980 khz; 1 kw-D, DA. 2801 E. Oakland Pk Blvd., Ft. Lauderdale (33306). (305) 566-8316. Sunrise Bcstg Corp. (acq 8-18-65). Rep: Groskin & Co., Busby Finch, Lathom & Widman. Format: Beautiful adult mus. ■ George T. Shupert, pres & gen mgr; William T. Heaton, VP & gen sls mgr; Norman R. Brownell, opns mgr & chief engr; Jack Swart, news dir. ■ Rates: \$15;14;15;14.

WRBD—1959: 1470 khz; 5 kw-D, DA. 4431 Rock Island Rd., Fort Lauderdale (33313). (305) 731-4800. Radio Broward of Florida. Net: ABC/C. Format: Black, R&B. ■ Donald J. Owlser, pres; Michael N. Korman, gen & coml mgr; Joe Fisher, prog dir; Willie Rawls, news dir; Robert Barnett, chief engr.

WCKO(FM)—Co-owned with WRBD. 1960: 102.7 mhz; 100 kw. Ant 350 ft. Prog sep from AM.

Port Charlotte

WEEJ(FM)—Not on air, target date unknown: 100.1 mhz; 3 kw. Ant. 190 ft. Box 1421, Punta Gorda (33950). Broadcast Systems Inc.

Port St. Joe

WJOE—Nov. 7, 1956: 1080 khz; 1 kw-D. Box 310 (32456). (904) 227-2426. Mills & Crisp Enterprises (acq 8-23-73). Format: C&W. ■ Paul Mills, pres.

Punta Gorda

WCCF—Sept. 15, 1961: 1580 khz; 1 kw-D, DA. Box 1929 (33950). (813) 639-1188. Charlotte County Bcstg Co. (acq 4-1-75). Net: MBS. Format: MOR, C&W. ■ H. Robert Reinhard, pres & gen mgr; Ron Brown, prog dir; Eric Hogberg, chief engr. ■ Rates: \$5.75;5.75;5.75;5.75.

WCCF-FM—Sept. 1, 1970: 92.7 mhz; 3 kw. Ant 140 ft. Stereo Prog sep from AM. Format: Btlf mus. Spec progs: Classical 3 hrs; Ger 1 hr wkly. ■ Rates same as AM.

Quincy

WCNH—March 1948: 1230 khz; 1 kw-D, 250 w-N. Box 630 (32351). (904) 627-6700. Big Bend Bcstg Corp. (group owner: acq 6-1-59). Net: MBS. Rep: Admiral. Format: Contemp MOR. ■ William S. Dodson, pres; Monte Bitner, gen mgr & chief engr; Cecil Morris, news dir; James W. Crosby, coml mgr; Jimmy Kent, prog dir & mus dir.

WCNH-FM—December 1966: 101.7 mhz; 3 kw. Ant 200 ft. Prog sep from AM.

Florida Radio

See page C-1 for explanation of listings.

Riviera Beach

WGMW(FM)—1971: 94.3 mhz; 3 kw. Ant 300 ft. 100 W. Blue Heron Blvd., West Palm Beach. (33404). (305) 842-4616. Wardell Bcstg. (acq 4-4-75). ABC/E. Rep: Selcom. Format: MOR. ■ William J. Hall, pres; Robert J. Ward, gen mgr; James W. Campbell, Jr., gen sls mgr; Steve St. John, prog & mus dir; Ed Hinkle, news dir; Jim Johnson, chief engr. ■ Rates: \$20;18;16;13.

WPOM—Aug. 17, 1959: 1600 khz; 1 kw-U, DA-1. 4286 Upthegrove Lane, West Palm Beach (33407). (305) 686-8000. Riviera Bcstg Co. (acq 4-71). Rep: Eastman. Format: All news. ■ Alan Kornish, pres; Tom Mayes, coml mgr; Dick Bate, prom mgr; Jim Johnson, chief engr. ■ Rates: \$24;22;24;20.

St. Augustine

WAOC—December 1953: 1420 khz; 1 kw-D. Box 1420. Atlantic Bank Bldg. (32084). (904) 824-1420. Gatorland Bcstg (acq 12-15-70). Rep: Carpenter. Format: C&W/Contemp. ■ Wayne Sims, pres & gen mgr & chief engr; Tom Charity, prog dir; Richard Harnage, news dir.

WFOY—1936: 1240 khz; 1 kw-D, 250 w-N. 1 Radio Rd. (32084). (904) 829-3416. Ponce de Leon Bcstg Co. (acq 9-55). Net: CBS. Rep: Southern Spot Sls. Format: MOR. ■ John E. Bernhard Jr., pres & gen mgr; Fred Schilling, coml mgr; Mrs. Frankie C. Walker, prog dir; Peg Medick, prom mgr; Edward Doyle, mus dir; Ivan Perry, news dir; Pat Bernhard, chief engr. ■ Rates: \$4;3;4;3.

WFOY-FM—August 1965: 97.7 mhz; 3 kw. Ant 160 ft. Stereo. Dups AM 40%. Format: Contemp. ■ Rates: \$3;2.50;3;2.50.

St. Petersburg

WAZE—See Clearwater.

WDAE—See Tampa.

WFSO—See Pinellas Park.

WKES(FM)—Co-Owned with WGNB, Indian Rocks Beach. July 1, 1961: 101.5 rhz; 100 kw. Ant 440 ft. Stereo. Box 8888 (33708). Southern Keswick Inc. Dup AM 70%.

WLCY—1959: 1380 khz; 5 kw-U, DA-N. Box 10,000 (33733). (813) 525-1111. TWX 810-863-0371. WLCY Inc. (acq 10-1-56). Group owner: Rahall Communications Corp. Net: ABC/C. Rep: Katz. Format: Contemp. ■ Jack Lee, pres; William R. Rice, gen mgr; Ray Yorke, coml mgr; Johnny Bridges, prog dir; Bill Alford, news dir; Bob Beattie, chief engr.

WLCY-FM—Sept. 1, 1970: 94.9 mhz; 100 kw. Ant 390 ft. Prog sep from AM. Stereo. Format: Hit Parade. ■ Robert Quedeen, sln mgr; Steve Cheney, prog dir.

WQSR(FM)—See Sarasota.

WQYK—See Tampa.

WQYK-FM—May 1958: 99.5 mhz; 100 kw. Ant 240 ft. Stereo. Box 1274. (33602). (813) 223-2584. Sun Coast Radio (acq 5-20-71). Group: Rowland Bcstg. Rep: ATA. Format: C&W. ■ Marshall Rowland, pres; Robert Rowland, gen mgr; Don Hibbitts, mgr; Don Beckman, prog dir; Dwayne Cornett, chief engr.

WQXM(FM)—See Clearwater.

WRBQ(FM)—See Tampa.

WSST—See Largo.

WSUN—Nov. 1, 1927: 620 khz; 5 kw, DA-N. 201 2nd Ave. N. (33701). (813) 821-6262. Tampa (813) 244-0700. Plough Bcstg Co. (group owner: acq 7-22-73). Net: ABC/E. Rep: Stone. Format: Modern Country H. Wayne Hudson, pres; Hugh A. Brown, VP & gen mgr; Tim Ridding, prog dir; Derrick Janiszcz, news dir; Leo Grant, chief engr. ■ Rates: \$33;26;28;17.

WTAN-AM-FM—See Clearwater.

***WUSF(FM)**—See Tampa.

WWBA—May 5, 1950: 680 khz; 1 kw-D. 2787 62nd Ave N. (33702). (813) 527-2111. Telex 052-3431. WWBA Inc. (acq 5-68). Rep: Buckley. Format: Btlf

Florida Radio

See page C-1 for explanation of listings.

mus. ■ Ed Winton, pres & gen mgr; Bill Dutcher, str mgr; Bill Schricker, sis mgr; Bill Hazelton, news dir.

WWBA-FM—Sept. 1, 1965: 107.3 mhz; 100 kw. Ant 360 ft. Stereo. Format: Btfl mus.

St. Petersburg Beach

WILZ—April 15, 1958: 1590 khz; 1 kw-D, DA. 200 Madonna Blvd., Tierra Verde (33715). (813) 866-2402. Millbeck Bcstrs (acq 10-6-69). Rep: Devney. Format: Rock. ■ Arthur Neil Millman, pres; D. Melvin Tinney, gen mgr; Scott Owens, prog dir; Dave Allison, mus dir; Carl Baumann, chief engr.

Sanford

WTRR—May 20, 1947: 1400 khz; 1 kw-D, 250 w-N. Box 1568 (32771). (305) 322-1400. Communico Bcstg. (acq 1-1-74). Audio news: APR. Format: Adult rock. Spec progs: Black 1½ hrs wkly. ■ William A. Reck, operating ptr; Myron A. Reck, ptr; Carl Hallsberg, Jr., coml mgr; Tim Trott, news dir; Jerry Allen, prog & mus dir; James Hickey, chief engr. ■ Rates: \$4;4;2.50.

Sarasota

WKXY—May 23, 1949: 930 khz; 1 kw-D, 500 w-N, DA-2. Box 2500 (33578). (813) 957-1151. Sarasota Bcstg Co. Net: ABC/C. Rep: Hopewell Jones, Cohen. Format: contemp. ■ A. G. Fernandez, pres, gen & coml mgr; Charles J. Fernandez, opns mgr; Charles Lawrence, prog dir; Robert L. Kohlmeier, chief engr.

***WKZM(FM)**—Nov. 10, 1974: 105.5 mhz; 3 kw. Ant 180 ft. Box 7627 (33578). (813) 371-3163. Christian Fellowship Mission Inc. Format: Relig, educ, pub affrs. Spec progs: Sp ¼ hr; black ½ hr wkly. ■ Lowell A. Brubaker, gen mgr & prog dir; William B. Miller, asst mgr; Dave Miller, news dir; John Sherrod, chief engr.

WQSA—Jan. 1, 1961: 1220 khz; 1 kw-D, DA. Box 7700 (33578). (813) 366-0424. Sarasota Radio Co. (acq 3-9-73). Rep: ABC-FM Spot Sls. Format: MOR, variety. Spec progs: Black 3 hrs; C&W 6 hrs wkly. ■ Edward A. (Ted) Rogers, pres & gen mgr; Carroll P. Newton, chrm; Lowell Shumaker, prog dir; Pat Patterson, mus dir; Tom Kenne, news dir; James E. Grant Jr., chief engr. ■ Rates: \$9.50;9.50;9.50;9.50.

WQSR(FM)—Co-owned with WQSA. Nov. 15, 1960: 102.5 mhz; 100 kw. Ant 570 ft. Progs sep from AM. Format: Rock. Spec progs: Black 2 hrs; relig 1 hr wkly. ■ Mark Beltaire, prog & mus dir. ■ Rates: \$30;30;40;40.

WSPB—Dec. 7, 1939: 1450 khz; 1 kw-D, 250 w-N. Drawer Z (33578). (813) 388-2131. Water-Weeks Bcstg Inc. (acq 9-1-72). Net CBS. Rep: Torbet. Format: MOR. Spec progs: Sp 1 hr; black ½ hr wkly. ■ Robert M. Weeks, pres; Cliff Larson, gen mgr; George Barber, coml mgr; Al Stockmeier, prog dir; Stan Grams, mus dir; Craig Sager, news dir; Gerry McGovgan, chief engr.

WSPB-FM—June 30, 1965: 106.3 mhz; 3 kw. Ant 260 ft. Stereo. Prog sep from AM. Format: MOR. ■ Robert Lewis, coml mgr.

WYND

Contemporary

WYND—Dec. 2, 1961: 1280 khz; 500 w-D, DA. Box 3618 (33578). (813) 958-5561. R&J Bcstg (acq 12-15-73). Rep: Masla. Audio news: APR. Format: Top 40. Spec progs: Black, 1½ hr wk, Sp. ½ hr wkly. ■ Jay M. Epstein, pres & gen mgr; Carl Strandell, prog & mus dir; Thurman Taylor, chief engr. ■ Rates: \$11;9.50;11;9.50.

Sebring

WJCM—May 22, 1950: 960 khz; 1 kw-D. Box 1766 (33870). (813) 385-7140, 7149. Asti Bcstg Co. Inc. (acq 9-1-74). Format: MOR. ■ Robert Asti, pres; A. Stockmeier, gen & coml mgr; C. Miller, prog & dir; Delores Kay news dir; L. Hill, chief engr. ■ Rates: \$5.75;5.75;5.75;—.

WSEB—Nov. 24, 1959: 1340 khz; 1 kw-D, 250 w-N. Box 871 (33870). (813) 385-5151. Morgan Bcstg Co.

(acq 7-31-73). Net: MBS. Format: MOR. ■ Harry J. Morgan, pres.

WSPK-FM—Co-owned with WSEB. July, 1967: 105.5 mhz; 3 kw. Ant 150 ft. Prog sep from AM. Format: Religious.

South Daytona

WELE—June 1957: 1590 khz; 1 kw-D. Box 4006 (32021). (904) 767-1131. WELW Radio Inc. (acq 11-1-72). Net: MBS. Rep: Media Sls South. Format: C&W. ■ Sidney Frazer, Sheldon Katz, co-owners; Gene McMahon, VP, gen mgr; Bob King, prog dir; Dave Bauder, news dir.

South Miami

WFUN—September 15, 1947: 790 khz; 5 kw-U, DA-2. 6101 Sunset Drive, Miami (33143). (305) 667-1601. Rounsaville of Miami Beach Inc. (group owner: acq 1-5-3). Net: ABC/C. Rep: Avco. Format: Contemp. ■ Ralph B. Johnson, pres; Jerry Norman, gen mgr; Don Wright, prog & mus dir; Jim Edwards, news dir; Virgil C. Roberts, chief engr.

Starke

WPXE—Feb. 23, 1957: 1490 khz; 1 kw-D, 250 w-N. Drawer 520 (32091). (904) 964-6001. Sanders Enterprises Inc. (acq 7-20-65). Net: MBS. Rep: Beaver. Format: C&W. Spec prog: Black 10 hrs wkly. ■ John Sanders, pres, gen & coml mgr; Lee Sanders, prog & mus dir, & prom mgr; Andy Denonn, news dir; Merrill H. Wall, chief engr. ■ Rates: \$4;4;4;4.

Stuart

WMCF



WMCF(FM)—Dec. 24, 1964: 92.7 mhz; 3 kw. Ant 300 ft. Stereo. Drawer 359 (33494). (305) 334-1122. Blue Water Bcstg Inc. Net: MBS. Format: Btfl mus. Spec prog: Classical 12 hrs wkly. ■ Lester M. Combs, pres & gen mgr; Jack Stuart, coml mgr; Roger O. White, prog dir; Ed Gluckler, news dir; Tom Frenock, chief engr. ■ Rates: \$6;6;6;6.

WSTU—Dec. 9, 1954: 1450 khz; 1 kw-D, 250 w-N. 1000 Alice Ave. (33494). (305) 287-2020. Harvey L. Glascock; WSTU Inc. (acq 10-1-69). Net: ABC/L. Format: MOR. ■ Harvey L. Glascock, pres, Ron Beckey, gen mgr; Bob Irwin, prog dir; Cy Yost, coml mgr; Paul Dunn, mus dir; Sammy Yates, news dir; James Rogers, chief engr. ■ Rates: \$11.50;10.50;11;10.

Tallahassee

WANM—August, 1974: 1070 khz; 10 kw-D. Box 10174 (32302). (904) 222-1070. WANM Inc. Net: Natl Black. Rep: Bernard Howard Co. Format: Black. ■ B. F. J. Timm, pres; Bob Maupin, gen mgr; Joe Bullard, prog dir; Charles Washington, chief engr. ■ Rates: \$11.50;9.50;11.50;—.

WBGM(FM)—See listing following WONS.

***WFSU-FM**—May 1954: 91.5 mhz; 3 kw. Ant 205 ft. (CP 50 kw Ant 500 ft). Stereo. 420 Duffenbaugh Bldg., Fla. State U. (32306). (904) 644-6220. Bd of Regents, State of Florida. Net: NPR. Format: Pub affrs, classcl, progsc, educ, jazz. Spec progs: Instructional 5-10 hrs, Black 10 hrs wkly. ■ James H. Irwin, gen mgr; Donald E. Martin, prog dir; Holly Chaaepel, prom dir; Daniel MacDonald, mus dir; Michael Cooper asst mus dir; Lucius B. Gantt, pub affairs dir; Dennis Boyle, prod mgr; Linda Knox, traf mgr; Harold Sturm, chief engr.

WGLF(FM)—December 1967: 104.1 mhz; 38 kw. Ant 440 ft. Box 1815 (32302). (904) 224-1227. Tallahassee Bcstg Co. (acq 4-7-70). Net: ABC/FM. Rep: Pro Meeker Sls. Format: Top 40. ■ B. F. J. Timm, pres; Bob Schneider, gen mgr; Danny Spears, prog dir; Chuck Washington, chief engr. ■ Rates: \$8.30;8.30;8.30;8.30.

WJZS(FM)—Not on air, target date unknown. 103.1 mhz; 3 kw. Ant 300 ft. Amrad Corp.

WMEN—Nov. 5, 1953: 1330 khz; 5 kw-D. Box 1695 (32302). (904) 877-5116. Plantation Radio Inc. (acq 9-7-71). Audio news: NBC/NIS. Rep: Masla, Busby Finch & Woods, Glidwell. Format: All news. ■ Cecil Grider,

pres; Charles Porretto, gen mgr; Jon Martin, coml mgr; Barry Gross, prog dir; Clarence Collins prom mgr; Dan Hayes, news dir; Lee Cardice, Joe Previtt, chief engr.

WOMA(FM)—See listing following WTNT.

WONS—Aug. 6, 1959: 1410 khz; 5 kw-D. Box 3127 (32303). (904) 385-1156. Champtown Industries Inc. (acq 8-1-69). Net: NBC. Rep: Selcom. Format: Oldies, MOR. ■ Donald C. Price, pres; Jan G. Rogers, gen mgr; Jim Jacobs, prog dir; Richard Smith, news dir; Fred Bowen, chief engr.

WBGM(FM)—Co-owned with WONS. July 15, 1962: 98.9 mhz; 100 kw. Ant 385 ft. Stereo. (904) 385-6512. Progs sep from AM. Format: Btfl mus, MOR. Spec prog: Classical 1 hr wkly.

WTAL—1935: 1450 khz; 1 kw-D, 250 w-N. Box 1369 (32302). (904) 877-1108 or 877-1100. Capitol City Bcstg Inc. (acq 5-28-65). Net: ABC/C. Rep: Devney, Media Sls South. Format: Contemp. ■ Wally Hoy, pres & gen mgr; Barbara Hoy, coml mgr; Joe Johnson, prog dir; Jack Sinks, news dir; Les Young, chief engr. ■ Rates: \$9;9;9;9.

WTNT—Oct. 15, 1946: 1270 khz; 5 kw-U, DA-N. Box 1047 (32302). (904) 222-1270. Walter Weeks Bcstg Co. Net: CBS. Rep: Meeker, Busby Finch & Woods. Format: MOR. ■ Robert M. Weeks, James W. Walter, co-owners; Robert Liles, prog dir & prog mgr; Dave Gussow, news dir; Emery K. Mallory, chief engr.

WOMA(FM)—Co-owned with WTNT. July 24, 1967: 94.9 mhz; 51 kw. Ant 210 ft. Stereo. Dups AM 10%. Format: C&W.

Tampa

WAZE—See Clearwater, Fla.

WAVV(FM)—See listing following WDAE.

WDAE

Personality MOR

WDAE—May 15, 1922: 1250 khz; 5 kw-U, DA-1. 101 N. Tampa St. (33602). (813) 229-0404. Rounsaville of Tampa Inc. (group owner: acq 11-64). Net: CBS. Rep: McGavren-Guild. Format: MOR. ■ Robert W. Rounsaville, chmn of bd; Ralph B. Johnson, pres; Donald K. Clark, gen mgr; Richard Weinkauf, coml mgr; Robert J. Snowden, prog dir; Bill Campbell, prom mgr; Jim Lord, mus dir; Dennis Crandall, news dir; Dick Lucas, chief engr. ■ Rates: \$54;44;49;26.

WAVV(FM)—Co-owned with WDAE. July, 1951: 100.7 mhz; 100 kw. Ant 460 ft. Stereo. Prog sep from AM (813) 229-1991. Audio news: UPI. Format: Btfl mus. ■ John Lotz, gen mgr; Thom Sanders, prog dir. ■ Rates: \$12;12;12;12.

WFLA—1924: 970 khz; 5 kw-U, DA-N. Box 1410 (33601). (813) 228-9797. TWX 810-8760-602. Telex 813-229-5597. WFLA Inc. Net: NBC. Rep: Blair, Unicom (Canada). Format: MOR. ■ Wm. B. Faber, pres; John Alexander, VP gen mgr; Art Ross, coml mgr; Rod Weller, prog dir; Ralph Smith, mus dir; Larry Kellogg, prom mgr; Robert Higby, news dir; Pat McLaughlin, chief engr. ■ Rates: \$45;35;45;10.

WFLA-FM—1948: 93.3 mhz; 100 kw. Ant 930 ft. Stereo. Prog sep from AM. Format: Btfl mus. ■ Scott Farrell, mus dir. ■ WFLA-TV affil. ■ Rates: \$30;30;30;30.

WHBO—November 1948: 1050 khz; 250 w-U. Box 17156 (33612). (813) 935-3171. Floradio Inc. (acq 1-1-62). Format: C&W. ■ Bob A. Martin, pres & gen mgr; Shirley Martin, VP & coml mgr; John Smith, prog & news dir; Elizabeth Horton, prom mgr; John Kansridle, chief engr.

WINO—Nov. 7, 1960: 1010 khz; 50 kw-D, DA. Box 1010, Seffner, Fla. (33584). (813) 689-8185. Rand Bcstg of Tampa-St. Petersburg Inc. Rep: PRO Time Sls. Format: Relig. ■ Rex Rand, pres; Phil Scott, gen mgr.

WLCY-FM—See St. Petersburg.

WOYK—1946: 1110 khz; 10 kw-D, DA. Box 1274. (33602). (813) 223-2584. Sun Coast Radio. (acq 12-15-69). Group: Rowland Bcstg. Rep: ATA. Format: C&W. ■ Marshall Rowland, pres; Robert T. Rowland, gen mgr; Don Hibbits, coml mgr; Don Beckman, prog

dir; ■ Rates: \$22;21;22;10.

WQYK-FM—See St. Petersburg.

WRBQ(FM)—Dec. 13, 1973: 104.7 mhz; 100 kw. Ant 555 ft. 5510 Gray St. (33609). (813) 879-1420. Southern Bcstg Co. (group owner: acq 6-73). Format: Top 40. ■ John G. Johnson, pres; Peter M. Schulte, gen mgr; Dorothy Jackson, coml mgr; Bill Garcia, prog dir; Kathie Tanner, prom mgr; John Powers, news dir; Ralph Beaver, chief engr. ■ Rates: \$56;45;56;56.

WSOL—1956: 1300 khz; 5 kw-D, DA. 1711 W. Kennedy Blvd. (33606). (813) 253-0135. Rust Craft Bcstg Co. (group owner: acq 1959). Format: Religi 60%, Sp 40%. Spec prog: Fr ½ hr wkly. ■ Marshall Berkman, pres; Albert B. Gale, gen & coml mgr; Elvan B. Wilson, prog dir; Norma M. Werner, prom mgr; Victoriano Marroero, Spanish news dir; Maurice Scott, chief engr.

WSST—See Largo.

WSUN—See St. Petersburg.

WTAN-AM-FM—See Clearwater.

WTMP—1954: 1150 khz; 5 kw-D, DA. Box 1101 (33601). (813) 626-4108. WTMP Inc. Group: Gulf South Communications Inc. (acq 8-18-72). Rep: Howard. Format: Soul, Rock, Rhythm & blues. ■ R. A. McLeod, Sr., pres; Robert L. Gilder, admin asst; Charles Gilbert, gen sis mgr; Claude E. Smith, prog dir.

***WUSF(FM)**—September 1963: 89.7 mhz; 85 kw. Ant 820 ft. 4202 Fowler Ave. (33620). (813) 974-2341, Ext 341. TWX: 1-800-424-8560. U. of S. Florida. Net: NPR. Format: Non coml diversified. Spec progs: Itat 1 hr; black 1 hr wkly. ■ Dr. William Mitchell, gen mgr; John E. Young, stn mgr; Linda Donaldson, traf mgr; Norm Palumbo, prod mgr; Neal Lavon, prog dir; Ted Sullivan, prom mgr; John Ralle, chief engr. ■ *WUSF-TV affil.

WYOU—June 2, 1965: 1550 khz; 10 kw-D. Box 1988 (33601). (813) 253-6071. WYOU Radio Inc. (acq 6-2-65). Group owner: T. B. Lanford. Net: MBS. Rep: Young, Adv Reprs. Format: C&W. ■ Art Reuben, pres & gen & prom mgr; Bill Polk, prog dir & chief engr; Homer Lee, coml mgr; Jimmy Williams, mus dir; Gordon Solie, news dir.

Titusville

***WPIO(FM)**—Oct. 19, 1975: 89.9 mhz; 10w. Ant 100 ft. Box 6501 (32780). (305) 267-3609. Florida Public Radio, Inc. Format: Educl, pub affairs. ■ Randy Henry, pres & gen mgr; Sidney Gills, prog & prom dir; Ron Arkeil, chief engr.

WRMF—Nov. 20, 1957: 1060 khz; 10 kw-D, 5 kw-N, DA 2. Box 1060 (32780). (305) 267-2141. 267-1060. WRMF Inc. Group: Fairbanks Bcstg. Net: ABC/I. Audio news: APR. Format: MOR. ■ R. M. Fairbanks, pres; Jas C. Hilliard, exec VP; R. L. Bright, gen & coml mgr; Larry Knight, prog mgr; Mark Simpson, prom mgr; Lou Josephs, mus dir; Allen Moore, news dir; Alan Sterger, chief engr. ■ Rates: \$ 9;7;9;3.50.

WRMF-FM—Sept. 1968: 98.3 mhz; 3 kw. Ant 234 ft. Stereo. Dups AM 90%. Format: MOR. ■ Rates same as AM.

Valparaiso-Niceville

WFSH—November 1958: 1340 khz; 1 kw-D, 250 w-N. Box 308, Valparaiso (32580). (904) 678-2141. WFSH Inc. (acq 6-71). Net: ABC/E. Format: C&W. ■ Charles F. Wister, pres; Dick Paisley, gen mgr; Chuck Ankers, prod dir; Larry Robinson, chief engr.

Venice

WAMR—Feb. 1, 1960: 1320 khz; 500 w-D. Box 767 (33595). (813) 488-4159. Venice Nokomis Bcstg Co. Format: MOR. ■ Larry Rhodes, pres; Richard Dounda, gen & coml mgr; Gregory Cohane, prom mgr; Bob Chambers, prog & mus dir; Joseph Barone, chief engr. ■ Rates: \$3.25;3.25;3.25;3.25.

WAMR-FM—March 1, 1974: 92.1 mhz; 2.75 kw. Ant 285 ft. Dups AM 60%. Format: MOR. ■ Rates same as AM.

Vero Beach

WAXE—May 1954: 1370 khz; 1 kw-D. Box 39 (32960). (305) 567-3934. Shargo Inc. (acq 3-4-64). Rep: Devney. Format: MOR. Spec progs: Black 1 hr wkly. ■ Richard L. Crago, pres & gen mgr; John

Schiavone, prog dir; Charles C. Castle, chief engr.

WGYL(FM)—November 1970: 93.5 mhz; 3 kw. Ant 140 ft. Stereo. 1500 20th St. (32960). (305) 567-8366. WGYL Radio Corp. Net: ABC/FM. Format: MOR. ■ Rudy Hubbard, pres; Chris Hubbard, gen mgr & chief engr; Pete Noel, news dir.

WTTB—June 7, 1954: 1490 khz; 1 kw-D, 250 w-N. Box 2440 (32960). (305) 562-5454. Tropics Inc. Net: MBS. Format: MOR days, rock night. Spec progs: C&W 7 hrs wkly. ■ Merrill P. Barber, pres; Robert H. Hazel, gen mgr; Robert Atkinson, coml mgr; Jack Fay, news dir; Richard Jackson chief engr. ■ Rates: \$3.25;3.25;3.25;3.25.

Wauchula

WAUC—Jan. 7, 1958: 1310 khz; 500 w-D. Box 936 (33873). (813) 773-3223. Barco Inc. (acq 3-1-73). Rep: Cooke. Format: C&W, MOR. Spec prog: Black 1 hr wkly. ■ Richard Rosenberger, pres; Samuel L. Rosenberger, gen mgr; Jerald A. Brush, prog dir & chief engr. ■ Rates: \$4.10;4.10;4.10;4.10.

West Palm Beach

WEAT—1948: 850 khz; 1 kw-U, DA-1. Box 70 (33402). (305) 965-5500. Gowdy Florida Bcstg. Group: Curt Gowdy Bcstg Corp. (acq 10-74). Net: ABC/I. Rep: Katz. Format: Modern country. ■ Curtis E. Gowdy, pres; Eleanor L. Larsen, stn mgr; Ron Winblad, gen sis mgr; Gene Barry, opns mgr; Jack Freese, news dir; William Coddling, chief engr. ■ Rates: \$45;45;45;30.

WEAT-FM—Aug. 30, 1969: 104.5 mhz; 100 kw. Ant 520 ft. Stereo. Prog sep from AM. Format: Beautiful music. ■ Rates same as AM.

WIRK—July 15, 1947: 1290 khz; 5 kw-D, 1 kw-N, DA-N. Box 3828 (33402). (305) 965-9211. Ken-Sell Inc. Rep: McGavren-Guild. Format: Top 40. ■ Joseph S. Field Jr., pres; Rome Hartman, gen mgr; James L. Barrette, coml mgr; Terry Lee, prog & mus dir; Ron Davis, news dir; Michael Bock, chief engr. ■ Rates: \$15;12;15;12.



WIRK-FM—Aug. 1, 1965: 107.9 mhz; 100 kw. Ant 340 ft. Stereo. Prog sep from AM. Net: ABC/FM. Format: C&W. ■ Barry Grant, prog dir; Pete Rinker, mus dir. ■ Rates same as AM.

WJNO—July, 1936: 1230 khz; 1 kw-U. Box 189 (33402). (305) 832-3638. Walter-Weeks Bcstg Inc. (acq 7-27-67). Net: ABC/E. Rep: Torbet. Format: MOR. Spec progs: Classcl 2 hrs; Sp 1 hr wkly. ■ Robert M. Weeks, pres; Robert L. Hoffer, VP & gen mgr; Larry Baronoff, gen sis mgr; Ray Edwards, opns dir; Robert Hundley, reg sis mgr; Steve Armstrong, news dir; Curtis B. Brinson, chief engr.

WJNO-FM—See Palm Beach.

WPOM
All News & Information

NBC News & Information

EASTMAN RADIO, INC.

WPOM—See Riviera Beach.

WWRN(FM)—Not on air, target date unknown: 92.1 mhz; 3 kw. Ant 280 ft. 391 Broadway, Riviera Beach. Sandpiper Bcstg Co. Inc.

Windemere

WVCF—Oct. 25, 1962: 1480 khz; 1 kw-D. Box 15550, Orlando (32808). (502) 876-2300. American Homes Stns Inc. (acq 12-6-63). Rep: National Time Sls. Format: Religi. ■ Louis G. Christensen, pres; Dr. Paul Kessler, corp sec; E. W. Jeffries, gen mgr; L. R. Munsey, asst mgr & chief engr.

Florida Radio

See page C-1 for explanation of listings.

Winter Garden

WOKB—Jan. 1, 1958: 1600 khz; 5 kw-D, DA. 1111 S. Division St., Orlando (32805). (305) 841-1600. Everback Bcstg Co. (acq 11-1-62). Net: Natl Black. Rep: Howard. Format: Black. ■ J. H. Everbach, pres; Bruce Webb, VP & stn mgr; Lee Sharp, prog & mus dir; Bob Mundy, chief engr. ■ Rates: \$14.45;11.55;14.45;—.

Winter Haven

WGTO—See Cypress Gardens.

WPCV(FM)—1962: 97.5 mhz; 100 kw. Ant 499 ft. 100 Cypress Gardens Blvd., Box 9206 (33880). (813) 294-5466. Orange Bcstg Co. Inc. Net: ABC/FM. Rep: Pro Time Sls, Busby Finch & Woods. Format: C&W. ■ Joe Garagiola, pres & gen mgr; Garland Burt, stn mgr; Hal Paul, coml mgr; Dan Sanborn, news dir; Frank Berry, chief engr. ■ Rates: \$7.70;6.50;7.70;6.50.

WSIR—Feb. 14, 1947: 1490 khz; 500 w-D. 250 w-N. Box 633, Southwest Lake Howard Drive (33880). (813) 294-4111. Cypress Central Communications Corp. (acq 5-24-73). Net: ABC/I. Rep: Admiral. Format: Contemp. ■ Randall E. Jeffery, pres & gen mgr; Craig N. Harper, coml mgr; Robert T. Stephenson, prom mgr; Kenneth R. Cooper, prog dir; Steve Day, mus dir; James E. Greenfield, news dir; L. Orden Craig, chief engr.

WZNG—Nov. 29, 1958: 1360 khz; 1 kw-D. 1505 Dundee Rd. (33880). (813) 299-1141. Vantage Bcstg Co. (acq 12-1-72). Net: Mutual Black. Rep: G.C.I. Sales, Jones. Format: Top 40. Spec progs: Talk 1 hr wkly. ■ David C. Buerger, pres & gen mgr; Diane Buerger, stn mgr; Bruce L. Parker, coml mgr; Bob Ryan, prog dir; Charlie Rock, mus dir; Paul Garber, chief engr.

Winter Park

WB JW—September 1954: 1440 khz; 5 kw-D, 1 kw-N, DA-N. Box 7475, Orlando (32804). (305) 425-6631. Rounsaville of Tampa Inc. (group owner: acq 4-1-71). Net: ABC/E. Rep: Avco. Format: Easy Istng. Spec prog: Point of View 3 hrs wkly. ■ Ralph Johnson, pres; Pierre Bejano, gen mgr; Jim Boynton, prog dir; Ron Krochman, mus dir; Bill Thomson, news dir; Don Anglin, chief engr.

WLOQ(FM)—Co-owned with WLOF Orlando. 1966: 103.1 mhz; 3 kw. Ant 105 ft. Box 15746 Orlando (32808). (305) 293-2431. Home Security Bcstg Co. (acq 4-1-72). Rep: Katz. Format: Good music. ■ Carl Glicker, pres & gen mgr; Jerry Frericks, coml mgr; Dave Elliott, news dir; Luke Beasley, chief engr.

***WPFL(FM)**—1974: 88.9 mhz; 13.7 w. Ant 84 ft. Stereo. 2100 Summerfield Rd. (32789). (305) 647-2890. Winter Park High School. Group: Orange County Bd of Pub Instruction. Format: Noncoml diversified. Spec progs: Black 1 hr wkly. ■ Virgil Miller, Faculty sponsor.

***WPRK(FM)**—Dec. 8, 1952: 91.5 mhz; 1.32 kw Ant 90.25 ft. horiz. 84.75 ft. vert. Rollins College (32789). (305) 646-2375. Rollins College. Format: Progsvr, classical. ■ Dr. Charles A. Rodgers, pres; A. Randall Taylor, gen mgr & news dir; Craig W. Morrison, prog dir; Jeremy A. Wood, prom mgr; Peter W. Daiger, mus dir; Kline Stephans, chief engr.

Zephyrhills

WPAS—May 9, 1962: 1400 khz; 1 kw-D, 250 w-N. Box 508 (33599). (813) 782-1418. WPAS Inc. (acq 8-26-74). Charles F. Wister. Format: MOR. ■ Charles F. Wister, pres; Bob Rice, gen mgr; Bobbi Butterfield, coml mgr; Dave Ayres, prom mgr; Ernie Dale, prog & mus dir; Guy Keating, news dir; Ralph Plerson, chief engr. ■ Rates: \$3.25;3.25;2.50.



2607 River Road
Cinnaminson, New Jersey, 08077
Telephone:(609) 786-1060

Georgia Radio

See page C-1 for explanation of listings.

Georgia

Adel

WBIT—March 19, 1955: 1470 khz; 1 kw-D. Box 508 (31620). (912) 896-4571. Timberland Communications Inc. (acq 6-1-69). Net: ABC/E; Georgia. Format: Diversified. Spec progs: Black 10 hrs; gospel 10 hrs, farm 5 hrs, wkly. ■ Ralph Deen, pres & gen mgr; George Deen, VP; Larry Scott Nixon, asst mgr; Don Dove, mus dir; Trisha Nipper, traf dir; Ken Roberts, news dir; Terry Permenter, sports dir; James E. Clegg Sr, chief engr. ■ Rates: \$3.25;3.25;3.25;—.

Albany

WALG—1940: 1590 khz; 5 kw-D, 1 kw-N. DA-2. Box W (31702). (912) 436-7233. Radio Albany Inc. (acq 7-60). Net: ABC/C Rep: Masla. Format: Contemp. ■ Whitfill S. Woodall, pres; Gibbs W. Liggin, gen mgr; Charles Roberts, coml mgr; Tom Cordell, prog dir; Sam Pruitt, news dir; Bill Birchfield, chief engr.

WWCW(FM)—Co-owned with WALG. Dec. 17, 1972: 101.7 mhz; 3 kw. Ant 300 ft. 436-9929. Prog sep from AM. Net: ABC/FM. Format: Contemp/MOR. ■ Elaine R. Vian, coml mgr.

WGPC—1933: 1450 khz; 1 kw-D, 250 w-N. 2011 Gillionville Rd. (31707). (912) 883-6500. Albany Bcstg Co. (acq 1-1-58). Group owner: J. W. Woodruff Jr, stns. Net: CBS. Rep: Torbet ■ J. W. Woodruff Jr, pres; L. M. George, VP, gen & coml mgr. ■ Rates: \$5.50;5.25;5.50;5.25.

WGPC-FM—Feb. 22, 1963: 104.5 mhz; 43 kw. Ant 140 ft. ■ Rates: \$5.50;—;—;5.25.

WJAZ-5000W

Metro Albany's
Exclusive Modern
Country Format

WJAZ—November 1952: 960 khz; 5 kw-D, DA. Box 505 (31702). (912) 432-9181. Dowdy Bros. Bcstg Co. (acq 3-1-75). Format: Mod C&W. Spec progs: Farm 14 hrs, gospel 12 hrs, wkly. ■ Roy M. Dowdy, owner & gen mgr; Clark Whitaker, coml mgr; Caroline Garner, prog dir; Bob Bowen, mus dir; Cliff Houston, news dir; Sam Dudas, chief engr. ■ Rates: \$11.9;11;—.

WJIZ(FM)—January 1965: 96.3 mhz; 100 kw. Ant 470 ft. Box 545 (31702). (912) 432-7447. James S. Rivers, Inc. (group owner). Net: MBS. Format: Black soul. ■ James S. Rivers, pres; Betty T. Smith, gen mgr; Doc Suttles, prog & mus dir.

WQDE—July 10, 1962: 1250 khz; 1 kw-D. Box 1624 (31702). (912) 436-0123. James L. Wigginst, J. Wayne Stuart. Net: MBS. Rep: Walton, Harkins. Format: C&W/Gospel.

WWCW(FM)—Listing Follows WALG.

Alma

WULF—October 1957: 1400 khz; 1 kw-D, 250 w-N, DA-1. Box 1987 (31510). (912) 632-4271. Queen City Bcstg System Inc. Group owner: Farnell O'Quinn. Net: ABC/F. Format: MOR. Spec progs: C&W 19 hrs, farm 2 hrs, wkly. ■ Farnell O'Quinn, pres; Larry D. Ring, gen mgr; Helen Davis, coml mgr. ■ Rates: \$4;4;4;—.

Americus

WDEC—July 5, 1947: 1290 khz; 1 kw-D. Box 1307 (31709). (912) 924-3681. Americus Bcstg Co. (acq 7-18-68). Net: ABC/C; Tobacco. Rep: Walton, Beaver, Dora-Clayton. Format: Contemp. ■ Conway M. Smith, pres & gen mgr; J. Arthur, coml mgr & prog dir; Jerry Krinsky, mus dir; Al Wuther, news dir; Dewey Stone, chief engr. ■ Rates: \$3.80;3.80;3.

WIPE(FM)—Co-owned with WDEC. Sept. 12, 1964: 94.3 mhz; 3 kw. Ant 180 ft. Stereo. Prog sep from AM. Net: Natl Black. Rep: Walton; C. K. Beaver. Format:

Black. ■ Conway M. Smith, pres; J. Arthur, coml mgr; Sam Cooke, prog dir; Curtis Kelly, news dir; Bob Alexander, mus dir; Dewey Stone, chief engr. ■ Rates: \$3;3;3;3.

WISK—Aug 28, 1962: 1390 khz; 5 kw-D. Box 727 (31709). (912) 924-6500. Sumter Bcstg Co. Inc. Net: ABC/I; Georgia News Network. Rep: Boiles. Format: Contemp. Spec prog: Gospel 10 hrs wkly. ■ Robert E. Lashley Jr, pres & gen mgr; Joel Mauk, coml mgr & news dir; David Cochran, prog dir.

WPUK(FM)—Co-owned with WISK. September 1973: 97.7 mhz; 3 kw. Ant 300 ft. Stereo. Format: MOR/popular.

Ashburn

WMES—May 27, 1961: 1570 khz; 1 kw-D. Box 32 (31714). (912) 567-3355. Ray L. Mercer. (acq 1-3-68). ■ Ray L. Mercer, pres & gen mgr; Evelyn J. Mercer, coml mgr; Donald Dasher, chief engr.

Athens

WDOL—June 10, 1957: 1470 khz; 1 kw-D. Box 1607 (30601). (404) 549-1470. University City Inc. Group owner: James Rivers Stns. Net: Georgia News. Rep: Smith, Carpenter. Format: C&W. Spec progs: Fr 3 hrs, Ger 3 hrs, Sp 2 hrs, Black 2 hrs, all wkly. ■ James S. Rivers, pres; Herschel M. Rivers, gen mgr; Don Watson, coml mgr; Bill Burpelt, prog & mus dir; George Inzer, prom mgr; Phil Sanderlin, news dir; Gerald Richey, chief engr.

WJSR(FM)—Co-owned with WDOL. January 1964: 104.7 mhz; 50 kw. Ant 230 ft. Prog sep from AM. Format: Prog, rock. ■ Kingston Hill, prog dir; Burl Hill, mus dir; Joe Hall, news dir.

WGAU

CBSRAD



WGAU—May 1, 1938: 1340 khz; 1 kw-D, 250 w-N. Box 5099 (30604). (404) 549-1340. Clarke Bcstg Corp. (acq 8-56). Net: CBS. Rep: Avery-Knodel. Format: MOR. ■ Randolph Holder Sr, pres & gen mgr; Richard A. Mattocks, coml mgr; Mary Betts, stn mgr; John Varner, news dir; Lesley Brooks, chief engr. ■ Rates: \$4.41;4.41;4.41;4.41.

WJSR(FM)—See listing following WDOL.

WNGC(FM)—Co-owned with WGAU. May 1948: 95.5 mhz; 5.2 kw. Ant 260 ft. (CP: 100 kw. Ant 650 ft). (404) 549-5500. Prog sep from AM. Format: C&W. ■ Larry England, mus dir. ■ Rates: \$4.23;4.23;4.23;4.23.

WRFC—May 1, 1948: 960 khz; 5 kw-D, 500 w-N, DA-N. Box 1152 (30601). (404) 543-3411. Radio Athens Inc. Net: ABC/I. Rep: Busby Finch & Woods. Format: top 40. ■ L. H. Christian, pres; Charles Giddens, gen mgr; Randy Reeves, prog dir; Bob Burton, news dir; Debbi Risher, prom mgr; Bill Branigan, mus dir; Luke Drewry, chief engr. ■ Rates: \$6;6;6;3.50.

***WUOG(FM)**—Oct 16, 1972: 90.5 mhz; 3.2 kw. Ant 145 ft. Stereo. Box 2065, Memorial Hall, University of Ga. (30602). (404) 542-6894. Net: ABC/FM. Format: Prog. Spec progs: Classical 9 hrs; Jazz 9 hrs, wkly. ■ Tommy Bowden, gen mgr; John Kelly, prog dir; Iris Horowitz, mus dir; Kay Warnalis, news dir; Wilbur Herrington, chief engr.

Atlanta

***WABE(FM)**—Sept 13, 1948: 90.1 mhz; 30 kw. Ant. 410 ft. 740 Bismarck Rd., N.E. (30324). (404) 873-4471. Board of Education of the City of Atlanta. ■ *WETV(TV) affil.

WAOK—March 15, 1954: 1380 khz; 5 kw-U, DA-N. 75 Piedmont, N.E. (30303). (404) 659-1380. Broadcast Enterprises Network Inc. (acq 5-14-74). Rep: McGavren-Guild-PGW. Net: Natl Black. Format: Black, R&B. ■ Ragan Henry, pres; Stan Raymond, VP & gen mgr; Ron Dobbins, stn mgr; Bill Green, coml mgr; Gene Michaels, news dir; Ivan Miles, chief engr. ■ Rates: \$58;38;53;38.

WAVO—See Decatur.

***WCLK(FM)**—Apr. 10, 1974: 91.9 mhz; 54 w. Ant.

340 ft. 240 Chestnut St. (30314). (404) 523-8435. Clark College. Format: Diversified. ■ V. W. Henderson, pres; Charles Hobson, gen mgr; Quo Vadis Gex, prog dir; Cecil O'Neal, chief engr.

WGKA—Sept. 1, 1955: 1190 khz; 1 kw-D. Suite 1910, 230 Peachtree St. (30303). (404) 521-1190. GCC Communications of Atlanta (group owner; acq 9-30-71). Rep: Herb Groskin. Format: Classic. Spec progs: Opera 3 hrs, Black 1 hr, Ger 1 hr, Greek 1 hr, wkly. ■ Alexander Tanger, pres; John Tenaglia, exec VP; John B. Frankhouser Jr, gen mgr; Walter Guthrie, prog dir; Scott Woodside, news dir; Chris Pappas, chief engr. ■ Rates: \$14;10;14;—.

WZGC(FM)—Co-owned with WGKA. Sept. 1, 1955: 92.9 mhz; 100 kw. Ant 590 ft. Stereo. Prog sep from AM. Rep: Century National. Format: Contemp. ■ Dale O'Brian, mus dir; Dan Mason, prog dir. ■ Rates: \$45;35;50;50.

WGST—March 17, 1922: 920 khz; 5 kw-D, 1 kw-N. Box 7888 (30309). (404) 892-0092. Meredith Corp. (group owner). Net: ABC/E. Rep: Blair. Format: MOR. ■ Richard F. Carr, gen mgr.

WGUN—July 1947: 1010 khz; 50 kw-D. Box 67, Decatur (30031). (404) 373-2521. WGUN Inc. Group owner: Dee Rivers Stns. Format: relig/C&W. ■ M. B. Rivers, pres; Ben Akerman, gen mgr & chief engr; Claude Jones, prog dir; Preston Mobley, news dir.

WIGO—Nov. 20, 1955: 1340 khz; 1 kw-D, 250 w-N. Box 54573, Atlanta (30308). (404) 875-8511. WIGO, Inc. (acq 10-60). Net: ABC/C; MBS/Black. Rep: QCI Sales. Format: Black. ■ Emil Mogul, pres; Joseph R. Fife, gen mgr; Ken Wilson, coml mgr; Scott Andrews, prog & mus dir; Chuck Cunningham, news dir; Bob Stewart, chief engr. ■ Rates: \$44;38;42;38.

WIIN—1948: 970 khz; 5 kw-D, DA-D. 1365 Peachtree St. N.E. (30309). (404) 892-3777. Georgia Network Inc. (acq May 1975). Net: MBS. Format: Contemp. ■ Lawrence Melear, VP.

WKLS(FM)—Dec. 2, 1960: 96.1 mhz; 100 kw. Ant 930 ft. Stereo. 100 10th St., (30309). (404) 892-9557. SJR Communications, Inc. (group owner; acq 1972). Rep: CBS/FM Radio Sales. Format: progs. ■ Don Waterman, gen mgr; Steve Mitchell, prog dir; Robert Helbush, chief engr. ■ Rates: \$39;39;46;46.

WLTA-FM—November 1963: 99.7 mhz; 100 kw. Ant 1,000 ft. Stereo. Box 7695 (30309). (404) 892-7766. Susquehanna Bcstg. Co. (group owner; acq 3-1-74). Rep: Robert E. Eastman Co. Format: MOR. ■ Arthur W. Carlson, exec VP; Jack DeHaven, VP & gen mgr; Larry King, prog dir; William Willis, pub aff dir; Pat Rogers, news dir.

WPCH(FM)—Co-owned with WAVO (Decatur). Feb 18, 1972: 94.9 mhz; 100 kw. Ant 950 ft. Stereo. 2203 La Vista Rd., N.E. (30329). (404) 321-0100. Subdrink Bcstg Co. (group owner, acq 2-1-72). Rep: Blair. Format: Beautifl mus. Spec progs: Black 1 hr wkly. ■ John E. Lauer, VP & gen mgr; Harry D. Johnson, opns dir.

WPLO—July 1, 1959: 590 khz; 5 kw-U, DA-N. Suite 665, 805 Peachtree St. N.E. (30308). (404) 872-5851. Plough Bcstg Co. Inc. (group owner). Rep: H-R/Stone. Format: C&W. ■ Harold R. Krelnstein, pres; C. B. (Rik) Rogers, gen mgr; Jim Clemens, prog dir; George Pass, chief engr.

WPLO-FM—July 1, 1959: 103.3 mhz; 100 kw. Ant 450 ft. Prog sep from AM.

WQXI—April 16, 1948: 790 khz; 5 kw-D, 1 kw-N, DA-N. 2970 Peachtree Rd. N.W. (30305). (404) 261-2970. TWX 810-751-3541. Jefferson Pilot Bcstg Co. (group owner; acq 3-1-74). Rep: RAR. Format: Contemp/Top 40. ■ Gerald S. Blum, gen mgr; Carolyn Reynolds, coml mgr; Pat Schuler, traf mgr; Scott Shannon, prog dir; David Collin, news dir; Tom Giglio, chief engr. ■ Rates: \$105;75;88;88.

WQXI-FM—See Smyrna.

***WRAS(FM)**—Jan. 18, 1971: 88.5 mhz; 19.5 kw. Ant. 340 ft. Stereo. University Plaza (30303). (404) 658-2240. Ga. State U. Format: Progs. Spec progs: Jazz 10 hrs, black 10 hrs, classical 3 hrs, drama 2 hrs, interviews 4 hrs, wkly. ■ Mark Gilson, gen mgr; Harvey Morris, chief engr.

***WREK(FM)**—March 25, 1968: 91.1 mhz; 40 kw. Ant. 135 ft. Stereo. Box 32743 (30332). (404) 894-2468. Radio Communications Bd. Georgia Institute of Technology. Format: Progs. ■ Edwin Kohler, chrmn; Frank

T. Riherd, gen mgr; George Taylor, bus mgr; George Schneider, mus dir; Victoria M. Gordon, news dir; Reginald A. Ratcliff, chief engr.

***WRFG(FM)**—July 15, 1973: 89.3 mhz; 1250 w. Ant 295 ft. Radio Free Georgia Bcstng Foundation. Box 5332 (30307). (404) 523-3471. Format: Variety black. Spec progs: C&W 12 hrs, folk 3 hrs, bluegrass 2 hrs, wkly. ■ Ebon Dooley, pres; Rodger French, prog dir; Larry Lee, mus dir; Ted Brodek, news dir; Jim Nelson, chief engr.

WRNG—See North Atlanta.

WSB—March 15, 1922: 750 khz; 50 kw-U. 1601 W. Peachtree St. N.E. (30309). (404) 897-7500. TWX 810-751-8288. Cox Bcstg Corp. (group owner; acq 1939). Net: NBC. Rep: Christal Co. Format: Variety. Spec progs: Black, 1 hr; Pub aff Doc 2 hrs, wkly. ■ Clifford M. Kirtland Jr., pres; Elmo Ellis, VP & gen mgr; Bill Vlands, stn mgr; Jack Lenz, gen sls mgr; George Fischer, prog dir; Aubrey R. Morris, prom mgr; Bob Ketchersid, news dir; Gene Christie, mus dir; C. H. Sutton, chief engr. ■ Rates: \$160;58;75;36.

WSB-FM—Nov. 10, 1934: 98.5 mhz; 100 kw. Ant 740 ft. Stereo. Prog sep from AM. Format: Btfl music. Spec progs: Black 1 hr wkly. ■ Theresa O'Shea, opns mgr & mus dir. ■ Rates: \$32;32;32. ■ WSB-TV affil.

WTJH—See East Point.

WXAP—1947: 860 khz; 1 kw-D. 148 Cain St. N.E. (30303). (404) 659-7777. Radio-Ad, Inc. (acq 1968). Net: Ga. News. Rep: Howard. Format: Black, jazz, gospel. ■ Louis O. Hertz, pres; J. B. Harrell, gen mgr; Tony Patrick, coml mgr; James Patrick, mus dir; D. Robert Scott, news dir; Charles Preston, chief engr. ■ Rates: \$31;41;27;—.

WYZE—March 15, 1956: 1480 khz; 5 kw-D. 1655 Peachtree St., Suite 1002. (30309) (404) 873-3632. WYZE Communications Inc. (acq 8-1-70). Rep: Masla. Format: C&W. Spec prog: Greek 1 hr wkly. ■ George Johnston III, pres; Tom Leslie, gen mgr; Buzz Weiss, news dir; Dan Dunningan, prog & mus dir & prom mgr; Lawson Leake, chief engr. ■ Rates: \$13;10;13;10.

WZGC(FM)—Listing follows WGKA.

Augusta

***WAGC-FM**—June 2, 1970: 90.7 mhz; 6.5 kw. Ant 400 ft. Augusta College (30904). (404) 733-2230. Format: Educl, cultural. ■ Harry Jacobs, gen mgr; Dave Huffstetler, prog dir; Kenneth Freeman, chief engr.

WAKN—See Aiken, S.C.

WAUG—March 10, 1952: 1050 khz; 5 kw-D. Box 669 (30903). (404) 722-1302. The Hunter Group Inc. (acq 1-15-67). Net: ABC/1; Georgia Network. Rep: David Carpenter Co. Format: Contemp/Rock/Top 40. ■ Robert Hunter, pres; Jack Carpenter, VP & gen mgr; Anna Deichmann, traf mgr; James DeMedicis, prog dir; Steve York, mus dir; Bob Honeycutt, chief engr.

WAUG-FM—March 10, 1952: 105.7 mhz; 50 kw. Ant 83 ft. Stereo. Dups AM 100%.

WBBQ—1947: 1340 khz; 1 kw-D, 250 w-N. Box 2066 (30903). (404) 279-6610. Savannah Valley Bcstg Co. Net: MBS. Rep: Eastman. Format: Contemp. ■ Geo G. Weiss, pres; Edward H. Dunbar, exec VP & gen mgr; William D. Lenz Jr, VP & asst mgr; Harley R. Drew, VP opns & prog dir; Henry Holmes, news dir; John Jenkins, mus dir; Kenneth R. Freeman, VP & chief engr. ■ Rates: \$20;17;20;17.

WBBQ-FM—March 1955: 104.3 mhz; 100 kw horiz; 35 kw vert. Ant 560 ft. Stereo. Musicast of the South Inc. Dup AM 100%. ■ Rates same as AM.

WBIA—1946: 1230 khz; 1 kw-D, 250 w-N. Box 1230 (30903). (404) 724-2421. WBIA Radio Inc. (acq 5-15-72). Net: NBC, State Bcst News Net. Rep: PRO Time Sales. Format: MOR/Contemp. ■ Boris Mitchell, pres; J. R. Owens Jr, gen mgr; Don Bonesteel, coml mgr; Charles F. Andrews, prog dir.

WFNL—See North Augusta, S.C.

WGAC—1940: 580 khz; 5 kw-D, 1 kw-N, DA-N, Box 1131 (30903). (404) 863-6786. CSRA Bcstg Inc. (acq 2-7-3). Group owner: Beasley Bcstg, Net: CBS. Rep: Torbet; ATA. Format: MOR/C&W. ■ George Beasley, pres; Alvin Jones, gen mgr; Bob Young, prog dir; George Fisher, prom mgr; Neil Linton, mus dir; Diane Tannen, news dir; Larry Sandlin, chief engr.

WGUS—July 30, 1958: 1380 khz; 1 kw-D. Box 1475 (30903). (803) 279-1380. Broadcasting Associates of America. (acq 9-9-59). Group owner: H. Calvin Young Stns. Rep: Savalli/Gates. Format: Mod C&W. ■ Cal Young, pres; Terry L. Brown, VP & gen mgr; Ray Anderson, coml mgr; Wayne Roberts, prog dir; Dave Hensley, mus dir; Ron Montgomery, prom mgr; Jay Patton, news dir; Sheldon Daitch, chief engr.

WGUS-FM—Nov. 11, 1967: 102.3 mhz; 3 kw. Ant 280 ft. horiz, 275 ft. vert. Stereo. Prog sep from AM. Format: Btfl mus. ■ Gary Starr, prom mgr; Wanda Lowery, prog dir.

WRDW—July 1930: 1480 khz; 5 kw-U, DA-N. Box 1405 (30903). (404) 738-2513. J. B. Broadcasting (acq 2-26-69). Net: ABC. Rep: Greener, Hiken, Sears, Ochs. Format: Black 90%. ■ James Brown, pres; Mal Cook, gen mgr; Jimmy F. Clark, prog dir; Jay Bell, news dir.

WTHB—May 1960: 1550 khz; 5 kw-D. Box 1584 (30903). (404) 279-2330. North Augusta Bcstg Corp. (acq January 1961). Net: ABC/E. National Black. Rep: Messina; Ochs. Format: Black. ■ Mrs. Francis B. Bennett, pres; Walter Brumblloe, gen mgr & chief engr; William Berry, news dir; Benny Williams, prog & mus dir. ■ Rates: \$8;8;8.

WZZW(FM)—Co-owned with WTHB. July 11, 1968: 103.1 mhz; 3 kw. Ant 300 ft. Stereo. Net: ABC/FM. Prog sep from AM. Format: MOR. ■ Charles Andrews, prog dir; David Timmerman, mus dir. ■ Rates: \$11;8;8;8.

Austell

WACX—April 16, 1968: 1600 khz; 1 kw-D. Box 746, Westside Dr. (30001). (404) 941-8300. South Cobb Bcstg Co. Net: Georgia. Format: C&W. ■ M. L. Lamar, pres; Al Cohen, gen mgr; Bob James, prog dir; Cleve Scovil, coml mgr; Dick Byrd, mus dir; K. B. Fincher, news dir.

Bainbridge

WAZA—March 17, 1958: 1360 khz; 1 kw-D. Box 157. (31717). (912) 246-2035. Sowega Bcstg, Inc. (acq 1-1-69). Net: ABC/C, Georgia News. Rep: Carpenter. Format: MOR. ■ Harry Schultz, pres; Roy Simpson, gen mgr; Ray Read, coml mgr; Charlotte Elkins, news dir; Rebel Owens, prog dir; Bill Schultz, prom mgr; Doc Page, chief engr. ■ Rates: \$4.15;4.15;4.15;4.15.

WJAD(FM)—Listing follows WMGR.

WMGR—1946: 930 khz; 5 kw-D, 500 w-N, DA-N. Box 706 (31717). (912) 246-1650. Decatur Bcstg Co. (acq 1975). Net: MBS; Tobacco, KBS. Format: C&W. Spec progs: Black 1½ hrs, Farm 15½ hrs, wkly. ■ John A. Dowdy, pres; Joe Hill, gen mgr; Tom Bryant, prog dir; Betty Pelton, news dir; Mike Pelton, chief engr; Mark Pelton, mus dir; Bill Searcy, prom mgr; Larry Fleming, coml mgr. ■ Rates: \$4.80;5;4.80;4.

WJAD(FM)—Co-owned with WMGR. Dec. 20, 1967: 97.3 mhz; 28.6 kw. Ant 145 ft. Progs sep from AM. Format: Top 40. Spec prog: Blind ½ hr wkly. ■ Rates: \$4.50;4.25;4.50;4.

Barnesville

WBAF—July 23, 1966: 1090 khz; 500 w-D. Box 420 (30204). (404) 358-1090. Barnesville Bcstg Co. Format: Black/C&W. ■ Wimley Waters, owner, gen, coml & prom mgr; Donald Lloyd, prog & news dir; Charles Waters, chief engr.

Baxley

WUFE—December 1954: 1260 khz; 5 kw-D. Box 389 (31513). (912) 367-3000. WHAB Radio Inc. Group owner: Farnell O'Quinn Stns. Spec prog: C&W 18 hrs wkly. ■ Farnell O'Quinn, pres; Alvin Graham, gen mgr; Bob Joiner, coml mgr; Bobby Holland, prog dir; Ann Lightsey, sec & treas; Bill Edenfield, chief engr.

Blackshear

WBSG—March 10, 1961: 1350 khz; 500 w-D. Box 400 (31516). (912) 449-6613. Country Colonel Bcstg. Corp. (acq 1-31-66). Format: Variety. ■ M. L. Dixon, pres; G. Troy Mattox, gen mgr & chief engr; Anne W. Boatwright, coml mgr; Sheila M. Dixon, prog dir.

Blakely

WBBK—Oct. 22, 1959: 1260 khz; 1 kw-D. Box 568 (31723). (912) 723-4000. Radio Blakely. Group

Georgia Radio

See page C-1 for explanation of listings.

owner: W. C. Woodall Jr Stns. Rep: TN Spot Sls, Carpenter, Net: Tobacco. Format: C&W. ■ W. C. Woodall Jr., pres; Wayne R. Foster, gen & coml mgr & chief engr; Eugenia Foster, prom mgr; Albert Newberry, news & prog dir; Buddy Smith, ann & sls; Lewis Fryer III, pub ser dir & asst engr.

Blue Ridge

WPPL(FM)—1971: 103.9 mhz; 3 kw. Ant 240 ft. Box 938 Highland St. (30513). (404) 632-2803. Fannin County Bcstg Co. ■ Robert P. Schwab, gen mgr.

Bremen

WWCC—October 1957: 1440 khz; 1 kw-D. Box 397 (30110). (404) 537-3275. Marlin L. Lamar (acq 1975). Net: Motor Racing Net. Rep: Carpenter. Format: Mod C&W. ■ Earlene Richardson, coml mgr; Jim Longshore, prog & mus dir; Tommy Busby, news dir; Terry Gladden, chief engr.

Brunswick

WGIG—March 5, 1949: 1440 khz; 5 kw-D. 1 kw-N, DA-N 801 Mansfield St. (31520). (912) 265-3870. Golden Isles Bcstg Corp. (acq 11-13-70). Group owner: Kirk Bcstg Net: ABC/C. Format: Contemp, Top 40. Spec prog: Black 6 hrs wkly. ■ James L. Kirk II, pres; Alan R. Bishop, gen mgr; Dave Foor, opns & prog mgr; Paul Lawrence, engr; Lee Hogan, mus dir; Bobby Holiday, pub serv dir; Paul Roberts, news dir; Marvin Massey, sls mgr.

WSBI-FM—Co-owned with WGIG. Nov. 8, 1965: 100.7 mhz; 26.5 kw. Ant 170 ft. Prog sep from AM. Net: ABC/E. Format: Btfl mus. ■ Tony Simon, opns mgr.

WMOG—June 1940: 1490 khz; 1 kw-D, 250 w-N. Box 100 (31520). (912) 265-5980. Radio Brunswick Inc. (acq 1-1-53). Net: CBS. Rep: Savalli/Gates. Format: MOR. ■ William G. Brown, pres; John Lane, VP & stn mgr, news dir; Clifton G. Moor, VP/opns mgr; Ken D. Kribbs, coml mgr; Don Brasfield, prog dir; Gil Moor, mus dir; Bill Brown, chief engr.

WSBI-FM—Listing Follows WGIG.

WYNR—Sept. 1, 1966: 790 khz; 500 w-D, DA, Rt. 1, Highway 303 (31520). (912) 264-3820. Southland Radio Inc. (acq 11-13-70). Format: C&W. Spec prog: Farm 1 hr wkly. ■ James L. Wiggins, owner; J. Wayne Stewart, pres & gen mgr; J. Jackson Pride, coml mgr; Deborah Pitts, prom mgr; Bob Lee, mus dir; Lenny McDonald, news dir; Coby Shubert, prog dir; Randy Williams, chief engr.

WYNR-FM—Sept. 1, 1966: 101.5 mhz; 33 kw. Ant 245 ft. Dups AM 100%.

Buford

WDYX—Dec. 10, 1956: 1460 khz; 5 kw-D. Box 609 (30518). (404) 945-5555. Buford Bcstg Inc. (acq 9-4-64). Net: Ga. Rep: Keystone. Format: C&W. Spec progs: Farm 1 hr, editorial 1 hr, pub affrs & featurttes, 2 hrs, wkly. ■ Robert P. Joseph, pres; Jacqueline A. Joseph, gen mgr; Hubert F. Ruberts, prog dir; Dale L. Tino, coml mgr; Dan Bergstrom, chief engr. ■ Rates: \$4;4;4.

WGCO(FM)—Co-owned with WDYX. Jan. 1, 1970: 102.3 mhz; 3 kw. Ant 225 ft. Box 241, Lawrenceville (30245). (404) 945-9953. Format: Religious. Spec prog: Pub affairs, 1 hr wkly. ■ Dan B. Dyer, prog dir; Randall O. Deaton, mus dir. ■ Rates: \$5;5;5;5.

Cairo

WGRA—1950: 790 khz; 1 kw-D. Box 120 (31728). (912) 377-4392. Grady-Mitchell Bcstg Co. Group owner: W. C. Woodall Jr. Stns. Net: Georgia Net. Rep: Keystone, TN Spot Sls. Format: C&W/Contemp. ■ W. C. Woodall Jr, pres; Tim Moran, gen mgr; Gary Hill, asst mgr & prog dir; Sharon Hawthorne, traf mgr; Randy Galliher, mus & news dir; Bill Edinfield, chief engr.

Calhoun

WEBS—Nov. 1, 1966: 1110 khz; 250 w-D. Box 168 (30701). (404) 629-2238. New Echota Bcstg Co. Rep: Carpenter. ■ Wm. E. Stocks, mgr.

Georgia Radio

See page C-1 for explanation of listings.

Camilla

WCLB—January 1955: 1220 khz; 1 kw-D. Drawer 113 (31730). (912) 336-5614. Chapel Bcstg Co. Inc. Format: Contemp. Spec prog: Black 4 hrs wkly. ■ Emerson Browne, pres; Charles L. Browne, gen & coml mgr; John I. Harter, chief engr.

Canton

WCHK—April 11, 1957: 1290 khz; 1 kw-D. Box 1290 (30114). (404) 479-2101. Cherokee Bcstg Co. Group owner: McClure Stns. Net: Georgia Network. Format: C&W. ■ C. A. McClure, pres; Byron L. Dobbs, gen & coml mgr, prog dir & chief engr.

WCHK-FM—Aug. 1, 1964: 105.5 mhz; 3 kw. Ant 81 ft. Dups AM 80%.

Carrollton

WLBB—Jan. 7, 1947: 1100 khz; 1 kw-D. Box 569 (30117). (404) 832-7041. Faulkner Radio Inc. (group owner: acq 11-62). Net: ABC/E. Format: C&W. Spec progs: Black 2 hrs wkly ■ Jimmy Faulkner, pres; Robert M. Thorburn, gen mgr; Tom Cordell, prog dir; Chris Clackum, news dir; Norman McGhee, chief engr. ■ Rates: \$8.50;8.50;8.50;8.50.

WBTR-FM—Co-owned with WLBB. 1964: 92.1 mhz; 3 kw. Ant 105 ft. Stereo. Prog sep from AM. ■ Rates: \$4.25;4.25;4.25;4.25.

WPPI—Nov 19, 1975: 1330 khz; 500 w-D. Peoples Bank Building (30117). Radio Carrollton. Format: Contemp. ■ William P. and Hollis B. Johnson, owners.

***WGGC(FM)**—Feb. 19, 1973: 89.3 mhz; 10 w. Ant 78.6 ft. Box 10014 (30117). (404) 834-1355. West Georgia College. Format: Progs. Spec progs: Port ¼ hr, wkly. ■ T. David Seiber, chmn; James M. Robertson, gen mgr; Richard H. Kerley, chief engr.

Cartersville

WBHF—July 17, 1946: 1450 khz; 1 kw-D, 250 w-N. Box 190 (30120). (404) 382-3000. Frier Bcstg Co. (acq 1972). Net: MBS. Format: C&W, day; Top 40/soul, night ■ Alma S. Frier, pres; Herschel Wisebram, gen mgr; Lee Burger, coml mgr & news dir; Wayne Fry, prog & mus dir. ■ Rates: \$3;2.40;3;2.40.

WKRW—Sept. 21, 1961: 1270 khz; 500 w-D. 1119 N. Tennessee Rd. (30120). (404) 382-1270. Bartow Radio Corp. (acq 10-74). Format: MOR. ■ Don H. Kordecki, mgr, ptrn & chief engr; Don Ruff, ptrn, coml mgr & news dir. ■ Rates: \$2.70;2.50;2.70;—.

Cedartown

WGAA—1941: 1340 khz; 1 kw-D. 250 w-N. Box 167 (30125). (404) 748-1340. Faulkner Radio Inc. (group owner; acq 5-9-68). Net: Georgia Network. Format: MOR. ■ James H. Faulkner Sr., pres; Robert M. Thorburn, gen mgr; Robert H. Bond stn & coml mgr; Charlotte Timms, prog & mus dir; Ken Johnson, prom mgr; Ken Johnson, news dir; Phil Baker, chief engr.

Clarkesville

WIAF—May 1, 1975: 1500 khz; 5 kw-D. Box 468 (30523). (404) 754-6272. R-J Co. Net: ABC/I, Georgia Net. Format: C&W. Spec prog: Audience participation 10%. ■ Robert P. Joseph, gen mgr; Jacqueline A. Joseph, prom mgr; Allen Cross, coml mgr. ■ Rates: \$3;3;3;3.

Claxton

WCLA—July 20, 1958: 1470 khz; 1 kw-D. Box 427 (30417). (912) 739-3035. The Evans County Bcstg Co. Net: MBS. Format: Variety Spec prog: Black 10 hrs wkly ■ W. Don Sports, pres, gen mgr & chief engr; Tom Palmer, coml mgr; Ann Jones, news dir. ■ Rates: \$3.50;3.50;3.50.

WCLA-FM—Sept. 15, 1972: 107.1 mhz; 3 kw. Ant 195 ft. Evans County Bcstg Co. Inc. Dups AM 100%. ■ Rates same as AM.

Clayton

WGHC—June 28, 1961: 1570 khz; 1 kw-D. Box 348 (30525). (404) 782-4251. Rabun Radio (acq 1-1-65).

Net: MBS. Format: Variety. ■ Carroll S. Lee, owner, pres & gen mgr; Grace S. Lee, VP & secy; W. L. Savage, coml mgr; Cliff Hannah, prog dir; Carroll S. Lee Jr., stn mgr, mus & news dir & chief engr.

Cleveland

WRWH—Sept. 27, 1959: 1350 khz; 1 kw-D. Box 181 (30528). (404) 865-3181. Newscis Inc. Net: Georgia Net. Format: Country/Gospel. ■ Ronald Whifeman, pres; Dean Dyer, gen mgr & prog/news dir; Bonnie Dyer, mus dir; Lamont Kinsey, chief engr. ■ Rates: \$2.50;2.50;2.50;—.

Cochran

WVMG—July 4, 1956: 1440 khz; 1 kw-D. Box 504 (31014). (912) 934-6261. Happy Acres Bcstg Co. Inc. (acq 7-15-72). Format: C&W. ■ Raymond B. Forehand, pres & chief engr; Freddie Frye, gen mgr, prog & mus dir; Sue Ann Frye, coml mgr; Steve Dykes, news dir.

WVMG-FM—July 4, 1968: 96.7 mhz; 3 kw. Ant 155 ft. Dups AM 75%.

Columbus

WCGQ(FM)—Listing follows WHYD.

WCLS—December 1954: 1580 khz; 1 kw-U, DA-2. Box 229 (31902). (404) 327-3648. Muscogee Bcstg Co. Net: ABC/C. Rep: Messina. Format: MOR. ■ Charlie H. Parish Jr., pres, gen mgr & chief engr; Warren Jones, prog mgr & prog dir; Raymond M. Fletcher, coml mgr; Mike Smith, mus dir; Robert Aiken, news dir.

WDAK

Adult Contemporary

EASTMAN RADIO, INC.



WDAK—August 1943: 540 khz; 5 kw-D, 550 w-N, DA-N. Box 1640 (31902). (404) 322-5447. Radio Columbus, Inc. Net: ABC. Rep: Eastman. ■ Allen M. Woodall Jr., pres; Bernie Barker, VP & gen mgr; Bill Jarrell, coml mgr; Alan Boyd, prog dir; J. Edward Wilson, news dir; Charlie Skinner, chief engr. ■ Rates: \$24.30;18.90;20.70;18.90.

WEIZ

Beautiful Music

EASTMAN RADIO, INC.

NAFMB



WEIZ(FM)—Co-owned with WDAK. March 4, 1971: 100.1 mhz; 3 kw. Ant 300 ft. Stereo. Box 2744. (31902). (205) 298-7872. Chattahoochee Bcstg Co. (acq 10-30-74). Format: Bfm mus. ■ Jim Martin, coml mgr; Jimmy Deere, prog & mus dir. ■ Rates: \$10;12;10;12.

WHYD—1947: 1270 khz; 5 kw-D. Box 1537 (31902). (404) 323-3603. WGBA Inc. (acq 1-1-56). Group owner: McClure. Net: MBS. Rep: Pro-Meeker; Southern Spot Sls. Format: C&W. Spec prog: Farm 2 hrs wkly ■ C.A. McClure, pres; Doyle Palmer, VP & gen mgr; Chuck Holiday, prog dir; F. Keith Brown, VP & chief engr; Miles Cannon, news dir. ■ Rates: \$9;7;9;7.

WCGQ(FM)—Co-owned with WHYD. July 15, 1966. 107.3 mhz; 100 kw horiz, 37 kw vert. Ant 530 ft. Stereo. Prog sep from AM. Format: Top 40. ■ Bill Lenkey, prog dir. ■ Rates: \$9;9;10;10.

WOKS—March 2, 1959: 1340 khz; 1 kw-D, 250 w-N. Box 1998 (31902). (404) 324-0261. Associated FM Bcstg (acq 10-25-74). Rep: Howard; Ochs. Format: Black. ■ Louis O. Hertz, pres; Buddy Moore, gen mgr;

Ron Brown, coml mgr; Warren Palmer, prog dir & prom mgr; Sam Greene, news dir; Jack Collingsworth, chief engr.

WPNX—1951: 1460 khz; 5 kw-D, 1 kw-N, DA-N. Box 687 (31902). (404) 322-2270. Bi-State Bcstg Co. (acq 9-1-71). Net: NBC. Rep: Dore; Carpenter. Format: Modern C&W. ■ Sidney F. Kaminsky, pres & gen mgr; T. Edward Hall, coml mgr; Chuck Holliday, prog & mus dir; Judy Kaminsky, prom mgr; Frank Pittman, news dir; John Simmons, chief engr.

WRBL—May 10, 1928: 1420 khz; 5 kw-U, DA-N. Box 270 (31902). (404) 324-2441. TWX 404-327-6345. Columbus Bcstg Co. Inc. (acq 10-26-53). Group owner: J. W. Woodruff Jr. Stns.' Net: CBS. Rep: Torbet. Format: MOR. ■ J. W. Woodruff Jr., pres & gen mgr; Chas. M. Rector, sta & sls mgr; Bill Bowick, prog dir; George Gingell, pub affrs dir; Dick McMichael, news dir.

WRBL-FM—Nov. 16, 1946: 102.9 mhz; 100 kw. Ant 1520 ft. Stereo. Dup AM 15%. WRBL-TV affil.

WRRH(FM)—Sept. 22, 1969: 104.9 mhz; 3 kw. Ant 21 ft. Stereo. 1115 14th St. (31901). (404) 322-0609. Kamman Enterprises Inc. (acq 6-13-74). Format: Rock. ■ S. Kaminsky & N. Goldman, owners; Jack Collingsworth, mus dir & chief engr.

Commerce

WJJC—June 27, 1957: 1270 khz; 1 kw-D. Box 379 (30529). (404) 335-3155. Jackson County Bcstg Co. Inc. (acq 1-58). Net: ABC/I, Georgia Net. Format: MOR/C&W. ■ O. Grady Cooper, pres & gen mgr; Elizabeth Layton, prog dir; Ben Hicks, news dir; William Carson, chief engr. ■ Rates: \$3.25;3.25;3.25;—.

Cordele

WFAV(FM)—Listing follows WMJM.

WMJM—Oct. 7, 1940: 1490 khz; 1 kw-D, 250 w-N. DA-1. Box 340 (31015). (912) 273-1404. Southeastern Bcst System Inc. Group owner: James Rivers Stns. Net: MBS. Format: Diversified. ■ James S. Rivers, pres; Sara J. Howell, bus mgr; Philip Streetman, news dir; Wayne Brown, coml mgr; Bill Goodson, prog dir & chief engr.

WFAV(FM)—Co-owned with WMJM. Feb. 22, 1969: 98.3 mhz; 3 kw. Ant 300 ft. Stereo. Prog sep from AM. ■ Phil Streetman, mus dir; Bill Goodson, prom mgr; Lee Wright, news dir.

Cornelia

WCOR—March 28, 1953: 1450 khz; 1 kw-D, 250 w-N. Box 100 (30531). (404) 778-2241. Habersham Bcstg Co. (acq 2-1-61). Net: ABC/E. Format: MOR. ■ John C. Foster, pres; Bobbie C. Foster, VP & gen mgr; Jack R. Willoughby, news dir; Boyd M. Anderson, chief engr. ■ Rates: \$2.40;2.40;2.40;2.40.

WCOR-FM—March 27, 1965: 99.3 mhz; 1.35 kw. Ant 420 ft. Stereo. Dups AM 97%. ■ Rates same as AM.

Covington

WGFS—1946: 1430 khz; 1 kw-D. Box 869 (30209). (404) 786-1430. R. William & Betty Jean Hoffman (acq 6-1-57). Format: Variety. ■ R. William Hoffman & Betty Jean Hoffman, co-owners; Bill Hoffman, gen mgr & chief engr. ■ Rates: \$3.45;3.45;3.45;—.

Cumming

WSNE—1962: 1170 khz; 1 kw-D. Box 609 (30130). (404) 887-3136. Howard Rowe & Assocs. Inc. (acq 9-19-68). ■ Howard M. Rowe, pres; Phil Castleberry, stn mgr; Pete Woodham, chief engr.

Cuthbert

WCUG—Dec. 1, 1971: 850 khz; 500 w-D. Box 348 (31740). (912) 732-3725. R. G. Blaskow, audio news: UPI. Format: C&W. Spec progs: Black 2 hrs, farm 7 hrs, wkly. ■ R. G. Blaskow, gen mgr; Ruth Blaskow, prog dir; Allene Nelson, news dir. ■ Rates: \$2.85;2.85;2.85;—.

Dalton

WBLJ—April 8, 1940: 1230 khz; 1 kw-D, 250 w-N. Box 809 (30720). (404) 278-3300. North Georgia Radio Inc. (acq 1-1-60). Net: MBS; Keystone. ■ Werner Wortsman, pres & gen mgr; Ken Mynatt, prog

dir; Barbara Wilson, news dir; Frank Painter, ecology dir; Charles Pritchard, chief eng.

WRCD—Oct. 1, 1954: 1430 khz; 1 kw-D, Box 1284 (30720). (404) 278-5511. Whitfield Bcstg Co. Inc. Format: C&W. ■ Jim Honey, pres, gen mgr & chief eng; Hugh Birdsong, coml mgr; Hilda Robertson, prog dir; Mike Dodd, news dir. ■ Rates: \$4.25;4.25;4.25;4.25.

WTTI—June 17, 1965: 1530 khz; 10 kw-U, DA-2 (CH). Box 216, Dalton Federal Bldg. (30720). (404) 226-2700. WTTI Bcstrs Inc. (acq 9-71). Format: Contemp. ■ Ron Arnold, VP & gen mgr; Faye Arnold, coml mgr & mus dir; Lamar McClure, prog dir; Larry Richter, chief eng. ■ Rates: \$5;4;3.50;—.

Dawson

WDWD—April 2, 1948: 990 khz; 1 kw-D, Box 390 (31742). (912) 995-5846. Dawson Bcstg Co. Group owner: W. C. Woodall Jr. Stns. Net: ABC/E. Format: Top 40/C&W. ■ W. C. Woodall Jr, pres & coml mgr; O. W. Parnacott, prog dir; Mrs. J. P. Orndorff, news dir; J. N. Stephens, chief eng. ■ Rates: \$5;5;5;—.

WDWD-FM—September 1969: 92.1 mhz; 3 kw. Ant 230 ft. Stereo. Progs sep from AM. Format: Good mus. ■ Rates: \$5;5;5;5.

Decatur

WAVO—July 19, 1958: 1420 khz; 1 kw-D, DA. Box 111 (30031). (404) 292-3800. Sudbrink Bcstg Co. (group owner; acq 2-1-71). Format: Relig. ■ Woody Sudbrink, pres; Dennis King, gen mgr; Rev. Phil Anderson, prog dir; Jim Dickson, chief eng.

WPCH (FM)—See Atlanta.

WQAK—Aug. 11, 1964: 1310 khz; 500 w-D. 1051 First National Bank Bldg. (30030). (404) 377-2676. George H. Buck Jr. (acq 4-1-73). Net: ABC/I. Format: MOR: Spec progs: Swing & Jazz. ■ George H. Buck Jr, pres; Ken Farnsworth, coml mgr; Joe Frye, prom mgr; Eleanor Gobey, mus dir; Charles Preston, news dir; Harry Overton, chief eng.

Donaldsonville

WSEM—Feb. 12, 1963: 1500 khz; 1 kw-D, Box 87 (31745). (912) 524-5123. Seminole Bcstg Co. (acq 3-1-71). Format: Country, Black and Gospel. ■ Gilbert Kelley, pres & gen mgr; Jack Argersinger, coml mgr; Gil Kelley Jr, mus dir; Craig Palmer, prog & news dir; Max Daniels, chief eng.

Douglas

WDMG

Contemporary-Cross Country Music

WDMG—March, 1947: 860 khz; 5 kw-U, DA-N, Box 860 (31533). (912) 384-3250. WDMG Inc. Group owner: Timm Stns. Net: Georgia News. Reps: Dora-Clayton. Format: Contemp, cross country. ■ B. F. J. Timm, pres; Roy L. Jones, gen mgr; Chris Jones, prog & mus dir; Eugene Payne, chief eng. ■ Rates: \$6.50;6.50;6.50;6.50.

WDMG-FM—Not on air, target date unknown: 99.5 mhz, 51 kw. Ant 200 ft.

WOKA—Dec. 10, 1962: 1310 khz; 1 kw-D, Box 471 (31533). (912) 384-8153. Coffee County Bcstrs. (acq 1971). Net: NBC. Format: C&W, MOR, farm. ■ Lauren N. Nobles, pres, gen mgr & news dir; Robert Mason, prog dir; Eldridge F. Mitchell, chief eng.

WOKA-FM—July 1971: 106.7 mhz; 34 kw. Ant 175 ft. Dups AM 25%.

Douglasville

WDGL—April 4, 1964: 1520 khz; 1 kw-D, 500 w-D (CH). 825 E. Broad St. (30314). (404) 942-5186. Douglas County Bcstg Co. ■ Bolling Branham, owner & gen mgr.

Dublin

WMLT—Jan. 12, 1945: 1330 khz; 5 kw-D, 500 w-N, DA-N, Box 130 (31021). (912) 272-4422. Dublin Bcstg Co. Rep: Jones. Format: Variety. ■ W. Newton Morris, pres; Ed Hilliard, gen mgr; Anne M. Evely, coml mgr; Dick Killebrew, news dir; Johnny Warren, chief eng.

WXLJ—March 16, 1958: 1230 khz; 1 kw-D, 250 w-N, Box 967 (31021). (912) 272-4282. Laurens County Bcstg Co. (acq 4-7-61). Rep: Walton, Ochs. Format: C&W, black. ■ Ted Kirby, pres & gen mgr; Mike Kirby, coml & prom mgr; Jim Brown, prog & mus dir; Tom Simmons, news dir.

WXLJ-FM—April 4, 1967: 92.7 mhz; 3 kw. Ant 220 ft. Dups AM 80%.

Eastman

WUFF—Sept. 1, 1961: 710 khz; 1 kw-D, Box 626 (31023). (912) 374-3437. Farnell O'Quinn (group owner). Net: NBC. Format: C&W. Spec progs: Black 5 hrs wkly. ■ Farnell O'Quinn, pres; Gene Rogers, gen & coml mgr; Clark Parkerson, chief eng.

New FM—Not on air, target date unknown: 92.1 mhz, 1.8 kw. Ant. 378 ft. Box 389, Baxley (31513). Farnell O'Quinn. Format: C&W, gospel, top 40.

East Point

WTJH—December 1949: 1260 khz; 5 kw-D, Box 967 (30344). (404) 344-2233. Radio Stn WTJH. Group owner: James Rivers Stns. Net: Keystone. Rep: Natl Time Sis. Format: Gospel. ■ Tolliver R. Rivers, pres & gen mgr; Bea Godbee, prog dir; Leroy Swanger, prom mgr; Billy Hill, chief eng.

Eatonton

WXPO—Dec. 15, 1966: 1520 khz; 1 kw-D, Box 552 (31024). (404) 485-8055. Eatonton Bcstg Co. (acq 6-1-70). Format: Top 40. Spec prog: Black 20 hrs wkly. ■ L. O. Benton, pres; Happy Howard, gen & coml mgr; Dee Swymer, stn mgr.

Elberton

WSGC—1946: 1400 khz; 1 kw-D, 250 w-N, Box 638 (30635). (404) 283-1400. Elberton Bcstg Co. Format: Progs. ■ Lewis Shurbutt, gen mgr.

WSGC-FM—1973: 92.1 mhz; 3 kw. Ant 300 ft. Dups AM 15%.

Fitzgerald

WBHB—Oct. 8, 1946: 1240 khz; 1 kw-D, 250 w-N, Box 100 (31750). (912) 423-2077. Ben Hill Bcstg Corp. (acq 7-55). Net: MBS. Rep: Tobacco Radio. Format: Black. Spec progs: Black 12 hrs, wkly. ■ Paul E. Reid, pres & gen mgr; Richard F. Cargile, prog & news dir & prom mgr; Charles Ridgeway, sports dir; Francis S. (Boone) Raynor, chief eng.

WSIZ—See Ocilla.

Forsyth

WFNE (FM)—Nov. 22, 1973: 100.1 mhz; 3 kw. Ant 300 ft. Box 693 (31029). (912) 994-9494. Forsyth Bcstg Co. Net: Georgia Net. Rep: W. O. Jones. Format: Progs, C&W. Spec prog: Farm 1 hr, rock around the world 1 hr, Southern rock 10 hrs, wkly. ■ Carmen D. Trevitt, pres; John W. Fetner, stn mgr; Donna Gallaher, coml mgr; Bruce Lee Parker, prog dir. ■ Rates: \$4.70;3.76;4.70;3.76.

Fort Valley

WFPM—June 1951: 1150 khz; 1 kw-D, Box 934. (31030). (912) 825-5547. Rocket Radio Inc. (acq 10-1-60). Format: Top 40. Spec prog: Black 7 hrs wkly. ■ Paul Reehling, pres & gen mgr; John P. Reehling, coml mgr; Jack McKeen, prog & mus dir; Joe Stephens, chief eng.

Gainesville

WDUN—April 2, 1949: 1240 khz; 1 kw-D, 250 w-N, Box 10 (30501). (404) 534-7331. Northeast Georgia Bcstg Co. Net: ABC/I; Georgia. Format: Top 40, Contemp. ■ John W. Jacobs Jr, pres & gen mgr; James N. Martin, stn mgr; Tom Harris, prog dir; Robert N. Howell, gen sis mgr; Mike Wolcott, chief eng. ■ Rates: \$6.25;5;6.25;5.

WWID (FM)—Co-owned with WDUN. April 3, 1949: 106.7 mhz; 100 kw. Ant 540 ft. Stereo. Prog sep from AM. Format: MOR. ■ Calvin Means, gen mgr. ■ Rates: \$5.50;5.50;5.50;5.50.

WFOX (FM)—Nov. 1, 1965: 97.1 mhz; 97 kw. Ant 540 ft. Stereo. Box 1567 (30501). (404) 536-9948. Radio Athens Inc. (acq 3-10-72). Audio news; UPI. Format:

Georgia Radio

See page C-1 for explanation of listings.

Adult contemp. ■ L. H. Christian, pres; A. J. Guest, VP & gen mgr; Ron Thompson, coml mgr; Dave Welch, prog dir; Randy Mullinax, chief eng. ■ Rates: \$5.50;5.50;5.50;5.50.

WGGA—Oct. 10, 1941: 550 khz; 5 kw-D, 500 w-N, DA-N, Box 1318 (30501). (404) 532-6211. WGGA Inc. (acq 12-15-67). Group owner: Kirk Bcstg. Net: CBS. Rep: Meeker; Busby, Finch & Wood. Format: MOR. ■ James L. Kirk II, pres; A. O. Healan, VP & gen mgr; Doris Smith, sis mgr; James A. Hartley, VP & ops mgr; Randy Reynolds, prog dir; Tony Maddox, news dir; Wilbert Darracott, chief eng.

WNRJ—Jan. 26, 1957: 1130 khz; 10 kw-D, Box 1398, 303 W. Washington St. (30500). (404) 532-6331. WLBA Inc. (acq 1975). Format: C&W. Spec progs: Gospel 14 hrs wkly. ■ Ernest H. Reynolds Jr et al, owners.

Garden City

WNMT—June 6, 1968: 1520 khz; 1 kw-D, Box 7042 (31408). (912) 234-5124. Woods & Watkins. Net: ABC/E. Format: C&W. ■ Chris Watkins, pres & gen mgr; Evelyne Pope, off mgr; M. E. Watkins, sec, treas & prog dir; Edgar Bigbie, chief eng.

Glennville

WKIG—June 25, 1961: 1580 khz; 1 kw-D, Box 98 (30427). (912) 654-3580. Tattnell County Bcstg Co. (acq 5-30-68). ■ Don P. Cobb, pres, gen & coml mgr; Judy W. Cobb, prog dir. ■ Rates: \$3.50;3.50;3.50;3.50.

Gordon

WKOG—Sept. 1, 1969: 1560 khz; 5 kw-D, 1 kw-CH, Box 356 (31031). (912) 628-2000. Piedmont Bcstg Co. Inc. Net: NBC. Format: C&W. ■ Cyler D. Garner, pres; Ralph V. Lavender, gen mgr; Edgar H. Discher, chief eng. ■ Rates: \$3.80;2.80;3.80;—.

WKOG-FM—Not on air, target date 12-75: 107.1 mhz; 3 kw. Ant 98 ft. Stereo. 575 Minton Dr. (31031).

Griffin

WGRI—September 1960: 1410 khz; 1 kw-D, Box 156 (30223). (404) 228-8496. WGRI Radio Inc. Rep: Don Blake. Format: C&W. ■ Guy Millner, pres; Johnny Mann, gen mgr; Anthony Berry, coml mgr; Stan Watson, prog, mus & news dir; Lanie Wiley, chief eng.

WHIE—Dec. 15, 1952: 1320 khz; 5 kw-D, Box 971. (30223). (404) 227-9451. Telerad Inc. (acq 1957). Net: ABC. Rep: Ochs. Format: MOR. ■ Fred L. Watkins, pres & gen mgr; Sid James, sports dir; Edelmia Phillips, women's dir; Cal Beverly, news dir; Ralph Gaskins, chief eng.

WKEU—1933: 1450 khz; 1 kw-D, 250 w-N, Drawer Q. (30223). (404) 227-5507. Radio Station WKEU. Net: MBX. Rep: Keystone. Format: MOR. ■ A. W. Marshall Jr, pres; Allen W. Marshall III, VP & gen mgr; WF Westmoreland, VP & sis mgr; R. Wayne Johnson, news dir. ■ Rates: \$3.45;3.45;3.45;3.45.

WKEU-FM—March 8, 1966: 97.7 mhz; 3 kw. Ant 300 ft. Stereo. Box 1001 (30223). Dup AM 25%. Format: Sports, Oldies, Bltt mus. ■ Rates: \$2.10;2.10;2.10;2.10.

Hartwell

WKLY—Sept. 5, 1947: 980 khz; 1 kw-D, Box 636. (30643). (404) 376-2233. Wkly Bcstg Co. ■ Max G. Pfaender, pres; Burch T. Griffin, gen & coml mgr; Jean Vickery, prog dir; Don Purvis, news dir; Broadus McLane, chief eng. ■ Rates: \$2.50;2.50;2.50;—.

Hawkinsville

WCEH—Dec. 11, 1952: 610 khz; 500 w-D, Box 489 (31036). (912) 892-9061. Tri-County Bcstg Co. Inc. Net: ABC; Tobacco Radio. Format: C&W. ■ James D. Popwell, exec VP & gen mgr; Rivers Jackson, coml mgr; Liz Davis, prog dir; Charlie Hill, prom mgr; Don Wingate, news dir; Jim Popwell Jr, chief eng.

WCEH-FM—Sept. 26, 1968: 103.9 mhz; 3 kw. Ant 255 ft. Format: Contemp. Progs sep from AM.

Georgia Radio

See page C-1 for explanation of listings.

Hazelhurst

WVOH—Sept. 6, 1962: 920 khz; 500 w-D. Box 757 (31539). (912) 375-4511. Jeff Davis Bcstrs Inc. Format: Variety, C&W. Spec prog: Gospel 7 hrs wkly. ■ John Hulett, pres, & chief engr; Hilda Lewis, coml mgr; Bob Holland, mus dir; Wilbur Health, news dir.

WVOH-FM—Not on air, target date unknown: 93.5 mhz, 3 kw. Ant. 232 ft. Dups AM.

Hinesville

WGML—Dec. 9, 1958: 990 khz; 250 w-D. Box 15 (31313). (912) 876-3599. Liberty Bcstg Co Inc. Net: MBS. Format: Mixed mus MOR. Spec prog: Black 3 hrs wkly. ■ E. D. Steele Jr, pres; Bob Bitzer, chief engr. ■ Rates: \$2.50;2.50;2.50;—.

Jackson

WJGA—April 24, 1967: 1540 khz; 1 kw-D. Box 3878 (30233). (404) 775-3151. Better Radio Inc. (acq. 9-15-72). Net: MBS. Rep: Keystone, Carpenter. Format: Top 40, MOR. ■ B. L. Williamson, pres; Charles Brown, gen mgr & prog dir; Ron Armistead, coml mgr; Johnny Smolka, news & prog dir; Johnny Morris, mus dir; Herbert Shapard, chief engr.

WJGA-FM—April 24, 1967: 92.1 mhz; 3 kw. Ant 275 ft horiz; 270 ft vert. (CP 1.20 kw. Ant 440 ft). Dup AM 100%.

Jasper

WYYZ—May 25, 1973: 1580 khz; 250 w-D. Box 280 (30143). (404) 692-6446. Pickens County Bcstg Co. Format: C&W, Gospel, Top 40. ■ Robert P. Schwab, owner, gen mgr.

Jesup

WIFO-FM—Listing follows WLOP.

WLOP—July 12, 1949: 1370 khz; 5 kw-D. Box 647 (31545). (912) 427-3711. Jesup Bcstg Corp. (acq. 9-17-70). Net: ABC/E, Tobacco Net, Georgia Net. Rep: T/N Spot Sls. Format: C&W. ■ John W. Davidson, pres; Charles Hubbard, gen & coml mgr; Roy Anderson, prog dir; Carolyn Dent, prom mgr; Jerry Rogers, sports dir; Hugh Harris, news dir; Raymond Bilbrey, chief engr.

WIFO-FM—Co-owned with WLOP July 1, 1968: 105.5 mhz; 3 kw. Ant 300 ft. Stereo. Prog sep from AM. Net: ABC/I. Format: R&B, Contemp, Top 40. ■ Roy Anderson, coml mgr.

WSOJ-FM—1974: 98.3 mhz; 3 kw. Ant 300 ft. 109 Beech St. (31014). Happy Acres Bcstg Co. ■ Raymond B. Forehand, pres.

Lafayette

WLFA—November 1954: 1590 khz; 5 kw-D. Box 746 (30728). (404) 638-3276. Radio Dixie Inc. (acq. 6-1-55). Audio news; UPI. ■ J. A. Gallimore, pres; C. W. Gwyn, gen mgr; Chas M. Lowry Jr, chief engr. ■ Rates: \$4;4;4;4.

La Grange

WLAG—May 1, 1941: 1240 khz; 1 kw-D, 250 w-N. Drawer 1429 (30240). (404) 882-3505. La Grange Radio (acq 1975). Net: MBS. Rep: Keystone. Spec progs: Black 6 hrs, C&W 18 hrs wkly. ■ Paul E. Reid & L. A. Wood, Jr, co-owners; Faye Scarbrough, prog dir; Peggy Patterson, mus dir; Mike Burnette, chief engr.

WLAG-FM—Sept. 1, 1947: 104.1 mhz; 29.5 kw. Ant 220 ft. Stereo. Format: C&W. Prog sep from AM. ■ Aileen Love, gen mgr.

WTRP—Jan. 9, 1953: 620 khz; 1 kw-D. Box 1203 (30240). (404) 884-9877. Chattahoochee Bcstg Co Inc. Rep: Dora-Clayton. Format: Contemp. Spec progs: Black 8 hrs, C&W 18 hrs, wkly. ■ Julian P. Hurst, gen mgr; Martha Anderson, stn mgr; Craig Thompson, prog dir; Robert Whately, news dir; Ray Reihan, chief engr.

Lawrenceville

WLAW—Jan. 7, 1959: 1360 khz; 1 kw-D. 829 Crogan St., N.E. (30245). (404) 843-2222. Radio Gwinnett Inc. ■ Robert J. McGarity, VP & gen mgr.

Louisville

WPEH—Sept. 10, 1960: 1420 khz; 1 kw-D. Box 425 (30434). (912) 625-7248. Peach Bcstg Co Inc. Net: Keystone. Format: C&W/Top 40/MOR. Spec progs: Black 6 hrs, wkly. ■ Otis G. Stephens, pres, gen & coml mgr; Wendell F. Stephens, prog dir; Sue Stephens, prom mgr; Sheldon Daitch, news dir, chief engr.

WPEH-FM—May 6, 1971: 92.1 mhz; 3 kw. Ant. 200 ft. Dups AM 75%.

Lyns

WBBT—March 12, 1959: 1340 khz; 1 kw-D, 250 w-N. Box 389 (30436). (912) 526-8122. Toombs County Bcstg Co. (acq 3-1-71). Net: MBS. Rep: Beaver. Format: C&W. ■ Joe Duggan, pres; Jerry Craft, gen & coml mgr; Lois Godbee, prog dir; Bruce Bostwick, chief engr.

Macon

WAVC—See Warner Robins.

WBML—Oct. 15, 1940: 1240 khz; 1 kw-D, 250 w-N. 847 Riverside Dr. (31201). (912) 743-5453. Prairie-land Bcstrs of Ga. Inc. (acq 1-1-73). Net: NBC. Format: Contemp, uptempo. ■ Jim Whitaker, pres & gen mgr; Ken Crook, prog dir; Jess Branson, news dir; Chuck Frost, coml mgr; Jan Howard, prom mgr; Bill Elder, mus dir; Ray McDonald, chief engr. ■ Rates: \$8.50;7.50;8.50;5.50.

WCRY—Nov. 25, 1957: 900 khz; 250 w-D. Box 900 (31202). (912) 746-6286. Middle Georgia Bcstg Co Inc. (acq 11-10-61). Net: MBS. Format: Btl mus. ■ Ben G. Porter, pres; Fred L. Newton, gen & coml mgr; Hal R. Sutton, chief engr. ■ Rates: \$12;11.50;12;11.

WCRY-FM—Oct. 19, 1973: 107.9 mhz; 100 kw. Ant 690 ft. Dups AM 80%. ■ Rates same as AM.

WDEN

Modern Country Music

WDEN—August 1967: 1500 khz; 1 kw-D. Box 46 (31202). (912) 745-3383. Elliott Bcstg Co. (acq 9-72). Audio news: APR. Rep: AT&T. Format: C&W. ■ J. Marvin Elliott, owner & pres; Wayne B. Sawyer, gen mgr; Alan Murray, prog dir; Wayne Ellis, coml mgr; Gordon Price, mus dir; Dennis Hayes, news dir; Judd Goodman, chief engr. ■ Rates: \$8.40;6.60;8.40;5.10.

WDEN-FM—June 10, 1968: 105.3 mhz; 50 kw. Ant 145 ft. Stereo. Dup AM 100%. ■ Rates same as AM.

WIBB—November 1948: 1280 khz; 5 kw-D. 830 Mulberry St. (31201). (912) 742-2505. WIBB Radio Inc. (acq 2-1-72). Net: MBS/Black. Rep: Dore; Dora-Clayton. Format: Black. ■ Al Brooks, pres & gen mgr; James R. Hunnicutt, stn mgr.

WMAZ—Oct. 30, 1922: 940 khz; 50 kw-D, 10 kw-N, DA-N. Box 5008 (31208). (912) 746-7311. TWX 912-788-3713. Multimedia Inc. (group owner). Net: CBS. Rep: Katz. Format: MOR. ■ Wilson Wearn, pres; Albert Sanders, VP & gen mgr; Bill Powell, dir of opns; Don McGouirk, admin coord; Otis Hughes Jr, sls mgr; Bill Tribble, news dir; Jim Lawhon, chief engr. ■ Rates: \$19.60;16.80;18.20;16.80.

WMAZ-FM—Feb. 10, 1947: 99.1 mhz; 100 kw. Ant 660 ft. Stereo. Prog sep from AM. Net: ABC/FM. Format: Contemp. ■ WMAZ-TV affil. ■ Rates: \$14;12;14;12.

WNEX—April, 1945: 1400 khz; 1 kw-D, 250 w-N. Box 6318 (31208). (912) 745-3301. Macon Bcstg Co. (acq 1-68). Net: ABC/C. Format: Contemp/Top 40/Rock. ■ Judy Tucker Lowe and Alfred Lowe Jr, owners; Terry Burgamy, prog & mus dir; Ken Lowe, prom mgr; Joe Ferry, news dir; Max F. Harper, VP & chief engr.

Madison

WYTH—June 1955: 1250 khz; 1 kw-D. Box 635 (30650). (404) 342-1250. Central Georgia Bcstg Co. (acq 9-1-59). Net: Keystone. Format: Variety, C&W. Spec progs: Black 13 1/2 hrs wkly. ■ James F. Small, pres & coml mgr; Annie Lee Small, gen mgr; Jim Small Jr, prog dir; John Lee Moody, prom mgr; George Cochran, mus dir; Dave Daniels, news dir; Victor LeRoy Johnson, chief engr. ■ Rates: \$3.50;3;3.50;—.

Manchester

WFDR—June 1957: 1370 khz; 1 kw-D. Box 510

(31816). (404) 846-3115. TWX 7551-35. WFDR Inc. (acq 12-2-69). Rep: Carpenter. ■ Jack Whitehorn, pres & gen mgr; Fred McCurdy Jr, coml & stn mgr; Bonnie Harris, prog dir; Jeff Tate, prom mgr; John Duskin, news dir; Joe Chasteen, chief engr.

WFDR-FM—1967: 93.3 mhz; 61 kw. Ant 460 ft. (CP 61 kw. Ant 490 ft). Stereo. Prog sep from AM. Format: Black, R&B.

Marietta

WBIE(FM)—Listing follows WCOB.

WCOB—Nov. 14, 1955: 1080 khz; 10 kw-D, DA. Box 491 (30061). (404) 428-0469. Marietta Bcstg Co. Net: ABC/I. Format: Nostalgia. ■ James M. Wilder, pres, gen mgr & chief engr; Lou Essick, coml mgr; Roger F. Allison, prog dir; John W. Clark, mus dir; Bob Rountree, news dir.

WBIE(FM)—Co-owned with WCOB. Nov 1960: 101.5 mhz; 100 kw. Ant 870 ft. Stereo. (404) 424-1015. Prog sep from AM. Format: C&W.

WFOM—Oct. 13, 1946: 1230 khz; 1 kw-D, 250 w-N. 835 S. Cobb Dr. (30060). (404) 428-3396. Woolfum Inc. (acq 12-69). Net: ABC/C. Format: Contemp. ■ James A. Davenport III, pres & gen mgr; Jerry Crowe, stn mgr; Red Jones, sls mgr; Mike Durrett, prom mgr & mus dir; Bob Casey, prog dir; Jean Ludwick, chief engr.

McRae

WDAX—July 27, 1957: 1410 khz; 1 kw-D. Box 1410 (31055). (912) 868-5611. Jesup Bcstg Corp. (acq 8-25-75). Format: C&W/Contemp. ■ John Davidson, pres; Dale Van Cantfort, gen mgr; Ken Howard, mus dir; Tara Van Cantfort, news dir; Cecil Williams, chief engr. ■ Rates: \$2.70;2.70;2.70;—.

Metter

WHCG(FM)—Listing follows WMAC.

WMAC—Dec. 22, 1961: 1360 khz; 500 w-D. Box 238 (30439). (912) 685-2136. Radio Metter. Format: Contemp-Solid Gold. ■ Jimmy Page, VP, gen & coml mgr; Eddie Lewis, prom mgr; Joyce Franklin, news dir; Glenn Deal, chief engr.

WHCG(FM)—Co-owned with WMAC. Aug. 1, 1971: 104.9 mhz; 3 kw. Ant 185 ft. Dups AM days.

Milledgeville

WLVG—March 29, 1946: 1450 khz; 1 kw-D, 250 w-N. Box 519 (31061). (912) 452-0587. Michael T. Landy (acq 8-9-57). Net: MBS. ■ Michael T. Landy, pres & coml mgr; Joseph S. Boone, gen mgr & chief engr; Josephine Ragsdale, prog dir; Ken Sherner, news dir.

WLVG-FM—June 30, 1966: 102.3 mhz; 3 kw. Ant. 160 ft. Stereo. Prog sep from AM.

***WXGC(FM)**—August 1975: 88.9 mhz, 10 w. Ant 70 ft. Box 889 Georgia College (31061). (912) 452-4915. Georgia College for Women. Format: Progs, ed. ■ Dr. J. Whitney Bunting, pres; Randy Smith, gen mgr.

WXLX—March 6, 1975: 1060 khz; 1 kw-D. Box 832 (31061). Oconee Bcstg Co. Net: ABC/E. Format: MOR, C&W. ■ Paul Wilkinson, pres; Bruce Culpeper, mgr; Binky Holland, prog dir; Steve Stoddard, sports dir; Lou Green, news dir; Robbie Hattaway, chief engr. ■ Rates: \$3.75;3.50;3.75;3.50.

Millen



WGSR—Oct. 11, 1958: 1570 khz; 250 w-D. Box 869 (30442). (912) 982-4142. Jenkins Bcstg System Inc. (acq 3-1-59). Format: Variety. Spec prog: Black 11 hrs wkly. ■ Jack V. LoPresti, pres, gen mgr & chief engr; Tommy Cooper, coml mgr; Bill Kent, news dir. ■ Rates: \$2.25;2.25;2.25;2.25.

Monroe

WKUN—Jan. 5, 1970: 1580 khz; 1 kw-U. 492 E. Spring St. (30655). (404) 267-6558. Community Bcstg Co Inc. Rep: Carpenter. Format: C&W/rock. ■

Deral Morris, pres & gen mgr; Hudson Randall, coml mgr; Chip Robinson, prog dir; Dillard Rowe, prom mgr; George Peters, mus dir; Freeman Rowe, news dir; Nick Geehr, chief engr.

Montezuma

WMNZ—Nov. 29, 1961: 1050 khz; 250 w-D. Box 511 (31063). (912) 472-8386. Macon County Bcstg Co. Net: Georgia News. Format: C&W, MOR. Spec progs: Black 12 hrs wkly. ■ William E. Blizzard Jr., pres, gen, coml & prom mgr & news dir; Danny Blizzard, prog & mus dir; Ray McDonald, chief engr.

Morrow

WSSA—November 1956: 1570 khz; 1 kw-D. Box 752, Foret Park, Ga. (30050). (404) 361-8844. Atlanta Bcstg Co. (acq 9-4-74). Format: C&W. ■ James Beatrice & James Simmons, owners; Dale L. Tino, gen mgr; Les Reed, prog & mus dir; Lester Hawks, chief engr.

Moultrie

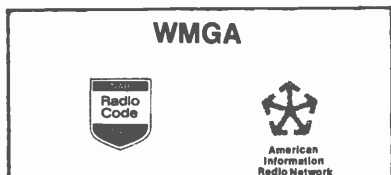

WMGA—September 1939: 1130 khz; 10 kw-D. (DA, CH), 250 w-N. Box 1380 (31768). (912) 985-1130. Radio Stn WMGA. Net: ABC. Rep: Carpenter. Format: MOR, heavy news, comment. Spec progs: Fr 24 hrs wkly. ■ Roy F. Zess, gen mgr; Bennett T. Willis, prog dir; Bill Shiver, prom mgr; Don Dickenson, chief engr. ■ Rates: \$8;7;8;7.

WMTM—Nov. 10, 1953: 1300 khz; 5 kw-D. Box 788 (31768). (912) 985-1300. Colquitt Bcstg Co. Net: MBS. Rep: Bolles; Busby, Finch & Woods. Format: Contemp. C&W. ■ Douglas J. Turner, pres; Donnie Turner, gen mgr.

WMTM-FM—Nov. 17, 1964: 93.9 mhz; 100 kw. Ant 165 ft. Stereo. Dup AM 40%.

Nashville

WNGA—1960: 1600 khz; 1 kw-D. Box 645 (31639). (912) 686-2001. Hanson R. Carter. Format: C&W. ■ Hanson R. Carter, pres; Duane Tucker, gen mgr.

Newnan

WCOH—December 1947: 1400 khz; 1 kw-D, 250 w-N. Box 1100 (30263). (404) 253-4636. Newnan Bcstg Co. (acq 9-14-53). Net: MBS. Rep: Ochs. Format: MOR, emphasis news, spts. Spec progs: Black 1 1/4 hrs; C&W 10 hrs; classical 1 hr, wkly. ■ James O. Hardin Jr., pres, gen, coml & prom mgr & prog dir; Alvin E. Johnston, news dir; Durward E. Roland, chief engr.

WCOH-FM—1948: 96.7 mc; 1.7 kw. Ant 380 ft. Dup AM 85%. Spec progs: Classical 10 hrs wkly.

WNEA—April 18, 1962: 1300 khz; 500 w-D. Box 1213 (30263). (404) 253-4711. Radio Newnan. Audio news: UPI. Rep: Carpenter. Format: Top 40, C&W. ■ Eathel Holley, pres; Johnny Brown, gen & coml mgr & chief engr; Johnny Sullivan Jr., prog, mus & news dir. ■ Rates: \$5;4.75;5;4.75.

North Atlanta

WRNG—Dec. 4, 1967: 680 khz; 25 kw-D. 3954 Peachtree Road, N.E. (30319). (404) 261-6800. TWX 810-751-2364. Ring Radio Co. Group owner: Southmedia Stns. Net: CBS, Georgia Net. Rep: Katz. Format: Talk. ■ Charles A. Smithgall, pres; Allan R. MacMillan, gen mgr; Harry Davey, prog dir; Bob Broadus, coml mgr; Judith C. Rambo, prom mgr; Ben C. Baldwin, news dir; Gordon Swan, chief engr.

Ocilla

WSIZ—March 14, 1961: 1380 khz; 5 kw-D. Box 186 (31774). (912) 468-7427. Oliva Bcstg Co. (acq 11-5-71). Net: ABC/C, Tobacco, Georgia Net. Rep: Bernard. Format: Contemp. Spec prog: Farm 10 hrs wkly. ■ George Olive Jr., pres; Ronald J. O'Quinn, gen mgr; H. R. Dunn, coml mgr; Howard Jordan, prog &

mus dir; Nelda Stone, prom mgr; Joel McRae, news dir; Buddy Mitchell, chief engr.

Perry

WPGA—1955: 980 khz; 1 kw-D. Box 980 (31069). (912) 987-2980. Radio Perry Inc. (acq 1-4-74). Net: ABC/E. Format: Contemp. ■ Lowell Register, pres & chief engr; James Worrall, gen mgr; Howard Moll, coml mgr; John Birdsong, prog dir.

WPGA-FM—May 3, 1966: 100.9 mhz; 3 kw. Ant 200 ft horiz, 195 ft vert. Stereo. Prog sep from AM.

Quitman

WSFB—Nov. 19, 1955: 1490 khz; 250 w, SH. Box 632 (31643). (912) 263-4373. R.B.H. Bcstg Co. Inc. (acq 11-1-61). Rep: Carpenter. ■ William F. Hoopes, pres.

Reidsville

New AM—Not on air, target date unknown: 1390 khz, 500 w-D. Box 500 (30453). Reidsville Bcstg Corp. Format: C&W. E. Lloyd Kilday, principal owner.

Rockmart

WPLK—Aug. 28, 1959: 1220 khz; 500 w-D. Box 192 (30153). (404) 684-7848. Georgia Radio Inc. Net: ABC/I&E. Spec progs: Talk 10 hrs wkly. ■ L. E. Gradick, pres & gen mgr; Cliff Williams, coml mgr; Kim Holtzendorf, prog dir; Jerry Gunn, news dir. ■ Rates: \$4.25;4.25;4.25;4.25.

WZOT(FM)—Co-owned with WPLK. Feb. 28, 1972: 107.1 mhz; 3 kw. Ant 220 ft. Net: ABC/FM. Format: C&W, Gospel. Prog sep from AM. ■ Rates same as AM.



Rome

WIYN—Aug. 1, 1962: 1360 khz; 500 w-D. Box 1311 (30161). (404) 234-6277. WIYN Radio Inc. Net: ABC/I&E. Spec prog: Talk 10 hrs wkly. ■ L. E. Gradick, pres & gen mgr; Jim McRee, coml mgr; Kim Holtzendorf, prog dir; Jerry Rucker, prom mgr; Windy Miller, news dir.

WLAQ—1947: 1410 khz; 1 kw-U, DA-N. Box 228 (30161). (404) 232-7767. Clarke Bcstg Corp. (acq 12-28-63). Net CBS. Rep: Savalli/Gates. Format: C&W. ■ Tom Lloyd, gen mgr; Cal Owens, prog dir; Jack Jarett, news dir; Randy Davis, sls mgr; Larry Smith, chief engr. ■ Rates: \$7.80;7.80;7.80;7.80.

WRGA—November 1929: 1470 khz; 5 kw-U, DA-N. Box 1187 (30161). (404) 232-9742. Rome Bcstg Corp. Net: MBS. Rep: Devney, Ochs. Format: Variety Spec progs: Black 1 hr, C&W 3 hrs, wkly. ■ Mather M. Payne, pres & gen mgr; Cap Hicks, coml mgr; Jerry Pless, prog dir; Don Wray, mus dir; Marvin W. Hicks, news dir; Lamar Ross, chief engr.

WRGA-FM—May 2, 1966: 102.3 mhz; 300 w vert; 295 w horiz. Ant 790 ft. Stereo. Dups AM 60%.

WROM—Dec. 29, 1946: 710 khz; 1 kw-D. Box 1546 (30161). (404) 232-0833. Coosa Valley Radio Co. Rep: Southern Spot Sls. ■ Charles E. Doss, pres & gen mgr; Patricia Henderson, adms asst; Warren Penney, sls mgr; David Glenn Irwin, prog dir; T. H. Robertson, chief engr. ■ Rates: \$7.06;5.88;7.06;4.71.

WROM-FM—May 22, 1965: 97.7 mhz 295 w horiz, 280 w vert. Ant 820 ft horiz, 810 ft vert. Stereo. Dups AM days. ■ Rates same as AM.

Rossville

WOWE(FM)—Listing follows WRIP

WRIP—Nov. 11, 1958: 980 khz; 500 w-D, DA. 270 N. Crest Road, Chattanooga, Tenn. (37404). (404) 866-3855. Jay Sadow. Rep: Clayton (Atlanta). Format: Gospel. ■ Jay Sadow, pres, gen & coml mgr; Sylvia Sadow, prog dir; Gordon Elliott, prom mgr; Dan Bowden, news dir.

Georgia Radio

See page C-1 for explanation of listings.

WOWE(FM)—Co-owned with WRIP. June 8, 1966: 105.5 mhz; 3 kw. Ant 270 ft. Prog sep from AM. Format: Prog rock. ■ WRIP-TV affil.

Royston

WBLW—June 1962: 810 khz; 250 w-D. Box 431, Royston, Ga. (30662). (404) 245-6101. Better Bcstg Inc. ■ B. L. Williamson, pres; Talmadge Williamson, VP & gen mgr.

Sandersville

WSNT—May 11, 1956: 1490 khz; 1 kw-D, 250 w-N. Box 150 (31082). (912) 552-5182. Radio Station WSNT Inc. Rep: Bolles. Format: Block, Black, C&W, MOR. ■ Webb Pierce, pres; Johnnie Bailes, gen mgr; James Whaley, coml mgr; Deborah Brown, prog dir; Jerry Knight, mus dir; Wayne Brooks, news dir; Bill Evans, chief engr.

WSNT-FM—1975: 94.3 mhz, 3 kw. Ant 185 ft.

Savannah

WEAS—Oct. 6, 1950: 900 khz; 5 kw-D. Box 8346 (31402). (912) 234-7264. WEAS Inc. Group owner: Dee Rivers Stns. Net: Nat Black. Format: Black. ■ E. D. Rivers, pres; Henry Wilson, coml mgr; Ron R. Pitts, gen mgr; Don Whipple, prog dir; Billy Whitten, news dir; Tommy Lester, mus dir. ■ Rates: \$23;21;23;19.

WEAS-FM—Aug. 1967: 93.1 mhz; 100 kw. Ant 310 ft. Stereo. Dups AM 75%. ■ Rates same as AM.

***WHCJ(FM)**—1975: 88.5 mhz; 10 w. Ant. 100 ft. State College Branch (31404). Savannah State College. ■ Prince A. Jackson, Jr, pres.

WJCL-FM—June 18, 1972: 96.5 mhz; 100 kw. Ant 1160 ft. Box 13646 (31406). (912) 352-2022. Lewis Bcstg Corp. Rep: Pro/Meeker, Busby, Finch, Latham & Widman. Format: Btl mus. ■ J. Curtis Lewis, pres; Christopher A. Barbieri, VP sls & prog; Edgar F. Bigbie, VP-engr; Al Jennings, dir of radio. ■ Rates: \$5;5;5;5.

WNMT—See Garden City, Ga.

WQQT—Aug. 14, 1946: 1450 khz; 1 kw-D, 250 w-N. 110 E. Congress St. (31401). (912) 232-4182. WQQT Inc. (acq 7-1-75). Net: MBS. Rep: Buckley Radio Sls. Format: C&W. ■ Robert A. Powers, pres & gen mgr; Dennis Eversoll, prog mgr; Scott Sieden, news dir; John All, chief engr. ■ Rates: \$ 11;9;11;9.

WSAV—Dec. 29, 1939: 630 khz; 5 kw-U, DA-N. Box 2429 (31402). (912) 236-0303. TWX 810-784-5661. WSAV Inc. Net: NBC. Rep: Eastman. Format: MOR. Spec prog: Farm 1 hr wkly. ■ Harben Daniel, pres & gen mgr; M. E. Thompson, VP & opns mgr; Ronald E. Winders, coml mgr; Ed Burchfield, prog dir; J. D. Browning, mus dir; Stan Bowman, news dir; Byron Strong, chief engr. ■ WSAV-TV affil. ■ Rates: \$17;14;15;9.

WSGA—May 1956: 1400 khz; 1 kw-D, 250 w-N. Box 8247 (31402). (912) 233-8807. WSGA Inc. (acq 3-7-74). Net: ABC/C. Rep: Torbet. Format: Contemp. ■ Norman Breen, pres & gen mgr; Jerry Rogers, prog dir & prom mgr; Robert Cobb, coml mgr; Mac King, mus dir; Dave Brannen, news dir; John All, chief engr.

WSGF(FM)—April 24, 1972: 95.5 mhz; 100 kw. Ant 320 ft. 409 E. Liberty St. (31401). (912) 232-5846. Stereo Bcstg Co. Inc. Rep: Masla. Format: Contemp MOR. ■ Donald K. Jones, pres; Don Brook, gen mgr; Bruce Lapp, prog dir; Del Geasey, mus dir; Bob Randall, chief engr.

WSOK—October 1946: 1230 khz; 1 kw-D, 250 w-N. Box 1288 (31402). (912) 233-1719. B.C.C. Ga. Inc. (acq 1-5-72). Rep: Howard. Format: Diversified. ■ Benjamin M. Tucker, chmn, gen mgr, prog dir; Gloria Tucker, coml mgr; Scipio Collins, prom mgr; Dean Reynolds, mus dir; Ron Pratt, news dir; E. F. Bigbie, chief engr.

WTOC—Oct. 15, 1929: 1290 khz; 5 kw-U, DA-N. Box 8086 (31402). (912) 232-0127. Savannah Bcstg Co. Net: CBS. Rep: Katz. Format: MOR. ■ F. Schley Knight, pres & gen mgr; Millard Gainey, coml mgr; Harley Carnes, news dir; Kyle Goodman, chief engr.

WTOC-FM—Nov. 29, 1946: 94.1 mhz; 80 kw horiz, 17.5 kw vert. Ant 370 ft. Prog sep from AM ■ WTOC-TV affil.

Georgia Radio

See page C-1 for explanation of listings.

WXLM(FM)—Feb. 4, 1969: 97.3 mhz; 100 kw. Ant 230 ft. Stereo. Box 9705 (31402). (912) 233-9211. Regency Bcstg. Net: Georgia. Rep: Groskin; Carpenter. Format: Good mus. ■ Russell L. Fredrich, pres & gen mgr; Don Addington, chief engr.

WZAT(FM)—Oct. 19, 1971: 102.1 mhz; 100 kw. Ant 230 ft. 226 East Broughton St. (31401). (912) 233-8177. Weis Bcstg Co. Rep: Torbet. Format: MOR. ■ Norman Breen, pres & gen mgr; Robert A. Cobb, VP & s/s mgr; Burl Q. Womack, prog dir.

Smyrna

WQXI-FM—Co-owned with WQXI, Atlanta. Jan. 1, 1964: 94.1 mhz; 100 kw. Ant 410 ft. 2970 Peachtree Rd., N.W., Atlanta. (30305). (404) 261-8419. Jefferson Pilot Bcstg Co. (group owner; acq 4-1-72). Prog dups AM 35%. Format: top 40. ■ Carroll Cook, traf mgr. ■ Rates: \$30;30;30;30.

WYNX

Gospel and Religious

WYNX—March 1962: 1550 khz; 10 kw-D. 2460 Atlanta St., S.E. (30080). (404) 436-6171. Jonquil Bcstg Co. (acq 1-66). Format: Religious. Spec progs: Black 4 hrs wkly ■ L. N. Polk, pres; Buzz Walker, mus dir; Ken Rogers, news dir; Thomas Conan Jr., chief engr. ■ Rates: \$5.50;4.50;5.50;4.50.

Soperton

WYOK—Not on air, target date 11-1-75. 1000 khz; 1 kw-D. Box 556 (30457). (912) 529-3311. Center Bcstg Co. Format: C&W. Spec prog: Farm 4 hrs, local news 6 hrs, wkly ■ H. Fred Tippett, pres, gen mgr & chief engr; Dana J. Tippett, prog dir; Bob Dyal, coml mgr; Wilbur Heath, news dir.

Statesboro

WMCD(FM)—Listing follows WWNS.

***WVGS(FM)**—1975: 91.3 mhz, 10 w. Ant 63 ft. Stereo. Georgia Southern College Box 11619 (30458). (912) 681-5525. Board of Regents, University System of Georgia. Format: Diversified. ■ Steven Thayer, stn mgr; Billy Johnson, chief engr.

WWNS—Dec. 1, 1946: 1240 khz; 1 kw-D. 250 w-N. Box 958 (30458). (912) 764-5446. Radio Statesboro, Inc. (acq 3-1-75). Net: ABC/C, ABC/I, ABC/E; Tobacco. Rep: Busby, Finch, Lathan & Widman. Format: MOR. Spec prog: Black 18 hrs wkly. ■ Cecil H. Grider, pres; James W. DeVan, gen mgr; Ray Shader, news dir; Scott Pendergraft, chief engr. ■ Rates: \$5.50;5.50;5.50;5.50.

WMCD(FM)—Co-owned with WWNS. May 1, 1967: 100.1 mhz; 3 kw. Ant 150 ft. horiz & 145 ft. vert. Stereo. Net: ABC/FM. Format: Top 40. Prog sep from AM. ■ Rates: \$4;4;4;4.

New AM—Not on air, target date unknown: 850 khz, 1 kw-U, DA-N. 403 College Blvd. (30458). Rosemore Bcstg Co. ■ Helen Rosengart, pres.

Summerville

WGTA—Aug. 27, 1950: 950 khz; 5 kw-D. Box 200 (30477). (404) 857-2466. Tri-State Bcstg Co. Rep: Carpenter. Format: Diversified. ■ William B. Farrar, pres & gen mgr; Charles C. Farrar, coml mgr; Jonnie Faye Campbell, prog dir; Lamarr Gravit, prom mgr; Don Bethune, news dir; Charles M. Lowry Jr., chief engr. ■ Rates: \$5;4.30;5;4.30.

Swainsboro

WJAT—Jan. 1, 1950: 800 khz; 1 kw-D. Box 289 (30401). (912) 237-2011. Radio Station WJAT Inc. (acq 12-2-68). Rep: TRN. Format: Block. ■ Webb Pierce, pres; John J. Bailes, gen & prom mgr; H. E. Buffington, coml mgr; Joseph A. Horne, mus & news dir; Doris M. Lewis, stn mgr; James W. Slawson, chief engr.

WJAT-FM—Dec. 18, 1968: 96.8 mhz; 3 kw. Ant 285 ft. horiz & 280 ft. vert. Dup AM 70%.

Sylvania

WBSL—Dec. 1, 1955: 1490 khz; 1 kw-D. 250 w-N.

Box 519 (30467). (912) 564-7461. Sylvania Bcstg System (acq 8-4-72). Net: Georgia. Rep: Tobacco. Format: EL/C&W, day; C&W/Top 40, night. ■ Shirley Mahaffey, pres, gen & coml mgr; Randall Johnson, prog dir; Kay Griner, prom mgr; Joe Oglesby, mus dir; Fransina Dixon, news dir; Jim Slawson, chief engr.

Sylvester

WOGA—Dec. 16, 1963: 1540 khz; 1 kw-D. Box 240 (31791). (904) 776-3421. Worth County Bcstrs. (acq 3-14-73). Net: Georgia Net. Audio news: APR Rep. Select Religious Bcstg. Format: Religious. Spec prog: Farm 7 hrs wkly. ■ William R. Crews, pres; Dr. W. R. Crews, gen mgr; Rich Seagers, prog dir; Joel Smith, chief engr. ■ Rates: \$2.50;2.50;2.50;2.50.

Tallapoosa

WKNG—Not on air, target date unknown, 1060 khz; 1 kw-D. Twin County Bcstg Co. (acq 1975). Olivie E. and Ivous T. Sisk owners.

Thomaston

WSFT—May 26, 1947: 1220 khz; 250 w-D. Box 689 (30286). (404) 647-5421. Thomaston Bcstg Co. Format: Variety. ■ W. H. Hightower Jr., pres; S. J. Carswell, gen mgr; Claude Thames, coml mgr; Bill Heule, prog & news dir; Don Standhardt, chief engr.

WTGA—Oct. 10, 1962: 1590 khz; 500 w-D. Box 550 (30286). (404) 647-7121. Radio Georgia Inc. (acq 12-65). Net: ABC/I. Rep: Busby, Finch & Woods. Format: MOR, Variety. Spec prog: Black 10 hrs wkly. ■ David L. Piper, pres, gen & prom mgr & prog mus, news dir chief engr; Bill Chapman, coml mgr.

Thomasville

WLOR—1947: 730 khz; 5 kw-D. Box 45 (31792). (912) 226-7911. Mills-Bellamy Ent. (acq 1-1-73). Net: ABC/E. Rep: Bernard, Jones (New York). Format: C&W. Spec prog: Gospel 20 hrs, farm 10 hrs, wkly. ■ Norris B. Mills, gen mgr; Emery T. Evans, stn & prom mgr; Gary Brinson, coml mgr; Carl Barnes, prog dir & chief engr; Richard Harris, mus dir; Mark Hagenan, news dir. ■ Rates: \$2.80;2.80;2.80;2.80.

WPAX—December 1922: 1240 khz; 1 kw-D. 250 w-N. Box 129 (31792). (912) 226-1240. Oliva Bcstg Co. (acq 1965). Net: CBS, Tobacco. Format: Contemp. ■ T. O. Collins, pres, gen & coml mgr; Dick Shannon, prog dir; Bob Willis, chief engr.

WTUF(FM)—1971: 107.1 mhz; 1.55 kw. Ant. 390 ft. Box 45 (31792). (912) 226-1041. Thomasville Bcstg Co. (acq 10-1-74). Net: Nat. Black. Rep: Bernard, Jones. Format: Block. ■ N. B. Mills, pres; Emery T. Evans, gen & prom & coml mgr; Curtis Thomas, prog dir; B. J. Jones, mus dir; Carl Barnes, chief engr. ■ Rates: \$2.80;2.80;2.80;2.80.

Thomson

WTHO—Feb. 22, 1971: 1530 khz; 1 kw-D. 500 w-CH. Box 286. (30824). (404) 595-5122. Bethany Bcstg Co. Format: MOR, C&W. Spec prog: Farm 2 1/2 hrs wkly. ■ Walter J. Brown, pres; Robert I. Chambers, gen & coml mgr; Aaron Hart, prog dir; Jerry Braswell, mus dir; Clarice Bowles, news dir; Bill Newsome, chief engr.

WTHO-FM—Feb. 22, 1971: 101.7 mhz; 3 kw. Ant 300 ft. Dups AM 100%.

WTWA—Jan. 10, 1948: 1240 khz; 1 kw-D. 250 w-N. Box 591 (30824). (404) 595-1561. Hickory Hill Bcstg Co. Net: MBS. Format: C&W. ■ Gene D. Harden, pres & gen mgr; Bill McConnel, coml mgr; John D. Reid, prog & news dir; Gene Harden, chief engr. ■ Rates: \$3;3;3;3.

Tifton

***WABR-FM**—December 1973: 90.5 mhz; 10 w. Ant 150 ft. Box 116, ABAC Station (31794). (912) 386-3211. Abraham Baldwin Agricultural College. Format: Progs. Spec progs: Classical 3 hrs, jazz 1 hr, country rock 1 hr, wkly. ■ Courtney Davis, stn mgr.

WCUP(FM)—Listing follows WWGS.

WTIF—1957: 1340 khz; 1 kw-D. 250 w-N. Box 968 (31794). (912) 382-1340. Radio Tifton (acq 2-28-75). Net: CBS, Georgia Net. Format: C&W. Spec progs: Farm 5 hrs wkly. ■ Al Cohen, VP & gen mgr; C. B. Mathis, prog dir; Anne King, coml mgr; John McClellan, news dir; Robert Newberry, chief engr. ■

Rates: \$3.85;3.85;3.85;3.85.

WWGS—1946: 1430 khz; 5 kw-D, 1 kw-N, DA-N. Drawer A (31794). (912) 382-1234. Tifton Bcstg Corp. Net: NBC Tobacco. Rep: Jones. Format: Contemp, C&W, Block. Spec prog: Black 6 hrs wkly. ■ Ralph N. Edwards, pres & gen mgr; William E. Sides, coml mgr; Bob Glenn Ritter, prog dir; Frank A. Raley, news dir; George F. Floyd, chief engr.

WCUP(FM)—Co-owned with WWGS. 1975: 100.3 mhz; 97 kw. Ant 580 ft. Stereo. Prog sep from AM. Beautiful music.

Toccoa

WLET—May 1, 1941: 1420 khz; 5 kw-D. 423 Prather Bridge Rd. (30577). (404) 886-2191. Kelott Inc. (acq 4-1-70). Format: C&W & Gospel. ■ H. Otto McDonald Jr., pres & gen mgr; Hiram K. McDonald, VP; Gene Bollinger, coml mgr; Betty McDonald, prog dir.

WLET-FM—November 1947: 106.1 mhz; 100 kw. Ant 285 ft. Prog sep from AM. Format: MOR, pop, teen rock.

WNEG—April 21, 1956: 630 khz; 500 w-D. Box 907 (30577). (404) 886-3131. Stephens County Bcstg Co. Inc. Net: Georgia News, Audio news; APR. Format: MOR. Spec progs: Black 3 hrs, farm 1 hr, wkly. ■ Roy E. Gaines, pres, gen & coml mgr; Mary Smith, prog dir; Gaynelle Thomason, prom mgr; Evelyn Gaines, mus dir; Lamar Ramey, news dir; Thomas Shockley, chief engr. ■ Rates: \$4.50;4.50;4.50;—.

Valdosta

WAFM—Nov. 25, 1971: 101.1 mhz; 60 kw. Ant 320 ft. Stereo. Box 338 (31601). (912) 244-5180. Christian Radio Fellowship Inc. Format: Religious. Spec prog: Farm 1 hr wkly. ■ T. Jack Tidwell, gen mgr & chief engr. ■ Rates: \$2.50;2.50;2.50;2.50.

WGAF—Nov. 3, 1951: 910 khz; 5 kw-U, DA-N. Box 100 (31601). (912) 242-5520. Valdosta Bcstg Co. Net: MBS. Format: Contemp. ■ Orson Woodall, pres & gen mgr; C. H. Fletcher, coml mgr & chief engr; Scott Griffith, prog dir; Gary Hill, prom mgr; David Murray, mus dir; Laura Flythe, news dir.

WGOV—1939: 950 khz; 5 kw-D, 1 kw-N, DA-N. Box 1207 (31601). (912) 244-2585. WGOV, Inc. Group owner: Dee Rivers Stns. Net: Mutual Black. Rep: Stars. Format: Block. ■ M. B. Rivers, pres; M. C. Carter, gen mgr; Jack Moore, coml mgr, prog & mus dir; Richard Williams, news dir, chief engr.

WGOV-FM—1968: 92.9 mhz; 100 kw. Ant 230 ft. Stereo. (912) 244-6816. Prog sep from AM. Net: MBS. Format: C&W. ■ James Renfro, prog, mus & news dir.

WJEM—August 1955: 1150 khz; 1 kw-D. Box 368 (31601). (912) 242-1565. Lowndes County Bcstg. (acq 1960). Rep: Carpenter. Format: C&W. ■ J. C. Johnson, pres; Vernon Arnold, gen & coml mgr; Gary Monroe, prom mgr; G. Alan Murray, prog dir; Gene Lester, mus dir; Phil Carlton, news dir; Robert Jackson, chief engr.

WVLD—Sept. 3, 1959: 1540 khz; 1 kw-D, 250 w-N. Box 1529 (31601). (912) 242-4821. Ev-Co Bcstrs. (acq 9-16-60). Net: ABC/C, State Bcst. Rep: Busby, Finch & Wood. Format: Contemp. ■ Al H. Evans, pres; Danny Dee, VP & gen mgr; Harrison Cooper, coml & prom mgr; Robert Harrison, prog dir; David Murry, mus dir; Jay Clark, news dir; A. M. Anderson, chief engr.

***WVVS(FM)**—July 26, 1971: 90.9 mhz; 180 w. Ant. 68 ft. Box 142 (31601). (912) 247-3248. Valdosta State College. Format: Progs. Spec progs: Black 2 hrs, classical 4 hrs, jazz 2 hrs, drama 1 hr, wkly. ■ S. Walter Martin, pres; Mark Elliott, gen mgr & prog dir; Scott Crane, mus dir; Pat Foley, pub affairs dir; Walt Taylor, dir of engr; C. H. Fletcher, chief engr.

Vidalia

WVOP



WVOP—Dec. 2, 1946: 970 khz; 5 kw-D. Box 900 (30474). (912) 537-9202. Vidalia Bcstg Co. Net: ABC/I. Rep: Carpenter. Format: C&W. ■ Edwin L. Bouchelle,

gen mgr; Edwin Johnson, prog dir; Rick Humphrey, coml mgr; John Sharpe, chief engr. ■ Rates: \$6.50;6.50;6.50;6.50.

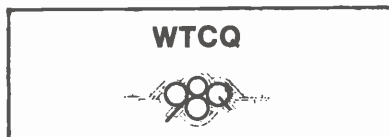

WTCQ(FM)—Co-owned with WVOP. March 5, 1969: 97.7 mhz; 3 kw. Ant 290 ft. Stereo. Prog sep from AM. Net: ABC/C. Format: Top 40. ■ E. Lloyd Kilday, coml mgr; Ken Curtis, prog dir; John Sciambi, mus dir. ■ Rates same as AM.

Warner Robins

WAVC—Oct. 13, 1954: 1350 khz; 5 kw-D. 1350 Radio Loop. (31093). (912) 923-4261. Warner Robins Bcstg Co. Inc. Format: Relig. ■ Edgar Nobles, pres & gen mgr, prog dir & prom mgr; Fred Gaudry, coml mgr.

WRBN—August 15, 1966: 1600 khz; 1 kw-D. Professional Bldg., Drawer A. B. (31093). (912) 922-2222. WRBN Inc. Format: Contemp. ■ Mary Jarrard, pres; John Lynn, gen mgr; Phil Clark, opns mgr; John Birdsong, prog & news dir; Ray Thomas Jr., sls mgr; Carroll Ayres, chief engr.

WRBN-FM—August 1969: 101.7 mhz; 3 kw. Ant 205 ft. Dups AM 80%.

Washington

WLOV—Sept. 1, 1955: 1370 khz; 1 kw-D. Box 400 (30673). (404) 678-2125. Better Bcstg Inc. (acq 5-15-65). Rep: Keystone. ■ W. T. Thornton, mgr & prog dir prom mgr & chief engr; Ron Reid, coml mgr & news dir.

WLOV-FM—June 1, 1970: 100.1 mhz; 2.4 kw. Ant 320 ft. Dups AM 80%.

Waycross

WACL—July 1, 1951: 570 khz; 5 kw-D, 1 kw-N, DA-N. Box 858 (31501). (912) 283-4660. Teletronics Inc. Net: ABC/C. Format: Top 40. ■ Bill Parker, coml mgr; Big Jeff, mus dir; Raymond Williamson, news dir; Jay Spurgeon, chief engr. ■ Rates: \$4;4;4;4.

WACL-FM—June 3, 1972: 103.3 mhz; 100 kw. Ant 370 ft. Stereo. Prog sep from AM. Format: MOR. Net: ABC/FM. ■ Jim Miller, coml mgr. ■ Rates: same as AM.



WAYX—Oct. 12, 1936: 1230 khz; 1 kw-D, 250 w-N. Box 683 (31501). (912) 283-7100. Radio Waycross Inc. (acq June 1975). Group owner: Bromo Communications. Net: CBS, Georgia Net. Rep: Southern Spot Sls. Format: MOR. ■ William G. Brown, pres; David B. Callaway, VP & gen mgr; Cecelia Darden, coml mgr; Mark Self, prog dir; Tommy Tucker, news dir; Stu Graham, chief engr. ■ Rates: \$3;2.50;3;2.50.

WAYX-FM—Oct. 10, 1971: 102.5 mhz; 100 kw. Ant 200 ft. Stereo. Prog sep from AM. Format: C&W ■ Rates same as AM.

Waynesboro

WBRO—April 26, 1954: 1310 khz; 1 kw-D. Box 151 (30830). (404) 554-2139. Radio Stn WBRO. Format: Block. Spec progs: Block 10 hrs, C&W 25 hrs, wkly. ■ Webb Pierce, pres; Doris E. Lewis, mgr; Robert Black, coml mgr; C. P. Lee, chief engr.

WVGA(FM)—1975: 100.9 mhz; 3 kw. Ant 300 ft. Suite 3, Johnson Bldg. Augusta, Ga. (30904). Burke Bcstg Co. Drew, Nicholson, Hunnicutt & Roberts, owners.

West Point

WBMK—August 1958: 1310 khz; 1 kw-D. 705 4th Ave. (38133). (404) 645-2991. Radio Valley Inc. Net: ABC/E, Keystone. Format: MOR. ■ C. Jim Murphy, pres & gen mgr; Vinson Smith, prog dir; Harlan Parks, news dir; John Lane, chief engr.

WCJM(FM)—Co-owned with WBMK. July 18, 1966: 100.8 mc; 1.85 kw. Ant 235 ft. Dups AM 100%.

WRLD—See Lanett, Ala.

Winder

WIMO—Nov. 4, 1952: 1300 khz; 1 kw-D. Box 526 (30680). (404) 867-9158. Winder-Monroe Bcstg Co. Net: ABC/E. Rep: Dora-Clayton. Format: MOR. ■ C. H. Grider, pres & gen mgr; H. L. Curry Jr., coml mgr; Kathleen Rhodes, prog dir; Ted Byrne, news dir; Ken Potter, chief engr.



Eleele

KUAI—June 30, 1965: 720 khz; 5 kw-U. Box 720 (96705). (808) 335-3171. American Islands Bcstg Corp. Net: CBS. Format: MOR. ■ John S. Short, pres, gen & coml mgr; William Dahle, VP & station mgr; Mark Jones, chief engr.

Hilo

KHLO—April 1, 1950: 850 khz; 1kw-U. Waiakea Resort Village, 400 Hualani (96720). (808) 935-0091. Escanaba Broadcasting Co. (acq 11-1-73). Net: NBC; CBS, MBS. Format: Top 40, oldies, MOR. Spec progs: Jap 24 hrs; Filipino 3 hrs, both wkly. ■ Dean W. Manley, gen mgr and chief engr; Jane Russell, coml mgr; Jay Michaels, prog dir. ■ Rates: \$8.25; 6.50; 8.25; 6.50.

KIPA—Sept 10, 1947: 620 khz; 1 kw-U (CP: 5kw). 614 Kilauea Ave., Box 1620 (96720). (808) 935-6858. Big Island Broadcasting Corp. (acq 1967). Rep: Century National Sales. Format: MOR. Japanese. Spec prog: Filipino 6½ hrs wkly. ■ Hugh Gordon, pres/gen mgr; Buddy Gordon, coml mgr; Cecil Seavey, opns & mus dir; Don Smith, news dir; Alan Roycroft, chief engr.

KKEA(FM)—Not on air, target date unknown: 97.9 mhz; 100 kw. Ant 630 ft. Mauna Kea Bcstg Co.

KPUA—1936: 970 khz (CP 670 khz); 5 kw-U. 58 Manaolana Pl. (96720). (808) 935-5461. Pacific Bcstg Corp. (acq 6-7-65). Group owner: Heftel. Net: ABC Radio, Coconut Wireless Network. Format: MOR. Spec prog: Jap 7 hrs wkly. ■ Cecil Heftel, pres; Gene Erger, VP & gen mgr; Hal Boudreau, res mgr; Melvin Medeiros, asst mgr & prog dir; Larry Tavares, sls mgr. ■ KPUA-TV affil.

Honolulu

KAIM—Aug 31, 1956: 870 khz; 5 kw-U. Box 375, 3555 Harding Ave. (96816). (808) 732-6602. Christian Bcstg Assn. Rep: Radio Reps, Walter F. Bennett. Format: Relig, classcl. Spec progs: Ilicano Filipino 23 hrs wkly. ■ Dan Liu, pres; Cliff R. Scott, gen mgr; Mike Riberdy, prog dir; Ronald Malone, chief engr.

KAIM-FM—Nov 1, 1953: 95.5 mhz; 37 kw. Ant minus 24 ft. Dup KAIM 50%. Stereo. Format: Classcl, relig.

KCCN—Sept 1, 1966: 1420 khz; 5 kw-U. 2270 Kalakaua Ave., Suite 904 (96815). (808) 923-0402. Grayson Enterprises Inc. (acq 10-70). Group owner: Grayson. Rep: Meeker. Format: Hawaiian mus. Spec progs: Filipino 10 hrs wkly. ■ Theodore Shanbaum, pres; Jim Wethington, gen mgr, coml mgr; Victor Opiopio, prog, prom & mus dir; Alan Roycroft, chief engr.

KEKI(FM)—Not on air, target date unknown: 93.9 mhz; 100 kw. Ant minus 480 ft. 45-114 Awele Place, Kaneohe (96744). Cyril C. Larsen.

KGMB—1929: 590 khz; 5 kw-U. Box 581, 1534 Kapiolani Blvd. (96814). (808) 941-3011. Heftel Bcstg Corp. (acq 6-1-65). Group owner: Heftel. Rep:

Georgia, Hawaii Radio

See page C-1 for explanation of listings.

Eastman. Format: MOR, news, personalities. ■ Cecil Heftel, pres; Earl McDaniel, exec VP, gen mgr; Richard Cramer, VP sls; Bob Fox, national sls mgr; Jim Stovall, local sls mgr; Robert Sevey, VP news; Linc Dixon, dir of engr; George Kennedy, prog dir. ■ Rates: \$47; 16.50; 22.50; —.

KGMB(FM)—Co-owned with KGMB. Oct 1, 1967: 93.1 mhz; 100 kw. Ant minus 125 ft. Prog sep from KGMB. Format: Contemp. ■ J. Paul Emerson, news dir; Dave Shaw, prog dir. ■ KGMB-TV affil. ■ Rates: \$12.50; 15; 15; 12.50.

KGU—May 11, 1922: 760 khz; 10 kw-U. 605 Kapiolani Blvd. (96813). (808) 536-3626. Communications Hawaii Inc. (acq 1-5-67). Net: NBC, MBS, Hukilau. Rep: Avco. Format: MOR. ■ Don Metzger, pres & gen mgr; Bernie Armstrong, prog dir; Dick Cook, news dir; Glenn Goldstein, coml mgr; Takumi Shigetani, chief engr.

KHSS(FM)—Listing follows KPOI.

KHVH—March 18, 1957: 1040 khz; 5 kw-U. 1060 Bishop St. (96813). (808) 524-3111. KHVH Inc. (acq 7-31-73). Net: CBS. Format: All news. ■ Lawrence S. Berger, gen mgr and pres; Robert Bowen, sls mgr; Ed Michelman, news dir; Susan Wagner, prom mgr; Sakae Kimata, chief engr. ■ Rates: \$23; 9; 17; 9.

KIKI—April 1951: 830 khz; 10 kw-U. 331-D Kamani St. (96813). (808) 536-3456. Kiki Limited. Rep: Natl Times Sls. Format: Progsrv rock. Spec prog: Filipino 3 3/4 hrs wkly. ■ C. C. Bud Larsen, pres, gen mgr; Pamela Straus, coml mgr; Ron King, prog dir; Rick Shannon, prom mgr; Mike Hamlin, mus dir; Alan Roycroft, chief engr.

KIOE—Jan 21, 1972: 1080 khz; 5 kw-D. 677 Ala Moana, 514 (96813). (808) 531-4187. Dakine Hawaiian Radio. (acq 8-19-75). Format: Rock, contemp. Rep: Oakes. ■ Jack O'Neill, coml mgr; Scott Edwards, prog, prom, & music dir; Dick Barr, news dir.

KISA—April 24, 1973: 1540 khz; 5 kw-D. 705 N. King St. (96817). (808) 847-0835. Manayan Enterprises (acq 1973). Format: Filipino. ■ Paul Wilcox, spec admin asst; Ben Manayan, gen mgr; Aurora Manayan, coml mgr; Nick De Lara, prog dir; Nick Cava, prom mgr; Henry Calugag, mus dir; Alan Roycroft, chief engr; Francis Cadoy, news dir.

KKUA—May 1947: 690 khz; 10 kw-U. 765 Amana St. (96814). (808) 946-2869 K(o)KUA Radio. One Corp. (acq 1-1-71). Rep: H. R./Stone. Format: Contemp. Top 40. ■ H.G. (Jock) Fearhead, pres; Robert S. Wilson, VP & gen mgr; Ron Castro, news prog & mus dir; Alan Roycroft, chief engr; Pat Hurth traf mgr; Michael W. Perry, prom mgr. ■ Rates: \$25; 15; 25; 13.

KNDI—July 11, 1960: 1270 khz; 5 kw-U. Box 1516 (96806). 923-1431. James T. Ownby. Format: Variety. Spec progs: Fr 2 hrs; Ge 2 hrs; Jap 19 hrs; Hawaiian 20 hrs all wkly. ■ James T. Ownby, owner, gen, sls & prom mgr, prog & news dir; Alan Roycroft, chief engr.

KOHO—December 1959: 1170 khz; 5 kw-U. 1140-A 12th Ave. (96816). (808) 737-5512. Cosmopolitan Bcstg Corp. (acq 9-8-61). Rep: AAA Reps. ■ Format: Talk, educ, religious, Japanese. ■ Walter Soga, pres; Akikazu Ishida, gen mgr; Sue Ogata, prog dir; Isao Murakami news dir; Alan Roycroft, chief engr. ■ Rates: \$11.80; 11.80; 11.80; 11.80.



KORL—1946: 650 khz; 10 kw-U. Box 27888 (96827). (808) 524-3880. Radio Hawaii Inc. (acq 3-17-54). Net: ABC/C. Audio news UPI. Rep: PRO/Meeker. Format: Top 40 ■ Jim Nelly, gen mgr and coml mgr; Lan Roberts, prog and mus dir, prom mgr. ■ Rates: \$17; 16; 17; 15.

KPOI—1946: 1380 khz; 5 kw-U. 1701 Ala Wai Blvd. (96815). (808) 941-6644. Communico Oceanic Corp. (acq 2-22-74). Group owner: Communico. Rep: Katz. Format: Top 40.

KHSS(FM)—Co-owned with KPOI. March 6, 1962: 97.5 mhz; 100 kw. Ant 30 ft. Prog sep from AM. Stereo. Format: Progsrv folk rock.

***KTUH(FM)**—July 7, 1969: 90.5 mhz; (CP 90.3); 10

Hawaii, Idaho Radio

See page C-1 for explanation of listings.

w. Ant 106 ft. 2500 Campus Road, Hawaii Hall 206 (96822). (808) 948-7431. U. of Hawaii. Net: NPR. Format: Classcl. educ. progsv. Spec progs: Hawaiian 8; Jazz 16 hrs; India 1 hr, all wkly. ■ Ross Stephenson, gen mgr.

KUMU—March 1, 1963: 1500 khz; 5 kw-U. 2005 Kalia Rd (96815). (808) 941-1566. Telex: WV1634233. John Hutton Corp. Rep: Torbet. Format: Beautiful music. ■ John H. Weiser Jr, pres & gen mgr; Ron Cooper, coml mgr; Colin J. Sharpe, prog dir & mus dir; Joyce Timpson, prog mgr; Bill Carnet, news dir; Alan Roycroft, chief engr.

KUMU-FM—Aug 16, 1971: 94.7 mhz; 60 kw. Ant minus 140 ft. (acq 8-16-71). Dups KUMU 50%. Stereo.

KZOO—Oct 18, 1963: 1210 khz; 1 kw-U. 250 Ward Ave. (96814). (808) 537-6915. Polynesia Bcstg Inc. (acq 4-1-67). Format: Jap. ■ Torao Kobayashi, pres & gen mgr; Harumi Oshita, prog dir; Lawrence Mizuno, coml mgr; Alan Roycroft, chief engr.

New FM—Not on air; target date unknown: 93.9 mhz; 100 kw. Ant minus 480 ft.

Kahului

KNUJ—Sept 14, 1962: 1310 khz; 5 kw-U. Box 35 (96732). (808) 877-5566. Broadcasting Consulting Services Inc. (acq 3-1-74). Net: Hukilau. Format: Popular. Spec progs: Filipino 1 1/2 hrs wkly; Jap 4 hrs wkly. ■ H. V. Shepard, pres; Tom Elkins, gen mgr; Norma Phegley, sls mgr; Rick Shane, prog dir; Chuck Bourne, news dir. ■ Rates: \$9; 8.50; 9; 7.50.

Kailua

KKAI(FM)—Not on air; target date unknown: 96.3 mhz; 25 kw. Ant 2120 ft. 6505 Wilshire Blvd., Suite 617, Los Angeles (90048). Mauna Kea Bcstg Co.

KLEI—1953: 1130 khz; 10 kw-U. 602 Kailua Rd. (96734). (808) 261-0811. Hawaiian Business News Ltd. (acq 2-22-71). Format: Good mus, big band. ■ Fred Livingston, pres & gen mgr; Terry O'Connell, mgr; John Henry Russell, prog & news dir; Allan Roycroft, chief engr; Stu Allen, prom mgr & mus dir.

Kealahou

KKON—October 1963: 790 khz; 1 kw-U. (CP 5 kw-D, 1 kw-N). Box 845 (96750). (808) 323-2434. Kona Coast Bcstg Corp. Net: CBS. Rep: KRNO San Bernardino, Calif. Format: Good music, Spec prog: Jap 7 hrs; Tagalog 1 hr, both wkly. ■ Thomas M. Jones, pres; Mrs. Carol Fujiwara, gen mgr; Stanley Sleightholm, chief engr.

Lihue

KIVM—May 8, 1940: 1350 khz; 5 kw-D. Box 1748 (96766). (808) 245-4741. Urbatek Systems Inc. (acq 11-1-71). Format: MOR. Spec progs: Filipino 10 hrs wkly. ■ Kenneth R. Harding, pres; Ben V. Cruz, gen mgr. ■ Rates: \$8; 6.50; 8; 6.50.

Wailuku

KAOI(FM)—June 1974. 95.1 mhz; 100 kw. Ant 1170 (CP Ant 1230 ft.). (808) 244-9145. Maui Broadcasting Corp. ■ Kirk Monroe, own.

KMVI—March 17, 1947: 550 khz; 5 kw-U. Box 550. (96793). (808) 244-3982. Maui Publishing Co. Format: MOR, variety. Spec progs: Jap 13 hrs; Filipino 7 hrs, both wkly. ■ J. Walter Cameron, pres; William Paine, gen mgr; Nora Cooper, stn mgr; L.D. Reynolds, mus dir; Spencer Shiraiishi, chief engr. ■ KMVI-TV affil.

Waipahu

KAHU—Sept 20, 1950: 940 khz; 10 kw-U. Box 1007, 94-1088 Farrington Hwy (96797). (808) 677-5667. Royal Hawaiian Radio Inc. (acq 8-22-75). Format: C&W. Spec progs: Filipino 11 hrs. ■ Waldo Russell Withers Jr., pres and gen mgr; Robb Lewis, prog and news dir; Terry Slane, mus dir; Helen G. Dodd, office mgr; Alan Roycroft, chief engr.

KULA(FM)—Co-owned with KAHU. 1976 target date: 92.3 mhz; 100 kw. Ant 1630 ft. Box 1007 (96797).

Idaho

Blackfoot

KBLI—June 1951: 690 khz; 1 kw-D. Box 192. (83221). (208) 785-1400. Western Communications (acq 1974). Net: ABC/C. Rep: Sandeberg-Glenn, Keystone. Format: MOR, C&W, Contemp. ■ Marvin K. and Patricia A. Frandsen, owners; Joe Dechene, chief engr.

KBLI-FM—Not on air; target date unknown: 97.7 mhz; 3 kw. Ant minus 70 ft. 75 E. Judicial St (83221).

Boise

KBBK-FM—Listing follows KBRJ.

KBOI—May 1, 1947: 670 khz; 50 kw-D, 25 kw-N, DA-N. Box 1280. (83701). (208) 336-3670. TWX 208-375-4455. KBOI Inc. (acq 1-27-75). Group owner: Pacific Northwest Bcstg Corp. Net: CBS. Rep: KATZ Radio Sales; Moore. Format: MOR/Upbeat. Spec progs: Basque 1/2 hr, Farm 7 1/2 hrs wkly. ■ Charles H. Wilson, pres & gen mgr; Lee Chabre, prog & mus dir; Al Vuylsteke, coml mgr; Doug Raper, news dir; Milt Daniel, chief engr. ■ Rates: \$15; 12; 15; 9.

KBOI-FM—Nov 1, 1960: 97.9 mhz; 17.5 kw. (CP: 46.7 kw.) Ant 2510 ft. Stereo. Dup KBOI 99%. Spec progs: Black 1 hr wkly. ■ Rates same as AM.

KBRJ—April 8, 1961: 950 khz; 5 kw-D. 9400 Fairview Ave. (83702). (208) 375-1111. MagicLand Bcstg Co. (acq 10-15-72). Net: Country Music Net. Rep: Masla, Hix. Format: C&W. Spec progs: Farm 1 hr, Sp 5 hrs wkly. ■ Rex K. Jensen, pres & gen mgr; Jack H. Jensen, coml mgr; Rockwell Smith, chief engr. ■ Rates: \$5.50; 5.50; 5.50; —.

KBBK-FM—Co-owned with KBRJ. Aug 1, 1968: 92.3 mhz; 44 kw. Ant 2500 ft. Stereo. Format: Top-40. Spec progs: Black 1 hr wkly. Prog sep from AM. ■ Bill Bailey, prog dir. ■ Rates: \$6.50; 6.50; 6.50; 6.50.

KFXD

TORBET
LABBER,
Inc.

KFXD—See Nampa.

KGEM—May 1, 1946: 1140 khz; 10 kw-U, DA-1. Box 5278. (83705). (208) 344-3511. Gem State Bcstg Corp. (acq 5-62). Group owner: Hatch Stns. Net: ABC, Intermountain. Rep: Petry. Format: C&W. ■ George C. Hatch, pres; Homer K. Peterson, gen mgr; R.C. Weisenburger, stn mgr; Jerry Moore, coml mgr; Tom Hill, ops dir.

KIDO—Nov 9, 1928: 630 khz; 5 kw-U, DA-2, 5th flr, Owyhee Plz 1109 Main, Box 8087 (83707). (208) 344-8661. Mesabi Western Corp. (acq 2-1-59). Net: NBC; Idaho Big Buy. Rep: Avery/Knodel; Broadcast Northwest; McGuire. ■ William E. Boeing Jr, chmn of bd; Jack J. Link, VP; James Davidson, gen mgr; Andy Enrico, sls mgr; Elaine Couch, prog dir; Vern Moore, news dir; Donald Cederstrom, chief engr.

KSPD—April 29, 1959: 790 khz; 1 kw-D. Box 2298 (83701). (208) 345-3790. Broadcast Journalism Co. (acq 9-19-73). Net: NBC/NIS. Rep: Savalli-Gates. Format: All news. ■ Earl J. McRoberts, pres & gen mgr; Ron Robie, coml mgr; M. Jean Wyatt, prog mgr; Barry Poole, news dir; Robert Hereau, chief engr. ■ Rates: \$7.50; 5.20; 7.50; 5.20.

KYME—Dec 4, 1955: 740 khz; 500 w-D. Box 1619. (83701). (208) 376-0740. KYME Bcstrs Inc. (acq 6-26-64). Rep: Sandeberg-Glenn. Format: Contemp. ■ M.W. Brainard, pres; Tom Hotchkiss, VP & gen mgr; Stephen D. Oliver, stn mgr; Art Gregory, prog & mus dir.

Burley

KBAR—Aug 31, 1946: 1230 khz; 1 kw-D, 250 w-N. Box 430 (83318). (208) 678-2244. Mini-Cassia Bcstg Inc. (acq 2-1-62). Net: ABC, Intermountain. Rep: Eastman Radio. Spec progs: Sp 3 hrs; C&W 8 hrs, both wkly. ■ Dean S. Leshner, pres; Robert W. Saxvik, VP & gen mgr. ■ Rates: \$3.85; 3.85; 3.85; 3.20.

KBAR-FM—Feb. 15, 1975: 98.3 mhz; 3 kw. Ant 103 ft. Stereo. Prog sep from AM. Net: ABC/FM. Format: Btfl mus. ■ Rates: \$3.15; 3.15; 3.15.

Caldwell

KBGN—Oct. 5, 1960: 910 khz; 1 kw-D. 3300 E.

Chicago (83605). (208) 459-3635. Christian Bcstg Co. of Idaho (acq 10-3-66). Rep: Savalli/Gates. Format: Inspirational/Christian. ■ Edwin L. Shaw, pres; Dick Shaw, gen mgr; John Runkle Jr., chief engr. ■ Rates: \$3.25; 3.25; 3.25; 3.25.

KBXL-FM—Co-owned with KBGW. Feb 22, 1961: 94.1 mhz; 25 kw. Ant 2,520 ft. Stereo. (208) 459-3636. Prog sep from AM. Format: Good music. ■ Lee Schafel, coml mgr. ■ Rates: \$8; 9; 9; 8.

KCID—1947: 1490 khz; 1 kw-D, 250 w-N. Box 1175. (83605). (208) 459-3608. Twin Cities Bcstg Co. (acq 11-71). Audio news: UPI Rep: Oakes. Format: MOR. Spec progs: Sp 12 hrs; classcl 1 hr; farm 19 hrs wkly. ■ Duane D. Wolf, pres; Dale G. Peterson, stn mgr; Sam Bass, ops dir; Dennis White, chief engr. ■ Rates: \$5.05; 5.05; 5.05; 5.05.

Coeur D'Alene

KVNI—October 1946: 1240 khz; 1 kw-D, 250 w-N. Box 308 (83814). (208) 664-9271. North Idaho Bcstg Co. (acq 1963). Net: MBS. Rep: Dahlisten; Simpson. Format: MOR. ■ Duane B. Magadone, pres; Vernon James, gen mgr; Bernard V. Heriman, coml mgr; Bob Angel, prog dir; Kathy O'Meara, news dir; Warren C. Brown, chief engr. ■ Rates: \$4.35; 4.35; 4.35; 4.35.

Emmett

KMFE(FM)—March 12, 1973: 101.7 mhz; 790 w. Ant 500 ft. Stereo. 204 W. Main (83617). (208) 365-5642. Emmett Valley Bcstrs Inc. Net: ABC/E. Format: MOR. Spec progs: Farm 4 hrs wkly. ■ Floyd D. Brown, pres, gen mgr, & chief engr; Melvin F. Gunter, prog dir, coml and prom mgr; Allen Brown, mus dir; Evelyn Brown, news dir. ■ Rates: \$4; 4; 4; 4.

Grangeville

KORT—Oct 8, 1954: 1230 khz; 1 kw-D, 250 w-N. Box 72 (83530). (208) 983-1230. 4-K Radio Inc. (group owner; acq 6-1-71). Net: ABC/C. Rep: Radio Time Sales; Walton; Tacher. Format: MOR; C&W. ■ John Sullivan, ops mgr; Jeff Ripley, mus dir; Dave Rowe, news dir. ■ Rates: \$2.75; 2.75; 2.75; 2.75.

Hailey

KSKI—Feb 10, 1960: 1340 khz; 1 kw-D, 250 w-N. Box 1340 (83333). (208) 788-4504. Sun Valley Radio Inc. (acq 3-1-73). Net: ABC/I; IMN. Format: MOR. ■ Kent Frandsen, pres; Warren Farwell, stn mgr; Eddie Young, mus dir; Carol Stevens, news dir; Douglas Barton, chief engr. ■ Rates: \$3.25; 3.25; 3.25; 3.25.

Idaho Falls

***KIBQ(FM)**—April 16, 1975: 91.9 mhz; 10 w. Bonneville High School, Rt. 1, Box 461 (83401). (208) 522-1881. Bonneville High School District #93. Format: Educational. ■ Ann Rydalc, gen mgr.

KID—1928: 590 khz; 5 kw-D, 1 kw-N, DA-N. Box 2008 (83401). (208) 522-5100. KID Bcstg Corp. (acq 1944). Net: CBS. Rep: McGavren-Guild; Moore. Format: MOR. Spec progs: Farm 6 hrs, classical 2 hrs, both wkly. ■ J. Allen Jensen, pres & gen mgr; Roy L. Southwick, VP stn mgr & prog dir; Ron Barker, news dir; Keith Conner, coml mgr; Jay Sorensen, mus dir; Carroll Secrist, chief engr. ■ Rates: \$10; 8; 10; 8.

KID-FM—May 1, 1965: 96.1 mhz; 100 kw. Ant 1500 ft. Stereo. Format: Btfl mus. Spec progs: Classical 7 hrs wkly. Prog sep from AM. ■ KID-TV affil.

KTEE—Sept 10, 1960: 1260 khz; 5 kw-D. Box 2147. (83401). (208) 523-3710. Benay Corp. (acq 2-22-62). Net: ABC/I; Intermountain. Rep: RKO. Format: Contemp. ■ Leo Higham, pres & gen mgr; Ken Madsen, coml mgr; Jack Sunday, prog & mus dir; Hanks and Sears, news dir. ■ Rates: \$5.25; 5.25; 5.25; 5.25.

KUPI—Nov 9, 1957: 980 khz; 1 kw-D. 854 Lindsay Blvd. (83401). (208) 522-1101. Idaho Bcstrs Inc. (acq 3-1-64). Audio news: UPI. Rep: Masla; Hix. Format: C&W. ■ Charles J. Saunders, pres; James C. Garchow, gen mgr; Gary Patrick, coml mgr; Dennis Carlson, prog dir; Bill Powell, news dir; Wells Brady, chief engr.

KUPI-FM—Aug 16, 1975: 99.1 mhz; 81 kw. Ant 500 ft. Stereo. Prog dups AM.

Jerome

KART—August 1956: 1400 khz; 1 kw-D, 250 w-N. SH. 901 N. Lincoln (83338). (208) 324-8181. KART

Bcstg Co. (acq 9-1-64). Rep: Feltis. Format: C&W. ■ Allen D. Lee, pres, gen mgr & farm dir; John Rue, stn and coml mgr.

KFMA(FM)—Co-owned with KART. August 1970: 92.7 mhz; 3 kw. Ant 175 ft. Stereo. Prog sep from AM. Format: MOR, rock.

Lewiston

***KLHS-FM**—October 1967: 89.1 mhz; 10 w. 1116 Ninth Ave. (83501). SH. 3-5557. Independent School District No. 1. ■ E. D. Sanman Jr., gen mgr; Jack McGee, prog dir.

KOZE—Oct 6, 1955: 1300 khz; 5 kw-D, 1 kw-N, DA-N. Box 936. (83501). (208) 743-2502. 4-K Radio Inc. (group owner; acq 6-1-71). Net: ABC/C. Rep: Walton; Radio Time Sls; Tacher. Format: Contemp. ■ Eugene A. Hamblin, pres; Gary L. Ball, news-sports; Michael R. Ripley, sec-treas-sales; Terry Breen, prog dir. ■ Rates: \$4; 4; 4.

KOZE-FM—Jan 17, 1961: 96.7 mhz; 900 w. Ant minus 630 ft. Stereo. Prog sep from AM. (208) 743-2282. Net: ABC/FM. Format: Btl flus. ■ Rates: \$2; 2; 2.

KPUL—See Pullman, Wash.

KRLC—March 1935: 1350 khz; 5 kw-D, 1 kw-N, DA-N. Box 238 (83501). (208) 743-1551. KRLC Inc. (acq 11-1-71). Net: CBS. Rep: Masla-Torbet Assoc. Art Moore. Format: Rock, Top 40. ■ Douglas A. MacKelvie, pres & gen mgr; Dan Glad, prog & mus dir; Beverly Swanson, coml mgr; Al Nelson, news dir; Chick Bobbitt, chief engr. ■ Rates: \$4.40; 4.40; 4.40; 3.30.

McCall

KMCL—Oct 15, 1965: 1240 khz; 500 w-D, 250 w-N. Box 907 (83638). (208) 634-2248. Golden Enterprises. (acq 2-28-71). Rep: Lucas. Format: C&W. Spec prog: Agriculture 2 hrs wkly. ■ Robert G. Christopher, pres; James H. McCall, gen mgr, news dir & chief engr; Carolyn H. McCall, coml mgr; Jennefer L. Waggoner, prog and mus dir; Debbie Ephraim, prom mgr. ■ Rates: \$2.90; 2.90; 2.90; 2.47.

Montpelier

KVSI—July 20, 1965: 1450 khz; 1 kw-D, 250 w-N. Box 340 (83254). (208) 847-1450. Tri-State Bcstg Co. (acq 11-1-68). Rep: Sandeberg-Glenn. Net: ABC/I; Intermountain network. Format: Contemp. ■ Keith Martindale, exec VP, gen mgr & news dir; James Burgoyne, coml mgr, prog dir & prom mgr.

Moscow

KPUL—See Pullman, Wash.

KRPL—May 20, 1947: 1400 khz; 1 kw-D, 250 w-N. Box 8849 (83843). (208) 882-2551. KRPL Inc. (acq Feb 1963). Net: ABC/I. Rep: Savalli/Gates; Moore. Format: Contemp. ■ John Mix, pres & gen mgr; Matt Shelley, news dir; Gary Cummings, prom mgr; Larry Ayer, chief engr. ■ Rates: \$4.25; 4.25; 3.75; 3.25.

KRPL-FM—Feb 24, 1973: 103.9 mhz; 180 w. Ant 990 ft. Stereo. Prog sep from AM. ■ Dennis T. Deccio, prog & mus dir, prom mgr; Tom Neal, coml mgr. ■ Rates: \$3; 3; 3.50; 3.50.

***KUID(FM)**—Sept 1, 1963: 91.7 mhz; 1.04 kw. Ant 1000 ft. Radio-TV Center, University of Idaho (83843). (208) 885-6723. TWX 510-776-0971. Regents of University of Idaho. Format: Progs. ■ Peter Haggart, gen mgr; Rick Houlberg, stn mgr; Kit Neraas, mus dir; Richard Carroll, chief engr. ■ *KUID-TV affil.

***KUOI-FM**—November 1968: 89.3 mhz; 10 w. Student Union Bldg., U. of Idaho (83843). (208) 885-6433. Assoc. Students of the U. of Idaho. Format: Diversified. ■ William Harland, gen mgr; Doug Stanfield, chief engr.

Mountain Home

KFLI—March 20, 1962: 1240 khz; 1 kw-D, 250 w-N. (208) 587-4425. KFLI Radio Inc. (acq 10-1-69). Net: MBS. Format: Variety. Spec prog: C&W 10 hrs. Sp 2 hrs, both wkly. ■ John C. Mitchell, pres; W. J. Abbott, gen mgr; Alvin Powers, news dir.

Nampa

KAIN—Nov 1, 1962: 1340 khz; 1 kw-D, 250 w-N. First National Plaza, 816 12th Ave South (83651).

466-1340. First National Bcstg Corp. (acq 5-69). Group owner: Brent Larson Stns. Net: Northwest News. Rep: Bernard Howard; Larson Group. Format: MOR. Spec progs: Farm 6 hrs; classl 1 hr; Sp 2 hrs; C&W 1 hr; Shoshone Indian ¼ hr, all wkly. ■ Brent Larson, pres; William H. Nichols, coml mgr; William S. Black, prog dir; Pat Crandall, coml mgr; Eugene Perkins, prom mgr; Carol Allen, mus dir; Fred Chapman, news dir; Don Bower, chief engr. ■ Rates: \$6.50; 5.50; 6.50; 4.75.

KFXD—May 17, 1920: 580 khz; 5 kw-U. DA-N. Box 160 (83651). (208) 345-8812. Idaho Broadcasting Co. (acq 10-1-62). Audio news: UPI. Rep: Torbet-Lasker; Tacher. Format: Top 40. Spec progs: Sp 1½ hrs wkly. ■ Wayne C. Cornliss, pres & gen mgr; Ron Grisham, coml mgr; Fred Novak, prog dir; Dave Hagen, news dir; Tom Hill, chief engr; Drew Harold, prom mgr; Tom Scott, mus dir. ■ Rates: \$8; 7; 8; 7.

KFXD-FM—Jan 10, 1975: 94.9 mhz; 46 kw. Ant 2520 ft. Box 107 (83701). Prog sep from AM. Format: MOR. ■ Tim Pace, coml mgr; Fran Martin, news dir; Bob Jordan, prom mgr; Wendy Green, chief engr. ■ Rates: \$5; 7; 7; 5.

KLER—Oct 15, 1958: 950 khz; 1 kw-D, 500 w-N, DA-N. Box 32 (83544). (208) 476-5124. 4-K Radio Inc. (group owner; acq 6-1-71). Net: ABC/C. Rep: Walton Bcstg; Radio Time Sales; Tacher. Format: Top 40, C&W. ■ Art Hunt, opns mgr ■ Rates: \$2.75; 2.75; 2.75; 2.75.

Payette

KYET—June 14, 1965: 1450 khz; 250 w-U. Box 157, Ontario, Ore. (97914). (503) 889-3158. D & H Bcstg, Inc. (acq November 1969). Rep: Feltis. Format: C&W. Spec prog: Sp 4 hrs wkly. ■ Richard Swan, pres; Ramona D. Swan, gen mgr; Barbara Fitch, coml mgr; Bill Horton, prog dir; Duane Kertual, prom mgr & news dir; Mike Cooley, chief engr.

William A. Exline, Inc.

31 CARROLL COURT

SAN RAFAEL, CALIFORNIA 94903

(415) 479-0717

MEDIA BROKERS - CONSULTANTS

Pocatello

***KBGL(FM)**—1952: 89.5 mhz; 10 w. Dept of Radio-TV, Idaho State U (83201). (208) 236-2857. Idaho State U. Format: Ed. ■ Herbert Everitt, gen mgr; Elmo Sackett, stn mgr; Don Rogers, prog dir; Gerald Smith, chief engr. *KBGL-TV affil.

KSEI—Sept 23, 1926: 930 khz; 5 kw-U, DA-N. Box 31 (83201). (208) 233-2121. KSEI Bcstrs Corp. (acq 10-1-57). Group owner: Moore. Net: NBC. Rep: Avery-Knodel; McGuire. ■ Earl Morgenroth, pres; Larry Wilmot, gen mgr; Larry Eckenrode, sls mgr; Bob Thaxter, prog dir; Bob Billings, chief engr; Dick Sybert, news dir. ■ Rates: \$7; 6; 7; 6.

KSIH(FM)—94.9 mhz; 100 kw. Ant 990 ft. Suite 215 Shene Bldg., Idaho Falls (83401). Southern Idaho Stereo F.M. Corp. (acq 6-6-74).

KSNN—Dec 20, 1956: 1290 khz; 1 kw-D, 538 South Main (83201). (208) 232-6565. Pocatello Bcstg Co. (acq 11-1-61). Rep: Masla; Young; Hix; Tacher. Format: Top 40. Spec progs: Sp 2 hrs wkly. ■ Daniel C. Libeg, pres & gen mgr; Calvin Hunter, prog dir; Barry Cuda, news dir; Dan Kingsley, mus dir; Jack Armstrong, coml mgr; Gwen Gray, prom mgr; Art Reis, chief engr. ■ Rates: \$4.75; 4.75; 4.75; 4.75.

KSNN-FM—Dec 27, 1969: 93.7 mhz; 29 kw. Ant 14 ft. Stereo. Dup AM 75%. Spec progs: Sp 2 hrs wkly. ■ Rates same as AM.

KWIK—September 1946: 1240 khz; 1 kw-D, 250 w-N. Box 2005 (83201). (208) 233-1133. KWIK Bcstg Co. (acq 9-1-63). ■ Robert E. Davis, pres & gen mgr; Dwight Zundel, chief engr; Glen Frank, opns dir; Charles Quillan, sls mgr.

Preston

KPST—Sept 4, 1948: 1340 khz; 250 w-SH. Box 235 (93263). (208) 852-1340. Voice of the Rockies Inc. Rep: Young; Feltis. Format: C&W. ■ Mike Adams, gen and prom mgr & chief engr; Heber Hansen, coml mgr; Earl Hawkins, prog and news dir.

Rexburg

KADQ(FM)—August 1975: 94.3 mhz; 3 kw. Ant 190 ft. Box 609 (83445). ■ Theodore W. Austin, own.

***KRIC(FM)**—Nov 13, 1972: 90.1 mhz; 10 w. Ant 90 ft. Ricks College (83440). (208) 356-2338. Ricks College. Format: Education. Spec progs: Ger 1 hr; Ital. ¼ hr; Sp 1 hr, all wkly. ■ Henry B. Eyring, pres; John A. Haebler, gen mgr; James Griffith, chief engr.

KRXK—January 1951: 1230 khz; 1 kw-D, 250 w-N. 54 College Ave. (83440). (801) 356-3651. Don T. Ellis (acq 6-18-68). Net: ABC; Keystone. Rep: Lucas. ■ Don Ellis, pres & news dir; Mitch Ellis, gen mgr & prog dir; Thomas Matthews, chief engr.

Rupert

KAYT—Oct 12, 1955: 970 khz; 1 kw-D, Box 427 (83350). (208) 436-4757. Inland Bcstg Co. Rep: Hopewell; Moore. Format: C&W. ■ Mervin V. Ling, pres, gen mgr & chief engr; John Hayes, stn & coml mgr.

Salmon

KSRA—March 1, 1959: 960 khz; 1 kw-D. Box 950 (83467). (208) 756-2218. Dale J. Smith. (acq Nov 1969). Net: Keystone. Rep: Feltis, Dove & Croghan. ■ Dale J. Smith, owner & gen mgr; Blair E. Smith, prog dir.

Sandpoint

KSPT—March 23, 1949: 1400 khz; 1 kw-D, 250 w-N. Box 640 (83864). (208) Congress 3-2179. Bauer Bcstg Co. Rep: Lucas; Moore. ■ Norman E. Bauer, gen & coml mgr; Ione M. Bauer, prog dir; Mardi A. Bauer, news dir; Walt Moreland Jr., chief engr.

Soda Springs

KBRV—Sept 22, 1957: 790 khz; 5 kw-D. 120 E. 2nd South (83276). (208) 547-3307. Thomas W. Mathis. (acq 11-20-74). Rep: Hix; Bournstein. Format: C&W. MOR. Spec progs: Farm 10 hrs wkly. ■ Thomas W. Mathis, owner & gen mgr; Johnny Biscuit, prog dir; Pam Ann mus dir; Doug Reed, sports dir. ■ Rates: \$4; 4; 4.

St. Anthony

KIGO—July 10, 1966: 1400 khz; 1 kw-D, 250 w-N. Box 609 (83445). (208) 624-3246. Theodore W. Austin. Format: C&W. Top 40. ■ Ted W. Austin Sr., pres; Ted W. Austin Jr., coml mgr & prog dir; Mike Foster, mus dir; Wells Brady, chief engr; Richard Howe, news dir.

St. Maries

KOFE—March 1, 1970: 1490 khz; 1 kw-D. St. Joe Radio (acq 10-24-74). Net: ABC/C; Walton Bcstg; Radio Time Sales; Tacher. Format: Contemp. ■ Mike Darling, opns mgr.

Twin Falls

KART—See Jerome.

KEEP—1946: 1450 khz; 1 kw-D, 250 w-N. Box 346 (88301). (208) 733-7512. Inland Radio Inc. (acq 11-1-69). Rep: Masla; Hix; Tacher. Format: Contemp. ■ David N. Capps, gen mgr; Walt Ross, coml mgr; Bruce Glennie, prog dir; Kelly Klaas, news dir.

KFMA-FM—See Jerome.

KLIX RADIO

MODERN COUNTRY MUSIC

Southern Idaho's Largest

Radio News Department

5000 Watts Twin Falls, Idaho

KLIX—1310 khz; 5 kw-D, 1 kw-N, DA-N. Box 1259 (83301). (208) 733-1310. Sawtooth Radio Corp. (acq

Idaho, Illinois Radio

See page C-1 for explanation of listings.

12-20-74). Net: ABC/I; IMN. Rep: Eastman; IMN. Format: Modern country. ■ Charles R. Tuma, pres & gen mgr; Noel Brittain, coml mgr; Jim Morrison news dir; Bill Kucera, chief engr; Johnny Mac, mus dir; Dave Winter, prog dir. ■ Rates: \$7.40; 5.90; 5.90; —.

KMTW(FM)—June 15, 1974: 96.5 mhz; 100 kw. Ant 130 ft. Stereo. Box N. (83301). (208) 734-2222. Media 5 Inc. Rep: Torbet-Lasker; ABC. Format: MOR day, Top 40 night. ■ Robert J. Coiner, pres; J. J. Alexander, gen mgr; Mark W. Whitesides, coml mgr; Don Elliott, news dir; J. Kelly Carlson, prog and mus dir and chief engr.

KTFI—October 1928: 1270 khz; 5 kw-D, 1 kw-N. Box 65 (83301). (208) 733-3381. Greentree Bcstg Co. (group owner; acq 6-1-73). Net: NBC. Rep: Avery-Knodel; Art Moore; McGuire, Format: MOR. ■ Charlie Powers, pres; Richard W. Ryall, gen mgr; Marti Overstreet, coml mgr; Ron Chancey prog dir; Bob Miller, news dir; Walt Snow, chief engr.

Wallace

KWAL—May 1938: 620 khz; 1 kw-U, DA-N. Box U. Osburn, Idaho (83849). (208) 752-6101. Metals Broadcasting Co (acq 10-1-63). Rep: Sandeberg-Glenn Co.; Moore. Format: MOR, C&W.

Weiser

KWEI—December 1947: 1260 khz; 1 kw-D. Box 791 (83672). (208) 549-0886. Oxbow Bcst Co. (acq 4-11-61). Rep: Hopewell; Moore. ■ Edwin C. Miller, pres, gen mgr & chief engr; Robert R. Cooper, stn mgr.

Illinois

HAMILTON-LANDIS
& ASSOCIATES, Inc.
NATIONWIDE MEDIA BROKERS
WASHINGTON, D. C., CHICAGO, DALLAS,
SAN FRANCISCO

SELL **MORE**
RADIO & TELEVISION STATIONS
IN THE MIDWEST—NEAREST OFFICE IS—
1429 TRIBUNE TOWER, CHICAGO 60611
(312) 337-2754

Alton

WOKZ—1948: 1570 khz; 1 kw-D. Box 615 (62002). (217) 466-3535. Morell Bcstg Co. (acq 10-7-1). Rep: Piano. Spec progs: C&W 8½ hrs wkly. ■ Walter Brink, gen mgr; Nick Bono, chief engr.

WOKZ-FM—September 1961: 100.3 mhz; 28 kw. Ant 490 ft. Dup AM 25%.

Anna

WRAJ—Jan 10, 1957: 1440 khz; 500 w-D. Box 120, 200 N. Main (62906). (618) 833-2148. Anna Bcstg Co. Group owner: Lackey. ■ Donald C. Michel, pres, gen mgr & chief engineer; Marian Michel, prog & mus dir.

WRAJ-FM—Jan 13, 1958: 92.7 mhz; 3 kw. Ant 290 ft. Dup AM 60%.

Arlington Heights

***WFVH(FM)**—Jan 29, 1975: 88.3 mhz; 10 w. Ant 100 ft. 2121 S. Goebbert Rd. (60005). (312) 640-6677. Forest View High School. Format: Educ, MOR. Spec progs: Black 1 hr; classical 1 hr; jazz 1 hr; C&W 1 hr wkly. LeRoy Thomson, stn advisor; Michael Suhecki, gen mgr.

WWMM(FM)—March 10, 1960: 92.7 mhz; 3 kw. Ant 300 ft. 120 W. University Dr. (60004). (312) 398-2300. Community Bcstrs Inc. (acq 10-1-72). Audio news: UPI. Format: Jazz. Stereo. ■ Robert M. Williams, pres & gen mgr; Sean Matthews, prog dir; Frank E. Kavenik, chief engr. ■ Rates: \$20;20;20;18.

Arthur

WFWA-FM—See Sullivan.

Aurora

WAUR(FM)—1965: 107.9 mhz; 50 kw. Ant 490 ft. 184 S. River St. (60506). (312) 892-2345. Stevens Communications Corp. (acq 12-20-72). Format: MOR. ■ Dale W. Stevens, pres; Harold L. Brokaw, VP & gen mgr; Richard L. Frederickson, coml mgr; Gary Lee, prog dir; Rand Brokaw, prom mgr; Ford Colley, mus dir; Dan Lewis, news dir; John Kitner, chief engr.

WFVR—Sept 21, 1960: 1580 khz; 250 w-D. DA. 1880 Plain Ave. (60505). (312) 898-1580. Salter Bcstg Co. Group owner: Russ Salter Stns. Rep: Pro Time Sales, Messina. Format: C&W. Spec prog: Sp 2½ hrs. ■ Russell G. Salter, pres; Charles O. Liedtke, gen mgr; William Blough, coml mgr; Keith Peterson, prog dir; Paul Gomez, news dir; Tom Farber, chief engr.

WKKD-FM—Co-owned with WFVR. Feb 12, 1961: 95.9 mhz; 3 kw. Ant 300 ft. Stereo. (312) 898-6668. Prog sep from AM. Format: MOR. ■ Charles F. Filippi, gen mgr & coml mgr.

WMRO—Dec 13, 1938: 1280 khz; 1 kw-D, 500 w-N, DA-2. 184 S. River (60506). (312) 897-4215. Stevens Bcstg (acq 6-24-69). Net: MBS. Rep: Ill. Farm. Format: Contemporary, talk, features. Spec prog: Sp 4 hrs, black 4 hrs, wkly. ■ Dale W. Stevens, pres; Harold L. Brokaw, VP & gen mgr; Gary Lee, prog dir; Dan Lewis, news dir; Ford Colley, mus dir; John Kitner, chief engr.

Beardstown

WRMS—Nov 1, 1959: 790 khz; 500 w-D, DA. 108 E. Main St. (62618). (217) 323-1790. Beardstown Bcstg Corp. (acq 8-21-72). Net: ABC/C. Format: Farm, oldies, Top 40, C&W. ■ John Conner, VP & gen mgr; David A. MacFee, pres; Arthur M. Zeeck, chief engr.

WRMS-FM—Not on air, target date December 1975: 94.3 mhz; 3 kw. Ant 300 ft.

Belleville

WIBV—July 13, 1947: 1260 khz; 5 kw-U, DA-2. Box 91 (62222). (618) 233-5000. Belleville Bcstg Company Inc. Net: ABC/I, MBS. Format: MOR. Spec progs: Ger 3½ hrs; black 1 hr, wkly. ■ Norman S. Greenberg, pres & gen mgr; Marvin M. Mollring, chief engr. ■ Rates: \$11;11;11;11.

WMRY(FM)—See East St. Louis.

Belvidere

WKWL(FM)—Feb 27, 1971: 104.9 mhz; 3 kw (CP 2.3 kw). Ant 300 ft. Bell School Rd., Rockford, Ill. (61107). (815) 398-6464. Belvidere Bcstg Co. Net: ABC/FM. Format: Good mus. Spec prog: Fr 4 hrs wkly. ■ Keith Walker, pres.

Benton

WORX(FM)—Oct 1, 1973: 106.3 mhz; 3 kw. Ant 300 ft. Suite 315 Wood Bldg (62812). (618) 439-3286. Rend Lake Bcstg Co. Rep: Gert Bunchez. Format: MOR, rock. Spec prog: Country 15 hrs wkly. ■ Gerald D. Owens, pres; Ned Mitchell, gen mgr & news dir; Ron Head, coml mgr; Bill Simpkins, prog dir; Everett Kennedy, chief engr.

Bloomington

WAKC—See Normal.

WBNO(FM)—Listing follows WJBC.

***WESN(FM)**—April 1972: 88.1 mhz; 10 w. Ant 100 ft. Stereo. 210 East University St. (61701). (309) 556-2332. Illinois Wesleyan University. Format: Progs, educ, jazz. Spec progs: Black 14 hrs; C&W 10 hrs, wkly. ■ Scott McDaniel, gen mgr.

WJBC—1925: 1230 khz; 1 kw-D, 250 w-N. Box 8 (61701). (309) 829-1221. Bloomington Bcstg Corp. (acq 1956). Net: ABC. Rep: McGavren-Guild-PGW. Spec prog: Farm 13 hrs wkly. ■ Timothy R. Ives, pres; John H. McDermott, coml mgr; Don Munson, opns dir; Larry Shoel, chief engr; Steve Vogel, news dir. ■ Rates: \$19;19;19;9.

WBNO(FM)—Co-owned with WJBC. 1947: 101.5 mhz; 50 kw. Ant 460 ft. Prog sep from AM. Stereo. ■ Denny Adkins, prog dir. ■ Rates: \$9.50;9.50;9.50;9.50.

Cahokia

***WRTE(FM)**—Jan 31, 1975: 89.5 mhz; 10 w. 1700 Jerome Lane (62206). (618) 332-3535. Cahokia Unit

School District No. 187. Format: MOR. ■ William C. Bailey, gen mgr.

Cairo

WKRO—Jan 8, 1942: 1490 khz; 1 kw-D, 250 w-I. Box 311 (62914). (618) 734-1490. Cairo Bcstg Co. Rep: PRO/Meeker. ■ Merrill C. Currier, pres & gen | mgr. ■ Rates: \$7.50; 7.50; 7.50; 7.50.

Canton

WBYS—Oct 5, 1947: 1560 khz; 250 w-D. Box 60 (61520). (309) 647-1560. Fulton County Bcstg Co. Net: ABC/I. Format: Contemp MOR, news, info. I Charles E. Wright, pres, gen mgr; John Brydon, con mgr; Dean Cramer, prog dir; Phillip Miller, news di Charles E. Wright, chief engr.

WBYS-FM—Oct 7, 1968: 98.3 mhz; 3 kw. Ant 265 ft. Stereo. Dups AM 50%.

Carbondale

WCIL—Nov 14, 1946: 1020 khz; 1 kw-D. Box 80 (62902). (618) 457-8114. Paul F. McRoy (acq 6-1-65). Net: ABC. Format: MOR. ■ Paul F. McRoy, gen mg Paul H. McRoy, stn mgr & ntl coml mgr; Kevin Pollt prog dir; Pat Burns, chief engr; Randy Taylor, news d ■ Rates: \$4.50;4.50;4.50;—.

WCIL-FM—July 1968: 101.5 mhz; 50 kw. Ant 300 ft. Stereo. Dups AM daytime. ■ Rates same as AM.

***WSIU(FM)**—Sept 15, 1958: 91.9 mhz; 50 kw. Ar 300 ft. Southern Illinois U. (62901). (618) 453-4343. TVX 618-510-5771. Southern Illinois U. Net: NPF Format: Variety. ■ Charles T. Lynch, chmn; David f Rochelle, dir bcstg svcs; Kenneth Gary Jr., stn mg Alan H. Frank, prog dir; Larry Richardson, mus supv Edward Brown, news dir; William Criswell, sports di William Dixon, chief engr.

Carlinville

***WIBI(FM)**—Not on air; target date unknown: 91. mhz; 23.5 kw horiz, 20.8 vert. Ant 260 ft. R.R. 3, Bo 225 (62626). Illinois Bible Institute.

Carmi

WROY—Dec 14, 1949: 1460 khz; 1 kw-D. Box 3 (62821). (618) 382-4161. Carmi Bcstg Co. Rep: UBC Sales, Walton. Format: Contemp, MOR, variety. ■ C. I Rebstock, pres; Robert F. Meskill, gen & coml mgr Jerome Davidson, chief engr; Robert F. Meskill, news dir. ■ Rates: \$8.60;8.60;8.60;6.15.

WRUL(FM)—Co-owned with WROY. 1952: 97.3 mhz; 11 kw. Ant 210 ft. Format: C&W. ■ Rates: \$7.40; 7.40; 7.40; 7.40.

Carthage

WCAZ—1922: 990 khz; 1 kw-D. 84 South Madison (62321). (217) 357-3128. Superior Bcstg Service Inc. Audio news: UPI. Format: MOR. Spec prog: C&W 16 hrs wkly. ■ Zoe Compton, pres; Jerry Nutt Jr., gen mgr; Betty Nutt, prog dir; Wayne Meredith, chief engr.

Casey

WKZI—Dec 14, 1963: 800 khz; 250 w-D. Box 428 (62420). (217) 932-4051. Ford FM. Inc. Net: ABC/E. Format: C&W. Spec prog: Farm 10 hrs wkly. ■ Paul Dean Ford, pres; Dick Harlan, stn mgr, sports and news dir; Jerry Cox, prog dir; Cleone Markwell Jr., chief engr. ■ Rates: \$6;6;—;—.

WPFR-FM—Co-owned with WKZI. See Terre Haute, Ind.

Centralia

WILY—Aug 15, 1946: 1210 khz; 1 kw-D. 326 E. Broadway (62801). (618) 532-1885. Prairieland Bcstrs Inc. (acq 8-1-67). Net: ABC. Format: MOR, talk

Hogan - Feldmann, Inc.
MEDIA BROKERS • CONSULTANTS
16255 Ventura Boulevard, Suite 415
Encino, California 91436
AREA CODE 213 986-3201

■ Stephen P. Bellinger, pres; Samuel A. Hassan, exec VP & gen mgr; Alan Moore, coml mgr; Jeff Leidy, news and prog dir; Meyer Gottesman, chief engr. ■ Rates: \$11.25;9.25;11.25;—.

WRXX(FM)—Co-owned with WILY. Dec 24, 1964: 95.3 mhz; 3 kw. Ant 215 ft. Prog separate from AM. Stereo. Format: C&W. ■ Rates: \$11.20; 11.20; 11.20; 11.20.

Champaign

WCCR—See Urbana.



WDWS—Jan 24, 1937: 1400 khz; 1 kw-D, 250 w-N. 48 Main St. (61820). (217) 356-1855. Champaign News Gazette Inc. Net: CBS. Rep: McGavren-Guild. ■ Maraien S. Chinigo, pres; Larry Stewart, gen mgr; Constance Vogt, prog dir; Ron Williams, news dir; Art Simpson, chief engr. ■ Rates: \$20;15;17;15.

WDWS-FM—1949: 97.5 mhz; 27 kw. Ant 430 ft. Prog sep from AM. ■ Rates: \$9;9;9.9.

WILL-AM-FM—See Urbana.

WLRW(FM)—Jan 1963: 94.5 mhz; 43 kw. Ant 400 ft. Stereo. 2410 W. Skyline Drive, Box 3520, Country Fair Stn. (61820). (217) 352-4141. Airways, Inc. (acq 12-1-71). Net: ABC/I. Format: Oldies, Top 40. Spec prog: Black 5 hrs wkly. ■ Richard G. Glover, pres & gen mgr; Larry Stirewalt, news dir; Jim Wnek, mus dir; Allen Wolfe, chief engr; Tom Trent, coml mgr; John Bowen, prom mgr. ■ Rates: \$8.25;7.8;25;7.

WPGU(FM)—See Urbana.

WTWC(FM)—See Urbana.

Charleston

WEIC—Dec 10, 1954: 1270 khz; 1 kw-D, 500 w-N. Box 158 (61920). (217) 345-2149. Withers Bcstg. (acq 9-30-75). Net: MBS, Brownfield Farm. Rep: Meeker. Format: Contemp. ■ John F. Hurlbut, pres; David E. Hurlbut, chief operator and gen mgr; Harvey J. Steele, mus dir; James Sharer, news dir. ■ Rates: \$4.30;4.30;4.30;4.30.

WEIC-FM—Oct 1, 1965: 92.1 mhz; 2.2 kw. Ant 140 ft. Dup AM 75%. Stereo. ■ Rates same as AM.

Chester

KSGM—July 5, 1947: 980 khz; 1 kw-D, 500 w-N, DA-N. Box 428, Ste. Genevieve, Mo. (63670). (618) TUXedo 3-2980. Donze Enterprises Inc. Net: MBS. ■ Elmer L. Donze, pres, coml, prom & gen mgr; Art Schwent, prog & news dir; Bob Scott, mus dir; Elmer L. Donze, chief engr. ■ Rates: \$5.20;5.20;5.20;5.20.

KSGM-FM—See Ste. Genevieve, Mo.

Chicago

WAIT—1941: 820 khz; 5 kw-D (L-SS Dallas, Tex). 679 N. Michigan Ave. (60611). (312) WH 4-6100. WAIT Radio (acq 9-12-62). Rep: Katz. ■ Maurice Rosenfield, exec dir; Frederick G. Harm, gen & coml mgr; Joseph R. Lacinia, prog mgr; Ronald Stephens, chief engr.

WBBM—1923: 780 khz; 50 kw-U. 630 N. McClurg Court (60611). (312) 944-6000. TWX 312-222-0698. CBS Inc. (Group owner; acq 1931). Net: CBS. Rep: CBS Radio Spot Sales. Format: News. ■ William C. O'Donnell, VP CBS Radio & gen mgr; Lee Leicingger, gen sls mgr; David A. Millberg, dir info svcs; John Hultman, news dir; Jim Durns, chief engr. ■ Rates: \$165;75;125;40.

WBBM-FM—Dec 7, 1941: 96.3 mhz; 6 kw. Ant 1,170 ft. Rep: CBS/FM Sls. ■ John N. Cattet, gen mgr; Bob Johnston, prog dir; Lois Gredell, sls mgr; Dick Bartley, mus dir; Anne McKean, opns mgr. ■ WBBM-TV affil. ■ Rates: \$56;40;72;72.

WBEE—See Harvey.

***WBEZ(FM)**—1942: 91.5 mhz; 39 kw. Ant 550 ft. 229

N. La Salle St. (60601). (312) 641-4088. Board of Education, City of Chicago. Net: NPR. Format: Instrctnl, cultr. ■ Carol R. Nolan, gen mgr; Tony D. Cristofano, prog dir; Joseph D. Franco, chief engr.

***WBHI(FM)**—Sept 9, 1974: 88.5 mhz; 10 w. 3939 W. 79th St. (60652). (312) LU 2-0950. Bogan High School. Format: MOR, beautiful mus. ■ William J. Scheid, principal; Phillip Windolph, gen mgr & chief engr.

WCFL—June 25, 1926: 1000 khz; 50 kw-U, DA-2. 300 N. State St. (60610). (312) 222-1000. TWX 25-3834. Chicago Federation of Labor & Industrial Union Council. Rep: McGavren-Guild. Format: Contemp. ■ William A. Lee, pres; Lew M. Witz, stn mgr; Ron O'Brien, prog dir; Mike Rollins, news dir; Mary Sweeney, prom mgr; James Loupas, chief engr. ■ WCFL-TV affil. ■ Rates: \$140;95;140;120.

WCGO—See Chicago Heights.

WCRW—July 1926: 1240 khz; 1 kw-D, SH, 250 w-N (shares time with WEDC and WSBC Chicago). 2756 Pine Grove Ave. (60614). (312) 327-6860. WCRW Inc. (acq 11-63). Format: Spanish & Greek, MOR. ■ Josephine A. White, pres & treas; Edward W. Jacker, VP & gen mgr. ■ Rates: \$15;15;15;15.

***WCYC(FM)**—Dec 1, 1969: 88.7 mhz; 10 w. Ant 88 ft. 304 West Randolph St. (60606). (312) 346-0830. Chicago Boys Clubs Educational Corp. Format: Educl, inform. Spec progs: Sp 4½ hrs; black 20 hrs; C&W 3 hrs, Polish 4 hrs wkly. ■ W. Clement Stone, pres; Daniel W. Swope, gen mgr; Fred C. Lickerman, C.B.C. exec. dir, M. Anthony Sledge, prog dir; Harold R. Kopta, chief engr.

WDAI(FM)—See listing following WLS.

WDHF(FM)—March 9, 1959: 95.5 mhz; 6 kw. Ant 1170 ft. 108 N. State (60602). (312) 726-8282. Metromedia (group owner; acq 3-13-73). Rep: Metro Radio Sls. ■ Stan Gurrell, sr VP & gen mgr; Sue Sturm, business mgr; Don Luck, prod dir; Ivan Bukousky, chief engr.

WEDC—1926: 1240 khz; 1 kw-D, 250 w-N, SH (shares time with WCRW and WSBC Chicago). 5475 N. Milwaukee Ave. (60630). (312) 631-0700. Foreign Language Bcstrs Inc. (acq 1965). Format: Sp, Spec progs: Pol 6¼ hrs; It 4½ hrs; Rus ¾ hr; Gk 1 hr; Ukran 1 hr; Slov ½ hr, wkly. ■ Leonard Slotkowski, pres; Mrs. A. B. Pucinski, gen, coml & prom mgr, prog, mus & news dir; Edward Jacker, consult engr.

WFMT(FM)—Dec 13, 1951: 98.7 mhz; 15.5 kw. Ant 1,170 ft. Stereo. 500 N. Michigan Ave. (60611). (312) 751-7100. WFMT Inc. (acq 3-5-70). Rep: Buckley. Format: Classcl music. Spec progs: Folk 8 hrs; drama 3 hrs; talk 8 hrs, wkly. ■ Raymond Nordstrand, pres, gen mgr; Steve Feder, coml mgr; Norman Pellegrini, prog & news dir; Nancy Joyce, prom mgr; Alfred C. Antlitz, chief engr. ■ Rates: \$50;35;50;50.

WFYR(FM)—November 1957: 103.5 mhz; 3 kw. Ant 1,556 ft. Stereo. 188 W. Randolph St. (60601). (312) 726-4522. RKO General Inc. (group owner; acq 3-73). Net: Ill. News. Rep: RKO, RRR. Format: Nostalgia, R&R. ■ Bruce F. Johnson, pres; Al Kucin, gen mgr; Linda Conner, coml mgr; Brian Beirne, prog dir; William Heizer, prom mgr; Bob Brown, news dir; John Q. Adams, news dir.

WGCI(FM)—Listing follows WVON.

WGN—June 1, 1924: 720 khz; 50 kw-U. 2501 Bradley Place (60618). (312) 528-2311. TWX 312-222-0332. WGN Continental Bcstg Co. (group owner). Rep: Buckley, Hyett, Creed, Glen-Warren (Canada). Format: MOR, talk, sports, farm. ■ Daniel T. Pecaro, pres & chief exec off; Donald Getz, VP & gen sls mgr; Robert Henley, VP & gen mgr; Richard D. Jones, prog mgr; William H. Willis, PR mgr; E. Boyd Seghers Jr., VP, mgr, sls, prom research & adv; Charles Harrison, VP & news mgr; Charles Allan, mus dir; Woodrow R. Crane, chief engr. ■ Rates: \$205; 105; 152; 105 or 70.

***WHPK-FM**—March 15, 1968: 88.3 mhz; 10 w. Ant 137.75 ft. 5706 S. University Ave. (60637). (312) 753-2356. The University of Chicago. Format: Varied. ■ Steve Peduto, stn mgr.

WICV(FM)—1940: 99.5 mhz; 6 kw. Ant 1,170 ft. 120 W. Madison St. (60602). (312) 263-0445. GCC Communications of Chicago Inc. (group owner; acq 1-73). Rep: Groskin & Co. Format: Classical. ■ Alexander

Tanger, pres; George Stone, gen mgr; R. C. Noble, news dir; Bill Ohl, chief engr.

WIND—1927: 560 khz; 5 kw-U. DA-2. 625 N. Michigan Ave. (60611). (312) 527-2170. TWX 910-221-5242. Westinghouse Bcstg Co. (group owner; acq 12-22-56). Rep: Radio Adv. Inc; McDer-mott (Canada). Format: MOR. ■ Donald H. McGannon, pres; Philip Nolan, gen mgr; R. C. Lindau, coml mgr; Robert Moomey, prog dir; Ann Jaeger, prom mgr; Ed Dorsey, news dir; John Tolefson, chief engr.

WJJD—Oct 13, 1924: 1160 khz; 50 kw-U. DA-1 (L-KSL Salt Lake City). 8 S. Michigan Ave. (60603). (312) 782-5466. Plough Bcstg Inc. (group owner; acq 9-13-53). Net: ABC/I. Rep: H-R/Stone. Format: C&W. ■ Harold R. Krelstein, pres; George G. Dubinetz, gen mgr; Craig Scott, opns dir; Reese Rickards, news dir; Don Jeffers, chief engr; Bill Hart, mus dir. ■ Rates: \$105;105;105;105.

WJJD-FM—Jan 2, 1961: 104.3 mhz; 14 kw. Ant 820 ft. Dups AM 85%.

WJPC—May 1922: 950 khz; 1 kw-D. 221 N. LaSalle (60601). (312) 726-1932. Johnson Publishing Co. (acq 5-29-73). Net: Natl Black. Rep: Johnson Pub Co Inc. Format: Black, contemp. ■ William Manney, pres & gen mgr; Sonny Taylor, prog & mus dir; Marv L. Dyson, sls mgr; Don Coleman, chief engr.

***WKKC(FM)**—1975: 89.3 mhz; 10 w. Ant 83 ft. 6800 S. Wentworth Ave. (60621). Kennedy-King College.

WLAK(FM)—April 7, 1958: 93.9 mhz; 6 kw. Ant 1530 ft. Stereo. 875 N. Michigan Ave. (60611). (312) 787-4511. Sudbrink Bcstg. (group owner). Rep: Bolton-Burchill. Format: Btlf mus. ■ Robert Sudbrink, pres; Norman Feuer, VP & gen mgr; Jack Lee, opns dir; Dennis Ciapura, chief engr. ■ Rates: \$65;75;75;45.

WLOO(FM)—1947: 100.3 mhz; 6 kw. Ant 1,170 ft. Stereo. John Hancock Center, 875 N. Michigan Ave. (60611). (312) 787-3900. Century Bcstg Corp. (group owner; acq 5-24-66). Rep: Century National. Format: Adult album. ■ Howard Grafman, pres; George Collias, VP; Darrell Peters, VP, gen mgr; Harvey Wittenberg, VP, coml mgr; Dave Collins, dir of engr. ■ Rates: \$64;68;68;64.

WLS—April 12, 1924: 890 khz; 50 kw-U. 360 N. Michigan Ave. (60601). (312) 782-2002. TWX 910-221-5335. WLS Inc. (acq 3-16-60). Group owner: ABC. Net: ABC/C. Rep: Blair. Format: Contemp. Spec progs: Sp ½ hr wkly; black 1 hr bi-monthly. ■ Martin Greenberg, gen mgr; John Gehron, prog dir; Michael Donovan, prom mgr; Jim Smith, mus dir; Bud Miller, news dir; Don Amel, chief engr; Nick Trigony, gen sls mgr. ■ Rates: \$195;120;195;120.

WDAI(FM)—Co-owned with WLS. April 1, 1946: 94.7 mhz; 6 kw. Ant 1,170 ft. Stereo. Progs sep from AM. (312) 782-6811. AM Bcstg Co. Net: ABC/FM. Rep: ABC FM Spot Sales. Format: Contemp. ■ Elton Rule, pres; Roger Turnbaugh, gen mgr; Bill Todd, prog dir; Alan Jones, prom mgr; Mary Klug, mus dir; Jeff Finch, news dir; Stan Read, gen sls mgr. ■ Rates: \$70;70;110;110.

WMAQ—April 1922: 670 khz; 50 kw-U. Merchandise Mart Plaza (60654). (312) 644-8300. TWX 312-222-9441. NBC inc. (group owner; acq 11-1-31). Net: NBC. Rep: Eastman. Format: Contemp. ■ Jack G. Thayer, pres; Charles H. Warner, gen mgr; Marshall Seese, coml mgr; Lawton Wilkerson, prog dir; Stephen Krasula, prom mgr; Joe Kaucky, mus dir; Frank Barnako, news dir; Harold Whiteberry, chief engr.

WNIS-FM—Co-owned with WMAQ. 1948: 101.1 mhz; 6 kw. Ant 1,170 ft. Stereo. Progs sep from AM. Format: Rock. ■ WMAQ-TV affil.

WMBI—July 28, 1926: 1110 khz; 5 kw (L-WBT Charlotte, N.C., KFAB Omaha). 820 N. LaSalle (60610). (312) 329-4300. Moody Bible Institute of Chicago. Format: Relig. ed. ■ Dr. George Sweeting, pres; Robert C. Nelf, bcstg dir; Jim Wick, stn mgr; Jerry Rice, prog dir; Walter Carlson, news dir; Robert Cathamer, chief engr.

***WMBI-FM**—July 25, 1960: 90.1 mhz; 100 kw. Ant 440 ft. Dup AM 55%.

WMPP—See Chicago Heights.

WNIB(FM)—July 9, 1955: 97.1 mhz; 3.5 kw. Ant 580

Illinois Radio

See page C-1 for explanation of listings.

ft. (CP 850 w. Ant 1,190 ft.) 12 E. Delaware (60611). (312) 337-5252. Northern Illinois Bcstg Co. Format: Classical. ■ William C. Florian, pres & gen mgr; Sonia Florian, prog dir; Curt Huff, asst mgr.

WSBC—1925: 1240 khz; 1 kw-D, 250 w-N, SH (Shares time with WCRW and WEDC Chicago). 4949 W. Belmont Ave. (60641). (312) 777-1700. WSBC Bcstg Co. (acq 1975). Format: Foreign lang. ■ Daniel R. Lee, VP gen mgr; Roy J. Bellavia, prog dir; H. C. Williams, chief engr.

WXRT(FM)—Co-owned with WSBC. 1950: 93.1 mhz; 50 kw. Ant 500 ft. Prog sep from AM. Format: Foreign language, rock.

WSDM(FM)—March 8, 1965: 97.9 mhz; 6 kw. Ant 1,170 ft. Stereo. 528 N. Michigan Ave. (60611). (612) 329-0030. L & P Bcstg Corp. Format: 75% rock & 25% contemp jazz. ■ Philip Chess, pres; Terry Chess, gen mgr; Barbara Van Dyke, coml mgr; Burt Burdeen, prog & mus dir; Danae Alexander, news dir; Bob Larsen, chief engr.

***WUIC(FM)**—July 29, 1975: 88.1 mhz; 10 w. Ant 150 ft. Box 4348 (60680). (312) 996-2720. Univ of Illinois. Format: Diversified. Spec progs: Black 5 hrs; jazz 10 hrs; Polish 2 hrs; Spanish 5 hrs; Ukran 2 hrs wkly. ■ John D. Wennstrom, gen mgr.

WXFM(FM)—See Elmwood Park.

WVON—1924: 1390 khz; 5 kw-U, DA-2. 24 West Erie St. (60610). (612) 943-8400. TWX 910-221-1403. Globetrotter Communications Inc. (group owner; acq 10-74). Net: ABC/E. Rep: Avco. Format: MOR. ■ George Gillet Jr., pres; James F. Mackin, gen mgr; Harry King, prog dir; Steve Schott, chief engr.

WGCI(FM)—March 19, 1965: 107.5 mhz; 33 kw. Ant 660 ft. Dup AM 40%. Stereo.

***WZRD(FM)**—July 8, 1974: 88.3 mhz; 10 w. Ant 302 ft. 5500 North St. Louis Ave. (60625). (312) 583-4071. Northeastern Illinois Univ. Format: Jazz, C&W, folk. ■ Carolyn Grisko, stn mgr; Richard Martin, prog dir.

WXRT(FM)—See listing following WSBC.

Chicago Heights



WCGO—Aug 29, 1959: 1600 khz; 1 kw-D, DA. 3313 Chicago Rd. (60411). (312) Skyline 6-6100. South Cook Bcstg Inc. Format: MOR. ■ Anthony V. Santucci, pres & gen mgr; William G. Biendorf, coml mgr; Robert Anderson, news dir. ■ Rates: \$11; 11; 11.

WMPP—Aug 15, 1963: 1470 khz; 1 kw-D, DA. 1000 Lincoln Highway, East Chicago Heights (60611). (312) 758-1400. Seaway Bcstg Inc.

WTAS(FM)—See Crete.

Cicero

WSDM(FM)—See Chicago.

Clinton

WHOW—Aug 1, 1947: 1520 khz; 5 kw-D, 1 kw-CH-D. Box 160 (61727). (217) 935-2161. Cornbelt Bcstg Co. (acq 9-50). Format: C&W. ■ J. R. Livesay, pres; R. O. Veach, gen, prog & coml mgr; Dave Hines, prog dir; John Barton, mus dir; Bill Ward, news dir; Lonnie Newnum, chief engr. ■ Rates: \$6.50; 6.50; 6.50; —.

WHOW-FM—Not on air; target date 1975: 95.9 mhz; 3 kw. Ant 300 ft. Stereo. Format: Btfl mus, C&W. ■ Rates: \$4.75; 4.75; 4.75; 4.75.

Columbia

WCBW(FM)—Feb. 15, 1964: 104.9 mhz; 2.73 kw. Ant 230 ft. Box 147 (62236). (618) 281-5031. Joseph L. Lepp Inc. Format: MOR. Spec progs: Ger 9 hrs, Pol 2 hrs, C&W 16 hrs, wkly. ■ Joseph L. Lepp, pres & gen mgr; Dorothy Lepp, coml mgr; Rick Lepp, prog dir &

prom mgr; Bob Thoma, news dir; Dick Ross, chief engr.

Crete

WTAS(FM)—Co-owned with WCGO, Chicago Heights. Sept 5, 1965: 102.3 mhz; 3 kw. Ant 300 ft. horiz, 295 ft. vert. Stereo. Box 607, Beecher, Ill. (60401). (312) 946-2226. South Cook Bcstg. Dups AM 25%. Format: MOR.

Crystal Lake

WIVS—Oct 1, 1965: 850 khz; 500 w-D, DA. 145 Virginia St. (60014). (815) 459-7000. Lake Valley Bcstrs Inc. (acq 10-30-69). Format: MOR, talk. ■ Malcolm K. Bellairs, pres; Jo Bellairs, gen mgr; Star Koerner, coml mgr; Iris Bryan, news dir; Mal Bellairs, mus dir; Bat Bellairs, prog dir; Bernard Carlson, chief engr.

WXRD(FM)—Co-owned with WIVS. See Woodstock.

Danville

WDAN—October 1938: 1490 khz; 1 kw-D, 250 w-N. 1500 N. Washington (61832). (217) 442-1700. First Danville Radio (acq 11-12-71). Net: CBS, Purity Sunbeam. Rep: Walton. Format: MOR. ■ J. Max Shaffer, pres & gen mgr; John Eckert, coml mgr; Bill Pickett, news dir; Don Russell, chief engr. ■ Rates: \$7;7;7.

WMBJ(FM)—Co-owned with WDAN. May, 1967: 102.1 mhz; 11 kw horiz, 9.4 kw vert. Ant 380 ft horiz, 370 ft vert. Format: MOR, contemporary. ■ Rates: \$3.75;3.75;3.75;3.75.

WIAI(FM)—March 2, 1970: 99.1 mhz; 50 kw. Ant 500 ft. 4 North Vermillion St. (61832). (217) 446-0180. Kickapoo Bcstg Co. Rep: Rgnl Reps. Format: C&W. Spec prog: Farm report 8 hrs wkly. Stereo. ■ Paul K. Bresee, pres; Russell D. Bredholt, gen mgr; Sharon Riggie, coml mgr; Ken Ball, prom mgr; Carl Suter, mus dir; Les P. Simpson, chief engr.

WITY—Nov 24, 1953: 980 khz; 1 kw-U, DA-2. Box 142 (61832). (217) 446-1313. Vermilion Bcstg Corp. Net: MBS. Rep: Masla, Bruce Schneider-St. Louis. Format: Contemp MOR-day, hard rock-night. Spec prog: Farm 6 hrs wkly. ■ John R. Ax, pres; Louis O. Mitzlaff II, gen mgr; Tom DiFilippo, sls mgr; Adrian Collier, prog dir; Nancy Potter, mus dir; David Coughlin, news dir; Ralph Cox, chief engr. ■ Rates: \$7;7;7.5.

WMBJ(FM)—See listing following WDAN.

Decatur

WDZ—March 17, 1921: 1050 khz; 1 kw-D. 265 S. Park St. (62523). (217) 423-9744. PrairieLand Bcstrs (acq-1-1-64). Group owner: PrairieLand Stations. Net: ABC/C. ■ Stephan P. Bellinger, pres and gen mgr; Reynold Fischmann, coml mgr; Fred Moore, prog dir & chief engr; Jeff Balding, news dir. ■ Rates: \$17;14;17;14.

***WJMU(FM)**—Sept 10, 1975: 89.9 mhz; 10 w. Ant 93 ft. 1184 W. Main St. (62522). (217) 428-8667. Millikin University. Net: ABC/E. Format: Progs rock, Top 40. Spec progs: Black 2 hrs; classical 2 hrs; jazz 2 hrs; C&W 2 hrs, wkly. ■ J. Roger Miller, pres; Stacy C. Myers, gen mgr.

WSOY—1925: 1340 khz; 1 kw-D, 250 w-N. 1100 E. Pershing Rd., Box 2250 (62526). (217) 877-5371. Illinois Bcstg Co. (group owner: acq 7-37). Net: CBS. Rep: McGavren-Guild-PGW. Format: MOR, Contemporary. Spec prog: Farm 14 hrs wkly. ■ Merrill Lindsay, pres; C. R. Griggs, exec VP & gen mgr; Orv Graham, coml mgr; Larry King, prog dir; Bill Homoky, news & pub affrs; Allan Doyle, tech dir. ■ Rates: \$19;16;16;13.

WSOY-FM—November 1946: 102.9 mhz; 54 kw. Ant 450 ft. Prog sep from AM. Net: ABC/FM. Format: Contemp, MOR. ■ Dave Naber, prog dir. ■ Rates: \$9.40;7.65;7.65;7.65.

Deerfield

WVVX-AM-FM—See Highland Park.

De Kalb

WLBK—Dec 7, 1947: 1360 khz; 1 kw-D. 711 N. First St. (60115). (815) 758-8686. DeKalb Radio Studios (acq 8-30-65). Audio news: Upl. Format: MOR. Spec prog: Farm 12 hrs wkly. ■ Jerome F. Cerny, pres; Joe

Barrie, coml mgr; Bill Cerny, stn mgr; Russell Pigott, news dir; Lois Still, women's edit; Bob Brown, farm dir. ■ Rates: \$8;7.50;7.50;—.

WLBK-FM—Dec 17, 1961: 92.5 mhz; 9.5 kw. Ant 155 ft. Stereo. Dups AM 15%. Format: Progs. ■ Jim Bulger, mus dir. ■ Rates: \$5;5;5;5.25.

***WNIU-FM**—April 1954: 89.5 mhz; 50 kw. Ant 250 ft. Stereo. Northern Illinois U. (60115). (815) 753-0213. Northern Illinois Univ. Net: NPR. Format: Variety. Spec progs: Farm 2½ hrs; jazz 6 hrs, wkly. ■ Robert W. Brown, gen mgr; Laura McClean, prog dir; Steve Ovitsky, mus dir.

Des Plaines

WYEN(FM)—1971: 106.7 mhz; 50 kw. Ant 300 ft. 2400 E. Devon Ave. (60018). (312) 297-8430. Wall-West Enterprises Inc. Format: Variety, contemp. MOR. ■ Ed Walters, pres & gen mgr; Jerry Westerfield, VP; Ray Smithers, prog dir; Ron Leppig, sls mgr; David Alpert, news dir; Mike Roche, chief engr; Bob Reynolds, mus dir.

Dixon

WIXN—July 1961: 1460 khz; 1 kw-D, DA. 1460 College Ave. (61021). (815) 288-3341. Farm Belt Radio Inc. (acq 2-1-66). Group owner: Russ Salter Stns. Net: MBS. Rep: Walton. Spec progs: C&W 10 hrs, farm 11 hrs, wkly. ■ Harry Campbell, pres, gen mgr; John Edmunds, prog dir & chief engr; Bud Lynott, sls mgr; Maynard Kidd, news dir.

WIXN-FM—Sept 1, 1965: 101.7 mhz; 3 kw. Ant 175 ft. Dup AM 70%.

WSDR—See Sterling.

Downers Grove

***WDGC-FM**—Feb 28, 1969: 88.3 mhz; 250 w. Ant 130 ft. 4436 Main St. (60615). (312) 968-5566. High School District #99, Dupage County. Format: Community public bcst. ■ Frederic L. Moore, gen mgr; Robert Foskett, prog dir.

Dundee

WVVF(FM)—June 8, 1967: 103.9 mhz; 3 kw. Ant 300 ft. Box 235 (60118). (312) 428-4421. WVVF Radio Inc. (acq 4-1-70). Format: Prog, rock. ■ Richard P. Willrett, pres & gen mgr; Robert Zirk, chief engr. ■ Rates: \$6.50;6.50;6.50;6.50.

DuQuoin

WDQN—1951: 1580 khz; 250 w-D. Box 190 (62832). (618) 542-3894. Marianne Showalter (acq 4-21-71). Net: ABC/E. Rep: Devney. Format: MOR, variety. ■ Gen Showalter, gen mgr; Jake Goble, coml mgr; Kent Wilbanks, mus dir; Randy Smith, news dir; Jim Schobert, chief engr.

WDQN-FM—Sept 1, 1969: 95.9 mhz; 3 kw. Ant 185 ft. Dups AM 90%.

East Moline

***WDLM**—April 3, 1960: 960 khz; 1 kw-D, DA. Box 87 (61244). (309) 234-5111. Moody Bible Institute of Chicago. Format: Religious. ■ Dr. George Sweeting, pres, MBI; Robert C. Neff, dir of bcstg, MBI; Lane D. Morgan, gen mgr; David L. Bergevin, asst mgr; James Wegner, news dir; Glenn Rogerson, chief engr.

WEMO(FM)—Not on air; target date unknown: 101.3 mhz; 50 kw. Ant 500 ft. Upper Rock Island County Holding Co.

East St. Louis

WESL—July 10, 1972: 1490 khz; 1 kw-D, 250 w-N. 149 S. 8th St. (62201). (618) 874-1490. East St. Louis Bcstg Co. Rep: Savalli-Gates. Format: Black, rock. ■ Dr. Wendell Hansen, pres & gen mgr; Jim Gates, prog dir; Frank Davis, coml mgr; Carole Carper, news dir; Robert O. Wolf, chief engr.

WMRY(FM)—June 6, 1965: 101.1 mhz; 50 kw. Ant 320 ft. 9500 Highway 460 West, Belleville, Ill. (62223). (618) 397-6700. Our Lady of the Snows Bcstg Corp. (acq 1-1-65). Audio news: UPI. Format: MOR, jazz. ■ Fr. William Westman, pres; Michael Bader, coml mgr; Ben Orf, chief engr; Greg Morgan, news dir. ■ Rates: \$7.50;7.50;6;6.

Edwardsville

***WSIE(FM)**—Sept 4, 1970: 88.7 mhz; 50 kw. Ant 500 ft. Stereo. Box 73, Southern Ill. U. (62026). (618) 692-2228. Board of Trustees, Southern Illinois U. Net: NPR. Format: Variety, cultural, informational, classical music. ■ Dr. John Regnell, mass communications chmn; Fred O. Criminger Jr., gen mgr & prog dir; Hugh Nenninger, chief engr.

Effingham

WCRA—June 8, 1947: 1090 khz; 1 kw-D. 201 N. Banker St. (62401). (207) 342-4141. Effingham Bcstg Co. Group owner: McNaughton Stns. Rep: Masla. ■ Jos E. McNaughton, pres; E. W. Howard, gen mgr; Stan Richardson, coml mgr; Larry Wilson, prog dir; Zona B. Davis, news dir. ■ Rates: \$5.50;5.50;5.50;—.

WCRA-FM—June 14, 1963: 95.7 mhz; 50 kw. Ant 480 ft. Prog sep from AM. ■ Rates: \$3.50; 3.50; 3.50; 3.50.

Eldorado

WKSJ(FM)—May 3, 1975: 102.3 mhz; 3 kw. Ant 300 ft. Stereo. Box 10 (62930). (618) 273-3331. Eldorado Bcstg Corp. Net: ABC/E. Format: MOR. Spec progs: Farm 1 hr, jazz 3 hrs, wkly. ■ Robert Unsell, pres, gen mgr & news dir; Ken Hamilton, coml mgr; Jerry Plasters, prog dir; Kay Insell, prom mgr; Herb Eckstein, chief engr. ■ Rates: \$4.12;4.12;4.12;4.12.

Elgin

***WEPS(FM)**—1950: 90.9 mhz; 364 w. Ant 24 ft. 4 S. Gifford (60120). (312) 741-6800 ext 238. Board of Education, Union School District 46. Net: NPR. Format: Educl. Spec prog: classical 5 hrs wkly. ■ Bill Marston, asst student prog dir; Bryan Hollowell, student & prom mgr; Charles Campbell & Steve Coleman, mus dirs; Dale Chandler, news dir.

WJKL(FM)—See listing following WRMN.

WRMN—1949: 1410 khz; 1 kw-D. Box 117 (60120). (312) 741-7700. Elgin Bcstg Co. (acq 1952). Group owner: McNaughton Stns. Rep: Masla. Format: MOR. Spec prog: Sp 7 hrs wkly. ■ Richard Jakle, pres and gen mgr; Joe David, prog dir; William Prenevost, sls mgr; Ken Kosek, news dir; Harold Catron, chief engr. ■ Rates: \$9.25;9.25;9.25;9.25.

WJKL(FM)—Co-owned with WRMN. September 1960: 94.3 mhz; 3 kw. Ant 210 ft. Prog sep from AM. Stereo. Format: Progs. Spec prog: Ger 2 hrs wkly. ■ Joseph Everhard, coml mgr; Armand Chianti, prog dir; Jeff Wright, mus dir; Steve Johnson, prom mgr. ■ Rates: \$12.80;12.80;16;16.

Elmhurst

WKDC—1974: 1530 khz; 250 w-D, DA. 130 N. York St. (60126). (312) 530-1530. DuPage County Broadcasting Inc. Net: ABC/E. Format: MOR. ■ Frank Blotter, pres; Bob Larson, coml mgr; F. Blotter, mus dir; Rick Larson, news dir.

***WRSE-FM**—Dec 7, 1962: 88.7 mhz; 10 w. 190 Prospect Ave. (60126). (312) 834-8807. Bd of Trustees, Elmhurst College. Format: Contemp, variety. ■ Donald R. Low, faculty advisor; David Hajek, gen mgr.

Elmwood Park

WXFM(FM)—1947: 105.9 mhz; 3 kw. Ant 1540 ft. 333 N. Michigan, Chicago (60601). (312) 943-7474. Stereo. WXFM Inc. (acq 10-65). Format: Classical, MOR, variety. ■ Robert C. Victor, pres; Anne M. Marer, gen mgr; James P. Walsh, opns mgr.

Elsah

***WTPC(FM)**—Dec 1, 1970: 89.7 mhz; 10 w. Ant 50 ft. Principia College (62028). (618) 466-2131, ext 295. The Principia Corp. Net: ABC/C. Format: Contemp, rock, Top 40. Spec progs: Fr 3 hrs, ed 14 hrs, wkly. ■ Robert C. Hummel III, gen mgr and chief engr.

Evanston

WEAW—1953: 1330 khz; 5 kw-D, DA. 2008 State Bank Plaza (60204). (312) 869-8904. Broadcast Communications Inc. Net: ABC/E. Rep: Wallace. Format: MOR, talk, relg, variety. ■ Edward A. Wheeler, pres; Dick Williamson, gen mgr; Paul Molloy coml mgr; Elyse Mundell, prog dir; George Beres, news dir;

Steve Gordoni, chief engr; Athena Sofios, opns mgr; ■ Rates: \$12;12;12;—.

WOJO(FM)—Co-owned with WEAW. 1946: 105.1 mhz; 6 kw. Ant 1,170 ft. Prog sep from AM. Net: ABC/E. Rep: Masla. Format: Spanish. ■ Bob Wilson, stn mgr; Lee Guss, coml mgr; Elena Savoy, prog dir. ■ Rates: \$12;12;12;12.

WLTD—1947: 1590 khz; 1 kw-D. 2100 Lee St. (60202). (312) 475-1590. Cummings Communications Corp. (group owner; acq 1-1-70). Format: Btfl mus. ■ Alan H. Cummings, pres; Ernest Anastos, gen mgr; Gene Cummings, chief engr. ■ Rates: \$12; 12; 12; —.

***WNUR(FM)**—May 8, 1950: 89.3 mhz; 1.04 kw. Ant 45 ft. (CP 7.2 kw. Ant 120 ft) Stereo. 1903 Sheridan Rd. (60201). (312) 492-7101. Northwestern U. Net: ABC/FM. Format: Progs, educl, variety. Spec progs: Black 4 hrs, live performances 8 hrs, women 3 hrs, wkly. ■ John Gartley, fac adv; Melanie K. Frey, gen mgr.

WOJO(FM)—See listing following WEAW.

Fairfield

WFIW—Aug 21, 1953: 1390 khz; 1 kw-D. Box 310 (62837). (618) 842-2159. Wayne County Bcstg Co. Format: Diversified. Spec prog: Farm 12 hrs wkly. ■ Thomas S. Land, pres & gen mgr; Bill Arthur, coml mgr; Dave Rigg, prog dir; Dave Land, mus dir and prom mgr; Darrell Linne, news dir; Gilbert T. Wallace, chief engr. ■ Rates: \$5.40;5.40;5.40;5.40.

WFIW-FM—1965: 104.9 mhz; 3 kw. Ant 195 ft. Dup AM 75%. ■ Rates same as AM.

Flora

WNOI(FM)—May 21, 1971: 103.9 mhz; 3 kw. Ant 300 ft. Box 368 (62839). (618) 662-8331. Vogel-Flora Corp. (acq 9-1-74). Group owner: Vogel Communications. Net: MBS. Format: C&W. ■ William R. Vogel, pres; Roy Tatman, gen mgr and coml mgr; Kathy Kitley, prom mgr; Steve McCarthy, prog, mus and news dir; Walter Haner, chief engr. ■ Rates: \$3;3;3;3.

Flossmoor

***WHF(FM)**—September 1965: 88.5 mhz; 10 w. 999 Kedzie (60422). (312) 798-9434. Community High School District No. 233. Format: Ed, Top 40. ■ Jerold A. Garber, gen mgr; Patricia Erickson, stn mgr.

Freeport

WACI(FM)—Nov 1, 1970: 92.1 mhz; 3 kw. Ant 300 ft. Stereo. Box 701 (61032). (815) 235-7192. WACI Inc. (acq 9-72). Rep: Smith. Format: Top 40. Spec progs: Farm 5 hrs, pub aff 7½ hrs, wkly. ■ P.J. Broderick, pres; Pat Hucke, gen and coml mgr; Jay Allen Reese, prog and mus dir; Chris O'Brian, news dir; John Shepler, chief engr. ■ Rates: \$6;6;6;6.

WFRL

Modern Country Music
Walton Broadcasting Sales

WFRL—Oct 28, 1947: 1570 khz; 5 kw-D, DA. Box 200 (61032). (815) 235-4113. Triad Stns Inc. (acq 10-1-59). Rep: Walton. Format: C&W, talk. Spec progs: Farm 15 hrs, Black 1 hr, wkly. ■ C. Wayne Wright, pres; R. A. "Dick" Greene, gen and coml mgr; Donald Martin, mus dir; Tom Taylor chief engr; John Uthlaut, news dir. ■ Rates: \$9.70;9.70;9.70;5.

WFRL-FM—April 11, 1965: 98.5 mhz; 19.6 kw. Ant 150 ft. Dup AM 75%. ■ Rates same as AM.

Galesburg

WAAG(FM)—See listing following WGIL.

WAIK—1957: 1590 khz; 5 kw-D, DA. 36 Park Plaza (61401). (309) 342-3161. Webster Bcstg Co. (acq 7-1-59). Net: ABC/E. Rep: Masla. Format: MOR. ■ F. C. Webster Jr., pres & gen mgr; Roger Dean, coml mgr; Val Scott, news dir; Ray Bevenour, chief engr.

WGIL—June 12, 1938: 1400 khz; 1 kw-D, 250 w-N. Box 1227 (61401). (309) 342-5131. Galesburg Bcstg Co. Net: MBS, Ill. Farm Radio. Format: MOR. Spec progs: Black 4 hrs; farm 18 hrs, wkly. ■ Roger Coleman, pres and gen mgr; Robert Simmons, coml mgr;

Illinois Radio

See page C-1 for explanation of listings.

Jim Abens, prog dir; Peggy Lundeen, prom mgr; Mike Briggs, news dir; James Thompson, chief engr; Eddie Gale, farm dir.

WAAG(FM)—Co-owned with WGIL. Dec 15, 1966: 94.9 mhz; 50 kw. Ant 350 ft. Stereo. (309) 342-9194. Prog sep from AM. Net: ABC/FM. Format: C&W. Spec prog: Sp 3 hrs wkly. ■ Jim Wyman, gen mgr; Scott Baecker, coml mgr; John Bierman, prog dir; Gerry Hinrichs, prom mgr; Peter Bailey, mus dir; Julie Kirkpatrick, news dir.

***WVKC(FM)**—April 10, 1962: 90.5 mhz; 10 w. Box 154, Knox College (61401). (309) 343-9940. Knox College. Net: ABC/C. Format: Prog rock, jazz. Spec prog: Black 5 hrs wkly. ■ Paul A. Heine, gen mgr; Scott Soloway, prog dir.

Geneseo

WGEN—Nov 7, 1963: 1500 khz; 250 w-D. Box 67, 1003 S. Oakwood (61254). (309) 944-4633. Geneseo Bcstg Co. (acq 2-7-70). Rep: Walton. Format: C&W, talk. ■ Joseph E. Lobaito, pres & gen mgr; Lee Bright, news dir; Jim Canada, mus dir; Maurice Ver Brugge, chief engr.

WRSQ-FM—Co-owned with WGEN. Not on air; target date unknown: 104.9 mhz; 3 kw. Ant 265 ft. Box 67 (61254).

Geneva

WGSB—Nov 11, 1961: 1480 khz; 1 kw-D, 500 w-N, DA-2. 1215 Fern Ave., St. Charles, Ill. (60174). (312) 584-1480. Brickhouse Bcstg Corp. (acq 11-20-70). Net: ABC/E. Format: MOR. Spec progs: Ger 5 hrs, Sp 3 hrs wkly. ■ Nelda Brickhouse, pres; William H. Shaw, gen mgr; Thomas C. Petersen, coml mgr; Jeff Martin, prog & news dir.

Glen Ellyn

***WGHS(FM)**—Dec 8, 1969: 88.5 mhz; 10 w. 670 Crescent Blvd. (60137). (312) 858-0827. Glenbard West High School, District #87. Format: Ed, progsv, classical, Top 40, talk. ■ Edward Rhodes, gen mgr.

Godfrey

***WLCA(FM)**—1974: 89.9 mhz; 10 w. Lewis and Clark Community College. ■ Ed Palen, gen mgr.

Granite City

WGNU—Dec 1, 1961: 920 khz; 500 w-D, DA. Box 178, St. Louis (63166). (618) 451-9950. Norman Bcstg Co. Rep: PRO Time Slis. Format: C&W. Spec prog: Ger 2 hrs wkly. ■ Charles H. (Chuck) Norman, pres, gen & coml mgr; Bob Baker, prog dir; Russ Benson, news dir; Harold McCarty, chief engr. ■ Rates: \$12;12;12;12.

WGNU-FM—Nov 24, 1965: 106.5 mhz; 50 kw. Ant 500 ft. Format: C&W, religious. ■ Rates same as AM.

Greenville

***WGRN(FM)**—Sept 26, 1966: 89.3 mhz; 10 w. 315 E. College (62246). (618) 644-1840, ext 211. Greenville College Educational Bcstg Foundation Inc. Format: Ed, MOR. ■ Orley R. Herron, pres; Ivan E. Ratcliffe, fac dir; Craig Tidball, stu mgr.

Harrisburg

WEBQ—Sept 1, 1923: 1240 khz; 1 kw-D, 250 w-N. 100 E. Poplar St., Box 390 (62946). (618) 253-7032. First Trust Assn. Rep: Walton. Format: MOR, contemp, variety. ■ Ken E. Hamilton, gen & coml mgr; James R. Mick, prog dir; Gary K. Hamilton, mus dir; Bill Baker, news dir; Harvey H. Slaton, chief engr.

WEBQ-FM—Sept 1, 1947: 99.9 mhz; 50 kw. Ant 310 ft. Dup AM 25%.

Harvard

MWCW—1955: 1600 khz; 500 w-D. 205 E. Brainard St. (60033). Esther Blodgett.

Harvey

WBEE—1955: 1570 khz; 1 kw-D, DA. 75 E. Wacker

Illinois Radio

See page C-1 for explanation of listings.

Dr., Chicago (60601). (312) 726-6842. Rollins Inc. (group owner). Format: Black adult jazz. ■ O. Wyane Rollins, pres; Charles R. Sherrill II, gen mgr; Paul Downs, VP, radio dir; Robert Foskett, ops dir; Bill Moon prog & mus dir; Jerome Burdeau, chief engr; Don Reece, news dir. ■ Rates: \$45;35;45;—.

Havana

WDUK(FM)—Feb 27, 1970: 99.3 mhz; 3 kw. Ant 300 ft. 200 N. Plum (62644). (309) 543-3331. Illinois Valley Radio (acq 3-5-73). Net: Illinois Farm. Format: MOR, C&W 25%. ■ Win Stimpson, pres, gen mgr & prog, mus & news dir; Marion Stimpson, traf dir. ■ Rates: \$2.75;2.75;2.75;2.75.

Herrin

WJPF—Aug 28, 1940: 1340 khz; 1 kw-D, 250 w-N. Box 550 (62948). (618) 942-2181. Greentree Bcstg. (group owner; acq 1-1-71). Net: MBS. Rep: Walton, Schneider. Format: MOR, contemp. ■ Charlie Powers, pres; Ron Hines, gen mgr.

Highland

WINU—Oct 1, 1963: 1510 khz; 1 kw-D, DA. Box 303 (62249). (618) 654-4161. Progressive Bcstg Corp. Audio news: UPI. Rep: Walton, Ill. Radio Network. Format: MOR. Spec prog: Farm 2 hrs wky. ■ Glenn F. Bircher, pres & gen mgr; M. Bircher, prog dir; J. Bircher, mus dir; W. Reker, news dir; Jon J. Bircher, chief engr; M. Becker, coml and prom mgr. ■ Rates: \$8.50;7;8.50;7.

Highland Park

WVXV—Aug 15, 1963: 1430 khz; 1 kw-D, DA. 443 Central Ave. (60035). (312) 432-1430. Vanguard Communications Inc. (acq 5-1-73). Net: ABC/IL. Rep: Walton. Format: Progressive.

WVXV-FM—Aug 15, 1963: 103.1 mhz; 3 kw. Ant 150 ft. Dup AM.

Hinsdale

***WHSD(FM)**—Dec 6, 1970: 88.5 mhz; 10 w. Ant 50 ft. 55th & Grant Sts. (60558). (312) 887-1345. Hinsdale Central High School, Dist #86. Format: Variety, contemp. ■ Silvia Hennessey, gen mgr; Harry Priestner, chief engr.

Jacksonville

WEAI(FM)—Listing follows WLDS.

WJIL—Dec 1, 1961: 1550 khz; 1 kw-D, DA. E. Morton Rd. (62650). (217) 245-5119. Morgan County Bcstg Inc. (acq 8-1-67). Net: ABC/IL. Rep: Walton Schneider. Format: C&W. ■ B. D. Hunter, pres; Ronald E. Gray, VP & gen mgr.

WLDS—Dec 9, 1941: 1180 khz; 1 kw-D. Box 477 (62651). (217) 245-7171. Jacksonville Radio & TV Bcstg Corp. (acq 12-51). Audio news: APR. Format: Btfl mus. ■ Robert A. Fay, pres; Gerald Cassens, gen mgr; Raymond Wells, prog dir; Jerry Symons, news dir; Robert Gerner, chief engr.

WEAI(FM)—Co-owned with WLDS. March 1948: 100.5 mhz; 10 kw. Ant 330 ft. Stereo. (217) 243-2323. (Acq 12-51). Prog sep from AM. Format: Young adult. ■ John J. Clark, ops dir.

Jerseyville

WJBM—Oct 11, 1959: 1480 khz; 500 w-D, DA. Box 310 (62052). (618) 498-2185. Tri-County Bcstg Co. Net: Keystone. Format: MOR. Spec progs: C&W 14 hrs; farm 12 hrs, wky. ■ Robert P. Skibbe, pres & gen mgr; Dr. F. Corecki, VP; James E. Midkiff, farm dir & chief engr; Paul E. Long, sls mgr; Janet Gorecki, treas; Ken Love, spts dir; John Gay, news dir; George Depper, prom mgr; Sherry Friend, sec; F. Alan Shook, mus dir; Jerry Jones, sls asst.

WJBM-FM—Oct 16, 1967: 104.1 mhz; 50 kw. Ant 380 ft. Dup AM 75%. Stereo.

Joliet

WAJP(FM)—April 17, 1960: 93.5 mhz; 3 kw. Ant 260 ft. 451 Ruby St. (60435). (815) SA 6-3760. WAJP Inc.

(acq 1975). Format: Btfl mus. Spec prog: Polkas 10½ hrs wky. ■ Mary Jane Pohlars, pres; Robert Baudek; gen mgr; D. F. Weber, prog dir; Perry Aharrah, chief engr.

WJOL—1929: 1340 khz; 1 kw-D, 250 w-N. Box 430 (60434). (815) 726-4761. Harris Enterprises (group owner). Net: ABC/IL. Rep: Bcstg Time. Format: MOR. Spec prog: Black 6 hrs wky. ■ Peter MacDonald, pres; William W. Hansen, gen mgr; Wally Nelson, prog dir; Don Neer, coml mgr; Larry Ryan, sports dir; Bob Herrick, news dir; Bruce Jensen, chief engr. ■ Rates: \$18;15;18;13.

WLLI-FM—Co-owned with WJOL. Feb 6, 1960: 96.7 mhz; 3 kw. Ant 300 ft. Prog sep from AM. Stereo. Format: C&W. ■ Rates: \$8;8;8;8.

WJRC Progressive

WJRC—April 10, 1964: 1510 khz; 500 w-D. Box 914, 57 W. Jefferson St. (60431). (815) 727-5176. WJRC Inc. (acq 9-1-75). Group owner: Progressive group. Net: MBS. Rep: Walton Farm Network. Format: MOR. Spec progs: Black 10 hrs; Greek 1 hr; farm 6 hrs; Sp 2 hrs wky. ■ William Lipsey, pres; J. Robert Wheeler, VP & gen mgr; H. James Wermer, coml mgr; Dale P. Zahn, prog dir; Julie S. Long, prom mgr; Pat Christopher, mus dir; Robert Herrick, news dir; Walter Lorenc, chief engr. ■ Rates: \$7.50;7.50;7.50;6.

WLLI-FM—Listing follows WJOL.

Kankakee

WBYG(FM)—Jan 5, 1962: 99.9 mhz; 6.6 kw. Ant 210 ft. Stereo. Box 183 (60901). (815) 939-4541. WKAK Inc. (acq 1-31-75). Net: ABC/FM. Format: Adult contemp. ■ Harry C. Fitzgerald, pres; Howard S. Dybedock, gen mgr & chief engr; Sandra Mackey, coml mgr; Frank Abshner, prog dir; Jonathan Lehrer, news dir; Greg Shelby, mus dir. ■ Rates: \$9;9;9;9.

WKAN—June 1, 1947: 1320 khz; 1 kw-D, 500 w-N, DA-N. 6 Dearborn Sq. (60901). (815) 933-6633. Mid-America Audio-Video Inc. Group owner: Mid-America Media. Audio news: UPI. Format: MOR. ■ Burrell L. Small, pres; Leslie H. Small, VP; Robert J. Hawkins, sec & exec asst to pres; Donald R. Hoover, stn mgr; Larry Anderson, prog dir; Edgar Munday, news dir; Joseph Cunat, chief engr. ■ Rates: \$14.35; 11.20; 14.35; 11.20.

***WKOC(FM)**—1968: 88.3 mhz; 10 w. Olivet Nazarene College (60901). (815) 939-5330. Olivet Nazarene College. Format: Variety. ■ Harold W. Reed, pres; Ray Moore, gen mgr.

Kewanee

WJRE(FM)—Listing follows WKEL.

WKEL—Sept 11, 1952: 1450 khz; 500 w-D, 250 w-N. Hotel Kewanee (61443). (309) 853-4471. Kewanee Bcstg Co. (acq 6-1-61). Group owner: McNaughton Stns. Net: ABC/IL. Format: MOR. ■ George Walker, mgng own, gen mgr; Louise Prusator, coml mgr; Larry Flannery, prog dir; Dave Clarke, news dir; Milton Nicholas Jr., chief engr. ■ Rates: \$5.95; 5.95; 5.95; 5.95.

WJRE(FM)—Co-owned with WKEL. May 20, 1966: 92.1 mhz; 3 kw. Ant 300 ft. Stereo. Net: ABC/C. Prog sep from AM. Format: Contemp. ■ Rates: \$5.50;5.50;5.50;5.50.

La Grange

***WLTL(FM)**—Jan 5, 1968: 88.1 mhz; 10 w. Ant 70 ft. 100 S. Brainard (60525). (312) 482-7530. Lyons Township High School. Net: Suburban High School Radio. Format: Progressive. Spec prog: Classical. ■ Karin Hells, stn mgr; James White, consulting engr.

WTAQ—Oct 1950: 1300 khz; 5 kw-D, 500 w-N, DA-2. 9355 W. Joliet Rd. (60525). (312) 352-1300. S&S Bcstg Co. Net: ABC/E. Spec progs: Italian 7½ hrs; Pol 5 hrs; Sp 20 hrs; Black 15 hrs, wky. ■ Charles F. Sebastian, pres; Arthur L. Schlam, VP-adm; William Wardle, dir of stn ops; Forrest Allan Mann, news dir; Andrew M. Weiss, chief engr.

Lake Forest

***WMXM(FM)**—Sept 10, 1973: 88.9 mhz; 10 w. Ant 86 ft. Lake Forest College (60045). (312) 234-5480.

Lake Forest College. Format: Progs. ■ Fred Cary Garfield, gen mgr.

Lansing

WLNR(FM)—Aug 28, 1961: 106.3 mhz; 3 kw. Ant 240 ft. 2915 Bernice Rd. (60438). (312) 474-3455. Illiana FM Bcstrs Inc. (acq 10-16-70). Format: Variety. Spec progs: Talk, old time radio. ■ John Vander, pres; Wendell H. Borriuk, gen & coml mgr; Warren Freiberg, prog dir; Donald T. Burgeson, prom mgr; Charmaine J. Simmons, mus dir; Morris Wayne, news dir; Art Karmgard, chief engr.

La Salle

WLPO—Nov 16, 1947: 1220 khz; 1 kw-D, DA. Box 215 (61301). (815) 223-3100. La Salle County Bcstg Corp. (acq 8-1-49). Format: MOR. Spec progs: Farm 3 hrs; talk 12 hrs, both wky. ■ Peter Miller, pres; Robert F. Vickrey, sls mgr; Joseph D. Hogan, prog & news dir; Stephen C. Vogler, chief engr. ■ Rates: \$105;117;105;105.

WLPO-FM—Dec 4, 1964: 99.3 mhz; 3 kw horiz, 2.95 vert. Ant 300 ft horiz 295 vert ft. Stereo. Prog separate from AM. Format: MOR. ■ Rates: \$64.80; 64.80; 64.80; 64.80.

Lawrenceville

WAKO—June 9, 1959: 910 khz; 500 w-D, DA. Box 210 (62439). (618) 943-3354. Stuart K. Lankford (acq 5-31-73). Net: MBS. Rep: Devney Organization. Format: MOR, C&W. ■ Stuart K. Lankford, gen mgr; JoAnn Gaitner, prog dir; Shirley Moore, coml mgr; John Powell, news dir; Ed Ruppel, chief engr.

WAKO-FM—March 1965: 103.1 mhz; 3 kw horiz; 2.40 kw vert. Ant 240 ft. Dups AM 90%.

Lincoln

***WLCC(FM)**—Jan 20, 1969: 88.9 mhz; 4.6 kw. Ant 140 ft. Box 178 (62656). (217) 735-1518. Lincoln Christian College. Net: NPR. Format: Cultural, informational, relig. ■ John Young, gen mgr.

***WLNX(FM)**—Jan 28, 1974: 90.1 mhz; 10 w. Ant 72 ft. 300 Keokuk St. (62656). (217) 735-3495. Lincoln College. Format: Progs, Top 40. ■ Cary B. Gaffney, gen mgr.

WPRC—September 1947: 1370 khz; 1 kw-D. Box 190 (62656). (217) 735-2337. Virginia Bcstg Corp. (acq 8-1-69). Net: UPI, Ill. News Network. Format: MOR, local sports, talk. Spec prog: Farm 6 hrs wky. ■ John L. O'Donnell, gen mgr; Pat Schmid, news dir; David Copeland, chief engr.

WPRC-FM—May 10, 1971: 100.1 mhz; 3 kw. Ant 200 ft. Dups AM 100%.

Litchfield

WSMI—Nov 2, 1950: 1540 khz; 1 kw-D. Box 10 (62056). (217) 324-5921. Talley Bcstg Corp. Group owner: Talley Radio Stations. Net: MBS, Illinois Radio. Rep: PRO/Meeker. Format: Farm, MOR. ■ Hayward L. Talley, pres & gen mgr; Will Godbey, loc sls mgr; Jim Wharton, ops mgr; Kay Smith, traf mgr; Johnny Kralik, sports dir; Larry Wilson, news dir; James Erp, chief engr; Ron Roebuck, farm dir.

WSMI-FM—March 5, 1960: 106.1 mhz; 19.5 kw (CP 39 kw). Ant 175 ft. Stereo. Prog sep from AM. Format: Mod, C&W.

Lockport

***WLRA(FM)**—Nov 1972: 88.1 mhz; 250 w. Ant 95 ft. Box 745, Lewis University (60441). (815) 838-3864. Lewis University. Format: Contemp, ed & rock. ■ Joe Vercellotti, stn mgr; Bob O'Neil, prog dir; Bob Schill, mus dir; Jim Boles, chief engr.

Loves Park

WLUV—Sept 29, 1962: 1520 khz; 500 w-D. Box 2201 (61111). (815) 877-6037. Loves Park Bcstg Co. Rep: Barnard. Format: C&W. ■ Angelo J. Salvi, pres, gen, coml & prom mgr; Tom Holdridge, prog dir; Larry Roberts, news dir; Larry Lang, chief engr.

WLUV-FM—March 25, 1964: 96.7 mhz; 3 kw. Ant 145 ft. Dup AM 15%. Stereo.

Macon

***WIUM(FM)**—May 23, 1956: 91.3 mhz; 5.7 kw. Ant 280 ft. Western Illinois U. (61455). (309) 298-1873. Net: ABC/FM. Format: Prog rock, classical, MOR, jazz. ■ E. C. Haddock, gen mgr; Tim McCartney, prog & news dir; Charles Gill, chief engr.

WKAI—July 4, 1947: 1510 khz; 1 kw-D, 250 w (CH). 119 W. Carroll St. (61455). (309) 633-5561. WKAI Bcstg Co. (acq 7-1-58). Format: 50% Contemp, 50% C&W. ■ William H. Rudolph, pres; Bob Wille, gen mgr & chief engr; Joe Ward, sls mgr; Ray Bayne, dir of ops. ■ Rates: \$6;6;6.

WKAI-FM—June 6, 1966: 100.1 mhz; 3 kw. Ant 190 ft. Progs sep from AM. Stereo. Net: RFD Farm. Format: MOR. ■ Rates same as AM.

Madison

WGNU—See Granite City.

Marion

WDDD(FM)—Nov 22, 1970: 107.3 mhz; 50 kw. Ant 500 ft. Stereo. Rte. 37 North (62959). (618) 997-2341. 3-D Communications Corp. Rep: Gert Bunchez. Format: C&W. ■ Dutch Doelitzsch, pres, gen mgr & chief engr; Roger Swan, prog dir; Steve Land, farm & news dir. ■ Rates: \$5.75;5.75;5.75;5.75.

WGQH—Sept 24, 1949: 1150 khz; 5 kw-D, DA. Box 340 (62959). (618) 993-8102. Marion Bcstg Co. Net: ABC/I. Format: Contemp, MOR, variety. Spec prog: Black 1½ hrs wkly. ■ George W. Dodds, pres; Russell D. Rose, gen mgr; Ina S. Trammell, coml mgr; Richard D. Hunt, news dir; Robert H. Feurer, chief engr.

Mattoon

WLBH—Nov 26, 1946: 1170 khz; 5 kw-D, DA. Box 564 (61938). (217) 234-6464. Mattoon Bcstg Co. Group owner: Livesay. Rep: Walton. Format: MOR, C&W. ■ J. R. Livesay, pres & gen mgr; Ken Wooddell, VP & stn mgr; Ken Jakle, prog dir; Bill Henry, news dir; Sam E. Miller, chief engr. ■ Rates: \$6.50;6.50;6.50;—.

WLBH-FM—August 1949: 96.9 mhz; 50 kw. Ant 500 ft. Prog separate from AM. Stereo. Format: Btfl mus. ■ J.R. Livesay II, stn mgr. ■ Rates: \$5.75;4.75;4.75;4.75.

***WLKL(FM)**—Jan 20, 1975: 90.3 mhz; 10 w. S. Rte 45, Mattoon (61938). (217) 235-3131. Community College District #517. Format: Educl. ■ Kenneth S. Beno, gen mgr.

McLeansboro

WMCL—January 26, 1968: 1060 khz; 250 w-D. Box 282 (62859). (618) 643-2311. Community Service Bcstg Inc. (acq 1-72). Format: Contemp country. ■ Jerome Glassman, pres; Jim Glassman, gen mgr; Alan Beck, sls mgr; Frank Kelley, opns mgr; Robert Wilt, chief engr. ■ Rates: \$7;7;7.

Mendota

WGQC—Sept 1, 1964: 1090 khz; 250 w-D. 706 Washington St. (61342). (815) 539-6751. Agri-Voice Inc. (acq 12-23-70). Net: ABC/E. Format: Farm, btfl mus. Spec prog: Farm 7½ hrs wkly. ■ Michael Ross, pres & gen mgr & farm dir; Lyle E. Cook, chief engr. ■ Rates: \$3.75;3.75;3.75;—.

WGQC-FM—Sept 1, 1965: 100.1 mhz; 3 kw. Ant 98 ft. Dups AM 100%. ■ Rates: \$3.75;3.75;3.75;2.25.

Metropolis

WMOK—Feb 4, 1951: 920 khz; 1 kw-D. Box 720 (62960). (618) 524-2106. Fort Massac Bcstg Co. Net: Keystone. ■ Mrs. Lindell Eikholz, pres; V. E. Smith, exec VP & gen mgr; James Young, coml mgr & prog dir; Odell Korte, news dir; Earl Abernathy, chief engr.

Moline

WHTT(FM)—November 22, 1970: 96.9 mhz; 50 kw. Ant 500 ft. Stereo. Box 3788, Davenport, Iowa (52803). Fred Epstein Organization Ltd. (acq 10-1-75). Net: ABC/FM. Rep: Katz. Format: MOR. ■ Fred Epstein pres; Melvin W. LaForce, gen mgr; Dan Olson, sls mgr; Robert E. Davis, prog mgr; Nathan H. Rosenthal, chief engr; Jerry Reid, news dir.

WQUA

Personality Contemporary MOR

WQUA—1946: 1230 khz; 1 kw-D, 250 w-N. 1801 6th Ave. (61265). (309) 764-6727. Mid-America Bcstg (acq 1960). Group owner: Mid-American Media. Rep: Eastman. Format: MOR. ■ Burrell L. Small, pres; G. Laverne Flambo, exec dir & gen mgr; John R. Dombek, stn mgr; Bob Allen, prog dir; Ken A. Buell, asst mgr; Mark Minnick, news dir; Pete Burke, chief engr. ■ Rates: \$ 21;16.50;16.50;16.50.

KRVR(FM)—Co-owned with WQUA. See listing under Davenport, Iowa.

Monmouth

WRAM

Walton Broadcasting Sales Corp.



WRAM—May 1957: 1330 khz; 1 kw-D, DA. 200½ S. Main St. (61462). (309) 734-2111. Monmouth Bcstg Co. (acq 2-71). Net: ABC/I. Rep: Walton, Keystone. Format: MOR talk. ■ John R. Hallstrom, pres & gen mgr; Louis Lease, asst mgr; Mark Hebard, news dir; Neil Zachmeyer, chief engr. ■ Rates: \$5.30; 5.30; 5.30; —.

WVPC-FM—Dec 6, 1967: 97.7 mhz; 3 kw. Ant 210 ft. Lamoreaux Bldg. (61462). (309) 734-5146. Richard P. Lamoreaux. Net: MBS. Format: MOR, C&W. ■ Richard P. Lamoreaux, pres, coml & prom mgr; Mary L. Lamoreaux, gen mgr; Carol J. Cooper, prog dir; Gene Thompson, news dir; Lon Helton, chief engr.

Monticello

WVLJ(FM)—Jan 18, 1972: 105.5 mhz; 3 kw. Ant 300 ft. RR #1 (61856). (217) 762-2588. Monticello Bcstg Co. Format: MOR. ■ Virgil J. Hague, pres; Richard L. Jones, gen & prom mgr; J. D. Scott, coml mgr; Richard P. Stout, prog. mus & news dir; Roy Kleven, chief engr.

Morris

WCSJ—Jan 15, 1964: 1550 khz; 250 w-D. Box 270 (60450). (815) 942-0022. Grundy County Bcstrs Inc. (acq 6-30-66). Rep: Walton. Format: MOR. ■ M. H. Stuckwish, pres & gen mgr; John M. Zalanka, news dir; Robert Brandell, prog & mus dir; Milburn Stuckwish, tech dir. ■ Rates: \$5.25;5.25;5.25;—.

WRMI-FM—Co-owned with WCSJ. 104.7 mhz; 3.4 kw. Ant 105 ft. Dups AM 40%. Format: MOR. ■ Rates: \$3.15;3.15;3.15;3.15.

Morrison

***WMHS(FM)**—1966: 91.5 mhz; 10 w. 643 Genesee Ave. (61270). (815) 772-4959. Morrison Community H. S. Format: Contemp, rock, talk, top 40, variety. ■ Steve Hardin, gen mgr.

Mt. Carmel

WSAB(FM)—Listing follows WVMC.

***WVJC-FM**—July 23, 1973: 89.1 mhz; 10 w. Ant 153 ft. 2200 College Drive (62863). (618) 262-7397. Illinois Eastern Community Colleges. Format: Top 40, contemp, rock. ■ Richard T. Ammon, bcst advisor.

WVMC—Dec 1, 1948: 1360 khz; 500 w-D. Box 553 (62863). (618) 262-5111. Jel-Co Radio Inc. (acq 1-1-62). Net: ABC/E. Rep: Walton. Format: Modern MOR. ■ John F. Hurlbut, pres, gen mgr & prom mgr; Kenneth Kessler, VP opns-sales; David Kunkel, prog & mus dir; Bill Yarbor, news dir; Robert Efland, VP-engr. ■ Rates: \$4.50;4.50;4.50;—.

WSAB(FM)—Co-owned with WVMC. Nov 28, 1960. 94.9 mhz; 37.4 kw. Ant 410 ft. Dups AM 65%. Format: MOR, semiclasscl, good mus. ■ Rates: \$4.50;4.50;4.50;3.50.

Mt. Vernon

WMIX—1946: 940 khz; 5 kw-D, DA. Box 1238

Illinois Radio

See page C-1 for explanation of listings.

(62864). (618) 242-3500. Withers Bcstg Co of Ill. (acq 5-30-73). Net: MBS, Southern Ill. Rep: PRO/Meeker. Format: MOR. ■ W. Russell Withers Jr., owner; Ron Marlo, coml mgr and prog dir; John Callarman, news dir; Ray Millmaker, chief engr; Allan Sledge, mus dir. ■ Rates: \$8;8;8.

WMIX-FM—1946: 94.1 mhz; 50 kw. Ant 550 ft. Dup AM 100%. Stereo. ■ Rates same as AM.

Murphysboro

WINI—Sept 15, 1954: 1420 khz; 500 w-D. Box 678 (62966). (618) 684-2128. Radio Stn WINI (acq 7-27-68). Audio news: UPI. Format: MOR, variety. ■ Dale W. Adkins, gen mgr & chief engr; David Heiser, news dir; Nancy J. Adkins, coml mgr. ■ Rates: \$6;6;6;6.

WTAO(FM)—August 1972: 104.9 mhz; 2.90 kw. Ant 200 ft. Box 286, Route 5 (62966). (618) 687-1779. Sunshine Bcstg Corp. Rep: Masla. Format: Prog rock. Stereo. ■ William Varecha, pres & gen mgr. ■ Rates: \$7;7;7.

Naperville

***WONC(FM)**—July 1, 1968: 89.1 mhz; 3.9 kw. Ant 98 ft. 30 N. Brainard (60540). (312) 355-9303-4. North Central College. Format: Variety. Spec progs: Black 10 hrs, Classical 2 hrs, jazz 5 hrs, wkly. ■ Herbert Nestler, bcstg dir; Peter Jones, gen mgr; Bucky Albright, prog dir; Lise Hinricks, mus dir; Joan Crawley, edu dir; Lisa Besavento, news dir; Dick Wolgast, chief engr.

WKKD-FM—See Aurora.

Normal

WAKC
Beautiful Country

TORRETT
LASKER
Inc. CBSRAD

WAKC—Sept 17, 1962: 1440 khz; 1 kw-D, 500 w-N, DA-2. 1218 S. Main (61761). (309) 829-3333. Great Oaks Bcstg Inc. (acq 3-1-74). Net: CBS, Illinois News. Rep: Torbett. Format: C&W. Spec prog: Farm 7 hrs wkly. ■ Allan Jackson, gen mgr; Larry Deutch, news dir; Edie Lane, coml mgr; Kelley Lenz, farm dir. ■ Rates: \$9;7;8.50;5.

***WGLT(FM)**—Feb 4, 1966: 91.7 mhz; 10 w. (CP 89.1 mhz; 2.3 kw. Ant 140 ft.) Illinois State Univ. (61761). (309) 436-8344. Illinois State Univ. Format: Jazz, classical, discussion, public affairs. Spec prog: Black 8½ hrs wkly. ■ G. Ben Paxton Jr., gen mgr; Hal Bouton, prod supervisor; David Mulcahey, chief engr.

WIHN(FM)—Dec 21, 1973: 96.7 mhz; 3 kw. Ant 300 ft. Stereo. 209 E. Washington St., Bloomington, Ill. (61701). (309) 827-6296. McLean Communications Corp. Audio news: UPI. Format: Top 40. ■ David S. Wolfenden, pres, coml & gen mgr; Dave Wilson, mus and prog dir; Tony Taylor, news dir; Andrew M. Rector, chief engr. ■ 6.47;6.47;6.47;4.82.

Oak Park

WBXM(FM)—Listing Follows WOPA.

WOPA—Oct 7, 1950: 1490 khz; 1 kw-D, 250 w-N. 408 S. Oak Park Ave. (60302). (312) 848-5760. Sonderling Bcstg Corp. (group owner). Format: Black, Spanish, variety. Spec progs: Ital 1½ hrs Pol 17 hrs, Greek 2½ hrs, Slovak ½ hr, Irish 4 hrs, Russian ½ hr, Ukrainian 2 hrs, Lithuanian 4½ hrs, wkly. ■ Egmont Sonderling, pres; Sidney Schneider, gen mgr; Wayne Osborne, prom mgr and news dir; Mark Nielsen, chief engr. ■ Rates: \$23;23;23;23.

WBXM(FM)—Co-owned with WOPA. Oct 17, 1950: 102.7 mhz; 6 kw. Ant 1,170 ft. Progs sep from AM. Stereo. Format: Black. ■ Ronald Craven, gen mgr; Dwight Lobbins, coml mgr; Earnest James, prog dir; Elijah Mitchell, news dir.

Illinois Radio

See page C-1 for explanation of listings.

Olney

WSEI(FM)—See listing under WVLN.

WVLN—Nov 11, 1947: 740 kHz; 250 w-D. Box L (62450). (618) 393-2156. Pub Service Bcstrs. Group owner: PSB Radio Group. Net: ABC/IL. Rep: Walton. Format: MOR, variety. ■ Donald G. Jones, pres; Lawrence W. Beabout, gen mgr; Joe Kosack, news dir; Donald Schnell, chief engr.

WSEI(FM)—Co-owned with WVLN. 1953: 92.9 mhz; 50 kw. Ant 290 ft. Dup AM 90%.

Ottawa

WCMY—March 5, 1952: 1430 kHz; 500 w-D. Box 430 (61350). (815) 434-6050. Virginia Bcstg Co. Rep: Walton. Format: MOR. ■ Dan Parker, gen mgr; Dale Miller, prog dir; Jim French, news dir. ■ Rates: \$7.60; 6.50; 7.60; —.

WOLI(FM)—Sept 1, 1965: 98.3 mhz; 3 kw. Ant 190 ft. horiz. 185 ft. vert. Box 763 (61350). (815) 434-0000. Van Schoick Enterprises Inc. (acq. 1-1-72). Net: ABC/C. Format: Top 40. ■ George Van Schoick, pres; Carolyn Van Schoick, gen & coml mgr; Pat Martin, mus and prog dir; Jean Marconnet, chief engr. ■ Rates: \$7.50; 7.50; 7.50; 7.50.

Paris

WACF(FM)—See listing under WPRS.

WPRS—1951: 1440 kHz; 1 kw-D. Box 398 (61944). (217) 465-6336. Paris Bcstg Corp. Net: ABC/E. Format: MOR. ■ Adlai C. Ferguson Jr., pres, gen mgr & chief engr. ■ Rates: \$7.70; 7.70; 7.70; 7.70.

WACF(FM)—Co-owned with WPRS. 1952: 98.5 mhz; 50 kw. Ant 500 ft. Stereo. Prog sep from AM. Format: C&W. ■ Rates: \$4; 4; 4; 4.

Park Forest

***WRHS(FM)**—Jan 21, 1960: 88.1 mhz; 10 w. 300 Sauk Trail (60466). (312) 747-0963. Rich Township High Schools. Net: Suburban High School Radio. Format: Progressive, Top 40, black, educ. Spec prog: Fr ½ hr wkly.

Park Ridge

***WMTH(FM)**—May 22, 1960: 88.5 mhz; 10 w. 2601 Dempster St. (60068). (312) 696-2525. Board of Education, School Dist. #207. Format: Variety. ■ William R. Mitchell, gen mgr; Theron Witfield, chief engr.

Pekin

WSIV—April 21, 1948: 1140 kHz; 5 kw-D (1 kw-D, CH). 28 S. Fourth St. (61554). (309) 346-2134. Dick Lashbrook Corp. (acq 11-18-71). Rep: Pro Time Sales. Format: Beautiful music. ■ Richard D. Lashbrook, pres & gen mgr; Rick Atterberry, news dir. ■ Rates: \$6.50; 6.50; 6.50; 6.50.

WSIV-FM—Nov 18, 1971: 95.3 mhz; 2.8 kw. Ant 89 ft. Dups AM 100%. Stereo. ■ Rates same as AM.

WZRO(FM)—1973: 104.9 mhz; 3 kw. Ant 265 ft. Box 918 (61554). (309) 382-3482. Peoria Valley Bcstg Inc. Format: C&W. ■ Syl Binkin, gen mgr; Mike Thatcher, sis mgr.

Peoria

***WCBU(FM)**—January 1970: 89.9 mhz; 11.1 kw. Ant 260 ft. 1501 W. Bradley Ave. (61625). (309) 693-7100. Bradley University. Stereo. Net: ABC/E, NPR. Format: Classcl. Spec prog: Jazz 4 hrs wkly. ■ Joel Hartman, gen mgr; Steve Connert, chief engr.

WIRL—1947: 1290 kHz; 5 kw-U, DA-2. Box 3335, W. Glen Station (61614). (309) 694-6262. Mid-America Media Inc. (group owner; acq 12-16-62). Rep: Eastman. Format: Contemp. ■ Burrell Small, pres; Howard H. Frederick, gen mgr; Mort Cantor, stn mgr; Bill McCluggage, prog dir; Ira Bittner, news dir; Joe Cunat, chief engr.

WSWT(FM)—Co-owned with WIRL. 1964: 106.9 mhz; 50 kw. Ant 477 ft. Kankakee TV Cable Co. Inc.

(acq 4-31-72). Progs sep from AM. Format: Good music. ■ Harold Bastian, stn mgr; Walter Thurman, prog dir.

WMBD—1927: 1470 kHz; 5 kw-U, DA-2. 212 S. W. Jefferson (61620). (309) 676-0711. TWX 910-652-3954. Midwest TV Inc. (group owner; acq 7-60). Net: CBS. Rep: Katz. ■ August C. Meyer, pres; William L. Brown, VP & gen mgr; Thomas I. Greer, stn mgr; Bill Rogers, prog dir; Duane Wallace, news dir; Neil Burk, chief engr; Colleen Callahan, farm dir; Jim Walker, mus dir.

WMBD-FM—1947: 93.3 mhz; 27 kw. Ant 560 ft. Prog sep from AM. Stereo. ■ WMBD-TV affil.

WPEO—1946: 1020 kHz; 1 kw-D. 121 N. Jefferson St. (61602). (309) 674-1020. Pinebrook Foundation (acq 1-6-70). Group owner: Crawford Bcstg Co. Net: MBS. Rep: Walton. Format: Relig. Spec prog: Farm 10 hrs wkly. ■ Richard T. Crawford, pres; Ron Billiter, prog dir; Gary Wilhte, news dir; Dale Knapp, chief engr.

WSWT(FM)—See listing following WIRL.

WWCT(FM)—May 14, 1971: 105.7 mhz; 36 kw. Ant 570 ft. 232 SW Jefferson (61602). (309) 674-2000. National Community Broadcasters Inc. Net: ABC/E. Rep: Masla. Format: Rock. Spec prog: Black 2 hrs wkly. ■ Thomas A. Murphy, bd chmn; Paul A. Carnegie, pres & gen mgr; Rob Klein, mus dir; Bruce Foster, chief-engr.

WXCL—Feb 8, 1960: 1350 kHz; 1 kw-U, DA-2. 3641 Meadowbrook Rd. (61604). (309) 685-5975. Peoria Valley Bcstg Inc. (acq 10-65). Net: ABC/IL. Rep: McGavren-Guild-PGW. Format: C&W. ■ Melvin Feldman, pres; Syl Binkin, VP & gen mgr; Mike Thatcher, coml mgr; Lee Ranson, music dir; Bill Marlowe, news dir. ■ Rates: \$30; 26; 30; 18.

Peru

WGSY(FM)—March 15, 1970: 100.9 mhz; 3 kw. Ant 145 ft. Stereo. 1725½ Fourth St. (61354). (815) 224-2100. George W. Yazell. Net: MBS. Format: Variety. Spec progs: Farm 2 hrs; jazz 1 hr, Polish 3 hrs, C&W 10 hrs, wkly. ■ George W. Yazell, own, mgr; Roger A. Yazell, prog dir. ■ Rates: \$10; 10; 10; 10.

Pittsfield

WBBA—Dec 1, 1954: 1580 kHz; 250 w-D. Radio Park (62363). (217) 285-2157. Pike Bcstg Co. (acq 12-1-56). ■ G. B. Meyer, pres, gen mgr & treas; Rex Fenton, chief engr.

WBBA-FM—Aug 1, 1966: 97.7 mhz; 3 kw. Ant 300 ft. Stereo. Prog sep from AM.

Plano

WSPY(FM)—Jan 19, 1974: 107.1 mhz; 3 kw. Ant 165 ft. Rte 1, Box 41 (60545). (312) 552-8985. Spy Bcstg Systems Inc. Net: Ill. Farm Network. Rep: Walton. Format: MOR. Spec prog: Farm 10 hrs wkly. ■ Larry Nelson, owner and pres; Bob Kramer, prod mgr; Dee Brown, coml mgr; Pam Nelson, owner and prog dir; Mark Morris, sports dir; Jim Mann, farm dir; Bruce Yentes, news dir. ■ Rates: \$9.50; 8.50; 9.50; 6.75.

Pontiac

WPOK—Sept 1, 1966: 1080 kHz; 1 kw-D, DA. Box 740 (61764). (815) 844-6101. Bret Bcstg Corp. (acq 2-19-71). Rep: Walton. Format: MOR. ■ Richard D. Lashbrook, pres; Dorothea K. Green, gen & coml mgr & news dir; Vince Young, prog dir; George E. Poulier, chief engr.

WPOK-FM—Sept 1, 1969: 103.1 mhz; 3 kw. Ant 185 ft. Dup AM 100%.

Princeton

WZOE—Oct 25, 1961: 1490 kHz; 1 kw-D, 250 w-N. Broadcast Center, Route 5 (61356). (815) 875-8014. WZOE Inc. (acq 10-26-74). Format: MOR. ■ Steve Samet, pres and gen mgr. ■ Rates: \$ 5.25; 5.25; 5.25; 3.

Quincy

WGEM—Jan 1, 1948: 1440 kHz; 5 kw-D, 1 kw-N, DA-2. Hotel Quincy (62301). (217) 222-6840. TWX 910-246-3209. Quincy Bcstg Co. Net: ABC. Rep: Avery-Knodel. ■ T. A. Oakley, pres; Joe Bonansinga, gen mgr; J. Ben Stewart, coml mgr; Fred Colgan, prog dir;

Robert Meyer, cont dir; Charlie Griffith, news dir; Jim Martens, chief engr.

WGEM-FM—1947: 105.1 mhz; 27.5 kw. Ant 640 ft. Dup AM. ■ WGEM-TV affil.

WQCY(FM)—Listing follows WTAD.

WTAD—July 25, 1925: 930 kHz; 5 kw-D, 1 kw-N, DA-N. 510 Main St, WCU Bldg. (62301). (217) 222-6200. TWX 910-246-3204. Lee Enterprises Inc. (group owner; acq 6-30-67). Net: CBS. Rep: Katz. Format: MOR. ■ Lloyd G. Schermer, pres; Lloyd Loers, VP; John Phillips, gen mgr; Jack Rose, gen sls mgr; Gary Schmedding, prog dir; Gene Terry, news dir; Ed Schnier, Hal Hackbarth, chief engr.

WQCY(FM)—1948: 99.5 mhz; 27 kw. Ant 750 ft. Dups AM 22%. ■ KHQA-TV Hannibal, Mo., TV affil.

***WWOC-FM**—April 1974: 90.3 mhz; 10 w. Ant 125 ft. 1831 College Ave. (62301). (217) 223-6880. Quincy College Corp. Format: Variety. Spec progs: Classical 15 hrs; Sp 1 hr; C&W ½ hr, wkly. ■ Fr. Titus Ludes, pres; C.J. Mason, gen mgr.

Rantoul

WRTL—Feb 1, 1963: 1460 kHz; 500 w-D, DA. Box 115 (61866). (217) 893-1460. Regional Radio Service. ■ William R. (Bob) Brown, gen mgr & chief engr; Donald R. Williams, coml mgr & farm news dir; Tom Elbring, prog dir; John Truscelli, mus dir; Dan Daugherty, sps dir; Sylvia Kramer, traff mgr.

WRTL-FM—March 15, 1972: 95.3 mhz; 3 kw. Ant 275 ft. Prog sep from AM. Stereo.

River Grove

***WRRG(FM)**—March 10, 1975: 88.9 mhz; 10 w. Ant 150 ft. 2000 Fifth Ave. (60171). (312) 456-0300, ext 452. Triton College. Format: Educl, variety. Spec prog: Jazz 4 hrs wkly. ■ John W. Cone, gen mgr.

Robinson

WTAY—Jan 9, 1956: 1570 kHz; 250 w-D. Box 245 (62454). (618) 544-2191. Ann Bcstg Corp. Format: MOR. ■ Kathryn A. Duncan, pres & gen mgr; Dennis Hare, coml & prom mgr; Roger Dee Reynolds, prog dir & mus dir; Jerry F. Tye, news dir, Raymond Michael, chief engr.

WTAY-FM—Jan 4, 1963: 101.7 mhz; 3 kw. Ant 245 ft. Dup AM 100%.

Rochelle

WRHL—Sept 16, 1966: 1060 kHz; 250 w-D, DA. Box 177 (61068). (815) 562-7001. Rochelle Bcstg Co. (acq 10-11-70). Net: Ill. Farm. Rep: Walton. Format: MOR & modern country. ■ Theodore D. Vlahos, pres; James F. Feather, gen mgr; Mike Fryer, news dir; Frank James, mus dir; Joseph E. McCormack, chief engr.

WRHL-FM—Oct 5, 1973: 102.3 mhz; 3 kw. Ant 180 ft.

Rock Falls

WSDR—See Sterling.

Rockford

WKWL(FM)—See Belvidere.

WLUV—See Loves Park.

WQFL(FM)—May 2, 1974: 100.9 mhz; 3 kw. Ant 300 ft. Stereo. 5500 E. Riverside Blvd. (61111). (815) 654-1200. Quest for Life Inc. Format: Religious. ■ Don Lyon, pres; Ron Tietsort, gen mgr; Ed Myers, prog dir; Bruce Evenson, news dir; Jim Landes, chief engr.

WROK—1923: 1440 kHz; 5 kw-D, 500 w-N, DA-D. 1100 Tamarack Lane (61125). (815) 399-2233. WROK Inc. (acq 10-1-63). Net: ABC/IL. Rep: McGavren-Guild. Format: Contemporary. ■ Vernon A. Nolte, pres; David W. Salisbury, gen mgr; Ronald Gallina, coml mgr; Carl Hamilton, prog dir; Bill Phillips, news dir; Gary Breed, chief engr. ■ Rates: \$25; 23; 25; 21.

WZOK(FM)—Co-owned with WROK. 1949: 97.5 mhz; 50 kw. Ant 235 ft. Prog sep from AM. Stereo. Format: Beautiful music. ■ Rates: \$8; 8; 8; 8.

WRRR—Dec 24, 1953: 1330 kHz; 1 kw-D, DA. 2830

Sandy Hollow Rd. (61109). (815) 874-7861. Radio Rockford Inc. (acq 3-25-71). Group owner: Cummings Communications Corp. Net: ABC/I. Rep: GCI. Format: MOR, talk. Spec prog: Sp 1 hr, Swedish 1 hr, wkly. ■ Alan H. Cummings, pres; Dean D. Osborne, exec VP & gen mgr; Ward W. Hartman, coml mgr; Frank Dawson, prog dir; Jay Anderson, news dir; Larry Caldwell, chief engr. ■ Rates: \$11; 9; 11; 9.

WYFE—Dec 1, 1964: 1150 khz; 1 kw-D, DA. 1901 Shaw Rd. (61111). (815) 877-6064. Town & Country Radio Inc. (acq 8-1-66). Group owner: Mid-West Family Stns. Net: MBS, Ill Farm. Rep: HR/Stone. Format: Oldies. ■ Tom Kushak, pres, gen & sls mgr; Jay Robins, prog dir; Duanne Daniels, station VP; Joey Edwards, mus dir; Rae Small, news dir; Robert Jordan, chief engr.

WYFE-FM—See Winnebago.

WZOK(FM)—See listing under WROK.

Rock Island

WHBF—Feb 16, 1925: 1270 khz; 5 kw-U, DA-N. Telco Bldg. (61201). (309) 786-5441. TWX 910-653-1508. Rock Island Bcstg Co. (acq 11-26-32). Net: CBS. Rep: Aveny-Knodel. Format: C&W. Spec prog: Farm 5 hrs; Sp 1 hr, wkly. ■ Marguerite F. Potter, pres; Ted Arnold, VP & gen mgr; Jack Z. Bennett, coml mgr; Richard Hauf, prog dir; Edna Hendrickx, prog mgr; Louis Plaisance, news dir; Jim Booth, chief engr; Edward E. DeLong, exec VP. ■ Rates: \$23; 18; 9.

WHBF-FM—Oct 1947: 98.9 mhz; 39 kw. Ant 900 ft. Stereo. Format: Top 40. Spec prog: Ger 1 hr; Greek 1 hr; It 1 hr; Scandinavian 1 hr, wkly. ■ Harlan Ralston, prog dir. ■ WHBF-TV affil. ■ Rates: \$13; 16; 16; 13.

***WVIK(FM)**—Feb 25, 1963: 91.1 mhz; 10 w. Augustana College Univ. (61201). (309) 794-7210. Augustana College. Format: Contemp. Spec prog: Sp 2 hrs; black 15 hrs; C&W 1 hr; talk 4½ hrs, wkly. ■ Rick McGuire, gen mgr; Marcus Schlichter, prog dir; Randall Whyte, prom mgr; Tom Morrow, mus dir; Arnold R. Cowan, news dir; Glenn Rogerson, chief engr.

Rockton

WRWC(FM)—March 1963: 103.1 mhz; 3 kw. Ant 300 ft. Box 283 (61072). (815) 624-7227. Salter Broadcasting Co. Group owner: Russ Salter Stns. Format: Beautiful music, big band. ■ Russel G. Salter, pres; Reinhard Metzger, gen mgr; Phill Davidson, coml mgr; Tom Farber, chief engr.

Salem

WJBD—Dec 16, 1956: 1350 khz; 500 w-D. Box 119 (62881). (618) 548-2000. Salem Bcstg Co. Format: MOR, variety. ■ Bryan Davidson, gen mgr, mus dir & chief engr; John Scrivner, coml mgr; Peggy Quick, prog dir; Sherman Doolen, news dir.

WJBD-FM—June 1, 1972: 100.1 mhz; 2.9 kw. Ant 150 ft. Dups AM 100%. Stereo.

Savanna

WCCI(FM)—1971: 100.1 mhz; 3 kw. Ant 300 ft. 316 Main St. Box 310 (61074). (815) 273-7757. Carroll County Bcstg Co. Rep: Keystone, Walton. Format: C&W. Spec prog: Farm 5 hrs; sports 5 hrs wkly. ■ Dennis W. Voy, own & gen mgr; Dennis O. Bowman, stn and coml mgr; Tom Cox, news dir; Robert Burns, chief engr. ■ Rates: \$4.50; 4; 3.50; 3.

Shelbyville

WSHY—Nov 24, 1972: 1560 khz; 500 w-D, DA. Box 343 (62565). (217) 774-2146. Shelbyville Bcstg Co. Format: MOR. ■ Donald E. Cutts, pres; William H. Beach, gen mgr; James P. Simpson, chief engr.

WSHY-FM—Dec 31, 1969: 104.9 mhz; 3 kw. Ant 120 ft.

Skokie

WCLR(FM)—Aug 18, 1961: 101.9 mhz; 3 kw. Ant 1520 ft. 4849 Golf Rd. (60076). (312) 677-5900. Bonneville Intnl Corp. (group owner; acq 8-75). Rep: Avco. Format: MOR. ■ Mo Gardner, VP & gen mgr; Bill King, prog dir; Marlin Taylor, mus dir; Bill Guthrie, news dir; Gary Schroder, chief engr; Jack Kelly, opns mgr.

South Beloit

WBEL—See Beloit, Wis.

Sparta

WHCO—February 1955: 1230 khz; 1 kw-D, 250 w-N. Box 255 (62286). (618) 433-2121. Hirsch Communication Engineering Corp. Group owner: Oscar C. Hirsch Stns. Format: MOR, talk, C&W, relig. ■ Robert O. Hirsch, pres; Jack L. Scheper, gen mgr & coml mgr; Lee Scheper, prom mgr; Jackie J. Scheper, women's dir; John Leslie Scheper, news dir; Mike Arnold, chief engr; Dan L. Schoeker, sports dir.

Springfield

WCVS—1922: 1450 khz; 1 kw-D, 250 w-N. 3055 S. Fourth St. (62708). (217) 544-9855. Eastern Bcstg Corp. (group owner; acq 4-1-66). Net: ABC/C. Rep: McGavren-Guild. Format: Contemp. ■ Roger A. Neuhoof, pres; Ken Spangler, VP & gen mgr; Jim Palmer, prog dir; James Gray, news dir; Robert Miller, chief engr. ■ Rates: \$22; 20; 22; 17.

WDBR-FM—See listing under WTAX.

WFMB(FM)—July 1965: 104.5 mhz; 20 kw. Ant 245 ft. 819-20 Myers Bldg. (62701). (217) 528-3033. Capital Bcstg Co. Net: ABC/I. Format: C&W. Spec prog: Gospel 3 hrs wkly. ■ Harold J. Hoskins, pres; William R. Wheeler, gen mgr; Martin Quick, chief engr.

WMAY—Oct 15, 1950: 970 khz; 1 kw-D, 500 w-N, DA-2. Box 460 (62705). (217) 525-0200. Springfield Bcstg Inc. (acq 12-1-63). Group owner: Stuart Stns. Net: NBC. Rep: H-R/Stone Radio. Format: MOR. ■ Richard Chapin, pres; Gary Fries, VP & gen mgr; J. Martin Kay, opns dir; Bill Rawson, news dir; Jim Dunn, chief engr.

***WSSR(FM)**—Jan 3, 1975: 91.9 mhz; 50 kw. Ant 500 ft. Stereo. Sangamon State Univ., L-130 (62708). (217) 786-6516. Sangamon State University. Net: NPR. Audio news: UPI. Format: Classical, pub affairs, variety. Spec prog: Farm 1 hr; black 3 hrs; jazz 5 hrs; bluegrass 3 hrs; folk 3 hrs, wkly. ■ Dale K. Ouzts, gen mgr; Howard T. Hill, stn mgr.

WTAX—1930: 1240 khz; 1 kw-D, 250 w-N. Box 3166 (62708). (217) 522-4441. Sangamon Bcstg Co. (acq 5-1-70). Net: CBS. Rep: Eastman. ■ Shelby T. Harbison, pres & gen mgr; Edward J. Mahoney, coml mgr; Bruce Bagg, prog dir; Ben Kilmington, news dir; Glen Hopkins, chief engr. ■ Rates: \$18; 18; 18; 18.

WDBR(FM)—Co-owned with WTAX. April 1948: 103.7 mhz; 17 kw. Ant 320 ft. Progs sep from AM. Format: Contemp. ■ Joc Jackson, opns dir. ■ Rates: \$13; 13; 13.

WVEM(FM)—Sept 1, 1965: 101.9 mhz; 50 kw. Ant 275 ft. Stereo. 1313 S. 9th St. (62703). (217) 528-4511. Dan Menghini. Rep: Bunchez. Net: ABC/FM. Format: MOR. ■ Dan Menghini, own, gen mgr. ■ Rates: \$10; 10; 10; 10.

Sterling

WJVM(FM)—Oct 22, 1966: 94.3 mhz; 3 kw. Ant 300 ft. horiz, 295 ft. vert. Box 658. (815) 625-2100. Communtron Inc. ■ John E. Rohwer, pres & gen mgr; Jack Radke, coml mgr; Voigt Smith, prog & news dir; Tom Friedlein, chief engr. ■ Rates: \$4; 4; 4; 4.

NEWSDR

News/Talk



WSDR—August 21, 1949: 1240 khz; 500 w-D, 250 w-N. Box 399, Lawrence Bldg. (61081). (815) 625-3400. Box 85, Dixon, Ill. (61021). (815) 288-3400. WSDR Inc. (acq 3-1-69). Audio news: UPI. Rep: Masla. Format: News, talk, big band. Spec prog: Sp 7 hrs; classical 2 hrs, wkly. ■ Thomas L. Davis, pres & gen mgr; G. W. Gamel, stn mgr; Ruth Wood Davis, wom dir; Don Oberbillig, sls mgr; Paul Katner, prog dir; Ira Kelly, news dir; Tom Ferguson, sps dir; Edward K. Fishr, chief engr; Carey Davis, prom mgr. ■ Rates: \$10; 8.75; 10; 8.75.

Streator

WIZZ—Sept 26, 1953: 1250 khz; 500 w-D, DA. Box

Illinois Radio

See page C-1 for explanation of listings.

377 (61364). (815) 672-2947. Streator Bcstg Co. Net: ABC/I, Illinois News. Format: MOR. ■ C. J. McDonald, VP & gen mgr; Ralph Hart, news dir. ■ Rates: \$6.50; 5.50; 5.50; 5.50.

WLAX(FM)—Co-owned with WIZZ. Sept 15, 1964: 97.7 mhz; 2.95 kw. Ant 140 ft. Progs sep from AM. Net: ABC/FM. Format: C&W. ■ Rates: \$5.50; 4.50; 4.50; 4.50.

Sullivan

WFWA(FM)—Dec 19, 1974: 106.3 mhz; 3 kw. Ant 300 ft. Route 2 (61951). (217) 728-7306. Spencer-Freeland Bcstg. Group owner: Michael R. Freeland Stns. Net: ABC/I, Orange and Blue Football Network. Rep: Keystone. Format: MOR, C&W. Spec prog: Farm 3 hrs; rock 7 hrs; gospel 3 hrs; big band 4 hrs wkly. ■ Michael R. Freeland, pres; Ron Lane, gen and prom mgr; Marilyn McNutt, net coord; William Oliver, prog, prod and mus dir; Randy Miller, news & sps dir; Paul Hutchcraft, chief engr. ■ Rates: \$3.50; 3.50; 3.50; 3.50.

Summit

***WARG(FM)**—Not on air; target date unknown: 88.9 mhz; 10 w. 7329 W. 63rd St. (60501). Community High School District #217. Audio news: APR. Format: non-coml diversified. Spec prog: Black 6 hrs; jazz 6 hrs, Pol 3 hrs, Sp 12 hrs, wkly. ■ Jon Beliveau, stn mgr.

Taylorville

WEEE(FM)—Listing follows WTIM.

WTIM—1952: 1410 khz; 1 kw-D, DA. Box 387 (62568). (217) 824-3366. PSB Radio Group (group owner; acq 1-1-69). Net: Ill. Radio Format: C&W, farm. ■ Donald G. Jones, pres; Larry Stewart, gen mgr; Chris Showalter, mus dir; Rob O'Brien, news dir; Gary L. Shultz, chief engr. ■ Rates: \$4.75; 4.75; 4.75; —.

WEEE(FM)—December 1969: 92.7 mhz; 3 kw. Ant 150 ft. Stereo. Box 238. Prog sep from AM. Format: MOR. Spec prog: Sports 10 hrs wkly. ■ Rates same as AM.

Tuscola

WITT(FM)—Nov 25, 1968: 93.5 mhz; 3 kw. Ant 115 ft. 600 S. Main St. (61953). (217) 253-3338. Format: All news, farm. ■ Frederick W. Siebold, own & mgr; Tom Stocker, sports dir; Jack Ashmore, news dir; Harold Otto, farm dir.

Urbana

WCCR—1948: 1580 khz; 250 w-D. 2410 Skyline Dr. (61820). (217) 352-4141. Airways Inc. (acq 12-1-71). Net: ABC/C. Rep: Devney, Schneider (St. Louis). Format: Modern C&W. ■ Richard G. Glover, pres & gen mgr; Larry Stirewalt, news dir; Allen Wolfe, chief engr. ■ Rates: \$8.25; 7; 8.25; 7.

WLRW(FM)—See Champaign.

***WILL**—March 1922: 580 khz; 5 kw-D, DA. 228 Gregory Hall (61801). (217) 333-0850. U. of Illinois. Net: NPR. Format: Classical, info. ■ John E. Corbally Jr, pres; Donald P. Mullanly, gen mgr; Edward F. Douglass, asst mgr radio; Robert C. Boston, dir comm rel; John Cramer, news dir; Rob R. Beldon, chief engr.

***WILL-FM**—Sept 1, 1941: 90.9 mhz; 105 kw. Ant 850 ft. Prog sep from AM. Format: Classical. ■ WILL-TV affil.

WLRW(FM)—See listing under WCCR.

WPGU(FM)—April 17, 1967: 107.1 mhz; 2.95 kw. Ant 235 ft. 1241 S. Euclid, Champaign, Ill. (61820). (217) 333-2016. Illini Publishing Co. Net: ABC/C. Format: Prog rock. Spec prog: Black 6 hrs; jazz 3 hrs; oldies 2 hrs; folk 3 hrs; new releases 3 hrs, wkly. ■ Charles Laughlin, gen mgr; Jack Schmerer, sports dir; Bernard Long, sls dir; Emily Recht, prog dir; Edward Sackley, mus dir; Michael Venere, gen mgr; John Strandin, news dir; James Thalmann, chief engr. ■ Rates: \$11; 11; 11; 11.

WTWC(FM)—Dec 4, 1967: 103.9 mhz; 3 kw. Ant 145 ft. Stereo. 505 S. Locust (61820). (217) 352-8223. Robert E. Durst. Net: ABC/FM. Format: Prog, under-

Illinois, Indiana Radio

See page C-1 for explanation of listings.

ground. Spec progs: Black 5 hrs; classical 12 hrs, wkly. ■ Robert E. Durst, pres & chief engr; Richard W. Warren, stn & coml mgr; Richard M. Warren & Joseph R. Lex Jr., prog dirs; Joseph R. Lex Jr., mus dir; Bob Epstein, news dir.

Vandalia

WKRV(FM)—See listing following WPMB.

WPMB

Modern Country Music
Walton Broadcast Sales

WPMB—Dec 9, 1963: 1500 khz; 250 w-D. 111 South Fifth St. (62471). (618) 283-2325. Clark Communications. (acq 6-1-70). Audio news: UPI. Rep: Walton. Format: C&W, talk. ■ Neil F. Clark, pres & gen mgr; B. John Clark, coml mgr and chief engr; Tom Isbell, prog & news dir; Bobbye Clark, off mgr. ■ Rates: \$6.50; 6.25; 6.—

WKRV(FM)—Co-owned with WPMB. May 28, 1974: 107.1 mhz; 3 kw. Ant 164 ft. Stereo. Prog sep from AM. Format: MOR. ■ Tom Wright, prog dir. ■ Rates: \$4.50; 4.25; 4; 4.

Watseka

WGFA—Sept 1, 1961: 1360 khz; 1 kw-D, DA. Box 68A (60970). (815) 432-4955. Iroquois County Bcstg Co. Net: ABC/E. Format: MOR. ■ S. L. Martin, pres; Bob Bivans, VP gen & coml mgr; Ron Hunt, prog dir; Del Trudeau, prom mgr; D. J. Ruth, treas & ofc mgr; R. A. Martin, sec; N. B. Bahler, news dir; Bob Bivans, engr.

WGFA-FM—March 2, 1962: 94.1 mhz; 19 kw. Ant 140 ft. Dup AM 70%.

Waukegan

WEFA(FM)—May 1963: 102.3 mhz; 3 kw. Ant 185 ft. 4 S. Genesee St. (60085). (312) 662-0540. WEFA Inc. (acq 1-64). Format: MOR. Spec progs: Ger 2 hrs; Sp 9 hrs; Black 5½ hrs; Yugoslav 1 hr; C&W 4½ hrs; Finish ¼ hr, wkly. ■ Goldie Luftig, pres; Roger E. Kaplan, gen mgr. ■ Rates: \$9; 9; 9; 9.

WKRS—Sept 25, 1949: 1220 khz; 1 kw-D, DA. Box 500 (60085). (312) 336-7900. News-Sun Bcstg Co. Net: MBS. Format: News, talk, adult music. ■ A. F. Sorenson, pres & gen mgr; Jerry Cray, coml mgr; David L. Davis, prog dir; Dick Tuchscherer, news dir; Verne Buland, chief engr.

West Frankfort

WFRX—May 2, 1951: 1300 khz; 1 kw-D. Box 128 (62896). (618) 932-6615. Pyramid Radio Bcstg & TV Co. Net: Keystone. Rep: Walton. ■ G. W. Lambert, pres; Art Smith, gen mgr; Glenn E. Ford, prog dir; Ron Clem, news dir; S. M. Durst, chief engr.

WFRX-FM—March 14, 1972: 97.7 mhz; 3 kw. Ant 165 ft. Prog sep from AM. Format: MOR, news & sports.

Wheaton

***WETN(FM)**—Feb 27, 1962: 88.1 mhz; 10 w. Ant 110 ft. Wheaton College (60187). (312) 682-5074. Trustees of Wheaton College. ■ Stuart Johnson, gen mgr; Jeff Beaumont, prog dir; Glenn Sparks, news dir; Dan Grove, chief engr.

Winnebago

WYFE-FM—Co-owned with WYFE Rockford. May 5, 1973: 95.3 mhz; 3 kw. Ant 300 ft. 1901 Shaw Rd., Rockford (61111). (815) 877-6064. Heart O'Wisconsin Broadcasters (acq 2-72). Net: Illinois Radio. Rep: HR/Stone. Format: Rock. ■ William R. Walker, pres.

Winnetka

***WNTH(FM)**—Oct 1, 1974: 88.1 mhz; 10 w. Ant 105 ft. 385 Winnetka Ave. (60093). (312) 446-7013. New Trier Board of Educ. (acq 1961). Net: NPR. Format: Variety. Spec progs: Fr 1 hr; Ger 3 hrs, Sp 1 hr, jazz 6

hrs, C&W 7 hrs; folk 2 hrs, wkly. ■ Michelle Hoffman, gen mgr.

Wood River

WRTH—Oct 5, 1961: 590 khz; 500 w-D. 1 kw-N, DA-2. 135 North Meramec, Suite 306, St. Louis (63105). (314) 862-9030. Avco (acq 3-16-69). Group owner: Avco Bcstg Corp. Net: ABC/E. Rep: Avco Radio-TV Sys. Format: Pop/standard. ■ John T. Murphy, pres; Joseph P. Costantino, VP & gen mgr; Bob McCarthy, gen sls mgr; Jerry Irvine, prog dir; Gene Shelton, mus dir; Jim Scanlan, news dir; Roger Hunter, chief engr.

Woodstock

WXRD(FM)—Co-owned with WIVS Crystal Lake. May 24, 1974: 105.5 mhz; 3 kw. Ant 300 ft. Dups AM 35%. Format: Progressive, contemp, C&W.

Zion

WKZN(FM)—Listing follows WZBN.

WZBN—Sept 19, 1967: 1500 khz; 250 w-D, DA. 2700 Sheridan Rd. (60099). (312) 746-1484. Zion Benton Bcstg. Audio news: UPI. Format: Btl mus. Spec progs: C&W 1 hr Polish 3 hrs; relig 6 hours, wkly ■ William J. Bicket, gen mgr; Rev. Willis Mayfield, stn mgr; Walter E. Stare, sls dir; Kathryn Paul, traff mgr; Charles King, chief engr.

WKZN(FM)—Co-owned with WZBN. 1962: 96.9 mhz; 10 kw horiz, 8.1 kw vert. Ant 500 ft. Dups AM 40%. Stereo.



Indiana

Anderson

WHBU—April 1923: 1240 khz; 1 kw-D, 250 w-N. Box 610 (46015). (317) 644-7791. Anderson Bcstg Corp. (acq 9-44). Net: CBS. Rep: Pearce (Detroit). Format: MOR, C&W. ■ C. Bruce McConnell, pres; John R. Atkinson, gen mgr; W. J. Hecht, chief engr. ■ Rates: \$8; 8; 8.

WHUT—1946: 1470 khz; 1 kw-D. Box 151 (46015). (317) 644-1255. Eastern Bcstg Corp. (group owner; acq 7-1-70). Net ABC/C. Rep: PRO Time Sls, Regional Reps. Format: Contemp. ■ Roger A. Neuhoff, pres; David Butler, gen mgr; Lew Shapiro, coml mgr; James Jacobs, prog dir; Jay Benoit, news dir; Terry Grieger, chief engr. ■ Rates: \$13; 13; 13; —.

WLHN(FM)—Co-owned with WHUT. Sept 11, 1973: 97.9 mhz; 50 kw. Ant 490 ft. Stereo. Box 98 (46015). (317) 643-9546. Prog sep from AM. Format: MOR ■ Mike Kase, prog dir. ■ Rates: \$13; 13; 13; 11.

Angola

WLKI

Contemporary Top 40



WLKI(FM)—Nov 7, 1969: 100.1 mhz; 3 kw. Ant 300 ft. North Wayne Plaza (46703), (219) 665-9554. Lake Cities Bcstg Inc. (acq 5-74). Net: ABC/FM. Rep: Regional. Format: Top 40. ■ Thomas R. Andrews, pres & gen mgr; Bill Kerner, sls mgr; David Christian, prog dir; Gary Allen, news dir; Thomas I. Wyant, chief engr. ■ Rates: \$3.85; 3.85; 3.85; 3.85.

Auburn

WIFF—Sept 3, 1968: 1570 khz; 500 w-D, DA. RR 2 (46706). (219) 925-1055. C. P. Broadcasters Inc. Format: C&W. ■ Wayne H. Paradise, pres & gen mgr; Ronald Hansley, chief engr; Phil Haberkorn, news dir.

WIFF-FM—April 10, 1967: 105.5 mhz; 3 kw. Ant 300 ft. Stereo. Prog sep from AM. Format: Top 40.

Aurora-Rising Sun

WSCH(FM)—1970: 99.3 mhz; 1.25 kw. Ant 440 ft. Box 993 (47001). (812) 438-2777. Dearborn County Bcstrs. Format: MOR. ■ John W. Schuler, pres.

Bedford

WBIF(FM)—Listing follows WBIW.

WBIW—October 1948: 1340 khz; 1 kw-D, 250 w-N. Box 657 (47421). (812) 275-7555. Bedford Bcstg Corp. Group: The Central Group. (acq 4-7-62). Net: ABC. Rep: Pro/Meeker, Rgnl Reps. ■ Lester G. Spencer, pres; Dean Spencer, gen mgr; Ott Medlock, coml mgr; Bill Silvers, news dir; Vance Lockenour, chief engr. ■ Rates: \$4; 4; 4; 4.

WBIF(FM)—Co-owned with WBIW. Not on air, target date unknown: 105.5 mhz; 3 kw. Ant 245 ft. Box 657 (47421). Bedford Bcstg Corp. Format: Talk, popular, old standard.

Bloomington

***WFUI(FM)**—Sept 30, 1950: 103.7 mhz; 31 kw. Ant 590 ft. (47401). (812) 337-1357. Trustees of Indiana U. Format: Classcl music. ■ Donley F. Feddersen, gen mgr; Herbert A. Seitz, dir of progmg; Richard D. Yoakam, news dir; William H. Kroll, opns svpr; L. James Roife, chief engr; Don Glass, prog dir.

WGTC(FM)—Listing follows WTTS.

WTTS—March 11, 1949: 1370 khz; 5 kw-D, 500 w-N, DA-2. 535 S. Walnut St. (47401). (812) 332-3366. TWX 810-351-1380. Sarkes Tarzian Inc. (group owner). Net: ABC/E. Rep: Pro/Meeker, Reg Reps. Format: MOR. ■ Sarkes Tarzian, pres; G.R. Holben, gen mgr; Maurice Latimer, coml mgr; Bruce Baker, prog dir; Jack Noel, prom mgr; Ann Smith, news dir; Lynn Bradley, chief engr. ■ Rates: \$10.60; 9.70; 10.60; 7.60.

WGTC(FM)—Co-owned with WTTS. Jan 7, 1960: 92.3 mhz; 37 kw. Ant 1,090 ft. Prog sep from AM. Net: ABC/I. Format: C&W. ■ Jack Noel, prog dir & prom mgr. ■ Rates: \$4.10; 4.10; 4.10; 4.10.

Bluffton

WCRD(FM)—Dec 10, 1963: 100.1 mhz; 3 kw. Ant 50 ft. (CP. Ant 130 ft) Box 321 (46714). (219) 824-2804. Wells County Radio Corp. ■ Herman Zeps, pres, gen mgr & chief engr; Chloe Kiser, coml mgr; Paul Kennedy, prog dir; Robert Ehler, prom mgr; Marion Baringer, news dir.

Boonville

WBNL—Sept 10, 1950: 1540 khz; 250 w-D. Box 273 (47601). (812) 897-2080. Boonville Bcstg Co. Net: MBS. Format: MOR. ■ Norman Hall, pres & gen mgr; Larry Swietzer, coml mgr & news dir; George McCoy, prog & mus dir; Brent Houston, sports dir; Jerry Kissenger, chief engr.

WBNL-FM—Dec 19, 1967: 107.1 mhz; 3 kw. Ant 185 ft. Dups AM 60%.

Brazil

WCM—1959: 1130 khz; 500 w-D, DA. Box 227 White Rock Rd. (47834). (812) 446-2317. Clay County Bcstg Co. (acq 1963). Group: Tedesco Stns. Rep: Regional Reps. Format: C&W. ■ Albert S. Tedesco, pres; Jack Teiken, gen mgr; Jan Birdsall, coml mgr; John Turner, prog dir; Gary Brown, prom mgr; Steve Smith, news dir; John Lawrence, chief engr.

WCM-FM—Nov 13, 1973: 97.7 mhz; 3 kw. Ant 300 ft. Stereo. Dups AM 100%.

Carmel

***WHJE(FM)**—91.3 mhz; 400 w. Ant 100 ft. 520 E. Main St. (46032). (317) 844-9453. Carmel Clay Schools. Format: Contemp, news. ■ Scott M. Gregg, gen mgr; Tom Allebrandi, chief engr.

Centerville

WHON—Licensed to Centerville. See Richmond.

Columbia City

WFDT(FM)—Oct 13, 1968: 106.3 mhz; 3 kw. Ant 105 ft. Stereo. 105 South Main St. (46725). (219) 244-7700. Dependable Bcstg Co. Rep: Indiana Radio Net. Format: MOR. ■ Diane M. Klabon and Thomas F. Jurek, owners.

Columbus

WCSE—1950: 1010 khz; 500 w-D. Box 709 (47201). (812) 372-4448. White River Bcstg Co. (acq 11-1-57). Rep: Rgnl Reprs. Format: Contemp ■ Harold Heminger, pres; James F. Kauper, VP & gen mgr; Michael T. Bova, Jr., coml mgr; Martin J. Brown, prog dir; Sam Simmermaker, news dir; Carl Plaster, chief engr.

WCSE-FM—1958: 101.5 mhz; 20 kw. Ant 300 ft. Stereo. Dup AM 10%. Format: C&W.

WWWY

MOR Adult Contemporary

WWWY(FM)—Feb 28, 1975: 104.9 mhz; 3 kw. Ant 300 ft. Stereo. 415 Washington St. (46173). (812) 372-9933. Bartholomew County Bcstg Co. Net: MBS, Ind Bcstrs Assn New. Rep: Keystone, Corlett. Format: MOR. Spec progs: farm 5 hrs; Black 1 hr wkly. ■ Edward W. Roehling, pres; Thomas L. Issac, exec VP, gen mgr & coml mgr; Wally Wawro, opns mgr & mus dir; Mark Pratt, prom mgr; Coleen Issac, news dir; David Kurtz, sports dir; Jim Walker, chief engr. ■ Rates: \$7; 7; 7; 5.25.

Connersville

WCNB—April 5, 1948: 1580 khz; 250 w-D. 406 Central Ave. (47331). (317) 825-6411. News Examiner Co. Net: ABC/E. Rep: Regional Reprs. Format: C&W. Spec progs: Gospel 5 hrs wkly. ■ George S. Tattam, pres; Francis E. Chomel, prog dir; Michael Peacock, mus dir; William Minck, chief engr. ■ Rates: \$5; 5; 5.

WCNB-FM—Feb 27, 1948: 100.3 mhz; 6.68 kw. Ant 270 ft. Prog sep from AM. Format: MOR. ■ Thomas Smith, mus dir. ■ Rates same as AM.

Corydon

WPDF—May 22, 1964: 1550 khz; 250 w-D. Box 100, 228 Elm St. (47112). (812) 738-3241. (812) 738-4756. Harrison Radio Inc. Format: MOR, C&W. Spec prog: Farm 10 hrs wkly. ■ Herbert L. Arms, pres & gen mgr; Mary R. Arms, prog dir; Wesley C. Arms, coml mgr & news dir; Lamar W. Harper, chief engr. ■ Rates: \$4.50; 4.50; 4.50; 4.50.

Crawfordsville

WCVL—Dec 12, 1964: 1550 khz; 250 w-U, DA-N. Box 603, Lagrange Rd. (47933). (317) 362-8200. WCVL Inc. (acq 3-6-68). Net: ABC/C. Rep: Selcom. Format: MOR. ■ John L. Sinclair Jr., pres & gen mgr; Dick Munro, sales mgr; Rich Adams, prog dir; Gary Davidson, news dir; Lee Hawk, chief engr. ■ Rates: \$7.75; 7.75; 6.70; 4.00.

WLFQ(FM)—Co-owned with WCVL June 1, 1974: 103.9 mhz; 3 kw. Ant 300 ft. Box 623 (47933). (317) 362-2700. Prog sep from AM. Format: C&W. ■ Rates: \$12; 12; 12; 9.

WNDY(FM)—Aug 13, 1953: 106.3 mhz; 900 w horiz, 890 w vert. Ant 77 ft. horiz, 72 ft. vert. 301 West Wabash Ave. (47933). (317) 362-6664. Wabash College Radio (acq 10-22-64). Format: Diversified. Spec progs: Farm, Jazz 5 hrs wkly. ■ Dr. J. O'Rourke, pres; K. Gray, gen mgr; P. Brown, prog dir; E. Smitt, chief engr. ■ Rates: \$23.40; 23.40; 23.40; 23.40.

Crown Point

WFLM(FM)—Nov 10, 1972: 103.9 mhz; 3 kw. Ant 300 ft. 250 N. Main St. (46307). (219) 663-7311. John Meyer Net: MBS. Rep: F. W. Smith. Format: Adult, easy listening. ■ John Meyer, gen mgr; Roger Knautz, prog dir; Claudia Sharp, coml mgr; Glenn Coble, prom mgr; Hank Harmon, mus dir; Richard Luedke, news dir; John Pelozo, sports dir; Gordon Boss, chief engr. ■ Rates: \$8.25; 6.20; 8.25; 6.20.

Danville

WGRT(FM)—Jan 10, 1975: 107.1 mhz; 3 kw. Ant 300 ft. Stereo. Box 301 (46122). (317) 745-6401. Hendricks County Bcstg Corp. Format: MOR. Spec prog: Farm 5 hrs wkly. ■ Gordon D. Graham, pres & coml mgr; Steve Miller, gen mgr & mus dir; Steve Ross, prog dir; Charlotte Sherley, prom mgr; Jay Stevens, news dir; Wayne B. Miller, chief engr.

Decatur

WADM—May 22, 1964: 1540 khz; 250 w-D. 233 N. 2d St. (46733). (219) 724-7161. Airon Inc. Net: MBS. Rep: Hopewell, Indiana Radio Net, Rgnl Reprs. Format: MOR. Spec progs: C&W 7 hrs, gosp 4 hrs wkly. ■ Gilbert Thomas, pres; Kenneth F. Pehlke, gen & coml mgr; David Sommerville, sec-treas; Larry F. Arnold, prog dir; Steve Sommers, news dir; Harold Adams, chief engr. ■ Rates: \$5.25; 5.25; 5.25; 5.25.

WADM-FM—Nov 8, 1966: 92.7 mhz; 3 kw. Ant 100 ft. Dup AM 75%. ■ Rates same as AM.

Elkhart

WCMR—March 16, 1956: 1270 khz; 5 kw-D, 500 w-N, DA-2. (46514). (219) 523-4567. TWX 219-875-5166. Progressive Bcstg System. Net: MBS. Rep: Devney. ■ Edwin C. Moore, gen mgr; James V. Hummel, coml mgr; Eric Culp, chief engr.

WXAX(FM)—Co-owned with WCMR. June 10, 1963: 104.7 mhz; 50 kw. Ant 195 ft. Stereo. Prog sep from AM.

WTRC—Nov 18, 1931: 1340 khz; 1 kw-D, 250 w-N. Box 699 (46514). (219) 293-5611. TWX 810-294-2242. Truth Radio Corp. Group: Communica. Net: NBC. Rep: Masla. Format: MOR. ■ John Diile Jr., chmn of bd; Ed Huot, stn & sis mgr; Allen Strike, prog dir; Ken Hinrichs, prom mgr; Lee Williams news dir; Tom Montgomery, chief engr. ■ Rates: \$16; 10.50; 14; 10.50.

WYEE(FM)—Co-owned with WTRC. April 1, 1947: 100.7 mhz; 14.5 kw. Ant 570 ft. Stereo. Prog sep from AM. Format: Easy listening. ■ Rates: \$9.50; 9.50; 9.50; 8.50.

***WVPE(FM)**—May 1972: 88.1 mhz; 10 kw. Ant 400 ft. 2424 California Rd. (46514). (219) 264-0771, ext 234. Elkhart Community Schools Corp. Net: NPR. Audio news: UPI. Format: Variety/Educational. ■ K.C. Kuespert, gen mgr & chief engr; Ned Trout, prog dir; D. Morgan, instructor; P. Tucker, aide.

WXAX(FM)—Listing follows WCMR.

WYEE(FM)—Listing follows WTRC.

Elwood

WBMP(FM)—June 28, 1964: 101.7 mhz; 3 kw. Ant 140 ft. Stereo. Box 101 (46036). (317) 552-5043. Heart of Hoosierland Co. (acq 1-1-71). Net: MBS. Format: MOR. Spec progs: Sp 2 hrs; C&W 12 hrs wkly. ■ Stanley L. Barton, pres; Scott Ridener, gen mgr; Donald Pille, prom mgr; Jim Toon, news dir.

Evansville

***WEVC(FM)**—April 1, 1951: 91.5 mhz; 5.7 kw. Ant 100 ft. Stereo. Box 329 (47702). (812) 479-2020. Univ. of Evansville. Format: Progs. Spec progs: Classical 8 hrs; Jazz 5 hrs wkly. ■ Gil Clardy, gen mgr & mus dir; Joe Ellsworth, news dir; Mike Orsburn, chief engr.

WGFB

Adult Contemporary



WGFB—Nov 22, 1923: 1280 khz; 5 kw-D, 1 kw-N, DA-N. 3809 Washington Ave (47734). (812) 477-8811. Metro Radio Co. Inc. (acq 4-1-75). Audio news: UPI. Rep: Pro/Meeker, Pearse Sls. Format: Top 40. Spec prog: farm 2 hrs wkly. ■ Timothy R. Ives, pres; Donald J. Newburg, VP & gen mgr; John E. Reiplinger, coml mgr; Randy Wheeler, news dir; Jim Wood, prog

Indiana Radio

See page C-1 for explanation of listings.

dir; Erwin P. Schoeny, chief engr. ■ Rates: \$18; 12.60; 15; 11.

WIKY. WIKY-FM

5:00 a.m. to 6:00 p.m.

MOR/Personalities

6:00 p.m. to 5:00 a.m.

Beautiful Music



EVERY-KNODEL, INC.

WIKY—Aug 6, 1947: 820 khz; 250 w-U, DA-1. 3848 (47736). (812) 424-8284. South Central Bcstg Corp. (group owner). Rep: Avery-Knodel, Rgnl Reprs. Format: MOR. Spec prog: Farm 1½ hrs wkly. ■ John A. Englebrecht, pres; Charles Blake, gen & coml mgr; Dave Lehman, prod mgr; Jim Burton, prog coord; John Bradford, news dir; Lee Thompson, chief engr. ■ Rates: \$17; 14; 17; 10.

WIKY-FM—Aug 29, 1948: 104.1 mhz; 50 kw. Ant 460 ft. Stereo. Dup AM 100%. ■ Rates same as AM.

WJPS—Oct 31, 1948: 1330 khz; 5 kw-D, 1 kw-N, DA-N. Box 3636 (47701). (812) 425-2221. Geyer Bcstg Inc. (acq 10-1-64). Net: ABC. Rep: Eastman, Ky Sis. Format: Contemp. ■ Wayne W. Geyer, pres & coml mgr; David R. Wood, stn mgr; Jim Stagg, prog dir; Stan Clark, news dir; John Wilson, chief engr.

***WPSR(FM)**—September 1957: 90.7 mhz; 14 kw. Ant 130 ft. 9201 Old Petersburg Rd. (47711). (812) 867-5876. Evansville Vanderburg School Corp. (acq 9-57). Format: Classical, Educational.

WROZ—1936: 1400 khz; 1 kw-D, 250 w-N. Box 139 (47701). (812) 422-4171. Radio Evansville Inc. (acq 10-61). Group: Fuqua Communications. Net: ABC/L. Rep: McGavren-Guild. Format: C&W. ■ Joseph V. Windsor, pres; Wilbur Walker, gen mgr; Billy "Tiny" Hughes, prog dir; Jay Michaels, mus dir; John Everett, news dir; Jerry Kissinger, chief engr. ■ Rates: \$24; 22; 24; 15.

WUAZ(FM)—See Henderson, Ky.

WVHI(FM)—Dec 22, 1964: 105.3 mhz; 50 kw horiz; 17 kw vert. Ant 320 ft. 6621 Kratzville Road (47712). (812) 425-4226. Valley Hi Bcstg Corp. Net: MBS. Format: Religious/sacred mus. ■ Samuel M. Angel, pres & gen mgr; John Johnson, prog dir; Ron Goodin, sales & prom mgr; Lenord Campbell, prog & mus dir; Maury Green, news dir; Jerry Kissinger, chief engr.

Fort Wayne

***WBCl(FM)**—Not on air; target date 10-15-75: 90.3 mhz; 50 kw. Ant 265 ft. Stereo. 1025 W. Rudisill Blvd. (46807). (219) 456-2111. Fort Wayne Bible College. Audio news: UPI. Format: Classical, religious. ■ Dr Timothy Warner, pres; Mike Hewberger, gen mgr; Bill Ryan, chief engr.

WCMX(FM)—Listing follows WFWR.

WFWR—June 17, 1968: 1090 khz; 1 kw-D, DA. 424 Reed Rd. (46805). (219) 422-4646. Fort Wayne Bcstg Co. Net: ABC/L. Format: C&W, religious. ■ Edwin C. Moore, VP & gen mgr; Guy Ewing, sis mgr; Jeffrey A. Carlson, prog & mus dir & chief engr.

WCMX(FM)—Co-owned with WFWR. Aug 24, 1970: 101.7 mhz; 3 kw. Ant 300 ft. Stereo. Dups AM 50%. Format: Good mus/contemp.

WGL—Jan 24, 1924: 1250 khz; 1 kw-U, DA-2. 2000 Lower Huntington Rd. (46809). (219) 747-1511. The News-Sentinel Bcstg Co. (acq 6-10-49). Net: CBS. Rep: Savalli/Gates. Spec progs: Sp 2 hrs; black 2 hrs both wkly. ■ Helene R. Foellinger, pres; Leonard E. Davis, VP, gen & coml mgr; Jon Patrick, prog dir; Dick James, news dir; Richard Miller, chief engr.

WLYV—March 28, 1948: 1450 khz; 1 kw-D, 250 w-N. 925 Anthony Wayne Bank Bldg. (46802). (219) 743-3443. Golden Bear Communications (acq 4-15-75). Net: ABC/E. Rep: McGavren-Guild, Rgnl Reprs. Format: C&W. ■ Herbert J. Weber, pres & gen mgr; Jim Seemiller, coml mgr; Jeff Blucher, prog dir &

Indiana Radio

See page C-1 for explanation of listings.

prom mgr; Jim Brady, mus dir; Scott Michaels, news dir; Roger Parkenson, chief engr.

WMEI—Nov 1947: 1380 khz; 5 kw-U, DA-2. Box 6000 (46806). (219) 447-5511. Pathfinder Communications Corp. (acq 4-14-57). Group: Communicana. Rep: Eastman. Format: Contemp. Spec prog: Farm ½ hr wkly. ■ John F. Dille, pres; Burton J. Sherwood, VP & gen mgr; Rick Hughes, prog & mus dir; Jack Maurer & Victor Locke, co-news dir; Bill Ryan, chief engr. ■ Rates: \$43; 37; 43; 37.

WMEF(FM)—Co-owned with WMEI. Feb 5, 1965: 97.3 mhz; 48 kw. Ant 510 ft. Quad stereo. Progs sep from AM. Format: Bflf mus. ■ Arthur R. Chapman II, prog dir. ■ Rates: \$37; 43; 43; 37.

WOWO—March 31, 1925: 1190 khz; 50 kw-U, DA-N. 128 W. Washington Blvd. (46802). (219) 742-8373. TWX 810-332-1515. Westinghouse Bcstg Co (acq 8-1-36). Rep: Radio Adv Reps. Audio news: Group W. Format: Farm, MOR, diversified, sports. ■ Marvin Shapiro, pres; Warren L. Maurer, gen mgr; Daniel F. Friel, Jr., sls mgr; Chris Rathaus, prog dir; Sam De-Vincent, mus dir; Dugan Fry, news dir; Bill Fong, prom mgr; B. L. Wolfe, chief engr. ■ Rates: \$68; 46; 49; 17.

WPTH(FM)—Feb 8, 1960: 95.1 mhz; 44 kw. Ant 680 ft. Stereo. Box 2671, Station D (46808). (219) 482-4596. Sarks Tarzian Inc. (group owner). Net: ABC/E. Format: Contemp. Spec progs: Classical 3 hrs wkly. ■ Don Ray, prog dir; Don Morgan, chief engr.

Frankfort

WILO—Nov 23, 1953: 1570 khz; 250 w-D. Box 255 (46041). (317) 659-3338. Kaspar Bcstg Co. Inc. (acq 10-1-59). Net: IBA News, Rural Radio Net. Rep: Hopewell. Format: Diversd; ■ V.J. Kaspar, pres & gen mgr; Vic Kaspar, prog dir; Harold "Skip" Davis, farm dir.

WILO-FM—Sept 14, 1962: 99.7 mhz; 5.9 kw. Ant 125 ft. Dup AM 70%.

Franklin

***WFCI(FM)**—Oct 15, 1960: 89.3 mhz; 10 w. Franklin College. (317) 736-8441. Franklin College of Indiana. ■ Raymond Cowan, faculty dir & chief engr.

WIFN(FM)—Dec 15, 1961: 95.9 mhz; 3 kw. Ant 300 ft. Box 194 (46131). (317) 736-9114. Vogel Douglas Corp. (acq 8-7-1). Group: Vogel. Net: MBS. Format: Top 40. Spec prog: Farm, wkly. ■ William R. Vogel, pres; Ronald Douglas, gen mgr & prog dir; Charles Sears, chief engr. ■ Rates: \$4.70; 4.70; 4.70; 4.70.

Gary

***WGVE(FM)**—Jan 1954: 88.7 mhz; 2.1 kw. Ant 91 ft. 1800 East 35th Ave. (46409). (219) 962-7571. School City of Gary. Net: NPR. Format: Ed/Pub Affairs. ■ Lawrence Ventura, gen mgr; Tony Rose, prog dir; Don Karp, chief engr.

WLTH—Nov 5, 1950: 1370 khz; 1 kw-D. 3669 Broadway (46409). (219) 884-9409. Northwestern Indiana Bcstg Corp. (acq 3-1-67). Net: MBS. Format: MOR, talk. Spec prog: Pol 1 hr wkly; Sp 4 hrs wkly; Greek 2 hrs wkly. ■ H.B. Snyder, pres; Dale Dawson, gen mgr; James Hallas, sls mgr; Tom Higgins, prog & mus dir; Dale Dawson, prom mgr; Mike Adler, news dir; Bill Eisele, chief engr. ■ Rates: \$16; 13; 16; 13.

WWCA—Dec 7, 1949: 1270 khz; 1 kw-U, DA-1. 545 Broadway (46402). 886-9171. Lake Bcstg Co. Net: ABC/E. Format: Black, community involved. ■ Dee O. Coe, pres; Joseph A. Haas, gen mgr; Ted Thorne, prog & news dir; Victor Voss, chief engr.

Gaston

***WDHS(FM)**—Nov 10, 1969: 91.1 mhz; 10 w. (CP: 89.9 mhz). R.R.1 (47342). (317) 358-4091. Harrison-Washington Community School Corp. Format: Educational. ■ Jim Mock, school board pres; Janice Pletcher, gen mgr; George A. Black, chief engr.

Goshen

***WGCS(FM)**—Oct 2, 1958: 91.1 mhz; 390 w. Ant 65 ft. Goshen College (46526). (219) 533-3161. Goshen College Bcstg Corp. Format: Classical, educl, religious. ■ J. Lawrence Burkholder, pres; Roy Umble,

gen mgr; L. Merlin Hoover, stn mgr; David Groff, prog dir; Larry Becker, mus dir; Jon Kennel, prom mgr; Kate Wenger, news dir; Vernon Schertz, engr sup; Caleb Hess; chief engr.

WKAM—1954: 1460 khz; 1 kw-D, 500 w-N, DA-N. 930 E. Lincoln Ave. (46526). (219) 533-1460. Kosciusko Bcstg Corp. (acq 10-15-56). Rep: Regional Reps. Format: MOR. ■ William N. Udell, pres; Gerald D. Grainger, gen mgr; Bill Musser, coml mgr; Dan Eckelbarger, mus dir; Carol Wargo, news dir. ■ Rates: \$36; 36; 36; 36.

Greencastle

***WGRE(FM)**—April 25, 1949: 91.5 mhz; 115 w. Ant 160 ft. Memorial Student Union (46135). (317) 653-3663. DePauw U. Format: Top 40, educl ■ William E. Kerstetter, pres; John R. Bittner, gen mgr; Larry White, prog dir; Karen Campbell, prom mgr; John Maxfield, mus dir; Richard Johnson, news dir; Robert Reeves, chief engr.

WXTA(FM)—May 16, 1966: 94.3 mhz; 3 kw. Ant 160 ft. Box 245 (46135). (317) 653-9717. Radio Greencastle (acq 8-7-1). Format: MOR; C&W. ■ Leon Buck, gen mgr & chief engr.

Greenfield

WSMJ(FM)—June 1, 1962: 99.5 mhz; 50 kw. Ant 240 ft horiz, 180 ft vert. Stereo. (CP: Ant 490 ft horiz, 485 ft vert). Box 248, 640 W. Ninth St. (46140). (317) 462-5511. WPFB Inc. (acq 2-1-65). Group: Braden. Net: IBA, Rural Radio. Audio news: UPI. Rep: Walton, Smith, Regional Reps. Format: Talk, MOR. Spec progs: Farm 8 hrs; Ger 1 hr wkly. ■ Paul F. Braden, pres; Earl W. Francis, gen mgr; Jay W. Riley, news dir; Curt Steele, chief engr.

Greensburg

WTRÉ—July 1, 1968: 1330 khz; 500 w-D, DA. 1011 Park Rd. (47240). (812) 663-3000. Soundiana Inc. ■ Robert V. Doll, pres; Robert A. Kincaid, VP & gen mgr; Randy Schneider, prog dir & chief engr; Chuck Underwood, news dir.

WTRÉ-FM—December 1962: 107.3 mhz; 50 kw. Ant 275 ft. Dup AM 50%.

Hammond

WJOB—1924: 1230 khz; 1 kw-D, 250 w-N. 6405 Olcott (46320). (219) 844-1230. Colby Bcstg Corp. (acq 2-23-60) Audio news: UPI. Format: MOR, talk. Spec progs: Black 10 hrs Sp 2 hrs; Pol 1 hr; Greek 1 hr wkly. ■ Julian Colby, pres; Judith Grambo, gen mgr; Roy Hoagland, coml mgr; Sharon Gardner, mus dir; Cosmo Currier Jr, news dir; Gordon Boss, chief engr. ■ Rates: \$14; 9; 12; 9.

WYCA(FM)—Sept 14, 1959: 92.3 mhz; 30 kw. Ant 400 ft. Stereo. 6336 Calumet Ave. (46324). (219) 933-0923; Ill (312) 734-0923. Crawford Bcstg Co. (group owner; acq 9-14-59). Format: Gospel. Spec prog: Black 3½ hrs wkly. ■ Dr. Donald Crawford, pres; Dick Marsh, gen mgr; Earl Larkins, prog dir; Susan Gayle, mus dir; Warren Shulz, chief engr. ■ Rates: \$8; 8; 8; 8.

Hartford City

WWHC(FM)—Feb 26, 1965: 104.9 mhz; 3 kw. Ant 155 ft. Stereo. Box 185 (47348). (317) 348-2665. Three J Radio Corp. Rep: Regional Reps. Format: MOR. Spec prog: C&W 4 hrs wkly. ■ John R. Maddox, pres; William C. Morris, gen mgr; John R. Maddox Jr, prog dir; Brian Trauring, prom mgr; Mark Prout, mus dir; Jan Porter, news dir; Richard H. Murray, chief engr. ■ Rates: \$2.90; 2.90; 2.90; 2.90.

Howe

***WHWE(FM)**—May 1, 1970: 89.7 mhz; 10 w. Ant 68 ft. Box 247 (46756). (219) 562-2501. Howe Military School. Format: Easy ltnsg; relig. ■ Col. Raymond Kelly, pres; William S. Hicks, gen mgr; Jim Boomgard, prog dir; Dean Harrison, prom mgr; Brad Bateman, news dir; Willard Davidson, chief engr; Dave Doles, music dir.

Huntingburg

WBDC(FM)—Not on air; target date unknown: 100.9 mhz; 3 kw. Ant 300 ft. Box 191 (47542). Dubois County Bcstg. ■ Paul E. Knies, owner.

Huntington

WHLT—May 25, 1957: 1300 khz; 500 w-D, DA. RR 4, Box 24 (46750). (219) 356-1640. Radio Huntington Inc., div of Williams County Bcstg (acq 9-22-71). Net: MBS. Rep: Regional Reps, Pearse. Format: MOR. ■ Carl L. Shipley, pres; Al Pillsbury, gen mgr; Don Jones, chief engr.

WHLT-FM—Sept 1, 1965: 103.1 mhz; 3 kw. Ant 91 ft. Dup AM 100%.

***WVSH(FM)**—Jan 1, 1950: 91.9 mhz; 920 w. Ant 110 ft. c/o Huntington North High School, 450 McGahn St. (46750). (219) 356-7818. Huntington County Community School Corp. Net: NPR. Format: Educl. ■ Roger H. Schepf, superintendent; Robert Straight, principal; William Walker Jr, gen mgr; Lloyd Myers, prog dir; Ken Wine, news dir; Paul Sale, sports dir; Don Bennet, chief engr.

Indianapolis

***WJAC(FM)**—Sept 3, 1949: 104.5 mhz; 36 kw. Ant 360 ft. 46th & Sunset (46208). (317) 283-9292. Butler U. Net: MBS. Format: Variety. ■ Alexander Jones, gen mgr; James R. Philippe, mgr; Ann Harper, opns mgr.

WATI—May 15, 1963: 810 khz; 250 w-D. 3490 Bluff Rd. (46227). (317) 787-2211. Sarks Tarzian Inc (group owner; acq 5-16-64). Rep: Century Natl. Format: Beautiful mus. ■ Sarks Tarzian, pres; Elmer Snow, bcstst div mgr; Robert Lamb, gen mgr; Bruce Shannon, mus & prog dir; Don Morgan, chief engr. ■ WTTV(TV) affil. ■ Rates: \$15; 13; 15. —.

***WBDG(FM)**—Sept 13, 1965: 90.9 mhz; 328 w horiz, 200 w vert. Ant 105 ft. 1200 N. Girls School Rd. (48224). (317) 244-7694. Metropolitan School District of Wayne Township. Net: NPR. Format: Educl. Spec progs: MOR 5 hrs wkly. ■ William D. Webb, gen mgr; William Wakefield, prog dir; Thomas Allebrandi, chief engr.

WBRI—March 12, 1964: 1500 khz; 5 kw-D, DA. 4802 E. 62d St. (46220). (317) 255-5484. Radio One-Five-Hundred Inc. Format: Relig. ■ Douglas D. Kahle, pres; Thomas J. Wallace, gen mgr; Robert L. Todd, prog mgr.

***WEDM(FM)**—Sept 14, 1970: 91.1 mhz; 10 w. Ant 60 ft. 9500 East 16th St. (46229). (317) 898-6133. Metropolitan District of Warren Township. Audio news: UPI. Format: Noncoml diversified. Spec progs: Classical 2 hrs; jazz 1 hr; C&W 2 hrs wkly. ■ Barbara Knave, gen mgr.

WFBQ(FM)—Listing follows WNDE.

WFMS(FM)—March 17, 1957: 95.5 mhz; 45 kw. Ant 520 ft. Stereo. Box 18270 (46218). (317) 359-5511. Radio Indianapolis Inc. (acq 11-20-72). Group: Susquehanna Bcstg. Audio news: UPI. Rep: Savalli/Gates. Format: MOR. ■ Louis J. Appell Jr, pres; Arthur W. Carlson, VP; Stan Barrett, stn mgr; Rick Bernard, prog mgr; Doug Ross, news dir; Craig Kallio, pub affairs dir; Rick Martin, chief engr.

***WIAN(FM)**—Oct 29, 1954: 90.1 mhz 10 kw. Ant 36 ft. 931 Fletcher Ave. (46203). (317) 266-4141. Board of School Commissioners of Indianapolis. Net: NPR. Format: Classical, talk, educl. ■ Nancy Hendricks, supvr, radio-TV; Art Van Allen, prog dir; John Woylinek, news dir; John L. Krom, chief engr.

WIBC—1938: 1070 khz; 50 kw-D, 10 kw-N, DA 2. 2835 N. Illinois St. (46208). (317) 924-5211. Fairbanks Bcstg. Co. Inc. (group owner; acq 10-25-48). Audio news: APR. Format: MOR. Spec progs: Farm 5 hrs; black 1 hr; Sp 1 hr wkly. ■ R. M. Fairbanks, pres; James C. Hilliard, exec VP & gen mgr; R. E. Yancey VP & gen sls mgr; George Johns, prog dir; Gary Todd, prom mgr; Fred Heckman, news dir; Richard Smart, VP engr.

WNAP(FM)—Co-owned with WIBC. Dec 5, 1960: 93.1 mhz; 50 kw. Ant 370 ft. Stereo. Progs sep from WIBC. Format: Top 40. Spec progs: Farm, black, Sp, all 1 hr wkly. ■ Donald Seeley, sls mgr; Chris Connor, prog dir; Tom Cochran, news dir; Bob Brockwicz, chief engr.

***WICR(FM)**—Aug 20, 1962: 88.7 mhz; 10 w. 4001 Otterbein Ave. (46227). (317) 783-3730. Indiana Central U. Format: Ed, rock, MOR. Spec progs: Fr 4 hrs; Sp 2 hrs; black 10 hrs C&W 6 hrs; relig 10 hrs wkly. ■ William Myers, gen mgr; Lewis Gibson, prog dir; Ames E. Brown III, prom mgr; Ronald Garner, news dir; Charles D. Sears, chief engr.

WIFE—July 27, 1941: 1310 khz; 5 kw-D, 1 kw-N, DA-N. 1440 N. Meridian St. (46202). (317) 637-1375. Star Stations of Indiana Inc. (group owner; acq 11-63). Rep: H-R/Stone. ■ Robert D. Kiley, pres & gen mgr; Jack N. Marsella, s/s mgr; Bill Bennett, news dir; Kay Porter Larson, prom mgr; Murray Smith, chief engr.

WIFE-FM—Oct 22, 1961: 107.9 mhz; 41 kw. Ant 910 ft. Stereo. Prog sep from WIFE.

WIRE—1923: 1430 khz; 5 kw-U, DA-N. 4560 Knollton Road (46208). (317) 925-9201. Mid-America NBC Inc. (group owner; acq 6-1-64). Net: ABC/E, NBC. Format: C&W. Spec prog: Farm 11 hrs wkly ■ Burrell L. Small, pres; Don N. Nelson, VP & gen mgr; F. Richard Lee, gen s/s mgr; Pieter Robinson, opns mgr; Lee Shannon, mus dir; Robert Miles, news dir; Bob Jenkins, farm dir; Gordon W. Trout, chief engr. ■ Rates: \$81; 65; 75; 34.

WXTZ(FM)—Co-owned with WIRE. May 15, 1964: 103.3 mhz; 13.2 kw. Ant 850 ft. (acq 3-72). Prog sep from AM. Format: Btlf music. ■ William Franzman, opns mgr. ■ Rates: \$34; 38; 38; 34.

***WJEL(FM)**—Sept 3, 1975: 89.1 mhz; 27 w. Ant 180 ft. 1605 E. 86th St. (46240). (317) 259-1171. Metropolitan School District of Washington Township. Format: Educl. ■ H. Dean Evans, supt; John King, gen mgr; Robert Tylnski, chief engr.

WNAP(FM)—Listing follows WIBC.

WNDE—Oct 23, 1924: 1260 khz; 5 kw-U, DA-N. 6161 Fall Creek Rd. (46220). (317) 257-7565. WFBI Inc. (acq 7-6-72). Group: Rahall. Net: ABC/C. Rep: Katz (USA). Format: Contemp/MOR. ■ Jack W. Lee, pres; Murray J. Green, gen mgr; T. J. Donnelly, gen s/s mgr; William Hennes, prog dir; Rosalie Klusker, prom mgr; Chuck Morgan, mus dir; Julian Mouton, news dir; Charles Collingwood, chief engr. ■ Rates: \$65; 51; 56; 51.

WFBQ(FM)—Co-owned with WNDE. Nov 26, 1959: 94.7 mhz; 52kw. Ant 850 ft. Stereo. Progs sep from AM. Format: Adult rock. ■ Rates: \$16; 16; 16; 16.

WNTS—Dec 19, 1956: 1590 khz; 5 kw-D, DA. 4800 E. Raymond St. (46203). (317) 359-5591. S & M Bcstg Co. (acq 4-15-74). Net: ABC/I. Format: News/Talk. ■ S. W. Smulyan, pres; J. H. Smulyan, VP & gen mgr; Mill Lewis, VP & s/s mgr; Richard Cummings, opns mgr; Bill Butler, news dir; Warren Fooks, chief engr.

WTLC(FM)—Jan 22, 1968: 105.7 mhz; 50 kw. Ant 135 ft. Stereo. 2128 N. Meridian St. (48604). (317) 784-4471. Community Media Corp. (acq 2-14-73). Rep: Selcom, Bottom Line. Format: Black. ■ Frank P. Lloyd, pres; Andy Johnston, gen mgr; Fred Moore, prog dir; Al Hobbs, s/s mgr. ■ Rates: \$19; 19; 21; 19.

WXLW—August 1948: 950 khz; 5 kw-D, DA. 3003 Kessler Blvd. (46222). (317) 925-6494. Shirk Inc. (acq 11-30-74). Net: CBS. Audio news: APR, UPI. Rep: Pro/Meeker. Format: MOR, Talk. ■ William S. Poorman, pres; Richard E. Wickham, VP & gen mgr; Wikemp Shafer, coml mgr; Steve Michaels, mus dir; Paul Scheuring, news dir. ■ Rates: \$25; 21; 25; —.

WXTZ(FM)—Listing follows WIRE.

Jasper

WITZ—July 4, 1948: 990 khz; 1 kw-D. Box 167 (47546). (812) 482-3131. Jasper On The Air Inc. Audio news: APR. Rep: Regional Reps Corp. Format: MOR. ■ Louis O. Mitzlaff, pres; G. Earl Metzger II, gen mgr; Bob Boyles, coml mgr; Ron Weeks, prog dir; Jerry Rauscher, news dir; Tom Holiday, mus dir. ■ Rates: \$5.50; 4.50; 5.00; 4.50.

WITZ-FM—Nov 1, 1954: 104.7 mhz; 50 kw. Ant 470 ft. Stereo. Dup AM 70%. ■ Rates same as AM.

Jeffersonville

WQHI(FM)—April 25, 1974: 95.7 mhz; 34 kw. Ant 580 ft. 207 Sparks Ave. (47130). (812) 288-8244. Whatever's Fair Inc. Rep: Selcom. Format: Black, Contemporary, Progressive. ■ John T. Rutledge, pres; Michael W. Balton, gen mgr; Leslie Balton, coml mgr; Charles B. Champion, prog & mus dir; William D. Elliot, chief engr.

WXXV—June 26, 1961: 1450 khz; 1 kw-D, 250 w-N. Box 666 (47130). (812) 283-3577. Electrocast Inc. Net: ABC/I. Ind. News Net. Rep: Nat Time Sls, Rgnl Reps. Format: MOR, Oldies. ■ Clarence Henson, pres; Charles H. Jenkins Jr., gen mgr; Michael Densford,

prog & mus dir; Jerry Fordyce, news dir; William Hiner, sales mgr; David Burns, chief engr. ■ Rates: \$9; 9; 9; 7.

Kendallville

WAWK—Nov 9, 1955: 1140 khz; 250 w-D. Box 47 (46755). (219) 347-2400. Noble DeKalb Bcstg Co. (acq 8-1-57). Audio news: AP. Format: MOR. ■ Paul L. King, pres & gen mgr; Fred Manahan, VP & prog mgr. ■ Rates: \$5.95; 5.95; 5.95; 5.95.

WAWK-FM—Dec 16, 1964: 93.3 mhz; 37 kw horiz, 6 kw vert. Ant 275 ft. Stereo. Dups AM 50%. ■ Rates same as AM.

Knox

WKVI—July 21, 1969: 1520 khz; 250 w-D. Box 12 (46534). (219) 772-6241. Kankakee Valley Bcstg Co. Rep: Robert J. Walton. Format: MOR. ■ Tom Bell, pres; Ted Hayes, gen mgr; Norm Strangland, news dir; Robert Densmore, chief engr.

WKVI-FM—July 21, 1969: 99.3 mhz; 3 kw. Ant 300 ft. Dups AM 100%.

Kokomo

WIOU—July 16, 1948: 1350 khz; 5 kw-D, 1 kw-N, DA-2. Box 2208 (46901). (317) 453-1212. Booth American Co. (group owner; acq 10-15-56). Net: ABC/I. Rep: Torbet, Regional Reps. Format: Contemp/MOR. Spec progs: Black 5 hrs; Sp 1½ hrs wkly. ■ John L. Booth, pres; William R. (Bill) Williamson, gen mgr; Donald R. Rice, coml mgr; Jim Day, prog mgr; Don McKellar, news dir; John Brown, chief engr.

WKMO(FM)—Co-owned with WIOU. Nov 20, 1964: 93.5 mhz; 3 kw. 185 ft. Stereo. Prog sep from AM. Format: Beautiful music.

WVKI(FM)—Oct 21, 1962: 100.5 mhz; 20 kw. Ant 460 ft. 304 N. Main (46901). (317) 452-9845. BGS Bcstg (acq 5-1-68). Net: MBS. Format: C&W. ■ James L. Gregg, pres & gen mgr; Charles Cropper, prog dir; Tony Morris, mus dir; Phil Jessup, news dir. ■ Rates: \$10.30; 10.30; 10.30; 7.30.

Lafayette

WASK—1942: 1450 khz; 1 kw-D, 250 w-N. Box 880 (47902). (317) 447-2186. Lafayette Bcstg Inc. (acq 4-5-7). Rep: Ohio Stns. ■ Henry Rosenthal, pres & gen mgr; Bill Kniesley, coml mgr; Jerry Collins, prog dir; Mike Piggott, news dir; George Williamson, chief engr.

WASK-FM—Aug 1, 1954: 105.3 mhz; 50 kw. Ant 310 ft. Stereo.

WAZY AM/FM

A Journal Star Station

WAZY—Nov 28, 1959: 1410 khz; 1 kw-D, DA. Box 1410 (47902). (317) 474-1410. Radio Lafayette (acq 3-1-70). Group owner: Journal-Star (Peoria). Net: ABC/C. Rep: Torbet. Format: Contemp, Top 40, Rock. ■ F. Patrick Nugent, exec VP; Hal M. Youart, gen mgr; Patrick Leahy, prog dir; Michael H. O'Reilly, mus dir; David La Prad, news dir; Robert F. Waiss, chief engr. ■ Rates: \$18; 15; 18; 15.

WAZY-FM—March 1965: 96.7 mhz; 3 kw. Ant 150 ft. Dups AM 100%. ■ Rates: \$9; 7.50; 9; 7.50.

***WJEF(FM)**—Feb 7, 1972: 91.9 mhz; 250 w. Ant 91 ft. 1801 South 18th St. (47905). (317) 474-3434. Lafayette School Corp. Format: Variety, educ, MOR. ■ William S. Fraser, dir of radio-TV; Stevan W. Speheger, chief engr.

WXUS(FM)—January 1, 1970: 92.7 mhz; 3 kw. Ant 215 ft. 1000 Ortman Lane (47905). (317) 474-1494. Tiprad Bcstg Co. Rep: Smith (New York). Format: Contemp/Top 40. ■ David M. Stevenson, pres & gen mgr; Don Walters, coml & prom mgr; Connie Stevenson, prog & mus dir; William Harris, chief engr.

La Porte

WCOE(FM)—Listing follows WLOI.

WLOI—1948: 1540 khz; 250 w-D. Box 385 (46350). (219) 362-6144. La Porte County Bcstg (acq 1955). Net: ABC/E. Rural Radio. Format: MOR. Spec prog: Farm 6 hrs wkly. ■ Dee O. Coe, pres; Kenneth S. Coe,

Indiana Radio

See page C-1 for explanation of listings.

gen mgr; Shaw Freidman, mus dir; Allan Reibe, news dir; Vic Voss, chief engr. ■ Rates: \$6.50; 6.25; 6.50; 6.25.

WCOE(FM)—Co-owned with WLOI Jan 23, 1964: 96.7 mhz; 3 kw. Ant 265 ft. (219) 362-7095. Duplicates AM 10% (news only). Format: C&W. ■ John Coe, mgr; Bruce Lather, prog dir; Debbie Miller, traf dir; Frank Thomas, chief engr. ■ Rates same as AM.

Lebanon

WNON(FM)—May 28, 1967: 100.9 mhz; 3 kw. Ant 300 ft. Box 227 (46052). (317) 482-4427. Boone Comm Inc. (acq 1-20-73). Rep: Walton, Rgnl Reps. Format: MOR. ■ Warren A. Wright, pres, gen & coml mgr; Greg A. Smith, prog & mus dir; Barbara J. Smith, news dir; Thomas M. Allebrand, chief engr.

Linton

WBTO—Oct 10, 1953: 1600 khz; 500 w-D. Box 231 (47441). (812) 847-4474. Linton Bcstg Inc. (acq 1-64). ■ H. D. Boardman, pres, gen & coml mgr & chief engr; Mrs. Geraldine Boardman, prog dir.

WBTO-FM—Sept 14, 1970: 93.5 mhz; 3 kw. Ant 230 ft. Format: Easy lstdg. Prog sep from AM.

Logansport

WSAL—Feb 24, 1949: 1230 khz; 1 kw-D, 250 w-N. Box 719 (46947). (219) 753-3111. Logansport Bcstg Corp. Net: MBS. Format: MOR. ■ Glenn L. Miller, pres; Joseph A. Wiler, gen & coml mgr; James A. Bender, opns dir; Victor Tanguy Jr, asst mgr & sports dir; Ellis Marvin, news dir; Ray Olson, chief engr. ■ Rates: \$9.10; 9.10; 9.10; 9.10.

WSAL-FM—May 11, 1965: 102.3 mhz; 3 kw. Ant 300 ft. Dup AM 90%. ■ Rates same as AM.

Lowell

WLCL-FM—Nov 24, 1972: 107.1 mhz; 3 kw. Ant 300 ft. Box 311 (46356). (219) 696-7731. William Joseph Dunn. Format: Contemp.

Madison

WORX—March 1956: 1270 khz; 1 kw-D, DA. Box 95, Telegraph Hill (47250). (812) 265-3322. WORX Div, Electronic Lab Inc. Net: ABC. Format: MOR. Spec progs: Sp 3 hrs wkly, farm 1 hr wkly; C&W 4½ hrs wkly. ■ Lester G. Spencer, pres; William C. Fowler, gen mgr; Bill Lamb, mus dir; Carolyn Bush, prom mgr; Mike Burton, news dir; Warren Arnett, chief engr. ■ Rates: \$9; 8; 9; 6.50.

WORX-FM—March 1950: 96.7 mhz; 3 kw. Ant 230 ft. Dup AM 75%.

Marion

WBAT—June 7, 1947: 1400 khz; 1 kw-D, 250 w-N, DA-1. 120 N. Miller Ave. (46952). (317) 664-6239. Marion Radio Corp. (acq 10-1-56). Group: Central. Net: CBS. Rep: Pro/Meeker. Format: Adult radio. Spec progs: Sp 3 hrs wkly, farm 1 hr wkly; C&W 4½ hrs wkly. ■ Lester G. Spencer, pres; William C. Fowler, gen mgr; Bill Lamb, mus dir; Carolyn Bush, prom mgr; Mike Burton, news dir; Warren Arnett, chief engr. ■ Rates: \$9; 8; 9; 6.50.

WGOM—May 11, 1955: 860 khz; 250 w-D, DA. Box 538, 820 S. Pennsylvania St. (46952). (317) 664-7396. WWRI Inc. (acq 1-1-66). Net: ABC/C. IBANN. Audio news: APR. Rep: Regional Reps. Format: Contemp. ■ Frank Bowie, pres; Louis Ul Disinger, VP, gen & coml mgr; Rich Coolman, prog dir; Frank Hawkins, prom mgr; Stan Niel, mus dir; Dave Smith, news dir; Ed Webster, chief engr. ■ Rates: \$7.25; 7.25; 7.25; 7.25.

WMRI(FM)—Co-owned with WGOM. Dec 19, 1948: 106.9 mhz; 50 kw. Ant 240 ft. Stereo. Prog sep from AM. Net: ABC/E. Format: Beautiful music. ■ Norm Wolf, prog & mus dir; William Louckes, chief engr. ■ Rates same as AM.

Martinsville

WCBK—April 18, 1967: 1540 khz; 250 w-D. 217 E. Washington St. (46151). (317) 342-3394. Morgan County Bcstrs Inc. Net: MBS. Spec prog: C&W 18 hrs

Indiana Radio

See page C-1 for explanation of listings.

wkly ■ David Keister, pres & gen mgr; Jeff Hancock, coml mgr; Jack Shannon, prog mgr; Bette Hoover, prom mgr; Jerry Holmes, news dir; Don Scales, chief engr. ■ Rates: \$7; 7; 7.

WCBK-FM—Oct 15, 1968: 102.3 mhz; 3 kw. Ant 300 ft. Dups AM 50%. ■ Rates same as AM.

Michigan City

WIMS—Aug 10, 1947: 1420 khz; 5 kw-D, 500 w-N, DA-2. Old Chicago Rd. (46360). (219) 874-5245. Northern Indiana Bcstrs Inc. (acq 12-50). Format: MOR. Spec progs: Pol 1½ hrs; black 2 hrs, C&W 5 hrs wkly. ■ William N. Udell, pres & gen mgr; S. C. McDonnell, Alan Mansfield, John Carpenter, coml dept; Patricia Turk, prog dir; Frank Flanagan, news dir; R. J. Schilling, chief engr & mus dir.

WMCB-FM—Sept 15, 1966: 95.9 mhz; 2.8 kw. Ant 220 ft. 1903 Springland Ave. (46360). (219) 879-8201. Mich. City FM Bcstrs. Net: Indiana Radio Net. Rep: Walton Blastg Corp. Format: Adult Contemp. Spec prog: Black 2 hrs wkly. ■ Thomas Burns, pres & gen mgr; Mary Ellen Burns, news mgr & news dir; C.W. Vanover, coml mgr; Greg Locndy, mus dir; Paul Schreiber, prom mgr; Harry Garba, chief engr. ■ Rates: \$5.50; 5.50; 5.50; 5.50.

Monticello

WVTL(FM)—April 16, 1967: 95.3 mhz; 3 kw. Ant 135 ft. Box 570 (47960). (219) 583-8266. Twin Lakes Bcstg Inc. (acq 3-1-74). Net: ABC/E. Rep: Regional Reps. Format: MOR. ■ Lee Buck, pres; Doug McLuen, VP & gen mgr; Robert Vizza, prog dir; Terry Etter, news dir; John Baluch, sports dir; Kenneth E. Gardner, chief engr.

Mt. Vernon

WPCC—Aug 21, 1955: 1590 khz; 500 w-D. Box 526 (47620). (812) 838-4484. Mt. Vernon Bcstg Co. (acq 3-28-74). Net: MBS. Format: MOR. ■ Kenneth Johnson, pres; Courtney Smith, gen & coml mgr & news dir; Jerry Kissinger, chief engr.

Muncie

***WBST(FM)**—Sept 1960: 90.7 mhz; 10 w. Center for Radio & TV, Ball State U. (47306). (317) 285-4174. Ball State U. Format: Fine Arts. ■ Dr. John J. Pruis, pres; Dr. William H. Tomlinson, dir; M. John Eiden, mgr; Garvin Phillips, chief engr.

WERK—Feb 14, 1965: 990 khz; 250 w-D, DA. Box 2812 (47302). (317) 289-3311. Muncie Bcstg Corp. Rep: Radio Time Sls. ■ Robt. J. Poorman, pres; William Shirk Poorman, gen mgr; Admin Ludwig, sls mgr; Larry McCabe, prog dir; Fred Moore Hinshaw, news dir; Horace N. Smith, chief engr.

WLBC—Nov 1926: 1340 khz; 1 kw-D, 250 w-N, 820 E. 29th St. (47302). (317) 288-4403. Tri City Radio Corp. Net: CBS. Rep: Meeker. Format: MOR. ■ Don Burton, pres; John M. Craig, coml mgr; Lee W. Allerton, prog dir; Larry T. Dotson, news dir; Patrick S. Finnegan, chief engr.

WLBC-FM—October 1947: 104.1 mhz; 50 kw. Ant 423 ft. Stereo. Prog sep from AM. Format: Solid good rock & roll.

***WWHI(FM)**—1950: 91.5 mhz; 330 w. 79 ft. 1601 E. 26th St. (47302). (317) 282-5971. South Side High School. Muncie Community Schools. Format: Ed. ■ James F. Bailey, gen mgr.

New Albany

WHEL—June 15, 1949: 1570 khz; 1 kw-D. Box 378 (47150). (812) 944-5474. WHEL Inc. (acq 3-73). Net: ABC. ■ James J. Nathan, pres.

***WNAS(FM)**—May 28, 1949: 88.1 mhz; 800 w. Ant minus 32 ft. 1020 Vincennes St. (47150). (812) 944-2216. New Albany-Floyd County Consolidated School Corp. Format: Educl. Spec prog: Fr 1 hr; Ger 1 hr; Sp 1 hr; black ½ hr wkly. ■ Lee Kelly, gen mgr; David Cooper, chief engr.

WREY—Feb 14, 1966: 1290 khz; 500 w-D, DA. Box 634 (47150). (812) 945-9195. New Albany Bcstg Co. Audio news: UPI. Spec progs: Farm 10 hrs; btfl mus

15 hrs wkly. Format: MOR. ■ Stuart K. Lankford, pres; Larry Price, gen mgr; Bob Anthis, coml mgr; Steve Sheley, opns dir; Michael A. Warner, mus dir; Larry Miller, prom mgr; Cathy Price, news dir; Linda Dillow, women's dir. ■ Rates: \$6; 5; 6; 4.50.

New Castle

WCTW—Nov 14, 1960: 1550 khz; 250 w-U, DA-2. Box 690 (47362). (317) 529-2600. Public Svc Bcstrs Inc. (acq 8-1-71). Group: PSB Radio. Format: MOR, C&W. Spec prog: farm 12 hrs wkly. ■ Donald G. Jones, pres; Kirk Patrick, gen mgr; Max Showalter, news dir; Rob Tooley, chief engr.

WMDH(FM)—Co-owned with WCTW. Aug 6, 1947: 102.5 mhz; 20 kw. Ant 225 ft. (CP-21 kw. Ant 440 ft.). Stereo. Box 687 (47362). Format: MOR. ■ William R. Van Arsdall, gen mgr.

Noblesville

WHYT—Nov 1, 1973: 1110 khz, 250 w-D, DA. 2401 Cicero Rd. (46060). (317) 773-0333. Mid-Indiana Bcstg Corp. Rep: Rgnl Reps. Format: MOR. Spec progs: C&W 6 hrs wkly. ■ Wendell Hansen, pres; Elaine Roberts, coml mgr; Donna Elliott, prom mgr; Hank Roedel, mus dir; Curt Gibson, news dir; Horace Smith, chief engr.

North Manchester

***WBKE-FM**—May 1967: 89.5 mhz; 3 kw. Ant 80 ft. Box 88, Manchester College (46962). (219) 982-2141, ext 241. Manchester College. Format: Educl, Variety. Spec prog: Classical 12 hrs wkly. ■ A. Blair Helman, pres; Samuel M. Davis, dir of bcstg; Mark Tomlinson, gen mgr; Randy Eckert, bus mgr; Mark Bontrager, prog dir; Rick Kasnet, mus dir; Karen Kennedy, news dir; Jay Shumway, prom mgr; Dick Murray, chief engr.

North Veron

WOCH—Jan 8, 1955: 1460 khz; 1 kw-D. Box 46 (47265). (812) 346-2777. Dorrell Ochs. Rep: Regional Reps, Walton. Format: C&W. ■ Dorrell Ochs, pres; Charles R. Plummer, gen & coml mgr; Mike Conn, prog dir; Tom Anderson, news & mus dir; Jimmie Ochs, chief engr.

WOCH-FM—March 19, 1963: 106.1 mhz; 50 kw. Ant 165 ft. Stereo. Dups AM 66% Format: Btfl mus.

Notre Dame

***WSND-FM**—Sept 17, 1962: 88.9 mhz; 3.4 kw. Ant 360 ft. Box 532 (46556). (219) 283-7342. The U. of Notre Dame du Lac. Net: Group W. Format: Classcl, educational, jazz. ■ Father Edmund P. Joyce C.S.C., pres; Mark Arminio, stn mgr; Richard Deak, bus mgr; Ed Jaroszewski, prog dir; Connel McGee, mus dir; Mark Krepich, news dir; John Vozzo, sports dir; Tom Canavan, chief engr.

Paoli

WVAK—Dec 7, 1963: 1560 khz; 250 w-D. Box 150 (47454). (812) 723-3600. Z. Denzel King and Virginia A. King. Format: C&W. ■ Z. Denzel King Sr., pres; Virginia A. King, gen mgr; Eric R. King, Sr., coml mgr & news dir; Gary D. King, prog dir & prom mgr; Arthur Little, chief engr.

WVAK-FM—1972: 95.3 mhz; 3 kw. Ant 300 ft. Dups AM 100%.

Pendleton

***WEEM(FM)**—October 1971: 91.7 mhz; 18 w. Ant 100 ft. Box 240 (46064). (317) 778-2161. South Madison Community School Corp. Net: NPR. Format: MOR, Variety. Spec progs: Black 1 hr; C&W 3 hrs; Pol 4 hrs wkly. ■ Earl Cousert, pres; Robert E. Nibarger, gen mgr; Tod Miller, coml mgr; Morris DeShong, prog dir; Ross Goodman, prom mgr; Randy Stohler, mus dir; Steve Stewart, news dir; Dave Hood, chief engr.

Peru

WARU—Sept 12, 1954: 1600 khz; 1 kw-D. Box "A" (46970). (317) 473-4448. Wabash-Peru Bcstg Co. (acq 6-58). Net: ABC/I. Rep: Devney, Regional Reps. Format: Easy rock. ■ Richard W. Schultz, pres, gen & coml mgr; Tom Rusk, prog mgr; Leon Thomas, news dir; Dave Walrod, chief engr.

WARU-FM—April 5, 1965: 98.3 mhz; 3 kw. Ant 43 ft.

Stereo. Dups WARU 15%. Format: Adult MOR.

Plainfield

WART(FM)—Aug 16, 1964: 98.3 mhz; 3 kw. Ant 200 ft. Stereo. Box 5 (46168). (317) 839-2366. A&R Bcstg Inc. (acq 9-13-74). Format: C&W. Spec prog: Farm 3½ hrs wkly. ■ Thomas M. Allebrandi, pres, gen mgr & chief engr. ■ Rates: \$5; 5; 5; 5.

Plymouth

WTCA—Aug 18, 1964: 1050 khz; 250 w-D, DA. 112 W. Washington St. (46563). (219) 936-4096. Community Service Bcstrs. Format: MOR. Spec progs: C&W 6 hrs wkly. ■ Kenneth E. Kunze, pres; gen mgr, prog dir & chief engr; R. S. Smith, coml mgr; Chris Kiefer, news dir; James C. Kunze, mus dir; Jeanne C. Kunze, women's dir. ■ Rates: \$5.75; 5.75; 5.75; 5.75.

WTCA-FM—July 20, 1966: 94.3 mhz; 3 kw. Ant 220 ft. Stereo. Dups AM 30%. ■ Rates same as AM.

Portland

WPGW—Jan 14, 1951: 1440 khz; 500 w-D, DA. Box 1440 (47371). (317) 726-8780. WPGW Inc. (acq 8-1-74). Net: ABC/C. Rep: Ohio Reps. Format: Contemp. ■ Robert C. Brandon, pres & gen mgr; Betty Stone, office mgr; Neil Hersberger, coml mgr; Greg Beumer, mus dir. ■ Rates: \$3.30; 3.30; 3.30; 3.30.

WPGW-FM—May 19, 1975: 100.9 mhz; 3 kw. Ant 180 ft.

Princeton

WRAY—Dec 16, 1950: 1250 khz; 1 kw-D. Box 8 (47670). (812) 385-4861. Princeton Bcstg Co Inc. Net: MBS. Rep: Devney. ■ Ray J. Lankford, stn mgr; Richard Lankford, sports & news dir; D. T. Critchfield, sls mgr; Jack Mauck, chief engr.

WRAY-FM—May 15, 1960: 98.1 mhz; 50 kw. Ant 400 ft. Stereo. Dup AM 100%.

Rensselaer

WJCK(FM)—1974: 97.7 mhz; 3 kw. Ant 300 ft. RR 6 Box 3 (47978). (219) 866-3252. J. C. Bcstg Inc. Rep: Walton. Format: Easy Listening. Spec progs: Farm 10 hrs; classical 12 hrs wkly. ■ John A. Felthouse, pres & chief engr; Don Brady, prog dir; Steve Winters, coml mgr; Robin Hartman, news dir. ■ Rates: \$2.88; 2.88; 2.88; 2.88.

WRIN—Sept 14, 1963: 1560 khz; 1 kw-D. (500 w-Ch). Box 282 (47978). (219) 866-5105. Jasper County Bcstg Corp. ■ Anthony DiCarlo, pres; Norman Miller, chief engr.

Richmond

***WECI(FM)**—September 1964: 91.5 mhz; 10 w. Box E 1239 (63141). (317) 962-3541. Earlham College. Net: NPR. Format: Progs, diversified. Spec progs: Jazz 8 hrs; black 8 hrs; folk 8 hrs; talk 1½ hrs wkly. ■ Nancy O'Leary, gen mgr; Kim Tekolske, Larry Passmore, mus dirs; John Seidenburg, news dir; John W. Schuerman, chief engr.

WHON—(Centerville) Feb 17, 1964: 930 khz; 500 w-D, DA. Box 1647 (47374). (317) 962-1595. Brewer Broadcasting Corp. (acq 3-10-66). Net: ABC/C. Rep: Smith, Regional Reps. Format: Contemp. ■ James R. Brewer, pres; Richard Huckaba, gen mgr; Mike Day, coml mgr; Jerry Brewer, prog dir; Charles Steger, chief engr.

WQLK(FM)—Co-owned with WHON. Oct 15, 1970: 96.1 mhz; 28 kw. Ant 350 ft. (317) 966-3932. Net: ABC/FM. Format: Nostalgic easy lstrg. ■ Phil Smith, sls mgr.

WKBV—Sept 27, 1926: 1490 khz; 1 kw-D, 250 w-N. Box 1646. 2301 W. Main St. (47374). (317) 962-6533. Central Bcstg Corp. (group owner; acq 1944). Net: ABC/I. Rep: PRO-Meeker; Pearse & Gray. Format: MOR, C&W, farm. ■ Lester G. Spencer, pres & gen mgr; Phil H. Stigleman, coml mgr; Jay Schultz, prom mgr; Charles Estes, prog dir; Jamalyn McNutt, mus dir; Ted Westbrook, news dir; Lou Duning, chief engr.

WKBV-FM—Dec 17, 1960: 101.3 mhz; 23 kw. Ant 280 ft. Stereo. Prog sep from AM. Format: Easy listening, Variety.

WQLK(FM)—Listing follows WHON.

Rising Sun

WSCH(FM)—See Aurora.

Rochester

WROI(FM)—Aug 29, 1971: 92.1 mhz; 3 kw. Ant 100 ft. Stereo. 116 W. Ninth St. (46975). (219) 223-6059. Fidelity Bcstg Co. Format: MOR. Spec prog: Farm 16 hrs wkly. ■ Joseph P. Sweeney, pres, gen mgr & coml mgr. ■ Rates: \$2.70; 2.70; 2.70; 2.70.

Rushville

WRCR

Farm-News-Sports

WRCR(FM)—August 5, 1971: 94.3 mhz; 750 w. Ant 550 ft. Stereo. 102 N. Perkins St. (46173). (317) 932-3983. Rush County Bcstg Co. Net: MBS; Ind. Bcstg Assn News. Rep: Keystone, Corlett (Detroit). Format: MOR. Spec prog: Farm 11 hrs wkly. ■ Gene H. Kinman, pres; Edward W. Roehling, VP & gen & coml mgr; David L. Williamson, asst & prom mgr; Eric Brenner, mus dir; William Bailey, news dir; H. G. Rummel, chief engr. ■ Rates: \$5.60; 5.60; 5.60; 4.20.

Salem

WSLM—Feb 14, 1953: 1220 khz; 5 kw-D, DA. Radio Ridge, Box 472 (47167). (812) 883-5750. Don H. Martin. Rep: PRO Time Sales, Kentucky Radio Sls, Crane (Southeast). Spec progs: C&W 18 hrs wkly ■ Don H. Martin, owner & gen mgr; Elmo Brough, coml mgr; J. R. Martin, prog dir; Charlotte R. Martin, prom mgr; Darrell Dixon, chief engr.

WSLM-FM—1962: 98.9 mhz; 50 kw. Ant 130 ft. Prog sep from AM.

Scottsburg

WMPI(FM)—Dec 16, 1966: 100.9 mhz; 3 kw. Ant 300 ft. Stereo. Box 270 (47170). (812) 752-3688. Vogel Bell Corp. (acq 8-1-70). Group: Vogel. ■ William R. Vogel, pres; Donnie Harden, gen mgr; Deborah Rushing, coml mgr; Carl Hickman, prog mgr & prom mgr; Larry Fawbush, news dir; Thomas Stonecipher, chief engr.

Seymour

WJCD—Nov 4, 1949: 1390 khz; 1 kw-D. 1534 Ewing St. (47274). (812) 522-1390. Dr. Azra C. Baker. ■ Dr. Azra C. Baker, own & gen mgr; Bob Shippee, mgr; Robert E. Luecke, chief engr.

WJCD-FM—Feb 23, 1961: 93.7 mhz; 5.6 kw. Ant 185 ft.

Shelbyville

WSVL—Jan 14, 1961: 1520 khz; 1 kw-D, 250 w-N, DA-2. Box 338 (46176). (317) 398-9757. Shelby County Bcstg Inc. Rep: Regional Reps. ■ R. D. Ingram, pres; John A. Hartnett, exec VP & gen mgr; George T. Lambert, coml mgr; Marvin Young, chief engr.

WSVL-FM—November 6, 1964: 97.1 mhz; 34 kw. Ant 295 ft. Stereo. Prog sep from AM.

South Bend

***WETL(FM)**—Nov 17, 1958: 91.9 mhz; 1.3 kw. Ant 105 ft. 635 South Main St. (46623). (219) 234-8141. South Bend Community School Corp. Format: Educl. ■ Howard N. Uhrig, gen mgr & chief engr; Jerry V. Limbert, prog dir.

WHME(FM)—Jan 19, 1968: 103.1 mhz; 3 kw. Ant 160 ft. Box 12 (46624). (219) 287-6518. Lester Sumrall Evangelistic Assn. Net: ABC/FM. Format: Religious. ■ Lester Sumrall, pres; Stephen Sumrall, gen mgr; Stephen Grauntner, chief engr.

WJVA—Dec 22, 1947: 1580 khz; 1 kw-D. 1129 N. Hickory (46624). (219) 234-1111. Booth American Co. (group owner; acq 8-56) Net: MBS. Rep: Torbet. Format: C&W. Spec prog: Black 1 hr; Pol 1 hr; Sp 1 hr wkly. ■ John L. Booth, pres; Edward Kosic, gen mgr; Dennis Rossow, coml mgr; Buddy King, mus dir; Nancy Turner, prog dir; Robert McKinney, chief engr.

WRBR(FM)—Co-owned with WJVA. 1965: 103.9 mhz; 3 kw. Ant 150 ft. Stereo. (CP: ant 155 ft). Prog sep from AM. Format: Top 40. ■ R.C. Rogers, prog dir;

Andy Carpenter, mus dir.

WNDU—1944: 1490 khz; 1 kw-D, 250 w-N. Box 1616 (46634). (219) 233-7111. Michiana Telecasting Corp. (acq 9-55). Net: ABC/I. Rep: McGavren-Guild. Format: Solid gold. Spec prog: Black 10 hrs; Pol 2 hrs, News Center 14 hrs wkly. ■ Rev. Theodore Hesburgh, C.S.C., pres; Wm. Thomas Hamilton, exec VP & gen mgr; Bob Nowicki, sls mgr; Bazil O'Hagan, VP, TV-radio-CATV opns; Chuck Linster, prog dir; Harry Kevoorkian, news dir; David Williams, prom mgr; Raymond Jackson, chief engr. ■ Rates: \$9.20; 17.40; 19.20; 12.

WNDU-FM—1962: 92.9 mhz; 20 kw. Ant 490 ft. Stereo. Progs sep from AM. Format: Hit parade. ■ WNDU-TV affili. ■ Rates same as AM.

WRBR(FM)—Listing follows WJVA.

WSBT—April 1922: 960 khz; 5 kw-U, DA-2. 300 W. Jefferson Blvd. (46601). (219) 233-3141. TWX 219-282-8154. South Bend Tribune. Net: CBS. Rep: Katz. Spec progs: Pol 1 hr; Hungarian 1 hr; Sp 1 hr wkly. Format: MOR, Contemp. ■ Franklin D. Schurz Sr., pres; Jack Douglas, gen mgr; James Freeman, loc & regnl sls mgr; Joe Kelly Jr., prog dir; Jerome Bleck, natl sls mgr; Justin R. Meacham, prom mgr; Jack Bowe, news dir; Robert W. Bell, chief engr. ■ Rates: \$19; 15; 17; 9.

WWJY(FM)—Aug 1, 1962: 101.5 mhz; 10 kw. Ant 960 ft. Dups AM 5%. Stereo. ■ WSBT-TV affili. ■ Rates: \$8; 8; 8; 8.

Sullivan

WNDI—Oct 7, 1963: 1550 khz; 250 w-D. Box 545 (47882). (812) 268-6322. WKQV Inc. (acq 5-1-71). Format: MOR. ■ Arthur F. Stanley, pres, gen mgr; Mike Smith, coml mgr; Jean Powers, prog dir; Rick O'Shay, mus dir; Helen Broshears, prom mgr; Allan Simpson, news dir; Pete Crasher, chief engr. ■ Rates: \$3; 3; 3; 3.

Tell City

WTCJ—Feb 1, 1948: 1230 khz; 1 kw-D, 250 w-N. Box 250 (47586). (812) 547-2345. Tell City Bcstg Co. Rep: Regional Reps. Format: Contemp. ■ James R. Brewer, pres; James L. Brewer, gen mgr; Donald Wrye, coml mgr; Dacid Strycker, prog dir. ■ Rates: \$3.05; 3.05; 3.05; 3.05.

Terre Haute

WAAC—May 23, 1958: 1300 khz; 500 w-D. Box 894 (47808). (812) 234-3791. Citizens Bcstg Co. (acq 4-5-63). Net: CBS. Rep: Alan Torbet. Format: MOR. Spec prog: Farm 1½ hrs wkly. ■ George A. Foulkes, pres & gen & coml mgr; Steve Snyder, prog dir; Don Sherwood, news dir; Nancy Bradford, prom mgr; Ron Howes, chief engr. ■ Rates: \$9; 7; 9; —.

WBQO(FM)—Listing follows WBOW.

WBOW—June 15, 1927: 1230 khz; 1 kw-D, 250 w-N. 1301 Ohio St. (47807). (812) 232-5034. Ohio Bcstg Corp. (acq 8-27-74). Group: Eastern. Net: ABC/C. Rep: McGavren-Guild-PGW. Format: Contemp. Spec progs: C&W 6 hrs; farm 10 hrs wkly. ■ Roger A. Neuhooff, pres; Harvey K. Gior, gen mgr; Richard Wickham, coml mgr; Jim McKnight, prog dir; Martin Piascak, news dir; James Underwood, chief engr.

WBQO(FM)—Co-owned with WBOW. Sept 28, 1967: 107.5 mhz; 46 kw. Ant 185 ft. Dups AM 80%.

***WISU(FM)**—Sept 1964: 89.7 mhz; 11.5 kw. Ant 360 ft. (812)232-6311. Indiana State U. Bd of Trustees. Net: NPR. ■ Dr. Joe T. Duncan, dir of bcstg.

WPFH(FM)—Sept 11, 1962: 102.7 mhz; 14 kw. Ant 500 ft. Stereo. RR 12, Box 379, West Terre Haute (47885). (812) 535-4262. Ford F.M. Inc. Net: ABC/FM. Format: Progs. Spec prog: Relg 20 hrs wkly. ■ Paul Dean Ford, pres; Richard B. Engelman, stn mgr; Michael L. Longest, sls mgr; Edward Ganzman, prog dir.

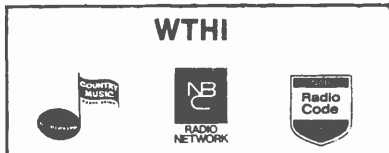

WTHI—Jan 6, 1948: 1480 khz; 5 kw-D, 1 kw-N, DA-2.

Indiana Radio

See page C-1 for explanation of listings.

918 Ohio St. (47808). (812)232-9481. TWX 810-356-2137. Wabash Valley Bcstg Corp. Net: NBC. Rep: Avery-Knodel Inc. Format: C&W. Spec prog: Farm 6 hrs wkly. ■ Anton Hulman Jr., pres & gen mgr; Robert K. Larr, VP & coml mgr; Robert Rouse, stn mgr; Russ Arnold, VP & chief engr. ■ Rates: \$17; 14; 17; 12.

WTHI-FM—October 1948: 99.9 mhz; 20 kw. Ant 410 ft. Stereo. Prog sep from AM. Format: Btfl mus. ■ WTHI-TV affili. ■ Rates same as AM.

WVTS(FM)—June 13, 1960: 100.7 mhz; 50 kw. Ant 500 ft. Stereo Quad. Box 900 (47808). (812) 533-2141. Raftis Bcstg Inc. (acq 2-8-73). Net: MBS. Rep: H-R/Stone. Format: Rock. ■ Michael J. Raftis, pres & gen mgr; Donald C. Gies, sls mgr; Rich Dickerson, opns mgr; R.J. Cortrecht, mus dir; Gary Bedwell, news dir; Harold Wesley, chief engr. ■ Rates: \$9; 8; 9; 9.

Valparaiso

WAKE—Nov 4, 1964: 1500 khz; 1 kw-D, DA. Box 149 (46383). (219)462-6111. Porter County Bcstg Corp. Net: ABC/I; IBA. Format: MOR, talk, farm. ■ Leonard J. Ellis, pres; O.J. Jackson, gen & coml mgr; Pat Paulic, prom mgr; Jim Pounds, news dir; Mark Albright, chief engr; Dan Allen, mus dir. ■ Rates: \$9; 8.50; 9; 8.

WLJE(FM)—Co-owned with WAKE. Oct 6, 1967: 105.5 mhz; 3 kw. Ant 235 ft. Stereo. (219)462-8125. Dups AM 75%. Format: C&W. ■ Rates: \$8; 8; 8.

WNWI—Dec 31, 1965: 1080 khz; 250 w-D. One Center St. (46383). (219)462-1080. Northwestern Indiana Radio Co. Rep: Walton. Format: MOR. Spec progs: Farm 3 hrs; classical 2 hrs, wkly. ■ G. Edward Hershman, pres; Paul D. Woidke, gen mgr; Mickey Hershman, coml mgr; Luke Nover, mus dir; Jim Sullivan, news dir; D.E. Wiggins, chief engr.

***WVUR-FM**—Sept 25, 1966: 89.5 mhz; 10 w. Box 246 (46383). (219)464-5202. Valparaiso University Association Inc. Net: ABC/C. Format: Top 40, Progressive, Educl. ■ Joseph E. Burks, gen mgr; Steve Lindstrom, prog dir; Keith Gould, prom mgr; Geoff Fisher, mus dir; Alfred Seib, news dir; Marilyn Vocke, chief engr.

Vevay

WMGH(FM)—Sept 6, 1974: 95.9 mhz; 2.82 kw. Ant 313 ft. RR 2, Box 103 (47043). (812)427-3310. Pioneer Bcstg Co. Format: Top 40, Jazz. Spec progs: Farm 2 hrs; classical 2 hrs; C&W 7 hrs, wkly. ■ Charles Green, pres; James Short, gen & coml mgr; Larry Fair, prog dir; Howard Hewitt, news dir; Dwight Moreillon, chief engr. ■ Rates: \$36; 36; 36; 36.

Vincennes

WAOV—Oct 22, 1940: 1450 khz; 1 kw-D, 250 w-N, DA-1. Box 139 (47591). (812)882-6060. Vincennes Sun Co. (acq 3-7-60). Net: CBS. Rep: Savalli-Gates, Regional Reps. Format: MOR, C&W. ■ Howard N. Greenlee, pres; William B. Kepler, gen mgr; Jane Holland, coml mgr; Nancy Hall, prog dir; Austin Edmonson, news dir; Terry Herrin, chief engr.

WAOV-FM—May 16, 1965: 96.7 mhz; 2.9 kw. Ant 110 ft. Prog sep from AM. Format: Top 40.

***WVUB(FM)**—Dec 7, 1970: 91.1 mhz; 50 kw. Ant 500 ft. Stereo. 1029 North Fourth St. (47591). (812) 882-2237. Vincennes University Net: NPR, IHETS, NOAH. Format: Noncoml diversified. Spec progs: Black 2 hrs; farm 6 hrs; jazz 6 hrs wkly. ■ Isaac K. Beckes, pres; Seth H. Sparkman Jr., gen & prom mgr; Mark R. Lange, opns dir; Carol Abendroth, traf & mus dir; James L. Jernigan, news dir; Michael Walker, chief engr.

Wabash

WAYT—November 1971: 1510 khz; 250 w-D. 1360 S. Wabash St. (46992). (219)563-1161. Wabash Bcstg Co. Group: Porter. Net: Indiana Bcstrs. Group. Rep: Regional Reps. Format: MOR. ■ Leonard J. Ellis, pres; Richard W. Long, gen mgr; Steve Ford, mus dir; James Lee, news dir; David Walrod, chief engr. ■ Rates: \$6.60; 6.60; 6.60; —.

WKUZ(FM)—April 15, 1966: 95.9 mhz; 3 kw. Ant 150

Indiana, Iowa Radio

See page C-1 for explanation of listings.

ft. Box 342 (46992). (219)563-4111. Upper Wabash Bcstg Corp. Net: Ind. Bcstrs News. Format: Easy Istng, contemp, Top 40, C&W. Spec prog: Gosp 5 hrs wkly. ■ Mrs. Paul G. Adams, pres; Paul G. Adams, gen & coml & prom mgr; Dimitri Gatzimas, news dir; Cathy Weise, womens affairs & prog dir; Pam Gatson, mus dir; Don Spangler, chief engr.

Warsaw

WRWS—1951: 1480 khz; 1 kw-D, 500 w-N, DA-1. Box 351 (46580). (219)267-3111. Reub Williams & Sons Inc. Audio news: UPI. Format: Drake Chenault "Hit Parade." Spec prog: Sp 1 hr wkly. ■ R. Williams, pres; M.R. Williams, gen mgr; Duane Pagel, mgr; Marie Snyder, prog dir; Harry Wilkins, chief engr. ■ Rates: \$4.25; 4.25; 4.25; 3.25.

WRWS-FM—1948: 107.3 mhz; 50 kw. Ant 290 ft. Stereo. Dups AM 10%. Format: MOR.

Washington

WAMW—January 1955: 1580 khz; 250 w-D, 3 E. Van Trees St. (47501). (812)254-4300. Washington Radio Inc. (acq 8-55). Net: ABC. Rep: Rgnl Reps. ■ David A. Draper, pres; Joe Edwards, gen mgr; Paul A. Newland, coml mgr; Eugene Cabel, prog dir; Paul Davis, chief engr. ■ Rates: \$4.25; 4.25; 4.25; 4.25.

WFML(FM)—Co-owned with WAMW. February 1948: 106.5 mhz; 14 kw. Ant 320 ft. Dups AM 100%. Rates same as AM.

West Lafayette

***WBAA**—April 4, 1922: 920 khz; 5 kw-D, 1 kw-N, DA-N. Purdue University (47907). (317)749-2385. Purdue U. Net: NPR. Format: Educl & Classical. Spec progs: Farm 1 hr, jazz 3 hrs, wkly. ■ David Bunte, gen mgr; Greg Zawisza, prog coord; Caryl Eckstein, mus dir; Bonnie Rollins, news dir; Ralph R. Townsley, chief engr.

West Terre Haute

WVVR(FM)—Jan 20, 1967: 105.5 mhz; 3 kw. Ant 295 ft. Box 207 (47885). (812)533-2161. United Bcstg Co. Inc. Net: MBS. Format: Relig. ■ Rev. Floyd Huey, pres; H.E. Huey, gen, coml & prom mgr & prog & news dir; Cleo A. Starkey, chief engr.

Winchester

WIUC(FM)—May 1967: 98.3 mhz; 3 kw. Ant 300 ft. Stereo. US 27 & Greenville Pike (47394). (317)584-9482. Ind-To Radio Inc. Rep: Regional Reps. Spec prog: Sp 1 hr wkly. ■ Martin R. Gilliams, pres & gen mgr; John Wallace, prog dir; Tom McCarty, prom mgr; Herbert Hobbs, news dir.

CSI ELECTRONICS INC.
2607 River Road
Cinnaminson, New Jersey, 08077
Telephone: (609) 786-1060

Iowa

HAMILTON-LANDIS & ASSOCIATES, Inc.
NATIONWIDE MEDIA BROKERS
WASHINGTON, D. C. CHICAGO, DALLAS, SAN FRANCISCO
SELL MORE
RADIO & TELEVISION STATIONS
IN THE MIDWEST—NEAREST OFFICE IS—
1429 TRIBUNE TOWER, CHICAGO 60611
(312) 337-2754

Algonia

KLGA—1956: 1600 khz; 5 kw-D, DA. Box 160 (50511). (515) 295-2475. KLGA Inc. (acq 12-1-63). Net: Iowa Town & Country. Format: Variety ■ George Allen, pres, gen & coml mgr; Jason Etherington, opns mgr; Randy Renshaw, news dir; Lyn Anderson, chief engr.

KLGA-FM—Aug 17, 1970. 92.7 mhz; 2.8 kw. Ant 195 ft. Dups AM.

Ames

KASI—1949: 1430 khz; 1 kw-D. KASI Radio Center. Box 728 (50010). (515) 232-1430. Ames Bcstg Co. (acq 1965). Iowa Radio. Rep: Midwest Radio. Format: MOR. ■ Dale Cowle, pres & gen mgr; Dave DoBell, coml mgr; Robert Burr, prog dir; Bud Chaldy, news dir; Ed Powers, chief engr. ■ Rates: \$9.35; 8.50; 9.35; 8.50.

KCCQ(FM)—Co-owned with KASI. June 20, 1968: 107.1 mhz; 3 kw. Ant 300 ft. Stereo. Prog sep from AM. Format: Contemp, prog. ■ Michael Costanzo, coml mgr; Steve Monaco, mus dir. ■ Rates: \$7; 7; 7; 7.

KLFM(FM)—June 2, 1967: 104.1 mhz; 100 kw. Ant 450 ft. Box 1647 (50010). (515) 232-0104. Bunce Bcstg Co (acq 10-1-75). Net: ABC/FM. Format: MOR. ■ Robert D. Bunce, pres and gen mgr; Steve Locker, news dir; Mark R. Lunde, opns mgr. ■ Rates: \$13; 15; 15; 11.

***KPGY(FM)**—Feb 16, 1971: 91.9 mhz; 10 w. Box 92 Friley Hall, Iowa St. Univ. (50010). (515) 294-9292. Residence Associations Bcstg Service Inc. Format: Rock. Spec progs: Jazz 14 hrs, talk 2 hrs, progressive 21 hrs, sports 7 hrs, wkly. ■ Jeffrey L. Couch, Preg McClure, co-mgrs.

***WOI**—1922: 640 khz; 5 kw-D. Iowa State U. (50010). (515) 294-5555. TWX 910-520-1152. Iowa State U. Net: NPR. Format: Fine arts-pub affrs. ■ W. Robert Parks, pres; Robert C. Mulhall, gen mgr; Donald D. Forsling, stn mgr; Jake Graves, prog dir; Douglas Brown mus dir; Kirk Winkler news dir; Keith K. Ketcham, chief engr; John Stribling, opns mgr.

***WOI-FM**—July 1, 1949: 90.1 mhz; 100 kw. Ant 1490 ft. Stereo. ■ WOI-TV affil.

Atlantic

KJAN AM-FM

KJAN—September 1950: 1220 khz; 250 w-D, N. Olive St. (50022). 712 243-3920. Hishna Valley Bcstg Co. (acq 5-23-55). Net: Iowa Radio. Audio news: UPI. Rep: Martin. Format: MOR day, C&W night. Spec progs: Farm 12 hrs wkly. ■ E. G. Faust, pres, coml & prom mgr; Franklin G. Miller, gen mgr & sec-treas; Robert Einhaus, prog, mus & news dir.

KJAN-FM—April 8, 1966: 103.7 mhz; 100 kw. Ant 240 ft. Stereo. Dups AM 100%.

Boone

***KFGQ**—1927: 1260 khz; 1 kw-D. 924 W. 2d St. (50036). (515) 432-2092. Boone Biblical College. Format: Relig. ■ Lois Crawford, pres & gen mgr; Anne Reiffenstein, prog dir & chief engr; Bob Woolsey, news dir.

***KFGQ-FM**—1950: 99.3 mhz; 3 kw. Ant 190 ft. Dups AM.

KWBG—Jan 15, 1950: 1590 khz; 1 kw-D, 500 w-N, DA-N. Box 366 (50036). (515) 432-1590. Ken Kilmer Bcstg Co. (acq 4-6-71). Net: ABC/I. Rep: Pro/Meeker. Format: MOR. ■ Ken Kilmer, pres & gen mgr; Dennis Borwick, stn mgr; Larry Kelley, prog dir; Bob Pink, chief engr. ■ Rates: \$10; 10; 8; 7.

KWBG-FM—May 15, 1975: 98.3 mhz; 3 kw. Ant 210 ft. Stereo. Dups AM 95%. ■ Rates same as AM.

Burlington

KBUR—July 1941: 1490 khz; 1 kw-D, 250 w-N. Roosevelt Ave. (52601). (319) 752-2701. RB Inc. (acq 10-1-72). Group owner: Harris Enterprises. Net: ABC. Rep: Avery-Knodel. Spec progs: Farm 14 hrs, Sp 1 hr

wkly. ■ David H. Steirle, pres & gen mgr; Willis E. Schwartz, coml mgr; Donald Brandt, sports dir; James Livengood, asst sls mgr; Jim Braadh, prom mgr; Cletus S. Paull, farm dir.

KGRS(FM)—Co-owned with KBUR. Nov 27, 1968: 107.3 mhz; 53 kw horiz; 11.5 kw vert. Ant 360 ft. horiz; 320 ft. vert. Stereo. Net: ABC/FM. Progs sep from AM. Format: Top 40. ■ James M. Livengood, gen mgr; Steve Staebell, prog dir.

KKUZ—July 30, 1965: 1150 khz; 500 w-D, DA. 408 N. Main St. (52601). (319) 754-7565. Big Country Bcstg Corp. (acq 1-27-71). Format: C&W, farm. ■ James Edwin Smith, pres, gen & coml mgr; Bill Deano, mus dir; Lee Lawrick, news dir; Gery Hodges, prog dir, opns mgr & chief engr. ■ Rates: \$6.50; 6.50; 6.50; 6.50.

Carroll

KCIM—June 8, 1950: 1380 khz; 1 kw-U, DA-2. Box 886 (51401). (712) 792-4321. Carroll Bcstg Co. Rep: Pro/Meeker. ■ Paul Collision, gen mgr; Lee Sandberg, natl sls mgr; Neil Trobak, news dir; Ron Tyrell, chief engr.

KCIM-FM—Jan 18, 1967: 93.7 mhz; 74 kw horiz, 9 kw vert. Ant 300 ft. Stereo. Prog sep from AM.

Cedar Falls

KCFI—Feb 2, 1958: 1250 khz; 500 w-D, DA. Box 157 (50613). (319) 277-1918. Jim Mudd Bcstg (acq 11-1-74). Format: MOR. ■ Jim Mudd pres & gen mgr; Jim Frandin, prog & news dir; John Peters, chief engr. ■ Rates: \$8.75; 7.50; 8.75; —.

***KHKE(FM)**—April 1, 1974: 89.5 mhz; 8 kw. Ant 410 ft. U. of Northern Iowa (50613). (319) 273-6400. U. of Northern Iowa. Net: NPR. Format: Educl. Spec progs: Sp ½ hr wkly. ■ John J. Kamerick, pres; Douglas L. Vernier, dir of bcastg.

***KUNI(FM)**—Sept 15, 1960: 90.9 mhz; 94 kw. Ant 1782 ft. Univ. of Northern Iowa (50613). (319) 273-6400. Univ of Northern Iowa. Net: NPR. Spec progs: Black 10 hrs wkly. ■ John J. Kamerick, pres; Douglas L. Vernier, dir of bcastg.

Cedar Rapids

***KCKK-FM**—Sept 5, 1972: 88.3 mhz; 10 kw. Ant 420 ft. Stereo. Box 2068 (52406). (319) 398-5446. Kirkwood Community College. Net: NPR. Format: Classical, educl. ■ Larry G. Patten, gen mgr; Dennis Trachta, opns coord; Jeff Schiel, prog prod; Richard Miller news & pub affrs prod; Orv Thein, chief engr.

***KCOE(FM)**—Oct 10, 1968: 90.3 mhz; 10 w. 1220 First Ave. N.E. (52402). (319) 362-5229. TWX: (319) 362-5229. Coe College. Net: MBS. Format: Progs. Spec progs: Black 6 hrs wkly. ■ Leo L. Nussbaum, pres; Dwayne Ackman, gen mgr.

KCRG—1947: 1600 khz; 5 kw-U, DA-N. 2d Ave. at 5th St. S. E. (52406). (319) 398-8422. TWX: (910) 525-1341. Cedar Rapids TV Co. Net: ABC/C. Rep: Buckley. Spec progs: Czech 4 hrs wkly. ■ Joseph F. Hladky Jr., pres; Edwin J. Lasko, VP, gen mgr; Ron Stack, sls mgr; Edna A. Herbst, VP, dir, prom & pub; Walter Alliss, chief engr. ■ KCRG-TV affil.

KHAK—July 1, 1961: 1360 khz; 1 kw-D, DA. Box 1360 (52406). (319) 365-9431. Communications Properties Inc. (group owner; acq 11-4-71). Net: MBS. Rep: Avery-Knodel; Ewing. Format: C&W. ■ Phillip T. Kelley, pres; James W. Young, gen mgr; Dave Donahue, prog dir; Pat Devaney, mus dir; Dick Hogan, news dir; Dennis Sloatman, chief engr.

KHAK-FM—July 1, 1961: 98.1 mhz; 6.8 kw. Ant 210 ft. Stereo. Dups AM 50%.

KLWW—August 1949: 1450 khz; 1 kw-D, 250 w-N. Box 876 (52406). (319) 363-8265. Black Hawk Bcstg Co. (group owner; acq 5-1-62). Audio news: APR. Rep: Robert E. Eastman Co. Inc. Format: Contemp. ■ Bob Buckmaster, bd chmn; Bill Bolster, VP-radio; Dave Schneider, gen mgr; Alice Kalusky, coml mgr; Peter Price, prog dir; Jim Holland, news dir; Willard Holtz, chief engr. ■ Rates: \$17.50; 15; 17.50; 13.50.

KQCR(FM)—1975: 102.9 mhz; 100 kw. Ant 390 ft. Cedar Rapids Bcstg Co. ■ G. Dale Cowle, owner.

***KTOF(FM)**—May 1971: 104.5 mhz; 100 kw. Ant 550 ft. 3962 Center Point Rd. N.E. (52402). (319) 393-1045. Iowa Evangelistic Assn. Format: Relig. ■

Maxine Bruinekool, actg pres; Rod Larson, stn mgr; Ralph Duckworth, prom mgr; Jerry Slegh, news dir; Eldon Schlenker, chief engr.

***KWMR(FM)**—April 30, 1970: 88.9 mhz; 10 w. 1330 Elmhurst Drive (52402). (319) 363-8123. Mount Mercy College. Format: Ed, rock, top 40. ■ M. J. McNamara, gen mgr.

WMT—1922: 600 khz; 5 kw-U, DA-N. Paramount Theatre Bldg. (52406). (319) 393-8200. TWX 910-525-1326. WMT Inc. (acq 6-13-68). Group owner: Orion. Net: CBS. Rep: Katz. ■ Ralph S. Jackson, pres; Lew Van Nostrand, VP & gen mgr; Frank Yanda, gen sls mgr; Jerry Bretey, mgr; Jack Crowner, farm serv dir; Dan Ulrelg, prom mgr; Roy Karon, news dir; Ross Wilson, chief engr. ■ Rates: \$63; 29; 29; 19.

WMT-FM—Feb 16, 1963: 96.5 mhz; 50 kw. Ant 540 ft. Stereo. Dups AM 3%. ■ WMT-TV affil. ■ Rates: \$10.25; 10.25; 10.25; 10.25.

Centerville

KCOG—March 1, 1949: 1400 khz; 500 w-D, 250 w-N. (CP 1 kw-D, 500 w-N) 317 ½ N. 13th St. (52544). (515) 856-3241. Chariton Valley Bcstg Co. (acq 4-24-74). Format: MOR, Top 40, Spec progs: Farm 10 hrs, C&W 18 hrs wkly. ■ Michael G. O'Connor, pres & gen mgr; Brad Cluff, news dir; Kelly Nelf, mus dir; Fred Jenkins, chief engr. ■ Rates: \$8; 7.20; 7.20; 3.25.

KCOG-FM—Oct 1, 1974: 98.7 mhz; 100 kw. Ant 450 ft. Progs sep from AM. Format: Relig. ■ Rates: \$6; 4.55; 4.55; 5.50.

Charles City

KCHA—November 1949: 1580 khz; 500 w-D, 207 N. Main St. (50616). (515) CA 8-1231. Radio Inc. (acq 6-57). Rep: Walton. ■ L.J. Bromberg, pres and gen mgr; Harriet Skillen, prog dir; Ken Ungs, news dir; Richard Tector, chief engr. ■ Rates: \$5.50; 5.50; 5.50; 5.50.

KCHA-FM—October 1971: 104.9 mhz; 3 kw. Ant 100 ft. ■ Rates same as AM.

Cherokee

KCHE—January 1953: 1440 khz; 500 w-D, Box 1440 (51012). (712) 225-2511. C&H Bcstg Inc. (acq 10-1-67). Rep: Walton; Soderlund. Format: MOR/news. Spec progs: Talk 8 hrs, farm 12 hrs, wkly ■ J. Alan Cramer, pres; Charles Kay Hutchinson, gen mgr; Chuck Reznikov, coml mgr; Jim Gloss, prog dir; John Raven, mus dir; Dave Lund, news dir; Goerge Keller, chief engr. ■ Rates: \$6.50; 5.50; 5; —.

Clarion

KRIT(FM)—May 18, 1964: 96.9 mhz; 93 kw. Ant 200 ft. Box 233 (50525). (515) 532-2829, 532-2820. Wright County Radio Inc. Rep: Hawkeye Radio Inc. Format: MOR, C&W. Spec progs: Farm 7 hrs wkly. ■ Gerald McLaughlin, gen mgr & prog dir; Ione Peterson, coml mgr; Dean Long, news dir. ■ Rates: \$4.15; 4.15; 4.15.

Clinton

KCLN—Dec 21, 1956: 1390 khz; 1 kw-D, DA. Box 875 (52732). (319) 243-1390. Valley Bcstg Co. (acq 12-23-63). Net: ABC/E. Rep: Walton. Format: MOR. ■ R. Z. Morrison, pres; Kenneth P. Kroemer, gen mgr; Donald Petersen, prog dir; Marie Udulutch, news dir; Stan Hardin, mus dir; William Diekman, chief engr. ■ Rates: \$7; 6; 7; —.

KCLN-FM—Dec 7, 1970: 97.7 mhz; 3 kw. Ant 300 ft. Dups AM 70%. Format: C&W. ■ Rates: \$7; 6; 7; 4.

KROS—Sept 28, 1941: 1340 khz; 1 kw-D, 250 w-N. Jacobsen Bldg. (52732). (319) 242-1252. PSB Inc. (group owner; acq 11-26-73). Net: Iowa Radio. Rep: Midwest Radio. ■ Donald G. Jones, pres; Don Sharp, gen mgr; Jim Brady, mus dir; Pat Sullivan, news dir; Wm. Scott, chief engr.

KSAY(FM)—July 1974: 96.1 mhz; 100 kw. Ant 360 ft. Prog sep from AM.

Council Bluffs

KQKQ-FM—Listing follows KRCB.

KRCB—1947: 1560 khz; 1 kw-D, Box 586. (51501).

(712) 322-4041; KRCB Inc. (acq 1975). Audio news: APR. Rep: PRO/Meeker. Format: MOR. Spec progs: Pol 8 hrs wkly. ■ John C. Mitchell, pres; John A. Howard, gen mgr; Richard Yantzie, stn mgr; Chuck Wolf, news dir; Paxton West, mus dir; James Droege, chief engr. ■ Rates: \$10.50; 10; 10.50; 10.

KQKQ-FM—Co-owned with KRCB. 1969: 98.5 mhz; 100 kw. Ant 175 ft. Stereo. Prog sep from AM. Format: Progs. ■ Bill Abbott, coml mgr; Paxton West, prog dir; Barry Taft, mus dir.

Creston

KSIB—Dec 7, 1946: 1520 khz; 1 kw-D, Box 457 (50801). (515) 782-2155. Southwest Bcstg Co. Net: MBS, Iowa Radio. Rep: Iowa Radio. ■ E. M. Horning, pres, gen mgr & prog dir; Verne Olson, news dir; Wayne J. Hatchett, coml mgr; Harold Bauman, chief engr.

KSIB-FM—March 1966: 101.7 mhz; 3 kw. Ant 255 ft. Dups AM 5%.

Davenport

***KALA(FM)**—Nov 4, 1967: 90.1 mhz; 10 w. Ant 102 ft. 518 West Locust St. (52803). (319) 324-2240. Ambrose College. Net: NPR. Format: Prog. Spec prog: 7 hrs blind wkly. ■ Dr. Wm. J. Bakrow, pres; Rev. Chas. C. Shepler, gen mgr; Paul Sachs, coml mgr; John M. Swart, prog dir; Jeff Nelson, prom mgr; Rovin J. McGraw, mus dir; Dave Hauser, chief engr; John Keith, news dir.

KIK(FM)—Listing follows WOC.

KRVR Beautiful Music

KRVR(FM)—Sept 1, 1966: 106.5 mhz; 60 kw. Ant 210 ft. 1706 Brady (52803). Mid-America Audio Video Inc. (acq 8-15-73). Group owner: Mid America Media. Format: Blt music. ■ Ed Wodka, VP/stn mgr; Lowell Dorman, opns mgr; John Dombek, prom mgr; Mark Minnick, news dir; Pete Burk, chief engr.

KSTT



KSTT—July 1946: 1170 khz; 1 kw-U, DA-2, 1111 E. River Drive. Box 3788 (52808). 326-2541. KSTT Inc. (acq 6-65). Audio news: APR. Rep: Katz. ■ Frederick Epstein, pres; Melvin W. Laforce, VP, gen & nat sls mgr; Dan Olson, sls mgr; Jack FitzGerald, prog dir; Jerry Reid, news dir; Paul Blair, chief engr. ■ Rates: \$33; 30; 33; 30.

KWNT—September 1952: 1580 khz; 500 w-D, 1019 Mound St. (52803). (319) 326-4407. Oneita G. Schmidt. (acq 8-26-74). Net: ABC/E. Rep: Savalli/Gates. Format: Mod C&W. ■ Charles L. Lintgen, gen, coml & prom mgr; Clayton Traver, mus & prog dir; Jim Collinson, news dir; Peter Burk, chief engr.

WOC—February 1922: 1420 khz; 5 kw-U, DA-2, 805 Brady St. (52808). (319) 324-1661. TWX 910-525-1189. WOC Bcstg Co. Group owner: Palmer. Net: NBC. Rep: Blair. Format: MOR. ■ D.D. Palmer, pres & treas; Lee Marts, gen mgr; Charles King, prog dir; Jack Thomsen, news dir; Don Hanley, stn & sls mgr; Coy Bullard, dir of engr.

KIK(FM)—Co-owned with WOC. October 1948: 103.7 mhz; 63 kw. Ant 760 ft. Format: Contemp/rock. ■ Dorothy Boyd, prom mgr. ■ WOC-TV affil.

Decorah

KDEC—May 1947: 1240 khz; 1 kw-D, 250 w-N. (Shares time with *KWLO). Locust Rd. (52101). (319) 382-4251. Scenic Bcstg Co. (acq 11-51). ■ Verne Koenig, pres, gen mgr & prog dir; Kenneth Bjerke, coml mgr; Darrel Winkie, news dir; Jeff Ellingsen, chief engr.

***KWLC**—December 1926: 1240 khz; 1 kw-D, 250 w-N. (shares time with KDEC). Luther College (52101). (319) 387-1240. Luther College. Format: Educ, pub serv & classical. Spec progs: Norwegian 1 hr wkly. ■

Paula Larson, gen mgr & prog dir; John Nemeck, head anncr; Chris Wollan & Rick Penning, mus dirs; Kurt Meyer, news dir; Bruce Larson, chief engr.

Denison

KDSN—April 11, 1956: 1530 khz; 500 w-D, Box 337 (51442). (712) 263-3141. Denison Bcstg Co. (acq 9-56). Rep: Walton; Soderlund Co. Format: MOR. ■ Walt Morrison, pres; Don Uker, VP & gen mgr; Chester Martin, coml mgr; Mike Morse, prog & mus dir; Paul Ouverson, prom mgr; Michael O'Sullivan, news dir; Don Ibel, chief engr.

KDSN-FM—Aug 1, 1968: 107.1 mhz; 3 kw. Ant 300 ft. Dups AM 100%.

Des Moines

KCBC—March 13, 1947: 1390 khz; 1 kw-U, DA-1, Box 1404 (50305). (515) 277-4483. Minnesota-Iowa Television Co. (acq 1975). Group owner: Black Hawk.

KDMI(FM)—August 1958: 97.3 mhz. 115 kw. Ant 450 ft. 2907 Merle Hay Rd. (50310). (515) 274-4969. Richards & Assoc. Inc. (acq 1960). Rep: Coleman. Format: Relig. ■ Maxine Bruinekool, actg pres; Jerry Slegh, gen mgr; Ralph Duckworth, prom mgr; Jerry Slegh, news dir; Eldon Schlenker chief engr.

***KDPS(FM)**—April 16, 1952: 88.1 mhz; 5.2 kw. Ant 285 ft. 1800 Grand Ave. (50307). (515) 284-7723. Des Moines Independent School Dist. Net: NPR. Format: Variety. ■ Mabel Tillery, gen mgr & prog, mus & news dir; Larry Smith, chief engr.

KGGO(FM)—Listing follows KSO.

KIOA—April 1947: 940 khz; 10 kw-D, 5 kw-N, DA-2, 215 Keo Way, Suite 213. (50309). (515) 282-9191. Mid America Broadcasting Inc. (acq 12-1-65). Group owner: Mid America Media. Rep: Eastman. Format: Contemp, Rock, Top 40. ■ Burrell Small, pres; Ed Wodka, VP & gen mgr; Peter McLane, opns dir; Tim Taylor, coml & prom mgr; Jim Vogelar, news dir; Karl Jessness, chief engr. ■ Rates: \$55; 50; 55; 50.

KIOA-FM—Sept 18, 1964: 93.3 mhz; 100 kw. Ant 420 ft. Stereo. Prog sep from AM. Format: Adult rock. ■ Jim Michaels, prog dir; Steve Matthews, mus dir. ■ Rates: \$20; 16; 20; 16.

KLYF(FM)—Listing follows WHO.

KRNO(FM)—Listing follows KRNT.

KRNT—March 17, 1935: 1350 khz; 5 kw-U, DA-N. Stauffer Publications Inc. (group owner; acq 9-1-74). Net: CBS. Rep: Katz. Format: Adult contemp. ■ Thad M. Sandstrom, VP-bcst; Al Lobeck, gen mgr; Ron Granzow, sls mgr; Del Hull, prog dir; Barbara Chase, prom mgr; Glenn Anderson, chief engr; Chuck Seel, news dir. ■ Rates: \$22; 15; 17; 12.

KRNO(FM)—Co-owned with KRNT, 1970: 102.5 mhz; 100 kw. Ant 510 ft. Stereo. Prog sep from AM. Format: Adult rock. ■ Rates: \$8; 8; 8; 8.

KSO—July 21, 1921: 1460 khz; 5 kw-U, DA-N, 3900 N. E. Broadway (50317). (515) 265-6181. Stoner Broadcasting System Inc. (group owner; acq 11-8-66). Net: ABC/E. Rep: Torbet. Format: C&W. Spec progs: Black 1½ hrs wkly. ■ Thomas Stoner, pres; Guy Fowler, VP & gen mgr; Rod Orr, sls mgr; Perry St. John, prog dir; Curtis King, mus dir; Tom Dresselhuys, news dir; Bob Harbert, prom mgr; Joe Roskos, chief engr.

KGGO(FM)—Co-owned with KSO, May 31, 1964: 94.9 mhz; 100 kw. Ant 285 ft. Stereo. Prog sep from AM. Format: Top 40 ■ Calvin Crane, sls mgr; Ted W. Scott, prog & mus dir.

KWKY—Feb 2, 1948: 1150 khz; 1 kw-U, DA-2, 419½ Locust St. (50309). (515) 244-7122. Norseman Bcstg. (acq 3-11-61). ■ Walter Martell, gen mgr; Smokey Smith, prog dir; Lyle Newman, chief engr. ■ Rates: \$10; 10; 10; 10.

WHO—April 10, 1924, 1040 khz; 50 kw-U, 1100 Walnut St. (50308). (515) 288-6511. TWX 910-520-2549. Palmer Bcstg Co. (group owner; acq 2-14-30). Net: NBC. Rep: Blair. Format: C&W, MOR, Variety. Spec progs: Farm 15 hrs wkly. ■ Dr. D.D. Palmer, pres & treas; Robert H. Harter, exec VP and gen mgr; Wayne J. Blick, sec; Abe Barron, sls mgr;

Iowa Radio

See page C-1 for explanation of listings.

Robert W. Gifford, prog dir; Kathie Swift, prom mgr; Robert Wilbanks, news dir; Robert Engelhardt, chief engr. ■ Rates: \$72; 52; 72; 31.

KLYF(FM)—Co-owned with WHO. Feb 1, 1948: 100.3 mhz; 87 kw. Ant 1,700 ft. Stereo. 244-5593. Prog sep from AM. Format: Btl mus. Spec progs: Sp ½ hr wkly. ■ Rates: \$22; 32; 32; 17.

Dubuque

KDTH—May 4, 1941: 1370 khz; 5 kw-D, 1 kw-N, DA-N, 8th & Bluff Sts. (52001). (319) 588-5700. Telegraph Herald Inc. Net: NBC. Format: MOR. Spec progs: C&W 3 hrs wkly. ■ F Robert Woodward Jr., pres; George A. Lipper, gen. mgr; Pat Fleming, coml mgr; Les Gardner, ops dir; Gordon Kilgore, pub affrs dir; Donald Abitz, chief engr. ■ Rates: \$12.30; 12.30; 12.30; 12.30.

KFMD(FM)—Co-owned with KDTH. June 25, 1967: 92.9 mhz; 76 kw. Ant 470 ft. Stereo. Prog sep from AM.

KIWI(FM)—Listing follows WDBQ.

WDBQ—Oct 30, 1933: 1490 khz; 1 kw-D, 250 w-N. WDBQ Bldg., 1170 Iowa St. (52001). (319) 583-6471. Communications Properties Inc. (group owner: acq 1-1-63). Net: ABC/C, Iowa Radio. Rep: Avery-Knodel. Format: Contemp. ■ Philip T. Kelly, pres & gen mgr; Loras Sabers, sls mgr; Paul Hemmer, prog dir; Chuck Bailey, mus dir; Bruce Dixon, news dir; Al Skinner, chief engr. ■ Rates: \$12.80; 12.80; 12.80; 10.40.

KIWI(FM)—Co-owned with WDBQ. Sept 1, 1965: 105.3 mhz; 25 kw. Ant 340 ft. (CP 50 kw. Ant 328 ft.) Stereo. Box 1280 (52001). (319) 556-5494. Prog sep from AM. Format: C&W. ■ Bill Alfredo, gen mgr. ■ Rates: \$9; 9; 9; 7.

Estherville

KILR—Dec 23, 1967: 1070 khz; 250 w-D; DA. Box 706 (51334). (712) 362-2644. Emmet Radio Corp. Net: Iowa Radio. Rep: Midwest Radio; Iowa Radio. Format: MOR. Spec progs: Farm 6 hrs wkly. ■ Daniel Sanderson, pres; Barry Hunsinger, gen & coml mgr; Randy Bach, prog dir. ■ Rates: \$5.75; 5.75; 5.75; 5.75.

KILR-FM—Oct 17, 1969: 95.9 mhz; 2.8 kw. Ant 300 ft. Dups AM 100%. ■ Rates same as AM.

Fairfield

KMCD—March 3, 1958: 1570 khz; 250 w-D. Box 648 (52556). (515) 472-4191. Carousel Bcstg Corp. (acq 12-19-72). Net: ABC/C. Rep: Devney. Format: MOR. ■ Ray L. Sherwood, pres & gen mgr & chief engr; John Sugden, coml mgr; Eric McKeever, prog dir; Caroline Herr, prom mgr; Nancy McMillen, mus dir; Jim Bartruff, news dir.

Fort Dodge

***KICB(FM)**—Sept 1971: 88.1 mhz; 10 w. 330 Ave M (50501). (515) 576-6049. Iowa Central Community College. Format: Variety, Top 40. ■ David White, gen mgr & chief engr; James M. Rawson, prog dir.

KKEZ(FM)—Listing follows KWMT.

KTGA(FM)—July 28, 1975: 92.1 mhz; 2.75 kw. Ant 310 ft. M-33 Warden Plaza (50501). (515) 576-7668. Gospel Radio Inc. Format: Relig. ■ Rev. N.S. Bemino, pres, gen & coml mgr & mus dir; Pat Connors, prog dir & chief engr; Gary Curtis, news dir.

KVFD—Dec 24, 1939: 1400 khz; 1 kw-D; 250 w-N. 912 1st Ave. So. (50501). (515) 573-4121. Fl. Dodge Bcstg Inc. (acq 8-1-71). Net: MBS; Iowa Radio. Rep: Midwest Radio; Iowa Radio. Format: Top 40. MOR. Spec progs: Farm 21 hrs; C&W 10 hrs, wkly. ■ Max Landes, pres, gen, coml & prom mgr; Drexel A. Peterson, prog dir; Robert Dean, news dir; Brand Larson, mus dir; Dave Sinclair, chief engr.

KWMT—April 1956: 540 khz; 5 kw-D, DA. Box 578. (50501). (515) 955-8533. KWMT Inc. (acq 7-68). Net: ABC/C. Rep: Avery-Knodel. ■ Wm. B. Quarton, chmn of bd; James W. Maurer, pres & gen mgr. ■ Rates: \$23; 18; 18; —.

KKEZ(FM)—Co-owned with KWMT. 1966: 94.5 mhz; 50 kw. Ant 290 ft. Stereo. ■ Rates: \$5; 5; 5; 5.

Fort Madison

KXGI—Feb 6, 1948: 1360 khz; 1 kw-D. Marquette Bldg. (52627). (319) 372-1241. Talley Bcstg Co. (acq 5-1-60). Net: MBS. ■ Hayward L. Talley, pres; Michael Finger Jr, VP & gen mgr; Richard Specht, news dir.

KXGI-FM—June 1, 1973: 101.7 mhz; 3 kw. Ant 245 ft.

Grinnell

***KDIC(FM)**—May 1968: 88.5 mhz; 10 w. Ant 74 ft. Grinnell College. (50112). (515) 236-6181, ext 302. Trustees of Iowa College. Format: Ed, Prog. Spec progs: Classical 12 hrs, black, women, French, Sp each 3 hrs wkly. ■ Stephen Hirtle, stn mgr.

KGRN—Nov, 15, 1957: 1410 khz; 500 w-D. Box 560 (50112). (515) 236-6106. Mitchell Bcstg Inc. (acq 11-15-57). Net: Iowa Town & Country. Rep: Walton. Format: MOR. Spec progs: C&W 6 hrs wkly. ■ Forrest J. Mitchell Jr, pres & gen & coml mgr; Jerry Roberts, prog dir; Kevin Ford, news dir; Ann Heathman, prom mgr; Donald Starnes, chief engr.

Humboldt



KHBH(FM)—Aug 5, 1970: 97.7 mhz; 3 kw. Ant 275 ft. Stereo. Broadcast Park, Hwy 3 E. (50548). (515) 332-4100. Christensen Bcstg Co. Net: ABC/FM; Hawkeye Radio. Format: MOR. ■ Robert H. Christensen II, pres, gen mgr, prog dir & chief engr; Virginia Christensen, sls mgr; Edward J. Campisi, news dir; Dale Christensen, spts dir. ■ Rates: \$5.25; 5.25; 5.25; 5.25.

Independence

KOUR—Dec 10, 1959: 1220 khz; 250 w-D. Box 778 (50644). (319) 334-2549; Leighton Enterprises Inc. (acq 12-19-68). Rep: Town & Country Radio. Format: C&W. Spec progs: Farm 20 hrs wkly. ■ Alver Leighton, pres; John A. Moline, gen mgr & chief engr; Ron Aben, prog dir; Ruth Decker, prom mgr; Wallace South, mus dir; Joe Palmer, news dir. ■ Rates: \$8; 8; 8; 8.

KOUR-FM—Jan 1, 1972: 95.3 mhz; 2.9 kw. Ant 200 ft. Dups AM 100%. ■ Rates same as AM.

Indianola

KBAB—July 22, 1963: 1490 khz; 500 w-D, 250 w-N. Box H (50125). (515) 961-6291. Warren Bcstg Inc. (acq 4-19-73). Net: ABC/E, MBS, Mutual Black. Rep: Keystone. Format: MOR. Spec progs: Farm 2 hrs wkly. ■ Sharp Lannom, pres; Mel Moyer, gen mgr; Jim Clendenan, coml mgr; Jim Beam, prog & mus dir; Larry Couter, news dir; Steve Brown, chief engr. ■ Rates: \$4; 3; 4; 3.

Iowa City

KICG(FM)—Listing follows KXIC.



KRNA(FM)—Oct 4, 1974: 93.5 mhz; 3 kw. Ant 270 ft. 1027 Hollywood Blvd. (52240). (319) 351-6426. Communicators Inc. Format: Contemp. ■ Eliot A. Keller, gen mgr; David Hoehne, sls mgr; Steve Lewis, prog dir; Bart Goynsnor, mus dir; Chuck Mulloy, news dir. ■ Rates: \$6.15; 6.15; 6.60; 6.60.

***KSUI(FM)**—Listing follows *WSUI.

KXIC—June 7, 1948: 800 khz; 1 kw-D, DA. Dubuque St. at Hwy 80 (52240). (319) 338-1181. Johnson County Bcstg Corp. Net: Iowa Radio. Rep: Iowa Radio. Format: Contemp. Spec progs: Farm 10 hrs wkly. ■ Gene Claussen, gen & coml mgr; Bob Shellady, prog dir; F. M. Broders, loc sls mgr; Roy Justis, news dir; Elliott Full, chief engr.

KICG(FM)—Co-owned with KXIC. May 1, 1966:

100.7 mhz; 26.5 kw horiz, 3.6 kw vert. Ant 245 ft. horiz, 265 ft. vert. Stereo. Prog sep from AM.

***WSUI**—1919: 910 khz; 5 kw-U, DA-2. U. of Iowa (52240). U. of Iowa. Net: NPR. Format: Classical, info, educ. Spec progs: Sp ½ hr wkly. ■ H. V. Cordier, gen mgr; George Klingler, prog dir; John Monick, mus dir; Terry Edmonds, chief engr.

***KSUI(FM)**—Co-owned with *WSUI. 1940: 91.7 mhz; 17.5 kw. Ant 90 ft. Prog sep from *WSUI.

Iowa Falls

KIFG—July 21, 1962: 1510 khz; 1 kw-D. (500 w CH). Box 919 (50126). (515) 648-4281. PBW Bcstg Corp. Format: MOR. ■ John P. Whitesell, pres; James W. Stair, gen, coml & prom mgr; Al Pool, prog & news dir; Craig Vance, mus dir; Aldis Hendrickson, chief engr.

KIFG-FM—Oct 1, 1965: 95.3 mhz; 3 kw. Ant 170 ft. Dups KIFG 100%.

Keokuk

KIMI(FM)—Jan 30, 1973: 95.3 mhz; 3 kw. Ant 235 ft. Stereo. 1008 Main St. (52632). (319) 524-7777. Keowa Broadcasting Inc. Format: Diversified. Spec progs: Farm 1 hr wkly. ■ Bob Clark, pres, gen & coml mgr; John Hallstrom, VP, Jay Corbin, sls dir; Jean Bracklesberg, mus dir; Rob Sherwood, prom mgr; Paul Spielman, chief engr. ■ Rates: \$5.15; 5.15; 5.15; 5.15.

KOKX—October 1947: 1310 khz; 1 kw-D, 500 w-N. DA-N. Eppers Hotel (52632). (319) 524-5410. KOKX Inc. (acq 9-10-71). Net: ABC/L, Iowa Radio. Format: Adult contemp. Spec prog: Telephone talk 3 hrs wkly. ■ Ronald D. Westby, pres & gen mgr; Don McKee, coml mgr; Jay Lawrence, prog & mus dir; Dick Partridge, news dir; James Cate, chief engr. ■ Rates: \$6.25; 6.25; 6.25; 5.

Knoxville

KNIA—Aug 30, 1960: 1320 khz; 500 w-D, DA. 1610 N. Lincoln. (50138). (515) 842-3161. Leighton Enterprises. (acq 12-1-71). Net: Town & Country. Format: MOR. Spec progs: Farm 8 hrs wkly. ■ Alver Leighton, pres; Lou Harpel, gen mgr; John Halley, coml mgr; John Freshwaters, coml mgr; Dennis Wieland, news dir; Ken Sargent, chief engr.

KRLS(FM)—Co-owned with KNIA. July 16, 1973: 92.1 mhz; 3 kw. Ant 300 ft. (Shares time with KTAV) Dups AM 75%. Format: Spts.

KTAV(FM)—1973: 92.1 mhz 3 kw. Ant 300 ft. (Shares time with KRLS.) Box 436 (50138). (515) 842-5057. American Radio Mission Inc. ■ Doug Smiley, gen mgr.

Le Mars

KLEM—Oct 12, 1954: 1410 khz; 1 kw-D. Box 1410. (51031). (712) 546-4121. KLEM Inc. (acq 7-6-61). Net: Iowa Radio. Rep: Ross Martin, Iowa Radio. Format: Contemp/MOR. ■ Paul W. Olson, pres & gen mgr; Gene Van Grouw, coml mgr; Larry Schmitz, news dir; Ray Heaton, chief engr. ■ Rates: \$4.45; 4.45; 4.45; 4.45.

KLEM-FM—Jan 1, 1967: 99.5 mhz; 47 kw. Ant 150 ft. Dups AM 10%. ■ Rates: \$3.56; 3.56; 3.56; 3.56.

Maquoketa

KMAQ—Aug 26, 1958: 1320 khz; 500 w-D. 129 N. Main St. (52060). (319) 652-2426. Maquoketa Bcstg Co. Net: Iowa Town & Country. Rep: Walton. Spec progs: C&W 15 hrs wkly. ■ Dennis W. Voy, owner, gen mgr & prog dir; Allen Embury, coml mgr; Robert Warner, mus dir; Leighton Hepker, news dir; Marland Jordan, prom mgr; Robert Burns, chief engr. ■ Rates: \$6.50; 6.50; 5.50; 4.50.

KMAQ-FM—Sept 1, 1967: 95.3 mhz; 3 kw. Ant 110 ft. Dups AM 90%.

Marshalltown

KFJB—June 23, 1923: 1230 khz; 1 kw-D, 250 W-N. 133 E. Main St. (50158). (515) 753-3361. Marshall Electric Co. (acq 6-47). Net: Iowa Radio. Rep: Martin. Format: MOR. Spec progs: C&W 7 hrs wkly. ■ Paul G. Norris Jr, pres; William P. White, gen & coml mgr; Allan N. Schrock, prog & news dir & prom mgr; Marvin Baker, mus dir; Herbert G. Anderson, chief engr.

KFJB-FM—January 1968: 101.1 mhz; 27.5 kw. Ant 310 ft. Dups AM 50%. Format: Good mus.

Mason City

KGLO—Jan 17, 1937: 1300 khz; 5 kw-U, DA-N. 112 N. Pennsylvania Ave. (50401). (515) 423-2540. TWX 910-523-6966. Lee Enterprises Inc. (group owner). Net: CBS. Rep: Katz. Format: MOR. ■ Lloyd D. Loers, VP & gen mgr; Earl L. Schoborg, gen sis mgr; Howard Kennedy, opns mgr; Max Lee, news dir; Lee Ellis, tech dir; David Sappenfield, chief engr. ■ Rates: \$13; —; 12; 11. ■ KGLO-TV affil.

KLSS(FM)—Listing follows KSMN.

KRIB—April 1948: 1490 khz; 1 kw-D, 250 kw-N. 402 19th St., S.W. (50401). (515) 424-1490. Radio Communications Inc. (acq 12-16-72). Net: ABC/C/I. Rep: Torbet; Hurley, Soderlund. Format: Top 40, oldies. Spec progs: Farm 10 hrs wkly. ■ C. Kenneth Kjeldseth, pres; Marie D. Oakes, VP & gen mgr; Robert Scott, prog dir; William Sevenbergen, chief engr. ■ Rates: \$8; 7; 8; 7.

KSMN—March 1, 1948: 1010 khz; 1 kw-D. Box 1446. (50401). (515) 423-8634. North Central Iowa Bcstg Co. (acq 11-63). Net: Iowa Radio. Audio news: UPI. Format: C&W. ■ Hayward L. Talley, pres; Dale S. Low, VP, gen mgr; Mike Gemmel, coml mgr; Doug Corbett, mus dir; Bruce Wilde, news dir. ■ Rates: \$6.40; 4.70; 4.70; 4.70.

KLSS(FM)—Co-owned with KSMN. Nov 1, 1967: 106.1 mhz; 100 kw. Ant 260 ft. Stereo. Dups AM 5%. Format: Rock. ■ Rates same as AM.

Mount Pleasant

KILJ(FM)—Oct 30, 1970: 105.5 mhz; 3 kw. Ant 300 ft. Box 281, 126 North Main St. (52641). (319) 385-8728. Pleasant Bcstg Co. ■ Forrest J. Mitchell, pres; Paul Dennison, gen mgr; Rich Dean, prog dir & news dir; Wayne Hansen, chief engr.

KKSI—December 1974: 1130 khz; 250 w-D. Box 1130 (52641). (319) 385-3111. BCST Co of Iowa Inc. Net: ABC/I. Rep: Messina. Format: MOR, oldies, C&W. Spec progs: Farm 6 hrs, classical 1 hr wkly. ■ Edward R. Carney Jr, pres, & gen mgr; Dale Spangler, coml mgr; Mike Meacham, mus & news dir; William Sites, sps & prom mgr. ■ Rates: \$6; 6; 6; 6.

Mount Vernon

***KRNL-FM**—April 1, 1948: 89.7 mhz; 10 w. Cornell College (52314). (319) 895-6239. Cornell College. Net: Midwest. Rep: Steven Debnar, Larry Jordan. Format: Prog/Ed. Spec progs: Black 21 hrs wkly. ■ Mark Thorpe, gen mgr; Edd Hajic, prog dir; Lames Davies, chief engr.

Muscatine

KFMH(FM)—Listing follows KWPC.

KWPC—Jan 5, 1947: 860 khz; 250 w-D. Box 116 (52761). (319) 263-2442. Muscatine Bcstg Inc. Net: Iowa Radio. Audio news: UPI. Rep: Midwest Radio; Iowa Radio. Format: Mod C&W. Spec progs: Sp 1 hr wkly. ■ George J. Volger, pres & gen mgr; Vince Beckey, VP & stn mgr; Steve Bridges, prog dir; Rod Neaville, news dir; Dave McGowan, chief engr. ■ Rates: \$7.25; 7.25; 7.25; 7.25.

KFMH(FM)—Co-owned with KWPC. February 1949: 99.7 mhz; 50 kw. Ant 245 ft. Dup AM 5%. Format: Progsv. ■ Rates: \$5.25; 5.25; 5.25; 5.25.

Newton

KCOB—Sept 15, 1955: 1280 khz; 1 kw-D. Box 1286 (50208). 792-5262. KCOB Communications (acq 1-1-72). Rep: Walton. Format: Contemp/C&W. ■ Richard C. Brandt, pres; John E. Carl, gen sis mgr.

KLVN(FM)—Co-owned with KCOB. Jan 3, 1969: 95.9 mhz; 3 kw. Ant. 190 ft. Prog sep from AM.

Oelwein

KOEL—July 1950: 5 kw-D, 500 w-N, DA-2. 109 S. Frederick Ave. (50662). (319) 283-1234. Hawkeye Bcstg Inc. (acq 9-1-61). Group owner: Stuart. Net: ABC/I. Rep: Meeker, Abels. Format: MOR. Spec progs: Farm 20 hrs wkly. ■ Richard W. Chapin, pres; Ray Leafstedt, VP & gen mgr; Larry Scott, opns mgr; Dick Petrik, news dir; Arnold Zaruba, chief engr. ■ Rates: \$14; 12; 14; 12.

KOEL-FM—Dec 29, 1971: 92.3 mhz; 100 kw. Ant 370 ft. Stereo. Dups AM 12%. Format: Mod Country. ■

Jack Mihall, stn mgr. ■ Rates: \$9; 8; 8; 8.

Oskaloosa

KBOE—Nov 15, 1950: 740 khz; 250 w-D. Box 380 (52577). (515) 673-3493. Oskaloosa Bcstg Co. Audio news: UPI. Rep: Midwest Radio. Format: Easy Istng. Spec progs: Farm 4½ hrs wkly. ■ Glen Stanley, gen mgr; Pat Flaherty, asst mgr; Gary Wilson, chief engr. ■ Rates: \$8; 8; 8.

KBOE-FM—Feb 7, 1964: 104.9 mhz; 2.9 kw. Ant 285 ft. ■ Rates: \$6; 6; 6; 6.

***KIGC(FM)**—1975: 88.7 mhz, 10 w. Ant. 80 ft. North Market & Trueblood Aves. (52577). William Penn College. ■ Terry L. Haskell, dean of men.

Ottumwa

KBIZ—1941: khz; 1 kw-D, 250 w-N. Broadcast Center Bldg. (52501). (515) 682-4535. TWX 910-520-1455. KBIZ Inc. (acq 12-15-64). Group owner: Post Corp. Net: CBS. Rep: H-R Stone Inc. Format: MOR. Spec progs: Farm 9½ hrs, C&W 3 hrs wkly. ■ V.J. Minahan, pres; David L. Nelson, VP & treas; Alvina M. Britz, gen mgr; Ruth Jannusch, opns mgr; William McCullough, sls mgr; Gerald Dreger, chief engr. ■ KTVO(TV) affil. ■ Rates: \$11; 9; 11; 7.

KLEE

Contemporary

KLEE—Aug 1, 1954: 1480 khz; 500 w-D. 212½ E. Main St. (52501). (515) 682-8711. Kleeco Radio Inc. (acq 3-63). Rep: Walton. Format: MOR. ■ Daniel C. Palen, exec dir & gen mgr; John C. Melcher, coml mgr; Mel Michaels, prog dir; Ken Williams, mus dir; John Cromwell, chief engr. ■ Rates: \$6; 6; 6; 6.

KLEE-FM—September 1975: 97.7 mhz; 3 kw. Ant 172 ft. Stereo. Prog sep from AM. Format: Diversified. ■ Rates: \$5.50; 5.50; 5.50; 5.50.

Pella

***KCUI(FM)**—June 2, 1961: 89.1 mhz; 10 w. Central College (50219). (515) 628-4151, X 235. Central College. Format: Variety. Spec progs: Sp 1 hr, Fr 1 hr, Ger 1 hr, Christian 15 hrs wkly. ■ Gary Timmet, advisor; John Eustace, gen mgr.

KNIA—See Knoxville.

New FM—Not on air, target date unknown: 103.3 mhz; 59 kw. Ant 339 ft. 2047 Winnebago St., Madison, Wis. (53704). Tulip City Bcstg Co.

Perry

KDLS—May 10, 1961: 1310 khz; 500 w-D, DA. Box 548 (50220). (515) 465-5357. Perry Bcstg Co. Rep: Walton. ■ Shirley Whitehead, pres; Tom Quinlan, gen mgr; Whitey Schleisman, coml mgr; Steve Locker, prog dir; Rollo Fletcher, prom mgr; Bill Zollman, news dir & chief engr. ■ Rates: \$2.50; 2.50; 2.50; 2.50.

KDLS-FM—Feb 26, 1971: 104.9 mhz; 3 kw. Ant 300 ft. Stereo. Prog sep from KDLS. ■ Rates: \$1.75; 1.75; 1.75; 1.75.

Red Oak

KOAK—Aug 16, 1968: 1080 khz; 250 w-D. Route 3 (51566). (712) 623-2584. Red Oak-Clarinda Radio Inc. (acq 7-72). Audio news: UPI. Rep: Walton. Format: MOR, farm. ■ Dwain Munyon, pres & gen mgr; Vern Olson, news dir.

Sheldon

KIWA—Oct 27, 1961: 1550 khz; 500 w-D. 411 9th St. (51201). (712) 324-2597. Sheldon Bcstg Co. Net: Iowa Town & Country. Rep: Walton. Format: MOR. Spec progs: C&W 12 hrs wkly. ■ E. C. Stangland, owner; W. L. Stangland, mgr; Frank Luepke, farm dir; Jim Wolff, chief engr.

KIWA-FM—Oct 1, 1971: 105.5 mhz; 3 kw. Ant 97 ft. Dups AM 100%.

Iowa Radio

See page C-1 for explanation of listings.

Shenandoah

KFNF Midwest Radio Reps



KFNF—1924: 920 khz; 1 kw-D, 500 w-N. 618½ Sheridan Ave., Box 10 (51601). (712) 246-2890. Shenandoah Bcstg Co. (acq 9-8-72). Net: Iowa Radio. Audio news: UPI. Rep: Midwest Radio; Iowa Radio; C. Ross Martin. Format: C&W, farm. ■ John H. Gayer, pres; Royce E. Willis, VP & gen mgr; Cliff Adams, farm dir; Kirk Leonard, news dir; Randy Fink, mus dir. ■ Rates: \$8; 6; 8; 6.

KMA—Aug 12, 1925: 960 khz; 5 kw-U, DA-N. Box 500, 208 N. Elm (51603). (712) 246-1020. May Bcstg Co. (group owner). Net: ABC/E. Rep: Katz Radio. Format: MOR, talk, farm. Spec prog: C&W 6½ hrs wkly. ■ Edward W. May, pres; Owen L. Saddler, exec VP & gen mgr; Carl "Andy" Andersen, stn mgr; Mike Goodin, prog dir; Don Hansen, mus dir; Ned Dermody, news dir; Don Burrichter, chief engr. ■ Rates: \$20; 20; 20; 13.

Sioux Center

***KDCR(FM)**—Aug 16, 1968: 91.3 mhz; 48 kw. Ant 300 ft. Stereo. Dordt College Campus (51250). (712) 722-0913. Dordt College Inc. Format: Educl. Spec prog: Dutch 1 hr wkly. ■ Rev. B.J. Haan, pres; Martin Dekkenga, gen mgr; Ronald P. Klemm, prog dir; Marvin DeYoung, chief engr.

KVDB—1969: 1090 khz; 500 w-D, DA. Box 233 (51250). 722-9931. Tri-State Bcstrs. Format: MOR/C&W. ■ Russell Vande Brake, owner; Donald Broek, mgr; Gary De Hann, sls mgr.

KVDB-FM—1973: 94.3 mhz; 3 kw. Ant 225 ft.

Sioux City

KBCM Big Country Music

KBCM(FM)—March 11, 1974: 95.5 mhz; 100 kw. Ant 898 ft. Stereo. 1400 Pierce St. (51105). (712) 258-5595. Hassenger Bcstg Corp. Net: ABC/E. Rep: Pro/Meeker. Format: C&W. ■ Tom Hassenger, pres; Jim Hassenger, VP & coml mgr; Roland Ashmore, sls mgr; Donald N. Miller, opns mgr; Paul J. Marshall, prom mgr; Jeff Martin, news dir; Gerald Calhoun, chief engr. ■ Rates: \$14.10; 9.40; 9.40; 9.40.

KMNS—May 1, 1949: 620 khz; 1 kw-U, DA-2. Box 177, 901 Steuben St. (51102). (712) 258-0628. Siouxland Bcstg Inc. (acq 6-16-58). Group owner: Stuart. Net: MBS. Rep: McGabren-Guild-PGW; Paul Abels. Format: MOR day, rock night. ■ Richard W. Chapin, pres; Albert Mangum, VP, gen mgr; Jeff Merritt, prog dir; Dick Michels, news dir; Gerry Gibbs, chief engr.

KSEZ(FM)—Co-owned with KMNS. Feb 6, 1960: 97.9 mhz; 38 kw. Ant 280 ft. Stereo. Net: ABC/FM. Format: Btl mus. ■ Jack Dewitt, stn mgr.

KSCJ—1927: 1360 khz; 5 kw-U, DA-N. Box 1379 (51102). (712) 239-2100. G&G Broadcasting Inc. (acq 12-10-70). Net: ABC/I. Rep: HR/Stone; Soderlund; Hix. Format: MOR. Spec prog: Farm 3 hrs wkly. ■ Raymond W. Grandie, pres & gen mgr; Al Lawrence, chief engr; Bill Grabau, VP & stn mgr. ■ Rates: \$14; 12; 14; 12.

KSEZ(FM)—Listing follows KMNS.

KTFC(FM)—July 1, 1965: 103.3 mhz; 93 kw. Ant 280 ft. Box 102-A, Route 2 (51106). (712) 252-4621. Donald A. Swanson. ■ Don Swanson, gen mgr.

KWSL—1938: 1470 khz; 5 kw-U, DA-2. Box 1230 (51102). (402) 987-3477. Radio Communications Inc. (acq 1975). Rep: Torbet-Lasker. Format: Top 40. ■ Carl

Iowa, Kansas Radio

See page C-1 for explanation of listings.

K. Kjedseth, pres & gen mgr; Robert De Carlo, prog dir; Tom Evans, news dir; John Bylin, chief engr.

Spencer

KICD—December 1942: 1240 khz; 1 kw-D, 250 w-N. Box 631 (51301). (712) 262-1240. Iowa Great Lakes Bcstg Co. (acq 4-45). Rep: Torbet. ■ Ben B. Sanders, pres; Jack W. Wedel, resident mgr; Dorothy Wilson, coml mgr; T. L. Shumate, prom mgr; Rich Fellingham, news dir; Eldon Kanago, chief engr.

KICD-FM—Sept 17, 1965: 107.7 mhz; 100 kw horiz, 92 kw vert. Ant 310 ft. Stereo. Dups AM 60%.

Storm Lake

KAYL—November 1948: 990 khz; 250 w-D. 604½ Lake Ave. (50588). (712) 732-3520. Northwest Iowa Bcstg Co. (acq 11-1-72). Net: Iowa Radio. ■ Paul Benson, pres; Chuck Ney, gen mgr & prog dir. ■ Rates: \$5.95; 7.15; 5.95; 5.95.

KAYL-FM—February 1949: 101.5 mhz; 17.5 kw horiz, 10.5 kw vert. Ant 400 ft. Audio news: UPI. Dups AM 35%. Format: MOR.

Twin Lakes

KTLEB(FM)—1975: 105.5 mhz; 3 kw. Ant 300 ft. Stereo. RFD 3 Rockwell City (50579). (712) 297-7586. Twin Lakes Bcstg Inc. Format: MOR, btfl mus, Top 40 (night). ■ Francis N. Donnelly, pres, gen & coml mgr; Rod White, prog dir; Eleanor Mills, news dir; news dir; Craig Pringle, chief engr. ■ Rates: \$6; 6; 6; 6.

Washington

KCII—Nov 12, 1961: 1380 khz; 500 w-D. Box 370 (52353). (319) 653-2113. Washington Radio Inc. (acq 10-1-70). Rep: Meeker. Format: MOR/Top 40, albums & gold. ■ Al Leighton, pres; Ken Light, gen mgr; Lee Thomas, prog dir; Dan Bryan, coml mgr.

KCII-FM—Not on air, target date unknown: 95.3 khz; 3 kw. Ant 300 ft. Box 524 (52353). Format: MOR/Easy lsg.

Waterloo

KFMW(FM)—Listing follows KWWL.

KLEU—1972: 850 khz; 500 w-D, DA. 3232 Osage Rd. (50701). (319) 234-2811. Marathon Communications Inc. Net: MBS. Rep: Dahisten, Wayne-Evans. Format: Contemp. Spec progs: Big band 5 hrs wkly. ■ William E. Payne, pres; William Bundy, VP and gen mgr; Gary Hubbard, coml mgr; Dave Jonasen, prog dir; Jim Collins, mus dir; Jim Knight, news dir; Rick Keefer, chief engr. ■ Rates: \$6; 5.50; 6; 5.50.

***KNWS**—1953: 1090 khz; 1 kw-D. 4880 La Porte Rd. (50702). (319) 234-2658. Northwestern College (acq 4-2-53). Format: Relig. ■ Russ Nelson, gen mgr; Doug Stevens, prog dir; Mary Robinson, mus dir; Randy Lubbers, traf dir; David Dobes, spts dir; Steve Ferrario, chief engr.

***KWNS-FM**—1965: 101.9 mhz; 100 kw. Ant 1010 ft. Dups AM 40%. Format: Good mus & relig.

KWWL—November 1947: 1330 khz; 5 kw-U, DA-2. 500 E. Fourth (50703). (319) 234-4401. TWX 910-525-1271. Black Hawk Bcstg Co. (group owner). Audio news: APR Rep: Robert Eastman. Format: MOR. Spec prog: Farm 6 hrs, 6-8 a.m. ■ Robert Buckmaster, chmn; James Bradley, exec VP; William Bolster, VP radio; Robert Beck, prog dir; Grant Price, VP news dir; Ed Tink, VP chief engr. ■ Rates: \$22; 18; 22; 14.

KFMW(FM)—Co-owned with KWWL. November 1968: 107.9 mhz; 100 kw. Ant 1,800 ft. Stereo. Prog sep from AM. ■ Daniel Davies, stn mgr. ■ Rates: \$8; 8; 8; 8. ■ KWLL-TV affil.

KXEL—July 14, 1942: 1540 khz; 50 kw-U, DA-N. Highway 281 East (50705). (319) 233-3371. Cy N. Bahakel (group owner; acq 1-11-58). Net: ABC/I. Rep: HR/Stone. Format: C&W. Spec progs: Black 3 hrs wkly. ■ Cy N. Bahakel, pres; J. Rick Hall, gen mgr; Hal

Hanna, prog dir; Jake Edwards, mus dir; Darwin Paus-tian, news dir; Tony Thill, chief engr.

KXEL-FM—Nov 21, 1962: 105.7 mhz; 100 kw. Ant 570 ft. Stereo. Prog sep from AM. Net: ABC/FM. Format: Contemp. Spec progs: Black 2 hrs wkly. ■ Wally Beardson, mus dir.

Waukon

KNEI—July 1, 1967: 1140 khz; 1 kw-D. Box 151 (52172). (319) 568-3476. David H. Hogendorn (acq 1972). Format: C&W, oldies. ■ David H. Hogendorn, pres, gen mgr & prog dir; James May, mus dir; Greg Grover, news dir; Charles Pettingill, coml mgr.

KNEI-FM—Sept 1, 1968: 103.9 mhz; 3 kw. Ant 300 ft. Dups AM 70%.

Waverly

KWAR(FM)—Sept 15, 1951: 89.1 mhz; 10 w. Wartburg College (50677). (319) 352-1200, ext 306. Wartburg College. Net: MBS, Longhorn, Intercollegiate Bcst System. Format: Educl, diversified. Spec prog: Black 3 hrs; Fr ½ hr, Ger ½ hr, Sp ½ hr. wkly. ■ Dr. Robert C. Gremmels, advisor; David Siefkes, stn mgr.

KWAY—May 6, 1958: 1470 khz; 1 kw-D, DA. Box 307 (50677). (319) 352-3550. Cedar Valley Bcstg Co. Net: Iowa Town & Country. Format: C&W, MOR. ■ John W. Talbot, pres & chief engr; J.D. Ball, gen mgr.

KWAY-FM—Dec 21, 1971: 99.3 mhz; 3 kw. Ant 180 ft. Dups AM 33%. Format: Easy lsg.

Webster City

KQWC—Feb 6, 1950: 1570 khz; 250 w-D. Box 222 (52355). (513) 832-1410. Gorich Radio Corp. Rep: Walton. Format: MOR, C&W. ■ Glenn R. Olson, pres; G. D. Warland, gen mgr; Jacque Sever, coml mgr; B.J. Wilson, prog dir; Creig Pringle, chief engr. ■ Rates: \$5; 5; 5; 5.

KQWC-FM—1969: 95.9 mhz; 3 kw. Ant 195 ft. Box 27, 508 2d St. (50595). (515) 832-3068. (acq 1972). ■ Glenn Olson, gen mgr.

CSI ELECTRONICS INC.
2607 River Road
Cinnaminson, New Jersey, 08077
Telephone: (609) 786-1060

Kansas

HAMILTON-LANDIS & ASSOCIATES, Inc.
NATIONWIDE MEDIA BROKERS
WASHINGTON, D. C. CHICAGO, DALLAS, SAN FRANCISCO
SELL MORE
RADIO & TELEVISION STATIONS
IN THE MIDWEST—NEAREST OFFICE IS—
1429 TRIBUNE TOWER, CHICAGO 60611
(312) 337-2754

Abilene

KABI—April 8, 1963: 1560 khz; 250 w-D. Box 237 (67410). (913) 263-1560. KABI Inc. ■ Norton E. Warner, pres; Leon Geisert, gen mgr.

KABI-FM—Dec 10, 1968: 98.3 mhz; 3 kw. Ant 100 ft. Dups AM 90%.

Arkansas City

KSOK—Jan 1, 1947: 1280 khz; 1 kw-D, 100 w-N. Box 917 (67005). (316) 442-5400. KSOK Bcstg Co. Inc. Group owner: Stauffer. Format: Btfl mus. ■ Stanley

Stauffer, pres; Mike Thompson, opns and coml mgr; Larry Smith, news dir. ■ Rates: \$6; 6; 6; 6.

Atchison

KARE—July 28, 1939: 1470 khz; 1 kw-U, DA-1. Box G (66002). (913) 367-1470. KARE Inc. (acq 1-20-50). Net: NBC. Rep: Walton. Format: MOR. ■ James M. Griffith, pres & gen mgr; William B. Ervin, coml mgr; Harold Schoeopner, prog & news dir; L. D. Winegardner, chief engr. ■ Rates: \$6; 5; 6; 4.

Baldwin City

***KNBU(FM)**—Nov 29, 1965: 88.9 mhz; 10 w. 7th and Dearborn Sts. (66006). (913) 594-6451, ext 300. Baker U. Format: Ed. Spec progs: Jazz 10 hrs; pub affs, 3 hrs; C&W 2 hrs; classical 8 hrs wkly. ■ Shirley Gilham, advisor; Carol Yeo, stn mgr.

Chanute

KKOY—Nov 17, 1952: 1460 khz; 1 kw-D. Box 748 (66720). (316) 431-3700. Neosho County Bcstg Inc. (acq 5-1-68). Net: ABC/I. Format: Contemp. Spec prog: Sp 1 hr wkly. ■ Dale W. McCoy Jr., pres & gen mgr; Dean Denning, sis mgr; James Fehr, prog dir; Judy Fisher, prom mgr; Pat Shehan, mus dir; Craig Martens, news dir; Al Diller Jr., chief engr. ■ Rates: \$4.50; 4; 4; 4.

KKOY-FM—Jan 1, 1971: 105.5 mhz; 3 kw. Ant 160 ft. Prog sep from AM. Format: C&W. ■ Rates: \$4; 4; 4.

Coffeyville

KGGF—1930: 690 khz; 10 kw-D, 5 kw-N, DA-2. Box 853 (67337). (316) 251-3800. Midwest Bcstg Co. (acq 10-15-47). Group owner: Seaton Stns. Net: ABC/C. Rep: PRO/Meeker. Format: MOR. ■ Richard M. Seaton, pres; Robert L. Pratt, VP & gen mgr; Warren L. Mowder, coml mgr; Bill Miller, opns & prom mgr; Robert McBride, prog dir; Fred Lee, news dir; D. W. Gillette, chief engr. ■ Rates: \$8; 7; 8; 7.

Colby

***KTCC(FM)**—May 1974: 91.9 mhz; 10 kw. Ant 160 ft. 1255 S. Range (67701). (913) 462-6762. Colby Community Junior College. Format: MOR, C&W. ■ Dennis L. Franz, pres; Bruce Smith, gen mgr.

KXXX—August 1947: 790 khz; 5 kw-D. Box 27 (67601). (913) 462-3305. Golden Plains Inc. (acq 8-6-5). Net: CBS. Rep: Avery Knodel. Format: MOR & farm. Spec progs: C&W 15 hrs wkly. ■ Ed Mason, pres & gen mgr; Jean Windscheffel, mus dir; Rich Hawkins, farm dir; Herb Deremer, rgnl sis mgr; Vernon Snider, chief engr. ■ Rates: \$21.75; 19.50; 21.75; 19.50.

KXXX-FM—September 1971: 100.3 mhz; 100 kw. Ant 610 ft. Stereo. Progs sep from AM. Format: Contemp & MOR. ■ Rates: \$10.88; 9.75; 10.88; 9.75.

Concordia

KNCK—Feb 6, 1954: 1390 khz; 500 w-D. Box 608 (66901). (913) 243-1414. General Bcstg Co. Rep: Keystone. Format: MOR. ■ W. F. Danenbager, pres; Wendell Wilson, stn mgr; Mike Farmer, traf mgr. ■ Rates: \$2; 2; 2; 2.

Dodge City

KEDD—March 1961: 1550 khz; 1 kw-D, DA. Box 1206 (67801). (316) 227-7151. Seward County Bcstg Co. Group owner: Alf M. Landon. Net: ABC/I. Format: Top 40. ■ Alf M. Landon, pres; James R. Hewes, gen mgr; Del Kehr, coml mgr & chief engr; S. Eric Warshaw, prog and mus dir & prom mgr; Ken Rucker, news dir.

KGNO—June 30, 1930: 1370 khz; 5 kw-D, 1 kw-N, DA-N. Box 1398 (67801). (316) 227-3151. Dodge City Bcstg Co. Inc. Rep: Savalli/Gates, Gray, Hix, Soderlund. Format: MOR. Spec progs: Farm 8 hrs, classical 1½ hrs wkly. ■ Martha E. Muncy, pres; Isadore A. Salm, gen & prom mgr; Gary Conard, coml mgr; Mike Kinman, prog & mus dir; Chuck Stark, news dir & chief engr.

KGNO-FM—May 1966: 95.5 mhz; 25 kw. Ant 165 ft. Stereo. Dups AM 40%.

El Dorado

KOYY—Nov 16, 1953: 1360 khz; 500 w-D. Box 550 (67042). (316) 321-1360. Neosho County Bcstg Inc. (acq 8-1-71). Format: MOR. ■ Dale W. McCoy Jr., pres;

H. Pat Powers, gen mgr; Richard Milhon, prog dir; Ed Logan, prom mgr; Dennis Whitener, coml mgr; Ken Dean, mus dir; Bill Conway, news dir; Al Diller, chief engr.

KOYY-FM—Feb 15, 1972: 99.3 mhz; 3 kw. Ant 135 ft. Dups AM 60%.

Ellsworth

KLOQ(FM)—See Lyons.

Emporia

KLRF(FM)—Listing follows KVOE.

KVOE—Jan 21, 1939: 1400 khz; 1 kw-D, 250 w-N. Box 968 (66801). (316) 342-1400. Bluestem Bcstg Co. (acq 8-1-57). Net: ABC/I. Rep: Keystone. Format: MOR, variety, C&W. ■ Edward H. McKernan Jr., pres & gen mgr; Rich Bisterfeld, coml mgr; Lyle Brown, prog & mus dir; Roger Hartsook, news dir; Dave Wiese, chief engr. ■ Rates: \$7.60; 7.60; 7.60; 7.60.

KLRF(FM)—Co-owned with KVOE. June 15, 1966: 104.9 mhz; 3 kw. Ant 300 ft. Stereo. Format: Progs, Contemp. ■ Rates: \$6.60; 6.60; 6.60; 6.60.

Fairway

KUDL—April 16, 1953: 1380 khz; 5 kw-D, 500 w-N, DA-2. 6230 Eby, Shawnee Mission, Kan. (66202). (816) 722-2866. Kansas Bcstg Inc. (acq 5-3-67). Group owner: Starr. Net: NBC/NIS. Rep: Torbet. Format: All news. ■ Peter H. Starr, pres; Vince Ford, gen mgr; Bob Read, news dir; Cal Babcock, chief engr. ■ Rates: \$26; 22; 26; 22.

KUDL-FM—See Kansas City, Kan.

Fort Scott

KMDO—Oct 8, 1954: 1600 khz; 500 w-D. Box 72 (66701). (316) 223-4500. Fort Scott Bcstg Co. (acq 2-1-60). Group owner: Lloyd C. McKenney Stns. Net: KBS. ■ Jim McKenney, gen mgr.

Garden City

KIUL—May 20, 1935: 1240 khz; 1 kw-D, 250 w-N. 308 N. Seventh St. Box 878 (67846). (316) 276-3251. KIUL Inc. (acq 1-1-53). Group owner: Harris Enterprises. Net: NBC. Rep: Devney. ■ Tony Jewell, pres & gen mgr; Ron Isham, coml mgr; Phil Weaver, prog dir; Mary Connors, prom mgr.

KUPK—1948: 1050 khz; 5 kw-D, DA. Box 798 (67846). (316) 276-2366. KAKE-TV and Radio Inc. (acq 9-1-65). Rep: Katz. Format: MOR. Spec progs: Sp 2 hrs, C&W 25 hrs wkly. ■ Martin Umansky, pres; Jim Throneberry, gen mgr; Bob Terry, mus dir; Rick Cheatum, opns dir & news dir; Doug Wagner, prom mgr; Bob Hill, chief engr.

KUPK-FM—Nov 30, 1962: 97.3 mhz; 11 kw. Ant 230 ft. Dup AM 98%. ■ KUPK-TV affil.

Goodland

KLOE—1947: 730 khz; 1 kw-D. Box 569 (67735). (913) 899-2309. KLOE Inc. (acq 11-1-60). Rep: Devney. Format: Variety. Spec prog: Sp 5 hrs wkly. ■ Ross Beach, pres; Kay Melia, gen mgr; Ken Halbleib, coml mgr; Rich Epp, prog dir; Larry Hevner, mus dir; Randy Jacobson, prom mgr; Phil Taylor, news dir; Wayne Pash, chief engr. ■ KLOE-TV affil.

Great Bend

***KBJC(FM)**—Feb 18, 1970: 91.9 mhz; 10 w. Barton County Community Junior College (67530). (316) 792-2701, ext 60. Licensee as above. Format: Progs/free form. ■ Dr. Jimmie Downing, pres; Ken Kempner, gen mgr; Harry McCormick, prom mgr.

KLOQ(FM)—See Lyons.

KVGB—March 10, 1937: 1590 khz; 5 kw-U, DA-N. 1200 Baker St. (67530). (316) 792-4317. Forward of Kansas Inc. (acq 3-1-70). Group owner: Forward Communications Corp. Net: NBC. Rep: PRO/Meeker, Hix. Format: MOR. Spec prog: Farm 6 hrs wkly. ■ Richard D. Dudley, pres; Robert D. Hilgendorf, gen mgr; Mike Jackson, news dir; Harold F. Riedl, chief engr.

KVGB-FM—Not on air; target date unknown: 104.3 mhz; 100 kw. Ant 805 ft. 1200 Baker St. (67530).

Hays

KAYS—Oct 15, 1948: 1400 khz; 1 kw-D, 250 w-N. Box 817 (67601). (913) 625-2578. KAYS Inc. Rep: Devney. ■ Ross Beach, pres; Robert E. Schmidt, VP & gen mgr; Robert C. Templeton, stn mgr; Mike Cooper, prog dir; Jim Brooks, continuity dir; Bob Chaffin, news dir; Ken Giebler, chief engr. ■ KAYS-TV affil.

KJLS(FM)—June 27, 1974: 103.3 mhz; 100 kw. Ant 463 ft. Stereo. Box 364 (67601). (913) 628-1064. L Steckline, M. Sanders. Format: C&W, rock. ■ Bill Kuhn, gen mgr; Troy Wayne, mus dir; Jim Weston, news dir; Odus Trober, chief engr.

Hutchinson

***KHCC(FM)**—Sept 11, 1972: 90.1 mhz; 83 w. Ant 57 ft. 1300 North Plum (67501). (316) 662-6646. Hutchinson Community College. Format: Variety. Spec progs: Farm 3 hrs, black 2½ hrs; classical 5 hrs; jazz 2 hrs; Sp 2 hrs wkly. ■ Vance Tyrell, progs coord.

KSKU(FM)—Oct 7, 1968: 102.1 mhz; 100 kw. Ant 550 ft. Stereo. 2627 E. 4th Ave. (67501). (316) 663-2115. Sampson Communications Co. (acq 9-5-75). Audio news: APR. Format: MOR, top 40. ■ Jack S. Sampson, pres & gen mgr; Bill Wolf, coml mgr; Steve Bridgewater, prog dir; Roger Cornish, news dir; Gary Essels, chief engr.

KWBW—May 28, 1935: 1450 khz; 1 kw-D, 250 w-N. 17th & Harding Sts. (67501). (316) 662-4486. Nation's Center Bcstg Co. (acq 11-16-56). Net: NBC. Rep: Walton. Format: Talk, MOR. ■ Fred L. Conger, pres & gen mgr; John M. Townley, coml mgr; George Bachelor, prog dir; Bill Turney, chief engr; Dan Deming, news dir. ■ Rates: \$8.50; 5.45; 5.45; 5.45.

KWBW-FM—March 15, 1972: 102.9 mhz; 28.5 kw. Ant 155 ft. Box 1036 (67501). (316) 662-4486. Rep: Walton. Format: C&W. ■ Richard Cornish, coml mgr & prom mgr; Larry James, prog dir & mus dir. ■ Rates: \$4.25; 4.25; 4.25; 4.25.

KWHK Contemporary

KWHK—Nov 1, 1946: 1260 khz; 1 kw-D, 500 w-N, DA-2. Box 1967 (67501). (316) 663-4461. KWHK Bcstg Co. (acq 8-6-60). Rep: PRO/Meeker, Gray. Format: Top 40. Spec prog: Sp ½ hr wkly. ■ William L. Mitchell chmn of the bd; Ken Willard, stn mgr; Clark Bevan, prog dir; J.W. Walker, mus dir; Bob Chaffin, news dir; Rich Cheatum, chief engr. ■ Rates: \$7.50; 6.25; 7.25; 2.50.

Independence

KIND—Dec 8, 1947: 1010 khz; 250 w-D. Drawer A (67301). (316) 311-3000. Central Bcstg Inc. Format: MOR; talk. ■ J. Nelson Rupard, pres & gen mgr; Jim Fischer, coml mgr. ■ Rates: \$48; 48; 48; 48.

KIND-FM—May 10, 1969: 101.7 mhz; 1.6 kw. Ant 155 ft. Dups AM 50%.

Iola

KALN—July 25, 1961: 1370 khz; 500 w-D, DA. Box 710 (66749). (316) 365-3151. Iola Bcstg Inc. (acq 9-1-73). Net: Keystone. Audio news: UPI. Format: MOR 65%, Top 40 35%. ■ Michael P. Russell, pres, gen & coml mgr; Steve Burrows, prog dir; Robert Wiles, chief engr. ■ Rates: \$4.50; 4.10; 4.10; 4.10.

Junction City

KJCK—May 15, 1949: 1420 khz; 1 kw-D. W. 6th at Garfield, Box 789 (66441). (913) 762-3165. Junction City Bcstg Co. Format: MOR. ■ R. L. Weir Jr., pres; Steve Roessler, gen mgr; Donald D. Wolf, coml mgr; Dan Weir, opns dir; Bruce Karns, news dir; Barry Lee Yazell, chief engr. ■ Rates: \$8.23; 7.05; 8.23; 7.05.

KJCK-FM—July 1, 1965: 94.5 mhz; 100 kw. Ant 540 ft. Stereo. Prog sep from AM. Format: Contemp. ■ Chris Favor, prog dir. ■ Rates same as AM.

Kansas City

KCKN—1925: 1340 khz; 1 kw-D, 250 w-N. Box 1165 (66117). (913) 321-3200. Kaye-Smith Radio (group owner; acq 7-1-65). Rep: McGavren-Guild-PGW. Format: C&W. Spec prog: Sp 1 hr wkly. ■ Lester M. Smith, exec dir; Glen M. George, stn mgr; Gary Reames, coml

Kansas Radio

See page C-1 for explanation of listings.

mgr; Gary Brazeal, opns dir; Mike Sharin, news dir; Jim J. Jett, chief engr. ■ Rates: \$57; 45; 47; 25.

KCKN-FM—May 28, 1963: 94.1 mhz; 100 kw. Ant 460 ft. Stereo. Dup AM 50%.

KUDL-FM—Co-owned with KUDL Fairway, Kan. Oct 9, 1959: 98.1 mhz; 100 kw. Ant 240 ft. Stereo. 6230 Eby, Shawnee Mission, Kan. (66202). (913) 722-2866. Starr Broadcasting Group of Kansas Inc. Group owner: Starr. Prog sep from AM. Net: ABC/I. Format: Oldies, Top 40. ■ Peter Starr, pres; Vince Ford, gen mgr; Jim Carnegie, prog dir; Cal Babcock, chief engr.

Larned

KANS—Nov 4, 1963: 1510 khz; 1 kw-D (500 w-CH). 8th & Topeka (67550). (316) 285-2127. Hillis F. Bell Jr. (acq 8-14-67). Rep: Richardson. Format: MOR. Spec progs: C&W 12 hrs wkly. ■ Hillis F. Bell Jr., pres & gen mgr; Gary Meserve, coml mgr; Doyle Mayse, news dir; Marilynn Bell, prom mgr; Chris Brickley, prog & mus dir; Jim Adams, chief engr.

KANS-FM—Nov 1, 1965: 96.7 mhz; 910 w. Ant 290 ft. Dup AM 100%.

Lawrence

***KANU(FM)**—Listing follows *KFKU.

***KFKU**—Sept 15, 1924: 1250 khz; 5 kw-U, DA-N (S-WREN Topeka). Bcstg Hall, U. of Kansas (66045). (913) 864-4530. U. of Kansas. Net: NPR. Format: Variety. ■ Archie Dykes, chancellor; Richard F. Wright, gen mgr; Michael Berndt, mus dir; William Redlin, news dir; Thomas P. Dolye, chief engr.

***KANU(FM)**—Co-owned with *KFKU. Sept 15, 1952: 91.5 mhz; 110 kw. Ant 660 ft. Stereo. Progs sep from AM. Spec prog: Black 4 hrs wkly. ■ Paul Dahringer, prog dir; John Eastley, prom mgr.

***KJHK(FM)**—1975: 90.7 mhz; 10 w. Office of Chancellor, Strong Hall, Jayhawk Blvd. (66045). University of Kansas.

KLWN—Feb 22, 1951: 1320 khz; 500 w-D. Box 3007 (66044). (913) 843-1320. Lawrence Bcstg Inc. Rep: Walton, Gray. Format: Talk, MOR. Spec progs: News & pub aff 24 hrs wkly. ■ Arden Booth, pres; Hank Booth, gen mgr; Bob Newton, opns mgr; Sonny Fender, prog dir; Carroll Macke, news dir; Harold Kinkaid, chief engr. ■ Rates: \$11.50; 7.50; 7.50; 7.50.

KLWN-FM—Aug 20, 1963: 105.9 mhz; 17 kw. Ant 135 ft. Stereo. Prog sep from AM. Format: Progs. ■ Mike Schmidt, prog dir. ■ Rates: \$7.50; 7.50; 7.50; 7.50.

Leavenworth

KCLO—1948: 1410 khz; 5 kw-D, DA. 335 Muncie Rd. (66048). (913) 682-1410. KCLO Inc. (acq 7-59). Group owner: Anderson Stns. Rep: Hopewell. Format: Contemp. Spec progs: Black 2 hrs, Sp 2½ hrs, wkly. ■ George Basil Anderson, pres & gen mgr; Lee Pemberton, coml & prom mgr, prog & mus dir; Art Pemberton, news dir & chief engr.

KCLO-FM—1962: 98.9 mhz; 100 kw horiz, 66 kw vert. Ant 410 ft. Stereo. Dup AM 10%.

Liberal

KLIB—Sept 15, 1960: 1470 khz; 1 kw-D. Box 856 (67901). (316) 624-2556. Communications Enterprises of Kansas Inc. Net: MBS. Format: C&W. ■ Chuck Davis, gen mgr; Bill Ray, prom mgr. ■ Rates: \$4; 4; 4; 4.

KSCB—July 25, 1948: 1270 khz; 1 kw-D, 500 w-N, DA-N. Box K (67901). (316) 624-3891. Seward County Bcstg Co. Group owner: Alf M. Landon Stns. Net: ABC/I. Rep: PRO/Meeker. Format: MOR, oldies. Spec prog: Farm 15 hrs wkly. ■ Alf M. Landon, pres; Stuart Melchert, gen mgr; Wayne Gray, coml mgr; Terry Martin, prog dir; Steve Kime, mus dir; Don Drees, farm dir; Howard Corr, news dir; John Deken, chief engr. ■ Rates: \$5; 5; 5; 3.

Lyons

KLOQ(FM)—April 10, 1970: 106.1 mhz; 62 kw. Ant 175 ft. Route 1, Box 149 (67554). (316) 278-3644.

Kansas Radio

See page C-1 for explanation of listings.

Rice County Bcstg Co. Inc. Net: ABC/E. Format: Btl mus. Spec progs: Farm 4 hrs, jazz 2 hrs, C&W 20 hrs; progs 20 hrs; news 12 hrs, wkly. ■ Rolan Cobb, pres & gen mgr; Cliff Shank, prom mgr; Jack Hartle, prog dir; Judy Van Zanten, mus dir; Timothy Stovall, news dir; Mike Hill, coml mgr; Art Schreiner, chief engr. ■ Rates: \$4.25; 4.25; 4.25; 4.25.

Manhattan

KMAN—June 1950: 1350 khz; 500 w-D. Box 1350 (66502). (913) 776-4851. Manhattan Bcstg Co. Group owner: Seaton Stns. Format: MOR. ■ Richard M. Seaton, pres; Lowell E. Jack, VP & gen mgr; Tom Rees, coml mgr; James Kastner, prom mgr; Roger Hamilton, prog dir; Ed Klimek, mus dir; Jerry Bohlen, news dir; Tim Hawks, chief engr. ■ Rates: \$9.80; 9.80; 9.80; —.

KMKF(FM)—Co-owned with KMAN. Sept 1, 1972: 101.7 mhz; 1.60 kw. Ant 400 ft. Stereo. Box 1017 (66502). (913) 776-4851. Progs sep from AM. Format: Easy Listening-AM, contemp, progs, rock-PM. ■ Ed Klimek, FM coord. ■ Rates: \$8.50; 8.50; 8.50; 8.50.

***KSAC**—Dec 1, 1924: 580 khz; 5 kw-D, 500 w-N (S-WIBW). Room 20, McCain Auditorium, Kansas State U. (66506). (913) 532-5851. Kansas State U. Format: Educl. ■ Duane C. Acker, pres; Jack M. Burke, mgr; Ralph S. Titus, spec affrs.

***KSDB-FM**—Co-owned with *KSAC. 1950: 88.1 mhz; 10 w. (913) 532-6960. Format: Top 40.

Marysville

KNDY—July 10, 1956: 1570 khz; 250 w-D. RR 3 (66508). (913) 562-2361. Apollo Broadcasting Corp. (acq 11-17-69). Format: C&W, MOR. Spec progs: Fr 3 hrs wkly. ■ Herbert R. Hoeflicker, pres & gen mgr; Ruby J. Hoeflicker, coml mgr; "Little Herb," prog & mus dir; Mert Gardner, news dir; Van Stewart, chief engr. ■ Rates: \$4.75; 4.75; 4.75; —.

KNDY-FM—July 23, 1974: 103.1 mhz; 3 kw. Ant 200 ft. Prog sep from AM. Format: C&W/Contemp. ■ Al Schwartz, prog & mus dir; Al Pickett, sports dir. ■ Rates: \$4.75; 4.75; 4.75; 4.75.

McPherson

KNEK—Jan 4, 1949: 1540 khz; 250 w-D. Box 186 (67460). (316) 241-1504. McPherson Bcstg Inc. (acq 9-26-52). Rep: Hopewell. Format: MOR. ■ K. R. Krehbiel, pres; Claude Hughes, gen mgr & prog dir; Vic Davis, coml mgr; Bob Haggood, news dir; Bob Battershell, chief engr.

KNEK-FM—Jan 12, 1974: 96.7 mhz; 3 kw. Ant 245 ft. McPherson Bcstg Inc. Dups AM 15%. Format: Btl mus, sports & news. Stereo.

Mission

KBEA—October 1957: 1480 khz; 1 kw-D, 500 w-N, DA-2. Box 1347 (66202). (913) 432-1480. KBEA Bcstg Co. (acq 12-1-72). Net: NBC, MBS, Missouri Network. Rep: Selcom. Format: MOR, news. Spec prog: Sp 1 hr wkly. ■ Robert P. Ingram, pres; Jay Tschirner, gen mgr; John Haseltine, prog dir; David Remley, coml mgr; Sandy Milzman, prom mgr; Charles Harness, news dir; C. B. Frazer, chief engr. ■ Rates: \$16; 12; 16; 10.

Newton

KJRG—May 24, 1953: 950 khz; 500 w-D. Box 567 (67114). (316) 283-5150. KJRG Inc. (acq 7-59). Group owner: Anderson Stns. Rep: Hopewell. Format: Religious. ■ Geo. Basil Anderson, pres; Gordon Anderson, gen mgr; Carl Weaver, chief engr.

KJRG-FM—1959: 92.3 mhz; 100 kw horiz. 63 kw vert. Ant 390 ft. Stereo. Prog sep from AM. Format: MOR.

Norton

KNBI—Oct 28, 1963: 1530 khz; 1 kw-D. Box 220 (67654). (913) 927-3378. Prairie Dog Bcstg (acq 9-11-74). Net: KU Sports Net. Rep: Keystone. Format: C&W, MOR. ■ David L. Tucker, pres, gen mgr & chief engr; Howard Henderson, prom mgr; James Garfield, news dir; Elliott Tucker, prog & mus dir.

Ottawa

KOFO—Sept 24, 1949: 1220 khz; 250 w-D. Box 16 (66067). (913) 242-1220. Ottawa Bcstg Co. (acq 12-1-54). Rep: PRO/Meeker. Format: MOR, talk. ■ Roderick B. Cupp, gen mgr; Burton H. Brewer, stn & prog dir; Donald F. Humphrey, coml mgr; John Collinson, chief engr. ■ Rates: \$6.50; 6.50; 6.50; —.

KOFO-FM—March 1, 1962: 95.7 mhz; 6.7 kw. Ant 340 ft. Dup AM 100%. ■ Rates same as AM.

***KTJO-FM**—May 1951: 88.1 mhz; 10 w. Ant 84 ft. Box 10, Ottawa University (66067). (913) 242-5200, ext 212. Ottawa University. Format: Variety. ■ Glen Duderstadt, gen mgr.

Parsons

KLKC—1948: 1540 khz; 250 w-D. Box 853 (67357). (316) 421-6400. Community Bcstg Co. (acq 2-54). Format: MOR. Spec prog: Sp 2 hr wkly. ■ Richard R. Combs, pres, gen mgr, news dir & chief engr; Eugene L. Joslin, stn mgr, prog dir & prom mgr.

Phillipsburg

KKAN—Dec 31, 1959: 1490 khz; 1 kw-D, 250 w-N. Box 307 (67661). (913) 543-3251. KKAN Inc. (acq 5-4-64). ■ Norton E. Warner, pres; Dwight C. Look, mgr.

Pittsburg

KOAM—Oct 11, 1937: 860 khz; 10 kw-D, 5 kw-N, DA-N. Box F (66762). (316) 231-7200. TWX 316-952-8230. Pittsburg Bcstg Inc. Net: NBC. Rep: Masla; Gray Format: Variety. ■ Lester Cox, pres; Joe L. Shiverdecker, gen mgr; Jerry Greech, coml mgr; Tom Marshall, prog and mus dir; Mike Kennedy, sports dir; Terry Frieden, news dir; Joe Patterson, chief engr. ■ Rates: \$10.20; 7.50; 10.20; 7.50.

KMRJ(FM)—Listing follows KSEK.

KSEK—May 1947: 1340 khz; 1 kw-D, 250 w-N. Box 610 (66762). (316) 231-2800. Douglas Bcstg Corp. (acq 5-1-74). Net CBS. Rep: PRO/Meeker. Format: MOR. Spec prog: Farm 9 hrs wkly. ■ James D. Harbart, pres and gen mgr; Tom Boone, coml mgr; Gary N. Hannes, prog dir; Rick Russell, mus dir; Iris Walkinshaw, prom mgr; Charlie Shipman, news dir; Jim Douglas, chief engr. ■ Rates: \$102; 102; 102; 84.

KMRJ(FM)—Co-owned with KSEK. April 20, 1975: 96.9 mhz; 100 kw. Ant 390 ft. 13005 W. 77th St. (66215). Dups AM 80%. Stereo. ■ James D. Harbart, pres.

Pratt

KWNS—Jan 19, 1963: 1290 khz; 5 kw-D, 500 w-N, DA-2. Box 486 (67124). (316) 672-5581. O'Malley-Kieffer Communications Co. (acq 11-21-73). Net: ABC/E. Rep: Walton, Messina. Format: Variety. Spec prog: Farm 9 hrs wkly. ■ Don O'Malley, pres and gen mgr; Dan Musil, prog dir; Roger Allen, mus dir; Harvey Watson, news dir; Tim Hawks, chief engr. ■ Rates: \$6.25; 4.80; 6.25; 4.80.

KWNS-FM—July 1, 1965: 93.1 mhz; 29 kw. Ant 120 ft. Dup AM 100%. ■ Rates same as AM.

Russell

KRSL—Jan 11, 1956: 990 khz; 250 w-D. Box 666 (67665). (913) 483-3121. Thompson Broadcasting of Russell (acq 9-1-58). ■ Fred L. Thompson, owner & gen mgr; Richard Dumer, stn mgr; Don Woelk, news dir.

KRSL-FM—July 1, 1965: 95.9 mhz; 3 kw. Ant 295 ft. Dup AM 90%.

Salina

KFRM—1947: 550 khz; 5 kw-D, DA. 737 N. West St., Wichita (67203). (316) 942-7981. Jaco Inc. (acq 10-22-66). Rep: Avery Knodel. Format: C&W, farm. ■ Mack Sanders, pres & gen mgr; Faye Graves, coml mgr; Gene Norris, prog dir & prom mgr; Juanita Rose, mus dir; Jerry Minsall, news dir; Ken Sollar, chief engr; Larry Steckline, farm dir.

KINA—April 20, 1964: 910 khz; 500 w-D, DA. Box 778 (67401). (913) 825-0266. Salina Radio Inc. Audio news: UPI. Format: MOR. ■ Sherwood R. Parks, pres, gen mgr; Bill Melton, sls mgr; Don Garry, prog dir;

John Pappert, prom mgr; Bill Moore, news dir; Don Garry, chief engr. ■ Rates: \$6.90; 6.90; 6.90.

KSAL—May 18, 1937: 1150 khz; 5 kw-U, DA-N. Box 180 (67401). (913) 823-3701. Salina Bcstg Inc (acq 2-11-59). Group owner: Stuart Bcstg Co. Net: ABC/I. Rep: McGavren-Guild, Hix. ■ Richard W. Chapin, pres; Kenneth J. Jennison, coml and gen mgr; James G. Robertson, prog dir; George Tyll, news dir; Martin Shay, mus dir; Don Englehardt, chief engr. ■ Rates: \$16; 14; 16; 10.

KYEZ(FM)—Co-owned with KSAL May 1, 1975: 93.7 mhz; 100 kw. Ant 510 ft. Net: ABC/FM. Audio news: UPI. Format: MOR. Stereo. ■ Michael Overton, gen mgr and prog dir. ■ Rates: \$9; 8; 9; 5.75.

KSKG(FM)—1961: 99.9 mhz; 100 kw. Ant 570 ft. Box 995 (67401). (913) 825-4631. Salina FM Inc. (acq 7-31-74). Net: ABC. Format: Relig-day, rock-night. ■ Wayne Pollard, pres & gen & coml mgr; Glen Martin, prog dir; Mike St. James, news dir; Odus Trober, chief engr.

KYEZ(FM)—Listing follows KSAL

Scott City

KFLA—Oct 13, 1962: 1310 khz; 500 w-D. Route 1, Box 6 (67871). (316) 872-5345. KFLA Inc. (acq 7-1-73). Group owner: Anderson Stns. Rep: Hopewell. Audio news: APR. Format: C&W, MOR, relig. Spec prog: Span ¼ wkly. ■ George Basil Anderson, pres & gen mgr; Bill Fry, prog dir, coml & prom mgr; Claude Van Horn, mus & news dir & chief engr. ■ Rates: \$4; 4; 4; 4.

KFLA-FM—Nov 9, 1964: 94.5 mhz; 100 kw. Ant 360 ft. Dup AM 25%. Stereo. Format: Btl mus.

Topeka

KEWI—July 1947: 1440 khz; 5 kw-D, 1 kw-N, DA-2. 5315 W. Seventh, Box 4407 (66604). (913) 272-2122. Midland Bcstrs Inc. (acq 2-62). Rep: Torbet. Format: Top 40. ■ Fred P. Reynolds, pres; Robert F. Russell, exec VP & gen mgr; Eugene Rohlmeier, sls mgr; Bob Finot, prog dir; Bruce Wayne, mus dir; Mike Mann, news dir; Wayne Nelson, chief engr. ■ Rates: \$14.25; 12.75; 14.25; 7.67.

KSWT(FM)—Co-owned with KEWI. July 1, 1971: 107.7 mhz; 100 kw. Ant 460 ft. Stereo. Prog sep from AM. Format: Btl mus. ■ George Haag, stn mgr. ■ Rates: \$10.50; 11.50; 11.25; 8.50.

KTOP—July 1947: 1490 khz; 1 kw-D, 250 w-N. Box 1490 (66601). (913) 234-3444. Harris Enterprises Inc. (group owner; acq 4-1-64). Net: NBC. Rep: Century. Format: Contemp. ■ Merle R. Blair, gen mgr; Jack Porteous, coml mgr; Joe Monteith, prog dir; Bob Potter, news dir; Larry Bostwick, chief engr. ■ Rates: \$8.75; 7; 8.75; 4.75.

KTOP-FM—May 29, 1960: 100.3 mhz; 5.3 kw. Ant 161 ft. Prog sep from AM. Net: MBS. Format: C&W. ■ Rates: \$3.75; 3.25; 3.75; 2.75.

KTPK Stereo

Drake Chenault
Great American Country



N A F M B

KTPK(FM)—1974: 106.9 mhz; 100 kw. Ant 340 ft. Stereo. 910 First Natl Bank Tower (66603). Shawnee Bcstg Co. ■ Marvin H. Wilson, pres; H. Pat Powers, gen & coml mgr; Patrick Christine, prog dir; Gary Krohe, mus dir; Phil Tysinger, prom mgr; Sheri McSpaden, news dir; Don Ruff, engr. ■ Rates: \$ 8; 9; 7; 7.

WIBW—May 8, 1927: 580 khz; 5 kw-U, DA-N (S-KSAC). Box 119 (66601). (913) 272-3456. TWX 910-744-6709. Stauffer Publications (group owner; acq 2-1-57). Net: CBS. Rep: Katz, Mountain States, Hix. Format: News, talk, good mus. Spec prog: Farm 20 hrs wkly. ■ Thad M. Sandstrom, VP bcstg; Darrel Witham, gen mgr; Jim Furman, sls mgr; Tom Crabtree, prog dir; Tom Parmley, news dir; Rich Hull, farm dir; Ed O'Donnell, chief engr. ■ Rates: \$42; 18; 18; 18.

WIBW-FM—Sept 1, 1961: 97.3 mhz; 97 kw. Ant 1220 ft. Stereo. Format: Rock. ■ Doug Potter, prog dir. ■ WIBW-TV affil. ■ Rates: \$9; 9; 9; 9.

WREN—June 15, 1926: 1250 khz; 5 kw-U, DA-N (S-KFKU). Box 1280 (66601). (913) 232-0505. WREN Bcstg Inc. (acq 11-52). Group owner: Alf M. Landon Stns. Net: ABC/I. Rep: Pro/Meeker. Format: MOR. Spec progs: Black 1 hr; relig 6 hrs wkly. ■ Alf M. Landon, pres; Russell W. Gibson, gen mgr; Steve Southerland, prog dir; Tom Taylor; news dir; Frank Edwards, mus dir; Al Keberlein, chief engr. ■ Rates: \$15.50; 11; 12.50; 5.50.

Ulysses

KULY—March 1, 1965: 1420 khz; 1 kw-D, 500 w-N, DA-2. Box 686 (67880). (316) 356-1420. Grant County Bcstg Inc. Audio news: APR. Rep: Walton. Format: MOR. Spec progs: Sp 5 hrs, farm 25 hrs wkly. ■ Sam Elliott, pres & gen mgr; Monte B. Smith, chief engr & prog dir; Billie Hillbig, coml mgr; John L. O'Sullivan, news dir; Dandy Schafer, mus dir. ■ Rates: \$5.30; 5.30; 5.30; 5.30.

Wellington

KLEY—Nov 19, 1966: 1130 khz; 250 w-D, DA. KLEY Drive (67152). (316) 326-3341. Sumner Bcstg Co. Spec progs: Sp 2 hrs; C&W 7 hrs; Pol 6 hrs wkly. ■ Ed Hundley, gen mgr; Henry Kreifels, chief engr; Carl Moore, coml mgr.

Wichita

KAKE—Oct 28, 1947: 1240 khz; 1 kw-D, 250 w-N. Box 1240 (67201). (316) 943-4221. TWX 910-741-6926. KAKE-TV & Radio Inc. Net: ABC/E. Rep: Katz. Format: MOR. ■ Mark H. Adams, chmn; Martin Umansky, pres; Frank Gunn, VP & gen mgr; Gene Rump, prog & mus dir; John Myers, prom mgr; John McKean, news dir; Harold H. Newby, chief engr. ■ KAKE-TV affil. ■ Rates: \$17; 15; 17; 13.

KARD(FM)—May 18, 1967: 107.3 mhz; 98 kw. Ant 865 ft. Stereo. Box 333 (67201). (316) 265-5631. TWX 910-741-6976. Kansas State Network Inc. (group owner; acq 4-17-67). Rep: Avco Sls. Format: Beautifl mus. ■ Frank Chappell, pres; Buc Weatherly, gen mgr & corp dir of radio; Jerryanne Hadley, prom mgr; Foster Byrd, opns mgr; Greg Garner, news dir; Rod Herring, chief engr. ■ KARD-TV affil.

KBRA(FM)—Listing follows KFH.

KBUL—April 17, 1972: 900 khz; 250 w-D, DA. 3357 West Central (67203). (316) 942-4222. Mr. D's Radio Inc. (acq 7-8-75). Net: ABC/C. Rep: Century. Format: Rock. Spec prog: Black 6 hrs wkly. ■ Lowell Denniston, pres; Robert D. Freeman, gen mgr; Dave Frieden, coml mgr; Roger Mundy, prog dir; Gary Richards, stn mgr; Charlie Cusack, mus dir; Steve McIntosh, news dir; Orin Friesen, chief engr.

KEYN-FM—Co-owned with KBUL. Sept 1, 1968: 103.7 mhz; 58 kw. Ant 310 ft. Stereo. Dups AM 100%.

KFDI—September 1923: 1070 khz; 10 kw-D, 1 kw-N, DA-N. Box 1402 (67201). (316) 838-9141. Wichita Grate Empire Bcstg Inc. (acq 1-17-66). Rep: Torbet, R&R. Format: C&W. ■ F.F. Mike Lynch, pres & gen mgr; Mike Oatman, stn mgr; Gary Hightower, prog dir; Ernie Tousey, sls mgr; Creetta Bressler, prom mgr; Joe Montgomery, news dir; Cliff Koch, corp engr.

KFDI-FM—June 6, 1963: 101.3 mhz; 100 kw. Ant 440 ft. Stereo. Dups AM 45%. ■ Jay Shankle, FM coord.

KFH—May 26, 1922: 1330 khz; 5 kw-U, DA-N. 104 S. Emporia (67202). (316) 262-4491. Radio Station KFH Co. (acq 11-1-69). Net: CBS. Rep: Blair. Format: Adult Contemp. Spec prog: Farm 15 hrs wkly. ■ J. Phillip Kassebaum, pres; Paul R. Porvaznik, exec VP & gen mgr; Dave Simons, loc sls mgr; J. J. Stone, prom mgr; Scot Michels, prog dir; John Speer, mus dir; George Doyle, news dir; Les Campbell, chief engr.

KBRA(FM)—Co-owned with KFH. Sept 19, 1948: 97.9 mhz; 85 kw. Ant 370 ft. Stereo. Prog sep from AM. Format: Beautifl mus.

KFRM—See Salina.

KJCT(FM)—Co-owned with KFRM. Salina. April 28, 1972: 95.1 mhz; 100 kw. Ant 440 ft. 737 N. West St. (67203). (316) 942-7981. JACO Inc. Rep: Avery-Knodel. Dups AM 15%. ■ Mack Sanders, pres; Faye Graves, gen sls mgr; Wayne Pollard, gen mgr.

KLEO—1936: 1480 khz; 5 kw-U, DA-2. 5610 E. 29th St. (67220). (316) 685-9261. Swanco Bcstg Inc. (group owner). Rep: Eastman. Format: Contemp. ■

Gery Swanson, pres; Sam E. Bakke, VP and gen mgr; Lloyd Connor, coml mgr; Gary Mack, prog dir; Ken Clifford, prom mgr; Thurman Mitchell, urban aff dir; Joe Shurtz, news dir; Earl Russell, chief engr. ■ Rates: \$23; 20; 23; 20.

***KMUW(FM)**—April 29, 1949: 89.1 mhz; 10 kw. Ant 310 ft. 1751 N. Fairmont (67208). (316) 689-3390. Wichita State U. Net: NPR. Format: Variety. Spec prog: Sp 7 hrs wkly. ■ Alan H. Frank, gen mgr.

KWBB—April 1, 1951: 1410 khz; 5 kw-D, 1 kw-N, DA-2. Box 486 (67201). (316) 838-3331. Wichita Bcstg Inc. (acq 12-17-71). Net: ABC/I. Rep: McGavren-Guild-PGW. Format: MOR. ■ C. Hewel Jones, pres, coml & prom mgr; Larry LaMotte, gen mgr; B. M. Sommers, mus dir; Jeff Hildebrandt, news dir; Steve Shuckman, chief engr.

Winfield

KNIC—Aug 10, 1963: 1550 khz; 250 w-D. 300 First National Bank (67156). (316) 221-3341. Courtney Bcstg Co. ■ Gene Courtney, owner, gen mgr & chief engr; Don Courtney, prog & news dir. ■ Rates: \$2.45; 2.45; 2.45; 2.45.

***KSWC(FM)**—November 1967: 88.3 mhz; 10 w. 100 College (67156). (316) 221-1070. Southwestern College. Format: Contemp, ed. ■ Martin F. Barnard, pres; David K. James, VP.

Kentucky

Albany

WANY—Oct 25, 1958: 1390 khz; 1 kw-D. Box 158 (42602). (606) 387-5186. Albany Bcstg Co. Rep: Keystone, Kentucky Radio Sls. Format: Variety. ■ Cecil Speck, pres; Darrel Speck, gen mgr & prog dir; Ray Mullinix, prog & coml mgr; Al Cross, mus dir; Sidney Scott, sls mgr; news dir, chief engr.

WANY-FM—April 18, 1966: 106.3 mhz; 2.7 kw. Ant 155 ft. Dups AM 75%.

Ashland

WAMX(FM)—1948: 93.7 mhz; 50 kw. Ant 400 ft. Stereo. Box 309 (41101). (606) 928-6464. Stereo 94 Inc. (acq 11-2-70). Net: ABC/E. Format: Contemp. ■ W. R. Martin, pres, coml & gen mgr; Dick Martin Jr., mus dir; C. Donald Rees II, chief engr. ■ Rates: \$3.75; 3.75; 3.75; 3.75.

WCMI—1935: 1340 khz; 1 kw-D, 250 w-N. Box 949 (41101). (606) 324-6111. Greater Ashland Bcstg Corp. (acq 12-1-70). Net: CBS. Rep: Masla, Regional Reps. Format: Top 40. ■ Joseph H. Sheppe, pres; David B. Barbour, gen mgr; David Curtis, sls mgr; Charles M. Dunlap, prog dir; Robert L. Gilmore, chief engr. ■ Rates: \$15; 11; 15; 11.

WHEZ(FM)—See Huntington, W.Va.

WTCR—August 1954: 1420 khz; 5 kw-D. Box 1420 (41101). (606) 928-6424. Greater Media Inc. (group owner). Net: ABC. Rep: Katz. Format: C&W. ■ Peter Bordes, pres; Ken Stephens, gen mgr; Mal Harrison, prog dir; Ron Lykins, news dir; Edwin F. Walters, chief engr.

Barbourville

WYWY—Dec 13, 1955: 950 khz; 1 kw-D. Box 768 (40906). (606) 546-4128. Barbourville Community Bcstg Co. (acq 11-6-66). Format: C&W. ■ Elmer Engle, pres; Bill Carson, gen mgr; Arvil Burnette, chief engr.

WYWY-FM—Oct 2, 1974: 93.5 mhz; 3 kw. Ant 300 ft. Stereo. Format: Contemp. Dups AM 6-10 a.m.

Bardstown

WBRT—December 1954: 1320 khz; 1 kw-D. 103 West Stephen Foster Ave. (40004). (502) 348-3943. Nelson County Bcstg (acq 9-66). Rep: Regional Reps. Format: Variety. C&W. Spec prog: farm 10 hrs wkly. ■ Ronald Felly, pres; C. Scott Cederholm, gen mgr; David Dean, chief engr. ■ Rates: \$3.85; 3.85; 3.85; 3.85.

Beattyville

WLJC(FM)—May 12, 1965: 102.3 mhz; 3 kw. Ant 265 ft. (41311). (606) 464-8672. Rev. Forest Drake. ■ Rev. Forest Drake, gen mgr; Margaret Drake, news dir; Perry Little, chief engr.

Benton

WCBL—Dec 13, 1954: 1290 khz; 5 kw-D. Box 7 (42025). (502) 527-2581. Purchase Bcstg Co. Net: ABC/C. Format: C&W. ■ Shelby McCallum, owner, gen mgr, chief engr; Jim Freeland, coml mgr; Bill Burns, prog dir; Alison Stacy, prom dir; Mike Haverkamp, mus dir; Bill Brien, news dir.

WCBL-FM—March 3, 1966: 102.3 mhz; 3 kw. Ant 125 ft. (502) 527-7716. Prog sep from AM. Format: Contemp. ■ Bill Brien, prog dir & prom mgr; Bill Burns, mus dir; Alison Stacy, news dir.

Berea

WKXO—July 18, 1971: 1500 khz; 250 w-D. Box 307 (40403). (606) 986-9321. Pilot Bcstg Co. (acq 8-1-75). Net: ABC/C. Rep: Regional Reps. Format: Contemp. ■ Roger M. Oliver, pres; James Tillery, VP; Mike Beverly, gen and coml mgr, mus dir; Don Stocker, opns mgr; Dorothy Shearard, news dir. ■ Rates: \$4.35; 2.90; 4.35; 2.90.

Bowling Green

WBGN—Nov 24, 1959: 1340 khz; 1 kw-D, 250 w-N. Box 900 (42101). (502) 842-1638. Bowling Green Bcstg Co. (acq 10-18-63). Rep: Regional Reps; Carpenter. Format: Top 40. ■ Bud Tyler, gen & coml mgr; Joe Greene, mus & prog dir; Keith Britnell, news dir; Kevin Proctor, prom mgr; J. Paul Brown, chief engr. ■ Rates: \$5.35; 5.35; 5.35; 5.35.

WDNS(FM)—Listing follows WKCT.

WKCT—Nov 1, 1947: 930 khz; 1 kw-D, 500 w-N. DA-N. Box 930 (42101). (502) 781-2121. Daily News Bcstg Co. Net: ABC/E. Format: Contemp. Spec prog: C&W 10 hrs wkly. ■ J. Ray Gaines, pres; Garland West, gen mgr; Hank Brosche, coml mgr; Vicki Reeves, stn dir; Gene Holly, prom mgr; Alan Palmer, news dir; Robert J. Hendrick, chief engr. ■ Rates: \$6.65; 5.65; 6.65; 5.65.

WDNS(FM)—Co-owned with WKCT. March 12, 1973: 98.3 mhz; 3 kw. Ant 300 ft. Stereo. Net: ABC/FM. Format: MOR. Dup AM 15%. ■ David White, coml mgr. ■ Rates: \$5.30; 5.30; 5.30; 5.30.

WLBJ—June 1940: 1410 khz; 5 kw-D, 1 kw-N, DA-N. Box 689 (42101). (502) 843-3212. Bowling Green Bcstrs Inc. (acq 1-56). Group owner: Bahakel Bcstg. Net: MBS. Rep: Savalli/ Gates. Format: C&W. ■ Cy N. Bahakel, pres; Dale Meador, gen mgr; Rick DuBose, coml mgr; Jay Preston, prom mgr; Don Pierson, prog dir; Jay Preston, mus dir; Rick Murcer, news dir; Dean Maggard, chief engr.

WLBJ-FM—May 1965: 96.7 mhz; 3 kw. Ant 195 ft. Format: C&W, Gospel.

Brandenburg

WMMG(FM)—August 23, 1972: 93.5 mhz; 3 kw. Ant 290 ft. Box 356 (40108). (502) 422-3961. Meade County Bcstg Inc. Format: C&W. ■ James E. Greer, pres; Albert L. Rider, gen mgr; Mark E. Strauss, prog dir; Robert L. Jones Jr., news dir.

Buffalo

WLCB—Nov 26, 1974: 1430 khz; 500 w-D, 100 N. Lincoln Blvd.; Hodgenville (42748). (502) 358-3181. Lincoln Bcstg Co. Inc. Net: MBS. Rep: Keystone,

Kentucky Radio

See page C-1 for explanation of listings.

Beaver. Format: C&W. ■ Joseph W. Myers, pres.

WLCB-FM—See Hodgenville.

Burkesville

WKYR—Not on air; target date 1975: 1570 khz; 1 kw-D. Box 591. Crossville, Tenn. (38555). (615) 484-5168. Cumberland County Bcstg Co. Format: Oldies, MOR, C&W. Spec progs: Farm 3 hrs; C&W 10 hrs, wkly. ■ Robert W. Gallagher, pres; Edward M. Johnson, gen mgr; Ransom Siler, chief engr. ■ Rates: \$16.80;16.80;16.80;16.80.

Cadiz

WKDZ—April 8, 1966: 1110 khz; 1 kw-D. Drawer D (42211). (502) 522-3232. Barkley Lake Bcstg Co. Inc. Rep: Keystone. Format: Variety. ■ John E. Woodruff, pres; Wilburn Wilson, gen mgr; Wanda DeName, coml mgr; J. Mack Mallory, mus dir; Rodney Cheatham, news dir; Leo Wilson, chief engr. ■ Rates: \$3.30; 3.30; 3.30; 3.30.

WKDZ-FM—May 18, 1972: 106.3 mhz, 3 kw. Ant 215 ft. Dups AM 100%. ■ Rates same as AM.

Campbellsville

WTCO—March 1948: 1450 khz; 1 kw-D, 250 w-N. Box 28 (42718). (502) 465-4178. Taylor County Bcstg Co. ■ Thomas Kerr, coml mgr.

WTCO-FM—Dec 1, 1964: 103.9 mhz; 2.35 kw. Ant 330 ft.

Carrollton

WVCM(FM)—April 12, 1968: 100.1 mhz; 1.35 kw. Ant 300 ft. Box 369 (41008). (502) 732-4263. Titan Bcstg Corp. Rep: Regional Reps. Format: C&W. ■ Jack Fultz, pres, gen mgr & chief engr; James Mariette, news dir.

Catlettsburg

WCAK(FM)—Jan 19, 1972: 92.7 mhz; 3 kw. Ant 300 ft. Box 635, 26th & Division St (41129). (606) 739-4113. K & M Bcstg Inc. Format: C&W, talk. ■ Hal Murphy, pres & gen mgr; Carole R. Murphy, coml mgr; Shaw McCarty, prog dir; Fred Elkins, chief engr.

Cave City

WKVE—May 23, 1975: 800 khz; 250 w-D. Box 800 (42127). (502) 773-3181. Twin City Bcstg Co. Net ABC/L. Format: MOR. Spec prog: Farm 1 hr wkly. ■ Barry Williams, managing partner; Mike Hartz, sls mgr; Dave Beshear, opns dir; Charles Anderson, chief engr. ■ Rates: \$4.25;3.75;4.25;—.

Central City

WMTA—Feb 1955: 1380 khz; 500 w-D. Box 31 (42330). (502) 754-1380. Central City-Greenville Bcstg Co. ■ Amos E. Stone, gen mgr.

WNES—Jan 1, 1955: 1050 khz; 500 w-D. Box 471 (42330). (502) 754-3000. Muhlenberg Bcstg Co. Rep: Keystone. Format: Top 40. Spec prog: Farm 12 hrs wkly. ■ Ronald L. Beane, VP & gen mgr; Scott Thomson, prog, mus & news dir.

WNES-FM—Dec 18, 1956: 101.9 mhz; 50 kw. Ant 215 ft. Dup AM 100%.

Columbia

WAIN—Aug 1, 1951: 1270 khz; 1 kw-D. Box 77 (42728). (502) 384-2134. Tri-County Bcstg Corp. Reps: Economy; Ky. Radio Slis. Format: MOR. Spec prog: Farm 2 hrs wkly. ■ Dr. L. R. McDonald, pres; Edwin R. Cundiff, gen mgr; Robert Bell, coml mgr; Sandy Wilcox, prog dir; Howard Harris, news dir & chief engr. ■ Rates: \$24;24;24;12.

WAIN-FM—Mar 1, 1968: 93.5 mhz; 3 kw. Ant 180 ft. Dups AM daytime. ■ Rates same as AM.

Corbin

WCTT—1947: 680 khz; 1 kw-U, DA-N. (40701). (606) 528-4717. Corbin Times-Tribune. Rep: Regional Reps; Beaver. Format: C&W day, rock evening. ■

Springer Hoskins, pres; John L. Crawford, sec, treas & gen mgr; Loren Hooker, prog dir and stn mgr; Johnny Reeves, coml mgr; Phil Taylor, news dir; Glenn Parks, mus dir; Charlie Sulfredge, chief engr.

WCTT-FM—June 1, 1967: 107.1 mhz; 3 kw. Ant 260 ft. horiz, 255 ft vert. Stereo. Dups AM 10%. Format: Smooth day gospel & country evening.



WYGO—Nov 23, 1961: 1330 khz; 5 kw-D, DA. 400 E. Center St. (40701). (606) 528-6617. James C. Vernon (acq 5-1-65). Net: ABC/C. Rep: Carpenter (South); Bernard (North). Format: Top 40. ■ James C. Vernon, pres; Mark E. Bollin, gen mgr; Howell Phillips, coml mgr; Chester Maggard, news dir; Dalton Hooper, mus dir; Ralph Hamilton, chief engr. ■ Rates: \$3.45; 3.45; 3.45; —.

WYGO-FM—1967: 99.3 mhz; 3 kw. Ant 83 ft. Dups AM 75%. Format: Oldies. ■ Rates same as AM.

Covington

WCLU—Oct 29, 1965: 1320 khz; 500 w-D, DA. 1115 1st Natl Bank Bldg, 4th & Walnut, Cincinnati, Ohio (45202). (513) 421-4950. WCLU Bcstg Co. Net: ABC, E. Rep: Savalli-Gates; Mid-West Time Slis. Format: C&W. ■ Irving Schwartz, pres, gen & coml mgr; Roy Wakely, opns supvr; Ila Lockhard, prom mgr; Rhoda Galen, mus dir; Johnny Walker, news dir; David Scherberg, chief engr.

Cumberland

WCPM—1951: 1280 khz; 1 kw-D. Keller St. (40823). (606) 589-4623. Cumberland City Bcstg (acq 11-1-57). ■ Elmo Mills, pres; J. P. Mills, gen mgr, prog & news dir; George Gibb, coml & prom mgr & chief engr.

Cynthiana

WCYN—Sept 1, 1956: 1400 khz; 500 w-D, 250 w-N. Box 207 (41031). (606) 234-1400. WCYN Radio. Rep: Keystone. Format: Block. Spec prog: Farm 8 hrs wkly. ■ Estil Reed Angerson, pres, gen mgr & chief engr; Bill Bishop, coml & prom mgr; Bob Harrington, prog dir; Tim Smith, mus dir; Allen Waugh, news dir. ■ Rates: \$3.60;3.60;3.60;3.60.

WCYN-FM—June 1, 1970: 102.3 mhz; 2.8 kw. Ant 98 ft. Dups AM 100%.

Danville

WHIR—Oct 27, 1947: 1230 khz; 1 kw-D, 250 w-N. Box 8 (40422). (606) 236-2711. WHIR Inc. (acq 11-30-59). Rep: Regional Reps. Format: Rock variety, top 40. Spec prog: Fr 8 hrs wkly. ■ John C. Farmer, pres & gen mgr; Ellen White, coml mgr, news dir; Raymond Ramsey, prog dir; Clarence Sallee, prom mgr; Roger Taylor, mus dir; Thor H. Bohoman, chief engr.

WMGE(FM)—Co-owned with WHIR. October 27, 1969: 107.1 mhz; 3 kw. Ant 150 ft. Prog separate from AM. Format: Easy Istng. ■ Rex Edwards, prom mgr.

Elizabethtown

WIEL—Oct 1, 1950: 1400 khz; 1 kw-D, 250 w-N. Box L (42701). (502) 765-2144. Elizabethtown Bcstg Co. Net: ABC/C. Rep: Keystone; Regional Reps. Format: Contemp. ■ Bill Walters, gen mgr; Mike Baldwin, coml mgr; George Bratcher, prog dir; Robert E. Lee, mus dir; Ron Boone, news dir; Ken Black, chief engr.

WQXE(FM)—Nov 24, 1969: 100.1 mhz; 3 kw. Ant 300 ft. Stereo. Box 517 (42701). (502) 769-3388. Hardin County Broadcasting Co. Format: MOR, Contemp. ■ Billy R. Evans, pres & gen mgr; William J. Harris, coml mgr; George Bratcher, prog & mus dir; Stan Cook news dir.

Elkhorn City

WECL(FM)—Sept 21, 1974: 103.1 mhz; 3 kw. Ant 300 ft. Box 34 (41522). (606) 754-5044. Mountain Interstate Bcstg Co. Inc. Format: Top 40. ■ Allen Epling,

pres and chief engr; Gayle Compton, gen mgr; Bruce Hopkins, coml mgr; Jeff Webb, prog and mus dir; Don Bevins, news dir. ■ Rates: \$4.50;4.50;3.75.

Eminence

WSTL—June 1, 1956: 1600 khz; 500 w-D. Box 185 (40019). (502) 845-5820. Radio 1600 (acq 8-26-74). Rep: Ky. Radio Slis; Keystone. Format: C&W. ■ Robert L. Cook, gen, coml & prom mgr; Bill Terry, prog & news dir; Virginia K. McGaughey, mus dir; Howard Shinn, chief engr.

Erlanger

WHKK(FM)—September 22, 1965: 100.9 mhz; 3 kw. Ant 300 ft. 100 Commonwealth Ave. (41018). (606) 341-2500. Christian Broadcasting Assn. Inc. (acq 11-27-68). Format: Relg. ■ Rev. Jack M. Mortenson, pres; Dan Hubbard, gen & prog mgr; Dale Millen, coml mgr; John Graham, news dir.

Fort Campbell

WABD—July 27, 1963: 1370 khz; 500 w-D. Box 521 (42223). (615) 431-4984. Fort Campbell Bcstg Co. Net: ABC/C. Format: Contemp Rock. ■ Gary Lathan, pres; Don Bilyeu, gen mgr; Jim Brandon, coml mgr; Gary Reeder, mus dir, chief engr; Chuck Smith, news dir.

WABD-FM—Aug 1969: 107.9 mhz; 23 kw (CP 80 kw). Ant 230 ft. Stereo. Dups AM 50%.

Fort Knox

WSAC—Oct 29, 1955: 1470 khz; 1 kw-D. Box 70 (40121). (502) 351-3121. Fort Knox Bcstg Corp. Format: Top 40. ■ Byron E. Cowan, pres & gen mgr; Brian Schmitzer, prog dir; Larry Ross, mus dir; Howard Herman, news dir; Greg Happel, chief engr. ■ Rates: \$7.65;6.55;7.65;—

WSAC-FM—Oct 1, 1967: 105.5 mhz; 3 kw. Ant 300 ft. horiz, 295 ft. vert. Stereo. Dups AM 60%. Format: Progs. ■ Kevin Cowan, mus dir. ■ Rates: \$7.65; 6.55; 7.65; 5.

Frankfort

WFKY—February 1946: 1490 khz; 1 kw-D, 250 w-N. Box P (40601). (502) 223-8281. Capital Communications Inc. (acq 6-1-74). Group owner: Armington-France-Gehring-Ocepek Stns. Audio news: UPI. Rep: PRO Meeker. Format: MOR. Spec progs: Block 18 hrs, farm 3½ hrs wkly. ■ Anthony Ocepek, pres; J. Edward Janeway, VP; Russ Hatter, gen mgr; Martin Eden, prog dir; Dan Gregory, mus dir; Anne Spokes, prom mgr; John Venters, news dir; Bill Peeples, chief engr. ■ Rates: \$6.80;4.50;6.80;3.30.

WKYW(FM)—Co-owned with WFKY. Jan 1, 1967: 104.9 mhz; 3 kw. Ant 260 ft. Stereo. Prog sep from AM. Format: C&W. Spec prog: Farm 3 hrs wkly. ■ Rates: \$3.50;2.50;3.50;2.50.

Franklin

WFKN—April 25, 1954: 1220 khz; 250 w-D. 103 N. High St. (42134). (502) 586-4481. The Franklin Favorite-WFKN Inc. (acq 6-74). Net: Keystone. Format: MOR, C&W. ■ Arthur Kockritz, pres; Henry D. Stone, gen & prom mgr & prog, mus, & news dir; Tom Brown, coml mgr; Frank Wakefield, chief engr.

Fulton

WFUL—July 8, 1951: 1270 khz; 1 kw-D. Box 388 (42041). (502) 472-1221. Ken-Tenn Bcstg Corp. (acq 8-1-64). Format: MOR. ■ Kenneth Z. Turner, pres & chief engr; C. Agnes Turner, prog dir; Robert Gene Gardner, prom mgr.

WFUL-FM—September 1954: 99.3 mhz; 680 w. Ant 150 ft. Dup AM 40%.

Georgetown

WAXU—Sept 6, 1957: 1580 khz; 10 kw-D, DA. Box 516 (40324). (502) 863-1580. Central Kentucky Bcstrs Corp. Net: MBS. Rep: Alan Torbet; Regional Reps. Format: C&W. ■ Robert E. Johnson, pres, gen mgr & chief engr; Ray Hooper, coml mgr; Chuck Ham, mus dir; Vern Thacker, news dir. ■ Rates: \$9.50;7.50;9.50;7.50.

WAXU-FM—Sept 10, 1973: 103.1 mhz; 3 kw. Ant 300 ft. Dups AM 100%. ■ Rates same as AM.

***WRVG(FM)**—Oct 1, 1963: 90.1 mhz; 10 w. Georgetown College (40324). (502) 863-7221. Georgetown College. Format: Contemp, talk, ungrnd, ed. ■ James P. Wagner, stn mgr & chief engr.

Glasgow

WCDS—Oct 1, 1962: 1440 khz; 1 kw-D. Box 478 (42141). (502) 651-3132 or 651-5552. John M. Barrick. Format: Top 40. ■ Billy D. Huffman, gen mgr; Ann Morgan, office & sales mgr; Allen Denton, prog dir; Mark Preston, news dir; Ellis Rice, chief engr. ■ Rates: \$2.15; 2.15; 2.15; 2.15.

WOVO(FM)—Co-owned with WCDS. July 14, 1972: 105.5 mhz; 1 kw. Ant 480 ft. Stereo. (502) 651-8375 or 842-6907. Format: Oldies, top 40. Prog sep from AM. ■ Rates: \$1.90; 1.90; 1.90; 1.90.

WGQC(FM)—See listing following WKAY.

WKAY—Sept 25, 1946: 1490 khz; 1 kw-D, 250 w-N. 510 Happy Valley Road (42141). (502) 651-2141. Heritage Communications Inc. (acq 4-2-71). Rep: Regional Reps. Format: MOR. ■ Clovis & Moena Sadler, co-owns.

WGCG(FM)—Co-owned with WKAY. June 23, 1961: 95.1 mhz; 13 kw. Ant 410 ft. (CP 40 kw. Ant 390 ft). Prog sep from AM. Format: C&W.

WOVO(FM)—See listing following WCDS.

Grayson

WGOH—June 1, 1959: 1370 khz; 5 kw-D. Box 487 (41143). (606) 474-5144. Carter County Bcstg Co. Audio news: UPI. Rep: Regional Reps. Format: C&W. ■ Harold E. Shuffelbarger, pres; Faye Bush, gen mgr; Ken Jackson, prog dir; James E. Phillips, news dir; William H. Craig, chief engr. ■ Rates: \$3.50; 3.10; 3.50; —

WGOH-FM—Feb 1967: 102.3 mhz, 1.45 kw. Ant 410 ft. ■ Rates: \$3.50; 3.10; 3.50; 2.30.

***WKCC(FM)**—1973: 91.5 mhz; 10 w. Ant 55 ft. c/o Kentucky Christian College (41143). (606) 474-6613. Kentucky Christian College. Format: Relig, educ. ■ Francis M. Nash, gen mgr & chief engr.

Greensburg

WGRK—March 15, 1972: 1550 khz; 250 w-D. Box 246 (42743). (502) 932-7401. Veer Bcstg. Net: ABC/I. Format: 40% country, 60% contemp. Spec prog: Farm 2 hrs wkly. ■ James M. Hay, pres; Michael R. Wilson, VP, gen mgr & chief engr; Joy L. Wilson, coml mgr. ■ Rates: \$3.30; 3.30; 3.30; 3.30.

Hardinsburg

WHIC—July 6, 1968: 1520 khz; 250 w-D. Box 203 (40143). (502) 756-2105. Breckinridge Broadcasting Co. Rep: Ky. Radio Sls. Format: MOR, C&W. ■ Paul L. Fuqua, pres; Jim Wooley, gen. coml, & prom mgr; Jo Ann Bruington, prog dir; Doyle Cunningham, mus dir; Jim Goodall, news dir; Paul St. John, chief engr.

WHIC-FM—July 9, 1970: 94.3 mhz; 3 kw. Ant 290 ft. Dup AM 100%. Stereo.

Harlan

WHLN—May 30, 1941: 1410 khz; 5 kw-D. Box 898 (40831). (606) 573-2540. Radio Harlan Inc. (acq 6-1-56). Format: MOR, Top 40, C&W, variety. ■ James T. Morgan, pres, gen coml mgr & news and mus dir; Ron Davis, prog dir; Dorothy Morgan, prom mgr; Gene M. Hopkins, chief engr. ■ Rates: \$3.50; 3.50; 3.50; —

Harrodsburg

WHBN—June 25, 1955: 1420 khz; 1 kw-D. Box 247 (40330). (606) 734-4321. Fort Harrod Bcstg Corp. (acq, 3-60). Rep: Hopewell; Kentucky Radio Sales. Format: C&W, variety. Spec progs: Black ½ hr; relig 15 hrs, wkly. ■ Robert L. Martin, pres, gen, coml & prom mgr & prog dir; Verna Farney, news dir; Tom Devine, chief engr.

WHBN-FM—December 9, 1969: 99.3 mhz; 3 kw. Ant 265 ft. Dup AM 100%.

Hartford

WLLS—June 21, 1969: 1600 khz; 500 w-D. Spinks' Shopping Center (42347). (502) 298-3268. Hayward F. Spinks. Net: MBS. Rep: Keystone; Regional Reps;

Walton. Format: C&W. Spec prog: Farm 1 hr wkly. ■ Hayward F. Spinks, pres; Lloyd C. Spivey Jr., gen & sls mgr, chief engr; Mary Lee Spivey, asst mgr. ■ Rates: \$2.2; 2.2.

WLLS-FM—May 18, 1972: 106.3 khz; 3 kw. Ant 280 ft. Dups AM 80%. Stereo. ■ Rates same as AM.

Hawesville

WKCM—Nov 7, 1972: 1140 khz; 500 w-D. Box 1140 (42348). (502) 972-8121. Hancock County Bcstrs. Net: ABC/E. Rep: Walton; Carpenter. Format: C&W. Spec prog: Farm 1 hr wkly. ■ Bayward H. Walters, pres & gen mgr; Kenneth V. Stumpf, stn mgr; J. Richard Warner, coml mgr; Caroline Sue Bennett, prog dir; Richard Gudal, news dir; John Johnston, chief engr.

Hazard

WKIC—November 1947: 1390 khz; 5 kw-D. Box 898 (41701). (606) 436-2121. Mountain Bcstg Service Inc. (acq 7-1-56). Net: ABC/E. Audio news: APR. Format: MOR, Top 40. ■ Ernest Sparkman, pres & gen mgr; Julius Lasso, coml mgr; Quentin Combs, news dir; Bob Hale, chief engr. ■ Rates: \$2.95; 2.95; 2.95; —

WSGS(FM)—Co-owned with WKIC. February 1959: 101.1 mhz; 100 kw. Ant 1,150 ft. 111 Main St. (41701). (606) 436-5580. Prog sep from AM. Net: ABC/C. Audio news: APR. Format: C&W. ■ Mildred Warren, mus dir; Joyce Brashear, chief engr. ■ Rates: \$2.95; 2.95; 2.95; 2.95.

Henderson

WBIC(FM)—Dec 1, 1971: 103.1 mhz; 3 kw. Ant 300 ft. Box 47 (42420). (502) 827-5359. Professional Bcstrs. Rep: Michael Fulford. Format: MOR. ■ H. Gene Baggett, pres; Walton Smith, VP; Donald Davis, gen mgr & sls mgr; Glenn Ingle, prom mgr; Marc Cline, prog dir; Robert Minton, mus dir; See Shannon, news dir; Bill Hilyerd, chief engr.

WKDQ(FM)—See listing following WSON.

WSON—Dec 17, 1941: 860 khz; 500 w-D. Box 418 (42420). (502) 826-3923. Henderson Bcstg Co. (acq 7-46). Group owner: Lackey. Net: CBS. Rep: Walton; Regional Reps. Format C&W. Spec prog: Farm 6 hrs wkly. ■ Hecht S. Lackey, Sr, pres; Henry G. Lackey, VP, gen & coml mgr; Marly Remanschnneider, prog dir; Greg Sureck, mus dir; Martin Schaeffer, prom mgr; Curtiss Hart, news dir; Scott Chase, chief engr. ■ Rates: \$6.35; 5.75; 6.35; 5.75

WKDQ(FM)—Co-owned with WSON. 1947: 99.5 mhz; 50 kw. Ant 275 ft. Format: Top 40. Prog sep from WSON. Stereo. ■ Rates: \$7.30; 7.30; 7.30; 7.30.

Hindman

WKCB—Jan 26, 1971: 1540 khz; 1 kw-D (500 w-CH). Box 427 (41822). (606) 785-3129. Knott County Bcstg Corp. Rep: Regional Reps. Ky. Radio Sls. Format: C&W, contemp. ■ Robert Morgan, pres; Steven D. Blair, gen & coml mgr; Shelby J. Bolen, prog dir; Dennis Goostin, mus & news dir; Esba Slone, chief engr.

WKCB-FM—1974: 107.1 mhz; 500 w. Ant 650 ft. Dups AM 100%.

Hodgenville

WLCB—See Buffalo, Ky.

WLCB-FM—February 1974: 106.3 mhz; 3 kw. Ant 235 ft. Box 63 (42748). Net: MBS. Format: Top 40.

Hopkinsville

WHOP—Jan 8, 1940: 1230 khz; 1 kw-D, 250 w-N. Box 709 (42240). (502) 885-5331. Hopkinsville Bcstg Co. Group owner: Lackey. Net: CBS. Rep: Walton. Format: MOR. Spec prog: Farm 17 hrs wkly. ■ Roger E. Jeffers, pres, gen & coml mgr; David Kinsey, prog dir; Jim Love, news dir; Debbie Joiner, prom mgr; Rick Shields, mus dir; Leo Wilson, chief engr. ■ Rates: \$7.10; 6; 6.60; 6.

WHOP-FM—May 1948: 98.7 mhz; 39 kw. Ant 210 ft. Stereo. Progs sep from AM. Format: C&W. Spec prog: Farm 12 hrs wkly. ■ Ross Sisk Jr, coml mgr. ■ Rates: \$7.10; 6; 6.60; 6.60.

WKO

Contemporary M-O-R

WKO—Sept 19, 1954: 1480 khz; 1 kw-D. 1107 S.

Kentucky Radio

See page C-1 for explanation of listings.

Virginia, Box 951 (42240). (502) 886-1204. Pennyrite Bcstg Co. Net: ABC/I. Rep: Hopewell Regional Reps. Format: MOR. Spec progs: Farm 5 hrs; black 5 hrs, wkly. ■ William H. Higgins, pres; Hal King, coml & gen mgr; Ranoal McCarly, mus dir; Don Marsillis, news dir; Marvin J. Mahoney, chief engr. ■ Rates: \$3.50; 2.75; 2.75; —.

WKOF(FM)—Co-owned with WKO. July 1, 1960: 100.3 mhz; Ant 93 ft. Dup AM 10%. Format: Easy Istng. Btfl mus. ■ Rates: \$3.50; 2.50; 2.50; 2.50.

Irvine

WIRV—July 2, 1960: 1550 khz; 1 kw-D. 201 Main St. (40336). (606) 723-2550. Irvena Bcstg Inc. (acq 1-65). Rep: Continental. Format: General. Spec progs: C&W 15 hrs wkly. ■ James M. Gaskin, pres, gen & coml mgr; Jackie Dial, asst coml mgr; Sue Wiseman, prog dir; Wallace Arthur, news dir; David E. Cox, asst mgr & chief engr.

Jackson

WEKG—April 6, 1969: 810 khz; 1 kw-D. 1138 Main St. (41339). (606) 666-7531. Intermountain Bcstg Inc. Net: ABC/E. Regional Reps. Format: C&W, Pop. ■ James H. Hay, pres; gen mgr, chief engr; Deborah Maddox, coml mgr; Michael Vance Hay, prom mgr; Michael L. Maddox, prog and mus dir; Jerry Little, news dir. ■ Rates: \$3; 3; 3.

Jamestown

WJKY—Sept 3, 1967: 1060 khz; 1 kw-D. Box 336 (42629). (502) 866-3487. Lake Cumberland Bcstrs (acq 7-1-70). Rep: Regional Reps; Ky Radio Sls. Format: MOR. Spec prog: C&W 10 hrs wkly. ■ Welby Hoover, owner and gen mgr; Mae Hoover, coml mgr; Maurice Daulton, prog dir; Bob Huddleston, chief engr.

WJRS-FM—Co-owned with WJKY. Sept 3, 1966: 103.1 mhz; 3 kw. Ant 185 ft. (CP 2 kw. Ant 360 ft). (502) 343-4444. Format: C&W. ■ Jeff Smith, mus dir; Eddie Coop, news dir. ■ Rates: \$2.10; 2.10; 2.10; 2.10.

Jenkins

WREM—Feb 1, 1970: 1000 khz; 1 kw-D. Box 312 (41537). (606) 832-2285. Cardinal Bcstg Co. (acq 4-3-72). Audio news: UPI. Format: C&W, contemp easy. ■ H. Gene Sturgill, pres & gen mgr; Gary Rakes, sls mgr; John Palumbo, chief engr; Steve Curran, sports dir; Bob Hodsdon, news dir; Teresa Donahue, traf mgr; Randy Donahue, news dir.

WREM-FM—May 10, 1975: 94.3 mhz; 125 w. Ant 1340 ft. Dups AM 80%. Format: C&W, MOR.

Lancaster

WIXI—Nov 5, 1966: 1280 khz; 1 kw-D. 108-A Stanford St. (40444). (606) 792-2152. Lancaster Bcstrs. Inc. Spec progs: Black 10 hrs; C&W 35 hrs, wkly. ■ Charles E. Phillips, James F. Stair & George R. Guertin, co-owners.

Lebanon

WLBN—Sept 1953: 1590 khz; 1 kw-D. Box 680 (40033). (502) 692-3126. Lebanon-Springfield Bostg Co. (acq 8-1-57). Net: Keystone. Rep: Hopewell, Regional Reps. Format: Variety. Spec progs: Black 5 hrs; jazz 4 hrs, wkly. ■ J. T. Whitmore, pres and gen mgr; Alan Baker, coml mgr; Cheryl Gibson, prog dir; Frank Kemp, mus dir; Merrilyn Broadbent, woman's dir; Alvin Wren, news dir; David Greenley, chief engr; Burma Raley, cont dir. ■ Rates: \$4; 4; 4; 4.

Leitchfield

WMTL—Jan 17, 1959: 1580 khz; 250 w-D. 53 Public Square (42754). (502) 259-3165. Rough River Bcstg Co. Inc. Rep: Keystone, Regional Reps. Format: C&W. ■ Porter Wallace, pres; J. J. Johnson, coml mgr & news dir; Dave Thompson, prog dir; Wm. G. Jones, chief engr.

WMTL-FM—Oct 29, 1967: 104.9 mhz; 3 kw. Ant 185 ft. Dups A/M 100%.

Lexington

***WBKF(FM)**—1944: 91.3 mhz; 50 kw. Ant 540 ft.

Kentucky Radio

See page C-1 for explanation of listings.

Rm. 340, McVey Hall, U. of Ky. (40506). (606) 257-2721. U. of Kentucky. Net: NPR. Format: Classical, talk, jazz. ■ Donald E. Wheeler, gen mgr; Reynolds Large, prog dir; William Lutes, mus dir; Noah D. Adams, prod mgr; Marvis Samons, chief engr.

WBLG—1946: 1300 khz; 1 kw-U DA-N. Box 1300 (40501). (606) 233-1515. Village Communications Inc. (acq 12-1-74). Net: NBC. Format: MOR. ■ James A. Heavner, pres; Robert D. Jennings, VP & gen mgr; James H. Tomblin, sls mgr; Jim Rivers, prog dir; Bob Hensley news dir; Rick Edwards, chief engr. ■ Rates: \$15; 14; 12.

WKQQ(FM)—Co-owned with WBLG. July 15, 1969: 98.1 mhz; 50 kw. Ant. 350 ft. Stereo. Box 100. (606) 252-6694. Format: Progs. ■ Harold Hinson, gen mgr; Jim Ballard, prog dir.

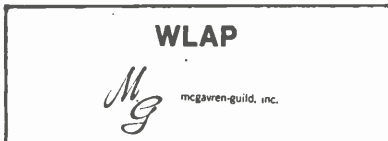

WLAP—September 1922: 630 khz; 5 kw-D, 1 kw-N, DA-2. Box 11670, Russell Cave Rd. at Huffman Mill (40511). (606) 293-0563. Illinois Bcstg Co. (group owner; acq 4-68). Net: CBS. Rep: McGavren-Guild. Format: Pop, contemp. ■ Merrill Lindsay, pres; James C. Allison II, gen & coml mgr; Herb Oscar Kent, prog dir; Lawrence M. Chiles, prom mgr; Dan Reynolds, mus dir; F. Wayne Gregory, news dir; Lewis Owens, chief engr. ■ Rates: \$15; 13; 15; 10.

WLAP-FM—1940: 94.5 mhz; 50 kw. Ant 280 ft. Progs sep from AM. Format: Contemp. ■ Rates: \$5.50; 5.50; 5.50; 5.50.

WVLK—Oct 1947: 590 khz; 5 kw-D, 1 kw-N, DA-2. Box 1559 (40501). (606) 254-1151. Bluegrass Bcstg Co. (group owner; acq 1951). Net: ABC/I, Rep: Eastman. Format: Contemp. ■ H. Hart Hagen, pres; William L. Stakelin, VP, gen mgr; L. W. Harper, coml mgr; Jim Jordan, prog dir & prom mgr; John Henderson, mus dir; Steve York, news dir; Paul Dunbar, chief engr.

WVLK-FM—92.9 mhz; 32 kw. Ant 290 ft. Stereo. (CP: 100 kw. Ant 850 ft.) Prog sep from AM. Format: MOR.

Liberty

WKDO—November 1963: 1560 khz; 250 w-D. Box B (42539). (606) 787-7331. Radio Station WKDO (acq 11-27-75). Rep: Hopewell, Ky. Radio Sls. Format: C&W. ■ Carlos Wesley, owner, gen & coml mgr; E. Paul Coop, prog & news dir; Sandra Allen, prom mgr; Alan Reed, chief engr.

London

WFTG—Sept 1, 1955: 1400 khz; 1 kw-D, 250 w-N. SH. Box 647 (40741). (606) 864-2148. London Bcstg Inc. Audio news: APR. Rep: Hopewell. ■ Elmo Mills, gen mgr; Raymond E. Asher, coml mgr; Russell B. Henson, chief engr. ■ Rates: \$3.45; 3.45; 3.45; 3.45.

WFTG-FM—Aug 15, 1970: 103.9 mhz; 3 kw. Ant 190 ft. Dup AM 10%. Format: MOR. ■ Rates same as AM.

Louisia

WKY—1970: 1270 khz; 1 kw-D. Box 28, Hwy 23 (41230). (606) 638-9491. Lawrence County Bcstg. Rep: Beaver. Format: Variety. ■ Walter E. May, pres; Marshall E. Sidebottom, gen & coml mgr; Karl C. Rankin Jr., prog dir; Dave Irwin, news dir; Jim Daniels, chief engr.

Louisville

WAKY—1936: 790 khz; 5 kw-D, 1 kw-N, DA-2, 558 River City Mall (40202). (502) 583-8803. WAKY Inc. (acq 5-15-75). Group owner: Multimedia Inc. Rep: Blair. Format: Contemp. ■ Donald W. Meyers, gen mgr; Robert L. Rice, coml mgr; John Randolph, prog dir; Reed Yaton, mus and news dir; Penny Whitaker, prom mgr; Archie Erickson, chief engr. ■ Rates: \$60; 50; 60; 50.

WAVE—Dec 30, 1933: 970 khz; 5 kw-U, DA-2. Box

1000 (40203). (502) 585-2201. Orion Bcstg (group owner). Net: NBC. Rep: Katz. Format: MOR. ■ T. Ballard Morton Jr., pres; Ralph Jackson, exec VP; James M. Caldwell, VP & gen mgr; Tom DeMuth, gen sales mgr; Harry Lockhart, opns mgr; Peppy Martin, prom mgr; George D. Brown, treas; Jim Keelor, news dir; Bernard Holtman, chief engr. ■ WAVE-TV affil. ■ Rates: \$50; 32; 42; 12.

WCSN(FM)—See listing following WKLO.

WFIA—March 1947: 900 khz; 1 kw-D. 310 W. Liberty St. (40202). (502) 583-4811. Radio 900 Inc. ■ Doug Kahle, pres; Russell Manship, gen mgr; Eddie Sears, sls mgr; George Ford, news dir; Wendell McFarland, chief engr.

WFIA-FM—1974: 103.9 mhz; 950 w. Ant 490 ft.

***WFPK(FM)**—Oct 4, 1954: 91.9 mhz; 20 kw. Ant 245 ft. Fourth & York Sts. (40203). (502) 583-1864. Louisville Free Public Library. Net: NPR. Format: Classcl. ■ Dorothy L. Day, gen mgr; Allen Hankins, prog dir; Wendell W. McFarland, chief engr.

***WFPL(FM)**—Co-owned with WFPK(FM). Feb 20, 1950: 89.3 mhz; 820 w. Ant 310 ft. Format: Talk. Spec prog: Fr 3½ hrs wkly. ■ Rena D. Stahmer, prog dir.

WHAS—July 18, 1922: 840 khz; 50 kw-U. Box 1084 (40202). (502) 582-7317. TWX 810-535-3326. WHAS Inc. Net: CBS. Rep: Major Market Radio. Format: MOR ■ Barry Bingham Jr., pres; Hugh Barr, gen mgr; Bill Aldridge, coml mgr; Jeff Douglas, prom mgr; Jerry David Melloy, mus dir; Bill Hunter, chief engr.

WNNS(FM)—Co-owned with WHAS. Sept 1966: 97.5 mhz; 100 kw. Ant 500 ft. Stereo. (502) 582-7531. Prog sep from AM. Format: Classical. ■ Brench Boden, prog dir. ■ WHAS-TV affil.

WHEL—See New Albany, Ind.

WINN—June 1940: 1240 khz; 1 kw-D, 250 w-N. 660 S. 3rd St. (40202). (502) 585-5148. Kentucky Central Bcstg Inc. (acq 12-81). Group owner: Bluegrass Bcstg Co. Net: ABC/E. Rep: Buckley. Format: C&W. ■ H. Hart Hagan, pres; Max Rein, VP & gen mgr; Moon Mullins, prog dir; Al Risen, mus dir; Jim Parr, news dir; Melvin C. Scarsdale, chief engr. ■ Rates: \$23; 17; 23; 13.

WKLO—November 1948: 1080 khz; 10 kw-D, 1 kw-N, DA-2. 307 W. Walnut St. (40202). (502) 589-4800. Great Trails Bcstg Corp. (group owner; acq 7-27-55). Net: ABC/C. Rep: Eastman. Format: Top 40. ■ E. A. Gudridge, pres & gen mgr; Bernie Thompson, gen sls mgr; Lee Gray, prog dir; Fleetwood Gruver, prod dir; Eileen Douglas, news dir; Bruce Clark, VP & chief engr. ■ Rates: \$33; 23; 33; 23.

WCSN(FM)—Co-owned with WKLO. 1963: 99.7 mhz; 20 kw. Ant 490 ft. Stereo. Progs sep from AM. Format: Btlf mus. ■ Bob Gardner, local sales mgr. ■ Rates: \$8.50; 8.50; 8.50; 8.50.

WLOU—Oct 21, 1951: 1350 khz; 5 kw-D. 2549 S. Third St. Box 8278 (40208). (502) 636-3535. Summers Bcstg (acq 3-72). Net: Natl Black. Rep: Howard. Format: Rhythm & blues. Spec prog: Black 1 hr wkly. ■ William E. Summers III, pres & gen mgr; Mildred Staton, traffic mgr; Duwayne McElroy, prom mgr; Otis Humphrey, prog dir; James Bev Smith, mus dir; June Diamond, news dir; Steve Dawson, chief engr.



WLRS(FM)—October 1964: 102.3 mhz; 3 kw. Ant 285 ft. Quad-stereo. 800 S. Fourth St. (40203). (502) 585-5178. Kentucky Technical Institute. Net: ABC/FM. Rep: ABC-FM Spot Sls. Format: Rock. ■ Clarence E. Henson, pres & chief engr; Louisa W. Henson, gen mgr; Clarence E. Henson Jr., VP & comptroller; Robin Walker, prog dir; George Owen, coml mgr; Kathy Jones, opn mgr; Dave Burns, chief engr. ■ Rates: \$18; 18; 22; 22.

WNNS(FM)—Listing follows WHAS.

WQHI(FM)—See Jeffersonville, Ind.

WTMT—Aug 20, 1958: 620 khz; 500 w-D, DA. 201 W. York St. (40203). (502) 583-3901. Jefferson Bcstg Co. Rep: Torbet, Regional Reps. Format: C&W. ■ Lee Stinson, pres & coml mgr; Richard H. Gundie, gen mgr; Kenny Holiday, prog dir; Robert Perry, prom mgr;

Thom Hall, news dir; Charles Cutler, chief engr.

WVEZ(FM)—April 1, 1967: 106.9 mhz; 24.5 kw. Ant 670 ft. Stereo. 100 E. Liberty St. (40202). (502) 587-1383. Stoner Bcstg Inc. (group owner; acq 5-7-74). Rep: Torbet. Format: Btlf mus. ■ Thomas H. Stoner, pres; Bruce Dodge Jr., VP, gen mgr; Glenn K. Bell, exec VP; Jerry Bigler, prog dir; James Schulke, mus dir; Louis Bornwasser, chief engr. ■ Rates: \$22; 25; 25; 22.

WXVW—See Jeffersonville, Ind.

Madisonville

WFMW—January 1947: 730 khz; 500 w-D. Box 338 (42431). (502) 821-4096. Gladys H. Kelley (acq 4-30-73). Audio news: UPI. Rep: Regional Rep, Keystone, Crane. Format: C&W. ■ Gladys H. Kelley, pres; Bob Simmons, gen mgr; Thomas B. Weaver, coml mgr; Dan Koeber, prog dir; Bob Mayes, mus dir; David Shinall, news dir; Charles Lee, chief engr. ■ Rates: \$6.25; 5; 5; 5.

WFMW-FM—April 19, 1949: 93.9 mhz; 27.1 kw. Ant 295 ft. Stereo. Prog sep from AM. Format: MOR. ■ Rates same as AM.

WTTL—Sept 16, 1956: 1310 khz; 1 kw-D, 500 w-N, DA-N. 265 S. Main Box 387 (42431). (502) 821-1310. Hopkins County Bcstrs (acq 2-1-59). Net: ABC/C. Rep: Hopewell. Format: Contemp, MOR. Spec prog: Black 20 hrs wkly. ■ Conway M. Smith, pres; Jerry McKonley, gen mgr; Rudy Owen, coml mgr; John Gatlin, news dir; Alan Cheek, prog dir; Phill Lindsey, prom mgr; Hobert Thompson, chief engr.

Manchester

WWXL—1956: 1450 khz; 1 kw-D, 250 w-N. 109 Court St. (40962). (606) 598-2669. Wilderness Road Bcstg Co. (acq 1956). Rep: Keystone, Ky. Radio Sales. Format: Variety. ■ Joe L. Tigue, pres; Lucy Howard, gen mgr; Harold Harris, coml mgr; Opal Horum, prog dir; Dwight Davidson, prom mgr; Cecil Corum, news dir; Bob Banks, chief engr.

WWXL-FM—Aug 9, 1967: 103.1 mhz; 2.85 kw. Ant 310 ft horiz, 300 ft vert. Dup AM 50%.

Marion

WMJL—July 10, 1968: 1500 khz; 250 w-D. Box 68 (42064). (502) 965-2271. Crittenden County Bcstg Co. Rep: Regional Reps. Format: C&W, MOR. ■ Sam Crowley, pres; Edwin E. Hill, gen, coml, prom mgr & prog & news dir; Kevin Workman, farm dir; Bill Morril, sports dir; Phil Harris, chief engr.

Mayfield

WNGO—Jan 7, 1947: 1320 khz; 1 kw-D. Box 679 (42066). (502) 247-5122. West Kentucky Bcstg Inc. (acq 11-3-57). Rep: Hopewell. ■ Charles W. Stratton, pres, gen mgr & chief engr; Gary Kidd, coml mgr; Jean Richardson, prog dir; Bill Scarborough, prom mgr; Jim Moore, mus dir; Al McClain, news dir. ■ Rates: \$5; 5; 5; 5.

WXID(FM)—Co-owned with WNGO. Nov 2, 1955: 94.7 mhz; 2.15 kw. Ant 155 ft. (CP 10 kw. Ant 160 ft.) Stereo. Prog separate from AM. Format: MOR. ■ Rates same as AM.

Maysville

WFTM—Jan 1, 1948: 1240 khz; 1 kw-D, 250 w-N. 626 Forest Ave. (41056). (606) 564-3361. Standard Tobacco Co. Net: MBS.

WFTM-FM—Oct 26, 1965: 95.9 mhz; 3 kw. Ant 300 ft. Dup AM 5%.

Middlesboro

WAFI—March 1, 1969: 1560 khz; 1 kw-D (500 w CH). Box 447 (40965). (606) 248-8768. Tri-State Bcstrs. Rep: Cowling. Format: C&W, rock. Spec prog: Black 1 hr wkly. ■ Walter Powell Jr., pres & gen mgr; Carl O'Connor, coml mgr; Doug Hammons, prog dir; Jerry Howell, prom mgr; Hugh Delk, news dir; Hiley Henderson, mus dir; Arthur D. Hammons, chief engr.

WMIK—Nov 15, 1948: 560 khz; 500 w-D. Box 608 (40965). (606) 248-5842. Cumberland Gap Bcstg Co. Format: C&W. ■ Helen K. Henry, pres; James E. Ballard, gen mgr; Maurice K. Henry, sec-treas; Kay Ballard, prog dir; Andy Militch, mus dir; Jimmie

Branham, chief engr; Rick Conley, news dir.

WMIK-FM—June 4, 1971: 92.7 mhz; 3 kw. Ant minus 190 ft. Stereo. Prog sep from AM. Format: MOR.

Monticello

WFLW—May 19, 1955: 1360 khz; 1 kw-D. Box 36 (42633). (606) 348-8427. Regional Bcstg Co. (acq 1-1-67). Rep: TN Spot Sls, KBS, Regional Reps, Kentucky Radio Sls. Format: C&W. ■ Stephen Staples, gen & coml mgr; Jean T. Staples, prog dir; Don Whitaker, prom mgr; Edwin Neal, news dir; Stephen Staples II, mus dir; Bruce Correll, chief engr.

WKYM(FM)—Co-owned with WFLW. December 19, 1965: 101.7 mhz; 710 w. Ant 560 ft. Stereo. Progs sep from AM. Net: ABC/I. Format: MOR. ■ Jim Sawyer, prom mgr; Tom Garrett, prod mgr; Stephen Staples Jr., news dir.

Morehead

***WMKY(FM)**—June 1965: 90.3 mhz; 50 kw. Ant 510 ft. Stereo. Box 903, Morehead State U. (40351). (606) 783-3371. Morehead State U. Net: NPR. Audio news: UPI. Format: Educ. Spec progs: Black 1 hr; farm 6 hrs, wkly. ■ Dr. Adron Doran, pres; Larry Netherlon, stn mgr; Maggie Kenner, traffic mgr; Richard Kunkel, prod dir; Myron Dban, prom mgr & mus dir; Ron Smith, news dir; Ray Roberts, chief engr.

WMOR—Feb 18, 1955: 1330 khz; 1 kw-D. 223½ Main St. (40351). (606) 784-4141. Morehead Bcstg (acq 11-20-56). Rep: Ky. Radio Sls. ■ J. Earl McBrayer, pres; William M. Whitaker, VP & gen mgr; Earl S. Young, chief engr.

WMOR-FM—June 15, 1965: 92.1 mhz; 2.8 kw. Ant minus 20 ft. Dup AM 50%.

Morganfield

WMSK—Nov 21, 1960: 1550 khz; 250 w-D. Box 369 (42437). (502) 389-1550. Union County Bcstg Inc. Rep: Hopewell, Ky. Radio Sls, Regional Reps. Format: MOR. ■ J. B. Crawley, gen mgr; Bob Hite, gen mgr; Don Sheridan, coml mgr; Joseph Greenwell, chief engr.

WMSK-FM—Aug 8, 1967: 95.3 mhz; 3 kw. Ant 180 ft. Dup AM 100%.

Mt. Sterling

WMST—Oct 17, 1957: 1150 khz; 500 w-D. Box 381 (40353). (606) 498-1150. Mount Sterling Bcstg Co. Rep: Regional Reps. Format: Variety. Spec prog: Farm 5 hrs; black 1 hr; C&W 20 hrs, wkly. ■ R. J. Reynolds, pres; Bob Spradlin, gen mgr; Carl Newman, mus dir; Jim Butler, news dir; Fred Spradlin, chief engr. ■ Rates: \$4; 4; 4.

WMST-FM—May 28, 1968: 105.5 mhz; 3 kw. Ant 300 ft. Stereo. Format: Btlf mus, C&W. Spec prog: Black 1 hr wkly. Prog sep from AM. ■ Rates: \$3; 3; 3; 3.

Mt. Vernon

WRVK—April 30, 1957: 1460 khz; 500 w-D. Box 1460, Renfro Valley (40703). (606) 256-2146. Cochran-Smith Bcstg (acq 1970). Rep: Ky. Radio Sls. Format: Country, gospel. ■ Hal Smith, pres; Virginia Sutton Bray, gen mgr; Pete Stamper, prog dir and coml mgr; Maurice Lackey, chief engr. ■ Rates: \$1.60; 1.60; 1.60.

Munfordville

WLOC—June 12, 1956: 1150 khz; 1 kw-D. Box 307 (42765). (502) 523-4111. South Central Kentucky Bcstg Co. (acq 6-60).

WLOC-FM—Aug 1, 1964: 102.3 mhz; 3 kw. Ant 99 ft. Dup AM.

Murray

WAAW(FM)—See listing following WNBS.

***WKMS-FM**—May 11, 1970: 91.3 mhz; 13 kw. Ant 490 ft. Stereo. Box 3204, Univ Sta. (42071). (502) 762-4661. Board of Regents, Murray State U. Net: NPR. Format: Classical, educ. ■ Dr. Ray Mofield, gen mgr; Jay Landers, stn mgr; J.D. Williams, prog dir; James McClure, chief engr.

WNBS—July 1948: 1340 khz; 1 kw-D, 250 w-N. Box

309 (42071). (502) 753-3411. Timkay Inc. (9-1-75). Net: ABC/I. Format: Variety. ■ Fransuelle Wilcox Cole, stn mgr; Paul Whitney, chief engr. ■ Rates: \$6.30; 4.50; 6.30; 4.50.

WAAW(FM)—Co-owned with WNBS. June 23, 1967: 103.7 mhz; 100 kw. Ant 300 ft. Stereo. Net: ABC/FM. Format: Good mus. Prog sep from AM. ■ John Miller, news dir. ■ Rates: \$3.75; 3.75; 3.75; 3.75.

Neon

WNKY—Aug 31, 1956: 1480 khz; 1 kw-D. Box 248 (41840). (606) 855-2041. Headwaters Bcstg Corp. (acq 1964). Net: MBS. Rep: Ky. Radio Sls, Keystone. Format: C&W. ■ Charles Whitaker, pres; Charles Engle, gen mgr; Tommy Abdo, chief engr.

Newport

WNOP—Aug 21, 1948: 740 khz; 1 kw-D. DA. Box 740 (41072). (606) 581-7100. Albert W. Vontz (acq 6-1-72). Net: ABC/E. Rep: Ky. Radio Sls-South, GCI Sls. Format: Jazz, comedy. ■ David V. Piontek, pres and gen mgr; Deanna Ziegler, coml mgr; Ray Scott, prog & mus dir; Jim Edwards, news dir; Nicky Cook, chief engr. ■ Rates: \$19; 10; 19; —.

Nicholasville

WNVL—Dec 1962: 1250 khz; 500 w-D. Box 247 (40356). (606) 885-6031. Greater Ky. Bcstg Corp. Format: C&W. ■ Walter E. May, pres; Dennis W. Nelson, gen mgr; John W. Best, coml & prom mgr; Mark Wayne, mus dir; Danny B. Craft, news dir; Harold Ransdell, chief engr.

Owensboro

WBKR(FM)—See listing following WOMI.

WOMI—Mar 7, 1938: 1490 khz; 1 kw-D, 250 w-N. Box 1330 (42301). (502) 683-1558. Owensboro Bcstg Co. Audio news: APR. Rep: Devney, Ky. Radio Sls. Format: Contemp. ■ Lawrence Hager Sr., pres; John Hagerman, gen mgr; Steven Hagan, prog dir; David Silvert, coml mgr; Harold I. Peters, chief engr. ■ Rates: \$ 9; 9; 9; 9.

WBKR(FM)—Co-owned with WOMI. 1948: 92.5 mhz; 77 kw. Ant 380 ft. Stereo. Prog sep from AM. Format: C&W. ■ Henry Bristow, prog dir. ■ Rates same as AM.

WSTO(FM)—Listing Follows WVJS.

WVJS—Nov 26, 1947: 1420 khz; 5 kw-D, 1 kw-N, DA-2. Box 371 (42301). (502) 683-3521. Owensboro on the Air Inc. Net: ABC/C. Rep: Masia/Young, R. S. Crane, Regional Reps, Riley Reps. Format: Variety. ■ Robert H. Steele, pres; Malcolm Greep, exec VP & gen mgr; Ray Weltstein, asst gen mgr and stn mgr; Leonard J. Norcia, coml mgr; James L. Orton, prog dir; Joel Utley, news dir; Earl Jago, chief engr.

WSTO(FM)—Co-owned with WVJS. June 7, 1948: 96.1 mhz; 100 kw. Ant 340 ft. Stereo. Net: ABC/FM. Prog sep from AM.

Paducah

WDXR—Dec 24, 1957: 1560 khz; 10 kw-D, 1 kw-N, DA-2. Box 298 (42001). (502) 443-1737. WDXR Inc. Net: NBC. Rep: Savalli/Gates, R. S. Crane, Regional Reps. Format: Contemp. ■ Lady Sarah McKinney-Smith, pres & gen mgr; Tom Nelson, stn mgr; Jack Pattie, prom mgr; Pat Martin, prog & mus dir; John Stewart, news dir; John Bartlett, chief engr. ■ WDXR-TV affil.

WKYQ(FM)—See listing following WKYX.

WKYX—1946: 570 khz; 1 kw-D, 500 w-N, DA-2. Box 931 (42001). (502) 442-6311. TWX 502-554-4422. WKYX Inc. (acq 11-23-71). Group owner: Nininger Stns. Net: ABC/C. Rep: McGavren-Guild. Format: Contemp. ■ Pete Nininger, pres; Gary Morse, gen mgr; Bill Leuer, coml mgr; Larry Sherwood, prod mgr; Bryan Sargeant, prog dir; Bill Hagy, mus dir; Keith Todd, news dir; J. B. Fowler, chief engr.

WKYQ(FM)—Co-owned with WKYX. 1947: 93.3 mhz; 31 kw. Ant 380 ft. 218 N. 6th (42001). (502) 442-7383. Net: ABC/E. Format: C&W. ■ Herb Estes, coml mgr; Danny Dariesworth, prog dir; Mike Larson, mus dir; John Stewart, news dir.

WPAD—Aug 23, 1930: 1450 khz; 1 kw-D, 250 w-N.

Kentucky Radio

See page C-1 for explanation of listings.

Box 450 (42001). (502) 442-8231. Paducah Bcstrs (acq 7-25-67). Net: CBS. Rep: Gert Bunchez & Assocs, Southern Spot Sales. Format: Modern country. Spec progs: Black 1 3/4 hrs, gospel 5 hrs, wkly. ■ Edward B. Fritts, gen & coml mgr; Ed Taylor, prog & mus dir; Larry Clisby, sports dir; Stan Howard, news dir; Earl Abanathy, chief engr.

WPAD-FM—Nov 26, 1946: 96.9 mhz; 70 kw. Ant 340 ft. Stereo. Dup AM 30%. Format: Btlf mus.

Paintsville

WSIP—April 24, 1949: 1490 khz; 1 kw-D, 250 w-N. Box 591 (41240). (606) 789-5311. Big Sandy Bcstg (acq 6-1-60). Net: CBS. Rep: Hopewell, Regional Reps. ■ Paul G. Fyffe, pres & gen mgr; Bill Barker, coml mgr; Robbin Mathis, prog dir; Jim Fyffe, news dir; Eugene Balddridge, chief engr.

WSIP-FM—Jan 12, 1965: 98.9 mhz; 31 kw. Ant 600 ft. (CP 29 kw. Ant 700 ft.). Dup AM.

Paris

WBGR—1955: 1440 khz; 1 kw-D. Box H (40361). (606) 987-1440. Blue Grass Radio Inc. (acq 5-1-72). Net: ABC/E. Format: C&W. ■ Adlai C. Ferguson Jr., pres & gen mgr; George Gordon, mgr; Doug Hicks, coml mgr; Rita Bishop, news dir; Bradford Carey, chief engr. ■ Rates: \$3.70; 3.70; 3.70; —.

WBGR-FM—June 5, 1968: 96.7 mhz; 3 kw. Ant 105 ft. Dup AM 100%. ■ Rates same as AM.

Pikeville

WDHR(FM)—See listing following WPKE.

WLSI—Jan 20, 1949: 900 khz; 5 kw-D. North Mayo Trail (41501) (606) 437-7323. Cumberland Pub. Rep: Regional Reps. Format: C&W. ■ Georgia G. Ward, pres & gen mgr; Irene Abernathy, coml mgr; Mike Paxton, asst & prom mgr & mus dir; James E. Allen, prog & news dir; Norman Beaty, chief engr.

WPKE—June 31, 1949: 1240 khz; 1 kw-D, 250 w-N. Box 2200 (41501). (606) 437-4051. East Kentucky Bcstg Corp. Group owner: Walter E. May. Net: MBS. Rep: Regional Reps. Format: MOR. Spec prog: Gospel 6 hrs wkly. ■ Walter E. May, pres & gen mgr and chief engr; Robert Tarbeck, coml mgr; David L. Chafin, prog dir & prom mgr; Darrel Mullins, mus dir; Manuel Cerdiera, news dir. ■ Rates: \$3.90; 3.90; 3.90; 3.90.

WDHR(FM)—Co-owned with WPKE. March 25, 1965: 92.1 mhz; 3 kw. Ant 300 ft. Box 2228. (606) 432-5300. Format: C&W. ■ Jim Casto, gen mgr; Dewey Cochran, coml mgr; John Little, prog dir; Alan Burton, mus dir; Irene Preston, prom mgr; Kay Ratliff, news dir. ■ Rates: \$4.25; 4.25; 4.25; 4.25.

Pineville

WANO—March 16, 1957: 1230 khz; 1 kw-D, 250 w-N. S/R5, Box 1 (40977). (606) 337-2100. Ken-Te-Ye Bcstg Co. (acq 1-1-58). Format: Diversified. Spec progs: Farm 1½ hrs; black 2 hrs; classical 5 hrs; jazz 2 hrs; relig 18 hrs; news 15 hrs, wkly. ■ South C. Bevins, pres and gen mgr; Charles D. Keyes, prog dir; David C. Peterson, mus dir; Warren A. Pursifill, news dir and sls mgr. ■ Rates: \$2.85; 2.85; 2.85; 2.85.

WTJM(FM)—Feb 24, 1973: 106.3 mhz; 350 w. Ant 750 ft. Box 208 (40977). (606) 337-2331. John O. McPherson. Net: ABC/E. Format: Modern country. ■ John O. McPherson, pres; Jennings Blakley, gen mgr; Lois McPherson, coml mgr; Lester Adkins, prog dir; Mark Tabor, mus dir; Johnnie Swaggler, news dir; Bill Lundy, prom mgr; Jimmie Branham, chief engr.

Prestonburg

WDOC—Nov 1957: 1310 khz; 5 kw-D. Box 309 (41653). (606) 886-2338. WDOC Inc. Net: ABC/C. Rep: Beaver, Regional Reps. Format: MOR. ■ Gorman Collins, pres & gen mgr; Harold Balderidge, coml mgr; Eva Collins, prom dir; Janet Whitten, prog dir; William Lafferty, chief engr.

WDOC-FM—Feb 11, 1963: 95.5 mhz; 78 kw. Ant 540 ft. Dup AM 10%. Format: Good mus & sports.

WPRT—Dec 5, 1952: 960 khz; 5 kw-D, 1024 South

Kentucky, Louisiana Radio

See page C-1 for explanation of listings.

Lake Dr. (41653). (606) 886-2050. Stephens Industries Inc. Format: C&W, rock. ■ D. C. Stephens, pres & gen mgr; C. Ollie Robinson, coml mgr & sports dir; Harry E. Hale, asst gen & prom mgr, chief engr.

WPRT-FM—Feb 10, 1967: 105.5 mhz; 1.7 kw. Ant 390 ft. Dups AM 100%.

Princeton

WPKY—March 15, 1950: 1580 khz; 250 w-D. Box 478 (42445). (502) 365-2072. Princeton Bcstg Co. Format: Variety. ■ Leslie Goodaker, owner, gen mgr & chief engr; Ellis Burnam, coml mgr; Twyman Boren, prog dir.

WPKY-FM—April 1st, 1969: 104.9 mhz; 3 kw. Ant 175 ft. Dups AM 100%.

Richmond

WCBR—March, 1969: 1110 khz; 250 w-D. Box O (40475). (606) 623-1235. WCBR Radio Inc. (acq 5-75). Net: MBS. Rep: Carpenter. Format: C&W. Spec prog: Farm 1 hr wkly. ■ Bill Robbins, pres; Phil Herald, gen mgr; Tom Friend, coml mgr; John Quincey, prog dir; Bill Hughes, prom mgr; Donald Walker, chief engr. ■ Rates: \$2.60; 2.60; 2.60; 1.75.

WCBR-FM—May 12, 1972: 101.7 mhz; 3 kw. Ant 230 ft. Dups AM 100%. ■ Rates same as AM.

***WEKU-FM**—Sept 1968: 88.9 mhz; 50 kw. Ant 720 ft. Eastern Kentucky University (40475). (606) 622-2474. Board of Regents, Eastern Kentucky University. Format: Cultural, informational, educ. ■ Fred C. Kolloff, dir, div of radio-TV; Loy Lee, stn mgr & mus coord; John Sullivan, news & pub affrs coord; Gene Robbins, chief engr; Don Walker, ops engr.

WEKY—Oct 17, 1953: 1340 khz; 1 kw-D, 250 w-N. Box 670 (40475). (606) 623-1340. Henkin Inc. (acq 8-1-66). Net: ABC/E. Audio news: UPI. Rep: Beaver; Regional Reps. Format: Top 40. Spec prog: Farm 5 hrs wkly. ■ Fred Hensley, pres; Ken MacDonald, gen mgr; Mark Cole, prog dir; Mark Huler, news dir; Arvil, chief engr. ■ Rates: \$5.50; 4.25; 5.50; 3.

Russell Springs

WJKY—See Jamestown.

WJRS-FM—See Jamestown.

Russellville

WAKQ(FM)—Listing follows WRUS.

WRUS—August 28, 1953: 610 khz; 500 w-D. Box 110 (42276). (502) 726-2471. South Kentucky Bcstg Co. Inc. Group owner: Hook Stns. Audio news: APR. Format: Farm, MOR, progs, relig, C&W. ■ Roth E. Hook, pres; W.P. Sosh, gen mgr; Hilton Ashby, coml mgr; Don Neagle, news dir. ■ Rates: \$5.90; 5.90; 5.90;—.

WAKQ(FM)—Co-owned with WRUS. March 28, 1965: 101.1 mhz; 100 kw. Ant 510 ft. (502) 726-3555. Prog separate from AM. ■ Rates same as AM.

St. Matthews

WSTM(FM)—Nov 19, 1966: 103.1 mhz; 2.95 kw. Ant 135 ft. Executive Park, Suite 312 (40207). (502) 897-6513. Scott Bcstg Co. (acq 1-31-73). Stereo. Format: MOR. ■ Dave Adler, ops dir; Don Rogan, prog dir; Peter Boyce, chief engr. ■ Rates: \$7; 7; 7; 7.

Scottsville

WLCK—Feb 27, 1958: 1250 khz; 500 w-D. Box 158 (42164). (502) 237-3148. Stateline Bcstg Inc. Rep: Regional Reps. Format: Contemp, C&W 75%. ■ Redman L. Turner, pres; Joseph P. Hite, gen & coml mgr; Bruce Wishart, prog dir; Joe Hite, mus dir; Douglas Combs, news dir; W. E. Harston, chief engr.

WLCK-FM—Feb 26, 1967: 99.3 mhz; 3 kw. Ant 260 ft.

Shelbyville

WCND—June 3, 1964: 940 khz; 250 w-D. Box 248 (40065). (502) 633-3814. WCND Inc. Net: MBS. Rep: Keystone, Regional Reps. Format: C&W, Contemp.

Spec prog: Farm 6 hrs wkly. ■ J. B. Crawley, pres; Dean Harden, gen mgr; Nick Woods, sls mgr.

Somerset

***WSCC(FM)**—Jan 12, 1967: 90.7 mhz; 10 w. 808 Monticello Rd. (42501). (606) 678-8174, ext 31. University of Kentucky, Somerset Community College. Format: Top 40. ■ Don Orwin, chmn telecommunication dept.

WSEK(FM)—Listing follows WSFC.

WSFC—Dec 14, 1947: 1240 khz; 1 kw-D, 250 w-N. Box 740 (42501). (606) 678-5151. Shamrock Communications Corp. (acq 11-1-74). Net: ABC/E. Rep: Kentucky Radio Sales, Regional Reps, Carpenter. Format: Contemp. ■ Hamilton Shea, pres; Jerry W. Padgett, gen mgr; Charles J. Coldiron, coml mgr; Stan Redmon, prog dir; Jack Rickert, mus dir; Madelynn Coldiron, news dir; Robert L. Shoopman Jr., chief engr. ■ Rates: \$5.05; 4.80; 5.05; 3.20.

WSEK(FM)—Co-owned with WSFC. Oct 1964: 96.7 mhz; 3 kw. Ant 215 ft. Net: ABC/FM. Format: C&W. Prog sep from AM. ■ Charles J. Coldiron, coml mgr; Jack Rickert, mus dir. ■ Rates: \$2.60; 2.60; 2.60; 2.60.

WTLO—Nov 1, 1958: 1480 khz; 1 kw-D. Drawer B (42501). (606) 678-8151. Cumberland Communications (acq 10-9-74). Audio news: APR. Rep: Hopewell. Format: Top 40. ■ J. Allen Brown, pres and gen mgr; Mitch Mize, coml mgr; Mike Carla, prog dir; Bill Hines, mus dir; Gwen Waddle, off mgr; Jowell Bell, news dir; Roy Taylor, chief engr. ■ Rates: \$7.40; 6.50; 7.40; 6.60.

Stanford

WRSL—Nov 1, 1961: 1520 khz; 500 w-D. Box 237 (40484). (606) 365-2126. Lincoln-Barrard Bcstg Inc. (acq 12-23-70). Rep: Ky. Radio Sls. Format: C&W, gospel. ■ Carl Smith, pres, gen mgr & chief engr; Junior Whittaker, coml mgr; Rich Wayne, prog dir; Arvil Jones, stn mgr; C. Lynn, news dir.

WRSL-FM—May 22, 1967: 95.9 mhz; 3 kw. Ant 85 ft. Prog sep from AM.

Stanton

WBFC—June 21, 1975: 1470 khz; 500 w-D. Box 398 (40380). (606) 633-2888. Forest Drake. Audio news: UPI. Format: Diversified. ■ Forest Drake, gen mgr; Debra Napier, prog dir; Betty Faulkner, mus dir; Gary Lutes, chief engr. ■ Rates: \$2.90; 2.90; 2.90;—.

WSKV-FM

Modern Country & Top 40



American Entertainment Radio Network

WSKV(FM)—Aug 10, 1974: 104.9 mhz; 440 w. Ant 680 ft. Stereo. Box 627 (40380). (606) 663-2811. Red River Gorge Bcstg Co. Net: ABC/E. Format: C&W, top 40. ■ A. Dale Bryant, pres; Chuck Edwards, gen mgr; Dave Johnson, coml mgr; Keith Chatfield, prom mgr; Rick Day, prog & mus dir; Ed Drake, news dir; James M. Hay, chief engr. ■ Rates: \$2.70; 2.70; 2.70; 2.70.

Tompkinsville

WTKY—May 28, 1960: 1370 khz; 1 kw-D. Box 308 (42167). (502) 487-6119. J. K. Whittimore (acq 7-1-70). Format: C&W. ■ J. K. Whittimore, gen & coml mgr & chief engr; Barbara Richardson, prog dir; Bill Mann, prom mgr; Robert Boyles, news dir.

WTKY-FM—Nov 15, 1971: 92.1 mhz; 3 kw. Ant 240 ft. Dup AM 65%.

Vanceburg

WKKS—June 1, 1958: 1570 khz; 250 w-D. 1106 Fair Lane (41179). (606) 796-3031. Ohio Valley Bcstg Co. (acq 1974).

Vancleve

WMTG—June 1948: 730 khz; 1 kw-D. (41385). (606) 666-5006. Kentucky Mountain Holiness Assn. ■ Karl Paulo, pres; Wilfred Fisher, gen mgr; Miss Violet Per-

son, prog dir; Louis Bouck, prod mgr; Sheldon Short, news dir; Kenneth Amspaugh, chief engr.

Versailles

WJMM(FM)—July 16, 1973: 100.9 mhz; 3 kw. Ant 300 ft. Box 434 (40383). (606) 873-8096. Mortenson Bcstg Co. Inc. (acq 7-13-73). Net: Tower of Faith Radio. Format: Religious. ■ Rev. Jack M. Mortenson, pres; Len Sorrell, gen mgr; Dwayne Jackson, coml mgr; Ron Hays, news dir; Nolin Pontrich, Dave Johnson, chief engr.

West Liberty

WLKS—July 25, 1965: 1450 khz; 1 kw-D, 250 w-N. 129 College St. (41472). (606) 743-3145. Morgan County Industries Inc. Rep: Keystone, Regional Reps. Format: C&W. ■ Dr. C. C. Smith, pres; Glenn Woodward, gen mgr; Joyce Osborne, coml mgr; Donnie Hammond, news dir; Paul Lyons, chief engr.

Whitesburg

WTCW—Feb 19, 1953: 920 khz; 5 kw-D. Box 747 (41858). (606) 633-2711. Folkways Bcstg Co. (acq 7-56). Net: CBS. Rep: Bernard, Ky. Radio Sales. Format: C&W. ■ Don F. Crosthwaite, pres & gen mgr & prog dir; Fred Bowen, coml mgr; Jeff Stepehns, mus dir; Jimmie Branham, news dir & chief engr.

WTCW-FM—Nov 25, 1964: 103.9 mhz; 210 w. Ant 940 ft. Dup AM 80%. Format: C&W.

Whitley City

WEQO—April 8, 1975: 1220 khz; 500 w-D. Box 475 (42653). (606) 376-5100. Country Roads Bcstg Corp. Audio news: UPI. Format: C&W. Spec prog: Farm 2 hrs wkly. ■ William R. Carrigan, pres; Marc A. Garabien, gen mgr; Carl E. Stump, chief engr. ■ Rates: \$2.45; 2.45; 2.45;—.

Williamsburg

WEJZ—March 7, 1959: 1440 khz; 1 kw-D. 107 S. 4th St. (40769). (606) 549-2285. Whitley County Bcstg Inc. Format: C&W. Honus S. Shain Jr., owner; Shelby Prewitt, coml mgr; Helene Cheek, prom mgr; David Smith, chief engr.

Winchester

WKDJ(FM)—1974: 100.1 mhz; 3 kw. Ant 300 ft. (40391). Clark Communications Co.

WWKY—Oct 19, 1954: 1380 khz; 1 kw-D. Box 535 (40391). (606) 744-2864. WWKY Inc. (acq 1-60). Net: ABC/C. Format: Contemp. ■ Wilda Horton, pres; David E. Griffith, gen & coml mgr; Mike McCoy, prog & prom mgr; Mark Roman, mus dir; Betty Gordon, news dir; Phil Fraley, chief engr.



Louisiana

Abbeville

KROF—July 9, 1948: 960 khz; 1 kw-D. Box 610 (70510). (318) 893-2531. Abbeville Bcstg Service. Rep: Torbet. Format: Rock. Spec prog: Fr 7 hrs wkly. ■ Paul F. Piazza, pres; Manuel Broussard, gen mgr; Robert E. Schlicher III, asst mgr & prog dir; Russ Bordenon, coml mgr; Garland Bernard, prom mgr; Brian Doucet, mus dir; Jay Walker, news dir; J. D. Broussard, Jr., chief engr.

KROF-FM—June 1, 1974: 104.9 mhz; 3 kw. Ant 240 ft. Dups AM 84%.

Alexandria

KALB—September 21, 1935: 580 khz; 5 kw-D, 1 kw-

N, DA-N, Box 471 (71301). (318) 443-2543. TWX 510-976-5709. Alexandria Bcstg Co. (acq 1946). Group owner: T. B. Lanford. Net: CBS. Rep: H-R/Stone. Format: MOR, Contemp, C&W. ■ T. B. Lanford, pres; Bruce Rainey, gen mgr; Bill Lynch, coml mgr; Ben Westbrook, prog dir; Gene Dupuis, mus dir; Donna Bryant, prom mgr; Tom Ham, news dir; Robert Richardson, chief engr. ■ Rates: \$15;13;15;11.

KSLL(FM)—Co-owned with KALB. 1947: 96.9 mhz; 100 kw. Ant 850 ft. Stereo. Prog sep from AM. Format: MOR. ■ Rates: \$5;5;5;5. ■ KALB-TV affil.

KDBS—December 1953: 1410 khz; 1 kw-D, Box 591 (71301). (318) 443-7454. KDBS Inc. (acq 1954). Net: ABC/C. Rep: Messina. ■ Irving Ward-Steinman, gen mgr; Jack Sharp, coml mgr; Henry J. Lazarone, chief engr.

KDBS-FM—November 1969: 100.3 mhz; 29.5 kw. Ant 130 ft.

KSLL(FM)—Listing follows KALB.

KSyl—April 1, 1947: 970 khz; 1 kw-U, DA-N, Box 7057 (71301). (318) 442-6611. KSyl Inc. Net: NBC. Rep: Masia. Format: Contemp, MOR. ■ Sylvan Fox, pres; Jim Richards, gen mgr & coml mgr; Shirley Racine, prom mgr & mus dir; Gerald Hambleton, news dir; Lenny Dupree, chief engr. ■ Rates: \$8.50;6.50;8.50;6.50.

Amite

WABL—January 1956: 1570 khz; 500 w-D, Box 787 (70422). (318) 748-8385. Amite Bcstg Co. (acq 5-21-58). ■ C. W. Fitz, pres & chief engr; Charles Hart, gen mgr; L. O. Valentine, coml mgr; Andrus Russell, prog dir; Barbara Andrews, news dir.

Bastrop

KTRY—February 1948: 730 khz; 250 w-D, Box 1075 (71220). (318) 281-3656. Jamie Patrick Bcstg Ltd. (acq 12-7-72). Net: ABC/E. Rep: Smith, Carpenter. Format: C&W. Spec prog: Black 12 hrs wkly. ■ Jamie Patrick, pres & gen mgr, prog & mus dir; Kathy Richie, coml mgr; Tom St. John, news dir; Harry Howard, chief engr.

KTRY-FM—March 1, 1974: 94.3 mhz; 3 kw. Ant 290 ft. Net: ABC/E. Format: MOR. Prog sep from AM. ■ Larry Shannon, prog & mus dir; Jerry Jordan, prom mgr.

KVOB—June 1, 1957: 1340 khz; 1 kw-D, 250 w-N. 121 Haynie Ave. (71220). (318) 281-1383. Hagan Broadcasting Co. (acq 4-1-89). Net: MBS. Rep: Hopewell, Beaver. Format: C&W. ■ Stan Hagan, pres & gen mgr; David Mayfield, stn mgr; Kathy McGlothlin, bus mgr. ■ Rates: \$4; 4; 4; 4.

Baton Rouge

WAFB-FM—Oct 1, 1968: 98.1 mhz; 100 kw. Ant 1500 ft. Box 2671 (70821). (504) 344-2666. Guaranty Bcstg Corp. Net: ABC/C. Rep: Meeker. Format: Contemp & solid gold. ■ Tom E. Gibbens, pres; Bill Healey, coml mgr; Grace McElveen, prom mgr; Carlton Cremeens, news dir; Donald K. Allan, chief engr.

WAIL—June 1, 1957: 1260 khz; 1 kw-D, 5700 Florida Blvd. Suite 604 (70806). (504) 926-7600. WAIL Inc. (acq 1-10-66). Rep: Savalli/Gates. Format: Adult contemp. ■ Mrs. Ralph L. Burge, pres; Harold G. Herthum, gen & coml mgr; Kinnon Thomas, prog & mus dir & prom mgr; David Brandao, news dir; Larry Ward, chief engr. ■ Rates: \$8;7;8;6.50.

WFMF(FM)—Listing follows WJBO.

WIBR—July 18, 1948: 1300 khz; 1 kw-U, DA-2. (CP DA-1). Box 1226 (70821). (504) 344-2666. Community Bcstg Inc. Rep: HR/Stone. Format: Top 40. ■ Robert Earle, pres; Bob Furlow, gen & coml mgr; Bernard Zuccaro, prog dir & prom mgr; Joe London, mus dir; Dick Berrington, news dir; Herb Coussou, chief engr. ■ Rates: \$18;16;18;16.

WJBO—Dec 11, 1934: 1150 khz; 5 kw-U, DA-1, Box 496 (70821). (504) 383-5271. Baton Rouge Bcstg Co. Group owner: Manship. Net: NBC. Rep: AVCO. Format: MOR. ■ Douglas L. Manship, pres; Roger S. Davison, gen mgr; Don Grady, prog dir; Bob Courtney, news dir; Ed Oliver, chief engr.

WFMF(FM)—Co-owned with WJBO. 1941: 102.5 mhz; 100 kw. Ant 560 ft. Stereo. Prog sep from AM. Format: Progs. ■ Tim Allen, coml mgr; Bill Fuagler, mus dir; Robbie Guidry, news dir. ■ WBRZ-TV affil.

WLCS—Nov 1, 1946: 910 khz; 1 kw-U, DA-1. One American Place, Suite 2420 (70825). (504) 383-4411. Air Waves Inc. (acq 7-5-54). Format: Top 40. ■ Lamar Simmons, pres; Gene Nelson, mus dir; Wilbur Lewis, coml mgr; Larry Hamilton, news dir; Gene Howell & Larry Ward, chief engr. ■ Rates: \$24;19;24;14.

WQXY-FM—Co-owned with WLCS. Sept 10, 1966: 100.7 mhz; 97 kw horiz; 91 kw vert. Ant 700 ft. (acq 8-2-73). Prog sep from AM. Format: Btfl music. ■ Wilda Kovacs, coml mgr; Eugene Nelson, prog dir. ■ Rates: \$9.50;9.50;9.50;9.50.

WLUX—1963: 1550 khz; 5 kw-D, 7370 Airline Hwy. (70805). (504) 356-4511. Jimmy Lee Swaggart. Net: ABC/E. Rep: Crane, Messina. Format: Beautiful music. ■ Jimmy Swaggart, owner & gen mgr; Leonard Benson, chief engr.

WQXY-FM—Listing follows WLCS.

WXOK—February 1953: 1460 khz; 5 kw-D, 1 kw-N, DA-N, Box 66475 (70806). (504) 927-7060. Security Bcstg of Baton Rouge Inc. (acq 6-1-72; group owner). Net: Mutual Black. Rep: Dore, Jones. Format: Black. ■ Edmond J. Muniz, pres; Lew Carter, gen & s/s mgr; Jim Foreman, opns mgr; Dennis Earl Lee, prog & mus dir; Kip Holden, news dir; Larry L. Ward, chief engr. ■ Rates: \$19;15;19;15.

WYNK—1956: 1380 khz; 5 kw-D, DA, Box 2541 (70821). (504) 343-8348. MissLou Bcstg Corp. (acq 10-6-62). Net: ABC/E. Audio news: APR. Rep: Masia. Format: C&W. Spec prog: Farm 5 hrs; Fr 1 hr wkly; Cajun classic hrl; ■ R. D. McGregor, pres, gen & coml mgr; Page Dew, prog dir; Bernard Aucoin, prom mgr; Gary Hale, mus dir; Dave Bess, news dir; Lewis Goode, chief engr.

WYNK-FM—Dec. 7, 1968: 101.5 mhz; 100 kw. Ant 330 ft. Stereo. Dup AM 10%. Format: C&W.

Bogalusa

WBOX—Jan 4, 1954: 920 khz; 1 kw-D, Box 897 (70427). (504) 732-4288. Moseley-Smith Bcstg Inc. (acq 3-1-75). Format: C&W. ■ Donald H. Smith, pres & gen mgr; June Moseley, s/s mgr; Harlan White, prog dir.

WIKC—May 15, 1947: 1490 khz; 1 kw-D, 250 w-N, Box 506 (70427). (504) 735-1490. Adams Properties Inc. (acq 1-7-73). Rep: Keystone. Format: Rock. Spec prog: Black 5 hrs wkly. ■ G. S. Adams, pres; Andrew Moses, gen mgr; Albert Bennett, prog & mus dir & chief engr; Launo Moore, coml mgr; Al Stone, news dir.

Columbia

KCTO—Nov. 1968: 1540 khz; 1 kw-D, Box 666 (71418). (318) 649-2331. Caldwell Bcstg Co. Rep: Beaver (South). Format: C&W. ■ H. Ted Woods, pres; Joe Steiner, gen mgr; Jim Crain, prog dir & chief engr; Linda Meredith, traf mgr; Billy Oliveaux, news dir.

Covington

WARB—November 1953: 730 khz; 250 w-D, Box 568 (70433). (504) 892-1600. WARB Inc. (acq 8-1-57). Format: MOR. ■ David C. Blossman, pres; J. Rick Webb, chief engr & gen mgr; Bill Stubbs, coml mgr; Sandra Bittola, prog dir.

Crowley

KAJN—1972: 1560 khz; 1 kw-D, DA, Box 1561 (70526). (318) 783-1560. Rice Capital Bcstg. Net: ABC/E. Rep: Riley. Format: MOR. ■ Joel Scarborough, gen mgr; Bob Mouisset, prog dir; Freddie Hebert, chief engr.

KSIG—May 1947: 1450 khz; 1 kw-D, 250 w-N, Box 228 (70526). (318) 783-2520. KSIG Bcstg Co. (acq 6-1-55). Net: MBS. Rep: Messina. Format: MOR, C&W. Spec progs: Fr 1 hr, Black 5 hrs wkly. ■ Louis M. Basso, pres & gen mgr; Shal Kanter, coml mgr; Phil Lizotte, news dir; Ralph Contheir, chief engr.

Denham Springs

WLBI—April 15, 1959: 1220 khz; 250 w-D, Box 68 (70726). (504) 665-5154. Livingston Bcstg Corp. (acq 2-6-72). Net: MBS, Louisiana Net. Rep: Keystone. Format: C&W. ■ Edwin Walker, pres; Lou Millet, gen, coml & prom mgr; Jim Horn, mus & prog dir; Jaycee Fontenot, news dir; Tommy Stevens, chief engr.

Louisiana Radio

See page C-1 for explanation of listings.

De Ridder

KDLA—Nov 11, 1950: 1010 khz; 1 kw-D, Box 46 (70634). (318) 463-7600. Century Bcstg (acq 8-1-70). Net: Louisiana Net. Audio news: UPI. Format: MOR. ■ Ralph L. Hooks, owner & pres; Wayne L. Sanders, gen & coml mgr. ■ Rates: \$3.80;3.80;3.80;3.80.

KEAZ(FM)—Co-owned with KDLA. March 1, 1965: 101.7 mhz; 2.7 kw. Ant 235 ft. Progs sep from AM. Format: Btfl mus. ■ Rates: \$2.25;2.25;2.25;2.25.

Donaldsonville

KSMI-FM—1972: 104.9 mhz; 3 kw. Ant 300 ft. Box 797, Hwy 1 (70346). (504) 473-3806. LaFourche Valley Enterprises. ■ Joseph M. Costello III, VP opns.

WSLQ—See Gonzales.

Eunice

KEUN—October 1952: 1490 khz; 1 kw-D, 250 w-N, Box 1049 (70535). (318) 457-3041. Tri-Parish Bcstg. Co. Format: Contemp, C&W. Spec progs: Fr 6 hrs, Black 6 hrs wkly. ■ Thomas C. Voinche, gen mgr; Karl R. DeRouen, coml mgr; John Dean, prog dir.

Farmerville

KTDL—Dec 7, 1962: 1470 khz; 1 kw-D, Box 64 (71241). (318) 368-2941. Union Bcstg Co. Inc. Net: Louisiana Net. Format: MOR contemp. Spec progs: C&W 12 hrs, gospel 6 hrs, farm 3 hrs wkly. ■ Don M. Barron, pres; Doyle L. Barron, gen & coml mgr; Robert Penny, prog dir; Fred Scott, mus dir; Jack James, prog dir; Glen Hayes, news dir; Thomas L. Gaddis, chief engr.

Ferriday

KFNV—1956: 1600 khz; 1 kw-D, Box 592 (71334). (318) 757-4200. MissLou Bcstg Co. (acq 1962). Net: ABC/E. Format: Top 40. ■ George Wilson, pres, gen mgr, prog & mus dir & chief engr; Eric E. Walter, coml mgr; Keith Chandler, prom mgr & news dir.

KFNV-FM—October 1971: 93.5 mhz; 3 kw. Ant 135 ft. Prog sep from AM.

Franklin

KFRA—June 4, 1961: 1390 khz; 500 w-D, Box 1111 (70538). (318) 828-5372. KFRA Inc. Format: MOR. ■ Lionel B. De Ville, pres; Chris Duplechain, gen, coml & prom mgr & news dir; Ken Sinitiere, prog dir.

KFRA-FM—May 9, 1975: 95.3 mhz; 3 kw. Ant 170 ft. Dups AM 100%.

Franklinton

WFCG—December 5, 1967: 1110 khz; 1 kw-D, Box 604 (70438). (504) 839-4110. GACO Bcstg Corp. Format: C&W. ■ J. A. Gatewood, pres & gen mgr; John Knight, stn mgr; Bob Green, prog dir; Keitha Burris, prom mgr; Don Passman, news mgr.

Garyville

WCKW(FM)—See LaPlace.

WKQT—Dec 22, 1970: 1010 khz; 500 w-D, Drawer B (70051). (504) 535-2424. 222 Corp. Net: ABC/N, Louisiana. Rep: Miller. Format: MOR. Spec progs: Black 1 1/2 hrs; C&W 19 hrs wkly. ■ Sidney J. Levet III, pres, gen & coml mgr & chief engr; Robert Martinez, prog & mus dir; Andrew B. Cashio Jr., prom mgr; Gerald Keller, spts dir; Henry Fried, news dir. ■ Rates: \$5.59; 5.59; 5.59; 5.59.

Golden Meadow

KLEB—May 13, 1963: 1600 khz; 1 kw-D, 1842 Henry St. (70357). (504) 475-5141. KLEB Bcstg. Format: C&W. Spec progs: Fr 12 hrs wkly. ■ John A. Egle, pres & gen mgr; R.W. Egle, coml mgr; Rickey Folse, prom mgr & prog dir; Jolyn Egle, news dir; Joette Toups, mus dir; Stephen Rush, chief engr. ■ Rates: \$4.72; 4.10; 4.10; 4.10.

KLEB-FM—November 15, 1966: 94.3 mhz; 3 kw. Ant 300 ft. Stereo. Dups AM 80%. Format: Top 40.

Louisiana Radio

See page C-1 for explanation of listings.

Gonzales

WSLG—April 13, 1969: 1090 khz; 500 w-D, DA. Box 236 (70737). (504) 644-5883. Ascension Parish Bcstg Co. Group owner: Hook (50%). Net: Louisiana Net. Rep: Southern Spot Sls, Keystone. Format: C&W. Spec prog: Black 4 hrs wkly. ■ Carl Sauceman, pres & gen mgr; Robin Coco, coml mgr; Ted Sauceman, stn mgr & chief engr.

Grambling

***KGRM(FM)**—1975: 91.3 mhz; 10 w. Grambling College (71245). ■ George L. Wesley, dir of bcstg.

Gretna

KGLA—Jan 6, 1969: 1540 khz; 500 w-D. Box 508 (70053). (504) 347-8491. West Jefferson Bcstg Inc. Rep: Messina. ■ Ralph M. Hartwell, pres; Sal Giangrosso, gen mgr; Ron Jones, prog dir; Lynn Sherman, news dir; Ralph M. Hartwell II, chief engr.

Hammond

***KSLU(FM)**—1974: 90.9 mhz; 10 w. Ant 116 ft. Box 746, University Station (70401). (504) 549-2330. Southeastern Louisiana U. Format: Diversified. ■ Jack Fisher, advisor; John A. Wiles III, gen mgr.

WCKW(FM)—See La Place.

WFPR—Nov 15, 1947: 1400 khz; 1 kw-D, 250 w-N. Box 1779 (70401). (504) 542-1400. Airweb Inc. (acq 8-15-57). Audio news: APR. Format: C&W/Top 40. ■ John A. Chauvin, pres, gen & prom mgr; Terrel McCrory, coml mgr; Carl Enna, prog, mus & news dir; Robert Priez, chief engr. ■ Rates: \$5.75;4;5.50;4.

WFPR-FM—Aug. 26, 1974: 107.1 mhz; 3 kw. Ant 300 ft. Stereo. Prog sep from AM. Dups AM 33%. Format: MOR. ■ Nanette Chauvin, prog dir. ■ Rates: \$4.50; 4.50; 4.50; 4.50.

WTGI(FM)—April 3, 1965: 103.3 mhz; 100 kw. Ant 155 ft. (CP: 50 kw vert. Ant 515 ft). Stereo. Box 70 (70401). (504) 345-5922. Tangi Bcstg Inc. (group owner; acq 5-67). Net: MBS, Louisiana Net. Rep: Beaver. Format: MOR, oldies, Top 40. Spec prog: Gospel 4 hrs wkly. ■ Paul Varnado, pres & gen mgr; Bernadette Varnado, prog dir; Shawn McWaters, news dir; Benton O. Bickham, coml mgr & chief engr. ■ Rates: \$7.50; 6; 7.50; 6.

Haynesville

KLUV—September 1956: 1580 khz; 1 kw-D. Box 189, 108 E. Main St. (71038). (318) 624-0105. Haynesville Bcstg Corp. (acq 11-15-67). Net: ABC/E. Rep: Keystone. Format: MOR. ■ Joseph P. Robillard, gen mgr & chief engr; Gail Robillard, prog dir; Jay Paul Robillard, mus dir. ■ Rates: \$30;30;30;—.

Houma

KCIL(FM)—Listing follows KJIN.

KHOM(FM)—Co-owned with KTIB (Thibodaux, La). Nov 15, 1968: 104.1 mhz; 56 kw. Ant 295 ft. 2306 W. Main St. (70360). (504) 876-5466. La Terr Bcstg Corp. Format: MOR. ■ James J. Buquet, Jr., pres; Raymond A. Saadi, gen mgr; Rod Rodrigue, coml mgr; Roy Vicknair, prog dir; Anna Slade, news dir. ■ Rates: \$6.50;6.50;6.50;6.50.

KJIN—April 1, 1946: 1490 khz; 1 kw-D, 250 w-N. Box 2068 (70360). (504) 872-6828. KCIL Inc. (acq 7-1-53). Net: Louisiana Net. Rep: Busby Finch, Latham & Widman. Format: Top 40. ■ Denver T. Brannen Sr., pres; Dave "Mac" McGriff, gen mgr; James H. Bozeman, opns mgr; Wayne Cordray, prog & mus dir; Hugh Smith, news dir & chief engr. ■ Rates: \$6.50;6;6.50;6.

KCIL(FM)—Co-owned with KJIN. Dec. 31, 1965: 107.1 mhz; 3 kw. Ant 300 ft. Stereo. Prog sep from AM. Format: Mod C&W. Spec prog: Fr 9 hrs wkly. ■ John "Moondog" Molins, mus dir. ■ Rates same as AM.

Jena

KCKW—Oct 4, 1962: 1480 khz; 500 w-D. Drawer KK (71342). (318) 992-4155. LaSalle Bcstrs. Net:

Keystone. Rep: Beaver. ■ R. W. Wagner, pres; Robert C. Wagner, gen mgr & chief engr.

KJNA(FM)—Co-owned with KCKW. Not on air, target date unknown: 99.3 mhz; 3 kw. Ant 73 ft.

Jennings

KJEF—November, 1950: 1290 khz; 1 kw-D. Drawer 1248 (70546). (318) 824-2934. Jennings Bcstg Co. Net: ABC/I. Format: Black, C&W. Spec prog: Fr 12 hrs wkly. ■ Clovis L. Bailey, pres, gen mgr & chief engr; Jerry Dugas, prom & coml mgr; Chuck Thomas, prog dir; Thad Carter, mus & news dir.

KJEF-FM—January 1963: 92.7 mhz; 2.9 kw. Ant 220 ft. Stereo. Prog sep from AM. Format: MOR.

Jonesboro

KTOC—Dec 4, 1958: 920 khz; 1 kw-D. Box 550 (71251). (318) 259-4600. Jackson Parish Bcstrs. ■ A. H. Colvin Jr., gen mgr; T. L. Colvin Sr., chief engr.

KTOC-FM—October 1, 1967: 104.9 mhz; 3 kw. Ant 245 ft. Stereo. Dup AM 10%.

Lafayette

KPEL—Jan 2, 1950: 1420 khz; 1 kw-D, 500 w-N, DA-N. Box 52046 (70501). (318) 234-7418. Radio Lafayette Inc. (acq 1-1-62). Net: ABC/I. Rep: Savalli/Gates. Format: MOR. Spec progs: Fr 1/4 hr wkly. ■ George Crouchet Jr., pres & gen mgr; Ron Gomez, VP & stn mgr; Lionel Prejean, coml mgr; Brad Broussard, prog dir; Ken Lormand, news dir; J. Clyde Prejean, chief engr.

KPEL-FM—Sept 15, 1966: 99.9 mhz; 100 kw. Ant 450 ft. Stereo. Dup AM 66%. ■ Dave Wenger Jr., coml mgr.

***KRVS(FM)**—88.3 mhz; 10 w. Box 74 (70501). U.S.L. Student Group.

KSMB(FM)—July 1965: 94.5 mhz; 29.5 kw. Ant 190 ft. Stereo. Box 3345 (70501). (318) 232-1311. Communications Bcstg. Net: ABC/C. Rep: Miller. Format: Top 40. ■ Rudy Barras, pres; Tom Galloway, stn mgr; Barry Thompson, coml mgr; Louis Cohen, prom mgr; Mike Mitchell, prog & mus dir; Mike Champagne, news dir; Jim Moore, chief engr. ■ Rates: \$7.05; 5.88; 7.05; 5.88.

KVOL—1935: 1330 khz; 5 kw-D, 1 kw-N, DA-N. Box 3030 (70501). (318) 234-5151. Radio Stn KVOL Inc. (acq 1-1-64). Group owner: Kirk. Net: NBC. Rep: Meeker. Format: Contemp. Spec progs: Fr 1/2 hr; black 7 hrs wkly. ■ James L. Kirk II, pres; Evans H. Hughes, gen mgr; Jim Trahan, stn mgr; Gregg Stevens, prog dir; Linda Wood, prom mgr; Lynn Stevens, coml mgr & news dir; Wally LeBlanc, chief engr.

KXKW—Nov 15, 1960: 1520 khz; 10 kw (CH), 500 w-N, DA-2. Box J (70501). (318) 232-2632. KXKW Inc. (acq 8-31-69). Net: MBS, IBC. Rep: Torbet. Format: C&W. Spec progs: Fr 2 1/2 hrs wkly. ■ James V. Hoffpauit, pres & gen mgr; Rick Richard, prog & news dir; Paul Thomas, mus dir; Clark L. White, coml mgr; David H. McDuffie, chief engr.

Lake Charles

KAOK—May 10, 1947: 1400 khz; 1 kw-D, 250 w-N. Drawer S (70601). (318) 436-7541. E. J. P. Inc. (acq 5-22-64). Net: ABC/C. Rep: Messina. Format: Top 40, Contemp. ■ Ed J. Prendergast, owner & pres; Tom Fletcher, VP & mgr; Doug Adams, prog dir; Gwen Prendergast, news dir; Dave Petrik, chief engr.

KGRA(FM)—Not on air, target date unknown: 103.7 mhz; 100 kw. Ant 441 ft. DJ of Lake Charles.

KIKS—See Sulphur, La.

KSNS(FM)—Co-owned with KIKS (Sulphur, La.). Not on the air, target date 11/75: 96.1 mhz, 100 kw. Ant 430 ft. Stereo. Box 190, Sulphur, La. (70663). (318) 527-5202. Net: Louisiana Net. Audio news: UPI. Prog sep from AM. Format: Top 40. ■ M.E. Carter, pres; L. Russell Keene, sec-treas; Susan N. Keene, VP.

KLCL—May 12, 1935: 1470 khz; 5 kw-U, DA-N. Box 3067. (70601). (318) 433-1641. KLCL Radio Inc. (acq 6-21-71). Net: NBC. Rep: Torbet. Format: C&W. Spec

progs: Fr 2 hrs; black 10 hrs wkly. ■ Perry S. Samuels, pres; Jim Toth, gen mgr; Jack O'Reilly, coml mgr; Ben Garofolo, prog & mus dir & prom mgr; Jerry Methvin, news dir; John Guthmann, chief engr.

KLCL-FM—Nov 8, 1965: 99.5 mhz; 35 kw. Ant 360 ft. Prog sep from AM. Format: MOR. ■ Jerry Methvin, prog dir.

KLOU—1947: 1580 khz; 1 kw-U, DA-N. Box 1725 (70601). (318) 436-7277. Dixie Bcstrs Inc. (acq 5-2-60). Audio news: APR. Rep: Avery-Knodel. Format: Top 40. ■ Albert D. Johnson, pres & gen mgr; Michael Byrd, coml & prom mgr; Jim Nettles, prog & mus dir; David Chimeno, chief engr. ■ Rates: \$7.25; 7.25; 7.25; 7.25.

Lake Providence

KBED(FM)—1974: 92.7 mhz; 2 kw. Ant 145 ft. Box 170, Lexington, Tenn. (38351). Lake Providence Bcstg Service Inc. ■ Bendell L. Enochs, pres.

KLPL—June 27, 1957: 1050 khz; 250 w-D. Hwy 65 N., Drawer 231 (71254). (318) 318-0834. Bendell L. Enochs (acq 1-5-71). Rep: Walton. Format: Rock, Top 40, black. ■ Bendell L. Enochs, pres; Ray A. Davidson Jr., gen & coml mgr; Bobby Dee, prog dir; Ronnie H. Brasher, chief engr.

La Place

WCKW(FM)—January 10, 1966: 92.3 mhz; 56 kw. Ant 265 ft. (CP 55 kw. Ant 260 ft). Stereo. Drawer B, Garyville, La. (70051). (504) 535-2424. 222 Corp. Net: ABC/I, Louisiana Net. Format: MOR, C&W. ■ Sidney J. Level III, pres, gen & coml mgr & chief engr; Robert E. Martinez, prog & mus dir; Andrew Cashio Jr., prom mgr; Gerald Keller, sps dir; Henry J. Fried, news dir. ■ Rates: \$5.59;5.59;5.59;5.59.

Leesville

KLLA—September 1956: 1570 khz; 1 kw-D. Box 1323 (71446). (504) 239-3403. Leesville Bcstg Co. Rep: Messina. Format: Rock, C&W. ■ John Anthony Lazarone, co-owner; Irving Ward-Steinman, co-owner & gen mgr; John N. Coburn, coml mgr; Elke Coburn, prog dir; Mike Farris, mus & news dir; Newman Coburn Jr., chief engr.

Mansfield

KDXI—June 15, 1954: 1360 khz; 1 kw-D. Drawer 740 (71052). (318) 872-4414. Heart of Dixie Bcstg (acq 10-67). Net: ABC/E. Format: C&W, gospel. Spec progs: Black 10 hrs; farm 3 hrs wkly. ■ Bennett Strange, pres, gen mgr, chief engr; Buford Strange, coml mgr; Griff Strange, prog mus & news dir; Jo-Ruth Strange, prom mgr. ■ Rates: \$5;2.50;2.50;—.

KJVC(FM)—Co-owned with KDXI. Not on air; target date 11/75: 92.7 mhz; 3 kw. Ant 300 ft. Stereo. Net: Louisiana Net. Prog sep from AM. Format: Touch of gold. Spec prog: Farm 3 hrs wkly. ■ Rates: \$5; 2.50; 2.50; 2.50.

Many

KWLA—Aug 1962: 1530 khz; (CP 1400 khz; 250 w-N). 1 kw-D. Box 856 (71449). (318) 256-5177. Toledo Investments Inc. Rep: Keystone. Spec progs: Black 4 hrs; C&W 20 hrs wkly. ■ Donald T. Lyons, VP, gen & coml mgr; Gene Elkins, prog dir; Ed Baldrige, chief engr.

Marksville

KAPB—Oct 28, 1954: 1370 khz; 1 kw-D. Box 7 (71351). (318) 253-7206. Avoyelles Bcstg Corp. Net: Keystone. Format: Variety. ■ Guy C. Billups Jr., pres; Chester J. Coco, exec VP; Chester A. Coco, sps mgr; Donald J. Bordenon, chief engr.

KAPB-FM—Aug 14, 1971: 97.7 mhz; 3 kw. Ant 215 ft. Stereo. Format: C&W. Dup AM 50%.

Minden

KASO—April 1, 1952: 1240 khz; 1 kw-D, 250 w-N. Box 774 (71055). (318) 377-1240. Cook Enterprises Inc. (acq 11-15-63). Net: Keystone. ■ Harold Ray (Boe) Cook, pres & gen mgr; M. S. O'Dell Jr., prog dir & chief engr.

Monroe

KLIC—June 23, 1950: 1230 khz; 1 kw-D, 250 w-N.

1700 Parkview Dr, Box 153 (71201). (318) 323-4617. KLIC Inc. Net: MBS. Rep: Masla. Format: Variety black. ■ Marie Cerniglia, pres; Ollie Bales, exec VP & gen. coml & prom mgr; Bob Cerniglia, prog dir; Don Archer, news dir; George Cerniglia, chief engr.

KMLB—July 1, 1930: 1440 khz; 5 kw-D, 1 kw-N. Box 4808 (71201). (318) 322-7161. Cyrene Bcstg Corp. (acq 9-11-72). Net: NBC. Format: MOR. Spec prog: Farm 7 hrs wkly. ■ Robert E. Powell, pres; Dona Butler, coml mgr; Tom Gay, prog dir; Lynn Haddad, prom mgr; Vic Parker, news dir; Harold Riggins, chief engr.

KMLB-FM—July 1946: 104.1 mhz; 17 kw. Ant 75 ft. Stereo. Format: Btlf mus. Prog sep from AM.

***KNLU(FM)**—Aug 31, 1973: 88.7 mhz; 10 w. Ant 75 ft. Stereo. Speech Dept, Northeast La. U. (71201). (318) 342-4073. Northeast La. U. Format: Variety. Spec progs: Classical 5 hrs; jazz 5 hrs; C&W 10 hrs wkly. ■ V. Jackson Smith, super; Bill Covington Jr, gen mgr.

KNOE—Oct 4, 1944: 540 khz; 5 kw-D, 1 kw-N, DA-2. Box 4067 (71201). (318) 387-9900. TWX 318-325-2240. James A. Noe. Net: ABC/C. Rep: McGavren-Guild-PGW. Format: Contemp. Spec prog: Farm 4 hrs wkly. ■ James A. Noe, pres; Richard H. Wilcox, gen mgr; Bill Murvin, prog dir; Mike Cochran, mus dir; Bob Jacobs, news dir; Ray Boyd, chief engr.

KNOE-FM—Jan 29, 1967: 101.9 mhz; 97 kw horiz, 96 kw vert. Ant 1,670 ft horiz, 1,660 vert. Stereo. Net: ABC/FM. Spec progs: Farm 2 1/2 hrs wkly. Prog sep from AM. ■ Greg Nolan, prog dir; Steve Stringer, mus dir; Earl Casey, news dir. ■ KNOE-TV affil.

KREB(FM)—Nov 15, 1965: 106.1 mhz; 30 kw. Ant 190 ft. Box 1345 (71201). (318) 387-3922. Twin City Bcstrs (acq 2-9-68). Rep: Smith. Format: C&W. ■ Jimmy L. Terry, pres & gen mgr; Edward Marshall, coml & prom mgr; Louise Strong, asst mgr & prog dir; Bill Warren, news dir; Tommy Reagan, chief engr.

Morgan City

KMRC—April 1954: 1430 khz; 500 w-D. Box 1430 (70380). (504) 384-1430. Tri-City Bcstg Inc. Format: Top 40. ■ Warren J. Fortier, pres; Farrell Bonner, gen mgr; Dennis Miller, prog & mus dir; Warren Soudier, news dir.

KMRC-FM—August 1, 1967: 96.7 mhz; 2.45 kw horiz, 580 w vert. Ant 255 ft. Stereo. Prog dups AM 100%.

Natchitoches

KNOC—May 1, 1947: 1450 khz; 1 kw-D, 250 w-N. 720 Front St., Box 607 (71457). (318) 352-9596. Natchitoches Bcstg Co. (acq 12-1-69). Net: ABC/E. Format: Variety. ■ Robert L. Burk, pres & coml mgr; B. Hillman Bailey Jr, chmn of bd; Rick Tarver, prog dir; David A. Bailey, prom mgr; Steve Gentry, mus dir; Norman A. Fletcher, news dir; Karl F. Bailey, stn mgr & chief engr. ■ Rates: \$5.10; 5.10; 5.10.

KDBH(FM)—Co-owned with KNOC. July 1, 1965: 97.7 mhz; 3 kw. Ant 140 ft. Box 607 (71457). Net: ABC/I. Prog sep from AM. Format: C&W. ■ Rates same as AM.

***KNWD(FM)**—Sept 1975: 91.7 mhz; 10 w. Ant 165 ft. Box 3038, NSU (71457). (318) 357-5693. Northwestern St. U. of La. Format: Progs. ■ Gary Palmer, gen mgr.

New Iberia

KANE—August 1946: 1240 khz; 1 kw-D, 250 w-N. Box 1240 (70560). (318) 365-3434. New Iberia Bcstg Inc. Net: ABC/E. Format: Contemp. Spec prog: Black 5 hrs wkly. ■ George H. Thomas, pres; Art Suberbielle, gen mgr; Eddie Provost, coml mgr; Ken Romero prog dir & chief engr; Ken Nowell, news dir. ■ Rates: \$4.84; 4.40; 4.84; 4.40.

KDEA(FM)—January 1969: 99.1 mhz; 51 kw. Ant 480 ft. Stereo. Box 907 (70560). (318) 365-6651. KDEA Stereo Radio Inc. (acq 7-9-74). Format: MOR. ■ Donald Bonin, pres & gen mgr; Frank Ellis, coml mgr; Lee T. Kleinpeter Jr, prog dir; Frank Falcon, news dir; Rick Morel, chief engr. ■ Rates: \$3.20; 3.20; 3.20; 3.20.

KNIR—Feb 15, 1966: 1360 khz; 1 kw-D. Box 1360 (70560). (318) 365-2401. Techedand Bcstg Inc. (acq 2-15-66). Rep: Beaver. Format: Contemp. ■ S. A.

Lopez, pres & gen mgr; Guy Martin Jr, coml mgr; Phil Rankin, prog dir; Mal Donado, prom mgr. ■ Rates: \$4.80; 4.60; 4.80; —.

New Orleans

KGLA—See Gretna, La.

WBOK—Feb 1951: 1230 khz; 1 kw-D, 250 w-N. Box 19085 (70179). (504) 827-1522. Starr-WBOK Inc. (acq 8-1-69). Group owner: Starr. Net: Natl Black. Rep: Torbet. Format: Black. ■ Dick Oppenheimer, VP; Roy Lemons, gen mgr; John Star, coml mgr; Ron Kelly, prog dir; Ray Rogers, news dir; Dale Johnson, chief engr.

WBYU(FM)—February 1953: 95.7 mhz; 100 kw horiz, 59.6 kw vert. Ant 570 ft. Stereo. 1001 Howard (70113). (504) 524-7262. Swanco Bcstg Inc. (group owner; acq 4-6-70). Rep: Buckley. Format: Btlf mus. ■ Gery Swanson, pres; John Hurlbutt, gen mgr; Mal Pelham, prog dir; Norm Wille, prom mgr; Doug Booth, chief engr. ■ Rates: \$24; 28; 26; 24.

WEZB(FM)—Sept 1, 1945: 97.1 mhz; 93 kw. Ant 450 ft. Stereo. 1500 Canal St. (70140). (504) 581-7002. EZ Communications (group owner; acq 1-2-72). Format: Btlf mus. ■ Arthur Keller, pres; Anthony Shepard, gen mgr; Michael Jackson, prog dir; Kemper Martin, chief engr.

WGSO—July 23, 1923: 1280 khz; 5 kw-U, DA-1. Box 2000 (70116). (504) 581-1280. Covenant Broadcasting Corp. of Louisiana (group owner; acq 1-3-73). Net: ABC/I. Rep: Eastman. Format: Diversified. ■ Fred E. Walker, pres; Al Smith, VP & gen mgr; Bob O'Brien, coml mgr; Dan Milham, prog dir; Ken Peterson, news dir; Lynn Michel, chief engr. ■ Rates: \$31; 17; 26; 17.

WQUE(FM)—Co-owned with WGSO. Jan 1, 1949: 93.3 mhz; 93 kw. Ant 460 ft. Stereo. Prog sep from AM. Format: Top 40. ■ Harold Wheelahan, mgr. ■ Rates: \$11; 11; 11; 11.

WJMR—Jan 27, 1946: 990 khz; 1 kw-D. 1500 Canal St. (70140). (504) 581-5777. Security Bcstg Inc. (acq 6-1-72). Net: MBS. Rep: Dora-Clayton, Carpenter. Format: Nostalgitic rock. Spec prog: Sp 4 hrs wkly. ■ Edmond J. Muniz, pres & gen mgr; Clarence Martin, prog dir; Clarence Hamann, mus dir; Max Mipro, chief engr.

WNOE—1925: 1060 khz; 50 kw-D, 5 kw-N, DA-2. 529 Bienville (70130). (504) 529-1212. WNOE Inc. (acq 1936). Rep: McGavren-Guild-PGW. Format: Contemp/ top 40. ■ James A. Noe Jr, pres; Eric Anderson, gen mgr; Roger Cavaness, coml mgr; Jason O'Brien, prog dir; Don Anthony, mus dir; Dave Kushler, news dir; James N. Cope, chief engr.

WNOE-FM—Sept 15, 1968: 101.1 mhz; 100 kw. Ant 440 ft. Stereo. Prog sep from AM. Format: Progs. ■ Sonny Fox, mus dir; Bobby Reno, prog dir.

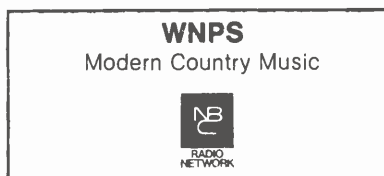

WNPS—1950: 1450 khz; 1 kw-D, 250 w-N. 1732 Canal St. Suite 210 (70112). (504) 523-1341. Greater New Orleans Educl TV Foundation (acq 1969). Net: NBC. Format: C&W. ■ William S. Hart, pres; J. Keith Coleman, gen & coml mgr; Dan Diamond, prog dir; Anthony Maurin, Jr, chief engr. ■ Rates: \$12.50; 11; 12.50; 11. ■ *WYES-TV affil.

WQUE(FM)—Listing follows WGSO.

WRNO(FM)—Oct 1967: 99.5 mhz; 100 kw. Ant 370 ft. Quad-Stereo. Box 6071 (70174). (504) 837-2424. Gulf South Bcstrs (group owner). Net: ABC/FM. Format: Progs. ■ Joseph M. Costello III, pres & gen mgr; Sharon McLeese, coml mgr; Doug Christian, prog dir; Joseph C. Pollet, chief engr. ■ Rates: \$23; 23; 32; 32.

WSDL—See Slidell, La.

WSHO—1926: 800 khz; 1 kw-D, DA. 2820 Canal St. (70119). (504) 822-2271. Americana Bcstg Corp. (acq 1-1-66). Group owner: H. Calvin Young. Rep: H. R. Stone. Format: C&W. ■ H. C. Young Jr, pres; Don Kern, VP, gen & coml mgr; Johnnie Jobe, prog & mus dir; Sam Schmid, chief engr.

Louisiana Radio

See page C-1 for explanation of listings.

WSMB—April 1, 1925: 1350 khz; 5 kw-U, DA-N. 13th Floor, Maison Blanche Bldg. (70112). (504) 523-5921. WSMB Joint Venture. (acq 3-57). Net: ABC/E. Rep: Metro Radio Sls. Format: MOR. ■ John M. Shaheen, pres; John L. Vath Sr, gen & coml mgr; Marshall Pearce, prog & mus dir; Gene Bellau, prom mgr; Jeff Hug, news dir; A. J. Bourgeois, chief engr.

WTIX—Sept 10, 1953: 690 khz; 10 kw-D, 5 kw-N, DA-2. 332 Carondelet St. (70130). (504) 523-2404. Storz Bcstg Co. (group owner; acq 9-23-58). Rep: Blair. Format: Top 40. ■ Robert H. Storz, pres; Fred Berthelson, VP; Joseph M. Kelly, gen mgr; Otto Goessl, loc coml mgr; Robert Mitchell, prog dir; Robert Walker, mus dir; Jeff Stierman, news dir; Oscar Talbot, chief engr.

***WTUL(FM)**—91.5 mhz; 10 w. Ant 177 ft. Tulane Univ Ctr. (70118). (504) 861-0288. Administrators of the Tulane Educl Fund. Net: MBS. Format: Progs/v Undergrd. ■ Alan Smaison, gen mgr; Douglas Vincent, prog dir.

WVOG—April 23, 1964: 600 khz; 1 kw-D. 125 N. Galvez St. (70119). (504) 821-5755. F. W. Robbert Bcstg Co. (acq 6-28-74). Format: Relig. ■ Fred Westenberg, pres; Clyde R. White, gen mgr; Sam Ford, prog & news dir. ■ Rates: \$9; 9; 9; —.

WWL—March 31, 1922: 870 khz; 50 kw-U, DA-1. 1024 N. Rampart St. (70116). (504) 529-4444. TWX 504-822-5346. Loyola U. of the South. Net: CBS. Rep: Katz. ■ The Very Rev. James C. Carter, S.J., pres; J. Michael Early, gen mgr; Ray M. Muro Jr, coml mgr; Mickey Wellman, prom mgr; John Pelva, prog dir; Phil Johnson, news dir; Hugh Burney, chief engr.

WWL-FM—March 15, 1970: 101.9 mhz; 95 kw. Ant 830 ft. Stereo. Prog sep from AM. ■ WWL-TV affil.

***WWNO(FM)**—Feb 20, 1972: 89.9 mhz; 11.5 kw. Ant 600 ft. c/o University of New Orleans (70122). (504) 288-3161. Louisiana State U. Net: NPR. Format: Classical. Jazz. Spec progs: Fr 4 hrs; black 4 hrs wkly. ■ Paul L. Doll, gen mgr; Thomas J. Struve, prog dir; David S. Ortiz, opns mgr; Richard Delacroix, chief engr.

WYLD—1949: 940 khz; 10 kw-D, 500 w-N, DA-2. 2906 Tulane Ave. (70119). (504) 822-1945. Peterson Bcstg Co. (acq Feb 1975). Rep: Howard. Format: Black. ■ Chas. T. Morey, pres; Robt. E. Barnett, coml mgr; George Vinnett, prog dir; Alvin Benjamin, chief engr. ■ Rates: \$25; 22; 22; 20.

WYLD-FM—1971: 98.5 mhz; 54 kw. Ant 290 ft. Stereo. (acq 1975). Format: Jazz, relig. AM simulcast. ■ Rates same as AM.

New Roads

KWRG—August 19, 1964: 1500 khz; 1 kw-D. Box 489 (70760). (318) 638-9058. Louis Bcstrs & Co. (acq 2-71). Rep: Keystone. Format: Contemp, C&W. Spec prog: Fr 2 hrs wkly. ■ Louis B. Cocco Jr, pres, gen. coml, prom mgr & news, prog dir; Johnny J. Gauthier, chief engr.

Oakdale

KCWR(FM)—Listing follows KREH.

KREH—1952: 900 khz; 250 w-D. Box 571 (71463). (318) 335-2308. Louisiana Bcstg Service. Group owner: Dixie. Net: ABC/E. Format: C&W. ■ C. Winsett Reddoh, gen mgr; Richard C. Bradford, coml mgr; Dottie Welch, news dir; Martin Theriot, prog dir; Mark Fallon, mus dir; Jim Perkins, chief engr.

KCWR(FM)—Co-owned with KREH. 1972: 104.9 mhz. 1.5 kw. Ant 230 ft. Hwy 10 East (71463). Prog sep from AM. Format: Contemp.

Oak Grove

KDDI(FM)—Listing follows KWCL.

KWCL—Aug 15, 1958: 1280 khz; 1 kw-D. Drawer K (71263). (318) 428-4243. KWCL Inc. (12-15-69). Net: Interstate. Rep: Beaver, Piano. Format: C&W. ■ David

Louisiana Radio

See page C-1 for explanation of listings.

C. Blossman, pres; Ivy Robinson, gen coml & prom mgr & chief engr; Rita Hoglund, news dir.

KDDI(FM)—Co-owned with KWCL. Jan 30, 1973: 96.7 mhz; 3 kw. Ant 300 ft. Stereo. KALM Inc.

Opelousas

KSLO—September 1947: 1230 khz; 1 kw-D, 250 w-N. Box 1150 (70570). (318) 942-2633. KSLO Bcstg Co. Net: ABC/I. Spec prog: Fr 20 hrs wkly. ■ W. E. Jones, gen mgr; Wandell Allegood, stn mgr; Ronald Mills, chief engr. ■ Rates: \$9.25; 9.25; 9.25.

KSLO-FM—June 18, 1965: 107.1 mhz; 3 kw. Ant 205 ft. Stereo. Progs sep from AM. ■ Rates same as AM.

Pineville

KPAL—1974: 1110 khz; 500 w-D. Pine Plaza Shopping Center (71360). (318) 445-5306. Audio news: UPI. Format: C&W. ■ Robert Cowan Wagner, owner.

Port Sulphur

KAGY—August 17, 1966: 1510 khz; 1 kw-D. Box 95 (70083). (504) 564-3388. River Bend Bcstg Co. (acq 11-74). Format: C&W. ■ Chalin O. Perez, et al, owners.

Rayville

KRIH—1957: 990 khz; 250 w-D. Box 990 (71269). (318) 728-2027. Ewing Inc. (acq 6-1-68). Rep: Bernard, Beaver. Format: C&W. Spec prog: Black 10 hrs wkly. ■ F. C. Ewing, pres; Thomas E. Ewing, gen & coml mgr; Martha Brown, prom mgr; Preston Allen, prog dir.

Ruston

***KLPI(FM)**—1973: 89.1 mhz, 10 w. Box 5358, Tech Station (71270). (318) 257-4485. Louisiana Tech University. Net: ABC/I, Louisiana Net. Format: Contemp. ■ Olav N. Pedersen, pres; Chuck Walmer, gen mgr.

KRUS—Nov 7, 1947: 1490 khz; 1 kw-D, 250 w-N. Box 430 (71270). (318) 255-2530. Ruston Bcstg Co. (acq 4-1-69). Group owner: Hook (50%). Net: Keystone. Format: Contemp. Spec prog: C&W 9 hrs wkly. ■ Dan Hollingsworth, gen & coml mgr & chief engr; Gary McKenney, prog dir; David Price, mus dir; Wayne Kendrick, sps dir; Dennis Maxwell, news dir. ■ Rates: \$5; 5; 5.

KRUS-FM—June 29, 1966: 107.1 mhz; 3 kw. Ant 215 ft. Stereo. Dup AM 3%. Format: MOR. ■ Rates same as AM.

Shreveport

KBCL—September 1957: 1220 khz; 250 w-D. 702 Petroleum Tower (71101). (318) 221-1606. Good Music Inc. (acq 4-11-75). Audio news: APR. Format: Btlf mus. ■ Hal Evans, pres; Joe Miot, gen mgr; Buddy Flowers, coml mgr; Gene Hall, prog, mus & news dir & prom mgr; A. T. Moore, chief engr. ■ Rates: \$7; 7; 7.

KEPT(FM)—Co-owned with KBCL. May 1959: 96.5 mhz; 100 kw. Ant 250 ft. Stereo. Prog sep from AM. Format: Relig. ■ Hal Evans, gen mgr; Paul Burks, coml mgr; Donna Hollingsworth, prog, mus & news dir. ■ Rates same as AM.

KCIJ—1950: 980 khz; 5 kw-D. Box 197 (71102). (318) 425-7724. Radiozark Bcstg of La. Inc. (acq 10-28-66). Net: MBS. Rep: Savalli/Gates. Format: Gosp. ■ John B. Mahaffey, pres; Hal Sell, gen mgr; Don Nugent, prog dir; A. T. Moore, chief engr.

KEEL—1922: 710 khz; 50 kw-D, 5 kw-N, DA-2. Box 7 (71120). (318) 425-8692. Multimedia Radio (group owner; acq 1975). Net: ABC/I. Rep: Blair. Format: Contemp. ■ Marie Gifford, gen mgr; Larry Ryan, prog & mus dir; M. J. Wayt, prom dir; Ken Booth, news dir; Rudy Johnson, chief engr.

KEPT(FM)—Listing follows KBCL

KMBQ(FM)—Co-owned with KEEL. May 17, 1968: 93.7 mhz; 100 kw. Ant 265 ft. Prog sep from AM. Format: Btlf mus.

KFLO—1975: 1300 khz; 500 w-D. 43 54th St, Gulfport, Miss. (39501). James E. Reese.

KJOE—Aug 1, 1954: 1480 khz; 1 kw-D. 526 Lane Bldg. (71101). (318) 222-0732. Coastal Bcstg Corp. (acq 1974). Net: NBC/NIS. Rep: Torbet-Lasker. Format: All news. ■ John Mitchell, pres and gen mgr; Deane Flett, coml mgr; Doyle Hardin, news dir; A. T. Moore, chief engr.

KMBQ(FM)—Listing follows KEEL.

KOKA—1950: 1550 khz; 10 kw-D, 500 w-N, DA-N. Box 1550 (71120). (318) 422-3122. KOKA Bcstg Co. (acq 12-16-72). Net: ABC/C, Natl Black. Rep: Howard, Ochs, Hepburn-McClain. Format: Black. ■ James A. Reeder, mgng ptrnr; Claude A. Davis, prog mgr; B. F. Allen, opns mgr; Sonrose Rutledge Jr, prog mgr; Rev. Amos Terrell, relig dir; A. T. Moore, chief engr.

KRMD—June 1928: 1340 khz; 1 kw-D, 250 w-N. Box 1739 (71102). (318) 423-6171. KRMD Inc. (acq 11-72). Net: NBC. Rep: Devney Organization, Pearse Sis. Format: MOR. ■ Jim R. Phillips, pres; Charles B. Jordan Jr, treas; Gary R. Akers, sec.

KRMD-FM—August 1948: 101.1 mhz; 25 kw. Ant 195 ft. Stereo. Prog sep from AM.

KROK(FM)—Listing follows KWKH.

***KSCL(FM)**—Not on air, target date unknown: 91.3 mhz; 10 w. Centenary Blvd & Kings Hwy (71104). Centenary College of Louisiana. ■ John H. Allen, pres.

KWKH—September 1925: 1130 khz; 50 kw-U, DA-N. Box 1130 (71120). (318) 222-8711. International Bcstg Corp. (acq 9-32). Net: CBS. Rep: Eastman. Format: MOR, C&W. Spec prog: Farm 5 hrs wkly. ■ Robert E. Brown, VP; Jack Timmons, gen mgr; Frank Page, opns dir; Chuck Fellers, sls dir; Jim Hawthorne, prog dir. Russ Wise, news dir; O. S. Droke, tech dir. ■ Rates: \$30; 26; 30; 26.

KROK(FM)—Co-owned with KWKH. Nov 5, 1948: 94.5 mhz; 100 kw. Ant 320 ft. Stereo. Prog sep from AM. Format: Top 40. ■ Gene Kent, prog dir. ■ Rates: \$9; 9; 9.

Slidell

WSDL—Dec 5, 1963: 1560 khz; 1 kw-D. Box 306 (70458). (504) 643-1808. Inter-American Bcstrs Inc. (acq 3-74). Rep: Dora-Clayton. Format: Top 40. ■ George A. Mayorat, pres.

WXEL(FM)—Sept 8, 1970: 105.3 mhz; 100 kw. Ant 350 ft. Stereo. Braniff Pl, New Orleans (70140). (504) 586-9935. Security Bcstg Inc. (acq 12-73). ■ Muniz, Bridgeman, O'Keefe & Youngblood, owners.

Springhill

KBSF—June 30, 1954: 1460 khz; 1 kw-D. Box 127 (71075). (318) 539-4616. Springhill Bcstg Co. (acq 2-3-59). Audio news: APR. Format: Diversified. Spec prog: Black 6 hrs wkly. ■ Johnnie K. Hill, owner & gen mgr; Jack Seney, prog dir; Lavelle Hughes Jr, chief engr. ■ Rates: \$2.60; —; —.

KTKC(FM)—Co-owned with KBSF. Sept 5, 1975: 92.7 mhz; 3 kw. Ant 185 ft. Stereo. ■ Rates: \$—; —; —; 2.

Sulphur

KEZM—1955: 1310 khz; 500 w-D, DA. Box 190 (70663). (318) 527-5202. KIKS Radio Inc. (acq 1974). Net: Louisiana. Audio news: UPI. Format: Btlf mus. ■ M. E. Carter, pres; Eddie Roberts, gen mgr; Thomas Arnold, chief engr.

KSNS(FM)—See Lake Charles, La.

Tallulah

KTLD—Sept 4, 1954: 1360 khz; 500 w-D. Box 1360 (71282). (318) 574-4052. Scokim Inc. (acq 6-1-67). Format: Rock. Spec progs: C&W 10 hrs wkly. ■ Chris C. Kimbell Jr, pres, gen, coml & prom mgr & chief engr; Bill Johnson, asst gen mgr, prog & mus dir.

Thibodaux

KTIB—Dec 24, 1953: 630 khz; 500 w-D. Box 682 (70301). (504) 447-9006. La Terr Bcstg Corp. (acq 11-16-73). Format: C&W. Spec prog: Fr 4 hrs wkly. ■

James J. Buquet, pres; Raymond Saadi, gen mgr; Ken Bourgeois, prog dir; Roy Pugh, coml mgr; Marie Bergeron, news dir.

***KVFG(FM)**—Feb 15, 1972: 91.5 mhz; 10 w. Box 2664, Nicholls State University (70301). (504) 446-1667. Nicholls State University. Format: Rock. ■ Peter Strawitz, media dir; Rick Foucheux, gen mgr.

KXOR(FM)—May 1, 1966: 106.3 mhz; 3 kw. Ant 285 ft. Quad Stereo. 106 Ridgefield Rd. (70301). (504) 446-5604. Gulf South Broadcasters (group owner; acq 9/73). Net: ABC/FM. Format: Top 40. ■ Joseph M. Costello, pres & gen mgr; Gregory R. Dumas, stn mgr. ■ Rates: \$6; 6; 6.

Ville Platte

KVPI—November 1953: 1050 khz; 250 w-D. Drawer J (70586). (318) 363-2124. Ville Platte Bcstg Co. Audio news: APR. Format: Variety. Spec progs: Fr 15 hrs; black 14 hrs wkly. ■ Lionel B. Deville, pres; Dan Andrus, gen & coml mgr; Bill Storms, prog dir & prom mgr; Mark Lane, mus dir; Brent Meche, news dir; J. L. Sylvester, chief engr.

KVPI-FM—February 26, 1967: 93.5 mhz; 3 kw. Ant 220 ft. Dups AM 100%-daytime.

Vivian

KNCB—April 9, 1966: 1600 khz; 5 kw-D. Box 1072 (71082). (318) 375-8278. North Caddo Bcstg Co. (acq 4-9-66). Audio News: APR. Format: Variety. ■ Ruby J. Dowd, pres, gen & coml mgr; Mike Johnston, mus & sports dir; Elizabeth Roberts, prog & news dir; Lloyd Cox, chief engr.

West Monroe

KUZN—August 1956: 1310 khz; 1 kw-D. Box 547 (71291). (318) 322-1491. Howard E. Griffith. Rep: PRO Time Sis, Riley. Format: C&W. Spec prog: Fr 1 hr wkly. ■ Howard E. Griffith, pres & chief engr; Chuck Morgan, gen mgr.

KYEA(FM)—Co-owned with KUZN. Aug 1, 1967: 98.3 mhz; 3 kw. Ant 260 ft. Progs sep from AM. Format: Black.

Winnfield

KVCL—Dec 17, 1955: 1270 khz; 1 kw-D. Box 548 (71483). (318) 628-5822. Winn Bcstg Co. (acq 10-1-58). Net: Louisiana Net. Rep: Messina. Format: C&W. Spec prog: Relig 6 hrs wkly. ■ Edward R. Hall, own & gen mgr & chief engr; George Feger, prom dir; Dorothy Bour, office mgr.

KVCL-FM—Nov 3, 1966: 92.1 mhz; 2.7 kw. Ant 120 ft. (318) 628-6700. Prog sep from AM. Format: MOR, Top 40.

Winnsboro

KMAR

Fritts Stations

ONLY STATIONS
LISTED HERE
OPERATE ON
FM

STATIONS, NEWS
PROGRAMS, UP
TO DATE, 17,
1975, 100

KMAR—Mar 1, 1957: 1570 khz; 1 kw-D. Box 312 (71295). (318) 435-5141. Franklin Parish Bcstg Co. (acq 10-1-73). Group owner: Edw. O. Fritts. Net: Louisiana Net. Rep: Bunchez, Southern Spd Sis. Format: C&W, MOR. Spec prog: Black 4 hrs; farm 14 hrs wkly. ■ Edward O. Fritts, pres; Don Murray, gen mgr; Dave Roberts, chief engr. ■ Rates: \$5; 5; 5.

KMAR-FM—Aug 1969: 95.9 mhz; 3 kw. Ant 170 ft. Dups AM 100%. ■ Rates same as AM.

CSI ELECTRONICS INC.

2607 River Road
Cinnaminson, New Jersey, 08077
Telephone: (609) 786-1060

Maine

Auburn

WBLM(FM)—See Lewiston.

WPNO—July 9, 1968: 1530 khz; 1 kw-D, 88 Court St. (04210). (207) 784-1531. Valley Communications Inc. (acq 3-1-73). Format: Rock. ■ John J. Pineau, pres; G. Bowles, gen mgr; J. Elie, coml mgr; Dave Dean, prog dir; M. Reynolds, mus dir; W. Riley, news dir; James Chadwick, chief engr. ■ Rates: \$5.90; —; —; —.

Augusta

WABK—See Gardiner.

WFAU—Oct 2, 1946: 1340 khz; 1 kw-D, 250 w-N. Box 307 (04330). (207) 623-3878. Capitol Communications Corp. (acq 8-8-65). Net: CBS. Rep: Fulford; New England Spot Sales. Format: C&W. Spec progs: Fr 1 hr wkly. ■ Harold Vigue, pres; Norman G. Gallant, gen mgr; Bart Ryan, coml mgr; Dale Prescott, prom mgr & prog, mus & news dir; Joseph Roy, chief engr.

WFAU-FM—July 1961: 101.3 mhz; 4.8 kw. Ant 315 ft. Dup AM 100%.

WKME(FM)—See Gardiner.

WRDO—Feb 23, 1932: 1400 khz; 1 kw-D, 250 w-N. 251 Water St. (04330). (207) 623-4735. Ocean Coast Properties (acq 7-7-1). ■ Philip L. Corper, pres.

Bangor

WABI—1924: 910 khz; 5 kw-U, DA-N. 35 Hildreth St. (207) 947-8321. TWX 710-222-1645. Community Bcstg Service (group owner; acq 1949). Net: ABC. Rep: Torbet; Kettell-Carter; McDermott. Format: Contemp. ■ Horace A. Hildreth, pres; Walter Dickson, exec VP & gen mgr; George Gonyar, opns mgr; George Springglen, sls mgr; George Hale, asst opns dir; Gordon Manuel, news dir; Dale Carter, chief engr.

WBGW(FM)—Co-owned with WABI. March 15, 1961: 97.1 mhz; 5 kw. Ant 1230 ft. Net: ABC/FM. Format: C&W. ■ Jim McFarlane, asst opns dir; ■ WABI-TV affil.

WGUY—1947: 1250 khz; 5 kw-D, 7 Main St. (04401). (207) 947-7354. Bangor Bcstg (acq 1-4-63). Format: Contemp. Rep: Masla; North Eastern. ■ Melvin L. Stone, pres; Robert P. Mooney, gen mgr & chief engr; Kevin Keough, prog dir; Michael O'Hara, mus dir; Neal Chamberlain, sls mgr; Mark Lawrence, news dir. ■ Rates: \$12; 12; 12; 12.

***WHSN(FM)**—1974: 89.3 mhz; 10 w. Ant. 71 ft. 1 College Circle (04401). Husson College.

WLBZ—December 1926: 620 khz; 5 kw-U, DA-N. 861 Broadway (04401). (207) 942-4656. Maine Bcstg Co. (group owner; acq 2-4-4). Net: NBC. Rep: Eastman; Creed. Format: MOR. ■ Mary Rines Thompson, pres; Jack Alwood, VP; Edward Guernsey, gen mgr; Irving Hunter, opns mgr; John Wellington, news dir; Lou Darling, chief engr. ■ WLBZ-TV affil.

***WMEH-FM**—Sept 14, 1970: 90.9 mhz; 13.5 kw. Ant 850 ft. Stereo. Alumni Hall, Orono (04473). (207) 866-4493. U of Maine. Net: NPR; Eastern Public Radio Net. Format: noncoml diversified. ■ Edward E. Winchester, actg gen mgr; Erik Van de Bogart, prog dir; Ken Krall, dir finance; Dan Everett, prog mgr; John M. Emery, mus dir; Keith McKeen, news dir; Don Winslow, chief engr.

New FM—Not on air, target date unknown: 92.9 mhz; 4.6 kw. Ant 352 ft. Box 951 (04401). Penobscot Bcstg. ■ James H. Goff & George E. Wildey, co-owners.

Bath

WJTO—Sept 30, 1957: 730 khz; 1 kw-D. Box 329 (04530). (207) 443-5542. Porter Bcstg Svcs. Rep: Northeast. Format: Rock. ■ Catherine J. Porter, pres; Turner Porter, gen mgr; Charles McCathrin, prog dir; Stephen McCausland, news dir; Greg Currier, chief engr. ■ Rates: \$5.75; 5.75; 5.75; 5.75.

WJTO-FM—June 1971: 95.3 mhz; 3 kw. Ant 175 ft. Dups AM 100%. Stereo. ■ Rates same as AM.

Belfast

WBME—Sept 20, 1964: 1230 khz; 250 w, SH. School St. (04915). (207) 338-2277. Spence Bcstg Corp. (acq 7-1-70). Net: Hughes Sports. Rep: New England Spot Sls. Format: Contemp. ■ A. W. Spence III, pres; Richard Marsano, gen mgr; Glen Soares, prog dir; Dennis Bryant, news dir.

Biddeford

***WBSF(FM)**—April 1, 1972: 91.7 mhz; 10 w. St. Francis College (04005). St. Francis College. ■ Michael McKenna, stn mgr.

WIDE—1948: 1400 khz; 1 kw-D, 250 w-N. Box 667 (04005). (207) 282-5121. Hoy Communications Corp. (acq 1-31-68). Net: ABC/I. Rep: Kettell-Carter. Format: MOR. Spec prog: Gk 2 hrs wkly. ■ F. Parker Hoy, pres; Frank DeFrancesco, gen mgr; James S. Ward III, coml mgr; Joseph J. Martelle, opns mgr; Herbert O. Wiles, chief engr. ■ Rates: \$5.25; 4.75; 4.75; 4.75.

WIDE-FM—August 1972: 94.3 mhz; 3 kw. Ant 170 ft. Dups AM 100%. ■ Rates same as AM.

Brunswick

***WBHS(FM)**—Sept 1, 1972: 91.9 mhz; 10 w. Ant 70 ft. Spring St. (04011). (207) 725-4298. School Board of Brunswick. Format: Rock/Top 40. Spec progs: C&W 1 hr, pub affrs 8 hrs wkly. ■ Peter Russell, advisor; Roger Bernier, chief engr.

***WBOR(FM)**—April 1957: 91.1 mhz; 10 w. Ant 70 ft. Moulton Union, Bowdoin College (04011). (207) 725-5008. Pres and Trustees of Bowdoin College. Format: Progressive rock/undgrnd. Spec prog: Black 10 hrs wkly. ■ F. Andrew deGanahl, gen mgr; R. Patrick Johnson, prog dir; Jose Diaz, mus dir; Dave Bolduc, prod mgr & new dir; Dana L. Harknett, chief engr.

WKXA—December 1955: 900 khz; 1 kw-D. River Rd. (04011). (207) 725-5507. AMCOM Corp. (acq 9-1-74). Net: ABC/I. Rep: Eckels & Queen. Format: MOR. ■ Bob Papper and Mike Ferring, gen mgrs; Kris St. John, mus dir; Roland Desjardins, chief engr. ■ Rates: \$5.50; 5.50; 5.50; 3.75.

WKXA-FM—April 11, 1965: 98.9 mhz; 80 kw. Ant 205 ft. Stereo. Dups AM 100%. ■ Rates same as AM.

Calais

WDQY—July 1, 1959: 1230 khz; 1 kw-D, 250 w-N. 281 Main St. (04619). (207) 454-7545. WDQY Inc. (acq 11-14-64). Rep: Kirby. Format: MOR. ■ Bob Smith, pres; Don Hollingdale, gen mgr; Joe Healy, coml & prom mgr; Ron Mackechnie, prog & mus dir; Bill Bagley, news dir; Sandy Haynes, chief engr. ■ Rates: \$8.50; 8.50; 8.50; 8.50.

WDQY-FM—Not on air, target date unknown: 92.7 mhz, 3 kw. Ant 300 ft. Format: Contemp, MOR.

Caribou

WDHP(FM)—See Presque Isle.

WFST—July 15, 1956: 600 khz; 5 kw-D. Box 600 (04736). (207) 493-3334. Northern Bcstg Co. (acq 5-7-68). Rep: Eckels & Queen. Format: C&W, Top 40. Spec prog: Farm 1 hr wkly. ■ R. Murray Briggs, pres; John McGowan Michaud, VP & gen mgr; Leo J. Dubay, sls mgr & chief engr. ■ Rates: \$6; 5; 6; 5.

WFST-FM—Oct 15, 1956: 97.7 mhz; 220 w. Ant 185 ft. Dups AM 100%. Format: Good mus. ■ Rates same as AM.

Dover-Foxcroft

WDME—August 13, 1967: 1340 khz; 1 kw-D, 250 w-N. 30 E. Main St. (04426). (207) 564-8246. Radio Voice of Dover-Foxcroft. Net: ABC/I. Rep: N.E. Spot Sls. Format: MOR, Top 40, C&W. ■ Frank A. Delle Jr, pres, gen mgr & chief engr; Bill Mack, prog dir, coml mgr; Carl Edwards, mus & news dir. ■ Rates: \$4.35; 4.35; 4.35; 2.

Ellsworth

WDEA
CBS RAD 

WDEA—Dec 13, 1958: 1370 khz; 5 kw-U, DA-2. 68 State St. (04605). (207) 667-9555. Grindstone Bcstg.

Maine Radio

See page C-1 for explanation of listings.

(acq June 1975). Net: CBS. Rep: Weed; Kirby; Stephens & Towndrow. Format: MOR. ■ Harvey E. DeVane, VP & gen mgr; William Wiggins, coml mgr; George DeForest, prog, mus & news dir; Clifford Royal, chief engr. ■ Rates: \$7.20; 7.20; 7.20; 7.20.

WDEA-FM—Dec 27, 1965: 95.7 mhz; 50 kw. Ant 320 ft. Dups AM 90%. ■ Rates same as AM.

Farmington

WKTJ—Dec 21, 1959: 1380 khz; 1 kw-D. Box 590 (04938). (207) 778-3000. Franklin Bcstg Corp. Rep: Kettell-Carter; McDermott. Format: Oldies, Top 40, C&W. ■ Eiden H. Shute Jr, pres; Linn S. Wells, gen mgr; Claire Taylor, office mgr; Dave Michaels, prog & mus dir; Larry Bisbee, news dir; Alfredo Ibarguen, chief engr. ■ Rates: \$3.80; 3.80; 3.80; 3.80.

WKTJ-FM—Aug 21, 1973: 99.3 mhz; 1.5 kw. Ant 400 ft. Dups AM 100%. ■ Rates same as AM.

***WUMF-FM**—February 1972: 91.9 mhz; 10 w. 86 Main St. (04938). (207) 778-4522. University of Maine at Farmington. Format: Contemp, Prog, Rock, Top 40, Underground. Spec prog: Educl 2 hrs wkly. ■ Richard Smith, univ admin; Michael McCullough, gen mgr; David Adams, prog dir; Michael Brown, mus dir; Susan Waldron, news dir; Alfredo Ibarguen, chief engr.

Fort Kent

***WUFK(FM)**—July 1974: 90.3 mhz; 10 w. Ant 40 ft. Alumni Hall, U of Maine, Orono (04473). U of Maine.

WLVC—July 30, 1975: 1340 khz; 250 w-U. Box C, Madawaska (04756). (207) 728-4000. Melvoc Inc. Net: ABC/I. Rep: McDermott (Canada); Kettell-Carter. Format: MOR, Top 40. Spec prog: Farm 3 hrs, classical 2 hrs wkly. ■ Vaughn P. Currier, pres; Bernard L. Talbot, VP & gen mgr; Robert M. Currier, stn mgr; Aurel J. Daigle, chief engr. ■ Rates: \$5; 5; 5; 3.

Gardiner

WABK—Sept 23, 1968: 1280 khz; 5 kw-U, DA-N. Box 442 (04345). (207) 582-3303. Abenaki Co. Format: Contemp, MOR, Rock. ■ James F. Mackin, VP & gen mgr; Don Brown, prog dir; Keith Corey, prom mgr; Henry Korytko, chief engr.

WKME(FM)—Co-owned with WABK. April 1, 1974: 104.3 mhz; 14.5 kw. Ant 340 ft. Format: Hit Parade. Dups AM 5%.

Gorham

***WMPG(FM)**—Sept 1, 1973: 91.1 mhz; 10 w. Ant 106 ft. 37 College Ave. (04038). (207) 839-6271. Trustees, U of Maine. Format: Noncoml diversified. Spec prog: C&W 2 hrs, Radio Canada Intl, 10 hrs wkly. ■ Bruce Childs, gen mgr.

Houlton

WHOU—July 10, 1950: 1340 khz; 1 kw-D, 250 w-N. Box 40 (04730). (207) 532-6587. WHOU Inc. (acq 1-1-67). Net: CBS. Format: MOR, Contemp, C&W. ■ Bob Smith, pres; Jim Hunt, gen, coml & prom mgr; Steve Logan, prog & mus dir; Dave Blanchette, news dir; Sandy Haynes, chief engr.

WHOU-FM—Not on air, target date unknown: 100.1 mhz; 3 kw. Ant 300 ft. Box 71 (04730). Format: Pops, C&W.

***WRNE(FM)**—March 27, 1974: 89.1 mhz; 10 w. Ant 55.6 ft. High St. (04730). Ricker College.

Lewiston

WBLM



WBLM(FM)—March 1, 1973: 107.5 mhz; 30 kw. Ant 610 ft. Stereo. Box 478 (04240). (207) 375-4208. Stereo Corp. (acq 7-16-75). Rep: Selcom; Eckels & Queen. Format: Progsrv. ■ Robert F. (Doc) Fuller, pres & gen mgr; John Isaacs, coml mgr; Jose Diaz, mus dir; Marilyn Klionsky, prom mgr; David Dye, prog dir; R. J. Hanson, news dir; Roland Desjardins, chief engr. ■ Rates: \$14; 14; 14; 14.

Maine Radio

See page C-1 for explanation of listings.

WCOU—Aug 21, 1938: 1240 khz; 1 kw-D, 250 w-N. 129 Lisbon St. (04240). (207) 784-6921. Mid-Maine Communications Inc. (acq 10-70). Net: CBS. Rep: Pro/Meeker; New England Spot Sales. Format: C&W. Spec prog: Fr 3 hrs wkly. ■ Philip M. Greene, pres & gen mgr; George Boyce, prog dir; Parker Vincent, cons engr. ■ Rates: \$6.40; 5.50; 6.40; 4.80.

WCOU-FM—Feb 29, 1948: 93.9 mhz; 13 kw. Ant 250 ft. Dups AM 100%. ■ Rates same as AM.

WLAM—Sept 4, 1947: 1470 khz; 5 kw-U, DA-1. Box 929 (04240). (207) 784-5401. Great Down East Wire-less Talking Machine Co. (acq 7-29-75). Net: ABC/C. Rep: Masia; Kettell-Carter. Spec prog: Fr 3 hrs wkly. Format: MOR. ■ Ronald R. Frizzel, Arnold S. Lerner, Myer Feldman, co-owners; Frank DeFrancesco, gen & prom mgr; Romeo E. Sansoucy, coml mgr; Robert L. Ouellette, prog & mus dir; Frederick H. Gage, news & sps dir; Herbert O. Wiles, chief engr.

***WRJR(FM)**—Oct 6, 1958: 91.5 mhz; 10 w. Box 339, Bates College (04240). (207) 784-9340. Pres & Trustees of Bates College. ■ Charles Kolstad, gen mgr & prog dir; Samuel Dyer, news dir; John Andrews, chief engr.

Lincoln

WLKN—Nov 9, 1964: 1450 khz; 1 kw-D, 250 w-N. Park St. Box 176 (04457). (207) 794-6555. Frank A. Delle Jr. Net: ABC/I. Rep: New England Spot Sis. Format: Contemp, C&W, MOR, Rock. ■ Frank A. Delle, pres, gen mgr & chief engr; Frank A. Delle Jr., coml mgr; Mike Dubay, prog dir; Roger Cochran, news dir. ■ Rates: \$5; 5; 5; 2.50.

WLKN-FM—April 1, 1975: 99.3 mhz; 1.75 kw. Ant 380 ft. Stereo. Dups AM 65%. ■ Rates same as AM.

Machias

WMCS—Dec 5, 1965: 1400 khz; 1 kw-D, 250 w-N. 12 Cooper St (04654). (207) 255-4452. Washington County Bcstg Inc. Net: CBS; Maine State Net. Rep: Piano; Kirby. Format: Variety. Spec prog: C&W 10 hrs wkly. ■ Winston D. Chapman, pres & coml mgr; Eric R. Lindquist, gen mgr & prog dir; George Phillips, chief engr. ■ Rates: \$4.50; 4.50; 4.50; 3.15.

Madawaska

WSJR—Dec 1, 1962: 1230 khz; 1 kw-D, 250 w-N. Box C (04756). (207) 728-4000. Melvoc Inc. (acq 11-11-65). Net: ABC/I. Rep: McDermott; Kettell-Carter; Atlantic. Format: MOR, Rock. Spec prog: Farm 3 hrs, classical 2 hrs, wkly. ■ Vaughn P. Currier, pres; Bernard L. Talbot, VP & gen mgr; Aurel Daigle, chief engr. ■ Rates: \$8; 8; 8; 5.

Millinocket

WMKR—Dec 7, 1963: 1240 khz; 1 kw-D, 250 w-N. Box 508 (04462). (207) 723-9657. Katahdin Radio Inc. (acq 10-15-71). Net: CBS. Rep: Kirby. Format: C&W, MOR. ■ John M. Keys, pres, gen, coml & prom mgr, news dir; David M. Keys, prog & mus dir; Jasper M. Haynes, chief engr. ■ Rates: \$4.75; 4.75; 4.75; 4.75.

Norway

WNWY-FM—Dec 12, 1970: 92.7 mhz; 2 kw. Ant 360 ft. 15 Pleasant St. (04268). (207) 743-6200. Oxford Hills Radio Communications Inc. Rep: Eckles & Queen. Format: Contemp, C&W, Pop, Gold. ■ Ariene M. Knight, pres; Raymond D. Knight, gen mgr & chief engr; Ruth Dullea, coml mgr.

Orono

***WMEB-FM**—91.9 mhz; 380 w. Ant 67 ft. 275 Stevens Hall, U of Maine (04473). (207) 581-7018. Board of Trustees, U of Maine. Format: Progs, Rock, Talk. ■ Gregory Bowler, stn mgr; Don Winslow, chief engr.

Portland

WCSH—July 13, 1925: 970 khz; 5 kw-U, DA-N. 579 Congress St. (04101). (207) 772-0181. TWX PO 93. Maine Radio & TV Co. (acq 6-10-55). Group owner: Maine Bcstg. Net: NBC. Rep: Eastman. Format: MOR. ■ Mary Rines Thompson, pres; Jack S. Atwood, exec

VP & gen mgr; Herbert W. Crosby, stn mgr; Kenneth L. Whitmore, news dir; Clem Payeur, chief engr. ■ WCSH-TV affil.

WDCS(FM)—June 1, 1960: 97.9 mhz; 30 kw. Ant 500 ft. Stereo. (CP: 49 kw). 638 Congress St. (04101). (207) 774-9816. Dirigo Communications Inc. (acq 3-1-71). Rep: Groskin; Kirby; Mulvihill. Format: Classcl. Spec prog: Fr 1 hr wkly. ■ Fred Miller, pres & gen mgr; Bob Himefelfar, coml mgr; Rainer Steinhoff, prog & mus dir; Mel Stone, natl sis mgr; Walter Thomes, news dir; Phil Lentz, chief engr.

WGAN—Aug 3, 1938: 560 khz; 5 kw, DA-1. 390 Congress St. (04111). (207) 772-4661. TWX 710-221-1674. Guy Gannett Bcstg Services Inc. Group owner: Guy Gannett. Rep: Blair. Format: MOR. ■ Jean Gannett Hawley, pres; Charles R. Sanford, VP & gen mgr; Robert E. Dow, stn mgr; Jim Sweet, prog dir; Jack Tupper, mus dir; Jeff Howlett, news dir; Lyman Brewer, chief engr. ■ Rates: \$25; 21; 25; 12.

WGAN-FM—February 1967: 102.9 mhz; 100 kw. Ant 1460 ft. Prog sep from AM. Format: Beaufit mus. ■ WGAN-TV affil. ■ Rates: \$22; 30; 30; 22.

WLOB—Feb 2, 1967: 1310 khz; 5 kw-U, DA-2. 779 Warren Ave. (04103). (207) 775-2336. Adams/Russell Co. (acq 3-1-71). Rep: McGavren-Guild-PGW; Northeastern Spot Sales. Format: Contemp. ■ John J. Lynch, pres; Stuart H. Flanders Jr, gen mgr; Jack Archibald, coml mgr; Paul Sebastian, prog dir; Art Wallis, prom mgr; Neal Steele, mus dir; John Wilkes, news dir; David De Bree, chief engr.

***WMEA(FM)**—April 1974: 90.1 mhz; 49 kw. Ant 1,920 ft. Stereo. Alumni Hill, Orono (04473). (207) 866-4493. U of Maine. Net: NPR, EPRN. Format: Classcl, Educl, Jazz, Pub Affrs. ■ Edward E. Winchester, actg gen mgr; Kenneth Krall, dir finance; Erik Van de Bogart, prog dir; Dan Everett, prog mgr; Keith McKeen, news dir; John Emery, mus dir; Don Winslow, chief engr.

WPOR—March 1946: 1490 khz; 1 kw-D, 250 w-N. 562 Congress St. (04101). (207) 773-8111. Ocean Coast Properties. (acq 3-2-71). Format: C&W. ■ Phil Corper, pres; Robert Gold, gen mgr; Scott Norton, coml mgr; Robert Willett, prog dir; Dean Williams, prom mgr; Ed Hazen, mus dir; Tom Hennessey, news dir; Phil Lentz, chief engr. ■ Rates: \$34; 30; 34; 26.

WPOR-FM—Oct 31, 1967: 101.9 mhz; 50 kw. Ant 500 ft. Dups AM 100%. ■ Rates same as AM.

Presque Isle

WAGM—Jan 6, 1932: 950 khz; 5 kw-U, DA-1. Box 1149 (04769). (207) 764-4461. TWX 710-229-1631. Arrostook Bcstg Corp. (acq 1957). Group owner: Diversified Communications. Net: ABC/I. Rep: Torbet; Kettell-Carter. Format: Contemp, C&W. Spec prog: Farm 1½ hrs wkly. ■ Russell W. Brace, pres; Keith H. Fowler, mgr of opns; Ronald Madore, sis mgr; Frank Moffitt, prog dir; Peter Hilton, news dir; Norman Johnson, chief engr. ■ WAGM-TV affil. ■ Rates: \$7; 6; 7; 4.

WDHP(FM)—Sept 26, 1973: 96.9 mhz; 100 kw. Ant 440 ft. Stereo. Box 969, Caribou, Me. (04736). (207) 764-3336. TWX: 800-432-7813. WDHP Inc. Net: ABC/FM. Rep: New England Spot Sales. Format: MOR, Gosp, Top 40. ■ Clarence B. Dow Sr, pres; Clarence Dow, Jr, gen mgr; Robert Dow, prog dir; Sharon Dow, mus dir; Ray Larson, news dir; Phyllis Belanger, office mgr; James Davidson, chief engr. ■ Rates: \$6.50; 6.50; 6.50; 6.50.

WEGP—June 24, 1960: 1390 khz; 5 kw-U, DA-N. 418 Main St. (04769). (207) 768-5141. K & M Radio Inc. Net: Lobster. Rep: McGavren-Guild-PGW; Segal. ■ Frank Carroll, pres; Dewey DeWitt, gen mgr; Clayton Smith, prog dir.

***WUPI(FM)**—May 7, 1973: 91.1 mhz; 10 w. Merriman House, Main St. (04769). U of Maine.

Rockland

WRKD—Oct 1, 1952: 1450 khz; 1 kw-D, 250 w-N. 415 Main St. (04841). (207) 594-8451. Knox Bcstg Inc. (acq 12-56). Net: ABC/I. Format: MOR. ■ Carleton D. Brown, pres; Paul R. Huber, gen mgr; Terrence Economy, coml mgr; Paul T. Mills, news dir; Ernest H. Hammond, chief engr.

WRKD-FM—April 16, 1968: 93.5 mhz; 3 kw. Ant 170 ft. Dups AM 99%.

Rumford

WRUM—Aug 21, 1953: 790 khz; 1 kw-D. 89 Congress St. (04276). (207) 364-3701. Rumford Bcstg Co. Net: CBS. Rep: Masia; Northeastern Spot Sales. Format: MOR, Top 40, Diversified. ■ Melvin L. Stone, pres; Kenneth J. Ellis, gen mgr; James J. Vessella, coml mgr; Don Roach, prog dir; Chet Sargent, mus dir; Gail Scribner, prom mgr; Sandy Ellsworth, news dir; Alan Gerace, chief engr. ■ Rates: \$5.50; 5.25; 5.50; 4.75.

WRUM-FM—Nov 15, 1975: 96.3 mhz; 30 kw. Ant 36 ft. Stereo. Dups AM 30%. Net: Maine Gospel Net.

Saco

WIDE-AM-FM—See Biddeford.

Sanford

WSME—Nov 9, 1957: 1220 khz; 1 kw-D. Box 1220 (04073). (207) 324-7271. Southern Maine Bcstg Corp. (acq 11-15-73). Rep: Pro/Meeker; New England Spot Sales. Format: Contemp. Spec prog: Fr 1 hr wkly. ■ Alvin Yudkof, pres; Charles Smith, VP & gen mgr; J. Sherwood Bent, opns mgr & chief engr. ■ Rates: \$4.75; 3.80; 4.75; 3.80.

WSME-FM—March 1, 1974: 92.1 mhz; 800 w. Ant 530 ft. Stereo. Dups AM 100%.

Scarborough

WJBO-FM—Co-owned with WJBO Westbrook. July 15, 1974: 106.3 mhz; 3 kw. Ant 300 ft. Box 607 (04074). (207) 854-8409. Greater Portland Radio Inc. Dups AM 100%. ■ Rates: \$24; 21; 24; 18.

Skowhegan

WSKW—1956: 1150 khz; 5 kw. Box 159, Middle Rd. (04976). (207) 474-5171. Kennebec Valley Bcstg System Inc. (Valley Communications Inc.) (acq 1965). Rep: PRO/Meeker; North Eastern Spot Sales. Format: Top 40; Contemp. Spec prog: C&W 2 hrs wkly. ■ John J. Pineau, pres; Richard D. Gleason, gen mgr; Larry Wells, mus dir; Mark Lawrence, news dir; George Thompson, chief engr.

WTOS-FM—Co-owned with WSKW. Nov 13, 1969: 105.1 mhz; 25 kw. Ant 2420 ft. Stereo. (CP: 106.7 mhz; Ant 2415 ft). Sugarloaf Bcstg Systems Inc. (Valley Communications Inc.) Format: Up Tempo, Easy Istng. Dups AM 15%.

South Paris

WKTP—Oct 28, 1955: 1450 khz; 1 kw-D, 250 w-N. Box 199 (04281). (207) 743-2311. Oxford Bcstg Corp. (acq 5-15-74). Net: ABC/E. Audionews: APR. Rep: Walton, Kettell-Carter. Format: Diversified. Spec prog: Farm, C&W 6 hrs wkly. ■ Robert Healy, pres; Gerald Higgins, gen mgr; Miriam Higgins, coml mgr; Kenneth Butterfield, prog, prom & news dir; Gary Newman, mus dir; Richard Cushman, chief engr. ■ Rates: \$4.90; 4.90; 4.90; 4.90.

Springvale

***WNCY(FM)**—Sept 9, 1973: 91.1 mhz; 10 w. Ant 60 ft. Box 275-P, Nasson College (04083). (207) 324-7021. Bd of Trustees Nasson College. Format: noncoml diversified. Spec prog: Classical 4 hrs, jazz 10 hrs, C&W 10 hrs wkly.

Waterville

***WMHB(FM)**—Oct 1, 1974: 91.5 mhz, 10 w. Ant 73 ft. Roberts Union, Colby College (04901). (207) 872-8037. Mayflower Hill Bcstg Corp. Format: Progs. Spec prog: Fr 3 hrs wkly. ■ Scott W. Anderson, pres & gen mgr.

WTVL—June 19, 1946: 1490 khz; 1 kw-D, 250 w-N. 36 Silver St. (04901). (207) 873-3311. Kennebec Bcstg Co. Net: ABC/E. Format: MOR. Spec prog: Fr 1 hr wkly. ■ Carleton D. Brown, pres & gen mgr; David Brown, VP, opns mgr; Dean Steeves, mus dir; John Stanley, news dir; Robert Woodbury, sports dir; Maurice Strout, chief engr. ■ Rates: \$7.75; 7.75; 7.75; 6.75.

WTVL-FM—March 26, 1968: 98.3 mhz; 3 kw. Ant 125 ft. Dups AM 96%.

Westbrook

WJBQ—Nov 8, 1959: 1440 kHz; 5 kw-D, 841 Main St. (04092). (207) 854-8409. Chandler Bcstg Inc. (acq 7-18-72). Net: ABC/C. Rep: McGavren-Guild; New England Spot Sales. Format: Contemp. ■ John W. Bride, pres; Richard A. Snyder, gen mgr; Douglas P. Finck, sls mgr; Jeff Ryder, prog dir; Eugene Terwilliger, chief engr. ■ Rates: \$24; 21; 24; 18.

WJBQ(FM)—See Scarborough.

WRON(FM)—Not on air, target date unknown: 100.9 mhz; 891 w. Ant 508 ft. Japat Inc.

Maryland

HAMILTON-LANDIS & ASSOCIATES, Inc.
NATIONWIDE MEDIA BROKERS
WASHINGTON, D. C., CHICAGO, DALLAS, SAN FRANCISCO
SELL MORE
RADIO & TELEVISION STATIONS
IN THE EAST—NEAREST OFFICE IS—
1730 K ST., N.W., WASHINGTON 20006
(202) 393-3456

Aberdeen

WAMD—May 1, 1957: 970 kHz; 500 w-U, DA-2. Box 516 (21001). (301) 272-4400. Hartford County Bcstg Co. Net: ABC/C. Rep: Dome-Messervy. Format: Contemp. ■ John L. Allen, gen mgr; Jean Allen, coml mgr.

Annapolis

WANN
Black Programing



WANN—Jan 10, 1947: 1190 kHz; 10 kw-D, DA. Box 631 (21404). (301) 269-0700. Annapolis Bcstg Corp. Format: Black. ■ Morris H. Blum, pres & gen mgr; Robert Z. Goldberg, VP sls; S. A. Travers, prog dir; Merrill W. Pittman, chief engr. ■ Rates: \$8.50; 8.50; 8.50; —.

WFSI(FM)—May 16, 1960: 107.9 mhz; 20 kw. Ant 500 ft. 918 Chesapeake Ave. (21403). (301) 269-5400. Family Stations Inc. (group owner; acq 1-7-72). Stereo. Format: Relig. ■ Harold Camping, pres; William A. Sadlier, stn mgr; David Pearl, prog dir.

WNAV—1949: 1430 kHz; 5 kw-D, 1 kw-N, DA-N Box 829 (21404). (301) 263-2639. Rau Radio Stns Inc. (group owner). Net: MBS. Rep: Market Four. Format: Contemp adult. ■ Henry Rau, chmn of the bd; Lloyd S. Smith, pres; Fred P. Koester, gen mgr; Stephen Hopp, prog dir; Ronald Roche, gen sls mgr. ■ Rates: \$10.50; 8.50; 10.50; 8.50.

WNAV-FM—1947: 99.1 mhz; 47 kw. Ant 360 ft. Prog sep from AM. Stereo. Format: Easy lstrg. ■ Rates: \$7; 8; 8; 8.

WYRE—1946: 810 kHz; 250 w-D, Box 1551 (21404). (301) 263-9211. Atlantic Bcstg Corp. (acq 8 15-75). Format: Top 40. ■ Kerby Scott, VP & gen mgr; Fred Garrett, mgr; Ed Gursky, prog dir; Howard Dicus, news dir; William Sacks, chief engr.

Baltimore

WAYE—July 27, 1955: 860 kHz; 1 kw-D, DA. 1111 Park Ave. (21201). (301) 728-7570. Warren Adler (acq 1-67). Rep: Selcom. Format: Rock. ■ Warren Adler, pres; Harvey J. Tate, gen mgr; Greg Seibold, coml mgr; Marty McLean, prog & mus dir; Carleton Robinette, chief engr.

WBAL—Nov 2, 1925: 1090 kHz; 50 kw-U, DA-N. 3800 Hooper Ave. (21211). (301) 467-3000. TWX

710-234-1688. WBAL Div. The Hearst Corp. (group owner; acq 1-14-35). Net: NBC. Rep: McGavren-Guild. Format: MOR. Spec progs: Black 1 hr wkly. ■ Alfred E. Burk, VP & gen mgr; Sidney Jordan, opns mgr; James P. Fox, gen sls mgr; Jack Lacy, mus dir; Richard Sher, news dir; N. Allen Hedrick, chief engr. ■ Rates: \$11; 39; 75; 30.

WBAL-FM—Dec 7, 1958: 97.9 mhz; 10.5 kw horiz, 1.95 kw vert. Ant 950 ft. Prog sep from AM. Net: NBC/NIS. Stereo. Format: All news. ■ Thomas H. O'Connor, prog dir; Alan Beck, sls mgr. ■ WBAL-TV affil. ■ Rates: \$50; 26; 40; 16.

***WBJC(FM)**—April 6, 1951: 91.5 mhz; 17.5 kw. Ant 185 ft. 2901 Liberty Heights Ave. (21215). (301) 462-5700. Community College of Baltimore. Stereo. Net: ABC/FM, NPR. Format: Variety, classical, jazz. ■ Kenneth Stein, gen mgr; William Quinn, prog dir; Clinton Coleman, news dir; Duke Baugh, mus dir; Frank Zeiler, chief engr.

WBMD—Dec 7, 1947: 750 kHz; 1 kw-D. 5200 Moravia Rd. (21206). (301) 485-2400. Key Bcstg Corp. Format: C&W. Spec progs: Farm 1½ hrs; Ger 1 hr; Pol 2 hrs; Greek 2 hrs, wkly. ■ Carl G. Brenner, VP & gen mgr; Buzz Lucas, coml mgr; Clark West, prog dir; Scott Brenner, chief engr.

WKTK(FM)—Co-owned with WBMD. See Catonsville.

WCAO—1922: 600 kHz; 5 kw-U, DA-1. 40 W. Chase St. (21201). (301) 685-0600. Plough Bcstg Co. (group owner; acq 5-19-56). Net: ABC/C. Format: Top 40. ■ H. Wayne Hudson, pres; Joseph Cahill, VP, gen mgr; Tom Kroh, gen sls mgr; Ron Riley, prog dir; Ted Jaffee, news dir; William Marshner, chief engr. ■ Rates: \$68; 57; 67; 57.

WCAO-FM—Dec 15, 1947: 102.7 mhz; 50 kw. Ant 400 ft. Prog sep from AM. Format: Classcl. Stereo. ■ Rates: \$28; 28; 28; 28.

WCBM—1924: 680 kHz; 10 kw-D, 5 kw-N, DA-2. 68 Radio Plaza, Owings Mills, Md. (21117). (301) 363-2000. Metromedia Inc. (group owner; acq 1963). Net: ABC/E. Rep: Metro Radio Sis. Format: MOR. ■ Harold K. Deutsch, VP, gen mgr; William R. Kunkel Jr, gen sls mgr; Bruce Holberg, prog dir; Bob Shilling, news dir; Myron Laufer, bus mgr; Elane Stein, dir pub affrs; Sam Houston, chief engr.

WDJQ(FM)—Listing follows WITH.

***WEAA(FM)**—Not on air, target date unknown: 88.9 mhz; 12.5 kw. Ant 215 ft. Hillen Rd & Coldspring Lane (21239). Morgan State College.

WEBB—April 5, 1955: 1360 kHz; 5 kw-D, DA. Clifton & Denison St. (21216). (301) 947-1245. JB Bcstg of Baltimore (acq 1-1-70). Net: MBS/Black. Rep: Mastia. Format: Black. ■ James Brown, pres; James Sears, gen mgr; Gregory Siebold, sls mgr; Willie Bacote, prog dir; Ev Dudley, prom mgr & news dir; Vickie Smith, news dir; Joseph Torres, chief engr.

WFBR—June 8, 1922: 1300 kHz; 5 kw-U, DA-1. 13 E. 20th St. (21218). (301) 685-1300. Baltimore Radio Show Inc. (acq 1930). Net: CBS. Rep: Blair. Format: Adult Contemp. ■ Harry R. Shriver, pres & gen mgr; Christopher T. Gallu, coml mgr; Norman Brooks, prog dir; Kay Stafford, prom mgr; Tom Mar, news dir; Floyd Daisey, chief engr.

WITH—March 1, 1941: 1230 kHz; 1 kw-D, 250 w-N. 7 E. Lexington St. (21202). (301) 539-7808. WITH Inc. (acq 3-1-65). Group owner: Reeves Telecom Corp. Net: ABC/I. Rep: Eastman. Format: MOR. ■ J. Drayton Hastie, pres; Gordon K. Faulkner, VP & gen mgr; Charles La Mason, prom mgr; Ed Graham, prog dir; Terry Johnston, prod mgr; Rolf Hertsgaard, news dir; S. E. Hawkins, chief engr.

WDJQ(FM)—Co-owned with WITH. 1949: 104.3 mhz; 20 kw. Ant 130 ft. (301) 539-1044. Net: MBS. Prog sep from AM. Format: Top 40. Stereo. ■ Jack Diamond, prog dir.

WLIF(FM)—Dec 24, 1970: 101.9 mhz; 9.6 kw. Ant 960 ft. 1570 Hart Rd. (21204). (301) 823-1570. Sudbrink Bcstg of Maryland Inc. (group owner; acq 10-30-70). Stereo. Rep: Katz. Format: Beautfl mus. ■ Robert W. Sudbrink, pres; Brian Bieler, VP, gen mgr; Harold W. Gore, exec VP; Niles Seaberg, opns dir; Richard Seaby, chief engr. ■ Rates: \$56; 76; 76; 40.

WLPL(FM)—Listing follows WSID.

Maine, Maryland Radio

See page C-1 for explanation of listings.

WMAR-FM—1960: 106.5 mhz; 29 kw. Ant 620 ft. 6400 York Rd. (21212). (301) 377-2222. TWX 087-835. A. S. Abell Co. (group owner). Rep: Katz. Format: MOR, good music. Stereo. ■ William F. Schrick Jr, pres; Robert C. Embry, gen mgr; John Cross, coml mgr; Richard Hageman, opns mgr; Carl Nopper, chief engr. ■ WMAR-TV affil.

WPOC(FM)—Feb 4, 1960: 93.1 mhz; 12.5 kw. Ant 870 ft. 711 W. 40th St. (21211). (301) 366-3693. Nationwide Communications Inc. (group owner; acq 8-15-74). Rep: Dome. Format: Hit Ctry. Spec prog: Gosp 2 hrs wkly. Stereo. ■ David Fuellhart, gen mgr; Carol Petasky, coml mgr; Peter Porter, prog dir; Bob Walker, mus dir; Tom Cheche, news dir; Cathy Patricia, prom mgr; Steve Crook, chief engr. ■ Rates: \$26; 20; 26; 13.

WRBS(FM)—Aug 1, 1964: 95.1 mhz; 50 kw horiz, 36 kw vert. Ant 260 ft. 3600 Georgetown Rd. (21227). (301) 247-4100. Peter and John Radio Fellowship Inc. (acq 9-64). Format: Relig. Stereo. ■ Rev. John O. Bisset, pres; J. Thomas Bisset, gen mgr; Walter Hill, news dir; Robert Shaffer, chief engr.

WSID—Nov 25, 1947: 1010 kHz; 1 kw-D. 6623 Reisterstown Rd. (21215). (301) 358-9600. United Bcstg Co. of Eastern Maryland (group owner; acq 6-16-49). Rep: UBC Sales. Format: Black, Black-Gold. ■ Richard Eaton, pres; Pierre Eaton, VP; Maynard Grossman, gen mgr; Bill Parris, prog & mus dir; William Simon, chief engr. ■ Rates: \$22; 22; 22; 22.

WLPL(FM)—Co-owned with WSID. 1960: 92.3 mhz; 20 kw. Ant 390 ft. (301) 358-4600. Prog sep from AM. Stereo. Format: Contemp, Rock, Top 40. ■ Rates: \$23; 23; 35; 35.

***WSPH(FM)**—Sept 17, 1974: 88.1 mhz; 10 w. Ant 80 ft. 7400 Old N. Point Rd. (21219). (301) 477-0750. Bd of Ed. Balt. County. Format: Variety. Spec progs: Fr 1 hr; Ger 1 hr; Black 5 hrs, wkly. ■ James Selway, gen mgr; Bill Ulrich, prog dir; Don Miller, chief engr.

WTOW—See Towson.

WWIN—1951: 1400 kHz; 1 kw-D, 250 w-N. 2800 Mathews St. (21218). (301) 366-1400. Belvedere Bcstg Corp. Rep: Savalli/Gates. Format: Black. ■ Thomas F. McNulty, pres; H. Shelton Earp, VP & gen mgr; Ken Quortin, coml mgr; Al Jefferson, prog dir; Mary Clayburn, public svcs dir; Leo Karns, chief engr.

Bel Air

***WHFC(FM)**—1972: 88.1 mhz; 10 w. Ant 60 ft. 401 Thomas Run Rd. (21014). (301) 838-1000. Harford Community College. Net: ABC/FM. Format: Contemp, rock. ■ Paul G. Yorkis, stn mgr; L. Edwards, chief engr.

WVOB—June 11, 1963: 1520 kHz; 250 w-D. 2 Hays St. (21014). (301) 838-2770. Bel Air Bcstg Co. Inc. Net: ABC/E. Format: MOR. ■ John D. Worthington III, pres; James V. McMahan Jr, gen mgr; Robert I. Callahan, sls mgr; Dean Hunter, prog dir; Scott Harris, news dir; Robert Nicholson, chief engr.

Bethesda

WGMS—Jan 2, 1946: 570 kHz; 5 kw-D, 1 kw-N, DA-2. 1 Central Plaza, 11300 Rockville Pike, Rockville, Md. (20852). (301) 468-1800. RKO General Inc. (group owner; acq 1-2-68). Rep: RKO Radio. Format: Classcl. ■ Frank Shakespeare, pres; Jerry R. Lyman, VP & gen mgr; Martin Conn, gen sls mgr; Mike Cuthbert, prog dir; Susan Loomis, prom mgr; Eileen Curtis, mus dir; H.K. Leyh, chief engr. ■ Rates: \$36; 32; 40; 36.

WGMS-FM—See Washington, D.C.

WHFS(FM)—Nov 12, 1961: 102.3 mhz; 2.3 kw. Ant 340 ft. Stereo. 4853 Cordell Ave. (20014). (301) 656-0600. High Fidelity Bcstrs Inc. (acq 6-19-67). Format: Progs. Spec progs: Fr 1 hr; Ger 1 hr; Greek 1 hr; Korean 2 hrs; East Indian 1 hr; Ital 1½ hrs; Hebrew 1½ hrs, wkly. ■ Phillip Margolius, pres; Jacob Einstein, exec VP, gen mgr; David Einstein, prog dir. ■ Rates: \$25; 25; 25.

WJMD(FM)—October 1959: 94.7 mhz; 17 kw. Ant 780 ft. 5530 Wisconsin Ave., Chevy Chase (20015). (301) 652-9470. SJR Communications Inc. (group owner). Rep: CBS/FM Sis. Format: Btfl mus. ■ Goff M. Lebharr, gen mgr; Fred E. Goodman, sls mgr; Andrew

Maryland Radio

See page C-1 for explanation of listings.

Bitsko, prog dir; Gary Hess, chief engr. ■ Rates: \$33; 31; 38; 23.

WUST—See Washington, D.C.

Braddock Heights

WZYQ-FM—Co-owned with WZYQ. Frederick, Md. April 8, 1972: 103.9 mhz; 270 w. Ant 840 ft. (CP 230 w. Ant 910 ft). Dups AM 66%. Stereo.

Brunswick

WTRI—Oct 2, 1966: 1520 khz; 500 w-D (250 w CH). Cummings Dr (21716). (301) 834-8141. Elektra Bcstg Corp. (acq 2-1-73). Format: C&W. ■ Bert Thornton, pres; gen mgr & farm dir; Emma Thornton, coml mgr; Fred Thornton, prog dir; Mike Smith, prom mgr; Jack Hyden, mus dir; Jane Darkis, news dir; Fran Little, chief engr.

Cambridge

WCEM—1947: 1240 khz; 1 kw-D, 250 w-N. Box 237 (21613). (301) 228-4800. WCEM Inc. (acq 8-21-75). ■ Edward Brigham, coml mgr; Bette B. Robbins, prog dir; Bill Reeder, news dir; John Richardson, chief engr.

WESP-FM—Co-owned with WCEM. Jan 29, 1968: 106.3 mhz; 3 kw. Ant 300 ft. Dups AM 60%.

Catonsville

WKTK(FM)—Co-owned with WBMD Baltimore. Nov 22, 1963: 105.7 mhz; 50 kw horiz, 45 kw vert. Ant 245 ft. 5200 Moravia Rd, Baltimore (21206). (301) 485-2400. Key Bcstg Co. Rep: ABC-FM Radio Spot Sls. Format: Adult rock. Stereo. ■ Steve Cochran, prog dir. ■ Rates: \$27; 27; 30; 30.

Chestertown

WCTR—June 16, 1963: 1530 khz; 250 w-D. Box 700 (21620). (301) 778-1530. WCTR Inc. Format: Contemp. MOR. Spec prog: Fr 5 hrs wkly. ■ Russell H. Morgan, pres; Reverdy F. Yarnall, gen mgr & news dir; Rip Yarnall, coml & prom mgr; Curt Van Loon, prog dir; Thomas M. Sorge, chief engr. ■ Rates: \$5.20; 5.20; 5.20; —.

Cumberland

WCUM—1948: 1230 khz; 1 kw-D, 250 w-N. Box 360 (21502). (301) 724-5400. WCUM Radio (acq 9-74). Net: ABC/C. Rep: Howard. Format: Top 40. ■ Donald W. Miller, pres; Ed Yetter, chief engr.

WCUM-FM—1948: 102.9 mhz; 1.25 kw. Ant minus 4 ft. Dups AM 100%.

WKGO(FM)—Listing follows WTBO.

WTBO—Dec 13, 1928: 1450 khz; 1 kw-D, 250 w-N. Box 510 (21502). (301) 722-6666. Welborne Bcstg Inc. (acq 12-1-72). Net: NBC. Rep: Devney. Format: Contemp. ■ David P. Welborne Jr., pres; Paul H. Miller, gen mgr; J. J. Jefferies, prog dir; Scott Robinson, news dir; Martin White, chief engr. ■ Rates: \$5.50; 4.50; 5.50; 4.50.

WKGO(FM)—Co-owned with WTBO. Sept 1, 1962: 106.1 mhz; 4 kw. Ant 1,400 ft. Prog sep from AM. Format: Easy lsg. Stereo. ■ Paul H. Miller, gen mgr; Sam Cozad, prom mgr. ■ Rates: \$4.50; 4.50; 4.50; 4.50.

WUOK—June 24, 1953: 1270 khz; 5 kw-D, 1 kw-N, DA-2. Box 1290 (21502). (301) 724-5000. Multi-Media Assoc (acq 8-71). Net: CBS. Rep: PRO Time Sls, Dome-Messervey. Format: Adult contemp. ■ James R. Reese Jr., pres; Ruth Kramer, coml mgr; Gary Kirtley, opns dir; David L. White, chief engr.

Easton

WEMD—Sept 29, 1960: 1460 khz; 1 kw-D, 500 w-N, DA-2. 3849 N. 30th St, Arlington, Va. (22207). (703) 525-7566. Easton Bcstg Co. ■ George Dietrich, gen mgr & news dir; Tom Gregory, prog dir; Tom Gregory, Erol Dietrich, chief engr.

WEMD-FM—May 14, 1975: 96.7 mhz; 3 kw. Ant 245 ft. Dups AM 100%.

Eikton

WSER—Aug 22, 1963: 1550 khz; 1 kw-D, DA. Box 38

(21921). (301) 398-3883. WSER Inc. (acq 10-72). Net: ABC/E. Format: MOR. Spec prog: Farm 1 hr wkly. ■ Oscar T. Grann, pres; Charles N. Doll, gen mgr; David Winchester, coml mgr; Tim Hall, news dir; Arthur Buist, chief engr. ■ Rates: \$5; 5; 5; 5.

Frederick

WFMD—Jan 1, 1936: 930 khz; 5 kw-D, 1 kw-N, DA-2. Box 151 (21701). (301) 663-4181. James L. Gibbons (acq 11-1-67). Net: CBS. Rep: Savalli/Gates, Dome-Messervey. Format: C&W, Up Tempo, MOR. ■ Jim Gibbons, owner & gen mgr; Frank Veihmeyer, mgr & sls mgr; Dick Denham, prog dir; Bill Rickett, news dir; Dick Delauter, chief engr.

WFRE(FM)—Co-owned with WFMD. Feb 19, 1961: 99.9 mhz; 9 kw. Ant 1,100 ft. Prog sep from AM. Stereo. Format: Btl Mus. ■ George Carr, sls mgr.

WZYQ—Co-owned with WZYQ-FM Braddock Heights, Md. Dec 15, 1960: 1370 khz; 500 w-D, DA. Route 12, Box 311 (21701). (301) 662-2148. Musical Heights Inc. Format: Contemp. ■ Leo L. Shank, pres; Howard Johnson, gen and prom mgr; Nancy L. Fowler, opns dir; Dennis Carpenter, prog and mus dir; Howard Fisher, chief engr. ■ Rates: \$9.35; 8.35; 9.35; 5.60.

Frostburg

WFRB—Dec 20, 1958: 560 khz; 1 kw-D. Box 430 (21532). (301) 689-8871. Western Maryland Bcstg Co. Inc. Format: C&W. ■ D. C. Loughry, pres; gen mgr & chief engr; R. Dean Hillegas, coml mgr; Robert P. Kerr, prog dir; Theo K. Evans, mus dir; Stanley L. Fisher, news dir.

WFRB-FM—Oct 1, 1965: 105.3 mhz; 13 kw. Ant 860 ft. Dup AM 100%. Stereo.

Glen Burnie

WISZ

Contemporary Country

WISZ—May 15, 1963: 1590 khz; 500 w-U, DA-2. Box 159 (21061). (301) 761-1590. WISZ Inc. (acq 6-1-64). Net: ABC/E. Rep: Masla. Format: Contemp country. ■ L. W. Gregory, pres; Henry C. Goldman, gen mgr; Bernard Stevens, sls mgr; Bill Barden, prog dir; Robert Murphy, chief engr.

WISZ-FM—Sept 15, 1964: 95.9 mhz; 3 kw horiz, 2.55 vert. Ant 300 ft. Dups AM 100%. ■ Rates: \$18; 16; 18; 14.

Hagerstown

WARK—July 20, 1947: 1490 khz; 1 kw-D, 250 w-N. 880 Commonwealth Ave. Box 626 (21740). (301) 733-4500. Rau Radio Stns Inc. (group owner: acq 12-5-60). Net: CBS. Rep: Wittig, UBC. Format: MOR, rock. Spec prog: C&W 17 hrs wkly. ■ Henry Rau, chmn bd; Lloyd S. Smith, pres; Jim Stevens, gen mgr; Lew Duffey, coml mgr; Dick Collyer, asst mgr; Patrick H. Kelly, treas; Grant Kemmerer, mus dir; Terry Keefer, news dir; Dave Lent, chief engr.

WARK-FM—March 1957: 106.9 mhz; 2.3 kw. Ant 230 ft. Dup AM 100%.

WJEJ

MOR—Talk—News

WJEJ—October 1932: 1240 khz; 1 kw-D, 250 w-N. Box 399 (21740). (301) 739-2323. Hagerstown Bcstg Co Inc. (acq 12-21-72). Group owner: A.V. Tidmore Stns. Net: ABC/E. Format: MOR. Spec progs: Farm 1 hrs; talk 10 hrs wkly. ■ John T. Staub, pres; gen mgr & prog dir; Betty Andrews, prom mgr; Bob Montgomery, mus dir; Ed Klitch & Bill Stoner, news dirs; Louis J. Scally, chief engr. ■ Rates: \$8; 7; 8; 7.

WJEJ-FM—1946: 104.7 mhz; 9.4 kw. Ant 1,320 ft. Dup AM 95%. Stereo. ■ Rates same as AM.

WYII(FM)—See Williamsport.

Halfway

WHAG—June 9 1962: 1410 khz; 1 kw-D, DA. 1250 Downsville Pike, Hagerstown (21740). (301) 797-7300. Regional Broadcasting Co. Net: ABC/N. Rep: Dome Assoc. Format: MOR. ■ Warren Adler, pres; Jeff Martin, gen mgr; Bob Scovitch, coml mgr; Jeff

Hunt, prog dir; Pete Wilson, mus dir; Lou Scally, chief engr. ■ Rates: \$5.75; 4.75; 5.75; 4.75.

WQCM(FM)—Co-owned with WHAG. January 1965: 96.7 mhz; 3 kw. Ant 165 ft. Stereo. Prog sep from AM. Format: Progs, top 40. ■ Stacy Drake, mus dir. ■ Rates: \$4.75; 4.75; 5.75; 5.75.

Havre de Grace

WASA—May 15, 1948: 1330 khz; 5 kw-D. Box 97 (21078). (301) 939-0800. Chesapeake Bcstg Corp. Net: MBS. Format: MOR. ■ Virginia Pate Welter, pres & gen mgr; Charles W. Irwin, coml mgr; C. Allen Anderson, sln mgr; Mark J. Mauney, chief engr.

WHDG(FM)—Co-owned with WASA. June 19, 1960: 103.7 mhz; 17.5 kw. Ant 340 ft. Prog sep from AM. Format: Relig, C&W.

La Plata

WSMD—October 1965: 1560 khz; 1 kw-D, 250 w-CH. Box 19 (20646). (301) 934-4612. (Washington 870-3004). Crystal Bcstg Co. (acq 1-15-74). Format: C&W. ■ Frank N. Manthos, pres and gen mgr; Mary S. Manthos, coml mgr; Steven M. Prentice, prog dir; Arnold B. Winselt, news dir; Luther R. Palmer Jr, chief engr. ■ Rates: \$11.15; 9.90; 11.15; 9.90.

WSMD-FM—February 1965: 104.1 mhz; 1.7 kw. Ant 245 ft. Dup AM 100%. ■ Rates same as AM.

Laurel

WLMD—Dec 23, 1965: 900 khz; 1 kw-D, DA. Box 42 (20810). (301) 953-2332. Interurban Bcstg Corp. (acq 2-9-72). Audio news: UPI. Format: Country gold. Spec progs: Sports talk 2 hrs wkly. ■ William A. Lemer, pres and gen mgr; Eric Stephens, opns coord; Michael Kirchen, coml mgr; Michael O'Connor, news dir; Michael Cain, chief engr. ■ Rates: \$22; 22; 22; 22.

Leonardtown

WKIK—Jan 7, 1953: 1370 khz; 1 kw-U, DA-N. Box 346 (20650). (301) 475-8937. Sound Media Inc. (acq 1-1-72). Audio news: UPI. Format: MOR. Spec prog: Telephone talk show 5 hrs wkly. ■ Richard Myers, pres & news dir; George Clark, gen mgr; Barbara Bishop, coml mgr; Richard Benjamin, prog & mus dir; Matt Minihan, prom mgr; Frank S. Miner, chief engr. ■ Rates: \$5.50; 3.79; 5.50; 3.22.

NEW FM—Co-owned with WKIK. Not on air; target date unknown: 97.7 mhz; 3 kw. Ant 300 ft.

Lexington Park

WPTX—April 20, 1953: 920 khz; 5 kw-D, 1 kw-N, DA-2. General Delivery (20653). (301) 475-8383. Key Bcstg Corp. (group owner: acq 12-1-60). Rep: Dome, Keystone. Format: MOR. Spec progs: Farm 2 hrs; black 12 hrs wkly. ■ Carl Brenner, VP; Martin J. Willis Jr., gen mgr; Dorothy Kidd & Lynn Dixon, coml mgrs; John Lehman, prog dir; Eric Bromley, news dir and prom mgr; Carey Corson, mus dir; George Byrne, chief engr. ■ Rates: \$8.50; 7.65; 8.50; 5.95.

Morningside

WPGC—October 1954: 1580 khz; 10 kw-D, DA. Box 8550, Washington (20027). First Media Corp. (acq 10-17-74). Rep: Buckley. Format: Contemp. ■ Glenn T. Potter, pres & gen mgr; William E. Prettyman Jr., sls mgr; Jim Collins, prog dir; Delores Masano, off mgr; Milford Smith, chief engr.

WPGC-FM—February 1959: 95.5 mhz; 50 kw. Ant 480 ft. Dups AM 100%. Stereo.

Oakland

WMSG—May 19, 1963: 1050 khz; 500 w-D. Oakland, Md. (21550). (301) 334-3800. Oakland Radio Station Corp. Spec prog: C&W 20 hrs. ■ C. W. Englander, pres; Thomas B. Butscher, gen mgr & prog dir; Dale Ellis, news dir; Gary L. Daniels, chief engr.

WMSG-FM—92.1 mhz; 430 w. Ant 690 ft horiz, 680 ft vert. Dups AM 70%.

Ocean City

WBCC-FM—See Salisbury.

WETT—July 1, 1960: 1590 khz; 1 kw-D, 500 w-N, DA-2. Box M (21842). (301) 289-6770. Public Svc. Enterprises (acq 1965). Format: Contemp, MOR. ■

Leonard F. Grazier Jr., pres, prog & mus dir; Gina Grazier, gen & coml mgr; John Holston, news dir; Juanita Raab, prom mgr; Leonard F. Grazier Sr., chief engr.

Owings Mills

WCBM—See Baltimore.

Pocomoke City

WDMV—Aug 1, 1955: 540 khz; 500 w-D, Box 210 (21851). (301) 957-0540. Leisure Time Communications (acq 11-13-73). Format: MOR, Top 40. ■ Joseph F. McInerney, pres; Andrew J. Douds, gen mgr; Loraine B. Dorman, coml mgr; John A. Walker, prom mgr; Jeffrey A. Hart, prog dir; Lee Duncan, mus dir; Robert H. Connelly, news dir; Jon B. Richardson, chief engr.

Potomac-Cabin John

WCTN—1965: 950 khz; 1 kw-D, DA, 7825 Tuckerman Lane, No. 216 (20854). (301) 299-6311. Seven Locks Bcstg Co. Audio news: UPI. Format: Contemp, sacred. ■ McArthur Jollay, pres; Keith Jollay, gen mgr; George Mattei, coml mgr; Craig Morgan, traf mgr; Jackie Fleming, mus dir; Jack Richards, chief engr. ■ Rates: \$8; 6; 8; 6.

Prince Frederick

WMJS(FM)—August 1971: 92.7 mhz; 1.85 kw. Ant 370 ft. Box 547 (20678). (301) 535-2201. MJS Communications Inc. (acq 6-19-73). Rep: Smith. Format: Country Stereo. ■ Melvin Golub, pres & gen mgr.

Rockville

WINX—November 1951: 1600 khz; 1 kw-D, 500 w-N, DA-N. Box 1726, Radio Center (20850). (301) 424-9292. Montgomery County Bcstg Co. Group owner: United Bcstg Sins. Rep: UBC Sales. Format: Top 40. ■ Richard Eaton, pres; Pierre Eaton, gen mgr & prog dir; Lynn Reynolds, sls mgr; Barbara Goldstein, coml mgr; Gene Alim, prom mgr; Bill Palmer, mus dir; Polly Doane, news dir; Bill Vickers, chief engr.

Salisbury

WBOC—Sept 13, 1940: 960 khz; 5 kw-D, 1 kw-N, DA-2. Box 2057 (21801). (301) 749-1111. TWX 301-344-4947. WBOC Inc. (acq 10-1-61). Group owner: A.S. Abell. Net: CBS. Rep: Devney. Format: MOR. ■ Samuel S. Carey, VP & gen mgr; Jack Ward, opns mgr; S. Terry Kleger, prog dir; Alan Landay, news dir; Bernard F. Sparks, chief engr.

WBOC-FM—July 31, 1965: 104.7 mhz; 30 kw. Ant 610 ft. Dups AM 19%. Stereo. Format: Beautfl mus, news. ■ WBOC-TV affil.

WDMV—See Pocomoke City.

WICO—September 1957: 1320 khz; 1 kw-D, Box 909 (21801). (301) 742-3212. Delmarva Bcstg Co. (acq 9-19-59). Format: C&W. ■ William B. Phillips, pres & gen mgr; Robert C. Doyle, VP; B.C. Hargraves, coml mgr; Carl Briggs, prog dir; C. R. Hook, mus dir; James Jester, chief engr. ■ Rates: \$6.25; 6.25; 6.25; —.

WICO-FM—Sept 3, 1969: 94.3 mhz; 3 kw. Ant 170 ft. Dups AM 50%. ■ Rates same as AM.

WJDY—March 14, 1958: 1470 khz; 5 kw-D, DA, Box 2 (21801). (301) 742-5191. Salisbury Bcstg. Rep: Wittig, Dome. ■ Norman Glenn, pres & gen mgr; Ed Vaughn, news dir; Jim King, mus dir; William H. Kline, chief engr; Roland Twigg, spts dir.

Silver Spring

WGAY—Dec 7, 1946: 1050 khz; 1 kw-D, World Bldg., 8121 Georgia Ave. (20910). (301) 587-4900. Greater Media Inc. (group owner; acq 5-7-71). Rep: Torbet. Format: Conservative popular. ■ Peter A. Bordes, pres; Theodore R. Dorf, VP & gen mgr; Charles Guy, mgr; John Dougan, prog dir; Bob Chandler, opns mgr; Delbert K. Keeling, chief engr.

WGAY-FM—See Washington, D.C.

***WGTS-FM**—May 8, 1957: 91.9 mhz; 29.5 kw. Ant 165 ft. 7600 Flower Ave. (20012). (301) 270-1834. Columbia Union College Inc. Net: MBS, NPR. Format: Talk, classcl. Stereo. ■ Donald Martin, gen mgr; Ingrid Phillips, prom mgr; James Gallagher, prog dir; Karen Stuart, mus dir; Edward Henkel, chief engr.

Thurmont

WTHU—June 12, 1967: 1450 khz; 500 w-D, 100 w-N, Box 16 (21788). (301) 271-7417. Catoclin Bcstg (acq 9-7-1). Net: ABC/I. Format: Mod Country. ■ Lauren A. Colby, pres; Petrina B. Colby, gen mgr; Gary Jagow, prog dir; Dean F. Aubol, coml mgr; Francis Little, chief engr. ■ Rates: \$6; 6; 6; 1.50.

Towson

***WCVT(FM)**—Not on air, target date unknown: 89.7 mhz; 1.85 kw. Ant 400 ft. AV Bldg, Towson State College (21204). Licensee as above. ■ Jay Harrison, gen mgr.

WLIF(FM)—See Baltimore.

WTOW—Oct 27, 1955: 1570 khz; 5 kw-D, 828 Dulaney Valley Rd., Suite 1 (21204). (301) 823-5357. Sudbrink Broadcasters Inc. (acq 4-7-5). Format: Relig, talk. Spec progs: Ital 3 hrs; Jewish 2 hrs; Polish 1 1/2 hrs; Sp 1 hr wkly. ■ Harold W. Gore, pres; Barry Banther, gen mgr; Susan L. Fishel, coml mgr; Sally Weinrich, prog dir and prom mgr; Harold Taylor, mus and news dir; Rick Seaby, chief engr. ■ Rates: \$9.50; 8; 9.50; 8.

Waldorf

WSMD—See La Plata.

Westminister

WTTR—July 1953: 1470 khz; 1 kw-D, Box 828 (21157). (301) 848-5511. Carroll County Bcstg Corp. Net: MBS. Format: C&W. ■ Russell H. Morgan, VP gen & coml mgr; Kaye G. Kolb, prog dir; Richard W. Story, news dir. ■ Rates: \$7.76; 7.76; 7.76; 7.76.

WTTR-FM—Nov 1, 1959: 100.7 mhz; 50 kw. Ant 350 ft. Dups AM 30%. Stereo. Format: MOR.

Wheaton

WDON—1954: 1540 khz; 1 kw-D, 2647 University Blvd. (20902). (301) 946-0900. WDON Inc. (acq 6-7-4). Format: C&W. ■ Gary Marshall, pres & gen mgr; Irvin D. Suthard, gen sls mgr; J. Rutherford, opns dir; Charles Montalbano, sports dir.

WASH(FM)—See Washington, D.C.

Williamsport

WYII

Modern Country Music

WYII(FM)—Nov 15, 1972: 95.9 mhz; 3 kw. Ant 300 ft. 6 E. Potomac St. (21795). (301) 582-1320. OEA Inc. Format: Modern Country Stereo. Spec prog: Farm 1 hr wkly. ■ Kenneth Smith, pres, gen mgr & chief engr; Brian L. Leiter, coml mgr; Barry Lupton, prog dir; John L. Shank, mus dir; Lois P. La Porte, news dir; Michael McGough, prom mgr. ■ Rates: \$6.47; 6.47; 6.47; 6.47.

Worton

***WKSH(FM)**—March 28, 1974: 90.5 mhz; 17.5 kw. Ant 215 ft. Kent County High School (21678). (301) 778-4249. Bd of Ed Kent County. Format: Contemp. Stereo. ■ James A. Hammond, sls mgr; Laura Gassner, stdnt mgr.



Massachusetts

Allston

***WGBH(FM)**—See Boston.

Amherst

***WAMH(FM)**—1955: 89.3 mhz; 150 w. Ant 720 ft.

Maryland, Massachusetts Radio

See page C-1 for explanation of listings.



Stereo. Station 2 (01002). (413) 542-2224. Trustees of Amherst College. Format: Progs; Variety. ■ Andy von Salis, gen mgr; Andy Balder, bus mgr; Peter Kranzler, prog dir; Bill Lord, mus dir; Jim Kennedy, news dir; Clay Harter, David Carbone, chief engr.

***WFCR(FM)**—May 1961: 88.5 mhz; 35 kw. Ant 720 ft. Stereo. Five College Radio, Hampshire House, U of Massachusetts (01002). (413) 545-0100. Net: NPR; Eastern Public Radio. Format: Noncoml diversified. Spec progs: Fr 1 hr; Sp 6 hrs; African & Caribbean 1 hr, jazz, 5 hrs, Black 12 hrs, wkly. ■ Horace W. Hewlett, pres; Godwin G. Oyewole, gen mgr; Thomas K. Paine, mgr opns; Charles Ferguson III, chief engr.

***WMUA(FM)**—Oct 30, 1949: 91.1 mhz; 1 kw. Ant 27 ft. 42 Marston Hall, U of Massachusetts (01002). (413) 545-2876. U of Massachusetts. Net: Natl Black. Audio news: UPI. Format: Progs, Black. Spec progs: Farm 1/2 hr, classcl, 8 hrs, Fr 1/2 hr, jazz 8 hrs, Pol 1/2 hr, Sp 5 hrs, C&W 4 hrs, wkly. ■ Mark Lee Berman, gen mgr; Scott J. Bacherman, prog dir; Susan Schader, mus dir; Ken Lindberg, news dir; Gary McAuliffe, chief engr.

WTTT—April 2, 1963: 1430 khz; 5 kw-D, DA, Box 67 (01002). (413) 256-6794. Amherst Bcstg Inc. (acq 9-1-66). Rep: Eckels; Rawalt. ■ Ted Peene, pres & gen mgr; Jim Perry, chief engr.

Andover

***WPA(FM)**—May 1, 1965: 91.7 mhz; 10 w. Phillips Academy (01810). (617) 475-5181. Trustees of Phillips Academy. Net: NPR. Format: Prog, Rock, Talk, Classcl, Black. ■ George Cogan, pres & gen mgr; Steven Goldberg, prog dir.

Attleboro

WARA—Oct 8, 1950: 1320 khz; 1 kw-U, DA-2, 8 N. Main St. (02703). (617) 222-1320. Attleboro Radio Assn. Inc. Audio news: APR. Rep: Creed; Fulford. Format: MOR, talk. Spec prog: Sp 1 hr wkly. ■ J. Ottmar, pres; Joseph C. Rayball, gen mgr; Mike Fernandes, prog & news dir; Stan Morgan, coml mgr; Ruth Jensen, prom mgr; Robert Bamberg, mus dir; Jesse Perry, chief engr. ■ Rates: \$11.50; 10.50; 11.50; 9.50.

Barnstable

WQRC(FM)—July 20, 1970: 99.9 mhz; 50 kw. Ant 330 ft. Stereo. 76 Falmouth Rd., Hyannis (02601). (617) 771-1224. Cape Cod Bcstg Co. Rep: Fulford; Creed. Format: Btl mus. Spec prog: classcl 4 hrs wkly. ■ Donald P. Moore, pres, gen mgr & chief engr; Paul F. Gallagher, coml mgr; Richard M. Golden, prog dir; Kevin Burke, news dir; Francis I. Broadhurst, dir of pub affrs; Donald P. Moore, chief engr. ■ Rates: \$10; 10; 10; 10.

Beverly

WMLO—Dec 23, 1963: 1570 khz; 1 kw-D, DA, Box 344 (01915). (617) 774-7000. Algonquin Bcstg Co. (acq 12-67). Format: MOR. Spec progs: Pol 2 hrs; Grk 2 hrs; Port 2 hrs, wkly. ■ John Weld, VP gen & coml mgr; Kenneth Elliott, prog, mus & news dir; William Horne, chief engr. ■ Rates: \$9; 9; 9; 9.

Boston

WBCN(FM)—May 1958: 104.1 mhz; 19 kw. Ant 740 ft. Stereo. 5005 Prudential Tower (02199). (617) 266-1111. WBCN Inc. Rep: Katz. Format: Progs. Spec progs: Black 1/4 hr, women's show 1/2 hr, wkly. ■ T. Mitchell Hastings Jr., pres; Alfred R. Perry, gen & coml mgr; Norman Winer, prog dir; Thomas Hedges, prom mgr; Bob Slavin, mus dir; John Scagliotti, news dir; Jerry Cushing, chief engr.

Massachusetts Radio

See page C-1 for explanation of listings.

WBOS—See Brookline.

***WBUR(FM)**—March 1950: 90.9 mhz; 20 kw. Ant 160 ft. (CP: 22.5 kw; Ant 260 ft.). 630 Commonwealth Ave. (02215). (617) 353-2790. Trustees of Boston. Net: NPR; Pacifica. Format: Concert; Jazz; pub affrs. Spec progs: Black 1½ hrs wkly ■ Bonnie Cronin, gen mgr; Steve Slade, prog dir; Tony Cennamo, mus dir; Jane Christo, prom mgr; Victor Wheatman, news dir; James Bonney, chief engr.

WBZ—Sept 19, 1921: 1030 khz; 50 kw-U, DA-1. 1170 Soldiers Field Rd. (02134). (617) 254-5670 TWX 716-330-6316. Westinghouse Bcstg Co. (group owner). Rep: Radio Adv. Reprs. ■ Bill Cusack, gen mgr; Doug Auerbach, gen sls mgr; Bob Oakes, prog dir; Dave Graves, prom mgr; Ed Bell, news dir; Norm Graham, chief engr.

WBZ-FM—July 1941: 106.7 mhz; 18 kw. Ant 760 ft. Stereo. Prog sep from AM. Format: Rock. Spec prog: Teen/Student talk 6 hrs wkly. ■ Clark Smidt, stan coordinator, prog dir. ■ WBZ-TV affil.

WCOP—1934: 1150 khz; 5 kw-U, DA-2. 234 Clarendon St. (02116). (617) 267-0123. Plough Bcstg Corp. (group owner; acq 5-56). Net: NBC. Audio news: UPI. Rep: H.R. Format: C&W. Spec progs: Black, Sp 1 hr, Chinese 1 hr wkly. ■ Harold R. Krelstein, chmn of bd; H.W. Hudson, pres; Martin M. Cohn, VP & gen mgr; Greg Kines, prog dir; Paul Davidson, chief engr. ■ Rates: \$32; 27; 30; 21.

WCOP-FM—1948: 100.7 mhz; 50 kw. Ant 500 ft. Stereo. Prog sep from AM. Spec prog: Religious 1 hr wkly. ■ Rates: \$16.50; 15.50; 18; 13.

WCOZ(FM)—Listing follows WHDH.

WCRB—See Waltham.

WEEI—Oct 7, 1924: 590 khz; 5 kw-U, DA-1. 4450 Prudential Tower (02199). (617) 262-5900. CBS Inc. (acq 12-1-36). Net: CBS. Audio news: APR. Rep: CBS Radio Spot Sales. Format: News. ■ Eugene Lothery, VP CBS Radio Div & gen mgr of WEEI; Robert G. McGroarty, gen sls mgr; Raymond W. Edwards, Jr., administration & finance; W. Gerard Bottorff, dir bcst standards; Deanna K. Harris, dir edit & pub aff; Lawrence F. Conti, dir tech opns; Michael Ludlum, prog & news dir. ■ Rates: \$125; 55; 75; 35.

WEEI-FM—1948: 103.3 mhz; 12 kw. Ant 890 ft. Stereo. 4418 Prudential Tower (02199). Progs sep from AM. Rep: CBS/FM Spot Sales. Format: Adult contemp. MOR. ■ Jon H. Arbenz, gen mgr; George A. Silverman, gen sls mgr; Peter Gray Miller, prog dir; David R. Austin, news/pub affrs dir; Mildred P. Laby, opns mgr.

***WERS(FM)**—October 1949: 88.9 mhz; 900 w. Ant 730 ft. 130 Beacon St. (02116). (617) 267-7821. Emerson College. Format: Variety. Spec progs: Sp 2 hrs; black 10 hrs wkly. ■ Richard Chapin, pres; John Bachman, gen mgr; Bob Edney, prog dir; Joel Schwelleng, mus dir; Barbara Peck, prom mgr; Doug Cope, news dir; Charles E. Phillips, chief engr.

WEZE—1922: 1260 khz; 5 kw-U, DA-N. 10 Arcade Statler Office Bldg. (02116). (617) 542-1717. WEZE Inc. (acq 7-11-73). Group owner: McCormick. Net: ABC/I. Rep: Eastman. Format: MOR. ■ William M. McCormick, pres; Albert Makkay, VP & gen mgr; Thomas Klotz, sls mgr; Don Latulippe, prom mgr; Wally O'Hara, news dir; Bernard Lyon, chief engr. ■ Rates: \$45; 40; 45; 25.

***WGBH(FM)**—Oct 6, 1951: 89.7 mhz; 100 kw horiz, 26 kw vert. Ant 650 ft. Stereo. 125 Western Ave. (02134). (617) 868-3800. WGBH Educational Foundation. Net: NPR, EPRN. Format: Classcl, educ, jazz. ■ David O. Ives, pres; Michael S. Rice, VP & gen mgr; John H. Beck, radio mgr; Cheryl Bibbs, mus dir; Carol Moreau, audience coord; Frank Fitzmaurice, pub affrs dir; William Busiek, chief engr. ■ *WGBH-TV, WGBX-TV, WGBY-TV affils.

WHDH—Dec 1, 1926: 850 khz; 50 kw-U, DA-2. 441 Stuart St. (02116). (617) 247-0850. WHDH Corp. (acq 11-28-73). Net: ABC/E. Audio news: UPI. Rep: Blair. Format: Contemp. MOR. ■ David C. Croninger, pres; John T. Pappas, coml mgr; Cario Lagrotteria, prog dir; Ken Murphy, mus dir; Chuck Williams, prom mgr; Nick Mills, news dir; Paul Hurd, chief engr. ■ Rates: \$155; 70; 95; 40.

WCOZ(FM)—Co-owned with WHDH. March 31, 1948: 94.5 mhz; 6.7 kw. Ant 1,140 ft. Stereo. Format: Good mus. ■ Bill Wayland, sls mgr.

WHRB-FM—See Cambridge.

WILD—1946: 1090 khz; 1 kw-D. 390 Commonwealth Ave (02215). (617) 267-1900. Sheridan Bcstg Corp. (group owner; acq 3-1-73). Net: Mutual Black, Natl Black. Audio news: APR. Format: Black, jazz. ■ Paul W. Yates, pres; Ken Hudson, gen mgr; Sunny Joe White, prom & mus dir; James M. Rowe, news dir; Donald Snider, chief engr.

WJIB(FM)—1945: 96.9 mhz; 8.7 kw. Ant 1,010 ft. Stereo. 68 Commercial Wharf (02110). (617) 523-6611. TWX 710-321-0399. General Electric Bcstg Inc. (group owner; acq 12-28-72). Rep: Christal. Format: Btfl mus. ■ Reid L. Shaw, pres; Edward T. Dolan, VP & gen mgr; Kenneth W. Mellgren, opns & prog dir; Charles M. Pickering, gen sls mgr; Warren Schroeger, coml mgr; Robert Mehrman, pub affrs dir; James K. Howard, chief engr. ■ Rates: \$75; 100; 90; 30.

WMEX—1934: 1510 khz; 50 kw-D, 5 kw-N, DA-2. 111 Broadway (02116). (617) 426-1700. Richmond Bros. Inc. (acq 8-21-57). Net: ABC/C. Rep: Bolton-Burchill. Format: MOR. ■ Richard J. Richmond, pres; Paul Kelley, gen mgr; Pat H. Whitley, prog dir; Liz Saunders, prom mgr; George Redpath, news dir; Bob Wotiz, chief engr.

***WRBB(FM)**—October 1970: 91.7 mhz; 10 w. Ant 106 ft. Box 96 Roxbury Crossing Sta. (02120). (617) 437-2657. Northeastern U. Net: ABC/I. Format: Non-coml diversified. Spec progs: Jazz 10 hrs, Sp 1 hr, Greek 1 hr, Hebrew 1 hr wkly. ■ Rick Morin, Brian Dwyer, gen mgrs.

WRKO—1922: 680 khz; 50 kw-U, DA-2. RKO General Bldg, Govt. Center (02114). (617) 742-9000. TWX 710-321-0469. RKO General Inc. (group owner; acq 1-1-43). Rep: RKO Radio Reprs. Format: Contemp. Spec progs: Black 1 hr; Drug Hotline 3½ hrs; Generation 2 hrs, wkly. ■ Bruce F. Johnson, pres; John Hobbs, gen mgr; Robert Fish, loc sls mgr; Paul Kirby prog dir; Carol Lynne Bolin, prom mgr; Christy Wright, mus dir; Roger Allan, news dir; George Capalbo, VP engr.

WROR(FM)—Co-owned with WRKO. Oct 1, 1948: 98.5 mhz; 5.8 kw. Ant 1190 ft. Prog sep from AM. Stereo. Format: Golden Oldies. ■ Gracie Johnson, sls mgr. ■ WNAC-TV affil.

WRYT—Oct 8, 1950: 950 khz; 5 kw-D. 312 Stuart St. (02116). (617) 423-0210. Pilgrim Bcstg Co. (acq 2-11-66). Group owner: ASI. ABC. ■ Ralph Guild, pres; George R. Fritizinger, exec VP; Ken Carter, gen mgr.

Bridgewater

***WBIM-FM**—1972: 91.5 mhz; 10 w. Ant 108 ft. Bridgewater State College.

Brockton

WBET—Nov 27, 1946: 1460 khz; 5 kw-D, 1 kw-N, DA-N. 60 Main St. (02403). (617) 586-1460. Enterprise Publishing Co. Audio news: UPI. Rep: Devney; Creed. Format: MOR Contemporary. ■ Charles A. Fuller, gen mgr; Arthur B. Jones, stn mgr; William Burke, coml mgr; Richard A. Benham, prog dir; Lawrence A. Ghorse, news dir; Elbridge Hooker, chief engr. ■ Rates: \$12.25; 9.80; 12.25; 9.80.

WBET-FM—July 21, 1948: 97.7 mhz; 3 kw. Ant 280 ft. Dups AM 100%. ■ Rates same as AM.

WOKW—July 17, 1961: 1410 khz; 1 kw-D, DA. Box 1410 (02403). (617) 587-1410. WOKW Inc. Net: MBS. Rep: Kettell-Carter. Format: MOR. ■ John J. Sullivan, pres & gen mgr; Henry J. Murray, coml mgr; Dick Bell, prog & music dir; Thomas R. Roulstone, news dir; Robert F. Burns, chief engr. ■ Rates: \$11.18; 9.43; 9.43; 9.43.

Brookline

WBOS(FM)—Listing follows WUNR.

WUNR—1947: 1600 khz; 5 kw-U, DA-1. 275 Tremont St. Block prog: 419 Boylston St. Boston (02116). (617) 357-8677. Champion Bcstg System Inc. Audio news: APR. Format: Talk, rel, Sp, Black. Spec progs: Pol, Greek, Portuguese, It, Sp, wkly. ■ Herbert S. Hoffman, pres; Alan Temple, gen mgr; Norman Ruby, prog dir; Jane Duncklee, mus dir; Anthony Olmedo, chief engr.

WBOS(FM)—Co-owned with WUNR. 1955: 92.9 mhz; 12 kw. Ant 880 ft. Format: Contemp. Prog sep from AM.

Cambridge

WCAS—May 15, 1967: 740 khz; 250 w-D. 620 Massachusetts Ave. (02139). (617) 492-6450. Kaiser Bcstg Corp. (group owner; acq 6-1-73). Format: Folk & folk/rock. Spec prog: Black ½ hr wkly. ■ Merrill G. Smith, gen mgr; Richard Starr, prog dir; Judith Brackley, news dir; Moe Shore, mus dir. ■ Rates: \$17; 17; 17.

WHRB-FM—May 1957: 95.3 mhz; 3 kw. Ant 110 ft. Stereo. 45 Quincy St. (02138). (617) 495-4818. Harvard Radio Bcstg Co. Inc. Rep: Mith. Format: Variety. Spec prog: Sp 2 hrs wkly. ■ David J. Bertram, pres & chief engr; Robert S. Goldfarb, stn mgr; Steve Littlejohn, mgng ed of news.

WJIB(FM)—See Boston.

***WTBS(FM)**—April 10, 1961: 88.1 mhz; 10 w. 3 Ames St (02142). (617) 253-4000. WTBS Foundation Inc. Format: Variety. ■ Barry A. Blesser, pres; David K. Gifford, gen mgr.

Chicopee

WACE—Dec 1, 1946: 730 khz; 5 kw-D. Box 1, Springfield, Mass. (01101). (413) 781-2240. Tele-Measurements Inc. (acq 2-17-64). Net: CBS. Rep: Meeker, Messina. Format: News, Solid Gold. Spec progs: Pol 8 hrs; Portuguese 2 hrs; Black 4 hrs; Greek ½ hr, wkly. ■ Jack R. Poppel, pres; Philip A. Zoppi, gen mgr; Richard Pecenak, prog dir; John Lingua, mus dir; Don Edwards, chief engr.

Concord

***WIGH(FM)**—88.3 mhz; 10 w. (617) 369-2440. Concord-Carlisle Regional School District.

Dudley

***WNRC(FM)**—1975: 91.1 mhz; 10 w. Dudley Hill Road (01570). Nichols College.

East Longmeadow

WTYM—1947: 1600 khz; 5 kw-D. 45 Fisher Ave. (01028). (413) 525-4141. Executive Bcstg Corp. (acq 8-20-63). Net: ABC/I. Rep: McGavren Guild. Format: Adult good mus. ■ Donald Wilks & Michael Schwartz, co-owners; Maureen O'Reill, of mgr; Jim Boldebook, opns mgr; Bob Brooks, mus dir; Fred Stevens, news dir; Ken Jones, chief engr. ■ Rates: \$20; 20; 20; 20.

Easton

***WSHL-FM**—1974: 91.3 mhz; 10 w. Ant 74 ft. 320 Washington St. (02356). (617) 238-2052. Stonehill College. ■ Format: Noncoml diversified. ■ Robert Mattaliano, gen mgr.

Fall River

WALE—May 6, 1948: 1400 khz; 1 kw-D, 250 w-N. Box 208, 130 Rock St. (02722). (617) 674-3535. Keynote Bcstg Inc. (acq 11-20-62). Net: MBS. Rep: Savalli/Gates; Segal. Format: info/adult music. Spec progs: Fr 1 hr, Pol 2 hrs, Portuguese 5 hrs wkly. ■ Col. Milton E. Miller, pres; Raymond J. Cheney, VP & gen mgr; Bill Tutt, VP sls & opns; George Taylor, prog dir; Dick Kingman, news dir; Carmela Bond, treas & office mgr; Hector Gauthier, prod & mus dir; Steve Sorel, chief engr. ■ Rates: \$16.20; 12.15; 16.20; 9.70.

WSAR—1921: 1480 khz; 5 kw-U, DA-2. Box 927 (02722). (617) 677-9477. Quality Radio Corp. (acq 2-25-65). Group owner: Knight Quality Net: ABC/C. Rep: Torbet; Knight Sls. Format: Contemp; Top 40. ■ Norman Knight, pres; Gordon Reid, gen mgr; Mary Murphy, coml mgr; Jack Michaels, prog dir; Curt Hansen, mus dir; Jim Murphy, news dir; Bob Saulniers, chief engr. ■ Rates: \$17; 15; 17; 11.

Falmouth

WCIB(FM)—1970: 101.9 mhz; 50 kw. Ant 240 ft. Stereo. Spring Bars Rd. (02540). (617) 548-3102. New England Media Corp. (acq 8-8-74). Rep: Northeast Spot Sls. Format: MOR, Gold. ■ Ken Patch, pres & gen mgr; Claudia Bearse, bus mgr; Herb Andrews, stn mgr. ■ Rates: \$10; 10; 10; 10.

Fitchburg

WEIM—October 1941: 1280 khz; 5 kw-D, 1 kw-N, DA-1. Box 727 (01421). (617) 343-3766. Knight Communications Corp. (group owner; acq 6-59). Net: ABC/C. Rep: Torbet; Knight. Format: Contemp. Spec progs: Sp 1 hr, Black 1 hr, Fin 1 hr, wkly. ■ Norman Knight, pres; Frank Filippone, gen mgr; Chris Sinnett, sls mgr; Jack Raymond, prog dir; Ray Chailfoux, prom mgr; Tony Mitchell, mus dir; Ted Kalin, chief engr. ■ Rates: \$12; 10; 12; 8.

WFGL—February 1950: 960 khz; 1 kw-U, DA-2. 170 Prichard St. (01420). (617) 343-4897. WFGL Inc. (acq 11-1-62). Net: MBS. Rep: Eckels & Queen. Format: MOR. ■ George I. Chatfield, pres; John O'Day, gen mgr; Ed Brougher, prog & mus dir; Francis E. Boyle, prom mgr; Scott May, news & mus dir; Richard Weatherbee, chief engr. ■ Rates: \$11; 11; 11; 11.

WFMP(FM)—Co-owned with WFGL. August 1960: 104.5 mhz; 50 kw. Ant 280 ft. Format: C&W. Dups AM 50%. ■ Jean Laverne, prog dir. ■ Rates same as AM.

Framingham

***WJDM-FM**—1973: 91.3 mhz; 10 w. Framingham State College (01701). (617) 875-6028. Format: Variety. ■ Randall Disch, gen mgr.

WKOX—April 1947: 1190 khz; 1 kw-D. 100 Mt. Wayte Ave. (01701). (617) 879-2222. Fairbanks Bcstg Co. (group owner; acq 1-71). Net: MBS. Rep: Creed. Format: MOR. Spec prog: Ital ½ hr; Sp ½ hr, wkly. ■ Richard M. Fairbanks, pres; George M. Corwin, VP & gen mgr; Al Fraser, prog & mus dir; Al Johnson, sls mgr; Jim Robbins, news dir; Francis W. Bartol, chief engr.

WVBF(FM)—Co-owned with WKOX. 1960: 105.7 mhz; 10.5 kw. Ant 950 ft. Stereo. Prog sep from AM. Rep: McGavren-Guild. Format: Contemp. ■ Jay Williams, stn mgr; John Gillis, prog dir; Charlie Kendall, mus dir; Mark Davis, news dir.

Franklin

***WGAO(FM)**—Fall 1975: 91.3 mhz. 10 w. Ant 95 ft. 99 Main St. (02038). (617) 528-9100 ext 239. Dean Jr College. ■ Alfred D. Nicholson, dean; Roger Turner, chief engr.

Gardner

WGAW—1946: 1340 khz; 1 kw-D, 250 w-N. Box 87, Green St. (01440). (617) 632-1340. New England Bcstg Co. (acq 11-59). Format: Contemp. Spec prog: Fr ½ hr wkly. ■ Douglas J. Rowe, pres; Don Boutwell, gen mgr; Kenneth Ash, prog dir; Gordon Wiley, chief engr.

Gloucester

WVCA-FM—Sept 14, 1964: 104.9 mhz; 3 kw. Ant 50 ft. 185 Main St. (01930). (617) 283-3700. Simon Geller. Format: Classcl. ■ Simon Geller, gen & coml mgr & chief engr. ■ Rates: \$—; 7.50; —; 15.

Great Barrington

WSBS—December 1957: 860 khz; 250 w-D. Box 297 (01230). (413) 528-0860. Berkshire Bcstg Co. (acq 9-12-68). Net: MBS. Format: MOR. ■ Donald A. Thurston, pres; John T. Ryan, mgr; Thomas Jaworski, news dir; Jack Seeley, chief engr.

Greenfield

WHAI—May 15, 1938: 1240 khz; 1 kw-D, 250 w-N. Box 32 (01301). (413) 774-4301. Haigis Bcstg Corp. Net: CBS. Rep: Market 4; Kirby. Format: MOR. Spec progs: C&W 15 hrs, Pol 1 hr wkly. ■ John W. Haigis Jr, pres; Charles D. Prentice Jr, gen mgr; Dennis McGahan, coml mgr; William Wiles, stn mgr; Ray Godin, news dir; Leland Wheeler, chief engr. ■ Rates: \$8.40; 7.15; 7.15; 3.90.

WHAI-FM—May 15, 1948: 98.3 mhz; 1 kw. Ant minus 240 ft. Dups AM 100%. ■ Rates same as AM.

Haverhill

WHAV—1947: 1490 khz; 1 kw-D, 250 w-N. 30 How St. (01830). (617) 374-4733. WHAV Bcstg Co. Inc. (acq 1954). ■ Henry Silver, pres; Edward Cetlin, gen & coml mgr & prog dir; Edwin Johnson, news dir; Russell Cooper, chief engr.

WHAV-FM—June 1959: 92.5 mhz; 50 kw. Ant 350 ft. Prog sep from AM. Stereo.

Holyoke

WREB—1950: 930 khz; 500 w-D. Box 507, 300 High St. (01040). (413) 536-3930. Algonquin Bcstg Corp. (acq 8-27-65). Net: MBS. Rep: Devney. Format: MOR, talk. Spec prog: Fr 5 hr wkly. ■ Joseph H. Alfano, pres; Edward Perry, stn mgr; B. Heister, prog dir; Wayne Dennis, sports dir; Richard LaVigne, news dir; Tracy Cole, chief engr.

Hyannis

WCOD-FM—June 2, 1967: 106.1 mhz; 25 kw. Ant 125 ft. Stereo. 105 Stevens St. (02601). (617) 775-6800. Kotcom Bcstg Inc. (acq 7-1-71). Net: ABC/C. Rep: Knight Quality Slis. Format: Top 40. ■ Dana M. Kott, pres, gen mgr & mus dir; Stephen S. Dane, sls mgr; Deven Black, news dir; Michael Ward, chief engr. ■ Rates: \$13; 13; 13; 13.

Lawrence

WCCM—August 1947: 800 khz; 1 kw-D. 33 Franklin St. (01840). (617) 683-7171. Curt Gowdy Bcstg Corp. (group owner; acq 5-31-63). Net: MBS. Format: MOR. Spec progs: Sp 1 hr, Talk 14 hrs, wkly. ■ Curt Gowdy, pres; Charles E. Dent, Luke Griffin, ops mgr; Norman Round, chief engr. ■ Rates: \$14; 12.50; 14; —.

WCGY(FM)—Co-owned with WCCM. April 1960: 93.7 mhz; 50 kw. Ant 430 ft. Stereo. (617) 729-9470. Prog sep from AM. Rep: ABC-FM Spot Slis. Format: Contemp. ■ Rates: \$13; 15; 15; 13.

WLLH—See Lowell.

Leominster

WLMS—Nov 13, 1967: 1000 khz; 1 kw-D. Box 1000 (01453). (617) 537-4141. Nashua Valley Bcst Inc. Net: ABC/I. Rep: Segal. Format: Good music/news. Spec progs: Fr 1 hr; Irish 3 hrs, wkly. ■ James A. Fitzgerald Jr, VP & gen mgr; Charles Carey, coml mgr; Don Stevens, prog dir; Don DiMonda, prom mgr; Paul Bourke, news dir; Herb Anderson, chief engr.

Lowell

WCAP—June 10, 1951: 980 khz; 1 kw-D. 243 Central St. (01852). (617) 454-0404. Northeast Radio Inc. Audio news: UPI. Rep: PRO/Meecker; Kettell-Carter. Format: MOR; Talk. ■ Israel Cohen, pres & gen mgr; Maurice Cohen, treas & sls mgr; Robert Dumais, prog & mus dir; Pauline Yates, ops mgr; Frank Coletta, news dir; Ted Cohen, chief engr. ■ Rates: \$ 11.25; 9.50; 9.50; —.

WLLH—1934: 1400 khz; 1 kw-D, 250 w-N. Box 1400 (01853). (617) 458-8486. WLLH Inc. (acq 7-1-63). Rep: Masla; Eckels & Queen. Format: Top 40. Spec prog: Sp 1 hr wkly. ■ Arnold S. Lerner, pres; Albert N. Armstrong, sls mgr. ■ Rates: \$12; 10; 12; 10.

WSSH(FM)—Co-owned with WLLH. 1947: 99.5 mhz; 39 kw. Ant 550 ft. Stereo. Box 1401 (01853). Prog sep from AM. Format: Btfl music. ■ Frank Messina, ops dir. ■ Rates: \$20; 25; 25; 20.

***WLT(FM)**—Dec 6, 1967: 91.5 mhz; 1.7 kw. Ant 39 ft. Stereo. 1 Textile Ave. (01854). (617) 459-0579. Lowell Tech Inst. Net: NPR; Pacifica. Format: Progs; Rock. Spec prog: Fr 1 hr wkly. ■ Robert Flagg, gen mgr; Phillip Goudreau, prog dir; Nancy Wolochowicz, prom mgr; Nick Fountas, mus dir; Brian Phillips, news dir; Kevin McNamara, chief engr.

WSSH(FM)—Listing follows WLLH.

Lynn

WLYN—November 1947: 1360 khz; 1 kw-D. Box 631 (01903). (617) 595-6200. Puritan Bcst Service Inc. Net: ABC/E. Rep: Bill Creed Assoc. Format: MOR; Variety; Italian. Spec progs: Gk 2 hrs; Portuguese 2 hrs; Sp 2½ hrs, wkly. ■ Paul A. Feinstein, pres & coml mgr; Irving W. Kaizer, gen & coml mgr; Bill Anthony, prog & mus dir; Jim Mann, news dir; Richard Levy, chief engr.

WLYN-FM—Aug 5, 1963: 101.7 mhz 2.64 kw. Ant 180 ft. Dup AM 33%. Format: Foreign language; C&W; Variety. Spec progs: Ital 18 hrs, Sp 2 hrs, Gk 17 hrs, Port 2 hrs wkly.

Massachusetts Radio

See page C-1 for explanation of listings.

Marlboro

WSRO—Jan 1958: 1470 khz; 1 kw-D, DA. 42 Curtis Ave. (01752). (617) 485-1470. WSRO Inc. (acq 12-1-62). Group owner: New England Bcstg Co. Audio news: UPI. Format: MOR. Spec prog: Portuguese 2½ hrs wkly. ■ Douglas J. Rowe, pres; Thomas M. McAuliffe, gen mgr; Don Wilson, asst gen mgr; Alan Harris, prog dir; Mervin T. Avants, chief engr. ■ Rates: \$6.25; 6.25; 6.25; —.

Maynard

***WAVM(FM)**—April 1974: 91.7 mhz; 10 w. Ant 43 ft. Great Rd. (01754). (617) 897-5213. Maynard Public Schools School Committee. Format: Noncoml diversified. Spec prog: Classcl 1 hr, Pol 2 hrs, C&W 2 hrs, wkly. ■ Joseph Magno, pres; Robert Gately, Gary Meakin, gen mgrs.

Medford

***WMFO(FM)**—March 1971: 91.5 mhz; 10 w. Ant 75 ft. Box 65 (02153). (617) 625-8566. Trustees of Tufts. Format: Progs. ■ Robert T. Shea, gen mgr; Manuel Rodriguez, prog dir; Larry Rosenberg, prom mgr; Steve Carr, mus dir; John Dineen, news dir; Robert Kiel, chief engr.

WWEL—Jan 20, 1952: 1430 khz; 5 kw-D. 99 Revere Beach Parkway (02155). (617) 396-1430. Conant Bcstg Co. Inc. Format: MOR. ■ Sherwood J. Tarlow, pres; Joseph Kruger, gen mgr; Arnie Ginsburg, stn mgr; Peter Casella, coml mgr; Chris Hall, chief engr. ■ Rates: \$15; 16; 16; 16.

WWEL-FM—Sept 1, 1960: 107.9 mhz; 21 kw. Ant 710 ft. Prog sep from AM. ■ Rates: \$20; 23; 23; 16.

Milford

WMRC—Oct 6, 1956: 1490 khz; 1 kw-D, 250 w-N. 11 Congress St. (01757). (617) 473-1490. Milford Radio Corp. (acq 12-1-61). Rep: National Time Slis; NE Spot Slis. Format: MOR. Spec prog: Port 1 hr wkly. ■ Lawrence Shane, pres & gen mgr; Edward Thompson, news dir; Kenneth G. Goodman, chief engr. ■ Rates: \$7.50; 7.50; 7.50; 7.50.

Milton

***WMLN-FM**—1975: 91.5 mhz; 10 w. Ant 100 ft. 848 Brush Hill Rd. (02186). Curry College. Format: Progs; top 40. Spec progs: Classcl, jazz. ■ John S. Hafer, pres; Paul A. Kaschul, gen mgr.

Natick



WGR1—November 1972: 1060 khz; 1 kw-D. (CP: 50 kw-D, 5 kw-N, DA-2). 24 West Central St. (01760). (617) 655-2500. Home Service Bcstg Corp. Format: Contemp. Spec prog: Talk 5 hrs wkly. ■ John H. Garabedian, pres & gen mgr; John N. Garabedian, treas; Craig K. Howard, sls mgr; Doris G. Carlson, pub aff dir; Donald J. Kelley, prog dir; Jim McAllister, news dir; Mark Parenteau, mus dir; Robert M. Lund, chief engr. ■ Rates: \$16; 13; 16; 16.

New Bedford

WBSM—July 17, 1949: 1420 khz; 5 kw-D, 1 kw-N, DA-2. Pope's Island. (02740). (617) 993-1767. Your Good Neighbor Stns. (acq 1971). Rep: Market 4. Format: Contemp, talk. Spec prog: C&W 12 hrs wkly. ■ Bruce M. Lyons, pres; Robert F. Nims, gen & coml mgr; Dick Stevens, prog dir; Jim Phillips, news dir; Greg Lynam, chief engr.

WGCY(FM)—Feb 22, 1949: 97.3 mhz; 50 kw. Ant 285 ft. 270 Union St. (02740). (617) 997-2929. Edmund Dinis. Rep: Webb; Kettel-Carter (Boston). ■ Edmund Dinis, owner; Antonio A. Costa, gen mgr & prog dir.

WMYS—Listing follows WNBH.

Massachusetts Radio

See page C-1 for explanation of listings.

WNBH—May 21, 1921: 1340 khz; 1 kw-D, 250 w-N, 737 County St. (02740). (617) 999-5228. New Bedford Radio Inc. (acq 10-1-66). Group owner: Hall. Net: ABC/I. Rep: PRO Time Sis. Format: MOR. Spec progs: Pol 1½ hrs; Port 11 hrs, wkly. ■ Robert Hall, pres; Donald Laufer, exec VP; Paul Levesque, VP & gen mgr; Robert Eisner, sis mgr; Len Thomas, prog dir; John Kahn, news dir; Herve Leduc, chief engr.

WMYS(FM)—Co-owned with WNBH. Dec 9, 1946: 98.1 mhz; 50 kw. Ant 500 ft. Progs sep from AM. Net: ABC/FM. Spec prog: Port 5 hrs wkly.

Newbury

***WQLI(FM)**—1974: 88.7 mhz; 10 w. Ant 55 ft. Elm St., Byfield, Mass. (01922). (617) 465-8789. Governor Drummer Academy. Format: Variety. ■ Jack Ragle, headmaster; Mark Manuelian, chief engr.

Newburyport

WNBP—March 10, 1957: 1470 khz; 500 w-D, 54 Pleasant St. (01950). (617) 462-6654. Tri-City Bcstg Corp. Net: ABC/E. Rep: Creed Assoc. Format: C&W; MOR; Variety. ■ Paul A. Feinstein, pres; Irving W. Kaizer, gen & coml mgr; Roger Parmelee, prom mgr & prog dir; Ed Sternfelt, news dir; Rick Levy, chief engr.

Newton

WNTN—April 1, 1968: 1550 khz; 10 kw-D, 143 Rumford Ave. (02166). (617) 969-1550. Newton Broadcasting Corp. (acq 9-25-75). Rep: Jed Radio. Format: Progs. Spec progs: Ital 1 hr; Sp 1 hr, wkly. ■ Orestes T. Demetriadis & John A. Booras, et al, owners; R. William Freston, gen sis mgr; Clifton Power, prog dir; Lawrence Cox, mus dir; Donald Cohen, pub serv & news dir; George Norton, chief engr.

***WZBC(FM)**—April 1974: 90.3 mhz; 10 w. Ant 67 ft. CP: 1 kw. Ant 220 ft.). Box C-158 Chestnut Hill (02167). (617) 332-3419. Trustees of Boston College. Net: Ivy. Format: Educl, progs. Spec prog: Black 6 hrs wkly. ■ Douglas Tanger, gen mgr; Peter Weisburg, bus mgr; Steve Evers, sis mgr; Bill DiMondi, prog dir; Beth Parker, mus dir; David Papandrea, sports dir; Ellis Gabovich, chief engr.

North Adams

***WJJW(FM)**—Sept 25, 1973: 89.5 mhz; 10 w. N. Adams State College (01247). (413) 663-9885. Licensee as above. Format: Progs. Spec progs: C&W 4 hrs; Jazz and Blues, 6 hrs, Black 3 hrs, classcl 6 hrs, wkly. ■ James T. Amster, pres; William A. Gould, gen mgr; Kevin E. Porter, prog dir.

WMNB—Nov 23, 1947: 1230 khz; 1 kw-D, 250 w-N, 466 Curran Hwy. (01247). (413) 663-6567. Berkshire Bcstg Co. Inc. (acq 7-22-66). Audio news: APR. Rep: Piano; Kirby. Format: MOR. ■ Donald A. Thurston, pres & gen mgr; Arlon C. Nelson, prog dir; Ronald W. Plock, news dir; A. Paul Willey, chief engr. ■ Rates: \$7; 7; 7; 7.

WMNB-FM—July 12, 1964: 100.1 mhz; 1 kw. Ant 480 ft. Stereo. Box 707. Prog sep from AM. Format: Beautiful mus. ■ Andre L. Speyer, mgr. ■ Rates same as AM.

North Andover

***WMMC(FM)**—March 17, 1972: 90.5 mhz; 10 w. Ant 58 ft. Box 911. Merrimack College (01845). (617) 683-8900. Bd of Trustees—Merrimack College. Format: Progs. Spec prog: Irish 3 hrs wkly. ■ James Greeley, moderator; Joseph Capone, stn mgr.

North Dartmouth

***WUSM(FM)**—September 1974: 90.5 mhz; 10 w. Ant 71.5 Old Westport Rd. (02747). Southeastern Massachusetts U. Format: Progs. Spec prog: Classcl 3 hrs; jazz 3 hrs, folk 3 hrs, wkly. ■ Daniel J. Roush, gen mgr.

Northampton

WHMP—December 1950: 1400 khz; 1 kw-D, 250 w-N, 78 Main St. (01060). (413) 584-4275. Pioneer Valley Bcstg Co. Net: ABC/I. Rep: Market 4; Kirby. For-

mat: MOR. Spec prog: Pol 3 hrs wkly. ■ Charles W. DeRose, pres & gen mgr; Andrew H. Wiernasz, coml mgr; Joseph T. Fennessey, stat mgr & prog dir; Dave Madsen, prom mgr; Glenn Cardinal, mus dir; Ronald D. Hall, news dir; Richard Rzeszutek, chief engr. ■ Rates: \$10; 8; 10; 8.

WHMP-FM—Nov 1, 1956: 99.3 mhz; 3 kw. Ant 300 ft. Dups AM 100%. Stereo. ■ Rates same as AM.

Orange

WCAT—May 13, 1956: 1390 khz; 1 kw-D, Box 90 (01364). (617) 544-2321. Berkshire Bcstg Co. Inc. (acq 12-13-69). Audio news: APR. Rep: Piano; Kirby. Format: MOR. ■ Donald A. Thurston, pres; Donald Domina, news dir; Andrew Leckart, chief engr. ■ Rates: \$6.50; 6.50; 6.50; 6.50.

Orleans

WVLC—April 10, 1970: 1170 khz; 1 kw-D, DA, Box 1170 (02653). (617) 255-3220. Seashore Bcstg Co. Inc. Audio news: APR. Format: Adult, news. ■ Howland B. Jones Jr., gen mgr & chief engr; Gordon Benoit, news dir; Ted Bell, prog dir. ■ Rates: \$12.17; 12.17; 12.17; 12.17.

WVLC-FM—July 25, 1974: 104.7 mhz; 50 kw horiz, 36 kw vert. Ant 300 ft. Stereo. Dups AM 100%. ■ Rates same as AM.

Pittsfield

WBEC—March 1947: 1420 khz; 1 kw-U, DA-N, 211 Jason St. Box 958 (01201). (413) 443-9595. WBEC Inc. (acq 4-15-61). Net: ABC. Rep: Webb; Kettel-Carter. Format: Contemp. Spec progs: Ital 2 hrs; Black ¼ hr, wkly. ■ R. S. Jackson, pres; Ronald A. Stratton, VP & gen mgr; Kent Thurston, prog dir; Thomas Twinam, news dir; Phil Weiner, coml mgr; Stanley Jarvis, chief engr.

WQRB(FM)—Co-owned with WBEC. October 1967: 105.5 mhz; 630 w. Ant 590 ft. (413) 443-9597. Prog sep from AM. Format: MOR. ■ Betsy Thompson, coml mgr; Alan Vaber, prog dir.

WBRK AM-FM

CBS RADIO

WBRK—Feb 20, 1938: 1340 khz; 1 kw-D, 250 w-N, Box 987 (01201). (413) 442-1553. Greylock Bcstg Co. (acq 11-1-58). Net: CBS. Audio news: APR. Rep: PRO/Meeker; New England Spot. Format: Upbeat MOR. Spec progs: Pol 1½ hrs; Black ½ hr, wkly. ■ E. H. Close, pres; Howard Shultis, VP & gen mgr; Ronald Lee, prog & mus dir; Goerge Burgoon, chief engr.

WBRK-FM—Oct 10, 1970: 101.7 mhz; 3 kw. Ant 145 ft. Dups AM 80%.

WGRG—Sept 9, 1971: 1110 khz; 1 kw-D, Box 1186, 73 Fourth St. (01201). (413) 499-1531. Radio Pittsfield Inc. Rep: Fulford; Northeastern Spot Sis. Format: Progs. ■ Jerry Graham, pres; Mike Adelson, gen exec.

WGRG-FM—1975: 95.9 mhz; 710 w. Ant 560 ft. Format: Progs. ■ Glen Lambert, prog dir; Ken Marks, mus dir; Dan Keilletter, chief engr.

WQRB-FM—Listing follows WBEC.

Plymouth

WPLM—Aug 8, 1955: 1390 khz; 5 kw-U, DA-2, Pilgrim Hwy. (02360). (617) 746-1390. Plymouth Rock Bcstg Co. Rep: Piano, Kirby. Format: MOR. ■ John T. Campbell, pres & gen mgr; Jane Day, coml mgr; Phyllis Elwell, news dir; Gary Collard, prog dir; Norman Guimond, chief engr.

WPLM-FM—June 25, 1961: 99.1 mhz; 50 kw. Ant 430 ft. Dupes AM 100%.

Quincy

WJDA—Sept 13, 1947: 1300 khz; 1 kw-D, Box 130 (02169). (617) 479-1300. South Shore Bcstg Co. Rep: Kirby. Format: Variety. ■ James D. Asher Jr., pres & gen mgr; Kenneth P. Fallon Jr., coml mgr; H. Winslow Bettinson, prog dir; Herbert Fontaine, news dir; A. Fred Lane, chief engr. ■ Rates: \$12; 12; 12; —.

Rockland

***WRPS(FM)**—February 1974: 91.5 mhz; 10 w. Ant 90 ft. 34 Goddard Ave. (02370). (617) 871-0541. Rockland Public Schools. ■ Stephen J. Budkiewicz, gen mgr.

Salem

WESX—Jan 1, 1939: 1230 khz; 1 kw-D, 250 w-N, Box 710 (01970). (617) 744-1230. North Shore Bcstg Corp. (acq 4-1-50). ■ Ruth S. Asher, owner; Norman Durkee, chief engr.

Sheffield

***WBSL(FM)**—September 1973: 91.7 mhz; 10 w. Ant 50 ft. Godman Hall, Undermountain Rd. (01257). (413) 229-6683. Berkshire School Inc. Format: Variety. Spec prog: Black 4 hrs; Jazz 10 hrs, C&W 4 hrs, wkly. ■ Thomas H. Dixon, gen mgr; Frank Marra, chief engr.

Southbridge

WESO—March 20, 1955: 970 khz; 1 kw-D, 399 Main St. (01550). (617) 764-4381. WESO Bcstg Corp. Rep: Fulford; Creed. Format: MOR. Spec progs: Fr 3 hrs; Pol 4 hrs; C&W 3 hrs wkly. ■ Peter A. Bordes, pres; Roger Lataille, gen mgr; William Richard, coml mgr; Russ Dowd, prog, mus & news dir; Richard Lavallee, chief engr.

WESO-FM—Nov 1, 1968: 100.1 mhz; 3 kw. Ant 295 ft. Stereo. Prog sep from AM. Format: Beautiful mus.

South Hadley

***WMHC(FM)**—May 14, 1957: 90.7 mhz; 10 w. (CP 91.5 mhz). Mount Holyoke College (01075). (413) 538-2044. Trustees of Mount Holyoke College. Net: IBS. Format: Progs. Spec prog: Black 10 hrs wkly. ■ Carolyn Hotchkiss, gen mgr; Jill Beebe, bus mgr.

Springfield

WACE—See Chicopee.

***WAIC(FM)**—February 1967: 91.9 mhz; 130 w. Ant 66 ft. 170 Wilbraham Rd. (01109). (413) 736-6255. American International College. Net: ABC/FM. Format: Progressive; Black. ■ Glenn S. Linder, gen mgr; Elliott Francis, prog dir; Leon Glasse, mus dir; Robert G. Merns, news dir; Bruce Felper, chief engr.

WAQY(FM)—Dec 17, 1966: 102.1 mhz; 27 kw. Ant 650 ft. Stereo. 45 Fisher Ave., East Longmeadow, Mass. (01028). (413) 525-4141. Executive Bcstg. (acq 10-7-72) Net: ABC/C. Rep: McGavren-Guild. Format: Top 40. ■ Michael E. Schwartz, pres; Robb Richards, coml mgr; Donald L. Wilks, gen mgr; Jim Boldenbook, prog dir; Bob Brooks, mus dir; Fred Stevens, news dir; Ken Jones, chief engr.

WHYN—1941: 560 khz; 5 kw-D, 1 kw-N, DA-2, 1300 Liberty St. (01101). (413) 785-1911. TWX 710-350-1369. WHYN Stns Corp. (acq 7-11-67). Group owner: Gannett. Rep: Blair. Format: Contemp. Spec prog: Relig 3 hrs wkly. ■ George H. Anderson, exec VP; James A. Kontoleon, VP & gen mgr; Phillip G. Drumheller, stn mgr; Robert Charest, prog dir; Durham Caldwell, news dir; Ted Gratkowski, chief engr.

WHYN-FM—1946: 93.1 mhz; 10 kw. Ant 940 ft. Prog sep from AM. Stereo. Format: Easy Istng. ■ WHYN-TV affil.

WMAS—Sept 1, 1932: 1450 khz; 1 kw-D, 250 w-N, 101 West St. (01104). (413) 737-1414. Valley Bcstrs Inc. (1-4-74). Net: ABC/E. Rep: Torbet; Creed. Format: MOR. Spec progs: Ger 1 hr, Sp ½ hr, Black ½ hr, GK ½ hr, Irish 2 hrs, wkly. ■ Marvin Sameth, pres; Zachary W. Land, gen & coml mgr; Stan Brooks, prog & mus dir; Joanne Spear, news dir; Charles Voboril, chief engr. ■ Rates: \$21; 21; 21; 21.

WMAS-FM—Dec 1, 1947: 94.7 mhz; 22 kw. Ant 170 ft. Stereo. Dups AM 100%. (acq 2-25-67). ■ Rates same as AM.

***WSCB(FM)**—March 1, 1958: 89.9 mhz; 10 w. Box 1703, Springfield College (01109). (413) 732-1000. Pres & Trustees of Springfield College. Format: Black & Progressive rock. ■ David B. Borofsky, gen mgr; Mike Walwer, sports dir; Elliott Dalynple, prog dir; James Reinaver, bus mgr; Lisa Swartz, traf mgr; Elliott Baker, music dir; Clayton Benton, educ dir; David Moffat, chief engr.

WSPR—June 1936: 1270 khz; 5 kw-D, 1 kw-N, DA-2. 63 Chestnut St. (01103). WSPR Inc. Rep: Eastman; Kettell-Carter. ■ Alan C. Tindal, pres & gen mgr; James Kirby, coml mgr; Mike Connors, prog dir; Sy Becker, news dir; Valentino Partyka, chief engr. ■ Rates: \$30; 25; 17.

***WTCC(FM)**—Aug 19, 1972: 90.7 mhz; 4 kw. Ant 115 ft. One Armory Square (01105). (413) 736-2783. Springfield Technical Community College. Net: Mutual Black. Format: Progs, Black, Free Form. Spec progs: Talk 2 hrs, jazz 4 hrs, classcl 2 hrs, gospel 4 hrs wkly. ■ Bruce Blanchard, gen mgr; Steven Soskowsky, prog dir; Nancy Gardner, traf mgr; Michael Beaulieu, news dir; Mark Wienasz, music dir; William Farrington, chief engr.

***WTRZ(FM)**—Oct 1, 1975: 89.1 mhz; 10 w. Ant 80 ft. Wilbraham Rd. (06119). (413) 783-4183 or 4084. Western New England College. Audio News: APR. Format: Progs, diversified. ■ Scott Harris, gen mgr; Paul Donovan, chief engr.

WTXL—See West Springfield.

Stockbridge

***WCWL(FM)**—April 1, 1975: 91.3 mhz; 1.45 kw. Ant 4 ft. 200 Stockbridge Rd., Lenox (01240). Berkshire Christian College. Format: Relig. ■ Dr. Garth Stordy, advisor; George Karl, stn mgr; David Vermilea, prom mgr; Dr. Russell Humphreys, chief engr.

Taunton

WPEP—Dec 22, 1949: 1570 khz; 1 kw-D, 49 Broadway (02780). (617) 824-7528. Silver City Bcstg Corp. Rep: Kirby, Format: MOR. Spec progs: Talk 3 hrs, Jazz 1 hr, Port 1 3 hrs, wkly. ■ Marguerite H. T. McGregor, owner & gen mgr; Richard Mulcahey, coml mgr; J. Marshall McGregor, stn mgr; Ruth Cushman, mus dir; Beth McGregor, prog dir & asst mgr; John Shaw, news dir; Richard Anderson, chief engr. ■ Rates: \$5.45; 5.45; —.

WRML(FM)—Jan 26, 1966: 93.3 mhz; 50 kw. Ant 340 ft. Box 2 (02780). (617) 822-5341. Audio Air Inc. Rep: Fulford; New England Spot Sis. Format: MOR. Spec progs: Port 1 hr, classcl 2½ hrs, Sp 1 hr, wkly. ■ Lucy P. McCarthy, pres; Joseph G. Quill, VP & gen mgr; Robert W. Newsham, coml mgr; Bruce Newbury, prog & mus dir; John F. McCarthy, treas; Louis Bienvenue, chief engr.

Tisbury

WVOI(FM)—July 1974: 95.5 mhz (CP: 92.7 mhz); 3 kw. Ant 279 ft. Edgartown Rd. (02568). Wasque Corp. ■ J. Robert Windsor, pres.

Walpole

***WWVA(FM)**—1975: 91.5 mhz; 17 w. 1303 Washington St. (02081). Walpole Public Schools.

Waltham

***WBRS(FM)**—Feb 5, 1968: 91.7 mhz; 10 w. 415 South St. (02154). (617) 647-2148. Brandeis U. Net: ABC/FM. Format: Progressive. Spec prog: Black 14 hrs wkly. ■ Don Weber, gen mgr; Fred Kessler, bus mgr.

WHET—1948: 1330 khz; 5 kw-U, DA-2. 750 South St. (02154). (617) 893-7080. Charles River Bcstg Co. (acq 1951). Audio news: UPI. Format: MOR. Spec progs: Sports 14 hrs avg, Sp ½ hr wkly. ■ Theodore Jones, pres; Richard L. Kaye, exec VP; Charles G. Pye Jr., gen & coml mgr; Bette Day, dir womens activities; Greg Jones, prog & mus dir; Kevin P. Mostyn, chief engr.

WCRB(FM)—1951: 102.5 mhz; 11 kw. Ant 920 ft. Stereo. Format: Diversified. Spec prog: Black 7 hrs, jazz 7 hrs, Sp ¼ hr, wkly. ■ Robert Smith, gen mgr; John Donofrio, ntl mgr; David Tucker, prog dir; Robert Goldfarb, mus dir; Manny Biderman, prom mgr; David MacNeill, news dir.

Ware

WARE—July 11, 1948: 1250 khz; 1 kw-U, DA-N. 90 South St. (01082). (413) 967-6231. Central Bcstg Corp. (acq 2-1-63). Rep: Piano; Northeast Spot Sis. Format: MOR, Top 40. Spec progs: Fr 2 hrs; Pol 10 hrs; Ger 2 hrs, Portuguese 2 hrs, C&W 2 hrs, wkly. ■ Allan W. Roberts, pres; Richard Vaughan, exec VP &

gen mgr; Dave Hanah, coml mgr; Gary James, prog dir; J. P. Ellery, news dir; Ed Hurt, chief engr. ■ Rates: \$15; 13; 15; 10.

Wellesley

***WZLY(FM)**—Not on air target date 2-76: 91.5 mhz; 10 w. Box 59 (02181). (617) 235-9150. Wellesley College. Audio news: APR. Format: Diversified, rock. ■ A. Monana Freyre, gen mgr; Eliane McDonough, chief engr.

Westfield

WDEW—December 1957: 1570 khz; 1 kw-D, 90 Elm St. (01085). (413) 568-8443. Radio Westfield Inc. (acq 7-21-66). Rep: Piano, Segal. Format: MOR. Spec progs: Ger 1½ hrs, Ital 1 hr, Pol ½ hr, wkly. ■ Alan W. Roberts, pres & gen mgr; Marlin Bollinger Jr., prog dir; Peter Aron, news dir; Burt Landry, chief engr.

***WSKB(FM)**—October 1974: 91.5 mhz; 10 kw. Ant 130 ft. Western Ave. (01085). Pres and Trustees of Westfield State College.

West Springfield

WTXL—Aug 28, 1949: 1490 khz; 1 kw-D, 250 w-N, DA-D. 34 Sylvan St. (01089). (414) 739-1935. Communications Industries Inc. (acq 3-70). Net: ABC/C. Rep: PRO Time Sis. Format: Contemp. Spec progs: Black 2 hrs; Port 2 hrs, wkly. ■ Howard S. Shulman, pres & gen mgr; Tom Loubier, coml mgr; John Allen, prog dir & prom mgr; Gerald Tower, mus & news dir; John Michnovic, chief engr.

Weston

***WRSB(FM)**—Sept 17, 1975: 88.3 mhz; 10 w. Ant 45 ft. 333 Winter St. (12193). (617) 235-7190. Rivers Country Day School. Format: Noncoml diversified. Spec prog: jazz 3 hrs wkly. ■ Greg Cahill, stn mgr; Alan Swartz, chief engr.

West Yarmouth

WOCB—1940: 1240 khz; 1 kw-D, 250 w-N. 278 South Sea Ave. (02673). (617) 775-0500. Sea-Mount Radio Corp. (acq 7-15-70). Net: ABC/E. Rep: Webb; Kettell-Carter. Format: MOR. ■ Chester S. Miller, pres & gen mgr; G. Wesley Stonstone, stn mgr; John L. Kuhn, gen sls mgr; Edgar Sémprini, news dir; Burton Fisher, chief engr. ■ Rates: \$11.50; 9.50; 10.50; 9.50.

WOCB-FM—1948: 94.9 mhz; 14 kw. Ant 245 ft. (CP: 50 kw). Dups AM 70%. Stereo. ■ Rates: \$4.75; 4.75; 4.75; 4.75.

Williamstown

***WCFM(FM)**—Sept 8, 1958: 91.9 mhz; 440 w. Ant minus 750 ft. Stereo. William College (01267). (413) 458-4820. Pres & Trustees of Williams College. Net: ABC/FM, Ivy. Format: Progs/Undergrnd. Spec progs: Black 10 hrs, C/W 1 hr wkly. ■ David Studenmund, pres; Wayne Lilley, mus dir & gen mgr; Bill Goodell, prog dir; Hank Korth, news dir; A. Paul Willey, chief engr.

Winchester

***WHSR-FM**—May 1, 1956: 91.9 mhz; 10 w. 80 Skillings Rd. (01890). (617) 729-9303. Winchester School Dept. Format: Progs. ■ David Frary, gen mgr; Peter Vee, prog dir.

Worcester

WAAB—1931: 1440 khz; 5 kw-U, DA-2. 34 Mechanic St. (01608). (617) 752-5611. Southern Mass. Bcstrs. (acq 9-7-11). Net: CBS. Rep: Eastman; Creed. Format: Talk, News. ■ George Gray, pres; Donald Kane, VP & gen mgr; Kris Ryan, prog dir.; Tom Cragin, chief engr. ■ Rates: \$12; 10; 12; 7.

WAAF(FM)—Co-owned with WAAB. June 15, 1961: 107.3 mhz; 16.5 kw. Ant 780 ft. Prog sep from AM. Stereo. Net: ABC/FM. Format: Progs. ■ Joseph Capobianco, prog dir; Patti Geier, news dir. ■ Rates: \$12; 14; 14; 14.

***WCWU(FM)**—Dec 5, 1973: 91.3 mhz; 80 w. Ant minus 37 ft. 950 Main St. (01610). (617) 793-7585. WCWU Inc. Format: Variety. Spec prog: Classcl 5 hrs wkly. ■ John Levin, pres, prog dir; George Sard, gen mgr; Owen Maercks, mus dir; Gary Corsini, news dir; Ralph Cohen, comm rel dir; Eric Blom, chief engr.

Massachusetts, Michigan Radio

See page C-1 for explanation of listings.

***WICN(FM)**—Nov 21, 1969: 90.5 mhz; 2 kw. Ant 16 ft. (CP: Ant 370 ft) Stereo. 75 Grove St. (01605). WICN Public Radio Inc. Format: Classcl, educ, progs. Spec progs: Black, 5 hrs, jazz 3 hrs, Pol 1 hr, Sp 2 hrs, It 1 hr, East Indian 1 hr, Lithuanian 2 hrs, Irish 3 hrs, women 1½ hrs, wkly. ■ Donald V. Reid, pres; Thomas M. Devin Jr., gen mgr; Carole M. Letteney, prog dir; Mark Allyn, chief engr; Roberta Beam, mus dir; Richard Courtemanche, news dir.

WNEB—Dec 18, 1946: 1230 khz; 1 kw-D, 250 w-N. 405 Main St. (01604). (617) 756-4672. WNEB Inc. (acq 1965). Rep: Web, Kettell-Carter. Format: C&W. Spec progs: Pol 1 hr; Irish 1 hr; Middle East 1 hr, Greek 1 hr, Scandinavian, 1 hr, Jewish ¼ hr, wkly. ■ Harold D. Glidden, pres & gen mgr; Mark L. Drew, coml mgr; Paul Stanford, news dir; Jerry Kopoyan, chief engr. ■ Rates: \$11; 11; 11; 9.

WORC—February 1925: 1310 khz; 5 kw-D, 1 kw-N, DA-2. 8 Portland St. (01606). (617) 799-0581. Knowles Bcstg Co. Inc. (acq 4-69). Rep: McGavren-Guild. Format: Contemp. Spec progs: Sp 1 hr, Portuguese 1½ hrs, Greek 1½ hrs, Albanian ½ hr wkly. ■ Roger Knowles, pres; Edward T. Deedy, gen mgr; Fred Botwinik, coml mgr; Richard Smith, prog dir; Dick Smith, mus dir; Philip Lagios, news dir; Bruce Callahan, chief engr. ■ Rates: \$19; 19; 19; 15.

WRSR(FM)—June 17, 1940: 96.1 mhz; 25 kw. Ant 640 ft. Stereo. Box 961, West Side Stn. (01602). (617) 757-6321. Knight Communications Corp. (group owner; acq 3-63). Rep: Torbet; Knight Sis. Format: Adult. ■ Norman Knight, pres; John I. Flynn, gen & coml mgr; Lester I. Ross, prog dir; John Patrick, news dir; Robert Nystrom, chief engr.

WTAG—May 1, 1924: 580 khz; 5 kw-U, DA-2. 20 Franklin St. (01613). (617) 791-5521. Worcester Telegram & Gazette Inc. Net: NBC. Rep: Blair. Format: MOR. Spec prog: C&W 2 hrs wkly. ■ Robert W. Booth, VP & exec dir; Herman H. Kramer, sls mgr; Richard F. Wright, stn mgr & prog dir; Thomas F. Gorman, mus dir; Donald Richards, news dir; John Andrews, chief engr. ■ Rates: \$22.50; 17.75; 20; 9.50.



Michigan

Adrian

WABJ—Nov. 13, 1946: 1490 khz; 1 kw-D, 250 w-N. 121 W. Maumee St. (49221). (517) 265-7123. Gerity Bcstg Co. (acq 3-47). Net: ABC/U. Audio news: APR. Rep: Mich Spot Sis. Format: MOR. Spec progs: Sp 4 hrs; farm 3½ hrs wkly; black ½ hr monthly. ■ James J. Murtagh, pres; William O. Murtagh, exec VP; Donald Aspacher, VP & stn mgr; Dan Baker, chief engr; Thomas Smith, mus dir; Michael Freedman, news dir.

WABJ-FM—Not on air, target date March 1, 1976: 95.3 mhz; 3 kw. Ant 300 ft. Stereo. Format: Btlf mus.

WLEN(FM)—June 10, 1965: 103.9 mhz; 3 kw. Ant 265 ft. Box 374 (49221). (313) 263-1039. Lenawee Bcstg Co. Net: MBS. Format: Contemp, C&W. Spec prog: Sp 3 hrs wkly. ■ John W. Koehn, pres; Richard D. Lackie, stn mgr; Jerold Rice, chief engr; Douglas Spade, prog dir; John Kushell, news dir.

***WVAC(FM)**—Feb. 13, 1967: 88.1 mhz; 10 w. Speech Dept., Adrian College, 110 S. Madison St. (49221). (313) 265-5161, ext. 440. Adrian College Bd of Trustees. Net: MBS. Format: Variety. Spec progs: Black 1 hr wkly. ■ Roger Wallace, dir of bcstg.

Albion

WALM—Nov. 2: 1952: 1260 khz; 1 kw-D. 500 w-N, DA-N. Irwin Ave. (49224). (517) 629-3945. Triad Stns

Michigan Radio

See page C-1 for explanation of listings.

Inc. (acq 1-1-63). Rep: Broadcast Time Inc. Max Goldfarb. Format: Good music. ■ C. Wayne Wright, pres; Richard Watson, VP & gen mgr; Judy McPeak, coml mgr; Gary Grice, sis mgr; Paul Landino, news dir; Alan Mather, prog dir & chief engr.

WUFN(FM)—May 4, 1971: 96.7 mhz; 3 kw. Ant 300 ft. (CP 1.2 kw. Ant 460 ft.). 2255 North Concord Rd. (49224). (517) 531-4478. Family Life Bcstg System. Format: Relig. Spec prog: Sp ½ hr; classcl 6 hrs wkly ■ Warren Bolthouse, pres; Daniel Uhtar, gen mgr; Randy Carlson, prog & mus dir; Bill Harrier, prom mgr; Douglas Nickelson, news dir and chief engr.

Allendale

***WSRX(FM)**—October 5, 1974: 88.5 mhz; 10 w. Ant 110 ft. Stereo. Grand Valley State Colleges (49401). (616) 895-4239. Board of Control of Grand Valley State Colleges. Format: Progs. Spec progs: Black 3 hrs; French 1 hr wkly ■ Jeff Ross, gen mgr.

Alma

WFYC—Aug 17, 1948: 1280 khz; 1 kw-D. Box 629 (48801). (517) 463-3175. WFYC Inc. (acq 8-14-57). Net: ABC/C. Mich Farm. Net. Rep: Hopewell. Format: MOR. Spec prog: Farm 4 hrs wkly. ■ Wayne G. Harris, pres; Gilbert E. Thomas, gen mgr; David W. Sommerville, stn mgr; Jon Heintlen, prog dir; Larry Franklin, news dir; Bill Keiser, chief engr. ■ Rates: \$72;72;72.

WFYC-FM—November 1964: 104.9 mhz; 3 kw. Ant 300 ft. Dup AM 50%.

Alpena

WATZ—1946: 1450 khz; 1 kw-D, 250 w-N. (49707). (517) 354-8400. Midwestern Bcstg Co. (group owner). Net: NBC, Paul Bunyan. Rep: Torbet. Format: MOR, top 40, variety. Spec progs: Ger 1 hrs; Polish 2 hrs, wkly. ■ Les Biederma, pres; John E. Walkmeyer, gen mgr; Russell Loomis, bus mgr; Ralph Diethelm, stn mgr; Bob Edwards, mus dir; Dick Manning, news dir; William H. Kiker, chief engr. ■ Rates: \$8.10;6.10;8.10;6.10.

WATZ-FM—1967: 93.5 mhz; 3 kw. Ant 255 ft. Dup AM 60%. Stereo. Format: Btfl mus, C&W.

WHSB(FM)—May 1965: 107.7 mhz; 98 kw. Ant 420 ft. 121 Water St. (49707). (517) 356-1551. Huron Shore Bcstrs Corp. Net: ABC/C. Format: MOR. Spec prog: Farm ½ hr; C&W 3 hrs; Pol 2 hrs wkly. ■ Harvey A. Klann, pres, & chief engr; Jerry Winder, gen and coml mgr; Tom Tolen, news dir. ■ Rates: \$4;4;4.

Ann Arbor

WAAM—October 1947: 1600 khz; 5 kw-U, DA-2. Box 1600 (48106). (313) 971-1600. WAAM Inc. (acq 5-1-72). Net: ABC/C. Rep: Alan Torbet. Format: Rock. ■ John L. Sinclair Jr., pres; Robert L. Sinclair, gen mgr.

***WCBN-FM**—January 1972: 89.5 mhz; 10 w. Stereo. 530 Student Activities Bldg. (48104). (313) 763-3501. Regents of the U of Michigan. Format: Variety. Spec progs: Sp 2 hrs; Black 5 hrs; native Indian 1 hr; women 1 hr, wkly. ■ Ross Ojeda, gen mgr.

WIOB(FM)—Co-owned with WNRS Saline. March 1962: 102.9 mhz; 10 kw. Ant 155 ft. Stereo. Box 5 (48107). (313) 663-0569. Community Music Service Inc. (group owner; acq 11-1-74). Net: ABC/FM. Format: Progs. Dup AM 55%. ■ Stuart D. Goldberg, gen mgr. ■ Rates: \$7.80;6.50;7.80;7.80.

WPAG



American
Information
Radio Network

WPAG—April 26, 1945: 1050 khz; 5 kw-D, DA. 3rd Floor, Hutzler Bldg. (48108). (313) 662-5517. Washtenaw Bcstg Co. Inc. Net: ABC/I. Rep: Pro/Meeker, Mich Spot Sls. Format: MOR. ■ Edward F. Baughn, pres & gen mgr; James L. Baughn, stn and coml mgr; Charles King, prog dir; Ted Heusel, news

dir; Jerry McCarty, chief engr. ■ Rates: \$14.50;13.50;14.50;13.50.

WPAG-FM—Feb 14, 1967: 107.1 mhz; 3 kw. Ant 260 ft. Dup AM from 6 a.m. to 7 p.m. Format: C&W (evenings). ■ 14.50;13.50;14.50;5.25.

***WUOM(FM)**—1948: 91.7 mhz; 230 kw. Ant 470 ft. 5501 L.S.A. Bldg. (48104). (313) 764-9210. The Regents of U. of Michigan. Format: Fine arts/educ. ■ Hazen Schumacher, dir of bcast; Evelyn Titus, bus mgr; Tom Hemingway, sports dir; Frank Nader, chief transmitter engr; Neal T. Bedford, mgr; E. G. Burrows, exec prod; Fred Remley, tech dir; Stephen V. Skelley, mus dir; Fred Hindley, news dir.

Auburn Heights

***WAHS(FM)**—1975: 89.5 mhz; 10 w. 2950 Waukegan St. (48057). Avondale School District.

Bad Axe

WLEW—1950: 1340 khz; 1 kw-D, 250 w-N, DA-D. 935 S. Van Dyke Rd. (48413). (517) 269-9931. Thumb Bcstg Co. (acq 9-1-71). Rep: Mich. Spot Sls. Format: Contemp. Spec prog: Pol 2 hrs wkly. ■ A. Arthur Ayman, pres, gen & coml mgr; Tom Meyer, stn mgr; Tom Lane, news dir; John T. Vobbe, chief engr. ■ Rates: \$6.35;6.35;6.35;6.35.

WLEW-FM—1956: 92.1 mhz; 3 kw. Ant 210 ft. Dup AM 20%. Format: MOR. ■ Rates: \$4.30;4.30;4.30;4.30.

Battle Creek

WBCK—July 9, 1948: 930 khz; 5 kw-D, 1 kw-N, DA-2. 390 Golden Ave. (49015). (616) 963-5555. Michigan Bcstg Co. Net: NBC. Rep: Masla. Format: MOR. ■ E. F. Cahill, gen mgr; David Eddy, prog dir; O. James Cleaver, news dir; Harley Hammond, chief engr.

WDFF(FM)—See listing following WVOC.

WKFR-FM—See listing following WKNR.

WKNR—October 1925: 1400 khz; 1 kw-D, 250 w-N. 710 Michigan Bank Bldg. (49015). (616) 964-7173. Engineering Investment Corp. (acq 6-1-66). Net: ABC/C. Rep: Pro Time Sls, Michigan Spot Sls. Format: Contemp. ■ Joseph A. Waldschmitt, pres; Kent Kanaga, gen mgr; Rick D'Amico, prog dir; Walter Ahlers, coml mgr; Dave Thomas, mus dir; Joe Landon, news dir; Prior Taylor, chief engr. ■ Rates: \$13;11;13;11.

WKFR-FM—Co-owned with WKNR. June 11, 1963: 103.3 mhz; 31 kw. Ant 72 ft. Stereo. Prog sep from AM. Format: MOR. ■ Rates: \$6.25;6.25;6.25;6.25.

WVOC/WDFF

WVOC—Nov 22, 1963: 1500 khz; 1 kw-D, DA. Box 17 (49016). (616) 962-6267. WVOC Inc. Net: MBS. Rep: Smith. Format: C&W, variety. ■ Don F. Price, pres & gen mgr; D. Burdette Price, mgr; John R. Loser, chief engr. ■ Rates: \$5.75;5.75;5.75;5.75.

WDFF(FM)—Co-owned with WVOC. March 1975: 95.3 mhz; 3 kw. Ant 270 ft. Stereo. (616) 965-0527. Format: Btfl mus, relig. ■ Mary Ann France, traff dir. ■ Rates same as AM.

Bay City

WBCM—June 5, 1925: 1440 khz; 1 kw-D, 500 W-N. Box 1440 (48706). (517) 894-2922. Tri Media Inc. (acq 7-1-73). Net: ABC/C. Rep: Masla. Format: Contemp. ■ Robert G. Liggett Jr., pres; Daniel F. Covell, gen mgr; Chris Martin prog dir.

WHNN(FM)—Co-owned with WBCM. June 15, 1960: 96.1 mhz; 97 kw. Ant 420 ft. Quad. (517) 894-2996. Format: Contemp, top 40, rock. ■ Frank H. Imburg, gen mgr; Gerald D. Arnold, coml mgr.

***WCHW-FM**—September 1, 1973: 91.3 mhz; 10 w. Ant 124 ft. 1624 Columbus Ave. (48706). (517) 893-9544. Bay City Public School District. Format: Contemp, Top 40, progsv. ■ Lawrence E. Sundberg, gen mgr; Cliff Saladine, chief engr.

WGER-FM—Nov. 12, 1961: 102.5 mhz; 86 kw. Ant 800 ft. (CP 740 ft.). Box 719 (48706). (517) 892-4501. Gerity Bcstg Co. Rep: McGavren-Guild. Format: Beautfl mus. ■ Gale Sullivan, VP & gen mgr; Kenneth

Fornier, prog dir; Cliff Houser, opns dir; James A. McLachlan, chief engr. ■ Rates: \$18;18;18;18.

WHNN(FM)—Listing follows WBCM.

WXOX—Nov. 26, 1956: 1250 khz; 1 kw-D. Box 1250 (48706). (517) 893-4588. Gateway Bcstg Co. (acq 12-10-69). Rep: H-R/Stone. Format: Contemp C&W. ■ Donald K. Mayle, exec VP; Dusty Rhodes, prog dir; Noble Gravelin, off mgr; Dave Kennedy, mus dir; Dave Maurer, news dir; Robert Friedle, chief engr. ■ Rates: \$18;16;18;—.

Benton Harbor

WHFB—Sept. 22, 1947: 1060 khz; 5 kw-D, 1 kw CH. Box 608 (49022). (616) 927-3581. Palladium Pub Co. Net: ABC/I. Rep: Pro/Meeker, Michigan Spot Sales. Format: MOR, variety. ■ Willard J. Banyon, pres; J. P. Scherer, gen mgr; Kent Slocum, dir of opns; Donald Cowden, chief engr.

WHFB-FM—Oct. 10, 1947: 99.9 mhz; 9.2 kw. Ant 225 ft. Stereo. Dup AM 10%. Net: ABC/FM. Format: MOR, beautfl mus. Spec prog: Ger 1½ hrs wkly.

Berrien Springs

***WAUS(FM)**—Jan. 10, 1971: 90.9 mhz; 17 kw. Ant 290 ft. Stereo. Box 113 (49103). (616) 471-3400. Andrews Bcstg Corp. Net: NPR. Format: Classcl, info, relig. ■ Wayne Woodhams, gen mgr and prog dir; Max J. Church, dir of dev.

Big Rapids

WBRN—Jan. 6, 1953: 1460 khz; 1 kw-D. 13574 Northland Dr. (49307). (616) 796-7684. WBRN Inc. (acq 10-1-55). Rep: Michigan Spot Sales. Format: MOR. ■ John A. White II, pres & gen mgr; Douglas Wilson, coml mgr; Garnet Zimmerman, chief engr. ■ Rates: \$4.50;4.50;4.50;4.50.

WBRN-FM—September 1964: 100.9 mhz; 3 kw. Ant 300 ft. Dup AM 65%.

Birmingham

WHNE(FM)—Sept 1, 1958: 94.7 mhz; 49 kw. Ant 300 ft. Stereo (CP 10 kw. Ant 960 ft.). Box 404 (48012). (313) 588-8100. TWX 810-232-5206. Greater Michigan Radio Inc. (acq 7-3-73). Group owner: Greater Media Inc. Rep: McGavren-Guild. Format: Gold. ■ Peter A. Bordes, pres; Chuck Borchard, gen mgr; Tom Miles, prog dir; Tom Campbell, news dir; Irving Laing, opns mgr.

Bloomfield Hills

***WBFH(FM)**—Not on air; target date unknown: 88.1 mhz; 10 w. 4175 Andover Rd. (48013). Bd of Educ of Bloomfield Hills School District.

Cadillac

WATT—September 1945: 1240 khz; 1 kw-D, 250 w-N. Box 520 (49601). (616) 775-7831. Mid-western Bcstg Co. (group owner). Net: NBC, Paul Bunyan. Rep: Torbet. Format: Contemp. Spec progs: C&W 6 hrs, relig 7 hrs wkly. ■ Les Biederma, pres; John E. Walkmeyer, gen mgr; Stanton C. Smart, stn & prom mgr; Nicholas Sinnacorri, mus dir; Richard Foltz, news dir; William H. Kiker, chief engr; R. F. Bartz, stn engr.

WITW(FM)—July 7, 1974: 96.7 mhz; 3 kw. Ant 295 ft. 116 N. Mitchell (49601). (616) 775-3443. Chief Pontiac Bcstg Corp. Format: Contemp, beautfl mus. ■ I. T. Wedin, pres; Richard K. Conder, stn mgr; Glenard Walker, chief engr. ■ Rates: \$4.40;4.40;4.40;4.40.

WKJF(FM)—See listing following WWAM.

WWAM—May 26, 1968: 1370 khz; 5 kw-D, 1 kw-N, DA-2. Box 627 (49601). (616) 775-3478. Fetzer Bcstg Co. (group owner). Net: CBS. Audio news: APR. Format: MOR. Spec prog: Farm 1 hr wkly. ■ Carl E. Lee, pres; Gene Ellerman, VP & gen mgr; Lyle Poag, sis mgr; Bob Lee, news dir; Mike Paulin, prom mgr; Lowell Shore, chief engr. ■ Rates: \$8; 7; 8; 7.

WKJF(FM)—Co-owned with WWAM. Oct 15, 1961: 92.9 mhz; 100 kw. Ant 895 ft. Dup AM 100%. Stereo. ■ WWTV(TV) & WWUP-TV affil. ■ Rates same as AM.

Caro

WKYO—May 19, 1962: 1360 khz; 500 w-D. 101 N. State St. (48723). (517) 673-2136. Tuscola Bcstg Co.

Net: Michigan Farm Radio. Format: MOR, loc news, farm, sports, C&W. ■ Robert Benkelman, pres; Glenn Tryon, VP & mgr; Fred McMullen, coml mgr; James Laracey, prom mgr; Mike Thorp, mus dir; John Bowles, news dir.

WKYO-FM—Oct 16, 1974: 104.9 mhz; 3 kw. Ant 300 ft. Format: Standards, loc news.

Charlevoix

WVOY Contemporary Music

WVOY—July 20, 1974: 1270 khz; 5 kw-U, DA-N. 211 Bridge St. (49720). (616) 547-4454. New Bcstg Corp. Format: Contemp. ■ Terry L. Edger, pres, gen mgr & chief engr; Tim E. Moore, coml mgr; John Carille, mus dir; Robert F. White, news dir. ■ Rates: \$7; 7; 7; 7.

Charlotte

WCER—Aug 25, 1956: 1390 khz; 5 kw-D, DA. Box 218 (48813). (517) 543-0340. Eaton County Bcstg Co. Net: ABC/E & MBS, Mich. Farm. Rep: Pearse Sis. Format: MOR. Spec progs: Farm 12 hrs; C&W 7 hrs, wkly. ■ Roy W. McLean, pres; Stanton C. Smart, gen mgr; Mark Taylor, prog and mus dir; Robert Sherwood, news and psa dir; J. Piddington, prom mgr; Dave Huva, chief engr. ■ Rates: \$ 5; 4.80; 4.80; —.

WCER-FM—November 1965: 92.7 mhz; 3 kw. Ant 160 ft. Dups AM 50%. ■ Rates: \$ 5; 4.80; 4.80; 3.90.

Cheboygan

WCBY—Oct 28, 1954: 1240 khz; 1 kw-D, 250 w-N. Box 384 (49721). (616) 627-2341. Net: ABC/I. Rep: Mich Spot Sls. Format: MOR. ■ Richard E. Hunt, pres; Don W. Deinzer, gen mgr; Bob Benedict, coml mgr; Loren Naffziger, prog & news dir; Noel Moss, chief engr.

WCBY-FM—Aug 15, 1968: 105.1 mhz; 25 kw. Ant 105 ft. Prog sep from AM.

Clare

WCRM—Nov 24, 1960: 990 khz; 250 w-D, DA. Box 73 (48617). (517) 386-9907. Mid-Michigan Bcstg Co. (acq 3-23-73). Format: Contemp. C&W. ■ Robert G. Schwartz, pres; William M. Keiser, Jr., gen, coml & prom mgr, prog dir & chief engr; Rick Duerson, mus dir; Marcia Datema, news dir.

WCRM-FM—June 28, 1967: 95.3 mhz; 3 kw. Ant 160 ft. Dups AM 100%.

Coldwater

WANG(FM)—See listing following WTVB.

WTVB—Aug 7, 1949: 1590 khz; 5 kw-D, 1 kw-N, DA-N. Box 1590 (49036). (517) 279-9767. Tri-State Bcstg (acq 4-1-72). Net: ABC/I. Rep: Walton, Pearse. Format: MOR. ■ Paul Ruse, pres & gen mgr; Quin Jones, opns mgr; Jim Keene, chief engr; John Cloghessy, news dir. ■ Rates: \$ 10.65; 7.25; 10.65; 4.40.

WANG(FM)—Co-owned with WTVB. Nov 11, 1950: 98.5 mhz; 50 kw. Ant 490 ft. Prog sep from AM. Format: C&W. ■ Bobby Hankins, prog & mus dir & prom mgr. ■ Rates same as AM.

Dearborn

WNIC—Dec 29, 1946: 1310 khz; 5 kw-U, DA-2. 15001 Michigan Ave. (48128). (313) 846-8500. Johns Communications (acq 5-7-4). Audio news: UPI. Rep: Buckley. Format: Btlf mus. ■ Ed Christian, VP & gen mgr; Ann Mitchell, coml mgr; Sharman Stewart, prom mgr; Jim Brooker, opns mgr; Jerry Martin, chief engr. ■ Rates: \$50; 40; 30.

WNIC-FM—December 1946: 100.3 mhz; 50 kw. Ant 400 ft. Dups AM 50%. ■ Rates same as AM.

Detroit

CKLW-AM-FM—See Windsor, Ontario, Canada.

WABX(FM)—May 4, 1960: 99.5 mhz; 36 kw. Ant 450 ft. Stereo. (CP 5.2 kw. Ant 870 ft.). 20760 Coolidge (48237). (313) 398-1100. Century Bcstg Corp. (group owner; acq 2-16-66). Rep: Century Ntl Sls. Format:

Progs rock. ■ Howard Grafman, pres; John Detz, VP, gen mgr & prog dir; Allan Wilson, stn mgr; George Goulson, prom mgr; Donna Harris, mus dir; James Paffenbarger, chief engr.

WBFQ(FM)—1961: 98.7 mhz; 50 kw. Ant 480 ft. Stereo. 8009 Lyndon Ave. (48238). (313) 863-5650. Trinity Bcstg Corp. (acq 3-11-61). Format: Relig. Spec progs: Farm 1 hr; classcl 1 hr; black 3 hrs wkly. ■ Joseph Ninowski Sr., pres; Dan Ninowski, gen mgr; Norman Leonard, prog dir; Richard Kennedy, chief engr.

WCAR—Dec 17, 1939: 1130 khz; 50 kw-D, 10 kw-N, DA-2. 18900 James Couzens Highway (48235). (313) 345-8600. WCAR Inc. Rep: Eastman.

WCAR-FM—Dec 8, 1964: 92.3 mhz; 10 kw. Ant 480 ft. Prog sep from AM.

WDEE—1925: 1500 khz; 50 kw-D, 5 kw-N, DA-2. 21700 Northwestern Hgwy, Southfield (48075). (313) 557-1500. Globetrotter Communications Inc. (group owner; acq 8-7-3). Net: ABC/I, MBS. Rep: Eastman. Format: Modern country. ■ George Gillett, pres; John Risher, stn mgr; Tom Collins, dir opns; Marie Stevens, coml mgr; Dave Williams, mus dir; Richard Haefner, news dir; Craig Roberts, chief engr. ■ WJBK-TV affil. ■ Rates: \$85; 70; 85; 55.

***WDET-FM**—Dec 18, 1948: 101.9 mhz; 79 kw. Ant 450 ft. 5035 Woodward Ave. (48202). (313) 577-4204. Wayne State U. (acq 5-5-2). Stereo. Net: NPR. Format: Alternative. Spec progs: Sp 1 hr; black 6 hrs; Amer. Indian 1 hr; sr. citizens 1/2 hr; Jewish 1/2 hr; feminist 2 hrs; gay 1/2 hr; children 2 hrs; East Indian 1/4 hr; Ger ethnic 1/2 hr wkly. ■ John B. Buckstaff, stn mgr; Orin D. Hood, Jr., mus dir; James G. Lowlor, exec prod; Michael J. McCoy, opns mgr; Paul J. Grzebiak, chief engr.

WDRQ(FM)—July 9, 1947: 93.1 mhz; 20 kw. Ant 500 ft. 15933 W. 8 Mile Rd. (48235). (313) 272-8000. Bartell Bcstg of Mich. (group owner; acq 2-7-1). Rep: Avco. Format: Contemp. ■ Tom Mosher, gen mgr; Bill Bailey, prog dir; Andy Carpenter, mus dir; Jim Hawk, news dir; Billy Vogel, prog mgr; David Richey, gen sls mgr; Chuck Scott, chief engr.

***WDR(FM)**—Feb 5, 1948: 90.9 mhz; 17 kw. Ant 175 ft. 9345 Lawton Ave. (48206). (313) 494-1570. Board of Education, City of Detroit. Format: Ed. Spec prog: Ethnic 3 hrs wkly. ■ Dr. John McArthur, acting gen mgr; Mary Daly, prog dir; Clifford Wiehr, acting chief engr. ■ *WTVS(TV) affil.

WGPR(FM)—1961: 107.5 mhz; 50 kw. Ant 360 ft. 2101 Gratiot (48207). (313) 961-8833. WGPR Inc. (acq 7-6-4). Stereo. Format: Black, R&B adult. ■ Dr. Wm. V. Banks, pres; James Panagos, VP stn & coml mgr; George E. White, VP, prom mgr; Garry Schmidt, chief engr.

WIID—See Garden City.

WJLB—1926: 1400 khz; 1 kw-D, 250 w-N. 3100 David Broderick Tower (48226). (313) 965-2000. Booth American Co. (group owner; acq 1939). Rep: Torbet. Format: Black, jazz. Spec prog: Relig 8 hrs wkly. ■ John L. Booth, pres; Norman Miller, gen mgr; Charles Sinnamon, gen sls mgr; Jacquelyn Hoston, merchandising; James Reese, news dir; Thomas Christie, chief engr. ■ Rates: \$70; 61; 70; 55.

WMZK(FM)—Co-owned with WJLB. May 1941: 97.9 mhz; 50 kw. Ant 410 ft. Prog sep from AM. (313) 965-4500. (acq 1941). Format: Bi-lingual. ■ James Brown Jr., gen mgr; Jerry Tertzakian, opns dir.

WJR—May 4, 1922: 760 khz; 50 kw-U. 2100 Fisher Bldg. (48202). (313) 875-4440. TWX 313-222-5352. Capital Cities Communications Inc. (group owner; acq 9-9-64). Net: CBS. Rep: Katz. Format: Variety. ■ William R. James, VP & gen mgr; Curt Hahn, stn mgr & prog dir; Richard Rakovan, gen sls mgr; James E. Long, nat sls mgr; W. Hal Youngblood, exec prod; John P. Begin, chief engr; Rose Carriere, sls svc mgr; Dave White, news dir.

WJR-FM—June 1, 1948: 96.3 mhz; 50 kw. Ant 480 ft. Prog sep from AM. Stereo. Format: Good mus. ■ John Dellemonache, prog dir.

WJZZ(FM)—May 26, 1960: 105.9 mhz; 34 kw. Ant 300 ft. 2994 E. Grand Blvd. (48202). (313) 871-0590. Bell Bcstg Co. Rep: Howard. Format: Jazz. ■ Mrs. Haley Bell, pres; Dr. C. Robert Bass, gen mgr; Dennis Jackson, coml mgr; Bill Curtis, prom mgr & prog dir; Bob Dawson, mus dir; Kenneth Nealy, chief engr.

Michigan Radio

See page C-1 for explanation of listings.

WLDM(FM)—Feb 12, 1949: 95.5 mhz; 165 kw horiz, 43 kw vert. Ant 320 ft. Stereo. 15401 W. Ten Mile Rd. (48237). (313) 547-3700. Lincoln Bcstg Co. Rep: Masla. Format: MOR. ■ Harold I. Tanner, pres & gen mgr; Robert J. Conger, coml mgr; Richard Kortjohn, mus and prog dir; Donald Burdick, prog mgr; Alan B. Hendry, news dir; William Chappell, chief engr.

WMUZ(FM)—Nov 11, 1958: 103.5 mhz; 115 kw horiz, 89 kw vert. Ant 300 ft. 12300 Radio Place (48228). (313) 272-3434. WMUZ Radio Inc. Group owner: Crawford Bcstg Co. Format: Relig. Spec progs: Romanian 1/2 hr; Arabic 1 hr; Ger 1/2 hr wkly. ■ Donald B. Crawford, pres; Harry W. Hoot, gen mgr; Steve Van Oort, prog dir; Charles Hopper, chief engr.

WMZK(FM)—See listing following WJLB.

WOMC(FM)—March 5, 1948: 104.3 mhz; 190 kw. Ant 330 ft horiz, 30 ft vert. Stereo. 2201 Woodward Heights Blvd. (48220). (313) 546-9600. Metromedia Inc. (group owner; acq 11-6-72). Rep: Metro Radio Sls. Format: Adult Contemp. ■ George Duncan, pres; Carl C. Brazell Jr., VP & gen mgr; James D. Mulla, coml mgr; Joseph Taylor, prog mgr; Donna Bennett, prom mgr; Bob Chenault, mus dir; Philip Harris, chief engr.

WORS-FM—March 7, 1960: 105.1 mhz; 50 kw. Ant 480 ft. Stereo. 1200 Sixth St, Suite 424 (48226). (313) 962-8282. Fine Arts Bcstrs Inc. Audio news: UPI. Rep: Groskin. Format: Fine arts. ■ Phyllis M. Akers, pres; Stanley R. Akers, VP.

WRIF(FM)—See listing following WXYZ.

WWJ—Aug 20, 1920: 950 khz; 5 kw-U, DA-N. 622 Lafayette Blvd. (48231). (313) 222-2406. TWX 810-221-1640. Evening News Assn. (group owner). Net: NBC. Rep: Christal, McDermott (Canada). Format: News/information. ■ Don F. DeGroot, VP & gen mgr; Nat A. Sibbold, stn mgr; John Albert, sls mgr; Peter A. Kizer, asst gen mgr; W. Sibert Martens, prog & prod mgr; R. Williams, prom mgr; Thomas Becherer, news dir; Leo Rymarz, chief engr.

WWJ-FM—May 9, 1941: 97.1 mhz; 12 kw. Ant 890 ft. Prog sep from AM. Stereo. Format: MOR. ■ Peter A. Kizer, stn mgr. ■ WWJ-TV affil.

WWWW(FM)—Oct 16, 1960: 106.7 mhz; 61 kw. Ant 510 ft. Stereo. 2930 East Jefferson Ave. (48207). (313) 961-4323. Starr Bcstg Group (group owner; acq 5-1-73). Net: ABC/C. Audio news: APR. Rep: CBS-FM Spot Sls. Format: Progs. ■ Peté Starr, pres; Bartley D. Walsh, gen mgr; Carol Booker, coml mgr; Paul Christy, prog dir; Jerry Lubin, mus dir; Carmen Harlan, news dir; Greg Urbiel, chief engr.

WXYZ—Oct 10, 1925: 1270 khz; 5 kw-U, DA-N. 20777 W. Ten Mile Rd., Southfield, Mich. (48075). (313) 444-1111. TWX 313-357-4605. WXYZ Inc. (acq 7-22-46). ABC-owned. Net: ABC/E. Rep: Blair. Format: MOR, Contemp. ■ Charles D. Fritz, VP & gen mgr; Jay Hoker, gen sls mgr; Mike Kincaid, natl sls mgr; Lillian Vires, traf mgr; Joseph Bacarella, opns dir; Michael G. Waterkotte, prom mgr; Don Patrick, news dir; Russell Harbaugh, chief engr. ■ Rates: \$130; 70; 100; 35.

WRIF(FM)—Co-owned with WXYZ. Jan 1, 1948: 101.1 mhz; 27.2 kw. Ant 880 ft. Stereo. (313) 444-1010. Net: ABC/FM. Rep: ABC-FM Spot Sls. Prog sep from AM. Format: Progs rock. ■ Jack Minkow, gen mgr; Barbara Collins, traf mgr; Rick Kaufman, gen sls mgr; Gloria Johnson, mus dir; Bill Johnson, news dir. ■ WXYZ-TV affil.

Dowagiac

WDOW—September 1960: 1440 khz; 1 kw-D. Box 150 (49047). (616) 782-5106. Dowagiac Bcstg Co. Inc. Group owner: Kuiper Stns. Rep: WFUR Inc., Grand Rapids. Format: MOR, talk. ■ William Kuiper, pres; Roland Earnst, gen & coml mgr, prog dir and chief engr. ■ Rates: \$4.25; 4; 4.25; —.

WDOW-FM—January 1971: 97.7 mhz; 3 kw. Ant 300 ft. Box 150 (49047). Dups AM 95%. ■ Rates: \$ 4.25; 4; 4.25; 2.85.

Drayton Plains

***WTSDFM**—Sept 18, 1972: 88.1 mhz; 10 w. Ant 125 ft. 2800 Bender Ave. (48020). Board of Education,

Michigan Radio

See page C-1 for explanation of listings.

Waterford Township School district. Format: Variety. ■ Myron A. Kupelian, gen mgr.

East Lansing

WFMK(FM)—July 16, 1959: 99.1 mhz; 110 kw. Ant 600 ft. Stereo. (CP 28 kw.) Box 991 (48823). (517) 349-4000. Mega Media Inc. (acq 12-15-70). Net: ABC/I. Rep: Masla, Pearse. Format: MOR. ■ Robert G. Liggett Jr., pres; Grant Santimore, coml mgr; Mike Doyle, prog dir; Steve Jackson, mus dir; Leonor Cameron, news dir.

***WKAR**—Aug 18, 1922: 870 khz; 10 kw-D, DA. Michigan State U (48824). (517) 355-6540. Bd of Trustees of Michigan State U. ■ Richard Estell, gen mgr; Steven Meuche, prog dir; Daniel Wardlow, prom mgr; Harold Prentice, mus dir; Steve Jensen, news dir; William Winters, chief engr.

***WKAR-FM**—Oct 10, 1948: 90.5 mhz; 125 kw. Ant 90 ft. Prog sep from AM. ■ WKAR-TV affil.

WVIC—Jan 20, 1965: 730 khz; 500 w-D, DA. 2517 Mt. Hope Ave., Lansing (48910). (517) 487-5986. WGSB Bcstg Co. Net: ABC/C. Audio news: UPI. Rep: Buckley. Format: Contemp, progrs. Spec progrs: Sp 2 hrs, Black 2 hrs wkly. ■ James Morse, pres; Joe D. Buys, VP gen mgr; Mark Shepard, prog dir; Paul Wesenfeld, news and pub aff dir; John Hanley, chief engr. ■ Rates: \$13.80; 12.60; 13.80; 5.75.

WVIC-FM—Nov 16, 1963: 94.9 mhz; 20 kw. Ant 250 ft. Dups AM 100%. Stereo. ■ Rates same as AM.

Escanaba

WBDN—Dec 1, 1958: 600 khz; 1 kw-D, DA. Box 600, 600 Ludington St. (49829). (906) 786-4118. Escanaba Bcstg Co. Net: ABC/C. Audio news: UPI. Rep: Savalli/Gates, Mich. Spot Sls. Format: Contemp, MOR. ■ Leroy J. Nelson, gen mgr; Donald A. Curran, stn mgr; Brady Nelson, mus dir; Peter Denman, opns dir; Wayne Peterson, chief engr.

WDBC—September 1941: 680 khz; 10 kw-D, 1 kw-N, DA-2. Box 680 (49829). (906) 786-6144. Communications Properties Inc. (group owner; acq 9-61). Net: CBS, Mich. Farm Net. Rep: Avery-Knodel, Comm. Sls. Format: MOR. Spec progrs: C&W 10 hrs; farm 4 1/2 hrs wkly. ■ Philip T. Kelly, pres; Gene Kauffman, gen mgr; Joe Demay, prog dir; Dave Andrews, news dir; Robert Haslow, chief engr. ■ Rates: \$9; 8; 9; 6.

Flint

WAMM—Dec 5, 1955: 1420 khz; 500 w-D, DA. 740 S. Saginaw St. (48502). (313) 239-8631. WAMM Inc. Rep: PRO Time Sls, Michigan Spot Sales. Format: R&B, black. ■ Neal Mason, pres; Norman McCarthy, coml mgr; Tony King, prog dir.

WCZN—Nov 11, 1946: 1570 khz; 1 kw-D. Box 1570 (48501). (313) 744-1570. Realin Corp. (acq 9-25-75). Net: MBS. Rep: H/R Stone. Format: Oldies. Spec progrs: Pol 1 1/4 hrs; Gospel 4 hrs wkly. ■ Frazier Reams Jr., John R. Linn, co-owners. ■ Rates: \$18; 16; 18; 16.

WWCK(FM)—Co-owned with WCZN. September 1964: 105.5 mhz; 3 kw. Ant 364 ft Stereo. (313) 744-1055. Net: ABC/FM. Format: Rock. ■ Bill Pearson, prog & mus dir; Bob Douglas, asst prog dir.

***WFBE(FM)**—Oct 5, 1953: 95.1 mhz; 3.7 kw. Ant 115 ft. 605 Crapo St. (48503). (313) 238-1631, ext 303. Flint Board of Education. Net: NPR. Format: Instructional/Cultural. ■ Susan Kilmer, mgr; Edward W. Rauch, chief engr; Sarah E. Andresen, prog dir; John R. Szucs, mus/news dir.

WFDF—May 25, 1922: 910 khz; 5 kw-D, 1 kw-N, DA-2. 406 Garland St. (48502). (313) 232-7158. WFDF Corp. (acq 1-1-74). Net: NBC. Rep: Blair. Format: MOR. Spec progrs: Pol 2 hrs; Sp 1/2 hr wkly. ■ Elmer A. Knopf, pres & gen mgr; Marvin Levey, co-mgr, coml & prom mgr; Daniel J. Hunter, prog & mus dir; Les Root, news dir; Gerald Wolpert, chief engr. ■ Rates: \$35; 28; 35; 23.

WGMZ(FM)—See listing following WKMF.

WKMF—April 10, 1953: 1470 khz; 5 kw-D, 1 kw-N, DA-2. Box 1470, G-3338 E. Bristol Rd. (48501). (313) 742-1470. WKMF Inc. (acq 8-1-68). Group owner:

Beck-Ross Communications. Net: ABC/E. Rep: Masla. Format: C&W. ■ Martin F. Beck, pres; A. William Lee, VP & gen mgr; James E. Taylor, chief engr.

WGMZ(FM)—Co-owned with WKMF Nov 4, 1961: 107.9 mhz; 50 kw. Ant 330 ft. (313) 743-1080. WGMZ Inc. (acq 9-1-71). Format: MOR. ■ Robert F. Crocker, sls mgr.

WTAC—April 26, 1946: 600 khz; 1 kw-D, 500 w-N, DA-2. Box 600 (48501). (313) 694-4146. Fuqua Communications Inc. (group owner; acq 8-8-66). Net: ABC/C. Rep: McGavren-Guild. Format: Contemp, top 40. ■ Joe Windsor, pres; Bryce Cooke, VP & gen mgr; Pete Cavanaugh, prog dir & prom mgr; Joe Franks, news dir; Norm Perry, chief engr.

WTRX—Oct 1, 1947: 1330 khz; 5 kw-D, 1 kw-N, DA-2. Box 1330 (48501). (313) 743-1150. Mid America Media Inc. (group owner; acq 7-3-73). Net: ABC/I. Rep: Eastman. Format: MOR. ■ Burrell L. Small, pres; F. Richard Lee, gen mgr; Jim Mahanay, prog dir; David Gale, chief engr; Art Reid, news dir. ■ Rates: \$22; 18; 22; 15.

WWCK-FM—See listing following WCZN.

Fremont

WSHN—May 23, 1961: 1550 khz; 1 kw-D. Box 280 (49412). (616) 924-4700. Stuart P. Noordyk. Rep: Smith. Format: MOR. ■ Stuart P. Noordyk, pres; Bernie Boersma, gen mgr & prog dir; Joe Seymour, chief engr.

WSHN-FM—1971: 100.1 mhz; 3 kw. Ant 185 ft. Dups AM.

Garden City

WIID Ethnic

WIID—Oct 23, 1963: 1090 khz; 250 w-D, DA. 32500 Park Lane (48135). (313) 525-1111. Grace/Woipin Bcstg Co. (acq 5-1-69). Format: Ethnic, foreign language. Spec progrs: Ital 7 1/2 hrs; Greek 4 hrs; Sp 6 hrs wkly. ■ Harvey Garcia, VP & gen mgr; John Roman, prog & news dir; Geri Zoch, coml mgr; Cecil Wilkenson, chief engr. ■ Rates: \$28; 28; 28; —.

Gaylord

WATC—July 29, 1950: 900 khz; 1 kw-D. Box 536 (49735). 732-5770. Midwestern Bcstg Co. (group owner). Net: NBC. Rep: Torbet. Format: Variety Spec prog: Polka party 2 hrs wkly. ■ Les Biederman, pres; John E. Walkmeyer, gen mgr; Bud Zimmerman, stn mgr; Bob McDonald, news dir; William H. Kiker, chief engr. ■ Rates: \$7.50; 5.65; 7.50; 5.65.

WWRM(FM)—Nov 18, 1972: 106.7 mhz; 50 kw. Ant 570 ft. Box 648 (49735). Alpine Bcstg Co. Rep: Mich. Spot Sls. ■ John D. DeGroot, pres, gen mgr, coml mgr; William Burns, prog & mus dir; Linda Thomas, prom dir; Timothy Maxwell, news dir; John G. Den Heeten, chief engr.

Gladwin

WJEB—July 1975: 1350 khz; 1 kw-D, DA. 3601 W. Woods Rd. (48624). (517) 426-4527. Gladwin Bcstg Co. Format: C&W. Spec prog: Farm 4 hrs wkly. ■ George E. Benko, pres; John David, gen mgr. ■ Rates: \$67.20; 48; 67.20; —.

Grand Haven

WGHN—July 16, 1956: 1370 khz; 500 w-D. 228 1/2 Washington St. (49417). (616) 842-8110. Community Bcstrs Inc. (acq 2-1-64). Rep: Mich. Spot Sls. Format: Contemp. ■ Douglas J. Tjapkes, pres, gen mgr & prog dir; Bill Halbert, sls mgr; Charles Lehner, mus dir; Bob Hecht, news dir. ■ Rates: \$5.15; 4.65; 4.65; 4.65.

WGHN-FM—Jan 28, 1969: 92.1 mhz; 3 kw. Ant 240 ft. Prog sep from AM. Stereo. ■ Rates same as AM.

Grand Rapids

***WCSG(FM)**—June 9, 1973: 91.3 mhz; 20 kw. Ant 285 ft. Stereo. 1001 East Beltline Ave., Northeast (49505). (616) 942-1500. Grand Rapids Baptist College and Seminary. Audio news: UPI. Format: Ed, classical, btfl mus, relig. ■ George R. MacKay, gen mgr & prog dir; John W. Seymour, consulting engr.

WCUZ—February 1945: 1230 khz; 1 kw-D, 250 w-N. 1 McKay Tower (49502). (616) 451-2551. Pathfinder Communications Corp. (group owner; acq 6-10-73). Net: MBS. Audio news: APR. Rep: Eastman. Format: C&W. ■ John F. Dille Jr., pres; Albert F. Schneider, stn & sls mgr; Burton J. Sherwood, VP; John Howard, prog & mus dir; Ric London, news dir; Tom Montgomery, chief engr. ■ Rates: \$35; 33; 29; 23.

WFUR—November 1947: 1570 khz; 1 kw-D. 399 Garfield Ave., S.W. (49504). (616) 456-9541. Furniture City Bcstg Corp. (acq 3-10-50). Group owner: Kuiper.

WFUR-FM—September 1960: 102.9 mhz; 40 kw. Ant 255 ft. Stereo.

WGRD—Nov. 1, 1947: 1410 khz; 1 kw-D. 122 Lyon St., N.W. (49502). (616) 459-4111. Regional Bcstrs of Michigan Inc. (acq 2-6-60). Group owners: Rgnl Bcstrs Group/Rep: Torbet. Format: Contemp. ■ Donald L. Anderson, gen mgr; Bob Malone, sls mgr; Ron White, prog dir; John Seymour, chief engr; Skip Essex, prog mgr. ■ Rates: \$21; 19; 21; 19.

WGRD-FM—August 1, 1962: 97.9 mhz; 19 kw. Ant 410 ft. Dups AM 100%. Stereo. ■ Rates same as AM.

WJFM(FM)—October 1951: 93.7 mhz; 470 kw horiz, 64 kw vert. Ant 780 ft. Broadcast House, 280 Ann St., N.W. (49504). (616) 363-7701. WJFM. Group owner: John E. Felzer Stns. Net: CBS. Rep: Avery-Knodel. Format: Adult. ■ Carl E. Lee, pres & gen mgr; Glenn Gilbert, stn mgr; Bruce M. Glycadgis, opns mgr. ■ Rates: \$9; 12; 12; 9.

WLAW—Sept 18, 1940: 1340 khz; 1 kw-D, 250 w-N. 101-C Waters Bldg. (49502). (616) 456-5461. Shepard Bcstg Corp. (group owner; acq 5-17-63). Net: ABC/C. Rep: McGavren-Guild. Format: Contemp, top 40. Spec prog: Pol 1 hr wkly. ■ Herbert J. Weber, pres & gen mgr; Bob Hamilton, natl prog dir; Bill Donovan, mus dir; John Westman, news dir; Bob McCellan, chief engr; John Leader, prog dir; Mel Vande Gevel, news dir; Dave Boot, stn engr.

WLAW-FM—January 1947: 96.9 mhz; 28 kw. Ant 180 ft. Prog sep from AM. Net: ABC/E. Format: Contemp, progrs. ■ Bill Evans, mus dir.

WMAX—Dec 25, 1954: 1480 khz; 5 kw-D. 210 Federal Square Bldg. (49502). (616) 458-3793. Great Lakes Bcstg Corp. (acq 10-13-70). Net: NBC/NIS, ABC/I. Rep: Blair. Format: All news. Spec progrs: Pol 1 hr; Sp 1 hr; black 30 min wkly. ■ James J. Gaskin, pres & gen mgr; Terry Thompson, coml mgr; Dick McKay, news & prog dir; Dale Scholten, chief engr. ■ Rates: \$12; 9.50; 12; 9.50.

WOOD—October 1924: 1300 khz; 5 kw-U, DA-N. 120 College Ave., S.E. Box B (49501). (616) 459-1919. TWX 810-273-6920. Wood Bcstg (acq 2-15-72). Net: NBC. Rep: Katz. Format: MOR. Spec prog: Farm 5 hrs wkly. ■ Michael O. Lareau, gen mgr; Jim White, coml mgr; Bill Strike, prog dir; Bob Burton, news dir; Jerry Vandersloot, chief engr. ■ Rates: \$50.50; 26; 31.50; 20.

WOOD-FM—Feb 26, 1962: 105.7 mhz; 265 kw. Ant 810 ft. Dups AM 10%. Stereo. Format: Btfl mus. ■ Rates: \$27.50; 27.50; 27.50; 27.50.

***WVGR(FM)**—Dec 7, 1961: 104.1 mhz; 107.5 kw. Ant 600 ft. 5501 LSA Bldg., Ann Arbor, Mich. (48104). (616) 795-3358. Regents of the U. of Michigan. Satellite *WUOM(FM) Ann Arbor. Net: NPR. Format: Fine arts/educl. ■ Hazen Schumacher, dir of bcstg; Neal T. Bedford, gen mgr; Fred Hindley, news dir; Fred Reilly, tech dir; Richard Clarke, chief engr.

WYON(FM)—1965: 101.3 mhz; 50 kw. Ant 420 ft. Box 143, Ionia, Mich. (48846). (616) 897-7526. MacPherson Enterprises Inc. Net: ABC/FM. Rep: Walton, Mich. Spot Sls. Format: MOR. ■ Monroe MacPherson Jr., pres & gen mgr; Douglas Chingo, coml mgr; James Lewis, news dir; John Seymour, chief engr.

WZZM-FM—Feb 28, 1962: 95.7 mhz; 50 kw. Ant 175 ft. (CP 311 ft). Box Z (49501). (616) 364-9551. West Michigan Telecasters Inc. Rep: ProMeeker. Format: Contemp, rock, top 40. ■ George U. Lyons, VP; Robert Wahlfell, stn mgr; Karen Lundquist, coml mgr; Paul Arbanas, prom mgr; Lee Deyoung, prog dir; Bill Gamble, mus dir; Jack Hogan, news dir; Dale Wolters, chief engr. ■ WZZM-TV affil.

Grayling

WGRY—Aug 1, 1970: 1590 khz; 1 kw-D. Route 2,

6514 Old Lake Rd. (49738). (517) 348-6181. Grayling Bcstg Co. Format: MOR. Spec prog: C&W 5 hrs wky. ■ James E. Sylvester, pres & gen mgr; Wayne A. Hindmarsh, VP ■ Rates: \$15; 15; 15.

Greenville

WPLB—May 19, 1960: 1380 khz; 1 kw-D, 500 w-N, DA-N. Box 99 (48838). (616) 754-3656. Flat River Bcstg Co. Rep: Mich. Spot Sls. Format: Contemp, C&W, MOR, progsv, top 40. ■ Pearle C. Lewis, pres; Robert G. Lewis, gen mgr; Larry L. Painter, prog dir; Wilma G. Painter, coml mgr. ■ Rates: \$8.50; 8.50; 8.50.

WPLB-FM—May 22, 1962: 107.3 mhz; 50 kw. Ant 360 ft. Prog sep from AM. Format: C&W. Stereo. ■ Rates same as AM.

Hancock

WMPL—March 2, 1957: 920 khz; 1 kw-D. 326 Quincy St. (49930). (906) 482-3700. Copper County Enterprises Inc. (acq 9-1-69). Net: NBC. Rep: Mich. Spot Sls. Format: Talk/news/info. ■ Joe Blake, pres & coml mgr; Bob Olson, gen mgr & prog dir; Bob Olson, prom mgr; Dick Storm, news dir & chief engr.

WMPL-FM—93.5 mhz; 3 kw. Ant 250 ft. Dups AM 100%.

Harrison

WKKM(FM)—March 26, 1975: 92.1 mhz; 3 kw. Ant 300 ft. 550 E. Larch Rd. (48625). (517) 539-7107. David A. Carmine. Net: ABC/FM. Format: Modern C&W. ■ David A. Carmine, owner and gen mgr; Dave Carr, coml mgr; Bill Rich, ops mgr & news dir; Fred Valli, mus dir; Christine M. Hoskey, traffic dir; William F. Gipperich, chief engr. ■ Rates: \$4; 4; 4.

Hastings

WBCH—November 1957: 1220 khz; 250 w-D. Box 88 (49058). (616) 945-3414. Barry Bcstg Co. (acq 8-17-58). Net: ABC/E. Rep: Mich. Spt Sls. Format: MOR. ■ Kenneth R. Radant, pres & gen mgr; Verna Senior, coml mgr; David McIntyre, prog dir; George Youngs, news dir; Dean Bass, chief engr.

WBCH-FM—December 1967: 100.1 mhz; 1.55 kw. Ant 295 ft.

Highland Park

***WHPR(FM)**—May 21, 1954: 88.1 mhz; 10 w. 12541 Second Ave. or c/o Instructional Materials Center, 20 Bartlett Ave. (48203). (313) 868-1264. School District of the City of Highland Park. Format: Ed. ■ Olga Moir, stn mgr; Greg Byndrian, prog dir; Douglas Schleutker, chief engr.

Hillsdale

WCSR—May 21, 1959: 1340 khz; 500 w-D, 250 w-N. 168 N. West St. (49242). (517) 437-4444. Flynn Enterprises Inc. (acq 11-15-61). Rep: Michigan Spot Sales. Spec prog: C&W 6 hrs wky. ■ Fahey J. Flynn, pres; Tony Flynn, gen mgr; Park Hayes, news dir; Lewis Munn, chief engr.

WCSR-FM—1973: 92.1 mhz; 3 kw. Ant 240 ft.

Holland

WHTC—July 1948: 1450 khz; 1 kw-D, 250 w-N. Box 911-B (49423). (616) 392-3121. Holland Bcstg. Net: MBS. Rep: Hopewell, Keystone. Format: MOR, talk. Spec progs: Sp 2 hrs; farm 2 hrs wky. ■ W. A. Butler, pres; William Gargano, gen mgr & prog dir; Reed Brown, news dir; Julius Van Oss, asst mgr; Dan Coltrane, chief engr. ■ Rates: \$6.25; 6.25; 6.25; 6.25.

WHTC-FM—September 1962: 96.1 mhz; 41 kw. Ant 295 ft. Stereo. Format: Btfl mus. ■ Rates: \$4; 4; 4; 4.

WJBL—Nov 2, 1956: 1260 khz; 5 kw-D, DA. 5658-143rd Ave. (49423). (616) 396-5281. Zonderman Bcstg Corp. (acq 3-6-1). Format: MOR. ■ Peter J. Vanden Bosch, pres, gen & coml mgr & prog dir; Lynn P. Wheaton, news dir; Donald R. Stuursma, chief engr.

WJBL-FM—March 24, 1961: 94.5 mhz; 10 kw. Ant 500 ft. Prog sep from AM. Stereo. Format: Relig.

Houghton

***WGGL-FM**—March 28, 1968: 91.1 mhz; 100 kw. Ant

860 ft. Stereo. Michigan Tech U. (49931). (906) 487-2617. Michigan Tech U. Net: NPR. Format: Variety. ■ Read G. Burgan, dir; James Lienau, engr.

WHDF—1929: 1400 khz; 1 kw-D, 250 w-N. Douglass House (49931). (906) 482-2442. Upper Michigan Bcstg Co. ■ Mrs. John Rice, pres; Roland B. Burgan, gen & coml mgr, news & prog dir & prom mgr. ■ Rates: \$9; 9; 9; 6.

Houghton Lake

WHGR—July 1954: 1290 khz; 4 kw-U, DA-N. 3431 Houghton Lake Drive (48629). (517) 366-5364. Sparks Bcstg Co. Net: ABC/I. Rep: Walton; Mich. Spot Sls. Format: MOR, top 40. Spec progs: Ger 1 hr; C&W 12 hrs wky. ■ Garnet G. Sparks, pres; Gordon B. Sparks, gen mgr; Marcia L. Pike, prog dir; Norman F. Pike, stn mgr; Mike Shaldenbrand, news dir; Harold Kelly, chief engr.

WJGS(FM)—July 1, 1961: 98.5 mhz; 100 kw. Ant 480 ft. Dups AM 5%. Format: Contemp btfl mus.

Howell

WHMI—Feb 17, 1957: 1350 khz; 500 w-D, 201 ½ W. Grand River (48843). (517) 546-0860. B. & H Bcstg Co. (acq 8-1-61). Net: ABC. Rep: Michigan Spot Sales. Format: MOR. ■ Ann H. Bignell, pres & gen mgr. ■ Rates: \$5.25; 5.25; 5.25; 5.25.

Inkster

WCHB—November 1956: 1440 khz; 1 kw-D, 500 w-N, DA-2. 32790 Henry Ruff Rd. (48141). (313) 278-1440. Bell Bcstg Co. Rep: Torbet. Format: Black. ■ Dr. Haley Bell, pres; Wendell Cox, VP & gen mgr; Charles S. Gerber, coml mgr; Bill Williams, prog dir; C. Robert Bass, ops mgr; Gary Shephard, news dir; Eugene K. Nealy, chief engr.

WJZZ(FM)—See Detroit.

Interlochen

***WIAA(FM)**—July 22, 1963: 88.3 mhz; 115 kw. Ant 350 ft. Stereo. (49643). (616) 276-9221, ext 337. National Music Camp. ■ Edward B. Catton, gen mgr; Edward Catton, prog dir; Thomas Torbet, news dir; Angus Forester, chief engr.

Ionia

WION—Feb 1, 1953: 1430 khz; 5 kw-D, DA. Box 143 (48846). (616) 527-4400. MacPherson Bcstg Co. Net: ABC/E. Rep: Walton, Mich. Spot Sls. Format: MOR. ■ Monroe MacPherson, pres & gen mgr; Douglas Ching, coml mgr; James Lewis, news dir; Larry Durbin, chief engr.

Iron Mountain

WJNR-FM—Aug 17, 1972: 103.9 mhz; 560 w. Ant 620 ft. 219 East A St. (49801). (906) 774-5731. J & R Electronics Inc. Audio news: APR. Rep: Mich Spot Sls. Format: MOR. Spec prog: C&W 3 hrs wky. ■ Richard E. Abraham, pres; Norman White, gen mgr; Gary Govanus, news dir; Terry Gruel, chief engr. ■ Rates: \$5.45; 5.45; 5.45; 5.45.

WMIQ—Jan 1947: 1450 khz; 1 kw-D, 250 w-N. 105 E. Kent St. (49801). (906) 774-4321. Iron Mountain-Kingsford Bcstg Co. (acq 9-68). Net: ABC/E. Rep: Pearse. Format: Variety. ■ Charles R. Henry, pres; William C. Johnson, gen mgr & prog dir; John Wallis, coml mgr; John Broderson, mus dir; David Lee Asp, news dir; Paul Anick, chief engr.

Iron River

WIKB—Nov 18, 1949: 1230 khz; 1 kw-D, 250 w-N. Box AC (49935). (906) 265-5104. Northland Adv. Inc. (acq 1-1-65). Group owner: Eugene A. Halker Stns. Net: NBC. Rep: Corbett Sls. Format: Contemp, variety. Spec progs: Pol 5 hrs; C&W 12 hrs wky. ■ Gene Halker, pres; Jay Barry, gen mgr & chief engr; Susan Brzozowski, coml mgr; Doug Damp, prog dir; Kurt Paro, mus dir; Bill Leonoff, news & pub affrs dir.

Ironwood

WIMI(FM)—Listing follows WJMS.

WJMS—Nov 3, 1931: 590 khz; 5 kw-D, 1 kw-N, DA-N. 222 S. Lawrence St. (49938). (906) 932-2411. Heath Communications Inc. (group owner; acq 4-1-70). Rep: PRO/Meeker; Communications Sls. Format: MOR,

Michigan Radio

See page C-1 for explanation of listings.

contemp, variety. Spec progs: Finnish 1 hr; C&W 10 hrs wky. ■ Charles K. Heath, chmn of bd; W. Donald Roberts, pres; Robert M. Knutson, VP & gen mgr; Jerry Cadwell, prog dir; William V. Weirick, news dir; Larry Logemann, chief engr. ■ Rates: \$7.30; 7.30; 7.30; 7.30.

WIMI(FM)—Co-owned with WJMS. Oct 1975: 99.7 mhz; 51 kw. Ant 570 ft. Prog sep from AM. Stereo. Format: Drake-Chenault Hit Parade. ■ Rates same as AM.

Ishpeming

WJPD

Tom Corlett



WJPD—1947: 1240 khz; 1 kw-D, 250 w-N. Box D, 110 Canada (49849), (906) 486-9937. WJPD Inc. (acq 10-1-66). Group owner: Halker Stns. Net: NBC. Rep: Corlette Assoc. Format: C&W, MOR, Top 40. ■ Eugene A. Halker, pres; Lane Dawson, VP, gen & prom mgr & mus dir; John Isaacson, coml mgr; Steve Holmgren, prog & news dir; Louis Roncaglione, chief engr.

WJPD-FM—May 15, 1975: 92.3 mhz; 100 kw. Ant 470 ft. Dups AM 90%. Stereo.

WMQT(FM)—See listing following WUPY.

WUPY—June 26, 1959: 970 khz; 5 kw-D. Box 467 (49849). (906) 485-5523. Taconite Bcstg Inc. (acq 8-8-71). Rep: Mich. Spot Sls. Format: Contemp, talk. ■ William J. Blake, pres, gen & coml mgr; Eric Scott, prog & mus dir; John Evans, news dir; Rich Nelson, chief engr.

WMQT(FM)—Co-owned with WUPY. Jan 26, 1974: 107.1 mhz; 540 w. Ant 630 ft. Dups AM 80%.

Jackson

WHFI(FM)—Listing follows WIBM.

WIBM/WHFI

Booth Broadcasting

WIBM—Nov. 20, 1926: 1450 khz; 1 kw-D, 250 w-N. Box 1450 (49204). (517) 787-1450. Booth Bcstg Co. (group owner; acq 1954). Net: ABC/C. Rep: Torbet. Format: Contemp. Spec progs: Pol 1 ½ hrs; Sp 1 ½ hrs wky. ■ John L. Booth, pres; Wayne H. Blackmon, gen mgr; Gary Osborn, ops mgr; Gary Cochran, coml mgr; Phil Rivers, mus dir; Robert McKinney, chief engr. ■ Rates: \$6; 5; 6; 5.

WHFI(FM)—Co-owned with WIBM. July 14, 1958: 94.1 mhz; 50 kw. Ant 315 ft. Prog sep from AM. Stereo. Format: Btfl mus. ■ Rates: \$6.50; 6.50; 6.50; 6.50.

WJCO—Jan 19, 1963: 1510 khz; 5 kw-D, DA. Box 380 (49204). (517) 783-2621. TWX 810-253-1941. Television Corp. of Michigan Inc. Rep: Rhein. Format: C&W. ■ Edward E. Wilson, pres; William J. Hart, gen mgr; Bill Mack, stn mgr; John Tallierico, news dir; Renwood C. Flagg, chief engr. ■ WILX-TV affil.

WKHM—1951: 970 khz; 1 kw-U, DA-2. 1700 Glenshire Drive (49201). (517) 784-7181. Patten Corp. (acq 6-16-71). Net: MBS. Rep: PRO Time Sls. Mich. Spot Sls. Format: MOR. ■ M. P. Patten, pres; Edwin R. Huse, VP & gen mgr; Roy Hines, prom mgr; Paul Landino, prog dir; M. J. Sims, news dir; Paul Wright, chief engr.

WKHM-FM—106.1 mhz; 20 kw. Ant 180 ft. Dups AM. Spec prog: Pol 1 hr wky.

Kalamazoo

WBUK—See Portage.

***WIDR(FM)**—July 7, 1975: 89.1 mhz; 10 w. Ant 158 ft. Student Services Bldg., Western Michigan U.

Michigan Radio

See page C-1 for explanation of listings.

(49008). (616) 383-1686. Western Michigan U. Net: ABC. Format: Progs. Spec prog: student public affairs 10 hrs wkly. ■ P. Glenn Bishop, tech dir; Dave Gorski, gen mgr.

WKMI—Aug 1947: 1360 khz; 5 kw-D, 1 kw-N, DA-N. Box 911 (49005). (616) 344-0111. Steere Bcstg Co. (acq 10-5-52). Net: ABC/C. Rep: McGavren-Guild. Format: Contemporary. ■ David E. Steere, pres & gen mgr; Robert M. Salmon, coml mgr; James R. Higgs, prog dir; Chas. Carney, news dir; Charles A. Gustafson, chief engr.

WKPR—Oct 20, 1960: 1420 khz; 1 kw-D, DA. Box 867 (49005). (616) 381-1420. Kalamazoo Bcstg Co. Inc. Group owner: Kuiper Stns. Format: MOR. ■ William E. Kuiper, pres, gen mgr & prog dir; Kenneth Byle, stn mgr & chief engr; Henry Wielhouwer, sls mgr; Curtis Fonger, news dir.

WKZO—Sept 10, 1931: 590 khz; 5 kw-U, DA-N. 590 W. Maple St. (49008). (616) 345-2101. TWX 810-277-8952. Fetzer Bcstg Co. (group owner). Net: CBS. Rep: Avery-Knodel. Format: MOR. Spec prog: Farm 11 hrs wkly. ■ John E. Fetzer, chmn; Carl E. Lee, pres & gen mgr; Otis Gaston, VP & stn mgr; Gordon Anderson, admin VP, radio opns mgr; Fred Douglas, news dir; Daryl Sebastian, public affairs dir; Arthur E. Covell, chief engr. ■ WKZO-TV affil. ■ Rates: \$28; 25; 28; 22.

***WMUK(FM)**—Jan 8, 1951: 102.1 mhz; 50 kw. Ant 490 ft. Friedmann Hall, Western Michigan U. (49008). (616) 383-1921. Stereo. Western Michigan U. Net: NPR. Format: Ed, fine arts, pub info. ■ Charles M. Woodliff, dir, instr/comm; Glenn Bishop, assoc dir; Garrard D. Macleod, gen mgr; Richard Atwell, prom mgr; Gerald Alexander, prog dir; Anthony E. Griffin, news dir; Douglas Howe, chief engr.

WQLR(FM)—June 19, 1964: 106.5 mhz; 40 kw. Ant 550 ft. Industrial State Bank Bldg. (49006). (616) 345-7121. Fairfield Bcstg Co. (acq 6-24-72). Rep: Torbet, McDermott (Canada). Format: Beautif. mus. ■ Stephen C. Trivers, pres & gen mgr; William J. Wertz, VP & prog dir; Bill Forsythe, news dir; John Seymour, chief engr. ■ Rates: \$17; 19; 19; 11.

WYYY—Feb 4, 1956: 1470 khz; 500 w-D. 2315 Schippers Lane (49001). (616) 381-1470. The Circle Corp. (acq 1-63). Net: MBS. Rep: Pro/Meeker; Mich. Spot Sls. Format: MOR. ■ E. J. Popke Jr., pres & gen mgr; Ronald Newhouse, coml mgr; Robert Miller, prog dir; Jannette Newton, prom mgr; Roy Gerritson, mus dir; Frank Adams, news dir; Kenneth Farrance, chief engr. ■ Rates: \$14; 11; 14; 11.

Lansing

WILS—1947: 1320 khz; 5 kw-D, 1 kw-N, DA-2. 600 W. Cavanaugh Rd. (48910). (517) 393-1320. Lansing Bcstg Co. Audio news: UPI. Rep: Torbet. Format: MOR, Top 40. Spec progs: Farm 2 hrs; Sp 1 hr wkly. ■ John C. Pomeroy, pres; E. L. Byrd, gen mgr; Dave Hicks, coml mgr; Erik O. Furseth, prog dir; Keith Cummings, news dir; John Hackman, chief engr. ■ Rates: \$14.90; 14.90; 14.90; 10.43.

WILS-FM—January 1967: 101.7 mhz; 3 kw. Ant 180 ft. Dups AM 50%. Format: Jazz, progs. ■ Rates: \$14.90; 14.90; 14.90; 8.80.

WITL—June 26, 1961: 1010 khz; 500 w-D, DA. Box 1010 (48904). (517) 393-1010. Metropolitan Radio Corp. (acq 4-11-64). Group owner: Mid-West Family Stns. Rep: McGavren-Guild. Format: Modern Country. ■ Chuck Mefford, pres & gen mgr; William Pacelli, coml mgr; Jim Walton, prog & mus dir; Duane Stacker, news dir; Chuck Drake, prom dir; Lloyd A. Klotz, chief engr. ■ Rates: \$20; 18; 20; 16.

WITL-FM—April 15, 1964: 100.7 mhz; 55 kw. Ant 165 ft. Dups AM 50%. Format: Modern country.

WJIM—1934: 1240 khz; 1 kw-D, 250 w-N. Box 1226 (48904). (517) 372-8282. TWX 517-372-0741. Gross Telecasting Inc. (group owner). Net: NBC. Rep: Eastman. ■ James H. Gross, pres & gen mgr; Bryan S. Halter, prog dir; Carl Onken, chief engr.

WJIM-FM—June 1960: 97.5 mhz; 28 kw. Ant 440 ft. Prog sep from AM. ■ WJIM-TV affil.

Lapeer

WMPC—Dec 2, 1926: 1230 khz; 1 kw-D, 250 w-N. Box 104 (48446). (313) 664-6211. The Calvary Bible Church. Format: Relig. ■ Arnold L. Bracy, pres & gen mgr; Nora Eastman, prog dir; Judy Rucker, news dir; Dan Baad, chief engr.

WTHM—Nov 16, 1962: 1530 khz; 5 kw-D, DA. Box 417 (48446). (313) 664-8555. WTHM Bcstg Co. (acq 3-1-73). Rep: Michigan Spot Sls. Format: MOR. ■ David R. Sommerville, pres & gen mgr; Robert Miller, news dir; Terry Lough, prog & mus dir; Don McComb, chief engr.

WTHM-FM—Feb 6, 1968: 103.1 mhz; 3 kw. Ant 300 ft. Dups AM 20%.

Ludington

WKLA—Oct 10, 1944: 1450 khz; 1 kw-D, 250 w-N. Box 609 (49431). (616) 843-3438. Raymond A. Plank (acq 4-1-50). Net: ABC/E. Rep: Hopewell, Michigan Spot Sales. Format: MOR. ■ Raymond A. Plank, pres & gen mgr; R. Thomas Plank, coml mgr; Marty Kryger, news dir; Lee Shipman, chief engr.

WKLA-FM—May 1, 1971: 106.3 mhz; 3 kw. Ant 250 ft. Dups AM 50%. Format: MOR.

Manistee

WMTE—June 7, 1951: 1340 khz; 1 kw-D, 250 w-N. Box 128 (49660). (616) 723-9906. Manistee Radio Corp., Charles E. Hedstrom. Net: ABC/C. Rep: Hopewell, Mich. Spot Sls. Format: Contemp. ■ Charles Hedstrom, pres, coml & gen mgr; Pete Nezki, prog dir; Edward Kenney, prom mgr; Bernard Schroeder, news dir; Dave Christian, mus dir; Charles Hagerman, chief engr.

WMTE-FM—Aug 1, 1970: 97.7 mhz; 3 kw. Ant 155 ft. Dups AM 75%.

Manistique

WITI—Feb 11, 1965: 1490 khz; 1 kw-D, 250 w-N. SH. 1501 Deer St. (49854). (906) 341-2024. WITI Inc. (acq 5-23-73). Rep: Mich. Spot Sls. Format: MOR, C&W, variety. ■ Douglas Tjapkes, pres; Donald O. Thompson, gen mgr; Joe West, news dir; Bradley Jones, chief engr.

Marine City

WSMA—Dec 10, 1951: 1590 khz; 1 kw-D, DA. 5300 Marine City Highway (48060). (313) 765-8893. Somerville Bcstg Co. (acq 2-1-67). Format: C&W. Spec progs: Farm 2½ hrs, Polka 2½ hrs, wkly. ■ Richard S. Somerville, pres; James Williams, prog dir; Dar Hollenrake, news dir; Mark Miller, prom mgr; Jeff Somerville, chief engr. ■ Rates: \$7; 7; 7; 7.

Marquette

WDMJ—July 4, 1931: 1320 khz; 1 kw-U, DA-N. Box 700, 1520 W. Washington St. (49855). (906) 225-1313. Lake Superior Bcstg Co. (acq 1940). Group owner: Frank J. Russell Stns. Net: ABC. ■ Frank J. Russell, pres; Robert L. Biolo, VP & gen mgr; Joseph D. Gagliardi, stn mgr; Paul Donovan, news dir; James P. Anthony, asst mgr & prog dir; Gary Schneider, prom mgr; Paul F. Anick, chief engr.

WDMJ-FM—Dec 16, 1965: 95.7 mhz; 100 kw. Ant 530 ft. Prog sep from AM. Stereo.

***WNMR(FM)**—August 1963: 90.1 mhz; 100 kw. Ant 970 ft. Stereo. Northern Michigan Univ. (49855). (906) 227-1300. Northern Michigan U. Net: NPR. Format: Variety. Spec prog: Intl music 1½ hrs wkly. ■ George Lott, dir learning resources; Stephen W. J. Dupras, gen mgr; James Steffey, chief engr; George Wendt, mus dir; Michael Brunswick, prod; Pricilla Anderson, dev dir.

WUUN(FM)—April 6, 1974: 100.1 mhz; 1.8 kw. Ant 370 ft. Ramada Inn. (49855). (906) 228-6800. Chappell Bcstg Inc. Rep: Avery Knodel. Format: Contemp, hit parade. ■ E. Nickolas Bridges, pres; Dan Smith, chief engr. ■ Rates: \$7.05; 7.05; 7.05; 7.05.

Marshall

WALM—See Albion.

WELL-FM—Co-owned with WALM, Albion. Oct 1,

1968: 104.9 mhz; 3 kw. Ant 300 ft. 111 W. Michigan Ave. (49068). (616) 781-2600. Triad Stations Inc. Format: Good Istng. ■ C. Wayne Wright, pres; Alan Mather, gen mgr & chief engr; Robert Widmark, coml mgr; Alice M. Wright, news dir.

Mason

***WUNN**—May 11, 1967: 1110 khz; 250 w-D. (48854). (517) 676-2488. Family Life Bcstg System (acq 1-1-69). Format: Religious. ■ Warren Bolthouse, dir; Randy Carlson, prog dir; Al Cook, news dir & gen mgr.

Menominee

WAGN—Nov 14, 1952: 1340 khz; 1 kw-D, 250 w-N. Box 375 (49858). (906) 863-5551. MenMar Bcstg Co. (acq 1-1-55). Net: ABC/I. Rep: Pearse. Format: MOR. ■ Loren B. Koelsing, pres & gen mgr; Harold P. Drago, coml mgr; William C. King, prog dir; Charles Patrick, Robert B. Maccaulay, news dir; Paul Anick, chief engr.

WL0T—See Marinette, Wis.

WMAM—See Marinette, Wis.

Midland

WMPX—1948: 1490 khz; 1 kw-D, 250 w-N. Box 1510 (48640). (517) 631-1490. Patten Corp. (acq 4-20-71). Net: MBS. Audio news: UPI. Rep: PRO Time Sls, Mich Spot Sls. Format: MOR, C&W. ■ Myron P. Patten, pres; Ronald W. Maines, VP & gen mgr; Phil Davidson, prog dir; Kirk Hughes, mus dir; Lee Schostak, news dir; Peter Wolf, chief engr. ■ Rates: \$10; 10; 5; 5.

WUGN(FM)—July 15, 1961: 99.7 mhz; 100 kw. Ant 690 ft. Stereo. 325 E. Main (48640). (517) 631-7060 or 695-5595. Family Life Bcstg Syst (acq 9-26-73). Audio news: UPI. Format: Helig. Spec prog: Sp ½ hr; Farm ½ hr wkly. ■ Warren Bolthouse, pres and gen mgr; William Harrier, stn mgr; Randy Carlson, prog and mus dir; Brent Williams, news dir; William Keiser, engr.

New FM—Not on air yet; target date unknown: 93.5 mhz; 3 kw. Ant 300 ft. Box 1844 (48640). Wolverine Radio Inc.

Monroe

WHND—July 12, 1956: 560 khz; 500 w-D, DA. Box 560 (48161). (313) 241-1550. TWX 810-232-5206. WQTE Bcstg Inc. (acq 6-30-73). Group owner: Greater Media Inc. Rep: McGavren-Guild. Format: Gaud. ■ Peter A. Bordes, pres; Chuch Borchard, gen mgr; Tom Miles, prog dir; Tom Campbell, news dir; Irving L. Laing, opns mgr.

WVMO(FM)—July 16, 1967: 98.3 mhz; 3 kw. Ant 300 ft. Box 801 (48161). (313) 242-6600. Monroe Bcstg Co. Format: MOR, C&W. ■ Ira C. Smith, gen mgr; Gene Basford, news dir; Jim Miller, prog dir; Jerry Rice, chief engr. ■ Rates: \$6.75; 6.75; 6.75; 6.75.

Mount Clemens

WBRB—May 18, 1957: 1430 khz; 500 w-D, DA. Box 489 (48043). (313) 293-1430. Mairite Bcstg Co. (group owner; acq 1-1-60). Net: ABC/I. Rep: Pearse Sls. ■ Milton Maltz, pres; Charles H. Park Jr., VP and gen mgr; Joe Maxwell, prog dir; Don Randall, mus dir; Fred Fisher, news dir; Tom Bracanovich, tech dir; James Deneweth, chief engr.

WBRB-FM—Nov 6, 1960: 102.7 mhz; 17 kw. Ant 400 ft. Dups AM.

Mount Pleasant

WCEN—Aug 8, 1949: 1150 khz; 1 kw-D, 500 w-N, DA-N. Box 407 (48858). (517) 773-5961. Central Mich. Bcstrs (acq 12-1-67). Net: MBS. Rep: Mich. Spt Sls. Format: MOR. ■ Anthony F. Bielawski, pres; Charles E. Anthony, gen mgr; Larry Wentworth, coml mgr; Dan Bethel, mus dir; Jim Hughes, news dir; Richard Leonard, chief engr. ■ Rates: \$7.50; 6.50; 7.50; 6.50.

WCEN-FM—1963: 94.5 mhz; 16 kw. Ant 230 ft. Prog sep from AM. Stereo. ■ Rates: \$4.50; 4.50; 4.50.

***WCMU-FM**—April 6, 1964: 89.5 mhz; 100 kw. Ant 420 ft. 155 Anspach, Central Michigan U. (48859). (517) 774-3105. Central Michigan U. Net: NPR. For-

mat: Classical/fine arts. ■ Dr. Harold Abel, pres; Mary E. Dirnberger, stn mgr; Thomas Hunt, prog dir; David G. Kanzeg, opns dir; Neal Johnson, news dir; Paul Baumgartner, chief engr. ■ *WCMU-TV affil.

***MWHW-FM**—Nov 20, 1972: 91.5 mhz; 32 w. Ant 112 ft. 180 Moore Hall, Central Mich U. (48859). (517) 774-3250. Bd of Trustees, Central Michigan U. Audio news: UPI. Format: MOR, jazz, classcl, progs. ■ Peter B. Oriik, gen mgr; H. Greydon Hyde, stn mgr; James L. Mead, opns mgr; Gary Wise, prog dir; Rick Staeb, mus dir; Cheryl Godwin, news dir; William Keiser, chief engr.

Munising

WGON—Sept 20, 1956: 1400 khz; 1 kw-D, 250 w-N. 110 W. Onota St. (49862). (906) 387-2518. Ollie's Idea Inc. (acq 7-74). Format: MOR, oldies, Top 40, C&W. Spec progs: Talk 5 hrs wkly. ■ George A. Freeman, pres; Paul E. Petosky, VP & gen mgr; Jack St. Andre, news dir; Barry Fitzpatrick, prog dir; Fred Ahlborn, mus dir; Peter Lindquist, chief engr.

WQXO(FM)—Co-owned with WGON. June 21, 1974: 98.3 mhz; 1.80 kw. Ant 380 ft. Dups AM 82%.

Muskegon

WKBB—1926: 850 khz; 1 kw-U, DA-1. Box 238 (49441). (616) 798-2141. Reams Communications Corp. (acq 7-8-68). Net: ABC/I. Reps: Meeker, Michigan Spot Sales. Format: MOR. Spec prog: Sp ½ hr wkly. ■ Frazier Reams Jr, pres; Harold Waddell, VP & gen mgr; Robert Peterman, coml mgr; Bill Stevens, prog dir; Bill Bennett, prom mgr; John Graska, news dir; George Krivitzky, chief engr.

WMUS—June 15, 1947: 1090 khz; 1 kw-D. Box 5260 (49445). (616) 744-1671. Greater Muskegon Bcstrs Inc. Net: MBS. Rep: Masla; Pearse. Format: Modern country. ■ R. Bunker Rogoski, pres & gen mgr; Tim Achterhoff, opns mgr, mus & prog dir & chief engr; Steve James, prom mgr; Nick Scott, prod mgr. ■ Rates: \$7.20; 7.20; 7.20; 5.40.

WMUS-FM—1962: 106.9 mhz; 31 kw. Ant 270 ft. Dups AM 100%. ■ Rates same as AM.



WQWQ-FM—Nov 18, 1971: 104.5 mhz; 50 kw. Ant 360 ft. Box 296 (49443). (616) 722-1681. Multi-Com Inc. Stereo. Net: ABC/FM. Format: Beautiful mus, MOR. Spec progs: Classical 4 hrs; farm 1 hr; jazz 2 hrs wkly. ■ Fred C. Culver Jr, pres; David H. Walborn, VP; Bill Winchell, gen & coml mgr & news dir; Marg Champagne, women's prog dir; Mary Bazzett, traf & continuity mgr; James Scollin Jr, prog & mus dir. ■ Rates: \$10.30; 10.30; 10.30; 10.30.

WTRU—1949: 1600 khz; 5 kw-U, DA-N. Box 248 (49443). (616) 733-2126. Regional Bcstrs of Michigan Inc. (group owner; acq 2-60). Rep: Torbet. ■ Frederick P. Tascone, gen mgr; Tom Wyant, prog dir; Bill Trap, news dir; Gerry Heykoop, chief engr.

Muskegon Heights

WKJR—February 1963: 1520 khz; 10 kw-D, DA. Box 839 (49443). (616) 798-2115. Muskegon Heights Bcstg Co. Group owner: Kuiper Stns. Format: Religious. ■ William Kuiper, pres; William E. Kuiper, gen mgr; Tom Dudenhofer, news dir; Herbert R. Smith, stn mgr; Philip Waite, chief engr. ■ Rates: \$4.50; 4.50; 4.50; 3.50.

WKJR-FM—March 29, 1974: 101.7 mhz; 3 kw. Ant 300 ft. ■ H. Albert Peterson, coml mgr.

Newbury

WNBY—May 16, 1966: 1450 khz; 1 kw-D, 250 w-N. Box 1 (49868). (906) 293-5114. Newberry Bcstg Co. Rep: Pearse, U.P. Sls. Format: Adult contemp, C&W. ■ L. B. Van Dam, gen & coml mgr; Dave Olivier, prog dir; Al Rogers, mus dir; Van Brown, news dir; Barbara Van, prom mgr; Matt Johns, chief engr. ■ Rates: \$3.84; 3.84; 3.84; 2.60.

Niles

WNIL—Dec 6, 1956: 1290 khz; 500 w-D. Box A (49120). (616) 683-5432. Niles Bcstg Co. (acq 1-1-59). Net: MBS, Mich. Farm Net. Rep: Mich. Spot Sls. Format: Contemp. Spec progs: C&W 10 hrs wkly. ■ J. Eric Plym, pres; Charles E. Frey, gen & coml mgr; Bob Wilson, news dir; Matthew Pierzchala, chief engr. ■ Rates: \$7; 6; 7; 6.

WNIL-FM—Sept 13, 1968: 95.3 mhz; 3 kw. Ant 160 ft. Dups AM 30%. Stereo. Format: Contemp. ■ Rates: \$4; 4; 4; 4.

Oak Park

***WOPR(FM)**—Oct 7, 1974: 90.3 mhz; 18.5 w. Ant 101 ft. 13701 Oak Park Blvd. (48237). (313) 548-WOPR. Board of Education of Oak Park School District. Format: Progs; Top 40. ■ Samuel Sniderman, supt of schools; Mark Kowalsky, stn mgr.

Olivet

***WOCR(FM)**—1975: 89.7 mhz; 10 w. Dole Hall (49076). Olivet College. ■ Willis A. Seiden, dir of info svcs.

Orchard Lake

***WBLD(FM)**—May 28, 1974: 89.3 mhz; 10 w. Ant 110 ft. Stereo. 4925 Orchard Lake Rd. (48033). (313) 851-8930. Board of Education of West Bloomfield School District. Format: Progs. ■ Jeff Leitson, gen mgr.

Otsego

WAOP—1958: 980 khz; 1 kw-D. Box 980 (49078). (616) 692-6851. Allegan County Bcstrs Inc. (acq 8-74). Net: ABC/I. Format: C&W. Spec progs: Farm 9 hrs; Sp 1 hr wkly. ■ Robert Doll, pres and gen mgr; Al Lietch, prog dir; Denny Gort, mus dir; Walker Sisson, chief engr. ■ Rates: \$6.40; 5; 6.40; —.

WAOP-FM—Jan 1, 1948: 1080 khz; 1 kw-D. Box E (48867). (517) 725-8196. Owosso Bcstg Co. Rep: Deveney. Spec progs: Slovakian ½ hr; C&W ¼ hr wkly. ■ Merrill Walker, pres and gen mgr; Arthur Kinsey, chief engr. ■ Rates: \$4.20; 4.20; 4.20; 4.20.

WAOP-FM—Dec 2, 1965: 103.9 mhz; 2.8 kw. Ant 255 ft. Prog sep from AM. Stereo. ■ Rates same as AM.

Petoskey

WJML—Dec 6, 1966: 1110 khz; 10 kw-D, DA. Perry-Davis Hotel (49770). (616) 347-8191. Harrington Bcstg Co. Net: ABC/I, Northern Power. Rep: Walton, Michigan Spot Sls. Format: MOR/Contemp. Spec prog: C&W 12 hrs wkly. ■ Michael D. Harrington, pres; David K. Williams, sls & prom mgr; Jay Alexander, mus dir; Marvin Veurink, chief engr.

WJML-FM—Dec 7, 1965: 98.9 mhz; 100 kw. Stereo. Ant 820 ft. Dups AM 100%.

WMBN—May 1946: 1340 khz; 1 kw-D, 250 w-N. Paul Bunyan Bldg., Traverse City, Mich. (49684). (616) 947-7675. Midwestern Bcstg Co. (group owner). Net: NBC, Paul Bunyan. Rep: Torbet. Format: MOR. ■ Les Biederman, pres; Bill Gray, stn mgr; Russell Loomis, bus mgr; John E. Walkmeyer, gen mgr; William H. Kiker, chief engr.

WMBN-FM—Jan 1, 1967: 96.7 mhz; 1 kw. Ant 320 ft. Stereo. Dups AM 80%.

Plymouth

***WSDP(FM)**—Feb 14, 1972: 89.3 mhz; 10 w. 46181 Joy Rd. (48170). (313) 453-3171, ext 226. Plymouth Community School District. Format: Contemp, MOR, educ, rock. ■ J. M. Hoben, pres; John Seidelman, gen mgr; Jeff Cardinal, ass't gen mgr.

Pontiac

WPON—December 1954: 1460 khz; 1 kw-D, 500 w-N, DA-N. Riker Bldg. (48059). (313) 338-0444. WPON Inc. (acq 10-15-62). Format: MOR, black, C&W. Spec prog: Sp 1 hr wkly. ■ H. Allen Campbell, pres & gen mgr; William E. Morgan, VP & stn mgr; Helen Sansone, VP/sls; Tom Quinn, news dir. ■ Rates: \$19; 19; 19; 15.20.

Michigan Radio

See page C-1 for explanation of listings.

Portage

WBUK—July 25, 1966: 1560 khz; 1 kw-D, 9112 S. Westledge Ave., Kalamazoo, Mich. (49002). (616) 327-7051. Taylor Bcstg Co. (acq 5-20-71). Net: ABC/E. Rep: Walton. Format: C&W. ■ Robert B. Taylor, gen & coml mgr & chief engr; Buck Evans, prog dir; Mike Stewart, news dir. ■ Rates: \$10; 10; 10; 10.

Port Huron

WHLS—Aug 8, 1938: 1450 khz; 1 kw-D, 250 w-N. 808 Huron Ave., Box 807 (48060). (313) 982-8536. Wismer Bcstg Inc. (acq 1-1-56). Rep: Mich. Spot Sls. Format: MOR. Spec progs: Black 1 hr; Sp 2 hrs wkly. ■ John F. Wismer, pres & gen mgr; A. Mike Mullins, prog dir; Ted Mireau, coml mgr; Ron Dzwonkowski, news dir; Marc Karrman, chief engr.

WSAQ(FM)—Aug 7, 1964: 107.1 mhz; 3 kw. Ant 300 ft. Stereo. Format: Btfl mus.

***WORW(FM)**—May 31, 1973: 91.9 mhz; 10 w. 1799 Krafft Rd. (48060). (313) 984-2672. Port Huron Area School District. Net: NPR. Format: Educ, oldies, soft rock. ■ Robert D. Trapp, pres & gen mgr.

WPHM—Dec 6, 1947: 1380 khz; 5 kw-U, DA-2. Box 247 (48060). (313) 985-5171. Enterform Inc. (acq 12-1-67). Net: ABC/I. Rep: Pearse. ■ Eugene E. Umior, gen mgr; Al Tyrrell, coml mgr; George Carroll, chief engr. ■ Rates: \$9; 9; 9; 9.

WSAQ(FM)—Listing follows WHLS.

***WSGR-FM**—October 1971: 91.3 mhz; 10 w. Ant 87 ft. 323 Erie St. (48060). (313) 984-5064. St. Clair County Community College. Format: Ed, variety. Spec prog: Black 1 hr wkly. ■ Donna R. Williams, gen mgr.

Rockford

WJPW—1965: 810 khz; 500 w-D. Box 810, 3691 Ten Mile Rd. N.E. (49341). (616) 866-1501. Jack Lee Payne. Net: ABC/E. Format: Farm, talk, MOR. ■ Jack Lee Payne, pres & gen mgr. ■ Rates: \$ 5; 5; 5; 5.

Rogers City

WHAK—May 1949: 960 khz; 5 kw-D. Moltke Dr. (49779). (517) 734-2175. Huron Shore Bcstrs Corp. Net: Huron Shore. Rep: Walton, Michigan Spot Sales. ■ Harvey A. Klann, pres, chief engr & gen mgr; Albert G. Klann, coml mgr; Tom Tolen, news dir.

Royal Oak

WEXL—October 1923: 1340 khz; 1 kw-D, 250 w-N, DA-D. Box 1340 (48068). (313) 544-2200. Sparks Bcstg Co. inc. Audio news: UPI. Format: Inspirational. ■ Garnet G. Sparks, pres; Gordon A. Sparks, gen mgr; Bill Payne, chief engr.

***WOAK(FM)**—Feb 2, 1957: 89.3 mhz; 10 w. 709 N. Washington (48067). (313) 541-7100, ext 27. School District of the City of Royal Oak. Net: NPR. Format: Contemp. Spec prog: Black 1½ hrs wkly. ■ Linda Cerveney, gen mgr.

Saginaw

WGER-FM—See Bay City.

WHNN(FM)—See Bay City.

WIOG(FM)—See listing following WSGW.

WKQC(FM)—See listing following WSAM.

WKNX—April 17, 1947: 1210 khz; 10 kw-D, DA. 5200 State St. (48603). (517) 799-1000. Lake Huron Bcstg Corp. Net: ABC/I. Rep: Eastman. Format: Oldies, MOR. Spec progs: Black 1 hr; Farm 1 hr; Sp 1 hr wkly. ■ William J. Edwards, pres; Howard H. Wolfe, gen mgr; Dan E. Stewart, coml mgr; Paul Pigeon, prog dir; Mike Ryan, prom mgr; Phil Barry, mus dir; Robert G. Dyer, news dir; Eugene Bardo, chief engr. ■ Rates: \$14; 12; 14; 12.

WSAM—1940: 1400 khz; 1 kw-D, 250 w-N. Box 1776 (48605). (517) 752-8161. MacDonald Bcstg Corp. (acq 11-1-62). Net: NBC. Reps: Wmbs, Mich. Spot Sls. Format: Top 40. ■ Kenneth Hugh MacDonald, pres, gen & coml mgr; Ann Webb, mus dir; Ken MacDonald

Michigan Radio

See page C-1 for explanation of listings.

Jr, prom mgr; Bill Corbier, news dir; William Friedle, chief engr.

WKCO(FM)—Co-owned with WSAM. 1947: 98.1 mhz; 50 kw. Ant 340 ft. Prog sep from AM. Stereo. Format: C&W.

WSGW—Aug 11, 1950: 790 khz; 5 kw-D, 1 kw-N, DA-2. Box 1945 (48605). (517) 753-4456. Booth American Co. (group owner). Net: CBS, Mich. Farm Net. Rep: Torbet. Format: MOR. Spec prog: Sp 2 hrs wkly. ■ John L. Booth, pres; John F. Casey, gen mgr; Rick Belcher, prog dir; Cliff Graff, chief engr. ■ Rates: \$12; 10; 12; 10.

W-106

Beautiful Music

WIOG(FM)—Co-owned with WSGW. Feb 19, 1969: 106.3 mhz; 3 kw. Ant 300 ft. Stereo. Prog sep from AM. Format: Btfl mus. ■ Rates: \$ 7; 7; 7.

WWWS(FM)—Nov 15, 1968: 107.1 mhz; 2 kw. Ant 360 ft. Box 3264 (48601). (517) 777-8011. Saginaw Bcstg Co. (acq 8-20-74). Net: Natl Black. Rep: Bob Dore. Format: Black, talk, R&B. Spec prog: Sp 12 hrs wkly. ■ Frank Perry Lloyd, pres; Calvin Beatty Jr, gen mgr; Andy Johnston, prom & coml mgr; Kermit Crockett, prog & mus dir; Prior Taylor, chief engr.

St. Ignace

WIDG—June 7, 1966: 940 khz; 5 kw-D. Box 1 (49781). (906) 643-9494. Mighty-Mac Bcstg Co. Reps: Massina, Goldfarb. Format: MOR. Spec progs: Jazz 1 hr; classcl 1 hr wkly. ■ Dr. Donald E. Benson, pres; Donald M. Angelo, gen mgr; Dennis Woytek, prog dir; Karen Sanborn, coml mgr; D. Manning, prom mgr; Jim Bernard, mus dir; Dick Stone, news dir; Louis Ozak, chief engr.

St. Johns

WRBJ—Sept 23, 1959: 1580 khz; 1 kw-D, DA. Box 320 (48879). (517) 224-7911. Diltmer Bcstg Co. (acq 12-1-65). Net: MBS, Mich. Farm Net. Rep: Walton, Mich. Spot Sls. Format: MOR. Spec prog: Sp 8 hrs wkly. ■ Robert D. Diltmer, pres & coml & gen mgr; Bob Diltmer II, prog dir; Bill Stoller, mus dir; Edd Monski, chief engr. ■ Rates: \$5.50; 5.50; 5.50.

WRBJ-FM—July 15, 1972: 92.1 mhz; 3 kw. Ant 125 ft. Prog sep from AM. Format: Easy Istng. ■ Renae Diltmer, prom mgr. ■ Rates: \$4.50; 4.50; 4.50; 4.50.

St. Joseph

WHFB-FM—See Benton Harbor.

WIRX(FM)—See listing following WSJM

WSJM/WIRX FM Stereo Modern Country



WSJM—Nov 18, 1956: 1400 khz; 1 kw-D, 250 w-N. Box 107 (49085). (616) 983-3992. WSJM Inc. (acq 1-1-59). Group owner: Mid-West Family Stns. Net: NBC. Rep: McGavren-Guild. Format: Top 40. ■ Joseph D. Mackin, pres & gen mgr; Mike Berlak, opns mgr and prog dir; Marilyn McKinley, prom mgr; Jim Stoddard, news dir; Craig Cole, mus dir; Bill Wheeler, chief engr. ■ Rates: \$21; 18; 21; 17.

WIRX(FM)—Co-owned with WSJM. June 20, 1966: 107.1 mhz; 3 kw. Ant 225 ft horiz, 220 ft vert. Prog sep from AM. Stereo. Format: Modern country. ■ Tom Ferren, FM mgr; Don Backus, prog dir. ■ Rates same as AM.

Saline

WNRS—1958: 1290 khz; 500 w-D, DA. Box 5, Ann Ar-

bor, Mich. (48107). (313) 663-0569. Community Music Service Inc. (acq 11-1-74). Net: MBS. Format: C&W. Spec prog: Sp 1 hr wkly. ■ James Trayhern, pres; Stu Goldberg, gen mgr; Eugene Skuratowicz, sls mgr; Jim Barrett, prog dir; Art Vuolo Jr, prom dir; Greg Bowman, news dir; Gary Sharpe, chief engr. ■ Rates: \$8; 7; 8; 6.

Sandusky

WMIC—June 27, 1968: 1560 khz; 1 kw-D, DA. 19 S. Elk (48471). (313) 648-2700. Sanilac Bcstg Co. Net: Mich. Farm Radio. Format: C&W, MOR. Spec prog: Pol 4 hrs wkly. ■ Bob Armstrong, gen mgr; Steve Smith, prog dir; Monte Dean, news dir; James Hughes, chief engr.

WMIC-FM—Aug 16, 1971: 97.7 mhz; 3 kw. Ant 140 ft. Dups AM 100%.

Sault Ste. Marie

WSMM(FM)—July 12, 1972: 92.7 mhz; 3 kw. Ant 285 ft. (CP 99.5 mhz; 26.5 kw. Ant 275 ft). Box 800 (49783). (906) 635-1504. Chippewa Bcstg Corp. (acq 6-1-74). Stereo. Audio news: UPI. Rep: Pierce. Format: Variety Spec progs: Farm ¼ hr; pub aff 3 hrs wkly. ■ D. Wayne Zimmerman, pres & gen mgr; Bob Gilray, sls mgr; Dave Benson, prog and news dir; Walter Kaay, mus dir; Tom Ewing, stn mgr; Paul Eichstaedt, chief engr. ■ Rates: \$6; 5.60; 4.50; 3.40.

WSOO—June 1, 1940: 1230 khz; 1 kw-D, 250 w-N. Box 400 (49783). (906) 632-2231. Miami County Bcstg Co. (acq 4-3-73). Net: ABC/I. Rep: Michigan Spot Sls, Oakes. Format: MOR. Spec prog: Finnish ¼ hr wkly. ■ Richard E. Hunt, pres & prog dir; Bob Benedict, gen & coml mgr; Marie Benedict, prom mgr; Dick Thomas, mus dir; Ernest Michaud, news dir; Noel Moss, chief engr.

Southfield

***WSHJ(FM)**—Feb 28, 1967: 88.3 mhz; 125 w. Ant 43 ft. 24675 Lahser Rd. (48075). (313) 352-9745. Bd. of Education Southfield Public Schools. Format: Oldies, progs, top 40. ■ Robert J. Sneddon, gen mgr; Daniel Sandberg, prog dir; Marty Ertz, mus dir; Charles Turell, prom mgr; Mike Kleiman, news dir; Robert Yonkers, chief engr.

South Haven

WJOR—1961: 940 khz; 1 kw-D, DA. Box 405, 559 Phoenix St. (49090). (616) 637-1138. Van Buren County Bcstg Co. (acq 8-15-67). Net: ABC/E. Mich. Farm Radio Net. Rep: Pro-Time Sls. Format: MOR. Spec prog: Pol 2 hrs; black 2 hrs; C&W 5 hrs wkly. ■ Dee O. Coe, pres; Ken Coe, gen mgr; Ralph Shaw, prog dir & prom mgr; Tom Mann, mus & news dir; Claire Wolf, sls mgr; Lee Emerson, sports dir; Vic Voss, chief engr.

Spring Arbor

***WSAE(FM)**—Oct 2, 1963: 89.3 mhz; 1 kw. Ant 200 ft. (49283). (517) 750-1200. Spring Arbor College. Format: Ed, classcl. ■ Carl V. Jacobson, dir media svcs.

Sturgis

WSTR—1951: 1230 khz; 1 kw-D, 250 w-N. Box 70 (49091). (616) 651-2383. Water Wonderland Bcstg Co. (acq 1-1-60). Rep: M. A. Sls, Mich. Spot Sls. Format: MOR. Spec progs: Farm 2½ hrs; Polish 1 hr wkly. ■ Lee Droeger, mgr; John Greenwood, chief engr. ■ Rates: \$5; 5; 5.

WSTR-FM—1951: 99.3 mhz; 850 w. Ant 390 ft. (CP 1.4 kw). Dups AM 95%. ■ Rates same as AM.

Tawas City

WDBI-FM—Nov 1, 1973: 101.7 mhz; 3 kw. Ant 275 ft. 1175 S. U-S 23 (48763). (517) 362-6149. Lawrence Norman DeBeau, Rep: Messina. Format: Btfl mus. ■ Lawrence N. DeBeau, pres, gen mgr & news dir; Mark L. DeBeau, prog dir; Mildred M. DeBeau, mus dir; Dale A. Palovich, prom mgr; James T. Butler Jr, coml mgr; James Totten, chief engr. ■ Rates: \$5.45; 5.45; 4.95.

WIOS—Sept 27, 1958: 1480 khz; 1 kw-D, DA. 532 Meadow Rd. (48763). (517) 362-3417. Carroll Enterprises (acq 5-1-69). Net: ABC/C. Audio news: UPI. Rep: Keystone, Walton, Mich. Spot Sls. Format: MOR.

■ John J. Carroll Sr, pres; John Carroll Jr, gen mgr; Mike Kwosian, prog and mus dir; Jerry Hollnagel, news dir; Robert Van Buhler, chief engr. ■ Rates: \$6; 5; 6; —.

Three Rivers

WLKM—May 3, 1962: 1510 khz; 500 w-D. Box 1510 (49093). (616) 278-1815. Voce of Three Rivers Inc. Net: MBS. Rep: Michigan Spot Sls. Format: MOR. Spec progs: Pub affrs 3 hrs; farm 5 hrs wkly. ■ Carl L. Shipley, pres; James J. Ganley, gen mgr; Dennis Rumsey, mgr & news dir; Irving Grove, chief engr. ■ Rates: \$4.80; 4.80; 4.80; —.

WLKM-FM—March 1975: 95.9 mhz; 3 kw. Ant 290 ft. Dups AM 80%. Stereo. ■ Rates: \$4.80; 4.80; 4.80; 3.00.

Traverse City

WCCW—July 15, 1960: 1310 khz; 5 kw-D. 246 East State St. (49684). (616) 946-6211. Radio Station WCCW Inc. Net: ABC/I, Northern Power. Rep: Walton Bcstg Sls, Mich. Spot Sls. ■ John R. Anderson, pres & gen mgr; Robert Burian, prog dir; Frank Nachazel, coml mgr; Michael Bradford, chief engr. ■ Rates: \$8.25; 5.90; 7.05; 5.90.

WCCW-FM—Nov 8, 1967: 92.1 mhz; 840 w. Ant 520 ft. Dups AM 15%. ■ Rates: \$—; 3.55; 3.55; 3.55.

WLDR(FM)—July 17, 1966: 101.9 mhz; 50 kw horiz, 3 kw vert. Ant 590 ft. 118 S. Union St. (49684). (616) 947-3220. Great Northern Bcstg System Inc. Audio news: UPI. Stereo. Format: MOR. ■ Rod Maxson, pres; Donald Wiitala, gen mgr; Leonard Burns, chief engr. ■ Rates: \$4.95; 4.95; 4.95; 4.95.

WTCM—1941: 1400 khz; 1 kw-D, 250 w-N. Paul Bunyan Bldg. (49684). (616) 947-7675. Mid-Western Bcstg Co. (group owner). Net: NBC. Rep: Torbet. ■ Les Bierderman, pres; Russ Loomis, bus mgr; John E. Walkmeyer, gen mgr; William H. Kiker, chief engr. ■ Rates: \$6.10; 5.65; 5.65; 4.70.

WTCM-FM—Dec 13, 1965: 103.5 mhz; 38 kw. Ant 715 ft. Dups AM 6-9 a.m. Format: C&W. ■ WPBN-TV affil. ■ Rates: \$6.10; 4.70; 4.70; 4.70.

Warren

***WPHS-FM**—March 20, 1964: 91.5 mhz; 10 w. 30333 Hoover Rd. (48093). (313) 573-0580. Warren Consolidated Schools. Format: Btfl mus, top 40. ■ Charles E. Lampinan, stn mgr.

West Branch

WBMB—1972: 1060 khz; 1 kw-D. 206 W. Houghton Ave. (48661). (517) 345-3300. Ogemaw Bcstg Co. Audio news: APR. Rep: Michigan Spot Sls. Format: Variety Spec progs: Farm 1½ hrs; Polish 2½ hrs wkly. ■ Robert Marshall, pres; Gene C. Flowers, coml & gen mgr; Peter Brooks, prog dir; Dennis Hill, mus dir; Barry Stutesman, news dir; Harold Holmes, chief engr. ■ Rates: \$5.75; 5.75; 5.75; 5.75.

Whitehall

WLRC—Oct 21, 1959: 1490 khz; 1 kw-D, 250 w-N. Box 158 (49461). (616) 893-1465. White River Communications. Net: ABC/C, ABC/E. Rep: Hopewell. Format: MOR/Contemp. ■ Ralph Triegger, pres; Kevin C. Driscoll, gen mgr; Roger Munyon, prog & news dir; Karl Lahm, chief engr.

WLRO(FM)—Co-owned with WLRC. April 1975: 95.3 mhz; 1.5 kw. Ant 410 ft.

Wyoming

WYGR—Nov 14, 1964: 1530 khz; 500 w-D, 250 w (CH). 1055 28th St., S.W. (49509). (616) 538-0800. Stuart P. Noordyk (acq 2-25-72). Net: ABC/I. Rep: Smith. Format: MOR, C&W. Spec progs: Black 1 hr; Sp 1 hr; Gosp 20 hrs wkly. ■ Stuart P. Noordyk, pres; Thomas L. Mix, gen & sls mgr; Roger Munyon, prog & mus dir; Pete Lenau, news dir; John Seymour, chief engr. ■ Rates: \$6; 6; 6.

Ypsilanti

***WEMU(FM)**—Dec 8, 1965: 88.1 mhz; 10 w. Eastern Michigan U. (48197). (313) 487-2229. Eastern Michigan U. Format: Educl. ■ Gary D. Hawks, VP; Richard E. Jacques, gen mgr; Art Timko, prog dir; Sam Eiler, news dir.

WSDS—1962: 1480 khz; 500 w-D. DA. 580 W. Clark Rd. (acq 6-1-68). Net: ABC. Format: C&W. ■ Robert W. Koch, pres & gen mgr; Jack Wilkerson, coml mgr & prog dir; Robert Catalano, opns mgr. ■ Rates: \$12.50; 10.50; 12.50; —.

WYFC—Nov 16, 1962: 1520 khz; 250 w-D. Box 1520 (48197). (313) 482-4000. Word Bcstrs (acq 12-73). ■ Douglas Schleutker, prog dir & chief engr.

Zeeland

WZND(FM)—Aug 23, 1971: 99.3 mhz; 3 kw. Ant 98 ft. Stereo. 410 East Main St. (49464). (616) 772-2144. West-State Bcstrs Inc. Net: ABC/FM. Rep: Pearse. Format: C&W. Spec prog: Relig 18 hrs wkly ■ Charles E. Rich, pres, gen & coml mgr; Craig R. Rich, prog, mus & news dir; Jack L. Maciejewski, tech dir. ■ Rates: \$6; 6; 6.

CSI ELECTRONICS INC.
2607 River Road
Cinnaminson, New Jersey, 08077
Telephone: (609) 786-1060

Minnesota

HAMILTON-LANDIS & ASSOCIATES, Inc.
NATIONWIDE MEDIA BROKERS
WASHINGTON, D. C., CHICAGO, DALLAS,
SAN FRANCISCO
SELL **MORE**
RADIO & TELEVISION STATIONS
IN THE MIDWEST—NEAREST OFFICE IS—
1429 TRIBUNE TOWER, CHICAGO 60611
(312) 337-2754

Aitkin

KEZZ(FM)—Listing follows KKIN.

KKIN & KEZZ

KKIN—June 1, 1961: 930 khz; 1 kw-D. Box 930 (56431). (218) 927-2344. Upper Minn Bcstg Corp. (acq 3-10-69). Net: MBS. Rep: Keystone, Ewing. Format: C&W. ■ R. J. Coursole, pres; Boyd Bremner, gen mgr; James Pryor, sis mgr; John Woodrow, prog dir & prom mgr; Kaye Frey, news dir; Richard Johnson, chief engr. ■ Rates: \$4; 4; 4; —.

KEZZ(FM)—Co-owned with KKIN. Jan. 3, 1972: 94.3 mhz; 3 kw. Ant 190 ft. Stereo. Prop sep from AM. Format: Btfl mus. ■ Rates: \$3; 3; 3; —.

Albany

KASM—Nov 20, 1950: 1150 khz; 1 kw-D. (56307). (612) 845-2184. Stearns County Bcstg. Rep: Bernard. Format: C&W. Spec prog: Ger ¼ hr wkly. ■ W. H. Blatner, pres; Urban J. Keppers, gen coml & prom mgr & prog dir; Cliff Mitchell, news dir; Charles Gilbert, chief engr.

Albert Lea

KATE—October 1937: 1450 khz; 1 kw-D, 250 w-N. 305 S. First Ave. (56007). (507) 373-2338. Communications Properties Inc. (group owner; acq 1-59). Net: ABC/I. Rep: Avery-Knodel; Weing. ■ Hart Carodozo, pres; Lawrence Waskosky, gen mgr; Paul Kero, prog mgr; Greg Hammer, mus dir; James Struck, news dir; Gary Hoff, chief engr. ■ Rates: \$9; 9; 9; 7.

KCPI-FM—Co-owned with KATE. July 1974: 95.3 mhz; 3 kw. Ant 300 ft. Stereo. (507) 373-2335. Prog sep from AM. Format: Variety, btfl mus. ■ Rates: \$11; 11; 9.

Alexandria

KCMT-FM—Dec. 25, 1970: 100.7 mhz; 100 kw. Ant 930 ft. 720 Hawthorne St. (56308). (612) 763-5166. Central Minnesota TV Co. (group owner). Net: NBC. Rep: Avery-Knodel. Hyatt. Format: C&W. ■ Tom Barnes Jr, pres; Glenn W. Flint, gen mgr; James Eyrdal, coml mgr; Kenneth C. Bechtel, prog dir; Gary Hallada, prom mgr; Dick Brant, mus dir; Carl Everson, chief engr; John Floyd, news dir ■ KCMT-TV affil.

KXRA—July 27, 1949: 1490 khz; 1 kw-D, 250 w-N. Box 26, 1312 Broadway (56308). (612) 763-3131. Alexandria Communications Corp. (acq 10-1-74). Net: ABC/I, Viking State News. Rep: Cooke, Wayne-Erano. Format: C&W, MOR, variety. ■ Robert E. Hines Jr, pres & gen mgr; Everette Q. Walters, coml mgr; Jim Trupe, prog dir; Al Esterberg, prom mgr; Dick Aga, mus dir; Ercel Aga, news dir; Joseph A. Rademacher, chief engr.

KXRA-FM—May 1, 1968: 92.7 mhz; 3 kw. Ant 150 ft. Stereo. Progs sep from AM.

Anoka

KANO—April 15, 1956: 1470 khz; 1 kw-D. Box 1470 (55305). (612) 421-2600. Community Service Radio Inc. (group owner; acq 5-6-74). Format: MOR/contemp. ■ Stewart Dahl, pres & gen mgr; Dave Burgge-man, coml mgr; Dean Sherwood, prog dir; Tim Winker, news dir; Tim Eilfmann, chief engr. ■ Rates: \$7.25; 6.25; 7.25; —.

KTWN(FM)—Co-owned with KANO. Aug. 1, 1968: 107.9 mhz; 57 kw. Ant 320 ft. Stereo. Prog sep from AM. Format: Classcl. ■ Ray Ose, gen mgr; David Madsen, prog dir; Scott O'Malley, coml mgr. ■ Rates: \$17.50; 17.50; 17.50; 17.50.

Austin

KAUS AM-FM

PRO/Meeker Radio
A COMMITMENT TO EXCELLENCE

KAUS—May 30, 1948: 1480 khz; 1 kw-U, DA-2. Box 159 (55912). (507) 437-7666. TWX 910-565-2103. Withers Bcstg Co. of Minn. (acq 10-11-74). Net: MBS. Rep: Pro/Meeker. Format: Top 40. Spec prog: Farm 12 hrs wkly. ■ W. Russell Withers, pres; Ken A. Soderberg, gen mgr; Craig Henderson, prog dir; Scott Davis, news dir; Jim Hardy, chief engr. ■ Rates: \$7; 7; 7.

KAUS-FM—May 30, 1968: 99.9 mhz; 100 kw. Ant 930 ft. Stereo. Dups AM 10%. Format: Btfl mus. ■ KAAL-TV affil. ■ Rates: \$5; 5; 5; 5.

***KEDQ(FM)**—Dec. 1, 1972: 90.7 mhz; 10 w. Ant 63 ft. 1800 Northwest Eighth Ave. (55912). Austin Community College.

KQAQ—April 16, 1960: 970 khz; 5 kw-D, 500 w-N, DA-2. Box 97 (55912). (507) 437-4567. Fort Dodge Bcstg (Austin Broadcasting Co.). Net: ABC/E, Minn Star. Rep: PRO Time Sales, Ewing. Format: MOR, C&W. ■ Donald F. Jones, pres & gen mgr; Tad Anthony, coml mgr; Tom Rudquist, news dir; Sheldon Miller, prom mgr; Don Franz, chief engr.

Bemidji

KBHP(FM)—Listing follows KBUN.

***KBBS(FM)**—Jan 19, 1970: 91.9 mhz; 10 w. Ant 90 ft. Birch Hall, Bemidji State U. (56601). (218) 755-2912. Bemidji State U. Net: NPR (tape), Assn of Minnesota Public Educ Radio Stns. Format: Educl. Spec progs: Children's 1 hr; black 1 hr; Ger ¼ hr; Sp ½ hr; Indian 25 3/4 hrs wkly. ■ Dr. R. D. Decker, pres; Kris O. Geisen, gen mgr & chief engr.

KBUN—1946: 1450 khz; 1 kw-D, 250 w-N. Box 766 (56601). (218) 751-4120. Paul Bunyan Bcstg Co. (acq 12-1-56). Net: North Star Net. Rep: M. A. Sales. Spec prog: Chippewa ¼ hr wkly. Format: 25% C&W, 25% rock, 25% MOR. ■ Anne P. Delong, pres; Ned J. Goodwin, VP & gen mgr; Robert R. Irish, coml mgr; Gary B. Benson, prog dir; Kathleen La Croix, traffic mgr; Stan Gorski, mus dir; Charles B. Matala, news dir; Richard D. Tyner, chief engr.

KBHP(FM)—Co-owned with KBUN. Aug 3, 1972: 101.1 mhz; 58 kw. Ant 350 ft. 502½ Beltrami Ave. (56601). (218) 751-3990. Dups AM 30%. Format: MOR. ■ James Thoreen, prog dir; Cheryl Berglund, traf mgr; James Canny, mus dir; Jerome Skeim, news dir.

Michigan, Minnesota Radio

See page C-1 for explanation of listings.

Benson

KBMO—December 1956: 1290 khz; 500 w-D. Box 208, 1205 Pacific Ave. (56215). (612) 842-4601. North Star Bcstg Co. (acq 12-1-60). ■ George J. McCarthy, pres; Ron Overlander, gen & coml mgr; Marvin E. Meyer, prog dir; George B. McClellan, news dir; Julian J. Meyer, chief engr. ■ Rates: \$4.20; 4.20; 4.20; —.

KBMO-FM—April 26, 1968: 93.5 mhz; 3 kw. Ant 165 ft. ■ Rates same as AM.

Blue Earth

KBEW—Aug 29, 1963: 1560 khz; 1 kw-D. Box 306 (56013). (507) 526-2181. Faribault County Bcstg Co. Net: ABC/E. Rep: Walton Broadcast Sales, Ewing. ■ Paul C. Hedberg, pres & gen mgr; Erle Oothoutd, prom mgr; Jeannette Matheson, coml mgr; Roy Haven, prog & mus dir; John Salewske, chief engr.

KBEW-FM—August 1966: 100.9 mhz; 3 kw. Ant 215 ft. Stereo. Dups AM 75%.

Brainerd

KLIZ



KLIZ—Aug 6, 1946: 1380 khz; 5 kw-U, DA-N. 2700 East Oak St. (56401). (218) 829-2853. Brainerd Bcstg Co. (acq 5-23-74). Net: NBC. Format: C&W. Spec prog: Talk 3 hrs wkly. ■ Earl R. Johnson, pres, gen mgr & news dir; Chet Hanson, coml mgr; Bob Stafford, prog dir; Denny Carrigan, mus dir; George Melin, chief engr. ■ Rates: \$5; 5; 5; 5.

KLIZ-FM—May 23, 1960: 95.7 mhz; 36 kw. Ant 360 ft. Stereo. Dups AM 10%. Format: Contemp. ■ Rates same as AM.

KVBR—May 16, 1964: 1340 khz; 1 kw-D, 250 w-N. KVBR Bldg. (56401). (218) 829-8747. Greater Minnesota Bcstg Corp. Net: ABC/I, Donnybrooke Radio. Format: MOR. ■ Charles B. Persons, pres & coml mgr; Scott D. Persons, gen mgr & mus dir; June A. Persons, prog dir; Wendell Meyers, prom mgr; Mark W. Persons, news dir & chief engr.

Breckenridge

KBMW—Aug 28, 1948: 1450 khz; 1 kw-D, 250 w-N. Box 249 (56520). (701) 642-6639. Interstate Bcstg Corp. (acq 10-1-54). Group owner: Ingstad. Net: ABC/E. Format: MOR. ■ Mrs. Robert E. Ingstad, pres; R. E. Ingstad Jr, gen mgr; Deann Aarnodt, coml mgr; George F. Kaufmann, prom mgr; Ken Farley, prog dir; Chris Delany, mus dir; Gary Rogers, news dir; Charles Sjoström, chief engr.

KKWB(FM)—Co-owned with KBMW. February 17, 1970: 104.9 mhz; 3 kw. Ant 155 ft. Stereo. Format: Easy listening. Progs sep from AM.

Buffalo

KRWC—Nov 16, 1971: 1360 khz; 500 w-D. Box 267 (55313). (612) 682-4444. Donnell Inc. Format: C&W, MOR. ■ Donald L. and Janet F. Wohlenhaus, owners; R. L. Hendricks, mus dir; Wayne L. King, prom mgr; William Kennedy, chief engr.

Cambridge

KABG(FM)—June 21, 1973: 105.5 mhz; 3 kw. Ant 300 ft. Stereo. 540 N. Emerson Ave. (55008). (612) 689-1055, 434-6901. Isanti Bcstg Co. Audio news: UPI. Rep: Jim King. Format: Diversified. Spec progs: Scandinavian 2 hrs; farm 3 hrs; C&W 12 hrs wkly. ■ Jack I. Moore, pres & gen mgr; Jack Carr, prog dir; Stuart Dahl, coml mgr; Tim Eilfmann, chief engr. ■ Rates: \$4.50; 4.50; 4.50; 4.50.

Cloquet

WKLK—Jan 31, 1950: 1230 khz; 1 kw-D, 250 w-N.

Minnesota Radio

See page C-1 for explanation of listings.

Box 309, Hwy. 33 South (55720). (218) 879-6725. Empire Bcstg Stations Inc. (acq 9-16-74). Net: ABC/I. Rep: U.B.C. Sales. Format: C&W, MOR. Spec progs: Pol 1 hr; Swed 1/2 hr; Fin 1 hr wkly. ■ Otto A. Korp, pres; Dennis Stramer, gen. coml, & prom dir; Howard Vargason, prog, mus, & news dir; Bill Meys, chief engr

WKLK-FM—November 1975: 100.9 mhz; 3 kw. Ant 300 ft.

Collegetville

***KSJR-FM**—January 21, 1967: 90.1 mhz; 150 kw. Ant 480 ft. (CP: Ant 640 ft.) Stereo. c/o William H. Kling (56321). (612) 363-7702. DACS 612-363-4221. Minnesota Public Radio Inc. Net: NPR; Minn Pub Radio. Format: Classical, news & pub affrs. ■ William H. Kling, pres; Arthur A. Hoehn, opns mgr; J. Michael Barone, mus dir; Daniel Rieder, tech dir; Mark Killian, chief engr.

Crookston

***KUCM-FM**—Oct 17, 1972: 91.7 mhz; 10 w. Univ of Minn Tech College (56716). (218) 281-2231. U. of Minn. Technical College-Crookston. Net: Assoc of Minn Pub Ed Radio Stns. Format: Contemp. ■ R. James Hodgson, gen mgr; Richard D. Tyner, chief engr.

KROX—April 1948: 1260 khz; 1 kw-D, 500 w-N, DA-N. Box 620 (56716). (218) 281-1140. Crookston Bcstg Co. (acq 6-52). Net: MBS. Rep: Cooke McDermott. ■ Jerome A. Dahlberg, pres & prog dir; William J. Kiewel, sec-treas & gen mgr; Earl Handyside, chief engr.

Detroit Lakes



KDLM—October 1951: 1340 khz; 1 kw-D, 250 w-N. Box 746 (56501). (218) 847-5624. Detroit Lakes Bcstg Corp. (acq 10-57). Format: MOR. ■ Al Leighton, pres; David Knutson, gen mgr; Bob Spilman, coml mgr; Dale Van de Loo, prog dir. ■ Rates: \$8.10; 8.10; 8.10; 8.10.

KVLR(FM)—Co-owned with KDLM. Not on air, target date Oct. 75: 95.3 mhz; 3 kw. Ant 275 ft. Stereo. Box 1010. (612) 847-5624. Knutson-Leighton Inc. Format: Hit parade MOR (automated). ■ David Knutson, pres & coml mgr; Andy Lia, prog dir. ■ Rates: \$6.50; 6.50; 6.50; 6.50.

Duluth

KAOH—March 11, 1963: 1390 khz; 500 w-D. Box 6167 (55806). (218) 727-1521. KAO Inc. (acq 5-24-70). Net: MBS. Rep: Masla. Format: C&W. ■ R. Bunker Rogoski, pres; J. R. Anderson, gen mgr; Allyn Schmitz, coml mgr; Jim Golden, prog dir; Kenneth Horyza, chief engr. ■ Rates: \$8; 8; 8.

KAOH-FM—Not on air, target date March 1976: 94.9 mhz; 25 kw. Ant 400 ft. Prog dups AM 50%.

KDAL—November 26, 1936: 610 khz; 5 kw-U, DA-N. 425 W. Superior (55802). (218) 727-8911. TWX 910-561-2522. KDAL Inc. (acq 1-16-61). Group owner: Continental. Net: CBS. Rep: Petry, Hyeit, Creed, Glen-Warren (Canada). ■ Odin S. Ramsland, pres & gen mgr; Cal Haworth, coml mgr; John Russell, prog dir; Gordon Paymar, prom mgr; William Cortez, news dir; Rudy Luukinen, chief engr. ■ KDAL-TV affil.

***KUMD-FM**—July 15, 1961: 89.1 mhz; 490 w. Ant 290 ft. 130 Humanities Bldg. U. of Minn. (55812). (218) 726-7181. Board of Regents, U. of Minnesota. Net: Pacifica. Format: Diversified. ■ Philip Glende, gen mgr; Dave Tuenge, prog dir; Barbara Olsen, news dir; Curt McNamara, chief engr.

WAKX—See Superior, Wis.

WAKX-FM—June 14, 1972: 98.9 mhz; 26 kw. Ant 470 ft. 410 W. Superior St. (55802). (218) 727-7271. Stereo Bcstg Inc. Net: ABC/I. Rep: Savalli/Gates, Ewing. Prog dups AM 100% daytime. Format: Top 40. ■ Lewis M. Latto, pres & gen mgr; Roger Johnson,

coml mgr; Chris "T", prog & mus dir; Harvey Goldberg, news dir; Wilfred Meys, chief engr. ■ Rates: \$11.50; 11.50; 11.50; 11.50.

WDSM—See Superior, Wis.

WDTH(FM)—May 26, 1971: 103.3 mhz; 100 kw. Ant 550 ft. 317 W. Superior St. (55802). (218) 722-7439. Board of Regents of U. of Minn. Net: ABC/FM. Rep: Webb. Format: Contemp. rock. ■ Robert Heller, assoc provost; Tom Kuhn, coml mgr; Dean C. Voight, Jr., prog dir; Bob Blesener, prom mgr; Fred Olson, mus dir; Tom Kuhn, news dir; Robert E. Peterson, chief engr.

WIBC—1924: 560 khz; 5 kw-U, DA-2. 1001 E. 9th St. (55804). (218) 728-4484. TWX 910 561-0056. Park Bcstg Inc. (group owner; acq 1968). Net: ABC/C. Rep: Katz. Format: Top 40. ■ Roy H. Park, pres; Robert Grann, VP & gen mgr; Gary Stevens, mus & prog dir; R. F. Mabrey, chief engr.

WGGR(FM)—July 1970: 105.1 mhz; 100 kw. Ant 750 ft. Stereo. 125 W. Superior St. (55802). (218) 727-7449. Titanic Corp. (acq 1969). Rep: Pro/Meeker, Wayne-Evans. Format: Btl mus. ■ William D. Gregory, pres; John Bartikoski, gen mgr; John Lokke, prog dir; Ralph Kersten, chief engr. ■ Rates: \$10.50; 14; 14; 10.50.

***WSCD-FM**—1975: 92.9 mhz; 46 kw. Ant 600 ft. 1200 Kenwood Ave. (55811). (218) 728-3657. TWX (218) 724-5021. Minnesota Public Radio (group owner). Net: NPR, Minnesota Public Radio Net. Format: Classcl, jazz, diversified, pub serv. ■ William Kling, pres; Dick Daly, gen mgr; M. Barone, mus dir; Carol Howe, prom mgr; G. Eichten, news dir; Charles Burdick, chief engr.

WWJC—April 26, 1963: 850 khz; 10 kw-D. 1120 E. McCuen St. (55808). (218) 626-2738. WWJC Inc. Net: ABC/E. Rep: Radio Reps Inc. Format: Good music, Inspirational. Spec prog: Swedish 1/2 hr wkly. ■ Floyd Bernard, pres; Roger Elm, gen mgr & chief engr. ■ Rates: \$3; 3; 3; 3.

East Grand Forks

KRAD—Aug 14, 1959: 1590 khz; 1 kw-U, DA-N. Box 560 (56721). (218) 773-2424. KRAD Inc. Net: MBS. Format: C&W. ■ Marlin T. Obie, pres; Jack French, VP & gen mgr; Duaine Sander, coml mgr; Bob Borino, prog dir; John French, prom mgr; Curt Zimmerman, news dir; Norm Bakken, chief engr. ■ Rates: \$7.50; 7.50; 7.50; 7.50.

KRAD-FM—Oct 15, 1975: 103.9 mhz; 3 kw. Ant 145 ft. Prog dups AM 100%. ■ Rates same as AM.

Ely

WELY—Oct 2, 1954: 1450 khz; 1 kw-D, 250 w-N. Box 540 (55731). (218) 365-3285. Northern Lakes Corp. (acq 9-1-68). Net: ABC/I, Keystone. Rep: Hurley. Format: MOR. ■ V. T. Hallett, pres & gen mgr; Robert Tuomela, chief engr.

Eveleth

WEVE—Dec 1948: 1340 khz; 1 kw-D, 250 w-N. Box 650 (55734). (218) 741-5922. Mesabi Communication Systems Inc. Net: MBS. Format: C&W, MOR. Spec progs: Finnish 1 1/2 hrs; Yugoslav mus 10 hrs wkly. ■ Gary Bloomquist, pres; Rey Kent, VP & gen mgr; Joe Cerar, prog dir & chief engr; Joe Russ, mus dir; Robert Aro, news dir.

Fairmont

KSUM—Jan 1, 1949: 1370 khz; 1 kw-U, DA-2. Box 491 (56031). (507) 235-5595. Woodward Bcstg Inc. (acq 11-15-62). Audio news: UPI. Spec progs: Farm 12 hrs; classcl 2 hrs wkly. Rep: Pro Time Sales, Bill Dahlston (W. Coast). Format: MOR. ■ Elizabeth Woodward, pres; Robert A. Laird, gen mgr; Ken Evans, sis mgr; Tom Schultz, prog dir; Elizabeth Laird, prom mgr; Clint Knapp, chief engr; Dick Mahar, news dir. ■ Rates: \$10.70; 8.55; 8.55; 8.55.

Faribault

KDHL—Jan 10, 1948: 920 khz; 5 kw-U, DA-2. 601 Central Ave. (55021). (507) 334-4345. KDHL Inc. Net: MBS. Rep: Avery-Knodel. Format: C&W, MOR, farm. ■ J. E. Hyde, pres; Warren D. Asher, gen mgr; Earle Miller, farm dir; Rance English, news dir; Jack Hyde, chief engr. ■ Rates: \$16; 11; 13; 11.

KDHL-FM—May 15, 1968: 95.9 mhz; 3 kw. Ant 280

ft. Stereo. Dups AM 90%. ■ Rates: \$6.65; 6; 6.20; 6.

Fergus Falls

KBRF—Oct 20, 1926: 1250 khz; 1 kw-U, DA-N. Box 494 (56537). (218) 736-7596. Empire Bcstg Stations (acq 8-1-67). Net: MBS. Rep: Savalli/Gates; Hurley. Format: C&W. ■ Otto A. Korp, pres & gen mgr; Don H. Fritzell, coml mgr; Larry B. Nornes, prog dir; John A. Brush, news dir; Harry Hammond, chief engr.

KBRF-FM—Jan 19, 1968: 103.3 mhz; 28.5 kw. Ant 270 ft. Stereo. Prog sep from AM.

Fosston

KEHG—December 12, 1966: 1480 khz; 5 kw-D. Box 49, Park Rapids (56470). (218) 435-2875. KEHG Radio Inc. Net: NBC, DBC. Format: C&W. Spec prog: Farm 1 hr wkly. ■ E. P. DeLa Hunt Jr., pres, gen mgr & chief engr; Jim Offerdahl, coml mgr; Dan Allan, prog dir.

KEHG-FM—June 13, 1969: 107.1 mhz; 3 kw. Ant 110 ft. Stereo. Prog dups AM 20%.

Golden Valley

KQRS—May 13, 1948: 1440 khz; 5 kw-D, 500 w-N, DA-N. 917 N. Lilac Dr, Minneapolis (55422). (612) 545-5601. Hudson Bcstg Corp. Group owner: James A. McKenna. Audio news: APR. Rep: ABC/FM Spt Sls. Format: Progs. Spec prog: Indian 1/2 hr wkly. ■ James A. McKenna, Jr., pres; Dick Poe, gen mgr & sis mgr; Tac Hammer, prog dir; Jim Larkin, mus dir; Terry Stripsky, chief engr. ■ Rates: \$21; 23; 28; 28.

KQRS-FM—Sept 1, 1963: 92.5 mhz; 27 kw horiz, 6.8 kw vert. Ant 210 ft. (CP: 100 kw. Ant 810 ft.) Stereo. Prog dups AM 100%. ■ Rates same as AM.

KUXL—Oct 27, 1961: 1570 khz; 1 kw-D. 5730 Duluth Street (55422). (612) 544-3196. Universal Bcstg Co. of Minneapolis-St. Paul Inc. (acq 12-64). Group owner: Universal Bcstg. Net: MBS/Black. Rep: Universal Bcstg Corp. Format: Black, religion, talk. Spec progs: Black 3 hrs; Hebrew 2 hrs; Spanish 2 hrs; Polish 1 hr wkly. ■ Lawrence Brandon, pres; John McCooley, gen mgr; Joe Barbeau, prog dir; Amos W. Johnson, mus dir; Allen Carlson, news dir; Richard Kruse, chief engr.

Grand Rapids

***KAXE(FM)**—Not on air, target date unknown: 91.7 mhz; 100 kw. Ant 460 ft. Box 196, Lake Elmo, Minn. (55042). Northern Community Radio. ■ Richard V. McClear, pres.

KOZY—January 1948: 1490 khz; 1 kw-D, 250 w-N. 213 1/2 N. First Ave. West (55744). (218) 326-3446. Itasca Bcstg Co. Net: MBS. ■ Robert D. Kennedy, pres & gen mgr; B. J. Germ, prog & news dir; Ross Fesenmeyer, chief engr.

KXGR(FM)—November 1975: 96.7 mhz; 1.7 kw. Ant 390 ft. Box 310 (55744). Grand Rapids Radio. ■ Roger D. Olsen and James R. Courseille et al, owners.

Hastings

KDWA—Oct 24, 1963: 1460 khz; 1 kw-D. 1800 1/2 Vermillion St. (55033). (612) 437-3182. Hastings Bcstg Co. Rep: Boiles. ■ David L. Boudoin, pres, gen & coml mgr & chief engr; John Trog, prog & prom mgr; Marianne Von Haden, mus dir; Lew Jaquis, news dir. ■ Rates: \$3.50; 3.25; 3.25; —.

Hibbing

WKKO—1975: 1060 khz; 1 kw-D. Wabana Lake Resort, RR No. 2, Box 543, Grand Rapids (55744). ■ Jerry J. Collins, owner.

WMFG—1935: 1240 khz; 1 kw-D, 250 w-N. Box 99 (55746). (218) 263-7531. Hibbing Bcstg Co. (acq 3-14-60). Net: ABC/I. Audio news: UPI. Rep: Boiles, Hurley. Format: MOR. ■ Frank P. Befera, pres; Lester Rutstein, gen mgr; Dave Cook, prog & news dir; Conrad Gabrielson, chief engr. ■ Rates: \$5; 5; 5; 5.

WMFG-FM—1971: 106.3 mhz; 600 w. Ant 270 ft. Stereo. Prog dups AM 50%. ■ Rates same as AM.

Hutchinson

KDUZ—Sept 16, 1953: 1260 khz; 1 kw-D. Box 32 (55350). (612) 896-1555. North American Bcstg Co. Group owner: Tedesco. Net: Central Livestock Assoc

Net. Rep: Hopewell. Format: C&W, MOR. ■ Albert S. Tedesco, pres; Heinz R. Fruck, gen mgr & news dir; Jim Lynn, coml mgr & prog dir; Darrell Gander, chief engr; Larry Graf, sls mgr.

KDUZ-FM—June 6, 1968: 107.1 mhz; 3 kw. Ant 195 ft. Prog dups AM 100%.

International Falls

KGHS—Sept 1, 1959: 1230 khz; 250 w-U. Box 591 (56649). (218) 283-3481. KGHS Inc. (acq 11-1-60). Net: ABC/I, Minn Star Net. Rep: Devney. Format: MOR. ■ Daniel D. Ganter, pres & gen mgr; Robert Bakken, news dir; Otis Bergvall, chief engr. ■ Rates: \$3.50; 3.50; 3.50; 3.50.

***KICC(FM)**—March 1970: 91.5 mhz; 10 w. Box 833 (56649). (218) 283-8712. Rainy River Community College. Format: Educl. Spec prog: Indian 4 hrs. wkly. ■ Wallace A. Simpson, pres; Richard R. Hill, gen mgr.

Litchfield

KLFD—Jan 2, 1959: 1410 khz; 500 w-D. Box 919 (55355). (612) 693-3212. Herbert P. Gross (acq 1962). Rep: Pro-Time Sales. Format: Contemp, MOR, variety. ■ Herbert P. Gross, pres; Darryl Hensley, VP & gen mgr; Darlene Halvorson, coml mgr; Jim Ohnstad, prog dir; Bob Elifson, mus dir; Steve Neighbors, news dir; Ralph Anderson, chief engr.

KLFD-FM—Aug 30, 1968: 95.3 mhz; 3 kw. Ant 105 ft. Prog dups AM 90%.

Little Falls

KLTF—October 1950: 960 khz; 5 kw-D. 70 Northeast First Ave. (56345). (612) 632-5414. Little Falls Bcstg Co. (acq 12-52). ■ John H. Lemme, pres & gen mgr; Richard J. Rudeck, coml mgr; John T. Peck, prog dir; Harriet Turner, prom mgr; Gordon Lommen, news dir & chief engr. ■ Rates: \$4.55; 5.70; 4.55; —.

Long Prairie

KEYL—September 1959: 1400 khz; 1 kw-D, 250 w-N. 123 Central Ave. (56347). (612) 732-2164. Dairyland Bcstrs Inc. (acq 2-1-67). Format: C&W, MOR. Spec prog: Farm 20 hrs wkly. Rep: Walton. ■ Ken Eidschink, pres & gen mgr; Al Peterson, prog dir; Vern Schmidt, coml mgr; David Ludere, mus dir; Kay King, news dir; Norm Wettstein, chief engr. ■ Rates: \$5.52; 5.52; 5.52; 5.52.

Luverne

KQAD—March 1, 1971: 800 khz; 500 w-D, DA. Box H (56156). (507) 283-4444. Siouxland Bcstg Inc. (group owner). Net: ABC/I. Audio news: APR. Rep: Walton, Ewing. Format: Btfl mus, farm. ■ Paul C. Hedberg, pres; Harold L. Norman, gen mgr; Tony Colloff, prog/mus dir; Lee Norman, coml & prom mgr; Sheldon King, news dir. ■ Rates: \$4.50; 4.50; 4.50; 4.50.

KQAD-FM—Sept 1, 1971: 100.9 mhz; 3 kw. Ant 240 ft. Stereo. Prog dups AM 100%. ■ Rates same as AM.

Mankato

KEYC-FM—April 1, 1968: 99.1 mhz; 100 kw. Ant 860 ft. Stereo. Inc 128 (56001). (507) 387-7905. Lee Enterprises Inc. (group owner). Format: MOR. ■ Donald G. Harter, gen mgr; V. L. Halligan, coml mgr; Charles Pasek, prog dir; Dave Hooge, studio supvr & chief engr. ■ KEYC-TV affil.

***KMSU(FM)**—1963: 90.5 mhz; 10 w. Mankato State U. (56001). (507) 389-2922. Mankato State U. Format: MOR, variety. Audio news: UPI. ■ Stephen C. Wolf, dir of radio & chief engr.

KTOE—1950: 1420 khz; 5 kw-U, DA-N. Box 1420 (56001). (507) 345-4537. Minnesota Valley Bcstg Co. Group owner: Linder. Net: ABC/I. ■ Don Linder, pres & coml mgr; Willard Smith, gen mgr; Wayne Quimby, mus dir; Marc Tall, news dir; Harley Engel, chief engr. ■ Rates: \$9.10; 9.10; 9.10; 9.10.

KYSM—July 25, 1938: 1230 khz; 1 kw-D, 250 w-N. Box 1240 (56001). (507) 345-4673. F. B. Clements & Co. Net: NBC. Rep: Walton. Format: MOR. ■ Dick Painter, gen mgr; Dennis Wasinger, coml mgr; Don Bendickson, news dir; Dick Siemers, chief engr. ■ Rates: \$5.90; 5.90; 5.90; 5.90.

KYSM-FM—April 1948: 103.5 mhz; 81 kw. Ant 530 ft. Prog dups AM 50%. ■ Rates: \$2.70; 2.70; 2.70; 2.70.

Maplewood

WMIN—Aug 1964: 1010 khz; 250 w-D, DA. 498 S. Century, St. Paul (55119). (612) 739-4433. Voyageurs Bcstg Co (acq 1975). Rep: Walton. Format: Polka, MOR. Spec prog: Ger & Span, each 1 hr wkly. ■ Obed Borgen, pres; Gerald Rosendahl, coml mgr; Tom Dohm, gen mgr

Marshall

KMHL—Nov 30, 1946: 1400 khz; 1 kw-D, 250 w-N. 1414 East College Dr. (56258). (507) 532-2282. KMHL Bcstg Co. (acq 1-1-68). Group owner: Linder. Net: ABC. Rep: Savalli/Gates. Format: MOR, C&W, Light rock. ■ Harry W. Linder, pres; Richard B. Lusk, gen mgr; Norm Shoephoester, coml mgr; Steve Easley, prog dir; David Neu, chief engr.

KMHL-FM—Dec 13, 1967: 100.1 mhz; 3 kw. Ant 300 ft. Stereo. Prog dups AM 10%.

Minneapolis-St Paul

***KBEM-FM**—Oct 5, 1970: 88.5 mhz; 2.15 kw. Ant 370 ft. 1101 Third Ave. S. Minneapolis (55404). (612) 348-4888. Special School District No. 1, Board of Education. Format: Instructional & community service. ■ Dr. John B. Davis Jr, sup; Frank F. Engdahl, consultant & gen mgr; William F. Lund, chief engr/stn mgr; Ted Allison, prod coord.

KDAN—July 1, 1965: 1370 khz; 500 w-D, DA. 3092 Military Road, Newport (55055). (612) 459-7000. KDAN Bcstg Co. Inc. (acq 10-17-73). Format: All news. ■ Richard H. Darby, pres; Russ Kent, gen & coml mgr; John Scherkenbach, prom mgr & prog/news dir; Scott Christiansen, chief engr

KDWB-AM



KDWB—Sept 19, 1959: 630 khz; 5 kw-D, 500 w-N, DA-2. Box 7630 (55119). (612) 739-4000. Doubleday Bcstg (group owner; acq 11-6-72). Rep: Radio Advertising Res. Format: Contemp. ■ David G. Scribner, pres; Gary G. Stevens, VP & gen mgr; Bob Harris, national sls mgr; Alan Goodman, gen sls mgr; John Sebastian, prog & mus dir; Bill Hartman, prom mgr; Lou Buron, local sls mgr; William Dorweiler, chief engr. ■ Rates: \$62; 40; 66; 51.

KEEY—1936: 1400 khz; 1 kw-D, 250 w-N. 611 Frontenac Place, St. Paul (55104). (612) 645-7757. Malrite Bcstg (group owner; acq 5-1-68). Rep: HR/Stone. Format: Btfl mus. ■ Milton Maltz, pres; David R. Millan, VP & gen mgr; Russ De Marois, sls mgr; Gary Glaenzler, chief engr.

KEEY-FM—June 1, 1969: 102.1 mhz; 100 kw. Ant 360 ft. (CP: Ant 810 ft.) Stereo. Prog sep from AM. Format: Btfl mus.

KNOF(FM)—April 10, 1960: 95.3 mhz; 3 kw. Ant 250 ft. 1347 Selby Ave., St. Paul (55104). (612) 645-8271. Selby Gospel Bcstg Co. Format: Gospel. ■ Rev. Fred Adam, pres, gen mgr & prog dir; Rev. Grace C. Adam, VP; James A. Peterson, chief engr.

KQRS-AM-FM—See Golden Valley.

KRSI—See St. Louis Park.

***KSJN(FM)**—July 1, 1967: 91.1 mhz; 100 kw. Ant 1310 ft. Stereo. 400 Sibley St., St. Paul (55101). (612) 291-1222. DACS: 612-224-3017. Minn. Public Radio Inc. Net: NPR; Minn Pub Radio. Format: Publ serv. ■ William H. Kling, pres; Margaret Moos, prom mgr; J. Michael Barone, mus dir; Gary Eichten, news dir; David Felland, opns dir; Daniel B. Rieder, dir of engr; D. Michael Shields, chief engr.

***KSJR-FM**—See Collegeville.

15 KSTP

The Music Station



KSTP—April 1928: 1500 khz; 50 kw-U, DA-N. 3415 University Ave., St. Paul (55114). (612) 645-2724.

Minnesota Radio

See page C-1 for explanation of listings.

TWX 612-551-0918. Telex 029-685. Hubbard Bcstg Inc. (group owner). Rep: McGavren/Guild, McDermott. Format: Contemp. ■ Stanley S. Hubbard, pres; Jack Nugent, gen mgr; Chuck Knapp, prog dir; Kay Greaser, prom mgr; Charlie Bush, news dir; Norman Paetznick, chief engr. ■ Rates: \$55; 40; 55; 35.



KSTP-FM—Nov 1, 1965: 94.5 mhz; 100 kw. Ant 1221 ft. Stereo. Prog sep from AM. Format: MOR. ■ John Mayasich, gen mgr. ■ KSTP-TV affil.

KTCR—April 5, 1962: 690 khz; 500 w-D, DA. 3701 Winnetka Ave. N., Minneapolis (55427). (612) 544-1558. Hennepin Bcstg Assoc. Group owner: Tedesco. Net: MBS. Rep: Masla. Format: C&W. ■ Albert S. Tedesco, pres; Robert J. Rock, gen mgr; Kenneth Firnstahl, coml mgr; Jerry Cuning, prog & news dir; Vern Weegman, prom mgr; Mike Knight, mus dir; Chuck Ingle, chief engr.

KTCR-FM—97.1 mhz; 50 kw. Ant 150 ft. 3800 Minnehaha Ave. S., Minneapolis (55406). (612) 721-7416. (acq 1-4-68).

***KTIS**—Feb 7, 1949: 900 khz; 1 kw-D. 3003 N. Snelling, Roseville (55416). (612) 636-2666. Northwestern College. Format: Relig. ■ W. B. Berntsen, pres; Cornelius Keur, gen mgr; Paul Ramseyer, prog dir; Don Rupp, news dir; Don Malley, chief engr.

***KTIS-FM**—May 1949: 98.5 mhz; 74 kw. Ant 270 ft. Stereo. Prog dups AM 50%. Format: Inspirational music.

***KUOM**—Jan 13, 1922: 770 khz; 5 kw-U (shares time with *WCAL, Northfield). Rarig Center, U. of Minn., Minneapolis (55455). (612) 373-3177. U. of Minn. Net: NPR. Format: Ed. ■ Burton Paulu, gen mgr; Marion Watson, prog dir; Curt Oliver, mus dir; David Olson, news dir; Larry Brogger, chief engr.

KUXL—See Golden Valley.

WAYL(FM)—Jan 6, 1961: 93.7 mhz; 100 kw. Ant 420 ft. (CP: Ant 430 ft.) Stereo. 215 Old Highway No. 8, New Brighton, Minn. (55119). (612) 633-9667. Entertainment Communications (group owner; acq 6-29-69). Rep: Torbet. Format: Btfl mus. ■ Joseph M. Field, pres; Sam Sherwood, VP & gen mgr; Larry Roberts, prog mgr & mus dir; Charles Loufek, coml mgr; Dennis Whitehead, chief engr. ■ Rates: \$29; 31; 33; 29.

WCCO—Oct 2, 1924: 830 khz; 50 kw-U. 625 Second Ave. South (55402). (612) 332-1202. TWX 612-321-1306. Midwest Radio-Television Inc. (acq 8-52). Group owner: Minneapolis Star and Tribune. Net: CBS. Rep: CBS Radio Spot Sales. Format: MOR. ■ Robert B. Ridder, chmn of bd; Larry Haeg, pres; F. Van Konyenburg, chmn of exec comm; Phil Lewis, gen mgr; Val Linder, prog dir; Clayton Kaufman, dir of sls; Gordon Mikkelsen, dir pub rel & spec prog; Charles Hartley, prom mgr; Curtis Beckman, news dir; Robert Woodbury, sls service mgr; Charles Kunze, chief engr.

WCCO-FM—102.9 mhz; 100 kw. Ant 1300 ft. 215 S. 11th St. Minneapolis (55403). ■ Robinson B. Brown, gen mgr; Bill Henderson, news dir; Paul E. Richardson, opns dir; Carl Lensgraf, mus dir. ■ WCCO-TV affil.

***WCTS-FM**—June 26, 1965: 100.3 mhz; 80 kw. Ant 430 ft. 2105 Fremont Ave. N. (55411). (612) 522-3620. Central Baptist Theological Seminary of Minneapolis. Format: Relig. ■ Dr. Richard V. Clearwaters, pres; Dr. Warren Vanheltso, gen mgr; Wayne Muri, tape lib; Jim Odens, mus lib; Dennis Whitehead, studio mgr & chief engr.

WDGY—1923: 1130 khz; 50 kw-D, 25 kw-N, DA-2. (CP: 50 kw-U, DA-2). 10332 Bloomington Freeway (55420). (612) 881-2633. Storz Bcstg Co. (group owner; acq 1-56). Format: Contemp. ■ Robert H. Storz, pres; Dale G. Weber, gen mgr; John Canton, prog dir; Ken Olsen, chief engr.

WL0L—1939: 1330 khz; 5 kw-D, DA-2. 730 Midwest

Minnesota Radio

See page C-1 for explanation of listings.

Plaza, 801 Nicollet Mall (55402). (612) 338-1330. TWX 612-321-1150. BFR Bcstg Corp. (acq 6-55). Group owner: Midcontinent. Net: ABC/I. Rep: Avco Radio-TV. ■ N. L. Bentson, pres; Wayne Williams, VP & gen mgr; Tom Wynn, prog dir; Mike Hoyt, prom mgr; Bill Allard, news dir; Wayne Seely, chief engr. ■ Rates: \$22; 18; 22; 16.

WLOL-FM—1956: 99.5 mhz; 72 kw. Ant 380 ft. Stereo. WLOL-FM Corp. Prog sep from AM. Format: Btfl mus. ■ Rates: \$10; 12; 10; 12.

WWTC—Aug 10, 1925: 1280 khz; 5 kw-U, DA-N. 609 2d Ave. South, Minneapolis (55402). (612) 333-2363. Buckley Bcstg Corp. (group owner; acq 1964). Audio news: NBC/NIS. Rep: Buckley. Format: All news. ■ Richard D. Buckley Jr, pres; Lee E. Zanin, gen mgr; Jim Stewart, opns dir; Doyle Rose, sls mgr; Ken Trimble, news dir; Michael J. McKenzie, chief engr. ■ Rates: \$31; 21; 26; 11.

Montevideo

KDMA—Dec 21, 1915: 1460 khz; 1 kw-U, DA-N. Box 471 (56265). (612) 269-8815. Midwest Bcstg Co. Group owner: Linder. Net: ABC/C; Minn. Viking State News. Rep: Savalli-Gates. Format: 1/3 Contemp, 1/3 C&W 1/3 Top 40. ■ Donald Linder & H. W. Linder, pres; Jerald C. Hennen, VP & gen mgr; Fred Ehlen, coml mgr; Jay Custafson, prog dir; Deanna Hodge, prom mgr; Mac Wilber, pres dir; Pete Peterson, chief engr; Corky Freeman, farm/news dir; Jerry Sawson, mgr-Granite Falls studio.

Moorhead

***KCCM-FM**—Jan 1, 1970: 91.1 mhz; 94 kw. Ant 300 ft. Stereo. Box 141, Concordia College (56560). (218) 299-3666. Minn. Publ Radio Inc. Net: NPR, Minn Public Radio Net. Format: Classical, news & pub affrs. ■ William H. Kling, pres; William Siemering, gen mgr; Dennis Hamilton, prog dir; Michael Barone, news dir; Gary Eichten, news dir; Steve Terhaar, chief engr.

KIDA(FM)—Listing follows KVOX.

KVOX—Nov 30, 1937: 1280 khz; 1 kw-D, 500 w-N, DA-N. Box 97 (56560). (218) 233-1522. Valley Communications Corp. (acq 6-1-74). Net: ABC/C. Format: Contemp. ■ Richard Herbst, pres/gen mgr; Harriet Morinville, coml mgr; Bob Denver, prog & mus dir; Ron Bee, opns mgr; Ellen Mrja, news dir; Steve Terhaar, chief engr. ■ Rates: \$7.75; 7.75; 7.75; 7.75.

KIDA(FM)—Co-owned with KVOX. Nov 30, 1966: 99.9 mhz; 26.5 kw. Ant 170 ft. Stereo. Net: ABC/FM. Prog sep from AM. Format: MOR. ■ Rates: \$4.60; 4.60; 4.60.

KWIM(FM)—November 1966: 98.7 mhz; 100 kw. Ant 410 ft. Stereo. (Dups KQWB Fargo, N.D. 05%). Box 2983, Fargo, N.D. (58102). (218) 236-9900. Midwest Radio Co. Rep: Torbet. Format: Rock. ■ Larry Lakoduk, pres; Jim Lakoduk, sls mgr; Tom Simmons, opns mgr; Wayne Hiller, prog dir; Jack Bell, prod mgr; Tom Simmons, mus dir; Curt Peterson, chief engr; Bruce Prentice, news dir.

Morris

KMRS—Sept 16, 1956: 1230 khz; 1 kw-D, 250 w-N. Box 231 (56267). (612) 589-3131. Western Minn. Bcstg. Group owner: Hedberg. Net: MBS. Rep: Walton. Format: C&W, MOR, R&B. Spec prog: Farm 12 hrs wkly. ■ Paul C. Hedberg, pres; Gene Steinhorst, gen mgr; Jack Klason, coml mgr; John Messenger, prog dir; Lee B. Temte, news dir; Maynard Meyer, chief engr. ■ Rates: \$6; 4.75; 6; 4.

***KUMM(FM)**—Sept 17, 1970: 89.7 mhz; 10 w. Ant 70 ft. University of Minnesota-Morris (56267). (612) 589-3741. University of Minnesota. Format: Progs, Top 40. ■ Robert Pratt, stn mgr.

New Prague

KTMF—Sept 22, 1969: 1350 khz; 500 w-D, DA, RR 2, Box 421 (56071). (612) 758-2571. TMF Communications. Format: Diversified. ■ Spec progs: Czech 7 hrs; farm 4 hrs wkly. ■ John Fair, pres; Ed Kabes, chief engr. ■ Rates: \$3.50; 3.50; 3.50; 3.50.

New Ulm

KNUJ—May 1949: 860 khz; 1 kw-D. 510½ Third St.

North (56073). (507) 354-2114. KNUJ Inc. Audio news: APR. Rep: Hurley. Format: MOR, C&W, farm, old time mus. Spec prog: Ger 3 hrs wkly. ■ Perry Galvin, gen mgr; Mike Stark, prog dir; Gerald Walston, chief engr. ■ Rates: \$11.50; 9.50; 9.50; 8.75.

KNUJ-FM—Nov 21, 1966: 93.1 mhz; 28 kw. Ant 380 ft. Stereo. Dups AM 10%. ■ Rates: \$3; 3; 3; 3.

Northfield

***KRLX(FM)**—January 25, 1975: 90.3 mhz; 10 w. Ant 72 ft. Carleton College (55057). (507) 645-4431. Carleton College. Format: Progs, Top 40, oldies. Spec prog: Black 4 hrs wkly. ■ Roy Hallanger, stn mgr; Benjamin Stiegler, chief engr.

KYMN—Sept 27, 1968: 1080 khz; 1 kw-D. Box 201 (55057). (507) 645-5695. KYMN Inc. (acq 2-1-73). Rep: Paul Ewing. Format: MOR. Spec progs: Farm, classcl 2 hrs; C&W 12 hrs wkly. ■ Stan Stydnicki, pres, gen mgr & chief engr; Wayne Eddy, VP & coml mgr; Steve Waller, prog & mus dir; Gene Thompson, news dir. ■ Rates: \$5.39; 4.90; 5.39; 4.90.

***WCAL**—Nov 23, 1918: 770 khz; 5 kw-U. (shares time with *KUOM Minneapolis.) (55057). (507) 663-3071. St. Olaf College. Net: NPR (assoc). Format: Educl, relig, classcl. Spec progs: Norwegian 3/4 hr, Swedish 3/4 hr, German 1/2 hr, Slovak 1/4 hr, Finnish, Latvian & Estonian rotate 1/2 hr wkly. ■ Paul E. Peterson, mgr & prog dir; Don Lee, chief anncr; Donald Omsgard, mus dir; J. Philip Stark, opns engr; John Mikaelson, maint engr.

***WCAL-FM**—April 5, 1968: 89.3 mhz; 100 kw. Ant 400 ft. Stereo. Prog dups AM 10%. Net: NPR. Spec progs: Black 2½ hrs wkly.

Ortonville

KDIO—July 23, 1956: 1350 khz; 1 kw-D. (56278). (612) 839-2581. Tri-State Bcstg Co. Rep: Cooke. ■ Richard S. Schultz, pres & chief engr; W. F. McCormick, gen mgr; Donald P. Egert, prog & news dir.

Owatonna

KRFO—1950: 1390 khz; 500 w-D. 301 N. Cedar St., Box K (55060). (507) 451-2250. Owatonna Bcstg Co. (acq 5-1-56). Format: MOR. Spec prog: Sp ½ hr wkly. ■ Duane Allen, pres & gen & coml mgr; Todd Hale, prog, mus & news dir; Gerald J. Boos, stn mgr & chief engr.

KRFO-FM—December 29, 1966: 104.9 mhz; 2.9 kw. Ant 175 ft. Prog dups AM 90%.

Park Rapids

KPRM—Dec 1, 1962: 1240 khz; 1 kw-D, 250 w-N. Box 49 (56470). (218) 732-3306. De La Hunt Bcstg Corp. (group owner). Net: NBC, DBC. Format: C&W. ■ E. P. De La Hunt Jr, pres, gen mgr & chief engr; Dan Allan, stn mgr & prog dir. ■ Rates: \$4; 4; 4; 4.

KPRM-FM—Dec, 1967: 103.7 mhz; 100 kw. Ant 295 ft. Stereo. Prog sep from AM. Format: Btfl mus. ■ Rates same as AM.

Pine City

WCMP—June 13, 1957: 1350 khz; 1 kw-D. Box 230 (55063). (612) 629-2525. WCMP Bcstg Co. (acq 1-1-68). Net: ABC. ■ Gerry Robbins, pres & gen mgr; Hank Melium, coml mgr; Ken Kern, news dir; Larry Severson, chief engr. ■ Rates: \$6.05; 6.05; 6.05; —.

Pipestone

KLOH—June 1955: 1050 khz; 1 kw-D, DA. Box 512 (56164). (507) 825-3363. KLOH Inc. (acq 1-63). Group owner: Ingstad. Net: ABC/C. Rep: PRO/Meeker. Format: C&W, 50's rock wknds. Spec prog: Farm 10 hrs wkly. ■ Robert Ingstad, pres; Walley Christensen, gen mgr; Chuck Walhof, prog dir; Diane Christensen, mus dir; Charles Dibble, prog mgr & news dir; Les Childers, chief engr. ■ Rates: \$7.50; 7.50; 7.50; 7.50.

KLOH-FM—Nov 20, 1968: 98.7 mhz; 40 kw. Ant 550 ft. Stereo. Prog sep from AM. Format: MOR, oldies. ■ Doug Bussliemen, prog dir. ■ Rates: \$4.50; 4.50; 4.50; 4.50.

***KRSW-FM**—December 1973: 91.7 mhz; 99 kw. Ant 800 ft. Worthington Community College (56187). Minnesota Public Radio Inc. Net: NPR. Format: Classical

& information. ■ William H. Kling, pres; F. Kim Hodgson, gen mgr; Paul Derby, chief engr.

Preston

KFIL—May 21, 1966: 1060 khz; 1 kw-D. Box 377 (55965). (507) 765-3856. KFIL Inc. Rep: Hurley. Format: C&W. ■ Obed S. Borgen, pres; Russell E. Chesney, gen mgr & prog dir; Denny Raye, news dir; Mike Anthony, mus dir; Reuben Rieck, chief engr. ■ Rates: \$5.85; 5.20; 5.85; 4.85.

KFIL-FM—September 1, 1970: 103.1 mhz; 3 kw. Ant 270 ft. Stereo. Prog dups AM.

Princeton

WKPM—February 1, 1967: 1300 khz; 1 kw-D. Box 188 (55371). (612) 389-1300. P. M. Bcstg Co. Audio news: APR. Format: MOR, diversified. Spec progs: C&W 14 hrs wkly. ■ Terry Montgomery, pres; Bruce Salberg, gen mgr; Dave Saline, prog dir; Brian McNee, news dir.

WQPM(FM)—Co-owned with WKPM. 1975: 106.3 mhz; 3 kw. Ant 295 ft.

Red Wing

KCUE—Jan 29, 1949: 1250 khz; 1 kw-D. Box 102 (55066). (612) 388-3512. Hiawatha Valley Public Service Bcstrs Inc. (acq 7-16-62). Net: ABC/I. Rep: PRO/Meeker, Ewing. Spec prog: C&W 6 hrs wkly. ■ George L. Brooks, pres & gen mgr; Jack Turnbull, coml mgr; Charles McMillen, news dir; Trent Allen, prog mgr; Gene Desermeaux, chief engr. ■ Rates: \$8.50; 8.50; 8.50; 4.50.

KCUE-FM—Aug 26, 1965: 105.5 mhz; 2.3 kw. Ant 340 ft. Stereo. Prog sep from AM. Net: ABC/FM. Format: Contemp, MOR. ■ Rates: \$8.50; 8.50; 7.50; 4.50.

Redwood Falls

KLGR—November 1954: 1490 khz; 1 kw-D, 250 w-N. Box 65 (56283). (507) 637-2989. Redwood Bcstg Inc. (acq 8-1-66). Net: ABC/I, Viking State News. Rep: PRO/Meeker. Format: C&W, MOR, Top 40, farm. ■ E. G. Randolph, pres; Mel Paradis, gen mgr; Dennis Mathis, sls mgr; Jim Marsh, farm dir; Wayne Olson, mus dir; Bruce Tolzmann, opns mgr; Gene Randolph, news dir & chief engr. ■ Rates: \$7.65; 7.65; 7.65; 6.45.

KLGR-FM—June 3, 1974: 97.7 mhz; 3 kw. Ant 300 ft. Stereo. Highway 19 W. (56283). Prog dups AM 20%. Format: Btfl mus. ■ Rates: \$5; 5; 5; 5.

Richfield

WYOO—Oct 18, 1949: 980 khz; 5 kw-U, DA-1. 2110 Cliff Rd., Eagan (55122). Fairchild Minnesota Inc. (acq 10-3-72). Rep: Eastman. Format: Oldies. ■ Al Lurie, pres; Marlin D. Schlotman, gen mgr; Michael O'Shea, prog dir; Ron Fraiser, news & sports dir; Joel Humke, chief engr.

WYOO-FM—Aug 10, 1959: 101.3 mhz; 100 kw. Ant 225 ft. (CP. Ant 810 ft.) Stereo. Prog sep from AM. Format: Top 40. ■ Bill Lake, prog dir.

Rochester

KNCV(FM)—Listing follows KWEB.

KNXR(FM)—Dec 24, 1965: 97.5 mhz; 96 kw. Ant 400 ft. (CP. 37 kw. Ant 620 ft.). Stereo. Downtown Holiday Inn Bldg. (55901). (507) 288-7700. United Audio Corp. Net: ABC/FM. Format: Variety. Spec prog: Classcl 4 hrs wkly. ■ Thomas H. Jones, pres & gen mgr; Donald H. Anderson, coml mgr. ■ Rates: \$9; 7.65; 9; 9.

KOLM—November 1963: 1520 khz; 10 kw-D (1 kw-CH). 114½ S. Broadway (55901). (507) 288-1971. Olmstead County Bcstg Co. Net: MBS. Rep: Savalli/Gates. Format: C&W. Spec prog: Farm 6 hrs wkly. ■ Howard G. Bill, pres; Martin Hedstrom, gen mgr & chief engr; Dick Lawrence, prog dir; Ron Howard, news dir; Ken Kious, mus dir. ■ Rates: \$8; 8; 8; 7.

KWWK(FM)—Co-owned with KOLM. July 4, 1967: 96.7 mhz; 3 kw. Ant 26 ft. (CP. Ant 295 ft.). Stereo. (507) 285-0322. Format: Rock. ■ John Glidden, coml mgr. ■ Rates: \$5.25; 5.25; 5.25; 7.

KROC—October 1935: 1340 khz; 1 kw-D, 250 w-N. 601 S.W. First Ave. (55901). (507) 288-4444. TWX 910-565-2477. Southern Minnesota Bcstg Co. Net:

Minnesota Radio

See page C-1 for explanation of listings.

pres & gen mgr & chief engr; Dan Allan, prog & mus dir. ■ Rates: \$—; 4; 4.

Waseca

KOWO—Dec. 22, 1971: 1170 khz; 1 kw-U. Box 483 (56093). (507) 835-5555. KOWO Inc. Format: Up-Tempo MOR, C&W. ■ Edwin Darby, pres; Larry Duker, mgr; Richard Johnson, chief engr.

KODE-FM—Co-owned with KOWO. Aug 22, 1972: 92.1 mhz; 3 kw. Ant 300 ft. Stereo. Prog dups AM 100%.

Willmar

KWLM—1940: 1340 khz; 1 kw-D, 250 w-N. Box 838 (56201). (612) 235-1340. Lakeland Bcstg Co. Group owner: Linder, Net: ABC/E. ■ H. W. Linder, pres; Jack Lynch, mgr; Bud Hanson, prog dir; Joe Martinson, prom mgr; Francois Peterson, chief engr. ■ Rates: \$9; 8; 9; 8.

KQIC(FM)—Co-owned with KWLM. July 1, 1965: 102.5 mhz; 70 kw. Ant 390 ft. Stereo. Prog sep from AM. ■ Steve Linder, mgr. ■ Rates: \$4.30; 4.30; 4.30; 4.30.

Windom

KDOM—Dec 28, 1958: 1580 khz; 250 w-D, DA. Wolff Lake Rd. (56101). (507) 831-3908. Schneider Bcstg (acq 3-15-70). Rep: Bolles; Walton Bcstg Sls. Format: C&W 60%, MOR 40%. ■ Larry Schneider, gen mgr; Frank Endersbe, coml & prom mgr; Mark Rudolph, prog dir & mus dir; Daniel L. Schillinger, news dir & chief engr.

KDOM-FM—Not on air, target date unknown: 94.3 mhz; 3 kw. Ant 95 ft.

Winona

KAGE—Feb 17, 1957: 1380 khz; 1 kw-D. Box 767 (55987). (507) 452-2867. KAGE Inc. (acq 1-7-3). Format: MOR. Net: Viking. Rep: Walton. ■ Jerry Papefuss, pres; Bud Baechler, gen mgr; Rick Charles, prog & mus dir; Bob Bambenek, news dir; Les Hittner, chief engr.

KAGE-FM—August 14, 1971: 95.3 mhz; 1 kw. Ant 490 ft. Stereo. Prog sep from AM. Format: Btfl mus, Contemp, C&W.

***KQAL(FM)**—Not on air; target date unknown: 89.5 mhz; 10 w. Ant 90 ft. Johnson & Sanborn Srs. (55987). Winona State College. ■ Jacque Reidelberger, faculty adv.

KWNO



American
Information
Radio Network

KWNO—January 1938: 1230 khz; 1 kw-D, 250 w-N. Box 466 (55987). (507) 452-4722. KWNO Inc. (acq 5-61). Net: ABC-I. Rep: PRO Time Sls. Format: Contemp. ■ H. R. Hurd, pres & coml mgr; C. E. Williams, VP & gen mgr; Allyn Thurley, prog dir; Wayne Valentine, news dir; Bill Koutsky, mus dir; Donald Sorem, chief engr. ■ Rates: \$5.50; 5.50; 5.50; 5.50.

Worthington

KWOA—1947: 730 khz; 1 kw-D. Box 592 (56187). (507) 376-6165. Worthington Bcstg Co. Rep: PRO Time Sls, Ewing. Format: MOR, farm. ■ Josephine C. Olson, pres & gen mgr; James J. Wychor, VP & stn mgr; Neil Roberts, news dir; Steve Larson, chief engr; Paul Rahders, prog dir. ■ Rates: \$14; 14; 14; 11.50.

KWOA-FM—May 3, 1961: 95.1 mhz; 100 kw. Ant 650 ft. Stereo. Prog sep from AM. ■ Rates: \$5; 5; 5; 5.

CSI ELECTRONICS INC.
2607 River Road
Cinnaminson, New Jersey, 08077
Telephone: (609) 786-1060

NBC. Rep: Avery-Knodel; Hyett/Ramland. Format: MOR. ■ W.T. Brink, VP-gen mgr; Robert Ryan, VP-news; Robert Cross, VP-engr. ■ Rates: \$11.20; 7.60; 7.60; 5.90.

KROC-FM—July 1, 1965: 106.9 mhz; 100 kw. Ant 1110 ft. Prog dups AM 100%. ■ Rates same as AM. ■ KROC-TV affil.

KWEB—Sept 1, 1957: 1270 khz; 5 kw-D, 1 kw-N, DA-2. Box 6428, 1107 N.W. 7th St. (55901). (507) 288-3888. Public Service Bcstg (acq 10-74). Group owner: PSB Radio. Net: ABC/I. Rep: PRO/Meeker, Ewing. Format: Top 40. ■ Donald Jones, pres; John Schaller, gen mgr; Denny Luell, prog & mus dir; Brad Larson, news dir; Jim Johnston, chief engr. ■ Rates: \$6; 5; 6; 5.

KNCV(FM)—Co-owned with KWEB. Nov 1, 1968: 101.7 mhz; 3 kw. Ant 46 ft. Prog dups AM 100%. ■ Rates same as AM.

KWWK(FM)—Listing follows KOLM.

Roseau

KRWB—April 5, 1963: 1410 khz; 1 kw-U, DA-N. Box 130 (56751). (218) 463-1410. William F. Rendell (acq 9-1-74). Net: MBS. Format: MOR, C&W, sports. ■ William F. Rendell, pres, gen mgr, prog & news dir; Jack McDonald, coml mgr; Mike Curtis, mus dir; Bob Anderson, chief engr.

Rushford

***KLSE-FM**—Dec 17, 1974: 91.7 mhz; 100 kw. Ant 590 ft. Stereo. 400 Sibley St., St Paul (55101). (612) 291-1222. Minn Public Radio (group owner.) Net: NPR, Minn. Pub Radio. Format: Public. ■ William H. Kling, pres; Bruce Larson, chief engr.

St. Cloud

KCLD—June 1938: 1450 khz; 1 kw-D, 250 w-N. Highway 152 (56301). (218) 251-1450. Leighton Enterprises, Inc. (group owner; acq 9-15-75). Net: NBC. ■ Al Leighton, pres & gen mgr; Arlan Schlagel, coml mgr; Jim Giebel, prog dir; Scott Slocum, mus dir; Mark Brenden, news dir; Dick Tyner, chief engr. ■ Rates: \$7.25; 7.25; 7.25; 7.25.

KCLD-FM—May 1948: 104.7 mhz; 40 kw. Ant 460 ft. Stereo. Prog dups AM 100%. ■ Rates same as AM.

***KVSC(FM)**—May 10, 1967: 88.5 mhz; 10 w. Ant 83 ft. 140 Stewart Hall, St. Cloud State U. (56301). 6. St. Cloud State U. Net: NPR. Format: Ed, jazz, progsv. Spec prog: French 2 hrs wkly. ■ Dr. Charles Graham, pres; Dr. R. John DeSanto, gen mgr.

WJON—September 1950: 1240 khz; 1 kw-D, 250 w-N. Box 220 (56301). (612) 251-4422. WJON Bcstg Co. (acq 5-31-62). Net: ABC/I. Format: News, sports, talk, Top 40. Spec prog: C&W 10 hrs; farm 14 hrs wkly. ■ Andy Hilger, pres & gen mgr; Mike Dime, stn mgr; Fred Barry, news dir; Don Koenig, coml mgr; Wayne David, sports dir; Tom Kay, mus dir; Michael Hendrickson, chief engr.

WWJO(FM)—Co-owned with WJON. 1975: 98.1 mhz; 100 kw. Ant 420 ft. Stereo. Prog dups AM 4%. Format: C&W, contemp. ■ Conrad Overboe, sports dir; Patrick McKeever, mus dir; Steve Johnson, news dir.

St. Louis Park

KFMX(FM)—Listing follows KRSI.

KRSI—May 13, 1958: 950 khz; 1 kw-U, DA-2. 11320 Valley View Rd, Eden Prairie (55343). (612) 941-5774. TWX: 910-576-2757. Park Bcstg of Minn. Inc. (acq 12-68). Group owner: Park. Net: ABC/E. Rep: Katz. Format: C&W. ■ Roy H. Park, pres; John G. Enoch, VP & gen mgr; Corinne Wiles, ops mgr Dick Roiseland, chief engr.

KFMX(FM)—Co-owned with KRSI. July 1, 1962: 104.1 mhz; 52 kw. Ant 190 ft. Stereo. Prog sep from AM. Net: NBC. Format: MOR.

St. Paul

— See Minneapolis.

St. Peter

KRBI—Aug 5, 1957: 1310 khz; 1 kw-D, DA. 1031 W. Grace St. (56082). (507) 931-3220. Seehafer &

Johnson Bcstg Corp. (group owner; acq 4-1-60). Net: ABC/E. Rep: Walton. Format: C&W country rock. ■ Don Seehafer, pres; Bob Johnson, coml & gen mgr; Bob Burt, coml, stn & prom mgr; Ken Lundberg, prog & mus dir; Bill Rau, chief engr. ■ Rates: \$4; 4; 4.

KRBI-FM—Sept 1, 1966: 105.5 mhz; 3 kw. Ant 130 ft. Prog dups AM 100%. ■ Rates same as AM.

Sauk Rapids

WHMH-FM—Listing follows WVAL.

WVAL—August 3, 1963: 800 khz; 250 w-D. Box 255 (56379). (612) 252-6200. Tri-County Broadcasting Inc. Format: C&W. Spec prog: Old Time Mus 2 hrs wkly. ■ Lois Ploeger, coml mgr; Peter Kaluza, prog dir; Dick Walters, prom mgr; Dennis Ryan, mus dir; Ron Grunert, news & farm dir; Dave McDonald, chief engr.

WHMH-FM—Co-owned with WVAL. October, 1975: 101.7 mhz; 3 kw. Ant 300 ft.

Shakopee

KSMW—Oct 6, 1963: 1530 khz; 500 w-D. 421 E. First Ave. Box 66 (55379). (612) 445-1866. Progress Valley Bcstg Inc. Rep: Bolles Co. Format: Adult, MOR, C&W, Polka. Spec progs: talk-interview 3 hrs wkly. ■ George J. McCarthy, pres; Ray Foslid, VP & gen mgr; Jay Thorpe, coml mgr; Mike Iverson, prog & news dir; Louise Krohn, office mgr; Greg St. Pete, mus dir. ■ Rates: \$5.90; 5.90; 5.90; —.

South St. Paul

KDAN—See Minneapolis.

Stillwater

WAVN—March 15, 1949: 1220 khz; 5 kw-D. 127 S. Water St. (55082). (612) 439-1220. WAVN Inc. (acq 12-1-67). Net: Viking. Rep: Keystone, Ewing. Format: MOR. Spec progs: Ger 1½ hrs, old time mus 1½ hrs wkly. ■ Henry L. Sampson, gen mgr; Jon R. Hanvelt, news dir; Eddie S. Cary, prog dir; David P. Schultz, chief engr. ■ Rates: \$7.80; 6.45; 7.80; —.

Thief River Falls

***KAVS(FM)**—Nov 15, 1971: 89.5 mhz; 10 w. Ant 100 ft. Stereo. Area Vocation-Technical School. Hwy 1 East (56701). (218) 681-5427. School Dist 564. Audio news: UPI. Format: C&W, MOR, top 40. ■ Arndt Aune, pres; Howard Rokke, gen mgr; Dick Tyner, chief engr.

KTRF—1946: 1230 khz; 1 kw-D, 250 w-N. Box 40 (56701). (218) 681-1230. KTRF Radio Corp. (acq 4-1-54). Net: MBS. Rep: Wayne-Evans. ■ Don Olson, pres & gen mgr; Dick Tyner, chief engr. ■ Rates: \$5.35; 5.35; 5.35; 4.70.

New FM—Co-owned with KTRF. Not on air; target date December 1975: 99.3 mhz; 3 kw. Ant 180 ft. Stereo. Prog sep from AM.

Virginia

WHLB—1936: 1400 khz; 1 kw-D, 250 w-N. Box 954 (55792). (218) 741-2233. Virginia Bcstg Co. (acq 11-1-58). Net: ABC/I. Rep: O'Connell, Reilly, Bolles. Format: MOR. ■ Frank Befera, pres; James Parise, gen mgr; Conrad Gabrielson, chief engr. ■ Rates: \$5; 5; 5; 5.

WIRN(FM)—Co-owned with WHLB. June 2, 1971: 107.1 mhz; 3 kw. Ant 105 ft. Stereo. Prog dups AM 100% ■ Rates same as AM.

Wadena

KWAD—Jan 1, 1948: 920 khz; 1 kw-U, DA-N. Box 551 (56482). (218) 631-1803. KWAD Bcstg Co. (acq 6-54). Group owner: Ingstad. Net: ABC/I. Rep: Masla. Format: MOR, C&W. Spec prog: Farm 10 hrs wkly. ■ Tom Ingstad, pres; Dave Walter, coml mgr & prom mgr; Ross Holland, mus dir; Lynn Thornton, prog & news dir; Chuck Sjostrom, chief engr. ■ Rates: \$4.75; 4.75; 4.75; 4.75.

KKWS(FM)—Co-owned with KWAD. Sept 23, 1968: 105.9 mhz; 50 kw. Ant 250 ft. Stereo. Prog dups AM 16%. Format: Btfl mus. ■ Rates same as AM.

Walker

KLLR—July 11, 1970: 1600 khz; 1 kw-D. Box 49, Park Rapids (56470). (218) 547-1200. De La Hunt Bcstg Corp. (group owner). Net: NBC, DBC. Rep: Walton. Format: C&W. ■ Edward P. De La Hunt Jr.,

Mississippi Radio

See page C-1 for explanation of listings.

Mississippi

HAMILTON-LANDIS

& ASSOCIATES, Inc.

NATIONWIDE MEDIA BROKERS
WASHINGTON, D.C., CHICAGO, DALLAS,
SAN FRANCISCO

SELL MORE

RADIO & TELEVISION STATIONS
IN THE SOUTHWEST—NEAREST OFFICE IS—
6060 N. CENTRAL EXPY., DALLAS 75206
(214) 691-2345

Aberdeen

WHAY(FM)—Listing follows WMPA.

WMPA—February 1952: 1240 khz; 1 kw-D, 250 w-N. Box 98 (39730). (601) 369-4561. J. W. Furr (acq 6-1-65). Group owner: Gulf Central. Net: NBC. Format: Top 40, MOR. ■ Jim Buffington, gen mgr and news dir; George Menetree, prog dir; David Addikison, chief engr. ■ Rates: \$2.50; 2.50; 2.50.

WHAY(FM)—Co-owned with WMPA. June 1, 1975: 105.5 mhz; 3 kw. Ant 300 ft. Stereo. Box 118 (601) 369-4040. Prog sep from AM. Format: C&W. ■ James Ellis III, gen and coml mgr. ■ Rates same as AM.

Amory

WAFM(FM)—Listing follows WAMY.

WAMY—Oct 23, 1955: 1580 khz; 5 kw-D. Box 268 (38821). (601) Clearbrook 6-5911. Bob McRaney Enterprises Inc. Rep: Hopewell, Beaver. ■ Bob McRaney Sr., pres & gen mgr.

WAFM(FM)—Co-owned with WAMY. 1974: 95.3 mhz; 3 kw. Ant 255 ft.

WHAY(FM)—See Aberdeen.

Batesville

WBLE—June 19, 1953: 1290 khz; 1 kw-D. Drawer 73 (39602). (601) 563-7266. Panola Bcstg Co. ■ Harold B. McCarley, pres; gen & coml mgr; Alfred E. Jennings, chief engr.

Bay St. Louis

WPUP—March, 1974: 1190 khz; 5 kw-D. Bay Bcstg Corp.

Bay Springs

WHII—June 26, 1971: 1570 khz; 1 kw-D. Box 548 (39422). (601) 764-3151. Cotton Valley Bcstg Co. Net: ABC/E. Rep: Keystone. Format: MOR, oldies, relig. C&W. Spec prog: Farm 3 hrs wkly. ■ Jerome Hughey, pres, gen & coml mgr, mus dir; Ann Hughey, prog mgr; A. R. Bird, prom mgr; Randy Robbins, news dir; Tom Biaz, chief engr.

WXIY(FM)—Co-owned with WHII. July 7, 1975: 93.5 mhz; 3 kw. Ant 134 ft. Dups AM 60%. Format: Black. ■ Rates: \$1.23; 1.23; 3.50.

Belzoni

WELZ—1959: 1460 khz; 1 kw-D. Box 215 (39038). Humphreys County Bcstg Co. Net: Keystone. Rep: Breen & Ward. Spec prog: Black 15 hrs wkly. ■ Roth E. Hook, pres; Carl B. Gibbons, gen mgr.

Biloxi

WLOX—May 1948: 1490 khz; 1 kw-D, 250 w-N. Box 549 (39530). (601) 432-5591. WLOX Bcstg Co. Net: MBS. Rep: Masla; Busby, Finch & Woods. Spec prog: Black 6 hrs wkly. ■ J. S. Love Jr., pres; Ray Butterfield, VP & gen mgr; Charles French, coml mgr; Roy Whitaker Jr., prog dir; Jim Allen, news dir; T. B. Majure, chief engr; Leon Duke, mus dir. ■ WLOX-TV affil.

WQID(FM)—Listing follows WVMI.

WVMI—April 1, 1950: 570 khz; 1 kw-D. Box 4565

(39533). (601) 388-2323. New South Communications Inc. (acq 8-1-61). Group owner: New South Radio. Audio news: APR. Format: C&W. Spec progs: Black 2 hrs; farm 1 hr wkly. ■ F. E. Holladay, pres; Wayne Vowell, gen mgr; Ann Arthur, coml mgr; Bob Lima, prog dir; Lance Carson, mus dir; Dave Vincent, news dir; Bob Thornton, chief engr. ■ Rates: \$7.50; 6.50; 7.50; 6.50.

WQID(FM)—Co-owned with WVMI. July 11, 1966: 93.7 mhz; 100 kw. Ant 270 ft. Stereo. Net: ABC/C. Rep: Torbet. Format: Top 40. Spec prog: Farm 6 hrs wkly. ■ Bob Lima, mus dir; Lynn Cole, prom mgr. ■ Rates same as AM.

Booneville

WBIP—Sept 1, 1950: 1400 khz; 1 kw-D, 250 w-N. Box 232 (38829). (601) 728-5301. Booneville Bcstg Co. Group owner: Roden. Net: ABC/C. Format: C&W. ■ E. O. Roden, pres; R. J. Bonds, VP & gen mgr; Don Murphy, prog dir. ■ Rates: \$3.50; 3.50; 3.50.

WBIP-FM—1974: 99.3 mhz; 3 kw. Ant 170 ft.

Brandon

WRJH(FM)—Listing follows WRKN.

WRKN—June 1967: 970 khz; 1 kw-D, DA. Box 145 (39042). (601) 825-5045. Radio Stn WRKN Inc. (acq 12-6-73). Rep: Beaver. Format: C&W. Spec prog: Farm 1 hr wkly. ■ Roy Harris, pres and gen mgr; Randy Harris, prog and mus dir, chief engr; Randy Barber, coml and prom mgr; Ricky Hargrove, news dir. ■ Rates: \$3.80; 3.80; 3.80; —

WRJH(FM)—Co-owned with WRKN. Nov 1974: 97.7 mhz; 3 kw. Ant 290 ft. Radio station WRJH Inc. Stereo. Format: Relig. Spec prog: Farm ½ hr wkly. ■ Rates: \$4.20; 4.20; 4.20; 4.20.

Brookhaven

WCHJ—Aug 15, 1955: 1470 khz; 1 kw-D. Box 711 (39601). (601) 833-6221. Rural Broadcasting Co. Format: Variety. ■ W. M. Jones, pres & gen mgr; Vera Jones, prog dir.

WJMB—April 1948: 1340 khz; 1 kw-D, 250 w-N, SH. Box 546 (39601). (601) 833-6911. Brookhaven Bcstg Inc. (acq 6-10-59). Net: Keystone. Rep: Continental. Spec prog: C&W 10 hrs wkly. ■ Aubrey H. Felder, pres & gen mgr; Ted Batson, prog dir.

WMRQ(FM)—Not on air; target date unknown: 92.1 mhz; 3 kw. Ant 300 ft. Box 202 (39601). 21st Century Bcstg. Format: Standard pops.

Calhoun City

WJRL—1530 khz; 250 w-D. Box 605 (38916). (601) 628-5130. Calhoun County Bcstg. Format: C&W. ■ Jesse R. Williams, pres; George Willhite, gen & coml mgr; Lee Ottis Bray, chief engr.

Canton

WMGO—Dec 9, 1954: 1370 khz; 1 kw-D. Box 182 (39046). (601) 859-2373. Canton Bcstg Inc. (acq 12-1-70). Net: Mississippi Radio News, Keystone. Format: Black, C&W, R&B, variety. Spec prog: Fr 1¼ hrs wkly. ■ Noel Pass, pres & gen mgr & prog dir; Ralph O. Williams, coml mgr; Ed Hobgood, chief engr.

WVLM(FM)—Not on air; target date unknown: 101.7 mhz; 2.9 kw. Ant 30 ft. 70 W. Burton Place, Chicago (60610). LLES Communications.

Carthage

WECP—March 15, 1966: 1080 khz; 250 w-D. Drawer L (39051). (601) 267-7949. Meredith Colon Johnston. Format: C&W. ■ Colon Johnston, pres, gen mgr, coml mgr, prog dir; Janie Rasberry, mus dir; David Ingram, news dir; Paul Miller, chief engr.

Clarksdale

WJBI(FM)—April 1, 1974: 101.7 mhz; 3 kw. Ant 200 ft. Box 1202 (38614). (601) 627-1113. Superior Bcstg Co. inc. Format: C&W. Spec prog: Farm 10 hrs wkly. ■ J. Boyd Ingram, pres & chief engr; James Lee Martin, gen mgr; Jody Jarrell, prog and mus dir; Wayne Powell, prom mgr; Jerry Helms, news dir.

WKDL—Sept 15, 1955: 1600 khz; 1 kw-D. Box 1216 (38614). (601) 627-1600. Southland Communica-

tions (acq 11-11-75). Net: ABC/E. Rep: Devney, McDermott, Messina, Crane, Gray. Format: contemp pop. ■ Rates: \$2.50; 2.35; 2.35.

WROX—1941: 1450 khz; 1 kw-D, 250 w-N. Drawer 1178 (38614). (601) 627-7343. Burney Imes Jr. (group owner; acq 1943). Net: MBS, Mid South Radio. Rep: Southern Spot Sls. Format: Contemp, black. Spec progs: C&W 12 hrs; farm 12 hrs wkly. ■ Tom Reardon, gen mgr; Paul Marks, agricultural prog dir; Jean Wimberly Cauthen, news dir; C. D. Graves, chief engr.

Cleveland

WCLD—1949: 1490 khz; 1 kw-D, 250 w-N. Drawer X (38732). (601) 843-4091. Radio Cleveland Inc. (acq 1957). Rep: Bolles, Southern Spot Sls. Format: Contemp, MOR, black. Spec progs: Farm 18 hrs; C&W 12 hrs wkly. ■ George C. Shurden, gen & coml mgr; John Kenney, prog dir; Percy Kuhn, chief engr. ■ Rates: \$2; 2; 2.

WCLD-FM—1972: 103.9 mhz; 1 kw (CP 1.6 kw). Ant 300 ft. Stereo. Prog sep from AM. Format: C&W. ■ Rates same as AM.

WDLT(FM)—Listing follows WDSK.

WDSK—June 25, 1958: 1410 khz; 1 kw-D. Highway 61 North (38732). (601) 846-6644. Horizon Radio Inc. (acq 7-1-73). Net: ABC/L. Rep: Walton. Format: C&W. ■ U. J. Gilbert, gen mgr.

WDLT(FM)—Co-owned with WDSK. June 22, 1970: 92.7 mhz; 3 kw. Ant 225 ft. (601) 846-6646. Dups AM 25%. Net: ABC/C. Format: Black. ■ Charles Blanks, mus dir.

Clinton

***WHJT(FM)**—1974: 93.5 mhz; 3 kw. Ant 300 ft. Box 4207 (39058). (601) 924-4505. Mississippi College. Rgnl net: MRS. Format: Classcl, jazz, btlf mus variety. ■ Hollis B. Todd, faculty dir; A. C. McCollough, stn mgr.

Columbia

WCJU—Dec 20, 1946: 1450 khz; 1 kw-D, 250 w-N. Box 472 (39429). (601) 736-2616. WCJU Inc. (acq 6-69). Net: ABC/E. Rep: Keystone. Format: Top 40, C&W. Spec progs: Farm 5 hrs; black 15 hrs; talk/pub aff 10 hrs, wkly. ■ M. E. Bullock, pres; Thomas F. McDaniel, gen mgr; Terry Anderson, sls mgr; Jan Harris, traf dir; Don Leake, chief engr. ■ Rates: \$2.25; 1.50; 1.50.

WFFF—April 14, 1961: 1360 khz; 1 kw-D. Box 550 (39429). (601) 736-2678. Haddox Enterprises Inc. (acq 1965). Format: Variety. ■ Lester Haddox, pres, gen mgr & chief engr; David Martin, coml mgr; Ronnie Geiger, prog dir; Blanche Weindel, news dir.

WFFF-FM—October 1966: 96.7 mhz; 3 kw. Ant 100 ft. Stereo. Prog sep from AM. Format: Easy lstng.

Columbus

WACR—March 1957: 1050 khz; 1 kw-D. Box 1078 (39701). (601) 328-1050. James W. Eatherton (acq 3-57). Format: Top 40. ■ James W. Eatherton, pres; James W. Ratherton III, coml mgr; Mrs. Eva Eatherton, woman's prog dir.

WCBI—October 1940: 550 khz; 1 kw-D, 500 w-N, DA-2. Box 271 (39701). (601) 328-7271. Columbus Bcstg Inc. (acq 1953). Group owner: Birney Imes Jr. Stns. Net: ABC/E. Reps: Keystone, Southern Spot Sls. Format: MOR, top 40. ■ Lamar Wingo, stn mgr; Pete Webb, coml mgr; Dave Barron, prog dir; Dean Green, chief engr. ■ WCBI-TV affil.

WJWF(FM)—Listing follows WMBC.

WMBC—Dec 4, 1969: 1400 khz; 1 kw-D, 250 w-N. Box 707 (39701). (601) 328-1400. J. W. Furr. Group owner: Gulf Central Radio. Net: NBC. Format: C&W. ■ J. W. Furr, owner; Doug Moulds, gen mgr; Frank Stenger, coml mgr; Ron Page, mus dir; Watt Hairston, chief engr.

WJWF(FM)—Co-owned with WMBC. Nov 1, 1969: 103.1 mhz; 3 kw. Ant 265 ft. Stereo. Dups AM 10%. Format: MOR.

***New FM**—Not on air; target date unknown: 90.9 mhz; 10w. 616 Third Ave. (39701). Golden Triangle Educl Media Corp. ■ David P. Coughlin, treas.

Corinth

WADI(FM)—Oct 26, 1968: 95.3 mhz; 3 kw. Ant 210 ft.

Stereo. Box 1367 (38834). (601) 287-3101. E. C. Holstford (acq 8-11-75). Net: ABC/FM. Rep: Carpenter. Format: C&W. ■ E. C. Holstford owner; J. A. Baxter Jr, gen mgr; Tom Muchmore, prog dir; Jan Prater, mus dir; Charles A. Weeks, chief engr.

***WALP(FM)**—Oct 26, 1970: 90.5 mhz; 1.8 kw. Ant 170 ft. Rte. 3, Box 60AA (38834). (601) 287-4446. Alcorn County School District. Format: Educ, pub svc. ■ Wesley Bradford, gen mgr.

WCMA—March 1, 1946: 1230 khz; 1 kw-D, 250 w-N. Box 471 (38834). (601) 286-5575. John Bell Bcstns Inc. (acq 1-1-74). Rep: Southern Spot Sls. Format: C&W. ■ John E. Bell, pres & gen mgr; Harold B. Dale, news dir; Talmadge E. Harvill, chief engr. ■ Rates: \$3.30; 3.30; 3.30; 3.30.

WKCU—Oct 24, 1965: 1350 khz; 1 kw-D, 2192 Hwy 72 East (38834). (601) 286-8451. The Progressive Bcstg Co. Net: MBS. Rep: Beaver. Format: C&W, top 40. Spec prog: Black 2 hrs wkly. ■ James D. Anderson, pres & chief engr; James H. Anderson, gen & coml mgr; Al Young, prog dir; Arlin Mohundro, prom mgr; Mike Young, mus dir; Jimmy Hinton, news dir.

WKCU-FM—January 1967: 94.3 mhz; 3 kw. Ant 145 ft. Prog sep from AM. Stereo.

Drew

WDRU(FM)—June 1, 1971: 95.3 mhz; 3 kw. Ant 295 ft. Stereo. Box 188 (38737). (601) 745-2623. Triangle Bcstg Co. Net: Miss. Radio News. Format: MOR. Spec prog: Farm news 10 hrs wkly. ■ George Woford, pres; Jim Love, gen mgr & prog dir; Karl Rushing, chief engr.

Ellisville

WBSJ(FM)—Oct 5, 1973: 102.3 mhz; 3 kw. Ant 298 ft. Drawer F (39437). (601) 477-8526. South Jones Broadcasters Inc. Format: Country/pop. Spec prog: Gospel 11 hrs wkly. ■ Glynn Holland, pres, prom mgr & chief engr; Herb Knotts, gen mgr; Charles Jackson, prog dir; Ed Holland, mus dir; Charlotte Williams, prom mgr; Ken Knotts, news dir. ■ Rates: \$2.75; 2.75; 2.75; 2.75.

Eupora

WEPA—May 3, 1974: 710 khz; 500 w-D. Box 710 (39744). (601) 258-7170. Tri-County Broadcasting Co. Rep: Keystone, Beaver. Format: Modern Country. ■ Olivie E. Sisk, pres; Harry Jackson, gen & coml mgr; Jim Mason, prog and mus dir; Carolyn Jackson, prom mgr; Rob Faulk, news dir; Mackey Dozier, chief engr. ■ Rates: \$3.50; 3.50; 3.50; —

Forest

WMAG—September 1955: 850 khz; 500 w-D. (CP 10 kw-D, DA). Box 1539 (39074). (601) 469-3701. Scott County Bcstg Co. Inc. Group owner: Hook. ■ R. E. Hook, pres; Hugh Hughes, gen mgr; Willie Weems, coml mgr.

WQST(FM)—Co-owned with WMAG. September 1965: 92.5 mhz; 27.5 kw. Ant 290 ft. horiz, 285 ft. vert. Prog sep from AM. Stereo.

Fulton

WFTA(FM)—Listing follow WFTO.

WFTO—August 15, 1967: 1330 khz; 1 kw-D. Box 587 (38843). (601) 862-3191. Itawamba County Bcstg Co. Group owner: King Country Net: Keystone, Beaver. Format: Modern country. ■ Olivie E. Sisk, pres; Ivous Sisk, gen and prom mgr; Fred Blackol, coml and news mgr; Henry Hankins, prog and mus dir; Gene Sisk, chief engr. ■ Rates: \$ 2; 2; 2; 2.

WFTA(FM)—Co-owned with WFTO. Not on air; target date unknown: 101.7 mhz; 3 kw. Ant 300 ft.

Greenville

WBAQ(FM)—May 1, 1970: 97.9 mhz; 26.5 kw. Ant 150 ft. Stereo. Box 656 (38701). (601) 335-3383. Greenville Bcstg Co. Net: ABC/I, Miss. Radio. Rep: Smith, Miller. Format: Contemp easy lstng. ■ Paul Artman, gen & coml mgr; Jim Pender, prog & news dir; Roby Roberts, mus dir; Percy L. Kuhn, chief engr. ■ Rates: \$3.50; 3.50; 3.50; 3.50.

WDDT—April 1953: 900 khz; 1 kw-D, 988 N. Broadway Ext. (38701). (601) 332-0526. Clearwater Bcstg Corp. Rep: Bernard. Format: Contemp. ■ John T. Gibson, pres; James P. Karr Jr, gen mgr; Dan Dymon, prog dir; Bob Meadors, chief engr. ■ Rates: \$ 8; 8; 8; —

WESY—See Leland.

WGVM—1948: 1260 khz; 5 kw-D. Box 1438 (38701). (601) 334-4559. Mid-America Bcstg Co. Rep: Devney, Crane. Format: C&W. Spec progs: Black 5 hrs; farm & agri 2 hrs wkly. ■ David M. Segal, pres; Joe Ray Sr, gen mgr; Mickey Farrel, prog dir; Charlie Durkin, mus dir; Randy Lee, news dir; Robert Meador, chief engr.

WDMS(FM)—Co-owned with WGVM. December 1967: 100.7 mhz; 51 kw. Ant 150 ft. Dup AM 100%.

WJPR—August 1937: 1330 khz; 1 kw-D, 500 w-N, DA-N. Box 540 (38702). (601) Edison 5-2617. WJPR Radio (acq: 7-8-61). ■ Benny Gresham, gen mgr.

Greenwood

WABG—February 1950: 960 khz; 1 kw-D, 500 w-N, DA-N. Box 408 (38930). (601) 453-7822. Greenwood Bcstg Inc. Group owner: Bahakel. Format: C&W, Farm. Spec prog: Black 12 hrs wkly. ■ Cy N. Bahakel, pres; Henry Hughes, gen mgr; Sonny Evans, prog dir and coml mgr; Bob Taylor, chief engr. ■ WABG-TV affil. ■ Rates: \$4.50; 4; 4.50; 4.

WGRM—1937: 1240 khz; 1 kw-D, 250 w-N. Box 553 (38930). (601) 453-1240. Twelve Forty Inc. Net: NBC. Format: oldies, C&W, MOR. Spec progs: Farm 3 hrs; classcl 3 hrs, wkly. ■ F. C. Ewing, gen mgr; Tom Ewing, gen and coml mgr.

WSWG—Sept 1, 1963: 1540 khz; 1 kw-D. Box 885 (38930). (601) 453-2174. Dixie Bcstg Co. Inc. Net: ABC/C. Rep: Crane. Format: Contemp. ■ Charles D. Saunders, pres; Bill W. Wallis, gen mgr; Steve Davenport, coml mgr; Jim Baird, prog & news dir; Keith Worrell, chief engr. ■ Rates: \$2.70; 2.70; 2.70; 2.25.

WSWG-FM—June 15, 1965: 99.1 mhz; 100 kw. Ant 220 ft. (601) 453-2174. Dixie Bcstg Inc. Dups AM 90%. Stereo. ■ Rates same as AM.

Grenada

WNAG—February 1949: 1400 khz; 1 kw-D, 250 w-N. Box 946 (39801). (601) 226-1400. Grenada Bcstg Inc. Group owner: Birney Iles Jr. Audio news: APR. Rep: Southern Spot Sls. Format: Top 40. ■ Birney Iles Jr, pres; Bob Evans Sr, gen mgr; Bob Evans Jr, coml mgr & prog dir; Joe Baragona, news dir & chief engr. ■ Rates: \$2.95; 2.35; 2.95; 2.35.

WRIL(FM)—Oct 16, 1970: 100.1 mhz; 3 kw. Ant 300 ft. Stereo. Box 941 (38901). (601) 226-6444. Pemberton Bcstg Co. Net: ABC/FM. Format: C&W. ■ Lane Tucker, pres, gen and prom mgr, prog and mus dir; Weldon Carnes, coml mgr; Herbie Latham, chief engr; Ricky Robertson, mus dir.

Gulfport

WGCM—1928: 1240 khz; 1 kw-D; 250 w-N. Box 1570 (39501). (601) 863-3522. E. O. Roden & Assoc. (group owner; acq 10-5-7). Net: ABC. Rep: Beaver. ■ E. O. Roden, pres; James E. Reese, gen mgr; Jim Wilkinson, oper mgr; Mrs. Pearleen Pearce, office mgr; Judy Lee Dunn, traf mgr; Joe Paul, news dir; Charles Cooper, chief engr.

WTAM(FM)—Co-owned with WGCM. Nov 14, 1969: 102.3 mhz; 3 kw. Ant 290 ft. (601) 864-7171. Prog sep from AM. Net: MBS/Black. Rep: Howard. Format: Black. ■ Carl Haynes, asst mgr; Orlander Grovesnor, mus dir; Yvonne Kaletsch, off mgr.

WGUF—May 7, 1975: 1130 khz; 500 w-D. Box 789 (39501). (601) 863-1130. WGUF Inc. Audio news: APR. Format: C&W. ■ Holton D. Turnbough, pres and gen mgr; Burt Rumbley, prog dir and chief engr; Skip Vierling, prom mgr. ■ Rates: \$ 4; 4; 4; 4.

WROA—Feb 27, 1955: 1390 khz; 5 kw-U, DA-2. Box 370 (39501). (601) 832-5111. Gulf Coast Bcstg Co. Inc. (acq 12-15-59). Net: ABC/E. Rep: Stone. Format: Top 40. Spec prog: Farm 1 hr wkly. ■ Charles W. Dowdy, pres; Morgan Dowdy, gen and coml mgr; Bill Hickman, prog dir; Faye McKinley, prod mgr; Steve Casey, mus dir; Ben Suddeth, news dir; John White, chief engr.

WROA-FM—1964: 107.1 mhz; 1.6 kw. Ant 400 ft. Stereo. Prog sep from AM. Net: ABC/FM. Format: Blt! mus.

WTAM(FM)—See listing following WGCM.

Hattiesburg

WBKH—Sept 1, 1954: 950 khz; 5 kw-D. Box 1508 (39402). (601) 582-8224. Deep South Radio Inc. (acq 8-5-6). Net: ABC/E. Rep: Devney, Beaver. ■ Kenneth L. Bailey, sec-treas & gen mgr; John A. Murphy, coml

Mississippi Radio

See page C-1 for explanation of listings.

mgr; F. Romeo Sullivan, prog dir & mus dir; Clyde Lott, news dir; Dean Evans, chief engr.

WFOR—April 1924: 1400 khz; 1 kw-D, 250 w-N. 2414 West Seventh (39401). (601) 544-1400. Radio Hattiesburg Inc. (acq 1965). Group owner: Gulf Central Radio. Net: NBC, Miss. Radio News. Rep: Bernard. Format: C&W, MOR, rock, talk. ■ J. W. Furr, pres; Jim Furr, gen mgr; Fred Windham, coml mgr; Dwayne Nicholas, prog dir; Cindy Wilson, news dir; Varnell Lee. spts dir; Jim Wood, mus dir; Harold Stanton, chief engr. ■ Rates: \$ 4.15; 3.60; 4.15; 3.60.

WHER(FM)—Co-owned with WFOR. July 1, 1966: 103.7 mhz; 100 kw. Ant 255 ft. Stereo. Prog sep from AM. Stereo. Format: Easy lstng, talk. ■ Rates: \$ 3.55; 3.55; 3.55; 3.55.

WHSY—Sept 24, 1948: 1230 khz; 1 kw-D, 250 w-N. Box 2078 (39401). (601) 583-1741. Hub City Bcstg Co. Group owner: Holt. Net: ABC/C. Rep: Carpenter. Format: Adult contemp. ■ Charles W. Holt, pres; Ted Tibbett, gen mgr; Jean Welborn, coml mgr; Mike Windham, prog dir & chief engr; Kenny Lamier, news dir. ■ Rates: \$ 5; 5; 5; 5.

WHSY-FM—July 1, 1967: 104.5 mhz; 50 kw. Ant 130 ft. Stereo. Prog sep from AM. Format: Progressive rock. ■ Doug Prichard, mus dir. ■ Rates: \$ 4; 4; 4; 4.

***WMSU(FM)**—May 10, 1973: 91.1 mhz; 10 w. Box 5166, Southern Stn (39401). (601) 601-4198. Univ. of Southern Mississippi. Audio news: UPI. Format: Diversified. ■ Robert Burr Cade, gen mgr.

WORV—June 7, 1969: 1580 khz; 1 kw-D. 604 Gussie Ave. (39401). (601) 544-1941. Circuit Bcstg Co. Net: Mutual Black. Format: Black. ■ Vernon C. Floyd, pres, gen mgr, coml mgr & chief engr; Mrs. Thelma L. Floyd, prog dir.

WXXX—September 1957: 1310 khz; 1 kw-D. Box 471, 103 Broadway Drive (39401). (601) 583-2618. Triple X Bcstg Co. (acq 11-1-70). Rep: Gil-Perna, Crane. Format: Contemp. Spec prog: Black 3 hrs wkly. ■ James McCollough, pres; Jim Cameron, gen mgr; Gene Wooten, prog, mus, & news dir; Keith Worrell, chief engr.

Hazelhurst

WMDC—June 1, 1953: 1220 khz; 250 w-D. Box 680 (39083). (601) 894-1441. Southwestern Bcstg Co. of Miss. (group owner). Net: Keystone. Spec prog: Black 10 hrs wkly. ■ A. M. Smith, strn mgr & chief engr; Mat Jones, coml mgr; Dot Jones, prog dir.

WMDC-FM—December 24, 1970: 100.9 mhz; 3 kw. Ant 275 ft. Dups AM 100%.

Holly Springs

WKRA—Sept 1, 1966: 1110 khz; 1 kw-D. Box 398 (38635). (601) 252-1110. Radio Station WKRA Inc. Rep: Hopewell, Beaver. ■ Sue A. Wallace, pres & gen mgr.

WKRA-FM—Not on air, target date unknown: 92.7 mhz; 3 kw. Ant 300 ft.

Houston

WCPC—Oct 21, 1955: 940 khz; 50 kw-D, DA. (CP 250 w-D, 50 w-N). Box 569 (38851). (601) 456-3071. WCPC Bcstg Co. Group owner: Mathis Stns. Audio news: UPI. Rep: Southern Spot Sls. Format: Variety. Spec prog: Black 10 hrs wkly. ■ Robin H. Mathis, pres, gen & coml mgr; Rick Huffman, prom dir; Charles Hester, news & farm dir; Wayne Parks, sports dir; John B. Skelton Jr, chief engr. ■ Rates: \$10; 10; 10; 10.

WCPC-FM—Sept 19, 1968: 93.3 mhz; 100 kw. Ant 490 ft. Prog sep from AM. Stereo. Format: C&W, Variety, easy lstng. ■ Rates same as AM.

Indianola

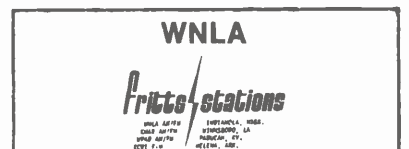

WNLA—May 1953: 1380 khz; 500 w-D. Box 667

Mississippi Radio

See page C-1 for explanation of listings.

(38751). (601) 887-1380. Fritts Bcstg Inc. (acq 10-1-63). Group owner: Edward O. Fritts Stns. Net: ABC/C. Rep: Bunchez, Southern Spot Sls. Format: Contemp. MOR. Spec progs: Black 4 hrs; farm 14 hrs wkly. ■ Edward O. Fritts, pres; Gerald Brophy, gen mgr; Charlotte Buchanan, news dir; Bill Jordan, prog dir; Bobby Williamson, prog dir; Charles T. Smith, chief engr. ■ Rates: \$ 5; 5; 5.

WNLA-FM—Sept 1, 1969: 105.5 mhz; 3 kw. Ant 195 ft. Stereo. Dups AM 100%. ■ Rates same as AM.

luka

WTIB(FM)—Listing follows WVOM.

WVOM—Sept 17, 1960: 1270 khz; 1 kw-D. 311 W. Eastport (38852). (601) 423-6059. Horizon Bcstg (acq 2-1-70). Net: ABC/I. Format: Country. ■ W. Dave Floyd, VP, gen mgr & chief engr; Gerald W. Hunt, coml mgr; Dee Davis, prog dir; Tersea Smith, prom mgr; Doug Azary, mus dir; Charles R. Zuba, news dir.

WTIB(FM)—Co-owned with WVOM. Nov 5, 1970: 104.9 mhz; 3 kw. Ant 225 ft. Prog sep from AM. Net: ABC/I. Format: C&W.

Jackson

WJDX—1929: 620 khz; 5 kw-D, 1 kw-N, DA-N. Box 2171 (39205). (601) 982-1062. WJDX Inc. Net: NBC. Rep: H-R Stone. Format: Adult contemp. ■ Harland L. Knight, pres; Chuck Cooper, gen, coml & prom mgr; Bill Tanner, prog dir; Bill Crews, mus dir; Howard Lett, news dir; Floyd Kinard, chief engr.

WZZQ(FM)—Co-owned with WJDX. 1948: 102.9 mhz; 100 kw. Ant 1800 ft. Stereo. Prog sep from AM. Format: Rock. ■ Johnny Sommer, prog dir; Lamar Evans, farm dir.

WJFR(FM)—Listing follows WSLI.

WJMI(FM)—Listing follows WOKJ.

WJQS—1947: 1400 khz; 1 kw-D, 250 w-N. Box 22604 (39205). (601) 948-2401. Town & Country Bcstg Inc. (acq 9-30-66). Net: CBS. Rep: Southern Spot Sls. Masia. Format: C&W. ■ Mrs. Ann C. Zimmerman, pres; G. Lee Hodges, gen & coml mgr & chief engr; John Friskillo, prog dir.

WJSU(FM)—August 1975: 90.7 mhz; 10 w. Ant 98 ft. 1325 Lynch (39203). Jackson State University.

WJXN



WJXN—1945: 1450 khz; 1 kw-D, 250 w-N. Box 3786 (39205). (601) 352-6673. Jackson Bcstg Co. Net: MBS. Rep: R.S. Crane. Format: C&W. ■ Elva I. Upton, pres; Rodger Earle Ownby, gen & sls mgr; Hal Harris, prog dir; Mack Daniels, mus dir; Billy Harris, chief engr. ■ Rates: \$5.75; 4.75; 5.75; 4.75.

WKXI(FM)—August 10, 1971: 94.7 mhz; 100 kw. Ant 320 ft. Stereo. Box 6689 (39212). (601) 372-9594. TAB Bcstg Inc. Net: National Black. Rep: PRO Time Sales. Format: Black. ■ J. Alex Bowab, pres; Carrol F. Jackson, gen and coml mgr; Herman Taylor mus & news dir; Morris Broyles, chief engr. ■ Rates: \$16; 13; 16; 13.

WLIN(FM)—Nov 19, 1973: 95.5 mhz; 100 kw. Ant 1,060 ft. Stereo. Suite 286, Highland Village (39211). (601) 982-7336. Metro Radio Inc. Rep: McGaven-Guild. Format: Btlf mus. ■ Charles Fletcher, pres & gen mgr. ■ Rates: \$18; 18; 18; 18.

WOKJ—September 1954: 1550 khz; 50 kw-D, 10 kw-N, DA-2. Box 3320 (39207). (601) 948-1515. Tri-Cities Bcstg Co. (acq 4-1-71). Group owner: Roden. Net: ABC/I. Rep: Howard. Format: Black. ■ E. O. Roden, pres; Zane Roden, exec VP mgr; Dick Dawkins, mus dir; Bruce Payne, news dir; Stan Conery, chief engr. ■ Rates: \$23; 19; 23; 15.

WJMI(FM)—Co-owned with WOKJ. 1967: 99.7 mhz; 54 kw. Ant 1060 ft. Stereo. ■ Rates: \$7.50; 7.50; 7.50; 7.50.

WRBC NBC-NIS

WRBC—1929: 1300 khz; 5 kw-D, 1 kw-N. Box 9801 (39206). (601) 956-4151. The Rebel Bcstg Co. Net: Miss. Radio News. Audio news: NBC/NIS. Rep: McGavren-Guild-PGW. Format: All news. Spec prog: Relg 6 hrs wkly. ■ W. B. McCarty Jr., pres; Dudley Evans, gen mgr; Carnell Tucker, coml mgr; Don Molino, news dir; W.W. Fulgham, chief engr. ■ Rates: \$12; 8; 12; varies.

WRKN—See Brandon.

WSLI—September 1938: 930 khz; 5 kw-D, DA-N. Box 8887 (39204). (601) 372-6311. TWX: 810-966-2735. Capitol Bcstg Co. (group owner; acq 6-30-55). Rep: Katz. Format: MOR. Spec prog: Classcl 18 hrs wkly. ■ L.M. Sepaugh, pres; Dick Voorhis, gen and coml mgr; Al Simmons, prog dir; Bill Voorhis, mus dir; Robert Wiggins, prom mgr; Dave Waite, news dir; C.A. Perkins, chief engr. ■ Rates: \$14.75; 7.60; 12.75; 7.60.

WJFR(FM)—Co-owned with WSLI. Sept 16, 1966: 96.3 mhz; 80 kw. Ant 1420 ft. Stereo. Prog sep from AM. ■ WJTV(TV) affil. ■ Rates: \$4.25; 4.25; 4.25; 4.25.

***WVLS(FM)**—August 20, 1975: 91.5 mhz; 450 w. Ant 102 ft. Box 6567 (39212). (601) 373-1802. Educational Bcstrs of Miss. Inc. Format: Diversified. ■ Robert Sanders, pres and gen mgr.

WWUN—April 8, 1965: 1590 khz; 5 kw-D, 1 kw-N, DA-N. Delta Station, Box E (39213). (601) 362-8854. Radio One Inc. Group owner: New South Radio. Rep: Torbet. Format: C&W. ■ Ed Holladay, pres; Jessie White, gen mgr; Wayne Powell, prom mgr; Charles Brewer, news dir; J. Boyd Ingram, chief engr.

Kosciusko

WKOZ—Oct 31, 1947: 1340 khz; 1 kw-D, 250 w-N. Box A (39090). (601) 289-1340. H. Mims Boswell Jr. (acq 6-1-62). Spec progs: Black 9 hrs; C&W 15 hrs, wkly. ■ H. Mims Boswell Jr., gen mgr; Ann Hutchinson, prog dir; Johnny Boswell, news dir; Jack Davis, chief engr.

WKOZ-FM—June 25, 1965: 105.1 mhz; 28.5 kw. Ant 165 ft. Prog sep from AM. Stereo.

Laurel

WAML—Oct 20, 1932: 1340 khz; 1 kw-D, 250 w-N. 441 No. Magnolia, Box 367 (39440). (601) 428-5601. New Laurel Radio Stn Inc. Net: NBC. Format: MOR, oldies, top 40. ■ Dave A. Matison Jr., pres; Frank Sumrall, gen mgr; Morris M. Caver, coml mgr; Dennis Smith, prog dir, prom mgr; Michael L. Robinson, mus dir; Jack Herrington, news dir; Walter Hilt, chief engr. ■ Rates: \$2.76; 2.76; 2.76; 2.76.

WLAU—June 15, 1946: 1430 khz; 5 kw-D. Box 167 (39440). (601) 649-1430. Southland Inc. (acq 4-12-65). Net: MBS. Rep: Devney. Format: C&W. Spec prog: Black 4 hrs wkly. ■ F. M. Smith, pres & gen mgr; F. M. Smith Jr., coml mgr; Harry K. Mauldin, chief engr.

WNSL—Feb 27, 1957: 1260 khz; 5 kw-D. Box 2336 (39440). (601) 425-1491. Voice of the New South Inc. Group owner: New South Radio. Net: ABC/C. Rep: Savalli/Gates. Format: Contemp. Spec progs: Fr 6 hrs; C&W 12 hrs wkly. ■ Joe Carson, pres; Granville Walters, gen mgr; Teck Jones, coml mgr; Ron Bunge, prog dir; Shelby Edwards, mus dir; Joe Murray, news dir; Ed Breland, chief engr. ■ Rates: \$3.80; 3.80; 3.80; 3.80.

WNSL-FM—March 10, 1959: 100.3 mhz; 28 kw. Ant 165 ft. Stereo. Prog sep from AM. Net: Mutual Black. Format: Black. ■ Rates same as AM.

Leland

WBAD(FM)—1974: 94.3 mhz; 3 kw. Ant 290 ft. Box 4426, Greenville (38701). (601) 335-9265. Interchange Communications. Net: Natl Black. Format: Black. ■ W. D. Jackson, pres. ■ Rates: \$8; 7; 8; 5.60.

WESY—April 8, 1958: 1580 khz; 1 kw-D. Drawer 340, Greenville (38701). (601) 332-0770. Miss-Ark Bcstg Co. Net: Mutual Black. Rep: Southern Spot Sls. Format: Black, relg. ■ Miller Abraham, gen mgr; Carl Abraham, prom mgr; John Abraham, coml mgr; Clyde Pinkney, mus dir; Jerome Daniels, news dir; Eddie Williams, prog dir; Percy Kuhn, chief engr. ■ Rates: \$5.75; 5.75; 5.75; —.

Lexington

WXTN—Oct 23, 1959: 1000 khz; 5 kw-D. Drawer M (39095). (601) 834-1254. WXTN Inc. Group owner: Mathis. Rep: Beaver. ■ Robin Mathis, pres; Fannie T. Coltran, gen mgr & chief engr.

Louisville

WLSM—March 11, 1953: 1270 khz; 5 kw-D. Box 111 (39339). (601) 773-3481. Louisville Bcstg Corp. Group owner: New South. Net: ABC. Rep: Beaver. ■ Joe Carson, pres; Fred Vice, gen mgr; John Jenkins, prog dir.

WLSM-FM—April 22, 1966: 107.1 mhz; 3 kw. Ant 300 ft. Prog sep from AM.

Lucedale

WRBE—Sept 3, 1960: 1440 khz; 5 kw-D. Box 827 (39452). (601) 947-8151. Allen Bcstg Co. (acq 1968). Net: MRN. Rep: Dora-Clayton, Keystone. Format: C&W. ■ Douglas T. Luze, pres; Pinky Grant, exec VP & gen mgr; Romeo Sullivan, prog dir; Chris Lewis, mus dir; Shim Aylesworth, chief engr.

Magee

WSJC—July 5, 1957: 810 khz; 50 kw-D, 500 w-N, DA-N. Box 426 (39111). (601) 849-3426. Southeast Mississippi Bcstg Co. Group owner: Mathis. Rep: Bernard, Beaver. Format: C&W, gospel, rock & easy lstng. ■ Mrs. Marvin Mathis, gen mgr; Mike Mathis, prog dir; Walter Hearn, chief engr.

WSJC-FM—April 11, 1970: 107.5 mhz; 100 kw. Ant 490 ft. Duplicates AM 3 hrs.

Marks

WQMA—Dec 1, 1969: 1520 khz; 250 w-D. Box B (38646). (601) 326-8161. Oultman Bcstg Co. Rep: MBA. Format: MOR. Spec prog: C&W 10 hrs wkly. ■ E. I. Scarbrough, mgr; William E. Hardy, gen mgr.

McComb



WAKK—April 25, 1975: 1140 khz; 500 w-D. Box 907 (39648). (601) 684-4116. HWH Bcstg Co. Audio news: UPI. Format: C&W. Spec prog: Black 10 hrs wkly. ■ Carroll Hines, pres; Maureen Clark, gen mgr; Jay Phillip Bradshaw, prog and mus dir; Charlie Shivers, news dir. ■ Rates: \$2.85; 2.85; 2.85; —.

WAPF—April 18, 1948: 980 khz; 5 kw-D. Box 604, 317 Canal St. (39648). (601) 684-7470. Southwestern Bcstg Co. of Mississippi (group owner). Rep: Bernard, Beaver. Format: variety. ■ Philip D. Brady, gen mgr & chief engr; Gordon Burt, coml mgr; Agnes Louise, news dir; Dwayne Graham, prog dir. ■ Rates: \$4.70; 4.70; 4.70.

WCCA(FM)—Co-owned with WAPF. Dec 14, 1967: 94.1 mhz; 57 kw. Ant 160 ft. Dups AM 80%.

WHNY—1939: 1250 khz; 5 kw-D, 1 kw-N, DA-N. Box E (39648). (601) 684-8140. Bcst Service Inc. (acq 1-54). Group owner: Holt. Net: ABC/C. Format: MOR. Spec prog: Black 2 hrs wkly. ■ Charles W. Holt, pres; Lamar D. Turminello, gen mgr; Steve King, prog and mus dir; Ronnie Boone, asst mgr; Tommy Strickland, chief engr.

WTBI(FM)—1974: 105.7 mhz; 100 kw. Ant 220 ft. (CP: 100 kw horiz, 6 kw vert. Ant 390 ft.). Empire Inc. (39648).

Meridian

WALT(FM)—See listing following WOKK.

WDAL—Feb 1, 1958: 1330 khz; 5 kw-D. Box 5314 (39301). (601) 693-2381. Broadcasters & Publishers Inc. (acq 3-1-66). Net: MBS, MRN. Rep: Dora Clayton. Format: Top 40. ■ Don Partridge, pres & gen mgr; Bubber Wallace, coml mgr; Larry Edwards, prog dir; Glen Murphey, prom mgr; Mike Partridge, mus dir; Keith Ballard, news dir; John Krost, chief engr.

WDAL-FM—February 1968: 101.3 mhz; 100 kw. Ant 580 ft. Stereo. Format: MOR, good mus.

WMOX—Dec 1, 1945: 1010 khz; 10 kw-D, 1 kw-N, DA-2. Box 1511 (39301). (601) 482-0171. Lauderdale Bcstg Inc. (acq 4-1-65). Net: ABC. Spec prog: C&W 14 hrs wkly. ■ Eddie Smith, gen mgr; Len Malth, coml mgr; Jerry Kerns, news dir; Steve Burkes, chief engr.

WOKK—1946: 910 khz; 5 kw-D, 1 kw-N. Box 5797 (39301). (601) 693-2661. New South Bcstg Corp. (group owner; acq 4-1-57). Net: ABC/I. Rep: Savalli/Gates. Format: C&W Spec prog: Black 9 hrs wkly. ■ F. E. Holladay, pres; Ken Rainey, gen mgr; Joe Carson, sec/treas; Lamar Williamson, news dir; R. K. Wall, chief engr.

WALT(FM)—Co-owned with WOKK. August 1967: 97.1 mhz; 100 kw. Ant 380 ft. Prog sep from AM. Stereo. Net: ABC/FM. Format: Live, contemp.

WQIC—December 1957: 1450 khz; 1 kw-D, 250 w-N. Box 5353 (39301). (601) 693-4851. Torgerson Bcstg Co. Inc. (acq 9-14-68). Rep: GCI; Carter Jones. Net: Mutual Black. Format: Black. ■ Stan Torgerson, pres & gen mgr; Mrs. Dorothy Torgerson, off mgr; James Walker, prog dir; Eddie Lee Griffin, mus dir; Larry Torgerson, sls mgr; Joe Saxon Jr, chief engr.

Mississippi State

***WMSB(FM)**—May 24, 1974: 89.1 mhz; 10 w. Ant 112 ft. Drawer NJ (39762). (601) 325-3910. Mississippi State U. Format: Progressive. ■ Dr. William L. Giles, pres; Dr. Robert G. Anderson, gen mgr; James Mahoney, sls mgr; Donald Beaugez, chief engr.

Monticello

WMLC—1969: 1270 khz; 1 kw-D. Box 1270 (39654). (601) 587-7997. Clinco Inc. Net: Mississippi Radio News. Rep: Keystone. Format: C&W Spec prog: Black 21 hrs wkly. ■ Jim Clinton, pres & gen mgr.

Moss Point

WCIS-AM-FM—See Pascagoula.

Natchez

WMIS—May 18, 1941: 1240 khz; 1 kw-D; 250 w-N. Box 1248 (39120). (601) 442-2522. Natchez Bcstg Co. Net: NBC. Format: Top 40, MOR. Spec progs: Black 14 hrs, C&W 12 hrs wkly. ■ Diana Ewing Nutter, pres; W. J. Wall, gen mgr; James B. Nutter, prom mgr; Bob Cupit, coml mgr; Al Britt, prog dir; Eric Walters, chief engr; Jeannerette Harlow, news dir; Jim Tillman, chief engr. ■ Rates: \$6.50; 6.50; 6.50.

WNAT—Dec 4, 1949: 1450 khz; 1 kw-D. 250 w-N. Box 768 (39120). (601) 442-4895. First Natchez Corp. (acq 11-20-58). Net: ABC/I. Rep: Southern Spot Sis. Format: Black, C&W. Spec prog: Farm 8 hrs wkly. ■ Mrs. William S. Perkins, pres & gen mgr; Helen B. Flowers, coml mgr; Gary Majors, prog & mus dir; Lee Anderson, black mus dir; Don Tiegesser, news dir; Julie Love, prom mgr; William Fulgham, chief engr.

WQNZ(FM)—Co-owned with WNAT. March 1968: 95.1 mhz; 99 kw. Ant 370 ft. Stereo. Prog sep from AM. Net: ABC/C. Format: ProgsV, Top 40. ■ David Kimbro, prog and mus dir.

New Albany

WNAU—March 27, 1955: 1470 khz; 500 w-U, DA-N. Box 808 (38652). (601) 534-4361. New Albany Bcstg Co. Rep: Beaver. Spec progs: Black 3 hrs; C&W 12 hrs wkly. ■ V. Keith Wroten, gen mgr & chief engr; J. Bryant & Chuck Stepp, coml mgr; Wynez Wroten, prog dir.

WNAU-FM—Sept 28, 1966: 103.5 mhz; 36 kw. Ant 79 ft. Prog sep from AM.

Newton

WBKN—March 15, 1955: 1410 khz; 500 w-D. 103 School St. (39345). (601) 683-3331. Robert L. Tatum (acq 7-1-72). Net: Miss. Radio News. Format: C&W. Spec prog: Black 4 hrs wkly. ■ Robert L. Tatum, pres;

John H. Tatum, gen & coml mgr & prog dir; David Skinner, prom mgr; Terry C. Burton, mus & news dir; William Dean, chief engr.

WGOT(FM)—Co-owned with WBKN. April 3, 1975: 106.3 mhz; 3 kw. Ant 158 ft. Dups AM 50%. Format: MOR.

Ocean Springs

WOSM(FM)—Feb 12, 1971: 103.1 mhz; 3 kw. Ant 295 ft. Box 789 (39564). (601) 875-9031. Charles H. Cooper. Audio news: APR. ■ C. H. Cooper, gen mgr & chief engr; Margaret Cooper, prog dir; Paul Riviere, mus & news dir. ■ Rates: \$4; 3; 4; 3.

Oxford

WSUH—May 1, 1955: 1420 khz; 1 kw-D. Box 511 (38655). (601) 234-6881. WSUH-WOOR Inc. (acq May 1974). Net: Keystone. Rep: Beaver.

WOOR(FM)—Co-owned with WSUH. Jan 1, 1969: 97.5 mhz; 27 kw. Ant 265 ft. Stereo. Prog sep from AM.

Pascagoula-Moss Point

WCIS—May 1, 1964: 1460 khz; 1 kw-D. Box 1789 (39567). (601) 762-1821. Standard Bcstg Inc. (acq 9-67). Net: MBS. Rep: Beaver. Format: C&W. ■ C. D. Burgess, gen mgr; Dan Lynch, coml mgr; Mel Cuevas, prog dir. ■ Rates: \$4.75; 4.25; 4.75; 4.25.

WCIS-FM—June 1, 1964: 104.9 mhz; 3 kw. Ant 150 ft. Stereo. Box 667, Moss Point (39563). (601) 762-1930. Prog sep from AM. Format: Religi, modern country. ■ Rates: \$4; 4; 4; 3.50.

WPBM(FM)—Not on air, target date unknown; 106.3 mhz; 2.2 kw. Ant 345 ft. Broadcasters and Publishers Inc.

WPMP—September 1951: 1580 khz; 1 kw-D. Box 789 (39567). (601) 762-3113. Crest Bcstg Co. Net: ABC. ■ William R. Guest Jr, pres; Walter L. Smith, VP & gen mgr; Hal Comello, coml mgr; Patrick J. Fagan, prog dir.

WPMP-FM—December 1964: 99.1 mhz; 26 kw. Ant 185 ft. Stereo.

Philadelphia

WHOC—July 31, 1948: 1490 khz; 1 kw-D, 250 w-N. Box 26 (39350). (601) 656-1490. William Howard Cole. Format: MOR, C&W. Spec prog: Black 8 hrs wkly. ■ William Howard Cole, pres & gen mgr; Joe Vines, coml & prom mgr; Rex Smith, prog, mus & news dir & chief engr.

WRJW—October 1949: 1320 khz; 5 kw-D. Box 849 (39466). (601) 798-4835. Tungs Bcstg Co. (acq 9-25-52). Net: ABC. ■ James O. Jones II, pres and gen mgr; Darris Moeller, coml mgr; Robert Ingram, prog & news dir; Henry Hunter, chief engr.

WJOJ(FM)—Co-owned with WRJW. November 1973: 106.3 mhz; 3 kw. Ant 175 ft. Stereo. Format: MOR.

Pontotoc

WSEL—Nov 30, 1962: 1440 khz; 1 kw-D. Box 240 (38863). (601) 489-1440. Pontotoc Bcstg Co. Net: MBS. Rep: Keystone, Continental Sis. Format: C&W, gosp. Spec progs: Black 8 hrs, rock 8 hrs wkly. ■ Lee Thompson, pres; W. S. Bridges, gen mgr; Mrs. W. S. Bridges, coml mgr; Bill Tate, prog dir; Danny Walls, prom mgr & mus dir; Vernon White, news dir; Ruth Bridges, chief engr.

WSEL-FM—Jan 1, 1966: 96.7 mhz; 3 kw. Ant 300 ft. Dups AM 100%.

Poplarville

WRPM—1963: 1530 khz; 10 kw-D, 1 kw-(CH). (CP: 10 kw CH). Box 352 (39470). (601) 795-4900. Ben O. Griffin. ■ Ben Griffin, owner, mgr & chief engr.

WRPM-FM—Feb 14, 1966: 107.9 mhz; 100 kw. Ant 420 ft. Prog sep from AM.

Prentiss

WKPO—July 21, 1965: 1510 khz; 1 kw-D, 250 w-CH. Box 445 (39474). (601) 792-5972. Jeff Davis Bcstg

Mississippi Radio

See page C-1 for explanation of listings.

Svc. Net: Miss. Radio. Format: C&W. Spec progs: Farm 2 hrs; black 1 3/4 hrs, wkly. ■ Albert Mack Smith, gen mgr; Charles R. Boone, prog & mus dir, coml and prom mgr & chief engr. ■ Rates: \$2.25; 2.25; 2.25;—

Quitman

WBFN—Feb 2, 1968: 1500 khz; 1 kw-D. Drawer 70 (39355). (601) 776-2931. A. C. Elliott Jr. Format: Contemp, C&W. ■ A. C. Elliott Jr, pres & chief engr. ■ Rates: \$2; 2; 2;—

Ripley

WCSA—June 22, 1964: 1260 khz; 500 w-D. Box 435 (38663). (601) 837-9024. Tippah Bcstg Co. ■ Lewis Davis, gen mgr; Oleta Jones, coml mgr; Wayne Davis, prog dir; Wayne Ridge, chief engr.

Senatobia

***WNJC-FM**—Jan 4, 1971: 90.1 mhz; 258 kw. Ant 145 ft. (CP 18 kw. Ant 390 ft). Box GG (38668). (601) 562-9221. Northwest Miss. Junior College. Net: NPR. Format: MOR. ■ Steve Cobb, gen mgr; James Jackson, prog dir; Ann Webb, news dir; Paul Copeland, chief engr.

WSAO—Aug 8, 1962: 1550 khz; 5 kw-D. Box 448 (38668). (601) 562-4445. Northwest Mississippi Bcstg Co. Group owner: Mathis. Rep: Southern Spot Sis. Format: Variety. Spec progs: Black 10 hrs; Farm 2 hrs wkly. ■ Robin H. Mathis, pres; Roger D. Webb, gen and prom mgr; Ricky A. Williams, prog and news dir; Linda Howe, mus dir; J.B. Skelton Jr, chief engr.

Starkville

WKOR—July 5, 1968: 980 khz; 1 kw-D. 201 Lampkin St. (39759). (601) 323-4980. Golden Triangle Radio Corp. Net: ABC/C. Rep: Carpenter. Format: Top 40. ■ Ben Yarber, pres & gen mgr; Glen James, prog dir; John Franklin, mus dir; Randy Bell, news dir.

WSSO—Nov 8, 1948: 1230 khz; 1 kw-D, 250 w-N. Box 1188 (39759). (601) 323-1230. Starkville Bcstg Co. Net: NBC. Rep: Keystone, Beaver. Format: MOR. Spec prog: Black 12 hrs wkly. ■ Joe Phillips, pres, gen mgr & chief engr; Norvell Williams, coml mgr; Joyce McDaniel, prog dir; John Weeks, mus and news dir.

WSMU-FM—Co-owned with WSSO. July 15, 1968: 106.3 mhz; 3 kw. Ant 220 ft. Stereo. Dups AM 100%.

Tupelo

WELO—May 1944: 580 khz; 1 kw-D, 500 w-N, DA-2. Box 410 (38801). (601) 842-7658. Tupelo Bcstg Inc. Group owner: Birney Imes Jr. Net: MBS; Mid-South. Rep: Southern Spot Sis. Format: C&W. Spec prog: Farm 14 hrs wkly. ■ Birney Imes Jr, pres; Bob Evans, gen mgr; Ernest Bowen, sls mgr; Paul Chamberlain, prog dir; Jim Duke, news dir; Leroy Green, chief engr. ■ Rates: \$5.38; 4.30; 5.38; 4.30.

WELO-FM—Sept 1968: 98.5 mhz; 100 kw. Ant 380 ft. Stereo. Progs sep from AM. Format: Btlf mus.

WJLJ—Aug 25, 1972: 1060 khz; 250 w-D. Box 1626 (38801). (601) 844-4646. Town and Country Bcstg of Tupelo Inc. Net: Miss. Radio. Rep: Beaver. Format: C&W. Spec progs: Farm 1 hr; black 2 hrs wkly. ■ Charles W. Russell, gen mgr & chief engr; Linda Russell, coml mgr; Jay Douglas, prog & mus dir; Terry Best, news dir; Warren Garling, prog dir; Harris Wallace, asst chief engr. ■ Rates: \$3.50; 3.25; 3.50; 3.

WTUP—Oct 1953: 1490 khz; 1 kw-D, 250 w-N. Box 258 (38801). (601) 884-1490. Lee Bcstg Corp. Group owner: Roden. Net: ABC/C. Rep: PRO Time Sis. Format: Contemp rock. ■ E. O. Roden, pres; T. L. Estess, gen & prom mgr; B. Pinkard, coml mgr; Jim McPherson, prog dir; Ron McDonald, mus dir; Larry Presley, news dir; Truman Patterson, chief engr.

Tylertown

WTYL—Feb 8, 1969: 1290 khz; 1 kw-D. Box 447 (39667). (601) 876-2105. Tylertown Bcstg Co. Rep: Beaver. Format: MOR. Spec progs: Black 9 hrs; C&W 18 hrs wkly. ■ Roy E. Powe, gen mgr & chief engr; Douglas Walker, prog & coml mgr; Lloyd Cole, mus & news dir.

WTYL-FM—April 9, 1970: 97.7 mhz; 3 kw. Ant 145 ft. Dups AM 90%.

Mississippi, Missouri Radio

See page C-1 for explanation of listings.

Vicksburg

WKVY-FM—April 1, 1970: 106.7 mhz; 58 kw. Ant 510 ft. Stereo. Box 1357 (39180). (601) 638-5111. Red Carpet City Bcstg Inc. Net: ABC/I. Rep: Beaver. Format: Modern country. ■ Allen U. Hollis, pres; W. K. Hoisington, gen mgr & chief engr; Bob Bishop, coml mgr; Ron Anderson, prog dir. ■ Rates: \$3.91; 3.91; 3.91.

WQBC—1931: 1420 khz; 1 kw-D, 500 w-N, DA-1. Box 589 (39180). (601) 636-1108. Hol-Co Inc. (acq 11-73). Net: ABC/E. Format: Black, MOR. ■ W. Frank Holifield, pres, gen & coml mgr; Frank Holifield Jr, coml mgr; Bill Hoisington, chief engr.

WQMV(FM)—March 19, 1966: 98.7 mhz; 56 kw. Ant 310 ft. Box 11 11, 2845 Clay St. (39180). (601) 636-5250. WQMV Radio Co. Net: MRN. Rep: Crane. Format: Contemp, MOR. ■ Waymond Eugene Underwood, pres, gen, prom & coml mgr; Mike Baroudy, prog & mus dir; Bill Ford, chief engr & news dir.

WVIM—1948: 1490 khz; 1 kw-D, 250 w-N, Box 76 (39180). (601) 636-1494. Vicksburg Radio Co. (acq 10-15-75). Format: C&W. ■ James West, Paul Meacham, co-owners; Wally Adams, gen mgr; Walt Hairston, chief engr.

Water Valley

WVLY—1320 khz; 500 w-D, Drawer 511, Hwy 75 (38965). (601) 473-1164. Tri Lakes Bcstg Co. Format: C&W. ■ Jimmy D. Martin, pres, gen mgr & prog dir; Mrs. Jim Martin, coml mgr; Jim Buckley, sls mgr; Del Strickland, news dir; Earl Neal, chief engr.

Waynesboro

WABO—Sept 11, 1954: 990 khz; 1 kw-D, Box 507 (39367). (601) 735-4331. Martin Bcstg Inc. (acq 12-18-61). Net: ABC/I. Format: Black, Top 40, C&W ■ Wilbur J. Martin Jr, pres, gen & coml mgr, prog dir, chief engr; Ginger Everitt, news dir; Mariin Smith, mus dir and prom mgr; Jeff Ketter, chief engr. ■ Rates: \$2.09; 1.90; 1.90; 1.90.

WABO-FM—June 13, 1973: 105.5 mhz; 3 kw. Ant 145 ft. Dups AM 50%. Stereo. Format: C&W, MOR. ■ Rates same as AM.

Wesson

***WWCL(FM)**—Sept 1, 1971: 91.1 mhz; 10 w. Ant 115 ft. Copiah-Lincoln Junior College (39191). (601) 643-5284. Format: Contemp. ■ Billy B. Thames, pres; Forest Case, gen mgr.

West Point

WKBB(FM)—Listing Follows WROB.

WROB—September 1947: 1450 khz; 1 kw-D, 250 w-N, Box 758 (39773). (601) 494-1450. Bob McRaney Enterprises Inc. Net: MBS. Rep: Southern Spot Sls. ■ Bob McRaney Sr, pres; Jack King, gen mgr & chief engr.

WKBB(FM)—Co-owned with WROB. April 14, 1974: 100.9 mhz; 3 kw. Ant 170 ft. Format: Contemp MOR.

Wiggins

WIGG—Feb 1968: 1420 khz; 1 kw-D, Box 1420 (39577). (601) 928-7281. Clinco Inc. (acq 11-71). Net: Miss. Radio News. Rep: Beaver. Format: MOR. Spec progs: Farm 10 hrs; black 15 hrs, wkly. ■ James E. Clinton, pres; Dave Nichols, gen mgr; Chris Humphries, mus dir; DeWayne Morris, news dir; Fritz Muffler, chief engr. ■ Rates: \$3; 3; 3; 3.

Winona

WONA—Oct 25, 1958: 1570 khz; 1 kw-D, Drawer 669 (38967). (601) 283-1570. Southern Electronics Co. Group owner: Birney Imes Jr. Net: Mid South. Rep: Bernard. ■ Bob Evans, pres; Jim Holt, gen & coml mgr & news dir; Martha Aldridge, prog dir; Maurice Gooch, chief engr. ■ Rates: \$2.07; 1.65; 2.07; —.

WONA-FM—Not on air, target date unknown: 96.7 mhz; 2.5 kw. Ant 185 ft.

Yazoo City

WAZF—July 7, 1947: 1230 khz; 1 kw-D, 250 w-N, Box 47 (39194). (601) 746-2371. Twelve-Thirty Inc. (acq 6-1-67). Rep: Hopewell. Format: Black. ■ Frank Holifield, pres; Chuck Ivey, coml mgr; John D. Harris, mgr & chief engr.

WJNS-FM—Dec 13, 1968: 92.1 mhz; 3 kw. Ant 300 ft. Stereo. Box 1048 (39194). (601) 746-5921. Gateway Bcstg Co. Rep: Southern Spot Sls. Format: C&W. ■ Joel Netherland, pres & gen mgr; Shirley Netherland, coml mgr; Nev Powell, prog dir; Leon Hill, chief engr. ■ Rates: \$3.50; 3.50; 3.50; 3.50.

WYAZ—Co-owned with WJNS. April 19, 1974: 1530 khz; 250 w-D, DA. (601) 746-7777. Prog sep from FM. Net: Natl Black. Rep: Dora-Clayton. Format: Black. ■ Bobby Little, prog dir. ■ Rates: \$3; 3; 3; —.



Missouri

Aurora

KSWM—Oct 19, 1961: 940 khz; 500 w-D, Box 410 (65605). (417) 678-4131. KSWM Inc. Format: C&W. ■ Galen O. Gilbert, pres; Joe L. McCullah, gen mgr; Gary Presley, prog dir; Bill Rapp, news dir & chief engr. ■ Rates: \$4.25; 3.50; 3.10—.

KSWM-FM—Feb 19, 1968: 100.1 mhz; 2.7 kw. Ant 170 ft. Stereo. Dup AM 10%. ■ Rates: \$3.30; 2.95; 2.15; 2.15.

Ava

KSOA—1968: 1430 khz; 500 w-D, Box 386 (65608). (417) 683-4191. Douglas County Bcstg Co. (acq 9-8-75). Format: C&W, MOR, Rock. ■ Robert & Violet Woods, Marvin & Linda Coombs, co-owners; Herb Starbuck, sls mgr.

Bolivar

KBLR—November 1961: 1130 khz; 250 w-D, DA, Box 360 (65613). (417) 326-5257. KBLR Inc. (acq 2-1-73). Net: MBS. Format: Contemp, C&W, MOR, Rock. ■ William J. Young, pres; James C. Young, gen mgr; Dolly Clark, prog dir; Roger Russ, mus dir; Douglas White, chief engr.

KLTB(FM)—Co-owned with KBLR. August 1967: 106.3 mhz; 3 kw. Ant 200 ft. Dup AM 100%.

Boonville

KWRT—Aug 11, 1953: 1370 khz; 1 kw-D, Radio Hill Rd. (65233). (816) 882-6505. Big Country of Missouri Inc. (acq 12-1-72). Format: C&W. ■ Kenneth L. Hodges, pres; Richard L. Billings, VP & gen mgr; Ted Bleil, prog dir; Mike Morgan, mus dir; Terry Vache, news & sports dir; Donald E. Shepard, chief engr.

KWRT-FM—Oct 1, 1974: 99.3 mhz; 3 kw. Ant 285 ft. Dups AM 100%.

Bowling Green

KPCR—Dec 13, 1966: 1530 khz; 1 kw-D, 250 w-CH, Box 1 (63334). (314) 324-2283. Pike County Bcstg Co. Net: Brownfield. Format: C&W. Spec prog: Farm 8 hrs wkly. ■ J. Paul Salois, pres, gen mgr & chief engr; Betty A. Salois, stn & sls mgr; Robert Chilton Jr, prog dir. ■ Rates: \$5.75; 5.25; 5.25; —.

KPCR-FM—Aug 1, 1975: 100.9 mhz; 3 kw. Ant 295 ft. Dups AM 67%. ■ Rates: \$—; —; 4.25; 3.75.

Branson

KBHM—Dec 21, 1956: 1220 khz; 1 kw-D, Box S (65616). (417) 334-3133. Shepherd of the Hills Bcstg

Co. Group owner: Neathery, McKenney Stns. Net: Mo. News Net Rep: Keystone; Magic Circle. Format: MOR. Spec prog: Gospel 10 hrs wkly. ■ Robert Neathery Sr, pres; Jon Glenn, gen mgr & prog dir & chief engr; Terry Claar, sls mgr; Rick Turner, news dir. ■ Rates: \$3; 3; 3; 3.

KIRK-FM—Co-owned with KBHM. March 1, 1971: 106.3 mhz; 3 kw. Ant 210 ft. Branson Heights Shopping Center (65616). (417) 334-5155. Format: C&W, rock. Spec progs: Gospel 10 hrs wkly. ■ Richard Lowe, prog dir; Gary Johnson, mus dir; George Keeler, news dir; Loy Ewbank, chief engr.

Brookfield

KGHM—Feb 14, 1956: 1470 khz; 500 w-D, DA, 107 S. Main St. (64628). (816) 258-7479. Brookfield Broadcasting Inc. (acq 12-2-74). Format: MOR, C&W. Spec prog: Farm 16 hrs wkly. ■ Gary S. Yantes, pres; Gary Coates, coml mgr; Craig Olsen, prog dir; John Van Zante, mus dir & chief engr; Rockwell Jones, news dir. ■ Rates: \$5.75; 5.75; 5.75; 5.75.

Buffalo

***KBFL(FM)**—Aug 20, 1965: 90.3 mhz; 780 w. Ant 245 ft. Locust & Main Sts. (65622). (417) 345-2412. School District No. 1, Dallas County. Net: NPR. Format: MOR with country flavor. ■ Dillard A. Mallory, supt of schools; Wayne Lemons, chief engr & gen mgr; Dennis Kelly, prog dir; Joyce Reed, news & pub affrs dir & prom mgr; Mary Williams, mus dir.

Butler

KMAM—May 11, 1962: 1530 khz; 500 w-D, E. Nursery St. (64730). (816) 679-4191. Bates County Bcstg Co. Rep: Magic Circle. Format: Black; standards, contemp, mod country. Spec prog: Farm 12 hrs wkly. ■ B. D. Thornton, pres, gen mgr & chief engr; J. D. Thornton, coml & prom mgr & mus dir; Sandra Dskman, prog dir; Nelson Morgan, farm & news dir. ■ Rates: \$6; 6; 6; 4.20.

KMOE(FM)—Co-owned with KMAM. Jan 15, 1975: 105.5 mhz; 3 kw. Ant 150 ft. Dups AM 70%. ■ Rates same as AM.

Cameron

KMRN—February 1971: 1360 khz; 500 w-D, DA, Box 1360 (64429). (816) 632-7201. Cameron Radio Inc. Net: Missouri Net. Format: Variety with emph on C&W. Spec prog: Farm 10 hrs wkly. ■ K. W. Clevenger, pres; Andy Willoughby, gen mgr; Chuck Reed, coml & prom mgr; Jim Dillman, prog & mus dir; Bud Griffith, news dir; John Meikle, chief engr. ■ Rates: \$4; 4; 4; 4.

Canton

KOCA(FM)—May 4, 1971: 102.3 mhz; 3 kw. Ant 175 ft. Box 6 (63435). (314) 288-4436. Decatur Bcstg (acq 1974). Format: C&W.

Cape Girardeau

KFMP(FM)—Dec 7, 1970: 102.9 mhz; 24 kw. Ant 680 ft. Stereo. Box 618 (63701). (314) 335-0103. KFMP Stereo (acq 5-70). Net: ABC/E. Format: MOR. ■ Ted W. Pylant, stn mgr.

KFVS—1925: 960 khz; 5 kw-D, 500 w-N, DA-N, 324 Broadway (63701). (314) 335-5511. TWX 314-334-4147. Hirsch Bcstg Co. (group owner). Rep: PRO/Meeker; Beaver; Gray. ■ Oscar C. Hirsch, pres; Ralph L. Hirsch, gen mgr & chief engr; Neal Edwards, coml mgr; Hildesgarde Bader, prog dir & prom mgr; Bill Reynolds, news dir. ■ KFVS-TV affil.

KGMO—1951: 1550 khz; 5 kw-D, DA, Box 552 (63701). (314) 335-8228. Withers Bcstg Co. (acq 6-72). Net: ABC/C. Rep: Pro Time Sls, Schneider. Format: Contemp. ■ James K. Withers, pres & gen mgr; Ruth H. Withers, asst mgr; David E. Newton, opns mgr & chief operator; John M. Harth, news dir.

KGMO-FM—March 17, 1969: 100.7 mhz; 28.5 kw. Ant 170 ft. Dups AM 100%.

KZYM—June 10, 1966: 1220 khz; 250 w-D, 1025 Broadway (63701). (314) 335-8291. Missouri-Illinois Bcstg Co. Format: Modern C&W. ■ Jerome B. Zimmer, gen mgr.

Carrollton

KAOL—April 18, 1959: 1430 khz; 500 w-D, Box 254 (64633). (816) 542-0404. Ray County Radio Co. (acq

5-16-74). Net: Missouri Net Inc, Brownfield. Audio news: UPI. Rep: Beaver, South, Hopewell, Keystone. Format: C&W, MOR, rock. Spec prog: Farm 7½ hrs wkly. ■ J. C. Alder, pres; James A. Austin, gen & coml mgr; Margaret Bolinger, prom mgr; Don Sibley, prog dir; Gene Pattie, mus dir; Jim Clark, news dir; Dan Davis, chief engr. ■ Rates: \$3.40; 3.40; 3.40.

KAOL-FM—July 13, 1962: 101.1 mhz; 110 kw. Ant 275 ft. Dup AM 100%. ■ Rates same as AM.

Carthage

KDMO—June 1, 1947: 1490 khz; 1 kw-D, 250 w-N. 1201 E. Chestnut (64836). (417) 358-2648. Carthage Bcstg Co. (acq 10-1-62). Net: ABC/I, Missouri News Net. Format: MOR. Spec progs: Farm 12 hrs wkly. ■ Ruth Kolpin, pres; Ron Petersen, gen & prom mgr; JoAnn Hall, coml mgr; Mark Elliff, mus dir; Bob Dean, news dir; Bill Peterson, prog dir; Dean Petersen, chief engr. ■ Rates: \$5.40; 5.40; 5.40; 5.40.

KRGK(FM)—Co-owned with KDMO. Jan 10, 1972: 104.9 mhz; 3 kw. Ant 195 ft. Dups AM 55%. Format: Btl mus. ■ Rates same as AM.

Caruthersville

KCRV—Feb 22, 1950: 1370 khz; 1 kw-D. Box 909 (63830). (314) 333-1370. Pemiscot Bcstrs. Net: MBS. Rep: Hopewell; Beaver. Format: C&W, MOR. Spec prog: Black 12 hrs wkly. ■ J. Eric Taylor, pres; Cleat Stanfill, gen & coml mgr; Billy Dee, prog & news dir; Tommy Loren, mus dir; Tom Hill, chief engr.

KCRV-FM—1975: 103.1 mhz; 3 kw. Ant 195 ft.

Charleston

KCHR—1953: 1350 khz; 1 kw-D. Box 432 (63834). (314) 683-4678. South Missouri Bcstg Co. Rep: Keystone. Format: MOR, C&W. Spec prog: Classcl 2 hrs wkly. ■ Kermit Barker, pres, gen mgr & chief engr; James L. Byrd III, prog dir; Dennis Mitchell, coml, mus & news dir

Chillicothe

KCHI—March 3, 1950: 1010 mhz; 250 w-D. Box 219 (64601). (816) 646-4173. Rontedick Inc. Rep: Hopewell. Format: Contemp. ■ Richard D. Lindman, pres; Gerald H. Peterson, gen & sales mgr; Joe Lyons, mus dir; David Strange, news dir; Gerald H. Peterson, chief engr. ■ Rates: \$7; 6; 7; 6.

KCHI-FM—Not on air, target date Nov 1, 1975: 103.9 mhz; 1.55 kw. Ant 400 ft.

Clayton

KADI—1945: 1320 khz; 1 kw-D (CP: 5 kw-D, DA). 2735 Bompert, St. Louis (63144). (314) 961-1320. St. Louis County Bcstg Co. (acq 1958). Group owner: Communications Fund Inc. Rep: Howard. Format: Black. ■ R. J. Miller, pres & gen mgr; P.F. O'Brien, coml mgr; Marshall Zwick, prog dir; Charles Rick, chief engr.

***KFUO**—Dec 14, 1924: 850 khz; 5 kw (LSR to SS Denver). 801 De Muñ Ave. (63105). (314) 725-3030. Lutheran Church-Missouri Synod. Audio news: UPI. Format: Concerts, talk, religious. ■ Rev. Paul Devantier, gen mgr; Ralph Buels, prog opns & mus dir; E. J. Draeger, bus affrs; John Fisher, chief engr.

***KFUO-FM**—Jan 1, 1948: 99.1 mhz; 100 kw. Ant 440 ft. Stereo. Progs sep from AM. Format: Concert mus.

***KHRU(FM)**—May 28, 1968: 88.1 mhz; 10 w. 1 Mark Twain Circle (63105). (314) 726-0881. School District of Clayton. Format: Educl, informational. ■ Charles R. Curtiss, stn mgr; Willie Agatstein, chief engr.

***KWUR(FM)**—Not on air, target date unknown: 90.3 mhz; 10 w. Lindell & Skinner Blvds, St. Louis (63130). Washington U. ■ William Danforth, chancellor.

Clinton

KDKD—1951: 1280 khz; 1 kw-D. KDKD Bldg. (64735). (816) 885-4801. Osage Bcstg Co. (acq 1-1-56). ■ William R. Tedrick, pres & gen mgr; Bob Tedrick, coml mgr & prog dir; John M. Blank, stn mgr, news dir & chief engr.

KDKD-FM—1975: 95.3 mhz; 3 kw. Ant 177 ft. Box 113 (64735). Format: Diversified.

Columbia

***KBIA(FM)**—1968: 91.3 mhz; 100 kw. Ant 610 ft. Room 409, Jesse Hall, Univ. of Missouri (65201). (314) 882-3431. The Curators of the University of Missouri. Net: NPR. Format: Fine Arts, Jazz, MOR. Stereo. ■ W. Theodore Eldredge, gen & prom mgr; Dick Bailey, asst mgr & mus dir; Roger Karwoski, opns mgr & chief engr; Roger Galke, news dir.

***KCOU(FM)**—Oct 31, 1973: 88.3 mhz; 10 w. Ant 91 ft. 101F Pershing Hall, University of Missouri (65201). (314) 442-0604. Independent Residence Hall Assoc Inc. Format: Progs v.

KFMZ(FM)—Oct 1, 1971: 98.3 mhz; 3 kw. Ant 300 ft. Stereo. Box 1345, 802 E. Broadway (65201). (314) 443-1525. Contemporary Bcstg Inc. Net: ABC/C. Rep: Torbet. Format: Contemp, Rock. ■ Mike Rice, pres; Norbert Hopfer, gen mgr; Dave Scott, coml mgr; Jim Butler, prog dir; Greg Whal, mus dir; James Bond, news dir; Greg Larson, chief engr.

KFRU—Oct 10, 1925: 1400 khz; 1 kw-D, 250 w-N. Box 718 (65201). (314) 449-4141. KFRU Inc. (acq 12-28-48). Net: ABC/I. Rep: PRO/Meeker; Gray. Format: Diversified. Spec prog: Mystery Theatre. ■ H. J. Waters Jr., pres; James C. Alridge Jr., stn mgr; Mary Sloan, coml mgr; Robert Haigh, chief engr; James Hall, mus dir. ■ Rates: \$10; 8; 10; 8.

***KOPN(FM)**—March 1, 1973: 89.5 mhz; 40 kw. Ant 200 ft. 915 E. Broadway (65201). (314) 443-5611. New Wave Corp. Format: Variety. Spec progs: Fr 2 hrs, Sp 3 hrs, Greek 1 hr, Indian 1 hr, African 2 hrs wkly. ■ Patricia Watkins, pres & prog dir; Stephen Dreher, gen mgr; Aaron Copeland, mus dir; Julie Gorman, news dir; Horace Enright, coml mgr; Robert Feirstein, prom mgr; William Muert, chief engr.

KTGR—Jan 1, 1967: 1580 khz; 250 w-D. Box 412 (65201). (314) 449-2433. Tiger Bcstg Co. (acq 1-1-67). Rep: Beaver; Hopewell. Format: Rock. ■ Bob Neathery, pres; Tad Estes, gen mgr; Jay Micheals, prog dir; Mark Schaefer, gen mgr; Pat Mahoney, news dir; Ken Kuenzie, chief engr.

KTGR-FM—Dec 3, 1967: 96.7 mhz; 3 kw. Ant 160 ft. (CP: 2.9 kw. Ant 300 ft.). Dups AM 100%.

***KWWC-FM**—Feb 2, 1965: 90.5 mhz; 10 w. Ant 45 ft. Stephens College (65201). (314) 442-2211 ext 304. Stephens College. Format: Educl, cultural. ■ Dr. George Whitehouse, gen mgr & chief engr.

Crestwood

KSHE(FM)—Feb 11, 1961: 94.7 mhz; 100 kw. Ant 510 ft. Stereo. 9434 Watson Rd. (63126). (314) 842-1111. Century Bcstg Corp. (group owner; acq 10-64). Rep: Century Bcstg Sys. Format: Prog rock. ■ Howard Grafman, pres; Sheldon Grafman, gen mgr & prog dir; Richard Fendelman, news dir; Milan Leggett, chief engr.

De Soto

KHAD—Nov 1, 1968: 1190 khz; 1 kw-D, DA. Box 585 (63020). (314) 586-8577. De-Soto Bcstg Co. Net: Mo. Net. Rep: Keystone; Magic Circle. Format: News, modern C&W, talk. ■ William H. Duff, pres; Pinkney B. Cole, gen & coml mgr & chief engr; Dave Burke, prom & news dir; Judy A. Cole, prog dir; Don Fregeau, mus dir. ■ Rates: \$4.50; 4.50; 4.50; 4.50.

Dexter

KDEX—Feb 1, 1956: 1590 khz; 1 kw-D. Box 380 (63641). (314) 624-3591. Dexter Bcstg Inc. (acq 1-16-67). Net: Magic Circle. Rep: Beaver. Format: C&W. ■ Jerry Grojean, ptrn & gen mgr.

KDEX-FM—July 17, 1969: 102.3 mhz; 2.35 kw. Ant 51 ft. Prog sep from AM.

Doniphan

KDFN—Feb 4, 1963: 1500 khz; 1 kw-D. Hunt Bldg. (63935). (314) 966-3124. Jack G. Hunt. ■ Jack G. Hunt, gen & coml mgr & chief engr; Myra L. Hunt, prog dir.

KOEA(FM)—Co-owned with KDFN. 1975: 97.7 mhz; 1 kw. Ant 480 ft.

East Prairie

KYMO—Nov 15, 1965: 1080 khz; 250 w-D. Drawer

Missouri Radio

See page C-1 for explanation of listings.

130 (63845). (314) 649-3597. Usher Bcstg (acq 6-1-69). Format: Contemp, C&W. ■ H. Charles Beggs, pres; Barney Webster, gen mgr; Jim Gianville, coml mgr; Gary Spear, prog dir; Tom Beggs, prom mgr; Scott Allen, mus dir; Ken Riddle, news dir; Bob Demay, chief engr.

El Dorado Springs

KESM—July 18, 1961: 1580 khz; 500 w-D. Box 228 (64744). (417) 876-2741. Daryl L. Fredine. (acq 3-1-71). Rep: Keystone; Magic Circle. Format: C&W, MOR. ■ Daryl Fredine, owner, gen & coml mgr. Doug Ferguson, prog dir; Jean Williams, news dir; Dennis W. Poik, chief engr.

KESM-FM—June 1, 1965: 107.1 mhz; 3 kw. Ant 135 ft. Dup AM 100%.

Excelsior Springs

KEXS—August 1968: 1090 khz; 250 w-D, DA. Drawer D (64024). (816) 637-6061. Jeffco Television Corp. Audio news: UPI. Format: C&W. ■ FW. Kasman, pres; Garrel Kundrock, gen mgr; Larry White, news dir; Darrel Duncan, chief engr.

Farmington

KREI—Dec 7, 1947: 800 khz; 1 kw-D. KREI Ave. (63640). (314) PL6-5125. KBOA Inc. Format: Easy lstng. Spec prog: C&W 14 hrs wkly.

Ferguson

***KCFV(FM)**—April 17, 1972: 89.5 mhz; 10 w. 3400 Pershall Rd., St. Louis (63135). (314) 524-8311. Junior College District of St. Louis County, Missouri. Format: Diversified. Spec progs: Black 4 hrs, C&W 2 hrs, oldies 2 hrs wkly. ■ Lynn Wahl, gen mgr; Bruce Kropp, stn mgr.

Festus

KJCF—May 10, 1951: 1400 khz; 1 kw-D, 250 w-N. Box 268 (63028). (314) 937-7642. United Broadcasting Inc. (acq 4-72). Format: Progs rock. Spec prog: Gosp 8 hrs wkly. ■ Harold Wright, pres; David M. Wright, gen mgr; Wally Taylor, coml mgr; Lloyd James, prog dir & prom mgr; Gib Colling, mus dir; Jack Lovelace, news dir; Richard Roth, chief engr. ■ Rates: \$5.30; 4.30; 5.30; 3.

KXEN—See St. Louis.

Flat River

KFMO—June 1, 1947: 1240 khz; 1 kw-D, 250 w-N. St. Joseph Drive (63601). (314) 431-2000. Lead Belt Bcstg Co. Group owner: Oscar Hirsch Stns. Rep: Meeker. Format: MOR, C&W. ■ Oscar C. Hirsch, pres; Jack L. Schepre, gen mgr; Kenneth Doggett, coml mgr & news dir; Waynele Scott, prog dir; Tom Reed, mus dir. ■ Rates: \$7; 6.75; 6.50; 6.

Florissant

New FM—Not on air, target date unknown: 97.1 mhz; 50 kw. Ant 500 ft. 2120 Pyrenees Dr. (63033). Florissant Bcstg Co.

Fredericktown

KFTW—June 29, 1963: 1450 khz; 1 kw-D, 250 w-N. Box 71 (63645). (314) 783-4461. Madison County Bcstg Co. (acq 10-74). Net: Keystone; Magic Circle. Rep: Crane. Format: C&W. ■ W. N. Cate Jr., et al, owners.

Fulton

KFAL—Nov 14, 1950: 900 khz; 1 kw-D. Box 581, 1805 Westminster (65251). (314) MI2-3341. KFAL Inc. (acq 6-1-68). Rep: Savalli/Gates. Format: C&W. ■ Bud Pratt, gen mgr; R. W. Terrell, coml mgr; Ron Lutz, farm dir.

KKCA(FM)—Co-owned with KFAL. 1970: 97.7 mhz; 3 kw. Ant 300 ft.

Greenfield

KRFG(FM)—April 5, 1974: 93.5 mhz; 2.35 kw. Ant 330 ft. Public Square (65661). (417) 637-5919.

Missouri Radio

See page C-1 for explanation of listings.

Watkins Investment Co. Net: Mo. News, Brownfield. Rep: Magic Circle. Format: Diversified. Spec prog: Farm 2 hrs wkly. ■ John A. Watkins, pres, gen mgr & chief engr; John K. Watkins, VP; Ed Kocca, prom mgr, mus dir; Rita Morton, news dir; Kirk Watkins, coml mgr. ■ Rates: \$3.25; 2.50; 2.50; 3.25.

Hannibal

KGRC(FM)—Nov 28, 1968: 92.9 mhz; 100 kw. Ant 490 ft. Stereo. Box 1017 (63401). (217) 224-4100. Great River Communications Inc. Net: ABC-FM. Format: Contemp. ■ Frank E. Laughlin, pres; Melvin Elzea, gen mgr; Mark Smith, coml mgr (Illinois); Ralph Williams, coml mgr (Mo.); Mark Mathew, prog dir; John Rinne, mus dir; Zelda Trump, news dir; Karl E. Holtmeyer, chief engr.

KHMO—April 1941: 1070 khz; 5 kw-D, 1 kw-N, DA-2. Box 711 (62301). (314) 221-3450. Springfield Bcstg Co. (acq 6-70). Net: NBC. Rep: Masla; Eugene F. Gray Co. Format: C&W. Spec progs: Farm 18 hrs wkly. ■ Don C. Dailey, VP; Joe Gross, gen mgr; Art Francis, sales mgr; Dennis James, prog dir; Jim Spurling, news dir; Ed Summers, chief engr. ■ Rates: \$13; 13; 12.75; 13.

Harrisonville

KIEE(FM)—July 19, 1974: 100.7 mhz; 26 kw. Ant 255 ft. Stereo. Box 468 (64701). (816) 884-5404. KIEE-FM Inc. Format: Diversified. Spec progs: Farm 4 hrs, class 2 hrs, jazz 1 hr wkly. ■ Arnold E. Wilson, pres, gen mgr & chief engr; Ed Bohl, news dir; Meg Ball, womens dir. ■ Rates: \$4; 4; 4.

Hayti

KCRV—See Caruthersville

Houston

KBTC—June 28, 1962: 1250 khz; 1 kw-D. Box C (65483). (417) 967-3353. Radio Co. of Texas County Inc. (acq 12-4-70). Net: Mo. Net, Brownfield. Rep: Smith; Magic Circle. Format: C&W. ■ Jeryl Smith, pres & gen mgr; Steve Gronemyer, prog dir; Ken Curtis, news dir; Walt Lawson, chief engr. ■ Rates: \$6; 6; 6.

KSCM-FM—Co-owned with KBTC. May 1965: 99.3 mhz; 3 kw. Ant 300 ft. Dups AM 75%. (417) 967-4153.

Independence

KCCV—1947: 1510 khz; 1 kw-D. 43 Blue Ridge Center, Kansas City (64133). (816) 353-8600. IGWT Inc. (acq 10-3-62). Format: Relig. ■ Richard Bolt, pres; Ben Weiss, prog dir, opns mgr & chief engr.

Ironton

KPIA—Sept 15, 1972: 1480 khz; 5 kw-D, DA. Box 437 (63650). (314) 546-7473. Iron County Bcstg Co. Net: Mo. Net. Audio news: APR. Rep: Beaver. Format: C&W. Spec prog: Farm 10 hrs wkly. ■ Gaylon Watson, pres, gen & coml mgr; Jackie Crowley, prog dir; Greg Hitchings, news dir; Wally Helwig, chief engr. ■ Rates: \$3.50; 3.50; 3.50; 3.50.

Jackson

KJAS—March 1972: 1170 khz; 250 w-D. Box 312 (63755). (314) 243-8179. Jackson Missouri Bcstg Co. Format: Rock, Top 40. ■ Robert Neathery Jr., pres; Ann B. Raymond, gen mgr; Robert Schultz, coml & prom mgr; J. D. Gates, prog & mus dir; James D. Smith, news dir; Dave Obergöenner, chief engr.

Jefferson City

KJFF(FM)—Listing follows KLIK.

KJMO(FM)—1974: 100.1 mhz; 3 kw. Ant 300 ft. Stereo. 3103 South Ten Mile Dr. (65101). (314) 893-3101. KAIR Inc. Format: MOR, btlf mus. ■ Charles Monti, VP & gen mgr; Gary Rice, prog dir.

KLIK—February 1954: 950 khz; 5 kw-D, 500 w-N, DA-N. Box 414 (65101). (314) 634-2950. KLIK Radio 950 Inc. (acq 6-68). Net: ABC/C. Rep: Avery-Knodel. ■ Stan G. Grieve, exec VP & gen mgr; Dave Neise, coml mgr; Dale Duncan, prog dir; Denning Banister, mus dir; Mike Shipley, news dir; Jim Nichols, chief engr.

KJFF(FM)—Dec 1, 1969: 106.9 mhz; 100 kw. Ant 215 ft. Stereo. Progs sep from AM. Net: ABC/FM. Format: MOR. ■ Dave Neise, coml mgr; Fran Mooney, mus dir; Mike Cleary, news dir; Rich McDonald, chief engr.

***KLUM-FM**—August 1973: 88.9 mhz; 41 kw. Ant 255 ft. 1004 E. Dunklin St. (65101). (314) 471-2885. Bd of Curators of Lincoln Univ. Net: NPR. Format: Cultural, informational. ■ Barbara A. Berry, gen mgr; Rodney K. Diggs, prod mgr; Beverly L. Kelsay, traf mgr; Lloyd Collins, chief engr.

KWOS—January 1937: 1240 khz; 1 kw-D, 250 w-N. Box 478 (65101). (314) 636-3137. KWOS Inc. (acq 11-1-71). Net: CBS, Missouri. Format: MOR. Spec prog: C&W 10 hrs wkly. ■ Wm. Natsch Jr., pres & gen mgr; Jack Renner, prog dir; Don Roberts, news dir; Leroy S. Hackmann, chief engr. ■ Rates: \$7.75; 7.75; 7.75; 7.75.

Joplin

KFSB—Nov 21, 1948: 1310 khz; 5 kw-D, 1 kw-N, DA-2. Box 1395 (64801). (417) 624-1310. J. R. Bcstg Co. (acq 3-14-71). Net: ABC/E. Rep: Walton; Schneider. Format: Contemp. ■ Richard D. Chegwin, pres & coml mgr & chief engr; John C. David, VP, gen & prom mgr & prog dir; Tom Jordan, mus dir; Mike Moore, news dir. ■ Rates: \$9.50; 9.50; 9.50; 9.50.

***KOBC(FM)**—March 17, 1969: 90.7 mhz; 30 kw. Ant 230 ft. Stereo. 1111 N. Main St. (64801). (417) 624-2623. Ozark Bible College. Format: Btlf mus, relig. Spec prog: Classl 14 hrs wkly. ■ Don Earl Boatman, pres; James Taylor, gen mgr; Ed Reynolds, prog dir; Dan Parsons, mus dir; David F. Reeder, chief engr.

KODE—June 1, 1946: 1230 khz; 1 kw-D, 250 w-N. Box 46, 3001 West 13th St. (64801). (417) 624-4333. TWX 910-744-4516. Gilmore Bcstg Corp. (group owner; acq 6-1-62). Net: CBS. Rep: PRO/Meeker. Format: Contemp MOR. ■ James S. Gilmore Jr., pres; Richard E. Reed, exec VP opns; Hamilton Shea, exec VP admin/corp dev; Robert E. Lee, VP & gen mgr; Steve Walker, sls mgr; M. Jay Corrington, asst stn mgr; Larry Meacham, news dir; Morris Sweet, chief engr. ■ KODE-TV affil.

KPCG(FM)—Nov 21, 1974: 102.5 mhz; 100 kw. Ant 440 ft. Stereo. Box 212 (64801). (417) 781-8800. Pentecostal Church of God of America. Format: Top 40, gospel, easy listening. Spec prog: Classl 3 hrs wkly. ■ Rev. W. H. Thompson, gen mgr & chief engr; Jim Nicholson, coml mgr; David F. Reeder, prog dir & prom mgr; Timothy D. Wilson, mus dir; Roland Loy Conner, news dir.

KQYX—May 25, 1962: 1560 khz; 10 kw-D, DA. Box 152 (64801). (417) 781-1313. William B. Neal. Net: ABC/C. Rep: Bunchez. Format: Contemp. ■ William B. Neal, pres & gen mgr & prog dir; Claud Taylor, coml mgr; Bryant Davis, prom mgr; Bob James, news dir; Floyd Haupt, chief engr. ■ Rates: \$4; 4; 4; 4.

KSYN(FM)—Co-owned with KQYX. Dec 19, 1960: 92.5 mhz; 100 kw. Ant 430 ft. Stereo. Prog sep from AM. Net: ABC/FM. Rep: Bunchez. Format: Variety. ■ Tom Holloway, prom mgr. ■ Rates same as AM.

WMBH—March 1928: 1450 khz; 1 kw-D, 250 w-N. Box 608 (64801). (417) 623-1450. Big Chief Bcstg of Mo. (acq 2-21-73). Rep: Avery Knodel. Format: C&W. Spec prog: Farm 2 hrs wkly. ■ William A. Serle, gen mgr; Robert Vestal, prog dir; Nelson Chandler, coml mgr; Gary Elliot, mus dir; Mike Nichols, news dir. ■ Rates: \$7.20; 6.40; 7.20; 6.40.

Kansas City

KAYO—Sept 1, 1971: 1190 khz; 1 kw-D, 250 w-N, DA-N. 424 Nichols Rd., Suite 201 (64112). (816) 753-7707. Coleman American Bcstg Co. (acq 8-29-75). Net: CBS. Rep: HR Stone. Format: MOR. ■ James F. Coleman, owner; Don Tawzer, stn mgr; Ev Wren, VP & prog dir; Mike Jorgenson, natl sls & prom mgr; John Shideler, chief engr; John Randall, mus dir; Phil Mueller, news dir.

KBEA—See Mission, Kan.

KBEQ(FM)—November 1960: 104.3 mhz; 50 kw. Ant 953 ft. 3100 Broadway, Suite 111 (64111). (816) 531-2535. KBEQ Inc. (acq 12-1-72). Rep: Metro. Format: Top 40. ■ Mar L. Wodlinger, pres & gen mgr; J. D. Williamson II, stn & coml mgr; Constance J. Wodlinger, prom mgr; Y. Nobby Day, prog dir; Bob Laurence, mus dir; Art Lee, news dir; Arthur Hadley, chief engr. ■ Rates: \$36; 42; 54; 54.

KCEZ(FM)—Listing follows KCMO.

KCCV—See Independence.

KCKN—See Kansas City, Kan.

KCMO—June 10, 1936: 810 khz; 50 kw-D, 10 kw-N, DA-N. 125 E. 31st St. (64108). (816) 531-6789. TWX 910-771-3112. ABC-Edith Corp. (group owner; acq 10-2-53). Net: ABC/E. Rep: Eastman. Format: Adult contemp. ■ Steve Shannon, VP & gen mgr; Wally Ranck, coml mgr; Kevin Buchta, prom mgr; Al Casey, prog dir; Marvin Bredemeier, chief engr.

KCEZ(FM)—Co-owned with KCMO. February 1948: 94.9 mhz; 100 kw. Ant 850 ft. Prog sep from KCMO. Stereo. Format: Easy lstng, good music. ■ Lew Campbell, coml mgr; Ruth Brock, prog dir. ■ KCMO-TV affil.

***KCUR-FM**—October 1957: 89.3 mhz; 100 kw. Ant 830 ft. Stereo. 5100 Rockhill Rd. (64110). (816) 276-1551. University of Missouri, Kansas City. Net: NPR. Format: Classical, pub affrs. ■ Sam Scott, dir of bcastg; Mark Morelli, prod mgr; Jan Lantz, prog dir; Bob Thatch, mus coord; Paul Boe, news dir; Billy Hunnault, chief engr.

***KLJC(FM)**—Aug 9, 1970: 88.5 mhz; 10 kw. Ant 175 ft. c/o H. S. Waterhouse, 1111 West 39th St. (64111). (816) 753-4514. Calvary Bible College. Format: Educl. ■ Leslie Madison, pres; George S. Pearson, VP & stn supvr; Harry S. Waterhouse, prog dir; Ben Weiss, chief engr.

KMBR(FM)—Listing follows KMBZ.

KMBZ—1921: 980 khz; 5 kw-U, DA-N. 4935 Belinder Rd., Shawnee Mission, Kan. (66205). (913) 236-9800. Bonneville International Corp. (group owner; acq 5-12-67). Rep: Avco. Format: MOR. ■ Walt Lochman, VP & gen mgr; Steve Bell, prog & mus dir; Noel Heckerson, news dir; Ellis Lanzrath, chief engr.

KMBR(FM)—Co-owned with KMBZ. October 1962: 99.7 mhz; 98 kw. Ant 950 ft. Prog sep from AM. Format: MOR. ■ Joe Abernathy, VP & gen mgr; Jim Gallant, prog & mus dir.

KPRS(FM)—Listing follows KPRT.

KPRT—1950: 1590 khz; 1 kw-D. 2301 Grand Ave. (64108). (816) 471-2100. KPRS Bcstg Corp. Net: Natl Black. Rep: Howard. Format: Black. ■ Andrew R. Carter, pres; John E. Carter, gen mgr; Bob L. Anderson, asst gen mgr; Robert Leedham, chief engr.

KPRS(FM)—1963: Co-owned with KPRT. 103.3 mhz; 100 kw. Ant 450 ft. Stereo. Progs sep from AM.

***KTSR(FM)**—Nov 11, 1960: 90.1 mhz; 10 w. 1700 E. Meyer Blvd. (64131). (816) 333-6256. Nazarene Theological Seminary Radio Corp. Format: 90% sacred music. ■ Dr. William Greathouse, pres; Paul M. Unterkicher, gen mgr; David Reed, chief engr.

KUDL—See Fairway, Kan.

KWKI(FM)—March 3, 1958: 93.3 mhz; 83 kw. Ant 290 ft. (CP: 100 kw.) Stereo. 1722 Main St. (64108). (816) 474-6400. FM Broadcasting Inc. (acq 2-71). Group owner: Communications Fund Inc. Net: ABC/FM. Rep: ABC-FM Spot Sls. Format: Progs. Spec progs: Black 3/4 hr wkly. ■ Richard J. Miller, pres; Arvie Baie, gen mgr; Peter Parisi, prog dir; Bob Leedham, chief engr. ■ Rates: \$15; 15; 15; 15.

KXTR(FM)—Sept. 3, 1959: 96.5 mhz; 90 kw. Ant 670 ft. Stereo. 15501 Swearingen Rd., Independence, Mo. (64050). (816) 257-4700. Senthosound Bcstg Assn Inc. (acq 5-22-65). Rep: Groskin. Format: Classl. ■ R. Edwin Browne, pres & gen mgr; Winton Johnston, gen sls mgr; Keith Painton, prog dir; Russell Resch, chief engr.

KYYS(FM)—Listing follows WDAF.

WDAF—Feb 16, 1922: 610 khz; 5 kw-U. 3030 Summit, Signal Hill (64108). (816) 753-4567. TWX 910-771-2047. Taft Bcstg Co. (group owner; acq 4-1-64). Net: ABC/I. Rep: Katz. Format: Contemp, MOR. ■ Lawrence H. Rogers II, pres; Robert R. Fanning, gen mgr; James B. Adams, gen sales mgr; Jay Cooper, prom mgr; Ross Reagan, prog dir; Charles Gray, news dir; James P. Schmidt, chief engr.

KYYS(FM)—Co-owned with WDAF. March 5, 1961: 102.1 mhz; 100 kw. Ant 940 ft. Progs sep from AM. Format: Rock. ■ Ron Voss, stn mgr; Max Floyd, prog dir. ■ WDAF-TV affil.

WHB—1922: 710 khz; 10 kw-D, 5 kw-N, DA-2. 106 West 14th (64105). (816) 221-8300. Storz Bcstg Co. (group owner; acq 1954). Rep: Blair. Format: Popular mus & news. ■ Robert H. Storz, pres; James H. Erwin, gen mgr; Johnny Dolan, prog dir.

Kennett

KBOA—July 19, 1947: 830 khz; 1 kw-D. Box 509 (63857). (314) 888-4616. KBOA Inc. (acq 11-21-66). Rep: Beaver. Format: MOR. ■ M. F. Dunne Jr, pres; Charles C. Earls, gen mgr; John C. Mays Jr, stn mgr; Steve Mays, prog dir; Tom Colvin, news dir; Larry Anthony, chief engr.

KTMO(FM)—Co-owned with KBOA. 1948: 98.9 mhz; 100 kw. Ant 370 ft. Stereo. (314) 888-4991. KBOA Inc. (acq 11-1-66). Progs sep from AM. Net: ABC/FM. Format: C&W. ■ Russell McCain, coml mgr; Jan Smith, prog dir; Joe Ross, news dir.

KBXM—May 21, 1964: 1540 khz; 1 kw-D, 500 w-CH. Box 569 (63857). (314) 888-5333. Bootheel Bcstg Co. ■ Larry Robinson, gen mgr.

Kirkville

KIRX—Oct 17, 1947. 1450 khz; 1 kw-D, 250 w-N. Box 130 (63501). (816) 665-3781. Community Bcstrs Inc. Net: ABC/E. Format: General. Spec progs: C&W 12 hrs, talk 12 hrs wkly. ■ Sam A. Burk, pres & gen mgr; Jay Way, stn mgr; Robert M. Carlson, prog dir; Alan C. Chettle, coml mgr; Anne Marie Burke, news dir; Chas Porter, chief engr. ■ Rates: \$8.25; 8.25; 6.75; 6.75.

KRXL(FM)—Co-owned with KIRX. September 1967: 94.5 mhz; 54 kw. Ant 430 ft. (816) 665-9828. Progs sep from AM. Net: ABC/FM; Mo. News; Brownfield. Format: Farm. ■ Rates: \$6; 5.25; 5.25; 5.25.

Lebanon

KJEL—Oct 20, 1973: 1080 khz; 250 w-D. Box 1112 (65536). (417) 532-9111. Risner Bcstg Inc. Format: MOR, news. ■ James L. Risner, pres, coml & prom mgr & chief engr; Judy Gaffney, gen mgr; Ella Mae Risner, prog & mus dir; Ed Sisson, news dir.

KJEL-FM—Oct 20, 1973: 103.7 mhz; 30 kw. Ant 255 ft. Dups AM 60%. Stereo.

KLWT—July 4, 1947: 1230 khz; 1 kw-D, 250 w-N. Radio Park, New Buffalo Rd. (65536). (417) KE2-2962. Lebanon Bcstg Co. Format: MOR. Spec prog: C&W 15 hrs wkly. ■ Jack A. Sellers, pres, gen mgr, coml mgr, prom mgr; Warren Goforth, prog & mus dir; Ben Franklin, news dir; Eugene Clay, chief engr.

Lexington

KBK(FM)—Listing follows KLEX.

KLEX—April 19, 1956: 1570 khz; 250 w-D. Box 188 (64067). (816) 259-3232. KLEX Inc. (acq 1-71). Net: Missouri. Rep: Keystone. Format: C&W, Top 40. ■ Dr. Inks Franklin, pres; Ray Beckwith, gen, coml & prom mgr; Don Sibley, prog dir; Tom Griggs, mus dir & chief engr; Edward Luehrman, news dir.

KBK(FM)—Co-owned with KLEX. Sept 11, 1969: 106.3 mhz; 3 kw. Ant 205 ft. Prog sep from AM.

Liberty

KBIL—Feb 14, 1967: 1140 khz; 500 w-D. Box 1140 (64141). (816) 781-6600. S & M Investments Inc. (acq 3-15-71). Audio news: APR. Rep: Young. Format: C&W. ■ Mack Sanders, pres; M. Crawford Clark, VP; Jimmy Dallas, gen & sls mgr; Charlotte Perry, mus dir; Homer Perkins, news dir.

***KWPB(FM)**—1974: 91.9 mhz; 10 w. Ant 46 ft. William Jewell College (64068). William Jewell College. (816) 781-3806. Format: Diversified.

Macon

KLTI—Jan 30, 1966: 1560 khz; 250 w-D. Box 188 (63552). KLTI Radio Inc. Format: C&W. ■ Leland E. Ebert, pres, gen mgr & chief engr; Imogene Ebert, VP, prog dir, prom & asst mgr.

Malden

KTCB—Sept 15, 1954: 1470 khz; 1 kw-D. Box 379 (63863). (314) 276-4551. Tri-County Bcstg Co. ■ Richard J. Wiethan, pres, gen mgr, prog & news dir &

chief engr; James C. Wiethan, coml & prom mgr.

Marshall

KMFL-FM—Listing follows KMMO.

KMMO—May 29, 1949: 1300 khz; 1 kw-D. Box 128 (65340). (816) 886-7422. KMMO Inc. (acq 11-15-51). Net: Missouri Agriculture. Format: C&W. ■ A. D. Sappington, pres; Harold Douglas, gen & coml mgr; Joe Harris, prog dir; Jack Abdon, news dir; W. W. Williams, chief engr.

KMFL-FM—Co-owned with KMMO. December 1968: 102.9 mhz; 56 kw. Ant 380 ft. Progs sep from AM. Format: MOR (day), rock (eve).

***KNOS(FM)**—Nov 1, 1968: 91.7 mhz; 10 w. Ant 51 ft. Missouri Valley College (65340). Missouri Valley College. Format: Ed. Spec prog: Black 4 hrs wkly. ■ Lloyd Purdy, gen mgr & chief mgr.

Marshfield

KEMM—Nov 1, 1969: 1510 khz; 250 w-D. Box 586 (65706). (417) 468-4647. Webster County Bcstg Co. Rep: Magic Circle. Format: C&W. Spec progs: Rock Sat & Sun afternoons. ■ Earl Steiner, pres; Larry Chisholm, gen mgr & chief engr; Bill Davis, news dir.

Maryville

KNIM—1953: 1580 khz; 250 w-D. Box 278 (64468). (816) 582-2151. Nodaway Bcstg Corp. (acq 4-1-72). Format: MOR. ■ George E. Powers, pres & gen mgr; Mike Elgert, coml mgr; Gary Cantrell, prog dir.

KNIM-FM—September 1972: 95.3 mhz; 3 kw. Ant 235 ft. Dups AM 80%.

***KXCV(FM)**—Jan 15, 1971. 90.5 mhz; 100 kw. Ant 510 ft. Northwest Mo. State U. (64468). (816) 582-2076. Bd of Regents for Northwest Missouri State U. Net: NPR. Format: Ed. ■ Robert P. Foster, pres; Rollie Stadlman, gen mgr; Cathran Cushman, prog dir; Michael Lazar, prog mgr; Donald Sanford, coml dir; Sharon Shipley, community affrs dir; Warren Stucki, chief engr.

Mexico

KWWR-FM—Listing follows KXEO.

KXEO—Dec 3, 1948: 1340 khz; 1 kw-D, 250 w-N. Box 475, 1705 E. Liberty (62562). (314) 581-2340. Audrain Bcstg Corp. Net: MBS. Format: Talk, easy ising, top 40. ■ W. Earl Dougherty, pres, gen & coml mgr; Karen Mossman, news dir; James Faughn, chief engr.

KWWR-FM—Co-owned with KXEO. Dec 14, 1966: 95.7 mhz; 55 kw. Ant 300 ft. Stereo. Progs sep from AM. Format: Btlf mus.

Moberly

KRES(FM)—Listing follows KWIX.

KWIX—June 1950: 1230 khz; 1 kw-D, 250 w-N. Box 619 (65270). (816) 263-1230. KWIX Inc. Format: MOR, talk. ■ Jerrell A. Shepherd, pres & gen mgr; Eugene Vaughn, coml mgr; Dick Womack, opns dir & chief engr; Sharon Brown, mus dir; Greg Walker, news dir.

KRES(FM)—Co-owned with KWIX. October 1966: 104.7 mhz; 50 kw. Ant 480 ft. Prog sep from AM. Net: ABC/C. Format: MOR. ■ Ben Morgan, coml mgr; Richard Womack, gen mgr; Tom Nau, mus dir; Jack Larkin, news dir; Tim Conley, chief engr.

Monett

KRMO—August 1950: 990 khz; 250 w-D. Box 270 (65708). (417) 235-5220. Monett Bcstg Co. Group owner: Lloyd C. McKenney Stns. Rep: Keystone; Magic Circle. ■ L. C. McKenney, owner & pres; Floyd V. Stewart, gen mgr; Marion J. Pilant, coml mgr; James Heimkamp, chief engr.

Mountain Grove

KLRS—Nov 16, 1954: 1360 khz; 1 kw-D. Route 4 (65711). (417) 926-4650. KLRS Bcstg Co. Format: C&W 80%, rock 20%. ■ Roger H. Taylor, pres; Fred Clift, gen mgr, prog & news dir; Dave Miller, mus & sports dir, chief engr.

Missouri Radio

See page C-1 for explanation of listings.

Neosho

KBTN—Feb 1, 1954: 1420 khz; 500 w-D. Box K (64850). (417) 451-1420. KBTN Inc. (acq 4-16-60). Net: Mo. News. Audio news: UPI. Format: MOR. Spec prog: Farm 6 hrs, C&W 12 hrs, religious 6 hrs wkly. ■ Galen O. Gilbert, pres; David L. Winegardner, VP & gen mgr; Bud Self, coml mgr; Cathy Bozan, news dir; Brent Thomas, prog dir; Wilbur Blankenship, chief engr. ■ Rates: \$4; 3.40; 3.40; 3.40.

Nevada

KNEM—1949: 1240 khz; 250 w-U. Box 447 (64772). (417) 667-3113. Radio KNEM Inc. (acq 1954). Format: MOR. ■ Kenneth E. White, pres, gen mgr & chief engr. ■ Rates: \$5.40; 5.40; 5.40; 5.40.

Osage Beach

KRMS—December 1952: 1150 khz; 1 kw-D. Box 225 (65065). (314) 348-2772. Central Missouri Bcstg Co. (acq 5-27-59). Spec prog: C&W 40%. ■ James L. Risner, co-owner, gen & coml mgr & chief engr; Ella Mae Risner, co-owner, prog dir & prom mgr.

KRMS-FM—April 12, 1964: 93.5 mhz; 2.4 kw. Ant 285 ft. Prog sep from AM.

Parkville

***KGSP(FM)**—April 1972: 90.3 mhz; 10 w. Ant 100 ft. Park College, Kansas City (64152). (816) 741-2000 ext 291. Bd. of Trustees of Park College. Format: Progressive, black. Spec prog: Classcl 4 hrs wkly. ■ Robert Owens, gen mgr; Norman Robertson, chief engr.

Piedmont

KPWB—May 16, 1966: 1140 khz; 1 kw-D. Box 50, Highway H (63957). (314) 223-4205. Wayne County Bcstg Co. (acq 7-71). Rep: Magic Circle. Format: C&W. ■ Gaylon Bumpus, pres; Dennis Hovis, gen & coml mgr; Jimmy Hagggett, prog & news dir; Alan Conner, prom mgr; Howard Counts, chief engr.

Point Lookout

***KSOZ(FM)**—Feb 10, 1962: 91.7 mhz; 25 kw. Ant 185 ft. School of the Ozarks (65726). (417) 334-3101. Net: NPR. Format: Progsv, talk, serious music. ■ Joe F. Embser, gen mgr; Bill Mahoney, prog dir; Gene Bridges, news dir; R. W. Stauffer, chief engr.

Poplar Bluff

KLID—May 22, 1961: 1340 khz; 1 kw-D, 250 w-N. KLID Bldg., Box 458, 11th & Vine (63901). (314) 785-9639. Don M. Lidenton. Net: ABC/C. Rep: Walton, Messina, Schneider, Magic Circle. Format: Contemp, variety, solid gold, MOR. ■ Don Lidenton, owner, gen & prom mgr & chief engr & coml mgr; Bob Holiday, mus dir; William B. Steiger, sls; Don M. Lidenton, prog dir. ■ Rates: \$6; 6; 6.

KPBM(FM)—Listing follows KWOC.

KWOC—May 10, 1938: 930 khz; 5 kw-D, 500 w-N, DA-N. Box 399 (63901). (314) 785-8950. Three Rivers Bcstg (acq 12-3-72). Net: MBS, Delta. Rep: Savalli/Gates; Gray. Format: C&W. Spec progs: Farm 4½ hrs wkly. ■ Delbert W. Shaffner, pres; Leland Shaffner, VP & gen mgr; Harold Baker, news dir; Dave Almond, mus dir; Earl Simpson, chief engr. ■ Rates: \$5.75; 5.75; 5.75; 4.15.

KPBM(FM)—Co-owned with KWOC. 1952: 94.5 mhz; 14 kw. Ant 215 ft. Prog sep from AM. (acq 12-3-72). Net: Mo. News. Format: MOR. ■ Rates: \$3.40; 3.40; 3.40; 3.40.

Portageville

KMIS—Sept 1, 1960: 1050 khz; 1 kw-D. Box 250 (63873). (314) 379-5436. New Madrid County Bcstg Co. Rep: Magic Circle. Format: C&W. ■ Smith Dunn, pres; Harry Moreland, stn & coml mgr; Kuz Moreland, prog & news dir; Al Lawrence, chief engr.

KMIS-FM—Not on air, target date unknown: 106.3 mhz; 3 kw. Ant 230 ft. Format: C&W, gospel. ■ J. Shelby McCallum, owner.

Missouri Radio

See page C-1 for explanation of listings.

Potosi

KYRO—Feb 22, 1959: 1280 khz; 500 w-D. Box 280 (63664). (314) 438-2136. Mid-Central Bcstg Co. (acq 10-15-70). Rep: Keystone. Format: C&W, talk. ■ J. W. Crismon, pres; Joe W. Duty, Bill Perry, gen mgr & prog dir; Joe W. Duty, coml mgr; Rik Edwards, prom mgr; Edi Doughty, mus dir; Bill Perry, news dir & chief engr.

Rolla

KCLU—Aug 19, 1960: 1590 khz; 1 kw-D. Box 728 (65401). (314) 364-1590. Rolla Bcstrs. Rep: Magic Circle. Format: Contemp. ■ Roy D. Stanley, owner & gen mgr; Mrs. Donna F. Stanley, stn mgr; Doug Gary, prog dir; Marvin Busch, coml mgr; Julia Stanley, mus dir.

KCLU-FM—Nov 20, 1964: 94.3 mhz; 2.8 kw. Ant 295 ft. Prog sep from AM.

***KMNR(FM)**—1974: 89.7 mhz; 300 w. Ant 230 ft. 203A Mining Bldg (65401). (314) 341-4272. Curators of Univ. of Missouri. Format: Prog, rock, underground. Spec progs: Black 14 hrs, C&W 4 hrs wkly. ■ David A. Heile, gen mgr; Debbie Manning, prom mgr; Doug Wohlert, prog dir; Joe Kracum, mus dir; Craig Bernstein, news dir; Jeff Bradshaw, chief engr.

KTTR—Sept 30, 1947: 1490 khz; 1 kw-D, 250 w-N. Box 727 (65401). (314) 364-2525. Phelps County Bcstg Inc. (acq 1-7-68). Net: ABC/E. Mo. News. Rep: Walton. Format: MOR. Spec prog: Farm 2½ hrs wkly. ■ Robert M. McKune, pres, gen mgr; Dottie Pearson, coml mgr; Kenneth D. Vanderlaan, opns mgr & prom dir; Mike Randsell, mus dir; David White, news dir; James C. Adams, chief engr.

KZNN(FM)—Co-owned with KTTR. Feb 12, 1973: 105.3 mhz; 28.5 kw. Ant 155 ft. Stereo. Prog sep from AM. Net: ABC/I. Format: C&W.

***KUMR(FM)**—January 1964: 88.5 mhz; 100 kw. Ant 480 ft. Stereo. G-6 Library (65401). (314) 341-4386. Curators of the University of Missouri. Net: NPR. Format: Classcl, pub affairs. ■ William Devine, gen mgr; Tim Jones, prog dir; Michael Morgan, mus dir; Ann Gminski, prom mgr; Charlotte Ekker, news dir; Mark Fehlig, chief engr.

KZNN(FM)—Listing follows KTTR.

St. Charles

***KCLC(FM)**—October 1968: 89.1 mhz; 1.5 kw. Ant 240 ft. Lindenwood College. (723-4133). Lindenwood Female College. Net: NER. Format: Public information, sports, mus. ■ Eugene Uram, faculty advisor; Bradley Anderson, gen mgr; Kenn Heinlein, prog dir; Garry Cipolla, mus dir; Jamison Braun, prom mgr; Mary Cox, news dir; William Ott, chief engr.

KIRL—April 3, 1958: 1460 khz; 5 kw-D, DA. Box 1460 (63301). (314) 946-6600. Contemporary Media Inc. (acq 8-1-68). Group owner: Rice Bcstg. Net: ABC/C. Format: Contemp. ■ Mike Rice, pres & gen mgr; Mai Rice, exec VP; Roger Hunter, VP, opns mgr; Jim Long, mus dir; Mark Hunter, news dir; Gerry Friton, tech dir. ■ Rates: \$22; 19; 22; 16.

Ste. Genevieve

KSGM—See Chester, Ill.

KSGM-FM—March 1967: 105.7 mhz; 100 kw. Ant 285 ft. Stereo. Box 428 (63670). (314) 883-2980. Dups AM 100%. Net: MBS. Format: Diversified. ■ Elmer L. Donze, pres & gen & prom mgr & chief engr; Art Schwent, prog dir. ■ Rates: \$5.20; 5.20; 5.20; 5.20.

St. Joseph

KFEQ—Feb 16, 1923: 680 khz; 5 kw-U, DA-2. Box 879 (64502). (816) 233-8881. Kays Inc. (acq 3-6-69). Audio news: APR. Rep: McGavren-Guild. Format: C&W. Spec prog: Farm 12 hrs wkly. ■ Ross Beach, pres; Robert E. Schmidt, VP; Terry King, gen mgr; Bob Rose, prog dir; Gene Millard, farm dir; Phil Clinton, mus dir; John Adams, news dir. ■ Rates: \$21; 17; 21; 14.

KKJO—June 1, 1946: 1550 khz; 5 kw-U, DA-N. Box 166 (64502). (816) 279-6346. St. Joseph Bcstg Inc. (acq 10-1-71). Net: ABC/C. Rep: PRO/Meeker. Format:

Contemp. ■ Don N. Nelson, pres; Deane Johnson, exec VP & gen mgr; William H. Johnson Jr, coml mgr; Greg Everett, prog dir; Tony Jones, mus dir; Dan Griffin, news dir; Roger Heard, chief engr. ■ Rates: \$16; 14; 16; 12.

KSFT(FM)—Listing follows KUSN.

KUSN—November 1955: 1270 khz; 1 kw-D. 2414 S. Leonard Rd. (64503). (816) 233-2577. KUSN Corp. Net: Mo. Net. Rep: Torbet. Format: C&W. ■ Frederick Reynolds, pres; Warren Rhyner, gen mgr; Dave Novak, prog dir; Ernest Miller, chief engr. ■ Rates: \$8.50; 8.50; 8.50; —.

KSFT(FM)—Co-owned with KUSN. Sept 1, 1962: 105.1 mhz; 30 kw. Ant 225 ft. Stereo. Format: Btfl mus. ■ Ken Beck, gen mgr; Mark Patton, news dir.

St. Louis

KADI—See Clayton.

KADI-FM—Dec 22, 1959: 96.3 mhz; 100 kw. Ant 200 ft. 2735 Bompert (63144). (314) 968-1900. Vanguard Bcstg Corp. (acq 11-65). Group owner: Communications Fund. Net: ABC/FM. Rep: ABC FM Spot Sls. Format: Progs. ■ R. J. Miller, pres & gen mgr; John Hoffman, gen sales mgr; Peter Parisi, prog dir; Bernadette Heyer, asst to pres; Charles Rick, chief engr.

KATZ



KATZ—Jan 3, 1955: 1600 khz; 5 kw-D, 1 kw-N, DA-N (CP: 5 kw-N). 912 Olive St. (63101). (314) 241-6000. Laclede Radio Inc. (acq 3-1-60). Net: MBS Progressive. Rep: Torbet. Format: Top 40 soul. ■ Allen Wolin, pres; Arnold Hartley, exec VP; Douglas Eason, VP & gen mgr; Lynette Fields, coml mgr; Keith Adams, prog dir; Johnny Jones, mus dir; Carl King, chief engr. ■ Rates: \$19; 16.80; 19; 15.70.

***KBDY(FM)**—Dec 25, 1973: 89.9 mhz; 20 w. Ant 372 ft. 2505 St. Louis Ave. (63106). (314) 231-9320. Montgomery-Hyde Park Neighborhood Advisory Council Inc. Format: Community access variety. Spec prog: Senior citizens 10 hr wkly. ■ George E. Hall II, chmn; Alberto Sharp, gen mgr; Perry Coleman, chief engr.

KCFM(FM)—November 1954: 93.7 mhz; 100 kw. Ant 440 ft. Stereo. 532 DeBaliviere (63112). (314) 726-1077. Commercial Bcstg Co. Rep: HR/Stone. Format: Btfl music. ■ Harry Eidelman, pres; Sibley Smith, gen mgr; Ron Parker, opns dir, news & pub affairs dir; Hal Capron, sls mgr; Edward B. Bench, chief engr.

KEZK(FM)—September 1968: 102.5 mhz; 63 kw. Ant 370 ft. (CP: 97 kw. Ant 450 ft.). 1780 S. Brentwood Blvd (63144). (314) 968-5550. Heftel Broadcasting-St. Louis Inc. (group owner). ■ William Clark, gen mgr.

***KFUO**—See Clayton.

KIRL—See St. Charles.

KJCF—See Festus.

KKSS(FM)—Sept 28, 1962: 107.7 mhz; 100 kw. Ant 320 ft. (CP: Ant 990 ft.). 1215 Cole St. (63106). (314) 231-5577. Amatoro Group Inc. (group owner; acq 12-6-73). Net: Mutual Black. Rep: Avery-Knodel. Format: Black. Spec prog: Jazz 12 hrs wkly. ■ Joseph Amatoro, pres; Allan J. Eisenberg, gen & coml mgr; Bernie Hayes, prog & mus dir, prom mgr; Johnny Jones, news dir; Bob Laughlin, chief engr. ■ Rates: \$33; 31; 33; 33.

***KLSR(FM)**—1973: 89.7 mhz; 10 w. Ant 130 ft. 4900 South Lindbergh Blvd. (63126). (314) 849-2000. Board of Education, Lindbergh School District. Format: Noncoml diversified. ■ Robert Harrison, sponsor.

KMOX

News/Information/Sports/Entertainment



KMOX—Dec 24, 1925: 1120 khz; 50 kw-U, 1 Memorial Drive (63102). (314) 621-2345. CBS Inc.

(group owner; acq 1932). Net: CBS. Rep: CBS Radio Spot Sales. Format: News, info, sports, entertainment. ■ Robert Hyland, rgnl VP CBS; Virginia Dawes, stn mgr; Viola Arnold, sales mgr; Jane Surneyer, prom mgr; James Butler, prog dir; Alin Angelides, news dir; Chris Sarros, dir tech opns. ■ Rates: \$113; 77; 83; 44.

KMOX-FM—November 1962: 103.3 mhz; 100 kw. Ant 1000 ft. Stereo. Progs sep from AM. Rep: CBS Radio FM Sales. Format: MOR. ■ Howard P. Burnhard, stn mgr; Viola S. Arnold, sls mgr. ■ Rates: \$18; 16; 18; 10.

***KOMR(FM)**—1975: 89.3 mhz; 10 w. Ant 60 ft. 3120 Lemay Ferry Rd. (63125). Mehville R-9 School District.

KSD—Feb 14, 1922: 550 khz; 5 kw-U, DA-N. 1111 Olive St (63101). (314) 421-5055. TWX 910-761-1037. KSD/KSD-TV Inc. Group owner: Pulitzer. Net: NBC. Rep: Blair. Format: Oldies, MOR. ■ Harold Grams, pres; Edward Newsome, gen mgr; Stan Greenberg, sls mgr; Scott Burton, prog dir; Len Martin, news dir; Fred J. Mueller, prom mgr; Dick Ulett, mus dir; Ed Risk, chief engr. ■ Rates: \$92; 77; 87; 42.

KSHE(FM)—See Crestwood.

***KSLH(FM)**—April 13, 1950: 91.5 mhz; 12.5 kw. Ant 400 ft. 1517 S. Theresa Ave. (63104). (314) 865-4550. St. Louis Board of Education. Format: Educl. ■ Ruth M. Dockery, gen mgr; John E. Mitchell Jr, engr.

KSLO(FM)—1960: 98.1 mhz; 100 kw. Ant 540 ft. Stereo. 111 S. Bemiston, Clayton (63105). (314) 725-9814. Bartell Bcstg of Mo. Inc. (group owner; acq 8-25-72). Audio news: APR. Upl. Format: Top 40. ■ E. A. W. Smith, VP & gen mgr; Stephen Dinkel, coml mgr; Gary Bridges, prog dir; Joan Kelly, mus dir; Robert Absheer, news dir; Don Schwartzbaugh, chief engr.

KSTL—June 4, 1948: 690 khz; 1 kw-D. 814 N. Third St. (63102). (314) 621-5785. Radio St. Louis Inc. Format: C&W, commercial relg. Spec prog: Farm 2 hrs wkly. ■ E. E. Haverstick, pres; Art Ford, VP & gen mgr; William Vietmeier, prog dir; Thad Shore, news & farm dir; Joe Tillery, chief engr. ■ Rates: \$ 11.20; 11.20; 11.20; 11.20.

KWK—March 17, 1927: 1380 khz; 5 kw-U, DA-2. 330 N. 4th St. (63102). (314) 241-7004. Curtis L. Mann, trustee in bankruptcy.

***KWMU(FM)**—June 2, 1972: 90.7 mhz; 97 kw. Ant 980 ft. Stereo. 8001 Natural Bridge Rd. (63121). (314) 453-5965. Curators, U. of Missouri. Net: NPR, Mo. News: ABC. Format: Fine Arts & news mag. Spec progs: Jazz 13 hrs, Folk 1½ hrs wkly. ■ Robert W. Thomas, dir & gen mgr; Robert N. Eastman, asst gen mgr; Jackie F. Eastman, mgr mus & fine arts; Mary Edwards, asst mus dir; Michael Olds, asst news dir; Barbara White, prom mgr; Deane Keune, chief engr.

KXEN—May 10, 1951: 1010 khz; 50 kw-D, DA. Box 28 (63166). (314) 436-6550. KXEN Inc. (acq 6-1-67). Format: Religious, gospel mus. ■ Harold S. Schwartz, pres; Bernie Harville Jr, gen mgr; Lee Riley, prog dir; R. B. Niekamp, chief engr. ■ Rates: \$10.50; 10.50; 10.50; 10.50.

KXOK—Sept 19, 1938: 630 khz; 5 kw-U, DA-2. 7777 Bonhomme (63105). (314) 727-6500. Storz Bcstg Co. (group owner; acq 12-14-60). Rep: Katz Radio. Format: Contemp. ■ Robert H. Storz, pres; Phillip W. Trammell, gen mgr; Scott Sherwood, prog dir; Robert R. Lynn, news dir; Steve Vlodke, chief engr.

WEW—April 26, 1921: 770 khz; 1 kw-D. 517 Stadium Plaza (63102). (314) 436-7077. Radio WEW Inc. (acq 4-1-64). Net: ABC. Format: Mus. ■ Charles P. Stanley, pres & gen mgr; R. Joseph Adams, coml mgr; Buddy Moreno, prog dir; Don Norman, news dir; Pat Casey, chief engr.

WGNU—See Granite City, Ill.

WIL—1922: 1430 khz; 5 kw-U, DA-2. 300 N. 12th St. (63101). (314) 436-1600. WIL Music Inc. (acq 8-1-67). Group owner: LIN Bcstg. Net: ABC/I. Rep: Katz. Format: Modern country. ■ Walter W. Clark, gen mgr; Bill Pauley, gen sls mgr; Walt Turner, prog & mus dir; Gene Hirsch, news dir; Mel Hart, chief engr.

WIL-FM—July 15, 1962: 92.3 mhz; 97 kw. Ant 510 ft. Prog sep from AM. Format: C&W.

WRTH—See Wood River, Ill.

Salem

KETU(FM)—January 1971: 95.9 mhz; 3 kw. Ant 165

ft. Crossroads Shopping Center (65560). (314) 729-4159. Tower Bcstg Co. Format: C&W, contemp, MOR. Spec prog: Farm 5 hrs wkly. ■ Betty Hart, pres; Douglas Mooney, gen, sis & prom mgr, prog dir; Tom Edwards, coml mgr; Dennis Vaughn, mus dir; Michael McNutt, news dir; Bill J. Rickerd, chief engr.

KSMO—November 1953: 1340 khz; 1 kw-D, 250 w-N. Box 32 (65560). (314) 729-6658. EmErIAnn Bcstg Co. (acq 6-23-66). Net: MBS. Format: C&W. Spec prog: Gospel 12 hrs wkly. ■ W. Earl Dougherty, pres; Jim Plank, gen mgr, prog, mus & news dir.

Sedalia

KDRO—Sept 13, 1939: 1490 khz; 1 kw-D, 250 w-N. Box 1306 (65301). (816) 826-5005. Sedalia Bcstg Corp. (acq 6-1-57). Net: CBS. Format: C&W. ■ James F. Glenn, pres; Herbert W. Brandes, gen mgr & coml mgr; Bill Byron, prog dir; R. L. Settles, prom mgr; Johnny Nace, mus dir; Scott Allen, news dir; Donald L. Harms, chief engr.

KSIS—Feb 18, 1954: 1050 khz; 1 kw-D. Box 1056 (65301). (816) 826-1050. Yates Bcstg Co. Net: ABC/I. Audio news: UPI. Format: MOR. Spec prog: Farm 12 hrs wkly. ■ Carl W. Yates Jr., pres & gen mgr; Bettie S. Yates, prom & coml mgr; Larry Emery, prog dir; Wes Yates, mus dir; Michael A. Owens, news dir; Carl E. Zimmerschied, chief engr. ■ Rates: \$5.25; 5.25; 5.25; 5.25.

KSIS-FM—May 11, 1964: 92.1 mhz; 2.65 kw. Ant 280 ft. Stereo. Prog sep from AM. Net: ABC/C. Format: MOR. ■ Rates: \$3; 3; 3; 3.

Sikeston

KMPL—March 17, 1966: 1520 khz; 5 kw-D (CH), 500 w-N, DA-3. Box 907 (63801). (314) 471-1520. Delta Radio Corp. (acq 4-1-73). Net: CBS. Rep: Schneider. Format: MOR. ■ John C. David, pres; Chuck Layton, news dir; Amos Hargrave, chief engr. ■ Rates: \$6.47; 6.47; 6.47; 6.47.

KMPL-FM—Sept 12, 1968: 97.7 mhz; 3 kw. Ant 205 ft. Progs sep from AM. Format: C&W. ■ Rates: \$3.53; 3.53; 3.53; 3.53.

KSIM—July 17, 1948: 1400 khz; 1 kw-D, 250 w-N. Box 69 (63801). (314) 471-1400. Sikeston Community Bcstg Co. Net: ABC. Rep: PRO/Meeker; Beaver. Format: MOR, news, sports. ■ James H. Bucher, pres; Jim Wenneker, gen & coml mgr; Merlin G. Hagy, prog & news dir; Duane Williams, chief engr. ■ Rates: \$6.75; 6.75; 6.75; 6.75.

Springfield

KBUG—July 10, 1973: 1060 khz; 500 w-D. Box 1957 (65802). (417) 831-1060. Babcom Inc. Format: MOR. ■ Larry Dixon, pres, gen & coml mgr; Ben Atwell, prog & mus dir; Chuck Wilcox, news dir; Richard Bowman, chief engr.

KGBX—1926: 1260 khz; 5 kw-U, DA-N. 605 Boonville (65801). (417) 869-2822. Springfield Bcstg Co. (acq 1944). Net: NBC; Mo. News. Audio news: APR. Rep: Masia; Gray. Format: MOR. Spec prog: Farm 18 hrs wkly. ■ Don C. Dailey, VP; Dan Vaughn, gen mgr; Lynn Herrin, coml mgr; Jerry Higley, prog dir; Ernest DeCamp, news dir; Kenneth Hargis, chief engr. ■ Rates: \$10.75; 10.75; 10.75; 10.75.

KICK—July 29, 1949: 1340 khz; 1 kw-D, 250 w-N. 610 College St. (65806). (417) 869-1561. Kickapoo Prairie Bcstg Inc. Net: Magic Circle. Rep: Hopewell. Format: Mod contemp. ■ Roger H. Taylor, pres; Robert Vinyard, gen mgr.

KLFJ—1974: 1550 khz; 500 w-D. Box 801 (65801). (417) 866-3717. Queen City Bcstg Co. Format: Relg. ■ Billy Wolfe, pres & gen mgr & chief engr; Gary Acker, coml mgr; Lola Wolfe, prog dir; Don Burrell, mus dir; Chuck Burton, news dir.

***KSMU(FM)**—May 7, 1974: 91.1 mhz; 5.8 kw. Ant 265 ft. Southwest Missouri State U. (65802). (417) 831-2463. Southwest Missouri State U. Net: NPR. Format: Fine arts & info. ■ Wayne C. Patterson, gen mgr; Warren A. Lacey, chief engr.

KTTS Modern Country Music

R
A
B

TORRET
LASKER,
Inc.

KTTS—May 10, 1942: 1400 khz; 1 kw-D, 250 w-N.

Box 1806 SSS (65805). (417) 865-6614. Springfield Great Empire Bcstg Inc. (acq 3-17-72). Group owner: Lynch. Rep: Torbet, Schneider. Format: C&W. ■ F. F. Mike Lynch, pres; Curtis W. Brown, gen, prom & coml mgr; Don Paul, prog dir; Dave Martin, mus dir; Jim Wise, news dir; Gene Pitts, chief engr. ■ Rates: \$9.45; 7.50; 9.45; 7.50.

KTTS-FM—August 1948: 94.7 mhz; 100 kw. Ant 615 ft. Dups AM 50%. Stereo. ■ Rates: \$ 5.80; 4.60; 5.80; 4.60.

KTXR(FM)—June 12, 1962: 101.5 mhz; 100 kw. Ant 1150 ft. 3006 E. Cherry St., Box 3925 (65804). (417) 862-3751. Stereo Bcstg Inc. Net: ABC/E. Rep: Savalli/Gates. Format: Easy Istng. ■ K. E. Meyer, pres; J. A. Meyer, gen mgr; Clifford Browne, VP; Dale Blankenship, chief engr.

KWFC(FM)—April 17, 1969: 97.3 mhz; 100 kw. Ant 480 ft. Stereo. Box 5027 (65801). (417) 886-0836. Baptist Bible College. Net: ABC/FM. Format: Relg. ■ G. B. Vick, pres; W. F. Askew, gen mgr; L. Alford, prog dir; Floyd Gilzow, news dir; Harley McDonald, chief engr. ■ Rates: \$2.50; 2.50; 2.50; 2.50.

KWTO—Dec 25, 1933: 560 khz; 5 kw-U, DA-N. MPO Box 907 (65801). (417) 862-4422. Salina Bcstg (acq 1974). Group owner: Stuart. Net: ABC/I. Format: C&W. ■ Ralph D. Foster, pres; David Whittaker, gen mgr; Leslie L. Kennon, VP & asst mgr; Ralph Hasty, prog dir; Ernest DeCamp, news dir; Gene Pitts, chief engr.

KWTO-FM—Nov 23, 1967: 98.7 mhz; 100 kw. Ant 290 ft. Prog sep from AM. Net: ABC/C. Format: Rock.

Sullivan

KTUI—Feb 14, 1966: 1560 khz; 1 kw-D. Box 151 (63080). (314) 468-4100. Meramec Valley Bcstg Co. Format: Contemp, C&W, MOR. ■ Glynn J. Rice, pres; Charles D. Strauser, gen mgr; Dave Schmidt, coml & prom mgr; Jerry L. Richardson, prog & mus dir; Darryll D. Johanning, chief engr.

Thayer

KALM—Dec 11, 1953: 1290 khz; 1 kw-D. Box 15 (65791). (417) 264-7211. Radio Strn KALM. Group owner: Neathery. Rep: Keystone, Magic Circle. Format: C&W. ■ Robert Neathery, pres; Charlie Hamilton, gen mgr; Robert Hamilton, coml & prom mgr & news dir; Marie Kisse, prog dir; Sam Beatty, chief engr.

KAMS(FM)—Co-owned with KALM. See Mammoth Springs, Ark.

Trenton

KTNN—April 17, 1955: 1600 khz; 500 w-D. Box 310 (64683). (816) 359-2261. Luehrs Bcstg Co. (acq 6-27-68). Net: Missouri. ■ Marvin E. Luehrs, gen mgr; Richard Porath, prog dir; Tom Mock, news dir; Jimmie L. Burnett, chief engr. ■ Rates: \$4.29; 4.29; 3.90; 3.90.

Union

KLPW—Aug 18, 1954: 1220 khz; 1 kw-D. Box 549 (63084). (314) 583-5155. Franklin City Bcstg Inc. Rep: Bunchez. Format: MOR, talk. ■ Frank Lohmeyer, pres, gen mgr & chief engr; Chuck Otte, prog dir; Ron Tobben, coml mgr; Jack Stiehr, news dir.

KLPW-FM—Aug 1, 1966: 101.7 mhz; 2.1 kw. Ant 340 ft. Prog sep from AM. Format: C&W. ■ Ron Toben, gen mgr; James Scott, prog dir.

Warensburg

***KCMW-FM**—April 1, 1962: 90.9 mhz; 100 kw. Ant 410 ft. Central Missouri State U. (64093). (816) 429-4010. Net: NPR. Format: Public radio variety. Spec progs: Farm 5 hrs, classl 18 hrs, jazz 19 hrs wkly. ■ Jerry Morgan Medley, gen mgr; Donald W. Connelly, instructional services coord; John Murray, ops coord; Harold E. Adams, chief engr; Sherry Coultas, traffic & cont coord; Rob Newton, news coord; John Beck, prod coord; Ed Loesch, asst engr.

KOKO

m
mutual broadcasting system, inc.

KOKO—December 1953: 1450 khz; 1 kw-D, 250 w-

Missouri, Montana Radio

See page C-1 for explanation of listings.

N. Box 398 (64093). (816) 747-9191. Johnson County Bcstrs Inc. (acq 11-60). Net: MBS. Format: Top-40, C&W. ■ Avis G. Tucker, pres; Jim McCollum, VP & gen mgr; Gladys Brown, bus mgr; Marion E. Woods, ops mgr, mus dir & chief engr; Dennis Campbell, farm dir; Bill Turnage, news dir. ■ Rates: \$9; 9; 9; 9.

Warrenton

KWRE—March 9, 1949: 730 khz; 1 kw-D. Box 220 (63383). (314) 456-3311. Kaspar Bcstg Co. of Mo.

Waynesville

KFBD—May 9, 1968: 1270 khz; 500 w-D. Rt. 2, Box 2B (65583). (314) 336-4600. James DeAngio. Format: C&W. ■ James DeAngio, gen mgr; Jo Anne DeAngio, prog dir; Ray Carson, mus dir; Fred Briesacher Jr., chief engr.

KFBD-FM—Dec 9, 1964: 97.7 mhz; 3 kw. Ant 290 ft. (CP. Ant 255 ft). Stereo. Prog sep from AM. Format: MOR.

KJPW—April 3, 1962: 1390 khz; 1 kw-D. Box 518 (65583). (314) 336-4913. Pulaski County Bcstrs Inc. (acq 6-1-74). Net: MBS. Rep: Savalli/Gates. Format: C&W. ■ Jim Dodds, pres; Clay Howlett & Don Coates, gen mgrs.

KYSD(FM)—Co-owned with KJPW. May 2, 1968: 102.3 mhz; 1 kw. Ant 480 ft. Stereo. Prog sep from AM. Format: C&W.

West Plains

KWPM—1947: 1450 khz; 1 kw-D, 250 w-N. 1111 East Abe Taylor (65775). (417) 256-3131. Robert F. Neathery (group owner). Net: Magic Circle, Brownfield. Rep: Bradley. ■ Robert F. Neathery, pres & gen mgr; Laurel R. Thompson, stn mgr & chief engr; Margaret Thompson, coml mgr; Mary Clark, prog dir; John Deidiker, news dir. ■ Rates: \$3.80; 3.80; 3.80; 3.80.

KWPM-FM—1951: 93.9 mhz; 77 kw. Ant 390 ft. Stereo. Prog sep from AM. Format: Easy Istng. ■ Rates same as AM.

Willow Springs

KUKU—October 1957: 1330 khz; 1 kw-D. Box 250 (65793). (417) 469-2500. Radio Strn KUKU. Group owner: Neathery. Rep: Magic Circle; Bradley. Format: Contemp, C&W. ■ Robert F. Neathery Jr., pres; Jack Whittaker, gen mgr; Dean Davis, prom mgr; Larry Spence, prog dir & news dir; Richard Carroll, chief engr.



Montana

Anaconda

KANA—August 1947: 580 khz; 1 kw-D. Box 1180 (59711). (406) 563-3473. Radio Station KANA (acq 3-2-73). Rep: Hix. Format: C&W. Spec prog: Talk 5 hrs wkly. ■ Jack K. Boley, pres & gen mgr; Cari Boley, prog dir; Jean Boley, news dir; Sam Miller, mus dir; Don Lyles, chief engr.

KGLM-FM—Co-owned with KANA. Jan 18, 1974: 97.7 mhz; 210 w. Ant 940 ft. Stereo. Prog sep from AM. Format: MOR/Soft Rock.

Baker

KFLN—July 14, 1964: 960 khz; 5 kw-D. Box 790 (59313). (406) 778-3371. Empire Bcstg Corp. (group owner). Format: Modern C&W. ■ Gary N. Petersen,

Montana Radio

See page C-1 for explanation of listings.

pres & gen mgr; Leo Miller, stn mgr; Russ Newell, prog dir; Tom Weir, chief engr. ■ Rates: \$6.05; 5.50; 6.05; 5.50.

KPWD(FM)—See Plentywood.

Belgrade

KGVW—Feb 1, 1959: 630 khz; 1 kw-D, Route No. 1, Box 72H (59714). (406) 388-4281. Christian Enterprises Inc. (group owner; acq 5-31-62). Format: Good music. ■ Harold Erickson, pres; Don Kuntz, gen & coml mgr & prog dir; Rodger Torrence, prom mgr; Ted Mangun, mus & news dir; Dale Heidner, chief engr.

KGVW-FM—Nov 1, 1963: 96.7 mhz; 2.9 kw. Ant 195 ft. (CP: 3 kw. Ant 205 ft.). Dups AM 10%.

Billings

KBMS(FM)—Listing follows KGHL.

KBMY-AM

A Journal Star Station

KBMY—Sept 8, 1946: 1240 khz; 1 kw-D, 250 w-N. Box 20316 (59102). (406) 259-4586. Radio Billings (acq 7-1-75). Group owner: Journal Star. Net: ABC/I. Rep: Hix. Format: Mod C&W. Spec prog: Mexican American 1 hr wkly. ■ H. P. Slane, pres; Cheri Mordhorst, stn mgr; Robert A. Toombs, gen mgr; Dick Green, opns mgr; Gary Anderson, news dir; Joe Lundy, chief engr. ■ Rates: \$9; 7; 9.

***KEMC(FM)**—April 25, 1973: 91.7 mhz; 10 w. Eastern Montana College (59101). (406) 657-2179. Eastern Montana College. Format: Variety. Spec progs: Ger 2½ hrs, childrens drama 4 hrs wkly. ■ Dr. Anne-Jan Boden, gen mgr.

KGHL—June 8, 1928: 790 khz; 5 kw-U, DA-N. Box 30198 (59107). (406) 656-1410. Communications Investment Corp. (acq 1-1-63). Group owners: G.C. Hatch Stns. Net: NBC; IMN. Rep: Eastman, Simpson. ■ George C. Hatch, pres; Homer K. Peterson, VP; Richard S. Kober, stn mgr; Fred Bartlett, chief engr; Mike Doty, prog dir; Warren Kemper, news dir.

KBMS(FM)—Co-owned with KGHL. Not on air, target date unknown: 98.5 mhz; 25.5 kw. Ant 400 ft. (acq 6-74).

KOOK—March 20, 1951: 970 khz; 5 kw-U, DA-N. Box 1276 (59103). (406) 248-7827. Matco Inc. (acq 9-1-72). Net: CBS; Silver Dollar. Rep: Torbet; Moore; McGuire. Format: Contemp. ■ Russell H. Matthias, pres; Lane A. Sanders, gen & coml mgr; Brian Bennett, prog dir; William Matthias, sec/treas; Allen Moos, mus dir; Rich Jessen, news dir; Steve Blodgett, chief engr. ■ Rates: \$7.85; 6.30; 7.85; 3.65.

KOYN—Sept 25, 1955: 910 khz; 1 kw-D. Box 956 (59101). (406) 245-4177. Meyer Bcstg Co. (group owner; acq 1968). Net: ABC/E. Rep: PRO/Meeker; Mountain Media. Format: C&W. Spec progs: Farm 2 hrs wkly. ■ William A. Ekberg, pres; Monty Wallis, stn mgr; Lonnie Bell, prom mgr; Ron Jones, coml mgr; Carl Hall, prog & mus dir; Dave Goss, news dir; Richard Rasky, chief engr. ■ Rates: \$6; 5.10; 6; —.

KOYN-FM—April 5, 1969: 93.3 mhz; 26.5 kw. Ant minus 68 ft. Stereo. Prog sep from AM. Net: ABC/C. Format: Contemp. ■ Chris Claussen, mus dir. ■ Rates: \$4.25; 4.25; 4.25; 4.25.

KURL—Oct 15, 1959: 730 khz; 500 w-D. Box 1875 (59103). (406) 245-3121. Christian Enterprises Inc. (group owner; acq 1-20-62). Audio news: UPI. Rep: Adv Sis West. Format: Relig/MOR. ■ Harold Erickson, pres & gen mgr; Albert Ortman, stn mgr & chief engr; Mike Welch, prod dir; Don Wiens, news dir. ■ Rates: \$3.50; 3.50; 3.50.

KURL-FM—Dec 17, 1963: 97.1 mhz; 17.5 kw. Ant minus 30 ft. Stereo. Prog sep from AM. Format: Btlf mus, MOR, classcl. ■ Rates: \$3; 3; 3.

Bozeman

KBMN—Sept 14, 1949: 1230 khz; 1 kw-D, 250 w-N. Box 1230 (59715). (406) 586-2394. Western Media Inc. (acq 9-1-75). Net: ABC/E; Intermountain. Format:

Contemp/MOR. Spec prog: Farm. ■ Len Kehl, gen mgr; Vern Veltkamp, sis mgr; Don Tuggle, prog & mus dir; Marilyn Wessel, news dir; Jack Nordquist, chief engr. ■ Rates: \$6.45; 6.20; 6.45; 6.20.

kboz 1090

KBOZ—Nov 23, 1975: 1090 khz; 5 kw-U, DA-N. Box 147 (59715). (406) 586-5466. Northern Sun Corp. Net: NBC. Format: MOR days, top 40 nights. Spec progs: Farm 2 hrs wkly. ■ William Reier, pres & gen mgr; Eugene Fennimore, chief engr. ■ Rates: \$8.25; 7.90; 8.25; 7.10.

***KGLT(FM)**—December 1967: 90.1 mhz; 10 w. Ant 121 ft. Stereo. Student Union Building, Montana State University (59715). (406) 994-3001. Montana State University. Format: Progs. Spec progs: Black 3 hrs, C&W 8 hrs, classcl 6 hrs, jazz 6 hrs wkly. ■ Terry L. Brown, gen mgr.

KXXL—Oct 15, 1939: 1450 khz; 1 kw-D, 250 w-N. 1450 W. Kagy Blvd., Box 37 (59715). (406) 587-5188. Empire Bcstg Corp. (group owner; acq 4-1-71). Rep: Torbet. Format: C&W, days/Top 40, nights. ■ Gary N. Petersen, pres; Larry Heinrich, stn mgr; Charlie McBrown, prog dir; Dean Alexander, news dir; Tom Weir, chief engr.

Butte

KBOW—February 1947: 550 khz; 5 kw-D, 1 kw-N, DA-N. 660 Dewey Blvd. (59701). (406) 723-7429. KBOW Inc. (acq 4-1-62). Net: CBS, IMN. Rep: RKO. Format: MOR, News. ■ Richard R. Miller, pres & gen mgr; Steve Sevensen, opns mgr & news dir; Martin Hansen, chief engr.

KBOW-FM—Oct 1, 1972: 94.1 mhz; 27.5 kw. Ant 1,840 ft. Net: ABC/I. ■ Jim Jones, opns mgr.

***KMSM-FM**—1975: 91.5 mhz; 10 w. Assoc. Students of Mont. Tech.

KXLF—1927: 1370 khz; 5 kw-U, Box 3500 (59701). (406) 792-9111. TWX 910-975-1890. Garryowen Butte Radio Inc. (acq 2-28-61). Group owner: Garryowen Stns. Net: NBC. Rep: Torbet, Moore, McGuire. Format: Contemp, MOR. ■ Joseph S. Sample, pres; Ron Jones, gen mgr; Joe Boyle, opns & prog dir; Alan Fetch, prom mgr; Burt Light, sports dir; Ken Woosley, news dir; Weldon Paulsen, chief engr. ■ KXLF-TV affil.

Dauler Lodge

KDRG—1963: 1400 khz; 1 kw-D, 250 w-N. Box 539 (59722). (406) 846-1221. Howard Neckels, receiver. ■ David Fransen, mgr.

Dillon

KDBM—Jan 1, 1957: 1490 khz; 1 kw-D, 250 w-N. Box 950 (59725). (406) 683-2800. Vigilante Bcstg Co. Net: ABC/IMN. Rep: Eastman. Format: MOR, C&W. ■ Burt H. Oliphant, pres, gen mgr & chief engr; Peggy S. Oliphant, news dir; Terry Hanna, prog dir.

KDBM-FM—August 1972: 98.3 mhz; 1 kw. Ant 480 ft. Stereo. Prog sep from AM. Format: Contemp.

Forsyth

New AM—Not on air, target date unknown: 1250 khz; 5 kw-D. 814 Knight St., Miles City (59301). Gold-Won Radio Corp. ■ Michael J. Dorris, B. Dean Holmes, et al, owners.

Glasgow

KLtz—Aug 14, 1954: 1240 khz; 1 kw-D, 250 w-N. Box 671 (59230). (406) 228-9336. Glasgow Broadcasting Co. Net: ABC/I, IMN. Rep: Eastman. Format: Contemp/C&W. ■ W. L. Bill Holter, pres; Linda Madson, gen mgr; James Paulson, coml mgr; Sam Cebula, news dir; John Sisson, chief engr. ■ Rates: \$8.65; 6.45; 8.65; 5.20.

Glendive

KGLE—Aug 22, 1962: 590 khz; 500 w-D. Box 931 (59330). (406) 365-3331. Christian Enterprises Inc. (group owner). Net: ABC/I. Rep: Keystone, Enterprise. Format: Btlf music. ■ Harold Erickson, pres; Tim Wall, stn mgr, prog/mus dir; Dale Dalbey, prom mgr; Dennis Howard, news dir & chief engr.

KIVE(FM)—Co-owned with KGLE. Dec 21, 1969: 96.5 mhz; 100 kw. Ant 30 ft. Stereo. Dups AM 20%.

KXGN—Sept 23, 1948: 1400 khz; 1 kw-D, 250 w-N. 210 South Douglas (59330). (406) 365-3377. Glendive Bcstg Corp. Rep: Devney. Format: MOR. ■ Lewis W. Moore, pres; Winnifred Norton, office mgr; Dan Frenzel, news dir; Donald J. Powers, chief engr. ■ KXGN-TV affil.

Great Falls

KANR(FM)—June 19, 1972: 98.9 mhz; 25 kw. Ant 45 ft. 2315 10th Ave., South (59405). (406) 452-6236. Frank Anderson. Format: Big bands, light classical. ■ Tony LoPunch, chief engr.

KARR—1947: 1400 khz; 1 kw-D, 250 w-N. Box 2204 (59401). (406) 542-2453. Greater Montana Bcstg Inc. (acq 3-31-73). Group owner: Cummings Communications. Net: NBC. Rep: Masla/Young, Hix, Wayne-Evans. Format: MOR. ■ Alan H. Cummings, pres; Sell Rappkoch, coml & gen mgr; Bob McNamer, stn mgr; Jeff Yetter, mus dir; E. R. Kukkola, chief engr.

KOPR-FM—Co-owned with KARR. Dec 31, 1963: 106.3 mhz; 3 kw. Ant 11 ft. Stereo. Prog sep from AM (except midnight to 8 AM). Format: Good mus.

KEIN



KEIN—July 1922: 1310 khz; 5 kw-D, 1 kw-N. Box 2624 (59401). (406) 761-1310. Meyer Great Falls Inc. (acq 8-72). Group owner: Meyer. Net: NBC. Rep: PRO/Meeker, Mountain Media, Tacher. Format: Top 40, contemp. ■ William A. Ekberg, pres; Thomas G. Barr, gen mgr; R. Brad Baker, stn mgr; Dan L. Gittings, sis mgr; Wayne N. Colfe, prog dir; E. Mark May, news dir; William Emerson, chief engr. ■ Rates: \$7.35; 6.05; 7.35; 4.85.

KMON—May 30, 1948: 560 khz; 5 kw-U, DA-N. Box 2427 (59401). (406) 453-0336. KMON Inc. (acq 11-63). Net: ABC/I. Rep: RKO, IMN. Format: C&W. ■ Al Donohue, pres, gen mgr; Gordon Stewart, coml mgr; Rhys Morgan, prog, mus dir; Bill Belcher, news dir; Al Verploegen, chief engr.

KNUW(FM)—Co-owned with KMON. Oct 1, 1972: 94.5 mhz; 36 kw. Ant 470 ft. Dups AM 5%. Net: ABC/C. Format: Hit parade, solid gold.

KOPR-FM—Listing follows KARR.

KUDI—1955: 1450 khz; 1 kw-D, 250 w-N. Box 2888 (59401). (406) 761-2800. Frontier Bcstg Inc. (acq 9-65). Rep: Moore, McGuire. Format: Contemp rock. ■ Sherlee T. Graybill, pres; Reg Streeter, gen mgr; Fred Thiel, sis mgr; Jack Stevens, prog dir; Jesse Waymire, chief engr.

Hamilton

KLYQ—Feb 3, 1961: 980 khz; 1 kw-D (CP: 1240 khz; 1 kw-D, 250 w-N). Box 668 (59840). (406) 363-3010. Bitter Root Bcstg Co. ■ Stan Hooper, pres, gen mgr & coml mgr; Luin K. Dexter, stn mgr, news dir & chief engr.

KLYQ-FM—Feb 11, 1969: 95.9 mhz; 2 kw. Ant minus 790 ft.

Hardin

KHDN—Dec 28, 1962: 1230 khz; 1 kw-D, 250 w-N. Box 389 (59034). (406) 665-1277. Big Horn Bcstg Inc. (acq 4-3-73). Rep: Adv Sis West. Format: C&W. ■ Alfred E. Sargeant, pres; Robert Lienweber, gen mgr; Charles Heit, prog dir & chief engr.

KRWS(FM)—1975: 95.3 mhz; 1 kw. Ant minus 12 ft. 617 North Crawford (59034). Alfred E. and Melodie Sargent.

Havre

KOJM—Oct 31, 1947: 610 khz; 1 kw-U, DA-2. Box K (59501). (406) 265-7841. North Montana Bcstrs Inc. (acq 4-1-67). Rep: Masla; Evans; Hix. Format: MOR, C&W. ■ Carlyle D. Leeds, pres & gen mgr; Stanley G. Stephens, VP; John Mosher, VP & coml mgr; Linda Ferguson, opn mgr; Thomas Ott, chief engr. ■ Rates: \$5.30; 4.30; 5.30; 4.30.

KPOX(FM)—Co-owned with KOJM. March 8, 1975: 92.5 mhz; 94 kw. Ant 1,790 ft. Stereo. Prog sep from AM. Format: Btfl mus, MOR. ■ Rates same as AM.

Helena

KBLL—September 1937: 1240 khz; 1 kw-D, 250 w-N. 2301 Colonial Drive (59601). (406) 442-6620. Holter Bcstg Corp. (acq 7-16-73). Net: NBC, IMN. Audio news: UPI. Rep: Eastman. Format: MOR. ■ W. L. Holter, pres; Carson Aasen, mgr; Al Johnson, prog mgr & mus dir; Tom Beausoleil, news dir.

KCAP—October 1949: 1340 khz; 1 kw-D, 250 w-N. 9 N. Last Chance Gulch (59601). (406) 442-4490. KCAP Bcstrs Inc. (acq 4-1-59). Group owner: Dale G. Moore Stns. Net: CBS; Silver Dollar. Rep: Savalli/Gates; McGuire. Format: Contemp. ■ Earl Morgenroth, pres; Larry Wilmot, gen mgr; Joanne Maynard, coml mgr; Jim Schaefer, prog dir; Bob Burch, sls mgr; Randy Rocks, mus dir; Cato Butler, news dir; Tom McGinley, chief engr.

KCAP-FM—1975: 103.1 mhz; 3 kw. Ant minus 250 ft. 110 Broadway.

***KHTC(FM)**—1971: 89.5 mhz; 10 w. 1115 Roberts (59601). (406) 442-6611. Helena Vocational Technical Ctr. Helena School District 1. Format: Educ/good mus. ■ William A. Korizek, dir vocational educ; Donald Liles, gen mgr/chief engr.

Kalispell

KALS(FM)—November 1974: 97.1 mhz; 70 kw horiz. 30 kw vert. Ant minus 195 ft. 2980 Hwy 2 East (59901). (406) 755-5218. North Valley Bcstg Enterprises Inc. Net: ABC/I, IMN. Format: Btfl mus, relig. Spec progs: Farm 1 hr, classcl 2½ hrs wkly ■ Harold Erickson, pres; Norm Fisher, gen mgr; Dale Carson, chief engr. ■ Rates: \$3; 3; 3; 3.

KGEZ—April 1927: 600 khz; 1 kw-U, DA-2. Box 600 (59901). (406) 755-6600. Skyline Broadcasters Inc. Net: CBS. Rep: Masla; Hix; Wayne-Evans; Time Sls NW. Format: C&W. Spec prog: Rock 15 hrs wkly. ■ Mike Manion, gen mgr & chief engr; Kelly Hartman, prog dir; Ed Folkwine, news dir. ■ Rates: \$4.75; 4; 4.75; 4.

KOFI—Nov 11, 1955: 1180 khz; 10 kw-U, DA-N. Box 608 (59901). (406) 755-6690. Flathead Valley Bcstrs. Audio news: UPI. Rep: Torbet, Moore. Format: MOR. ■ William H. Patterson, gen & coml mgr & chief engr; Leslie L. Sterling, partner, prom mgr; Len Anderson, prog dir; Randy Johnson, mus dir; Orin F. Bleken, news dir. ■ Rates: \$ 5.25; 4.20; 5.25; 4.20.

KSSR(FM)—Not on air, target date unknown: 98.5 mhz; 35 kw. Ant 2,720 ft. 137 W. Center St. (59901). Suhr Transport. ■ Carl Suhr, VP.

Lewistown

KXLO—1947: 1230 khz; 1 kw-D, 250 w-N. Box 620 (59457). (406) 538-3441. KXLO Broadcast Inc. (acq 4-16-73). Format: C&W, MOR. Spec prog: Farm 18 hrs wkly. Net: ABC/I, IMN. Rep: Eastman, IMN. ■ Fred Lark, pres & gen mgr; Lew Boucher, opns mgr; Joseph Zahler, prog & news dir; Dave Sather, chief engr.

KLCM-FM—Co-owned with KXLO. 95.9 mhz; 3 kw. Ant minus 228 ft. Montana Broadcast Communications Inc. Prog sep from AM. Format: Good mus.

Libby

KLCB—Dec 23, 1950: 1230 khz; 1 kw-D, 250 w-N. Box 730 (59923). (406) 293-6234. Lincoln County Bcstrs Inc. (acq 12-66). Net: ABC/I, IMN. Rep: RKO, IMN. Format: MOR, C&W, diversified. ■ Robert Knickerbocker, exec VP; Vernon Geier, coml mgr; John Johanson, prog & news dir; Mike Gilbert, mus dir; Larry Haines, chief engr. ■ Rates: \$4.15; 4.15; 4.15; 4.

Livingston

KPRK—Jan 10, 1947: 1340 khz; 1 kw-D, 250 w-N. SH. Box 691 (59047). (406) 222-2841. KPRK Inc. (acq 8-1-63). Net: ABC/I, IMN. Rep: Eastman; IMN. Format: MOR. ■ Jack F. Hinman, pres & gen mgr; Gerry Kirby, coml mgr; Alice Henery, news & prog dir; Jim Elgas, chief engr. ■ Rates: \$4.10; 4.10; 3.40; 3.40.

Miles City

KATL—Sept 4, 1941: 1340 khz; 1 kw-D, 250 w-N. Box 700 (59301). (406) 232-2280. Star Printing Co.

Net: ABC/I, IMN. Rep: Eastman. Format: MOR. ■ Paul Husted, pres; Fred B. Hunnes, gen & coml mgr; Lee Langdord, prom mgr; Al Homme, mus dir; Terry Virag, news dir; J. Michael Dorris, chief engr.

Missoula

KGMV—1947: 1450 khz; 1 kw-D, 250 w-N. Box 1495 (59801). (406) 549-6489. Mission Broadcasters Inc. (acq 4-18-68). Rep: Advertising Sls W. Format: Top 40. ■ Louis C. Erck, pres; Roger Burton, gen mgr; Doc Holiday, prog & mus dir; Douglas E. Smith, chief engr.

KGVO—Jan 28, 1931: 1290 khz; 5 kw-U, DA-N. Drawer M (59801). (406) 549-5152. KGVO Bcstrs Inc. (acq 11-4-59). Group owner: Western Bcstg. Net: CBS. Rep: Avery-Knodel; McGuire. Format: Contemp, progs, C&W. Spec progs: Farm 2½ hrs. ■ Earl E. Morgenroth, pres; Larry B. Peterson, gen mgr; Tom Ash, prog dir; Tinsley Palmer Buls, mus dir; Richard Newton, news dir; Tom McGinley, chief engr. ■ Rates: \$6.90; 5.80; 6.90; 5.80; ■ KGVO-TV affil.

***KUFM(FM)**—Jan 31, 1965: 89.1 mhz; 7.4 kw. Ant 2510 ft. School of Journalism (59801). (406) 243-4931. U. of Montana. Net: NPR. Format: Public aff. Spec prog: Black 2 hrs, jazz 10 hrs, Indian 1 hrs, folk 7 hrs, children's 7 hrs wkly. ■ Phillip J. Hess, dir; Terry J. Conrad, prog dir; Roger Johnson, news dir; W. D. Kinghorn, chief engr.

KYLT—July 15, 1955: 1340 khz; 1 kw-D, 250 w-N. Box 2277 (59801). (406) 728-5000. Scottie Bcstg Co. (acq 12-31-66). Rep: Torbet, Moore, Hix. Format: Contemp. ■ W. L. Holter, pres; Gene Peterson, gen mgr; Cary Nicklay, office mgr; Vern Argo, prog & mus dir; Curt Gerke, prog dir; Carol Hangan, traf mgr; Ray Nicklay, news dir; Bill Schwanke, sports dir; Tom McGinley, chief engr.

KYLT-FM—July 29, 1974: 100.1 mhz; 2.9 kw. Ant minus 810 ft.

KYSS—June 27, 1959: 930 khz; 5 kw-D. 400 Ryman (59801). (406) 728-9300. Garden City Bcstg Inc. (acq 4-60). Net: ABC/I, IMN. Rep: Eastman. Format: C&W. ■ Chester M. Murphy Jr., pres & gen mgr; Margaret Murphy, office mgr; Darin Flynn, prog dir; Tom Newcomb, sls mgr; Eva Shelhamer, mus dir; James Goodrich, news dir & chief engr.

KYSS-FM—May 11, 1969: 94.9 mhz; 30 kw. Ant 2,490 ft. Stereo. Prog sep from AM. Format: Big band, instrumental. Spec prog: Classical 4 hrs wkly. ■ Max Murphy, prog & mus dir.

William A. Exline, Inc.
31 CARROLL COURT
SAN RAFAEL, CALIFORNIA 94903
(415) 479-0717
MEDIA BROKERS - CONSULTANTS

Plentywood

KPWD(FM)—June 1, 1962: 100.1 mhz; 880 w. Ant 34 ft. 216 N. Main (59254). (406) 765-1480. BCT Bcstg (acq Jan 1, 1975). Net: ABC/E, IMN. Rep: Adv Sls W. Format: MOR. Spec prog: Farm 10 hrs wkly. ■ Bill E. Stallard, pres & gen mgr; Bill R. Hansen, coml mgr; Cheryl A. Stallard, prog dir; William Lapke, chief engr. ■ Rates: \$3.30; 2.70; 2.40; 2.10.

Polson

KERR—Not on air, target date unknown: 1070 khz. Box 1233, Bismarck, N.D. (58501). KBMR Radio Inc.

Red Lodge

KRBN—Dec 7, 1961: 1450 khz; 1 kw-D, 250 w-N. Box 908 (59068). (406) 446-2710. Carbon County Bcstrs Inc. Rep: Webb. Format: Progs/C&W. Spec prog: Features 4 hrs wkly. ■ Leslie E. Marcus, pres, gen & coml mgr; Joe Flaherty, stn mgr, prog dir & chief engr; Frank Zimmerman, news dir & prom mgr.

Scobey

KCGM(FM)—June 21, 1971: 95.7 mhz; 52 kw. Ant 660 ft. (59263). (406) 487-2293. Prairie Communications Inc. Format: C&W, MOR. ■ Larry C. Bowler, pres;

Montana, Nebraska Radio

See page C-1 for explanation of listings.

Gifford Wood, gen & prom mgr; Beverly Wahl, coml mgr & mus dir; Vera Juel, prog dir; Linda Levad, news dir; David Jorgenson, chief engr.

Shelby

KSEN—Aug 11, 1947: 1150 khz; 5 kw-U, DA-2. 120 Pine Ave. (59474). (406) 434-5241. Tri-County Radio Corp. Net: CBS. Rep: Eastman, IMN. Format: MOR, Up-tempo. ■ John Lyon, pres; Jerry Black, gen mgr; Richard Puff, coml mgr; Alex Bronsen, prog dir; Ben Light, prom mgr; Howard West, news dir; Fred Nichols, chief engr.

KSEN-FM—Not on air, target date unknown: 96.3 mhz; 28 kw. Ant 270 ft. 130 Front St. Prog dups AM 50%.

Sidney

KGCX—Oct 1, 1926: 1480 khz; 5 kw-U, DA-1. Box 31 (59270). (406) 482-2115. KGCX Inc. Net: MBS. Rep: Masla. Format: MOR, C&W, oldies. Spec prog: Farm 6 hrs wkly. ■ Oscar H. Halvorson, pres & chief engr; Duane Simpson, gen mgr; Bernie Arcand, coml mgr; Dave Halvorson, prog & news dir; Larry Jenkins, mus dir.

West Yellowstone

KWYS—Dec 20, 1967: 920 khz; 1 kw-D. Box 9 (59758). (406) 646-7361. Empire Bcstg Corp. (group owner). Net: ABC, IMN. Rep: Torbet. ■ Gary N. Peterson, pres.

Wolf Point

KVCK—Sept 1, 1957: 1450 khz; 1 kw-D, 250 w-N. Box 668 (59201). (406) 653-1900. Hi Line Bcstg Co. (acq 1975). Net: MBS. Rep: Masla, Hix. Format: C&W/MOR. ■ Richard C. Fisher, pres & gen mgr; A. T. Shamley, prog & mus dir; R. L. Behr, coml mgr & news dir; Ollie Coburn, chief engr. ■ Rates: \$4.30; 4.30; 4.30; 3.30.

Nebraska

HAMILTON-LANDIS
& ASSOCIATES, Inc.
NATIONWIDE MEDIA BROKERS
WASHINGTON, D. C., CHICAGO, DALLAS,
SAN FRANCISCO
SELL **MORE**
RADIO & TELEVISION STATIONS
IN THE MIDWEST—NEAREST OFFICE IS—
1429 TRIBUNE TOWER, CHICAGO 60611
(312) 337-2754

Ainsworth

KBRB—Feb 6, 1968: 1400 khz; 1 kw-D, 250 w-N. 122 East Second, Box 285 (69210). (402) 387-1410. K. B. R. Bcstg Co. Format: Diversfd. ■ Lorris C. Rice, pres, gen, coml & prom mgr; Kenneth W. Hever, prog dir; Renee Burger, news dir; Wes Jones, chief engr. ■ Rates: \$2.50; 2.50; 2.50; 2.50.

Alliance

KCOW—January 1949: 1400 khz; 1 kw-D, 250 w-N. Box 600 (69301). (308) 762-1400. KLOE Inc. (acq 1-1-67). Net: ABC/C, ABC/E, Intermountain. Rep: Soderlund. Format: MOR. Spec progs: Farm 5 hrs, C&W 14 hrs wkly. ■ Ross Beach Jr., pres; Jim Kamerzell, gen mgr; Dave Anderson, prog & mus dir; Larry Patrick, news dir; Bob Carr, chief engr. ■ Rates: \$3.85; 3.85; 3.85; 3.85.

Aurora

KROA(FM)—See Grand Island.

Beatrice

KWBE—June 12, 1949: 1450 khz; 1 kw-D, 250 w-N. Box 1450 (68310). (402) 223-5121. MIA Enterprises

Nebraska Radio

See page C-1 for explanation of listings.

Inc. (acq 2-1-57). Net: Cornhusker. Rep: Pro/Meeker, Soderlund, Audio news: UPI. Format: Diversified. Spec progs: Farm 4 hrs; Polish 5 hrs wkly. ■ Gordon C. Bud Pentz, pres & gen mgr; Dorothy Hertzell, coml mgr; Shelby Henderson, ops mgr; Stanley Wirth, news mgr; Arlin Holte, engr mgr. ■ Rates: \$8.25; 8.25; 8.25; 4.75.

KWBE-FM—Nov 26, 1962: 92.9 mhz; 97 kw. Ant 310 ft. Stereo. Progs sep from AM. Format: C&W. ■ Rates: \$4.50; 4.50; 4.50; 4.50.

Blair

***KDCV-FM**—Oct 1, 1972: 91.1 mhz; 10 w. Ant 60 ft. Dana College (68008). (402) 426-4101. Format: Variety. ■ Earl Mezoff, pres; Darrell W. Dibben, gen mgr; Arvin Hernes, chief engr.

Broken Bow

KCNI—Sept 28, 1949: 1280 khz; 1 kw-D. Box 409 (68822). (308) 872-5881. Custer County Bcstg Co. Rep: Bernard Soderlund. ■ Georgia A. Crawford, gen mgr & prog dir; Harold Hromas, chief engr.

Chadron

KCSR—May 9, 1954: 610 khz; 1 kw-D. Box 913 (69337). (308) 432-5545. Big Sky Bcstg Co. (acq 10-1-71). Net: ABC/I, Hometown, IMN. Rep: IMN, hrs wkly. Format: MOR. Spec progs: C&W 6 hrs, farm 7 hrs wkly. ■ Kerm Kath, pres; Lee Hall, gen mgr; Max H. Sydow, asst mgr; Ron Mead, prog dir & chief engr; Pat Benton, prod mgr; Bill Davis, news dir. ■ Rates: \$7; 7; 6; —.

Columbus

KJSK—April 28, 1948: 900 khz; 1 kw-D. Box 99 (68601). (402) 564-2891. KJSK Inc. (acq 7-1-59). Group owner: Anderson. Rep: Hopewell, Walton. Format: MOR, btfl mus, relig. ■ George Basil Anderson, pres; Terry A. Cowan, gen mgr & chief engr; Darrel Zook, mus dir; Wally Burgeson, news dir. ■ Rates: \$4.75; 4.75; 4.75; 4.75.

KJSK-FM—August 1964: 101.1 mhz; 100 kw. Ant 200 ft. Stereo. Dup AM 10%. Format: Btfl mus. ■ Rates same as AM.

***KTLX(FM)**—July 1974: 91.9 mhz; 10 kw. Ant 78 ft. 2171 31st Ave. (68601). (402) 564-8548. T.L.C. Educational Corp. Format: Ed. ■ Walter Gengenbach, pres; Richard Vlach, gen mgr.

KTTT—Dec 2, 1962: 1510 khz; 500 w-D. Box 518 (68601). (402) 564-2866. City and Farm Bcstg Inc. Rep: Pro/Meeker, Soderlund. Format: MOR. Spec progs: C&W 12 hrs, Polkas 10 hrs, farm 15 hrs wkly. ■ William Whitlock, pres; Joseph L. Stavos, gen & prom mgr; Ron Kruse, coml mgr; Ralph Wayne, prog & mus dir; James Jaworski, news dir; Harold Hardy, chief engr. ■ Rates: \$8; 8; 8; —.

KTTT-FM—Nov 25, 1969: 93.5 mhz; 3 kw. Ant 250 ft. Prog dups AM 100%. Format: Top 40 after AM signoff. ■ Rates: \$8; 8; 8; 4.50.

Cozad

KAMI—Nov 24, 1965: 1580 khz; 1 kw-D. Box 206 (69130). (308) 784-3665. KAMI Country Bcstg Corp. (acq 5-74). Rep: Keystone. Format: MOR, C&W. ■ Andy Anderson, gen mgr & chief engr; Charles Andersen, coml mgr & prog dir. ■ Rates: \$4; 4; 4; 4.

Fairbury

KGMT—June 13, 1960: 1310 khz; 500 w-D. Box 425 (68352). (402) 729-3382. Great Plains Bcstg Co. (acq 1975). Net: ABC/E. Rep: Hopewell, Soderlund. Format: C&W. Spec prog: Polka 7½ hrs wkly. ■ Frank R. Newell, pres & gen mgr; Steve Mickelson, coml mgr; Joe McIntosh, prog & mus dir; Jim Kokesh, news dir & chief engr. ■ Rates: \$4.50; 4.50; 4.50; 4.50.

Falls City

KTNC—Aug 3, 1957: 1230 khz; 100 w-U, 2001 Stone St. (68355). (402) 245-2453. S.E. Neb Bcstg Co. Net: ABC/I. Rep: Mastia, Soderlund, Hix. Format: MOR. ■ William L. Hardt, coml mgr; Dennis Maze, coml mgr;

Kevin Sanders, prog dir; Hal Mann, news dir; Dan Sudenga, chief engr.

Fremont

KHUB—December 1939: 1340 khz; 500 w-D, 250 w-N. Box 669 (68025). (402) 721-5012. KHUB Inc. (acq 7-1-56). Net: ABC/I. Rep: Pro Time Sis, Soderlund. Format: Contemp, MOR, Top 40. Spec prog: Polka 4 hrs wkly. ■ H. C. Snyder, pres; Glen Ilgenfritz, VP & gen mgr; Bob B. Palmer, prog dir; Larry Casey, news dir; H.C. Snyder, chief engr. ■ Rates: \$7.30; 7.30; 7.30; 5.65.



KHUB-FM—July 1972: 105.5 mhz; 3 kw. Ant 56 ft. Dups AM 100%. ■ Rates same as AM.

Grand Island

KMMJ
MOR plus Farm



EVERY-KNODEL, INC.



KMMJ—Nov 1925: 750 khz; 10 kw-D, DA. (L-WSB). Box 1847 (68801). (308) 382-2800. United Communications Inc. (acq 11-1-67). Audio news: UPI. Format: MOR, farm. ■ Rex H. Lathen, pres & gen mgr; Willard L. Morton, stn mgr; Roger Lawrence, prog dir; Jack Spaulding, news dir; Rich Balvanz, farm dir; Martyn Shunkwiler, chief engr. ■ Rates: \$22; 17; 17; —.

KRGI—April 1, 1953: 1430 khz; 5 kw-D, 1 kw-N, DA-N. Box G (68801). (308) 381-1430. Grand Island Bcstg Co. (acq 6-15-57). Group owner: Stuart. Net: ABC/C. Rep: McGavren-Guild-PGW, Abels. Format: MOR, Top 40. ■ Richard W. Chapin, pres; Harry Kaplan, VP & gen mgr; Keith O'Neil, prog dir; Linda White, mus dir; Ed Barnett, news dir; Elmer G. Nelson, chief engr.

KRGI-FM—October 1975: 96.5 mhz; 100 kw. Ant 416 ft. Prog sep from AM.

KROA(FM)—Aug 11, 1967: 95.7 mhz; 100 kw. Ant 460 ft. Stereo. Box 1781 (68801). (402) 845-6595. Midwest Broadcasting Co. (acq 11-30-71). Format: Beautifl mus. Spec progs: Farm 2 hrs; classcl 4 hrs wkly. ■ Herb Roszhard Jr., pres, gen & coml mgr; Bob Cook, prog & mus dir & chief engr; Gary Wegner, news dir. ■ Rates: \$5.50; 5.50; 5.50; 5.50.

Hastings

***KCNT(FM)**—Feb 22, 1971: 88.1 mhz; 10 w. Ant 58 ft. Box 1024 (68901). (402) 463-9811. ext. 349. Central Technical Community College. Format: Contemp. ■ Bruce Ebmeier, gen mgr; Carl Brown, chief engr.

KHAS—Sept 1, 1940: 1230 khz; 1 kw-D, 250 w-N. Box 726, Tribune Bldg. (68901). (402) 462-5101. Nebraska Bcstg Co. Group owner: Seaton. Net: CBS. Rep: Pro/Meeker, Soderlund, Hix, Messina. Format: MOR. Spec progs: Sp 1 hr, C&W 2 hrs, farm 2 hrs; classcl 2 hrs wkly. ■ Donald R. Seaton, pres; John W. Powell, exec VP & gen mgr; Roy Crocker, asst gen mgr; Bill Sole, pub affrs dir; Roger Geldet, mus dir; Steve Klein, prom dir; Bruce Carlson, news dir; Jack Kidd, continuity dir; Jack Nixon, sppts dir; John Pierce, chief engr. ■ Rates: \$7.50; 6.75; 6.75; 5.65. ■ KHAS-TV affil.

KICS—April 15, 1964: 1550 khz; 500 w-U. Box 1005 (68901). (402) 463-1314. Apache Bcstg Corp. (acq 2-1-75). Net: ABC/C, IMN. Format: Contemp. Spec prog: Farm 15 hrs wkly. ■ Ron Swanson, VP & gen mgr; Robert Allen, prog dir; Ken Grozsecki, sis mgr; Mike Cahill, news dir; Elmer Nelson, chief engr. ■ Rates: \$7.25; 6.75; 7.25; 6.75.

KICS-FM—February 1965: 93.5 mhz; 3 kw. Ant 155 ft. Dups AM 50%. Format: Progs. ■ Rates: \$4.95; 3.75; 4.95; 3.75.

Holdrege

KUVR—October 1956: 1380 khz; 500 w-D. 613 4th Ave. (68949). (308) 995-4020. W. W. Bcstg Inc. Net:

ABC/C. Format: Contemp, MOR. Spec prog: Swedish ½ hr wkly. ■ William Whitlock, pres & coml mgr; Jack Stitzel, stn mgr; Dave Thorell, prog dir; John Shafer, news dir; Harold Erickson, chief engr.

KUVR-FM—October 1970: 97.7 mhz; 3 kw. Ant 155 ft. Dups AM 25%.

Kearney

KGFV—1927: 1340 khz; 1 kw-D, 250 w-N. Box 666 (68847). (308) 237-2131. Central Nebraska Bcstg Inc. Net: MBS. Rep: PRO Time Sis, Soderlund. Format: MOR. ■ John C. Mitchell, pres; John A. Howard, gen mgr; John McDonald, stn mgr; Al Smith, asst. stn mgr; Rikki Lopez, prog dir; Steve Lewis, prom mgr; Paul Wice, news dir; Virgil Finke, chief engr.

***KOVF-FM**—March 8, 1968: 91.3 mhz; 10 w. Ant 99 ft. Kearney State College (68847). (308) 237-5961, ext 343. Kearney State College. Format: MOR. ■ Milton J. Hassel, pres; George Tubbs, gen mgr; Jan Parker, chief engr.

KRNY—Dec 5, 1956: 1460 khz; 5 kw-D. Box 822 (68847). (308) 234-1977. Semeco Bcstg Corp. (group owner; acq 4-1-71). Net: ABC/C. Rep: IMN. Format: Top 40. Spec prog: Sp 2 hrs wkly. ■ W. O. Corrick, pres; Richard Roessler, gen mgr; Alan Brecht, coml mgr; Gary Eubank, mus dir; Bary Butters, news dir. ■ Rates: \$6.25; 6.25; 6.25; 6.25.

KRNY-FM—Nov 1, 1962: 98.9 mhz; 40 kw. Ant 1010 ft. Dups AM 80%. ■ Rates same as AM. ■ KHOL-TV affil.

Kimball

KIMB—Jan 13, 1959: 1260 khz; 414 West Second (69145). (308) 235-3634. KIMB Inc. (acq 7-1-61). Rep: Hix. Format: MOR. ■ Norton Warner, pres; Joan Wood, gen mgr; Jon Rogers, mus dir; Ed Norden, news dir; Don Short, chief engr.

Lexington

KRVN—Feb 1, 1951: 880 khz; 50 kw-U, DA-N. Box 619 (68550). (308) 324-2371. Nebraska Rurla Radio Assn. Net: ABC/I. Rep: Katz, Soderlund. Format: C&W, farm. ■ Ira Beachler, pres; Max Brown, gen & coml mgr; Ellen Shrum, prog dir; Rex Messersmith, farm dir; Don Colvin, mus dir; Paul Arnold, news dir; Robert J. Bitner, chief engr. ■ Rates: \$27; 27; 17; 13.

KRVN-FM—Nov 1, 1962: 93.1 mhz; 35 kw. Ant 350 ft. Prog dups AM 25%. ■ Rates: \$7; 7; 7; 7.

Lincoln

KBHL(FM)—1975: 95.3 mhz; 3 kw. Ant 117 ft. 4503 St. Paul Ave. (68504). Sound Experience Bcstg Co.

KECK—Dec 21, 1965: 1530 khz; 5 kw-D, DA. Box 6006 (68506). (402) 489-6575. J-P Enterprises (acq 3-1-68). Rep: Avery-Knodel. Format: C&W. ■ James Treat, pres & gen mgr; Larry Campbell, coml mgr; Bruce Dillman, prog dir; Dave Kump, chief engr.

KHAT(FM)—Co-owned with KECK. Feb 23, 1973: 106.3 mhz; 2.9 kw. Ant 145 ft. Stereo. Box 6066 (68506). (402) 489-1063. Progs sep from AM. Format: C&W.

KFMQ(FM)—June 22, 1958: 101.9 mhz; 100 kw. Ant 180 ft. Stereo. Terminal Bldg. (68508). (402) 432-8565. KFMQ Inc. (acq 2-15-66). Format: Adult rock. ■ S. L. Agnew, pres & gen mgr; A.R. Farrington, coml mgr; Larry Morphew, prog dir; George Bier, mus dir; Randy McCutcheon, news dir; Steven Agnew, chief engr. ■ Rates: \$9.50; 9.50; 12.50; 12.50.

KFOR—1924: 1240 khz; 1 kw-D, 250 w-N. Box 80209 (68501). (402) 432-6606. Cornbelt Bcstg Corp. (acq 1944). Group owner: Stuart. Net: ABC/I. Rep: McGavren-Guild-PGW. Format: MOR. ■ Richard W. Chapin, pres; Roger T. Larson, gen & coml mgr; Jim Miller, prog dir; Joe Kafka, news dir; Steve Moreen, chief engr.

KFOR-FM—May 2, 1965: 102.7 mhz; 100 kw. Ant 430 ft. Stereo. (402) 477-1333. (acq 8-24-73). Net: ABC/FM. Format: Beautifl mus. ■ Dave Polson, prog dir.

KHAT(FM)—Listing follows KECK.

KLIN—August 1947: 1400 khz; 1 kw-D, 250 w-N. 400 S. 13th St. (68508). (402) 475-4567. KLIN Inc. (acq 9-71). Net: CBS. Rep: Torbet. Format: MOR. ■

Norton E. Warner, pres; Diana H. Warner, sec-treas.

KLIN-FM—Sept 1, 1968: 107.3 mhz; 100 kw. Ant 165 ft. Progs sep from AM. Format: MOR.

KLMS Contemporary

KLMS—October 1949: 1480 khz; 1 kw-U, DA-2. Box 81804 (68501). (402) 489-3855. Telegraph-Herald (acq 10-74). Audio news: UPI. Rep: Pro/Meeker. Format: Top 40. ■ Harley Lampman, gen mgr; Lee Thomas, stn & prog mgr; Ken Berg, coml mgr; Fred James, mus dir; Marshall Pritchard, news dir; Carl Lewis, chief engr. ■ Rates: \$15.25; 11.70; 15.25; 11.70.

***KRNU(FM)**—Feb 23, 1970: 90.3 mhz; 10 w. Ant 180 ft. 601 N. 12th St. (68508). (402) 472-3054. University of Nebraska. Net: ABC/C. Format: Contemp, classical MOR. Spec prog: Sp ½ hr wkly. ■ D. B. Varner, pres; Larry Walklin, gen mgr; Peter Mayeux, prog & pub affrs dir; James Randall, farm dir; Edward Bailey, news dir; Thomas Spann, ops dir; Adolph Dvorak, chief engr. ■ KUON-TV affil.

***KUCV(FM)**—Jan 1, 1968: 91.3 mhz; 10 w. Union College (68506). (402) 488-2331. Union College. Audio news: UPI. Format: Relig, classcl, educ. ■ William Rankin, faculty sponsor; Ron Carlson mgr; Marvin Nelson chief engr.

McCook

KBRL—Sept 26, 1947: 1300 khz; 5 kw-D, DA. Box 371 (69001). (308) 345-2400. KBRL Bcstg Co. (acq 2-16-72). Net: MBS. Rep: Mastal/Young, Soderlund, Hix. Format: MOR, btlf mus, Top 40. Spec progs: C&W 12 hrs, farm 8 hrs wkly. ■ Edwin S. Towle III, pres, Donald Schaff, mgr; Deborah Lundberg, mus dir; Douglas Goder, news dir; William Berg, chief engr. ■ Rates: \$5.10; 4; 5.10; —.

KICX—June 23, 1961: 1360 khz; 1 kw-D. Box 333 (69001). (308) 345-5400. Semeco Bcstg Corp. (group owner; acq 4-1-66). Net: ABC/C, IMN. Rep: Intermountain. Format: Variety, MOR. ■ W.O. Corrick, pres; Steve Walker, gen mgr; Jerry Springer, coml mgr & prog dir. ■ Rates: \$5.10; 5.10; 5.10; 5.10.

Nebraska City

KNCY—June 29, 1959: 1600 khz; 500 w-D, DA. Box 278 (68410). (402) 873-3348. The KNCY Radio Corp. (acq 12-1-67). Rep: Soderlund. Format: MOR, oldies, btlf mus. Spec prog: C&W 10 hrs wkly. ■ Carl M. Adams, pres; David J. Messing, gen mgr & chief engr; Nicholas Linberg, news dir; Bill Clevenger, prom mgr; Roger Roach, mus dir; Warren Copenhaver, prog dir; Dorothy Greenamyre, coml mgr. ■ Rates: \$6.20; 6.20; 6.20; —.

KNCY-FM—Not on air, target date January 1976: 97.7 mhz; 3 kw. Ant 125 ft. Stereo. Dups AM 67%.

Norfolk

WJAG—July 26, 1922: 780 khz; 1 kw (L-WBBM). Box 789 (68701). (402) 371-0780. WJAG Inc. Group owner: Beef Empire. Net: Beef Empire Stns. Rep: McGavren-Guild-PGW, Nebraska Hometown Radio Co. Format: MOR, C&W. ■ E. F. Huse, pres; Robert E. Thomas, VP & gen mgr; Hollis Francis, coml & prom mgr; Wayne Larson, prog dir; Rich Dillman, news dir; Jerry Jaroska, chief engr. ■ Rates: \$22; 22; 17; —.

WJAG-FM—Aug 1, 1971: 106.7 mhz; 43 kw. Ant 520 ft. Format: MOR.

North Platte

KAHL Farm & Ranch Radio

KAHL—January 1966: 1410 khz; 1 kw-D, 500 w-N, DA-N. Box 248, 1301 E. 4th St. (69101). (308) 532-1120. A. E. Dahl (acq 2-1-71). Net: ABC/I, IMN. Rep: Hix, Soderlund. Format: Diversified. Spec prog: Farm 6½ hrs wkly. ■ A. E. Dahl, pres & gen mgr; Nelson Dahl, prog dir & chief engr; Lloyd Johnson, coml mgr; Glen Ardvack, mus dir; Dan Meyer, news dir. ■ Rates: \$15; 15; 15; 7.50.

KJLT—July 1, 1957: 970 khz; 5 kw-D. Box 709 (69101). (308) 532-5515. Tri-State Bcstg Assn Inc. (acq 7-1-57). Spec progs: Sp ½ hr wkly. ■ John Townsend, pres & chief engr.

KODY—July 5, 1930: 1240 khz; 1 kw-D, 250 w-N. Box 1085 (69101) (308) 532-3344. North Platte Bcstg Inc. (acq 12-31-72). Net: NBC. Reps: Torbet, Abels & Meyers. Format: MOR. ■ Richard Wagner, pres; Ted Ballenger, gen mgr; Steve McConnell, coml mgr; Neil Nelkin, prog dir; Jim Huttenmaier, news dir; Joe Miller, chief engr.

Ogallala

KIBC(FM)—1975: 93.5 mhz; 3 kw. Ant 300 ft. 20 N. Spruce St. (69153). Industrial Business Corp. Format: Standards, semi-classcl. ■ Willard Soper, Russell M. Every, et al, owners.

KOGA—Jan 23, 1955: 930 khz; 500 w-D, (CP: 500 w-U, DA-2). Box 509 (69153). (308) 284-3633. Ogallala Bcstg Co. Net: ABC/I, IMN. Rep: Eastman, IMN. Format: MOR. Spec prog: Farm 10 hrs wkly. ■ Ray H. Lockhart, pres & gen mgr; Larry Radka, chief engr. ■ Rates: \$5.70; 5.70; 5.70; 4.70.

Omaña

KEFM(FM)—Listing follows KOIL.

KEZO(FM)—Listing follows WOW.

KFAB—1924: 1110 khz; 50 kw-U, DA-N. 5010 Underwood Ave. (68132). (402) 556-8000. KFAB Bcstg Co. Group owner: May, Lincoln Journal. Net: NBC. Rep: Christal. ■ Edward W. May, pres; Lyell Bremser, VP & gen mgr; Ken Headrick, stn mgr; Lyle Nelson, sis mgr; Tom Johnson, prog mgr; Walt Kavanagh, mgr news & pub affrs; John Bruna, chief engr. ■ Rates: \$6.45; 49; 28.50.

KGOR(FM)—1959: 99.9 mhz; 115 kw. Ant 1230 ft. Stereo. Prog sep from AM. ■ Rates: \$22; 24; 26; 26.

***KGBI-FM**—May 17, 1966: 100.7 mhz; 100 kw. Ant 470 ft. Stereo. 1515 S. 10th St. (68108). (402) 342-3377. Grace Bible Institute Inc. Format: Relig, Classcl. Spec prog: Black ½ hr wkly. ■ Dr. Robert W. Benton, pres; Ward Childerston, gen mgr; Frank S. Harder, bus mgr; James C. Droeger, chief engr.

KGOR(FM)—Listing follows KFAB.

***KIOS-FM**—September 1969: 91.5 mhz; 24.5 kw. Ant 490 ft. Stereo. 3219 Cumming St. (68131). (402) 556-2770. School District of City of Omaha. Net: NPR. Format: Classcl, educ. ■ James L. Minear, gen mgr; Don Garland, prog & mus dir; Ruth Myers, prom mgr; Tony Calta, chief engr.

KLNG—March 1942: 1490 khz; 1 kw-D, 250 w-N. 511 S. 17th St. (68102). (402) 342-8282. Paxton Radio Inc. (acq 1970). Group owner: Welcome. Net: CBS, ABC/I. Format: News & talk. ■ Harrison M. Fuerst, pres; Frank Scott, VP; Jerry B. Misner, stn mgr; David P. Felice, news & prog dir; Geoff Hammond, prod & coml mgr; Dick Dennis, chief engr. ■ Rates: \$24; 18; 22; 15.

KOIL—June 1925: 1290 khz; 5 kw-U, DA-N. 8901 Indian Hills Dr. (68114). (402) 397-1290. Central States Bcstg Inc. (acq 10-53). Group owner: Star Stns. Rep: McGavren-Guild. Format: Top 40. ■ Don W. Burden, chmn of the bd; Don Tawzer, VP & gen mgr; Joe Medakovich, AM sis mgr; Tom Page, prog dir; Carl Mann, mus dir; J. Bell, news dir; Gerald E. Weist, VP engr; Don Eliason, chief engr.

KEFM(FM)—Co-owned with KOIL. Sept. 1966: 96.1 mhz; 100 kw horiz, 98 kw vert. Ant 275 ft. Stereo. Prog sep from AM. Net: ABC/I. Format: MOR. ■ Tom Sullivan, gen mgr; John Erling, prog dir; Clay Rogers, sis mgr.

KOOO—March 2, 1957: 1420 khz; 1 kw-D, DA. Box 37 W.D. (68131). (402) 556-6700. Pier San of Nebraska Inc. (acq 6-23-60). Net: MBS. Rep: Avery-Knodel. Format: C&W. ■ Mack Sanders, pres; Faye Graves, gen mgr; Norma Hayden, mus dir; Jack Walsh, news dir; Don Nistl, chief engr.

KOOO-FM—May 12, 1972: 104.5 mhz; 31 kw. Ant 285 ft. Stereo. Dups AM 100%.

KOWH—March 1922: 660 khz; 1 kw-D. 3910 Harney St. (68131). (402) 422-1600. Reconciliation Inc. (acq 1-1-71). Net: ABC/E. Format: Talk, MOR, relig. ■ Keith Donald, gen mgr; Mike Jones, prog dir; Richard Den-

Nebraska Radio

See page C-1 for explanation of listings.

nis, chief engr. ■ Rates: \$12; 10; 12; 10.

KOWH-FM—1959: 94.1 mhz; 100 kw. Ant 510 ft. Stereo. Dups AM 50%. ■ Richard Baker, prog dir. ■ Rates: \$9; 6.50; 9; 6.50.

KRBC—See Council Bluffs, Iowa.

***KVNO(FM)**—Aug 27, 1972: 90.7 mhz; 3 kw. Ant 640 ft. Box 688 (68101). (402) 554-2716. The University of Nebraska Bd of Regents. Net: MBS. Format: Fine Arts. Spec progs: Ger 10 mins, Sp 30 mins, Black 30 mins wkly. ■ Paul Borge, gen mgr; Frederic A. Leigh, prog dir; Susan Selvey, prom mgr; Norman Herzog, chief engr.

WOW—April 2, 1923: 590 khz; 5 kw-U. 3501 Farnam St. (68131). (402) 346-3400. TWX 910-622-0488. Meredith Corp. (group owner; acq 9-19-51). Net: ABC/C. Rep: Blair. Format: MOR. ■ Jim Eddens, VP & gen mgr; Dick Martin, gen sis mgr; Tom Barsanti, ops mgr; Ray Olson, pub affr dir; Jan Mahood, coml ops supvr; Mark O'Brien, news dir; Harry Stutzman, chief engr. ■ Rates: \$60; 50; 60; 50.

KEZO(FM)—Co-owned with WOW. May 15, 1961: 92.3 mhz; 92 kw. Ant 1,210 ft. (402) 345-9292. Progs sep from AM. Stereo. Format: Btlf mus. ■ Sandy Jackson, prog dir; Don Pearson, sis mgr. ■ Rates: \$25; 30; 25; 25. ■ WOW-TV affil.

O'Neill

KBRX—November 1955: 1350 khz; 1 kw-D. Box 150 (68763). (402) 336-1612. Ranchland Bcstg Co. Inc. (acq 7-1-61). Rep: Soderlund. ■ Gilbert L. Poese, pres & gen mgr; Carlee Mathis, chief engr. ■ Rates: \$3; 3; 3; 3.

KBRX-FM—December 1973: 92.7 mhz; 3 kw. Ant 225 ft. ■ Rates same as AM.

Ord

KNLV—July 1965; 1060 khz; 1 kw-D. Box 268, 16th & M St. (68862). (308) 728-3263. KNLV Inc. (acq 6-1-74). Rep: Walton, Soderlund. Format: MOR, top 40. Spec progs: C&W 12½ hrs; polka 5 hrs wkly. ■ Dean W. Misko, pres; Kaye F. Fuller, coml mgr; Allen Bundy, sis mgr; Dean W. Pennington, mus dir; Phil Mrsny, chief engr.

Plattsmouth

KOTD—Oct 26, 1970: 1,000 khz; 250 w-D, DA. Box 509 (68048). (402) 296-3366 & -4291. Platte Broadcasting Co. Rep: Walton, Soderlund. Format: C&W, MOR. ■ Charles Warga, pres & gen mgr; Jo Warga, comptroller; Glen Harger, coml mgr; Brien Connealy, mus & news dir; Larry G. Gaul, chief engr. ■ Rates: \$4.50; 4.50; 4.50; 4.50.

Scottsbluff

KEYR—See Terrytown.

KNEB—Jan 1, 1948: 960 khz; 1 kw-D, 500 w-N, DA-2. Box 239 (69361). (308) 632-7121. Scotts Bluff Bcstg Corp. (acq 1-18-70). Net: ABC/I. Rep: Eastman, IMN-Sis. Format: Contemp, MOR, C&W. Spec progs: Farm 8½ hrs wkly. ■ George H. Haskell, pres & gen mgr; Wayne McIntosh, VP & prog dir; Leslie Proctor, sec-treas & chief engr.

KNEB-FM—Dec 20, 1960: 92.9 mhz; 6.6 kw. Ant 61 ft. Stereo. Prog sep from AM. Format: MOR.

KOLT—Feb 15, 1930: 1320 khz; 5 kw-D, 1 kw-N, DA-N. Box 660 (69361). (308) 635-1320. Hilliard Co. Net: CBS, Neb Hometown Group. Rep: Torbet. Format: MOR. ■ LL Hilliard, pres; Russ Hilliard, gen mgr & chief engr; Cindy Schwab, coml mgr; Mel Sauer, prog dir; David King, news dir; Jack Edwards, mus dir; Red Davis, farm dir.

Sidney

KSID—June 2, 1952: 1340 khz; 1 kw-D, 250 w-N. Box 37, Legion Park (69162). (308) 254-5803. KSID Radio Inc. (acq 1962). Net: ABC/I, IMN. Rep: IMN. Format: Top 40, C&W, MOR. ■ David W. Young, pres & gen mgr; Joyce Huddleston, prog dir; Don Decker, coml & prom mgr; Rob Turner, mus dir; Dan Stahre, news dir; Les McConnell, chief engr.

Nebraska, Nevada Radio

See page C-1 for explanation of listings.

KSID-FM—Sept 13, 1974: 95.3 mhz; 3 kw. Ant 54 ft. Dups AM 100%.

Superior

KRFS—March 17, 1959: 1600 khz; 500 w-D. Box 100 (68978). (402) 897-3207. Valley Bcstg Co. (acq 7-31-74). Rep: Hopewell. Format: Top 40, oldies. Spec prog: Farm 2½ hrs; audience participation 2½ hrs wkly. ■ LeRoy Wolfe, pres; Charles Wolfe, gen mgr; Rick Carpenter, coml mgr; Brenda Schultz, traf dir. ■ Rates: \$4.50; 4.25; 4.25.—

Terrytown

KEYR—June 15, 1961: 690 khz; 1 kw-D. DA. Box 1263, Scottsbluff (69361). (308) 632-4119. Western Nebraska Bcstg Inc. (acq 8-1-71). Rep: Devney, McGuire (Denver), Soderlund (Omaha). Format: C&W. Spec prog: Sp 3 hrs wkly. ■ G.W. Doc Embree, pres & gen mgr; Ester Embree, prog dir; Glen Colton, news dir; John Embree, mus dir & chief engr.

Valentine

KVSH—March 6, 1961: 940 khz; 5 kw-D. 126 West Third St. (69201). (402) 376-2400. Beef Country Co. (acq 10-7-1). Net: ABC/I, IMN. Rep: Eastman, Abels. Format: MOR. ■ Kermit Kath, pres; Larry Russell, gen mgr; Wallace Bazyn, coml mgr; Dave Dent, prog dir; Tom Flynn, chief engr.

Wayne

KTCH—March 18, 1968: 1590 khz; 500 w-D. Box 484 (68787). (402) 375-3700. Theodore S. Storck (acq 12-1-74). Net: ABC/C. Rep: Soderlund. Format: MOR. Spec prog: C&W 16 hrs, farm 5 hrs, polka 1 hr wkly. ■ Theodore Storck, pres, gen mgr & news dir; Jan Lehman, coml mgr; Paul Patrick, prog dir; Mark Smith, mus dir; Earl Fuoss, prom mgr; Douglas Thompson, chief engr. ■ Rates: \$3.25; 3; 3; 2.75

KTCH-FM—October 1975: 104.9 mhz; 3 kw. Ant 113 ft. 12725 Milton St., Los Angeles (90066). Prog dups AM 75%. ■ Rates same as AM.

***KWSC(FM)**—Nov 1971: 91.9 mhz; 320 w. Ant 96 ft. Wayne State College (68787). Wayne State College. Format: Progressive, rock, top 40, classical, ed. ■ William L. Hagerman, faculty adv; John LaPuzza, gen mgr; Bruce Sedivy, prog dir; Richard Hall, prom mgr; Ed Wilberding, mus dir; Richard Dillman, news dir; William J. Kaup, chief engr.

York

KAWL—September 1954: 1370 khz; 500 w-D. Box 531 (68467). (402) 362-4433. Prairie States Bcstg Co. Inc. Rep: Messina. Format: MOR. ■ Metville L. Gleason, pres & gen mgr & chief engr; Roger K. Heers, coml mgr; David L. Johnson, prog & mus dir; Robert J. Wilson, prom mgr; Ray Kresha, news dir.

KAWL-FM—Dec 20, 1970: 104.9 mhz; 2.75 kw. Ant 310 ft. Stereo. Dups AM 8%.

Nevada

Carson City

KKBC—Listing follows KPTL.

***KNIS(FM)**—Nov 25, 1970: 94.7 mhz; 29.5 kw. Ant 2,150 ft. Stereo. 6363 Hwy 50 E. (89701). (702) 882-0888. Western Inspirational Bcstrs. Format: Relig. ■ G.A. Storrs, pres; Cliff Denney, gen mgr; Bob Carlson, prog & news dir.

KPTL—May 14, 1955: 1300 khz; 5 kw-U. Box 653. (89701). (702) 882-1319. Kelly Bcstg. (acq 3-19-71). Rep: Selcom. Format: MOR with country blend. ■ William Cody Kelly, pres; Phil Doersman, gen mgr; Don Hollister, chief engr.

KKBC(FM)—Co-owned with KPTL. June 27, 1972:

97.3 mhz; 52 kw. Ant 2240 ft. (702) 882-6263. Prog sep from AM. Format: Adult stereo rock.

Elko

KELK—Dec 7, 1948: 1240 khz; 1 kw-D, 250 w-N. Box 790 (89801). (702) 738-7118. Elko Bcstg Co. (acq 11-1-74). Net: ABC/I, IMN. Rep: Eastman, IMN. Format: MOR, diversified. Spec prog: Basque 1½ hrs; C&W 19 hrs, farm 2 hrs, classici 2 hrs, Shoshone ½ hr wkly. ■ D. Ray Gardner, pres, gen mgr & coml mgr; Jack Giudici, prog & mus dir; Stuart Rider, news dir & prom mgr; Art Sciotto, chief engr. ■ Rates: \$57; 57; 57; 57.

Ely

KELY—July 8, 1950: 1230 khz; 250 w-SH. Box 600 (89301). (702) 289-2077 & 3963. David I. Hansen. Audio news: UPI. Format: Diversified. ■ David I. Hansen, owner & operator. ■ Rates: \$2.50; 2.50; 2.50; 2.50.

Fallon

KVLV—May 9, 1957: 980 khz; 5 kw-D. 1155 Gum-mow Drive (89406). (702) 423-2243. Lahontan Valley Bcstg Co. Net: Nevada. Format: C&W. ■ Lester W. Pearce, gen mgr & chief engr; Mike McGuinness, stn mgr; Katherine E. Pearce, prog dir; Lynn L. Pearce, news dir.

KVLV-FM—Nov 29, 1966: 99.3 mhz; 2.9 kw. Ant 250 ft. Dups AM 20%. Format: MOR, variety.

Henderson

KBMI

All News and Information

KBMI—1954: 1400 khz; 1 kw-D, 250 w-N, DA-2. Box 15223, Las Vegas (89114). (702) 732-7753. Broadcast Assocs. (acq 8-28-72). Audio news: NBC/NIS. Rep: Century Natl. Format: All news. ■ Steve Gold, pres & gen mgr; Hank Thornley, Valerie Wierne-Baird, VPs; Christy Winlow, coml mgr; Larry Shipp, prog dir; Chuck Moshontz, news dir; Gordon Alsum, chief engr. ■ Rates: \$12.50; 9; 12.50; 9.

***KILA(FM)**—July 18, 1972: 95.5 mhz; 100 kw horiz, 61 kw vert. Ant 1120 ft. Box A (89015). (702) 564-2596. Southern Nevada Communications Corp. Format: Variety, religious. ■ Jack G. French, pres & gen mgr; Brad Staheli, prog dir; Calvin Stein, chief engr.

KVOV—May 1956: 1280 khz; 5 kw-D. Box 400 (89015). (702) 564-2591. KTOO Bcstg Co. Inc. (acq 2-1-70). Net: Mutual Black. Audio news: APR. Rep: Lucas; Carpenter; Messina. Format: Black. Spec prog: Sp 7 hrs wkly. ■ Cy Newman, pres, gen mgr; Col. Ed Brown, VP & stn mgr; Gino Barmore, prog dir; Paul Dawkins, mus dir; Bob Stone, chief engr. ■ Rates: \$7; 7; 7; —.

KXTZ(FM)—February 10, 1971: 94.1 mhz; 41 kw. Ant minus 140 ft. Stereo. 307 Water St. (89015). (702) 564-2696. Pennino Music Co. Rep: Groskin. Format: Btfl mus. ■ Jeannette Banocci, pres; Jack Banocci, VP & gen mgr; Debbie Oaks, coml mgr; Robert C. Allen, stn mgr; George Smith, chief engr.

Las Vegas

***KCEP(FM)**—1974: 88.1 mhz; 10 w. Ant 49 ft. 900 W. Owens Ave. (89106). Operation Opportunities.

KDWN

EASTMAN RADIO, INC.

KDWN—April 7, 1975: 720 khz; 50 kw-D, 10 kw-N, DA-2. No. 1 Main St. (89101). (702) 385-7212. Radio Nevada. Net: MBS. Format: MOR. ■ A.J. Williams, pres & gen mgr; D. Hubbard, coml mgr; C. Griggs, prog dir; M. Harris, news dir; J. DeAngelo, chief engr. ■ Rates: \$15; 13; 15; 13.

KENO—1941: 1460 khz; 5 kw-D, 1 kw-N, DA-N. 4660 S. Decatur Blvd. (89102). (702) 876-1460. Lotus Communications Corp. (group owner; acq 6-1-65). Net: ABC/C. Format: Top 40, rock. Spec prog: Spanish & Black. ■ Howard A. Kalmenson, pres; Jerry Roy, VP &

gen mgr; Scott Gentry, prog dir; Dave Winter, mus dir; Norm Sealey, news dir; Tony Carnavalee, chief engr. ■ Rates: \$14; 12; 14; 12.

KFMS

Contemporary Stereo Rock

KFMS(FM)—March 22, 1963: 101.9 mhz; 20 kw. Ant 41 ft. Stereo. Box 15223 (89114). (702) 732-7753. Broadcasts Assoc. Inc. (acq 12-1-74). Rep: Century Natl. Format: Top 40, oldies. ■ Steve Gold, pres & gen mgr; Len Howard, VP; Lucy Driver, coml mgr; Larry Shipp, prog & mus dir; Bob Kennard, prom mgr; Chuck Moshontz, news dir; Gordon Alsum, chief engr. ■ Rates: \$9; 7.50; 9; 7.50.

KLAV—1947: 1230 khz; 1 kw-D, 250 w-N. 2634 State St. (89109). (702) 735-6633. Frontier Bcstrs Inc. (acq 7-1-71). Net: CBS. Rep: Buckley. Format: MOR. Spec prog: Fr 1 hr, Ger 2 hrs, Ital 3 hrs, Pol 1 hr, Sp 1 hr wkly. ■ Bernard Brodie, pres; Robert J. Blum, VP & gen mgr; Chris Corey, coml mgr; Harvey Allen, prog & mus dir; Ruth Irwin, prom mgr; Murray Westgate, news dir; Gordon Atteberry, chief engr.

KLUC—1956: 1140 khz; 10 kw-D. Box 14805 (89114). (702) 739-9383. KLUC Bcstg Co. (acq 9-1-70). Rep: Masla. Format: Contemp. ■ Richard C. Phalen Jr., pres & gen mgr; Michael McCarthy, prog dir; Len E. Mitchell, mus dir; Bill McCarty, news dir; Gordon Alsum, chief engr. ■ Rates: \$9; 9; 9; 9.

KLUC-FM—98.5 mhz; 5.78 kw. Ant 93 ft. Stereo. Dups AM 100%. ■ Rates same as AM.

KORK—June 1953: 920 khz; 5 kw-D, 500 w-N, DA-2. Box 2927, 1950 Sandhill Road (89104). (702) 457-5511. Southwestern Bcstg Co. (acq 7-15-55). Group owner: Donrey Media. Net: NBC. Rep: McGavren-Guild. Format: MOR, personality. ■ Donald W. Reynolds, pres; Joseph W. McMurray, gen mgr; Darrell Dryer, news dir; Gordon Alsum, chief engr. ■ Rates: \$13.50; 11; 12; 11.

KORK-FM—Nov 29, 1961: 97.1 mhz; 44 kw. Ant 195 ft. Stereo. Prog sep from AM. Format: Btfl mus.

KRAM—1947: 1340 khz; 1 kw-D, 250 w-N. 925 E. Desert Inn Rd. (89109). (702) 732-1363. Nevada Bcstg Inc. (acq 10-1-68). Net ABC/E. Rep: Torbet. Format: Modern country. Spec prog: Relig 5 hrs wkly. ■ James B. Francis, pres; Mel Ryan, VP & gen mgr; Robert D. Hanna, VP; Chuck Wagner, sis mgr; Tony Brown, opns mgr; Janie Clark, traffic mgr; Mike Farrell, mus dir; Jean Scott, traff mgr; Gordon Atteberry, chief engr.

***KRUD(FM)**—Not on air, target date 12-1-75: 90.9 mhz; 37.3 kw. Ant 36 ft. Stereo. Box 1426 (89104). Nevada Public Radio Corp. Net: NPR. Format: MOR, diversified, black. ■ William L. Motley, chmn of bd; Mary Logan, gen mgr; Curt Hemming, mus dir; Mike Caldwell, prom mgr; Bill Motley, chief engr.

KTRI(FM)—Listing follows KVEG.

KUDO(FM)—Not on air, target date unknown: 93.1 mhz; 42 kw. Ant 1190 ft. Quality Bcstg Corp.

KVEG

Solid Gold

KVEG—Feb 21, 1962: 970 khz; 500 w-D. Castaways Hotel (89109). (702) 735-8644. Las Vegas Electronics Inc. (acq 9-1-71). Rep: Dahlstén. Format: Oldies. Spec prog: Talk, 2½ hrs wkly. ■ Robert A. Bernstein, pres; Bob Ruark, VP & gen mgr; Bill Utton, stn mgr; Dave Davidson, opns mgr; Gordon Alsum, chief engr. ■ Rates: \$6.50; 6; 6.50; 5.75.

KTRI

Stereo Country

KTRI(FM)—Co-owned with KVEG. Sept 1, 1966: 92.3 mhz; 27 kw horiz, 9.2 kw vert. Ant 180 ft. Stereo. Prog sep from AM. (702) 735-1415. Net: ABC/I. Format: C&W. Spec prog: Talk 5 hrs wkly. ■ Johnny Gunn, stn mgr. ■ Rates same as AM.

KVOV—See Henderson.

William A. Exline, Inc.
31 CARROLL COURT
SAN RAFAEL, CALIFORNIA 94903
(415) 479-0717
MEDIA BROKERS - CONSULTANTS

Reno

KBBT—July 1946: 1340 khz; 1 kw-D, 250 w-N. Box 1170 (89504). (702) 322-1340. Sierra Bcstg Co. (acq 10-1-53). Net: CBS. Format: C&W. ■ Robert Day, gen & coml mgr; Rick Freeman, prog dir & chief engr. ■ Rates: \$4; 3; 4; 3.

KCBN—Oct 30, 1963: 1230 khz; 1 kw-D, 250 w-N. Box 1049 (89504). (702) 786-1230. B.B.C. Inc. (acq 7-17-63). Net: ABC/C. Rep: Eastman; Simpson-Reilly. Format: Contemp. ■ Lorraine Walker, pres & gen mgr; Jerry Schafer, coml mgr; Johnny Michaels, prog dir; Julie Day, exec opns mgr; George Webb, chief engr.

KRNO(FM)—Co-owned with KCBN. August 1975: 106.9 mhz; 60 kw horiz, 20 kw vert. Ant 460 ft. Stereo. Prog sep from AM. ■ Dave Price, prog dir.

KCRL—October 13, 1970: 780 khz; 50 kw-U, DA-N. Box 7160 (89510). (702) 322-9145. TWX 910-395-7080. Capital C Inc. Rep: Torbet, Tacher. Format: Classcl, semi-classcl, easy lstng. ■ Charles E. Cord, pres & gen mgr; Jim Elliott, stn mgr; Clyde Petersen, sls mgr; Euell Labhard, prog dir; Dick De Witt, news dir; Clyde H. Bond, chief engr. ■ KCRL-TV affil. ■ Rates: \$9; 7.50; 9; 7.50.

KGLR(FM)—June 20, 1971: 105.7 mhz; 31 kw. Ant minus 390 ft. Stereo. 308 E. Plumb Lane (89502). (702) 826-3800. KGLR Inc. (acq 1975). Group owner: Leisure Time Communications. Net: ABC/FM. Rep: Savalli-Gates. Format: Rock. ■ Joseph T. McInerney, pres; Philip D. Doersam, ptrn & gen mgr; Penny Doersam, ptrn & sls mgr.

KNEV(FM)—Dec 25, 1953: 95.5 mhz; 50 kw. Ant 530 ft. Stereo. Box 1250 (89504). (702) 322-5638. Everett B. Cobb. Net: MBS. Nevada. Rep: Sandeberg-Glenn. Format: MOR. ■ Everett B. Cobb, gen mgr; Dale Walker, coml mgr; Eleanore B. Cobb, prog dir; William Sawyer, mus dir; Jerry E. Cobb, chief engr.

KNIS(FM)—See Carson City.

KOBY—April 6, 1969: 1550 khz; 10 kw, DA-D. Box 5606 (89503). (702) 747-2500. James M. Cunningham & Thompson Magowan. (acq 2-12-72). Net: ABC/E. Rep: AAA; Sandeberg-Glenn. Format: Adult MOR. ■ Tom Magowan, gen mgr; Sue Page, exec asst mgr; James Blaine, chief engr.

KOH—Oct 25, 1928: 630 khz; 5 kw-D, 1 kw-N, DA-N. Box 2271 (89505). (702) 323-5106. TWX 702-358-0252. McClatchy Newspapers. (acq 4-9-31). Group owner: McClatchy Bcstg. Net: NBC. Rep: Katz. Spec prog: Farm 2 hrs wkly. ■ Eleanor McClatchy, pres; Hewitt Kees, stn mgr; Wesley Craig, chief engr; Kenn Douglas, farm edit.

KOLO—1946: 920 khz; 5 kw-D, 1 kw-N, DA-N. Box 821 (89504). (702) 786-0920. Western Bcstg Co. (acq 1955). Group owner: Donrey Media. Net: MBS. Rep: McGavren-Guild. Format: Contemp, MOR. ■ Donald W. Reynolds Sr., pres; Tim Grant, VP & gen mgr; David Finley, prog dir; John Gunn, news dir; Carl Roloff, chief engr. ■ KOLO-TV affil.

KONE—Jan 29, 1955: 1450 khz; 1 kw-D, 250 w-N. Box 1928 (89505). (702) 329-9261. Lotus Bcstg Inc. (acq 9-67). Group owner: Lotus Communications Corp. Net: ABC/E. Rep: Lotus. Format: Modern C&W. ■ Howard A. Kalmenson, pres; David T. Newman, gen mgr; Craig Thomas, coml mgr; Martin Flynn, prog mgr; Johnny Steele, prog dir; Rick Freeman, mus dir; Joe Walther, news dir; Ed Pike, chief engr.

KRNO(FM)—Listing follows KCBN.

KSRN(FM)—Oct 12, 1966: 104.5 mhz; 25 kw. Ant 2900 ft. Sls S. Virginia (89501). (702) 786-1045. Reesco Inc. Net: ABC/L. Rep: Potter. Format: Adult MOR. ■ Carl E. Roloff, pres & gen mgr; M.L. Roloff, coml & prom mgr; Amos Soma, prog & mus dir; Larry Kirk, chief engr. ■ Rates: \$5.50; 5.50; 5; 4.

***KUNR(FM)**—Oct 7, 1963: 88.7 mhz; 2 kw. Ant minus 450 ft. U. of Nevada (89507). (702) 784-6591. U. of Nevada. Format: Educl, classcl. ■ Wendell H. Dodds, gen mgr; Jerome Wilhelmi, chief engr.

Sparks

KWRL—Aug 9, 1960: 1270 khz; 1 kw-D. Box 2807, Reno (89505). (702) 786-5900. Transierra Media Inc. (acq 2-1-73). Format: Oldies, top 40. ■ Doug James, pres; Donald S. Beck, VP & gen & coml mgr; Dan Cook, prog dir; Morry Kaplan, mus dir; Johnny M., news dir; Jim Blain, chief engr. ■ Rates: \$4.25; 4.25; 4.25; 4.25.

Winnemucca

KWNA—Jan 17, 1955: 1400 khz; 1 kw-D, 250 w-N-SH. Box 591 (89445). (702) 623-2030. Northwest Radio & Television Corp. Format: MOR. ■ Lee Boner, pres & gen & coml mgr; Jim Boner, chief engr.

New Hampshire

HAMILTON-LANDIS & ASSOCIATES, Inc.
NATIONWIDE MEDIA BROKERS
WASHINGTON, D. C., CHICAGO, DALLAS, SAN FRANCISCO
SELL MORE
RADIO & TELEVISION STATIONS
IN THE EAST—NEAREST OFFICE IS—
1730 K ST., N.W., WASHINGTON 20006
(202) 393-3456

Berlin

WBRL—Aug 8, 1962: 1400 khz; 1 kw-D, 250 w-N. 40 Main St. (03570). (603) 752-2670. Berlin Communications Inc. (acq 4-4-71). Net: ABC/L. Rep: Piano, Northeastern Spot Sales. Format: Top 40. Spec progs: Fr, farm, classcl, wkly. ■ Richard L. Blais, pres; Robert Dale, gen & coml mgr; Rod Ross, prog dir; Mike Martel, prom mgr; Dave Page, prog dir; Rod Ross, prom mgr; Bill Pucko, news dir; Gary Blais, chief engr. ■ Rates: \$7; 7; 7; 7.

WMOU—Oct 11, 1946: 1230 khz; 1 kw-D, 250 w-N. 40 Main St. (03570). (603) 752-1230. White Mountain Bcstg Co (acq 2-6-69). Net: CBS. Rep: Queen. Format: Contemp, local news. Spec prog: Fr 3 hrs wkly. ■ Robert R. Powell, pres; John T. Gallus, gen mgr; John Gallus, coml mgr; Paul Gagne, prog & mus dir; Robert Barbin, news dir; Peter Galligan, prom mgr; R. Poirier, chief engr. ■ Rates: \$4.50; 4; 4.50; 4.

WXLQ(FM)—Co-owned with WMOU. October 1952: 103.7 mhz; 17 kw. Ant 160 ft. Prog sep from AM. Format: Top 40, oldies. ■ Rates same as AM.

Claremont

WECM(FM)—Listing follows WTSV.

WTSV—1948: 1230 khz; 1 kw-D, 250 w-N. 221 Washington St. (03743). (603) 543-7735. Electromagnetic Corp. (acq 10-7-72). Rep: Pro/Meeker; New England Spot Sales. Format: "Hit Parade." Spec progs: Fr 2 hrs; Pol 1½ hrs; C&W 7½ hrs wkly. ■ Palmer C. Dante, pres; William Schnaudt, coml mgr; Cliff Koradi, gen mgr; Tom Cuddy, news dir. ■ Rates: \$7.60; 6.90; 7.60; 5.40.

WECM(FM)—1948: 106.1 mhz; 8.9 kw. Ant 990 ft. Stereo. Prog sep from AM. Format: Great American Country. ■ Rates same as AM.

Concord

WKXL—June 15, 1946: 1450 khz; 1 kw-D, 250 w-N. Box 875 (03301). (603) 225-5521. Capitol Bcstg Corp. (acq 4-1-57). Net: CBS. Rep: Pro/Meeker; New England Spot Sls. Format: MOR. ■ Frank B. Estes, pres & gen mgr; Richard W. Osborne, coml & stn mgr; Helen R. Paige, comptrllor; Gardner Hill, prog dir; Ruth La Fantasie, news dir; Leslie LeBlanc, chief prog engr. ■ Rates: \$9.40; 7.25; 9.40; 7.25.

WKXL-FM—March 7, 1972: 102.3 mhz; 3 kw. Ant 285 ft. Dups AM 80%.

Nevada, New Hampshire Radio

See page C-1 for explanation of listings.

***WSPS(FM)**—1974: 90.5 mhz; 10 w. St. Paul's School (03301). St. Paul's School. ■ Jonathan Panek, gen mgr.

Conway

WBNC—Dec 21, 1955: 1050 khz; 1 kw-D. Box W (03818). (603) 447-5988. North Country Radio Inc. (acq 3-23-59). Rep: Market 4 Radio. Format: Contemp. ■ Lawrence H. Sherman, pres, gen mgr; Joan T. Sherman, coml mgr; Donald Masters, chief engr; Fred Gardella, prog dir.

WBNC-FM—June 23, 1967: 93.5 mhz; 3 kw. Ant minus 230 ft. Dup AM 40%.

Dover

WDNH(FM)—August 1970: 97.5 mhz; 50 kw. Ant 290 ft. Stereo. Box 576 (03820). (603) 742-7059. Eastminster Bcstg Co. Rep: Kirby (Boston). Format: Modern country. Spec prog: Fr 1 hr wkly. ■ Samuel Bronstein, treas; Maggi Tornrose, gen mgr.

WTSN—1956: 1270 khz; 5 kw-U, DA-2. Box 400 (03820). (603) 742-1270. WTSN Inc. Rep: McGavren-Guild; Creed (Boston). Format: Contemp; top 40. ■ Bruce M. Lyons, VP & bus mgr; James M. McCann, VP & coml mgr; Jerry Lipman, stn mgr; Paul LeBlanc, prog dir. ■ Rates: \$7.50; 7.50; 7.50; 7.50.

Durham

***WUNH(FM)**—July 15, 1963: 91.3 mhz; 1.75 kw. Ant 255 ft. Memorial Union Bldg. (03824). (603) 868-2541. U. of New Hampshire. Net: ABC/C. Format: Progressive. ■ Gordon L. Vickers, gen mgr; Steve Rhodes, prog dir; Garry Harworth, mus dir; Kevin Cokely, news dir; Dianne Sawyer, chief anncr; Gregory Rocco, chief engr.

Exeter

WKXR—June 4, 1966: 1540 khz; 1 kw-D. 11 Downing St., Box 154 (03833). (603) 772-4757. Coastal Bcstg Co. Inc. Net: MBS. Rep: Pro/Meeker; New England Spot Sls. Format: MOR, info. Spec prog: Farm ½ hr wkly. ■ Frank B. Estes, pres-treas; Ronald P. Allard, VP & gen mgr; Helen R. Paige, comptrllor; Sherman E. Chester Jr., news dir; John Kershaw, mus dir; Leslie LeBlanc, chief engr; Robert E. Lindner, resident engr. ■ Rates: \$6.48; 5.40; 5.40; 4.05.

WKXR-FM—Sept 21, 1972: 107.1 mhz; 3 kw. Ant 68 ft. Dups AM daytime. Format: MOR, info—days, btfl mus—nights.

***WPEA(FM)**—1967: 90.5 mhz; 10 w. Box 1000, Phillips Exeter Academy (03833). (603) 778-0162. Trustees of Phillips Exeter Academy. Format: noncoml diversified. ■ David L. Covington, gen mgr.

Franklin

WFTN—Oct 30, 1966: 1240 khz; 1 kw-D, 250 w-N. Central St. (03235). (603) 934-2500. Northeast Communications Corp. (acq 9-30-74). Net: ABC/L. Rep: Savalli/Gates; Eckles & Queen. Format: MOR, variety. Spec progs: C&W 6 hrs, talk 7½ hrs, oldies 5 hrs wkly. ■ Jeff Fisher, pres, gen mgr & news dir; Jeff Messerman, coml mgr; Lew White, mus & prog dir; Jerry Plano, prom mgr; Richard Walsh, chief engr. ■ Rates: \$5.75; 5.75; 5.75; 5.75.

Hanover

WDCR—March 4, 1958: 1340 khz; 1 kw-D, 250 w-N. Box 957 (03755). (603) 643-4500. Trustees of Dartmouth College. Rep: New England Spot Sls. Format: Classcl. Spec progs: Black 14 hrs, progs 14 hrs, Jazz 12 hrs, pub affrs 9 hrs wkly. ■ Christopher Davidson, gen mgr; Royce Yudkoff, sales mgr; John Fidler, prog dir; Jeffrey Sudikoff, news dir; Charles Peos, mus dir; William Sinclair, chief engr. ■ Rates: \$6.30; 4.75; 4.75; 3.30.

WFRD(FM)—Not on air, target date October 1975: 99.3 mhz; 3 kw. Ant 285 ft. Stereo. Dups AM 20%.

WTSL—Oct 1950: 1400 khz; 1 kw-D, 250 w-N. Box 1400, Lebanon, N.H. (03766). (603) 448-1400. Sound Citizen Communications Corp. (acq 11-7-74). Net: CBS. Rep: Market 4, Northeastern. Format: MOR. Spec prog: C&W 6 hrs wkly. ■ Rates: \$7.06; 7.06; 7.06; 7.06.

New Hampshire, New Jersey Radio

See page C-1 for explanation of listings.

Henniker

***WNEC-FM**—Feb 9, 1971: 91.7 mhz; 10 w. New England College Library (03242). (603) 438-3228. New England College. Net: ABC/FM. Format: Prog, R&B, rock. ■ Winslow Damon, gen mgr; Andrea Johnson, prog dir; Kerry A. Leichtman, mus dir; Steve Marini, prom mgr; Peter D. Wildermuth, news dir; Phillip Reeder, chief engr.

Keene

WKBK—June 1959: 1220 khz; 1 kw-D. 13 Lamson St. (03431). (603) 352-6113. Monadnock Bcstg Corp. (acq 5-17-62). Net: ABC/C. Rep: Northeast Spot Sales. Format: Contemp. Spec prog: C&W 5 hrs wkly ■ David F. Shurtleff, pres; Talbot R. Hood, VP & gen mgr; Nancy K. Hilton, coml mgr; Doug White, prog dir; Neil Patrizzi, mus dir; Lonna Slaby, news dir; Garnet Drakiotis, chief engr.

WKNE—June 2, 1927: 1290 khz; 5 kw-U, DA-1. Box 466 (03431). (603) 352-9230. WKNE Corp. (acq 5-46). Net: CBS. Rep: PRO/Meeker; Eckels & Queen. ■ E. H. Close, pres & gen mgr; Darrel Clark, stn mgr; Bill Raymond, prog dir. ■ Rates: \$9; 7.65; 9; 7.65.

WNBX(FM)—Co-owned with WKNE May 1964: 103.7 mhz; 42 kw. Ant 530 ft. Stereo. Dup AM 33%. Format: Btfl mus. ■ Rates: \$4.50; 4.50; 4.50.

***WKNH(FM)**—November 1975: 89.1 mhz; 10 w. Ant 81 ft. Elliot Hall (03431). (603) 352-7635. Keene State College of U. of New Hampshire. Net: NPR, Pacifica. Format: progs, jazz. Spec prog: Classcl 5 hrs, educ 15 hrs wkly. ■ Vincent S. Vitale, gen mgr.

WNBX(FM)—Listing follows WKNE.

Laconia

WEMJ—April 9, 1961: 1490 khz; 1 kw-D, 250 w-N. Box 1490 (03246). (603) 524-6050. WTSN Inc. (acq 1974). Group owner: Granite State Bcstg. Net: ABC/L. Rep: PRO/Meeker; Northeastern. Format: Contemp, MOR. ■ Ralph Gottlieb, pres; Gary Howard, gen mgr; Ed Doherty, prog dir; Ben Walters, news dir; Robert Mallory, chief engr; Bernard La Croix, coml mgr; Arthur Morley, mus dir. ■ Rates: \$7; 7; 7.

WLNH



WLNH—Aug 22, 1922: 1350 khz; 5 kw-D. Parade Road (03246). (603) 524-1323. WLNH Radio Inc. (acq 6-25-75). Group owner: Sconnix. Net: CBS. Rep: Creed. Format: MOR, top 40. ■ Randall O. Deneal, pres; Paul Hemphill, mgr; James Marshall Rising, prog dir; Paul Fuller, mus dir; Bill White, news dir; Lindsey Collins, chief engr. ■ Rates: \$7.20; 6; 7.20; 6.

WLNH-FM—Nov 22, 1965: 98.3 mhz; 3 kw. Ant 235 ft. Dup AM 65%.

Lebanon

WECM(FM)—See Claremont.

Littleton

WLTN—Oct 10, 1963: 1400 khz; 1 kw-D, 250 w-N. 20 Main St. (03561). (603) 444-3911. Profile Bcstg Co. (acq 7-1-75). Rep: Eckels & Queen. Format: MOR, oldies. ■ Peter C. Aydelott, pres & gen mgr; William E. Aydelott, prog dir; Fred C. Tabbut, chief engr.

Manchester

WFEA—March 8, 1932: 1370 khz; 5 kw-U, DA-1. (CP 1 kw-U, DA-1). Box 149 (03105). (603) 625-5491. Century Bcstg Group Inc. (acq 5-16-67). Net: ABC/C. Rep: Bassett; Kettell-Carter. ■ H. D. Newirth, pres & gen mgr; Vic Pryles, prog dir; Evelyn Redmond, bus mgr; Warren Bailey, news dir; Richard Whooley, dir of ops.

WGIR—October 1941: 610 khz; 5 kw-D, 1 kw-N, DA-2. Box 487 (03105). (603) 625-6915. Knight Radio Inc. (acq 4-6-1). Group owner: Knight Quality

Stns. Net: NBC. Rep: Torbet; Knight Sls. Format: MOR, talk, sports. Spec prog: Fr 1 hr wkly. ■ Norman Knight, pres; Bernie Mack, gen & coml mgr; Len Marcotte, mus dir; Bob Lobel, spts dir; Norman Gagnon, chief engr. ■ Rates: \$20; 15; 20; 11.

WGIR-FM—June 5, 1963: 101.1 mhz; 9.6 kw. Ant 960 ft. horiz, 950 ft. vert. Dup AM 100%. ■ Rates same as AM.

WKBR—Oct 1, 1946: 1250 khz; 5 kw-U, DA-2. 155 Front St. (03102). (603) 669-1250. Granite State Bcstg Co. Inc. Rep: McGavren-Guild; Creed. ■ Ralph Gottlieb, pres; James McCann, gen & coml mgr; Tom Holt, prog dir & prom mgr; Peter Morrisson, news dir.

WZID(FM)—1948: 95.7 mhz; 10.5 kw. Ant 930 ft. 155 Front St. (03102). Radioactive Group (acq 5-75). Format: Good mus. ■ Bruce Lyons, mgr.

Mt. Washington

WMTQ(FM)—July 9, 1958: 94.9 mhz; 48 kw. Ant 3760 ft. 638 Congress St., Portland, Me. (04101). (207) 773-0209. Alpine Bcstg Corp. (acq 12-15-71). Rep: Century; Crupi. Format: Btfl mus. ■ Norman R. Alpert, pres & gen mgr; Joseph Desimone, stn mgr; Ann Rawlings, prom mgr; Parker Vincent, chief engr. ■ Rates: \$26; 26; 26; 24.

Nashua

WOTW—September 1947: 900 khz; 1 kw-D. Lund Road (03060). (603) 889-4900. Eastminster Bcstg Corp. (acq 3-64). Rep: Messina. Format: Golden oldies. Spec progs: Fr 1 hr; Pol 4½ hrs; Greek 3-2/3 hrs wkly. ■ Herbert Miller, pres; Maury Parent, gen mgr; Janice Tremblay, coml mgr; Dave MacFarland, prog dir; John H. Spence Sr., news dir; Norman Round, chief engr.

WOTW-FM—September 1947: 106.3 mhz; 3 kw. Ant 165 ft. Prog sep from AM. Format: C&W. ■ Flo Murock, prog dir.

WSMN—March 9, 1958: 1590 khz; 5 kw-U, DA-1. Box 1590 (03060). (603) 882-5107. 1590 Bcstg Corp. (acq 4-23-59). Net: ABC. Rep: PRO/Meeker; Northeastern Spot Sales. Format: MOR, news, talk. ■ Gerald Q. Nash, pres; David A. Rock, gen mgr; Charles O'Neil, prog dir; Ed Lecius, news dir; Donald F. Ayers, chief engr.

Newport

WCNL—Aug 11, 1960: 1010 khz; 250 w-D. Box 389, 120 Belknap Ave. (03773). (603) 863-1010. Eastminster Bcstg Corp. (acq 6-15-70). Net: MBS. Rep: Pro Time Sls. Format: C&W. Spec prog: Fr 1 hr wkly. ■ Samuel Bronstein, treas; Phillip H. Spellane, gen & prom mgr; Ray Reed, prog & news dir; Jerome Erikson, chief engr.

WCNL-FM—1971: 101.7 mhz; 2 kw. Ant minus 210 ft. Dups AM 90%.

Peterborough

WSCV—May 19, 1970: 1050 khz; 1 kw-D. Box 418 (03458). (603) 924-3834. Shannon Communications Corp. (acq 11-75). Rep: Fulford; Eckels & Queen. Format: MOR. ■ Francis X. Dealy, pres & gen mgr; Mal Tobey, stn mgr; Francine Dealy, VP; Michael M. Colby, prog dir; Stuart F. Richter, mus dir; David G. Goblaskas, news dir; Lindsay M. Collins, chief engr. ■ Rates: \$5.50; 5; 5; 5.

WSLE(FM)—Co-owned with WSCV. Nov 13, 1972: 92.1 mhz; 140 w. Ant 1120 ft. Stereo. Dups AM 80%.

Plymouth

***WPCR-FM**—Sept 29, 1974: 91.7 mhz; 10 w. Ant 95 ft. Box 189 (03264). (603) 536-1760. Plymouth State College. Net: ABC/C. Format: Top 40. ■ Dana Lunden, gen mgr.

WPNH—Nov 10, 1965: 1300 khz; 1 kw-D. 2 High St. (03264). (603) 536-2500. Pemigewasset Bcstrs Inc. Rep: Market 4, Eckels & Queen. Format: MOR 75%. C&W 25%. ■ Richard F. Morse Jr, pres & gen mgr; William Webb, sales mgr; David Adams, prog dir; Thomas Kallecher, news dir; J. Gordon Keyworth, chief engr. ■ Rates: \$5; 5; 5; 5.

WPNH-FM—Oct 1, 1975: 100.1 mhz; 1.55 kw. Ant 380 ft. Dups AM 75%. ■ Rates same as AM.

Portsmouth

WBBX—Dec 5, 1960: 1380 khz; 1 kw-U, DA-N. 1380 Broadcast Plaza (03801). (603) 436-1380. Curt Gowdy Bcstg Corp. (group owner: acq 5-1-69). Net: ABC/L. Rep: Selcom. Format: Contemp. ■ Curtis E. Gowdy, pres; John F. Bassett, gen mgr; George A. Lovejoy, sls mgr; Rod Stevens, prog & mus dir & prom mgr; John Fleming, news dir; Roger Wood, chief engr. ■ Rates: \$10.50; 9.40; 10.50; 9.40.

WHEB—1932: 750 khz; 1 kw-D (L-WSB). Box 120 (03801). (603) 436-7300. Knight Bcstg of New Hampshire Inc. (acq 1-22-59). Group owner: Knight Quality Stns. Rep: Torbet; Knight Sls. Format: Contemp; Top 40. ■ Norman Knight, pres; Clifford Taylor, gen mgr; Floyd Wright, mus dir; Andy Carey, prog dir; David Cokely, news dir; D. Ellis, sports dir; Anthony Vaccaro, chief engr. ■ Rates: \$10; 8; 10; 6.

WHEB-FM—Jan 14, 1964: 100.3 mhz; 5.7 kw. Ant 140 ft. Dup AM 100%. Stereo. ■ Rates same as AM.

Rochester

WWNH—1947: 930 khz; 5 kw-U, DA-N. Rochester Hill Rd. (03867). (603) 332-0930. Strafford Bcstg Corp. Net: CBS. Rep: Oakes; Northeastern Spot Sales. Format: Contemp. Spec prog: Pol 2 hrs wkly. ■ Marcia L. Nescol, pres & gen mgr; Robert J. Connelly, stn mgr; Joe Riley, news dir; John Chick, chief engr.

Wolfboro

WASR—April 1970: 1420 khz; 1 kw-D. Box 900. Varney Rd. (03894). (603) 569-2232. Radio Wolfboro. Net: ABC/E. Rep: Eckels & Queen. Format: Easy listening, news. Spec progs: Farm 1 hr, C&W 2 hrs wkly. ■ Alan W. Severy, pres & gen mgr; Sharon J. Severy, sls mgr; Bill Vreeke, mus dir; George Hall, chief engr. ■ Rates: \$4.75; 4.25; 4.25; —.

New Jersey

HAMILTON-LANDIS & ASSOCIATES, Inc.
NATIONWIDE MEDIA BROKERS
WASHINGTON, D. C. CHICAGO, DALLAS, SAN FRANCISCO
SELL **MORE**
RADIO & TELEVISION STATIONS
IN THE EAST—NEAREST OFFICE IS
1730 K ST., N.W., WASHINGTON 20006
(202) 393-3456

Asbury Park

WHTG—See Eatontown.

WJLK/WJLK-FM

M Jack Masia & Company, Inc.

WJLK—1926: 1310 khz; 1 kw-D, DA, 250 w-N. Press Plaza (07712). (201) 774-7000. Press Bcstg Co. (acq 4-1-50). Format: MOR, news, AM drive. ■ Thomas B. Tighe, pres; Robert McAllan, exec VP; Richard E. Lewis, stn mgr; Vincent Hartnett, prog dir; Jackson L. Anderson, coml mgr; Jack Christie, news dir; Al Bonner, chief engr. ■ Rates: \$15.40; 14.65; 15.40; 8.80.

WJLK-FM—Nov. 20, 1947: 94.3 mhz; 3 kw. Ant 280 ft. horiz, 260 ft. vert. Dups AM. ■ Rates same as AM.

Atlantic City

WAYV(FM)—April 1961: 95.1 mhz; 10 kw. Ant 300 ft. Ritz Apts., Iowa at Bdwalk (08401). Format: Btfl mus. ■ Carl G. Monk, gen mgr; Frederick Chassey, chief engr. ■ Rates: \$8; 9; 8.50; 5; 5.

WFPG—1940: 1450 khz; 1 kw-D, 250 w-N. Steel Pier (08401). (609)348-4646. Eastern Bcstg Co. (acq 1-16-61). Net: CBS. Rep: PRO Time Sales. Format: MOR, news. Spec prog: Black 3 hrs wkly. ■ Dan Diener, pres; Catherine Clark, gen mgr; Bill Rosenfelt, coml mgr; Allan Segal, prog dir; Howard Berger, news dir; Marvin Pincus, chief engr.

WFPG-FM—September 1962: 96.9 mhz; 50 kw. Ant 300 ft. Stereo. Dups AM 25%. Format: Btfl music. ■ Bob Williams, prog dir.

WGRF(FM)—See Pleasantville.

WMID—May 30, 1947: 1340 khz; 1 kw-D, 250 w-N. Box 1137, Ohio & Murray Aves. (08404). (609) 334-5113. WMID Inc. (acq 5-1-67). Group owner: Merv Griffin, Net: ABC/C. Rep: Tobet-Lasker Inc. Format: Adult contemp. ■ Merv Griffin, pres; Robert F. Johnstone, gen mgr; Gary Lane, prog dir; Robert Palitz, chief engr.

WMGM(FM)—Co-owned with WOND Pleasantville. June 14, 1961: 103.7 mhz; 20 kw. Ant 145 ft. Stereo. 15 Shore Rd., Linwood (08221). (609) 641-1400. South Jersey Radio Inc. Group owner: Green Group. Rep: Selcom. Format: Btfl mus. ■ Howard L. Green, pres; Jack J. Kessler, gen mgr; Bill Hammersley, coml mgr; Harry Gahagan, prog dir; Mike Shurman, news dir; Ed Storic, chief engr.

WOND—See Pleasantville.

WUSS—April 8, 1955: 1490 khz; 1 kw-D, 250 w-N. 1500 Absecon Blvd. (08401). (609) 347-4200. Atlantic Business & Community Development Corp. (acq 11-74). Net: Natl Black. Format: Black, Sp, rel, jazz. ■ Laurence McCall, pres; James Byrd, gen mgr; Kingsley Smith, prog dir; Phil Neuman, news dir; Raymond Kibittlewski, chief engr. ■ Rates: \$60; 60; 60; 60.

Avalon

WWOC(FM)—Not on air, target date unknown: 94.3 mhz; 3 kw. Ant 300 ft. Avalon Bcstg Co.

Blairstown

WFMV-FM—Co-owned with WCRV, Washington. Oct 21, 1973: 106.3 mhz; 275 w. Ant 860 ft. Stereo. Box 428 (07825). (201) 362-8221. Warren Bcstg Corp. Rep: Pro/Meeker. Format: Solid gold ■ Nick DeRienzo, pres & gen mgr; Chuck Betyeman, coml mgr; Johnny Michaels, prog dir; Tommy John, mus dir; Glen Maggion, news dir; Geoffrey Kevin Doll, chief engr.

Bricktown

***WBGD(FM)**—June, 1975: 91.9 mhz 10 w. Ant 72 ft. Stereo. 346 Chambers Bridge Rd. (08723). Brick Township Bd. of Educ. Format: Educl, diversified. ■ Robert H. Boesch, chief engr.

Bridgeton

WSNJ—August 1937: 1240 khz; 1 kw-D, 250 w-N. Box 69 (08302). (609) 451-2930. Eastern States Bcstg Corp. Net: MBS. Format: Diversified. Spec progs: Pol 4 hrs, farm 10 hrs wkly. ■ Irvin F. Foster, pres; Irvin Foster mgr; Edward L. Bold, exec VP, coml mgr; chief engr; Herbert Stiles, prog dir; Louise H. Foster, prom mgr; Harvey Alden, news dir.

WSNJ-FM—1946: 107.7 mhz; 15.2 kw. Ant 486 ft. Dup AM 90%.

Camden

WCAM—September 1925: 1310 khz; 1 kw-D, 250 w-N. City Hall (08101). (609) 365-5600. City of Camden. Rep: Bernard. Format: Variety. Spec progs: Sp 18½ hrs, Pol 1 hr, Irish 1 hr wkly. Mayor Angelo Errichetti, pres; Pat Deisi, gen mgr & prog dir; Greg Walsh, coml mgr; Alan Jay, mus dir; John Heat, chief engr.

***WKDN-FM**—June 1, 1966: 106.9 mhz; 18 kw. Ant 340 ft. 2906 Mt. Ephraim Ave. (08104). (609) 854-5300. Family Stations Inc. (group owner; acq 7-23-68). Format: Relig, MOR. ■ Harold Camping, pres; Dane Rohm, stn mgr; P. Michael Ziemann, prog dir; Robert Zane, chief engr.

WTMR—Nov 1, 1948: 800 khz; 5 kw-D, DA. 2775 Mt. Ephraim Ave. (08104). (609) 962-8000. Roberts Bcstg Co. (acq 7-1-68). Net: MBS. Format: MOR. ■ Thomas M. Roberts, pres & gen mgr; Mitt Stevens, coml mgr; Bob Roberts, mus dir; Sam Virgillo, engr.

Canton

WNNN(FM)—Co-owned with WJIC Salem. Jan 15, 1973: 101.7 mhz; 3 kw. Ant 300 ft. Box 132, Salem (08079). (609) 935-1510. Jersey Information Center. Group owner: Baker Net: ABC/I. Rep: Select Religious. Format: Relig. ■ Dr. Vernon H. Baker, pres; John H. Prince, gen & coml mgr; Charles McCormick, mus dir;

Ben Ferguson, chief engr. ■ Rates: \$4.25; 4.25; 4.25; 4.25.

Cape May

WRIO-FM—June 3, 1967: 102.3 mhz; 3 kw. Ant 145 ft. (CP: Ant 270 ft). Box 258 Rio Grande (08242). (609) 886-1144. Cape Christian Broadcasters Inc. (acq 1-14-72). Format: Relig, btfl mus. Spec prog: C&W 6 hrs wkly. ■ William C. Lamson Sr, pres & gen mgr; David Brown, chief engr.

Dover

WDHA-FM—Feb 22, 1961: 105.5 mhz; 3 kw. Ant 560 ft. Quad Stereo. 419 Route 10 (07801). (201) 366-3424. Drexel Hill Assoc. Audio news: UPI. Format: Top 40, adult contemp. Spec progs: Pol 4 hrs, classcl 5 hrs, big band 5 hrs, jazz 10 hrs wkly. ■ Peter Arnov, pres; Peter A. Linder, gen mgr, prog & mus dir; F. Barry Farquhar, coml mgr; Don Barry, news dir; Stu Engelke, chief engr. ■ Rates: \$18; 18; 18.

WRAN—Aug 19, 1964: 1510 khz; 10 kw-D, 500 w-N, DA-N. Box 1510 AM (07801). (201) 366-1510. Community Bcstg of N.J. (acq 1974). Net: MBS. Rep: Masla. Format: MOR. Spec prog: Sp 2 hrs wkly. ■ Richard E. Baily Jr, pres & gen mgr; Stephen D. Halton, prog dir; Jeff Olgang, news dir; Charles Blanding, chief engr.

East Orange

***WFMU(FM)**—1958: 91.1 mhz; 1.44 kw. Ant 360 ft. Prospect St. (07019). (201) 266-7900. Upsala College. Format: Progressive, rock. Spec prog: Educl 15 hrs wkly. ■ Carl Fjellman, pres of Upsala; Bruce Longstreet, gen mgr & prog dir; James B. Boraz, mus dir; George Fenwick Jr, chief engr.

Eatontown

WHTG—Nov 1, 1957: 1410 khz; 500 w-D. 1129 Hope Rd., Asbury Park (07712). (201) 492-2000. Harold M. Gade. Rep: Pro/Meeker. Format: Btfl mus. ■ Harold M. Gade, pres; Theo Gade, gen mgr; Faye B. Gade, asst mgr. ■ Rates: \$14; 14; 14; 14.

WHTG-FM—Oct 11, 1961: 106.3 mhz; 3 kw. Ant 210 ft. Stereo. Dup AM daytime. ■ Rates same as AM.

Egg Harbor

WRDR(FM)—Sept 23, 1971: 104.9 mhz; 3 kw. Ant 280 ft. 182 N. White Horse Pike, Hamonton. (08037). (609) 561-1900. Rodio Radio Inc. Format: Albums (70% instrumental). ■ James N. Rodio, pres & gen mgr; Wm. Ordille, coml mgr; John Runfola, prog & mus dir; Richard Tyler, news dir; Bob Frey, prom mgr & spts dir; Donn Cross, chief engr.

Elizabeth

WJDM—March 11, 1970: 1530 khz; 500 w-D. 9 Caldwell Place (07201). (201) 965-1530. Radio Elizabeth Inc. Rep: Webb. Format: MOR. Spec progs: Sp 5 hrs, Black 1 hr wkly. ■ Harry Anger, pres & gen mgr; Ken Holmberg, gen sis mgr; Gary Cubberly, prog dir; Bill Schaefer, mus dir; Gerard Klein, news dir; Charles Blanding, chief engr. ■ Rates: \$15; 12.50; 15; —.

Flemington

***WCVH(FM)**—June 5, 1974: 90.5 mhz; 69 w. Ant 300 ft. Rt. 31 (08822). (201) 782-9595. Hunterdon Central High School. Format: Educl. ■ David R. Kelber, gen mgr; Gene Lieber, mus dir; Cary Assante, prom mgr; Dudley Bullock, chief engr.

Franklin

WSUS(FM)—Feb 28, 1965: 102.3 mhz; 360 w. Ant 750 ft. Box 102 (07416). (201) 827-2525. Sussex County Stereo Inc. (acq 10-71). Net: MBS. Format: Contemp, C&W. Spec prog: Farm 2 hrs wkly. ■ Peter M. Bardach, pres; Jay Edwards, gen & coml mgr; Bill Trousedale, prog dir; Jerry Miller, news dir. ■ Rates: \$11; 10; 11; 9.

Franklin Lakes

***WRRH(FM)**—Feb 22, 1963: 88.7 mhz; 10 w. Ramapo High School, George St. (07417). (201) 891-1503. Bd. of Educ. of Ramapo Regional High School. Format: Educl, mus. ■ Jim Cavanaugh, gen mgr.

New Jersey Radio

See page C-1 for explanation of listings.

Glassboro

***WGLS-FM**—January 1964: 89.7 mhz; 250 w. Ant 87 ft. Box 116 (08028). (609) 445-7335. Glassboro State College. Net: ABC/FM. Format: Music-entertainment, educ. Spec prog: Consumer info 4 hrs wkly. ■ Mike Donovan, faculty adv; Bob Catania, stn mgr; Larry Di Bona, on air dir; Lynn Bandell, news dir; Bob Fox, pub; Amy Binder, prog dir; Lee Thrower, mus dir; Dave Bon-tempo, sports dir; Neva Horwath, consumer info; William Mollenhauer, chief engr.

Hackensack

WWDJ—1924: 970 khz; 5 kw-U, DA-N. Box 970 (07602). (201) 343-5097. Combined Communications Corp. (group owner; acq 8-26-74). Format: Religious. ■ Larry Wasserstein, pres & gen mgr; Steve Hollis, prog & news dir; James Gailbreath, chief engr. ■ Rates: \$50; 50; 50; 50.

Hackettstown

***WNTI(FM)**—Dec 5, 1958: 91.9 mhz; 5.6 kw. Ant 510 ft. Centenary College for Women. (07840). (201) 852-1400. Centenary College for Women. Format: Educl. ■ Dr. Edward W. Seay, pres; Michael F. Fisher, gen mgr; Stefan G. Straka, chief engr.

Hammonont

WRDI—May 11, 1961: 1580 khz; 1 kw-D. 182 N. White Horse Pike (08037). (609) 561-1900. Rodio Radio (acq 12-1-67). Spec progs: It 6 hrs, Sp 7 hrs, C&W 3 hrs wkly. ■ James N. Rodio, pres & gen mgr; William Ordille, coml mgr; John Runfola, prog dir; Ann Lemons, prom mgr; Richard Tyler, news dir; Bob Frey, spts dir; Donn Cross, chief engr.

Hanover

***WHPH(FM)**—April 18, 1966: 90.3 mhz; 10 w. Ant 68 ft. 63 Mt. Pleasant Ave. (07936). (201) 887-7511. Handover Park Regional School Dist Bd of Education. Format: MOR 60%, top 40 40%. ■ David R. Craske, gen mgr.

Highland Park

***WVHP-FM**—Jan 1973: 90.3 mhz; 10 w. Ant 75 ft. North Fifth Ave. (08904). (201) 572-2404. Highland Park High School. Format: Variety, educ. ■ Jonah Giacalone, gen mgr.

Lakewood

WHLW—Nov 20, 1970: 1170 khz; 5 kw-D, DA. Box 1170 (08701). (201) 364-4400. Mid State Bcstg Co. Net: MBS. Format: Contemp, Variety, personality. Spec progs: Black 1½ hrs, relg 2 hrs wkly. ■ Joey Reynolds, gen mgr; Louis Yager, VP sales, Rob Weitz, coml mgr; Jay Sorensen, prog & mus dir; Harry Kalish, news dir; Marsha Kniceley, pub affrs dir; Bruce Smith, graphic arts dir; Richard Swetits, chief engr.

Lincroft

***WBJB-FM**—Jan 13, 1975: 90.5 mhz; 2.25 kw. Ant 100 ft. Brookdale Community Coll. (07738). (201) 842-1900 ext 295. Bd of Trustees of Brookdale Community College. Format: Progressive, diversified, educ. Spec prog: Sp 4 hrs wkly. ■ Louis Pullano, gen mgr; Terry Hand, prog dir; Frank Dacey, chief engr; Rick Hansen, stn mgr; Kevin Smith, mus dir; Joe Aimee, prom mgr; Jim Unterburger, news dir; Patricia Thomas, traf dir; John Bertie, opns dir.

Long Branch

WRLB(FM)—June 1, 1960: 107.1 mhz; 3 kw. Ant 190 ft. Stereo. 156 Broadway (07740). (210) 222-1071. Long Branch Bcstg Co. Format: MOR. Spec progs: Black 15 hrs, jazz 10 hrs, Pol 4 hrs, C&W 2 hrs, Greek 1 hr wkly. ■ Phillip DeSantis, pres; Mickey Caruso, gen mgr; Michael J. Bolduc, opns mgr & news dir; Mike Megill, mus dir; Theodore Caine, chief engr. ■ Rates: \$10; 8.10; 8.10; 6.50.

Millville

WMBV—December 1953: 1440 khz; 1 kw-D, DA. Box 1440, South Vineland (08360). (609) 825-2600.

New Jersey Radio

See page C-1 for explanation of listings.

Union Lake Bcstrs Inc. (acq 2-1-69). Rep: Market 4 Radio, Dome. Format: Contemp. ■ Joseph Coccaro, pres & gen mgr; Joseph A. McCullley Jr, coml & prom mgr; Al Sergi, prog dir; Vic Davis, mus dir; Jim Quinn, news dir; Richard F. Arsenault, chief engr.

WMVB-FM—Feb 20, 1962; 97.3 mhz; 5.2 kw. Ant 195 ft. (CP 10 kw. Ant 165 ft.). Dups AM 90%.

Morristown

***WJSV(FM)**—Feb 22, 1971; 90.5 mhz; 10 w. Ant 80 ft. 50 Early St. (07960). (201) 539-6100, ext 852. Morristown Board of Education. Format: Ed. Spec progs: Fr ½ hr, Ger ½ hr Ital ½ hr, Sp 1 hr. Black 2 hrs wkly. ■ G. Reginald Harrison, gen mgr; Bruce Lontka, chief engr.

WMTR—Dec 12, 1948; 1250 kHz; 5 kw-D, DA. Box 1250 (07960). (201) 538-1250. Drexel Hill Assoc. Ltd. (acq 10-6-70). Audio news: UPI. Rep: Groskin Co. Format: Easy Istng/MOR. ■ Peter L. Arnow, pres; F. Barry Farquhar, coml mgr; Brian Emery, prog dir; Don Barry, news dir; Stuart Engelke, chief engr. ■ Rates: \$37; 37; 37; —.

Mount Holly

WJZZ—1963; 1460 kHz; 5 kw-D, DA. Box 585, Burlington (08016) (609) 386-1555. West Jersey Bcstg Co. (acq 7-1-67). Format: C&W. ■ Henry H. Bisbee, pres; Jack Seaner, gen mgr; Samuel H. Michael, sec-treas. ■ Rates: \$9.60; 8; 9.60; 8.

Newark

***WBGO(FM)**—Feb 7, 1948; 88.3 mhz; 20 kw. Ant 220 ft. 345 High St. (07102). (201) 733-6859. Newark Bd. of Educ. Format: Educl. ■ Marie C. Scanlon, supt.

WFME(FM)—94.7 mhz; 36 kw. Ant 570 ft. 289 Mt. Pleasant Ave., W. Orange (07052). (201) 736-2277. Family Stns Inc. (group owner; acq 3-10-66). Format: Sacred. ■ Harold Camping, pres; Scott L. Smith, VP; Clyde Casto, gen mgr; Harry Barr, prog dir; Richard Van Dyke, sec-treas; Walter Santner, pub affrs, Michael Price, chief engr.

WHBI(FM)—June 15, 1962; 105.9 mhz; 10 kw. Ant 390 ft. 80 Riverside Drive, New York (10024). (201) 799-8000 or 877-5200. Cosmopolitan Bcstg Corp. Format: Black, It. Spec progs: Pol 2 hrs, Sp 13 hrs wkly. ■ Don Lewis, pres; Allen D. Collins, gen mgr; Sandra Davis, off mgr; Gilbert Abbey, chief engr.

WNJR—1947; 1430 kHz; 5 kw-U DA-N. 1700 Union Ave., Union (07083). (201) 688-5000, 1430 Assoc. (acq May 1975). Net MBS/Black, Natl Black. Format: Black, rock. ■ Harvey Lynch, gen mgr; Ralph Quortin, sales mgr; Jeff Dixon, prog dir; William Doneghy, asst gen mgr; Jerry Love, mus dir; Ken Bieber, chief engr. ■ Rates: \$38; 33; 38; 33.



WVNJ—December 1948; 620 kHz; 5 kw-U, DA-2. 621 N. Mt. Pleasant Ave., Livingston (07039). (201) 994-9191. Newark Bcstg Corp. (acq 11-8-53). Net: ABC/E. Rep: Buckley. Format: Btfl mus. ■ Edward Scudder Jr., pres; Roy M. Schwartz, gen mgr; Larry Yount, prog dir; Carole Baldino, news dir; Gerald Corby, chief engr. ■ Rates: \$55; 50; 55; 45.

WVNJ-FM—June 1, 1961; 100.3 mhz; 24 kw horiz; 16 kw vert. Ant 670 ft. Stereo. Progs sep from AM. Format: Btfl mus. ■ Rates: \$32; 32; 32.

New Brunswick



WCTC—Dec 12, 1946; 1450 kHz; 1 kw-D, 250 w-N. 385 George St. (08901). (201) 247-1450. Raritan

Valley Bcstg Co. (acq 5-1-57). Group owner: Greater Media Inc. Rep: Eastman. Format: MOR. Spec progs: Pol 1½ hrs, Hungarian 1½ hrs, Sp 1 hr, Jewish 1 hr, Black 1 hr wkly. ■ Peter A. Bordes, pres; Anthony V. Marano, VP & gen mgr; Harry Mitchell, coml mgr; John Taylor, prog dir; Walt Sodie, news dir; Clarence Dingman, chief engr. ■ Rates: \$42; 40; 42; 35.

WQMR(FM)—Co-owned with WCTC. 1947; 98.3 mhz; 3 kw. Ant 110 ft. Dup AM. ■ Rates same as AM.

***WRSU-FM**—Jan 27, 1974; 88.7 mhz; 1.35 kw. Ant 125 ft. Stereo. 126 College Ave. (08903). (201) 967-1396. Board of Governors, Rutgers U. Format: Progressive. Spec progs: Black 9 hrs, Sp 5 hrs; Broadway 2½ hrs, Hungarian 1 hr, It 1 hr, Asian 1 hr, Israeli folk 1 hr, Chinese 1 hr, Greek 1 hr wkly. ■ Mitchell I. Hymowitz, gen mgr; Stephen F. Goffreda, asst gen mgr; Howard Joffe, educl prog dir; David S. Greenfield & Jack Wrightson, prog dir; Irv Lukin, mus dir; Michael A. Blishak, news dir; Brandon Macy, sports dir; Mark A. Harris, chief engr.

Newton

WIXL-FM—Listing follows WNNJ.

WNNJ—Dec 15, 1953; 1360 kHz; 1 kw-D. Box 40 (07860). (201) 383-3400. Sussex County Bcstrs Inc. Net: ABC/I. Rep: Roslin. Format: Uptempo contemp adult. ■ Ralph Rood III, gen mgr; Glenn Gleixner, prog dir; Tad Diesel, news dir; Joel Williams, chief engr. ■ Rates: \$8.55; 6.25; 8.25; —.

WIXL-FM—Co-owned with WNNJ. Oct 15, 1961; 103.7 mhz; 5 kw. Ant 140 ft. Stereo. Prog sep from AM. Net: ABC/E. Format: Btfl Mus. ■ Rates: \$5.50; 4.50; 5.50; 4.

Ocean City-Somers Point

WSLT—June 12, 1964; 1520 kHz; 1 kw-D, DA. 957 Asbury Ave. (08226). (609) 399-1555. Salt Tee Radio (acq 8-1-71). Format: Solid gold. ■ Lester Allen, pres; Bob Richter, gen mgr; Ed Rosenfield, coml mgr; Bob Everland, prog & opns dir; Tom Cogan, mus dir; Jack Breslin, news dir; Raymond Kibitlowski, chief engr.

WSLT-FM—Oct 1, 1972; 106.3 mhz; 2.90 kw. Ant 310 ft. Stereo. (609) 398-1063. Progs sep from AM. Format: Btfl mus.

Parsippany-Troy Hills

WPRJ—Jan 13, 1973; 1310 kHz; 1 kw-D, DA. Percypeny Lane (07054). (201) 335-9778. Percypeny Radio. Format: Contemp, MOR. ■ Paul F. Godley Jr, pres; William P. Godley, VP & gen mgr; Steve Yarris, news dir; John Stanley, chief engr.

Paterson

WPAT—1941; 930 kHz; 5 kw-U, DA-2. 1396 Broad St. Clifton (07013). (201) 472-0930. TWX: 710-989-7032. Capital Cities Communications Inc. (group owner; acq 10-6-1). Rep: Katz. Format: Btfl mus. ■ Thomas Murphy, chmn & chief exec; Daniel B. Burke, pres; James P. Arcara, VP & gen mgr; Aaron Daniels, natl sales mgr; Fred Weinhaus, local sales mgr; Robert Leeder, prog dir; Ralph Sanabria, mus dir; John Cichowski, dir of comm affairs; Don LeBrecht, opns mgr; Joseph E. Martin, chief engr.

WPAT-FM—March 1957; 93.1 mhz; 12.5 kw. Ant 870 ft. Stereo. Progs sep from AM. ■ Bud Schweska, mus dir.

Plainfield

WERA—Sept 16, 1961; 1590 kHz; 500 w-D, DA. 120 W. 7th St. (07060). (201) 755-1590. Tri-County Bcstg Corp. Format: Easy Istng. Spec prog: Sp 1 hr wkly. ■ Henry J. Behre, exec VP & gen mgr; Brian Morgan, coml mgr; Barbara L. Ballard, admin asst; Chuck Irving, mus dir; Bob Moore, pub serv dir; Peter Richard, news dir; Bob Balfour, chief engr. ■ Rates: \$15.25; 13.50; —; —.

Pleasantville

WGRF(FM)—Co-owned with WMID, Atlantic City. 1974; 99.3 mhz; 3 kw. Ant 290 ft. Box 1137, Ohio & Murray Aves., Atlantic City (08404). (609) 344-5113. WMID Inc. Group owner: Merv Griffin. Rep: Torbet-Lasker Inc. Format: The Great Ones. ■ Merv Griffin, pres; Robert F. Johnstone, gen mgr; Robert Palitz, chief engr.

WOND—July 1950; 1400 kHz; 1 kw-D, 250 w-N. 15 Shore Rd., Linwood (08221). (609) 641-1400. South Jersey Radio Inc. (acq 7-15-55). Group owner: Green Group. Net: ABC/E. Format: MOR. ■ Howard L. Green pres; Jack J. Kessler, gen mgr; Harry Gahagan, prog dir; Michael Shurman, news dir; Thomas McNally, chief engr.

WMGM(FM)—Co-owned with WOND. See Atlantic City.

Point Pleasant

WADB(FM)—Oct 4, 1968; 95.9 mhz; 3 kw. Ant 155 ft. Stereo. 1715 F St., South Belmar (07719). (201) 681-3800. Pleasant Broadcasters Inc. Format: Btfl mus. ■ Adamant Brown, pres & chief engr; William R. Stark, sales mgr; Lea McDougal, traffic mgr; Tom F. Huges, stn mgr & prog dir; John F. Croft Jr, opns mgr.

Pompton Lakes

WKER—Oct 3, 1964; 1500 kHz; 1 kw-D, DA. Box 1500 (07442). (201) 839-1500. WKER Radio Inc. Format: Variety. Spec prog: Relg 2 hrs wkly. ■ Robert A. Kerr, pres & gen mgr; Joan Brooks Kerr, exec VP; Lee Novak, exec asst & treas; Tom Niven, opns dir & sec; Roy Terhune, VP engr.

Princeton

WHWH—Sept 10, 1963; 1350 kHz; 5 kw-U, DA-2. Box 1350 (08540). (609) 924-3600. Nassau Bcstg Co. Net: ABC/E & ABC/I. Audio news: UPI. Rep: Masla; Dome. Format: MOR. ■ Herbert W. Hobler, pres; John J. Morris, exec VP; Tom Weaver, stn mgr; Chris Canali, prog dir; Hal Stein, prom mgr; Ed Klein, music dir; William Schirman, news dir; Robert Stone, chief engr. ■ Rates: \$20; 17.20; 20; 14.60.

WPRB(FM)—October 1955; 103.3 mhz; 17 kw. Ant 195 ft. Box 342 (08540). (609) 921-9284. Princeton Bcstg Serv. Net: ABC/FM. Rep: NEAS. Format: Progressive. Spec progs: Black 2 hrs, C&W 2 hrs, Folk 2 hrs wkly. ■ Ned Nalle, gen mgr; Steve Eckert, sls dir; Allen Furbeck, prog dir; Peter Grossman, mus dir; John Haber, bus mgr; Toni DeMatto, news dir; Michael Rosenberg, tech dir. ■ Rates: \$7.50; 7.50; 7.50; 7.50.

Princeton Junction

***WPPH(FM)**—November 1975; 90.3 mhz; 10w. Box 48, 89 Washington Rd. (08550). West Windser Plainsboro Rgnl School District.

Salem

WJIC—Aug 1, 1966; 1510 kHz; 150 w-D, DA. Box 132 (08079). (609) 935-1510. Jersey Information Center. Group owner: Baker. Net: ABC/I. Rep: Dome. Format: MOR. Spec progs: Farm 1 hr, Black 4 hrs, jazz 8 hrs wkly. ■ Vernon Baker, pres; John Prince, gen mgr; Paul Thomas Jr, prog dir; Gloria Jennings, news dir; Benjamin Ferguson, chief engr. ■ Rates: \$7.50; 7.50; 7.50; —.

WNNN(FM)—Co-owned with WJIC. See Canton.

Somerville

WBRW—Dec 23, 1971; 1170 kHz; 500 w-D, DA. Box 1170 (08876). (201) 725-1170. Somerset Valley Bcstg Co. Format: MOR. ■ Lester Granetz, pres; Harry H. Haslett, gen mgr; Mark Lewis, prog dir; Ralph Saro, news dir; Barry T. Gerstenberg, chief engr.

South Orange

***WSOU(FM)**—April 14, 1948; 89.5 mhz; 2 kw. Ant 370 ft. Stereo. 400 So. Orange Ave. (07079). (201) 762-8950. Seton Hall Univ. Net: ABC/I. Format: Variety. Spec progs: Black 13 hrs, Pol 2 hrs, Sp 3 hrs, Greek 1 hr, Ukrainian 1 hr, Lithuanian 1 hr wkly. ■ Cliff Hesse, dir; Dennis Mazzocco, gen mgr; Roger Dornal, prog dir; Walter Schoenkecht, opns dir; Matt Korol, sports dir; Bob Recchia, news dir; Thomas Parnham, chief engr.

Stirling

WKMB—Feb 1972; 1070 kHz; 250 w-D. 1390 Valley Rd. (07980). (201) 647-4400. K&M Broadcasters Inc. Net: ABC/I. Format: Contemp MOR. ■ Herbert P. Michels, pres, Alice Dunne, gen mgr, prog & news dir; William Michels, coml mgr; Ron Leslie, mus dir. ■ Rates: \$9; 8; 9; 8.

Teaneck

***WFDU(FM)**—Aug 30, 1971: 89.1 mhz; 550 w. Ant 500 ft. Stereo. (Shares time with WNYU New York). 795 Cedar Lane (07666). (201) 836-4024. Fairleigh Dickinson University. Audio news: APR. Format: Diversified. ■ Dr. Jerome Pollack, pres; David S. Overcash, gen mgr; Phil Okun, prog dir; Bob Ostro, mus dir; Terry Moss, news dir; Philip Rosenblatt, chief operator; Dan Ellsweig, chief engr.

Toms River

WOBM(FM)—March 1, 1968: 92.7 mhz; 3 kw. Ant 300 ft. Stereo. Box 927 (08753). (201) 269-0927. Seashore Bcstg Corp. Audio news: UPI. Format: MOR. ■ Roy G. Simmons, pres; Paul Most, gen mgr; Bob Levy, sales mgr; Greg Kozlar, prog dir; Tom Kuhn, news dir; Rudolph Clapp, chief engr. ■ Rates: \$23.55; 16.80; 23.55; 9.45.

Trenton

WBJH(FM)—Listing follows WBUD.

WBUD—Jan 20, 1947: 1260 khz; 5 kw-D, 1 kw-N, DA-2. Box 551 (08601) (609) 882-7191. WBUD Inc. Audio news: NBC/NIS. Format: All news. ■ R. M. Hardin, pres, Theresa Rose, gen mgr; Joe Del Masters, coml mgr; Rick Randacora, news dir; John Ferrara, chief engr.

WBJH(FM)—Co-owned with WBUD. Aug 27, 1962: 101.5 mhz; 20 kw. Ant 130 ft. (CP: Ant 120 ft.) Stereo. Net: NBC. Format: Progs.

WCHR(FM)—See listing following WTTM.

WPST(FM)—January 1949: 97.5 mhz; 50 kw. Ant 410 ft. Box 9750. (609) 896-0975. Nassau Bcstg Co. (acq 12-1-64). Net: ABC/II. Rep: Masla, Dome. Format: MOR. ■ Herbert J. Hobler, pres; John J. Morris, exec VP; Phil Geiger, gen mgr; Tom Taylor, prog dir; Hal Stein, prom mgr; William Schirmann, news dir; Bob Stone, chief engr. ■ Rates: \$18; 15; 18; 12.

WTNJ—1923: 1300 khz; 5-D, DA. Box 2050, Princeton (08540). (609) 924-3842. Progressive Communications Inc. (acq 5-15-73). Rep: G.C.I. Format: Black. Spec prog: Sp 5 hrs wkly. ■ Herbert M. Greenberg, chmn of board, Jeanne Greenberg, pres & gen mgr; Nick Maggio, opns mgr; Maurice Brown, prog dir; Curtis Gray, news dir; George Kowal, chief engr.

***WTSR(FM)**—Sept 1966: 91.3 mhz; 1.5 kw. Ant 35 ft. Kendall Hall, Trenton State College (08625). (609) 771-2420. Trenton State College Radio System. Format: Progs, educ. Spec prog: Black 3 hrs wkly. ■ Phil Opalski, stn mgr; Jim Neilland asst stn mgr; Nick Troisi, prog dir; Tom Couo & Cindy Gilbert, prom mgrs; Wally Chase, mus dir; Trey Altomose, news dir; Bruce Wortman, chief engr.

WTTM—April 2, 1942: 920 khz; 1 kw-U, DA-1. 333 West State St. (08618). (609) 695-8515. Scott Bcstg Co. of N.J. (acq 11-1-63). Group owner: Great Scott. Net: MBS. Rep: Torbet. Format: MOR. Spec progs: Pol 3 hrs, Ital 1½ hrs; Ukr ½ hr; Hung 1 hr, Ger 1 hr wkly. ■ Herbert Scott, pres; Donald Kirby, gen mgr; Dave Lord, prog dir; Rick Brancadora, news dir; Ronald Simpson, chief engr.

WCHR(FM)—Co-owned with WTTM. Aug 7, 1965: 94.5 mhz; 50 kw. Ant 240 ft. Woodside Rd., Yardley, Pa. (19067). (215) 493-4252. Prog sep from AM. Format: Relg. ■ Charles Zulker, gen mgr.

Upper Montclair

***WMSC(FM)**—Dec 9, 1974: 90.3 mhz; 10 w. Ant 685 ft. Stereo. Montclair State College (07043). (201) 893-4256. Board of trustees, Montclair State College. Format: Diversified. ■ James Johnson, gen mgr.

Vineland

WDVL—Aug 19, 1959: 1270 khz; 500 w-D, DA. Box 457 (08360). (609) 691-7550. Frank & Vita Marie Ventresca. Format: Sp, Top 40. Spec progs: It 5 hrs, Greek 1 hr, relg 7 hrs wkly. ■ Vita Marie Ventresca, owner & gen, coml & prom mgr; Christine A. Curcio, prog dir; Edward Ventresca, mus dir; George Swindell, chief engr. ■ Rates: \$5; 4.50; 5; 4.50.

WDVL-FM—Oct 1968: 92.1 mhz; 3 kw. Ant 180 ft. (CP: Ant 250 ft.). Prog sep from AM. Format: Black, Top 40 ■ Rates same as AM.

WWBZ



WWBZ—July 29, 1946: 1360 khz; 1 kw-U, DA-N, Box 810, 2115 S. Delsea Dr. (08360). 692-6500. Community Bcstg Svc Inc. Net: ABC. Rep: Messina; Gill-Perna. Format: Contemp. Spec progs: Pol 1 hr, Sp 4 hrs wkly. ■ Lewis D. DeMarco, pres; Robert C. Crager, VP & gen mgr; John F. Serra, coml mgr; Warren L. Crescenzo, prog dir; John McIntyre, mus & news dir; Fran Fekel, chief engr. ■ Rates: \$8; 8; 8; 8.

Washington

WCRV—July 1, 1956: 1580 khz; 1 kw-D, kw-D. Box 150 (07882). (201) 689-1580. Warren Bcstg Corp. (acq 3-1-65). Rep: Pro/Meeker. Format: C&W ■ Nick DeRienzo, pres & gen mgr; Kurt Gebouer, prog dir & coml mgr; Wayne Scott, mus dir; Steve Crocker, news dir; Doug Frieberg, chief engr.

West Long Branch

***WMCX(FM)**—May 2, 1974: 88.1 mhz; 13 w. Ant 85 ft. Stereo. Box 88 (07764). (201) 222-8484. Monmouth College. Net: ABC/FM. Format: Progs. Spec prog: Rel. & pub affairs 15 hrs wkly. ■ Steven M. Galante, gen mgr.

Wildwood

WCWC—Nov 25, 1951: 1230 khz; 1 kw-D, 250 w-N, 3010 New Jersey Ave. (08260). (609) 522-1416. Jersey Cape Bcstg Corp. (acq 7-16-65). Net: MBS. Rep: Dome. Format: Contemp, MOR. ■ Wm. C. Woltring Jr., pres & gen mgr; Frank Strohm, coml mgr; Barry Kay, prog dir; Carlton S. Owens, opns mgr & chief engr; Mike McDarby, news dir; Frank W. Strohm, sis mgr.

WCWC-FM—Dec 17, 1959: 100.7 mhz; 3.5 kw. Ant 90 ft. Dups AM 100%. ■ WCWC-TV affil.

Zarephath

***WAWZ**—March 15, 1931: 1380 khz; 5 kw-U, DA-2, (S-WBNX). Box 97 (08890). (201) 469-9200. Pillar of Fire. Format: Relg. Spec progs: Black 1¼ hrs, Ukran 1½ hrs, Sp 4 hrs wkly. ■ Arthur K. White, pres; S. R. Crawford, gen mgr; James M. Pearsall, prog dir; Robert H. Flett, mus dir; Alan Chambers, chief engr.

***WAWZ-FM**—Aug 22, 1954: 99.1 mhz; 37 kw. Ant 570 ft. Stereo. Prog sep from AM. Format: Relg.

CSI ELECTRONICS INC.
2607 River Road
Cinnaminson, New Jersey, 08077
Telephone: (609) 786-1060

New Mexico

Alamogordo 2 FM (As)

KALG

Modern Country Music



KALG—June 28, 1950: 1230 khz; 1 kw-D, 250 w-N, Box 720 (88310). (505) 437-1505. Basin Bcstg Inc. (acq 11-50). Net: MBS. Rep: Messina. Format: C&W ■ Wayne Phelps, pres; Don Thompson, stn & coml mgr, prog dir; Nancy Dale, news dir; Doug Tyler, chief engr. ■ Rates: \$2; 5; 5; 5.

KINN—June 10, 1957: 1270 khz; 1 kw-D. Box 618

New Jersey, New Mexico Radio

See page C-1 for explanation of listings.

(88310). (505) 437-4440. Kinn Inc. (acq 7-1-71). Net: ABC/C. Rep: Savalli/Gates. Format: Contemp. Spec prog: Sp 3 hrs wkly. ■ William R. Lask, pres & gen mgr; Jeff Blipcher, prog dir; Les Fenter, news dir; Wm. R. Lask, chief engr.

Albuquerque

KABQ—1947: 1350 khz; 5 kw-D, 500 w-N, DA-N, Box 4486, 1309 Yale S. E. (87106). (505) 243-1744. Albuquerque Corp. (acq 4-7-72). Rep: Howard; Hix. Format: Spanish. ■ Ed. Gomez, pres; C. T. McKasson, gen mgr; J. Mark Wilkinson, opns mgr; Eliseo Casillas, asst opns mgr; Amparo Garcia, mus dir; Emiliano Herrera, news dir; Hubert Beavers, chief engr.

KAMX—Feb 22, 1971: 1520 khz; 1 kw-D. Box 4150 (87106). (505) 247-0701. Alvin L. Korngold. Net: All Spanish Net. Rep: Savalli/Gates. Format: Spanish. ■ Alvin L. Korngold, licensee; Gloria Sanchez, coml mgr; Alberto Vera, mus dir; Napoleon Gonzales, news dir; Don Davis, chief engr.

KFMG(FM)—Co-owned with KAMX. Not on air, target date March 1976: 107.9 mhz; 5 kw. Ant 495 ft. Rep: Century Time Sls. Format: Progs.

***KANW(FM)**—October 1950: 89.1 mhz; 7.5 kw. Ant minus 19 ft. Box 25704 (87125). (505) 242-7163. Albuquerque Board of Educ. Format: Ed. ■ Julius Beverly, gen mgr, prog dir & chief engr.

KDAZ—1959: 730 khz; 1 kw, DA-D. Box 4338 (87106). (505) 268-4395. Pan-American Bcstg Co. (acq 5-1-65). Rep: Masla. ■ Belarmino R. Gonzales; George A. Gonzales, Carlos K. Espinosa & Carlos L. Jaramilla, co-owners.

KDEF—September 1953: 1150 khz; 5 kw-D, 500 w-N, DA-N, 506 Second St., NW (87102). (505) 247-2333. Desert Horizons Inc. (acq 5-24-73). Group owner: Media Horizons. Net: ABC/C. Rep: Century Natl. Format: MOR. ■ M. Kenneth Cowan, pres; Larry Filkins, gen mgr; Barbara Ransom, bus mgr; Dan Evans, prog dir; Paul Britt, mus dir; Elton Boyd, news dir; I. Daniel Martin, chief engr.

KDEF-FM—June 25, 1961: 94.1 mhz; 1.6 kw. Ant minus 150 ft. Dups AM 50%.

KFMG(FM)—Listing follows KAMX.

KHFM(FM)—November 1954: 96.3 mhz; 3.3 kw. Ant minus 20 ft. Stereo. 5900 Domingo Rd., N.E. (87106). (505) 256-9001. CHE Bcstg Co. Format: Classical. ■ William Weinrod, pres; Brian Flora, stn mgr; Charles Maldonado, prog dir; John Timm, prom mgr; Janet Flora, mus dir; Gary Lain, news dir; Michael Langner, chief engr.

***KIPC(FM)**—Not on air, target date unknown: 91.5 mhz, 8.3 kw. Ant 4160 ft. Stereo. Box 6067 (87107). (202) 243-1395. Albuquerque Public Broadcasting Corp. Net: NPR. Format: Diversified. Spec progs: Navajo & Pueblo 35 hrs wkly. ■ Curtis C. Schultz, gen mgr; Max Rudolph, prog dir; Roxy Gordon, mus dir; Consuelo Burrell, prom mgr; Vic Velarde, news dir.

KKIM—April 15, 1972: 1000 khz; 10 kw-D, 301 Los Ranchos, N.W. (87107). (505) 898-7777. Christian Enterprises (group owner). Format: MOR.

KMYR(FM)—Nov 11, 1963: 99.5 mhz; 19.5 kw. Ant minus 150 ft. Stereo. 4011 Menaul N.E. (87110). (505) 265-7661. Fontana Media Corp. (acq 8-74). Rep: Selcom. Format: Progs. Spec progs: Concerts, interviews 2 hrs wkly. ■ David L. Arnold, pres, gen mgr & chief engr; Janet Van Meter, coml mgr; Frank Cody, prog dir; Jeff Pollack, mus dir; Peter MacKay, prom mgr; Zane Blaney, news dir. ■ Rates: \$8; 8; 10; 10.



KOB—April 5, 1922: 770 khz; 50 kw-U, DA-N, Box 1351 (87103). (505) 243-4411. TWX 910-989-1682. Hubbard Bcstg Inc. (group owner; acq 5-10-57). Net: NBC. Rep: McGavren Guild, Mt. Media. Format: MOR. ■ Stanley E. Hubbard, chmn of bd; Stanley S. Hub-

New Mexico Radio

See page C-1 for explanation of listings.

bard, pres; Ronald L. Sack, gen mgr; Lloyd Barham, coml mgr; Larry Sherman, prog dir; Stan Romero, pub affrs dir; Leo Zani, news dir; Fern Bibeau, chief engr. ■ Rates: \$ 29; 22; 29; 22.

KOB-FM—Aug 1, 1967: 93.3 mhz; 8.2 kw. Ant 4150 ft. Prog sep from AM. Format: Btlf mus. ■ Larry Garcia, coml mgr. ■ KOB-TV affil. ■ Rates: \$16; 16; 16; 16.

KPAR—Dec 16, 1969: 1190 khz; 1 kw-D. Box 2121 (87103). (505) 243-6000. Sun Country Radio Inc. Rep: Torbet. Format: Good mus. ■ Sam E. Pendleton, pres, gen mgr; Dennis Trambly, stn mgr; David Thompson, chief engr.

KPAR-FM—December 1974: 100.3 mhz; 9 kw. Ant 4110 ft.

KQEO—1947: 920 khz; 1 kw-D, 500 w-N, DA-N. 2000 Indian School Rd. N.W. (87104). (505) 247-8188. Swanco Bcstg Inc. Group owner: Swanco Stns. ■ Ken Baugh, VP & gen mgr; Gary Diamond prog dir; Lannon Mintz, sls mgr.

KRKE—March 28, 1928: 610 khz; 5 kw-U, DA-N. Box 737 (87103). (505) 765-5600. Gaylord Bcstg Co. (group owner; acq 11-74). Net: CBS, MBS. Audio news: APR. Rep: Katz. Format: Top 40. ■ Edward L. Gaylord, pres; Dell Wood, gen mgr. ■ Rates: \$24; 19; 24; 19.

KRST (FM)—Listing follows KRZY.

KRZY—June 1956: 1450 khz; 1 kw-D, 250 w-N. Box 3280 (87110). (505) 266-5833. TWX: 910-989-1668. Burroughs Bcstg Co. (acq 5-1-62). Group owner: John Burroughs Stns. Net: CBS. Rep: Buckley. Format: Mod C&W. ■ Ray Moran, pres, gen mgr; Ross Kailey, VP; John Findlay, coml mgr; Tom DiFrancesco, prog dir; Mike Sieglung, mus dir; Guy D. Smith, chief engr. ■ Rates: \$19.50; 17.50; 19.50; 17.50.

KRST (FM)—Co-owned with KRZY. Sept 15, 1965: 92.3 mhz; 9 kw. Ant 4110 ft. (505) 266-7946. Prog sep from AM. Stereo. Format: Progs. ■ Rates: \$11.50; 11.50; 14.50; 14.50.

***KUNM (FM)**—Oct 19, 1966: 90.1 mhz; 8.7 kw. Ant 4,070 ft. Stereo. New Mexico Union, UNM (87131). (505) 277-5227. Regents of the U. of New Mexico. Audio news: UPI. Format: Diversified. Spec prog: Black 5 hrs. Sp 5 hrs, various Indian 3 hrs wkly. ■ Sharon Irish, gen mgr; Annette Griswold, prog dir; Jim Stansbury, news dir; Mike Wolfe, chief engr.

KZIA

News, Talk & Conversation



American Information Radio Network

mutual broadcasting system, inc.



American Entertainment Radio Network

KZIA—May 14, 1956: 1580 khz; 1 kw-D. Box 25166 (87125). (505) 262-1733. Zia Telecommunications (acq 11-67). Net: ABC//E; MBS. Rep: Riley South. Format: Talk, news. Spec prog: Sp 1½ hrs wkly. ■ John Deme, pres, gen & coml mgr; Jay Howard Deme, prog dir; Michael J. Santullo, news dir; Alan P. Deme, chief engr. ■ Rates: \$7.70; 7.70; 7.70; —.

Artesia

KVSP—Nov 14, 1946: 990 khz; 1 kw-D, 250 w-N. 317 W. Quay (88210). (505) 746-2751. Artesia Bcstg Inc. (acq 1948). Net: MBS. Rep: Burn-Smith; Sandeberg-Glenn. Riley Reps; Bob Hix; Wayne-Evans & Assoc. Format: Top 40 & C&W. Spec progs: Sp 8 hrs, farm 2½ hrs wkly. ■ Martin Yates III, pres; Dave Button, gen & prom mgr; Tim Orwig, news dir; Fred Hebert, chief engr. ■ Rates: \$3.50; 3.50; 3.50; 3.50.

KVSP-FM—May 9, 1969: 92.9 mhz; 50 kw. Ant 1,090 ft. Stereo. Prog sep from AM. Format: Btlf music. Rates same as AM.

Aztec 1 FM (C)

KHAP—Sept 4, 1959: 1340 khz; 1 kw-D, 250 w-N. Box 1340 (87410). (505) 334-2266. San Juan Bcstg Corp. (acq 9-74). Rep: Mountain Media; Messina; BW Bcst Sis. Format: C&W. Spec prog: Sp 3 hrs wkly.

Bayard

KNFT
Mountain Media



R
A
B

KNFT—July 4, 1968: 950 khz; 1 kw-D. U.S. 180 East, Silver City (88061). (505) 388-1958. KNFT Inc. (acq 12-31-73). Net: ABC//I. Rep: Mario Messina, Mtn Media. Format: Modern C&W. ■ Keith LeMay, pres, gen mgr & chief engr; Tom Pearson, coml mgr; John Palmer, opns dir. ■ Rates: \$4.55; 4.55; 4.55; 4.55.

Belen 1 FM (A)

KARS—Oct 7, 1961: 860 khz; 250 w-D. Box 860 (87002). (505) 864-7447. Brooks Bcstg Co. (acq 6-25-71). Net: ABC//E. Rep: Mountain Media, Miller. Format: MOR. Spec prog: Sp 1½ hrs wkly. ■ William T. Brooks, pres & gen mgr; Eugene Seibel, chief engr.

Carlsbad

KAVE—Sept 15, 1937: 1240 khz; 1 kw-D, 250 w-N. Box 1538, 101 N. Halagueno St. (88220). (505) 885-8017. Western State Bcstrs Inc. (acq 1-14-71). Format: MOR/rock. ■ Frank Cooke, pres & gen mgr; J. M. Dustin, coml & prom mgr; Jefferson Lyon, prog & mus dir; John Tobola, news dir; O. C. Grube, chief engr.

KBAD—May 17, 1950: 740 khz; 1 kw-D. Box 70 (88220). (505) 885-2151. Radio Carlsbad Inc. (acq 10-6-3). Net: ABC//C. Audio news: APR. Rep: Mario Messina. Format: Mod country. Spec progs: Farm 5 hrs wkly. ■ Robert S. Swayze, pres; Bob Blair, gen mgr; Ed Lyon, prog dir; O. C. Grube, chief engr. ■ Rates: \$4.15; 4.15; 3.10.

KBAD-FM—Sept 15, 1966: 92.1 mhz; 3 kw. Ant 165 ft. Net: ABC//I. Dups AM 80%. Spec prog: Sp 9 hrs wkly. ■ Rates same as AM.

KCCC—July 1, 1966: 930 khz; 1 kw-D. 1206 W. Mermod St. (88220). (505) 887-5521. Klob Broadcasting Co. Rep: Savalli/Gates. Format: C&W. Spec prog: Sp 14 hrs wkly. ■ Marion Jenkins, pres & gen mgr; Laverne Hale, coml & prom mgr; Lyn Alexander, prog & news dir; O. C. Grube, chief engr.

Clayton 1 FM (A)

KLMX—Nov 10, 1949: 1450 khz; 1 kw-D, 250 w-N. Box 547 (88415). (505) 374-2555. Ari-Ne-Mex Bcstg Corp. Rep: Hopewell. ■ Arthur Jernigan, pres; Eli H. Garcia, gen, coml & prom mgr & news dir; Lloyd Eby, chief engr.

Clovis

KCLV—February 1953: 1240 khz; 1 kw-D, 250 w-N. Box 1907, 2112 Thornton (88101). (505) 763-4401. Lonnie D. Alsop (acq 7-1-71). Group owner: Zia Bcstg. Net: ABC//C. Audio news: UPI. Rep: Messina. Format: Top 40. Spec prog: Farm 5 hrs wkly. ■ Lonnie D. Alsop, pres; Jimmy Davis, gen mgr; John Gentry, coml mgr; Jack Crow, prog dir; Terry Moore, news dir; Randall Hays, chief engr. ■ Rates: \$4.25; 4; 4; 2.75.

KICA—1933: 980 khz; 1 kw-U, DA-N. Box K (88101). (505) 763-5511. KICA Inc. (acq 11-1-72). Rep: Savalli/Gates; Riley, Bob Hix. Format: Contemp. Spec progs: Fr 8 hrs; C&W 5 hrs wkly. ■ John Mahaffey, pres; Bill Torbet, gen mgr; Norman Stratton, coml mgr; Keith Ingram, prog & mus dir; Earlene Gunnels, prom mgr; Gary Winter, news dir; William Merryman, chief engr.

KMTY-FM—Jan 8, 1970: 99.1 mhz; 100 kw. Ant 230 ft. Stereo. Box 1890 (88101). (505) 762-3707. Friend Radio Inc. Net: MBS. Rep: Devney. Format: C&W. Spec progs: Farm 20 hrs wkly. ■ Ken White Sr., pres; Mickale Landrith, gen mgr; Kurt Verlei, coml mgr; Loren Nancarrow, prog dir; Kirk Johns mus dir; Valerie Rosat, prom mgr; Karen Stanley, news dir; Bill Merryman, chief engr. ■ Rates: \$5; 5; 5; 5.

KTQM-FM—Listing follows KWKA.

KWKA—1971: 680 khz; 50 w-U, DA-1. Box 926 (88101). (505) 762-4411. Norman E. Petty. Net: CBS. Format: Pop music. ■ Norman Petty, gen mgr.

KTQM-FM—Co-owned with KWKA. March 1, 1963: 99.9 mhz; 50 kw. Ant 300 ft.

Deming 1 FM (A)

KOTS—March 10, 1954: 1230 khz; 1 kw-D, 250 w-N. Drawer 470 (88030). (505) 546-9011. Luna County Bcstg Co. Net: ABC//E. Format: MOR, C&W. Spec prog: Sp 9 hrs wkly. ■ Robert W. Tobey, pres & gen mgr; Bob Bowen, coml mgr & prog & mus dir; Judy White, news dir; Gene Truesdale, chief engr. ■ Rates: \$4.50; 4.50; 4.50; —.

Espanola

KBSO (FM)—Listing follows KDCE.

KDCE—970 khz; 1 kw-D. Box 159 (87532). (505) 753-5970. George A. Gonzales Bcstg Co. (acq 4-26-73). Rep: Gill-Perna; Wallace; Hix. ■ George Gonzales, gen mgr.

KBSO (FM)—Co-owned with KDCE. January, 1975: 102.3 mhz; 1.1 kw. Ant 460 ft.

Farmington

KENN—November 1951: 1390 khz; 5 kw-D, 1 kw-N, DA-N. Box K (87401). (505) 325-3541. KENN-Land Bcstg (acq 3-15-54). Net: ABC//I, Intermountain. Rep: Eastman, IMN. Format: MOR. Spec progs: Navajo 7½ hrs wkly. ■ C. O. "Ken" Kendrick, pres; Bob G. Williams, gen & coml mgr; Tim Stiefried, prog dir; Bob Hunger, mus dir; Helen Sharer, news dir; Miles Davis, chief engr. ■ Rates: \$5.80; 5.80; 5.80; 5.80.

KRAZ (FM)—Listing follows KRZE.

KRWN (FM)—Co-owned with KENN. 1974: 92.9 mhz; 30 kw. Ant 430 ft. Box 1047. (505) 327-4449. Music Men Inc. Prog sep from AM. Format: Btlf mus. Spec prog: Classcl 2 hrs wkly. ■ Rates: \$3.75; 3.75; 3.75; 3.75.

KRZE—July 1, 1958: 1280 khz; 5 kw-D. Box 1529 (87401). (505) 327-9696. E. Boyd Whitney (acq 12-9-67). Audio news: UPI. Format: C&W. ■ E. Boyd Whitney, pres; Dale Felkner, gen, coml mgr & news dir; Gary Beckner, prog, mus dir & prom mgr; Gene Stonebraker, chief engr. ■ Rates: \$66; 66; 66; 66.

KRAZ (FM)—Co-owned with KRZE. Sept 1, 1969: 96.9 mhz; 30 kw. Ant 300 ft. Box G. (505) 327-3696. Prog sep from AM. Format: Oldies, Top 40. ■ Rates: \$21; 21; 21; 21.

KWYK—Aug 1, 1957: 960 khz; 1 kw-D. 1515 W. Main (87401). (505) 325-1996. Basin Bcstg Co. Format: Contemp & Am. Indian. ■ Jim Gomer, ptnr & gen mgr; Bill Wiggleton, prog dir; Homer Pirkey, coml mgr; Wallace Lewis, prom mgr; Dwight Harp, news dir.

Gallup

KGAK—Feb 9, 1945: 1330 khz; 5 kw-D, 1 kw-N, DA-N. 401 E. Coal Ave. (87301). (505) 863-4444. Gallup Bcstg Co. (acq 9-1-67). Net: MBS. Rep: Savalli/Gates, Mountain Media. Format: C&W, MOR, Navajo. ■ Jack B. Chapman, pres & gen mgr; Mark Ramsay, prog dir; Norman Howard, mus dir; John McBrean, news dir; Robert Adamson, chief engr.

KGFL (FM)—Listing follows KYVA.

KQNM (FM)—Co-owned with KGAK. August, 1975: 93.7 mhz; 30 kw. Ant 160 ft.

KYVA—July 15, 1959: 1230 khz; 1 kw-D, 250 w-N. 306 S. First St., Drawer K (87301). (505) 863-6222. KYVA Inc. (acq 2-1-65). Group owner: 2588 Newport Corp. Net: ABC//I, IMN. Rep: Messina. Format: Top 40. Spec progs: Navajo 15 hrs. Sp 3 hrs wkly. ■ Ray Kandel, pres; Robert J. Barnett, gen mgr; Steve Reno prog dir; Sammy Chioda, mus dir & prom mgr; Donna Barnett, news dir; Ted Foster, coml mgr & chief engr. ■ Rates: \$2.40; 2.40; 2.40; 2.40.

KGFL (FM)—Co-owned with KYVA. Oct 6, 1974: 94.5 mhz; 25 kw. Ant 70 ft. Prog sep from AM. Format: C&W. ■ Rates: \$3.50; 3.50; 3.50; 3.50.

1 FM (A) Grants

KMIN—Sept 1, 1956: 980 khz; 1 kw-D. Box 980 (87020). (505) 287-2980. KMIN Inc. (acq 11-1-64). Net: IMN. Format: C&W. ■ Mrs. James B. Barber, pres; Bernard J. Bustos, VP, gen mgr & chief engr; Al Stotts, coml mgr; Chuck Jackson, prog dir; Bernie Bernard, prom mgr; Jean Baca, mus dir; Kathy Johnson, news dir.

Hobbs 1 FM(C)

KHOB—Aug 7, 1954: 1390 kHz; 5 kw-D. Box 40 (88240). (505) 393-5148. Smith Corp. (acq 5-13-74). Rep: Messina. Format: Top 40. ■ Dan Smith, pres & gen mgr; Mel Holborn, sls mgr; Tom Wood, prog dir.

KSCR(FM)—Co-owned with KHOB. August 1965: 95.7 mhz; 36 kw. Ant 115 ft. Stereo. Prog sep from AM. Format: MOR.

KWEW—Aug 8, 1938: 1480 kHz; 5 kw-D, 1 kw-N, DA-N. Box 777 (88240). (505) 393-3137. KWEW Inc. (acq 1951). Net: MBS. Rep: Hix. Format: MOR, variety. Spec progs: Black 1 hr, Sp 2 hrs wkly. ■ Harry McAdams, pres & gen mgr; Gilbert Haugen, stn mgr; Garry Johnston, news dir; Alton Cope, chief engr.

Humble City

KCIA—July 17, 1971: 1110 kHz; 1 kw-D. Box 149 (88251). (505) 392-6546. Media Corp. Net: ABC/E. Rep: Miller. Format: C&W. Spec prog: Black ½ hr wkly. ■ John A. Parry, pres; Barbara McDaniels, coml mgr; Ruby Thornton, news dir; Albert Harkins, chief engr.

KPOE(FM)—Co-owned with KCIA. March 1975: 94.1 mhz; 100 kw. Ant 334 ft. Box 26 (88251). Prog sep from AM.

Las Cruces

KASK Fulltime Stereo Rock

KASK(FM)—December 12, 1974: 103.1 mhz; 780 w. Ant minus 111 ft. Stereo. 1018 First Natl Tower (88001). (505) 524-2103. Logan D. Mathews. Net: ABC/FM. Format: Progs, top 40. ■ Logan D. Mathews, pres & gen mgr; Greg Dvorak, coml mgr; John Forsythe, prog & mus dir; Rodney Norris, chief engr. ■ Rates: \$ 4; 4; 4.

KGRD-FM—Listing follows KGRT.

KGRT—Dec 15, 1955: 570 kHz; 5 kw-D. Box 968 (88001). (505) 526-6681. KGRT Inc. (acq 5-75). Net: ABC/C. Format: Contemp. ■ John B. and Fredna B. Mahaffey, owners; Jack Fargason, coml mgr; Larry Edwards, prog dir; Bob Foster, news dir; Rodney Norris, chief engr.

KGRD-FM—Co-owned with KGRT. Sept 8, 1966: 103.9 mhz; 2.70 kw. Ant 3 ft. Stereo. Prog sep from AM. Format: C&W.

KOBE—April 1947: 1450 kHz; 1 kw-D, 250 w-N. Drawer X (88001). (505) 526-2496. Las Cruces Bcstg. (acq 10-31-64). Audio news: APR. Rep: Mesa, Hix. Format: MOR. Spec progs: Sp 18 hrs, farm 6 hrs wkly. ■ Walter Rubens, pres & gen mgr; Dennis Forsyth, coml mgr; Robert O. Clark, prog dir; Allen Turney, news dir; Richard Pacholski, chief engr. ■ Rates: \$4.75; 4.75; 4.75.

KOPE(FM)—See Mesilla Park.

***KRWG(FM)**—Oct 3, 1964: 90.7 mhz; 100 kw. Ant 350 ft. Stereo. Box 3J, Ctr. for Broadcasting & Intl. Communications (88003). (505) 646-3525. Regents of New Mexico State Univ. Net: ABC, NPR. Format: Classical/ed. Spec prog: Sp 14 hrs wkly. ■ Harold A. Servis, gen mgr; Richard Munoz, Spanish news dir; Fred Dabney, prod dir; Ed Suina, asst news dir; John Athey, prog dir; James Doiron, chief engr.

Las Vegas

***KEDP(FM)**—Oct 1, 1967: 91.1 mhz; 72w. Ant minus 215 ft. New Mexico Highlands Univ. (87701). (505) 425-7511. Ext 363. Board of Regents, New Mexico Highlands Univ. ■ Albert L. Soderblom, gen mgr; Henry Valerio, chief engr.

KFUN—Dec 25, 1941: 1230 kHz; 1 kw-D, 250 w-N. Box 710 (87701). (505) 425-6766. Mark/Way Inc. (acq 5-1-70). Net: MBS. Rep: Savalli-Gates; McGuire. Format: Contemp, Sp, C&W. ■ S. Carl Mark, pres; Dennis D. Mitchell, gen mgr & chief engr; Bill Downs, coml mgr; Fred Baca, Sp prog dir; Mike Edwards, mus dir; Victor Velarde, news dir.

KFUN-FM—June 19, 1973: 100.9 mhz; 3 kw. Ant minus 77 ft. Prog sep from AM. Format: MOR.

Los Alamos

KRSN—Dec 9, 1949: 1490 kHz; 1 kw-D, 250 w-N. Box 749 (87544). (505) 662-4343. Community Bcstg Co. (group owner; acq 11-1-56). Net: ABC/I. Rep: Young, Hix. Spec prog: Classl 20 hrs wkly. ■ Darrel K. Burns, owner, gen & coml mgr; Kay Richardson, prog dir; Larry Burton, news dir.

KRSN-FM—June 1956: 98.5 mhz; 15 kw. Ant 21 ft. Stereo. Dups AM 80%.

Lovington

KLEA—Dec 25, 1952: 630 kHz; 500 w-D. Box 877 (88260). (505) 396-2244. Lea County Bcstg Co. Format: C&W. ■ Iva Lee Worley, pres; Hoyt Caldwell, VP & gen mgr; Betty Shelton, prog dir; Jim Rhea, asst mgr & news dir; Mike Olds, sports dir; Jackie Harrell, chief engr.

KLEA-FM—October 1965: 101.7 mhz; 3 kw. Ant 280 ft. Dups AM 70%.

Mesilla Park

KOPE(FM)—Co-owned with KOBE Las Cruces. June 1, 1974: 104.9 mhz; 3 kw. Ant minus 32 ft. Stereo. Format: Btfl mus. ■ Octavia Zombora, prog dir; Sandy Moncharnok, coml mgr; Pat Lang, news dir. ■ Rates: \$3.25; 3.25; 3.25.

Portales 1 FM(A)

KENM—February 1950: 1450 kHz; 1 kw-D, 250 w-N. Box 886 (88130). (505) 356-6681. Portales Bcstg Co. (acq 1975). Rep: Savalli/Gates. Format: C&W. Spec prog: Farm 4 hrs wkly. ■ Larry Ackers, VP & gen mgr; John McKissack, prog dir; Bedford Forrest, farm & ranch dir.

Ramah

***KTDB(FM)**—April 24, 1972: 89.7 mhz; 2.6 kw. Ant 330 ft. Box 18 (87321). (505) 783-5456. Ramah Navajo School Board. Net: NPR. Format: Variety, community radio serv. 80% Navajo Lang. ■ Chavez Coho, pres; Leonard Eriacho, gen mgr & chief engr; Samuel Henio, prog dir; Olson Piro, opns mgr; Julian Cojo, Dennis Maria, Louise Lorenzo, prods.

Raton 1 FM(A)

KRTN—1948: 1490 kHz; 1 kw-D, 250 w-N. Box 638 (87740). (505) 445-3652. Raton Bcstg Co. (acq 2-66). Rep: Hopewell; Bob Hix. Format: MOR. Spec progs: C&W 9 hrs wkly. ■ James T. Roper, pres, gen mgr; Flolene Roper, prog dir; James T. Roper, news dir; Wallace Clark, chief engr. ■ Rates: \$2.80; 2.80; 2.80.

Roswell 1 FM(C)

KBIM—May 1953: 910 kHz; 5 kw-D, 500 w-N, DA-N. Box 910 (88201). (505) 622-2120. TWX 910-986-0072. Hoisum Inc. Net: ABC/C; ABC/I. Rep: Avery-Knodel; Hix. Format: Contemp. ■ John King, VP & gen mgr; David Simmons, natl sls mgr; Frank Tracy, news dir; Gene Rader, dir of engr. ■ Rates: \$7; 6.50; 7; 6.50.

KBIM-FM—June 1959: 94.9 mhz; 100 kw horiz; 89 kw vert. Ant 1880 ft. Stereo. Prog sep from AM. Format: MOR. ■ KBIM-TV affil. ■ Rates: \$3.60; 3.60; 3.60.

KKAT—March 15, 1927: 1430 kHz; 5 kw-D, 1 kw-N, DA-N, Box 1797, 1621 N. Washington (88201). (505) 623-1430. Pecos Valley Ent. (acq 6-71). Net: CBS. Rep: Messina. Format: Contemp/progsv. ■ Jim Talley, pres & gen mgr; Jerry C. Walker, asst gen mgr; Murray Bush, coml mgr; Charley J. King, mus dir; David Poorbaugh, news dir.

KRDD—1963: 1320 kHz; 1 kw-D. Box 1615 (88201). (505) 623-1330. Reginaldo Espinoza. ■ Reginaldo Espinoza, owner; Eduardo B. Leaton, sls mgr.

KRSY—May 1947: 1230 kHz; 1 kw-D, 250 w-N. Box 1981 (88201). (505) 622-0290. Troy Raymond Moran (acq 11-1-74). Rep: Buckley. Format: C&W, MOR. Spec prog: Farm 6 hrs wkly. ■ Troy Raymond Moran, pres; Jim Clark, gen mgr; Rich Williams, prog dir; Steve Smith, mus dir; Guy Smith, chief engr. ■ Rates: \$7; 6; 7; 2.50.

KWSW—Dec 20, 1965: 1020 kHz; 50 kw-U, N, DA-N. Box 670 (88201). (505) 622-6450. Berrendo Bcstg Co. (acq 12-1-73). Net: NBC. Rep: HR Stone. Format:

New Mexico Radio

See page C-1 for explanation of listings.

MOR. ■ Merle H. Tucker, pres & gen mgr; Ralph K. Berg, coml mgr; Gerald Hedlund, prog dir; Steve Chapman, mus dir; Charley Wells, news dir; Tom Rose, chief engr.

Ruidoso 1 FM(A)

KRRR—November 1959: 1360 kHz; 5 kw-D, DA. Box 39 (88345). (505) 257-7333. Sierra Blanca Bcstg Co. (acq 4-1-65). Audio news: APR. Format: C&W, MOR, diversified. Edward Hyman, pres; Gary M. Hilliard, prog dir. ■ Rates: \$3.70; 3.70; 3.70; —.

Santa Fe

KAFE—June 1966: 810 kHz; 5 kw-D. Box 4097 (87501). (505) 982-4303. Enchanted Land Bcstg Inc. (acq 3-23-71). Rep: Grant-Webb, Hix, Dahlsen. Format: C&W. ■ Dale Wood, pres & gen mgr; Cheryl Wood, coml mgr; Chuck Brown, news dir; Ken Hightower, chief engr. ■ Rates: \$6; 5.25; 5.25; 5.25.

KAFE-FM—March 1969: 97.3 mhz; 28 kw. Ant 80 ft. Prog sep from AM. Format: MOR. ■ Rates: \$3; 3; 3; 3.

KSNM(FM)—Aug 15, 1965: 95.5 mhz; 29.5 kw. Ant 130 ft. Stereo. Drawer E (87501). (505) 982-4424. Ivan R. Head. Rep: Miller. Format: Easy ltnng, classical, jazz. ■ Ivan R. Head, pres & gen mgr, news dir; Ludlow White, prog & mus dir; Neal Storr, chief engr.

KTRC—Feb 20, 1947: 1480 kHz; 1 kw-D, 250 w-N. Box 2227 (87501). (505) 982-2666. Santa Fe Bcstg Co., Inc. (acq 10-1-68). Group owner: KWHK Inc. Net: ABC/I. Rep: Devney, Mtn Media. Format: MOR. Spec prog: Sp 14 hrs wkly. ■ Bill Mitchell, pres; Bill Hanrahan, gen mgr & chief engr; Dave Ward, coml mgr; Phil Moore, prog & mus dir; Duane Meneely, news dir. ■ Rates: \$4.75; 4.75; 4.75; 3.75.

KVSF—1935: 1260 kHz; 1 kw-U. Box 2407 (87501). (505) 982-4455. New Mexico Bcstg Inc. (acq 6-39). Group owner: Harriscope Bcstg Corp (28%). Net: MBS. Rep: Alan Torbet. Format: Top 40/contemp. ■ Bruce A. Hebenstreit, pres; Alfred R. Sena, gen mgr; Michael Brasher, mus dir; Bob Barth, news dir.

Santa Rosa 1 FM(A)

KSYX—Nov 2, 1960: 1420 kHz; 1 kw-D. Drawer K (88435). (505) 472-3808. Tri City Broadcasters Inc. (acq 11-1-68). Net: Keystone. Rep: Mario Messina. Format: Block. Spec prog: Sp 15 hrs wkly. ■ Robert D. Dietrich, pres & gen mgr.

Silver City 1 FM(A)

KSIL—Sept 15, 1946: 1340 kHz; 1 kw-D, 250 w-N. Box 590 (88061). (505) 538-2951. KSIL Inc. (acq 9-65). Net: ABC/C. Rep: Masia, Hix. Format: MOR. Spec prog: Sp 13 hrs wkly. ■ Dennis Behan, pres; Bud McMurray, gen mgr; Dan Stokes, mus dir; Bill Barrett, news dir; Russ Roberts, chief engr. ■ Rates: \$5.80; 5.80; 5.80.

Socorro 1 FM(A)

KSRC—June 20, 1958: 1290 kHz; 1 kw-D. Box 1277 (87801). (505) 835-1290. Socorro Bcstg Co. (acq 6-1-59). Format: C&W, MOR, Spanish. ■ Walter C. Shrode, pres, prog & mus dir; Robert Sparks, chief engr.

Taos

KKIT—Dec 23, 1961: 1340 kHz; 1 kw-D, 250 w-N. Box 665 (87571). (505) 758-2231. TWX 7551-86. Sam Inc. (acq 4-1-65). Net: ABC/C, IMN. Format: Variety. Spec progs: Sp 18 hrs, Tewa (Taos Pueblo Indian) 3 hrs wkly. ■ Stephen A. Machcinski Jr., pres & gen mgr; Barbara C. Machcinski, VP & prog dir; C. G. Cunningham, chief engr.

Truth or Consequences

KCHS—September 1944: 1400 kHz; 250 w-U. Box 351 (87901). (505) 894-2400. Bairdland Bcstg Inc. (acq 3-13-64). Format: C&W. ■ Neil R. Baird Sr., pres, gen mgr & news dir; Robert Fuller, coml mgr; Tom Gius, prog dir.

New Mexico, New York Radio

See page C-1 for explanation of listings.

Tucumcari

KTNM—1941: 1400 khz; 1 kw-D, 250 w-N. Box 668 (88401). (505) 461-0522. Tucumcari Bcstg Inc. (acq 10-1-60). Format: C&W. Spec prog: Sp 12 hrs wkly. ■ S. J. Barnes, pres & gen mgr; Arnett Hooser, coml mgr; Charles Lacy, chief engr.

KTNM-FM—Jan 19, 1968: 92.7 mhz; 3 kw. Ant 64 ft. Prog sep from AM.

New York

Albany

WABY—1934: 1400 khz; 1 kw-D, 250 w-N. 80 Braintree St. (12205). (518) 459-2111. WABY Inc. (acq 11-16-70). Net: ABC/E, ABC/I. Format: Oldies 50%, news 30%, sports 20%. Spec prog: Black 6 hrs, It 1 hr, Greek 1 hr wkly. ■ Robert Badger, VP & gen mgr & prog dir; Chris Martin, coml mgr; Ed Alger, prom mgr; Richard Murray, mus dir; Bruce Williamson, news dir; Bill Hoffman, chief engr. ■ Rates: \$12; 12; 12; 7.

WAMC(FM)—October 1958: 90.3 mhz; 10 kw. Ant 1,970 ft. Albany Medical College of Union U. (518) 445-5306. Net: NPR; EPRN. ■ Albert P. Fredette, gen mgr; Robert K. Wallace, prog dir; J. August Berger, chief engr.

WGNA(FM)—Co-owned with WHAZ Troy. December 1973: 107.7 mhz; 8.8 kw. Ant 980 ft. Box 1069 (12201). (518) 273-6500. WPOW Inc. Group owner: Camp Stns. Format: C&W. ■ John R. Linstra, VP; Buddy Starcher, gen mgr; Gordon Hall, coml mgr; Gary Koster, chief engr; Jay P. Scott, prog dir.

WGY—See Schenectady.

WHAZ—See Troy.

WHRL(FM)—Sept 1, 1966: 103.1 mhz; 1.45 kw horiz, 1.35 kw vert. Ant 400 ft horiz, 390 ft vert. Stereo. Box 333 (12201). (518) 283-1123. Regal Bcstg Corp. Format: Btfl mus. Spec prog: Opera 3 hrs wkly. ■ Robert L. Hill, pres & gen mgr; Lorraine Winkler, coml mgr; Bill Patrick, prog dir; Robert L. Levy, chief engr. ■ Rates: \$8.50; 8.50; 8.50; 8.50.

WHSB-FM

N A F M B

WHSB(FM)—Co-owned with WTRY Troy. Fall 1967: 106.5 mhz; 11.5 kw. Ant 900 ft. Stereo. 92 4th St, Troy (12180). (518) 274-1100. Scott Bcstg Co. (acq 2-1-72). Group owner: Great Scott. Prog sep from AM. Net: MBS. Audio news: APR. Rep: McGavren-Guild Format: Btfl mus. ■ Herb Scott, pres; Richard E. Vazzana, VP & gen mgr; Jon Knott, prog dir. ■ Rates: \$ 16; 16; 16; 16.

WOKO—June 14, 1924: 1460 khz; 5 kw-U, DA-N. Box 1460 (12201). (518) 449-1460. Area Radio Inc. (acq 3-20-68). Group owner: Welcome Radio. Net: ABC/I. Rep: Katz. Format: Modern country. Spec prog: Farm 6 hrs wkly. ■ Harrison M. Fuerst, pres; William A. Musser, VP & gen mgr; Charlie Pitts, prog dir; Joe Gunther, sls mgr; Roz Danto, prom mgr; Bill Brady, pub affrs dir; John Murphy, news dir; Dave Abdo, chief engr. ■ Rates: \$27; 25; 27; 23.

WPTR—May 1948: 1540 khz; 50 kw-U, DA-1. Box 1540, 4243 Albany St. (12205). (518) 456-1144. WPTR Inc. (acq 11-66). Group owner: Rust. Net: ABC/C. Rep: Eastman. ■ William F. Rust Jr., pres; George E. Geib, gen mgr; J. W. Wagner, prog dir; Bruce Wayne, news dir; James Cruise, chief engr. ■ Rates: \$32; 29; 32; 29.

WQBK—See Rensselaer.

WRWO—Sept 30, 1947: 590 khz; 5 kw-D, 1 kw-N. DA-2. Box 590, 341 Northern Blvd. (12204). (518) 436-4841. TWX 710-441-8203. Capital Cities Communications Inc. (group owner; acq 11-3-54). Net: CBS. Rep: Blair. Format: Familiar music. ■ Daniel B.

Burke, pres; Thomas S. Murphy, chmn; Robert M. Peebles, VP & gen mgr; Richard S. Berkson, sls mgr; Ray Heikamp, prog dir; Daniel Bormann, bus mgr; Aaron Shepard, news dir; Bill Olsen, chief engr. ■ Rates: \$50; 40; 45; 30.

WROW-FM—October 1966: 95.5 mhz; 9.4 kw. Ant 950 ft. Stereo. Dups AM 1%. Format: Btfl mus. ■ Rates: \$12; 19; 19; 12.

WTRY—See Troy.

WWOM(FM)—1972: 100.9 mhz; 3 kw. Ant 300 ft. Box 5146 (12205). (518) 456-6101. Metroland Broadcasting Corp. Rep: Selcom. Format: Adult btfl. ■ Orville J. Sather, pres; Joseph A. Reilly, VP, gen mgr; Guss Cawley, gen sls mgr; Ed Reilly, opns mgr; Rich Hill, chief engr. ■ Rates: \$ 23; 24; 23; 15.

Alfred

WALF(FM)—1971: 89.7 mhz; 10 w. Ant 54 ft. Box 811 (14802). (607) 871-2287; 871-2200. Alfred University. Net: ABC/I. Format: Progs. Spec progs: Classical 4 hrs, jazz 4 hrs, Concert Series, 1 hr, Old Time Radio, 1 hr wkly. ■ Barry Stern, gen mgr.

WETD(FM)—March 19, 1973: 91.3 mhz; 10 w. Electrical Engineering Dept., Alfred State College (14802). (607) 871-6357. Educational Foundation of Alfred. Format: Educational. ■ W. David Baker, gen mgr.

Hogan-Feldmann, Inc.
MEDIA BROKERS - CONSULTANTS
16255 Ventura Boulevard, Suite 415
Encino, California 91436
AREA CODE 213 986-3201

Amherst

WUFO—1948: 1080 khz; 1 kw-D. 89 LaSalle Ave. Buffalo, N.Y. (14214). (716) 834-1080. Sheridan Bcstg (group owner; acq 3-1-72). Net: Mutual Black/Nat'l Black. Rep: Howard. Format: Black, R&B. Spec progs: Relig 5 hrs, pub affrs 1 hr wkly. ■ Paul W. Yates, pres; Fred Johnson, gen & prom mgr; Don Mullins, coml mgr; Roy Sampson, prog dir; Bob Wean, chief engr.

Amsterdam

WCSS—April 8, 1948: 1490 khz; 1 kw-D, 250 w-N. Midline Rd. (12010). (518) 843-2500. Community Service Bcstg Corp. Net: ABC/E. Rep: Market 4; James Smith. Format: MOR, contemporary. Spec progs: Polish 2 hrs, Sp 2½ hrs wkly. ■ Philip Spencer, pres & gen mgr; William Pope, coml mgr; James Taylor, prog & mus dir; Roy Frank, news dir; Lloyd Smith, chief engr.

WCSS-FM—Aug 1, 1975: 97.7 mhz; 3 kw. Ant 135 ft. Dups AM 80%. Format: Rock & Gold.

WKOL—1961: 1570 khz; 1 kw-D. Box 3 (12010). (518) 843-1570. WKOL Inc. (acq 1973). Net: MBS. Rep: Market 4 Radio; Dome. Format: C&W. Spec progs: Farm 1 hr; It 3 hrs, Pol 1 hr; relig 3 hrs wkly. ■ Joseph Sabatino, gen mgr; Pat Aragona, stn mgr; Samuel S. Sumner, coml mgr; Bernie Short, prog dir; George Hartwell, news dir; Howard Friedman, chief engr. ■ Rates: \$6.05; 5.50; 6.05; 5.50.

Auburn

WAUB—Dec 24, 1959: 1590 khz; 500 w-D, DA. Box 160 (13021). (315) 253-3040. Cayuga Bcstg Corp. (acq 3-1-62). Net: ABC/I. Format: MOR. Spec progs: Pol 2 hrs; Black 2 hrs wkly. ■ Gerald S. Mirabito, pres; Robert B. Morgan, gen & coml mgr; Jay Lawrence, prog & mus dir; Phyllis Wolniale, prom mgr; Mason Speed, news dir; William D. Bender, chief engr. ■ Rates: \$3.80; 3.80; 3.80; 3.80.

WTDN(FM)—Oct 31, 1972: 88.9 mhz; 10 w. Ant 102 ft. Stereo. Cayuga College (13021). (315) 253-0449. Board of Trustees, Cayuga County Community College. Format: Diversified. Spec prog: Black 3½ hrs, classical 4½ hrs, jazz 3½ hrs, folk 3½ hrs wkly. ■ Dr. Albert T. Skinner, pres; Frank J. Messere, gen mgr.

WMBO—Jan 26, 1927: 1340 khz; 1 kw-D, 250 w-N. Metcalf Plaza (13021). (315) 253-7355. Auburn Media Inc. (acq 10-71). Net: MBS. Rep: Market 4

Radio; Regional Reps. Format: MOR. ■ Floyd J. Keesee, pres & gen mgr; A. J. Hefner, coml mgr; Jeff Long, prog dir; Norma Carbary, prom mgr; Dave Greene, mus dir; Dennis Deninger, news dir. ■ Rates: \$7.50; 7.50; 7.50; 7.50.

WRLX(FM)—Co-owned with WMBO. May 20, 1949: 106.9 mhz; 45 kw. Ant 530 ft. Prog sep from AM. Format: Btfl music. ■ Rates same as AM.

Babylon

WBAB-FM—Listing follows WNYG.

WGLI—September 1958: 1290 khz; 5 kw-D, 1 kw-N. DA-2. 1290 Peconic Ave. (11704). (516) MOhawk 9-1290. WGLI (acq 6-66). Group owner: Beck-Ross. Net: ABC/E. Rep: Masla; Creed. Format: MOR. Spec prog: It'l 4 hrs wkly. ■ Martin F. Beck, pres & gen mgr; Herbert Usenheimer, stn mgr; James E. Champlin, natl sls mgr; Chris Michaels, prog dir; Frank Holliday, asst prog dir; Dick Moore, mus dir; Sandra Toscano, coml mgr; John Allen, news dir; Jerry Mehrab, chief engr. ■ Rates: \$25; 21; 25; 17.

WNYG—Jan 1, 1958: 1440 khz; 1 kw-D. Rt. 109 (11704). (516) 661-4000. Babylon-Bay Shore Bcstg Corp. (acq 2-5-58). Format: Contemp. Spec prog: It'l 5 hr wkly. ■ Muriel Horenstein, pres & gen mgr; Larry Walsh, VP sls; Mark Alan, prog dir; Scott Robbins, mus dir; Tim Ryan, news dir; John Blake, chief engr.

WBAB-FM—Aug 27, 1958: 102.3 mhz; 3 kw. Ant 115 ft. Dups AM 75%.

WTFM(FM)—See Lake Success.

Baldwinsville

WBXL(FM)—Jan 29, 1975: 90.5 mhz; 10 w. Ant 72 ft. East Oneida Southeast Complex (13027). (315) 635-3941. Baldwinsville Central School District. Format: Noncoml diversified. Spec progs: Jazz 2 hrs, C&W 1 hr, It'l ¾ hrs wkly. ■ Donald E. Luce, pres & gen mgr.

WSEN—Feb 25, 1959: 1050 khz; 1 kw-D, DA. Box 1050 (13027). (315) 458-3039. Sentry Communications Inc. (acq 2-22-74). Net: ABC/I. Rep: Masla. Format: C&W. Spec progs: Ger 2 hrs, It'l 2 hrs, Pol 2 hrs, Bl 4 hrs wkly. ■ Roger O'Connor, pres; Jack Burgess, gen mgr & chief engr; Shirley Zakraysek, coml mgr; Jim Shafer, prog dir & prom mgr; Daniel J. Dunn, mus dir; Arnie Pugh, news dir.

WSEN-FM—Nov 10, 1967: 92.1 mhz; 3 kw. Ant 300 ft. Dups AM 90%.

Batavia

WBTA

WALTON FARM RADIO

WBTA—Feb 6, 1941: 1490 khz; 500 w-D, 250 w-N. Alva Place (14020). (716) 344-1490. Batavia Bcstg Corp. (acq 1-1-68). Audio news: APR. Rep: Market 4 Radio. Format: MOR. Spec prog: Farm 15 hrs wkly. ■ William F. Brown Jr., pres, gen mgr & prog dir; William F. Brown III, coml mgr; James H. Gerrety, news dir. ■ Rates: \$10; 10; 10; 6.

Bath

WVIN—Nov 2, 1962: 1380 khz; 500 w-D, 10 Pulteney Sq. (14810) (607) 776-3326. Genkar Inc. (acq 10-74). Rep: PRO/Meeker. Format: Top 40. Spec prog: Swing Era 17 hrs wkly. ■ Morris F. Genthner, pres & gen mgr; Ann D. Genthner, stn mgr; Stephen Rouse, prog dir; Glenn Augustus, news dir; W. J. Sitzman Jr., chief engr. ■ Rates: \$4.50; 4.50; 4.50; 4.50.

Beacon

WBNR—Dec 17, 1959: 1260 khz; 1 kw-D, DA. 475 South Ave. (12508). (914) 831-1260. Beacon Bcstg Corp. (acq 6-1-67). Net: ABC/E. Rep: Masla. Spec progs: It'l 1 hr, Sp 1 hr wkly. ■ Robert E. Lessner, pres & gen mgr; Robert A. Outer, sls mgr; Alford H. Lessner, VP, prog dir & stn mgr; Rick Liotta, mus dir; Henry Gross, news dir; William Rossini, chief engr. ■ Rates: \$16.47; 14.12; 16.47; 14.12.

WFMN(FM)—See Newburgh.

WSPK(FM)—See Poughkeepsie.

Binghamton

WAAL(FM)—March 1954: 99.1 mhz; 7.1 kw. Ant 1,090 ft. Stereo. Box 997 (13902). (607) 723-8989. Butternut Bcstg q 1975). Net: ABC/FM. Format: Adult rock. ■ Fred Tascone, pres; Alfred A. Ruscito, gen mgr; E. A. Berstein, coml mgr; Robert Lindquist, prog dir; Roger L. Funk, chief engr.

WENE—See Endicott.

***WHRW(FM)**—March 1, 1966: 90.5 mhz; 1.45 kw. Ant 47 ft. Stereo. State U. of N.Y. (13901). (607) 798-2137. State Univ of New York. Net: Pacifica. Format: Educal/Diversified. ■ Philip L. Deitch, gen mgr; Diane Smith, news dir; Roger L. Funk, chief engr.

WINR—1946: 680 khz; 1 kw-D, 500 w-N, DA-2. 1913 Vestal Parkway E, Vestal, N.Y. (13850). (607) 754-6565. WINR Bcstg (acq 10-6-75). Net: NBC. Rep: H-R Stone. Format: Contemp. ■ Robert E. Lessner, pres; Alfred H. Lessner, VP; Robert A. Outer, VP; Thomas Shiptenko, stn mgr. ■ Rates: \$22; 19; 22; 17.

WKOP—June 1947: 1360 khz; 5 kw-D, 500 w-N, Box 567 (13902). (607) 722-3437. Andrew Jarema (acq 10-30-74). Net: CBS. Rep: PRO/Meeker. Format: Modern country Spec progs: Ital 2 hrs, Pol 4 hrs, Bl 1 hr, Greek 1 hr w/ky. ■ George Rydos, coml mgr; Charles Austin, prog dir; Steve Geimman, news dir. ■ Rates: \$20; 16; 20; 12.

WNBF—1928: 1290 khz; 5 kw-U, DA-N. Chenango & Henry Sts. (13901). (607) 772-8400. Stoner Bcstg System of New York Inc. (group owner; acq 1972). Net: ABC/I. Rep: Blair. Format: MOR, talk. Spec prog: Black 3 hrs w/ky. ■ Tom Stoner, pres; Gary H. Voss, VP & gen mgr; Carl Wall, news dir; Bill Parker, prog dir; Steve Osufka, chief engr.

WQYT(FM)—Co-owned with WNBF September 1956: 98.1 mhz; 10 kw. Ant 960 ft. Stereo. Prog sep from AM. Format: Btfl mus. ■ James Schulke, mus dir.

***WSKG-FM**—October 1975: 89.3 mhz; 43 kw. Ant 530 ft. Box 97, Endwell, N.Y. (13760). (607) 754-4777. Southern Tier Educational Television Association Inc. Net: NPR. Format: Classical. ■ Arthur F. Dees, pres & gen mgr; Timothy Conroy, dev mgr; Scott Dillard, prog mgr; Joseph Rona, mus lib; Cheryl Stack, comm serv prod; Fred Landerl, news dir; Edward Y. Wright, chief engr. ■ *WSKG(TV) affil.

Boonville

WBRV—June 22, 1955: 900 khz; 1 kw-D. Box 341 (13309). (315) 942-4311. Black River Radio Inc. Format: C&W, MOR, talk, Top 40. ■ Livingston Lansing, pres; David McGrath, gen mgr; Joseph Giblin, coml & prom mgr; George Capron, prog & mus dir; John Isley, news dir; Edward Schnabl, chief engr.

Brentwood

***WXBA(FM)**—June 21, 1975: 88.5 mhz; 10 w. Ant 52 ft. Ross High School (11717). (516) 435-2201. Brentwood Public Schools. Format: Adult diversified. ■ Everett A. Reese, dir.

Brewster

WPUT—March 14, 1963: 1510 khz; 1 kw-D, DA. Prospect Hill Road (10509). (914) 279-7171. Putnam Bcstg Corp. (acq 10-23-68). Net: ABC/E. Rep: GCI Sales Inc. Format: MOR. ■ M. S. Novik, pres; Richard Novik, treas & gen mgr; Ken Stein, prog dir; Eric Gross, news dir.

Briarcliff Manor

WRNW(FM)—April 8, 1960: 107.1 mhz; 3 kw. Ant 330 ft. Stereo. 55 Woodside Ave. (10510). (914) 762-1071. Lake Champlain Bcstg Corp. (acq 1969). Format: Progsrv rock. ■ Joe Newman, pres; Donald Jay Barnett, gen mgr & prog dir; Kent Murphy, coml mgr; Stan Froelich, prom mgr; Tom Kijek, mus dir; Robert S. Jewell, chief engr. ■ Rates: \$15; 12; 12; 15.

Brockport

WADD—Feb 15, 1970: 1560 khz; 1 kw-D, DA. Box 337 (14420). (716) 637-3930. Brockport Bcstg Inc. Net: MBS. Format: MOR. Spec progs: C&W 3 hrs, farm 1 hr w/ky. ■ Erwin L. Duryea, pres; Timothy J. Lyman, gen mgr; Eric Hardenbrook, prog dir; Gary Arnold, news dir. ■ Rates: \$6.75; 6.75; 6.75; —.

***WBKT(FM)**—November 1975: 90.5 mhz; 10 w c/o David W. Field, Senior High School (14420). Brockport Central School District.

Brooklyn

***WNYE(FM)**—See New York.

Brookville

***WCWP(FM)**—April 1965: 88.1 mhz; 100 w. Ant 190 ft. (CP 940 w ver). C. W. Post Center, Greenvale, N.Y. (11548). (516) 299-2626. C. W. Post College of Long Island U. Net: NPR. Format: Diversified. ■ William J. Mozer, dir.

Buffalo

WADV(FM)—Nov 14, 1962: 106.5 mhz; 30 kw. Ant 423 ft. Stereo. 2200 Rand Blvd., Lafayette Sq. (14203). AdverCast Inc. Format: MOR/Personality. ■ Daniel J. Lesniak, pres & coml mgr. ■ Rates: \$16; 20; 20; 16.

WBEN—Sept 8, 1930: 930 khz; 5 kw-U, DA-N. 2077 Elmwood Ave. (14207). (716) 876-0930. WBEN Inc. Net: CBS. Rep: Major Mkt Radio Inc. ■ Leslie G. Arries Jr., pres & gen mgr; Paul A. Butler, stn mgr; Bruce Wexler, prog dir; Robert J. Russo, gen sis mgr; Ronald E. Rice, loc sis mgr; Phil Buchanan, news dir; Gerald Klambunde, chief engr.

WBEN-FM—Nov 11, 1946: 102.5 mhz; 110 kw. Ant 1,350 ft. Prog sep from AM. ■ Edward Tucholka, prog dir. ■ WBEN-TV affil.

***WBFO(FM)**—Jan 7, 1959: 88.7 mhz; 770 w. Ant 230 ft. 3435 Main St. (14214). (716) 831-5393. State U. of New York at Buffalo. Net: NPR. Format: Variety. Spec progs: Sp 2 hrs, Bl 8 hrs w/ky. ■ Marvin F. Granger, gen mgr; Marcia Alvat, prog dir.

WBLK-FM—See Depew.

WBNY(FM)—Nov 11, 1966: 96.1 mhz; 50 kw. Ant 480 ft. Stereo. 2500 Rand Bldg. (14203). (716) 856-3550. McCormick Communications of Buffalo Inc. (group owner; acq 1-8-74). Rep: Buckley Radio Sis. Format: Btfl mus. ■ William M. McCormick, pres; Stuart M. Cohen, gen mgr; Leo Vogel, prog dir; Ward Miller, chief engr.

WBUF(FM)—1947: 92.9 mhz; 94 kw. Ant 570 ft. 1233 Main St. (14209). (716) TT 2-430Q. Functional Bcstg Inc. (acq 4-59). Group owner: Amalgamated Music Enterprises. Rep: Selcom. Format: Progsrv. Spec prog: It 1½ hrs w/ky. ■ Albert Wertheimer, pres; Carl J. Spavento, stn mgr; Bruce Kaplan, lcl sis mgr; Cal Brady, prog dir; Michael Bayba, chief engr. ■ Rates: \$17; 17; 26; 26.

WDCX(FM)—February 1963: 99.5 mhz; 110 kw. Ant 640 ft. 23 North St. (14202). (716) 883-3010. Kimtron Inc. Crawford (group owner). ■ Donald B. Crawford, pres; W. Neale Carr, gen mgr; Milton Ellis, prog dir; Charles Hart, chief engr.

WEBR—Oct 14, 1924: 970 khz; 5 kw-U, DA-1. 23 North St. (14202). (716) 886-0970. Queen City Radio Corp. (acq 8-72). Net: ABC/E. Format: MOR. ■ Larry Levite, pres & gen mgr; Larry Grogan, coml mgr; Steve Lapa, prog dir & prom mgr; Mary Brady, mus dir; John McKay news dir; Don Lange, chief engr. ■ Rates: \$28; 23; 26; 19.

WREZ(FM)—Co-owned with WEBR. June 6, 1960: 94.5 mhz; 105 kw. Ant 710 ft. Dups AM 25%. 23 North St. (14202). (716) 886-0970. WBCE Inc. (acq 12-17-72). Net: ABC/E. Rep: Eastman. Format: Jazz. MOR. ■ Bill McKibben, pres; Larry Grogan, VP sis; Mike Dewey, news dir; Don Lange, tech dir. ■ Rates: \$10; 10; 10; 10.

WGR—May 22, 1922: 550 khz; 5 kw-U, DA-N. 464 Franklin St. (14202). (716) 881-4555. TWX 710-522-1729. Taft Bcstg Co. (group owner; acq 4-1-64). Net: ABC/I. Rep: Katz; Unicom Bcst Sis. Format: MOR. ■ Lawrence Rogers II, pres; Harold Calvin, gen mgr; Larry Anderson, prog dir; Jerry Reo, mus dir; Pam Yost, prom mgr; Bill Hartnett, news dir; Harold Higgins, chief engr. ■ Rates: \$65; 54; 59; 27.

WGRQ(FM)—Co-owned with WGR. Sept 14, 1959: 96.9 mhz; 12.5 kw. Ant 890 ft. 59 Virginia Place (14202). Prog sep from AM. Rep: Katz. Format: Progsrv. ■ John Hayes, stn mgr; John McGhan, prog dir; Roger Christian, mus dir; Frank Stasio, news dir. ■ WGR-TV affil. ■ Rates: \$32; 35; 40; 40.

New York Radio

See page C-1 for explanation of listings.

WKBW—1925: 1520 khz; 50 kw-U, DA-1. 1430 Main St. (14209). (716) 884-5101. Capital Cities Communications Corp. (group owner; acq 1961). Rep: Blair. Format: Contemp. ■ R. Thomas Cronk, VP & gen mgr; Norman Schruttt, gen sis mgr; Robert Harper, prog dir; Jim Quinn, mus dir; James McLaughlin, news dir; Leroy Fiedler, chief engr. ■ WKBW-TV affil. ■ Rates: \$72; 55; 70; 50.

WNIA—See Cheektowaga.

WREZ(FM)—Listing follows WEBR.

WWOL—1947: 1120 khz; 1 kw-D. Lafayette Hotel, Lafayette Sq. (14203). (716) 854-1120. Radio Buffalo Inc. (acq 12-1-62). Group owner: Rust Craft. Net: NBC. Rep: GCI. Format: C&W. Spec progs: Ger 3 hrs, Ital 1½ hrs, Pol 3 hrs, Greek 2 hrs w/ky. ■ Marshall Berkman, pres; Aden Joshua McElveen, gen mgr; David Snow, prog & mus dir; Tom Hill, prom mgr; Dick Spaulding, news dir; Walter Williams, chief engr. ■ Rates: \$18; 16; 18; 16.

WWOL-FM—1954: 104.1 mhz; 50 kw. Ant 250 ft. Dups AM 80%. ■ Rates same as AM.

WYSL—1934: 1400 khz; 1 kw-D, 250 w-N. 425 Franklin St. (14202). (716) 854-1400. Howard Communications (acq 1074). Net: ABC/C. Rep: Masla. Format: Top 40. ■ Robert Howard, pres & gen mgr; Warren M. Kelly, VP & stn mgr; Prosper Azerraf, gen sis mgr; Harvey M. Moore, prog & mus dir; Virginia Quigley, VP & opns dir; William Dolan, news dir; Dick Gideon, chief engr. ■ Rates: \$42; 37; 42; 37.

WYSL-FM—1947: 103.3 mhz; 49 kw. Ant 340 ft. Stereo. Dups AM 50%. Format: Top 40. ■ Rates same as AM.

Canandaigua

WCGR—April 5, 1961: 1550 khz; 250 w-D. Box 155 (14424). (315) 394-1550. Canandaigua Bcstg Co. Net: ABC/E. Rep: Regional Reps. Format: MOR. Spec progs: Talk 5 hrs w/ky. ■ George Kimble, pres & gen mgr; Rus Kimble, VP & news dir; Chuck Kraushaar, mus dir; Al Rossi, prom mgr; Jim Herendence, sis mgr; Frank Shoupe, chief engr. ■ Rates: \$4.75; 4.75; 4.75; 4.75.

WFLC(FM)—July 16, 1974: 102.3 mhz; 3 kw. Ant 285 ft. Prog sep from AM. Format: C&W. ■ Rates: \$4.50; 4.50; 4.50; 4.50.

Canton

***WLSU(FM)**—December 1964: 96.7 mhz; 2.6 kw. Ant 310 ft. Stereo. St. Lawrence U. (13617). (315) 379-5356 or 379-6302. St. Lawrence U. Net: NPR; NPRN. Format: Classcl, pub affrs, limited MOR, jazz. Spec prog: Instr medical conference, 4 hrs w/ky. ■ Richard D. Hutto, bcstg dir & gen mgr; James A. Arvidson, prog coord & opns mgr; Jacqueline Sharpe, news & pub affrs dir; Francis P. Murphy, chief engr.

Catskill

WCKL—Feb 6, 1970: 560 khz; 1 kw-D, DA. Box 445 (12414). (518) 943-5464. Caranje Bcstg Co. Rep: Market 4. Format: MOR. Spec prog: Ger ½ hr, Ital ½ hr, Pol ½ hr w/ky. ■ Carmine A. Pizza, pres & gen mgr; Vincent Kelly, coml mgr; Guy Garachan, prog dir; Lance Wheeler, prom mgr; Roger Lawrence, news dir; George Samsel, chief engr. ■ Rates: \$7.45; 6.30; 7.45; 6.30.

Central Square

***WCSO(FM)**—May 2, 1961: 89.3 mhz; 1.5 kw. Ant 81 ft. Paul V. Moore High School (13036). (315) 668-6993. Central Square Central School District #1. Format: Variety. ■ Hugh B. White, dir.

Cheektowaga

WNIA—August 1956: 1230 khz; 550 w-D, 250 w-N. 2900 Genesee St., Buffalo, N.Y. (14225). (716) 894-1230. Niagara Bcstg System. Rep: Masla. Spec prog: Pol 3 hrs w/ky. ■ Gordon P. Brown, owner & gen mgr; Mary Lounsbury, prog dir; Sybilla A. Reber, prom mgr.

Cherry Valley

WJIV(FM)—1948: 101.9 mhz; 7.1 kw. Ant 1,080 ft.

New York Radio

See page C-1 for explanation of listings.

Box 490, Oneida, N.Y. (13421). (315) 363-6052. Christian Bcstg Network (group owner). ■ Rates: \$5.20; 5.20; 5.20; 5.20.

Clinton

***WHCL-FM**—Feb 18, 1963: 88.7 mhz; 10 w. Ant 220 ft. Box 82, Hamilton College (13323). (315) 859-7200. The Trustees of Hamilton College. Format: Progs. Spec progs: C&W 6 hrs; jazz 6 hrs, classcl 20 hrs wkly ■ Gary Buonanno, gen mgr.

Corning

WCBA—1949: 1350 khz; 1 kw-D. Box 1047 (14830). (607) 962-4646. WCBA Radio Inc. (acq 9-56). Rep: Market 4. Audio news: UPI. Format: Contemp. ■ Joyce B. Carpenter, pres; Dean Slack, gen mgr; Pat Holden, coml mgr; Paul Clarke, prog & mus dir; David Game, news dir; H. A. Broneous, chief engr.

WCLI—November 1949: 1450 khz; 1 kw-D, 250 w-N. Box 100 (14830). (607) 962-2424. Radio Corning Inc. (acq 9-16-53). Net: MBS. Rep: Dore. Format: MOR. ■ Gordon M. Jenkins, pres & gen mgr; F. R. Dal Gray, coml mgr & prom mgr; George P. Droelle, stn mgr & prog dir; Bernard Hamilton, chief engr; Dick Martin, news dir. ■ Rates: \$6.25; 5.75; 6.25; 5.

WCLI-FM—May 1947: 106.1 mhz; 22 kw horiz, 18 kw vert. Ant 540 ft. Dups AM 70%. ■ Rates same as AM.

***WCEB(FM)**—April 30, 1974: 91.9 mhz; 10 w. Ant 93 ft. Box 200, Corning Community College (14830). (607) 962-9330. Corning Community College. Format: Rock. ■ Randy Horton, pres & gen mgr; George Huffsmith, prog dir.

Cornwall

WWLE—Nov 22, 1969: 1170 khz; 1 kw-D, DA. 240 Hudson St. (12520). (914) 534-7854. WWLE Inc. (acq 4-28-71). Net: ABC/I. Rep: Market 4. Format: MOR, nostalgia. Spec prog: C&W 12 hrs wkly. ■ Paul Lofaro, exec VP & gen mgr; Robert J. Maines Jr., dir stn opns; Spencer Wade, mus dir; John Roberts, prog dir; Charles M. Mayr, news dir. ■ Rates: \$11.50; 11.50; 11.50; 11.50.

Cortland

WKRT—Nov 15, 1947: 920 khz; 1 kw-D, 500 w-N, DA-N. Box 746 (13045). (607) 756-2828. Radio Cortland Inc. (acq 7-22-50). Net: Yankee. Rep: Market 4. Format: MOR. Spec progs: Ital 1 hr; C&W 1 hr wkly. ■ Leighton A. Hope, pres; William L. Thompson, gen, coml & prom mgr & prog dir; Edward P. Hogan, mus dir; James Mc Nerney, news dir; Bruce Mackey, chief engr.

WKRT-FM—Nov 15, 1947: 99.9 mhz; 14 kw. Ant 710 ft. Dups AM 100%.

Depew

WBLK-FM—December 1964: 93.7 mhz; 50 kw. Ant 400 ft. 814 Rand Bldg., Buffalo, N.Y. (14203). (716) 852-3500. WBLK Bcstg Corp. Rep: Dore; Carpenter. Format: Black. ■ Franklin W. Lorez, pres & stn mgr; George Murray, chief engr.

DeRuyter

WOIV(FM)—1948: 105.1 mhz; 42 kw. Ant 540 ft. Box 490, Oneida, N.Y. (13421). (315) 363-6052. Christian Bcstg Network (group owner). ■ Rates: \$5.20; 5.20; 5.20; 5.20.

Dix Hills

***WYDC(FM)**—Not on air, target date 11-74: 88.9 mhz; 10 w. Ant 100 ft. 100 Duryea Rd., Melville, N.Y. (11746). (516) 293-2468. Half Hollow Hills Youth Development Corp. Format: Ed. ■ Frank Petralito, pres; John Flanagan, gen mgr & news dir.

Dundee

WFLR—Oct 1, 1956: 1570 khz; 1 kw-D. Box 22, Penn Yan, N.Y. (14527). (315) 536-4454. Finger Lakes Bcstg Inc. Rep: Market 4, Regional Reps. Format: MOR. ■ Henry Valent, pres; Robert N. Burns, gen mgr;

John C. Clancy, stn mgr; Robert William Nenno, sis mgr; William Sitzman, chief engr; Robert Penrod, news dir.

WFLR-FM—Aug 20, 1968: 95.9 mhz; 930 w. Ant 460 ft. Dups AM 90%.

Dunkirk

WDOE—Dec 24, 1949: 1410 khz; 1 kw-D, 500 w-N, DA-N. Willow Rd. (14048). (716) 366-1410. Lake Shore Bcstg Co. (acq 2-1-57). Group owner: Goldman. Net: ABC/I; N.Y. State Net. Rep: Masla. Format: MOR, contemp. ■ Simon Goldman, pres; R. David Ridgeway, VP & gen mgr; Carl Duane, stn mgr; Eric Chase, prog dir; Jerry Kittle, news dir; Carl Riddlebarger, chief engr.

East Syracuse

WYRD—See Syracuse.

Ellenville

WELV—December 1964: 1370 khz; 500 w-D. Box 309 (12428). (914) 647-5678. Catskill Bcstg Corp. Net: ABC/E. Rep: Masla. Format: MOR, C&W. Spec progs: Ger 2 hrs; Ital 1 hr; Pol 12 hrs; Hebrew 4 hrs wkly. ■ Sy Dresner, pres; Alfred Dresner, gen mgr; Dot Chase, coml mgr; Bob Mangles, prog dir; Ted Allen, prom mgr; Dan Williams, news dir; Wes Wood, chief engr.

WELV-FM—August 1971: 99.3 mhz; 3 kw. Ant minus 320 ft. Dups AM 100%.

Elmira

***WECW(FM)**—Jan 19, 1959: 88.1 mhz; 10 w. Elmira College (14901). (607) 734-3911. Elmira College. Net: ABC/FM; NPR. Format: Progs, educl, classical. Spec prog: Jazz 6 hrs wkly. ■ Edward Subkis, gen mgr.

WEHH—See Elmira Heights.

WEHH-FM—Aug 1, 1966: 94.3 mhz; 950 w. Ant 480 ft. Box 2097 (14903). (607) 739-5422. Elmira Heights-Horseheads Bcstg Co. Prog sep from WEHH. Net: MBS. Format: Good mus. ■ Frank P. Saia, gen & coml mgr, prog dir & chief engr; Mark D. Saia, mus dir; Jeff Strailay, news dir.

WELM—April 1947: 1410 khz; 1 kw-D, 500 w-N, DA-N. 1705 Lake Rd. (14902). (607) 733-5626. Condit Communications (acq 1975). Net: CBS. Rep: PRO/Meeker. Format: MOR, contemp. Spec progs: Pol 1 hr; BI 1 hr wkly. ■ Charles P. LeMieux, owner. Robert A. Chalk, VP & gen mgr; Marty Chalk, sis dir; Ronald Ferro, prog dir; Paul Williams, news dir; Jon Toombs, chief engr.

WENY—1939: 1230 khz; 1 kw-D; 250 w-N. Box 208 (14902). (607) 739-0344. WENY Inc. (acq 9-21-61). Group owner: Green Group. Net: NBC. Rep: Selcom. Format: Contemp. ■ Howard L. Green, exec VP & gen mgr; Ted Hodge, stn & prom mgr; Steve Christy, prog dir; Jay Flannery, mus dir; Vincent Murphy, news dir; Wes Thompson, chief engr. ■ Rates: \$14; 13; 14; 10.

WENY-FM—Aug 15, 1965: 92.7 mhz; 700 w. Ant 560 ft. Prog sep from AM. Format: Bltl mus. Spec prog: Jazz 2 hrs wkly. ■ WENY-TV affil. ■ Rates: \$5.30; 5.30; 5.30; 5.30.

Elmira Heights

WEHH—July 4, 1956: 1590 khz; 500 w-D. Box 2097, (14903). (607) 739-5422. Elmira Heights-Horseheads Bcstg Co. Net: MBS. Format: MOR. ■ Frank P. Saia, gen & coml mgr, prog dir & chief engr; Mark P. Saia, mus dir; Jeff Strailay, news dir. ■ Rates: \$3; 3; 3; 3.

WEHH-FM—See Elmira.

Endicott

WENE—September 1947: 1430 khz; 5 kw-U, DA-N. 909 E. Main St. (13760). (607) 785-3351. January Enterprises (acq 8-1-66). Group owner: Merv Griffin. Net: ABC/C. Rep: Torbet-Lasker. Format: Top 40. Spec prog: Farm ½ hr, Black ½ hr wkly. ■ Merv Griffin, pres; Steven B. Labunski, exec VP; William Knudson, gen mgr; Fred Merrin, prog dir; John Carter, mus dir; Steve Craig, news dir; Jack Fischler, chief engr.

WMRV(FM)—Co-owned with WENE. 1969: 105.7 mhz; 35 kw. Ant 570 ft. Stereo. Prog sep from AM. Format: MOR.

Fredonia

WBUX—August 1958: 1570 khz; 250 w-D. 27 E. Main St. (14063). (716) 672-2157. Catoctin Bcstg Inc. (acq 2-26-75). Net: MBS. Rep: Market 4, Air Time. Format: MOR, contemp, talk. Spec progs: talk, polka prog, Pol 1½ hrs wkly. ■ Lauren A. Colby, pres; Henry R. Serafin, VP & gen mgr & prog dir; Leo Lehnen, coml mgr; Ed Scott, mus dir; Jim Gardner, news dir; Robert Kovacs, chief engr.

Freeport

WGBB—August 1924: 1240 khz; 1 kw-D, 250 w-N. 1240 Broadcast Plaza, Merrick, N.Y. (11566). (516) 623-1240. Nassau Radio Corp. (acq 5-21-65). Group owner: Susquehanna. Rep: Torbet; Greater NY Radio Sis. Format: MOR, variety, contemp. ■ Louis J. Appell Jr., pres; Louis Faust, VP & gen mgr; Arthur W. Carlson, VP; Bob Lawrence, prog dir; Mark Cooper, sis mgr; Jerry Scott, news dir; Al Lush, chief engr. ■ Rates: \$40; 30; 37; 30.

Fulton

WKFM(FM)—Listing follows WOSC.

WOSC—August 1949: 1300 khz; 1 kw-D. 1 W. Bridge St., Oswego, N.Y. (13126). (315) 343-2630. Cassill Radio Corp. (acq 8-54). Net: MBS. Format: MOR. Spec prog: Farm 2 hrs, Pol 2 hrs, C&W 18 hrs wkly. ■ Robert L. Rooney, VP, gen mgr & chief engr; Nelson Guyette, prog dir; Bob Stewart, mus dir; Carl Dunn, news dir. ■ Rates: \$7; 4.25; 5.50; 4.25.

WKFM(FM)—Co-owned with WOSC. Aug 1, 1961: 104.7 mhz; 50 kw. Ant 310 ft. Stereo. Radio Park (13069). (315) 695-2165. Prog sep from AM. Rep: Selcom. Format: Rock. ■ Robert Rooney, sis mgr; George Burns, prog dir. ■ Rates: \$8; 6; 10; 8.

Garden City

***WBAU(FM)**—July 31, 1972: 90.3 mhz; 390 w. Ant 155 ft. ST-*WHPC(FM). Box 365 (11530). (516) 747-4757. Adelphi University. Format: Variety. Spec progs: Blues 4 hrs, BI 6 hrs, classcl 6 hrs, jazz 4 hrs, talk 10½ hrs, folk 4 hrs, Pol 1 hr, informational 21 hrs wkly. ■ Graeme Bond, gen mgr; Diane Rau, prom mgr; Susan O'Connell, mus & prog dir; John Schmidt, tech dir; John Williams, news dir.

***WHPC(FM)**—Oct 12, 1972: 90.3 mhz; 390 w. Ant 155 ft. ST-*WBAU(FM) Nassau Community College (11530). (516) 742-0600 (ext 607). Nassau Community College. Format: Informational, ed, variety. ■ Michael Balas, gen mgr; Ralph Paul, stn mgr; James Green, prog dir; Steve Greco, opns dir; James Allsopp, chief engr.

WLIR(FM)—Oct 28, 1959: 92.7 mhz; 3 kw. Ant 285 ft. Stereo. 175 Fulton Ave., Hempstead, N.Y. (11550). (516) 485-9200. Stereo Bcstrs Inc. Format: Progs. ■ John R. Rieger, pres & gen mgr; Elton L. Spitzer, stn mgr; Zim Barstein, prom mgr; Paul Robinson, prog dir; Gil Colquitt, mus dir; Ed Zeidner, news dir; Gerald Mehrab, chief engr. ■ Rates: \$33; 28; 33; 33.

Geneseo

***WGSU(FM)**—Feb 18, 1963: 89.3 mhz; 1.8 kw. Ant 11 ft. State University College (14454). (716) 245-5586. State U. of New York. Format: Ed. ■ John Davlin, gen mgr & prog dir; Fred Ambrose, chief engr.

Geneva

WECQ(FM)—1974: 101.7 mhz; 3 kw. Ant 125 ft. Box 213 (14456). (315) 781-1101. Buccaneer Broadcasting Ltd.

WEOS-FM—Sept 1, 1974: 89.7 mhz; 460 w. Ant minus 8 ft (CP 1.5 kw). (14456). (315) 789-8970. The Colleges of the Seneca. Net: NPR. Format: Progs. Spec progs: bl 6 hrs, C&W 3 hrs wkly. ■ Dr. Alan A. Kuusisto, pres; James M. Kias, gen mgr.

WGVA—1947: 1240 khz; 1 kw-D, 250 w-N. Box 526 (14456). (315) 781-1240. Radio Geneva Inc. (acq 4-15-71). Net: ABC/C. Rep: Market 4. Format: MOR. Spec progs: Sp 1 hr, farm 6 hrs wkly. ■ Milton Jacobson, pres; Donald P. Rich, gen mgr; Lee O'Day, prog dir; Ray Donalds, mus dir; William Sitsman, chief engr. ■ Rates: \$7.70; 7.15; 7.70; 7.15.

Glens Falls



Glens Falls

WBZA—May 28, 1959: 1410 kHz; 1 kw-D. Box 928 (12801). (518) 792-2151. Pathfinder Communications Corp. (4-71). Format: MOR. Spec prog: Farm ½ hr wkly. ■ Dennis H. Curley, pres & gen mgr; Gary McNulty, sls mgr; David J. Story, prog dir; Paul Van Amburgh, stn mgr; Jim Scott, news dir; David Cockrell, chief engr. ■ Rates: \$9.90; 8.90; 9.90; 8.90.

WBZA-FM—June 26, 1967: 107.1 mhz; 3 kw. Ant minus 14 ft. Stereo. Prog sep from AM. Format: C&W. ■ Nancy Crannell, prog dir. ■ Rates same as AM.

WWSG—Dec 18, 1946: 1450 kHz; 1 kw-D, 250 w-N. 217 Dix Ave. (12801). (518) 793-4444. Normandy Bcstg Corp. (acq 7-1-59). Net: ABC/E. Format: Personality. MOR, talk. Spec prog: C&W 16 hrs wkly. ■ Christopher P. Lynch, pres & gen mgr; Don Weaver, coml & prom mgr; Henry Lizewskie, prog & mus dir; Kip Grant, news dir; Dave Covey, chief engr.

WWSG-FM—September 1967: 95.9 mhz; 3 kw. Ant 920 ft. Dups AM 100%.

Gloversville

WENT—July 1, 1944: 1340 kHz; 1 kw-D, 250 w-N. Harrison St, RM (12078). (518) 725-7175. Dean Bcstg Co. (acq 6-1-75). Net: CBS. Rep: Market 4. Format: MOR. Spec progs: Itat 2 hrs, Farm 2 hrs, Black 1 hr, Community Line 5 hrs, Women 1½ hrs wkly. ■ Richard D. Ruby, pres; Lawrence D. Peck, VP & gen mgr; Joan T. Bubela, asst mgr; Doris Conroy, prom mgr; Peter R. Bucky, prog dir; John Markiewicz, mus dir; John M. Reich, news dir; Lloyd Smith, chief engr. ■ Rates: \$4; 4; 4; 4.

Gouverneur

WIGS—July 15, 1964: 1230 kHz; 1 kw-D, 250 w-N. 40 Church St. (13624). (315) 287-1230. DeHart Bcstg Corp. (acq 1974). Audio news: APR. Rep: PRO/Meeker. Format: Farm, MOR. ■ Robert W. Hartshorn, pres; Mike Joyce, mus dir; John Friot, news dir; Ron Pasha, chief engr. ■ Rates: \$4.75; 4.75; 4.75; 4.75.

WIGS-FM—Dec 5, 1967: 92.7 mhz; 3 kw. Ant 62 ft. Dups AM 100%. ■ Rates same as AM.

Greece

***WGMC(FM)**—Nov 1, 1973: 90.1 mhz; 10 w. Box 7197 (14515). (716) 225-5330. Board of Education of Greece Central School District Number One. Format: Community, ed. Spec progs: Farm 1 hr, Classical 1 hr, Jazz 3 hrs, C&W 2 hrs wkly. ■ Louis Betstadt, stn mgr; Vivian King, prog dir.

Hamilton

***WRCU-FM**—March 22, 1970: 90.1 mhz; 1 kw. Ant 112 ft. WRCU-FM (13346). (315) 824-4377. Colgate University. Audio news: UPI. Format: Progs. Spec progs: Black 2½ hrs, Sp 2½ hrs, Womenspeak 1 hr, Caribbean 1 hr, Jazz 5 hrs, Folk 2½ hrs, News 10 hrs, Classi 5½ hrs, Oldies 1½ hrs wkly. ■ John Hoyns, gen mgr; A. Peter Gregory, prog dir; David Stonchill, bus mgr; Clint Cole, tech dir; Andrew Sapiro, mus dir; Susan Lee, news dir; James Lloyd, chief engr.

Hammondsport

WVIN-FM—Co-owned with WVIN Bath. Oct 10, 1971: 98.3 mhz; 1.7 kw. Ant 390 ft. Stereo. Dups AM 100%. Bully Hill Rd. (14840). (607) 868-3206. Genkar Inc (acq 10-74). ■ Rates: \$4.50; 4.50; 4.50; 4.50.

Hempstead

WHLI—July 22, 1947: 1100 kHz; 10 kw-D, DA. 384 Clinton St. (11372). (516) IV 1-8000. FM Bcstg Corp. Rep: Masla & Co. Format: Contemp, MOR. ■ Paul Godofsky, pres & gen mgr; Joseph A. Lenn, exec VP sls; Jerry Carr, prog dir; Stephen Godofsky, prom mgr & mus dir; Howard Loeb, news dir; Richard Silvera, chief engr. ■ Rates: \$37; 30; 37; —.

WIOK(FM)—July 22, 1957: 98.3 mhz; 3 kw. Ant 330 ft. Stereo, quad. Prog sep from AM. (516) 481-0798. Format: Btfl mus. ■ Rates: \$21; 21; 21; 21.

***VWHC(FM)**—May 11, 1959: 88.7 mhz; 320 w. Ant 105 ft. (CP: 470 w horiz, 110 w vert. Ant 190 ft). Hofstra U. (11550). (516) 489-8870, 560-3389. Hofstra U. Format: Educl. Spec progs: Fr ½ hr, Pol 2½ hr, Sp 1 hr; Black 2 hrs; Radio drama 2½ hrs, C&W 1 hr; Jazz 7 hrs; Classcl 6 hrs; Swing mus 2 hrs wkly. ■ Phillip Selby, stn mgr; Jeffrey C. Kraus, gen mgr; James Emmerich, prog dir; Rob Wilson, mus dir; Janet Pearl, news dir; Linda Daileader, PR; Gerry Laytin, prog opns dir; Theodore Ronneburger, chief engr.

Henrietta

***WITR(FM)**—April 12, 1975: 89.7 mhz. 10 w. Ant 134 ft. Stereo. Box 9969 (14623). (716) 464-2000. Rochester Institute of Technology. Format: Progs. Spec progs: Black 4 hrs, Jazz 8 hrs wkly. ■ Randy Drawas, gen mgr.

***WRHR(FM)**—1974: 90.5 mhz. 10 w. Ant 45 ft. Central School District No. 1. (14467). (716) 334-7745. Format: Educl. ■ Richard Tracy, stn mgr.

Herkimer

WALY—October 1956: 1420 kHz; 1 kw-D. Box 511 (13350). (315) 866-1420. Owego Community Service Bcstg (acq 7-1-72). Net: MBS. Rep: Market 4; Jim Smith. Format: MOR. ■ Phillip Spencer, pres & gen mgr; Robert Kinum, stn & coml mgr; Mark Fuller, prog dir; Stan Joseph, news dir; Lloyd Smith, chief engr.

Hornell

WWHO—1949: 1320 kHz; 5 kw-D. Box 624 (14843). (607) 324-2000. Steuben Broadcasters Inc. (acq 10-1-68). Audio news: UPI. Rep: Masla; Regional Reps. Format: MOR. ■ Jonas Termin, pres & gen mgr; Donald C. Hartman, VP & coml mgr; John Meschi, prog & mus dir; Dolores Dytche, news dir; James Parker, chief engr. ■ Rates: \$10; 10; 10; 10.

WWHO-FM—1946: 105.3 mhz; 8.3 kw. Ant 560 ft. Dups AM 68%. Format: Variety. ■ Rates same as AM.

WLEA—September 1951: 1480 kHz; 1 kw-D. Glenwood Hill Rd. (14843). (607) 324-1480. Patricus Enterprises Inc. Net: ABC/E. Format: Btfl music, talk. ■ Kevin P. Doran, pres, gen mgr; Carol Strobel, office mgr; Fred Witter, chief engr. ■ Rates: \$6.20; 5.05; 6.20; 4.50.

Horseheads

WIQT Beautiful Music

WIQT—May 7, 1967: 1000 kHz; 1 kw-D. Box 288 (14845). (607) 739-3555. Chemung County Radio Inc. Net: ABC/E; NY Farm. Rep: Market 4; New England Spot Sls; Messina. Format: Btfl music. ■ John A. Arikian, pres; Richard R. Ferry, gen & coml mgr; David Ridenhour, prog dir; Bill Statham, news dir; Ray Bird, mus dir; Doug Christy, prom mgr; Robert Gauss, chief engr. ■ Rates: \$13; 11; 13; 8.

WQIX(FM)—Co-owned with WIQT. July 4, 1970: 100.9 mhz; 3 kw. Ant 245 ft. Stereo. (607) 739-0771. Progs sep from AM. Net: ABC/FM. Format: Modern country. Spec prog: Farm 7 hrs wkly. ■ Rates: \$12; 10; 12; 7.

Hudson

WHUC—1947: 1230 kHz; 1 kw-D, 250 w-N. Union Turnpike (12534). (518) 828-3341. Colgreen Bcstg Co. (acq 1-1-58). Net: ABC/I. Format: Contemp. Spec progs: Pol 1 hr wkly. ■ Albert Heit, pres; W. Irving Rose, gen & coml mgr; Jared Willets, prog dir; Jack Rose, news dir; Henry Ellenbogen, chief engr. ■ Rates: \$7.50; 7.50; 7.50; 7.50.

WHUC-FM—Jan 20, 1969: 93.5 mhz; 3 kw. Ant minus 15 ft. Dups AM 100%. ■ Rates same as AM.

Huntington

WGSM—Sept 1, 1951: 740 kHz; 5 kw-D, DA. 1 kw-CR-D. Box 740 (11746). (516) 423-6740. WGSM Radio Inc. (acq 5-12-65). Group owner: Greater Media. Rep: Torbet; Greater NY Radio. ■ Peter A. Bordes, pres; Richard J. Scholem, gen mgr; Marion Ellis, coml mgr; Jim Ferguson, prog dir; Mike Eau Claire, news dir; Harold Kneller, chief engr.

New York Radio

See page C-1 for explanation of listings.

Hyde Park

WHVW—July 4, 1963: 950 kHz; 500 w-D. Box 95 (12538). (914) 454-1020. Castle Communications Corp. (group owner; acq 3-6-75). Format: Contemp. ■ James F. O'Grady Jr., pres; Ronald M. Gilbert, gen mgr; Thomas Shovan, prog & mus dir; Michael Bennett, news dir; David Groth, chief engr. ■ Rates: \$13; 10; 12; 10.

WHVW-FM—Aug 18, 1970: 97.7 mhz; 3 kw. Ant 300 ft. Stereo. Prog sep from AM. Format: Btfl mus. ■ Rates: \$6; 6.50; 6.50; 6.50.

Islip

WLIX—1960: 540 kHz; 250 w-D. 2960 Sunrise Hwy. E. Islip (11730). (516) 277-1100. L. I. Bcstg Corp. (acq 2-1-67). Rep: Market 4. Format: Familiar Favorites. Spec progs: C&W 3 hrs, Itat 4 hrs wkly. ■ Malcolm E. Smith Jr., pres; Harry Greenburg, gen mgr; Warren Green, prog dir; Lyndon R. Snyder, chief engr. ■ Rates: \$28; 26; 28; —.

Ithaca

WEIV(FM)—1948: 103.7 mhz; 12 kw. Ant 890 ft. Drawer G (14850). (607) 278-8080. TWX 510-255-9304. Christian Bcstg Network Inc. (group owner; acq 1-1-69). Rep: Adam Young. Format: Contemp, MOR, gospel. ■ M. G. Robertson, pres; Eric Au-Coin, gen mgr; James Wall, coml mgr; Bill Freeman, opns mgr; William Covert, chief engr. ■ Rates: \$5.20; 5.20; 5.20; 5.20.

WHCU—1922: 870 kHz; 5 kw-D, DA. Box 69 (14850). (607) 272-2345. Cornell University. Net: CBS. Audio news: UPI. Rep: Market 4. Format: Diversified. Spec prog: Farm 1 hr wkly. ■ Don Martin, gen mgr; Rudy Paolangel, coml mgr; Barbara Hall, women's edit; Pamela Kern, news dir; Tom Joseph, mus dir; Robert Denison, chief engr. ■ Rates: \$10.60; 10.60; 9.40; 8.25.

WHCU-FM—1947: 97.3 mhz; 52 kw. Ant 730 ft. Stereo. Dups AM 20%. Format: Educl, classcl, black. Spec prog: Farm 1 hr wkly. ■ Rates: \$ 10.60; 7.05; 7.05; 6.

***WICB(FM)**—Jan 14, 1947: 91.7 mhz; 10 w. (CP: 5.5 kw. Ant 105 ft). South Hill Broadcast Center (14850). (607) 274-3216. Ithaca College. Net: ABC/C. Format: Diversified. Spec prog: Black 5 hrs wkly. ■ Dr. James Whalen, pres; Rudy Paolangel, gen mgr.

WTKO Contemporary Music

WTKO—April 1956: 1470 kHz; 1 kw-D, 500 w-N, DA-N. Box 10 (14850). (607) 272-9040. WTKO Radio Inc. Net: ABC/I. Format: Contemp. Spec progs: Black 5 hrs, C&W 10 hrs wkly. ■ Ellis E. Erdman, chmn of the bd; Robert Newman, pres; Phebe W. Erdman, VP; John Regan, asst VP; opns; James Stevenson, asst VP sls; Gordon Francis, chief engr; Robert Lynch, news dir.

WVBR-FM—June 4, 1958: 93.5 mhz; 3 kw. Ant 250 ft. 227 Linden Ave. (14850). (607): 273-4000. Cornell Radio Guild Inc. Stereo. Net: ABC/FM. Rep: NEAS. Format: Progs rock. Spec progs: Black 7 hrs; C&W 4 hrs; jazz 4 hrs; folk 6 hrs, oldies 4 hrs wkly. ■ Glen M. Schiller, pres & gen mgr; Jose A. Perez, sls mgr; Thomas L. Cummings, coml & prom mgr; Gordon Clark, prog dir; Roberta Haber, mus dir; Brad Kalbfeld, news dir; Bruce Laskin, chief engr.

Jamestown

WHUG(FM)—Listing follows WKSN.

WJTN—October 1924: 1240 kHz; 500 w-D, 250 w-N. Box 1139 (14701). (716) 487-1151. James Bcstg Inc. (acq 1955). Group owner: Goldman. Net: ABC/E. Rep: Masla; Eckles & Queen; Regional Reps. Format: MOR. Spec progs: Itat 1 hr; Sp 1 hr; Swed 2 hrs wkly. ■ Simon Goldman, pres; J. Carl Willems, gen mgr; Merrill Rosen, sls mgr; George Pflieger, prog dir; Almon Hazard, news dir; Herbert Niklaus, chief engr. ■ Rates: \$9.30; 8.10; 9.30; 8.10.

WJSE(FM)—Co-owned with WJTN. October 1947:

New York Radio

See page C-1 for explanation of listings.

93.3 mhz; 11 kw. Ant 640 ft. Dups AM 9%. ■ Rates: \$5; 4.60; 4.60; 4.60.

WKSN—Jan 26, 1948: 1340 khz; 250 w-U. Box 1199 (14701). (716) 484-9191. Trend Bcstg Inc. (acq 3-18-71). Rep: PRO/Meeker; Dome-Messervey. Format: Contemp. Spec progs: Talk 5 hrs wkly. ■ Warren A. Koerbel, pres & gen mgr; Ted Abbott, prog dir; Michael J. Felice, stn mgr; Dan Fischer, ops mgr; Burton O. Waterman, chief engr. ■ Rates: \$8.25; 7.50; 8.25; 7.50.

WHUG(FM)—Co-owned with WKSN. Feb 1, 1965: 101.7 mhz; 2.9 kw. Ant 300 ft. Stereo. Prog sep from AM. Net: ABC/FM. Format: Btlf mus. ■ Rates: \$4; 4; 4.

WWSE(FM)—Listing follows WJTN.

Johnstown

WIZR—1964: 930 khz; 1 kw-D. Box 307 (12095). (518) 762-4631 or 829-7112. Street Bcstg Corp. (acq 8-15-74). Audio news: APR. Rep: Masla. Format: MOR; Top 40. Spec prog: Sports 3-10 hrs wkly. ■ Richard I. Street, pres; Dean Edwards, gen mgr; Art Simmons, sls mgr; Gael Joyal, ops mgr; Bob Gaylor, mus dir; Dan Dickson, news dir; Elaine Ordon, traf mgr; Edward Johnson, chief engr. ■ Rates: \$9.50; 7; 8.25; 4.95.

WIZR-FM—June 26, 1968: 104.9 mhz; 3 kw. Ant 300 ft. Dups AM 90%. Format: Contemp, sports 10%. ■ Rates same as AM.

Kingston

WBPM(FM)—Listing follows WGHQ.

WGHQ

Independent—MOR

WGHQ—March 4, 1956: 920 khz; 5 kw-D, DA. UPO 427 (12401). (914) 331-8200. Historic Hudson Valley Radio Inc. (acq 1975). Rep: Masla. Format: MOR. Spec progs: Ger ½ hr, relg 8 hrs, farm 1 hr wkly. ■ Harry M. Thayer, pres; Walter C. Maxwell, exec VP; Tony Bell, sls mgr; Bill Skilling, prog & mus dir; Steve Boutelle, news dir; Dick Hyatt, chief engr. ■ Rates: \$14; 12; 14; —.

WBPM

Stereo Rock

WBPM(FM)—Co-owned with WGHQ. Dec 13, 1965: 94.3 mhz; 760 w. Ant 540 ft. Stereo. 82 John St. (12402). (914) 331-8202. Prog sep from AM. Format: Oldies, Top 40. ■ Dick Hyatt, prog dir, chief engr; John Nichols, news dir. ■ Rates: \$11.50; 11.50; 11.50; 11.50.

WKNY—Aug 1, 1935: 1490 khz; 1 kw-D, 250 w-N. 212 Fair St. (12401). (914) 331-1490. Kingstons Bcstrs Inc. (acq 11-63). Group owner: Regional Bcstrs. Net: CBS. Rep: Torbet. Format: Contemp, MOR. Spec progs: Ger 1 hr; Pol 1 hr; Black 1 hr; C&W 17 hrs wkly. ■ Joseph Shuler, stn mgr; Dave Ocker, sls mgr; Gale Sharrat, office mgr; John Belaudier, prog dir; Mark Allen, mus dir; Ward Todd, news dir; Henry Ellenbogen, chief engr.

WKOT—Aug 5, 1959: 1550 khz; 500 w-D. Box 280 (12401). (914) 331-6300. Town & Country Bcstg Corp. (acq 6-30-73). Net: ABC/E. Rep: Michael Fullford; New England Spot Sls. Format: Country modern. Spec progs: Black 1 hr, Ital 1 hr wkly. ■ Gordon G. Zellner, pres, gen & coml mgr; Warren Robinson, mus dir & prom mgr; Tony Angelo, news & pub affrs dir; Ronald J. Meyer, chief engr.

Lake Placid

WIRD—Nov 21, 1961: 920 khz; 5 kw-D. Box 831 (12946). (518) 523-3341. WIRD Inc. (acq 2-11-74). Rep: Gill-Perna. Format: MOR, top 40. Spec prog: C&W 18 hrs wkly. ■ Donald A. Nardiello, pres, gen & coml mgr; Robert Mack, prog, mus & news dir; Henry Premo, chief engr.

Lake Ronkonkoma

***WSHR(FM)**—January 1968: 91.9 mhz; 1.85 kw. Ant

145 ft. Smith Road (11779). (516) 737-3000. Board of Education, Central School District 5. Format: MOR, Top 40, educ. Spec progs: Classical 3 hrs, It 1 hr, jazz 1 hr, Sp 1 hr, C&W 2 hrs wkly. ■ Stuart Harris, faculty advsr & chief engr; Paul D. Birek, asst; Ellen Crum, personnel svcs; Debbie Lenane, gen mgr; Scott Gennett, prog dir; Wendy Marlbor, mus dir; Ed Lenane, news dir; David Russo, tech dir.

Lake Success

WTFM(FM)—Nov 25, 1961: 103.5 mhz; 7.1 kw horiz, 4.6 kw vert. Ant 960 ft horiz, 950 ft vert. Stereo. 173-15 Long Island Expressway, Fresh Meadows, N.Y. (11365). (212) 357-8000. WTFM Inc. Format: Btlf music. Spec progs: GTE Hour 5 hrs, London Phase 4 1 hr wkly. ■ Sidney Horne, VP & gen mgr; Robert Zidel, sls mgr; Gerald Janes, prog dir; Fred Darwin, news dir; Lawrence Strasser, chief engr.

Lancaster

***WSMH-FM**—1974: 91.3 mhz; 10 w. St. Mary's High School (14086).

WXRL

Modern Country Music



mutual broadcasting system, inc.

WXRL—Jan 17, 1965: 1300 khz; 1 kw-D, DA. 5360 William St. (14086). (716) 684-4142. Dome Bcstg (acq 11-1-70). Net: MBS. Format: Modern country. Spec progs: Ital 1 hr; Pol 8 hrs; Sp 2 hrs, farm 5 hrs wkly. ■ Louis A. Schriver, pres, gen & coml mgr; Joan C. Schriver, prog dir; Joan Davis, traf mgr; Armand Cory Jr, news dir; Joanie Marshall, mus dir; Robert Shane, chief engr. ■ Rates: \$12; 12; 15; 11.

Liberty

WVOS—1947: 1240 khz; 1 kw-D, 250 w-N. Box 150 (12754). (914) 292-5533. Sullivan County Bcstg Corp. (acq 1949). Format: MOR. Spec progs: Farm 1 hr, C&W 14 hrs, Telephone Talk Show 4 hrs wkly. ■ Seymour D. Lubin, pres; Harry G. Borwick, treas; William B. Orr, coml mgr; John Carlini, chief engr. ■ Rates: \$17.50; 17.50; 17.50; 15.75.

WVOS-FM—December 1964: 95.9 mhz; 600 w horiz, 590 w vert. Ant 588 ft. Dups AM 75%. ■ Rates same as AM.

Little Falls

WLFH—June 10, 1951: 1230 khz; 1 kw-D, 250 w-N, DA-2. 341 South Second St. (13365). (315) 823-1230. RBT Bcstg Corp. (acq 7-10-73). Net: ABC/E. Format: Contemp, C&W. Spec progs: Ital 3 hrs; Pol 5 hrs, Bl 1 hr, classical 1 hr, farm 3 hrs, jazz 4 hrs wkly. ■ Klem Walters, pres & gen mgr; Alfred F. Vesp, prog dir; Jim Brady, coml mgr; Terry Walters, prom mgr; Richard Richman, mus dir; Bruce Allan, news dir; Doug Kehrig, chief engr. ■ Rates: \$6.50; 6; 6.50; 5.

Lockport

WLVL—May 8, 1947: 1340 khz; 1 kw-D, 250 w-N, DA-D. 320 Michigan St. (14094). (716) 433-5944. Hall Communications (group owner: acq 5/70). Net: ABC/I. Format: Btlf mus. ■ Robert Hall, pres; Donald Lauffer, VP; David Reese, gen mgr; Chuck Nellis, prog dir; Gary Drake, news dir; Leon Urban, chief engr. ■ Rates: \$99; 99; 99; 99.

Loudonville

***WVCR-FM**—April 26, 1963: 88.3 mhz; 370 w. Ant 790 ft. (CP: 360 w. Ant 860 ft). Siena College (12211). (518) 783-2402. Siena College. Format: Progs rock, ed. Spec progs: Bl 12 hrs, classical 3 hrs, jazz 2 hrs, Pol 1 hr wkly. ■ Rev. Matthew Conlin, pres; Nicholas Bruno, gen mgr; Kule Colonnese, bus mgr; Mark Carros, asst mgr; Joseph Camerino, ops mgr; Rory MacPherson, prog dir; Ellen Flahive, mus dir; Walter Laskos, news dir; David Rodman, chief engr.

Malone

WICY—Nov 4, 1946: 1490 khz; 1 kw-D, 250 w-N. WICY Bldg, Porter Rd. (12953). (518) 483-1100. North Country Bcstg Co. Inc. Net: MBS. Rep: Dore;

Regional Reps. Format: MOR, rock. ■ Mitchell C. Tackley, pres & gen mgr; Alice M. Pelkey, coml mgr; Donald J. Paye, prog & news dir; Adolph Stromer, chief engr.

Massena

WMSA—Oct 12, 1945: 1340 khz; 1 kw-D, 250 w-N. Box 210 (13662). (315) 769-3594. Brockway Co. Net: ABC/E. Format: Contemp. ■ John B. Johnson, pres; James W. Higgins, gen mgr; Tony C. Malara, dir of bcstg; Sam Frazier, coml & prom mgr, mus, news & prog dir, chief engr.

WYBG—Oct 19, 1958: 1050 khz; 1 kw-D. Sheraton Inn (13662). (315) 764-0554. Twin Tier Bcstg (acq 10-14-67). Rep: Piano. Format: Contemp, C&W, variety. ■ M. Desisti, pres; Nat Natali, gen mgr; A. Orlando, VP; John Stevens, news dir; Bill Robbins, chief engr. ■ Rates: \$3.35; 3.35; 3.35; 3.35.

Mechanicville

WMVI—Not on air, target date unknown: 1170 khz; 250 w-D. 117 Bajart Place, Yonkers, N.Y. (10705). (518) YO 5-1968. Mechanicville Bcstg Co. Format: MOR, local news. ■ Ralph Nardella Jr, pres; John Farina, gen mgr; Allan Wise, prog dir; Robert Meiners, chief engr.

Middletown

WALL—Aug 6, 1942: 1340 khz; 1 kw-D, 250 w-N. 62 North St. (10940). (914) 342-3917. Castle Communications Corp. (acq 7-30-71). Audio news: AP. Rep: Torbet. Format: Contemp. Spec prog: Pol 1½ hrs, Farm 1½ hrs wkly. ■ James F. O'Grady Jr, pres & gen mgr; Joseph J. Madden, treas & bus mgr; John Zaimes, sls mgr; David Charity, prog dir; Albert Larson Jr., news dir; Patricia M. O'Grady, cmnty rel dir; Leighton M. Nickerson, chief engr. ■ Rates: \$18; 15; 18; 15.

WALL-FM—Nov 11, 1966: 92.7 mhz; 3 kw. Ant 190 ft. Stereo. Prog sep from AM. Format: Btlf mus. Spec progs: Classical 2 hrs, Quad 2 hrs wkly. ■ Arthur Livesey, prog dir. ■ Rates: \$10; 10; 10; 10.

WTBQ—See Warwick.

Mineola

WTHE—Jan 1, 1964: 1520 khz; 1 kw-D (250 w CH). 266 Maple Place (11501). (516) 742-1520. Bursam Communications Corp. (acq 7-11-69). Group owner: Universal. Net: ABC/I. Format: C&W. Spec progs: Sp 10 hrs; Black 10 hrs; Greek 3 hrs wkly. ■ Richard L. Winslow, gen mgr; Lee G. Philips, coml mgr, prog dir, news dir; Hella Newell, mus dir; Lee G. Philips, prom mgr; George T. Adee II, chief engr.

Montour Falls

WXXY(FM)—Co-owned with WGMF Watkins Glen. March 1, 1973: 104.9 mhz; 1 kw. Ant 410 ft. Stereo. Box 577 (14865). (607) 739-3448. Watkins Glen-Montour Falls Bcstg Corp. Rep: Market 4. Format: Solid Gold. ■ Doris Packwood, pres & gen mgr; Joseph Fazzary, dir of sls; Patricia Bilinski, coml & ops mgr. ■ Rates: \$10; 9; 10; 9.

Mount Kisco

WVIP—Oct 27, 1957: 1310 khz; 5 kw-D, DA. Box 608 (10549). (914) 241-1310. VIP Bcstg Corp. (acq 7-22-66). Net: ABC/I. Rep: Masla. Format: Easy Istng. MOR. ■ Martin Stone, pres; Kenneth R. Harris, exec VP & gen mgr; Helen Horowitz, traf & coml mgr; Michael Sarnoff, news dir; Willard Draper, chief engr. ■ Rates: \$24; 19; 24; 15.

WVIP-FM—Jan 15, 1964: 106.3 mhz; 1.2 kw. Ant 440 ft. Stereo. Dups AM 50%. ■ Rates same as AM.

Nanuet

WKOW—See Spring Valley.

WACK—Oct 19, 1957: 1420 khz; 500 w-D. 110 East Union St. (14513). (315) 331-1420. Pembroke Pines Inc. (acq 11-1-72). Net: ABC/I. Rep: Market 4. Format: MOR. Spec progs: Bl ½ hr, Sp 1 hr wkly. ■ Robert Pluntner, pres; Russell A. Martin, stn mgr; William Powley, coml mgr; Harry Waldbilbig, prom mgr; David W. Peters, prog & mus dir; Alexis Muller, chief engr.

Newburgh

WFMN—Listing follows WGNV.

WGNY—Feb 25, 1933: 1220 khz; 5 kw-D, DA. Box 591 (12550). (914) 561-2131. Hudson Horizons (acq 2-18-68). Group owner: Media Horizons. Rep: Century National Sis. Format: MOR. Spec progs: Black ½ hr wkly ■ Kenneth Cowan, pres; Campbell K. Thompson, gen mgr; Michael T. Burns, coml mgr; Jeffery Topps, mus & prog dir; William Schweizer, news dir; Arthur M. Reynolds, chief engr. ■ Rates: \$15.50; 11.75; 15.50;

WFMN(FM)—Co-owned with WGNY. Oct 29, 1966: 103.1 mhz; 3 kw. Ant 200 ft. Box J (12550). Stereo Newburgh Inc. (acq 4-1-73). Progs sep from AM. Format: Good mus. ■ Rates: \$6.50; 8.50; 9.50; 6.50.

New City

WRKL—July 4, 1964: 910 khz; 1 kw-D, DA. 169 N. Main St. (10956). (914) 354-2000. Rockland Bcstrs. (acq 6-69). Rep: Market 4 Radio. Format: MOR. ■ B. Ramey, owner; Matt Ricciardi, gen & coml mgr; Peter Brooks, prog dir; Steven Possell, mus dir; John Russell Trunzo, news dir; Larry Beavers, chief engr.

New Rochelle

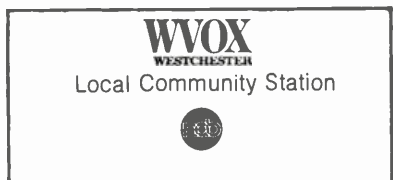

WVOX—1950: 1460 khz; 500 w-D. One Broadcast Forum (10801). (914) 636-1460. Hudson-Westchester Radio Inc. (group owner; acq 5-1-68). Net: MBS. Rep: Marv Roslin; Hudson-Westchester Radio Sis. Format: Suburban cmnly stn. Spec progs: Ger 4 hrs; Ital 4 hrs; Pol 2 hrs; Black 1 hr; open line 5 hrs wkly. ■ William O'Shaughnessy, pres & chmn; Jean T. Ensign, exec VP & stn mgr; Mark Mason, VP & ops mgr; Otto Miller III, dir sts dev; Robert French, coml mgr; Ray LeFebvre, dir of cmnty svcs; Judy Fremont, VP & creative dir; Cameron Connell, bus mgr; Mark Mason, ops mgr; Peter Allen, mus dir; Randy Berlage, news dir; Ann Thayer O'Shaughnessy, sec-treas; Seymour Sinuk, chief engr. ■ Rates: \$19; 13; 16; 10.

WVOX-FM—1953: 93.5 mhz; 3 kw. Ant 145 ft. Dups AM 60%.

New York

TO BUY OR SELL A

TELEVISION OR RADIO STATION

HAMILTON-LANDIS & ASSOC., Inc.

WASHINGTON, D.C.	CHICAGO
1730 K St., N.W. (202) 393-3456	1429 Tribune Tower (312) 337-2754
SAN FRANCISCO	DALLAS
111 Sutter St. (415) 392-5671	6060 N. Central Expy. (214) 691-2345

NATIONWIDE • NEGOTIATIONS FINANCING • APPRAISALS

WABC—Oct 7, 1921: 770 khz; 50 kw-U. 1330 Ave. of the Americas (10019). (212) LT 1-7777. TWX 212-640-4540. ABC Inc. (group owner; acq 2-9-53). Net: ABC/C. Rep: Blair. Format: Programed for mass appeal. ■ Elton Rule, pres (ABC Inc.); Robert Biernecki, gen sls mgr; Alfred Racco, VP & gen mgr; Rick Sklar, dir, stn ops; Harold L. Neal Jr., (pres, ABC Radio); Charles A. DeBare (pres ABC O&D); Neil Atkinson, sls mgr; Pat Pantoni, prog mgr; Paul Ehrlich, news dir; Winston Lloyd, chief engr.

WPLJ(FM)—Co-owned with WABC. Jan 18, 1960: 95.5 mhz; 4.6 kw. Ant 1300 ft. Stereo. Progs sep from AM. Net: ABC/FM. Format: Mass appeal; album oriented rock. ■ Willard Lochridge, gen mgr; Larry

Berger, prog dir; Donna Albertal, coml mgr; Larry Divney, sls mgr; Russ King, opns dir. ■ WABC-TV affil.

WADO—March 12, 1934: 1280 khz; 5 kw-U, DA-1. 205 E. 42nd St. (10017). (212) 983-8824. Bartell Bcstrs of New York Inc. (group owner; acq 8-18-59). Audio news: UPI. Format: Spanish. ■ Nelson G. Lavergne, VP & gen mgr; Bem Morales, sls mgr; Luis Feliciano, prog dir; Angel Richardson, news dir; Philip Greenstone, chief engr. ■ Rates: \$75; 60; 50; 40.

***WBAI(FM)**—1954: 99.5 mhz; 5.4 kw horiz, 3.85 kw vert. Ant 1220 ft. Stereo. 359 E. 62d St. (10021). (212) 826-0800. Pacifica Foundation (group owner; acq 1-9-60). Format: Educational-eclectic. ■ David B. Finkel, pres; Edwin A. Goodman, chmn; Larry Josephson, gen mgr; Dick Demenus, prod dir; Marnie Mueller, prog dir; Richard Rosenblum, prom mgr; Judy Sherman, mus dir; Kathy Dobbin, asst to the mgr; Charles Ruas, drama & lit dir; Mike Edl, chief engr.

WBLS(FM)—Listing follows WLBI.

WBNX—1927: 1380 khz; 5 kw, DA-1 (ST-WAWZ Zarephath, N.J.). 801 Second Ave. (10017). (212) 594-1380. United Bcstg Co. of New York (group owner; acq 12-4-60). Rep: UBC Sis. Format: Contemp/Spanish, Ital. Spec progs: Fr ½ hr wkly. ■ Richard Eaton, pres; Howard Weiss, gen mgr; Elsa Eaton, VP; Manolo Iglesias, news dir; Leon Lloyd, chief engr.

WCBS—1924: 880 khz; 50 kw-U. 51 W. 52d St. (10019). (212) 765-4321. CBS Inc. (group owner). TWX 212-640-6080. Net: CBS. Rep: CBS Radio Spot Sales. Format: All-news. ■ Sam C. Digges, pres; David L. Nelson, VP & gen mgr; Lou Adler, dir of news; Winifred Mullen, dir of info service; Ernest McDaniel, dir of opns.

WCBS-FM—1941: 101.1 mhz; 4.6 kw. Ant 1,300 ft. (CP: 3.6 kw. Ant 1,420 ft.). Prog sep from AM. Rep: CBS/FM Sis. Format: Solid Gold Rock. ■ James R. McQuade, gen mgr; William Brown, prog dir; Michael T. Purcell, prom dir; Debbie Meehan, mus dir; Amy Goldberg, commun. aff dir; William Gilliland, news dir. ■ WCBS-TV affil.

WEVD—May 1927: 1330 khz; 5 kw, DA-2 (ST-WPOW New York). 1700 Broadway (10019). (212) 757-0880. Forward Assoc. Inc. Format: Ethnic. ■ Israel Breslow, pres; Joel J. Plavin, gen mgr; Danny Stiles, sls mgr; William Gunther, mus dir; David Niles, prog dir; Norma Greenstein, assoc prog dir; David Winter, chief engr.

WEVD-FM—1950: 97.9 mhz; 5.3 kw horiz, 3.8 kw vert. Ant 1,220 ft.

***WFUV(FM)**—July 1947: 90.7 mhz; 50 kw. Ant 215 ft. Fordham U., Bronx, N.Y. (10458). (212) 933-2233. Fordham U. Net: ABC/E. Format: Classical, contemp, educ. Spec progs: Fr 1 hr; Haitian 1 hr; Black 5 hrs wkly. ■ Frank A. Seitz, gen mgr; Steven Polrone, prog dir; Mike Fornatale, mus dir; James Curry, news dir; Robert S. Jewell, chief engr.

WHN—1922: 1050 khz; 50 kw-U, DA-1. 400 Park Ave. (10022). (212) 898-1000. TWX 710-589-4402. Storer Radio Inc. (group owner; acq 1-5-62). Net: ABC/E. Rep: Buckley. Format: Modern country. ■ John D. Kelly, VP & gen mgr; John Mazer, opns mgr; John P. Newman, dir prom publicity; Robert Mounty, gen sls mgr; Vern Hendrickson, N.Y. sls mgr; Steve Warner, mus dir; Mike Prelee, news dir; William Dunkin, chief engr.

WHOM—1930: 1480 khz; 5 kw-U, DA-2. 136 W. 52d St. (10019). (212) Circle 6-3900. SJR Communications (group owner; acq 1974). Rep: Savalli/Gates. Format: Spanish. Spec progs: Ger 6 hrs; Ital 6 hrs wkly. ■ Arthur Shaer, gen mgr; Ralph Costantino, prog dir.

WKTU(FM)—Co-owned with WHOM. 1951: 92.3 mhz; 5.4 kw horiz, 3.8 kw vert. Ant 1220 ft. Stereo. Dups AM 20%.

WINS—1924: 1010 khz; 50 kw-U, DA-1. 90 Park Ave. (10016). (212) 867-5100. Westinghouse Bcstg Co. (group owner; acq 7-26-62). Rep: Radio Adv Reps. Format: News. ■ Donald H. McGannon, chmn & pres; Robert W. Dickey, gen mgr; Robert C. McKee, Jr., gen sls mgr; Sherrie Sutton, prom mgr; Bill Scott, exec ed; Adam Powell, Ed Richards, news dirs. ■ Rates: \$235; 80; 125; 50.

***WKCR-FM**—April 1956: 89.9 mhz; 3.8 kw. Ant 640 ft. Stereo. (CP: 700 w. Ant 1370 ft.). 595 W. 114th St. (10027). (212) 280-5011. Trustees of Columbia U. in the City of N.Y. Format: noncoml diversified. Spec progs: Sp 9 hrs; C&W 2½ hrs, Haitian 2½ hrs wkly. ■

New York Radio

See page C-1 for explanation of listings.

Richard Scheinin, pres; Joseph N. Graif, gen mgr; Kenneth Howitt, bus mgr; Fred Kameny, prog dir; Susan Giles, prom mgr; Leonard Gordon, news dir; Richard Rohr, chief engr.

WKTU(FM)—Listing follows WHOM.

WLBI—1942: 1190 khz; 10 kw-U, DA-1, L WOWO, Ft. Wayne, Ind. 310 Lenox Ave. at 125th St. (10027). (212) 831-1000. Inner City Bcstg Corp. (acq 7-72). Rep: Dore; Ochs; Adv Sis. West. Format: Community oriented. ■ Carl H. McCall, pres; Bill Taylor, gen mgr; John Williams, gen sls mgr.

WBLS(FM)—Co-owned with WLBI. Sept 15, 1965: 107.5 mhz; 2 kw horiz, 1.45 kw vert. Ant 1,220 ft. 801 Second Ave. (10017). (212) 725-4500. ICBC Corp. (acq 1974). Net: MBS/Black. Rep: Ochs. Format: Music. ■ Frankie Crocker, prog dir.

WMCA—1925: 570 khz; 5 kw-U, DA-1. 888 7th Ave. (10019). (212) 586-5700. Straus Communications Inc. (acq 11-43). Net: ABC/I, MBS. Rep: Eastman. Format: Telephone talk. ■ R. Peter Straus, pres; Gary Lewis, gen sls mgr; Ruth Meyer, opns mgr; Barbara Burns, prom mgr; John Pate, chief engr. ■ Rates: \$155; 100; 155; 80.

WNBC
MOR (adult contemporary)

WNBC—Aug 28, 1922: 660 khz; 50 kw-U. 30 Rockefeller Plaza. (10020). (212) Circle 7-8300. TWX 212-640-5788. NBC (group owner; acq 1926). Net: NBC. Format: Bright MOR. ■ Jack G. Thayer, pres; Perry Bascom, VP & gen mgr; John C. Lund, prog mgr; Gloria Gibson, prom mgr; Don Camera, gen sls mgr; Jeff Mazzei, mus coord; Richard Stapleton, news mgr; Lou Bruno, chief engr. ■ Rates: \$220; 80; 120; 60.

WNWS-FM
All News

WNWS-FM—Co-owned with WNBC. 1940: 97.1 mhz; 3.6 kw. Ant 1450 ft. Prog sep from AM. Audio news: NBC/NIS. Format: All news. ■ Larry Lynn, gen sls mgr. ■ WNBC-TV affil.

WNCN(FM)—Dec 1, 1956: 104.3 mhz; 5.4 kw horiz, 3.8 kw vert. Ant 1220 ft. Stereo. 2 W. 45th St. (10036). (212) 867-6171. Starr. WNCN Inc. (group owner; acq 5-1-73). Format: Classical. ■ Peter H. Starr, pres; Allan J. Eisenberg, gen mgr; Paul Wachsmith, coml mgr; Larry Miller, prog & mus dir; John Parsons, news dir; Bob Beamish, chief engr.

WNEW
METRO RADIO SALES
A TIME WARNER COMPANY

WNEW—Feb 13, 1934: 1130 khz; 50 kw-U, DA-2. 565 Fifth Ave. (10017). (212) 986-7000. Metromedia Inc. (group owner; acq 1958). Audio news: AP; UPI. Rep: Metro Radio Sales. Format: MOR. ■ Varner Paulsen, VP & gen mgr; Bill Hogan, gen sls mgr; Carolyn Parinello, mus dir; Robert Bruno, prog dir; Jim Gordon, news dir; Paul Champion, chief engr.

WNEW-FM—August 1958: 102.7 mhz; 4.1 kw. Ant 1360 ft. Stereo. Prog sep from AM. (212) 986-8844. Format: Progs; ■ Mei Karmazin, VP & gen mgr; Scott Muni, prog dir; Dom Fioravanti, gen sls mgr; Dennis Elsas, mus dir; Mitch Katz, tech svpr; ■ WNEW-TV affil.

WNWS-FM—Listing follows WNBC.

***WNYC**—July 7, 1924: 830 khz; 1 kw, DA-1 (L-WCCO Minneapolis). 2500 Municipal Bldg. (10007). (212) 566-2113. City of New York Municipal Bcstg System. Net: NPR. Format: Diversified. ■ Arnold Labaton, dir; Matt Biberfeld, exec off; Richard Pyatt, prog mgr; Lawrence Poppo, mus dir; Morris Kunins, chief engr.

***WNYP-FM**—Feb 5, 1941: 93.9 mhz; 5.3 kw horiz,

New York Radio

See page C-1 for explanation of listings.

3.8 kw vert. Ant 1220 ft. Quad Stereo. (CP: 3.6 mhz. Ant 1440 ft.). Prog sep from AM. Format: Talk, Classical. ■ Max Biberfeld, prog dir. ■ *WNYC-TV affil.

***WNYE(FM)**—November 1938: 91.5 mhz; 20 kw. Ant 430 ft. 29 Fort Greene Place, Brooklyn (11217). (212) 596-3335. Board of Education, City of New York. ■ Mrs. Cecil H. Sufferin, dir of bcstg; Dr. Florence M. Monroe, asst dir of bcstg. ■ WNYE-TV affil.

***WNYU-FM**—May 3, 1973: 89.1 mhz; 8.3 kw Ant 255 ft. Stereo. ST: *WFDU(FM) Teaneck, N.J. 566 LaGuardia Place (10012). (212) 598-3036. New York Univ. Format: Public radio. Spec progs: Jazz 7½ hrs, Black 4 hrs, classical 2½ hrs, folk 3 hrs, Live mus 1½ hrs wkly ■ Richard Roth, gen mgr; Jeffrey Reynolds, prog dir; Burl Britt III, mus dir; Agnes E. Green, jazz dir; Christopher Long, classical dir; Jeffrey Honeyman, opns dir; Mark Rosenwald, maintenance engr; Paul Solomon, news dir; Suzan Prince, PR, prom mgr; Robert Jewell, chief engr.

WOR—Feb 22, 1922: 710 khz; 50 kw-U, DA-1. 1440 Broadway. (10018). (212) 764-7000. RKO General Inc. (group owner; acq 1952). Format: Talk. ■ Bruce Johnson, pres; Herb Saltzman, VP & gen mgr; James Kelly, s/s mgr; Barbara Sheehan, prom mgr; Dan Griffin, opns dir; James McAleer, prog mgr; George Brown, news dir; Orville Sather, chief engr.

WXLO(FM)—Co-owned with WOR. 1941: 98.7 mhz; 5.4 kw horiz, 3.8 kw vert. Ant 1220 ft. Prog sep from AM. ■ Ron Ruth, gen mgr; Goff Lebar, gen s/s mgr; Sebastian Stone, prog dir.

WPIX-FM—1945: 101.9 mhz; 5.4 kw horiz, 3.8 kw vert. Ant 1220 ft. Stereo. (CP: 3.6 kw Ant 1420 ft.). 220 E 42d St, Room 2812 (10017). (212) 883-6000. WPIX Inc. (acq 9-64). Rep: Selcom. Format: Disco, Top 40. ■ Richard Newman, coml mgr; Neil McIntyre, prog dir. ■ WPIX(TV) affil. ■ Rates: \$35; 40; 50; 50.

WPLJ(FM)—Listing follows WABC.

WPOW—1924: 1330 khz; 5 kw, DA-1 (ST-WEVD New York). 305 E. 40th St. (10016). (212) MU 7-8288. WPOW Inc. (acq 7-15-59). Group owner: Camp. Spec progs: Pol 5 hrs; Ukr 1 hr; Czech 2 hrs; Greek 1 hr, wkly. ■ Ruth S. Camp, pres; H. Ed Smith, mgr & chief engr; Arnold Brown, prog dir.

WQXR—Dec 3, 1936: 1560 khz; 50 kw-U, DA-2. 229 W. 43d St. (10036). (212) 556-1144. Interstate Bcstg Co. (acq 2-1-44). Rep: Michigan Spot Sls; Radio Time Sls, Walton Bcstg Sls. Format: Classical music. ■ Walter Neiman, pres & gen mgr; Robert L. Krieger, asst gen mgr & VP s/s; Robert Sherman, prog dir; Carol Haffel, prom mgr; William D. Strauss, news dir; George Jellinek, mus dir; Zaven N. Masoomian, chief engr.

WQXR-FM—Nov 8, 1939: 96.3 mhz; 5.4 kw horiz, 3.8 kw vert. Ant 1220 ft. Stereo. Dups AM 100%.

WRFM(FM)—Dec. 14, 1953: 105.1 mhz; 5.4 kw horiz, 3.7 kw vert. Ant 1220 ft. 485 Madison Ave. (10022). (212) 752-3322. Radio New York Worldwide Inc. (acq 12-14-53). Group owner; Bonneville Intl. Rep: Avco; Eckels & Queen (Boston). Format: MOR. ■ John C. Moler, pres & gen mgr; Norma Sams, admin asst, prog dir; William Calvert, natl s/s mgr; Joe Roberts, chief anncr; Jim Branch, news dir; Joseph Losgar, chief engr. ■ Rates: \$90; 90; 90; 75.

WRVR(FM)—Jan 1, 1961: 106.7 mhz; 5.4 kw horiz, 3.8 kw vert. Ant 1,220 ft. 85 Claremont Ave. (10027). (212) 678-6855. Riverside Bcstg Co. Inc. Format: Jazz, news, pub affirs. ■ William L. Green, pres; Robert A. Orenbach, gen mgr; Larry Horwin, s/s mgr; Barney Lane, prog dir; Ed Beach, mus dir; Robin Sperling, prom mgr; Robert Siegel, news dir; George Endres, chief engr. ■ Rates: \$32; 32; 40; 40.

WWRL—Aug 26, 1926: 1600 khz; 5 kw-U, DA-1. (CP DA-2). 41-30 58th St, Woodside, N.Y. (11377). (212) 335-1600. Sonderling Bcstg Co. (group owner; acq 1964). Rep: Howard. Format: Black. ■ Egmont Sonderling, pres; Mark Olds, gen mgr; Arthur Harrison, coml mgr; Sonny Taylor, prog dir; Geraldine Shannon, mus dir; Bob Tilton, prom mgr; Dick London, news dir; John Kirby, chief engr. ■ Rates: \$58; 48; 58; 39.

WXLO(FM)—Listing follows WOR.

Niagara Falls

WBNY(FM)—See Buffalo.

WHLD—May 20, 1940: 1270 khz; 5 kw-D, DA. Box 398 (14302). (716) 265-3421. Hilda Carpenter Hull (acq 1955). Format: MOR. Spec progs: Ital 6 hrs; Pol 6 hrs wkly. ■ Mrs. Hilda C. Hull, own; Edward F. Joseph, gen & coml mgr; Roger Smith, prog & mus dir; Sam Phillips, news dir; Robert J. Wilson, chief engr. ■ Rates: \$7; 7; 7.

WHLD-FM—Jan 1, 1946: 98.5 mhz; 46 kw. Ant 420 ft. Prog sep from AM. Format: Easy listng & classical. ■ Rates same as AM.

WJLL—Dec 21, 1947: 1440 khz; 1 kw-D. 1224 Main St. (14301). (716) 285-5795. Niagara Frontier Bcstg Corp. (acq 3-28-55). Net: MBS. Audio news: UPI. Format: MOR, talk, oldies, sports. ■ Thomas W. Talbot, pres & gen mgr; Bob Rogers, coml mgr; Jimmy Thompson, news dir; Bill Chappelle, chief engr. ■ Rates: \$12.50; 7.75; 12.50; —.

North Syracuse

WEZG(FM)—Listing follows WSOQ.

WSOQ—Aug 1, 1959: 1220 khz; 1 kw-D. Box 20 (13212). (315) 458-1220. WSOQ Inc. (acq 6-6-2). Net: MBS. Format: Talk, b/f/mus. Spec progs: Ger 1 hr; Ital 3 hrs, Pol 3 hrs, Sp 1 hr, jazz 3 hrs wkly. ■ Francis H. Harms, pres & gen mgr; Beverly A. Harms, stn mgr; Mike Solan, s/s mgr; Robert Fisher, news dir; David Wickham, chief engr. ■ Rates: \$6; 6; 6.

WEZG(FM)—Co-owned with WSOQ. March 1972: 100.9 mhz; 3 kw. Ant 165 ft. Prog sep from AM. Rep: Katz. Format: Btfl music. ■ Rates: \$20; 23; 23; 13.

Norwich

WCHN—January 1953: 970 khz; 500 w-D. 14 S. Broad St. (13815). (607) 334-2218. Radio Norwich Inc. Rep: Market 4 & Regional Reps. Format: MOR. Spec progs: C&W 8 hrs, farm 9½ hrs, classical 12½ hrs, jazz 2 hrs, wkly. ■ William J. Hall, pres & gen mgr; Robert G. Fischer, news dir; Phillip G. Penfold, coml mgr; Nicholas R. Marasco, chief engr.

WCHN-FM—1961: 93.9 mhz; 3.2 kw. Ant 250 ft. Dups AM 75%.

Ogdensburg

WSLB—1940: 1400 khz; 1 kw-D, 250 w-N. Box 239 (13669). (315) 393-1100. The Wireless Works, Inc. (acq 8-12-72). Audio news: UPI. Format: Contemp. Sp progs: Pub affrs 4½ hrs wkly. ■ Chris Coffin, pres, stn mgr & tech dir; Patricia Tocattian, gen mgr; Janis Barth, news dir; Bruce Dana, mus dir. ■ Rates: \$5.64; 3.76; 5.64; 3.76.

Olean

WEBF(FM)—Listing follows WHDL.



WHDL—1929: 1450 khz; 1 kw-D, 250 w-N. 3219 W. State Rd. (14760). (716) 372-0161. WHDL Inc. (acq 1935). Net: ABC/E. Rep: Bassett. Format: Contemp. ■ John R. Henzel, pres & gen mgr; Joseph K. Eade, coml mgr; Doni McLean, prog dir; Doris Dor, prom mgr; Wallace D. Taylor, chief engr. ■ Rates: \$13; 13; 13.



WEBF(FM)—Feb 1, 1949: 95.7 mhz; 43 kw. Ant 740 ft. Stereo. Progs sep from AM. ■ Rates: \$7; 7; 7.

WMNS—May 20, 1957: 1360 khz; 1 kw-D. 168½ N. Union St. (14760). (716) 372-6660. Radio Olean Inc. (acq 12-28-61). Format: Contemp. ■ James C. Gleason, pres & gen mgr; James C. Gleason, Jr., coml mgr; Jack Gaeta, prog & news dir; Michael Ceci, chief engr. ■ Rates: \$7.75; 7.75; 7.75; 7.75.

Oneida

WMCR—Sept 26, 1956: 1600 khz; 1 kw-D. Genesee St. (13421). (315) 363-6050. Warren Bcstg Co. Inc. (acq 1-1-69). ■ William J. Warren, pres; Vivian Warren, VP & coml mgr. ■ Rates: \$6.50; 6.50; 6.50; 6.50.

WMCR-FM—September 1972: 106.3 mhz; 390 w. Ant 720 ft. ■ Rates same as AM.

Oneonta

WDOS—Dec 1, 1947: 730 khz; 1 kw-D. 104 Chestnut St. (13820). (607) 432-1500. Sea-Mount Radio Corp. of N.Y. (acq 1-1-71). Net: ABC/E. Rep: Market 4. Format: MOR. Spec prog: Farm 1 hr wkly. ■ Eugene J. Brown, pres; Al Sayers, VP/gen mgr; Robert Evans, s/s & asst gen mgr; Bart Bonney, chief engr. ■ Rates: \$7.90; 7.60; 7.60; —.

WSRK(FM)—Co-owned with WDOS. Jan 26, 1970: 103.9 mhz; 850 w. Ant 520 ft. Box 160 (13820). Net: ABC/C. Format: Top 40. ■ Rates: \$3.80; 3.80; 3.80; 3.80.

WONT(FM)—Nov 28, 1972: 103.1 mhz; 2 kw. Ant 360 ft. Box 308, 142 Main St. (13820). (607) 432-0154. Franklin Mountain Bcstg Corp. Net: ABC/I. Format: Btfl mus. ■ Anthony Leo Grande, pres; Keith L. Andre, VP & gen mgr; David Maurer, opns mgr; Michael Doherty, news dir; Timothy Braddock, chief engr. ■ Rates: \$6.20; 6; 6.20; 6.

***WONY(FM)**—1975: 90.9 mhz; 10w. Morris Hall, S.U.C.O. (13820). (607) 431-2711 or 432-7130. State University of New York. Net: Pacifica. Format: noncoml diversified. ■ Francis Daley, dean of students and community affairs; Jim Hathaway, gen mgr.

***WRHO(FM)**—Jan 1, 1970: 89.5 mhz; 10 w. Hartwick College (13820). (607) 432-3262. Hartwick College. Audio news: UPI. Spec prog: classical 2 hrs wkly. Format: Progs. ■ Mark Whitrock, gen mgr.

WSRK(FM)—Listing follows WDOS.

Ossining

***WOSS(FM)**—Feb 22, 1972: 90.3 mhz; 10 w. Ossining High School, 29 S. Highland Ave. (10562). (914) 941-3512. Board of Education, Union Free School District 1. Format: Variety ed. ■ Mrs. Sophie Ravis, George Legg, co-admins.

Oswego

WKFM(FM)—See Fulton.

WOSC—See Fulton.

***WRVO(FM)**—Jan 6, 1969: 89.9 mhz; 930 w. Ant 46 ft. (CP: 24 kw; Ant 430 ft.). Lanigan Hall, State University College, State University of New York. Format: Educl, cultural. ■ William D. Shigley, gen mgr; John B. Hurlbutt, prog dir; Harry F. Matthews, chief engr.

WSGO—March 9, 1961: 1440 khz; 1 kw-D. (13126). (315) 343-1440. Robert C. Gessner (acq 9-1-71). Reg net: Keystone, N.Y. Farm. Rep: Market 4. Format: Top 40. Spec progs: Ital 1½ hrs, Farm 1½ hrs, wkly. ■ Robert C. Gessner, gen & coml mgr & chief engr; Sam Fredericks, prog dir; Roberta Capron, stn mgr; Phil Thorne, mus dir; Bill Foley, news dir. ■ Rates: \$7; 5.50; 7; 4.

WSGO-FM—March 15, 1973: 105.5 mhz; 3 kw. Ant 110 ft. Dups AM 100%. ■ Rates same as AM.

Owego

WEBO—July 27, 1957: 1330 khz; 1 kw-D. Box 295 (13827). (607) 687-0371; 748-9131. WEBO Radio Inc. (acq 5-9-69). Net: MBS. Rep: Market 4; New England Spot Sls. Format: MOR. ■ Warren F. Haas, pres; Frank B. Penny, VP; Jay Dunn, news dir.

WEBO-FM—Sept 3, 1972: 101.7 mhz; 1.15 kw. Ant 450 ft. Stereo. Dups AM 95%.

Patchogue

WALK—April 1952: 1370 khz; 500 w-D. Box 230 (11773). (516) GRower 5-5200. Island Bcstg System Inc. (acq 10-6-63). Group owner: Horizons. Rep: Bassett. ■ E. W. Wood Jr., pres; Jack Ellsworth, stn mgr & prog dir; Conrad Mikorenda, coml mgr; George Drake, news dir; John Sitone, chief engr.

WALK-FM—December 1952: 87.5 mhz; 15 kw. Ant 520 ft. Dup AM 100%.

WBLI(FM)—Dec 1, 1958: 106.1 mhz; 10 kw. Ant 470 ft. Stereo. 31 W. Main St. (11772). (516) 475-1061. WBLI Inc. (acq 1969). Group owner: Beck-Ross. Rep: Masla. Format: Oldies, Top 40. ■ Martin F. Beck, pres; Herb Usenheimer, gen mgr; Michael Scalz, prog dir; Herbert Usenheimer, sls mgr; James E. Champlin, ntl sls mgr; Len Rothberg, opns mgr; Barry Neal, mus dir; John Allen, news dir; Frederick De Costerd, chief engr. ■ Rates: \$28; 35; 35; 35.

WSUF—Dec 1, 1951: 1580 khz; 10 kw-D, 5 kw, DA-D (CH). 1580 Pennsylvania Ave. (11772). (516) 475-1580. WSUF Broadcasting Co. (acq 4-6-73). Net: ABC/I. Rep: PRO Time Sls; Carpenter. Format: Contemp. ■ Donald Karnes, VP & gen mgr; Rose O'Brian, loc sls; John Carroll, ntl sls mgr; Steve Epstein, prog dir; Ray Coleman, mus dir; Barbara Lyble, prom mgr; Peter TenHaagen, news dir; Wayne Wicks, chief engr.

Paul Smith's

***WPSA(FM)**—Jan 10, 1973: 89.1 mhz; 10 w. Paul Smiths College of Arts & Sciences.

Peekskill

WHUD(FM)—Listing follows WLNA.

WLNA—1948: 1420 khz; 1 kw-D. Box 188 (10567). (914) 737-1124. Highland Bcstg Corp. Rep: Masla. ■ Irving E. Cottrell, pres & gen mgr; Dorothy Fellman, VP & opns mgr; Francis V. Lough, coml mgr; George Bidas, prog dir; Scott Witt, news dir; Nathaniel B. Johnson, chief engr.

WHUD(FM)—Co-owned with WLNA. Oct 24, 1958: 100.7 mhz; 50 kw. Ant 500 ft. Progs sep from AM. ■ James D. Roosa Jr., VP & mgr.

Plainview

***WPOB(FM)**—September 1973: 88.5 mhz; 10 w. John F. Kennedy High School (11803). (516) 938-5400 ext. 259. Central School District 4. Format: Progs, talk, ed. ■ Dr. Louis Brown, dir of educ communications.

Plattsburgh



WEAV—Feb 3, 1935: 960 khz; 5 kw-U, DA-2. Box 540 (12901). (518) 561-0960. Plattsburgh Bcstg Corp. Net: CBS. Rep: Market. Format: Top 40. ■ George F. Bissell, Jr., gen/coml mgr; Tim McDonald, prog dir; Leon Kelly, news dir; Jack Nazak, chief engr. ■ Rates: \$7.50; 7.50; 7.50; 7.50.

WGFB(FM)—Co-owned with WEAV. Feb 3, 1960: 99.9 mhz; 4.04 kw. Ant 780 ft. Stereo. Prog sep from AM. Format: Easy Istg. ■ Dale Forgette, prog dir. ■ Rates: \$4.71; 4.71; 4.71; 4.71.

WIRY—Jan 30, 1950: 1340 khz; 1 kw-D, 250 w-N. Box 869 (12901). (518) 563-1340. WIRY Inc. (acq 1-1-59). Net: MBS. Rep: Masla. ■ Donald L. Pelkey, pres & gen mgr; Don Pelkey Jr., coml mgr; Gordon R. Little, prog dir; Sidney J. Spiegel, news dir; Robert E. Broadwell, chief engr. ■ Rates: \$10.50; 9.75; 10.50; 9.75.

WKDR—June 15, 1968: 1070 khz; 5 kw-D. Box 518 (12901). (518) 561-7600. Metro Group Bcstg. Net: ABC/E. Rep: PRO/Meekeer. New England Reps. Format: C&W. Spec progs: sports talk 2 hrs wkly. ■ R. C. Guibord, pres; Peter B. Guibord, VP, gen mgr; Bonnie Rogers, sls mgr; R. Robinson, prog dir; C. Stone, mus dir; R. Black, stn mgr, news dir; K. Martineau, chief engr. ■ Rates: \$8.60; 8.60; 8.60;—.

Port Jervis

WDLC—July 4, 1953: 1490 khz; 1 kw-D, 250 w-N. Box 920 (12771). (914) 856-5185. Port Jervis Bcstg Co. (acq 3-28-56). Format: C&W, MOR. ■ Oscar Wein, pres & gen mgr; Robert I. Wein, VP, sls & opns; Katherine Wein, prog dir & stn mgr; Tracy Baxter, news dir; Henry Spahr, chief engr. ■ Rates: \$6.25; 4.50; 5.50; 3.85.

WDLC-FM—Oct 30, 1970: 96.7 mhz; 3 kw. Ant 300 ft. Stereo. Dups AM 97%.

Potsdam

WPDM—April 30, 1955: 1470 khz; 1 kw-D. Box 348 (13676). (315) 265-5510. St. Lawrence Radio Inc. Net: ABC/I. Format: MOR. ■ Fred G. Hartman Jr., pres; John R. Murphy, gen mgr; Conrad Elliott, sports dir; Betty Bombard, otc mgr; David A. Kyle, treas; Nat Natalie, mus dir; Pamela Steppe, news dir; Roy Krause, chief engr.

WPDM-FM—Oct 15, 1968: 99.3 mhz; 3 kw. Ant 155 ft. Dups AM 80%.

***WTSC-FM**—Nov 3, 1963: 91 mhz; 700 w. Ant 135 ft. Stereo. Clarkson College (13676). (315) 265-7180. Board of Trustees, Clarkson College. Net: ABC/FM; ICRN. Format: Progressive. Spec prog: Classical & jazz, 3 hrs wkly. ■ Gary Stork, gen mgr; Ed Petruzzelli, prog dir; Mike Rogers, mus dir; Dennis Greci, news dir; Dave Bernhardt, chief engr.

Poughkeepsie

WEOK—October 1949: 1390 khz; 5 kw-D, DA. Box 416 (12602). (914) 471-1500. WEOK Bcstg Corp. (acq 4-1-70). Rep: Masla; Eckels & Queen. Format: MOR. Spec progs: Ger ½ hr; Pol 1 hr; Black ½ hr, wkly. ■ Louis H. Pellis, pres & gen mgr; Frank A. Sause, coml & prom mgr; Ralph C. Arrigate, prog dir; Glenn V. Laxton, news dir; John Kostenko, chief engr.

WPDH(FM)—Co-owned with WEOK. December 1961: 101.5 mhz; 14 kw horiz, 11 kw vert. Ant 830 ft. Stereo. Prog sep from AM. Format: Modern country. Spec progs: Ital ½ hr; Pol 1 hr; Black 2 hrs, wkly. ■ Raphael Mark, stn mgr; Ted Jones, prog dir; John Kostenko, chief engr.

WKIP—June 1940: 1450 khz; 1 kw-D, 250 w-N, DA-2. Box 1450 (12602). (914) 471-2300. Olympian Bcstg Corp. (acq 10-16-70). Net: ABC/C. Rep: H-R Stone. Format: MOR. ■ Leonard R. Kinney, pres & gen mgr; Joel Andrews, VP, lcl sls; Jack McWeeney, VP, ntl sls mgr; Rae Hues, sec-treas; John Walker, prog dir; Tom Cooper, news dir; Jim Brooks, chief engr. ■ Rates: \$11.20; 8.55; 11.20; 7.35.

WPDH(FM)—Listing follows WEOK.

WSPK(FM)—Dec 7, 1947: 104.7 mhz; 5 kw. Ant 1250 ft. Stereo. Box 1703 (12601). (914) 831-1260. Lance Communications Inc. (acq 9-11-70). Net: MBS. Format: Adult rock. Sp progs: Ital 1 hr; Sp 1 hr; BI 4 hrs wkly. ■ Alford H. Lessner, pres, gen mgr; Robert E. Lessner, VP, stn mgr; Robert A. Outer, VP & sls mgr; Rick Liotta, prog & mus dir; Henry Gross, news dir; William Rossini, chief engr. ■ Rates: \$14; 8; 10; 8.

Pulaski

WSCP—See Sandy Creek.

Remsen

WADR—Dec 12, 1966: 1480 khz; 5 kw-D. Box 1480 (13438). (315) 831-3941. P.H. Inc. (acq 9-6-66). Rep: Masla. Format: C&W. ■ Joseph Uzdavinis, pres; Bill Schweitzer, gen & coml mgr; Joe Mulvihill, prog & news dir; Dave Haouch, prom mgr; Bill Rutherford, chief engr.

Rensselaer

WQBK—Dec 3, 1961: 1300 khz; 5 kw-D, DA. Box 1300, Albany, N.Y. (12201). (518) HOBar 2-5555. People Communications Corp. (acq 7-29-70). Rep: New England Spot Sls. Audio news: UPI. Format: talk. Spec progs: Ital 2 hrs; Sports 4 hrs, farm & garden, 1 hr wkly. ■ Laurence Barnett, gen mgr; Bill Edwards, prog dir; Steve Fitz, telephone talk host; Bob Raffaele, chief engr. ■ Rates: \$14.50; 14.50; 14.50;—.

WQBK-FM—Dec 1, 1972: 103.9 mhz; 3 kw. Ant 87 ft. Stereo. Prog sep from AM. Format: Progs. ■ Jack Hopke, dir. ■ Rates: \$10.50; 10.50; 10.50; 10.50.

WRCN—Aug 8, 1963: 1570 khz; 1 kw-D, DA. Box 666 (11901). (516) 727-1570. East Shore Bcstg Corp. (acq 8-71). Net: ABC. Format: Contemp, top 40. ■ Richard I. Adrian, Jimmie Lee Pulbese, owns. ■ Rates: \$15; 13; 15; 13.

WRCN-FM—Aug 14, 1962: 103.9 mhz; 2.6 kw. Ant

New York Radio

See page C-1 for explanation of listings.

320 ft. Stereo. Dups AM 60%.

WRIV—June 1955: 1390 khz; 1 kw-D. Box 314 (11901). (516) Park 7-1200. Island Bcstg System Inc. (acq 10-63). Group owner: Horizons. Rep: Bassett. ■ Edward W. Wood Jr., pres & gen mgr; Pat Wood, prog dir; Gus Lellman, sls mgr; Ted Marvel, news dir; John Sitone, chief engr. ■ WRIV-TV affil.

Rochester

WAXC—Sept 11, 1925: 1460 khz; 5 kw-U, DA-N, 50 Chestnut Plaza (14604). (716) 546-2325. Sande Broadcasting Co. (acq 1-72). Net: ABC/C. Rep: Eastman. Format: Contemp. ■ John Nichols, pres; John Sayre, gen mgr; Joe Farrar, coml mgr; Larry White, prog, mus dir; Dave Mason, prom mgr; Charles Hill, news dir; Frank Seidert, chief engr.

WBFB—1947: 950 khz; 1 kw-U, DA-2. 850 Midtown Tower (14604). (716) 232-7550. TWX 510-253-3422. WBFB Inc. (acq 1966). Group owner: LIN. Net: ABC/C. Rep: Blair. Format: Contemp. Spec prog: Sp 1 hr wkly. ■ Dan Clayton, pres & gen mgr; Mark Driscoll, prog & mus dir; Jean Beamish, coml mgr; Alex Lamulis, news dir; Harvey Rees, chief engr.

WBFB(FM)—Co-owned with WBFB. February 1961: 92.5 mhz; 50 kw. Ant 500 ft. Stereo. Prog sep from AM. Format: Classcl. Spec progs: Ital 2 hrs, Sp 2 hrs, wkly. ■ Nick Nickson, gen mgr.

WCMF(FM)—June 9, 1960: 96.5 mhz; 20 kw. Ant 290 ft. Stereo. 129 Leighton Ave. (14609). (716) 288-3200. Community Music Service Inc. Rep: ABC-FM Spot Sls. Format: Stereo Rock. Spec prog: Sp 2 hrs wkly. ■ James Trayhern, pres & gen mgr; David Hanna, coml mgr; Bernie Kimble, prog dir; Fred Horton, mus dir; Blaine Schwartz, news dir; Walter Peltan, pub svc mgr; Jacob Schanker, chief engr. ■ Rates: \$30; 28; 36; 36.

WDKX(FM)—April 1974: 103.9 mhz; 8 kw. Ant 536 ft. 1337 E. Main St. (14609). (716) 288-5470. Monroe County Broadcasting Co. Ltd. Format: R&B. ■ William Curtis Chatman, gen mgr; Little John Smith, prog dir; R. J. Redenburg, chief engr.

WEZO(FM)—Listing follows WNYR.

WHAM—July 11, 1922: 1180 khz; 50 kw-U, 350 East Ave. (14604). (716) 454-4884. TWX 510-253-5559. Rust Communications Group (group owner; acq 5-62). Net: ABC/I. Rep: McGavren-Guild. Format: MOR. Spec prog: Opinion. ■ W. F. Rust Jr., pres; Robert L. Luther, gen mgr; William Kimble, prog dir; David A. Sennett, mus dir; Mike Morgan, news dir; Walter Helinski, chief engr.

WHFM(FM)—Co-owned with WHAM. 1939: 98.9 mhz; 50 kw. Ant 340 ft. Prog sep from AM. Net: ABC/C. Format: Rock. ■ Al Peterson, prog dir; Jeff Gerber, mus dir.

***WIRQ(FM)**—January 1960: 90.9 mhz; 10 w. 260 Cooper Rd. (14617). (716) 342-6461. Board of Education, Central School District. Net: ABC/FM. Format: Variety. Spec progs: Ital 1 hr; Sp 1 hr; C&W 1 hr; Black 3 hrs, wkly. ■ Eric Young, gen mgr; Bruce Pilato, prog & mus dir.

WNYR—1947: 680 khz; 250 w-D. 931 E. Main St. (14601). (716) 473-6800. TWX 510-253-4566. Malrite of New York Inc. (group owner; acq 8-1-65). Net: ABC/E. Rep: Katz. Format: C&W. Spec prog: Ital 1 hr wkly. ■ Milton Maltz, pres; Bill Scarborough, VP, gen & prom mgr; Earl Morgan, prog dir; Bob Kirby, mus dir; Gary Sankey, coml mgr; Tom Jones, news dir; Gary Felger, chief engr.

WEZO(FM)—Co-owned with WNYR. Nov 14, 1966: 101.3 mhz; 50 kw. Ant 390 ft. Stereo. Prog sep from AM. Format: Btlf music, easy Istng. ■ Dale Hartnett, prog dir; Marlin Taylor, mus dir.

WROC—Nov 22, 1947: 1280 khz; 5 kw-U, DA-N, 201 Humboldt St. Broadcast Center (14610). (716) 288-8400. Rust Craft Bcstg of New York Inc. (group owner; acq 3-15-65). Net: NBC. Rep: Buckley. ■ Ervin F. Lyke, VP & mgng dir; George R. Libutt, gen mgr; Gary Smith, prog dir.

WPXY(FM)—Co-owned with WROC. Sept 14, 1959: 97.9 mhz; 50 kw. Ant 400 ft. Stereo. Prog sep from AM. ■ WROC-TV affil.

New York Radio

See page C-1 for explanation of listings.

***WRUR-FM**—March 6, 1966: 88.5 mhz; 970 w. Ant 120 ft. Stereo. Box 5068 River Station (14627). (716) 275-6666. U. of R. Bcstg Corp. Net: NPR. Format: Progs, jazz, classcl, oldies. Spec progs: Sp ½ hr, Medieval 1 hr, Bl 3 hrs, wkly. ■ Suzanne Weiss, gen mgr; Joel Lind, prog dir; Zachary Goldstein, bus mgr; Matt Frohlich, mus dir; Jesse Finkelstein, prom mgr; Paul Tullihl, news dir; Tony Ravinsky, chief engr; Ron Bello, consulting engr.

WSAY—1936: 1370 khz; 5 kw-U, DA-N, 250 East Ave. (14604). (716) 232-5580. Federal Bcstg System Inc. Rep: Masla. Format: Progs, R&B, rock. Spec progs: Ital 2½ hrs; Jewish 2½ hrs; Caribbean-Spanish ½ hr, Bl ½ hr, wkly. ■ Gordon P. Brown, pres, gen mgr & chief engr; Sybilla A. Reber, asst mgr & prog dir; Annette C. Capitano, coml mgr & pub svc dir; John Sebaste, mus dir.

WVOR(FM)—March 1964: 100.5 mhz; 50 kw. Ant 350 ft. 333 Midtown Tower (14604). (716) 454-3942. Amalgamated Music Enterprises Inc. Net: MBS. Rep: Groskin. Format: MOR. Spec prog: It 3 hrs, Pol 1 hr, Sp 2 hrs, wkly. ■ Bud Wertheimer, gen mgr; Bob Bittner, prog dir. ■ Rates: \$11; 12; 12; 11.

***WXII-FM**—December 1974: 91.5 mhz; 36 kw. Ant 255 ft. Stereo. Box 21 (14601). (716) 325-7500. TWX 716-232-2190. Rochester Area Educ TV Assoc Inc. Format: Variety Spec progs: Ital 1 hr; Sp 3 hr; Black 4 hrs, classical 15 hrs, jazz 10 hrs, Pol 1 hr, wkly. ■ William J. Pearce, pres; Joe Grant, dir, radio svcs; Dave Dial, dir; James H. Bryant, dev dir; Dave Ansted, engr sup.

Rome

WKAL—September 1946: 1450 khz; 1 kw-D, 250 w-N. South Jay St. (13440). (315) 336-7700. Maurer Bcstg Corp. (acq 8-1-61). Net: MBS. Rep: Market 4; Corlett (Detroit); New England Spot Sls. Format: Contemp. Spec prog: Pol 2 hrs wkly. ■ J. B. Maurer, pres & gen mgr; Woodard J. Maurer, coml mgr; Mark Howell, mus & news dir; Gerald Prouty, chief engr. ■ Rates: \$6.25; 5.30; 6.25; 5.30.

WKAL-FM—August 1968: 95.9 mhz; 3 kw. Ant 105 ft. Stereo. Dups AM 100%. ■ Rates same as AM.

WRNY—Oct 12, 1959: 1350 khz; 500 w-D. Box 67 (13440). (315) 336-5600. Promedia Communications Inc. (acq 3-15-69). Net: ABC/I. Rep: Fullford Co. Format: MOR. Spec progs: Pol 2 hrs; Black 7 hrs; C&W 1 hr; Big Bands 2 hrs, wkly. ■ Carl Eilenberg, pres & gen mgr; Norma Eilenberg, sls & prom mgr; Maria Rich, prog & mus dir; Carl Eilenberg, news dir; Milt Thompson, chief engr. ■ Rates: \$5; 4.60; 5; 4.60.

Sag Harbor

WLNG—Aug 13, 1963: 1600 khz; 500 w-D. Box 815 (13963). (516) 725-2300. East Coast Bcstg Corp. (acq 1-1-68). Net: MBS. Rep: AAA Reps. Format: MOR, oldies. ■ Robert O. King, pres; Paul Sidney, VP, gen mgr & prog dir; Joe Ricker, news dir; Edward Eichorn, chief engr.

WLNG-FM—April 13, 1969: 92.1 mhz; 3 kw. Ant 125 ft. Dup AM 70%.

St. Bonaventure

***WSBU(FM)**—April 13, 1975: 88.3 mhz; 10 w. Ant 90 ft. Drawer O (14778). (716) 375-2306. St. Bonaventure University. Format: Top 40, oldies, progs. ■ Rev. Damian McElrath, pres; Jim Marchiony, gen mgr.

Salamanca

WGGO—June 18, 1957: 1590 khz; 1 kw-D. 680 Broad St. (14779). (716) 945-1515. John R. Newman, James R. Clark Jr. (acq 10-74). Group owner: Altair. Net: ABC/I. Format: All hit music. Spec prog: Pol 1 hr wkly. ■ John R. Newman, pres; Don Bray, mus dir; Paul Hennessey, news dir. ■ Rates: \$3.60; 2.60; 3.60; 3.60.

Sandy Creek

WSCP—Aug 8, 1974: 1070 khz; 1 kw-D. Box 293 (13145). (315) 387-3404. Oswego Jefferson Bcstg Inc. Format: C&W. Spec prog: Farm 2 hrs wkly. ■ Stephen C. Sattler, pres; James J. Foederer, VP & gen

mgr; Paul Kerr, coml mgr; Larry Kay, prog dir; Robert Collins, chief engr; Michael Donovan, news dir. ■ Rates: \$5; 5; 5; 5.

Saranac Lake

WNBZ—Sept 11, 1927: 1240 khz; 1 kw-D, 250 w-N. Box 211 (12983). (518) 891-1544. WNBZ Inc. (acq 3-1-63). Net: ABC/I. Rep: Dore. Format: MOR. ■ James Rogers III, pres, gen & coml mgr, prog dir; Roy Kristofferson, mus & news dir; Christopher Brescia, chief engr.

Saratoga Springs

WKAJ—March 23, 1964: 900 khz; 250 w-D. 71 West Ave., Box 557 (12866). (518) 584-1610. Community Radio of Saratoga Springs Inc. Format: MOR. ■ Kent E. Jones, pres & gen mgr; Paul Campion, exec VP; Herb Sabin, prog dir; Leroy L. Fuller Jr., stn engr; William Bingham, chief engr.

WKAJ-FM—May 27, 1968: 102.3 mhz; 2 kw. Ant 74 ft. Dup AM 60%.

***WSPN(FM)**—1974: 91.1 mhz; 10 w. Skidmore College (12866). ■ Roger LaMay, gen mgr.

Schenectady

WGFM(FM)—Listing follows WGY.

WGY—February 1922: 810 khz; 50 kw-U, 1400 Balltown Rd. (12309). (518) 377-2261. TWX 710-442-2974. General Electric Bcstg Co. Inc. (group owner). Net: NBC. Rep: Christal. Format: MOR, Contemp. Spec prog: Black 3 hrs wkly. ■ Reid Shaw, pres; James Delmonico, gen mgr; John E. Schmulbach, coml mgr; Leo R. Fowler, prog & mus dir; Walter McDowell, prom mgr; Don Decker, news dir; George Davis, chief engr. ■ Rates: \$78; 61; 68; 40.

WGFM(FM)—Co-owned with WGY. November 1940: 99.5 mhz; 10 kw. Ant 930 ft. ■ John E. Schmulbach, coml mgr. ■ WRGB(TV) affil. ■ Rates: \$20; 27; 27; 25.

***WMHT-FM**—June 8, 1972: 89.1 mhz; 11 kw. Ant 930 ft. Box 17 (12301). (518) 356-1700. TWX 710-442-2993. Mohawk-Hudson Council on Educational TV Inc. Net: NPR; EPRN. Format: Classical. ■ Donald E. Schein, pres & gen mgr; Joy K. Martin, prog dir; Arthur J. Singer, prom mgr; Richard A. Hill, chief engr. ■ WMHT(TV) affil.

***WRUC(FM)**—1975: 90.9 mhz; 10 w. Ant 80 ft. Union College (12308). Trustees of Union College. ■ Dr. Harold C. Martin, pres.

WSNY—July 15, 1942: 1240 khz; 1 kw-D, 250 w-N, 144 Lafayette St. (12305). (518) 393-3622. Radio WSNY/1240 Inc. (3-15-71). Net: MBS/Black. Format: Black, contemp, MOR, progs, talk, top 40. Spec progs: Ital 1 hr, Pol 1 hr, wkly. ■ Henry Valentino, pres; Richard E. Parry, gen mgr; Debbie Ring, coml mgr; Bob Roberts, prog & mus dir & prom mgr; Jim Laine, news dir; Bob Smith, chief engr.

WTRY—See Troy

Seneca Falls

WSFW—Oct 1, 1968: 1110 khz; 1 kw-D. Box 1 (13148). (315) 568-9888. Waterfalls Bcstg Corp. Rep: Market 4; Format: MOR. ■ Samuel Bunis, pres; Robert N. Burns, gen mgr; Robert Martin, coml mgr; Paul Mann, news dir.

WSFW-FM—Nov 1, 1968: 99.3 mhz; 3 kw. Ant 235 ft. Dups AM 100%.

Smithtown

WCTO(FM)—1961: 94.3 mhz; 3 kw. Ant 300 ft. Box 697, Long Island, N.Y. (11746). (516) 423-6729. Greater Media Inc. (group owner; acq 1961). Rep: Century Nil Sls. Format: Btl music. ■ Peter Bordes, pres; Richard J. Scholem, gen mgr; Neil Ward, sls mgr; Paul Fleishman, opns mgr; Mike Eau Claire, news dir; Harold Knelter, chief engr.

South Bristol Township

WMIV(FM)—1948: 95.1 mhz; 9.5 kw. Ant 990 ft. Drawer G, Ithaca, N.Y. (14850). (607) 272-8080. Christian Bcstg Network (group owner; acq 1-1-69). Rep: Young. Format: Gospel. ■ M. G. Robertson, pres; Bill Freeman, gen mgr; James Wall, coml mgr; William Covert, chief engr. ■ Rates: \$5.20; 5.20; 5.20; 5.20.

Southampton

WWRJ(FM)—Oct 1971: 95.3 mhz; 2.4 kw. Ant 330 ft. Arcade Bldg, Main St. (11968). (516) 283-5200. Sandpiper Broadcasting (acq 8-71). Format: Btl music. ■ James E. Kleid, gen mgr.

Spring Valley

WKQW—Sept 1, 1965: 1300 khz; 500 w-D, DA. Box 1300, Nanuet, N.Y. (10954). (914) 634-1300. WKQW Radio Inc. (acq 7-30-71). Rep: Michael Fullford Co. Format: Progressive, MOR. Spec progs: Ital ½ hr; C&W 2 hrs wkly. ■ William A. Littauer, pres & gen mgr; Richard Warden, coml mgr; Don Maline, prog dir; Henry Gross, news dir.

Syosset

***WKWZ(FM)**—July 24, 1973: 88.5 mhz; 10 w. Ant 90 ft. Southwoods Rd. (11791). (516) 921-8850. Syosset Central School District. Format: Community prog. Spec progs: Black 3 hrs, classical 6 hrs, jazz 8 hrs, Indian problems ½ hr, wkly. ■ A. T. Zodda Jr., fac adv; Bruce Burger, stn mgr.

Syracuse

***WAER(FM)**—January 1946: 88.3 mhz; 6 kw. Ant 180 ft. Stereo. NCC II, 215 University Place (13210). (315) 423-2406. Syracuse U. Bd of Trustees. Net: NPR. Format: Alternative/Progressive. Spec progs: Pacifica, ZBS Media, The Rest of the News, wkly. ■ Dr. Lawrence Myers, gen mgr; Larry Fox, prog dir; John E. Murphy, prog dir; Harold Cobin, prom mgr; George Gilbert, mus dir; David Wickham, chief engr; Ken Kane, news dir.

***WCNY-FM**—Dec 4, 1971: 91.3 mhz; 18.6 kw. Ant 740 ft. Stereo. 506 Old Liverpool Rd. (13088). (315) 457-0440. TWX 541-0430. Public Bcstg Council of Central N.Y. (acq 9-4-74). Net: NPR. Format: Diversified. ■ Richard Russell, pres & gen mgr; Cerid Reed, prog dir; Thomas Fanella, dir of dev; Gloria Kriz, mus dir; Thomas Tradup, news dir; S. Paul Barron, dir of engr. ■ WCNY-TV affil.

WDDS-FM—1956: 93.1 mhz; 97 kw. Ant 660 ft. 738 Erie Blvd. (13210). (315) GR 5-1631. Signal Bcstg Co. (acq 1975). Net: ABC/FM. Rep: Groskin. ■ Carl J. Spavento, VP network opns; Albert L. Wertheimer, exec VP; James A. McKechnie, dir of sls; William F. Roseboom, dir of pub rel; Lawrence Gordon, VP; Wendell Martin, chief engr.

WFBL—Feb 4, 1922: 1390 khz; 5 kw-U, DA-N. Box 1390, Eastwood Station (13206). (315) 463-8631. First Bcstg Corp. (acq 3-1-56). Net: CBS. Rep: McGavren-Guild-PGW; Stephens & Towndron (Canada). Format: MOR. ■ Roy Furmark, pres; Henry T. Wilcox, gen mgr; Joseph Bell, gen sls mgr; James B. Ashbery, prog dir; Art Peterson, news dir; Jeff Baker, chief engr. ■ Rates: \$34; 33; 34; 29.

WHEN—April 14, 1941: 620 khz; 5 kw-D, 1 kw-N, DA-N. 980 James St. (13203). (315) 474-8511. TWX 710-541-0443. Meredith Corp. (group owner; acq 4-54). Net: ABC/E. Rep: Eastman. Format: Adult contemp. ■ E. C. Stiker, VP & gen mgr; James B. Ashbery, prog dir; Lee M. Vanden-Handel, sls mgr; Linda L. Arnold, mkt dir; Robert Arndt, chief engr; Rod Wood, news dir; ■ WHEN-TV affil.

WMHR(FM)—March 9, 1969: 102.9 mhz; 11 kw. Ant 720 ft. Stereo. 4044 Makyes Rd. (13215). (315) 469-5051. Mars Hill Bcstg Co. Rep: Radio Reps Inc; Ledbetter. Format: Christian. Spec prog: Black 1½ hr wkly. ■ Gordon Bell, gen mgr; Robert Couch, coml mgr; Jack Williamson, prog dir; Cindy Bell, prom mgr; Jeff Bulow, news dir; Clayton Roberts, chief engr. ■ Rates: \$2.25; 2.25; 2.25; 2.25.

WNDR—1946: 1260 khz; 5 kw-U, DA-N. Box 1212 (13201). (315) 446-1515. Tower Bcstg Corp. (acq 4-1-69). Net: ABC/C. Rep: Blair. Format: Contemp. Spec progs: Farm 5 hrs, Ital 1 hr, Pol 1 hr, Black 1 hr, wkly. ■ Robert Forrest, pres; Dan Leonard, gen mgr; Pete Berry, prog dir; George Plavocos, coml mgr; Dick Mastriano, news dir; Roy Taylor, chief engr. ■ Rates: \$36; 32; 34; 26.

WOLF—1940: 1490 khz; 1 kw-D, 250 w-N, DA-D. Box 1490 (13201). (315) 422-7211. WOLF Bcstg Service Inc. (acq 5-19-68). Group owner: Reg. Bcstrs. Audio news: UPI. Rep: Katz. Format: Top 40. Spec prog: Black 3 hrs wkly. ■ Edwin A. Bernstein, pres; Thomas R. Shine, VP & gen mgr; Don Brown, coml mgr; Howard Castle, prog dir; Ron Bee, news dir; Vincent J.

Mangiameli, chief engr. ■ Rates: \$27; 27; 32; 32.

WONO(FM)—Sept 1, 1958: 107.9 mhz; 10.5 kw. Ant 490 ft. Stereo. 345 Peat St. (13210). (315) 472-4541. Sentinel Heights FM Bcstrs Inc. (acq 1974). Rep: Groskin. Format: Fine arts. ■ Stephen Jacobs, gen mgr; Mrs. Margaret Prausnitz, coml mgr; Henry Fogel, prog dir; Allen Rockford, prog mgr; William Dunn, news dir; John Bunkfeld, chief engr.

WOSC—See Fulton.

WKFM(FM)—See Fulton.

WSEN—See Baldwinsville.

WSOQ—See North Syracuse.

WSYR—1922: 570 khz; 5 kw-U. DA-2. 1030 James St. (13203). (315) 474-3911. TWX 710-541-0428. Newhouse Bcstg Corp. (group owner; acq 1948). Net: NBC. Rep: Christal; McDermott (Canada). ■ E. R. Vadeboncoeur, pres; David J. Shurtleff, VP & gen mgr; Norman Cisna, coml mgr; Alan Milair, prog dir; Louis B. Switzer, prom mgr; Richard Hoffman, news dir; A. J. Eicholzer, chief engr.

WSYR-FM—1946: 94.5 mhz; 100 kw. Ant 650 ft. Stereo. Dups AM 50%. ■ WSYR-TV affil.

WYRD—Dec 6, 1955: 1540 khz; 1 kw-D. 300 Erie Blvd. E. (13224). (315) 446-7442. WYRD Inc. (acq 1974). Group: Crawford. Format: Christian. Spec prog: Black 2 hrs wkly ■ Richard T. Crawford, pres & gen mgr; Paul J. Plunkett, prog dir; Roy Taylor, chief engr.

Ticonderoga

WIPS—July 1955: 1250 khz; 1 kw-D. Box 352, Fort Ti Road (12883). (518) 585-2868; (902) 897-5000. Molsinger Communications Inc. (acq 1-1-74). Audio news: UPI. Rep: Masla; MacDermott. Format: Diversified. Spec progs: Farm 6 hrs, classical ½ hr, C&W 13 hrs, wkly ■ John K. Molsinger, pres & gen mgr; Dave Downing, prog & news dir & chief engr; Linda Nadeau, coml mgr; Tom McCormick, mus dir. ■ Rates: \$7.06 7.06; 7.06; 7.06.

Troy

WFLY(FM)—August 1948: 92.3 mhz; 10 kw horiz. 2.25 kw vert. Ant 840 ft. 4243 Albany St., Box 1540 (12205). (518) 456-1144. Rust Communications Group Inc. (group owner; acq 3-75). Rep: Eastman. Format: MOR. ■ William Rust, pres; George E. Geib, gen mgr; Andrew Schirn, prog dir; Robert MacFarland, chief engr. ■ Rates: \$6; 6; 6; 6.

WGNA(FM)—See Albany.

WHAZ—August 1922: 1330 khz; 1 kw-D. Box 784 (12181). (518) 272-1010. WPOW Inc. (acq 6-14-67). Group owner: Camp. Format: Religious, country gospel music. Spec prog: Ital 3 hrs wkly ■ John R. Linstra, pres; Buddy Starcher, gen mgr; Gordon Hall, coml mgr; Bud Clayton, prog dir; Gary Koster, chief engr.

WHSB(FM)—See Albany.

***WRPI(FM)**—Nov 1, 1957: 91.5 mhz; 10 kw. Ant 370 ft. Stereo. Communications Center (12181). (518) 270-6248. Rensselaer Polytechnic Institute. Net: ABC/FM. Format: Progressive. Spec prog: Black 3 hrs, Jazz 4 hrs, classical 3 hrs, East Indian 2 hrs, Folk 3 hrs, wkly ■ Richard Speicher, pres; Tom Lucke, gen mgr.

WTRY



WTRY—April 15, 1940: 980 khz; 5 kw-U. DA-N. 92 Fourth St. (12180). (518) 274-1100. Scott Bcstg Co. Inc. of N.Y. (acq 2-1-72). Group owner: Great Scott. Rep: McGavren-Guild. Format: Top 40. Spec prog: Farm 3½ hrs wkly ■ Herbert Scott, pres; Richard E. Vazzana, gen & coml mgr; Dan Martin, prog dir; John Gabriel, mus dir; Don Fields, news dir; Robert W. Smith, chief engr. ■ Rates: \$32; 26; 29; 26.

Utica

WBVM
Lekom, Inc.

WBVM—Jan 29, 1962: 1550 khz; 1 kw-D. Box 1550

(13503). (315) 735-2785. WBVM Assoc. (acq 12-5-74). Audio news: UPI. Rep: Selcom. Format: Solid gold. Spec progs: Ital 1½ hrs; Pol 5 hrs, wkly ■ George W. Stevens, pres & gen mgr; Jim Pastrick, prog dir; Douglas Kehrig, chief engr. ■ Rates: \$9; 7.20; 7.80; 7.20.

WIBQ(FM)—Listing follows WIBX.

WIBX—Dec 5, 1925: 950 khz; 5 kw-U. DA-1. Box 950 (13503). (315) 736-9313. WIBX Inc. (acq 12-74). Net: CBS. Rep: PRO/Meeker; Regional Reps; Stephens, Towndrow (Canada). Format: MOR. Spec progs: Ukrainian 1 hr; Pol 5 hrs wkly. ■ Frederic C. Bowen, pres & gen mgr; William J. Heiderich, VP loc/reg sls; J. R. Buckley, prog dir; Betty Allinger, mus dir; David Miller, news dir; Everett A. Radley, chief engr. ■ Rates: \$23; 20; 21; 13.

WIBQ(FM)—Co-owned with WIBX. Jan 1, 1974: 98.7 mhz; 25 kw. Ant 660 ft. Stereo. Prog sep from AM. Format: MOR. ■ Rates: \$12; 13; 13; 12.

WLFH—See Little Falls.



WOUR(FM)—June 1967: 96.9 mhz; 16 kw. Ant 790 ft. Stereo. 288 Genesee St. (13502). (315) 797-0803. Bunkfeldt Bcstg (acq 11-72). Rep: Marv Roslin. Format: Progressive. Spec prog: Live concerts 1 hr, wkly ■ Rudolf Bunkfeldt, pres; Robert N. Putnam, Jr., gen mgr; Jerry Gilels, coml mgr; Jeffrey A. Chard, prog dir; Mark William Cohen, Gilels, coml mgr; Tom Starr, mus dir; Marjorie Marable, news dir; John Bunkfeldt, VP/ chief engr; Tony Yoken, dir special projects. ■ Rates: \$15; 13; 15; 15.

WRUN—April 24, 1948: 1150 khz; 5 kw-D, 1 kw-N, DA-2. Thomas Road, Oriskany, N.Y. (13424). (315) 736-5225. 1150 Broadcasting Inc. (acq 2-22-70). Group owner: Woods Communication. Net: ABC/C. Rep: Buckley. Format: MOR. Spec prog: C&W 12 hrs wkly. ■ John Woods, pres; John R. Sadowski, gen mgr; John Carlucci, mus dir; Don DeRosa, prog dir; Gary Kennerknecht, news dir; Robert Hajec, chief engr. ■ Rates: \$11.50; 10.75; 9.80; —

WRUN-FM—Oct 10, 1948: 104.3 mhz; 100 kw horiz. 33 kw vert. Ant 500 ft. Stereo. Prog sep from AM. Format: Bill mus. ■ Mark Warner, prog dir. ■ Rates: \$8.65; 10.75; 9.80; —

WTLB—1946: 1310 khz; 1 kw-D, 500 w-N, DA-N. Kellogg Rd., Washington Mills (13479). (315) 797-1330. WTLB Inc. (acq 6-15-71). Rep: Eastman. Format: Contemp. ■ Paul A. Dunn, pres & gen mgr; Edward J. Carey, VP & stn mgr; Art Levy, prog dir; John Reitz, mus dir; Brian Whittemore, news dir; David Doughty, chief engr.

WTLB-FM—April 23, 1962: 107.3 mhz; 3.6 kw. Ant 165 ft. (CP: 3.5 kw. Ant 500 ft.). Stereo. Box 1073 (13501). (315) 733-7555. WTLB Inc. (acq 11-74). Format: MOR. ■ Burt Pery, sls mgr; George Smith, prog dir.

Valhalla

***WARY(FM)**—Oct 3, 1973: 88.5 mhz; 40 w. Ant. 358 ft. 75 Grasslands Rd. (10595). (914) 946-0576. Westchester Community College. Format: Progs, variety. ■ Blair H. Davis, gen mgr; Darell L. Adler, prog dir; John L. Wagner, news dir; Paul Hiech, dir of dev; Doug Olson, mus dir; David Glick, news dir; William Winters, chief engr; Richard Conte, tech dir; John R. Prof, opns mgr.

Walton

WDLA—May 30, 1951: 1270 khz, 1 kw-D. Box 58 (13856). (607) 865-4321. Delaware County Bcstg Corp. Audio news: UPI. Rep: Market 4. Format: MOR. Spec progs: C&W 15 hrs, Farm 6 hrs wkly. ■ Myra Youmans, pres; Amos F. Finch, VP & gen mgr; Alma Lynch, prom mgr; John Clark, prog & news dir; Ron R. Galley, mus dir; Lee VerNooy, farm dir; Phillip Vessey, chief engr.

WDLA-FM—Nov 16, 1973: 92.1 mhz; 490 w. Ant 660 ft. Dups AM 75%.

Warsaw

WCJW—May 16, 1973: 1140 khz; 1 kw-D, DA.

New York Radio

See page C-1 for explanation of listings.

Merchants Rd. (14569). (716) 796-8131. WCJW Radio Inc. (acq 1975). Rep: Savalli/Gates. Format: MOR. Spec prog: Farm 18 hrs wkly. ■ John B. Weeks, pres & chief engr; Ralph L. Hager, gen, coml & prom mgr; Randy Brunner, prog dir; William McCough, news & mus dir.

Warwick

WTBO—July 24, 1969: 1110 khz; 250 w-D. Box 454 (10990). (914) 986-2966. Warwick Bcstg Corp. Net: MBS. Format: MOR. Spec prog: Pol 1 hr wkly ■ Edward N. Klein, pres, gen mgr & news dir; Clesie Everett, VP & opns mgr; Stephen Ostrow, coml mgr; John Benedict, prog & mus dir; Henry A. Shelleday, chief engr.

Watertown

WATN—Feb 3, 1941: 1240 khz; 1 kw-D, 250 w-N. 199 Wealtha Ave. (13601). (315) 782-3320. Watertown Bcstg Corp. Net: MBS. Format: Good music, C&W. ■ G. Harry Righter, pres & gen mgr; Donald Schryver, chief engr.

WNCQ(FM)—Listing follows WOTT.

WOTT—Nov 2, 1959: 1410 khz; 5 kw-D, 1 kw-N, DA-N. Box 29A, Gifford Rd. RD 2, (13601). (315) 782-6540. R.B.G. Productions. (acq 6-1-67). Rep: Selcom. Format: Contemp. ■ J. Graham, pres; James Brett, VP, nl & reg sls; Earl Babel, VP, loc sls; Donald Alexander, VP, stn mgr; Steve Behm, prog dir; Len Henry, news dir; Mark Hutchins, chief engr. ■ Rates: \$15; 13; 15; 7.50.

WNCQ(FM)—Co-owned with WOTT. Nov 22, 1968: 97.5 mhz; 41 kw. Ant 285 ft. Stereo. Prog sep from AM. Format: MOR, contemp. ■ Rates: \$7.50; 6.50; 7.50; 3.75.

WWNY—April 29, 1941: 790 khz; 1 kw-U, DA-N. Box 211 (13601). (315) 788-3800. TWX 510-257-4560. The Brockway Co. Net: CBS. Rep: Avery-Knodel, US; Radio-TV Reps, Canada. ■ John B. Johnson, pres; James W. Higgins, gen mgr; Tony Malara, mgr of bcstg; David G. Propeck, natl sls mgr; Rod Abare, prog dir; Robert S. Thompkins, news dir; Lois T. Dempster, dir of community svcs & prom; Glenn H. Hall, dir of opns, Tom Bruce, dir of radio; Michael R. Yonkovic, dir of engr. ■ WWNY-TV affil. ■ Rates: \$18; 16; 16; 13.

Watkins Glen

WGMF—June 22, 1968: 1500 khz; 250 w-D. Jefferson Hotel (14891). (607) 535-2779. Watkins Glen-Montour Falls Bcstg Corp. (acq 5-1-72). Net: ABC/C. Format: Adult contemporary. Spec progs: Ital 1½ hr; C&W 1 hr, Top 40 5 hrs, wkly. ■ Doris Packwood, pres & gen mgr; Joseph Fazzary, dir of sls; Patty Bilinski, coml opns mgr; Ray O'Donnell, chief engr. ■ Rates: \$6.50; 5.50; 5.50; 5.50.

WXXY(FM)—See Montour Falls.

Waverly

WATS—See Sayre, Pa.

WAVR(FM)—Co-owned with WATS Sayre, Pa. October 1974: 102.3 mhz; 1.5 kw. Ant 405 ft. Stereo. Box 188 (14892). (717) 888-7745. Wats Bcstg Inc. Dups AM 100%. Net: ABC/E. Format: MOR. Spec prog: Farm 1 hr wkly. ■ Robert E. Klose, pres & gen mgr; Virginia C. Klose, VP, sec; Sylvia J. Hinrichson, stn & sls mgr; George A. Thomas, opns mgr & mus dir; Tony Pettit, news dir; Lawrence Brown, contract engr. ■ Rates: \$6.20; 4.80; 5.50; 4.40.

Wellsville

WLSV—Oct 31, 1955: 790 khz; 1 kw-D. 56½ N. Main St. (14895). (716) 593-3727. Radio Services of Wellsville. Format: MOR, Top 40, C&W. ■ J. S. Mumma, VP; Larry J. Perrotto, gen mgr; Robert G. Gabler, mgr; Donald Fredeen, coml mgr; Rodney Biehler, prog dir; Donald Sky, chief engr.

Wethersfield Township

WBIV(FM)—1948: 107.7 mhz; 32 kw. Ant 470 ft. Drawer G, Ithaca, N.Y. (14850). (607) 272-8080. Christian Bcstg Network (group owner; acq 1-1-69). Rep:

New York, North Carolina Radio

See page C-1 for explanation of listings.

Young. Format: Gospel. ■ M. G. Robertson, pres; Bill Freeman, gen mgr; James Wall, coml mgr; William Covert, chief engr. ■ Rates: \$5.20; 5.20; 5.20.

White Plains

WFAS—Aug 11, 1932: 1230 khz; 1 kw-D, 250 w-N. Box 551 (10602). (914) OWens 3-2400. Courtland Bcstg Corp. Net: ABC/E. Rep: Torbet. Format: Contemp. MOR. ■ Alfred G. Grosby, pres & gen mgr; John A. Winkel, sls & coml mgr; Vincent Lupiano, prog & mus dir; Gabe Dalmath, news dir; Jack Pearson, chief engr. ■ Rates: \$38; 26; 34; 16.

WWYD(FM)—Co-owned with WFAS. Sept 1, 1947: 103.9 mhz; 500 w. Ant 670 ft. Stereo. Prog sep from AM. Format: Easy lstng. ■ Albert R. Levey, coml & gen sls mgr. ■ Rates: \$23; 28; 28; 23.

CSI ELECTRONICS INC.
2607 River Road
Cinnaminson, New Jersey, 08077
Telephone: (609) 786-1060

North Carolina

HAMILTON-LANDIS & ASSOCIATES, Inc.
NATIONWIDE MEDIA BROKERS
WASHINGTON, D. C., CHICAGO, DALLAS, SAN FRANCISCO
SELL **MORE**
RADIO & TELEVISION STATIONS
IN THE EAST—NEAREST OFFICE IS—
1730 K ST., N.W., WASHINGTON 20006
(202) 393-3456

Aberdeen

WEEB—See Southern Pines.

WIOZ(FM)—See Southern Pines.

Ahoskie

WRCS—April 25, 1948: 970 khz; 1 kw-D. Box 232 (27910). (919) 332-3101. Roanoke-Chowan Bcstg Co. Net: TN News; Caranet. Rep: Hopewell, Southern Spot Sls. Format: MOR. Spec Progs: C&W 13 hrs wkly. ■ Lee S. Lipsitz, pres; Sammy DouLhite, gen mgr; Bill Prudan, coml mgr; Steve Montgomery, prog dir; Donnie Upchurch, prom mgr; Roger Murray, mus dir; Whit Powell, news dir; Charles Savin, chief engr.

WRCS-FM—Sept 2, 1968; 99.3 mhz; 3 kw. Ant 300 ft. Stereo. Progs sep from AM. Format: Contemp.

Albemarle

WABZ—July 1947: 1010 khz; 1 kw-D. Box 608 (28001). (704) YUkon 2-1020. Radio Station WABZ Inc. (acq 1-1-53). Format: Btfl mus, news, sports. ■ E. Keith Almond, pres; Mrs. Ramelle G. Varner, gen mgr; Robert G. Richards, prog dir; John D. Brooks, chief engr.

WABZ-FM—February 1958: 100.9 mhz; 3 kw. Ant 200 ft. Prog dups AM 100%.

WZKY—July 9, 1956: 1580 khz; 250 w-D. Box 550 (28001). (704) 982-1111. Radio Stn WZKY Inc. (acq 12-9-59). Group owner: Suburban. Net: Tobacco, NC News. ■ Robert R. Hilker, pres; Richard R. Norwood, gen mgr; Leon Warren, prog dir; Bill Tadlock, prom mgr; Jim Bell, chief engr. ■ Rates: \$ 2.75; 2.75; 2.75; 2.75

Asheboro

WCSE(FM)—Listing follows WGWR.

WGWR TN

WGWR—May 24, 1947: 1260 khz; 5 kw-D, 500 w-N, DA-2. Box 309 (919) 625-2187. Asheboro Bcsto Co. Net: NC News. Rep: T-N Spot Sales. Format: MOR, variety. ■ Roy Cox Jr., pres; Add Penfield, gen mgr; Edward F. Swicegood II, coml mgr; D. K. McLaughlin, prog dir; A. B. Brown, news dir; Ed Ellison, chief engr. ■ Rates: \$ 6; 5; 6; 5.

WCSE(FM)—Co-owned with WGWR. Nov 1948: 92.3 mhz; 20 kw. Ant 650 ft. Stereo. (919) 625-2189. Prog sep from AM. Format: C&W. ■ Don Bowman, prog dir. ■ Rates: \$4.50; 4.50; 4.50; 4.50.

WZOO—May 3, 1971: 710 khz; 1 kw-D, DA. Box 460 (27203). (919) 672-0985. RCR Ltd. Audio news: APR, UPI. Rep: Southern Spot Sls. Format: MOR. ■ Fred Keith Jr., pres; Bobby J. Watkins, gen & coml mgr; Bill Cox, prog dir; Dave Scott, mus dir; Frank Timberlake Jr., news dir; Robert R. Fleming, chief engr. ■ Rates: \$69; 69; 69;—.

Asheville

***WBUM-FM**—1975: 91.3 mhz; 440 w. Ant 850 ft. 2 South Lexington (28801). (704) 253-1818. Greater Asheville Educl Radio Assn. Format: Educl, black. ■ James E. Robinson, pres & gen mgr; William Candler, chief engr.

WFGW—See Black Mountain.

WISE—1939: 1310 khz; 5 kw-D, 1 kw-N, DA-N. 90 Lookout Rd. (28804). (704) 253-5381. Basic Media Ltd. (acq 8-1-70). Net: ABC/C. Rep: McGavren-Guild. Format: Contemp, Top 40. ■ N. Eric Jorgensen, pres & gen mgr; Joe Lyle Hall, sls mgr; Bob Kagan, prog & mus dir; Dee Jones, asst prog dir; Dick Cullom, news dir. ■ Rates: \$15.50; 11.50; 15.50; 11.50.

WKKE MOR



WKKE—August 1947: 1380 khz; 5 kw-D, 1 kw-N, DA-N. Box 2156 (28802). (704) 252-6703. Greater Asheville Bcstg Co. (acq 9-21-69). Net: CBS. Rep: Buckley. Format: MOR. Spec prog: Jazz 12 hrs wkly. ■ Robert M. Hauck, pres; Eugene Hester Jr., VP & gen mgr; Steve Sandman, prog dir; Ed Fisher, mus dir; James Carrier, chief engr. ■ Rates: \$ 7.35; 6.15; 7.35; 4.90.

WLOS-FM—August 1947: 99.9 mhz; 35 kw. Ant 2,670 ft. Stereo. Box 2150 (28802). (704) 255-0013. TWX 510-933-0166. Wometco Skyway Bcstg Co. (acq 9-58). Group owner: Wometco Int. Net: ABC/E. Rep: PRO/Meeker Time Sls. Format: Btfl mus. ■ Morton S. Cohn, pres; William E. Pfeiffer, stn mgr; John Gosnell, prog dir; Bruce Barnes, coml mgr; Frank Wyatt, mus dir; Dave Guthrie, prom mgr; Joe Foster, news dir; Lee Davis, chief engr. ■ WLOS-TV affil. ■ Rates: \$7.60; 7.60; 7.60; 7.60.

WMIT(FM)—See Black Mountain.

WSKY—April 11, 1947: 1230 khz; 1 kw-D, 250 w-N. Box 2956 (28802). (704) 253-4451. Radio Asheville Inc. Net: Tobacco. Rep: T. N. Sls. Format: C&W. ■ Zeb Lee, pres; David A. Hogan, mus dir; C. Kenneth Blackwell, news dir; Charles W. Sumner, chief engr.

***WUNF-FM**—1975: 88.1 mhz; 11 kw. Ant minus 140 ft. University Heights (28804). U. of N.C. at Asheville.

WWNC—Feb 22, 1927: 570 khz; 5 kw-U, DA-N. Box 2451 (28802). (704) 253-3835. Multimedia (group owner; acq 1-1-68). Net: NBC. Rep: Katz. Format: C&W. ■ Wilson Wearn, pres; Claude E. Freeman, stn mgr; Gordon Peed, coml mgr; Del Wilkerson, news dir; Dave Jacobs, prog dir & mus dir; Robert Harman, chief engr. ■ Rates: \$ 23; 13; 11; 11.

Beaufort

WBMA

Modern Country Music
Rada Broadcasting, Inc.

WBMA—November 1954: 1400 khz; 1 kw-D, 250 w-N. Box 156 (28516). (919) 728-3131. Rada Bcstg Inc. Audio news: APR, UPI. Format: C&N, relig. Spec progs: Farm 2 hrs, btfl mus 7 hrs wkly. ■ Richard Ray Cummins, pres; Hilda Cummins, gen & coml mgr; Robert Cummins, prog, mus & news dir & prom mgr & chief engr. ■ Rates: \$ 43.20; 36; 43.20; 36.

Belmont

WCGC—Dec 11, 1954: 1270 khz; 1 kw-D, 500 w-N, DA-N. Box 888 (28012). (704) 825-8224. Central Bcstg Co. Group owner: Suburban. Net: ABC/I. Rep: Southern Spot Sls. Format: MOR. Spec progs: Black 1 hr, C&W 20 hrs wkly. ■ Robert R. Hilker, pres; Everette Gantt, gen mgr; Jim Beatty, prog dir; Nancy Jones, prom mgr; David Tobin Jr., mus dir; Ralph Winters, chief engr.

Benson

WPYB—Sept 1, 1961: 1130 khz; 1 kw-D. Box 215 (27504). (919) 894-3009. Dispatch Bcstg (group owner; acq 1-1-67). Rep: Southern Spot Sls. Format: C&W. ■ Joe S. Sink, pres; Bob Johnson, gen mgr; Charles Fowler, coml mgr; Wayne Howell, prog & mus dir; Walter L. Johnson, chief engr.

Black Mountain

WBMS—Feb 26, 1966: 1350 khz; 500 w-D. Box 668 (28711). (704) 669-6451. Swannanoa Valley Bcstg Co. Rep: Keystone. Format: C&W, gosp, variety.

WFGW—May 27, 1962: 1010 khz; 50 kw (10 kw-CH)-D, DA. Box 158 (28711). (704) 669-8477. Blue Ridge Bcstg Corp. Net: ABC/I. Format: Relig. Spec progs: Black ¼ hr, classcl ½ hr wkly. ■ Billy Graham, pres; Edna Edwards, gen mgr; Bob Robinson, prog dir; William L. Clements Jr., chief engr.

WMIT(FM)—Co-owned with WFGW. 1941: 106.9 mhz; 36 kw horiz; 22.5 kw vert. Ant 3090 ft. Stereo. Prog dups AM 30%. Format: Relig.

Boiling Springs

***WGWG(FM)**—Jan 24, 1974: 88.3 mhz; 4.7 kw. Ant 220 ft. Box 13 (28017). (704) 434-2349. Gardner-Webb College. Format: Edcl. ■ E. Eugene Poston, pres; Ellis Greenway, gen mgr.

Boone

***WASU-FM**—April 1972: 90.5 mhz; 340 w. Ant minus 120 ft. Speech Dept. (704) 262-3170. Appalachian State University. Net: NPR. Format: Progs, classical. ■ Charles Porterfield, chmn Speech Dept; Dr. Jay Mesbahee, dir of bcstng; Eric Loy, stn mgr; Hugh Lowe, mus dir; Steve Myers, news dir; Ed Chipman, chief engr.

WATA—September 1950: 1450 khz; 1 kw-D, 250 w-N. Box 72 (28607). (704) 264-2411. Wilkes Bcstg Co. Group owner: Potter, Net: ABC. ■ Doris B. Potter, pres; Roland B. Potter, gen mgr; Zara Jane Smith, stn mgr & prog dir; Ronald Hester, prom mgr; Robert Russell White, news dir; Edwin Chipman, chief engr.

Brevard

WPNF—July 6, 1950: 1240 khz; 1 kw-D, 250 w-N. Box 1076 (28712). (704) 883-3511. Pisgah Bcstg Co. Format: MOR. Spec progs: Farm 1 hr, black 8 hrs wkly. ■ Mrs. Ed M. Anderson, pres; Mrs. Katherine Anderson, gen mgr; Tom Israel, coml mgr; Fred Reiter, prog dir; Leon Southerland, chief engr. ■ Rates: \$4.15; 3.65; 4.15; 3.65

Bridgeton

WSFL(FM)—Co-owned with WGSE, New Bern. July 20, 1968: 106.5 mhz; 100 kw. Ant 730 ft. Box 3436. New Bern (28560). (919) 638-5048. P&C Bcstg Co. (acq 9-72). Rep: Savalli/Gates. Format: Contemp. ■ J. D. Conner, pres; Vera Conner, VP & gen mgr; Royal Bruce, prog dir.

Bryson City

WBHN—Oct 1, 1967: 1590 khz; 500 w-D. Box 820 (28713). (704) 488-2682. Ron Bcstg Inc. (acq 6-1-74). Format: C&W. ■ Robert O. Noel, pres; Nancy L. Noel, VP & prog dir; Bruce B. MacMurray, sls mgr; Deborah S. Jones, mus dir; Grady A. Barefield, news dir; Gary Edwards, chief engr.

Buie's Creek

***WCCE(FM)**—Oct 7, 1974: 90.1 mhz; 3 kw. Ant 105 ft. Stereo. Box 1058 (27506). (919) 893-5561. Campbell College Inc. Net: NC News. Format: MOR. ■ Randy M. Cotten, mgr

Burgaw

WBBS—June 21, 1963: 1470 khz; 1 kw-D. Box 696 (28425). (919) 259-4734. Brown Bcstg Inc. (group owner; acq 5-1-73). Net: ABC/C. Rep: Southern Spot Sls. Format: Contemp. ■ Hershel Brown, pres; Norman O. Brown, VP; Bryant Cook, opns mgr; Les Everhart, chief engr.

WBBS-FM—Dec 13, 1964: 99.9 mhz; 28 kw. Ant 150 ft. Prog dups AM 100% daytime.

Burlington-Graham

WBAG—1946: 1150 khz; 1 kw-D. Box 1328 (27215). (919) CAnal 7-4261. Burlington-Graham Bcstg Co. Audio news: UPI. Format: Contemp. ■ G. C. (Jack) Starnes, gen mgr & news dir; Phil Eakin, coml mgr; Paul Allen, prog dir; Bob James, mus dir; Darrell Johnson, chief engr. ■ Rates: \$ 8.50; 8.50; 8.50.

WBAG-FM—1947: 93.9 mhz; 10 kw. Ant 300 ft. Stereo. Prog dups AM. ■ Rates: \$ 8.50; 8.50; 8.50.

WBBS—September 1941: 920 khz; 5 kw-D. Box 1119 (27215). (919) 584-0126. TWX 919-584-0126. Rau Stns (group owner; acq 12-74). Net: MBS. Format: Contemp. ■ Henry Rau, chmn; Lloyd Smith, pres; James R. Brown, gen mgr; Bob Galen, prog dir; Jack Lampe, news dir; Charles Justice, chief engr. ■ Rates: \$ 6; 5; 6;—.

WNCB(FM)—Co-owned with WBBS. December 1946: 101.1 mhz; 28.5 kw. Ant 490 ft. Stereo. Format: Mus. ■ Rates: \$7; 6.50; 7; 6.

WSML—See Graham.

Burnsville

WKYK—May 28, 1967: 1540 khz; 1 kw-D. Box 744 (28714). (704) 682-3798. Mark Media Inc. (acq 4-10-69). Group owner; Sink Stns. Audio news: UPI. Rep: Southern Spot Sls, Mark Media. Format: C&W, variety. Spec prog: Farm 1 hr wkly. ■ J. Ardell Sink, pres; Richard N. Bacon, gen mgr; Robert Wyatt, stn & coml mgr; James McAuliffe, mus dir; Michael Paige, prog dir; Rick Willis, news dir; Mary Pike, prom mgr; Bob Herman, chief engr. ■ Rates: \$ 4.50; 4.50; 4.50; 4.50.

Canton

WPTL—Aug 3, 1963: 920 khz; 500 w-D. Box 471 (28716). (704) 648-3576. P/M Bcstg Inc. (acq 11-72). Format: C&W. ■ Charles R. Price Jr., pres; Clay H. Cline, gen & coml mgr, prog dir; James Haynie, mus dir; Dave Burnett, prom mgr; Chuck King, news dir; Ellis Fox, chief engr.



WWIT—July 12, 1954: 970 khz; 1 kw-D. Box 391 (28716). (704) 648-3588. WWIT Inc. (acq 3-15-75). Audio news: APR, UPI. Rep: Clayton. Format: Relg, Top 40, C&W. ■ Dan Greene Jr., pres & gen mgr; Jack Armstrong, coml mgr & mus dir; James Haynie, prog dir; David Jackson, news dir; Ken Woodard, chief engr. ■ Rates: \$ 5.80; 5.80; 5.80; 4.60.

Chadbourn

WVOE—April 24, 1962: 1590 khz; 1 kw-D. Route 3, Box 39 (29431). (919) 654-3991. Ebony Enterprises Inc. Rep: Dora-Clayton. Format: Black. ■ Lester Moore, pres; Margeret Reaves, gen mgr; Jessie L. Godwin, sls mgr; Wayne Gilbert, prog dir; Gene West, chief engr.

Chapel Hill

WCHL—Jan 25, 1953: 1360 khz; 1 kw-U. DA-N. Box 2127 (27514). (919) 942-8765. Village Bcstg Inc. Group owner: Village Cos. Net: MBS. Rep: Groskin, Southern Spot Sls. Format: Contemp. ■ James A. Heavner, pres; George McCall Jr., gen mgr; Richard A. Hungate, prog dir; Lee W. Hauser, sls mgr; Bob Holliday, news dir; Erick Steinberg, chief engr

WRBX—December 1973: 1530 khz; 5 kw-U, DA-D. 311 West Rosemary (27514). (919) 942-8576. Stuart Epperson. Group owner: Carolina Triangle Bcstg. Net: ABC/E. Format: Contemporary Christian. Spec prog: Classcl 4 hrs wkly. ■ Stuart Epperson, pres & gen & coml mgr & chief engr; Glenn Gravit, prog, mus, & news dir; Debbie Parnell, prom mgr. ■ Rates: \$ 3.50; 3.50;—.

***WUNC(FM)**—Nov 3, 1952: 91.5 mhz; 50 kw. Ant 822 ft. Stereo. Swain Hall, U. of N.C. (27514). (919) 966-5454. U. of North Carolina. Net: NPR. Format: Educl, classcl, jazz. ■ N. Ferebee Taylor, chancellor; Donald Trapp, dir; Timothy L. Warner, chief engr. ■ *WUNC-TV affil.

Charlotte

WAME—Jan 18, 1955: 1480 khz; 5 kw-U. DA-2. Box 1008 (28231). (704) 377-5916. Mission Charlotte Co. (acq 4-1-69). Group owner: Mission Bcstg. Net: MBS. Audio news: APR. Rep: Metro Radio Sls. Format: Modern Country. Spec prog: Farm 1 hr wkly. ■ Jack Roth, pres; Hap Pate, VP & gen mgr; Cloyd Bookout, news dir; Johnny Jacobs, coml mgr; Bobby Dorton, off mgr; Edd Robinson, prog mgr; Rich Jones, mus dir; Ted Bryan, chief engr. ■ Rates: \$ 34; 27; 34; 20.

WAYS—1941: 610 khz; 5 kw-D. 1 kw-N. DA-2. 400 Radio Rd. (28216). (704) 392-6191, 394-6385. SIS Radio Inc. (group owner; acq 5-18-65). Rep: Eastman. Format: Contemp. ■ Stanley N. Kaplan, pres; George Francis, gen mgr; Ben F. Mann, natl sls mgr; Claire Shaffner, local sls mgr; Jay Thomas, prog dir; Beau Matthews, mus dir; John Kilgo, news dir; Don Strawn, chief engr.

WROQ(FM)—Co-owned with WAYS. July 21, 1962: 95.1 mhz; 100 kw. Ant 300 ft. (CP. Ant 570 ft). SIS Radio Inc. (acq 1-17-73). Format: Adult rock. ■ Larry Sprinkle, opns mgr.

WBT—April 10, 1922: 1110 khz; 50 kw-U, DA-N. One Julian Price Pl. (28208). (704) 374-3500. Jefferson Pilot Bcstg Co. (group owner; acq 9-45). Rep: Blair. Format: MOR/Contemp. ■ Charles Crutchfield, pres; Cullie Tarleton, VP & gen mgr; Barry Rouse, coml mgr; Tom McMurray, prog dir; Andy Bickel, opns mgr; Russ Ford, news dir; Tommy Stutts, chief engr.

WBT-FM—Aug 15, 1962: 107.9 mhz; 97 kw. Ant 970 ft. Stereo. Prog sep from AM. Format: Beautiful music. ■ Bill Taylor, opns dir. ■ WBT(TV) affil.

WCGC—See Belmont.

WEZC(FM)—1972: 104.7 mhz; 100 kw horiz, 91 kw vert. Ant 1,230 ft. Stereo. 516 Fenton Place (28207). (704) 334-7333. E.Z. Listings (group owner). Rep: Groskin. Format: Easy Lstngs-MOR. ■ Art Keller, pres; Bob Lee, gen mgr; Yates Davis, opns mgr; Jeff Watts, chief engr.

WGIV—Dec 13, 1947: 1600 khz; 1 kw-D, 500 w-N, DA-N. Box 3856 (28203). (704) 333-0131. New GIV Inc. (acq 9-74). Net: Black Audio. Rep: Howard. Format: Black. ■ Todd Branson, VP, gen & coml mgr; E. Manny Clark, prog dir; Jerry Stowe, mus dir; Bill Ward, news dir; S. K. Lineberger, chief engr.

WHVN—Aug 23, 1958: 1310 khz; 1 kw-D. Box 8588 (28208). (704) 333-1101. WKTC Corp. (acq 8-1-71). Net: MBS. Format: Christian. ■ George H. Buck Jr., pres; Thomas J. Gentry, gen mgr; Fletcher Edens, prog & mus dir; Sam Norman, chief engr.

WIST—Dec 6, 1928: 1240 khz; 1 kw-D, 250 w-N. Box 59 (28201). (704) 376-3511. Metrolina Bcstg Corp. (acq 1974). Net: CBS. Format: Progs, talk. ■ Albert R. Munn, R. T. Belcher, owners; Garrett W. Allen, exec VP & gen mgr; Betty Wilson, sls mgr; Dan R. Cook, prog dir; William Fox, mus dir; Rebecca W. Turner, prom mgr; Jeff Watts, chief engr.

WROQ(FM)—Listing follows WAYS.

WRPL—May 7, 1964: 1540 khz; 1 kw-D. 1402 E. Morehead St. (28204). (704) 372-1540. Voice of

North Carolina Radio

See page C-1 for explanation of listings.

Charlotte Bcstg Corp. Group owner: Lyon. Net: ABC/C. Rep: Dore. Format: Progs. Spec prog: Jazz 4 hrs wkly. ■ R. A. Lyon, pres; Albert Cafaro, gen & prom mgr & prog dir; R. C. Lincoln, coml mgr; Chris Hensley, mus dir; Barry Sidwell, news dir; Tom Hayes, chief engr. ■ Rates: \$ 12; 11; 12;—.

WSOC—Oct 14, 1933: 930 khz; 5 kw-D, 1 kw-N, DA-N. Box 2536 (28201). (704) 372-0930. Carolina Bcstg Co. (acq 5-14-59). Group owner: Cox. Net: NBC. Rep: Christal. Format: Adult contemp. ■ Clifford M. Kirtland, pres; Lee Morris, gen mgr; Barry Noll, gen sls mgr; John Harper, opns mgr; Penney Kalkhurst, prom mgr; Denny Miller, mus dir; Gary Edwards, news dir; Charles Whitley, chief engr.

WSOC-FM—1947: 103.7 mhz; 97 kw. Ant 1040 ft. Stereo. Prog sep from AM. Net: ABC/FM. Format: C&W. Spec prog: Black ½ hr bluegrass 1 hr wkly. ■ WSOC-TV affil.

Cherry Point

WKVO—See Havelock.

WKVO-FM—See Havelock.

Cherryville

WCSL—June 28, 1967: 1590 khz; 1 kw-D. Box 367 (28021). (704) 435-3297. Mark Media Inc. (acq 12-31-70). Group owner: Sink Stns. Audio news: UPI. Rep: Mark Media Group Sls. Format: C&W, diversified. Spec prog: Farm 1 hr wkly. ■ J. Ardell Sink, pres; Gary Jarrett, gen mgr & chief engr; Calvin Hastings, asst & coml mgr; Hal Owens, prog & news dir; Howard Black, prom mgr; Bob Dayes, mus dir. ■ Rates: \$ 3.50; 3.50; 3.50.

Clayton

WHPY—1974: 1590 khz; 5 kw-D. Clayton Bcstg Co. (27520).

Clinton

WCLEN—1975: 1170 khz; 1 kw-D. 1829 Front St, Durham (27702). Sampson Bcstg Co. ■ Lawrence B. Carr, pres.

WRRZ—May 4, 1947: 880 khz; 1 kw-D. Box 378 (28228). (919) 592-2165. WRRZ Radio Co. (acq 6-1-55). Net: NC News. Audio news: APR. Rep: Tobacco. Format: Variety. Spec prog: Farm 7½ hrs wkly. ■ George S. Walston, gen mgr; Nolan Wiggins, prog & mus dir; Leah Henry, coml mgr; Gene Kirby, news dir; Delma Patrick Dixon, chief engr. ■ Rates: \$4.50; 4.50; 4.50; 4.50.

WRRZ-FM—June 11, 1967: 107.1 mhz; 3 kw. Ant 300 ft. Prog dups AM 65%. Format: Btl mus. ■ Rates: \$2.50; 2.50; 2.50; 2.50.

Concord

WEGO—March 5, 1943: 1410 khz; 1 kw-D. Box 128 (28025). (704) 786-9112. Concord-Kannapolis Bcstg Co. (acq 7-1-57). Group owner: Suburban. Net: NC News. Rep: Southern Spot Sls. Format: C&W. Spec prog: Black 1 hr wkly. ■ Robert R. Hilker, pres; Charles A. Hicks, gen & coml mgr; James W. Driggers, prog dir; Larry Thomas, prom mgr & news dir; David Caldwell, mus dir; Ken Kennedy, chief engr. ■ Rates: \$3.50; 3; 3.50; 3.

WPEG(FM)—Co-owned with WEGO. June 15, 1962: 97.9 mhz; 10 kw. Ant 390 ft. (704) 786-9111. Stereo. Prog sep from AM. Format: Top 40. ■ Rates same as AM.

Dallas

WAAK—Jan 1, 1963: 960 khz; 1 kw-D. Box 477 (28034). (704) 922-3411. Fred H. Whitley. ■ Fred H. Whitley, gen mgr; William E. Rumpie, chief engr.

Davidson

***WDAY(FM)**—Sept 1, 1973: 90.5 mhz; 10 w. Ant 60 ft. Box 278 (28036). (704) 892-1908. Trustees of Davidson College. Format: Progs. ■ Mark Wilensky, mgr & prog dir.

Dunn

WCKB—Dec 6, 1946: 780 khz; 1 kw-D. Box 431

North Carolina Radio

See page C-1 for explanation of listings.

(28334). (919) 892-3133. North Carolina Central Bcstrs Inc. Format: MOR. Spec prog: Black 6 hrs wkly. ■ Robie S. Butler, pres; Bob Jenkins, VP & gen, coml & prom mgr; Ron Tart, prog & mus dir; John G. Thomas, news dir; Toby Johnson, chief engr. ■ Rates: \$2.90; 2.90; 2.90; 2.90.

WQTI(FM)—Co-owned with WCKB. May 17, 1971: 103.1 mhz; 3 kw. Ant 240 ft. Stereo. Prog sep from AM. Format: C&W, pop, gosp. ■ Rates same as AM.

Durham

***WAFR(FM)**—Sept 20, 1971: 90.3 mhz; 3 kw. Ant 150 ft. Box 1166 (27701). (919) 688-2371. Community Radio Workshop Inc. Net: NPR. Format: Educl, black. ■ Robert Spruill, pres; Obataiye Akinwale, dir of bcstg.

WDBS(FM)—May 15, 1971: 107.1 mhz; 3 kw. Ant 295 ft. Stereo. Box 4742 (27706). (919) 684-3686. WDBS Inc. (acq 5-71). Rep: Frederick Smith, NYC. Audio news: UPI. Format: Progs. ■ Bob Conroy, pres; Katherine Stanford, gen mgr; David Kramer, sis mgr; Steve Tulsky, prog dir; Celeste Wesson, news dir. ■ Rates: \$10; 10; 10; 10.

WDCG(FM)—Listing follows WDNC.

WDNC—April 9, 1934: 620 khz; 5 kw-D, 1 kw-N, DA-2. Box 2126 (27702). (919) 682-0319. Durham Radio Corp. Rep: HR/Stone. Format: Contemp. ■ Harold Vester, gen mgr; Bob Harris, prog dir; Peter Deane, news dir; Barry Hayes, chief engr.

WDCG(FM)—Co-owned with WDNC. Feb 28, 1948: 105.1 mhz; 36 kw. Ant 380 ft. Stereo. Prog sep from AM. Net: ABC/E. Format: C&W.

WSRC—Oct 14, 1954: 1410 khz; 1 kw-D. Box 1331 (27702). (919) 477-7331. Carolina Radio of Durham Inc. (acq 2-1-62). Net: NPR. Rep: Dore, Southern Spot Sls. Format: Black. ■ James H. Mayes Jr., pres & gen mgr; Lee Smith, coml mgr; Cal Ogle, engr supvr. ■ Rates: \$7.50; 7.50; 7.50; 7.50.

WSSB—1947: 1490 khz; 1 kw-D, 250 w-N. Box 1266, 1822 Nixon St. (27702). (919) 682-8100. 1490 Inc. (acq 7-1-69). Group owner: Woods Communications. Net: ABC/C. Rep: PRO Time Sls. Format: Contemp. ■ John Woods, pres; Hal Vester, gen mgr; M. G. Bobbitt Jr., coml mgr; Tim Edwards, prog dir; Billy Kelley, news dir; Mike Campbell, chief engr.

WTIK

Modern Country Music



WTIK—1945: 1310 khz; 5 kw-D, 1 kw-N, DA-2, Box 1571 (27702). (919) 477-7351. W&W Bcstg Co. (acq 9-1-56). Net: MBS. Audio news: UPI. Rep: Torbet. Format: C&W. ■ C. H. Wentz, pres; Herry L. Welch Sr., sec-treas; H. L. Welch Jr., gen mgr; Tony Rigsbee, prog & news dir; John Scott, mus dir; Sandra Clements, prom mgr; Grover C. Baker, chief engr. ■ Rates: \$11; 10; 11; 7.50.

Eden

WCBX—Aug 16, 1970: 1130 khz; 1 kw-D. Box A (27288). (919) 623-3121. Radio Eden Inc. Format: Contemp. ■ Ray A. Childers, pres; Bertha B. Childers, gen & coml mgr; Richard H. Dinsmore, prog dir.

WEAF(FM)—Listing follows WLOE.

WLOE—Dec 20, 1946: 1490 khz; 1 kw-D, 250 kw-N. Box 548 (27288). (919) 623-3118. So Com Inc. (acq 6-19-72). Net: MBS. Rep: Southern Spot Sls. Format: Contemp. ■ W. Jack Brown, pres; David L. Boliek, gen mgr; Betty G. Moore, coml mgr; Mike Moore, prog dir; Joanne Boliek, news dir; Eldred Winn, chief engr.

WEAF(FM)—Co-owned with WLOE. March 20, 1949: 94.5 mhz; 27 kw. Ant 96 ft. Stereo. Progs sep from AM. Format: C&W.

Edenton

WBXB(FM)—Not on air, target date December 1975: 100.1 mhz; 3 kw. Ant 195 ft. Stereo. Box O (27932). Chohan Bcstrs. Format: Oldies, btl mus. ■ Carmen Sarai Barry, pres; Roy Godwin, gen mgr; Dorothy Lillibridge, sis mgr; Charles F. Barry III, chief engr. ■ Rates: \$ 3; 3; 3; 3.

WCDJ—November 1955: 1260 khz; 1 kw-D. Box 180 (27932). (919) 482-2103. Colonial Bcstrs Inc. (acq 6-10-62). ■ William T. Watkins, pres; James F. Flanagan, gen & coml mgr; Carolyn A. Bunch, prog dir; Robert Dail, news dir & chief engr.

Elizabeth City

WCNC—September 1939: 1240 khz; 1 kw-D, 250 w-N. Box 1246 (27909). (919) 335-4379. Albemarle Bcstg Co. Audio news: UPI. Rep: Southern Spot Sls. Format: Contemp. ■ J. L. Lamb Sr., pres; J. L. Lamb Jr., gen mgr & chief engr; Desmond S. Barclay, asst mgr; Jeff Thompson, farm & news dir.

WGAI—Nov 2, 1947: 560 khz; 1 kw-D, 500 w-N, DA-2. Box 1408 (27909). (919) 335-4371. Campbell Bcstg Inc. (acq 1974). Net: MBS. Rep: T-N. Format: Contemp. ■ Robert L. Snowden, gen mgr; P. R. Ward, chief engr.

WMYK(FM)—Nov 30, 1973: 93.7 mhz; 100 kw. Ant 440 ft. (CP 80 kw Ant 940 ft). Stereo. Box 269, Moyock, N.C. (27958). (919) 435-6138; (804) 421-9695. Love Broadcasting. Format: Progs, contemp. Spec prog: Classi 4 hrs wkly. ■ Robert A. Bennis, pres & gen mgr; William Koenig, prog dir & chief engr; Mike Murray, sis mgr; Harold Guilfoil, mus dir; Michael Bennis, prom mgr; John Stevens, news dir. ■ Rates: \$14; 14; 14; 14.

Elizabethtown

WBLA—Aug 3, 1956: 1440 khz; 1 kw-D. Box 458 (28337). (919) 862-3184. Bladen Bcstg Corp. Net: Tobacco. Rep: Keystone, Hopewell. Format: Variety, black. ■ Chatham C. Clark, gen mgr; Robert Hester, coml mgr; John Tomlin, prom mgr; Gene Wells, chief engr. ■ Rates: \$4.25; 4.25; 4.25; 4.25.

Elkin

WIFM—1949: 1540 khz; 1 kw-D, 500 w-CH. Drawer 1038 (28621). (919) 835-2511. Tri-County Bcstg Co. (acq 12-1-54). Net: ABC/I. Format: MOR, Top 40, C&W, gosp. ■ H. F. Lafoon, pres; W. P. Erwin, gen mgr; Leon Reece, stn mgr; Alan Combs, coml mgr; Ralph Shaw, news dir; Richard H. Paulson, chief engr. ■ Rates: \$3; 3; 3; 3.

WIFM-FM—1949: 100.9 mhz; 3 kw. Ant 60 ft. Prog dups AM 15%. ■ Rates: \$2.25; 2.25; 2.25; 2.25.

Fair Bluff

WWKO—Oct 21, 1967: 1480 khz; 1 kw-D. Box 338 (28439). (919) 649-6325. Universal Bcstg Co. Inc. Format: C&W, Top 40. ■ Marion H. Davis, pres; Bob Morgan, gen mgr & sec-treas; Vic Cotto, news dir; Joe Miles, chief engr.

Fairmont

WFMO—July 13, 1953: 860 khz; 1 kw-D. Box 665 (28340). (919) 628-6781. Carolinas Bcstg Inc. Net: Tobacco. Rep: TN Spot Sls. Format: Contemp. ■ James C. Clark, VP & gen mgr; John W. Pittman, coml mgr; Bob Evans, prog dir; Bob Fee, prom mgr; Joe Miles, chief engr.

WXKY(FM)—Co-owned with WFMO. 1975: 100.9 mhz; 3 kw. Ant 300 ft.

WFAG—Dec 12, 1959: 1250 khz; 500 w-D. Box 229 (27828). (919) 753-4122. Farmville Bcstg Co. (acq 7-16-73). NC News. Rep: Spec. Prog. Format: C&W. Spec prog: Black 3 hrs, auto races 5 hrs, Farm 15 hrs weekly. ■ L. Gene Gray, pres, gen mgr & chief engr; H. Steve Hardy, coml mgr; John Moore, prog & mus dir; John Seid, prom mgr; Ken Cobb, news dir. ■ Rates: \$4; 4; 4; 4.

WRQR(FM)—Co-owned with WFAG. Mar 22, 1974: 94.3 mhz; 3 kw. Ant 300 ft. Stereo, quad. (919) 753-4110. Format: Progs. Spec prog: Earth news, jazz 3 hrs, talk 2 hrs wkly. ■ Danny Miller, prog dir; Jay Dalton, mus dir. ■ Rates same as AM.

WFAI—1947: 1230 khz; 1 kw-D, 250 w-N. Box 649 (28302). (919) 483-0393. Beasley Bcstg Co. (group owner (60%); acq 9-1-71). Net: ABC/E. Rep: Torbet. Format: C&W. ■ George G. Beasley, pres; Danny Highsmith, gen mgr; Rudy Hickman, prog & mus dir; Gobert Warren, news dir; John Franchioni, chief engr. ■ Rates: \$9.60; 7.20; 9.60; 7.20.

WFLB—1947: 1490 khz; 1 kw-D, 250 w-N. Box 530 (28302). (919) 323-0925. WFLB Radio Inc. (acq 2-74). Net: ABC/C. Rep: Busby Finch & Woods, PRO Time Sls. Format: Contemp. ■ Gardner H. Altman Jr., pres; Chris Mack, ops mgr; Marty Webb, coml mgr; Charlie Walker, prog dir; Hershell Barbour, stn mgr; Larry Cannon, mus dir; Johnny Joyce, news dir; Phillip White, chief engr.

WFNC—1940: 940 khz; 50 kw-D, 1 kw-N, DA-N. Box 5297 (28303). (919) 867-3131. Cape Fear Bcstg Co. Net: CBS. Rep: T-N Spot Sls. Format: Contemp. ■ Victor W. Dawson, pres & gen mgr; Paul Michels, stn mgr; George W. Weaver, prog dir; Jeff Thompson, news dir; Jess Sprouse, chief engr.

WQSM(FM)—Co-owned with WFNC. 1946: 98.1 mhz; 50 kw. Ant 280 ft. Progs sep from AM. Format: C&W. ■ Rudy Zurlo, stn & coml mgr; Bill Bullard, prog dir; Andy Andrews, mus dir.

WIDU—Jan 20, 1958: 1600 khz; 1 kw-D. Box 247 (28302). (919) 483-6111. WIDU Bcstg Inc. Net: MBS, Mutual Black. Rep: Ochs. Format: Black. ■ W. B. Belche, pres & gen mgr; William A. Hennessee, prog, mus & news dir; Forrest Tyndall, coml mgr; Gene Wells, chief engr.

WQSM(FM)—Listing follows WFNC.

Forest City

WAGY—Oct 15, 1958: 1320 khz; 1 kw-D. Box 280 (28043). (704) 245-9887. Try-City Bcstg Co. Format: C&W, talk, gospel. ■ G. T. Becknell, pres, gen mgr & chief engr; Willie Fulton, coml mgr; "Pappy" Bedford, prog dir; Jessie Cochran, news dir. ■ Rates: \$2.50; 2.50; 2.50; 2.50.

WBBO—Sept 10, 1047: 780 khz; 1 kw-D. W. Main St. (28043). (704) 245-4205. Rutherford County Radio Co. Net: ABC/C. Rep: Carpenter. Format: Top 40. Spec progs: Black 3 hrs wkly. ■ Mrs. Ed M. Anderson, pres & gen mgr; Carl Hanson Jr., coml mgr; Patrick D. Nanney, prog dir; Kathy Pate, prom mgr; Beauregard Love, mus dir; Jimmy Taylor, news dir; Henry E. Melton, chief engr. ■ Rates: \$3; 3; 3; 2.75.

WBBO-FM—Sept 10, 1947: 93.3 mhz; 1.5 kw. Ant 345 ft. Prog dups AM 40%. Format: C&W. ■ Pat Nanney, mus dir. ■ Rates: \$2; 1.50; 2; 1.50.

Franklin

WFSC

Action Radio

WFSC—May 5, 1957: 1050 khz; 1 kw-D. Box 470 (28734). (704) 524-4418. WFSC Inc. Net: ABC/I. Format: C&W, MOR, talk. ■ Edwin P. Healy, pres & gen mgr; Brenda Sourhard, stn & coml mgr; Randy Raby, prog dir; Ronald Franklin, mus dir; Carol Owens, prom mgr; Nancy Powell, news dir; Rick Cruse, tech supvr. ■ Rates: \$2.95; 2.95; 2.95; —

WFSC-FM—Sept 1, 1965: 96.7 mhz; 3 kw. Ant minus 300 ft. Prog sep from AM. Format: Btl mus, MOR. ■ Rates: \$1.50; 1.50; 1.50; 1.50.

Fuquay Varina

WAKS—1949: 1460 khz; 1 kw-D. Box 588 (27526). (919) 552-2263. Wake County Bcstg Co. (acq 3-71). Net: MBS. Rep: TN Spot Sls. Format: C&W. Spec prog: Black 6 hrs wkly. ■ Jim Butts, VP, gen & coml mgr; Rick Butts, prog & mus dir, prom mgr; Walt Pearson, news dir; Toby Johnson, chief engr. ■ Rates: \$4.50; 4.50; 4.50; —

Garner

WKBO—Aug 11, 1969: 1000 khz; 250 w-D. Box 1386, Raleigh, N.C. (919) 772-2573. Edward G. Atsinger III. Net: ABC/I. Format: C&W. ■ Edward G. Atsinger III, pres; Edward G. Atsinger Jr., gen mgr; Austin Rigsbee, coml mgr; Buck Poe, prog dir; Gary Joyner, new & pub affrs dir; B. W. Hayes, tech dir. ■ Rates: \$6; 6; 6; 4.

Gastonia

WGAS—See South Gastonia.

WGNC—March 1939: 1450 khz; 1 kw-D, 250 w-N. 1770 N. Chester St. (28052). (704) 865-8501. Catherine T. McSwain, ■ Pat McSwain, gen mgr & prog dir; Carl Rhyne, coml mgr; W. C. Groves Jr., chief engr.

WGNC-FM—September 1947: 101.9 mhz; 11.1 kw. Ant 890 ft. Prog dups AM.

WLTC—March 8, 1948: 1370 khz; 5 kw-D, Box 3927, Akers Station (28052). (704) 865-1280 & -1079. Gastonia Bcstg Service Inc. Rep: Bernard; Imbornone; Messina. Format: C&W. Spec prog: Gospel in song 10 hrs wkly. ■ J. B. Petty, pres & gen mgr; B. C. Morrow, coml mgr; Glenn Jones, prog & mus dir; Gerald Webb, news dir; Don Voight, chief engr. ■ Rates: \$6.50; 6.50; 6.50; 6.50.

Goldsboro

WEQR(FM)—Listing follows WGBR.

WFMC—Nov 11, 1951: 730 khz; 1 kw-D, Box 2006 (27530). (919) 734-4211. Southern Radio & TV Corp. (acq 1-9-67). Group owner: Beasley (60%). Net: Carahet. Rep: Jones, Southern Spot Sls. Format: C&W. ■ George G. Beasley, pres; Robert L. Denmark, gen mgr; Charles Little, prog & mus dir; Bob Wilson, coml & prom mgr; Brantley Watkins, news dir; Bill Burwell, chief engr.

WOKN(FM)—Co-owned with WFMC. Feb 2, 1972: 102.3 mhz; 3 kw. Ant 275 ft. (919) 734-4213. Prog sep from AM. WOKN Inc. Net: Natl Black Rep: Howard. Format: Black. ■ Robert Swinson Jr., gen mgr; Sandy Little, coml mgr; James Swinson, prog & mus dir.

WGBR—1939: 1150 khz; 5 kw-D, DA-2, Box 207 (27530). (919) 736-1150. Eastern Carolina Bcstg Inc. Net: ABC/N, Tobacco. Rep: T-N Spot Sls. Format: Contemp. ■ Vassie G. Balkcum, pres & gen mgr; C. Robert Ray, ops mgr; Jim Washam, prog dir; Bob Hill, coml & prom mgr; William G. Justice, news dir; Roy Pike, chief engr. ■ Rates: \$9; 9; 9; 9.

WEQR(FM)—Co-owned with WGBR. 1945: 96.9 mhz; 50 kw. Ant 320 ft. Stereo. Prog dups AM 25%. Format: Btlf mus. ■ Rates same as AM.

WOKN(FM)—Listing follows WFMC.

WYNG—Oct 22, 1955: 1300 khz; 1 kw-D, Box 128 (27530). (919) 734-1300. Peace Bcstg Corp. (acq 10-15-69). Rep: Southern Spot Sls. Format: Contemp. ■ Brice Miller, gen mgr; Brock Abernathy, sis mgr; Warren Henderson, prog dir; Jerry Parker, stn mgr; Gary Weber, ops mgr; Wendy Waites, news dir; Charles Lee, chief engr. ■ Rates: \$4.50; 4.25; 4.50; 4.25.

Graham

WSML—Dec 2, 1967: 1190 khz; 500 w-D, DA, Box 227 (27533). (919) 227-4254. Smiles of Graham Inc. Rep: Southern Spot Sls. Format: Btlf mus, rock. Spec prog: C&W 18 hrs wkly. ■ Norman J. Suttles, pres; Aubrey Aycok, gen mgr; Berry Tysor, chief engr. ■ Rates: \$ 4; 3.50; 4; 3.50.

Granite Falls

WKJK—Feb 22, 1963: 900 khz; 500 w-D, Box 486 (28630). (704) 396-3361. Bcstg Enterprises Inc. (acq 7-22-66). Format: C&W. ■ John Morris, pres & gen mgr; David Dancy, coml mgr; Herman Holland, prog dir; Ed Logan, mus dir; Norman Whisnant, chief engr. ■ Rates: \$4.25; 4.25; 4.25; 4.25.

Greensboro

WBIG—Aug 19, 1926: 1470 khz; 5 kw-U, DA-N, Box 20204 (27420). (919) 288-4131. North Carolina Bcstg Inc. (acq 1934). Net: CBS. Rep: Torbet. Format: Contemp. ■ Allen Wannamaker, pres; Dan T. Griffin, gen mgr; W. H. Henry, coml mgr; Henry Boggan, prog dir; Lloyd Gordon, news dir; W. G. Barnes, chief engr.

WCOG—1947: 1320 khz; 5 kw-D, 1 kw-N, DA-2, Box 8717 (27410). (919) 299-0346. Thoms Bcstg Co. (acq 12-1-57). Group owner: Thoms Sns. Net: ABC/C. Rep: Eastman. Format: Contemp. ■ Harold H/Thoms, pres; James P. Poston, gen & coml mgr; Bob Dayton, prog dir; Kitty Lawhorn, prom mgr; Jimmy Fulmer, mus

dir; Tim Walker, chief engr. ■ Rates: \$13.50; 11.25; 15.75; 11.25.

WEAL

All Hit Soul Music-News
Mutual Black
Bernard Howard Company
NCAB

WEAL—Oct 5, 1962: 1510 khz; 1 kw-D, 250 w-CH. Box 6626 (27405). (919) 272-5121. WEAL Inc. (acq 1974). Net: MBS. Rep: Howard. Format: Black. ■ Eugene Tanner, trustee; William P. Mitchell, stn dir & dir of s/s; Ruenell Stewart, ops mgr; Lee Miller, asst ops mgr; Larry Allen, chief engr. ■ Rates: \$11; 11; 11; 11.

WGBG—Feb 16, 1942: 1400 khz; 1 kw-D, 250 w-N. Box 22005 (27420). (919) 273-3631. Greensboro Bcstg Inc. Net: ABC/ Rep: Pro Time Sls. Format: C&W. ■ Ralph M Lambeth, pres & gen mgr; Hal Olivey, coml mgr; Tim Rowe, prog dir; Martin Rudisill, mus dir; Jeff Gupton, news dir; Larry Allen, chief engr. ■ Rates: \$15; 12; 15; 12.

WPET—1954: 950 khz; 500 w-D, Box 950 (27402). (919) 275-4464. Mido Communications Inc. (acq 12-67). Rep: Meeker, Pearse, Southern Spot Sls. Format: C&W. ■ Donald L. Wilkes, pres; Tom Armshaw, gen, coml & prom mgr; Del Maynard, prog & news dir; Herman Hall, chief engr.

WRQK(FM)—Co-owned with WPET. Jan 9, 1958: 98.7 mhz; 100 kw. Ant 380 ft. Stereo. 311 Asheboro St. (27406). (919) 274-9711. Greensboro FM Inc. (acq 4-3-73). Net: TN. Format: C&W.

***WQFS(FM)**—January 1970: 90.7 mhz; 10 w. Guilford College (27410). (919) 294-0706. Trustees of Guilford College. Format: Progressive, jazz, underground. Spec prog: Talk 12 hrs wkly. ■ Charles Allsopp, pres & gen mgr; Alan I. Socol, coml mgr.

WQMG(FM)—July 8, 1962: 97.1 mhz; 20 kw. Ant 520 ft. Stereo. Box 6702 (27405). (919) 275-1657. Murray Hill Bcstg Co. Audio news: UPI. Rep: Selcom. Format: MOR. Spec progs: Classical 8 hrs, jazz 5 hrs wkly. ■ Joyce Webster, pres & gen mgr; Jerry Carpenter, mus dir; Joe Blevins, traf dir; Allan C. Godwin, chief engr. ■ Rates: \$14; 14; 14; 9.50.

WROK(FM)—Listing follows WPET.

***WUAG(FM)**—July 20, 1964: 89.9 mhz; 10 w. Elliott U. Center, U. of N.C. at Greensboro (27412). (919) 379-5450. U. of North Carolina at Greensboro. Format: Educl, progrsv, diversified. ■ Emil W. Young Jr., dir radio and television; Paul D. Bell, stn mgr; Woodrow McDougald, chief engr.

Greenville

WGNL—July 15, 1962: 1550 khz; 1 kw-D, Box 1485 (27834). (919) 752-1115. Greenville Bcstg Co. Inc. (acq 5-13-74). Rep: Bernard. Format: Contemp. Spec progs: Black 10 hrs wkly. ■ Ralph A. Gardner, pres & gen mgr; Johnny West, ops mgr; Steve Gannon, prog dir; Bill Allen, news dir; Ronald Johnson, chief engr.

WNCT—1940: 1070 khz; 10 kw-U, DA-N, Box 898 (27834). (919) 758-1070. TWX: 510-929-1619. Roy H. Park Radio Inc. (group owner). (acq 1962). Net: CBS. Rep: Katz. Format: C&W. Spec prog: Farm 14 hrs wkly. ■ Roy H. Park, pres; Roger Turner, VP; William L. Fowler, gen mgr; Irene Moore, coml mgr; Charles Hudde, prog dir; Billy Yeargin, farm dir; Ken S. Tanner, news dir; Jay R. Griffith, chief engr. ■ Rates: \$11; 7; 11; 4.

WNCT-FM—Dec 22, 1963: 107.7 mhz; 100 kw. Ant 560 ft. Stereo. Prog sep from AM. Format: C&W. Spec prog: Farm 14 hrs wkly. ■ Rates same as AM. ■ WNCT-TV affil. ■ Rates same as AM.

WOOW

Contemporary

WOOW—October 1959: 1340 khz; 1 kw-D, 250 w-N. Box 647 (27834). (919) 758-1171. WOOW Bcstg Inc. (acq 5-66). Net: ABC/C. Rep: Pro/Meeker; Southern Spot Sls. Format: Top 40. Spec prog: Farm 2 hrs wkly. ■ Mark Clements, chmn; Danny Jacobson, pres, gen & coml mgr; Carl Davis, prog dir & chief engr; Larry Fitzgerald, mus dir & prom mgr; David Haines, news

North Carolina Radio

See page C-1 for explanation of listings.

dir. ■ Rates: \$14.50; 12.50; 14.50; 11.

Hamlet

WKDX—June 30, 1957: 1250 khz; 1 kw-D, Box 826 (28345). (919) 582-2653. Richmond County Bcstg Co. Inc. Group owner: Lyon. Spec prog: C&W 6 hrs wkly. ■ R. A. Lyon, pres; W. E. Benoist, gen mgr; Mrs. Lettje M. Brown, prog dir; David M. Raley, chief engr.

Havelock-Cherry Point

WKVO—June 16, 1962: 1330 khz; 1 kw-D, Box 247 (28532). (919) 447-5100. Southeast State Bcstg Corp. (acq 5-1-69). Net: ABC/C. Format: Contemp. ■ Charles P. Wenk, pres & gen mgr; Bruce Kent, coml mgr; Gary Sapiane, prog dir; Jim Hartline, chief engr.

WKVO-FM—Nov 12, 1971: 104.9 mhz; 3 kw. Ant 165 ft. Prog dups AM 60%.

Henderson

WHNC—June 6, 1945: 890 khz; 1 kw-D, Box 1240 (27536). (919) 438-7136. Henderson Radio Corp. (acq 10-7-11). Group owner: Beasley (50%). Net: Carolina Radio, Tobacco. Format: C&W. Spec prog: Black 1 hr wkly. ■ George C. Beasley, pres.

WXNC(FM)—Co-owned with WHNC. June 6, 1948: 92.5 mhz; 15.5 kw. Ant 260 ft. Prog sep from AM.

WIZS—Sept 1, 1960: 1450 khz; 1 kw-D, 250 w-N. Box 1299 (27536). (919) 438-8135. Stanley H. Fox (acq 9-1-60). Group owner: Fox Sns. Net: Carolina Radio. Rep: Walton, TN Spot Sls. Format: C&W, black. ■ Stan Fox, pres; Thomas J. Moore, gen & coml mgr; William Sutton, prog dir; John Rose, news dir; Walter L. Johnson, chief engr.

WXNC(FM)—Listing follows WHNC.

Hendersonville

WHKP—Oct 22, 1946: 1450 khz; 1 kw-D, 250 w-N. Box 2470 (28739). (704) 693-9061. Radio Hendersonville Inc. (acq 1947). Audio news: UPI. Rep: Hopewell, Keystone, Southern Spot Sls. Format: Contemp. ■ Kermit E. Edney, pres; Art Cooley, gen mgr; Bill Edmundson, coml mgr; Doug Brooks, prog dir; Boyce Orr, off mgr; Jerry King, mus dir; Frank Hawkins, news dir; Norman Lyda, chief engr. ■ Rates: \$8.10; 7.25; 7.25; 7.25.

WKIT(FM)—Co-owned with WHKP. April 15, 1958: 102.5 mhz; 100 kw. Ant 332 ft. (704) 693-4193. Net: ABC/FM. Rep: Southern Spot Sls. Format: C&W. ■ Rates: \$ 11; 10; 10; 10.

WHVL—Dec 25, 1964: 1600 khz; 1 kw-D, DA, 717 Greenville Hwy (28739). (704) 692-1600. The Mountaineire Corp. Format: C&W. ■ A. E. Perkins, pres & gen mgr; Ruth Goud, coml mgr; Henry Condey, prog & news dir; Jim Odum, prom mgr; Bill Houser, mus dir & chief engr.

WKIT(FM)—Listing follows WHKP.

Hickory

WHKY—June 10, 1940: 1290 khz; 5 kw-D, 1 kw-N, DA-N, 526 Main Ave. S.E., Box 1059 (28601). (704) 322-5115. Catawba Valley Bcstg Inc. Net: ABC/E. Format: Top 40. ■ Robert E. Cline, pres; Edmund S. Long, gen mgr; Mrs. Mary Ann Mull, prog dir; James O. Carr, news dir; Thomas E. Long, asst mgr & chief engr. ■ Rates: \$4.25; 4.25; 4.25; 4.25.

WHKY-FM—Jan 20, 1959: 102.9 mhz; 14.8 kw. Ant 325 ft. Stereo. Prog sep from AM. Format: Relig(am). progs(pm). ■ WHKY-TV affil. ■ Rates same as AM.

WIRC—Dec 5, 1948: 630 khz; 1 kw-D, 329 First Ave., N.W. (28601). (704) 327-3527. Foothills Bcstg Inc. Net: ABC/I. Rep: Southern Spot Sls. Format: MOR. ■ Edmond H. Smith Jr., pres; Elmer Troutman, gen mgr & chief engr; Maynard Taylor, coml mgr; Rose Mary Roseback, prom mgr; Dave Campbell, prog dir; Tom Peeler, news dir. ■ Rates: \$4.70; 4.70; 4.70; 4.70.

WXRC(FM)—Co-owned with WIRC. Dec 7, 1962: 95.7 mhz; 27 kw. Ant 350 ft. Stereo. Prog sep from AM. Format: C&W. ■ Don Honeycutt, prog dir; Ed Barnes,

North Carolina Radio

See page C-1 for explanation of listings.

news dir. ■ Rates: \$4.90; 4.90; 4.90; 4.90.

WSPF—Oct 27, 1963: 1000 khz; 1 kw-D. Box 1709 (28601). (704) 328-1731. Piedmont Bcstg Inc. Audio news: UPI. Rep: Carpenter. Format: Top 40. ■ Willis A. Deal, pres, gen. sjs & prom mgr; Rick Reynolds, mus dir. ■ Rates: \$5; 5; 5.

WXRC(FM)—Listing follows WIRC.

High Point

WGLD—June 1953: 1590 khz; 1 kw-D. Country Club Dr. (27260). (919) 885-8109. Radio Stn WNOS Inc. (acq 1975). Group owner: Mann Media. Net: N.C. News. Format: Modern country rock. ■ Bernard Mann & Gilbert Gans, owners; Dean Thompson, sports dir; Bill Brown, coml mgr; ■ Rates: \$6.50; 6.50; 6.50.

WGLD-FM—June 1953: 100.3 mhz; 2.7 kw. Ant 195 ft. Prog dups AM. ■ Rates same as AM.

WHPE—July 1947: 1070 khz; 1 kw-D. Box 1819 (27261). (919) 883-1466. Bible Bcstg Net (acq 10-74). Format: Christian. ■ Keith Davey, pres; Joseph J. Mast, gen mgr & prog dir; Rex Luther, chief engr.

WHPE-FM—November 1947: 95.5 mhz; 100 kw. Ant 470 ft. Prog dups AM 100%.

WMFR—Oct 15, 1935: 1230 khz; 1 kw-D, 250 w-N. Box 2208 (27261). (919) 885-2191. Radio Station WMFR Inc. (acq 7-1-40). Net: ABC. Rep: Devney; Southern Spot Sls. ■ Frank S. Lambeth, pres & gen mgr; Gerald Sullivan, asst mgr & prom mgr; Lorraine Gundy, news dir; Larry Craver, prog dir; J. Howard McCurry, H. Frank Shaw, sjs reps; Roby L. Fritts, chief engr. ■ Rates: \$7.50; 7.50; 7.50; 7.50.

WMFR-FM—1946: 99.5 mhz; 10 kw. Ant 350 ft. Stereo. Prog dups AM 25%. ■ Rates same as AM.

Jacksonville

WBBS—Oct 10, 1968: 1290 khz; 1 kw-D. Drawer AM (28540). (919) 347-6141. Brown Bcstg Co. Inc. (group owner). Net: ABC. Rep: Southern Spot Sls. Format: Contemp. ■ Herschel Brown, pres; Shelton Kellum, gen mgr; Norman O. Brown, VP; Ronald Bee, coml mgr; Jim Kelso, prog dir; Raeford Brown, chief engr.

WJNC—Oct 16, 1945: 1240 khz; 1 kw-D, 250 w-N. Drawer A-J (28540). (919) 455-2202. Onslow Bcstg Corp. (acq 10-1-55). Rep: Devney. Format: MOR. Spec progs: Black 6½ hrs wkly. ■ Robert P. Mendelson, pres, gen mgr; Jack Butler, prog dir; Eugene Loveall, coml mgr; James B. Hartline, chief engr.

WRCM(FM)—Co-owned with WJNC. April 28, 1965: 92.1 mhz; 3 kw. Ant 220 ft. Prog sep from AM. Format: C&W.

WLAS—June 21, 1954: 910 khz; 5 kw-D. Box 38 (28540). (919) 347-4111. Seaboard Bcstg Corp. Net: Tobacco. Rep: T-N. Spot Sales. Format: C&W. ■ Sidney Popkin, gen mgr; Harold Foster, coml mgr; Ron Henderson, prog dir; John Newman, news dir; Edgar O. Hathaway, chief engr.

WXQR(FM)—Co-owned with WLAS. March 14, 1966: 105.5 mhz; 3 kw. Ant 246 ft. horiz, 240 ft. vert. Marine Bcstg Corp. Prog sep from AM. ■ William Waldron, coml mgr.

Kannapolis

WGTL—June 10, 1947: 870 khz; 1 kw-D. Box 148 (28081). (704) 933-8700. Fred H. Whitley Inc. ■ Fred H. Whitley, own & gen mgr; William E. Rumble, chief engr.

WRKB—Dec 11, 1960: 1460 khz; 500 w-D. 101 W. First St. (28081). (704) 933-1121. Foy T. Hinson. Spec prog: C&W 9 hrs wkly. ■ Foy T. Hinson, gen mgr; Rick Hall, coml mgr; George Berry, prog dir & chief engr.

WRKB-FM—October 1964: 99.7 mhz; 10 kw. Ant 320 ft. Prog dups AM 90%.

King

WKTE—Dec 4, 1963: 1090 khz; 1 kw-D. Box 465 (27021). (919) 983-3111. Stokes County Bcstg Co. (acq 11-1-67). Rep: Keystone. Format: Modern coun-

try, bluegrass. ■ Thomas E. Pendleton, pres; Harrell Powell Jr., gen mgr; Faye H. Cheek, coml mgr & news dir; Chuck Webster, prog dir; Ray Gallimore, mus dir; Rubin L. Hicks, opns mgr; mgr; Gary Tilton, chief engr.

Kings Mountain

WKMT—March 12, 1953: 1220 khz; 1 kw-D. Box 669 (28086). (704) 739-3671. R. H. Whitesides. Format: C&W. MOR. Spec prog: Black 3 hrs wkly. ■ Jonas R. Bridges, gen mgr; Mike Riddle, coml mgr; Doris S. Bridges, prog dir; Willard Boyles, prom mgr; Jim Arp, mus dir; Raymond Galloway, news dir; Don Welch, chief engr.

Kinston

WELS—September 1950: 1010 khz; 1 kw-D. 1413 W. Vernon Ave. (28501). (919) 523-5151. Farmers Bcstg Serv Inc. Net: Southern Farm. Rep: Carpenter. Format: C&W. Spec prog: Black 10 hrs wkly. ■ William S. Page, pres; Jack P. Hankins, gen mgr; Patrick C. Howell, prog & news dir; Don Price, chief engr. ■ Rates: \$4; 4; 4;—

WFTC—Feb 28, 1937: 960 khz; 5 kw-D, 1 kw-N, DA-N. Box 609 (28501). (919) 523-4111. HGR Bcstg Co. (acq 4-1-62). Net: ABC/E. Rep: T-N Spot Sls. Format: MOR. ■ W. J. Rider, pres; William T. Woodard, gen mgr; James B. Ham, coml mgr; Jack Rider, news dir; Eugene Underwood, chief engr. ■ Rates: \$5.50; 5.50; 5.50.

WRNS(FM)—Co-owned with WFTC. Oct 12, 1968: 95.1 mhz; 100 kw. Ant 265 ft. Stereo. Prog dups AM 10%. Format: C&W. ■ Rates same as AM.

WISP—May 1954: 1230 khz; 1 kw-D, 250 w-N. Box 606 (28501). (919) 523-6161. Smiles of Kinston Inc. (acq 11-1-61). Net: ABC/C, Tobacco. Rep: Southern Spot Sls. Format: Contemp. Top 40. ■ Norman J. Suttles, pres; Richard Surlis, gen mgr; Bob Dean, prog dir.

WRNS(FM)—Listing follows WFTC.

Laurinburg

WEWO—Sept 1, 1947: 1080 khz; 5 kw-D, 1 kw-CH. Box 512 (28352). (919) 276-2911. Curtis & Assocs. (acq 6-20-68). Group owner: Curtis Radio. Net: N.C. News. Rep: Southern Spot Sls. Format: MOR. ■ Donald W. Curtis, pres & gen mgr; Badger Johnson, coml mgr; Al Smith McLean, spec prog dir; Fred Fox, asst mgr & prog dir; Michael Murphy, mus dir; Larry English, prom mgr; Bill Cinst, pub affs dir; David Bennett, chief engr. ■ Rates: \$2.80; 2.80; 2.80; 2.80.

WSTS(FM)—Co-owned with WEWO. May 1, 1951: 96.5 mhz; 100 kw. Ant 600 ft. Stereo. Prog sep from AM. Format: Relig. ■ Herb Wicker, coml mgr; Dillard Stouall, prog dir; Tommy Woodie, mus dir; Frank Abney, prom mgr; Chuck Rosser, news dir; Joyce Hatchell, bus mgr; Charles Locklear, opns mgr. ■ Rates: \$6; 6; 6; 6.

WLNC—Jan 3, 1962: 1300 khz; 500 w-D. Box 1776 (28352). (919) 276-1300. Laurinburg Bcstg Co. Rep: Keystone, Dora-Clayton. Format: Top 40. Spec prog: Black 4 hrs wkly. ■ George W. Phillips, owner & gen mgr; Dot Phillips, off mgr & prog dir; Mike Phillips, mus dir & chief engr; Stewart Thrower, coml mgr; Elsie Williams, asst mgr; Ed McConeghy, news dir.

WSTS(FM)—Listing follows WEWO.

Leaksville

WEAF(FM)—See Eden.

WLQE—See Eden.

Lenoir

WJRI—March 15, 1947: 1340 khz; 1 kw-D, 250 w-N. Box 1350 (28645). (704) 754-5361. WJRI Inc. (acq 10-23-65). Audio news: APR. Rep: Keystone. Format: Top 40. ■ Mrs. Katherine B. Rabb, pres; Donnie Goodale, gen & coml mgr; Bob Stewart, prog & mus dir; Nancy Honeycutt, prom mgr; Jeff Joines, news dir; Olan Harmon, chief engr. ■ Rates: \$3.50; 3.50; 3.50; 3.50.

WKGX—Feb 13, 1969: 1080 khz; 1 kw-D. Box 452 (28645). (704) 758-1080. Furniture City Broadcasters. Group owner: Beasley (35%). Rep: Southern Spot Sls. Format: C&W. ■ George G. Beasley, pres; Mike Spargo, gen mgr; Dorothy Eller, coml mgr; Alvin Finley, prog & mus dir; Frank Ballew, chief engr.

Lexington

WBUY—Sept 22, 1946: 1440 khz; 5 kw-D, 1 kw-N, DA-N. Box 668 (27292). (704) 246-2716 & 4110. Davidson County Bcstg Co. Net: N.C. News. Rep: T-N. Format: All hit mus. ■ Greeley Hilton, pres & gen mgr; Dewey Hutchins, stn mgr; William B. Hilton, coml mgr; Sam Anson, prog & mus dir; Paul Nunn, news dir; Bill Everhart, prog mgr; Fred Honeycutt, chief engr. ■ Rates: \$5.10; 5.10; 5.10; 5.10.

WLXN(FM)—Co-owned with WBUY. Aug 24, 1949: 94.1 mhz; 10 kw. Ant 195 ft. Prog dups AM 90%. ■ Rates same as AM.

Lincolnton

WLON—Aug 28, 1953: 1050 khz; 1 kw-D. Box 430 (28092). (704) 735-8071. Lincoln County Bcstg Co. Inc. Rep: Beaver, Southern Spot Sls. Format: Contemp. ■ W. Jack Brown, pres, gen & coml mgr; Wayne Howard, prog, mus & news dir & prom mgr; Dennis C. Long, chief engr.

Louisburg

WYRN—Sept 11, 1958: 1480 khz; 500 w-D. Box 463 (27549). (919) 496-3105. Franklin Bcstg Co. (acq 3-1-69). Net: Tobacco. Format: C&W, rock, Top 40. ■ Euland Clay McBride, pres, coml & prom mgr & prog dir; Mollie B. Evans, gen mgr, sec & treas; Larry Bledsoe, mus dir; Asher F. Johnson Jr., news dir, chief engr & VP.

Lumberton

WAGR—Nov 27, 1954: 580 khz; 500 w-D. Box 1056 (28358). (919) 739-3394. Southeastern Bcstg Corp. (acq 4-2-57). Net: Southern Farm. Audio news: UPI. Rep: Southern Spot Sls. Format: Contemp. Spec prog: C&W 18 hrs wkly. ■ Al Kahn, pres & gen mgr; Hugh Hines, coml mgr; Bob Waters, news dir; L. Steven Davis, chief engr. ■ Rates: \$4.60; 4.60; 4.60; 4.60.

WJSK(FM)—Co-owned with WAGR. July 19, 1964: 102.3 mhz; 3 kw. Ant 270 ft. (919) 738-4771. Prog sep from AM. Format: C&W, gosp. ■ Rates: \$2.80; 2.80; 2.80; 2.80.

WTSB—June 8, 1946: 1340 khz; 1 kw-D, 250 w-N. Box 393 (28358). (919) 739-6056. Robeson Bcstg Corp. Net: ABC, Carolina. Rep: Carpenter. Format: MOR. ■ J. A. Sharpe Jr., pres; Ron Pait, gen & coml mgr; Dave Britt, prog dir; Chris Lee, news dir; Bruce Worrell, chief engr. ■ Rates: \$5; 5; 5; 5.

WTSB-FM—Dec 1, 1960: 95.7 mhz; 6.5 kw. Ant 130 ft. Prog dups AM 90%. ■ Rates same as AM.

Marion

WBRM—May 9, 1949: 1250 khz; 1 kw-D. Drawer 219 (28752). (704) 652-6049. Lake City Bcstg Corp. Net: Tobacco. Format: Good music, C&W. ■ W. P. Erwin, pres; Jack Reynolds, gen mgr & news dir; J. C. Pleasant, coml mgr.

Marshall

WMMH—Sept 20, 1956: 1460 khz; 500 w-D. Box 528 (28753). (704) 649-3051. Marshall Bcstg Co. (acq 8-8-57). Rep: Keystone. Format: C&W, gospel. ■ Andrew D. Shields, pres, gen mgr; Quentin Ramsey, coml mgr; Farrell Brady, prog and news dir; John Chandler, chief engr.

Mars Hill

***WVMH-FM**—1975: 90.5 mhz; 10 w. Box 1161-C (28754). Mars Hill College.

Mayodan

WMYN—July 15, 1957: 1420 khz; 500 w-D. Box 311, Madison, N.C. (27025). (919) 548-9207. Mayo Bcstg Corp. Spec prog: C&W 20 hrs wkly. ■ J. B. Shelton, pres; Banner F. Shelton, gen mgr; Jim Walton, chief engr. ■ Rates: \$2.50; 2.50; 2.50; 2.50.

Mebane

WQWX—Dec 7, 1973: 1060 khz; 1 kw-D, 500 w (CH), DA-D. Box 68 (27302). (919) 563-3000. Radio Mebane-Hillsborough Inc. Group owner: Curtis Radio. Format: C&W. ■ Donald W. Curtis, pres; William Diffee, gen & coml mgr; Tony Walker, prog & news dir; Ed Payne, mus dir; Bettie Lyons, prom mgr; Dave Bennett, chief engr. ■ Rates: \$3; 3; 3; 3;—

Mocksville

WDSL—October 1964: 1520 khz; 5 kw-D, 1 kw-CH. Box 404 (27028). (704) 634-2177. WDSL Inc. Group owner: Potter. Format: C&W, top 40, gospel. ■ Doris B. Potter, pres; Stanley B. Clifton, VP s/s; John Butero, ops & news dir; Roland B. Potter, sec/treas; Jack Scott, chief engr. ■ Rates: \$1.85; 1.85; 1.85; 1.85.

Monroe

WIXE—May 3, 1968: 1190 khz; 500 w-D. Box 1007 (28110). (704) 289-2525. Monroe Bcstg Co. Rep: Crane. Format: C&W. ■ Joe N. Ross, pres; Ray Atkins, gen mgr; Robert M. Smith, coml mgr & chief engr; John R. Griffin, prog dir & prom mgr; Walter C. Sprouse Jr., news dir.

WMAP—July 1947: 1060 khz; 1 kw-D. Box 160 (28110). (704) 283-8115. Union Bcstg Corp. (acq 1953). Net: ABC/C. Rep: T-N Spot Sls. Format: MOR. Spec prog: Farm 1 hr wkly. ■ Frank A. Funderburk, pres & coml mgr; Bill Benton, gen mgr; Tom Desio, prog dir & prom mgr; Rick McCollum, mus dir; Olin Sikes, news dir; M. Howard Baucom, chief engr. ■ Rates: \$3; 3; 3; 3.

Mooresville



WHIP—1950: 1350 khz; 1 kw-D. (28115). (704) 664-5051. Wayne M. Nelson. ■ Wayne M. Nelson, gen mgr; Leoma Showmar, prog & news dir; E. M. Stanton Jr., chief engr. ■ Rates: \$4.50; 4.50; 4.50;—

Morehead City

WMBL—July 29, 1947: 740 khz; 1 kw-D. Box 432 (28557). (919) 726-3188. Carteret Bcstg Inc. Rep: Webb. Spec prog: Black 2 hrs, C&W 8 hrs wkly. ■ Grover C. Munden, pres; Robert R. Pate, gen mgr; John C. Erwin, prog dir; Bob Campbell, news dir; Robert L. Staham, chief engr.

WMBL-FM—Dec 20, 1972: 95.9 mhz; 3 kw. Ant 280 ft.

Morganton

WMNC—Sept 23, 1947: 1430 khz; 5 kw-D, 1 kw-N, DA-N. Box 969 (28655). (704) 437-0521. WMNC Inc. (acq 7-1-72). Net: NBC. Format: Top 40. ■ Nathan J. Cooper Sr., pres; Joe Cooper, stn mgr; Roy T. Waters, coml mgr; Madelyn Y. Patton, prog dir; Jack Morgan, news dir; Dan Deaton, mus dir; David Linsafelt, prom mgr; James C. George, chief engr. ■ Rates: \$3.70; 3.70; 3.70; 2.70.

WMNC-FM—Aug 3, 1963: 92.1 mhz; 3 kw. Ant 145 ft. (704) 437-0522. Prog sep from AM. Format: C&W. Spec prog: Gospel 15 hrs wkly. ■ Ernie Penley, mus dir; Bob Chandler, news dir. ■ Rates same as AM.

WSVM—See Valdese.

Mount Airy

WPAQ—February 1948: 740 khz; 10 kw-D, 1 kw (CH). Box 907 (27030). (919) 786-6111. Ralph D. Epperson. Rep: Wallace. Format: MOR. Spec progs: Farm 2½ hrs, community affrs ½ hr wkly. ■ Ralph D. Epperson, owner & chief engr; Blair Eubanks, gen mgr; Lucy Bowman, coml mgr; Carol Leonard, prog dir & prom mgr; Richard Goodman, news dir; Earlene Epperson, mus dir. ■ Rates: \$4.70; 4.70; 4.70; 4.70.

WSYD—Oct 4, 1951: 1300 khz; 5 kw-D, 1 kw-N, DA-N. Box 1126 (27030). (919) 786-2147. TWX 919-786-2147. Mount Airy Bcstrs Inc. Net: MBS. ■ Erastus F. Poore, pres, gen & coml mgr; Mrs. Bonnie F. Monday, prog dir & prom mgr; Mike Poore, news dir; Paul Johnson, chief engr.

Mount Olive

WDJS—Dec 27, 1961: 1430 khz; 1 kw-D. E. Center St. Box 429 (28365). (919) OLfield 8-4145. The Mount Olive Bcstg Co. Format: C&W. Spec prog: Black 2 hrs wkly. ■ James H. Mayo, gen mgr; chief engr & s/s mgr; Brantly Watkins, news dir; Ann W. Mayo, prog dir; Jesse Holmes, farm news.

Moyock

WJLY(FM)—See Chesapeake, Va.

Murfreesboro

WWDR—March 20, 1965: 1080 khz; 1 kw-D. Radio Bldg (27855). 398-4111. Murfreesboro Bcstg Corp. Rep: T-N Spot Sls. ■ Mrs. Donald A. Burnett, pres; James F. Ramsey, gen mgr; Charles Brown, prog & mus dir; Florence Brown, news dir; Lloyd Gatting, chief engr. ■ Rates: \$3.55; 3.55; 3.55;—

WWDR-FM—Oct 11, 1970: 98.3 mhz; 3 kw. Ant 285 ft. Stereo. Progs sep from AM. Format: Easy Istng. ■ Rates: \$3; 3; 3; 3.

Murphy

WCVP—Oct 12, 1958: 600 khz; 1 kw-D. Box 280 (28906). (704) 837-2151. Cherokee Bcstg Co. Format: C&W. ■ Max M. Blakemore, gen mgr & chief engr; Grady Carringer, coml mgr; Elvia Blakemore, prog dir; Dennis G. Blakemore, news dir.

WKRK—Aug 8, 1958: 1320 khz; 5 kw-D. Box 339 (28906). (704) 837-6200. Childress Bcstg Corp. of Murphy. Group owner: Childress Stns. Rep: Carpenter. Format: MOR, C&W, pub affrs. ■ Paul V. Ridenhour, pres, gen mgr & news dir; James Goodwin, coml mgr; William A. Younce, prog dir; W. T. Brown, sec, treas & prom mgr; Jim Foust, chief engr; Loran C. Davis, VP & farm dir.

New Bern

WGSE—Jan 1973: 1380 khz; 5 kw-U. Box 3436 (28560). (919) 638-5048. P&C Bcstg Co. Format: Black. ■ J. D. Conner, pres; Vera Conner, VP & gen mgr; Royal Bruce, prog dir.

WHIT—April 23, 1942: 1450 khz; 1 kw-D, 250 w-N. Drawer 1049 (28560). (919) 637-4450. New Bern Bcstg Inc. (acq 5-1-65). Net: TN. Rep: T-N Spot Sls. Format: C&W. ■ Boyce J. Hanna, pres; Gray Ingram, gen mgr.

WRNB—July 5, 1953: 1490 khz; 1 kw-D, 250 w-N. Drawer 2684 (28560). (919) 637-6144. 1st Capital Radio. (acq 1975). Group owner: Gray Bcstg Ent. Rep: Southern Spot Sls. Format: Contemp. ■ Theodore Gray, pres; George B. Nelson, VP & gen mgr; Ed Best, chief engr.

WSFL(FM)—See Bridgeton.

Newton

WNNC—June 18, 1948: 1230 khz; 1 kw-D, 250 w-N. Box 940 (28658). (704) 464-4041. Newton-Conover Bcstg Inc. (acq 8-5-54). Rep: Carpenter. Format: Contemp. ■ Earl Holder, pres; Bob Campbell gen & coml mgr & prog dir; David Crouch, news dir; Eddie Rose, chief engr.

North Wilkesboro

WKBC—June 1947: 810 khz; 1 kw-D. Box 938 (28659). (919) 667-2221. Wilkes Bcstg Co. Group owner: Potter. Net: MBS. Format: C&W. Spec prog: Gospel 8 hrs wkly. ■ Doris B. Potter, pres & gen mgr; Roland B. Potter, sec-treas; Stanley B. Clifton, VP/s/s; Z. Jane Smith, VP; Ed Racey, news dir; James Flesher, chief engr.

WKBC-FM—July 1962: 97.3 mhz; 20 kw. Ant 950 ft. Stereo. Prog sep from AM. Format: MOR, top 40.

Oxford

WCBO—June 9, 1949: 1340 khz; 1 kw-D, 250 w-N. Box 644 (27565). (919) 693-6416. Radio Granville Inc. (acq 5-23-73). ■ Roy A. Childers, pres.

Pinehurst

WEEB—See Southern Pines.

WIOZ(FM)—See Southern Pines.

Plymouth

WPNC—Sept 11, 1959: 1470 khz; 1 kw-D. Box 1067 (27962). (919) 793-4104. Ralph D. Epperson (group owner: acq 5-64). Audio news: UPI. Rep: Southern Spt Sls. Format: top 40. ■ William Banners III, gen mgr; Larry Riggs, coml mgr; Stan Alamanachuk, prog dir; Ty

North Carolina Radio

See page C-1 for explanation of listings.

Rhodes, mud dir; Thomas H. Peele, opns mgr; Walter Johnson Jr., chief engr. ■ Rates: \$2.50; 2.50; 2.50; 2.50.

Raeford

WSHB—April 25, 1963: 1400 khz; 1 kw-D, 250 w-N. Box 669 (28376). (919) 875-2148. Friendly Bcstg Co. (acq 8-26-66). Rep: Southern Spot Sls. Format: Top 40. Spec progs: Black 2½ hrs, C&W 2 hrs wkly. ■ William S. Wellons Sr., pres; C. D. Bounds, VP & gen mgr; Larry Long, asst mgr; Hal Burrows, prog dir; Helen Inman, s/s mgr; Dave Allen, mus dir; Steve Dees, news dir; Dave Raley, chief engr.

Raleigh

WAKS—See Fuquay Varina.

***WCPE(FM)**—Not on air, target date January 1976: 89.7 mhz; 10 w. Ant 356 ft. Stereo. Box 5010 (27607). Educational Information Corp. Format: Educl. Spec progs: Farm 5 hrs, black 3 hrs, blind 3 hrs wkly. ■ Jim Sempstrot, gen mgr.

WKIX—1947: 850 khz; 10 kw-D, 5 kw-N, DA-N. Box 12526 (27605). (919) 851-2711. Southern Bcstg Co. (group owner; acq 8-1-67). Rep: Eastman. Format: Contemp. ■ John G. Johnson, pres; Frank Maruca, gen mgr; Joe Wright, s/s mgr; Steve Roddy, prog dir; Ron McKay, mus dir; Scott White, news dir; Terry Tucker, chief engr. ■ Rates: \$40; 35; 40; 35.

WYYD(FM)—Co-owned with WKIX. 1947: 96.1 mhz; 98 kw. Ant 930 ft. Stereo. Box 10404. (919) 851-2086. Progs sep from AM. Format: Btlf mus. ■ Barry Noll, s/s mgr; Jim Davis, opns mgr. ■ Rates: \$18; 22; 22; 20.

***WKNC-FM**—September 1965: 88.1 mhz; 2.9 kw. Ant 240 ft. Stereo. Box 5748 (27607). (919) 737-2400. N.C. State U. Net: ABC/I. Format: Progs, jazz, classical. Spec prog: Black 6 hrs wkly. ■ Michael L. Upchurch, gen mgr; Rad Messick, prog dir; Rob Garner, mus dir; Frank Lynch, chief engr.

WLLE—November 1954: 570 khz; 500 w-D. Box 190 (27602). (919) 833-3874. WLLE Inc. (acq 9-1-65). Net: MBS. Rep: Howard. Format: Black. ■ Wallace L. Hankin, pres; Charles F. Blalock Sr., gen mgr; Jim Barbot, chief engr. ■ Rates: \$9; 8; 9; 8.

WPTF—Sept 22, 1924: 680 khz; 50 kw-U, DA-N. WPTF Bldg., 410 S. Salisbury St. (27602). (919) 832-8311. Durham Life Bcstg Soc. (acq 1927). Net: NBC. Rep: Christal. Format: MOR. ■ Carl V. Venters Jr., pres & gen mgr; Jack Allers, s/s mgr; Charles Stegall, prog dir; Bob Butler, mus dir; Irene Cheshire, prom mgr; Daniel F. Giddens, news dir; Lewis Parrish, chief engr. ■ Rates: \$68; 42; 47; 27.

WQDR(FM)—Co-owned with WPTF. August 1949: 94.7 mhz; 100 kw. Ant 560 ft. Stereo quad. Box 1511 (27602). (919) 833-1616. Prog sep from AM. Format: Contemp, album rock. ■ David Berry, coml mgr; Frank Laseler, opns mgr; Bill Hard, prog dir. ■ Rates: \$20; 20; 30; 20.

WRAL(FM)—1947: 101.5 mhz; 250 kw. Ant 990 ft. Stereo. Box 12000 (27605). (919) 828-2511. Capitol Broadcast. Net: T-N. Rep: Katz. Format: Contemp. ■ Wally Voight, gen mgr; Bob Inskeep, prog dir; Howard Jerigan, coml mgr; Keith Isley, mus dir; Mike Edwards, news dir; Lee Poole, chief engr. ■ Rates: \$26; 22; 26; 21.

WRNC—March 1939: 1240 khz; 1 kw-D, 250 w-N. Box 27946 (27611). (919) 834-6401. Raleigh Radio Inc. (acq 1965). Group owner: Radio Smiles. Rep: Savalli/Gates, Southern Spt Sls. Format: Gospel, relig. ■ M. L. Street, VP; E. E. Heffington, coml mgr; Steve Pritchard, prog dir; John Francioni, chief engr.

***WSHA(FM)**—Nov 18, 1968: 88.9 mhz; 12.5 kw. Ant 115 ft. 118 E. South St. (27602). (919) 755-4890. Shaw University. Format: Black, educ, jazz, R&B. ■ Dr. J. Archie Hardgraves, pres; Robert John Keiber, gen mgr; Carl Sanders, coml mgr; Mac McLean, prog dir; Henry Lee, mus dir; Deloris Ramsey, news dir.

WYNA—Aug 15, 1962: 1550 khz; 1 kw-D. Box 30099 (27612). (919) 782-9233. North Carolina Electronics Inc. (acq 8-74). Net: ABC/E, Tobacco. Rep: GCI, Carter Jones. Format: Modern country. ■ J. F. (Jack) Maure, pres; Brad Paulson, gen mgr; Harvey Riddle, prog dir &

North Carolina Radio

See page C-1 for explanation of listings.

chief engr; Myrtle Lassiter, prom mgr; Jack McDonald, mus dir; Kyle Whitford, news dir.

WYWD(FM)—Listing follows WKIX.

Red Springs

WYRU—June 15, 1970: 1510 kHz; 5 kw-D, 1 kw-N. (CP 500 w-CH). Box 711 (28377). (919) 843-5946. K & R Bcstg Corp. Format: Top 40. ■ Thomas J. Rodgers, pres; Harry Odum, gen mgr; Michael Boone, prog & mus dir; Terry Tucker, chief engr.

Reidsville

WFRC—1947: 1600 kHz; 1 kw-U, DA-N. Box 990 (27320). (919) 349-4361. WFRC Inc. (acq 10-1-72). Net: ABC/E. Format: Contemp. Spec prog: Fr 1 ½ hrs wkly. ■ Gene Smith, pres, gen mgr & chief engr; Lee McDaniel, coml mgr; Bob Abbot, prog & mus dir.

WREV—1950: 1220 kHz; 1 kw-D. Box 1349 (27320). (919) 342-1333. Reidsville Bcstg Inc. Audio news: UPI. Rep: Carpenter. Format: C&W. Spec prog: Black 7 hrs wkly. ■ William M. Oliver Sr., pres; William M. Oliver Jr., stn mgr & news dir; Jerry Huskey, coml mgr; Benjamin Grogan, chief engr. ■ Rates: \$2.97; 2.97; 2.97;—

WWMO(FM)—Co-owned with WREV. Sept 6, 1948: 102.1 mhz; 50 kw. Ant 285 ft. Stereo. Prog sep from AM. Format: Relig. ■ Rates: \$2.45; 3.45; 3.45; 3.45.

Roanoke Rapids



WCBT—November 1940: 1230 kHz; 1 kw-D, 250 w-N. Box 70 (27870). (919) 537-4184. WCBT Radio Inc. (acq 9-69). Rep: TN Spot Sls. Format: Contemp. ■ William Jefferay, pres; Dick Jones, VP, gen mgr & chief engr; Johnny Draper, stn mgr; Russ Barrett, opns mgr; Wayne Conner, news dir. ■ Rates: \$3.85; 3.65; 3.85; 3.65.

***WPGT(FM)**—Dec 8, 1972: 90.1 mhz; 860 w. Ant 84 ft. 338 Roanoke Ave. (27870). (919) 537-8333. Roanoke Christian School. Net: MBS. Format: Relig & educ. Spec prog: Black ½ hr wkly. ■ Marvin E. Faile, pres & gen mgr; Jack Nichols, prog dir.

WPTM(FM)—August 1974: 102.3 mhz; 3 kw. Ant 300 ft. Stereo. Box 1076 (27870). (919) 537-1023 & -1289. Halifax County Bcstg Inc. Audio news: APR. Rep: Carpenter. Format: C&W. Spec prog: Farm 10 hrs wkly. William Pruden, pres and gen mgr. ■ Rates: \$3; 2.50; 3; 2.50.

Rockingham

WAYN—September 1946: 900 kHz; 1 kw-D. Box 591 (28379). (919) 895-4041. WAYN Inc. (acq 7-1-64). Rep: Carpenter. Format: Adult Top 40. ■ William Futterer, pres & gen mgr; William Futterer III, prog & mus dir, coml & prom mgr; Jay Smith, news dir; Bill Gaston, chief engr.

WLWL—Oct 27, 1969: 1500 kHz; 500 w-D. (250 w-CH). Box 1233 (28379). (919) 997-2526. Sandhills Bcstg Co. Inc. Rep: Southern Spot Sls. Format: Rock, black. ■ Robert E. Perkins, pres, gen mgr & chief engr; Vickie Perkins, coml mgr & prog dir.

***WRSH(FM)**—May 1973: 91.1 mhz; 10 w. Ant 60 ft. Long Drive (28379). Richmond County Bd of Educ.

Rocky Mount

WCEC—November 1947: 810 kHz; 1 kw-D. Box 4005 (27801). (919) 442-3108. Eastern Carolina Electronics Inc. Net: N.C. News. Rep: T-N Spot Sls. Format: MOR. Spec progs: Black 14 hrs, farm 5 hrs wkly. ■ Joe Warner, pres & gen mgr; Ray Thompson, coml mgr; Stephen Reed, prog & news dir; Viles Williams, chief engr. ■ Rates: \$5.60; 5.60; 5.60; 5.60.

WFMA(FM)—Co-owned with WCEC. November 1947: 100.7 mhz; 100 kw. Ant 360 ft. Prog sep from AM. Format: C&W. ■ Rates: \$4; 4; 4; 4.

WEED—Sept 10, 1933: 1390 kHz; 5 kw-D, 1 kw-N. DA-N. Box 2267 (27801). (919) 443-3119. Radio Station WEED Inc. (acq 1-1-68). Net: ABC/C. Rep: Devney; Southern Spot Sls. Format: Contemp. ■ William Avera Wynne, pres; W. A. Wynne Jr., gen mgr; George Peterson, coml mgr; Ed Collins, prog dir; Butch Pindell, news dir; L. P. Jones Jr., chief engr. ■ Rates: \$3.50; 2.80; 3.50; 2.80.

WRSV(FM)—1949: 92.1 mhz; 1.3 kw. Ant 160 ft. Prog sep from AM. Box 2666 (919) 442-9776. Net: Mutual Black. Rep: Southern Spot Sls. Format: Black. ■ Charles O. Johnson, gen mgr; Rogger Wiggins, prog dir. ■ Rates: \$3.25; 2.75; 3.25; 2.75.

WFMA(FM)—Listing follows WCEC.

WRMT—Dec 15, 1958: 1490 kHz; 1 kw-D, 250 w-N. Box 283 (27801). (919) 442-8091. Atlantic Radio Corp. (acq 9-1-61). Group owner: Fox Stns. Rep: Walton; Beaver. Format: Contemp, oldies. Spec prog: Black 2 hrs wkly. ■ Stanley H. Fox, pres; John Stinson, gen mgr; Scott Derringer, prog dir; Jackson Bradley, mus dir; John Bleakley, news dir; Toby Johnson, chief engr.

Rose Hill

WEGG—1971: 710 kHz; 250 w-D. RFD 2 (28458). (919) 289-2031. Duplin County Bcstrs. Net: ABC/I, Southern Farm. Rep: Southern Spot Sls. Format: Gospel-country. ■ J. B. Wilson Jr., pres & mus dir; William D. Mills, VP; Ernie Scott, opns mgr, prog dir & prom mgr; Truman King, news dir; Johnny Brown, chief engr.

Roxboro

WKRX(FM)—Listing follows WRXO.

WRXO—1949: 1430 kHz; 1 kw-D. Box 1176 (27573). (919) 599-2119. Roxboro Bcstg Co. Rep: T-N Spot Sls. Format: MOR. Spec progs: Black 4 hrs, C&W 10 hrs, farm 8 hrs wkly. ■ H. Wharton Winstead Jr., pres & gen mgr; Ted Nelson, news dir; Wilbur Brann, chief engr. ■ Rates: \$3.35; 3.35; 3.35; 3.35.

WKRX(FM)—1958: 96.7 mhz; 3 kw. Ant 300 ft. Prog sep from AM. Format: C&W. Spec prog: Farm 4 hrs wkly. ■ Rates same as AM.

Rutherfordton

WCAB—Oct 19, 1966: 590 kHz; 500 w-D. Box 511 (28139). (704) 287-3356. Isothermal Bcstg Co. Format: MOR. Spec progs: Black 4 hrs, farm 1 hr, C&W 2 hrs wkly. ■ Charles R. Melton, pres and prog dir; Ernest R. Griswold, gen & coml mgr; Ron Wood, mus dir; Joyce Buckaloo, prom mgr; Tom Greene, news dir; Bill Padgett, chief engr.

St. Pauls

WLAB—Aug 1, 1966: 1060 kHz; 250 w-D. Rt 3, Box 169 (28384). (919) 865-5198. St. Pauls Bcstg Co. Inc. (acq 10-1-74). Format: Top 40, C&W, diversified. Spec prog: Farm 5 hrs wkly. ■ Richard Dale Brooks, pres; Dale Brooks, gen & coml mgr; Rick Brooks, prog & mus dir; Theresa Brooks, news dir; Milton Newsome, chief engr.

Salisbury

WRDX(FM)—Listing follows WSTP.

WSAT—April 28, 1948: 1280 kHz; 1 kw-U, DA-N. Drawer 99 (28144). (704) 633-0621. Mid-Carolina Bcstg Co. Net: ABC/C. Format: Mor, C&W. ■ C. H. Wentz, pres; Harry L. Welch, gen & coml mgr; Gales Adkins, prog dir; Russell McIntire, news dir; E. L. Sherman, chief engr.

WSTP—Jan 1, 1939: 1490 kHz; 1 kw-D, 250 w-N. Box 4157 (28144). (704) 636-3811. WSTP Inc. (acq 10-20-56). Net: MBS. Rep: Devney, Southern Spot Sls, Messina. Format: MOR. Spec progs: Black 1 hr, farm 2 hrs wkly. ■ Tom Harrell, pres & gen mgr; Bob Bailey, asst & opns mgr; Terry Setzer, news dir; Jim Lloyd, mus dir; Earl Carney, sis mgr; Fred Ostwalt, chief engr. ■ Rates: \$6; 6; 6; 6.

WRDX(FM)—Co-owned with WSTP. March 16, 1946: 106.5 mhz; 15 kw. Ant 250 ft. Dups AM 33%. Net: N.C. News. Format: C&W. ■ Bob Bailey, prog dir; Tom Howell, mus dir; Sharon Barber, news dir; Anne Langingham, comptroller. ■ Rates: \$4.50; 4.50; 4.50; 4.50.

Sanford

***WDCC(FM)**—1971: 89.5 mhz; 10 w. Kelly Dr. (27330). (919) 775-5401. Central Carolina Technical Institute. Format: Variety, educ. ■ J. F. Hockaday, pres; Jerry M. Farmer, R-TV dept head; Toby Johnson, chief engr.

WEYE—Oct 2, 1952: 1290 kHz; 1 kw-D. (27331). (919) 775-3021. Crest Bcstg Corp. (acq 9-1-64). Group owner: Fox Stns. Net: ABC/C. Rep: Southern Spot Sls. Format: Contemp/Rock. ■ Stan Fox, pres; Bob Massie, gen mgr; Norwood Anderson, coml mgr; Wayne Howell, prog dir; Irv Fox, sec-treas; Toby Johnson, chief engr.

WWGP—1946: 1050 kHz; 1 kw-D. Drawer R (27330). (919) 775-3525. WWGP Bcstg Corp. (acq 7-1-58). Net: N.C. News. Rep: T-N Spot Sls. Format: C&W. Spec prog: Farm 6 hrs wkly. ■ Frank J. Abbott Jr., pres; Richard K. Feindel, gen & coml mgr & prog dir; Bill Cameron, mus dir; Joan Merritts, news dir; James Curtis Paterson, chief engr. ■ Rates: \$6.50; 6.50; 6.50; 6.50.

WWGP-FM—1950: 105.5 mhz; 490 w. Ant 340 ft. Dups AM 65%. Format: Oldies. ■ Rates: \$2.75; 2.75; 2.75; 2.75.

Scotland Neck

WYAL—April 3, 1960: 1280 kHz; 5 kw-D. Box 425 (28784). (919) 826-3114. WYAL Radio Inc. Net: N.C. News. Rep: TN Spot Sls. Format: Relig. ■ John Laurino, pres; Jack N. Miller, gen mgr. ■ Rates: \$4; 4; 4; 4.

Selma

WBZB—Aug 4, 1964: 1090 kHz; 1 kw-D. Box 1 (27576). (919) 965-3753; 965-5328. WBZB Bcstg Svc Inc. Rep: TN Spot Sls. Format: C&W. Spec progs: Black 1 hr, Gospel 1 ½ hrs wkly. ■ J. E. Barry, pres; Richard C. Bridges, gen mgr; Tommy Williams, prog dir; Julia Epperson, coml mgr; Bruce Creekmore, chief mgr; E. J. "Lack" Attayek Jr., prom mgr. ■ Rates: \$3.15; 3.15; 3.15; 3.15.

Shallotte

WVCB—June 11, 1964: 1410 kHz; 500 w-D. Shallotte Bcstg Co. (28459). (919) 754-4512. Shallotte Bcstg Co. Format: C&W. ■ A. Earl Milliken & John G. Worrell, co-mgrs; Ruth Jenrette, traf mgr; Arthur L. Madeley, chief engr.

Shelby

WADA—July 9, 1958: 1390 kHz; 1 kw-D, 500 w-N, DA-N. Drawer 1390 (28150). (704) 482-1390. Cleveland County Bcstg Co. Group owner: Hanna Group Industries. Format: MOR, C&W. Spec progs: Black 2 hrs wkly. ■ Boyce J. Hanna, pres & gen mgr; Ken Vassy, stn mgr & chief engr; David Austin, coml mgr; Joan Allen, prom mgr; Tom Black, news dir; Glenn Wall, spts dir. ■ Rates: \$4; 4; 4; 4.

WBT—See Charlotte.

WOHS—Aug 21, 1946: 730 kHz; 1 kw-D. Box 1590 (28150). (704) 487-6313. Western Carolina Radio Corp. Net: MBS. Rep: Southern Spot Sls. Format: Contemp. Spec prog: Black 8 hrs wkly. ■ Harold R. Watson, pres & gen & sis mgr; Don Richards, news dir; Andy Foster, spts dir; Steve Greene, chief engr. ■ Rates: \$3.50; 3.50; 3.50; 3.50.

WOHS-FM—1948: 96.1 mhz; 2.6 kw. Ant 460 ft. Format: C&W. ■ Rates same as AM.

Siler City

WNCA—Aug 19, 1952: 1570 kHz; 1 kw-D, DA. Box 429 (27344). (919) 742-2135. Chatham Bcstg Co. of Siler City (acq 3-1-62). Rep: Southern Spot Sls. Format: C&W. Spec prog: Farm 5 hrs wkly. ■ David P. Welborne, pres; Lindsay P. Berrier, gen mgr; Harvey M. Yon, mus dir; Roy A. Edwards, news dir; L. L. Holland, chief engr. ■ Rates: \$4.20; 3.20; 4.20; 3.20.

Smithfield

WMPM—1950: 1270 kHz; 5 kw-D. Box 240 (27577). (919) 934-2434, 934-7161. Carolina Bcstg Svc. (acq 12-1-58). Net: Caranet, Tobacco. Audio news: UPI. Rep: Southern Spot Sls. Format: MOR, C&W, talk. ■ Ellis C. Barbour, pres; Carl E. Lamm, gen mgr, prog dir; Mable S. Talton, stn mgr; Marjorie Lamm, news dir;

Travis Lamm, mus dir; Forest Jernigan, chief engr.

WBZB—See Selma.

South Gastonia

WGAS—Aug 14, 1959: 1420 khz; 500 w-D. Box 250, Gastonia (28052). (704) 865-5796. MGM Bcstg Corp. Rep: TN Spot Sls. Format: MOR, contemp. Spec prog: Black 5 hrs wkly. ■ Glenn F. Mace, pres, gen mgr & chief engr; Edson I. Gray, coml & prom mgr; Dan Bell, prog dir; Carroll Henderson, news dir. ■ Rates: \$2.35; 2.35; 2.35.

Southern Pines

WEEB—Nov 15, 1947: 990 khz; 5 kw-D. Box 570 (28387). (919) 692-7440. The Sandhills Community Bcstrs Inc. Net: ABC/C/I. Rep: Southern Farm; T-N Spot Sls. Format: MOR. ■ Jack S. Younts, pres & gen mgr; Millard S. Younts, stn & coml mgr; Elizabeth M. Younts, mus dir; Frieda Walker, traf mgr; Fletcher Moore, chief engr.

WIOZ(FM)—Aug 14, 1973: 107.1 mhz; 3 kw. Ant 300 ft. Box 2107 (28387). (919) 692-2107. 107 Inc. Rep: Southern Spot Sls. Format: MOR. ■ William R. Gaston, pres, gen mgr & chief engr; Lynn D. Dukas, sls mgr; Donald A. Stafford, prog dir; Mark T. Garrison, news dir.

Sparta

WCOK—Aug 23, 1967: 1060 khz; 250 w-D. Box 617 (28675). (919) 372-8231. Sparta-Independence Radio Corp. Format: C&W. Spec prog: Rock 18 hrs wkly. ■ H. Sid Comer, pres; H. Clark Comer, VP; David Wright, gen & prom mgr, prog & news dir; Terry Choate, mus dir; Hershey Shumate, chief engr.

Spring Lake

WFBS—May 22, 1963: 1450 khz; 1 kw-D, 250 w-N. Box 707 (28390). (919) 497-3176. Radio Smiles Inc. Rep: Southern Spot Sls. Format: Contemp. ■ Jerry Oakley, VP & gen mgr; Norman Suttles, sec-treas; Lynda Padilla, prog dir; Ken Sweet, mus dir; Doug Fellows, news dir; Terry Jordan, chief engr. ■ Rates: \$3.25; 3.25; 3.25.

Spruce Pine

WTOE—Dec 24, 1955: 1470 khz; 1 kw-D. Box 668 (28777). (704) 765-7441. Toe River Valley Bcstg. Rep: Carpenter. Format: MOR. ■ Tom N. Cooper, pres; Richard Hollifield, coml mgr; Roger Garland, prom mgr; Jerry Warren, mus dir; Gay Duncan, news dir; Darrell Burleson, chief engr. ■ Rates: \$3; 3; 3;—

Statesville

WDBM—Oct 7, 1957: 550 khz; 500 w-D. Box 1027 (28677). (704) 872-2455. Radio Statesville Inc. (acq 9-1-75). Group owner: Ferguson. Audio news: UPI. Format: C&W. ■ Miles H. Ferguson, pres; Al Pearce, gen mgr; Ken Rigsby, coml mgr; Benny Anthony, prog dir; Gary Millsaps, mus dir; Jerry Brown, news dir; Walter Z. Morrison, chief engr. ■ Rates: \$4.10; 4.10; 4.10; 4.10.

WDBM-FM—March 16, 1961: 96.9 mhz; 3.6 kw. Ant 340 ft. Dups AM 60%. ■ Rates same as AM.

WFMX(FM)—Listing follows WSIC.

WSIC—May 3, 1947: 1400 khz; 1 kw-D, 250 w-N. Radio Bldg, Radio Road (28677). (704) 872-6345. Statesville Bcstg Co. Inc. Net: ABC/C, N.C. News. Rep: TN Spot Sls. Format: MOR. ■ John David Bradsher, gen mgr; Frank Stuart, stn mgr; Ken Abernathy, chief engr. ■ Rates: \$4.80; 3.30; 4.38; 3.30.

WFMX(FM)—Co-owned with WSIC; May 3, 1947: 105.7 mhz; 100 kw. Ant 290 ft. (704) 872-6348. Prog sep from AM. Rep: Southern Spot Sls. Format: C&W, relg. ■ J. D. Benfield, stn mgr. ■ Rates: \$4.50; 4.05; 4.05; 4.05.

Sylva

WMSJ—Nov 8, 1957: 680 khz; 1 kw-D, 250 w-N. Box 1044 (28779). (704) 586-2221. WMSJ Inc. Group owner: Childress Stns. Net: MBS. Format: MOR, Top 40. ■ James B. Childress, pres & gen mgr; Roy Burnette, coml mgr; Rich McTigue, mus dir; Cebelle Pipes, prom mgr; Glenn Trent, news dir.

Tabor City

WKSM(FM)—Listing follows WTAB.

WTAB—July 1, 1954: 1370 khz; 5 kw-D. Box 127 (28463). (919) 653-2131. Tabor City Bcstg Co. Net: MBS. Rep: Southern Spot Sls. Format: Blocked C&W, Top 40. ■ Willie D. Ward, pres; James C. Cox, gen coml & prom mgr & prog dir; Sam Sharp, mus dir; Eugene West, chief engr. ■ Rates: \$3.50; 3.50; 3.50;—

WKSM(FM)—Co-owned with WTAB. June 1964: 104.9 mhz; 3 kw. Ant 160 ft. Prog sep from AM. Format: Btlf mus. ■ Rates: \$2.10; 2.10; 2.10; 2.10.

WCPS—January 1947: 760 khz; 1 kw-D. Box 100 (27886). (919) 823-2191. Coastal Plains Bcstg Inc. Net: N.C. News. Format: MOR. Spec progs: Black 8 hrs, C&W 6 hrs wkly. ■ Robert L. Harper, pres & gen mgr; Len Heilbronner, coml mgr; Jim Frantz, prog dir; Bob Coker, chief engr.

WCPS-FM—September 1952: 104.3 mhz; 7 kw. Ant 260 ft. Prog dups AM 75%.

Taylorsville

WSTH—May 2, 1964: 860 khz; 250 w-D. Box 997 (28681). (704) 632-4621. Alexander Bcstg Co. Format: C&W. Spec prog: Black 1 hr wkly. ■ W. Scott Stamey, pres; Frank Smith & Lem Hafer, co-mgrs; Frank Smith, coml & prom mgr, prog & news dir; Steve Hughes, mus dir; Jeff Watts, chief engr.

WTLK—July 1962: 1570 khz; 500 w-D. Box 847 (28681). (704) 632-4214. International Bcstg Co. Inc. (acq 3-66). Net: TN. Rep: T-N Spot Sls, Keystone. Format: Contemp. ■ Hoyt P. Potts, pres, gen & coml mgr & chief engr; Ronnie Campbell, prog dir; Lem Hafer, prom mgr; William Stamey, mus dir; Roe Milstead, news dir.

Thomasville

WTNC—September 1947: 790 khz; 1 kw-D. 726 Salem St. (27360). (919) 476-7701. Thomasville Bcstg Co. Rep: Keystone. Format: Variety. ■ R. F. VanLandingham, pres; Harold G. Harrison, gen mgr & coml & prom mgr; Jesse R. Hill, news dir; Clyde C. Fritts, chief engr. ■ Rates: \$4; 4; 4; 2.

WTNC-FM—April 1949: 98.3 mhz; 3 kw. Ant 250 ft. Prog dups AM 100%. ■ Rates same as AM.

Troy

WJRM—Dec 8, 1961: 1390 khz; 1 kw-D. Box 549 (27371). (919) 976-8811. Montgomery Bcstg Inc. (acq 6-1-62). Format: Diversified. ■ John C. Wallace, pres, gen mgr; Golia S. Loffin, coml & prom mgr; Mrs. Tommye S. Wallace, prog & mus dir; John Inman, news dir; Douglas Byrd, chief engr. ■ Rates: \$3; 3; 3; 3.

Tyron

WTYN—Oct 1, 1954: 1550 khz; 1 kw-D. Box 940 (28782). (803) 457-4105. Gene Milsteen (acq 5-1-71). Rep: Beaver. Format: Contemp. ■ Gene Milsteen, own, gen & coml mgr; H. L. Rickenbacker, prog & mus dir; G. O. Carver, prom mgr; Kim Petty, news dir; Fred Edney, chief engr. ■ Rates: \$3; 2.50; 3;—

Valdese

WSVM—Oct 6, 1961: 1490 khz; 1 kw-D, 250 w-N. Box 99 (28690). (704) 874-0000. Burke County Bcstg Co. Group owner: Suburban. Format: Contemp. ■ Robert R. Hilker, pres; William R. Rollins, gen mgr; Charles R. Moseley, coml mgr; Richard W. Burton, news dir; Vivian A. Barrett, women's dir; Norman F. Beach, chief engr. ■ Rates: \$3.50; 3.50; 3.50; 3.50.

Wadesboro

WADE—July 23, 1947: 1210 khz; 1 kw-D. Box 341 (28170). (704) 694-2175. Carolinas Adv inc. Group owner: Lyon. Net: Tobacco Radio. Rep: TN Spot Sls. Format: C&W. Spec prog: Black 6 hrs wkly. ■ R. A. Lyon, pres; Jack W. Miller, gen mgr; Katherine M. Kendale, coml mgr; Bob Rogers, prog dir; David Thomas, news dir; Robert C. Swink, chief engr.

Wallace

WLSE—May 13, 1953: 1400 khz; 1 kw-D, 250 w-N. Box 449 (28466). (919) 285-2187. Duplin Bcstg Co. Rep: T-N Spot Sls. Format: Variety. Spec prog: Black 3½ hrs wkly. ■ Harry Kramer, pres; Grace Heath, gen mgr; Ruth McNeil, coml mgr; Bill Dixon, prog dir; Stanley King, prom mgr; Mike Huffman, mus dir; Charlie Johnson, chief engr.

North Carolina Radio

See page C-1 for explanation of listings.

WLSE-FM—July 20, 1972: 94.3 mhz; 3 kw. Ant 300 ft.

Wanchese

WOBR—May 29, 1970: 1530 khz; 250 w-D. Box 400 (27981). (919) 473-3434. WOBR Inc. Net: N.C. News. Format: C&W, top 40, variety. ■ Douglas L. Craddock, pres & gen mgr; Ken Wright, stn and coml mgr & mus dir; Carol Hayward, prog dir & prom mgr; Kinney Mann, news dir; Goodrich Williams, chief engr.

WOBR-FM—June 1, 1973: 95.3 mhz; 3 kw. Ant 175 ft. Stereo. Dups AM 100% Sept-June, sep from AM summers. Format: Btlf mus.

Warrenton

WARR—1970: 1520 khz; 1 kw-D. Box 616 (27589). Radio Voice of Warrenton. Rep: Southern Spot Sls. ■ Vernon H. Steed, gen mgr & plnr; Jim Mayes, plnr.

***WMIP(FM)**—Not on air, target date unknown: 90.9 mhz; 100 kw. Ant 320 ft. Box 365 (27589). Sound and Print United. ■ Valeria Lynch Lee, pres.

Warsaw

WTRQ—Jan 21, 1971: 1560 khz; 10 kw-D. Rt 2, Box 236 D (28398). (919) 293-7861. Quinn Broadcasting. Rep: Southern Spot Sls. Format: MOR. ■ Gerald Quinn, pres; J. L. Moseley, gen mgr; Richard Williams, prog dir; James Blanchard, chief engr.

Washington

WEWE—Sept 6, 1961: 1320 khz; 500 w-D. Box 439 (27889). (919) 946-1016. Radio Washington Inc. (acq 10-1-75). Audio news: APR. Format: MOR, oldies. Spec prog: Farm 1 hr wkly. ■ Charles Carawan, pres, gen & coml mgr; Charlie Byrd, mus dir; Cynthia Heath, news dir; Gene Brown, chief engr. ■ Rates: \$5; 4; 5;—

WITN—March 3, 1942: 930 khz; 5 kw-D, 1 kw-N. DA-N. Box 793 (27889). (919) 946-2162. Tar Heel Bcstg System. Net: ABC/I/E, TN. Format: Contemp, C&W, MOR. ■ Robert E. Frowein, gen mgr; Merrill Daniels, coml mgr & news dir; Gene Hudson, prog dir; Richard Thomas, mus dir; John Wilroy, chief engr.

WITN-FM—Jan 20, 1961: 93.3 mhz; 97 kw. Ant 1220 ft. Stereo. Prog sep from AM. ■ WITN-TV affil.

Waynesville

WHCC—August 1947: 1400 khz; 1 kw-D, 250 w-N. Box 659 (28786). (704) 456-8661. Waynesville Bcstg Co. (acq 8-1-65). Audio news: UPI. Rep: Keystone. Format: MOR. Spec prog: Farm 1 hr wkly. ■ A. W. Askins Jr, pres, gen mgr, prog dir & chief engr; Mrs. Betty-Jo Nichols, coml & prom mgr, news dir; Sam Brown, mus dir. ■ Rates: \$2; 2; 2; 2.

Weldon

WSMY—Dec 24, 1959: 1400 khz; 1 kw-D, 250 w-N. Box 910, Roanoke Rapids, N.C. (27870). (919) 536-3115. Smiles of N.C. (acq 3-1-67). Net: ABC/C. Rep: Southern Spot Sls. Format: Top 40. ■ Derwood H. Godwin, pres; George B. Wilkes III, gen mgr; Fred Leemhuis, prog dir; Wayne Lewis, sls mgr; Ken Perry, news dir; Larry Powell, chief engr. ■ Rates: \$3.75; 3.50; 3.75; 3.50.

Wendell-Zebulon

WETC—June 16, 1959: 540 khz; 5 kw-D, DA. Box 280 (27591). (919) 269-9325. Wendell-Zebulon Radio Co. Net: Caranet. Rep: Southern Spot Sls. Format: C&W. ■ Lewis V. Parris, pres; Bill Kirby, gen mgr; Charles C. Hocutt, coml mgr; Henry Holt, prog dir; Aaron Pitt, prom mgr; Donnie Nolan, news dir; Andy Owens, chief engr.

West Jefferson

WKSK—May 27, 1959: 580 khz; 500 w-D. Box 411 (28694). (919) 246-6001. Childress Bcstg Corp. of West Jefferson. Group owner: Childress Stns. Format: C&W, Top 40. ■ James B. Childress, pres; Jan Caddell, gen mgr; L. Clay Denny, coml mgr; Larry Carlton, prog dir; Swansie Baldwin, prom mgr; Larry Graybeal, mus dir; Gary Pennell, news dir; Robert Marsh, chief engr.

North Carolina, North Dakota Radio

See page C-1 for explanation of listings.

Whiteville

WENC—July 14, 1946: 1220 khz; 5 kw-D. Box 700 (28472). (919) 642-2133. Whiteville Bcstg Co. Net: Tobacco. Rep: T-N Spot Sls. Format: Contemp, C&W. ■ J. Herman Leder, pres; Don Viets, gen mgr; Bill Ghent, prog dir; William F. Rodgers, chief engr.

WENC-FM—Feb 21, 1962: 99.1 mhz; 45 kw. Ant 150 ft. Prog dups AM 80%.

New FM—Not on air, target date unknown: 1540 khz; 1 kw-D. Box 427 (28472). Waccamaw Bcstg Co. Format: Easy Istng, Top 40. ■ Gregory H., J. Howard, and James D. Singletary, co-owners.

Wilkesboro

WWWC—Jan 26, 1970: 1240 khz; 500 w-D, 250 w-N. Box 580 (28697). (919) 667-1241. Wilkes County Radio Co. Net: ABC/E. Format: C&W, top 40, rock, MOR, contemp. ■ Paul L. Cashion, pres; J. B. Wilson Jr., VP gen & coml mgr; Ric Ross, prog & mus dir; Ken Welborn, prom mgr; Steve Kern, news dir; John Wiles, chief engr.

***New FM**—Not on air, target date unknown: 90.1 mhz 10 w. Ant 29 ft. Collegiate Dr. (28697). Wilkes Community College. ■ Al G. Stanley, instructor/chief of ops.

Williamston

WIAM—March 1951: 900 khz; 1 kw-D. Box 590 (27892). (919) Swift 2-4161. Fargay Bcstrs Inc. (acq 8-1-53). Format: Contemp, C&W, MOR. ■ William H. Farrior, pres & gen mgr; Rod Davis, prog dir; Perlie Jernigan, chief engr. ■ Rates: \$1.75; 1.75; 1.75; 1.75.

WSEC(FM)—Aug 1, 1962: 103.7 mhz; 50 kw. Ant 175 ft. Prog dups AM 50%. ■ Rates same as AM.

Wilmington

WAAV(FM)—Listing follows WGNI.

WGNI—Dec 24, 1946: 1340 khz; 1 kw-D, 250 w-N. 211 N. Second St. (28401). (919) 763-6511. New Hanover Bcstg Co. (acq 7-1-48). Net: N.C. News. Rep: Tobacco. Format: Top 40. ■ Leo Brody, pres; Jim Pridmore, gen mgr; Tommy Thompson, coml mgr; Mike Fenley, opns mgr; Mike Grohman, prog dir; Charles Lewis, chief engr. ■ Rates: \$5.50; 4.25; 5.50; 3.75.

WAAV(FM)—Co-owned with WGNI. March 1, 1970: 102.7 mhz; 50 kw. Ant 145 ft. Stereo. ■ Zeke Church, coml mgr. ■ Rates: \$5; 5; 5; 5.

WHSL—Aug 15, 1963: 1490 khz; 1 kw-D, 250 w-N. Drawer 2025 (28401). (919) 762-4491. Progressive Bcstg Corp. (acq 11-69). Net: MBS. Rep: Torbet, Jones. Format: Contemp, MOR, oldies. ■ W. O. Jones, pres; William B. Humble, gen mgr; Burl Lauter, coml mgr; Larry Thomas, opns dir; Betty Cress, prom mgr; Bill Johnson, mus dir; Bill Hillman, news dir; Art Madeley, chief engr.

WJIL(FM)—Co-owned with WHSL. Feb 23, 1970: 97.3 mhz; 27.5 kw. Ant 125 ft. Stereo. Prog sep from AM. Net: MBS/Black. ■ Otis Jones, asst mgr; Wayne Sharp, prog dir; Louis Ashe, prom mgr.

WKLM—Dec 20, 1957: 980 khz; 5 kw-D. Box 432 (28401). (919) 763-4633. Arlington-Fairfax Bcstg Corp. Group: Thomas Sns. Net: ABC. Rep: Young, Carpenter. Format: C&W.

WMFD—April 15, 1935: 630 khz; 1 kw-U, DA-2. Box 1889 (28401). (919) 762-4474. Dunlea Bcstg Industries Inc. Net: CBS. Audio news: APR. Rep: Devney, Southern Spot Sls. Format: MOR. ■ R. A. Dunlea Jr., pres; R. J. Hurley, gen & coml mgr; John Powell, news dir; Greg Allinson, prog & mus dir; Howard Bright, chief engr. ■ Rates: \$7; 7; 7; 7.

WMFD-FM—March 31, 1969: 100.9 mhz; 2.15 kw. Ant 350 ft. Stereo. Format: Btlf mus. Spec prog: Classcl 1 hr wkly. ■ Rates: \$4; 4; 4; 4.

WWIL(FM)—Listing follows WHSL.

Wilson

WGTM—July 18, 1937: 590 khz; 5 kw-U, DA-2. Box

3837 (27893). (919) 243-2188. Campbell Bcstg Inc. (acq 1-1-64). Net: N.C. News. Rep: T-N Spot Sls. Format: MOR. Spec prog: C&W 15 hrs, black 4 hrs, farm 10 hrs wkly. ■ A. Hartwell Campbell, pres; Tom Campbell, VP-sls, prom mgr; Vann Campbell, gen mgr; Jim Apple, opns mgr & mus dir; Rod Wheelen, news dir; Carlester Crompler, sps dir; William J. Bunn, chief engr. ■ Rates: \$5.20; 4.70; 5.20; 4.70.

WLLY—1961: 1350 khz; 1 kw-D. Davis Bldg. (27893). (919) 287-1830. Harry A. Epperson. ■ Raymond P. Frazier, mgr; Lorraine Gay, prog dir.

WVOT—June 1948: 1420 khz; 1 kw-D, 500 w-N, DA-N. Drawer 170 (27893). (919) 243-5157. Wilson Radio Co. Net: Caranet, Farm Directors Radio Net. Rep: Southern Spot Sls. Spec progs: Black 15 hrs, C&W 20 hrs wkly. ■ H. W. Anderson, pres; H. W. Severance, gen mgr; P. O. Barnes, coml mgr; Bill Wiggs, prog & news dir & chief engr; "Butch" Moore, asst mgr.

WVOT-FM—March 1, 1961: 106.1 mhz; 23 kw. Ant 185 ft. Prog dups AM 100%.

Windsor

WBTE—1969: 990 khz; 1 kw-D. Box 509 (27983). (919) 794-3131. Bertie County Bcstg Co. Net: N.C. News. Rep: Southern Spot Sls. Format: C&W. Spec progs: Black 10 hrs, farm 5 hrs wkly. ■ Berney Stevens, pres; Don Upchurch, gen mgr; Wayne Stevens, coml mgr; Joanie Hoggard, mus dir; Susan Smith, news dir; Perlie Jernigan, prog dir, prom mgr & chief engr. ■ Rates: \$6.50; 6.50; 6.50; 6.50.

Winston-Salem

WAAA—Oct 28, 1950: 980 khz; 1 kw-D. Box 11197 (27106). (919) 767-0430. Media Bcstg Corp. (acq 9-1-56). Rep: Howard. Format: Black. ■ Robert B. Brown, pres; James Warren, gen mgr.

WSGH-FM—Co-owned with WAAA. Dec 7, 1958: 107.5 mhz; 40 kw horiz, 12.5 kw vert. Ant 280 ft horiz, 290 ft vert. Box 11967. Golden Circle Corp. Prog sep from AM. Format: Contemp. ■ Dennis Immel, gen mgr.

WAIR—March 25, 1937: 1340 khz; 1 kw-D, 250 w-N. Box 2099 (27102). (919) 722-1347. Holiday Bcstg Corp. (acq 8-11-61). Net: T-N News. Rep: Savalli-Gates. Format: Contemp, top 40, black. ■ John W. Goope, pres; Nick P. Patella, exec VP & gen mgr; Arthur Gibson, prog dir; Bruce Key, mus dir.

WSEZ(FM)—Co-owned with WAIR. April 1947: 93.1 mhz; 34 kw. Ant 250 ft. Stereo. Box 598. (919) 724-5504. Traid Bcstg Corp. Prog sep from AM. Format: Easy Istng. ■ Don Matney, gen mgr.

***WFDD-FM**—March 13, 1961: 88.5 mhz; 36 kw. Ant 410 ft. Box 7405, Reynolda Stn. (27109). (919) 725-9711, ext 218. Trustees of Wake Forest Univ. Net: NPR. Format: Classical & educational. ■ Julian C. Burroughs Jr, prof of speech (Radio-TV-Film). ■ Lewis S. Kanoy, chief engr.

WKBX—October 1964: 1500 khz; 10 kw-D (1-kw-CH), DA-D. 3066 Trendwest Dr. (27103). (919) 765-1551. Stuart W. Epperson. Net: MBS. Format: C&W. ■ Stuart W. Epperson, pres; Curly Howard, gen mgr; Ed Snow, prog & mus dir; L. B. Saunders, coml mgr; Bob Mahoney, prom mgr; Ralph Smith, news dir; Wayne Outland, chief engr.

WPGD—Oct 1, 1966: 1550 khz; 1 kw-D. Drawer N-1 (27105). (919) 723-3508. Forsyth County Bcstg Co. (acq 10-71). Format: Gospel. ■ Robert A. Mayer, pres; D. W. Long, gen mgr; Larry Conier, coml mgr; Ray Testerman, chief engr.

WSEZ(FM)—Listing follows WAIR.

WSGH-FM—Listing follows WAAA.

WSJS—April 17, 1930: 600 khz; 5 kw-U, DA-2. Box 3018 (27102). (919) 724-1936. Triangle Bcstg Corp. Net: NBC. Rep: Katz. Format: MOR/Contemp. ■ Lee R. Wallenhaupt, pres; Richard Barron, gen mgr; Roger Stockton, sls mgr; Randall Gibson, opns mgr; Suzanne DeLoach, prom mgr; Wayne Willard, news dir; Leon Lasley, chief engr.

WTQR(FM)—Co-owned with WSJS. Dec 1, 1947: 104.1 mhz; 50 kw. Ant 1420 ft. Stereo. (919) 724-5886. Prog sep from AM. Format: Country. ■ William H. Brown, stn & sls mgr; Dixie Pfaff, prog dir. ■ WSJS-TV affil.



WTOB
Woods Communication Corp.

WTOB—April 22, 1947: 1380 khz; 5 kw-D, 1 kw-N, DA-N. Box 5129 (27103). (919) 723-4353. Woods Communications Corp. (group owner; acq 8-23-73). Rep: Buckley. Format: MOR, Top 40. ■ John Woods, pres & gen mgr; Robert Sprink, coml mgr; Bill McQuage, prog & news dir; Jay McDaniel, mus dir; Loomis Barker, prom mgr; J. Wayne Outland, chief engr. ■ Rates: \$33; 30; 33; 25.

WTQR(FM)—Listing follows WSJS.

Yadkinville

WYDK—May 22, 1968: 1480 khz; 1 kw-D, DA. Rt. 1, Box 125 (27055). (919) 679-2200. B & B Bcstg Corp. (acq 10-73). Format: Contemp country. ■ Douglas Renegar, gen mgr; John N. Norman, prog dir; Bill Miller, chief engr.



CSI ELECTRONICS INC.

2607 River Road
Cinnaminson, New Jersey, 08077
Telephone: (609) 786-1060

North Dakota

Belcourt

***KEYA(FM)**—October 1975: 88.5 mhz; 19 kw. Ant 360 ft. Stereo. Box 190 (58316). (701) 477-5686. Couture School Board, District No. 27. Net: NPR. Format: Diversified. Spec progs: Farm 2 hrs, Chippewa, Cree, Metis 5 hrs wkly. ■ Fayes Albert, chmn; Dallas Brien, gen mgr; Bill Haines, prog dir; Millynn Moore, community affairs dir; Kevin Richards, chief engr.

Bismarck

KBMR—Aug 15, 1958: 1130 khz; 10 kw-D. Box 1233 (58501). (701) 255-1234. KBMR Radio Inc. (acq 4-1-65). Net: ABC/FM. Rep: Eastman, IMN. Format: C&W 100%. ■ Alvin L. Anderson, pres & gen mgr; Ros Henke, coml mgr; Jack Fisher, prog dir; Marv Allen, mus dir; Steve Burdine, news dir; Jack Schwartz, chief engr. ■ Rates: \$9.50; 7.60; 7.60; 7.60.

KODY(FM)—Co-owned with KBMR. Sept 13, 1968: 94.5 mhz; 100 kw. Ant 680 ft. Stereo. Prog sep from AM. Format: Btlf mus. ■ Rates: \$5.10; 5.10; 5.10; 5.10.

KBOM—1925: 1270 khz; 1 kw-D, 250 w-N. Box 1377 (58501). (701) 663-6411. Matcoo Inc. (acq 2-2-71). Net: CBS. Rep: Torbet, John L. McGuire. Format: Personality. MOR. ■ Russell H. Matthias, pres; William W. Matthias, sec-treas; Ronald V. Jones, gen mgr & natl sls mgr; Alan Fetch, prog & mus dir; Gary Lee, news dir; Robert Watts, chief engr.

KFYR—1925: 550 khz; 5 kw-U, DA-N. Box 1738 (58501). (701) 223-0900. TWX 910-677-2339. Meyer Bcstg Co. (group owner). Net: NBC. Rep: Blair. Format: Contemp. ■ Wm. A. Ekberg, pres; Thomas G. Bar, gen mgr; Jerry Hegel, coml mgr; Dan Brannan, prog dir; John Sullivan, prom mgr; John Ruby, mus dir; Dewey Hegggen, news dir; Herbert R. Leupp, chief engr. ■ Rates: \$20; 16; 20; 16.

KFYR-FM—Aug 15, 1966: 92.9 mhz; 45 kw. Ant 1400 ft. Quad. Net: ABC/C. Format: Solid gold. Prog sep from AM. ■ Dave Montgomery, prog dir. ■ KFYR-TV affil. ■ Rates: \$3.50; 3.50; 3.50; 3.50.

KODY(FM)—Listing follows KBMR.

Carrington

KDAK—Oct 16, 1961: 1600 khz; 500 w-D. 859 Main St. (58421). (701) 652-3152. Central Bcstg Co. Rep: Keystone. Format: MOR. ■ F. W. Carr, pres & chief engr; Shearn Hirsch, gen mgr. ■ Rates: \$5.50; 5.50; 5.50; 5.50.

Devils Lake

KDLR

M

Jack Masla & Company, Inc.

KDLR—Jan 25, 1925: 1240 kHz; 250 w-U. Box 190 (58301). (701) 622-2161. KDLR Inc. Net: MBS. Rep: Masla; Wayne-Evans. Format: MOR. Spec progs: Farm 10 hrs, Sioux Indian ¼ hr, Bert Wick Presents 2½ hrs. ■ Bert Wick, pres; Paul R. Lange, exec VP & gen mgr; Harry Kosieracki, coml mgr; Wilber Clemenson, prog dir; Karl Lange, prom mgr; Lyle Romine, mus dir; Lee Halvorson, news & sports dir; Dave Haug, chief engr. ■ Rates: \$7.50; 6.85; 7.50; 6.25.

KDLR-FM—Jan 1, 1967: 96.7 mhz; 3 kw. Ant 165 ft. Dup AM 15%. Format: Btlf mus. Spec prog: N.Y. Philharmonic 2 hrs wkly. ■ Rates: \$—; 3.50; 3.50; 4.

Dickinson

KDIX—1947: 1230 kHz; 1 kw-D, 250 w-N. Box 1368 (58601). (701) 225-5133. Dickinson Bcstg Corp. (acq 10-25-66). Net: CBS. Rep: Torbet. Format: Contemp, C&W. ■ Stanley Deck, pres; Robert J. Weiler, mgr & coml mgr; Thomas Nelson, news dir; William Kohler, chief engr. ■ KDIX-TV affil.

Fargo

***KDSU(FM)**—Jan 17, 1966: 91.9 mhz; 1.20 kw. Ant 110 ft. (58102). (701) 237-8321. North Dakota State U. Net: NPR. Format: Educl, diversified. ■ Dr. L.D. Loftsgard, pres; C.H. Logan, gen mgr & dir of educ bcstg; John L. Tilton, prog dir; James R. Hetland, chief engr.

KFGO

KFGO—March 14, 1948: 790 kHz; 5 kw-U, DA-N. 405 S. Seventh St. (58102). (701) 237-5245. Communications Properties Inc. (group owner; acq 12-6-65). Net: CBS. Audio news: APR. Rep: Knodel; Ewing. Format: C&W 100%. ■ Phillip T. Kelly, pres; Richard C. Voight, gen mgr; Jay Joiner, news dir; W. Tom Simmons, opns mgr; Jack Everton, coml mgr; Bill Hoverson, prog & mus dir; Norris Pederson, chief engr.

***KFNW**—Oct 25, 1955: 1170 kHz; 1 kw-D. (701) AD 2-5949. Northwestern College. ■ Cornelius Keur, dir of radio; Dave Kersey, gen mgr & prog dir; Gerry Johnson, contract engr.

***KFNW-FM**—March 12, 1965: 97.9 mhz; 29 kw. Ant 210 ft. Dup AM 56%.

KQWB—March 26, 1960: 1550 kHz; 5 kw-D. Box 2983 (58102). (218) 236-7900. Midwest Radio Co. (acq 3-1-65). Net: ABC/C. Rep: Torbet. Format: Rock. ■ Larry Lakoduk, pres, gen & coml mgr; Wayne Hiller, prog dir; Jay Edwards, news dir; Charlie Fox, mus dir; Woody Black, chief engr.

KWIM(FM)—See Moorhead, Minn.

KVOX—See Moorhead, Minn.

WDAY—May 22, 1922, 970 kHz; 5 kw-U, DA-N. 207 N. 5th St. (58102). (701) 237-6500. TWX 910-673-8301. WDAY Inc. Group owner: Forum Communications. Net: NBC. Rep: McGavren-Guild. ■ William Marciel, pres; Bill Burr, gen mgr; Jack Dunn, exec VP; Norm Engstrom, prog dir; Roy Pedersen, prom mgr; Norm Schrader, news dir; Lance Lee, chief engr.

WDAY-FM—1965: 93.7 mhz; 42 kw. Ant 1, 150 ft. prog sep from AM. Stereo. ■ WDAY-TV affil.

Grafton

KXPO—July 12, 1958: 1340 kHz; 1 kw-D, 250 w-N. Box 312 (58237). (701) 352-0431. KGPC Co. (acq 12-12-72). Net: MBS. Format: MOR. ■ Gary C. Pearson, pres, gen & prom mgr; Del Nygard, coml mgr; Dick Oliver, prog dir; Jeff Davies, mus dir; Noel Stendahl, news dir; Ken Berndt, chief engr. ■ Rates: \$4.50; 4; 3.30; 2.

Grand Forks

***KFJM**—Aug 13, 1923: 1370 kHz; 1 kw-D. Box 8116 (58201). (701) 777-2577. U. of North Dakota. Net: NPR. Format: Diversified. Spec progs: Sp ½ hr, Am. Indian ½ hr, wkly. ■ David Beach, gen mgr; Michael Turner, news dir; John Assen, chief engr; Christine Engel, producer; Elaine Dunlap, traf mgr; Lynette Jackson, women's dir.

***KFJM-FM**—Not on air, target date Jan 1, 1976: 89.3 mhz; 37.5 kw. Ant 215 ft. Stereo. Dups AM 50%.

KKXL

Contemporary

KKXL—Aug 13, 1923: 1440 kHz; 1 kw-D, 500 w-N. Box 997 (58201). (701) 775-0575. Red River Valley Bcstg Co. (acq 7-23-73). Group owner: Ingstad Bcstg. Net: CBS. Audio news: APR. Rep: Masla. Format: Top 40. ■ Tom Ingstad, pres & gen mgr; Dan Sollom, pub affairs & news dir; Randy Holland, sis mgr; Mark Renier, prog dir; Chuck Sjostrom, chief engr. ■ Rates: \$13; 7; 6.

KKDQ(FM)—March 1975: 92.9 mhz; 100 kw. Ant 210 ft. Stereo. Prog sep from AM. Format: Rock, Top 40.

KNOX-AM/KTYN-FM

A Journal Star Station

KNOX—Sept 7, 1947: 1310 kHz; 5 kw-U, DA-N. Box 1638 (58201). (701) 775-4611. Radio Grand Forks Inc. (acq 2-1-73). Group owner: Journal Star. Net: ABC/E. Rep: Torbet, Evans. Format: MOR. ■ Justin Hoberg, gen mgr; Bob Lockhart, coml mgr; Chuck Scott, prog dir; Charles Johnson, news dir; Don Peterson, chief engr. ■ Rates: \$22; 18; 22; 16.

KTYN(FM)—Co-owned with KNOX. Feb 4, 1967: 94.7 mhz; 100 kw. Ant 235 ft. Format: Btlf mus. ■ Rates: \$4.50; 4.50; 4.50; 4.50.

KRAD—See East Grand Forks, Minn.

Hettinger

KNDC—March 1, 1954: 1490 kHz; 1 kw-D, 250 w-N. SH. Box 151 (58639). (701) 567-2421. Hettinger Bcstg Co. (acq 11-67). Rep: Masla, Dakota Farm Net. Format: C&W, MOR. ■ Allen R. McIntyre, pres & gen mgr; Steve Petz, coml mgr; Mike Weringler, mus dir; Tim Kochel, chief engr; Bill McIntyre, prog & news dir. ■ Rates: \$5; 5; 4.50; —.

Jamestown

KEYJ—Aug 12, 1954: 1400 kHz; 1 kw-D, 250 w-N. Box 1170 (58401). (701) 252-2160. KEYJ Inc. (acq 11-15-68). Net: ABC/C. Format: MOR, rock. Spec prog: C&W 12 hrs wkly. ■ Robert L. Richardson, pres & gen mgr; Joyce Meyer, prog dir; Mark Richardson, mus dir; John Bible, chief engr.

KSJB—1937: 600 kHz; 5 kw-U, DA-1. Box 600 (58201). (701) 252-3570. Triple R Inc. (acq 4-1-65). Net: ABC/E. Rep: Torbet; Wayne-Evans. Format: C&W. ■ Ed Crilly, pres & gen mgr; Bonnie Walz, coml mgr; Jack Leonard, prog & news dir; Al Bertz, prom mgr; Ole Olson, mus dir; Harvey Van Erem, chief engr. ■ Rates: \$14; 11; 14; 11.

KSJM(FM)—Co-owned with KSJB. February 1968: 93.3 mhz; 28.5 kw. Ant 255 ft. Stereo. Format: MOR. ■ Rates: \$5.50; 5.50; 5.50; 5.50.

Langdon

KNDK—June 27, 1967: 1080 kHz; 1 kw-D. Langdon Nadak (58249). (701) 256-2146. Johnson, Johnson & Laidlaw (acq 10-4-74). ■ T.L. Laidlaw, gen, coml mgr & prog dir; Kenneth Torkelson, news dir; Myles Erickson, chief engr. ■ Rates: \$2.60; 2.60; 2.60; 2.60.

Mandan

KBOM—See Bismarck.

Mayville

KMAV—Oct 20, 1967: 1520 kHz; 250 w-D. Box 29 (58257). (701) 786-2006. KMAV Inc. Net: MBS. For-

North Dakota Radio

See page C-1 for explanation of listings.

mat: C&W. Spec prog: Sp 2½ hrs wkly. ■ Francis J. Phelan, pres; Austin G. Kramer, gen mgr, prog & mus dir, chief engr; G. Everett Thoreson, prom mgr & mus dir; Bob Allen, mus & news dir. ■ Rates: \$5; 5; 5; —.

Minot

KCJB—March 1950: 910 kHz; 5 kw-D, 1 kw-N; DA-2. Box 1686 (58701). (701) 838-0361. TWX 910-675-2496. Big K Inc. (acq 1974). Rep: HR/Stone; Hurley. Format: Contemp. ■ Chester Reiten, pres; Rod Romine, gen & sis mgr; Euneva Christenson, opns mgr; John Williams, news dir; Duane Asse, chief engr.

KCJB-FM—Nov 15, 1966: 97.1 mhz; 50 kw. Ant 830 ft. Prog sep from AM. Stereo. Format: Easy Listng. ■ KXMC-TV affil.

KHRT—Nov 17, 1957: 1320 kHz; 1 kw-D. Box 1210 (58701). (701) 838-5111. K-HRT Bcstg Corp. (acq 10-1-67). Net: ABC. Format: MOR. Spec progs: C&W 4 hrs, goss 10 hrs wkly. ■ Harold Christensen, pres & gen mgr; A. Gaylord Folden, coml mgr; Weston Bell, chief engr.

KLPM

MOR

M

Jack Masla & Company, Inc.

KLPM—Oct 28, 1929: 1390 kHz; 5 kw-D, 1 kw-N. Box 10, 320 Third Ave., S.W. (58701) (701) 852-0145. Minot Bcstg Co. Inc. (acq 3-30). Net: MBS. Rep: Masla; Messner. Format: MOR. Spec prog: Scandinavian 1 hr wkly. ■ Leslie E. E. Maupin, pres & gen mgr; Gary Knight, coml mgr; Kay Rice, prom mgr; Paul A. Newburgh, news dir; C. W. Baker, chief engr. 50; 6.50; 5; 3.25.

KMOT-FM—Sept 7, 1970: 93.7 mhz; 27.5 kw. Ant 600 ft. Stereo. Box 1118 (58701). (701) 852-4101. Meyer Broadcasting Co. (group owner). Net: ABC/FM. Format: MOR. ■ William A. Ekberg, pres; Stan Wilsin, gen mgr; Norm Buckner, coml mgr; Jim Mackey, prog dir; Dennis Kahn, mus dir; Paul R. Unwin, news dir; Ray Swenson, chief engr. ■ Rates: \$3; 3; 3.

KTYN—Sept 13, 1968: 1430 kHz; 5 kw-D. Box 637 (58701). (701) 838-0301. Knok Radio Inc. Rep: Torbet. ■ Justin Hoberg, pres; Richard Gehl, gen & prom mgr; Jerry Gutensohn, coml mgr & news dir; Mark Swendsen, prog dir; Al Wayne, mus dir; James Rufus, chief engr.

Oakes

KDDR—July 31, 1959: 1220 kHz; 1 kw-D. Box 411 (58474). (701) 742-2187. Berry Iverson Bcstg Corp. of N.D. (acq 12-21-72). Net: ABC/C. Dakota Region News. Rep: Keystone. Format: C&W, rock, nostalgia. ■ Ronn Scott, pres; Robert C. Matson, gen mgr; Marilyn Wiek, coml mgr; Scott Jeffrey, prog dir & chief engr; David J. Law, news dir.

Rugby

KGCA—Aug 21, 1961: 1450 kHz; 1 kw-D, 250 w-N. Box 31 (58368). (701) 776-5254. Rugby Bcstrs Inc. Net: MBS. Rep: Keystone. Format: C&W, MOR. ■ Oscar Halvorson, pres; Dale C. Moldenauer, gen, coml & prom mgr; Dave Prentice, prog dir; Irene Voeller, mus dir; Clem Jay, news dir; Ray Frederich, chief engr.

Tioga

KTGO—Feb 27, 1967: 1090 kHz; 250 w-D. Box 456 (58852). (701) 664-3322. Tioga Bcstg Corp. Format: C&W, talk. ■ Pius Hornstein, pres; Jim Karn, gen mgr & prog dir; Ralph Lockwood, news dir; Mike Thompson, VP & chief engr. ■ Rates: \$6.75; 7.50; 7.50; 5.75.

Valley City

KOVC—Oct 19, 1936: 1490 kHz; 1 kw-D, 250 w-N. Box 1146 (58072). (701) 845-1490. KOVC Inc. Group owner: Ingstad Bcstg. Net: ABC/L. Format: MOR. ■ Dale Olson, gen mgr; Al James, prog & prom mgr; Phil Dutcher, coml mgr; Dennis Pittman, mus dir; Bill Fink, news dir; Charles Sjostrom, chief engr.

North Dakota, Ohio Radio

See page C-1 for explanation of listings.

Wahpeton

KBMW—See Breckenridge, Minn.

Williston

KEYZ—1948: 1360 khz; 5 kw-U, Da-N. Box 1367 (58801). (701) 572-3911. Charles L. Scofield (acq 1951). Net: ABC/I, Intermountain. Audio news: APR. Rep: Hurley. Format: C&W. ■ Charles L. Scofield, gen mgr & chief engr; Earl Gross, prog dir; Robert Gundersen, mus dir; Ben Innis, news dir; Robert H. Miller, stn mgr.

KGCX—See Sidney, Mont.

Ohio

HAMILTON-LANDIS
& ASSOCIATES, Inc.
NATIONWIDE MEDIA BROKERS
WASHINGTON, D. C., CHICAGO, DALLAS,
SAN FRANCISCO
SELL **MORE**
RADIO & TELEVISION STATIONS
IN THE MIDWEST—NEAREST OFFICE IS—
1429 TRIBUNE TOWER, CHICAGO 60611
(312) 337-2754

Akron

WHEZ(FM)—Listing follows WAKR.

WAKR—Oct 16, 1940: 1590 khz; 5 kw-U DA-N. Box 1590 (44309). (216) 535-7831. Summit Radio Corp. Group owner: Group One. Rep: McGavren-Guild. Format: Contemp. ■ Viola G. Berk, pres; Roger G. Berk, VP & gen mgr; S. J. Yacovazzi, stn mgr; Nick Barry, asst stn mgr; Larry Crawford, prog dir; Fred Anthony, news dir; Irwin L. Knopp, chief engr. ■ Rates: \$ 35; 24; 28; 12.

WAEZ(FM)—Co-owned with WAKR. October 1947: 97.5 mhz; 50 kw. Ant 500 ft. Prog sep from AM. ■ WAKR-TV affil. ■ Rates: \$ 18; 18; 18; 18.

***WAPS(FM)**—Oct 4, 1955: 89.1 mhz; 1.3 kw. Ant 44 ft. 70 N. Broadway (44308). (216) 434-1661, ext 205. Board of Education, Akron City School District. Format: Educl. ■ Robert Meadows, gen mgr.

***WAUP(FM)**—Dec 10, 1962: 88.1 mhz; 3 kw. Ant 115 ft. Stereo. 302 East Buchtel Ave. (44325). (216) 375-7105. U. of Akron, Net: ABC/I. Format: Variety Jazz. Spec progs: Ital 1 hr; Greek 2 hrs wkly. ■ Donald G. Boggs, stn mgr; Dr. William B. Steis, gen mgr; Richard Paul Lampson, prog dir; Jon Thibo, prom mgr; Richard E. McGraw, chief engr.

WCUE—See Cuyahoga Falls.

WCUE-FM—1950: 96.5 mhz; 50 kw. Ant 105 ft (CP Ant 440 ft). 424 Sackett Ave. (44313). (216) 923-9761. WCUE Radio. Progs sep from AM. Format: Progs. Spec progs: Black 3 hrs wkly. ■ Rates: \$ 12; 14; 16; 16.

WDBN(FM)—See Medina.

WHLO—October 1944: 640 khz; 1 kw-U, DA-1 (L-KFI). 2650 West Market (44313). (216) 867-1650. Radio Akron Inc. (acq 11-16-59). Group owner: Susquehanna Bcstng Co. Rep: Eastman. Format: Contemp, news. Spec progs: Serbian 1 hr; Black 1 hr wkly. ■ Louis J. Appell Jr, pres; Allen Saunders, VP & gen mgr; Arthur W. Carlson, VP; Bob Winer, sls mgr; George Joachim, prog dir; Dave Lieberth, news dir; Don Krieger, chief engr.

WSLR—1925: 1350 khz; 5 kw-U, DA-1. 369 S. Portage Path (44320). (216) 535-6165. Welcome Radio Inc. (group owner; acq 12-64). Net: ABC/E. Rep: Katz. Format: C&W. ■ Harrison M. Fuerst, pres; Richard M. Lumenello, VP & gen mgr; Robert I. Barnes, sls mgr; Craig Scott, prog dir; Bill Hart, mus cir; Tom Locicero, news dir; George Paul, chief engr.

Alliance



WFAH—Sept 2, 1953: 1310 khz; 1 kw-D, DA. Box 718 (44601). (216) 821-1111. D. A. Peterson Inc. Net: ABC/I. Format: Rock. ■ Donald A. Peterson, pres; Robert A. Gates, mgr; Tony Gates, coml mgr; Richard Elliott, prog mgr; Bruce Harian, chief engr. ■ Rates: \$ 7; 6; 7; 6.

WFAH-FM—March 26, 1947: 92.5 mhz; 27 kw. Ant 140 ft. Stereo. Progs sep from AM. Format: Up-tempo pops. ■ Rates: \$ 5.15; 5.15; 5.15; 5.15.

***WRMU(FM)**—Oct 17, 1970: 91.1 mhz; 2.8 kw. Ant 190 ft. Mount Union College, 1972 Clark Ave. (44601). (216) 823-2414. Mount Union College. Format: Ed. ■ Charles Morford, stn dir; Don Sheehan, gen mgr; Dan Buckel, prog dir; Allen Ramsier, mus dir; Samuel Shimp, chief engr.

Archbold

WHFD(FM)—April 15, 1968: 95.9 mhz; 3 kw. Ant 300 ft horiz, 295 ft vert. Stereo. 303½ N. Defiance St. (43502). (419) 445-9050. Nobco Inc. Audio news: UPI. Format: MOR. Spec progs: C&W 5 hrs; classcl 1 hr; Sp 1 hr; Farm 3 hrs wkly. ■ Max E. Smith Sr, pres & gen mgr; Terry J. Foss, coml mgr; Bob Heisler, prog & mus dir & prom mgr; James Keen, chief engr. ■ Rates: \$ 5.75; 5.75; 5.75; 5.75.

Ashland

WNCO—1949: 1340 khz; 1 kw-D, 250 w-N. Box 311 (44805). (419) 289-2605. Ashland Bcstg Corp. (acq 3-1-65). Net: MBS. Rep: Pro Time Sales, Regional Reps. Format: MOR day, top 40 evening. ■ Walter R. Stampfli, VP & gen mgr; Charles Ticknor, coml mgr; Gary Gott, prog dir; Sheldon Little, mus dir; Al Lawrence, news dir; Fred Mullens, chief engr. ■ Rates: \$ 9.50; 8.50; 9.50; 6.50.

WNCO-FM—May 1947: 101.3 mhz; 50 kw. Ant 390 ft. Stereo. Progs sep from AM. Format: C&W. ■ Tex Regan, mus dir. ■ Rates same as AM.

***WRDL(FM)**—Aug 24, 1967: 89.5 mhz; 10 w. 401 College Avenue (44805). (419) 289-4160. Ashland College. Net: MBS. Format: Contemp 50%, educt 50%. ■ Dr. Glenn L. Clayton, pres; Richard Leidy, gen mgr.

Ashtabula

WAQI—Feb 6, 1964: 1600 khz; 1 kw-D, DA. Box 236 (44004). (216) 998-3700. Quest Inc. Net: ABC/E. Rep: Regional Reps. Format: MOR. ■ Kenneth Mapes, pres; Rick Randy, gen mgr; Al Newkirk, news dir; Harry Hensel, chief engr.

WREO—Sept 21, 1937: 970 khz; 5 kw-D, 1 kw-N, DA-2. Box 738 (44004). (216) 993-2126. Radio Enterprises of Ohio Inc. Format: Rock, Top 40. Spec progs: Ital 1½ hrs; Pol 1½ hrs wkly. ■ D. C. Rowley, pres; R. D. Rowley, gen mgr; G. H. Murray, coml mgr; David Rowley, prog & stn dir; Frank Stacy, news dir; Frank N. Bernato, chief engr. ■ Rates: \$ 8.50; 8.20; 8.50; 8.20.

WREO-FM—1949: 97.1 mhz; 50 kw. Ant 500 ft. Stereo. Prog sep from AM. Net: ABC/FM. Format: MOR. ■ Rates: \$ 5; 5; 5; 5.

Athens



WATH—Oct 25, 1950: 970 khz; 1 kw-D, Drawer C (45701). (614) 593-6651. WATH Inc. (acq 9-5-73). Rep: Regional Reps. Format: MOR. Spec progs: C&W 12 hrs; Farm 3½ hrs wkly. ■ Fred A. Palmer, pres & gen mgr; David W. Palmer, stn mgr; Ty Richards, prog dir; A. MacDonnell Thayer, sls mgr; Keith A. Hubbell, chief engr. ■ Rates: \$ 6.60; 5.50; 6.60; 5.50.

WXTQ(FM)—Co-owned with WATH. Sept 16, 1964: 105.5 mhz; 3 kw. Ant 290 ft. Stereo. Dups AM 50%. Format: Top 40. ■ Rates: \$ 5.50; 5; 5.50; 5.

***WOUB**—Sept 15, 1957: 1340 khz; 250 w-U. 29 S. College St. (45701). (614) 594-5321. TWX 810-239-2992. Ohio U. Net: ABC/I, NPR. Format: Contemp. ■ Joseph Welling, dir, telecommunications center; Ted Jacobson, prog dir; Jean Mezza, dir info services; John Chalfant, news dir; Don Smith, chief engr.

***WOUB-FM**—Dec 13, 1949: 91.3 mhz; 50 kw. Ant 500 ft. Progs sep from AM. Format: Appalachian, pub affrs. ■ *WOUB-TV affil.

Batavia

***WCNE(FM)**—Dec 5, 1969: 88.7 mhz; 3.5 kw. Ant 160 ft. 5327 Hutchinson Rd. (45103). (513) 625-1211. Clermont Northeastern Schools. Format: Educl, info. ■ Robert C. Rossetol, gen mgr; Richard Woodruff, chief engr.

Bellaire

WOMP—Dec 2, 1947: 1290 khz; 1 kw-D. Box 448 (43906). (614) 676-5661. T/R Inc. (group owner; acq 4-1-65). Rep: Savalli/Gates, Regional Reps. Format: Contemp, talk. Spec progs: Czech 2 hrs, Pol 4 hrs, Greek 1 hr wkly. ■ Clay Littick, pres; Robert Andre, gen & coml mgr; Robert Blair, prog dir; Don Sherwood, news dir; Frank Viola, chief engr.

WOMP-FM—1947: 100.5 mhz; 13.5 w. Ant 520 ft. Dups AM 65%.

Bellefontaine

WOGM(FM)—Listing follows WTOO.

WTOO—1951: 1390 hz; 500 w-D. Box 338 (43311). (513) 592-5796, 593-0100. Triplett Bcstg Co. Inc. (acq 12-1-72). Net: ABC/I. Format: Top 40. ■ Wendell A. Triplett, pres; Robert S. Triplett, gen mgr & chief engr; Gwen Foreman, coml mgr; Robert J. Gibbons, prog dir; Douglas E. Triplett, opns mgr; Michael J. Lyons, news dir. ■ Rates: \$ 5.25; 5.25; 5.25; —.

WOGM(FM)—Co-owned with WTOO. July 15, 1969: 98.3 mhz; 1.30 kw. Ant 430 ft. (CP 890 w. Ant 510 ft). Stereo. (acq 12-1-72). Prog sep from AM. Net: ABC/FM. Rep: Rgnl Reps, Keystone. Format: Btfl mus. ■ Rates: \$ 3.15; 3.15; 3.15; 3.15.

Bellevue

WNRR(FM)—Apr 4, 1973: 92.1 mhz; 1.1 kw. Ant 125 ft (CP 1.85 kw. Ant 150 ft). 108½ E. Main (44811). (419) 483-2511. Bellevue Community Bcstg Co. Net: ABC/FM. Format: Btfl mus day, progressive night. Spec prog: Farm 1½ hrs wkly. ■ John Bedard, pres; Robert Ladd, gen mgr, news dir & chief engr; Steve Eliot, coml mgr and mus dir; Tom Goodsite, prog dir; Tom Pope prom mgr. ■ Rates: \$5; 5; 5; 5.

Berea

***WBWC(FM)**—March 2, 1958: 88.3 mhz; 10 w. Stereo. Box A-2, College Union (44017). (216) 826-2145. Baldwin-Wallace College. Net: ABC/FM. Format: Diversified. ■ Philip M. Johnson, gen mgr; Edmund Smith, chief engr.

Bowling Green

WAWR-FM—June 1964: 93.5 mhz; 3 kw. Ant 175 ft. Box 163 (43402). (419) 352-8411. Portage Valley Bcstrs Inc. Group owner: Ohio Radio. Format: MOR, progs. ■ Robert W. Reider, pres; Wayne Kenney, gen mgr; Bill Leutz, chief engr.

***WBGU(FM)**—November 1951: 88.1 mhz; 1.35 kw. Ant 110 ft. 413 South Hall, Bowling Green State U. (43403). (419) 372-2826. Bowling Green State U. Net: NPR. Audio news: UPI. Format: Classcl, pub aff. Spec prog: Jazz 12 hrs wkly. ■ Dr. Duane E. Tucker, dir of bcstg; Frank W. Baker, gen mgr; Larry R. Yambor, prog dir; William C. Leutz, chief engr. ■ *WBGU-TV affil.

WMGS—December 1954: 730 khz; 1 kw-D, DA. 138 N. Main (43402). (419) 352-5233. WMGS Inc. (acq 7-1-61). Rep: Regional Reps, Walton, Pearse. Format: C&W. Spec prog: Farm 4 hrs wkly. ■ C. Richard Marsh, receiver; Carl A. Cook, gen & coml mgr; Dave Rusk, sales mgr; Rol Evans, prog dir; Jim Radke, news dir; C. Daniel Cook, chief engr.

Bryan

WBNO—December 1962: 1520 khz; 500 w-D, 250 w-CH. Box 603 (43506). (419) 636-3175. Williams County Bcstg System Inc. (acq 2-67). Net: ABC/C. Format: MOR, C&W, progressive. ■ Carl Shipley, pres; Luke Thaman, gen mgr; Jim Glendening, coml mgr; Bill Priest, opns mgr; Mary Thaman, news dir; J. B. Orendorff, sports dir; Richard Murray, chief engr.

WBNO-FM—June 30, 1966: 100.9 mhz; 3 kw. Ant 155 ft. Dups AM 70%.

Bucyrus

WBGO—Dec 22, 1962: 1540 khz; 500 w-D, DA. Box 789 (44820). (419) 562-7979 or 562-2222. Brokensword Bcstg Co. Net: Ohio Farm. Audio news: UPI. Rep: PRO/Meeker. Regional Reps. Format: MOR, talk. Spec progs: C&W 12 hrs; farm 7 hrs wkly. ■ Thomas P Moore, pres & gen mgr; J. LaVonne Moore, stn mgr; Charles R. Brown, coml mgr; Doyle Weaver, sports dir; Walter Poffenbaugh, farm dir; Eugene Luidhart, news dir; Fred Clinger, chief engr. ■ Rates: \$5.60; 4.80; 5.60; 3.50.

WBGO-FM—Sept 5 1964: 92.7 mhz; 3 kw. Ant 300 ft. Stereo. Dup AM 75%.

Cambridge

WILE—April 9, 1948: 1270 khz; 1 kw-D. Box 338 (43725). (614) 432-5605. Cloverleaf Bcstg Corp. (acq 11-1-67). Format: MOR. ■ William R. Coffey, gen mgr; George E. Long, coml mgr; Dennis West, prog dir; Robert E. Fiedler, chief engr.

WILE-FM—October 1964: 96.7 mhz; 1.3 kw. Ant 420 ft. Dups AM 60%. Stereo.

Campbell

WHOT—Oct 16, 1955: 1330 khz; 1 kw-D, 500 w-N, DA-2. 401 N. Blaine Ave., Youngstown, Ohio (44505). (216) 746-8464. WHOT Inc. Group owner: Myron Jones. Rep: Eastman, Regional Reps. Format: Contemp. ■ Myron Jones, pres; William Fleckenstein, gen mgr; William Glover, coml mgr; Richard Thompson, prog dir; Pete Antolich, chief engr.

WHOT-FM—See Youngstown.

Canal Fulton

***WNWR(FM)**—Not on air yet; target date unknown: 90.9 mhz; 840 w. Ant 47 ft. 8590 Erie Ave. N.W. (44614). (216) 854-4179. Northwest Local Board of Education, Northwest High School. Format: Top 40. ■ Robert D. Sassaman, gen mgr; Bruce Grizer, opns mgr; Gene Wise, news dir; Douglas Slaybaugh, chief engr.

Canton

WHBC—March 9, 1925: 1480 khz; 5 kw-U, DA-N. Box 1045 (44701). (216) 456-7166. Beaverkettle Co. (acq 12-11-67). Net: ABC/E. Rep: Torbet. Format: MOR. Spec progs: Farm 1 hr; black 19 hrs wkly. ■ Paul E. Gilmor, pres & gen mgr; Bill Steffy, sls mgr; Bob Krahl-ing, prog dir; Jim Burnett, news dir; Todd T. Taylor, opns mgr; Wm. C. Glasser, studio svpr; John Schen, engr.

WHBC-FM—Feb 2, 1948: 94.1 mhz; 44 kw horiz, 17 kw vert. Ant 370 ft. Stereo.

WHLQ(FM)—March 1, 1961: 106.9 mhz; 27.5 kw. Ant 340 ft. Stereo. 1452 Cleveland Ave. (44703). (216) 455-1650. Radio Akron (acq 1971). Group owner: Susquehanna. Rep: Eastman, Susquehanna Bcstg Co. ■ Arthur W. Carlson, VP; Allen Saunders, gen mgr; Joel Speiser, stn mgr.

WINW—April 14, 1966: 1520 khz; 1 kw-D, DA. 4111 Martindale Rd. NE. (44705). (216) 492-5630. North American Radio (acq 7-22-74). Net: ABC/C. Rep: Time Sls, Regional Reps. Format: Contemp, rock. ■ Earl E. Wise, pres; Jack Steenbarger, gen mgr; Jim Caspar, prog dir; Mark Heil, mus dir; Bill Swartz, prom dir; Ron Colander, chief engr.

WNYN—1947: 900 khz; 500 w-D. Bcst Center, 1515 Cleveland, N.W. (44703). (216) 456-8396. Keys Corp. (acq 1-1-67). Rep: GCI Sales. Format: C&W. Spec prog: Greek 1 1/4 hr wkly. ■ Donald C. Keyes, pres & gen mgr; Tracy L. Jackson, VP/coml & stn mgr; Lee Philips, prog dir; Bob Gordon, pub affrs dir; Bill Mathews, chief engr. ■ Rates: \$10.45; 7.70; 10.45; 7.70.

WOIO—Aug 11, 1946: 1060 khz; 5 kw-D, DA. Box 9260 (44711). (216) 477-8585. Douglas Properties Corp. (acq 8-1-61). Net: MBS. Format: MOR. Spec prog: Black 1 1/2 hrs wkly. ■ Sidney J. Collins, pres; Douglas P. Collins, gen mgr; Mike Morgan, prog dir; Keith London, mus dir; Tom Henry, news dir; Landolin Walter Jr., chief engr. ■ Rates: \$11; 9.50; 11; 9.50.

WTOF(FM)—Nov 19, 1961: 98.1 mhz; 36 kw. Ant 570 ft. Stereo. 619 Peoples Merchants Trust Bldg. (44702). (216) 452-4009. Christian Bcstg Assn. (acq 6-1-64). Format: Relig. ■ Rev. Jack M. Mortenson, pres; Rev. Jack B. Nelson, gen & coml mgr; Roger Manning, mus dir; George Courlas, news dir; David S. Johnson, chief engr.

Castalia

WGGN(FM)—Jan 1975: 97.7 mhz; 3 kw. Ant 300 ft. 305 Gildona Drive, Sandusky (44870). Christian Faith Bcstg. Inc.

Cedarville

***WCDR-FM**—Dec 1, 1962: 90.3 mhz; 3 kw. Ant 370 ft. Stereo. N. Main St. (45314). (513) 776-5595. Cedarville College. Audio news: UPI. Format: Classical, religious. ■ James T. Jeremiah, pres; Paul Gathany, gen mgr; Dave Boston, chief engr.

Celina

WCSM—Sept 11, 1963: 1350 khz; 500 w-D, DA. Box 341 (45882). (419) 586-5134. Johnson Bcstg Corp. (acq 10-7-11). Net: ABC/I. Rep: Meeker, Regional Reps, Pearse Sls. Format: Progs. ■ Hugh E. Johnston, pres & gen mgr; Milt Miller, prog & news dir.

WCSM-FM—96.7 mhz; 3 kw. Ant 125 ft. Dups AM 75%.

WMER(FM)—Dec 18, 1960: 94.3 mhz; 740 w. Ant 115 ft. 126 West Fayette (45822). (419) 586-7386. KMJ Bcstg Inc. (acq 2-11-75). Format: Variety, MOR. ■ Keith M. Balfour, pres & gen mgr; Jackie Balfour, coml mgr and mus dir; Dave Helmstetter, news dir; Mark V. Klosterman, VP; Esther Schmidt, prom mgr; J. P. Moore, chief engr. ■ Rates: \$3.60; 3.60; 3.60; 3.60.

Centerville

***WCWT-FM**—Not on air yet; target date 1975: 91.9 mhz; 10 w. 500 E. Franklin (45459). (513) 433-8841. Centerville City Board of Education. Format: Variety. ■ Ken Carper, gen mgr; Roy Grimes, chief engr.

Chardon

WBKC—Feb 14, 1969: 1560 khz; 1 kw-D, DA. Box 266 (44024). (216) 286-1560. B-K Bcstg Co. Net: MBS. Rep: Rgnl Reps. Format: MOR. Spec prog: Slovenian 2 hrs wkly. ■ Art King, pres; Albert J. Kipp, gen, coml mgr; Kenny Bass, sales mgr; Chris Johnson, prom mgr, prog & mus dir; Wayne Marsh, news dir; Carol Yehl, traffic mgr; Chib Binder, engr. ■ Rates: \$5; 4; 5; 4.

Chillicothe

WBEX—September 1947: 1490 khz; 1 kw-D, 250 w-N. Box 244 (45601). (614) 773-2244. Shawnee Bcstg Co. (acq 1951). Group owner: Truman A. Morris Sns. Net: MBS. Rep: Regional Reps, Keystone. Format: MOR. ■ Truman A. Morris, pres; Don W. Hughes, gen & coml mgr; Mary W. Morris, prog dir; Joe Humphreys, mus dir; Bill Spahr, news dir; Marion Kepp, chief engr.

WBEX-FM—July 1, 1961: 93.3 mhz; 18.5 kw. Ant 185 ft. Dups AM 20%. Format: C&W.

WCHI—1951: 1350 khz; 1 kw-D. Box 508, 1022 Eastern Ave. (45601). (614) 775-1350. Court House Bcstg Co. (acq 8-15-60). Format: Contemp. ■ W. N. Nungesser, pres; Grace Nungesser, VP & gen mgr; Ron Caldwell, coml mgr; Robert E. Nelson, prog dir & prog mgr; Jack Edwaras, news dir; C. F. Lawhorn, chief engr. ■ Rates: \$2.35; 2.10; 2.35; 2.00.

Cincinnati

***WAIF(FM)**—Nov 19, 1975: 88.3 mhz; 1.6 kw. Ant 390 ft. Stereo. 2525 Victory Pkwy (45206). (513) 961-8900. Stepchild Radio of Cincinnati Inc. Format: Variety. ■ D. Lenz, chairperson; N. Rubin, stn coord; J. Bakan, prog dir; M. Gozner, news dir; S. Lewis, chief engr.

Ohio Radio

See page C-1 for explanation of listings.

***WAKW(FM)**—Oct 22, 1951: 93.3 mhz; 50 kw. Ant 360 ft. 6275 Colledgeue Place (45224). (513) 542-3442. Pillar of Fire. ■ Arthur Kent White, pres; Russel L. Croucher, gen mgr & prog dir; Paul F. Blue, chief engr.

WCIN—October 1953: 1480 khz; 5 kw-D. 550 w-N, DA-2. 105 Glenwood Ave. (45217). (513) 281-7180. Rounsaville of Cincinnati Inc. (group owner). Net: Nall Bcstg. Rep: Howard. Format: Black. ■ R. B. Johnson, pres; H. E. (Sonny) Burns, VP, gen mgr; Bob Long, prog dir; Carl J. Dehmar, chief engr. ■ Rates: \$18; 13; 18; 6.50.

WCKY—Sept 16, 1929: 1530 khz; 50 kw-U, DA. (LSS-Sacramento, Calif.) 501 Carew Tower (45202). (513) 241-6565. Post-Newsweek Stns (group owner; acq 11-69). Net: CBS. Rep: Buckley. Format: MOR. Spec prog: Farm 1 1/2 hrs wkly. ■ Robert B. Mitchell, gen mgr; Steve Kline, gen sls mgr; Bruce Still, prog dir; Jim Silver, mus dir; Mark Neeley, news dir; James Ranney, transmitter svpr. ■ Rates: \$42; 33; 38; 14.

WCLU—See listing in Covington, Ky.

WEBN(FM)—Aug 31, 1967: 102.7 mhz; 31 kw. Ant 610 ft. Stereo. 2724 Erie Ave. (45208). (513) 871-8500. Circe Communications Inc. (acq 7-1-72). Format: Rock. Spec progs: Classcl 4 hrs; talk 3 hrs wkly. ■ Frank Wood, pres & gen and prom mgr; Carolyn Gilbert, traffic and continuity; Denton Marr, acting opns and mus dir; Mark Scheerer, news dir; Fred Williams, chief engr. ■ Rates: \$27; 27; 32; 32.

***WGUC(FM)**—Sept 21, 1960: 90.9 mhz; 31.5 kw. Ant 610 ft. 110 Emery Hall (45221). (513) 475-4443. U. of Cincinnati. Net: NPR. Format: Classcl, pub affrs. ■ George Bryant, gen mgr; Carolyn Watts, asst mgr; Robert Stevenson, prog mgr.

***WJVS(FM)**—Not on air; target date 1975: 88.3 mhz; 175 w. Ant 105 ft (ST WAIF). 3254 East Kemper Rd. (45236). (513) 771-8810. Great Oaks Joint Vocational School District. Format: Educ, MOR. ■ Dr. Harold Carr, supt; Earle O. Forste, chief engr & gen mgr.

WKRC—1922: 550 khz; 5 kw-D, 1 kw-N, DA-2. 1906 Highland Ave. (45219). (513) 421-1750. Talt Bcstg Co. (group owner; acq 1939). Net: ABC/E. Rep: Katz. Format: Contemp. ■ Lawrence H. Rogers II, pres; Leon Lowenthal, VP & gen mgr; Marilyn Tyree, coml mgr; J. David Martin, gen sls mgr; James Durham, opns dir; Mike Biere, prom mgr; Dusty Rhodes, mus dir; Charles C. Bolland, news dir; Ray Owen, chief engr.

WKRC(FM)—Co-owned with WKRC. 1947: 101.9 mhz; 23 kw. Ant 690 ft. Stereo. Prog sep from AM. ■ Ed Prijatelj, prog dir. ■ WKRC-TV affil.

WLQA(FM)—Oct 1, 1959: 98.5 mhz; 15 kw. Ant 810 ft. Quad Stereo. 7505 Reading Rd. (45237). (513) 821-9898. Radio Cincinnati Inc. (acq 1-7-73). Group owner: Susquehanna. Rep: Eastman. Format: MOR. Spec prog: Classical 2 hrs wkly. ■ A. W. Carlson, VP; Allen Saunders, VP Midwest; Barry E. Gaston, stn mgr; Bill Stabler, prog dir; Norm Swenson, mus dir; Paul Rogers, news dir; Fred Greaves, chief engr.

WLW—March 22, 1922: 700 khz; 50 kw-U 140 W. Ninth St. (45202). (513) 241-1822. TWX 513-577-1258. Avco Bcstg Corp. (group owner; acq 1945). Net: NBC. Rep: Avco Radio-TV Sales. Format: Contemp, MOR. ■ John T. Murphy, pres; Charles K. Murdock, sr VP & gen mgr; Bernie Kvale, asst gen mgr & coml mgr; Marian Shumate, prom mgr; Michael O'Shea, prog & mus dir; Bill RIDENOUR, news dir; James D. Hampton, chief engr. ■ WLWT-TV affil. ■ Rates: \$89; 61; 73; 35.

***WNSD(FM)**—1974: 90.1 mhz; 10 w. Ant 538 ft. 4850 Poole Rd. (45239). Northwest Local School District.

WSAI—June 7, 1923: 1360 khz; 5 kw-U, DA-N. W. 8th St. and Matson Place (45204). (513) 251-5700. Combined Communications Corp. (group owner; acq 8-26-74). Format: Top 40, contemp. ■ Ralph Beaudin, pres, radio dir; John F. Bayliss, pres & gen mgr; Jim Smith, gen sales mgr; Bob DeLuca, local sales mgr; Robin Mitchell, prog dir; Bob Goode, mus dir; Joe Gillespie, news dir; Jim Eberhart, chief engr. ■ Rates: \$67; 57; 67; 57.

WSAI-FM—1955: 94.1 mhz; 32 kw. Ant 600 ft.

Ohio Radio

See page C-1 for explanation of listings.

Stereo. (513) 471-9535. Rep: Blair. Simulcast M-F 6-10 AM. ■ Rates: \$67; 23; 28; 28.

WUBE—1927: 1230 khz; 1 kw-D, 250 w-N. Box 1232 (45201). (513) 621-6960. Kaye-Smith Enterprises (group owner; acq 1-15-66). Audio news: APR. Rep: McGavren-Guild-PGW. Format: C&W. ■ Lester M. Smith, exec dir; Bill Jenkins, gen mgr; Verl Wheeler, sls mgr; Mike Millard, prog dir; Larry Boelten, mus dir; Charles Lindsey, news dir; Bob Craig, chief engr. ■ Rates: \$31; 28; 31; 22.

WUBE-FM—July 20, 1949: 105.1 mhz; 11 kw. Ant 920 ft. Stereo. Dups AM 45%. ■ Rates same as AM.

***WVXU-FM**—Aug 4, 1970: 91.7 mhz; 65 w. Ant 650 ft. Alter Hall 11 (45207). (513) 745-3738. Xavier University. Format: Variety. ■ Rev. Robert W. Mulligan S.J., pres; Rev. L. J. Flynn S.J., gen mgr.

WWEZ(FM)—Aug 19, 1964: 92.5 mhz; 11 kw. Ant 910 ft. (acq 2-71). 1071 Celestial St. (45202). (513) 721-5678. Sudbrink Bcstg Inc. of Ohio. (group owner). Format: Btlf mus. ■ James M. Robinson, gen mgr; John Stolz, opns mgr; Ted Kendrick, chief engr.

WZIP—1947: 1050 khz; 1 kw-D. Vernon Manor Hotel, 400 Oak St. (45219). (513) 221-5100. Harold W. Gore (acq 4-21-75). Net: ABC/E. Rep: Savalli/Gates. Format: Relig, C&W. ■ Harold W. Gore, owner; James J. Taszarek, VP & gen mgr; Jack Lee, opns mgr.

Circleville

WNRE—1974: 1540 khz; 1 kw-D. Box 676 (43113). (614) 474-3344. Circleville Bcstg Co. Inc. Rep: Keystone. Format: C&W, MOR. ■ Nelson R. Embrey II, pres, gen mgr & chief engr; P. J. Ryal, coml & prom mgr; Honor L. Whitacre, prog dir; Alan Bradshaw, mus dir; James Schoby, news dir.

WNRE-FM—Oct 1, 1965: 107.1 mhz; 3 kw. Ant 58. Box 496 (43113).

Cleveland

WBQ—1947: 1540 khz; 1 kw-D. 2644 St. Clair Ave. (44114). (216) 241-7555. Booth Bcstg Co. (acq 1964). Group owner: Booth American. Net: MBS/Black. Rep: Howard. Format: Black. ■ John L. Booth, pres; George Abram, gen mgr; Jim Stephens, prog dir; Chal Boring, chief engr. ■ Rates: \$18; 18; 18; —.

WXEN(FM)—Co-owned with WBQ. May 4, 1960: 106.5 mhz; 16.5 kw. Ant 130 ft (CP 50 kw. Ant 190 ft). Stereo. Prog sep from AM. Format: Foreign language. ■ Gordon Stenback, VP opns; Kalman Novak, stn mgr; Gene Zadar, sls and opns mgr. ■ Rates: \$18; 18; 18; 18.

***WBOE(FM)**—October 1938: 90.3 mhz; 15 kw. Ant 360 ft. (CP 50 kw. Ant 500 ft). 10600 Quincy Ave. (44106). (216) 421-7373. Board of Education, Cleveland City School District. ■ Paul W. Briggs, supt of schools; Jay Robert Klein, directing spvr; Charles E. Siegel, coordinator; William V. Nelson, chief engr.

WCLV(FM)—April 1, 1950: 95.5 mhz; 27 kw horiz, 22.8 kw vert (CP 19.5 kw vert). Ant 640 ft. Stereo. Penthouse E., Terminal Tower (44113). (216) 241-0900. Radio Seaway Inc. (acq 11-1-62). Rep: Masla. Format: Classical. Spec prog: Jazz 7 hrs wklly. ■ C. K. Patrick, pres & gen mgr; Robert Conrad, VP, prog dir; Anthony F. Bianchi, opns mgr & news dir; Harry Dennis, gen sls mgr; Albert Petrak, mus dir; Mrs. N. Cridland, office mgr; Joseph Zelle, chief engr. ■ Rates: \$26; 26; 26; 26.

***WCRF(FM)**—Nov 23, 1958: 103.3 mhz; 25.5 kw. Ant 660 ft. 9756 Barr Road (44141). (216) 526-1111. Moody Bible Institute of Chicago. Format: Relig. ■ George Sweeting, pres; Robert Neff, dir of bcstg; J. Richard Florence, stn mgr; James G. Wagner, asst mgr & engr in chg.

***WCSB(FM)**—Not on air target date March 1976: 89.3 mhz; 15 w. Ant 190 ft. 1983 E. 24th St. (44115). (216) 687-3523. Cleveland State U. Format: Variety. ■ Walter B. Waejen, pres; Paul Bunker, gen mgr.

WDMT(FM)—July 14, 1959: 107.9 mhz; 70 kw. Ant 390 ft. 14781 Sperry Rd. (44065). (216) 338-3108. Beasley Radio Co. (acq 1975). Rep: AAA, Walton. Format: Mod C&W. ■ Bob Finnegan, stn mgr; Shorty Haines, farm dir.

WDOK(FM)—See listing following WIXY.

WERE—July 6, 1949: 1300 khz; 5 kw-U, DA-1. 1500 Chester Ave. (44114). (216) 696-1300. TWX 810-421-8528. Cleveland Bcstg (acq 1-9-70). Group owner: ASI Communications. Audio news: NBC/NIS. Rep: McGavren-Guild. Format: All news. Spec progs: Ital ½ hr; Pol 2 hrs; Slovak 1 hr; Czech ½ hr wklly. ■ Paul Neuhoft, VP & gen mgr; Mickey Franko, gen sls mgr; John Webster, prog dir; Penny Bailey, prom mgr; Larry Matthews, news dir; Robert Groome, chief engr. ■ Rates: \$60; 50; 60; 30.

WGAR—December 1930: 1220 khz; 50 kw-U, DA-1. 9446 Broadview Rd. (44147). (216) 526-6700. Nationwide Communications Inc. (group owner; acq 1954). Net: ABC/E. Rep: Blair, Unicom Bcst Sls (Canada). Format: MOR. ■ Richard Janssen, gen mgr; Loren Owens, prog dir; Art Caruso, gen sls mgr; Martha Brunstein, dir adv & sls prom; Chuck Collier, mus dir; John O'Day, news dir; Robert A. Raymond, chief engr.

WKSW(FM)—Co-owned with WGAR. July 1948: 99.5 mhz; 50 kw. Ant 500 ft. 1375 Euclid Ave. Rm. 400 (44115). (216) 696-2455. Xpns sep from AM. Format: Modern country. ■ Charles Fullerton, pres; Murray J. Green, gen mgr; Laura Syracuse, coml mgr; Rosalie Klusker, prom mgr; Ben Peyton, prog dir; Jane Temple Hughes, news dir; Chris Winterflower, chief engr.

WGCL(FM)—Oct 23, 1949: 98.5 mhz; 40 kw. Ant 600 ft. 1715 Euclid Ave. (44115). (216) 861-0100. GCC Communications of Cleveland (group owner; acq 1-7-1). Rep: Century Natl Sls. Format: Solid Gold. ■ Alexander M. Tanger, pres; Arthur R. Zweig, gen mgr; Sam Garfield, chief engr.

WHK—July 26, 1921: 1420 khz; 5 kw-U, DA-N. 5000 Euclid Ave. (44103). (215) 391-5000. Malrite of Ohio (group owner; acq 11-7-2). Rep: Katz. Format: C&W. ■ Milton Waltz, pres; Carl B. Hirsch, VP & gen mgr; Gil Rosenwald, gen sales mgr; John Chaffee, prom mgr; Dave Donahue, prog dir; Ron Jones, mus dir; George Richards, news dir; Gary Sharpe, chief engr.

WMMS(FM)—Co-owned with WHK. Nov 11, 1948: 100.7 mhz; 32 kw. Ant 600 ft. Stereo. Prog sep from AM. Format: Adult rock. ■ Denny Sanders, creative services mgr; John Gorman, prog dir; Donna Halper, mus dir.

WIXY—April 30, 1950: 1260 khz; 5 kw-U, DA-2. 3940 Euclid Ave. (44115). (216) 391-1260. Globetrotter Communication Inc. (group owner; acq 1971). Net: ABC/C. Rep: Metro Radio Sls. Format: Top 40, personality. ■ George Gillett, pres; John Hill, gen sls mgr; Nick Anthony, VP, gen mgr; David Ross, local sls mgr; Steve Kelly, prog dir; Rick Felt, prom mgr; Chuck Boland, news dir.

WDOK-FM—April 30, 1950: 102.1 mhz; 50 kw. Ant 370 ft. Stereo. Prog sep from AM. 1935 Rockside Rd. Seven Hills (44131). (216) 398-5555. Net: ABC/I. Format: Btlf mus. ■ Ron Smith, stn mgr; Dick Conrad, prog dir.

WJMO-WLYT(FM)—See Cleveland Heights.

WJW—1926: 850 khz; 10 kw-D, 5 kw-N, DA-2. 1621 Euclid Ave., Suite 400 (44115). (216) 781-8500. TWX 810-421-8315. Storer Bcstg Co. (group owner; acq 11-17-54). Net: MBS. Rep: CBS Spot Sls. Format: MOR. ■ Richard Bremkamp, gen mgr; Jules Blum, gen sales mgr; Robert West, prog dir; Marty Louis, mus dir; Bob Larkin, news dir; Bill Fletcher, chief engr. ■ WJW-TV affil.

WKSW(FM)—Listing follows WGAR.

WMMS-FM—Listing follows WHK.

WQAL(FM)—1948: 104.1 mhz; 29 kw. Ant 630 ft. 3101 Euclid Ave. (44115). (216) 391-6666. Group owner: SJR Communications. Rep: CBS-FM. Format: Good music. ■ Golf Lebbar, gen mgr; Louis J. Slatino, opns mgr.

***WRUW-FM**—Feb 26, 1967: 91.1 mhz; 10 w. Stereo. 11220 Bellflower Rd. (44106). (215) 368-2207. Case Western Reserve University. Format: Diversified. ■ John D. Cremer, stn dir; Neil Feldman, gen mgr.

WWWE—1923: 1100 khz; 50 kw-U, DA-1. Park Centre, 1250 Superior Ave. (44114). (216) 781-1100. Ohio Communications Inc. (acq 11-7-72). Net: NBC. Rep: Eastman. Format: MOR. ■ Nick J. Milet, pres; Tom Embrescia, VP & gen mgr; Jim Embrescia, gen sales mgr; Joe Restifo, prog & opns mgr. ■ Rates: \$ 70; 60; 70; 55.

WWWM(FM)—Co-owned with WWWE. Nov. 4, 1954: 105.7 mhz; 27 kw. Ant 900 ft (CP: Ant 880 ft). Stereo. Prog sep from AM. Format: Progs. ■ Eric Stevens, prog dir. ■ Rates: \$36; 36; 40; 40.

WXEN-FM—Listing follows WBQ.

WZAK(FM)—May 26, 1963: 93.1 mhz; 27.5 kw. Ant 620 ft. 1303 Prospect Ave. (44115). (216) 621-7897. Trans World Bcstg Corp. Rep: National Time Sls. Format: Ethnic. Spec progs: Croatian 3½ hrs; Czech 1½ hrs; German 1½ hrs; Greek 4 hrs; Hindi 1¼ hr; Hungarian 6½ hrs; Italian 4 hrs; Pakistan 1 hr; Serbian 3 hrs; Slovak 1½ hrs; Slovenian 4 hrs wklly. ■ Xenophon Zapis, pres; Joseph F. Bauer, sls mgr & coml mgr; Mrs. Betty Bauer, prog dir; Jack Cory, prom mgr, news dir; Pat Malley, chief engr. ■ Rates: \$15; 15; 15; 15.

Cleveland Heights

WJMO—1947: 1490 khz; 1 kw-D, 250 w-N. 11821 Euclid Ave. (44106). (216) 795-1212. Friendly Bcstg Co. (acq 9-1-52). Group owner: United Bcstg. Rep: UBC Spot Sales. Format: Black. ■ Richard Eaton, pres; Ben Hawkins, gen mgr; Van Lane, VP sls, prom mgr; Rudy Green, prog dir; Charm Warren, mus dir; Chuck Denison, news dir; John Horton, chief engr.

WLYT(FM)—Co-owned with WJMO. Nov 23, 1960: 92.3 mhz; 25 kw. Ant 245 ft (CP 27 kw. Ant 235 ft). Stereo. 2156 Lee Rd. (44118). (216) 371-3535. Prog sep from AM. Format: Top 60. ■ Bill Sheara, gen & sls mgr.

Columbus

WBNS—1922: 1460 khz; 5 kw-D, 1 kw-N, DA-N. 62 W. Broad St. (43215). (216) 224-9265. TWX 614-759-0444. RadioOhio Inc. (acq 1933). Net: CBS. Rep: Blair. Format: Contemp, MOR. ■ Richard W. Wolfe, pres; Eugene C. D'Angelo, gen mgr; Guy Fracasso, gen sales mgr; Ron Castelli, prom mgr; David Hammond, prog dir; Jack Evans, mus dir; David Marsett, news dir; William Orr, chief engr.

WBNS-FM—June 1959: 97.1 mhz; 54 kw. Ant 310 ft. Stereo. Prog sep from AM. ■ WBNS-TV affil.

***WCBE(FM)**—Sept 26, 1956: 90.5 mhz; 11 kw. Ant 530 ft. Stereo. 270 E. State St. (43215). (614) 225-2750. School District of Columbus. Net: NPR. ■ John H. Sittig, gen mgr; Robert Bower, prog dir; Sharon Miller, prom mgr; Michael Thomas, mus dir; Fred Ufferman, chief engr.

WCOL—1922: 1230 khz; 1 kw-D, 250 w-N. 22 S. Young St. (43215). (614) 221-7811. Great Trails Bcstg Corp. (group owner; acq 1-1-52). Rep: Eastman. Format: Rock. ■ Dan Morris, pres & gen mgr; Tilford C. Carpenter, VP engr; Don I. Roberts, VP sls; Bryan McIntyre, opns dir; Jay Solomon, news dir; Sharon DeBord, VP administration.

WCOL-FM—1947: 92.3 mhz; 50 kw. Ant 310 ft. Stereo. Prog sep from AM. Format: Progressive. ■ Bob Gooding, prog dir.

***WFAC(FM)**—Aug 5, 1975: 91.5 mhz; 10 w. Columbus Community Educl. Bcstg.

WMNI—April 26, 1968: 920 khz; 1 kw-D, 500 w-N, DA-2. Southern Hotel (43215). (614) 221-1354. North American Bcstg Co. Net: MBS. Rep: McGavren-Guild-PGW. Format: C&W. ■ William R. Mnich, pres & gen mgr; Ronald E. Barlow, VP; Marty Howard, sls mgr; Otto R. Moore, mus dir; Martin Petree, VP, news dir; John A. Brookbank, chief engr.

WMNI-FM—April 26, 1962: 99.7 mhz; 50 kw. Ant 542 ft. Format: MOR.

WNCI

NATIONWIDE COMMUNICATIONS INC.

ABC-FM  Spot Order Inc.®

N A F M B

R A B

WNCI(FM)—July 1961: 97.9 mhz; 185 kw. Ant 570 ft

Delphos

WDOH(FM)—Dec 16, 1972: 107.1 mhz; 3 kw. Ant 300 ft. Box 31 (45833). (419) 692-3963. Tri-County Bcstg Co. Format: Contemp, rock, top 40. Spec prog: Polka 8 hrs wkly. ■ Ray Tanner, pres & chief engr; Ted Jones, gen mgr; George Davis, coml mgr; Dave Roach, prom mgr; Ann Ayres, prog dir; Bob Ulm, news dir.

Dover-New Philadelphia

WJER—Feb 10, 1950: 1450 khz; 1 kw-D, 250 w-N. 646 Boulevard, Dover (44622). (216) 343-775. Dover Bcstg Co. Group owner: Greer Stns. Rep: Regional Reps. Format: MOR, rock. Spec prog: Swiss 1 hrs wkly. ■ Paul S. Linsley, pres; Donald R. Graff, gen mgr & chief engr; Lawrence Pozzi, coml mgr; Gary A. Piccola, asst gen mgr; Barry Jackson, prog & mus dir; Rex Ridenour, news dir.

WJER-FM—Aug 29, 1968: 101.7 mhz; 3 kw. Ant 280 ft. Stereo. Dups AM 20%.

East Liverpool

WELA(FM)—Listing follows WOHI.

WOHI—Dec 1, 1949: 1490 khz; 500 w-D, 250 w-N. 236 W. 6th St. (43920). (216) 385-1490. Constrander Corp. (acq 10-71). Net: ABC/E. Format: MOR. ■ Frank Managano, pres; Bernard Brobst, exec VP/gen mgr. ■ Rates: \$7.15; 7; 7.15; 4.

WELA(FM)—Co-owned with WOHI. April 15, 1959: 104.3 mhz; 26 kw. Ant 330 ft. Stereo. Prog sep from AM. Box 90 (43920). (216) 385-0400. Format: Easy lstrng. ■ Rates: \$5.50; 5; 5.50; 4.50.

Eaton

WCTM—Not on air, target date unknown: 1130 khz; 250 w-D. 505 N. Barron St. (45320). (513) 456-4200. Western Ohio Bcstg Service Inc. ■ Stanley Coning, gen mgr.

WJAI(FM)—Co-owned with WING, Dayton. Nov. 28, 1960: 92.9 mhz; 20 kw. Ant 125 ft. 505 N. Barron St. (45320). (513) 456-4200 (acq 1974). Audio news: UPI. Format: Btlf mus. Spec prog: Farm 6 hrs wkly. ■ Donald Robertson, stn mgr; Robert Melberth, VP coml mgr; Ron Faig, mus dir.

Elyria

WEOL—November 1948: 930 khz; 1 kw-U, DA-2. 4th Floor, EST Bldg. (44035). 322-3761. Elyria-Lorain Bcstg Co. Net: ABC/E. Rep: Regional Reps. Format: Contemp, MOR. Spec prog: Sp 1½ hrs wkly. ■ Otto B. Schoepfle, pres; Paul Nakel, VP & gen mgr; Bartlett Tylen, lcl sis mgr.

WBEA(FM)—Co-owned with WEOL. November 1948: 107.3 mhz; 50 kw. Ant 285 ft. Stereo. Prog sep from AM.

Fairfield

WCNW—Feb 14, 1964: 1560 khz; 5 kw-D, 1 kw-CH, DA-2. Box 50 (45014). (513) 874-5000. Bcst Management Corp. (acq 10-75). Net: MBS. Rep: Regional Reps. Format: C&W. ■ Lou Westendorf, gen & coml mgr; Johnny Wade, prog & mus dir; Tony Masters, news dir; Myles Davis, chief engr.

WCNW-FM—Sept 20, 1962: 94.9 mhz; 29 kw. Ant 350 ft. (CP 50 kw. Ant 490 ft). Stereo. Dups AM 95%.

Findlay

WFIN—Dec 15, 1941: 1330 khz; 1 kw-D. 101 W. Sandusky St. (45840). (419) 422-4545. Findlay Pub Co. (acq 1949). Net: Agri Bcstg, Ohio News. Rep: Regional Reps. Format: MOR. Spec prog: Sp 1 hr wkly. ■ H. H. Heminger, pres; Clyde W. Johnson, VP, gen mgr; Gary G. Wright, coml mgr; Mike McKlirick, prog dir; Steve Douglas, mus dir; Tom Sheldon, news dir; Edgar C. Smith, chief engr. ■ Rates: \$8.90; 8.90; 8.90; 8.90.

WHMQ(FM)—Co-owned with WFIN. 1948: 100.5 mhz; 20 kw. Ant 240 ft. Stereo. Prog sep from AM. Format: Top 40, oldies. ■ Doug Hill, opns dir. ■ Rates: \$5.45; 5.45; 5.45; 5.45.

(CP: Ant 540 ft). Stereo. 4900 Sinclair Rd. (43229). (614) 846-3698. Nationwide Communications Inc. (group owner). Net: ABC/C. Format: Contemp. ■ Phil Sheridan, gen mgr; Jim Rapo, lcl sis mgr; Rob Kemper, prom mgr; E. Karl, prog dir; Damon Sheridan, mus dir; Bill Blinn, news dir; Bill Shingler, chief engr. ■ Rates: \$32; 32; 37; 37.

***WOSU**—April 20, 1920: 820 khz; 5 kw (LSS Dallas, Tex.) 2400 Otelantay River Rd. (43210). (614) 421-2540. Ohio State U. Net: NPR. Format: Educi, news. ■ Richard B. Hull, dir bcstg, Kent W. Creswell, gen and prog mgr; Mary Rousculp, mus dir; Donald G. Davis, news dir; Larry Reynolds, chief engr.

***WOSU-FM**—December 1949: 89.7 khz; 14 kw. Ant 300 ft. (CP: 50 kw. Ant 470 ft). Prog sep from AM. ■ *WOSU-TV affil.

WRFD—Sept 27, 1947: 880 khz; 5 kw-D. N. High St. & Powell Road (43215). (614) 885-5342. Buckeye Media (acq 1974). Net: ABC/II. Rep: Buckformate. Format: MOR. Spec prog: Fr 10 hrs wkly.

WTVN—1924: 610 khz; 5 kw-U, DA-N. 42 E. Gay St. (43215). (614) 224-1271. TWX 810-482-1617. Talft Bcstg Co. (group owner; acq 7-24-54). Net: ABC/E. Rep: Katz. Format: MOR. Spec prog: Black ½ hr wkly. ■ Lawrence Rogers II, pres; Carl J. Wagner, VP, radio (Talft Bcstg) & gen mgr; John Dollar, gen sales mgr; Sudone Cater, prom dir; Jim Lohse, prog dir; John Potter, mus dir; Bill Patterson, news dir; Glade Grable, chief engr. ■ Rates: \$75; 65; 66; 44.

WTVN-FM—April 1, 1959: 96.3 mhz; 25 kw. Ant 570 ft. (CP 40 kw. Ant 550 ft). Stereo. Prog sep from AM. ■ Perry Frey, stn mgr; Dave Parr, opns coord. ■ WTVN-TV affil. ■ Rates: \$13; 16; 16; 13.

WVKO—Nov 21, 1951: 1580 khz; 1 kw-D, DA. 4401 Carriage Hill Lane (43220). (614) 451-2191. Skyway Bcstg Corp. Net: Mutual Black. Rep: Howard. Format: Black. ■ Bert Charles, pres & gen mgr; Wm. Selander, coml mgr; Les Brown, prog dir; Carolyn Sloan, prom mgr; Reggie Cook, mus dir; Bill Moss, news dir; Nick Bodi, chief engr. ■ Rates: \$17.50; 15; 17.50; 15.

WVKO-FM—Nov 11, 1948: 94.7 mhz; 52 kw. Ant 220 ft. Prog sep from AM. Format: Btlf mus, black. ■ Rates: \$6; 6; 6; 6.

Conneaut

WFIZ(FM)—Listing follows WWOW.

WWOW—Oct 25, 1959: 1360 khz; 500 w-D. 211 Main St. (44030). (216) 593-2233. Contemporary Media Inc. (1-1-71). Rep: Regional Reps. Format: C&W. ■ Donald A. Bruck, pres & gen mgr; Clyde Kunkel, sis mgr; Kenneth Vaughn, prog & news dir; Ron Terry, chief engr.

WFIZ(FM)—Co-owned with WWOW. April 5, 1964: 105.5 mhz; 2.5 kw. Ant minus 21 ft. Dups AM 80%.

Coshocton

WTNS—Nov 9, 1947: 1560 khz; 1 kw-D. 114 N. 6th St. (43812). (614) 622-1550. Coshocton Bcstg Co. Format: MOR, C&W. ■ Bruce W. Wallace, pres & gen mgr; James T. Sigman, sales mgr; John Terry, news dir; Herman L. Philabaum, chief engr. ■ Rates: \$5.50; 5.50; 5.50; 2.75.

WTNS-FM—April 25, 1968: 99.3 mhz; 1.2 kw. Ant 440 ft. Dups AM 45%. ■ Rates: \$5.50; 2.75; 5.50; 2.75.

Cuyahoga Falls

WCUE—1950: 1150 khz; 1 kw-D, 500 w-N, DA-2. 424 Sackett Ave., Akron (44313). (216) 923-9761. WCUE Radio Inc. (acq 12-17-62). Net: ABC/C. Rep: Mastia. Format: Top 40. Spec prog: Black 3 hrs wkly. ■ George W. Mamas, pres; John J. Demeter, gen & coml mgr and VP; Robert W. Knight, prog dir; Ed Richards, news dir; Henry Neiderkofler, VP & chief engr. ■ Rates: \$29; 24; 26; 24.

WCUE-FM—See Akron.

Dayton

WAVI

Exclusive News/Talk

WAVI—March 1, 1955: 1210 khz; 250 w-D. 1400 Cincinnati St. (45408). (513) 224-1137. WAVI Bcstg

Corp. Net: ABC/E. Rep: PRO/Meeker, Regional Reps. Format: Talk, news. ■ H. K. Crowl, pres; Joseph B. Whalen, VP & gen mgr; Michael C. Jacques, stn & sales mgr; Art Barrett, news dir; Keith Hardin, chief engr.

WDAO-FM

Ohio's Stereo Soul Giant

WDAO(FM)—Co-owned with WAVI. September 1964: 107.7 mhz; 50 w. Ant 420 ft. Stereo. Prog sep from AM. Net: ABC/C. Mutual Black. Rep: Howard. Format: Stereo soul. ■ John Jay, stn & sales mgr.

***WDPS(FM)**—Not on air; target date unknown: 90.1 mhz; 10 w. 348 W. First St. (45402). Dayton City Schools.

***WGXM(FM)**—October 1974: 88.1 mhz; 10 w. Ant 80 ft. 2251 Timber Lane (45414). (513) 275-8434. Northridge Local School Dist. Bd. of Ed. Format: Contemp. ■ William Howell, gen mgr.

WHIO—Feb 9, 1935: 1290 khz; 5 kw-U, DA-N. 1414 Wilmington Ave. (45401). (513) 254-5311. TWX 513-944-0475. Miami Valley Bcstg Corp. Group owner: Cox. Net: CBS. Rep: Christal. Format: MOR. ■ Cliff Curtland, pres; Ron Kempff, gen mgr; Lou Emm, prog dir; Roy Whitaker, prom mgr; Kris Rankin, coordinator mus; Dick Bieser, news dir; Donald Hapner, chief engr.

WHIO-FM—1946: 99.1 mhz; 50 kw. Ant 1,060 ft. Stereo. Prog sep from AM. Format: Adult mus. ■ Ken Honeyman, prog & mus dir. ■ WHIO-TV affil.

WING—May 24, 1921: 1410 khz; 5 kw-U, DA-N. 717 E. David Rd. (45429). (513) 222-3773. Great Trails Bcstg Corp. (group owner; acq 5-39). Rep: Eastman. Format: Contemp. ■ James W. Bennett, pres & gen mgr; Robert Melberth, VP & gen sis mgr; Deborah Parenti, VP & mktg mgr; Steve Kirk, opns mgr; Bill Carr, mus dir; Roy Dittman, VP & mgng news dir; Jacob Yancey, VP & chief engr.

WONE—March 20, 1949: 980 khz; 5 kw-U, DA-N. 11 S. Wilkinson St. (45402). (513) 224-1501. Group One Bcstg Co. (group owner; acq 1-1-65). Net: ABC/I. Rep: McGavren-Guild-PGW. Format: C&W. ■ Roger G. Berk, pres; Don L. Kidwell, VP & gen mgr; E. F. Devine, bus mgr; Don G. Schwartz, sales mgr; Terry Wood, prog dir; Kent Scott, news dir; Robert Minton, chief engr.

WTUE(FM)—Co-owned with WONE. 1959: 104.7 mhz; 50 kw. Ant 370 ft. Prog sep from AM. Rep: Blair. Format: Contemp. ■ Greg Mason, prog dir.

***WSMR(FM)**—Feb 17, 1970: 89.3 mhz; 10 w. 1900 Harshmann Rd. (45424). Mad River Local Board of Education. Format: Diversfd. Spec progs: Fr 1 hr; Black 1 hr wkly.

WVUD-FM—See Kettering.

Defiance

WONW—1949: 1280 khz; 1 kw-D, 500 w-N. DA-N. Radio Drive (43512). (419) 782-7776. Tri-State Bcstg Inc. Net: MBS. Rep: Devney, Ohio Stations. Format: C&W, MOR. Spec progs: Polka 4 hrs; Sp 3 hrs wkly. ■ Glenn R. Thayer, pres & gen mgr; Marvin D. Sebring, coml mgr.

De Graff

***WDEQ-FM**—Sept 1, 1967: 91.1 mhz; 10 w. Moore St. (43318). (513) 585-5981. Riverside Local Board of Education. Format: Educl.

Delaware

WDLR—Jan 18, 1961: 1550 khz; 500 w-D, DA. Box 448 (43015). (614) 363-1107. Radio Delaware Inc. (acq 2-74). Format: MOR. ■ Jim Shaheen, pres & gen mgr; Jim Lloyd, coml mgr; Tom Jeffrey, mus dir; Jim Atkinson, news dir; Steve Messer, chief engr.

***WLSN(FM)**—April 28, 1952: 91.1 mhz; 10 w. Ant 105 ft. Stocum Hall (43015). (614) 359-5224. The Trustees of Ohio Wesleyan University. Net: ABC/FM. Format: Rock, educ, pub svc. ■ Thomas Chipka, dir of bcstg; Robert W. Bauter, gen mgr; R. Scott Frothingham, prog dir; Donna Potoma, mus dir; Sue Botiggi, news dir; George Clark, prom mgr; L. Foster, chief engr.

Ohio Radio

See page C-1 for explanation of listings.

***WLFC(FM)**—1973: 88.3 mhz; 10 w. Ant 50 ft. 1000 N. Main St. (45840). Findlay College. Format: Progs, Top 40. ■ Glen R. Rasmussen, pres; B. Derek Shaw, gen mgr.

Fostoria

WFOB—Dec 9, 1952: 1430 khz; 1 kw-U. DA-2. Drawer W (44830). (419) 435-5555. Seneca Radio Corp. Rep: Regional Reps. Format: MOR, talk, C&W. Spec prog: Sp 5 hrs w/ky. ■ Melvin L. Murray, pres & gen mgr; Roger V. Wise, VP & coml mgr; Gene Kinn, prog & news dir; David L. Smith, chief engr.

WFOB-FM—1946: 96.7 mhz; 3 kw. Ant 190 ft. Prog dups AM 90%.

Fremont

WFRO—December 1949: 900 khz; 500 w-D, DA. 905 W. State St. (43420). (419) 332-8218. Wolfe Bcstg Corp. Format: Contemp. ■ Margaret R. Wolfe, pres; Thomas J. Wolfe, gen mgr & prog dir; Art Smith, news dir; Shelby H. Bristow, chief engr. ■ Rates: \$7.05; 5.20; 7.05; 7.05.

WFRO-FM—Dec 15, 1946: 99.1 mhz; 20 kw horiz; 4.2 kw vert. Ant 195 ft horiz; 180 ft vert. Dups AM 15%. ■ Rates: \$5.30; 4; 5.30; 5.30.

Gahanna

***WCVO(FM)**—Oct 13, 1972: 104.9 mhz; 3 kw. Ant 300 ft. Box 367, New Albany (43054). (614) 855-9171. Christian Voice of Central Ohio. Format: Relg, secular. ■ Pat Petterson, pres & gen mgr; John Foster, mus & news dir; Joe Patton, prom mgr; John Hull, chief engr.

Galion

WGLX—Aug 21, 1972: 1570 khz; 500 w-D, DA. Box 161 (44833). (419) 468-4664. Radio Galion Inc. Net: ABC/E. Format: Variety. ■ Joseph S. Billow, pres and gen mgr; Cheryl Sorrenson, coml mgr; Jean E. Billow, prog dir and prom mgr; Jon Shane Mick, mus dir; Linda McMillen, news dir; Don Geib, chief engr.

WQLX(FM)—Co-owned with WGLX. Nov 8, 1974: 102.3 mhz; 3 kw. Ant 330 ft. Dups AM 80%. Format: Btlf mus.

Gallipolis

WJEH—June 19, 1950: 990 khz; 1 kw-D, 250 w-CH. Box 448 (45631). (614) 446-3543. Wagner Bcstg Corp. (acq 6-1-67). Rep: Regional Reps. Format: MOR. Spec prog: C&W 17 hrs w/ky. ■ Paul E. Wagner, pres; William C. Miller, gen mgr & prog dir; Wanda Eshenaur, coml mgr; Dale Whitt, mus dir; Dick Thomas, news dir; Rany Callihan, chief engr.

WJEH-FM—Dec 15, 1961: 101.5 mhz; 15.4 kw. Ant 150 ft. Prog sep from AM.

Gambier

***WKCO(FM)**—1975: 91.9 mhz; 10 w. Kenyon College (43022). ■ Samuel S. Lord, finance VP.

WURD(FM)—Not on air target date March 1976: 97.7 mhz; 3 kw. Ant 300 ft. Box 222 (45121). (513) 378-6151. Brown County Radio. Audio news: APR. Format: MOR, C&W. Spec prog: Farm 10 hrs w/ky. ■ Claude Rost, pres; Fred Komola, gen mgr; Fran Stratman, coml mgr. ■ Rates: \$3.75; 3.75; 3.75; 3.75.

Granville

***WDUB(FM)**—Feb 7, 1962: 90.9 mhz; 10 w. Ant 150 ft. Stereo. Slayter Hall, Box 2422, Denison U. (43023). (614) 587-0810. Denison U. Format: Free form. ■ Eric Efrigg, stn mgr; Jim Estabrook, prog dir; Mike Smith, chief engr.

Greenville

WDRK(FM)—April 15, 1962: 106.5 mhz; 12 kw. Ant 170 ft. Box 129 (45331). (513) 548-1997. Lewel Bcstg Inc. Rep: Regional Reps. Format: Contemp, talk. Spec progs: Agriculture 14 hrs; religious 8 hrs w/ky. ■ C. L. Rutherford, VP sls; Gary Bowman, farm dir; R. L.

Rumley, VP opns; Dave Thomas, news dir; Stephen Long, chief engr.

***WGVO(FM)**—Not on air, target date unknown: 88.3 mhz; 156 w. Ant 107 ft. Memorial Hall, 4th St. (45331). (513) 548-3185. Greenville Bd. of Educ. Format: Variety. ■ Gregory A. Shreeve, gen mgr.

Hamilton

***WHSS(FM)**—May 12, 1975: 89.5 mhz; 10 w. 1165 Eton Rd. (45013). (513) 869-3275. Hamilton City School Dist. Format: Variety. ■ Walter Maude, gen mgr.

WMOH—Aug 15, 1944: 1450 khz; 1 kw-D, 250 w-N. 220 High St. (45011). (513) 863-6800. Raymar Communications Inc. (acq 12-4-72). Net: ABC/C. Rep: H-R/Stone. Format: Contemp. Spec prog: Black 1 hr w/ky. ■ Bill McRae, pres & gen mgr; Richard Delaney, VP & coml mgr; Joe London, prog & mus dir & prom mgr; Bob Long, news dir; Wayne McKenzie, chief engr. ■ Rates: \$15; 14.50; 15; 11.

WYCH(FM)—Co-owned with WMOH. April 15, 1961: 103.5 mhz; 7.2 kw. Ant 255 ft. Dups AM 45%. Format: Btlf mus, variety Spec progs: Ger 5 hrs; black 1 hr w/ky. ■ Rates: \$3.50; 3.50; 3.50; 3.50.

WQMS(FM)—May 26, 1958: 96.5 mhz; 50 kw. Ant 433 ft. 770 New London Rd. (45013). (513) 863-3100. Trinity Bcstg Corp. (acq 8-13-70). Format: Contemp relig. ■ Joseph Ninowski, pres; A. Jack Myczka, VP, gen, coml & prom mgr, prog, mus & news dir; Steve Turner, chief engr. ■ Rates: \$9; 9; 9; 4.50.

WYCH(FM)—Listing follows WMOH.

Heath

WHTH—Oct 16, 1970: 1000 khz; 250 w-D, DA. Box 1057, N. 40th St., Newark (43055). (614) 344-0361. Runnymede Inc. Audio news: UPI. Format: MOR, contemp. ■ Dr. Phillip Haynes, pres; Carey Justice, gen mgr; Tom Swank, coml mgr; Jack Gieseler, prog dir; Gary Donovan, mus dir; Jeff Johnson, news dir; James Feasal, chief engr. ■ Rates: \$6.75; 5.75; 5.75; 4.75.

WNKO(FM)—Co-owned with WHTH. See Newark.

Hillsboro

WSRW—July 15, 1956: 1590 khz; 500 w-D. Drawer A (45133). (513) 393-1590. Highland Bcstg Co. (acq 7-59). Audio news: UPI. Rep: Keystone, Regional Reps. Format: Easy lting, C&W. ■ Tom Archibald, gen mgr; Willard Parr, stn mgr; Chester Irwin, coml mgr; Delmar Overstake, chief engr. ■ Rates: \$3.05; 3.05; 3.05; 3.05.

WSRW-FM—July 25, 1952: 106.7 mhz; 44 kw (CP: 45 kw). Ant 160 ft. Prog dups AM. ■ Rates same as AM.

Holland

WPOS-FM—Sept 1, 1966: 102.3 mhz; 3 kw. Ant 250 ft. 7112 Angola Rd. (43528). (419) 865-5551. Maumee Valley Bcstg Assoc. (acq 8-1-65). ■ Lowell B. Yoder, pres; Clayton B. Shepler, gen mgr; Marvin Grieser, asst mgr; Walter Stamm, VP; Duane Ashbaucher, treas; Gail Zwayer, chief engr.

Ironton

WIRO—September 1951: 1230 khz; 1 kw-D, 250 w-N. Box 292 (45638). (614) 532-1922. Tri Radio Bcstg Inc. (acq 2-26-62). Net: MBS. Rep: Keystone, Regional Reps of Ohio. Format: MOR. ■ Kenneth H. Aubie, pres, gen mgr & chief engr; Ronald Bell, coml mgr; Stu Williams, prog dir; Larry Howard, news dir; Marlene Ferguson, off mgr. ■ Rates: \$8; 8; 8; 8.

WITO(FM)—Co-owned with WIRO. July 1, 1973: 107.1 mhz; 3 kw. Ant 125 ft. Prog sep from AM. Format: C&W. ■ Rose A. Aubie, gen mgr; J. C. Young, prog and mus dir. ■ Rates: \$4; 4; 4; 4.

Jackson

WCJO(FM)—Listing follows WLMJ.

WLMJ—December 1953: 1280 khz; 1 kw-D. Box 72 (45640). (614) 286-2141. Radio Jackson Inc. (acq 7-11-67). Rep: Keystone, Regional Reps. Format: C&W. ■ Lloyd White, pres & gen mgr; Jim G. Hedrick, prog dir; Al Eisanugle, news dir; Ed Reichelderfer, chief engr.

WCJO(FM)—Co-owned with WLMJ. 1971: 97.7 mhz; 2.35 kw. Ant 330 ft. (CP: 3 kw. Ant 300 ft.) Progs sep from AM. Format: Progressive rock.

Johnstown

WWWJ(FM)—June 16, 1975: 103.1 mhz; 3 kw. Ant 300 ft. 3WJ, Box 373 (43031). (614) 967-6776. Radio Johnstown. Group owner: Triple S Communications. Net: Agri Bcstg, Ohio News. Audio news: APR. Format: Variety. Spec progs: Farm 1 1/2 hrs; relig 8 hrs w/ky. ■ Richard N. Seiler, gen mgr; Robert G. Shaw, prog dir; John W. Smith, chief engr. ■ Rates: \$5; 5; 5; 5.

Kent

WKNT—March 1964: 1520 khz; 1 kw-D, DA. Box 629 (44240). (216) 673-1530. Media-Com Inc. (acq 1971). Net: ABC/E. Rep: Hopewell, Rgnl Reps. ■ Dick Klaus, pres.

WKNT-FM—Feb 19, 1962: 100.1 mhz; 3 kw. Ant 295 ft. Dups AM 10%.

***WKSU-FM**—1950: 89.7 mhz; 7.5 kw. Ant 320 ft. 524 Wright Hall, Kent State U. (44242). (216) 672-2359. Kent State U. Net: NPR. Format: Fine arts. ■ John E. Perry, gen mgr; Dennis L. Miller, prog dir; Richard Dain, chief engr.

Kenton

WKTN-FM—June 20, 1963: 95.3 mhz; 2.6 kw. Ant 270 ft. 113 W. Carroll St. (42169). (219) 672-4669. Ohio Radio Inc. (group owner). Format: Contemp. ■ Robert W. Reider, pres & gen mgr; Ralph Zachariah, coml mgr; Robert Morris, chief engr.

Kettering

***WKET(FM)**—May 5, 1975: 89.5 mhz; 10 w. Ant 150 ft. 3490 Far Hills Ave. (45429). (513) 298-8641. Kettering City School Dist. Format: Educl, MOR. Top 40. ■ John T. Lucas, supt of schools; Ed Moore, stn mgr.

WVUD-FM—Feb 20, 1962: 99.9 mhz; 50 kw. Ant 500 ft. 300 College Park Ave., Dayton (45469). (513) 229-2225. U. of Dayton (acq 6-64). Net: ABC/FM. Rep: ABC/FM Spot Sls. Format: Progs. ■ Rev. Raymond A. Roesch, S. M., pres; George C. Biersack, gen mgr; Stephen Dougherty, asst gen mgr; Jeff Vargo, prog dir; John Fudge, chief engr.

Lancaster

WHOK—October 1948: 1320 khz; 1 kw-D. 1660 Columbus-Lancaster Rd. N.W. (43130). (614) 653-4373. WHOK Inc. (acq 5-72). Group owner: Armstrong-France-Gehring-Oceper. Format: MOR. ■ William M. France, pres; Stanley C. Robinson, gen mgr; Roger W. Hanners, coml mgr; Martin Fye, prog dir; Louis Varga, news dir; Charles Houston, chief engr.

WHOK-FM—December 1958: 95.5 mhz; 50 kw. Ant 225 ft. Progs sep from AM. Format: C&W.

Lima

WCIT—Aug 22, 1963: 940 khz; 250 w-D, DA. 1301 N. Cable Rd., Box 940 (45802). (419) 228-9248. Riggs Bcstg Corp. (acq 2-15-68). Rep: PRO/Meeker, Pearse. Format: Top 40. ■ Richard H. Riggs, pres & gen mgr; Robert Rice, coml mgr; Debbie Roby, prog dir; Peggy Ammon, prom mgr; George Burns, mus dir; Bill Appel, news dir; Ray Allen, chief engr. ■ Rates: \$14; 13; 14; 13.

WLSR(FM)—Co-owned with WCIT. Nov 25, 1970; 104.9 mhz; 3 kw. Ant 220 ft. Stereo. Prog sep from AM. Net: ABC/FM. Format: Btlf music. Spec prog: Classcl 4 hrs w/ky. ■ Mrs. Norma Riggs, gen mgr; Kathy Rohrbach, prog dir; Gary Schaal, mus dir; Carol Lynn Riggs, prom mgr; Randy Hartley, news dir. ■ Rates: \$9; 9; 9; 9.

WIMA

AVERY-KNODL, INC.

WIMA—Dec 5, 1948: 1150 khz; 1 kw-U, DA-2. Box 1150 (45802). (419) 223-2060. Lima Bcstg Corp. (acq 8-1-71). Net: ABC/E. Audio news: APR. Rep: Avery-Knodel. Format: MOR. Spec progs: Farm 3 hrs; black 2 hrs w/ky. ■ Les C. Rau, exec VP & gen mgr; Robert Mack, coml mgr; Art Vespnick, prog & mus dir; Tom Watkins, news dir; N. Porenpelman, chief engr. ■ Rates: \$21.50; 16.50; 19; 9.50.

WIMA-FM—Dec 1948: 102.1 mhz; 15 kw. Ant 250 ft. (419) 228-7515. Net: ABC/J. Progs sep from AM. Format: Modern country. Spec progs: Farm 1½ hrs; black 1 hr wkly. ■ Jack Stower, opns mgr. ■ Rates: \$11; 9; 10; 8.

WLSR-FM—Listing follows WCIT.

***WTGN(FM)**—Sept 27, 1966: 97.7 mhz; 3 kw. Ant 300 ft. 1500 Elida Rd. (45805). (419) 227-2525. Associated Christian Bcstrs. Format: Inspirational. ■ Stanley Tam, pres; Ron Mighell, VP & gen mgr; Keith Curtis, prog dir; Rod Ovitt, news dir; John Marshall, chief engr.

Logan

WLGJ—December 1967: 1510 khz; 1 kw-D, 250 w-CH. Box 429 (43138). (614) 385-2151. Logan Bcstg Co. Format: Contemp. ■ Dannie Devoil, pres; Gary Boyer, gen mgr; Roger Hinnerman, coml mgr; Sandy Grove, prom mgr; Steve Kurtz, prog & news dir; Chuck Anthony, mus dir; Paul Jassogne, sports dir; Jerry Carmean, chief engr.

WLGJ-FM—Dec 10, 1965: 98.3 mhz; 3 kw. Ant 240 ft. horiz, 235 ft vert. Dups AM 100%.

London

WLNO(FM)—Oct 6, 1965: 106.3 mhz; 3 kw. Ant 300 ft. Box 6 (43140). (614) 852-1717. WLNO-FM Inc. (acq 1974). Rep: Regional Reps. Format: C&W.

Lorain

WLRO—Dec 1969: 1380 khz; 500 w-D, 939 Broadway (44052). (216) 244-1380. Lorain Community Bcstg. Net: MBS. Rep: PRO/Meeker. Audio news: APR. Format: Top 40. Spec progs: Pol 2 hrs; Sp 1 hr; Black 3 hrs wkly. ■ Andrew Warhola, pres; Alynne Harrison, gen mgr; Ted Zaborniak, prog dir; Mike Shea, mus dir; Reid Kollins, news dir. ■ Rates: \$12; 12; 12; 12.

WZLE(FM)—July 1975: 104.9 mhz; 3 kw. Ant 300 ft. 214 Sheffield Center. Lake Erie Bcstg Co.

Mansfield

WCLW—Dec 30, 1957: 1140 khz; 250 w-D, DA. 771 McPherson St. (44905). (419) 525-2333. Greater Mansfield Bcstg. (acq 3-7-75). ■ Frederick Eckardt, pres & gen mgr; Wayne Snyder, coml mgr; Lynn Eckardt, news dir; William Ball, chief engr.

WCLW-FM—Oct 18, 1962: 105.3 mhz; 30 kw. Ant 220 ft (CP 50 kw. Ant 370 ft). Dups AM.

WMAN—Dec 4, 1939: 1400 khz; 1 kw-D, 250 w-N. Box 8 (44901). (419) 524-2211. Richland Inc. Net: ABC/J. Rep: Torbet, Regional Reps. Format: MOR. Spec progs: Ger 1 hr; Black 1 hr wkly. ■ Vaughn P. Rubin, pres; Charles M. Carson, VP, gen & coml mgr; Robert A. James, prog dir; Dan Sterling, mus dir; Robert Kitley, news dir; Ed Huber, chief engr.

WVNO-FM—Aug 11, 1962: 106.1 mhz; 50 kw. Ant 360 ft. Stereo. 2900 Park Ave. West (44906). (419) 529-5900. Johnny Appleseed Bcstg Co. Net: ABC. Format: MOR. ■ Gunther S. Meisse, pres & gen mgr; Glenn Cheesman, coml mgr; Charles Beekley, prog dir; Steve Nelson, news dir; H. James Hire, chief engr. ■ Rates: \$13; 13; 13; 13.

Marietta

WBRJ—Aug 4, 1964: 910 khz; 5 kw-D, DA. Box 329 (45750). (614) 373-0910. 5 KW Inc. (acq 4-74). Group owner: Gannett. Rep: Torbet, Regional Reps, Gateway. Format: C&W.

***WMCO(FM)**—Oct 1, 1960: 89.3 mhz; 10 w. Marietta College (45750). (614) 373-0200. Marietta College. Format: MOR, classical, variety. ■ Bernard Russi Jr., dir of bcstg.

WMOA—Sept 8, 1946: 1490 khz; 1 kw-D, 250 w-N, 925 Lancaster St, Box 708 (45750). (614) 373-1490. WMOA Inc. (acq 7-1-68). Group owner: Ray S. Rosenblum Stns. Net: CBS, Ohio Agri-Bcstg, Ohio News. Format: Contemp. ■ Ray H. Rosenblum, pres; Larry Steinel, gen mgr; John Wharf, sales mgr; L. P. Steinel, farm dir; Ann Mulligan, news dir; Janet Steinel, office mgr. ■ Rates: \$5; 5; 5; 5.

WMOA-FM—Dec 1, 1966: 94.3 mhz; 3 kw. Ant 300 ft. Stereo. Prog sep from AM. Format: Background music. ■ Rates: \$1.80; 1.80; 1.80; 1.80.

***WMRT(FM)**—Nov 13, 1975: 88.3 mhz; 9.2 kw. Ant 205 ft. Marietta College (45750). (614) 373-0200. Marietta College. Format: Variety. ■ Bernard Russi Jr., dir of bcstg.

Marion

WDIF(FM)—Feb 27, 1975: 94.3 mhz; 3 kw. Ant 300 ft. Stereo. 135 S. Prospect St. (43302). (614) 387-9343. Scantland Bcstg Co. Net: ABC/C. Rep: Rgnl Reps. Format: Progs, Top 40. ■ George F. Scantland III, owner, gen mgr; Phil Hoover, gen sis mgr; Bob North, prog dir; Thom Rivers, mus dir; Bob Bender, news dir; Bill Whitmer, chief engr. ■ Rates: \$9.50; 8.50; 9.50; 9.50.

WMRN—Dec 23, 1940: 1490 khz; 1 kw-D, 250 w-N. Box 518 (43302). (614) 383-1131. Marion Bcstg Co. (acq 1-9-67). Format: MOR. Spec prog: Farm 5 hrs wkly. ■ Worth Kramer, pres; Arthur L. Martin, VP & gen mgr; Roger Fischer, prog dir; Tom Judd, news dir; F. J. Peters, VP & chief engr.

WMRN-FM—April 1953: 106.9 mhz; 25 kw. Ant 340 ft. Stereo. Prog sep from AM. Format: Btlf mus.

Massillon

WTIG—Aug 1, 1957: 990 khz; 250 w-D, DA. Box 573, Massillon Bldg. (44646). (216) 832-5023. Scott Bcstg Co. (acq 11-16-66). Group owner: Great Scott. Net: MBS. Rep: Keystone, Regional Reps, Michigan Spot. Format: MOR. Spec prog: Black 1 hr wkly. ■ Herbert Scott, pres; Charles McFarren, gen and coml mgr; Thomas Hoffner, news dir; Myron Kiefaber, chief engr. ■ Rates: \$6.60; 6.60; 6.60; 6.60.

Medina

WDBN(FM)—1960: 94.9 mhz; 118 kw. Ant 430 ft. Stereo. 4986 Gateway Dr. (44256). (216) 523-1345. WDBN Inc. (acq 4-16-68). Rep: Torbet. Format: Easy Lstng. ■ Robert McBride Miller, pres; Manuel Eisner, VP & coml mgr; Jeff Baxter, prog dir; Walt Henrich, news dir; James Beebe, chief engr.

Miamisburg

***WFCJ(FM)**—January 1961: 93.7 mhz; 59 kw. Ant 300 ft. Stereo. Box 222 (45342). (513) 866-2471. Miami Valley Christian Bcstg Assn. Inc. Format: Traditional Christian mus. ■ L. Morse Weimer, pres; Marvin D. Sparks, gen mgr; Wilbur G. Powell, VP; Homer S. Speece, sec-treas; Robert J. Derringer, asst mgr & prog dir; Elaine M. Lewis, office mgr; John Elliott, chief engr.

***WRSF(FM)**—1974: 89.7 mhz; 10 w. Ant 65 ft. 6th St. & Park Ave. (45342). Miamisburg School Dist.

Middleport-Pomeroy

WMPO—Aug 28, 1959: 1390 khz; 5 kw-D. Box 71 (45760). (614) 992-5355. Radio Mid-Pom Inc. Net: ABC/E. Rep: Hopewell, Regional Reps. Format: MOR. ■ John E. M. Kerr, pres, gen mgr & chief engr; Bob Cooper, stn mgr; Dean Lutz, coml mgr; Bill Pyne, prog dir; Peter Chase, mus dir; Melissa Corise, news dir.

WMPO-FM—Aug 27, 1973: 92.1 mhz; 1.9 kw. Ant 370 ft. Stereo. Dups AM 40%. Format: C&W.

Middletown

WPBF(FM)—Listing follows WPFB.

WPFB—Sept 1, 1947: 910 khz; 1 kw-D, 100 w-N. 4505 Central Ave. (45042). (513) 422-3652. Radio Station WPFB Inc. Group owner: Braden Stns. Rep: Walton, Regional Reps. Format: Variety, C&W. ■ Paul F. Braden, pres; Earl W. Francis, exec VP; Ray Iglehart, Jr., VP/gen mgr; Joe LeMoynne, VP & sales mgr; Bill Hart, prog dir; Ovie Loman, tech dir; Ruth Braden, mus dir; Lowell Thomas, news dir; Cal Williams, chief engr.

WPBF(FM)—Co-owned with WPFB. July 1, 1959: 105.9 mhz; 34 kw. Ant 590 ft. (513) 422-3625. Dups AM 27%. Format: Black, relig, MOR. Spec prog: Ger 8 hrs wkly.

Milford

WLYK(FM)—Aug 1, 1969: 107.1 mhz; 3 kw. Ant 300 ft. Stereo. Box 216 (45150). (513) 831-9595. Beautiful Island Bcstg (acq 5-1-75). Group owner: Perry Bcstg. Net: MBS. Format: Btlf mus. ■ Perry Samuels, pres and gen mgr; Jerry Leshner, off mgr; Bud Stagg, prog

dir; Sandra Megowan, prom mgr; Dan Strong, news dir.

Morrow

***WLMH(FM)**—88.1 mhz; 10 w. Ant 200 ft. 605 Welch Rd. (45152). Little Miami Local Schools.

Mount Vernon

WMVO—Nov 26, 1953: 1300 khz; 500 w-D, DA. Box 348 (43050). (614) 393-2111. Mt. Vernon Bcstg Co. Rep: Regional Reps, Dome. Format: MOR. ■ Mrs. Charles Zelkowitz, bd chmn; Stephen W. Zelkowitz, pres & gen mgr; Ron Staats, prog dir; Dave Nelson, news dir; Donald Talbot, chief engr.

WMVO-FM—May 26, 1951: 93.7 mhz; 20 kw. Ant 370 ft. Format: C&W, gospel.

Napoleon

WNDH(FM)—June, 1972: 103.1 mhz; 3 kw. Ant 300 ft. Box 87 (43545). (419) 592-8060. Maumee Valley Bcstg Inc. Net: ABC/E. Format: MOR. Spec progs: Ger 10 hrs; Sp 2 hrs wkly. ■ Ray Malone, pres & gen mgr; Dick McBroom, coml mgr; Bob McLimans, prog dir. ■ Rates: \$5.40; 5.40; 5.40; 5.40.

Nelsonville

WNAL—Not on the air; target date unknown: 940 khz; 250 w-D, DA. Rt 33 N at Johnson Rd. (45701). (614) 592-1466. Valley Bcstg Inc. ■ G. Kenner Bush, sec-treas.

Newark

WCLT—Jan 4, 1949: 1430 khz; 500 w-D, 25 W. Main St. (43055). (614) 345-4004. WCLT Radio Inc. (acq 1-1-58). Net: MBS. Rep: Meeker, Regional Reps. Format: Contemp. ■ Thomas A. Rogers, pres; Robert H. Pricer, gen mgr; Pat Plunkett, coml mgr; Fred Pyle, opns dir; David Gelfer, prog dir; Gerald Izor, news dir; Ralph Renner, chief engr.

WCLT-FM—Aug 7, 1947: 100.3 mhz; 50 kw. Ant 390 ft. Stereo. Prog sep from AM. Format: MOR.

WHTH—See Heath.

WNKO(FM)—Co-owned with WHTH, Heath. Dec 8, 1972: 101.7 mhz; 3 kw. Ant 300 ft. Stereo. Prog sep from AM. Format: MOR. ■ John Hall, prog dir. ■ Rates: \$5; 4; 4; 3.50.

New Boston

WIOI—Sept 2, 1959: 1010 khz; 1 kw-D. Box 909, Portsmouth (45662). (614) 354-2801. New Boston Bcstg Inc. (acq 4-1-62). Net: MBS. Rep: King Communications. Format: Contemp, Top 40. ■ Charles R. Maillet, pres; K. O. McGlove, gen mgr; Russell Newman, chief engr.

New Concord

***WMCO(FM)**—Jan 28, 1961: 90.7 mhz; 10 w. Cambridge Hall (43762). (614) 826-8379. Muskingum College. Audio news: UPI. Format: Variety, educl. ■ Judson D. Ellertson, chmn speech dept; Stephen E. Brown, faculty adv & gen mgr.

New Philadelphia

WJER—See Dover-New Philadelphia.

WNPQ(FM)—Feb 2, 1969: 95.9 mhz; 3 kw. Ant 229.6 ft. Stereo. Box 143 (44663). (614) 343-2700. Tuscarawas Broadcasting Co. Rep: Regional Reps. Format: Big Bands, MOR. Spec prog: Ital 1 hr wkly. ■ James Natoli Jr., pres & chief engr; Ken Neff, VP, gen, coml & prom mgr; John Griffin, prog dir; Denny Newell, news dir.

Niles

WNIO—Nov 1, 1963: 1540 khz; 500 w-D, DA. Box 625 (44406). (216) 545-4024. P. S. Bcstg Corp. (acq 9-27-73). Net: MBS. Format: C&W. Spec progs: Ital 2 hrs; Pol 4 hrs wkly. ■ James D. Psihoulis, pres & gen mgr; Karl Brant, prog dir; Sandra Craven Stewart, prom mgr; Domonic Baragona, chief engr.

Ohio Radio

See page C-1 for explanation of listings.

Norwalk

WLKR—March 18, 1968: 1510 khz; 500 w-D, DA. Box 547 (44857). (419) 668-8151. Ohio Radio Inc. (group owner). Format: Contemp. ■ Robert W. Reider, pres; James R. Westerhold, gen mgr; Dan Swander, prog dir; Henry Timmon, news dir. ■ Rates: \$6.75; 6.75; 6.75.

WLKR-FM—Sept 17, 1962: 95.3 mhz; 2.50 kw. Ant 125 ft. Dup AM 100%. ■ Rates same as AM.

Oberlin

***WBOC-FM**—September 1961: 88.7 mhz; 10 w. Stereo. Wilder Hall (44074). (216) 775-8139. Oberlin College Student Network Inc. Audio news: UPI. Format: Progressive, rock, classical. Spec prog: Black 5 hrs wkly. ■ William Leonard, gen mgr.

WOBL—Dec 24, 1971: 1570 khz; 250 w-D, DA. Box 277 (44074). (216) 774-1570. WOBL Inc. (acq 9-71). Format: C&W. ■ Harry Wilber, pres & gen mgr; Shirley Wilber, coml mgr; Tony Matthews, prog dir; Ken Lewis, news dir; E. R. Dachel, chief engr.

Oxford

***WMUB(FM)**—1950: 88.5 mhz; 820 w. Ant 260 ft. Miami U. (45056). (513) 529-3521. President & Trustees of Miami University. Net: NPR. Audio news: UPI. Format: Variety. ■ Ernest E. Phelps, gen mgr; James Miskimen, prog dir; James Bennett, ops mgr; Gary Ozanich, asst prod mgr; Robert W. Bullio, chief engr. ■ *WMUB-TV affil.

WOXR(FM)—Dec 24, 1959: 97.7 mhz; 3 kw. Ant 255 ft. 118 E. High St. (45056). (513) 523-8411. BGS Bcstg (acq 5-68). Format: Contemp, progressive. Spec prog: Classcl 4 hrs wkly. ■ James Gregg, pres; Rick Sellers, gen mgr & prog dir; Tina Buhler, coml mgr; Chris Williams, prom mgr; Mark Fullerton, mus dir; Gail Cameron, news dir; John Terhar, chief engr.

Painesville

WPVL—April 25, 1956: 1460 khz; 1 kw-D, DA. (CP 1 kw-D, 500 w-N, DA-2). 1 Radio Place. (44077). (216) 352-3155. Lake Communications Corp. (acq 12-70). Group owner: Armington-France-Gehring-Ocepeck. Format: Popular stds. ■ Anthony S. Ocepeck, pres; Gary Kneisley, stn mgr; Thomas E. Guthrie, gen sls mgr; Scot McLean, prog supvr; Mike Stout, news dir; Emeric Bennett, chief engr. ■ Rates: \$14.80; 14.80; 14.80; 14.80.

Paris

***WMCN(FM)**—Not on air, target date unknown: 90.1 mhz; 10 kw. Ant 310 ft. Calvary Christian College (44669).

Parma

WSUM—May 31, 1973: 1000 khz; 500 w-D, DA. Box 29088 (44129). (216) 237-3300. Northeast Communications Corp. Format: MOR, talk, news, drama. ■ Charles Rich, pres; William Hull, gen mgr; Ray Williams, mus dir; Les Clark, news dir. ■ Rates: \$12.25; 10; 12.25; 10.

Piqua

WPTW—November 1947: 1570 khz; 250 w-D. 1625 Covington Ave. (45356). (513) 773-3513. WPTW Radio Inc. (acq 11-1-59). Rep: Regional Reps. ■ C. Oscar Baker, pres, gen mgr, coml mgr, prom mgr & mus dir; Joanna Hill, prog dir; Jack Michaels, news & farm dir; Donald Kuether, chief engr.

WPTW-FM—Nov 30, 1960: 95.7 mhz; 35.6 kw. Ant 164 ft. Stereo. Dup AM 50%.

Pomeroy

WMPO—See Middleport-Pomeroy.

Port Clinton

WRWR-FM—Oct 4, 1961: 94.5 mhz; 6.7 kw. Ant 165 ft. Box P (43452). (419) 734-3148. Ohio Radio Inc. (group owner). Format: Contemp. ■ Robert W. Reider,

pres & gen mgr; Lavrel Haas, chief engr. ■ Rates: \$5.75; 5.75; 5.75; 5.75.

Portsmouth

WNXT—Aug 30, 1951: 1260 khz; 5 kw-D, 1 kw-N, DA-2. Box 1228 (45662). (614) 353-1161. T/R Inc. (group owner; acq 6-16-64). Net: ABC. Rep: Savalli/Gates, Ohio Sns. ■ Clay Littick, pres; Bob Wagner, gen mgr; Carl Mitchell, coml mgr; William Adams, prog dir; James Huffer, news dir; Howard Polts, chief engr.

WNXT-FM—Sept 1, 1965: 99.3 mhz; 900 w. Ant 490 ft. Dups AM 10%.

WPAY AM-FM Country Sunshine A Paul F. Braden Station CBSRAD■O

WPAY—April 15, 1935: 1400 khz; 1 kw-D, 250 w-N, Box 951 (45662). (614) 353-5176. Radio Station WPAY (acq 2-1-57). Group owner: Braden, Net: CBS. Format: C&W. Spec prog: Black 12 hrs wkly. ■ Paul F. Braden, pres; Jesse C. Veach, gen mgr; Don Vineyard, prog dir; Sam McKibben, news dir; Ernie Wells, chief engr. ■ Rates: \$8.25; 6.20; 6.20; 5.

WPAY-FM—June 15, 1948: 104.1 mhz; 93 kw horiz, 58 kw vert. Ant 610 ft. Dups AM 30%. Format: Relg. ■ Rates same as AM.

Reading

***WRCJ(FM)**—September 1969: 89.3 mhz; 10 w. (CP 2 kw. Ant 135 ft.) 810 E. Columbia Ave. (45215). (513) 733-4422. Reading Community City Schools. Net: NPR. Format: Variety/ed. ■ Donald A. Parks, gen mgr.

Salem

WSOM—June 25, 1965: 600 khz; 500 w-D, DA. 300 E. State St. (44460). (216) 337-9544. Salem Bcstg Co. Audio news: APR. ■ Lee R. Dixon, pres & gen mgr; Robert C. Harnack, VP & stn mgr; Donald E. Dixon, coml mgr.

WSOM-FM—Nov 25, 1958: 105.1 mhz; 100 kw. Ant 400 ft. Dups AM 100%.

Sandusky

WLEC—Dec 7, 1947: 1450 khz; 1 kw-D, 250 w-N, Box 417 (44870). (419) 626-2000. Miller Broadcasting (acq 1-72). Net: MBS. Rep: Regional Reps. Format: MOR. Spec progs: C&W 18 hrs; Fr 1 hr wkly. ■ Richard H. Miller, pres; David E. Mehling, VP & gen mgr; Karl Bates, prog dir; Bill Zimmerman, mus dir; Jeff A. Wilkins, news dir; Natalie Marshall, pub aff dir; Jay Leibach, chief engr. ■ Rates: \$7.50; 6; 7.50; 6.

WLEC-FM—Aug 15, 1959: 102.7 mhz; 5.9 kw. Ant 120 ft. Format: Blfl mus. ■ Rates: \$5.50; 4.50; 5.50; —

Sidney

WMVR—Nov 1, 1963: 1080 khz; 250 w-D, DA. Box 608 (45365). (513) 492-4101. Dean Miller Broadcasting. Net: MBS/MBS-Black. Rep: Pierce, Regional. Format: Contemp. ■ Dean Miller, pres; William Ted Jones, gen mgr; John Cavinec, coml mgr; George Cole, news dir; Don Kuether, chief engr.

WMVR-FM—1965: 105.5 mhz; 3 kw. Ant 155 ft. Prog sep from AM. Format: Easy Istng.

Springfield

WBLV—1947: 1600 khz; 1 kw-D. 1711 W. Main St. (45504). (513) 324-5643. Champion City Bcstg Co. (acq 1954). Net: MBS. Rep: Devney. Format: MOR. ■ Robert L. Yontz, pres & gen mgr; Ronald Yontz, coml mgr; June Powers, prog dir & prom mgr; Roger Sharp, news dir; Michael Flaharty, chief engr.

WBLV-FM—August 1958: 102.9 mhz; 50 kw. Ant 160 ft. Stereo. Prog sep from AM.

***WEEC(FM)**—Dec 15, 1961: 100.7 mhz; 77 kw. Ant 280 ft. 2348 Troy Rd. (45504). (513) 399-7837. World Evangelistic Enterprise Corp. Format: Relg/Public service. Spec prog: Black 1 hr wkly. ■ Mike Maddex, pres; Larry R. Huff, stn mgr; David Bastress, chief engr.

WIZE—Nov 1, 1940: 1340 khz; 1 kw-D, 250 w-N, Box 1104 (45501). (513) 399-4955. Great Trails Bcstg Corp. (group owner). Net: ABC/C. Rep: Eastman. ■ Stephen T. Joos, pres; & gen mgr; Gerry Allen, news dir.

***WUSO(FM)**—Feb 20, 1966: 89.1 mhz; 10 w. Box 749 (45501). (513) 327-6415. Wittenberg U. Net: ABC/FM, IBS. Format: Jazz, classical, progressive. ■ Barry A. Baines, gen mgr; William N. Hadler, prog dir; William H. Gibb, mus dir; Richard Tettelbach, news dir; Robert Dill, chief engr.

Stuebenville

WLIT—Sept 25, 1973: 950 khz; 500 w-D, DA. Box 1798 (43952). (614) 264-7771. Capitol Bcstg Corp. Net: NBC. Format: MOR. Spec prog: Pol 1 hr wkly. ■ E. M. Johnson, pres; Dean Lutz, coml mgr; Jack Kane, prog and news dir; Jerry Roman, chief engr. ■ Rates: \$4; 4; 4; 4.

WRKY(FM)—Listing follows WSTV.

WSTV—Nov 4, 1940: 1340 khz; 1 kw-D, 250 w-N, 320 Market St. (43952). (614) 282-0911. Rust Craft Bcstg Co. (group owner). Net: MBS. Rep: Torbet. Format: MOR. Spec prog: Ital 2 hrs wkly. ■ Marshall Berkman, pres; William B. Chesson, gen mgr; Virginia Firm, coml mgr; Thomas Abernethy, prog & prom dir; Scott McMurray, news dir; William Chesnes, chief engr. ■ Rates: \$9; 8.50; 9; 8.

WRKY(FM)—Co-owned with WSTV. May 1, 1947: 103.5 mhz; 12 kw horiz, 9.5 kw vert. Ant 880 ft. Dups AM 10%. Format: Rock. ■ WSTV-TV affil. ■ Rates same as AM.

Streetsboro

***WSTB(FM)**—Sept 1973: 91.5 mhz; 330 w. Ant 105 ft. 1951 Annalane Dr. (44240). (216) 626-2221. Streetsboro City School District. Net: NPR. Format: Variety. ■ William P. Weisinger, gen mgr; Steven Follin, ops mgr; Anthony Libertore, chief engr.

Struthers

***WKTL(FM)**—Sept 6, 1965: 90.7 mhz; 910 w. Ant 26 ft. 111 Euclid Ave., Struthers High School (44471). (216) 755-1435. Struthers Bd. of Educ. Net: NPR. Format: MOR, btfl mus. Spec progs: Croatian 1 hr; Italian 1 hr; Slovak 2 hrs; Slovenian 2 hrs; Spanish 1 hr; Ukrainian 1 hr; Polish 1 hr wkly. ■ Robert J. Milanchus, bkstn dir; Lewis Moler, chief engr; Mark E. Koch, asst bcstg dir; Jeanne Zenlko, Barb Brown, news dirs.

Sylvania

WXEZ(FM)—Co-owned with WOHO Toledo. Nov 29, 1968: 105.5 mhz; 2.25 kw. Ant 340 ft. Broadcast House, Toledo, Ohio (43616). (419) 255-1470. Midwestern Bcstg Co. (acq 3-72). Rep: Blair. Format: Beautiful mus. ■ Lewis W. Dickey, pres; Irwin Young, gen mgr; Bob Sowers, chief engr.

Tiffin

***WHEI(FM)**—1972: 88.9 mhz; 10 w. Ant 80 ft. Greenfield St. (44883). Heidelberg College.

WTTF—Dec 19, 1959: 1600 khz; 500 w-D, DA. 185 S. Washington (44883). (419) 447-2212. WTTF Inc. Net: ABC/E. Format: MOR. Spec progs: C&W 20 hrs; farm 10 hrs wkly. ■ Robert G. Wright, pres & gen mgr; Richard Wright, VP; Robert (Ed) Wright, prog dir; Jack Kagy, news dir; Loren Guild, chief engr. ■ Rates: \$7; 7; 7; 7.

WTTF-FM—1963: 103.7 mhz; 3.9 kw. Ant 125 ft. Dups AM 100%. ■ Rates same as AM.

Toledo

***WAMP-FM**—Feb 1975: 88.3 mhz; 10 w. 2400 Colliewood (43620). (419) 244-6875. Toledo Board of Education. Format: Variety. Spec prog: Ethnic 10-15 hrs wkly. ■ Frank Dick, pres; Gerald Friedberg, gen mgr.

WANR—Nov 28, 1966: 1520 khz; 1 kw-U, DA-2. Commodore Perry Mortor Inn (43604). (419) 248-4655. Raystay Co. (acq 9-23-73). Net: MBS. Rep: Stone, Regional Reps. Format: All news. ■ George F. Gardner, pres; Jules Blum, gen mgr; London Mitchell, prog and ops dir; Dick Lambert, news dir; Jim Hartzler, chief engr.

WCWA—April 10, 1938: 1230 khz; 1 kw-D, 250 w-N. 604 Jackson St. (43604). (419) 248-2627. Reams Bcstg Corp. (acq 1964). Net: ABC/E. Rep: McGavren-Guild. Format: Contemp, MOR. ■ Frazier Reams, pres; Bob Martz, gen mgr; Mike Gallagher, coml mgr; Terry Shaw, prog dir; Lou Herbert, news dir; Dennis Moon, chief engr. ■ Rates: \$34; 32; 34; 30.

WIOT(FM)—Co-owned with WCWA. October 1949: 104.7 mhz; 50 kw. Ant 620 ft (CP Ant 540 ft). Stereo. Prog sep from AM. (419) 248-3377. Format: Prog rock. Spec prog: Ger 1 hr wkly. ■ Dorian Paster, prog dir; Neal Lasher, mus dir; Rick Bird, news dir. ■ Rates same as AM.

***WGTE-FM**—Not on air target date April, 1976: 91.3 mhz; 28.5 kw. Ant 550 ft. 415 N. St. Clair (43604). Greater Toledo Educational Television Foundation.

WIOT(FM)—Listing follows WCWA.

WKLR(FM)—Listing follows WTOD.

WLQR(FM)—Aug 11, 1946: 101.5 mhz; 11 kw (CP 15 kw). Ant 810 ft. 300 Colton Bldg., Madison & Erie Sts. (43624). (419) 248-4486. Susquehanna Bcstg Co. (group owner; acq 3-1-71). Audio news: UPI. Rep: Eastman. Format: Adult MOR. ■ L. J. Appell Jr., pres; A. W. Carlson, VP radio; S. J. Goldberg, gen mgr; R. McDonald, prog dir; T. Taylor, chief engr. ■ Rates: \$28; 28; 32; 18.

WMGS—See Bowling Green.

WMHE(FM)—Oct 14, 1957: 92.5 mhz; 50 kw. Ant 480 ft. 4665 W. Bancroft St. (43615). (419) 531-1681. Hillebrand Electronics. Net: ABC/FM. Rep: Torbet. Format: Contemp, Top 40. ■ William A. Hillebrand, pres; Ruth H. Ray, gen mgr; Charles A. Myers, bus mgr; Dan Myers, mus dir; Joanne Hill, news edit; Wilbur McCoy, chief engr. ■ Rates: \$15; 16; 19; 21.

WOHO—October 1954: 1470 khz; 1 kw-U, DA-2. Broadcast House (43616). (419) 255-1470. The Midwestern Bcstg Co. (acq 3-15-65). Rep: Blair. Format: Contemp. ■ Lewis W. Dickey, pres & gen mgr; David Wilder, gen sls mgr; Don Armstrong, prog dir; Craig Edwards, news dir; Robert Sowers, chief engr.

WSPD—April 15, 1921: 1370 khz; 5 kw-U, DA-N. Box 963 (43696). (416) 248-6401. Storer Bcstg Co. (group owner; acq 1-28). Net: NBC. Rep: CBS Radio Spot Sls. Format: MOR, Contemp, C&W. ■ Peter Storer, pres; Doug Sinn, gen mgr; Bill Burchett, gen sales mgr; Jack Lawyer, prog dir; Neil Carmean, news dir; Bill Ruppert, chief engr. ■ Rates: \$45; 29; 29; 19.

WTOD—June 16, 1946: 1560 khz; 5 kw-D, DA. 3225 Arlington Ave. (43614). (419) 385-2507. Booth American Co. (group owner; acq 8-17-57). Net: ABC/I. Rep: Masla. Format: C&W. Spec prog: Pol 3½ hrs wkly. ■ John Booth, pres; James W. Wood, gen mgr; Bill Hughes, opns mgr; Bill Manders, prog dir; Joe Hood, coml mgr; Bob Pepas, mus dir; Jim Vitac, news dir; Ted Miolsky, chief engr. ■ Rates: \$16; 16; 16; 16.

WKLR(FM)—Co-owned with WTOD. Dec 7, 1956: 99.9 mhz; 8.8 kw. Ant 160 ft. Prog sep from AM. (416) 244-4679. Net: MBS/Black. Format: Black. ■ Charles Welch, prog dir; Pat Love, mus dir. ■ Rates: \$12; 12; 12; 12.

WXEZ(FM)—See Sylvania.

Uhrichsville

WBTC—Dec 13, 1963: 1540 khz; 250 w-D. 2305 N. Water ext. (44683). (614) 922-2700. Tuscarawas Bcstg Co. Rep: Regional Reps. Format: MOR, talk. Spec prog: Ital 1 hr wkly. ■ James Natoli Jr., pres & chief engr; Ken Nellf, VP, gen, coml & prom mgr; John Griffin, prog dir; Denny Newell, news dir.

University Heights

***WUJC(FM)**—May 13, 1969: 88.9 mhz; 10 w. Ant 153 ft (CP 750 w. Ant 340 ft). c/o John Carroll U. (44118). (216) 932-7946. John Carroll University. Net: ABC/C, ABC/I. Format: Contemp, educ, local news. Spec prog: Fr 2 hrs wkly. ■ Tim Iacofano, gen mgr; Phil Hartman, opns mgr.

Upper Sandusky

WYAN-FM—Dec 11, 1973: 95.9 mhz; 3 kw. Ant 300 ft. Box 32 (43351). (419) 294-2848. Triplett Bcstg Co. Rep: Grant Webb, Regional Reps. Format: MOR. ■ Wendell A. Triplett, pres; Robert S. Triplett, VP & gen

mgr; James C. Pride, coml & prom mgr; David Russell, prog & mus dir; Mary Koehler, news dir; Charles Clifford, chief engr.

Urbana

WCOM-FM—Aug 1, 1965: 101.7 mhz; 3 kw horiz 1.55 kw vert. Ant 300 ft. Stereo. Box 232 (43078). (513) 653-5011. Champaign Communications Inc. (acq 11-16-70). Format: MOR Spec prog: Farm 6 hrs wkly. ■ James W. Bissey, pres & gen mgr; Ronald L. Howard, coml & prom mgr; Beth Evisizor, prog dir; Larry Kirkpatrick, news dir; Bob Snyder, chief engr. ■ Rates: \$4; 4; 4; 3.

***WUHS(FM)**—Sept 15, 1969: 91.7 mhz; 10 w. 500 Washington Ave. Urbana City Board of Education. ■ Dan Conley, gen mgr.

Van Wert

WERT—Nov 27, 1958: 1220 khz; 250 w-D. Box 487 (45891). (419) 238-1220. WERT Inc. (acq 6-30-71). Net: MBS. Rep: Regional Reps, Pearse. Format: Talk, variety. Spec prog: Sp ½ hr wkly. ■ J. R. Livesay, pres; Donna Wermer, mgr; Mark Hartman, coml mgr; Jack Snyder, news edit; Dick Wyandt, chief engr. ■ Rates: \$5.25; 5.25; 5.25; 5.25.

WERT-FM—Oct 1, 1962: 98.9 mhz; 6.3 kw. Ant 130 ft. Dups AM 100%. ■ Rates same as AM.

Wapakoneta

WERM(FM)—July 1, 1964: 92.1 mhz; 3 kw. Ant 150 ft. Box 407 (45859). (419) 394-2113. West Central Ohio Bcstrs Inc. ■ H. B. Miller, pres & gen mgr; E. R. Miller, mgr & prog dir.

Warren

WHHH—Nov 11, 1941: 1440 khz; 5 kw-U, DA-2. Second National Bank Bldg. (44481). (216) 392-2529. Radio Station WHHH Inc. (acq 5-1-62). Rep: Grant Webb, State. Spec prog: Greek 1 hr wkly. ■ Helen Hart Hurlbert, pres; Robert E. Hardy, mgr & chief engr; Chester Waggoner, coml mgr

WTCL—April 7, 1971: 1570 khz; 500 w-D, DA. 1295 Lane West Rd., S.W. (44481). (216) 399-6424. Warren Bcstg Corp. (acq 1-2-75). Audio news: UPI. Format: MOR, solid gold. Spec prog: Pol 1½ hrs; Greek 1 hr; Ital 1 hr wkly. ■ L. W. Stauffer, pres and gen mgr; Michael L. Stauffer, coml mgr; Mike Hissom, news dir; Terry Bolinger, chief engr.

Washington Court House

WCHO—February 1952: 1250 khz; 500 w-D. 1535 N. North St., Box 1 (43160). (614) 335-0941. Court House Bcstg Co. Format: MOR. ■ W. N. Nungesser, pres & gen mgr; Robert Lutz, coml & prom mgr, news dir & chief engr.

WCHO-FM—December 1968: 105.5 mhz; 3 kw. Ant 300 ft. Dups AM 90%.

Waverly

WIBO(FM)—Listing follows WPKO.

WPKO—1954: 1380 khz; 1 kw-D, DA. Box 227 (45690). (614) 947-2166 or 774-1810. Bennett Bcstg Co. (acq 10-68). Net: ABC/E. Rep: Regional Reps. Format: Variety, C&W. Spec prog: Gospel music 10 hrs wkly. ■ Tyrone Henry, gen mgr and chief engr; Grace Neal, opns mgr; Mark Bayes, pub affrs dir. ■ Rates: \$2.64; 2.40; 2.64; 2.40.

WIBO(FM)—Co-owned with WPKO. March 1971: 100.9 mhz; 920 w. Ant 500 ft. Stereo. Prog sep from AM. Net: ABC/FM. Format: Easy lting, MOR. ■ Gary Baer, prog dir. ■ Rates same as AM.

Wellston

WKOV—1953: 1330 khz; 500 w-D. Box 190 (45692). (614) 384-2000. Jackson County Bcstg Inc. (acq 9-14-70). Net: ABC/I. Format: Music, news, sports. ■ Lewis E. Davis, pres; John Wilson, VP & gen mgr; Jerry W. Simpson, prog dir.

WKOV-FM—July 17, 1971: 96.7 mhz; 3 kw. Ant 100 ft. Dups AM 10%. Format: Bltl music.

Westerville

WBBY-FM—May 5, 1969: 103.9 mhz; 2 kw. Ant 360

Ohio Radio

See page C-1 for explanation of listings.

ft. Box 753, Sunbury (43074). (614) 965-3038. Mid-Ohio Communications Inc. Rep: Sandeberg-Glenn. Format: Old gold, rock. ■ William R. Bates, pres & chief engr; Kenneth M. Bates, gen mgr/prog dir; Richard E. Sieter, coml mgr.

***WOBN(FM)**—Oct 8, 1958: 91.5 mhz; 10 w. Ant 108 ft. Otterbein College (43081). (614) 891-3316. Otterbein College. Format: Pub svc, educ, entertainment. ■ Dr. J. A. Grissinger & Don Hines, advisors; Leonard Robinson, stn mgr.

Wilberforce

***WCSU-FM**—Dec 15, 1962: 88.9 mhz; 250 w. Ant 180 ft. (45384). (513) 376-7223. Central State University. ■ Louis Jackson, pres; La Rue Turner, gen mgr & chief engr; Willis Parker, prog dir.

Willoughby

WELW—Jan 25, 1965: 1330 khz; 500 w-D, DA. Box 599, 36913 Stevens Blvd. (44094). (216) 946-1330. Radio 1330 Inc. (acq 1-1-69). Net: MBS. Format: C&W. ■ Lawrence Goldstein, pres; Raymond Koepen, gen mgr; Daniel Bradford, prog dir; Thomas Becker, mus dir; Leo D'Arcy, news dir; Gary Blumh, chief engr.

WDMT(FM)—Co-owned with WELW. See Cleveland.

Wilmington

WDHK(FM)—1974: 102.3 mhz; 3 kw. Ant 300 ft. (45177). Clinton County Bcstg Corp.

WKFI—Dec 5, 1964: 1090 khz; 1 kw-D, DA. Box 1 (45177). (513) 382-1608. 5 kw inc. (acq 5-9-74). Group owner: Gannett. Net: MBS. Rep: Regional Reps. Format: MOR. Spec prog: Farm 16 hrs wkly. ■ Roland G. Roy, gen mgr & chief engr; Fred J. Komala, sales mgr; James Spragg, prog dir; Robert Beckell, mus dir; Cam McCartney, news dir; Ken Broo, sports dir.

Wooster

***WCWS(FM)**—April 1968: 91.9 mhz; 390 w. Ant 43 ft. Wishart Hall, College of Wooster (44691). (216) 264-9010. College of Wooster. Format: Diversifd. ■ Dr. Winford B. Logan, dir of bcstg; Jonathon Hull, gen mgr; G. Scott Mitchell, prog dir; James Becker, mus dir; Glenn Forbes, news dir; Cathy Sheldon, pub affrs dir; James McKay, sports dir; Kirk Fisher, prod dir; Anthony Alford, prom mgr; Brent Warner, chief engr.

WWST—1947: 960 khz; 1 kw-D. Box 384 (44691). (216) 264-5122. Wooster Republican Printing Co. Group owner: Dix. Audio news: UPI. Rep: Hopewell, Keystone, Regional Reps. Format: Contemp, MOR, variety. Spec prog: Farm 3 hrs wkly. ■ E. B. (Ted) Evans, gen mgr; Charles Craig, asst mgr; Ken Nemeth, prog & news dir; Roy Bates, sports consultant; Michael Epler, chief engr. ■ Rates: \$6.40; 5.30; 5.30; 5.30.

WWST-FM—1947: 104.5 mhz; 52 kw. Ant 330 ft. Dups AM 16%. Format: MOR. ■ Rates: \$5.30; 5.30; 5.30; 5.30.

Worthington

WRFD—See Columbus.

Xenia

WBZI(FM)—Listing follows WGIC.

WELX—Sept 1, 1968: 1110 khz; 250 w-D, DA. Box 456 (45385). (513) 372-7649. H&H Bcstrs Inc. (acq 6-28-75). Net: MBS/Black. Rep: GCI. Format: Jazz, black. Spec prog: Gospel 12 hrs wkly. ■ Harold J. Wright, pres & gen mgr; Dee Dee Hurd, prog, mus and news dir; Eleanor Wright, chief engr.

WHBM(FM)—Co-owned with WELX. June 18, 1972: 103.9 mhz; 1 kw. Ant 160 ft. Dups AM 70%.

WGIC—Nov 11, 1963: 1500 khz; 500 w-D. Box 99 (45385). (513) 372-3531. Baker Bcstrs Inc. Group owner: Vernon H. Baker Sins. Net: ABC/C. Rep: Regional Reps. Format: Top 40. ■ Vernon H. Baker, pres; Richard A. Moran, VP & gen mgr; C. David Richey, asst gen mgr & coml mgr; John Bracken, prog dir; William R. Nance, prom mgr; Paul Kintzel, news dir; William T. Hughes, chief engr. ■ Rates: \$7; 6.35; 7; —.

Ohio, Oklahoma Radio

See page C-1 for explanation of listings.

WBZI(FM)—Co-owned with WGIC. March 3, 1967: 95.3 mhz; 3 kw. Ant 300 ft. Dups AM 10%. Format: Gospel. ■ Rates: \$4.50; 4.50; 4.50; 4.50.

Yellow Springs

***WYSO(FM)**—Feb 8, 1958: 91.5 mhz; 2.4 kw. Ant 400 ft. Stereo. Antioch Union Bldg. (45387). (513) 864-2022. Antioch College. Net: NPR. Format: Diversified. ■ Jo Anne Wallace, gen mgr; Jon Herbst, prog dir; Carol Pierson, asst mgr; John McChesney, cmnl affrs dir; Jim Bailey, chief engr; Sherry Novick, dev.

Youngstown

WBBW—Feb 20, 1949: 1240 khz; 1 kw-D, 250 w-N. 418 Knox (44502). (216) 744-4421. Mahoning Valley Bcstg Corp. Net: ABC/I & ABC/E. Rep: McGavren-Guild-PGW. Format: Talk, news and sports. Spec progs: Itl 1 hr; Black 2 hrs wkly. ■ John Cherpack Jr., pres; Dick James, gen mgr; Anthony N. Ross, prog dir; Nick Anthony, asst prog dir; Helen Paes, news dir; George Dvepp, chief engr. ■ Rates: \$26; 19; 26; 13.

WOOD(FM)—Co-owned with WBBW. June 1959: 93.3 mhz; 14.5 kw. Ant 280 ft. Stereo. Prog sep from AM. ■ Rates: \$6.50; 6.50; 6.50; 6.50.

WFMJ—Sept 7, 1939: 1390 khz; 5 kw-U, DA-N. 101 W. Boardman St. (44503). (216) 744-8611. WFMJ Bcstg Co. Rep: Buckley. Format: Contemp. ■ William J. Brown, pres; Mitchell F. Stanley, stn & coml mgr; John Dunn, news dir; Frank Dieringer, chief engr. ■ WFMJ-TV affil.

WGFT—Not on air; target date unknown: 1500 khz; 500 w-D, DA. Media Inc.

WHOT—See Campbell.

WHOT-FM—November 1959: 101.1 mhz; 24.5 kw. Ant 110 ft. Stereo. (216) 746-8464. Dups WHOT, Campbell 50%.

WKBN—1926: 570 khz; 5 kw-U, DA-N. 3930 Sunset Blvd. (44501). (216) 782-1144. TWX 216-736-0108. WKBN Bcstg Corp. Net: CBS. Rep: Katz. Format: MOR, C&W. ■ W. P. Williamson Jr., chmn of bd; W. P. Williamson III, pres; Carl F. Glade, coml mgr; Don Guthrie, prog dir; Ted Conner, pub rel mgr; Peter J. Ford, dir of engr. ■ Rates: \$35; 23; 28; 13.

WKBN-FM—Aug 26, 1947: 98.9 mhz; 50 kw. Ant 540 ft. (CP 4.5 kw. Ant 1370 ft.). Stereo. Prog sep from AM. Format: Btfl music. ■ John D. Crognale, mgr. ■ WKBN-TV affil. ■ Rates same as AM.

WNIO—See Niles.

***WYSU(FM)**—September 1969: 88.5 mhz. 22.5 kw. Ant 110 ft. Stereo. A&S Bldg, 521 Wick Ave, Youngstown State University (44503). (216) 746-1851. Youngstown State University. Net: NPR. Format: Fine arts. ■ Stephen J. Greevich, dir of bcstg; Robert W. Peterson, stn mgr. William Foster, mus and prog dir; Lewis Moler, dir of bcst engr.

Zanesville

WHIZ—July 8, 1924: 1240 khz; 1 kw-D, 250 w-N. Lind Arcade Bldg. (43701). (614) 452-5431. South-eastern Ohio Bcstg System Inc. (acq 6-47). Group owner: T/R Inc. Net: NBC. Rep: Savalli/Gates, Regional Reps. ■ Clay Littick, pres; Robert F. Hodous, gen mgr; Rich Peterson, prog dir; C. E. Hartmeyer, chief engr; Allan Land, group mgr.

WHIZ-FM—Dec 16, 1961: 102.5 mhz; 20 kw. Ant 490 ft. Dups AM 20%. ■ WHIZ-TV affil.

CSI ELECTRONICS INC.
2607 River Road
Cinnaminson, New Jersey, 08077
Telephone: (609) 786-1060

Oklahoma

Ada

KADA—September 1934: 1230 khz; 1 kw-D, 250 w-N. Box 609 (405) 332-1212. KADA Bcstg Inc. Net: ABC; Okla. News. Rep: Melville. Format: C&W, MOR days; Rock, eve. ■ Jerry Spencer, pres & gen mgr; Roy Cofman, coml mgr; Zoe Fulton, office mgr; David White, chief engr.

KEOR—See Atoka.

KTEN-FM—Co-owned with KEOR. April 15, 1971: 93.3 mhz; 100 kw. Ant 630 ft. Box 10 (74820). (405) 332-3311. TWX 405-332-1141. Oklahoma Broadcasting Co. Net: ABC/E; ABC/C. Rep: Savalli/Gates, Walton. Dups AM 20%. Format: Contemp, MOR. ■ Bill Hoover, pres & gen mgr; Jim Kirk, prog dir; Charles Stacey, news dir; James Lollar, chief engr; Paula Hall, coml mgr; Bob Chambers, prom mgr; Paul Overton, mus dir.

Altus

KWHW—April 2, 1947: 1450 khz; 1 kw-D, 250 w-N. Box 577 (73521). (405) 482-1450. KWHW Radio Inc. (acq 9-9-69). Net: ABC/E; Okla. News. Format: MOR. ■ Hugh Garnett, pres; George Wilburn, VP & gen mgr; Sue Denton, coml mgr; Dan O'Neil, music dir; Keith Dobson, news dir; George Whitaker, chief engr. ■ Rates: \$5.95; 4.95; 4.95; 4.95.

KWHW-FM—April 1, 1974: 93.5 mhz; 3 kw. Ant 300 ft. Stereo. Progs sep from AM. Format: Btfl mus. ■ Rates: \$4.50; 4.50; 4.50; 4.50.

Alva

KALV—Oct 18, 1956: 1430 khz; 500 w-U, DA-1. Box 843 (73717). (405) 327-1430. Martin Bcstg Corp. (acq 1-1-69). Net: ABC/I; Okla. News. Format: C&W. Spec prog: Farm 10 hrs wkly. ■ Lynn L. Martin, pres & gen mgr; Marione E. Martin, chief engr; Jan Smith, prog dir. ■ Rates: \$4.50; 3.60; 3.60; 3.60.

Anadarko

KRPT 850 radio
Anadarko Broadcasting Co.

KRPT—Dec 17, 1970: 850 khz; 500 w-D, DA. Box 969 (73005). (405) 247-6682. Anadarko Bcstg Co. Net: ABC/I, Okla. News, Weatherscan. Format: C&W, MOR. Spec progs: Farm 1 hr, Indian 1 hr, wkly. ■ Howard McBee, pres; G. Harold Wright, gen mgr; Karen A. Hynley, coml mgr; Harry B. Gilstrap, opns mgr & chief engr; David Myers, mus dir. ■ Rates: \$4.30; 4.30; 4.30; 4.30.

Ardmore

KKAJ
Oklatex Radio

KKAJ(FM)—June 24, 1974: 95.7 mhz; 100 kw. Ant 450 ft. Stereo. Box 488 (73401). (405) 226-0421. Arbuckle Broadcasters, Inc. Rep: Messina. Format: MOR. ■ Hal Cochran, pres & gen mgr; Curt Cochran, coml mgr & chief engr; Dick Moore, news dir; ■ Rates: \$5; 4.40; 4.40; 4.4.

KVSO—1935: 1240 khz; 1 kw-D, 250 w-N. Box 429 (73401). (405) 223-3030. KVSO Bcstg Co. Net: ABC/I; Okla. News; Weatherscan. Format: C&W, rock, variety. Spec progs: Black ½ hr, farm 1 hr, Air Force, Navy & Marines 2 hrs, wkly. ■ Jim Fischer, gen & coml mgr; Patty Drake, prog dir; George Kost, mus dir & chief engr; Robert Bust, news dir. ■ Rates: \$5; 5; 5; 5.

Atoka

KEOR—Jan 29, 1968: 1110 khz; 5 kw-D, DA. Box 10 (74820). (405) 332-3311. TWX 405-332-1141. Oklahoma Bcstg Co. Net: ABC/C; ABC/E. Rep: Savalli/Gates; Walton. Format: C&W. ■ Bill Hoover, pres & gen mgr; Paula Hall, coml mgr; Bob Chambers, prom mgr; Jim Kirk, prog dir; Glenn Steel, mus dir; Charles

Stacey, news dir; James Lollar, chief engr.

KTEN-FM—See Ada.

Bartlesville

KWON—April 1942: 1400 khz; 1 kw-D, 250 w-N. Box 1215 (74003). (918) 336-1400. KWON Radio Inc. (acq 5-11-73). Net: CBS. Format: MOR. ■ Herb Remick, VP & gen mgr; Jim Willaford, prog mgr; Bill Mingle, sports dir. ■ Rates: \$5.75; 4.75; 5.75; 4.75.

KYFM(FM)—Nov 6, 1961: 100.1 mhz; 3 kw. Ant 300 ft. Stereo. Midpoint Bldg, Box 1100 (74003). (918) 336-1001. Thompson Bcstg Co. (acq 8-28-68). Net: ABC/I; Okla. News. Format: Btfl mus. Spec prog: Talk 10 hrs wkly. ■ Fred L. Thompson, own & gen mgr; John Ransom, stn mgr & news dir; Larry Martin, sls mgr. ■ Rates: \$5; 4; 5; 4.

Bethany

KGOY(FM)—Oct 29, 1965: 104.9 mhz; 3 kw. Ant 190 ft. (CP: 1.8 kw. Ant 255 ft.). 4034 Coronado Pl., Oklahoma City (73122). (405) 789-7746. KGOY Radio Inc. (acq 12-12-72). Net: Okla. News. Rep: Miller. Format: Gospel. ■ David M. Stevenson, pres & gen mgr; Buddy Bradshaw, prog dir; Ellard Foster, chief engr. ■ Rates: \$3.40; 3.40; 3.40; 3.40.

Blackwell

KLTR—October 1952: 1580 khz; 1 kw-D. Box 70 (74631). (405) 363-4567. Indian Nation Bcstrs (acq 7-71). Net: Weatherscan, Okla. News. Format: C&W. ■ Don M. Kelly, pres; James E. Dixon, gen mgr; Bill Hurley, coml mgr; Jay Holmes, prog dir.

KLOR-FM—Co-owned with KLTR. See Ponca City.

Broken Arrow

KGOW(FM)—Co-owned with KTOW. Sand Springs. Dec. 23, 1970: 92.1 mhz; 3 kw. Ant 245 ft. Stereo. Box 550 (74012). (918) 251-1511. Proud Country Entertainment (acq 3-75). Dups AM 100%. ■ Rates: \$14; 12; 14; 11.

Chickasha

KWCO—November 1946: 1560 khz; 1 kw-D, 250 w-N, DA-N. Box 770 (73018). (405) 224-2890. Sooner Bcstg Corp. (acq 5-10-65). Net: ABC/I. Rep: Hopewell. Format: MOR. ■ Jack G. Brewer, pres & gen mgr; Michael McKee, coml & prom mgr & chief engr; George Fields, prod dir; Lee Hamrick, mus dir; David L'Roy, news dir.

KXXX(FM)—Nov 4, 1966: 105.5 mhz; 3 kw. Ant 195 ft. Box 1268 (73018). (405) 224-1604. Brewer Bcstg Corp. (acq 4-73). Net: Okla. News. Format: C&W. ■ Jack G. Brewer, pres & gen mgr; Mike McKee, coml mgr & chief engr; Charles Jones, prom mgr; Bill Maddox, prog dir & mus dir; David L'Roy, news dir.

Claremore

KWPR—Jan 17, 1958: 1270 khz; 500 w-D, Box 577 (74017). (918) 341-1281. Green County Bcstg Co. (acq 1-1-72). Net: Okla. News. Format: MOR. ■ Leon Shearhart, VP & gen mgr; Danny Pack, mus dir; Ron Roden, prom mgr; E. Preston Walker, news dir; Mo Ingram, chief engr.

Clinton

KWOE—April 15, 1949: 1320 khz; 1 kw-D. Box 568 (73601). (405) 323-0617. Western Oklahoma Bcstg Co. Net: INN. Spec prog: C&W 7 hrs wkly. ■ Lonnie J. Preston, pres, gen mgr & news dir; Alice Preston, prog dir; Mike Fagan, prom mgr; Ray Summers, chief engr. ■ Rates: \$5; 5; 5; 4.

KWOE-FM—September 1968: 106.9 mhz; 100 kw. Ant 285 ft. Stereo. Prog sep from AM. ■ Rates same as AM.

Cushing

KUSH—1953: 1600 khz; 1 kw-D. Box 791 (74023). (918) 225-0922. Cimarron Valley Bcstrs Inc. (acq 3-4-66). Net: ABC/I; Okla. News. Rep: Reilly. Format: C&W. ■ Don M. Kelly, pres & gen mgr; Larry H. Lehr, stn mgr; Harold Kincaid, chief engr. ■ Rates: \$4.20; 4.20; 4.20; 4.20.

Duncan

KRHD—October 1947: 1350 khz; 250 w-D, 100 w-N, 1701 Pine St. (73533). (405) 255-1350. Duncan Bcstg Co. Inc. Group owner: Drewry. Net: Okla News. Rep: Avery-Knodel. Format: C&W; MOR. ■ R. H. Drewry, pres; Lester A. Agee, gen mgr & chief engr; Tiny Duval, coml mgr; Lee Hermon Vosburg, prog dir.

KRHD-FM—Not on air, target date unknown; 102.3 mhz; 3 kw. Ant 160 ft.

Durant

***KHIB(FM)**—Feb 1, 1972: 91.9 mhz; 10 w. Southeastern State Univ. (74701). (405) 924-0121, ext 420. Southeast Okla. State Univ. Format: Prog. Spec progs: Vietnamese refugee orientation, 4 hrs, Black 2 hrs wkly. ■ Rodger R. Biles, gen mgr.

KSEO—May 1947: 750 khz; 250 w-D. Drawer 190 (74701). (405) 924-3100. Durant Publishing Co. (acq 6-57). Rep: Smith. Format: MOR. ■ Glen D. Burke, gen mgr; Ed Badger, coml mgr; Bill Edwards, chief engr.

KSEO-FM—November 1958: 107.1 mhz; 475 w. Ant 365 ft. (CP: 1.5 kw. Ant 570 ft.). Dup AM 75%.

Edmond

***KCSC(FM)**—April 1966: 90.1 mhz; 28.5 kw. Ant 235 ft. Central State Univ. (73045). (405) 341-2980, Ext 2814. Central State Univ. Format: MOR. ■ Bill Lillard, pres; Jim Mullinex, prog dir; Clyde Martin, classcl music dir; William Demand, chief engr.

KWHP(FM)—June 28, 1962: 97.7 mhz; 3 kw. Ant 300 ft. Box 686 (73034). (405) 341-8440. William Haydon Payne. Rep: Miller. Format: Contemp. ■ William Haydon Payne, gen mgr & chief engr; Michael Erickson, prog dir; Jim Wood, music dir; Ken Fearnow, stn mgr; Duane Hanshaw, coml mgr; Roger Kelcy, news dir. ■ Rates: \$8; 8; 9; 9.

Elk City

KADS—1929: 1240 khz; 1 kw-D, 250 w-N. Box 949 (73644). (405) 225-1755. Beckham Bcstg Co. (acq 4-1-70). Net: ABC/I, Okla. News. Format: Farm, blfl mus, rel, C&W. ■ Bob Brewer, pres; Joe Tilton, gen mgr; Roy Maynard & Joe Tilton, chief engr; Sandy Burks, coml mgr; Wayne Phillips, prom mgr; Jerry Moran, prog dir; Pam Byrd, news dir; Sandra McClure, mus dir. ■ Rates: \$4.50; 4.50; 4.50; 4.50.

El Reno

KELR—Sept 9, 1962: 1460 khz; 500 w-D. Box 640 (73036). (405) 262-4248. Young People's Church of the Air Inc. (acq 7-7-67). Group owner: Crawford. Format: Relig. ■ Donald B. Crawford, pres; Bertha J. Sanders, coml mgr; Robert Franks, prog dir; Larry G. Jones, news dir; Bill B. Marshall, chief engr.

Enid

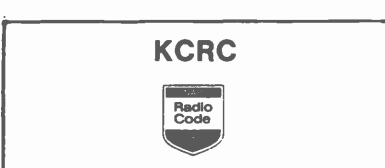

KCRC—1926: 1390 khz; 1 kw-U, DA-1. Box 1390 (73701). (405) 237-1390. Enid Radiophone Co. (acq 1931). Net: ABC; Okla. News. Rep: Savalli/Gates; R&R (Tulsa). Format: Contemp, C&W, variety. Spec progs: Black 5 hrs, farm 3 hrs wkly. ■ Milton B. Garber, pres; Pat Murphy, VP & gen mgr; Jim Hannon, stn mgr; Milton Mason, prog dir; Phil Brown, news dir; Robert F. Phillips, chief engr. ■ Rates: \$4.40; 4.40; 4.40; 4.40.

KCRC-FM—May 1, 1967: 96.9 mhz; 58 kw. Ant 185 ft. Stereo. Net: ABC/FM. Prog sep from AM. Format: Easy listening—MOR.

KGWA—1950: 960 khz; 1 kw-U, DA-1. Box 960 (73701). (405) 234-4230. Public Bcstg Service Inc. (acq 1955). Group owner: Drewry. Rep: Avery-Knodel. Format: C&W. Spec prog: Black 4 hrs wkly. ■ Allan Page, pres & gen mgr; Chuck Middleton, coml mgr; Bert Chambers, prog dir; Tom Holland, news dir; Ray Miller, chief engr.

Eufaula

KCES(FM)—June 15, 1967: 102.3 mhz; 3 kw. Ant 190 ft. Box 152, Rte 1 (74432). Tri-City Bcstg Co. ■ Harmon Davis, pres.

Frederick

KTAT—1948: 1570 khz; 250 w-D. Drawer B (73542). (405) 335-5555. Tillman Bcstg Co. (acq 7-7-65). Net: ABC/I; Okla. News. Rep: Messina. Format: Diversified. Spec prog: Farm 16 hrs wkly. ■ Roy V. Floyd, pres; Mary Ann Brewer, prog dir; Nick Long, news dir; Mark Martich, coml mgr.

Guthrie

KOKC—Nov 16, 1955: 1490 khz; 500 w-D, 250 w-N. Box 1490 (73044). (405) 282-5005. Proctor Inc. Net: ABC/I, Okla. News. Rep: Keystone; R&R. Format: C&W. ■ Herb Owen, pres; Dennis O. Spence, gen mgr, prog & mus dir; Robert Glover, coml mgr; Madison Randall, sec-treas; R. B. Phillips, chief engr. ■ Rates: \$3.45; 3.45; 3.45; 3.45.

Guymon

KGYN—Dec 12, 1948: 1210 khz; 10 kw-U, DA-N. Box 130 (73942). (405) 338-6533. Plains Bcstg Co. Format: C&W. ■ T. M. Raburn Jr., pres & gen mgr; M. C. McClure, chief engr.

Henryetta

KHEN—July 19, 1956: 1590 khz; 500 w-D. Box 310 (74437). (918) 652-3308. Henryetta Radio Co. (acq 5-26-71). Net: ABC/I; Okla. News. Rep: Messina. Format: MOR. Spec progs: Gospel 5 hrs, classical 2 hrs, wkly. ■ Ronald MacRoberts, pres, gen & coml mgr; Jim Glassman, prog & mus dir; Mike Murphy, prom mgr; H. Ted Davidson, chief engr.

KHEN-FM—Dec 20, 1966: 99.5 mhz; 28.5 kw. Ant 255 ft. Stereo. Dups AM 70%. Gospel, night.

Hobart

KTJS—June 21, 1947: 1420 khz; 1 kw-D. Box 311 (73651). (405) 726-2420. Alfred R. Fuchs (acq 3-54). Net: ABC/I; Okla. News. Format: MOR. ■ A. R. Fuchs, pres, gen mgr & chief engr; Bill R. Nichols, coml mgr; Wayne Fuchs, prog & mus dir; Paul Shields, news dir. ■ Rates: \$3; 3; 3; 3.

Holdenville

KVYL—Oct 23, 1963: 1370 khz; 500 w-D. Box 856 (74848). (405) 379-2370. Canadian River Bcstg Co. (405) 379-2370. Canadian River Bcstg Co. Format: C&W. ■ Don Hopson, pres, gen mgr & chief engr; Bill Anderson, prog dir. ■ Rates: \$; 2; 3; —.

KWSH—See Wewoka.

Hugo

KIHN—October 1948: 1340 khz; 1 kw-D, 250 w-N. Box 430 (74743). (405) 326-6411. Little Dixie Bcstg Co. Format: Variety. ■ D. W. Brawner, pres & gen mgr.

Idabel

KBEL—June 3, 1948: 1240 khz; 1 kw-D, 250 w-N. Box 400 (75455). (405) 286-3092. Idabel Bcstg Co. Net: ABC/C; Tex St. Net: Okla. News. Format: C&W. ■ David H. Ward, pres; Lou Delle Stanley, prog dir; J. P. Stanley, stn, coml & gen mgr; Cliff Taylor, chief engr.

KWDG(FM)—Co-owned with KBEL. Oct 1, 1973: 96.7 mhz; 3 kw. Ant 300 ft.

Langston

***KALU(FM)**—March 3, 1975: 90.7 mhz; 10 w. Ant 77 ft. Box 837 (73050). (405) 466-2314. Langston U. Format: Diversified. Spec prog: Black 6 hrs wkly. ■ Thomas English, pres; Lester V. LeSure, gen mgr.

Lawton

KCCO
Country and Western

KCCO—May 27, 1956: 1050 khz; 250 w-D, DA. Box 1050 (73501). (405) 355-1050. Progressive Bcstg

Oklahoma Radio

See page C-1 for explanation of listings.

Co. Audio news: UPI. Rep: Messina. Format: C&W. Spec prog: Farm 3 hrs wkly. ■ Ross B. Baker, gen mgr; Jeff Holt, coml mgr; Bill Garrett, prog dir; Robert Stabler, prom mgr; Dick Massie, mus dir; Harry Edens, news dir; Ken Hittle, chief engr.

KRLG-FM Adult Rock

KRLG(FM)—Co-owned with KCCO. Oct 23, 1970: 98.1 mhz; 100 kw. Ant 75 ft. Stereo. Box 1098 (73501). (405) 355-0098. Prog sep from AM. Format: Contemp, MOR. ■ Judy Wint, prog dir; Ralph Ford, mus dir; Ron Kirby, coml mgr; Dave Freeman, news dir; Ken Hittle, chief engr. ■ Rates: \$6.50; 6.50; 6.50; 6.50.

KLAW(FM)—Jan 1, 1965: 101.5 mhz; 2.5 kw. Ant 117 ft. Stereo. 318 Security Bank Bldg (73501). (405) 357-2860. Lawton Bcstg Corp. (acq 2-75). Net: ABC/I. Rep: Miller. Format: MOR. ■ Neil Springborn, gen mgr; Paul Hughes, sales mgr; Harry Edens, prog dir; Rich White, mus dir; Cheryl Bassel, news dir; Morris Wallace, chief engr.

KRLG(FM)—Listing follows KCCO.

KSWO—May 1, 1941: 1380 khz; 1 kw-U, DA-2. Box 709 (73501). (405) ELgin 5-1380. TWX 910-836-3600. Oklahoma Quality Bcstg Co. (acq 5-1-45). Group owner: Drewry. Net: ABC; Okla. News. Rep: Avery-Knodel. Format: Contemp. Spec prog: Black 6 hrs wkly. ■ R. H. Drewry, pres; Bill Shoemate, gen mgr; Ken McKay, sis mgr; Ron Richards, prog dir; Hugh Johnson, news dir; Jim Lockard, chief engr. ■ KSWO-TV affil. ■ Rates: \$7.60; 7.60; 7.60; 6.50.

Madill

KMAD—May 20, 1962: 1550 khz; 250 w-D. Box 576 (73446). (405) 795-2345. Radio Station KMAD (acq 7-25-74). Net: ABC/I. Okla. News. Rep: Smith. Format: C&W. ■ Sky Corbin, gen mgr, prog & mus dir & coml mgr; David Mills, news dir; Charles Carter, chief engr.

McAlester

KNED—March 14, 1950: 1150 khz; 1 kw-D, 500 w-N, DA-N. Box 1068 (74501). (918) 423-1460. Little Dixie Radio (acq 2-16-63). Net: Okla. News. Rep: Keystone; Miller. Format: MOR, C&W. ■ Francis Stipe, pres & gen mgr; Frank Hopkins, coml mgr; Lee Anderson, prog & news dir. ■ Rates: \$4.40; 4.40; 4.40; 4.40.

KNED-FM—November 1965: 101.3 mhz; 28 kw. Ant 135 ft. Dups AM 10%.

KTMC—March 3, 1946: 1400 khz; 1 kw-D, 250 w-N. Box 848 (74501). (918) 423-1400. Indian Nations Radio (acq 10-71). Rep: Riley. Format: Contemp. ■ Lewis W. Coleman, gen mgr; Laura Curtis, coml mgr; Greg Brown, prog dir.

Miami

KGCL—April 17, 1959: 910 khz; 1 kw-U, DA-1. Box 511 (74354). (918) 542-3303. Miami Radio Inc. (acq 6-1-66). Net: ABC; Okla. News. Format: C&W. ■ K. C. Jeffries, pres & gen mgr; Kent Jeffries, VP; Gary Lanier, prog dir; Wayne Douthit, prom mgr; Dan Adams, news dir; Clyde Bruell, chief engr.

KGCL-FM—December 1974: 100.9 mhz; 3 kw. Ant 265 ft.

Midwest

KRMC—April 1973: 1220 khz. 250 w-D. Box 488, Rt. 8 (73109). (405) 672-5577. Midwest Broadcasting Corp. (acq 11-74). Net: All news. ■ Jack Deskin, pres; Aliph Moss, coml mgr; L. V. McDaniel, chief engr; David Parrett, opns dir; Deloris Booth, bus mgr. ■ Rates: \$8; 6.40; 8; —.

Muskogee

KBIX—May 1, 1963: 1490 khz; 1 kw-D, 250 w-N. Box 1608 (74401). (918) 682-1331. Oklahoma Press Publishing Co. (group owner). Net: ABC/I; Okla. News. Rep: Devney; Keystone; Clyde Melville Co. Format: Contemp. ■ Tams Bixby III, pres; Richard Embody, gen & coml mgr, & news dir; Larry Arnel, prog dir; Ron Rogers, music dir; Gayle Lee, chief engr.

Oklahoma Radio

See page C-1 for explanation of listings.

KMMM-FM—March 13, 1967: 106.9 mhz; 97 kw. Ant 125 ft. Box 36 (74401). (918) 682-3462. K Triple M Corp. Net: ABC/C. Format: C&W, MOR, variety. Spec prog: Classcl 10 hrs; jazz 7 hrs wkly. ■ Daniel E. Wolff, pres & chief engr; E. C. Wolff, coml mgr; Imelda Wolff, mus dir.

KMUS—July 3, 1948: 1380 khz; 1 kw-D, 500 w-N, DA-N. Box 128 (74401). (918) 682-2488. Horace C. Boren (acq 5-58). Reprs: Bolies; Gray. Format: MOR. Spec prog: Relig 5 hrs wkly. ■ Horace C. Boren, pres & gen mgr; Mrs. H. C. Boren, VP; James E. Keitel Sr., coml & stn mgr & chief engr; Nancy Howard, women's dir; Jim Kizzia, C&W sls dir.

Norman

KGOU(FM)—Sept 25, 1970: 106.3 mhz; 3 kw. Ant 150 ft. (CP: Ant 180 ft.). 780 Van Vleet Oval (73069). (405) 325-3388. U. of Oklahoma. Format: Contemp; prog. ■ Linda Durbin, stn mgr; T. Roy Carmichael, prog dir; Doyle Paden, sls mgr; I. V. McDaniel, chief engr.

KNOR—November 1949: 1400 khz; 1 kw-D, 250 w-N, 2020 E. Alameda St. (73069). (405) 321-1400. Cleveland County Bcstg Co. Inc. Format: Top 40. ■ Tol E. Dickenson, pres; Bob Waddle, gen mgr; Steve Bridgewater, prog dir; Tim Granahan, news dir; Charlie Cusack, mus dir; Ray Perriguy III, chief engr. ■ Rates: \$10.50; 8.50; 10.50; 8.50.

WNAD—Sept 26, 1922: 640 khz; 1 kw-D. U. of Oklahoma. Box 640 (73069). (405) 329-0640. Okla Communications Inc. (acq 1-28-73). Net: CBS. Format: C&W. Spec prog: Indian ½ hr wkly. ■ John Borders, pres; Robert D. Thompson, gen mgr; Paul Cannon, prog dir; J. St. John, mus dir; J. J. Corbin, news dir; Joshua Socolof, engr.

Nowata

KNFB(FM)—March 19, 1965: 94.3 mhz; 3 kw. Ant 110 ft. 110 N. Maple St. (74048). (918) 273-1821. Jack Powell (acq 10-74). Net: Okla. News. Format: Easy Istng. Spec prog: C&W 12 hrs wkly. ■ Dwight Mitchell, pres; Jim Wiley, gen mgr; Joe Bill Johnson, ops mgr; John Worwick, prog dir; Dean McKee, news dir; Earl DeShazo, chief engr.

Oklahoma City

KAEZ(FM)—Not on air; target date unknown. 107.7 mhz; 58 kw. Ant 285 ft. All American Bcstg.

KAFG(FM)—Listing follows KTOK.

KBYE—1946: 890 khz; 1 kw-D. Box 1937 (73120). (405) 478-7100. FJL Bcstg Inc. (acq 1969). Net: WeatherScan. Audio news: APR. Rep: Ochs. Format: Relig. ■ Jerry Lynch, pres; Tom Lynch, gen & coml mgr; Roy Mandabach, prom mgr, prog, mus & news dir; Paul Reynolds, chief engr.

KFJL(FM)—Co-owned with KBYE. June 1969: 98.9 mhz; 100 kw. Ant 499 ft. Stereo. Prog sep from KBYE. Format: Black. ■ Ron Williams, prog & news dir; Harvey Johnson, mus dir.

KEBC(FM)—June 6, 1967: 94.7 mhz; 29 kw. Ant 330 ft. Stereo. (CP: 50 kw). Box 94580 (78109). (405) 631-1494. Electronic Bcstg Co. (acq 2-72). Rep: Robbins. Net: ABC/E. Format: C&W. ■ D. J. Lynch, pres; Tom Lynch, gen & prom mgr & mus dir; George Thomas, coml & prog dir; Ron Williams, news dir; Paul Reynolds, chief engr.

KFJL(FM)—Listing follows KBYE.

KFNB-FM
Today's Beautiful Music



EVERY-KNODEL, INC.

KFNB(FM)—March 16, 1962: 101.9 mhz; 63 kw. Ant 420 ft. Stereo. 2620 First National Center West (73102). (405) 232-0321. First National Bcstg Corp. Rep: Avery-Knodel. Format: Btlf mus. Spec prog: Ger ¼ hr wkly. ■ L. Dean Hoye, pres; Richard C. Corner, gen mgr; Jim Fletcher, prog dir; Glenn Danely, chief engr. ■ Rates: \$8; 8; 8; 6.50.

KGOY(FM)—See Bethany.

KJAK(FM)—Listing follows KLPR.

KKNG(FM)—1964: 92.5 mhz; 100 kw. Ant 235 ft. 110 N.E. 48th St. (73105). (405) 525-5595. Swanco Bcstg (group owner; acq 2-3-72). Rep: McGovern-Guild. Format: Btlf music. ■ Gery Swanson, pres; Marc Alan McLean, VP & gen mgr; Jack Karhu, prog dir; Richard C. Floyd, sls mgr; Josh Socolof, chief engr. ■ Rates: \$28; 32; 32; 28.

KLÉC—1948: 800 khz; 250 w-D. 1919 N. Broadway (73103). (405) 521-1412. Carroll Boyington & Son Electric Inc. (acq 9-15-72). Format: Btlf mus. ■ Carroll Boyington, pres; Donald P. Hodges, gen mgr.

KLPR—1946: 1140 khz; 1 kw-D. Box 94970 (73109). (405) 634-1411. SGI Bcstg (acq 10-15-70). Rep: Savalli/Gates; Bruce Schneider. ■ Ed Sossen, pres; Gary Bilbrey, gen mgr; Jay Bennett, prog dir; Dean Cole, news dir; Lloyd Ridner, chief engr.

KJAK(FM)—Co-owned with KLPR. Oct 17, 1960: 100.5 mhz; 100 kw. Ant 480 ft. Stereo. Dups AM 50%.

KOCY—1922: 1340 khz; 1 kw-D, 250 w-N, 101 N.E. 28th St. (73105). (405) 528-5543. Bonebrake & Co. (acq 1938). Net: CBS. Rep: GCI Sls. Format: MOR. ■ Matthew H. Bonebrake, pres; R. K. Bonebrake, gen mgr; Ben Buckland, coml mgr; Ralph Robison, prog dir & prom mgr; Paul Cinnamon, chief engr; John Allan, news dir; John Strealey, mus dir. ■ Rates: \$20; 17; 20; 10.

KXXY(FM)—Co-owned with KOCY. October 1964: 96.1 mhz; 100 kw. Ant 255 ft. Prog sep from AM. Stereo. Format: Contemp. ■ Rates: \$23; 23; 28; 28.

KOFM(FM)—Nov 25, 1965: 104.1 mhz; 100 kw. Ant 1425 ft. Stereo. Box 14448, (73114). (405) 478-0444. American Radio Corp. of Oklahoma (acq 10-1-74). Group owner: American Media Inc. Net: ABC/FM. Rep: Century Ntl. Format: Adult Stereo rock. ■ Robert D. Freeman, pres; Jerry Pryor, gen mgr; Paul Freudenberger, sls mgr; J. Robert Darr, ops dir; Pat Clarke, prom mgr; Bob Cherry, news dir; Larry Fetzer, chief engr. ■ Rates: \$25; 23; 25; 28.

KOMA—1927: 1520 khz; 50 kw-U, DA-N, Box 1520 (73101). (405) 794-1573. Storz Bcstg Co. (group owner; acq 11-21-58). Rep: Blair. Format: Contemp. ■ Robert H. Storz, pres; Tom S. Raddell, gen mgr; Ken Schubert, loc sls mgr; J. Robert Darr, prog & mus dir; J. D. Vansickle, news dir; John Timm, chief engr.

KTOK—Jan 29, 1927: 1000 khz; 5 kw-U, DA-2. Box 1000 (73101). (405) 235-1671. Covenant Bcstg Corp. (group owner; acq 11-73). Net: ABC/I. Rep: Eastman. Format: MOR. ■ Fred Walker, pres; Kenneth L. Gaines, VP & gen mgr; Glenn Valentine, coml mgr; Lillian Swaim, rsch & prom; Bob Durgin, news dir; Bob Riggin, prog & mus dir; Chester Lee Grubbs, dir of engr.



KAFG(FM)—Co-owned with KTOK. April 9, 1961: 102.7 mhz; 100 kw. Ant 300 ft. Box 1000 (73101). (405) 235-1671. Covenant Radio of Oklahoma Inc. (acq 11-73). Rep: Eastman. Format: Solid gold. ■ Woody Woodard, VP & gen mgr; Ron Moxey, coml mgr; Jay Perkey, chief engr, prog dir & mus dir; Bruce Dirks, news dir.

KXXY(FM)—Listing follows KOCY.

WKY
Gaylord Broadcasting Co.



REPRESENTED BY
KATZ RADIO



WKY—January 1920: 930 khz; 5 kw-U, DA-N. Box 14068 (73114). (405) 478-1212. TWX 910-830-6866. Gaylord Broadcasting Co. (group owner; acq 8-1-28). Rep: Katz. ■ Edward L. Gaylord, chmn & pres; Lee Allan Smith, VP & gen mgr; Dee Sadler, coml mgr; Dan Williams, prog dir; Jack R. Sherry, prom mgr; Bo Nance, news dir; Sandy Jones, mus dir; John Bushnell, chief engr. ■ Rates: \$ 55; 40; 50; 30.

Okmulgee

KBEV(FM)—Listing follows KOKL.

KOKL—October 1937: 1240 khz; 1 kw-D, 250 w-N. Box 756, 410 West 6th (74447). (918) 756-2646. Brewer Communications Inc. (acq 6-1-73). Net: ABC/I. Format: C&W. ■ James R. Brewer, pres & gen mgr; Paul Brown, coml mgr; John Rooney, sports dir; Dick Liftin, news dir; Gerald McKee, chief engr. ■ Rates: \$7.50; 6.75; 7.50; 6.75.

KBEV(FM)—Co-owned with KOKL. Not on air, target date unknown: 104.9 mhz; 3 kw. Ant 101 ft.

Pauls Valley

KVLH—December 1947: 1470 khz; 250 w-D. Box 610 (73075). (405) 238-3314. Garvin County Bcstg Inc. (acq 1-1-70). Net: ABC/I; Okla. News. Rep: Keystone. Format: MOR. Spec prog: C&W 10 hrs wkly. ■ Ronald R. Casey, pres, gen mgr & chief engr; Dick Mayo, mus dir; Betty Crump, sls mgr; Debbie Oxner, news dir; ■ Rates: \$4.60; 3.25; 3.25; 3.25.

Pawhuska

KOKN—Oct 19, 1963: 1500 khz; 5 kw-U, DA-D. (500 w Non-DA, CH). Box 1207 (74-56). (405) 287-1211. Cherokee Bcstg Co. Format: MOR/C&W. Spec prog: Osage Indian 1 hr wkly. ■ Galen O. Gilbert, pres; Jesse Gilbert, gen mgr & chief engr; Gary Brown, prog dir; Joanne Brazee, news dir.

Ponca City

KLOR-FM—Co-owned with KLTR Blackwell. December 1965: 99.3 mhz; 3 kw. Ant 145 ft. Suite 414, Community Bldg. (74601). (405) 765-6681. Indian Nation Bcstrs (acq 7-1-71). Net: Okla. News. Format: Contemp. ■ Don M. Kelly, pres; Stan Bivin, gen mgr; Skip Stow, coml mgr; Jay Holmes, prod dir; Jesse Baldwin, mus dir; Steve Leonard, news dir. ■ Rates: \$4; 4; 4; 3.

KLTR—See Blackwell.

WBBZ—1927: 1230 khz; 1 kw-D, 250 w-N. Box 588 (74601). (405) 765-6607. Ponca City Publishing Co. (acq 1949). Net: MBS. Rep: Savalli/Gates. Format: MOR. ■ Allan W. Muchmore, mgnt ptrnr; Don Putnam, coml mgr; G. T. Overall, chief engr; Tom Muchmore, news dir. ■ Rates: \$4.80; 3.80; 4.80; 3.80.

Poteau

KINB(FM)—Oct 18, 1969: 107.3 mhz; 70 kw. horiz 30 kw vert. Ant 1810 ft. Drawer H (74953). (918) 647-2127. U. F. Nowlin (acq 1974). Format: C&W/pop. ■ Vick F. Nowlin, pres & gen mgr; Hosea Shankle, prox mgr; Ron Allison, prom mgr; Lavon Coyle, news dir; Lloyd Sims, chief engr.

KLCO—Nov 25, 1953: 1280 khz; 1 kw-D. Box 521 (74953). (918) 647-2288. LeFlore Bcstg Co. Ne' ABC/I; Okla. News. Rep: R & R. Format: MOR. Spe prog: Relig 8¼ hrs wkly. ■ R. B. Bell, pres, gen mgr; V. Raleigh Sexton, coml mgr; Gary Elmore, prom mgr; Gerald Billy, mus dir.

KLCO-FM—1967: 97.9 mhz; 100 kw. Ant 2000 ft. Prog sep from AM. Format: C&W. Spec progs: Relig; hrs; area info 20 hrs wkly. ■ Lavon Coyle, coml mgr; Jim Ball, chief engr; Peggy Severson, prog dir; Roi Coyle, sports dir.

Pryor

KKMA(FM)—Listing follows KOLS.

KOLS—July 3, 1950: 1570 khz; 1 kw-D. Box 66 (74361). (918) 825-2763. Communications Mktg Consultants Inc. (acq 9-4-74). Rep: Messina. Format: Religious. ■ Robert M. Candlin, pres; Jimmie Bland, stn mgr.

KKMA(FM)—Co-owned with KOLS. July 3, 1969: 104.5 mhz; 100 kw. Ant 320 ft. Dups AM 50%. Format: Easy Istng.

Sallisaw

KBJS—Not on air, target date unknown: 1510 khz; 1 kw-D, 500 w-CH. Box 780 (74501). Little Dixie Radio Inc.

KRBB—Sept 16, 1968: 1560 khz; 250 w-D. Box 666 (74955). (918) 775-9109. Big Basin Bcstrs. Net: ABC/I; Okla. News. Format: C&W, top 40. ■ Paul S.

tions Corp. (acq 4-1-73). Net: NBC. Rep: Eastman; Moore. Format: Contemp/MOR, discussion. ■ Ralph Pettit, VP & gen mgr; Bill Ford, prog & mus dir; Linn Harrison, sls mgr; Mimi Barnecut, prom mgr; Fred Webb, news dir; Ted Hicks, chief engr.

***KWAX(FM)**—1949: 91.1 mhz; 20 kw. Ant minus 46 ft. Rm 351, Villard Hall Eugene (97403). (503) 686-4243. State Bd of Higher Educ. Net: NPR. Format: Classical & fine arts. ■ John R. Shepherd, gen mgr; J. Tom Duncan prog dir; Charles Harris, mus dir; Dan Slater, opns mgr; Chris Kovarik, news dir; Farnk D. Murphy, chief engr.

KZEL-FM—April 22, 1962: 96.1 mhz; 100 kw. Ant 870 ft. Stereo. Box 1122 (97401). (503) 747-1221. FM/96 Ltd. Format: Contemp, prog rock. ■ Jack Arthur West, pres & gen mgr; Jeffrey Ross, coml mgr; Gary Palmatier, prog dir; Stan Garrett, mus dir; Timothy J. Helfrich, news dir; Barbara C. West, office mgr; Lee Wood, chief engr.

Grants Pass

KAGI—Dec 16, 1939: 930 khz; 5 kw-D, 1 kw-N, DA-N. Box 148 (97526). (503) 476-4477. KAGI Inc. (acq 9-61). Group owner: California-Oregon Bcstg. Net: MBS. Rep: Young; Moore. ■ J. Edwin Arnold, pres & mgr; Harry Carmichael, coml mgr; Mike Carmichael, prog dir; Jim Broeffle, news dir; John Tatt, chief engr.

KAJO—Aug 15, 1957: 1270 khz; 5 kw-D. Box 230 (97526). (503) 476-6608. Grants Pass Bcstg Co. Rep: Simpson-Reilly. Format: Easy lstng. ■ Jim Wilson pres; Elzie Parker, gen & coml mgr; Barbara Ullian, prog dir; Shirley Campbell, news dir; Marvin Pangburn; chief engr.

Gresham

KRRD—Sept 28, 1956: 1230 khz; 1 kw-D, 250 w-N. Box 32 (97030). (503) 667-1230. Net: MBS. Community Communications Corp. (acq 7-1-74). Rep: Don R. Pickens. Format: C&W. ■ David J. Benjamin, chmn of the bd & co-mgr; Charles W. Banta, pres & co-mgr; Ed Keelber, prod mgr; Bob Zane, mus dir; Cliff Schrock, chief engr; Don Coss, prog dir; Dan MacDonald, news dir. ■ Rates: \$16; 15; 16; 14.

Hermiston

KOHU—Feb 6, 1956: 1360 khz; 1 kw-U, DA-N. Box 145 (97838). (503) 567-6500. Hermiston Bcstg Co. (acq 7-66). Format: C&W, MOR, rock. ■ Robert Chopping, pres; Harmon Springer, gen mgr & chief engr; Leon Mach, prog & mus dir. ■ Rates: \$5.30; 4.25; 5.30; 4.25.

Hillsboro

KUIK—1954: 1360 khz; 1 kw-D. Box 496 (97123). (503) 640-1360. Sho-N-Tel Inc. (acq 1-1-67). Format: Contemp; MOR. Spec prog: Sp 3 hrs wkly. ■ Richard M. Millison, pres; Richard Milliston Jr, gen mgr; Joel Cole, prog dir; Richard Johnson, news dir; Mike Mowrey, chief engr. ■ Rates: \$6; 6; 6; 6.

Hood River

KIHR—Oct 17, 1950: 1340 khz; 1 kw-D, 250 w-N. Box 360 (97031). (503) 386-1511. Columbia Gorge Bcstrs Inc. (acq 4-1-67). Net: MBS. Rep: Moore; Adv Sls West; Savalli/Gates. Format: MOR. ■ Paul Walden, pres, gen mgr & chief engr; Bill Baker, coml & stn mgr. ■ Rates: \$4.70; 4.20; 4.70; 4.20.

John Day

KJDY—Dec 13, 1963: 1400 khz; 1 kw-D, 250 w-N, SH. Box 113 (97845). (503) 575-1185. T. A. Smith (acq 2-19-75). Rep: Bernard Howard. ■ J. L. "Buss" Jolley, mgr.

Klamath Falls

KAGM(FM)—Listing follows KAGO.

KAGO—July 19, 1923: 1150 khz; 5 kw-D, 1 kw-N, DA-N. Box 1150 (97601). (503) 882-2551. Klamath Bcstg Co. (acq 10-1-60). Group owner: Key Stns. Rep: Torbet; Moore. ■ John L. Fern, VP & gen mgr; William Garrand, opns mgr.

KAGM(FM)—Co-owned with KAGO. Oct 15, 1973: 98.5 mhz; 26.5 kw. Ant 360 ft. (503) 884-0661. Format: MOR.

KFLS—1946: 1450 khz; 1 kw-D, 250 w-N. Box 1450 (97601). (503) 882-4656. Floyd L. Wynne. (acq 1-1-71). Net: CBS; Golden West Sports. Rep: Savalli/Gates; Tacher. Format: MOR. ■ Floyd L. Wynne, gen mgr; Robert Phelps, mus dir; James G. Byrne, news dir; John English, chief engr. ■ Rates: \$5.60; 5.60; 5.60; 5.60.

KLAD—September 1955: 960 khz; 5 kw-D (CP 5 kw, DA-N). Box 960 (97601). (503) 882-8833. 960 Radio Inc. (acq 8-1-69). Rep: PRO Meeker; Simpson/Reilly. Format: C&W. Spec progs: Farm 6 hrs, Sp 1 hr wkly. ■ Cyrus L. Smith, pres & gen mgr; Nellie E. Smith, office mgr; August O. Crandall, mus dir; Chuck Britten, news dir; Bill Walsler, prog dir; Ed Ewell, chief engr. ■ Rates: \$6; 6.20; 5.20; —.

KLAD-FM—July 19, 1974: 92.5 mhz; 27.5 kw. Ant 30 ft. Dupes AM 10% Net: NBC. Audio news: NBC/NIS. Format: C&W. ■ Rates: \$3.60; 3; 3; 2.60.

***KTEC(FM)**—September 1951: 88.1 mhz; 10 w. Oregon Technical Institute (97601). (503) 882-6321, ext 379. Oregon State board of Higher Education. Format: Progs, rock. Spec progs: Sp 3 hrs; Black 3 hrs wkly. ■ Stephen C. Paynter, gen mgr; William Clark, chief engr.



La Grande

***KEOL(FM)**—February 1974: 91.1 mhz; 10 w. Ant. 35 ft. Eastern Oregon State College (97850). (503) 963-9111. Ore State Bd of Higher Ed. Format: Progs, rock, top 40. ■ Clifford E. Gibbs, gen mgr.

KFMT(FM)—March 29, 1974: 98.3 mhz; 1.45 kw. Ant 700 ft. Stereo. Box 627 (97850). (503) 963-8531. Struck and Assocs Inc. Rep: Tacher Co Inc. Format: MOR. ■ Monte Struck, pres & gen mgr & prog dir; Lanny Larson, coml mgr; Jerry Winkle, chief engr. ■ Rates: \$5; 5; 5.

KLBM—1938: 1450 khz; 1 kw-D, 250 w-N. Box 907 (97850). (503) 963-4121. KLBM Inc. (acq 1-1-73). Net: ABC/I. Rep: Sandeberg-Glenn; Moore. Format: Contemp. ■ Ken Lillard, pres, gen & coml mgr; Robert Maszk, news dir; Warren Curry, chief engr.

Lake Oswego

KQIV(FM)—1972: 106.7 mhz; 100 kw. Ant 600 ft. Quad. Box 2905, Portland (97208). (503) 653-2270 or 225-0509. Willamette Bcstg Co. Inc. Net: Mutual Black. Rep: GCI. Format: Soul; jazz. ■ Walter Kraus, pres; Roy Jay, gen mgr, prog & mus dir; Ace Anderson, sls mgr; Bob McClanathan, chief engr. ■ Rates: \$10; 10; 15; 15.

Lakeview

KQIK—Dec 5, 1956: 1230 khz; 1 kw-D, 250 w-N. Box 311 (97630). (503) 947-3351. Lake County Communications Inc. (acq 4-1-74). Format: C&W, MOR. ■ Ernest Riedelbach, pres & gen mgr; Richard Carter, news dir; Robert Leland, chief engr.

Lebanon

KGAL—1950: 920 khz; 1 kw-U, DA-1. Box 749, Albany (97321). (503) 926-8683. Juniper Bcstg (group owner; acq 11-74). Rep: Savalli/Gates; Tacher. Format: Top 40. ■ Ronald L. Hughes, gen mgr; Ernest Hopsinger, chief engr. ■ Rates: \$8.30; 7; 8.30; 6.

KOMS(FM)—April 8, 1974: 103.7 mhz; 30 kw. Ant 285 ft. Box 502 (97355). (503) 259-1718. C. T. Isley. Format: Btl mus. ■ C. T. Isley, pres, gen mgr & chief engr; Louise Isley, stn mgr.

Lincoln City

KBCH—May 27, 1955: 1380 khz; 1 kw-D. Box 358 (97367). (503) 994-2181. Lincoln City Bcstg Inc. (acq 3-1-74). Net: ABC/I. Rep: Lucas; Moore. Format: MOR. ■ Leo A. (Bud) McLachlan, pres & gen mgr; Paul

Oregon Radio

See page C-1 for explanation of listings.

Schmidt, prog dir; Roger J. Robertson, sls mgr; Joe Della Valle, news dir.

McMinnville

KMCM—June 18, 1949: 1260 khz; 1 kw-U, DA-N. Box 207 (97128). (503) 472-2151. Norjud Bcstg Inc. (acq 11-16-68). Net: ABC/I; North-west Radio. Rep: Masla 2; Moore. Format: C&W. Spec prog Sp 6 hrs wkly. ■ Norman Aldred, gen mgr; Jeff Davis, prog dir & chief engr; Mike Kolb, mus dir; Phil Pratt, news dir; Larry Ward, coml mgr; Judy Alred, prog mgr.

***KSLC(FM)**—Jan 17, 1972: 90.3 mhz; 10 w. Ant 95 ft. Box 365, Linfield College (97128). (503) 472-3851. Linfield College. Net: ABC/E. Format: Diversified. Spec progs: Black 2½ hrs wkly. ■ Craig Singletary, faculty adviser; Gary Walker, gen mgr.

Medford

KBOY—May 31, 1954: 730 khz; 1 kw-D. Box 730 (97501). (503) 779-2244. KBOY Broadcasters Inc. (acq 12-24-74). Net: ABC/E. Rep: PRO/Meeker; Tacher. Format: Rock/top 40. ■ Robert Este, pres; Rudy Usetecka, gen mgr; Jonathan R. James, prog dir; Ed Tomlin, chief engr.

KBOY-FM—February 1958: 95.3 mhz; 800 w. Ant minus 225 ft. (CP: 810w). Dupes AM 50%.

KMED—1922: 1440 khz; 5 kw-D, 1 kw-N. Box 10 (97501). (503) 773-7373. TWX 510-757-0606. Radio Medford Inc. (acq 7-1-50). Net: NBC. Rep: Buckley Radio Sls; Simpson/Reilly. Format: MOR. ■ J. L. DeArmond, pres; Ray Johnson, exec VP & gen mgr; Art Chipman, natl sls mgr; Sam Price, stn mgr & prog dir; Hank Henry, news dir; Ellis Feinstein, dir engr.

KTMT(FM)—Co-owned with KMED. Oct 15, 1970: 93.7 mhz. 18.5 kw. Ant 3260 ft. Stereo. Progs sep from AM. ■ Sam Price, mgr; George Rambo, chief engr. ■ KMED-TV affil.

KSHA—April 7, 1962: 860 khz; 1 kw-D. 27 W. Main (97501). (503) 772-8600. Westone Bcstg Corp. Rep: Webb; Time Sls NW. Format: C&W. ■ Virgil Watkins, gen mgr; M. Campbell, coml mgr; Robert Johnson, prog mus & news dir; Ed Tomlin, chief engr.

KTMT(FM)—Listing follows KMED.

KYJC—October 1947: 1230 khz; 1 kw-D, 250 w-N. Box 1745 (97501). (503) 779-3131. Mattco Inc. (acq 3-1-74). Net: ABC/C. Rep: Torbet; Moore. Format: Contemp. ■ Russell H. Mathias, pres; Craig Finley, gen & prom mgr; Jerry Allen, prog mgr; Lindsay Martin, coml mgr; Jay LaCoy, mus dir; Sam Crockell, news dir; Mel Tynan, chief engr. ■ Rates: \$9.10; 7.25; 9.10; 3.25.

Newport

KNPT—June 24, 1948: 1310 khz; 5 kw-D, 1 kw-N, DA-N. Box 1028 (97365). (503) 265-2266. Yaquina Radio Inc. Net: ABC/I; Oregon Coast Info News. Rep: Lucas; Moore. Format: MOR, rock. ■ Tom Becker, pres; Ron Phillips, gen mgr; Bill Gardiner, coml & prom mgr; Tom Mathews, prog & mus dir; Paul Riess, news dir; Owen Ford, chief engr.

KNPT-FM—Not on air, target date unknown: 102.5 mhz; 100 kw. Ant 891 ft. 1932 N. Coast Hgy (97365).

KTDO—See Toledo.

North Bend

KBBR—December 1950: 1340 khz; 1 kw-D, 250 w-N. Box 308 (97459). (503) 756-5108. Big Bay Radio Inc. (acq 12-1-59). Rep: Masla/Young; Simpson/Reilly. Format: C&W. ■ Bill Karl, pres & gen mgr; Art Schuldt, chief engr.

Ontario

KSRV—Nov 23, 1946: 1380 khz; 5 kw-D, 1 kw-N, DA-N. Box 129 (97194). (503) 889-8651. Inland Radio Inc. Rep: Sandeberg-Glenn; Tacher. Format: MOR. ■ David N. Capps, pres; Keith M. Snodgrass, gen & coml mgr; Ben Cook, news dir; Charles E. Harland, chief engr. ■ Rates: \$5.25; 5.25; 5.25; 5.25.

Oregon Radio

See page C-1 for explanation of listings.

Oregon City

KYXI—July 4, 1947: 1520 khz; 50 kw-D, 10 kw-N, DA-2, Box 22125, Portland (97222). (503) 656-1441. KYXI Inc. (acq 1-26-73). Net: NBC. Rep: Eastman, Tacher. Format: MOR. ■ James McGovern, pres & gen mgr; Denton Holmes, coml mgr; Robert Reed, prog & news dir; Mark Andrews, mus dir; William Gott, chief engr.

KGON(FM)—Co-owned with KYXI. See Portland.

Pendleton

***KRBM(FM)**—April 18, 1970: 90.9 mhz; 10 w. 2411 N.W. Carden Ave. (97801). Blue Mountain Community College. Format: Pop/MOR/C&W. ■ Blaine T. Hanks, gen mgr.

KTIX—1941: 1240 khz; 1 kw-D, 250 w-N. Box 579 (79801). (503) 276-1311. Eastern Oregon Bcstrs Inc. (acq 8-1-67). Group owner: Juniper Bcstg. Rep: Masla/Young; Tacher. Format: Contemp. ■ Ronald Hughes, gen mgr; Ron Ihli, sis mgr; Tom S. Bingham, prog dir & prom mgr; Don Redfield, mus dir; Garry Elwood, news dir & chief engr.

KUMA—Aug 25, 1955: 1290 khz; 5 kw-U, DA-N. Box 278 (97801). (503) 276-1511. Pendleton Bcstg Co. (acq 11-1-66). Net: ABC. Rep: Howard. ■ Ted A. Smith, owner, VP & gen mgr; Walter V. Mott, coml mgr; Don Harris, mus dir; Don Morris, chief engr.

Portland

***KBOO(FM)**—June 1968: 90.7 mhz; 12.5 kw horiz, 1.3 kw vert. Ant 800 ft. 3129 S.E. Belmont St. (97214). (503) 234-5431. KBOO Foundation. (acq 8-5-75). Net: NPR. N.W. PRN. Format: Classical, jazz. Spec prog: Third world 9 hrs wkly. ■ Richard Trefren-Walter, stn mgr; Dave Kelly, pub affairs dir; Andy Simon, arts dir; Susan Sargent, office mgr; Karen Burdick, prog dir; Stu Rasmussen, chief engr.

***KBPS**—March 23, 1923: 1450 khz; 1 kw-D, 250 w-SH-N. 546 N.E. 12th Ave. (97232). (503) 234-5469. Benson Polytechnic School (acq 1923). Net: NPR. Spec progs: Sp ½ hr; Black ½ hr wkly. ■ Dr. Patricia Green Swenson, gen mgr; Darryl Conser, prod mgr; Wendell Bates, chief engr.

KEX

Adult Personality Entertainment
A Golden West Broadcasters Station

KEX—1926: 1190 khz; 50 kw-U DA-1, 2130 S.W. 5th Ave. (97201). (503) 225-1190 or 256-1190. TWX (503) 910-464-8066. Golden West Bcstrs Inc. (group owner; acq 9-1-62). Net: ABC/I. Rep: Major Market Radio. Format: Contemp/MOR. ■ Richard P. Kale, VP & gen mgr; Don E. Breede, Western sis mgr; Lon Snider, natl sis mgr; Eric G. Norberg, prog dir; Gary Blair, prom dir; Bob Swanson, mus dir; Jim Howe, news dir; Paul Mathew, chief engr; Susan Shortridge, continuity dir; Rosemary Schlack, traf mgr; Darrell Aune, sports dir; Sandra Willis, office mgr. ■ Rates: \$55; 25; 31; 19.

KGON(FM)—Co-owned with KYXI Oregon City. December 1967: 92.3 mhz; 100 kw. Ant 920 ft. Box 22125 (97222). (503) 656-1441. KGON Inc. (acq 11-1-73). Format: Contemp. ■ Craig McCoy, gen mgr; Robert Brooks, prog dir; Mike Johnson, mus dir; Paul Hanson, news dir.

KGW—March 25, 1922: 620 khz; 5 kw-U, DA-1, 1501 S.W. Jefferson (97201). (503) 224-8620. King Bcstg Co. (group owner; acq 11-1-53). Net: NBC. Audio news: UPI. Rep: Blair. Format: Contemp. ■ Ancil H. Payne, pres; Forest W. Amsden, gen mgr; Keith A. Lollis, stn mgr; Mike Phillips, prog dir; Jackie Crist, prom mgr; Sidney Coker, mus dir; Bob Beran, news dir; Clare Hanawalt, chief engr. ■ Rates: \$53; 43; 53; 43.

KINK(FM)—Co-owned with KGW. Dec 12, 1968: 101.9 mhz; 97 kw. Ant 1,610 ft. Prog sep from AM. Stereo. ■ Jeff Douglas, mgr. ■ KGW-TV affil. ■ Rates: \$16; 16; 19.

KJIB(FM)—Listing follows KWJJ.

KKEY—October 1968: 1150 khz; 5 kw-D, DA, Box 3316 (97208). (503) 222-1150. Western Bcstg Co. ■ Ralph C. Weagant, pres & gen mgr; Ernest Crater, coml mgr; Ronald Hudson, chief engr.

KLIO—June 1948: 1290 khz; 5 kw-D, Oaks Park (97208). (503) 234-8448. Cascade Bcstg Co. (group owner; acq 4-1-67). Rep: Savalli/Gates. Format: Sounds of the 40's. ■ David M. Jack, pres; Aileen Goodman, stn mgr; Lawrence D. Lester, news dir; Joe Allen, chief engr. ■ Rates: \$18; 18; 18; 12.

KLSC—1949: 1410 khz; 5 kw-D, 4700 S.W. Council Crest (97201). (503) 226-7676. Romito Corp. (acq 12-1-65). Net: ABC/C. Audio news: UPI. Rep: ABC-FM Spot Sales. Format: Golden oldies. ■ Wally Rossmann, pres; Fred C. Delahay, gen mgr; Bill Drake, prog dir; Mark Lewis, news dir; Thomas Cauthers, chief engr. ■ Rates: \$16; 13; 16; 13.

KPAM-FM—Co-owned with KLSC. Sept 1, 1946: 97.1 mhz; 100 kw horiz, 40 kw vert. Ant 980 ft. Stereo. Format: Contemp/top 40. ■ Michael O'Brien, prog & mus dir. ■ Rates: \$21; 19; 21; 19.

***KOAP-FM**—1962: 91.5 mhz; 61 kw. Ant 910 ft. 2828 S.W. Front Ave. (97201). (503) 229-4892. State of Ore, acting by and through the State Board of Higher Education (acq 4-30-62). Net: NPR. ■ Donald Bryant, dir Ore Pub Bcstg, Robert Hinz, dir of ops, Ore Pub Bcstg; Thomas M. Doggett, prog dir, Ore Pub Bcstg; Bob Roberts, mus dir; Harold Hepler, chief engr. ■ *KOAP-TV affil.

KOIN—Oct 18, 1925: 970 khz; 5 kw-U, DA-N. 140 S.W. Columbia St. (97201). (503) 228-3333. TWX 910-464-6197. Mt. Hood Radio & Bcstg Corp. (acq 1-22-52). Group owner: Newhouse. Net: CBS. Rep: Century Natl Sis. Format: MOR. ■ C. Howard Lane, pres; Richard J. Butterfield, gen mgr; J. Robert McGill, stn mgr; Jack Hayes, prog mgr; Darrell Rutter, sis mgr; Larry Hogan, prom mgr; Ted Bryant, news dir; Al Bishop, chief engr.

KOIN-FM—Sept 12, 1948: 101.1 mhz; 100 kw. Ant 1640 ft. Dup AM 50%. Stereo. Format: Classcl, btl mus, jazz. ■ KOIN-TV affil.

KPAM-FM—Listing follows KLSC.

KPDQ

Inspirational Radio Northwest



KPDQ—July 30, 1947: 800 khz; 1 kw-D, 4903 N. E. Sandy Blvd. (97123). (503) 282-3232. KPDQ Inc. Format: Relg. Spec prog: Korean ½ hr wkly. ■ John W. Davis, pres; Robert W. Ball, gen mgr; Donald Lucich, coml mgr; Joe Akorn, opns mgr; Gary Hurst, news dir; Don Wilkinson, chief engr. ■ Rates: \$13; 13; 13; -.

KPDQ-FM—1961: 93.7 mhz; 57 kw. Ant 940 ft. Dup AM 50%. ■ Rates: \$9; 9; 9; 9.

KPOK—Nov 12, 1923: 1330 khz; 5 kw-U, DA-1, 1019 S.W. 10th Ave. (97205). (503) 227-3484. Tracy Bcstg Co. (acq 5-16-73). Rep: Torbet. Format: "Rock" in County. Spec progs: Public service & religious, Sunday morn. ■ Robert O. Franklin, gen mgr; Joe Ferguson, prog dir; Bob Taylor, mus dir; Neal Penland, news dir; Dan M. Hern, coml mgr; Larry Anderson, prom mgr; Herb Davidson, chief engr.

KUPL(FM)—Co-owned with KPOK. 1948: 98.5 mhz; 100 kw horiz, 56 kw vert. Ant 1,036 ft. Stereo. (503) 221-0760. Dups AM 50%. Format: Btl Mus. ■ Larry Wilson, prog dir.

KQFM(FM)—May 1946: 100.3 mhz; 100 kw. Ant 930 ft. Stereo. Box 644 (97207). (503) 227-6681. Point-O-Salecast Inc. (acq 9-1-69). Format: MOR instrumental. ■ David M. Myers, pres; Ted O. Thompson, coml mgr; Bob Reed, prog dir; William E. Laurens, chief engr. ■ Rates: \$10; 10; 10; 10.

***KRRC(FM)**—May 1958: 89.3 mhz; 10 w. Reed College (97202). (503) 771-2180. The Reed Institute. Format: Variety. Spec progs: Black 15 hrs; classical 15 hrs; C&W 2 hrs; humor 2 hrs, wkly. ■ G. F. Haertig, pres; John Penney, gen mgr.

KUPL(FM)—Listing follows KPOK.



KVAN—See Vancouver, Wash.

KWJJ—Jan 17, 1925: 1080 khz; 50 kw-D, 10 kw-N, DA-2, 931 S.W. King Ave. (97205). (503) 228-4393. TWX (503) 910-464-8094. Roy H. Park Bcstg of Roanoke Inc. (group owner; acq 2-11-73). Net: ABC/E. Rep: KATZ; Moore. Format: C&W. ■ Roy H. Park, pres; James J. Opsitnik, gen mgr; Denis Ackerman, mus dir; Bob Bililand, news dir; Anita P. Carlson, prom mgr; Sammy Taylor, prog dir; Les Windes, chief engr.

KJIB(FM)—Co-owned with KWJJ. 1968: 99.5 mhz; 50 kw. Ant 870 ft. Stereo. Contemporary FM Inc. (acq 6-6-74). Progs sep from AM. Format: MOR.

KXL—1926: 750 khz; 50 kw-U, DA-1 (L-WSB). Box 22106 (97222). (503) 654-3193. Kaye-Smith Radio (group owner; acq 6-7-58). Net: ABC/I. Rep: McGavereen-Guild. Format: Popular. ■ Lester M. Smith, exec dir; Ray G. Watson, gen mgr; Bob Kellogg, opns mgr; Wayne Jordan, prog dir; Ted Thompson, sis mgr; John Salisbury, news dir; Bill Bise, chief engr.

KFL-FM—June 18, 1965: 95.5 mhz; 100 kw. Ant 990 ft. Dups AM 50%. Stereo.

Prineville

KRCO—Feb 1, 1950: 690 khz; 1 kw-D, Box K (97754). (503) 447-6239. Radio Central Ore. Inc. Rep: Masla/Young; Tacher. Format: MOR, C&W. ■ Collin R. Matheny, pres & gen mgr; Hal Newhouse, coml mgr; Robert Arnott, prog & news dir; Bob Matheny, chief engr. ■ Rates: \$6.20; 6.20; 6.20; 6.20.

Redmond

KPRB—October 1952: 1240 khz; 1 kw-D, 250 w-N, SH, Box 787 (97756). (503) 548-2497. Big Sky Bcstrs Inc. (acq 3-1-75). Rep: Savalli/Gates; Simpson/Reilly. Format: C&W. Spec prog: Farm 3½ hrs wkly. ■ Ronald E. Post, pres & gen mgr; Gloria Phillips, & news dir; Harry E. Gift, prog dir & chief engr; Valerie Holt, mus dir. ■ Rates: \$5.40; 4.50; 5.40; 3.40.

Reedsport

KDUN—June 2, 1961: 1470 khz; 5 kw-D, Box 1470 (97467). (503) 271-3674. KDUN Radio Inc. (acq 3-72). Rep: Sandeberg-Glenn; Moore Assoc. Format: MOR. Spec progs: C&W 5 hrs, Scandinavian 1 hr wkly. ■ I. Jerome Kenagy, pres, gen mgr & prog dir; Stephen D. Kenagy, sis mgr & mus dir; Wes Lockard, chief engr. ■ Rates: \$4.80; 4.80; 4.80; 4.80.

Roseburg

KQEN—Sept 19, 1950: 1240 khz; 1 kw-D, 250 w-N, Box 847 (97470). (503) 673-4464. KQEN Bcstg Inc. (acq 1-1-64). Net: ABC/L. Rep: Simpson; Pacific Bcst Sis. Format: MOR. ■ Lyle E. Fenner, pres, gen mgr & prog dir; James Macke, news dir & chief engr.

KRRR—June 1935: 1490 khz; 1 kw-D, 250 w-N, Box 910 (97470). (503) 673-5553. Douglas County Tri-casters Inc. (acq 3-1-61). Net: CBS. Rep: Savalli/Gates; Moore. Format: C&W. ■ James H. Johnson, pres & gen mgr. ■ Rates: \$5.50; 4; 5.50; 4.

KRSB(FM)—Oct 1, 1970: 103.1 mhz; 2.76 kw. Ant 309 ft. (CP: 2.7 kw. Ant: 310 ft.). 727 S.E. Cass St. (97470). (503) 672-6641. W.R.R. Inc. Net: ABC/E. Format: Contemp/MOR. ■ Tom Worden, pres & gen mgr & prog dir; Karen Worden, coml mgr; Bill Stout, prom mgr; Bob Reese, chief engr.

KYES—November 1955: 950 khz; 1 kw-D, Box 538 (97470). (503) 673-6678. Douglas Bcstrs Inc. Rep: Masla/Young; Tacher. Format: Contemp. ■ Elliott Molschenbacher, pres & gen mgr; Dave Weisman, coml mgr.

St. Helens

KOHI—March 2, 1960: 1600 khz; 1 kw-D, Box 187 (97051). (503) 397-1600. Columbia County Bcstrs Inc. Net: ABC/E. Rep: Masla/Young; Western States Radio Empire; Tacher. Format: Contemp. ■ L. Berniece Brownlow, pres; Charles T. Brownlow, VP & L. Berniece Brownlow, coml mgr; G. Garcia, prog dir; Joe W. Allen, chief engr.

Salem

KBZY—May 1957: 1490 khz; 1 kw-D, 250 w-N. Box 308 (97308). (503) 364-6748. Salem Bcstg Co. Rep: Torbet; Moore. Format: Top 40. Spec progs: Sp 1½ hr; religious 5 hrs wkly. ■ C. O. Fisher, pres; John Vaughan, gen mgr; Jerry Wipper, sls mgr; Wes Ryan, prog dir; San Pence, music dir; Randy Pugsley, chief engr. ■ Rates: \$7.50; 6.75; 7.50; 6.75.

KCCS—Dec 12, 1961: 1220 khz; 1 kw-D. 2808 Market St., N.E. (97301). (503) 364-1000. First Assembly of God Church. (acq 10-71). Rep: Sandeberg-Glenn. Format: Contemp, religious. ■ Daie Brown, stn mgr; Del Bachelder, coml mgr; Calvert C. Applegate, chief engr.

KGAY—1951: 1430 khz; 5 kw-D. Box 1430 (97308). (503) 581-1430. Capitol Equities Inc. (acq 8-15-68). Net: ABC/E. Rep: Selcom Inc. Format: C&W. ■ Donald H. Cushing, pres; Leslie J. Manning, gen mgr; Robert Ratter, coml mgr; Randy Smith, prog dir; Peter R. Kerr, news dir; Calvert C. Applegate, chief engr.

KORI(FM)—Listing follows KSLM.

KSLM—1934: 1390 khz; 5 kw-D, 1 kw-N. Box 631 (97308). (503) 364-8433. Oregon Radio Inc. (acq 3-1-44). Net: MBS. Rep: Howard; Simpson/Reilly. Format: MOR. Spec progs: Farm 6 hrs, Sp 3 hrs wkly. ■ Mrs. Lou C. Paulus, pres; Bruce S. Kerr, VP, gen mgr; Esther Konatz, coml mgr; Bob McCarl, prog dir; Karen Oliver, news dir; Tom Wirth, chief engr. ■ Rates: \$9.50; 7.10; 8.15; 3.60.

KORI(FM)—Co-owned with KSLM. July 3, 1970: 105.1 mhz; 100 kw. Ant 850 ft. Prog sep from AM. Stereo. Format: Top 40. Spec prog: Farm 3 hrs wkly. ■ Ed Bowen, prog dir. ■ Rates: \$4.30; 4.30; 4.30; 4.30.

Seaside

KSWB—July 12, 1968: 930 khz; 1 kw-D. Box 24 (97138). (503) 738-5555. Seaside Bcstg Corp. (acq 6-30-72). Net: ABC/C. Rep: Advertising Sls West; Tacher. Format: Contemp. ■ Robert E. Gilbert, pres & chief engr; Kenneth E. Karge, gen & coml mgr; Sam D. Kirkaldie, prog dir & prom mgr; Eugene Linton, mus & news dir.

Springfield

KORE—September 1927: 1050 khz; 1 kw-D. Box 296 (97477). (503) 746-1631. Norwood Bcstg Co. (acq 8-1-71). Net: MBS. Rep: Radio Time Sls. Format: C&W. ■ James Norwood, pres & gen mgr; Ron Norwood, prog dir; Ted Hicks, chief engr.

KSNDFM—Dec 18, 1958: 93.1 mhz; 2.6 kw. Ant 81 ft. Stereo. Sterling Recreation Organization (acq 9-22-75). Format: C&W.

Sweet Home

KFIR—Aug 7, 1968: 1370 khz; 1 kw-D. Box 611 (97386). (503) 367-4444. Campbell Bcstg Corp. (acq 1974). Net: ABC/E. Rep: Simpson/Reilly. Format: MOR, C&W. ■ Steve Campbell, pres & gen mgr; June Cook, coml mgr; Bob Greenwood, prod dir; Pete Henry, mus dir; Herb Schacher, prom mgr; Dennis Davis, news dir; Dick Meyers, chief engr. ■ Rates: \$3.90; 3.90; 3.90; —.

The Dalles

KACI—June 1955: 1300 khz; 1 kw-D. Box 516 (97508). (503) 296-2211. Radio KACI Inc. Group owner: Juniper Bcstg. Format: Contemp, C&W, MOR. ■ Gary Capps, pres; Bob Walters, gen mgr; Jim Davis, prog dir; Dick Licardi, news dir.

KCIV(FM)—Nov 28, 1968: 104.5 mhz; 32 kw. Ant 1,892 ft. Stereo. Box 104 (97058). (503) 296-4355. Leslie L. Cunningham. Format: Btlf music. Spec progs: Farm 1-5 hrs, classcl 5 hrs, C&W 4 hrs wkly. ■ Leslie L. Cunningham, owner, gen mgr & prog dir; Brian R. Schutz, sls mgr; Jim Roth, chief engr. ■ Rates: \$5; 5; 5; 5.

KODL—Oct 12, 1940: 1440 khz; 1 kw-U, DA-N. Box 741 (97058). (503) 296-2101. Larson-Wynn Inc. (acq 9-1-74). Net: CBS. Rep: Howard; Moore. Format: MOR/Rock. Spec progs: Farm 2 hrs, C&W 16 hrs wkly. ■ Brent T. Larson, pres; Al Wynn, VP & gen mgr; Roger Nichols, sls mgr; Dave Frenchin, prog dir; John Swindle, news dir; Ben L. Roth, chief engr. ■ Rates: \$6.50; 4.75; 6.50; 4.75.

Tillamook

KTIL—August 1947: 1590 khz; 5 kw-D, 1 kw-N, DA-N. Box 112 (97141). (503) Victor 2-4422. Beaver Bcstg System Inc. (acq 12-1-62). Rep: Sandeberg-Glenn; Tacher. Net: ABC/E. ■ Philip Tonken, pres; Robert Douglas, VP, gen & coml mgr; Al Berger, prog dir; Jim Clark, news dir; Mildred Davy, women's dir; Larry Brunen, chief engr.

Toledo

KTDO—Sept 26, 1960: 1230 khz; 1 kw-D, 250 w-N. Box 910, Newport (97365). (503) 336-2252. Charles Farmer (acq 1969). Net: MBS. Rep: Simpson/Reilly. Format: C&W. ■ Jim Biggs, stn mgr & chief engr; Rick Tillotson, sls mgr. Mick Owens, news & mus dir. ■ Rates: \$4.40; 3.80; 4.40; 3.80.

Woodburn

KWRC—July 10, 1964: 940 khz; 250 w-D. 698 N. Pacific Hwy (97071). (503) 981-3516. O. L. Withers, pres; Byron Stephenson, gen mgr; Mick Schiel, coml mgr; Pat Stevens, prog dir; Graeme Strickland, prom mgr; Spencer Grew, news dir; Cal Benniger, chief engr.

CSI ELECTRONICS INC.
2607 River Road
Cinnaminson, New Jersey, 08077
Telephone: (609) 786-1060

Pennsylvania

HAMILTON-LANDIS & ASSOCIATES, Inc.
NATIONWIDE MEDIA BROKERS
WASHINGTON, D. C. CHICAGO, DALLAS, SAN FRANCISCO
SELL MORE
RADIO & TELEVISION STATIONS
IN THE EAST—NEAREST OFFICE IS—
1730 K ST., N.W., WASHINGTON 20006
(202) 383-3456

Allentown

WAEB—1949: 790 khz; 1 kw-U, DA-2. Box 2727, Lehigh Valley (18001). (215) 434-4424. Rust Communications Group Inc. (group owner; acq 8-10-57). Rep: Eastman. Format: Contemp. ■ William F. Rust Jr, pres; S. Robert Ackley, gen mgr; Ronald C. Sotak, stn mgr; Jeff Frank, mus dir; Jim Hertzler, news dir; William R. Gottshall, chief engr.

WXKW(FM)—June 30, 1961: 104.1 mhz; 20 kw. Ant 87 ft. Stereo. Prog sep from AM. Format: Standards.

WEZV(FM)—See Bethlehem.

WFMZ
Beautiful Music

WFMZ(FM)—July 1947: 100.7 mhz; 12.5 kw. Ant 870 ft. Stereo. East Rock Rd. (18103). (215) 797-4530. Maranatha Bcstg Corp. (acq 3-1-65). Audio news: UPI. Rep: Selcom. Format: Btlf music. Spec progs: Ger 1 hr; classcl 19 hrs; relg 16 hrs wkly. ■ Richard C. Dean, pres, gen mgr, prog dir; Alice Wick, ctrlr; Don Wooton, chief engr; Dave Hinson, prom and sls mgr and mus dir; Paul Britlin, news dir; Kathy Yelsits, coml and traf mgr. ■ Rates: \$15; 14; 15; 10.

WHOL
Modern Country Music

WHOL—Sept 12, 1948: 1600 khz; 500 w-D, DA. 1125 Colorado St. (18105). (215) 434-4801. Empire Bcstg Inc. (acq 3-1-64). Net: ABC/E. Format: C&W. ■

Oregon, Pennsylvania Radio

See page C-1 for explanation of listings.

Ray M. Schacht, pres; Carl Stuart, gen mgr; James A. Herbert, coml mgr & chief engr; Alan J. Winkler, prom mgr; Phil May, mus dir. ■ Rates: \$13; 10.60; 13; —.

WKAP—September 1948: 1320 khz; 5 kw-D, 1 kw-N, DA-2. Box 246, Whitehall, Pa. (18052). (215) 435-9572. WKAP Inc. Group owner: Rahall. Net: ABC/I. Rep: Buckley Format: Adult Contemp. Ogden R. Davies, corp VP, bcstg; Jerry Duckett, VP, gen mgr; Harold Tower, coml mgr; Tom Moran, prog dir and prom mgr; Steve Kelly, mus dir; Alan D. Raber, news dir; Charles LaBar, chief engr. Rates: \$24; 22; 24; 20.

***WMUH(FM)**—Feb 6, 1966: 89.7 mhz; 10 w. Ant 90 ft. Box 10-B, Muhlenberg College (18104). (215) 433-5957. Muhlenberg College. Net: MBS. Format: Progressive, Top 40. ■ Jonathan Phillips, gen mgr; Phil Galasso, chief engr.

WSAN—May 24, 1923: 1470 khz; 5 kw-U, DA-N. Box 568 (18105). (215) 434-9511. Lehigh Valley Bcstg Co. (acq 6-6-50). Net: NBC. Format: Progressive. ■ Revel H. Musselman, gen mgr & chief engr; Rick Musselman, prog & mus dir.

WXKW(FM)—Listing follows WAEB.

Altoona

WFBG—Oct 30, 1924: 1290 khz; 5 kw-D, 1 kw-N. Hilltop, Logan Blvd. (16603). (814) 943-1136. Gilcom Corp. (acq 10-28-72). Net: ABC/C. Rep: Blair, Unicom Bcst Sls, Dome. Format: Contemp. ■ Edward T. Giller, pres & gen mgr; George Germann, coml mgr; Kevin O'Brian, mus dir; Don Paul, prog dir; Don Ross, news dir; Joe Jarrett Jr, chief engr. ■ Rates: \$18; 14; 18; 7.50.

WFBG-FM—Oct 17, 1960: 98.1 mhz; 30 kw. Ant 1,020 ft. Stereo. Prog sep from AM. Net: ABC/FM. Format: MOR. ■ Rates: \$8; 8; 8; 8.

WHGM(FM)—See Bellwood.

WRTA—June 12, 1946: 1240 khz; 1 kw-D, 250 w-N. Box 272 (16603). (814) 943-6112. Altoona Trans-Audio Corp. (acq 4-56). Net: ABC/I. Rep: Meeker. Format: Oldies. Spec prog: Talk 11 hrs wkly. ■ Martin F. Malarkey, pres; Louis H. Murray, exec VP; David R. Wolf, gen mgr; Tom Casey, stn mgr; Don Girard, mus dir; Karl King, news dir; Terry Macalarney, chief engr. ■ Rates: \$12.50; 10; 12.50; —.

WVAM—July 1948: 1430 khz; 5 kw-D, 1 kw-N, DA-N. Broadcast House, 2727 West Albert Dr. (16602). (814) 944-9456. Blair County Bcstrs Inc. (acq 6-7-66). Net: MBS. Rep: McGavren-Guild. Format: Contemp. Spec progs: Ital ½ hr; Pol 1 hr wkly. ■ Randolph Burdsall, pres; Denny J. Bixler, VP; Robert K. Abernathy, gen mgr; Roger Corey, prog dir; George Maifair, mus dir; Jeffrey Keith, chief engr. ■ Rates: \$8.50; 6.50; 8.50; 6.50.

WVAM-FM—July 1948: 100.1 mhz; 360 w. Ant minus 345 ft. Prog sep from AM. Format: C&W.

Ambridge

WMBA—March 1, 1958: 1460 khz; 500 w-D, DA. Box 309 (15003). (412) 266-1110. Bride Bcstg Inc. (group owner; acq 5-1-70). Net: MBS. Rep: Messina, Dome. Format: MOR. Spec progs: Black 3 hrs; Pol 5 hrs wkly. ■ John W. Bride, pres; Nick Desantis, gen mgr; Jim Ladd, opns mgr; Rick Pantale, prog and mus dir, chief engr; Don Vohar, news dir. ■ Rates: \$8.50; 8; 8; 8.

Anrville-Cleona

WAHT—Aug 4, 1968: 1510 khz; 5 kw-D, DA. Box 15, Lebanon, Pa. (17042). (717) 273-8547. Valley Communications Corp. Net: MBS. Rep: Devney. Format: MOR. Spec prog: C&W 2 hrs wkly. ■ William E. Sullivan, pres & gen mgr; Tim Burns, prog & news dir; Robert Keller, coml mgr; William Margut, chief engr.

Apollo

WAVL—Dec 13, 1947: 910 khz; 1 kw-D, Box 277 (15613). (412) G rover 2-3921. Tri-Borough Bcstg Co. Net: Keystone. ■ Cecil F. Clifton, pres, gen mgr & coml mgr; Silas West, farm dir; Andrew J. West, bus mgr; Wilkes Burley, chief engr.

Pennsylvania Radio

See page C-1 for explanation of listings.

Barnesboro

WNCC—Oct 15, 1950: 950 khz; 500 w-D. 803 Maple Ave. (15714). (814) 948-9200. WNCC Inc. (acq 1-28-60). Net: Keystone. Rep: Dome-Messervey. Spec progs: Pol 3 hrs; C&W 2½ hrs wkly. ■ J. Howard Bair, pres & chief engr; Eric M. Bauer, bus mgr; C. Elaine Bair, prog dir; Greg Buggey, news dir.

Beaver Falls



WBVP—May 25, 1948: 1230 khz; 1 kw-D. 250 w-N. Box 719 (15010). (412) 846-4100. Beaver Valley Bcstg (acq 10-1-67). Group owner: Hall. Net: ABC/I. Rep: Market 4. Format: Variety. ■ Robert M. Hall, pres; Walter G. Broadhurst, gen mgr; Bill Kelly, prog dir; Dennis Atkins, news dir; Paul Sokoll, chief engr. ■ Rates: \$9.50; 9.50; 9.50; 9.50.

WWKS(FM)—Co-owned with WBVP. May 1960: 106.7 mhz; 16.5 kw. Ant 255 ft. (CP 47 kw. Ant 520 ft). Stereo. Prog sep from AM. ■ Rates: \$10; 10; 10; 10.

***WGEV(FM)**—Nov 15, 1965: 88.3 mhz; 10 w. Geneva College (15010). (412) 846-5105. Geneva College, Board of Trustees. Net: NPR. Format: Rock. ■ Edwin Clarke, pres; C. Benjamin Hale, gen mgr & dir of bcstg.

Bedford

WAKM(FM)—Listing follows WBFD.

WABC—Aug 5, 1974: 1600 khz; 1 kw-D. Box 1 (15522). (814) 623-1171. Bedford County Broadcast Enterprises. Net: ABC/C. Format: Top 40, oldies. ■ John H. Cessna, gen mgr; Sherwood B. Hawley, prog mgr; Mark C. Bagley, mus dir; Jay B. Cessna, news dir; William H. Smith, chief engr. ■ Rates: \$2.60; 2.60; 2.60;—

WBFD—July 2, 1955: 1310 khz; 5 kw-D. Box 572 (15522). (814) 623-5131. Inquirer Printing Co. Rep: Weed. ■ John A. Biddle, pres; Hugo K. Frear, gen mgr; Glenn B. Ritchey, stn & sls mgr; George Sciranko, prog dir; Paul Q. Foor, chief engr. ■ Rates: \$8; 8; 8;—

WAKM(FM)—Co-owned with WBFD. Dec 22, 1966: 100.9 mhz; 3 kw. Ant 205 ft. Stereo. Prog sep from AM.

Bellefonte

WBLF—Aug 1, 1958: 970 khz; 500 w-D. Box 88 (18603). (814) 355-4751. Bellefonte Bcstg Co. Inc. Group owner: Allegheny Mtn. Net. Net: MBS, Allegheny Mtn. Format: MOR. ■ Cary H. Simpson, pres; James F. Kerschner, gen mgr; Ruth M. Thomas, news dir; Earl Pennington, prog dir; J. G. Daugherty, chief engr. ■ Rates: \$6.90; 4; 6.90;—

Bellwood

WHGM(FM)—March 28, 1970: 103.9 mhz; 250 w. Ant 870 ft (CP 225 w. Ant 908 ft). Box 609, Altoona, Pa. (16603). (814) 943-2607. John R. Powley. Format: Btlf mus, relig. ■ John R. Powley, gen mgr & chief engr; Sandra B. Powley, prog dir.

Berwick

WBRX—Aug 1, 1957: 1280 khz; 1 kw-D. Box 387 (18603). (717) 752-4546. Berwick Bcstg (acq 9-1-66). Net: Keystone. Format: MOR. ■ Edward R. Newman, pres; John J. Wellenhofer, VP & gen & coml mgr; William Kisbaugh, prog dir; Tony Hogg, chief engr.

Bethlehem

WEZV(FM)—Listing follows WGPA.

WGPA—Feb 14, 1946: 1100 khz; 250 w-D. Box 111, 428 Brodhead Ave. (18016). (215) 866-8074. The Holt Corp of Pa. Inc. (acq 1-12-73). Net: ABC/E. Rep: McGavren-Guild. Format: MOR. ■ Arthur H. Holt, pres

& gen mgr; Arthur White, stn mgr; Robert G. Wolken, prog dir; Gordon Holt, mus dir; Harrison Knerr, news dir; Gilbert Akoyd, chief engr.

WEZV(FM)—Co-owned with WGPA. Feb 14, 1946: 95.1 mhz; 11 kw. Ant 630 ft. Format: Btlf mus. ■ Robert Grayson, coml mgr; Paul Galgon, prom mgr; Kevin Sanford, news dir.

***WLVR-FM**—May 8, 1973: 91.3 mhz. 10 w. Ant 99 ft. Lehigh Univ. (18015). (215) 691-0188. Lehigh Univ. Format: Progs. ■ Chad Paul, gen mgr.

Bloomsburg

WCNR—Sept 26, 1947: 930 khz; 1 kw-D. 125 W. Main St. (17815). (717) 784-1200. Columbia Montour Bcstg Co. Inc. (acq 4-30-66). Net: ABC/I. Rep: Selective Bcst Adv. Format: Contemp, MOR. ■ Ed Darlington, pres & gen mgr; Joe Darlington, coml mgr; Carey Williams, prog dir; Carl Conner, prom mgr; Richard Heller, news dir; Robert Fulton, chief engr.

WHLM—1947: 550 khz; 1 kw-U. DA-2. 107 W. Main (17815). (717) 784-5500. Bloom Radio, div Magee Industrial Enterprises. Net: NBC. Rep: Dome. Format: Contemp, MOR, talk. ■ James Magee, pres; Robert Sweppenheiser, gen mgr; Bruce Musser, prom mgr; L. J. Pat Campbell, coml mgr; Thomas Benintende, prog dir; Tom Benson, mus dir; Ed Edwards, news dir; Tony Hogg, chief engr.

WHLM-FM—September 1956: 106.5 mhz; 8.8 kw horiz; 4.8 kw vert. Ant 600 ft horiz, 540 ft vert (CP 88 kw. Ant 570 ft). Dups AM 100%.

Boyetown

WBYO(FM)—Oct 31, 1960: 107.5 mhz; 20 kw. Ant 300 ft. Stereo. Box 177 (19512). (215) 369-1075. Boyetown Bcstg Inc. Format: Religious. Spec progs: C&W 17 hrs; Pa. Dutch 1 hr wkly. ■ David G. Hendricks, pres, prog dir & gen mgr; Mrs. Nedra Hendricks, coml mgr; Wilmer Borneman, chief engr. ■ Rates: \$5; 5; 5; 5.

Braddock

WLOA—June 1947: 1550 khz; 1 kw-D. 1233 Braddock Ave. (15104). (412) 351-3030. Matta Bcstg Co. Rep: Groskin. Format: Soft MOR. ■ William J. Matta, pres; George Baker, news dir; Fred Sand, chief engr. ■ Rates: \$19; 19; 19; 19.

WLOA-FM—June 1959: 96.9 mhz; 60 kw. Ant 520 ft. Stereo. Dup AM 100%. ■ Rates same as AM.

Bradford

WESB—April 1947: 1490 khz; 1 kw-D. 250 w-N. Box 545 (16701). (814) 368-4141. Radio Station WESB. ■ T. R. Bromeley, mgng partner; Glenn Flynn, coml mgr; Kevin Kelley, mus dir; William Winn, prog & news dir & chief engr; James Sheffer, prom mgr. ■ Rates: \$5.85; 5.85; 5.85; 5.85.

Brownsville

WASP—Aug 2, 1968: 1130 khz; 5 kw-D. DA, 1 kw-CH. Box 270 (15417). (412) 785-3450. Brownsville Inc. Format: C&W. Spec progs: Talk 10 hrs; Pol 1½ hr wkly. ■ D. C. Loughry, pres & gen mgr & chief engr; Robert Williams, opns dir; David Bridges, prog and mus dir.

Butler

WBUT—March 14, 1949: 1050 khz; 250 w-D. Box 1645 (16001). (412) 287-5778. WBUT Inc. (acq 4-18-64). Rep: Dome-Messervey. Format: MOR. Spec prog: C&W 2 hrs wkly. ■ Larry M. Berg, pres & gen mgr; Guy A. Travaglio, sls mgr; Robert Natili, prog dir & news dir; George Foy, chief engr. ■ Rates: \$5.35; 5.35; 5.35; 5.35.

WBUT-FM—March 14, 1949: 97.7 mhz; 720 w. Ant 290 ft. Dups AM 85%. ■ Rates same as AM.

WISR—Sept 26, 1941: 680 khz; 250 w-D. Box 151 (16001). (412) 283-1500. Butler Bcstg Inc. Format: MOR, talk. ■ Joel W. Rosenblum, pres & gen mgr; J. Victor O'Brien, coml mgr; Warren Ihlentfeld, prog, mus & news dir; Gerald D. Coleman, pln svc dir; Lorraine C. Laconi, office mgr; Paul F. Rex, chief engr. ■ Rates: \$5; 5; 5; 5.

California

***WVCS(FM)**—May 1974: 91.9 mhz; 10 w. California

State College (15149). (412) 938-3000. California State College. Format: Progs, variety. Spec prog: Black 5 hrs. ■ Louis Romero, stn mgr; Gary Persons, chief engr.

Canonsburg

WARO—Nov 28, 1957: 540 khz; 250 w-D. DA. Box 191 (15317). (412) 531-8800. Universal Communications of Pittsburgh Inc. (acq 5-67). Group owner: Universal. Rep: Universal Bcstg. Format: Relig. Spec prog: Pol 1 hr wkly. Lawrence Brandon, pres; Ronald Dagg, gen mgr. Rates: \$11; 9; 11;—

Carbondale

WC DL—January 1950: 1440 khz; 5 kw-D. Salem Rd. (18407). (717) 282-2770. Carbondate Bcstg Inc. Format: Variety. Spec progs: Pol 7 hrs; C&W 11 hrs wkly. ■ Robert G. Adams, pres; Marjorie Zaposky, gen mgr; Paul Oles, coml mgr; Joseph Martin, prog & news dir; Andrew Fundak, chief engr. ■ Rates: \$5; 5; 5;—

WC DL-FM—Dec 22, 1964: 94.3 mhz; 330 w. Ant 770 ft. Dup AM 60%. ■ Rates: \$5; 5; 5; 5.

Carlisle

***WDCV-FM**—Not on air, target date unknown: 88.3 mhz; 10 w. Box 640 (17013). (717) 249-2200. Trustees of Dickinson College.

WHYL—April 1948: 960 khz; 5 kw-D. DA. Box 219 (17013). (717) 249-1717. Richard F. Lewis Jr. Inc. of Carlisle (acq 1952). Group owner: Mid-Atlantic. Net: MBS. Rep: PRO/Meeker; Dome. Format: MOR. ■ William M. Allison, gen & coml mgr; Ron Loy, gen prom dir; Richard Bear, AM prog dir; Kirk Wilson, news dir; Brian Greenway, chief engr.

WHYL-FM—1959: 102.3 mhz; 3 w. Ant 165 ft. Dups AM 30%. Format: C&W. ■ James Mills, FM prom dir.

WIOO—July 8, 1965: 1000 khz; 1 kw-D. Box 399 (17013). (717) 243-1200. WIOO Inc. Net: ABC/E. Rep: Market 4 Radio. Format: Contemp, oldies, Top 40. Spec prog: C&W 2 hrs wkly. ■ Harold Swidler, pres & gen mgr; Everlyn Trimmer, office mgr; R. J. Harris, prog dir & prom mgr; Mike Kurtis, mus dir; D. St. Clair, news dir; Curt Allen, chief engr.

Carnegie

WZUM—July 1962: 1590 khz; 1 kw-D. DA. 201 Ewing Ave., Pittsburgh (15205). (412) 922-0550. Hickling Bcstg Corp. (acq 9-75). Net: MBS. Format: Contemp, Polish, variety. Spec progs: Lithuanian ½ hr; Greek ½ hr wkly. ■ Robert K. and Dolores M. Hickling, Michael Samara, et al, owners; Sandra Craven Stewart, mgr; Ron Capon, chief engr.

Central City

WCCS(FM)—Oct 19, 1972: 101.7 mhz; 500 w. Ant 650 ft. Box 100 (15926). (814) 754-4602. Central Broadcasting Co. Format: Easy Istng 71%, Relig 26%, Polish 3%. ■ Benjamin F. Thomas, pres; Richard B. Elliott, Jr., gen mgr; Greg Chiappelli, prog dir; Bill Bridgewater, mus dir and chief engr. ■ Rates: \$4.60; 4.60; 4.60; 4.60.

Chambersburg

WCBG—1956: 1590 khz; 5 kw-D, 1 kw-N, DA-N. Radio Hill (17201). (717) 263-4131. Four States Broadcasting Station Inc. (acq 1964). Net: NBC. Rep: Masla, Dome. Format: Top 40. ■ Norman E. Messner, pres; Molly Darr Messner, VP and gen mgr; Robert Huffman, prog dir; Michael McGough, mus dir; Margaret H. Wright, traf dir; Charles Hubley, loc sls mgr; Charles Hennegan, news dir; Harry M. Taylor, chief engr. ■ Rates: \$7.50; 7.50; 7.50; 7.50.

WCHA—Aug 11, 1946: 800 khz; 1 kw-D. Professional Arts Bldg. (17201). (717) 264-7121. Chambersburg Bcstg Co. ■ John S. Booth, pres; Earl P. Strine, gen mgr; David Myers, coml mgr; Rod Burnham, prog dir; Marlin Myers, news dir; Chris Snively, chief engr. ■ Rates: \$7.50; 7.50; 7.50;—

WCHM(FM)—Co-owned with WCHA. April 15, 1948: 95.1 mhz; 2.8 kw. Ant 240 ft. Stereo. Prog sep from AM.

Charleroi

WESA—1948: 940 khz; 250 w-D. Box 584 (15022). (412) 483-6551. Laubach Radio Properties Inc. (acq 4-23-65). Format: MOR. Spec progs: Pol 2 hrs; Black

½ hr wkly. ■ John L. Laubach Jr., pres; Carl J. Marcocci, exec VP; Jay Morton, stn mgr; Gary Persons, prog dir; Bob Keller, news dir; Vern Evans, chief engr.

WWFM(FM)—July 10, 1967: 98.3 mhz; 3 kw. Ant 230 ft. Horiz, 225 ft. vert. Dups AM 100%.

Chester

WEZZ—September 1947: 1590 khz; 1 kw-U, DA-N, 3500 Edgmont Ave. (19015). (215) 874-4321. Radio Del-Val Inc. (acq 10-25-65). Group owner: Mediamerica. Format: Talk. Spec progs: Ital 1 hr; Pol 2 hrs wkly. ■ Ernest Tannen, pres & gen mgr; Wynn Moore, prog dir; Don Merriman, coml & prom mgr; Skip Powers, news dir; Bruce Jacobs, chief engr.

WVCH—April 4, 1948: 740 khz; 1 kw-D, 3rd & Ave. of the States (19013). (215) 872-8861. WVCH Communications (acq 10-74). Net: ABC/E. Format: MOR, relig. ■ Thomas H. Moffitt, pres, gen & coml mgr; Paulynne Haber, prog dir; Ted Boyda, mus dir; John Scala, prom mgr; Tim McFarland, news dir; Charles Robinson, chief engr. ■ Rates: \$11.50; 11.50; 11.50; 11.50.

Clarion

WWCH—June 12, 1960: 1300 khz; 500 w-D. Box 17* (16214). (814) 226-8600. Clarion County Bcstg Corp Rep: Dome-Messervey. Format: MOR. ■ William C. Hearst, pres; Norman Wallace, gen, coml & prom mgr & prog & news dir; Leonard Schmadier, chief engr.

Clearfield

WCFA—1947: 900 khz; 1 kw-D. Box 1032 (16830). (814) 765-5541. Clearfield Bcstrs Inc. Group owner: Progressive Publishing. Net: ABC/C. Rep: Market 4 Radio, Dome-Messervey. Format: Top 40. ■ W. K. Ulerich, pres; Carl A. Falvo, exec VP & gen mgr; Margaret Nemeth, coml mgr; John Ianaro, sls mgr; Rod Dormire, news dir; Thomas Wonderling, chief engr. ■ Rates: \$5.10; 5.10; 5.10; —

WCFA-FM—July 12, 1967: 93.5 mhz; 3 kw. Ant 98 ft. Dups AM 22%. Net: ABC/FM. Format: Easy Lstng. ■ Patty Gross, prog dir. ■ Rates: \$2.75; 2.75; 2.75; 2.75.

Coatesville

WCOJ—Nov 29, 1949: 1420 khz; 5 kw-U, DA-N. Box 231 (19320). (215) 384-2100. Chester County Bcstg Co. Format: MOR. ■ Louis N. Seltzer, pres & chief engr; William S. Halpern, gen mgr; Donald G. Kimes, coml & prom mgr; Art Douglas, prog dir.

Columbia

WHEX—Nov 1, 1957: 1580 khz; 500 w-D. 355 Poplar St. (17512). (717) 684-2591. Hix County Radio (acq 8-75). Rep: Mediamerica, Walton. Format: Solid gold, farm. ■ Sy Levy, gen mgr; Bill Rife, coml & prom mgr; Dave Pennington, prog & news dir; Bob Stevens, mus dir; John Hogg, chief engr.

Connellsville

WCVI—April 23, 1947: 1340 khz; 1 kw-D, 250 w-N, Box 838, 133 E. Drawford Ave. (15425). (412) 628-4600. Connellsville Bcstrs Inc. (acq 6-28-51). Net: ABC. Rep: Dome-Messervey. Format: C&W, MOR, Top 40. Spec prog: Pol 2 hrs wkly. ■ William Ellis, gen & coml mgr; Phil Cryster, prog dir; Ron Allen, news dir.

Corry

WWCB—April 2, 1955: 1370 khz; 1 kw-D, 500 w-N, DA-N. Box 4 (16407). (814) 664-2168. Corry Bcstg (acq 1974). Rep: Dome. Format: Diversfd. Spec progs: C&W 18 hrs; Classical 1 hr; Broadway 1 hr wkly. ■ Arthur Arkelian & Robert Shupala, owners.

Coudersport

WFRM—May 1953: 600 khz; 1 kw-D, 9 South Main St. (16915). (814) 274-8600. Farm & Home Bcstg Co. Group owner: Allegheny Mtn. Net. Net: MBS, Allegheny Mtn. Net. Rep: Dome. Format: Contemp. ■ Cary H. Simpson, pres; Phyllis Craley, stn & coml mgr; David Lent, prog dir; Karmon Wood, mus dir; Edward Easton, news dir; Martin Weiss, chief engr. ■ Rates: \$6.90; 6.90; 6.90; —

Danville

WPGM—June 1963: 1570 khz; 1 kw-D, 8 E. Market

St. (17821). (717) 275-1570. Montrose Bcstg Corp. (acq 1-6-64). Audio news: APR. Format: Relig, blfl music. ■ W. Douglas Roe, pres; Lawrence Souder, gen mgr, prog & news dir; Kevin G. Ferris, prom mgr; Arthur H. Brown, mus dir; John Rejmer, chief engr.

WPGM-FM—Sept 6, 1968: 96.7 mhz; 340 w. Ant 760 ft. Stereo. Dups AM 75%.

Doylestown



WBUX—1948: 1570 khz; 5 kw-D, DA. Box 512 (18901). (215) 348-3583. Central Bucks Bcstg Co. (acq 8-1-75). Rep: PRO/Meeker. Format: MOR. ■ George Pleasants, gen mgr; Tom Calvin, prog dir; Bill Shupert, opns mgr. ■ Rates: \$11; 11; 11; 11.

DuBois

WCED—February 1941: 1420 khz; 5 kw-D, 500 w-N, DA-N, 80 N. Park Place (15801). (814) 371-6100. Tri-County Bcstg Co. Net: CBS. Rep: Devney Dome-Messervey. ■ Jason S. Gray, pres; George W. Williams, gen & coml mgr; Ed Paul, prog dir; Bev Betton, prom mgr; Eric Decker, news dir; Frank Humphreys, chief engr.

WCED-FM—1948: 102.1 mhz; 11.5 kw. Ant 640 ft. Progs sep from AM. Format: C&W.



WDBA(FM)—1975: 107.3 mhz; 50 kw. Ant 500 ft. Stereo. 28 W. Scribner Ave. (15801). (814) 371-1330. DuBois Area Bcstg Co. Inc. Rep: Quality Programming. Audio news: APR. Format: Blfl mus, relig. ■ Ralph J. Boyer, pres; Donald B. Shobert, gen mgr; Paul Dillon, coml mgr; Charles Moore, prom mgr; Gerald E. Meloon. ■ Rates: \$4.90; 4.90; 4.90; 4.90.

Easton

WEEX—May 1956: 1230 khz; 1 kw-D, 250 w-N, DA-D. Box 190 (18042). (215) 258-6155. WEEX Inc. Net: ABC/C. Rep: Torbet, Dome. Format: Top 40. ■ Donald W. Diehl, pres; Thomas W. Wolfe, gen mgr; Bill Robbins, prog dir; Mickey Hagerly, mus dir; Walt Mitchell, news dir; Steve Boyer, chief engr. ■ Rates: \$10; 8.25; 10; 8.25.

WQQQ(FM)—Co-owned with WEEX. June 1950: 99.9 mhz; 50 kw. Ant 450 ft. Stereo. Prog sep from AM. (215) 258-8775. Format: Blfl mus. ■ Rates: \$11.80; 11.80; 11.80; 8.75.

WEST—1936: 1400 khz; 1 kw-D, 250 w-N, 436 Northampton St. (18042). (215) 258-6131. Sound Communications Corp. (acq 4-1-73). Net: CBS. Rep: H-R/Stone. Format: MOR. ■ Frank G. Stisser, pres; Theodore W. Pierce, gen mgr; Lloyd O. Nicely, coml mgr; Joseph Prentice, prog mgr; Eugene Bethman, prom mgr/mus dir; Timothy Cain, news dir; Steve Boyer, chief engr.

WLEV(FM)—Co-owned with WEST. 1948: 96.1 mhz; 50 kw. Horiz, 47 kw. vert. Ant 500 ft. Prog sep from AM. Format: Contemp.

***WJRH(FM)**—March 1953: 90.5 mhz; 10 w. Stereo. Box 505, College Station (18042). (215) 258-5437. Lafayette College. Net: ABC/FM. Format: Progressive, variety. ■ Irving J. Goldstein, pres and gen mgr.

WLEV(FM)—Listing follows WEST.

WQQQ(FM)—Listing follows WEEX.

East Stroudsburg

***WESS(FM)**—March 10, 1971: 88.7 mhz (CP 90.3 mhz); 10 w. Ant minus 160 ft. Student Center, Box 198 (18301). (717) 421-9833. Student Activity Association of East Stroudsburg State College. Net: NPR. Format: Progs, educ. ■ David M. Arndt, stn opns mgr.

Pennsylvania Radio

See page C-1 for explanation of listings.

Ebensburg

WEND—May 25, 1961: 1580 khz; 1 kw-D, 250 w-N, 120 S. Center St. (15391). (814) 472-8801. WEND Inc. (acq 4-1-72). Net: MBS. Rep: Dome-Messervey. Format: Top 40. Spec prog: Pol 1 hr wkly. ■ Robert E. Civis, co-owner, stn & sls mgr; Francis Krug, co-owner, chief engr.

WYIQ(FM)—July 15, 1962: 99.1 mhz; 45 kw. Horiz, 43 kw. vert. Ant 520 ft. (CP 50 kw. Ant 500 ft). Stereo. Box 787 (15907). (814) 539-8779. Cambria County Bcstg Co. (acq 4-1-72). Group owner: Allegheny Mtn. Net. Net: Allegheny Mtn. Rep: Selcom, Dome. Format: C&W. Spec prog: Pol 3 hrs wkly. ■ Cary H. Simpson, pres; David C. Hill, gen mgr; David McDermott, coml mgr; Robert McCabe, prog dir; Ronald Kauffman, mus dir; Fritz Gorba, news dir; Robert Lynn, chief engr. ■ Rates: \$10; 8; 10; 6.

Elizabethtown

WPDC—May 1958: 1600 khz; 500 w-D. Box 1600 (17022). (717) 367-7700. Smith Communications Inc. (acq 11-70). Format: MOR. ■ Charles C. Smith, pres, gen mgr & prog dir; D. L. Salter, chief engr. ■ Rates: \$6; 6; 6; 6.

WPDC-FM—April 30, 1964: 106.7 mhz; 20 kw. Horiz, 10 kw. vert. Ant 500 ft. Dups AM 70%.

Ellwood City

WFEM(FM)—Aug 4, 1968: 92.1 mhz; 3 kw. Ant 300 ft. 226 Fifth St. (16117). (412) 758-4527. Scott Bcstg of Pa. Inc. Group owner: Great Scott Stns. Rep: Market 4, Dome. Format: C&W. Spec prog: Farm 1 hr wkly. ■ Herbert Scott, pres; Lawrence A. Conti Jr., prog dir, gen & coml mgr; Richard Whiting, mus dir; Thomas Krestel, news dir; Jim Douglas Zagrodnick, chief engr. ■ Rates: \$6.50; 6.50; 6.50; 6.50.

Emporium

WLEM—March 2, 1958: 1250 khz; 1 kw-D. Box 310 (15834). (814) 483-3712. Emporium Bcstg Co. (acq 1-27-71). Rep: Dome-Messervey, Market 4. Format: Variety Spec prog: C&W 1 hr wkly. ■ Anne L. Spotts, pres; Rita Rolf, coml mgr; Debra Lanzillo, sls mgr; Jeannine A. Spotts, news dir; Vito Lanzillo, gen mgr; chief engr.

Ephrata

WGSB—July 26, 1955: 1310 khz; 5 kw-D, DA. 44 Bethany Rd. (17522). (717) 733-2226. Garden Spot Bcstrs Inc. Net: ABC/E. Rep: Selcom. Format: MOR. Spec prog: Pa. Dutch ½ hr wkly. ■ Samuel R. Youse, pres & gen mgr; John P. Weis, stn and coml mgr. ■ Rates: \$12.50; 12.50; 12.50; —

WIOV(FM)—Co-owned with WGSB. Nov 9, 1962: 105.1 mhz; 50 kw. Ant 500 ft. Stereo. Box 105 (17522). Prog sep from AM. Net: ABC/E. Format: C&W. Spec progs: Farm 10 hrs; Sp 1 hr wkly. ■ Rates: \$15; 15; 15; 15.

Erie

WCCK(FM)—Listing follows WWGO.

***WERG(FM)**—Dec 1, 1972: 89.1 mhz; 10 w. Gannon College, Box 192 (16501). Gannon College. Format: Variety Spec progs: Pol 3 hrs; Black 10 hrs; Italian 2 hrs wkly. ■ Marc A. Anderson, pres and gen mgr.

WHYP—See North East.

WJET—1951: 1400 khz; 1 kw-D, 250 w-N, 1635 Ash St. (16503). (814) 455-2741. Jet Bcstg Inc. Group owner: Myron Jones. Rep: Eastman, Dome-Messervey. Regional Reps. Format: Contemp. ■ Myron Jones, pres; Rick Hanna, gen mgr; Sandy Beach, prog dir; Kay Jones, mus dir; Matthew Locke, news dir; John Kanzius, chief engr. ■ Rates: \$22; 20; 22; 17.

WLVU(FM)—Listing follows WWYN.

***WQLN-FM**—January 7, 1973: 91.3 mhz; 35 kw. Ant 500 ft. 8425 Peach St. (16509). (814) 868-4654. Public Bcstg of N.W. Pennsylvania. Net: NPR. Format: Variety Spec progs: Farm 20 hrs; Sp 2 hrs; children 2 hrs wkly. ■ Robert Chitester, pres; David H. Roland, dir of bcstg; Paul Brown, prog mgr; Art Martinucci, dir

Pennsylvania Radio

See page C-1 for explanation of listings.

comm aff; Don Hain, dir engr.

WRIE—1947: 1330 khz; 5 kw-U, DA-2. Box 2072 (16512). (814) 796-6777. Radio Erie Inc. (acq 11-1-67). Net: ABC/E. Rep: McGavren-Guild. Format: MOR. ■ F. Brady Louis, gen mgr; F. Bill Erb, stn mgr; Norm Pringle, prog & mus dir; Bob Hughes, news dir; Ruth Collander, prom mgr; Ken Husband, chief engr.

WWGO—April 21, 1935: 1450 khz; 1 kw-D, 250 w-N. Box 1184 (16501). (814) 456-7078. Burbach Bcstg Co. (acq 9-67). Net: ABC/I. Rep: Katz. Format: C&W. Spec prog: Ital 2 hrs wkly. ■ John L. Laubach, pres; Carl Marcocci, VP & gen mgr; Ronald P. Smith, stn mgr; Ron Rondo, prog dir; Rick Schaeffer, news dir; Joe Allison, chief engr.

WCCK(FM)—Co-owned with WWGO. May 1, 1969: 103.7 mhz; 50 kw. Ant 500 ft. Stereo. Prog sep from AM. Net: ABC/FM. Format: Contemp.

WWYN—1941: 1260 khz; 5 kw-U, DA-2. 3204 State St. (16508). (814) 456-2096. WERC Inc. (acq 1959). Group owner: Goldman. Net: NBC. Rep: Masia, King. Format: Talk. ■ Simon Goldman, pres; Art Arkelian, exec VP & gen mgr; Bob Cannon, prog dir; Wayne Smith, news dir; George MacMurdy, chief engr.

WLVU(FM)—Co-owned with WWYN. 1949: 99.9 mhz; 9.7 kw. Ant 400 ft. Stereo. (814) 459-2597. Prog sep from AM. Net: ABC/FM. Format: Good music. Spec progs: Ital 3 hrs; Pol 2 hrs wkly.

Everett

WSKE—March 15, 1963: 1050 khz; 250 w-D. Box 187 (15537). (814) 652-2600. Radio Everett Inc. (acq 7-1-67). Net: ABC/E. Format: C&W. ■ Melvin "Shorty" King, pres & coml mgr; Sandra King, gen & prom mgr & prog dir; John Shambach, news dir; Fran Little, chief engr. ■ Rates: \$2.50; 2.50; 2.50; 2.50.

Farrell

WFAR—Oct 3, 1954: 1470 khz; 1 kw-D, 500 w-N, DA-N. 147 Radio Rd. (16121). (412) 346-4171. Sanford A. Schafitz. Rep: Dome-Messervey, Regional Reps. Format: Contemp. Spec progs: Ital 3 hrs; Sp 3 hrs; Pol 10 hrs; Black 6 hrs wkly. ■ Sanford Schafitz, owner; Albert Zippay, gen mgr; Robin Scott, mus dir; Jean Rocco, prog dir; Louise Gray, coml mgr; Tony Costanza, prom mgr; Harold Winn, news dir; Sandy Aron, chief engr.

Franklin

WFRA—April 13, 1958: 1450 khz; 1 kw-D, 250 w-N. Box 908 (16323). (814) 432-2188. Northwestern Pennsylvania Bcstg Co. Inc. Net: MBS. Format: Contemp & MOR. ■ Robert H. Sauber, pres, gen & coml mgr & chief engr; Roy C. McIntyre, loc sls mgr; Linda Lewis, news dir. ■ Rates: \$6.40; 6.40; 6.40; 6.40.

WVEN(FM)—Co-owned with WFRA. March 5, 1971: 99.3 mhz; 3 kw. Ant 230 ft. Dups AM 100%. ■ Rates same as AM.

Freeland

WACM(FM)—Not on air, target date unknown: 103.1 mhz; 400 w. Ant 730 ft. 1730 M St., Suite 910, Washington (20036). Mountain Bcstg. Format: C&W.

Gettysburg

WGET—Aug 27, 1950: 1320 khz; 1 kw-D, 500 w-N, DA-2. Box 280 (17325). (717) 334-3101. Times and News Publishing Co. Net: MBS. ■ Richard E. Selby, gen mgr; Gilson C. Sheffer, prog dir; Lester Blair, chief engr.

WGET-FM—July 5, 1962: 107.7 mhz; 10 kw. Ant 350 ft. Stereo. Prog sep from AM.

Greencastle

WKSL(FM)—May 6, 1967: 94.3 mhz; 1.7 kw. Ant 360 ft. Box 10 (17225). (717) 597-7151. Greencastle Bcstg Inc. Format: C&W, MOR. Spec progs: Ger 5 hrs; Pol 4½ hrs; black ½ hr wkly. ■ Benjamin F. Thomas, prop & gen mgr; Robert L. Thomas, coml mgr & mus dir; Ben F. Thomas, Jr., news dir; Harold D. Kuhns, chief engr.

Greensburg

WHJB—Oct 28, 1934: 620 khz; 1 kw-D, 500 w-N, DA-2. 245 Brown St. (15601). (412) 834-0600. WHJB Radio (acq 1-1-62). Net: MBS. Rep: Dome. Format: oldies, Top 40. Spec prog: Pol 2 hrs wkly. ■ Melvin A. Goldberg, pres; Joseph A. McGranaghan Jr., gen and coml mgr; Barry Banker, prog dir; Jim Taylor, mus dir; David Raye, prom mgr; Robert Haberkost, chief engr. ■ Rates: \$11.50; 9.75; 11.50; 8.

WOKU-FM—Co-owned with WHJB. July 8, 1968: 107.1 mhz; 3 kw horiz, 2.95 kw vert. Ant 300 ft. Dups AM 20%. Format: Oldies. ■ Rates: \$6.75; 5.75; 6.75; 5.

Greenville

WGRP—Sept 19, 1959: 940 khz; 1 kw-D, DA. Box 189 (16125). (412) 588-8900. Greenville Bcstg Co. Rep: Dome-Messervey. Spec progs: C&W 15 hrs wkly. ■ Kenneth B. Anderson, gen mgr & chief engr; Merle G. Anderson, stn mgr & prog dir; Dennis A. Huff, coml mgr; Tom Sliwinski, news dir. ■ Rates: \$6.50; 6.50; 6.50; 6.50.

WGRP-FM—July 1965: 107.1 mhz; 3 kw. Ant 240 ft. Dup AM 65%. ■ Rates: \$5; 5; 5; 5.

***WTGP(FM)**—Sept 3, 1971: 88.1 mhz; 10 w. Stereo. Thiel College (16125). (412) 588-7700. Thiel College. Format: Progs, variety. ■ Jim Cunningham, gen mgr.

Grove City

WEDA-FM—Sept 10, 1962: 95.1 mhz; 3 kw. Ant 195 ft. 125 S. Broad St. (16127). (412) 458-6500. WEDA Inc. ■ James V. Perry, pres & gen mgr; Mary Emanuele, coml & prom mgr; Michael Troy, prog dir & news dir; Robert Hoag, chief engr. ■ Rates: \$5; 5; 5; 5.

***WSAJ**—April 1920: 1340 khz; 100 w-SH. Grove City College (16127). (412) 245-9352. Grove City College. Net: IBS. Format: Variety, Top 40, progs, rock. ■ Charles S. MacKenzie, pres; Jeffrey D. Harman, gen mgr.

***WSAJ-FM**—September 1968: 89.5 mhz; 10 w. Dups AM.

Hanover

WHVR—Jan 9, 1949: 1280 khz; 5 kw-D, 500 w-N, DA-2. Box 234 (17331). (717) 637-3831. Radio Hanover Inc. Format: MOR. ■ John D. Bare, pres & gen mgr.

WYCR(FM)—Co-owned with WHVR. Dec 22, 1962: 98.5 mhz; 10.5 kw. Ant 930 ft. Stereo. Prog sep from AM. Format: Rock. ■ John W. Lawrence, stn mgr.

Harrisburg

WCMB—Feb 19, 1948: 1460 khz; 5 kw-U, DA-N. Box 3433 (17105). (717) 234-3005. Hudson Bcstg Corp. (acq 1-1-59). Group owner: McKenna. Net: ABC/I. Rep: Buckley. Format: MOR. Spec progs: Black 11 hrs; C&W 7 hrs; talk 5 hrs wkly. ■ Ed K. Smith, VP & gen mgr; Jacques Schmitt, coml mgr; Bob Janis, ops dir; David Hunter, news dir; John Thomas, chief engr. ■ Rates: \$26; 15; 19; 9.

WSFM(FM)—Co-owned with WCMB. July 1965: 99.3 mhz; 3 kw. Ant 235 ft. Stereo. Prog sep from AM. Net: ABC/FM. Format: MOR Standards. ■ David Herlihy, FM mgr. ■ Rates: \$6; 6; 6; 6.

WFEC—May 28, 1945: 1400 khz; 1 kw-D, 250 w-N. Box 1172 (17101). (717) 238-5122. Scott Bcstg Corp. (acq 10-15-68). Group owner: Great Scott Stns. Net: ABC/C. Rep: McGavren-Guild. Format: Top 40. ■ Herbert Scott, pres; Robert Maley, gen mgr; Bob Alexander, ops mgr; Ralph S. Hartman, gen sls mgr; Richard W. Irwin, prog dir; Michael Burgess, news dir; William O. Kuntz, dir of engr. ■ Rates: \$15; 10; 15; 7.

WHP—1924: 580 khz; 5 kw-U, DA-N. 3300 N. Sixth St. (17110). (717) 238-2100. TWX 510-650-0816. WHP Inc. Net: CBS. Rep: Katz. Format: MOR. Spec progs: Black ½ hr; C&W 1½ hrs; Farm 2½ hrs wkly. ■ Joseph M. Higgins, pres & gen mgr; Donald C. Yeiser, gen sls mgr; John Bowling, sls mgr; Maurice Gannaway, prog dir & dir of engr; John Sebastian, news dir.

WHP-FM—1946: 97.3 mhz; 14 kw. Ant 840 ft. Dups AM 10%. Format: Btlf mus. ■ WHP-TV affil.

WKBO—1922: 1230 khz; 1 kw-D, 250 w-N. 411 S. 40th St. (17113). (717) 561-0710. Harrea Bcstrs Inc.

(acq 8-71). Rep: Torbet. Format: Rock, contemp. Spec prog: Black 1½ hrs wkly. ■ Michael M. Rea, pres; J. Albert Dame, VP & gen mgr; Robert Maley, coml mgr; Robert A. Klepic, prog dir; Kenneth Adams, mus dir; Tom Hal German, news dir; Gary Magill, chief engr.

***WMSF(FM)**—Sept 30, 1962: 94.9 mhz; 50 kw. Ant 205 ft. Stereo. 24 S. 2nd St. (17101). (717) 238-6763. Market Square Presbyterian Church. Format: Classcl, Relig. Spec progs: Jazz 3 hrs; progressive 2 hrs; black 2 hrs; Ger 2 hrs; community 3 hrs; talk & shows 2 hrs wkly. ■ Rev. Kendall Link, communications/stn mgr; Marian M. Warden, prog dir; Kenneth L. Landis, mus dir; David Blunk, news dir; Robert Young, chief engr.

WRHY(FM)—See Starview.

WSFM(FM)—Listing follows WCMB.

WTPA-FM—104.1 mhz; 10 kw. Ant 670 ft. 3235 Hoffmann St. (17105). (717) 238-7171. Newhouse Bcstg Corp. (group owner). ■ WTPA-TV affil.

Havertown

***WHHS(FM)**—Dec 6, 1949: 89.3 mhz; 10 w. Ant 75 ft. Mill Rd. & Leedom Ave. (19083). (215) Hilltop 6-7111. School District of Havertown Township. Net: IBS. Format: Ed. ■ Dr. Harry R. Henly, supt of schools; Samuel Klugman, gen mgr.

Hazleton

WAZL—Dec 19, 1932: 1490 khz; 1 kw-D, 250 w-N. 706-12 Hazleton National Bank Bldg. (18201). (717) 454-3531. Hazleton Bcstg Co. (acq 12-1-47). Net: NBC. Rep: Market 4. Format: Contemp. ■ Victor C. Diehm, bd chmn; Victor C. Diehm, Jr., pres & gen mgr; Joe Kalie, prog dir; David Diehm, dir of sls; Jim Boyle, news dir; Ron J. Gillenardo, chief engr. ■ Rates: \$7.20; 5.80; 7.20; 5.80.

WVCD(FM)—Co-owned with WAZL. 1949: 97.9 mhz; 25 kw. Ant 660 ft. Stereo. Progs sep from AM. Format: Btlf mus. ■ William Waschko, prod mgr. ■ Rates: \$9; 8; 9; 8.

Hershey

***WITF-FM**—April 1, 1971: 89.5 mhz; 15 kw. Ant 820 ft. Box Z (17033). (717) 534-3333. TWX: 510-657-4010. South Central Educational Bcstg Council. Net: NPR, EPRN. Format: Classcl. ■ Andrew M. Bradley, pres; Dr. Robert F. Larson, exec VP & gen mgr; Dr. Walter P. Sheppard, stn mgr & prog dir; Peter A. Goldsmith, mus dir; Michael L. Greenwald, prom mgr; John Bosak, chief engr. ■ *WITF-TV affil.

Honesdale

WHPA—1972: 1590 khz; 500 w-D. Box 1590, 849 Main St. (18431). (717) 253-4674. Wayne County Bcstg. Format: Contemp, MOR rock, Top 40. Spec progs: Ger 2 hrs; C&W 6 hrs wkly. ■ Terry W. Clark, gen & sls mgr; Adrian Harrington, prog dir; Barry Mitchel, mus dir; Gary McCue, news dir; Jan Van Osten, chief engr.

Huntingdon

WHUN—March 2, 1947: 1150 khz; 5 kw-D. Box 404 (16652). (814) 643-3340. Huntingdon Bcstrs Inc. Format: MOR. ■ John H. Biddle, pres; W. E. Germann, prog dir; Dave Bithell, news dir; Carl E. Smeal, chief engr.

WHUN-FM—Sept 12, 1967: 106.3 mhz; 3 kw. Ant 150 ft. Dups AM 100%.

Indiana

WDAD—Nov 4, 1945: 1450 khz; 1 kw-D, 250 w-N. Box 668 (15701). (412) 349-1450. WDAD Inc. (acq 8-58). Group owner: Progressive Publishing. Net: CBS. Format: MOR. ■ W. K. Ujeric, pres; Ray Goss, gen mgr; Richard Sherry, coml mgr; Jack Benedict, prog dir; Bernie Smith, news dir; Dyle Miller, chief engr. ■ Rates: \$7.05; 5.65; 7.05; 3.50.

WDMU(FM)—Co-owned with WDAD. Aug 14, 1968: 103.1 mhz; 3 kw. Ant 170 ft. Prog sep from AM. Format: Good music. ■ Rates: \$3; 3; 3; 3.

***WIUP-FM**—October 1969: 91.3 mhz; 1.60 kw. Ant 88 ft. Davis Hall, Indiana Univ. of Pa. (15701). (412) 357-2491. Indiana Univ. of Pa. Format: Variety. ■ William Lesko, gen mgr; Paula Olson, stn mgr; Stanley Crawford, chief engr.

WQMU(FM)—Listing follows WDAD.

Jeanette

WBCW—Jan 28, 1974: 1530 khz; 1 kw-D, 250 w-CH. 111 S. Fourth St. (15644). (412) 527-5656. Central Westmoreland Bcstg Co. Net: ABC/I. Format: Talk, Top 40, easy Istng. Spec progs: Ital 1 hr; Pol 5 hrs; farm 1 hr; Slovenian 2 hrs wkly. ■ Verna M. Calisti, pres & gen mgr; James Rhea, prog & news dir; Jacqueline Rae Calisti, mus dir; John M. Orange, chief engr. ■ Rates: \$7.50; 7.50; 5; 5.

Jenkintown

WIBF-FM—Nov 1, 1960: 103.9 mhz; 180 w. Ant 1000 ft. The Benson East (19046). (215) 886-2000. Fox Bcstg Co. Net: ABC/E. Rep: Dirigo, Groskin. Format: Relg, ethnic, MOR. Spec progs: Ger 1 hr; Ital 13 hrs; Pol 2 hrs; Sp 18 hrs; Black 2½ hr; Korean 1 hr; Greek 2½ hrs; Ukraian 2½ hrs; Jewish 1½ hrs wkly. ■ William L. Fox, pres, gen & coml mgr; Douglas Henson, stn mgr; Larry Molinaro, mus dir; Donald Hess, news dir; Fredrick Moore, chief engr.

Johnstown

WAAT(FM)—Sept 1, 1974: 92.1 mhz; 175 w. Ant 1000 ft. Box 728, 510 Locust St. (15907). (814) 539-1000. Community Broadcasters Inc. Net: ABC/FM. Format: Relig. ■ W. Ronald Smith, pres; John P. Foster, gen mgr; Clyde May, chief engr.

WCRO—September 1947: 1230 khz; 1 kw-D, 250 w-N. 605 Main St. (15901). (814) 536-5158. Century Bcstg Corp. Net: ABC/C. Rep: H-R/Stone. Format: Top 40. Spec progs: Pol 1 hr; farm 2½ hrs; intl music ½ hr wkly. ■ John J. Keel, pres; Sandy D. Neri, gen mgr & prog dir; Jack Michaels, mus dir; Mike Farrow, prom mgr; Scott McCloud, news dir; Fred Kending, chief engr. ■ Rates: \$10.50; 10.50; 10.50; 9.50.

WIYQ(FM)—See Ebsenburg.

WJAC—April 1925: 850 khz; 10 kw-U, DA-1. Hickory Lane (15907). (814) 255-5831. TWX 814-248-8354. WJAC, Inc. (acq 1932). Net: NBC. Rep: Torbet. Format: Variety, MOR. Spec prog: Talk 6½ hrs daily. ■ Alvin D. Schrott, pres & gen mgr; John B. Rogers, coml mgr; Ronald J. Kabo, sls mgr; Larry E. Pearce, stn & opns mgr; Theodore Campbell, chief engr.

WJAC-FM—August 1949: 95.5 mhz; 57 kw horiz, 54 kw vert. Ant 1060 ft. Stereo. Dups AM 10%. Format: Good Istng. ■ WJAC-TV affil.

WJNL—August 1946: 1490 khz; 1 kw-D, 250 w-N. 341 Lincoln St. (15901). (814) 536-0761. Cover Bcstg, debtor in possession. Net: CBS. Rep: PRO/Meeker. Format: Contemp/MOR. ■ Rates: \$17; 15; 17; 13.

WJNL-FM—Aug 14, 1973: 96.5 mhz; 50 kw. Ant 490 ft. Dups AM 100%. ■ WJNL-TV affil.

Kane

WKZA—June 7, 1954: 960 khz; 1 kw-D. Box 518 (16735). (814) 837-7100. WKZA Bcstg Co. (acq 7-1-65). Rep: Dome-Messervy, Gateway. Format: Contemp. Spec progs: C&W 3 hrs; Polka 1½ hrs wkly. ■ Edward H. Lenaway, pres & gen mgr; Guy Willey, coml mgr; Lynn O. Smith, prog & mus dir; Nancy Morgan, news dir; Rita Lenaway, prom mgr; Frank Muisiner, chief engr.

Kittanning

WACB—1948: 1380 khz; 1 kw-D. Box 511 (16201). (412) 543-1381. WACB Inc. (acq 12-1-64). Spec prog: C&W 6 hrs wkly. ■ Ray H. Rosenblum, pres; G. Earl Sadlon, gen mgr; David Cameron, prog dir; Norman E. Gour, chief engr.

Lancaster

WDAC(FM)—Dec 13, 1959: 94.5 mhz; 50 kw. Ant 500 ft. Box 22 (17604). (717) 284-4123. Crawford Bcstg Co. (group owner). Format: Relig. ■ Donald B. Crawford, pres; Paul R. Hollinger, gen mgr; Donald Powell, coml mgr; John E. Eby, prog dir; Ralph Haneman, chief engr.

***WFNM(FM)**—May 1973: 88.7 mhz; 10 w. Ant 64 ft. Franklin and Marshall College. (17604). (717) 394-6808. Franklin and Marshall College. Format: MOR. ■ Joseph Falk, gen mgr.

WGAL—1922: 1490 khz; 1 kw-D, 250 w-N. 24 S. Queen St. (17603). (717) 397-0333. WGAL Inc. Group owner: Steinman. Net: NBC. Rep: PRO/Meeker. Spec progs: Farm 1 hr; Sp 1 hr wkly. ■ Harry J. Shaub, exec VP & gen mgr; H. Eugene Peters, stn mgr; Don Gable, coml mgr; Harold E. "Chip" Miller Jr., natl sls mgr; Brian Kintzer, prog dir; Wayne Seacat, chief engr.

WGAL-FM—1944: 101.3 mhz; 4.6 kw. Ant 1290 ft. (CP 14.5 kw. Ant 680 ft). Stereo. Prog sep from AM. Format: Blf mus. ■ Larry Blazic, coml mgr.

WLAN—Aug 9, 1946: 1390 khz; 5 kw-D, 1 kw-N, DA-2. Box 868 (17604). (717) 394-7261. Peoples Bcstg Co. Net: ABC/C. Rep: Masla, Dome. Format: Top 40. Spec progs: Sp 1½ hr; Black ½ hr wkly. ■ Frank H. Altdoerffer, pres & dir of engr; Samuel M. Altdoerffer, gen mgr; William Cifuni, coml mgr; James Rowley, news dir; Robert Dettrey, prog dir; Rick Lewis, mus dir; Dennis S. Eberly, chief engr. ■ Rates: \$14.50; 13.50; 14.50; 12.50.

WLAN-FM—January 1948: 96.9 mhz; 50 kw. Ant 76 ft. Stereo. Prog sep from AM. Net: ABC/FM. Format: Blf mus. ■ Walter C. Schmid, prog dir. ■ Rates: \$7.25; 6.25; 7.25; 6.25.

Lansdale

WNPV—Oct 17, 1960: 1440 khz; 500 w-D, DA. Box 1440 (19446). (215) 855-8211. Equitable Publishing Co. ■ George W. Knipe, pres; Howard C. Berky, coml mgr; John G. Skibbe, stn mgr; Richard Heist, sls mgr & prog dir; Richard R. Wright, chief engr.

Lansford

WLSH—Dec 24, 1952: 1410 khz; 5 kw-D, DA. Box D (18232). (717) 645-3123. Miners Bcstg Service Inc. Audio news: UPI. Format: MOR. Spec progs: Big Band 1 hr; C&W 3 hrs; gospel 1 hr; Pol 2 hrs wkly. ■ John W. Angst, gen mgr. ■ Rates: \$5; 5; 5; —

Latrobe

WQTW—1952: 1570 khz; 1 kw-D. Box 208 (15650). (412) 539-2511. Regency Bcstg Corp. (acq 10-31-73). Format: talk, Top 40. Spec prog: Pol 5 hrs wkly. ■ Nick A. Convello, pres & gen mgr; C. Loretta Joyner, office mgr; Charles F. Reid, coml & prom mgr; Steven Coffelt, news dir; Randy Davis, prog & mus dir & chief engr.

WTRA—Aug 11, 1956: 1480 khz; 500 w-D. Miller Hotel (15650). (412) 537-3338. WTRA Bcstg Co. Group owner: Rennekamp (25%). Format: Contemp, C&W, rock. Spec prog: Pol 4 hrs wkly. ■ Albert A. Calisti, gen mgr & chief engr; Ron Klink, coml mgr & prog dir; Bonnie Flickerger, mus dir; John Ross, news dir.

Lebanon

WAHT—See Annville-Cleona.

WLBR—Nov 13, 1946: 1270 khz; 5 kw-D, 1 kw-N, DA-2. Route 72 North (17042). (717) 272-7651. Lebanon Bcstg Co. Net: ABC/I. Rep: Masla, Dome. Format: MOR. ■ H. Raymond Stadium, pres; Lester P. Etter, mng & prog dir; Edward J. Burris, coml mgr; Lee Richwine, mus dir; Hy White, news dir; William Zehring, chief engr. ■ Rates: \$12.10; 10.30; 12.10; 10.30.

WUFM(FM)—Co-owned with WLBR. January 1948: 100.1 mhz; 3 kw. Ant 270 ft horiz, 265 ft vert. Stereo. Prog sep from AM. Format: Solid gold. ■ Rates: \$8; 8; 8; 8.

New AM—Not on air, target date unknown: 940 khz; 1 kw-D. Box 322 (17042). Lebanon Valley Radio.

Lehighton

WYNS—April 12, 1962: 1150 khz; 1 kw-D, DA. Box 115 (18235). (215) 377-1150. Valley Bcstg Co. Rep: Gill-Perna, Regional Reps, Messina (Southwest). Format: Top 40. ■ Martin H. Philip, pres; Frances J. Philip, gen mgr.

Lehman

***WPSI(FM)**—October 1974: 89.1 mhz; 10 w. Lehman (18708). (717) 675-2171. Penn. State University.

Levittown-Fairless Hills

WBCB—Dec 8, 1957: 1490 khz; 1 kw-D, 250 w-N.

Pennsylvania Radio

See page C-1 for explanation of listings.

200 Magnolia Dr. (19054). (215) 949-1490. O'Keefe Bcstg Co. Format: MOR. ■ William J. Garry, pres & gen mgr; Bob Burton, prog & mus dir; John Shuster, prom mgr; Vince Reed and Allan Mallory, news dirs; Theodore Klatt, chief engr. ■ Rates: \$8.65; 8.65; 8.65; 8.65.

Lewisburg

***WVBU-FM**—October 1965: 90.5 mhz; 10 w. Box C-3088, Bucknell Univ. (17837). (717) 524-3489. Bucknell Univ. Net: NPR. Format: Variety. ■ Peter G. Davey, gen mgr.

Lewistown

WKVA—Dec 4, 1949: 920 khz; 1 kw-D, 500 w-N, DA-N. Box 432, 3 West Hale St. (17044). (717) 248-6771. Central Pennsylvania Bcstg Co. (acq 3-1-51). Net: ABC/I. Rep: Gill-Perna, Regional Reps. Format: Contemp, C&W, rock. ■ Robert L. Wilson, pres & gen mgr; David Wilson, coml mgr; Richard C. Lyons, prog dir; Lauretta M. Corbin, traf mgr; Ron Patterson, news dir; Robert M. Riden Jr., chief engr.

WMRF—June 1, 1941: 1490 khz; 1 kw-D, 250 w-N. 5 W. Market St. (17044). (717) 248-6757. Lewistown Bcstg Co. Net: NBC. Rep: Burn-Smith. ■ Thomas W. Metzger, pres & gen mgr; Frank Triolani, stn & coml mgr; Thekla Leeper, prog dir; Kenneth Callahan, chief engr.

WMRF-FM—Oct 1, 1964: 95.9 mhz; 2.8 kw. Ant 55 ft. Dups AM.

Lincoln University

***WLIU(FM)**—Aug 1, 1975: 88.7 mhz; 10 w. Ant 40 ft. Lincoln University (19352). (215) 932-8300. Lincoln University. Format: Variety. ■ Charles Breza, chief engr.

Linesville

WVCC(FM)—May 4, 1970: 101.7 mhz; 3 kw. Ant 220 ft. Box 307 (16424). (814) 683-4000. Arthur W. Cervi. Net: MBS. Format: Easy Istng. Spec progs: C&W 6 hrs; Classical 6 hrs wkly. ■ A. W. Cervi, pres & gen mgr; R. M. Geilik, news dir.

Lock Haven

WBZP—Feb 20, 1947: 1230 khz; 1 kw-D, 250 w-N. 132½ E. Main St. (17745). (717) 748-4038. Lock Haven Bcstg Corp. Net: MBS, Pa. State Net. Rep: Devney, Dome-Messervy. Spec prog: C&W 12 hrs wkly. ■ Harry Shaffer, pres; Harris Lipez, gen & coml mgr; Jim Eckert, prom mgr; John Lipez, news dir; Albert Stratmoen, chief engr.

WBZP-FM—September 1965: 92.1 mhz; 3 kw horiz, 940 w vert. Ant 255 ft. Stereo. Dups AM 100%.

Loretto

WWSF—Dec 7, 1963: 1400 khz; 1 kw-D, 250 w-N. (15940). (717) 472-7000. Saint Francis College. Format: MOR. ■ Fr. Sean Sullivan, pres; Dick Wayne, gen & coml mgr; David McElDowney, prog & news dir; Joseph Knorosky, chief engr.

Lykens

WQIN—1975: 1290 khz; 500 w-D. 455 Main St. (17048). Quinn Bcstg. Format: Standard pops.

Mansfield

***WNTF(FM)**—Sept 15, 1968: 89.5 mhz; 10 w. Ant 320.4 ft. Box 89, South Hill, Mansfield State College (16933). (717) 662-2147. Mansfield State College. Audio news: UPI. Format: Ed. ■ Lawrence Park, pres; Richard Coffey, gen mgr.

Martinsburg

WJSM—Feb 27, 1968: 1110 khz; 1 kw-D. R.D. 2 (16662). (814) 793-2188. Sherwat Media Assoc. (acq 10-1-75). Audio news: UPI. Format: Relig. Spec prog: Farm 2 hrs wkly. ■ Sherwood B. Hawley, gen mgr; Larry S. Walters, stn mgr. ■ Rates: \$3; 3; 3; 3.

WJSM-FM—April 19, 1965: 92.7 mhz; 390 w. Ant 610 ft horiz, 600 ft vert. Dups AM 100%. ■ Rates same as AM.

Pennsylvania Radio

See page C-1 for explanation of listings.

Mckean

WMDI(FM)—102.3 mhz; 1.5 kw. Ant 400 ft. Box 365 (15422). (814) 796-2085. Mikro-Dawn Inc. Reps: Smith, Pournaras. Format: Progs. ■ Donald L. Mikorch, pres; Keith Shidemantle, gen and sls mgr; Garrett Hart, prog and mus dir; Ted Levin, chief engr. ■ Rates: \$4.20; 4.20; 5.20; 5.20.

McKeesport



WEDO—1947: 810 khz; 1 kw-D. 704 Locust St. (15132). (412) 462-9922. 810 Inc. (acq 5-72). Net: NBC. Format: MOR, oldies. ■ Ralph Baron, pres; John Long, VP and gen mgr; Jim Shields, coml mgr; Calvin Smiley, opns mgr and news dir; Dennis Reed, mus dir; Dave Leiner, prom mgr; Richard Ruby, chief engr. ■ Rates: \$11; 10; 12; 10.

WIXZ—April 1947: 1360 khz; 5 kw-D, 1 kw-N, DA-N. Box 1360 (15132). (412) 566-1360. Renda Bcstg Corp. (acq 6-19-74). Format: C&W. Spec prog: Pub serv 2 hrs; farm ½ hr wky. ■ Anthony F. Renda, pres; John J. Poister, opns mgr; Jim Shields, sls mgr; Don Evans, mus dir; Kirk McCall, news dir; Art Reed, chief engr.

Meadville

***WARC(FM)**—Feb 3, 1963: 90.3 mhz; 33 w. Ant 79 ft. Stereo. Box 165, Allegheny College (16335). (814) 724-5375. Allegheny College. Net: ABC/FM. Format: Progs. Spec prog: Pub serv 12 hrs wky. ■ Paul Weinberg, gen mgr.

WMGW—1947: 1490 khz; 1 kw-D, 250 w-N. 964 Park Ave. (16335). (814) 724-1111. Regional Bcstrs Inc. (group owner; acq 1957). Net: ABC/N. Format: MOR, rock. Spec prog: Pol 2 hrs wky. ■ James R. Nicholson, gen mgr; Michael J. Ciesi, asst mgr; Nick Bernard, news & prog dir; David Hanahan, mus dir; Sam Pero, chief engr.

WZPR(FM)—Co-owned with WMGW. 1948: 100.3 mhz; 10 kw. Ant 530 ft. Stereo. Format: Easy Istng.

Mercer

WWIZ(FM)—October 1972: 103.9 mhz; 3 kw. Ant 300 ft. Box 1120, Sharon, Pa. (16146). (412) 981-4580. PS Bcstg Corp. Format: C&W. ■ James D. Pshoulis, pres & gen mgr; Sandra Craven Stewart, prom mgr; Joe Wirshinsky, chief engr.

Mercersburg

WRCV(FM)—Not on air, target date January 1976: 92.1 mhz. 3 kw. Ant 295 ft. Stereo. Box 92 (17236). (202) 338-4191. Fulton Bcstg Co. Format: MOR. Spec prog: Farm 3 hrs wky. ■ Susan B. & Richard A. Fulton, owners; Richard W. G. Whitney, gen mgr. ■ Rates: \$48.60; 48.60; 48.60; 48.60.

Mexico

WJUN—Sept 8, 1955: 1220 khz; 1 kw-D. Box 97, Millintown, Pa. (17059). (717) 463-2135. Juniata Perry Bcstg Co. Net: MBS. Rep: Burn-Smith, Dome-Messervey. Format: MOR. ■ T. W. Metzger, pres & gen mgr; Ralph S. Parker, coml mgr; Don Lorenz, prog dir; Kenneth G. Callahan, chief engr.

Millflintburg

WJRR-FM—1975: 98.3 mhz; 3 kw. Ant 52 ft. 2025 Mahaffey Lane (17701). Buffalo Valley Bcstg Co. Format: MOR, C&W. ■ Fred R. Jechler, pres.

Milton

WMLP—Oct 27, 1955: 1380 khz; 1 kw-D. Box 334 (17847). (717) 742-8705. WMLP Inc. (acq 8-1-61). Format: Top 40. ■ Joseph Kesnow, pres; Douglas J. Kesnow, gen mgr; John H. Yingling, sls mgr; Paul Her-

bert, prog dir; Wm. Earley, mus dir; Harry Bingaman, chief engr.

WMLP-FM—Oct 1, 1967: 100.9 mhz; 410 w. Ant 690 ft. Stereo. Prog sep from AM. Format: C&W.

Monroeville

WPSL—Sept 27, 1964: 1510 khz; 250 w-D. No. 1 Sylves Lane (15146). (412) 823-1500. Monroeville Bcstg Co. Format: MOR. Spec progs: Irish 2 hrs; Pol 2 hrs; Polka 9 hrs wky. ■ Sarah S. Thompson, pres; Anthony G. Garofalo, gen & coml mgr & chief engr; Gordon Greenawalt, prog dir; Steve Synder, news dir.

Montrose

***WPEL**—May 30, 1953: 1250 khz; 1 kw-D. Locust & High Sts. (18801). (717) 278-2811. Montrose Bcstg Corp. Format: Good music, relig. Spec prog: Ukrainian 1½ hrs; farm 1½ hrs wky. ■ W. Douglas Roe, pres & gen mgr; William M. Farley, prom mgr; Doris R. Archer, prog dir; Doris Archer, mus dir; Robert Brigham, chief engr.

***WPEL-FM**—June 5, 1961: 96.5 mhz; 57 kw. Ant 460 ft. Stereo. Dups AM 100%.

Mount Carmel

WMIM—1969: 1590 khz; 500 w-D. Third & Oak St. (17851). (717) 339-1600. Mount Carmel Bcstg Co. Net: MBS. Audio news: UPI. Rep: Dome. Format: MOR. Spec progs: Farm 1 hr; Ital 1 hr; Pol 2 hrs wky. ■ Ed Romance, pres & gen mgr; Al Mason, news dir; Ray Willard, chief engr.

Nanticoke

WMJW(FM)—Oct 31, 1973: 92.1 mhz. 670 w. Ant 552 ft. Box 64 (18634). (717) 829-1957. Thunder Bcstg Corp. Format: Contemp, MOR. ■ Francis S. Koscielski, pres; Frank Stanley, gen mgr & prog dir; Sally Janora, coml mgr; Pete Maxwell, prom mgr; Rob Neyhard, mus dir; Davis S. DeCosmo, news dir; Ron Balonis, chief engr. ■ Rates: \$5.50; 5.50; 5.50.

WNAK—February 1947: 730 khz; 1 kw-D. 40 E. Main St. (18634). (717) 735-0730. Seven-Thirty Bcstrs Inc. (acq 3-28-66). Rep: Torbet. Format: MOR. ■ Harold F. Detweiler, pres; R. W. Neilson, exec VP & gen mgr & news dir; Larry Woods, prog dir; Robert Baird, coml mgr; Charmaine Grove, prom mgr; Norman Williams, mus dir; Ronald Schacht, chief engr.

New Castle

WBZY—Aug 25, 1968: 1148 khz; 5 kw-D, DA. Kennedy Square West (16101). (412) 658-3587. Lawrence County Bcstg Corp. Audio news: APR. Rep: Dore. Format: MOR. ■ Robert Purcell, pres; Terry T. Abrams, gen mgr; Paul A. Burak, coml mgr; Thomas Tisley, opns mgr; Stanley Rapchak, chief engr. ■ 5; 5; 5; 5.

WKST—Oct 23, 1938: 1280 khz; 1 kw-U, DA-N. 219 Savannah-Gardner Rd. (16101). (412) 654-5501. Scott Bcstg Co. of Pa. (acq 1-1-65). Group owner: Great Scott Stns. Net: ABC/C/IE. Rep: Market 4; Dome, Rqnt Reps. Format: MOR, oldies. Spec progs: Ital 1 hr; Pol 2 hrs; farm 2 hrs wky. ■ Herbert Scott, pres; David Weinfeld, gen mgr; John Nuzzo, prog dir; Dave Deal, news dir; Jim Douglas, chief engr. ■ Rates: \$7; 7; 7.

New Kensington

WKPA—October 1940: 1150 khz; 1 kw-D, DA. 810 Fifth Ave. (15068). (412) 337-3588. Gateway Bcstg Enterprises Inc. (acq 7-2-64). Net: MBS. Rep: Gateway. Format: Contemp. Spec progs: Ital 3 hrs; Pol 2 hrs wky. ■ Nelson L. Goldberg, pres & gen mgr; Joe Falsetti, coml mgr; Kit Baron, prog dir; Rhonda Gelman, mus dir; Bob Tatrn, news dir; Mike Matey, chief engr.

WYDD(FM)—Co-owned with WKPA. See Pittsburgh.

WNUF(FM)—Aug 17, 1967: 100.7 mhz; 20 kw. Ant 460 ft. Stereo. 404 North Ave., Pittsburgh, Pa. (15209). (412) 825-5430. Milton James Hammond. Format: Big Band music. ■ Milton James Hammond, pres; Tal Weimer, gen mgr; Dorothy Crombosbt, coml mgr; Bob Curti, prog dir; R. J. Sestili, news dir; Ray Whanger, chief engr.

New Wilmington

***WKPS(FM)**—Jan 31, 1968: 88.9 mhz; 39 w. Ant

minus 28 ft. Box 59, Westminster College (16142). (412) 946-8553. Board of Trustees of Westminster College. Net: ABC/I. Format: Variety. ■ Dr. Earlard I. Carlson, pres; Mark S. Klinger, dir of bcsstg; Craig D. Robertson, stn mgr; James Marshall, chief engr.

Norristown

WNAR—Aug 16, 1946: 1110 khz; 500 w-D. Box 431 (19404). (215) 272-7600. WNAR Inc. (acq 11-30-68). Rep: Market 4 Radio. Format: Contemp. ■ Victor Mauck Jr., pres; Robert M. Altman, VP & gen mgr; Anthony Bekas, prog dir; Al Novack, news dir; Albert Smith, engr. ■ Rates: \$19; 14; 19; 8.

***WVVE(FM)**—1975: 91.7 mhz; 50 w. Ant 13 ft. New Hope St. and Plymouth Rd. (19401). Central Montgomery County Vo-Tech School. Format: Variety. Spec prog: Farm. 2 hrs wky. ■ John E. Fick, gen mgr and chief engr.

North East

WHYP—Nov 24, 1966: 1530 khz; 1 kw-D, 250 w-CH. Box 112. (16428). (814) 725-9664. James D. Brownyard. Format: C&W. ■ James D. Brownyard, pres; Jim Brownyard, gen mgr; H. I. Brownyard, prog dir; Dusty Rhodes, prom mgr; H. K. Rhodes, news dir; William Sebenick, chief engr.

WHYP-FM—March 29, 1970: 100.9 mhz; 3 kw. Ant minus 95 ft. Dups AM 100%.

Oil City

WKRZ—Feb 14, 1946: 1340 khz; 1 kw-D, 250 w-N. DA-D. 746 Orange St. (16301). (814) 644-1269. WKRZ Inc. Group owner: Rennemkamp. Net: NBC. Rep: Dome, Keystone. Format: Variety. Spec progs: Pol 1 hr; farm 2 hrs; classcl 3 hrs; C&W 15 hrs wky. ■ Olivia T. Rennemkamp, sec-treas; Kenneth Rennemkamp Jr., gen mgr; Patric J. Folwell, mgr and news dir; Judy Jackman, coml mgr; Phillip Orr, prom mgr; Sam Gordon, mus dir; Michael Zizzone, Jr., chief engr.

WDJR(FM)—Co-owned with WKRZ. May 1, 1959: 98.5 mhz; 2.9 kw. Ant 300 ft. Dup AM 99%.

Palmyra

WCTX(FM)—Sept 22, 1959: 92.1 mhz; 3 kw. Ant 230 ft. Stereo. Box 231 (17078). (717) 838-1318. Clinton Bcstg (acq 4-14-69). Net: ABC/FM. Format: Btl music. ■ Hugh Clinton, pres & gen mgr. ■ Rates: \$4; 3.75; 4; 3.75.

Philadelphia

KYW—1921: 1060 khz; 50 kw-U, DA-1. Independence Mall, East Philadelphia (19106). (215) 238-4700. Westinghouse Bcstg Co. (group owner). Rep: Radio Adv Reps. Format: All news. ■ Donald H. McGannon, pres; Frank Ozarar, gen mgr; Charles Heiser, gen sls mgr; Fred Walters, exec edit; Lynda Dartnell, prom mgr; Nelson Cohen, news dir; Chris Payne, chief engr. ■ KYW-TV affil. ■ Rates: \$175; 75; 110; 30.

WCAU—1922: 1210 khz; 50 kw-U. City Line & Monument Aves. (19131). (215) 839-7000. Telex 849-279. CBS Inc. (group owner; acq 8-29-58). Net: CBS. Rep: CBS Radio Spot Sales. Format: News. ■ Robert B. Sherman, VP & gen mgr; Ralph D'Amico, dir of news & prog; Bill Shermar, prog dir; William R. Davol, dir of info svcs; John J. Miller, chief engr. ■ Rates: \$120; 70; 90; 50.

WCAU-FM—May 16, 1944: 98.1 mhz; 3.6 kw. Ant 1,000 ft. (CP: 8.9 kw). Stereo. Prog sep from AM. Format: Contemp, rock, solid gold. ■ James Keating, gen mgr; Henry Tronco, gen sls mgr; Jim Nettleton, prog dir; Art Andrews, news dir. ■ WCAU-TV affil.

WDAS—1923: 1480 khz; 5 kw-D, 1 kw-N, DA-2. Belmont Ave. & Edgely Rd. (19131). (215) Trinity 8-2000. Max M. Leon Inc. (acq 1950). Rep: Avco. Format: R&B. ■ Max M. Leon, pres; Robert A. Klein, gen mgr; Alexander S. Klein Jr., gen sls mgr; Robert J. Humes, sls mgr; Irving Leon, coml mgr; Jimmy Bishop, prog dir; Arthur Newsham, prom mgr; Robert Perkins, news dir; Robert Myers, chief engr.

WDAS-FM—1959: 105.3 mhz; 50 kw. Ant 185 ft. Stereo. Prog sep from AM. Format: Black. ■ Harvey Holiday, opns mgr.

WDVR(FM)—May 13, 1963: 101.1 mhz; 23.5 kw. Ant 650 ft. Box 4595, 10 Presidential Blvd. (19131), (215)

Demaree, gen mgr, chief engr, sec & treas; Levoy P. Demaree, VP; Don Neal, prog dir. ■ Rates: \$2.50; 2.50; 2.50.

KRBB-FM—May 18, 1972: 95.9 mhz; 3 kw. Ant 245 ft. Dups AM 100%. ■ Rates same as AM.

Sand Springs

KTOW—July 22, 1961: 1340 khz; 500 w-D, 250 w-N. Box 637 Tulsa (74101). (918) 245-9577. Proud Country Entertainment Inc. (acq 12-16-71). Net: ABC/E. Format: C&W. ■ Mack Sanders, pres; Joe Bowen, gen mgr; Ron Evans, prog dir; Glenn Couch, news dir; Jan Blumer, coml mgr; Fran Couch, music dir; Don Denver, chief engr. ■ Rates: \$14; 12; 14; 11.

Sapulpa

KXOJ—June 15, 1962: 1550 khz; 50 w-D, DA. Box 1250 (74066). (918) 224-2620. KXOJ Inc. (acq 5-2-73). Net: ABC/I; Okla News. Rep: Keystone; Messina. Format: MOR. Spec prog: Talk 6 hrs wkly. ■ Mike Stephens, pres, gen, coml & prom mgr; Sonny Hall, chief engr & news dir; Joy Stephens, prog dir; Michael Trout, mus dir. ■ Rates: \$3.65; 3; 3; 3.

Seminole

KVYL—See Holdenville.

KWSH—See Wewoka.

Shawnee

KGFF—Dec 10, 1930: 1450 khz; 1 kw-D, 250 w-N. Box 9 (74801). (405) 273-4390. KGFF Bcstg Co. Group owner: Stauffer Bcstg. Net: Okla News. Rep: Avery-Knodel. ■ Oscar S. Stauffer, pres; William A. Weaver, gen & coml mgr; Dennis Ladd, prog dir; Jeral C. Ziegler, news dir; Randall Mullinax, chief engr. ■ Rates: \$4.50; —; —; —.

Stillwater

***KOSU-FM**—September 1956: 91.7 mhz; 100 kw. Ant 400 ft. Dept of Journ & Bcstg, Communications Bldg., Oklahoma State U. (74074). (405) 372-6211. Oklahoma State U. Net: NPR. Format: Classcl, ed. Spec progs: Fr 1 hr; Ger 1 hr; Sp ½ hr; Black 1 hr wkly. ■ Robert B. Kamm, pres of Okla. State Univ; Ed Paulin, gen mgr; Margaret Danner, mus dir; James Dexter, news dir; Ruth Leierer, prom mgr; Robert Cauthon, chief engr.

KSPI—June 1, 1947: 780 khz; 250 w-D. Box 231 (74074). (405) 372-7800. Stillwater Publishing Co. Net: MBS. Format: MOR & solid gold, night. Spec progs: C&W 10 hrs, farm 3 hrs, wkly. ■ J. R. Bellatti, gen mgr; Bill Platt, stn mgr; Gene Ragsdale, prog & mus dir; Leon Matthews, prom mgr; Lawrence Gibbs, news dir; Paul Basure, chief engr. ■ Rates: \$3.70; 3.05; 3.70; 3.05.

KSPI-FM—Nov 1, 1947: 93.9 mhz; 10 kw. Ant 300 ft. Dups AM 50%. Stereo. ■ Rates same as AM.

KVRO(FM)—Feb 6, 1967: 105.5 mhz; 440 w. Ant 58 ft. Stereo. Box 1226 (74074). (405) 372-6000. KVRO Inc. Net: Okla News. Rep: Frederick W. Smith; Miller. Format: Contemp. ■ John Elsner, pres; Dick Ralston, stn mgr; Duane V. Smith, sls mgr; Jeff Hoyt, prog dir; James I. Dexter, news dir; Robert E. Cauthon, chief engr.

Tahlequah

KTLO—August 1957: 1350 khz; 1 kw-D. Box 497 (74464). (918) 456-2511. KTLO Radio I. Spec prog: Cherokee 3 hrs wkly. ■ Jim McCracken, prog dir; Fonda Purget, news dir; Jim Masters, chief engr.

KTLO-FM—Aug 20, 1966: 101.7 mhz; 1.9 kw. Ant 75 ft horiz, 70 ft vert. Stereo. Prog sep from AM.

Tonkawa

***KAYE-FM**—Not on air, target date 1975: 90.5 mhz; 22.4 w. Ant 84 ft. 1220 E. Grand (74653). (405) 628-2581. Northern Oklahoma College. Format: Diversified. Spec prog: Persian 1 hr wkly. ■ Edwin E. Vineyard, pres; Jim Morgan, gen mgr.

Tulsa

KAKC—1946: 970 khz; 1 kw-D, 500 w-N, DA-2. Box 970 (74101). (918) 743-9877. TWX 910-845-2230.

Mark/Way Inc. (acq 10-5-62). Net: MBS. Rep: Katz. Format: Contemp. ■ S. Carl Mark, pres & gen mgr; Wes Stegeman, coml mgr; Lawrence White, chief engr; Gary Stevens, prog dir; Don Bishop, mus dir; Guy Brandon, news dir.

KAKC-FM—March 1964: 92.9 mhz; 100 kw. Ant 680 ft. Stereo. Dups AM 25%. Format: Contemp.

KBJH(FM)—Nov 16, 1973: 98.5 mhz; 100 kw. Ant 660 ft. Box 702 (74101). (918) 836-6584. American Christian College Inc. Net: Mutual Black. Format: Relig. Spec prog: Talk 14 hrs wkly. ■ Dr. David Nobel, pres; Dennis Blake, coml mgr; George Kimball, chief engr; Robert Hickling, gen mgr; Jim Lawson, mus dir; Chuck Fullheart, prog dir & news dir.

KELI—Jan 22, 1934: 1430 khz; 5 kw-U, DA-N. Box 3685 (74152). (918) 622-1430. Bcstg Associates Inc. (acq 11-29-61). Group owner: Sammons-Ruff. Rep: Buckley Radio Sls. Format: Relig. ■ Raymond Ruff, pres; Joe Henderson, gen mgr; Ray Klinge, coml mgr; Dean Kelly, prog dir; Bob Davis, mus dir; Paul Wade, news dir; Glenn Thomas, chief engr.

KFMJ—1946: 1050 khz; 1 kw-D. Box 746 (74101). (918) 585-5555. KFMJ Inc. (acq 4-1-66). Rep: Avco Radio Sls. Format: Relig. ■ George Kravis, pres; Paul Benton, gen mgr; Cliff Allen, opns mgr; Nate Wilcox, chief engr; Bob Bethell, news dir.

KRAV(FM)—Co-owned with KFMJ. Nov. 21, 1962: 96.5 mhz; 96.5 kw. Ant 680 ft. (CP: Ant 380 ft.). Stereo. Box 746 (74101). Prog sep from AM. Format: Conservative Adult/Popl.

KKUL(FM)—Nov 1, 1966: 103.3 mhz; 100 kw. Ant 195 ft. Stereo. (CP: 3 kw). Box 15666 (74115). (918) 437-3777. Central Bcstg Corp. Net: Mutual Black. Rep: Bernard Howard. Format: Black. ■ Gene C. Howard, pres; Owen Austin, gen mgr; Court Newkirk, coml mgr; Dan Davis, mus dir; Sam Griffin, stn mgr. ■ Rates: \$6; 6; 6.

KMOD(FM)—Listing follows KXXO.

KRAV(FM)—Listing follows KFMJ.

KRMG—Dec 31, 1949: 740 khz; 50 kw-D, 25 kw-N, DA-2. 1502 S. Boulder (74119). (918) 584-4291. Swanco Bcstg Co. (group owner; acq 6-63). Rep: Eastman. Format: MOR. ■ Gery Swanson, pres; Ron B. Blue, VP & gen mgr; Jerry Vaughn, prog dir; Ed Brocksmith, news dir; Dan Bell, coml mgr; Dick Ford, mus dir; Gery Chew, prom mgr; Leonard Ballard, chief engr.

KWEN(FM)—Co-owned with KRMG. 1961: 95.5 mhz; 100 kw. Ant 300 ft. Progs sep from AM. Format: Btlf mus. ■ Ed Monray, VP & gen mgr; Scott Blaker, prog dir.

KVOO—Jan 23, 1925: 1170 khz; 50 kw-U, DA-N. 3701 S. Peoria, Box 1349 (74101). (918) 743-7814. Southwestern Sales Corp. (acq 10-26-26). Rep: Blair. Format: C&W. ■ Harold C. Stuart, pres; Jack R. Cresse, gen mgr; Jay Jones, prog dir; Alan Lambert, news dir; Lester Nichols, chief engr.

KWEN(FM)—Listing follows KRMG.

***KWGS(FM)**—1947: 89.5 mhz; 5.4 kw. Ant 500 ft. Stereo. 600 S. College (74104). (918) 939-6351 ext 540. U. of Tulsa. Audio news: UPI. Format: Diversified. ■ Gary Chew, gen mgr; Bill Belknap, prog dir; Jill Lyon, opns dir.

KXOJ—See Sapulpa.

KXXO—July 15, 1938: 1300 khz; 5 kw-D, 1 kw-N, DA-2. 2805 E. Skelly Dr., Suite 807 (74105). (918) 749-4631. San Antonio Bcstg Inc. (acq 10-1-73). Net: ABC/I. Rep: Torbet. Format: MOR. ■ L. Lowry Mays, pres; Douglas McCall, gen mgr; Roger Wilcox, prog dir; Paul Wade, news dir; Gil Fallim, chief engr. ■ Rates: \$18; 13; 13; 13.

KMOD(FM)—Co-owned with KXXO. Oct 10, 1959: 97.5 mhz; 50 kw. Ant 380 ft. 3002 University Club Tower (74119). (918) 582-4166. San Antonio Bcstg Inc. (acq 10-73). Format: Progressive. ■ Travis Reeves, gen mgr. ■ Rates: \$12; 12; 12; 14.40.

Vinita

KVIN—Jan 12, 1955: 1470 khz; 500 w-D. Communications Center (74301). (918) 256-7224. PBL Bcstg Co. (acq 10-73). Net: ABC/I; Okla. News. Rep: Bunchez; Messina. Format: Contemp, C&W. ■ Wayne

Oklahoma, Oregon Radio

See page C-1 for explanation of listings.

L. Bord, pres & gen mgr; Jim Chase, prog dir; Paul Langston, mus dir; Sammie Klinglesmith, news dir; Raymond Pope, coml mgr; David Boyd, prom mgr; Bill Davis, chief engr.

Wagoner

KJEM—March 1, 1966: 1530 khz; 250 w-D. Box 219 (74467). (918) 485-2186. NEO Bcstg Co. Net: I.N.N. Rep: Messina. Format: C&W. ■ Bob Ingram, pres & gen mgr.

Weatherford

KWEY—June 1, 1970: 1590 khz; 1 kw-D, DA. Box 587 (73096). (405) 772-5939. KWEY Inc. Net: ABC/I; Okla. News. Format: Contemp, C&W, MOR. ■ Paul H. Bunning, pres; Richard D. Johnson, gen mgr; Bert Jones, coml mgr; Vic Rugh, chief engr. ■ Rates: \$5; 4.75; 4.75; 4.50.

Wewoka

KWSH—July 1951: 1260 khz; 1 kw-U, DA-N. Box 1260 (74884). (405) 257-5441. Tri-Cities Bcstg Co. Net: Okla News. Rep: Melville. Format: C&W, MOR, top 40. ■ Wayne Robison, gen mgr; Frank Caldwell, chief engr; Susie Robison, prog dir.

Woodward

KSIW—September 1947: 1450 khz; 1 kw-D, 250 w-N. Box 128 (73801). (405) 256-7455. Woodward Bcstg Co. (acq 1948). Format: Variety. ■ Lenora Woods Ryan, pres & gen mgr; Joyce Nelson, asst stn mgr; Frank White, chief engr. ■ Rates: \$5.25; 5.25; 5.25; 5.25.

KSIW-FM—Nov 1, 1974: 93.5 mhz; 3 kw. Ant 150 ft. Prog sep from AM. Stereo. ■ Rates same as AM.

CSI ELECTRONICS INC.
2607 River Road
Cinnaminson, New Jersey, 08077
Telephone: (609) 786-1060

Oregon

HAMILTON-LANDIS & ASSOCIATES, Inc.
NATIONWIDE MEDIA BROKERS
WASHINGTON, D. C., CHICAGO, DALLAS, SAN FRANCISCO
SELL MORE
RADIO & TELEVISION STATIONS
IN THE WEST—NEAREST OFFICE IS—
111 SUTTER ST., SAN FRANCISCO 94104
(415) 392-5671

Albany

KHPE(FM)—Listing follows KWIL

KRKT—1959: 990 khz; 250 w-D. Box 1007 (97521). (503) 926-8628. Linn Benton Bcstrs (acq 5-1-73). Net: ABC/I. Rep: Masla; Moore. Format: C&W. ■ Robert A. Esty, pres & gen mgr; Harry Gift, prog dir; Marv Garstems, mus dir; Richard Meyers, chief engr.

KWIL—Jan 14, 1941: 790 khz; 1 kw-U, DA-2. Box 278 (97321). (503) 926-2233. Albany Radio Corp. (acq 7-1-57). Net: MBS. Rep: Burn-Smith Co.; Sandeberg-Glenn. Format: MOR/Christian. ■ Larry Gordon, pres & gen mgr; Jack Lute, coml mgr; Keith Retzer, chief engr. ■ Rates: \$4.70; 4.70; 4.70; 4.70.

Oregon Radio

See page C-1 for explanation of listings.

KHPE(FM)—Co-owned with KWIL Jan 12, 1969: 107.9 mhz; 100 kw. Ant 1160 ft. Stereo. Progs sep from AM. Format: Pop, standard. ■ Larry Gordon, gen mgr. ■ Rates: \$4.10; 4.10; 4.10; 4.10.

Ashland

KCMX—1946: 580 khz; 1 kw-U, DA-2. Box 399 (97520). (503) 482-2211. C&W Bcstrs Inc. (acq 10-71). Net: CBS. Rep: Jalco-Lucas; Tacher. Format: C&W. ■ Michael M. Lochrie, pres & gen mgr; Walter A. Graff, coml mgr & sec; Robin Lawson, prog & news dir; Jim Chesky, prom mgr; Mel Tynan, chief engr.

KDOV—1960: 1350 khz; 1 kw-D. Box 1 (97520). (503) 482-3411. Faith Tabernacle Inc. Rep: Oakes. ■ Leo Wine, pres & gen mgr.

***KSOR(FM)**—April 1969: 90.1 mhz; 10 w. Ant 41 ft. Southern Oregon College (97520). (503) 482-6423. Oregon State Board of Higher Education. Format: Diversified, classcl. Spec prog: Drama 1 hr wkly. ■ Ronald Kramer, dir of bcstg; Dennis Sherwood, stn mgr.

Astoria

KAST—1922: 1370 khz; 1 kw-U, DA-N. Box 445 (97103). (503) 325-2911. Astoria Bcstg Co. (acq 7-3-35). Net: ABC/I. Rep: Sandeberg-Glenn; Art Moore. Format: MOR-Day, Soft rock & country-night. ■ C. Howard Lane, pres; Robert Chopping, gen & coml mgr; Doug McDowell, mus dir; Mary Ristola, prog dir; Chuck Hughes, prom dir; Jason O'Brien, news dir; Joe Fickenger, chief engr. ■ Rates: \$4.60; 3.85; 4.60; 3.85.

KVAS—1950: 1230 khz; 1 kw-D, 250 w-N. Radio Central (97103). (503) 325-6221. Lower Columbia Bcstg Co. (acq 3-7-4). Net MBS. Rep: Simpson Reilly & Assoc. Format: C&W, Top 40. ■ Charles A. Farmer, pres, gen mgr & chief engr; Pat Martin, mus dir; Andy Wetherill, prom mgr. ■ Rates: \$4.20; 3.60; 4.20; 3.60.

Baker

KBURN—1939: 1490 khz; 1 kw-D, 250 w-N. 2030 Auburn Ave. (97814). (503) 523-4431. Oregon Trail Bcstg Co. (acq 6-1-55). Rep: Burns-Smith; Moore. Format: MOR. ■ Kenneth B. Lockwood, pres & gen mgr; Kenneth F. Holden, VP & coml mgr; Howard G. Rhoads, prog dir & prom mgr; David R. Moffitt, news dir; Ronald E. Johnson, chief engr.

Bend

KBND—1938: 1110 khz; 10 kw-D, 1 kw-N, DA-N. Box 1071 (97701). (503) 382-5263. KBND Inc. (acq 6-12-65). Audio news: APR. Rep: PRO/Meeker; Moore. Format: MOR. ■ Douglas Kahle, pres; John Stenkamp, VP, gen mgr & prom dir; Bill Jay, mus dir; Mark Malinowski, coml mgr; Jack Thornton, news dir & chief engr. ■ Rates: \$6.90; 6.90; 6.90; 6.90.

KGRL—Feb 4, 1960: 940 khz; 1 kw-D. Box 590 (97701). (503) 382-5611. Juniper Bcstg Inc. (group owner; acq 10-64). Rep: Masla; Tacher. Format: Contemp. ■ Gary L. Capps, pres & gen mgr; Jim Bowers, sls mgr; Ben Tracy, prog dir; Rick Marshall, mus dir; Bill Bowers, news dir; Allan Boyd, chief engr.

KXIQ(FM)—Co-owned with KGRL. December 1974: 94.1 mhz; 50 kw. Ant 1910 ft. Prog sep from AM. Stereo. Format: C&W. ■ Dan Brooks, prog dir.

KICE(FM)—July 4, 1973: 100.7 mhz; 50 kw horiz, 20 kw vert. Ant 520 ft. Stereo. Box 751 (97701). (503) 389-4567. Paulina Bcstg Corp. Net: ABC/FM. Rep: Simpson/Reilly. Format: Easy lisng. Spec progs: Jazz 6 hrs, mus of 30's 40's 50's 5 hrs, wkly. ■ Richard Gervis, pres; Jack Elder, gen mgr; Marv Rheinholdt, chief engr.

KXIQ(FM)—Listing follows KGRL.

Brookings

KURY—May 2, 1958: 910 khz; 1 kw-D. Box 1029 (97415). (503) 469-3524. KURY Radio Inc. (acq 11-1-64). Rep: Savalli/Gates; Moore. Format: MOR. ■ Norm Oberst, pres, gen & coml mgr; Joel Buffington, prog dir; Paul Black, prom mgr; Norm Suiter, news dir; Vern Garvin, chief engr; Lois Mauti, office mgr.

Burns

KRNS—Sept 28, 1957: 1230 khz; 1 kw-D, 250 w-N. SH. Box 271 (97720). (503) 573-6300. KRNS Radio. (acq 1974). Net: Travelers. Rep: Savalli/Gates; Moore. ■ William I. Hampton, Paul B. Patrick, co-owns.

Central Point

***KCHC(FM)**—September 1974: 91.7 mhz; 18 w. Ant 35 ft. 4410 Rogue Valley Blvd. (97501). (503) 664-1241. School District 6. Format: Educl, top 40. ■ Dean Wilson, chmn.

Coos Bay

KOOS—March 15, 1928: 1230 khz; 1 kw-D, 250 w-N. Box 180 (97420). (503) 267-2121. Kerry Radio Inc. (acq-1-70). Net: ABC/I. Rep: Grant Webb; Tacher. Format: MOR/top 40. ■ James F. Johnson, pres & gen mgr; Irving Brown, chief engr.

KYNG—Dec 7, 1956: 1420 khz; 1 kw-D. Box 657 (97420). (503) 267-7055. Pacific Western Bcstrs Inc. (acq 12-7-57). Rep: Sandeberg-Glenn; Tacher. Format: Top 40, solid gold. ■ Phillip F. Waters, pres & gen mgr; Phil James Keller, prog dir; Cecilia Murphy, sls mgr; Irv Brown, chief engr.

Coquille

KWRO—Feb 1, 1949: 630 khz; 5 kw-D. Box 250 (97423). (503) 396-2141. KWRO Inc. Rep: Savalli/Gates; Moore. Format: MOR. ■ Mrs. William E. Walsh pres; Karen Moore Fitch, gen, prom, coml mgr & prog dir; Steve Bone, mus dir; Lois Gordon, news dir. ■ Rates: \$6; 6; 6; 6.

Corvallis

***KBVR(FM)**—Oct 26, 1965: 90.1 mhz; 10 w. Shepard Hall, Oregon State Univ (97331). (503) 754-3522. St Bd of Higher Education. Format: Progressive rock. ■ James W. Sawyer, faculty advisor; Hal Combs, gen mgr; Dave Bennett, chief engr.

KFLY—August 1955: 1240 khz; 1 kw-D, 250 w-N. Box K (97330). (503) 753-6633. Radio Corvallis Inc. (acq 3-7-1). Net: ABC/C. Rep: Howard; Simpson-Reilly. Format: Top 40; contemp. ■ Ted Jackson, pres & gen mgr; Gil Robbins, coml mgr; Jackie Tandy, traf mgr; Chuck Larabee, mus dir; Nathan Donihue, prog dir; John Meacham, news dir; Carol Wisner, copywriter, Howard Payne, chief engr.

KFLY-FM—Oct 1, 1966: 101.5 mhz; 28 kw. Ant 100 ft. Dups AM 75%. Format: Good music/classcl. ■ Fred Bender, prog mgr.

KLOO—Aug 23, 1947: 1340 khz; 1 kw-D, 250 w-N. Box 731 (97330). (503) 753-4493. KLOO Inc. (acq 4-1-64). Net: Keystone. Rep: Moore; Sandeberg-Glenn; Keystone. ■ Robert L. Houghlum, pres, gen mgr, news dir & chief engr; Buck Wilson, coml & prom mgr; Bob Johnson, mus dir.

KLOO-FM—January 1973: 106.1 mhz; 27.5 kw. Ant minus 87 ft. Dups AM 100%.

***KOAC**—Dec 7, 1922: 550 khz; 5 kw-U, DA-2. Covell Hall, Ore. State U (97331). (503) 754-1311. State Board of Higher Education. Net: NPR. ■ Don Bryant, exec. dir; Robert Hinz, dir of ops; Thomas Doggett, dir of prog & prod; Bob Mundt, prom mgr; Frank Woodman, mus dir; Bonnie Solow, news coord; Ben Ballard, chief engr.

***KOAP(FM)**—Co-owned with KOAC. See Portland. ■ *KOAC-TV & KOAP-TV affils.

Cottage Grove

KNND—August 1953: 1400 khz; 1 kw-D, 250 w-N. SH. Box 7 (97424). (503) 942-2468. KTOB Inc. (acq 4-1-74). Net: MBS. Rep: Radio Time Slis; Moore. Format: Contemp MOR. ■ Bob Lipman, pres; Pete Fischer, gen mgr & news dir; Dave Brower, prog dir & coml mgr; Lloyd Williams, mus dir; Phil Hills, chief engr.

Dallas

KROW—April 15, 1955: 1460 khz; 5 kw-D. Box 396 (97338). (503) 362-2400. KROW Bcstrs (acq 9-75). Rep: Young. Format: Contemp. ■ D. H. Maves, pres; David Melohovitch, gen mgr; Rick Evans, coml mgr; Don Richards, prog dir; Lincoln-Smith, news dir; Cal Applegate, chief engr.

Eagle Point

***KEPO(FM)**—Not on air, target date 1975: 89.1 mhz; 10w. Ant 50 ft. Box 97 (97524). (203) 826-3364. School District 9.

Enterprise

KWVR—June 1, 1960: 1340 khz; 250 w-SH. 102 SW First St. (97828). (503) 426-3444. David D. Dirks (acq 11-74). Format: C&W, MOR.

Eugene

KASH

KASH—Sept 19, 1947: 1600 khz; 5 kw-D, 1 kw-N, DA-N. Box 10767 (97401). (503) 345-3357. Frederic A. Danz (acq 8-11-71). Group owner: Sterling Bcstg. Audio news: UPI. Rep: GC; Simpson-Reilly. Format: Oldies. Spec prog: Farm 5 hrs wkly. ■ Frederic A. Danz, pres; Ralph Armstrong, gen mgr; Gracie Johnson, coml mgr; David Beecher, lcl prog dir; Bo Donovan, group prog dir; Haagan Higgins, prom mgr; Dan Eilers, news dir; Bruce Earl, chief engr. ■ Rates: \$12; 10; 12; 8.

KATR—June 12, 1962: 1320 khz; 1 kw-D. 130 E. 13th Ave (97401). (503) 345-3338. Westone Bcstg Corp. Net: ABC/I. Rep: Savalli/Gates; Grant Webb; Tacher. Format: Talk, btfl mus ■ Willard Hargan, pres; Virgil Watkins, gen & coml mgr; Don James, prog & mus dir; George Hathaway, chief engr. ■ Rates: \$5.25; 4.50; 5.25; 4.50.

KBDF—Nov 9, 1949: 1280 khz; 5 kw-D, 1 kw-N, DA-N. Box 506, 1600 Coburg Rd (97401). (503) 345-4304. Mattco Inc. (acq 1-1-74). Rep: Torbet. Format: Top 40. ■ Russell Matthias, pres; Michael Cole, gen mgr; Tom Carnes, coml mgr; John Peterson, mus dir; Ernie Ross, news dir; Richard Harker, opns dir & chief engr.

KBMC(FM)—Oct 10, 1965: 94.5 mhz; 3.4 kw. Ant 800 ft. 2895 Hilyard St. (97405). (503) 344-1300. Good Shepherd Bcstg Inc. (acq 10-65). Rep: Chance. Format: Relig. ■ Al Wheeler, pres & gen mgr; Bernice E. Poling, prog dir; Flo Sullivan, news dir; Mark Reed, chief engr. ■ Rates: \$4; 3.50; 3.50; 5.

KEED—Sept 7, 1954: 1450 khz; 1 kw-U. Box 1450 (97401). (503) 344-1457. Monroe Bcstg Corp. (acq 10-75). Rep: Masla; Broadcast Northwest. Format: Solid Gold. ■ Don Berry, prog dir; Mike Shannon, mus dir; John Thomas, news dir; Richard Harker, chief engr.

KFMY(FM)—Dec 26, 1958: 97.9 mhz; 3.5 kw. Ant 780 ft. Stereo. 4555 Blanton Rd. (97405). (503) 343-4511. Music Inc. Net: ABC/E. Rep: Potter. Format: Familiar progrsv. ■ Lytle N. Young, pres; Timothy L. Young, coml & gen mgr; Gary T. Torresani, prog dir & prom mgr; Janice Whitaker, mus dir; Cliff Nagler, news dir; James Brock, chief engr.

***KLCC(FM)**—Feb 17, 1967: 90.3 mhz; 440 w. Ant 720 ft. Box 1-E (97401). (503) 747-4500. Lane Community College. Net: NPR; Northwest Pub Radio. Format: Jazz, cmnty affairs. ■ Virginia DeChaine, gen mgr; Tom Lichty, prog dir; Ken Strobeck, mus dir; Roger Wood, news dir; William Riley, chief engr.

KORE—See Springfield.

KPNW—Feb 12, 1962: 1120 khz; 50 kw-U, DA-1. Box 1120 (97401). (503) 342-6171. Pacific N.W. Bcstg Corp. Rep: Buckley; Tacher. Format: Contemp. ■ Charles H. Wilson, pres; Roy L. Cordell, exec VP & gen mgr; Dave Woodward, coml mgr; Russ Doran, prog dir; Ron Garner, VP prog; Charles E. Ray, news dir; Tony Mulder, chief engr.

KPNW-FM—November 1968: 99.1 mhz; 97 kw. Ant 1490 ft. Stereo. Prog sep from AM. Net: ABC/FM. Format: MOR.

***KRYM(FM)**—Dec 8, 1947: 91.9 mhz; 1.9 kw. Ant minus 35 ft. 200 N. Monroe St (97402). (503) 687-3370. School District 4 J. Net: NPR. Format: Contemp & educl. ■ Helen Tyler, gen mgr; Robert Rathman, prog & mus dir & chief engr.

KSND(FM)—See Springfield.

KUGN—July 4, 1946: 590 khz; 5 kw-D, 1 kw-N, DA-N. Box 590 (97401). (503) 344-6215. Obie Communica-

839-7832. WDWV Inc. Rep: McGavren-Guild. Format: Btlf mus. ■ David L. Kurtz, chmn & chief engr; Jerry Lee, pres & gen mgr; Bruce Cotter, sls mgr, Don LeBrecht, prog dir. ■ Rates: \$59; 70; 70; 59.

WFIL—1922: 560 khz; 5 kw-U, DA-2. 4100 City Line Ave. (19131). (215) 879-1600. TWX 710-670-9799. LIN Bcstg Corp. (group owner; acq 4-28-71). Rep: Blair. ■ James M. DeCaro, pres & gen & natl sls mgr; Jay Cook, prog dir; Ray McCloy, chief engr; Eugene Vassall, sls mgr.

WFLN—July 23, 1958: 900 khz; 1 kw-D, DA. 8200 Ridge Ave. (19128). (215) 1Vridge 2-6000. Franklin Bcstg Co. Net: NBC. Rep: Masla. Format: Classcl. ■ Raymond S. Green, pres; Harry J. Haas Jr, VP sls & gen mgr; Dave Conant, prog dir; Jules Rind, news dir; Thomas D. Moyer, chief engr. ■ Rates: \$30; 26; 30; 26.

WFLN-FM—March 1, 1949: 95.7 mhz; 50 kw. Ant 500 ft. Dups AM 100%. ■ Rates same as AM.

WHAT—1925: 1340 khz; 1 kw-D, 250 w-N. WHAT Bldg., 3930-40 Conshohocken Ave. (19131). (215) 878-1500. Independence Bcstg Co. (acq 1940). Rep: Howard. Format: Black, R&B. ■ William A. Banks, pres; Dolly Banks, stn mgr; Jack-Dash, coml mgr; Henry Stevens, prom mgr; Chris Turner, prog & mus dir; Jack O'Reilly, news dir; Robert Hoy, chief engr.

WVDB(FM)—Co-owned with WHAT. 1957: 96.5 mhz; 12 kw. Ant 890 ft (CP 48 kw, Ant 500 ft). Stereo. Banks Bcstg Co. Inc. Prog sep from AM. Format: Jazz, progsv. ■ Jay Peter Volkens, news dir; Sid Mark, prog & mus dir.

WIBG—1924: 990 khz; 50 kw-D, 10 kw-N, DA-2. 117 Ridge Pike, Lafayette Hill, Pa. (19444). (215) 242-6300. Buckley Enterprises (group owner; acq 5-7-4). Net: ABC/C. Rep: Buckley. Format: Contemp, Top 40. ■ Richard D. Buckley Jr, pres; Thomas R. Pate, gen mgr; Perry Silver, local sls mgr; Jerry Del Colliano, prog dir; Janis Kerrigan, prom mgr; Doug Tomes, mus dir; Ken Natz, news dir; Archie Sichel, chief engr.

WIFI(FM)—September 1958: 92.5 mhz; 50 kw. Ant 500 ft. Stereo. Decker Square, Bala Cynwyd. (19004). (215) TE 9-0900. GCC Communications of Phila. (acq 5-15-70). Group owner: GCC. Rep: ABC/FM Spot Slis, Creed. Format: Rock. ■ Alexander M. Tanger, pres; Daniel M. Lerner, gen mgr; Steve Kelly, prog dir.

WIOQ(FM)—1941: 102.1 mhz; 27 kw. Ant 650 ft. 2 Bala Cynwyd Plaza, Bala Cynwyd. (19004). (215) 835-6100. Richer Communications Inc. (acq 1971). Net: ABC/FM. Rep: Selcom. Format: Progsv. ■ T. Richard Butera, pres; William W. Staats, gen mgr; Jeff Poll, VP dir of sls; Roy Laurence, prog dir; Alex Demers, mus dir; William R. Fantini, news dir; J. Alan Handley, chief engr. ■ Rates: \$34; 38; 38; 30.

WIP—March 16, 1922: 610 khz; 5 kw-U, DA-1. 19th & Walnut Sts. (19103). (215) L0cust 8-2900. Metromedia Inc. (group owner; acq 2-8-60). Rep: Metro Radio Sales. Format: Contemp MOR. ■ Donald J. Kelly, VP & gen mgr; William S. Dallmann, gen sls mgr; Dean Tyler, prog dir; Paul Rust, news dir; Delmar Dengage, chief engr. ■ Rates: \$165; 94; 110; 47.

WMMR(FM)—Co-owned with WIP. April 20, 1942: 93.3 mhz; 25 kw. Ant 670 ft. Stereo. (215) 561-9933. Format: Progressive rock. ■ Joel Samuelsohn, VP & gen mgr; T. Morgan, prog dir; A. Camiolo, sls mgr. ■ Rates: \$44; 38; 50; 50.

***WKDU(FM)**—91.7 mhz; 10 w. Ant 217 ft. 3210 Chestnut St. (19104). (215) 895-2580. Drexel University. Format: Black progsv, rock, top 40. ■ Richard B. Hamilton, gen mgr; Warren Merrick, stn mgr.

WMGK(FM)—Listing follows WPEN.

WMMR(FM)—Listing follows WIP.

WPBS(FM)—1961: 98.9 mhz; 14 kw. Ant 830 ft. Stereo. 440 Domino Lane (19128). (215) 483-7200. Bulletin Co. Format: Btlf mus. ■ Edward J. Meehan Jr, VP & gen mgr; Phyllis Thomas, asst to gen mgr; Thomas A. Lucidon, coml mgr; Edward Hunt, prog dir; John McCall, mus dir; Helen Missimer, traf mgr; Juan Varela, news dir; Frank Hogan, chief engr. ■ Rates: \$33; 32; 32; 10.80.

WPEN—April 1929: 950 khz; 5 kw-U, DA-N. 2212 Walnut St. (19103). (215) L0cust 4-6000. Greater Philadelphia Radio Inc. (acq 10-7-4). Group owner: Greater Media. Net: ABC/E, MBS. Rep: H. R. Stone. Format: MOR. ■ Larry Wexler, gen mgr; Dick Harvey, prog dir; Mark Olkowski, chief engr.

WMGK(FM)—1942: 102.9 mhz; 50 kw. Ant 420 ft. Dups AM 40%.

***WPWT(FM)**—January 1950: 91.7 mhz; 180 w. Ant 10 ft. 1533 Pine St. (19102). (215) Klngsley 6-0745. Philadelphia Wireless Technical Institute. ■ Mary T. Van Horn, pres of bd of dir; H. A. Raske, pres & gen mgr; E. Cromwell, prog dir & prom mgr; Wm. Wayne Zerling, VP & chief engr.

WRCP—July 11, 1947: 1540 khz; 50 kw-D, DA. 2043 Locust St. (19103). (215) 564-2300. Rust Craft Bcstg of Pa. Inc. (acq 8-9-65). Group owner: Rust Craft. Net: ABC/I. Rep: Avery-Knodel. Format: C&W. Spec prog: Ital ½ hr wkly. ■ Matt Mills, gen mgr; Melva Perez, prom mgr; Frank Baker, prog dir; Neil Howard, mus dir; Michael Plymstead, sls mgr; Mike Venditti, chief engr. ■ Rates: \$34; 30; 34; 18.

WRCP-FM—February 1965: 104.5 mhz; 26 kw. Ant 195 ft. Stereo. Dups AM 90%.

***WRTI(FM)**—July 9, 1953: 90.1 mhz; 5 kw. Ant 400 ft. Annenberg Hall, 2013 N. 13th St. (19122). (215) 787-8405. Temple University School of Communications & Theater. Format: Jazz. ■ Dr. Kenneth Harwood, gen mgr; John Roberts, exec stn mgr; Bob Ultenweiler, stn mgr; John Wright, chief engr.

WTEL—1925: 860 khz; 10 kw-D, DA. 4140 Old York Rd. (19140). (215) GLadstone 5-9200. WTEL Inc. (acq 12-31-58). Format: Relig, Sp. Spec prog: Ger 6 hrs; Ital 7 hrs; Pol 8 hrs wkly. ■ George D. Hopkinson, pres & treas; Quentin C. Sturm, exec VP & gen mgr. ■ Rates: \$12; 12; 12; 12.

***WUHY-FM**—1954: 90.9 mhz; 11 kw. Ant 920 ft. 4548 Market St. (19139). (215) EVergreen 2-9300. TWX 215-569-9815. WHYNY Inc. Net: EPRN, NPR, Pacifica Net. Format: Listener supported, Variety. ■ Elkins Wetherill, chmn of bd; Warren A. Kraetzer, pres & gen mgr; David Karpoif, prog dir; Les Spencer, stn mgr; Edward Cunningham, mus prod; Terry Gross, news dir; Robert Hall, dir of engr. ■ WHYTY-TV and WUHY-TV affils.

WVDB(FM)—Listing follows WHAT.

WWSH(FM)—Nov 11, 1959: 106.1 mhz; 19 kw. Ant 740 ft. Stereo. 555 City Line Ave., Bala Cynwyd, Pa. (19004). (215) 835-2350. United Artists Broadcasting Inc. (group owner; acq 9-30-70). Format: Btlf mus. ■ James E. Connor, gen mgr; Lewis C. Greist, sls mgr; Nelson Hobbell, opns mgr; Fred Moore, chief engr. ■ Rates: \$70; 85; 90; 40.

***WXPN(FM)**—April 1957: 88.9 mhz; 1.9 kw. Ant 280 ft. 3905 Spruce St. (19104). (215) 387-5401. U. of Pennsylvania. Format: Variety. ■ Jamie Garner, stn mgr.

WYSP(FM)—1948: 94.1 mhz; 39 kw. Ant 550 ft. Suburban Station Bldg., 1617 JKK Blvd. (19103). (215) 665-9790. SJR Communications Inc. (group owner; acq 8-6-71). Format: MOR. ■ Jerry Michaels, gen mgr; Henry A. Tronco, sls mgr; Frank X. Feller, prog dir; Terry Smith, chief engr.

Philipsburg

WPHB—June 1, 1956: 1260 khz; 5 kw-D. Box 361, Radio Park (16866). (814) 342-2300. Moshannon Valley Bcstg Co. (acq 1-28-71). Format: MOR, C&W. Spec prog: Pol 2 hrs wkly. ■ Dr. William Harvey, pres; C. Dean Sharpless, gen mgr & chief engr; Mrs. Ruth Gearhart, coml mgr; William Burchill, prog & news dir; Sheldon Sharpless, prom mgr.

Pittsburg

KDKA—Nov 2, 1920: 1020 khz; 50 kw-U. 1 Gateway Center (15222). (412) 391-3000. TWX 412-642-3036. Westinghouse Bcstg Co. (group owner). Rep: R.A.R. Format: MOR, top 40. ■ Donald H. McGannon, chmn; Ed Wallis, area VP; A. B. Hartman, gen mgr; Warren Maurer, gen sls mgr; Alan Mitchell, prog dir; Joe Houston, prom mgr; Ed Salamon Jr, rch dir; William S. Brady, news dir; Paul Stewart, engr prog mgr.

KDKA-FM—April 4, 1942: 92.9 mhz; 47 kw. Ant 890 ft. Dups AM 5%. ■ KDKA-TV affil.

KQV—Nov 19, 1919: 1410 khz; 5 kw-U, DA-2. 411 7th Ave. (15219). (412) 281-9100. TWX 710-664-4282. Taft Bcstg Co. (group owner; acq 11-7-4). Net: ABC/C. Rep: Blair. Format: All news. ■ Steve Berger, VP & gen mgr; Gil Rozzo, gen sls mgr; Mike Waterkotte, prom mgr; Jim Carnage, prog dir;

Pennsylvania Radio

See page C-1 for explanation of listings.

Anderson Little, mus dir; Ted Ruscitti, chief engr.

WVDE(FM)—Co-owned with KQV. May 10, 1962: 102.5 mhz; 55 kw. Ant 820 ft. Stereo. Prog sep from AM. Net: ABC/FM. Rep: ABC/FM Spot Slis. Format: Progressive. Spec prog: Black 1½ hrs wkly. ■ Ken Karpinski, prog dir; Pamela Cleeland, prom mgr; Tom Daniels, mus dir; Carl Eckels, news dir.

WAMO—Aug 1, 1948: 860 khz; 1 kw-D. 1811 Blvd of Allies (15219). (412) 471-2181. Sheridan Bcstg Corp. (group owner; acq 3-1-72). Nets: Natl Black, MBS/Black. Rep: Howard. Format: Black. ■ Skip Finley, gen mgr; Matt Ledbetter, prog dir; Derek Hill, news dir; George Mellinger, chief engr. ■ Rates: \$26; 19; 26; —.

WAMO-FM—1960: 105.9 mhz; 72 kw. Ant 430 ft. Stereo. Dups AM 30%. ■ Rates: \$—; 16; —; 16.

WARO—See Canonsburg.

WVDE(FM)—Listing follows KQV.

***WDUQ(FM)**—Dec 15, 1949: 90.5 mhz; 25 kw. Ant 480 ft. 801 Bluff St. (15219). (412) 434-6030. Duquesne Univ. Net: NPR. Format: Variety. Spec prog: Community profiles 1 hr wkly. ■ Dr. Kenneth Duffy, gen mgr; Debbie Miller, prog dir; Fred McWilliams, chief engr.

WEDO—See McKeesport.

WEED—1947: 1080 khz; 1 kw-D (CP 50 kw-D, 25 kw-CH). 107 6th St. (15222). (412) 471-9950. Golden Triangle Bcstg Inc. (acq 8-1-59). Group owner: Myron Jones. Net: ABC/I. Rep: HR/Stone. Format: C&W. ■ Myron Jones, pres; Roger Willoughby-Ray, gen mgr; Mike Civiletti, coml mgr; Don Evans, prog dir; Ed Polotowski, prom mgr; Fred Trainer, news dir; Bob Brandon, chief engr; Bid Causey, opns mgr.

WEPP-FM—September 1962: 107.9 mhz; 36 kw. Ant 420 ft. Dups AM 50%.

WJOI Beautiful Music



WJOI(FM)—July 19, 1948: 93.7 mhz; 41 kw. Ant 550 ft. Stereo. 1715 Grandview Ave. (15211). (412) 381-8100. WKOI Inc. Group owner: Greer Stns. Format: Btlf mus. ■ Robert G. Clarke, VP/gen mgr; Jerome Roberts, prog dir; T. J. Feola, sls mgr; Glen Anderson, chief engr. ■ Rates: \$24; 24; 24; 21.

WKTO—Oct 19, 1921: 1320 khz; 5 kw-U, DA-N. 100 Forbes Ave. (15222). (412) 391-9800. WKTO Inc. (acq 3-12-73). Group owner: Heftel. Audio news: APR. Format: Top 40. Spec prog: Black 1 hr wkly. ■ William Cunningham, pres & gen mgr; Bill Tanner, prog dir; Mark Shands, mus and news dir; Bob Gass, chief engr. ■ Rates: \$59; 57; 59; 57.

WSSH(FM)—Co-owned with WKTO. March 8, 1948: 99.7 mhz; 10.5 kw. Ant 930 ft. Stereo. (412) 391-0395. Prog sep from AM. Rep: Eastman. Format: Btlf mus. ■ Dave Gorman, prog dir; Jim Schulke, mus mgr; Chris Hood, chief engr. ■ Rates: \$46; 48; 48; 46.

WLOA—See Braddock.

WPEZ(FM)—Listing follows WWSW.

WPIT—1947: 730 khz; 5 kw-D. Gateway Towers, Suite 200, Gateway Center (15222). (412) 281-1900. Rust Craft Bcstg of Pa. Inc. Group owner: Rust Craft. Spec prog: Ger, Greek, Ital, Ukrainian, Lithuanian, opera, football. ■ Marshall L. Berkman, pres; Andrew F. Hofmann, VP & gen mgr; Michael Komichak, chief engr & asst mgr.

WPIT-FM—1960: 101.5 mhz; 19 kw. Ant 520 ft. Dups AM 33%.

***WQED-FM**—Jan 25, 1973: 89.3 mhz; 43 kw. Ant 500 ft. 4802 5th Ave. (15213). 683-1300. Metropolitan Pittsburgh Bcstg Inc. Net: NPR. Format: Fine Arts. ■ Thomas Skinner, VP; John J. Sommers, gen mgr; Lisa Cantini, prog dir; John Roberts, prog mgr; Martin Schneider, mus dir; Gerald D. Jones, chief engr.

Pennsylvania Radio

See page C-1 for explanation of listings.

***WRCT(FM)**—April 1974: 88.3 mhz; 10 w. Ant 100 ft. 5000 Forbes Ave. (15213). Carnegie-Mellon Student Govt Corp. ■ Robert W. McCurdy, pres, bd of dirs.

WSSH(FM)—Listing follows WKTO.

WTAE—May 1922: 1250 khz; 5 kw-U. DA-N. 400 Ardmore Blvd. (15230). (412) 242-4300. TWX 710-664-4267. Hearst Corp. (group owner; acq 1931). Rep: McGavren-Guild. Format: Adult contemp. ■ Franklin C. Snyder, VP & gen mgr; Ted J. Atkins, VP & stn mgr; Jim McQuaide, s/s mgr; Chuck Brinkman, mus dir; James Greenwood, chief engr.

WTAE-FM—Aug 8, 1960: 96.1 mhz; 50 kw. Ant 500 ft. Stereo. Dups AM 50%. ■ WTAE-TV affil.

WWSW—1932: 970 khz; 5 kw-U, DA-2. One Allegheny Sq. (15212). (412) 322-5500. WWSW Radio Inc. Net: CBS. Rep: Blair. Format: MOR. ■ O. M. Schloss, pres; John D. Gibbs, exec VP & gen mgr; John A. Jurewicz, bus mgr; James Tedder, prog dir; Philip Chimes, chief engr. ■ Rates: \$67; 55; 67; 36.

WPEZ(FM)—Co-owned with WWSW. 1940: 94.5 mhz; 50 kw. Ant 810 ft. Format: Contemp. ■ Steve Berger, stn mgr; Charles Weaver, bus mgr. ■ Rates: \$25; 34; 25; 14.

WYDD(FM)—Co-owned with WKPA, New Kensington, Pa. Feb 4, 1963: 104.7 mhz; 50 kw. Ant 500 ft. Stereo. WYDD Suite, Gateway Towers (15222). (412) 362-2144. Gateway Bcstg Enterprises Inc. Net: MBS. Rep: Selcom, Gateway. Format: Progressive. ■ Nelson L. Goldberg, pres & gen mgr; Jim Augustine & Louis Sopowitz, coml mgrs; Kit Baron, prog & mus dir; Rhonda Gelman, prom mgr; Mike Matey, chief engr.

***WYEP-FM**—April 30, 1974: 91.5 mhz; 840 w. Ant 519 ft. 4 Cable Place (15213). (412) 687-0200. Pittsburgh Community Bcstg Corp. Net: NPR. Format: Community radio. Spec prog: Sp 2 hrs; Nat. amer 2 hrs; Gay 2 hrs; Fr 2 hrs w/ky. ■ John Schwartz, gen mgr; Joe Coluccio, prog dir; Sean Connolly, prom mgr; Greg Tolliver, news dir; Mike Uschak, chief engr.

WZUM—See Carnegie.

Pittston

WARD—June 21, 1953: 1540 khz; 1 kw-D. Box 1540 (18640). (717) 655-5521. Ward Bcstg Corp. (acq 1-28-75). Format: MOR. Spec prog: Ital 1 hr w/ky. ■ James F. Ward, pres; R. W. Brenner, stn mgr; Samuel M. Liguori, prog dir; Frank Silva, spts dir; John C. Watkins, news dir; Joseph M. Coleman, chief engr. ■ Rates: \$5; 5; 5.

Portage

WWML—Aug 30, 1960: 1470 khz; 500 w-D. 712 Main St. (15946). 736-8000. Mainline Bcstg Co. Rep: Dome-Messervey. Format: MOR. Spec prog: Pol 8 hrs w/ky ■ George Wasko, pres & gen mgr; Ken Karachowsky, prog dir; Joseph Knorosky, chief engr.

Pottstown

WPAZ—Oct 1, 1951: 1370 khz; 1 kw-D. Broadcast Lodge (19464). (215) 326-4000. Pottstown Bcstg Co. Group owner: Great Scott Stns. Net: MBS. Format: MOR. Spec prog: Pol 2 hrs w/ky. ■ Herbert Scott, pres, natl s/s & gen mgr; Robert Eppheimer, loc s/s dir; Nancy Boritz, prog dir; Jim Plummer, news dir; William Kuntz, chief engr. ■ Rates: \$15; 13; 13.

WRFY-FM—See Reading.

Pottsville

WAVT-FM—Listing follows WPPA.

WPAM—1946: 1450 khz; 1 kw-D, 250 w-N. Box 629 (17901). (717) 622-1450. Miners Bcstg Service Inc. Audio news: UPI. Format: MOR. Spec prog: Pol 2 hrs; C&W 3 hrs; Gospel 1 hr w/ky. ■ R. Mickey Angst, stn mgr. ■ Rates: \$6; 6; 6.

WPPA—May 9, 1946: 1360 khz; 5 kw-D, 500 w-N, DA-2. Box 540 (17901). (717) 622-1360. Pottsville Bcstg Co. Group owner: A. V. Tidmore. Net: MBS. Format: MOR, Contemp. ■ A. V. Tidmore, own & gen mgr; Ralph L. Price, coml mgr; James B. Thompson, prog & news dir; Walter Jones, spts dir; Russell Bassett, chief engr; Sidney W. McIlvain, farm dir.

WAVT-FM—Co-owned with WPPA. Nov 20, 1948: 101.9 mhz; 29 kw. Ant 543 ft. Stereo. Prog sep from AM. Format: Good music.

Punxsutawney

WPME—March 18, 1953: 1540 khz; 5 kw-D, 1 kw-CH. Box 38 (15767). (814) 938-6000. Punxsutawney Bcstg Co. (acq 4-71). Format: MOR. Spec prog: Pol 3 hrs; C&W 11 hrs; Farm 1 1/4 hrs w/ky. ■ Charles M. Erhard Jr., pres, gen & coml mgr; Robert L. Curry, prog, mus & news dir; John M. Leisering, prom mgr; Thomas Ottavi, chief engr.

WPME-FM—Dec 12, 1973: 105.5 mhz; 3 kw. Ant 300 ft. Dups AM 80%.

Reading

WEEU—1931: 850 khz; 1 kw-U, DA-N. 34 N. Fourth St. (19601). (215) 376-7335. WEEU Bcstg Co. (acq 12-46). Net: ABC/E. Rep: Avery-Knodel. Format: MOR. Spec prog: Sp 1/2 hr; Farm 5 hrs w/ky. ■ Wm. J. Rohn, pres; K. Richard Creitz, exec VP, gen mgr; Richard Schlipp, coml mgr; Jack B. Gounder, prog and mus dir and prom mgr; Robert Smith, news dir; Robert Schlottman, chief engr.

WHUM—Sept 1, 1946: 1240 khz; 1 kw-D, 250 w-N. Berkshire Hotel (19603). (215) 376-3987. Eastern Radio Corp. (acq 1-5-71). Net: NBC. Rep: Dome-Messervey. Format: MOR days, talk night. ■ Sidney Goldstein, exec VP & pres & gen mgr; Warren Ruffner, coml mgr; Jack Daniels, prog & mus dir; Joe Wambach, news dir; James Hodgkins, chief engr. ■ Rates: \$12; 50; 8; 12.50; 8.50.

WRWA—September 1922: 1340 khz; 1 kw-D, 250 w-N. Box 244, 19 N. Fifth St. (19603). (215) 376-7173. Rust Communications Group Inc. (group owner; acq 4-6-59). Rep: Eastman, Format: Contemp. ■ William F. Rust Jr., pres; Benjamin Varishone, gen mgr; Doug Weldon, prog dir; Don Greth, news dir; Edward Gurtowski, chief engr.

WRFY-FM—Oct 1, 1962: 102.5 mhz; 42 kw horiz. 32 kw vert. Ant 540 ft. Stereo. 2325 Perkiomen Ave. (19606). (215) 779-4545. City Bcstg Co. Net: ABC-FM. Format: Btfl mus. ■ Frank A. Franco, VP, treas; Mrs. Helene Franco, gen mgr; Anthony B. Balta, s/s mgr; Thomas Franco, pub affrs dir; S. Martin Miller, news dir; Gerhard Klemm, chief engr.

***WXAC(FM)**—1967: 91.3 mhz; 10 w. Albright College (19604). (215) 921-2217. Albright College. Audio news: UPI. Format: Progressive. ■ Scott Rudnick, pres and gen mgr.

Red Lion

WGC B—Oct 22, 1950: 1440 khz; 1 kw-D. Box 88 (17356). (717) 244-3145. Red Lion Bcstg Co. Inc. Spec prog: Ger 1/4 hr w/ky. ■ John Norris, pres & gen mgr; Al Stella, news dir; Geary Russell, chief engr.

WGC B-FM—October 1960: 96.1 mhz; 20 kw. Ant 420 ft. Stereo. Dups AM 10%.

Ridgway

WKBI—See St. Mary's.

WKBI-FM—August 1966: 94.3 mhz; 740 w. Ant 550 ft. Stereo. Main & Broad Sts (15853). (814) 773-3166. Elk Cameron Bcstg Co. Group owner: Allegheny Mtn. Network. Net: MBS. Rep: Dome. Format: C&W. ■ Cary H. Simpson, gen mgr; Eugene Dendorfer, s/s mgr; Catherine Daugherty, gen mgr; Mary Sullivan, news dir; Jon Malburg, prog & mus dir & chief engr.

Roaring Spring

WKMC—1955: 1370 khz; 1 kw-D. South Main St. Ext. (16673). (814) 224-2151. Cove Bcstg Co. (acq 9-18-69). Audio news: APR. Format: C&W. Spec prog: Farm 2 hrs w/ky. ■ Louis J. Maierhofer, pres & gen mgr; John D. Reilly, coml mgr; J. J. Seckel, prom mgr; Dick Richards, prog dir; Larry Walters, mus dir; Walter Frank, news dir; J. Terry McCalarnay, chief engr. ■ Rates: \$7; 6; 6.75; 5.50.

St. Mary's

WKBI—July 23, 1950: 1400 khz; 1 kw-D, 250 w-N. 10 Railroad St. (15857). (814) 834-2821. Elk-Cameron Bcstg Co. Group owner: Allegheny Mtn. Network (50%) and Rennaekamp (50%). Net: MBS; Allegheny Mountain Network. Rep: Dome. Format: MOR/Contemp. ■ Cary H. Simpson, pres; John P. Knorr, stn mgr;

Dave Mazzaferro, prog & mus dir; Peter Steinhof, prom mgr; Mary Grace Zitzler, news dir; Jon Malburg, chief engr. ■ Rates: \$6; 4; 6; 6.

WKBI-FM—See Ridgway.

Sayre

WATS—June 1950: 960 khz; 1 kw-D. 106 W. Lockhart St. (18840). (717) 888-7745. WATS Bcstg Inc. (acq 7-31-70). Net: ABC/E. Format: MOR. ■ Robert E. Klose, pres & gen mgr; Virginia C. Klose, VP & sec; Sylvia J. Hinrichsen, stn & s/s mgr; George Thomas, opns mgr & mus dir; Tony Pettit, news dir; Lawrence Brown, contract engr. ■ Rates: \$6.20; 4.80; 5.50; 4.40.

WAVR(FM)—Co-owned with WATS. See Waverly N.Y.

Scranton

WARD—See Pittston.

WARM—1940: 590 khz; 5 kw-U, DA-2. Box 590, Avoca (18641). (717) 346-4646. WARM Bcstg Co. (acq 6-15-58). Group owner: Susquehanna. Audio news: UPI. Rep: Eastman. Format: Top 40. ■ Louis J. Appell Jr., pres; George Gilbert, stn opns mgr; Arthur W. Carlson, VP Susquehanna Bcstg; James Davey, coml mgr; Jack Herr, VP, WARM; Ron Allen, prog dir; Jerry Heller, news dir; Charles Morgan, chief engr. ■ Rates: \$55; 37; 45; 22.

WBAX—See Wilkes-Barre.

WBRE-AM-FM—See Wilkes-Barre.

WEJL—Nov 22, 1922: 630 khz; 500 w-D. 149 Penn Ave. (18503). (717) 346-6555. The Scranton Times. Group owner: Shamrock Development. Net: ABC/I. Rep: Selcom, Dome. Format: Contemp, easy istng. Spec prog: Farm 1/2 hr w/ky. ■ William R. Lynett, mgr; Joseph Silva, prog dir; Margaret Sieboda, news dir; Norman Avery, chief engr. ■ Rates: \$10; 10; 10; —.

WEZX(FM)—Co-owned with WEJL. Nov 1, 1967: 107.1 mhz; 125 w. Ant 1,170 ft. Stereo. Prog sep from AM. Format: Easy istng. ■ William Longworth, gen mgr.

WGBI—Jan 12, 1925: 910 khz; 1 kw-D, 500 w-N. 1000 Wyoming Ave. (19509). (717) 342-7634. TWX 510-671-4607. WGBI Radio Inc. Net: CBS. Rep: Avco. Format: C&W. ■ M. E. Megargee, pres; Madge Megargee Holcomb, gen mgr; Gerald Petrella, coml mgr; Mort Rosenthal, prog dir; Doug-Holcomb, prom mgr; Thomas Powell, news dir; Robert Leach, chief engr. ■ Rates: \$16; 14; 16; 12.

WGBI-FM—Dec 25, 1948: 101.3 mhz; 7 kw. Ant 1,110 ft. Stereo. Prog sep from AM. Format: Top 40. ■ WDAU-TV affil. ■ Rates same as AM.

WICK—April 17, 1954: 1400 khz; 1 kw-D, 250 w-N. 116 Adams Ave. (18501). (717) 346-6563. Scranton Radio Corp. Net: MBS. Rep: Savall/Gates. Format: Talk, big bands. Spec prog: Jazz 6 hrs w/ky. ■ Joseph W. Dobbs, pres; William Straw, stn mgr; Glenn Kalina, prog dir; William Hessmiller, chief engr.

WILK—See Wilkes-Barre.

WSCR—1947: 1320 khz; 1 kw-D, 500 w-N, DA-N. 1520 North Keyser Ave. (18504). (717) 347-3388. Rice Communications Inc. (acq 7-1-66). Net: NBC. Rep: PRO/Meeker. Format: Contemp, Top 40. ■ William Thomas Rice Sr., pres & gen mgr; Mary Ann Martine, coml mgr; Vince Luciano, prog dir; Bruce Michaels, prom mgr; Tom Rice Sr., news dir; V. Albert, mus dir; Joe Coleman, chief engr.

***WVIA-FM**—April 23, 1973: 89.9 mhz; 5 kw. Ant 1,250 ft. Public Bcstg Ctr. (18640). (717) 655-4561. TWX 510-658-3448. N.E. Pa. Educ TV Assoc. Net: NPR, Pa. Public Radio Network. Audio news: UPI. Format: Classcl. ■ Roy J. Hoinowski, dir rad opns & prog dir; George H. Strimel, pres and gen mgr; Jack Lewis, prom mgr; Paul Ewanosky, chief engr.

***WVMW-FM**—September 1974: 91.5 mhz; 10 w. Stereo. 2300 Adams Ave. (18509). (717) 343-6521. Marywood College. Format: Prog, classcl, educ. ■ Sister M. Coleman Nee, pres; Sally A. Liptes, stn mgr.

WWDL-FM—Nov 26, 1964: 104.9 mhz; 145 w. Ant 1,093 ft. Stereo. 1049 North Sekol Rd. (18504).

344-1221. Lane Bcstg Corp. Audio news: UPI. Rep: PRO/Meeker. Format: Contemp MOR. Spec prog: Farm 1 hr wkly. ■ Douglas V. Lane, pres & gen mgr; William J. Lane, VP; Virginia B. Lane, sec; Louis K. Schwass, prog dir; John Winslow, news dir; David Michlowski, chief engr. ■ Rates: \$15; 15; 15; 15.

WYZZ(FM)—See Wilkes-Barre.

Selinsgrove

***WQSU(FM)**—September 1967: 88.9 mhz; 5.6 w. Ant 620 ft. Susquehanna University (17870). (717) 374-9700. Susquehanna Univ. Net: IBS. ■ Larry D. Augustine, gen mgr; Dave Lightcap, chief engr.

WSEW—Jan 16, 1967: 1240 khz; 1 kw-D, 250 w-N. Box 1240, R.D. 1 (17870). (717) 374-1155. B & K Bcstg. Audio news: UPI. Format: Diversfd. Spec progs: Farm 1½ hrs wky; C&W 2 hrs wky. ■ William F. Mahoney, pres & gen and coml mgr; Nick Reed, prog and mus dir; Ed Maddon, prom mgr and sports dir; Robert Richter, news dir; Gary Nichols, chief engr.

Shamokin

WISL—January 1948: 1480 khz; 1 kw-U, DA-N. Rock & Sunbury Sts. (17872). (717) 648-6831. Radio Anthracite Inc. (acq 7-18-57). Rep: Forjoe. Spec prog: Pol 6 hrs wky. ■ Henry W. Lark, pres; Bernard Friedman, gen mgr; Frank Eckker, coml mgr; Bernie Saks, prog dir; Bernie Flynn, prom mgr; Tom Kutza, news dir; Al Donovan, chief engr.

WISL-FM—September 1968: 95.3 mhz; 1.75 kw. Ant 300 ft. Dups AM 95%.

Sharon

WPIC—Oct 25, 1938: 790 khz; 1 kw-D. 2030 Pine Hollow Blvd. Box 211 (16146). (412) 346-4113. Sharon Bcstg Co. (acq 5-21-59). Group owner: Rgnl Bcstrs. Net: ABC/I. Format: MOR. ■ Joseph Dobosh, gen mgr; Ralph Evans, prog dir; Charles Ring, chief engr.

WYFM(FM)—Co-owned with WPIC. 1947: 102.9 mhz; 26 kw. Ant 455 ft. Stereo. Dups AM 1%. Rep: Selcom. Format: Top 40. Spec progs: Black ½ hr; Hungarian ½ hr wky. ■ Dan Messersmith, prog & mus dir.

Shenandoah

WMBT—March 19, 1963: 1530 khz; 250 w-D. Box 1530 (17976). (717) 462-2759. Schuylkill Trans-Audio Corp. Format: Contemp. ■ Ron Stewart, gen & coml mgr; Andrew Popalis, prog, mus & news dir; Russel Bassett, chief engr.

Shippensburg

WSHP—Dec 5, 1961: 1480 khz; 500 w-D. Box 1480 (17257). (717) 532-4105. Town Radio Inc. Format: MOR. Spec prog: C&W 16 hrs wky. ■ Arthur K. Greiner, pres & gen mgr; Nancy E. Reese, asst gen mgr; Judy A. Gray, coml mgr; Marsha D. Carlin, asst coml mgr; Larry Flood, prog dir; Ted Foreman, prog dir; Laura G. Christman, prom mgr; Brian McGuire, news dir; John Nordine, chief engr. ■ Rates: \$3.50; 3.50; 3.50; 3.50.

***WSYC-FM**—88.7 mhz; 13 w. Ant 40 ft. Prince St. (17257). (717) 532-6006. Shippensburg State College. Format: Educl, progrsv. ■ Andrew R. Rolfe, gen mgr and chief engr.

Somerset

WVSC—Jan 15, 1951: 990 khz; 5 kw-D, DA. Box 231 (15501). (814) 445-4186. Ridge Communications Inc. (acq 5-11-72). Net: ABC/I. Rep: Regional Reps, Dome-Messervy. Format: MOR, C&W. ■ I. Richard Adams, pres & gen mgr; Gerald Chabol, coml & prom mgr; Yvonne Kaufman, prog dir; Walter Ebie, news dir; Harold Showman, mus dir & chief engr. ■ Rates: \$10; 10; 10; 10.

WVSC-FM—June 15, 1966: 97.7 mhz; 3 kw horiz, 2.95 kw vert. Ant 270 ft horiz, 265 ft vert. Dups AM 80%.

South Williamsport

WMPT—Feb 21, 1958: 1450 khz; 1 kw-D, 250 w-N. Box 883, Williamsport (17701). (717) 323-3608. Will-Mont Bcstg Co. Net: ABC/C. Rep: Market 4. Format: Top 40. ■ Galen D. Castlebury Jr., pres & gen mgr;

Robert Jackson, coml mgr; Robert Evans, prog dir & prom mgr; Greg Isadore, mus dir; Clyde Thompson, news dir; John Crawford, chief engr.

WMPT-FM—June 1, 1968: 99.3 mhz; 105 w. Ant 1,230 ft. Stereo. Dups AM 70%.

Starview

WRHY(FM)—Nov 22, 1971: 92.7 mhz; 720 w. Ant 560 ft. (CP: 820 w. Ant 530 ft.). R.D. 1, Mt. Wolf (17347). (717) 266-1574. Capital Media Inc. Audio news: UPI. Format: Contemp, progrsv. Spec progs: Black 2 hrs; relig 7 hrs; jazz 2 hrs wky. ■ Carl Fehrenbach, pres; Gordon Moul, gen and prom mgr, prog dir and chief engr; Dave Cameron, coml mgr; Pat Richards, mus dir; Ted Furman, news dir. ■ Rates: \$10; 10; 10; 10.

State College

WBLF—See Bellefonte.

***WDFM(FM)**—Dec 6, 1953: 91.1 mhz; 870 w horiz, 850 w vert. Ant minus 78 ft horiz, minus 83 ft vert. Stereo. 304 Sparks Bldg. (16802). (814) 865-1876. Pennsylvania State U. Format: Classical. ■ Harold Nelson, gen mgr; Mel Klein, bd chm; Carl Vole Jr, chief engr.

WMAJ—1945: 1450 khz; 1 kw-D, 250 w-N. Box 888 (16801). (814) 237-7217. Centre Bcstrs Inc. (acq 1958). Net: NBC. Rep: Bernard. Format: Contemp. ■ M. J. Bergstein, pres & gen mgr.

WXLRFM—Co-owned with WMAJ. Feb 7, 1965: 103.1 mhz; 3 kw horiz, 2.95 kw vert. Ant minus 55 ft horiz, minus 50 ft vert. Stereo. Progs sep from AM.

WQWK(FM)—Listing follows WRSC.

WRSC—May 29, 1961: 1390 khz; 1 kw-D. 160 Clearview Ave. (16801). (814) 238-5085. State College Communications (acq 1-7-75). Group owner: Eastern. Net: ABC/C. Format: Contemp. ■ Robert K. Zimmerman, gen mgr; Howard McAnany, coml mgr; Fred Hansberger, prog and news dir; Chuck Varesko, mus dir; George Werl, chief engr. ■ Rates: \$6.75; 6.75; 6.75; 6.75.

WQWK(FM)—Co-owned with WRSC. April 1965: 96.7 mhz; 3 kw. Ant 78 ft. Stereo. Dups AM 50%. Format: Progressive rock. ■ Chris Borad, prog dir.

WXLRFM—Listing follows WMAJ.

Stroudsburg

WVPO—1947: 840 khz; 250 w-D. 22 S. Sixth St. (18360). (717) 421-2100. Sea-Mount Radio Corp. of Penna. (acq 7-15-70). Rep: Dome Market 4. Format: MOR. ■ Ronald C. Drescher, pres & gen mgr; George Bihler, sls mgr; Maurice Stuart, dir of ops; Ernest Transue, chief engr.

WVPO-FM—Oct 1, 1964: 93.5 mhz; 330 w. Ant 780 ft. Dups AM 80%.

Sunbury

WKOK—1933: 1070 khz; 10 kw-D, 1 kw-N, DA-2. Box 1070 (17801). (717) 286-5838. Sunbury Bcstg Corp. Net: CBS. Rep: Smith, Dome. Format: MOR. Spec prog: Farm 2 hrs wky. ■ Roger S. Haddon, pres; James K. Stock, gen mgr; Marvin Benfer, coml mgr; Than Mitchell, prog dir; Stephen Kusheloff, news dir; John W. Keller Jr., chief engr. ■ Rates: \$5.50; 5.50; 5.50; 5.50.

WKOK-FM—Sept 15, 1948: 94.1 mhz; 12.5 kw. Ant 875 ft. Dups AM 60%. Format: C&W. ■ Rates same as AM.

Swarthmore

***WSRN-FM**—Dec 1, 1972: 91.5 mhz; 10 w. Swarthmore College (19801). (215) KI 3-3220. Swarthmore College. Format: Progressive, classcl, jazz. ■ Susan Goldman, stn mgr.

Tamaqua

WZTA(FM)—June 14, 1965: 105.5 mhz; 3 kw. Ant minus 11 ft. Dutch Hill (18252). (717) 668-2992. Z Broadcasting Inc. Format: Easy listng. ■ Floyd R. Zimmerman, pres & gen mgr; Jim Douglass, stn mgr; Barbara Stegmeier; office mgr. ■ Rates: \$35; 35; 35; 35.

Pennsylvania Radio

See page C-1 for explanation of listings.

Telford

***WBMR(FM)**—June 1967: 89.7 mhz; 10 w. Stereo. 145 N. Third St. (215) 723-7700. United Educational Bcstg Inc. ■ Richard C. Dean, pres; James Stitzinger, prog dir; Arthur J. C. Lawn, chief engr.

Titusville

WTIV—Nov 27, 1955: 1230 khz; 1 kw-D, 250 w-N. Box 184 (16354). (814) 827-3651. Crawford County Bcstg Co. Inc. Group owner: Myron Jones. Net: MBS. Format: MOR. Spec prog: C&W 3 hrs wky. ■ Robert H. Sauber, pres, gen & coml mgr & chief engr; John Litzinger, loc sis mgr; Timothy E. Nelson, prog & news dir. ■ Rates: \$6.10; 6.10; 6.10; 6.10.

Towanda

WTTC—Aug 7, 1960: 1550 khz; 500 w-U. 214½ Main St. (18848). (717) 265-2165. Twin Tier Bcstg Inc. (acq 11-1-65). Net: MBS. Format: MOR, C&W. Spec prog: Pol 1½ hrs wky. ■ Charles L. Snyder, gen mgr; William L. Di Buio, prog dir; Robert Brigham, chief engr.

WTTC-FM—November 1959: 95.3 mhz; 720 w. Ant 125 ft. Dups AM 60%.

Tyrone

WGMR(FM)—Aug 15, 1961: 101.1 mhz; 7.6 kw, Ant 1,060 ft. Box 204, State College, Pa. (16801). (814) 238-0717. Cary H. Simpson. Group owner: Allegheny Mtn. Network. Net: Allegheny Mountain. Rep: Dome-Messervy. Format: Country. ■ Cary Simpson, pres; William E. Moses, gen mgr; Harold G. Green, coml mgr; Dimitry Shilenok, prog dir; Jim Cameron, prom mgr; Lou Kolb, mus dir; Jim Melchiorre, news dir; J. Glenn Daugherty, chief engr.

WTRN—Jan 12, 1955: 1340 khz; 1 kw-D, 250 w-N. Box 247 (16886). (814) 684-3200. Tyrone Bcstg Co. Group owner: Allegheny Mtn. Network. Net: MBS, Allegheny Mountain. Rep: Dome. ■ Cary N. Simpson, pres; William E. Moses, gen & sls mgr; Ann G. Searer, bus mgr; Dennis L. Smith, prog dir; Joyce Nowlin, prom mgr; R. J. Harkins, mus dir; Neal Stevens, news dir; Robert H. Lynn, chief engr. ■ Rates: \$6.90; 4; 6.90; 6.90.

Union City

WCTL(FM)—Oct 31, 1967: 106.3 mhz; 3 kw. Ant 300 ft. RFD 3 (16438). (814) 438-2747. Inspiration Time Inc. (acq 3-7-72). Net: CBN. Rep: Robertson. Format: Variety. Spec progs: Pol ¼ hr; Black ½ hr wky. ■ Richard E. Frank, pres & gen mgr, prog dir & coml mgr; Jim Peer, prom, news, mus dir; Alvin Landers, chief engr.

Uniontown

WMBS—July 15, 1937: 590 khz; 1 kw-U, DA-N. 82 W. Fayette St. (15401). (412) 438-3900. Fayette Bcstg Corp. Net: CBS. Rep: Piano, Dome-Messervy. Format: MOR. Spec progs: Pol ½ hr wky. ■ Simon W. Rider, VP, gen mgr; Larry Ross, prog dir; Hester W. Nagy, coml & prom mgr; Charles H. Underwood, news dir; William J. Henzly, chief engr. ■ Rates: \$9.05; 7.75; 9.05; 7.75.

WPQR-FM—Dec 20, 1968: 99.3 mhz; 3 kw. Ant 300 ft. Stereo. Warner 639 (15401). (412) 437-2813. Warman Bcstg. Net: ABC/FM. Spec progs: Ital 1 hr; Pol 4 hrs wky. ■ Edwin Warman, pres; Edward E. Olesh, VP & gen mgr; Lorraine Livingston, coml mgr; Gregory Schafer, prom mgr; William P. Colborn, prog, mus, & news dir; William H. Schiffbaver, chief engr.

Warren

WNAE—Dec 28, 1945: 1310 khz; 5 kw-D. 310 Sec-ond Ave. (16365). (814) 723-1310. Kinzua Bcstg Co. (acq 1974). Audio news: UPI-Format: Contemp. ■ W. LeRoy Schneck, pres; Frank Foster, coml mgr; Robert Seiden, news dir; Homer Haines, chief engr.

WRRN(FM)—Co-owned with WNAE. March 1948: 92.3 mhz; 26 kw. Ant 410 ft. Stereo. Dups AM 17%. Format: MOR.

Washington

***WJCR(FM)**—Nov 26, 1972: 88.3 mhz; 10 w. 1 South

Pennsylvania, Rhode Island Radio

See page C-1 for explanation of listings.

Lincoln St. (15301). (412) 228-2419. Washington & Jefferson College. Net: NPR, IBS. Format: Progs. ■ David Mulvey, pres and gen mgr.

WJPA—Feb 1, 1941: 1450 khz; 1 kw-D, 250 w-N. 98 S. Main St. (15301). (412) 222-2110. Washington Bcstg Co. Net: MBS. Rep: Direct, Rgnl Reps. Format: MOR, Top 40. ■ A. Boyd Siegel, pres; John L. Merdian, VP & coml mgr; Jay Mitchell, prog and news dir; Dennis Presky, chief engr. ■ Rates: \$10; 10; 10.

WJPA-FM—Sept 26, 1964: 95.3 mhz; 1.95 kw. Ant 360 ft. Dups AM 100%. ■ Rates same as AM.

WKEG—1970: 1110 khz; 1 kw-D, DA. Box 86 (15301). (412) 225-8300. Genas Bcstg Inc. (acq 9-72). Format: MOR. ■ Joseph P. Nascone, pres, gen mgr; Ed Sherlock, prog, mus dir; Sharon Snyder, prom mgr; Earl Bugaie, news dir; William Sheehan, chief engr.

Waynesboro

WAYZ—Aug 19, 1953: 1380 khz; 1 kw-D. 33 E. Main (17268). (717) 762-3138. Richard F. Lewis Jr. Inc. of Waynesboro. Group owner: Mid Atlantic. Net: ABC/C. Format: C&W. ■ Marian F. Lewis, pres; Roy Nester, gen mgr; Peter Coolbaugh, prog dir; Tom Ankerbrand, mus dir; Gary Barkdoll, news dir; Larry Angle, chief engr.

WAYZ-FM—Feb 3, 1959: 101.5 mhz; 3.2 kw. Ant 21 ft. Dups AM 100%.

WEEO—Jan 12, 1971: 1130 khz; 1 kw-D, DA. Box 309 (17268). (717) 762-9336. Raystay Co. (acq 8-70). Format: Top 40. ■ George Gardner, pres; Thomas Boock, gen mgr; Jim Daniels, coml mgr; Rick Shannon, prog dir; Patti Bauer, mus dir; Kevin Armstrong, news dir; Jim Hartzler, chief engr. ■ Rates: \$5.65; 5.20; 5.55; 5.20.

Waynesburg

WANB—Sept 27, 1956: 1580 khz; 250 w-D. Box 406 (15370). (412) 627-5555. Commonwealth Bcstrs Inc. (acq 1975). Rep: Dome-Messervy. Format: MOR. Spec prog: Talk 5 hrs wkly. ■ Kenneth R. Strawberry, owner; Arnold W. Albright, VP & gen mgr; R. G. Klopsch, VP & stn mgr; David D. Maset, prog dir; R. E. Kern, chief engr.

Wellsboro

WGCR(FM)—Listing follows WNBT.

WNBT—May 13, 1955: 1490 khz; 1 kw-D, 250 w-N. Box 98 (16901). (717) 724-1490. Farm & Home Bcstg Co. Group owner: Allegheny Mtn. Network (70%). Net: MBS, Allegheny Mountain. Rep: Dome. Format: MOR, Top 40. ■ Cary H. Simpson, pres; Paul Bryan, gen mgr; Don Agriss, prog dir; Wells M. Farr, chief engr; Mike Remish, news dir. ■ Rates: \$6; 6; 6.

WGCR(FM)—Co-owned with WNBT. July 2, 1969: 104.5 mhz; 50 kw. Ant 380 ft. Stereo. Format: C&W. ■ Terry Goff, sls mgr; Joan McKenna, mus dir. ■ Rates: \$6.50; 6.50; 6.50; 6.50.

West Chester

WCHE—Oct 4, 1963: 1520 khz; 250 w-D. 133 N. High St. (19380). (215) 692-3131. Farwill Communications Inc. (acq 12-7-64). Audio news: APR. Format: MOR. ■ Frank A. Robino Jr., pres; William H. Gehlert, gen & coml mgr; Kenneth Brown, prog & mus dir; Michele Iaia, news dir; Charles Breza, chief engr. ■ Rates: \$6; 5.50; 6; —.

Wilkes-Barre

WARM—See Scranton.

WBAX—May 1, 1922: 1240 khz; 1 kw-D, 250 w-N. One Broadcast Plaza (18703). (717) 288-7575. WBAX Inc. (acq 9-1-71). Group owner: Griffin. Net: ABC/E. Rep: Torbet-Lasker. Format: Contemp. ■ Merv Griffin, pres; Richard Booth, gen mgr; Stephen B. Labunski, exec VP; Bill Stuart, prog dir; Bill Small, news dir; Paul Kelly, chief engr.

WBRE—1923: 1340 khz; 1 kw-D, 250 w-N. 62 S. Franklin St. (18703). (717) 823-0117. TWX 717-480-0510. WBRE Radio Inc. Net: NBC. Rep: PRO/Meeker. Format: MOR. ■ Muriel B. Baltimore, pres; David M.

Baltimore, Joseph Gries, stn & coml mgr; Guy Randall, prog & mus dir; George Andresky Sr., chief engr.

WBRE-FM—1947: 98.5 mhz; 6.9 kw. Ant 1,100 ft. Stereo. Dups AM 98%. ■ Jack Demsky, chief engr. ■ WBRE-TV affil.

***WCLH(FM)**—Feb 6, 1972: 90.7 mhz; 175 w. Ant 1,020 ft. Stereo. (18703). (717) 825-7663. Wilkes College. Format: Variety. ■ Deborah Schneider, student mgr.

WEJL—See Scranton.

WGBI-AM-FM—See Scranton.

WICK—See Scranton.

WILK—Feb 13, 1947: 980 khz; 5 kw-D, 1 kw-N, DA-N. 88 N. Franklin St. (18711). (717) 824-4666. Wyoming Valley Bcstg Co. Net: ABC/C. Audio news: APR. Rep: PRO/Meeker; Dome. Format: Contemp. ■ Mitchell Jenkins, pres; Roy E. Morgan, exec VP & gen mgr; Lee Vincent, coml mgr; Emerson Ramage, prom mgr; Don Bruce, prog dir; James Morgan, production svpr; John Bugbee, news dir; Ronald Balonis, chief engr. ■ Rates: \$14; 13; 14; 13.

WNAK—See Nanticoke.

WPTS—See Pittston.

***WRKC(FM)**—Sept 18, 1968: 88.5 mhz; 440 w. Ant minus 470 ft. 133 N. Franklin St. (18711). (717) 824-9931, ext 284. King's College. Net: ABC/I. Format: Progressive, altern news, jazz. ■ Fr. James Sheerer, pres; Robert Manfre, gen mgr.

WSCR—See Scranton.

WWDL-FM—See Scranton.

WYZZ(FM)—1946: 92.9 mhz; 7.5 kw. Ant 1,060 ft. Stereo Center, 156 Prospect St. (18702). (717) 823-1166. Scranton-Wilkes-Barre Fine Music Bcstg Inc. (acq 12-28-61). Net: ABC/FM. Rep: Groskin, Selective Bcstg Adv. Format: Btlf music, classcl. ■ Richard G. Evans Sr., pres & gen mgr; Mrs. Richard G. Evans Sr., opns & stn mgr & sec-treas; Richard G. Evans Jr., VP dev; Robert L. Evans, VP mktg & coml mgr; Robert L. Edwards, mus dir; Ronald E. Schacht, chief engr.

Williamsport

WILQ-FM—Listing follows WLYC.

WLYC—June 1951: 1050 khz; 1 kw-D. Box 389, 331 Pine St. (17701). (717) 322-4676. Pennsylvania Radio (acq 1975). Net: MBS. Rep: Webb, Gateway Reps. Spec prog: Ital ½ hr wkly. ■ Kerby Confer, Paul H. Rothfuss, co-owners; John H. Ellis, chief engr.

WILQ-FM—July 31, 1949: 105.1 mhz; 3.8 kw. Ant 1,140 ft. Stereo. Dups AM 75%.

WMPA—See South Williamsport.

WRAC—April 10, 1930: 1400 khz; 1 kw-D, 250 w-N. 1559-61 W. Fourth St. (17701). (717) 322-6116. Wright-Mackey Corp. (acq 11-1-62). Net: NBC. Rep: PRO/Meeker; Dome. Format: MOR, C&W. ■ J. Wright Mackey, pres & gen mgr; Lawrence A. Paoloni, coml mgr; Everett W. Rubendall, prog & news dir; Foster E. Gaines, mus dir; Glenn L. Sherman, chief engr.

WRAC-FM—April 1, 1948: 102.7 mhz; 53 kw. Ant 1,270 ft. Dups AM 100%.

WWPA—May 22, 1949: 1340 khz; 1 kw-D, 250 w-N. 330 Government Place (17701). (717) 323-7119. Summit Enterprises Inc. (acq 3-16-61). Net: CBS. Rep: Devney. Format: Contemp, MOR. ■ Woodrow W. Ott, pres & gen mgr; Philip D. Lane, stn, coml, & prom mgr; Frank Barber, prog & news dir; Ken Sawyer, opns mgr; Carl W. Steinbacher, chief engr.

Windber

WWBR

Country-Western Station

WWBR—May 18, 1964: 1350 khz; 1 kw-D. 1311 Midway (15963). (814) 467-8388. WWBR Inc. Net: ABC/E. Format: C&W. Spec progs: Pol 3½ hrs; Hungarian ½ hr wkly. ■ Louis Popp, pres and gen mgr; Glenn R. Thomas, coml mgr; Gary Ringler, prog and mus dir, prom mgr; Harry Hlosky, news dir; Stan Rapski, chief

engr. ■ Rates: \$9.20; 9.20; 9.20; —.

York

WNOW—1948: 1250 khz; 1 kw-D. Box 1747 (17405). (717) 755-1049. Rust Communications Group Inc. (group owner; acq 1957). Net: ABC/I. Rep: Torbet. Format: Modern country. Spec prog: Farm 3 hrs wkly. ■ William F. Rust Jr., pres; S. R. Ackley, VP & gen mgr; Evan Burian, stn mgr; David H. Marino, prog and mus dir; Michael Pintek, news dir; Forest Back, chief engr.

WOXA(FM)—Co-owned with WNOW. 1948: 105.7 mhz; 46 kw horiz, 38 kw vert. Ant 520 ft. Stereo. Prog sep from AM. Format: Top 40. ■ Steve Ort, mus dir and prom mgr.

WRHY(FM)—See Starview.

WSBA—Sept 1, 1942: 910 khz; 5 kw-D, 1 kw-N, DA-2. Box 910 (17405). (717) 764-1155. Susquehanna Bcstg Co. (group owner). Audio news: UPI. Rep: Eastman. Format: Music, news. ■ Louis J. Appell Jr., pres; Chris J. Huber Jr., sls mgr; Arthur W. Carlson, VP radio; Mike McKay, prog dir; Philip K. Eberly, VP & stn mgr; Bill Shepherd, news dir; Ray Ensminger, chief engr. ■ Rates: \$49; 43; 47; 28.

WSBA-FM—Sept 1, 1962: 103.3 mhz; 7.9 kw. Ant 750 ft. Prog sep from AM. ■ C. J. Huber, stn mgr; Johnny Andrews, opns mgr; Joel Desenberg, prog dir; Bob Shipley, mus dir; Marshall Passmore, news dir. ■ WSBA-TV affil.

WYCR(FM)—See Hanover.

WZIX—1932: 1350 khz; 5 kw-D, 1 kw-N, DA-N. 13 S. Beaver St. (17401). (717) 846-8875. Music Fair Enterprises Inc. (acq 7-31-73). Net: MBS, MBS Black. Rep: PRO/Meeker. Format: -Contemp. Spec progs: Black 3 hrs; C&W 9 hrs wkly. ■ Shelly Gross, pres; George Trout, gen mgr; Clare I. Miller, coml mgr; Al Gregson, prog & mus dir; Jim DeAngelo, prom mgr & news dir; Edgar Zug, chief engr.

CSI ELECTRONICS INC.
2607 River Road
Cinnaminon, New Jersey, 08077
Telephone: (609) 786-1060

Rhode Island

HAMILTON-LANDIS

& ASSOCIATES, Inc.
NATIONWIDE MEDIA BROKERS
WASHINGTON, D. C., CHICAGO, DALLAS,
SAN FRANCISCO
SELL MORE
RADIO & TELEVISION STATIONS
IN THE EAST—NEAREST OFFICE IS—
1730 K ST., N.W., WASHINGTON 20006
(202) 393-3456

East Greenwich

WARV—See Warwick-East Greenwich.

Kingston

***WRIU(FM)**—Feb 16, 1964: 91.1 mhz; 10 w. 304 Memorial Union, Univ. of R.I. (02881). (401) 792-2398. U. of R.I. Audio news: APR. Format: Progs, jazz. ■ Marionrose E. Laplante, gen mgr.

Middletown

WKFD—See Wickford.

WOTB(FM)—Co-owned with WKFD. Not on air, target date unknown: 107.1 mhz; 3 kw. Ant 295 ft. Stereo. Emerson Rd., Jamestown (02835). (401) 847-1370. Bay Broadcasters. Rep: North Eastern Spot Sales. Format: Btlf mus. ■ Ronald L. Hickman, pres & gen mgr; Barbara Hickman, VP & coml mgr.

Newport

WADK—Nov. 6, 1948: 1540 khz; 1 kw-D. Box 367 (02840). (401) 846-1540. Key Stns Inc. (acq 7-16-60). Net: ABC/I. Rep: Masia; Eckles. Format: Good mus, talk, news. Spec prog: Port 3 hrs wky. ■ Arnold Lerner, pres; John Moitza, prog dir; Gary W. Crowder, stn mgr; Robert Angel, coml mgr; Robert Sullivan, news dir.

Pawtucket

WGNG—Feb 12, 1950: 550 khz; 1 kw-D. 500 w-N, DA-N. Box 55, Cumberland (02864). (401) 725-9000. Roger Williams Bcstg Co. Inc. Rep: Eastman, Santo Crupi. Format: Contemp. ■ Dominick A. Hysko, pres; Donald R. Hysko, gen mgr; Brad Pierce, prog dir; Ernie R. Latessa, sls mgr; Dennis W. Cole, prom mgr; Mike Cabral, news dir; Craig Healy, chief engr. ■ Rates: \$36; 30; 36; 30.

Portsmouth

***WJHD(FM)**—April 3, 1972: 90.7 mhz; 10 w. Portsmouth Abbey School (02871). (401) 683-2000. The Order of St. Benedict. Format: Classcl. Spec prog: Opera (Sun night), rock. ■ Geoffrey Chase, dir & chief engr; David McCarthy, advisor & prog dir.

Providence

WBRU(FM)—Feb 21, 1966: 95.5 mhz; 50 kw. Ant 220 ft. Stereo. 75 Waterman St. (02912). (401) 272-9550. Brown Bcstg Service Inc. Net: ABC/FM. Audio news: APR. Rep: ABC-FM Spot Sis. Format: Progs rock. Spec progs: Jazz 4 hrs, oldies 3 hrs, black 4 hrs wky. ■ Lee L. Verstandig, pres; Michael Baumstein, gen mgr; Keith Burke, sales mgr; William Blumenthal, bus mgr; Barnett Malin, prog dir; Jeremy Butler, mus dir; Douglas Manning, news dir; John King, chief engr. ■ Rates: \$20; 25; 25; 25.

***WDOM(FM)**—March 15, 1966: 91.3 mhz; 10 w. Box 377, Friar Stn. (02918). (401) 865-2460. Providence College. Net: MBS. Format: Ed/progs. ■ Roger Desautels, dir; Gregory Varian, gen mgr.

WEAN—June 2, 1922: 790 khz; 5 kw-U, DA-2. 10 Dorrance St. (02903). (401) 277-7000. Providence Journal Co. (acq 10-9-54). Net: ABC/C. Rep: Torbet. Format: MOR. ■ Michael Metcalf, pres; Lincoln W. N. Prati, gen mgr; Austin Mulligan, natl sales mgr; Earnest Latessa, local sales mgr; Leigh Morgan, prog dir; Harry McKenna, news dir; Thomas Robertson, opns dir; Joseph Drury, chief engr.

WPJB-FM—Co-owned with WEAN. July 11, 1948: 105.1 mhz; 50 kw. Ant 500 ft. Stereo. Prog sep from AM. Format: Btfl music.

WHIM—April 15, 1947: 1110 khz; 1 kw-D. 115 Eastern Ave., East Providence (02914). (401) 438-6110. Franks Bcstg Co. (acq 9-22-71). Net: ABC/E. Rep: Katz; Kettell-Carter (Boston). Format: C&W. Spec progs: Ital 2 hrs, Armenian 1 hr, Pol 1 hr, Port 1 hr wky. ■ John E. Franks, pres; A. Victor Sylvia, VP gen sis mgr; Carroll Philbrook, VP opns mgr & chief engr; Tom Allen, prog dir; Mark Wayne, mus dir. ■ Rates: \$37; 30; 37; —.

WHIM-FM—March 14, 1966: 94.1 mhz; 50 kw. Ant 430 ft. Stereo. Dups AM 100%. ■ Rates same as AM.

WICE—1947: 1290 khz; 5 kw-D, 1 kw-N, DA-2. 198 Dyer St. (02903). (401) 521-2711. Crohan Communications (acq 1974). Rep: Eastman. Format: Contemp. Spec prog: Black 1 hr wky.

WJAR—Sept 6, 1922: 920 khz; 5 kw-U, DA-N. 176 Weybosset St. (02903). (401) 751-5700. TWX 710-381-1749. Outlet Co. (group owner). Net: NBC. Rep: McGavren-Guild-PGW. Format: Adult contemp. ■ David E. Henderson, pres; Alan H. Andrews, gen mgr; Howard Holland, coml mgr; Jeff Mathieu, prog dir; Mike Ivers, mus dir; Arthur Alpert, news dir; George St. Andre, chief engr. ■ WJAR-TV affil.

WLKW—April 12, 1961: 990 khz; 50 kw-U, DA-D. 228 Weybosset St. (02903). (401) 331-7810. Radio Rhode Island Inc. Group owner: McCormick Communications. Net: ABC/I. Rep: Avco; Creed. Format: Btfl music. ■ William M. McCormick, pres; Albert Makkay, gen mgr; Robert Carson, gen sis mgr; Anthony Rizzini, prog dir; Paul Temple, opns; Joseph Petit, chief engr.

WLKW-FM—June 7, 1968: 101.5 mhz; 50 kw. Ant 500 ft. Stereo. Dups AM 100%.

WPJB-FM—Listing follows WEAN.

WPRO—Oct. 16, 1931: 630 khz; 5 kw-U; DA-N. 1502 Wampanoag Trail, East Providence (02915). (401) 433-4200. Capital Cities Communications (group owner; acq 4-5-59). Rep: Blair. Format: Contemp. ■ Thomas S. Murphy, chmn of the bd; Dick Rakovan, gen mgr; Bill Campbell, coml mgr; Jay Clark, prog dir & prom mgr; Mark Haines, news dir; Egidio J. Policastro, chief engr. ■ Rates: \$60; 30; 48; 35.

WPRO-FM—April 1949: 92.3 mhz; 50 kw. Ant 550 ft. (CP: 39 kw). Prog sep from AM. Format: Top 40. ■ Gary Berkowitz, prog dir; Danny Centofanti, prom mgr; Robert J. Boogie, mus dir. ■ Rates: \$26; 26; 40; 32.

WRIB Inspirational

WRIB—June 16, 1946: 1220 khz; 1 kw-D. Water St., East Providence (02914). (401) 434-0406. WRIB Inc. (acq 1-1-73). Audio news: APR. Rep: Bernard. Format: Relig. Spec progs: Ital 5 hrs, Port 2 hrs, Greek 3 hrs, farm ½ hr wky. ■ Arthur Tacker, pres & gen mgr; John Pierce, asst to pres & prog dir; Donna Pisaluro, mus dir; Gloria Isabella, pub serv dir; Craig Healy, chief engr.

Smithfield

***WJMF(FM)**—Aug 31, 1974: 91.5 mhz; 10 w. Ant 56 ft. Box 1974 (02917). (401) 231-9150. Bryant College of Business Administration. Format: Progs. ■ Gary S. Squires, chmn of the bd; Newton Buchner, gen mgr.

Warwick-East Greenwich

WARV—Aug 12, 1959: 1590 khz; 1 kw-D. (CP: 1 kw-N, DA). 19 Luther Ave., Warwick (02886). (401) 737-0700. Warwick Radio Stn. (acq 5-1-75). Group owner: Three East Communications Co. Audio news: UPI. Rep: Eckles & Queen. Format: Top 40. Spec progs: Fr 1 hr, Greek 1 hr wky. ■ James B. Bocock, pres; Donald A. Brown, VP & gen mgr; Daniel H. McClellan, coml mgr; Ann Jacobs, mus dir; Cheryl Jennings, prom mgr; Bernard Grace, news dir; William Bevins, prog dir; Richard Murphey, chief engr. ■ Rates: \$8; 8; 8; 6.

Westerly

WERI—July 1949: 1230 khz; 1 kw-D, 250 w-N. Colonial Office Bldg. (02891). (401) 596-7728. Westerly Bcstg Co. (acq 1967). Rep: AAA Reps; Michael Fulford Co. Inc. Format: Info. ■ Natalie Urso, pres; Carl Grande, gen mgr; Bob Canty, coml mgr; Bob Terry, prog dir; Steve Caminis, news dir; Dick Ober, chief engr.

WERI-FM—Oct 17, 1967: 103.7 mhz; 16 kw. Ant 140 ft. Dups AM 80%.

West Warwick

WKRI—Aug 1956: 1450 khz; 1 kw-D, 250 w-N. 1501 Main St. (02893). (401) 821-6200. Consolidated Communications Inc. Net: MBS. Rep: Eckles & Queen. Format: MOR, contemp, sports. Spec progs: Fr 1½ hrs, Pol 1 hr, Greek 1 hr, Port 1 hr wky. ■ Hal Carpenter, pres, gen & coml mgr; Bill Harper, prog dir; Jim Roberts, news dir; Joe Mattias, chief engr.

Wickford

WKFD—1961: 1370 khz; 500 w-D. Box 441, 19 Updike Ave., N. Kingstown (02852). (401) 295-1370. The Radio Lighthouse Inc. (acq 6-6-69). Rep: North Eastern Spot Sis. Format: MOR. Spec prog: Port 4 hrs wky. ■ Ronald L. Hickman, pres & gen mgr; Barbara Hickman, VP; Dal Dearmin, opns mgr; Steve Bousquet, news dir. ■ Rates: \$9.10; 9.10; 9.10; 9.10.

WOTB-FM—See Middletown.

Woonsocket

WNRI—Nov 28, 1954: 1380 khz; 1 kw-D. 786 Diamond Hill Rd. (02895). (401) 769-6925. K/S Bcstg Co. (acq 5-16-75). Net: ABC/I. Rep: Eckles & Queen. Format: Top 40. Spec progs: Fr 4 hrs, Pol 1 hr, Port 1½ hrs wky. ■ Paul Perry Kafatsanas, pres; Norman J. Slemenda, gen & coml mgr; Paul Perry, prom mgr, prog and mus dir; Tom Koller, news dir; Craig Healy, chief engr. ■ Rates: \$6; 5; 6; 5.

WWON—Nov 11, 1946: 1240 khz; 1 kw-D, 250 w-N. 98 Getchell Ave. (02895). (401) 762-1240. Woonsocket Bcstg Co. (acq 7-11-50). Net: MBS. Rep: Kirby.

Rhode Island, South Carolina Radio

See page C-1 for explanation of listings.

Format: MOR, talk. Spec progs: Fr 3 hrs, Pol 1 hr wky. ■ Drew H. Palmer, pres; Dave Russell, gen mgr; John Guerin, coml mgr; Gene O'Neill, news dir; Ron Des Lauriers, chief engr; Roger Bouchard, prog dir. ■ Rates: \$7; 6; 7; 6.

WWON-FM—Nov 11, 1946: 106.3 mhz; 3 kw. Ant 215 ft. Stereo. Dups AM 5%. Format: Easy Istng. ■ Rates: \$5; 5; 5; 5.

South Carolina

**HAMILTON-LANDIS
& ASSOCIATES, Inc.**
NATIONWIDE MEDIA BROKERS
WASHINGTON, D. C., CHICAGO, DALLAS,
SAN FRANCISCO
SELL **MORE**
RADIO & TELEVISION STATIONS
IN THE EAST—NEAREST OFFICE IS—
1730 K ST., N.W., WASHINGTON 20006
(202) 393-3456

Abbeville

WABV—March 1956: 1590 khz; 1 kw-D. Box 700 (29620). (803) 459-2163. Abcco Inc. (acq 1-6-73). Format: C&W. ■ Randy G. Ghent, gen mgr; Bert Landreth, prog dir. ■ Rates: \$2.20; 2.20; 2.20; 2.20.

Aiken

WAKN—1952: 990 khz; 1 kw-D. Box 811 (29801). (803) 648-5464. Eagle Enterprises Inc. (acq 5-1-70). Rep: Meeker; Busby, Finch & Woods. Format: Contemp. ■ Michael L. Laughlin, pres; Philip M. Gagnon, gen mgr; Frank W. Stewart Jr., coml mgr; George Wood, prog dir; Marion Fulmer, chief engr.

WNEZ(FM)—Co-owned with WAKN. August 1966: 99.3 mhz; 3 kw. Ant 300 ft. Stereo. Prog sep from AM. Format: MOR.

WLOW—Dec 16, 1962: 1300 khz; 500 w-D. Box 2206 (29801). (803) 648-6861. Briar Creek Bcstg (acq 9-6-74). Net: ABC/E. Rep: Southern Spot Sis. Format: MOR. Spec prog: Farm 5 hrs wky. ■ A. Mills Filtzner, pres, gen mgr & chief engr; Dave Delehnn, prog, mus & news dir; Cheryl Filtzner, sls mgr.

WLOW-FM—Sept 17, 1966: 95.9 mhz; 3 kw. Ant 200 ft. Dups AM 70%.

Allendale

WDOG—Jan 1, 1966: 1460 khz; 1 kw-D. Box 442 (29810). (803) 584-3500. All-Fair Bcstg Corp. Group owner: Chas. E. Bell Stns. Net: ABC/C. Rep: Carpenter. Format: C&W, MOR. Spec progs: Black 20 hrs wky. ■ Chas. E. Bell, pres; H. Carl Gooding, gen mgr & coml mgr; Lisa Gooding, prom dir; Alberta Davis, news dir. ■ Rates: \$2.50; 2.50; 2.50; —.

Anderson

WAIM—April 1935: 1230 khz; 1 kw-D, 250 w-N. 321 Kingsley Rd. (29623). (803) 226-1511. Wilton E. Hall. Net: CBS, Palmetto. Rep: Devney; Dora-Clayton. Spec prog: Black 3 hrs wky. ■ Wilton E. Hall, owner; Glenn P. Warnock, gen mgr; John F. McCallum, coml mgr; Betty K. Black, prog dir; Marshall Gaillard, news dir; Robert K. Baldwin, chief engr.

WCAC(FM)—Co-owned with WAIM. 1947: 101.1 mhz; 6.4 kw. Ant 330 ft. Dups AM 95%. ■ WAIM-TV affil.

WANS—Sept 22, 1949: 1280 khz; 5 kw-D, 1 kw-N. DA-N. Box 211 (29621). (803) 224-3424. Radio Anderson Inc. (acq 8-1-57). Net: ABC/C, Tobacco. Rep: Savalli/Gates; TN Spot Sis. Format: Contemp. Spec prog: Black 12 hrs wky. ■ Nicholas T. Frangias, pres; Carolyn K. Turrer, VP & gen mgr; Shirley Palmer, coml mgr; Mickee C. Tabor, prog dir; J. Clark Brown, prom mgr; Dan Scott, mus dir; Jay Clark, sports dir; James B. Graham, chief engr; Dale A. Keeney, news dir.

South Carolina Radio

See page C-1 for explanation of listings.

WANS-FM—Oct 24, 1967: 107.3 mhz; 100 kw. Ant 260 ft. Dups AM 100%.

WCAC(FM)—Listing follows WAIM.

Bamberg-Denmark

WWBD—June 23, 1957: 790 khz; 1 kw-D. Box 543 (29003). (803) 245-2411. WWBD Inc. (acq 10-1-62). Net: Keystone. Format: C&W. Spec prog: Black 14 hrs wkly. ■ Vic Whelstone Jr, pres & gen mgr; Bob Clary, coml mgr & news dir; Guy Kirby, prog dir; Don Cubison, chief engr.

WWBD-FM—May, 1967: 92.7 mhz; 3 kw. Ant 300 ft. Prog sep from AM. Format: Good mus days, C&W evenings.

Barnwell

WBAW—Oct 12, 1953: 740 khz; 1 kw-D. Box 447 (29812). (803) 259-3507. Radio WBAW Inc. (acq 8-30-56). Net: Tobacco. Rep: Hopewell; Busby, Finch & Woods. Format: Contemp. Spec prog: C&W 12 hrs wkly. ■ Joe Wilder, pres & gen mgr; Dick Wilson, coml mgr; Drew Wilder, prog dir; Steve Sloan, news dir; Fayne Anderson, chief engr.

WBAW-FM—Aug 31, 1966: 101.7 mhz; 3 kw. Ant 280 ft. Dups AM 100%.

Batesburg

WBRL—May 10, 1956: 1430 khz; 5 kw-D. Drawer 410 (29006). (803) 532-6254. The Ridge Bcstg Co. (acq 5-1-59). Format: MOR, C&W. ■ H. E. Crapps Sr, pres & gen mgr; Redd Reynolds, coml mgr; Ed Crapps Jr, prog dir; Glenn Taylor, news dir; Ken Durst, chief engr.

WBRL-FM—August 5, 1965: 92.1 mhz; 3 kw. Ant 300 ft. Dups AM 100%.

Beaufort

WBEU—March 1954: 960 khz; 1 kw-D. 3040 West Boundary St. (29902). (803) 524-3050 or 524-3118. Beaufort Bcstg Co. Net: ABC/C. Rep: Keystone; Southern Spot Sls. Format: Contemp. ■ John M. Trask Jr, pres; Randy G. Ghent, gen & coml mgr; Bill Calvert, prog dir; Edward S. Borden, chief engr.

WBEU-FM—Aug 8, 1962: 98.7 mhz; 18 kw. Ant 225 ft. (CP: 36 kw). Stereo. Prog sep from AM. Net: ABC/FM. Format: Btlf mus, progsv.

WSIB—Feb 10, 1962: 1490 khz; 500 w-D, 250 w-N. Drawer W (29902). (803) 524-4700. Sea Island Bcstg Co. of S.C. (acq 5-29-65). Group owner: Bell. Net: MBS, Mutual Black. Rep: Carpenter. Format: Top 40, black. Spec prog: Talk 4 hrs wkly. ■ Charles E. Bell, pres, gen mgr & chief engr; Kenneth J. Burck, stn mgr, prog & news dir; Ray Tucker, mus dir; Deloris R. Burch, prom mgr. ■ Rates: \$3; 3; 3; 3.

Belton

WHPB—October 1956: 1390 khz; 1 kw-D. Box 490 (29627). (803) 338-7786. Andco Bcstg Co. Inc. (acq 10-1-68). Format: C&W. Spec prog: Gospel. ■ William L. Thompson, pres; William S. Brisse, sec-treas; Jacob H. Brisse, coml mgr; Bill McCown, news dir; Kenneth Allison, prog, mus dir & chief engr. ■ Rates: \$2.20; 2.20; 2.20;—

Bennettsville

WBSC—June 1947: 1550 khz; 10 kw-D, 5 kw-N, DA-N. Drawer 629 (29512). (803) 479-7121. Big Bend Bcstg Corp. (group owner; acq 9-23-62). Net: MBS. Rep: Southern Spot Sls. Format: Contemporary, black. ■ A. K. Harmon, VP & gen mgr. ■ Rates: \$3.75; 3.75; 3.75; 3.75.

Bishopville

WAGS—Feb 24, 1954: 1380 khz; 1 kw-D. Box 549, Camden (29020). (803) 484-5415. Lee County Bcstg. Rep: Southern; Keystone. Format: Variety. ■ H. S. Bowden, pres; Thomas J. Richards, gen mgr; L. Bryan Hicks, coml mgr; Tomie Howard, prog dir; Roger Hamlin, news dir; Ben Team, chief engr.

Burnettown

WVAP—Sept 28, 1968: 1510 khz; 500 w-D. Box 1, Langley (29834). (803) 593-3915. Midland Valley Investment Co. Inc. Format: C&W. ■ Harry Parker, pres; George E. Hydrick, gen mgr; Wayne Roberts, prog dir; Larry Sandlin, chief engr.

Camden

WACA—July 24, 1948: 1590 khz; 1 kw-D. Box 549 (29020). (803) 432-2311. Camden Bcstg Corp. Format: Contemp. ■ H. S. Bowden, pres; Tom Richards, gen mgr; Bryan Hicks, prog dir & coml mgr; Roger Hamlin, mus dir; Joe Rodgers, news dir; Ben Team, chief engr.

WPUB—Dec 15, 1970: 1130 khz; 1 kw-D. Box 753, 1109 Broad St. (29020). (803) 432-1130. Kershaw County Bcstg Co. Format: Variety. ■ Austin M. Sheheen Jr, pres; Cecil A. Bowers, gen mgr; Rod Poole, prog dir; Roger Hamlin, mus dir; Eric Brown, news dir; R. H. Miller, chief engr.

WPUB-FM—December 1974: 94.3 mhz; 3 kw. Ant 180 ft. (803) 432-1131. Format: MOR, Top 40. Prog sep from AM. ■ Rod Poole, gen mgr; Roger Hamlin, prog dir; Phil Rogers, mus dir; Brenda F. Reece, coml mgr; Saily Wells Cook, news dir.

Cayce

WCAY—Aug 22, 1958: 620 khz; 500 w-D. Box 125 (29033). 796-1850. Lexington County Bcstrs Inc. Net: MBS. Rep: Carpenter. Format: Farm, C&W. ■ J. Lin Tice Jr, pres; Kent Kirkland, coml mgr; Joe E. Morris, bus mgr; Dave Kirby, prog dir; Jack Rogers, mus dir; Mike Day, prom mgr; Ron Crisp, chief engr; Lennie Dolin, news dir. ■ Rates: \$10; 9; 9;—

WZLD(FM)—August 1974: 96.7 mhz; 3 kw. Ant 300 ft. (803) 796-8896. WZLD Inc.

Charleston

WCSC—May 14, 1930: 1390 khz; 5 kw-U, DA-N. Box 186 (29402). (803) 722-7611. WCSC Inc. (acq 1-1-44). Audio news: UPI. Rep: McGavren-Guild. Format: MOR. ■ John M. Rivers Jr, pres; Tony D. Warren, gen mgr; Suzanne Sumler, coml mgr; Mike Hiott, prog dir; Gloria S. Wilson, prom mgr; Debbie Cunningham, mus dir; Rod Bullard, chief engr; John Dozier, news dir. ■ Rates: \$17; 14; 17; 14.

WXTC(FM)—Co-owned with WCSC. April 1948: 96.9 mhz; 100 kw. Ant 780 ft. Stereo. Prog sep from AM. ■ Jim Vann, prog dir. ■ WCSC-TV affil. ■ Rates: \$7; 7; 7; 7.

WEZL(FM)—Oct 5, 1970: 103.5 mhz; 25 kw. Ant 275 ft. 133 Church St. (29401). (803) 577-3135. Fine Arts Bcstg Inc. Net: ABC/C. Rep: Carpenter. Format: C&W. ■ Charles N. Barton, pres; Jay D. Mullen, gen mgr; Blackstone Smith, coml mgr; Charles Lindsey, prog dir; Barbara Seay, prom mgr; Bruce Cotton, mus dir; Tom O'Brien, chief engr; Jack Luker, news dir.

WKTM(FM)—Co-owned with WNCG, North Charleston. July 17, 1962: 102.5 mhz; 50 kw. Ant 190 ft. (CP: 59 kw. Ant 195 ft.). Stereo. O'Hear Ave. (29406). Prog sep from AM. Net: ABC/C. Format: Contemp.

WOKE—1946: 1340 khz; 1 kw-D, 250 w-N. Box 183 (29402). (803) 723-1643. Weaver Bcstg Corp. (acq 7-20-55). Net: NBC. Rep: Dora-Clayton. Format: MOR, variety. Spec prog: Local sports, Black 3 hrs wkly. ■ Harry C. Weaver, pres & gen mgr; Alyce Clayton, wom dir; Lynn Terrell, mus dir; Pat Joyce, news dir; Gordon Knight, contract engr.

WPAL—1947: 730 khz; 1 kw-D. Box 3437 (29407). (803) 766-5584. Brothers Bcstg Inc. (acq 7-12-72). Net: Mutual Black, National Black. Rep: Howard. Format: Black, contemp. ■ Ken Goodman, pres & gen mgr; Herb Cunningham, sis mgr; Clarence Pitts, prog & mus dir; Charles McHan, chief engr. ■ Rates: \$24; 22; 24; 22.

WPXI(FM)—Listing follows WTMA.

WWWZ(FM)—Co-owned with WPAL. See Summerville.

WQSN—1948: 1450 khz; 1 kw-D, 250 w-N. Box 891 (29402). (803) 722-2652. Low Country Bcstg Co. (acq 10-55). Rep: H-R/Stone. Format: C&W. ■ Barry Winton, pres; Douglas R. Clements, VP & gen mgr. ■ Rates: \$20.50; 16.50; 20.50; 12.50.

***WSCI(FM)**—April 15, 1973: 89.3 mhz; 97 kw. Ant 540 ft. Stereo. 26 Broad St. (29401). (803) 722-3170. S.C. Educational TV Commission. Net: NPR. Format: Educl. Spec prog: Black 6½ hrs wkly. ■ Henry J. Cauthen, pres & gen mgr; William D. Hay, dir of radio; Joseph A. Martin Jr, mgr & prog dir; Charlton Bowers, chief engr.

WTMA—1939: 1250 khz; 5 kw-U, DA-N. Box 10208, Rivers Annex (29411). (803) 556-5660. Charleston Communications Corp. (acq 11-18-75). Net: ABC/C. Rep: Eastman. Format: Contemp. ■ Charles E. Smith, VP; Bob Chrystie, gen mgr; Gordon Stenback, coml mgr; John Trenton, prog dir; Frank Hunt, news dir; Bill Medley, chief engr.

WPXI(FM)—Co-owned with WTMA. 1945: 95.1 mhz; 100 kw. Ant 360 ft. ■ Ted Bell, opns mgr.

WXTC(FM)—Listing follows WCSC.

Cheraw

WCRE—July 1953: 1420 khz; 1 kw-D. Box 631 (29520). (803) 537-7887. Town & Country Radio Inc. (acq 2-19-72). Group owner: Gray Bcstg Enterprises. Net: ABC/C. Rep: Southern Spot Sls. Format: Variety. Spec progs: Black 4 hrs, farm 4 hrs wkly. ■ Theodore J. Gray Jr, pres; Michael Orr, gen mgr; Al Hamrick, coml mgr; James Reddish, mus dir; Dave Raley, chief engr. ■ Rates: \$2.25; 2; 2.25; 2.

Chester

WCMJ(FM)—Co-owned with WYCL, York. Aug 30, 1969: 99.3 mhz; 2 kw. Ant 360 ft. Box 297 (29706). (803) 377-3193. Chester County Bcstg. Audio news: APR. Rep: Beaver; Riley. Format: C&W. ■ C. Curtis Sigmon, pres; Gerald James, stn mgr; Carroll Henderson, news dir; Robert Strickland, chief engr.

WGCD—July 18, 1948: 1490 khz; 1 kw-D, 250-N. Box 746 (29706). (803) 377-1111. The Dispatch Bcstg Co. (group owner; acq 7-1-55). Net: ABC/C. Format: Oldies, top 40, black. ■ C. V. Sink, pres; Robert L. Heinlein, gen mgr & prog dir; Chris Johnson, coml mgr; Joel Shockley, chief engr; Jim Lane, mus & news dir. ■ Rates: \$4.50; 4; 4.50; 4.

Clemson

WCCP—July 27, 1969: 1560 khz; 1 kw-D (500 w-CH). Box 322 (29631). (803) 654-5400. Tri-County Bcstg Corp. Format: MOR. ■ Robert E. Liverance, pres & chief engr; Maurice Liggett, coml mgr; Matt Phillips, gen mgr; Red Durkan, news dir. ■ Rates: \$2.35; 2.35; 2.35; 2.35.

***WSBF-FM**—March 16, 1961: 88.1 mhz; 10 w. Box 2156 Clemson University (29632). (803) 656-2279 or 654-3706. Clemson University. Net: MBS. Format: Progs. Spec progs: Black 4 hrs, C&W 3 hrs wkly. ■ Walter T. Cox, advisor; B. Edward O'Dell, prog dir.

Clinton

WPCC—Sept 11, 1957: 1410 khz; 1 kw-D. Box 663 (29325). (803) 833-4215. Radio Station WPCC Inc. (acq 1964). Net: ABC/C. Rep: Keystone. Format: Top 40. ■ E. M. Spencer, pres; Dan Lynch, gen mgr & prog dir; Henry T. Lashley, asst mgr; Hayne Davis, prom mgr; Jimmy Cheeks, news dir; John Wallace, mus dir; Norman Payne, chief engr. ■ Rates: \$3.93; 3.93; 3.93; 3.93.

Columbia

***WBCT(FM)**—Not on air; target date unknown: 90.5 mhz; 15.8 kw. Ant 223 ft. Harding & Blanding Sts. (29204). Benedict College. ■ Ronald W. Saufley, asst to pres.

WCAY—See Cayce.

WCOS—1939: 1400 khz; 1 kw-D, 250 w-N. Box 738 (29202). (803) 252-2177. WCOS Inc. (acq 2-1-58). Rep: H.R/Stone. Format: Contemp. ■ George H. Buck Jr, pres; Jess E. Plummer, gen & coml mgr; Woody Windham, prog dir; Jack Grant, prom mgr; Mike Rast, news dir; Milton Holladay Jr, chief engr. ■ Rates: \$27; 22; 27; 22.

WCOS-FM—March 1951: 97.9 mhz; 10 kw. Ant 402 ft. Stereo. Prog sep from AM. Format: Underground. ■ Rates: \$17; 13; 15; 13.

WIS—July 10, 1930: 560 khz; 5 kw-U, DA-N. Box 21567 (29221). (803) 772-0256. Cosmos Bcstg

Corp. (group owner; acq 1931). Net: NBC. Rep: McGavren-Guild. Format: MOR. ■ Charles A. Batson, pres; John A. Grimes, gen mgr; John M. Carroll, sls mgr; David T. Kirschner, prog dir; Jerry Pate, news dir; Joseph Davenport, chief engr. ■ WIS-TV affil. ■ Rates: \$44; 32; 39; 17.

***WLTR(FM)**—Not on air, target date unknown: 91.3 mhz; 100 kw. Ant 850 ft. 2712 Millwood Ave. (29205). South Carolina Educl TV Commission.

***WMHK(FM)**—Not on air, target date unknown: 89.7 mhz; 60 kw. Ant 410 ft. Box 3122 (29703). Columbia Bible College Bcstg Co. Format: Educl, relig. ■ David Morrison, prog dir; Marcia Williams, off mgr; Rashie Kennedy Jr., chief engr.

WNOK—Jan 1, 1947: 1230 khz; 1 kw-D, 250 w-N. 6027 Devine St., Drawer M (29205). (803) 776-1230. TWX 803-733-1131. Palmetto Radio Corp. Net: CBS. Rep: Avery-Knodel. Format: Contemp. ■ Erwin Kahn, pres; H. Moody McElveen Jr., exec VP & gen mgr; Frank T. Stish, managing dir; Doug Enlow, prog dir; John R. Cook, news dir; James R. Kelly III, chief engr.

WNOK-FM—July 15, 1959: 104.7 mhz; 100 kw. Ant 460 ft. Stereo. (803) 776-1233. Prog sep from AM. Format: MOR. ■ William L. McElveen, mgng dir; Camille Bradford, coml mgr; Ron L. Wells, prog dir. ■ WNOK-TV affil.

WOIC—June 30, 1954: 1320 khz; 5 kw-D, 1 kw-N, DA-N. Box 565 (29202). (803) 256-1551. Nuance Corp. (acq 2-1-74). Net: ABC/C, Natl Black. Rep: Eastman. Format: R&B. Spec prog: Black 15 hrs wkly. ■ I. S. Leevy Johnson Esq., pres; Elliott E. Franks III, gen mgr; Douglas W. Craig, coml mgr; William E. Terrell, prog dir; David Jones, mus dir; Sandra Davis, news dir; Daryl Nations, chief engr. ■ Rates: \$22.50; 18.15; 22.50; 18.15.

WOXL—1470 khz; 5 kw-D. Box 3277 (29230). (803) 779-7910. Metro Communications (acq 1974). Net: ABC/C. Format: Relig. Spec prog: Black 4 hrs wkly. ■ Garrett M. Alderfer, pres; Dorothea S. Alderfer, VP; John Montgomery, opns mgr. ■ Rates: \$8; 8; 8;—

***WUSC-FM**—1952: 89.9 mhz; 10 w. U. of South Carolina (29208). (803) 777-3110. Div of Continuing Educ. U. of South Carolina. Format: Classcl, ed. ■ Wm. H. Patterson, pres; Nicholas Mitchell, gen mgr; J. Michael Foster, prog and mus dir; Robert Lambert, chief engr.

WXRY(FM)—Feb 6, 1971: 93.5 mhz; 3 kw. Ant 380 ft. Stereo. Box 6827, 2400 Decker Blvd. (29260). (803) 788-6500. Frank D. Ward Inc. Rep: Mastia, Atlanta Spot Sls. Format: Btlf music. ■ Frank D. Ward, pres & gen mgr; R. Lanier Jones, VP & sls mgr; Danny Dart, prom mgr; Marty Wexker, mus dir; Milton Holiday, chief engr; Gary Stevens, news dir. ■ Rates: \$18; 18; 18; 18.

Conway

WLAT—August 1945: 1330 khz; 5 kw-D, 500 w-N, DA-N. Box 799 (29526). (803) 248-9040. Coastal Bcstg Co. Net: MBS, Tobacco. ■ L. M. Hawley, pres & gen mgr; Mike Green, news dir & coml mgr; J. E. Hawley, prog dir & chief engr; Marvin Ingram, prom mgr; Gary Norris, mus dir.

WLAT-FM—July 1964: 104.1 mhz; 65 kw. Ant 140 ft. Stereo. Prog sep from AM.

Darlington

WDAR Country & Western



WDAR—1955: 1350 khz; 1 kw-D. Box 9, 106 Smith Ave. (29532). (803) 393-4081. Rebel Radio Inc. (acq 5-9-69). Net: ABC/C, Tobacco Radio Net. Rep: TN Spot Sls. Format: C&W. ■ Stanley Boyd, pres; Bill C. Walls, gen mgr; Freeland L. Riles, coml mgr; Allan Miller, prog dir; Frank Lewis, prom mgr; Rudolph Hatcher, chief engr. ■ Rates: \$3.75; 3.75; 3.75;—

WDAR-FM—March 1966: 105.5 mhz; 3 kw. Ant 260 ft. Dups AM 100%. ■ Rates same as AM.

Dillon

WDSC—May 22, 1946: 800 khz; 1 kw-D. Box 231 (29536). (803) 774-9031. Border Bcstg Co. Net: ABC/E. Rep: Dora-Clayton; Tobacco Radio Net. Format: Variety, C&W. Spec prog: Black 6 hrs wkly. ■ Joseph Martin, pres & gen mgr; Lee Lumpkin, coml mgr; Eddie Levinor, prog dir; John Quick, news dir & prom mgr; Ray Allen, chief engr.

WDSC-FM—Feb 16, 1954: 92.9 mhz; 10.5 kw. Ant 270 ft. Dups AM 100%.

Due West

***WARP(FM)**—Sept 14, 1970: 91.7 mhz; 10 w. Ant 107 ft. Box 959, Erskine College (29639). (803) 379-8818. Erskine College Board of Trustees. Format: Variety. ■ Pierce Hellams, gen mgr; Becky Miller, prog dir; David Robinson, mus dir; J. R. Henry, chief engr.

Easley

WELP—March 1951: 1360 khz; 1 kw-D. Box 667 (29640). (803) 859-4401. Pickens County Bcstg Inc. Audio news: UPI. Net: Keystone. Format: Relig, C&W. ■ Cleatus O. Brazzell, pres, gen mgr; Freeman Martin, coml mgr; Chas. B. Smith, prog dir; James C. Clark, news dir; Larry Turner, chief engr.

WELP-FM—1964: 103.9 mhz; 2.3 kw. Ant 340 ft. Dups AM 10%. Format: MOR, top 40.

Florence

WJMX—July 13, 1947: 970 khz; 5 kw-D, 1 kw-N, DA-N. Box 1211 (29501). (803) 665-0970. Atlantic Bcstg Co. Net: CBS, Tobacco Radio Net. Rep: Devney; Carpenter. Format: Top 40. Spec prog: Farm 7 hrs wkly. ■ E. E. Stone, pres; Paul H. Benson Jr., principal own & gen mgr. ■ Rates: \$10; 10; 10; 6.

WSTN(FM)—Co-owned with WJMX. Oct 1, 1964: 106.3 mhz; 1.5 kw. Ant 289 ft. Stereo. Dups AM 25%. Net: CBS. Format: Btlf mus. ■ Rates: \$4.50; 4.50; 4.50; 4.50.

WOLS—Nov 18, 1937: 1230 khz; 1 kw-D, 250 w-N. 141 S. Dargan St. Box 690 (29501). (803) 662-3271. Florence Bcstg Co. (acq 1941). Rep: Messina; Southern Spot Sls. Format: Diversified. ■ A. P. Skinner, pres & gen mgr; Doug Williams, prog & news dir; M. W. Pell, chief engr. ■ Rates: \$3.75; 3.75; 3.75; 3.75.

WSTN(FM)—Listing follows WJMX.

WYNN—Nov 5, 1958: 540 khz; 250 w-D. Box 1586 (29501). (803) 662-6364. Forjay Bcstg (acq 4-16-72). Rep: Howard. Format: Black. ■ James N. Maurer, pres & gen mgr; Jack Maurer, coml & prom mgr; Gene Allen, prog & news dir; Andrew Bailey, mus dir; Bernard Moore, chief engr.

Fountain Inn

WFIS—October 1956: 1600 khz; 1 kw-D. Box 156 (29644). (803) 963-5991. Fountain Inn-Simpsonville Enterprises Inc. Audio news: UPI. Format: C&W. Spec progs: Black 18 hrs, gospel 20 hrs wkly. ■ Leroy A. Hamilton Sr., pres & chief engr; Ben H. Davis Jr., VP gen & sls mgr; Jerry D. Wickline, news dir. ■ Rates: \$4; 2.60; 4; 2.60.

Gaffney

WAGI-FM—Listing follows WEAC.

WEAC—Sept 28, 1962: 1500 khz; 1 kw-D, 500 w-CH. Box 1210 (29340). (803) 489-9066. Gaffney Bcstg Inc. Audio news: UPI. Rep: Penn Watson; Southern Spot Sls. Format: Solid gold & top 40. ■ E. Raymond Parker, pres & treas; Ronald Owenby, gen mgr; Bright G. Parker, VP & sec; Ed Elliot, prog dir; Jim Holland, news dir; Cleo Vaughn, traf mgr; Don H. Lovelace, tech adv; Craig S. Turner, chief engr. ■ Rates: \$6; 3.65; 3.65; 3.65.

WAGI-FM—Co-owned with WEAC. 1959: 105.3 mhz; 100 kw. Ant 890 ft. Stereo. Dups AM 5%. (acq 1-15-71). Format: C&W, gospel. ■ Rates same as AM.

WFGN—1948: 1570 khz; 250 w-D. Box 47 (29340). (803) 489-4795. Cherokee Radio Co. Net: ABC/C. Rep: Keystone. Format: Contemp. Spec progs: Farm 1 hr, Black 2 hrs wkly. ■ A. Ray Godshall, pres; Keith Johnson, gen mgr; Chris Tallant, prog dir; John Randall, chief engr. ■ Rates: \$2.75; 2.75; 2.75; 2.75.

South Carolina Radio

See page C-1 for explanation of listings.

Georgetown

WGMB(FM)—Listing follows WINH.

WGTN—July 1, 1949: 1400 khz; 1 kw-D, 250 w-N. Drawer 1400 (29440). (803) 546-4161. Seacoast Bcstg Corp. (acq 7-6-71). Audio news: APR. Rep: Keystone. Format: MOR. ■ Richard T. Laughridge, pres; J. William Nichols, gen mgr; Tom Walters, prog dir; Jay Aldridge, chief engr. ■ Rates: \$2.50; 2.50; 2.50; 2.50.

WSHG(FM)—Co-owned with WGTN. May 1, 1973: 106.3 khz; 3 kw. Ant 130 ft. Stereo. Format: C&W. ■ Rates same as AM.

WINH—March 1962: 1470 khz; 1 kw-D. Drawer W (29440). (803) 546-5141. Winyah Bay Bcstg Co. Inc. (acq 5-1-67). Net: ABC/I. Rep: Southern Spot Sls. Format: MOR. ■ Harry R. Fogel, pres & gen mgr; James C. Ruling, coml mgr; Harry K. Gindhart, opns mgr; Ann Israel, prom mgr; Allen S. Hovermale, chief engr; Barry Walters, news dir. ■ Rates: \$3.15; 3.15; 3.15; 3.15.

WGMB(FM)—Sept 25, 1971: 97.7 mhz; 3 kw. Ant 180 ft. (803) 546-2120. Net: ABC/C. Format: Top 40. ■ Barry Walters, mus dir; H. Haft, prog dir. ■ Rates: \$2.15; 2.15; 2.15; 2.15.

WSHG(FM)—Listing follows WGTN.

Greenville

WBRR—See Travelers Rest.

***WEPR(FM)**—Sept 3, 1972: 90.1 mhz; 100 kw. Ant 1,100 ft. Stereo. 2712 Millwood Ave., Drawer L (29250). (803) 758-7318. S.C. Educational TV Commission. Net: NPR. Format: Educl, classcl. Spec progs: Farm 2 hrs wkly. ■ Henry J. Canthen, pres & gen mgr; Wm. D. Hay, dir of radio; Charlton Bowers, chief engr; Alton H. Reeves, prog dir; Joseph R. Pinkston, news dir.

WESC—March 1947: 660 khz; 10 kw-U, DA-D. Box 2447 (29602). (803) 242-4660. Bcstg Co. of the Carolinas Inc. (acq 4-58). Net: ABC/E. Rep: Buckley. Format: C&W. ■ Robert A. Schmid, pres; John Y. Davenport, VP & gen mgr; Wally A. Mullinax, coml mgr; Bob Hooper, prog dir; Nancy Teague, prod dir; Paul Brown, news dir; Don Gowens, chief engr. ■ Rates: \$21; 17; 21; 9.

WESC-FM—March 1948: 92.5 mhz; 100 kw. Ant 612 ft. Stereo. Format: Btlf mus. ■ Lowell Fletcher, prog dir; Virginia Case, mus dir. ■ Rates: \$13; 9; 11; 9.

WFBC—1933: 1330 khz; 5 kw-U, DA-N. Box 788, 505 Rutherford St. (29602). (803) 233-4601. TWX 810-281-2182. Multimedia Inc. (group owner; acq 1-1-68). Net: NBC. Rep: Katz. Format: Contemp. ■ Wilson Wearn, pres; Bruce Buchanan, VP & gen mgr; Keener R. Garrett, coml mgr; Billy Powell, prog dir; Dave Partidge, news dir; W. E. Garrison, chief engr.

WFBC-FM—1947: 93.7 mhz; 100 kw horiz, 97 kw vert. Ant 1,850 ft. Stereo. Dups AM 22%. ■ WFBC-TV affil.

WHYZ—May 26, 1966: 1070 khz; 50 kw-D, DA. Box 4308 (29608). (803) 246-1441. WHYZ Inc. (acq 10-17-70). Format: Rock, contemp. ■ Dexter Stuckey, pres; Raymond Somers, gen mgr; Ben Howard, coml & prom mgr; G. Stephen Green, prog dir; John Paul Heatherton, news dir; Ray Slatton, chief engr.

WMRB—Feb 8, 1954: 1490 khz; 1 kw-D, 250 w-N. Box 8876 (29604). (803) 242-1490. Paramount Bcstg Co. (acq 4-21-54). Net: CBS. Format: Easy ltnsg, big band. ■ C. F. Cope, pres, gen & coml mgr; W. T. Arrington, stn mgr & prog dir; Bill Krieger, prom mgr; L. F. Poole, mus dir; Evelyn M. Rust, news dir; B. S. Anderson, chief engr.

WMUU—Sept 15, 1949: 1260 khz; 5 kw-D. Bob Jones U. (29614). (803) 242-6240. WMUU Inc. (acq 3-27-75). Format: Classical, religious. ■ Jim Ryerson, stn mgr; Walter Siagle, coml mgr; Dayton Walker, prog dir; Charles Koelsch, mus dir; Chuck Lee, news dir; William Greaves, chief engr.

WMUU-FM—Aug 15, 1960: 94.5 mhz; 100 kw. Ant 1,190 ft. (CP: Ant 1,200 ft.) Stereo. Dups AM 90%.

WQOK—1950: 1440 khz; 5 kw-U, DA-N. Drawer T (29610). (803) 246-2112. WQOK Inc. (acq 5-27-68).

South Carolina Radio

See page C-1 for explanation of listings.

Net: ABC/C. Rep: H-R Stone. Format: Contemp, undergroud. ■ T. C. Hooper, pres; gen & coml mgr; Steve Chris, prog & mus dir; Billy Shand, news dir.

WSHG(FM)—See Georgetown.

Greenwood

WCRS MOR (Adult Contemporary)



WCRS—Sept 1, 1941: 1450 khz; 1 kw-D, 250 w-N. Box 1247 (29646). (803) 223-8553. Grenco Inc. Net: NBC. Format: MOR. ■ Douglas Featherstone, pres; Dan Crosland, gen & prom mgr; Ralph Norman, coml mgr; Dianne Lyle, prog dir; Darroll Evans, mus dir; Dave Cureton, news dir; Charles M. Sparks, chief engr. ■ Rates: \$3.45; 3.45; 3.45.

WCRS-FM—April 28, 1965: 96.7 mhz; 3 kw. Ant 430 ft. Dups AM 100%. ■ Rates same as AM.

WGSW—April 15, 1953: 1350 khz; 1 kw-D. Box C (29646). (803) Barksdale 3-5945. Radio Greenwood Inc. Group owner: W. C. Woodall Jr. Stns. Net: ABC/C. Rep: Walton; Carpenter. Format: C&Ws top 50. Spec prog: Black 10 hrs. ■ W. C. Woodall Jr, pres; George B. Cook Jr, gen & coml mgr; Mel Riley, prog dir; Orson Woodall, news dir; Doug Giles, chief engr.

WMTY—June 20, 1973: 1090 khz; 1 kw-D. Rt. 4, Box 361-B (29646). (803) 223-4300. United Community Enterprises Inc. Net: MBS. Rep: Southern Spot Sls. Format: C&W. ■ John Y. Davenport, pres; Norm Wiseman, VP, gen, coml & prom mgr, prog dir; Wally Mullinax, VP; Darrel Cooke, mus dir; Wesley English, chief engr; Kerry Bryson, news dir. ■ Rates: \$2.75; 2.75; 2.75.

Greer

WCKI—March 3, 1955: 1300 khz; 1 kw-D. Box 709 (29651). (803) 877-8458. Sira-Pak Radio Inc. (acq 5-4-64). Format: Town & Country. Spec prog: Black 1 hr wkly. ■ Marshall T. Pack, pres; Frank Foster, gen mgr; Dan Greene, coml mgr; Ronald Pack, prog dir & prom mgr; William Steadman, news dir; Bill Pack, chief engr. ■ Rates: \$3; 3; 3.

WEAB—June 15, 1949: 800 khz; 250 w-D. Box 70 (29651). (803) 877-3141. Edd A. Burch (acq 12-10-62). Net: ABC, Keystone. Format: C&W. ■ Edd A. Burch, own; John A. Salter Jr, gen mgr.

Hampton

WBHC—September 1957: 1270 khz; 1 kw-D. Box 666 (29924). (803) 943-2831. Hampton County Bcstns Inc. Net: MBS. ■ Joe Wilder, pres; Carl (Tony) Gross, VP & gen mgr; Adeline Gross, traf mgr; James Boyd, prog dir; Clyde Jones, chief engr.

WJBW-FM—Co-owned with WBHC. September 1970: 103.1 mhz; 3 kw. Ant 140 ft. Dups AM 25%. Format: MOR.

Hartsville

WHSC—Oct 1, 1946: 1450 khz; 1 kw-D, 250 w-N. Box 940 (29550). (803) 332-8101. Hartsville Bcstg Co. Net: MBS. Audio news: APR. Format: MOR. Spec progs: Farm 4 hrs, C&W 10 hrs wkly. ■ J. L. Wiggins, pres; Oby B. Lyles, gen mgr; Louis Cook, prom mgr; Roy Gregg, mus dir; Ron Funderburke, chief engr. ■ Rates: \$2.25; 2.25; 2.25; 2.25.

WSDC—Dec 4, 1972: 1490 khz; 250 w-U. Box 1166 (29550). (803) 332-1576. Community Bcstg Co. of Hartsville. Net: ABC/E. Format: MOR. ■ Harold Bledsoe, pres, gen mgr; John Bledsoe, coml mgr; Mike Ousley, prog & mus dir; Jim Hohn, news dir; David Raley, chief engr. ■ Rates: \$2.25; 2.25; 2.25; 2.25.

Hemingway

WKYB—April 28, 1967: 1000 khz; 10 kw-D, 5 kw-CH.

Box 1000 (29554). (803) 558-2558. Hemingway Bcstg Co. Inc. Format: Contemp. ■ Dexter Stuckey, pres; Donald Hastings, gen mgr & chief engr; Marion Parnell, coml mgr; Hal O'Neal, prog dir. ■ Rates: \$3.25; 3.25; 3.25.

Hilton Head Island

WHHR(FM)—July 14, 1973: 106.3 mhz; 3 kw. Ant 300 ft. Stereo. Box 5683 (29928). (803) 785-3394. Hilton Head Radio Corp. Audio news: UPI. Rep: Southern Spot Sls. Format: Easy lstng. ■ John J. Henry, pres & gen mgr; David E. Linsay, VP & asst gen mgr; Bob Dickensheets, news dir; Denny Fussell, chief engr. ■ Rates: \$6.50; 5; 6.50; 5.

Holly Hill

WKHJ—Dec 1, 1972: 1440 khz; 1 kw-D. Box 1087 (29059). (803) 496-5352. Radio Holly Hill Inc. (acq 5-1-74). Group owner: J. Ardell Sink Stns. Rep: Dora-Clayton; Mark Group Sls. Format: MOR, top 40. Spec progs: Black 5 hrs, farm 1 hr wkly. ■ J. Ardell Sink, pres; G. Wayne Koonts, gen mgr; Steve Judy, asst mgr & coml mgr; Garry Morgan, prog dir; Anna Koonts, prom mgr; Danny Folk, mus dir; Alan Hovermale, chief engr; Andy Poudair, news dir. ■ Rates: \$3.50; 3.50; 3.50.

Johnston

WJES—June 12, 1961: 1570 khz; 250 w-D. Box 1 (29832). (803) 275-4444. Edgefield-Saluda Radio Co. Rep: Keystone. Format: MOR. ■ Claude Casey, pres & gen mgr; Frank Davis, mus dir; Mike Casey, coml & news dir; H. L. Evans, chief engr. ■ Rates: \$2; 2; 2.

Kershaw

WKSC—Dec 21, 1961: 1300 khz; 500 w-D. 502 W. Church St. (29067). (803) 475-8585. Kershaw Bcstg Corp. Net: ABC/I. Format: C&W, MOR. ■ Jess B. Tatum, pres, gen mgr & chief engr; Mozelle P. Byrd, coml mgr; Johnny Shackelford, prog dir.

Kingstree

WKDK—July 1949: 1310 khz; 5 kw-D. Box 525 (29556). (803) 382-2361. Davidson Communications (acq 6-30-75). Net: Keystone, Tobacco Radio Net. Format: C&W, MOR. ■ John W. Davidson, owner.

WKDK-FM—May 28, 1966: 100.1 mhz; 3 kw. Ant 205 ft. Prog sep from AM. Format: MOR.

WKSP—July 1, 1967: 1090 khz; 500 w-D. Box 698 (29556). (803) 382-2382. Williamsburg County Bcstg Co. Inc. Format: Contemp; rock, top 40. ■ M. H. Jacobs, pres; Edward F. Seeger, gen mgr & news dir; Carolyn H. Blease, coml & prom mgr; J. Gregory Buttermore, prog & mus dir; Donald O. Bryant, chief engr.

Lake City

WJOT—Oct 9, 1953: 1260 khz; 1 kw-D. Box 1177 (29560). (803) 394-2088. Coastline Bcstg Co. (acq 1-24-69). Rep: TN Spot Sales Inc. Format: MOR, C&W. Spec prog: Black 4 hrs wkly. ■ F. Arnold Graham, pres & gen mgr; S. Charles Green, coml mgr; Henley McElveen Jr, chief engr.

Lancaster

WAGL—Aug 7, 1962: 1560 khz; 10 kw-D. Box 28 (29720). (803) 283-8431. Palmetto Bcstg System Inc. Net: ABC. ■ B. L. Phillips, pres, gen & coml mgr; Bill W. Griffin, prog dir; Tom Talbert, news dir; Steve Hall, mus dir; Barbara Baldwin, prom mgr. ■ Rates: \$4.15; 4.15; 4.15; —

WLCM—Nov 26, 1951: 1360 khz; 1 kw-D. 103 S. Catawba St. (29720). (803) 283-2051. Royal Bcstg Co. Audio news: APR. Format: C&W. Spec progs: Farm 2 hrs, black 1½ hrs wkly. ■ C. K. Connelly Jr, pres; Gene Baker, VP & gen mgr; Zery V. Gwynn, coml mgr; James E. Knight, opns mgr; Glenn Hamrick, mus dir; Heath Newman, news dir; G. T. Gilmore Sr, chief engr. ■ Rates: \$3.75; 3.75; 3.75; 3.75.

WPAJ-FM—Co-owned with WLCM. July 27, 1964: 107.1 mhz; 3 kw. Ant 220 ft. Stereo. Prog sep from AM. Format: Adult contemporary. ■ Rates: \$2.25; 2.25; 2.25; 2.25.

Laurens

WLBG—March 1, 1947: 860 khz; 1 kw-D. Box 269

(29360). (803) 984-3511. Laurens-Clinton Bcstg Co. (acq 4-1-55). Audio news: UPI. Spec prog: Black 7 hrs wkly. ■ C. W. Hogan, gen mgr; Larry Gar, coml mgr; M. L. Outz, farm dir; Mary Moore, news dir; Harold Ward, chief engr. ■ Rates: \$3.25; 3; 3.25; —

WLBG-FM—November 1960: 100.5 mhz; 100 kw. Ant 450 ft horiz, 440 ft vert. Dups AM 60%. ■ Rates same as AM.

Leesville

WBLR—See Batesburg.

Loris

WLSC—August 1958: 1570 khz; 1 kw-D. Box 578 (29569). (803) 357-3183. Media Services Inc. (acq 9-15-73). Net: ABC/FM. Rep: Keystone; Continental; Southern Spot Sls. Format: C&W, rock. Spec prog: Black 10 hrs wkly. ■ Harry R. Fogel, pres; Charles Powell, gen & coml mgr.

Manning

WTWE(FM)—Listing follows WYMB.

WYMB—July 15, 1957: 1410 khz; 1 kw-D. Box 400 (29102). (803) 435-8388. Clarendon County Bcstg Corp. (acq 5-15-68). Net: Tobacco Radio Net. Format: Contemp. Spec progs: Black 15 hrs, C&W 5 hrs wkly. ■ Betty T. Roper, pres; Carl Roach, gen & coml mgr.

WTWE(FM)—Co-owned with WYMB. April 16, 1973: 92.1 mhz; 3 kw. Ant 160 ft. Stereo. 92 Water's Edge (29102). (803) 435-2098. Prog sep from AM. Format: C&W.

Marion

WATP—July 1957: 1430 khz; 1 kw-D. Box 1033 (29571). (803) 423-5971. Swamp Fox Bcstg Corp. (acq 3-7-68). Format: C&W. ■ Richard T. Laughridge, pres; Charles S. Morris, VP; Harry Hyman, gen mgr & chief engr.

WATP-FM—September 18, 1970: 94.3 mhz; 3 kw. Ant 190 ft. Prog sep from AM. Format: Btlf mus.

Moncks Corner

WBEB—December 1963: 950 khz; 500 w-D. Box 67 (29461). (803) 899-2195. Berkeley Bcstg Corp. (acq 12-67). Format: C&W. ■ Paul A. Brissette Jr, pres; Vincent M. French, VP & gen mgr; Clarence Jackson, chief engr.

WTWF(FM)—Dec 7, 1969: 105.5 mhz; 3 kw. Ant 265 ft. Box 758 (29461). (803) 899-7111. Double R Broadcasting (acq 3-25-74). Format: Contemp. ■ Carl D. Roach, pres; Betty T. Roper, VP; Bo Wyley, stn mgr; Al Earnhardt, prog dir; Alan Hovermale, engr.

Mullins

WCIG(FM)—Listing follows WJAY.

WJAY—June 1, 1949: 1280 khz; 5 kw-D. Drawer 542 (29574). (803) 464-9252. Mullins & Marion Bcstg Co. Net: ABC/C, Tobacco. Rep: TN Spot Sls. Format: MOR. Spec progs: Black 6 hrs, C&W 12½ hrs, farm 5 hrs, relig 5½ hrs wkly. ■ William L. Harrelson, pres; William B. Sanders, VP & gen mgr; Richard Blount, prog & news dir, prom mgr; Charlie Carpenter, chief engr & mus dir. ■ Rates: \$4.50; 4.50; 4.50; 4.50.

WCIG(FM)—Co-owned with WJAY. April 5, 1975: 107.1 mhz; 3 kw. Ant 235 ft. Stereo. Dups AM 60%. Format: Black. Spec prog: Gospel 10 hrs wkly. ■ Larry Williams, coml mgr. ■ Rates same as AM.

Myrtle Beach

WKZQ(FM)—Listing follows WTGR.

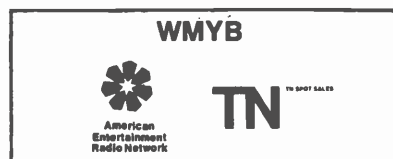

WMBY—June 16, 1948: 1450 khz; 1 kw-D, 250 w-N. Box 1497 (29577). (803) 448-3189. Golden Strand Bcstg Co. (acq 9-11-64). Net: ABC/E. Format: MOR.

Rep: TN Spot Sls. ■ Wade H. Alley, pres & gen mgr; Ron Gorby, prog dir; P.W. Smith, coml mgr; Paul Eskew, news dir; Bob Smith, chief engr. ■ Rates: \$5; 5; 5; 5.

WMBY-FM—Jan 11, 1965: 92.1 mhz; 3 kw. Ant 326 ft. Dups AM 100%. ■ Rates same as AM.

WTGR—April 24, 1965: 1520 khz; 5 kw-D. Box 2005 (29577). (803) 448-5005. Grand Strand Bcstg Corp. Audio news: UPI. Rep: Southern Spot Sls. Format: Top 40. ■ Thomas J. Rogers, pres; Wyatt B. Thompson Jr, gen mgr; Jim Squire, prog & news dir; Jim Wilson, mus dir; Bill Files, chief engr. ■ Rates: \$12; 12; 12; 12.

WKZQ(FM)—Co-owned with WTGR. July 3, 1969: 101.7 mhz; 3 kw. Ant 300 ft. Stereo. Box 2389 (29577). (803) 448-5713. Progs sep from AM. Rep: Carter Jones. Format: Solid Gold. ■ Bill Henneey, gen mgr; Gregg Fowler, prog dir; Pat Millan, mus dir; David Joyer, news dir. ■ Rates: \$7.50; 7.50; 7.50; 7.50.

Newberry

WKDK—October 1946: 1240 khz; 1 kw-D, 250 w-N. Box 753 (29108). (803) 276-2957. Newberry Bcstg Co. (acq 1951). Net: Tobacco. Rep: Dora-Clayton. Format: Contemp. ■ James F. Coggins, pres; E. F. McCutchen, gen & coml mgr; Shotsie McCutchen, news dir; Mary Beck, prog dir & prom mgr; E. R. Gilliam Sr, chief engr. ■ Rates: \$3; 3; 3; 3.

WKMG—May 22, 1968: 1520 khz; 1 kw-D. Box 70 (29108). (803) 276-2507. Service Radio Co. Inc. Net: ABC/E. Format: Modern country. Spec progs: Farm 2 hrs, relig & gospel 10 hrs wkly. ■ Roscoe Bedenbaugh, dir & gen mgr. ■ Rates: \$2; 2; 2; 2.

North Augusta

WFNL—May 9, 1962: 1600 khz; 500 w-D. Box 1454 Augusta. (404) 738-4581. The Warner GP Inc. (acq 2-21-73). Net: MBS. Rep: GCI; Carter Jones. Format: C&W. ■ Richard Warner, pres, gen & coml mgr; Jim Turner, prog dir; Hank Schneider, prom mgr; Carole Witche, mus dir; Ken Freeman, chief engr; Ruth Nelson, news dir.

WGUS—See Augusta Ga.

WTHB—See Augusta Ga.

North Charleston

WNCG—Nov 17, 1960: 910 khz; 500 w-D. Box 5758 (29406). (803) 554-7154. KTM Bcstg Co. (acq 8-29-64). Net ABC/II. Rep: Buckley Radio Sls. Format: MOR. ■ Ansley D. Cohen Jr, pres & gen mgr; Jack Kennedy, asst gen mgr; Howard Keller, sls mgr; Bill Dudley, ops mgr; J. J. Scott, prog dir; Edd Salen, cont dir; Jeff Warner, news dir; Bill Dudley, chief engr.

North Myrtle Beach

WNMB(FM)—Aug 15, 1972: 105.5 mhz; 3 kw. Ant 300 ft. Stereo. 429 Pine Ave. (29582). (803) 249-1610. N. Myrtle Beach Bcstg Corp. Rep: Carpenter. Format: Easy top 40. ■ Harry D. Dunagan, pres & gen mgr; William N. Norman, stn & coml mgr; John Smithson, mus & news dir; Carroll Williams, chief engr.

Orangeburg

WDIX—Dec 9, 1946: 1150 khz; 5 kw-D, 500 w-N, DA-2. Box 1326 (29115). (803) 534-4461. WDIX Inc. Net: ABC/C. Rep: Southern Spot Sls. Format: MOR. ■ Frank B. Best, pres; Frank B. Best Jr, gen mgr; Robert L. Magee, prog dir; James D. Black, chief engr.

WDIX-FM—July 6, 1967: 106.7 mhz; 50 kw. Ant 323 ft. (CP: 100 kw. Ant 570 ft.). Stereo. (803) 534-1716. Format: Oldies, top 40, diversified. Spec prog: Black 3 hrs wkly. ■ Douglas G. Thompson, gen mgr; Roy Hahn, prog dir. ■ Rates: \$3.80; 2; 3.80; 2.

WHCE-FM—September 1973: 103.9 mhz; 3 kw. Ant 300 ft. Drawer 1507 (29115). (803) 534-8995. Orange County Bcstg Corp. Net: MBS. Rep: Dora Clayton. Format: C&W 80%, rel 20%. Spec prog: Farm 3½ hrs wkly. ■ H. Edward Crapps Sr, pres; J. A. Phillips, gen mgr; Ronald Shuler, prog & mus dir; Bryan Matthews, news dir; J. D. Black, chief engr. ■ Rates: \$4.50; 4; 4.50; 4.

WORQ—Nov 3, 1958: 1580 khz; 1 kw-D. Box 1386 (29115). (803) 536-1580. Radio Orangeburg Inc. (acq 7-1-62). Net: MBS. Format: Adult contemp, 40% gold.

■ Ed Crapps, pres; Ted Bell, gen mgr; Douglas G. Thompson, gen sls mgr.

WTND—June 13, 1948: 920 khz; 1 kw-D. Drawer 730 (29115). (803) 534-1301. WTND Inc. Rep: TN Spot Sls. Format: MOR, C&W. ■ J. H. Gressette, pres; L. Richard Rhame, gen mgr; Milton A. Blakely, coml mgr; Dan Orta, chief engr. ■ Rates: \$3.75; 3.75; 3.75; 3.75.

PageLand

WCPL(FM)—Feb 22, 1975: 102.3 mhz; 3 kw. Ant 300 ft. Stereo. Box 5 (29728). (803) 672-7839. Roberts Bcstg Co. Inc. Audio news: UPI. Format: Top 40, C&W. Spec prog: Farm ½ hr wkly. ■ Laura Stallings, pres; Wayne Haas, gen mgr, prog and mus dir; Judy Shack, coml mgr; Johnny Shack, prom mgr; Duane Stegall, news dir; Lee Simmons, chief engr. ■ Rates: \$26.40; 26.40; 26.40; 26.40.

WPSC—April 3, 1975: 1510 khz; 500 w-D. 1009A Westview Drive, Hartsville (29550). PageLand Broadcasting. ■ Louis M. Cook, principal.

Pickens

WKKR—Sept 3, 1967: 1540 khz; 1 kw-D. Box 837 (29671). (803) 878-4711. Mark Media Inc. (acq 2-24-73). Group owner: J. Ardell Sink Stns. Rep: Mark Group Sls. Format: C&W. MOR. Spec prog: Farm 1 hr wkly. ■ J. Ardell Sink, pres; Joseph E. Denney, gen mgr; Doug Winkler, asst & coml mgr; Joe Denny, prog dir; Steve Clark, mus dir; Lynett Gatlin, prom mgr; Mark Bishop, news & mus dir; Larry Turner, chief engr. ■ Rates: \$3.50; 3.50; 3.50; 3.50.

Ridgeland

WBUG—1964: 1430 khz; 1 kw-D. Drawer E, Old Tillman Rd. (29936). (803) 726-5595. Ridgeland Bcstg Co. (acq 4-3-75). Rep: Southern Spot Sls. Format: Diversified. ■ Dale R. Hawkins, pres; Nicholas Harvey, coml mgr; Terry Travis, prog dir; Carrol Baker, chief engr. ■ Rates: \$4.75; 4.75; 4.75; —

Rock Hill

WRHI—Dec 14, 1944: 1340 khz; 1 kw-D, 250 w-N. Box 429 (29730). (803) 327-2085. York County Bcstg Inc. (acq 1-72). Net: MBS. Format: Contemp. ■ James S. Beaty Jr, pres, gen mgr & chief engr; Barry Dominick, stn mgr; Harper S. Gault, coml mgr & news dir. ■ Rates: \$4.25; 3.75; 4.25; 3.75.

WTYC—1949: 1150 khz; 1 kw-D. Box 1091 (29730). (803) 366-4148. Tri-County Bcstg Co. (acq 11-1-58). Audio news: UPI. Rep: Southern Spot Sls. Format: MOR. ■ T. Lamar Simmons, pres; Ted Burwell, gen & coml mgr; Bob Latham, prog & news dir; E. L. Burwell, chief engr. ■ Rates: \$3.50; 3.50; 3.50; 3.50.

St. George

WPWR(FM)—Listing follows WQIZ.

WQIZ—Aug 23, 1962: 810 khz; 5 kw-D. Box 903 or 904 (29477). (803) 563-4371. Soundamerica Corp. Audio news: UPI. Format: Black. ■ Clarence E. Jones, pres & gen mgr; Margaret Jones, VP, sec & coml mgr; Isaac Heyward, gospel prog dir; Elmo Harvey, soul prog mgr; Donald Cubbison, chief engr.

WPWR(FM)—Co-owned with WQIZ. January 5, 1971: 107.5 mhz; 100 kw. Ant 440 ft. Quadstereo. Dups AM days, top 40 night. ■ Clarence Jones, prog dir.

St. Matthews

WQKI—Not on air; target date unknown: 710 khz; 1 kw-D, DA. Central Carolina Bcstg.

Seneca

WBFM(FM)—Listing follows WSNW.

WSNW—June 1, 1949: 1150 khz; 1 kw-D. Box 793 (29678). (803) 882-2388. Blue Ridge Bcstg Co. Inc. Net: MBS. Format: MOR, C&W. ■ J. A. Gallimore, pres; C. Wayne Gallimore, gen mgr & prog dir; H. Irwin Bridges 3rd, sls mgr; Kenneth R. Sparks, prom mgr; Herbert J. Hosea, chief engr; Larry E. Mack, news dir. ■ Rates: \$3.10; 3; 3.10; 3.

WBFM(FM)—Co-owned with WSNW. June 6, 1953: 98.1 mhz; 50 kw. Ant 280 ft. Dups AM 50%. Stereo. Format: MOR, easy lstng. Spec prog: C&W 6 hrs wkly. ■

South Carolina Radio

See page C-1 for explanation of listings.

Rates same as AM.

Spartanburg

WASC—Jan 15, 1968: 1530 khz; 1 kw-D, 250 w-CH. Box 5686 (29301). (803) 585-1537. Carolina Radio Bcstg Co. Group owner: Beasley Bcstg Group. Net: ABC/II. Rep: Torbet; Southern Spot Sls. Format: C&W. ■ George G. Beasley, pres; K. Joe Sessoms, gen mgr; Janet Jones, coml mgr; Joe W. Crowe, prog & mus dir; Danny Diar, news dir; James E. Harrelson, chief engr.

WKDY—Sept 1, 1952: 1400 khz; 1 kw-D, 250 w-N. Box 5035 (29304). (803) 583-2727. Capitol Bcstg (acq 4-71). Net: ABC. Format: C&W. Spec prog: Black 12 hrs wkly. ■ E. M. Johnson, pres; Paul Howard, gen mgr; Ross Holmes, coml mgr; Lee Nolan, prog dir; Don Mobley, mus dir; Danny Taylor, chief engr. ■ Rates: \$10; 9; 10; 9.

WORD

Contemporary Music and News

WORD—September 1940: 910 khz; 5 kw-D, 1 kw-N, DA-2. Box 3257 (29302). (803) 583-2711. Associated Bcstg Corp. (acq 6-25-75). Audio news: UPI. Rep: Robert Eastman Co. Format: Contemp. ■ Charles A. Brooks, pres & gen mgr; Thomas Herndon, sls mgr; Ron Brandon, prog dir; Mrs. Aussie Geer, news dir; Buddy Morgan, chief engr. ■ Rates: \$22.50; 17.50; 22.50; 17.50.

WSPA—February 1930: 950 khz; 5 kw-U, DA-N. Box 1717 (29301). (803) 585-7777. TWX 810-282-2591. Spartan Radiocasting Co. Net: CBS. Rep: McGavren-Guild-PGW. Format: Contemp, MOR. ■ Walter J. Brown, pres; Charles R. Sanders, VP & gen mgr; Don Noe, prog & mus dir; Harold Beckholt, chief engr. ■ Rates: \$39; 29; 34; 24.

WSPA-FM—Aug 29, 1946: 98.9 mhz; 100 kw. Ant 1,910 ft. (CP: 26 kw). Stereo. Prog sep from AM. Format: Btlf mus. Spec prog: Classcl 1 hr wkly. ■ Larry Alverson, stn mgr. ■ WSPA-TV affil. ■ Rates same as AM.

Summerville

WAZS—June 7, 1963: 980 khz; 1 kw-D. Box 859 (29483). (803) 873-2691. Radio Summerville Inc. (acq 2-22-65). Format: C&W. ■ W. L. Phillips, pres & gen & coml mgr; B. Wyley, prog dir; P. Firetag, news dir; R. L. Bullard, chief engr.

WWWZ(FM)—May 10, 1974: 93.5 mhz; 3 kw. Ant 280 ft. Box 3437 (29407). (803) 766-5584. Brothers Broadcasting Corp. Rep: Howard. Format: Contemp, progs, R&B. ■ Ken Goodman, pres & gen mgr; George Kaywood, prog dir; Ron Cohen, sls mgr; Charles McHan, chief engr; Arthur Kornicney, news dir. ■ Rates: \$11; 10; 9; 9.

Sumter

WDXY—May 23, 1960: 1240 khz; 1 kw-D, 250 w-N. Box 1269 (29150). (803) 775-2321. WDXY Inc. Rep: Smith; Dora-Clayton. Format: Contemp. ■ W. C. Bochman, pres & gen mgr; Joe Anthony, coml mgr; Robert Powell, prog dir; Jim Squire, mus dir; Ron Stevens, news dir; Alan Hovermale, chief engr.

WFIG—March 16, 1940: 1290 khz; 1 kw-U, DA-N. 45 N. Main St., Drawer 38 (29150). (803) 773-7305. Gamecock City Bcstg Inc. Rep: T-N Spot Sls. Format: C&W. ■ John E. Miles, pres & gen mgr.

WWDN-FM—Co-owned with WFIG. 1961: 101.3 mhz; 2.9 kw. Ant 245 ft. (CP: 100 kw. Ant 630 ft.).

***WMPR(FM)**—Aug 35, 1975: 88.1 mhz; 100 kw. Ant 1,200 ft. Drawer L. Columbia, S.C. (29250). (803) 758-7318. S.C. Educational TV Commission. Net: S.C. Educl. Format: Educl. ■ Henry J. Cauthen, pres; William D. Hay, dir of radio; Charlton Bowers, chief engr.

WSSC—April 27, 1953: 1340 khz; 1 kw-D, 250 w-N. Box 1468 (29150). (803) 773-7369. Radio Sumter Inc. (acq 1-1-62). Net: ABC/II. Audio news: APR. Rep: Carpenter (Atlanta). Format: MOR. ■ C. Edward Damron, pres & gen mgr; Dan Mellette, coml mgr; Katie Damron, prog dir; Jeff Irwin, prom mgr; Dan

South Carolina, South Dakota Radio

See page C-1 for explanation of listings.

Daniels, mus dir; Al Earnhardt, news dir; Alan Hovermale, chief engr. ■ Rates: \$3.75; 3.75; 3.75; 3.75.

WWDM(FM)—Listing follows WFIG

Travelers Rest

WBBR

mutual broadcasting system, inc.

R
A
B



Radio
Code

WBBR—Oct 12, 1964: 1580 khz; 1 kw-D. Box 456 (29690). (803) 834-7265. Piedmont Bcstg Co. Net: MBS. Rep: Busby, Finch, Latham & Widman. Format: Gosp, soul. ■ William H. Kirby, pres & gen mgr; Gary Vincent, prog & mus dir; Robert I. Slater, coml mgr; Cecil Staton, news dir. ■ Rates: \$4.20; 4.20; 4.20; 4.20.

Union

WBCU—August 9, 1949: 1460 khz; 1 kw-U, DA-N, SH. 210 E. Main (29379). (803) 427-2411. Bcstg Co. of Union Inc. (acq 10-52). Format: Contemp. ■ Edward L. B. Osborne, pres, treas, gen & coml mgr; Tom Anderson, chief engr. ■ Rates: \$4.60; 4.60; 4.60; 4.60.

Walhalla

WGOG—April 15, 1959: 1000 khz; 1 kw-D. Box 278 (29691). (803) 638-3616. Oconee Bcstg Co. Inc. Net: ABC/I. Format: Contemp. ■ Dorothy Friend, pres & gen mgr; Edithe Mooneyham, VP & coml mgr; George F. Allgood Jr, prog & news dir; Jerry Dyar, prom mgr; Sam Lee, mus dir; Marvin Hill, sis mgr.

Walterboro

WALD—August 1947: 1060 khz; 1 kw-D. Box 833 (29488). (803) 538-5401. Walterboro Radiocasting Co. (acq 3-57). Net: ABC. Rep: Southern Spot Sls. Spec progs: Black 5 hrs, C&W 10 hrs wkly. ■ Robert S. Taylor, pres; Klein B. Beach Jr, VP, gen mgr & chief engr; Randy Peters, coml mgr; Bill Finigan, prom mgr, news & prog dir.

WALD-FM—Sept 1968: 100.9 mhz; 3 kw. Ant 180 ft. Dups AM 100%.

West Columbia

WCAY—See Cayce.

WSCQ

NBC's News & Information Service

WSCQ(FM)—Aug 3, 1975: 100.1 mhz; 2.4 kw. Ant 330 ft. Stereo. Box 888 (29169). (803) 796-9080. Congaree Bcstrs Inc. Audio news: NBC/NIS. Rep: Dora Clayton. Format: All news. ■ Barnett F. Goldberg, pres, gen mgr & chief engr; Donald Padgett, coml mgr; John Hicks, prog dir; Tom Peach, news dir. ■ Rates: \$16.25; 14.50; 11.50; 8.50.

Winnsboro

WCKM—April 25, 1961: 1250 khz; 500 w-D. Box 505 (29180). (803) 635-5587. Guardian Research Inc. (acq 1974). Format: Variety, contemp. ■ Leroy Hamilton, pres & chief engr; William Roberts, gen mgr, coml, prom, prog, mus & news dir. ■ Rates: \$3.50; 2.40; 3.50; 2.40.

Woodruff

WSJW—July 7, 1967: 1510 khz; 1 kw-D, 250 w (CH). Box 30 (29388). (803) 476-8180. RFD Radio (acq 10-15-75). Format: C&W. ■ Ronald K. Edwards, owner; Frances Rhodes, chief engr.

York

WYCL—April 19, 1956: 980 khz; 1 kw-D, DA. Box 398

(29745). (803) 684-4241. York-Clover Bcstg Co. Inc. Audio news: APR. Rep: Riley Media Sls South, Keystone. Format: Top 40. ■ C. Curtis Sigmon, pres, gen mgr & chief engr; Jim Stephens, prog dir; Lavinia Cox, PR dir; Carroll Henderson, news dir. ■ Rates: \$4.15; 3.65; 4.15; 3.65.

CST ELECTRONICS INC.

2607 River Road
Cinnaminson, New Jersey, 08077
Telephone: (609) 786-1060

South Dakota

**HAMILTON-LANDIS
& ASSOCIATES, Inc.**

NATIONWIDE MEDIA BROKERS
WASHINGTON, D. C. CHICAGO, DALLAS,
SAN FRANCISCO

SELL **MORE**
RADIO & TELEVISION STATIONS
IN THE MIDWEST—NEAREST OFFICE IS—
1429 TRIBUNE TOWER, CHICAGO 60611
(312) 337-2754

Aberdeen

KABR—September 1933: 1420 khz; 1 kw-D. Box 75 (57401). (605) 225-1420. Transmedia of South Dakota Inc. (acq 2-1-70). Rep: Masla. Format: Contemp pop. ■ Jeff Solem, pres & gen mgr; Lynn Solem, coml mgr; Donald F. Briscoe, prog dir & mus dir & prom mgr; Eugene A. Schultz, chief engr.

***KASD(FM)**—Oct 5, 1970: 90.1 mhz; 10 w (CP 970 w. Ant 43 ft). Stereo. Box 883, Northern State College (57401). (605) 622-2631. Northern State College. Format: Progs, educl, Top 40. ■ Steve Shantz, gen mgr.

KKAA Modern Country Music

CBSRADIO

PRO/MeekerRadio
A Division of Southern Bell

KKAA—Sept 12, 1974: 1560 khz; 5 kw-U, DA-2. Box 317 (57401). (605) 229-1560. Dakota North Plains Corp. Net: CBS. Rep PRO/Meeker. Format: C&W, news. Spec prog: Farm 13 hrs wkly. ■ David Laustsen, VP, gen mgr; Bob Matson, sis mgr; Jeff Thomason, prog dir; Dick Sundstrom, mus dir; Jean Barnum Laustsen, prom mgr; Chuck Timanus, news dir; Bard Kallestad, chief engr. ■ Rates: \$7.60; 6.40; 7.60; 4.45.

KSDN—April 16, 1948: 930 khz; 1 kw-U, DA-N. Highway 281 (57401). (605) 225-5930. Green Bay Bcstg Co. (acq 1975). Net: ABC. Rep: Walton, Hurley. ■ Ben A. Laird, owner; Stan Olson, gen mgr; Jerry Oster, chief engr.

New FM—Co-owned with KSDN. Not on air, target date unknown: 94.1 mhz; 100 kw. Ant 196 ft. Box 36 (54305). Format: MOR/standard pops.

Belle Fourche

KBFS—July 22, 1959: 1450 khz; 1 kw-D, 250 w-N. Box 787 (57717). (605) 892-2671. Joseph Kopp. Net: Keystone. Rep: Boiles. Format: MOR. Spec prog: C&W 18 hrs wkly. ■ Joseph Kopp, own, gen & coml mgr; Alan Herbert, prog & mus dir; Will Walker, chief engr.

Brookings

KBRK—July 28, 1955: 1430 khz; 1 kw-D. College Theatre Bldg. (57006). (605) 692-6233. Brookings Bcstg Co. Rep: Masla. ■ Robert J. Reimers, pres gen mgr & chief engr; Grant Peterson, coml mgr; Eugene J. Platek, prog dir & prom mgr; W. H. Nolan, news dir.

KBRK-FM—Aug 10, 1968: 94.3 mhz; 3 kw. Ant 175 ft. Dups AM 60%.

***KESD(FM)**—July 1967: 88.3 mhz; 38 kw horiz, 17.5 kw vert. Ant 610 ft. South Dakota State U. (57006). (605) 688-4316. S. D. State U. Audio news: APR. Net: NPR; S. Dak Pub Radio. Format: Diversified, classcl. Spec prog: Am Ind ½ hr wkly. ■ Eric Brown, dir; James Boyd, gen mgr; Mike Atkins, prog dir; Dale Blegen, news dir; Bernadette Wolfe, prod; Wilbur Kraft, chief engr. ■ *KESD-TV affil.

Deadwood

KDSJ—July 2, 1947: 980 khz; 1 kw-U, DA-N. Box 567 (57732). (605) 578-1862. Heart of the Black Hills Stns. (group owner). ■ Eli & Harry Daniels, owners. ■ KDSJ-TV affil. ■ Rates: \$5.50; 5.50; 5.50; —

Hot Springs

KOBH—July 4, 1958: 580 khz; 500 w-D. Box 611 (57747). (605) 745-3152. Ponderosa Broadcast House Inc. (acq 3-1-69). Net: ABC/I. Intermountain Net. Rep: Eastman. Format: C&W. ■ Major Short, pres, gen mgr & prog dir; Donna Short, coml mgr; Andy Oleske, news dir; Del Brandt, chief engr.

Huron

KIJV—July 1, 1947: 1340 khz; 1 kw-D, 250 w-N. 1726 Dakota Ave. S (57350). (605) 352-8621. James Valley Bcstg Co. (acq 9-20-74). Format: MOR. ■ Marshall Johnston, pres; David Fish, gen mgr & prog dir; Milt Herrick, coml mgr; Tom Frith, news dir; H. M. Bud Holle, farm dir; Charles A. Flynn, chief engr. ■ Rates: \$49.20; 46.80; 49.20; 46.80.

KIJV-FM—Nov 1, 1972: 92.1 mhz; 3 kw. Ant 185 ft. Dups AM 20%. Format: C&W. ■ Rates: \$24; 24; 24; 24.

New AM—Not on air, target date unknown: 1190 khz; 500 w-D. 215 West Broadway, Pierre (57501). Dakota Communications Ltd. ■ Thomas C. & Patricia A. Adams, co-owners.

Lemmon

KBJM—March 7, 1966: 1400 khz; 1 kw-D, 250 w-N. Box 89 (57638). (605) 374-5747. Lemmon Bcstg Co. Format: C&W. ■ Wayne D. Tisdale, gen and coml mgr; Patricia A. Tisdale, asst mgr; Bruce Delauries, prog and mus dir; Tim Kochel, chief engr. ■ Rates: \$2.85; 2.85; 2.85; 2.85.

Madison

KJAM—Dec 3, 1959: 1390 khz; 500 w-D. Box D (57042). (605) 256-4515. Madison Bcstg Co. Inc. (acq 3-75). Audio news: UPI. Spec prog: C&W 10 hrs wkly. ■ John A. Goeman, pres, gen & coml mgr; Randy Optiz, spts dir; Grant Graff, news dir; John Goeman, chief engr. ■ Rates: \$4.50; 4.50; 4.50; 4.50.

KJAM-FM—Dec 17, 1967: 103.1 mhz; 3 kw. Ant 300 ft. Dups AM 100%. ■ Rates same as AM.

Millbank

KMSD—March 20, 1975: 1510 khz; 5 kw-D. Box 66 (57252). (605) 432-5516. Sturgis Radio Co. Inc. Audio news: UPI. Format: Farm, C&W. ■ Les Kleven, pres; Larry Bauer, gen mgr; Dennis Comfort, prog dir; Craig Johnson, news dir.

Mitchell

KMIT(FM)—March 1975: 102.3 mhz; 3 kw. Ant 300 ft. 506 E. 15th Ave. (57301). BMA Bcstg.

KORN

Adult, Rock, Talk

Korn Palace Broadcasting, Inc.

mutual broadcasting system, inc.

M Jack Masla & Company, Inc.

KORN—1947: 1490 khz; 1 kw-D, 250 w-N. Box 921

(57301). (605) 996-5621. Korn Palace Bcstg (acq 11-1-75). Net: MBS. Rep: Masla. Format: MOR. Spec progs: Farm 7 hrs wkly. ■ Mike Edwards, gen mgr; Tony Sieler, coml mgr; Randy Ross, mus dir. ■ Rates: \$6; 6; 6.

Mobridge

KOLY—Aug 10, 1956: 1300 khz; 5 kw-D. Box 1300 (57601). (605) 845-3654. Mobridge Bcstg Corp. Net: ABC/E. Rep: Masla; Pearce. Format: Variety, C&W. ■ O. P. Coleman, gen mgr & chief engr; Bill James, mus dir; Darrell Gill, news dir. ■ Rates: \$6; 6; 5.50.

KOLY-FM—Oct 1, 1973: 99.5 mhz; 56 kw. Ant 560 ft. Dups AM 80%. ■ Rates same as AM.

Pierre

KCCR—Feb 4, 1959: 1240 khz; 1 kw-D, 250 w-N. Box 309 (57501). (605) 224-7381. Sorenson Bcstg Corp. (group owner; acq 3-1-72). Net: ABC/I, Intermountain. Rep: Eastman, IMN. Format: MOR. Spec prog: Farm 6 hrs wkly. ■ Dean Sorenson, pres; Jim Thompson, gen and coml mgr; Gerry Norine, prom mgr; Duayne Boesch, coml mgr; Mary Hansen, mus dir; Joan Likness, news dir; Dale Morud, chief engr. ■ Rates: \$5; 5; 5.

KGFX—1927: 1060 khz; 10 kw-D, 1 kw-N, DA-D. Box 1197 (57501). (605) 224-8686. James River Bcstg (acq 11-15-68). Group owner: Ingstad. Net: NBC. Format: C&W. ■ Robert Ingstad, pres; Jerry Gutensohn, gen & coml mgr; Mark Swendsen, prod and mus dir; Rod Reel, prod dir; Mike Thomas, news dir; Rick Anderson, chief engr. ■ Rates: \$10; 10; 10.

Rapid City

KIMM—March 16, 1962: 1150 khz; 5 kw-D. Box 2006 (57701). (605) 348-1100. James E. Taylor (acq 7-1-66). Net: ABC/C; IMN. Rep: Eastman; IMN. Format: C&W. ■ James E. Taylor, own & gen mgr; Ron Hansen, coml mgr; Jim Shaw, prod dir.

KKLS—June 7, 1959: 920 khz; 1 kw-D. Box 460 (57701). (605) 343-6161. James River Bcstg (acq 7-1-68). Group owner: Ingstad. Rep: Masla, Hix. Format: Contemp; rock. ■ Robert Ingstad, Jr., pres; William Spitzer, gen mgr; Tom Franklin, ops dir; Abner George, news dir; Ken Olson, sls mgr. ■ Rates: \$9; 8; 8.

KKLS-FM—1971: 93.9 mhz; 60 kw. Ant 360 ft. Dups AM 100%. ■ Rates same as AM.

KOTA—November 1936: 1380 khz; 5 kw-U, DA-N. Box 1760 (57701). (605) 342-2000. TWX 910-688-0244. Duhamel Bcstg Enterprises (group owner; acq 5-54). Net: CBS. Rep: H-R Stone, Soderlund, Wayne-Evans, John McGuire. Format: Uptempo MOR. Spec progs: C&W 11 hrs; farm 15 hrs wkly. ■ Helen S. Duhamel, pres & gen mgr; William F. Duhamel, VP & stn mgr; Dan Lemeister, sls mgr; Larry Dirksen, prod dir; Verne Sheppard, farm dir; Gene Carlson, news dir; Sherry Waldron, prom mgr; Fred Wuenschel, chief engr. ■ KOTA-TV affil. ■ Rates: \$14; 12; 10.

***KTEQ(FM)**—August 7, 1971: 88.1 mhz; 10 w. Box 881, Surbeck Ctr. (57701). (605) 394-2231. Tech Educational Radio. Format: Variety. ■ Paul Raap, pres/gen mgr.

KTOQ—Sept 26, 1973: 1340 khz; 1 kw-D, 250 w-N. Box 962 (57701). (605) 343-0888. Midland Bcstg of S.D. (acq 9-4-73). Audio news: UPI. Rep: Savall-Gates, Mountain Media. Format: C&W. Spec progs: Farm 2 hrs; Sioux ½ hr wkly. ■ Stephen L. Hughes, pres; Kevin R. Jensen, gen mgr; Cal Kincaid, coml mgr; Scott Norman, ops mgr; Jerry McGovern, prom mgr; William Hinde, chief engr. ■ Rates: \$7.40; 5.55; 7.40; 5.55.

KVSR(FM)—Oct 1, 1968: 97.9 mhz; 100 kw. Ant 390 ft. Box 15, Keystone Rte. (57701). (605) 342-6822. Donald A. Swanson (acq 1974).

Redfield

KFCB—December 1962: 1380 khz; 500 w-D, DA. Box 110 (57469). (605) 472-1380. Victoria Bcstg System Inc. (acq 11-73). Format: MOR, C&W. Spec prog: Rock 15 hrs wkly. ■ Gordon T. Sjodin, pres & gen mgr; Dorothy Wilcox, coml mgr; Robert Miller, prod dir & chief engr.

Sioux Falls

***KAUR(FM)**—Oct 9, 1972: 89.1 mhz; 10 w.

Augustana College (57102). (605) 336-5463. Net: ABC/I. Format: Progressive, jazz, classical. ■ Robert Ellsworth, gen mgr.

***KCFS(FM)**—Sept 10, 1972: 90.1 mhz; 10 w. Sioux Falls College (57101). (605) 336-2850. Ext 200. Sioux Falls College. Net: S. Dak. Pub Radio. Format: Variety. ■ Mary Alice Patterson, advisor.

KCHF—June 13, 1970: 1520 khz; 500 w-D. 224 S. Main Ave. (57101). (605) 339-1520. Sioux Empire Bcstg Co. Net: MBS. Rep: Walton. Format: MOR. ■ E. C. (Red) Stangland, pres & gen mgr; Robert Shrewsbury, stn and coml mgr; Roger Loftness, prod dir; Philip Sabag, ops mgr; Craig Williams, chief engr.

KCHF-FM—May 6, 1969: 93.5 mhz; 3 kw. Ant 120 ft. Stereo. Dups AM 100%.

KDLO-FM—See Watertown.

KELO—1937: 1320 khz; 5 kw-U, DA-N. 501 S. Phillips (57102). (605) 336-1100. Midcontinent Bcstg Co. (group owner; acq 1952). Audio news: UPI. Rep: H-R/Stone, Evans. Format: MOR. Spec prog: Farm 2 hrs wkly. ■ Joe Floyd, pres; Evans Nord, VP and gen mgr; Jim Molohon, coml and prom mgr; Neil Shurts, prod dir; Phil Hever, mus dir; Leo Hartig, news dir; Les Froke, chief engr.

KELO-FM—July 11, 1965: 92.5 mhz; 100 kw. Ant 1,900 ft. Stereo. Prog sep from AM. Format: Btfl mus. ■ KELO-TV affil.

KIOV(FM)—Listing follows KXRB.

KISD—May 6, 1948: 1230 khz; 1 kw-D, 250 w-N. 130 N. Main (57102). (605) 336-1230. Deck Communications Corp. (acq 5-1-72). Net: ABC/C. Rep: Torbet. Format: Contemp. Top 40. ■ Stanley Deck, pres; Bruce R. Long, gen, coml & prom mgr; Doug Jones, asst mgr; Tim Anderson, prod mgr; Jon Michaels, news dir; Norm Alunzo, chief engr.

***KNWC**—March 25, 1961: 1270 khz; 1 kw-U, DA-N. Box 205A (57102). (605) 339-1270. Northwestern College. Audio news: UPI. Format: Christian. ■ William B. Berntsen, pres; Cornelius Keut, exec dir; Harv Hendrickson, stn mgr.

***KNWC-FM**—March 28, 1969: 96.5 mhz; 100 kw. Ant 265 ft. Stereo. Dup AM 50%.

KPAT(FM)—Listing follows KSOO.

KSOO—1926: 1140 khz; 10 kw-D, 5 kw-N, DA-N. 210 W. Ninth St. (57102). (605) 339-1140. KSOO Radio Inc. (acq 11-10-72). Net: ABC/E. Rep: McGavren-Guild-PGW, Hyyet, Soderlund. Format: Contemp MOR. ■ Sylvia R. Henkin, pres; Joseph Henkin II, gen mgr; Wayne Pritchard, stn mgr; Darrell Stitt, prod dir; Kurt Browall, coml mgr; Tom Sorenson, news & pub affrs dir; Joe Morrison, farm dir; Ray Loftness, ops mgr; Roland Marty, chief engr. ■ Rates: \$20; 17; 13; 13.

KPAT(FM)—Co-owned with KSOO. Oct 1, 1973: 97.3 mhz; 51 kw. Ant 1880 ft. Stereo. (acq 2-73). (605) 339-1141. Format: Top 40. ■ Gerry Van Loh, chief engr. ■ Rates: \$5.50; 4.50; 5.50; 4.50.

KXRB—Feb 1969: 1000 khz; 10 kw-D, DA. 100 North Phillips Ave. (57102). (605) 336-7393. John L. Breece. Audio news: UPI. Rep: Torbet. Format: C&W. Spec prog: Farm 10 hrs wkly. ■ John L. Breece, pres and chief engr; Kay Douglas, gen and sls mgr; Len Anthony, prod dir and prom mgr; Rick Stewart, mus dir; Jerry Dahman, news dir; Denny Oviatt, farm dir. ■ Rates: \$18; 14; 18; 18.

KIOV(FM)—Co-owned with KXRB. March 1975: 104.7 mhz; 100 kw. Ant 740 ft. Stereo. (605) 336-6550. Format: C&W. Spec prog: Farm 1 hr wkly. ■ Kurt Andrews, mus dir. ■ Rates: \$6; 6; 6.

Spearfish

***KBHU-FM**—Oct 18, 1974: 89.1 mhz; 10 w. Ant 55 ft. Stereo. Black Hills State College (57783). (605) 642-6737. Black Hills State College. Format: Variety. ■ Dr. M. N. Freeman, pres; Richard Boyd, gen mgr.

Springfield

***KSTI(FM)**—Dec 11, 1969: 88.5 mhz; 10 w. (57062). (605) 369-2938. University of South Dakota. Format: Progressive.

Sturgis

KBHB—Sept 27, 1962: 810 khz; 5 kw-D. Box 779

(57785). (605) 347-2526. Sturgis Radio Inc. Rep: Masla. Format: C&W. ■ Les Kleven, pres, gen mgr & chief engr; Dana Caldwell, coml mgr; Gary Hendricks, stn mgr & prod dir; Marquette Kleven, prom mgr; Dave Sandlin, news dir.

KBHB-FM—Dec 5, 1972: 93.1 mhz; 52 kw. Ant 1060 ft. Stereo. Prog sep from AM. Jerry McGovern, gen mgr.

Vermillion

***KUSD**—May 1922: 690 khz; 1 kw-D, DA. 310 E. Clark St. (57069). (605) 677-5277. U. of South Dakota. Net: NPR. Audio news: UPI. Format: Classcl, educl. Spec prog: Indian ½ hr wkly. ■ Martin Busch, dir; W. T. Swisher, dir of radio ops; James Prusha, chief engr.

***KUSD-FM**—Oct 1, 1967: 89.7 mhz; 20 kw horiz, 21.5 kw vert. Ant 520 ft. Stereo. Dups AM 80%. ■ *KUSD-TV affil.

KVRA—Nov 16, 1967: 1570 khz; 500 w-D. R.R. No. 3, Box 79 (57069). (605) 624-2662. Siouxland Bcstg Inc. Rep: Dakota Farm Net. Format: MOR. ■ Doyle C. Ritter, pres & gen mgr; Darrell J. Wilson, ops mgr; Bill Richardson, news dir; Roy Jorgensen, chief engr.

KVRF(FM)—Co-owned with KVRA. Nov 16, 1967: 102.3 mhz; 3 kw. Ant 255 ft. Stereo. Dups AM 100%.

Watertown

KDLO-FM—Co-owned with KELO-AM-FM, Sioux Falls. March 1, 1968: 96.9 mhz; 100 kw. Ant 1,280 ft. Satellite to KELO-FM.

KSDR—April 16, 1961: 1480 khz; 1 kw-D. Box 293 (57201). (605) 886-5747. The Berry-Iverson Co. (acq 1-1-67). Net: ABC/C. Rep: Keystone. Format: Contemp. ■ A. G. Berry, pres; Ronn Scott, VP & gen mgr; Michael Parsley, coml mgr; David E. Kempf, prom mgr; Ken Curry, prod dir; Austin Harris, mus dir; David J. Law; news dir; David Hempel, chief engr.

KWAT—March 8, 1940: 950 khz; 1 kw-U, DA-N. Box 827 (57201). (605) 886-8444. Midland Natl Life Ins. Co. Net: MBS. Rep: Masla. Format: MOR. ■ William A. Riggsbee, pres; Ross E. Case, gen & prom mgr; Rick Gereau, coml mgr; Doug Olson, prod dir; Jessie Voorhees, news dir; Bruce Erlandson, chief engr. ■ Rates: \$5.55; 5.55; 5.55; 5.55.

KWAT-FM—Sept 29, 1968: 96.1 mhz; 100 kw. Ant 290 ft. Stereo. Progs sep from AM. Format: C&W-day, MOR-night. ■ Dick Myers, ops mgr. ■ Rates: \$2.50; 2.50; 2.50; 2.50.

Winner

KWYR—Sept 27, 1957: 1260 khz; 5 kw-D. Box 491 (57580). (605) 842-3333. Midwest Radio Corp. (acq 11-23-58). Net: NBC. Format: MOR, C&W, farm. ■ Al Clark, pres, gen mgr; Steve Clark, VP stn mgr; Ben Viedt, news dir; Charles Hogue, sports dir; Dan Sudenga, prod and mus dir; Randy Achterhoff, prom mgr; Doug Fickbohm, chief engr. ■ Rates: \$9.60; 9.60; 9.60; 9.60.

KWYR-FM—Nov 25, 1971: 93.7 mhz; 100 kw. Ant 560 ft. Stereo. Dups AM 66%. Format: Good mus, contemp, MOR-night. ■ Rates: \$4.80; 4.80; 4.80; 4.80.

Yankton

KOHU(FM)—Aug 7, 1973: 104.1 mhz; 100 kw. Ant 430 ft. Box 794 (57078). (605) 665-4498. Oyatc Inc. Net: ABC/C. Format: Top 40, oldies. ■ W. F. Stange, pres; Ron Heuer, gen mgr; Bob Link, coml mgr; Lynn McColley, prod dir; Randall Rosenberg, mus dir; James Scieszinski, prom mgr; Mark Wilson, news dir; Robert Ray, chief engr. ■ Rates: \$7.50; 7.50; 7.50; 5.25.

KYNT—March 15, 1955: 1450 khz; 1 kw-D, 250 w-N. Box 625 (57078). (605) 665-7892. Sorenson Bcstg Corp. (acq 7-1-73). Net: MBS. Format: MOR-days, contemp-night. ■ Dean Sorenson, pres; Tom Kearns, gen & coml mgr; Gary Hall, prod dir; Roland Peterson, farm dir; Mike Johnson, sps dir; Helen Light, news dir; Ed Nelson, chief engr. ■ Rates: \$6.90; 6.90; 6.90; 6.90.

WNAX—November 1922: 570 khz; 5 kw-U, DA-N. 3rd & Mulberry. (57078). (605) 665-7442. TWX

South Dakota, Tennessee Radio

See page C-1 for explanation of listings.

910-668-3602. Roy H. Park Bcstg (group owner; acq 12-68). Net: CBS. Rep: Katz. Format: C&W, farm. ■ Roy H. Park, pres; Larry Edwards, gen mgr; Steve Anthony, opn mgr; Gene Williams, farm dir; Bob Hill, news dir; Robert Ray, chief engr. ■ Rates: \$40; 28; 28; 19.

Tennessee

Alcoa

WEAG—Aug 25, 1957; 1470 khz; 1 kw-D. Box 127 (37701). (615) Yukon 3-0890. Blount County Bcstg Co. (acq 9-12-60). ■ Herman Petre, pres, gen & coml mgr; Charles Pickel, news & prog dir; Ted Tefettel, chief engr.

Ardmore

WSLV—Sept 30, 1967; 1110 khz; 1 kw-D. Box 96 (38449). (615) 427-2178. Stateline Bcstg Co. Audio news: APR. Rep: Beaver. Format: Oldies, gospel. ■ E. D. Hildreth, pres, Joan Kilgore, gen mgr; Rachel Mitchell, coml mgr; Jeanne Bowman, prog dir; Tom Bowman, mus dir; Douglas Hildreth, chief engr. ■ Rates: \$3.03; 3.03; 3.03; 3.03.

Athens

WLAR—May 15, 1946; 1450 khz; 1 kw-D, 250 w-N. Box 449 (37303). (615) 745-1314. Athens Bcstg Co. (acq 6-30-66). Net: MBS, Keystone. Rep: Carpenter. Format: C&W. ■ Helen Arterburn, pres; Thomas A. Arterburn, gen & coml mgr; Darrell Patterson, prog dir; David Gussaw, news dir; Andrew M. Bates, chief engr.

WYXI—Oct 5, 1966; 1390 khz; 500 w-D. 14 Decatur Pike (37303) (615) 745-1390. 3 J's Bcstg Co. Net: ABC/E. Rep: Dora-Clayton (Atlanta). Format: C&W. ■ John P. Frew, gen mgr; Julia N. Frew, prog dir.

Berry Hill

WBOL—December 1951; 1470 khz; 5 kw-D, 1 kw-N, DA-2. Box 8085, Nashville (37207). (615) 227-1470. Rounsaville of Nashville Inc. (group owner; acq 11-56). Net: ABC/C. Rep: H-R/Stone. Format: Black, R&B, soul. ■ Ralph B. Johnson, pres; Clarence E. Kilcrease, VP & gen mgr; Edwin R. Dyer, gen sls mgr; John Heidelberg, prog dir; Stephen Crumbley, mus dir; Wayne Robinson, chief engr.

Bolivar

WBOL—Oct 19, 1962; 1560 khz; 250 w-D. Box 191 (38008). (901) 658-5400. Bolivar Bcstg Svc Inc. (acq 7-1-67). Net: ABC/I, Tenn. News Service. Rep: Beaver. Format: Diversified, C&W. Spec prog: Farm 4 hrs wkly. ■ Ben Enoch, pres & chief engr; Bill Morrow, gen & prom mgr; Nancy Morrow, coml mgr; Rickey Mathis, prog dir; Johnny Shaw, mus dir; Danny Potter, news dir.

WVST(FM)—Co-owned with WBOL. Jan 27, 1975; 96.7 mhz; 3 kw. Ant 300 ft. Format: C&W. Spec prog: Farm 2 hrs wkly

Bristol

WFHG—See Bristol, Va.

WFHG-FM—1946; 96.9 mhz; 10 kw. Ant 260 ft.

WKYE—Aug 18, 1962; 1550 khz; 1 kw-D. Box 706, 1009 W. State St., Bristol, Va. (24201). (703) 669-1550. Bristol Bcstg Corp. (acq 7-8-75). Net: ABC. Rep: Dora-Clayton; Carpenter. Format: C&W. ■ John Lee Davenport, pres; Garrett W. Haston, VP & gen mgr; William E. Rhegness, sls mgr; George McGovern, natl prog dir; Bob Dale, prom mgr; Ned Michels, news dir; Mich Sandage, chief engr.

WOPI—June 15, 1929; 1490 khz; 1 kw-D, 250 w-N. 1234 W. State St. (37620). (615) 764-5131. Tolar, Tolar & Tolar Partnership d/b/a Radio Stn WOPI. (acq 9-1-72). Net: NBC. Rep: Devney. Format: MOR, C&W night. Spec prog: Talk 5 hrs wkly. ■ Ray Tolar, gen, coml mgr & chief engr; Frances Tolar, bus mgr; Doug Smith, continuity dir; Tom Tolar, opns mgr; Anne Tolar, pub rel & mus dir; Dave Miller, news dir; Nancy Tolar, traff dir. ■ Rates: \$9; 9; 9; 9.

Brownsville

WBHT—Oct 14, 1963; 1520 khz; 250 w-D. Box 198 (38012). (901) 772-1730. Brownsville Bcstg Co. (acq 4-1-69). Rep: Beaver. Format: Farm, C&W. ■ Ed Perkins, pres; Hack Johnson, stn mgr; Dee Winchester, coml mgr; Brad Hosford, prog dir & chief engr; Jim Norris, mus dir.

WTBG-FM—Co-owned with WBHT. Nov 9, 1965; 95.3 mhz; 3 kw. Ant 150 ft. Dups AM 60%. Format: Black.

Camden

WFWL—Sept 18, 1956; 1220 khz; 250 w-D. Box 543 (38320). (901) 584-7570. Camden Bcstg Co. Inc. Group owner: Michael R. Freeland Stns. Net: ABC/I. Format: Country/Politan. ■ Michael R. Freeland, pres; Ron Lane, gen mgr; Mildred Walker, coml mgr; Charlie Baylor, prog & mus dir; Betty Wilson, prom mgr; Steve Freeland, news dir.

Carthage

WRKM—June 20, 1959; 1350 khz; 1 kw-D. Box 179 (37030). (615) 735-1350. Carthage Bcstg Inc. ■ Reggie L. Honey, pres, gen mgr & chief engr; Curtis M. Gregory, coml mgr; Norris Kemp, prog dir; Leslie Hudson, news dir.

WRKM-FM—July 18, 1975; 102.3 mhz; 3 kw. Ant 300 ft. Stereo. Dups AM 80%.

Centerville

WHLP—Nov 16, 1955; 1570 khz; 1 kw-D. Box 66 (37033). (615) 729-3575, 729-2571. Trans-Air Bcst Corp. (acq 7-13-60). Format: C&W, Top 40, rock. ■ David Price, pres, gen, coml & prom mgr; Steve Turner, prog & news dir; Scott Price, mus dir; Ronald Lynch, chief engr. ■ Rates: \$3.15; 3.15; 3.15; 3.15.

WIKAFM—Co-owned with WHLP. May 1974; 96.7 mhz; 3 kw. Ant 300 ft. Dups AM 75%. ■ Rates same as AM.

Chattanooga

WDEF—Jan 1, 1941; 1370 khz; 5 kw-U, DA-N. 3300 Broad St. (37402). (615) 267-3392. TWX 810-573-5242. Roy H. Park Bcstg of Tennessee Inc. (group owner; acq 2-64). Net: CBS. Rep: Katz. Format: MOR. ■ Roy H. Park, pres; Donald M. Olson, gen mgr; Jim King, prog dir; Luther Masingill, mus dir; Dave Carlock, news dir; Gene Landau, chief engr. ■ Rates: \$45; 30; 33; 22.

WDEF-FM—Sept 15, 1964; 92.3 mhz; 97 kw. Ant 870 ft. Stereo. Dups AM 20%. Format: C&W. ■ WDEF-TV affil. ■ Rates: \$45; 14; 14; 14.

WDOO—April 13, 1925; 1310 khz; 5 kw-U, DA-N. Box 4232 (37405). (615) 266-5117. WDOO of Chattanooga Inc. (acq 6-62). Group owner Bahakel Bcstg. Net: ABC/E. Rep: H-R/Stone. Format: C&W. Spec prog: Farm 19 hrs wkly. ■ Cy N. Bahakel, pres; Wm. R. Nash, VP & gen mgr; Lloyd Payne, prog & mus dir; Robert L. Fansler, prom mgr; Steve Wallace, news dir; S. Parks Hall, chief engr. ■ Rates: \$29; 21; 29; 14.

WDOO-FM—February 1960; 96.5 mhz; 19 kw. Ant 1,010 ft. (CP: 100 kw. Ant 1040 ft). Stereo. Dups AM 20%. Net: ABC/FM. Format: relig. ■ Rates: \$11; 11; 11; 11.

WDXB—July 4, 1948; 1490 khz; 1 kw-D, 250 w-N. Read House (37402). (615) 266-1114. WDXB Bcstg Co. (acq 1-1-68). Net: NBC. Rep: Avco. Format: MOR. ■ J. R. Corbus, pres; W. S. Sanders, exec VP; James M. Clark, VP & gen mgr; Stan Reynolds, prog dir; Charles Champion, mus dir; Bettye Burchard, prom mgr; Charles Curle, chief engr. ■ Rates: \$11; 8.50; 9.50; 6.50.

***WDYN-FM**—June 1, 1968; 89.7 mhz; 62 kw. Ant 820 ft. 1901 Union Ave. (37411). (615) 698-5202. Tennessee Temple College. Format: Relig/ed. ■ Lee Roberson, pres; Jerry L. Siler, gen mgr; Gene Landau, chief engr.

WFLI—See Lookout Mountain.

WGOW

Turner Communications Corp.

WGOW—1936; 1150 khz; 5 kw-D, 1 kw-N, DA-N. Box 4704 (37405). (615) 266-6141. Turner Communica-

tions Corp. (group owner; acq 11-15-68). Rep: Eastman. Format: Top 40. ■ R. E. Turner, pres; R. H. Elliott, gen mgr; Tex Myer, stn mgr; Max O'Brien, mus dir; Ron Wilson, chief engr.

WYNO(FM)—Co-owned with WGOW. November 1960; 106.5 mhz; 50 kw. Ant 1,080 ft. Stereo. (615) 265-0544. Format: Btlf mus. ■ Bob Riley, stn mgr; Jerry Lingerfelt, coml mgr.

***WMBW(FM)**—Aug 1, 1969; 88.9 mhz; 100 kw. Ant 1,270 ft. 1002 American National Bank Bldg. (37402). (615) 266-2795. Moody Bible Inst. of Chicago (acq 5-18-73). Format: Educl. ■ George Sweeting, pres-MB; Robert Neff, bcastg dir-MB; Dean Sippel, mgr; John Cooke, asst mgr; Alan Hill, chief engr.

WMOC—Oct 5, 1961; 1450 khz; 1 kw-D, 250 w-N. 3661 Brainerd Rd. (37411). (615) 267-1128. Mayer Bcstg Co. (acq 7-29-74). Format: Gospel, Black. ■ Robert A. Mayer, pres; Tommy L. Sneed, gen, coml, & prom mgr; prog dir; Mike Allison, mus dir; Mike Royer, news dir; Steve Smith, chief engr.

WNOO—June 1951; 1260 khz; 1 kw-D. 1108 Hendricks St., Box 5056 (37406). (615) 698-8617. WMFS Inc. (acq 7-12-66). Net: Mutual Black. Rep: Dore; Webb. Format: Black. ■ William Watt, pres; Fred Webb, gen mgr; Emanuel Minton, stn mgr & prog dir; Bobby Q. Day, mus dir; Cecil Brown, news dir; Ron Wilson, chief engr. ■ Rates: \$13.40; 11.50; 13.40; 13.40.

WOWE(FM)—See Rossville, Ga.

WRIP—See Rossville, Ga.

WSIM(FM)—See Red Bank.

***WSMC-FM**—See Collegedale.

WYNQ(FM)—Listing follows WGOW.

Church Hill

WMCH—May 8, 1954; 1260 khz; 1 kw-D. Box 128 (37642). (615) 357-5601. Lola B. Wallace. Format: C&W, relig. ■ Lola B. Wallace, pres; Bettye Jo Creasy, gen mgr; Dallas Broome, coml mgr; Darrell Smith, chief engr.

Clarksville

WDXN—Nov 12, 1954; 540 khz; 1 kw-D. Box 724, Bailey Bldg. (37040). (615) 645-2411. Jack Mayer (acq 1-1-74). Format: Contemp country. Spec progs: Farm 4½ hrs, black ½ hr wkly. ■ Jack Mayer, gen & sls mgr; Larry Leslie, prog dir; Mabel Steeley, news dir; J.C. Morrow, chief engr. ■ Rates: 3.25; 3.25; 3.25; 3.25.

WJZM—Oct 19, 1941; 1400 khz; 1 kw-D, 250 w-N. 411 Madison St., Box 648 (37040). (615) 645-6414. Radio Stn WJZM (acq 8-70). Format: Contemp. ■ John H. Bailey, mgr & chief engr; Charles E. Malone, gen mgr; Bob Wicks, prog dir; Barbara Syme, news dir.

Cleveland

WBAC—June 18, 1945; 1340 khz; 1 kw-D, 250 w-N. Box 1059 (37311). (615) 476-7593. WBAC Inc. (acq 3-1-59). Net: MBS. Spec prog: Black 1 hr wkly. ■ Clyde W. Thomason, VP & gen mgr; Cordel A. Whitlock, asst mgr; Reba Wilson, coml mgr; Charles Daugherty, chief engr.

WCLE—May 2, 1957; 1570 khz; 1 kw-D. 67 Ocoee St. N.W. (37311). (615) 472-6511. Southeastern Enterprises Inc. ■ Carl J. Hoskins, pres; Jack L. Hoskins, VP & gen mgr; Joe Wilson, coml mgr; Tom Rowland, prog & news dir; Ronald L. Murray, chief engr.

WCLE-FM—Aug 1, 1961; 100.7 mhz; 50 kw. Ant 360 ft. Dup AM 30%.

***WSMC-FM**—See Collegedale.

Clinton

WCFA(FM)—Listing follows WYSH.

WYSH—November 1960; 1380 khz; 1 kw-D. Box 329 (37716). (615) 457-1380. Clinton Bcstrs Inc. Rep: Beaver. Format: C&W. ■ George R. Guertlin, pres; James F. Stair, gen mgr; Charles E. Phillips, coml mgr; Rochelle Hamilton, prog dir; Walter Stair, mus dir; Sandria Elliott, news dir; James F. Stair II, chief engr.

WCFA(FM)—Co-owned with WYSH. July 4, 1966;

104.9 mhz; 3 kw. Ant 75 ft. (CP: Ant 300 ft.). (615) 457-9221. Format: Rock. ■ James F Stair II, prog dir & prom mgr; Keith Duckett, mus dir.

Collegedale

***WSMC-FM**—November 1961: 90.7 mhz; 79 kw. Ant 570 ft. Stereo. Box 870 (37315). (615) 396-2320. Southern Missionary College Inc. Net: NPR. Format: Fine arts, info ■ Don Self, gen mgr; Grey Rumsey, mus dir; David Brooks, development dir; Milford Crist, ops dir; John Beckett, chief engr.

Collierville

WMSO—Oct 1, 1966: 1590 khz; 500 w-D. 4554 Fleming Rd. (38017). (901) 853-8181; 853-9676. Albert L Crain (acq 11-1-70) Net: ABC/E. Format: C&W/gospel, soul. ■ Albert L Crain, pres, gen mgr & chief engr; Michael E. Carlisle, asst mgr & C&W mus dir; Tom Muse, coml mgr; James Chambers, spiritual mus dir; Duck Davis, soul mus dir.

Colonial Village

WSKT—See Knoxville.

Columbia

WKOM(FM)—Listing follows WKRM.

WKRM—Nov 25, 1946: 1340 khz; 1 kw-D, 250 w-N. Box 113 (38401). (615) 388-3636. Middle Tennessee Bcstg Inc. Audio news: APR. Rep: Devney; Ken Marston. Format: Top 40. Spec progs: Black 1 hr, C&W 12 hrs, farm 12 hrs wkly. ■ R. M. McKay Jr., pres & gen mgr; Tom Ehlke, coml mgr; Robert McKay III, prog & mus dir; Jerry Dooley, news dir; Cameron McKay, chief engr. ■ Rates: \$5; 5; 5; 5.

WKOM(FM)—Co-owned with WKRM. Jan 1, 1967: 101.7 mhz; 3 kw. Ant 300 ft. Stereo. Progs sep from AM. (Acq 9-1-72). Format: C&W. ■ Rates: \$3; 3; 3; 3.

WMCP—Nov 12, 1956: 1280 khz; 1 kw-D. Box 711 (38401). (615) 388-3241. Maury County Boosters Corp. (acq 3-1-58). Format: C&W. ■ T. Earl Williford, pres & gen mgr; J. W. Anderson, chief engr; Mack Shaw, coml mgr. ■ Rates: \$6; 6; 6; —.

Cookeville

WHUB—July 20, 1940: 1400 khz; 1 kw-D, 250 w-N. Box 715 (38501). (615) 526-2131. WHUB Inc. Net: CBS, Keystone. Format: Diversified. ■ M. Luke Medley, pres; Stacey Mott, gen mgr; Martin Medley, coml mgr; Gene Davidson, prog dir; Ransom Siler, chief engr. ■ Rates: \$4.40; 3.20; 4; 3.20.

WHUB-FM—March 26, 1964: 98.3 mhz; 1.5 kw. Ant 400 ft. Stereo. Prog sep from AM. Format: MOR. ■ Rates: \$2.25; 2.25; 2.25; 2.25.

WPTN—July 10, 1962: 1550 khz; 250 w-D. Box 635 (38501). (615) 526-7144. WPTN Inc. Format: C&W, rock. ■ Redman L. Turner, pres; Larry Nunn, gen & coml mgr; Louise Keltner, asst mgr; Robert M. Cox Jr., prog & news dir; Ransom Siler, chief engr.

WPTN-FM—March 8, 1963: 94.3 mhz; 3 kw. Ant 210 ft. Stereo. Dups AM.

***WTTU(FM)**—May 22, 1972: 88.5 mhz; 10 w. Box 5113 (38501). (615) 528-4144. Tennessee Technological University. Format: Contemp/ed. ■ Arliss L. Roaden, pres; Donald W. Caldwell, gen mgr; Ransom W. Siler, chief engr.

Copperhill

WLSB—Dec 2, 1958: 1400 khz; 1 kw-D, 250 w-N. Box A/C (37317). (615) 496-3631. Copper Basin Bcstg Inc. (acq 12-1-62). Net: Keystone. ■ Robert P. Schwab Sr., pres & gen mgr.

Covington

WKBL—Aug 16, 1955: 1250 khz; 1 kw-D. Box 299 (38019). (901) 476-7129. Tipton County Bcstrs (acq 7-5-7). Format: C&W. Spec prog: Black 5 hrs wkly. ■ Bob Whiteley, pres, coml mgr & chief engr; Dave Stewart, prog dir; Judy Townsend, prom mgr; Kathy Whiteley, gen mgr.

WKBL-FM—Aug 31, 1965: 93.5 mhz; 3 kw. Ant 180 ft. Dups AM 65%.

Cowan

WZYX—March 10, 1957: 1440 khz; 1 kw-D. Box 398 (37318). (615) 932-7471. Guidon Bcstg Co. Inc. (acq 4-20-61). ■ Joe Brewer, pres & gen mgr; Mary Lou Garner, prog dir; Jerry Nelson, prom mgr; Frank Spencer, chief engr.

Crossville

WAEW—1952: 1330 khz; 1 kw-D. Drawer W (38555). (615) 484-5115. WAEW Inc. (acq 6-2-58). Net: MBS. Rep: Carpenter. Format: All hit mus. ■ Dr. R. Gene Cra-vens, pres; Fred Warren Dean Jr., gen mgr; Jessie Dean, stn mgr; Mel Matthews, news dir; Alva Henry, coml mgr; Dave Gray, mus dir; Archie Kendrick, chief engr. ■ Rates: \$2.50; 2.50; 2.50; 2.50.

WAEW-FM—May 12, 1967: 99.3 mhz; 3 kw. Ant 170 ft. Horiz, 165 ft. vert. Stereo. Dups AM 85%. ■ Rates same as AM.

WCSV—June 15, 1968: 1490 khz; 1 kw-D, 250 w-N. Box 591 (38555). (615) 484-5168. WCSV Inc. Net: ABC/E. Rep: Crane. Format: Top 40, MOR. Spec prog: Farm 3 hrs wkly. ■ Millard V. Oakley, pres; Mack Johnson, VP, gen & coml mgr; James V. Hamby, prog & mus dir, prom mgr & chief engr. ■ Rates: \$6; 4; 4; 2.50.

Dayton

WDNT—Dec 6, 1957: 1280 khz; 1 kw-D. Box 290 (37321). (615) 775-2321. Norman A. Thomas (group owner). Net: MBS, Vol Net. Audio news: APR. Rep: Carpenter. Format: C&W. ■ Norman A. Thomas, pres; Jack S. Pullin, gen mgr & chief engr; Bill McConnell, coml mgr; Gail Newell, prog dir; Jim Lowe, news dir. ■ Rates: \$3; 3; 3; —.

WNFM(FM)—Co-owned with WDNT. Not on air, target date 1975: 104.9 mhz; 3 kw. Ant minus 198 ft. Format: C&W, gospel, classcl.

Dickson

WDKN—Jan 1, 1955: 1260 khz; 1 kw-D. Box 607 (37055). (615) 446-4000. Dickson County Bcstg Co. Net: ABC; Keystone. Spec prog: C&W 40 hrs wkly. ■ William A. Potts, pres, treas & gen mgr; Richard Albright, coml mgr; Joseph D. Webster, prog dir; Leslie D. Filson, chief engr. ■ Rates: \$2.50; 2.50; 2.50; 2.50.

WDKN-FM—April 27, 1964: 102.3 mhz; 3 kw. Ant 250 ft. Dups AM 66% ■ Rates same as AM.

Dyersburg

WASL(FM)—Listing follows WTRO.

WLSG—July 13, 1946: 1450 khz; 1 kw-D; 250 w-N. Box 627 (38024). (901) 285-1294. State Gazette Bcstg Co. (acq 12-5-2). Net: Delta Farm. Rep: Crane. Format: C&W; gospel. Spec prog: Farm 9 hrs wkly. ■ Robert W. Ward, pres & gen mgr; Jo Ann Ward, coml mgr; Jean Fisher, prog dir; William Bryant, prom mgr & mus dir; Dennis Moody, news dir; James Stutts, chief engr. ■ Rates: \$3; 3; 3; 3.

WTRO



American
Contemporary
Radio Network

WTRO—March 1, 1957: 1330 khz; 500 w-D. Box 100 (38024). (901) 285-1330. McQueen & Co. (acq 4-13-60). Net: ABC/C. Rep: Beaver, Southern Spot Sls. Format: Top 40. Spec prog: Farm 5 hrs wkly. ■ Alvin Wood, pres, gen mgr; Carl G. Minton, coml mgr; Larry Wood, prog & mus dir; Linda Graves, prom mgr; Douglas L. Viar, news dir; Fred Standish, chief engr. ■ Rates: \$3.60; 3.60; 3.60; 3.60.

WASL

Stereo Country

WASL(FM)—July 1, 1968: 100.1 mhz; 3 kw. Ant 195 ft. Stereo. Prog sep from AM. Net: ABC/FM. Format: C&W ■ Rates same as AM.

Elizabethton

WBEJ—July 1946: 1240 khz; 1 kw-D, 250 w-N. Box

Tennessee Radio

See page C-1 for explanation of listings.

829 (37643). (615) 542-2184. WBEJ Inc. (acq 2-15-56). Format: MOR. ■ R. C. Turrentine Jr., pres; Mack Morris, gen mgr; James P. Austin, coml mgr; Cleo Reed, prog dir; Lynn R. Williams, chief engr.

WIDD—Nov 11, 1964: 1520 khz; 1 kw-D, 500 w. CH. 604½ E. Elk Ave. (37643). (615) 543-3191. Holston Bcstg Corp. Format: C&W. ■ J. H. Lewis, pres & gen mgr; E. Eugene Hopson, coml mgr; Bill Harris, prog dir; Bill Hale, news dir; Ben Mcdearis, chief engr.

WIDD-FM—May 17, 1968: 99.3 mhz; 3 kw. Ant minus 79 ft. (acq 6-23-75).

Englewood

WENR—April 21, 1967: 1090 khz; 1 kw-D. Box 745 Athens. (37303). (615) 887-7291. Norman Thomas & Assoc. Inc. (group owner). Format: Contemp. ■ Norman A. Thomas, pres; Sue Kean, gen & coml mgr; Jim Sliger, chief engr.

Erwin

WEMB—May 17, 1956: 1420 khz; 5 kw-D. Box 280 (37650). (615) 743-6123. WEMB Inc. (acq 4-1-61). Rep: Keystone. Format: C&W, Variety. ■ J. E. True Jr., gen mgr; James F. Buchanan, coml mgr; Tony Treadway, news dir; Daniel M. True, chief engr.

WXIS(FM)—Co-owned with WEMB. Nov 21, 1968: 103.9 mhz; 3 kw. Ant minus 430 ft. Stereo. Prog sep from AM.

Etowah

WCPH—1955: 1220 khz; 1 kw-D. Box L (37331). (615) 263-5585. McMinn Bcstrs Inc. (acq 11-16-61). Format: MOR. ■ Clarence K. Daugherty, pres; John R. Blair, gen mgr, prog dir, chief engr; Mike Stephens, mus dir; Philip Roy, coml mgr & news dir.

Fayetteville

WEKR

Ken Marston & Associates

WEKR—Oct 1, 1948: 1240 khz; 1 kw-D, 250 w-N. Box M (37334). (615) 433-3545. James Porter Clark (acq 10-1-60). Net: MBS, Keystone. Rep: Marston. ■ James Porter Clark, own; Edward K. Chapman, mgr; Tom Waynick, prog dir; Carl Chapman, news dir; Ernest J. Tucker, chief engr. ■ Rates: \$3; 3; 3; 3.

WIXC—Dec 11, 1970: 1140 khz; 1 kw-D. Box 757 (37334). (615) 433-2537. Huntsville, Ala. (205) 536-7260. Lincoln County Bcstg Co. Net: ABC/I. Format: Modern country. Spec prog: Black 2 hrs wkly. ■ Bill Malone, gen & prom mgr & prog dir; Sue Brooks, coml mgr; Doug Roach, news dir; Robert Gay, chief engr.

WYTM-FM—March 27, 1970: 105.5 mhz; 3 kw. Ant 295 ft. c/o Joseph D. Young, Box 717 (37334). (615) 433-1531. Time Broadcasters Inc. Audio news: UPI. Format: Mod C&W. ■ Joseph D. Young, pres & gen mgr; George Lambertson, chief engr.

Franklin

WAGG—March 11, 1953: 950 khz; 1 kw-D. 950 Mallory Rd. (37064). (615) 794-1594. Williamson County Bcstg Inc. Format: Country. ■ William R. Ormes, pres, gen mgr; Ann Lynch, prom mgr; Ralph Dawson, news dir.

WIZO—Feb 1, 1969: 1380 khz; 1 kw-D. Box 1380. (37064). (615) 794-4103. Harpeth Valley Bcstg Co. Inc. Net: MBS. Format: Mod C&W. ■ Robert E. Sewell, pres; James H. Hayes, VP & gen mgr; Joy Rodgers, coml mgr; Dan Rodgers, stn mgr; Mike Smiley, prog & mus dir; Charles Dibrell, news dir; Revis V. Hobbs, chief engr.

WIZO-FM—Nov 16, 1961: 100.1 mhz; 2.5 kw. Ant 320 ft. Stereo. Progs sep from AM. (acq 1-1-70). Format: MOR. ■ Judy Hayes, coml mgr, prog & mus dir; Stanley Bassett, prom mgr.

Gallatin

WAMG—Nov 1, 1966: 1130 khz; 250 w-D. Box 521

Tennessee Radio

See page C-1 for explanation of listings.

(37066). (615) 452-3456. Southern Broadcasters Inc. (acq 9-70). Rep: Bernard. Format: C&W. ■ I. D. Lewis, pres; Bob R. Perry, gen mgr; Elizabeth Fugua, coml mgr; Bill Hart, prog & mus dir; Gene Mullican, prom mgr; Ken Larkin, news dir; R. W. Watson, chief engr.

WHIN—Aug 2, 1948: 1010 khz; 1 kw-D. Highway 109 North, Route 1 (37066). (615) 452-4747. Sumner County Bcstg Co. Format: Top 40. ■ T. B. Perkins, pres; William D. Buntin, gen mgr; Jack Williams, chief engr.

WHIN-FM—Dec 1, 1960: 104.5 mhz; 50 kw. Ant 600 ft. Stereo. (615) 452-6300. (acq 11-1-72). Prog sep from AM. Format: Solid gold contemp.

Greeneville

WGRV—1946: 1340 khz; 1 kw-D, 250 w-N. Box 243 (37743). (615) 638-4147. Radio Greeneville Inc. Rep: Carpenter. ■ Paul O. Metcalfe, pres, treas & gen mgr; P. Ronald Metcalfe, stn mgr; Leroy Moon, coml mgr; Pete Luttrell, news dir; Charlie Garant, prog dir. ■ Rates: \$3.35; 3.05; 3.35; 1.95.

WOFM(FM)—Co-owned with WGRV. 1956: 94.9 mhz; 26.5 kw. Ant 245 ft. Stereo. Prog sep from AM. Format: C&W. ■ Ray Smith, stn mgr. ■ Rates: \$2.30; 2.30; 2.30.

WSMG—Dec 1, 1961: 1450 khz; 1 kw-D, 250 w-N. Box 737 (37743). (615) 638-3188. Burley Bcstrs Inc. (group owner; acq 10-1-72). Net: ABC/E. Format: C&W. Spec prog: Farm 2 hrs, sports 4 hrs wkly. ■ Don A. Crisp, pres & chief engr; Kenney Dearstone, gen mgr; J. P. Sauceman, coml mgr; Darrel Bryan, prog & mus dir; Don Mitchell, news dir. ■ Rates: \$3.60; 3.60; 3.60; 3.60.

Harriman

WHBT—May 1946: 1600 khz; 5 kw-D. Box 221 (37748). (615) 882-1600. Folkways Bcstg Inc. (acq 1958). Rep: Carpenter. Format: MOR. ■ Kenneth J. Crosthwait, pres & gen mgr; Ed Willis, coml mgr.

Hartsville

WJKM—September 1, 1966: 1090 khz; 250 w-D. Box 385 (37074). (615) 374-2111. Hartsville Bcstg Corp. Net: ABC/I. Format: C&W, rock, Top 40. Spec progs: Gospel 1 hr, big band 1 hr wkly. ■ Chester J. Davis, pres & gen mgr; Janice Mungle, coml mgr; Kay Inman, prog & news dir; Patsy Meador, prom mgr; Charles Stezak, mus dir; William Johnson, chief engr.

Henderson

***WFHC-FM**—May 22, 1967: 91.5 mhz; 10 w. Freed-Hardeman College, Box 712 (38340). (901) 989-4611. Freed-Hardeman College. Net: MBS; NER. ■ E. Claude Gardner, pres; John Robert Hall, stn advisor; Bob Brooks, prog dir; Ben Enochs, chief engr.

WHHM—Dec 13, 1967: 1580 khz; 250 w-D. Box 203 (38340). (901) 989-5981. Chester County Bcstg (acq 1-1-71). Format: C&W. Spec prog: Farm 15 hrs wkly. ■ Don Fenimore, pres, gen mgr & chief engr; Wanda Smith, coml mgr; Randle Fenimore, mus dir; Mike Whited, news dir; Tony Chapman, prom mgr.

Hendersonville

92-Q stereo 92.1
WBYY

WBYY(FM)—Oct 16, 1970: 92.1 mhz; 3 kw. Ant 300 ft. Stereo. 361 West Main St, Box 372 (37075). (615) 824-7177. Hendersonville Bcstg Corp. Rep: PRO/Meeker. Format: Contemp, solid gold. ■ William R. Sinks, pres; Robert P. Reich Jr., gen mgr; Maggie Williamson, traf mgr; Jim O'Brien, prog dir; Jim Sparks, news dir; Bill Berlin, mus dir; Bob White, dir of sls; Dave Lewis, chief engr. ■ Rates: \$18; 14.50; 18; 14.50.

Hohenwald

WMLR—July 4, 1970: 1540 khz; 250 w-D. Box 1540 (38462). (615) 796-2257. Lewis County Bcstg Co. Net: ABC/E. Rep: Beaver. Format: Variety. ■ Revis V. Hobbs, pres; Jim Hensley, coml mgr; Greg Wise, news dir; Julia F. Lane, chief engr; Ronnie Bo Lane, gen mgr.

Humboldt

WHMT—July 5, 1972: 1190 khz; 500 w-D. Box 1190 (38343). (901) 784-1190. Communications Associates. Rep: Beaver. Format: C&W. ■ Donald Stephenson, pres; F. Darrell Boyd, gen mgr; Paul Cole, chief engr.

WIRJ—Feb 3, 1949: 740 khz; 250 w-D. 2606 E. End Dr. (38343). (901) 784-1740. Gibson County Bcstg Co. Net: ABC/C. Rep: Crane. Format: MOR. ■ James Welch, pres & gen mgr; Bill Carter, prog & news dir; Ruth Ann Meales, mus dir; John Marino, chief engr. ■ Rates: \$4.70; 4.70; 4.70; —.

WIRJ-FM—Sept 1, 1964: 102.3 mhz; 2.83 kw. Ant 310 ft. Prog sep from AM. Format: C&W. ■ Bob Carlton, prog dir. ■ Rates: \$3.50; 3.50; 3.50.

Huntington

WJPJ—Oct 21, 1975: 1530 khz; 1 kw-D. David B. Jordan.

Jackson

WDXI—Oct 31, 1948: 1310 khz; 5 kw-D, 1 kw-N, DA-N, Box 489 (38301). (901) 427-9611. Community Service Bcstg Inc. (group owner; acq 1-1-74). Rep: PRO/Meeker; Southern Spot Sls. Format: Contemp, C&W, black. Spec prog: Farm 2 hrs wkly. ■ Jerome Glassman, pres; Jim Glassman, gen mgr; Frank Hickman, coml mgr; Bob Bohn, news dir; Tom Britt, prog dir & chief engr. ■ Rates: \$8.40; 8.40; 8.40; 5.25.

WJAK—Dec 13, 1954: 1460 khz; 1 kw-D. 416 Airways Blvd. (38301). (901) 424-1460. Jackson Bcstg Enterprises Inc. (acq 11-1-66). Rep: Doral/Clayton. Format: Top 40. Spec prog: Black 5 hrs wkly. ■ Robert G. Blow, chmn; Bob Blow Jr., pres & gen mgr; Charles Dolejs, stn mgr; Joe Case, prog dir; Tom Mapes, sports dir; Karolyn Henry, news dir; Bill Winsett, chief engr.

WKIR(FM)—Listing follows WTJS.

WTJS—1931: 1390 khz; 5 kw-D, 1 kw-N, DA-N. Box 1119 (38301). (901) 427-3316. Radio station WTJS Inc. (acq 10-17-73). Group owner: Kirk Bcstg. Net: ABC/IE. Format: MOR. Spec progs: Black 2 hrs, C&W 3 hrs wkly. ■ James L. Kirk II, pres; Jim Hoppers, VP & gen mgr; Bob Emerson, VP sls; Curtis White, prog dir; Jim Hoppers Jr., mus dir; Vincent Z. Tapler, news dir; Carl Martin, chief engr. ■ Rates: \$5; 5; 5.

WKIR(FM)—Co-owned with WTJS. 1947: 104.1 mhz; 50 kw. Ant 640 ft. (CP: 100 kw. Ant 655 ft.). Net: ABC/FM. Prog sep from AM. Format: Soft rock. ■ Rates: \$3.25; 3.25; 3.25; 3.25.

Jamestown

WCCL—Oct 28, 1957: 1260 khz; 1 kw-D. Box 130 (38557). (615) 879-8188. Jamestown Bcstg Co. ■ Howard Ray Cravens, gen mgr.

WDEB—Jan 12, 1968: 1500 khz; 1 kw-D; 500 w (CH). Box 69 (38556). (615) 879-8164. Surber Bcstg (acq 4-1-72). Format: C&W, gospel, Top 40. ■ N. A. Baz, pres; O. F. Surber, gen & coml mgr; Earl Howard, prog & news dir & prom mgr; Gary Crockett, mus dir; Jim Boles, chief engr.

WDEB-FM—Oct 10, 1972: 103.9 mhz; 1.20 kw. Ant 450 ft. Stereo. Dups AM 80%.

Jefferson City

WJFC—Nov 1, 1961: 1480 khz; 500 w-D. Box 271 (37760). (615) 475-3825. Jefferson County Bcstg Inc. Format: C&W, Variety. ■ Paul O. Metcalfe, pres; Wayne Roberts, VP & gen mgr; Ross Lindsey, chief engr.

Jellico

WJJT

Your Friendly Giant

WJJT—Feb 1, 1972: 1540 khz; 1 kw-D (500 w-CH). Box 210 (37762). (615) 424-7231. Jellico Bcstg Corp. Format: Contemp, C&W. Spec prog: Gospel 19 hrs wkly. ■ John R. Callahan, gen mgr; Tim Zecchini, prog dir; Dick Brown, mus dir; Dave Smith, chief engr. ■ Rates: \$3.50; 3.50; 3.50; —.

Johnson City

WETB—Oct 1, 1947: 790 khz; 1 kw-D. Box 1716

(37601). (615) 928-7131. Press Inc. Net: MBS. Format: Contemp. ■ Carl A. Jones, pres; Arthur Kelsey, gen mgr; Don Gibson, prog & news dir; Ken Bates, mus dir; Lynn Williams, chief engr.

***WETS(FM)**—Feb. 26, 1974: 89.5 mhz; 70 kw. Ant 2,200 ft. Stereo. Box 2305, East Tenn State Univ. (37601). (615) 926-2184. East Tenn State Univ. Net: NPR. Format: Variety. Spec prog: Black 6 hrs wkly. ■ Delos P. Culp, pres; Richard F. Ellis, gen mgr; William Sarchey, prog dir; Marla Morrison, mus dir; Eugene B. Jones, chief engr.

WJCW—Dec 13, 1938: 910 khz; 5 kw-D, 1 kw-N, DA-N. Box W (37601). (615) 926-6167. Tri-Cities Bcstg Inc. (acq 6-1-60). Net: CBS. Rep: Masla; Carpenter. Format: C&W. ■ James C. Wilson, pres; Rocky Stone, gen mgr; Bobbie Kabell, coml mgr; Rocco Cook, prog dir; Bill Williams, mus dir; Ron Mitchell, news dir; Edward L. Bryant, chief engr.

WQUT(FM)—Co-owned with WJCW. March 1, 1948: 101.5 mhz; 100 kw. Ant 1500 ft. Stereo. Prog sep from AM. Format: Rock folk, rock. ■ Bill Cramer, prog & mus dir.

WJSO—See Jonesboro.

Jonesboro

WJSO—Oct 16, 1958: 1590 khz; 5 kw-D. Box 5188, Johnson City (37601). (615) 926-3121. Mountain View Bcstg Co. Group owner: Norman Thomas Stns. Rep: Pro Time Sls; Media Sls South. Format: Contemp. ■ Norman Thomas, pres & gen mgr; Don Dale, prog & mus dir; Wayne Sparks, coml mgr; Rockne Stump, prom mgr; Al Lefevre, chief engr. ■ Rates: \$6; 6; 6; 6.

Kingsport

WGOC—Sep 20, 1967: 1090 khz; 1 kw-D. Box 1369 (37662). (615) 247-7131. J. T. Parker Bcstg Corp. Rep: Carpenter. Format: C&W. ■ J. T. Parker Jr., pres; Phil Roberts, gen mgr; Dick McClellan, coml mgr; Dan Arnold, prog dir; Mary Moody, mus dir; Ray Buckles, prom mgr; Tom Light, news dir; Mitch Sandidge, chief engr.

WKIN—October 1951: 1320 khz; 5 kw-D. Drawer K (37662). (615) 246-8131. Radio Stn WKIN. Group owner: Bahakel Bcstg. Rep: Savalli-Gates. Format: Top 40. ■ Cy N. Bahakel, pres; Ken Maness, gen mgr; Oscar Harris, prog dir; Ric Darby, chief engr.

WKPT—July 14, 1940: 1400 khz; 1 kw-D, 250 w-N. 222 Commerce St. (37662). (615) 245-4161. TWX 810-574-5180. Holston Valley Bcstg Corp. (6-1-66). Net: NBC. Rep: Torbet; Jones. Format: MOR. ■ William M. Boyd, pres; Robert I. Ratcliff, exec VP & gen mgr; Phil J. Weaver, VP & stn mgr; George E. DeVault Jr, VP ops & prog dir; Doug Newton, sps dir; Bob Lawrence, mus dir; Bill Freehoff, news dir; Howard T. Dougherty, VP engr & chief engr. ■ Rates: \$11.50; 11.50; 11.50.

WKPT-FM—February 1948: 98.5 mhz; 45 kw. Ant 960 ft. Stereo. Dups AM 5%. Net: ABC/FM. Format: Btl mus. ■ WKPT-TV affil. ■ Rates same as AM.

Knoxville

WBIR—Jan 21, 1941: 1240 khz; 1 kw-D, 250 w-N. 1513 Hutchison Ave. (37917). (615) 637-1010. TWX: 810-583-0172. Multimedia Inc. (group owner; acq 1-1-61). Net: CBS. Rep: Katz. Format: Contemp. ■ Wilson C. Wearn, pres; Neal W. Branch, gen mgr; Ray Davidson, coml mgr; Ken McGavin, prog dir; A. Russ Brashear, news dir; Walt Martin, prom mgr; Robert E. Horton, chief engr.

WBIR-FM—October 1949: 103.5 mhz; 100 kw. Ant 1720 ft. Stereo. Dups AM 15%. Net: ABC/FM. Format: Top 40. ■ WBIR-TV affil.

WETE—Feb 12, 1927: 620 khz; 5 kw-U, DA-2. 1515 Magnolia Ave N.E. (37917). (615) 546-6121. Knoxville Bcstg (acq 9-16-71). Group owner: Hall Communications. Net: ABC/I. Rep: H/R Stone. Format: Modern MOR. ■ Robert M. Hall, pres; Donald Lauffer, exec VP; Glynn Theg, VP & gen mgr; Donald Tonkin, chief engr.

WEZK(FM)—April 10, 1967: 97.5 mhz; 100 kw. Ant 1140 ft. Stereo. Box 1388 (37901). (615) 687-2312. TWX 810-583-0178. South Central Bcstg Corp. (group owner). Audio news: APR. Rep: Avery-Knodel Inc. Format: Good mus. ■ John D. Engelbrecht, pres & gen mgr; Harry Stephenson, sls mgr; Donna Keathley,

admin dir; Carl Lawson, chief engr. ■ WTVK(TV) affil.
■ Rates: \$8.10; 9.20; 9.20; 8.10.

WIVK—March 23, 1953: 850 khz; 50 kw-D, DA. Box 10207, 6711 Kingston Pike (37919). (615) 588-6511. Dick Bcstg Inc. Rep: Torbet. Format: Contemp. C&W. ■ James A. Dick, pres, gen mgr; Claude Tomlinson, prog dir; Bobby Denton, mus dir & stn mgr; Mike Hammond, news dir; Ken Russell, coml mgr; Milton Jones, chief engr. ■ Rates: \$29; 27; 29;—.

WIVK-FM—Dec 16, 1965: 107.7 mhz; 100 kw. Ant 390 ft. Dups AM 50%. ■ Rates: \$29; 27; 29; 16.

WJBE—January 1960: 1430 khz; 1 kw-D. Box 281 (37914). (615) 637-1430. J. B. Bcstg Ltd. (acq 1-68). Rep: Masia; Ochs. Format: R&B, gospel, jazz. ■ James Brown, pres; Ralph Stone, ntl sls mgr; Willie J. Sanders, gen mgr; Jim Taylor, opns mgr; Frank Folsom, chief engr.

***WKCS(FM)**—December 1952: 91.1 mhz; 310 w. Ant 73 ft. 2509 Broadway, N.E. (37917). (615) 524-3001. Fulton High School. Format: Rock. Spec prog: Black 5 hrs wkly. ■ Lynn Davis, gen & prom mgr; Sundra Thompson, prog dir; Donny Mettaberger, mus dir; Mike Burruss, news dir; Dale Patterson, chief engr.

WKGN

PRO/Meeker Radio

WKGN—1946: 1340 khz; 1 kw-D, 250 w-N. Box 1870. (37901). (615) 573-2931. Creative Bcst Inc. (acq 2-1-75). Net: ABC/C. Rep: PRO/Meeker. Format: Top 40. ■ Lewis M. Manderson Jr., pres; Vic Rumore, gen mgr; Molly Skeen, coml mgr; Dr. Al Adams, prog & mus dir. prom mgr; Joe Anderson, news dir; Ed Martin, chief engr. ■ Rates: \$14.25; 12; 14.25; 12.

WKXV—February 1953: 900 khz; 1 kw-D. Box 2269 (37901). (615) 524-9866. Knoxville Ra-Tel Inc. Rep: Carpenter. Format: Variety. ■ B. L. Boring, pres; Marvin Thompson, mgr & coml mgr; Bob Lawson, prog dir; Jackie Thompson, news dir.

WNOX—1921: 990 khz; 10 kw-U, DA-N. 4400 White Springs Rd. (37917). (615) 523-3171. Scripps-Howard Bcstg Co. (group owner; acq 12-35). Rep: Blair. Format: Contemp. ■ Donald L. Perris, pres; Peter R. Dreyer, gen mgr; Robert E. Byerley, coml mgr; Edward Roy, prog dir; Janice McCroskey, admin asst; Richard Winstead, mus dir; Paul Oscar Anderson, news dir; John Maples, chief engr.

WOKI—See Oak Ridge.

WROL—Sept 1, 1960: 1490 khz; 1 kw-D, 250 w-N. 1830 White Ave, Suite 300 (37916). (615) 637-1490. WROL Inc. Net: ABC/I. Format: Adult progressive rock. ■ Smauel P. Thrower, pres & gen mgr; Gary Adkins, prog dir; Bill Blackburn, chief engr.

WSKT—May 21, 1961: 1580 khz; 5 kw-D (1 kw CH). Box 2310 (37901). (615) 523-1616. Morgan Bcstg Co. Net: MBS. Format: Inspir, news. ■ Harry J. Morgan, pres & gen mgr; Gerry Morgan, coml mgr; Tom Burchfield, prog dir; John England, chief engr.

***WUOT(FM)**—October 1949: 91.9 mhz; 100 kw. Ant 550 ft. Stereo. 232 Communications and Extension Bldg., U. of Tennessee (37916). (615) 974-5375. U. of Tennessee. Net: NPR. Format: Classical. ■ Raymond Shirley, dir; Norris Dryer, prog dir; Joseph Chasteen, chief engr.

Lafayette

WEEN—Nov 3, 1958: 1460 khz; 1 kw-D. Box 160 (37083). (615) 666-2169. Lafayette Bcstg Inc. Net: Tenn. News Serv. Format: Top 40, C&W. Spec prog: Farm 5 hrs wkly. ■ Billie G. Speck, pres & gen mgr; Peggy Nichols, coml mgr; Wardean Perdue, prog & news dir; Tommy Minchey, mus dir; Ivon Davis, chief engr. ■ Rates: \$2.55; 2.55; 2.55;—.

La Follette

WLAF—May 17, 1953: 1450 khz; 1 kw-D, 250 w-N. N. Fifth St. (37766). (615) 562-3557. Campbell County Bcstg Corp. (acq 10-24-66). Net: Keystone. Format: C&W. ■ J. P. Mills, pres; Elmer Longmire, gen mgr; Jim Wilson, prog dir; Carl Stump, chief engr.

Lawrenceburg

WDXE—July 21, 1951: 1370 khz; 1 kw-D. 120½ N.

Military (38464). (615) 762-4411. H-M-S Bcstg Co. (acq 12-73). Net: Keystone. Format: C&W. ■ Robin Mathis, gen mgr; Milton D. Griffin, stn mgr; Bud Sawyer, asst mgr; Don Hollander, prog dir; Larry Meek, news dir; Phillip Kemper, chief engr.

WDXE-FM—Aug 28, 1964: 95.9 mhz; 3 kw. Ant 205 ft. Prog sep from AM.

Lebanon

WCOR—October 1949: 900 khz; 500 w-D. Box 549 (37087). (615) 444-0474. WCOR Bcstg (acq 11-69). Format: Top 40, R&B (Sat afternoon). ■ Jack Hendrickson, pres & gen mgr; Bill Handy, stn mgr; Coleman Walker, prog dir; Jim Henderson, news dir; Lee Raines, chief engr.

WCOR-FM—Aug 31, 1962: 107.3 mhz; 18 kw. Ant 175 ft. Stereo. Prog sep from AM. Format: MOR. ■ Lee Raines, stn mgr.

***WFMQ(FM)**—Dec 15, 1966: 91.3 mhz; 480 w. Ant 86 ft. Box 609 (37087). (615) 444-0305. Cumberland College of Tennessee. Format: Classcl. Spec progs: Fr 1 hr, Ger 1 hr, Sp 1 hr wkly. ■ Ernest Stockton Jr., pres; William O. Barry, gen mgr; James A. Sparks, prog dir; Chester Hatcher, chief engr.

***WLCH(FM)**—1972: 88.7 mhz; 10 w. Castle Heights Foundation (acq 9-74).

Lenoir City

WBLC—June 15, 1965: 1360 khz; 1 kw-D. Box 100 (37771). (615) 986-8021. Livesay Bcstg Corp. (acq 3-1-68). Format: MOR, soft rock. ■ Earl Lauderdale, pres & gen mgr; Robert Van McKeenan, VP & sls mgr; Rick Smith, prog & news dir.

WLIL—May 30, 1950: 730 khz; 1 kw-D. Box 340 (37771). (615) 986-7536. WLIL Inc. Group owner: Arthur Wilkerson Stns. Format: Variety. ■ Arthur Wilkerson, pres & gen mgr; Dwight D. Wilkerson, VP; Mrs. Evelyn B. Wynn, sec. coml & office mgr; Joanne Greenway, prog & mus dir; Glenn McNish, prom, news & sports dir & sls mgr; Allen Breazeale, chief engr. ■ Rates: \$6; 6; 6.

WLIL-FM—Sept 19, 1967: 93.5 mhz; 2.85 kw. Ant 165 ft. Dups AM 40%. ■ Rates same as AM.

Lewisburg

WJJM—May 15, 1947: 1490 khz; 1 kw-D, 250 w-N. Box 20 (37091). (615) 359-4511. Louis D. Lingner (acq 9-15-53). Net: MBS, Keystone. Format: C&W. ■ Louis D. Lingner, pres & gen mgr; Sara Smith, coml mgr & prog dir; Jim Travis, prom mgr; Perry Gillum, news dir; R. C. Wiley, chief engr.

WJJM-FM—Feb 20, 1969: 94.3 mhz; 3 kw. Ant 115 ft. Dups AM 100%.

Lexington

WDXL—July 1954: 1490 khz; 1 kw-D, 250 w-N. Box 170 (38351). (901) 968-3776. Lexington Bcstg Svc Inc. (acq 1955). Net: ABC/I, Keystone. Rep: Beaver. Format: C&W, MOR, top 40. Spec prog: Black 14 hrs wkly. ■ L. T. Hay, pres; Ben Enoch, gen mgr & chief engr; A. D. Ward, coml mgr; Gordon Vestal, prog dir; Dorothy Ward, news dir.

WDXL-FM—September 1964: 99.3 mhz; 3 kw. Ant 150 ft. Prog sep from AM. Format: MOR.

Livingston

WLIV—Nov 26, 1956: 920 khz; 1 kw-D. Box 359 (38570). (615) 823-1226. WLIV Inc. (acq 9-1-65). Format: C&W, contemp. ■ Richard Gillespie, pres, gen mgr & news dir; Drew Huffines, coml mgr & prog dir; Art Johnson, prom mgr; Jack Woodward, mus dir; Ransom Siler, chief engr.

WLIV-FM—Dec 1966: 95.9 mhz; 3 kw. Ant 155 ft. Dups AM 30%.

Lobelville

WTHJ(FM)—1974: 94.3 mhz; 3 kw. Ant 300 ft. Mid-South Professional Svcs Inc.

Lookout Mountain

WFLI—Feb 20, 1961: 1070 khz; 50 kw-D; 1 kw-N, DA-2. O'Grady Drive, Chattanooga (37409). (615)

Tennessee Radio

See page C-1 for explanation of listings.

821-3555. WFLI Inc. Format: Contemp rock. ■ William E. Bennis Jr., pres; Dale Anthony, gen mgr; Bob Todd, prog dir; E. A. Davis, mus dir; Dick James, news dir; Joe Pateet, chief engr.

Madison

WENO—Sept 16, 1957: 1430 khz; 5 kw-D, 1 kw-N, DA-N. Box 5236, Nashville (37206). (615) 868-9366. Central Bcstg Corp. Group owner: H. Calvin Young Stns. Net: MBS. Rep: Howard. Format: Top 40, country, hits of the 50's. ■ H. C. Young Jr., pres; Casey Jenkins, gen mgr; Bob Carlton, prom mgr; Johnny Koval, prog & mus dir; Betsy Smith, asst mgr; Sonny Ledet, news dir; Don Anderson, chief engr.

Madisonville

WKYZ—July 12, 1967: 1250 khz; 500 w-D. Highway 411 S. (37354). (615) 442-4567. Monroe Bcstrs Inc. Format: C&W. ■ Bob E. Harriell, pres, gen & coml mgr; Lynda Land, prog & mus dir; Carleton Scruggs, prom mgr; James Sliger, chief engr.

Manchester

WMSR—March 5, 1957: 1320 khz; 5 kw-D. Box 290 (37355). (615) 728-3526. WMSR Inc. (acq 9-65). Format: C&W, MOR, rock. ■ Ray Spivey, pres; Russell Daniel, VP, gen & coml mgr; Jim Harper, prog dir; Vernon Bogle, mus dir; Johnny Hill, news dir; Norman Reynolds, chief engr. ■ Rates: \$2.75; 2.75; 2.75; 2.75.

WMSR-FM—June 20, 1962: 99.7 mhz; 18.8 kw. Ant 172 ft. Stereo. Prog sep from AM. ■ Rates same as AM.

Martin

WCMT—June 8, 1957: 1410 khz; 1 kw-D. Box 318 (38237). (901) 586-6110. Jones T. Sudbury. Rep: Beaver. Format: Diversified. ■ J. T. Sudbury, own; D. A. Drumm, gen mgr; Dorris Gill, prog dir; Gary Tuck, news dir; Herbert Cathey, chief engr. ■ Rates: \$4.00; 4.00; 4.00; 4.00.

WCMT-FM—Sept 26, 1968: 101.7 mhz; 3 kw. Ant 175 ft. Prog sep from AM. Format: MOR. ■ Rates same as AM.

***WUTM(FM)**—Sept 1, 1971: 90.3 mhz; 10 w. Univ of Tenn. at Martin (38238). (901) 587-7777. University of Tennessee. Format: MOR. ■ David Briody, faculty advisor; Richard D. Swiers, gen mgr.

Maryville

WGAP

100% Country

WGAP—Aug 13, 1947: 1400 khz; 1 kw-D, 250 w-N. Box 607 (37801). (615) 983-4310. Stephen Y. Corbett (acq 11-74). Net: MBS. Rep: Southern Spot Sls. Format: C&W. ■ Steve Corbett, gen mgr; Harry Robertshaw, prog dir; Glenn Morton, news dir; Harry Plumlee, chief engr. ■ Rates: \$4.35; 4.35; 4.35; 4.35.

McKenzie

WHDM—Jan 29, 1954: 1440 khz; 500 w-D. Box 370 (38201). (901) 352-3371. Northwest Tenn. Bcstg Co. Inc. (acq 10-71). Net: Keystone. Rep: Hopewell; Beaver. Spec prog: C&W 12 hrs wkly. ■ Ed Perkins, gen mgr; John Latham, stn mgr; Emily Jones, prog dir; Lou Owen, news dir; Martin Dill, chief engr.

WKTA(FM)—Feb 11, 1963: 106.9 mhz; 7.1 kw. Ant 290 ft. Stereo. Rt. 2 (38201). (901) 352-2212. Huntingdon-McKenzie Bcstg Corp. (acq 5-20-75). Net: ABC/FM. Format: C&W, MOR, gospel. Spec prog: Black 2 hrs wkly. ■ Meredith C. Johnson, Richard E. Bennett, co-owners; Richard E. Bennett, gen mgr; Marsha Barger, news dir; Martin Dill, chief engr.

McMinnville

WAKI—1947: 1230 khz; 1 kw-D, 250 w-N. Box 409 (37110). Durham Bcstg Corp. Rep: Carpenter. ■ Tollye Wayne, gen mgr.

Tennessee Radio

See page C-1 for explanation of listings.

WBMC—May 1, 1955: 960 kHz; 500 w-D. Box 759 (37110). (615) 473-2104. Cumberland Valley Bcstg Co. Audio news: APR. Rep: Hopewell. Format: C&W, gospel. ■ James W. R. White, pres; Franklin H. Brown, gen mgr; Linda Porter, prog dir; Bud Godwin, prog mgr; Bill Zechman, news dir. Hal Wilson, chief engr. ■ Rates: \$5; 4.60; 4.60; 4.

WBMC-FM—Jan 23, 1964: 103.9 mhz; 3 kw. Ant 130 ft. Stereo. Progs sep from AM. (acq 2-1-71). Format: Easy lstrng. ■ Rates: \$2.50; 2.50; 2.50; 2.50.

Memphis

KSUD—See West Memphis, Ark.

KWAM—1946: 990 kHz; 10 kw-D, DA. Box 12107 (38112). (901) 323-2679. KWAM Inc. (acq 1951). Group owner: Dee Rivers Stns. Net: MBS. Rep: Bunchez. Format: Relig, black. ■ E. D. Rivers, pres; E. W. Bie, gen mgr; Eugene Walton, prog dir; Jim Climer, news dir; Earle Hodges, chief engr.

KWAM-FM—March 10, 1965: 101.1 mhz; 100 kw. Ant 390 ft. Stereo. Prog sep from AM. Net: ABC/E. Format: C&W. ■ Jim Climer, coml mgr; Gary Powell, gen, mus & news dir.

WDIA—June 7, 1947: 1070 kHz; 50 kw-D, 5 kw-N, DA-2. Box 12045 (39112). (901) 278-4551. Sponderling Bcstg Corp. (group owner; acq 1-1-57). Net: ABC/C. Format: Black. ■ Egmont Sonderling, pres; Charles A. Scroggs, ex VP & gen mgr; Archie S. Grinalds, VP, sls mgr; Lee Armstrong, prog dir; A. C. Williams, dir com rel; Robert D. Thomas, mus dir; Gerald Hearn, news dir; Henry A. Fones, chief engr.

WQUD-FM—Co-owned with WDIA. Sept 15, 1968: 104.5 mhz; 100 kw. Ant 750 ft. Prog sep from AM. Net: ABC/FM. Rep: Howard; Riley. Format: Good mus. ■ Bob McDowell, prog dir; Charles Sullivan, sls mgr.

***WEVL-FM**—Not on air; target date 1975: 90.3 mhz; 10 w. Ant 150 ft. Box 2118 (38101). (901) 726-9789. Southern Communication Volunteers. Format: Alternative, diversified. ■ Edwin Thomas, pres; Dennis Batson, gen mgr; Doyle Stewart, mus dir.

WEZI(FM) Beautiful Music

WEZI(FM)—Feb 9, 1968: 105.9 mhz; 100 kw. Ant 760 ft. Stereo. 5900 Poplar Ave. (38138). (901) 767-6532. Southern Bcstg Co. (group owner; acq 11-30-72). Audio news: UPI. Rep: Eastman. Format: Btlf mus. ■ John G. Johnson, pres; Dave Thomas, gen & coml mgr; Don Nutting, mus, prog, news dir & prom mgr; Dave Peacock, chief engr. ■ Rates: \$28; 28; 28; 28.

WHBQ



WHBQ—March 18, 1925: 560 kHz; 5 kw-D, 1 kw-N, DA-2. 485 S. Highland (38111). (901) 323-7661. TWX 901-278-1314. RKO General Inc. (group owner; acq 7-8-54). Audio news: UPI. Rep: RKO Radio Reps. Format: Contemp. ■ Dwight Case, pres; James A. Bedwell Jr., VP & gen mgr; Dick French, gen sls mgr; Dave Williams, prog dir; Sam McCullough, prom mgr; Sid Leak, news dir; Welton Roy, chief engr. ■ WHBQ-TV affil. ■ Rates: \$38; 31; 38; 28.

***WKNO-FM**—March 1, 1972: 91.1 mhz; 40 kw. Ant 580 ft. Memphis State U. Box 80,000 (38152). (901) 458-2521. Memphis Community Television Foundation. Net: NPR. Format: Variety. ■ Howard D. Holst, gen mgr; A. Fred Willis, prog dir; Robert R. Nollner, chief engr.

WLOK—March 1, 1956: 1340 kHz; 1 kw-D, 250 w-N. Box 69 (38101). (901) 527-9565. Star WLOK Inc. (acq 6-13-69). Group owner; Starr Bcstg Group Inc. Net: Natl Black. Rep: Torbet. Format: Black. ■ Peter H. Starr, pres; Bill McKay, VP & gen mgr; Lynn Higbee, coml mgr; Garland Markham, prog dir; O. C. Wallace,

news dir; John Wampler, chief engr. ■ Rates: \$22; 21; 22; 19.

***WLYX(FM)**—1972: 89.3 mhz; 1.1 kw. Ant 150 ft. (CP: 2.75 kw. Ant 195 ft). 2000 N. Parkway (38128). (901) 272-1232. Southwestern at Memphis (acq 2-25-75). Net: ABC/FM. Format: Variety. Spec prog: Sp ½ hr. ■ James H. Daughdrill, pres; George McClintock, gen mgr & chief engr; Cindy Little, prog dir; Joe Spake, mus dir; Elvin Sledge, news dir.

***WSWM(FM)**—Co-owned with WLYX(FM). August 1975: 91.7 mhz; 10 w. Ant 160 ft. Format: Diversified ■ Dawn Grim, prog dir.

WMC—Jan 21, 1923: 790 kHz; 5 kw-U, DA-N. Box 420, 1960 Union Ave (38104). (901) 274-8515. TWX 901-278-1822. Scripps-Howard Bcstg Co. (group owner). Net: NBC. Rep: Blair. Format: Country. ■ Donald L. Perris, pres; Dean L. Osmundson, gen mgr; Bob Webber, coml mgr; Bob Young, prog dir; Bart Lamb, prom mgr; Buddy Frase, chief engr.

WMC-FM—May 22, 1947: 99.7 mhz; 300 kw horiz; 100 kw vert. Ant 910 ft. Stereo. Prog sep from AM. Format: Contemp rock. ■ Greg Hamilton, prog dir. ■ WMC(TV) affil.

WMP5—March 1925: 680 kHz; 10 kw-D, 5 kw-N, DA-N. Box 3584 (38103). (901) 525-2663. Plough Bcstg Inc. (group owner; acq 3-4-5). Rep: H-R/Stone. Format: Contemp. ■ Harold R. Kreisteln, pres; H. Wayne Hudson, gen mgr; John Rhea, coml mgr; Roy Mack, prog dir; Mike Day, news dir; L. S. Stevens, chief engr.

WMP5-FM—Jan 1, 1961: 97.1 mhz; 100 kw. Ant 530 ft. Prog sep from AM. Format: Classical.

WMOQ—April 11, 1964: 1480 kHz; 5 kw-D. Chisca Plaza Hotel, 272 S. Main (38101). (901) 523-1604. Dalworth Bcstg Co. Inc. ■ Kurt A. Meer, pres; Eddie Steward, gen mgr; Art Scott, prog dir.

***WOOX(FM)**—April 8, 1974: 88.5 mhz; 2.15 kw. Ant 960 ft. 3333 Covington Pike (38128). (901) 386-0410. Bd of educ, Memphis City Schools. Format: Top 40, educ. ■ William A. McGinnis, dir; Franklin Schroer, consultant; Janice Knapp, prom & pub rel mgr; Carol Christenson, gen mgr; James Futrell, prog dir; Joseph Dyer, mus dir; John Lynch, news dir; Harry Gibson, chief engr.

WQUD(FM)—Listing follows WDIA.

WREC—September 1922: 600 kHz; 5 kw-U, DA-N. Peabody Hotel (38103). (901) 528-0060. TWX: 810-591-1627. Summit Communications of Tenn. Inc. (group owner; acq 1-10-75). Net: CBS. Format: MOR. Spec prog: Farm ½ hr wly. ■ Lee Wallenhaupt, pres; Al Brooks, gen mgr; Bill Williams, sls mgr; Allan Tynes, prog dir; Tom Booth, mus dir; Jay Boland, news dir; Howard Moran, chief engr.

WREC-FM—March 1967: 102.7 mhz; 100 kw. Ant 900 ft. Stereo. Prog sep from AM. Format: Btlf mus.

***WSWM(FM)**—Listing follows WLYX.

WWEI—Oct 1955: 1430 kHz; 1 kw-D. Mid-City Bldg., 1331 Union Ave. (38104). (901) 725-7657. Tri-State Bcstg Service Inc. Net: ABC/L. Format: Talk. ■ Sam C. Phillips, pres; Bill Thomas, gen & coml mgr; Chris Thomas, news dir; Doug Cousar, chief engr.

Milan

WKBJ—April 27, 1955: 1600 kHz; 1 kw-D. Box 230 (38358). (901) 686-7481. West Tennessee Bcstg Co. Rep: Southern Spot Sls. Format: C&W. ■ W. G. Denney, pres; Bill J. Haney, gen mgr; Larry H. Dunphy, prog dir; Linda Hawks, coml mgr; Tom Neal, mus & news dir; Bill George, prom mgr; Charles Wingate, chief engr.

WKBJ-FM—Dec 12, 1964: 92.3 mhz; 28.5 kw. Ant 175 ft. Dups AM 15%. Format: MOR.

Millington

WTNN—June 22, 1962: 1380 kHz; 500 w-D. Box 265 (38053). (901) 872-3396. The Moore Co. (acq 8-27-73). Net: ABC/E. Format: Gospel mus ■ Gary Acker, pres; Steve L. Williams, gen, coml & prom mgr & news dir; Rick Smith, prog dir; Dave Church, chief engr.

Morristown

WAZI(FM)—Listing follows WMTN.

WCRK—October 1947: 1150 kHz; 1 kw-D, 500 w-N, DA-N. Box 220 (37813). (615) 586-9101. WCRK Inc. (acq 11-22-60). Net: MBS. Rep: Carpenter. ■ John P. Hart, pres; Howell Ashford, VP & gen mgr; Ed Dodson, prog dir; James A. Redden, chief engr.

WMTN—Oct 19, 1957: 1300 kHz; 5 kw-D, DA. Box 70 (37814). (615) 586-7993. East Tennessee Bcstg Corp. Audio news: UPI. Format: C&W. ■ George R. Guertin, pres, gen mgr & chief engr; Don Crisp, sls mgr; Jim Potts, prog dir; Johnny Walker, mus dir. ■ Rates: \$6; 6; 6; 6.

WAZI(FM)—Co-owned with WMTN. May 31, 1964: 95.9 mhz; 3 kw. Ant 260 ft. Stereo. Box 1759 (615) 586-9696. Progs sep from AM. Format: MOR. ■ Ross Woody, coml mgr. ■ Rates: \$5; 5; 5; 5.

Mountain City

WMCT—Dec 8, 1967: 1390 kHz; 500 w-D. 1211 North Church St. (37683). (615) 727-6701. Johnson County Bcstg Co. Rep: Keystone. Format: C&W. ■ Frances Atkinson, pres; Paul Gobble, gen & coml mgr; Willis Walker, prog dir; B.H. Morrison, chief engr. ■ Rates: \$2.80; 2.80; 2.80; 2.80.

Murfreesboro

WGNS—Jan 1, 1947: 1450 kHz; 1 kw-D, 250 w-N. Box 1439 (37130). (615) 893-5373. Vogel-Hale Corp. (acq 4-1-70). Group owner: Vogel Communications. Net: MBS. Format: Contemp. ■ William R. Vogel, pres; Monte Hale, VP & gen mgr; Paul Rebmann, prog dir; Dale Hendricks, sls; Fred Alverson, asst news, Major Briggs, chief engr. Neil Lancaster, asst mgr; Dan Jaynes, news dir.

***WMOT(FM)**—April 9, 1969: 89.5 mhz; 50 kw. Ant 297 ft. Stereo. Middle Tenn. State U. (37132). (615) 898-2800. TWX 615-893-0181. Middle Tenn. State University. Net: ABC/L, MBS, Mutual Black, NPR. Format: Music, news & pub affairs. ■ Harold Baker, gen mgr; Stan Myatt, opns coord; Patrick Jones, opns dir; Dennis L. Adamson, news dir; Thelma Wilkerson, Gregory Jaeger, assoc prods; James B. Gilmore, chief engr.

WMTS—Nov 1, 1953: 810 kHz; 5 kw-D. Box 860 (37130). (615) 893-6611. WMTS Inc. Format: C&W. ■ Mary Reeves Davis, pres; Tom Perryman, VP; Gary Lynn Petty, gen mgr. ■ Rates: \$4; 4; 4; 4.

WMTS-FM—Aug 10, 1963: 96.3 mhz; 20 kw. Ant 170 ft. Stereo. Prog sep from AM. Format: Contemp, big band oldies. ■ Rates: \$3.50; 3.50; 3.50; 3.50.

Nashville

WENO—See Madison.

WAMB—December 1968: 1190 kHz; 250 w-D. 1617 Lebanon Rd. (37210). (615) 889-1960. Great Southern Bcstg Co. of Nashville. Net: MBS. Audio news: APR. Format: Big band, standards ■ William O. Barry, pres; Bart Walker, VP & gen mgr; Kenneth Stumpf, coml mgr; Cheryl McKinney, mus dir; Buzz Benson, prog dir; Chris Connors, prom mgr; Chester Hatcher, chief engr.

WZEZ(FM)—Co-owned with WAMB. Nov 15, 1971: 92.9 mhz; 100 kw. Ant 510 ft. Stereo. Prog sep from AM. Format: Btlf mus. ■ C.J. McKinney coml mgr; C.R. Chenoweth, prog dir; Buzz Benson, mus dir.

WKDA—1948: 1240 kHz; 1 kw-D, 250 w-N. 1202 Stahlman Bldg. (37201). (615) 254-1355. WKDA Bcstg Co. (acq 10-1-59). Audio news: UPI. Rep: Torbet. Format: C&W. ■ Stuart Hepburn, pres; Jim Ragan, gen & coml mgr; Mike Hanes, prog dir; Chris McGuire, mus dir; Mike McClellan; news dir; George Hale, chief engr. ■ Rates: \$15; 11; 15; 11.

WKDA-FM—Jan 1, 1967: 103.3 mhz; 100 kw. Ant 505 ft. Stereo. Prog sep from AM. Hickory Bcstg Corp. Format: Progs. ■ Jack Crawford, prog dir; David Walton, mus dir; Bob Wilkin, news dir. ■ Rates: \$21; 21; 21.

WLAC—Nov 24, 1926: 1510 kHz; 50 kw-U, DA-N. 159 4th Ave. North (37219). (615) 256-0161. WLAC Inc. (acq 1952). Net: ABC/L. Audio news: UPI. Rep: Blair. Format: Top 40. Spec prog: Black 20 hrs wly. ■ James M. Ward, pres & gen mgr; William T. Byram, coml mgr; Dick Kent, prog & mus dir; George Baber, news dir; Rick Snowdon, ntl sls mgr; Monte Maupin,

prom mgr; Everett Lawson, chief engr. ■ Rates: \$33; 29; 33; 38.

WLAC-FM—1953: 105.9 mhz; 100 kw. Ant 410 ft. Stereo. Prog sep from AM. (Acq 1964). Net: ABC/FM. Format: MOR. ■ Bill Gerson, prog dir; John Conley, mus dir. ■ Rates: \$33; 33; 33; 28.

WMAK—July 1, 1948: 1300 khz; 5 kw-U, DA-N. Box 2628, Uptown Station (37219). (615) 255-3536. Mooney Bcstg Corp. (group owner; acq 11-1-67). Rep: McGavren-Guild-PGW. Format: Contemp. ■ George P. Mooney, pres; John E. Patton, gen mgr; Mark Damon, prog dir; Richard Honeycutt, coml mgr; Nancy Solinski, mus dir; David Tower, news dir; Lester Vaden, chief engr. ■ Rates: \$47; 42; 47; 37.

WNAH Gospel Music

WNAH—Dec 24, 1949: 1360 khz; 1 kw-D. Whitehall Bldg., 1701 W. End Ave. (37203). (615) 254-7611. Hermitage Bcstg Corp. Format: Gospel & relig. ■ V. T. Irwin Jr., pres, gen & coml mgr; Hoyt Carter Jr., prog dir; Bill Grist, prom mgr; Gary McCollum, mus dir; Howard Woodard, news dir & chief engr. ■ Rates: \$42; 42; 42; 42.

***WNAZ-FM**—May 24, 1967: 88.9 mhz; 10 w. 333 Murfreesboro Rd. (37210). (615) 244-6000, ext 297 or 209. Trevecca Nazarene College Inc. Net: ABC/I. Format: Top 40, easy lting Spec prog; Relig, gospel 11 hrs wkly. ■ Dr. Mark R. Moore, pres; Karl E. Payton, gen mgr.

***WPLN(FM)**—Dec 17, 1962: 90.3 mhz; 100 kw. Ant 350 ft. Stereo. 8th Ave. N. & Union (37203). (615) 244-4700. TWX 810-371-1541. Public Library of Nashville & Davidson County. Net: NPR. Format: Classical, Cultural, educl, jazz. ■ David Marshall Stewart, chief librarian; Alvin Lewis Bolt, gen mgr; Susan Manning, prog dir; Brenda B. Lane, prom mgr; Paul W. Moore, asst gen mgr; Dr. Calvert Bean, mus dir; William A. Hill Jr., chief engr.

***WRFN(FM)**—Not on air, target date unknown: 88.1 mhz; 700 w. Ant 6 ft. Fisk U.

***WRVU(FM)**—Dec 3, 1971: 91.1 mhz; 430 w. Ant 150 ft. Box 952, Stn B (37235). (615) 322-3691. Vanderbilt Student Communications. Format: Progs. Spec prog: Broadway 1 hr wkly. ■ K. Dwayne Hastings, stn mgr; David R. Hampton, prog dir; Bill Gwinn, bus mgr; Steven R. Bond, mus dir; Carol Ann Koster, news dir; Barney Richard Kantar, chief engr.

WSIX—Jan 7, 1927: 980 khz; 5 kw-U, DA-N. 441 Murfreesboro Rd. (37210). (615) 259-2200. TWX 810-371-1943. General Electric Bcstg Co. (group owner; acq 4-6-66). Net: ABC/I. Rep: Katz. Format: MOR. ■ Charles Duke, VP & gen mgr; James A. Tandy, gen mgr; Selden Spurlock, gen srs mgr; Don Sullivan, prog dir; Jim Travis, news dir; Bob Sticht, mus dir; Marti Rosenberg, prom dir; Gene Parker, chief engr. ■ Rates: \$47; 37; 34; 22.

WSIX-FM—1959: 97.9 mhz; 100 kw. Ant 1110 ft. Stereo. Prog sep from AM. Net: ABC/E. Format: Metropolitan country. ■ Doug Dickens, prog dir. ■ WNGE TV affil. ■ Rates same as AM.

WSM—1925: 650 khz; 50 kw-U, Box 100 (37202). (615) 749-2244. TWX 810-371-1148. WSM Inc. Net: NBC. Rep: Christal. Format: MOR, country. ■ Irving C. Waugh, pres; Len Hensel, VP & gen & coml mgr; Al Voecks, prog & news dir; Ted Johnson, mus dir; Irish Bahan, prog mgr; Tom Bryant, prod dir; Lee Whitehurst, chief engr. ■ Rates: \$76; 60; 76; 46.

WSM-FM—Nov 1, 1962: 95.5 mhz; 100 kw. Ant 1,410 ft. Stereo. Progs sep from AM. ■ WSM-TV affil. ■ Rates: \$10; 10; 10; 10.

WVOL—See Berry Hill.

WVGM—April 23, 1967: 1560 khz; 10 kw-D, DA. Box 12040 (37212). (615) 298-4417; 292-1560. Crawford Bcstg Co. (group owner; acq 1970). Format: Sacred. Spec prog: Talk show 5 hrs wkly. ■ Donald B. Crawford, pres; Roy Bee, prog dir; Bob Clark, prom dir; Fay Lindsey, traf & off mgr; Scott Marshall, pub svc dir; Lloyd Keen, chief engr.

WZEZ(FM)—Listing follows WAMB.

Newport

WLIK—April 9, 1954: 1270 khz; 5 kw-D, 500 w-N,

DA-N. Knoxville Hwy. (37821). (615) 623-3095. WLIK Inc. Group owner: Arthur Wilkerson Stns. Net: Keystone. Format: C&W, top 40. ■ Arthur Wilkerson, pres & gen mgr; Dwight D. Wilkerson, VP, coml mgr & chief engr; Jim Phillips, prog dir; Wayne Harris, mus dir; Bill Beason, news dir.

Oak Ridge

WATO—Feb 1, 1948: 1290 khz; 5 kw-D, 500 w-N, DA-2, Box 3268, 112 Eastburn Lane (37830). (615) 483-3535. WATO Inc. (acq 6-1-67). Group owner; Rau Radio Stns. Net: MBS. Format: MOR. ■ Lloyd S. Smith, pres; Leonard M. McCoig, gen mgr; Bill Fultz, coml mgr; Gary Stone, prog dir; Kevin Dempsey, mus dir; Gary Drum, creative dir; David Brown, chief engr.

WUUU(FM)—Co-owned with WATO. Feb, 1967: 94.3 mhz; 2.45 kw. Ant minus 45 ft. Stereo. Prog sep from AM. Rep: Carpenter. Format: Btfl mus.

WOKI—Aug 25, 1973: 1550 khz; 1 kw-D, 114 Tulsa Rd. (37830). (615) 483-8451. Radioak Inc. Format: Contemp. ■ John W. Pirkle, pres & gen mgr; Andy Reeves, srs mgr; Mike Beverly, opns dir; Patricia Lemons, traf mgr; Raymond S. Wilck III, news dir; Stephen F. Smith, chief engr.

WOKI-FM—April 20, 1974: 100.3 mhz; 100 kw. Ant 2000 ft. Stereo. Dups AM daytime. Format: Contemp rock.

WUUU(FM)—Listing follows WATO.

Olive Hill

***WDXN(FM)**—Jan 10, 1975: 89.1 mhz; 1.5 kw. Ant 250 ft. Rt. 2 Box 212 Savannah, Tenn. (38372). (901) 925-3098. Rural Life Foundation. Format: Btfl mus, educl. Spec prog: Farm ½ hr wkly. ■ Lester L. Dickman, pres; Albert K. Neilsen, gen mgr & chief engr; Jerry Mathis, prog dir.

Oneida

WBNT—Aug 1, 1959: 1310 khz; 1 kw-D. Box 370 (37841). (615) 569-8598. Oneida Broadcasters Inc. (acq 5-1-69). Format: C&W. ■ George Guertin, pres; Hillard Mattie, gen & coml mgr; Everett S. Posey Jr., mus dir; James Joseph Brooks, chief engr.

WBNT-FM—June 10, 1965: 105.5 mhz; 3 kw. Ant 285 ft. Dups AM 25%. Format: Gospel 7 hrs daily. ■ Milford Cecil, coml mgr & prog dir.

Paris

WTPR—May 8, 1947: 710 khz; 250 w-D. Box 700 (38242). (901) 642-2621. H-M-S Bcstg Co. (acq 1-1-74). Rep: Southern Spot Sls. Format: MOR. ■ Robin H. Mathis, pres; Joe P. VanDyke, stn mgr; Reed Brewer, asst mgr; Bill McCutcheon, prog dir; Barry Crowe, news dir; Don Somerville, chief engr.

WTPR-FM—Sept 1967: 105.5 mhz; 3 kw. Ant 200 ft. Stereo. Prog sep from AM.

Parsons

WTBP—Oct 3, 1970: 1550 khz; 500 w-D. Box F (38363). (615) 847-3011. Townsend Bcstg Corp. Rep: Beaver. Format: C&W. ■ H. L. Townsend Jr., pres; Ralph D. Clenney, gen & prom mgr & chief engr; Edna Maxwell, coml mgr; Branson Townsend, mus prog & news dir. ■ Rates: \$2.15; 2.15; 2.15; —.

Pikesville

WUAT—Dec. 19, 1972: 1110 khz; 250 w. Box 442 (37367). (615) 447-2906. Pikesville Bcstg Co. Rep: Carpenter. Format: Mod country. ■ Proctor Upchurch, pres; Jean Upchurch, gen mgr; Ken Smith, prog & news dir; Jaie Taylor, mus dir; Archie Kendrick, chief engr.

Pulaski

WKSJ—May 6, 1947: 1420 khz; 1 kw-U, DA-N. 104 South Second St. (38478). (615) 363-2505. Richland Bcstg Co. (acq 1-1-63). Net: ABC. Format: Contemp talk. ■ George M. Martin, pres & gen mgr; Bill Adams, coml mgr; Nathan P. Street, prog & news dir; Harold Starks, chief engr. ■ Rates: \$2.50; 2.50; 2.50; 2.50.

WMGL(FM)—Jan 6, 1971: 98.3 mhz; 3 kw. Ant 300 ft. Stereo. Box 361 (38478). (615) 363-6439. SGB Enterprises Inc. (acq 4-21-75). Audio news: APR. Rep:

Tennessee Radio

See page C-1 for explanation of listings.

Beaver. Format: C&W, MOR. ■ Charles R. Solomon, pres & gen mgr; Ben H. Irvin, prom mgr; Kyle Green, coml mgr & chief engr; Bill Moore, prog dir; Norris Hammond, news dir. ■ Rates: \$2.10; 2.10; 2.10; 2.10.

Red Bank

WSIM(FM)—Nov 27, 1972: 94.3 mhz; 3 kw. Ant 22 ft. Stereo. Box 15608, Chattanooga (37415). (615) 875-9400; 877-2303. Roy Davis. Rep: Dora-Clayton. Format: Adult contemp. ■ Roy Davis, gen mgr; Roberta Davis, coml mgr & prog dir; Henry Green, chief engr.

Ripley

WTRB—Dec 11, 1954: 1570 khz; 1 kw-D. Box 410 (38063). (901) 635-2221. Lauderdale Bcstg Co. (acq 11-13-57). ■ Don Paris, gen & coml mgr.

Rockwood

WOFE—May 12, 1957: 580 khz; 1 kw-D. Box 387 (37854). (615) 354-0580. WOFE Radio Inc. (acq 2-1-71). Group owner: Farnell O'Quinn. Rep: Keystone. Format: MOR. ■ Farnell O'Quinn, pres, gen mgr & chief engr; David Ledford, coml & prom mgr; Stan Barrett, prog dir; Dick Hayes, chief engr.

Rogersville

WRGS—Aug 20, 1954: 1370 khz; 1 kw-D. Burem Road (37857). (615) 272-2628. WRGS Inc. Net: ABC/I. Format: C&W. ■ C. Philip Beat, pres & gen mgr; Mavis Livingston, coml mgr; Steve Waller, prog & news dir; Lanis Yeary, prom mgr; Jeannie Butler, mus dir; John Waller, chief engr. ■ Rates: \$3.50; 3.50; 3.50; 3.50.

Savannah

WORM—June 29, 1956: 1010 khz; 250 w-D. Box B (38372). (901) 925-4981. Savannah Bcstg Service Inc. (acq 8-1-57). Rep: Beaver. ■ Neal B. Bunn, VP & gen mgr; Mel Carnal, coml mgr; Albert Nielsen, chief engr.

WORM-FM—Aug 25, 1966: 101.7 mhz; 3 kw. Ant 175 ft.

Selmer

WDTM—Oct 31, 1967: 1130 khz; 250 w-D. Box 128 (38375). (901) 645-6165. McNairy County Bcstg. ■ Mike Michael, stn mgr.

Sevierville

WSEV—April 23, 1955: 930 khz; 5 kw-D. Box 192 (37862). (615) 453-2844. Tenn. Valley Bcstg Co. (acq 7-1-74). Format: MOR, C&W. ■ Frank A. Woods, pres; Hugh E. Trotter, VP & gen mgr; Mary Sue Poe, coml mgr; Sam Truan, mus dir; Truett Frazier, news dir; A. T. Henderson Jr., chief engr.

WSEV-FM—Feb 3, 1961: 102.1 mhz; 22 kw. Ant 380 ft. Stereo. Prog sep from AM.

Sewanee

***WUTS(FM)**—April 3, 1972: 88.1 mhz; 10 w. Box 1068 (37375). (615) 598-5913. University of the South. Format: Progressive. Spec progs: Fr 2 hrs opera 2 hrs, current issues 4 hrs wkly. ■ Tyndall Harris, gen mgr.

Shelbyville

WHAL—Dec 1946: 1400 khz; 1 kw-D, 250 w-N. Box 696 (37160). (615) 684-1400. Bedford Bcstg Co. (acq 11-25-75). Net: ABC/E. Format: MOR, Top 40. Spec prog: Black 6 hrs wkly. ■ Edward M. Johnson, ptnr; Robert W. Gallaher, gen mgr; Charlie Christian, coml mgr; Richard Overcast, prom mgr, news prog & mus dir; Aaron Womble, chief engr. ■ Rates: \$4; 4; 4; 3.

WHAL-FM—May 1, 1962: 102.9 mhz; 60 kw. Ant 510 ft. Dups AM 100%. ■ Rates same as AM.

WLIJ—Dec 2, 1959: 1580 khz; 1 kw-D. Box 7 (37160). (615) 684-1514. Arthur Wilkerson (group owner). Format: Variety. ■ Arthur Wilkerson, own & gen mgr; Roy Womble, stn & coml mgr.

Tennessee, Texas Radio

See page C-1 for explanation of listings.

Smithville

WJLE—April 11, 1964: 1480 khz; 1 kw-D. Route 1 (37166). (615) 597-4265. Center Hill Bcstg Corp. Rep: Beaver. ■ W. E. Vanatta, pres; Kenneth Smith, gen mgr; Kathy White, prog dir; Jack Atnip, news dir; Alvin Byars, chief engr.

WJLE-FM—1970: 101.7 mhz; 3 kw. Ant 195 ft.

Soddy-Daisy

WEDG—Feb 27, 1970: 1240 khz; 1 kw-D, 250 w-N. 11826 Backvalley Rd., Rt 1 (37379). (615) 332-1240. Southeast Community Media (acq 9-9-75). Net: ABC/I. Rep: Beaver. Format: C&W. ■ Norma Cooper, prog dir; Dusty Layne, mus dir; Tim Holcomb, prom mgr; Dianne Summers, news dir; Gene Landau, chief engr.

WPJD—May 23, 1970: 1550 khz; 250 w-D. 3906 S. Mission Dr., Chattanooga (37412). (615) 332-4187. Format: Gospel. C. Alfred Dick (acq 8-74).

South Pittsburg

WEPG—July 9, 1954: 910 khz; 500 w-D. Box 8 (37380). (615) 837-7577. Marion County Bcstg Svc Inc. (acq 6-1-65). Net: Keystone. ■ Eaton P. Goyan Jr., pres & gen mgr & chief engr; Eaton P. Goyan III, coml & prom mgr & news dir; Diane Smith, prog dir; Dave Daffron Jr., mus dir.

Sparta

WSMT—April 26, 1953: 1050 khz; 1 kw-D. Box 390 (38583). (615) 836-3714. Upper Cumberland Country Bcstg Co. (acq 11-1-69). ■ Joe L. Kuhn, pres; Van L. Slack, VP & gen mgr; Martha Ann Kuhn, treas; Sylvia Marie Slack, treas; Gordon L. Moore, chief engr.

WSMT-FM—Aug 2, 1964: 105.5 mhz; 3 kw. Ant 36 ft. Dups AM 80%.

WUCR—Dec 1, 1971: 860 khz. 250 w-D. Box 237 (38583). (615) 738-2256. WUCR Inc. (acq 7-10-74). Net: ABC/E. Format: Contemp. ■ Robert W. Gallaher, pres & gen mgr; Ed Whiteaker, coml mgr; Don Howard, prog & news dir; Dawn Y. Gallaher, VP, sec, treas; Janet L. Davis, exec sec; Ransom Siler, chief engr. ■ Rates: \$3.45; 3.45; 3.45; 3.45.

Springfield

WDBL—July 24, 1950: 1590 khz; 1 kw-D. Beautiful Signal Hill (37172). (615) 384-5541. Middle Tenn. Enterprises (acq 1-70). Rep: Beaver, Keystone. Format: C&W, Soul. Spec prog: Relg, 10 hrs wkly. ■ W. J. Webster, pres; Billy B. Gray, gen & coml mgr; Walter George, prog dir; Mrs. Roberta Bell, prom mgr; Don Coleman, news dir; Jay Alley, chief engr.

WDBL-FM—Aug 31, 1964: 94.3 mhz; 3 kw. Ant 326 ft. (CP: Ant 300 ft.). Dups AM 65%.

Sweetwater

WDEH—1955: 800 khz; 1 kw-D. Box 330 (37874). (615) 337-5025. Sweetwater Radio Inc. (acq 2-18-66). Format: Variety. ■ R. L. Sherlin, pres & gen mgr; Doyle Lowe, coml mgr; David Scarborough, prog dir; Lemuel Stephens, chief engr.

WDEH-FM—Sept 1967: 95.3 mhz; 2.55 kw. Ant 150 ft. Prog sep from AM.

Tazewell

WNTT—July 1, 1960: 1250 khz; 500 w-D. Box 95 (37879). Caliborne Bcstg Co. ■ Floyd Turner, gen & coml mgr.

Trenton

WTNE—Dec 9, 1966: 1500 khz; 250 w. Town House Office Bldg. (38382). (901) 855-1500. Trentone Inc. Rep: Beaver. Format: MOR, C&W. ■ Billy H. Elliott, pres; Deion R. Courtney, gen mgr & chief engr; J. T. Meals, prog dir; William Halbrook, news dir. ■ Rates: \$1.95; 1.95; 1.95; 1.95.

Tullahoma

WJIG—Aug 1, 1947: 740 khz; 250 w-D. Drawer C (37388). (615) 455-2607. Quin-Abi Bcstg (acq 9-4-75). Format: C&W, Top 40. ■ Jerry P., Brenda J. & Jerry D. Newton, co-owners; Jerry Douglas, coml mgr; Georgia Short, prog dir; Flint Jordan, prom mgr; Jacky Dickey, mus dir; Jim Mitchell, news dir; Norman A. Reynolds, chief engr.

WJIG-FM—July 1, 1962: 93.3 mhz; 100 kw. Ant 230 ft. Stereo. Prog sep from AM. Format: MOR.

Union City

WALR-FM—1974: 104.9 mhz; 3 kw. Ant 300 ft. Box 370, McKenzie (38201). Perkins Bcstg Co.

WENK—Oct 26, 1946: 1240 khz; 1 kw-D, 250 w-N. Box 687 (38261). (901) 885-1240. WENK of Union City Inc. (acq 1-74). Audio news: UPI. Rep: Keystone. Format: Diversified. Spec progs: Farm 6 hrs, C&W 12 hrs wkly. ■ James L. Rippy, Jr., pres; Verne A. Brooks, gen mgr; William L. Pope, coml mgr; Terry L. Hailey, prog dir; Jim Cawley, news dir; Charles R. Holland, chief engr. ■ Rates: \$5.90; 5.90; 5.90; 5.90.

Wartburg

WECO—Aug 31, 1970: 940 khz; 1 kw-D. Box 100 (37887). (615) 346-3900. Morgan County Bcstg Co. Format: C&W. ■ William R. Carrigan, pres & gen mgr; Carl Stump, chief engr.

WEOQ—See Whitley City, Ky.

Waverly

WPHC—Sept 25, 1963: 1060 khz; 1 kw-D. Box 415 (37185). (615) 296-2456. Humphreys County Bcstg Co. Net: ABC/E. Audio news: APR. Rep: Ken Marston Assoc. Format: C&W. Spec prog: Farm 1½ hrs wkly. ■ R. M. McKay Jr., pres; Dean Buch, gen mgr & chief engr; Daryl Lynn, prog dir. ■ Rates: \$2.60; 2.60; 2.60; —.

WVRY(FM)—Co-owned with WPHC. Sept 26, 1972: 104.9 mhz; 3 kw. Ant 300 ft. Prog sep from AM. Format: MOR. ■ Rates: \$2.45; 2.45; 2.45; 2.45.

Waynesboro

WAAN—Jan 31, 1970: 1480 khz; 1 kw-D. Box 368 (38485). (615) 722-3631. Waynesboro Bcstg Co. Inc. Net: ABC/I. Rep: Keystone; Beaver. Format: C&W Spec prog: Farm 1 hr wkly. ■ Carl Swafford, pres & gen mgr; Dora Swafford, coml mgr; Freddy Swafford, prog dir; Jerry Kilpatrick, mus dir; Charles Peterson, atty; Shirley Smith, news dir; Jerry Mathis, chief engr; Ann Petersen, women's dir. ■ Rates: \$2; 2; 2; —.

Winchester

WCDT—March 8, 1948: 1340 khz; 1 kw-D, 250 w-N. Box 340 (37398). (615) 967-2201. Franklin County Radio & Bcstg Co. Inc. (acq 8-1-56). Net: MBS. Rep: Beaver. Format: MOR, C&W. Spec prog: Black 6 hrs wkly. ■ Francis V. Frassarand, pres; Robert Neil Bracken, gen mgr; Jack W. Vineyard, prog dir; Bill N. Morris, asst mgr; Henry Cox, mus dir; Aileen Doney, news dir; Earl C. Grover, chief engr. ■ Rates: \$3; 3; 3; 3.

Woodbury

WBRV—Oct 24, 1963: 1540 khz; 500 w-D. Box 1540 (37190). (615) 563-2313. Tenn. Valley Bcstg Corp. (acq 9-74). Format: Contemp, C&W. ■ Frank A. Woods, pres; Hugh (Skip) Trotter, VP; Billy Allen, gen mgr; H.L. Townsend Jr., senior VP.

CSI ELECTRONICS INC.
2607 River Road
Cinnaminson, New Jersey, 08077
Telephone: (609) 786-1060

Texas

**HAMILTON-LANDIS
& ASSOCIATES, Inc.**
NATIONWIDE MEDIA BROKERS
WASHINGTON, D.C., CHICAGO, DALLAS,
SAN FRANCISCO
SELL MORE
RADIO & TELEVISION STATIONS
IN THE SOUTHWEST—NEAREST OFFICE IS—
6060 N. CENTRAL EXPY., DALLAS 75206
(214) 691-2345

Abilene

KCAD—Aug 29, 1962: 1560 khz; 500 w-D. 109 Westgate (79605). (915) 692-1188. KCAD Inc. Rep: Torbet. Format: C&W. ■ D. W. Morton, pres & gen mgr; Virgil Terry, stn & coml mgr; Johnny Golf, prog dir; Rod Spain, news dir; Glen Welch, chief engr.

KFMN(FM)—April 30, 1961: 99.3 mhz; 3 kw. Ant 145 ft. Stereo. 102 Pine St. (79601). (915) 677-3632. David L. Boyll (acq 3-74). Net: ABC/FM. Rep: Paul Miller, Dallas. Format: Contemp. ■ David Boyll, owner & gen mgr; David R. Perry, mus dir; L. D. Irvine, chief engr. ■ Rates: \$3.50; 3.50; 3.50; 3.50.

KNIT—June 15, 1957: 1280 khz; 500 w-D. Box 3098 (79604). (915) 677-1404. West Texas Media Inc. (acq 10-73). Net: ABC. Rep: Masla, Riley. ■ Frank J. Gerow, Page W. Nelson, owners.

KNIT-FM—July 1, 1969: 105.1 mhz; 49 kw. Ant 154 ft. Stereo. Prog sep from AM.

KORQ(FM)—Listing follows KWKC.

KRBC—Oct 1, 1936: 1470 khz; 5 kw-D, 1 kw-N. DA-N. Box 178, 4510 S. 14th (79605). (905) 692-4242. Radio Abilene Inc. (acq 7-1-63). Net: ABC/C. Rep: Eastman. Format: Contemp, talk. ■ Bill Fox, pres & gen mgr; Ron Wimberly, coml mgr; Dave Dalzell, prog dir & prom mgr; Gary Bell, mus dir; Bill Tate, news dir; Herman Ridgeway, chief engr. ■ KRBC-TV affil.

KWKC—June 19, 1948: 1340 khz; 1 kw-D, 250 w-N. Box 2201 (79604). (905) 673-2545. Frontier Bcstg Inc. (acq 9-73). Net: TSN. Rep: Meeker, Messina. Format: C&W. ■ Lloyd Mynatt, gen mgr; Chris Clark, stn mgr; Art Randall, prog dir; Terry Belyeau, news dir.

KORQ(FM)—Co-owned with KWKC. 1974: 100.7 mhz; 100 kw. Ant 1280 ft.

Alamo Heights

KDRY—Nov 8, 1963: 1110 khz; 1 kw-D. Box 6628 (78209). (512) 824-5361. National Enterprises Inc. Format: Relg. ■ Dr. Sam Morris, pres & gen mgr; Sam Morris Jr., prog dir.

KITE—See Terrell Hills.

Alice

KBIC
Bright & Beautiful Music
U.P.I.
N A F M B
Radio Code

KBIC(FM)—Jan 1, 1974: 102.3 mhz; 3 kw. Ant 300 ft. Stereo. Box 1250 (78332). (512) 664-4356. Bethany Investment Corp. Audio news: UPI. Format: Btl mus. ■ Ray Snowden, gen mgr. ■ Rates: \$4.60; 4.60; 4.60; 2.76.

KDSE(FM)—Listing follows KOPY.

KOPY—1947: 1070 khz; 1 kw-U, DA-N. Box 731 (78332). (512) 664-4322. Norman Bcstg Corp. (acq 6-1-60). Rep: Piano, Riley. Format: C&W, Spanish. ■ R. N. Aylin, pres; Damon K. Meek Jr., VP, gen & prom mgr;

Pat Wiman, coml mgr; Jerry King, prog & mus dir; Ken Sralla, news dir; Thomas A. Doyle, chief engr.

KDSE(FM)—Co-owned with KOPY. Not on air, target date unknown: 92.1 mhz; 3 kw. Ant 300 ft. Format: Spanish.

Alpine

KVLF—February 1947: 1240 khz; 1 kw-D, 250 w-N. Box 779 (79830). (915) 837-2144. Big Bend Bcstrs (acq 1950). Rep: Melville. Format: MOR. Spec prog: Sp 6 hrs wkly. ■ Gene Hendryx, pres & gen mgr; Pat Powell, coml mgr; Jim McLane, prom mgr; Ron Engleman, prog dir. ■ Rates: \$3.50; 3.50; 3.50; 3.50.

Amarillo

***KACV-FM**—Not on air, target date January 1976: 89.9 mhz; 29.5 kw. Ant 580 ft. Stereo. Box 447 (79178). (806) 376-5111. Amarillo Jr. College Dist. Format: Classcl. ■ Allen Shifrin, gen mgr; Don Ford, chief engr.

KDJW—1946: 1010 khz; 5 kw-D, 500 w-N, DA-2. Box 5844 (79107). (806) 372-6543. John B. Walton (acq 12-66). Group owner: Walton Stns. Net: ABC/I. Rep: McGavren-Guild. Format: C&W. ■ John B. Walton, pres; Paul Hull, gen mgr; Jim Davis, coml mgr; Jonathan E. Fricke, prog dir; Claud Foster, chief engr.

KDJW-FM—March 1946: 94.1 mhz; 54 kw. Ant 700 ft. Progs sep from AM. Format: Contemp.

KGNC—June 19, 1922: 710 khz; 10 kw-U, DA-2. Box 710 (79105). (806) 355-9801. Stauffer Publications Inc. (group owner: acq 2-16-66). Net CBS. Rep: Katz. Format: MOR, farm, C&W. ■ Thad M. Sandstrom, VP; George Logan, gen mgr; Jim A. Martin, sales mgr; John Dawson, prog dir; Royce Bodiford, news dir; Lee Wilcox, news dir; Henry White, chief engr. ■ Rates: \$20; 18; 20; 14.

KGNC-FM—Dec 24, 1958: 97.9 mhz; 45 kw. Ant 1,290 ft. Stereo. Progs sep from AM. Format: Btlf mus. ■ Rates: \$11; 13; 13; 11.

KIXZ—June 1947: 940 khz; 5 kw-D, 1 kw-N, DA-2. Box 10004 (79106). (806) 355-4477. Bcstg Assoc Inc. (acq 7-1-64). Group owner: Sammons-Ruff Stns. Rep: Buckley. Format: Contemp. ■ Raymond Ruff, pres; Tom York, gen mgr; Truett Ball, sales mgr; Lisa Breeden, coml mgr; Dayton Todd, prog dir; C. C. Crowe, mus dir; Jay Daniels, news dir; Jerry Hickman, chief engr. ■ Rates: \$13; 12; 13; 11.

KPUR—Aug 1, 1939: 1440 khz; 5 kw-D, 1 kw-N, DA-N. Box 128 (79105). (806) 374-1637. Lone Star Bcstg Co. (acq 1-1-58). Net: Texas State. Rep: Eastman. Format: Contemp/rock. ■ Charlie B. Jordan, pres & gen mgr; Jay Speegle, coml mgr; Bobby Brooke, prog dir; Charlie Broomhead, opns mgr; Bob Izzard, news dir; Jim Shelton, chief engr.

KQIZ—Sept 15, 1955: 1360 khz; 500 w-D. Box 1816 (79105). (806) 374-5235. Tascosa Bcstg. (acq 1-75). Net: MBS. Rep: Sandburg. Format: MOR. Spec prog: Sp 20 hrs, black 8 hrs wkly. ■ James D. Shelton, Keith Adams et al, owners; John Shipley, prog dir; Bob Fox, mus dir; Mancel Skelton, chief engr.

KWAS(FM)—1975: 101.9 mhz; 100 kw. Ant 729 ft. Rt 3 Box 102 (79107). (806) 381-0161. Good News Bcstg Co. Net: Texas State, Commodity News. Format: MOR, gospel. ■ Gary L. Acker, owner & gen mgr.

KZIP—Sept 15, 1955: 1310 khz; 1 kw-D. Drawer 5905. (79107). (806) 374-3796. Panhandle Bcstg Co. Group owner: Pinkston Stns. Net: ABC/E. Rep: Messina. Format: C&W. ■ D. P. Pinkston, owner; Charlie Phillips, gen mgr; Ron Peterson, coml mgr; Mike Fox, prog dir; Janie Kirkland, news dir; Jerry Hickman, chief engr. ■ Rates: \$48; 48; 48; 48.

Andrews

KACT—Jan 12, 1955: 1360 khz; 1 kw-D. (CP: 50 kw). Drawer 308 (79714). (806) 523-2845. Pam Stations Inc. Net: Texas State. Format: C&W. ■ Richard A. Peterson, pres; Pete Peterson, gen mgr.

Arlington

KAMC(FM)—April 1949: 94.9 mhz; 100 kw. Ant 670 ft. Box 460 (76010). (817) 265-3101. KAMC Radio Inc. (acq 1-1-72). Format: Progs. ■ J. D. Osburn, pres & gen mgr; Don Klingner, coml mgr; Ken Bateman, prog

dir; Stuart McRae, mus dir; Jack Richardson, chief engr. ■ Rates: \$13; 13; 15; 15.

Athens

KBUD—May 17, 1948: 1410 khz; 1 kw-D. Box 309 (75751). (214) 675-2277. Henderson County Bcstg Co. Net: Texas State. Format: C&W. ■ J. B. McNutt Jr., pres, gen mgr & chief engr; Joe Short, stn mgr. ■ Rates: \$4.40; 4.40; 4.40; —.

Atlanta

KALT—Oct 18, 1950: 900 khz; 1 kw-D. Box 289 (75551). (214) 796-2817. Ark-La-Tex Bcstg Co. (acq 1974). Net Texas State. Rep: Keystone. Format: MOR/C&W. ■ David A. Wommack, pres; David A. Wommack Jr., gen mgr; George Wommack, prog dir; Jeane Wright, coml mgr; Karen Kirkland, news dir; James Waites, chief engr. ■ Rates: \$2.70; 2.70; 2.70; 2.70.

KLUK(FM)—Not on air, target date unknown: 99.3 mhz; 3 kw. Ant 187 ft. Cass County Bcstg Co.

Austin

KASE(FM)—Listing follows KVET.

KHFI-FM—1950: 98.3 mhz; 1.3 kw. Ant 420 ft. Box 490 (78767). (512) 476-4611. Kingstip Communications Inc. Rep: Buckley. Format: Btlf mus. ■ Henry B. Tipple, pres. ■ KTVV-TV affil.

KIXL—Aug 8, 1959: 970 khz; 1 kw-D, DA. 1018 W. 11th (78703). (512) 477-9926. Advance Inc. (acq 4-1-74). Net: ABC/C. Rep: Torbet. Format: Oldies. Spec progs: Black 1½ hrs wkly. ■ R. Miller Hicks, chmn; Otis Dunagan Jr., gen mgr; Don Cadden, sls mgr; Kris Van Cleve, news dir; Bill Curtis, chief engr. ■ Rates: \$10; 7.75; 10; —.

KRMH(FM)—Co-owned with KIXL. See San Marcos.

KLBJ—1939: 590 khz; 5 kw-D, 1 kw-N, DA-N. Box 1209 (78767). (512) 474-6543. LBJ Corp. (group owner: acq 1943). Net: CBS. Rep: Katz. Format: Btlf mus. ■ J. C. Kellam, pres & gen mgr; Patrick J. Nugent, gen sales mgr; Richard (Cactus) Pruro, prog mgr; David Lane Smith, mus dir; John O'Brien, news dir; Joyce Kuhn, prom mgr; Fred Hill, chief engr. ■ Rates: \$15.75; 9; 13.50; 6.75.

KLBJ-FM—1960: 93.7 mhz; 97 kw. Ant 1,050 ft. Prog sep from AM. Format: Progressive. ■ Greg Thomas, mus dir. ■ Rates: \$7.25; 5.25; 9.25; 9.25.

***KMFA(FM)**—January 1967: 89.5 mhz; 1.30 kw. Ant 880 ft. 1014 Perry Brooks Bldg. (78701). (512) 472-1257. Capitol Bcstg Assn. Format: Classcl. ■ Charles Alan Wright, bd chmn; Kenneth W. Byrd, stn mgr; Leonard Masters, prog dir; Thomas Morris, chief engr.

KNOW—1922: 1490 khz; 1 kw-D, 250 w-N. Box 2197, 1907 N. Lamar (78767). (512) 477-9841. Pioneer Bcstg Co. (acq 6-1-49). Group owner: Mayes Stns (96%). Format: Contemp. ■ Wendell Mayes, pres; Harry L. Smith Jr., gen mgr/loc sls mgr; Dave Jarrott, prog dir; Bill Mayne, mus dir; Bob Shrader, news dir; Wayne Hardin, chief engr. ■ Rates: \$23; 13.20; 18; 8.35.

KOKE—Aug 12, 1958: 1370 khz; 1 kw-D. Box 1208 (78767). (512) 454-2561. KOKE Inc. (acq 8-63). Net: Texas State. Rep: Selcom. Format: C&W. ■ Iva Lea Barton, chmn; Kenneth Moyer, VP & gen mgr; Jim Ray, coml mgr; Jerry Gee, prog & mus dir; Mike Wolverton, news dir; Steve Brightwell, chief engr. ■ Rates: \$13; 11; 13; —.

KOKE-FM—Jan 5, 1968: 95.5 mhz; 10 kw. Ant 265 ft. Stereo. (Acq 1-5-68). Prog sep from AM. Format: prog country, Spanish. ■ Rusty Bell, prog dir; Steve Gary, mus dir; Skip Lamb, prom mgr. ■ Rates: \$8; 8; 9; 9.

KRMH(FM)—See San Marcos.

***KUT-FM**—Nov 10, 1958: 90.7 mhz; 4.1 kw. Ant 225 ft. Box 7158 University Station (78712). (512) 471-1631. U. of Texas. Net: ABC/E, MBS, Mutual Black, NPR, Texas State. Format: Diversified. Spec progs: Sp 10 hrs, inatl 2 hrs, black 15 hrs wkly. ■ William S. Giorda, stn mgr; William F. Grimes, prog dir; Glenn English, chief engr.

KVET—1946: 1300 khz; 5 kw-D, 1 kw-N, DA-2. 705 N. Lamar (78703). (512) 474-1300. KVET Bcstg Inc.

Texas Radio

See page C-1 for explanation of listings.

(acq 7-1-65). Rep: McGavren-Guild. Format: C&W. ■ Roy Butler, pres; C. Ronald Rogers, gen mgr; Jerry Green, prog dir; Harvie Jordan, news dir; Charles Cramer, chief engr. ■ Rates: \$19; 12.50; 16; 12.50.

KASE(FM)—Co-owned with KVET. March 30, 1969: 100.7 mhz; 98 kw. Ant 510 ft. Stereo. Prog sep from AM. Format: Btlf mus. ■ Terry May, prog dir.

Ballinger

KRUN—August 1947: 1400 khz; 1 kw-D, 250 w-N. Box 351 (76821). (915) 365-3544. Central West Bcstg Co. (acq 1-1-53). Net: Texas State. Rep: Cowart. Format: Variety Spec prog: Sp 4 hrs wkly. ■ Dean Smith, pres & gen mgr; Odell Denton, chief engr. ■ Rates: \$4; 3.90; 3.75; 3.75.

Bay City

KIXO—Aug 1, 1947: 1270 khz; 1 kw-U, DA-N. Box 1391 (77414). (713) 245-4642. John George Long. Net: MBS. Audio APR. Format: C&W. Spec prog: Farm 1 hr, Sp 5 hrs wkly. ■ John George Long, pres; Ray Lacey, gen mgr; John Ford, coml mgr; Jim Corson, mus dir; Dan Samer, prog dir & chief engr.

Baytown

KBUK—1947: 1360 khz; 1 kw-U, DA-2. Box 419 (77520). (713) 424-5531. Bay Radio Inc (acq 8-21-74). Format: C&W. ■ Dave Perkins, VP & gen mgr; Dick Sims, coml mgr; Chet Good, prog & mus dir; Ed Martin, chief engr.

Beaumont

KAYC—1938: 1450 khz; 1 kw-D, 250 w-N. Box 870 (77704). (713) 833-9421. Texas Coast Bcstrs of Beaumont Inc. (acq 6-1-62). Rep: Katz. ■ David H. Morris, pres; Ed Diltter, gen mgr; Al Caldwell, opns mgr; Carl Wilkerson, chief engr.

KAYD(FM)—1948: 97.5 mhz; 50 kw. Ant 320 ft. Stereo. prog sep from AM.

KBPO(FM)—Listing follows KLVI.

KJET—July 1947: 1380 khz; 1 kw-D. Box 6067 (77705). (713) 842-2210. Gibson Bcstg Co. (acq 2-22-63). Net: Mutual Black. Rep: Howard. Format: Black. ■ R. Thomas Gibson, pres; Jerry Moon, gen mgr; Gene Cordray, coml mgr; Bob Collins, prog dir; R. L. Ruth, news dir; Bill Averitt, chief engr.

KWIC(FM)—Co-owned with KJET. July 10, 1967: 107.7 mhz; 100 kw. Ant 250 ft. (713) 842-4751. Prog separate from AM. Format: progs. ■ Tom Boggess, stn mgr; Michael Block, prog dir.

KLVI—1924: 560 khz; 5 kw-U, DA-N. Box 5463 (77702). (713) 838-3911. Radio Beaumont Inc. (acq 1-1-64). Net: Texas State. Rep: McGavren-Guild-PGW. Format: Contemp. ■ John H. Hicks, III, pres & gen mgr; Robert S. Hicks, coml & prom mgr; Bob Brown, prog dir; Dave Hofferth, news dir; Mark Allen, chief engr. ■ Rates: \$20; 16; 20; 12.

KBPO(FM)—Co-owned with KLVI. Sept 1966: 94.1 mhz; 100 kw horiz, 24.5 kw vert. Ant 240 ft horiz, 235 ft vert. Stereo. Progs sep from AM. Net: NBC. Format: Btlf mus. ■ Steve Hicks, gen mgr; Don Howard, coml mgr. ■ Rates: \$4; 2.85; 4; 2.85.

KTRM—May 1, 1947: 990 khz; 1 kw-U, DA-1. Box 5425 (77702). (713) 892-4990. Central Bcstg Corp. (group owner: acq 1974). Net: ABC/I. Rep: Torbet. Format: C&W. ■ Lester Spencer, pres; William Quigg, VP; Gene Dickerson, gen mgr; Jerry Fretness, coml mgr; Gary Powers, prog dir; Buddy Johnson, mus dir; Gary Cook, news dir; Derrell Pitcock, chief engr. ■ Rates: \$12; 10; 12; 10.

KTRM-FM—Feb 1, 1966: 95.1 mhz; 28 kw. Ant 220 ft. Stereo. Prog sep from AM. Net: ABC/I. Format: Gospel. ■ Don Hebert, prog dir. ■ Rates: \$3; 3; 3; 3.

***KVLU(FM)**—1974: 91.3 mhz; 24 kw. Ant 550 ft. 4400 Port Arthur Road (77710). Lamar University

KWIC(FM)—Listing follows KJET.

Beeville

KIBL—Oct 20, 1949: 1490 khz; 1 kw-D, 250 w-N. Box

Texas Radio

See page C-1 for explanation of listings.

700 (78102). (512) 358-1490. Bee Bcstg Inc. (acq 8-1-71). Net: MBS. Rep: Miller. Format: C&W, Spanish. ■ Don Funkhouser, pres & gen mgr; David Smith, mgr; Jeane Funkhouser, coml mgr; Rich Wilson, prog & mus dir; Judy Telge, news dir; Eddie Bertram, chief engr.

KJDF(FM)—Co-owned with KIBL. Not on air, target date unknown: 104.9 mhz; 3 kw. Ant 300 ft. Bee Bcstg.

Bellville

KACO—1974: 1090 khz; 250 w-D. Box 100 (77418). J. Lee & Dinah L. Dittert. Rep: Riley. Format: C&W, MOR, top 40, variety. ■ Dinah L. Dittert, gen mgr; William VanSandt, prog dir; Lou Allen Sprunger, news dir; Kenneth Williamson, chief engr.

Belton

KTON—Dec 1, 1961: 940 khz; 1 kw-D, DA. Box 240 (76513). (817) 939-3738. Belton Bcstrs Inc. (acq 3-8-66). Group owner: Sigmor. Net: ABC/I. Rep: PRO Time Sls. Format: C&W. ■ Tom E. Turner Sr., pres; Gaylon Christie, gen mgr; Neil Collier, coml mgr; Chuck Kelly, prog dir; Jim Sims, prom mgr; Ken Sullivan, mus dir; Don Maples, news dir; Carl Knelly, chief engr.

KTON-FM—April 25, 1970 106.3 mhz; 950 w. Ant 490 ft. Stereo. Prog dups AM 75%.

Big Lake

KWGH—May 16, 1958: 1290 khz; 1 kw-D. Box 290 (76932). (915) 884-2828. WMO Bcstg Co., Inc. Net: Texas State. Format: Contemp. Spec prog: Sp 2 hrs wkly. ■ Mrs. N. W. Hickman, pres; Robert C. Tipton, prom mgr; Paul Harrison, news dir; Rudi Ruben, chief engr.

Big Spring

KBST—Dec 23, 1936: 1490 khz; 1 kw-D, 250 w-N. Box 1632 (79720). (915) 267-6391. Snider Corp. (acq 10-11-59). Net: ABC/C, Texas State. Rep: Riley, Masla. Format: Contemp. ■ B. Winston Wrinkle, pres & gen mgr; Ted Walker, prog dir; Carl Cramer, news dir.

KBYG—1949: 1400 khz; 1 kw-D, 250 w-N. Box 1713 (79720). (915) 263-7326. Tentex Bcstg Inc. (acq 1975). Net: ABC/E. Rep: Savalli-Gates. Format: MOR. ■ Hugh D. Frizzell, pres; James G. Baum, gen mgr; Don Norman, news dir; George Reynolds, chief engr.

KHEM—Sept 11, 1956: 1270 khz; 1 kw-D. Box 750 (79720). (915) 267-2523. The Cobra Corp. (acq 1959). Rep: Messina. Format: C&W. ■ Jo Ann Bradbury, pres; Gary Bradbury, gen mgr; prog dir; & chief engr; Bill Birrell, coml mgr.

KFNE-FM—Co-owned with KHEM. 1961: 95.3 mhz; 1.8 kw. Ant 300 ft horiz, 295 ft vert. Stereo. prog sep from AM.

Bonham

KFYN—May 1948: 1420 khz; 250 w-D. Box 248 (75418). (214) 583-3151. Fannin Bcstg Co. (acq 11-1-67). Net: TSN. Rep: Busby, Finch & Woods. Format: C&W. ■ William Bennet Jr., gen mgr; Don Blair, prog dir; Dorothy M. Veldman, coml mgr; Bruce Baughman, news dir; Wesley Ruddell, chief engr.

Borger

KBBB—November 1957: 1600 khz; 5 kw-D. Box 1478 (79007). (806) 273-7575. Orville M. Rippy (acq 6-1-72). Net: TSN. Rep: Messina. Format: Contemp, C&W. ■ Gary Rippy, gen & coml mgr; Ralph Robinson, prog/mus dir; Barbara Roberts, prom mgr; Dave Winegardner, news dir; Gene Miller, chief engr.

KBBB-FM—March 1975: 104.3 mhz; 26 kw. Ant 175 ft.

KQTY—Jan 10, 1947: 1490 khz; 1 kw-D, 250 w-N. Box 165, Suite 207, Hotel Borger (79007). (806) 273-7533. Big-Tex Media (acq 1975). Net: ABC/C. Rep: Southwest Radio. Format: C&W/rock. ■ Phil Londagin, news dir; Wade Young, mus dir & chief engr.

Bowie

KBAN—May 29, 1959: 1410 khz; 500 w-D, DA. Box

1080 (76230). (817) 872-2288. Bowie-Nocona Bcstg Co. (acq 5-6-1). Net: TSN. Rep: Riley. Format: C&W, relig, talk. Spec prog: Farm 5 hrs wkly. ■ Earle Flechter, pres; Olie Carrier, gen & coml mgr; Patti Scott, prog dir; Ken Seigler, mus dir; Debbie Jones, prom mgr; Larry Rounsavall, news dir. ■ Rates: \$2.80; 2.80; 2.80; —

Brady

KNEL—December 1935: 1490 khz; 1 kw-D, 250 w-N. Box 630 (76825). (915) 597-2119. Radio Brady Inc. (acq 6-1-70). Net: Texas State. Rep: Riley. Format: C&W. Spec prog: Farm 4 hrs wkly. ■ Ed Keeling Jr., pres & gen mgr; B. C. Cole, coml mgr; Dan Harrison, news dir; Edsel Malmstrom, chief engr. ■ Rates: \$4.25; 4.25; 4.25; 4.25.

Breckenridge

KSTB—September 1947: 1430 khz; 1 kw-D. Box 232 (76024). (817) 559-3331. Regal Bcstg Corp. (acq 8-1-73). Net: TSN. Rep: Keystone. Format: C&W. ■ Vellton A. Moser, pres, gen mgr & chief engr; Lloyd C. Mayberry, prog dir; Paul Luther, news dir.

Brenham

KTTX—April 15, 1947: 1280 khz; 1 kw-D. Box 1280 (77833). (713) 836-3655. Tom S. Whitehead Inc. (acq 5-1-62). Net: TSN. Rep: Messina. Format: C&W. Spec prog: Polka 4 hrs wkly. ■ Tom S. Whitehead Sr., pres; Tom S. Whitehead Jr., VP & gen mgr; Ronnie Whitehead, prog dir; Jim Swift, news dir; Randy Reets, opns mgr; Lonnie Scholtmann, chief engr. ■ Rates: \$5.50; 5.50; 4.50; —.

KWHI-FM—Co-owned with KTTX. Sept 15, 1964: 106.3 mhz; 3 kw. Ant 300 ft. Prog sep from AM. Format: MOR. ■ Rates: \$4.90; 4.90; 4; 4.

Brownfield

KKUB—August 1949: 1300 khz; 1 kw-D. Box 1300 (79316). (803) 637-4531. Brownfield Radio Inc. (acq 7-8-64). Rep: Riley. Spec prog: Sp 16 hrs wkly. ■ D. M. Wiggins, pres; Jim Farr, gen mgr; Ed Duran, coml mgr. ■ Rates: \$4.80; 4.80; 4.80; —.

Brownville

KBOR—Feb 22, 1949: 1600 khz; 1 kw-U, DA-2. Box 2049 (78520). (512) 542-5677. Brownville Bcstg Co. Net: Texas State. Rep: Walton, Melville. Format: MOR. ■ Minor J. Wilson, pres & gen mgr; Boris Hidalgo, coml mgr; Rick McDevitt, mus dir; Hank Hollingsworth, news dir; Willis A. Wilson, chief engr.

KDUV(FM)—January 1975: 100.3 mhz; 100 kw. Ant 450 ft. Box 4300 (78520). (521) 541-3151. Media Properties Inc. Format: MOR. ■ Paul Veale Sr., pres; Ron Whitlock, gen mgr; Roy Zepeda, mus dir; Skipper Wood, opns dir; Rick Price, chief engr.

Brownwood

KBWD

A Jamar media station

KBWD—Aug 17, 1941: 1380 khz; 1 kw-D, 500 w-N. Box 280 (76801). (915) 646-3505. Brown County Bcstg Co. Group owner: Jamar. Net: ABC/C, Texas State. Rep: Avery-Knodel. Format: Contemp. Spec prog: C&W 10 hrs wkly. ■ Bill Jamar, pres; Ken Schulze, gen mgr; Lane Bowen, coml mgr; Keith Corey, prog & mus dir; Dallas Huston, news dir; Jim Laird, chief engr. ■ Rates: \$12; 10; 12; 10.

KOXE(FM)—Co-owned with KBWD, May 17, 1975: 101.5 mhz; 100 kw. Ant 490 ft. Stereo. (915) 646-1015. Prog sep from AM. Format: C&W. Spec prog: Farm 2½ hrs, Sp 1 hr wkly. ■ Lane Bowen, gen mgr. ■ Rates same as AM.

KEAN—1953: 1240 khz; 1 kw-D, 250 w-N. Box 100 (76801). (915) 646-9300. KEAN Radio Corp. Net: MBS, Mutual Black. Rep: Paul Miller. Format: C&W. Spec prog: Sp 2 hrs wkly. ■ Pat Davidson, pres; Dave Fair, gen mgr & news dir; Helene Prater, coml mgr; Rick Whitworth, prom mgr; Roy Cox, prog & mus dir; Dale Seaburg, chief engr.

KLSN(FM)—September 1965: 99.3 mhz; 720 w. Ant 115 ft. Stereo. 300 N. Main (76801). (915) 646-5576.

G. B. E. Inc. (acq 8-2-73). Net: ABC/FM. Rep: Miller. Format: MOR. Spec prog: Clsscl 3 hrs, Broadway 1 hr, progrs 4 hrs, relig 2 hrs wkly. ■ Ernest F. Cadenhead Jr., M. Bryan Healer, owners; Stephen F. Pasquini, gen mgr; Peggy Pasquini, coml mgr; David Lee, prog dir & prom mgr; Tony Cipolla, sls dir; Bill Rodert, news dir; Steve Keating, chief engr. ■ Rates: \$4; 4; 4; 3.

Bryan

KTAM—Sept 10, 1947: 1240 khz; 1 kw-D, 250 w-N, DA-1. Box 3069 (77801). (713) 822-2511. Bryan Bcstg Co. (acq 2-6-73). Net: ABC/I. Rep: Smith, Riley. Format: Top 40. Spec prog: Farm 1 hr, Sp 3 hrs wkly. ■ Carolyn G. Vance, pres; Dan D. Acree, ssn mgr; Roy Garcia, prog dir; Gary McDonald, mus dir; Steve St. Paul, news dir; J. M. Kirkland, chief engr. ■ Rates: \$9; 7.50; 9; 7.50.

KORA-FM—Co-owned with KTAM. April 1, 1966: 98.3 mhz; 3 kw. Ant 245 ft. Stereo. Prog sep from AM. Net: ABC/FM. Format: C&W. ■ Jan Landers, prog dir; Windy Ray, mus dir. ■ Rates: \$5.50; 5.50; 4; 5.50; 4.

WTAW-AM-FM—See College Station

Burnet

KHLB—Aug 19, 1963: 1340 khz; 1 kw-D, 250 w-N. Box 398 (78611). (512) 756-2147. Highland Lakes Bcstg (acq 8-7-11). Net: ABC/E, Texas State. Rep: Cowart. Format: C&W. Spec prog: Farm 4 hrs wkly. ■ Harry J. Kaindl Sr., pres; Harry J. Kaindl Jr., gen mgr & chief engr; LaVerne Kaindl, coml mgr; Charlie King, prog dir.

Cameron

KMIL—September 1955: 1330 khz; 500 w-D. Drawer 832 (76520). (817) 697-6633. Milam Bcstg Co. (acq 1-1-60). Format: C&W. Spec prog: Sp 5 hrs, gospel 5½ hrs wkly. ■ Narvie L. Caperton, pres; Eugene Smitherman, gen mgr, news dir & chief engr; Charles W. McGregor, coml mgr & prog dir. ■ Rates: \$3.50; 3.50; 3.50; 3.50.

Canyon

KCAN—May 8, 1962: 1550 khz; 1 kw-D. Box 956 (79015). (806) 655-2589. Palo Duro Bcstg Co. (acq 9-7-3). Net: TSN. Format: C&W. ■ Ernest Coker Jr., Joe W. Cooper, owners.

***KWTS(FM)**—1971: 91.1 mhz; 10 w. Ant 61 ft. Box 275, West Texas Station (79016). (806) 656-3993. West Texas State U. Format: Progressive, variety. Spec prog: Educl 5 hrs wkly. ■ Paul Matney, mgr.

Carrizo Springs

KBEN—Aug 9, 1955: 1450 khz; 1 kw-D, 250 w-N. 203 S. 4th St. (78834). (512) 876-2210. Walter H. Herbolt Jr. (acq 3-5-6). Net: TSN. Format: Spanish, C&W. Spec prog: Farm 3½ hrs wkly. ■ Walter H. Herbolt Jr., owner, gen mgr & chief engr; Noelia Herbolt, prog & news dir; Joe M. Villarreal, mus dir. ■ Rates: \$3.50; 3.50; 3.50; 3.50.

Carthage

KGAS—October 1955: 1590 khz; 1 kw-D. Drawer B (75633). (214) 693-6668. Beverly E. Brown. (acq 3-9-65). Net: Texas State. Rep: Keystone. Format: MOR. Spec prog: C&W 10 hrs, hymns & gospel 5 hrs wkly. ■ Bev E. Brown, owner-mgr. ■ Rates: \$3.72; 3.72; 3.72; —.

Center

KDET—Feb 22, 1949: 930 khz; 1 kw-D. 205 Austin St. (75935). (713) 598-3305. Center Bcstg Inc.

Childress

KCTX—May 8, 1947: 1510 khz; 250 w-D. Box 272 (79201). (817) 937-2563. Golden West Bcstg Co. Rep: Messina. Format: C&W, rock, top 40. Spec prog: Black 10 hrs wkly. ■ George E. Morey, pres; Mike Morey, gen & coml mgr; Kathy Morey, prom mgr; Bob Seagraves, prog dir; Barry Dill, mus dir; Jack Cox, chief engr.

Clarendon

KBGH—See Memphis.

Clarksville

KCAR—April 27, 1956: 1350 khz; 500 w-D. Box 609. (75426). (214) 427-3862. KCAR Inc. (acq 6-1-56). Rep: Melville. Format: C&W. ■ Maurice Wooley, pres; Winifred Bishop, gen mgr & news dir; Letha Hall, coml mgr; Jerry Anderson, prog & mus dir; Bruce Anderson, chief engr. ■ Rates: \$4; 4; 4; —.

Clear Lake City

KLYX(FM)—Feb 1, 1964: 102.1 mhz; 100 kw. Ant 790 ft. 3100 Richmond Ave., Houston (77006). (713) 527-9545. Amaturo Group Inc. (group owner; acq 1973). Net: NBC/NIS. Rep: Bunchez. Format: All news. ■ Joe Amaturo, pres; Gary J. Star, gen mgr; Jack Ford, news dir; L. Detrich, chief engr.

Cleburne

KCLE—April 1947: 1120 khz; 250 w-D. Box 1529 (76031). (817) 645-6643. KCLE Inc. (acq 7-1-68). Format: MOR. ■ Earle Fletcher, pres; Jack Auldridge, VP & gen mgr; Tommy Jeter, prog dir; Joe Long, news dir; Edward Craig, chief engr.

Cleveland

KJCH

Metro Country Music

KJCH—March 1974: 1410 khz; 500 w-U, DA-2. Box 520 (77327). (713) 592-7711. Jesse C. Howard. Rep: Riley. Format: C&W. ■ J.C. Howard, pres; Royce Guinn, gen mgr; Bobbie McClain, coml mgr; Jim Bradley, prog & mus dir; Glen Dodson, prom mgr; Dick Shotwell, news dir; Robert McWhorter, chief engr. ■ Rates: \$4; 3.50; 4; 2.75.

KSTA—Nov 1, 1947: 1000 khz; 250 w-D. Box 432 (76834). (915) 625-2518. Coleman County Bcstrs. (acq 9-6-64). Net: Texas State. Rep: Keystone, Melville. Format: C&W. Spec prog: Farm 14 hrs, relig 14 hrs, Sp 2 hrs wkly. ■ Robert L. Griffiths, pres & gen mgr; Jerry Rogers, coml & prom mgr & prog & mus dir; Bob Griffiths, news dir; J. D. Larson, chief engr.

KSTA-FM—1974: 107.1 mhz; 3 kw. Ant 180 ft. Stereo. Prog sep from AM.

College Station

WTAW—Oct 7, 1922: 1150 khz; 1 kw-D. Box 3008 (77801). (713) 822-6171. Radio Bryan Inc. (acq 1957). Net: Texas State. Rep: Savalli/Gates. Format: C&W. Spec prog: Farm 1 hr wkly. ■ Rodger B. Watkins, pres & gen mgr; Joe Monroe, coml mgr; Andy Delery, mus dir; Ben D. Downs, prom mgr; Howard Price, news dir; Tony Nemece, chief engr. ■ Rates: \$9.50; 7; 9.50; —.

WTAW-FM—Aug 8, 1964: 92.1 mhz; 3 kw. Ant 275 ft. Stereo. Progs sep from AM. (713) 846-0011. Format: Contemp. Spec progs: Black 16 hrs, Sp 16 hrs, farm 1 hr wkly. ■ Don David, prog dir; Bob Hill, mus dir; James S. Welch, prom mgr.

Colorado City

KVMC—June 16, 1950: 1320 khz; 1 kw-D. Box 990 (79512). (915) 728-3320. Radio Stn KVMC (acq 5-69). Net: Texas State. Rep: Melville; Keystone. Format: C&W, MOR, variety. Spec prog: Sp 5 hrs wkly. ■ Drew Ballard, owner & gen mgr; Virginia Dearen, coml mgr; Joy Culwell, prom mgr; Jon Honea, prog & mus dir; Ed Newton, news dir; Porter Richardson, chief engr.

Columbus

KULM(FM)—Sept 4, 1973: 98.3 mhz; 3 kw. Ant 200 ft. Spring St. (78934). (713) 732-5766. John L. Labay

Comanche

KCOM—April 1, 1962: 1550 khz; 250 w-D. Box 9 (76442). (915) (915) 356-2558. Arrowhead Bcstg Inc. (acq 4-1-74). Net: TSN. Rep: Melville. Format: C&W. Spec prog: Sp 1 hr wkly. ■ Roy E. Parker, pres; Bill B. Day, gen mgr, prog dir & chief engr; Bill Rodert, news dir; Ronald D. Hicks, sports dir.

Commerce

***KETR(FM)**—April 7, 1975: 88.9 mhz; 7.1 kw. Ant

245 ft. Box BB, East Texas Station (75428). (214) 886-6163. East Texas State U. Net: NPR, Texas State. Format: Diversified. ■ Phil Wayne Ebsenberger, s/n mgr; R. Stetson Lambertson, prog dir; David Rhodes, mus dir; Carolyn Philpel, prom mgr; Marguerite Van Ness, news dir; Jerome A. Erickson, chief engr.

Conroe

KIKR—April 16, 1951: 900 khz; 500 w-D. DA. Box 68 (77301). (713) 756-5501. Family Group Ent. (acq 9-73). Rep: Messina. Format: C&W. ■ Rigby Owen Sr, pres; Errol Coker, gen mgr & chief engr; Rhett Butler, prog dir; Dan Nichol, coml & prom mgr; Larry Strickland, mus dir; Tom Bacon, news dir. ■ Rates: \$6.60; 6.10; 6.60; 6.10.

KNRO-FM—Co-owned with KIKR. Feb 14, 1965: 106.9 mhz; 100 kw. Ant 240 ft. Stereo. Format: MOR. Spec prog: Black ½ hr, relig 1½ hrs wkly. ■ Larry Galla, mus dir. ■ Rates same as AM.

Corpus Christi

KCCT—June 1954: 1150 khz; 1 kw-D, DA. Box 5206 (78405). (512) 884-2426. Radio KCCT Inc. (acq 8-15-74). Rep: Devney. Format: Spanish. ■ Manuel Davila Jr, VP; Gabe Lozano Sr, gen mgr; Hector Rodriguez, prog dir; David Lozano, coml mgr; Jose Claire, news dir; C. D. Parker, chief engr.

KCTA—Oct 24, 1959: 1030 khz; 50 kw (L—SR Boston, SS Corpus Christi). Box 898 (78403). (512) 643-3541. Bcstg Corp of the Southwest. (acq 1975). Rep: Continental. Format: Relig. Spec prog: Sp 14 hrs wkly. ■ W. D. York, pres; Anne Savoy, opns; Genaro Tamez, coml mgr; D. Lindemann, news dir; A. Kriegel, chief engr.

KOUL(FM)—Co-owned with KCTA. See Sinton.

KEYS—March 1941: 1440 khz; 1 kw, DA-N. Box 1460 (78403). (512) 882-7411. Radio Corpus Christi (acq 12-31-66). Net: Texas State. Rep: Katz. Format: Contemp. ■ Arnold Malkan, pres; E. C. Stern Jr., gen mgr; Don Sitton, coml mgr; Ron Ames, prog dir & prom mgr; Roger Ramsey, mus dir; Ron Morgan, news dir; Marc Parma, chief engr. ■ Rates: \$17; 14; 17; 14.

KIKN—See Sinton.

KIOU(FM)—Sept 1, 1967: 96.5 mhz; 97 kw. Ant 870 ft. Stereo. 807 Wilson Tower (78401). (512) 882-4394. Stereo Bcstg Corp. Rep: ERA. Format: Btlf mus. ■ Stephen A. DeWalt, pres-gen mgr; Gordon L. Clark, news dir; Stephen R. West, chief engr. ■ Rates: \$14; 14; 14; 14.

KMIO-FM—See Sinton.

KRYS—1927: 1360 khz; 1 kw-U, Box 9698 (78408). (512) 882-8481. Big C. Bcstg Corp. (acq 6-68). Group owner: Sigmor. Net: ABC/I. Rep: Masla. Format: MOR. ■ Tom E. Turner Sr., pres; Jim Springer, gen mgr; Dan Daniels, prog dir; Ken Sullivan, news dir; Gary Wachter, chief engr. ■ Rates: \$18; 15; 18; 12.

KSIX—September 1947: 1230 khz; 1 kw-D, 250 w-N. Show Room Bldg. (78401). (512) 884-1616. Corpus Christi Bcstg Co. Net: CBS. ■ Vann M. Kennedy, pres & gen mgr; Charles R. Manning, coml mgr; Vivian L. Mitchell, prog dir; Ken Cessna, news dir; Eric M. Beals, chief engr.

KSIX-FM—January 1970: 93.9 mhz; 100 kw. Ant 840 ft. Prog sep from AM. Format: Btlf mus. ■ KZTV(TV) affil.

KUNO—May 1950: 1400 khz; 1 kw-D, 250 w-N. Drawer 4722 (78408). (512) 884-5202. KUNO Radio Inc. (acq 6-58). Rep: Savalli-Gates. Format: Spanish. ■ McHenry T. Tichenor, pres; Jack Robards, gen mgr; Don Sitton, coml mgr & prom mgr; Jose Ponce DeLeon, mus dir; Victor Lara Ortega, prog dir; Francisco Fregoso Gomez, news dir; John Mayberry, chief engr.

KZFM(FM)—Dec 7, 1964: 95.5 mhz; 41 kw. Ant 320 ft. 1718-600 Bldg. (78401). (512) 883-3516. Texas Media Group Inc. (acq 8-73). Net: ABC/C. Rep: Avery-Knodel. Format: Contemp. ■ Frank J. Gerow, pres; Roger Stoner, VP & gen mgr; Clyde Bourke, sales mgr; Sherry Corbin, PR dir; Jim Allen, prog dir; Bud Lockhart, news dir; Bill Oglesby, chief engr. ■ Rates: \$10; 9; 10; 8.

Corsicana

KAND—May 17, 1937: 1340 khz; 1 kw-D, 250 w-N.

Texas Radio

See page C-1 for explanation of listings.

Box 959 (75110). (214) 874-7421. Kan-D Land Inc. (acq 6-1-68). Net: Texas State. Rep: Paul Miller. Format: C&W, MOR. ■ Richard C. Parker, pres; Perry Taylor, gen mgr; Charles Barnaby, coml mgr; Jay Harper, prog dir; Charlotte Hayes, mus dir; Dewey Beal, news dir; Gene Hellums, chief engr. ■ Rates: \$7.40; 6.10; 7.40; 5.10.

KCIR(FM)—Nov 1, 1972: 107.9 mhz; 25 kw. Ant 520 ft. Box 1081 (75110). (214) 872-2611. DK Television Inc. Net: ABC/E. Format: Contemp. ■ Richard I. Kearley Jr., pres; Ray Murphy, gen mgr & chief engr; Chris Heaton, coml mgr; Bob Whittington, prog & mus dir; Bob Noel, news dir.

Crane

KBSN—Dec 1959: 970 khz; 1 kw-D. Box 1116 (79731). (915) 558-3202. Albert L. Crain. (acq 7-73). Texas State. ■ Albert L. Crain, pres.

Crockett

KIVY—Jan 19, 1950: 1290 khz; 1 kw-D. Box 1109 (75835). (713) 544-2171. Pioneer Bcstg. Format: C&W. ■ James H. Gibbs, pres, gen, coml & prom mgr, prog & news dir.

KIVY-FM—June 1, 1970: 92.7 mhz; 3 kw. Ant 200 ft. Dups AM 30%. Format: MOR, pop.

Cuero

KCFH—March 18, 1949: 1600 khz; 500 w-D. Box 864 (77954). (512) 275-3430. Norman Bcstg Crop. (acq 5-1-70). Net: TSN. Rep: Messina. Format: C&W. Spec prog: Sp 9 hrs, polka 3 hrs wkly. ■ Robert N. Aylin, pres; Michael Yocum, gen mgr; John Bumgardner, coml mgr & chief engr; John Bradley, prog & mus dir.

Dangerfield

KEGG—August 1966: 1560 khz; 1 kw-D, DA. Box 600 (75638). (214) 645-3806. KEGG Bcstg Co. (acq 1974). Group owner: Acker. Net: Interstate Bcstg Co. Rep: Messina. Format: MOR. ■ Gary L. Acker, owner; Charles Hays, mgr.

Dalhart

KXIT—1948: 1410 khz; 500 w-D. Box 1350 (79022). (806) 249-4747. Dalhart Bcstrs. (acq 7-55). Net TSN. Rep: Messina. Format: C&W, MOR. ■ Robert J. Beller, gen mgr & chief engr; Rayford Rose, coml mgr; Doan R. Beller, prog dir; Charley Martin, news dir.

KXIT-FM—1968: 95.9 mhz; 750 w. Ant 170 ft. Dups AM 2%.

Dallas

KAFM(FM)—Listing follows KRLD.

KAMC(FM)—See Arlington.

KBOX—1952: 1480 khz; 5 kw-D, 1 kw-N, DA-2. 9900 McCree Rd. (75238). (214) 348-3800. Group One Bcstg Co. of Texas (group owner; acq 8-1-67). Rep: McGavren-Guild. Format: C&W. ■ Roger G. Berk, pres; Chester Maxwell, VP & gen mgr; Craig Magee, asst gen mgr & gen sales mgr; Tom Allen, opns dir; Dave O'Brein, news dir; George Pechacek, chief engr.

KTLC(FM)—Co-owned with KBOX. Dec 25, 1965: 100.3 mhz; 89 kw. Ant 1,280 ft. Prog sep from AM. Stereo. Format: Btlf Mus. ■ Dave Manders, asst gen mgr & gen sales mgr; Bob Davis, prog dir.

***KCBI(FM)**—Not on air, target date December 1975: 89.3 mhz; 1.3 kw. Ant 428 ft. 1707 San Jacinto (75201). (214) 742-3111. Criswell Bible Institute. Format: Educl. ■ Dr. Paige Patterson, pres; Jack Bird, gen mgr.

***KCHU(FM)**—August 29, 1975: 90.9 mhz; 100 kw. Ant 790 ft. Stereo. 2516 Maple Ave. (75201). (214) 742-6262. Agape Bcstg Foundation Inc. Audio news: Reuters. Format: Diversified. Spec prog: Black 6 hrs, Sp 4 hrs, Greek 4 hrs, Indian 1 hr, Icl pub affrs 15 hrs wkly. ■ Dennis Gross, pres & gen mgr; Mark Newberger, asst mgr; Fred Weiss, prog dir; Barbara Whitlow, news dir; Larry Bolef, chief engr.

Texas Radio

See page C-1 for explanation of listings.

KCWV(FM)—See Victoria.

KDTX(FM)—1965; 102.9 mhz; 100 kw. Ant 1,570 ft. Box 7030 (75209). (214) 350-5540. KDTX Inc. Group owner. Start. Audic news: UPI. Rep: Oakes. Format: Inspirational. ■ Peter H. Starr, pres; Dick Oppenheimer, VP opns; Al Buttolph, gen mgr; Bob Easley, prog dir; Pat Tate, news dir; Joe Willis, sls mgr; Loen McWhorter, mus dir; Ben Harold, prom mgr; Bill Thompson, chief engr. ■ Rates: \$8; 7.50; 9; 5.

***KERA-FM**—July 11, 1974; 90.1 mhz; 95 kw. Ant 1260 ft. 3000 Harry Hines (75201). (214) 744-1300. Public Communication Foundation for North Texas. Net: NPR. Format: Talk, classical, jazz, pub affrs, variety. Spec prog: Fr ¼ hr, Ger 1 hr, Sp 2 hrs, Arabic ½ hr wkly. ■ Robert Wilson, pres; Bruce McKenzie, stn mgr; Tony Garrett, prog dir; Dave Lambie, news dir; Pat Perrini, prom mgr; William McCutcheon, chief engr. ■ KERA-TV affil.

KEZT(FM)—June 8, 1947; 104.5 mhz; 100 kw. Ant 390 ft. 1401 S. Akard (75215). (214) 741-5016. Crescent Communications Corp. (acq 4-1-72). Format: Easy lstrg. ■ Sidney L. Carr, pres; Bob E. Tripp, chief engr.

KFJZ—See Fort Worth.

KJIM—See Fort Worth.

KKDA—See Grand Prairie.

KLIF—1947; 1190 khz; 50 kw-D, 5 kw-N, DA-2, 2120 Commerce St. (75201). (214) 747-9311. Fairchild KLIF Inc. (acq 1-31-72). Group owner: Fairchild Bcst Group. Audio news: UPI. Rep: Blair. Format: Top 40. ■ Alan Henry, pres; Klee C. Dobra, gen mgr; David Paul McNamee, prog dir; Mikie Baker, mus dir; Joe Salvadore, news dir; Steve Schott, chief engr. ■ Rates: \$70; 56; 70; 52.

KNUS(FM)—1961; 98.7 mhz; 100 kw. Ant 520 ft. 1917 Elm St. (75201) (214) 651-1010. TWX 910-861-4467. McLendon Corp. (group owner). Rep: ABC/FM Spot Sls. Format: Stereo rock. ■ Barton R. McLendon, chmn & gen mgr; Gordon B. McLendon, pres.

KNOK-AM-FM—See Ft. Worth.

KOAX(FM)—April 5, 1968; 105.3 mhz; 100 kw. Ant 1560 ft. Suite 125, Campbell Ct. Bldg. 8350 N. Central Expwy. (75206). (214) 369-1171. Able Communications of Texas (group owner; acq 2-2-71). Rep: Masla. Format: Btlf mus. ■ Irene B. Runnels, VP & gen mgr; Bob Gaskins, opns dir; Bob Hornberger, chief engr.

KPBC—June 8, 1947; 1040 khz; 1 kw-D. 1401 S. Akard St. (75215). (214) 651-0022. Crawford Bcst Co. (group owner; acq 10-26-73). Format: Reli. ■ Donald B. Crawford, pres; Rosalie Crawford, gen mgr; W. R. Reed, coml mgr; James Thompson, prog dir; David Benware, mus dir.

KRLD—October 1926; 1080 khz; 50 kw-U, DA-N. 7901 Carpenter Freeway (75245). (214) 634-1080. KRLD Corp. (acq 7-1-70). Net: ABC/I, MBS, TSN. Rep: CBS Spt Sls. Format: C&W, MOR btlf mus. ■ Philip R. Jonsson, pres; John C. Butler, exec VP & gen mgr; Al Lurie, coml mgr; Garry Brant, prog dir; Joe Holstead, news dir; Rick Neace, chief engr. ■ Rates: \$60; 44; 60; 22.

KAFM(FM)—Co-owned with KRLD. April 1, 1948; 92.5 mhz; 99 kw. Ant 1,670 ft. Stereo. Box 47201 (75247). Prog dups AM .5%. Rep: CBS-FM Radio Sales. Format: Progs, C&W. ■ Robert O. Cooper, gen mgr; Chuck Dunaway, prog dir; Rich Klopp, coml mgr. ■ Rates: \$14; 14; 17; 17.

***KRSM(FM)**—1975; 88.5 mhz; 10 w. Ant 88 ft. 10600 Preston Road (75320). (214) 363-6491 ext 30 & 41. St. Mark's School of Texas. Net: Longhorn. Format: Educi, diversified. ■ Ken Walters, gen mgr; Ted Wilke, chief engr.

KSKY—Sept 30, 1941; 660 khz; 10 kw-D. 2927 Maple Ave. (75201). (214) 742-6193. Sky Bcstg Service. Format: Gospel. Spec prog: Czech mus ½ hr wkly. ■ Andy Bell, gen mgr; Bill Simmons, prog dir; Bill Clauss, news dir; Morris M. King, chief engr. ■ Rates: \$86.40; 86.40; 86.40; —.

KTLC(FM)—Listing follows KB0X.

KVIL—See Highland Park.

***KVTT(FM)**—Jan 26, 1950; 91.7 mhz; 780 w. Ant 69 ft. 2608 Inwood Rd. (75235). (214) 352-5557. Elkins Educational Research Foundation Inc. (acq 2-70). Format: Ed. ■ C. C. (Bill) Elkins Jr., pres & gen mgr; Leonard Hancock, chief engr.

KWXI(FM)—Co-owned with KFJZ. See Ft. Worth.

KXOL—See Ft. Worth.

KZEW(FM)—Listing follows WFAA.

WBAP—See Ft. Worth.

WFAA—June 26, 1922; 570 khz; 5 kw-U, DA-2. Communications Center. (75202). (214) 748-9631. TWX 910-861-4139. Belo Bcstg Corp. (group owner). Net: CBS, Continental News. Rep: Katz. Format: MOR. Spec prog: Farm 3 hrs wkly. ■ James M. Moroney Jr., chmn; Mike Shapiro, pres; John Dew, VP & stn mgr; Ken Summers, prog dir; Rod Barker, gen sales mgr; Robert Scott, news dir; Chris Irby, chief engr.

KZEW(FM)—Co-owned with WFAA. 1961; 97.9 mhz; 99 kw. Ant 1,680 ft. Stereo. Prog sep from AM. Format: Rock. ■ WFAA-TV affil.

WRR

All-News

WRR—1920; 1310 khz; 5 kw-U, DA-N. Fair Park Station (75226). (214) 823-1310. City of Dallas. Net: MBS. Audio news: NBC/NIS; UPI. Format: All news. Avery-Knodel. ■ Edd Routt, gen mgr; Bill Whitley, coml mgr; Paul Pryor, managing editor; Jim Rhodes, chief engr. ■ Rates: \$22; 18; 22; 12.

WRR-FM—1948; 101.1 mhz; 100 kw. Ant 500 ft. Rep: Groskin Co. Format: Classical. ■ Edward J. Hill, stn mgr; Margaret Moore, prog dir. ■ Rates: \$11; 9; 11; 13.

Del Rio

KDLK—1947; 1230 khz; 250 w. 405 Bedell Ave. (78840). (512) 775-4941. Western Plains Bcstg Co. (acq 5-1-68). Net: TSN. Rep: Riley. Format: Contemp. Sp. ■ Rodney Robertson, pres; Hollis Gotcher, prog dir.

KDLK-FM—Aug 15, 1966; 94.3 mhz; 3 kw. Ant 68 ft. (CP 2.65 kw. Ant 135 ft). Prog sep from AM. Format: Easy lstrg.

KWMC—Aug 20, 1967; 1490 khz; 1 kw-D, 250 w-N. Box 1505 (78840). (512) 775-3591. Amistad Bcstg Co. Net: TSN. Rep: Messina. Format: C&W, farm, Sp. ■ Daniel R. McDuff, pres & gen mgr; Marvin Yust, coml mgr; Jay Marvin, prog & mus dir; Ronnie Polar, prom mgr & chief engr; Al Yanelli, news dir. ■ Rates: \$7; 6.30; 7; 6.30.

Denison

***KGCC(FM)**—March 18, 1969; 89.7 mhz; 28.5 kw. Ant 275 ft. Box 979 (75020). (214) 465-6033. Grayson County Junior College. Format: Contemp. ■ Dr. Truman Wester, pres; Tom E. Spellman, gen mgr & chief engr.

Denison-Sherman

KDSX—Sept 26, 1948; 950 khz; 500 w-U, DA-2. Box 331, Denison (75020). Drawer D, Sherman (75090). (214) 465-1600. KDSX Inc. Net: ABC/I. Format: Top 40, news. ■ B. V. Hammond Jr., pres & gen mgr; Bill Hooten, coml mgr; K. B. Lorange, prog dir; Phil Ransom, news dir; Bob Stewman, chief engr. ■ Rates: \$4.65; 3.90; 4.65; 2.85.

KDSX-FM—June 29, 1967; 101.7 mhz; 3 kw. Ant 260 ft. Stereo. Prog dups AM 25%. Format: Good mus, simulcast AM news. ■ Rates: \$2; 2; 2; 2.

Denton

KDNT—1938; 1440 khz; 5 kw-D, DA-N. 235 W. Hickory St. (76201). (817) 382-2552. Bass Bros Telecasters Inc. (acq 3-15-72). Group owner: Bass Bcstg. Net: Texas State. Rep: Riley. Format: MOR. ■ Mel Wheeler, pres; W. Hal Thompson, gen & coml mgr; Scott Causey, prog mus dir; Hal Whatley, chief engr.

KDNT-FM—1947; 106.1 mhz; 100 kw horiz, 44 kw vert. Ant 265 ft. Prog sep from AM.

***KNTU(FM)**—November 1969; 88.5 mhz; 440 w. Ant 125 ft. North Texas State Univ. Box 5008 (76203). (817) 788-2502, ext 372. North Texas State University. Format: Contemp. Spec prog: Educi 5 hrs wkly. ■ Edwin L. Glick, dir radio; Henry Kaplan, mgr; Clay Kistler, news dir; Frank Bonner, chief engr.

Diboll

KSPL—June 2, 1957; 1260 khz; 1 kw-D. Box 336 (75941). (713) 829-5597. William L. Walling (acq 12-73). Audio news: APR. Format: C&W. ■ William Walling, pres; Phil Parr, gen mgr & prog dir; Mollie Parr, coml mgr; Norman Johnson, news dir; William Crow, chief engr. ■ Rates: \$3.50; 3.50; 3.50; 1.50.

KSPL-FM—June 29, 1960; 95.5 mhz; 6 kw. Ant 455 ft. Dup AM 90%. ■ Rates same as AM.

Dimmitt

KDHN—Dec 22, 1963; 1470 khz; 500 w-D, DA. Box 608 (79027). (806) 647-3186. High Plains Bcstg Co. Net: ABC/E. Rep: Bernard; Messina. Format: C&W. ■ Steve Taylor, pres; Jerry Marvin, gen mgr & prog dir; Susan Hanners, coml & prom mgr; Ron Bates, chief engr.

Dumas

KDDD—May 1, 1948; 800 khz; 250 w-D. Box 555 (79029). (806) 935-4141. Dumas Bcstrs Inc. (acq 5-1-59). Net: TSN. Format: C&W. ■ Kenneth E. Duke, pres & chief engr; Alfred A. Tremble, VP.

KMRE(FM)—Co-owned with KDDD. June 29, 1960; 95.3 mhz; 680 w. Ant 260 ft. Prog sep from AM. Format: Btlf mus.

Eagle Pass

KEPS—August 1957; 1270 khz; 1 kw-D. Box 1123 (78852). (512) 773-9246. Eagle Pass Bcstrs Inc. (acq 8-1-64). Format: C&W, MOR, Spanish. ■ E. J. Harpole, pres; Al Kinsall, gen & coml mgr; Ed Quinn, mus dir; Marge Munt, news dir; Chuck Gavin, chief engr.

KINL(FM)—Co-owned with KEPS. Nov 2, 1971; 92.7 mhz; 3 kw. Ant 185 ft. Stereo. Prog sep from AM. ■ George Whilite, stn mgr.

Eastland

KERC—August 1953; 1590 khz; 500 w-D. Box 590 (76448). (817) 629-2621. Eastland County Bcstg Co. (acq 6-1-61). Rep: Melville. ■ James Staggs, gen mgr.

Edinburg

KBFM(FM)—Feb 1972; 104.1 mhz; 100 kw. Ant 320 ft. 311 W. University Drive (78539). (512) 383-4961. Cameo Broadcasters. (acq Nov 1974). Rep: Messina. Format: Progs, adult contemp. ■ Larry Rose, pres; G. H. Bason, gen mgr; Carolyn Blakey, coml mgr; Rick Powell, prog dir; Steve Russell, mus dir; L. D. Campbell, chief engr. ■ Rates: \$10.50; 8.50; 9.50; 7.50.

KESI(FM)—Listing follows KURV.

KURV—October 1947; 710 khz; 250 w-U, DA-N. Box 1638 (78539). (512) 383-2777. Magic Valley Radio Inc. (acq 10-15-60). Audio news: NBC/NIS. Format: All news. Spec prog: Farm 10 hrs wkly. ■ Lloyd Hawkins, pres; Lawrence E. Hawkins, gen mgr; Ray Hall, prog dir; John Ortiz, news dir; Michael Hales, chief engr. ■ Rates: \$7.40; 6.05; 7.40; 6.05.

KESI(FM)—Partially co-owned with KURV. Sept 12, 1974; 107.9 mhz; 100 kw. Ant 490 ft. (512) 383-7478. Valley Bcstrs Inc. Format: Btlf mus. Spec prog: Farm 7½ hrs wkly. ■ Rates: \$10.35; 9.60; 10.35; 9.60.

Edna

KWBY—Sept 17, 1971; 1130 khz; 5 kw-D, DA. Drawer FF (77957). (512) 782-3515. Cosmopolitan Enterprises Inc. Rep: Paul Miller. Format: C&W. Spec prog: Sp 12 hrs, farm 1 hr wkly. ■ Lester A. Meis, pres; Robert Boutin, VP & gen mgr; Mae K. Boutin, coml mgr; Ross Elliott, prog dir; F. Paul McKaig, mus dir; Bryan A. Blake, prom mgr. ■ Rates: \$7.10; 6; 6; 7.10.

El Campo

KULP—1948; 1390 khz; 500 w-D. Box 1390

Texas Radio

See page C-1 for explanation of listings.

(77437). (713) 543-3303, Bar-B Bcstg Inc. (acq 7-1-68). Spec prog: Sp 14 hrs, C&W 10 hrs, Czech 5 hrs wkly. ■ Fred V. Barbee Jr., pres; John W. Fox III, gen mgr; Joe Miller, chief engr.

KULP-FM—September 1968: 96.9 mhz; 27 kw. Ant 180 ft. Progs sep from AM.

El Paso

KAMA—July 13, 1972: 1060 khz; 10 kw-D. 4141 Pinnacle St. (79902). (915) 544-7600. KAMA Radio Inc. (acq 7-1-74). Rep: Avco. Format: Spanish. ■ Jack R. McVeigh Sr., pres & gen mgr; Jack R. McVeigh Jr., gen sls & prom mgr; Billie M. McVeigh, prog dir; Ernesto Quinones, mus mgr; Manny Escobrias, news mgr; Mike Gaglio, chief engr. ■ Rates: \$30; 26; 30; 20.

KAMA-FM—Not air, target date October 1975: 93.1 mhz; 30 kw. Ant 1,190 ft. Stereo. Prog dups AM 100%. ■ Rates same as AM.

KELP—June 1947: 920 khz; 1 kw-D, 500 w-N, DA-N. 4140 Rio Bravo, Box 12277 (79912). (915) 544-7980. Walton Enterprises Inc. (group owner; acq 3-1-66). Audio news: APR. Rep: Eastman. Format: Top 40. ■ John B. Walton Jr., pres; Robert Gourley, gen & coml mgr; Bruce Brown, prog dir; Mike Edwards, prom mgr; John Thompson Jr., mus dir; Dieter Jester, news dir; Carr Stalneker, chief engr. ■ Rates: \$30; 25; 30; 20. ■ KERP-TV affil.

KEZB(FM)—Listing follows KHEY.

KHEY—1947: 690 khz; 10 kw-U, DA-2, 2419 N. Piedras St. (79930). (915) 566-9301. KHEY Inc. (acq 12-69). Net: ABC/II. Rep: KATZ Radio. Format: C&W. ■ Jim R. Phillips, pres; & gen mgr; Gary Ackers, coml mgr; Colin Gronmatski, prom mgr; Jud Milton, prog dir; Charles Russell, mus dir; Tee Casper, news dir; Herb Rand, chief engr. ■ Rates: \$35; 27; 35; 27.

KEZB(FM)—Co-owned with KHEY. Aug 1, 1974: 96.3 mhz; 87 kw. Ant 730 ft. Stereo. Prog sep from AM. Format: Btfl mus. ■ Karen Linton, prog dir; Tim Phifer, news dir; Rob Burton, prom mgr; Chuck Gipe, chief engr. ■ Rates: \$19; 17; 19; 17.

KINT—April 10, 1959: 1590 khz; 1 kw-D. Box 10243 (79993). (915) 779-6454. Taber Bcstg Co. (acq 1974). Net: ABC/C. Format: Top 40. ■ James M. Taber, pres & gen mgr; Charles Ashworth, stn mgr; J.J. Mitchell, mus dir; Johnny Kaye, prog dir; Larry Bauhus, news dir. ■ Rates: \$11; 9; 11; 9.

KINT-FM—Aug 15, 1969: 97.5 mhz; 60 kw. Ant 1,080 ft. Stereo. Prog dups AM 100%. ■ Rates same as AM.

KISO—June 1958: 1150 khz; 1 kw-D. 444 Executive Center Blvd. (79902). (915) 533-3404. Mesa Radio Inc. 2-1-75). Net: CBS. Format: C&W. ■ F. Daniel Marcy, pres & gen mgr; Rob Camp, prog dir; Martin J. Peters, news dir. ■ Rates: \$6.75; 6.75; 6.75; 6.75.

KLOZ(FM)—Co-owned with KISO. Dec 5, 1969: 102.1 mhz; 27 kw. Ant 1,160 ft. Stereo. Prog dups AM 50%. (915) 544-3500. Format: Contemp. ■ Algie Felder, chief engr. ■ Rates same as AM.

KPAS(FM)—July 4, 1975: 93.9 mhz; 100 kw. Ant 980 ft. 3901 N. Mesa (79902). (915) 533-8211. El Paso Bcstg Corp. Rep: H-R Stone, Gates. Format: Inspirational. Spec progs: Farm 2 hrs, Sp 6 hrs wkly. ■ Michelle A. Haston, pres; Garrett W. Haston, gen mgr; Earle Goldstein, coml mgr; F. Lee Gerton, prom mgr; Mike Borschow, prog dir; Burt Asmis, mus dir; Morris Courtwright, chief engr. ■ Rates: \$13.50; 13.50; 13.50; 13.50.

KROD—June 1, 1940: 600 khz; 5 kw-U, DA-N. 2201 Wyoming (79903). (915) 544-8864. Desert Horizons Inc. (acq 5-27-73). Group owner: Media Horizons. Net: ABC/E. Rep: Century Natl. Format: MOR. Spec prog: News promg 3½ hrs wkly. ■ Ken Cowan, pres; Irving N. Prell, gen mgr & natl sls mgr; Walt Dalton, gen sls mgr; Dennis Stein, loc sls mgr; Paul Bain, prog dir; Bill Belterson, mus dir; Bill Blair, prom mgr; Tom Twinam, news dir; Gus Gavalton, engr. ■ Rates: \$26; 21; 26; 21.

KUOE(FM)—Co-owned with KROD. Not on air, target date unknown: 95.5 mhz; 100 kw. Ant 1,200 ft.

KSDL(FM)—Not on air, target date unknown: 92.3 mhz; 100 kw. Ant 1,860 ft. Box 149, Humble City, N.M. (88251). Media Corp. ■ Glen L. Houston, John A. Parry, Theodore R. Johnson, owners.

KSET—Dec 3, 1949: 1340 khz; 1 kw-D, 250 w-N. Box 20,000 (79998). (915) 532-4979. Financial Computer Services. Net: MBS. Rep: Torbet. Format: Btfl mus. ■ Sam R. Hawks, pres; (Mr.) Audrey Lewis, gen & sales mgr; Mike Shumer, prog dir; Ed Hopper, mus dir; Matt Sandeford, chief engr.

KSET-FM—Nov 29, 1958; 94.7 mhz; 100 kw. Ant 730 ft. Stereo. Prog sep from AM. Format: Btfl mus.

***KTEP(FM)**—Sept. 14, 1950: 88.5 mhz; 94 kw. Ant 1,910 ft. Stereo. Box 328, Univ of Texas at El Paso (79968). (915) 747-5152. Univ of Texas at El Paso. Net: ABC/E, NPR. Format: Public. Spec prog: Sp 4 hrs, Ger 1 hr, black 4 hrs wkly. ■ Louis H. Valles, gen mgr; Dallas Ann Brown, prog dir; Marianne Schumaker, mus dir; W. Louis Brown, chief engr.

KTSM—Aug 22, 1929: 1380 khz; 5 kw-D, 500 w-N. 801 N. Oregon (79925). (915) 532-5421. TWX 910-964-1329. Tri-State Bcstg Co. Net: NBC. Audio news: NBC/NIS. Rep: Avery-Knodet. Format: All news. ■ Karl O. Wyler, pres & gen mgr; John Phelan, VP coml mgr; Doug Moser, prog dir; Jack Rye, exec VP; Jeff Gates, news dir; W. T. McGill, chief engr.

KTSM-FM—June 11, 1962: 99.9 mhz; 87 kw. Ant 1,820 ft. Stereo. Prog sep from AM. Format: Solid gold. ■ KTSM-TV affil.

KUOE(FM)—Listing follows KROD.

Falfurrias

KPSO—Jan 1, 1953: 1260 khz; 500 w-D, DA. Box 309 (78355). (512) 325-2112. Brooks Bcstg Corp. (acq 1975). Format: Spanish, C&W. ■ Raymond O. Creely, pres; James R. Merrell, loc mgr; Joseph D. Hale, chief engr. ■ Rates: \$4.50; 4.50; 4.50; —.

Farwell

KZOL—April 17, 1958: 1570 khz; 250 w-D. Box 458 (79325). (806) 481-3318. Best Bcstg Co. Inc. (acq 1-12-66). Format: C&W. ■ Gil W. Patschke, pres.

Floydada

KFLP—1951: 900 khz; 250 w-D. Box 490 (79235). (806) 983-2841. Radio Nine. Rep: Natl Time Sls; Messina. Format: C&W.

Fort Stockton

KFST—May 8, 1954: 860 khz; 250 w-D. Box 165 (79735). (915) 336-2228. KFST Inc. (acq 3-1-61). Rep: Hopewell; Riley. Spec prog: Sp 10 hrs wkly. ■ James W. Hawkins, pres, gen mgr & chief engr; Bob Davis, prog dir; Dave Martin, coml mgr/news dir.

KPJH(FM)—Co-owned with KFST. 1974: 94.3 mhz; 2.95 kw. Ant 235 ft.

Fort Worth

KAFM(FM)—Co-owned with KRLD. See Dallas.

KAMC(FM)—See Dallas.

KBUY—1945: 1540 khz; 50 kw-D, 1 kw-N, DA-2. Box 2049 (76101). (817) 926-5301. John B. Walton Jr. (group owner; acq 9-1-66). Net: TSN. Rep: Avco. Format: Modern country. ■ John B. Walton Jr., pres; Paul Hull, gen mgr; William C. Chadwick III, stn mgr; Ned Follis, natl sls mgr; Jim Christoferson, opns mgr; Randy Ryder, news dir; Jim Schumacher, chief engr.

KBUY-FM—Dec 24, 1964: 93.9 mhz; 100 kw. Ant 430 ft. Progs sep from AM. Format: Spanish. ■ Marcos Rodriguez, stn mgr; Victor Mantecon, coml mgr; Gus Perez, prog dir; Addie Uranga, news dir.

KFJZ—1922: 1270 khz; 5 kw-U, DA-1. Box 1317 (76101). (817) 737-6631. Communications Properties Inc. (group owner; acq 2-72). Net: Texas State. Rep: Blair. Format: Contemp, top 40. ■ Stan Wilson, pres & gen mgr; Ray Menefee, coml mgr; Beau Weaver, prog dir; George Erwin, mus dir; Joe Holstead, news dir; Darryl Parker, chief engr.

KWXI(FM)—Co-owned with KFJZ. April 1959: 97.1 mhz; 98 kw. Ant 1,460 ft. Stereo. First III Cable TV Inc. (acq 3-1-73). Progs sep from AM. Format: MOR. ■ Don Lachance, stn mgr; Bob Test, prog & mus dir.

KFWD(FM)—April 10, 1962: 102.1 mhz; 100 kw. Ant 1,420 ft. Dallas-Fort Worth Airport (75261). (817) 267-4411. KFWD (acq 5-1-71). Rep: Selcom. Format:

Contemp. ■ John S. Tyler, partner; Charles H. Strickland, gen sales mgr; Sylvia J. Clark, prog dir; Johnnie Morgan, mus dir; Carlos Hurd, chief engr.

KJIM—Feb 15, 1947: 870 khz; 250 w-D. Box 7321, 2214 E. Fourth (76111). (817) 336-7175. Fort Worth KJIM Inc. (acq 1975). Net: MBS. Rep: Torbet. Format: MOR, Dance Band. ■ William B. Hill, pres; Ed Stevens, coml mgr; Dave Byrn, prom mgr; Tom Casey, prog & mus dir; Bob Lashbrook, news dir; Carlos Hurd, chief engr.

KLIF—See Dallas.

KNOK—Dec 6, 1946: 970 khz; 1 kw-D. Box 7116 (76111). (817) 831-2170. KNOK Bcstg Co. Rep: Howard. Format: Black. ■ S. J. Hepburn, pres & gen mgr; D. McClain, stn mgr.

KNOK-FM—Feb 8, 1965: 107.5 mhz; 100 kw. Ant 450 ft. Stereo. Prog dups AM 50%.

KNUS(FM)—See Dallas.

KOAX-AM-FM—See Dallas.

KPLX(FM)—Dec 15, 1962: 99.5 mhz; 100 kw. Ant 600 ft. 6465 Spur 303 (76112). (817) 429-0995. Radio Metroplex Inc. (acq 1974). Group owner: Susquehanna. Audio news: UPI. Rep: Savalli/Gates. Format: MOR. ■ Wally Tucker, gen mgr; Paul McAlister, sls mgr; Bill Crable, prog dir; Bob Burns, mus dir; Craig Eaton, chief engr. ■ Rates: \$24; 26; 24; 12.

KRLD—See Dallas.

KSCS(FM)—Listing follows WBAP.

KSXY—See Dallas.

***KTCU-FM**—Oct 6, 1964: 89.1 mhz; 10 w. Ant 115 ft. Texas Christian U. (76129). (817) 926-2461, ext 242. Texas Christian U. ■ James Moudy, pres; R. C. Norris, gen mgr.

KTLC(FM)—Co-owned with KBOX. See Dallas.

KWXI(FM)—Listing follows KFJZ.

KXOL—April 1947: 1360 khz; 5 kw-D, 1 kw-N, DA-N. Box 2287 (76101). (817) 335-4841. Metro Bcstg Corp. (acq 11-1-73). Group owner: Sigmor. Net: ABC/C. Format: Contemp. ■ Tom E. Turner, pres; Gaylon W. Christie, gen mgr; Cleon Nettles, coml mgr; Paxton Mills, prom mgr; Casey Jones, prog dir; J. Maxwell Taylor, mus dir; Joe Salvador, news dir; Tom Green, chief engr.

KZEW(FM)—Co-owned with WFAA. See Dallas.

WBAP—May 2, 1922: 820 khz; 50 kw-U, DA-1. 3900 Barnett St. (76103). (817) 429-2330. Capital Cities Communications Inc. (group owner; acq 1974). Net: NBC. Rep: Eastman. Format: C&W. Spec prog: Farm 8 hrs wkly. ■ Warren Potash, VP & gen mgr; Guy A. Woodward, natl sls mgr; Ted Norman, stn mgr; Jim Stanton & Vern Orr, loc sls mgrs; Don Thompson, prog mgr; Art Davis, mus dir; Bob White, news dir; Ed Bates, chief engr. ■ Rates: \$165; 85; 130; 60.

KSCS(FM)—Co-owned with WBAP. March 8, 1949: 96.3 mhz; 99 kw. Ant 1,680 ft. Stereo. Prog sep from AM. ■ Rates: \$25; 25; 25; 25.

WFAA—See Dallas.

WRR-AM-FM—See Dallas.

Fredericksburg

KNAF—November 1947: 910 khz; 1 kw-D. Box 311 (78624). (512) 997-2197. Gillespie Bcstg Co. (acq 1968). Rep: Messina. Format: C&W. ■ Norbert Fritz, pres, gen mgr & chief engr; Tom Warren Balmos, coml mgr; Bill Jung, prog dir; Mrs. Alene Fritz, news dir. ■ Rates: \$4.20; 4.20; 4.20; 4.20.

KNAF-FM—Feb 18, 1971: 101.1 mhz; 100 kw. Ant 650 ft. Stereo. Prog dups AM 18%. Format: Btfl mus. ■ Rates same as AM.

Freepost

KBRZ—October 1952: 1460 khz; 500 w-D. Box AA (77541). (713) 233-2655. Coastal Bcstg Inc. (acq 1974). Rep: Messina. Format: C&W.

Texas Radio

See page C-1 for explanation of listings.

KGOL(FM)—Co-owned with KBRZ. See Lake Jackson.

Gainesville

KGAF—1947: 1580 kHz; 250 w-D. Box 368 (76240). (817) 665-5546. First IV Media Inc. (acq 11-15-1974). Net: Texas State. Format: MOR. Spec prog: Farm 10 hrs, C&W 4 hrs wkly. ■ Richard Klement, pres; Ed C. Hinkle, gen mgr; Pat Bolin, prog dir; Tim Reiger, news dir; J.O. Miller, chief engr. ■ Rates: \$6.45; 5.70; 5.70; —.

KGAF-FM—1958: 94.5 mhz; 100 kw. Ant 370 ft. Prog dups AM 100%. ■ Rates same as AM days/2.85 nights.

Galveston

KGBC—May 1947: 1540 kHz; 1 kw-D, 250 w-N, DA-N. Box 1138 (77550). (713) 744-4567. Harbor Bcstg Inc. (acq 12-20-64). Net: ABC/I. Rep: Savalli/Gates. Format: MOR, black. Spec prog: Sp 5 hrs wkly. ■ Pete Miller, pres; Vandy Anderson, exec VP & gen mgr; Woody Carson, coml mgr; Luke Stripling, chief engr. ■ Rates: \$15.50; 15; 15.50; 15.

KILE—1922: 1400 kHz; 1 kw-D, 250 w-N. Box 1441 (77550). (713) 762-8434. Galveston Radio Inc. (acq 9-1-63). Net: Texas State. Rep: Masla, Riley (Dallas). Format: Top 40. Spec prog: Sp 2 hrs wkly. ■ Tom Wiseheart, pres & gen mgr; Lou Muller, stn & coml mgr; Dan Gallo, prog dir; Larry Sanville, news dir; Scott Michaels, chief engr. ■ Rates: \$11; 11; 11; 9.50

KUFO(FM)—Feb 11, 1968: 106.5 mhz; 26 kw. Ant 195 ft. Stereo. (77550). (716) 763-1696. Beacon Bcstg Co. (acq 1974).

Gatesville

KMCS(FM)—Not on air, target date unknown: 98.3 mhz; 3 kw. Ant 300 ft. 813 Main (76528). McClarin Bcstg Co. Format: C&W, easy lstng. ■ George W. McClarin, owner.

Georgetown

KGTN—Dec 8, 1962: 1530 kHz; 1 kw-D. Box 100 (76226). (512) 863-3911. Georgetown Bcstg Co. Net: Texas State. Format: C&W, rock, talk, Sp. Spec prog: black 4 hrs wkly. ■ Gary Seaman, gen mgr; Gary Duck, coml mgr & prog dir; Jennifer Robbins, news dir; Jim Boutwell, chief engr. ■ Rates: \$4.20; 4.20; 4.20; 4.20.

KGTN-FM—March 1, 1972: 96.7 mhz; 3 kw. Ant 295 ft. Prog dups AM 50%. ■ Rates same as AM.

Gilmer

KHYM—June 17, 1973: 1060 kHz; 5 kw-D. Rt 4 (75644). (214) 725-6100. K-HYM Bcstg Co. Net: MBS. Rep: Paul Miller. Format: Relig. Spec prog: Farm 2 hrs, C&W 3 hrs wkly. ■ J. R. McClure, pres; Robby McClure, gen & prom mgr & prog dir; Paula Chamberlain, coml mgr; Jac Ferril, mus dir; Phillip Williams, news dir; Mike Ross, chief engr. ■ Rates: \$7; 6; 7; 5.50.

Gladewater

KEES—1949: 1430 kHz; 1 kw-D. Rt 4, Box 531 Longview (75601). (214) 753-0411. Gemini Enterprises (acq 1962). Rep: Savalli/Gates; Morton. Format: C&W. ■ O. L. Kimbrough, owner & pres; J. H. Reynolds, VP & gen mgr; R. W. Murray, opns mgr; Jerry Lee, prog mgr; Dave Charles, prog & mus dir; Don Clark, news dir & chief engr.

Gonzales

KCTI—Dec 17, 1947: 1450 kHz; 250 w. Box 158 (78629). (512) 672-3631. Gonzales Bcstg Co. Format: Diversified. Spec prog: Sp 6 hrs, black 2½ hrs, farm 12 hrs, Czech 17 hrs wkly. ■ Lawrence M. Walshak, gen & coml mgr; Frank Wilson Jr., prog dir & chief engr; Frank Sievers, news dir. ■ Rates: \$2.25; 2.25; 2.25; 2.25.

Graham

KSWA—1948: 1330 kHz; 500 w-D. Box 1050

(76046). (817) 549-1330. KSWA Inc. (acq 12-7-67). Net: Texas State. Rep: Riley. Format: C&W. ■ James M. Jones, gen mgr & chief engr. ■ Rates: \$3.80; 3.80; 3.80; —.

KWKQ(FM)—Co-owned with KSWA. August 1975: 107.1 mhz; 3 kw. Ant 100 ft. Stereo. Prog sep from AM. Format: Btlf mus. ■ Rates same as AM.

Grand Prairie

KKDA—Aug 1, 1957: 730 kHz; 500 w-D, DA. Box 707, Dallas (75050). (214) 264-2304. Republic Broadcasting Corp. (acq 8-12-68). Net: ABC. Rep: Torbet. Format: C&W. ■ Irene B. Runnels, gen mgr; Tony Lawrence, prog dir; Bruce Hughes, news dir; Russell Richardson, chief engr.

Greenville

KGVL—March 26, 1946: 1400 kHz; 1 kw-D, 250 w-N. Box 1015 (75401). (214) 455-1400. Radio Station KGVL Inc. (acq 9-55). Net: Texas State. Rep: Savalli/Gates. Format: MOR day, top 40 night. Spec prog: Black 2 hrs wkly. ■ Leo Hackney, pres, gen & coml mgr; J. P. Kimzey, prom mgr; Wes Marshall, mus dir; Barbara Smith, news dir; Jim Brashears, chief engr.

Hamilton

KCLW—May 22, 1948: 900 kHz; 250 w-D. Box 592 (76531). (817) 386-5259. McClarin Bcstg. (acq 6-1-72). Net: Texas State. Format: C&W. ■ George McClarin, pres & chief engr; Bill Edgar, gen mgr & coml mgr, prog & news dir; Bobby Swinson, mus dir.

Harlingen

KELT(FM)—Listing follows KGBT.

KGBT—1941: 1530 kHz; 50 kw-D (DA-CH), 10 kw-N, DA-N. Drawer 711 (78550). (512) 423-3910. TWX 512-423-8990. Harbenito Radio Corp. Rep: Savalli/Gates. Format: Spanish. ■ McHenry T. Tichenor, pres; Carlos A. Cantu, VP/gen mgr; Tony Solis, asst VP & coml mgr; Rogelio Botello Rios, prog dir; Efre Palacios, news dir; Alex Giese, chief engr. ■ Rates: \$20; 20; 20; 20.

KELT(FM)—Co-owned with KGBT. January 1960: 94.5 mhz; 100 kw. Ant 730 ft. Prog sep from AM. Format: Contemp. ■ David Lykes, gen mgr; Bill Walters, stn mgr; Larry James, opns mgr; Jim Mattison, chief engr. ■ Rates: \$8; 8; 8; 8. ■ KGBT-TV affil.

KMBS(FM)—June 1975: 96.1 mhz; 100 kw. Ant 565 ft. 302 W. Adams (77550). (512) 423-3211. Magic Valley Bcstg Inc. Rep: PRO/Meeker. Format: MOR. ■ Patrick C. McBride, pres; Hector Garcia, prog dir; Pete Paligonia, chief engr. ■ Rates: \$8.50; 7; 8.50; 6.50.

Henderson

KGRI—September 1947: 1000 kHz; 250 w-D. Box 311 (75652). (214) 657-4528. George A. Freeman (acq 1974). Format: C&W.

KGRI-FM—Aug 1, 1965: 100.1 mhz; 3 kw. Ant 200 ft. Prog sep from AM.

KWRD—March 1956: 1470 kHz; 500 w-D. Box 219 (75652). (214) 657-2324. Wes Dean & Associates. Rep: Cowart. Format: MOR. ■ Helen Dean, gen & coml mgr & prog dir; Ken Hale, news dir; Lynn Roy, chief engr.

Hereford

KPAN—August 1948: 860 kHz; 250 w-D. Drawer 1757 (79045). (806) 364-1860. KPAN Bcstrs. Group owner: Forby Stns. Net: TSN. Format: MOR. Spec prog: Sp 18 hrs wkly. ■ Clint Forby, pres & gen mgr; Buddy Peeler, stn mgr; Jim Tucker, coml mgr; Tom Simmons, prom mgr; Hank Hardisty, prog dir; Mike Pennington, mus dir; Mike Aipperspach, news dir; Larry Wornock, chief engr. ■ Rates: \$4.50; 3.50; 3.50; 3.50.

KPAN-FM—Sept 1, 1965: 106.3 mhz; 2.85 kw. Ant 250 ft. Dup AM 100% until 7 pm. ■ Rates same as AM.

Highland Park

KVIL—March 1, 1960: 1150 kHz; 1 kw-D, DA. 300 Park Cities Bank Bldg., Dallas (75205). (214) 526-8666. Fairbanks Bcstg Co. of Texas. (group owner; acq 7-1-73). Net: ABC/C. Audio news: APR.

Rep: Buckley. Format: Contemp. MOR. Spec prog: Sp 1 hr wkly. ■ Richard M. Fairbanks, pres; James C. Hilliard, exec VP; David Spence, gen mgr; Ron Chapman, prog dir; Jerry Bobo, coml mgr.

KVIL-FM—Aug 14, 1961: 103.7 mhz; 100 kw. Ant 1,570 ft. Stereo. Dup AM 50%.

Hillsboro

KHBR—May 21, 1948: 1560 kHz; 250 w-D. Box 569 (76645). (817) 582-3431. KHBR Radio Inc. (acq 1955). Net: Texas State. Rep: Messina. Format: Contemp, C&W, MOR, Top 40. Spec prog: Czech 2 hrs wkly. ■ Nelson W. Galle, pres; Rick Bailey, gen & prom mgr & prog dir; J. K. Lane Jr., VP; John Coleman, mus & news dir; Jim Levines, chief engr.

KHBR-FM—October 20, 1959: 102.5 mhz; 3.2 kw. Ant 155 ft. Dups AM 50%. Format: Big bands.

Hondo

KRME—Feb 13, 1970: 1460 kHz; 500 w-D. Box 447 (78861). (512) 426-3367. Radio Medina Inc. Rep: Keystone; Messina. Format: C&W, Sp. ■ William E. Berger, pres; James V. Fridle, VP & gen mgr; Ron Powers, coml mgr; Armondo Gonzalez, Spanish prog; George I. Gooding, chief engr.

Houston

KAUM(FM)—Listing follows KXYZ.

KCOH—1948: 1430 kHz; 1 kw-D. 5011 Almeda (77004). (713) 522-1001. Call of Houston Inc. Net: Mutual Black. Rep: Savalli-Gates. Format: R&B & Black. ■ Spec prog: Jazz 2½ hrs wkly. ■ Dorothy G. Meeker, pres; Mike Petrizzo, VP & gen mgr; Martin P. Russo, gen sls mgr; Wash Allen, prog dir & prom mgr; Travis O. Gardner, mus dir; Ken Brantley, news dir; Joe Morgan, chief engr. ■ Rates: \$30; 22; 20; —.

KENR

Modern Country

KENR—Jan 17, 1968: 1070 kHz; 10 kw-D, 5 kw-N, DA-2. 2 Greenway Plaza East (77046). (713) 621-1550. Lake Huron Bcstg Corp. Audio news: APR. Rep: Metro Radio Sis. Format: Modern country. Spec prog: Farm 2½ hrs wkly. ■ William J. Edwards, pres; Robert M. Chandler, VP & gen mgr; Ric Libby, opns mgr; Bruce Nelson, mus dir; Frank Boardman, news dir; Benjamin W. Walker, chief engr. ■ Rates: \$58; 48; 58; 48.

KEYH

All News

KEYH—1974: 850 kHz; 10 kw-D, DA. 3130 Southwest Freeway, Suite 501 (77006). (713) 527-9363. Artile Bcstg Co. Rep: Masla. Net: MBS. Audio news: APR, UPI. Format: All news. ■ Richard Albitz, pres; Tom L. Peryman, gen & coml mgr; Bruce Dadd, news dir; David Armstrong, chief engr. ■ Rates: \$25; 17; 25; —.

KFMK(FM)—January 1958: 97.9 mhz; 18 kw. Ant 235 ft. (CP: 100 kw. Ant 440 ft). Stereo. 1900 Medical Towers Bldg. (77025). (713) 523-3217. Liberty Communication Corp. (acq 8-67). Group owner: Crawford Bcstg. Format: Gospel. ■ Donald B. Crawford, pres; David Thomson, gen mgr; Curry Juneau, stn mgr; Harold Jones, chief engr.

KHCB-FM—March 10, 1962: 105.7 mhz; 100 kw. Ant 370 ft. Box 45345 (77045). (713) 433-4533. Houston Christian Bcstrs Inc. Format: Relig. Spec prog: Sp 8 hrs wkly. ■ Peter S. Steigerwald, pres & gen mgr; Rex E. Sanders, chief engr.

KIKK—See Pasadena.

KIKK-FM—Oct 4, 1959: 95.7 mhz; 48 kw. Ant 790 ft. Box 1152, Pasadena (77501). (713) 473-4433. KIKK Inc. (acq 2-1-73). Group owner: Sponderling Bcstg. Rep: Buckley. Format: C&W.

KILT—1948: 810 kHz; 5 kw-U, DA-2. 500 Lovett Bldg. (77006). (713) 526-3461. Lin-Texas Bcstg (acq 4-15-68). Group owner: Lin Bcstg. Format: Contemp, top 40. ■ Dickie Rosenfeld, pres & gen mgr; Harry Rogers, coml mgr; Bill Young, prog dir; Jim Carola, news dir; Glenn Cook, chief engr.

KILT-FM—1961; 100.3 mhz; 97 kw. Ant 790 ft. Stereo. Progs sep from AM.

KLEF Savalli/Gates, Inc.

KLEF(FM)—Nov 1, 1964; 94.5 mhz; 100 kw. Ant 590 ft. 1401 S Post Oak Rd. (77027). (713) 622-5533. Entertainment Communications (group owner; acq 6-5-69). Rep: Savalli-Gates. Format: Classical. ■ Joseph M. Field, pres; William B. Berkey, VP & gen mgr; Mark Fowler, prog dir; R. J. Keefe, mus dir; Paul Dudeck, chief engr. ■ Rates: \$16; 18; 18.

KLOL(FM)—Listing follows KTRH.

KLVL—See Pasadena.

KLYX(FM)—See Clear Lake City.

KNUZ—Feb 18, 1948; 1230 khz; 1 kw-D, 250 w-N. Box 188 (77001). (713) 523-2581. TWX 910-881-2606. Texas Coast Bcstrs Inc. (group owner). Rep: Katz. Format: C&W. ■ David H. Morris, pres & gen mgr; Forrest H. Patton, coml mgr; Larry Vance, prom mgr; Arch Yancey, prog dir; Buddy Covington, mus dir; Jack Pieper, news dir; Johnny Walker, chief engr. ■ Rates: \$48; 43; 38.

KQUE(FM)—Co-owned with KNUZ. Oct 4, 1960; 102.9 mhz; 280 kw. Ant 540 ft. Stereo. TWX: 713-571-2231. Prog sep from AM. Audio news: APR. Format: MOR. ■ Webb Hunt, prog dir; Ken Grant, mus dir. ■ Rates: \$34; 30; 34; 26.

KODA—July 31, 1961; 1010 khz; 5 kw-D, DA. 4808 San Felipe Rd. (77027). (713) 622-1010. Taft Bcstg Co. Net: MBS. Rep: Selcom. Format: MOR. ■ Paul E. Taft, pres; B. Thomas Hoyt, gen mgr; Jason Williams, ops mgr; Boyd Elton, news dir; Wes Whiddon, chief engr.

KODA-FM—Nov 9, 1958; 99.1 mhz; 97 kw. Ant 790 ft. Stereo. Prog sep from AM. Format: Beautiful mus.

***KPFT(FM)**—March 1970; 90.1 mhz; 49 kw. (CP: 97 kw). Ant 440 ft. 419 Lovett Blvd. (77006). (713) 224-4000. Pacifica Foundation Inc. (group owner). Net: NPR. Format: Progs, black. Spec prog: Ger 4 hr, Sp ½ hr, C&W 10 hrs wkly. ■ Ed Goodman, pres; Thorne Dreyer, gen mgr; Ms. Pat Fauchaux, dev dir; Patricia Smith, prom dir; Bruce Litvin, traffic & ops dir; Thom Clark, mus dir; Tom Curtis, news dir; Joe Bleakie, chief engr.

KPRC—May 9, 1925; 950 khz; 5 kw-U, DA-N. Box 2222 (77001). (713) 771-4631. KPRC Radio Co. Net: NBC. Rep: CBS Radio Spot Sls. Format: MOR. ■ Jack Harris, pres & gen mgr; Cleve Griffin, mgr; George Stokes, coml mgr; Jack London, prog dir; Kirt Harris, prom mgr; Marie Lantrip, mus dir; Don Watson, news dir; O. B. Johnson, chief engr. ■ KPRC-TV affil.

KQUE(FM)—Listing follows KNUZ.

KRBE(FM)—Nov 8, 1959; 104.1 mhz; 96 kw. Ant 790 ft. Stereo. 8208 Westpark Dr., Suite 200 (77042). (713) 781-6111. GCC Communications of Houston (group owner; acq 1975). Rep: Century Natl Sls. Format: Contemp, top 40. ■ William J. Edwards, pres; Ed Shane, prog dir; Mike Martin, news dir; Jack Richardson, chief engr.

KRLY(FM)—Jan 1, 1964; 93.7 mhz; 97 kw. Ant 790 ft. Stereo. 3935 Westheimer, Suite 94 (77027). (713) 626-8130. Zantano Communications Corp. (acq 7-6-61). Net: Texas State. Rep: CBS/FM Sls. Format: Contemp, top 40. ■ Robert S. Anderson Sr., pres & gen mgr; Ronald A. Neel, local sales mgr; Ron Foster, prom mgr; Ray Cooper, prog dir; William E. Cordell, chief engr.

KTRH—March 29, 1930; 740 khz; 50 kw-U, DA-2. Box 1520 (77006). (713) 526-4591. Rusk Corp. (acq 11-30-65). Net: CBS, MBS. Rep: Christal. Format: Talk, spts. Spec prog: Farm 12 hrs, hunting/fishing 14 hrs wkly. ■ John T. Jones Jr., pres; Frank Stewart, gen mgr; E.V. Fritsch, coml mgr; Dorothy Shelley, prom mgr; Hal Kemp, stn mgr; Ben Baldwin, news dir; Lester A. Mullan, chief engr. ■ Rates: \$62; 38; 44; 29.

KLLOL(FM)—Co-owned with KTRH. 1947; 101.1 mhz; 97 kw. Ant 790 ft. Stereo. Progs sep from AM. Format: Progs. ■ Jerry Lee, stn mgr; Jim Hilty, prog dir; Jackie McCauley, mus dir; Bob Wright, news dir. ■ Rates: \$24; 24; 30; 30.

***KTRU(FM)**—May 20, 1971; 91.7 mhz; 340 w. Ant 155 ft. Stereo. Rice Memorial Centre, Rice University (77001). (713) 527-4088. William Marsh Rice University. Net: MBS, Texas State. Format: Progs, classical, jazz, educ. ■ Philip Walters, gen mgr; Charles Burnett, spec prog dir; Barbie Siever, prog dir; Dave Horanson, mus dir; Ronny Newmar, annr dir; Peter Camp, news dir.

***KTSU(FM)**—Oct 1, 1973; 90.9 mhz; 10 w. 3201 Wheeler Ave. (77004). (713) 527-7175. Texas Southern U. Net: NPR, Natl Black, Longhorn Radio. Format: Black, progressive, talk, variety. ■ Granville Sawyer, pres; Ms. Valita F. Waits, gen mgr.

***KUHJ(FM)**—Nov 6, 1950; 88.7 mhz; 12 kw. (CP 20 kw). Ant 110 ft. 3801 Cullen Blvd. (77004). (713) 749-1100. U. of Houston. Net: MBS, Mutual Black. Format: Diversified. Spec prog: Greek ½ hr, Arabic ½ hr wkly. ■ Philip G. Hoffman, pres; Arvil Cochran, stn mgr; ■ *KUHT(TV) affil.

KULF—Oct 16, 1944; 790 khz; 5 kw-U, DA-2. 2100 Travis St. (77002). (713) 224-7900. Southern Bcstg Co. (group owner; acq 3-14-61). Rep: Eastman. Format: MOR. ■ John G. Johnson, pres; William R. Bosse, VP & gen mgr; Bill Wamsley, prog dir; Jim Heath, mus dir; Dan Ammerman, news dir; Norman Sartain, chief engr. ■ Rates: \$78; 58.50; 70.50; 28.50.

KXYZ—1930; 1320 khz; 5 kw-U, DA-N. 1602 Fannin Bank Bldg. (77025). (713) 795-4820. KXYZ Inc. (acq 7-15-68). Group owner: ABC. Net: ABC/E. Rep: McGavren-Guild. Format: Adult contemp. ■ Ronald L. Sack, VP & gen mgr; John Hare, gen sales mgr; Thomas Wright, news dir; John Foote, chief engr.

KAUM(FM)—Co-owned with KXYZ. 1960; 96.5 mhz; 100 kw. Ant 580 ft. Stereo. Prog sep from AM. (713) 795-4770. Net: ABC/FM. Rep: ABC/FM Spot Sls. Format: Rock. ■ James E. Hankins, gen mgr; Ted Holcolm, sls mgr; Bruce Johnson, prog dir.

KYND(FM)—See Pasadena.

KYOK—1947; 1590 khz; 5 kw-U, DA-N. Box 8218 (77004). (713) 526-7131. Starr Broadcasting Co. (group owner; acq 6-6-69). Net: ABC/C, Natl Black. Rep: Torbet. Format: Black. ■ Peter H. Starr, pres; Edward S. Howard, gen mgr; Martin Russo, coml mgr; Rick Roberts, prog dir; George Frazier, mus dir; James White, news dir; Don Nash, chief engr.

Huntsville

KSAM—Nov 3, 1938; 1490 khz; 1 kw-D, 250 w-N. Box 312 (77340). (713) 295-2651. Huntsville Bcstg Co. (acq 1974). Net: Texas State. Rep: Racey, Keystone. Format: C&W, rock. Spec prog: Black 3½ hrs wkly. ■ Jack Nichols, gen mgr, prog dir & chief engr; Douglas M. Millins, coml mgr; I. J. Waldon, news dir; Ron Edwards, sports dir.

KSAM-FM—Aug 1, 1965; 101.7 mhz; 710 w. Ant 430 ft. Prog sep from AM.

***KSHU(FM)**—1973; 89.3 mhz; 10 w. Ant 217 ft. Dept of Speech & Drama, Sam Houston Univ. (77340). (713) 295-0481. Sam Houston State U. Format: Diversified. ■ Dr. Robert E. Summers, dir of bcstg; John Scogin, chief engr.

Jacksonville

KEBE—Jan 12, 1947; 1400 khz; 1 kw-D, 250 w-N. Box 1648 (75766). (214) 586-2211. Waller Bcstg Inc. (acq 11-25-58). Net: ABC/E. Rep: Messina. Format: Contemp. ■ Dudley Walker, pres & gen mgr; Merv Dawson, coml mgr; Tom Metzger, ops mgr; Max Stevens, prom mgr; David Higginbotham, chief engr.

KOOI(FM)—Co-owned with KEBE. Sept 9, 1967; 106.5 mhz; 100 kw. Ant 640 ft. Stereo. Progs sep from AM.

Jasper

KTXJ—Aug 6, 1948; 1350 khz; 1 kw-D. Box 6090 (75951). (713) 384-2544. Jasper Bcstg Service (acq 7-13-71). Audio news: UPI. Rep: Riley. Format: C&W. ■ Thomas H. Spurlock, mng plnr & gen mgr; Art Lay, coml mgr; Ken Poston, news & prog dir; Allen Thompson, chief engr. ■ Rates: \$3; 3; 3; 3.

KTXJ-FM—November 1964; 102.3 mhz; 2.9 kw. Ant 140 ft. Prog dups AM 20%. Format: MOR, top 40. ■ Rates same as AM.

Texas Radio

See page C-1 for explanation of listings.

Junction

KMBL—1953; 1450 khz; 1 kw-D, 250 w-N. 214 Pecan St. Box 206 (76849). (915) 446-3371. Heart-of-the-Hills Communications Corp. (acq 5-10-74). Rep: Messina. Format: Block, C&W. Spec prog: Ger 12 hrs, Sp 4 hrs, big bands 10 hrs, classical 5 hrs wkly. ■ Curtis C. Short Jr., pres, gen mgr, prog & news dir; John C. Parker, coml mgr; Dean LaRue Haley, prom mgr; Jimmy Modgling, mus dir; Grant H. Sittler, chief engr.

Keene

***KSUC(FM)**—June 13, 1974; 88.3 mhz; 1.85 kw. Ant 235 ft. Southwestern Union College (76059). (817) 645-3921. Southwestern Union College. Format: Inspirational. ■ Donald R. McAdams, pres; Robert R. Mendenhall, gen mgr; Michael Wiist, prog dir; L. Sheree Parris, stn prom; Kit Curl, news dir; David Chapline, chief engr.

Kenedy-Karnes

KAML—November 1954; 990 khz; 250 w-D. Box 990 (78119). (512) 583-2990. Nine-Ninety Co. (acq 2-15-71). Format: Diversified. Spec prog: Farm 10 hrs wkly. ■ Dayton Smith, pres, gen mgr & chief engr; Jack Ferguson, prog dir. ■ Rates: \$3.70; 3.70; 3.70; 3.70.

Kermit

KERB—June 1950; 600 khz; 1 kw-D. DA. Drawer X (79745). (915) 586-3481. KERB Broadcasting Inc. (acq 10-1-68). Net: Keystone, Texas State. Rep: Messina. Format: C&W. ■ Floyd Shelton, pres; Ken Welch, gen mgr; Jean Welch, prog dir; Bob Jones, news dir; Doug Welch, chief engr. ■ Rates: \$3; 3; 3; 3.

Kerrville

KERV—Nov 5, 1948; 1230 khz; 1 kw-D, 250 w-N. Box 2187 (78028). (512) 257-8200. KGKL Inc. (acq 1973). Audio news: APR. Format: MOR. Spec prog: Farm 1 hr, classcl 2 hrs wkly. ■ Leroy J. Gloger, pres; Bill J. Vance, gen mgr; Ken Jumper, prog dir; Dave Garrett, news dir; Dan Walther, chief engr. ■ Rates: \$78; 60; 78; 60.

KPFM(FM)—Co-owned with KERV. Sept 12, 1975; 94.3 mhz; 3 kw. Ant 105 ft. Stereo. Leroy J. Gloger. Prog sep from AM. Format: C&W.

Kilgore

KOCA—Dec 23, 1936; 1240 khz; 1 kw-D, 250 w-N. Box 192 (75662). (214) 984-2001. Radio Kilgore Inc. (acq 4-20-73). Audio news: APR. Rep: Melville. Format: MOR. Spec prog: Farm 1 hr, black 5 hrs wkly. ■ Douglas B. Humble, pres; John Logan, gen mgr; Jim Hodo, mus dir & prom mgr; Mike Crowell, news dir; Karem O. Soule, chief engr. ■ Rates: \$4.20; 4.20; 4.20; 4.20.

Killeen

KIXS—July 4, 1955; 1050 mhz; 250 w-D. Box 880 (76541). (817) 634-3181. Accnt Radio Corp. (acq 5-1-73). Net: Texas State. Format: Top 40. ■ Ken Williams, pres & gen mgr; Rick Archer, VP, sls mgr; Bill Hilton, prog dir; Michael Anthony, mus dir; Troy Deneke, news dir; Bob White, chief engr. ■ Rates: \$11; 8; 6.50; 6.50.

KIXS-FM—Aug 1, 1961; 93.3 mhz; 760 w. Ant 185 ft. (CP: 2.3 kw; 175 ft). Stereo. Prog dups AM 97%. ■ Rates same as AM.

***KNCT-FM**—Nov 23, 1970; 91.3 mhz; 50 kw. Ant 1,170 ft. Central Texas College, Highway 190 West (76541). (817) 526-1268. Central Texas College. Net: NPR. Format: MOR, public. Spec prog: Farm ½ hr, black ½ hr, Sp ½ hr, nostalgia 5 hrs wkly. ■ Dr. Luis M. Morton Jr., pres; Richard D. Wilson, gen mgr; Edward B. Jasuta Jr., stn mgr; Steve A. Hanik, prog dir; Mona Lane, prom mgr; Gene Stephens, news dir; Lee Roy Franklin, chief engr.

Kingsville

KINE—Nov 1948; 1330 khz; 1 kw-D. Box 846

Texas Radio

See page C-1 for explanation of listings.

(78363). (512) 592-5211. Radio Station KINE Inc. (acq 1950). Net: TSN. Format: Sp, C&W. ■ J. H. Clement, pres; Andy Cook, gen mgr; Glen Barber, coml mgr; Bill Vessey, mus dir; Lynn Blackburn, news dir; R. T. Whitaker, chief engr. ■ Rates: \$4.50; 4.50; 4.50.

KPUP(FM)—Co-owned with KINE. May 2, 1970: 97.7 mhz; 3 kw. Ant 130 ft. Stereo. Prog sep from AM. Format: MOR. ■ Rates same as AM.

***KTAI(FM)**—Feb 20, 1970: 91.9 mhz; 10 w. Box 2271 (78363). (512) 595-3402. Texas A&I University. Format: Progrs. Spec prog: Sp ½ hr wkly. ■ Stephen Hofer, stn mgr; Delbert Seese, chief engr.

La Grange

KVLG—June 27, 1959: 1570 khz; 250 w-D, DA. Drawer K (78945). (713) 968-3173. Lloyd E. Kolbe (acq 3-1-68). Format: C&W. Spec prog: Czech-German 8 hrs wkly. ■ Lloyd E. Kolbe, gen mgr; Glenn Gaertner, coml mgr & chief engr; David Pringle, prog dir; Joyce Kolbe, mus dir; Don Chovanec, news dir.

KVLG-FM—Dec 21, 1970: 104.9 mhz. 3 kw. Ant 205 ft. Dups AM 20%. Format: MOR.

Lake Jackson

KBRZ—See Freeport.

KGOL(FM)—Co-owned with KBRZ. April 1963: 107.3 mhz; 28 kw. Ant 180 ft. Box AA, Freeport (77541). (713) 265-4291. Coastal Bcstg Inc. (acq 1974). Rep: Messina. Format: Easy lstdg day, C&W night.

Lamesa

KPET—May 21, 1947: 690 khz; 250 w-U, Box 30 (79331). (915) 872-2404. KPET Radio Inc. (acq 1974). Net: Texas State. Rep: Melville, Bernard. Format: C&W. Spec prog: Sp 10½ hrs wkly.

Lampasas

KCYL—1948: 1450 khz; 1 kw-D, 250 w-N. Drawer 886 (78550). (512) 556-3671. Lampasas Bcstg Co. (acq 5-28-74). Net: MBS. Rep: Riley. Format: C&W. Spec prog: Sp 3 hrs wkly. ■ Stephen S. Sampson, pres & gen mgr; Jeanine Curtis, coml mgr; Suzanne Parsons, prom mgr; Don Studebaker, prog dir; John R. Clemmetsen, news dir; Scott Witcher Jr., chief engr. ■ Rates: \$4.50; 4; 4.50; 4.

Laredo

KLAR—August 1961: 1300 khz; 1 kw-D, 500 w-N. Box 1899 (78040). (512) 723-7459. Radio Laredo Inc. (acq 5-1-71). Rep: Young, Melville (Dallas). Format: Contemp. ■ John H. Hicks, pres; Tommy Thompson, gen mgr; Harold Ellington, coml mgr; Jay Dickey, prog dir; Lou Asher, prom mgr; Roberto Gutierrez, news dir; Aaron Brown, chief engr.

KVOZ—April 15, 1952: 1490 khz; 1 kw-D, 250 w-N. Box 1638 (78040). (512) 723-4396. Border Bcstns Inc. Net: TSN. Rep: UBC, Messina. Format: MOR, Spanish. Spec prog: Talk 5 hrs wkly. ■ E. J. Harpole, chmn of bd; Bill Harrel, pres; Mike Rooney, stn mgr; Doug Stalker, coml mgr & spts dir; Tom Piper, prog dir; John Lawson, news dir; John Tucker, chief engr. ■ Rates: \$7; 5.50; 7; 5.50.

KOYE(FM)—Co-owned with KVOZ. Feb 2, 1972: 94.9 mhz; 100 kw. Ant 950 Box 1731 (78040). (512) 723-4398. ■ Ervin Parks, stn mgr; Tom Herring Jr., prog dir; Thomas Mitchell, sales mgr. ■ Rates: \$5; 5; 5; 5.

Levelland

KLVT—August 1949: 1230 khz; 1 kw-D, 250 w-N. Box 1230. (805) 894-3134. KLVT Radio. Group owner: Formby Stns. Net: TSN. Format: MOR. Spec prog: Sp 15 hrs, Fr 9 hrs, C&W 9 hrs wkly. ■ Clint Formby, pres; Gene Stanley, gen mgr & chief engr; Terry Isaacs, prog dir; Del Kirby, news dir.

Liberty

KPXE—Dec 21, 1968: 1050 khz; 250 w-D, DA. 1211

N. Main (77575). (713) 336-5793. Dorsey Eugene Newman (acq 8-73). Net: ABC/C. Rep: Messina. Format: MOR. Spec prog: Black 3 hrs wkly. ■ Gene Newman, pres; Frank Johnson, opns mgr.

Littlefield

KZZN—1947: 1490 khz; 1 kw-D, 250 w-N. Box 192 (79339). (806) 385-4474. Littlefield Bcstg Co. (acq 1974). Net: TSN. ■ Jim Vandenberg, mgr.

Livingston

KETX—June 28, 1957: 1440 khz; 5 kw-D. Box 111 (77351). (713) 327-8916. Polk County Bcstg Co. Net: TSN. Format: Mod C&W. ■ Harold J. Haley, pres & gen mgr.

KETX-FM—Sept 1, 1970: 92.1 mhz; 1.85 kw. Ant 370 ft. Dups AM 100%.

Lockhart

KCLT—Feb 1, 1967: 1060 khz; 250 w-D, DA. Box 240 (78644). (512) 398-5232. Radio Caldwell County Inc. (acq 9-28-73). Net: Texas State. Format: C&W, MOR. Spec prog: Sp 6 hrs wkly. ■ L. M. Preuss III, pres; W. R. Buchanan, VP & gen mgr; Emit Huntsman, prog dir; Steve Lewis, news dir. ■ Rates: \$4.37; 4.37; 4.37; —.

Longview

KFR0—1935: 1370 khz; 1 kw-U, DA-N. Curtis Bldg., Box 792 (75601). (214) 753-4461. Voice of Longview Inc. Net: ABC/E. Continental. Rep: Messina. Format: Top 40, diversified, jazz. Spec prog: Black 1 hr, farm 1 hr, classical 1 hr, C&W 10 hrs wkly. ■ James R. Curtis Sr., pres & mus dir; T. R. Putman, coml mgr; M. H. Bair, prog dir; James R. Curtis Jr., prom mgr & news dir; Irene Shirley, sec treas; L. George, chief engr.

KLUE

Adult Contemporary

KLUE—1948: 1280 khz; 1 kw-D. Box 7100 (75601). (214) 757-2020. Radio Longview Inc. (acq 9-59). Net: Texas State. Rep: Masia, Riley. Format: MOR. Spec prog: Black 19 hrs wkly. ■ H. A. Bridge Jr., pres & gen mgr; Lowell Wolfe, coml mgr; Glenn Ivey, prog dir & chief engr; Jean Brooks, prom mgr; John McCarty, mus dir; Charles Palmer, news dir. ■ Rates: \$4.75; 4.25; 4.75; 4.25.

KYKX(FM)—March 3, 1963: 105.7 mhz; 100 kw. Ant 260 ft. Stereo. Box 8389 (75601). (214) 757-2662. 105 Inc. (acq 7-1-74). Rep: Miller. Format: C&W. ■ Dick Osburn, pres; Rusty Reynolds, VP & gen mgr; Larry Wilson, prog dir; Gary Koefler, coml mgr; Karen Rector, prom mgr; Steve Bridges, chief engr. ■ Rates: \$6.50; 5.25; 6.50; 5.25.

Lubbock

KDAV—Sept 19, 1953: 580 khz; 500 w-D, DA. Box 6070 (79413). (806) 745-4500. Western Bcstg Co. (acq 5-1-66). Group owner: Pinkston Stns. Net: ABC/E. Rep: Avery-Knodel, Walton. Format: C&W. ■ D.P. Pinkston & Robert Clark, owners; Bob Clark, gen coml mgr; Jim Spann, prog dir; Ralph Newton, mus dir; Jim Roberts, news dir; Joe Brown, farm & ranch dir; James Lotspeich, chief engr. ■ Rates: \$10; 9; 10; 9.

KEND—May 14, 1947: 1590 khz; 1 kw-U, DA-2. 2112 Broadway (79401). (806) 747-0101. The End Corp. (acq 6-17-71). Net: NBC. Rep: Messina. Format: Contemp. ■ Lew Delia, pres, gen & prom mgr; Paul Beane, news dir; George Birdsong, chief engr.

KFY0—September 6, 1927: 790 khz; 5 kw-D, 1 kw-N, DA-2. Box 10527 (79408). (806) 765-5567. KFY0 Inc. (acq 4-8-36). Net: CBS. Rep: Torbet. Format: MOR. ■ Eva Metcalf, pres; Gordon Thompson, gen mgr; Jack Dale, coml mgr; Bob Nash, prog dir & prom mgr; Max Mott, news dir; Roger Hively, chief engr. ■ Rates: \$12; 18; 12; 8.

KLBK—Jan 1, 1955: 1340 khz; 1 kw-D, 250 w-N. Box 1559 (79408). (806) 745-2345. Grayson Enterprises Inc. (group owner; acq 11-1-61). Net: ABC/C. Rep: HR/Stone. Format: Contemp. ■ Theodore Shanbaum, pres; Chuck Spough, gen mgr; Curt Lancaster, coml mgr; Bryan King, prom mgr; Kevin Stone, prog dir; Jerry Browning, mus dir; Tom Allen, news dir.

KLBK-FM—Aug 1, 1966: 94.5 mhz; 100 kw. Ant 680

ft. Stereo. Prog sep from AM. ■ KLBK-TV affil.

KLFB—Nov 15, 1967: 1420 khz; 500 w-D. Box 5697 (79417). (806) 765-8114. La Fiesta Bcstg Co. Rep: Savalli/Gates. Format: Spanish. ■ John A. Fiache, pres; Gussie McClellan & Marcos A. Garcia, assoc mgr; Marcos A. Garcia, news dir; Roger Hively, chief engr. ■ Rates: \$5; 5; 5; 4.25.

KLLL—April 1953: 1460 khz; 1 kw-D. Box 10327 (79408). (806) 763-1911. Corbin Bcstg Co. (acq 5-1-58). Net: TSN. Rep: Eastman. Format: C&W. ■ Larry W. Corbin, pres, gen & coml mgr; O. G. King, mus dir; Chip Polk, prog dir; Jack McCarty, prom mgr; Jim Bandy, news dir; Robert Purrington, chief engr. ■ Rates: \$12; 10; 12; 4.

KLLL-FM—Oct 12, 1958: 96.3 mhz; 48 kw. Ant 630 ft. Stereo. Dups AM 50%. ■ Rates same as AM.

***KOHM(FM)**—Jan 1973: 91.1 mhz; 340 w. Ant 115 ft. 3211 47th St. (79413). (806) 799-9035. Lubbock Independent School District. Format: Top 40. Spec prog: Fr 1 hr, Ger 1 hr, Sp 1 hr wkly. ■ B. J. Randles, pres; Charles Wilson, gen mgr & chief engr.

KSEL—Nov 1, 1946: 950 khz; 5 kw-D, 500 w-N, DA-2. Box 2805 (79408). (806) 745-2828. TWX 910-896-4557. KSEL Inc. (acq 1975). Group owner: Harris Enterprises. Rep: Eastman. Format: Contemp, top 40, black. Spec prog: Sp 15 hrs wkly. ■ Robert Wells, VP; Chuck Spough, coml mgr; Mike Deardorf, prog & mus dir & prom mgr; Bob Howell, news dir; Bill Baker, chief engr.

KSEL-FM—Nov 1963: 93.7 mhz; 100 kw. Ant 740 ft. Stereo. Prog sep from AM. Format: Progrs.

KTEZ(FM)—1975: 101.1 mhz; 59 kw. Ant 760 ft. Box 3205, Albuquerque, N.M. (87110). Troy Raymond Moran.

***KTXT-FM**—April 1, 1961: 91.9 mhz; 10 w. Box 4080, Texas Tech University (79409). (806) 742-6276. Texas Tech Univ. Net: ABC/FM. Format: Contemp. Spec prog: Black 3 hrs, Sp 4 hrs wkly. ■ Kenneth A. Jarvis, dir of radio. ■ *KTXT-TV affil.

KWGO-FM—July 15, 1964: 99.5 mhz; 44 kw. Ant 740 ft. (CP: 46 kw. Ant 630 ft.). Red Raider Inn, 6025 Avenue A (79404). (806) 747-6942. Clyde R. Stevens & Mexican American Svcs. (acq 7-75). Format: Contemp. ■ Clyde R. Stevens, pres.

Lufkin

KLUF—Dec 5, 1947: 1420 khz; 1 kw-U, DA-N. Box 1866 (75901). (713) 634-7773. Radio Lufkin Inc. (acq 5-23-73). Net: MBS. Rep: Savalli/Gates. Format: MOR, Fr. ■ R. Steven Hicks, pres; H. E. Rowin, gen & coml mgr; Dan Herod, prog dir/prom mgr; Joe Keith, mus dir; Mike Curry, news dir; Maynard Campbell, chief engr.

KLUF-FM—Not on air, target date unknown: 105.1 mhz; 100 kw, Ant 490 ft.

KRBA—May 3, 1938: 1340 khz; 1 kw-D, 250 w-N. Box 1345 (75901). (713) 634-6661. Darrell E. Yates. Net: Texas State. Rep: Cowart. Format: Block, contemp. Spec prog: Sp 1 hr, black 5½ hrs wkly. ■ Darrell E. Yates, owner & gen mgr; Mrs. Shirley Yates, prog dir; Sammie Williams, news dir; E. C. Gresham, chief engr.

Marlin

KAWA—See Waco.

Marshall

KDOX—Oct 7, 1957: 1410 khz; 500 w-D, DA. Box 1326 (75670). (214) 938-5136. Singleton and King Bcstg (acq 1975). Net: ABC/C. Rep: Messina. Format: C&W. Spec prog: Black 2½ hrs wkly. ■ Dean Singleton & Kelly King, owners; Sam Litzenberg, gen mgr; Jim Alexander, coml mgr; Joel T. Wheeler, mus dir; Dan Dillinger, chief engr.

KMHT

Adult Contemporary

KMHT—1947: 1450 khz; 1 kw-D, 250 w-N. Box AA (75670). (214) 938-6789. Radio Marshall Inc. (acq 1955). Net: Texas State. Rep: Masia, Riley. Format: MOR, black. ■ H. A. Bridge Jr., pres & gen mgr; Vinson

L. Stevens, coml mgr; Charlie Fox, prog dir; Peggy Ives, prom mgr; Johnny Rice, mus dir; John Gordon, news dir; Glen Ivey, chief engr. ■ Rates: \$4; 3.75; 4; 3.75.

McAllen

KIRT—See Mission.

KQXX(FM)—Co-owned with KIRT. Oct 4, 1966: 98.5 mhz; 26 kw. Ant 280 ft. Stereo. Box 1806 (78501). (512) 682-3231. Rio Bcstg Co. Rep: Eduardo Cabellero Sp Media, Paul Miller. Format: C&W day, Spanish night. ■ Edward L. Gomez, pres; C. T. (Chuck) McKasson, gen mgr; Roy Martinez, prog dir; Lawson Campbell, chief engr. ■ Rates: \$5.50; 5.50; 5.50; 5.50.

KRIO
Adult Top 40



EASTMAN RADIO, INC.

KRIO—1947: 910 khz; 5 kw-U, DA-2. 500 E. Beaumont (78501). (512) 686-5454. El Rio Bcstg (acq 9-75). Audio news: APR. Rep: Eastman. Format: Top 40. Spec prog: Farm 5 hrs wky. ■ Charles M. Trub, pres & gen mgr; Dave B. Highbaugh, stn mgr; Melvin Bedford, prog dir; Bill Spangler, news dir; Donald McCleary, chief engr. ■ Rates: \$15; 12; 15; 12.

***KVMV-FM**—March 9, 1972: 96.9 mhz; 76 kw. Ant 235 ft. Box 1603 (78501). (512) 787-5947. Rio Grande Family Radio Fellowship Inc. Format: Relg, Sp, variety. ■ John A. Pankratz, pres & chief engr; Thomas Haughey, mus dir.

McKinney

KMMK(FM)—August 1, 1969: 95.3 mhz; 3 kw. Ant 215 ft. Box 446 (75069). (214) 542-1151. Modern Media of McKinney Inc. (acq 1-2-74). Format: MOR. Spec prog: Farm 3 hrs wky. ■ C. R. Graham, pres & gen mgr; Gary Bond, prog & farm dir; Don Faulkner, chief engr. ■ Rates: \$5; 5; 5; 5.

KYAL—Sept 29, 1947: 1600 khz; 5 kw-D, DA. 1310 Ave K, Plano, Tex. (75074). (214) 424-8541. A.H.B. Bcstg Corp. (acq 3-69). Net: TSN. Rep: Messina. Format: C&W. Spec prog: Relig 6 hrs wky. ■ John Pickens, pres; Troy Young, gen mgr; Tom McCall, prog dir; Morgan Choat, chief engr. ■ Rates: \$10.50; 9.50; 10.50; 7.50.

Memphis

KBGH—April 26, 1966: 1130 khz; 1 kw-D, DA. Box 1130 (79245). (806) 259-3511. V. C. Lloyd, R. V. Floyd, Mary A. Brewer. Rep: Messina. ■ John R. Fowler, pres; Jim Markgraf, VP & gen mgr; Arnold Cruze, chief engr.

Merkel

KWFA—June 1, 1963: 1500 khz; 250 w-D. Box 220 (79536). (915) 928-4701. Harold D. Nichols. Format: C&W. Spec prog: Sp 5 hrs wky. ■ Harold D. Nichols, pres; John Curtis, gen mgr; Bill Barnett, prog dir; Don Pugh, mus dir; William H. Miller, chief engr.

Mexia

KBUS—May 21, 1956: 1590 khz; 500 W-D. Box 227 (76667). (817) 562-3874. Limestone Bcstg Inc. (acq 1975). Net: TSN. Format: C&W. Spec prog: Black 6 hrs wky. ■ Sarah Frances Collins, pres; Bill Collins, VP, treas, gen & coml mgr; William F. Collins, chief engr.

Midland

KBAT(FM)—Listing follows KWEL.

KCRS—Dec 20, 1935: 550 khz; 5 kw-D, 1 kw-N, DA-2. Box 4607 (79701). (915) 563-0550. Midland Bcstg Co. (acq 8-1-57). Group owner: Mayes Stn. Rep: Eastman. Format: MOR, top 40. ■ Wendell Mayes Jr., pres; Parker M. Humes, gen mgr; Dick Baze, prog dir; James McWain, chief engr. ■ Rates: \$13; 11; 13; 9.

KJBC—Aug 6, 1950: 1150 khz; 1 kw-D. South Lamesa Rd. (79701). (915) 684-5152. Hugh M. McBeath (acq 7-15-64). Format: C&W. Spec prog: Sp 6 hrs wky. ■ Hugh M. McBeath, gen mgr & chief engr; Keith Ward, prog dir.

KNAM—Nov 27, 1963: 1510 khz; 500 w-D. 2001 West Wall (79701). (915) 683-2828. Green Dolphin Bcstg Corp. (acq 10-1-70). Net: TSN. Rep: PRO/Meeker, Riley. Format: Easy MOR. Spec prog: Sp 6 hrs wky. ■ Max (Howard) Lloyd, pres; Michael Fitzgerald, gen mgr; Wayne Weeks, coml & prom mgr; Mary Lou Cassidy, prog dir; William F. Conner, mus dir; Jim Moore, news dir; Max (Howard) Lloyd, bus mgr & chief engr. ■ Rates: \$9; 6; 8; 6.

KNFM(FM)—Partially co-owned with KNAM. Nov 2, 1959: 92.3 mhz; 100 kw. Ant 390 ft. Stereo. (915) 683-3878. Permian Bcstrs Inc. Prog dups AM 85%. Format: MOR. ■ Michael Fitzgerald, pres. ■ Rates same as AM.

KWEL—April 1957: 1600 khz; 1 kw-D. 401 W. Missouri (79701). (915) 682-4331. KWEL Inc. (acq 5-1-69). Net: ABC/IL. Format: MOR. ■ Bob Hicks, pres & gen mgr; Don Richardson, stn mgr; Paul Boe, mus dir; Jim Stallons, news dir. ■ Rates: \$4.50; 4; 4.50; 4.

KBAT(FM)—Co-owned with KWEL. 1974: 93.3 mhz; 100 kw. Ant 440 ft. Stereo. (915) 563-2121. Format: C&W. ■ Dick Rowland, stn mgr; John Robison, mus dir. ■ Rates: \$6.60; 5.80; 6.60; 5.80.

Mineola

KMOO—Sept 12, 1963: 1510 khz; 250 w-D. Box 499 (75773). (214) 569-3823. A-C Corp. (acq 1-8-68). Net: Texas State. Format: C&W. ■ Sam Curry, pres, gen mgr & news dir; Jeanne Dean, coml mgr; Bill Taylor, prog dir & chief engr; Mike Gunn, mus dir; Monty Montgomery, prom mgr.

Mineral Wells

KMWT(FM)—1970: 95.9 mhz; 3 kw. Ant 295 ft. Box 927 (76067). (817) 325-9509. Triple H Radio Inc. Rep: Miller. ■ E. Hal Hall, pres & gen mgr.

KORC—1946: 1140 khz; 250 w-D. Box 638 (76067). (817) 325-1140. White Fuel Corp. (acq 3-1-73). Net: Texas State. Rep: Messina. Format: C&W. ■ W. Erie White, pres; Roy Floyd, gen mgr; Dale Kincaid, coml mgr; John Polsen, mus dir; Art Von Reyn, news dir. ■ Rates: \$57.60; 50.40; 57.60; —.

Mission

KIRT—Feb 24, 1957: 1580 khz; 1 kw-D. Box 985 (78572). (512) 585-1629. Rio Bcstg Co. (acq 8-1-70). Rep: Spanish Media, Paul Miller. Format: Spanish. ■ Edward L. Gomez, pres; C. T. (Chuck) McKasson, gen mgr; Humberto Pedrazza, prog dir; Lawson Campbell, chief engr. ■ Rates: \$11; 11; 11; 11.

KQXX(FM)—Co-owned with KIRT. See McAllen.

Monahans

KVKM—March 12, 1947: 1330 khz; 5 kw-D, 1 kw-N, DA-N. Box 1058 (79756). (915) 943-3238. Monahans Bcstg Co. (acq 1975). Net: TSN. Rep: Melville. ■ William W. Jamar Jr., owner; Dick Aker, prog dir; Charles Roberts, news dir; David Smoot, chief engr.

Morton

KRAN—Dec 6, 1961: 1280 khz; 500 w-D. Box 1077 (79346). (806) 266-5545. Morton Radio Corp. (acq 1975). Format: C&W, relig. ■ W.J. Duncan, pres, gen, coml & prom mgr; Edward Akin, prog, mus & news dir; Randall Clayton, chief engr.

Mount Pleasant

KIMP—Oct 7, 1948: 960 khz; 1 kw-D. Box 990 (75455). (214) 572-8726. Mt. Pleasant Bcstg Co. Net: TSN. Format: MOR. ■ David H. Ward, pres; Ruby Stanley, stn & coml mgr; Clint Cooper, news dir; Clarence C. Taylor, chief engr.

KPXI(FM)—Co-owned with KIMP. October 1961: 100.7 mhz; 54 kw. Ant 170 ft. Prog sep from AM. Format: Easy Istng.

Muleshoe

KMUL—July 6, 1956: 1380 khz; 1 kw-D. Box 486 (79347). (806) 272-4273. Radio Station KMUL. Format: MOR, Spanish. ■ Leola Randolph, pres; Gilbert Lamb, gen mgr; Eugene Howard, coml mgr, prog dir & chief engr; Gerald Reid, mus dir; Magann Rennels, news dir.

Texas Radio

See page C-1 for explanation of listings.

KMUL-FM—Feb 16, 1966: 103.1 mhz; 2.9 kw. Ant 75 ft. Prog sep from AM.

Nacogdoches

KEEE—March 27, 1947: 1230 khz; 1 kw-D, 250 w-N. Box 1111 (75961). (713) 564-4444. Stone Fort Bcstg Co. (acq 1974). Net: ABC/E. Rep: Groskin; Riley. Format: Contemp. ■ Evelyn Stallings, pres; Dino Summerlin, VP & gen mgr; Bobby Dobbs, prog dir; Ron Minatrea, mus dir; Bob Hill, news dir; Jimmy Rucker, prom mgr; Jim Stallworth, chief engr.

KJCS(FM)—Partially co-owned with KEEE. May 1967: 103.3 mhz; 100 kw. Ant 360 ft. Stereo. (713) 564-4443. Voice of the Lakes Bcstg Inc. Format: Easy Istng. ■ Tony Frank, prog dir.

***KSAU(FM)**—June 5, 1975: 90.1 mhz; 1 kw. Ant 116 ft. Box 3048 (75961). (713) 569-4000. Stephen F. Austin State U. Format: Diversified. Spec prog: Sp 1 hr wky. ■ Dr. Robert T. Ramsey, asst prof; Beverly E. Brock, gen mgr.

KSFA—June 2, 1947: 860 khz; 1 kw-D. Box 848 (75961). (713) 564-3723. Texan Bcstg Inc. (acq 8-1-59). Rep: Messina. Format: Modern C&W. ■ Bob Dunn, gen mgr; Berl Raborn, coml mgr; Barney Varde-man, prom mgr; Royce Luman, prog dir; Carson Baker, mus dir; Johnny Rice, news dir; John Parker, chief engr.

KSFA-FM—July 15, 1967: 92.1 mhz; 1.90 kw. Ant 370 ft. Stereo. Prog sep from AM. Format: Golden rock day, progrsv night. ■ Tom Baker, mgr; Ray Scott, prom mgr; Bob Jefferies, gen mgr; Johnny B. Goode, mus dir; Johnny Rice, news dir.

Navasota

KWBC—Sept 21, 1960: 1550 khz; 250 w-D. Box 715 (77868). (713) 825-6484. Whitten Bcstg Co. Net: TSN. Rep: Riley. Format: MOR. ■ Robert H. Whitten, owner, coml & prom mgr; Pat Craddock, prog & news dir & chief engr.

New Boston

KNBO—Oct 16, 1969: 1530 khz; 1 kw-D. Box 848 (75570). (214) 628-2561. Bowie County Broadcasting Co. Inc. Net: TSN. Rep: Earle Racey Associates. Format: C&W. ■ Richard E. Knox, pres & gen mgr; John Butler, prog dir/mus dir; Bruce Anderson, news dir; George Hammond, chief engr.

KNBO-FM—Not on air, target date unknown: 95.9 mhz; 3 kw. Ant 300 ft.

New Braunfels

KGNB—April 1, 1950: 1420 khz; 1 kw-D. Box 593 (78130). (512) 625-7311. Comal Bcstg Co. Net: Texas State. Rep: Cowart. Format: MOR, talk. Spec prog: Sp 6 hrs wky. ■ C. Herb Scoog, pres & gen mgr; Joe Houde, prog dir; Steve Smith, sls mgr; Bob Friemuth, news dir; Kelcy O'Neil, chief engr. ■ Rates: \$4.70; 4.15; 4.70; 4.15.

KNBT(FM)—Co-owned with KGNB. Nov 22, 1968: 92.1 mhz; 3 kw. Ant 300 ft. Stereo. Prog sep from AM. Format: Btl mus. Spec progs: Ger 4 hrs wky. ■ Rates same as AM.

Odessa

KBSN—See Crane.

KBZB—Jan 29, 1947: 920 khz; 1 kw-D, 500 w-N, DA-N. Box 3509 (79761). (915) 332-5791. Atkins & Green Bcstg (acq 12-1-68). Net: Texas State. Rep: Masla, Riley. Format: Contemp, MOR. ■ Dianne J. Atkins, pres; Jack E. Townzen, gen mgr; Jerry J. Britt, prog dir; Chas. H. Debenport, chief engr.

***KOCV(FM)**—Jan 6, 1964: 91.3 mhz; 5 kw. Ant 255 ft. Box 3752 (79761). (915) 337-5381. Odessa College. ■ Phil Speegle, pres; Wally Jackson, faculty advisor.

KOYL—Sept 7, 1957: 1310 khz; 1 kw-D. 4000 Rasco Ave. (79762). (915) 366-2801. Mid-Cities Bcstg Corp. Net: ABC/E. Rep: Messina. Format: C&W. Spec progs: Black 2 hrs, Sp 1 hr wky. ■ Edward L. Roskelley, pres

Texas Radio

See page C-1 for explanation of listings.

& gen mgr; Thomas J. Roskelly, news dir.

KOYL-FM—April 1, 1966: 97.9 mhz; 34 kw. Ant 100 ft. Dups AM 15%. Net: ABC/C. Format: Contemp.

KOZA—Jan 20, 1947: 1230 khz; 1 kw-D, 250 w-N. Box 351 (79760). (915) 332-4301. Odessa Bcstg Co. Rep: H-R. Format: Top 40, contemp, rock. ■ Steve Trigg, pres; Frank Childs, gen mgr; Jim Simpson, chief engr.

KQIP(FM)—1961: 96.9 mhz; 1.7 kw. Ant 195 ft. Stereo. Suite 1001, ABC Bank Bldg. (79760). (915) 337-6262. Texas Bcstg Industries Inc. Format: MOR. ■ James F. McCubbin, pres; Roy A. Elsner, treas & gen mgr; Mari Nell Lynn, prog dir; Susan Elsner, mus dir; Bill Moseley, prom mgr; David Higgins, news dir. ■ Rates: \$6.75; 6.75; 6.75; 6.75.

KRIG—June 1946: 1410 khz; 1 kw-U, DA-N. Box 4312 (79760). (915) 332-6871. KRIG Inc. (acq 2-24-65). Audio news: UPI. Rep: Savalli-Gates. Format: MOR. Spec prog: Sp 4 hrs wkly. ■ R. D. Brown, pres; Johnny May, gen & coml mgr & prog dir; Tim Roberts, coml mgr; Ron Wood, mus dir; Mark Hanna, news dir; Bob Mettler, chief engr. ■ Rates: \$8.50; 7.50; 8.50; 7.50.

Orange

KIOF(FM)—Not on air, target date unknown: 106.1 mhz; 100 kw. Ant 909 ft. Ken Stevens.

KOBS-FM—June 11, 1972: 104.5 mhz; 55 kw. Ant 215 ft. Rt. 3, Box 483-E (77630). (713) 745-2222. Charles Hubert Kobs. Format: Contemp, rock. ■ Charles Kobs, pres, coml & prom mgr & chief engr; Mrs. Kobs, gen mgr, prog & news dir; Nancy Kobs, mus dir.

KOGT—1947: 1600 khz; 1 kw-U, DA-N. Box 1329 (77630). (713) 883-4381. Sabine Area Bcstg Corp. (acq 10-24-66). Net: ABC/E. Format: C&W. Spec prog: Farm 7½ hrs, Cajun Jr. 3 hrs, gospel 6 hrs wkly. ■ Ed Lovelace, pres; Richard Corder, gen mgr; Don Wriberg, mus dir; Bill Maulsby, news dir; Randy Schell, chief engr. ■ Rates: \$6.50; 5.50; 6.50; 3.70.

Palestine

KLIS(FM)—June 15, 1970: 94.3 mhz; 3 kw. Ant 300 ft. Box 788 (75801). (214) 729-0181. Vista Bcstg Co. Rep: Paul Miller. Format: MOR. Spec prog: Talk 7 hrs wkly. ■ L. D. Harris, pres & gen mgr; Benny Toole, coml mgr; Carole Ann Allen, ofc mgr; Mitch Blackman, prog dir; Bill Henderson & Bob Harrington, mus dir; Marvin Crain, news dir & chief engr.

KNET—Jan 2, 1936: 1450 khz; 1 kw-D, 250 w-N. Box 649 (75801). (214) 729-6077. KNET Inc. (acq 6-1-66). Net: Texas State. Rep: Messina. Format: Contemp, C&W, top 40. Spec prog: Black 1½ hrs wkly. ■ Tolbert Foster, pres; Ben L. Slack, gen mgr; Mike Poarch, prog dir; Jack Beazley, news dir; George Ferrer, chief engr.

Pampa

KGRO—1951: 1230 khz; 1 kw-D, 250 w-N. Box 1779 (79065). (806) 669-6809. Pampa Bcstrs Inc. (acq 8-12-66). Group owner: Jim Hughes Sln. Net: ABC/E, Texas State. Format: MOR, farm. ■ Jim Hughes, pres & chief engr; Darrell Sehorn, coml mgr; Ed Roberts, mus dir; Margaret Winkleman, news dir. ■ Rates: \$3.64; 3.64; 3.64.

KPDN—April 6, 1936: 1340 khz; 1 kw-D, 250 w-N. Hughes Bldg. (79065). (806) 669-7461. Top O'Texas Bcstg Co. (acq 9-52). Net: MBS. Rep: Messina. Format: MOR. Spec prog: Gospel 10 hrs wkly. ■ Warren L. Hasse, owner; Dennis I. Dehn, gen mgr & chief engr; Ray Rodgers, coml mgr; Earl Davis, prog dir; Alan Thompson, mus dir; Alan Griton, news dir. ■ Rates: \$3.25; 3.25; 3.25; 3.25.

Paris

KPLT—Nov 19, 1936: 1490 khz; 1 kw-D, 250 w-N. Box 9 (75460). (214) 784-3311. KPLT Inc. (acq 9-60). Net: Texas State. Rep: Savalli/Gates. Format: Contemp. ■ Jeff Methven, pres, gen mgr & chief engr; Leroy Snow, coml mgr; Mike Rogers, prog dir; Roy Castlebury, mus dir.

KPLT-FM—Aug 14, 1966: 99.3 mhz; 3 kw. Ant 175 ft. Stereo. Prog sep from AM. (214) 784-3313. Format: Contemp. MOR.

KPRE—September 1950: 1250 khz; 500 w-D. 210 First National Bank Bldg. (75460). (214) 784-6676. Lamar County Bcstg Co. (acq 8-58). Rep: Hopewell, Melville. Format: C&W. ■ C. Glyn Lowe, pres; Pee Wee Reid, VP & gen mgr; Stan Abbott, coml mgr; Roy Norman, prog & mus dir; Jerry Barham, news dir; George Fleming, chief engr.

Pasadena

KIKK—October 1957: 650 khz; 250 w-D. Box 1152 (77501). (713) 473-4433. KIKK Inc. (acq 2-73). Group owner: Sonderling Bcstg. Rep: Buckley. Format: C&W.

■ Egmont Sonderling, pres; Al Greenfield, gen mgr; Deane Hardy, coml mgr; Chris Collier, opns mgr; Dianne DeArmond, prom mgr; Joe Ladd, mus dir; Al Sellers, news dir; Grady Moates, chief engr.

KIKK-FM—See Houston.

KLVL—May 5, 1950: 1480 khz; 1 kw-D, 500 w-N, DA-N, 2903 Canal St, Houston (77003). (713) 225-3208. Felix H. Morales. Rep: National Time Sales, Oakes. Format: Spanish. Spec prog: Black 11 hrs wkly. ■ Felix H. Morales, mgr; Johnny P. Hernandez, sis mgr; Joe Morales, prog mgr & news dir; Charles R. Swanson, chief engr.

KYND-FM—August 1962: 92.5 mhz; 97 kw. Ant 800 ft. 1001 E. Southmore (77502). (713) 477-3611. KYND Inc. (acq 6-73). Group owner: Southern Bcstg. Rep: Eastman. Format: Btlf. ■ John G. Johnson, pres; William R. Bosse, VP & gen mgr; Phillip E. McDonald, gen sales mgr; Donald H. Friedrich, local sales mgr; Jim Sharon, opns mgr; Jon Bennett, chief engr. ■ Rates: \$45; 50; 15; 16.

Pearsall

KVWG—Nov 3, 1962: 1280 khz; 500 w-D. Box (78061). (512) 334-2500. Radio Station KVWG. Net: Texas State. Format: C&W, Spanish. ■ R. T. Rose Jr., gen mgr, news dir & chief engr; Ramon R. Montemayor, Jr., prog & mus dir.

Pecos

KIUN—Oct 23, 1935: 1400 khz; 1 kw-D, 250 w-N. Box 469 (79772). (915) 445-2497. KIUN Inc. Net: Texas State. Rep: Hopewell. Format: MOR; variety. Spec prog: Sp 12 hrs, C&W 20 hrs wkly. ■ Bill H. Hubbs, pres & gen mgr; Patricia Lee Hubbs, coml mgr; Phillip George, prog dir; Dale Roger, prom mgr; Larry Boehnemann, chief engr. ■ Rates: \$1.90; 1.90; 1.90; 1.90.

Perryton

KEYE—Nov 19, 1948: 1400 khz; 1 kw-D, 250 w-N. Box 630 (79070). (806) 435-5458. Perryton Radio Inc. (acq 8-69). Net: Texas State. Rep: Riley. Format: MOR. Spec prog: C&W 12 hrs wkly. ■ Jerry Garrison, pres & gen mgr; Meredith McVey, coml mgr; Carol Waggoner, prog dir; Bob Tate, J. R. Collins, chief engr.

Plainview

KKYN—October 1, 1974: 1090 khz; 1 kw-D. Box 147 (79072). (806) 293-2661. Panhandle Bcstg Inc. Net: ABC/I. Rep: Riley. Format: Modern country. Spec prog: Sp 3 hrs, farm 1½ hrs wkly. ■ Ralph Wayne, pres; Bruce H. Campbell, VP & gen mgr; Danny Harp, coml mgr; Barry Miller, treas; Rick Gibson, prog dir; George Owens, pub svc dir; Bill Bruder, news dir; Tex Howard, chief engr. ■ Rates: \$6; 5; 4.

KPLA(FM)—Listing follows KVOP.



KVOP—Aug 14, 1944: 1400 khz; 1 kw-D, 250 w-N. Box 1420 (79072). (806) 296-2771. Plainview Bcstg Co. (acq 8-1-75). Group owner: Jamar. Net: TSN. Format: MOR. ■ William Jamar Jr., pres; William R. Rice, gen mgr; Tut Tawwater, prog dir; Girard Fox, coml mgr; B. D. Perkins, prom mgr; Chuck Martin, news dir; Hugh Smith, chief engr. ■ Rates: \$9; 8; 8; 8.

KPLA(FM)—Co-owned with KVOP. Spet 1961: 97.3 mhz; 3 kw. Ant 125 ft. Prog sep from AM. Format: Spanish. ■ Rene DeLeon, coml mgr. ■ Rates: \$7; 7; 7; 7.

***KWLD(FM)**—Not on air, target date unknown: 91.5 mhz; 370 w. Ant 120 ft. 1900 W. 7th St. (79072). Wayland Baptist College. ■ Roy C. McClung, pres.

Pleasanton

KBOP—Feb 8, 1951: 1380 khz; 1 kw-D. Box 247 (78064). (512) 569-4871. Atascosa Bcstg Co. Format: C&W, Sp. Spec prog: Gospel 12 hrs wkly. ■ Ben L. Parker, owner; Bill Schlotter, coml mgr; Travis E. Hall, stn mgr; Esteban Martinez, Sp dir; Mona L. Parker, chief engr.

KBOP-FM—Not on air, target date unknown: 98.3 mhz; 3 kw. Ant 230 ft. 215 N. Main (78064). Prog sep from AM. Format: Country, folk, gosp.

Port Arthur

KOLE—1947: 1340 khz; 1 kw-D, 250 w-N. Box 336 (77640). (713) 982-9436. Gulf States Bcstg Co. (acq 11-1-72). Net: ABC/C. Rep: Selcom, Paul Miller. Format: Top 40. ■ Robert D. Hanna, pres; Bill Prikrly, gen mgr; Jay Scott, prog dir; Charles Dietrich, news dir.

KPAC—August 1934: 1250 khz 5 kw-D, 1 kw-N. DA-N. Box 520 (77640). (713) 985-7458. (722-1463 Beaumont). Port Arthur College. Net: MBS. Rep: Buckley. Format: MOR day, soul eve. ■ Sam Monroe, pres; Jim Monroe, stn mgr & prog dir; Willis Swearingen, news dir; Beatrice Sticker, traf mgr; Al Alvarado, chief engr.

KPAC-FM—April 15, 1963: 98.5 mhz; 3.8 kw. Ant 380 ft. (713) 962-4731. Format: Easy lstng.

KYKR—Jan 11, 1969: 1510 khz; 1 kw-D. 3333 25th St. (77640). (713) 985-2543. KWEN Bcstg Co. Audio news: UPI. Rep: Masla; Riley. Format: C&W. ■ J. H. Joynr, gen mgr & chief engr; Charlie Russell, prog dir; Bart Evans, mus dir; Jim Love, opns mgr; Mark Stephens, news dir. ■ Rates: \$10; 7; 10; 5.40.

KYKR-FM—July 4, 1969: 93.3 mhz; 25 kw. Ant 190 ft. Stereo. (CP: 100 kw. Ant 420 ft.). Dups AM 100%. ■ Rates same as AM.

Portland

KOUL(FM)—Co-owned with KCTA, Corpus Christi. See Sinton.

Port Lavaca

KGUL—June 7, 1961: 1560 khz; 500 w-D. Box 386 (77799). (512) 552-2951. Radio Sln KGUL. Spec prog: Sp 17 hrs wkly. ■ Lewis O. Seibert, pres; L. Dean Holford, gen mgr; Mila E. Cameron, news dir.

Port Neches

KSUZ—June 13, 1959: 1150 khz; 500 w-D, DA. Box 545 (77651). (713) 727-2177. L & R Bcstg Corp. (acq 4-1-74). Rep: Savalli-Gates. Format: MOR. Spec prog: Gospel mus 6 hrs, farm 2 hrs wkly. ■ Lester J. Ledet, pres; Robert F. Ritchey, gen mgr. ■ Rates: \$7.75; 2.90; 2.90; —.

Post

KPOS—September 1955: 1370 khz; kw-D. Box 98 (79356). (806) 495-2831. Boles Bcstng. (acq 1-2-73). Rep: Keystone. Format: C&W. ■ James Boles, pres; Don Boles, gen mgr; Gail Boles, coml mgr; Steve Mason, prog dir; Maxine Marks, prom mgr; D. J. Atkinson, mus cir & chief engr; Jerry Aihart, news dir.

Quanah

KOLJ—May 11, 1951: 1150 khz; 500 w-D. Box 589 (79252). (817) 663-5309. Fay Neel Eggleston (acq 10-1-61). Rep: Messina. Format: C&W. Spec prog: Sp ½ hr, relig 10 hrs wkly. ■ Fay Neel Eggleston, gen mgr; James A. Garrett, asst mgr; Bill Enloe, chief engr. ■ Rates: \$10; 10; 10; 10.

Ralls

KCLR—May 31, 1963: 1530 khz; 5 kw-D (1 kw CH). Box 669 (79357). (806) 762-1314. KCLR Inc. (acq 4-1-69). Rep: Messina. Format: C&W, Spanish, relig. ■ F. T. Wilson, pres; Jerry W. Mings, prog, mus & news dir; W. D. Taylor, chief engr. ■ Rates: \$6; 6; 6.

Raymondville

KSOX—June 1, 1957: 1240 khz; 1 kw-D, 250 w-N, 345 S, 7th (78580). (512) 689-3333. Edgar L. Clinton (acq 9-1-69). Rep: Messina. Format: C&W. ■ Edgar L. Clinton, pres, gen mgr & prog dir; Burney Jones, chief engr.

Richmond

KFRD—See Rosenberg-Richmond.

Robstown

KROB—Feb 22, 1963: 1510 khz; 500 w-D, Box 752 (78380). (512) 387-1510. Coastal Bend Bcstg Corp. Rep: Masla, Riley. Format: C&W. ■ George Leon Gossage, pres; W. A. Raekke, gen mgr; Jerry Allen, coml mgr; Mrs. W. A. Reake, prog dir; Mrs. G. L. Gossage, prom mgr; Mike Smith, news dir; & chief engr.

KROB-FM—Oct 13, 1966: 99.9 mhz; 36 kw. Ant 185 ft. Prog dups AM 100%.

Rosenberg-Richmond

KFRD—Nov 15, 1948: 980 khz; 1 kw-D, Box 832 (77471). (713) 232-3776. Fort Bend Bcstg Co. Format: Variety, Spanish. Spec prog: Czech 8 hrs wkly. ■ Jean E. Junker, pres; W. J. Sloan Jr., gen mgr; George Thompson, coml mgr; Paul Collins, prog dir; Morgan Jefferys, news dir; Frank Wood, chief engr. ■ Rates: \$8.25; 8.25; 8.25; 8.25.

KFRD-FM—Aug 8, 1968: 104.9 mhz; 3 kw. Ant 230 ft. Prog dups AM 50%. ■ Rates same as AM.

Rusk

KTLU—1955: 1580 khz; 500 w-D, Box 475 (75785). (214) 683-2258. E. H. Whitehead. ■ Sam Florian, gen mgr.

San Angelo



KGKL—Dec 4, 1928: 960 khz; 5 kw-D, 1 kw-N, DA-N, Box 1878 (76901). (915) 655-6715. KGKL Inc. (acq 4-5-71). Group owner: Gloger. Net: ABC/C. Rep: Torbet. Format: MOR. Spec prog: Farm 4 hrs wkly. ■ Leroy J. Gloger, pres; Bill Neil, gen, coml mgr; Dave Dumas, prog dir; Roy Cox, mus dir; Gene Turney, news dir; Bill Poteet, chief engr. ■ Rates: \$8.50; 7.50; 8.50; 7.50.



KIXY—Nov 28, 1954: 1260 khz; 1 kw-D, City Hall Plaza at 1st St. (76901). (915) 653-3387. Solar Bcstg Inc. Net: Texas State. Audio news: UPI. Rep: PRO/Meeker, Cowart. Format: Top 40, MOR, oldies. Spec prog: Classcd 2 hrs wkly. ■ Walton A. Foster, pres & gen mgr; Bob McClellan, coml mgr; John Raymond Long, prog & mus dir; Fred Key, prom mgr; Dan Wilson, news dir & chief engr. ■ Rates: \$9; 8.50; 9; 8.50.

KIXY-FM—October 1966: 94.7 mhz; 39 kw. Ant 140 ft. Stereo. Prog dups AM days, Top 40 & MOR nights. ■ Art Foster, mus dir. ■ Rates same as AM.

KPEP—November 1954: 1420 khz; 1 kw-D, Box 1351 (76901). (915) 655-8116. Simestone Bcstg Corp. (acq 1975). Rep: Messina. Format: C&W. Spec prog: Sp 8 hrs wkly. ■ Richard D. Sims & Robert Stone Street, owners; Ray Villandry, coml mgr; Chet Young, prog dir; James Stone, mus & news dir & prom mgr.

KSJT(FM)—Dec 24, 1965: 97.5 mhz; 34 kw. Ant 100 ft. Box 1296 (79601). (915) 653-5008. Concho Valley Bcstg Co. Format: Ethnic. ■ Thomas H. Earnest, pres, gen mgr & chief engr; Pepe Avalos, prog dir.

KTEO—1947: 1340 khz; 1 kw-D, 250 w-N, Box 1711 (76901). (915) 653-6863. Angelo Bcstg Inc. (acq

2-1-75). Net: Continental News. Rep: Masla, Riley. Format: C&W. Spec prog: Sp 4 hrs wkly. ■ O.P. (Bob) Bobbitt, pres; Kor Rushing, gen mgr; Wayne Cotton, coml mgr; T. C. Carter, prog dir; H. Walter Hart, mus dir; Lew Kordek, news dir; Steve Wray, chief engr.

KWLW(FM)—Feb 1, 1965: 93.9 mhz; 34 kw. Ant 145 ft. Stereo. Box 1726 (76901). (955) 655-1681. West Texas Bcstg Corp. (acq 4-1-73). Net: ABC/FM. Rep: Frederick W. Smith. Format: MOR. Spec prog: Classcd 2 hrs wkly. ■ Dr. Maurice J. Voity Jr., pres & gen mgr; Larry Charlesworth, stn mgr & chief engr; John A. McGee, coml mgr; Robert Wertz, prog & mus dir; Steve Hayes, news dir.

San Antonio

KAPE—June 1960: 1480 khz; 500 w-D, DA, 608 E. Travis (78205). (215) 223-3877. Southern Sound Sys. Bcstg Corp (acq 3-1-71). Net: ABC/C, Mutual Black. Format: Black & R&B. Spec prog: Gospel 7 hrs wkly. ■ Center Atkins Jr., pres; Jerry Moon, gen mgr; Franklin Collins, coml mgr; Rudy Green, prog dir; Cesta Ayers, mus dir; Lee "Doc" Holliday, news dir; Frank Page, chief engr. ■ Rates: \$13; 11; 13; 11.

KBUC—1948: 1310 khz; 5 kw-D, DA, Box 20267 (78220). (512) 222-9191. Turner Bcstg Corp. (acq 1-20-67). Group owner: Sigmot. Net: ABC/I. Format: C&W. ■ Harrell Banks, gen mgr; Randall Clay, coml mgr; Bill King, prog dir; Tom Wayne, mus dir; Jerry Franklin, news dir; Ray Hettinger, chief engr. ■ Rates: \$30; 25; 30; 18.

KBUC-FM—Dec 31, 1967: 107.5 mhz; 100 kw. Ant 285 ft. Prog dups AM 100%. ■ Rates same as AM.

KCOR—Feb 1, 1946: 1350 khz; 5 kw-U, DA-N, 411 East Durango (78204). (512) 225-2751. Harbenito Radio Coop (acq 11-1-75). Rep: Torbet. Format: Spanish. ■ McHenry Tichenor, pres; Nathan Safir, gen mgr; Sam Murray, coml mgr; Salvador Garza, prog dir; Gumerindo Autunez, mus dir; Clarence Grantrath, prom mgr; Mateo Camargo, news dir; Marvin Fiedler, chief engr. ■ Rates: \$40; 37; 37; 31.

KQXT(FM)—Co-owned with KCOR. Nov 19, 1967: 101.9 mhz; 100 kw horiz; 50 kw vert. Ant 670 ft. Stereo. Prog sep from AM. Format: Btl mus. ■ David Safir, prog dir. ■ Rates: \$19; 19; 19; 19.

KEDA—March 14, 1966: 1540 khz; 1 kw-D, 226 1/2 Dolorosa St. (78205). (512) 226-5254. D & E Bcstg Co. Rep: UBC Sis. Format: Ethnic. ■ Manuel G. Davila, gen & coml mgr; W. G. Egerton, asst mgr & dir of engr. ■ Rates: \$16; 14; 16; —.

KEEZ(FM)—Listing follows WOAI.

KEXL(FM)—Co-owned with KITE, Terrell Hills. Oct 1, 1966: 104.5 mhz; 100 kw horiz. 64 kw vert. Ant 660 ft. 8400 Data Point, Suite 535 (78229). (512) 696-9940. Doubleday Bcstg Co. (group owner: acq 3-1-67). Prog sep from AM. Rep: Radio Advertising Reps, Riley. Format: Progs. ■ David G. Scribner, pres; H. J. (Hal) Davis, gen mgr; Rex Tackett, stn mgr; Allen Grimm, prog & mus dir; Sam Kindrick, news dir; David Stephen, chief engr. ■ Rates: \$11; 11; 11; 11.

KISS(FM)—Listing follows KMAC.

KITE—See Terrell Hills.

KITY(FM)—Listing follows KONO.

KKYX—1926: 680 khz; 50 kw-D, 10 kw-N, DA-N, 8022 Bandera Rd. (78228). (512) 684-0068. Swanco Bcstg Co Inc. (group owner: acq 6-14-67). Net: Texas State. Rep: Eastman. Format: C&W. ■ Gery Swanson, pres; Richard F. Marcellan, VP & gen mgr; Dennis Griffin, coml mgr; Bill Rohde, prog dir; Max Gardner, mus dir; Paul Morgan, prom mgr; Joe Simpson, news dir; Edward J. Pryor, chief engr.

KMAC—Dec 26, 1926: 630 khz; 5 kw-U, DA-2, Aurora Apt Hotel, 509 Howard St. (78212). (512) 223-6211. The Walmac Co. ■ Howard W. Davis, own, gen & coml mgr; Shirley Browning, prog dir; Bob Baker, prom mgr; Joe Anthony, mus dir; Lou Roney, news dir; Clarence W. Betz, chief engr.

KISS(FM)—Co-owned with KMAC. December 1946: 99.5 mhz; 12.9 kw. Ant 570 ft. Prog dups AM 5%. Format: Contemp.

KMFM(FM)—May 5, 1964: 96.1 mhz; 60 kw. Ant 130 ft. Stereo. 134 E. Agarita Ave. (78212). (512) 732-7807. Harry Pennington Jr. ■ Harry Pennington Jr., owner; Rosa Lee Pennington, gen mgr.

Texas Radio

See page C-1 for explanation of listings.

KONO—January 1927: 860 khz; 5 kw-D, 1 kw-N, DA-N, Box 2338, 317 Arden Grove (78298). (512) 225-5111. Mission Central Co. Group owner: Mission Bcstg. Net: MBS. Rep: McGavren-Guild. Format: Contemp. ■ Jack Roth, pres; Bruce Dodge, VP & gen mgr; Henly Roberts, coml mgr; Rick Reynolds, prog dir; Bill Kiley, chief engr; George W. Ing, dir of engr.

KITY(FM)—Co-owned with KONO. 1947: 92.9 mhz; 100 kw. Ant 390 ft. Stereo. Prog sep from AM. Format: Adult contemp. ■ Stan Webb, gen mgr; Charlie Van, sls mgr.

KQAM—Nov 13, 1961: 1150 khz; 1 kw-D, DA, KBER Square (78222). (512) 648-1150. KEPO Bcstg Inc. Net: MBS. Rep: Masla. Format: C&W. ■ James E. Edwards, gen mgr; Doug Shane, prog dir; Jim Morgan, prom mgr; Mike Murphy, mus dir; Richard T. Roberts, news dir; Tom Ortiz, chief engr.

KSAQ(FM)—Co-owned with KQAM. June 25, 1966: 100.3 mhz; 100 kw. Ant 155 ft. Prog dups AM 100%.

KQXT(FM)—Listing follows KCOR.

***KRTU(FM)**—Not on air; target date unknown: 91.7 mhz, 18 kw. 715 Stadium Dr. (78284). Trinity University. ■ Bill Hays, chmn department of journalism and broadcasting.

***KSYM(FM)**—Sept 15, 1966: 90.3 mhz; 800 w. Ant 110 ft. 1300 San Pedro Ave. (78284). (512) 734-7311, ext 391. San Antonio College. Net: ABC/C. Format: Contemp. Spec prog: Sp 2 hrs wkly. ■ Jerome Weynand, pres; Jean Longwith, gen mgr; John Siercovich, chief engr.

KTSA—1922: 550 khz; 5 kw-U, DA-N, Box 18128 (78218). (512) 655-5500. Waterman Bcstg Corp. of Texas (acq 1965). Rep: Blair. Format: Contemp. ■ Bernard Waterman, pres; Ken Dowe, exec VP; Lee Taylor, gen & sls mgr; Lee Randall, prog dir; John Quinones, news dir; Tom Ortiz, chief engr. ■ Rates: \$63; 63; 63; 56.

KTFM(FM)—Co-owned with K TSA. 1969: 102.7 mhz; 99 kw horiz, 63 kw vert. Ant 660 ft. Format: Album rock. ■ Trigger Black, prog dir. ■ Rates: \$18; 20; 20; 20.

KUKA—Jan 1, 1953: 1250 khz; 1 kw-D, 501 W. Quincy St. (78212). (512) 225-5757. Por Favor Inc. (acq 6-1-61). Format: Spanish. ■ June Coe, pres; Marshall Coe, coml mgr; Gilbert Villareal, prog & mus dir & prom mgr; Angel Toledo, news dir; Ken Hyman, chief engr. ■ Rates: \$8; 8; 8; 8.

WOAI—September 1922: 1200 khz; 50 kw-U, 1031 Navarro St. (78205). (512) 226-9331. Clear Channel Communications (group owner: acq 6-13-75). Net: NBC, CBS. Format: MOR, news, farm. ■ L. Lowry Mays, pres; John W. Barger, gen mgr; J. Stanley Webb, gen sls mgr; Bob Guthrie, news dir; Phil Keen, chief engr. ■ Rates: \$30; 20; 29; 16.

KEEZ(FM)—Co-owned with WOAI. 1951: 97.3 mhz; 100 kw horiz, 70 kw vert. Ant 450 ft. Stereo. 2800 Tower Life Bldg. (78205). (512) 223-3004. San Antonio Bcstg Inc. (acq 11-15-72). Prog sep from AM. Format: Top 40. ■ Henry Roberts, gen mgr; Brooks Knight, coml mgr; John Shannon, prog & mus dir & prom mgr; Dave Hayden, chief engr. ■ Rates: \$12; 12; 13; 13.

San Marcos

KCNV—1948: 1470 khz; 250 w-D, Box 2150 (78666). (512) 392-3354. Central Bcstg Co. (acq 7-29-57). Audio news: UPI. Format: Top 40, C&W, Sp. ■ William C. Veidt, pres & gen mgr; David Jacobsen, news dir; Vicki Roberts, mus & prog dir; William Forest Veidt, sls mgr; Octaviano Rivera, Sp prog dir; Troy Kimmel, weather.

KIXL—See Austin.

KRMH(FM)—Co-owned with KIXL. June 1, 1971: 103.7 mhz; 97 kw. Ant 530 ft. 1018 W. 11th St. Austin (78703). (512) 477-9926. Advance Inc. Net: ABC/FM. Rep: Torbet. Format: MOR. ■ R. Miller Hicks, chmn of bd; Otis Dunagan Jr., gen mgr; Don Cadden, sls mgr; Kris Van Cleve, news dir; William Curtis, chief engr. ■ Rates: \$9.50; 9.50; 9.50; 9.50.

Texas Radio

See page C-7 for explanation of listings.

San Saba

KBAL—Dec 15, 1956: 1410 khz; 500 w-D. Box 206 (76877). (915) 372-5131. Hill Country Bcstg Co. (acq 12-31-69). ■ M. Bryan Healer, Ernest F. Cadenhead Jr., Stephen F. Pasquini & David Joel Fair, owners; Bobby Stewart, chief engr.

Sequin

KWED—Sept 9, 1948: 1580 khz; 1 kw-D. Box 989 (78155). (512) 379-2234. Sequin Bcstg Co. (acq 12-31-69). Format: Bflm news, Spanish. Spec prog: Farm 6 hrs, C&W 6 hrs wkly. ■ Stanley W. McKenzie, pres & gen mgr; Edward Englehardt, coml mgr; Ed Leal, prog dir; Ken Eilert, news dir; Joe DeMoss, chief engr. ■ Rates: \$5.50; 5; 5.50; 4.50.

KWED-FM—Sept 9, 1970: 105.3 mhz; 38 kw. Ant 130 ft. Dups AM 40%. Format: MOR. ■ Rates same as AM.

Seminole

KIKZ—April 15, 1968: 1250 khz; 1 kw-D. 120 S.E. Ave B (79360). (915) 758-3798. KIKZ Inc. (acq 8-1-71). Net: Voice of Southwest. Rep: Messina. Format: C&W. Spec prog: Sp 5 hrs wkly. ■ Michael Horne, pres; Guy Russell, gen & coml mgr; Dave Fisher, prog & news dir; Sam Perry, chief engr. ■ Rates: \$5; 5; 5; —.

Seymour

KSEY—October 26, 1950: 1230 khz; 1 kw-D (SH), 250 w-N. Box 1191 (76380). (817) 888-2525. Floyd Bcstg Inc. (acq 1-1-75). Rep: Keystone, Messina. Format: C&W days, rock nights. ■ W. Dave Floyd, pres, gen mgr & chief engr; Joe Langdon, coml mgr; Bob Bohannon, prog & mus dir; B. J. Floyd, prom mgr; Debbie Vincent, news dir. ■ Rates: \$3.50; 3.50; 3.50; 3.50.

Shamrock

KBYP—1948: 1580 khz; 250 w-D. Box 21 (79079). (806) 256-2157. Eugene B. Henderson (acq 1962). Rep: Messina. Format: Variety, C&W. Spec prog: Relig 15 hrs wkly. ■ Johnny Carman, pres & gen mgr; Gladys Yates, coml mgr; Charlie Martin, sps dir; Bill Franklin, prog & news dir; Troy D. Johnson, chief engr.

Sherman

KDSX—See Denison-Sherman.

KIKM—October 1936: 910 khz; 1 kw-U, DA-1. Drawer M (75090). (214) 893-1151. Sher-Den Communications (acq 1975). Net: Texas State. Rep: Savalli/Gates. Format: MOR. Spec prog: Sp 10½ hrs wkly. ■ Lon H. Williams, pres; Louis S. Nemeck, gen mgr; Ken Towson, prog dir; Terry James, mus dir; Roy Hall, news dir; Carl Stein, chief engr.

KiKM-FM—April 1969: 96.7 mhz; 3 kw. Ant 265 ft. Box 1395 (75090). (214) 893-6314. Rep: Paul Miller. Format: Easy C&W, farm & ranch. ■ Commodore R. Wood, gen mgr; Tom Lively, prog & mus dir; Jack Flippen, news dir; Chuck Bunting, sls & prom mgr; Ken Wilson, chief engr.

KTXO—Dec 19, 1947: 1500 khz; 1 kw-D, DA. Box 220 (75090). (214) 893-7477. KTXO Inc. (acq 5-72). Rep: Messina. Format: C&W. ■ Larry L. Henderson, pres, gen & coml mgr; Duane Peters, prog dir; John Guinn, news dir; Tom Spellman, chief engr.

Silsbee

KKAS—Oct 13, 1959: 1300 khz; 500 w-D. Box 455 (77656). (713) 385-2883. Jewel P. White (acq 12-1-64). Rep: Riley. Format: MOR, C&W. ■ J.P. White, pres & gen mgr; John Pat White, chief engr. ■ Rates: \$2.80; 2.80; 2.80; —.

Sinton

KIKN—July 13, 1959: 1590 khz; 1 kw-D, 500 w-N. Box 2827 (78403). (512) 884-3986. TWX 512-883-7041. Allen E. Schepper (acq 3-26-75). Net: ABC/E. Audio news: APR. Rep: Torbet. Format: C&W. Spec prog: Farm 6 hrs wkly. ■ Allen E. Schepper, pres

& gen & sls mgr; Ed Sharpe, opns mgr; & mus dir; Ron Butler, news dir & chief engr. ■ Rates: \$16; 13; 16; 11.

KMIO(FM)—July 1, 1972: 101.3 mhz; 100 kw. Ant 360 ft. Stereo. Box 1366 (78387). (512) 854-1016. Sinton Bcstg Co. (acq 5-1-69). Rep: Buncher. Format: Spanish. ■ Johnny Masqueda, gen mgr; Rafael Palafox, prog dir; Claude E. Sessions Jr., chief engr.

KOUL(FM)—Co-owned with KCTA. Corpus Christi. May 20, 1968: 103.3 mhz; 100 kw. Ant 310 ft. Box 898, Corpus Christi (78403). (512) 643-3541. Bcstg Corp. of the Southwest. Format: MOR. ■ Ms. Dove, mgr.

Slaton

KCAS—Jan 15, 1962: 1050 khz; 250 w-D. 133 S. Ninth St., Box 276 (79364). (806) 828-6217. Star of the Plains Bcstg Co. (acq 1975). Group owner: Jim Hughes Stns. Net: ABC/I. Audio news: APR. Rep: Keystone, Bernard. Format: MOR. Spec prog: Farm 7 hrs, relig 12 hrs. Sp 6 hrs wkly. ■ Elmer F. Smith, pres; Fred Smith, res mgr & prog dir; Amy H. Smith, VP & prom mgr; Terry Bavousett, news & sps dir; Scott Harris, farm dir. ■ Rates: \$6; 6; 6; 6.

Snyder

KSNY—Dec 22, 1949: 1450 khz; 1 kw-D, 250 w-N. Box 1008 (79549). (915) 573-9322. Snyder Bcstg Co. (acq 1952). Group owner: Mayes Stn. Net: TSN, Keystone. Rep: Eastman. ■ Mrs. Flora Hughes, pres; Mel Z. Gilbert, gen mgr; Frank Taylor, stn mgr; Bob Clifton, prom mgr.

Spearman

KBMF-FM—Dec 16, 1963: 98.3 mhz; 3 kw. Ant 215 ft. 605 E. Kenneth (79081). (806) 659-2529. Hansford Bcstg Co. (acq 1-1-66). Net: TSN. Rep: Messina. Format: MOR. ■ Coy Palmer, pres, gen & coml mgr; Clara Wise, prog dir; Dwayne Smith, chief engr.

Stamford

KDWT—1947: 1400 khz; 1 kw-D, 250 w-N. Box 1205 (79553). (915) 773-3401. ABKO Bcstg Co. (acq 7-1-58). Net: Texas State. Spec prog: Sp 2 hrs wkly. ■ A. Boyd Kelly, pres; Robert A. Prichard, VP gen mgr & chief engr; Glen McCandless, coml mgr, prog & news dir.

Stephenville

KSTV—1947: 1510 khz; 250 w-D. Box 102 (76401). (817) 968-2141. Dixie Bcstrs (acq 5-57). Group owner: Dixie Stns. Format: C&W. ■ C. Winslett Reddoch, gen mgr; Mel Bennett, coml mgr; Buddy Bruner, prog dir; Pam Young, news dir; C. W. Reddoch, chief engr.

KWWM(FM)—Co-owned with KSTV. August 15, 1968: 98.3 mhz; 3 kw. Ant 205 ft. Prog sep from AM.

Sulphur Springs

KSST—March 1947: 1230 khz; 1 kw-D, 250 w-N. Box 284 (75482). (214) 885-3111. Hopkins County Bcstg Co. (acq 1948). Net: TSN. Format: Variety. ■ William Bradford, pres, gen mgr & chief engr; Clovis Pinion, coml mgr & mus dir; Eliene Whitworth, prog dir; Rod Henderson, prom mgr; Mark Bradford, news dir. ■ Rates: \$3.65; 3.65; 3.65; 3.65.

Sweetwater

KXOX—November 1939: 1240 khz; 1 kw-D, 250 w-N. Box 570. (79556). (915) 236-6655. Stein Bcstg Inc. (acq 1975). Net: Texas State. Rep: Melville. Format: MOR, top 40, C&W. Spec prog: Sp 5 hrs, black 6 hrs, farm 2½ hrs wkly. ■ Jack Stein, pres & gen mgr; Johnny Moore, coml mgr; Earl B. Ray, chief engr. ■ Rates: \$3.25; 3.15; 2.35; 1.75.

Taylor

KTAE—April 1, 1948: 1260 khz; 1 kw-D. Box 1160 (76574). (512) 352-3631. KTAE Inc. Format: Variety, C&W. Spec prog: Sp 6 hrs, black 14 hrs wkly. ■ G. G. Conoley, pres & gen mgr; John Wehby, coml mgr; Fred Switzer, prog & news dir; Ed Urbanek, mus dir; A. J. Zrubek, chief engr. ■ Rates: \$4.40; 4.40; 4.40; —.

Temple

KTEM—Nov 25, 1936: 1400 khz; 1 kw-D, 250 w-N. Box 1230 (76501). (817) 773-5252. KTEM Radio Inc.

(acq 3-20-70). Group owner: Formby Stns. Rep: Melville. Format: Contemp, MOR. ■ Clint Formby, pres; George A. Franz, gen mgr; Jerry Snyder, coml mgr; Stan Teater, prom mgr; Mike O'Donnel, prog dir; Bob Kelly, mus dir; Joe Graham, news dir; Charles Schlieper, chief engr. ■ Rates: \$9.10; 8.30; 9.10; 8.30.

KPLE(FM)—Co-owned with KTEM. April 4, 1975: 104.9 mhz; 2.9 kw. Ant 300 ft. Stereo. (817) 773-1003. Format: Easy contemp.

Terrell

KTER—October 1952: 1570 khz; 250 w-D. Box 220 (75160). (214) 563-6497. TWX 214-563-6497. Terrell Bcst Corp. (acq 5-6-59). Net: Texas State. Format: C&W. Spec prog: Sp 3 hrs, farm 3 hrs, black 2 hrs wkly. ■ Bill Pirtle, pres & gen mgr.

Terrell Hills

KITE—Oct 17, 1947: 930 khz; 5 kw-D, 1 kw-N, DA-N. 8400 Data Point, Suite 535, San Antonio (78229). (512) 696-9940. Doubleday Bcstg Co. (group owner; acq 3-1-67). Net: ABC/C. Rep: Radio Advertising Reps, Riley. Format: MOR. ■ David G. Scribner, pres; H. J. Davis, gen mgr; Tom East, opns dir; Gene Kelly, prog mgr; Will Sinclair, news dir; David Stephen, chief engr. ■ Rates: \$25; 12.50; 16.50; 8.25.

KEXL(FM)—Co-owned with KITE. See San Antonio.

Texarkana

KADO—Oct 23, 1961: 940 khz; 1 kw-D. 303 W. Broad St. (75501). (214) 793-4671. KATQ Inc. Net: ABC/E. Rep: Carpenter, Paul Miller. Format: C&W. ■ Floyd Bell, pres & gen mgr; Roy P. Jones, stn, coml mgr; John H. Bell, prog dir & chief engr; Ron Jennings, mus dir.

KADO-FM—See Texarkana, Ark.

KCMC—Feb 26, 1932: 740 khz; 1 kw-U, DA-1. Box 521 (75501). KCMC Inc. (acq 1936). ■ Herman Cecil, mgr. ■ Rates: \$10; 8; 10; 8.

KTAL-FM—Co-owned with KCMC. 1945: 98.1 mhz; 100 kw horiz, 61 kw vert. Ant 1,360 ft. ■ KTAL-TV affil.

KOSY—See Texarkana, Ark.

KOSY-FM—July 15, 1965: 102.5 mhz; 35 kw. Ant 260 ft. Stereo. Box 2018 (75501). (501) 772-3771. Gateway Bcstg Co. Progs sep from AM. Rep: Savalli Gates. Format: Easy Istg. ■ Rates: \$6; 6; 6; 6.

KTAL-FM—Listing follows KCMC.

KTF5—1946: 1400 khz; 1 kw-D, 250 w-N. Box 1260 (75501). (214) 793-1109. KTF5 Radio Inc. (acq 3-1-67). Net: Texas State. Rep: Messina, Devney. ■ Hugh Frizzell, pres & gen mgr; Tom Alford, stn mgr; Jim Cooper, prog dir.

Texas City

KTLW

 KTLW logo featuring a stylized 'M' and the text 'media company radio television representative'.

KTLW—November 1947: 920 khz; 1 kw-D. Box 2279 (77590). (713) 945-4418. Texas City Bcstg Service. Audio news: APR. Rep: Messina. Format: C&W. Spec prog: Sp 1½ hrs wkly. ■ J. G. Long, pres; Ray Lacey, gen mgr; Craig Hildreth, asst mgr; Chuck Tiller, prog & mus dir & prom mgr; Bob Greer, news dir; Luke Strippling, chief engr. ■ Rates: \$9; 9; 9; 7.75.

Tulia

KTUE—November 1954: 1260 khz; 1 kw-D. Box 169 (79088). (806) 995-3531. W. A. and Doris Amburn (acq 6-1-61). Net: Texas State. Rep: Messina. Format: C&W. Spec progs: Sp 14 hrs, gospel 14 hrs wkly. ■ W. A. Amburn, pres & gen mgr; Glen Amburn, prog, mus & news dir & coml & prom mgr; B. K. Barer Jr., chief engr.

Tyler

KDOK—1930: 1490 khz; 1 kw D, 250 w-N. Box 3007 (75701). (214) 593-2510. KDOK Bcstg Co. (acq 12-23-65). Net: Texas State. Rep: Smith; Dahlster; GCI Cowart. Format: Contemp. ■ Mary A. Adams, pres; William B. Adams, gen mgr; Jack Monroe, prog

dir; Bill Whitworth, coml mgr; Bill Young, prog consultant; Dave Moreland, mus dir; Bill Atkins, news dir; Robie D. Morgan Jr., chief engr. ■ Rates: \$5; 4.40; 5; 4.40.

KNUE(FM)—Co-owned with KDOK. Dec 13, 1964: 101.5 mhz; 39 kw. Ant 380 ft. Stereo. Prog sep from AM. Format: Btfl mus, MOR. ■ Rates: \$4.40; 3.80; 4.40; 3.80.

KROZ(FM)—Listing follows KZEY.

KTBB—Aug 28, 1947: 600 khz; 1 kw-U, DA-N. Box 929 (75701). (214) 597-7278. Smith County Bcstrs (acq 4-1-74). Group owner: Formby Stns. Net: ABC/C. Rep: Selcom. Format: MOR. ■ Clint Formby, pres; Don Chaney, gen mgr; Harley Calvery, coml mgr; Ken Charles, prog dir; Steve Cannon, mus dir; Mike Edwards, news dir; Bob Wileman, chief engr. ■ Rates: \$7.25; 6.10; 7.25; 6.10.

KZAK AM/FM

Modern Country

KZAK—Feb 1, 1966: 1330 khz; 1 kw-U. Box 3367 (75701). (214) 593-1771. Oil Center Bcstg Co. (acq 12-23-65). Audio news: UPI. Rep: Riley. Format: C&W. Spec prog: Rel 5½ hrs wkly. ■ Aubrey E. Irby, pres & gen mgr; Will Nunnally, stn mgr; Neal White, prog dir; Tommy Boudreau, chief engr.

KZAK-FM—July 1961: 93.1 mhz; 4.8 kw. Ant 380 ft. Dups AM 100%.

KZEY—Jan 1, 1958: 690 khz; 1 kw-D, DA. Box 4248 (75701). (214) 593-1744. Tyler Bcstg Co. Net: Natl Black. Rep: Howard. Format: Black. ■ Tom Gibson, pres; Rick Reynolds, VP & gen mgr; Matt Walker, prog dir; Ray Wells, chief engr.

KROZ(FM)—Co-owned with KZEY. 1975: 92.1 mhz; 3 kw. Ant 280 ft.

Uvalde

KVOU—April 4, 1947: 1400 khz; 1 kw-D, 250 w-N. Box 758 (78801). (512) 278-2555. Uvalde Bcstrs Inc. Net: Texas State. Format: C&W, Spanish. ■ E. J. Harpole, pres; Nona Whitley, gen mgr; Scottie Molloy, coml & prom mgr; Pat Covey, prog & mus dir; Nona Whitley, news dir; W. Jay Harpole, chief engr.

KYUF(FM)—Not on air, target date unknown: 95.3 mhz; 3 kw. Ant 125 ft. Box 758 (78801). Uvalde Bcstrs Inc. Format: Contemp, C&W. ■ E. J. Harpole, pres.

Vernon

KVWC—July 1939: 1490 khz; 1 kw-D, 250 w-N. Box 1419 (76384). (817) 552-6221. KVWC Inc. (acq 6-1-61). Audio news: APR. Rep: Riley. Format: C&W, farm. Spec prog: Sp 5 hrs wkly. ■ Joe Garrison, pres, gen mgr & chief engr; Shirley Yoakum, office mgr; Dorothy Garrison, coml mgr; Dan Hendrix, prog & news dir; Ken Ingram, prom mgr.

KVWC-FM—April 10, 1972: 102.3 mhz; 650 w. Ant 340 ft. Prog sep from AM. Format: Oldies.

Victoria

KCWM(FM)—Listing follows KVIC.

KNAL—April 16, 1948: 1410 khz; 500 w-U, DA-N. Box 2209 (77901). (512) 573-9176. Victoria Bcstrs, (acq 6-15-59). Group owner: KWTX Stns. Format: C&W. ■ M. N. Bostick, pres; Robert C. Martin, gen & coml mgr; Russell Walters, chief engr. ■ Rates: \$5.70; 5.70; 5.70.

KTXN-FM—May 1, 1965: 98.7 mhz; 39 kw. Ant 150 ft. 501 First Victoria Bank Bldg. Net: ABC/C/EI, MBS. Rep: Messina. Format: MOR. Spec prog: Sp 3 hrs wkly. ■ John J. Tibiletti, pres, gen mgr & chief engr; Weldon Horadam, bus/opns mgr; Joyce Mutina, coord.

KVIC

Contemporary Music

KVIC—August 1939: 1340 khz; 1 kw-D, 250 w-N. Box 3487 (77901). (512) 573-9171. Pioneer Bcstg Co. Group owner: Mayes Stns (acq 12-1-64). Rep: Riley. Format: Contemp. ■ Wendell Mayes Jr., pres;

Robert E. Woodman, VP & gen mgr; Cindy Broussard, office mgr; Kathy Hebert, prom mgr; Dave Jagger, prog dir; Philip Robbins, mus dir; Bill Stevens, news dir; Bill Crow, chief engr. ■ Rates: \$6.85; 4.85; 6.85; 3.85.

KCWM(FM)—Co-owned with KVIC. Not on air, target date January 1976: 95.1 mhz, 57 kw. Ant 450 ft. 3613 North Main (77901). Prog sep from AM. Format: MOR.

Waco

KAWA—April 1953: 1010 khz; 10 kw-D, DA. Box 1908 (76703). (817) 771-2101. Centrum Corp. (acq 1-19-73). Rep: Torbet. Format: C&W. Spec prog: Polka 2 hrs wkly. ■ Ronald J. Romanski, pres & gen mgr; David C. Fricker, VP opns; Joe J. Webb, coml mgr; Tim Jerigan, prog dir; Ralph Wilkins, mus dir; David O'Brien, news dir; Marlene Elmore, office mgr; Joe Galloway, chief engr.

KEFC(FM)—Partially co-owned with KAWA. Sept 6, 1959: 95.5 mhz; 3.1 kw. Ant 220 ft. Box 3332 (76707). (817) 752-9656. Centracast Corp. (acq 1974). Net: ABC/E. Format: Contemp.

KHO(FM)—Listing follows WACO.

KRZI—Oct 18, 1962: 1580 khz; 1 kw-D, 500 w-N. DA-2. Box 8093 (76710). (817) 772-0930. KRZI Radio Inc. (acq 4-7-73). Net: Texas State. Rep: PRO Time Sis. Format: Contemp. Spec progs: Sp 1 hr, black 3 hrs wkly. ■ Herb Harding, pres & gen mgr; Jean Pro, coml mgr; Charles Pro, prog dir & prom mgr; Gary Ryder, mus dir; Max Tooker, news dir; Brice Palmer, chief engr.

***KWBU(FM)**—March 15, 1966: 107.1 mhz; 3 kw. Ant 190 ft. Stereo. Div of Radio-TV-Film; Dept of Oral Communication, Baylor Univ. (76703). (817) 755-1511. Baylor U. Net: NPR, Texas State. Format: Prog. ■ Abner V. McCall, pres; Joseph C. Walters, gen mgr; Cade Garrison, opns super; Alan Sayre, mus dir; Jim Tapley, news dir; Paul Wagenschein, chief engr.

KWTX—May 1, 1946: 1230 khz; 1 kw-D, 250 w-N. Box 7528 (76710). (817) 776-1330. TWX 910-894-5206. KWTX Bcstg Co. Group owner: KWTX Stns. Net: MBS. Rep: McGavren-Guild. Format: MOR. ■ M. N. Bostick, pres & gen mgr; Frank Fallon, stn mgr; Dave South, prog dir; Ron Hall, news dir; Bill Moore, chief engr.

KWTX-FM—Dec 1, 1970: 97.5 mhz; 71 kw. Ant 890 ft. Stereo. Dups AM 8%. ■ KWTX-TV affil.

WACO—July 22, 1922: 1460 khz; 1 kw-U, DA-N. Box 7912 (76710). (817) 772-7100. TWX 910-894-5205. WACO Radio Inc. (acq 7-1-70). Net: ABC/C/FM/I. Rep: Eastman. Format: Contemp, top 40. ■ M. T. Tichenor, pres; Robert E. Weathers, gen mgr; Jim Miller, prog dir; Ray Kaluza, coml mgr; Reginald T. Thomas, mus dir; Evelynne Holmes Vick, pub affrs coord; Wayne Claiborne, news dir; Jack Vinson, chief engr.

KHO(FM)—Co-owned with WACO. June 1960: 99.9 mhz; 3.4 kw. Ant 450 ft. Stereo. Prog sep from AM. Format: C&W.

Waxahachie

KBEC—July 6, 1955: 1390 khz; 500 w-D, DA. Box 558 (75165). (214) 937-1390. Richard Tuck Enterprises. Format: C&W. Spec prog: Sp 12 hrs wkly. ■ Richard Tuck, owner, gen mgr & chief engr; Dub Estes, mgr; Bill Hux, sales mgr; Ernie Garth, prog dir; Charles Alexander, mus dir; Richard Edgin, news dir.

Weatherford

KZEE—Aug 12, 1956: 1220 khz; 250 w-D. Box 219 (76086). (817) 594-3826. KZEE Radio Inc. (acq 9-1-74). Net: Texas State. Format: C&W. ■ Galen O. Gilbert, pres; David L. Solmonson, VP, gen mgr & chief engr; Robert L. McMahon Jr., coml mgr; Judy Castels, prom mgr; John Wallis, prog dir; Travis Jeane, mus dir; Jay Van Dyke, news dir. ■ Rates: \$6; 4; 6; —.

Wellington

KBGH—See Memphis.

Weslaco

KRGV—April 1927: 1290 khz; 5 kw-U, DA-N. Box 626 (78596). (512) 968-3131. TWX 910-870-1580. Mobile Video Tapes Inc. (acq 3-1-64). Group owner:

Manship Stns. Net: NBC. Rep: H-R/Stone. Format: Contemp. ■ Douglas L. Manship, pres; Earl Noel, gen mgr; Gary Allen, coml mgr; Manny Lopez, prog dir; Ken Garcia, mus dir; Bob Richardson, news-dir. ■ KRGV-TV affil.

Wharton

KANI—June 17, 1962: 1500 khz; 500 w-U, DA-1. Box 111 (77488). (713) 532-3800. TWX 713-532-3800. Beverly Ann Irish (acq 1975). (Temporary authority to operate until interim operation is granted). Format: C&W, folk.

Wichita Falls

KBID(FM)—May 11, 1975: 92.9 mhz; 100 kw. Ant 920 ft. Stereo. Box 1794 (76307). (817) 322-5546. Mustang Bcstg Co. Net: ABC/E. Format: MOR adult. ■ Vernon Beck, pres & chief engr; Mack Leshar, gen mgr; Chris Miller, prog dir; Jack Reynolds, mus dir. ■ Rates: \$5.40; 5.40; 5.40; 5.40.

KLUR(FM)—April 14, 1963: 99.9 mhz; 100 kw. Ant 820 ft. Stereo. Box 5344 (76307). (817) 322-3127. KLUR Bcstg Co. (acq 7-6-70). Net: ABC/I. Rep: Selcom. Format: C&W. ■ Sam F. Beard, gen mgr; Jim Hill, prog dir; Pat Kirby, news dir; Leon Hoefner, chief engr. ■ Rates: \$7.20; 7.20; 7.20; 7.20.

KNIN—1947: 990 khz; 10 kw-D, 1 kw-N, DA-2. Box 787 (76307). (817) 723-0791. Wichita Bcstg Corp. (acq 8-1-61). Net: ABC. Format: Contemp. ■ Bob H. Walker, pres, gen & coml mgr; Bob Casey, prom mgr, prog & mus dir; Richard Long, news dir; Eddie Bell, chief engr.

KNTO(FM)—Sept 21, 1961: 103.3 mhz; 100 kw. Ant 440 ft. Stereo. Box 4327 (76308). (817) 723-6688. Wichita Radio Corp. (acq 1-1-73). Net: Texas State. Format: MOR. ■ Stephen P. Leon, pres; Virginia A. Rigby, gen mgr; John P. Foertsch, stn mgr; Bob Elliott, mus dir; Bill Enloe, chief engr.

KTRN—1948: 1290 khz; 5 kw-D, 1 kw-N, DA-N. Box 5005 (76307). (815) 855-3555. Bcstg Assocs. (acq 4-1-60). Group owner: Sammons-Ruff. Rep: Petry. ■ Raymond Ruff, pres; R. M. (Mack) Lester, gen mgr; Tom York, prog & mus dir; Jay Walker, news dir; Vernon Beck, chief engr.

KWFT—July 15, 1939: 620 khz; 5 kw-U, DA-N. Box 420 (76307). (815) 322-4416. North Texas Radio Inc. (acq 11-1-57). Net: CBS. Rep: H-R/Stone. Format: MOR. ■ Don F. Whan, pres & gen mgr; A. L. Pierce, coml mgr; Homer Cunningham, prog dir; Evelyn Smith, prom mgr; Earl Sargent, farm serv dir; Joe Tom White, news ed; Lonnie Padron, chief engr.

Woodville

KVLL—Jan 4, 1968: 1220 khz; 250 w-D. Box 458 (75797). (713) 283-3081. Trinity Valley Bcstg Co. (acq 4-25-75). ■ Jack Jackson, Billy C. Dove, Kenneth P. Bond, co-owners; Orvis Woods, prog dir; Bill McPheeters, prom mgr; Edgar Lamb, chief engr.



Utah

Beaver

***KBBD(FM)**—Sept 15, 1975: 90.1 mhz; 10 w. Ant 72 ft. 150 N. Main (84713). (801) 438-2481. Beaver County School District. Format: Variety Spec progs: Farm 1 hr, educ 5 hrs wkly. ■ Wallace R. Dean, advisor.

Blanding

KUTA—Sept 15, 1961: 790 khz; 1 kw-D. Box 790

Utah Radio

See page C-1 for explanation of listings.

HAMILTON-LANDIS
& ASSOCIATES, Inc.
NATIONWIDE MEDIA BROKERS
WASHINGTON, D. C. CHICAGO, DALLAS,
SAN FRANCISCO
SELL **MORE**
RADIO & TELEVISION STATIONS
IN THE WEST—NEAREST OFFICE IS—
111 SUTTER ST., SAN FRANCISCO 94104
(415) 392-5671

(84511). (801) 678-2261. Blue Mountain Bcstg (acq 3-1-75). Net: ABC/I, IMN. Format: MOR. Spec progs: Navajo 5½ hrs wkly. ■ Geo. C. Walton pres & gen mgr. ■ Rates: \$30; 30; 30.

Brigham City

KBUH—Feb 19, 1948: 800 khz; 250 w-D. Box 800, 948 W. Forrest St. (84302). (801) 723-3401. Community Bcstg Co. (group owner; acq 6-1-71). Net: ABC/E. Rep: Masla; Young; Hix. Format: MOR. Spec prog: Sp 1 hr wkly. ■ Darrel K. Burns, gen mgr; G. Norman Thompson, stn mgr; Larry Jewell, prog dir; Dean Burns, mus dir; Tom Category, news dir; Jeffrey Reeves, sls mgr; Robert Jensen, chief engr.

KBUH-FM—Oct 20, 1972: 107.1 mhz; 3 kw. Ant minus 590 ft. Stereo. Dups AM 100%.

Cedar City

KBRE—1970: 940 khz; 10 kw-D. Box 858, 47 S. 100 West (84720). (801) 586-9428. New Era Bcstg Co. Net: ABC/I. Rep: RRR-IMN Sls. Format: C&W, MOR, rock. ■ Charles F. Hunter, pres, gen mgr; Jon Charles Hunter, prog dir.

KBRE-FM—May 10, 1974: 94.9 mhz; 25.5 kw. Ant minus 160 ft. Net: ABC/FM, Intermountain. Format: Progs.

***KCDR-FM**—October 1966: 88.1 mhz; 265 w. Ant minus 890 ft. Southern Utah State College (84720). (801) 586-4411. Southern Utah State College. Net: Utah Public Radio. Format: Free form. Spec progs: Ger 4 hrs, Black 1 hr, Am. Indian 1 hr wkly. ■ Royden C. Braithwaite, pres; Frain G. Pearson, gen mgr.

KSUB—July 4, 1937: 590 khz; 1 kw-U, DA-N. Box 819 (84720). (801) 586-6547. Southern Utah Bcstg Co. (acq 12-9-59). Net: CBS. Rep: Masla; Evans; Hix. Format: Contemp, MOR. ■ Lucile M. Johnson, pres; Donald E. Cartwright, gen mgr & prog dir; Don McAllister, coml mgr; Art Challis, news dir; R. N. Gunn, chief engr. ■ Rates: \$4.35; 4.15; 4.35; 4.15.

KSUB-FM—Not on air, target date unknown: 92.5 mhz; 30 kw. Ant 12 ft.

Centerville

KBBC—Dec 1, 1957: 1600 khz; 1 kw-D. Box 430, Bountiful (84010). (801) 292-2471. Davis Bcstg Co. Net: MBS. Audio news: NBC/NIS. Format: All news. ■ Charles Clark Ronnow, pres and gen mgr; Michael G. Kavanagh, news dir; Dennis Silver, chief engr. ■ Rates: \$7; 6.25; 7; 6.25.

KSTU(FM)—Co-owned with KBBC. Not on air, target date unknown: 105.5 mhz; 3 kw. Ant minus 920 ft. ■ Lois I. Pingree, executrix.

Delta

KDLT—Not on air, target date unknown: 540 khz; 1 kw-D. 79 S. Center St. (84624). Glen S. Gardner.

Ephraim

***KEPH(FM)**—1972: 89.5 mhz; 10 w. 150 E. 1st North (84627). Snow College.

Gunnison

***KGVH(FM)**—1975: 91.7 mhz; 10 w. 51 S. Main St., Manti (84662). South Sanpete School District.

Logan

KBLW—June 1954: 1390 khz; 1 kw-D, 500 w-N, DA-

N. Box 526 (84321). (801) 752-1390. People's Bcstg Co. Inc. (acq 3-68). Net: MBS. Audio news: UPI. Rep: Savalli/Gates, Bournstein. Format: MOR, Top 40. Spec progs: Farm 12 hrs, C&W 14 hrs wkly. ■ Glacus G. Merrill, pres; Gregory Merrill, gen & coml mgr, news dir; Darla Clark, prog and mus dir; Rickey Hughes, chief engr.

***KUSU-FM**—1953: 91.5 mhz; 1 kw (CP: 18.5 kw). Ant minus 570 ft. Stereo. Radio-TV Bldg., Utah State U. (84322). (801) 752-4100, ext 7773. Utah State U. Net: NPR. Format: Diversifd. ■ Glen L. Targgart, pres; Frank Jones, mgr; Gerald L. Allen, stn mgr; Richard Meng, prog dir; Boyd V. Humpherys, chief engr.

KVNU—Nov 20, 1938: 610 khz; 5 kw-D, 1 kw-N, DA-N. 1393 N. Main St., Box 267 (84321). (801) 752-5141. Cadhe Valley Bcstg Co. Net: ABC/C, IMN. Audio news: APR. Format: Top 40, MOR. ■ Helen Bullen, pres; Reed Bullen, gen and coml mgr; David Hull, prog dir; Jennie Christensen, news dir; Bill Neville, chief engr.

KVWJ(FM)—Nov 11, 1974: 94.5 mhz; 25 kw. Ant minus 980 ft. Stereo. 666 N. Main (84321). (801) 752-5895. Bridgerland Bcstg Co. Net: ABC/FM. Audio news: APR. Format: Progs, Top 40. ■ Jeffrey B. Jacobsen, pres; John Biscuit, gen mgr and prog dir; Robert J. Wood, chief engr. ■ Rates: \$3; 3; 3; 3.

Manti

KMTI—Not on air, target date April 1976: 1340 khz; 1 kw-D, 250 w-N. Box 1340 (84642). (801) 835-7401. Sanpete County Bcstg Co. Net: ABC/C/I, IMN. Format: MOR. Spec prog: Farm 2 hrs wkly. ■ Douglas L. Barton, pres, gen mgr and chief engr; Janice Barton, coml mgr; Ned Jensen, mus dir.

***KSME(FM)**—Not on air, target date unknown: 90.7 mhz; 10 w. 51 S. Main St. (84642). South Sanpete School District.

Moab

KURA—1956: 1450 khz; 1 kw-D, 250 w-N. 83 N. Main St. (84532). (801) 259-6161. Moab Bcstg & TV Corp. (acq 1971). Net: ABC/I, IMN. Format: C&W, MOR, Top 40. ■ Dixie L. Barker, pres & gen mgr; T. Dee Tranter, prog, mus & news dir; Rand Taylor, coml & prom mgr; Ron Dickerson, chief engr.

Mount Pleasant

***KMTP(FM)**—1974: 91.1 mhz; 10 w. Ant 885 ft. 41 W. Main St. (84657). North Sanpete School District.

Murray

KMOR—Nov 8, 1948: 1230 khz; 1 kw-D, 250 w-N. 4984 S. 360 West (84107). (801) 266-4418. Seagull Enterprises Inc. Format: C&W. Spec progs: Sp 4 hrs wkly. ■ Charles R. Sadler, pres; Jay Gardner, VP, gen mgr & prog dir; Val Tucker, news dir; Ray Peterson, coml mgr.

Ogden

KANN—September 1961: 1090 khz; 1 kw-D. 2222 Washington Blvd. (84401). (801) 394-3438. Southern Nevada Communications (acq 10-75). Audio news: UPI. Rep: Savalli-Gates. Format: Reig. ■ Jack G. French, owner.

KDAB(FM)—Co-owned with KSXX, Salt Lake City. July 13, 1975: 101.1 mhz; 100 kw. Ant 700 ft. 2510 Washington Blvd. (84401). (801) 394-0122. Star Bcstg. Format: Soft rock. Spec prog: Farm 1¼ hrs wkly. ■ Paul R. Droubay, gen mgr; Dave Page, stn and coml mgr; Mike Scott, opns mgr; Robert Chamberlain, chief engr. ■ Rates: \$7.25; 5.25; 5.25; 4.75.

KLO—1924: 1430 khz; 5 kw-U, DA-1 (CP: 1 kw-U, DA-1). Box 1430 (84402). (801) 399-1111. KLO Bcstg Co. (acq 1975). Net: ABC/I, IMN. Rep: RKO. Format: MOR. Spec prog: Black ½ hr wkly. ■ Wm. T. Layman, gen mgr; David C. Page, gen & coml mgr; Dale S. Nelson, prog dir; Dan Breinholt, news dir; David Parkinson, mus dir; Terry P. Ingram, chief engr.

KQPD(FM)—Aug 1, 1964: 101.9 mhz; 96.3 kw. Ant 39 ft. Stereo. Box 9526 (84409). (801) 621-7240. Wasatch Bcstg Partnership (acq 7-12-73). Audio news: UPI. Format: Btlf mus. ■ Frank C. McIntyre, pres & gen mgr; Doris McIntyre, stn mgr; Muriel Monroe, coml mgr; Larry Ames, prog dir; Steve Braegger, mus dir; Cliff Peterson, chief engr. ■ Rates: \$6.50; 6.50; 6.50; 6.50.

KSVN—Jan 1, 1946: 730 khz; 1 kw-D. Box 107 (84402). (801) 621-7430. Weber Bcstg Inc. (acq 9-71). Net: ABC/E. Rep: Masla; Hix/Wayne-Evans. Format: C&W. Spec prog: Sp 3 hrs wkly. ■ Fred D. Bond, gen mgr; Bruce Holland, opns mgr & mus dir; Rick Worth, news dir; Rex Greene, coml mgr. ■ Rates: \$4.25; 3.50; 4.25; 3.50.

KVOG—April 1948: 1490 khz; 1 kw-D, 250 w-N. Box 325 (84402). (801) 392-7535. United Bcstg Co. Net: MBS, Diamond. Rep: Webb. Spec prog: Sp 2 hrs wkly. ■ Arch G. Webb, pres & gen mgr; David B. Affleck, coml mgr & news dir; Samuel T. Stephens, chief engr.

***KWCR-FM**—May 21, 1966: 88.1 mhz; 10 w. Department of Communications, 3570 Harrison Blvd. (84403). (801) 399-5941, ext 497. Weber State College Board of Trustees. Net: ABC/FM, NPR, Big Sky. Format: Educ. Spec progs: Sp 1 hr, C&W ½ hr wkly. ■ Wm. P. Miller, pres; Wm. V. Sanders, gen mgr; Douglas Threkeid, coml mgr; Jim Minster, prog dir; Randy Campbell, prog mgr; Rich Ashby, news dir; Rich Christensen, chief engr.

Orem

***KOHs(FM)**—Oct 1974: 91.5 mhz; 10 w. Stereo. 175 S. 400 E. (84057). (801) 225-9155. Alpine School District. Format: MOR, educl, top 40. ■ Bob Robertson, pres; Clifton Pyne, gen mgr.

Parowan

***KPWN(FM)**—1970: 90.9 mhz; 10 w. Ant 88.5 ft. c/o Kent F. Peterson, 75 North 300 West, Cedar City (84720). Iron County School District. ■ James L. Benson, gen mgr.

Price

KOAL—October 1936: 1230 khz; 1 kw-D, 250 w-N. Box AC (84501). (801) 637-1167. Eastern Utah Bcstg Co. Net: ABC, IMN. Rep: Petry. ■ Jack Richards, pres; Thomas B. Anderson, gen & coml mgr & prog dir; Norm Smith, news dir; John Stocks, chief engr.

Provo

***KBYU-FM**—May 5, 1960: 88.9 mhz; 32 kw. Ant 2,850 ft. Stereo. Harris Fine Arts Center, Brigham Young U. (84062). (801) 374-1211. Brigham Young U. Net: NPR. Audio news: UPI. Format: Classical. Spec progs: French 2 hrs, Sp 1 hr wkly. ■ Dallin H. Oaks, university pres; Bruce L. Christensen, gen mgr. ■ *KBYU-TV affil.

KEYY—December 1949: 1450 khz; 1 kw-D, 250 w-N. Box KEYY (84601). (801) 373-2174. Mid-Utah Bcstg Co. Inc. Audio news: UPI. Rep: Savalli/Gates; Bournstein. Format: Top 40. ■ Larry V. Bell, pres; Russell J. Heaton, gen mgr; Larson Bennett, prog dir; Steve Hope, mus dir; Clark Bowler, news dir; Jim Huffman, chief engr. ■ Rates: \$8.50; 8.50; 8.50; 8.50.

KFMC(FM)—Listing follows KOVO.

KIXX—Nov 24, 1947: 1400 khz; 250 w-U. Box 1400 (84601). (801) 373-1000. Mesa Bcstg. Rep: Masla; Mtn States; Hix. ■ David L. Barney, VP & gen mgr; Dwayne Case, sls mgr; Leslie Bagley, opns mgr & prog dir.

KOVO—1939: 960 khz; 5 kw-D, 1 kw-N, DA-N. Box 960 (84601). (801) 373-8550. KOVO Inc. (acq 10-1-57). Net: ABC/C, IMN. Rep: RKO. Format: Top 40, variety. ■ Ashley L. Robison, pres, gen mgr; Ray Bishop, prog, mus dir; Richard W. Mathis, prom mgr; Melvin Rogers, news dir; Ken Atkins, chief engr.

KFMC(FM)—Co-owned with KOVO. Feb 14, 1968: 96.1 mhz; 37 kw. Ant 2620 ft. Stereo. (801) 359-0782. Prog sep from AM. Net: ABC/E. Format: Contemp.

KRMQ(FM)—Not on air, target date 1975: 94.9 mhz; 29 kw. Ant minus 630 ft. Box KRMQ (84601). (801) 373-2176. Equivox Inc. ■ Larry V. Bell, pres and gen mgr.

Richfield

KSVC—1947: 980 khz; 5 kw-D. Box 848 (84701). (801) 896-4456. Sevier Valley Bcstg Co. (acq 7-15-72). Rep: Masla; Young; Hix. Format: MOR, C&W. ■ James Clawson, pres & gen mgr; Kim Findlay, prog dir; Jody Clawson, mus dir; Dennis Green, coml mgr; Jeffrey L. Conder, chief engr; Charlie Wanias, news dir.

St. George

KDXU—July 3, 1957: 1450 khz; 1 kw-D, 250 w-N. Box K (84770). (801) 673-3579. Julie P. Miner (acq 10-1-68). Net: ABC/I; IMN. Rep: IMN. Format: MOR. ■ Julie P. Miner, owner; L. Brent Miner, asst mgr; L. John Miner, gen mgr, mus dir, & chief engr; Charles Wanias, news and prog dir. ■ Rates: \$4.25; 3.75; 4.25; 3.75.

KDXU-FM—June 15, 1973: 93.5 mhz; 3 kw. Ant minus 25 ft. Stereo. Dups AM 10%. Net: ABC/FM. Format: Easy Istng. ■ Rates: \$3.50; 3.50; 3.50; 3.75.

***KRDC-FM**—1975: 90.1 mhz; 10 w. Dixie College (84770). (801) 673-4811, ext 331. Dixie College. Format: Variety. ■ Ned E. Carnahan, instructor, advisor.

Salt Lake City

KALL—1945: 910 khz; 5 kw-D, 1 kw-N, DA-N. 312 E. South Temple (84111). (801) 364-3561. Communications Investment Corp. Group owner: Hatch Stns. Net: ABC, IMN. Rep: Eastman Radio. ■ George C. Hatch, pres; Homer K. Peterson, exec VP; Bennie L. Williams, gen and s/s mgr; Paul Engeman, dir of bcstg; Rex L. Vance, chief engr. ■ Rates: \$31; 27; 29; 27.

KALL-FM—Dec 1, 1968: 94.1 mhz; 24 kw. Ant 3,030 ft. Stereo. Prog sep from AM. ■ Paul Engeman, asst mgr. ■ KUTV-TV affil. ■ Rates: \$13; 11; 13; 11.

KCPX—1923: 1320 khz; 5 kw-U, DA-1. 1760 Fremont Dr. (84104). (801) 486-3392. TWX 910-925-5685. KCPX Inc. (acq 1959). Group owner: Columbia Pictures. ■ William E. Wright, stn mgr; Bruce Cummings, coml mgr; Gary Waldron, prog dir; Joe Lee, news dir; Richard Peterson, chief engr. ■ Rates: \$33; 30; 33; 30.

KCPX-FM—1947: 98.7 mhz; 27 kw. Ant 2,930 ft. ■ Rates: \$15; 12; 15; 12.

KFMC-FM—See Provo.

KLUB—Aug 1, 1938: 570 khz; 5 kw-U, DA-1. Box 389, 1550 W. 22d N. (84110). (801) 359-7794. Carman Corp. Rep: McGavren-Guild. Format: Good music & standards. ■ Frank C. Carman, pres & gen mgr; Allan Thomas, natl coml mgr; Paul Coburn, prog dir; Hal Coltriest, VP stn mgr; Clayton Holm, news dir; Delbert Williams, chief engr. ■ Rates: \$34; 23; 29; 17.

KLUB-FM—Feb 1, 1961: 97.1 mhz; 13 kw. Ant 3,650 ft. Stereo. Prog sep from AM. Format: Btlf mus. ■ F. Robert Robinson Jr., stn mgr. ■ Rates: \$8; 14; 14; 8.

KMOR—See Murray.

KNAK—February 1945: 1280 khz; 5 kw-D, 500 w-N, DA-N. 1042 S. 6th W. (84104). (801) 364-3685. Granite District Radio Bcstg. Co. Net: ABC. Rep: Forjoe. Format: Contemp. ■ Clyde Anderson, coml mgr; Paul Freeman, Lloyd L. Young, news dirs; Ronald B. England, chief engr.

KRGO—Nov 16, 1956: 1550 khz; 10 kw-D. 5065 W. 2100 St. (84120). (801) 299-3449. Group Communications (acq 3-1-68). Net: ABC/E. Format: C&W. ■ Sherwin Brotman, pres; Gene Guthrie, gen, coml & prom mgr; Fred Wix, prog, mus & news dir; Karl Huffman, chief engr.

KRSP—Sept 2, 1967: 1060 khz; 10 kw-D. Box 7760 (84107). (801) 262-5541. Holiday Bcstg Co. Rep: Selcom. Format: Contemp, Top 40. ■ Ralph J. Carlson, pres & gen mgr; Doris Redmond, coml mgr; Alan Hauge, prog, mus dir; John Pack, news dir; Chris Murray, chief engr.

KRSP-FM—Aug 21, 1968: 103.5 mhz; 100 w. Ant minus 119 ft. Stereo. Prog sep from AM.

KSL—May 6, 1922: 1160 khz; 50 kw-U. 145 Social Hall Ave. (84111). (801) 524-2500. KSL Inc. Group owner: Bonneville. Net: CBS. Rep: Avco; Hix (Denver). Format: MOR. Spec progs: Farm 4½ hrs, relig 3 hrs wkly. ■ L.H. Curtis, pres; Dean Lindsay, stn and gen s/s mgr; Philip R. Muefler, radio news dir; Russ Wood, local s/s mgr; Flo Wineriter, prog dir; Dave Finley, chief engr; A. Lee Pocock, prom dir. ■ Rates: \$60; 44; 53; 23.

KSL-FM—Dec 6, 1946: 100.3 mhz; 13 kw horiz, 11.5 kw vert. Ant 3,650 ft. (CP 12 kw. Ant 3740 ft). Stereo. (801) 524-2600. Prog sep from AM. Format: Btlf mus. Spec progs: Classcl 1½ hrs; poetry ½ hr, relig ½ hr wkly. ■ Raymond W. Fritsch, gen mgr; Michael C. Peterson, prog dir, prom mgr; Bill Cawley, coml mgr. ■ KSL-TV affil.

KSOP—Feb 1, 1955: 1370 khz; 1 kw-D. Box 15669 (84115). (801) 484-4435. KSOP Inc. (acq 1-1-66). Rep: Torbet; Moore; McGuire. Format: C&W. ■ M.H. Hilton, pres; Greg Hilton, gen mgr; Richard Pexton, prog dir; Stella Serrano, coml mgr; Henry Hilton, prom mgr; Ben Petersen, news dir; Lyle Wahluquist, chief engr; Larry Hunter, mus dir. ■ Rates: \$23; 20; 23; 18.

KSOP-FM—Dec 10, 1964: 104.3 mhz; 13 kw. Ant 3,630 ft. Stereo. Dups AM 50%.

KSXX—May 13, 1960: 630 khz; 1 kw-D, DA. 36 S. State (84111). (801) 355-2953. D&B Bcstg Co. Inc. Net: NBC. Format: Talk. ■ Starley D. Bush, pres; Paul R. Droubay VP, coml mgr & mgr; Donna Rigby, traffic mgr; Bill Terry, prog dir; Robert Chamberlain, chief engr. ■ Rates: \$13; 12; 12; 10.

***KUER(FM)**—June 6, 1960: 90.1 mhz; 22.5 kw. Ant 2,940 ft. 116 Kingsbury Hall, U. of Utah (84112). (801) 581-6625. U. of Utah. Net: NPR. Spec prog: Sp ½ hr wkly. ■ Rex L. Campbell, gen mgr; Gene Pack, prog dir.

KWHO—Nov 15, 1955: 860 khz; 1 kw-D. 512 E. 2d St. (84102). (801) 322-5819. Reese C. Anderson (acq 6-4-56). Format: Classcl. Spec progs: Sp 1½ hrs, Ger 1 hr, Dutch 1 hr wkly. ■ Reese C. Anderson, pres & gen mgr; Lavar F. Reese, coml mgr; John G. Dehnell, prom mgr & prog, mus & news dir; Ben Lesser, news dir; Dennis M. Silver, chief engr. ■ Rates: \$3.75; 3.75; 3.75; 3.75.

KWHO-FM—July 31, 1965: 93.3 mhz; 37 kw. Ant minus 93 ft. Stereo. Prog sep from AM. Format: Top 40, oldies. ■ Rates: \$3.50; 3.50; 3.50; 3.50.

William A. Exline, Inc.
31 CARROLL COURT
SAN RAFAEL, CALIFORNIA 94903
(415) 479-0717
MEDIA BROKERS - CONSULTANTS

Spanish Fork

KONI—July 24, 1960: 1480 khz; 1 kw-D. Box 379 (84660). (801) 489-5166. Pioneer Bcstg Co. Format: C&W. ■ George K. Culbertson, pres, gen mgr & chief engr; Charlotte L. Culbertson, prog dir.

KONI-FM—Nov 1, 1967: 106.3 mhz; 220 w. Ant 920 ft. Stereo. Dups AM 70%.

Tooele

KDYL—July 3, 1956: 990 khz; 1 kw-D. Box 490 (84074). (801) 882-1441. Tooele County Radio and TV Bcstg Inc. Net: Western States Radio Empire. Rep: Young, Feltis/Dove/Croghan; Hix. ■ Wendell Winegar, pres; Richard Hales, coml mgr; Rex LeFevre, prom mgr; Jack Tranter, dir; Robert Chamberline, chief engr.

Vernal

***KUIB(FM)**—June 20, 1972: 89.1 mhz; 10 w. Ant 60 ft. Stereo. 161 N. 10th W. (84078). (801) 789-1891. Uintah School District. Net: Utah Public Radio. Format: Variety. ■ Thomas W. Bridges, gen mgr.

KVEL—Jan 19, 1947: 920 khz; 5 kw-D. Box 307 (84078). (801) 789-0920. Uintah Bcstg & TV Co. Net: ABC/I, IMN. Format: MOR. ■ J.C. Wallentine, pres; Margaret Hemmert, stn mgr; Fred R. Brown, mus & news dir; Howard Johnson, chief engr. ■ Rates: \$3.75; 3.75; 3.75; 3.75.

KVEL-FM—May 1, 1975: 92.7 mhz 1.35 kw. Ant 430 ft. Stereo. Progs sep from AM. Format: Oldies, btlf mus, C&W. ■ Rates: \$4; 4; 4; 4.

Vermont

Barre

WORK(FM)—Listing follows WSNO.

WSKI—See Montpelier.

WSNO—Oct 13, 1959: 1450 khz; 1 kw-D, 250 w-N. Box 1 (05641). (802) 476-4168. Radio Barre Inc. (acq

Utah, Vermont Radio

See page C-1 for explanation of listings.

9-1-74). Net: CBS. Rep: Northeastern Spot Sls. Format: MOR, contemp. Spec prog: C&W 12 hrs wkly. ■ Robert I. Kimmel, pres; Alan H. Noyes, gen mgr; Mike Donovan, coml mgr; Bill Noyes, prog dir; Allan R. Machell, chief engr. ■ Rates: \$3.90; 3.90; 3.90; 3.90.

WORK(FM)—Co-owned with WSNO. Aug 5, 1974: 107.1 mhz; 1.5 kw. Ant 410 ft Dups AM 20%. Format: Contemp. ■ Rates: \$5.20; 5.20; 5.20; 5.20.

Bennington

WBTN—Sept 13, 1953: 1370 khz; 1 kw-D. Box 560 (05201). (802) 442-6321. Catamount Bcstrs Inc. Rep: Webb; Kirby. ■ Mrs. Belva Chase Keyworth, pres, treas & stn mgr; Robert Harrington, asst stn mgr.

Brattleboro

WKVT

Middle-of-the-Road, Uptempo

WKVT—Nov 29, 1959: 1490 khz; 1 kw-D, 250 w-N. Box 818 (05301). (802) 254-2343. Radio Brattleboro Inc. (acq 8-1-65). Net: CBS. Rep: PRO/Meeker; Northeastern Spot Sls. Format: MOR. Spec progs: Pol 1 hr, C&W 3 hrs, farm 2½ hrs wkly. ■ David E. Parnigoni, pres & gen mgr; Gary Ferguson, asst gen mgr; Michael Clark, prog dir; Robert Mocek, mus dir; Anthony Townshend, pub svc mgr; Owen May, news dir; David Calef, chief engr. ■ Rates: \$7.10; 6.35; 7.10; 3.80.

WKVT-FM—Not on air, target date unknown: 92.7 mhz; 410 w. Ant 712 ft. Stereo. Dups AM 90%.

WTSa—April 19, 1950: 1450 khz; 1 kw-D, 250-N. Box 819 (05301). (802) 254-4577. Southern Vermont Broadcasters (acq 1-8-58). Rep: PRO/Meeker; New England Spot. Format: Contemp. Spec prog: C&W 6 hrs wkly. ■ John K. Healy, pres & gen mgr; B.L. Healy, coml & prom mgr; Tom Gavin, mus dir; Larry Smith, news dir.

WTSa-FM—Not on air, target date unknown: 96.7 mhz; 3 kw. Ant 169 ft.

Burlington

WDOT—April 19, 1954: 1400 khz; 1 kw-D, 240 2-N. 395 College St. (05401). (802) 862-5776. Hunter Bcstg Inc. (acq 2-25-64). Net: ABC/C. Rep: Bassett; Segal. Format: Contemp. ■ William A. Hunter, pres & gen mgr; Daniel F. Shannon, coml mgr; Charles Cuisamano, prog dir; John Hill, news dir; Tom McKinney, chief engr.

WEZF(FM)—July 19, 1969: 92.9 mhz; 36 kw. Ant 2700 ft. Stereo. Box 22 (05401). (802) 655-3663. TWX (802) 510-299-0022. International Television Corp. (acq 4-14-74). Rep: PRO/Meeker; Creed. Format: Btlf mus. ■ Donald G. Martin, pres; John R. Hughes, gen mgr; William Arnold, mgr; Sarge Cathrall, chief engr. ■ WEZF-TV affil.

WJOY—Sept 14, 1946: 1230 khz; 1 kw-D, 250 w-N. Joy Drive, Broadcast Park, S. Burlington (05401). (802) 658-1230. Vermont Bcstg Corp. Net: CBS. Rep: PRO/Meeker; Kettell-Carter. Format: Contemp, MOR. ■ Frank A. Balch, pres & gen mgr; Vincent J. D'Acuti, coml & prom mgr; John Nichols, prog dir; Debbie Mesce, news dir; Dennis Snyder, chief engr. ■ Rates: \$11; 18; 11; 8.

WQCR(FM)—Co-owned with WJOY. June 26, 1962: 98.9 mhz; 3.3 kw. Ant 310 ft (CP: 290 ft). Stereo. Prog sep from AM. ■ Rates: \$7; 9; 9; 7.

***WRUV(FM)**—Oct 3, 1965: 90.1 mhz; 400 w. Ant 140 ft. Stereo. 489 Main St. (05401). (802) 656-4399. U. of Vermont & State Agricultural College. Net: ABC/FM. Format: Educl, progsv, classical, jazz. ■ Brian Marshall, faculty advisor & chief engr; David A. Leonard, gen mgr.

WVMT—1922: 620 khz; 5 kw-U, DA-2. Box 1044 (05401). (802) 655-1620. Vermont Radio Inc. (acq 2-1-63). Group owner: Goldman. Net: NBC. Rep: Masla; Eckles & Queen. Format: MOR. Spec progs: Open Mike. ■ Simon Goldman, pres; George Cameron, gen mgr; Thomas Cheek, prom & coml mgr; Brent Jarvis, prog & mus dir; Ernie Farrar, news dir; Burt Dean, chief engr. ■ Rates: \$11; 9; 9; 6.

Vermont, Virginia Radio

See page C-1 for explanation of listings.

Colchester

***WWPV-FM**—Aug 10, 1973; 88.7 mhz; 10 w. Saint Michaels College (05404). (802) 655-0176. Board of Trustees, St. Michaels College. Format: Progs, classcl, educ. ■ Joan L. Van Zandt, gen mgr; Warren C. Chase, chief engr.

East Montpelier

***WVEP(FM)**—March 5, 1973; 88.3 mhz; 10 w. RR No. 2, Montpelier (05602). (802) 229-0321. Union High School Dist No. 32. Format: Progs, Top 40, educ. Spec prog: Black 5 hrs, farm 2 hrs wkly. ■ Andrew C. Wismuller, pres & gen mgr.

Johnson

***WJSC-FM**—July 16, 1972; 90.1 mhz; 10 w. (05656). (802) 635-2314. Vermont State College. Net: NPR. Format: Progs. ■ William A. Price III, gen mgr; T. Hugh McKinney, chief engr.

Middlebury

WCVM(FM)—Listing follows WFAD.

WFAD—Dec 24, 1965; 1490 khz; 1 kw-D, 250 w-N. Box 150, 29 Court St. (05753). (802) 388-2490. Addison Bcstg Inc. (acq 8-1-73). Net: CBS. Rep: New England Spot Sls. Format: MOR. Spec prog: C&W 1½ hrs wkly. ■ Timothy Buskey, pres & coml mgr; Mark Brady, VP, gen mgr & prog dir; Ken Gilbert, mus dir; Larry Maier, chief engr. ■ Rates: \$5.50; 5; 5.50; 4.

WCVM

Solid Gold

WCVM(FM)—Co-owned with WFAD. April 2, 1975: 100.9 mhz; 3 kw. Ant minus 146 ft. (802) 388-6782. Format: Oldies. ■ Rates: \$5.25; 5.25; 5.25; 5.25.

***WRMC-FM**—February 1968; 91.7 mhz; 10 w. Box 2200 (05753). (802) 388-6323. President and Fellows of Middlebury College. Format: Classcl, prog rock. ■ Christopher Graff, pres & gen mgr; Steve Carr, chief engr.

Montpelier

WSKI—Dec 7, 1947; 1240 khz; 1 kw-D, 250 w-N. 94 Main St. (05602). (802) 223-5275. Green Mt. Bcstg Inc. (acq 12-1-58). Net: ABC/E. Rep: Market 4 Radio; Creed. Format: Variety. Spec prog: Farm 1 hr wkly. ■ Daniel B. Ruggles III, pres & gen mgr; Victor Lavin, coml mgr; Thomas Cheney, prog dir; Robert J. Bannon, news dir; Gerard Marcolte, chief engr. ■ Rates: \$6; 6; 6; 6.

Newport

WIKE—Oct 12, 1952; 1490 khz; 1 kw-D, 250 w-N. Box 377 (05855). (802) 334-6521. Memphremagog Bcstg Co. Inc. (acq 10-52). Net: CBS. Rep: M.A. Sales; New England Spot Sls. Format: Easy lstrng, top 40, C&W, MOR. ■ E. Dean Finney, pres & gen mgr; Roger Stourbridge, stn & prom mgr & prog, mus & news dir; William Graham, coml mgr; Harry Stevenson, chief engr.

Northfield

***WNUB-FM**—Dec 8, 1967; 89.1 mhz; 10 w. Jackman Hall, Norwich University (05663). (802) 485-8400. Norwich U. Net: ABC/FM. Format: Variety. ■ Leonard M. Lugi, pres; Dennis M. Ryan, gen mgr.

Plainfield

***WDGR(FM)**—May 11, 1973; 91.1 mhz; 10 w. Ant 50 ft. Goddard College (05667). (802) 454-8311, ext 437. Goddard College Corp. Format: Variety. ■ Joan Carra, gen mgr.

Putney

***WVUS(FM)**—1974; 88.9 mhz; 10 w. Stereo. Box 480, Windham College (05346). (802) 387-5377. Windham College Radio System. Format: Progs, jazz,

folk. Spec progs: Educ 12 hrs wkly. ■ Richard Sprachman, gen mgr; Paul Flint III, chief engr.

Randolph

WCVR—Nov 30, 1968; 1320 khz; 1 kw-D. Box 1320 (05060). (802) 728-3326. Central Vermont Radio Corp. (acq 2-72). Group owner: Sconnix. Net: ABC/E. Rep: Eckles and Queen. Format: MOR, C&W. ■ Theodore E. Nixon, pres & gen mgr; Al Frawley, prog & news dir; Raymond J. Normandin, sis mgr; Lindsey Collins, chief engr. ■ Rates: \$4.40; 3.35; 4.40; 3.35.

Randolph Center

***WVTC(FM)**—90.7 mhz; 10 w. Ant 63 ft. Box 1, Morey Hall, Vermont Technical College (05061). (802) 728-5646. Vermont State Colleges, Vermont Technical College. Format: Top 40. ■ Howard Marc Ginsberg, pres & gen mgr; Charles Roberts, chief engr.

Rutland

WHWB—June 1949; 1000 khz; 1 kw-D. Box 518 (05702). (802) 773-3315. Central Vermont Bcstg Corp. (acq 1954). Audio news: UPI. Rep: Gill-Perna. Format: MOR. Spec progs: Ital 1 hr, Pol 1 hr wkly. ■ John Carusone Jr., pres; Francis E. McCormack, gen mgr; Edward Larson, prog dir; Paul Thayer, coml mgr; Robert Bascom, mus dir; Michael Calhoun, news dir; Manual Martin, chief engr. ■ Rates: \$6.50; 6.50; 6.50; 6.50.

WHWB-FM—March 25, 1971; 98.1 mhz; 50 kw. Ant minus 300 ft. Dups AM 30%. Format: C&W. ■ Rates same as AM.

WRUT(FM)—Listing follows WSYB.

WSYB—Dec 10, 1930; 1380 khz; 5 kw-D, 1 kw-N, DA-N. Box 249 (05701). (802) 775-5597. Vermont Radio Inc. (acq 11-1-70). Group owner: Goldman. Net: NBC. Rep: Masla; Eckles & Queen. Format: Contemp. Spec progs: Pol 1 hr, C&W 6 hrs, talk 5 hrs wkly. ■ Simon Goldman, pres; Ralph Smith, stn & coml mgr; George Cameron, VP/gen mgr; Alex Dunn, prog & mus dir; Ted Pendelton, news dir. ■ Rates: \$6.30; 5.80; 6.30; 5.80.

WRUT(FM)—Co-owned with WSYB. 1974; 97.1 mhz; 830 w. Ant 2,589 ft. Format: Btlf mus. ■ Rates: \$5.10; 4.60; 5.10; 4.60.

St. Albans

WWSR—1941; 1420 khz; 1 kw-D. Swanton Rd. (05478). (802) 524-2133. Radio St. Albans Inc. (acq 9-59). Rep: Northeastern Spot Sls. Format: MOR, easy lstrng. Spec progs: C&W 7 hrs, talk 5 hrs wkly. ■ Robert I. Kimmel, pres; John O. Kimmel, gen mgr; Cecil Fahl, natl sis mgr; John H. Shaefer, opns mgr; David R. Kimmel, sis mgr; Jack E. Dodd, coml mgr; Albert D. Corey, news dir; Theodore Boisvert, chief engr. ■ Rates: \$5.60; 5.60; 5.60; —.

WWSR-FM—April 1970; 102.3 mhz; 3 kw. Ant 215 ft. Stereo. Box 270 (05478). Progs sep from AM. Format: Contemp, top 40, hit parade. ■ Albert Corey, prom mgr; Art Riddlesworth, news dir. ■ Rates: \$5.60; 5.60; 5.60; 5.60.

St. Johnsbury

WTWN—July 10, 1949; 1340 khz; 1 kw-D, 250 w-N. Box 249 (05819). (802) 748-2344. Twin State Bcstrs Inc. Net: CBS, North Country Sns of Vt. Rep: Masla; New England Spot Sls. Format: MOR. ■ E. Dean Finney, pres & gen mgr; Douglas N. Brown, asst mgr & prog dir; Lawrence Knight, coml mgr; Bryan Meilleur, news dir; Frank Maley, chief engr.

Springfield

WCFR—May 26, 1954; 1480 khz; 5 kw-D. Box 800 (05156). (802) 885-4555. New England Bcstg Co. (acq 10-1-74). Group owner: Sconnix. Net: ABC/C. Rep: Eckles & Queen. Format: MOR, top 40. ■ Theodore E. Nixon, pres; Frank P. Zezza, gen mgr; Gary Wheelock, prog dir; Mike Evans, mus dir; Lawrence Cohen, news dir; Lindsey Collins, chief engr. ■ Rates: \$6.05; 5.50; 6.05; 5.

WCFR-FM—Jan 1, 1972; 93.5 mhz; 3 kw. Ant 175 ft. Dups AM 60%. Format: Easy lstrng.

Stowe

***WMTF(FM)**—April 30, 1975; 91.5 mhz; 10 w. Moun-

tain Rd. (05672). (902) 253-4779. Stowe School. Format: Educ, MOR, oldies, top 40. ■ Bob Paine, pres; Dave Katz, gen mgr.

Waterbury

WDEV—July 16, 1931; 550 khz; 5 kw-D, 1 kw-N, DA-2. 9 Stowe St. (05676). (802) 244-7321. Radio Vermont Inc. (acq 1969). Rep: Devney; Kettell-Carter. Format: MOR. ■ Lloyd E. Squier, pres; Craig S. Parker, gen mgr; Michael Carey, prog dir; Jack Donovan, prom mgr; John Irving, news dir; Peter S. Dean, chief engr. ■ Rates: \$8; 8; 8; 8.

White River Junction

WNHV—Feb 28, 1963; 910 khz; 1 kw-D. Box 910 (05001). (802) 295-3093. N.H.-Vt. Bcstg Corp. (acq 10-1-66). Net: ABC/I. Rep: Fulford; Eckles & Queen. Format: MOR, C&W. ■ Rex Marshall, pres & gen mgr; Ray Reed, prog dir; Terry Boone, coml mgr; George Peabody, mus dir; Dan Colgan, news dir; Bill Taylor, chief engr.

WNVH-FM—Feb 15, 1969; 95.3 mhz; 3 kw. Ant minus 77 ft. Stereo. Dups AM 60%. Format: Good music. ■ Rates: \$8.50; 6.30; 6.30; 2.90.

Virginia

HAMILTON-LANDIS
& ASSOCIATES, Inc.
NATIONWIDE MEDIA BROKERS
WASHINGTON, D. C., CHICAGO, DALLAS,
SAN FRANCISCO
SELL **MORE**
RADIO & TELEVISION STATIONS
IN THE EAST—NEAREST OFFICE IS—
1730 K ST., N.W., WASHINGTON 20006
(202) 393-3456

Abingdon

WBBI—Dec 10, 1956; 1230 khz; 1 kw-D, 250 w-N. Box 190 (24210). (703) 628-2147. Burley Bcstg Inc. Net: MBS. Format: C&W, rock. ■ Lindy M. Seamon, pres, gen mgr & chief engr; Virginia Henninger, coml mgr; Lee Harmon, prog dir, prom mgr; Alan Davis, mus dir; Sid Collier, news dir.

WBBI-FM—Dec 10, 1966; 92.7 mhz; 1.8 kw. Ant 370 ft. Progs sep from AM. Format: Variety.

Alexandria

WPIK—Dec 10, 1945; 730 khz; 5 kw-D, DA. 523 First St. (22314). (703) 683-3000. Potomac Bcstg Corp. Net: MBS. Format: C&W. ■ Carl L. Lindberg, pres; James A. Arthur, VP & gen mgr.

WXRA(FM)—Co-owned with WPIK. See Woodbridge.

Altavista

WKDE—April 29, 1962; 1000 khz; 1 kw-D. Box 512 (24517). (703) 369-5588. Altavista Bcstg Corp. Group owner: Gray Rep. Southern Spot Sls. Format: C&W. ■ Ted J. Gray Jr., pres; Lester Woodie, gen mgr; Bernice Johnson, coml mgr; Doug Catlin, prog dir; Ted Gray Jr., chief engr.

WKDE-FM—June 30, 1969; 105.5 mhz; 3 kw. Ant 120 ft. Dups AM 100%.

Appomattox

WTTX—June 1, 1974; 1280 khz; 1 kw-D. Box 637 (24522). (804) 352-8353. WTTX Radio Inc. (acq 1973). Group owner: Gray Net. ABC/I, VA Agrinet. Rep: Southern Spot Sls. Format: Variety. ■ Ted J. Gray Jr., pres; Joc Cusaac, gen mgr; Ray Sheppard, prog dir; Jody Rainwater, coml mgr; Mark Carter, mus dir; Terry Shinn, chief engr. ■ Rates: \$2.25; 2.25; 2.25; —.

Arlington

WAVA—Nov 7, 1946; 780 khz; 1 kw-D. 1901 N. Ft. Myer Drive (22209). (703) 522-1111. U.S. Transdynamics Corp. (acq 8-1-60). Net: VA. News. Audio news: UPI. Rep: Masla. Format: News. Spec

prog; Jewish 2 hrs wkly. ■ Arthur W. Arundel, pres; Wynn Hott, gen mgr; Al Kessler, opns dir; James Limbach, news dir; Bill Ashley, chief engr. ■ Rates: \$37; 32; 27; 13.50.

WAVA-FM—Aug 1, 1948: 105.1 mhz; 50 kw. Ant 500 ft. Dups AM 100%. ■ Rates combined with AM.

WEAM—April 7, 1947: 1390 khz; 5 kw-U, DA-2. 2131 Crimmins Lane, Falls Church (22043). (703) 534-1390. Arlington Fairfax Bcstg Co. (acq 5-31-48). Group owner: Thoms. Net: ABC/C. Rep: Eastman. Format: Progs. ■ Harold H. Thoms, pres; Bruce A. Houston, VP & gen mgr; Frank Adair, prog dir; Morgan Burrows, chief engr. ■ Rates: \$28; 22; 28; 22.

Ashland

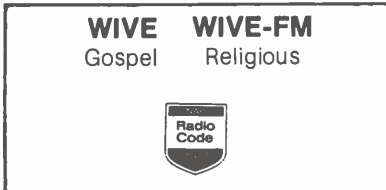

WIVE—May 1, 1962: 1430 khz; 1 kw-D. Box 272 (23005). (804) 798-4711. Christian Enterprises Inc. (acq 3-13-66). Audio news: UPI. Format: C&W, gospel. Spec progs: Black 2 hrs, farm ¼ hr wkly. ■ James N. Birkitt, pres; Clarence E. Morrison, coml and gen mgr; John Rysuck, mus dir; Wes Lund, prog dir; L.B. Kizzie, prom mgr; Jack Rabito, news dir; Don Arnold, chief engr. ■ Rates: \$5.75; 5.75; 5.75; 5.75.

WIVE-FM—Dec 7, 1967: 100.1 mhz; 3 kw. Ant 300 ft. Stereo. Dups AM 50%. Format: Religious. ■ Rates same as AM.

Bassett

WODY—Oct 1, 1960: 900 khz; 500 kw-D, DA. Drawer 231 (24078). (703) 629-2509. WODY Inc. Format: C&W. ■ E. Arnold Terry, pres, gen and coml mgr; Shirley Prillaman, prog dir; Donald I. Fields, mus dir; Bennie R. Shouse, news dir; Jim Ottaway, chief engr. ■ Rates: \$4.95; 4.95; 4.95; 4.95.

Bedford

WBLT—Feb 9, 1950: 1350 khz; 1 kw-D. Box 506 (24523). (703) 586-8245. Bedford Bcstg Corp. Net: Agrinet, Virginia. Audio news: UPI. Format: Variety. Spec prog: Farm 5 hrs wkly. ■ James E. Synan, pres; James W. Patterson, sls mgr; Dana Carden, prom mgr; H. Watts Key, mus dir; John Laughlin, chief engr. ■ Rates: \$2.40; 2.40; 2.40; —.

Big Stone Gap

WLSD—Aug 20, 1953: 1220 khz; 1 kw-D. Drawer W (24219). (703) 523-1700. Gap Bcstg Co. Net: ABC/I. Format: MOR. Spec prog: C&W 15 hrs wkly. ■ W.H. Wren, owner; Robert L. Tamer, sls mgr & chief engr; David Hartley, mus dir. ■ Rates: \$2.50; 2.50; 2.50; —.

WLSD-FM—April 8, 1975: 93.5 mhz; 120 w. Ant 1210 ft. Stereo. Progs sep from AM. Format: Btfl mus. ■ Russell Fig, mus dir. ■ Rates: \$5; 5; 5; 5.

Blacksburg

WJJJ—See Christiansburg.

WKEX—July 9, 1969: 1430 khz; 1 kw-D. 400 Lark Lane (24006). (703) 552-2252. William B. Mathews Jr. Format: C&W. ■ William B. Mathews Jr., owner; Donald Fleeger, gen mgr; Tom Rutledge, chief engr.

WQBx—1973: 710 khz; 5 kw-D, DA. c/o Box A, Eden, N.C. (27288). Radio Montgomery Inc. ■ Ray Childers, gen mgr; Robin Good, stn and opns mgr; Reggie Neel, prog dir; Linda Wilcoxon, traf dir; Ed Tillett, news dir; Paxton Durham, chief engr.

***WUVT-FM**—Oct 23, 1969: 90.7 mhz; 770 w. Ant 150 ft. Squires Center (24061). (703) 552-0640. Virginia Polytechnic Institute & State Univ. Net: MBS. Format: Variety. ■ Ron Brown, gen mgr; John Blackwell, prog dir; Milton Szymanski, mus dir; Mark Stein, news dir; Ray Wittersheim, prom mgr; Randolph Leech, chief engr.

WVVV(FM)—Co-owned with WJJJ, Christiansburg, Va. December 1964: 104.9 mhz; 2.7 kw. Ant 310 ft.

Stereo. Box 882 (24060). (703) 382-4993. Blacksburg-Christiansburg Bcstg Co. Group owner: Suburban. Net: ABC/C. Audio news: APR. Rep: Southern Spot Sls. Format: Top 40. ■ Robert R. Hilker, pres. ■ Rates: \$2.75; 2.75; 2.75; 2.75.

Blackstone

WBBC(FM)—Listing follows WKLV.

WKLV—1947: 1440 khz; 5 kw-D. Drawer 192 (23824). (804) 292-4146. Blackstone Bcstg Corp. (acq 12-51). Format: C&W, MOR, contemp, R&B. ■ Harris L. Umstead, pres; J.E. Fox, gen mgr & chief engr; Gary R. Taggart, prog dir. ■ Rates: \$3.30; 3.30; 3.30; —.

WBBC(FM)—Co-owned with WKLV. Not on air, target date unknown: 93.5 mhz; 1.8 kw. Ant 370 ft.

Bluefield

WBDY(FM)—December 1970: 106.3 mhz; 3 kw. Ant 96 ft. Box 509 (24605). (703) 326-1063. Bluefield Bcstg Co. (acq 7-18-75). Net: MBS. Format: C&W. Spec prog: Relg 6 hrs wkly. ■ Aubrey Farber, pres; Michael V. Brown, gen mgr & prog dir; Earl Frye, coml mgr; Gordon Jennings, mus dir; Marvin Smallwood, news dir & chief engr; Charles Hannum, prom mgr. ■ Rates: \$2.50; 2.50; 2.50; 2.50.

Bristol

WFHG—January 1947: 980 khz; 5 kw-D, 1 kw-N, DA-N. Box 799 (24201). (703) 669-8112. Bristol Bcstg Inc. (acq 1948). Group owner: Nininger. Net: MBS. Rep: Stone. ■ W.C. Nininger, pres; W.L. Nininger, gen mgr; Jack Martin, coml mgr; Robert M. Fleming, prog dir; Ned Michaels, news dir; John Hughlett Jr, chief engr.

WFHG-FM—See Bristol, Tenn.

WKYE—See Bristol, Tenn.

WOPI-AM-FM—See Bristol, Tenn.

WZAP—1946: 690 khz; 10 kw-D. Box 1038 (24201). (703) 466-2201. 690 Radio Inc. Net: MBS. Rep: PRO/Meeker; Ayer. Format: C&W. Spec prog: Farm 2 hrs wkly. ■ R. Al Morris, VP & gen mgr; John Faniola, chief engr. ■ Rates: \$13.50; 12.50; 13.50; —.

Broadway-Timberville

WBTX—May 18, 1972: 1470 khz; 5 kw-D. Box 337, Broadway (22815). (703) 896-8933. Massanutten Bcstg Co. Inc. Net: ABC/E. Rep: Atlanta Spot Sls. Format: Btfl mus. Spec prog: Religious 15 hrs wkly. ■ Samuel Shank, pres; David Eshleman, gen mgr; John Mueller, opns mgr; Stephen Foster, news dir; Frank Farrow, chief engr. ■ Rates: \$4.68; 4.25; 4.68; —.

Brookneal

WODI—Oct 8, 1965: 1230 khz; 1 kw-D, 250 w-N, SH. Box 510 (24528). (804) 376-2288. WODI Inc. Net: Agrinet. Rep: TN. Format: C&W. Spec progs: Gospel 8 hrs, easy Istng 7 hrs wkly. ■ Graham L. Jones, pres, gen mgr & chief engr; Lois Daniel, coml mgr; Joseph Johnson, prom mgr. ■ Rates: \$2.40; 2.40; 2.40; 2.40.

Buena Vista

WBNV—Not on air, target date unknown: 1270 khz; 1 kw. Box 97, Waynesboro, Va. (22980). WANV Inc. (acq 1974).

Charlottesville

WCCV-FM—Listing follows WCHV.

WCHV—1930: 1260 khz; 5 kw-D, 1 kw-N, DA-2. Box 5387 (22903). (804) 977-5566. Realty Co. (acq 9-1-74). Net: ABC/I. Rep: Savalli/Gates; Dome. Format: MOR. ■ Lyell B. Clay, pres; Michael J. Ludgate, VP & gen mgr; Edward L. Owens, prog dir; Bob Gibson, news dir; Jim Racey, mus dir; Tommy Walker, opns mgr; Forest Whitehead, chief engr. ■ Rates: \$11; 6.50; 9.50; 3.

WCCV-FM—Co-owned with WCHV. 1959: 97.5 mhz; 50 kw. Ant 450 ft. Stereo. Prog sep from AM. Format: MOR. ■ Rates: \$5.75; 5.75; 5.75; 5.75.

WELK—October 1957: 1400 khz; 1 kw-D. 250 w-N. Box 1294 (22902). (804) 977-5091. WELK Inc. (acq 4-3-69). Net: ABC/C. Rep: Market 4. Format: Contemp.

■ Robert W. Stroh, pres; John Powell, stn & coml mgr; Richard Mountjoy, prog dir; Dave Straker, news dir. ■ Rates: \$9.30; 6.95; 9.30; 4.50.

WINA—September 1949: 1070 khz; 5 kw-U, DA-N. Box 1230 (22902). (804) 977-3030. Charlottesville Bcstg Corp. (acq 1970). Net: CBS, Agrinet, Virginia. Rep: PRO/Meeker. Format: MOR. Spec prog: Farm 8½ hrs wkly. ■ Laurence E. Richardson, pres; Colin Rosse, exec VP, gen & coml mgr; Wells Bunyec, prog dir; George Habel, news dir; Bill Ray, VP progmg & farm dir; Lee Garlock, chief engr. ■ Rates: \$10.50; 6; 8.25; 4.25.

WQMC(FM)—Co-owned with WINA. October 1954: 95.3 mhz; 2.8 kw. Ant 145 ft. Stereo. Prog sep from AM. Format: Btfl mus. ■ Colin Rosse, gen mgr. ■ Rates: \$4; 3; 4; 3.

***WTJU(FM)**—May 10, 1957: 91.3 mhz; 750 w. Ant 105 ft. Stereo. Station No. 1, U. of Va. (22904). (804) 924-3418. U. of Va. Format: Progs, jazz, classical, educ. ■ William Bruckner, pres; John Hoffacker, stn mgr; Tom Moody, prog dir; Phil Fowler, news dir; Steven Silverman, sports dir; Steven Shapiro, finance dir.

Chase City

WMEK—Jan 18, 1959: 980 khz; 500 w-D. Box 697 (23924). (804) Drake 2-3141. Mecklenburg Bcstg Inc. Net: ABC. Spec prog: C&W 9 hrs wkly. ■ John L. Cole Jr, pres; Arthur A. Moran Jr, gen & coml mgr; Tom Waxter, prog dir.

Chatham

WKBY—June 8, 1966: 1080 khz; 1 kw-D. Rt. 2, Box 105A (24531). (804) 432-8108. Pittsylvania County Bcstg Inc. (acq 11-68). Net: Tobacco. Format: C&W. ■ Everett C. Peace Jr, pres; Maria Reynolds, gen mgr; Larry Reid, prog dir; Neil Ryan, mus dir; Ken Hendrix, news dir; Ken Morris, chief engr.

Chesapeake

WCPK—1967: 1600 khz; 1 kw-D. 500 E. Liberty St. (23324). (804) 543-3535. Payne of Virginia Inc. (acq 7-15-67). Net: NBC. Rep: Torbet. Format: Easy Istng. ■ Charles F. Payne, own & pres; John Howell, dir pub affrs; Katy Payne, ofc mgr; Raymond Jones, opns mgr; Gordon Pace, chief engr.

***WFOS(FM)**—May 2, 1955: 90.5 mhz; 10 w. 2500 Rodgers St. (23324). (804) 543-3538. Chesapeake Public Schools. Format: Variety, ed. Spec progs: Ger ½ hr, Black 1 hr wkly. ■ Preston Best, gen mgr; Bill Benton, prog dir.

WJLY(FM)—(Moyock, N.C.) Oct 17, 1974: 92.1 mhz; 3 kw. Ant 300 ft. Stereo. Drawer D (23320). (804) 421-2126. Stoneland Corp. Rep: Avery-Knodel. Format: Top 40, oldies. Spec prog: Folk music 3 hrs wkly. ■ Paul F. Rule, pres, gen mgr & coml mgr; Mark Groves, stn mgr & news dir; Doug Bartron, mus dir; Joseph H. Wetherbee Jr, chief engr. ■ Rates: \$9; 6.75; 9; 4.50.

Chester

WDYL(FM)—Listing follows WIKI.

WIKI—September 1964: 1410 khz; 5 kw-D. 10600 Jefferson Davis Hwy, Richmond (23234). (804) 275-6161. WIKI Radio Inc. Format: Religious/Black Gospel. ■ John Laurino, pres; Dorna M. Laurino, exec VP; Gordon L. Hood, gen mgr; Vernon Lee, pub aff dir and prog dir; Charles Burlew, stn mgr; Marg Weatherhead, traf dir.

WDYL(FM)—Co-owned with WIKI. December 1968: 92.1 mhz; 3 kw. Ant 260 ft. Prog sep from AM. Format: Relig/Gosp.

Christiansburg

WJJJ—October 1954: 1260 khz; 1 kw-D. Box 30 (24073). (703) 382-4993. Blacksburg-Christiansburg Bcstg Co. (acq 1-1-67). Group owner: Suburban. Net: ABC/C. Rep: Keystone; Southern Spot Sls. Format: Contemp. Spec prog: C&W 12 hrs wkly. ■ Robert R. Hilker, pres; Lewis H. Bagwell Jr, gen & coml mgr; Larry Dillon, prog dir; Dave Riddle, news dir; Robert L. Richardson. ■ Rates: \$4; 4; 4; 4.

Virginia Radio

See page C-1 for explanation of listings.

WVTV(FM)—Co-owned with WJZZ. See Blacksburg.

Clifton Forge

WXCF—Oct 19, 1950: 1230 kHz; 1 kw-D, 250 w-N. Box 104 (24422). (703) 862-5751. Alleghany-Highlands Radio Inc. (acq 1-29-73). Format: MOR, Rock. ■ Calvin Wright, pres; Larry M. Reid, gen mgr; Charles Seebeck, sls mgr; James Cox, chief engr.

Clintwood

WDIC—May 1961: 1430 kHz; 1 kw-D. Box 412, Rt. 1 (24228). (703) 835-2741. Dickenson County Bcstg Corp. Format: MOR. ■ Joe Turner, pres; Kemire Sutherland, gen mgr, coml mgr & news dir; John Mullins, prom mgr; Betty R. Large, prog dir; Larry C. Sutherland, chief engr.

Collinsville

WFIC—March 1, 1970: 1530 kHz; 1 kw-D (250 w CH). Box 475 (24078). (703) 647-3761. Radio Collinsville Inc. (acq 9-25-74). Net: ABC/C. Format: Top 40. ■ Sonny Woody, pres & gen mgr; Gary Cross, mus dir; Gary Seegar, news dir. ■ Rates: \$3.75; 3.75; 3.75; 3.75.

Colonial Heights

WPVA—See Petersburg.

Covington

WKEY—May 23, 1941: 1340 kHz; 1 kw-D, 250 w-N. Box 710 (24426). (703) 962-1133. WKEY Inc. (acq 6-1-73). Net: ABC/E, Agrinet. Format: Contemp, C&W. ■ E.H. Barr, pres; James E. Croy, gen mgr; Kenneth L. Bryant, stn mgr & coml mgr; John Lee Davis, prog dir; Will Shawver, prom mgr; Ranny Mason, mus dir; Dwight Rohr, news dir; Jean Woods, chief engr. ■ Rates: \$4.75; 4.75; 4.75; 4.75.

WKEY-FM—October 1964: 100.9 mhz; 3 kw. Ant minus 255 ft. Dups AM 15%. Net: ABC/FM. Format: Easy Istng. ■ Rates same as AM.

Crewe

WSVS—April 7, 1947: 800 kHz; 5 kw-D. 800 Melody Lane (23930). (804) 645-7734. Southern Va. Bcstg Corp. Net: MBS. Format: C&W, MOR, contemp. Spec progs: Black 15 hrs, rock 15 hrs wkly. ■ C.E. Wilson, pres & chief engr; Thelbert R. Silverman, gen mgr; Jimmy Lewis, coml mgr; Rich Shingleton, prog dir; Joe Deiss, mus dir; Randy Shavis, news dir. ■ Rates: \$5; 5; 5; 5.

WSVS-FM—June 9, 1949: 104.7 mhz; 14 kw. Ant 450 ft. Dups AM 50%. (804) 645-7735. Net: Virginia, Agrinet. Format: C&W. ■ Mary Ann Silverman, coml mgr; Al Mull, prog dir & chief engr; Craig Jennings, news dir. ■ Rates same as AM.

Crozet

WPED—March 16, 1970: 810 kHz; 250 w-D. Box 8 (22932). (804) 823-5600. McClenahan Bcstg (acq 1974). Format: Modern country. Spec prog: Farm 2 hrs wkly. ■ W. Edward McClenahan, gen and coml mgr; Buddy Padgett, prog and mus dir; John Dutram, chief engr. ■ Rates: \$6; 4; 6; 4.

Culpeper

WCUL(FM)—Listing follows WCVA.

WCVA—February 1949: 1490 kHz; 1 kw-D, 250 w-N. Box 672 (22701). (703) 825-3900. Culpeper Bcstg Corp. Net: ABC/E. Format: MOR. ■ L.B. Henretty, pres; Leonard M. Dawson, gen mgr; Tucker Butler, asst & coml mgr; Buck Childs, chief engr.

WCUL(FM)—Co-owned with WCVA. Dec 4, 1971: 103.1 mhz; 3 kw. Ant 300 ft. Stereo. Prog sep from AM. Format: Btfl music.

Danville

WAKG(FM)—Listing follows WBTM.

WBTM—May 24, 1930: 1330 kHz; 5 kw-D, 1 kw-N,

DA-N, 710 Grove St. (24541). (804) 793-4411. Piedmont Bcstg Corp. Net: ABC/E. Rep: Southern Spot Sis. Format: MOR. ■ WE. Gardner Jr., pres; T. David Luther, gen & natl sls mgr; Alex Vardavas, mus dir; Leon Smith, news dir; Millard McKinsey, chief engr.

WAKG(FM)—Co-owned with WBTM. June 3, 1968: 103.3 mhz; 100 kw. Ant 630 ft. Stereo. Box 1629 (24541). (804) 797-4290. Prog sep from AM. ■ Ann F. Siddle, VP & gen mgr; Philip R. Watlington, prog dir.

WDVA

Modern Country Music

WDVA—June 29, 1947: 1250 kHz; 5 kw-U, DA-N. One Radio Lane (24541). (804) 797-1250. Va.-Carolina Bcstg Corp. Net: MBS. Rep: TN Spot Sis. Format: C&W. ■ Henry H. Hogan, pres; Eddie Allgood, VP & gen mgr; Ralph Hess Jr., VP & loc sls mgr; Jean R. Collins, treas & natl-rgrl sls mgr; Homer Thomasson, VP & asst mgr; Jeff Waugh, VP & opns mgr; Charlie Craig, news dir; William C. Campbell, chief engr. ■ Rates: \$6.88; 6.88; 6.88; 6.88.

WILA—ug 25, 1957: 1580 kHz; 1 kw-D. Box 3444 (24541). (804) 792-2133. WILA Inc. (acq 1-1-70). Net: MBS/Black. Rep: Dore; Ochs. Format: Black. ■ Neill K. McMillan, pres & gen mgr; Tom Price, coml mgr; James R. Woodson, opns dir; Roger Lea, chief engr. ■ Rates: \$4.25; 4.25; 4.25; —.

WYPR—Sept 7, 1959: 970 kHz; 1 kw-D. Box 3325 (24541). (804) 792-6022. WYPR Radio Inc. (acq 12-1-73). Net: ABC/C. Rep: Carpenter. Format: Top 40. ■ Dick Campbell, pres & gen and coml mgr; Don Webb, prog dir; Jim Hill, mus dir; Brenda Blankenship, prom mgr; Greg Maund, chief engr.

Deerfield

WABH—March 9, 1962: 1150 kHz; 1 kw-D. WABH Rt. 629 (24432). (703) 939-1150. TWX (703) 939-1150. Deerfield Bcstg Co. (acq 8-1-73). Format: Solid gold. Spec prog: Italian 6 hrs wkly. ■ Robert L. Dean, pres & gen mgr; Ralph Layne, prog dir & coml mgr; J.D. Simmons, mus dir; Erica Wessler, news dir & prom mgr; Vincent O'Connell, chief engr.

Emporia

WEVA—Nov 4, 1952: 860 kHz; 1 kw-D. Box 1056 (23847). (804) 634-2133. Stone Bcstg Corp. Rep: Tobacco Radio. Format: Contemp. Spec prog: C&W 14 hrs wkly. ■ Willis L. Stone, pres & gen mgr; Donald O. Collins, coml mgr; Dick Phillips, prog dir; Rick Franklin, news dir; Elton A. Short Jr., chief engr. ■ Rates: \$5; 5; 5; 5.

Exmore

WEXM-FM—1972: 107.5 mhz; 27.4 kw. Ant 260 ft. Route 123 (23350). (804) 442-2980. Parker-Rew Enterprises, Rep: Frederick W. Smith. ■ James A. Rew Jr., pres & gen mgr.

Fairfax

WEEL—Oct 21, 1955: 1310 kHz; 5 kw-D, 500 w-N, DA-2. 3909 Oak St. (22030). (703) 273-4000. OK Bcstg Corp. Rep: Groskin. Format: Contemp. ■ Arthur Keller, pres; Greg Pearson, gen & coml mgr; Bradley Field, prog dir; Dick Shannon, news dir; Bernard A. Terrien, chief engr. ■ Rates: \$14.50; 11.50; 14.50; 11.50.

WEZR(FM)—Co-owned with WEEL. See Manassas.

Falls Church

WFAK—September 1948: 1220 kHz; 5 kw-D. 161-B, Hillwood Ave., Tower Sqaure (22046). (703) 532-1220. Newcomb Bcstg Corp. Format: Relig. Spec progs: Black 3 hrs, Greek 1 hr wkly. ■ Lamar A. Newcomb, pres; Mitchell A. Miller, gen & coml mgr & chief engr; Roy C. Martin, prog & mus dir; Bill Turkington, prom mgr & news dir. ■ Rates: \$20; 20; 20; 20.

Farmville

WFLO—August 1947: 870 kHz; 1 kw-D. Box 367 (23901). (804) 392-4195. Colonial Bcstg Co. Inc. (acq

4-71). Format: Contemp, C&W. ■ John D. Wilson, pres & gen mgr; T.J. Fulcher Jr., sls dir; Al Smith, prog dir; Gene Eike, news dir; O.C. Covington, chief engr. ■ Rates: \$4.50; 4.50; 4.50; 4.50.

WFLO-FM—May 1961: 95.7 mhz; 6.3 kw. Ant 300 ft. Dups AM 10%. Format: MOR. ■ Rates same as AM.

Franklin

WYSR—Oct 13, 1956: 1250 kHz; 1 kw-D. Box 569 (23851). (804) 562-3135. Franklin Bcstg Corp. (acq 8-10-59). Net: Tobacco. Format: Variety. Spec progs: Black 15 hrs, C&W 15 hrs wkly. ■ Thomas F. Clark, pres; A.G. Biedenbender, news dir; Richard Harris, chief engr.

Fredericksburg

WFLS—July 15, 1960: 1350 kHz; 1 kw-D. 616 Amelia St. (22401). (703) 373-1500. Star Bcstg Corp. Rep: Dome-Messervey. ■ Charles S. Rowe, pres; Josiah P. Rowe III, gen mgr; James William Poole, stn mgr & chief engr; Randolph P. Ludlam, coml mgr; Dick Ricky, prog dir; John Allen, news dir.

WFLS-FM—June 12, 1962: 93.3 mhz; 50 kw. Ant 350 ft. Dups AM 75%.

WFVA—Sept 8, 1939: 1230 kHz; 1 kw-D, 250 w-N. Drawer 269 (22401). (703) 373-7721. Fredericksburg Bcstg Corp. Group owner: Mid Atlantic. Net: ABC/C. Rep: PRO/Meecker. Format: Contemp. Spec prog: Black 1 hr wkly. ■ Walter M. Lowry Jr., pres; Marion Park Lewis, exec VP; John Carl Morgan, gen and coml mgr; tech dir; Dick Rossi, mus & prog dir; John Calhoun, news dir; Keith E. Angstadt, chief engr. ■ Rates: \$5.60; 5; 5.60; 5.

WFVA-FM—May 15, 1960: 101.5 mhz; 5.1 kw. Ant 58 ft. Stereo. Dups AM 98%.

Front Royal

WFFV(FM)—Jan 17, 1973: 99.3 mhz; 3 kw. Ant 300 ft. Stereo. Box 252, Middleton (22645). (703) 869-1343. Wayside Bcstg Corp. Net: ABC/FM. Format: Btfl mus. Spec prog: Classical 7 hrs wkly. ■ Leo M. Bernstein, pres; Michael Paul Carnell, VP & gen mgr; Norman Schmidt, prog and mus dir; George Stoddart, news dir; Mary Campbell, coml traf mgr; Francis Little, chief engr. ■ Rates: \$5; 5; 5; 5.

WFTR—Sept 19, 1948: 1450 kHz; 1 kw-D, 250 w-N. Box 192 (22630). (703) 635-4121. WFTR Inc. (acq 7-1-69). Net: MBS. Format: Contemp. ■ Charles B. Britt, pres & gen mgr; Jim Lawrence, prog dir; Donald L. Peikay, VP; Bob Kern, news dir; Robert J. Traister, coml mgr & chief engr.

WIXV(FM)—Co-owned with WFTR. Not on air, target date unknown: 95.3 mhz; 3 kw. Ant 170 ft. (acq 1973).

Galax

WBOB—Feb 1, 1947: 1360 kHz; 1 kw-D. Box 270 (24333). (703) 236-2921. Carroll-Grayson Bcstg Corp. Format: MOR. ■ Robert V. Morris, pres; Joseph P. Crockett, gen mgr; J. Brice Parks, sls mgr; Mrs. Muriel M. Bell, prog dir; Roger Poole, news dir; Edward Boyer, chief engr.

WBOB-FM—98.1 mhz; 6.8 kw. Ant 590 ft. Dups AM 40%.

Gate City

WGAT—July 24, 1959: 1050 kHz; 1 kw-D. Box 37 (24251). (703) 386-7025. Tri-Cities Bcstg Corp. (acq 3-30-65). Net: MBS, Farm Directors Radio Net. Rep: Piano. Format: C&W, MOR. ■ J. Herman Long, pres & gen mgr; Carroll Dean, prog dir; Chuck Newton, news dir; Alan Giles, chief engr.

WGAT-FM—Feb 21, 1970: 104.9 mhz; 1 kw. Ant 480 ft. Progs sep from AM.

Gloucester

WDDY—Jan 20, 1957: 1420 kHz; 1 kw-D. Box 673 (23061). (804) 693-2105. Cape Radio Inc. (acq 6-16-58). Rep: Bolles. Spec progs: Black 12 hrs, C&W 12 hrs wkly. ■ Arthur Lazarow, pres & gen mgr; Joan R. Lazarow, asst gen mgr; Charles Lawrence, chief engr. ■ Rates: \$2.40; 2.40; 2.40; —.

Gretna

WMNA—Aug 11, 1956: 730 khz; 1 kw-D, DA. Box 730 (24557). (804) 656-1234. Central Va. Bcstg Co. Net: MBS. Format: Variety. Spec progs: C&W 15 hrs, Black 10 hrs wkly. ■ Lyle C. Motley, pres & gen mgr; Shirley Bailey, coml mgr; Charlotte B. Wells, prog & mus dir; Robey F. Thompson, prom mgr & chief engr; R.G. Rowland, news dir. ■ Rates: \$2.40; 2.40; 2.40.

WMNA-FM—Feb 28, 1959: 106.3 mhz; 3 kw. Ant 260 ft. Stereo. ■ Rates same as AM.

WMNA on 730 Khz in
Virginia's
Largest County
1ST IN FARM POPULATION
1ST IN CROP INCOME IN VA.

Grundy

WMJD(FM)—Listing follows WNRG.

WNRG—Nov 16, 1955: 940 khz; 5 kw-D. Box V (24614). (703) 935-2587. Virginia-Kentucky Bcstg Co. Rep: Bernard. Format: MOR. ■ Herman G. Dotson, pres; Ronald F. Cole, gen mgr.

WMJD(FM)—Co-owned with WNRG. June 21, 1965: 97.7 mhz; 950 w. Ant 490 ft. Prog sep from AM.

Hampden-Sydney

***WWHS-FM**—Oct 11, 1972: 91.7 mhz; 10 w. Stereo. Ant 140 ft. Box 606, Hampden-Sydney College (23943). (804) 223-8773. Pres & Bd of Trustees of Hampden-Sydney College. Format: Variety. Spec progs: Pol 2 hrs, educ 15 hrs wkly. ■ Christopher M. West, prog dir; John R. Butcher, chief engr.

Hampton

***WHOV(FM)**—March 5, 1964: 88.3 mhz; 10 w. Hampton Institute (23368). (804) 727-5407. Hampton Institute. Format: Free format (experimental). ■ William Kearney, pres; Charles S. Harris, gen mgr.

WVEC—July 1, 1948: 1490 khz; 1 kw-D, 250 w-N. Box 400 (23669). (804) 722-6331. TWX 710-882-0072. Peninsula Radio Corp. Net: ABC/I. Rep: Savalli/Gates. Format: MOR. ■ Thomas P. Chisman, pres & gen mgr; Harrol A. Brauer Jr., VP-sls; Lawrence W. Kliever, VP-ops; James O. Gray, prom mgr; Bob Wells, prog dir; Tony Burden, news dir; George Hillier, chief engr. ■ Rates: \$12.50; 12.50; 12.50.

WVHR(FM)—Co-owned with WVEC. June 1, 1962: 101.3 mhz; 50 kw. Ant 380 ft. Stereo. Dups AM 25%. Net: ABC/FM. ■ Rates: \$7; 7; 7.

Harrisonburg

***WEMC(FM)**—1955: 91.7 mhz; 10 w. Stereo. 1200 Park (22801). (703) 433-2781, ext 411. Eastern Mennonite College. Net: ABC/FM/I. Format: Religious, educ, classcl. ■ Gene R. Damoth, gen mgr.

WHBG—August 1956: 1360 khz; 5 kw-D. Box 392 (703) 434-1311. Radio Harrisonburg Inc. (acq 7-59). Net: ABC/C. Rep: Waiton. ■ W.W. Greer Jr., pres; Bill Kramer, VP & gen mgr; Joe Grimm, asst mgr; David Frankel, sls mgr; Roger Allen, prog dir; Harold Richardson, chief engr.

WKCY—May 11, 1967: 1300 khz; 5 kw-D. Box 1107 (22801). (703) 434-1777. Radio Blue Ridge Inc. Audio news: UPI. Format: C&W, MOR. ■ Donald W. Miller, pres & gen mgr; Tom Manley, coml mgr; Owen M. Voigt, prog mgr & chief engr; Loretta Burkeholder, mus dir; Tommy Thompson, news dir. ■ Rates: \$11.42; 8.59; 11.42; 8.59.

***WMRA(FM)**—June 18, 1969: 91.1 mhz; 10 w. Ant 30 ft. (CP 90.7; 19.5 kw. Ant 730 ft). Madison College (22801). (703) 433-6221. Madison College. Net: NPR. Format: Variety. ■ Dr. Ronald Carrier, pres; Sanford H. Kirkland III, gen mgr.

WQPO(FM)—Listing follows WWSA.

WWSA—June 9, 1935: 550 khz; 5 kw, 1 kw-N, DA-N. Box 752, Rawley Pike (22801). (703) 434-0331. TWX

703-434-6345. Gilmore Bcstg Corp. (group owner; acq 9-65). Net: NBC. Rep: PRO/Meeker; Dome. Format: MOR. ■ James Gilmore Jr., pres; Hamilton Shea, exec VP admin/corp dev; Arthur Hamilton, gen mgr; Richard E. Reed, exec VP ops; Alvin Mullenax, stn & coml mgr; Robert MacNeill, ops mgr; Tom Lewis, news dir; Vincent D. O'Connell, chief engr.

WQPO(FM)—Co-owned with WWSA. Dec 3, 1946: 100.7 mhz; 7.2 kw. Ant 340 ft. Stereo. Progs sep from AM. Format: Contemp. ■ WWSA-TV affil.

Herndon

WOHN—Aug 14, 1965: 1440 khz; 1 kw-D, DA. Box 666 (22070). (703) 471-7676. My Staff Inc. (acq 3-71). Net: Keystone. Rep: Keystone. Format: C&W. ■ James S. Beattie Sr., pres; James S. Beattie Jr., gen mgr.

Highland Springs

WENZ—May 18, 1959: 1450 khz; 1 kw-D, 250 w-N. 111 N. 4th St., Richmond, Va. (23219). (804) 643-7437. Baron Radio Inc. (acq 11-1-65). Net: MBS, MBS/Black. Rep: Howard. Format: Black. ■ Ralph J. Baron, pres; George J. Lund, exec VP & gen mgr; John Marver, sls & stn mgr; Calvin Booker, mus dir; James Carter, local sls mgr; Claudette McDaniel, woman's pub affrs; Joseph Woodford, rgnl sls mgr; Ed Burkhardt, chief engr. ■ Rates: \$19; 15; 19; 15.

Hillsville

WHHV—Sept 16, 1961: 1400 khz; 1 kw-D, 250 w-N. Box 648 (24343). (703) 728-9114. Hillsville-Galax Bcstg Co. (acq 11-1-67). Group owner: Suburban. Net: MBS. Format: C&W 50% wkly. ■ Robert R. Hilker, pres; Frank Thomas, gen mgr; Zane G. Bennett, asst mgr; Bob Brown, coml mgr; Willa V. Thomas, prog dir; Art Vile, chief engr.

Hopewell

WHAP—May 31, 1949: 1340 khz; 1 kw-D, 250 w-N. Box 621 (23860). (804) 458-8518. Radio Hopewell Inc. (acq 5-1-71). Net: ABC/I. Format: MOR. ■ Roy D. Wooster Jr., pres; George Thoma, gen mgr; Dan Vanko, chief engr. ■ Rates: \$6.15; 6.15; 6.15; 6.15.

Jamesville

WEXM—Not on air, target date unknown: 1520 khz; 500 w-D, DA, c/o James A. Rew Jr., Olney, Va. (23418). Parker-Rew Enterprises.

Kilmarnock

WKWI(FM)—Sept 1, 1975: 101.7 mhz; 1.9 kw. Ant 235 ft. Stereo. Box 814 (22482). (804) 435-1414. Kilmarnock Bcstrs. Format: MOR. ■ Dean Loudy, gen mgr; Ray Cook, prog dir; James Sandman, news dir. ■ Rates: \$3.90; 3.50; 3.50; 3.

Lawrenceville

WLES—September 1959: 580 khz; 500 w-D. Court St. (23868). (804) 848-2600. Brunswick Bcstg Co. (acq 1-66). ■ E.N. Doyle Jr., mgr.

Lebanon

WLRV—October 1974: 1380 khz; 500 w-D. Box 1380 (24266). (703) 889-1380. J.T. Parker Bcstg Corp. Format: C&W, MOR. ■ J.T. Parker Jr., pres; Phil Roberts, gen mgr; William M. Sandidge, chief engr.

Leesburg

WAGE—March 6, 1958: 1290 khz; 1 kw-D. Box 1290, 182 Wage Drive (22075). (703) 777-1290. Radio WAGE Inc. (acq 5-28-62). Group owner: Tidmore (15.5%). Rep: Dome. Audio news: UPI. Format: MOR. ■ Huntington Harris, pres; Wm. H. Spencer Jr., gen & prom mgr; Phil Long, sls mgr; Frank Lambert, prog & mus dir; Wm. J. Chewning, news dir; John R. Gill, chief engr. ■ Rates: \$5.80; 5.80; 5.80; —.

Lexington

***WLUR(FM)**—Feb 27, 1967: 91.5 mhz; 148 w. Ant minus 175 ft. Stereo. Washington and Lee U. (24450). (703) 463-2869. Washington & Lee U. Format: Variety. ■ Robert E.R. Huntington, pres; Jeryl R. Davis, gen mgr; Craig Dorval, prog dir; Doug Dewing, Dave Meschutt, mus dirs; Bob Smith, prom mgr; Scott

Virginia Radio

See page C-1 for explanation of listings.

Thomas, news dir; Tom Tinsley, chief engr; E. Hadley Lowell, pub affrs.

WREL—Nov 14, 1948: 1450 khz; 1 kw-D, 250 w-N. Drawer 902 (24450). (703) 463-2161. Rockbridge Bcstg Corp. Format: Contemp. ■ Ted Feazall, coml mgr; Brenda D. Elliott, stn mgr; James Geason, news dir; James I. Bray, chief engr.

Luray

WRAA—1964: 1330 khz; 1 kw-D. Box 128 (24505). WRAA Broadcasters Inc. (acq 1971).

Lynchburg

WBRG—Sept 7, 1956: 1050 khz; 1 kw-D. Box 1079 (24505). (804) 845-5916. Tri-County Bcstg Inc. (acq 7-1-67). Rep: PRO/Meeker; Busby, Finch & Woods. Format: C&W. ■ Harry A. Epperson Sr., pres; Thomas L. Buckley, gen mgr, news dir & prom mgr; Sallie B. Henry, traf mgr; Victor Bosiger, prog dir & chief engr; Thomas Williams, mus dir.

WGOL(FM)—Listing follows WLLL.

WJJS-FM—Listing follows WLGm.

WLGm—Feb 22, 1962: 1320 khz; 1 kw-D. 801 Main St. (24504). (804) 847-6666. Rulon-Maynard Corp. (acq 3-28-66). Rep: Bernard Ochs. Format: Mod MOR. ■ L. John Denney, pres; Gene B. Creasy, gen mgr; Wayne Campbell, sls mgr; Ron Joseph, stn mgr; Jonathan Mumm, news dir; George W. Sellers, chief engr.

WJJS-FM—Co-owned with WLGm. Aug 1, 1964: 101.7 mhz; 3 kw. Ant 290 ft. Prog from AM. Net: MBS/Black. ■ Brett Lewis, prog & mus dir; Fletcher Hubbard, stn mgr.

WLLL—Nov 1, 1963: 930 khz; 5 kw-D. Box 1510, N. One Radio La. (24505). (804) 239-0333. Griffith Bcstg Corp. Net: NBC. Rep: PRO/Meeker; Southern Spot Sls. Format: Top 40. ■ A. Hundley Griffith, pres & gen mgr; Joseph Cleary, coml mgr; David R. Freer, prom mgr.

WGOL(FM)—Co-owned with WLLL. Sept 1, 1970: 98.3 mhz; 3 kw. Ant 240 ft. Stereo. Drawer 1660 (24505). Prog sep from AM. Format: Gold. ■ M.C. Bowers, chief engr.

WLVA—April 21, 1930: 590 khz; 1 kw-U, DA-2. Box 238 (24502). (804) 845-1242. Evening Star Bcstg Co. (group owner; acq 1965). Net: ABC/I. Rep: Masla. Format: MOR. ■ Richard S. Stakes, pres; Terry McRight, gen mgr; Jerry McElroy, coml mgr; Ken Correll, prom mgr and prog dir; Chip Miller, news dir; Mickey Arnold, mus dir; Barry Taylor, chief engr. ■ WLVA-TV affil. ■ Rates: \$11.75; 8.80; 9.75; 7.85.

WWOD—May 1947: 1390 khz; 5 kw-D, 1 kw-N, DA-N. Box 1390 (24505). (804) 384-1211. Lynchburg Independent Bcstrs. Group owner: Bahakel. Net: MBS. Rep: Savalli/Gates. Format: C&W. ■ Cy N. Bahakel, pres; Wayne Campbell, gen mgr & prom mgr; Cheryl Nash, office mgr; Henry M. Ford, coml mgr; Bill Bender, prog dir; Marvin Yust, mus dir; Lynn Nash, news dir; James Barnard, chief engr.

WWOD-FM—1948: 100.1 mhz; 3 kw. Ant 155 ft. (804) 384-1213. Prog sep from AM. Format: Gospel. ■ Eugene Cokman, coml mgr & prog dir; John Abbott, ops mgr; Richard Sanders, mus dir.

Manassas

WEZR(FM)—Co-owned with WEEL Fairfax, Va. April 8, 1968: 106.7 mhz; 50 kw. Ant 500 ft. Stereo. 3909 Oak St., Fairfax (22030). (703) 273-4000. EZ Communications Inc. (group owner). Rep: Groskin. Format: Easy Istng. ■ Joe Murray, gen mgr; John D. Chadwick, prog dir.

WPRW—Oct 1, 1957: 1460 khz; 5 kw-U, DA-2. Box 151 (22110). (703) 388-3108. Prince William Bcstg Corp. Net: MBS. Format: Contemp. ■ Harold H. Hersch, pres; E. Richard Westlake, gen mgr; Ken Poe, coml mgr; Randy Lee Swingle, prog dir; William Harris, chief engr. ■ Rates: \$11.95; 8.80; 11.95; 8.80.

Marion

WMEV—Dec 12, 1948: 1010 khz; 1 kw-D. Box 470

Virginia Radio

See page C-1 for explanation of listings.

(24354). (703)783-3151. Mountain Empire Bcstg Corp. Net: ABC/C. Rep: Dome-Messervy. Format: Variety. ■ Mrs. Stella W. Maloney, pres & gen mgr; Lewis Preston Collins III, sls; George Mizelle, prom mgr; Deborah Wymer, prog dir; Stella Maloney, news dir; Fred Cox, chief engr. ■ Rates: \$5; 5; 5; 5.

WMEV-FM—June 21, 1961: 93.9 mhz; 3.5 kw. Ant 1,480 ft. Dups AM 80%. ■ Rates same as AM.

WOLD—April 25, 1962: 1330 khz; 1 kw-D. Box 31 (24354). (703) 783-7109. Emerald Sound Inc. (acq 1965). Net: MBS. Format: modern country. ■ Robert S. Dix, pres & gen mgr & chief engr; Patricia Ann Dix, prog dir; Michael S. Battaglia, news dir; Daniel S. Tilson, prom and mus dir. ■ Rates: \$4.50; 4.50; 4.50; —.

WOLD-FM—March 14, 1968: 102.3 mhz; 3 kw. Ant 300 ft. Stereo. Prog sep from AM. Format: Contemp Adult. ■ Rates: \$4.50; 4.50; 4.50; 4.50.

Martinsville

WHEE—Aug 4, 1954: 1370 khz; 5 kw-D. Drawer 3551 (24112). (703) 632-9811. Patrick Henry Bcstg Corp. Net: North Carolina Weather. Audio news: UPI. Format: MOR. Spec progs: Gosp 5 hrs, C&W 15 hrs, black 15 hrs, farm 5 hrs wkly. ■ Thomas W. Patterson, pres, gen & coml mgr; H. Lewis Compton, mus dir and prom mgr; Mrs. Alice F. Divers, prog dir; Richard Rogers, news dir; C. J. Ronk, chief engr. ■ Rates: \$4.25; 4.25; 4.25; —.

WMVA—December 1941: 1450 khz; 1 kw-D, 250 w-N. Box 3831 (24112). (703) 632-2152. Martinsville Bcstg Inc. Net: NBC. Format: Contemp/MOR. ■ Lynwood J. Judkins, VP & gen mgr; Louis Campbell, sls & coml mgr; H. P. Bluhm, prog dir; Owen Hall, news dir; William M. Farley, chief engr; Barry Kirks, mus dir. ■ Rates: \$6.65; 6.65; 6.65; 6.65.

WMVA-FM—January 1950: 96.3 mhz; 100 kw. Ant 600 ft. Stereo. Dups AM 100%. ■ Rates same as AM.

Mount Jackson

WSIG—April 23, 1954: 790 khz; 1 kw-D. Box 425 (22842). (703) 477-2937. Richard F. Lewis Jr. Inc. of Mt. Jackson. Group owner: Mid Atlantic. Net: MBS. Rep: Dome-Messervy. Format: C&W, news. ■ John P. Lewis, pres; Dick Mawyer, gen & coml mgr; Frank Crum, prog dir; Alan Arehart, mus dir; Spencer McIntosh, news dir; Jim Bowman, chief engr. ■ Rates: \$5.89; 4.94; 5.89; —.

Narrows-Pearisburg

WNRV—August 1953: 990 khz; 5 kw-D. Box A (24134). (703) 921-3390. Mrs. Megan H. McWilliams, gen mgr; Robert M. Whitehead, VP & stn mgr; Harry Gentry, coml mgr; James R. Boulton, chief engr.

Newport News

WGH—October 1928: 1310 khz; 5 kw-U, DA-N. Box 98 (23607). (804) 826-1310. Hampton Roads Bcstg Corp. (acq 1938). Rep: Blair. Audio news: UPI. Format: Top 40. ■ Raymond B. Bottom Jr., VP; Ambert Dail, gen mgr; Al Nelowet, sls mgr; Jim Stewart, prog dir; George Crawford Jr., mus dir; Jim Moore, news dir; Joe Looper, chief engr. ■ Rates: \$33; 28; 33; 28.

WGH-FM—November 1948: 97.3 mhz; 74 kw. Ant 400 ft. Stereo. Prog sep from AM. Audio news: APR. Format: Classcl. ■ Raymond B. Bottom Jr., VP & gen mgr; Vianne Webb, prog & mus dir; Chuck Adams, prod dir.

WTID—November 1947: 1270 khz; 1 kw-D. Box 5211 (23605). (804) 723-3391. Bay Cities Bcstg Corp. (acq 9-75). Format: C&W. Spec progs: Relg 10 hrs wkly. ■ Aubrey E. Loving, pres; Joseph B. Burton, gen & coml mgr; Mike Allen, prog, opns & mus dir; John Hart, prom mgr; Gary Shannon, news dir; James R. Wilkie, chief engr.

WQRK(FM)—Co-owned with WTID. See Norfolk.

Norfolk

WCMS—July 1, 1954: 1050 khz; 5 kw-D, DA. 5600 Curlew Dr. (23502). (804) 420-1050. WCMS Radio

Norfolk Inc. (acq 7-1-61). Rep: Buckley. Format: C&W. ■ George A. Crump, bd chmn; Irvine B. Hill, pres & gen mgr; Joseph Hoppel, prog dir; Earl Jolley, chief engr. ■ Rates: \$28; 21.75; 28; 11.25.

WCMS-FM—Oct 1, 1962: 100.5 mhz; 50 kw. Ant 380 ft. Dups AM 50%.

WFOG(FM)—See Suffolk.

WGH-AM-FM—See Newport News.

WKLX—See Portsmouth.

WNOR—1948: 1230 khz; 1 kw-D, 250 w-N. 252 W. Brambleton Ave. (23510). (804) 623-9667. Commonwealth Bcstg Col (acq 1967). Net: ABC/C. Rep: Katz. Format: Contemp. ■ Stan Wilson, pres; Fred Gage, exec VP & gen mgr; Paul Todd, prog mgr, VP & asst mgr; Darryl Hosack, news dir; Josh Barry, sls mgr; Susan Dempsey, prom mgr; Joe Hardin, chief engr.

WNOR-FM—1960: 98.7 mhz; 46 kw. Ant 520 ft. Stereo. Dups AM 10%. Format: Progs, Top 40. ■ Jim Lowe, coml mgr.

WOWI(FM)—June 1948: 102.9 mhz; 50 kw. Ant 470 ft. 2712 Colley Ave. (23517). (804) 622-4600. Metro Communications Corp. (acq 12-74). Format: Contemp, Top 40. ■ Robert LaFerme, gen & coml mgr; Edna Brauer, prog dir; Louis J. Hardin, chief engr; John Nesci, news dir.

WPCE—See Portsmouth.

WPMH—See Portsmouth.

WQRK(FM)—Co-owned with WTID Newport News. July 1967: 104.5 mhz; 50 kw horiz, 9.1 kw vert. Ant 400 ft. horiz, 350 ft. vert. Stereo. 11 Koger Center (23502). (804) 461-1045. Bay Cities Bcstg Corp. (acq 9-75). Rep: ABC-FM Spot sls. Prog sep from AM. Format: Contemp. ■ Gene Loving, pres and gen mgr; Jim Lowe, sls mgr; Paul Todd, prog dir; Gloria Heinrich, news dir.

WRAP—September 1952: 850 khz; 5 kw-D, 1 kw-N, DA-2. Box 598 (23501). (804) 484-5243. Rollins Bcstg of Delaware (group owner). Net: Natl Black Net. Rep: H-R/Stone. Format: Black, contemp. ■ O. Wayne Rollins, pres; Terry Watts, gen mgr; Maurice Ward, prog dir; Chester Benton, mus dir & prom mgr; Ann Ranson, news dir; Stuart Barondess, coml mgr; Ray Mills, chief engr.

WTAR—Sept 21, 1923: 790 khz; 5 kw-U, DA-N. 720 Boush St. (23510). (804) 625-6711. TWX (804)-625-8148. WTAR Radio-TV Corp. (acq 1932). Group owner: Landmark. Net: CBS. Rep: Christal. Format: MOR. ■ William Gietz, pres; Larry Saunders, gen mgr; Edmond H. Johnson, Jr., coml mgr; Dick Lamb, prog dir; Jeff Dane, prom mgr; Tom Looney, mus dir; James Mays, news dir; John Zaun, chief engr. ■ Rates: \$38; 25; 30; 25.

WTAR-FM—Sept 21, 1961: 95.7 mhz; 40 kw. Ant 880 ft. Stereo. Format: Btl mus. ■ Thurman Washington, stn mgr; John Craver, opns mgr. ■ WTAR-TV affil. ■ Rates: \$13; 13; 13; 13.

***WTGM(FM)**—July 15, 1973: 89.5 mhz; 26.5 kw. Ant 320 ft. Box 3311 (23514). (804) 625-0404. Hampton Roads Educl TV Assn. Net: NPR. Format: Classical Cmnty progs. ■ Edgar S. Everhart, pres; Charles G. Massie Jr., gen mgr; John C. Jarvis Jr., prod dir; William G. Parker Jr., studio engr; G.B. Gebler, mus dir; Richard A. Peabworth, chief engr.

WTID—See Newport News.

WVAB—See Virginia Beach.

WVEC—See Hampton.

WXRI(FM)—See Portsmouth.

WYFI(FM)—Oct 2, 1971: 99.7 mhz; 50 kw. Ant 400 ft. Box 33 (23501). (804) 623-6262. Bible Bcstg Network (acq 12-24-70). Format: Christian. ■ Keith Davey, pres; Lowell Favey, gen mgr.

WZAM—Not on air, target date January 1976: 1110 khz; 50 kw-U, c/o B. Benns, 2500 Va. Ave NW, Washington, D.C. (20037). James River Bcstg Corp. ■ Mrs. Barbara Benns, pres; Michael J. Benns, chief engr.

Norton

WNVA—March 1946: 1350 khz; 5 kw-D. Box 500 (24273). (703) 679-2211. Radio-Wise Inc. Rep:

Keystone. Format: Contemp, C&W. ■ R. B. Helms, pres & gen mgr; William G. Stallard, VP & stn mgr; Jim Baker, prog dir; Bill Coomer, prom mgr; Steve Campbell, mus dir; Gary Lawson, news dir; Raymond Waddell, chief engr. ■ Rates: \$31.5; 3.15; 3.15; 3.15.

WNVA-FM—July 25, 1969: 106.3 mhz; 700 w. Ant 560 ft. Dups AM 90%. ■ Rates: \$3.15; 3.15; 3.15; 2.75.

Orange

WJMA—Sept 10, 1949: 1340 khz; 1 kw-D, 250 w-N. Box 271 (22960). (703) 672-1000. WJMA Inc. (acq 7-1-61). Format: Variety, MOR. Spec progs: Farm 3 hrs, classcl 4 hrs, jazz 2 hrs, C&W 6 hrs wkly. ■ Arch Harrison Jr., pres, gen & coml mgr; C. W. Little, asst mgr; E. V. Bossieux, chief engr. ■ Rates: \$4; 4; 4; 4.

WJMA-FM—Nov 22, 1971: 96.7 mhz; 3 kw. Ant 170 ft. Dups AM 95%.

Pennington Gap

WSWV—June 1, 1959: 1570 khz; 1 kw-D. Box 338 (24277). (703) 546-2520. Lee County Bcstg Co. ■ Daniel E. Gabriel, pres.

WSWV-FM—1973: 105.5 mhz; 3 kw. Ant minus 58 ft. 108 S. Johnson Dr. (24227).

Petersburg

WPLZ(FM)—Listing follows WSSV.

WPVA—1955: 1290 khz; 5 kw-D. Box 87 (23803). (804) 732-3478. Sterling Broadcasting (acq 2/1/72). Rep: Dore; Pearse Slis; Crane. Format: Mod C&W. ■ Sterling Livingston, pres/gen mgr; Thomas A. Sawyer, prog dir; Lyle Bradley, mus dir; Jim Richards, news dir; Aaron Nester, chief engr. ■ Rates: \$9.50; 6; 9.50; 3.75.

WPVA-FM—Nov 17, 1972: 95.3 mhz; 3 kw. Ant 240 ft. Dups AM 100%.

WPLZ(FM)—Listing follows WSSV.

WSSV—May 7, 1945: 1240 khz; 1 kw-D, 250 w-N. Box 231 (23803). (804) 733-4567. Petersburg Bcstg Inc. (acq 11-1-70). Net: MBS. Rep: Savalli/Gates; Dome. Format: Contemp. ■ William L. Eure Jr., pres & gen mgr; Michael A. Ogburn, prom mgr & prog & mus dir; Tom O'Shea, news dir; Paul H. Bock Jr., chief engr. ■ Rates: \$8.75; 8; 8.75; 7.25.

WPLZ(FM)—Co-owned with WSSV. Oct 1, 1966: 99.3 mhz; 3 kw. Ant 290 ft. Stereo. Prog sep from AM. Format: Btl mus. ■ Richard P. Oakley, gen mgr. ■ Rates: \$10; 9; 10; 9.

Portsmouth

WKLX—January 1942: 1350 khz; 5 kw-U, DA-2. 4325 Cedar Lane (23703). (804) 484-7596. Rust Communications Group Inc. (group owner; acq 8-18-70). Net: ABC/E. Rep: McGavren-Guild. Format: MOR. ■ William F. Rust Jr., pres; C. Robert Ray, gen mgr; Mike Deeson, prog dir; Allan Pressley, news dir; Greg Gabriele, chief engr.

***WNHS(FM)**—Sept 14, 1973: 88.7 mhz; 300 w. Ant 115 ft. 2900 Turnpike Rd. (23707). (804) 393-8664. School Board, City of Portsmouth. Format: Educl, Top 40. ■ Joe Cyrus Phibbe, opns, gen mgr.

WPCE—Jan 11, 1964: 1400-khz; 1 kw-D, 250 w-N. 505 Washington St. (23704). (804) 393-1041. Tidewater Radio Show (acq 12-74). Net: Mutual Black. Rep: Bernard. Format: C&W. ■ Allan M. Jumba, prog dir; Gerry X. Davis, mus dir; John Hart, news dir; Tom Small, coml mgr; Tom Hilton, chief engr.

WPMH—Dec 12, 1971: 1010 khz; 5 kw-D, DA. Box 666 (23705). (804) 488-8364. Chesapeake-Portsmouth Bcstg Corp. Format: Inspirational. ■ Ralph D. Epperson, pres; Dan Cameron, VP; Chuck Sherman, gen mgr. ■ Rates: \$7.50; 7.50; 7.50; 7.50.

WXRI(FM)—Aug 3, 1962: 105.3 mhz; 50 kw. Ant 500 ft. Stereo. Box 111 (23705). (804) 393-2505. TWX 710-882-3276. Christian Bcstg Net (group owner). Rep: Adam Young. Format: Relg, Contemp, MOR. ■ M. G. (Pat) Robertson, pres; Eric C. AuCoin, dir of radio; Mike Little, prog dir; David Morrow, coml mgr; Don Roberts, chief engr. ■ WYAH-TV affil.

Pulaski

WBLB
Full Time Country

WBLB—May 8, 1973: 1510 khz; 1 kw-D (250 w CH). Box 915 (24301). (703) 980-3411. Boyd Bcstg Corp. Net: Virginia News, Agrinor. Rep: Savalli/Gates. Format: C&W. ■ Stanley M. Boyd, pres; Samuel W. Raymond, gen mgr & chief engr; Harold N. Hill, prog & mus dir. ■ Rates: \$2.10; 2.10; 2.10; 2.10.

WPUV—May 31, 1946: 1580 khz; 5 kw-D, 1 kw-CR. Box 351 (24301). (703) 980-2702. Pulaski Bcstg Corp. (acq 1964). Net: ABC/I. Rep: Dome; Keystone. Format: Contemp. Spec prog: C&W 10 hrs wkly. ■ John A. Columbus Sr., pres, gen mgr & chief engr; Blair B. Brockmeyer, coml mgr; John A. Columbus Jr., VP & dir pub affrs; Jane Graham, news dir. ■ Rates: \$5; 5; 5; —.

WPUV-FM—Dec 1, 1967: 107.1 mhz; 2.85 kw. Ant minus 58 ft. Dups AM 35%. ■ Rates: \$5; 5; 5; 5.

Quanto

WPWC—Dec 22, 1961: 1530 khz; 250 w-D. Box 172 (22134). (703) 640-7161. Happy Bcstg Corp. (acq 6-1-74). Rep: Dome. Format: C&W, variety, gospel. ■ Raymond Woolfenden Sr., pres & gen mgr; Raynee Woolfenden, prog dir; Doris Woolfenden, sec & comptroller; William K. Harris, chief engr.

Radford

WRAD—1950: 1460 khz; 5 kw-D, 500 w-N, DA-N. Box 1168 (24141). (703) 639-2461. WRAD Bcstg Co. (acq 10-9-57). Group owner: Dix. Audio news: UPI. Format: Top 40. ■ E. B. Evans, gen mgr; Grant Graham, coml mgr; Vic Avers, news dir; Ervin White, chief engr. ■ Rates: \$3; 3; 3; 3.

WRAD-FM—1965: 101.7 mhz; 3 kw. Ant 64 ft horiz, 59 ft vert. ■ Rates same as AM.

Richlands

WGTH(FM)—Not on air, target date unknown: 105.5 mhz; 300 w. Ant 64 ft. High Knob Broadcasting Inc.

WRIC—Oct 5, 1951: 540 khz; 1 kw-D. Box 838 (24641). (703) 964-4066. Clinch Valley Bcstg Corp. Net: ABC/I. Format: C&W. ■ C. D. Lawson, pres & gen mgr; Bob Smallwood, prog dir. ■ Rates: \$12; 12; 12; —.

Richmond

WANT—May 4, 1951: 990 khz; 1 kw-D. Broad-Grace Arcade Bldg. (23219). (804) 643-8368. Old Dominion Bcstg Co. Inc. (acq 6-26-67). Rep: Torbet. Format: Black 100%. ■ John L. Sinclair, pres; John L. Marver, gen mgr; Eugene Richardson, coml mgr; Ben Miles, prog dir; Kirby Carmichael, mus dir; William Patterson III, prog mgr; John T. Mitchell, news dir; James Grainger, chief engr.

***WBBL**—January 1924: 1480 khz; 5 kw-U, DA-2 (ST-WLEE). 1627 Monument Ave. (23220). (804) Elgin 9-2463. Grace Covenant Presbyterian Church. ■ Harry B. Grymes, gen mgr, prog dir; R. W. Raube, chief engr.

WEET—September 1955: 1320 khz; 1 kw-D. Box 27184 (23261). (804) 353-6641. WEET Radio Bcstgs (acq 4-16-67). Net: ABC/E. Format: C&W. ■ Ray B. Bentley, pres & gen mgr; E. J. Ruppe, coml mgr.

WENZ—See Highland Springs.

WEZS(FM)—Dec 23, 1961: 103.7 mhz; 74 kw. Ant 440 ft. Stereo. 5900 Midlothian Turnpike (23225). (804) 231-6231. Professional Bcstg In. (acq 1969). Group owner: EZ Communications. Rep: McGavren-Guild. Format: Easy Istng. ■ Arthur Kellar, pres; Constance Golden, gen mgr; Helen Chisholm, sls mgr; Bob Gilmore, opns dir; Thomas L. Mann, chief engr.

WGOE—June 16, 1964: 1590 khz; 5 kw-D. 104 W. Franklin Rd. (23220). (804) 649-9196. WGOE Radio Inc. (acq 7-1-75). Format: Progs. Spec prog: Jazz 5 hrs wkly. ■ Barry Coffman, pres, gen mgr; David Heren, sls mgr; David Ritz, prog dir; Chuck DuCoty, opns mgr; James M. Grainger, chief engr. ■ Rates: \$16; 14; 16; 14.

WIKI—See Chester.

WIVE-AM-FM—See Ashland.

1430 Kc 100.1 FM
Stereo

WIVE

serving

METROPOLITAN RICHMOND

"A Christian Commercial Station"

We mail to 20,000 families

WLEE—October 1945: 1480 khz; 5 kw-U, DA-2 (ST-WBBL). Box 8477, 6200 W. Broad St. (23226). (804) 288-2835. Nationwide Communications Inc. (group owner; acq 12-11-67). Net: ABC/C. Rep: Katz. Format: Contemp. ■ John Langlois, sls mgr; John A. Piccirillo, gen mgr; Bob Paiva, prog dir.

***WRFK-FM**—May 1957: 106.5 mhz; 50 kw. Ant 235 ft. Stereo. 3401 Brook Rd. (23227). (804) 355-0671. TWX: (804) 355-6325. Union Theological Seminary in Va. Net: NPR. Format: Classical. ■ Peter Darg, gen mgr; Carlton Brooks, news dir; Samuel Straus, chief engr.

WRGM—May 8, 1964: 1540 khz; 10 kw-D, DA. 6001 Wilkinson Rd. (23227). (804) 266-8787. Dales Bcstg Corp. (acq 7-2-75). Format: Sports, MOR, oldies. ■ Les Sand, pres and gen mgr; Nancy Mitchell, coml mgr; Joel Edwards, prog dir; Ray Morgan, sps dir; Jack Hansen, chief engr. ■ Rates: \$7; 7; 7; 7.

WRNL—Nov 15, 1937: 910 khz; 5 kw-U, DA-N. 7100 Bethlehem Rd. (23228). (804) 283-9731. Rust Communications (group owner; acq 10-7-71). Net: ABC/I. Rep: McGavren-Guild. Format: MOR. ■ William F. Rust Jr., pres; James B. Boccock, stn mgr; Bob Evans, sls mgr; Don Brown, prog dir; Charles Sandberg, news dir.

WRXL(FM)—Co-owned with WRNL. March 4, 1949: 102.1 mhz; 140 kw. Ant 320 ft. Progs sep from AM. (804) 288-1020. ■ James B. Boccock, natl sls mgr; Robert McKay, prog dir.

WRVA—Nov 2, 1925: 1140 khz; 50 kw-U, DA-1. Box 1516 (23212). (804) 643-6633. WRVA Radio Inc. (acq 12-16-69). Group owner: Southern Bcstg. Net: NBC. Rep: Eastman. Format: MOR. ■ John B. Tansey, pres & gen mgr; Harold B. Barre, coml mgr; Walt Williams, prog dir; William P. McGowan, news dir; T. W. Chezik, chief engr. ■ Rates: \$58; 43; 58; 29.

WRVQ(FM)—Co-owned with WRVA. Aug 10, 1948: 94.5 mhz; 200 kw. Ant 355 ft. Stereo. Box 1394 (23221). (804) 649-9151. (acq 1968). Audio news: UPI. Rep: Eastman. Format: Top 40. ■ John G. Johnson, pres; J. Phillip Goldman, gen mgr; Bob McNeill, prog dir; Scott Richards, mus dir; Bob Walker, news dir; Jon Hill, coml mgr; Harry Long, chief engr. ■ Rates: \$38; 30; 38; 30.

WRXL(FM)—listing follows WRNL.

WTVR—1926: 1380 khz; 5 kw-U, DA-N. 3314 Cutshaw Ave (23230). (804) 355-3217. TWX 710-956-0107. Roy H. Park Broadcasting of Virginia Inc. (acq 11-15-65). Group owner: Park. Net: CBS. Format: C&W. ■ Roy H. Park, pres; Wesley R. Richards, gen mgr; Chuck Deel, prog dir; Mark Thomas, coml mgr; Bill Burton, news dir; Jim DeAras, chief engr. ■ Rates: \$34; 32; 34; 25.

WTVR-FM—February 1946: 98.1 mhz; 50 kw. Ant 840 ft. Stereo. Prog sep from AM. Format: Btlf mus. ■ Berry Greene, opns dir. ■ WTVR-TV affil. ■ Rates: \$13; 11; 13; 9.

WXGI—Oct 1, 1947: 950 khz; 5 kw-D. Box 8872 (23225). (804) 233-7666. Radio Virginia Inc. Format: C&W. ■ D. H. Robertson, pres; David M. Wilburn, gen & coml mgr; George Popkins, prog dir.

Roanoke

WFIR—June 20, 1924: 960 khz; 5 kw-U, DA-N. Box

Virginia Radio

See page C-1 for explanation of listings.

150 (24002). (703) 345-1511. Beaverkettle Co. (acq 11-1-69). Net: CBS. Rep: Torbet. Format: MOR. ■ Paul Gilmor, pres; Richard Jacobs, gen & sls mgr; Brian Strobel, prog dir; Randy Webster, news dir; Bob Dixon, mus dir; Elbyrne St. Clair, chief engr. ■ Rates: \$20; 17; 14; 11.

WKBA—(Vinton) Oct 9, 1961: 1550 khz; 10 kw-D, DA. 2043 10th St., N.E. (24012). (703) 343-5597. Roanoke Vinton Radio Inc. Net: Keystone. Format: C&W, Gospel. ■ Stuart Epperson, pres; Harry Peyton, gen mgr; Betty Bivens, prog & mus dir; Dave Massey, news dir & prom mgr; Therl "Zeke" Leonard, sls mgr; Marvin Parsons, chief engr.

WLRG(FM)—Dec 17, 1960: 92.3 mhz; 20 kw. Ant minus 57 ft. Box 624 (24004). (703) 366-5350. CEBE Investment (acq 9-15-72). Net: ABC/FM. Rep: Bunche. Format: MOR. ■ Aylett B. Coleman, pres; George W. Chernaui, gen & prom mgr; Gerald Holm, sls mgr; Steve McFarland, prog dir; Mike Garber, news dir; Robert Nash, chief engr.

WPVR(FM)—Nov 1, 1969: 94.9 mhz; 50 kw. Ant 1,910 ft. Box 732 (24004). (703) 345-3841. James L. Gibbons (acq 11-1-69). Rep: Selcom. Format: Btlf mus. ■ James L. Gibbons, pres and gen mgr; Bob Passmore, sls mgr; Chuck Myers, prog dir; Barbara West, office mgr; Tony Atwater, news dir; Bob Richardson, chief engr. ■ WDBJ-TV affil.

WRIS—Feb 28, 1953: 1410 khz; 5 kw-D. Box 6099 (24017). (703) 342-3131. WRIS Inc. (acq 5-9-64). Net: MBS. Rep: Messina. Format: MOR. ■ Lloyd Gouchenour, pres & coml mgr; Gary E. Cooper, prog dir.

WJLM(FM)—Co-owned with WRIS. See Salem.

WRIS 1410 kc 5,000 watts MBS Net.	Phone collect (703-342-3131) Quality Music Studios/Offices 219 Luckett St. N.W. ROANOKE, VA. 24017 P.O. 6099
WJLM 93.5	Inspirational Radio 18 hours per day Rates—details—on request

WROV—1946: 1240 khz; 1 kw-D, 250 w-N. 15th & Cleveland Ave. (24015). (703) 343-4444. WROV Bcstgs (acq 6-11-55). Net: ABC/C. Audio news: APR. Rep: Eastman. Format: Top 40. ■ Burton L. Levine, pres and coml mgr; Don Foutz, gen mgr; Bart Prater, prog dir; Richard S. Bentz, creative dir; Mark Fryburg, news dir; David Levine, prom mgr; Chuck Holloway, mus dir; Alfred Beckley, chief engr. ■ Rates: \$28; 24; 28; 24; (17 after 9 p.m.).

WSLC—Oct 1, 1940: 610 khz; 5 kw-D, 1 kw-N, DA-2. Box 6002 (24017). (703) 387-0234. Bass Brothers Telecasters Inc. (group owner; acq 8/1/72). Net: NBC. Rep: Katz. Format: C&W. ■ Melvin L. Wheeler, pres; Herm Reavis, gen/coml mgr; Mel Foley, prog dir; K. E. Smith, mus dir; John Aldizer, Jr., chief engr.

WSLQ(FM)—Co-owned with WSLC. Nov 1, 1947: 99.1 mhz; 200 kw. Ant 1,890 ft. (CP 140 kw. Ant 1910 ft). Stereo. Prog sep from AM. Format: Rock. ■ John F. Willett, gen mgr.

WTOY—April 1957: 910 khz; 1 kw-D. 26 E. Church Ave. (24011). (703) 343-5545. T. & H. Bcstg Inc. (acq 1-69). Net: MBS/Black. Rep: Masia. Format: Black, R&B. ■ Connie T. Hausman, pres; Barry L. Hausman, gen mgr; Darlene Freeman, coml mgr; Bobby Rush, prog dir; Bobby Knight, mus dir; David Burch, prom mgr; Clarence Hamler, news dir; Ben T. Giraudan, chief engr.

***WVWR-FM**—Aug 1, 1973: 90.1 mhz; 4.1 kw. Ant minus 86 ft. (CP 89.1 mhz; 100 kw. Ant 1970 ft). Stereo. Box 4195, Va. Western Community College (24015). (703) 343-4970. State Board for Community Colleges. Net: NPR. Format: Educl, informational, cultural. ■ Dr. Harold H. Hooper, pres; Chris J. Ryg, gen mgr; Gary Anderson, prog dir; Wayne R. Michie, dir of engr.

Rocky Mount

WNLB—Dec 10, 1959: 1290 khz; 1 kw-D. Box 602 (24151). (703) 483-7011. Boyd Bcstg Corp. (acq

Virginia Radio

See page C-1 for explanation of listings.

6-30-74). Net: Va. News, Agrinet. Rep: Savalli-Gates. Format: C&W. ■ Stanley M. Boyd, pres; Samuel W. Raymond, gen mgr; & chief engr; Wayne E. Ross, prog dir.

WYTI—March 31, 1957: 1570 khz; 1 kw-D. Drawer 430 (24151). (703) 483-9955. WYTI Inc. Net: Keystone. Format: C&W, rock, contemp. ■ William E. Jefferson, pres; Linda Mason, prog dir; Glenn Lynch, mus dir/news dir; C. J. Rank, chief engr.

Salem

WBLU—Sept 7, 1956: 1480 khz; 5 kw-D. Box 408, West Salem Square (24513). (703) 389-5443. Omnibus Group Inc. (acq 2-28-74). Format: C&W. ■ Ralph Grover, pres; Clifford H. Davis, gen & coml mgr; Chuck Holladay, prog & mus dir; Charles S. Davis, news dir; Arnold Edwards, chief engr.

WJLM(FM)—Co-owned with WRIS, Roanoke. March 7, 1969: 93.5 mhz; 3 kw. Ant minus 83 ft. Box 6099, Roanoke (24017). (703) 342-3131. WRIS Inc. Net: MBS. Rep: Messina. Format: Inspirational. ■ Lloyd Gochenour, gen mgr.

Smithfield

WEOO—Not on air, tarted date 1975: 940 khz; 1 kw-D, DA. Box 339, State Route 655 (23430). (703) 357-4173. Radio Tidewater. Group owner: Vernon H. Baker. Format: C&W, variety. ■ Vernon H. Baker, pres; Jack Inman Jr., gen mgr.

South Boston

WHLF—Sept 1, 1947: 1400 khz; 1 kw-D, 250 w-N. Box 526 (24592). (804) 572-2988. Halifax Bcstg Co. Inc. Net: Tobacco. Audio news: UPI. Format: MOR. Spec progs: Black 3 hrs, farm 12 hrs wkly. ■ John L. Cole Jr., pres & gen mgr; H. Preston Young Jr., coml mgr; Kenneth W. Parton, prog & mus dir; John L. Cole III, prom mgr; James M. Chandler, news dir; James C. Bishop, chief engr. ■ Rates: \$3.35; 3.35; 3.35; 3.35.

WJLC-FM—Co-owned with WHLF. Oct 1, 1960: 97.5 mhz; 29 kw. Ant 250 ft. Stereo. Dups AM 20%. Format: Top 40. ■ Rates same as AM.

South Hill

WJWS—Nov 1, 1953: 1370 khz; 5 kw-D. Box 216 (23970). (804) 447-4007. Old Belt Bcstg Corp. (acq 7-1-64). Net: Tobacco. Rep: Bernard. Format: MOR, progs, Top 40. ■ W. B. Hoffer, pres & coml mgr; A. W. Walthall, gen mgr & prog dir; R. L. Ezell, prom mgr; Frank Malone, mus dir; Norman L. Talley, news dir; Charles E. Brown, chief engr.

WSHV(FM)—Co-owned with WJWS. Dec 23, 1966: 105.5 mhz; 3 kw. Ant 230 ft. Stereo. Prog sep from AM.

Staunton

WKDW—April 1954: 900 khz; 1 kw-D. Box 2189 (24401). (703) 886-2377. American Home Bcstg Corp. (acq 1-74). Audio news: APR. Rep: Dome & Associates. Format: Modern Country. Spec prog: Farm 3 hrs wkly. ■ Brice A. Miller, pres & gen mgr; Herb Berg, stn & coml mgr; Jerry Clegg, opns mgr; Don Houser, news dir; Don Mansfield, prog dir; Buddy Brown, prom mgr; Roger Stevens, chief engr. ■ Rates: \$5.75; 4.75; 5.75; 4.75.

WSGM(FM)—Co-owned with WKDW. May 29, 1959: 93.5 mhz; 500 w (CP: 2.1 kw horiz, 2.5 kw vert). Ant 350 ft. Stereo. Format: Btfl, contemp mus. ■ Rates: \$4; 5; 5; 5.

WTON—March 9, 1964: 1240 khz; 1 kw-D, 250 w-N. Box 1085 (24401). (703) 885-5188. Augusta County Bcstg Corp. (acq 9-1-73). Net: ABC/I & ABC/E. Format: Contemp/MOR. ■ Al Charles, pres & gen mgr; Jeff Nichols, coml & prom mgr; Joe Bourdow, prog dir; Cliff Somers, mus dir; Bob Burnett, news dir; Paul Schwartzendruber, chief engr.

Stuart

WHEO—Oct 12, 1959: 1270 khz; 1 kw-D. Rt. 1, Box 24 (24171). (703) 694-3114. Community Bcstg Co. (acq 8-29-69). Rep: Keystone. Format: C&W, rock. ■ James E. Litten, pres & gen mgr; Harry Lee Litten, prog mgr; Bruce Dollarhite, chief engr.

Suffolk

WFOG(FM)—Listing follows WLPM.

WLPM—March 17, 1950: 1450 khz; 1 kw-D, 250 w-N. 967 Windsor Rd. (23434). (804) 539-2394. Smiles of Tidewater Inc. (acq 1974). ■ Earl Hundley, gen mgr; Robert L. LaFerme, s/s dir; Bell, stn mgr & prog dir; Frank Facenda, news dir; George Bevins, chief engr.

WFOG(FM)—Co-owned with WLPM. December 1965: 92.9 mhz; 50 kw. Ant 480 ft. Stereo. No 1 Hague Towers, 330 W. Brambleton Ave. Norfolk (23510). (804) 622-6771. Prog sep from AM. Rep: Eastman. Format: Btfl music. ■ Robert Laferme, gen mgr; Bob Calvert, prog dir; Tom Bradshaw, mus dir.

Tappahannock

WRAR—Nov 1, 1970: 1000 khz; 500 kw-D. Box 1023 (22560). (804) 443-4321 or 333-5000. Rappahanock Bcstg Co. Net: ABC/I. Format: Contemp. ■ George C. Clanton, pres; Danny C. Wadsworth, gen mgr & VP; John J. Heimerl, opns dir; Lin Wadsworth & Ruth Rouzie, s/s reps; Robert W. Brinkley, news dir; M. G. Stewart, pub aftrs dir.

WRAR-FM—July 26, 1971: 105.5 mhz; 3 kw. Ant 210 ft. (CP: Ant 300 ft). Stereo. (22506). (804) 443-2711. Dups AM 50%.

Tasley

WESR—Jan 23, 1958: 1330 khz; 5 kw-D. Box 1330 (23441). (804) 787-3200. Accomack-Norhampton Bcstg Co. Inc. Group owner: Vernon H. Baker. ■ Vernon H. Baker, pres; C. Brooks Russell, VP & gen mgr.

WESR-FM—July 1969: 103.3 mhz; 50 kw. Ant 320 ft. Dups AM 100%.

Tazewell

WTZE—April 22, 1966: 1470 khz; 1 kw-D. Box 69 (24651). (703) 988-4150. Tazewell Bcstg Co. (acq 4-1-68). Format: C&W. ■ James L. Cox, VP & gen mgr; Dorothy Nuckles, coml mgr; Fred Cox, chief engr. ■ Rates: \$3; 3; 3; 3.

WTZE-FM—Sept 1, 1968: 100.1 mhz; 3 kw. Ant minus 105 ft. Dups AM 70%. ■ Rates same as AM.

Vinton

WKBA—Licensed to Vinton; See Roanoke.

Virginia Beach

WVAB—Dec 10, 1954: 1550 khz; 5 kw-D. Box 986, 3108 Pacific Ave. (23451). (804) 425-1550. Sea Bcstg Corp. (acq 9-28-66). Format: Btfl mus, nostalgia. ■ Sidney S. Kellam, pres; Jack H. Harris, exec VP & gen mgr; Judy Hundley, coml mgr; Donald Beckstrom, opns & prog dir; Linda Lockhart, prom mgr; Phil Bricker, prod mgr; Bob Harris, news dir; Joe Page, chief engr.

Warrenton

WEER—Nov 21, 1957: 1250 khz; 1 kw-D. Box 817 (22816). (703) 347-1250. Elektra Bcstg Corp. of Virginia (acq 3-14-68). Net: Agri-Net of Va. ■ George H. Gillespie, pres; Daniel W. Kirby, gen, coml & prom mgr; Frederick T. Diehl, asst prog dir, asst stn mgr, mus dir; William J. Bloomer III, asst news & sports dir; James R. Thoroman, chief engr. ■ Rates: \$5; 5; 5; 5.

WEER-FM—March 28, 1966: 107.7 mhz; 3.8 kw. Ant 800 ft. Dups AM 100%. ■ Rates same as AM.

WKCW—Dec 7, 1957: 1420 khz; 5 kw-D. Box 740 (22186). (703) 347-1420. WKTF Inc. (acq 10-58). Rep: Media Sis. Format: C&W. Spec progs: Farm 12 hrs, gospel 8½ hrs wkly. ■ Fred J. Crescente, pres; Stu Brooks, gen mgr; Eileen Davis, coml mgr; Tom Reeder, prog and mus dir, prom mgr; Tom Ross, chief engr; Bob Morrow, news dir. ■ Rates: \$10; 10; 10; 10.

Warsaw

WNNT—July 3, 1949: 690 khz; 250 w-D. Box 877 (22572). (804) 333-4900. Northern Neck and Tidewater Bcstg Inc. (acq 1963). Rep: Dome-Messervey. Format: C&W. Spec prog: Farm 12 hrs wkly. ■ Patricia P. Williams, pres; William Martin, gen and coml mgr news dir; Jim Thorne, prog dir & chief engr. ■ Rates: \$3.50; 3.50; 3.50; 3.50.

WNNT-FM—March 1, 1967: 100.9 mhz; 2.4 kw. Ant 330 Ft. Dups AM 100%. ■ Rates same as AM.

Waynesboro

WANV—March 10, 1965: 970 khz; 5 kw-D, 1 kw-N, DA-2. Box 97 (22980). (703) 942-1153. WANV Inc. Format: Moderate contemp. ■ M. Robert Rogers, pres; Charles E. Neer, gen mgr; Gary Ratcliff, asst mgr; Tom Freed, news dir; Preston Thompson, mus dir; Rex House, chief engr.

WAYB—Dec 19, 1947: 1490 khz; 1 kw-D, 250 w-N. Box 40 (22980). (703) 942-1490. Waynesboro Bcstg Corp. (acq 1954). Net: MBS. Audio news: APR. Rep: Dome. Format: MOR. Spec prog: Farm 1½ hrs wkly. ■ N. Wilbur Kidd, gen mgr; Bob Foster, mus dir; Ray Moore, news dir; Glenn Channells, chief engr. ■ Rates: \$3.25; 3.25; 3.25; 3.25.

Williamsburg

WBCI(FM)—Listing follows WMBG.

***WCWM(FM)**—Sept 28, 1959: 89.1 mhz; 77 w. Ant 125 ft. College of William & Mary (23185). (804) 229-4068. College of William & Mary. Net: ABC/FM. Format: Progressive. ■ Dave Oxenford, stn mgr; Ben Ball, prog dir; Kevin Christiano, news dir; Frederick McCune, chief engr.

WMBG—Nov 14, 1959: 740 khz; 500 w-D. Box 180 (23185). (804) 229-7400. Williamsburg Bcstg Co. (acq 8-9-61). Net: ABC/C. Format: Top 40. Spec prog: Black 2 hrs wkly. ■ William E. Allau Jr., pres; Don Bently, gen mgr, coml mgr; Dan Donanvan, prog dir; Brian Costello, news dir; George V. Ramsey, chief engr. ■ Rates: \$7; 6; 6; —.

WBCI(FM)—Co-owned with WMBG. July 29, 1963: 96.5 mhz; 50 kw. Ant 430 ft. Stereo. Prog sep from AM. Format: Btfl mus. ■ W. Pat Collins, s/s & opns mgr. ■ Rates: \$8.50; 8.50; 8.50; 8.50.

Winchester

WEFG(FM)—Listing follows WHPL.

WHPL—Jan 27, 1961: 610 khz; 500 w-U, DA-2. Box 828 (22601). (703) 662-5101. Shenval Bcstg Corp. Net: NBC. Rep: Devney. Format: Contemp C&W. ■ Edwin R. Fischer, pres; John P. Bell Jr., gen mgr & chief engr; Kay Bell, coml mgr; Bill Peters, prog dir; Pam Bell, mus dir; James Copen, news dir.

WEFG(FM)—Co-owned with WHPL. Dec 10, 1965: 102.5 mhz; 21 kw. Ant 330 ft. Stereo. (703) 667-7721. Prog sep from AM. Format: contemp "Hitparade." ■ Mike Ball, prog dir; Arthur V. D'Onofrio, coml mgr.



WINC—June 15, 1941: 1400 khz; 1 kw-D, 250 w-N. Box 605 (22601). (703) 667-2224. Richard F. Lewis Jr. Inc. of Winchester. Group owner: Mid Atlantic. Net: ABC/C, Mid-Atlantic, Virginia, Agrinet. Rep: Dome, PRO/Meeker. Format: Contemp. Spec prog: Farm 2 hrs wkly. ■ John Lewis, pres; Philip Whitney, gen mgr and coml mgr; Joe Pasquali, prog dir; Phil Luttrell, prom mgr; Norman Mann, mus dir; David Lewis, news dir; Arch McKay, chief engr. ■ Rates: \$6.60; 5; 6.60; 5.

WRFL(FM)—Co-owned with WINC. October 1946: 92.5 mhz; 22 kw. Ant 1,430 ft. (703) 667-7904. Dups AM 33%. Format: C&W. ■ Buddy Allen, prog dir. ■ Rates: \$—; 4.30; 4.30; 3.50.

Woodbridge

WXRA(FM)—Co-owned with WPIK Alexandria, Va. Dec 25, 1958: 105.9 mhz; 50 kw. Ant 310 ft. (CP 50 kw horiz, 36 kw vert. Ant 410 ft). 523 1st St., Alexandria, Va. (22314). (703) 683-3000. Potomac Bcstg Corp. Dups AM 47%. Net: MBS. Rep: Torbet-Lasker. Format: C&W. ■ Carl L. Lindberg, pres; James A. Arthur, VP & gen mgr.

Wytheville

WYVE—Sept 21, 1949: 1280 khz; 1 kw-D. Box 534 (24382). (703) 228-3185. Wythe County Bcstg. Audio

news: UPI. Rep: Dome; Carpenter; KBS. Format: MOR. Spec prog: Farm 12 hrs wkly. ■ Arthur M. Gates, gen mgr; Edward A. Zuber, coml mgr; Craig Allison, prog and news dir; Fred Cox, chief engr. ■ Rates: \$3.60; 3.60; 3.60; —.

Yorktown

***WYCS(FM)**—February 1966: 91.5 mhz; 21 kw. Ant 155 ft. Box 452 (23490). (804) 898-5957. York County School Bd. Format: Ed. Spec prog: Visually handicapped ½ hr wkly. ■ Donald Bruno, dir; supvr; William M. Swartz, gen mgr; Richard H. Swartz, mus dir; Drborah Bagwell, prog dir; Gary Eugene Becknell, chief engr.

WYVA-FM—July 4, 1975. 94.1 mhz; 50 kw. Ant 500 ft. Box 941 (23690). (804) 898-7294. Cradle of Democracy Bcstg Co. Audio news: UPI. Format: MOR. Spec prog: Sports 2 hrs wkly. ■ William H. Eacho Jr., pres and gen mgr; William E. Burbage, coml mgr; Berwell H. Bridges Jr., prog dir; Robert O. Fitchett, mus dir; Allen N. Gregg, prom mgr; John S. Halstead, news dir; Charles E. Rinehart, chief engr. ■ Rates: \$5; 5; 5; 5.

CSI ELECTRONICS INC.
2607 River Road
Cinnaminson, New Jersey, 08077
Telephone: (609) 786-1060

Washington

HAMILTON-LANDIS & ASSOCIATES Inc.
NATIONWIDE MEDIA BROKERS
WASHINGTON, D. C., CHICAGO, DALLAS, SAN FRANCISCO
SELL MORE
RADIO & TELEVISION STATIONS
IN THE WEST—NEAREST OFFICE IS—
111 SUTTER ST. SAN FRANCISCO 94104
(415) 392-5671

Aberdeen

KBKW—Aug 1, 1949: 1450 khz; 1 kw-D, 250 w-N. Box 188, 701 E. Heron (98520). (206) 532-1450. KBKW Inc. (acq 10-1-69). Net: ABC/I. Rep: Devney; Simpson Reilly. Format: C&W. ■ John R. Dimeo, pres; Don Downing, VP & gen mgr; Terry Downing, treas & prog dir; Forrest Smith, mus dir; Craig Hamilton, news dir; Josh Logan chief engr.

KDUX(FM)—See Ocean Shores.

KGHO-AM-FM—See Hoquiam.

KXRO—May 28, 1928: 1320 khz; 5 kw-D, 1 kw-N, DA-N. Box 47 (98520). (206) 533-1320. Aberdeen Bcstg Co. (acq 5-15-65). Group owner: Robertson-Clapp Stns. Net: NBC. Rep: Webb; Moore. Format: MOR. ■ Miller Robertson, pres; Joe Kendall, gen mgr; Robert Eubanks, coml mgr; Kathy Dove, traf mgr; Allen Walters, prog & mus dir; Doyle Wenzel, news dir; Dave Herbert, chief engr.

Anacortes

KAGT—Dec 18, 1963: 1340 khz; 1 kw-D, 250 w-N. Box 96 (98221). (206) 293-3141. Island Bcstg Inc. Rep: Savalli/Gates; Simpson/Reilly (Seattle). ■ William Berry, pres, gen & prom mgr; James A. Henry, coml mgr; Johnny Hayden, prog dir; Wally Johnson, news dir; John Plattner, chief engr.

Auburn

KASY—Aug 6, 1958: 1220 khz; 250 w-D. Box 459 (98002). (206) 883-5220. Auburn Bcstrs Inc. Format MOR. ■ Edward J. Garre, pres & gen mgr; Dennis

Garre, prog & mus dir; Bruce McMichael, news dir; Jerry Beffa, chief engr. ■ Rates: \$4.90; 4.10; 4.90; 4.10.

***KGRG(FM)**—December 1974: 89.9 mhz; 10 w. Ant 570 ft. 12401 S.E. 320th St. (98002). (206) 833-9111, ext 268. Green River Community College. Format: Top 40. ■ James Alan Willhight, gen mgr.

Bellevue

***KASB(FM)**—March 22, 1971: 89.3 mhz; 10 w. 601 108th Ave. (98004). (206) 455-6154. Bellevue School District No. 405. Format: MOR, top 40, educ. ■ Dr. Dennis Carmichael, pres; Bill Poirier, gen mgr.

***KBKS(FM)**—Feb 3, 1973: 91.3 mhz; 10 w. Ant 210 ft. Bellevue Community College (98007). (206) 641-2221. Bellevue Community College.

KZAM—March 1958: 1540 khz; 5 kw-U, DA-N. 1200 112th N.E. (98004). (206) 454-1540. Bellevue Eastside Radio Ltd. (acq 9-15-72). Format: Progs. ■ A. S. Ballinger, part, gen mgr; Howard Leenderstein, gen s/s mgr; Tom Cordory, prog dir; Jon Kertzer, mus dir; Shelley Morrison, prom mgr; Denny Fleenor, news dir; James Stevens, chief engr. ■ Rates: \$20; 20; 25; 25.

KZAM-FM—November 1964: 92.5 mhz; 100 kw. Ant 1,100 ft. Stereo. Dups AM 100% ■ Rates same as AM.

Bellingham

KARI—See Blaine.

KERI(FM)—July 2, 1965: 104.3 mhz; 60 kw. Ant 2,310. (CP: 51 kw. Ant 2300 ft.). Box 1170 (98225). (206) 734-1170. Bellingham Buyer Inc. (acq 2-12-73). Net: MBS. Rep: Simpson-Reilly. Format: Contemp. ■ Robert Pollack, pres; James M. Tincker, VP & gen mgr; Michael Pollock, coml mgr; Marty Rowe, prog dir; Terry Allen, news dir; Brandt Herrett, chief engr.

KGMI—1927: 790 khz; 5 kw-D, 1 kw-N, DA-N. Box 943 (98225). (206) 734-9790. KGMI Inc. (acq 9-69). Net: ABC/I. Rep: Howard; Moore. Format: MOR. ■ James L. Hamstreet, pres & gen mgr; John Munroe, prog dir; Harry Pagels, prom mgr; Haines Fay, news dir; Dan Coulthurst, chief engr. ■ Rates: \$9.55; 7.40; 8.80; 7.40.

KISM(FM)—Co-owned with KGMI. March 1960: 92.9 mhz; 50 kw. Ant 2,440 ft. Stereo. Prog sep from AM. Net: ABC/C. Format: Oldies. ■ Ginger Wright, ops dir; Mike Bettelli, prog dir. ■ Rates: \$4.95; 4.95; 4.95; 4.95.

KOQT—May 1963: 1550 khz; 1 kw-D. Box 1071 (98225). (206) 734-1550. Hillcrest Chapel Inc. (acq 7-22-71). Format: Religious. ■ Rev. Richard Ellison, pres; Mike Ellison, gen mgr; James Overrein, prog dir; Steve Phillips, chief engr.

KPUG—Feb 29, 1948: 1170 khz; 5 kw-D, 1 kw-N, DA-N. Box 655 (98225). (206) 734-1170. KUPG Inc. Net: MBS. Rep: Avery-Knodel; Simpson-Reilly. Format: Contemp. ■ James Tincker, gen mgr; Dick Stark, stn mgr; David Hall, s/s mgr; Greg Collins, prog dir; Terry Allan, news dir; Pat Henry, chief engr.

***KUGS(FM)**—February 1974: 89.3 mhz; 10 w. Ant 62 ft. 516 High St. (98225). Western Washington State College.

Bellingham-Ferndale

KBFW—April 4, 1958: 930 khz; 1 kw-D. Box D (98225). (206) 734-8555. Watcom Management Co. (acq 8-68). Group owner: Sterling Recreation Organization, Bcst Div. Rep: Meeker; Tacher. Format: Modern country. Spec prog: Sp 2 hrs wkly. ■ Fredric A. Danz, pres, SRO; Bruce Johnson, pres, bcst div; Bob Wood, gen mgr; Jim Hensley, s/s mgr; Al Sande, prod mgr; Bo Donovan, group prog dir; Tom Edwards, prog dir; Dale Hansen, mus dir; Pete Kremen, news dir; Steve Lewis chief engr; Bruce Earl, dir of engr.

Blaine

KARI—Feb 12, 1960: 550 khz; 1 kw-D, 1 kw-N, DA-2. Box X (98230). (206) 332-5500. Birch Bay Bcstg Inc. Group owner; Ostrander-Wilson Stns. Format: Gosp. Spec progs: Ger 5 hrs, Ital 2 hrs, Sp 3 hrs, farm 6 hrs wkly. ■ George A. Wilson, pres; Don J. Bevilacqua, gen mgr; Gary Mann, prog dir; Jim Scott, mus dir & chief engr; Bob Dunn, coml mgr; Bob Partlow, news dir. ■ Rates: \$7; 7; 7; 7.

Virginia, Washington Radio

See page C-1 for explanation of listings.

KERI(FM)—See Bellingham.

Bremerton

KBRO—May 1947: 1490 khz; 1 kw-D, 250 w-N. Box 1490 (98310). (206) 377-3995. Bremerton Bcstg Co. Rep: Sande-Glenn; Tacher. Format: Contemp/MOR. ■ Lillian S. Bartley, own & gen mgr; Ron Rogerson, s/s dir; Lois Duprey, bus mgr; Joe Arney, s/s mgr; Doug Hicks, news dir; Karl Lentz, chief engr.

KBRO-FM—Aug 22, 1964: 106.9 mhz; 30 kw. Ant 86 ft. Stereo. Dups AM news. Format: C&W.

Burien

KOIN—Oct 10, 1970: 800 khz; 500 w-D, DA. Box 66558 (98166). (206) 243-8803. Suburban Bcstrs Inc. (acq 6-1-71). Format: C&W. ■ John Mowbray, pres & gen mgr; Barbara Page, mus dir; Brian Calkins, prog dir; Ron Parker, chief engr. ■ Rates: \$9.50; 9.50; 9.50; —.

Centralia-Chehalis

***KCED(FM)**—Feb 17, 1975: 91.3 mhz; 10 w. Box 639 (98531). (206) 736-8044. Centralia Community College. Net: WSU Tape Net. Format: Progs. Spec prog: Farm ½ hr wkly. ■ Nels Hanson, pres; Mike Dennistoun, Gaylord Hinze, gen mgrs.

KELA—Nov 1, 1937: 1470 khz; 5 kw-D, 1 kw-N. 1635 So. Gold St., Centralia (98531). (206) 736-3321. Box 827, Chehalis (98532). (206) 748-3321. KELA Corp. (acq 6-15-65). Net: MBS. Rep: Howard; Simpson/Reilly. ■ Joe Chytil, pres; Ted Chytil, stn mgr; Dick Dawson, coml mgr; William Moeller, prog dir; Jim Cook, news dir; William Tilton, chief engr. ■ Rates: \$8.65; 8.10; 8.65; 7.60.

KELA-FM—Aug 24, 1965: 102.9 mhz; 28.5 kw. Ant 185 ft. Dups AM 10%. Format: C&W. ■ Rates: \$5.90; 5.70; 5.90; 5.50.

KITI—October 1954: 1420 khz; 1 kw-D. St. Helens Hotel (98532). (206) 748-3379. KITN-KITI Corp. (acq 7-1-55). Net: ABC. Rep: Masla. Format: Adult. ■ Donald F. Whitman, pres & gen mgr; Harry Minor, s/s mgr; Don Wesel, news editor; E. M. Whitman, VP & engrg dir.

Chelans

KOZI—March 1, 1957: 1230 khz; 1 kw-D, 250 w-N. Box 819 (98816). (509) 682-4033. Northtranch Bcstg Co. (acq 12-15-69). Net: ABC/C. Rep: Savalli/Gates; Advertising Sls West. Format: Diversified. ■ Jerry E. Isenhardt, pres, gen mgr; Scott Brundage, coml mgr; Wayne Wright, prom mgr; Steve Byquist, chief engr. ■ Rates: \$6.50; 4.50; 4.50; 4.50.

Cheney

***KEWC-FM**—Nov 11, 1963: 89.9 mhz; 10 w. Dept of RTV, Eastern Washington State College (99004). (509) 359-2229. Eastern Washington State College Bd of Trustees. ■ Dr. Howard E. Hopf, chmn, Dept of Radio-TV; Sam R. Smith, gen mgr.

Clarkston

KCLK—March 2, 1971: 1430 khz; 500 w-D. Box 86 (99403). (509) 758-3361. Clarkston Bcstrs. Rep: Savalli/Gates; Simpson/Reilly. Format: C&W. Spec prog: Farm 1 hr wkly. ■ W. E. Lawrence, pres & gen mgr; George Walton, coml mgr; Chuck Boyk, prog dir; John Richardson, chief engr. ■ Rates: \$6; 6; 6; 6.

KCLK-FM—1974: 94.1 mhz; 30 kw. Ant minus 500 ft. Stereo. Dups AM 100%. ■ Rates same as AM.

KPUL—See Pullman.

KRLC—See Lewiston, Idaho.

Colfax

KCLX—1950: 1450 khz; 1 kw-D, 250 w-N. Box 710 (99111). (509) 397-3441. Adrian De Vries (acq 9-75). Rep: Hopewell, Moore. Format: MOR. ■ Adrain De Vries, gen mgr, prog & news dir; E. O. McVay, chief engr. ■ Rates: \$4.70; 4.70; 4.70; 3.60.

Washington Radio

See page C-1 for explanation of listings.

College Place

***KGTS(FM)**—Oct 5, 1963: 91.3 mhz; 200 w. Ant minus 63 ft. (99324). (509) JA 7-2454. Walla Walla College. Format: Semiclassic. ■ Loren Dickinson, gen mgr; Ted Duncan, chief engr.

Colville

KCVL—Nov 15, 1955: 1270 khz; 1 kw-D. Box 111 (99114). (509) 684-6481. Colville Bcstg Co. (acq 11-1-61). Rep: Masla/Young; Tacher. Format: Contemp/C&W. ■ Norman Davis, gen mgr; Greg Lawrence, prog dir; Dennis Blair, asst mgr & chief engr; Bill Greer, news dir. ■ Rates: \$4.75; 4.75; 4.75; —.

Edmonds

KBIO(FM)—Listing follows KGDN.

KGDN—1954: 630 khz; 5 kw-D. 19303 Fremont Ave. North, Seattle (98133). (206) 546-3128. King's Garden Inc. Audio news: UPI. Format: Relig. Spec prog: Light classcl 5 hrs wkly. ■ Clarence Reimer, pres; Jack Kandel, gen mgr; Marty Johnson, opns dir; Ken Gaydos, news dir; Chuck Lee, prog dir; Chris Myhre, chief engr.

KBIO(FM)—Co-owned with KGDN. March 11, 1960: 105.3 mhz; 115 kw. Ant 465 ft. Stereo. Prog sep from AM. (206) 546-3126. Format: Contemp btfl mus. ■ John Sherman, prog dir.

Ellensburg

KXLE—1947: 1240 khz; 1 kw-D. 250 w-N. Box 249 (98926). (509) 925-1488. KXLE Inc. (acq 3-1-65). Net: ABC/E. Rep: Simpson-Reilly. Format: Variety. ■ John R. DiMeo, pres; Del Day, gen mgr; Terri Downing, prog dir; Jim McCurdy, chief engr.

KXLE-FM—1972: 95.3 mhz; 1.4 kw. Ant minus 145 ft. Dups AM 100%.

Ephrata

KULE—Aug 17, 1950: 730 khz; 1 kw-D. Box 1077 (98823). (509) 754-4686. Mid-Columbia Bcstg (acq 7-74). Net: ABC/E. Rep: Young/Masla. Format: MOR. Spec prog: Fr 6 hrs wkly. ■ Greg Click, gen mgr.

Everett

KRKO—1920: 1380 khz; 5 kw-U, DA-N. Box 1227 (98206). (206) 355-1144. Seattle: (206) 743-1144. Everett Bcstg Inc. (acq 1938). Rep: Howard; Simpson/Reilly. Format: Contemp. ■ William R. Taft, pres & gen mgr; Bob Young, sis mgr; Dave Corbin, prog dir; Shirley Bartholomew, news dir; Dale Good, chief engr. ■ Rates: \$16; 12.50; 14; 7.50.

KWYZ—June 1957: 1230 khz; 1 kw-D. 250 w-N. Box 1234 (98206). (206) 252-5123. Snohomish County Bcstg Corp. (acq 2-16-72). Rep: Sandberg-Glenn; Tacher. Format: Contemp, country. Spec prog: Sp 1 hr wkly. ■ Robert Brown, pres; Randy Thaul, sis mgr; Martin Hamstra, gen mgr; Hal Murray, mus dir; Tom Lewis, prog & news dir. ■ Rates: \$19; 13; 15; 9.

Forks

KVAC—1967: 1490 khz; 1 kw-D. 250 w-N. Box 450 (98331). (206) 374-6233. Forks Bcstg Co. Net: MBS, Big Timber. Format: MOR. Spec prog: C&W 18 hrs wkly. ■ Gordon F. Otos, pres & gen mgr; Larry A. Bailey Sr, prog & mus dir & prom mgr; Paul Bragg, coml mgr & news dir.

Grand Coulee

KFDR—Sept 15, 1950: 1360 khz; 1 kw-D. Box 1360 (99133). (509) 633-1600. New Deal Bcstg Co. (acq 2-72). Rep: Sandberg-Glenn; Tacher. Format: MOR. ■ Frank A. Del Vecchio, pres; Trudy Del Vecchio, coml mgr; Linda Quinton, prom mgr; Jim Ross, prog dir; Bob Gary, news dir.

Hoquiam

KGHO—Nov 16, 1961: 1560 khz; 1 kw-D. 31st and Bay Sts. (98550). (206) 532-1200. Grays Harbor Bcstg Co. (acq 7-15-65). Rep: Broadcast Northwest.

Format: Contemp, rock, top 40. ■ Ernest Linnekohl, pres & gen mgr; Ted Egger, coml mgr; Stan Foreman, prog & mus dir; Dale Hubbard, prom mgr; Bill Hardy, news dir; Robert S. Snow, chief engr.

KGHO-FM—Sept 3, 1965: 103.9 mhz; 2.6 kw. Ant 40 ft. (CP: 2.55 kw. Ant 320 ft.). Dups AM 60%. ■ Tim Andrew, prom mgr.

Kelso

KLOG—Oct 8, 1949: 1490 khz; 1 kw-D. 250 w-N. Box 90 (98626). (206) 636-0110. Wash. Interstate Bcstrs Inc. (acq 7-28-67). Net: ABC/C. Rep: Radio Time Sls; Moore. Format: Contemp. ■ Steve Hanson, pres, gen mgr; Ted Ryan, coml mgr; Bob Taylor, prog dir; Jonathan Walker, mus dir; Bill Cole, news dir, chief engr.

Kennewick-Richland-Pasco

KONA—January 1948: 610 khz; 5 kw-U, DA-2. Box 2623 Tri-Cities (99302). (509) 547-1618. Tri-City Communications Inc. Net: ABC/I. Rep: Masla/Young; Moore. Format: MOR. ■ Thomas C. Bostic, pres; Dean W. Mitchell, gen mgr; Mike Berriochoa, news dir.

KONA-FM—August 1, 1969: 105.3 mhz; 100 kw. Ant 1,180 ft. Stereo. Prog sep from AM. Net: ABC/FM. Format: Btfl mus.

KOTY—Aug 1945: 1340 khz; 1 kw-D. 250 w-N. Box 6127 (99336). (509) 586-4165. KUTI Communicators Inc. (acq 4-7-73). Net: MBS. Rep: Torbet; Tacher. Format: C&W. ■ Don Heinen, pres; Robert H. Larson, gen mgr; Al Kusters, prog & mus dir; Rich Perkins, coml mgr; Jo Ann Blake, news dir; Laurence Craig, chief engr. ■ Rates: \$6.75; 5.75; 6.75; 5.75.

Kirkland

KILO—1964: 1460 khz; 5 kw-D. DA. Box 250 (98033). (206) 822-4002. Gio-Lee Bcstg Corp. (acq 8-29-75). Net: Northwest Rock Radio Net. Format: Progs. ■ Spec progs: Black 2 hrs, Pol ½ hr; jazz 20 hrs wkly. ■ Howard R. Slobodin, prog; Allan J. Slobodin, gen mgr. ■ Rates: \$14; 14; 14; 14.

KYAC-FM—See Seattle.

Lacey

KITN—See Olympia.

Longview

KBAM

Country Music

 mutual broadcasting system, inc.

KBAM—Aug 15, 1955: 1270 khz; 5 kw-D. Box 96 (98632). (206) 423-1210. Armak Bcstrs Inc. (acq 4-1-65). Net: MBS. Rep: Mesia; Tacher (Portland-Seattle). Format: C&W. ■ Arne G. Peterson, pres & gen mgr; Howard Kynaston, coml mgr; Jerry Galloway, news dir; David A. Peterson, prog dir; Danny L. Houle, mus dir; David R. Sawyer, prom mgr; Harold L. Mahnke III, chief engr. ■ Rates: \$5.35; 5.35; 5.35; —.

KEDO—May 1938: 1400 khz; 1 kw-D. 250 w-N. Box 779 (98632). (206) 425-1500. KEDO Inc. (acq 7-1-70). Group owner: Sterling Recreation Org. Bcst Div. Net: ABC/I. Rep: Simpson/Reilly. Format: MOR. ■ F. A. Danz, pres; Donavon B. Larson, gen mgr; Morris Garman, coml mgr; James Carter, prog dir; Bob Donovan, mus dir; Mark Johnson, news dir and prom mgr; Michael Moseman, chief engr. ■ Rates: \$5.35; 4.60; 5.35; 4.85.

KLYK(FM)—Co-owned with KEDO. July 7, 1968: 105.5 mhz; 3 kw. Ant minus 21 ft. Stereo. (206) 423-6482. Vision Corp. (acq 7-74). Net: ABC/FM. Format: Btfl mus. ■ Rates: \$4.50; 4.50; 4.50; 4.50.

KLOG—See Kelso.

***KLVR(FM)**—1972: 90.3 mhz; 10 w. 1600 Maple St. (98632). (206) 425-6500. Lower Columbia College. Net: ABC/FM. Format: Variety. ■ John Diehnel, gen mgr; Larry Blair, prog dir.

KLYK(FM)—See listing following KEDO.

Lynden

KLYN-FM—Nov 8, 1960: 106.5 mhz; 100 kw. Ant 430

ft. Stereo. 525 Front St. (98264). (206) 354-4473. KLYN-FM Inc. Net: ABC/E. Format: Btfl mus. Spec prog: Sp 2 hrs wkly. ■ Sidney Baron, pres; Jim Baron, gen & coml mgr.

Mercer Island

***KMIH(FM)**—February 1970: 90.1 mhz; 10 w. Ant 63 ft. 9100 S.E. 42d (98040). Mercer Island School District No. 400. Format: Diversfd.

Moses Lake

KSEM—November 1947: 1470 khz; 5 kw-D. 1 kw-N. DA-2. Drawer S (98837). (509) 765-3441. KSEM Inc. Net: ABC/E. Rep: Devney; Tacher. Format: MOR, Top 40. Spec prog: Sp 6 hrs wkly. ■ Jessica L. Longston, pres; John Croghan, gen mgr; Bob Roberts, prog dir; Mike Blatman, news dir; Howard Compton, chief engr. ■ Rates: \$6.40; 6.40; 6.40; 3.20.

KWIQ—Feb 20, 1956: 1260 khz; 1 kw-D. Box 999 (98837). (509) 765-4104. KWIQ Radio Inc. (acq 4-27-61). Rep: Savalli/Gates; Moore. Format: C&W. Spec prog: Sp 6½ hrs wkly. ■ W. E. Lawrence, pres & gen mgr; Norm Johnson, coml mgr; Matt Kearney, prog dir; Marty Burgess, chief engr. ■ Rates: \$6; 6; 6; 6.

KWIQ-FM—May 22, 1968: 100.3 mhz; 27.5 kw. Ant 210 ft. Stereo. Dups AM 100%. ■ Rates same as AM.

Mountlake Terrace

KAAR—Sept 22, 1968: 1510 khz; 250 w-D. DA. 21401 52nd Ave. W. (98043). (206) 774-2171. Mount-Ed-Lynn Inc. Format: Talk. ■ Elliott Boisen, pres; Mike Longergan, gen coml mgr; Dick Stokke, prog & mus dir; Steve James, news dir; Vern Downing, chief engr.

Mount Vernon

KAPS—March 17, 1963: 1470 khz; 500 w-D. DA. Box 70 (98273). (206) 424-7676. Totem Bcstrs Inc. (acq 4-13-67). Net: ABC/E. Rep: Radio Time Sls, Tacher. Format: C&W. Spec progs: Sp 1 hr, farm 2½ hrs, gospel 3 hrs wkly. ■ George B. Aller, pres & gen mgr; Thomas Hartley, asst mgr; John E. Nelson, prog dir; Rita L. Aller, traf mgr; Phil Parmalee, chief engr. ■ Rates: \$5; 4.30; 5; 3.35.

KBRC—Dec 11, 1946: 1430 khz; 5 kw-D, 1 kw-N. DA-N. Box 250 (98273). (206) 424-2430. Beckley Radio Co. Audio news: UPI. Rep: Cooke; Pacific Bcst Sls; Moore. Format: MOR, Top 40. Spec prog: Farm 1½ hrs wkly. ■ Leo Beckley, pres & gen mgr; Dennis Willis, prog & mus dir, prom mgr; Chuck Payne, coml mgr; Gary Sayles, news dir; Mike Stevens, chief engr.

***KSVR(FM)**—May 4, 1973: 90.1 mhz; 10 w. Ant 75 ft. 2405 College Way (98273). Skagit Valley College.

Neah Bay

***KRNB-FM**—September 1975: 90.1 mhz; 10 w. Ant 77 ft. Box 115 (98357). Makah Communications Enterprises.

Newport

***KUBS(FM)**—Sept 10, 1973: 91.5 mhz; 10 w. Ant 80 ft. Box 68 (99156). (509) 447-4931. Newport Consolidated Joint School District No 56-415. Format: MOR, top 40, prog. ■ Jerry Sherman, gen mgr; Roy Clark Jr, chief engr.

Ocean Shores

KDUX-FM—Oct 4, 1964: 104.7 mhz; 48 kw. Ant 155 ft. Stereo. Box 401 (98551). (206) 289-2444. KDUX Inc. (acq 9/72). Rep: Coleman. Format: Album standards. ■ Dale Gunderson, pres & gen mgr; Greg Gunderson, mus dir; Robert Snow, chief engr.

Olympia

***KAOS(FM)**—1973: 89.3 mhz; 10 w. Ant 203 ft. (CP: 1.55 kw. Ant minus 14 ft.). No. 305 (98505). (206) 866-5267. Evergreen State College. Format: Contemp, progs, talk, educ. Spec prog: Black 7 hrs wkly. ■ Charles McCann, pres; Joseph Murphy, gen mgr & mus dir.

KGY—April 15, 1922: 1240 khz; 1 kw-D. 250 w-N. Box 1249 (98507). (206) 943-2140. Tom Olsen (acq 1-15-39). Net: MBS. Rep: Corlett; Moore; O'Connell. Format: MOR. ■ Tom Olsen, own & pres; Herb Ander-

son, gen mgr; Harry Fullick, coml mgr; Don Jones, opns mgr & chief engr; Dick Pust, prog dir; Bob O'Brian, mus dir; Bob Macleod, news dir.

KITN—October 1956: 920 khz; 1 kw-D. Box 48 (98507). (206) 491-9200. KITN-KITI Corp. Net: ABC. Reps: Masla; Tacher. Format: Btlf mus. ■ Donald F. Whitman, pres, gen mgr; Harry Minor, sls mgr; E. M. Whitman, VP & engrg dir. ■ Rates: \$7.35; 5.88; 7.35; 5.88.

Omak

KOMW—Sept 30, 1947: 680 khz; 1 kw-D. Box 151 (98841). KOMW Inc. Rep: Masla/Young; Tacher. ■ Dean C. Nichols, pres & gen mgr; Robert M. Christenson, coml mgr; Betty Nichols, prog dir; Daniel A. Powers, news dir; Jerry Robinson, chief engr.

Opportunity

KZUN—November 1955: 630 khz; 1 kw-D. Box 14029, Spokane (99214). (509) WALnut 4-2400. KZUN Inc. (acq 7-24-75). Rep: AAA Reps. ■ Robert L. Swartz, pres; Jack Armstrong, coml mgr; Leon Skidmore, chief engr.

KZUN-FM—April 1, 1961: 96.1 mhz; 3.7 kw. Ant minus 205 ft. Dups AM 75%.

Othello

KRSC—April 11, 1958: 1400 khz; 1 kw-D, 250 w-N SH. 180 E. Main St. (99344). (509) 488-2791. Basin Bcstg Corp. (acq 1-1-68). Rep: Devney; Tacher. Format: Contemp/C&W. Spec prog: Sp 6 hrs wkly. ■ R. D. Leary, pres; Richard Barrie, gen mgr & prog dir; Don Lockwood, coml & prom mgr & chief engr.

Pasco

KALE—See Richland.

***KOLU(FM)**—Sept 1, 1971: 90.1 mhz; 390 w. Ant minus 125 ft. 4921 W. Wernett (99301). (509) 547-2021. Riverview Baptist Christian Schools. Format: Religious, classical, cultural. ■ Dallas Dobson, gen mgr; Tom Groff, prog dir; William Brownson, chief engr.

KONA-AM-FM—See Kennewick-Richland-Pasco.

KORD—July 28, 1956: 910 khz; 1 kw-D. Box 2485 (99302). (509) 547-9791. KIXI Inc. (acq 1969). Net: ABC/E. Rep: H/R Stone; Broadcast Northwest. Format: MOR. Spec prog: Sp 1 hr wkly. ■ Wally Nelskog, pres; William Wippel, gen and coml mgr; Mike Jacobs, prog & news dir; Mark Riley, news dir; Jim Stargel, chief engr.

KORD-FM—Oct 15, 1965: 102.7 mhz; 100 kw. Ant 860 ft. Stereo. Dups AM 100%.

KOTY—See Kennewick.

Port Angeles

KAPY—June 16, 1961: 1290 khz; 1 kw-D, DA. Box 392 (98362). (206) 452-9228. Port Angeles Radio Inc. (acq 11-1-67). Rep: Radio Time Slis Internat; Moore. Format: MOR. ■ Charles Herring, pres, gen mgr & news dir; Dave Brewer, coml mgr; John Palmer, prog dir; Mary Helen Herring, mus dir; Eric Rush, chief engr.

KONP—1945: 1450 khz; 250 w. Box 831 (98362). (206) 457-1450. Radio Pacific Inc. Net: MBS. Rep: Savalli/Gates; Simpson-Reilly. Format: MOR. ■ George Buck, gen mgr; Glenda Amundson, stn mgr; Peggy Buck, mus dir. ■ Rates: \$4.85; 4.85; 4.85; 4.85.

Prosser

KACA(FM)—Sept 6, 1962: 101.7 mhz; 3 kw. Ant minus 275 ft. Stereo. Box 591 (99350). (509) 286-1017. Cormac C. Thompson. Net: MBS. Format: Easy lting, classical. Spec prog: Classical 8 hrs wkly. ■ Cormac C. Thompson Sr., own & chief engr; Inez Thompson coml & prom mgr; Cormac C. Thompson Jr., stn mgr, prog, news, mus dir.

KARY—Dec 14, 1956: 1310 khz; 1 kw-D. Box 1310 (99350). (509) 786-1310; 882-5400. Prosser-Grandview Bcstrs Inc. (acq 9-24-64). Rep: Devney; Simpson-Reilly. Format: C&W. Spec prog: Sp 6-12 hrs wkly. ■ Sidney Roach, pres, gen, coml, prom mgr & chief engr; Rita Stacy, prog & mus dir; J. R. Roach, news dir.

Pullman

KPUL—1950: 1150 khz; 1 kw-D(ST-KWSU). Box 1 (99163). (208) 882-0100 or (509) 332-6551. Radio Palouse (acq 12-7-74). Net: ABC/E. Rep: Masla/Young; Simpson-Reilly; Hix. Format: C&W. Spec prog: Farm 6 hrs wkly. ■ Bill Weed, gen & coml mgr; Eric Kidder, prog & mus dir; Jim Allmendinger, prog dir; Chick Bobbitt, chief engr. ■ Rates: \$5.85; 5.85; 5.85; 5.85.

KQQQ(FM)—Fall 1967: 104.9 mhz; 1.7 kw. Ant 57 ft. Stereo. Prog sep from AM. Format: Top 40. ■ Bobby Mitchell, prog dir; J.P. Huddleston, news dir; E. Armstrong, chief engr. ■ Rates: \$4.15; 4.15; 4.15; 4.15.

***KWSU**—June 1922: 1250 khz; 5 kw-U, S-KYAC night. (99163). (509) 335-2681. Washington State U. Net: NPR. Format: Variety, classical. ■ Glenn Terrell, pres; Gordon Tuell, gen mgr; Burt Harrison, stn mgr & prog dir; Suzy Franko, prom mgr; Elmer Erickson, mus dir; Rick Simon, news dir; Frank Coile, supvr engrg. ■ *KWSU-TV affil.

Puyallup

KUPY—Dec 1, 1951: 1450 khz; 1 kw-D, 250 w-N. 1520 E. Main St. (98371). (206) 845-7545. KAYE Bcstrs Inc. (acq 3-27-66). Format: C&W. Spec progs: Ger 1 hr, Sp 1 hr wkly. ■ H. Robert Wanker, pres & gen mgr; John Upham, coml mgr; Paul Larson, prog & mus dir; Bud Blair, news dir; Chuck Ellsworth, chief engr.

Quincy

KPOR—Sept 10, 1957: 1370 khz; 1 kw-D. Box 578 (98848). (509) 787-2721. Ray E. and Elena Russell (acq 10-7-3). Net: MBS. Rep: Moore. Format: C&W. Spec prog: Sp 4 hrs wkly.

Raymond

KAPA—June 1950: 1340 khz; 1 kw-D, 250 w-N, SH. 2065 Ocean Ave. (98577). (206) 875-5661. Willapa Bcstg Co. (acq 8-16-56). Rep: Adv Slis West; Moore. Format: MOR. ■ Robert E. Claunch, pres & gen mgr; John W. Reavley, coml mgr; Harold Nugent, chief engr.

Richland

KALE—April 1, 1950: 960 khz; 1 kw-U, DA-N. Box K, Tri-Cities (99302). (509) 586-2151. Inc. (acq 6-24-70). Group owner: Sterling Recreation Org. Bcst Div. Net: ABC/C. Rep: GCI; Simpson & Reilly. Format: Contemp. Spec prog: Sp 2½ hrs wkly. ■ F. A. Danz, pres; Malcolm C. Klein, dir of bcstg; Rodney V. Loudon, gen mgr, bcst dir; Rick Hubbard, prog dir; Herb Brindamour, coml mgr & prom dir; Mike Conklin, news dir; Dean LeMaster, chief engr & mus dir.

KONA-AM-FM—See Kennewick-Richland-Pasco.

KORD—See Pasco.

Seattle

KAYO Modern Country Music



KAYO—1926: 1150 khz; 5 kw-D, 1 kw-N. 2939 4th Ave. South (98134). (206) 623-2480. Washington Telecasters Inc. (acq 2-5-3). Group owner: Longston. Net: ABC/E. Audio news: APR. Rep: Torbet; Tacher. Format: C&W. ■ Jessica L. Longston, pres; R. E. Pollock, coml mgr; John R. DiMeo, gen mgr; Ben Peyton, prog dir; Lee White, prom mgr; Dave Young, mus dir; Dennis Buckle, news dir; Andy Thompson, chief engr. ■ Rates: \$27; 23; 25; 18.

KBIQ(FM)—See Edmonds.

KBLE—1948: 1050 khz; 5 kw-D. 114 Lakeside Ave. (98122). (206) 324-2000. KBLE-AM Inc. Group owner: Ostrander-Wilson. ■ George A. Wilson, pres; George W. Boucher, gen mgr; Anita Busek, opns mgr; Ann Smith, prog dir; Ernest H. Opel, chief engr. ■ Rates: \$10; 10; 10; 10.

KBLE-FM—May 6, 1964: 93.3 mhz; 100 kw. Ant 1,070 ft. KBLE-FM Inc. Prog sep from AM. ■ Rates: \$8; 8; 8; 8.

***KCMU(FM)**—1972: 90.5 mhz; 10 w. 304 School of

Washington Radio

See page C-1 for explanation of listings.

Communications, U of Washington (98103). (206) 543-4631. Univ. of Washington Bd of Regents. Net: NPR. Format: Rock, public affairs. ■ Prof. Don Godfrey, fac adv; Bob Branom, stn mgr.

KETO-FM—Sept 1, 1959: 101.5 mhz; 100 wk. Ant 1140 ft. Stereo. 400 N.E. 45th St. (98105). (206) 634-1015. KETO FM Assocs. (acq 3-6-74). Net: ABC/FM. Format: Contemp country. ■ John Maxon, VP; Todd M. Bitts, gen mgr; Brian Calkins, prog dir. ■ Rates: \$13; 20; 20; 13.

KEZX(FM)—May 1958: 98.9 mhz; 35 kw. (CP 100 kw). Ant 1,100 ft. Stereo. Edgewater Inn, Pier 67 (98121). (206) MAin 4-3345. Marketcasters Inc. (acq 4-1-67). Group owner: Able Communications Inc. Rep: Torbet. Format: Good music. ■ Fred Von Hofen, pres & gen mgr; Jim Kniest, VP & sls mgr; Kirk Lawrence, prog dir; Russ Mendenhall, chief engr.

KING—1927: 1090 khz; 50 kw-U, DA-2. 320 Aurora Ave. North (98109). (206) 223-5226. TWX (910) 444-2010. Telex 032-0251. King Bcstg Co. (group owner; acq 5-27). Audio news: UPI. Rep: Blair. Format: Contemp/Top 40. ■ Ancil H. Payne, pres; Eric Bremmer, gen mgr; Jim D. Kime, stn mgr; Ralph Heyward, sls mgr; Hal S. Widsten, coml mgr; Sharon Craig, prom mgr; Alan Hanson, prog dir; David McGovern, news dir; Harrison Klein, chief engr. ■ Rates: \$44; 33; 44; 28.

KING-FM—1947: 98.1 mhz; 20 kw. Ant 700 ft. Format: Classical. ■ Stanton J. Barnes, stn mgr; James F. Wilke, prog dir. ■ KING-TV affil.

KIRO Newsradio 7.

KIRO—1927: 710 khz; 50 kw-U, DA-N. 3d & Broad Sts. (98121). (206) MAin 4-7077. TWX 910-444-1350. Bonneville International Corp. (group owner). Net: NBC, MBS. Audio news: APR, UPI. Rep: CBS Radio Spot Slis. Format: MOR, Blocks of news. Spec prog: Farm 1 hr wkly. ■ Jack Adamson, gen mgr; Phil Syrdal, gen sls mgr; Norm Woodruff, news & prog opns dir; Bill Perrone, cont dir; Dave Hubert, chief engr. ■ Rates: \$75; 45; 47; 22.

KSEA(FM)—1946: 100.7 mhz; 100 kw. Ant 730 ft. Stereo. Prog sep from AM. Format: Btlf music. ■ Dick Dixon, stn mgr; Marlin Taylor, prog dir; Marie Hall, cont dir; Robert Warns, news dir; Jerry Valentine, chief engr. ■ KIRO-TV affil. ■ Rates same as AM.

KIXI—1947: 910 khz; 1 kw-U, DA-1. 801 Pine St. Box 21269 (98101). (206) 623-6910. KIXI, Inc. (acq 10-15-71). Net: CBS. Rep: HR Stone; Art Moore. Format: Btlf mus & news. ■ Wally N. Nelskog, pres; Gilbert J. Jacobson, gen mgr; Bill Walker, coml mgr; Bob Liddle, prog dir; Ken Stuart, news dir; Lauchy McMillan, chief engr. ■ Rates: \$40; 35; 37; 25.

KIXI-FM—May 25, 1960: 95.7 mhz; 100 kw. Ant 1240 ft. Stereo. Dups AM 50%. ■ Rates same as AM.

KJR—1924: 950 khz; 5 kw-U, DA-N. Box 3726 (98124). (206) 937-5100. Kaye-Smith Radio (group owner; 1958). Net: ABC/C. Rep: McGavren-Guild-PGW. Format: Top 40. ■ Lester M. Smith, exec dir; Pat O'Day, stn mgr; Shannon Sweatte, asst mgr; Lee Hurley, tech dir.

KISW(FM)—Co-owned with KJR. 1950: 99.9 mhz; 66 kw. Ant 1,170 ft. Stereo. Prog sep from AM. (acq 1969). Net: ABC-FM. Format: Prog rock. ■ Lee Michaels, prog dir; Bob Bingham, stn mgr.

***KNHC(FM)**—Jan 25, 1971: 89.5 mhz; 1.5 kw. Ant 320 ft. Stereo. 10750 30th Ave. N.E. (98125). (206) 363-2474. Lawrence Adams/Nathan Hale High School. Format: Diversified. ■ Lawrence E. Adams, gen mgr & prog dir; Tom Hodgson, Don Gallacher, prom mgrs; Tim Shook, mus dir; Ralph Jacobson, news dir; Marvin E. Arnold, chief engr.

KMPS—1922: 1300 khz; 5 kw-U, DA-N. Box 24888 (98124). (206) 622-2312. Hercules Bcstg Co. (acq 8-22-75). Audio news: UPI. Rep: Eastman; Tacher. Format: C&W. ■ Manning Slater, pres; James B. McGovern, gen & coml mgr; Rick Stewart, prog dir; Jay Hoffer, mus dir; George Garrett, news dir; William Wolfenbarger, chief engr.

KEUT(FM)—Co-owned with KMPS. July 8, 1961: 94.1 mhz; 100 kw. Ant 1,165 ft. Stereo. Prog sep from

Washington Radio

See page C-1 for explanation of listings.

AM. Format: Bfl mus. ■ Terry Rose, prog dir; James A. Schulke, mus dir.

KOMO—1926: 1000 khz; 50 kw-U, DA-N. 100 4th Ave. North (98109). (206) MAIN 4-6000. TWX 206-998-1278. Fisher's Blend Station Inc. Net: ABC. Rep: Katz; Simpson & Reilly. ■ W. W. Warren, pres & gen mgr; Jay Ward, VP & stn mgr; Fred Kaufman, sis mgr; Larry Nelson, prog mgr; Bryan Johnson, news dir; Ralph Miffiin, dir of engr. ■ KOMO-TV affil. ■ Rates: \$70; 35; 43; 24.

KQIN—See Burien.

KRAB(FM)—Dec 13, 1962: 107.7 mhz; 45 kw. Ant 1190 ft. 1406 Harvard Ave. (98122). (206) 325-5110. Jack Straw Memorial Foundation (acq 4-15-64). Net: NPR. Format: Ed. ■ Helen Norton, pres; C. H. Reinsch, gen mgr; Leila Gorbman, prog dir; Jeff Follette, mus dir; Thomas Eckles, chief engr.

***KUOW(FM)**—Jan 16, 1952: 94.9 mhz; 86 kw. Ant 730 ft. Stereo. U. of Washington (98195). (206) 543-2710. U. of Washington (98195). Net: NPR. Format: Classical. Spec prog: Sp 2 hrs wkly. ■ Ken Kager, mgr; Donald Wirtz, prog dir; Neil Burmester, mus dir; Juris Jansons, news dir; Hal Syrstad, chief engr.

KUUU—Feb 15, 1968: 1590 khz; 5 kw-U, DA-N. 1426 5th Ave. (98101). (206) 223-3911. Sterling Recreation Org. Co. (acq 8-29-75). Rep: GCI. Format: Oldies. ■ Bruce F. Johnson, pres bcst div; Wm. C. Osewalt, gen mgr; Bruce M. Earle, group dir of engr; Terry MacDonald, prog dir; Steve Nicholl, news dir; Gregg Ogonowski, chief engr. ■ Rates: \$18; 15; 18; 15.

KZOK(FM)—Co-owned with KUUU. December 1964: 102.5 mhz; 100 kw. Ant 1,170 ft. Stereo. Prog sep from AM. Format: Contemp. ■ Jeffrey D. Salgo, prog dir; Norm Gregory, mus dir; Donn Werrbach, chief engr. ■ Rates: \$27; 37; 37; 37.

KVI—1929: 570 khz; 5 kw-U. 809 Tower Bldg, 7th Ave & Olive (98101). (206) 223-5700. TWX 910-444-2185. Golden West Bcstrs Inc. (group owner; acq 7-1-59). Audio news: UPI. Rep: Major Market Radio. Format: MOR. ■ Jack J. Bankson, VP & gen mgr; Richard F. Robertson, gen sis mgr; Don Hofmann, prog dir; Jack Spencer, news dir; Elaine Staake, traf mgr; Jack McDonald, prom mgr; Dick Velo, chief engr. ■ Rates: \$80; 30; 41; 16.

KXA—1926: 770 khz; 1 kw-U, L-WABC. 320 2d Ave. W. (98119). (206) 284-8600. KXA Radio Inc. (acq 1946). Rep: Meeker. Format: Classical. Spec progs: Scandinavian 1½ hrs. Greek 1 hr. British 1 hr. Slavic 1 hr wkly. ■ Wesley I. Dumm, pres; David M. Crandell, exec VP & gen mgr; Bob MacDonald, prog dir; Arthur Jacobson, coml mgr; Bryant Smith, chief engr.

KYAC—Aug 20, 1920: 1250 khz; 5 kw-U, ST-KWSU night. 1426 Fifth Ave. (98101). (206) 223-3900. Carl Dek Inc. (acq 7-15-75). Rep: Meeker. Format: Talk. ■ David R. Newton, gen mgr; Curtiss M. Hanson, gen sis mgr; Nancy Shannon, prog dir; Peggy Brittel, prom mgr; Phil Cogan, news dir; Norman J. Fish, chief engr.

KYAC-FM—1959: 96.5 mhz; 19 kw. Ant 1070 ft. Stereo. 427 3rd Ave. (98119). (206) 284-2464. (Acq 1-73). Net: MBS/Black. Rep: Howard. Format: Black. ■ Don T. Dudley, gen mgr; Michael S. MacEwan, mktg dir; Paul Cutchlow, prog dir; Enrique Rodriguez, sis mgr; Veltry Johnson, news dir; Ron Putnam, chief engr.

KZOK(FM)—Listing follows KUUU.

Shelton

KMAS—Sept 21, 1962: 1280 khz; 1 kw-D. Box 760 (98584). (206) 426-4404. ABT Inc. Rep: Young/Tacher. Format: MOR. Spec prog: C&W 4 hrs wkly. ■ Bruce E. Jorgenson, pres; Tom Griese, coml mgr; David L. Kight, prog dir; Tom Trotzer, mus dir; Darrell Prowse, news dir.

Spokane

KEZE—March 21, 1957: 1380 khz; 5 kw-D. Box 8256 (99203). (509) 535-3688. Bellevue Bcstrs (acq 3-21-58). Net: MBS. Rep: Avery-Knodel; Feltis. Format: Easy Istng. ■ F. Kemper Freeman, pres; Sam R. Smith, gen mgr; Ed Mosley, news dir; David Lindsay, prog dir. ■ Rates: \$12; 9.60; 12; 4.80.

KEZE-FM—Nov 8, 1965: 105.7 mhz; 41 kw. Ant 540

ft. (acq 8-14-70). Dups AM 100%. ■ Leon Skidmore, chief engr. ■ Rates same as AM.

KGA—1926: 1510 khz; 50 kw-U, DA-N. Box 8348 (99203). (509) 535-4606. Liddie Bcstg (acq 1-68). Net: ABC/I. Rep: H-R Stone; Neidigh; Time Sls Northwest (Seattle, Portland). Format: C&W. ■ Wes Monroe, pres; Stephen Dean, gen mgr; Kay Eaton, coml mgr; Ron Norwood, prog dir; Ron Hardin, news dir; Tom German, chief engr.

KHQ—1922: 590 khz; 5 kw-U. South 4202 Regal (99203). (509) 543-0511. TWX 510-773-1830. KHQ Inc. (acq 3-1-46). Net: NBC. Rep: Katz; Art Moore. Format: MOR. ■ J. Birney Blair, pres & gen mgr; Jack Reber, coml mgr; Charles Heaton, prog dir; Dean Mell, news dir; Dee Waymire, chief engr. ■ Rates: \$32; 21; 27; 15.

KHQ-FM—May 1, 1966: 98.1 mhz; 47 kw. (CP: 94 kw). Ant 2,030 ft. Stereo. Prog sep from AM. Format: Contemp. ■ Duff Johnson, prog dir. ■ KHQ-TV affil. ■ Rates: \$10; 10; 10; 10.

KICN(FM)—Listing follows KUDY.

KJRB—1947: 790 khz; 5 kw-U, DA-N. Box 8007 (99203). (509) Keystone 4-9363. Seattle, Kaye-Smith Enterprises. (group owner; acq 6-7-58). Rep: McGavren-Guild-PGVW. Format: Contemp. ■ Lester M. Smith, pres; Dan A. Doeleman, gen mgr; Ross Woodward, news dir; Vince Hoffart, chief engr.

***KMBI**—July 12, 1959: 1330 khz; 5 kw-D. Box 8024 (99203). (509) 535-3077. Moody Bible Institute (acq 6-7-4). ■ D. Gary Leonard, gen mgr.

KMBI-FM—April 22, 1968: 107.9 mhz; 56 kw. Ant 2,380 ft. Dups AM 30%. (acq 6-74).

***KPBX-FM**—1972: 91.1 mhz; 10 w. (CP: 4.2 kw. Ant 542 ft.). 27th Ave. (99203). Spokane Public Bcstg Assn.

KREM—1947: 970 khz; 5 kw-D, 1 kw-N, DA-N. 4103 S. Regal (99203). (509) 534-0423. King Bcstg Co. (group owner; acq 1-1-58). Rep: Blair. Format: Contemp. Top 40. ■ Ancil H. Payne, pres; Larry B. Campbell, stn mgr; Tom Long, coml mgr; Rob Glendenning, prog dir; Steve Alexander, news dir; Ronna Myhre, prom mgr; Warren Pritchard, chief engr.

KREM-FM—September 1955: 92.9 mhz; 4.8 kw. Ant 720 ft. Prog sep from AM. Format: Progressive. ■ Jim Wellington, prog dir. ■ KREM-TV affil.

***KSFC(FM)**—March 1973: 91.9 mhz; 10 w. W. 3410 Ft. George Wright Dr. (99204). (509) 456-2995. Spokane Falls Community College. Format: Contemp. ■ Richi Shackette gen supvr; Gary Stewart, chief engr.

KSPO—September 1921: 1230 khz; 1 kw-D, 250 w-N. Suite 608, Columbia Bldg., 1st & Howard (99201). (509) 838-4288. Radio Spokane Inc. (acq 3-1-71). Net: ABC/E. Rep: Torbet; Tacher. Format: C&W. ■ Richard B. Wheeler, pres; Robert Flynn, gen mgr; Rich Newman, sis mgr; Bill James, prog dir; Randy Wilken, prom mgr; Earle Miller, mus dir; Rick Vann, news dir; Larry Gilbert, chief engr.

KUDY—1965: 1280 khz; 5 kw-D, DA. Box 8436 (99203). (509) 535-4781. Ranier Bcstg (acq 1-1-70). Group owner: Casade Bcstg Corp. Rep: Savalli/Gates. Format: Relig. ■ David M. Jack, pres; Frank Herron, prog dir; Coy Baker, coml mgr; Joe W. Allen, chief engr. ■ Rates: \$7.10; 7.10; 7.10; 7.10.

KICN(FM)—Co-owned with KUDY. Oct 10, 1975: 98.9 mhz; 27.7 kw. Ant 286 ft.

KUPY—See Puyallup.

KXLY—October 1922: 920 khz; 5 kw-U. West 500 Boone Ave. (99201). (509) 328-6292. TWX 510-773-1852. Spokane Television Inc. (acq 3-21-62). Group owner: Morgan Murphy Stns. Net: CBS. Rep: Eastman; Simpson & Reilly. Format: MOR. ■ Mrs. Morgan Murphy, pres; Wayne McNulty, gen mgr; Ed Mahoney, coml mgr; Chuck Harmon, prog & mus dir; Brian Williams, prom mgr; T. O. Jorgenson, chief engr. ■ Rates: \$8; 6.50; 8; 6.50.

KXLY-FM—1960: 99.9 mhz; 4.6 kw. Ant 3,000 ft. Stereo. Prog sep from AM. ■ KXLY-TV affil. ■ Rates: \$7.25; 7.25; 7.25; 7.25.

KXXR—Sept 1, 1962: 1440 khz; 5 kw-D. W. 933 Third Ave. (99204). (509) 624-1193. Independent Bcstg Corp. (acq 7-1-69). Rep: Savalli-Gates; Bcst Sls NW. ■ Edward F. Kelley, pres & gen mgr; Donald R. Berry,

VP sis; Nada Potoshnik, asst stn mgr; Ed Parents, mngng news edit; Ronald Stiffler, chief engr.

KXXR-FM—Sept 30, 1965: 93.7 mhz; 28.5 kw. Ant 330 ft. Stereo. Dups AM 49%. Format: Good music.

KZUN—See Opportunity.

Sumner-Puyallup

KDFL—Oct 1, 1965: 1560 khz; 250 w-D. Box 156 Sumner (98390). (206) 863-1560. Valley Communications Corp. (acq 4-7-69). Rep: Masla/Young. Format: Vintage-20's, 30's, 40's. ■ James E. Weese, pres; Loren Gallagher, gen mgr; Gayle Pierce, coml mgr; Bill West, prog & mus dir; Dale Hancock, news dir & chief engr.

Sunnyside

KREW—September 1950: 1230 khz; 1 kw-D, 250 w-N. Box 149 (98944). (509) 837-2277. Bennett Bcstg Co. (acq 7-1-65). Net: CBS. Rep: Simpson & Reilly. Format: MOR. Spec prog: Sp 6 hrs wkly. ■ Don G. Bennett, pres & coml mgr; Jean Runyon, prog dir; Dave Lester, news dir; Mac Davis, chief engr. ■ Rates: \$5.75; 5.75; 5.75; 6.50.

KREW-FM—August 1, 1974: 96.7 mhz; 3 kw. Ant 28 ft. Stereo. Dups AM 75%.

William A. Exline, Inc.
31 CARROLL COURT
SAN RAFAEL, CALIFORNIA 94903
(415) 479-0717
MEDIA BROKERS — CONSULTANTS

Tacoma

KLAY-FM—May 1959: 106.1 mhz; 25 kw. Ant 100 ft. Stereo. 215 Tacoma Ave. South (98402). (206) 627-3137. Clay F. Huntington. Format: Progressive. ■ Clay Huntington, pres; Win McCracken, gen mgr, prog dir; Mark Pierce, mus & news dir; Janet Patjens, coml mgr; Clay Freinwald, chief engr. ■ Rates: \$5; 5; 5; 5.

KMO—1922: 1360 khz; 5 kw-U. Box 1277 (98401). (206) 927-1360. Bcst House Inc. (acq 4-1-63). Rep: Selcom. Format: C&W. ■ Edward A. Wheeler, pres; James L. Baine, VP, gen mgr & sis mgr; Don Chapman, prog & mus dir; John Johnson, news dir; Clay Freinwald, chief engr. ■ Rates: \$14; 13; 14; 12.

***KPEC-FM**—Feb 1, 1955: 90.9 mhz; 39 kw. Ant 180 ft. 4500 Steilacoom Blvd. S.W. (98499). (206) 552-5431. Clover Park School District 400. Format: MOR. ■ J. A. Brevik, gen mgr & prog dir; Bill Evans, chief engr. ■ *KPEC-TV affil.

***KPLU-FM**—February 1966: 88.5 mhz; 40 kw. Ant 130 ft. Pacific Lutheran U. (98447). (206) 531-3838. Pacific Lutheran Univ Inc. ■ Judd C. Doughty, gen mgr; David Hartley, prog dir; David O. Christian, chief engr.

KTAC—August 1942: 850 khz; 10 kw-D, 1 kw-N, DA-2. 2000 Tacoma Mall Off Bldg. (98411). (206) 473-0085. Entertainment Communications Inc. (group owner; acq 6-73). Rep: HR/Stone, Tacher. Format: Contemp, Top 40. ■ Joseph M. Field, pres; Harold S. Greenberg, VP & gen mgr; Derek Shannon, prog dir; Bruce Cannon, mus dir; Gary West, news dir; Terry Denbrook, chief engr. ■ Rates: \$40; 34; 40; 32.

KTAC-FM—June 2, 1958: 103.9 mhz; 1 kw. Ant 490 ft. Stereo. Format: Contemp. Dups AM 50%. ■ Rates: \$40; 34; 40; 16.

KTNT—Oct 14, 1952: 1400 khz; 1 kw-D, 250 w-N. Box 5200 (98405). (206) 597-8700. Tribune Pub Co. Rep: Pro/Meeker; Moore. Format: Contemp. ■ Robert Zerbel, gen mgr; Ted Rose, coml mgr; Harold McMillian, prog dir; Carl Sawyer, mus dir; John Hayden, news dir; Jerry Beffa, chief engr.

KTNT-FM—Oct 26, 1948: 97.3 mhz; 10.2 kw. Ant 410 ft. (CP: 100 kw horiz; 41 kw vert. Ant 380 ft.) Prog sep from AM.

***KTOY(FM)**—June 1, 1949: 91.7 mhz; 38 kw. Ant 310 ft. Stereo. 1101 S. Yakima Ave. (98405). (206) 597-7234. Tacoma School District 10. Net: NPR. For-

mat: Top 40. Spec prog: Black 30 hrs, Sp 6 hrs, farm 5 hrs, NW Am Ind 1/2 hr wkly. ■ Lee D. Perkins, stn mgr; Russ Stringham, prod dir; Sherry Lamb, traf; Darren Lamb, prog dev; M.J. Strom, prom mgr; Bill Luckhurst, chief engr. ■ *KTPS(TV) affil.

Toppenish

KENE—July 1954: 1490 khz; 1 kw-D, 250 w-N. Box 350 (98948). (509) 3900. Radio Bcstrs Inc. (acq 11-1-74). Net: MBS. Rep: Devney; Simpson/Reilly. Format: Town & country. Spec progs: Sp 20 hrs, farm 7 hrs wkly. ■ Donald R. Nelson, pres & gen mgr; Kenneth Nelson, coml mgr; Rex Jennings, prog dir & chief engr; Bob Finley, mus dir; Sandy Kelley, prom mgr; John Johnson, news & sports dir. ■ Rates: \$4; 4; 4.

Vancouver

KGAR—Aug 10, 1963: 1550 khz; 1 kw-D. Box 1887 (98663). (503) 285-5575. Gordon A. Rogers. Net: ABC/C, Mutual Black. Format: Contemp. Spec prog: Black 6 hrs wkly. ■ Gordon A. Rogers, pres; R. T. Fletcher, gen & coml mgr; Bob Duke, prog & mus dir, prom mgr; Mike Garland, news dir; Tim L. Freed, chief engr.

KISN—1939: 910 khz; 5 kw-U, DA-2. 10 N.W. 10th, Portland (97209). (503) 226-7191. Star Bcstg Inc. (group owner; acq 5-1-59). Rep: Buckley; Simpson/Reilly. Format: Contemp. ■ D. W. Burden, chmn & pres; Steve Shepard, natl sls mgr; Sol Rosinsky, gen mgr; Bill Failing, sls mgr; Bill Stevens, prog dir; Whitey Coker, news dir; Sam Lee, mus dir; Byron Swanson, chief engr.

KKEY—See Portland, Ore.

KVAN—1955: 1480 khz; 1 kw-D. 11197 North Portland Rd., Portland (97203). (503) 286-8181 or 286-5938. New Bcstg Corp. (acq 3-74). Net: NW Rock Radio. Format: Progs. Spec progs: Black 2 hrs, jazz 15 hrs wkly. ■ Howard R. Slobodin, pres & gen mgr. ■ Rates: \$14; 14; 14.

Walla Walla

***KGT(SFM)**—See College Place.

KHIT—Dec 6, 1956: 1320 khz; 1 kw-D. Box 796 (99362). (509) 525-3190. STLUC Inc. (acq 1973). Audio news APR. Rep: Savalli/Gates; Hix; Tacher. Format: Contemp. ■ Carl S. Tyler, pres & gen mgr; Mary Cosgrove, news dir.

KTEL—1946: 1490 khz; 1 kw-D, 250 w-N. Box 948 (99362). (509) JAcKson 5-4103. Walla Walla Bcstg Co. (acq 7-51). Net: ABC/I. Rep: Sandeberg-Glenn; Simpson/Reilly. Format: C&W, rock. ■ Jack Keating, pres, gen mgr & prom mgr; David Dirks, coml mgr/ prog, mus & news dir; Beven Roth, chief engr.

KUJ—1928: 1420 khz; 5 kw-U, DA-N. Box 513 (99362). (509) 529-1230. VBR Bcstrs (acq 4-1-69). Net: CBS. Rep: Burn-Smith; Pacific Bcst Sls; Art Moore. Format: Contemp, MOR. ■ Verne Russell, pres, gen & coml mgr; Mike Purdy, mus dir; Jim Schick, news dir; Glenn Dubbe, chief engr.

***KWCW(FM)**—1971: 90.5 mhz; 10 w. Stereo. KWCW Radio (99362). (509) 529-5106. ASWC Radio Committee. Format: Progressive. ■ Walter Jaccard, gen mgr; Sue Stevens, prog dir.

Wenatchee

KIAM-FM—Not on air; target date Jan 1, 1976: 104.9 mhz; 105 w. Ant 1330 ft. Stereo. Box 1972 (98801). (509) 663-8513. Bethesda Christian Temple. Audio news: UPI. Format: Relg. Spec prog: Classcl 5 hrs wkly. ■ Larry M. Titus, pres; William B. Mustard, gen mgr; Ron Mahan, mus dir; Jeff Hamilton, news dir; Albert Rodarmel, chief engr. ■ Rates: \$5.75; 5.75; 5.75; 4.

KMEL—1948: 1340 khz; 1 kw-D, 250 w-N. Box 638 (98801). (509) 662-7135. Frontier Bcstg Co. (acq 5-1-58). Rep: Tacher. Format: Top 40. ■ Craig R. Lawrence Jr., pres, gen & coml mgr; Don Bernier, prog dir; Scott Gardner, news Gregory John Chase, chief engr.

KPQ—1930: 560 khz; 5 kw-U, DA-N. Box 159 (98801). (509) 663-5121. Westcoast Bcstg Co. (acq 12-72). Net: ABC/I. Rep: B-H Co. Format: News, talk, sports, MOR, contemp. Spec prog: RFD 6 hrs wkly. ■ James W. Wallace Sr., pres; Jim Wallace Jr., gen mgr; Dave Sands, coml mgr; Don McMaster, prog & mus

dir; Bob Davies, prom mgr; Ron Ruhser, news dir; Duane Lee, chief engr.

KPO-FM—Dec 1967: 102.1 mhz; 35 kw. Ant 2655 ft. Stereo. Prog sep from AM. Net: ABC-FM. Format: Variety, MOR.

KUEN—Nov 17, 1956: 900 khz; 1 kw-D. Box 79 (98801). (509) 663-5186. KUEN Inc. (acq 11-1-59). Group owner: Robertson Clapp Stns. Net: CBS. Rep: Webb; Moore. Format: C&W. ■ Miller Robertson, pres; Matthew N. Clapp, VP & sec; Howard Curtis, gen mgr & prog dir; Dave Allen, music dir; Dave Gellatly, news dir; Jack Sneider, chief engr.

Yakima

KBBO—1947: 1390 khz; 1 kw-D, 500 w-N, DA-N. Box 172 (98907). (509) 248-1390. Yakima Bcstg Co. (acq 7-1-62). Net: MBS. Format: Relig. ■ Dick Waldbaver, pres; Arvid A. Erickson, gen mgr & chief engr; Lou Gillespie, coml mgr; Albert J. Chery, prog dir.

KFFM(FM)—See listing following KMWX.

KIT—April 8, 1929: 1280 khz; 5 kw-D, 1 kw-N. Box 1222 (98901). (509) 457-8115. Goetz Enterprises Inc. (acq 6-1-65). Net: ABC/I. Rep: Avery-Knodel; Simpson/Reilly. Format: Adult sound. ■ Jack H. Goetz, pres & gen mgr; Ron King, sls mgr; Jerry Springer, mus dir; Grant McDaniel, prog dir; Vern Chartier, prom mgr; Al Bell, news dir; H. Ben Murphy, chief engr.

KIT-FM—Dec 15, 1968: 94.5 mhz; 25 kw. Ant 910 ft. Stereo. Dups AM 40%. Format: Btfl music.

KMWX—Oct 19, 1944: 1460 khz; 5 kw-U, DA-N. Box 702 (98907). (509) 248-1460. Yakima Valley Communications Inc. (acq 12-4-61). Net: NBC. Rep: Masla-Young; Art Moore, Masla. Format: MOR/Up Tempo. ■ Tom Bostic, pres; Monte O. DeVon, gen & coml mgr; Art Fulton, prog & mus dir; Carl Clark, news dir; Mel Burrill, chief engr.

KFFM(FM)—Co-owned with KMWX. September 1970: 107.3 mhz; 100 kw. Ant 904 ft. Stereo. Progs sep from AM. Format: Solid gold, Top 40.

KQOT—Oct 17, 1962: 930 khz; 1 kw-D. Box 1194 (98901). (509) CHestnut 8-4643. KQOT Inc. Net: Market 1. Format: Rock. ■ Robert R. Moore, pres, gen & coml mgr & chief engr; Dorothy McCue, asst mgr. ■ Rates: \$4.25; 4.25; 4.25; 4.25.

KUTI—1955: 980 khz; 5 kw-D. Box 261 (98907). (509) 248-2900. KUTI Communicators Inc. (acq 9-65). Net: ABC/E. Rep: Torbet; Tacher. Format: C&W. ■ Don Heinen, pres, gen mgr; Ken Julian, coml mgr; Bob Reece, prog dir; Jim Breedlove, prom mgr; Steve Knight, news dir; Larry Craig, chief engr. ■ Rates: \$6.50; 5.50; 6.50; 5.50.

KUTI-FM—July 1, 1971: 104.1 mhz; 61 kw. Ant 780 ft. Stereo. Prog sep from AM. (acq 6-74). Format: C&W. ■ Rates: \$3; 3; 3; 3.

CSI ELECTRONICS INC.
2607 River Road
Cinnaminon, New Jersey, 08077
Telephone: (609) 786-1060

West Virginia

HAMILTON-LANDIS & ASSOCIATES, Inc.
NATIONWIDE MEDIA BROKERS
WASHINGTON, D. C. CHICAGO, DALLAS, SAN FRANCISCO
SELL MORE
RADIO & TELEVISION STATIONS
IN THE EAST—NEAREST OFFICE IS—
1730 K ST., N.W., WASHINGTON 20006
(202) 393-3456

Washington, West Virginia Radio

See page C-1 for explanation of listings.

Beckley

WBKW(FM)—Listing follows WJLS.

WCIR—Nov 14, 1966: 1070 khz; 10 kw-D, 500 w-N. Box 1063 (25801). (304) 252-6452. Waldron Bcstg Corp. Net: MBS. Format: Top 40. ■ Thomas M. Waldron, pres; Thomas K. Martin, gen mgr; Mrs. Betty Elkins, coml mgr; William F. Mahoney Jr., prog dir; Andrew T. Ridenour, mus dir; John D. Sessler, chief engr. ■ Rates: \$5.25; 4.75; 5.25; 4.75.

WCIR-FM—Oct 1971: 103.7 mhz; 25 kw. Ant 360 ft. Format: MOR. ■ Rates: \$4.25; 3.75; 4.25; 3.75.

WJLS—March 20, 1939: 560 khz; 5 kw-D, 500 w-N, DA-N. WJLS Bldg., Main & Kanawha (25801). (304) 253-7311. Personality Stns Inc. Rep: Dome-Messervey, Regional Reps. Format: C&W. ■ Joe L. Smith Jr., pres; Bill Blake, VP & gen mgr; William A. O'Brien, coml mgr; Richard Janney, prog dir; Darrell Menz, news dir; Jeff Miller, chief engr. ■ Rates: \$11; 9; 11; 7.

WBKW(FM)—Co-owned with WJLS. Nov 6, 1946: 99.5 mhz; 34 kw. Ant 1,050 ft. Stereo. (304) 252-8578. Prog sep from AM. Format: Relig. ■ Lorraine Jones, prog dir. ■ Rates: \$3; 3; 3; 3.

***WVPB(FM)**—May 1, 1974: 91.7 mhz; 10.5 kw. Ant 920 ft. Box AH (25801). (304) 255-1501. West Virginia Educational Bcstg Authority Net: NPR. Format: Variety. Spec prog: Black 1 hr wkly. ■ Arthur E. Albrecht, gen mgr; Robert Robinson, opns mgr; H. Leon Drye, chief engr. ■ WSWP-TV affil.

WVNR

A Rahall Communications Station

WVNR—Nov 17, 1946: 620 khz; 1 kw-D, 500 w-N, DA-N. Drawer AE (25801). (304) 253-8330. Rahall Bcstg Co. Group owner: Rahall Communications Corp. Net: ABC/C. Format: Top 40. ■ N. Joe Rahall, pres; Anthony P. Gonzalez, gen mgr; Fred Persinger, coml mgr; Charles Gillespie, prog dir; Dan Blaney, prom mgr; Mike Harrison, mus dir; Phil Vogel, news dir; Jack Slygh, chief engr. ■ Rates: \$11; 9; 11; 9.

Berkeley Springs

WCST—Sept 7, 1958: 1010 khz; 250 w-D. Box 8 (25411). (304) 258-1010. Berkeley Springs Radio Stn Corp. Format: C&W. ■ Carl Johnson, pres; Kenneth E. Robertson, gen & coml mgr & chief engr. Barry Lupton, news dir.

WCST-FM—December 1965: 93.5 mhz; 3 kw. Ant 70 ft. Prog dups AM 65%.

Bethany

***WVBC(FM)**—Jan 1, 1966: 88.1 mhz; 10 w. Bethany College (26032). (304) 829-7853. Bethany College. Format: Variety. ■ Cecil Underwood, pres; E.L. "Ted" Burrows, gen mgr.

Bluefield

WHIS—June 27, 1929: 1440 khz; 5 kw-D, 500 w-N. Broadcast Center, E. Cumberland Rd. (24701). (304) 327-7114. Daily Telegraph Printing Co. (group owner). Net: NBC. Rep: Avery-Knodel. Format: MOR. ■ Ned Shott, pres; John Shott, VP & gen mgr; Frank Barnes, coml mgr; Shane Randall, prog dir; Eriean Branch, prom mgr; Mike Stater, news dir; Kenneth Dick, chief engr.

WHIS-FM—April 21, 1963: 104.5 mhz; 5.9 kw. Ant 1, 170 ft. Stereo. Prog sep from AM. Format: Btfl mus. ■ WHIS-TV affil.

WKOY—May 18, 1948: 1240 khz; 1 kw-D, 250 w-N. Box 800 (24701). (304) 327-6124. Fincastle Communications Co. Inc. (acq 1975). Group owner: Bristol Bcstg. Net: ABC/C. Rep: Burn-Smith. Format: Contemp. ■ William Deskins, O.C. Young, George Hendrick, and John Wilkinson, owners; Frank Harigan, gen mgr.

Buckhannon

WBUC—Dec 13, 1959: 1460 khz; 5 kw-D. Drawer C

West Virginia Radio

See page C-1 for explanation of listings.

(26201). (304) 472-1460. Radio Station WBUC Inc. Format: C&W, MOR. ■ James D. Newman, pres; Terry R. Miller, gen mgr; Phil Phillips, stn mgr; Mike Fincham, prog dir.

***WVWF(FM)**—September 1968: 88.9 mhz; 14 kw. Ant 840 ft. Box 51, West Virginia Wesleyan College (26201). (304) 473-7031. W. Va. Wesleyan College Board of Trustees. Net: NPR. Spec prog: Black 2½ hrs wkly. ■ Richard H. Madden, gen mgr; Jennifer Roth, prog dir; Jean Summers, opns dir; Tim Myers, prod; Arnold W. Sayre, chief engr.

Charleston

WBES(FM)—Listing follows WCHS.



WCAW—1946: 680 khz; 50 kw-D, 250 w-N, DA-N. Box 4318 (25304). (304) 925-4986. Capitol Bcstg Corp. (group owner; acq 1-56). Net: ABC/E. Format: Country. ■ E. M. (Pete) Johnson, pres; Paul N. Miles, gen mgr; Robert Knowles, coml mgr; Tom Miller, prog dir; Rick Johnson, mus dir; Paul Jeffers, news dir; Calvin Drennen, chief engr. ■ Rates: \$33; 29; 33; 29.

WVAF(FM)—Co-owned with WCAW. Feb 1, 1965: 99.9 mhz; 50 kw. Ant 500 ft. horiz, 490 ft vert. Stereo. Format: Relig, progs. ■ George Asseley, gen mgr; Tom Owens, prog dir. ■ Rates: \$10; 10; 10; 10.

WCHS—Sept 15, 1927: 580 khz; 5 kw-U, DA-N. 1111 Virginia St. East (25301). (304) 342-8131. TWX 710-939-8720. Rollins Bcstg of Delaware Inc. (acq 11-1-60). Group owner: Rollins Inc. Net: CBS. Rep: Blair Form: MOR. ■ O. Wayne Rollins, pres; James C. Roddy, group VP; Paul H. Dowas, VP radio dir; Jack Rattigan, gen mgr; Joe Farris, sis mgr; Jim Little, opns/ prog dir; Bill McQueen, news dir. ■ Rates: \$34; 24; 34; 14.

WBES(FM)—Co-owned with WCHS. Sept 16, 1969: 96.1 mhz; 14.5 kw. Ant 830 ft. Stereo Prog sep from AM. Format: Btfl mus. ■ William H. Phillips, gen mgr; Elizabeth J. Eakin, prog dir. ■ Rates: \$15; 26; 15; 12.

WKAZ—Feb 24, 1957: 950 khz; 5 kw-D, 1 kw-N, DA-N. Box 871 (25323). (304) 344-9691. WKAZ Inc. (acq 5-1-64). Group owner: Nininger Stns. Net: ABC/C. Rep: McGavren-Guild-PGW. Format: Contemp, Top 40. ■ W. L. Nininger, exec VP; Fred B. Winton, gen mgr; Charles Cooper, prog dir; David Douglas, news dir; Kurt Ziegler, sis mgr; Bob Turley, opns mgr; L. Lovejoy, chief engr.

WQBE(FM)—Co-owned with WKAZ. Feb 19, 1959: 97.5 mhz; 9 kw. Ant 110 ft. (304) 344-4433. Format: Contemp/Gold. Progs sep from AM.

WSCW—See South Charleston.

WTIO(FM)—Listing follows WTIP.

WTIP—Nov 4, 1946: 1240 khz; 1 kw-D, 250 w-N. 817 Suncrest Place (25301). (304) 342-3136. Chemical City Bcstg Inc. Net: NBC. Rep: Century National Sis. Dome. Format: Btfl music. ■ Gus Zaharis, pres & gen mgr; Charles Coleman, prog dir; B. A. (Bud) Burka, coml mgr; Marilyn Fletcher, opns mgr; James Zaharis, chief engr. ■ Rates: \$10; 9; 10; 9.

WTIO(FM)—Co-owned with WTIP. September 1964: 102.7 mhz; 50 kw. Ant 470 ft. Prog dups AM 100%. ■ Rates same as AM.

WVAF(FM)—Listing follows WCAW.

WXIT—1939: 1490 khz; 1 kw-D, 250 w-N. Box 3142 (25332). (304) 342-4166. Steere Bcstg Corp. of W. Va. Net: ABC/I. Format: Contemp. ■ David E. Steere, pres; R. C. Knightstep, gen mgr; Sean McNeil, prog dir; Terry Love, mus dir; Jerry Burkheimer, prom mgr; J.R. Combs chief engr. ■ Rates: \$9; 8.50; 9; 8.

Charles Town

WXVA—May 28, 1962: 1550 khz; 5 kw-D. Box 188 (25414). (304) 725-7055. WXVA Bcstg Corp. (acq

8-1-70). Rep: Dome. Format: MOR. ■ John P. Luce, pres, gen & prom mgr, prog dir & chief engr; Mike Carrell, coml mgr.

WZFM(FM)—Co-owned with WXVA. Aug 28, 1966: 98.3 mhz; 3 kw. 110 ft. Prog dups AM 100%.

Clarksburg

WBOY—April 21, 1937: 1400 khz; 1 kw-D, 250 w-N. 912 West Pike St. (26301). (304) 624-7571. TWX 304-366-2376. Northern West Va. Radio Bcstg Co. (acq 7-10-64). Net: NBC. Rep: Masla, Regional Reps, Dome-Messervier. Format: MOR. Spec prog: Farm 2 hrs wkly. ■ Nathan W. Levine, pres; Roger Garrett, gen mgr; Jim Dumire, coml mgr; Doris Dean, prog dir; John Pratt, prom mgr & news dir; Joe Wright, chief engr. ■ WBOY-TV affil. ■ Rates: \$6.50; 6; 6.50; 6.

WHAR—Nov 28, 1946: 1340 khz; 1 kw-D, 250 w-N. 350 W. Main St. Box 2423 (26301). (304) 624-5525. Harrison Corp. (acq 11-68). Net: ABC/C. Rep: PRO Time Sis, Gateway. Format: Contemp, top 40. ■ James T. Fawcett, pres; Robert Hilber, gen mgr; Flora Ves-pont, sec-treas; Nick Tennis, prog dir; William F. Mahoney, mus dir; Beryl Snyder, chief engr.

WVHF-FM—Co-owned with WHAR. 1975: 92.7 mhz; 460 w. Ant 670 ft.

WDPX—August 1947: 750 khz; 1 kw-D. Box 1920 (26301). (304) 624-6425. Rau Radio Stations Inc. (group owner; acq 12-1-73). Audio news: APR. Rep: Devney. Format: C&W. ■ Henry Rau, chmn of bd; Lloyd S. Smith, pres; Walker L. Trumble, gen mgr; Michael King, prog & mus dir; & prom mgr; Lewis R. Robbins, news dir; David Harper, coml mgr; Joseph Sweeney, chief engr. ■ Rates: \$10; 10; 10; 10.

WDPX-FM—August 19, 1974: 104.9 mhz; 2.5 kw. Ant 320 ft. Stereo. Prog dups AM 100%. ■ Rates same as AM.

WRGT-FM—June 15, 1972: 106.5 mhz; 50 kw. Ant 500 ft. Box 2091 (26301). (304) 624-6353. Multi-Media Associates. Format: Contemp, oldies. ■ James R. Reese Jr., pres & gen mgr; Mike Shirley, prog dir; Rick Williams, mus dir; Peter Martin, news dir; Walter Lindsey, coml mgr; Mike Simons, opns mgr; David Anderson, chief engr.

Elkins

***WCDE(FM)**—1975: 90.3 mhz; 10 w. Ant 2090 ft. Box J. Davis and Elkins College (26241). (304) 636-6565. Davis and Elkins Board of Trustees. Format: Educl, progs, talk. Spec prog: Black 8 hrs wkly. ■ Nancy Erickson, gen mgr; Francis Fisher, chief engr.

WDNE—February 1948: 1240 khz; 1 kw-D, 250 w-N. Box 967 (26241). (304) 636-1300. Marja Bcstg Corp. (acq 12-1-55). Net: Keystone. ■ John P. Carr, pres; William G. Carr, stn mgr; Ken Hinkle, coml mgr; Dale Wilson, prog dir; Dave Saffle, news dir.

Fairmont

WFGM(FM)—1975: 97.9 mhz; 47 kw. Ant 520 ft. 101 12th St. (26554). Mountain Bcstg. ■ Robert L. Purcell and Earl Judy Jr., owners.

WMMN—Dec 22, 1928: 920 khz; 5 kw-U, DA-N. Fairmont Hotel (26554). (304) 363-5200. Marion Bcstg Corp. (acq 1975). Net: CBS. Rep: Gill-Perna. Format: MOR, Contemp. ■ Robert Levine, pres; Chuck Warner, prog dir; Bob Hank, prom mgr; Bud Forte, mus dir; Gary Karl, news dir; Wayne Shroyer, chief engr. ■ Rates: \$13; 10; 13; 10.

WTCS—January 1948: 1490 khz; 1 kw-D, 250 w-N. Box 1549 (26554). (304) 366-3700. Fairmont Bcstg Co. (acq 5-1-56). Format: MOR, Top 40. Spec prog: Ital 3 hrs wkly. ■ Nick Fantasia, pres, news dir, coml & gen mgr; Joan Shannon, prog dir; Nicolena Fantasia, mus dir & prom mgr; Charles F. Snoderly, chief engr.

Fisher

WELD—Aug 1, 1956: 690 khz; 500 w-D. (26818). (304) 538-6062. South Branch Bcstg Corp. Group owner: Mid Atlantic Network. Net: MBS. Rep: Dome-Messervier. Format: C&W. ■ Daniel Pennell, mgr.

Fort Gay

***WFGH(FM)**—1973: 90.7 mhz; 7.8 kw. Ant 205 ft. Fort Gay High School, Wayne (25514). Wayne County Board of Education.

Grafton

WVWV—January 1957: 1260 khz; 500 w-D. Box 2 (26354). (304) 265-2000. WVWV Inc. Net: MBS. Format: MOR. Spec prog: C&W 6¼ hrs wkly. ■ J. Patrick Beacom, pres; Jean Bolyard, VP & gen mgr; Bernadine Waters, news dir; Charles Dodge, chief engr.

Hinton

WMTD—Jan 11, 1963: 1380 khz; 1 kw-D. Box 820 (25951). (304) 466-1380. Bluestone Bcstrs Inc. (acq 1963). Net: ABC/E, Keystone. Spec prog: C&W 12 hrs wkly. ■ Lonnie R. Mullins, gen mgr & chief engr. Thelma Mullins, news & prog dir.

Huntington

WCMI—See Ashland, Ky.

WEMM(FM)—Sept 6, 1971: 107.9 mhz; 50 kw. Ant 500 ft. 1307 16th St. (25701). (304) 525-5141. Christian Bcstg Assn. Format: Christian, gospel. ■ Jack M. Mortenson, pres & gen mgr; James Vallance, prog dir; Mrs. Marty Boltman, office mgr; David Johnson, chief engr.

WGNT—1923: 930 khz; 5 kw-D, 1 kw-N, DA-N. Box 1187 (25714). (304) 523-8401. Stoner Bcstg System Inc. (group owner; acq 6-1-70). Net: NBC. Rep: McGavren-Guild. Format: MOR. ■ Thomas H. Stoner, pres; Toufie L. Kassab, gen mgr; Mike McKay, prog dir; Bob Miller, mus dir; Dick Brown, news dir; Carroll Kessell, chief engr.

WHEZ(FM)—Listing follows WTCR.

WKEE—July 1947: 800 khz; 5 kw-D. Box 2288 (25701). (304) 525-7788. WKEE Inc. (acq 11-8-65). Group owner: Reeves Telecom Corp. Net: ABC/C. Rep: Avco. Format: Contemp, Top 40. ■ J. Drayton Hastie, pres; James Eblin, VP gen & coml mgr; Cris Robins, prog dir; Norm Philips, mus dir; Gordon Hall, news dir; Brooks Cline, prom mgr; Raydon Thompson, chief engr. ■ Rates: \$11.50; 9; 11.50; 9.

WKEE-FM—Nov 19, 1957: 100.5 mhz; 53 kw. Ant 560 ft. Stereo. Prog dups AM 50%. ■ Rates same as AM.

***WMUL(FM)**—Nov 1, 1961: 88.1 mhz; 10 w. Marshall U. (25701). (304) 696-6640. Marshall U. Format: Contemp, class, progs. Spec progs: Pub affrs 2½ hrs, sports 5 hrs wkly. ■ Dr. Robert B. Hoyes, pres; Charles W. Dinkins, dir closed circuit TV; George Parnicza, chief engr.

WTCR—See Ashland, Ky.

WHEZ(FM)—Co-owned with WTCR. May 1, 1966: 103.3 mhz; 50 kw. Ant 490 ft. 3570 Skyview Drive (25701). (304) 529-2558. Greater Media Inc. (group owner). Rep: Katz. Format: Btfl mus. ■ Peter Bordes, pres; Mike McDaniel, gen mgr; Charles Legg, prog dir; James A. Schulke, mus dir; Edwin F. Walters, chief engr. ■ Rates: \$32; 22; 28; 22.

WVHY—1946: 1470 khz; 5 kw-D. 31 W. 6th Ave. (25701). (304) 523-3421. Ohio River Bcstg Corp. (acq 5-61). Audio news: APR. Rep: Bernard. Format: C&W. ■ Richard Husted, pres; Robert O'Dell, VP & gen mgr; Doris Wilson, coml mgr; Brad Henderson, prog dir; Karl Rankin, mus dir; Bill Williams, news dir; Robert Nixon, chief engr. ■ Rates: \$12; 9; 12; 9.

Hurricane

WZTO—July 2, 1971: 1080 khz; 5 kw-D, DA. Box 454 (25226). (304) 562-9155. Putnam Bcstg Co. Inc. Audio news: UPI. Format: Rock, soul. Spec prog: Gospel 12 hrs wkly. ■ Oshel Craigo, pres; John Valteau, gen mgr; Lee Daugherty, prog dir; Glenna Racer, prom mgr; Jerry Fletcher, mus dir; Ed McDonald, news dir; Don Seaton, chief engr.

Keyser

WKLP—Aug 31, 1965: 1390 khz; 1 kw-D. Box 967 (26726). (304) 788-1662. Potomac Bcstg Co. (acq 2-1-70). Format: MOR. Spec prog: C&W 18 hrs wkly. ■ Tom Butscher, pres; Gary Watson, gen mgr; Dick Long, news dir; Chris Kiser, mus dir; Gary Daniels, chief engr.

WKLP-FM—September 15, 1973: 94.1 mhz; 6 kw. Ant 790 ft. Prog dups AM 80%.

WKYR—See Cumberland, Md.

Kingwood

WFSP—Aug 25, 1967: 1560 khz; 1 kw-D (250 w-CH). Box 186 (26537). (304) 329-1780. Presraco Inc. Rep: Dome-Messervly. Format: Contemp. ■ James C. Crane, pres, Arthur W. George, VP; Dave Price, prog dir; Rick James, mus dir; Ron Witt, news dir; Spencer Everly Jr, chief engr.

Logan

WLOG—May 27, 1940: 1230 khz; 1 kw-D, 250 w-N. Box 1800 (25601). (304) 752-6280. Guyan Valley Bcstg Co. (acq 2-1-63). Net: MBS. Spec prog: C&W 15 hrs wkly. ■ E. M. (Bill) Bailey, pres & gen mgr; Denny Frost, coml mgr; Lucille Gallion, prog dir; Jerry Godby, news dir; David Viars, chief engr. ■ Rates: \$3.50; 3.50; 3.50; 3.50.

WVOW—May 1954: 1290 khz; 5 kw-D, 1 kw-N, DA-N. Box 1776 (25601). (304) 752-5080. Logan Bcstg Corp. Format: MOR. ■ William P. Becker, pres & gen mgr; Martha Jane Becker, coml & prom mgr; Bill Sheridan, mus & prog dir; Jim Mitchell, news dir; Mike Baldwin, chief engr.

WVOW-FM—Aug 1969: 101.9 mhz; 15 kw horiz, 13.5 kw vert. Ant 830 ft. Prog dups AM 100%.

Martinsburg

WEPM—Oct 13, 1946: 1340 khz; 1 kw-D, 250 w-N. Box 767 (25401). (304) 263-5252. Martinsburg Bcstg Co. Net: MBS. Rep: Devney. Format: Variety. ■ C. Leslie Golliday, owner & gen mgr; George N. O'Brien, coml mgr; Edward Dockeney, prog dir; Michael Hurst, mus dir; William U. Weller, chief engr.

WESM(FM)—1949: 97.5 mhz; 9 kw. Ant 1,010 ft. Stereo. Prog dups AM 100%.

WRNR—Not on air, target date January 1976: 740 khz; 250 w-D, DA. 221 North Maple Ave. (25401). (304) 267-4220. Shenandoah Communications Inc. Format: Top 40.

Matewan

WHJC—Dec 2, 1951: 1360 khz; 1 kw-D, Box 68 (25678). (304) 427-7261. Three States Bcstg Co. Format: C&W. ■ Clifton Branham, pres & chief engr; George Warren Jr., gen & prom mgr; Corenia Harris, coml mgr; Gary K. Figart, prog & news dir.

Milton

WNST—June 26, 1973: 1600 khz; 5 kw-U, Box 266 (25541). (304) 743-9056. Naseeb S. Twell. Format: Modern country. ■ Naseeb S. Twell, owner & gen mgr; Roger Twell, coml mgr & news dir; Geof Sturm, prog & mus dir; N. S. Twell, owner & gen mgr; Roger Twell, coml mgr; Geof Sturm, prog & mus dir; N. S. Twell, prom mgr. ■ Rates: \$6.30; 5.25; 6.30; 5.25.

Montgomery

WMON—July 14, 1946: 1340 khz; 1 kw-D, 250 w-N, Drawer 750 (25136). (304) 442-9555. Greater Montgomery Bcstg Inc. (acq 8-23-67). Net: NBC. Rep: Regional Reps. ■ Robert Harvit, pres; Jack Caldo, gen & coml mgr; Kim Smith, prog dir; Rich Lively, news dir; Joe Winner, chief engr. ■ Rates: \$2.30; 2.30; 2.30; 2.30.

Morgantown

WAJR

Top 40 (Contemporary)



WAJR—December 1940: 1440 khz; 5 kw-D, 500 w-N, DA-2. Box 867 (26505). (304) 292-6301. West Virginia Radio Corp. Group owner: Greer Stns. Net: NBC. Format: Top 40. John R. Raese, gen mgr; Bill Price, prog dir; Steve Durst, mus dir; E. W. (Woody) O'Hara, sps dir; James Murphy, chief engr. ■ Rates: \$6; 6; 6.

WAJR-FM—1948: 101.9 mhz; 50 kw. Ant 260 ft. Stereo. Prog sep from AM. Format: Btl mus. ■ E.W. (Rudy) Rokos, mus dir. ■ Rates: \$3.75; 3.75; 3.75; 3.75.

WCLG—1954: 1300 khz; 1 kw-D, Box 885 (26505). (304) 292-2222. Freed Bcstg Corp. (acq 12-19-59). Format: Top 40. ■ William S. Freed, pres & gen mgr; Garry Bowers, coml mgr; Bob Sherman, prog dir; Fred Hiser, mus dir; Charles Hussion, news dir; Richard H. McGraw, prom mgr; Jeff Browne, chief engr. ■ Rates: \$7.70; 7; 7.70; 7.

WCLG-FM—Sept 28, 1974: 100.1 mhz; 3 kw. Ant 87 ft. Stereo. Prog dups AM 70%. Format: Pop-progsv. ■ Bob Sherman, prom mgr. ■ Rates same as AM.

Moundsville

WEIF—Oct 1, 1950: 1370 khz; 1 kw-D, Box O (26041). (304) 845-1230. Hank Grewe Bcstg (acq 6-9-64). Net: MBS. Rep: Keystone. Format: Rock and gold. ■ Henry Grewe, pres & gen mgr; Randy Chamberlain, prog dir; Joey Daniels, mus dir; Kenneth Forney, chief engr.

New Martinsville

WETZ—May 25, 1953: 1330 khz; 1 kw-D, Box 249 (26155). (304) 455-3030. Magnolia Bcstg Co. (acq 4-1-55). Rep: Dome-Messervly, Regional Reps. Format: MOR. Spec prog: Gospel 6 hrs wkly. ■ Harry G. Bright, pres & gen mgr; George K. Eubanks, coml mgr; Carman Harmon, prog dir; David Miles, chief engr.

Oak Hill

WOAY—1947: 860 khz; 10 kw-D (5 kw-CH). Box 251 (25901). (304) 469-3361. Robert R. Thomas Jr. Rep: Savalli/Gates. Format: MOR. ■ Robert R. Thomas Jr., pres & gen mgr & coml mgr; Hugh McPherson, mus dir; Arnell Church, news dir; Don Moye, chief engr.

WOAY-FM—1948: 94.1 mhz; 25.5 kw. Ant 650 ft. Stereo. Prog dups AM 50%. ■ WOAY-TV affil.

Parkersburg

WADC—April 9, 1954: 1050 khz; 5 kw-D, 703 Market St. (26101). (304) 485-7354. Franklin Bcstg Inc. (acq 8-15-74). Net: MBS. Format: MOR. ■ Calvin Dailey Jr., pres, gen & prom mgr; C.J. Fagan, prog dir; Randy Mollendick, mus dir; Mark Allen, news dir; Jeff Thurston, coml mgr; Charley Fagan, chief engr.

WIBZ(FM)—Co-owned with WADC. Sept 1, 1965: 99.3 mhz; 3 kw. Ant 210 ft. Stereo. Randy Jay Bcstg Co. Net: ABC/FM. Format: Top 40. ■ Raymond Reich, gen mgr; Steve Wells, coml mgr; Linda Wild, news dir. ■ Rates: \$6; 5.50; 6; 5.50.

WKYG—September 1947: 1230 khz; 1 kw-D, 250 w-N, Box 368 (26101). (304) 485-4565. Community Bcstg Service (acq 10-7-72). Net: ABC/I. Rep: Savalli/Gates. Format: Modern country. ■ H. Smoot Fahlgren, pres; Gary Pinkerman, coml & gen mgr; John Potts, prog dir; Bruce Scott, mus dir; Kirk McCall, news dir; Tim Miller, chief engr.

WKYG-FM—March 1967: 103.1 mhz; 730 w. Ant 550 ft. Prog dups AM 100%. ■ WTAP-TV affil.

WPAR

Adult Contemporary—Top 40

WPAR—July 12, 1935: 1450 khz; 1 kw-D, 250 w-N, Box 449 (26101). (304) 485-4491. Burka Bcstg Co. Inc. (acq 9-1-74). Net: NBC. Rep: Century Natl; Dome & Assoc. Format: Top 40. ■ Bernard (Bud) Burka, pres; Joe M. Rada, gen mgr; Charles Long, coml mgr; Randy Moellendick, prog dir; Robert Jones, mus dir; Don Statts, news dir; Tim Miller, chief engr. ■ Rates: \$8; 7; 8; 7.

WXIL(FM)—1975: 95.1 mhz; 50 kw. Ant 500 ft. Stereo. Box 1228 (26101). (304) 485-7425. Electrocom. Format: Contemp. ■ David A. Strock, pres; Vincent B. Ritzenthaler, gen mgr; Tom Haislop, coml mgr; Joe Johnson, prog & mus dir; Abby Hayhurst, prom mgr; Neil Haislop, news dir; Tim Miller, chief engr.

Philippi

***WQAB(FM)**—October 1975: 91.3 mhz; 10 w. Ant 46 ft. Alderson-Broadbudd College (26416). Alderson-Broadbudd College. Format: Diversified. ■ Mike Dugman, gen mgr; Richard Hudson, media specialist.

Pineville

WWYO—1949: 970 khz; 1 kw-D, Box 549 (24874).

West Virginia Radio

See page C-1 for explanation of listings.

(304) 732-7970. Wyoming Bcstg Co. Audio news: UPI. Rep: Regional Reps. Format: Contemp, MOR. ■ Robert D. Bailey Jr., pres; Robert D. Bailey III, exec VP; Roger L. Fox, gen mgr & chief engr. ■ Rates: \$3.50; 3.50; 3.50.

Princeton

WAey—December 1947: 1490 khz; 1 kw-D, 250 w-N, Box 1011 (24740). (304) 425-2151. Betap Corp. (acq 4-1-73). Format: C&W. ■ Henry G. Beam, pres, gen & coml mgr; Earle Trigg, prog dir; Dottie O'Daily, mus dir; Joe Lacky, news dir; Raymond G. Kelly, chief engr.

WAey-FM—September 1971: 95.9 mhz; 3 kw. Ant 285 ft. Stereo. Prog sep from AM.

Rainelle

WRRL—1974: 1130 khz; 1 kw-D, Box 764 (25962). (304) 438-7811. R-B Co. ■ Bruce Glenn Barker, pres.

Ravenswood

WMOV—1953: 1360 khz; 1 kw-D, Box 647 (26164). (304) 273-2544. Good Neighbor Bcstrs Inc. Format: C&W, MOR, Top 40. ■ Rex Osborne, pres & gen mgr; Sam Jackson, coml mgr; D. Hoyt, prog dir; H. Jones, prom mgr; Ruth Brooks, mus dir; I. Hoyt, news dir; C. Marlow, chief engr. ■ Rates: \$5.50; 5.50; 5.50; 5.50.

Richwood

WVAR—January 1958: 600 khz; 1 kw-D, Box 349 (26261). (304) 846-2514. R-S Bcstg Co. (acq 1-1-65). Format: Variety. ■ C. Farrell Johnson, pres & chief engr; Jane W. Mundy, coml mgr; Randall F. Smith, prog dir; James A. Hardman, prom mgr.

Romney

***WJGF(FM)**—March 30, 1973: 91.5 mhz; 10 w. Ant 42 ft. East Main St. (26757). (304) 822-3521, ext. 241. West Virginia Schools for the Deaf and Blind. Net: MBS. Format: Variety. ■ Clarence Williamson, gen mgr; J.G. Freeland, dir & chief engr.

Ronceverte

WRON—1947: 1400 khz; 1 kw-D, 250 w-N, Box 100 (24970). (304) 643-3425. Radio Greenbrier Inc. (acq 1969). Net: MBS. Rep: Dome. Format: Contemp, C&W. ■ Roy D. Wooster Jr., pres; Charles M. Gaylord, gen & coml mgr; Mike Kidd, prog, mus & news dir; Ralph David Moore, chief engr. ■ Rates: \$6.15; 6.15; 6.15; 5.80.

St. Albans

WKLC—Jan 14, 1956: 1300 khz; 1 kw-D, Box 556, 100 Kanawha Terrace (25177). (304) 727-1300. WBH Inc. (acq 7-71). Net: MBS. Format: C&W. Spec prog: Relig 15 hrs wkly. ■ William B. Harrison, pres; Skeeter Dodd, gen mgr; Ronald Kidd, prog dir; William Ford, chief engr; Jack O. Batten, coml mgr.

WKLC-FM—Jan 1, 1966: 105.1 mhz; 50 kw. Ant 500 ft. Stereo. Prog sep from AM. Format: Easy lting. Spec prog: Classcl 2 hrs wkly.

Shepherdstown

***WSHC(FM)**—1974: 88.7 mhz; 10 w. Ant 80 ft. Box 277, Shepherd College (25443). Shepherd College. Format: Progs, Top 40. ■ Prince B. Woodward, chancellor; George Wilson, fac adv; Joe Griffin, mgr.

South Charleston

WSCW—Dec 13, 1963: 1410 khz; 1 kw-D, Box 8718 (25303). (304) 744-5388. CLW Bcstrs. (acq 11-3-75). Rep: Quality Progm. Format: Relig & inspirational. ■ Spiros Zodiates, pres; Bill Jeffers, gen & coml mgr; James E. Damron, ops mgr; William T. Kitchen, chief engr. ■ Rates: \$6; 6; 6.

Spencer

WVRC—Sept 12, 1961: 1400 khz; 1 kw-D, 250 w-N, 106 Radio St. (25276). (304) 927-3760. Roane Bcstg Co. (acq 7-1-66). Format: C&W. ■ Richard Dale

West Virginia, Wisconsin Radio

See page C-1 for explanation of listings.

Brooks, gen mgr & VP; Ann Ward, news dir; William Brannon, coml mgr; Charles R. Marlow, chief engr.

Sutton

WSGB—Jan 22, 1964: 1490 khz; 1 kw-D, 250 w-N. Box 514 (26601). (304) 765-7373. Multi-Media Assoc. III (acq 5-1-74). Format: MOR, C&W. ■ James R. Reese Jr., pres & gen mgr; Steven Sanders, prog & mus dir; Liz Singleton, prom mgr & news dir; Dolores Prince, coml mgr; Tom Spencer, chief engr.

Weirton

WEIR—Sept 15, 1950: 1430 khz; 1 kw-U, DA-2. Box 2494 (26062). (304) 723-1430. 1430 Corp. (acq 10-17-68). Net: ABC/C. Rep: Dome-Messervy, Regional Reps. Format: Oldie/contemp. Spec prog: Ital 1 hr, Greek 1 hr wkly. ■ Mone Anathan Jr., pres; James R. Lang, gen mgr; Robert P. Anathan, sec-treas; Jack Dibrell, prog dir; Charles Calabrese, news dir; Ron Glock, chief engr. ■ Rates: \$7.50; 6; 7.50; 6.

Welch

WELC—Aug 19, 1950: 1150 khz; 1 kw-D, Box 949 (24801) (304) 436-2131. Pocahontas Bcstg Co. Audio news: UPI. Rep: Keystone. Format: MOR, C&W. Spec prog: C&W 10 hrs wkly. ■ Sam Sidote, pres, gen & coml mgr; Mary Sidote, prog dir & prom mgr; John Sidote, mus dir; John Villani, news dir; John Gorosky, chief engr. ■ Rates: \$3; 3; 3;—.

WXEE—Dec 1, 1955: 1340 khz; 1 kw-D, 250 w-N. Major Communications Corp. (acq 8-1-71). Net: ABC/C. Audio news: APR. Format: Top 40. Spec progs: Relig 10 hrs, black 3 hrs wkly. ■ Gerald E. Davis, pres, gen mgr & chief engr; Tim Meadows, coml mgr & prom dir; Steve Johnson, news dir; Deborah McCoy, mus dir; Gene Stump, sports dir.

Weston

WHAW—Feb 14, 1948: 980 khz; 1 kw-D, Box 431 (26542). (304) 269-5555. Central W. Va. Service Corp. (acq 6-11-54). ■ Richard H. Ralston, pres; Mrs. Ruth Brown, secy-treas; Terry B. White, gen mgr & prog dir; Stanley Brown, chief engr. ■ Rates: \$2.55; 2.55; 2.55; 2.55.

WHAW-FM—Aug 29, 1972: 102.3 mhz; 940 w. Ant 490 ft. Format: Variety. ■ Rates same as AM.

Wheeling

WKWK—May 2, 1941: 1400 khz; 1 kw-D, 250 w-N. 1201 Main St. Suite 3 (26003). (304) 232-2250. Community Service Bcstg (acq 1975). Net: ABC/C. Rep: McGavren-Guild-PGW. ■ Jerome, Elaine, Harry, and James Glassman, owners; Vincent B. Ritzenthaler, gen mgr; Bob Dorris, prog dir; Jim Ullom, news dir; Fred Baker, chief engr.

WKWK-FM—March 17, 1948: 97.3 mhz; 50 kw. Ant 460 ft. Prog dups AM.

WNEU—April 7, 1963: 1600 khz; 5 kw-D. Broadcast House (26003). (304) 233-1470. Radio Wheeling Inc. (acq 11-1-71). Net: CBS. Format: MOR. ■ Gene B. Johnson, pres & gen mgr; Neil B. Fondas, sls mgr; Mike McVay, prog dir; Donald Wayne, news dir; Carl Robbins, chief engr. ■ Rates: \$14; 9; 14;—.

WTRF(FM)—October 1966: 107.5 mhz; 12.5 kw horiz; 11 kw vert. Ant 870 ft horiz; 910 ft. vert. Stereo. 96 16th St. (26003). (304) 232-7777. TWX 710-932-8241. Forward Tele-Productions Inc. (acq 4-8-69). Group owner: Forward Communications Corp. Net: NBS. Format: Variety. ■ Robert W. Ferguson, exec VP; George Young, acct exec; Mark Davis, news dir; Howard Daubenmeyer, chief engr. ■ WTRF-TV affil.

WVVA—December 1926: 1170 khz; 50 kw-U, DA-N. 1015 Main St. (26003). (304) 232-1170. Basic Communications Inc. (acq 9-1-72). Group owner: Columbia Pictures Industries. Rep: Robert Eastman. Format: C&W. ■ J. Ross Felton, gen mgr; Emil Mogul, exec VP; Richard L. Howard, stn mgr; Ron Thompson, prog mgr; Bob Berry, mus dir; Bob Cain, news dir; Cathy Gurley, prom mgr; Carl D. Miller, chief engr. ■ Rates: \$48; 44; 48; 30.

WVVA-FM—September 1947: 98.7 mhz; 7.4 kw. Ant

470 ft. Prog dups AM 100%. ■ Rates same as AM.

White Sulphur Springs

WSLW—1971: 1310 khz; 5 kw-D. Box 610, 73 E. Main St. (24986). (304) 534-1310. Regional Radio Inc. Net: ABC/I. Format: Contemp/MOR. ■ Claude F. Jones, gen mgr & chief engr. ■ Rates: \$2.25; 2.10; 2.25;—.

Williamson

WBTH—April 19, 1939: 1400 khz; 1 kw-D, 250 w-N. Box 261 (25661). (304) 235-3600. Harvit Bcstg Corp. (acq 6-8-66). Net: MBS. Format: MOR. ■ Robert B. Harvit, pres & gen mgr; Miki Thompson, continuity dir; Dennis Hatfield, sls mgr; Don Anderson, prom mgr; Mark Smith, mus dir; Alan Kennedy, prog mgr; Harold Creameans, chief engr. ■ Rates: \$2.75; 2.75; 2.75; 2.75.

**2607 River Road
Cinnaminson, New Jersey, 08077
Telephone: (609) 786-1060**

Wisconsin

**HAMILTON-LANDIS
& ASSOCIATES, Inc.**
NATIONWIDE MEDIA BROKERS
WASHINGTON, D. C. CHICAGO, DALLAS,
SAN FRANCISCO
SELL
MORE
RADIO & TELEVISION STATIONS
IN THE MIDWEST—NEAREST OFFICE 15—
1429 TRIBUNE TOWER, CHICAGO 60611
(312) 337-2754

Antigo

WATK—March 15, 1948: 900 khz; 250 w-D. 612 Superior St. (54409). (715) 623-4124. Antigo Bcstg Co. (acq 3-15-48). Format: MOR, variety. ■ Mary Jo Ross, pres; Gary D. Ross, gen mgr; Robert Carroll, prog dir; Gary Hartl, mus dir; Bob Becker, chief engr.

WATK-FM—Nov 11, 1973: 104.9 mhz; 3 kw. Ant 280 ft.

Appleton

WAPL—1952: 1570 khz; 1 kw-D. 103 W. College Ave. (54911). (414) 734-9226. Dixon Inc. (acq 7-1-60). Net: ABC/E. Audio news: APR. Format: C&W. Spec prog: Farm 5 hrs, classcl 2 hrs wkly. ■ John J. Dixon, pres & gen mgr; Dean Alexander, asst gen mgr; Jack Watson, prog & mus dir; Gary Rogers, pub serv dir; Cliff Lee, coml mgr; Jack Sigl, news dir; Charles Strauss Jr, chief engr. ■ Rates: \$8.50; 7.50; 8.50;—.

WAPL-FM—Dec 24, 1965: 105.7 mhz; 50 kw. Ant 210 ft. Stereo. Prog dups AM 60%. Net: ABC/E. Format: C&W. Spec prog: Classcl 3 hrs, polka 2 hrs wkly. ■ Rates: \$8.50; 7.50; 8.50; 5.50.

WHBY—Dec 1, 1925: 1230 khz; 1 kw-D, 250 w-N. 600 S. Lawe St. (54911). (414) 733-7791. Telegraph-Herald Inc. (acq 1975). Net: MBS, Wisconsin. Rep: Burn-Smith, Devney. Wisconsin Net. Format: MOR. ■ Lewis Process, gen, coml & prom mgr; Jim Choudoir, prog, mus dir; Dan Glasheen, news dir; George Merkl, chief engr.

***WLFM(FM)**—March 10, 1956: 91.1 mhz; 10.5 kw. Ant 120 ft. Stereo. 115 N. Park Ave. (54911). (414) 739-3681, ext 602. Lawrence U. Format: Fine Arts. Spec prog: Sp 2 hrs wkly. ■ Dr. Thomas S. Smith, pres; Larry E. Page, dir of bcstg & chief engr; Scott Klug, student mgr.

WYNE—Aug 22, 1970: 1150 khz; 1 kw-D, DA-D. Box 92 (54911). (414) 233-6050, 739-1158. Total Radio

Inc. Net: ABC/C. Rep: PRO Time Sis. Format: Contemp. ■ Carl (Como) Tuter, pres; Howard Johnson, gen mgr; Scott Walker, prog dir & chief engr; Charlie Bennett, mus dir; Greg Jarret, news dir. ■ Rates: \$11.25; 8.75; 11.25; 8.75.

Ashland

WATW—May 1, 1940: 1400 khz; 1 kw-D, 250 w-N. Box 269 (54806). (715) 682-2727. WATW Inc. (acq 7-1-56). Group owner: Halker Stns. Format: MOR. Spec prog: Farm 3 hrs, classcl 2 hrs wkly. ■ Eugene Halker, pres; Thomas Tibbits, gen mgr; Steve Henderson, prog dir; Clarence Campbell, sports dir; Russ Johnston, chief engr. ■ Rates: \$6; 6; 6; 6.

WATW-FM—August 1, 1972: 95.9 mhz; 3 kw. Ant 155 ft. WATW-FM Inc. Dups AM 100%. ■ Rates same as AM.

Auburndale

***WBLB**—1922: 930 khz; 5 kw-D. 732 N. Midvale Blvd., Madison (53705). (608) 266-0036. State of Wis., Education Communications Bd. See *WERN(FM) Madison.

Baraboo

WBOO—Aug 14, 1967: 740 khz; 250 w-D. Baraboo Natl Bank Bldg, 425 Oak (53913). (608) 356-3507. Baraboo Bcstg Co. Net: ABC/C. Format: Contemp. ■ Burt N. Murphy, pres, gen mgr, news dir & chief engr; P. E. Flaminio, coml mgr; Pauline K. Murphy, asst mgr & mus dir.

WLVE(FM)—Co-owned with WIBU, Poyette. 1947: 94.9 mhz; 37 kw. Ant 1,300 ft. 1245 E. Washington Ave., Madison (53703). (608) 251-3955. Community Service Radio Inc. (group owner; acq 11-1-69). Net: Wisconsin. Format: Contemp, easy lstrng. ■ Thomas R. Holter, pres & gen mgr; Victor M. Aime, coml mgr; Mike Reed, prog dir; Tom Ramsey, news dir; John Herbert, chief engr. ■ Rates: \$11; 11; 11; 11.

Beaver Dam

WBEV—March 21, 1951: 1430 khz; 1 kw-D. 98 Stodard St, Box B (53916). (414) 885-4442. Beaver Dam Radio Inc. (acq 2-1-73). Group owner: McNaughton Stns. Net: ABC/I, Midwest Farm & Outdoor. Format: MOR. Spec prog: Sp 1/2 hr, farm 10 hrs wkly. ■ W. John Klinger, mgng owner; Jim Swierzynski, sports dir; John Moser, opns & news dir; Clifford Groth, chief engr.

WBEV-FM—July 15, 1968: 95.3 mhz; 3 kw. Ant 300 ft. Dups AM 100%.

Beloit

***WBGR-FM**—Nov 30, 1965: 88.1 mhz; 10 w. (53511). (608) 365-9734. Beloit College. Net: MBS. Format: Educi, diversified. ■ Carl Balson, dir of radio-TV.

WBEL—1948: 1380 khz; 5 kw-U, DA-N. Box 27, 504 West Grand Ave. (53511). (608) 365-6641. Salter Bcstg Co. (group owner). (Licensed to South Beloit, Ill. Main studios in Beloit, Wis.) Net: Wisconsin Farm. Audio news: UPI. Rep: PRO/Meeker. Format: C&W, MOR. Spec prog: Farm 3 hrs, black 1 hr wkly. ■ Russell G. Salter, pres; Joseph E. Moen, VP & gen mgr; Irv Andreoni, sls mgr; Bill Dommer, asst mgr; Mrs. Dee Cecka, office mgr. Jerry Dunbar, mus dir; John Weitzel, news dir; Chuck Ingle, chief engr. ■ Rates: \$10.50; 10.50; 10.50; 10.50.

WGEZ—Sept 26, 1948: 1490 khz; 1 kw-D, 250 w-N. Box 416 (53511). (608) 365-8865. Telegraph Herald Inc. (group owner; acq 10-1-69). Net: MBS. Format: Contemp, oldies. ■ Robert F. Woodward Jr, pres; Jack B. Ludescher, gen mgr; Tim Grant, prog dir; Larry Davis, news dir; Don Abitz, chief engr. ■ Rates: \$8; 8; 8; 8.

Berlin

WISS—June 28, 1971: 1090 khz; 250 w-D. Box 5 (54923). (414) 361-3551. Kingsley H. Murphy Jr. Format: C&W 75%, oldtime polka 25%. ■ Kingsley H. Murphy Jr, pres; Malcolm H. MacDonald, gen & coml mgr; Bob Bandy, prog & mus dir & prom mgr; Michael Young, news dir; Lee Mielke, chief engr.

WISS-FM—July 31, 1972: 102.3 mhz; 1.70 kw. Ant 155 ft. Dups AM 100%.

Black River Falls

WWIS—Aug 23, 1958: 1260 khz; 1 kw-D. Box 427 (54615). (715) 284-4391. WWIS Radio Inc. (acq 5-1-68). Format: Variety. ■ Robert E. Smith, pres; Charles Nibbe, sis mgr; Theresa Kerr, traf mgr; Nelson Lent, VP, gen mgr & chief engr; Richard Emerson, news dir. ■ Rates: \$4; 4; 4.

Brule

***WWSA(FM)**—Sept 14, 1952: 89.9 mhz; 38 kw. Ant 550 ft. 732 N. Midvale Blvd. State of Wis. Educational Communications Bd. See *WERN(FM) Madison.

Burlington

***WBSD(FM)**—1975: 89.1 mhz; 10 w. Burlington Area School District.

Chippewa Falls

WAXX—Sept 7, 1958: 1150 khz; 5 kw-D. 1907 S. Hastings Way, Eau Claire (54701). (715) 832-3474. TWX 715-221-0559. Radio Wausau Inc. (acq 7-1-63). Group owner: Post Corp Stns. Net: ABC. Rep: PRO Time Sts, Hurley. ■ Victor Minahan, pres; David L. Nelson, VP-treas, mgr Post Corp stns; Elmo Reed, dir engrg Post Corp stns; Al Howard, gen mgr; Clarence Swanson, news dir; Robert Fallis, chief engr.

WEAU-FM—Co-owned with WAXX. See Eau Claire.

WCFW(FM)—Oct 20, 1968: 105.5 mhz; 3 kw. Ant 300 ft. 1034½ Warren St. (54729). (715) 723-2257. Bushland Radio Specialties. Format: MOR, old time polka. Spec prog: Classical 1 hr wkly. ■ Roland L. Bushland, gen mgr & prog dir; Ray W. Bushland, news dir; Larry Seidling, chief engr. ■ Rates: \$3.75; 3.75; 3.75.

Colfax

***WHWC(FM)**—June 28, 1950: 88.3 mhz; 10 kw. Ant 1,050 ft. 732 N. Midvale Blvd, Madison (53705). (608) 266-0036. State of Wis Educational Communications Bd. See *WERN(FM) Madison.

Delafield

***WHAD(FM)**—May 30, 1948: 90.7 mhz; 79 kw. Ant 700 ft. 732 N. Midvale Blvd., Madison (53705). (608) 266-0036. State of Wis Educational Communications Bd. See *WERN(FM) Madison.

Dodgeville

WDMP—Nov 1, 1968: 810 khz; 250 w-D. Box 116 (53533). (608) 935-2302. Dodge-Point Bcstg Co. Net: Wis. Farm. Rep: Walton. Format: C&W. ■ Louise E. Hamlin, pres; Richard A. Carroll, gen mgr; Andy Carson, prog dir; Phil Winn, news dir & chief engr.

WDMP-FM—Nov 1, 1968: 99.3 mhz; 1.1 kw. Ant 460 ft. Prog dups AM 100%.

Durand

WRDN—Oct 24, 1968: 1430 khz; 1 kw-D. Box 208, 300 W. Main St. (54736). (715) 672-8989. WRDN Inc. (acq 11-1-72). Net: MBS. Format: C&W. ■ Steven W. Noetzel, gen mgr; Debra Duray, prog dir; Jerry Schroeder, sis mgr; Dick Johnson, chief engr.

WRDN-FM—Sept 1, 1973: 95.9 mhz; 930 w. Ant 500 ft. Prog dups AM 100%.

Eagle River

WERL—May 23, 1961: 950 khz; 1 kw-D. Box 309 (54521). (715) 479-4451. Eagle River Bcstg Co. Rep: Walton. Format: MOR. Spec prog: Ger 2 hrs wkly. ■ George Palo, pres & gen mgr; Linda Jorgensen, coml mgr; Robert Rosenak, stn mgr; Chris Oatman, prog dir; Dave Sommers, chief engr.

WERL-FM—July 31, 1971: 94.3 mhz; 3 kw. Ant 200 ft. Prog dups AM 90%. Format: MOR.

Eau Claire

WBIZ—Nov 11, 1947: 1400 khz; 1 kw-D. 250 w-N. Box 24 (54701) (715) 835-5111. WBIZ Inc. (acq 4-1-54). Net: MBS. Rep: Savalli/Gates. Format: News, info, spts. ■ Howard G. Bill, pres; Lou Kassera, gen mgr; Steve Kane, opns mgr; Mike Sillivan, news dir; Don Winget, chief engr. ■ Rates: \$8; 6.60; 8; 4.

WBIZ-FM—December 1967: 100.7 mhz; 100 kw. Ant 740 ft. Stereo. Prog sep from AM. (715) 835-1007. Format: Top 40. ■ Jim Hansen, sis mgr. ■ Rates: \$7.61; 10.38; 10.38; 7.61.

WEAQ—May 1937: 790 khz; 5 kw-U, DA-N. Box 1 (54701). (715) 832-3463. Bcstrs Svcs Inc. (acq 11-1-59). Net: NBC, Wis. Rep: Torbet, Ewing. Format: Contemp. ■ Charles R. Dickoff, pres & gen mgr; Don Smith, sis mgr; Steve Dickoff, prog dir; Scott Christenson, mus dir; Fran Booton, news dir; Hank Kaul, chief engr. ■ Rates: \$10.20; 8.72; 10.20; 6.17.

WEAU-FM—Co-owned with WAAX Chippewa Falls. Feb 1965: 104.5 mhz; 84 kw. Ant 1,800 ft. 1907 S. Hastings Way (54701). (715) 832-3474. TWX 715-221-0559. WEAU, Inc. Group owner: Post Corp. Prog dups AM 67%.

WIAL(FM)—1946: 94.1 mhz; 100 kw horiz, 31 kw vert. Ant 360 ft. Stereo. Box 600 (54701). (715) 834-5385. WIAL Stereo Radio Inc. (acq 11-1-59). Net: Wis. Rep: Torbet, Ewing. Format: Btlf mus. ■ Charles R. Dickoff, pres & gen mgr; Steven Dickoff, prog & mus dir; Fran Booton, news dir; Robert Onarheim, sis mgr; Larry Roth, chief engr. ■ Rates: \$5.03; 5.03; 5.03; 5.03.

WOKL—April 1948: 1050 khz; 1 kw-D. 1819 Mitchell St. (54701). (715) 832-1629. OK Radio. (acq 6-22-61). Net: ABC/E. Rep: Keystone KBS. Format: All time hits. ■ Robert E. Nelson, pres & public service dir; Del Franklin, prog & news dir; Don Winget, chief engr.

***WUEC(FM)**—1975: 89.7 mhz; 10 w. Ant 132 ft. 1866 Van Hise Hall, Madison (53706). Bd of Regents, U. of Wis.

Fond Du Lac

KFIZ—August 1922: 1450 khz; 1 kw-D, 250 w-N. Box 1167, 307 N. Main St. (54935). (414) 921-3770. Pub Service Bcstrs. (group owner; acq 10-7-72). Net: ABC/C, Wisconsin State. Rep: Walton. Format: MOR, talk. ■ Donald Jones, pres; Will Darch, gen, coml mgr & prog dir; Steve Peterson, news dir; Peter Dean, mus dir; Wendell S. Meyers, chief engr.

WFON(FM)—Oct 5, 1967: 107.1 mhz; 3 kw. Ant 300 ft. Stereo. Box 1195 (54935). (414) 921-1071. Costas Enterprises. Net: MBS; Midwest Farm & Outdoor Net. Audio news: APR. Format: MOR, diversified. Spec prog: Sp 1 hr, Farm 5 hrs wkly. ■ Loula Beckman, pres; Donald Rabbit, gen mgr; Paul C. Chasteen, coml mgr; Felix Templeton, news dir; Ray Yorton, chief engr. ■ Rates: \$5.25; 5.25; 5.25; 5.25.

Fort Atkinson

WFAW—Jan 24, 1963: 940 khz; 500 w-D, DA. Box 94 (53538). (414) 563-6351. Goetz Bcstg Corp. (group owner). Net: ABC/C. Format: Contemp. ■ Nathan L. Goetz, pres; Vern Falk, VP & gen mgr; Jim Dunn, news dir; Jerry Clements, prog dir; Dick Woodkey, mus dir; Scott Trentadue, coml mgr; Cliff Groth, chief engr. ■ Rates: \$5.88; 5.88; 5.88; 5.88.

WFAW-FM—Sept 4, 1959: 107.3 mhz; 50 kw. Ant 210 ft. Stereo. Progs sep from AM. Net: Midwest Farm & Outdoor Net. Rep: Bill Hoelt. Format: MOR. ■ Rates same as AM.

Green Bay

WDUZ—June 19, 1947: 1400 khz; 1 kw-D, 250 w-N. 225 N. Adams, Box 36 (54305). (414) 435-5331. Green Bay Bcstg Co. Net: ABC/C. Rep: H-R/Stone. Format: Contemp, top 40. ■ Ben A. Laird, pres; Ken Peterson, gen mgr; James V. Mattson, sis mgr; William C. Laird, prog dir; John Dussling, news dir; Gregg Albert, mus dir; Jack Dexter, chief engr.

WDUZ-FM—July 1, 1967: 98.3 mhz; 3 kw. Ant 295 ft. Stereo. Prog sep from AM. Format: Better mus/Lush.

***WGBP-FM**—February 1975: 90.1 mhz; 10 w. 610 Maryhill Dr. (54303). (414) 494-2311. Premontré Bd. of Educ. Format: Diversified. ■ Clayton Toonen, gen mgr; Dennis Ledvina, chief engr.

***WGBW(FM)**—Aug 26, 1974: 91.5 mhz; 3 kw horiz, 1.2 kw vert. Ant 115 ft. Instructional Svcs. U. of Wis. at Green Bay (54302). (414) 465-2444. Bd. of Regents, U. of Wis. System. Format: Alternative radio. ■ Anabelle L. Hitchcock, stn mgr; Gary W. Mach, chief engr; Gerard Schmitz, opns mgr; Mark Stensvold, prog dir; Harvey Arnold, tech opns.

WGEE—April 6, 1925: 1360 khz; 5 kw-U, DA-N. 115

Wisconsin Radio

See page C-1 for explanation of listings.

S. Jefferson St. (54301). (414) 435-3771. TWX 910-263-1260. Midwest Communications (acq 1975). Net: CBS, Wis. Audio news: APR. Rep: Blair. Format: C&W. Spec prog: Farm 5 hrs wkly. ■ D.E. Wright, pres & gen mgr; Dan Udvig, prom mgr; John Zucker, stn mgr; Randy Allen, mus dir; Steve Ellingboe, news dir; W.J. Stangel, chief engr. ■ Rates: \$18; 12; 12; 12.

WIXX(FM)—Co-owned with WGEE. Nov 1, 1960: 101.1 mhz; 100 kw. Ant 1,080 ft. Stereo. Prog dups AM 5%. Net: ABC/FM. Format: Adult oriented rock. ■ Dennis Mentzos, sis mgr.

WNFL—Dec 12, 1947: 1440 khz; 5 kw-D, 500 w-N, DA-2. Box 520 (54305). (414) 468-5445. Communications Prop. Inc. (group owner; acq 3-1-73). Net: NBC. Midwest Farm-Outdoor. Rep: Avery-Knodel. Format: MOR. ■ James L. Zimmerman, gen mgr; Jon Stubb, prog dir; Jim Trotter, mus dir; Dan Jones, news dir; Art Carlson, sis mgr; Roland Henry, chief engr. ■ Rates: \$10.75; 9.10; 10.75; 6.75.

***WPNE-FM**—January 15, 1973: 89.3 mhz; 55 kw. Ant 940 ft. 732 North Midvale Blvd., Madison (53705). (608) 266-0036. Educational Communications Board. See *WERN(FM) Madison.

Hartford

WTKM—1951: 1540 khz; 500 w-D. Box 216 (53027). (414) 673-3550. Iroquois County Bcstg Co. (acq 11-1-70). Rep: Walton. Format: MOR, polka. Spec prog: Ger 2½ hrs wkly. ■ Samuel Martin, pres; Jerry Gresenz, gen, coml & prom mgr; Carl Hulbert Jr., prog, mus & news dir; Dick Feutz, chief engr. ■ Rates: \$5.50; 5.50; 5.50; 5.50.

WTKM-FM—Oct 1, 1973: 104.9 mhz; 3 kw. Ant 300 ft. Prog dups AM 50%. Format: MOR, polka. ■ Rates same as AM.

Hayward

WHSM—Dec 21, 1957: 910 khz; 5 kw-D. Box D (54843). (715) 634-4836. WHSM Inc. (acq 12-72). Rep: Walton. Format: Diversified. ■ Henry L. Sampson, pres; Michael Anthony Smyrak, gen mgr; Mark Charles, news dir; Robert Kolsky, chief engr. ■ Rates: \$5.60; 4.50; 4.50; 2.70.

WRLS-FM—April 16, 1968: 92.1 mhz; 3 kw. Ant 300 ft. Stereo. Box 2000 Rt. 3 (54843). (715) 634-4871. Pine-Aire Bcstg Corp. Net: ABC/I, Wisconsin State. Format: MOR, sports. ■ C. Roland Williamson, pres; Bernard Tworek, gen mgr; Don Crawford, coml mgr; Dave Ortmann, prom mgr; Dick Bender, stn mgr; Richard K. West, mus dir; Ray Mrawski, news dir; Al Flora, chief engr.

Highland

***WHHI(FM)**—Sept 14, 1952: 91.3 mhz; 43 kw. Ant 610 ft. 732 N. Midvale Blvd., Madison (53705). (608) 266-0036. State of Wis Educational Communications Board. See *WERN(FM) Madison.

Holmen

***WHLA(FM)**—Nov 21, 1950: 90.3 mhz; 57 kw. Ant 1,010 ft. 732 N. Midvale Blvd., Madison (53705). (608) 266-0036. State of Wis. Educational Communications Board. See *WERN(FM) Madison.

Jackson

WYLO—May 1, 1964: 540 khz; 250 w-D, DA. Box 3096 Milwaukee (53218). (414) 353-5300. Universal Bcstg of Milwaukee. (acq 4-1-67). Group owner: Universal Bcstg Stns. Rep: Meeker. Format: C&W. Spec prog: Ger 15½ hrs, Pol 1 hr wkly. ■ Marvin B. Kosofsky, pres; Sol Radoff, gen & coml mgr; Bob Bradley, prog dir; Dennis Hilgart, prom mgr; Skip Schafer, news dir; Nels Harvig, chief engr.

Janesville

WCLO—July 1930: 1230 khz; 1 kw-D, 250 w-N. 1 South Parker Dr. (53545). (608) 752-7895. Southern Wis. Radio Inc. Net: Wisconsin. Format: MOR. ■ Marshall Johnson, pres; Robert Dalley, VP & gen mgr; Bill Bessire, coml & prom mgr; Larry Tainter, prog &

Wisconsin Radio

See page C-1 for explanation of listings.

news dir; Cliff Hahn, chief engr. ■ Rates: \$12.55; 11.55; 12.55; 9.65.

WJVL(FM)—Co-owned with WCLO. October 1947: 99.9 mhz; 20 kw. horiz, 18 kw vert. Ant 200 ft. horiz, 135 ft. vert. Stereo. Prog sep from AM. ■ Rates: \$4; 4; 3; 3.75.

Kaukauna

WKAU—Sept 25, 1965: 1050 khz; 1 kw-D. DA. Box 1050 (54130). (414) 739-9311. Fox River Communications. Group owner: Forward communications. Rep: Meeker. Format: Contemp. ■ Richard Dudley, pres; James S. Esler, gen & coml mgr; B. J. Corcker, prog dir; Steve Bailey, mus dir; Billy Day, news dir; Jim Rammer, chief engr; Ron Martin, prom mgr.

WKAU-FM—Sept 1, 1969: 104.9 mhz; 3 kw. Ant 200 ft. Prog dup AM 100%.

Kenosha

***WGTD(FM)**—Not on air, target date unknown: 91.1 mhz; 800 w. Ant 145 ft. 3520 30th Ave. (53140). Gateway Vocational, Technical & Adult Educd District.

WLIP—May 11, 1947: 1050 khz; 250 w-D. Box 659, 625 57th St. (53140). (414) 657-6162. Kenosha Bcstg Co. Rep: Devney. Format: MOR. Spec prog: Ital 2 hrs wkly. ■ William L. Lipman, pres & gen mgr; Hugh L. Gately, coml mgr; Anna Lee Lipman, first VP; Steve Kelley, prog dir; Al Gelsone, mus dir; Bill Berra, news dir; Jim Sorenson, chief engr.

WLIP-FM—Dec 22, 1962: 95.1 mhz; 4 kw. Ant 255 ft. (CP: 4.5 kw. Ant 225 ft.). Stereo. Prog sep from AM. Format: MOR.

Kewaunee

WAUN(FM)—1974: 92.7 mhz; 3 kw. Ant 300 ft. Box 224A, Route 3 (54216). Harbor Cities Bcstg Inc. ■ Robert F. and Betty J. Stroebek, George and Mary E. Scoufis, principal owners.

La Crosse

WIZM—Jan 2, 1923: 1410 khz; 5 kw-U. DA-N. Box 1262 (54601). (608) 782-1230. Family Radio Inc. (acq 7-12-71). Group owner: Mid-West Family. Net: NBC, Wis. Rep: HR Stone. Format: Adult Contemp. ■ Dick Record, pres & gen mgr; Bill Mann, VP/sls mgr; Paul Kavanaugh, prog dir; Gayle Olson, Rick Wise, news dir; John A. Bauer, chief engr. ■ Rates: \$7; 6; 7; 3.

WKTY—May 1948: 580 khz; 5 kw-D, 1 kw-N. DA-2. Box 1148 (54601). (608) 782-6430. Lee & Assoc. Inc. (acq 4-1-54). Net: ABC/E. Rep: Avery-Knodel, Ewing (Minneapolis). Format: MOR, news. Spec prog: Farm 15 hrs wkly. ■ Herbert H. Lee, pres; R. H. Topinka, exec VP & gen mgr; Philip A. Dyer, coml mgr; Charlie Kearns, sports dir; Earl Hunter, farm dir; Marilyn Bahwell, prog & mus dir; Philip Uehling, chief engr. ■ Rates: \$14; 14; 14; 14.

WSPL(FM)—Co-owned with WKTY. January 1972: 95.9 mhz; 235 w. Ant 900 ft. Prog sep from AM. Format: Progsv rock. ■ Rates: \$5; 5; 5; 5.

WLCX—May 1947: 1490 khz; 1 kw-D, 250 w-N. Box 821 (54601). (608) 784-4521. La Crosse Radio Inc. (acq 4-8-57). Rep: Webb. Format: Contemp. ■ Joseph H. Rohrer, pres & gen mgr; Peter Clarke, coml mgr; Joe Rohrer Jr., prog dir & chief engr; Jean Gitz, prom mgr; Dick Allen, mus dir; Paul Lake, news dir.

WLXR(FM)—Co-owned with WLCX. 1975: 104.9 mhz; 1.35 kw. Ant 430 ft. Box 821 (54601).

***WLSU(FM)**—Jan 4, 1971: 88.9 mhz; 690 w. Ant 490 ft. Florence Wing Communications Center, U. of Wis-La Crosse (54601). (608) 784-1741. Bd of Regents, U. of Wis. System. Net: NPR. Format: Ed, jazz, classical. ■ James P. Conway, gen mgr; Glen Slaats, prog dir.

WWLA Contemporary Music

PRO/Meeker Radio
A DIVISION OF PROGRESS RADIO

WWLA(FM)—Dec 6, 1966: 93.3 mhz; 100 kw. Ant

540 ft. Stereo. Route 1, Grandad Bluff (54601). (608) 784-7373. William E. & Louise A. Bruring. Net: ABC/C. Format: Contemp. ■ William E. Bruring, pres & chief engr; Allen W. Smith, gen mgr; Gary Demaroney, prog dir; Dan Jackson, mus dir; John Fitch, news dir; Steve Adler, prom mgr. ■ Rates: \$5.50; 5.50; 7; 7.

Ladysmith

WLDY—September 1948: 1340 khz; 1 kw-D, 250 w-N. Box 351 (54848). (715) 532-5588. Flambeau Bcstg Co. (acq 7-55). Format: Variety. ■ Charles Nelson, owner; Calvin Crotty, stn & coml mgr; John Lovely, prog & news dir; Bruce Anderson, chief engr. ■ Rates: \$6; 6; 6; 6.

WWIB(FM)—Dec 30, 1972: 103.7 mhz; 100 kw. Ant 680 ft. Box 44, Cornell (54732). (715) 239-6138. Stewards of Sound Radio. Format: Relig. ■ Warren Steward, gen mgr; Pete Loken, bus mgr; Bob Larson, prog dir; Harlan Reinders, stn mgr & chief engr; Rod Larson, prom mgr.

Lake Geneva

WMIR

Now Sounds—Now News

WMIR—May 15, 1964: 1550 khz; 1 kw-D, DA. Box 552 (53147). (414) 248-6656. Southern Wisconsin Co., Inc. Rep: Walton. Format: Contemp. ■ Miriam B. Monroe, pres; Alvina Lang, gen mgr; Ed R. Brun, coml mgr; Gerry L. Dexter, prog dir; Lee Thomas, news dir; Terry Havel, mus dir. ■ Rates: \$6.50; 6.50; 6.50; 6.50.

Madison

***WERN(FM)**—Listing follows *WHA.

***WHA**—1922: 970 khz; 5 kw-D. 821 University Ave. (53706). (608) 263-3970. Regents of U. of Wis System. Net: NPR, Wisconsin Ed. Radio Net. Format: Educational. ■ Ronald C. Bornstein, dir; Claire Kentzler, assoc dir; James Collins, prog dir; Roy Vogelman, news dir; Linda Clauder, mus dir; Rudy Wolff, asst tech dir; Hayward Allen, prom mgr. ■ WHA-TV affil.

***WERN(FM)**—March 30, 1947: 88.7 mhz; 25 kw. Ant 990 ft. 732 N. Midvale Blvd. (53705). (608) 226-0036. State of Wis. Educational Communications Bd. Format: Educl. ■ Anton Moe, exec dir; Nancy Bauer, instructional sys dir; Paul Norton, dir of admin & opns; Norman Michie, prog dir; William P. Estes, William C. Woods, dir of engr.

WIBA—April 2, 1925: 1310 khz; 5 kw-U. DA-N. Box 99 (53701). (608) 233-5311. Badger Bcstg Co. Net: NBC. Rep: Meeker, Hyett, Busby Finch & Woods, Pearse. Format: MOR. ■ Fred H. Gage, pres & gen mgr; James G. Mader, prog & mus dir; W. J. Hughes, sls dir; Robert D. King, news dir; John Corstuel, chief engr.

WIBA-FM—March 1947: 101.5 mhz; 50 kw. Ant 450 ft. Stereo. Prog dup AM 10%. Format: progs. ■ Jim Packard, prog & mus dir.

WISM—September 1948: 1480 khz; 5 kw-U, DA-2. Box 2058 (53701). (608) 271-1484. WISM Inc. (acq 11-1-59). Group owner: Mid-West Family Net: Wisconsin. Rep: McGavren-Guild. Format: Contemp. ■ William R. Walker, pres & gen mgr; Phillip Fisher, VP & sls mgr; Bill Vancil, prog mgr; Chris Cain, chief engr. ■ Rates: \$22.50; 16.50; 20; 14.

WISM-FM—September 1948: 98.1 mhz; 20 kw. Ant 350 ft. (CP: 500 ft.). Stereo. Midwest FM Inc. Progs sep from AM. Format: MOR. ■ Rates: \$13; 13; 13; 13.

WMAD—Aug 12, 1964: 1550 khz; 5 kw-D, DA. Box 4408. (53711). (608) 271-6611. Hudson Bcstg Corp. (acq 1-1-69). Group owner: McKenna Stns. Net: ABC/I. Rep: Buckley Radio Slis. Format: Modern country. ■ James A. McKenna Jr., pres; Don C. Wirth, gen mgr; Ted Kelly, opns dir; Pat Martin, mus dir; Mark Hendrickson, news dir; Victor Landau, chief engr.

WMAD-FM—See Middleton.

***WNWC(FM)**—April 30, 1959: 102.5 mhz; 50 kw. Ant 460 ft. Stereo. 3250 Gammon Rd., Rt. 2 (53711). (608) 271-1025. Northwestern College (acq 1-19-73). Audio news: UPI. Format: Relig. Spec prog: Farm 2 hrs

wkly. ■ William B. Berntsen, pres; Cornelius Keur, gen mgr; Carl A. Ramsey, stn mgr; Jay Werth, mus dir; Greg Walters, public affrs & news dir; Lloyd Berg, chief engr.

***WORT(FM)**—Sept 15, 1975: 89.7 mhz; 4 kw. Ant 105 ft. Box 466 (53701). (608) 255-5153. Back Porch Bcstg. Format: Diversified, farm. ■ Michael O'Connor, pres; John Ohlinger, gen mgr; Wally Snurf, chief engr; David Kao, coml mgr; Joanie Rubel, mus dir; Lorenzo Milan, prog dir; Jeff Lang, prom mgr; Pat Ryan, news dir.

WTSO—January 1948: 1070 khz; 10 kw-D, 5 kw-N, DA-2. 5721 Tokay Blvd. Box 44 (53701). (608) 274-1070. Mid-Continent Bcstg Co. of Wis. Inc. (acq 9-1-60). Group owner: Mid-Continent Bcstg. Rep: H-R/Stone, Wayne-Evans. Format: MOR, talk. N. L. Bentson, pres; Roger Russell, gen & coml mgr; Perry Murphy, prog dir; Cal Casey, mus dir; John Hoffland, news dir; Sherman Stern, chief engr.

WZEE(FM)—Co-owned with WTSO. 1948: 104.1 mhz; 6.3 kw. Ant 1,120 ft. Stereo. (Acq 11-1-74). Prog sep from AM. ■ Roger Russell, VP.

Manitowoc

WCUB—November 1952: 980 khz; 1 kw-D. Box 98 (54220). (414) 682-8226. Cub Radio. (acq 1-1-61). Audio news: APR. Rep: Selcom. Format: C&W. Spec prog: Farm 10 hrs wkly. ■ J. E. Severson, pres; Lee Davis, exec VP & gen mgr; Bob Barrock, VP sls; Bob Irish, prog dir; Mike Kinzel, news dir; Hubert Willis, chief engr. ■ Rates: \$8; 8; 8; 8.

WKKB(FM)—Co-owned with WCUB. Sept 1, 1966: 92.1 mhz; 3 kw. Ant 160 ft. Stereo. Prog sep from AM. Format: Btfl mus. ■ James Van Sleet, coml mgr; Bill Walters, prog dir. ■ 6; 6; 6; 6.

WOMT MOR/Contemporary

R
A
B

Robert Walton



WOMT—Nov 8, 1926: 1240 khz; 1 kw-D, 250 w-N. Box 685 (54220). (414) 682-8247. Seehafer & Johnson Bcstg Corp. (group owner; acq 1-1-70). Rep: Walton. Format: MOR/Contemp. ■ Don Seehafer, pres & gen mgr; Ben Jakel, coml mgr; Al Ross, prog dir; John Collins, news dir; Andy Anderson, chief engr. ■ Rates: \$7; 7; 7; 7.

WQTC-AM-FM—See Two Rivers.

Marinette

WAGN—See Menominee, Mich.

WLOT—July 25, 1969: 1300 khz; 1 kw-D. 1706 Main St. (54143). (715) 732-0123. Near-North Bcstg Co. Format: Contemp. ■ Keith B. Peterson, gen mgr; Curt Dean, prog dir, mus dir; Clark Nevada, news dir; Robert Haslow, chief engr.

WLST(FM)—Co-owned with WLOT. Not on air, target date unknown: 95.1 mhz; 100 kw. Ant 433 ft. Prog dup AM.

WMAM—Oct 8, 1939: 570 khz; 250 w-D, 100 w-N. 400 Wells St. (54143). (715) 735-6631. Marinette Central Bcstg Co. (acq 9-1-60). Group owner: Frank J. Russell Stns. Net: NBC, Wisconsin. Rep: Devney. Format: MOR. Spec prog: C&W 6 hrs wkly. ■ Frank J. Russell, pres; Howard L. Emich, gen & coml mgr; W. J. Liegeois, prog dir; Paul V. Anick, chief engr. ■ Rates: \$5; 5; 5; 5.

Marshfield

WDLB—Feb 2, 1947: 1450 khz; 1 kw-D, 250 w-N. 1710 N. Central Ave. (54449). (715) 384-2191. Goetz Bcstg Corp. (acq 7-65). Format: Contemp, C&W. Spec prog: Ger ½ hr wkly. ■ Nathan L. Goetz, pres; Jack Hackman, VP & gen mgr; Mike Heimke, coml mgr; E. J. Stone, mus dir; Gary Diamond, prog dir; Don Meyers, news dir; Barry Nienow, chief engr. ■ Rates: \$5.90; 5.90; 5.90; 5.

WDLB-FM—Dec 1, 1965: 106.5 mhz; 56 kw. Ant 400 ft. Stereo. Box 630 (54449). (715) 384-2192. Prog sep

from AM. Format: Btfl mus. ■ Rates same as AM.

Mauston

WRJC—Jan 4, 1962: 1270 khz; 500 w-D. Box 58 (53948). (608) 843-8001. G&R Bcstg. (acq 10-15-69). Net: MBS, Keystone, Pearse. Format: MOR. Spec prog: C&W 15 hrs, top 20 7 hrs wkly ■ George S. Blum, gen mgr & chief engr; Ruby E. Blum, coml mgr; Les Vance, news dir.

Medford

WIGM—Oct 26, 1941: 1490 khz; 1 kw-D, 250 w-N. Box 59 (54451). (715) 748-2566. WIGM Inc. (acq 6-55). Net: ABC/E. Rep: Corlett. ■ Paul Allman, pres & gen mgr; Joe Dahlvig, VP & coml mgr; Duane Frey, prog dir; Ray Bohnert, sec, treas, news dir & chief engr.

WIGM-FM—Dec 14, 1968: 99.3 mhz; 3 kw. Ant 240 ft. Prog dups AM 100%.

Menomonee Falls

WZMF(FM)—July 30, 1966: 98.3 mhz; 3 kw. Ant 280 ft. Stereo. Box 216 (53051). (414) 251-7070. Falls Bcstg Corp. Rep: ABC/FM Spot. Format: Progs. ■ R. F. Amann, pres & gen mgr; VP Reitman, prog dir; Steve Stevens, opns dir; Phil Klingler, chief engr.

Menomonie

WDMW(FM)—Listing follows WMNE.

WMNE—May 1951: 1360 khz; 1 kw-D. Box 1360 (54751). (715) 235-2112. Phillips Bcstg Co. (acq 6-23-75). Net: Keystone. Audio news: UPI. Rep: Hopewell. Format: MOR. Spec prog: Farm 15 hrs wkly ■ Michael A. Phillips, owner-manager; John R. Doatas, sls mgr; Wayne Crego, prog dir; Jan Mickelson, mus dir; Murray Schmidt, sps dir; Graydon Royce, news dir ■ Rates: \$6; 5; 6; 5.

WDMW(FM)—Co-owned with WMNE. July 19, 1967: 92.1 mhz; 3 kw. Ant 150 ft. Stereo. Prog dups AM 70%. Format: Top 40 days, stereo rock nights. ■ Rates: \$5; 5; 5; 5.

***WVSS(FM)**—90.7 mhz; 1.05 kw. Ant 14 ft. 820 Broadway St. (54751). (715) 232-2411. Board of Regents, U of Wis Systems. Format: Variety. ■ Arthur Matthews, pres; William Otto, gen mgr; Candy Matson, traf dir; Bob Schroeder, prog dir; Gordy Howard, mus dir; Paul Winer, prom mgr; Laurel Schircecy, news dir; George Seaf, Bruce Crownhart, engns.

Merrill

WJMT—May 10, 1960: 730 khz; 1 kw-D. 120 South Mill St. (54452). (715) 536-6262. Heath Communications Inc. (group owner; acq May 1971). Rep: PRO Time Sis. Format: MOR, contemp. Spec prog: Ger 1 hr, farm 7 hrs wkly. ■ W. Donald Roberts Jr., pres; Wayne H. Smith, VP & gen mgr; Steve Richards, prog dir; Steve Skogen, mus dir; Kim Louma, news dir. ■ Rates: \$4.50; 4.50; 4.50.

WJMT-FM—Aug 25, 1968: 93.5 mhz; 3 kw. Ant 220 ft. Prog dups AM 100%. ■ Rates same as AM.

Middleton

WMAD—See Madison.

WMAD-FM—Oct 12, 1970: 106.3 mhz; 1.75 kw. Ant 380 ft. Box 4408 (53711). Group owner: McKenna Stns. Net: ABC/I. Rep: Buckley. Format: Modern country. ■ James A. McKenna Jr., pres; Don C. Wirth, VP & gen mgr; Ted Kelly, opns mgr; Pat Martin, mus dir; Mark Hendrickson, news dir; Victor Landau, chief engr.

Milton

***WMD(FM)**—1974: 89.9 mhz; 10 w. Ant 65 ft. (53563). Milton College. Format: Progs, top 40.

Milwaukee

WAMA—See West Allis.

WAWA-FM—Sept 1960: 102.1 mhz; 50 kw. Ant 360 ft. Stereo. 12800 W. Bluemound Rd., Elm Grove (53122). (414) 787-4625. Suburbanair Inc. Group owner: McKenna Stns (32%). Rep: Masla. Prog dups AM 40%. Format: Black.

WBCE(FM)—Listing follows WRIT.

WEMP—Oct 14, 1935: 1250 khz; 5 kw-U, DA-2. 200 N. Jefferson St. (53202). (414) 272-1250. Consolidated Bcstg Corp. (acq 3-28-55). Net: CBS. Rep: Buckley. Format: MOR. ■ A.M. Sphaeris, gen mgr; Allen F. Timm, sls mgr; Tom Shanahan, prog dir; Bob Betts, news dir; Rolland E. Paske, chief engr.

WNUW(FM)—Co-owned with WEMP Nov 1, 1962: 99.1 mhz; 50 kw. Ant 450 ft. Rep: ABC/FM Spot Sis. Prog sep from AM. Format: Contemp, Rock 'n Stereo. ■ Rik DeGrave, sln mgr

WEZW(FM)—See Wauwatosa.

WFMR(FM)—May 1956: 96.5 mhz; 50 kw. Ant 320 ft. Stereo. Box 1635 (53201). (414) 372-8000. Koss Bcstg Corp. (acq 3-9-73). Rep: Groskin. Format: Classcl, jazz. ■ Jerold W. Ross, pres; Claudia Burns, gen mgr; JoAnn Strohn, coml mgr; Mark Kremer, mus dir; Martin Franke, chief engr. ■ Rates: \$22; 22; 24; 24.

WISN—1922: 1130 khz; 50 kw-D, 10 kw-N, DA-2. (CP 25 kw-N). Box 402 (53201). (414) 342-3000. TWX 414-322-8323. WISN Div. Hearst Corp. (group owner; acq 1924). Net: ABC/I/E. Rep: McGavren-Guild-PGW. Format: MOR. ■ John E. Hinkle Jr., VP & gen mgr; Lee Dolnick, sls mgr; Tom Lambert, prog dir; Tom Sprtel, mus dir; Don Froehlich, news dir; Bob Johnson, chief engr.

WISN-FM—January 1961: 97.3 mhz; 11.5 kw. Ant 910 ft. Stereo. Prog sep from AM. Format: Btfl mus. ■ Chuck Arnold, mus & prog dir. ■ WISN-TV affil.

WKTI(FM)—Listing follows WTMJ.

WNOV—Aug 15, 1946: 860 khz; 250 w-D. 3801 N. 20th St. (53206). (414) 445-1986. Courier Comm Inc. (acq 1-2-73). Format: Black, top 40. ■ Jerrel W. Jones, pres & gen mgr; Niobe Hackney, coml mgr; Frank Barrow, prog dir; Robert O. Mayer, chief engr.

WNUW(FM)—Listing follows WEMP.

WOKY—1947: 920 khz; 5 kw-D, 1 kw-N, DA-2. 3500 N. Sherman Blvd. (53216). (414) 442-0150. Bartell Bcstrs Inc. (group owner). Audio news: UPI. Rep: Blair. Format: Contemp. ■ John Norwood, pres; Ralph J. Barnes, VP & gen mgr; Jim Brown, prog dir; Daniel Abernathy, news dir; Beth Fast, mus dir; William Grevenow, chief engr. ■ Rates: \$68; 46; 68; 57.

WQFM(FM)—June 1958: 93.3 mhz; 50 kw. Ant 210 ft. 606 West Wisconsin Ave. (53203). (414) 276-2040. Shamrock Development Corp. (group owner; acq 5-10-73). Audio news: APR. Rep: Torbet. Format: Jazz, MOR. ■ Tony Smith, gen mgr; Joseph Santoro, prog dir; Bobbie Kraeger, mus dir; Mary Curran, news dir; Irwin Gerber, chief engr. ■ Rates: \$13.50; 13.50; 16; 16.

WRIT—1955: 1340 khz; 1 kw-D, 250 w-N. 5407 W. McKinley Dr. (53208). (414) 453-4130. Great Trails Bcstg (group owner; acq 10-1-62). Audio news: NBC/NIS. Rep: Eastman. Format: All news. ■ Bernie Strachota, pres & gen mgr; Kay McCombs, traf dir; Lynn Miller, sls svc dir; Wayne Weinberg, news dir; LeRoy Woliakowski, VP & tech dir; Jack Gallo, sls mgr.

WBCE(FM)—Co-owned with WRIT. 1960: 102.9 mhz; 50 kw. Ant 430 ft. Prog sep from AM. Format: C&W. ■ Robb Edwards, prog dir.

WTMJ—July 25, 1927: 620 khz; 5 kw-U, DA-N. 720 East Capitol Dr. (53201). (414) 332-9611. WTMJ Inc. Net: NBC. Rep: Christal. Format: MOR. ■ Michael McCormick, pres; Richard Herbst, VP; William Haig, sln mgr; Donald Richards, sls mgr; Jack Lee, prog dir; James McDonald, prom mgr; Jack Krueger, mgr of public affrs; Don Loose, mgr of news opns; Arthur L. Olszky, news edit; James Wullman, chief engr.

WKTI(FM)—Co-owned with WTMJ. June 1959: 94.5 mhz; 5.6 kw. Ant 910 ft. Stereo. Prog sep from AM. ■ WTMJ-TV affil.

***WUWM(FM)**—Sept 24, 1964: 89.7 mhz; 4 kw. Ant 140 ft. 3223 N. Downer Ave., U. of Wisconsin (53201). (414) 963-4664. (414) 351-1293. Regents of U of Wisconsin. Net: NPR. Audio news: APR. Format: Diversified. Spec prog: Fr 1 hr, Ger 1 hr, Pol 1 hr, Sp 3 hrs, Black 1 hr, Rus 1 hr, Urdu 1 hr, Slovenian 1 hr wkly. ■ Dr. Werner Baum, chancellor, Dr. Ruane B. Hill, gen mgr; Nelson Kading, prog dir; Patrick Crosby, news dir; Earl Lindgren, chief engr.

***WVCY(FM)**—1961: 107.7 mhz; 38 kw. Ant 440 ft.

Wisconsin Radio

See page C-1 for explanation of listings.

2712 W. Vliet St. (53208). (414) 933-1440. Wisc Voice of Christian Youth Inc. (acq 1-70). Format: Relig. ■ Victor Eliason, gen mgr; Gordon Morris, prog dir.

WYLO—See Jackson.

***WYMS(FM)**—March 5, 1973: 88.9 mhz; 1 kw. Ant 870 ft. c/o Robert R. Suchy, 5225 N. Vliet St., Drawer 10K (53201). (414) 475-8143. Milwaukee Bd of School Dirs. Format: Instructional. ■ Robert Suchy, gen mgr; Aaron Shansky, prog dir; Guy Morrison, chief engr.

WZUU—April 20, 1947: 1290 khz; 1 kw-D. 520 W. Capitol Dr. (53212). (414) 964-8300. Malrite of Wisconsin (acq 5-1-68). Group owner: Malrite Bcstg. Rep: H-R Stone. Format: Top 40. ■ Milton Maltz, pres; William Luchtman, gen mgr; Chris Curtis, prog & mus dir; Judy Bauman, coml mgr; David Haines, news dir; Doug Blair, prom mgr; Joel Hodroff, chief engr. ■ Rates: \$38; 34; 38; 30.

WZUU-FM—May 10, 1961: 95.7 mhz; 50 kw. Ant 350 ft. Stereo. Prog dups AM 100%. ■ Rates same as AM.

Minocqua

WMMH(FM)—April 1, 1975: 95.9 mhz; 3 kw. Ant 155 ft. Box 403 (54548). Lakeland Communications. Audio news: UPI. Format: Top 40, C&W. ■ William Heschek, pres; Fred Bierbaum, gen & coml mgr; John Grisa, mus dir; Kim LePaek, news dir; Richard Cooper, chief engr. ■ Rates: \$3.40; 3.40; 3.40; 3.

Monroe

WEKZ—July 27, 1951: 1260 khz; 1 kw-D. Box 460 (53566). (608) 325-2161. Green County Bcstg Corp. ■ Kenneth W. Stuart, pres; Joseph G. Urban, gen mgr; Stanley J. Neuberger, coml mgr; Don Jacobson, news dir; A.L. Stewart, chief engr.

WEKZ-FM—June 1959: 93.7 mhz; 15 kw. Ant 180 ft. Prog dups AM 90%.

Neenah-Menasha

WMKC(FM)—See Oshkosh.

WNAM—May 23, 1947: 1280 khz; 5 kw-D, 1 kw-N, DA-2. Box 707 (54956). (414) 722-6471. Cummings Communications Corp. (group owner; acq 8-7-1). Rep: Buckley, Ewing. Format: Contemp. ■ Alan H. Cummings, pres; Floyd E. Beaton, gen mgr; Dave Moore, prog dir; Larry Clark, mus dir; Tom Helms, news dir; Gordon Daily, chief engr.

WROE(FM)—Nov 1971: 94.3 mhz; 2.6 kw. Ant 320 ft. Stereo. Box 1024 (54956). (414) 725-5331. R N-M Inc. (acq 9-1-75). Format: Btfl mus. ■ William Hansen, pres; James F. Bethke, gen mgr; Robert Ruen, coml mgr; N.D. Ritenour; Brad Kissel, chief engr. ■ Rates: \$10; 14; 10; 10.

Neillsville

WCCN—Sept 22, 1957: 1370 khz; 5 kw-D. Wisconsin Pavilion (54456). (715) 743-3333. Central Wisconsin Bcstg Inc. Net: MBS. Format: C&W, MOR. Spec prog: Farm 5 hrs wkly. ■ Howard Sturtz II, pres; Charles Klieforth, gen mgr & chief engr; Wayne Grav, coml & prom mgr; Mike Kissling, prog dir; Steve Mabie, mus dir; Robert Luloff, news dir.

WCCN-FM—July 1964: 107.5 mhz; 100 kw. Ant 195 ft. Prog dups AM 60%. Format: Btfl mus, big band.

New London

WLIH-FM—Oct 6, 1967: 93.5 mhz; 3 kw. Ant 260 ft horiz, 255 ft vert. Stereo. Box 935 (54961). (414) 982-3000. New London Enterprises Inc. Format: Solid gold No. 1 music. Spec prog: C&W 12 hrs, Polka 2 hrs wkly. ■ Edwin Wohl, pres; Charles H. Schmallerberg, gen mgr; Dale Sternhagen, prom mgr; Carla Fenske, coml mgr; Jan Schmallerberg, prog dir; Dick Johnson, mus dir; Craig Bain, news dir; C. Schmallerberg, chief engr.

New Richmond

WIXK—Sept 29, 1960: 1590 khz; 5 kw-D. 125 E.

Wisconsin Radio

See page C-1 for explanation of listings.

Third St. (54017). (715) 246-2254. Smith Bcstg Inc. (acq 1-1-65). Net: MBS. Format: Easy Lstg. ■ Robert E. Smith, pres, gen mgr & coml mgr; Gwynn Christensen, sports dir; Ev Peterson, news dir; Paul Leuck, chief engr; Essie Krumm, office mgr; Craig Carlson, prog dir.

WIXK-FM—Sept 1, 1968: 107.1 mhz; 3 kw. Ant 270 ft. Prog dups AM 70%.

Oconto

WOCO—March 11, 1966: 1260 khz; 1 kw-D. Box 197 (54153). (414) 834-3540. Walter P. Kaszynski (acq 8-27-71). Format: C&W, variety. ■ Walter P. Kaszynski, gen mgr & chief engr; Dorothy Kaszynski, prog dir; Jerry Finn, coml mgr; Bill Peshek, mus dir; Bill McGrail, news dir. ■ Rates: \$2.65; 2.65; 2.65; 2.65.

WOCO-FM—Aug 1, 1968: 107.1 mhz; 3 kw. Ant 210 ft. Prog dups AM 40%. Format: Sounds of now & then. ■ Rates: \$5; 5; 5.

Oshkosh

WAGO—July 1, 1969: 690 khz; 250 w-D. DA. Box 437 (54901). (414) 233-0309. WAGO Radio Inc. (acq 1975). Net: ABC/E. Rep: Hurley, Michigan Spot Sls. Format: Top 40. ■ Obed S. Borgen, owner; Jerry Hughes, gen mgr; Chuck Leonard, prog dir & chief engr; Mark Bradley, news dir. ■ Rates: \$6.75; 5.50; 6.75; 5.50.

WMKC(FM)—Jan 30, 1967: 96.7 mhz; 3 kw. Ant 295 ft. Box 257 (54901). (414) 233-3030. Kimball Bcstg Co. Net: ABC/FM. Rep: Webb. Format: MOR. ■ Ted Layhe, pres; Bill Shaw, gen & coml mgr; William Vogelgesang, prog dir & chief engr; Thomas Luljak, news dir.

WOSH(FM)—Sept 1, 1966: 103.9 mhz; 3 kw. Ant 285 ft. Stereo. Box 2846 (54901). (414) 235-3150. Prog sep from AM. Format: Top 40. ■ Charlie Hartwig, prog dir; J.B. Gibson, mus dir. ■ Rates: \$13; 13; 13; 13.

***WRST-FM**—April 20, 1966: 90.3 mhz; 960 w. Ant 125 ft. U. of Wis-Oshkosh (54901). (414) 424-4343. Board of Regents, U of Wis System. Net: NPR. Format: Progs, jazz, classc. ■ Robert L. Snyder, gen mgr; Jay Patrick Walsh, prog dir; John A. Bredesen, chief engr.

WYTL—Dec 31, 1941: 1490 khz; 1 kw-D, 250 w-N. Box 1490 (54901). (414) 235-3150. Value Radio Corp. (acq 9-1-59). Group owner: Mid West Family Sns. Rep: H-R Stone. Format: C&W, farm. ■ Philip J. Robbins, exec VP & gen mgr; Daniel R. Davis, prog dir; Derik Ryan, mus dir; Roland "Bud" McBain, VP & opns mgr; John Wittenmeier, chief engr. ■ Rates: \$15.25; 13; 15.25; 13.

Park Falls

WNBI—April 13, 1968: 980 khz; 1 kw-D. Box 309 (54552). (715) 762-3221. Northland Bcstg Inc. Net: Keystone. Format: MOR, talk. Spec progs: C&W 14 hrs, farm 7 hrs wkly. ■ Desmond H. Callaghan, pres; George Palo, VP & gen mgr; James H. Luebke, coml mgr; Russell O'Chocki, prog & mus dir; Alan Ambrosious, prom mgr; Randy McKibben, news dir; Dave Sommers, chief engr.

WNBI-FM—April 13, 1968: 98.3 mhz; 3 kw. Ant 245 ft. Prog dups AM 100%.

Platteville

***WSUP(FM)**—Feb 25, 1964: 90.5 mhz; 420 w. Ant 140 ft. Room 42 Pioneer Tower, UW (53818). (608) 342-1165. Board of Regents of Wis. State U. ■ Prof. Paul W. Gauger, gen mgr.

WSWW—Feb 22, 1955: 1590 khz; 1 kw-D, 500 w-N, DA-N. Box 1 (53818). (608) 348-2775. Southwest Wisconsin Co. (acq 12-1-71). Net: MBS. Rep: Webb. Format: MOR. ■ Robert J. Bodden, pres, gen mgr & news dir; Jack O'Neill, spts dir; Mary Bodden, woman's dir; Austin Baxter, farm dir; Don Larsen, chief engr.

WSWW-FM—Sept 1, 1966: 107.1 mhz; 3 kw. Ant

235 ft. Prog dups AM 100%.

Plymouth

WPLY—April 1954: 1420 khz; 500 w-D, Box 420 (53073). (414) 893-2661. WPLY Inc. (acq 7-57). Rep: PRO Time Sls. Format: C&W. Spec prog: Sp ½ hr wkly. ■ R. Bunker Rogoski, pres; Dalton C. Hille, gen mgr; Brian Peters, news dir; Rick Crain, prog & mus dir; Glen Loest, chief engr.

Portage

WPDR—July 31, 1952: 1350 khz; 1 kw-D. Box 388 (53901). (608) 742-2350. Kramer Bcstg Inc. (acq 7-1-74). Net: ABC/E, Midwest Farm & Outdoor. Format: Contemp. Spec progs: C&W 6 hrs, talk 11 hrs, farm 9 hrs wkly. ■ Edward Kramer, pres & gen mgr; Dan Lee, prog dir; Bob Viking, sports dir; Thom Gerretsen, news dir; Carol Mork, opns mgr; Robert J. Hoffman, coml mgr; Dan Lee, mus dir; Kenneth Ebnetter, chief engr. ■ Rates: \$6; 6; 6; 3.

WPDR-FM—Nov 8, 1966: 100.1 mhz; 3 kw. Ant 300 ft. Prog dups AM 75%. ■ Rates same as AM.

Port Washington

WGLB—Dec 6, 1963: 1560 khz; 250 w-D, DA. Box 347 (53074). (414) 284-2666. WGLB Inc. (acq 5-16-73). Rep: Webb. Format: Pop country. Spec prog: Polkas 3 hrs, Ger 14 hrs, Pol 1 hr, Greek 1 hr wkly. ■ Daniel C. Palen, pres, gen mgr; Howard J. Fuys, coml mgr; Sharon Jeffery, prog dir; Rayford Styles, mus dir; Paul Scott, news dir; Richard Bluedorn, chief engr.

WGLB-FM—Oct 1969: 100.1 mhz; 3 kw. Ant 180 ft. Prog dups AM 100%.

Poynette

WIBU—July 1925: 1240 khz; 1 kw-D, 250 w-N. Route 2 (53955). (608) 635-4532. Community Service Radio Inc. (group owner; acq 11-1-69). Net: Wisconsin Net. Format: MOR, news. Spec prog: Farm 13 hrs wkly. ■ Thomas R. Holter, pres & gen mgr; Victor M. Aime, coml mgr; Mike Reed, prog dir; Tom Ramsey, news dir; John Herbert, chief engr. ■ Rates: \$6.75; 5.75; 6.75; 5.75.

Prairie Du Chien

WPRE—Dec 11, 1952: 980 khz; 1 kw-D. Box 90 (53821). (608) 326-2411. Prairie Bcstg Co. ■ W.C. Schlaugat Jr., pres, gen mgr & chief engr; Robert Dillman, coml mgr; Norbert Aschom Jr., prog & news dir.

WPRE-FM—1968: 94.3 mhz; 3 kw. Ant minus 46 ft.

Racine

WFNY(FM)—Aug 6, 1962: 92.1 mhz; 3 kw. Ant 270 ft. Box 565, 5730 Taylor Ave. (53401). (414) 554-8626. Lakeshore Bcstg Corp. Format: Easy Lstg. ■ Jerome P. Feeney, pres & gen mgr; Gene H. Miller, news dir; George Feichtner, chief engr.

WRJN—December 1926: 1400 khz; 1 kw-D, 250 w-N. 4201 Victory Ave. (53405). (414) 634-3311. Sentry Bcstg (acq 7-2-69). Net: ABC/L, Wisconsin Net. Format: MOR. Spec prog: Sp ¼ hr wkly. ■ Peter A. Barnard, pres; W.P. Gumm Jr., gen mgr; James L. Sorensen, prog dir; Donn R. Edmark, news dir; David E. Dzurick, chief engr. ■ Rates: \$9.50; 9.50; 9.50; 9.50.

WRKR—June 4, 1950: 1460 khz; 500 w-D, 2200 N. Green Bay Rd. (53405). (414) 632-1627. WRAC Bcstg. (acq 7-1-68). Group owner: J.W. O'Connor. Net: ABC/C. Rep: Masia. Format: Top 40. ■ J.W. O'Connor, pres; Richard R. Lange, gen mgr; Ken Rhodes, prog dir; Dave Patrick, mus dir. ■ Rates: \$10.50; 9.50; 10.50; 9.50.

WRKR-FM—Aug 1948: 100.7 mhz; 50 kw. Ant 500 ft. Stereo. Prog dups AM 92%. ■ Rates same as AM.

Reedsburg

WRDB—February 1953: 1400 khz; 1 kw-D, 250 w-N. Box 349 (53959). (608) 524-2321. Sauk Bcstg Corp. (acq 3-1-71). Net: ABC/L. Format: Contemp, C&W. ■ Nathan Goetz, pres; Charles N. Gill, gen mgr; Wayne Hackbarth, news dir; F.B. Nienow, chief engr.

WRDB-FM—July 16, 1967: 104.9 mhz; 3 kw. Ant 230 ft. Prog dups AM 10%.

Rhineland

WOBT—March 9, 1947: 1240 khz; 1 kw-D, 250 w-N. Box 738 (54501). (715) 362-6140. Oneida Bcstg Co. Net: NBC. Audio news: UPI. Rep: PRO/Meeker. Format: Uptempo MOR. ■ Thomas Cleary, pres; Robert E. O'Brien, gen mgr; Robert Carroll, news dir; Gary Majkowski, chief engr. ■ Rates: \$5; 5; 5; 5.

WRHN(FM)—Co-owned with WOBT. Jan 26, 1966: 107.9 mhz; 25 kw. Ant 300 ft. Stereo. Prog sep from AM. Format: Btfl mus. ■ Rates same as AM.

Rice Lake

WJMC—1938: 1240 khz; 1 kw-D, 250-N. Box 352 (54868). (715) 234-2131. WJMC Inc. (acq 1-19-73). Net: MBS, Wisconsin Net. Rep: PRO/Meeker, Hurley. Format: MOR. Spec prog: Farm 15 hrs wkly. ■ Russell J. Brown, pres & gen mgr; Carl Klaus, coml mgr; Bob Groshong, prog dir; Dick Kaner, news dir; Bob Kolsky, chief engr. ■ Rates: \$5.95; 5.95; 5.95; 5.95.

WJMC-FM—1947: 96.3 mhz; 100 kw horiz, 12 kw vert. Ant 540 ft. Prog dups AM 90%.

Richland Center

WRCO—October 18, 1949: 1450 khz; 1 kw-D, 250 w-N. Box 529 (53581). (608) 647-2111. Richland Bcstg Corp. (acq 1-28-67). Net: ABC/C. Format: MOR, C&W, rock. ■ John F. Monroe, pres; Peter Athanas, VP & gen mgr; Gerald Cook, sls mgr; Rod Perry, stn mgr; Brian Kennedy, news dir; Jim Greeley, farm dir; Steve Kennedy, prog dir. ■ Rates: \$5.80; 5.80; 4.90.

WRCO-FM—August 1965: 100.9 mhz; 3 kw. Ant 240 ft. Prog dups AM 90%. ■ Rates same as AM.

Ripon

WCWC—Sept 15, 1957: 1600 khz; 5 kw-U, DA-2. Box 156 (54971). (414) 748-5111. Greycote Inc. (acq 8-1-61). Audio news: UPI. Rep: Walton. Format: MOR, top 40. Spec prog: Farm 18 hrs wkly. ■ Ralph D. Bice, pres; Paul Veleke, gen mgr; Terry Allan, prog & mus dir; Nancy Erdman, coml mgr; Jeff Nordstrom, chief engr.

WCWC-FM—Feb 1, 1965: 95.9 mhz; 3 kw. Ant 300 ft. horiz, 295 ft. vert. Prog dups AM 100%.

***WRPN-FM**—1961: 90.1 mhz; 10 w. Ant 110 ft. Stereo. Ripon College (54971). (414) 748-8147. Bd of Trustees of Ripon College. Format: Progs. Spec prog: Fr ½ hr, Sp ½ hr wkly. ■ Bruce M. Batterson, gen mgr; Jim Haney, prog dir.

River Falls

WEVR—Sept 14, 1969: 1550 khz; 1 kw-D, 500 w-N. Box 43, Radio Road (54022). (715) 425-5317. (612) 436-8634. Hanten Bcstg Company Inc. (acq 6-1-74). Format: Contemp, C&W. ■ Jack Hanten, pres & gen mgr; Al Murray, chief engr.

WEVR-FM—Sept 30, 1970: 106.3 mhz; 3 kw. Ant 300 ft. Stereo. Prog dups AM 100%.

***WRWF(FM)**—Nov 2, 1968: 88.7 mhz; 750 w. Ant 260 ft. 306 North Hall, U. of Wisc-River Falls (54022). (715) 425-3169. Board of Regents, U of Wisconsin System. Net: NPR. Format: Noncoml diversified. ■ J. Michael Norman, gen mgr; Julie Reilly, Tenlee Stout, prog dirs; Sharon Murphy, mus dir; Peg Flynn, news dir; Alan E. Murray, chief engr.

Sauk County

WVLR(FM)—Sept 18, 1964: 96.7 mhz; 3 kw. Ant 300 ft. Stereo. 907 John Adams St. (53583). (608) 643-3375. Sauk Prairie Radio Inc. Format: MOR. ■ Thomas F. Clark, pres & gen mgr; Diane M. Clark, coml & prom mgr & news dir; Cindy Accola, mus dir; Richard E. Dasenbrock, prog dir.

Shawano

WTCH—Sept 3, 1948: 960 khz; 1 kw-U, DA-N. Box 489 (54166). (715) 526-2121. Shawano County Leader Pub. Co. Rep: Hopedew. Format: C&W, MOR. ■ J.P. Donald, gen mgr; R.G. Gruetzmacher, stn mgr.

WTCH-FM—Dec 1966: 100.1 mhz (CP: 99.3 mhz); 3 kw. Ant 180 ft. Prog sep from AM.

Sheboygan

WHBL—1926: 1330 khz; 5 kw-D, 1 kw-N, DA-2. Box 27 (53081). (414) 458-2107. Sheboygan County Bcstg. (acq 7-72). Net: ABC/E. Wisconsin. Rep: Walton. Format: Variety. Spec prog: Sp 1 hr, farm 10 hrs, classcl 2 hrs, Ger 1 hr wkly. ■ Michael Walton, pres & gen mgr; Bob Lardie, sls mgr; Ted Charles, news dir; Chris Bauer, chief engr. ■ Rates: \$9; 7; 9; 6.

WHBL-FM—1972: 97.7 mhz; 3 kw. Ant 240 ft. Stereo. Prog sep from AM. Format: Btlf mus. ■ Rates: \$5; 5; 5; 5.

WKTS—January 1956: 950 khz; 500 w-D, DA. 814 N. 8th St. (53081). (414) 457-5561. First Sheboygan Corp. (acq 1-1-74). Rep: Meeker, Wayne-Evans. Format: Adult contemp. ■ Steven T. Moravec, pres; Michael C. Steele, VP & gen mgr; John A. Harlow, opns dir.

***WSHS(FM)**—Nov 19, 1971: 91.7 mhz; 10 w. 1042 School Ave (53081). (414) 458-4621. Board of Education. Sheboygan Public Schools. Format: MOR, educ, contemp. Spec prog: Fr 1 hr, Ger 1 hr, Sp 1 hr, educ 15 hrs wkly. ■ Jerrold H. Molepske, gen mgr & news dir; Chris Bauer, chief engr.

Shell Lake

WCSW—Dec 30, 1967: 940 khz; 1 kw-D. Box 190 (54871). (715) 468-2123. Charles Lutz. Net: ABC/E. Format: C&W, MOR. Spec prog: Chippewa Ind. ½ hr wkly. ■ Charles R. Lutz, gen mgr; Charles & Betty Lutz, pres & mus dirs; James Steen, Dennis Gebart, Donald Tobias, news dirs; Truman Smith, chief engr.

WKCF(FM)—Dec 1974: 95.3 mhz; 3 kw. Ant 300 ft. Stereo. 125 Fifth Ave. (54871). (715) 468-2213. Erwin Giaddenbegk. Format: MOR.

Sparta

WCOW—June 1951: 1290 khz; 5 kw-D. 209 E. Main St. (54656). (608) 269-3307. Sparta-Tomah Bcstg Co. Net: MBS. Rep: Walton. Format: MOR. ■ John D. Rice, pres & gen mgr; Robert C. Mulvancy, prom mgr; Eugene G. Kuderer, coml mgr; James Behling, news dir; Sam Sololik, chief engr.

WCOW-FM—March 1, 1960: 97.1 mhz; 47 kw. Ant 360 ft. horiz, 350 ft. vert. Stereo. Prog dups AM 35%. Format: News, MOR.

Stevens Point

WSPT—1949: 1010 khz; 1 kw-D. Box 247 (54481). (715) 341-1300. Stevens Point Bcstg Co. (acq 8-50). Audio news: UPI. Format: Contemp. Spec prog: Pol 1½ hrs, farm 8½ hrs wkly. ■ Peter A. Barnard, pres; James P. Schu, gen mgr; Donn Nichols, mus & prog dir; Rita Jo Sandy, news dir; Jim Tuszka, chief engr. ■ Rates: \$10; 10; 10; 10.

WSPT-FM—May 1, 1961: 97.9 mhz; 50 kw. Ant 340 ft. Stereo. Prog dups AM 99%. ■ Rates same as AM.

***WSPF(FM)**—Sept 28, 1968: 89.9 mhz; 300 w. Ant 67 ft. 2100 Main St. (54481). (715) 346-2696. Wisconsin State Univ. Format: Ed. ■ F.G. Fritz, gen mgr; Tim Donovan, stn mgr.

Sturgeon Bay

WDOR—Sept 8, 1951: 910 khz; 1 kw-D. 800 S. 15th Ave. (54235). (414) 743-4411. Door County Bcstg Inc. Net: ABC/I. Wisconsin. Format: Contemp. Spec prog: Opinion/talk 5 hrs wkly. ■ Edward D. Allen Jr., pres & gen, natl sls & prom mgr; Cyril Annoye, lcl sls mgr; Edward D. Allen III, prog, news & mus dir.

WDOR-FM—Dec 12, 1966: 93.9 mhz; 39 kw. Ant 640 ft. Prog dups AM 33%. Net: ABC/I. Format: MOR.

Sun Prairie

WYXE(FM)—April 12, 1972: 92.1 mhz; 3 kw. Ant 300 ft. Box 3470, Madison (53704). (608) 837-8591. Sun Bcstg Co. Net: ABC/C. Rep: Pro Time Slis. Format: Contemp. ■ Don Timmerman, gen mgr; Carl Como Tuter, pres; John Phillips III, news dir; Jonathan Pockett, prog dir; Bill Tuck, mus dir; Cliff Groth, chief engr.

Superior

WAKX—June 18, 1959: 970 khz; 500 w-D. Northland

Bldg., 410 W. Superior St., Duluth, Minn. (55802). (218) 727-7271. Stereo Bcstg Inc. (acq 12-1-74). Net: ABC/I. Rep: Savalli-Gates, Ewing. Format: Top 40. ■ Lewis M. Latto, pres & gen mgr; Roger J. Johnson, coml mgr; Chris "T", prog & mus dir; Harvey Goldberg, news dir; Wilfred A. Meys, chief engr. ■ Rates: \$14; 9; 14; 9.

WAKX-FM—See Duluth, Minn.

WDSM—Oct 1939: 710 khz; 5 kw-U, DA-N. 230 East Superior St. (55802). (218) 727-8046. TWX 218-820-0275. WDSM Inc. (acq 6-1-75). Net: NBC. Rep: Torbet, Hurley. Format: Modern C&W. ■ Robert B. Ridder Jr., pres & gen mgr; Tim Michaels, prog dir; James Peterson, coml mgr; Daryl Knutson, prom mgr; Dick Anthony, news dir; Carl Williams, chief engr. ■ Rates: \$15; 10; 15; 7.

***WSSU(FM)**—Jan 31, 1966: 91.3 mhz; 940 w. Ant minus 72 ft. Stereo. WSSU(FM) (54880). (715) 392-3461. U. of Wis Bd of Regents. Format: Variety. Spec prog: Black 4 hrs, Ger ½ hr, educ 6 hrs wkly. ■ Dr. Karl W. Meyer, pres; Ron Larson, gen mgr; Sherwin Palmer, chief engr.

Suring

WRVM(FM)—Sept 15, 1967: 102.7 mhz; 100 kw. Ant 500 ft. Box 212 (54174). (414) 842-2839. WRVM Inc. (acq 1-1-69). Format: Relig, public svc. Spec prog: Ger ¼ hr, Pol ¼ hr wkly. ■ Donald Abel, pres; Ken Hellinga, gen, coml & prom mgr; prog dir; Howard Lundgren, news dir; Ron Cowell, chief engr.

Tomah

WTMB—April 20, 1959: 1460 khz; 1 kw-D. Box 588 (54660). (608) 372-2180. Tomah-Mauston Bcstg Co. Net: Wisconsin. Format: MOR. Spec prog: C&W 10 hrs, talk 15 hrs wkly. ■ Hugh W. Dickie, pres & gen mgr; Phyllis Rice, coml & prom mgr; Daniel M. Erickson, prog dir; Kevin Clark, sports & news dir; Murray Ritland, chief engr.

WTMB-FM—Jan 29, 1965: 93.9 mhz; 100 kw. horiz, 97 kw. vert. Ant 660 ft. Stereo. Prog dups AM 50%. Format: MOR.

Tomahawk

WYYS—August 1968: 810 khz; 1 kw-D. Box 81 (54487). (715) 453-4481. WYYS Inc. (acq 8-1-74). Rep: Walton. Format: Contemp. ■ Robert P. Hansen, VP & gen mgr; Gary Morgan, news dir.

Two Rivers

WQTC—1951: 1590 khz; 1 kw-D. Box 266 (54241). (414) 793-1348. Twin "C" Inc. (acq 8-1-72). Net: ABC/C. Rep: Masla, Wayne Evans. Format: Top 40. ■ Ed Crilly, pres; John Barber, mus dir; Don Timmerman, stn mgr. ■ Rates: \$7.50; 7; 7.50; 7.

WQTC-FM—Nov 19, 1965: 102.3 mhz; 3 kw. Ant 230 ft. Prog dups AM 100%.

Viroqua

WGBM(FM)—Listing follows WISV.

WISV—Feb 25, 1958: 1360 khz; 1 kw-D. Route 4 (54665). (608) 637-7200. Robinson Corp. (acq 1-1-67). Rep: Walton. Format: MOR, C&W. ■ Parks Robinson, pres & gen mgr; David Robinson, mus & prog dir; Gary Gilbertson, sps & news dir; James Graham, coml mgr; Verle Erickson, chief engr.

WGBM(FM)—Co-owned with WISV. Oct 6, 1967: 102.3 mhz; 3 kw. Ant 300 ft. Stereo. Prog dups AM 16%. Format: Contemp, MOR. Spec prog: C&W 6 hrs wkly.

Watertown

WTTN—April 2, 1950: 1580 khz; 1 kw-D. 104 W. Main St. (53094). (414) 261-1580. Watertown Radio Inc. Rep: Hopewell. Format: MOR. ■ Carl V. Kolata, pres & gen mgr; Dean Jansa, coml mgr; Tom Mack, news dir; Clifford Groth, chief engr.

WTTN-FM—Aug 1, 1961: 104.7 mhz; 20 kw. Ant 285 ft. Prog dups AM 85%.

Waukesha

WAUK—March 27, 1947: 1510 khz; 10 kw-D, DA.

Wisconsin Radio

See page C-1 for explanation of listings.

1460 Whitehall St. (53186). (414) 542-6636. Stebbins Communications (acq 1975). Rep: Mich Spot Slis. Format: Contemp, MOR, variety. Spec prog: Sp 1 hr wkly. ■ Mrs. M. Earlene & Paul M. Stebbins, owners; John S. Helder, VP; Walter G. Smith, stn mgr & sls mgr; Joseph L. Braick, asst mgr & prog dir; Elliot Douck, news dir.

WAUK-FM—Jan 1, 1962: 106.1 mhz; 19.5 kw. Ant 180 ft. Prog dups AM 10%. Format: MOR.

Waupaca

WDXU—April 29, 1956: 800 khz; 5 kw-D, DA. Box 247 (54981). (715) 258-5528. Laird Bcstg Co. Net: ABC/C. Audio news: UPI. Rep: H-R Stone. Format: MOR. Contemp. Spec prog: Farm 10 hrs wkly. ■ Dorothy J. Laird, pres; Morgan Marti, stn mgr; Randy Kellogg, prog dir; Gary Douglas, mus dir; Warren Phillips, news dir; Steve Konopka, chief engr.

WDXU-FM—Jan 29, 1967: 92.7 mhz; 3 kw. Ant 255 ft. Stereo. Prog dups AM 100%.

Waupun

WLKE—May 26, 1966: 1170 khz; 1 kw-D. 609 Home Ave. (53963). (414) 324-4441. Collins Bcstg Corp. Rep: Webb. Format: C&W. ■ Jerry J. Collins, pres; Donald D. Sabatke, VP & gen mgr; Donn West, coml mgr; John Ray, news dir; Norm Gray, prog dir; Van Steiner, chief engr.

WLKE-FM—1974: 99.3 mhz; 2.8 kw. Ant 300 ft. (acq 1974).

Wausau

WDEZ(FM)—Listing follows WRIG.

***WHRM(FM)**—June 10, 1949: 91.9 mhz; 75 kw. (CP: 77 kw). Ant 1,120 ft. 732 N. Midvale Blvd., Madison (53705). (608) 266-0036. State of Wisconsin Educational Communications Bd. See *WERN(FM) Madison.

WIFC(FM)—Listing follows WSAU.

WRIG—Aug 1958: 1400 khz; 1 kw-D, 250 w-N. 529 Third St. (54401). (715) 845-4275. WRIG Inc. Format: Contemp. ■ D.E. Wright, pres & gen mgr; Elroy Sellin, coml mgr; Don Roberts, prog & mus dir; Mary Nellis, news dir. ■ Rates: \$8.50; 7; 8.50; 7.

WDEZ(FM)—Co-owned with WRIG. March 27, 1964: 101.9 mhz; 100 kw. Ant 490 ft. Stereo. Prog sep from AM. Format: Btlf mus. ■ Rates: \$6.20; 6.20; 6.20; 6.20.

WSAU—Jan 30, 1937: 550 khz; 5 kw-U, DA-2. Box 1088 (54401). (715) 845-4211. Forward Communications Corp. (group owner; acq 7-1-54). Net: NBC. Format: Solid gold, MOR. ■ Richard D. Dudley, pres; Dave Raven, exec VP & gen mgr/coml mgr; John Davison, prog dir; Rudy Topinka, news dir; Pete Radunz, sls mgr; Don Cochart, chief engr.

WIFC(FM)—Co-owned with WSAU. 1947: 95.5 mhz; 100 kw. Ant 1,080 ft. Stereo. Prog dups AM 20%. ■ WSAU-TV affil.

WXCO—Aug 1, 1953: 1230 khz; 1 kw-D, 250 w-N. Box 778 (54401). (715) 845-8218. Seehafer & Johnson Bcstg Corp. (group owner; acq 9-26-73). Net: CBS. Rep: Piano Slis. Format: C&W. ■ Robert J. Bertrand, stn mgr; Gene Converse, prog & news dir & chief engr; Don Seehafer, gen mgr.

Wauwatosa-Milwaukee

WEZW(FM)—Jan 1, 1961: 103.7 mhz; 14.5 kw. Ant 820 ft. Stereo. 1572 E. Capitol Dr., Milwaukee (53211). (414) 961-1030. Sudbrink Broadcasting of Wisconsin. (acq 2-71). Group owner: Sudbrink Bcstg. Rep: Katz. Format: Good mus. ■ Robert Emery, VP & gen mgr; William Moos, opns mgr; Edward Jurich, chief engr. ■ Rates: \$47; 52; 50; 27.

West Allis

WAWA—Oct 29, 1961: 1590 khz; 1 kw-D, DA. 12800 Bluemond Rd., Elm Grove (53122). (414) 786-1590. Suburbanaire Inc. Group owner: McKenna Stns. Net: MBS/Black. Format: Black. ■ Neil K. Searles, pres & gen mgr; O.C. White, prog dir & asst gen mgr; Walter

Wisconsin, Wyoming Radio

See page C-1 for explanation of listings.

Beach, news dir; Jack Krause, asst gen mgr & chief engr.

WAWA-FM—See Milwaukee.

West Bend

WBKV—November 1950: 1470 khz; 1 kw-D. Box 60 (53095). (414). 334-2344. West Bend Bcstg Co. (acq 11-70) Rep: Devney. ■ Marshall W. Johnston, pres; Capps B. Sutherland, gen mgr; Bill Bessire, coml mgr; Paul Krejci, prog dir & chief engr; John Schaller, news dir.

WBKV-FM—September 1958: 92.5 mhz; 47 kw. Ant 500 ft. Stereo. Progs sep from AM.

Whitewater

***WSUW(FM)**—91.7 mhz; 340 w. Ant 185 ft. 301 Hyer Hall, U. of Wisc-Whitewater (53190). (414) 472-1312. Wis. State Univ. Net: NPR. Format: Variety. Spec prog: Black 5 hrs wkly. ■ Kent Kjellgren, gen mgr; Bob Clifford, prog dir; Clifford Groth, consulting engr.

Wisconsin Dells

WNNO—May 1969: 990 khz; 500 w-D. Box 990 (53965). (608) 254-2546. Taylor Electric Co. (acq 10-1-73). Net: MBS, Keystone. Rep: Walton, Keystone. Format: Contemp. ■ John W. Taylor, gen mgr; Chuck Bailey, prog mgr; Bruce Golla, news dir; Clista McAllister, coml mgr; Wayne Phillips, stn mgr. ■ Rates: \$3.50; 3.50; 3.50; —.

WNNO-FM—May 1974: 107.1 mhz; 2.6 kw. Ant 320 ft. Prog dups AM 70%. ■ Rates: \$2.50; 2.50; 2.50; 2.50.

Wisconsin Rapids

WFHR—Nov 1, 1940: 1320 khz; 5 kw-D, 500 w-N, DA-N. 220 First Ave. S. (54494). (715) 424-1300. Advance Bcstg Corp. Net: CBS, Wisconsin. Rep: PRO/Meeker. Format: Up tempo, MOR. ■ Louise F. Huffman, pres; Jack R. Gennaro, VP & gen mgr; Arnie Strope, prog dir; Dennis Gibson, loc sls mgr; Cliff Borden, news dir; Rollyn Beusch, chief engr. ■ Rates: \$6.85; 6; 6.85; 6.

WWRW(FM)—Co-owned with WFHR. Aug 1, 1946: 103.3 mhz; 73 kw horis, 8.4 kw vert. Ant 330 ft. Stereo. Prog sep from AM. Format: Adult contemp. ■ Roger Sweet, coml mgr. ■ Rates: \$4.50; 4.50; 4.50; 4.50.

Wyoming

HAMILTON-LANDIS & ASSOCIATES, Inc.
NATIONWIDE MEDIA BROKERS
WASHINGTON, D. C., CHICAGO, DALLAS,
SAN FRANCISCO
SELL **MORE**
RADIO & TELEVISION STATIONS
IN THE WEST—NEAREST OFFICE IS—
111 SUTTER ST., SAN FRANCISCO 94104
(415) 392-5671

Buffalo

KBBS—April 17, 1956: 1450 khz; 250 w-U. 90 S. Main St. (82834). (307) 684-7070. KBBS Inc. (acq 5-1-64). Net: ABC/I, IMN. Rep: RKO. Format: Variety. ■ Jeanette Maxwell, pres, gen & coml mgr; Marilyn Maxwell, prog dir; Steve Lawrence, prom mgr & mus dir; Susan Willis, news dir; Ralph Burger, chief engr.

Casper

KATI—May 5, 1956: 1400 khz; 1 kw-D, 250 w-N. Box 2006 (82601). (307) 234-4545. Modcom Corp. (acq 2-23-64). Net: CBS. Rep: Mountain; Hix. Format: Con-

temp. ■ Patrick H. Meenan, pres; Larry Wakefield, gen mgr; Jack Blancy, prog dir; Frank Barrett coml mgr; Bob Coleman, sports dir; Doc Mueller, mus dir; Jane Campbell, news dir; Steve Fritz, chief engr.

KAWY(FM)—Co-owned with KATI. Oct 1, 1967: 94.5 mhz; 25 kw. Ant minus 126 ft. (307) 235-1515. Prog sep from AM. Format: MOR. Spec prog: Black 3 hrs wkly. ■ Roger Moody, gen mgr; John Enyert, prog dir

KTWO—1930: 1030 khz; 50 kw-U, DA-N. Box 2720 (82602). (307) 237-3711. TWX 910-949-4462. Hariscope Bcstg Corp. (group owner; acq 3-59). Net: NBC. Rep: Alan Torbet, McGuire. Format: MOR. ■ Burt I. Harris, pres; Jack Rosenthal, exec VP; Dave Allen, sls mgr; Bruce King, mus dir; Stas Loutas, prom mgr; Bob Horner, news dir; Bob Price, gen mgr. ■ KTWO-TV affil. ■ Rates: \$8.50; 7.50; 8.50; 6.50.

KVOC—Oct 1, 1946: 1230 khz; 1 kw-D, 250 w-N. Box 2090 (82601). (307) 265-2727. KVOC Inc. (acq 6-19-64). Net: ABC/I, IMN. Rep: IMN; Eastman. Format: Modern C&W. Spec progs: Farm 1 hr, Sp 1 hr wkly. ■ Harry Bubeck, pres; Fred Hildebrand, gen mgr; Jerry Bolling, mus dir; Ron Barnhart, coml & prom mgr; Jack Russalesi, news dir; Roy Hodgson, chief engr. ■ Rates: \$7.25; 5.75; 7.25; 5.75.

Cheyenne

KFBC—1940: 1240 khz; 1 kw-D, 250 w-N. 2923 E. Lincolnway (82001). (307) 634-4461. Frontier Bcstg Co. Net: ABC, IMN. Rep: Petry. ■ Robert S. McCracken, pres; William C. Grove, chief engr, exec VP & gen mgr; Larry Birleffi, stn coml mgr; Donna Kailey, prog dir; Chuck Hughes, news dir.

KFBC-FM—September 1968: 97.9 mhz; 34 kw. Ant 580 ft. Dups AM 100%. ■ KFBC-TV affil.

KNIE—Sept 9, 1959: 1590 khz; 1 kw-D. (CP 1530 khz; 10 kw-D, 1 kw-N, DA-2). Box 1383 (82001). (307) 634-7975. Northern States Bcstg Co. (acq 9-15-71). Rep: Adam Young; Bob Hix. Format: MOR. ■ F. R. Kadrie, pres; V. J. Tedesco, exec dir; Charles E. Hughes, stn mgr; Barbara Mark, coml mgr; Jack Bell, mus dir; J. Michael Hale, prog dir & chief engr.

KRAE—April 29, 1961: 1480 khz; 1 kw-D. Box 189 2109 E. 10th St. (82001). (307) 632-5898. KRAE Inc. (acq 6-8-75). Rep: Alan Torbet; Mountain Media. Format: Contemp C&W. Spec prog: Sp 2½ hrs, wkly. ■ Tom Bauman, owner, gen & coml mgr; Bob Nelson & Jim Rolco, news dir; Roland Madden, chief engr.

KVWO—1952: 1370 khz; 1 kw-D. Box 926 (82001). (307) 632-0551. KVVO Inc. (acq 12-71). Net: MBS. Rep: Masla; Messina; Hix. Format: C&W. ■ John Hough, pres; Bill C. Hart, gen mgr; Bob McBride, prog dir; Blaine Randles, mus dir; Mark Sands, news dir; Dave Montgomery, coml mgr; Barbara Mark, sls mgr; Bob Goodrich, chief engr.

KVWO-FM—August 1961: 106.3 mhz; 3 kw. Ant 68 ft. Stereo. Dups AM 100%.

Codey

KODI—March 1947: 1400 khz; 1 kw-D, 250 w-N. Box 1222 (82414). (307) 587-2211. Shoshone Communications Corp. (acq 12-74). Net: NBC. Rep: Adam Young/Masla; Bob Hix. Format: Variety, C&W. ■ Doris Miller, mgr; Mike Cook, prog dir; Ed Husman, asst mgr; Roger Sedam, sls mgr; Joan Donnelly, o/c mgr.

***KYDZ(FM)**—Not on air yet; target date unknown: 90.1 mhz; 10 w. 1225 10th St. (82414). Park County School District No. 6, State of Wyoming.

Douglas

KWIV—June 22, 1957: 1470 khz; 1 kw-D, 500 w-N. Drawer X (82633). (307) 358-2768. Douglas Bcstg Inc. (acq 8-6-74). Format: Variety. ■ Harry Fondren Jr, pres and gen mgr; William Spencer, coml mgr; Joe Summers, chief engr. ■ Rates: \$2.94; 2.94; 2.94; 2.94.

Evanston

KEVA—June 27, 1953: 1240 khz; 1 kw-D, 250 w-N. Box 190 (82930). (307) 789-9101. KEVA Inc. (acq 10-15-71). Net: MBS. Rep: Masla; Hix. Format: C&W. Spec prog: Farm 1 hr wkly. ■ Michael B. Lish, gen, coml & prom mgr, music and news dir; Neil J. Morley, prog dir; Ron B. England, chief engr. ■ Rates: \$3.25; 3.25; 3.25; 3.25.

Gillette

KIML—Sept 13, 1957: 1270 khz; 5 kw-D, 1 kw-N, DA-N. Box 1009 (82716). (307) 682-4747. Gillette Bcstg Co. (acq 11-21-57). Net: ABC. Rep: Petry. ■ Wm. H. Edelman Jr, pres; Roy A. Mapel, gen mgr & chief engr.

Jackson

KMTN(FM)—Dec 17, 1974: 96.9 mhz; 48 kw. Ant 940 ft. Stereo. Box 927 (83001). (307) 733-4500. Teewinot Broadcasting. Format: Diversified. Spec progs: Jazz 2 hrs, C&W 18 hrs wkly. ■ Olan Riniker, VP and gen mgr; Dave Tallmadge, sls mgr; Jeff Woodruff, news dir; Wayne Mills, chief engr.

KSQT—July 20, 1962: 1340 khz; 1 kw-D, 250 w-N. Box 100 (83001). (307) 733-2120. Snow King Bcstg Corp. (acq 8-14-75). Net: ABC/I, IMN. Format: MOR. ■ Robert W. Campbell, pres; Maria M. Campbell, VP; William L. McManus, stn mgr, chief engr; Sandra L. McManus, bus mgr; Skip Mahony, spts dir; David F. Young, news dir.

Kemmerer

KMER—Dec 7, 1962: 950 khz; 5 kw-D. 436 Fossil Butte Dr. (83101). (307) 877-4422. Lincoln Bcstg Co. (acq 2-5-66). Net: ABC/I, IMN. Rep: RKO, IMN. Format: C&W, MOR. ■ Samuel L. Hymas, pres; Alan E. Zeigler, gen, coml & prom mgr & prog, mus & news dir; Karl C. Huffman, chief engr.

Lander

KDLY(FM)—Listing follows KOVE.

KOVE—1947: 1330 khz; 5 kw-D, 1 kw-N, DA-N. Box 430 (82520). (307) 332-5683. Fremont Bcstg Inc. (acq 1958). Net: CBS. Rep: Hix. Format: C&W, Contemp. ■ Dan Breece, pres; Joe Kenny, gen mgr & mus dir; Ginny Goehring, coml mgr; Jim Sutter, prog dir; Lee Roberts, news dir; Dick Pace, chief engr.

KDLY(FM)—Co-owned with KOVE. 1975: 97.5 mhz; 25 kw. Ant minus 424 ft.

Laramie

KIOZ(FM)—See listing after KOJO.

KOJO—Feb 27, 1962: 1490 khz; 500 w-D, 250 w-N. Box 818 (82070). (307) 745-7396. Wycom Corp. (group owner; acq 10-1-71). Net: NBC, MBS. Rep: Masla; Hix. Format: Modern country. Spec prog: Sp 2 hrs wkly. ■ Bill Sims, pres, gen mgr; Bob Flotte, sls mgr; Wayne Deahl, mus dir; Al Harris, news dir; Steve Broomell, chief engr. ■ Rates: \$3.80; 3.80; 3.80; 3.80.

KIOZ(FM)—Co-owned with KOJO. Sept 23, 1974: 102.9 mhz, 30 kw. Ant 1,150 ft. Stereo. 409 S. 4th St. Prog sep from AM. Net: NBC. Format: Contemp, rock. Spec prog: Classcl 4 hrs wkly. ■ Rates: \$4; 4; 4; 4.

KOWB Curt Gowdy Broadcasting, Inc.

KOWB—Feb 20, 1948: 1290 khz; 5 kw-D, 1 kw-N, DA-2. Box 1290 (82070). (307) 745-4888. Curt Gowdy Enterprises (group owner; acq 12-1-66). Net: ABC/C, ABC/I, ABC/E, MBS, IMN. Rep: RKO; IMN. Format: Contemp, C&W, talk, variety. ■ Curt Gowdy, pres; Jim Ballas, gen & prom mgr & prog dir; Andy Hoefler, coml mgr; Duane Allen, mus dir; Ralph Berg, news dir; Ken Keating, sports dir; Robert Rule, chief engr. ■ Rates: \$6; 6; 6; 6.

***KUWR(FM)**—Sept 10, 1966: 91.5 mhz; 10 w. Box 3661, University Stn. (82070). (307) 766-5155. U of Wyoming. Net: NPR. Format: Diversified. ■ Richard D. Barry, gen mgr.

Newcastle

KASL—July 10, 1953: 1240 khz; 1 kw-D, 250 w-N. Box 422 (82701). (307) 746-4433. Nodok Inc. (acq 2-74). Net: ABC/I, MBS, IMN. Rep: RKO, IMN. Format: Contemp MOR. Spec progs: Community Forum 6 hrs wkly.

Powell

KPOW—March 30, 1941: 1260 khz; 5 kw-D, 1 kw-N,

DA-N. Box 968 (82435). (307) 754-2251. Macnel Inc. (acq 9-30-64). Net: ABC/I, IMN. Rep: Eastman; IMN. Format: MOR. Spec progs: Sp 1/2 hr, C&W 18 hrs wkly. ■ William A. Mack, pres & gen mgr; Art Brooks, prod dir; Doc DeVore, prod dir; Justin Kilness, chief engr. ■ Rates: \$5.70; 4.80; 5.70; 4.80.

Rawlins

KRAL—February 1947: 1240 khz; 1 kw-D, 250 w-N. 319 Wyoming St. (82301). (307) 324-2711. Korral Radio Inc. (acq 3-1-68). Net: ABC/C, ABC/I, IMN. ■ Ralph W. Sterling, pres; Dorothy Sterling, gen mgr; Phillip Trotter, prod and mus dir; Donald Britton, news dir; La Monda Treick, prom mgr.

William A. Estline, Inc.
31 CARROLL COURT
SAN RAFAEL, CALIFORNIA 94903
(415) 479-0717
MEDIA BROKERS - CONSULTANTS

Riverton

***KCWC(FM)**—March 1974: 88.1 mhz; 10 w. Ant 50 ft. Central Wyoming College (82501). (307) 856-9291. Central Wyoming College. Net: NPR. Format: Diversified. Spec prog: Farm. ■ Duncan Harvey, assoc prof of radio-TV.

KVOW—July 2, 1948: 1450 khz; 1 kw-D, 250 w-N. Box 393 (82501). (307) 856-2251. Riverton Broadcasting Co. (acq 4-1-61). Net: ABC/I, Intermountain. Rep: Eastman. Format: C&W, MOR. ■ Tony A. Kehl, pres & gen mgr; Rick Scott, prod dir; Larry Hedrick, news dir; Jeff Kehl, chief engr; Jim Dabney, coml mgr. ■ Rates: \$4.85; 4; 4.85; 4.

Rock Springs

KRKK—1938: 1360 khz, 1 kw-D, 250 w-N. Box 2128 (82901). (307) 362-3793. Media West Inc. (acq 8-7-4). Rep: Eastman. Format: Contemp, Top 40, C&W. ■ William J. Luzmore III, gen mgr.

Sheridan

KROE—March 18, 1961: 930 khz, 1 kw-D, Box 3048 (82801). (307) 674-4323. Sheridan Communications Co. (acq 11-20-74). Net: CBS. Rep: Meeker; Hix. Format: Top 40. Spec prog: Polish 1 1/2 hrs wkly. ■ Kim Love, pres and gen mgr; Jean Mock, coml mgr; Zeke Holst, prod and mus dir; Terry Lloyd, prom mgr; Jim Malen, news dir; Frank Rosenthal, chief engr. ■ Rates: \$4; 4; 4.

KWYO—July 9, 1934: 1410 khz, 1 kw-D, 500 w-N. Wycom Inc. (group owner; acq 6-1-75). Net: ABC/I, Intermountain. Rep: RKO; IMN. Format: C&W, oldies, MOR. Spec prog: Classical, 5 hrs wkly. ■ William Sims, pres; Donald R. Hargis, gen mgr; FC Taggart, coml mgr; Thomas J. Couch, prod and mus dir; Dale Sichel, prom mgr; Richard W. Anderson, news dir; Doug Ryan, chief engr. ■ Rates: \$4.50; 3.50; 3.50; 3.50.

Thermopolis

KRTR—1955: 1490 khz; 250 w-U. 500 Arapahoe St. (82443). (307) 864-2351. Mildred V. Ernst. Net: Monarch Sports. Format: MOR. ■ Mildred V. Ernst, pres; Charles Bauer, prod dir; Karl V. Kertson, chief engr.

KTHE—April 1957: 1240 khz; 1 kw-D, 250 w-N. Box 591 (82443). (307) 864-2119. Big Horn Basin Bcstg Co. (acq 6-1-72). Rep: Hix. Format: Modern C&W. ■ James A. Ostby, pres, gen mgr; & chief engr; Donna M. Ostby, prod dir; Marland Jordan, mus & news dir.

Torrington

KGOS—May 15, 1950: 1490 khz; 1 kw-D, 250 w-N. Box 670 (82240). (307) 532-2158. Kermit G. Kath (acq 3-1-56). Net: ABC/I, IMN. Format: MOR, variety. Spec progs: Sp 1 hr, C&W 18 hrs, Farm 12 hrs wkly. ■ Kermit G. Kath, gen mgr; Bill Law, coml mgr; Bob Francom, prod dir; Evelyn Graham, prom mgr; Keith Lewis, news dir; Greg Kath, mus dir; Bob Hinze, chief engr.

Wheatland

KYCN—Nov 16, 1960: 1340 khz; 250 w-U. Box 250 (82201). (307) 322-3883. Pioneer Bcstg Inc. (acq 7-1-63). Format: MOR Hymns, C&W, rock. ■ Grover D. Allen, pres, gen & coml mgr & news dir; Charlesa M. Allen, prod dir; L. L. Stoffel, chief engr. ■ Rates: \$3; 3; 3; 3.

Worldan

KWOR—March 7, 1946: 1340 khz; 1 kw-D, 250 w-N. Box 409 (82401). (307) 347-3231. KWOR Inc. (acq 6-7-4). Net: ABC/I, IMN. Format: MOR, C&W. ■ Tony A. Kehl, pres; Ken R. Brown, gen, coml & prom mgr and chief engr; Ron Thiel, prod, mus & news dir.

Guam

Agana

KATB—1975: 570 khz; 5 kw-U. 12225 E. Beverly Blvd., Whittier, Calif. (90608). Far East Bcstg Co. ■ Dr. Eugene R. Berterman.

KMAI—Not on air, target date unknown: 720 khz; 10 kw-U., Box 2890 (96910). Guam Broadcasting Co.

KSTO(FM)—Sept 1973: 95.5 mhz; 2.6 kw. Ant 47 ft. (CP: 802 w. Ant 474 ft.). Box 8637, Tamuning (96911). 772-8614. Claude F. Shouse Jr. (acq 5-7-4). Net: ABC/E. Format: Contemp, MOR. ■ Claude F. Shouse Jr., gen mgr; Jack W. Rowsey, sis mgr.

KTWG—1975: 770 khz; 10 kw-U. c/o Dr. Paul E. Freed, 560 Main St., Chatham, N.J. (07926). Trans World Radio Pacific. ■ Dr. Paul E. Freed, pres; Rev. Milton G. Frazier, V chmn.

KUAM—March 14, 1954: 610 khz; 10 kw-D, 1 kw-N. Telex 721142. Box 368 (96910). 777-9861. Pacific Bcstg Corp. (acq 6-1-64). Net: CBS, NBC. Rep: Intercontinental Services Ltd. ■ H.S. Killgore, pres; Wm. B. Nielson, exec VP; Russell A. Greer Jr., gen mgr; Patricia Clymer, prod dir; FH. Mullen, prom mgr; Rosario Camacho, pub affairs mgr; James D. Martin, chief engr.

KUAM-FM—Sept 1, 1966: 93.9 mhz; 3.9 kw. Ant 77 ft. Prog sep from AM. ■ KUAM-TV affil.

***KUFE**—Not on air, target date unknown: 940 khz; 10 kw-U. 12225 E. Beverly Blvd., Whittier, Calif. (90608). Far East Bcstg Co. ■ Dr. Eugene R. Berterman, exec dir.

AFRTS stations

The U.S. Armed Forces Radio and Television Service operates radio stations in Guam at the following locations:

Andersen—1300 khz; 0.5 w.
Andersen—1090 khz; 6 w.
Andersen (FM)—89.5 mhz; 17 w.
Barrigada—1460 khz; 25 w.
Finegayan—1550 khz; 25 w.
Naval Air Station—1360 khz; 25 w.
Naval Magazine—1340 khz; 25 w.
Naval Station—1300 khz; 25 w.
Nimitz Hill—1240 khz; 25 w.
S. Finegayan Housing—1590 khz; 25 w.
U.S. Naval Facility—1600 khz; 25 w.

Puerto Rico

Aguada

WRFE(FM)—1975: 105.5 mhz; 190 w. Ant 980 ft. 846, Bo. Piedras, Blancos, Aguada (00602). Aurio Matos.

Aquadilla

WABA—Nov 15, 1951: 850 khz; 500 w. Box 188-Victoria Station (00603). (809) 891-1230. Aquadilla Radio & TV Corp. Inc. (acq 1973). Net: Cadená Radio El Mundo. Rep: Inter-American Publications; Promociones Max Muniz. Format: Contemp. ■ Hector Reichard, pres; Pilo Hernandez, gen, coml & prom mgr;

Wyoming, Guam, P.R. Radio

See page C-1 for explanation of listings.

Alex Hernandez, prod dir; Jose Hernandez, chief engr.

WIVA-FM—Co-owned with WABA. April 16, 1964: 100.3 mhz; 15 kw. (CP:50 kw) Ant 1,000 ft. Stereo. Prog sep from AM.

WTPM(FM)—May 27, 1971: 92.9 mhz; 17.5 kw. Ant 980 ft. Stereo. Box 647 (00603). (809) 891-0897. Ricardo Vega. Format: MOR. Spec progs: English 1 hr, classcl 1 1/2 hrs wkly. ■ Ricardo Vega, pres, gen mgr & chief engr; Santiago Sud-Mendez, coml mgr; Loida Quinones, prod & news dir; Dimas Ruiz, prod dir; Carmen L. Vega, mus dir. ■ Rates: \$1.75; 1.75; 1.75.

WUNA—1956: 1340 khz; 250 w-U, Box 809 (00603). (809) 891-2312. Noroeste Bcstg Corp. ■ William Carpenter, pres; Frank Arredondo, gen mgr; Guillermo Mota, coml mgr; Odarit V. Tirado, prod dir; Ronald T. Cushing, chief engr.

Arecibo

WCMN—June 24, 1947: 1280 khz; 5 kw-D, 1 kw-N. Box 436 (00612). (809) 876-0070. Caribbean Bcstg Corp. Format: Progs. ■ Carlos Esteve, pres; Byron Mitchell, gen mgr; Rafael Gonzalez, prod dir; Marie Maldonado, news dir; Carlos Arroyo, chief engr. ■ Rates: \$2.55; 2.55; 2.55; 2.55.

WCMN-FM—Jan 1, 1967: 107.3 mhz; 50 kw. Ant minus 135 ft. (CP: 25 kw horiz, 1.55 kw vert. Ant 135 ft). Stereo. Prog sep from AM. ■ Rates same as AM.

WMIA—Feb 21, 1957: 1070 khz; 500 w-U. Box 1055 (00612). (809) 878-1275. Abacoa Radio Corp. group owner: Piralio Lopez Stns. ■ Carlos M. Piralio, pres; Epilanio Rodriguez-Velez, gen & coml mgr; Miguel Melendex de la Rosa, prod & news dir; Manuel Piralio, prom mgr; Francisco Santiago, chief engr.

WNIK—1230 khz; 1 kw-D, 250 w-N. 462 Jose de Diego Ave., Box 908 (00613). (809) 878-1366. Arecibo Radio Corp. ■ M. A. Cabrera, pres; Frank Velazquez, gen, coml & prom mgr; Angel M. Natal, prod, mus & news dir; Melvin R. Thomas, chief engr.

WNIK-FM—July 17, 1965: 106.5 mhz; 19.5 kw. Ant minus 270 ft. Stereo. Prog sep from AM.

Barceloneta

WBQN—March 1, 1975: 1160 khz; 250 w-U, DA-1. Box 11395 (00617). (809) 846-6155; 6185. WBQN Radio Borinquen. Format: Spanish. ■ Angel M. Rivera, pres; Luis R. Rivera, gen mgr; Ramon Rodriguez, prod dir; Luis Rivera, chief engr. ■ Rates: \$2.50; 2.50; 2.50; 2.50.

Bayamon

WEYA(FM)—Co-owned with WRIA San Juan. Dec 3, 1959: 94.7 mhz; 31 kw. Ant 110 ft. (CP 36 kw. Ant 115 ft). Stereo. 74 Mayaguez St, San Juan (00917). (809) 766-5000. Radio Aeropuerto Inc. (acq 12-31-66). Group owner: Piralio Lopez. Audio news: APR. Format: Btl music. ■ Carlos M. Piralio-Lopez, pres & gen mgr and chief engr; Jose C. Ruiz, prod & news dir; Paulina Burgos, coml mgr. ■ Rates: \$1.06; 1.06; 1.06; 1.06.

WLUC—1966: 1600 khz; 1 kw-U, DA-1. Box 9394, Santurce (00908). (809) 785-1600. Lucas Tomas Muniz. Format: MOR. ■ Lucas Tomas Muniz, own & pres; Herran Nigaghioni, gen mgr; Tomas G. Muniz, coml mgr & prod dir; Manuel Ruiz Martinez, news dir; Rodolfo Rivas, chief engr.

WRSJ

Adult MOR Contemporary

WRSJ—1947: 1560 khz; 5 kw-D, 250 w-N. Box 1560 (00619). (809) 782-6388. P. H. Bcstg Corp. (acq 1974). Audio news: UPI. Rep: Panamerican. Format: MOR. ■ Paul Hernandez Jr., pres; Amaury Santiago, VP, chief engr and gen mgr; Miguel Ortiz, coml mgr; Jose A. Cruz, prod and mus dir; Jose M. Alvarado, chief engr. ■ Rates: \$15.60; 9.75; 10.75; 7.80.

WXYX(FM)—Not on air, target date unknown: 100.7 mhz; 50 kw. Ant minus 45 ft. RAAD Bcstg Corp

Cabo Rojo

WEKO—January 1970: 930 khz; 500 w-D, DA. Cabo

Puerto Rico Radio

See page C-1 for explanation of listings.

Rojo (00623). David Ortiz Radio Corp.

Caguas

WNEI—July 21, 1947: 1430 khz; 5 kw-D, 500 w-N, Box 487 (00625). (809) 744-3131. Turabo Radio Corp. (acq 4-1-73). Format: Top 40. ■ Jesus M. Soto, pres & chief engr; Carmen Pagan, gen mgr; Victor J. Falcon, coml mgr; Luiz R. Leon, prog & mus dir; Jesus M. Ayala, news dir.

WPRM-FM—See San Juan.

WVJP—Nov 24, 1947: 1110 khz; 250 w-U, Box 207 (00625). (809) 743-5790. Borinquen Bcstg Co. ■ Hector Pereira, gen mgr; Jorge L. Arzuaga, coml mgr; Federico Virella, prom mgr; Manuel Rivera Ortiz, prog dir; Vicente Pinero Schroder, news dir; Jesus R. Gomez, chief engr.

WVJP-FM—October 1968: 103.3 mhz; 50 kw. Ant minus 370 ft. Stereo. Progs sep from AM.

Camuy

WCHQ—Oct 23, 1971: 1360 khz; 1 kw-D, 500 w-N, DA-2, Box 458 (00627). (809) 898-2510. Camuy Bcstg Corp. Format: Contemp. ■ Dr. Jesus Rodriguez Garcia, pres; Gilberto Rodriguez, treas; Jose A. Cordero Martinez, sec; Ronald T. Cushing, chief engr.

WCHQ-FM—Aug 15, 1968: 102.9 mhz; 5.9 kw. Ant minus 135 ft.

Carolina

WOLA-FM—Listing follows WVOZ.

WVOZ—March 16, 1964: 1400 khz; 1 kw-D, 250 w-N, Villa Fontana Park (00630). (809) 769-4103. International Bcstg Co. Net: Cadena Radio Voz. Format: Variety. ■ Angel O. Roman, pres; Pichin Roman-Collazo, gen mgr, prog & mus dir; Pedro Roman-Collazo, news dir; Pedro Ramon Roman, prom mgr; Margarita Mazario Espinosa, coml mgr; Jose J. Arzuaga Jr., chief engr.

WOLA-FM—Co-owned with WVOZ. Feb 8, 1967: 107.7 mhz; 30 kw. Ant 89 ft. Prog sep from AM. Suite 1201 Darlington Bldg, Rio Piedras, PR. (00925). (809) 764-1077. Format: Rock. ■ Rolando Sanchez Garcia, prog & mus dir.

Cayey

WLEY—Dec 3, 1965: 1080 khz; 250 w-U, Box 1186. (809) 738-2276. Ponce Bcstg Corp. Rep: Cordero. ■ Charles Cordero, pres & gen mgr; Ramon A. Rodriguez, coml mgr; Rene Poltevin, news dir; Julius H. Conesa, chief engr.

Cidra

WBRQ(FM)—March 1, 1972: 97.7 mhz; 280 w. Ant 860 ft. Box 2 (00639). (809) 743-8260. Arroyo and Fortuno Associates. Net: Cadena Radio X. Format: Progs.v. ■ George M. Arroyo, pres; Tomas Carrasquillo, gen and coml mgr; Janet Ramirez, prog dir; Ruben D. Rodriguez, news dir; Tania Arroyo, mus dir; Rafael Ruiz, chief engr. ■ Rates: \$2.85; 2.85; 2.85; 2.85.

Coamo

WCPR—1967: 1450 khz; 1 kw-D, 250 w-N, Box 316 (00640). (809) 825-1775. Coamo Bcstg Corp. Format: Top 40. ■ Jose David Soler, pres, gen mgr & chief engr; Elliot Ortega, news dir. ■ Rates: \$3.50; 3.50; 3.50; 3.50.

Corozal

WORO(FM)—July 1968: 92.5 mhz; 50 kw. Ant 1010 ft. 208 Eleanor Roosevelt St. Hato Rey (00918). (809) 767-3500. Jose Arturo Fernandez. ■ Jose Arturo Fernandez, pres & chief engr; Francisco Fernandez Rosa, coml mgr.

Fajardo

WMDD—May 31, 1947: 1480 khz; 5 kw-U, Box 948 (00648). (809) 863-0202. Pan Caribbean Bcstg Corp. (acq 6-15-65). format: Music, news ■ Richard L. Friedman, pres & gen mgr; Laura Jimenez, coml mgr; Angel

Luis Vasquez, prog dir; Enrique Alvira, news dir; Carmelo Soto Perez, chief engr.

WMDD-FM—Feb 15, 1969: 96.5 mhz; 6.8 kw. Ant 300 ft. Prog sep from AM. Format: Good music.

Guayama

WXRf—July 1948: 1590 khz; 1 kw-U, Box 600 (00654). (809) 864-2320. Guayama Bcstg Co. Inc. Format: Sp popular. ■ Rafael Fuster Jr., pres; Gumerindo Cordero Jr., gen, prom & coml mgr & prog dir; Gene Retske, chief engr.

WXRf-FM—November 1966: 106.9 mhz; 50 kw. Ant minus 240 ft. Stereo. Prog sep from AM. Format: MOR. ■ Gene Retske, prog dir.

Hormigueros

WBOZ-FM—Not on air, target date unknown: 92.1 mhz; 3 kw. Ant minus 38 ft. Stereo. c/o Radio Voz, Villa Fontana Park, Carolina (00630). (809) 769-4103 or 769-3185. Southwestern Bcstg Corp. Audio news: UPI. Format: Spanish. ■ Pedro Roman-Collazo, pres, coml mgr, mus & news dir; Pinchin Roman-Collazo, gen & prom mgr, prog dir; Samuel Perez, chief engr.

Humacao

WALO—Feb 11, 1958: 1240 khz; kw-D, 250 w-N, Box C (00661). (809) 852-1230. Ochoa Bcstg Corp. (acq 3-19-70). Format: Diversifd. ■ Efrain Archilla-Roig, pres & gen mgr; Efrain Archilla-Diez, stn mgr & chief engr, Luis A. Gandara, prog dir; Angelo Pen'a Perez, news dir. ■ Rates: \$5; 5; 5.

Isabela

WISA—Oct 19, 1961: 1390 khz; 1 kw-D, 500 w-N, Box W (00662). (809) 872-2680. Radio Noroeste Bcstg (acq 8-3-65). ■ Luis A. Mejia, pres; Samuel Rodriguez, coml mgr; Ronald T. Cushing, chief engr.

WISA-FM—101.5 mhz; 3.3 kw. Ant minus 8 ft. Dups AM 100%.

Juana Diaz

WCGB—Nov 23, 1967: 1050 khz; 1 kw-D, Box 248 (00665). Grace Broadcasters Inc. Format: Religious 25%, MOR. Spec prog: English 2½ hrs wkly. ■ Larry Trumbower, dir & chief engr; Melvin Rivera, gen mgr & prog dir. ■ Rates: \$4.50; 4.50; 4.50; 4.50.

Juncos

WCID—1971: 1460 khz; 500 w-D, DA, Box WW (00666). (809) 734-8060. Juncos Bcstg Co. ■ Ramon A. Rodriguez, pres, gen mgr; Juan Roman Rodriguez, coml mgr; Altigracia Liado, prog dir, prom mgr; Raul Martinez, chief engr.

Luquillo

WZOL(FM)—Not on air, target date unknown: 92.1 mhz; 3 kw. Ant 110 ft. Box 10547, Caparra Heights (00922). Carlos Rivera.

Manati

WMLD(FM)—Listing follows WMNT.

WMNT—1959: 1500 khz; 1 kw-D, 250 w-N, Box 6 (00701). (809) 854-2225. Arecibo Bcstg Corp. (acq 12-30-70). Format: MOR. ■ Jose A. Rivas, pres & prog dir; Pedro Collazo Barbosa, loc mgr; Jose A. Jimenez, coml mgr; Jesus M. Soto, treas & chief engr; Charlie Barbosa, news dir.

WMLD(FM)—Co-owned with WMNT. 1973: 96.9 mhz; 18 kw. Prog sep from AM.

Maricao

WAEL—See Mayaguez.

WAEL-FM—July 1970: 96.1 mhz; 10.5 kw. Ant 1950 ft. Box AE (00708). (809) 832-4560. Progs sep from AM. group owner: Pirralo Lopez. Format: Btlf mus. ■ Rates: \$2; 2; 2; 2.

Mayaguez

WAEL—1949: 600 khz; 1 kw-U, DA-1, Box AE (00708). (809) 832-0600. WAEL Inc. (acq 1957). Group owner: Pirralo Lopez. ■ Manuel Pirralo, pres & gen mgr; Pedro Ojeda, coml mgr. ■ Rates: \$3; 3; 3; 3.

WAEL-FM—See Maricao.

WKJB—Dec 6, 1946: 710 khz; 1 kw-D, 500 w-N, Box 1293 (00708). (809) 832-4585. Radio Station WKJB AM-FM Inc. Rep: Promotores Asociados. Format: Top 40. ■ Jose A. Bechara Sr., pres; Jose A. Bechara Jr., gen mgr; Fain Ramos, coml & prom mgr; Esteban Rosado Baez, news dir; Ismael Lopez, prog & mus dir; Guillermo A. Bonet, chief engr.

WKJB-FM—Jan 15, 1963: 99.1 mhz; 13.3 kw. Ant minus 10 ft. Stereo. Prog sep from AM. Format: Rock.

WORA—May 12, 1947: 760 khz; 5 kw-U, DA-1, Box 43 (00708). (809) 832-1150. Radio Americas Corp. Group owner: Quality Bcstg. Net: Radio P.R. Rep: Island Network. Format: Top 40. ■ Alfredo R. de Arellano Jr., pres; Jose A. Sepulveda, gen, coml & prom mgr; Nelson Rios, prog & mus dir; Nelson Nin Lugo, chief engr.

WORA-FM—Oct 12, 1947: 97.5 mhz; 25 kw. Ant 990 ft. Prog sep from AM. Format: English 100%. ■ David Saxon, asst mgr for FM. ■ WORA-TV affil.

WOYE-FM—Co-owned with WFBA San Sebastian. June 13, 1967: 94.1 mhz; 20 kw. Ant minus 160 ft. Box 1360 (00708). (809) 832-1292. Pepino Bcstg (acq 1974). Rep: Schellenberg. Spec prog: Sp 16 hrs wkly. ■ Felix Bonnet Velez, owner.

WPRA—Oct 16, 1937: 990 khz; 1 kw-U, Box 1869 (00708). (809) 832-3020. WPRA Inc. Format: Variety. ■ Andres Camara, pres; Ederlinda C. de Tamayo, gen & prom mgr; Virginia Di Cristina, coml mgr; Wilfredo Padilla, prog dir; Antonio Rosas Rosado, mus dir; Jorge Silvestry Torres, news dir; Guillermo A. Bonet, chief engr.

WRPC(FM)—Co-owned with WPRA. See San Germain.

WTIL—November 1950: 1300 khz; 1 kw-U, Box 1360 (00708). (809) 832-1291. Mayaguez Radio Corp. (acq 6-52). Rep: Svend A. Schellenberg Associates Inc. ■ Gilbert Mamary, pres & gen mgr; Alberto Basora, coml mgr; Rafael Colon Diaz, prog dir; Hermes Matos, news dir; Aristides Zapata, chief engr.

Penuelas

New AM—Not on air, target date unknown: 1570 khz; 1 kw-D, T 56 Las Delicias, Ponce (00731). Penuelas Bcstg Corp. Format: Variety.

Ponce

***WEUC**—1957: 1420 khz; 1 kw-U, Station 6, Catholic U. of Puerto Rico (00731). (809) 842-2031. Catholic University Service Assn. ■ Edwin Rosado, gen mgr; Pedro Lugo, coml & prom mgr; Juan Ricart, prog dir; Zaham Rubio, asst dir; Nestor Figueroa, news dir; Carlos Arrou, chief engr.

WISO—Sept 15, 1953: 1260 khz; 1 kw-U, Box 2023 (00732). (809) 843-4124. South P.R. Bcstg Corp. Group owner: Pirralo Lopez. ■ Luis E. Freyre, pres & coml mgr; Radames Mayraol, prog & news dir; Modesto Delgado, chief engr.

WLEO—Nov 3, 1956: 1170 khz; 250 w-U, Box 38, Ponce Playa (00731). (809) 842-3038. Ponce Bcstg Corp. Rep: Inter-American Publications; Hermidas. Format: Contemp. ■ J. H. Conesa Sr., pres; J. H. Conesa Jr., gen mgr; Ricardo Velez, prog dir; Gilberto Santiago, chief engr. ■ Rates: \$5.50; 5.50; 5.50; 3.58.

WZAR(FM)—Co-owned with WLEO. March 17, 1966: 101.9 mhz; 11.5 kw. Ant 2,580 ft. Stereo. Prog sep from AM. Format: Hit parade, Spanish/English bilinqual. ■ Rates: \$4; 4; 4; 4.

WPAB—Aug 14, 1940: 550 khz; 5 kw-D, 1 kw-N, Box 4469 (00731). (809) 842-3260. Portorican American Bcstg Co. Rep: Schellenberg. Format: MOR. ■ Alfonso Gimenez-Aguayo, pres; Alfonso Gimenez-Porrata, gen mgr. ■ Rates: \$6; 6; 6; 6.

WPAB-FM—May 1969: 93.3 mhz; 14.5 kw. Ant minus 225 ft. Stereo. Prog sep from WPAB. Format: Btlf music. ■ Rates: \$2; 2; 2; 2.

WPRP—1936: 910 khz; 5 kw-D, 500 w-N, Box 430 (00731). (809) 842-0166. Voice of Puerto Rico Inc. (acq 1946). Group owner: Quality Bcstg. Net: Cadena, Quality Bcstg. Format: MOR. ■ Alfredo R. de Arellano Jr., pres; Alfred D. Heger, gen mgr; Miquel Borrero, rec mgr; Albanez Figueroa, prog dir; Carlos Morales, sis mgr; Alfonso Santos, chief engr.

WPRP-FM—January 1970: 105.1 mhz; 9 kw. Ant minus 150 ft. Prog sep from AM.

WZAR(FM)—Listing follows WLEO.

WZBS—Feb 1, 1973: 1490 khz; 1 kw-D, 250 w-N. Box 4512 (00731). (809) 843-8110. Zaba Radio Corp. Spec prog: English 5 hrs wkly. ■ Dr. Rene Bartolomei, pres; Dr. Humberto Zayas Chardon, gen mgr; Carlos M. Torres, coml & prom mgr, prog & mus dir; Carlos Arroyo, chief engr.

Quebradillas

WREI(FM)—Nov 16, 1974: 98.3 mhz; 3 kw. Ant minus 40 ft. Box 6495, Santurce (00914). (829) 895-3725. Arzuaga & Davila Associates. Net: Cadena Radio X. Format: Oldies, progs. ■ Jose J. Arzuaga Jr., pres, gen mgr, & chief engr; Roberto Davila, Emely Rios, prom mgrs; Rafael Serra, news dir; Elliot Gonzalez, coml mgr; Jose Sanchez, prog dir; Pedro Emilio Nolla, mus dir.

Rio Piedras

WFID(FM)—Nov 17, 1958: 95.7 mhz; 30 kw. Ant 3 ft. Stereo. Box 20079 (00928). (809) 767-7018. Fidelity Bcstg Corp.

WRAI—See San Juan.

WUNO—See San Juan.

Salinas

WHOOY—April 6, 1967: 1210 khz; 1 kw-D. Box 427 (00751). (809) 824-3420. Island Broadcasting Corp. ■ Johnny Ortiz, pres & chief engr; Wito Morales, gen. coml & prom mgr, prog & news dir.

San German

WPRA—See Mayaguez.

WRPC(FM)—Co-owned with WPRA. Feb 1, 1969: 95.1 mhz; 50 kw. Ant minus 140 ft. Box 1869, Mayaguez (00708). (809) 892-1520. WPRA Inc. (acq 5-10-73). Progs sep from AM. Format: Popular. ■ Andres Camara, pres; Wilfredo Padilla, gen mgr & mus dir; Pedro Velez, chief engr.

WRSQ—1090 khz; 250 w-U. (00753). Southwestern Bcstg Corp.

San Juan

WAPA—Jan 15, 1947: 680 khz; 10 kw-U, Box 4563 (00905). (809) 724-3000. Hearst Radio Inc. (group owner; acq 3-17-64). Format: Contemp. ■ Franklin Snyder, pres; Ray Owen, gen mgr; Jose Bonilla, coml mgr; Francisco Aranzamendi, prog dir; Jose Ramon Diaz, news dir; Miguel Triay, chief engr

WBMJ—1968: 1190 khz; 10 kw-D, 5 kw-N, DA-1. Penthouse One, Boringuen Hotel (00907). (809) 724-1190. Mid-Ocean Bcstg Co. Format: Contemp. ■ James L. Saphier, pres; Bob Bennett, gen mgr; Bill Johnson, coml mgr; Rudy Rivas, chief engr.

WCAD-FM—Listing follows WKVM.

WHOA—Nov 1, 1954: 870 khz; 5 kw-U, DA-1. Box V (00919). (809) 765-8700. Continental Bcstg Corp. Net: ABC/1 & NBC. Format: MOR, Contemp, English. ■ Carmina Mendez, pres & gen mgr; Vincent J. Polley, mgr & coml mgr; Bob Miller, mus dir; W. Blanco Pi, chief engr; Mike Cooney, prod dir; Mary Novak, info specialist; Marcia Gold, women's editor.

WIAC—1947: 740 khz; 10 kw-U, DA-1. Box 4504 (00905). (809) 724-0730. Bestov Bcstg Inc. of Puerto Rico (acq 1954). Format: Talk. ■ Luis S. Mejia, pres; Luis A. Mejia, gen mgr; Mrs. Elsa Fernandez, coml mgr; Wilfredo Lopez, prog dir; Enrique Cruz, mus dir; Francisco Cancel, news dir.

WIAC-FM—March 1, 1961: 102.5 mhz; 91 kw horiz, 53 kw vert. Ant 310 ft. Stereo. Prog sep from AM. Format: Rock, underground, English. ■ George J. Ward, coml mgr, prog & mus dir.

***WIPR**—Jan 26, 1948: 940 khz; 10 kw-U, DA-1. Box 909, Hato Rey (00919). (809) 766-5701. Dept of Education, Puerto Rico. ■ Mrs. Celeste Benitez de Rexach, sec of educ; Jose M. Garcia, gen mgr; Felix Rodriguez Baez, prog dir; Luisita Rodriguez, mus dir; Jose Manuel Alvarez, news dir; Manuel A. Collazo, chief engr.

***WIPR-FM**—June 3, 1960: 91.3 mhz; 125 kw. Ant 2720 ft. Dups AM 100%. ■ *WIPR-TV affil.

WKAQ—Dec 3, 1922: 580 khz; 5 kw-U, Box 4668 (00936). (809) 764-0580. Telex 385751. El Mundo Bcstg Corp. (acq 10-31-49). Rep: Inter-American Publications. Format: Top 40. ■ Mrs. Argentina Hills, pres; Reinaldo Royo Jr., gen mgr; Ivan Vazquez, coml mgr; Jose Juan Ortiz, prog dir; Raul Muxo, sls mgr; Jose Arzuaga, chief engr.

WKAQ-FM—Oct 8, 1958: 104.7 mhz; 50 kw. Ant 1,120 ft. Stereo. Dups AM 17%. ■ WKAQ-TV affil.

WKVM—1951: 810 khz; 25 kw-U, DA-1. Box 4189 (00907). (809) 722-0151. American Colonial Bcstg Corp. (group owner). Format: Progressive, R&B, variety. ■ Ralph Perez Perry Sr., pres; Ralph Perez Perry Jr., gen mgr; Rafael Garcia Roig, coml mgr; Georgina Rivera, prog dir; Luis Rivera, mus dir; Nestor Varas, news dir; Jose Alfredo Puras, chief engr.

WCAD-FM—Co-owned with WKVM. 105.7 mhz; 50 kw. Ant 1,100 ft. ■ WKVM-TV affil.

WNEL—See Caguas.

WPRM-FM—April 1959: 98.5 mhz; 25 kw. Ant 1910 ft. Stereo. Box 487 (00906). (809) 744-3131. ARSO Radio Corp. (acq 4-1-73). Format: Btl mus. ■ Jesus M. Soto, pres, gen mgr & chief engr; Victor J. Falcon, coml mgr; Manuel Rivera Orla, prog & mus dir, prom mgr; Jose A. Lebron, news dir.

WQBS—Jan 11, 1960: 630 khz; 1 kw-U, DA-N (CP: 5 kw-U, DA-1). Box 9986, Suite 1513 1st Federal Bldg., Santurce (00908). (809) 725-4020. Quality Broadcasting Corp. of San Juan (group owner; acq 12-1-60). Format: MOR. ■ Alfredo Ramirez de Arellano, pres; Alfred D. Herger, gen mgr & mus dir; Ismael Nieves & Rita Seda, coml mgrs; Wilson Laracuente, prom mgr; Pedro Ruiz Lopez, prog dir; Nephthali Rodriguez, news dir; Edmund Reid, chief engr.

WQBS-FM—March 1, 1961: 99.9 mhz; 32 kw. Ant 180 ft. Dups AM 25%.

WQII—1947: 1140 khz; 10 kw-U, DA-1. Box 101, Guaynabo (00057). (809) 790-5001. Metro Bcstg Co. Inc. (acq 1969). Format: Top 40. ■ David F. Gleason, gen mgr; Wilma Mendoza, asst mgr; Danny Garcia, coml mgr; Saul Maldonado, ops mgr; Jaime Marzan, news dir; Grafton Olivera, chief engr. ■ Rates: \$14; 12; 14; 12.

WSRA(FM)—Co-owned with WQII. 93.7 mhz; 50 kw. Ant 6 ft. (CP: Ant 260 ft). Stereo. Prog sep from AM. Format: Btl mus. ■ Rates: \$4; 4; 4; 4.

WRAI—July 4, 1949: 1520 khz; 10 kw-U, DA-1. 74 Mayaguez St. (00917). (809) 766-5000. Radio Aeropuerto Inc (acq 12-3-59). Group owner: Piralto Lopez. Rep: Contemporary Media. Format: Rock, English. ■ Carlos M. Piralto, pres; Bob Norman, gen & coml mgr; Dave White, prog & mus dir; Tom Sherwood, news dir; Rafael A. Valdes, chief engr.

WEYA(FM)—Co-owned with WRAI. See Bayamon.

WRSJ—See Bayamon.

WUNO—Oct 15, 1949: 1320 khz; 5 kw-D, 1 kw-N. Box Q, Hato Rey (00919). (809) 765-4720. San Juan Bcstg Corp. (acq 5-1-70). Group owner: Mooney. Format: Top 40. ■ George P. Mooney, pres; Virginia P. M. Meyer, gen mgr; Manuel Rivera Morales, coml mgr; Luis Antonio Cosme, news & prog dir; Valentin Montanez, chief engr.

New AM—Not on air, target date unknown: 1030 khz; 10 kw-U. Box 13573, Santurce (00908). Cavallaro Bcstg Corp. Format: MOR.

San Sebastian

WFBA—Feb 15, 1965: 1460 khz; 500 w-U. Box CC (00755). (809) 896-1024. Pepino Broadcasters Inc. Format: Variety. ■ Felix Bonnet-Velez, pres, gen mgr; William Rivera, coml mgr; Felix Bonnet, prog dir & prom mgr; Guillermo Bonet, chief engr.

WOYE(FM)—Co-owned with WFBA. See Mayaguez.

Utua

WUPR—April 18, 1964: 1530 khz; 1 kw-D, 250 w-N. Box 868 (00761). (809) 894-2460. Central Bcstg Corp. ■ Roberto Martinez, pres; Beniot Martinez, gen mgr & news dir; Melvin T. Villanueva, mus dir; Ricardo

Puerto Rico, V.I. Radio

See page C-1 for explanation of listings.

L. Segarra, coml mgr & prog dir; Pablo Llerandi, prom mgr; Roberto A. Salva, chief engr.

WUPR-FM—Feb 1, 1970: 104.1 mhz; 50 kw. Ant 710 ft. Stereo. Prog sep from AM.

Vega Baja

WEGA—1972: 1350 khz; 500 w-D, DA (CP 500 w-U, DA-2). (00763). (809) 858-2575. Vega Broadcasting Co.

Vieques

WIVV—Dec 8, 1956: 1370 khz; 5 kw-D; 1 kw-N. Box A, San Juan (00936). (809) 761-4242. Calvary Evangelistic Mission Inc. Format: Relig, entertainment, English. Spec prog: Sp 6 hrs wkly. ■ Donald D. Luttrell, pres & gen mgr; Ruth Luttrell, coml mgr; Janet Luttrell, prog dir; John Hill, chief engr.

WZVS-FM—Not on air, target date July 1, 1976: 98.9 mhz; 50 kw. Ant 952 ft. Stereo. Box 3282, San Juan (00904). (809) 723-5814. Carlos J. Colon-Ventura. Net: Cadena Radio X. Format: Jazz, progs. ■ Carlos J. Colon-Ventura, pres; Rafael Valle-Valle, gen mgr; Nydia Rios, coml mgr; Jose Carlos Colon, prog dir; Raisacc Colon, mus dir; Kenneth A. Colon, prom mgr; Carlos Colon-Avila, news dir; Jose Sanchez, chief engr. ■ Rates: \$3; 3; 3; 3.

Yabucoa

WXEW—May 8, 1975: 840 khz; 250 w-D.

Yauco

WKFE—Nov 3, 1961: 1550 khz; 250 w-U. Box 324 (00768). (809) 856-1320. Ponce Bcstg Corp. Rep: Cordero. Format: MOR. ■ Charles Cordero, pres & gen mgr; Jaime Bermudez, stn mgr; Frankie Rodriguez, news dir; J. H. Conesa, chief engr.

AFRTS stations

The U.S. Armed Forces Radio and Television Service operates radio stations in Puerto Rico at the following locations:

Ft. Allen—1200 khz; 5 w.
Ft. Allen (FM)—90.5 mhz; 60 w.
Ramey AB (FM)—90.5 mhz; 15 w.
Roosevelt Roads —1200 khz; 50 w.
Roosevelt Roads (FM Stereo)—90.5 mhz; 250 w.
San Juan/Ft Buchanan —1040 khz; 50 w.
San Juan/Ft Buchanan (FM)—90.5 mhz; 350 w.
Vieques Island/Camp Garcia (FM)—89.5 mhz; 10 w.

Virgin Islands

Charlotte Amalie

WIBS(FM)—Not on air, target date unknown: 97.9 mhz; 5.78 kw. Ant 1,355 ft. Arrouo & Figueroa Assoc.

WSTA—Aug 1, 1959: 1340 khz; 250 w-U. Box 489, St. Thomas (00801). (809) 774-1340. V.I. Industries Inc. (acq 3-24-61). Net: MBS, NBC. Rep: T.I.E. States Ltd.; Schellenberg & Kirwan. Format: Diversified. Spec prog: Talk 18 hrs wkly. ■ William O'Neil, pres; Big Saul, gen mgr; Irvin Brown, prog dir; Ray Jones, mus dir; Ron Martin, news dir; Karp Niel, chief engr. ■ Rates: \$8.40; 6.40; 6.40; 4.40.

WVVI—Nov 19, 1962: 1000 khz; 1 kw-U. Box 5170, St. Thomas (00801). (809) 774-1000. Thousand Islands Corp. (acq 5-15-70). Net: CBS. Format: Contemp/MOR. Spec prog: Calypso 5 hrs wkly. ■ Robert E. Noble, pres & gen mgr; Lawrence A. (Rick) Ricardo, stn mgr; Gene Francis, prog dir; Harvey Henne, sls mgr; Lee Carle, news dir. ■ Rates: \$10; 6-8; 10; 6.

Christiansted

WIVI-FM—May 17, 1965: 99.5 mhz; 4.9 kw. Ant 205 ft. Box 310, St. Croix (00820). (809) 773-0347. H.R.H. Inc. (acq 1974). Net: Virgin Islands Network. Rep: Pan American Bcstg Co. Format: MOR.

V.I., Samoa, Micronesia Alberta Radio

See page C-1 for explanation of listings.

WSTX—1952: 970 khz; 5 kw-D, 1 kw-N. Box 428 (00820). (809) 773-0390. Virgin Islands Bcstg Corp. ■ William M. Carpenter, pres; William de la Cruze, VP; Ruth J. Carpenter, gen mgr; Bill Thompson, prog dir; Herbert Schoenbohm, chief engr.

Frederiksted

WRRR—Not on air, target date unknown: 1290 khz; 500 w-D, DA. (00840). ■ Carlos A. Lopez-Lay.

WVIS(FM)—June 10, 1973: 106.1 mhz; 5.8 kw. Ant 830 ft. Stereo. Box 1403, Saint Croix (00840). (809) 772-0968. Bahr & Arroyo Assoc. Net: Cadena Radio X. Rep: Ochs. Format: Black, jazz. ■ Joseph Bahr, pres & chief engr and coml mgr; George Arroyo, VP; Julio Bahr, gen mgr; Ken Webb, prog dir; Tee Reid, mus and news dir; Joseph Ramirez, prom mgr.

American Samoa

Leone

WVUV—April 16, 1975: 1120 khz; 10 kw-U. Box 280, Pago Pago (96799). 688-7511. Radio Samoa Ltd. Net: CBS. Format: Diversified; ½ English, ½ Samoan. ■ Lawrence S. Berger, pres; Ronald E. Pritchard, gen mgr; Julie Burford, prog dir; Muaitofiga F. Lutu, news dir; Sam Hall, chief engr. ■ Rates: \$4.50; 3.60; 4.50; 3.60.

Micronesia

(Trust Territory of the Pacific)

Micronesia Broadcasting Service—Saipan (96950). Elias H. Thomas, dir. Government-owned.

noncommercial, operating the following stations:

WSZB Koror—1500 khz; 1 kw. (96940).

WSZO Majuro—1440 khz; 10 kw. (96960).

WSZD Ponape—1450 khz; 10 kw. (96941).

KJQR Saipan—1350 khz; 1 kw. (96950).

WSZC Truk—1300 khz; 5 kw. (96942).

WSZA Yap—1480 khz; 1 kw. (96943).

AFRTS stations

The U.S. Armed Forces Radio and Television Service operates radio stations in Micronesia at:

Kwajalein—1220 khz; 1 kw.

Kwajalein (FM)—100 mhz; 1 kw.

AFRTS stations elsewhere in U.S. Pacific Territory:

Phoenix Islands

Canton Island—1385 khz; 250 w.

Midway Island—920 khz; 250 w.

Wake Island—1490 khz; 50 w.

Canada

Note: Unless indicated as French (Fr), programming is in English on Canadian stations in all provinces except Quebec. In Quebec, programming is in French unless shown as English (Eng). Due to Canada's geographic expanse, several Canadian stations have affiliates on shortwave (sw) frequencies for domestic broadcasting. In all cases they duplicate the AM station programming 100%.

Format: Btfl mus. Spec prog: Classcl 18 hrs, jazz 7 hrs, wkly.

Camrose

CFCW—Nov 2, 1954: 790 khz; 50 kw-U, DA-2. 4872 50th St. (T4V 1P8). (403) 672-3151. Telex 037-2656. CFCW Radio Ltd. Rep: Weed/Walton (U.S.); Unicom, Western Bcst Sls (Canada). Format: C&W. Spec prog: Uk 6 hrs wkly. ■ H. J. Yerxa, pres; W. H. Holte, VP, gen & coml mgr; Rich Sims, prog dir.

Cold Lake

CHCL—1956: 1450 khz; 40 w-U. Box 1220 (T0A 2M0). (403) 594-4449. Col. James F. Dunlod.

Drumheller

CJDV—1958: 910 khz; 5 kw-U, DA-2. Box 1480 (T0J 0Y0). (403) 823-3384. Telex 03-84226. Dinosaur Bcstg (1957) Ltd. Audio news: BN. Rep: A. McDermott (Toronto); Paul McDermott (Montreal). Format: C&W. ■ Tony Mayer, pres; James L. Fisher, gen mgr; Winnie Streit, coml mgr; George Walters, prog dir.

Edmonton

CBX—1948: 740 khz; 50 kw-U, DA-2. Box 555 (T5J 2P4). (403) 469-2321. Telex 0372-287. CBC. ■ D. Field, stn mgr.

CFRN—1934: 1260 khz; 50 kw-U, DA-N. Broadcast House Box 5030 Postal Station "E" (403) 484-3311. Sunwapta Bcstg Ltd. ■ G. R. A. Rice, pres; T. Coumant, mgr.

CFRN-FM—July 13, 1964: 100.3 mhz; 16.2 kw. Ant 375 ft. Prog sep from AM. Stereo.

CHED—March 4, 1954: 630 khz; 10 kw-U, DA-2. CHED Ltd. ■ Jerry Forbes, gen mgr.

CHFA—(Fr) Nov 23, 1949: 680 khz; 5 kw-U, DA-1. Box 555 (T5J 2P4). (403) 424-2157. CBC. Net: CBC. Format: Educl, pub affrs. ■ Guy Pariseau, gen mgr & prog dir.

CHQT—Aug 19, 1965: 1110 khz; 10 kw-U, DA-N. 10154 103rd St. (T5J 0X7). (403) 424-1131. Telex 037-2503. CHQT Bcstg Ltd. (acq 5-1-72). Format: Easy Istng. ■ Lewis R. Roskin, pres & gen mgr; Bill Bagshaw, coml mgr; Bob Bradburn, prog dir.

CJCA—May 22, 1922: 930 khz; 10 kw-D, 5 kw-N, DA-N. 10230 108th St. (T5J 2X3). (403) 423-4930. Telex 037-2229. Edmonton Bcstg Co. Ltd. Format: MOR. ■ J. T. Strain, gen mgr.

CJCA-FM—1949: 97.3 mhz; 100 kw.

***CKUA**—Nov 21, 1927: 580 khz; 10 kw-U, DA-2. 10526 Jasper Ave (T5J 1T7). (403) 422-5161. Telex 037-3948. Alberta Educl Communications Corp. (acq 4-1-74). ■ J. W. Hagerman, mgr.

***CKUA-FM**—June 28, 1948: 98.1 mhz; 352 w. Ant 113 ft. Dups AM.

Edson

CJYR—April 4, 1968: 970 khz; 10 kw-U, DA-1. Box 1450 (T0E 0P0). (403) 723-4461. Yellowhead Bcstg Ltd. Format: MOR, C&W, Top 40, oldies. ■ Ernie Mushtuk, pres; Chuck Benson, gen mgr; Gail Johnston, coml mgr; Wax Williams, prog dir.

Fort McMurray

CJOK—1973: 1230 khz; 1 kw-D, 500 w-N. Box 3000 (T0A 1K0). Charest Communication Ltd.

Grande Prairie

CFGP—Nov 2, 1937: 1050 khz; 10 kw-U, DA-1. 10008 103d Ave. (T8V 1B8). (403) 532-1050. Northern Bcstg Ltd. ■ W. Everitt, pres & gen mgr.

Jasper

CKYR—Co-owned with CJYR Edson. Feb 19, 1970: 1450 khz; 100 w. Box 1450, Edson, Alberta (T0E 0P0). (403) 723-4461 (Edson). Yellowhead Bcstg Ltd. Dups CJYR.

Lethbridge

CHEC—1959: 1090 khz; 5 kw-U, DA-2. Box 1090 (T1J 4A3). 329-4144. Southern Alberta Ltd. Audio news: BN. Format: Top 40. Spec prog: Indian news media ½ hr wkly. ■ Ronald J. Bruchet, VP & gen mgr.

CHEC-FM—1959: 100.9 mhz; 250 w. Ant 160 ft. Prog sep from AM.

CJOC—May 10, 1926: 1220 khz; 10 kw-D, 5 kw-N, DA-N. Box 820 (T1J 3Z9). (403) 327-3161. TWX 038-4915. Lethbridge Bcstg Ltd. Audio news: BN. Format: Diversified. Spec prog: Blackfoot Ind. ½ hr wkly. ■ G. Brown, pres & gen mgr. ■ CJOC-TV affil.

Lloydminster

CKSA—April 1, 1957: 1080 khz; 10 kw-U, DA-N. Radio-Television Bldg, 5026 50th St. (S9V 0Z1). (403) 875-3321. Telex 037-32511. Sask-Alta Bcstrs Ltd. ■ Arthur F. Shortell, pres & gen mgr.

Medicine Hat

CHAT—Nov 1, 1946: 1270 khz; 10 kw-U, DA-N. Box 1270 (T1A 7H5). (403) 526-2821. TWX 038-4824. Monarch Bcstg Ltd. Rep: All-Canada. Format: C&W; MOR; Top 40. Spec prog: Ger ½ hr wkly. ■ W.H. Yuill, pres; Orv Kope, gen mgr; Pat O'Connor, prog & mus dir; W. Fieldhouse, coml mgr.

Peace River

CKYL—Nov 1, 1954: 610 khz; 10 kw-U, DA-N. Box 1150 (T0H 2X0). (403) 624-2535. Telex 037-5126. Peace River Bcstg Ltd. (acq 1-60). ■ G. W. Cambridge, pres & gen mgr.

Red Deer

CKGY—1973: 1170 khz; 10 kw-D, 5 kw-N. Box 339

Alberta

Blairmore

CJPR—1972: 1490 khz; 1 kw-D, 250 w-N. Box 780 (403) 542-2806. Lethbridge Bcstg Ltd. Partially dups CJOC Lethbridge.

Brooks

CKBR—1973: 1340 khz; 1 kw-D, 250 w-N. Box 180 (T0J 0J0). (403) 362-3418. Bcstg 1957 Ltd. Format: Farm, C&W. ■ Tony Mayer, pres.

Calgary

CBR—Oct 1, 1964: 1010 khz; 50 kw-U, DA-2. Box 2640 (T2P 2M7). (403) 283-3311. Telex 038-21604. CBC. ■ J. Phillips, stn mgr.

CBR-FM—Sept 29, 1975: 102.1 mhz; 100 kw. Ant 788 ft. Stereo.

CFAC—May 1922: 960 khz; 50 kw-U. 1301 17th Ave. S.W. (T2P 0C5). (403) 244-9311. Telex 038-22514. Calgary Bcstg Co. Format: Town & Country. ■ J. McColl, pres & gen mgr.

CFCN—May 18, 1922: 1060 khz; 50 kw-U, DA-2. Broadcast House Station "E" (T2C 3L9). (403) 249-9101. TWX 038-21637. The Voice of the Prairies Ltd. (acq 1-67). Rep: Stephens & Towndrow (Canada); Weed, Walton U.S. Format: MOR. ■ E. W. Chapman, pres; Norman H. Haines, gen mgr; Clare Johnson, coml mgr; Gord Kelly, prog dir. ■ CFVP affil: 6030 khz; 100 watts.

CHFM-FM—Listing follows CKXL.

CHQR—November 1964: 810 khz; 50 kw-U, DA-2. 830 9th Ave. S.W. (T2P 1L7). (403) 263-5522. TWX Brd Bnd 833-2-561. Radio QR Ltd. (acq 4-15-70). Format: MOR. Rep: Standard Bcst Sls. ■ T. Soskin, pres & gen mgr; G. Walker, gen sls mgr & asst mgr; J. Crane, prog & mus dir.

CKXL—1927: 1140 khz; 10 kw-U, DA-N. Box 1140 (T2P 2M7). (403) 264-8000. Telex 038-21741. Moffat Communications Ltd. (acq 11-22-69). Audio news: BN. Format: Top 40. ■ J. R. Mitchell, pres; Thomas E. McBride, gen mgr.

CHFM-FM—Co-owned with CKXL. Aug 29, 1962: 95.9 mhz; 11 kw. Ant 354 ft. Stereo. Prog sep from AM.

(T4N 5E9). (403) 343-1170. Park Country Bcstg Ltd. Format: Farm, C&W.

CKRD—April 30, 1949: 850 khz; 10 kw-D, 1 kw-N, DA-N. Box 5555 (T4N 5H6). (403) 347-6681. Telex 038-3116. Central Alberta Bcstg (1961) Ltd. Audio news: BN. Format: MOR. ■ H.L. Flock, pres.

CKRD-FM—1965: 98.9 mhz; 1.46 kw. Dups AM 30%. Stereo. Format: Btlf mus. ■ CKRD-TV affil.

St. Paul

CIOK—1975: 1310 khz; 10 kw-U, Box 910 (403) 645-4425. Radio 1310 Ltd. Format: MOR.

Taber

CKTA—1974: 1570 khz; 5 kw-U. Box 2199 (T0K 2G0). (403) 223-4455. Southern Alberta Bcstg Ltd. Format: Town & Country.

Westlock

CFOK—1975: 1370 khz; 10 kw-U. Box 1800. (403) 342-4421. Charest Communications Ltd. Format: MOR.

Wetaskiwin

CJOI—1971: 1440 khz; 1 kw-U, DA-1. Box 1000. (403) 352-6006. Parkland Radio Ltd.

British Columbia

Abbotsford

CFVR—Aug 20, 1962: 1240 khz; 1 kw-D, 250 w-N, DA-N. 2722 Allwood St. (V2T 3R8). (604) 859-5277. Fraser Valley Bcstrs Ltd. Rep: All Canada. Format: Contemp MOR. ■ Dennis Barkman, pres; Bob Singleton, gen mgr; Peter Alpen, coml mgr; Brad Williams, prog dir & prom mgr.

Burns Lake

CFLD—Nov 25, 1965: 1400 khz; 1 kw-D, 250 w-N. Box 600 (V0J 1E0). (604) 692-3414. Telex 047-7119. CFBV Ltd. Audio news: SBN. Format: MOR. Spec progs: Farm 2 hrs, Ger 1 hr wkly. ■ R. A. East, pres; N.C. Weseen, gen mgr.

Campbell River

CFWB—Sept 10, 1963: 1490 khz; 1 kw-D, 250 w-N. 922 Dulbeau St. (604) 287-7106. CFPC Radio Ltd. ■ William Browne, pres; Bob McInnes, gen mgr.

Castlegar

CKQR—Sept 22, 1969: 1230 khz; 1 kw-D, 250 w-N, DA-D. Box 1230 (V1N 1G9). (604) 365-7225. Valley Bcstrs Ltd. Format: C&W; MOR; Top 40. ■ Nick Oglow, pres; Gordon A. Brady, gen mgr; Serge Plotnikoff, coml & prom mgr; Fred Jack, prog & mus dir.

Chilliwack

CHWK—June 23, 1927: 1270 khz; 10 kw-U, DA-N. Box 386 (Y2P 6J7). (604) 795-5711. Fraser Valley Bcstrs Ltd. (acq 1969). Audio news: BN. Format: MOR. Spec progs: Farm 1 hr, Ger 1 hr wkly. ■ Dennis Barkman, pres & mgng dir.

Clearwater

CHNL-1—1400 khz; 1 kw-D, 250 w-N. Rebroadcasts CHNL Kamloops.

Courtenay

CFCP—1959: 1440 khz; 1 kw-U, DA-N. 1595 Cliffe Ave. (604) 334-2421. CFPC Radio Ltd. ■ William Browne, pres; Earl H. Kidder, stn mgr.

Cranbrook

CKEK—Oct 19, 1957: 570 khz; 10 kw-D, 1 kw-N. 28 8th Ave., South (604) 426-2224. E K Radio Ltd. Rep: Group One; Western Bcst Sls. Format: MOR. ■ Lloyd J. Hoole, pres; Cornel A. Sawchuk, gen mgr; Gary D. Cavers, coml mgr; Gerlad Ridgely, prog dir; John Renzie, chief engr.

Creston

CFKC—Sept 21, 1968: 1340 khz; 250 w-U. Box 310 (V0B 1G0). (604) 428-2424. Kokanee Bcstg Ltd. Audio news: SBN. Format: Contemp; C&W; MOR. Spec prog: Farm 2 hrs wkly. ■ G. A. Green, pres; D. H. Glover, gen mgr.

Dawson Creek

CJDC—1947: 1350 khz; 1 kw-U. 901 102d Ave. (V1G 2B6). (604) 782-3341. Telex 049-5727. Radio Station CJDC (Dawson Creek, B.C.) Ltd. Format: Farm, C&W, MOR. ■ CJDC-TV affil.

Duncan

CKAY—October 1964: 1500 khz; 5 kw-D, 1 kw-N. 160 Jubilee St. (V9L 1W7). (604) 746-4115. Radio CKAY Ltd. (acq 5-71). Rep: Group One. Audio news: SBN. Format: C&W. ■ Ernest Mykyte, pres.

Fernie

CFEK—May 3, 1971: 1240 khz; 1 kw-D, 500 w-N. Box 885 (604) 423-4449. E K Radio Ltd. ■ Lloyd J. Hoole, pres.

Fort Nelson

CFNL—Nov 20, 1967: 590 khz; 250 w. Box 880 (604) 774-2525. TWX 049-5338. Telex 036-75116. Northern Lights Bcstg Ltd. (acq 1971). Format: MOR. ■ Gene Daniels, pres; Len Novak, gen & coml mgr, prog dir.

Fort St. John

CKNL—June 1962: 560 khz; 1 kw-U, DA-N. Box 6310. (604) 785-6634. Telex 049-5516. Northern Lights Bcstg Ltd. (acq 1971). ■ George Cambridge, pres; Gene Daniel, mgng dir.

Golden

CKGR—Co-owned with CKXR Salmon Arm. 1400 khz; 1 kw-D, 250 w-N.

Grand Forks

CKGF—June 1969: 1340 khz; 1 kw-D, 250 w-N. Box 1570. (604) 442-8200. Okanagan Radio Ltd. ■ Ken Davis, pres; Wilfred R. Warner, coml, prom mgr & prog, mus dir.

Hope

CKGO—1490 khz; 250 w-U, DA-1. Box 1600 (V0X 1L0). (604) 869-9313. Fraser Valley Bcstrs Ltd. ■ D. C. Barkman, pres.

Kamloops

CFFM-FM—Listing follows CFJC.

CFJC—1927: 910 khz; 10 kw-D, 1 kw-N. 460 Pemberton Terrace. (604) 372-3322. Twin Cities Radio Ltd. ■ D. S. Clark, own & mgr.

CFFM-FM—Co-owned with CFJC. May 21, 1962: 98.3 mhz; 3.9 kw. Ant 469 ft. Prog sep from AM. Stereo. On 5 Translators.

CHNL—May 16, 1970: 610 khz; 10 kw-D, 5 kw-N. Box 610, 611 Lansdowne St. (604) 372-2296. Telex 048-8233. NL Bcstg Ltd. ■ J. Skelly, pres & gen mgr.

Kelowna

CJOV-FM—Listing follows CKOV.

CKIQ—Nov 8, 1971: 1150 khz; 10 kw-D, 1 kw-N. 2419 Hwy 97N. (604) 765-5185. TWX 048-5240. Four Seasons Radio Ltd. Audio news: SBN. Rep: Western; Unicom; Oakes. Format: Contemp, C&W, Top 40. Spec prog: Ethnic 2 hrs wkly. ■ Walter E. Gray, pres & gen mgr; Cliff Kliewer, coml mgr; Bob Harrison, prog dir & prom mgr.

CKOV—Nov 4, 1931: 630 khz; 5 kw-D, 1 kw-N. Box 100 (V1Y 7N3). (604) 762-3331. Okanagan Bcstrs Ltd. Audio news: BN. Format: Talk, MOR. Spec prog: Farm 1 hr wkly. ■ G. T. Browne, pres; David S. Dunn, gen mgr.

CJOV-FM—Partially co-owned with CKOV. 104.7

Alberta, British Columbia Radio

See page C-1 for explanation of listings.

mhz; 3.8 kw. Ant 1611 ft. Stereo. Prog sep from AM. Format: Diversified. ■ B. D. Browne, pres.

Kitimat

CKTK—March 23, 1964: 1230 khz; 1 kw-D, 250 w-N. Rm 315 Federal Bldg. (V8C 1T6). (604) 632-2102. Skeena Bcstrs Ltd. Net: CBC. Format: MOR. ■ J. B. Cooper, mgr.

Langley

CJJC—Jan 19, 1963: 800 khz; 10 kw-U, DA-2. 20590 Fraser Hwy (V3A 4G2). (604) 534-5341. City and County Radio Ltd. Audio news: BN. Rep: Radio & TV Reps Ltd. Format: Diversified, C&W. ■ Joe Chesney, pres & gen mgr; Peter Legge, stn mgr; Phil Roberts, prog dir.

MacKenzie

CKMK—1240 khz; 1 kw-D, 250 w-N. Radio Station CKPG Ltd.

Merritt

CJNL—1970: 1230 khz; 1 kw-D, 250 w-N. Box 1630 (V0K 2B0). (604) 378-4288. N. L. Bcstg Ltd. Audio news: BN. Format: MOR, Top 40. ■ J. Skelly, pres; R. Clarke, gen & prod mgr.

Nanaimo

CHUB—May 24, 1949: 1570 khz; 10 kw-U, DA-2. Box 1570. (604) 753-4341. Nanaimo Bcstg Ltd. (acq 1-16-62). ■ Bob Giles, pres; George Lawlor, gen mgr.

Nelson

CKKC—July 15, 1939: 1390 khz; 1 kw-U, DA-1. Box 250 (V1L 5P9). (604) 352-7277. Kokanee Bcstg Ltd. ■ D.H. Glover, mgng dir.

New Westminster

CFMI-FM—Listing follows CKNW.

CKNW—Sept 1, 1944: 980 khz; 50 kw-U, DA-1. 815 McBride Plaza (V3L 2CL). (604) 522-2711. Radio NW Ltd. (acq 4-1-56). Rep: Standard; Western. Format: MOR; talk. ■ William J. Hughes, pres; Hal Davis, gen mgr.

CFMI-FM—Co-owned with CKNW. March 22, 1970: 101.1 mhz; 100 kw. Ant 1096 ft. Prog sep from AM. Stereo.

100 Mile House

CKBX—July 30, 1971: 1240 khz; 1 kw-D, 250 w-N. Box 939 (V0K 2E0). (604) 395-2828. Cariboo Broadcasters Ltd. ■ John Boates, pres & gen mgr; Ken Wilson, stn mgr.

Osoyoos

CKOO—December 1966: 1240 khz; 1 kw-D, 250 w-N. Box 539 (V0N 1V0). (604) 495-6200. Okanagan Radio Ltd. ■ Dennis Barkman, pres; Roy Francis, mgr.

Parksville-Qualicum

CHPQ—1973: 1370 khz; 1 kw-U. Box 1370 (V0R 2S0). (604) 248-6177. Nanaimo Bcstg Corp. Rep: Radio-TV Reps. Audio news: SBN. ■ Robert Giles, pres; George Lawlor, gen mgr.

Penticton

CKOK—September 1948: 800 khz; 10 kw-D, 500 w-N. 33 Carmi Ave. (604) 492-2800. Telex 04-8850. Okanagan Radio Ltd. (acq 4-21-72). ■ Kenneth L. Davis, pres; Gerald W. Pash, mgng dir.

CKOK-FM—June 1, 1965: 97.1 mhz; 1.8 kw. Ant 755 ft. Prog sep from AM. Stereo.

British Columbia, Manitoba Radio

See page C-1 for explanation of listings.

Port Alberni

CJAV—April 1, 1946: 1240 kHz; 1 kw-D, 250 w-N, 205 3d Ave. S (V9Y 7N4). (604) 723-2455. CJAV Ltd. (acq 4-1-72). Net: CBC. Audio news: SBN. Format: Adult Contemp; talk; variety. ■ Bill Gibson, pres; Maurice Inwards, gen mgr.

Powell River

CHQB—March 21, 1967: 1280 kHz; 1 kw-U, DA-1, 7074 Westminster Ave. (V3A 2C2). (604) 485-4207. Sunshine Coast Bcstg Ltd. Net: CBC. Audio news: SBN. ■ W.E. Browe, pres.

Prince George

CJCI—Aug 5, 1970: 620 kHz; 10 kw-U, DA-N, Box 758 (V2L 4T4). (604) 563-0367. Prince George Bcstg Ltd. Audio news: SBN. Format: MOR. ■ R.A. East, pres & gen mgr.

CKPG—Feb 8, 1946: 550 kHz; 10 kw-U, DA-N, 1220 6th Ave. (604) 564-8861. Radio Station CKPG Ltd. ■ J. E. Stark, pres; G. M. Leighton, gen mgr. ■ CKPG-TV affil.

Prince Rupert

CFPR—1936: 860 kHz; 10 kw-U, DA-1, Box 99 (V8J 3P4). (604) 624-2161. Telex 047-8930. CBC. ■ C.E. Delmage, stn mgr.

CHTK—1965: 560 kHz; 1 kw-D, 250 w-N, 300 2nd Ave., W (V8J 1G6). (604) 624-9111. CHTK Radio Ltd. Format: MOR. ■ Roy B. Last, gen mgr.

Princeton

CINL—1972: 1400 kHz; 1 kw-D, 250 w-N, Box 1400 (V0X 1W0). (604) 295-6737. Princeton Broadcasting Ltd.

Guesnel

CKCO—Aug 28, 1957: 920 kHz; 10 kw, DA-2, 160 Front St. (V2J 2K1). (604) 992-6202. Telex 047-82537. Cariboo Bcstrs Ltd. Format: Progressive. Spec prog: C&W 2 hrs, Ger ½ hr, Ital ½ hr wkly. ■ John Boates, pres & gen mgr.

Revelstoke

CKCR—Nov 21, 1965: 1340 kHz; 1 kw-D, 250 w-N, Box 1420. (604) 837-2149. Hall-Gray Bcstg Ltd. ■ R. J. Hall, gen mgr.

Salmon Arm

CKXR—Nov 18, 1965: 580 kHz; 10 kw-D, 1 kw-N, DA-N, Box 69 (604) 832-2161. Hall-Gray Bcstg Ltd. ■ R. J. Hall, gen mgr.

Smithers

CFBV—Oct 25, 1963: 1230 kHz; 1 kw-D, 250 w-N, Box 335 (V0J 2N0). (604) 847-2521. Telex 047-8332. CFBV Ltd. Audio news: SBN. ■ R. A. East, pres; N.C. Weseen, gen mgr.

Summerland

CKSP—1972: 1450 kHz; 1 kw-D, 250 w-N, Box 1170 (V0H 1Z0). (604) 494-7956. Okanagan Radio Ltd. Format: C&W. Spec prog: Farm ½ hr wkly. ■ Ken Davis, pres; Russ Mitten, mgr.

Taber

CKTA—1570 kHz; 5 kw-U. Southern Alberta Bcstg Ltd. Rebroadcasts CHEC Lethbridge.

Terrace

CFTK—1960: 590 kHz; 1 kw-U, DA-1, 4625 Lazelle Ave. (V8G 1S4). (604) 635-6316. Telex 047-85529. Skeena Bcstrs Ltd. Audio news: SBN. Format: MOR. ■ J. Fred Weber, pres; Al Parfitt, gen mgr. ■ CFTK-TV affil.

Trail

CJAT—Dec 25, 1931: 610 kHz; 10 kw-U, 1300 Cedar

Ave. (604) 368-5511. Kootenay Bcstg Ltd. Format: MOR. ■ L. J. Hoole, pres; J. P. Kobluk, mgr.

CJAT-FM—Nov 2, 1968: 106.7 mhz; 12.6 kw. Ant 1,485 ft. Stereo. Format: Easy Istng.

Vancouver

CBU—1925: 690 kHz; 50 kw-U, DA-1, 747 Bute St. (V6B 4A2). (604) 684-0246. CBC. ■ K. P. Caple, dir for the Prov. of B.C. ■ CKZU (sw) affil: 6160 kHz; 500 w-DA.

CBU-FM—1947: 105.7 mhz; 100 kw. Ant 1,823 ft. Prog sep from CBU. Stereo.

CBUF-FM—(Fr). Co-owned with CBU. Dec 1, 1967: 97.7 mhz; 50 kw. Ant 1,823 ft. Box 4600, 747 Bute St. (V6B 4A2). (604) 684-0246. CBC. Prog sep from AM. Stereo. ■ CBUT(TV) affil.

***CFRO-FM**—April 22, 1975: 102.7 mhz; 3.7 kw. 333 Carrall St. (604) 684-8494. Vancouver Co-op Radio. Format: Diversified. Spec progs: Fr 2 hrs, It 2 hrs, Sp 2 hrs, Punjabi 2 hrs wkly

CFUN—April 20, 1922: 1410 kHz; 50 kw-U, DA-2, 1900 West 4th Ave. (V6J 1M6). (604) 731-9222. Telex 04-508830. CHUM Western Ltd. (acq 1-1-73). ■ Allan Waters, pres; M. Ronald Carabine, VP & gen mgr.

CHOM—Dec 10, 1959: 1320 kHz; 50 kw-U, DA-2, 1134 Burrard St. (V6Z 1Y8) (604) 682-3141. Telex 04-51110. Q Bcstg Ltd. (acq 8-23-69). Rep: Stephens & Towndrow. Format: MOR. ■ John E. Stark, pres; M.L. Foisy & N.L. Hullah, gen mgrs.

CHQM-FM—Aug 10, 1960: 103.5 mhz; 100 kw. Ant 1630 ft. horiz, 1580 ft vert. Stereo. Prog sep from AM. Format: Blff mus.

CJOR—1926: 600 kHz; 10 kw-U, DA-1, 840 Howe St. (604) 685-6464. Jim Pattison, pres; Donald K. Wall, gen mgr.

CJVB—June 1972: 1470 kHz; 10 kw-U, DA-2, 814 Richards St. (V6B 3A7). (604) 688-9931. Great Pacific Bcstg Ltd. Format: Multilingual-Cosmopolitan mus. ■ Jan Van Bruchem, pres; E. G. Rudy Hartman, stn mgr; Don Browning, coml mgr.

CKLG—June 1954: 730 kHz; 10 kw-U, DA-2, 1006 Richards St. (V6B 1S8). (604) 681-7511. Telex 04-5992. Moffat Communications Ltd. (acq 8-6-1). Audio news: BN. Format: Top 40. ■ R. L. Moffat, chmn; R. J. Mitchell, pres; Don Hamilton, VP & gen mgr; Alan Anaka, gen sis mgr; Frank Callaghan, prog mgr; Larry Sell, news dir; Peter Macintosh, chief engr.

CKLG-FM—October 1964: 99.3 mhz; 100 kw. Ant 1200 ft. Prog sep from AM. Stereo. Format: Progs.

CKWX—April 1, 1923: 1130 kHz; 50 kw-U, DA-N, 1275 Burrard St. (V6Z 1Z8). (604) 684-5131. Telex 04-51197. CKWX Radio Ltd. (acq 10-10-66). Audio news: BN. Format: C&W. ■ J. Dalton Elton, pres & gen mgr; John E. Newbery, coml mgr; Tom Peacock, prog dir; Harold Kendall, mus dir; Phil Baldwin, prom mgr, Campbell McCubbinn, news dir; Stan Davis, chief engr. ■ CKFX (sw) affil: 6080 kHz; 10 w.

Vanderhoof

CIWH—Co-owned with CJCI, Prince George. November 1973: 1340 kHz; 1 kw-D, 250 w-N, Box 1370 (V0J 3A0). (604) 564-4914. Dups CJCI 90%. Audio news: SBN. Format: MOR. ■ Ron A. East, pres & gen mgr.

Vernon

CJIB—September 1947: 940 kHz; 10 kw-U, 3315-B 30th Ave. (604) 545-2141. Interior Bcstrs Ltd. Format: MOR. ■ A. G. Gil Seabrook, pres & gen mgr.

Victoria

CFAX—Sept 4, 1959: 1070 kHz; 10 kw-U, DA-1, 620 View St. (V8W 1J6). (604) 386-2441. CFAV Radio 1070 Ltd. (acq 9-1-63). Audio news: SBN. Format: MOR. ■ Mel Cooper, pres & gen mgr.

CFMS-FM—Listing follows CKDA.

CJVI—April 2, 1923: 900 kHz; 10 kw-U, DA-1, 817 Fort St. (604) 382-8221. Telex 044-8111. Island Bcstg Co. (acq 10-1-41). Audio news: BN. Format: C&W. ■ John E. Ansell, pres & gen mgr.

CKDA—Jan 18, 1950: 1220 kHz; 50 kw-U, DA-1, Box

967. (604) 384-9311. Capital Bcstg System Ltd. ■ David M. Armstrong, pres & gen mgr.

CFMS-FM—March 18, 1965: 98.5 mhz; 19 kw. Ant 567 ft. Prog sep from CKDA. Stereo.

Williams Lake

CKWL—Feb 25, 1959: 570 kHz; 1 kw, DA-2, 98A 2nd Ave. N. (604) 392-5512. Cariboo Bcstrs Ltd. (acq 9-1-71). ■ John Boates, pres, gen & coml mgr. Partially dups CKCO Quesnel.

Manitoba

Altona

CFAM—March 13, 1957: 950 kHz; 10 kw-U, DA-2, Box 950 (204) 324-6464. Southern Manitoba Bcstg Ltd. Format: Comm serv, family prog. ■ Walter E. Kroeker, pres; Elmer Hildebrand, mgr.

Boissevain

CJRB—1973: 1220 kHz; 10 kw-U, Box 950, Altona. (204) 534-6000. Southern Manitoba Bcstg Co. Ltd.

Brandon

CKX—Dec 11, 1928: 1150 kHz; 10 kw-U, DA-2, 2940 Victoria Ave. (204) 728-1150. Western Manitoba Bcstrs Ltd. ■ John B. Craig, pres.

CKX-FM—Dec 16, 1963: 96.1 mhz; 58 kw. Ant 1042 ft. Stereo. Prog sep from AM.

Churchill

CHFC—Sept 13, 1959: 1230 kHz; 250 w-U, Box 40 (R0B 0K0). CBC. Net: CBC AM. Format: Diversified. Spec progs: Chipewyan 5 hrs, Eskimo 5 hrs wkly.

Dauphin

CKDM—Jan 6, 1951: 730 kHz; 10 kw-D, 5 kw-N, DA-N, 27 3rd Ave, N.E. (R7N 2V5). (204) 638-3230. Dauphin Bcstg Co. ■ J. C. Maillard, pres; J. Hugh Dunlop, gen mgr.

Flin Flon

CFAR—Nov 14, 1937: 590 kHz; 10 kw-D, 1 kw-N, DA-D, Box 430 (R8A 1N3). (204) 687-3469. Arctic Radio Corp. (acq 12-70). ■ E. A. Rawlinson, pres.

Portage la Prairie

CFRY—Oct 18, 1956: 920 kHz; 10 kw-U, DA-2, 1500 Saskatchewan Ave. W (R1N 0N6). (204) 857-5111. Portage-Delta Bcstg Ltd. ■ R. D. Hughes, pres & mgr.

St. Boniface

CKSB—(Fr). May 27, 1946: 1050 kHz; 10 kw-U, DA-N, 607 Langevin St. (R2H 2W2). (204) 247-4843. Canadian Bcstg Corp. (acq 4-1-73). Format: Diversified. Spec progs: Farm 1½ hr, Jewish 1 hr wkly. ■ A.W. Johnson, pres; Maxime Desaulniers, gen mgr & prog dir.

Steinbach

CHSM—March 19, 1964: 1250 kHz; 10 kw-U, DA-2, Box 950, Altona (204) 324-6464. Southern Manitoba Bcstg Ltd. ■ W. E. Kroeker, pres; Elmer Hildebrand, mgr.

The Pas

CJAR—1974: 1240 kHz; 1 kw-D, 500 w-N, Box 2683. Arctic Radio Corp. Ltd.

Thompson

CHTM—March 29, 1964: 610 kHz; 1 kw-U. Broadcast Centre, 60 Seal Road (R8N 1S4). (204) 778-7361. Telex 0766-4516. Mystery Lake Bcstg Ltd. Audio news: SBN. Format: News, MOR. Spec progs: Cree 8 hrs, Port 1 hr wkly. ■ D. Rae Sutherland, pres; Don Robertson, gen mgr.

Winnipeg

CBW—Sept 3, 1948: 990 kHz; 50 kw-U, Box 160

(R3C 2H1). (204) 774-2541. Telex O3-5435. CBC. ■ A. W. Johnson (Ottawa), pres; David L. Cruickshank, gen mgr & prog dir.

CBW-FM—Oct 11, 1965: 98.3 mhz; 354 kw. Dups AM 16%. Stereo.

CFRW—Nov 1, 1963: 1470 khz; 10 kw-U, DA-1. 432-Main St. (R3B 2Z7). (204) 957-0000. CHUM (Manitoba) Ltd. (acq 7-31-74). Rep: Major Market. Audio news: BN. Format: Top 40. ■ A. F. Waters, pres; Bob Laine, gen mgr; Doug McLean, coml mgr; Pat St. John, prog & mus dir; Mike Rivers, prom mgr; Ron Hill, news dir; Bruce Edgar, chief engr.

CHIQ-FM—Co-owned with CFRW. Nov 1, 1963: 94.3 mhz; 6.5 kw. Ant 400 ft. Stereo. Prog sep from AM. Format: MOR.

CJOB—1946: 680 khz; 10 kw-D, 2.5 kw-N, DA-N. 930 Portage Ave. (R3G 0P8). (204) 786-2471. Radio O. B. Ltd. ■ R. M. MacLennan, pres & gen mgr.

CJOB-FM—March 1948: 97.5 mhz; 310 kw. Ant 228 ft. Stereo. Prog sep from AM.

CKRC—1928: 630 khz; 10 kw-U, DA-2. 300 Carleton St. Box 9700 (R3C 3E5). (204) 942-2231. Telex 07-57885. Armadale Communications Ltd. Format: Contemp. ■ M. Sifton, pres; Gary L. Miles, mgr.

CKY—1949: 580 khz; 50 kw-U, DA-2. Polo Park (R3B 0L7). (204) 775-0371. Telex: 07-57745. Moffat Communications Ltd. Format: Contemp. ■ J. R. Mitchell, pres; Alden Diehl, VP & gen mgr.

CKY-FM—1962: 92.1 mhz; 360 kw. Ant 388 ft. Prog sep from AM. Stereo. Format: MOR; variety.

New Brunswick

Bathurst

CKBC—April 18, 1955: 1360 khz; 10 kw-U, DA-N. Box G (E2A 3Z2). (506) 546-4461. Bathurst Bcstg Ltd. ■ W. A. Winton, pres; Al Hebert, prog dir.

Campbellton

CKNB—1939: 950 khz; 10 kw-D, 1 kw-N, DA-2. Box 340 (E3N 3G7). (506) 753-4415. Restigouche Bcstg Ltd. (acq 3-16-67). Format: MOR. Spec prog: Fr 18 hrs wkly. ■ J. W. Shoono, pres; D. Alberts, VP & gen mgr.

Edmundston

CJEM—(Fr). Dec 10, 1944: 570 khz; 5 kw-D, 1 kw-N. 91 Canada Road (506) 735-3351. Edmundston Radio Ltd. Net: CBC. Format: MOR; variety. ■ Jean Marc Muchaud, pres; George A. Label, gen mgr.

Fredericton

CBZ—March 4, 1964: 970 khz; 10 kw-U, DA-N. Box 1538 (E3B 5G2). 455-8974. Telex 014-46175. CBC. Format: Diversified. ■ Ray de Boer, location mgr.

CFNB—Jan 12, 1923: 550 khz; 50 kw-U, DA-2. Box 217; 125 Hanwell Rd. (506) 455-5501. Radio Atlantic (1970) Ltd. Format: C&W, MOR, progrsv. ■ D. Malcolm Neill, pres; Jack T. H. Fenety, VP & gen mgr.

Moncton

CBA—1939: 1070 khz; 50 kw-U. Box 950 (E1C 8N8). (506) 855-3370. Telex 014-2284. CBC. ■ G. Theriault, stn mgr.

CBAF—(Fr). Feb 20, 1954: 1300 khz; 5 kw-U, DA-1. Box 950 (E1C 8N8). (506) 855-3370. Telex 014-2284. CBC. ■ G. Theriault, stn mgr.

CKCW—1934: 1220 khz; 10 kw-U, DA-N. Box 1220 (E1C 8R1). (506) 855-1220. Telex 014-2250. The Island Radio Bcstg Co. Ltd. Format: Contemp; C&W; MOR. ■ J. W. Schoone, pres; Gary Crowell, gen mgr.

Newcastle

CFAN—April 4, 1949: 790 khz; 1 kw-U, DA-1. Box 338 (E1V 3M5). (506) 622-3311. Eastern Bcstg Co. Ltd. (acq April 1970). ■ Jack Schoone, pres; Ian Byers, gen mgr.

Richibucto

CBHM-FM—(Fr) 98.5 mhz; 58.5 w. Ant 30 ft. CBC.

Saint John

CBD—Oct 1, 1964: 1110 khz; 10 kw-U, DA-2. Box 1538, Fredericton (E3B 5G2). (506) 455-8974. Telex 014-46175. CBC. Format: Diversified. ■ Ray DeBoer, location mgr; Leon Cole, prog opns off; Fred Blair, senior news edit; Bill Pitcher, tech supvr.

CFBC—Nov 20, 1946: 930 khz; 10 kw-D, 5 kw-N, DA-2. Box 930, 68 Carleton St. (506) 652-1680. Fundy Bcstg Co. Ltd. ■ J. Turnbull, pres; Gary L. Crowell, gen mgr.

CFBC-FM—1965: 98.9 mhz; 5.6 kw. Ant 171 ft. Dups AM 6%. Stereo.

CHSJ—April 18, 1934: 1150 khz; 10 kw-D, 5 kw-N, DA-2. 335 Union St. (E2L 1B3). (506) 657-3410. TWX 014-47218. New Brunswick Bcstg Ltd. ■ R. Costello, pres.

Woodstock

CJCJ—July 1959: 920 khz; 10 kw-D, 1 kw-N, DA-1. Box 70 (EOJ 2B0). (506) 328-6661. Carleton-Victoria Bcstg Co. Ltd. Net: CBC. Audio news: SBN. Format: Diversified. Spec prog: Farm 4 hrs wkly. ■ W. B. Groh, pres; Bruce A. Smith, gen mgr.

Newfoundland

Baie Verte

CKIM—1240 khz; 1 kw-D, 500 w-N. The Colonial Bcstg System Ltd.

Clarenceville

CKVO—710 khz; 10 kw-U. Rebroadcasts VOXM St. John's.

Corner Brook

CBY—1949: 990 khz; 10 kw-U. Box 610 (A2H 6G1). (709) 634-3141. Telex 016-290. St. John's. CBC. ■ C. V. Hierlihy, stn mgr.

CFCB—Oct 3, 1960: 570 khz; 1 kw-U, Premier Dr., Box 2020. (709) 634-3111. Humber Valley Bcstg Ltd. ■ Dr. Noel Murphy, pres; James R. O'Rourke, gen mgr.

Gander

***CBG**—1949: 1450 khz; 250 w-U. 98 Sullivan Ave., Box 369 (A1V 1W7). (709) 256-4311. Telex 016-328. CBC. ■ M. A. Grace, stn mgr.

CJCR—1350 mhz; 1 kw-U. Rebroadcasts CJON St John & CJCN Grand Falls.

CKGA—730 khz; 1 kw-U, DA-1. Box 620, Grand Falls. (709) 256-8730. Colonial Bcstg System Ltd.

Goose Bay

CFLN—1974: 1230 khz; 1 kw-D, 250 w-N. Box 4000. (709) 896-2968. Humber Valley Bcstg Co. Ltd.

Grand Bank

CJOX—Aug 27, 1968: 610 khz; 10 kw-U. Box 189 (709) 832-2650. Newfoundland Bcstg Co. Ltd. Format: Diversified. Spec prog: Newfoundland mus 10 hrs wkly. ■ Colin Jamieson, pres.

Grand Falls

CBT—July 1949: 540 khz; 10 kw-U. High & Mill St. (A2A 2J7). (709) 489-2103. CBC. ■ M.A. Grace, stn mgr.

CJCN—680 khz; 10 kw-U, DA-2. Box 458 (709) 489-2470. Newfoundland Bcstg Ltd. Format: MOR & C&W. ■ Colin Jamieson, pres.

CKCM—620 khz; 10 kw-U, DA-1. Box 620 (709)

Man., N.B., Nfld., N.W.T. Radio

See page C-1 for explanation of listings.

489-2192. Colonial Bcstg System Ltd. Format: C&W, contemp. ■ J.M. Murdoch, mgr.

Happy Valley

CFGB—Feb 23, 1959: 1340 khz; 1 kw-U. Box 736 (A0P 1E0). (709) 896-2911. Telex 016-2224. CBC. ■ B.M. Dawe, stn mgr.

Marystown

CBNM—Dec 18, 1969: 740 khz; 10 kw-U, DA-N. Box 5490. CBC. ■ B.M. Dawe, coml mgr.

CHCM—1961: 560 khz; 1 kw-D, 500 w-N. Box 560, Ville Marie Dr. (709) 279-2560. Colonial Bcstg System Ltd. ■ J.V. Butler, pres; Russ Murphy, stn mgr.

Port au Choix

CFNW—1960: 790 khz; 1 kw-U, DA-1. Box 790, Corner Brook (709) 634-3111. Humber Valley Bcstg Co. Dups CFGB, Corner Brook.

Port-aux-Basques

CFGN—1971: 1230 khz; 250 w-U, DA-N. Box 989, High St (709) 634-2183. Humber Valley Bcstg Co.

St. Anthony

CBNA—600 khz; 10 kw-U, DA-2. Box 5490, St. John's. CBC.

CFNN-FM—97.9 mhz; 126 w. Rebroadcasts CFGB Corner Brook.

St. John's

CBN—April 1, 1949: 640 khz; 10 kw-U. Box 5490, T.A. Bldg., Duckworth St. (A1C 5W5). (709) 753-1300. Telex 016-4590. CBC. ■ CKZN(sw) affil: 6160 khz; 300 w.

CBN-FM—1975: 106.9 mhz.

CJON—1951: 930 khz; 25 kw-U, DA-N. Box 2020. (709) 579-5015. Telex 016-355. Newfoundland Bcstg Ltd. ■ Colin Jamieson, pres & gen mgr.

***VOAR**—1929: 1230 khz; 100 w-D. 106 Freshwater Rd. (A1C 2N8). (709) 576-4051. Seventh-Day Adventist Church. Format: Relig; classical, talk. ■ James M. Campbell, pres & mgr.

VOXM—Oct 19, 1936: 590 khz; 10 kw-U, DA-N. Box 8-590 (A1B 3P5). (709) 726-5590. Colonial Bcstg System Ltd. Format: C&W; MOR. ■ J.V. Butler, pres; W. Williamson, gen mgr.

VOWR—1924: 800 khz; 1 kw-U. Box 1567, Patrick St. (709) 579-9233. Wesley United Church Radio Board. Format: Diversified. ■ Everett E. Hudson, pres, gen & prom mgr, mus dir.

Stephenville

CFSX—Nov 14, 1964: 910 khz; 500 w-U. Box 276 (709) 643-2191. Humber Valley Bcstg Co. Ltd. Format: Diversified. ■ N.F. Murphy, pres.

Wabush

CFLW—1340 khz; 250 w-U, DA-1. 4 Grenfell Drive. (709) 282-3601. Humber Valley Bcstg Co. ■ N.F. Murphy, pres.

AFRTS station

The U.S. Armed Forces Radio and Television Service operates a radio station in Newfoundland at:

Argentia—1480 khz; 50 w.

Northwest Territories

Baker Lake

CKQN-FM—1973: 99.3 mhz; 60 w. Ant minus 50 ft.

N.W.T., Nova Scotia, Ont. Radio

See page C-1 for explanation of listings.

Qamanittuap Naalautaa Society. Format: Eskimo 80%.

Fort Simpson

CFMR—1961: 1490 khz; 50 w-U. Box 100 (XOE 0N0). (403) 695-2323. Fort Simpson Bcstg Society. Format: Diversified. Spec prog: Slavery 4 hrs, Fr 2 hrs wkly. ■ Robert Yachney, pres, gen mgr & news dir.

Frobisher Bay

CFBB—Feb 6, 1961: 1210 khz; 250 w-U. Box 490 (XOA 0H0). (819) 979-5353. CBC. Format: Diversified. ■ Albert Johnson, pres; Aimo Mookiguak, stn mgr.

Inuvik

CHAK—Nov 18, 1969: 860 khz; 1 kw-U. Box 1220 (XOE 0T0). (403) 979-2871. Telex 037-44510. CBC. ■ A. W. Johnson, pres; Nellie Cournoyea, gen mgr.

Tuktoyaktuk

CFCT—1971: 600 khz; 1 kw-U. (XOE 1C0). (403) 977-2277. Tuktoyaktuk Bcstg Society. Net: CBC. Format: Diversified. Spec prog: Eskimo 5 hrs wkly. ■ R. Le Meur, gen mgr.

Yellowknife

CFYK—Dec 13, 1958: 1340 khz; 1 kw-U. Box 160, 50 St. & 51 Ave. (XOE 1H0). (403) 873-3464. Telex 037-45517. CBC. Format: Diversified. Spec progs: Slavery 5½ hrs, Dogrib 1½ hrs, Chipewyan 1½ hrs, wkly. ■ Patrick Riley, area mgr.

Nova Scotia

Amherst

CKDH—Oct 25, 1957: 900 khz; 1 kw-U. DA-2. Box 8 (B4H 3Y6). (902) 667-3875. Tantramar Bcstg Ltd. (acq 4-1-65). Audio news: BN. Format: Talk, diversified. ■ W.A. Winton, pres; Fred W. Arenburg, mgr.

Antigonish

CJFX—March 25, 1943: 580 khz; 10 kw-U. DA-1. Box 970 (902) 863-4580. Telex 019-36532. Atlantic Bcstrs Ltd. ■ D.J. MacEachern, Bruce F. Rafuse, gen mgr.

Bridgewater

CKBW—Dec 24, 1947: 1000 khz; 10 kw-U. DA-N. 215 Dominion St. (B4V 2G8). (902) 543-2401. Acadia Bcstg Ltd. Net: CBC. Format: MOR. ■ James A. Machead, pres & gen mgr.

Dartmouth

CFDR—Dec 5, 1942: 790 khz; 5 kw-U. DA-1. Box 1007 (902) 469-9231. Dartmouth Bcstg Ltd. ■ C. A. Patterson, pres & gen mgr.

Digby

CKDY—Jan 30, 1970: 1420 khz; 1 kw-U. DA-1. Box 1003. Evangeline Bcstg Ltd. ■ F.J. Burns, pres.

Halifax

CBH—September 1944: 860 khz; 10 kw-U. DA-N. Box 300 (B3J 3E9). (902) 422-8311. Telex 019-216-18. CBC. ■ A.K. Morrow, rgnl dir; J. McEwen, dir of radio.

CBH-FM—June 1, 1975: 102.7 mhz; 100 kw. Ant 744 ft. Stereo. Prog sep from AM.

CHNS—May 12, 1926: 960 khz; 10 kw-U. DA-N. 5230 Tobin St. (902) 422-1651. Maritime Bcstg Ltd. ■ L.F. Daley, pres; Harold E. Blackader, gen mgr. ■ CHNX(sw) affil: 6130 khz; 500 w.

CHFX-FM—Co-owned with CHNS. Feb 9, 1970: 96.1 mhz; 60 kw. Ant 546 ft. (902) 425-5210. Prog sep from AM.

CJCH—Nov 4, 1944: 920 khz; 10 kw-D, 5 kw-N. DA-N. 2885 Robie St. (902) 453-2524. Telex 014-422500. Radio CJCH-920 Ltd. (acq 7-1-65). ■ Allan F. Waters, pres; Wayne Hooper, gen mgr.

Kentville

CKEN—1948: 1490 khz; 1 kw-D, 500 w-N. DA-1. 11 Webster St. (902) 678-2111. Evangeline Bcstg Ltd. ■ W.A. Bishop, mgr.

CKWM-FM—Co-owned with CKEN. March 14, 1965: 97.7 mhz; 18 kw. Ant 680 ft.

Middleton

CKAD—1962: 1350 khz; 1 kw-U. DA-1. 11 Webster St., Kentville, N.S. Evangeline Bcstg Ltd. ■ W.A. Bishop, mgr.

New Glasgow

CKEC—Dec 23, 1953: 1320 khz; 5 kw-U. DA-N. 94 Provost St. (B2H 5E7). (902) 752-4200. Douglas B. Freeman. (acq 1964). Format: Oldies, C&W. ■ Doug Freeman, pres & mgr/dir.

Port Hawkesbury

CIGO—1975: 1410 khz; 10 kw-U. Bag 1410. (902) 625-1222. Audio news: BN.

Sydney

CBI—1948: 1140 khz; 10 kw-U. DA-N. Box 700, Alexandra St. (B1P 6H7). (902) 539-5050. Telex 014-45109. CBC.

CHER—Dec 21, 1965: 950 khz; 10 kw-U. DA-1. Box 950. (902) 539-8500. Radio Cape Breton Ltd. (acq 12-74). Audio news: BN. Format: MOR. ■ Vincent Campbell, pres & gen mgr.

CJCB—Feb 14, 1929: 1270 khz; 10 kw-U. DA-N. Radio Bldg., Charlotte St. (B1P 6K2). (902) 564-5596. Celtic Investments Ltd. Audio news: BN. Rep: Major Market Bcstrs. Format: Diversified. ■ J.M. Nathanson, pres; Norris L. Nathanson, gen mgr; Don Brown, sls mgr; Fred Denny, prog dir; Don MacIsaac, news dir; Alf Vernon, chief engr.

CJCB-FM—September 1963: 94.9 mhz; 675 w. Ant 190 ft. Format: Classcl, MOR, btlf mus.

Truro

CKCL—Sept 10, 1947: 600 khz; 1 kw-U. DA-1. Box 788 (B2N 5E8). (902) 895-4491. Colchester Bcstg Co. Ltd. Audio news: SBN. Format: MOR, C&W, Top 40. Spec prog: Dutch ½ hr wkly. ■ W.A. Winton, pres.

CKCL-FM—1965: 100.9 mhz; 11.5 kw. Ant 189 ft. Dups AM 20%. Format: Classcl, talk, MOR, btlf mus.

Windsor

CFAB—1945: 1450 khz; 250 w-U. 87 Gerrish St. (902) 678-2111. Evangeline Bcstg Ltd. ■ F.J. Burns, pres; W.A. Bishop, mgr.

Yarmouth

CJLS—1968: 1340 khz; 5 kw-D, 1 kw-N. DA-2. 222 Main St. (902) 742-7175. Telex 014-48522. Radio CJLS Ltd. (acq 11-68). Format: MOR. ■ L.G. Trask, pres; B.P. Wyman, gen mgr.

Ontario

Ajax

CHOO—Nov 21, 1967: 1390 khz; 10 kw-U. DA-1. 97 McMaster Ave. (L1S 2E6). (416) 477-2466. Community Communications Inc. (acq 8-31-73). Format: C&W. ■ J.H. McCarthy, pres & gen & coml mgr.

Bancroft

CJNH—1240 khz; 1 kw-U. Complete listing under CJBQ Belleville.

Barrie

CKBB—Aug 31, 1949: 950 khz; 10 kw-D, 2.5 kw-N,

DA-2. Box 950 (705) 726-6466. Telex 0687-5220. Barrie Bcstg Ltd. ■ H.J. Snelgrove, pres; Wayne F. Bjorgan, gen mgr.

Belleville

CJBO—Aug 12, 1946: 800 khz; 10 kw-U. DA-2. 45 Bridge St. E. Box 488 (K8N 1L5). (613) 968-5555. Quinte Bcstg Ltd. ■ Frank C. Murray, gen mgr.

CJBO-FM—August 1962: 97.1 mhz; 17.4 kw. Ant 135 ft. Prog sep from AM.

Blind River

CJNR—March 1, 1958: 730 khz; 1 kw-U. DA-N. 15 Charles Walk, Suite 6, Elliott Lake Box 1120 (P0R 1B0). (705) 848-2567. Algonquin Radio-TV Ltd. Net: CBC. Format: MOR. Spec progs: C&W 5 hrs, Fr 1 hr wkly. ■ Carmen Greco, pres; Harry Wolfe, gen mgr.

Brampton

CHIC—Dec 23, 1953: 790 khz; 1 kw-D, 500 w-N. DA-2. 2 Eilen St. (L6V 1J6). (416) 451-3110. CHIC Radio Limited. Format: Talk, news. Spec progs: It 12 hrs, Greek 14 hrs, East Ind 1½ hr, Croatian 1 hr, Macedonian 2½ hrs wkly. ■ Leslie A. Allen, pres & gen mgr.

CHIC-FM—Aug 8, 1960: 102.1 mhz; 857 w. Ant 151 ft. Dups AM 50%.

Brantford

CKPC—December 1923: 1380 khz; 10 kw-U. DA-2. 571 West St. (N3T 5P8). (519) 753-2664. Telephone City Bcst Ltd. ■ Richard D. Buchanan, gen mgr.

CKPC-FM—May 1949: 92.1 mhz; 50 kw. Ant 385 ft. Prog sep from AM. Stereo.

Brockville

CFJR—April 1926: 1450 khz; 1 kw-D, 250 w-N. DA-D. Box 666 (K6V 5V9). (613) 345-1666. Eastern Ontario Bcstg Co. (acq 1963). Net: CBC. Format: Variety. ■ John A. Radford, pres & gen mgr.

Cambridge

CFTJ—Sept 17, 1954: 1320 khz; 1 kw-U. DA-2. 46 Main St. (N1R 1V4). (519) 621-7510. Galt Bcstg Ltd. (acq 8-1-56). Format: MOR. Spec prog: Port 1½ hrs wkly. ■ John V. Evans, pres & gen mgr.

Chatham

CFCO—1926: 630 khz; 10 kw-D, 1 kw-N. DA-2. Box 630 (N7M 5K9). (519) 352-3000. Great Lakes Bcstg System Ltd. (acq 5-14-62). Format: MOR, C&W. Spec prog: Farm 8 hrs wkly. ■ D.G. Campbell, pres; Don Thomas, gen mgr.

Cobourg

CHUC—Aug 27, 1957: 1450 khz; 1 kw-U. DA-2. Box 520. (416) 372-5401. Radio CHUC Ltd. ■ D.B. Williamson, pres; D.J. Fox, mgr.

Collingwood

CKCB—1965: 1400 khz; 1 kw-D, 250 w-N. 84 Huronario St. (705) 445-2011. Barrie Bcstg Ltd. ■ R.T. Snelgrove, pres; Wayne Bjorgan, gen mgr; Robert Hooper, loc stn mgr. Rebroadcasts CKBB Barrie, Ont.

Corwall

CFML—(Fr) Nov 11, 1959: 1170 khz; 10 kw-D. DA. 1308 Pitt St. (K6V 3T6). (613) 932-6456. CFML Radio (Cornwall) Ltd. (acq 8-18-65). ■ Yvon Bertrand, pres; Bernard Bertrand, gen mgr.

CJSS—1945: 1220 khz; 1 kw-U. DA-2. Box 969, 237 Water St. E. (613) 932-5180. Tri-Co Bcstg Ltd. (acq 8-1-63). ■ Paul Emard, mgr.

CJSS-FM—1947: 104.5 mhz; 850 w. Ant 186 ft. Dups AM.

Dryden

CKDR—August 1963: 900 khz; 1 kw-D, 250 w-N. Box 580. (807) 223-2355. Lake of the Woods Bcstg Ltd. ■ D.A. Fawcett, pres.

Elliott Lake

CKNR—Co-owned with CJNR Blind River. 1340 kHz; 250 w-U. 15 Charles Walk (P5A 2A2). (705) 848-2567. Algonquin Radio-TV Ltd.

Fort Frances

CFOB—Nov 11, 1944: 800 kHz; 1 kw-D, 500 w-N. Box 800. (807) 274-5341. Border Bcstg Ltd. (acq 7-1-69). ■ D.A. Fawcett, pres; Gordie McBride, mgr

Guelph

CJOY—June 14, 1948: 1460 kHz; 10 kw-D, 5 kw-N, DA-2. Box 217. (519) 824-7000. CJOY Ltd. Format: MOR. ■ W.O. Slatter, pres; Neil A. Stillman, gen mgr.

CKLA-FM—1969: 106.1 mhz; 50 kw. Ant 249 ft. Box 217. Prog sep from AM. Stereo.

Hamilton

CHAM—November 1959: 1280 kHz; 10 kw-U, DA-2. 105 Main Street E., Terminal Towers (LBN 1G5). (416) 528-0181. Radio Rogers Ltd. (acq 1967). Audio news: BN. Format: Contemp. ■ E.S. Rogers, pres.

CHML—May 27, 1927: 900 kHz; 5 kw-U, DA-1. 848 Main St. E. (LBM 1M1). (416) 549-2411. Radio M L Ltd. (acq 7-1-71). ■ Tom Darling, pres & gen mgr.

CKDS-FM—Co-owned with CHML Sept 14, 1964: 95.3 mhz; 100 kw. Ant 1000 ft. Stereo. 11 Springer Ave. (LBM 1M1). (416) 549-2435. Prog sep from AM.

CKOC—May 20, 1922: 1150 kHz; 10 kw-U, DA-2. Box 1150 (LBN 3P5). (416) 545-5885. Telex 021-660416. Armadale Communications Ltd. (acq 3-1-39). Format: Talk, Top 40. Spec prog: Rel 3 hrs wkly. ■ R.K. MacDonald, gen mgr.

Hearst

CFLH—(Fr) Feb 2, 1967: 1340 kHz; 1 kw-D, 250 w-N. CFCL, Box 620, Timmins. J. Conrad Lavigne Ltd. ■ J.C. Lavigne, pres.

Huntsville

CKAR—June 1958: 630 kHz; 1 kw-U, DA-N. Box 820. (705) 789-4461. Muskoka-Parry Sound Bcstg Ltd. ■ G.N. Mackenzie, pres.

Kapuskasing

CFLK—(Fr) Feb 2, 1967: 1230 kHz; 100 w. c/o CFCL, Box 620, Timmins. J. Conrad Lavigne Ltd. ■ J.C. Lavigne, pres.

CKAP—July 31, 1965: 580 kHz; 10 kw-D, 1 kw-N, DA-1. 24 Byng Ave. (P5N 1X5). (705) 335-5800. Kapuskasing Bcstg Ltd. Format: MOR. ■ Miro Spacek, pres; Barry N. Squirrel.

Kenora

CJRL—Feb 19, 1938: 1220 kHz; 1 kw-D, DA. Box 2490 (P9N 1F9). (807) 468-3181. Lake of the Woods Bcstg Ltd. Rep: Major Market Bcstrs. Format: MOR. ■ D.A. Fawcett, pres.

Kingston

***CFRC**—October 1922: 1490 kHz; 100 w. Carruthers Hall (K7L 3N6). (613) 547-6677. Queen's University. ■ Steven Cutaway, stn mgr.

***CFRC-FM**—January 1956: 91.9 mhz; 1.27 kw. Ant 100 ft. Prog sep from AM.

CKLC—Nov 18, 1953: 1380 kHz; 10 kw-U, DA-2. Box 1380, 99 Brock St. (K7L 4Y5). (613) 544-1380. St. Lawrence Bcstg Ltd. Format: Contemp; talk. ■ T.D. French, pres; C. John Bermingham, VP & stn mgr.

CKLC-FM—1953: 98.3 mhz; 50 kw. Ant 1000 ft. Prog sep from AM. Stereo. Format: Diversified.

CKWS—Aug 31, 1942: 960 kHz; 10 kw-D, 5 kw-N, DA-2. 170 Queen St. (K7K 1B2). (613) 544-2340. Frontenac Bcstg Ltd. Net: CBC. Format: MOR. ■ Arthur L. Davies, pres; Allan Brooks, gen mgr.

CKWS-FM—Aug 31, 1942: 96.3 mhz; 2.7 kw. Ant 500 ft. Prog sep from AM. Stereo. ■ CKWS-TV affil.

Kirkland Lake

CJKL—March 30, 1934: 560 kHz; 5 kw-U, DA-N. Box 430. (705) 567-3366. Kirkland Lake Bcstg Ltd. ■ Robert Ancell, pres.

Kitchener

CFCA-FM—Listing follows CKKW.

CHYM—May 11, 1965: 1490 kHz; 10 kw-D, 5 kw-N, DA-2. 305 King St. W. (519) 743-2611. Greatlakes Bcstg System Ltd. (acq 3-16-67). ■ Donald G. Campbell, pres.

CHYM-FM—May 11, 1965: 96.7 mhz; 25 kw. Ant 658 ft. Dups AM 25%. Stereo.

CKKW—Aug 1, 1959: 1090 kHz; 10 kw-U, DA-2. 864 King St., West (N2G 1E8). (519) 579-1090. Telex 069-5432. Toronto (416) 366-0852. Central Ontario TV Ltd. (acq 12-1-63). Audio news: BN. Format: MOR, C&W. Spec prog: Talk 5 hrs, news & info 7 hrs wkly. ■ H.W. Main, chmn; W.D. McGrew, pres.

CFCA-FM—Co-owned with CKKW. April 3, 1967: 105.3 mhz; 100 kw. Ant 812 ft. Stereo. Dups AM 25%. (519) 576-1053. Central Ontario TV Ltd. Format: Btl mus.

CKWR-FM—1974: 98.7 mhz; 202 w. Ant 146 ft. 1342 King St. E. (N2G 2N7). (519) 579-1150. Wired World Inc.

Leamington

CHYR—Jan 19, 1955: 710 kHz; 10 kw-D. Box 70. (519) 326-6171 or 776-7303.

CHYR-7—Co-owned with CHYR. Jan 19, 1955: 730 kHz; 500 w-N, DA-2 (nighttime operation only). Box 70. (519) 326-6171 or 776-7303. Sun Parlor Bcstrs Ltd. ■ E.S. Rogers, pres.

Lindsay

CKLY—December 1955: 910 kHz; 10 kw-D, 5 kw-N, DA-2. 249 Kent St. West (K9V 2Z3). (705) 324-9103. Greg-May Bcstg Ltd. (acq 6-22-61). ■ J.A. McNabb, pres & gen mgr.

London

CFPL—September 1922: 980 kHz; 10 kw-D, 5 kw-N, DA-2. Box 2580 (W6A 4H3). (519) 438-8391. CFPL Bcstg Ltd. Format: MOR, talk. Spec prog: Farm 1 hr wkly. ■ Murray T. Brown, pres; C.N. Knight, gen mgr.

CFPL-FM—Nov 10, 1958: 95.9 mhz; 179 kw. Ant 885 ft. Prog sep from AM. Stereo. Format: Educl, btl mus. ■ CFPL-TV affil.

CJKB—Jan 25, 1967: 1290 kHz; 10 kw-U, DA-1. Box 1290, Station "A" (N6A 5A2). (519) 433-6111. Mid-diesex Bcstrs Ltd. (acq 7-26-72). ■ Rick Richardson, pres & gen mgr.

CKSL—June 1956: 1410 kHz; 10 kw-U, DA-2. 343 Richmond St., Box 5172 (N6A 4E4). (519) 432-4181. London Bcstrs Ltd. ■ F. Vincent Regan, pres; W.E. (Bill) Robinson, mgr.

Longlac

CHAP—(multi) 1974: 1450 kHz; 40 w-U. Box 609 (POT 2A0). (807) 876-2865. Kenomadiwin Inc.

Midland

CKMP—July 1, 1959: 1230 kHz; 1 kw-D, 250 w-N. 490 Dominion (L4R 1P6). (705) 536-2268. Midland-Penetang Bcstg Ltd. Group owner: Countryside Bcstg. Format: MOR. ■ R.B. Armstrong, pres & gen mgr.

Mississauga

CJMR—June 17, 1974: 1190 kHz; 10 kw-D. Box 1190, Port Credit Postal Station. (416) 279-1190. CJMR 1190 Radio Ltd. Format: MOR. Spec prog: Hindi 3½ hrs wkly.

New Liskeard

CJTT—Oct 27, 1969: 1230 kHz; 1 kw-D, 250 w-N. 213 Whitewood Ave. Box 1058 (P0J 1P0). (705) 647-6041. Kirkland Lake Bcstg Ltd. Format: Diversified. ■ Robert Ancell, pres.

Ontario Radio

See page C-1 for explanation of listings.

Niagara Falls

CJRN—June 1, 1947: 710 kHz; 5 kw-U. Box 710 (L2E 6X7). 4668 St. Clair Ave. (416) 356-6710. Radio Niagara Ltd. ■ James O'Brien, pres; David E. Lyman, gen mgr.

North Bay

CFCH—March 3, 1931: 600 kHz; 10 kw-D, 5 kw-N, DA-2. Box 3000. (705) 474-2000. Northern Bcstg Ltd. ■ R.D. Ancell, pres; G.C. Ackhurst, gen mgr.

CKAT-FM—Co-owned with CFCH. Jan 19, 1967: 93.7 mhz; 5.86 kw. Ant 226 ft. Stereo. (705) 474-3693. (acq July 1973). Format: MOR.

Oakville

CHWO—Nov 17, 1956: 1250 kHz; 10 kw-D, 5 kw-N, DA-2. 490 Wyecroft Rd. (L6K 2H1). (416) 845-2821. CHWO Radio Ltd. Format: Oldies, MOR. Spec prog: Ethnic 4½ hrs wkly. ■ Mrs. Jean E. Caine, pres & gen mgr.

Orillia

CFOR—Sept 1, 1942: 1570 kHz; 10 kw-D, 1 kw-N. 241 West St. North (705) 326-3511. Orillia Bcstg Ltd. (acq 1968). ■ Allan Rogers, pres; Sherman D. Fysh, gen mgr.

Oshawa

CKLB—1950: 1350 kHz; 10 kw-D, 5 kw-N, DA-2. 360 King St. W. (L1J 2K2). (416) 723-3415. Lakeland Bcstg Ltd. ■ Gordon G. Garrison, pres & gen mgr.

CKQS-FM—Co-owned with CKLB. Sept 12, 1957: 94.9 mhz; 50 kw. Ant 474 ft. Dups AM 30%. Stereo.

Ottawa

CBO—Feb 27, 1924: 910 kHz; 5 kw-U, DA-1. Box 3220, Station C (K1Y 1E4). (613) 725-3511. Telex 053-4260. CBC. ■ Gordon Bruce, dir of Ottawa area; Larry O'Neil, coml mgr; Deana Ruterford, prom mgr; Lou Webb, chief engr.

CBO-FM—Feb 18, 1947: 103.3 mhz; 70 kw. Stereo.

CBOF—(Fr) Co-owned with CBO. Aug 1, 1964: 1250 kHz; 10 kw-U, DA-1. Box 3220, Station C (K1Y 1E4). (613) 725-3511. Telex 053-4260. Societe Radio-Canada. ■ Gordon Bruce, area dir.

CBOF-FM—(Fr) Sept 12, 1974: 102.5 mhz; 70 kw. Ant 1077 ft. Stereo. Dups AM 100%.

CFGO—June 7, 1964: 1440 kHz; 50 kw-U, DA-1. 88 Argyle Ave. (K2P 1B4). (613) 238-6500. Confederation Bcstg (Ottawa) Ltd. ■ W.O. Morrison, pres & gen mgr.

CFMO-FM—Listing follows CFRA.

CFRA—May 3, 1947: 580 kHz; 50 kw-D. 10 kw-N, DA-2. 150 Isabella St. (K1S 5A3). (613) 233-6241. Radio Station CFRA Ltd. Audio news: BN, CCNS. Format: MOR, Top 40. Spec prog: C&W 7 hrs wkly. ■ Allan Waters, pres; Terry Kielty, VP & gen mgr; Jim Smith, VP sls; Ernie Calcutt, news & sps dir; Paul Ski, prog dir; George Roach, dir of engr; Dave Watts, Nancy Moore, mus coords; Ann Dempsy, Don Turner, prom coords.

CFMO-FM—Co-owned with CFRA. 1959: 93.9 mhz; 95 kw. Ant 1077 ft. Stereo. (613) 233-6731. Prog sep from AM. Format: Classcl, MOR, btl mus. ■ Gord Atkinson, stn mgr; Ray Eckford, prog dir.

CJRC—(Fr) June 3, 1968: 1150 kHz; 50 kw-D, 5 kw-N, DA-2. 681 Belfast Rd. (K1G 0Z4). (613) 237-7100. CJRC Radio Capitale Lt'ee. Net: Radiomutuel. Rep: Mutuel Com. Format: MOR. ■ M. Joyal, pres; G. Lebel, gen mgr; G. Brazeau, coml mgr; M. Lavoie, prod & mus dir; P. Daunais, news dir; M. Mokhtar, chief engr.

CKBY-FM—Listing follows CKOY.

CKOY—June 1, 1949: 1310 kHz; 50 kw-U, DA-2. Box 6305, Stn J (K2A 3X7). (613) 722-6501. CKOY Ltd. Format: Solid gold, progressive. ■ Gordon F. Henderson, pres; John J. Daly, mgng dir.

CKBY-FM—Co-owned with CKOY. Oct 29, 1969:

Ontario Radio

See page C-1 for explanation of listings.

105.3 mhz; 74 kw. Ant 1077 ft. Prog sep from AM. Stereo. Format: C&W.

Owen Sound

CFOS—March 1, 1940: 560 khz; 1 kw-U, DA-2. 270 Ninth St. E. (N4K 5P5). (519) 376-2030. Grey & Bruce Bcstg Ltd. ■ W.N. Hawkins, pres & gen mgr.

Parry Sound

CKAR-1—1340 khz; 250 w-U. 28 William St. (705) 746-2163. Muskoka-Parry Sound Bcstg Ltd. Satellite of CKAR Huntsville.

Pembroke

CHOV—August 1942: 1350 khz; 1 kw-U, DA-1. Box 100. (613) 735-6807. Ottawa Valley Bcstg Ltd. ■ E.G. Archibald, pres; Edgar R. Bowman, gen mgr.

Peterborough

CHEX—March 31, 1942: 980 khz; 10 kw-D, 5 kw-N, DA-2. Box 659 (K9J 6Z9). (705) 742-0451. Telex 029-810. Kawartha Bcstg Co. Ltd. Net: CBC. Format: Contemp; variety. ■ Robertson Davies, pres; Wally Rewegan, gen mgr.

CHEX-FM—1968: 101.5 mhz; 31.4 kw. Ant 518 ft. Prog sep from AM. Stereo. Format: Contemp.

CKPT—October 1959: 1420 khz; 5 kw-U, DA-2. 131 Charlotte St. (K9J 6Y8). (705) 742-8844. Radio CKPT 1420 Ltd. ■ Alan F. Waters, pres & gen mgr.

Renfrew

CKOB—Sept 9, 1974: 1400 khz; 250 w-U. Box 96. (613) 432-6428. Opeongo Bcstg Co. Ltd. Format: MOR, news.

Richmond Hill

CFGM—July 1, 1957: 1310 khz; 50 kw-U, DA-2. 1254 Yonge St. (L4C 4S5). (416) 961-1310. CFGM Bcstg Ltd. (acq 1-13-71). Spec prog: BN. Format: C&W. ■ Allan Slaight, pres; Jack G. Carnegie, gen mgr.

St. Catharines

CHSC—March 1, 1967: 1220 khz; 1 kw-D, 500 w-N, DA-1. Box 1220, 36 Queenston St. (L2R 7C7). (416) 682-6691. Radio Station CHSC Ltd. ■ R.E. Redmond, pres; Michael F. Hanson, gen mgr.

CHSC-FM—March 1, 1967: 105.7 mhz; 50 kw. Ant 500 ft. Dups AM 25%.

CKTB—1930: 610 khz; 10 kw-D, 5 kw-N, DA-1. Box 610 (L2R 6X7). (416) 684-1174. Niagara District Bcstg Ltd. (acq 10-4-44). ■ Mary C. Burgoyne, pres & mgng dir.

CKTB-FM—February 1949: 97.7 mhz; 50 kw. Ant 414 ft. Dups AM 66%.

St. Thomas

CHLO—May 14, 1948: 1570 khz; 10 kw-U, DA-2. Box 160, 133 Curtis St. (N5P 3T8). (519) 631-3910; London, Ont. (519) 432-2286. Souwesto Bcstrs Ltd. (acq 11-1-59). Format: Contemp. Spec prog: It 1½ hrs, Croatian 1 hr wkly. ■ John L. Moore, pres & gen mgr.

Sarnia

CHOK—July 27, 1946: 1070 khz; 10 kw-U, DA-2. Box 1070 (N7T 7K5). (519) 336-1070. Sarnia Bcstg (1964) Ltd. ■ Allan Slaight, pres; Karl E. Monk, gen mgr.

CKJD—Aug 3, 1968: 1250 khz; 1 kw-U, DA-2. Box 1250, 546 N. Christine St. (N7T 5W6). (519) 336-1250. Dancy Bcstg Ltd. (acq 6-72). Group owner: Rogers Bcstg. Format: Contemp MOR. ■ K.J. Dancy, pres; Len. C. Evans, VP & gen & natl sls mgr.

Sault Ste. Marie

CJIC—Oct 15, 1934: 1050 khz; 10 kw-D, 2.5 kw-N, DA-N. 119 East St. (705) 253-1121. TWX 027-7716. Hyland Radio-TV Ltd. Format: MOR. ■ R.H. Ramsay, pres & gen mgr.

CJIC-FM—May 15, 1964: 100.5 mhz; 3.6 kw. Ant 10 ft. Prog sep from AM. Stereo.

CKCY—May 25, 1955: 920 khz; 10 kw-D, 5 kw-N, DA-2. Box 920 (P6A 5N6). (705) 254-7111. Algonquin Radio-TV Ltd. ■ C.P. Greco, pres & gen mgr.

CKCY-FM—May 13, 1964: 104.3 mhz; 6.76 kw. Ant 103 ft. Prog sep from AM. Stereo.

Simcoe

CHNR—June 23, 1956: 1600 khz; 10 kw-U. Box 1600 (N3Y 4K8). (519) 426-7700. Simcoe Bcstg Co. Ltd. (acq 1975). ■ William Stoessel, pres & gen mgr.

Smiths Falls

CJET—Oct 22, 1955: 630 khz; 10 kw-U, DA-2. Box 630, (K7A 4T4). (613) 283-4630. Rideau Bcstg Ltd. Net: CBC. Format: C&W. ■ J.W. Pollie, pres; H. Botham, mgr.

CJET-FM—Jan 20, 1969: 101.1 mhz; 47.3 kw. Ant 278 ft. Prog sep from AM. Stereo.

Stratford

CJCS—1927: 1240 khz; 500 w-D, 250 w-N. Box 904 (N5A 6W3). (519) 271-2450. CJCS Ltd. (acq 3-64). Format: MOR. ■ Allan D. Rogers, pres; Stan Tapley, gen mgr.

Sudbury

CFBR—(Fr) Dec 8, 1957: 900 khz; 10 kw-D, 1 kw-N, DA-2. Box 700 (P3A 4C5). (705) 674-6401. Sudbury Bcstg Ltd. ■ F.B. Richard, pres & gen mgr.

CHNO—Co-owned with CFBR. June 24, 1947: 550 khz; 10 kw-D, 2.5 kw-N, DA-2. ■ F.B. Richard, pres; Peter Scott, gen mgr.

CKSO—Aug 23, 1935: 790 khz; 10 kw-D, 5 kw-N, DA-2. Box 400. (705) 674-0711. Telex 027-7584. Cambrian Bcstg Ltd. ■ W.B. Plaundt, pres & gen mgr.

CKSO-FM—September 1965: 92.7 mhz; 100 kw. Ant 889 ft. Prog sep from AM. Stereo. ■ CKSO-TV affil.

Thunder Bay

CBQ—1959: 800 khz; 10 kw-D, 5 kw-N, DA-1. 213 Myles St. (P7C 1J5). CBC. (acq 1973).

CFPA—Sept 3, 1944: 1230 khz; 1 kw-D, 250 w-N. Box 2747. (P7B 5G2). (807) 344-2404. Ralph H. Parker Ltd. Format: MOR. Spec progs: Ital 2 hrs, Finnish 2½ hrs wkly. ■ Ralph H. Parker, pres & gen mgr.

CKPR—Feb 3, 1930: 580 khz; 5 kw-D, 1 kw-N. 87 N. Hill St. (P7A 5V6). (807) 334-3526. Telex 0734521. H.F. Dougall Ltd. Format: Contemp top 40; C&W; talk. ■ H. Frazer Dougall, pres; George D. Jeffrey, mgr.

CJSD-FM—October 1948: 94.3 mhz; 95 kw. Ant 1009 ft. Stereo. Prog sep from AM. Spec progs: C&W 2½ hrs, Fr 1 hr, Ger 1 hr, Ital 1 hr, Finnish 1 hr, Croatian 1 hr, Greek 1 hr, Slavic 1 hr, Dutch 1 hr wkly.

Tillsonburg

CKOT—April 30, 1955: 1510 khz; 1 kw-D, DA. Box 10 (N4G 4H3). (519) 842-4281. Tillsonburg Bcstg Ltd. ■ John Lamers Sr, pres; John D. Lamers Jr, stn & sls mgr.

CKÖT-FM—Dec 1, 1965: 101.3 mhz; 50 kw. Ant 454 ft. Prog sep from AM. Stereo.

Timmins

CFCL—(Fr) Dec 23, 1951: 620 khz; 10 kw-D, 5 kw-N, DA-2. Box 620 (P4N 7G3). (705) 264-4211. J. Conrad Lavigne Ltd. ■ J. Conrad Lavigne, pres.

CKGB—Sept 15, 1933: 680 khz; 10 kw-U, DA-2. Box 1046 (P4N 7H8). (705) 264-2351. Timmins Bcstg Ltd. Format: MOR. Top 40. Spec progs: Cree ¼ hr, It 1 hr wkly. ■ Gordon V. Marratto.

CKGB-FM—1948: 94.5 mhz; 425 w. Ant 102 ft. Dups AM 66%.

Toronto

CBL—1927: 740 khz; 50 kw-U. Box 500, Terminal A (M5W 1E6). (416) 925-3311. CBC. ■ N. Lacey, gen

mgr; A. Simon, prog mgr; E.H. Jones, chief engr.

CBL-FM—1946: 94.1 mhz; 55.7 kw. Ant 389 ft. Prog sep from AM. Stereo.

CFGM—See Richmond Hill.

CFRB—Feb 19, 1927: 1010 khz; 50 kw-U, DA-2. 2 St. Clair Ave. West (M4V 1L6). (416) 924-5711. CFRB Ltd. Audio news: SBN. Rep: Standard Bcst Sls. Format: MOR; variety. ■ Donald H. Hartford, pres/gen mgr; Donald W. Insley, VP mgr; Patrick Hurley, VP & coml mgr; John Spragge, prog dir; Arthur Collins, mus dir; Paula Quigley, prom mgr; Don Johnston, news dir; Clive Eastwood, VP & chief engr. ■ CFRX(sw) affil: 6070 khz; 1 kw.

CKFM-FM—Co-owned with CFBR. July 1, 1961: 99.9 mhz; 100 kw. 24 St. Clair Ave., E. (M4V 1K6). (416) 922-9999. Prog sep from AM. Stereo. Format: MOR; variety. ■ W.R. Baitentine, VP & opns mgr; Ray Purves, VP sls; Shelia Conner, mus dir.

CFTR—Aug 8, 1962: 680 khz; 10 kw-D, 25 kw-N, DA-2. 25 Adelaide St. E. (M5C 1H3). (416) 864-2000. Radio Rogers Ltd. ■ Edward S. Rogers, pres; Keith J. Dancy, exec VP & gen mgr.

CHFI-FM—Co-owned with CFTR. Feb 8, 1957: 98.1 mhz; 210 kw. Ant 816 ft. (416) 864-2270. Prog sep from AM. Stereo.

CHIC—See Brampton.

CHIN—(Multi) 1966: 1540 khz; 50 kw-U, DA-D. 637 College St. (M6G 1B6). (416) 531-9991. Radio 1540 Ltd. Audio news: BN. Format: Multicultural (ethnic prog). ■ John B. Lombardi, pres; Carl Redhead, VP & stn mgr; Bill Evano, VP sls; Jimmy Wong, asst opns mgr; Umberto Manca, VP It progmg; Vic James, news dir; Paul Hunter, VP engr.

CHIN-FM—1967: 100.7 mhz; 50 kw. Ant 310 ft. Stereo. Dups AM 100%.

CHUM—1945: 1050 khz; 50 kw-U, DA-2. 1331 Yonge St. (M4T 1Y1). (416) 925-6666. CHUM Ltd. Audio news: BN. Format: Top 40. Spec prog: Talk 10 hrs wkly. ■ A.F. Waters, pres & gen mgr; J.W. Armstrong, VP sls & opns; J. Robert Wood, prog dir; Lyn Smith, adv & pub rel dir; Dick Smyth, news dir; George Jones, chief engr.

CHUM-FM—Sept 15, 1963: 104.5 mhz; 100 kw. Ant 289 ft. Stereo. Format: MOR contemp. ■ Duff Roman, prog dir.

CJBC—(Fr) 1947: 860 khz; 50 kw-U. Box 500, Terminal A. (416) 925-3311. TWX 022-763. CBC. ■ Al Johnson, pres; J.R. St. Cyr, stn mgr.

***CJRT-FM**—1948: 91.1 mhz; 50 kw. Ant 389 ft. Stereo. 297 Victoria St. (M5B 1W1). (416) 595-5281. CJRT-FM Inc. (acq 1975). Format: Educl, classical; jazz. ■ Donald B. McCaskill, pres; Cameron Finley, gen mgr; Margaret Norquay, prog dir; Paul Robinson, mus dir; Adriane Markow, prom mgr; Bud Riley, news dir; Kurt Mayer, chief engr.

CKEY—Aug 28, 1944: 590 khz; 10 kw-U, DA-2. One Yonge St. (M5E 1G1). (416) 361-1281. Shoreacres Bcstg Co. Ltd. Audio news: Newsradio. Format: MOR. ■ Douglass C. Trowell, pres; Stuart C. Brancy, VP & gen mgr; Michael Mangialardo, coml mgr; Tayler Parnaby, news dir.

CKFH—Feb 21, 1951: 1430 khz; 50 kw-U, DA-2. One Grenville St. (M4Y 1A2). (416) 923-0921. Foster Hewitt Bcstg Ltd. Audio news: BN. Rep: Opex Communications; Bolton Burchill. Format: C&W. ■ F.W. (Bill) Hewitt, pres; Barry J. Nesbitt, VP gen & prom mgr & prog dir; Ronald M. Hewat, VP & coml mgr; John Winter, mus dir; Glen Cole, news dir; Gerald Wilson, chief engr.

CKFM-FM—Listing follows CFBR.

Wawa

CJWA—July 1, 1964: 1240 khz; 1 kw-D, 250 w-N. Box 1220. (705) 856-2328. Hyland Radio-TV Ltd.

Welland

CHÖW—June 4, 1957: 1470 khz; 1 kw-U, DA-2. Regional Rd. No. 23. (L3B 3N5). (416) 732-4433. Wellport Bcstg Ltd. Audio news: BN. Format: MOR, C&W. ■ Gordon W. Burnett, pres & gen mgr.

Windsor

CBE—July 1, 1950: 1550 kHz; 10 kw-U, DA-1. 267 Pelissier (N9A 4K5). (519) 254-5116. Telex 024-77622. CBC. Format: Diversified. Spec prog: Farm 10 hrs w/ky. ■ A.W. Johnson, pres; Bruce D. Macpherson, gen mgr; Marilyn Piche, prog asst; Beth Ward, mus dir; Margaret Butcher, prom mgr; Hal Sullivan, news dir.

CBEF—(Fr.) May 1970: 540 kHz; 2.5 kw-D, 5 kw-N, DA-1. 267 Pelissier (N9A 4K5). (519) 254-5116. Telex 024-77622. CBC. Net: CBC AM. Format: Diversified. ■ Bruce D. Macpherson, gen mgr; Claude Hurlubise, prog dir; Francine Desbiens, mus dir; Alain Charbonneau, news dir; R. Clarke, chief engr.

CJOM-FM—Listing follows CKWW.

CKLW—June 1, 1932: 800 kHz; 50 kw-U, DA-2. 26400 Lahser Rd., Southfield, Mich. (48076). (313) 353-6200. TWX 810-224-4968. CKLW Radio Bcstg Ltd. (acq 12-70). Rep: Bolton. Format: Top 40. ■ H.W. McCord, pres & gen mgr.

CKLW-FM—1949: 93.9 mhz; 50 kw. Ant 567 ft. Prog sep from AM. Stereo. Format: C&W.

CKWW—March 29, 1964: 580 kHz; 500 w-U, DA-1. 1150 Ouellette Ave. (N9A 1E2). (519) 252-5751. Radio Windsor Canadian Ltd. Audio news: BN. Rep: Radio House Ltd. Format: Contemp. ■ Geoff Stirling, pres; Larry Thoman, gen mgr; David Oliver, coml mgr; John Henderson, prog & mus dir; Neil Thomas, news dir; Wally Dowhan, chief engr.

CJOM-FM—Co-owned with CKWW. July 10, 1967: 88.7 mhz; 84 kw. Ant 269 ft. (519) 252-7313. Prog sep from AM. Stereo. Format: Btlf mus.

Wingham

CKNX—Feb 20, 1926: 920 kHz; 10 kw-D, 1 kw-N, DA-2. 215 Carling Terrace. (519) 357-1310. CKNX Bcstg Ltd. ■ CKNX-TV affil.

Woodstock

CKOX—Dec 6, 1947: 1340 kHz; 1 kw-D, 250 w-N, DA-D. Box 100. (519) 537-3414. Oxford Bcstg Ltd. (acq 8-67). ■ T.G. Ferris, pres; W.D. Hulme, gen mgr.

Prince Edward Island

Charlottetown

CBC-FM—103.1 mhz; 59.2 w. Ant 108 ft. CBC. ■ A.W. Johnson, pres. ■ CBCT(TV) affil.

CFCY—Aug 15, 1924: 630 kHz; 10 kw-U, DA-2. Box 1060, 51 University Ave. (902) 894-7347. The Island Radio Bcstg Co. Net: CBC. Format: C&W; MOR; top 40. ■ J. W. Schoone, pres; Frank Lewis, gen mgr.

CHTN—1974: 1190 kHz; 10 kw-U, Box 1190. (902) 892-8591. Northumberland Bcstg. Co. Ltd.

Summerside

CJRW—Nov 17, 1948: 1240 kHz; 250 w-U. 218 Water St. C1N 1B3. (902) 436-2201. The Gulf Bcstg Co. Format: MOR. ■ Paul H. Schurman, pres & gen mgr.

Quebec

Note: Programming on stations in Quebec is in French unless indicated as English (Eng).

Alma

CFGT—October 1953: 1270 kHz; 10 kw-D, 5 kw-N, DA-1. 790 Ave. DuPont-Sud. (G8B 2V4). (418) 662-3461. Radio Lac St. Jean Ltee. ■ Emilien Villeneuve, pres; Lionel Tremblay, gen mgr.

Amos

CHAD—Dec 1, 1941: 1340 kHz; 1 kw-D, 250 w-N. 69, Ire Ave. (J9T 1T7). (819) 732-3411; 732-2686. (Amos); 762-0741 (Rouyn). Telex 011-77526 (Rouyn). Radio Nord Inc. ■ Alain Gourd, gen mgr.

Asbestos

CJAN—1972: 1340 kHz; 1 kw-D, 250 w-N. Box 57 (J1T 1S4). (819) 879-5439. Radio Victoriaville Ltee. Audio news: BN. Format: MOR.

Cabano

CJAF—Co-owned with CJFP Riviere du Loup. 1959: 1240 kHz; 1 kw-D, 250 w-N. Radio CJFP Ltee. ■ L. Simard, pres.

Causapscal

CJBM—Co-owned with CJBR, Rimouski. September 1963: 1450 kHz; 1 kw-D, 250 w-N.

Chapais

CFED—1969: 1340 kHz; 250 w-U. Progs originate from CJMD Chibougamau.

Chibougamau

CJMD—Nov 21, 1969: 1240 kHz; 1 kw-D, 250 w-N. 552 3e Rue (G8R 1N9). (819) 276-4171. CJMD Inc. Format: Top 40; talk. ■ Mrs. Carmaen Duchaine, pres; Gilbert Savard, gen mgr.

Chicoutimi

CBJ—Sept 20, 1933: 1580 kHz; 10 kw-U, DA-1. 121 rue Racine-est (G7H 1R6). (418) 543-7747. Telex: 011-36121. CBC. Audio news: SBN. Format: Variety. ■ Jacques Lambert, stn mgr.

***CBJ-FM**—Sept 9, 1974: 100.9 mhz; 98 kw. Ant 294 ft. Prog sep from AM. Format: Contemp; talk.

CBJE-FM—(Eng) 107.9 mhz; 98 kw. Ant 294 ft. Rebroadcasting CBM Montreal.

CHUT-FM—1975: 96.7 mhz; 42 kw. 930 est Jacques Cartier. (418) 545-1311. La Radio Communautaire FM du Saguenay Lac St-Jean Inc.

CJMT—Feb 28, 1954: 1420 kHz; 10 kw-D, 2.5 kw-N, DA-1. 365 rue Racine-est. (G7H 1S8). (418) 543-1717. CJMT Ltee. Format: MOR. ■ Pierre Tremblay, pres, dir general; Gaston Senechal, gen mgr.

Dolbeau

CHVD—1967: 1230 kHz; 10 kw-D, 250 w-N. 1264 Walberg Blvd. (G8L 1H1). (418) 276-3333. Radio Maria Chapdelaine Inc. ■ Mrs. Carmen Duchaine, pres.

Drummondville

CFDM-FM—Listing follows CHR.D.

CHRD—Dec 23, 1954: 1480 kHz; 10 kw-U, DA-2. 449 Heriot St.; Box 250. (819) 472-5458. Radio Drummond Ltee. ■ Maurice Sigouin, pres; J. A. Savoie, mgr.

CFDM-FM—Co-owned with CHRD. 1970: 104.3 mhz; 50 kw. Ant 132 ft.

CKRV—1974: 1400 kHz; 250 w-U. Box 892, 2070 St. Georges. (819) 477-5114. La Radio Des Plaines Ltee.

Granby

CHEF—March 14, 1946: 1450 kHz; 10 kw-D, 250 w-N, DA-1. 13 Principale (J2G 2V4). (514) 372-2433. La Voix l'Est Ltee. (acq 1958). Group owner: Les Journal Trans-Canada. Audio news: BN. Format: Diversified. ■ M. Roland Gagne, pres.

Hauterive

CHLC—Sept 21, 1962: 580 kHz; 5 kw-D, 2.5 kw-N, DA-2. 399 Puyjalon (418) 589-3771. Radio Cote-Nord Inc. Format: Diversified. ■ Sylvia Seguin, pres; Claude Ouellet, gen mgr.

Hull

CKCH—June 30, 1933: 970 kHz; 5 kw-U, DA-1. 72 Laval St. (819) 777-2773. CKCH Radio Ltee. (acq 7-1-70). ■ Roch Demers, pres; Michael P. LaLonde, gen mgr.

CKCH-FM—Jan 1, 1970: 94.9 mhz; 74 kw. Ant 1077 ft. Prog sep from AM. Stereo.

Ontario, P.E.I., Quebec Radio

See page C-1 for explanation of listings.

Iles-de-la-Madeleine

CBIM-FM—93.5 mhz; 4.5 kw. Ant 670 ft. CBC. Rebroadcasting CBGA Matane.

Joliette

CJLM—May 8, 1960: 1350 kHz; 10 kw-D, 1 kw-N, DA-2. 854, rue Papineau. (J6E 2L6). (514) 759-0772. Radio Joliette Ltee. (acq 8-72). ■ F. Delaney, pres; Jacques M. Goulet, gen mgr.

Jonquiere

CKRS—June 23, 1947: 590 kHz; 10 kw-D, 5 kw-N, DA-1. 175 Sir Wilfrid Laurier (G7X 7X3). (418) 542-4551. Telex 011-36117. Radio-Saguenay Ltee. Format: Contemp. ■ Jules Landry, pres; Tom Burham, gen mgr.

Lachute

CJLA—Dec 1, 1974: 630 kHz; 500 w-D, 1 kw-N. 385 Main St. (J8H 1Y1). (514) 562-5363. 500 w-D, 1 kw-N. Radio Lachute Inc. Audio news: BN. Format: Diversified.

Lac Megantic

CKFL—March 6, 1968: 1400 kHz; 1 kw-D, 250 w-N. Box 130 (G6B 2S2). (819) 583-0663. Radio Megantic Ltee. Format: Diversified. ■ Francois Labbe, pres & gen mgr.

L'Annonciation

CKLR—1975: 1490 kHz; 1 kw-D, 250 w-N. Radio CKML Inc.

La Pocatiere

CHGB—1938: 1310 kHz; 10 kw-D, 5 kw-N, DA-N. 508-4 Ave. (418) 856-1310. Radio La Pocatiere Ltee. (acq 12-14-70).

CHGB-FM—1966: 102.9 mhz; 790 w. Ant 244 ft. Prog sep from AM.

La Sarre

CKLS—Sept 1, 1950: 1240 kHz; 1 kw-D, 250 w-N. Bpx 70, Rouyn (819) 333-5505 (La Sarre); (819) 762-0741 (Rouyn). Telex 011-77526 (Rouyn). Radio La Sarre Inc. ■ Alain Gourd, pres & gen mgr.

La Tuque

CFLM—Oct 3, 1959: 1240 kHz; 1 kw-D, 250 w-N. 529 Rue St. Louis, Box 310 (G9X 3P3). (819) 523-4575. Radio La Tuque Ltee. ■ J. Trepanier, pres & gen mgr.

Laval

CFGL-FM—1968: 105.7 mhz; 100 kw-U. Ant 398 ft. "GL" Bldg., Place Laval. (514) 663-7550. Stereo Laval Inc. ■ R. Saucier, pres.

Levis

CFLS—1240 kHz; 250 w-U. 5 est, Trans Canada (G6V 6P5). (418) 833-2151. Etchemin Inc. ■ A. Begin, J. Cote, L. R. Ruel, exec offs.

Longueuil

CHRS—1956: 1090 kHz; 10 kw-U. 2019 Boul Taschereau. (514) 674-6238. Radio Rive-Sud (CHRS) Ltee. Audio news: BN. Format: MOR.

Maniwaki

CBFL-FM—Dec 16, 1967: 98.9 mhz; 58.5 w. Ant 30 ft. CBC.

Matane

CBGA—1250 kHz; 10 kw-D, 5 kw-N, DA-N. 155 St. Sacrement St. (G4W 1Y9). (418) 562-0290. CBC. (acq 9-1-72). Format: MOR.

CHRM—1975: 1290 kHz; 10 kw-U. 800 Avenue du Phare Ouest (418) 562-4141. Les Communications Matane Inc. Audio news: BN.

Quebec Radio

See page C-1 for explanation of listings.

Mont Laurier

CKML—May 19, 1963: 610 khz; 1 kw-U, DA-N. Box 90, 515 boul Paquette (J9L 3H1). (819) 623-1011. Radio CKML Inc. Net: CBC. Format: Contemp. ■ Patrick Ryan, pres; Paul Lessard, gen mgr.

Montmagny

CKBM—Jan 31, 1954: 1490 khz; 1 kw-D, 250 w-N. 121 Rue St. Thomas (G5V 1M3). (418) 248-0801. Radio Alleghany Inc. ■ Andre Mercier, pres & gen mgr.

Montreal

CBF—1937: 690 khz; 50 kw-U. Box 6000 (H3C 3A8). (514) 285-3211. Telex 05-267417. CBC. Format: Talk, diversified. ■ A.W. Johnson, pres; Raymond David, VP & gen mgr; Jean Blais, dir of radio; Lorenzo Godin, prog dir.

CBF-FM—1947: 100.7 mhz; 100 kw. Ant 823 ft. Prog sep from AM. Stereo. ■ CBFT(TV) affil.

CBM—(Eng) 1933: 940 khz; 50 kw-U. Box 6000 (H3C 3A8). (514) 868-3211. TWX 01-2288. ■ Pierre DesRoches, mgr.

CBM-FM—(Eng) 1947: 95.1 mhz; 24.6 kw. Ant 823 ft. Prog sep from AM. Stereo. ■ CBMT(TV) affil.

CFCF—(Eng) November 1919: 600 khz; 5 kw-U, DA-1. 405 Ogilvy Ave. (514) 273-6311. Telex 01-2592. Multiple Access Ltd. (acq 7-72). ■ D. W. G. Martz, senior VP; W. Machny, VP & gen mgr. ■ CFCX(sw) affil: 6005 khz; 500 w.

CFQR-FM—(Eng) Co-owned with CFCF October 1966: 92.5 mhz; 41.4 kw. Ant 979 ft. Prog sep from AM. Stereo. ■ CFCF-TV affil.

CFMB—Dec 21, 1962: 1410 khz; 10 kw-U, DA-1. 2015 Drummond St. (H3G 1W8). (514) 845-8144. CFMB Ltd. ■ Casimir G. Stanczykowski, pres & gen mgr.

CFQR—Listing follows CFRX.

CHOM—Listing follows CKGM.

CJAD—(Eng) Dec 8, 1945: 800 khz; 50 kw-D, 10 kw-N, DA-2. 1407 Mountain St. (514) 844-0111. CJAD Ltd. ■ H. T. McCurdy, pres & gen mgr.

CJFM-FM—(Eng) Co-owned with CJAD. Oct 1, 1962: 95.9 mhz; 41.2 kw. Ant 979 ft. Prog sep from AM. Stereo. ■ Barry Martin, gen & sls mgr.

CJMS—Nov 3, 1953: 1280 khz; 50 kw-U, DA-2. 1700 Rue Berri, Montreal (H2L 4E8). (514) 849-5373. CJMS Radio-Montreal Ltee. (acq 11-3-53). Net: Radiomutuel. Format: Adult contemp. ■ Ed Prevost, pres; L-Raymond Daoust, gen mgr.

CKMF-FM—Co-owned with CJMS. May 18, 1964: 94.3 khz; 41.4 kw. Ant 979 ft. 225 est, rue Roy. (514) 282-3943. Supravox Corp. Ltee. Prog sep from AM. Stereo. Format: MOR.

CKAC—Sept 22, 1922: 730 khz; 50 kw-U, DA-1. 1400 Metcalfe St. (H3A 1X4). (514) 845-5155. CKAC Ltee. (acq 7-69). ■ Roch Demers, pres; Paul-Emile Beaulne, gen mgr.

CKGM—(Eng) Dec 7, 1959: 980 khz; 10 kw-U, DA-1. 1310 Greene Ave. (H3Z 2P5). (514) 931-6251. Maisonneuve Bcstg Ltd. ■ Geoff Stirling, chmn; Jim Sward, VP & gen mgr.

CHOM-FM—(Eng) Co-owned with CKGM. Sept 16, 1963: 97.7 mhz; 41.2 kw. Ant 979 ft. Prog sep from AM. Stereo.

CKLM—1570 khz; 50 kw-U, DA-2. 1184 Rue Ste. Catherine West (H3B 1K2). (514) 861-9091. Entreprises Tele-Capitale Ltee. (acq 1973). Audio news: BN. Format: MOR. ■ Jean Pouliot, pres; Guy Morin, gen mgr; Pierre Bertrand, coml mgr; Denys Bergeron, prog dir; Fancois Roy, mus dir; Serge Raymond, prom mgr; Guy Morin, news dir; Yves Hamel, chief engr.

CKMF-FM—Listing follows CJMS.

CKVL-AM-FM—See Verdun.

New Carlisle

CHNC—Dec 23, 1933: 610 khz; 10 kw-D, 5 kw-N, DA-1. Box 610, Rue Principale (G0C 1Z0). (418) 752-2215. Telex 014-43212. La Cie Gaspesienne De Radiodiffusion Ltee. Net: CBC AM. Audio news: SBN. Format: Top 40, MOR, diversified. ■ Mc. Lucien Grenier, pres; Arthur (Art) Houde, VP, gen mgr.

Plessisville

CKTL—Oct 18, 1972: 1420 khz; 1 kw-D, 250 w-N, DA-2. Box 160 (G6L 2Y7). (819) 362-3414. Radio Plessisville. Ltee. Audio news: BN, SBN. Format: Diversified.

Pointe Claire

CFOX—(Eng) March 15, 1960: 1470 khz; 10 kw-D, 5 kw-N, DA-2. Box 1470, Montreal, z 101. (514) 697-1470. Radio CFOX Inc. (acq 8-1-72). Group owner: IWC Communications. Net: BN. Format: MOR. Spec prog: Talk 14 hrs wkly. ■ Peter Webb, VP & gen mgr.

Quebec

CBV—Sept 29, 1934: 980 khz; 5 kw-U, DA-1. Box 10400 (G1V 2X2). (418) 656-9440. Telex 011-286. CBC. ■ A. W. Johnson, pres; R. Dussault, gen mgr; Jacques-Henri Gagnon, stn mgr.

***CBV-FM**—1974: 95.3 mhz; 100 kw. Ant 541 ft.

CFOM—(Eng) 1949: 1340 khz; 250 w-U, Box 1340. (418) 872-2871. Goodwill Bcstrs of Quebec Inc. (acq 5-1-71). ■ C. N. Lucas, pres; Norman Wright, VP & gen mgr.

CHRC—April 1, 1926: 800 khz; 50 kw-U, DA-1. Box 8080 (G1K 7R9). (418) 688-8080. Telex 011-230. CHRC Ltee. (acq 9-1-72). ■ Jean A. Pouliot, pres; Pierre Beaulne, exec VP & gen mgr.

CHRC-FM—Nov 1, 1949: 98.1 mhz; 81 kw. Ant 1184 ft. Prog sep from AM. Stereo.

CJRP—June 15, 1969: 1060 khz; 50 kw-D, 10 CJRP Radio Provinciale Ltee. (acq 6-15-69). Format: Top 40; R&B; variety. ■ Ed Prevost, pres; Gilbert Herard, gen mgr.

CKCV—July 1, 1926: 1280 khz; 10 kw-D, 5 kw-N, DA-2. 800 Place D'Youville (418) 694-1280. CKCV (Quebec) Ltee. Format: MOR. ■ Claude Croteau, gen mgr.

***CKRL-FM**—89.1 mhz; 1.4 kw. Ant 255 ft. Universite Laval. Campus Laval FM Inc. Stereo.

Rimouski

CJBR—Nov 15, 1937: 900 khz; 10 kw-U, DA-N. 273 Ouest, rue St. Jean Baptiste. (418) 723-2217. Telex: 011-8-6343. CJBR Radio Ltee. (acq 6-17-70). Format: MOR. ■ Andre Mercier, pres; Andre Decarie, gen mgr.

CJBR-FM—November 1947: 101.5 mhz; 20 kw. Ant 931 ft. Prog sep from AM. Stereo.

Riviere du Loup

CJFP—1947: 1400 khz; 10 kw-D, 5 kw-N. One Rue Fontenac (G5R 1R7). (418) 862-8241. Telex 011-3915. Radio CJFP Ltee. Format: MOR. ■ Luc Simard, pres.

Roberval

CHRL—June 1, 1949: 910 khz; 10 kw-D, 2.5 kw-N. Boulevard St. Joseph. (GH8 2L4). (418) 275-1831. Radio Roberval Inc. Net: CBC. Format: Top Million Sellers. ■ Benoit Levesque, pres & gen mgr.

Rouyn

CKRN—Oct 2, 1939: 1400 khz; 1 kw-D, 250 w-N, 68 Gamble W (J9X 5A5). (819) 762-0741. Telex 011-77526. Radio Nord Inc. Net: CBC. Format: Contemp. ■ Alain Gourd, pres & gen mgr.

Saguenay

CHLC—See Hauterive.

Ste. Agathe des Monts

CJSA—July 17, 1967: 1230 khz; 1 kw-D, 250 w-N.

Box 60, 3 Est. Rue Principale. (819) 326-1230. Radio CUSA Inc. Audio news: SBN. Format: Diversified. ■ Andre Senez, pres & coml mgr.

Ste. Anne des Monts

CBGN—1340 khz; 1 kw-D, 250 w-N. 155 St. Sacrement, Matane (418) 562-0290. CBC (acq 9-1-72). Format: Progressive. ■ Andret Giroux, gen mgr.

CJMC—1974: 1490 khz; 1 kw-U. Box 820 Gaspe. (418) 763-5522. Radio du Golfe, Inc. Audio news: BN. Format: C&W, MOR.

St. Eleuthere

CHRT—Co-owned with CJFP Riviere-du-Loup. 1450 khz; 250 w-U.

St. Georges de Beauce

CKRB—1953: 1460 khz; 10 kw-D, 5 kw-N, DA-N. Box 100. (418) 228-8811. Radio Beauce Inc.

St. Hyacinthe

CKBS—Oct 1, 1959: 1240 khz; 250 w-U. 855 Rue Ste. Marie. (514) 774-6486. Radio St. Hyacinthe Ltee.

St. Jean

CHRS—December 1956: 1090 khz; 10 kw-D. 2019 Boul. Taschereau, Longueuil (J4K 2Y1). (514) 674-6238. Radio Rive-Sud (CHRS) Ltee. (acq 1974). Audio news: BN, SBN. Format: Talk, MOR, news. ■ Pierre Paul Elie, pres & gen mgr.

St. Jerome

CJEN—March 14, 1954: 900 khz; 1 kw-U, DA-1. Box 900 (J7Z 5K9). (514) 435-1544. Radio Laurentides Inc. ■ Jean Lalonde, pres & gen mgr.

Ste-Marie-de-Beauce

CJVL—1974: 1360 khz; 10 kw-D, 5 kw-N. Box 1370, Route Kennedy (G0S 2Y0). (418) 387-1360. Clival Inc. Audio news: BN.

St. Pamphile

CHAL—Co-owned with CHGB, La Pocatiere, Quebec: 1350 khz; 1 kw-U.

Sept-Iles

CKCN—March 30, 1963: 560 khz; 10 kw-D, 5 kw-N, DA-2. 106 Napoleon St. (418) 962-3838. Radio Sept-Iles Inc. Audio news: BN. Format: MOR. ■ Benoit Roberge, pres & gen mgr.

Shawinigan

CKSM—April 30, 1951: 1220 khz; 10 kw-D, 2.5 kw-N, DA-2. Box 695. (819) 536-4494. La Compagnie de Radiodiffusion de Shawinigan Falls Ltee. (acq 11-67). ■ Arthur Lacourriere, pres; Alain Chartier, mgr.

Sherbrooke

CHLT—June 1937: 630 khz; 10 kw-D, 5 kw-N, DA-2. 3330 King St. West (819) 569-9331. CHLT Radio Sherbrooke Ltee. (acq 6-17-70). ■ Roch Demers, pres; Lloyd G. Scheib, gen mgr.

CHLT-FM—September 1962: 102.7 mhz; 62 kw. Ant 1851 ft. Stereo.

CJRS—August 1967: 1510 khz; 10 kw-U, DA-2. 2655 Ouest rue King. (819) 567-8951. CJRS Radio Sherbrooke Ltee. ■ J. Lagasse, pres.

CKTS—(Eng) July 1, 1946: 900 khz; 10 kw-D, 5 kw-N, DA-2. 3330 King St. West (819) 569-9331. CKTS Radio Sherbrooke Ltee. (acq 1971). Group owner: Telemedia Ltee. Format: Top 40. ■ R. Demers, pres.

Sorel

CJSO—June 16, 1945: 1320 khz; 10 kw-D, 5 kw-N, DA-2. 59a Prince St. (J3P 4J5). (514) 743-3318. Radio Richelieu Ltee. (acq 8-71). Format: Variety. ■ Franklin Delaney, pres; Pierre Vachon, gen mgr.

Temiscaming

CKVT—1340 khz; 250 w-U. C.P. 388. (819)

629-2710. Radio Temiscamingue Inc. ■ Herve Leblanc, pres.

Thetford Mines

CKLD—Feb 12, 1950: 1230 khz; 1 kw-D, 250 w-N. 327 Ave. L'Abbe. (418) 335-7533. Radio Megantic Ltee. (acq 1-3-70). Audio news: BN SBN. Format: MOR, C&W. Francois Labbe, pres; Francois Bastien, mgr.

Trois Rivieres

CHLN—Oct 17, 1937: 550 khz; 10 kw-D, 5 kw-N, DA-2. 3550 Boulevard Royale (G9A 5G8). (819) 375-4856. Radio Trois-Rivieres Inc. (acq 7-70). ■ Maurice Dansereau, pres; Maurice Duval, gen mgr.

CJTR—Feb 6, 1954: 1140 khz; 10 kw-U, DA-2. Edifice Place Royale, 1350 Rue Royale. (819) 375-4855. CJTR Radio Trois-Rivieres Ltee. (acq 4-23-68). Format: Btff mus. ■ Donat Bazinet, pres; Richard Gendron, gen mgr.

Val d'Or

CKVD—1939: 900 khz; 10 kw-D, 2.5 kw-N, DA-1. Angle 3e avenue et 3e rue. (819) 824-3643. (Val d'Or); 762-0741 (Rouyn). Telex 011-77526. Radio-Nord Inc. ■ David A. Gourd, pres & gen mgr.

Valleyfield

CFLV—Nov 10, 1961: 1370 khz; 10 kw-D, 5 kw-N. Box 1370 (J6T 1A9). (514) 373-1370. Radio Valleyfield Ltee. Net: Bcst news; TELBEC. Format: MOR. ■ A. Cholette, pres; Jean-Claude Lefebvre, gen mgr.

Verdun

CKVL—Nov 3, 1946: 850 khz; 50 kw-D, 10 kw-N, DA-2. 211 Gordon Ave. (H4G 2R2). (514) 766-2311. Telex 01-2868. Radio Futura Ltd. Format: Talk. ■ Jack Tietolman, pres; Albert Cloutier, gen mgr.

CKVL-FM—1953: 96.9 mhz; 307 kw. Ant 712 ft. Prog sep from AM. Stereo. Format: Progs. ■ Paul Tietolman, stn mgr.

Victoriaville

CFDA—Oct 19, 1951: 1380 khz; 1 kw-U, DA-N. Box 490 (G6P 6T3). (819) 752-5545. Radio Victoriaville Ltee. (acq 1-3-70). Audio news: BN, SBN. Format: MOR, C&W. ■ Francois Labbe, pres; Francois Bastien, mgr.

Ville-Marie

CKVM—Jan 7, 1950: 710 khz; 10 kw-D, 1 kw-N, DA-N. 62 Rue Sainte Anne (J0Z 3W0). (819) 629-2710. Radio Temiscamingue Inc. ■ H. Leblanc, pres; C. E. Laverdiere, gen mgr.

CKVT—Co-owned with CKVM. October 1969: 1340 khz; 250 w-U.

Ville Vanier

CFOM—See Quebec.

Westmount

CKGM—See Montreal.

Saskatchewan

Estevan

CJSL—August 1959: 1280 khz; 1 kw-U, DA-1. Box 365 (S4A 2A4). (306) 634-3432. Soo Line Bcstg Ltd. Format: MOR. Spec prog: Farm 4 hrs wkly. ■ G. Laing, pres; Mike Shainline, gen mgr.

Gravelbourg

CFGR—(Fr) 1952: 1230 khz; 250 w-N. 1840 McIntyre, Regina (S4P 2R1). (306) 523-6641. CBC.

CFRG—(Fr) 1952: 710 khz; 5 kw-D. 1840 McIntyre, Regina (S4P 2R1). (306) 523-6641. CBC. Format: Contemp, MOR. ■ Raymond J. Marcotte, gen & prog mgr; August Bendet, coml mgr; Sandra Ruhr, mus dir; Rejean Chenard, news dir; Stan Ewert, chief engr.

Foreign AM Near Canada

Greenland

570 khz Godthab, 25 kw. Gronlands Radio, 3900 Godthab.
650 khz Godhavn, 5 kw. Gronlands Radio.
700 khz Simiutak, 20 kw. Gronlands Radio.

AFRTS stations

The U.S. Armed Forces Radio and Television Service operates radio stations in Greenland at the following locations:

Sondrestrom—1420 khz; 250 w.
Thule—1425 khz; 1 kw.
Thule—1210 khz; 250 w.

St. Pierre et Miquelon

1375 khz, 4 kw. Office de Radiodiffusion-Television Francaise.

Melfort

CJVR—Oct 8, 1966: 1420 khz; 10 kw-U, DA-N. Box 1420, 611 Main St. N (306) 752-2867. Radio CJVR Ltd. ■ M. H. Dokken, pres.

Moose Jaw

CHAB—April 22, 1922: 800 khz; 10 kw-U, DA-N. 116 Main St. North (S6H 3J7). (306) 692-6464. Moffat Communications Ltd. (acq 1968). Format: MOR. ■ Ronald Mitchell, pres; V. Traill gen mgr.

North Battleford

CJNB—Jan 28, 1947: 1050 khz; 10 kw-U, DA-N. Box 1460. (306) 445-2477. Telex 074-2527. Northwestern Bcstg Ltd. ■ E. A. Rawlinsong, pres; Harry Dekker, mgr.

Prince Albert

CKBI—1934: 900 khz; 10 kw-U, DA-2. CKBI Bldg., 10th St. (306) 763-7421. Telex 034-2932. Central Bcstg Ltd. ■ Frank F. Rawlinsong, gen mgr.

Regina

CBK—July 29, 1939: 540 khz; 50 kw-U. 1840 McIntyre St. (306) 523-6641. Telex 031-2289. CBC. ■ G. Hurren, mgr. ■ CBKRT(TV) affil.

CJME—Nov 24, 1959: 1300 khz; 1 kw-U, DA-1. Box 1300 (S4P 3B9). (306) 527-4191. Telex 071-2693. Midwest Bcstrs Ltd. (acq 4-6-7). ■ E. A. Rawlinsong, pres.

CKCK—July 29, 1922: 620 khz; 5 kw-U, DA-N. Box 6200 (S4P 3H7). (306) 522-8591. Telex: 071-2433. Armadale Communications Ltd. Format: Contemp MOR; C&W. ■ M. Sifton, pres; R. A. Lamborn, gen mgr. ■ CKCK-TV affil.

CKRM—July 27, 1926: 980 khz; 10 kw-D, 5 kw-N, DA-2. 2060 Halifax St. (S4P 3J4). (306) 523-5661. Telex 071-2710. Buffalo Bcstg Ltd. (acq 6-15-70). Format: C&W. ■ George G. Gallagher, pres & gen mgr.

CFMQ-FM—Co-owned with CKRM. Feb 4, 1966: 92.1 mhz; 6.2 kw. Ant 153 ft. Stereo. Box 9800 (S4P 3J4). (306) 525-9195. Telex 071-2710. Buffalo Bcstg Co. Ltd. ■ George G. Gallagher, pres & gen mgr.

Rosetown

CKKR—Aug 8, 1966: 1330 khz; 10 kw-U, DA-1. Box

Quebec, Saskatchewan, Yukon Radio, Mexican AM

490 (S0L 2V0). (306) 882-2686. Goose Lake Bcstg Ltd. Format: C&W. Spec prog: Farm 3 hrs, Uk 6½ hrs wkly. ■ Stan Solberg, pres & mgr.

Saskatoon

CFMC-FM—Dec 12, 1965: 103.9 mhz; 6.02 kw. Ant 102 ft. Stereo. 1221 Eighth St. E. (S7H 0S5). (306) 343-1608. General Bcstg Ltd. ■ J. Semenchuck, pres; V. J. Balkwill, gen mgr.

CFNS—(Fr) Nov 6, 1952: 1170 khz; 1 kw-U. 1840 McIntyre St., Regina (S4P 2R1). (306) 523-6641. Telex 071-2289. Societe Radio-Canada.

CFQC—July 18, 1923: 600 khz; 5 kw-U, DA-N. 216 First Ave. N (306) 242-6611. TWX 034-2228. CFQC Bxstg Ltd. (acq 1972).

***CJUS-FM**—Dec 9, 1965: 89.7 mhz; 3.8 kw. Ant 152 ft. Stereo. 386, Sub RO, 6, University of Saskatchewan (S7N 0W0). (306) 343-3747. Telex 4644. University of Saskatchewan. Format: Top 40; C&W; progressive; R&B, Sp. ■ G. E. Walburn, stn mgr.

CKOM—June 8, 1951: 1250 khz; 10 kw-U, DA-N. 3333 Eighth St. E (S7H 0W3). (306) 374-3690. Saskatoon Community Bcstg Ltd. ■ Robert A. Hosie, pres & gen mgr.

Shaunavon

CJSN—Dec 6, 1966: 1490 khz; 1 kw-D, 250 w-N. Box 1176. (306) 297-2671. Frontier City Bcstg Ltd. ■ Albert Yahneke, pres.

Swift Current

CKSW—June 1, 1956: 1400 khz; 1 kw-D, 250 w-N. Box 370, 134 Central Ave. (306) 773-4605. Frontier City Bcstg Ltd. ■ Douglas W. Scott, pres; W. C. Gilbey, mgr.

Weyburn

CFSL—Aug 16, 1957: 1190 khz; 10 kw-D, 5 kw-N, DA-N. 305 Souris Ave. N.E. (S4H 2K2). (306) 842-4666. Soo Line Bcstg Ltd. Format: MOR. ■ Thomas G. Laing, pres; James T. Laing, gen mgr & prog dir.

Yorkton

CJGX—Aug 19, 1927: 940 khz; 10 kw-U, DA-N. Tower Theatre Bldg., Second Ave. (S3N 1G2). (306) 783-2256. Telex 074-21513. Yorkton Bcstg Ltd. (acq 3-66). Format: MOR. ■ Ed A. Lawrence, VP & gen mgr.

Yukon Territory

Whitehorse

CFWH—1958: 570 khz; 1 kw-U, Box 160 (X0E 1H0). (403) 667-6261. CBC.

CKRW—November 1969: 610 khz; 1 kw-U. 203-4103 Fourth Ave. (Y1A 1H6). (403) 667-4247. Klondike Bcstg Co. Audio news: SBN. Format: Diversified. ■ R. Hougen, pres; L. J. Farewell, gen mgr.

AM Radio in Mexico

Note: The list of Mexican radio stations is based on information that the country periodically files with the FCC and does not necessarily reflect existing operations. [The abbreviation u.c. denotes under construction].

500

540 khz XEWA San Luis Potosi, S.L.P., 150 kw (relay).
550 khz XEACD Acapulco, Gro., 500 w-D, 250 w-N, u.c.
550 khz XEKL Jalapa, Ver., 1 kw-D/250 w-N.
550 khz XEPL Cd. Cuauhtemoc, Chih., 500 w-D/150 w-N.
550 khz XEQW Merida, Yuc., 2 kw-D/200 w-N.

550 khz XEUC Tehuantepec, Oax., 1 kw-D/250 w-N.
560 khz XEOC Mexico City, 1 kw.
560 khz XEHA Tecate, B.C., 250 w, u.c.
560 khz XEYO Huatabampo, Son., 1 kw-D/500 w-N, u.c.

570 khz XEBJB Monterrey N.L., 5 kw-D/250 w-N.
570 khz XELQ Morelia, Mich., 1 kw.
570 khz XENZ Culiacan, Sin., 1 kw-D/250 w-N.
570 khz XEOA Oaxaca, Oax., 5 kw-D/250 w-N.
570 khz XETJ Torreon, Coah., 1 kw-D/250 w-N.
570 khz XEVX Comalcalco, Tab., 1 kw-D/250 w-N.
580 khz XEAV Guadalajara, Jal., 10 kw-D/1 kw-N.

Mexican AM

580 khz XEMU Piedras Negras, Coah., 5 kw-D/250 w-N.
580 khz XEFI Chihuahua, Chih., 5 kw-D/250 w-N.
580 khz XEDZ Cordoba, Ver., 1 kw-D/450 w-N.
580 khz XEHP Ciudad Victoria, Tams., 1 kw-D/150 w-N.
580 khz XEUE Tuxtla Gutierrez, Chis., 1 kw-D/200 w-N.
590 khz XEHO Hermosillo, Son., 1.5 kw-D/500 w-N.
590 khz XEPH Mexico City, 5 kw.
590 khz XEFD Rio Bravo, Tams., 5 kw-D/250 w-N.
590 khz XEE Durango, Dgo., 1 kw-D/150 w-N.

600

600 khz XEBB Acapulco, Gro., 5 kw-D/1 kw-N.
600 khz XEDN Torreón, Coah., 1 kw.
600 khz XEGTO Guanajuato, Gto., 500 w.
600 khz XEMN Monterrey, N.L., 500 w-D.
600 khz XERJ Mazatlan, Sin., 5 kw-D/1 kw-N.
600 khz XETA Zitcuaro, Mich., 500 w-D/150 w-N.
600 khz XEZ Merida, Yuc., 2 kw.
610 khz XEBX Sabinas, Coah., 5 kw-D/500 w-N.
610 khz XECV Ciudad Valles, S.L.P., 1 kw-D/250 w-N.
610 khz XEEL Fresnillo, Zac., 5 kw-D/1 kw-N.
610 khz XEJA Jalapa, Ver., 1 kw-D/500-N.
610 khz XEUF Uruapan, Mich., 5 kw-D/1 kw-N.
610 khz XEGS Guasave, Sin., 1 kw-D/500 w-N.
610 khz XEKZ Tehuantepec, Oax., 1 kw-D/500 w-N.
620 khz XEAM Villahermosa, Tab., 1 kw-D/100 w-N.
620 khz XEBU Chihuahua, Chih., 5 kw-D/250 w-N.
620 khz XECK Durango, Dgo., 1 kw-D/100 w-N.
620 khz XEGH Reynosa, Tams., 250 w-D., u.c.
620 khz XENK Mexico City, 10 kw-D/5 kw-N.
620 khz XEYO Tepic, Nay., 1 kw-D/250 w-N.
630 khz XEFB Monterrey, N.L., 10 kw.
630 khz XEFU Cosmaloapan, Ver., 5 kw-D/750 w-N.
630 khz XEFX Guaymas, Son., 250 w.
630 khz XEID Cananea, Son., 5 kw-D, u.c.
630 khz XEJB Guadalajara, Jal., 500 w.
630 khz XETK Mazatlan, Sin., 1 kw-D/250 w-N.
630 khz XETS Tapachula, Chis., 1 kw-D/500 w-N.
630 khz XEACA Acapulco, Gro., 5 kw-D/250 w-N.
640 khz XEWM San Cristobal las Casas, Chis., 250 w-D.

650

650 khz XEZM Zamora, Mich., 5 kw-D.
650 khz XETNT Los Mochis, Sin., 500 w-D.
650 khz XEEJ Puerto Vallarta, Jal., 250 w-D.
660 khz XERPM Mexico City, 10 kw-D/5 kw-N.
660 khz XEACB Cd. Delicias, Chih., 500 w-D., u.c.
660 khz XEYF Matias Romero, Oax., 5 kw-D/250 w-N.
670 khz XEIS Ciudad Guzman, 1 kw-D.
670 khz XETOR Torreón, Coah., 1 kw-D.
680 khz XELG Leon, Gto., 10 kw-D/5 kw-N.
680 khz XEKC Oaxaca, Oax., 5 kw-D/1 kw-N, u.c.
680 khz XEKQ Tapachula, Chis., 5 kw-D/500 w-N.
680 khz XELV Hermosillo, Son., 250 w-D., u.c.
680 khz XENF Tepic, Nay., 250 w-D, u.c.
680 khz XEORO Guasave, Sin., 1 kw-D.
680 khz XEFO Chihuahua, Chih., 1 kw-D.
680 khz XEFJ Teziutlan, Pue., 1 kw-D/100 w-N.
690 khz XEN Mexico City, 20 kw-D/5 kw-N.
690 khz XETRA Tijuana, B.C., 50 kw.
690 khz XETRAN Progreso, Yuc., 50 kw., u.c.
690 khz XERG Monterrey, N.L., 500 w-D/200 w-N.

700

700 khz XEDKR Zapopan, Jal., 1 kw-D.
700 khz XETN Morelion, Gto., 250 w-D, u.c.
700 khz XEVC Cordoba, Ver., 500 w-D.
710 khz XEON Tuxtla Gutierrez, Chis., 3 kw-D/1 kw-N.
710 khz XEKU Acapulco, Gro., 500 kw-D/150 w-N.
710 khz XERL Colima, Col., 1 kw-D/200 w-N.
710 khz XEBL Culiacan, Sin., 5 kw-D/250 w-N.
710 khz XEMP Mexico City, 1 kw-D/500 w-N.
710 khz XEPQ Mazquiz, Coah., 1 kw-D/100 w-N.
710 khz XEPS Empalme, Son., 1 kw-D/250 w-N.
710 khz XERPO Oaxaca, Oax., 1 kw-D/100 w-N.
710 khz XEZR Rio Grande, Zac., 500 w-D/250 w-N.
710 khz XERK Tepic, Nay., 1 kw-D/180 w-N.
730 khz XEX Mexico City, 100 kw.

750

760 khz XERA San Cristobal las Casas, Chis., 5 kw-D.
760 khz XEABC Los Reyes, Mex., 5 kw.
760 khz XEDGO Durango, Dgo., 1 kw-D.
760 khz XEEQ San Luis Potosi, S.L.P., 250 w-D.
760 khz XEZZ Tonalá, Jal., 5 kw-D.
770 khz XEML Apatztingan, Mich., 1 kw-D.

770 khz XEGK Tamazunchale, S.L.P., 1 kw-D, u.c.
770 khz XEHB San Francisco del Oro, Chih., 500 w-D.
780 khz XEZN Celaya, Gto., 250 w-D, u.c.
790 khz XEBI Aguascalientes, Ags., 1 kw-D/250 w-N.
790 khz XEFE Nuevo Laredo, Tams., 1 kw-D/500 w-N.
790 khz XESU Mexicali, B.C., 1 kw-D.
790 khz XENT La Paz, Terr., B.C., 5 kw-D, 750 w-N.
790 khz XERC Mexico City, 10 kw-D/1 kw-N.
790 khz XEGZ Cd. Lerdo, Dgo., 1 kw-D/250 w-N.
790 khz XEVA Villahermosa, Tab., 5 kw-D/200 w-N.
790 khz XERPC Chihuahua, Chih., 5 kw-D/400 w-N.
790 khz XELN Linares, N.L., 1 kw-D.

800

800 khz XEROK Ciudad Juarez, Chih., 150 kw.
800 khz XEAN Ocotlan, Jal., 1 kw-D.
800 khz XEMMM Tijuana, B.C., 500 w-D.
810 khz XEHT Huamantla, Tlax., 500 w-D.
810 khz XERI Reynosa, Tams., 500 w-D.
810 khz XEYM Morelia, Mich., 1 kw-D, u.c.
810 khz XERSV Ciudad Obregon, Son., 5 kw-D/250 w-N.
810 khz XEFW Tampico, Tams., 50 kw.
810 khz XEUX Tuxpan, Nay., 5 kw-D.
810 khz XEOE Tapachula, Chis., 1 kw-D/250 w-N.
810 khz XEGO Cozumel, Q.R., 1 kw.
820 khz XEKG Fortin de las Flores, Ver., 1 kw-D.
820 khz XEBA Guadalajara, Jal., 1 kw-D.
820 khz XESB Santa Barbara, Chih., 750 w-D.
830 khz XELA Mexico City, 10 kw-D/5 kw-N.
830 khz XEVQ Novolato, Sin., 1 kw-D.
840 khz XEFG Celaya, Gto., 1 kw.
840 khz XEIL Tepic, Nay., 500 w-D.
840 khz XEMY Ciudad Mante, Tams., 500 w.

850

850 khz XEM Chihuahua, Chih., 5 kw-D.
850 khz XETO Orizaba, Ver., 5 kw.
850 khz XEZR Zaragoza, Coah., 1 kw-D.
850 khz XEUS Hermosillo, Son., 1 kw-D.
850 khz XEZF Mexicali, B.C., 250 w-D.
860 khz XENW Culiacan, Sin., 1 kw-D/250 w-N.
860 khz XEDU Durango, Dgo., 1 kw-D/500 w-N.
860 khz XERPN Cd. Juarez, Chih., 1 kw.
860 khz XETW Tampico, Tams., 500 w-D.
860 khz XEAL Manzanillo, Col., 1 kw-D/100 w-N.
860 khz XEUN Mexico City, 45 kw-D/25 kw-N.
860 khz XENL Monterrey, N.L., 5 kw-D/2 kw-N.
860 khz XEMO Tijuana, B.C., 5 kw.
860 khz XEZR Zaragoza, Coah., 250 w-N.
860 khz XEZS Tenosique, Tab., 1 kw-D/150 w-N.
870 khz XEACF Irapuato, Gto., 1 kw-D.
870 khz XENH Escuinapa, Sin., 1 kw-D.
870 khz XELY Morelia, Mich., 1 kw-D.
880 khz XETZ Tequila, Jal., 10 kw-D.
880 khz XEEM Rio Verde, S.L.P., 1 kw-D.
880 khz XEPNK Los Mochis, Sin., 5 kw-D, u.c.

900

900 khz XEW Mexico City, 250 kw.
900 khz XEWB Veracruz, Ver., 50 kw-D/10 kw-N (relay).
910 khz XEAO Mexicali, B.C., 250 w.
910 khz XEHO Ciudad Obregon, Son., 1 kw-D/250 w-N.
920 khz XEQD Chihuahua, Chih., 1 kw-D, 100 w-N.
920 khz XEOP Villa Frontera, Coah., 250 kw-D/200 w-N.
920 khz XEMJ Piedras Negras, Coah., 1 kw-D/250 w-N.
920 khz XEVV Chiapa de Corzo, Chis., 5 kw-D/250 w-N.
920 khz XECO Culiacan, Sin., 1 kw-D/100 w-N.
920 khz XELT Guadalajara, Jal., 1 kw-D/250 w-N.
920 khz XEBH Hermosillo, Son., 5 kw-D/1 kw-N.
920 khz XEOK Monterrey, N.L., 1 kw-D/250 w-N.
920 khz XEBM San Luis Potosi, S.L.P., 5 kw-D/1 kw-N.
920 khz XETAA Torreón, Coah., 1 kw-D/200 w-N.
930 khz XEU Veracruz, Ver., 5 kw-D/1 kw-N.
940 khz XEWV Mexicali, B.C., 1 kw-D.
940 khz XEQ Mexico City, 150 kw-D/50 kw-N.
940 khz XERKS Reynosa, Tams., 1 kw.

950

950 khz XEFA Chihuahua, Chih., 500 w-D/250 w-N.
950 khz XEYJ Nueva Rosita, Coah., 1 kw-D/100 w-N.
950 khz XEGM Tijuana, B.C., 25 kw-D/5 kw-N.
950 khz XERN Montermores, N.L., 1 kw.
950 khz XEMAB Cd. del Carmen, Camp., 250 w.
950 khz XEORF El Fuerte, Sin., 1 kw-D/ 500 w-N.
960 khz XEROO Chetumal, Q.R., 1 kw-D/500 w-N.

960 khz XEIQ Ciudad Obregon, Son., 1 kw-D/500 w-N.
960 khz XECC Cd. Camargo, Chih., 250 w-D/100 w-N.
960 khz XEGB Coatzacoalcas, Ver., 1 kw-D/500 w-N.
960 khz XECZ San Luis Potosi, S.L.P., 500 w-D/250 w-N.
960 khz XEKS Saltillo, Coah., 500 w-D/100 w-N.
960 khz XEHK Guadalajara, Jal., 1 kw-D/250 w-N.
960 khz XEMM Morelia, Mich., 500 w-D/200 w-N.
960 khz XEOZ Jalapa, Ver., 1 kw-D/250 w-N.
960 khz XECS Manzanillo, Col., 1 kw-D/200 w-N.
960 khz XEK Nuevo Laredo, Tams., 2 kw-D/1 kw-N.
960 khz XEUQ Zahuatanejo, Gro., 1 kw-D/100 w-N.
970 khz XECJ Apatztingan, Mich., 5 kw-D/250 w-N.
970 khz XEJ Ciudad Juarez, Chih., 10 kw-D/5 kw-N.
970 khz XEBJ Ciudad Victoria, Tams., 1 kw-D/5 kw-N.
970 khz XEEZ Caborca, Son., 250 w-D/100 w-N.
970 khz XEQX Monclova, Coah., 500 w-D/150 w-N.
970 khz XEUG Guanajuato, Gto., 1 kw-D/250 w-N.
970 khz XEO Matamoros, Tams., 1 kw.
970 khz XEOW Mazatlan, Sin., 1 kw-D/250 w-N.
970 khz XEDF Mexico City, 10 kw-D/5 kw-N.
970 khz XEVT Villahermosa, Tab., 5 kw-D/400 w-N.
970 khz XEMH Merida, Yuc., 1 kw-D/100 w-N.
980 khz XEFQ Cananea, Son., 500 w.
980 khz XEOT San Pedro de las Colonias, Coah., 500 w, u.c.
980 khz XELC La Piedad, Mich., 5 kw-D/200 w-N.
980 khz XEKE Navojoa, Son., 1 kw-D/250 w-N.
980 khz XEQO Cosmaloapan, Ver., 5 kw.
980 khz XENR Nueva Rosita, Coah., 5 kw-D/500 w-N.
980 khz XEQG Queretaro, Qro., 10 kw-D/150 w-N.
980 khz XETU Tampico, Tams., 10 kw-D/1 kw-N.
980 khz XEX Tepic, Nay., 1 kw.
990 khz XEBC Ciudad Guzman, Jal., 1 kw-D/100 w-N.
990 khz XEER Cd. Cuauhtemoc, Chih., 500 w-D/200 w-N.
990 khz XEOL Teziutlan, Pue., 500 w-D/100 w-N.
990 khz XECL Mexicali, B.C., 5 kw.
990 khz XET Monterrey, N.L., 50 kw.
990 khz XEHT La Paz, Terr., B.C., 1 kw-D/250 w-N.
990 khz XETG Tuxtla Gutierrez, Chis., 10 kw, u.c.
990 khz XEUM Valladolid, Yuc., 500 w-D/250 w-N.

1000

1000 khz XEFV Ciudad Juarez, Chih., 1 kw-D.
1000 khz XEOY Mexico City, 10 kw.
1000 khz Rio Bravo, Tams., 250 w-D, u.c.
1010 khz XEWS Culiacan, Sin., 5 kw-D/250 w-N.
1010 khz XEDX Ensenada, B.C., 500 w-D/250 w-N.
1010 khz XEEB Esperanza, Son., 250 w.
1010 khz XEKD Cd. Acuna, Coah., 500 w-D/200 w-N.
1010 khz XEXN Ures, Son., 500 w-D/200 w-N.
1010 khz XEHL Guadalajara, Jal., 10 kw-D/5 kw-N.
1010 khz XETX Nuevo Casas Grandes, Chih., 1 kw-D/250 w-N.
1010 khz XEVK Torreón, Coah., 5 kw-D/100 w-N.
1010 khz XEFM Veracruz, Ver., 1 kw-D/200 w-N.
1020 khz XEBR Macuspana, Tab., 1 kw-D/100 w-N, u.c.
1020 khz XEXL Patzcuaro, Mich., 1 kw-D.
1030 khz XELJ Lagos de Moreno, Jal., 250 w-D.
1030 khz XEVR Ixtlan del Rio, Nay., 250 w-D, u.c.
1030 khz XEQR Mexico City, 10 kw-D/5 kw-N.
1040 khz XECX Tala, Jal., 250 w-D.
1040 khz XEGR Coatepec, Ver., 1 kw-D.

1050

1050 khz XED Mexicali, B.C., 10 kw-D/1 kw-N.
1050 khz XEG Monterrey, N.L., 150 kw.
1060 khz XEEP Mexico City, 1 kw.
1070 khz XEIT Ciudad del Carmen, Cam., 1 kw-D/250 w-N.
1070 khz XESP Tlaquepaque, Jal., 5 kw-D/1 kw-N.
1070 khz XEY Tehuacan, Pue., 1 kw-D/250 w-N.
1070 khz XEMI Minatitlan, Ver., 500 w-D/100 w-N.
1080 khz XEAU Monterrey, N.L., 500 w-D.
1080 khz XECN Irapuato, Gto., 1 kw-D.
1080 khz XEDY Cd. Morelos, B.C., 500 w-D.
1080 khz XEXK Poza Rica, Ver., 250 w-D.
1090 khz XEVL Nuevo Laredo, Tams., 1 kw-D.
1090 khz XEPRS Rosarito, B.C., 50 kw.
1090 khz XEOD Boca del Rio, Ver., 1 kw.
1090 khz XEHR Puebla, Pue., 500 w-D/250 w-N.
1090 khz XELB La Barca, Jal., 250 w-D.

1100

1100 khz XEBD Perote, Ver., 250 w.
1100 khz XEJAC Cardenas, Tab., 1 kw.
1110 khz XELEO Leon, Gto., 5 kw-D.
1110 khz XERCN Mexico City, 50 kw.
1110 khz XEFZ Monterrey, N.L., 250 w-D.
1110 khz XEVS Villa de Seris, Son., 250 w-D.

1110 khz XEWR Cd. Juarez, Chih., 500 w-D.
 1110 khz Campache, Camp., 500 w-D/250 w-N, u.c.
 1110 khz XEQO Rio Bravo, Tams., 1 kw-D.
 1110 khz XESON Navajoa, Son., 1 kw-D, u.c.
 1120 khz XEZB Oaxaca, Oax., 500 w-D.
 1120 khz XETR Ciudad Valles, S.L.P., 1 kw-D.
 1120 khz XEUNO Guadalajara, Jal., 500 w-D.
 1130 khz XEEF Compostala, Nay., 1 kw-D.
 1130 khz XEZL Jalapa, Ver., 10 kw.
 1130 khz XEHN Nogales, Son., 1 kw-D, u.c.
 1130 khz XEFN Uruapan, Mich., 1 kw-D.
 1140 khz XEMR Monterrey, N.L., 50 kw.
 1140 khz XEXF Leon, Gto., 5 kw-D.

1150

1150 khz XEAD Guadalajara, Jal., 1 kw-D/120 w-N.
 1150 khz XERN Mexicali, B.C., 1 kw-D/500 w-N.
 1150 khz XEJP Mexico City, 10 kw.
 1150 khz XEBF S. Pedro de las Colonias, Coah., 1 kw-D/250 w-N.
 1150 khz XEJS Hidalgo del Parral, Chih., 1 kw-D/500 w-N.
 1150 khz XEWY Alamo, Ver., 1 kw-D, u.c.
 1150 khz XEXP Tuxtepec, Oax., 500 w-D.
 1150 khz XEXP Merida, Yuc., 1 kw-D/350 w-N.
 1150 khz XEXZ Zacatecas, Zac., 1 kw-D/200 w-N.
 1150 khz XESO Ciudad Obregon, Son. 5 kw-D/300 w-N, u.c.
 1150 khz XERTM Macuspana, Tab., 1 kw-D/125 w-N.
 1160 khz XEBE Perote, Ver., 1 kw-D.
 1160 khz XEGI Tamazunchale, S.L.P., 500 w-D.
 1160 khz XEYV Acambaro, Gto., 1 kw-D.
 1160 khz XEIW Uruapan, Mich., 1 kw-D.
 1170 khz XECD Puebla, Pue., 1 kw-D/350 w-N.
 1170 khz XEGV Caborca, Son., 250 w-D, u.c.
 1170 khz XEQV Arcelia, Gro., 50 kw.
 1170 khz XERT Reynosa, Tams., 5 kw-D.
 1170 khz XELP La Piedad, Mich., 250 w-D/100 w-N.
 1170 khz XEUVA Aguascalientes, Ags., 500 w-D.
 1170 khz XEZS Coatzacoalcos, Ver., 500 w-D/250 w-N.
 1180 khz XEYV Huatusco, Ver., 1 kw-D.
 1180 khz XEACN San Francisco del Rincon, Gto., 500 w-D.
 1180 khz XEFR Mexico City, 1 kw.
 1190 khz XEDO Jofulla, Mor., 1 kw-D.
 1190 khz XEMBC Mexicali, B.C., 250 w-D.
 1190 khz XEPZ Ciudad Juarez, Chih., 1 kw-D.
 1190 khz XEWK Guadalajara, Jal., 50 kw-D/10 kw-N.
 1190 khz XECT Monterrey, N.L., 500 w-D, u.c.
 1190 khz XEGJ Arriaga, Chis., 250 w-D, u.c.
 1190 khz XEPK Pachuca, Hgo., 500 w-D.
 1190 khz XESOL Cd. Hidalgo, Mich., 1 kw.
 1190 khz XEVN Nogales, Son., 500 w-D, u.c.
 1190 khz Cd. Madero, Tams., 500 w-D, u.c.

1200

1200 khz XEZI Zacapu, Mich., 1 kw-D.
 1200 khz XEPW Poza Rica, V.C., 250 w-D.
 1220 khz XEB Mexico City, 100 kw.
 1230 khz XESCT Ensenada, Baja Calif., 1 kw-D/250 w-N.
 1240 khz XELD Autlan de Navarro, Jal., 1 kw-D/100 w-N.
 1240 khz XEIZ Monterrey, N.L., 500 w-D/250 w-N.
 1240 khz XEBN Ciudad Delicias, Chih., 1 kw-D/250 w-N.
 1240 khz XEWG Cd. Juarez, Chih., 250 w.
 1240 khz XEBO Guaymas, Son., 1 kw-D/250 w-N.
 1240 khz XENG Huachuquinango, Pue., 1 kw-D/200 w-N.
 1240 khz XEVM Piedras Negras, Coah., 250 w-D/200 w-N.
 1240 khz XERZ Leon, Gto., 1 kw-D/250 w-N.
 1240 khz XETC Torreón, Coah., 500 w-D/250 w-N.
 1240 khz XEMQ Merida, Yuc., 1 kw-D/250 w-N.
 1240 khz XERPA Morelia, Mich., 500 w.
 1240 khz XEIF San Blas, Sin., 1 kw-D/250 w-N.
 1240 khz XESI Santiago Ixcuintla, Nay., 1 kw-D/300 w-N.
 1240 khz XECE Oaxaca, Oax., 500 w-D/250 w-N.
 1240 khz XECG Nogales, Son., 1 kw-D/250 w-N.
 1240 khz XES Tampico, Tams., 1 kw-D/250 w-N.
 1240 khz XEOV Orizaba, Vera Cruz, 250 w-D/200 w-N.
 1240 khz XELM Tuxtla Gutierrez, Chis., 1 kw-D/250 w-N.

1250

1250 khz XEMG Arriaga, Chis., 1 kw-D/250 w-N.
 1250 khz XESC Sabinas, Coah., 1 kw-D, u.c.
 1250 khz XEZT Puebla, Pue., 500 w-D/100 w-N.
 1250 khz XEUO Chetuma, Quin. Roo, 250 w.
 1250 khz XETF Veracruz, Ver., 1 kw-D/500 w-N.

1250 khz XEAT Hidalgo del Parral, Chih., 250 w.
 1250 khz XEJX Queretaro, Qro., 1 kw-D/100 w-N.
 1250 khz XEDK Guadalajara, Jal., 5 kw-D/1 kw-N.
 1250 khz XEDL Hermosillo, Son., 1 kw-D/500 w-N.
 1250 khz XESJ Saitlito, Coah., 1 kw-D/500 w-N.
 1250 khz XEPI Tixla, Gro., 1 kw-D/100 w-N, u.c.
 1260 khz XEZH Salamanca, Gto., 500 w-D.
 1260 khz XESIN Culiacan, Sin., 5 kw-D/500 w-N.
 1260 khz XEDW Minatitlan, Ver., 1 kw-D/250 w-N.
 1260 khz XEXR Ciudad Valles, S.L.P., 1 kw-D.
 1260 khz XEMF Monclove, Coah., 1 kw-D/250 w-N.
 1260 khz XER Linares, N.L., 1 kw-D/250 w-N.
 1260 khz XEOG Ojinaga, Chih., 1 kw-D/500 w-N.
 1260 khz XEL Mexico City, 10 kw-D/1 kw-N.
 1270 khz XEAZ Tijuana, Baja Calif., 500 w.
 1270 khz XEOH Cd. Camargo, Chih., 1 kw-D/150 w-N.
 1270 khz XEAX Oaxaca, Oax., 5 kw-D/500 w-N.
 1270 khz XEHD Durango, Dgo., 250 w-D, u.c.
 1270 khz XEWN Gomez Palacio, Dur., 500 w-D/150 w-N.
 1270 khz XEGL Navojoa, Son., 1 kw-D/500 w-N.
 1270 khz XERPL Leon, Guo., 1 kw-D/150 w-N.
 1270 khz XENY Nogales, Son., 1 kw-D/250 w-N.
 1270 khz XEZU Zacapu, Mich., 500 w-D/250 w-N.
 1270 khz XEQH Ixmiquilpan, Ver., 1 kw-D/100 w-N.
 1270 khz XENX Mazatlan, Sin., 1 kw-D/150 w-N.
 1270 khz XEMW San Luis Rio Colorado, Son., 1 kw-D.
 1270 khz XERRT Cd. Madero, Tams., 250 w-D/200 w-N.
 1270 khz XEYUC Merida, Yuc., 1 kw-D/500 w-N, u.c.
 1270 khz XEPV Papanila, Ver., 1 kw-D/250 w-N.
 1280 khz XECAM Campeche, Cam., 500 w-D/200 w-N.
 1280 khz XEAG Cordoba, Ver., 1 kw.
 1280 khz XEAM Monterrey, N.L., 5 kw-D/500 w-N.
 1280 khz XEBW Chihuahua, Chih., 1 kw-D/600 w-N.
 1280 khz XEOP Guadalajara, Jal., 1 kw-D/250 w-N.
 1280 khz XEYX Huixtla, Chis., 1 kw-D/100 w-N.
 1280 khz XEUU Colima, Col., 500 w-D/150 w-N.
 1280 khz XESQ San Miguel Allende, Gto., 500 w-D/250 w-N.
 1280 khz XEHS Los Mochis, Sin., 250 w.
 1280 khz XEANA Caborca, Son., 500 w-D, u.c.
 1280 khz XEEG Panzacola, Tlax., 1 kw-D/250 w-N.
 1280 khz XELK Zacatecas, Zac., 5 kw-D/250 w-N.
 1290 khz XETH Palizada, Camp., 250 w-D/100 w-N.
 1290 khz XEDB Tonala, Chiap., 1 kw-D/250 w-N.
 1290 khz XEAD Ciudad Obregon, Son., 1 kw-D/100 w-N.
 1290 khz XEIX Jiquilpan, Mich., 1 kw-D/100 w-N.
 1290 khz XEDA Mexico City, 10 kw-D/1 kw-N.
 1290 khz XERE Salvatierra, Gto., 250 w-D.
 1290 khz XEYI Rio Verde, S.L.P., 250 w-D/100 w-N.

1300

1300 khz XESW Ciudad Madera, Chih., 1 kw-D, u.c.
 1300 khz XEABA, Nueva Rosita, Coah., 1 kw-D/100 w-N.
 1300 khz XELE Tampico, Tams., 500 w-D/150 w-N.
 1300 khz XEGA San Andres Tuxtla, Ver., 500 w.
 1300 khz XEP Ciudad Juarez, Chih., 1 kw-D/500 w-N.
 1300 khz XEKW Morelia, Mich., 500 w.
 1300 khz XEHU Martinez de la Torre, Ver., 1 kw-D/100 w-N.
 1300 khz XEJL Guamuchil, Sin., 1 kw-D/250 w-N.
 1300 khz XEXW Nogales, Son., 1 kw-D/100 w-N.
 1310 khz XEY La Paz, B.C., 500 w.
 1310 khz XEC Tijuana, B.C., 250 w.
 1310 khz XEAM Matamoros, Tams., 1 kw-D/250 w-N.
 1310 khz XETAP Tapachula, Chis., 1 kw-D, u.c.
 1310 khz XEBP Torreón, Coah., 10 kw-D/250 w-N.
 1310 khz XEFH Agua Prieta, Son., 1 kw.
 1310 khz XEHJ Petatlan, Gro., 250 w.
 1310 khz XEVV Villa de Juarez, N.L., 1 kw-D/250 w-N.
 1310 khz XEHV Veracruz, Ver., 1 kw.
 1310 khz XETIA Guadalajara, Jal., 1 kw-D/250 w-N.
 1310 khz XEHIT Pueblo, Pue., 250 w-D/100 w-N.
 1310 khz XEUP Tizimin, Yuc., 1 kw-D/250 w-N.
 1310 khz XEPO San Luis Potosi, S.L.P., 500 w-D/250 w-N.
 1310 khz XERU Chihuahua, Chih., 1 kw-D/250 w-N.
 1320 khz XESR Santa Rosalia, B.C.S., 150 w.
 1320 khz XEUH Tuxtepec, Oax., 1 kw-D/100 w-N.
 1320 khz XEJZ Cd. Jimenez, Chih., 1 kw-D/250 w-N.
 1320 khz XECY Huejutla, Hgo., 1 kw-D/250 w-N.
 1320 khz XENP Ocotlan, Jal., 500 w-D/200 w-N.
 1320 khz XEAI Mexico City, 10 kw-D/1 kw-N.
 1320 khz XEUI Comitán, Chis., 1 kw-D/500 w-N.
 1320 khz XERQ Montemorelos, N.L., 1 kw-D/100 w-N, u.c.
 1320 khz XERJ Mazatlan, Sin., 5 kw-D/500 w-N.
 1320 khz XESY Magdalena, Son., 200 w.
 1320 khz XENI Nueva Italia, Mich., 1 kw-D/250 w-N.
 1330 khz XEBO Irapuato, Gto., 5 kw-D/1 kw-N.

1330 khz XEAJ Saitlito, Coah., 500 w-D/100 w-N.
 1330 khz XEAH Juchitan, Oax., 500 w.
 1330 khz XEUAS Culiacan, Sin., 5 kw-D/1 kw-N, u.c.
 1330 khz XEFC Merida, Yuc., 1 kw.
 1330 khz XEWQ Monclove, Coah., 1 kw-D/250 w-N.
 1330 khz XEUZ Martinex de la Torre, Ver., 1 kw-D/100 w-N.
 1330 khz XERP Ciudad Madero, Tams., 10 kw-D/100 w-N.
 1340 khz XEBY Tuxpam, Ver., 250 w.
 1340 khz XEAA Mexicali, B.C., 1 kw-D/250 w-N.
 1340 khz XEBCC Cd. del Carmen, Camp., 250 w, u.c.
 1340 khz XECI Acapulco, Gro., 1 kw-D/250 w-N.
 1340 khz XERCH Ojinaga, Chih., 250 w-D/100 w-N.
 1340 khz XEDH Cd. Acuna, Coah., 1 kw-D/250 w-N.
 1340 khz XEJK Ciudad Delicias, Chih., 1 kw-D/250 w-N.
 1340 khz XEBK Nuevo Laredo, Tams., 250 w.
 1340 khz XEOB Tulancingo, Hgo., 250 w-D/250 w-N.
 1340 khz XERLK Atlacomulco, Mex., 500 w-D.
 1340 khz XEOM Coatzacoalcos, Ver., 1 kw-D/250 w-N.
 1340 khz XEOE Escuinapa, Sin., 250 w.
 1340 khz XECR Morelia, Mich., 250 w.
 1340 khz XEJC Cuernavaca, Mor., 500 w-D/250 w-N.
 1340 khz XEMA Fresnillo, Zac., 1 kw-D/250 w-N.
 1340 khz XEZE Santiago Ixcuintla, Nay., 250 w-D/200 w-N, u.c.
 1340 khz XEDKT Guadalajara, Jal., 1 kw-D/250 w-N.
 1340 khz XELU Cd. Serdan, Pue., 250 w.
 1340 khz XEMT Matamoros, Tams., 250 w.
 1340 khz XECV Los Mochis, Sin., 1 kw-D/200 w-N.
 1340 khz XERP Ciudad Victoria, Tams., 1 kw-D/250 w-N.
 1340 khz XEOS Cd. Obregon, Son., 250 w.
 1340 khz XEYR Teapa, Tab., 250 w-D/150 w-N.
 1340 khz XENV Monterrey, N.L., 1 kw-D/250 w-N.
 1340 khz XESL San Luis Potosi, S.L.P., 500 w-D/250 w-N.

1350

1350 khz XETB Torreón, Coah., 5 kw-D/500 w-N.
 1350 khz XELBL San Luis Rio Colorado, Sen., 500 w-D.
 1350 khz XEJF Tierra Blanca, Ver., 500 w-D/100 w-N.
 1350 khz XEYV Yajalon, Chis., 500 w-D, u.c.
 1350 khz XEZD Cd. Camargo, Tams., 250 w.
 1350 khz XEQK Mexico City, 1 kw.
 1350 khz XETM Naco, Son., 1 kw.
 1350 khz XEYJ El Grullo, Jal., 1 kw-D/100 w-N.
 1360 khz XEDI Chihuahua, Chih., 1 kw-D/200 w-N.
 1360 khz XEKF Iguala, Gro., 1 kw-D/500 w-N.
 1360 khz XESA Culiacan, Sin., 1 kw-D/500 w-N.
 1360 khz XEUL Progreso, Yuc., 250 w.
 1360 khz XEY Celaya, Gto., 1 kw-D/250 w-N.
 1360 khz XEAGV Cd. Mendoza, Ver., 250 w-D, u.c.
 1360 khz XEFBF Martinez de la Torre, Ver., 500 w-D/100 w-N, u.c.
 1360 khz XELS Armeria, Col., 1 kw-D/100 w-N.
 1360 khz XEQY Toluca, Mex., 500 w-D.
 1360 khz XETP Cd. Valles, S.L.P., 5 kw-D, u.c.
 1360 khz Piedras Negras, Coah., 500 w-D/250 w-N, u.c.
 1360 khz XEDQ San Andres Tuxtla, Ver., 1 kw-D/100 w-N.
 1370 khz XEA Campeche, Cam., 1 kw.
 1370 khz XEGNK Nueva Laredo, Tams., 250 w-D.
 1370 khz XEHG Mexicali, B.C., 500 w-D.
 1370 khz XEJE Dolores Hidalgo, Gto., 500 w-D.
 1370 khz XEMON Monterrey, N.L., 10 kw, u.c.
 1370 khz XEHX Ciudad Obregon, Son., 10 kw-D/5 kw-N, u.c.
 1370 khz XERPU Durango, Dgo., 1 kw-D/100 w-N.
 1370 khz XEHF Nogales, Son., 5 kw.
 1370 khz XEPA Puebla, Pue., 5 kw-D/1 kw-N.
 1370 khz XEPJ Tlaxiapa, Jal., 1 kw-D/500 w-N.
 1380 khz XEFAC Salvatierra, Gto., 1 kw-D.
 1380 khz XEKT Tecate, B.C., 250 w-D/100 w-N.
 1380 khz XEGW Ciudad Victoria, Tams., 5 kw-D/150 w-N.
 1380 khz XENSM La Paz, B.C.S., 250 w, u.c.
 1380 khz XERS Gomez Palacio, Dgo., 500 w-D/250 w-N.
 1380 khz XECO Mexico City, 5 kw.
 1380 khz XEKV Villahermosa, Tab., 1 kw-D/500 w-N.
 1380 khz XEYB Cosamalapan, Ver., 1 kw, u.c.
 1380 khz XEZW Cd. Hidalgo, Chis., 1 kw-D/250 w-N, u.c.
 1380 khz Tepic, Nay., 1 kw-D/500 w-N, u.c.
 1390 khz XERW Leon, Gto., 1 kw-D/250 w-N.
 1390 khz XEOR Reynosa, Tams., 1 kw.
 1390 khz XEYL Tuxpam, Ver., 5 kw-D/1 kw-N.

Mexican AM, FM

1390 khz XETY Tecoman, Col., 5 kw-D/250 w-N.
 1390 khz XEXO Ciudad Mante, Tams., 5 kw-D/100 w-N.
 1390 khz XEXH Mixquiahuala, Hgo., 100 w-D, u.c.
 1390 khz XEJI Tehuantepec, Oax., 2.5 kw-D/250 w-N.
 1390 khz XEOC Puerto Panasco, Son., 500 w-D.
 1390 khz XEV Chihuahua, Chih., 1 kw-D/500 w-N, u.c.
 1390 khz XESX Tuxtla, Chis., 5 kw-D.

1400

1400 khz XEWU Matehuala, S.L.P., 250 w-D/200 w-N.
 1400 khz XELH Acaponeta, Nay., 1 kw-D/250 w-N.
 1400 khz XEKJ Acapulco, Gro., 500 w-D/250 w-N.
 1400 khz XEFS Izucar de Matamoros, Pue., 250 w-D.
 1400 khz XESH Sabinas Hidalgo, N.L., 250 w-D/100 w-N.
 1400 khz XEUBJ Oaxaca, Oax., 1 kw-D/200 w-N.
 1400 khz XEPB Hermosillo, Son., 1 kw-D/200 w-N.
 1400 khz XEVI San Juan del Rio, Gro., 500 w-D/200 w-N.
 1400 khz XEGD Hidalgo del Parral, Chih., 1 kw-D/200 w-N.
 1400 khz XEAC Aguascalientes, Ags., 500 w-D/200 w-N.
 1400 khz XEARO Nueva Rosita, Coah., 1 kw-D/150 w-N.
 1400 khz XEDE Saltillo, Coah., 500 w-D/250 w-N.
 1400 khz XEEJ El Dorado, Sin., 250 w-D/150 w-N.
 1400 khz XEIH Fresnillo, Zac., 500 w-D/250 w-N.
 1400 khz XELR Linares, N.L., 250 w-D/100 w-N, u.c.
 1400 khz XEPF Ensenada, B.C., 200 w.
 1400 khz XEPG Veracruz, Ver., 250 w, u.c.
 1400 khz XERUY Merida, Yuc., 1 kw-D/250 w-N.
 1400 khz XESG Navojoa, Son., 500 w-D/200 w-N, u.c.
 1400 khz XEQJ Tamazula, Jal., 1 kw-D/100 w-N.
 1400 khz XEXI Ixtapan de la Sal, Mex., 250 w.
 1400 khz XEI Morelia, Mich., 1 kw-D/250 w-N.
 1400 khz XETO Tampico, Tams., 1 kw-D/250 w-N.
 1400 khz XEAB Santa Ana, Son., 1 kw-D/250 w-N.
 1410 khz XEKB Atemajac, Jal., 5 kw-D/250 w-N.
 1410 khz XEAS Nuevo Laredo, Tams., 1 kw-D/250 w-N.
 1410 khz XEIR Cd. Yalies, S.L.P., 1 kw-D, u.c.
 1410 khz XERCM Cd. Victoria, Tams., 1 kw-D/150 w-N, u.c.
 1410 khz XEYD Francisco 1. Madero, Coah., 1 kw-D/100 w-N.
 1410 khz XEBS Mexico City, 5 kw-D/1 kw-N.
 1410 khz XECF Los Mochis, Sin., 1 kw-D/500 w-N.
 1410 khz XETAB Villahermosa, Tab., 5 kw-D/500 w-N.
 1420 khz XEGF Gutierrez Zamora, Ver., 500 w-D/00 w-N.
 1420 khz XEF Ciudad Juarez, Chih., 5 kw-D/500 w-N.
 1420 khz XEWE, Irapuato, Gto., 10 kw-D/180 w-N.
 1420 khz XEWF Cuernavaca, Mor., 1 kw.
 1420 khz XEH Monterrey, N.L., 1 kw.
 1420 khz XERD Pachuca, Hgo., 1 kw-D/250 w-N.
 1420 khz XEWJ Tehuacan, Pue., 1 kw-D/250 w-N.
 1420 khz XEWP Sayula, Jal., 500 w-D.
 1420 khz XEXX Tijuana, B.C., 2 kw.
 1420 khz XEEW Matamoros, Tams., 5 kw-D/2.5 kw-N.
 1420 khz XEJV Jaltipan, Ver., 1 kw-D/250 w-N.
 1430 khz XEOX Ciudad Obregon, Son., 50 kw-D/500 w-N.
 1430 khz XELL Veracruz, Ver., 1 kw-D/250 w-N.
 1430 khz XERAC Campeche, Cam., 1 kw-D/250 w-N.
 1430 khz XEIG Iguala, Gro., 1 kw-D/100 w-N.
 1430 khz XEIA Allende, Coah., 1 kw-D/250 w-N, u.c.
 1430 khz XETI Tempoal, Tams., 500 w-D.
 1430 khz XETUN San Luis Potosi, S.L.P., 1 kw.
 1430 khz XECA Ixtepac, Oax., 1 kw-D/200 w-N.
 1430 khz XEWD Ciudad Miguel Aleman, Tams., 2 kw-D/250 w-N.
 1430 khz XETT Tlaxcala, Tax., 500 w-D.
 1440 khz XEYSD Villa Constitucion, B.C.S., 1 kw-D/150 w-N.
 1440 khz XELZ Mexico City, 10 kw-D/1 kw-N.
 1440 khz XEHW Rosario, Sin., 250 w.
 1440 khz XEEA Ciudad Camargo, Chih., 5 kw-D/1 kw-N.
 1440 khz XEEC Tapacoyan, Ver., 250 w.
 1440 khz XEEK Cheran, Mich., 1 kw-D.
1450
 1450 khz XEZC Rio Grande, Zac., 250 w.
 1450 khz XECM Ciudad Mante, Tams., 1 kw-D/250 w-N.
 1450 khz XERY Arcelia, Gro., 1 kw-D/100 w-N, u.c.
 1450 khz XECB San Luis Colorado, Son., 250 w.
 1450 khz XEDJ Magdalena, Son., 1 kw-D/250 w-N.
 1450 khz XEFK Torreón, Coah., 1 kw-D/250 w-N.
 1450 khz XEPY Merida, Yuc., 500 w-D/250 w-N.
 1450 khz XEPP Orizaba, Ver., 1 kw-D/250 w-N.

1450 khz XEIN Cintalapa, Chis., 1 kw-D/200 w-N.
 1450 khz XEJD Poza Rica, Ver., 1 kw-D/250 w-N.
 1450 khz XEJTF Zacoalco, Jal., 500 w-D/250 w-N.
 1450 khz XEKM Minatitlan, Ver., 1 kw-D/250 w-N.
 1450 khz XENA Queretaro, Gro., 1 kw-D/250 w-N.
 1450 khz XEGC Sahuayo, Mich., 1 kw-D/250 w-N.
 1450 khz XEQU Ojinaga, Chih., 1 kw-D/250 w-N.
 1450 khz XESS Ensenada, B.C., 1 kw-D/250 w-N.
 1450 khz XETD Tecuala, Nay., 250 w.
 1450 khz XEVH Vallehermoso, Tams., 1 kw-D/250 w-N.
 1450 khz XEYZ Aguascalientes, Ags., 250 w.
 1450 khz XEXD Atlixco, Pue., 500 w-D/250 w-N.
 1450 khz XEJM Monterrey, N.L., 1 kw-D/250 w-N.
 1460 khz XEHE Atotonilco el Alto, Jal., 250 w.
 1460 khz XEJH Jalapa, Ver., 500 w.
 1460 khz XELX Zitacuaro, Mich., 10 kw-D.
 1460 khz XEOLA Altamira, Tams., 1 kw.
 1460 khz XEPD Nueva Rosita, Coah., 1 kw.
 1460 khz XEUJ Cd. del Carmen, Camp., 250 w.
 1460 khz XEXQ San Luis Potosi, S.L.P., 250 w.
 1460 khz XEYC Ciudad Juarez, Chih., 1 kw.
 1470 khz XEACE Mazatlan, Sin., 1 kw.
 1470 khz XEAY Parras, Coah., 1 kw-D/250 w-N.
 1470 khz XEBBC Tijuana, B.C., 5 kw.
 1470 khz XECAV Durango, Dgo., 1 kw-D/250 w-N.
 1470 khz XECU Los Mochis, Sin., 250 w.
 1470 khz XEDS Colima, Col., 1 kw-D/200 w-N.
 1470 khz XEHI Ciudad Miguel Aleman, Tams., 1 kw-D/250 w-N.
 1470 khz XEHM Cd. Delicias, Chih., 1 kw.
 1470 khz XELOM Loma Bonita, Oax., 5 kw.
 1470 khz XEOS Fresnillo, Zac., 1 kw-D.
 1470 khz XESM Mexico, D.F., 10 kw-D/5 kw-N.
 1470 khz XEYA Irapuato, Gto., 1 kw-D.
 1480 khz XEGX San Luis de la Paz, Gto., 500 w-D/100 w-N.
 1480 khz XEMC Salvierra, Gto., 250 w-D.
 1480 khz XEMCA Cd. Morelos, B.C., 500 w-D/100 w-N.
 1480 khz XENS Navojoa, Son., 1 kw.
 1480 khz XEOU Huajuapán de Leon, Oax., 500 w-D.
 1480 khz XEPR Poza Rica, Ver., 5 kw-D/500 w-N.
 1480 khz XETKR Monterrey, N.L., 1 kw-D/250 w-N.
 1480 khz XEXC Taxco, Gro., 1 kw-D/125 w-N.
 1480 khz XEXU Villa Frontera, Coah., 1 kw-D.
 1480 khz XEZJ Zapopan, Jal., 250 w-D/200 w-N.
 1490 khz XEAO Agua Prieta, Son., 1 kw-D/250 w-N.
 1490 khz XEAR Tampico, Tams., 250 w-D/150 w-N.
 1490 khz XECH Toluca, Mex., 250 w.
 1490 khz XECJC Cd. Juarez, Chih., 250 w.
 1490 khz XEDG Chihuahua, Chih., 1 kw-D/250 w-N.
 1490 khz XEED Ameca, Jal., 1 kw-D/250 w-N.
 1490 khz XEDR Guaymas, Son., 1 kw-D/250 w-N.
 1490 khz XEFF Matehuala, S.L.P., 1 kw-D/250 w-N.
 1490 khz XEGG Cd. Mante, Tams., 250 w-D/100 w-N.
 1490 khz XEGT Zamora, Mich., 1 kw-D/250 w-N.
 1490 khz XEIB Todos Santos, B.C.S., 250 w.
 1490 khz XEJR Hidalgo del Parral, Chih., 1 kw-D/200 w-N.
 1490 khz XEAQ Agua Prieta, Son., 250 w-D.
 1490 khz XEKN Huetamo, Mich., 250 w.
 1490 khz XEME Valladolid, Yuc., 500 w.
 1490 khz XEMK Huixtla, Chis., 500 w-D/200 w-N.
 1490 khz XEMS Matamoros, Tams., 1 kw-D/250 w-N.
 1490 khz XEPOP Puebla, Pue., 250 w.
 1490 khz XERO Aguascalientes, Ags., 250 w.
 1490 khz XESK Ruiz, Nay., 250 w-D/200 w-N.
 1490 khz XEVP Guasave, Sin., 500 w-D/200 w-N.
 1490 khz XEVZ Acayucan, Ver., 250 w-D/200 w-N.
 1490 khz XEXE Queretaro, Gro., 1 kw-D/200 w-N.
 1490 khz XEYT Teocelo, Ver., 250 w-D/100 w-N.

1500

1500 khz XEEP Ensenada, B.C., 500 w-D.
 1500 khz XEFL Guadajuato, Gto., 250 w.
 1500 khz XEJQ Parras de la Fuente, Coah., 250 w-D.
 1500 khz XERH Mexico City, 20 kw-D/5 kw-N.
 1500 khz XEUU Villahermosa, Tab., 250 w.
 1500 khz XEGN Piedras Negras, Coah., 250 w-D.
 1510 khz XEJPM Cardel, Ver., 500 w-D.
 1510 khz XEKI Villa de Seris, Son., 250 w-D.
 1510 khz XELW Cd. Guzman, Jal., 500 w-D.
 1510 khz XEOF Cortazar, Gto., 5 kw-D.
 1510 khz XEQI Monterrey, N.L., 500 w-D.
 1510 khz XEYQ Fresnillo, Zac., 1 kw-D.
 1520 khz XEACC Cd. Camargo, Chih., 1 kw-D.
 1520 khz XEATP Tehuacan, Pue., 250 w.
 1520 khz XEEH San Luis Rio Colorado, Son., 1 kw-D.
 1520 khz XEVO San Rafael, Ver., 250 w-D.
 1520 khz XEVU Mazatlan, Sin., 500 w-D.
 1520 khz XEVUC Villa Union, Coah., 1 kw-D.
 1520 khz XEYZ El Limon, Tams., 1 kw.
 1520 khz XEPQ Huimanguillo, Tab., 1 kw-D/100 w-N.
 1530 khz XESD Silao, Gto., 1 kw-D/100 w-N.

1530 khz XEUR Mexico City (Texcoco), 5 kw.
 1530 khz XEYX Altamirano, Gro., 500 w-D.
 1530 khz XEEF Compostela, Nay., 1 kw.
 1540 khz XENC Celaya, Gto., 1 kw-D/250 w-N.
 1540 khz XENJ Tepatlitan, Jal., 1 kw.
 1540 khz XEOM Hermosillo, Son., 5 kw.
 1540 khz XEVF Villa Flores, Chis., 500 w-D.

1550

1550 khz XEBG Tijuana, B.C., 1 kw.
 1550 khz XEDV El Oro, Mex., 500 w-D.
 1550 khz XENU Nuevo Laredo, Tams., 5 kw-D.
 1550 khz XEXB Jalapa, Ver., 10 kw.
 1560 khz XEDD Montemoreles, N.L., 500 w-D.
 1560 khz XEJP Ciudad Juarez, Chih., 1 kw, u.c. (Same call letters assigned to Zaragoza, Coah.)
 1560 khz XEOEC Panzacola, Tlax., 1 kw-D.
 1560 khz XESE Champoton, Cam., 5 kw-D.
 1560 khz XEVIP Mexico City, 10 kw-D/500 w-N.
 1560 khz XEQZ Cd. Cuauhtemoc, Chih., 2 kw-D/250 w-N.
 1560 khz XERX Salamanca, Gto., 1 kw-D/250 w-N.
 1570 khz XERF Ciudad Acuna, Coah., 250 kw.
 1580 khz XEAF Apaseo el Grande, Gto., 1 kw-D.
 1580 khz XEGOL Campeche, Camp., 250 w-D/150 w-N.
 1580 khz XELI Chipancingo, Gro., 1 kw-D/250 w-N.
 1580 khz XENQ Tulancingo, Hgo., 1 kw-D/500 w-N.
 1580 khz XEQL Zamora, Mich., 1 kw-D/250 w-N.
 1580 khz XEUY Las Choapas, Ver., 250 w-D/100 w-N.
 1580 khz XEFP Jalpa, Zac., 250 w-D.
 1580 khz XEDM Hermosillo, Son., 50 kw.
 1590 khz XEACH Monterrey, N.L., 5 kw.
 1590 khz XEART Zacatepec, Mor., 1 kw.
 1590 khz XEBZ Meoqui, Chih., 1 kw-D.
 1590 khz XEKC Mexicali, B.C., 10 kw-D.
 1590 khz XENMB Valladolid, Yuc., 10 kw-D.
 1590 khz XEVOZ Mexico City, 10 kw-D/5 kw-N.
 1590 khz XEPT Misantha, Ver., 1 kw-D/100 w-N.

1600

1600 khz XEACG Acapulco, Gro., 500 w.
 1600 khz XEAE Ciudad Acuna, Coah., 1 kw.
 1600 khz XEAK Acambaro, Gto., 500 w-D/200 w-N.
 1600 khz XEPE Nogales, Son., 1 kw-D.
 1600 khz XEOA Autlan de Navarro, Jal., 1 kw-D.
 1600 khz XEOT Veracruz, Ver., 250 w.
 1600 khz XERCP Puerterero, Mich., 200 w-D.
 1600 khz XERTP San Martin Texmelucan, Pue., 500 w-D.
 1600 khz XEZA Topolobampo, Sin., 1 kw-D/200 w-N.
 1600 khz XEZK Tepatlitan, Jal., 1 kw-D/250 w-N.

FM Radio in Northern Mexico

Note: Stations listed are within 200 miles of the U.S. border. Antenna heights are in feet above average terrain

Baja California

Mexicali

XHMC-FM—104.9 mhz; 970 w. Ant 180 ft.
 XHFE-FM—89.9 mhz; 900 w. Ant 111 ft.
 XHJC-FM—91.5 mhz; 939 w. Ant 104 ft.
 XHMMF-FM—92.3 mhz; 18.5 kw. Ant 70.9 ft.
 XHPF-FM—101.9 mhz; 1 kw. Ant 147 ft.
 XHVG-FM—103.3 mhz; 955 w. Ant 139 ft.

Tijuana

XETRA-FM—91.1 mhz; 100 kw. Ant 801 ft.
 XHERS-FM—104.5 mhz; 57.3 kw. Ant 350 ft.
 XHFG-FM—107.3 mhz; 4.55 kw. Ant 985 ft.
 XHIS-FM—90.3 mhz; 93 kw. Ant 456 ft.
 XHOF-FM—98.9 mhz; 3.6 kw. Ant 115 ft.
 XHQS-FM—95.7 mhz; 2.8 kw. Ant 295 ft.
 XHRM-FM—92.5 mhz; 4.6 kw. Ant 203 ft.

Coahuila

Ciudad Acuna

XHPL-FM—99.7 mhz; 823 w. Ant 75 ft.

Monclova

XHMS-FM—99.5 mhz; 383 w. Ant minus 199 ft.
 XHTF-FM—100.3 mhz; 362 w. Ant minus 150 ft.

Piedras Negras

XHRE-FM—105.5 mhz; 1.89 kw. Ant 108 ft.

XHSG-FM—99.9 mhz; 392 w. Ant 133 ft.
XHSL-FM—99.1 mhz; 969 w. Ant 108 ft.
XHTA-FM—94.5 mhz; 865 w. Ant 111 ft.

Sabinas

XHEC-FM—91.9 mhz; 3.88 kw. Ant 101 ft.

Saftillo

XHRP-FM—94.7 mhz; 2.9 kw. Ant minus 558 ft.

Chihuahua

Chihuahua

XHSU-FM—106.1 mhz; 956 w. Ant minus 98 ft.

Ciudad Juarez

XHEM-FM—103.5 mhz; 2.3 kw. Ant minus 17 ft.
XHGH-FM—105.9 mhz; 3.4 kw. Ant minus 222 ft.
XHH-FM—100.7 mhz; 286 w. Ant minus 134 ft.
XHIM-FM—105.1 mhz; 940 w. Ant minus 19 ft.
XHPX-FM—98.3 mhz; 4 kw. Ant minus 101 ft.
XHTO-FM—104.3 mhz; 9.5 kw. Ant minus 118 ft.

Nuevo Leon

Monterrey

XÉT-FM—94.1 mhz; 1.95 kw. Ant 78 ft.
XHL-FM—101.3 mhz; 3.8 kw. Ant minus 430 ft.

Radio Stations in Bermuda & Caribbean

Bahamas

(All Bahamian stations are owned by the Broadcasting Corp. of the Bahamas.)

AM

810 khz ZNS3 Freeport, Grand Bahama Island, 1 kw.
1240 khz ZNS2, Nassau, 1 kw.
1540 khz ZNS 1 Nassau, 20 kw.

FM

107.1 mhz ZNS1-FM Nassau.
107.9 mhz ZNS2-FM Nassau.

Bermuda

AM

960 khz ZFB-1, Capital Bcstg Co. Ltd., Box 652, Pembroke West (Somerset), 1 kw.
1235 khz ZBM-1, Bermuda Bcstg Co. Ltd., Box 452, Hamilton, 1 kw.
1340 ZBM-2, Bermuda Bcstg, Hamilton, 1 kw.

FM

89.1 ZBM-FM, Bermuda Bcstg, Hamilton.
94.6 ZFB-FM, Capital Bcstg, Hamilton.

British Virgin Islands

780 khz ZBVI Roadtown, Tortola; Virgin Islands Bcstg Ltd. 10 kw.

Cuba

(All stations listed under Cuba are government owned although in many cases they still use the call letters of the former commercial licenses. Data is the best available, but reliability may vary due to inadequate reporting.)

540-590 khz

570 CMHI Santa Clara, Radio Rebelde, 10 kw (relay).
580 CMJM Ciego de Avila, Radio Rebelde, 500 w.
590 CMW Havana-S. Antonio de las Vegas, Radio Rebelde, 150 kw.

600-690 khz

600 CMKV Holguin (San German), Radio Rebelde, 150 kw (relay).
610 CMHV Trinidad, Radio Rebelde, 1 kw.
620 CMKF Baracoa, Radio Rebelde, 1 kw (relay).
630 CMHQ Santa Clara, Radio Liberacion, 50 kw (relay).
640 CMQ Havana, Radio Liberacion, 50 kw.
650 CMKU Santiago de Cuba, Radio Liberacion, 2 kw (relay).
660 CMHG Santa Clara, Radio Progreso, 10 kw (relay).
670 CMKP San Pedro de Cacocum, Radio Progreso, 50 kw (relay).
680 CMHN Cienfuegos, Radio Progreso, 5 kw (relay).
690 CMBC Havana (Guanabacoa), Radio Progreso, 50 kw.

700-790 khz

700 CMJT Ciego de Avila, Radio Progreso 1 kw (relay).

XHJD-FM—98.9 mhz; 3.7 kw. Ant minus 135 ft.
XHMG-FM—100.5 mhz; 3.8 kw. Ant minus 392 ft.
XHNL-FM—94.9 mhz; 6.7 kw. Ant minus 392 ft.
XHL—FM—90.1 mhz; 1.6 kw. Ant minus 246 ft.
XHPJ-FM—106.9 mhz; 850 w. Ant minus 568 ft.
XHQQ-FM—93.3 mhz; 2.4 kw. Ant 519 ft.
XHRK-FM—95.7 mhz; 850 w. Ant minus 565 ft.
XHRL-FM—98.1 mhz; 10 kw. Ant minus 468 ft.
XHSR-FM—97.3 mhz; 18.9 kw. Ant minus 343 ft.
XHSRO-FM—92.5 mhz; 6.6 kw. Ant minus 121 ft.
XHSP-FM—99.7 mhz; 1.7 kw. Ant 401 ft.

Sonora

Nogales

XHNI-FM—105.1 mhz; 3.7 kw. Ant minus 119 ft.
XHQT-FM—102.7 mhz; 4 kw. Ant minus 279 ft.
XHRZ-FM—103.5 mhz; 940 w. Ant minus 92 ft.

Tamulipas

Matamoros

XHMLS-FM—101.5 mhz; 3.3 kw. Ant minus 170 ft.

Nuevo Laredo

XHNK-FM—99.3 mhz; 850 w. Ant 148 ft.
XHNOE-FM—94.1 mhz; 890 w. Ant 100 ft.

710 CMDU Guantanamo, Radio Progreso, 250 w (relay).
720 CMGN Colon, Radio Rebelde, 30 kw (relay).
730 CMKJ Holguin, Radio Liberacion, 10 kw (relay).
740 CMJL Camaguey, Radio Liberacion, 1 kw (relay).
740 CMAQ Pinar del Rio, Radio Liberacion, 1 kw (relay).
760 CMCI Havana, Radio Nacional, 10 kw (relay).
770 CMKB Las Mercedes, Radio Revolucion, 5 kw (relay).
780 CMJN Camaguey, Radio Rebelde, 60 kw (relay).
790 CMCH Havana, Radio Cadena Habana, 10 kw.

800-890 khz

810 CMJE Camaguey, Radio Progreso, 5 kw (relay).
820 CMCA Havana, Radio Cordon de la Habana, 10 kw.
820 CMDT Bayamo, Radio Progreso, 1 kw (relay).
840 CMHW Santa Clara, W, La Frecuencia del Azucar, 10 kw.
840 CMKC Santiago, Radio Revolucion, 2 kw.
860 CMJY Ciego de Avila, Radio Cadena Agramonte, 1 kw (relay).
870 CMBL Havana, CMBL Radio Internacional, 10 kw.
870 CMDN Guantanamo, Radio Rebelde, 10 kw (relay).
880 CMAF Pinar del Rio, Radio Progreso, 10 kw (relay).
890 CMHD Santa Clara, Radio Musical Nacional, 1 kw (relay).
890 CMDZ Santiago de Cuba, Radio Musical Nacional, 1 kw.

900-990 khz

900 CMJV Ciego de Avila, Radio Liberacion, 1 kw (relay).
910.CMJB Camaguey, Radio Musical Nacional, 1 kw (relay).
920 CMKH Guantanamo, Radio Musical Nacional, 250 w (relay).
930 CMAG Consolacion del Sur, Radio Musical Nacional, 250 w (relay).
930 CMGL Matanzas, Radio Relej Nacional, 1 kw (relay).
940 CMHP Sancti Spiritus, W, La Frecuencia del Azucar, 250 w (relay).
950 CMDJ Guantanamo, Radio Revolucion, 1 kw (relay).
950 CMBF Havana, Radio Musical Nacional, 10 kw.
960 CMHB Sancti Spiritus, Radio Progreso, 1 kw.
960 CMKN Santiago de Cuba, Radio Rebelde, 1 kw.
980 CMCK Havana, Coko El Periodico del Aire, 5 kw.
990 CMHT Sancti Spiritus, Radio Sancti Spiritus, 1 kw.

1000-1090 khz

1000 CMAP Guane, Radio Guama, 250 w.
1010 CMKM Holguin, Radio Musical Nacional, 5 kw (relay).
1010 CMAS Pinar del Rio, Radio Guama La Voz de la Cordillera de los Organos, 1 kw.
1019 CMAC San Cristobal, R, Guama, 1 kw.

Mexican, Caribbean Radio

1030 CMFA Camaguey, Radio Cadena Agramonte, 5 kw.
1040 Neuva Gerona Isla de Pinos, Radio Caribe, 1 kw.
1059 CMKG Baracoa, Radio Revolucion, 1 kw.
1060 CMBO Havana, Radio Enciclopedia Nacional, 5 kw.
1080 CMBM Santa Fe, Isla de Pinos, Radio Caribe, 1 kw.

1100-1190 khz

1100 CMHU Cienfuegos, Radio Ciudad del Mar, 1 kw.
1120 CMDL Holguin, Radio Angulo, 1 kw.
1130 CMDW Guantanamo, Radio Liberacion, 1 kw.
1130 CMHA Santa Clara, Onda Musical, 1 kw.
1140 CMJK Camaguey, Radio Camaguey, 1 kw.
1150 CMDO Banes, Radio Banes, 250 w.
1160 CMAD Artemisa, Radio Artemisa, 1 kw.
1190 CMJP Ciego de Avila, Camagueyana, Radio Surcos, 1 kw.

1200-1290 khz

1200 Santiago de Cuba, Radio Relej Nacional, 2 kw (relay).
1210 CMJX Moron, Radio Moron, 1 kw.
1210 CMKD Holguin, Radio Relej Nacional, 1 kw (relay).
1220 CMGY Perico, Radio Veintiseis, 5 kw (relay).
1230 CMGM Jaguey Grande, Radio Nacional, 1 kw.
1240 CMGW Matanzas, Radio Veintiseis, 1 kw.
1240 CMKE Victoria de las Tunas, Radio Revolucion, 250 w (relay).
1250 CMKA Guantanamo, Radio Relej Nacional, 250 w. (relay).
1260 CMAX Consolacion del Norte, Radio Relej Nacional, 1 kw (relay).
1260 CMDE Bayamo, Radio Relej Nacional 250 w (relay).
1270 CMJG Camaguey, Radio Relej Nacional, 1 kw (relay).
1280 CMHM Santa Clara, Relej Nacional, 1 kw. (relay).
1280 CMDP Victoria de las Tunas, Radio Relej Nacional, 250 w (relay).
1290 CMKS Guantanamo, Radio Guantanamo, 1 kw.

1300-1390 khz

1300 CMJD Ciego de Avila, Radio Musical Nacional, 250 w.
1300 CMJQ Neuvitas, Radio Neuvitas, 1 kw.
1307 CMHK Cruces, Radio Relej Nacional, 1 kw (relay).
1310 CMDL Bayamo, Radio Revolucion, 1 kw.
1320 CMAD Pinar del Rio, Radio Relej Nacional, 250 w (relay).
1330 CMJS Ciego de Avila, Radio Relej Nacional, 1 kw (relay).
1350 CMKY Puerto Padre, Radio Puerto Padre, 250 w.
1360 CMBG Havana, Radio Popular, 1 kw.
1370 CMKW Santiago de Cuba, Radio Siboney, 1 kw.
1390 CMKX Bayamo, Radio Bayamo, 1 kw.

1400-1490 khz

1400 CMJI Florida, Radio Cadena Agramonte, 250 w.
1420 CMDX Baracoa, La Voz de Baracoa, 1 kw.
1430 CMKZ Palma Soriano, Radio Baragua, 250 w.
1450 CMJW Santa Cruz del Sur, Radio Mabo, 250 kw.
1460 CMCG Marianao, Radio Marianao, 1 kw.
1470 CMGE Cardenas, Radio Ciudad Bandera, 1 kw.

1500-1600 khz

1520 CMKT Victoria de las Tunas, Radio Victoria, 1 kw.
1550 CMDV Santiago de Cuba, Radio Santiago.
1560 CMGB Cardenas, Radio Relej Nacional, 250 w (relay).
1590 CMDF Manzanillo, Radio Manzanillo, 250 w.

AFRTS stations

The U.S. Armed Forces Radio and Television Service operates radio stations in Cuba at:

Guantanamo Bay—1340 khz; 1 kw.
Guantanamo Bay (FM)—103 mhz; 40 w.
Guantanamo Bay (FM stereo)—102 mhz; 1 kw.

Dominican Republic

540-590 khz

540 HICM Santa Domingo, Radio ABC, 5 kw-D/1 kw-N.
560 HIAA Santiago de los Caballeros, Radio Ritmos, 5 kw.
570 HIMS Santo Domingo, Radio Cristal, 10 kw-D/5 kw.
590 HIDV La Vega, Radio Santa Maria, 10 kw.

600-690 khz

620 HIGD Santo Domingo, Radio Television

Caribbean Radio, AM Calls

Dominicana, 10 kw.
630 HIAF Monte Cristi, Radio Monte Cristi, 1 kw.
650 HIAT Santo Domingo, Radio Universal, 5 kw-D/2 kw.
660 HIAM Santiago de los Caballeros, Radio Quisqueyana, 2 kw.
690 HIAW Santo Domingo, Radio Guarachita, 5 kw.

700-790 khz

700 HIDC Valverde/Mao, Radio Mao, 1 kw.
720 HIAQ Santiago de los Caballeros, Radio Notre 3 kw.
730 HIZ Santo Domingo, Broadcasting Nacional, 5 kw.
750 HIBD Santiago, Radio Libertad, 5 kw.
770 HIBM Pena/Santiago, Radio Tamboril, 500 w.
780 HIBO Costanza, Radio Costanza, 5 kw.
790 HIL Santo Domingo, La Voz del Tropico, 5 kw.

800-890 khz

820 HIAZ Santiago, Radio Santiago, 5 kw.
830 HIJB Santo Domingo, Radio HIJB, 10 kw.
840 HIAB Puerto Plata, Radio Puerto Plata, 1 kw.
860 HILR Santo Domingo, Radio Clarin, 50 kw-D/5 kw-N.
880 HIOR Valverde/Mao, Radio Santa Cruz de Mao, 1 kw.
890 HIJP Santo Domingo, Radio Continental, 5 kw.

900-990 khz

900 HIBN Puerto Plata, Radio Puerto Plata, 1 kw.
910 HIBA Santo Domingo, Radio Reloj de Emisoras Unidas, 250 w.
910 HIDE San Francisco, Radio Tiempo, 500 w.
920 HICK Santiago, 2 kw.
930 HICK Santiago, Ondas del Yaque, 5 kw.
950 HIG Santo Domingo, Radiodifusora HIG, 1 kw.
960 HIF Puerto Plata, La Voz del Atlantico, 1 kw.
980 HISA Santiago, Radio Cibao, 3 kw.

1000-1090 khz

1000 HIHG Dajabon, Radio Beler, 1 kw.
1030 HIDL La Vega, Radio Novedades, 5 kw.
1010 HIJP Santo Domingo, Radio Commercial, 50 kw-D/250 w-N.
1040 HION Santo Domingo, Radio Central, 1 kw.
1050 HICB Santiago, La Voz de la Hispanota, 1 kw.
1060 HIRV San Pedro de Macoris, Radio Mar, 1 kw.
1070 HIBI San Francisco de Macoris, Radio HIBI, 1 kw-D/250 w-N.
1080 HIMC Santo Domingo, Radio Programas Quisqueya (RPQ), 500 w.
1090 HIJM Santiago, Radio Amistad, 1 kw.

1100-1190 khz

1100 HIPS Nagua, Radio Nagua, 5 kw.
1110 HIJJ Jarabacoa, Radio Jarabacoa, 500 w.
1100 HIHD San Pedro de Macoris, Radio Oriente, 1 kw.
1120 HICN Santo Domingo, Radio Antillas, 5 kw.

1130 HIRL Santiago, Radio Exitos, 1 kw-D/250 w-N.
1150 HIAS Santo Domingo, Onda Musical, 1 kw.
1160 HIBG Santiago, Radiolandia, 5 kw.
1180 HIBE Santo Domingo, Radio Mil, 50 kw-D/1 kw-N.
1190 HIVP Villa Tapia, Radio Villa Tapia, 1.5 kw.

1200-1290 khz

1200 HIBS San Pedro de Macoris, Radio San Pedro, 1 kw.
1200 HIMR Azua, Radio Monte Rio, 250 w.
1210 HICJ San Francisco de Macoris, Radio Merengue, 1 kw.
1220 HIN Santo Domingo, Radio HIN, 10 kw.
1240 HIAU Puerto Plata, La Voz de la Libertad, 3 kw.
1240 HICV Barahona, Radio Barahona, 1 kw.
1250 HIBC San Francisco de Macoris, La Voz del Progreso, 5 kw-D/500 w-N.
1260 HIT Santo Domingo, Radio Vision, 1 kw.
1270 HICA Bani, Radio Ambiente, 1 kw.
1270 HIDS Santiago, Radio Television Dominicana, 1 kw (relay).
1290 HIVM Bonao, Radio Bonao, 1 kw.
1290 HIVD Janico, Radio Janico, 500 w.

1300-1390 khz

1300 HIQ Santo Domingo, Radio Radio, 1 kw.
1310 HIDS El Seibo, Radio Television Dominicana, 1 kw (relay).
1310 HIDS Pedernales, Radio Television Dominicana, 1 kw.
1310 HIAV Bani, Radio Bani, La Voz del Sur, 500 w.
1310 HIHM La Vega, Radio Real, 500 w.
1320 HIHD San Pedro de Macoris, 1 kw.
1330 HIFA Moca, La Voz de las Fuerzas Armadas, 5 kw (relay).
1340 HIBZ San Juan, 1 kw-D/250 w-N.
1340 HIMP San Jose de Ocoa, Radio Ocoa, 250 w.
1350 HIX Santo Domingo, Radio Listin, 1 kw.
1360 HISD La Vega, Radio Television Dominicana, 1 kw (relay).
1360 HIMG La Romana, Radio Ratas Musical, 1 kw.
1360 HISD Monte Cristi, Radio Television Dominicana, 1 kw.
1370 HISD Barahona, Radio Television Dominicana, 1 kw (relay).
1380 HIJR Santo Domingo, 5 kw-D/1 kw-N.
1380 HISC Santiago, Radio Nacional, 5 kw.
1390 HISD San Juan, Radio Television Dominicana, 1 kw (relay).

1400-1490 khz

1400 HIAL La Vega, Ondas del Valle, 1 kw.
1410 HIRM Higüey, Radio El Sol, 500 w.
1410 HIAE Santo Domingo, Radio Tricolor, 5 kw.
1420 HIAE Barahona, Radio Guarocuya, 500 w.
1430 HIVG La Vega, Radio La Vega, 3 kw.
1440 HIAK Santo Domingo, Radio Ozama, 1 kw.
1440 HIFS Nagua, Radio Bahía, 1 kw.
1440 HIAJ San Juan, Radio San Juan, 1 kw.
1440 HILF Higüey, Radio Cayacoa, 500 w.
1450 HIAR San Cristobal, Radio San Cristobal, 500 w.

1460 HIAN Hato Major, Radio Magua, 5 kw.
1470 HIAG Santiago, Radio Azul, 5 kw.
1480 HIAH Santo Domingo, Radio Sensacional, 5 w.
1490 HIKF Azua, Radio Azua, 1 kw.
1490 HIRP El Seibo, Radio Seibo, 500 w.
1490 HIAP Moca, Radio Glaray, 250 w.

1500-1600 khz

1500 HIJK Santiago, Radio Zamba, 1 kw.
1510 HIBL Santo Domingo, Radio Pueblo, 10 kw.
1540 HIBD La Romana, La Voz de la Romana, 250 w.
1540 HIFB Santo Domingo, Radio El Mundo, 1 kw.
1560 HIJC Santiago de los Caballeros, Radio Maiba, 5 kw.
1560 HIPZ Pedernales, Radio Pedernales, 1 kw.
1570 HIRJ La Romana, Radio Juventud, 250 w.
1570 HIAJ Santo Domingo, Radio Union, 1 kw.
1580 HIWJ Samana, Radio Samana, 500 w.
1580 HIFU Neyba, Radio Neyba, 1 kw.
1590 HIDA Santiago de los Caballeros, Radio Hit Musical, 1 kw.
1600 HIBS San Pedro de Macoris, Radio San Pedro, 1 kw.
1600 HIFA Santo Domingo, La Voz de las Fuerzas Armadas, 5 kw.

Haiti

660 khz 4VUE Port au Prince, Radio Lumiere, 250 w.
760 khz 4VI Aux Cayes, Radio Lumiere, 1 kw.
780 khz 4VIE Jeremie, Radio Lumiere, 250 w.
830 khz 4VEF Cap Haitien, La Voix Evangelique d Haiti, 2.5 kw.
860 khz 4VDS Port au Prince, Radio Progres, 1 kw.
880 khz 4VAA Port au Prince, Radio Nationale, 400 w.
910 khz Port au Prince, Radio Nouveau Monde, 10 kw.
930 khz 4VHS Les Gonaives, Radio Variete, 200 w.
960 khz 4VCD Port au Prince, Radio Carillon, 300 w (variable frequency).
1035 khz 4VEC Cap Haitien, La Voix Evangelique d Haiti, 10 kw.
1080 khz 4VA Port au Prince, La Voix de la Revolution Duvalieriste, 1 kw.
1120 khz 4VF Port au Prince, Radio Union, 800 w.
1170 khz 4VRD Port au Prince, Radio Tropiques, 500 w.
1190 khz 4VAE Jeremie, Radio Grande Anse, 150 w.
1280 khz Port-au-Prince, Radio Metropole, 1 kw.
1430 khz 4VGM Port au Prince, MBC, 1 kw (variable frequency).
1460 khz 4VEA Cap Haitien, La Voix du Nord, 100 w (variable frequency).
1500 khz 4VOC Port au Prince, Radio Select, 350 w.

Jamaica

550 khz Montego Bay, Radio Jamaica, 5 kw.
560 kw Kingston, Jamaica Bcstg Corp., 5 kw.
580 khz Point Galina, Radio Jamaica, 5 kw.
620 khz Mandeville, Jamaica Bcstg Corp., 5 kw.
700 khz Montego Bay, Jamaica Bcstg Corp., 5 kw.
720 khz Kingston, Radio Jamaica, 5 kw.
750 khz Port Maria, Jamaica Bcstg Corp., 5 kw.
770 khz Spurtree, Radio Jamaica, 5 kw.

U.S. AM Radio by Call Letters

KAAA Kingman, AZ
KAAP Santa Paula, CA
KAAR Mountlake Terrace, WA
KAAT Denver, CO
KAAY Little Rock, AR
KABC Los Angeles, CA
KABI Abilene, KS
KABL Oakland, CA
KABQ Albuquerque, NM
KABR Aberdeen, SD
KACE Riverside, CA
KACI The Dalles, OR
KACO Bellville, TX
KACT Andrews, TX
KACY Port Huene, CA
KADA Ada, OK
KADE Boulder, CO
KADI Clayton, MO
KADL Pine Bluff, AR
KADO Texarkana, TX
KADS Elk City, OK
KAPE Santa Fe, NM
KAFF Flagstaff, AZ
KAFY Bakersfield, CA
KAGE Winona, MN
KAGH Crosslet, AR
KAGI Grants Pass, OR
KAGO Klamath Falls, OR
KAGT Anacortes, WA
KAGY Port Sulphur, LA
KAHI Auburn, CA

KAHL Little Platte, NE
KAHU Waipahu, HI
KAHM Honolulu, HI
KAIN Nampa, ID
KAIR Tucson, AZ
KAJN Crowley, LA
KAJO Grants Pass, OR
KAKC Tulsa, OK
KAKE Wichita, KS
KALB Alexandria, LA
KALE Richland, WA
KALG Alamogordo, NM
KALI San Gabriel, CA
KALL Salt Lake City, UT
KALM Thayer, MO
KALN Iola, KS
KALO Little Rock, AR
KALT Atlanta, GA
KALV Alva, OK
KAMA El Paso, TX
KAMD Camden, AR
KAMI Cozad, NE
KAML Kenedy-Karnes, TX
KAMO Rogers, AR
KAMP El Centro, CA
KAMX Albuquerque, NM
KANA Anaconda, MT
KANC Anchorage, AK
KAND Corsicana, TX
KANE New Iberia, LA
KANI Wharton, TX

KANN Ogden, UT
KANO Anoka, MN
KANS Larned, KS
KAOH Duluth, MN
KAOK Lake Charles, LA
KAOL Carrollton, MO
KAPA Raymond, WA
KAPB Marksville, LA
KAPE San Antonio, TX
KAPI Pueblo, CO
KAPR Douglas, AZ
KAPS Mount Vernon, WA
KAPY Port Angeles, WA
KARE Atchison, KS
KARI Blaine, WA
KARM Fresno, CA
KARN Little Rock, AR
KARR Great Falls, MT
KARS Belen, NM
KART Jerome, ID
KARV Russellville, AR
KARY Prosser, WA
KASA Phoenix, AZ
KASH Eugene, OR
KASI Ames, IA
KASL Newcastle, WY
KASM Albany, MN
KASO Minden, LA
KAST Astoria, OR
KASY Auburn, WA
KATA Arcata, CA

KATB Agana, GM
KATE Albert Lea, MN
KATI Casper, WY
KATL Miles City, MT
KATO Safford, AZ
KATR Eugene, OR
KATY San Luis Obispo, CA
KATZ St. Louis, MO
KAUS Austin, MN
KAVA Burney, CA
KAVE Carlsbad, NM
KAVI Rocky Ford, CO
KAVL Lancaster, CA
KAVR Apple Valley, CA
KAWA Waco, TX
*KAWC Yuma, AZ
KAWL York, NE
KAWT Douglas, AZ
KAWW Heber Springs, AR
KAYC Beaumont, TX
KAYL Storm Lake, IA
KAYO Seattle, WA
KAYQ Kansas City, MO
KAYS Hays, KS
KAYT Rupert, ID
KAZA Gilroy, CA
KAZM Sedona, AZ

KBAB Indianola, IA
KBAD Carlsbad, NM
KBAI Morro Bay, CA

KBAL San Saba, TX
KBAM Longview, WA
KBAN Bowie, TX
KBAI Burley, ID
KBBA Benton, AR
KBBB Borer, TX
KBBC Centerville, UT
KBBO Yakima, WA
KBBO Ventura, CA
KBRR North Bend, OR
KBBS Buffalo, WY
KBBV Big Bear Lake, CA
KBCH Lincoln City, OR
KBCL Shreveport, LA
KBDF Eugene, OR
KBEA Mission, KS
KBEC Waxahachie, TX
KBEE Modesto, CA
KBEL Idabel, OK
KBEN Carrizo Springs, TX
KBET Reno, NV
KBEW Blue Earth, MN
KBFS Belle Fourche, SD
KBFW Bellingham-Ferndale, WA
KBGH Memphis, TX
KBGN Caldwell, ID

KBHB Sturgis, SD
KBHC Nashville, AR
KBHM Branson, MO

KBHS Hot Springs, AR
 KBIB Monette, AR
 KBIF Fresno, CA
 KBIL Liberty, MO
 KBIM Roswell, NM
 KBIS Bakersfield, CA
 KBIX Muskogee, OK
 KBIZ Ottumwa, IA
 KBJM Lemmon, SD
 KBJS Sallisaw, OK
 KBJT Fordyce, AR
 KBKR Baker, OR
 KBKW Aberdeen, WA
 KBLC Lakeport, CA
 KBLE Seattle, WA
 KBLF Red Bluff, CA
 KBLI Blackfoot, ID
 KBLH Helena, MT
 KBLR Bolivar, MO
 KBLU Yuma, AZ
 KBWL Logan, UT
 KBMI Henderson, NV
 KBMN Bozeman, MT
 KBMO Benson, MN
 KBMR Bismarck, ND
 KBMW Breckenridge, MN
 KBMY Billings, MT
 KBND Bend, OR
 KBOA Kennett, MO
 KBOE Oskaloosa, IA
 KBOI Boise, ID
 KBOK Malvern, AR
 KBOL Boulder, CO
 KBOM Bismarck-Mandan, ND
 KBON San Bernardino, CA
 KBOP Pleasanton, TX
 KBOR Brownsville, TX
 KBOW Butte, MT
 KBOX Dallas, TX
 KBOY Medford, OR
 KBOZ Bozeman, MT
 *KBPS Portland, OR
 KBRS Ainsworth, NE
 KBRC Mount Vernon, WA
 KBRE Cedar City, UT
 KBRF Fergus Falls, MN
 KBRI Brinkley, AR
 KBRJ Boise, ID
 KBRK Brookings, SD
 KBRL McCook, NE
 KBRN Brighton, CO
 KBRO Bremerton, WA
 KBRR Leadville, CO
 KBRS Springdale, AR
 KBRT Avalon, CA
 KBRV Soda Springs, ID
 KBRX O'Neill, NE
 KBRZ Freeport, TX
 KBSE Springhill, LA
 KBSN Crane, TX
 KBST Big Spring, TX
 KBTA Batesville, AR
 KBTC Houston, MO
 KBTM Jonesboro, AR
 KBTN Neosho, MO
 KBUS San Antonio, TX
 KBUD Athens, TX
 KBUG Springfield, MO
 KBUH Brighton City, UT
 KBUK Caytown, TX
 KBUL Wichita, KS
 KBUN Bemidji, MN
 KBUR Burlington, IA
 KBUS Mexico, TX
 KBUY Fort Worth, TX
 KBUZ Mesa, AZ
 KBWD Brownwood, TX
 KBXM Kennett, MO
 KBYE Oklahoma City, OK
 KBYG Big Spring, TX
 KBYP Shamrock, TX
 KBYR Anchorage, AK
 KBZB Odessa, TX
 KBZY Salem, OR
 KBZZ La Junta, CO
 KCAB Dardanelle, AR
 KCAD Abilene, TX
 KCAL Redlands, CA
 KCAM Glennallen, AK
 KCAN Canyon, TX
 KCAP Helena, MT
 KCAR Clarksville, TX
 KCAS Slaton, TX
 KCAT Pine Bluff, AR
 KCBC Des Moines, IA
 KCBN Reno, NV
 KCBQ San Diego, CA
 KCBS San Francisco, CA
 KCCC Corning, AR
 KCCB Carlisbad, NM
 KCCL Paris, AR
 KCCN Honolulu, HI

KCCO Lawton, OK
 KCCR Pierre, SD
 KCCS Salem, OR
 KCCCT Corpus Christi, TX
 KCCV Independence, MO
 KCEE Tucson, AZ
 KCEY Turlock, CA
 KCFH Cuero, TX
 KCFI Cedar Falls, IA
 KCGS Marshall, AR
 KCHA Charles City, IA
 KCHE Cherokee, IA
 KCHF Sioux Falls, SD
 KCHI Chillicothe, MO
 KCHJ Delano, CA
 KCHR Charleston, MO
 KCHS Truth or Consequences, NM
 KCHV Coachella, CA
 KCIA Humble City, NM
 KCID Caldwell, ID
 KCII Washington, IA
 KCIJ Shreveport, LA
 KCIM Carroll, IA
 KCIN Victorville, CA
 KCJB Minot, ND
 KCKC San Bernardino, CA
 KCKN Kansas City, KS
 KCKX Jena, LA
 KCKY Coalgate, AZ
 KCLA Pine Bluff, AR
 KCLD St. Cloud, MN
 KCLE Cleburne, TX
 KCLK Clarkston, WA
 KCLM Redding, CA
 KCLN Clinton, IA
 KCLO Leavenworth, KS
 KCLR Ralls, TX
 KCLS Flagstaff, AZ
 KCLT Lockhart, TX
 KCLU Rolla, MO
 KCLV Clovis, NM
 KCLW Hamilton, TX
 KCLX Colfax, WA
 KCMC Texarkana, TX
 KCMJ Palm Springs, CA
 KCMO Kansas City, MO
 KCMX Ashland, OR
 KCNI Broken Bow, NE
 KCNO Alturas, CA
 KCNY San Marcos, TX
 KCOB Newton, IA
 KCOG Centerville, IA
 KCOH Houston, TX
 KCOK Tulare, CA
 KCOL Fort Collins, CO
 KCOM Comanche, TX
 KCON Conway, AR
 KCOB San Antonio, TX
 KCOW Alliance, NE
 KCPX Salt Lake City, UT
 KCRS Sacramento, CA
 KCRD Cedar Rapids, IA
 KCRF Reno, NV
 KCRS Midland, TX
 KCRV Trinidad, CO
 KCRV Caruthersville, MO
 KCSJ Pueblo, CO
 KCSR Chadron, NE
 KCTA Corpus Christi, TX
 KCTI Gonzales, TX
 KCTO Columbia, LA
 KCTX Childress, TX
 KCTY Salinas, CA
 KCUB Tucson, AZ
 KCUV Red Wing, MN
 KCUZ Clifton, AZ
 KCVL Colville, WA
 KCVR Lodi, CA
 KCVL Lampasas, TX
 KDAC Fort Bragg, CA
 KDAK Carrington, ND
 KDAL Duluth, MN
 KDAN Minneapolis, MN
 KDVA Lubbock, TX
 KDAY Santa Monica, CA
 KDAZ Albuquerque, NM
 KDB Santa Barbara, CA
 KDBM Dillon, MT
 KDBS Alexandria, LA
 KDCE Espanola, NM
 KDDA Dumas, AR
 KDDR Dumas, TX
 KDDD Oakes, ND
 KDEC Decorah, IA
 KDEF Albuquerque, NM
 KDEN Denver, CO
 KDEO El Cajon, CA
 KDES Palm Springs, CA
 KDET Center, TX
 KDEW De Witt, AR

KDEX Dexter, MO
 KDFL Summer-Puyallup, WA
 KDFN Doniphan, MO
 KDOG Durango, CO
 KDHI Twentynine Palms, CA
 KDHL Fairbault, MN
 KDHN Dimmit, TX
 KDIA Oakland, CA
 KDIO Ortonville, MN
 KDIX Dickinson, ND
 KDJI Holbrook, AZ
 KDJW Amarillo, TX
 KDKA Pittsburgh, PA
 KDKB Mesa, AZ
 KDKD Clinton, MO
 KDKO Littleton, CO
 KDLA De Ridder, LA
 *KDLG Dillingham, AK
 KDLK Del Rio, TX
 KDLM Detroit Lakes, MN
 KDLR Devils Lake, ND
 KDLS Perry, IA
 KDLT Delta, UT
 KDMA Montevideo, MN
 KDMO Carthage, MO
 KDMS El Dorado, AR
 KDNT Denton, TX
 KDOO Tyler, TX
 KDOL Mojave, CA
 KDOM Windon, MN
 KDON Salinas, CA
 KDOT Scottsdale, AZ
 KDOW Ashland, OR
 KDOX Marshall, TX
 KDOE De Queen, AR
 KDOR Deer Lodge, MT
 KDRO Sedalia, MO
 KDRS Paragould, AR
 KDRY Alamo Heights, TX
 KDSJ Deadwood, SD
 KDSN Denison, IA
 KDSX Denison-Sherman, TX
 KDTA Delta, CO
 KDTH Dubuque, IA
 KDUN Reedsport, OR
 KDUZ Hutchinson, MN
 KDWA Hastings, MN
 KDWB St. Paul, MN
 KDWN Las Vegas, NV
 KDWT Stamford, TX
 KDXE N Little Rock, AR
 KDXI Mansfield, LA
 KDXU St George, UT
 KDYL Tooele, UT
 KDZA Pueblo, CO
 KEAN Brownwood, TX
 KEAP Fresno, CA
 KEBE Jacksonville, TX
 KECK Lincoln, NE
 KEDA San Antonio, TX
 KEDD Dodge City, KS
 KEDO Longview, WA
 KEED Eugene, OR
 *KEEE Nacogdoches, TX
 KEEL Shreveport, LA
 KEEN San Jose, CA
 KEEP Twin Falls, ID
 KEES Gladewater, TX
 KEET St. Paul, MN
 KEGG Daingerfield, TX
 KEGL Santa Clara, CA
 KEHG Fosston, MN
 KEIN Great Falls, MT
 KELA Centralia, WA
 KELD El Dorado, AR
 KELI Tulsa, OK
 KELK Elko, NV
 KELO Sioux Falls, SD
 KELP El Paso, TX
 KELR El Reno, OK
 KELY Ely, NV
 KEMM Marshfield, MO
 KENA Mena, AR
 KEND Lubbock, TX
 KENE Toppensish, WA
 KENI Anchorage, AK
 KENN Portales, NM
 KENN Farmington, NM
 KENO Las Vegas, NV
 KENR Houston, TX
 KEOR Atoka, OK
 KEOS Flagstaff, AZ
 KEPS Eagle Pass, TX
 KERB Kermit, TX
 KERC Eastland, TX
 KERE Denver, CO
 KERN Bakersfield, CA
 KERR Polson, MT
 KERV Kerrville, TX
 KESM El Dorado Spgs, MO
 KEST San Francisco, CA
 KETX Livingston, TX

KEUN Eunice, LA
 KEVA Evanston, WY
 KEVT Tucson, AZ
 KEWI Topeka, KS
 KEWQ Paradise, CA
 KEX Portland, OR
 KEXO Grand Junction, CO
 KEXS Excelsior Spgs, MO
 KEYE Perryton, TX
 KEYH Houston, TX
 KEYJ Jamestown, ND
 KEYL Long Prairie, MN
 KEYR Terrytown, NE
 KEYS Corpus Christi, TX
 KEYY Provo, UT
 KEYZ Williston, ND
 KEZE Spokane, WA
 KEZM Sulphur, LA
 KEZY Anaheim, CA
 KFAB Omaha, NE
 KFAC Los Angeles, CA
 KFAL Fulton, MO
 KFAR Fairbanks, AK
 KFAX San Francisco, CA
 KFAY Fayetteville, AR
 KFBC Cheyenne, WY
 KFBD Waynesville, MO
 KFBR Sacramento, CA
 KFBR Nogales, AZ
 KFCS Redfield, SD
 KFDF Van Buren, AR
 KFDI Wichita, KS
 KFDR Grand Coulee, WA
 KFEL Pueblo, CO
 KFEQ St. Joseph, MO
 KFFA Helena, AR
 KFGO Fargo, ND
 *KFGQ Boone, IA
 KFH Wichita, KS
 KFI Los Angeles, CA
 KFIL Preston, MN
 KFIR Sweet Home, OR
 KFIV Modesto, CA
 KFIZ Fond Du Lac, WI
 KFJB Marshalltown, IA
 *KFJM Grand Forks, ND
 KFJZ Fort Worth, TX
 *KFKA Greeley, CO
 *KFKU Lawrence, KS
 KFLA Scott City, KS
 KFLI Mountain Home, ID
 KFLJ Walsenburg, CO
 KFLN Baker, MT
 KFLO Shreveport, LA
 KFLP Floydada, TX
 KFLS Klamath Falls, OR
 KFLY Corvallis, OR
 KFMB San Diego, CA
 KFMJ Tulsa, OK
 KFML Denver, CO
 KFMO Flat River, MO
 KFNF Shenandoah, IA
 KFNW Ferriday, LA
 *KFNW Fargo, ND
 KFOR Lincoln, NE
 KFOX Long Beach, CA
 KFPW Fort Smith, AR
 KFOD Anchorage, AK
 KFRA Franklin, LA
 KFRB Fairbanks, AK
 KFRC San Francisco, CA
 KFRD Rosenberg-Richmond, TX
 KFRE Fresno, CA
 KFRM Salina, KS
 KFRU Longview, TX
 KFRU Columbia, MO
 KFSA Fort Smith, AR
 KFSS Joplin, MO
 KFSC Denver, CO
 KFST Fort Stockton, TX
 KFTM Fort Morgan, CO
 KFTW Fredericktown, MO
 KFVN Las Vegas, NM
 *KFUO Clayton, MO
 KFVS Cape Girardeau, MO
 KFWB Los Angeles, CA
 KFWJ Lake Havasu City, AZ
 KFXD Nampa, ID
 KFXM San Bernardino, CA
 KFYN Bonham, TX
 KFYO Lubbock, TX
 KFYZ Bismarck, ND
 KFYV Arroyo Grande, CA
 KGA Spokane, WA
 KGAF Gainesville, TX
 KGAK Gallup, NM
 KGAL Lebanon, OR
 KGAR Vancouver, WA
 KGAS Carthage, TX
 KGAY Salem, OR
 KGB San Diego, CA

KGBC Galveston, TX
 KGBS Los Angeles, CA
 KGBT Harlingen, TX
 KGBX Springfield, MO
 KGCA Rugby, ND
 KGCC Sidney, MT
 KGDN Edmonds, WA
 KGEE Bakersfield, CA
 KGEK Sterling, CO
 KGEM Boise, ID
 KGEN Tulare, CA
 KGER Long Beach, CA
 KGEZ Kalispell, MT
 KGFF Shawnee, OK
 KGFL Los Angeles, CA
 KGFW Kearney, NE
 KGFX Pierre, SD
 KGGF Coffeyville, KS
 KGHL Billings, MT
 KGHM Brookfield, MO
 KGHO Hoquiam, WA
 KGHS International Falls, MN
 KGIL San Fernando, CA
 KGIW Alamosa, CO
 KGKL San Angelo, TX
 KGKO Benton, AR
 KGLA Gretna, LA
 KGLC Miami, OK
 KGLE Glendive, MT
 KGLN Glenwood Springs, CO
 KGLO Mason City, IA
 KGMB Honolulu, HI
 KGMI Bellingham, WA
 KGMO Cape Girardeau, MO
 KGMR Jacksonville, AR
 KGMS Sacramento, CA
 KGMT Fairbury, NE
 KGMY Missoula, MT
 KGNB New Braunfels, TX
 KGCN Amarillo, TX
 KGNO Dodge City, KS
 KGO San Francisco, CA
 KGOE Thousand Oaks, CA
 KGOL Palm Desert, CA
 KGOS Torrington, WY
 KGPD Clovis, CA
 KGRB West Covina, CA
 KGRI Henderson, TX
 KGRB Bend, OR
 KGRN Grinnell, IA
 KGRQ Pampa, TX
 KGRS Las Cruces, NM
 KGST Fresno, CA
 KGTN Georgetown, TX
 KGU Honolulu, HI
 KGUC Gunnison, CO
 KGUL Port Lavaca, TX
 KGVL Greenville, TX
 KGVO Missoula, MT
 KGVV Belgrade, MT
 KGW Portland, OR
 KGWA Enid, OK
 KGW Olympia, WA
 KGYN Guymon, OK
 KHAC Window Rock, AZ
 KHAD De Soto, MO
 KHAK Cedar Rapids, IA
 KHAP Aztec, NM
 KHAR Anchorage, AK
 KHAS Hastings, NE
 KHBM Monticello, AR
 KHBR Hillsboro, TX
 KHCS Phoenix, AZ
 KHDN Hardin, MT
 KHEM Big Spring, TX
 KHEN Henryetta, OK
 KHEP Phoenix, AZ
 KHEY El Paso, TX
 KHIL Wilcox, AZ
 KHIT Walla Walla, WA
 KHJ Los Angeles, CA
 KHLB Burnet, TX
 KHLO Hilo, HI
 KHMO Hannibal, MO
 KHOB Hobbs, NM
 KHOG Fayetteville, AR
 KHOS Tucson, AZ
 KHOT Madera, CA
 KHOW Denver, CO
 KHQZ Harrison, AR
 KHQ Spokane, WA
 KHRT Minot, ND
 KHSJ Hemet, CA
 KHSI Chico, CA
 KHUB Fremont, NE

AM Calls

KHUM Eureka, CA	KJEF Jennings, LA	KLOH Pipestone, MN	KNDC Hettinger, ND	KOOL Phoenix, AZ
KHVM Honolulu, HI	KJEL Lebanon, MO	KLOK San Jose, CA	KNDE Sacramento, CA	KOOO Omaha, NE
KHYM Gilmer, TX	KJEM Wagoner, OK	KLOM Lompoc, CA	KNDI Honolulu, HI	KOOS Coos Bay, OR
KHYT Tucson, AZ	KJET Beaumont, TX	KLOO Corvallis, OR	KNDK Langdon, ND	KOPO Tucson, AZ
KIAK Fairbanks, AK	KJIM Fort Worth, TX	KLOU Lake Charles, LA	KNKY Marysville, KS	KOPY Alice, TX
KIBE Palo Alto, CA	KJIN Houma, LA	KLOV Loveland, CO	KNEA Jonesboro, AR	KOOT Bellingham, WA
KIBL Beeville, TX	KJJJ Phoenix, AZ	KLPL Lake Providence, LA	KNEB Scottsbluff, NE	KORC Mineral Wells, TX
KIBS Bishop, CA	KJLT North Platte, NE	KLPM Minot, ND	KNED McAlester, OK	KORD Pasco, WA
KICA Clovis, NM	KJNO Juneau, AK	KLPR Oklahoma City, OK	KNEI Waukon, IA	KORE Springfield, OR
KICD Spencer, IA	KJNP North Pole, AK	KLPU Union, MO	KNEL Brady, TX	KORK Las Vegas, NV
KICK Springfield, MO	KJOE Shreveport, LA	KLRA Little Rock, AR	KNEM Nevada, MO	KORL Honolulu, HI
KICO Calexico, CA	KJOY Stockton, CA	KLRS Mountain Grove, MO	KNET Palestine, TX	KORN Mitchell, SD
KICS Hastings, NE	KJPW Waynesville, MO	KLSC Portland, OR	KNEW Oakland, CA	KORT Grangeville, ID
KICX McCook, NE	KJR Seattle, WA	KLTF Little Falls, MN	KNEX McPherson, KS	KORV Oroville, CA
KICY Nome, AK	KJRB Spokane, WA	KLTI Macon, MO	KNEZ Lompoc, CA	KOSE Osceola, AR
KID Idaho Falls, ID	KJRG Newton, KS	KLTR Blackwell, OK	KNFT Bayard, NM	KOSI Aurora, CO
KIDD Monterey, CA	KJSK Columbus, NE	KLZ Glasgow, MT	KNGS Hanford, CA	KOSY Texarkana, AR
KIDO Boise, ID	KJWH Camden, AR	KLUB Salt Lake City, UT	KNIA Knoxville, IA	KOTA Rapid City, SD
KIEV Glendale, CA	KKAA Aberdeen, SD	KLUC Las Vegas, NV	KNIC Winfield, KS	KOTD Plattsmouth, NE
KIFG Iowa Falls, IA	KKAM Pueblo, CO	KLUE Longview, TX	KNIE Cheyenne, WY	KOTN Pine Bluff, AR
KIFN Phoenix, AZ	KKAN Phillipsburg, KS	KLUF Lufkin, TX	KNIM Maryville, MO	KOTY Deming, NM
KIFW Sitka, AK	KKAR Pomona, CA	KLUV Haynesville, LA	KNIN Wichita Falls, TX	KOTY Kennewick, WA
KIGO St. Anthony, ID	KKAS Silsbee, TX	KLVI Beaumont, TX	KNIR New Iberia, LA	*KOTZ Kotzebue, AK
KIHN Hugo, OK	KKAT Rosewell, NM	KLVL Pasadena, TX	KNIT Abilene, TX	KOUR Independence, IA
KIHR Hood River, OR	KKDA Grand Prairie, TX	KLVT Levelland, TX	KNLV Ord, NE	KOVC Valley City, ND
KIIO Manitou Springs, CO	KKEE Salinas, CA	KLWN Lawrence, KS	KNND Cottage Grove, OR	KOVE Lander, WY
KIIS Los Angeles, CA	KKEY Portland, OR	KLWT Lebanon, MO	KNOC Natchitoches, LA	KOVO Provo, UT
KIIX Fort Collins, CO	KKHI San Francisco, CA	KLWW Cedar Rapids, IA	KNOE Monroe, LA	KOWB Laramie, WY
KIUV Huron, SD	KKIM Albuquerque, NM	KLXD Bakersfield, CA	KNOK Fort Worth, TX	KOWH Omaha, NE
KIKI Honolulu, HI	KKIN Aitkin, MN	KLYO Hamilton, MT	*KNOM Nome, AK	KOWL South Lake Tahoe, CA
KIKK Pasadena, TX	KKIO Santa Barbara, CA	KLYR Clarksville, AR	KNOR Norman, OK	KOWN Escondido, CA
KIKM Sherman, TX	KKIS Pittsburg, CA	KLZ Denver, CO	KNOT Prescott, AZ	KOWO Waseca, MN
KIKN Sinton, TX	KKIT Taos, NM	KMA Shennandoah, IA	KNOW Austin, TX	KOXR Oxnard, CA
KIKO Miami, AZ	KKJO St. Joseph, MO	KMAC San Antonio, TX	KNOX Grand Forks, ND	KOYI Phoenix, AZ
KIKR Conroe, TX	KKLS Rapid City, SD	KMAD Madril, OK	KNPT Newport, OR	KOYL Odessa, TX
KIKX Tucson, AZ	KKOK Lompoc, CA	KMAI Agana, GM	KNUI Kahului, HI	KOYN Billings, MT
KIKZ Seminole, TX	KKON Kealakekua, HI	KMAK Fresno, CA	KNUJ New Ulm, MN	KOYY El Dorado, KS
KILE Galveston, TX	KKOH Chanute, KS	KMAM Butler, MO	KNUZ Houston, TX	KOZE Odessa, TX
KILO Kirkland, WA	KKSI Mt. Pleasant, IA	KMAN Manhattan, KS	*KNWC Sioux Falls, SD	KOZI Lewiston, ID
KILR Estherville, IA	KKUA Honolulu, HI	KMAQ Maquoketa, IA	*KNWS Waterloo, IA	KOZY Grand Rapids, MN
KILT Houston, TX	KKUB Brownfield, TX	KMAR Winnsboro, LA	KNX Los Angeles, CA	KPAC Port Arthur, TX
KIMB Kimball, NE	KKUZ Burlington, IA	KMAS Shetland, WA	KNYN Williams, AZ	KPAG Pagosa Springs, CO
KIML Gillette, WY	KKXL Grand Forks, ND	KMAV Mayville, ND	KOA Denver, CO	*KOAC Corvallis, OR
KIMM Rapid City, SD	KKYX San Antonio, TX	*KMBI Spokane, WA	KOAD Lemoore, CA	KOAL Red Oak, IA
KIMN Denver, CO	KKZZ Lancaster, CA	KMBL Junction, TX	KOAK Remo, CA	KOAL Price, UT
KIMP Mount Pleasant, TX	KLAC Los Angeles, CA	KMBY Monterey, CA	KOAL Price, UT	KOAM Pittsburg, KS
KINA Salina, KS	KLAD Klamath Falls, OR	KMCD Fairfield, IA	KOB Albuquerque, NM	KOB Las Cruces, NM
KINC Independence, CA	KLAK Lakewood, CO	KMCL McCall, ID	KOBH Hot Springs, SD	KOBH Yuba City, CA
KIND Independence, KS	KLAM Cordova, AK	KMCM McMinnville, OR	KOBY Reno, NV	KOCA Kigore, TX
KINE Kingsville, TX	KLAN Lemoore, CA	KMCW Augusta, AR	KOCY Oklahoma City, OK	KODA Houston, TX
KING Seattle, WA	KLAR Laredo, TX	KMDO Fort Scott, KS	KODE Joplin, MO	KODI Cody, WY
KINN Alamogordo, NM	KLAV Las Vegas, NV	KMED Medford, OR	KODL The Dalles, OR	KODY North Platte, NE
KINO Winslow, AZ	KLBJ Austin, TX	KMEL Wenatchee, WA	KOEL Oelwein, IA	KOFE St. Maries, ID
KINS Eureka, CA	KLBK Lubbock, TX	KMEN San Bernardino, CA	KOFO Ottawa, KS	KOFY San Mateo, CA
KINT El Paso, TX	KLBM La Grande, OR	KMEO Phoenix, AZ	KOGA Ogallala, NE	KOGA San Diego, CA
KINY Juneau, AK	KLBS Los Banos, CA	KMER Kemmerer, WY	KOGT Orange, TX	KOH Reno, NV
KIOA Des Moines, IA	KLCB Libby, MT	KMFB Mendocino, CA	KOHI St. Helens, OR	KOHU Honolulu, HI
KIOE Honolulu, HI	KLCK Lake Charles, LA	KMHL Marshall, MN	KOHU Hermiston, OR	KOIL Omaha, NE
KIOT Barstow, CA	KLCO Blytheville, AR	KMHT Marshall, TX	KOIN Portland, OR	KOIM Havre, MT
KIOX Bay City, TX	KLCP Poteau, OK	KMIL Cameron, TX	KOJO Laramie, WY	KOKA Shreveport, LA
KIPA Hilo, HI	KLFA Lexington, IA	KMIN Grants, NM	KOKC Guthrie, OK	KOKE Austin, TX
KIQI San Francisco, CA	KLFG Golden Meadow, LA	KMIS Portageville, MO	KOKL Okmulgee, OK	KOKN Pawhuska, OK
KIQS Willows, CA	KLFE Ottumwa, IA	KMJ Fresno, CA	KOKO Warrensburg, MO	KOKY Keokuk, IA
KIRL St. Charles, MO	KLFI Kaiua, HI	KMLB Monroe, LA	KOKY Little Rock, AR	KOLE Port Arthur, TX
KIRO Seattle, WA	KLFL Le Mars, IA	KMLO Vista, CA	KOLJ Quanah, TX	KOLM Rochester, MN
KIRT Mission, TX	KLFO Wichita, KS	KMML Grand Island, NE	KOLS Pryor, OK	KOLA Rochester, MN
KIRV Fresno, CA	KLFR Orofino, ID	KMMO Marshall, MO	KOLT Scottsbluff, NE	KOLY Moberide, SD
KIRX Kirksville, MO	KLFW Lexington, IA	KMNS Sioux City, IA	KOMA Oklahoma City, OK	KOMO Seattle, WA
KISA Honolulu, HI	KLFX Wellington, KS	KMO Tacoma, WA	KOMW Omak, WA	KOMY Watonville, CA
KISD Sioux Falls, SD	KLFB Lubbock, TX	KMON Great Falls, MT	KONA Kennewick, WA	KONE Reno, NV
KISN Vancouver, WA	KLFD Litchfield, MN	KMND Mineola, TX	KONG Visalia, CA	KONI Spanish Fork, UT
KISO El Paso, TX	KLFL Springfield, MO	KMOR Murray, UT	KONO San Antonio, TX	KONP Port Angeles, WA
KIST Santa Barbara, CA	KLGA Algona, IA	KMOX St. Louis, MO	KOOK Billings, MT	
KIT Yakima, WA	KLGR Redwood Falls, MN	KMPC Los Angeles, CA		
KITE Terrell Hills, TX	KLIB Liberal, KS	KMPG Hollister, CA		
KITI Chehalis, WA	KLIM Monroe, LA	KMPL Sikeston, MO		
KITN Olympia, WA	KLID Poplar Bluff, MO	KMPS Seattle, WA		
KIUL Garden City, KS	KLIF Dallas, TX	KMRC Morgan City, LA		
KIUN Pecos, TX	KLJK Jefferson City, MO	KMRR Cameron, MO		
KIUP Durango, CO	KLIN Lincoln, NE	KMRS Morris, MN		
KIWM Lihue, HI	KLIP Fowler, CA	KMSD Millbank, SD		
KIYV Crockett, TX	KLIO Portland, OR	KMTI Manti, UT		
KIWA Sheldon, IA	KLIV San Jose, CA	KMLU Muleshoe, TX		
KIXI Seattle, WA	KLIX Twin Falls, ID	KMSU Muskogee, OK		
KIXL Austin, TX	KLIZ Brainerd, MN	KMVI Wailuku, HI		
KIXS Killeen, TX	KLKC Parsons, KS	KMWX Yakima, WA		
KIXX Provo, UT	KLKA Leesville, LA	KMYC Marysville, CA		
KIXY San Angelo, TX	KLKL Lubbock, TX	KNAB Burlington, CO		
KIXZ Amarillo, TX	KLKR Walker, MN	KNAF Fredericksburg, TX		
KJAM Madison, SD	KLMO Longmont, CO	KNAK Salt Lake City, UT		
KJAN Atlantic, IA	KLNR Lamar, CO	KNAL Victoria, TX		
KJAS Jackson, MO	KLMS Lincoln, NE	KNAM Midland, TX		
KJAY Sacramento, CA	KLNX Clayton, NM	KNBA Vallejo, CA		
KJBC Midland, TX	KLNG Omaha, NE	KNBI Norton, KS		
KJCF Festus, MO	KLO Ogden, UT	KNBO New Boston, TX		
KJCH Cleveland, TX	KLOA Ridgecrest, CA	KNBR San Francisco, CA		
KJCK Junction City, KS	KLOC Ceres, CA	KNBY Newport, AR		
KJDY John Day, OR	KLOE Goodland, KS	KNCB Vivian, LA		
	KLOG Kelso, WA	KNCK Concordia, KS		
		KNCR Fortuna, CA		
		KNCY Nebraska City, NE		

KQAO Austin, MN
 KQEN Roseburg, OR
 KQEO Albuquerque, NM
 KQIK Lakeview, OR
 KQIL Grand Junction, CO
 KQIN Burien, WA
 KQIZ Amarillo, TX
 KQMS Redding, CA
 KQOT Yakima, WA
 KQRS Golden Valley, MN
 KQTY Berger, TX
 KQV Pittsburgh, PA
 KQWB Fargo, ND
 KQWC Webster City, IA
 KQXI Arvada, CO
 KQYX Joplin, MO
 KRAD East Grand Forks, MN
 KRAE Cheyenne, WY
 KRAI Craig, CO
 KRAC Sacramento, CA
 KRAL Rawlins WY
 KRAM Las Vegas, NV
 KRAN Morton, TX
 KRBA Lufkin, TX
 KRBB Sallisaw, OK
 KRBC Abilene, TX
 KRBI St. Peter, MN
 KRBN Red Lodge, MT
 KRCB Council Bluffs, IA
 KRCC Prineville, OR
 KRDO Roswell, NM
 KRDG Redding, CA
 KRDO Colorado Springs, CO
 KRDR Gresham, OR
 KRDS Tolleason, AZ
 KRDU Dinuba, CA
 KRE Berkeley, CA
 KRED Eureka, CA
 KREH Oakdale, LA
 KREI Farmington, MO
 KREL Corona, CA
 KREM Spokane, WA
 KREO Indio, CA
 KREW Sunnyside, WA
 KREX Grand Junction, CO
 KRFO Owatonna, MN
 KRFS Superior, NE
 KRGI Grand Island, NE
 KRGO Salt Lake City, UT
 KRGV Weslaco, TX
 KRHD Duncan, OK
 KRIB Mason City, IA
 KRIG Odessa, TX
 KRIH Rayville, LA
 KRIO McAllen, TX
 KRIZ Phoenix, AZ
 KRKC King City, CA
 KRKE Albuquerque, NM
 KRKK Rock Springs, WY
 KRKM North Pole, AK
 KRKO Everett, WA
 KRKS Denver, CO
 KRKT Albany, OR
 KRLA Pasadena, CA
 KRLC Lewiston, ID
 KRLD Dallas, TX
 KRLN Canon City, CO
 KRLW Walnut Ridge, AR
 KRMC Midwest City, OK
 KRMD Shreveport, LA
 KRME Hondo, TX
 KRMG Tulsa, OK
 KRML Carmel, CA
 KRMO Monett, MO
 PRMS Osage Beach, MO
 KRNR Roseburg, OR
 KRNS Burns, OR
 KRNT Des Moines, IA
 KRNY Kearney, NE
 KROB Robstown, TX
 KROC Rochester, MN
 KROD El Paso, TX
 KROE Sheridan, WY
 KROF Abbeville, LA
 KROP Brawley, CA
 KROS Clinton, IA
 KROW Dallas, OR
 KROX Crookston, MN
 KROY Sacramento, CA
 KRPL Moscow, ID
 KRPT Anadarko, OK
 KRRR Ruidoso, NM
 KRSC Othello, WA
 KRST St. Louis Park, MN
 KRSL Russell, KS
 KRSN Los Alamos, NM
 KRSP Salt Lake City, UT
 KRSY Roswell, NM
 KRTN Raton, NM
 KRTR Thermopolis, WY
 KRUN Ballinger, TX
 KRUS Ruston, LA

KRUX Glendale, AZ
 KRVN Lexington, NE
 KRWB Roseau, MN
 KRWC Buffalo, MN
 KRXA Seward, AK
 KRXX Rexburg, ID
 KRY5 Corpus Christi, TX
 KRYT Colorado Springs, CO
 KRZE Farmington, NM
 KRZI Waco, TX
 KRZY Albuquerque, NM
 *KSAC Manhattan, KS
 KSAL Salina, KS
 KSAM Huntsville, TX
 KSCB Liberal, KS
 KSCJ Sioux City, IA
 KSCO Santa Cruz, CA
 KSD St. Louis, MO
 KSDN Aberdeen, SD
 KSDO San Diego, CA
 KSDR Watertown, SD
 KSEE Santa Maria, CA
 KSEI Pocatello, ID
 KSEK Pittsburg, KS
 KSEL Lubbock, TX
 KSEM Moses Lake, WA
 KSEM Shelby, MT
 KSEO Durant, OK
 KSET El Paso, TX
 KSEY Seymour, TX
 KSFA Nacogdoches, TX
 KSFE Needles, CA
 KSFO San Francisco, CA
 KSGM Chester, IL
 KSGT Jackson, WY
 KSHA Medford, OR
 KSJB Creston, IA
 KSID Sidney, NE
 KSIG Crowley, LA
 KSIL Silver City, NM
 KSIM Sikeston, MO
 KSIR Estes Park, CO
 KSIS Sedalia, MO
 KSIW Woodward, OK
 KSIX Corpus Christi, TX
 KSJB Jamestown, ND
 KSKI Hailey, ID
 KSKY Dallas, TX
 KSL Salt Lake City, UT
 KSLM Salem, OR
 KSLO Opelousas, LA
 KSLV Monte Vista, CO
 KSLY San Luis Obispo, CA
 KSMA Santa Maria, CA
 KSMM Shakopee, MN
 KSNO Mason City, IA
 KSNO Salem, MO
 KSNN Pocatello, ID
 KSNO Aspen, CO
 KSNY Snyder, TX
 KSO Des Moines, IA
 KSOA Ava, MO
 KSOH Little Rock, AR
 KSOK Arkansas City, KS
 KSOM Ontario, CA
 KSON San Diego, CA
 KSOO Sioux Falls, SD
 KSOP Salt Lake City, UT
 KSOX Raymondville, TX
 KSPD Boise, ID
 KSPI Stillwater, OK
 KSPL Diboll, TX
 KSPO Spokane, WA
 KSPR Springdale, AR
 KSPT Sandpoint, ID
 KSRA Salmon, ID
 KSRC Socorro, NM
 KSRM Soldotna-Kenai, AK
 KSRO Santa Rosa, CA
 KSRV Ontario, OR
 KSSS Colorado Springs, CO
 KSST Sulphur Springs, TX
 KSTA Coleman, TX
 KSTB Breckenridge, TX
 KSTL St. Louis, MO
 KSTN Stockton, CA
 KSTP St. Paul, MN
 KSTR Grand Junction, CO
 KSTT Davenport, IA
 KSTV Stephenville, TX
 KSUB Cedar City, UT
 KSUD West Memphis, AR
 KSUE Susanville, CA
 KSUM Fairmont, MN
 KSUN Bisbee, AZ
 KSUZ Port Neches, TX
 KSVN Richfield, UT
 KSVN Ogden, UT
 KSVP Artesia, NM
 KSWA Graham, TX
 KSWB Seaside, OR
 KSWM Aurora, MO

KSWO Lawton, OK
 KSW5 Roswell, NM
 KSWW Wickenburg, AZ
 KSXX Salt Lake City, UT
 KSYX Yreka, CA
 KSYL Alexandria, LA
 KSYX Santa Rosa, NM
 KTAC Tacoma, WA
 KTAE Taylor, TX
 KTAM Bryan, TX
 KTAN Sierra Vista, AZ
 KTAN Phoenix, AZ
 KTAT Frederick, OK
 KTBB Tyler, TX
 KTBC Malden, MO
 KTCH Wayne, NE
 KTCR Minneapolis, MN
 KTCS Fort Smith, AR
 KTDL Farmerville, LA
 KTDQ Toledo, OR
 KTEO Idaho Falls, ID
 KTEL Walla Walla, WA
 KTEM Temple, TX
 KTEO San Angelo, TX
 KTER Terrell, TX
 KTFI Twin Falls, ID
 KTF5 Texarkana, TX
 KTG0 Tioga, ND
 KTGR Columbia, MO
 KTHE Thermopolis, WY
 KTHO South Lake Tahoe, CA
 KTHS Berryville, AR
 KTI8 Thibodaux, LA
 KTLT Tillamook, OR
 KTIM San Rafael, CA
 KTIJ Porterville, CA
 *KTIS Minneapolis, MN
 KTIJ Pendleton, OR
 KTJS Hobart, OK
 KTKN Ketchikan, AK
 KTKR Taft, CA
 KTKT Tucson, AZ
 KTLT Tallulah, LA
 KTLK Denver, CO
 KTLQ Mountain Home, AR
 KTLQ Tahlequah, OK
 KTLU Rusk, TX
 KTLW Texas City, TX
 KTMK McAlester, OK
 KTMF New Prague, MN
 KTMN Trumann, AR
 KTMS Santa Barbara, CA
 KTNK Falls City, NE
 KTNM Tucumcari, NM
 KTN2 Tacoma, WA
 KTOB Petaluma, CA
 KTOC Jonesboro, LA
 KTKM Mankato, MN
 KTKO Oklahoma City, OK
 KTKM Salinas, CA
 KTON Belton, TX
 KTOP Topeka, KS
 KTOO Rapid City, SD
 KTOV Sand Springs, OK
 KTPA Prescott, AR
 KTRB Modesto, CA
 KTRC Thief River Falls, MN
 KTRF Thiel River Falls, MN
 KTRH Houston, TX
 KTRM Beaumont, TX
 KTRN Wichita Falls, TX
 KTRT Truckee, CA
 KTRY Bastrop, LA
 K TSA San Antonio, TX
 KTSM El Paso, TX
 KTTN Trenton, MO
 KTRR Rolla, MO
 KTT5 Springfield, MO
 KTTT Columbus, NE
 KTTX Brenham, TX
 KTUC Tucson, AZ
 KTUE Tulia, TX
 KTUF Tempe, AZ
 KTUI Sullivan, MO
 KTWG Agana, GM
 KTW0 Casper, WY
 KTXJ Jasper, TX
 KTXO Sherman, TX
 KTYD Santa Barbara, CA
 KTYM Inglewood, CA
 KTYN Minot, ND
 KUAD Windsor, CO
 KUA1 Elele, HI
 KUAM Agana, GM
 *KUAT Tucson, AZ
 KUBA Yuba City, CA
 KUBC Montrose, CO
 KUDE Oceanside, CA
 KUDI Great Falls, MT
 KUDL Fairway, KS
 KUDY Spokane, WA
 KUEN Wenatchee, WA

*KUF6 Agana, GM
 KUGN Eugene, OR
 KUIH Santa Maria, CA
 KUIK Hillsboro, OR
 KUJ Walla Walla, WA
 KUKA San Antonio, TX
 KUKI Ukiah, CA
 KUKU Willow Springs, MO
 KULE Ephrata, WA
 KULF Houston, TX
 KULP El Campo, TX
 KULY Ulysses, KS
 KUMA Pendleton, OR
 KUMU Honolulu, HI
 KUNO Corpus Christi, TX
 KUOA Siloam Springs, AR
 *KUOM Minneapolis, MN
 KUPD Tempe, AZ
 KUPI Idaho Falls, ID
 KUPK Aberdeen, TX
 KUPY Puyallup, WA
 KURA Moab, UT
 KURL Pocatello, MT
 KURV Edinburg, TX
 KURY Brookings, OR
 *KUSD Vermillion, SD
 KUSHushing, OK
 KUSN St. Joseph, MO
 KUTA Blanding, UT
 KUTI Yakima, WA
 KUTY Palmdale, CA
 KUUU Seattle, WA
 KUVR Holdrege, NE
 KUXL Golden Valley, MN
 KUZV West Monroe, LA
 KUZ2 Bakersfield, CA
 KVAC Forks, WA
 KVAN Vancouver, WA
 KVAS Astoria, OR
 KVBR Brainerd, MN
 KVCK Wolf Point, MT
 KVCL Winfield, LA
 KVCV Redding, CA
 KVDB Sioux Center, IA
 KVEC San Luis Obispo, CA
 KVEE Conway, AR
 KVEG Las Vegas, NV
 KVEL Durnal, UT
 KVEN Ventura, CA
 KJET Austin, TX
 KVFC Cortez, CO
 KVFD Fort Dodge, IA
 KVGB Great Bend, KS
 KVI Seattle, WA
 KVIC Victoria, TX
 KVIL Highland Park, TX
 KVIN Vinita, OK
 KVIO Cottonwood, AZ
 KVIP Redding, CA
 KVKM Monahans, TX
 KVLFP Alpine, TX
 KVLG La Grange, TX
 KVLH Pauls Valley, OK
 KVLV Woodville, TX
 KVLV Fallon, NV
 KVMA Magnolia, AR
 KVMC Colorado City, TX
 KVML Sonora, CA
 KVN1 Coeur D'Alene, ID
 KVN2 Logan, UT
 KV0B Bastrop, LA
 KVOC Casper, WY
 KV0E Emporia, KS
 KV0G Ogden, UT
 KVOK Kodiak, AK
 KVOL Lafayette, LA
 KVOM Morrilton, AR
 KVON Napa, CA
 KV0O Tulsa, OK
 KVOP Plainview, TX
 KVOR Colorado Springs, CO
 KV0U Uvalde, TX
 KV0V Henderson, NV
 KV0W Riverton, WY
 KV0X Moorhead, MN
 KV0Y Yuma, AZ
 KV0Z Laredo, TX
 KVPI Ville Platte, LA
 KVRA Vermillion, SD
 KVRC Arkadelphia, AR
 KVRE Santa Rosa, CA
 KVRH Salida, CO
 KVSA McGehee, AR
 KVSF Santa Fe, NM
 KVSH Valentine, NE
 KVSI Montpelier, ID
 KVSJ Show Low, AZ
 KVSQ Ardmore, OK
 KVWC Vernon, TX
 KVWG Pearsall, TX
 KVWM Show Low, AZ
 KVWO Cheyenne, WY

KVYL Holdenville, OK
 KWAC Bakersfield, CA
 KWAD Wadena, MN
 KWAK Stuttgart, AR
 KWAL Wallace, ID
 KWAM Memphis, TN
 KWAT Watertown, SD
 KWAY Waverly, IA
 KWBB Wichita, KS
 KWBC Navasota, TX
 KWBE Beatrice, NE
 KWBG Boone, IA
 KWBW Hutchinson, KS
 KWBY Edna, TX
 KWZB Englewood, CO
 KWCK Searcy, AR
 KWCL Oak Grove, LA
 KWCO Chickasha, OK
 KWEE Rochester, MN
 KWED Seguin, TX
 KWEI Weiser, ID
 KWEL Midland, TX
 KWEW Hobbs, NM
 KWEY Weatherford, OK
 KWFA Merkel, TX
 KWF7 Wichita Falls, TX
 KWG Stockton, CA
 KWGH Big Lake, TX
 KWHK Hutchinson, KS
 KWHN Fort Smith, AR
 KWH0 Salt Lake City, UT
 KWHW Altus, OK
 KWIK Pocatello, ID
 KWIL Albany, OR
 KWIP Merced, CA
 KWIO Moses Lake, WA
 KWIV Douglas, WY
 KWIX Moberly, MO
 KWIZ Santa Ana, CA
 KWJJ Portland, OR
 KWK St. Louis, MO
 KWKA Clovis, NM
 KWK C Abilene, TX
 KWKH Shreveport, LA
 KWKW Pasadena, CA
 KWKV Des Moines, IA
 KWL A Many, LA
 *KWLC Decorah, IA
 KWLW Wilmar, MN
 KWMC Del Rio, TX
 KWM7 Fort Dodge, IA
 KWNA Winnemucca, NV
 KWNO Winona, MN
 KWNS Pratt, KS
 KWNT Davenport, IA
 KW0A Worthington, MN
 KWOC Poplar Bluff, MO
 KW0E Clinton, OK
 KWON Bartlesville, OK
 KW0R World, WY
 KW0S Jefferson City, MO
 KW0W Pomona, CA
 KWPC Muscatine, IA
 KWPM West Plains, MO
 KWPR Claremore, OK
 KWRC Woodburn, OR
 KWRD Henderson, TX
 KWRE Warrenton, MO
 KWRF Warren, AR
 KWRG New Roads, LA
 KWRL Sparks, NV
 KWRO Coquille, OR
 KWRT Boonville, MO
 KWSD Mt. Shasta, CA
 KWSH Wewoka, OK
 KWSL Sioux City, IA
 KWSO Wasco, CA
 KWSR Rifle, CO
 *KWSU Pullman, WA
 KWTC Barstow, CA
 KWTO Springfield, MO
 KWTX Waco, TX
 KWUN Concord, CA
 KWRV Enterprise, OR
 KWWL Waterloo, IA
 KWXY Cathedral City, CA
 KWYK Farmington, NM
 KWYN Wynne, AR
 KWY0 Sheridan, WY
 KWRV Winner, SD
 KWYS West Yellowstone, MT
 KWY2 Everett, WA
 KXA Seattle, WA
 KXAR Hope, AR
 KXEL Waterloo, IA
 KXEM McFarland, CA
 KXEN St. Louis-Festus, MO
 KXEO Mexico, MO
 KXEX Tucson, AZ
 KXEX Fresno, CA

AM Calls

KXGI Fort Madison, IA
 KXGN Glendive, MT
 KXIC Iowa City, IA
 KXIT Dahlart, TX
 KXIV Phoenix, AZ
 KXJK Forrest City, AR
 KXKW Lafayette, LA
 KXL Portland, OR
 KXLE Ellensburg, WA
 KXLF Butte, MT
 KXLO Lewistown, MT
 KXLR North Little Rock, AR
 KXLY Spokane, WA
 KXO El Centro, CA
 KXOJ Sapulpa, OK
 KXOK St. Louis, MO
 KXOL Fort Worth, TX
 KXOW Hot Springs, AR
 KXOX Sweetwater, TX
 KXPO Grafton, ND
 KXRA Alexandria, MN
 KXRB Sioux Falls, SD
 KXRO Aberdeen, WA
 KXRX San Jose, CA
 KXSL Bozeman, MT
 KXXO Tulsa, OK
 KXXR Spokane, WA
 KXXX Cobay, KS
 KXYZ Houston, TX
 KYA San Francisco, CA
 KYAC Seattle, WA
 KYAK Anchorage, AK
 KYAL McKinney, TX
 KYCA Prescott, AZ
 KYCN Wheatland, WY
 KYES Roseburg, OR
 KYET Payette, ID
 KYJC Medford, OR
 KYKR Port Arthur, TX
 KYLT Missoula, MT
 KYME Boise, ID
 KYMN Northfield, MN
 KYMO East Prairie, MO
 KYNG Coos Bay, OR
 KYNO Fresno, CA
 KYNT Yankton, SD
 KYOK Houston, TX
 KYOR Blythe, CA
 KYOS Merced, CA
 KYOU Greeley, CO
 KYRO Potosi, MO
 KYSM Mankato, MN
 KYSN Colorado Springs, CO
 KYSO Missoula, MT
 *KYUK Bethel, AK
 KYVA Gallup, NM
 KYWH Philadelphia, PA
 KYXI Oregon City, OR
 KZAK Tyler, TX
 KZAM Bellevue, WA
 KZEE Weatherford, TX
 KZEY Tyler, TX
 KZIA Albuquerque, NM
 KZIP Amarillo, TX
 KZIQ Ridgecrest, CA
 KZNG Hot Springs, AR
 KZOL Farwell, TX
 KZON Santa Maria, CA
 KZOO Honolulu, HI
 KZOT Marianna, AR
 KZRK Ozark, AR
 KZUL Parker, AZ
 KZUN Opportunity, WA
 KZYM Cape Girardeau, MO
 KZZN Littlefield, TX
 WAAA Winston-Salem, NC
 WAAB Worcester, MA
 WAAC Terre Haute, IN
 WAAK Dallas, NC
 WAAM Ann Arbor, MI
 WAAN Waynesboro, TN
 WAAO Andalusia, AL
 WAAX Gadsden, AL
 WAAY Huntsville, AL
 WABA Aguadilla, PR
 WABB Mobile, AL
 WABC New York, NY
 WABD Ft. Campbell, KY
 WABF Fairhope, AL
 WABG Greenwood, MS
 WABH Deerfield, VA
 WABI Bangor, ME
 WABJ Adrian, MI
 WABK Gardiner, ME
 WABL Amite, LA
 WABO Waynesboro, MS
 WABQ Cleveland, OH
 WABV Abbeville, SC
 WABY Albany, NY
 WABZ Albemarle, NC

WACA Camden, SC
 WACB Kiltanning, PA
 WACE Chocopee, MA
 WACK Newark, NY
 WACL Waycross, GA
 WACO Waco, TX
 WACR Columbus, MS
 WACT Tuscaloosa, AL
 WACX Austell, GA
 WACY Kissimmee, FL
 WADA Shely, NC
 WADC Parkersburg, WV
 WADD Brockport, NY
 WADE Wadesboro, NC
 WADK Newport, RI
 WADM Decatur, IN
 WADO New York, NY
 WADR Remsen, NY
 WADS Ansonia, CT
 WAEB Allentown, PA
 WAEL Mayaguez, PR
 WAEW Crossville, TN
 WAEY Princeton, WV
 WAFI Middlesboro, KY
 WAGC Centre, AL
 WAGE Leesburg, VA
 WAGF Dothan, AL
 WAGG Franklin, TN
 WAGL Lancaster, SC
 WAGM Presque Isle, ME
 WAGN Menominee, MI
 WAGO Oshkosh, WI
 WAGR Lumberton, NC
 WAGS Bishopville, SC
 WAGY Forest City, NC
 WAHT Anville-Cleona, PA
 WAIK Gainesburg, IL
 WAIB Baton Rouge, LA
 WAIM Anderson, SC
 WAIN Columbia, KY
 WAIR Winston-Salem, NC
 WAIT Chicago, IL
 WAJF Decatur, AL
 WAJR Morgantown, WV
 WAKA Gainesville, FL
 WAKC Normal, IL
 WAKE Valparaiso, IN
 WAKI McMinnville, TN
 WAKK McComb, MS
 WAKN Aiken, SC
 WAKO Lawrenceville, IL
 WAKR Akron, OH
 WAKS Fuquay Varina, NC
 WAKX Superior, WI
 WAKY Louisville, KY
 WALD Wallerburg, SC
 WALE Fall River, MA
 WALG Albany, GA
 WALK Patchogue, NY
 WALL Middletown, NY
 WALM Albion, MI
 WALO Humacao, PR
 WALY Herkimer, NY
 WAMA Selma, AL
 WAMB Nashville, TN
 WAMD Aberdeen, MD
 WAME Charlotte, NC
 WAMG Gallatin, TN
 WAMI Opp, AL
 WAML Laurel, MS
 WAMM Flint, MI
 WAMO Pittsburg, PA
 WAMR Venice, FL
 WAMS Wilmington, DE
 WAMW Washington, IN
 WAMY Amory, MS
 WANA Annsiston, AL
 WANB Waynesburg, PA
 WANL Lneville, AL
 WANM Tallahassee, FL
 WANN Annapolis, MD
 WANO Pineville, OH
 WANR Toledo, KY
 WANS Anderson, SC
 WANT Richmond, VA
 WANV Waynesboro, VA
 WANW Albany, KY
 WAOA Opelika, AL
 WAOC St. Augustine, FL
 WAOK Atlanta, GA
 WAOP Otsego, MI
 WAOV Vincennes, IN
 WAPA San Juan, PR
 WAPE Jacksonville, FL
 WAPF McComb, MS
 WAPG Arcadia, FL
 WAPI Birmingham, AL
 WAPL Appleton, WI
 WAPR Avon Park, FL
 WAPX Montgomery, AL
 WAQI Ashtabula, OH
 WARA Attleboro, MA

WARB Covington, LA
 WARD Pittston, PA
 WARE Ware, MA
 WARF Jasper, AL
 WARI Abbeville, AL
 WARK Hagerstown, MD
 WARM Scranton, PA
 WARO Canonsburg, PA
 WARR Warrenton, NC
 WARU Peru, IN
 WARV Warwick, RI
 WASA Havre De Grace, MD
 WASC Spartanburg, SC
 WASK Lafayette, IN
 WASP Brownsville, PA
 WASR Wolfesboro, NH
 WATA Boone, NC
 WATC Gaylord, MI
 WATH Athens, OH
 WATI Indianapolis, IN
 WATK Antigo, WI
 WATM Atmore, AL
 WATN Watertown, NY
 WATO Oak Ridge, TN
 WATP Marion, SC
 WATR Waterbury, CT
 WATS Sayre, PA
 WATT Cadillac, MI
 WATV Birmingham, AL
 WATW Ashland, WI
 WATZ Alpena, MI
 WAUB Auburn, NY
 WAUC Wauchula, FL
 WAUD Auburn, AL
 WAUG Augusta, GA
 WAUJ Waukesha, WI
 WAVA Arlington, VA
 WAWC Warner Robins, GA
 WAVE Louisville, KY
 WAVI Dayton, OH
 WAVL Apollo, PA
 WAVN Stillwater, MN
 WAVO Decatur, GA
 WAVS Fort Lauderdale, FL
 WAVU Albertville, AL
 WAVZ New Haven, CT
 WAWA West Allis, WI
 WAWK Kendallville, IN
 *WAWZ Zarephath, NJ
 WAXC Rochester, NY
 WAXE Vero Beach, FL
 WAXU Georgetown, KY
 WAXY Chippewa Falls, WI
 WAXW Waynesboro, VA
 WAYC Bedford, PA
 WAYD Ozark, AL
 WAYE Baltimore, MD
 WAYL Lehigh Acres, FL
 WAYN Rockingham, NC
 WAYR Orange Park, FL
 WAYS Charlotte, NC
 WAYT Wabash, IN
 WAYX Waycross, GA
 WAYZ Waynesboro, PA
 WAZA Bambridge, GA
 WAZE Clearwater, FL
 WAZF Yazoo City, MS
 WAZL Hazleton, PA
 WAZS Summerville, SC
 WAZY Lafayette, IN
 *WBA West Lafayette, IN
 WBAC Cleveland, TN
 WBAF Barnesville, GA
 WBAG Burlington, NC
 WBAL Baltimore, MD
 WBAM Montgomery, AL
 WBAP Fort Worth, TX
 WBAR Barlow, FL
 WBAT Marion, IN
 WBAW Barnwell, SC
 WBAX Wilkes-Barre, PA
 WBBA Pittsfield, IL
 WBBD Burlington, NC
 WBFB Rochester, NY
 WBBI Abingdon, VA
 WBCK Blakely, GA
 *WBBL Richmond, VA
 WBMM Chicago, IL
 WBBO Forest City, NC
 WBBO Augusta, GA
 WBRR Traveler's Rest, SC
 WBBS Jacksonville, NC
 WBBT Lyons, GA
 WBBW Youngstown, OH
 WBBX Portsmouth, NH
 WBBZ Ponca City, OK
 WBCA Bay Minette, AL
 WBGB Levittown, PA
 WBCH Hastings, MI
 WBCK Battle Creek, MI
 WBGM Bay City, MI
 WBCC Bucyrus, OH
 WBCU Union, SC

WBCW Jeannette, PA
 WBDN Escanaba, MI
 WBEC Pittsfield, MA
 WBEE Harvey, IL
 WBEJ Elizabethton, TN
 WBEL Beirut, WI
 WBEN Buffalo, NY
 WBFR Moncks Corner, SC
 WBET Brockton, MA
 WBEU Beaufort, SC
 WBEV Beaver Dam, WI
 WBEX Chillicothe, OH
 WBFC Stanton, KY
 WBFD Bedford, PA
 WBFN Quitman, MS
 WBGC Chipley, FL
 WBGN Bowling Green, KY
 WBGR Paris, KY
 WBHB Fitzgerald, GA
 WBHC Hampton, SC
 WBHF Cartersville, GA
 WBHN Bryson City, NC
 WBHP Huntsville, AL
 WBHT Brownsville, TN
 WBIA Augusta, GA
 WBIB Centerville, AL
 WBIG Greensboro, NC
 WBIL Tuskegee, AL
 WBIP Booneville, MS
 WBIR Knoxville, TN
 WBIS Bristol, CT
 WBIT Adel, GA
 WBIV Bedford, IN
 WBIX Jacksonville Beach, FL
 WBIZ Eau Claire, WI
 WBJW Winter Park, FL
 WBKC Chardon, OH
 WBKH Hattiesburg, MS
 WBKN Newton, MS
 WBKV West Bend, WI
 WBKA Elizabethtown, NC
 WBLB Pulaski, VA
 WBLC Lemor City, TN
 WBLE Batesville, MS
 WBLF Bellefonte, PA
 WBLG Lexington, KY
 WBLJ Dalton, GA
 WBLE Evergreen, AL
 WBLR Batesburg, SC
 WBLT Bedford, VA
 WBLU Salem, VA
 WBLW Royston, GA
 WBLV Springfield, OH
 WBMA Beaufort, NC
 WBMB West Branch, MI
 WBMC McMinnville, TN
 WBMD Baltimore, MD
 WBME Belfast, ME
 WBMJ San Juan, PR
 WBMK West Point, GA
 WBML Macon, GA
 WBMS Black Mountain, NC
 WBNC Conway, NH
 WBNI Boonville, IN
 WBNO Bryan, OH
 WBNR Beacon, NY
 WBNS Columbus, OH
 WBNT Oneida, TN
 WBNU Buena Vista, VA
 WBNU New York, NY
 WBOB Galax, VA
 WBOC Salisbury, VA
 WBOK New Orleans, LA
 WBOL Bolivar, WI
 WBOO Baraboo, WI
 WBOP Pensacola, FL
 WBOW Terre Haute, IN
 WBOX Bogalusa, LA
 WBOY Clarksburg, WV
 WBZP Lock Haven, PA
 WBON Barcelona, PR
 WBRB Mount Clemens, MI
 WBRD Bradenton, FL
 WBRE Wilkes-Barre, PA
 WBRG Lynchburg, VA
 WBRI Indianapolis, IN
 WBRJ Marietta, OH
 WBRK Pittsfield, MA
 WBRL Berlin, NH
 WBRM Marion, NC
 WBRN Big Rapids, MI
 WBRO Waynesboro, GA
 WBRT Bardstow, KY
 WBRV Boonville, NY
 WBRW Somerville, NJ
 WBRX Berwick, PA
 WBRV Woodbury, TN

WBT Charlotte, NC
 WBTA Batavia, NY
 WBTC Uhrichsville, OH
 WBTE Windsor, NC
 WBTH Williamson, WV
 WBTM Danville, VA
 WBTN Bennington, VT
 WBTR Linton, IN
 WBTS Bridgeport, AL
 WBTX Broadway, VA
 WBUC Buckhannon, WV
 WBUD Trenton, NJ
 WBUG Ridgefield, SC
 WBUR Portage, MI
 WBUL Birmingham, AL
 WBUT Butler, PA
 WBUX Doylestown, PA
 WBWY Lexington, NC
 WBWZ Fredonia, NY
 WBVM Utica, NY
 WBVP Beaver Falls, PA
 WBVE Calera, AL
 WBYS Canton, IL
 WBZ Boston, MA
 WBZA Glens Falls, NY
 WBZB Selma, NC
 WBZY New Castle, PA
 WCAI Rutherfordton, NC
 WCBI Fort Myers, FL
 *WCAL Northfield, MN
 WCAM Camden, NJ
 WCAO Baltimore, MD
 WCAP Lowell, MA
 WCAR Detroit, MI
 WCAS Cambridge, MA
 WCAT Orange, MA
 WCAU Philadelphia, PA
 WCAW Charleston, WV
 WCAZ Cayce, SC
 WCAZ Carthage, IL
 WCBG Chambersburg, PA
 WCBM Columbus, MS
 WCBK Martinsville, IN
 WCBL Benton, KY
 WCBM Baltimore, MD
 WCOB Oxford, NC
 WCBR Richmond, KY
 WCBW New York, NY
 WCBT Roanoke Rapids, NC
 WCBX Eden, NC
 WCBY Cheboygan, MI
 WCCC Hartford, CT
 WCCF Punta Gorda, FL
 WCCM Lawrence, MA
 WCCN Neillsville, WI
 WCCO Minneapolis, MN
 WCCP Clemson, SC
 WCCR Urbana, IL
 WCCW Traverse City, MI
 WCDJ Edenton, NC
 WCDL Carbondale, PA
 WCDQ Hamden, CT
 WCDJ Glasgow, KY
 WCDT Winchester, TN
 WCEC Rocky Mount, NC
 WCED Du Bois, PA
 WCEH Hawkinsville, GA
 WCEN Cambridge, MD
 WCEN Mount Pleasant, MI
 WCER Charlotte, MI
 WCFI Chicago, IL
 WCFR Springfield, VT
 WCGJ Juana Diaz, PR
 WCGC Belmont, NC
 WCGJ Jacksonville, FL
 WCGO Chicago Heights, IL
 WCGR Canandaigua, NY
 WCHA Chambersburg, PA
 WCHB Inkster, MI
 WCHE West Chester, PA
 WCHI Chillicothe, OH
 WCHJ Brookhaven, MS
 WCHL Canton, GA
 WCHL Chapel Hill, NC
 WCHN Norwich, NY
 WCHO Washington Court House, OH
 WCHO Camuy, PR
 WCHS Charleston, WV
 WCHV Charlottesville, VA
 WCID Junco, PR
 WCIL Carbondale, IL
 WCIN Cincinnati, OH
 WCIR Beckley, WV
 WCIS Pascagoula, MS
 WCIT Lima, OH
 WCJU Columbia, MS
 WCJW Warsaw, NY
 WCKB Dunn, NC
 WCKC Milton, FL
 WCKI Greer, SC
 WCKL Catskill, NY

WCKM Winnsboro, SC
 WCKY Cincinnati, OH
 WCLA Claxton, GA
 WCLB Camilla, GA
 WCLC Janestown, TN
 WCLD Cleveland, MS
 WCLE Cleveland, TN
 WCLG Morgantown, WV
 WCLI Corning, NY
 WCLN Clinton, NC
 WCLQ Janesville, WI
 WCLS Columbus, GA
 WCLT Newark, OH
 WCLU Covington, KY
 WCLW Mansfield, OH
 WCMA Corinth, MS
 WCMB Harrisburg, PA
 WCMC Wildwood, NJ
 WCMI Ashland, KY
 WCMN Arecibo, PR
 WCMP Pine City, MN
 WCMQ Miami, FL
 WCMR Elkhart, IN
 WCMS Norfolk, VA
 WCMT Martin, TN
 WCMY Ottawa, IL
 WCNB Connerville, IN
 WCNC Elizabeth City, NC
 WCND Shelbyville, KY
 WCNH Quincy, FL
 WCNL Newport, NH
 WCNR Bloomsburg, PA
 WCNU Crestview, FL
 WCNW Fairfield, OH
 WCNX Middletown, CT
 WCOA Pensacola, FL
 WCOB Marietta, GA
 WCOG Greensboro, NC
 WCOH Newnan, GA
 WCOJ Coatesville, PA
 WCOK Sparta, NC
 WCOL Columbus, OH
 WCON Cornelia, GA
 WCOP Boston, MA
 WCOR Lebanon, TN
 WCOS Columbia, SC
 WCOU Lewiston, ME
 WCOV Montgomery, AL
 WCOW Sparta, WI
 WCOX Camden, AL
 WCPA Clearfield, PA
 WCPH Houston, MS
 WCPH Etowah, TN
 WCPK Chesapeake, VA
 WCPM Cumberland, KY
 WCPR Coamo, PR
 WCPB Tarboro, NC
 WCRA Effingham, IL
 WCRE Cheraw, SC
 WCRI Scottsboro, AL
 WCRK Norristown, TN
 WCRL Oneonta, AL
 WCRM Clare, MI
 WCRO Johnstown, PA
 WCRS Greenwood, SC
 WCRW Birmingham, AL
 WCRV Washington, NJ
 WCRW Chicago, IL
 WCRY Macon, GA
 WCSA Ripley, MS
 WCSC Charleston, SC
 WCSH Portland, ME
 WCSI Columbus, IN
 WCSJ Morris, IL
 WCSL Cherryville, NC
 WCSM Celina, OH
 WCSR Hillsdale, MI
 WCSS Amsterdam, NY
 WCST Berkeley Springs, WV
 WCSV Crossville, TN
 WCSW Shell Lake, WI
 WCTA Andalusia, AL
 WCTC New Brunswick, NJ
 WCTM Eaton, OH
 WCTN Potomac-Cabin John, MD
 WCTR Chestertown, MD
 WCTT Corbin, KY
 WCTW New Castle, IN
 WCUB Manitowoc, WI
 WCUE Cuyahoga Falls, OH
 WCUG Culbert, GA
 WCUM Cumberland, MD
 WCUZ Grand Rapids, MI
 WCVA Culpeper, VA
 WCVI Conellsville, PA
 WCVL Crawfordsville, IN
 WCVP Murphy, NC
 WCVR Randolph, VT
 WCVS Springfield, IL
 WCWA Toledo, OH
 WCWC Ripon, WI
 WCYN Cynthiana, KY

WCZN Flint, MI
 WDAD Indiana, PA
 WDAE Tampa, FL
 WDAF Kansas City, MO
 WDAK Columbus, GA
 WDAL Meridian, MS
 WDAN Danville, IL
 WDAR Darlington, SC
 WDAS Philadelphia, PA
 WDAT Daytona Beach, FL
 WDAX Mc Rae, GA
 WDAY Fargo, ND
 WDBC Escanaba, MI
 WDBF Delray Beach, FL
 WDBL Springfield, TN
 WDBM Statesville, NC
 WDBO Orlando, FL
 WDBG Dubuque, IA
 WDCF Dade City, FL
 WDCL Dunedin, FL
 WDCC Hanover, NH
 WDDT Greenville, MS
 WDDY Gloucester, VA
 WDEA Ellsworth, ME
 WDEB Jamestown, TN
 WDEC Americus, GA
 WDEE Detroit, MI
 WDEF Chattanooga, TN
 WDEH Sweetwater, TN
 WDEL Wilmington, DE
 WDEM Macon, GA
 WDEV Waterbury, VT
 WDEW Westfield, MA
 WDGL Douglasville, GA
 WDGY Minneapolis, MN
 WDJM Memphis, TN
 WDJC Clintwood, VA
 WDIG Dothan, AL
 WDX Orangeburg, SC
 WDJM Mount Olive, NC
 WDJZ Bridgeport, CT
 WDKD Kingstree, SC
 WDKN Dickson, TN
 WDLA Walton, NY
 WDLB Marshfield, WI
 WDLR Port Jervis, NY
 *WDLM East Moline, IL
 WDLF Panama City, FL
 WDLR Delaware, OH
 WDMC Dover Foxcroft, ME
 WDMG Douglas, GA
 WDMJ Marquette, MI
 WDMP Dodgeville, WI
 WDMV Pocomoke City, MD
 WDNC Durham, NC
 WDNE Elkins, WV
 WDNG Anniston, AL
 WDNT Dayton, TN
 WDOC Prestonburg, KY
 WDOO Chattanooga, TN
 WDOE Dunkirk, NY
 WDOG Allendale, SC
 WDOL Athens, GA
 WDON Wheaton, MD
 WDOR Sturgeon Bay, WI
 WDOS Oneonta, NY
 WDOT Burlington, VT
 WDOV Dover, DE
 WDOW Dowagiac, MI
 WDOG Duquoin, IL
 WDRC Hartford, CT
 WDSK Dillon, SC
 WDSG Dyersburg, TN
 WDSK Cleveland, MS
 WDSL Mocksville, NC
 WDSM Superior, WI
 WDSR Lake City, FL
 WDTM Selmer, TN
 WDUJ Gainesville, GA
 WDUX Waupaca, WI
 WDUZ Green Bay, WI
 WDVV Danville, VA
 WDVH Gainesville, FL
 WDWL Vineland, NJ
 WDWL Dawson, GA
 WDWV Champaign, IL
 WDXB Chattanooga, TN
 WDXE Lawrenceburg, TN
 WDXI Jackson, TN
 WDXL Lexington, TN
 WDXN Clarksville, TN
 WDXR Paducah, KY
 WDXY Sumter, SC
 WDXV Buford, GA
 WDEZ Decatur, IL
 WEAB Greer, SC
 WEAC Gaffney, SC
 WEAG Alcoa, TN
 WEAL Greensboro, NC
 WEAM Arlington, VA
 WEAN Providence, RI
 WEAQ Eau Claire, WI

WEAS Savannah, GA
 WEAT West Palm Beach, FL
 WEAV Plattsburgh, NY
 WEAW Evanston, IL
 WEBB Baltimore, MD
 WEBC Duluth, MN
 WEBJ Brewton, AL
 WEBO Owego, NY
 WEBO Harrisburg, IL
 WEBR Buffalo, NY
 WEBS Calhoun, GA
 WECO Warburg, TN
 WECF Carthage, MS
 WEDC Chicago, IL
 WEDG Saddy-Daisy, TN
 WEDO McKeesport, PA
 WEEB Southern Pines, NC
 WEEB Rocky Mount, NC
 WEYE Boston, MA
 WEEL Fairfax, VA
 WEEN Lafayette, TN
 WEEQ Waynesboro, PA
 WEEP Pittsburg, PA
 WEEW Warrenton, VA
 WEEV Richmond, VA
 WEEU Reading, PA
 WEEW Washington, NC
 WEEZ Easton, PA
 WEEZ Chester, PA
 WEGA Vega Baja, PR
 WEGG Rose Hill, NC
 WEGO Concord, NC
 WEGP Presque Isle, ME
 WEHH Elmira Heights, NY
 WEIC Charleston, IL
 WEIF Moundsville, WV
 WEIM Fitchburg, MA
 WEIR Weirton, WV
 WEIS Centre, AL
 WEJJ Scranton, PA
 WEGK Jackson, KY
 WEKO Cabo Rojo, PR
 WEKR Fayetteville, TN
 WEKY Richmond, KY
 WEKZ Monroe, WI
 WELB Elba, AL
 WELC Welch, WV
 WELF Fisher, WV
 WELS South Dayton, FL
 WELI New Haven, CT
 WELK Charlottesville, VA
 WELM Elmira, NY
 WELO Tupelo, MS
 WELP Easley, SC
 WELR Roanoke, NC
 WELS Kingston, AL
 WELV Ellenville, NY
 WELW Willoughby, OH
 WELX Xenia, OH
 WELY Ely, MN
 WELZ Belzoni, MS
 WEMB Erwin, TN
 WEMD Easton, MD
 WEMJ Laconia, NH
 WEMP Milwaukee, WI
 WENC Whiteville, NC
 WEND Ebensburg, PA
 WENE Endicott, NY
 WENG Englewood, FL
 WENK Union City, TN
 WENN Birmingham, AL
 WENO Madison, TN
 WENR Englewood, TN
 WENT Gloversville, NY
 WEMY Elmira, NY
 WENZ Highland Springs, VA
 WEOK Poughkeepsie, NY
 WEOL Elyria, OH
 WEOO Smithfield, VA
 WEPA Eupora, MS
 WEPG South Pittsburg, TN
 WEPM Martinsburg, WV
 WEQO Whittier City, KY
 WERA Plainfield, NJ
 WERC Birmingham, AL
 WERD Jacksonville, FL
 WERE Cleveland, OH
 WERH Hamilton, AL
 WERI Westerly, RI
 WERK Muncie, IN
 WERL Eagle River, WI
 WERT Van Wert, OH
 WESA Charleroi, PA
 WESB Bradford, PA
 WESC Greenville, SC
 WESL East St. Louis, IL
 WESO Southbridge, MA
 WESR Tasley, VA
 WEST Easton, PA
 WESX Salem, MA
 WESY Leland, MS
 WETB Johnson City, TN

WETC Wendell-Zebulon, NC
 WETA Knoxville, TN
 WETO Deland, FL
 WETT Ocean City, MD
 WETU Wetumpka, AL
 WETZ New Martinsville, WV
 *WEUC Ponce, PR
 WEUP Huntsville, AL
 WEVA Emporia, VA
 WEWB New York, NY
 WEVE Eyelet, MN
 WEVR River Falls, WI
 WEW St. Louis, MO
 WEWL Laurinburg, NC
 WEXL Royal Oak, MI
 WEXM Jamesville, VA
 WEXT West Hartford, CT
 WEXY Oakland Park, FL
 WEYQ Sanford, NC
 WEYY Talladega, AL
 WEZE Boston, MA
 WEZJ Williamsburg, KY
 WEZQ Winfield, AL
 WEZY Cocoa, FL
 WFAA Dallas, TX
 WFAB Miami, FL
 WFAD Middleburg, VT
 WFAH Farmville, NC
 WFAH Alliance, OH
 WFAI Fayetteville, NC
 WFAH Farrell, PA
 WFAV White Plains, NY
 WFAU Augusta, ME
 WFAW Fort Atkinson, WI
 WFAV Falls Church, VA
 WFBA San Sebastian, PR
 WFBC Greenville, SC
 WFBG Altoona, PA
 WFBK Syracuse, NY
 WFBK Baltimore, MD
 WFBK Spring Lake, NC
 WFCG Franklinton, LA
 WFDL Flint, MI
 WFDL Manchester, GA
 WFEA Manchester, NH
 WFEW Sylacauga, AL
 WFEC Harrisburg, PA
 WFFF Columbia, MS
 WFFG Marathon, FL
 WFLG Fitchburg, MA
 WFGN Gaffney, SC
 WFGW Black Mountain, NC
 WFHG Bristol, VA
 WFHK Pell City, AL
 WFHR Wisconsin Rapids, WI
 WFIA Louisville, KY
 WFIC Collinsville, VA
 WFIF Milford, CT
 WFIG Sumter, SC
 WFIL Philadelphia, PA
 WFIN Findlay, OH
 WFIK Roanoke, VA
 WFIS Fountain, SC
 WFIW Kissimmee, FL
 WFIW Fairfield, IL
 WFIK Huntsville, AL
 WFKN Franklin, KY
 WFKY Frankfort, KY
 WFLA Tampa, FL
 WFLB Fayetteville, NC
 WFLI Lookout Mountain, TN
 WFLN Philadelphia, PA
 WFLQ Farmville, VA
 WFLR Dundee, NY
 WFLS Fredericksburg, VA
 WFLW Monticello, KY
 WFMG Goldsboro, NC
 WFMD Frederick, MD
 WFMH Culman, AL
 WFMJ Youngstown, OH
 WFMQ Fairmont, NC
 WFMW Madisonville, KY
 WFNC Fayetteville, NC
 WFNL North Augusta, SC
 WFOB Fostoria, OH
 WFOV Marietta, GA
 WFOR Hattiesburg, MS
 WFOY St. Augustine, FL
 WFPA Fort Payne, AL
 WFPG Atlantic City, NJ
 WFPM Fort Valley, GA
 WFPB Hammond, LA
 WFRM Franklin, PA
 WFRB Frostburg, MD
 WFRD Reidsville, NC
 WFRM Freeport, IL
 WFRM Coudersport, PA
 WFRQ Fremont, OH
 WFRX West Frankfort, IL
 WFSK Franklin, NC
 WFSH Valparaiso, FL
 WFSO Pinellas Park, FL

WFSP Kingwood, WV
 WFST Caribou, ME
 WFTC Kinston, NC
 WFTG London, KY
 WFTL Fort Lauderdale, FL
 WFTM Franklinville, KY
 WFTN Mayfield, NH
 WFTO Fulton, MS
 WFTP Fort Pierce, FL
 WFTF Front Royal, VA
 WFTW Ft. Walton Beach, FL
 WFUL Fulton, KY
 WFUN South Miami, FL
 WFRB Grand Rapids, MI
 WFWA Fredericksburg, VA
 WFRV Aurora, IL
 WFWL Camden, TN
 WFWR Fort Wayne, IN
 WFYC Alma, MI
 WGAA Cedartown, GA
 WGAC Augusta, GA
 WGAD Gadsden, AL
 WGAH Valdosta, GA
 WGAJ Elizabeth City, NC
 WGAN Lancaster, PA
 WGAN Portland, ME
 WGAH Maryville, TN
 WGAR Cleveland, OH
 WGAH South Gastonia, NC
 WGBT Gate City, VA
 WGAU Athens, GA
 WGAU Gardner, MA
 WGAU Silver Spring, MD
 WGBB Freeport, NY
 WGBF Evansville, IN
 WGBG Greensboro, NC
 WGBI Scranton, PA
 WGBR Goldsboro, NC
 WGBS Miami, FL
 WGBB Red Lion, PA
 WGCN Chester, SC
 WGCN Greenwich, CT
 WGCN Guilford, MS
 WGEA Geneva, AL
 WGEN Green Bay, WI
 WGEN Quincy, IL
 WGEN Geneseo, IL
 WGET Gettysburg, PA
 WGEZ Beloit, WI
 WGFV Watseka, IL
 WGFV Covington, GA
 WGFV Youngstown, OH
 WGGG Gainesville, FL
 WGGG Gainesville, FL
 WGGH Marion, IL
 WGGO Salamanca, NY
 WGH Newport News, VA
 WGHK Clayton, GA
 WGHN Grand Haven, MI
 WGHQ Kingston, NY
 WGCX Xenia, OH
 WGIJ Brunswick, GA
 WGIJ Galesburg, IL
 WGIJ Manchester, NH
 WGIJ Charlotte, NC
 WGKA Atlanta, GA
 WGRK Perry, FL
 WGL Fort Wayne, IN
 WGLB Port Washington, WI
 WGLG Mendota, IL
 WGLD High Point, NC
 WGLI Babylon, NY
 WGLX Galion, OH
 WGMA Hollywood, FL
 WGMF Watkins Glen, NY
 WGMF Hinesville, GA
 WGMG Bethesda, MD
 WGN Chicago, IL
 WGNB Indian Rocks Beach, FL
 WGNK Gastonia, NC
 WGNK Panama City Beach, FL
 WGNB Pawtucket, RI
 WGNL Wilmington, NC
 WGNV Greenville, NC
 WGNV Murfreesboro, TN
 WGNV Huntington, WV
 WGNU Granite City, IL
 WGNV Newburgh, NY
 WGOO Kingsport, TN
 WGOE Richmond, VA
 WGOO Wallahalla, SC
 WGOH Grayson, KY
 WGOK Mobile, AL
 WGOH Marion, IN
 WGOH Munising, MI
 WGOV Valdosta, GA
 WGOV Chattanooga, TN
 WGPB Bethlehem, PA
 WGPC Albany, GA

AM Calls

WGR Buffalo, NY
 WGRA Cairo, GA
 WGRD Grand Rapids, MI
 WGRG Pittsfield, MA
 WGRI Griffin, GA
 WGRK Greensburg, KY
 WGRM Greenwood, MS
 WGRO Lake City, FL
 WGRP Greenville, PA
 WGRV Greenville, TN
 WGRY Grayling, MI
 WGS A Ephrata, PA
 WGSB Geneva, IL
 WGS New Bern, NC
 WGSN Huntington, NY
 WGSO New Orleans, LA
 WGSR Millen, GA
 WGST Atlanta, GA
 WGSV Guntersville, AL
 WGSW Greenwood, SC
 WGTA Summerville, GA
 WGLT Kannapolis, NC
 WGTM Wilson, NC
 WGTN Georgetown, SC
 WGTO Cypress Gardens, FL
 WGTR Natick, MA
 WGTW Mount Dora, FL
 WGTX Defuniak Springs, FL
 WGUU Gulfport, MS
 WGU New Port Richey, FL
 WGUN Atlanta, GA
 WGU August, GA
 WGUY Bangor, ME
 WGV Geneva, NY
 WGVN Greenville, MS
 WGW Asheville, NC
 WGY Schenectady, NY
 WGY Greenville, AL
 *WHA Madison, WI
 WHAG Halfway, MD
 WHAI Greenfield, MA
 WHAK Rogers City, MI
 WHAL Shelbyville, TN
 WHAM Rochester, NY
 WHAN Harnes City, FL
 WHAP Hopewell, VA
 WHAR Clarksburg, WV
 WHAS Louisville, KY
 WHAT Philadelphia, PA
 WHAV Haverhill, MA
 WHAW Weston, WV
 WHAZ Troy, NY
 WHB Kansas City, MO
 WHBB Selma, AL
 WHBC Canton, OH
 WHBF Rock Island, IL
 WHBG Harrisonburg, VA
 WHBL Sheboygan, WI
 WHBN Harrodsburg, KY
 WHBO Tampa, FL
 WHBO Memphis, TN
 WHBT Harrisburg, TN
 WHBU Anderson, IN
 WHBY Appleton, WI
 WHCC Waynesville, NC
 WHCO Sparta, IL
 WHCU Ithaca, NY
 WHDF Houghton, MI
 WHDH Boston, MA
 WHDL Olean, NY
 WHDM McKenzie, TN
 WHEB Portsmouth, NH
 WHEE Martinsville, VA
 WHEL New Albany, IN
 WHEN Syracuse, NY
 WHEO Stuart, VA
 WHEP Foley, AL
 WHET Wayland, MA
 WHEX Columbia, PA
 WHFB Benton Harbor, MI
 WHGR Houghton Lake, MI
 WHHH Warren, OH
 WHHL Pine Castle, FL
 WHHM Henderson, TN
 WHHO Hornell, NY
 WHHV Hillsville, VA
 WHHY Montgomery, AL
 WHIC Hardinsburg, KY
 WHIE Griffin, GA
 WHII Bay Springs, MS
 WHIM Providence, RI
 WHIN Gallatin, TN
 WHIO Dayton, OH
 WHIP Mooresville, NC
 WHIR Danville, KY
 WHIS Bluefield, WV
 WHIT New Bern, NC
 WHIY Moulton, AL

WHIZ Zanesville, OH
 WHJB Greensburg, PA
 WHJC Malewan, WV
 WHK Cleveland, OH
 WHKP Hendersonville, NC
 WHKY Hickory, NC
 WHLB Virginia, MN
 WHLD Niagara Falls, NY
 WHLF South Boston, VA
 WHLI Hempstead, NY
 WHLM Bloomsburg, PA
 WHLN Harlan, KY
 WHLO Akron, OH
 WHLP Centerville, TN
 WHLS Port Huron, MI
 WHLT Huntington, IN
 WHLW Lakewood, NJ
 WHMA Anniston, AL
 WHMI Howell, MI
 WHMP Northampton, MA
 WHMT Humboldt, TN
 WHN New York, NY
 WHNC Henderson, NC
 WHND Monroe, MS
 WHNY McComb, MI
 WHO Des Moines, IA
 WHOA San Juan, PR
 WHOC Philadelphia, MS
 WHOD Jackson, AL
 WHOK Lancaster, OH
 WHOL Allentown, PA
 WHOM New York, NY
 WHON Centerville, IN
 WHOO Orlando, FL
 WHOP Hopkinsville, KY
 WHOS Decatur, AL
 WHOT Campbell, OH
 WHOU Houlton, ME
 WHOU Clinton, IL
 WHOY Salinas, PR
 WHP Harrisburg, PA
 WHPA Honesdale, PA
 WHPB Belton, SC
 WHP High Point, NC
 WHPL Winchester, VA
 WHPY Clayton, NC
 WHRT Hartselle, AL
 WHSC Hartsville, SC
 WHSL Wilmington, NC
 WHSM Hayward, WI
 WHSY Hattiesburg, MS
 WHTC Holland, MI
 WHTG Eatontown, NJ
 WHTH Heath, OH
 WHUB Cookeville, TN
 WHUC Hudson, NY
 WHUM Reading, PA
 WHUN Huntingdon, PA
 WHUT Anderson, IN
 WHVL Hendersonville, NC
 WHVN Charlotte, NC
 WHVR Hanover, PA
 WHVV Hyde Park, NY
 WHWB Rutland, VT
 WHWH Princeton, NJ
 WHYD Columbus, GA
 WHYL Carlisle, PA
 WHYN Springfield, MA
 WHYR North East, PA
 WHYT Noblesville, IN
 WHYZ Greenville, SC
 WIAC San Juan, PR
 WIAD Jacksonville, FL
 WIAF Clarksville, GA
 WIAM Williamston, NC
 WIBA Madison, WI
 WIBB Macon, GA
 WIBC Indianapolis, IN
 WIBG Philadelphia, PA
 WIBM Jackson, MI
 WIBR Baton Rouge, LA
 WIBU Poynette, WI
 WIBV Belleville, IL
 WIBW Topeka, KS
 WIBX Utica, NY
 WICC Bridgeport, CT
 WICE Providence, RI
 WICH Norwich, CT
 WICK Scranton, PA
 WICO Salisbury, MD
 WICY Malone, NY
 WIDD Elizabethton, TN
 WIDE Biddeford, ME
 WIDG St. Ignace, MI
 WIDU Fayetteville, NC
 WIEL Elizabethtown, KY
 WIFE Indianapolis, IN
 WIFF Auburn, IN
 WIFM Elkin, NC
 WIGG Wiggins, MS
 WIGM Medford, WI
 WIGO Atlanta, GA

WIGS Gouverneur, NY
 WIID Garden City, MI
 WIIN Atlanta, GA
 WIKB Iron River, MI
 WIKC Bogalusa, LA
 WIKE Newport, VT
 WIKI Chester, VA
 WIKY Evansville, IN
 WIL St. Louis, MO
 WILA Danville, VA
 WILD Boston, MA
 WILE Cambridge, OH
 WILI Wilimantic, CT
 WILK Wilkes-Barre, PA
 *WILL Urbana, IL
 WILM Wilmington, DE
 WILO Frankfurt, IN
 WILS Lansing, MI
 WILY Centralia, IL
 WILZ St. Petersburg Beach, FL
 WIMA Lima, OH
 WIMO Winder, GA
 WIMS Michigan City, IN
 WINA Charlottesville, VA
 WINC Winchester, VA
 WIND Chicago, IL
 WINE Brookfield, CT
 WINF Manchester, CT
 WING Dayton, OH
 WINH Georgetown, SC
 WINI Murphysboro, IL
 WINK Fort Myers, FL
 WINN Louisville, KY
 WINO Tampa, FL
 WINR Binghamton, NY
 WINS New York, NY
 WINU Highland, IL
 WINE Canton, OH
 WINX Rockville, MD
 WINY Putnam, CT
 WINZ Miami, FL
 WIOD Miami, FL
 WIOI New Boston, OH
 WION Ionia, MI
 WIOO Carlisle, PA
 WIOS Tawas City, MI
 WIOU Kokomo, IN
 WIP Philadelphia, PA
 WIPC Lake Wales, FL
 *WIPR San Juan, PR
 WIPS Ticonderoga, NY
 WIRT Horseheads, NY
 WIRA Fort Pierce, FL
 WIRB Enterprise, AL
 WIRC Hickory, NC
 WIRD Lake Placid, NY
 WIRE Indianapolis, IN
 WIRJ Humboldt, TN
 WIRK West Palm Beach, FL
 WIRL Peoria, IL
 WIRO Ironton, OH
 WIRY Irvine, KY
 WIRY Plattsburgh, NY
 WIS Columbia, SC
 WISA Isabela, PR
 WISE Asheville, NC
 WISK Americus, GA
 WISL Shamokin, PA
 WISM Madison, WI
 WISN Milwaukee, WI
 WISO Ponce, PR
 WISP Kinston, NC
 WISR Butler, PA
 WISS Berlin, WI
 WIST Charlotte, NC
 WISV Viroqua, WI
 WISZ Glen Burnie, MD
 WITH Baltimore, MD
 WITL Lansing, MI
 WITN Washington, NC
 WITY Danville, IL
 WITZ Jasper, IN
 WIVE Ashland, VA
 WIVK Knoxville, TN
 WIVS Crystal Lake, IL
 WIVV Viqueques, PR
 WIVY Jacksonville, FL
 WIXC Fayetteville, TN
 WIXE Monroe, NC
 WIXI Lancaster, KY
 WIXN New Richmond, WI
 WIXN Dixon, IL
 WIXY Cleveland, OH
 WIXZ McKeesport, PA
 WIYN Rome, GA
 WIZE Springfield, OH
 WIZM La Crosse, WI
 WIZO Franklin, IN
 WIZR Johnstown, NY
 WIZS Henderson, NC
 WIZZ Streator, IL

WJAC Johnstown, PA
 WJAG Norfolk, NE
 WJAK Jackson, TN
 WJAM Marion, AL
 WJAR Providence, RI
 WJAT Swainsboro, GA
 WJAX Jacksonville, FL
 WJAY Mullins, SC
 WJAZ Albany, GA
 WJBB Haleyville, AL
 WJBC Bloomington, IL
 WJBD Salem, IL
 WJBE Knoxville, TN
 WJBL Holland, MI
 WJBM Jerseyville, IL
 WJBO Baton Rouge, LA
 WJBO Westbrook, ME
 WJBY Gadsden, AL
 WJCD Seymour, IN
 WJCM Sebring, FL
 WJCO Jackson, MI
 WJCW Johnson City, TN
 WJDA Quincy, MA
 WJDB Thomasville, AL
 WJDM Elizabethville, NJ
 WJDX Jackson, MS
 WJDY Salisbury, MD
 WJEB Gladwin, MI
 WJEH Gallipolis, OH
 WJEF Hagerstown, MD
 WJEM Valdosta, GA
 WJER Dover-New Phila, OH
 WJES Johnston, SC
 WJET Erie, PA
 WJFC Jefferson City, TN
 WJGA Jackson, GA
 WJHO Opelika, AL
 WJIC Salem, NJ
 WJIG Tullahoma, TN
 WJIL Jacksonville, IL
 WJIM Lansing, MI
 WJJC Commerce, GA
 WJJD Chicago, IL
 WJJJ Christiansburg, VA
 WJUL Niagara Falls, NY
 WJUM Lewisburg, TN
 WJUT Jellico, TN
 WJZZ Mount Holly, NJ
 WJKM Hartsfield, TN
 WJKY Jamestown, NY
 WJLB Detroit, MI
 WJLD Homewood, AL
 WJLE Smithville, TN
 WJLJ Tupelo, MS
 WJLK Asbury Park, NJ
 WJLS Beckley, WV
 WJMA Orange, VA
 WJMB Brookhaven, MS
 WJMC Rice Lake, WI
 WJML Petoskey, MI
 WJMO Cleveland Heights, OH
 WJMR New Orleans, LA
 WJMS Ironwood, MI
 WJMT Merrill, WI
 WJMW Athens, AL
 WJMX Florence, SC
 WJNC Jacksonville, NC
 WJNL Johnstown, PA
 WJNO West Palm Beach, FL
 WJOB Hammond, IN
 WJOE Port St. Joe, FL
 WJOL Joliet, IL
 WJON St. Cloud, MN
 WJOR South Haven, MI
 WJOT Lake City, SC
 WJOY Burlington, VT
 WJPA Washington, PA
 WJPC Chicago, IL
 WJPD Ishpeming, MI
 WJPF Herrin, IL
 WJPJ Huntington, TN
 WJPR Greenville, MS
 WJPS Evansville, IN
 WJPW Rockford, MI
 WJOS Jackson, MS
 WJR Detroit, MI
 WJRC Joliet, IL
 WJRD Tuscaloosa, AL
 WJRI Lenoir, NC
 WJRL Calhoun City, MS
 WJRM Troy, NC
 WJSB Crestview, FL
 WJSM Martinsburg, PA
 WJSO Jonesboro, TN
 WJTN Jamestown, NY
 WJTO Bath, ME
 WJUN Mexico, PA
 WJVA South Bend, IN
 WJW Cleveland, OH
 WJWL Georgetown, DE
 WJWS South Hill, VA
 WJXN Jackson, MS

WJZM Clarksville, TN
 WKAC Athens, AL
 WKAI Macomb, IL
 WKAJ Saratoga Springs, NY
 WKAL Rome, NY
 WKAN Goshen, IN
 WKAN Kankakee, IL
 WKAQ Boynton Beach, FL
 WKAP Allentown, PA
 WKAP San Juan, PR
 *WKAR East Lansing, MI
 WKAT Miami Beach, FL
 WKAA Kaukauna, WI
 WKAX Russellville, AL
 WKAY Glasgow, KY
 WKAZ Charleston, WV
 WKBA Vinton, VA
 WKBC North Wilkesboro, NC
 WKBI St. Marys, PA
 WKBJ Milan, TN
 WKBK Keene, NH
 WKBL Covington, TN
 WKBN Youngstown, OH
 WKBO Harrisburg, PA
 WKBO Garner, NC
 WKBR Manchester, NH
 WKBV Richmond, IN
 WKBW Buffalo, NY
 WKBX Winston-Salem, NC
 WKBY Chatham, VA
 WKCB Muskegon, MI
 WKCB Hindman, KY
 WKCM Hawesville, KY
 WKCT Bowling Green, KY
 WKCU Corinth, MS
 WKCV Warrenton, VA
 WKCY Harrisonburg, VA
 WKDA Nashville, TN
 WKDC Elmhurst, IL
 WKDE Altavista, VA
 WKDK Newberry, SC
 WKDL Clarksdale, MS
 WKDO Liberty, KY
 WKDR Plattsburgh, NY
 WKDW Staunton, VA
 WKDX Hamlet, NC
 WKDY Spartanburg, SC
 WKDZ Cadiz, KY
 WKEE Huntington, WV
 WKEG Washington, PA
 WKEI Kewanee, IL
 WKEM Immokalee, FL
 WKEN Dover, DE
 WKER Pompton Lakes, NJ
 WKEU Griffin, GA
 WKEX Blacksburg, VA
 WKFY Covington, VA
 WKFD Wickford, RI
 WKFE Yaouco, PR
 WKFI Yumcington, OH
 WKGN Knoxville, TN
 WKGX Lenoir, NC
 WKHJ Holly Hill, SC
 WKHM Jackson, MI
 WKIC Hazard, KY
 WKIG Glennville, GA
 WKIK Leonardtown, MD
 WKIN Kingsport, TN
 WKIP Poughkeepsie, NY
 WKIS Orlando, FL
 WKIX Raleigh, NC
 WKIZ Key West, FL
 WKJB Mayaguez, PR
 WKJK Granite Falls, NC
 WKJR Muskegon Heights, MI
 WKKE Asheville, NC
 WKKO Cocoa, FL
 WKKO Hibbing, MN
 WKKR Pickens, SC
 WKKS Vanceburg, KY
 WKXX Deland, FL
 WKLA Ludington, MI
 WKLC St. Albans, WV
 WKLF Clanton, AL
 WKLK Cloquet, MN
 WKLM Wilmington, NC
 WKLO Louisville, KY
 WKLP Keyser, WV
 WKLV Blackstone, VA
 WKLX Portsmouth, VA
 WKLY Hartwell, GA
 WKMB Stirling, NJ
 WKMC Roaring Spring, PA
 WKMF Flint, MI
 WKMG Newberry, SC
 WKMI Kalamazoo, MI
 WKMK Blountstown, FL
 WKMT Kings Mountain, NC
 WKND Windsor, CT
 WKNE Keene, NH
 WKNG Tallapoosa, GA
 WKNR Battle Creek, MI

AM Calls

- WKNT Kent, OH
 WKNX Saginaw, MI
 WKNY Kingston, NY
 WDOA Hopkinsville, KY
 WKOG Gordon, GA
 WKOK Sunbury, PA
 WKOL Amsterdam, NY
 WKOP Binghamton, NY
 WKOR Starkville, MS
 WKOT Kingston, NY
 WKOV Wellston, OH
 WKOX Framingham, MA
 WKOY Bluefield, WV
 WKOZ Kosciusko, MS
 WKPA New Kensington, PA
 WKPM Princeton, MN
 WKPO Prentiss, MS
 WKPR Kalamazoo, MI
 WKPT Kingsport, TN
 WKOT Garyville, LA
 WKOW Spring Valley, NY
 WKRA Holly Springs, MS
 WKRC Cincinnati, OH
 WKRG Mobile, AL
 WKRI West Warwick, RI
 WKRK Murphy, NC
 WKRM Columbia, TN
 WKRO Cairo, IL
 WKRS Waukegan, IL
 WKRT Cortland, NY
 WKRW Cartersville, GA
 WKRZ Oil City, PA
 WKSC Kershaw, SC
 WKSJ Prichard, AL
 WKSK West Jefferson, NC
 WKSN Jamestown, NY
 WKSP Kingstree, SC
 WKSR Pulaski, TN
 WKST New Castle, PA
 WKTE King, NC
 WKTJ Farmington, ME
 WKTP South Paris, ME
 WKTO Pittsburgh, PA
 WKTS Sheboygan, WI
 WKTX Atlantic Beach, FL
 WKTY La Crosse, WI
 WKTZ Jacksonville, FL
 WKUL Cullman, AL
 WKUN Monroe, GA
 WKVA Lewistown, PA
 WKVE Cave City, KY
 WKVI Knox, IN
 WKVM San Juan, PR
 WKVO Havlock, NC
 WKVT Brattleboro, VT
 WKWF Key West, FL
 WKWK Wheeling, WV
 WKXA Brunswick, ME
 WKXL Concord, NH
 WKXO Berea, KY
 WKXR Exeter, NH
 WKXV Knoxville, TN
 WKXY Sarasota, FL
 WKY Oklahoma City, OK
 WKYB Hemingway, SC
 WKYE Bristol, TN
 WKYG Parkersburg, WV
 WKYK Burnsville, NC
 WKYO Cao, MI
 WKYR Burkesville, KY
 WKYF Paducah, KY
 WKYZ Madisonville, TN
 WKZA Kane, PA
 WKZI Casey, IL
 WKZO Kalamazoo, MI
 WLAB St. Pauls, NC
 WLAC Nashville, TN
 WLAD Danbury, CT
 WLAF Lafollette, TN
 WLAG La Grange, GA
 WLAM Lewiston, ME
 WLAN Lancaster, PA
 WLAP Lexington, KY
 WLAQ Rome, GA
 WLAR Athens, TN
 WLAS Jacksonville, NC
 WLAT Conway, SC
 WLAU Laurel, MS
 WLAV Grand Rapids, MI
 WLAW Lawrenceville, GA
 WLAY Muscle Shoals, AL
 WLBB Carrollton, GA
 WLBC Muncie, IN
 WLBE Leesburg, FL
 WLBG Laurens, SC
 WLBI Mattoon, IL
 WLBI Denham Springs, LA
 WLBJ Bowling Green, KY
 WLKB De Kalb, IL
 *WLBL Auburndale, WI
 WLBN Lebanon, KY
 WLBR Lebanon, PA
 WLBS Bangor, ME
 WLBC Buffalo, KY
 WLCK Scottsville, KY
 WLCM Lancaster, SC
 WLCO Eustis, FL
 WLCS Baton Rouge, LA
 WLCC La Crosse, WI
 WLCY St. Petersburg, FL
 WLDS Jacksonville, FL
 WLDT Ladysmith, WI
 WLEA Hornell, NY
 WLEC Sandusky, OH
 WLEE Richmond, VA
 WLEM Emporium, PA
 WLEO Ponce, PR
 WLES Lawrenceville, VA
 WLET Toccoa, GA
 WLEW Bad Axe, MI
 WLEY Cayce, PR
 WLFA Lafayette, GA
 WLFB Little Falls, NY
 WLMG Lynchburg, VA
 WLGK Logan, OH
 WLBN New York, NY
 WLJJ Shelbyville, TN
 WLJK Newport, TN
 WLIL Lenoir City, TN
 WLIP Kenosha, WI
 WLIO Mobile, AL
 WLIS Old Saybrook, CT
 WLIT Steubenville, OH
 WLIV Livingston, TN
 WLIX Islip, NY
 WLIZ Lake Worth, FL
 WLKE Waupun, WI
 WLKM Three Rivers, MI
 WLKN Lincoln, ME
 WLKR Norwalk, OH
 WLKS West Liberty, KY
 WLKW Providence, RI
 WLLA Raleigh, NC
 WLLH Lowell, MA
 WLLL Lynchburg, VA
 WLLS Hartford, KY
 WLLY Wilson, NC
 WLMJ Laurel, MD
 WLMJ Jacksonville, OH
 WLMN Leominster, MA
 WLNK Peekskill, NY
 WLNK Laurinburg, NC
 WLSG Sag Harbor, NY
 WLNH Laconia, NH
 WLOA Braddock, PA
 WLOB Portland, ME
 WLOC Mumfordsville, KY
 WLOD Pompano Beach, FL
 WLOE Eden, NC
 WLOF Orlando, FL
 WLOG Logan, WV
 WLOI La Porte, IN
 WLOK Memphis, TN
 WLOL Minneapolis, MN
 WLOM Lincolnton, NC
 WLOP Jesup, GA
 WLOR Thomasville, GA
 WLOT Marinette, WI
 WLOU Louisville, KY
 WLOW Washington, GA
 WLOW Aiken, SC
 WLOX Biloxi, MS
 WLPH Irondale, AL
 WLPN Suffolk, VA
 WLPO La Salle, IL
 WLOH Chiefland, FL
 WLRC Whitehall, MI
 WLRO Lorain, OH
 WLRV Lebanon, VA
 WLS Chicago, IL
 WLSB Copperhill, TN
 WLSL Lorain, SC
 WLSD Big Stone Gap, VA
 WLSL Wallace, NC
 WLSH Lansford, PA
 WLSI Pikeville, KY
 WLSM Louisville, MS
 WLSV Wellsville, NY
 WLTC Gastonia, NC
 WLTD Evanston, IL
 WLTH Gary, IN
 WLTN Littleton, NH
 WLUV Loves Park, IL
 WLUX Baton Rouge, LA
 WLWZ Bayamon, PR
 WLYB Lynchburg, VA
 WLYC Fort Kent, ME
 WLYL Lockport, NY
 WLYN Luverne, AL
 WLYC Cincinnati, OH
 WLYL Rockingham, NC
 WLYC Williamsport, PA
 WLYN Lynn, MA
 WLYV Fort Wayne, IN
 WMAC Metter, GA
 WMAD Madison, WI
 WMAF Madison, FL
 WMAG Forest, MS
 WMAJ State College, PA
 WMAK Nashville, TN
 WMAW Washington, DC
 WMAM Marinette, WI
 WMAN Mansfield, OH
 WMAP Monroe, NC
 WMAQ Chicago, IL
 WMAS Springfield, MA
 WMAX Grand Rapids, MI
 WMAZ Springfield, IL
 WMAZ Macon, GA
 WMBA Ambridge, PA
 WMBC Columbus, MS
 WMBD Peoria, IL
 WMBG Williamsburg, VA
 WMBH Joplin, MO
 *WMBI Chicago, IL
 WMBL Morehead City, NC
 WMBM Miami Beach, FL
 WMBN Petoskey, MI
 WMBO Auburn, NY
 WMBR Jacksonville, FL
 WMBU Uniontown, PA
 WMBT Shenandoah, PA
 WMC Memphis, TN
 WMC New York, NY
 WMC Church Hill, TN
 WMCL McLeansboro, IL
 WMCP Columbia, TN
 WMCR Oneida, NY
 WMCS Machias, ME
 WMCT Mountain City, TN
 WMCW Harvard, IL
 WMDC Hazlehurst, MS
 WMDD Fajardo, PR
 WMEE Fort Wayne, IN
 WMEK Chase City, VA
 WMEI Melbourne, FL
 WMEN Tallahassee, FL
 WMES Ashburn, VA
 WMEV Marion, VA
 WMEB Boston, MA
 WMFC Monroeville, AL
 WMFD Wilmington, NC
 WMFG Hibbing, MN
 WMFJ Daytona Beach, FL
 WMFR High Point, NC
 WMGA Moultrie, GA
 WMGO Canton, MS
 WMGR Bainbridge, GA
 WMGS Bowling Green, OH
 WMGJ Meadville, PA
 WMGY Montgomery, AL
 WMAA Arcibo, PR
 WMIC Sandusky, MI
 WMID Atlantic City, NJ
 WMIK Middlesboro, KY
 WMIM Mt. Carmel, PA
 WMIN Maplewood, MN
 WMIO Iron Mountain, MI
 WMIR Lake Geneva, WI
 WMIS Natchez, MS
 WMIX Mt. Vernon, IL
 WMJL Marion, KY
 WMJM Cordale, GA
 WMKR Millinocket, ME
 WMLC Monticello, MS
 WMLO Beverly, MA
 WMLP Milton, PA
 WMLR Hohenwald, TN
 WMLS Sylacauga, AL
 WMLT Dublin, GA
 WMMB Melbourne, FL
 WMMH Marshall, NC
 WMMM Westport, CT
 WMMN Fairmont, WV
 WMMW Meriden, CT
 WMNA Gretna, VA
 WMNH North Adams, MA
 WMNC Morgantown, NC
 WMNE Menomonee, WI
 WMNI Columbus, OH
 WMNS Olean, NY
 WMNT Manati, PR
 WMMZ Montezuma, GA
 WMOA Marietta, OH
 WMOB Mobile, AL
 WMOO Chattanooga, TN
 WMOG Brunswick, GA
 WMOH Hamilton, OH
 WMOK Metropolis, IL
 WMON Montgomery, WV
 WMOO Mobile, AL
 WMOO Ocala, FL
 WMOR Morehead, KY
 WMYO Berlin, NH
 WMOV Ravenswood, WV
 WMOX Mendon, MS
 WMPA Aberdeen, MS
 WMPD Lapeer, MI
 WMPH Hancock, MI
 WMPM Smithfield, NC
 WMPQ Middleport, OH
 WMPR Chicago Heights, IL
 WMPX Memphis, TN
 WMPY South Williamsport, PA
 WMPZ Midland, MI
 WMQM Memphis, TN
 WMRB Greenville, SC
 WMRC Millford, MA
 WMRF Lewistown, PA
 WMRN Marion, OH
 WMRO Aurora, IL
 WMSA Massena, NY
 WMSG Oakland, MD
 WMSJ Sylva, NC
 WMSK Morgantown, KY
 WMSL Decatur, AL
 WMSO Collierville, TN
 WMSR Manchester, TN
 WMT St. Sterling, KY
 WMT Cedar Rapids, IA
 WMTA Central City, KY
 WMTD Vanclve, KY
 WMTD Hinton, WV
 WMTL Manatee, MI
 WMTL Leitchfield, KY
 WMTM Moultrie, GA
 WMTN Morristown, TN
 WMTT Morristown, NJ
 WMTS Murfreesboro, TN
 WMTY Greenwood, SC
 WMUS Muskegon, MI
 WMUU Greenville, SC
 WMVA Marlinsville, VA
 WMVB Millville, NJ
 WMVG Milledgeville, GA
 WMVI Mechanicville, NY
 WMVO Mount Vernon, OH
 WMVR Sidney, OH
 WMYB Myrtle Beach, SC
 WMYN Mayodan, NC
 WMYR Fort Myers, FL
 WNAE Bridgeport, CT
 WNAE Norman, OK
 WNAE Warren, PA
 WNAE Grenada, MS
 WNAH Nashville, TN
 WNAK Natick, MA
 WNAL Nelsonville, OH
 WNAW Neenah-Menasha, WI
 WNAW Norristown, PA
 WNAW Natchez, MS
 WNAU New Albany, MS
 WNAV Annapolis, MD
 WNAF Yankton, SD
 WNBC New York, NY
 WNBK Binghamton, NY
 WNBH New Bedford, MA
 WNBK Park Falls, WI
 WNBW Newburyport, MA
 WNBK Murray, KY
 WNBK Wellsboro, PA
 WNBK Newberry, MI
 WNBZ Saranac Lake, NY
 WNC Siler City, NC
 WNCB Barnesboro, PA
 WNCG North Charleston, SC
 WNCO Ashland, OH
 WNCY Greenville, NC
 WND Dayton Beach, FL
 WNDI Indianapolis, IN
 WNDI Sullivan, IN
 WNDR Syracuse, NY
 WNDU South Bend, IN
 WNEA Newnan, GA
 WNEB Worcester, MA
 WNEG Toccoa, GA
 WNEL Caguas, PR
 WNER Live Oak, FL
 WNES Central City, KY
 WNEU Wheeling, WV
 WNEW New York, NY
 WNEF Macon, GA
 WNF Live Oak, FL
 WNGA Nashville, GA
 WNGO Mayfield, KY
 WNH New Haven, CT
 WNHV White River Junction, VT
 WNIA Cheektowaga, NY
 WNIC Dearborn, MI
 WNIA Arcibo, PR
 WNIL Niles, MI
 WNIO Niles, OH
 WNJR Newark, NJ
 WNKY Neon, KY
 WNLA Indianola, MS
 WNLB Rocky Mount, VA
 WNLK Norwalk, CT
 WNMT Garden City, GA
 WNNC Newton, NC
 WNNJ Newton, NJ
 WNNO Wisconsin Dells, WI
 WJNT Warsaw, VA
 WNOE New Orleans, LA
 WNOG Naples, FL
 WNOK Columbia, SC
 WNOO Chattanooga, TN
 WNOP Newport, KY
 WNOB Norfolk, VA
 WNOV Milwaukee, WI
 WNOW York, PA
 WNOX Knoxville, TN
 WNP New Orleans, LA
 WNP Tuscaloosa, AL
 WNPV Lansdale, PA
 WNR Circleville, OH
 WNRG Grundy, VA
 WNRJ Woonsocket, RI
 WNRJ Gainesville, GA
 WNRK Newark, DE
 WNRS Saline, MI
 WNRV Narrows, VA
 WNSL Laurel, MS
 WNST Milton, WV
 WNTN Newton, MA
 WNTS Indianapolis, IN
 WNTT Tazewell, TN
 WNTY Southington, CT
 WNUF Fort Walton Beach, FL
 WNUV Talladega, AL
 WNUA Norton, VA
 WNVL Nicholasville, KY
 WNVY Pensacola, FL
 WNVV Valparaiso, IN
 WNX Portland, ME
 *WNYC New York, NY
 WNYG Babylon, NY
 WNYN Canton, OH
 WNYR Rochester, NY
 WOAI San Antonio, TX
 WOAP Owosso, MI
 WOAY Oak Hill, WV
 WOBL Oberlin, OH
 WOBR Wanchese, NC
 WOBT Rhineclaire, WI
 WOC Davenport, IA
 WOCB West Yarmouth, MA
 WOCH North Vernon, IN
 WOCN Miami, FL
 WOCO Oconto, WI
 WODI Brookneal, VA
 WODY Bassett, VA
 WOFE Rockwood, TN
 WOGA Sylveste, GA
 WOGO New Smyrna Beach, FL
 WOHI East Liverpool, OH
 WOHN Herndon, VA
 WOHO Toledo, OH
 WOHS Shelby, NC
 *WOI Ames, IA
 WOIC Columbia, SC
 WOIO Canton, OH
 WOKA Douglas, GA
 WOKB Writter Garden, FL
 WOKC Okeechobee, FL
 WOKE Charleston, SC
 WOKI Oak Ridge, TN
 WOKJ Jackson, MS
 WOKL Meridian, MS
 WOKL Eau Claire, WI
 WOKO Albany, NY
 WOKS Columbus, GA
 WOKW Brockton, MA
 WOKY Milwaukee, WI
 WOKZ Ailton, IL
 WOL Washington, DC
 WOLD Marion, VA
 WOLF Syracuse, NY
 WOLS Florence, SC
 WOMI Owensboro, KY
 WOMP Wellaire, OH
 WOMT Manitowoc, WI
 WONA Winona, MS
 WOND Pleasantville, NJ
 WONE Dayton, OH
 WONN Lakeland, FL
 WONS Tallahassee, FL
 WONW Defiance, OH
 WOOD Grand Rapids, MI
 WOOF Dothan, AL
 WOOK Washington, DC
 WOOW Greenville, NC
 WOPA Oak Park, IL
 WOPI Bristol, TN
 WOR New York, NY
 WORA Mayaguez, PR

AM Calls

WORC Worcester, MA
 WORD Spartanburg, SC
 WORG Orangeburg, SC
 WORL Orlando, FL
 WORM Savannah, TN
 WORV Hattiesburg, MS
 WORX Madison, IN
 WOSC Fulton, NY
 *WOSU Columbus, OH
 WOTT Watertown, NY
 WOTW Nashua, NH
 *WOUB Athens, OH
 WOWW Omaha, NE
 WOWL Florence, AL
 WOVOW Fort Wayne, IN
 WOVVV Naugatuck, CT
 WOZK Ozark, AL
 WOZN Jacksonville, FL
 WPAB Ponce, PR
 WPAD Paducah, KY
 WPAG Ann Arbor, MI
 WPAL Charleston, SC
 WPAM Pottsville, PA
 WPAQ Mount Airy, NC
 WPAR Parkersburg, WV
 WPAS Zephyrhills, FL
 WPAT Paterson, NJ
 WPAX Thomasville, GA
 WPAY Portsmouth, OH
 WPAZ Pottstown, PA
 WPBR Palm Beach, FL
 WPCC Clinton, SC
 WPCE Portsmouth, VA
 WPFC Panama City, FL
 WPCO Mt. Vernon, IN
 WPDCE Elizabethtown, PA
 WPDF Corydon, IN
 WPDPM Potsdam, NY
 WPDO Jacksonville, FL
 WPDOR Portage, WI
 WPDY Clarksburg, WV
 WPED Crozet, VA
 WPEH Louisville, GA
 *WPEL Montrose, PA
 WPEN Philadelphia, PA
 WPEO Peoria, IL
 WPEP Taunton, MA
 WPET Greensboro, NC
 WPGA Pensacola, FL
 WPFB Middletown, OH
 WPGA Perry, GA
 WPGC Morningside, MD
 WPGD Winston-Salem, NC
 WPGM Danville, PA
 WPGW Portland, IN
 WPHB Philipsburg, PA
 WPHC Waverly, TN
 WPHM Port Huron, MI
 WPIC Sharon, PA
 WPID Piedmont, AL
 WPIK Alexandria, VA
 WPIR Pittsburgh, PA
 WPIJ Sodus-Daisy, TN
 WPKA Waverly, OH
 WPKY Princeton, KY
 WPLA Plant City, FL
 WPLB Greenville, MI
 WPLK Rockmart, GA
 WPLM Plymouth, MA
 WPLQ Atlanta, GA
 WPLY Plymouth, WI
 WPMB Vandalia, IL
 WPMX Punxsutawney, PA
 WPMH Portsmouth, VA
 WPMW Pascagoula, MS
 WPNK Plymouth, NC
 WPNF Brevard, NC
 WPNH Plymouth, NH
 WPNQ Auburn, ME
 WPNX Phenix City, AL
 WPOK Pontiac, IL
 WPOM Riviera Beach, FL
 WPON Pontiac, MI
 WPOP Hartford, CT
 WPOR Portland, ME
 WPOW New York, NY

 WPPA Pottsville, PA
 WPPJ Carrollton, GA
 WPPA Mayaguez, PR
 WPRC Lincoln, IL
 WPRE Prairie Du Chien, WI
 WPRJ Parsippany, NJ
 WPRN Butler, AL
 WPRO Providence, RI
 WPRP Ponce, PR
 WPRS Paris, IL
 WPRT Prestonburg, KY
 WPRW Manassas, VA
 WPCS Pageland, SC

WPSL Monroeville, PA
 WPTF Raleigh, NC
 WPTL Canton, NC
 WPTN Cookeville, TN
 WPTR Albany, NY
 WPTW Piqua, OH
 WPTX Lexington Park, MD
 WPUB Camden, SC
 WPUJ Bartow, FL
 WPUP Bay St. Louis, MS
 WPUT Brewster, NY
 WPUV Pulaski, VA
 WPUA Petersburg, VA
 WPUV Painesville, OH
 WPUW Quantico, VA
 WPUX Prattville, AL
 WPUX Starke, FL
 WPUY Benson, NC
 WQAK Decatur, GA
 WQAM Miami, FL
 WQBA Miami, FL
 WQBC Jacksonville, MS
 WQBK Rensselaer, NY
 WQBS San Juan, PR
 WQBE Albany, GA
 WQDI Homestead, FL
 WQDY Calais, ME
 WQIC Meridian, MS
 WQII San Juan, PR
 WQIK Jacksonville, FL
 WQIN Lykens, PA
 WQIZ St. George, SC
 WQKI St. Matthews, NC
 WQMA Marks, MS
 WQOK Greenville, SC
 WQPD Lakeland, FL
 WQQT Savannah, GA
 WQQW Waterbury, CT
 WQSA Sarasota, FL
 WQSN Charleston, SC
 WQTC Two Rivers, WI
 WQTW Latrobe, PA
 WQTY Montgomery, AL
 WQUA Moline, IL
 WQWV Mebane, NC
 WQXI Atlanta, GA
 WQXL Columbia, SC
 WQXR New York, NY
 WQYK Tampa, FL

 WRAA Luray, VA
 WRAB Arab, AL
 WRAD Radford, VA
 WRAG Carrollton, AL
 WRAI San Juan, PR
 WRAJ Anna, IL
 WRAK Williamsport, PA
 WRAM Monmouth, IL
 WRAN Dover, NJ
 WRAP Norfolk, VA
 WRAR Tappahannock, VA
 WRAW Reading, PA
 WRAY Princeton, IN
 WRBC Jackson, MS
 WRBD Pompano Beach, FL
 WRBE Lucedale, MS
 WRBJ St. Johns, MI
 WRBL Columbus, GA
 WRBN Warner Robins, GA
 WRBX Chapel Hill, NC
 WRC Washington, DC
 WRCD Dalton, GA
 WRCN Riverhead, NY
 WRCO Richland Center, WI
 WRCF Philadelphia, PA
 WRCQ New Britain, CT
 WRCS Anokis, NC
 WRDB Reedsburg, WI
 WRDI Hammonton, NJ
 WRDN Durand, WI
 WRDU Augusta, ME
 WRDW Augusta, GA
 WREB Holyoke, MA
 WREC Memphis, TN
 WREL Lexington, VA
 WREM Jenkins, KY
 WREN Topeka, KS
 WREO Ashland, OH
 WREV Reidsville, NC
 WREY New Albany, IN
 WRFC Athens, GA
 WRFD Columbus, OH
 WRFS Alexander City, AL
 WRGA Rome, GA
 WRGI Marco Island, FL
 WRGM Richmond, VA
 WRGS Rogersville, TN
 WRHC Coral Gables, FL
 WRHI Rock Hill, SC
 WRHL Rochelle, IL
 WRIB Providence, RI
 WRIC Richlands, VA

WRIE Erie, PA
 WRIG Wausau, WI
 WRIN Rensselaer, IN
 WRIP Rossville, GA
 WRIS Roanoke, VA
 WRIT Milwaukee, WI
 WRIV Riverhead, NY
 WRJC Mauston, WI
 WRJN Racine, WI
 WRJW Picayune, MS
 WRKB Knapolis, NC
 WRKD Rockland, ME
 WRKL New City, NY
 WRKM Carthage, TN
 WRKN Brandon, MS
 WRKO Boston, MA
 WRKR Racine, WI
 WRKT Cocoa Beach, FL
 WRLD Lanett, AL
 WRMA Montgomery, AL
 WRMF Titusville, FL
 WRMG Red Bay, AL
 WRMN Elgin, IL
 WRMS Beardstown, IL
 WRMT Rocky Mount, NC
 WRNB New Bern, NC
 WRNC Raleigh, NC
 WRNG North Atlanta, GA
 WRNL Richmond, VA
 WRNR Martinsburg, WV
 WRNY Rome, NY
 WROA Gulfport, MS
 WROB West Point, MS
 WROC Rochester, NY
 WROD Daytona Beach, FL
 WROK Rockford, IL
 WROL Knoxville, TN
 WROM Rome, GA
 WRON Ronceverte, WV
 WROS Scottsboro, AL
 WROW Roanoke, VA
 WROY Albany, NY
 WROX Clarksdale, MS
 WROY Carmi, IL
 WROZ Evansville, IN
 WRPL Charlotte, NC
 WRPM Poplarville, MS
 WRR Dallas, TX
 WRRR Fredericks, VI
 WRRR Rainelle, WV
 WRRR Rockford, IL
 WRRZ Clinton, NC
 WRSC State College, PA
 WRSG San German, PR
 WRSJ Bayamon, PR
 WRSL Stanford, KY
 WRSW Warsaw, IN
 WRTA Altoona, PA
 WRTH Wood River, IL
 WRTL Rantoul, IL
 WRUF Gainesville, FL
 WRUM Rumford, ME
 WRUN Utica, NY
 WRUS Russellville, KY
 WRVA Richmond, VA
 WRVK Mt. Vernon, KY
 WRWH Cleveland, GA
 WRXO Roxboro, NC
 WRYM New Britain, CT
 WRYT Boston, MA
 WRYZ Jupiter, FL

 WSAC Fort Knox, KY
 WSAI Cincinnati, OH
 *WSAJ Groves City, IN
 WSAL Logansport, IN
 WSAM Saginaw, MI
 WSAN Allentown, PA
 WSAO Senatobia, MS
 WSAR Fall River, MA
 WSAT Salisbury, NC
 WSAU Wausau, WI
 WSAV Savannah, GA
 WSAY Rochester, NY
 WSB Atlanta, GA
 WSBY York, PA
 WSBW New Smyrna Beach, FL
 WSBG Chicago, IL
 WSBP Chattahoochee, FL
 WSBR Boca Raton, FL
 WSBT Great Barrington, MA
 WSBT South Bend, IN
 WSCM Panama City Beach, FL
 WSCP Sandy Creek, NY
 WSCR Scranton, PA
 WSCV Peterborough, NH
 WSCW South Charleston, WV
 WSDC Hartselle, SC
 WSDL Sildell, LA
 WSDR Sterling, IL
 WSDS Ypsilanti, MI
 WSEB Sebring, FL
 WSEL Pontotoc, MS

WSEM Donaldsonville, GA
 WSEN Baldwinville, NY
 WSER Eikton, MD
 WSEV Sevierville, TN
 WSEW Selwingsgrove, PA
 WSFB Quitman, GA
 WSFC Somerset, KY
 WSFT Thomaston, GA
 WSWF Seneca Falls, NY
 WSGA Savannah, GA
 WSGB Sutton, WV
 WSGC Elberton, GA
 WSGN Birmingham, AL
 WSGO Oswego, NY
 WSGW Saginaw, MI
 WSHB Raeford, NC
 WSHF Shreveport, LA
 WSHN Fremont, MI
 WSHO New Orleans, LA
 WSHP Shippensburg, PA
 WSHY Shelbyville, IL
 WSIB Beaufort, SC
 WSIC Statesville, NC
 WSID Baltimore, MD
 WSIG Mt. Jackson, VA
 WSIP Paintsville, KY
 WSIR Winter Haven, FL
 WSIV Pekin, IL
 WSIX Nashville, TN
 WSIZ Ocala, GA
 WSJC Magee, MS
 WSJM St. Joseph, MI
 WSJR Madawaska, ME
 WSJS Winston-Salem, NC
 WSJW Woodruff, SC
 WSKE Everett, PA
 WSKI Montpelier, VT
 WSKT Knoxville, TN
 WSKW Skowhegan, ME
 WSLA Asheville, NC
 WSLB Ogdensburg, NY
 WSLC Roanoke, VA
 WSLG Gonzales, LA
 WSLI Jackson, MS
 WSLM Salem, IN
 WSLR Akron, OH
 WSLT Ocean City-Somer, NJ
 WSLV Ardmore, TN
 WSLW White Sulphur Springs, WV
 WSM Nashville, TN
 WSM Marine City, MI
 WSMB New Orleans, LA
 WSMO La Plata, MD
 WSMF Sanford, ME
 WSMG Greenville, TN
 WSMI Litchfield, IL
 WSMH Graham, NC
 WSMN Nashua, NH
 WSMO Sparta, TN
 WSMY Weldon, NC
 WSN Cumming, GA
 WSNL Torrington, CT
 WSNJ Bridgeton, NJ
 WSNB Barre, VT
 WSNL Sandersville, GA
 WSNW Seneca, SC
 WSNY Shenectady, NY
 WSOB Charlotte, NC
 WSOB Savannah, GA
 WSOB Tampa, FL
 WSOB Salem, OH
 WSON Henderson, KY
 WSOO Sault Ste. Marie, MI
 WSOB North Syracuse, NY
 WSOY Decatur, IL
 WSPA Spartanburg, SC
 WSPB Sarasota, FL
 WSPD Toledo, OH
 WSPF Hickory, NC
 WSPR Springfield, MA
 WSPV Stevens Point, WI
 WSRC Durham, NC
 WSRF Fort Lauderdale, FL
 WSRM Marlboro, MA
 WSRW Hillsboro, OH
 WSSA Morrow, GA
 WSSB Durham, NC
 WSSC Sumter, SC
 WSSO Starkville, MS
 WSSV Largo, FL
 WSSP Petersburg, VA
 WSTA Charlotte Amalie, VI
 WSTC Stamford, CT
 WSTH Taylorsville, NC
 WSTL Eminence, KY
 WSTP Salisbury, NC
 WSTR Sturgis, MI
 WSTU Stuart, FL
 WSTV Steubenville, OH
 WSTX Christiansted, VI
 WSUB Groton, CT
 WSUB Patchogue, NY

WSUH Oxford, MS
 *WSUI Iowa City, IA
 WSUM Parma, OH
 WSUN St. Petersburg, FL
 WSUX Seaford, DE
 WSUZ Palatka, FL
 WSWA Harrisonburg, VA
 WSWL Shelbyville, IN
 WSWM Valdeese, NC
 WSWV Crews, VA
 WSWG Greenwood, MS
 WSWN Belle Glade, FL
 WSWV Pennington Gap, VA
 WSWW Platteville, WI
 WSYB Rutland, VT
 WSYD Mount Airy, NC
 WSYL Sylvania, GA
 WSYR Syracuse, NY
 WTAB Tabor City, NC
 WTAC Flint, MI
 WTAD Quincy, IL
 WTAE Pittsburgh, PA
 WTAG Worcester, MA
 WTAL Melbourne, FL
 WTAL Tallahassee, FL
 WTAN Clearwater, FL
 WTAQ La Grange, IL
 WTAR Norfolk, VA
 WTAW College Station, TX
 WTAX Springfield, IL
 WTAY Robinson, IL
 WTBC Tuscaloosa, AL
 WTBF Troy, AL
 WTBJ Monticello, FL
 WTBO Cumberland, MD
 WTBP Parsons, TN
 WTBO Warwick, NY
 WTCA Plymouth, IN
 WTCC Flomaton, AL
 WTCH Shawano, WI
 WTCT Tell City, IN
 WTCL Warren, OH
 WTCM Traverse City, MI
 WTCO Campbellsville, KY
 WTCR Ashland, WI
 WTCR Fairmont, WV
 WTCW Whitesburg, KY
 WTEL Philadelphia, PA
 WTGA Thomaston, GA
 WTRG Myrtle Beach, SC
 WTHB Augusta, GA
 WTHD Milford, DE
 WTHE Mineola, NY
 WTHI Terre Haute, IN
 WTHM Lapeer, MI
 WTHO Thomson, GA
 WTHU Thurmont, MD
 WTIC Hartford, CT
 WTID Newport News, VA
 WTIF Tifton, GA
 WTIG Massillon, OH
 WTIK Durham, NC
 WTIJ Mayaguez, PR
 WTIK Taylorville, IL
 WTIJ Charleston, WV
 WTIQ Manistee, MI
 WTIW Titusville, PA
 WTIW New Orleans, LA
 WTJH East Point, GA
 WTJS Jackson, TN
 WTKM Hartford, WI
 WTKO Ithaca, NY
 WTKY Tompkinsville, KY
 WTLB Utica, NY
 WTLK Taylorsville, NC
 WTLN Apopka, FL
 WTLW Somers, KY
 WTLS Tallahassee, AL
 WTMMA Charleston, SC
 WTMB Tomah, WI
 WTMK Ocala, FL
 WTMJ Milwaukee, WI
 WTMP Tampa, FL
 WTMR Camden, NJ
 WTMV Louisville, KY
 WTNB Thomasville, NC
 WTNB Orangeburg, SC
 WTNB Trenton, TN
 WTNJ Trenton, NJ
 WTNM Millington, TN
 WTNB Cochocton, OH
 WTNNT Tallahassee, FL

 WTOB Winston-Salem, NC
 WTOC Savannah, NC
 WTOP Toledo, OH
 WTOE Spruce Pine, NC
 WTON Staunton, VA
 WTOO Bellefontaine, OH
 WTOP Washington, DC
 WTOR Marianna, FL
 WTOP Towson, MD
 WTOY Roanoke, VA

WTPR Paris, TN
 WTOX Selma, AL
 WTRA Latrobe, PA
 WTRB Ripley, TN
 WTRC Eikhart, IN
 WTRF Greensburg, IN
 WTRI Brunswick, MD
 WTRL Bradenton, FL
 WTRN Tyrone, PA
 WTRO Dyersburg, TN
 WTRP La Grange, GA
 WTRQ Warsaw, NC
 WTRR Sanford, FL
 WTRS Dunnellon, FL
 WTRU Muskegon, MI
 WTRX Flint, MI
 WTRY Troy, NY
 WTSA Brattleboro, VT
 WTSB Lumberton, NC
 WTSL Hanover, NH
 WTSN Dover, NH
 WTSO Madison, WI
 WTSV Claremont, NH
 WTTB Vero Beach, FL
 WTTD Towanda, PA
 WTTT Tiffin, OH
 WTTI Dalton, GA
 WTTL Madisonville, KY
 WTTM Trenton, NJ
 WTTN Watertown, WI
 WTRR Westminster, MD
 WTTT Bloomington, IN
 WTTT Amherst, MA
 WTTX Appomattox, VA
 WTUG Tuscaloosa, AL
 WTUP Tupelo, MS
 WTVG Wilmington, DE
 WTVB Coldwater, MI
 WTVL Waterville, ME
 WTVN Columbus, OH
 WTVR Richmond, VA
 WTVW Thomson, GA
 WTVB Aburrdand, FL
 WTVN St. Johnsbury, VT
 WTVL West Springfield, MA
 WTYC Rock Hill, SC
 WTYL Tylerstown, MS
 WTYM East Longmeadow, MA
 WTYN Tryon, NC
 WTYT Marianna, FL
 WTEZ Tazewell, VA
 WUAT Pikesville, TN
 WUBE Cincinnati, OH
 WUCR Sparta, TN
 WUFF Baxley, GA
 WUFE Eastman, GA
 WUO Amherst, NY
 WULA Eufaula, AL
 WULF Alma, GA
 WUNA Aguililla, PR
 WUNI Mobile, AL
 *WUNN Mason, MI
 WUNO San Juan, PR
 WUNR Brookline, MA
 WUOK Cumberland, MD
 WUPR Utuado, PR
 WUPY Ishpeming, MI
 WUSS Atlantic City, NJ
 WUST Washington, DC
 WVAB Virginia Beach, VA
 WVAK Paoli, IN
 WVAL Sauk Rapids, MN
 WVAM Altoona, PA
 WVAP Burnelltown, SC
 WVAR Richmond, WV
 WVBS Burgaw, NC
 WVCB Shallotte, NC
 WVCF Windermere, FL
 WVCG Coral Gables, FL
 WVCH Chester, PA
 WVCC Hampton, VA
 WVIC East Lansing, MI
 WVIM Vicksburg, MS
 WVIN Bath, NY
 WVIP Mt. Kisco, NY
 WVIX Pensacola, FL
 WVJP Caguas, PR
 WVKS Owensboro, KY
 WVKO Columbus, OH
 WVKY Louisa, KY
 WVLC Orleans, MA
 WVLD Valdosta, GA
 WVLK Lexington, KY
 WVLN Ciney, IL
 WVLY Water Valley, MS
 WVMC Mt. Carmel, IL
 WVMG Cochran, GA
 WVMI Biloxi, MS
 WVMT Burlington, VT
 WVNA Tuscumbia, AL
 WVNJ Newark, NJ
 WVOB Bel Air, MD
 WVOC Battle Creek, MI

WVOE Chadbourne, NC
 WVOG New Orleans, LA
 WVOH Hazlehurst, GA
 WVOJ Jacksonville, FL
 WVOK Birmingham, AL
 WVOL Berry Hill, TN
 WVOM Iuka, MS
 WVON Chicago, IL
 WVOP Vidalia, GA
 WVOS Liberty, NY
 WVOT Wilson, NC
 WVOW Huntsville, AL
 WVOW Logan, WV
 WVOX New Rochelle, NY
 WVOY Charlevoix, MI
 WVOZ Carolina, PR
 WVPO Stroudsburg, PA
 WVRC Spencer, WV
 WVSA Vernon, AL
 WVSC Somerset, PA
 WVSM Rainsville, AL
 WVUV Leone, AS
 WVVV Grailton, WV
 WVXX Highland Park, IL
 WVWI Charlotte Amalie, VI
 WWAB Lakeland, FL
 WWAM Cadillac, MI
 WWBA St. Petersburg, FL
 WWBC Cocoa, FL
 WWBD Bamberg-Denmark, SC
 WWBR Winder, PA
 WWBZ Vineland, NJ
 WWCA Gary, IN
 WWCB Cory, PA
 WWCC Bremen, GA
 WWCH Clarion, PA
 WWCM Brazil, IN
 WWCO Waterbury, CT
 WWDC Washington, DC
 WWDJ Hacksensack, NJ
 WWDR Murrefreestown, NC
 WVEE Memphis, TN
 WWEL Medford, MA
 WWFL Clermont, FL
 WWGM Nashville, TN
 WWGO Erie, PA
 WWGP Sanford, NC
 WWGS Tifton, GA
 WWHY Huntington, WV
 WWIN Baltimore, MD
 WWIS Black River Falls, WI
 WWIT Canton, NC
 WWJ Detroit, MI
 WWJB Brooksville, FL
 WWJ Duluth, MN
 WWKE Ocala, FL
 WWKO Fair Bluff, NC
 WWKY Winchester, KY
 WWL New Orleans, LA
 WWLE Cornwall, NY
 WWML Portage, NC
 WWNC Asheville, NC
 WWNH Rochester, NH
 WWNR Beckley, WV
 WWNS Statesboro, GA
 WWNY Watertown, NY
 WWOD Lynchburg, VA
 WWOK Miami, FL
 WWOL Buffalo, NY
 WWON Woonsocket, RI
 WWOW Conneaut, OH
 WWPA Williamsport, PA
 WWPF Palatka, FL
 WWRL New York, NY
 WWSG Glens Falls, NY
 WWSF Loretto, PA
 WWSR St. Albans, VT
 WWSW Wooster, OH
 WWSW Pittsburgh, PA
 WWTG Minneapolis, MN
 WWUN Jackson, MS
 WVVA Wheeling, WV
 WVWB Jasper, AL
 WVWC Wilkesboro, NC
 WVWE Cleveland, OH
 WVWF Fayette, AL
 WVWR Russellville, AL
 WVXL Manchester, KY
 WVYN Erie, PA
 WVYO Pineville, WV
 WXAL Demopolis, AL
 WXAP Atlanta, GA
 WXCF Clifton Forge, VA
 WXCL Peoria, IL
 WXCO Wausau, WI
 WXEE Welch, WV
 WXEW Yabucoa, PR
 WXGI Richmond, VA
 WXIT Charleston, WV
 WXLJ Dublin, GA
 WXLW Indianapolis, IN
 WXLX Milledgeville, GA

WXOK Baton Rouge, LA
 WXOR Florence, AL
 WXOX Bay City, MI
 WXPQ Eatonton, GA
 WXRFL Guayama, PR
 WXRL Lancaster, NY
 WXTN Lexington, MS
 WXVA Charles Town, WV
 WXVW Jeffersonville, IN
 WXXX Hattiesburg, MS
 WXYZ Detroit, MI
 WYAL Scotland Neck, NC
 WYAM Bessemer, AL
 WYAZ Yazoo City, MS
 WYBG Massena, NY
 WYCL York, SC
 WYDE Birmingham, AL
 WYDK Yadkinville, NC
 WYFC Ypsilanti, MI
 WYFE Rockford, IL
 WYGO Corbin, KY
 WYGR Wyoming, MI
 WYHI Fernandina Beach, FL
 WYLD New Orleans, LA
 WYLO Jackson, WI
 WYLS York, AL
 WYMB Manning, SC

WYNA Raleigh, NC
 WYND Sarasota, FL
 WYNE Appleton, WI
 WYNG Goldsboro, NC
 WYNK Baton Rouge, LA
 WYNN Florence, SC
 WYNR Brunswick, GA
 WYNS Leighton, PA
 WYNX Smyrna, GA
 WYOK Soperton, GA
 WYOO Richfield, MN
 WYOU Tampa, FL
 WYPR Danville, VA
 WYRD East Syracuse, NY
 WYRE Annapolis, MD
 WYRN Louisville, TN
 WYRU Red Springs, NC
 WYSE Inverness, FL
 WYSH Clinton, TN
 WYSL Buffalo, NY
 WYSR Franklin, VA
 WYTH Madison, GA
 WYTI Rocky Mount, VA
 WYTL Oshkosh, WI
 WYLO Weytheville, VA
 WYWY Barbourville, KY
 WYXI Athens, TN

AM, FM Calls

WYYS Tomahawk, WI
 WYYY Kalamazoo, MI
 WYZZ Jasper, GA
 WYZE Atlanta, GA
 WZAM Norfolk, VA
 WZAP Bristol, VA
 WZBN Zion, IL
 WZBS Ponce, PR
 WZEP Defuniak Springs, FL
 WZIP Cincinnati, OH
 WZIX York, PA
 WZKY Albemarle, NC
 WZNG Winter Haven, FL
 WZOB Fort Payne, AL
 WZOE Princeton, IL
 WZOO Asheville, NC
 WZST Leesburg, VA
 WZTQ Hurricane, WV
 WZUM Carnegie, PA
 WZUU Milwaukee, WI
 WZYO Frederick, MD
 WZYX Cowan, TN
 WZZA Tuscumbia, AL

U.S. FM Radio by Call Letters

KAAM Berryville, AR
 KAAP-FM Santa Paula, CA
 KABG Cambridge, MN
 KABJ-FM Abilene, KS
 KABL-FM San Francisco, CA
 KACA Prosser, WA
 *KACV-FM Amarillo, TX
 KADI-FM St. Louis, MO
 KADL-FM Pine Bluff, AR
 KADO-FM Texarkana, AR
 KADQ Rexburg, ID
 KADX Denver, CO
 KAEZ Oklahoma City, OK
 KAFF-FM Santa Fe, NM
 KAFF-FM Flagstaff, AZ
 KAFG Oklahoma City, OK
 KAFI Auburn, CA
 KAFM Dallas, TX
 KAGB-FM Inglewood, CA
 KAGF-FM Winona, MN
 KAGH-FM Crosssett, AR
 KAGM Klamath Falls, OR
 *KAHR Fremont, CA
 *KAHS Arcata, CA
 KAIM-FM Honolulu, HI
 KAIR-FM Tucson, AZ
 KAKC-FM Tulsa, OK
 *KALA Davenport, IA
 KALJ Yuma, AZ
 KALL-FM Salt Lake City, UT
 KALS Kalispell, MT
 *KALU Langston, OK
 *KALW San Francisco, CA
 *KALX Berkeley, CA
 KAMA-FM El Paso, TX
 KAMB Merced, CA
 KAMC Arlington, TX
 KAMO-FM Rogers, AR
 KAMS Mammoth Spring, AR
 *KANG Angwin, CA
 KANR Great Falls, MT
 KANS-FM Larned, KS
 *KANU Lawrence, KS
 *KANW Albuquerque, NM
 KAOH-FM Duluth, MN
 KAOI Waiuku, HI
 KAOI-FM Carrollton, MO
 *KAOS Olympia, WA
 KAPB-FM Marksville, LA
 KAPX San Clemente, CA
 KARA Santa Clara, CA
 KARD Wichita, KS
 *KASB Bellevue, WA
 *KASD Aberdeen, SD
 KASE Austin, TX
 *KASF Alamosa, CO
 KASK Las Cruces, NM
 *KASU Jonesboro, AR
 *KAUG Salinas, CA
 KAUM Houston, TX
 *KAUR Sioux Falls, SD
 KAUS-FM Austin, MN
 KAVI-FM Rocky Ford, CO
 KAVR-FM Apple Valley, CA
 *KAVS Thief River Falls, MN
 KAWL-FM York, NE
 KAWW-FM Heber Springs, AR
 KAWY Casper, WY
 *KAXE Grand Rapids, MN

*KAXR Flagstaff, AZ
 KAYD Beaumont, TX
 *KAYE-FM Tonkawa, OK
 KAYL-FM Storm Lake, IA
 KBAD-FM Carlsbad, NM
 KBAR-FM Burley, ID
 KBAS Lake Havasu City, AZ
 KBAT Midland, TX
 KBAY San Jose, CA
 KBZA Bisbee, AZ
 KBBB-FM Borger, TX
 KBBC Phoenix, AZ
 *KBBB Beaver, UT
 *KBBF Santa Rosa, CA
 KBBK-FM Boise, ID
 KBBL-FM Riverside, CA
 KBBY Ventura, CA
 KBCA Los Angeles, CA
 KBCM Sioux City, IA
 KBKR Steamboat Springs, CO
 *KBCS Bellevue, WA
 *KBDR Merced, CA
 *KBDY St. Louis, MO
 KBED Lake Providence, LA
 KBEE-FM Modesto, CA
 KBEK Lexington, MO
 *KBEM-FM Minneapolis, MN
 KBEO Kansas City, MO
 KBEV Okmulgee, OK
 KBEWF-FM Blue Earth, MN
 KBEZ Salinas, CA
 KBFC Forrest City, AR
 KBFE Casa Grande, AZ
 *KBFL Buffalo, MO
 KBFM Edinburg, TX
 *KBGL Pocatello, ID
 KBHB-FM Sturgis, SD
 *KBHI-FM Modesto, CA
 KBHL Lincoln, NE
 KBHP Bemidji, MN
 KBHS-FM Hot Springs, AR
 *KBHU-FM Spearfish, SD
 *KBIA Columbia, MO
 KBIC Alice, TX
 KBID Wichita Falls, TX
 KBIG Los Angeles, CA
 KBIM-FM Roswell, NM
 KBIO Edmonds, WA
 *KBJC Great Bend, KS
 KBJH Tulsa, OK
 KBLE-FM Seattle, WA
 KBLI-FM Blackfoot, ID
 KBLJ La Junta, CO
 KBMC Eugene, OR
 KBMF-FM Spearman, TX
 KBMO-FM Benson, MN
 KBMS Billings, MT
 KBOW West Covina, CA
 KBOE-FM Oskaloosa, IA
 KBOI-FM Boise, ID
 *KBOO Portland, OR
 KBOP-FM Pleasanton, TX
 KBOS Tulare, CA
 KBOW-FM Butte, MT
 KBOY-FM Medford, OR
 KBPI Denver, CO
 *KBPK Buena Park, CA
 KBPO Beaumont, TX
 KBRA Wichita, KS

KBRE-FM Cedar City, UT
 KBRF-FM Fergus Falls, MN
 KBRG San Francisco, CA
 KBRI-FM Brinkley, AR
 KBRR-FM Brookings, SD
 KBRO-FM Bremerton, WA
 KBRX-FM O'Neill, NE
 *KBSB Bemidji, MN
 KBSS Espanola, NM
 KBTM-FM Jonesboro, AR
 KBUC-FM San Antonio, TX
 KBUH-FM Brigham City, UT
 KBUY-FM Fort Worth, TX
 KBUZ-FM Mesa, AZ
 KBVL Boulder, CO
 *KBVR Corvallis, OR
 KBXL-FM Caldwell, ID
 *KBYU-FM Provo, UT
 KCAL-FM Redlands, CA
 KCAP-FM Helena, MT
 *KCB Dallas, TX
 *KCBS-FM San Francisco, CA
 *KCBX San Luis Obispo, CA
 *KCCK-FM Cedar Rapids, IA
 *KCCM-FM Moorhead, MN
 KCCO Ames, IA
 *KCDC Longmont, CO
 *KCDR-FM Cedar City, UT
 *KCED Centralia, WA
 *KCEE-FM Tucson, AZ
 *KCEP Las Vegas, NV
 KCES Eufaula, OK
 KCEZ Kansas City, MO
 KCFM St. Louis, MO
 *KCFR Denver, CO
 *KCFX Sioux Falls, SD
 *KCFV Ferguson, MO
 KCGM Scobey, MT
 KCHA-FM Charles City, IA
 *KCHC Central Point, OR
 KCHF-FM Sioux Falls, SD
 KCHI-FM Chillicothe, MO
 *KCHO Chico, CA
 *KCHU Dallas, TX
 KCII-FM Washington, IA
 KCIL Houma, LA
 KCIM-FM Carroll, IA
 KCIR Corsicana, TX
 KCIV The Dalles, OR
 KCIZ Springdale, AR
 KCJB-FM Minot, ND
 *KCJH Stockton, CA
 KCKN-FM Kansas City, KS
 *KCLC St. Charles, MO
 KCLD-FM St. Cloud, MN
 KCLK-FM Clarkston, WA
 KCLN-FM Clinton, IA
 KCLO-FM Leavenworth, KS
 KCLU-FM Rolla, MO
 KCMK Glenwood Springs, CO
 KCMT-FM Alexandria, MN
 *KCMU Seattle, WA
 *KCMW-FM Warrensburg, MO
 *KCN Hastings, NE
 KCNW Riverside, CA
 *KCOE Cedar Rapids, IA
 KCOG-FM Centerville, IA
 KCOL-FM Fort Collins, CO
 *KCOU Columbia, MO

FM Calls

KCPJ-FM Albert Lea, MN
 *KCPR San Luis Obispo, CA
 KCPX-FM Salt Lake City, UT
 KCRK-FM Enid, OK
 KCRI Helena, AR
 KCRV-FM Caruthersville, MO
 *KCRW Santa Monica, CA
 *KCSB-FM Santa Barbara, CA
 *KCSO Edmond, OK
 *KCSJ Chino, AZ
 *KCSM San Mateo, CA
 *KCSN Northridge, CA
 *KCSS Torlock, CA
 *KCSU-FM Fort Collins, CO
 KCTB-FM Flagstaff, AZ
 KCTC Sacramento, CA
 KCTY-FM Salinas, CA
 KCUE-FM Red Wing, MN
 *KCUJ Pella, IA
 *KCUV-FM Crookston, MN
 *KCUR-FM Kansas City, MO
 *KCWC Riverton, WY
 KCWM Victoria, TX
 KCWR Oakdale, LA
 KDAB Ogden, UT
 KDAR Oxnard, CA
 KDB-FM Santa Barbara, CA
 KDBH Natchitoches, LA
 KDBM-FM Dillon, MT
 KDBS-FM Alexandria, LA
 *KDCR Sioux Center, IA
 *KDCV-FM Blair, NE
 KDDI Oak Grove, LA
 KDEA New Iberia, LA
 KDEF-FM Albuquerque, NM
 KDES-FM Palm Springs, CA
 KDEW-FM De Witt, AR
 KDEX-FM Dexter, MO
 KDFC San Francisco, CA
 KDFM Walnut Creek, CA
 KDHL-FM Faribault, MN
 *KDHS Modesto, CA
 *KDIC Grinnell, IA
 KDIG San Diego, CA
 KDJO Pueblo, CO
 KDJW-FM Amarillo, TX
 KDKA-FM Pittsburgh, PA
 KDKB-FM Mesa, AZ
 KDKD-FM Clinton, MO
 KDKL-FM Del Rio, TX
 KDLO-FM Watertown, SD
 KDLR-FM Devils Lake, ND
 KDLS-FM Perry, IA
 KDLY Lander, WY
 KDMI Des Moines, IA
 KDNO Delano, CA
 KDNT-FM Denton, TX
 KDOL-FM Mojave, CA
 KDOM-FM Windom, MN
 KDOT-FM Scottsdale, AZ
 *KDPS Des Moines, IA
 *KDRC-FM St. George, UT
 KDSE Alice, TX
 KDSD-FM Denison, IA
 *KDSU Fargo, ND
 KDSX-FM Denison-Sherman, TX
 KDTX Dallas, TX
 KDUO Riverside, CA
 *KDUR Durango, CO
 KDUV Brownsville, TX
 KDUX-FM Ocean Shores, WA
 KDUZ-FM Hutchinson, MN
 *KDVS Davis, CA
 KDXU-FM St. George, UT
 KDZA-FM Pueblo, CO
 KEAR San Francisco, CA
 KEAZ De Ridder, LA
 KEBC Oklahoma City, OK
 KEBR Sacramento, CA
 *KECR El Cajon, CA
 *KEDP Las Vegas, NV
 *KEDQ Austin, MN
 KEDY Mt. Shasta, CA
 KEFY-FM St. Paul, MN
 KEEZ San Antonio, TX
 KEFC Waco, TX
 KEFM Omaha, NE
 *KEGH-FM Elk Grove, CA
 KEHG-FM Fosston, MN
 KEKI Honolulu, HI
 KELA-FM Centralia, WA
 KELO-FM Sioux Falls, SD
 KELS Harlingen, TX
 *KEMC Billings, MT
 *KEMR Loma Linda, CA
 *KEOL La Grande, OR
 *KEPC Colorado Springs, CO
 *KEPH Ephraim, UT

*KEPO Eagle Point, OR
 KEPT Shreveport, LA
 *KERA-FM Dallas, TX
 KERI Bellingham, WA
 *KERS Sacramento, CA
 *KESD Brookings, SD
 KESI Edinburg, TX
 KESM-FM El Dorado Springs MO
 KETO-FM Seattle, WA
 *KETR Commerce, TX
 KETU Salem, MO
 KETX-FM Livingston, TX
 KEUT Seattle, WA
 *KEWC-FM Cheney, WA
 KEWE Camarillo, CA
 KEWT Sacramento, CA
 KEXL San Antonio, TX
 *KEYA Belcourt, ND
 KEYC-FM Mankato, MN
 KEYN-FM Wichita, KS
 KEZB El Paso, TX
 KEZE-FM Spokane, WA
 KEZH Prescott, AZ
 KEZK St. Louis, MO
 KEZL San Diego, CA
 KEZO Omaha, NE
 KEZQ Little Rock, AR
 KEZR San Jose, CA
 KEZT Dallas, TX
 KEZU El Dorado, AR
 KEZX Seattle, WA
 KEZY-FM Anaheim, CA
 KEZZ Aitkin, MN
 KFAC-FM Los Angeles, CA
 KFAT Gilroy, CA
 KFBC-FM Cheyenne, WY
 KFBD-FM Waynesville, MO
 KFBI-FM Sacramento, CA
 *KFCC Fresno, CA
 KFDI-FM Wichita, KS
 KFDM Yakima, WA
 *KFGQ-FM Boone, IA
 KFIG Fresno, CA
 KFIL-FM Preston, MN
 KFJN Jonesboro, AR
 KFJB-FM Marshalltown, IA
 *KFJC Los Altos, CA
 KFJL Oklahoma City, OK
 *KFJM-FM Grand Forks, ND
 KFKZ Greeley, CO
 KFLA-FM Scott City, KS
 KFYL-FM Corvallis, OR
 KFMA Jerome, ID
 KFMB-FM San Diego, CA
 KFMC Provo, UT
 KFMD Dubuque, IA
 KFME Chico, CA
 KFME Albuquerque, NM
 KFMM Muscatine, IA
 KFMI Eureka, CA
 KFMM Houston, TX
 KFMM Tucson, AZ
 KFMM Abilene, TX
 KFMP Cape Girardeau, MO
 KFMO Lincoln, NE
 KFMR Fremont, CA
 KFMS Las Vegas, NV
 KFMT La Grande, OR
 KFMO Oak Creek, CO
 KFNV Magnolia, AR
 KFNM Waterloo, IA
 KFMX St. Louis Park, MN
 KFMV Eugene, OR
 KFMZ Columbia, MO
 KFNB Oklahoma City, OK
 KFNE Big Spring, TX
 KFNV-FM Ferriday, LA
 *KFNW-FM Fargo, ND
 KFOG San Francisco, CA
 KFOR-FM Lincoln, NE
 KFRC-FM Franklin, LA
 KFRA-FM San Francisco, CA
 KFRD-FM Rosenberg-Richmond, TX
 KFRY Fresno, CA
 KFSD-FM San Diego, CA
 KFSG Los Angeles, CA
 KFTM-FM Fort Morgan, CO
 KFUN-FM Las Vegas, NV
 *KFUO-FM Clayton, MO
 KFWD Fort Worth, TX
 KFXD-FM Nampa, ID
 KFYE Fresno, CA
 KFYZ-FM Bismarck, ND
 KGAF-FM Gainesville, TX
 KGB-FM San Diego, CA
 *KGBI-FM Omaha, NE
 KGBS-FM Los Angeles, CA
 *KGCC Denison, TX
 *KGED Batesville, AR
 KGFM Bakersfield, CA

KGGO Des Moines, IA
 KGHO-FM Hoquiam, WA
 KGIW-FM Alamosa, CO
 KGLC-FM Miami, OK
 KGLR-FM Anacosta, MT
 KGLP Gallup, NM
 KGLR Reno, NV
 *KGLT Bozeman, MT
 KGMO-FM Cape Girardeau, MO
 KGMO Honolulu, HI
 KGMR-FM Jacksonville, AR
 KGNC-FM Amarillo, TX
 KGNO-FM Dodge City, KS
 KGOL Lake Jackson, TX
 KGON Portland, OR
 KGOR Omaha, NE
 KGOT Anchorage, AK
 KGOU Norman, OK
 KGOW Broken Arrow, OK
 KGOY Bethany, OK
 KGRA Lake Charles, LA
 KGRC Hannibal, MO
 KGRD-FM Las Cruces, NM
 KGRE Greeley, CO
 *KGRG Auburn, WA
 KGRI-FM Henderson, TX
 *KGRM Grambling, LA
 KGRS Burlington, IA
 *KGGP Parkville, MO
 KGTM-FM Georgetown, TX
 *KGTG College Place, WA
 KGUS Hot Springs, AR
 *KGVH Gunnison, UT
 KGVW-FM Belgrade, MT
 KHAK-FM Cedar Rapids, IA
 KHAR-FM Anchorage, AK
 KHAT Lincoln, NE
 KHAY Ventura, CA
 KHBM-FM Monticello, AR
 KHBR-FM Hillsboro, TX
 KHBT Humboldt, IA
 KHCB-FM Houston, TX
 *KHCC Hutchinson, KS
 *KHDX Conway, AR
 KHEN-FM Henryetta, OK
 KHEP-FM Phoenix, AZ
 KHFX Yuba City, CA
 KHFI-FM Austin, TX
 KHFM Albuquerque, NM
 KHFO Osceola, AR
 *KHIB Durant, OK
 KHIG Paragould, AR
 *KHKE Cedar Falls, IA
 KHLS Blytheville, AR
 KHOF Los Angeles, CA
 KHOM Houma, LA
 KHOO Waco, TX
 KHOP Modesto, CA
 KHOW-FM Denver, CO
 KHQZ-FM Harrison, AR
 KHPE Albany, OR
 KHQ-FM Spokane, WA
 *KHRR Clayton, MO
 KHSJ-FM Hemet, CA
 KHSS Honolulu, HI
 *KHSU-FM Arcata, CA
 *KHTE Helena, MT
 KHUB-FM Fremont, NE
 KIAM-FM Wenatchee, WA
 KIBC Ogallala, NE
 *KIBO Idaho Falls, ID
 *KICB Fort Dodge, IA
 *KICC International Falls, MN
 KICD-FM Spencer, IA
 KICE Bend, OR
 KICG Iowa City, IA
 KICN Spokane, WA
 KICS-FM Hastings, NE
 KID-FM Idaho Falls, ID
 KIDA Moorhead, MN
 KIEE Harrisonville, MO
 KIFG-FM Iowa Falls, IA
 KIFM Bakersfield, CA
 *KIGC Oskaloosa, IA
 KIKK Davenport, IA
 KIIQ-FM Manitow Springs, CO
 KIIS-FM Los Angeles, CA
 KIUV-FM Huron, SD
 KIKK-FM Houston, TX
 KIKM-FM Sherman, TX
 KIKO-FM Globe, AZ
 *KILA Henderson, NV
 KILM Mt. Pleasant, IA
 KILR-FM Estherville, IA
 KILT-FM Houston, TX
 KIMI Keokuk, IA
 KIMN-FM Denver, CO
 KINB Poteau, OK
 KINF-FM Independence, KS
 KING-FM Seattle, WA
 KINK Portland, OR

KINL Eagle Pass, TX
 KINT-FM El Paso, TX
 KIOA-FM Des Moines, IA
 KIOF Orange, TX
 KIOI San Francisco, CA
 KIOO Porterville, CA
 KIOQ-FM Bishop, CA
 *KIOS-FM Omaha, NE
 KIOU Corpus Christi, TX
 KIOV Sioux Falls, SD
 KIOY Hanford, CA
 KIOZ Laramie, WY
 *KIPB Albuquerque, NM
 KIOQ Los Angeles, CA
 KIRK-FM Branson, MO
 KISM Bellingham, WA
 KISR Fort Smith, AR
 KISS San Antonio, TX
 KISW Seattle, WA
 KIT-FM Yakima, WA
 KITA Modesto, CA
 KITT San Diego, CA
 KITY San Antonio, TX
 KIVE Glendive, MT
 KIVY-FM Crockett, TX
 KIWA-FM Sheldon, IA
 KIWI Dubuque, IA
 KIXI-FM Seattle, WA
 KIXS-FM Killen, TX
 KIXY-FM San Angelo, TX
 KJAK Oklahoma City, OK
 KJAM-FM Madison, SD
 KJAN-FM Atlantic, IA
 KJAX Stockton, CA
 KJAZ Alameda, CA
 KJCK-FM Junction City, KS
 KJCS Nacogdoches, TX
 KJCT Wichita, KS
 KJDF Beaville, TX
 KJEF-FM Jennings, LA
 KJEL-FM Lebanon, MO
 KJFF Jefferson City, MO
 *KJHK Lawrence, KS
 KJIB Portland, OR
 KJLH Compton, CA
 KJLS Hays, KS
 KJMO Jefferson City, MO
 KJNA Jena, LA
 KJOI Los Angeles, CA
 KJOK Yuma, AZ
 KJRG-FM Newton, KS
 KJSK-FM Columbus, NE
 KJVC Mansfield, LA
 KJZZ Anchorage, AK
 KKAJ Kailua, HI
 KKAJ Ardmore, OK
 KKBC Carson City, NV
 KKCA Fulton, MO
 KKDO Grand Forks, ND
 KKEA Hilo, HI
 KKEG Fayetteville, AR
 KKEZ Fort Dodge, IA
 KKFM Colorado Springs, CO
 KKHI-FM San Francisco, CA
 KKIQ Livermore, CA
 KKL5-FM Rapid City, SD
 KKMA Pryor, OK
 KKNQ Oklahoma City, OK
 KKNV Fresno, CA
 KKOP Redondo Beach, CA
 KKOS Carlsbad, CA
 KKOY-FM Chanute, KS
 KKSS St. Louis, MO
 KKTU Ukiah, CA
 KKUL Tulsa, OK
 *KKUP Cupertino, CA
 KKWB Breckenridge, MN
 KKWS Wadena, MN
 KKYK Little Rock, AR
 KKYH Hanford, CA
 KKLAD-FM Klamath Falls, OR
 KKLAK-FM Lakewood, CO
 KLAU Lawton, OK
 KLAY-FM Tacoma, WA
 KLAB-FM Austin, TX
 KLBK-FM Lubbock, TX
 KLSB-FM Los Banos, CA
 *KLCC Eugene, OR
 KLCD-FM Lake Charles, LA
 KLCM-FM Lewistown, MT
 KLCO-FM Poteau, OK
 KLEA-FM Lovington, NM
 KLEB-FM Golden Meadow, LA
 KLEE-FM Oltumwa, IA
 KLEF Houston, TX
 KLEM-FM Le Mars, IA
 KLF-D-FM Litchfield, MN
 KLGM Ames, IA
 KLGA-FM Algona, IA
 KLGR-FM Redwood Falls, MN
 KLGT Breckenridge, CO

*KLHS-FM Lewiston, ID
 KLIL Ukiah, CA
 KLIN-FM Lincoln, NE
 KLIR-FM Denver, CO
 KLIS Palestine, TX
 KLIZ-FM Brainerd, MN
 *KLJC Kansas City, MO
 KLLL-FM Lubbock, TX
 *KLLU Riverside, CA
 KLMO-FM Longmont, CO
 KLOH-FM Pipestone, MN
 KLQ Houston, TX
 KLOM-FM Lompoc, CA
 *KLON Long Beach, CA
 KLOO-FM Corvallis, OR
 KLOQ Lyons, KS
 KLOR-FM Ponca City, OK
 KLOS Los Angeles, CA
 KLOV-FM Loveland, CO
 KLOZ El Paso, TX
 *KLPI Ruston, LA
 KLPW-FM Union, MO
 KLRB Carmel, CA
 *KLRE Little Rock, AR
 KLRP Emporia, KS
 KLRQ San Diego, CA
 *KLSE-FM Rushford, MN
 KLSN Brownwood, WA
 *KLSR St. Louis, MO
 KLSM Mason City, IA
 KLTA Dinuba, CA
 KLTV Bolivar, MO
 KLUB-FM Salt Lake City, UT
 KLUC-FM Las Vegas, NV
 KLUF-FM Lufkin, TX
 KLUK Atlanta, TX
 *KLUM-FM Jefferson City, MO
 KLUR Wichita Falls, TX
 KLVE Los Angeles, CA
 KLVN Newton, IA
 *KLVR Longview, WA
 KLWN-FM Lawrence, KS
 KLYD-FM Bakersfield, CA
 KLYF Des Moines, IA
 KLYK Longview, WA
 KLYN-FM Lynden, WA
 KLYO-FM Hamilton, MT
 KLYR-FM Clarksville, AR
 KLYX Clear Lake City, TX
 KLFZ-FM Denver, CO
 KMAG Fort Smith, AR
 KMAO-FM Maquoketa, IA
 KMAR-FM Winnsboro, LA
 KMAX Arcadia, CA
 *KMBI-FM Spokane, WA
 KMBO Shreveport, LA
 KMBR Kansas City, MO
 KMBS Harlingen, TX
 *KMCR-FM Phoenix, AZ
 KMCS Gatesville, TX
 KMEO-FM Phoenix, AZ
 KMET Los Angeles, CA
 *KMFA Austin, TX
 KMFB-FM Mendocino, CA
 KMFE Emmett, ID
 KMFL-FM Marshall, MO
 KMFM San Antonio, TX
 KMHL-FM Marshall, MN
 *KMIH Mercer Island, WA
 KMIO Sinton, TX
 KMIS-FM Portageville, MO
 KMII Mitchell, SD
 KMJ-FM Fresno, CA
 KMKF Manhattan, KS
 KMLA Ashdown, AR
 KMLB-FM Monroe, LA
 KMMK McKinney, TX
 KMMM-FM Muskogee, OK
 KMMT Mammoth Lakes, CA
 *KMNR Rolla, MO
 KMOD Tulsa, OK
 KMOE Butler, MO
 KMOT-FM Minot, ND
 KMOX-FM St. Louis, MO
 KMPL-FM Sikeston, MO
 KMPX San Francisco, CA
 KMRC-FM Morgan City, LA
 KMRE Dumas, TX
 KMRJ Pittsburg, KS
 *KMSA Grand Junction, CO
 *KMSM-FM Butte, MT
 *KMSU Mankato, MN
 *KMTE Sitka, AK
 KMTN Jackson, WY
 *KMPY Mt. Pleasant, UT
 KMTW Twin Falls, ID
 KMTY-FM Clovis, NM
 KMUL-FM Muleshoe, TX
 *KMUV Wichita, KS
 KMWT Mineral Wells, TX
 KMYO-FM Little Rock, AR
 KMYR Albuquerque, NM

FM Calls

KMYT Merced, CA	*KOVF-FM Kearney, NE	KREW-FM Sunnyside, WA	KSIX-FM Corpus Christi, TX
KNAC Long Beach, CA	KOWH-FM Omaha, NE	KREX-FM Grand Junction, CO	*KSJC Stockton, CA
KNAF-FM Fredericksburg, TX	KOWN-FM Escondido, CA	KRFD Marysville, CA	KSJM Jamestown, ND
KNAI-FM San Francisco, CA	KOKE Brownwood, TX	KRFG Greenfield, MO	*KSJN St. Paul, MN
KNBO-FM New Boston, TX	KOYE Laredo, TX	KRFM Phoenix, AZ	KSJO San Jose, CA
*KNBS Manteca, CA	KOYL-FM Odessa, TX	KRFO-FM Owatonna, MN	*KSJR-FM Collegeville, MN
KNBT New Braunfels, TX	KOYN-FM Billings, MT	KRGI-FM Grand Island, NE	*KSJS San Jose, CA
*KNBU Baldwin City, KS	KOYY-FM El Dorado, KS	KRGK Carthage, MO	KSJT San Angelo, TX
*KNCC Tsaile, AZ	KOZE-FM Lewiston, ID	KRHD-FM Duncan, OK	KSJG Salina, KS
*KNCT-FM Killeen, TX	KOZN-FM San Diego, CA	*KRIC Rexburg, ID	KSKR Mena, AR
KNCV Rochester, MN	KPAC-FM Port Arthur, TX	KRAC El Dorado, AR	KSJU Hutchinson, KS
KNCY-FM Nebraska City, NE	KPAM-FM Portland, OR	KRIT Clarion, IA	KSL-FM Salt Lake City, UT
KNDY-FM Marysville, KS	KPAN-FM Hereford, TX	KRLS Lawton, OK	*KSLC McMinville, OR
KNEB-FM Scottsbluff, NE	KPAR-FM Albuquerque, NM	KRLN-FM Canon City, CO	*KSLH St. Louis, MO
KNED-FM McAlester, OK	KPAS El Paso, TX	KRLS Knoxville, IA	KSLI Alexandria, LA
KNEI-FM Waukon, IA	KPAT Sioux Falls, SD	KRLT South Lake Tahoe, CA	KSLO-FM Opelousas, LA
KNEU El Centro, CA	KPAY-FM Chico, CA	KRLQ Northfield, MN	KSLQ St. Louis, MO
KNEV Reno, NV	KPBM-FM Poplar Bluff, MO	KRLY Houston, TX	*KSLU Hammond, LA
KNEX-FM McPherson, KS	*KPBS-FM San Diego, CA	KRMD-FM Shreveport, LA	KSMA-FM Santa Maria, CA
KNFB Nowata, OK	*KPBX-FM Spokane, WA	KRMH San Marcos, TX	KSMB Lafayette, LA
KNFM Midland, TX	KPCG Joplin, MO	KRMQ Provo, UT	*KSMC Moraga, CA
KNGT Jackson, CA	KPCR-FM Bowling Green, MO	KRMS-FM Osage Beach, MO	*KSMI-FM Donaldsonville, LA
*KNHC Seattle, WA	*KPCS Pasadena, CA	KRNA Iowa City, IA	KSMU Springfield, MO
*KNHS Torrance, CA	*KPEC-FM Tacoma, WA	*KRNB-FM Neah Bay, WA	KSND Springfield, OR
KNIK-FM Anchorage, AK	KPEL-FM Lafayette, LA	*KRNLFM Mount Vernon, IA	KSNM Santa Fe, NM
KNIM-FM Maryville, MO	KPEN Los Altos, CA	KRNO Reno, NV	KSNM Santa Fe, NM
*KNIS Carson City, NV	*KPFA Berkeley, CA	KRNO Des Moines, IA	KSNM Santa Fe, NM
KNIT-FM Abilene, TX	*KPFB Berkeley, CA	*KRNU Lincoln, NE	KSNL Pocatello, ID
KNIX Phoenix, AZ	*KPFK Los Angeles, CA	KRNW Boulder, CO	KSNS Lake Charles, LA
KNJO Thousand Oaks, CA	KPFM Kerrville, TX	KRNY-FM Kearney, NE	KSOL San Mateo, CA
*KNLU Monroe, LA	*KPFM Houston, TX	KROA Grand Island, NE	KSOM-FM Ontario, CA
KNOB Long Beach, CA	KPGA Pismo Beach, CA	KROB-FM Robstown, TX	KSON-FM San Diego, CA
KNOE-FM Monroe, LA	*KPGY Ames, IA	KROC-FM Rochester, MN	KSOP-FM Salt Lake City, UT
KNOF St. Paul, MN	KPHD Fresno, CA	KROF-FM Abbeville, LA	*KSOR Ashland, OR
KNOK-FM Fort Worth, TX	KPIK-FM Colorado Springs, CO	KROG Sonora, CA	*KSOZ Point Lookout, MO
*KNOS Marshall, MO	KPIP Roseville, CA	KROK Shreveport, LA	KSPC Claremont, CA
KNPT-FM Newport, OR	KPJH Fort Stockton, TX	KROI Sacramento, CA	KSPI-FM Stillwater, OK
KNRO-FM Conroe, TX	KPLA Plainview, TX	KROJ-FM San Francisco, CA	KSPN Santa Monica, CA
KNTD Wichita Falls, TX	KPLM Temple, TX	KROZ Tyler, TX	KSRN Reno, NV
*KNTU Denton, TX	KPLT-FM Paris, TX	*KRPL-FM Moscow, ID	KSRN Tracy, CA
KNUE Tyler, TX	*KPLU-FM Tacoma, WA	*KRPS-FM Phoenix, AZ	KSSR Kaiserslautern, MO
KNUJ-FM New Ulm, MN	KPLX Fort Worth, TX	*KRRC Portland, OR	KSTA-FM Coleman, TX
KNUS Dallas, TX	KPMJ Oxnard, CA	KRSB Roseburg, OR	*KSTI Springfield, SD
KNUW Great Falls, MT	KPNW-FM Eugene, OR	KRSL-FM Durango, CO	KSTN Apache Junction, AZ
KNWA Fayetteville, AR	KPOC-FM Pocatello, ID	KRSM Dallas, TX	KSTN-FM Stockton, CA
*KNWC-FM Sioux Falls, SD	KPOE Humble City, NM	KRSN-FM Los Alamos, NM	KSTO Agana, GM
*KNWD Natchitoches, LA	KPOL-FM Los Angeles, CA	KRSP-FM Salt Lake City, UT	KSTP-FM St. Paul, MN
*KNWS-FM Waterloo, IA	*KPOO San Francisco, CA	KRST Albuquerque, NM	KSTU Centerville, UT
KNX-FM Los Angeles, CA	KPOF-FM Wenatchee, WA	*KRSW-FM Pipestone, MN	KSUB-FM Cedar City, UT
KNXR Rochester, MN	KPOX Havre, MT	KRTH Los Angeles, CA	*KSUC Keene, TX
*KOAP-FM Portland, OR	KPRI San Diego, CA	*KRTU San Antonio, TX	KSUE-FM Susanville, CA
KOAO Denver, CO	KPRM-FM Park Rapids, MN	*KRUD Las Vegas, NV	*KSUI Iowa City, IA
KOAX Dallas, TX	KPRS Kansas City, MO	KRUS-FM Ruston, LA	*KSUL Long Beach, CA
KOB-FM Albuquerque, NM	KPUB-FM Pueblo, CO	KRVE Los Gatos, CA	KKSV-FM Artesia, NM
*KOBG Joplin, MO	KPUP Kingsville, TX	*KRVH Rio Vista, CA	*KSVR Mt. Vernon, WA
KOBS-FM Orange, TX	KPWD Plettywood, MT	*KRVN Eugene, OR	*KSWC Winfield, KS
KOCM Newport Beach, CA	*KPWN Parowan, UT	KRVN-FM Lexington, NE	*KSWH Arkadelphia, AR
KOCN Pacific Grove, CA	KQAD-FM Luverne, MN	KRVR Davenport, IA	KSWM-FM Aurora, MO
*KOCV Odessa, TX	*KQAL Winona, MN	*KRVS Lafayette, LA	KSWT Topeka, KS
KODA-FM Houston, TX	KQCA Canton, MO	*KRWG Las Cruces, NM	*KSYM-FM San Antonio, TX
KOEA Doniphan, MO	KQCR Cedar Rapids, IA	KRWV Farmington, NM	KTAC-FM Tacoma, WA
KOEL-FM Oelwein, IA	KQDE-FM Waseca, MN	KRWX Hardin, MT	KTAI Kingsville, TX
KOEF-FM Oklahoma City, OK	KODY Bismarck, ND	KRXL Kirksville, MO	KTAL-FM Texarkana, TX
KOFO-FM Ottawa, KS	*KQED-FM San Francisco, CA	KRYT-FM Colorado Springs, CO	KTAN-FM Sierra Vista, AZ
*KOHF Fremont, CA	KQFM Portland, OR	*KSAK Walnut, CA	KTAV Knoxville, IA
*KOHM Lubbock, TX	KQHU Yankton, SD	KSAM-FM Huntsville, TX	*KTCC Colby, KS
*KOHX Orem, UT	KQIC Willmar, MN	KSAN-FM San Francisco, CA	KTCH-FM Wayne, NE
KOIN-FM Portland, OR	KQIP Odessa, TX	KSAO San Antonio, TX	KTCL Fort Collins, CO
KOKE-FM Austin, TX	KQIV Lake Oswego, OR	*KSAU Nacogdoches, TX	KTCR-FM Minneapolis, MN
KOKR Newport, AR	KQIX-FM Grand Junction, CO	KSBY Mission Viejo, CA	KTCU-FM Fort Worth, TX
KOLA San Bernardino, CA	KQKQ-FM Council Bluffs, IA	*KSCJ Shreveport, LA	*KTDB Ramah, NM
*KOLU Pasco, WA	KQLH San Bernardino, CA	KSCM-FM Houston, MO	*KTEC Klamath Falls, OR
KOLY-FM Moberge, SD	KQNM Gallup, NM	KSCO-FM Santa Cruz, CA	KTEN-FM Ada, OK
KOME San Jose, CA	KQOD Ogden, UT	KSCR Hobbs, NM	*KTEP El Paso, TX
*KOMR St. Louis, MO	KQOO Pullman, WA	KSCS Fort Worth, TX	*KTEO Rapid City, SD
KOMS Lebanon, OR	KQRS-FM Golden Valley, MN	KSDL El Paso, TX	KTEZ Lubbock, TX
KONA-FM Kennewick, WA	KQOU Houston, TX	*KSDS San Diego, CA	KTFC Sioux City, IA
KONG-FM Visalia, CA	KQWC-FM Webster City, IA	KSEA Seattle, WA	KTFM San Antonio, TX
KONI-FM Spanish Fork, UT	KQXT San Antonio, TX	KSEL-FM Lubbock, TX	KTGA Fort Dodge, IA
KOOI Jacksonville, TX	KQXX McAllen, TX	KSEN-FM Shelby, MT	KTGR-FM Columbia, MO
KOOL-FM Phoenix, AZ	KQYN Twenty-nine Palms, CA	KSEO-FM Durant, OK	KTHO-FM South Lake Tahoe, CA
KOQO-FM Omaha, NE	*KRAB Seattle, WA	KSER Searcy, AR	KTIM-FM San Rafael, CA
KOPE Mesilla Park, NM	KRAD-FM East Grand Forks, MN	KSET-FM El Paso, TX	*KTIS-FM Minneapolis, MN
*KOPN Columbia, MO	KRAI-FM Craig, CO	KSEZ Sioux City, IA	*KTJO-FM Ottawa, KS
KOPR-FM Great Falls, MT	KRAV Tulsa, OK	KSFA-FM Nacogdoches, TX	KTKC Springhill, LA
KORA-FM Bryan, TX	KRAZ Farmington, NM	*KSFJ Mountain View, CA	KTLC Twin Lakes, IA
KORD-FM Richland, WA	KRBB-FM Sallisaw, OK	KSFM Woodland, CA	KTLD Dallas, TX
KORI Salem, OR	KRBE Houston, TX	KSFT St. Joseph, MO	KTLO-FM Mountain Home, AR
KORJ Garden Grove, CA	KRBI-FM St. Peter, MN	KSFX San Francisco, CA	KTQG-FM Tahlequah, OK
KORK-FM Las Vegas, NV	*KRBM Pendleton, OR	KSGM-FM Ste. Genevieve, MO	*KTLX Columbus, NE
KORO Abilene, TX	*KRCC Colorado Springs, CO	KSHB Crestwood, MO	KTMO Kennett, MO
KOSI-FM Denver, CO	KRDO-FM Colorado Springs, CO	*KSHU Huntsville, TX	KTMS-FM Santa Barbara, CA
KOSO Patterson, CA	CO	KSIB-FM Creighton, IA	KTMT Medford, OR
KOST Los Angeles, CA	KRE-FM Berkeley, CA	KSID-FM Sidney, NE	KTNM-FM Tucumcari, NM
*KOSU-FM Stillwater, OK	KREB Monroe, LA	KSIH Pocatello, ID	KTNT-FM Tacoma, WA
KOSY-FM Texarkana, TX	KREM-FM Spokane, WA	KSIS-FM Sedalia, MO	KTOC-FM Jonesboro, LA
KOTE Lancaster, CA	KRES Moberly, MO	KSIW-FM Woodward, OK	*KTDF Cedar Rapids, IA
KOTN-FM Pine Bluff, AR			
*KOTO Telluride, CO			
KOUL Sinton, TX			
KOUR-FM Independence, IA			
KOVA Ojai, CA			
			KTON-FM Belton, TX
			*KTOO Juneau, AK
			KTOP-FM Topeka, KS
			KTOT-FM Big Bear Lake, CA
			*KTOY Tacoma, WA
			KTPK Topeka, KS
			KTQM-FM Clovis, NM
			KTRI Las Vegas, NV
			KTRM-FM Beaumont, TX
			*KTRU Houston, TX
			KTRY-FM Bastrop, LA
			*KTSC-FM Pueblo, CO
			KTSM-FM El Paso, TX
			*KTSR Kansas City, MO
			*KTSU Houston, TX
			KTTS-FM Springfield, MO
			KTTT-FM Columbus, NE
			*KTUH Honolulu, HI
			KTWN Anoka, MN
			*KTJX-FM Jasper, TX
			KTXX Victoria, TX
			KTXR Springfield, MO
			*KTYT-FM Lubbock, TX
			KTYD-FM Santa Barbara, CA
			*KUAC College, AK
			KUAD-FM Windsor, CO
			*KUAF Fayetteville, AR
			KUAM-FM Agana, GM
			*KUAT-FM Tucson, AZ
			*KUBS Newport, WA
			*KUCA Conway, AR
			*KUCL Irvine, CA
			*KUCR Riverside, CA
			*KUCV Lincoln, NE
			KUDE-FM Oceanide, CA
			KUDL-FM Kansas City, KS
			KUDO Las Vegas, NV
			*KUER Salt Lake City, UT
			*KUFM Missoula, MT
			KUFO Galveston, TX
			*KUGS Bellingham, WA
			*KUHJ Houston, TX
			*KUIB Vernal, UT
			KUIC Vacaville, CA
			*KUID Moscow, ID
			KULA Waipahu, HI
			KULM Columbus, TX
			KULP-FM El Campo, TX
			*KUMD-FM Duluth, MN
			*KUMM Morris, MN
			*KUMR Rola, MO
			KUMU-FM Honolulu, HI
			KUNA San Luis Obispo, CA
			*KUNC-FM Greeley, CO
			*KUNF La Canada, CA
			*KUNI Cedar Falls, IA
			*KUNM Albuquerque, NM
			KUNR Reno, NV
			KUOA-FM Siloam Springs, AR
			KUOE El Paso, TX
			*KUOI-FM Moscow, ID
			*KUOP Stockton, CA
			*KUOR-FM Redlands, CA
			*KUOW Seattle, WA
			KUPD-FM Tempe, AZ
			KUPI-FM Idaho Falls, ID
			KUPK-FM Garden City, KS
			KURL Portland, OR
			KURL-FM Billings, MT
			*KUSC Los Angeles, CA
			*KUSD-FM Vermillion, SD
			*KUSF San Francisco, CA
			*KUSP Santa Cruz, CA
			*KUSU-FM Logan, UT
			*KUT-FM Austin, TX
			KUTE Glendale, CA
			KUTI-FM Yakima, WA
			KUUL Madera, CA
			KUVR-FM Holdrege, NE
			*KUWR Laramie, WY
			KUZZ-FM Bakersfield, CA
			KVCL-FM Winnfield, LA
			*KVCN San Bernardino, CA
			KVDE-FM Sioux Center, IA
			KVEE-FM Conway, AR
			KVEJ-FM Vernal, UT
			*KVFG Thibodaux, LA
			KVFM San Fernando, CA
			KVGB-FM Great Bend, KS
			*KVHS Concord, CA
			*KVJK Travis AFB, CA
			KVIL-FM Highland Park, TX
			KVIM Coachella, CA
			KVIP-FM Redding, CA
			KVLG-FM La Grange, TX
			KVLR Detroit Lakes, MN
			*KVLV Beaumont, TX
			KVLF-FM Fallon, NV
			KVMN Pueblo, CO
			KVMT Vail, CO

FM Calls

- *KVMV-FM McAllen, TX
 *KVNO Omaha, NE
 KVOD Denver, CO
 KVOR-FM Colorado Springs, CO
 KPVI-FM Ville Platte, LA
 KVRÉ-FM Santa Rosa, CA
 KVRV Vermillion, SD
 KVRH-FM Salida, CO
 KVRO Stillwater, OK
 *KVSC St. Cloud, MN
 KVSF Rapid City, SD
 *KVTT Dallas, TX
 KVWC-FM Vernon, TX
 KVWJ Logan, UT
 KVWM-FM Show Low, AZ
 KVWO-FM Cheyenne, WY
 *KVXJ Crescent City, CA
 KVVN St. Helena, CA
 KWAM-FM Memphis, TN
 KWAO Sun City, AZ
 *KWAR Waverly, IA
 KWAS Amarillo, TX
 KWAT-FM Watertown, SD
 KWAV Monterey, CA
 *KWAX Eugene, OR
 KWAY-FM Waverly, IA
 KWBE-FM Beatrice, NE
 KWBG-FM Boone, IA
 *KWBI Morrison, CO
 *KWBU Waco, TX
 KWBW-FM Hutchinson, KS
 *KWCR-FM Ogden, UT
 *KWCV Walla Walla, WA
 KWGD Idabel, OK
 KWED-FM Seguin, TX
 KWHE Camden, AR
 KWEN Tulsa, OK
 KWFC Springfield, MO
 KWFM Tucson, AZ
 KWGO-FM Lubbock TX
 *KWGS Tulsa, OK
 KWHI-FM Brenham, TX
 KWHO-FM Salt Lake City, UT
 KWHP Edmond, OK
 *KWHs West Sacramento, CA
 KWHW-FM Altus, OK
 KWIC Beaumont, TX
 KWIM Moorhead, MN
 KWIN Lodi, CA
 KWIO-FM Moses Lake, WA
 KWIZ-FM Santa Ana, CA
 KWKI Kansas City, MO
 KWKK Dardanel, AR
 KWKC Graham, TX
 *KWLD Plainview, TX
 KWLV San Angelo, TX
 *KWMR Cedar Rapids, IA
 *KWMT St. Louis, MO
 KWNS-FM Pratt, KS
 KWQA-FM Worthington, MN
 KWOD Sacramento, CA
 KWOE-FM Clinton, OK
 *KWPB Liberty, MO
 KWPM-FM West Plains, MO
 KWRT-FM Boonville, MO
 *KWSB-FM Gunnison, CO
 *KWSC Wayne, NE
 KWSM Tulare, CA
 KWST Los Angeles, CA
 KWTO-FM Springfield, MO
 *KWTS Canyon, TX
 KWTX-FM Waco, TX
 *KWUR Clayton, MO
 *KWVC-FM Columbia, MO
 KWVK Rochester, MN
 KWVM Stephenville, TX
 KWWR-FM Mexico, MO
 KWXI Fort Worth, TX
 KWXY-FM Cathedral City, CA
 KYYD Security, CO
 KYYN-FM Wynne, AR
 KWYR-FM Winner, SD
 KWYT Salinas, CA
 *KXCV Maryville, MO
 KXEL-FM Waterloo, IA
 KXEW-FM Tucson, AZ
 KXFM Santa Maria, CA
 KXGI-FM Fort Madison, IA
 KXGO Arcata, CA
 KXGR Grand Rapids, MN
 KXIQ Bend, OR
 KXIT-FM Dalhart, TX
 KXL-FM Portland, OR
 KXLE-FM Ellensburg, WA
 *KXLU Los Angeles, CA
 KXLY-FM Spokane, WA
 KXOA Sacramento, CA
 KXOR Thibodaux, LA
- KXOW-FM Hot Springs, AR
 KXRA-FM Alexandria, MN
 KXTC Glendale, AZ
 KXTR Kansas City, MO
 KXTZ Henderson, NV
 KXXK Chickasha, OK
 KXXR-FM Spokane, WA
 KXXX-FM Colby, KS
 KXXY Oklahoma City, OK
 KYA-FM San Francisco, CA
 KYAC-FM Seattle, WA
 *KYDZ Cody, WY
 KYEA West Monroe, LA
 KYEZ Salina, KS
 KYFM Bartlesville, OK
 KYKR-FM Port Arthur, TX
 KYXK Longview, TX
 KYLT-FM Missoula, MT
 KYMS Santa Ana, CA
 KYND-FM Pasadena, TX
 KYOR-FM Blythe, CA
 KYOT Sterling, CO
 KYSD Waynesville, MO
 KYSM-FM Mankato, MN
 KYSS-FM Missoula, MT
 KYTN Grand Forks, ND
 KYUF Uvalde, TX
 KYXY San Diego, CA
 KYYS Kansas City, MO
 KZAK-FM Tyler, TX
 KZAM-FM Bellevue, WA
 KZAP Sacramento, CA
 KZEL-FM Eugene, OR
 KZEN Seaside, CA
 KZEW Dallas, TX
 KZFM Corpus Christi, TX
 KZNN Rolla, MO
 KZOK Seattle, WA
 KZOZ San Luis Obispo, CA
 *KZSC Santa Cruz, CA
 KZST Santa Rosa, CA
 *KZSU Stanford, CA
 KZUN-FM Opportunity, WA
 KZZZ Kingman, AZ
 *New FM Kodiak, AK
 *New FM Arkadelphia, AR
 *New FM Glenwood Springs, CO
 *New FM Ignacio, CO
 *New FM Lakeland, FL
 New FM Eastman, GA
 New FM Honolulu, HI
 New FM Pella, IA
 New FM Leonardtown, MD
 New FM Midland, MI
 New FM Thief River Falls, MN
 *New FM Columbus, MS
 New FM Florissant, MO
 New FM Aberdeen, SD
 New FM Bangor, ME
 *New FM Wilkesboro, NC
 WAAF Worcester, MA
 WAAG Galesburg, IL
 WAAL Binghamton, NY
 WAAT Johnstown, PA
 WAAP Wilmington, NC
 WAAW Murray, KY
 WAAZ-FM Crestview, FL
 WABB-FM Mobile, AL
 WABD-FM Ft. Campbell, KY
 *WABE Atlanta, GA
 WABJ-FM Adrian, MI
 WABO-FM Waynesboro, MS
 *WABR-FM Tifton, GA
 WABX Detroit, MI
 WABZ-FM Albermarle, NC
 WACF Paris, IL
 *WACG-FM Augusta, GA
 WACI Freeport, IL
 WACL-FM Waycross, GA
 WACM Freeport, PA
 WACT-FM Tuscaloosa, AL
 *WADB Point Pleasant, NJ
 WADI Corinth, MS
 WADM-FM Decatur, IN
 WADY Buffalo, NY
 WAEL-FM Maricao, PR
 *WAER Syracuse, NY
 WAEW-FM Crossville, TN
 WAEY-FM Princeton, WV
 WAEZ Akron, OH
 WAFB-FM Baton Rouge, LA
 *WAFG Fort Lauderdale, FL
 WAFI Milford, DE
 WAFM Amory, MS
 *WAFR Durham, NC
 WAFV Valdosta, GA
 WAGI-FM Gaffney, SC
 WAHR Huntsville, AL
 *WAHS Auburn Heights, MI
 WAIA Miami, FL
 *WAIC Springfield, MA
 *WAIF Cincinnati, OH
- WAIN-FM Columbia, KY
 WAIV Jacksonville, FL
 *WAJC Indianapolis, IN
 WAJP Joliet, IL
 WAJR-FM Morgantown, WV
 WAKG Danville, VA
 WAKM Bedford, PA
 WAKO-FM Lawrenceville, IL
 WAKQ Russellville, KY
 *WAKW Cincinnati, OH
 WAKX-FM Duluth, MN
 WALD-FM Waltherboro, SC
 *WALF Alfred, NY
 WALK-FM Patchogue, NY
 WALL-FM Middletown, NY
 *WALP Corinth, MS
 WALR-FM Union City, TN
 WALT Meridian, MS
 WALX Selma, AL
 *WAMC Albany, NY
 *WAMH Amherst, MA
 WAMI-FM Opp, AL
 WAMO-FM Pittsburgh, PA
 *WAMP-FM Toledo, OH
 WAMR-FM Venice, FL
 *WAMU-FM Washington, DC
 WAMX Ashland, KY
 WANG Coldwater, MI
 WANS-FM Anderson, SC
 WANY-FM Albany, KY
 WAOV-FM Vincennes, IN
 WAPI-FM Birmingham, AL
 WAPL-FM Appleton, WI
 *WAPS Akron, OH
 WAQT Carrollton, AL
 WAQY Springfield, MA
 *WARC Meadville, PA
 *WARG Summit, IL
 WARI-FM Abbeville, AL
 WARK-FM Hagerstown, MD
 *WARP Due West, SC
 WART Plainfield, IN
 WARU-FM Peru, IN
 *WARY Valhalla, NY
 WASH Washington, DC
 WASK-FM Lafayette, IN
 WASL Dyersburg, TN
 *WASU-FM Boone, NC
 WATK-FM Antigo, WI
 WATM-FM Attmore, AL
 WATP-FM Marion, SC
 WATW-FM Ashland, WI
 WATZ-FM Alpena, MI
 WAUG-FM Augusta, GA
 WAUK-FM Waukesha, WI
 WAUN Kewaunee, WI
 *WAUP Akron, OH
 WAUR Aurora, IL
 *WAUS Berrien Springs, MI
 WAVA-FM Arlington, VA
 *WAVM Maynard, MA
 WAVR Waverly, NY
 WAVT Pottsville, PA
 WAVV Tampa, FL
 WAWA-FM Milwaukee, WI
 WAWK-FM Kendallville, IN
 WAWR-FM Bowling Green, OH
 WAWY Fort Lauderdale, FL
 WAYD-FM Ozark, AL
 WAYF-FM Lehigh Acres, FL
 WAYL Minneapolis, MN
 WAYY Atlantic City, NJ
 WAXY-FM Waycross, GA
 WAYZ-FM Waynesboro, PA
 WAZI Morristown, TN
 WAZY-FM Lafayette, IN
 WBAB-FM Babilon, NY
 WBAD Leland, MS
 WBAG-FM Burlington, NC
 *WBAL New York, NY
 WBAL-FM Baltimore, MD
 WBAQ Greenville, MS
 *WBAU Garden City, NY
 WBAW-FM Barnwell, SC
 WBBA-FM Pittsfield, IL
 WBBC Blackstone, VA
 WBBI-FM Abingdon, VA
 WBBM-FM Chicago, IL
 WBBQ-FM Forest City, NC
 WBBQ-FM Augusta, GA
 WBBY-FM Westerville, OH
 WBCH-FM Hastings, MI
 WBCI Williamsburg, VA
 *WBCF Fort Wayne, IN
 WBCN Boston, MA
 WBCO-FM Bucyrus, OH
 *WBCR-FM Beloit, WI
 WBCS Milwaukee, WI
 *WBCT Columbia, SC
 WBDC Huntingburg, IN
 *WBDD Indianapolis, IN
- WBDY Bluefield, VA
 WBEA Elyria, OH
 WBEN-FM Buffalo, NY
 WBES Charleston, WV
 WBET-FM Brockton, MA
 WBEU-FM Beaufort, SC
 WBEV-FM Beaver Dam, WI
 WBEX-FM Chillicothe, OH
 *WBZZ Chicago, IL
 WBFB Rochester, NY
 WBFG Detroit, MI
 *WBFH Bloomfield Hills, MI
 WBFM Seneca, SC
 *WBFO Buffalo, NY
 *WBGD Bricktown, NJ
 WBGW Tallahassee, FL
 *WBGU Newark, NJ
 WBGR-FM Paris, KY
 *WBGU Bowling Green, OH
 WBGW Bangor, ME
 *WBHI Chicago, IL
 *WBHM Birmingham, AL
 *WBHS Brunswick, ME
 WBIC Henderson, KY
 WBIE Marietta, GA
 WBIF Bedford, IN
 *WBIM-FM Bridgewater, MA
 WBIP-FM Booneville, MS
 WBIR-FM Knoxville, TN
 WBIV Wethersfield, NY
 WBIZ-FM Eau Claire, WI
 *WBJB Trenton, NJ
 WBJW-FM Orlando, FL
 *WBKE-FM North Manchester, IN
 WBKR Owensboro, KY
 *WBKT Brockport, NY
 WBKV-FM West Bend, WI
 WBKW Beckley, WV
 *WBKY Lexington, KY
 *WBLD Orchard Lake, MI
 WBLI Patchogue, NY
 WBLK-FM Depew, NY
 WBLM Lewiston, ME
 WBLR-FM Batesburg, SC
 WBLN New York, NY
 WBLX Mobile, AL
 WBLY-FM Springfield, OH
 WBMC-FM McMinnville, TN
 WBMP Etowah, IN
 *WBMR Telford, PA
 *WBMU-FM Asheville, NC
 WBMX Oak Park, IL
 WBNC-FM Conway, NH
 WBNL-FM Boonville, IN
 WBNQ-FM Bryan, OH
 WBNQ Bloomington, IL
 WBNS-FM Columbus, OH
 WBNT-FM Oneida, TN
 WBNY Buffalo, NY
 WBOB-FM Galax, VA
 WBOC-FM Salisbury, MD
 *WBOE Cleveland, OH
 WBOP-FM Pensacola, FL
 WBOQ Terre Haute, IN
 *WBOR Brunswick, ME
 WBOS Brookline, MA
 WBOZ-FM Hormigueros, PR
 WBPM Kingston, NY
 WBPZ-FM Lock Haven, PA
 *WBQM Decatur, AL
 WBRB-FM Mount Clemens, MI
 WBRE-FM Wilkes-Barre, PA
 WBRK-FM Pittsfield, MA
 WBRN-FM Big Rapids, MI
 WBRQ Cidra, PR
 *WBRS Waltham, MA
 WBRU Providence, RI
 *WBSD Burlington, WI
 *WBSF Biddeford, ME
 WBSJ Ellisville, MS
 *WBSL Sheffield, MA
 *WBST Muncie, IN
 WBT-FM Charlotte, NC
 WBTO-FM Linton, IN
 WBTR-FM Carrollton, GA
 WBUF Buffalo, NY
 *WBUR Boston, MA
 WBUS Miami Beach, FL
 WBUS-FM Butler, PA
 *WBWC Berea, OH
 WBXB Edenton, NC
 *WBXL Baldwinville, NY
 WBYG-FM Kankakee, IL
 WBYO Boyertown, PA
 WBYQ Hendersonville, TN
 WBYN-FM Canton, IL
 WBYU New Orleans, LA
 WBZ-FM Boston, MA
 WBZA-FM Glens Falls, NY
 WBZI Xenia, OH
- WCAC Anderson, SC
 WCAD-FM San Juan, PR
 WCAK Caltletsburg, KY
 *WCAI-FM Northfield, MN
 WCAO-FM Baltimore, MD
 WCAR-FM Detroit, MI
 WCAU-FM Philadelphia, PA
 *WCBE Columbus, OH
 WCBK-FM Martinsville, IN
 WCBFL Benton, KY
 *WCBN-FM Ann Arbor, MI
 WCBR-FM Richmond, KY
 WCBF-FM New York, NY
 *WCBU Peoria, IL
 WCBW Columbia, IL
 WCBY-FM Cheboygan, MI
 WCCA McComb, MS
 WCCC-FM Hartford, CT
 *WCCF Buie's Creek, NC
 WCCF-FM Punta Gorda, FL
 WCCI Savanna, IL
 WCCK Erie, PA
 WCCN-FM Neillsville, WI
 WCCO-FM Minneapolis, MN
 WCCS Central City, PA
 WCCV-FM Charlottesville, VA
 WCCW-FM Traverse City, MI
 *WCDE Elkins, WV
 WCDL-FM Carbondale, PA
 *WCDR-FM Cedarville, OH
 *WCEB Corning, NY
 WCED-FM Du Bois, PA
 WCEH-FM Hawkinsville, GA
 WCFN-FM Mount Pleasant, MI
 WCFR-FM Charlotte, MI
 WCFR Clinton, TN
 *WCFM Williamstown, VA
 WCFR-FM Springfield, VT
 WCFW Chippewa Falls, WI
 WCGO Columbus, GA
 WCGY Lawrence, MA
 WCHK-FM Canton, GA
 WCHM Chambersburg, PA
 WCHN-FM Norwich, NY
 WCHO-FM Washington Court House, OH
 WCHO-FM Camuy, PR
 WCHR Trenton, NJ
 *WCHW-FM Bay City, MI
 WCIH Fallmouth, MA
 WCIG Mullins, SC
 WCIL-FM Carbondale, IL
 WCIR-FM Beckley, WV
 WCIS-FM Pascagoula, MS
 WCJM West Point, GA
 WCJO Jackson, OH
 WCKO Pompano Beach, FL
 WCKS Cocoa Beach, FL
 WCKW La Place, LA
 WCLA-FM Claxton, GA
 WCLD-FM Cleveland, MS
 WCLE-FM Cleveland, TN
 WCLG-FM Morgantown, WV
 *WCLH Wilkes-Barre, PA
 WCLI-FM Corning, NY
 *WCLK Atlanta, GA
 WCLR Skokie, IL
 WCLT-FM Newark, OH
 WCLV Cleveland, OH
 WCLW-FM Mansfield, OH
 WCMC-FM Wildwood, NJ
 WCMF Rochester, NY
 WCMJ Chester, SC
 WCMN-FM Arcadio, PR
 *WCMO Marietta, OH
 WCMQ-FM Hialeah, FL
 WCMO-FM Norfolk, VA
 WCMT-FM Martin, TN
 *WCMU-FM Mount Pleasant, MI
 WCMX Fort Wayne, IN
 WCNA-FM Scottsboro, AL
 WCNB-FM Connersville, IN
 *WCNE Batavia, OH
 WCNH-FM Quincy, FL
 *WCNI New London, CT
 WCNL-FM Newport, NH
 WCNW-FM Fairfield, OH
 *WCNY-FM Syracuse, NY
 WCOD-FM Hyannis, MA
 WCOE La Porte, IN
 WCOH-FM Newnan, GA
 WCOL-FM Columbus, OH
 WCOM-FM Urbana, OH
 WCON-FM Cornelia, GA
 WCOF-FM Boston, MA
 WCOF-FM Lebanon, TN
 WCOF-FM Columbia, SC
 WCOU-FM Lewiston, ME
 WCOV-FM Sparta, WI
 WCOZ Boston, MA
 WCPA-FM Clearfield, PA
 WCPM-FM Houston, MS

*WCPE Raleigh, NC
 WCPL Pageland, SC
 WCP5-FM Tarboro, NC
 WCRA-FM Effingham, IL
 WCRB Waltham, MA
 WCRD Bluffton, IN
 *WCRF Cleveland, OH
 WCRM-FM Clare, MI
 WCRS-FM Greenwood, SC
 WCRY-FM Macon, GA
 *WCSB Cleveland, OH
 WCCS Asheville, NC
 *WCSG Grand Rapids, MI
 WCSI-FM Columbus, IN
 WCSM-FM Celina, OH
 WCSN Louisville, KY
 *WCSO Central Square, NY
 WCSR-FM Hillsdale, MI
 WCSS-FM Amsterdam, NY
 WCST-FM Berkeley Springs, WV
 *WCSU-FM Wilberforce, OH
 WCTA-FM Andalusia, AL
 WCTL Union City, PA
 WCTO Smithtown, NY
 *WCTS-FM Minneapolis, MN
 WCTT-FM Corbin, KY
 WCTX Palmyra, PA
 WCTY Norwich, CT
 WCUE-FM Akron, OH
 WCUL Culppeper, VA
 WUCUM-FM Cumberland, MD
 WCUP Tifton, GA
 *WCUW Worcester, MA
 *WCVH Flemington, NJ
 WCVM Middlebury, VT
 *WCVQ Gahanna, OH
 *WCVT Towson, MD
 WCVU Naples, FL
 WWCW-FM Ripon, WI
 *WCWL Stockbridge, MA
 *WCWM Williamsburg, VA
 *WCWP Brookville, NY
 *WCWS Wooster, OH
 *WCWT-FM Centerville, OH
 *WCYC Chicago, IL
 WCVN-FM Cynthia, KY
 WDAC Lancaster, PA
 WDAI Chicago, IL
 WDAL-FM Meridian, MS
 WDAO Dayton, OH
 WDAR-FM Darlington, SC
 WDAS-FM Philadelphia, PA
 *WDVA Davidson, NC
 WDAY-FM Fargo, ND
 WDBA Du Bois, PA
 WDBI-FM Tawas City, MI
 WDBL-FM Springfield, TN
 WDBM-FM Statesville, NC
 WDBN Medina, OH
 WDBO-FM Orlando, FL
 WDBR Springfield, IL
 WDBS Durham, NC
 *WDCC-FM Sanford, NC
 WDCG Durham, NC
 WDCS Portland, ME
 *WDCV-FM Carlisle, PA
 WDCX Buffalo, NY
 WDDD Marion, IL
 WDDS-FM Syracuse, NY
 WDEA-FM Elyria, OH
 WDEB-FM Jamestown, TN
 WDEF-FM Chattanooga, TN
 WDEH-FM Sweetwater, TN
 WDEN-FM Macon, GA
 *WDEQ-FM De Graff, OH
 *WDET-FM Detroit, MI
 WDEZ Wausau, WI
 *WDFM State College, PA
 WDFP Battle Creek, MI
 *WDGC-FM Downers Grove, IL
 WDGM Leesburg, FL
 *WDGR Plainfield, VT
 WDHA-FM Dover, NJ
 WDHF Chicago, IL
 WDHK Wilmington, OH
 WDHQ Presque Isle, ME
 WDHK Pikeville, KY
 *WDHS Gaston, IN
 WDFJ Marion, OH
 WDX-FM Orangeburg, SC
 WDXI Orlando, FL
 WDJJ Birmingham, AL
 WDJW Westport, CT
 *WDJM-FM Framingham, MA
 WDJQ Baltimore, MD
 WDJR Oil City, PA
 WDKD-FM Kingstree, SC
 WDKN-FM Dickinson, TN
 WDKX Rochester, NY
 WDLA-FM Walton, NY
 WDLB-FM Marshfield, WI
 WDLG-FM Port Jervis, NY

WDLT Cleveland, MS
 WDMG-FM Douglas, GA
 WDMJ-FM Marquette, MI
 WDMP-FM Dodgeville, WI
 WDM5 Greenville, MS
 WDMT Cleveland, OH
 WDMW Menomonee, WI
 *WDNA Miami, FL
 WDNH Dover, NH
 WDNJ Daytona Beach, FL
 WDNS Bowling Green, KY
 *WDNX Olive Hill, TN
 WDOC-FM Prestonburg, KY
 WDDO-FM Chattanooga, TN
 WDOH Delphos, OH
 WDOCK-FM Cleveland, OH
 *WDOM Providence, RI
 WDROR-FM Sturgeon Bay, WI
 WDOH-FM Dowagiac, MI
 WDSY Dayton, OH
 WDOQ-FM Duquoin, IL
 WDRC-FM Hartford, CT
 WDRK Greenville, OH
 WDRM Decatur, AL
 WDRQ Detroit, MI
 WDRU Drew, MS
 WDCS-FM Dillion, SC
 WDSO Dover, DE
 WDTL Duluth, MN
 *WDTT Detroit, MI
 *WDUB Granville, OH
 WDUK Havana, IL
 *WDUQ Pittsburgh, PA
 WDUW Bradenton, FL
 WDUX-FM Waupaca, WI
 WDUZ-FM Green Bay, WI
 WDVV Pittsburgh, PA
 WDVV-FM Vineland, NJ
 WDVPR Philadelphia, PA
 WDWDF-FM Dawson, GA
 *WDWN Auburn, NY
 WDW5-FM Champaign, IL
 WDXE-FM Lawrenceburg, TN
 WDXL-FM Lexington, TN
 WDXL Chester, VA
 *WDYN-FM Chattanooga, TN
 *WEAA Baltimore, MD
 WEAH Eden, NC
 WEAJ Jacksonville, IL
 WEAS-FM Savannah, GA
 WEAT-FM West Palm Beach, FL
 WEAU-FM Eau Claire, WI
 WEFB Olean, NY
 WEBN Cincinnati, OH
 WEBO-FM Owego, NY
 WEBQ-FM Harrisburg, IL
 *WECI Richmond, IN
 WECI Elkhorn City, KY
 WECM Claremont, NH
 WECQ Geneva, NY
 *WECW Elmira, NY
 WEDA-FM Grove City, PA
 *WEDM Indianapolis, IN
 WEDR Miami, FL
 *WEEC Springfield, OH
 WEEE Taylorville, IL
 WEEI-FM Boston, MA
 WEEJ Port Charlotte, FL
 *WEEM Pendleton, IN
 WEEP-FM Pittsburgh, PA
 WEEB-FM Warrenton, VA
 WEEA Waukegan, IL
 WEEG Winchester, VA
 *WEGE Auburn, AL
 WEHH-FM Elmira, NY
 WEIC-FM Charleston, IL
 WEIV Ithaca, NY
 WEIZ Phenix City, AL
 *WEKU-FM Richmond, KY
 WEKZ-FM Monroe, WI
 WELA East Liverpool, OH
 WELF-FM Deland, FL
 WELM-FM Marshall, MI
 WELO-FM Tupelo, MS
 WELP-FM Easley, SC
 WELR-FM Roanoke, VA
 WELV-FM Ellenville, NY
 *WEMC Harrisonburg, VA
 WEMD-FM Easton, MD
 WEMM Huntington, WV
 WEMO East Moline, IL
 *WEMU Ypsilanti, MI
 WENC-FM Whiteville, NC
 WENN-FM Birmingham, AL
 WENY-FM Elmira, NY
 *WEO5-FM Geneva, NY
 *WEPR Greenville, SC
 *WEPS Elgin, IL
 WEOR Goldsboro, NC
 WERC-FM Birmingham, AL
 *WERG Erie, PA
 WERH-FM Hamilton, AL

WERI-FM Westerly, RI
 WERL-FM Eagle River, WI
 WERM Wapakoneta, OH
 *WERN Madison, WI
 *WERS Boston, MA
 WERT-FM Van Wert, OH
 WESC-FM Greenville, SC
 WESM Martinsburg, WV
 *WESN Bloomington, IL
 WESO-FM Southbridge, MA
 WESP-FM Cambridge, MD
 WESR-FM Tasley, VA
 *WESS East Stroudsburg, PA
 *WESU Middletown, CT
 *WETA-FM Washington, DC
 *WETD Alfred, NY
 *WETL South Bend, IN
 *WETN Wheaton, IL
 *WETS Johnson City, TN
 *WEVC Evansville, IN
 WEVD-FM New York, NY
 *WEVL Memphis, TN
 WEVR-FM River Falls, WI
 WEXM-FM Exmore, VA
 *WEXP Gadsden, AL
 WEYA Bayamon, PR
 WEZB New Orleans, LA
 WEZC Charlotte, NC
 WEZF Burlington, VT
 WEZG North Syracuse, NY
 WEZI Memphis, TN
 WEZK Knoxville, TN
 WEZL Charleston, SC
 WEZN Bridgeport, CT
 WEZO Rochester, NY
 WEZR Manassas, VA
 WEZS Richmond, VA
 WEZV Bethlehem, PA
 WEZW Wauwatosa, WI
 WEZX Scranton, PA
 WEZY-FM Cocoa, FL
 WEZZ Clanton, AL
 *WFAC Columbus, OH
 WFAH-FH Alliance, OH
 *WFAM Jacksonville, FL
 WFAW Washington, DC
 WFAU-FM Augusta, ME
 WFAV Cordele, GA
 WFAW-FM Fort Atkinson, WI
 WFBG-FM Greenville, SC
 *WFBG Flint, MI
 WFBG-FM Altoona, PA
 WFBQ Indianapolis, IN
 *WFCI Franklin, IN
 *WFCJ Miami Springs, OH
 *WFCR Amherst, MA
 *WFC5 New Britain, CT
 *WFDD-FM Winston-Salem, NC
 WFDK-FM Manchester, GA
 WFDL Columbia City, IN
 *WFDU Teaneck, NJ
 WFEW Ellwood City, PA
 WFFF-FM Columbia, MS
 WFFV Front Royal, VA
 *WFGH Fort Gay, WV
 WFGM Fairmont, WV
 *WFHC-FM Henderson, TN
 WFHG-FM Bristol, TN
 WFLA-FM Louisville, KY
 WFLD Rio Piedras, PR
 *WFLI Melbourne, FL
 *WFLU Bloomington, IN
 WFLW-FM Fairfield, IL
 WFLZ Conneaut, OH
 WFLA-FM Tampa, FL
 WFLC Canandaigua, NY
 WFLM Crown Point, IN
 WFLN-FM Philadelphia, PA
 WFLD-FM Farmville, VA
 WFLR-FM Dundee, NY
 WFLS-FM Fredericksburg, VA
 WFLY Troy, NY
 WFMA Rocky Mount, NC
 WFM5 Springfield, IL
 WFME Newark, NJ
 WFMF Baton Rouge, LA
 WFMH-FM Cullman, AL
 WFMJ Montgomery, AL
 WFMK East Lansing, MI
 WFML Washington, IN
 WFMN Newburgh, NY
 WFMF Fitchburg, MA
 *WFMQ Lebanon, TN
 WFMR Milwaukee, WI
 WFM5 Indianapolis, IN
 WFM5 Chicago, IL
 *WFMU East Orange, NJ
 WFMV-FM Blairtown, NJ
 WFMW-FM Madisonville, KY
 WKMX Statesville, NC
 WFMZ Allentown, PA
 WFNE Forsyth, GA

*WFNM Lancaster, PA
 WFNW Racine, WI
 WFOB-FM Fostoria, OH
 WFOG Suffolk, VA
 WFON Fond Du Lac, WI
 *WFOS Chesapeake, VA
 WFOX Gainesville, GA
 WFOY-FM St. Augustine, FL
 WFPG-FM Atlantic City, NJ
 *WFPK Louisville, KY
 *WFPL Louisville, KY
 WFRP-FM Hammond, LA
 WFRB-FM Frostburg, MD
 WFRD Hanover, NH
 WFRE Frederick, MD
 WFRI Auburn, AL
 WFRM-FM Freeport, IL
 WFRD-FM Fremont, OH
 WFRX-FM West Frankfort, IL
 WFSF-FM Franklin, NC
 WFSI Annapolis, MD
 WFSY-FM Caribou, ME
 *WFSU-FM Tallahassee, FL
 WFTA Fulton, MS
 WFTG-FM London, KY
 WFTM-FM Maysville, KY
 WFTW-FM Ft. Walton Beach, FL
 WFUL-FM Fulton, KY
 WFRU-FM Grand Rapids, MI
 *WFUV New York, NY
 WFUZ Ocala, FL
 WFWA-FM Fredericksburg, VA
 *WFWH Arlington Heights, IL
 WFWA Sullivan, IL
 WFYC-FM Alma, MI
 WFYN-FM Key West, FL
 WFYR Chicago, IL
 WGAL-FM Lancaster, PA
 WGAN-FM Portland, ME
 *WGAO Franklin, MA
 WGMT-FM Gate City, VA
 WGAZ-FM Washington, DC
 *WGBH Boston, MA
 WGBI-FM Scranton, PA
 WGBM Viroqua, WI
 *WGBP-FM Green Bay, WI
 *WGBW Green Bay, WI
 WGC8-FM Red Lion, PA
 WGC1 Chicago, IL
 WGCL Cleveland, OH
 WGCQ Buford, GA
 WGC8 Wellsboro, PA
 *WGCS Goshen, IN
 WGCY New Bedford, MA
 WGEA-FM Geneva, AL
 WGEF-FM Quincy, IL
 WGER-FM Bay City, MI
 WGET-FM Gettysburg, PA
 *WGEV Beaver Falls, PA
 WGF4-FM Watska, IL
 WGF8 Plattsburg, NY
 WGF8 Schenectady, NY
 WGGC Glasgow, KY
 *WGGG-FM Houghton, MI
 WGGP Castalia, OH
 WGGP Duluth, MN
 WGH-FM Newport News, VA
 WGHM-FM Grand Haven, MI
 *WGH5 Glen Elyn, IL
 WGR-FM Manchester, NH
 WGLB-FM Port Washington, WI
 WGLC-FM Mendota, IL
 WGLD-FM High Point, NC
 WGLF Tallahassee, FL
 WGLO Fort Lauderdale, FL
 *WGLS-FM Glassboro, NJ
 *WGLT Normal, IL
 WGLY Goulds, FL
 WGM5 Georgetown, SC
 *WGM6 Greece, NY
 WGM7 Tyrone, PA
 WGM5-FM Washington, DC
 WGMW Riviera Beach, FL
 WGMZ Flint, MI
 WGN1 Albany, NY
 WGN2-FM Gastonia, NC
 WGN3-FM Panama City, FL
 WGN4-FM Granite City, IL
 WGOH-FM Grayson, KY
 WGOK-FM Fairhope, AL
 WGOJ Lynchburg, VA
 WGOV Newton, MS
 WGOV-FM Valdosta, GA
 WGOV-FM Albany, GA
 WGRP Detroit, MI
 WGRD-FM Grand Rapids, MI
 *WGRE Greencastle, IN
 WGRG Pleasantville, NJ
 WGRG-FM Pittsfield, MA
 *WGRN Greenville, IL

FM Calls

WGPR-FM Greenville, PA
 WGR0 Buffalo, NY
 WGR1 Danville, IN
 *WGSU Geneseo, NY
 WGSY Peru, IL
 *WGTB-FM Washington, DC
 WGTG Bloomington, IN
 *WGTD Kenosha, WI
 WGTG-FM Toledo, OH
 WGTB Richlands, VA
 *WGTB-FM Takoma Park, MD
 *WGUC Cincinnati, OH
 WGTU-FM New Port Richey, FL
 WGTU-FM Augusta, GA
 *WGVG Gary, IN
 WGV1 Gainesville, FL
 *WGV0 Greenville, OH
 *WGWG Boiling Springs, NC
 *WGXN Dayton, OH
 WGY1 Vero Beach, FL
 WFTA Fulton, MS
 WHA1-FM Greenfield, MA
 WHAL-FM Shelbyville, TN
 WHAV-FM Haverhill, MA
 WHAW-FM Weston, WV
 WHAY Aberdeen, MS
 WHBC-FM Canton, OH
 WHBF-FM Rock Island, IL
 WHBI Newark, NJ
 WHBL-FM Sheboygan, WI
 WHBM Xenia, OH
 WHBN-FM Harrodsburg, KY
 WHCE-FM Orangeburg, SC
 WHCG Metter, GA
 *WHCJ Savannah, GA
 *WHCL-FM Clinton, NY
 WHCN Hartford, CT
 *WHCR Montgomery, AL
 WHCU-FM Ithaca, NY
 WHDG Havre De Grace, MD
 WHEB-FM Portsmouth, NH
 *WHEI Tiffin, OH
 WHER Hattiesburg, MS
 WHEW Fort Myers, FL
 WHEZ Huntington, WV
 WHEB-FM Benton Harbor, MI
 *WHFC Bel Air, MD
 WHFD Archbold, OH
 *WHFH Flossmoor, IL
 WHFI Jackson, MO
 WHFM Rochester, NY
 WHFS Bethesda, MD
 WHGM Bellwood, PA
 *WHHI Highland, WI
 WHHO-FM Hornell, NY
 WHHR Hilton Head Island, SC
 *WHHS Havertown, PA
 WHHY-FM Montgomery, AL
 WHIC-FM Hardinsburg, KY
 *WHIL-FM Mobile, AL
 WHIM-FM Providence, RI
 WHIN-FM Gallatin, TN
 WHIO-FM Dayton, OH
 WHIS-FM Bluefield, WV
 WHIZ-FM Zanesville, OH
 *WHJE Carmel, IN
 *WHJT Clinton, MS
 WHKK Erlanger, KY
 WHKY-FM Hickory, NC
 *WHLA Holmen, WI
 WHLD-FM Niagara Falls, NY
 WHLM-FM Bloomsburg, PA
 WHLO Canton, OH
 WHLT-FM Huntington, IN
 WHMA-FM Aniston, AL
 WHME South Bend, IN
 WHMH-FM Sauk Rapids, MN
 WHMP-FM Northampton, MA
 WHMQ Findlay, OH
 WHNE Birmingham, MI
 WHNN Bay City, MI
 WHOD-FM Jackson, AL
 WHOK-FM Lancaster, OH
 WHOO-FM Orlando, FL
 WHOP-FM Hopkinsville, KY
 WHOU-FM Youngstown, OH
 WHOU-FM Houlton, ME
 *WHOV Hampton, VA
 WHOW-FM Clinton, IL
 WHP-FM Harrisburg, PA
 *WHPC Garden City, NY
 WHPF-FM High Point, NC
 *WHPH Hanover, NJ
 *WHPK-FM Chicago, IL
 *WHPR Highland Park, MI
 WHRF-FM Cambridge, MA
 WHRL Albany, NY
 *WHRM Wausau, WI
 *WHRS Boynton Beach, FL

FM Calls

*WHRW Binghamton, NY
 *WHSB Brule, WI
 *WHSB Alpena, MI
 *WHSB Hinsdale, IL
 *WHSB Albany, NY
 *WHSN Bangor, ME
 *WHSR-FM Winchester, MA
 *WHSB Hamilton, OH
 *WHSY-FM Hattiesburg, MS
 *WHTB Talladega, AL
 *WHTC-FM Holland, MI
 *WHTG-FM Eatontown, NJ
 *WHTT Moline, IL
 *WHUB-FM Cookeville, TN
 *WHUC-FM Hudson, NY
 *WHUD Peekskill, NY
 *WHUG Jamestown, NY
 *WHUN-FM Huntingdon, PA
 *WHUR-FM Washington, DC
 *WHUS Storrs, CT
 *WHVW-FM Hyde Park, NY
 *WHWB-FM Rutland, VT
 *WHWC Colfax, WI
 *WHWE Howe, IN
 *WHYI Fort Lauderdale, FL
 *WHYL-FM Carlisle, PA
 *WHYN-FM Springfield, MA
 *WHYP-FM North East, PA
 *WIAA Interlochen, MI
 *WIAC-FM San Juan, PR
 *WIAI Danville, IL
 *WIAL Eau Claire, WI
 *WIAN Indianapolis, IN
 *WIBA-FM Madison, WI
 *WIBF-FM Jenkintown, PA
 *WBI Carlisle, NY
 *WIBO Waverly, OH
 *WIBQ Utica, NY
 *WIBS Charlotte Amalie, VI
 *WIBW-FM Topeka, KS
 *WIBZ Parkersburg, WV
 *WICB Ithaca, NY
 *WICN Worcester, MA
 *WICO-FM Salisbury, MD
 *WICR Indianapolis, IN
 *WICV Chicago, IL
 *WIDD-FM Elizabethton, TN
 *WIDE-FM Biddford, ME
 *WIDR Kalamazoo, MI
 *WIFC Wausau, WI
 *WIFE-FM Indianapolis, IN
 *WIFF-FM Auburn, IN
 *WIFI Philadelphia, PA
 *WIFM-FM Elkin, NC
 *WIFN Franklin, IL
 *WIFO-FM Jesup, GA
 *WIGL Miami, FL
 *WIGM-FM Medford, WI
 *WIGS-FM Gouverneur, NY
 *WIHN Normal, IL
 *WIHS Middletown, CT
 *WIKA Centerville, TN
 *WIKY-FM Evansville, IN
 *WIL-FM St. Louis, MO
 *WILE-FM Cambridge, OH
 *WILL-FM Urbana, IL
 *WILO-FM Frankfort, IN
 *WILQ-FM Williamsport, PA
 *WILS-FM Lansing, MI
 *WIMA-FM Lima, OH
 *WIMI Ironwood, MI
 *WINE-FM Brookfield, CT
 *WINK-FM Fort Myers, FL
 *WINZ-FM Miami Beach, FL
 *WIOF Waterbury, CT
 *WIOG Saginaw, MI
 *WIOK Hempstead, NY
 *WIOQ Philadelphia, PA
 *WIOT Toledo, OH
 *WIOV Ephrata, PA
 *WIOZ Southern Pines, NC
 *WIPE Americus, GA
 *WIPR-FM San Juan, PR
 *WIOB Ann Arbor, MI
 *WIOH Concord, MA
 *WIRB-FM Enterprise, AL
 *WIRJ-FM Humboldt, TN
 *WIRK-FM West Palm Beach, FL
 *WIRN Virginia, MN
 *WIRQ Rochester, NY
 *WIRX St. Joseph, MI
 *WISA-FM Isabela, PR
 *WISL-FM Shamokin, PA
 *WISM-FM Madison, WI
 *WISN-FM Milwaukee, WI
 *WISS-FM Berlin, WI
 *WISU Terre Haute, IN
 *WISZ-FM Glen Burnie, MD

*WITF-FM Hershey, PA
 *WITL-FM Lansing, MI
 *WITN-FM Washington, NC
 *WITO Ironton, OH
 *WITR Henrietta, NY
 *WITT Tuscola, IL
 *WITW Cadillac, MI
 *WITZ-FM Jasper, IN
 *WIUC Winchester, IN
 *WIUE Dayton, OH
 *WIUM Macomb, IL
 *WIUP-FM Indiana, PA
 *WIVA-FM Aguadilla, PR
 *WIVE-FM Ashland, VA
 *WIVI-FM Christiansted, VI
 *WIVK-FM Knoxville, TN
 *WIVY-FM Jacksonville, FL
 *WIXK-FM New Richmond, WI
 *WIXL-FM Newton, NJ
 *WIXN-FM Dixon, IL
 *WIXV Front Royal, VA
 *WIXX Green Bay, WI
 *WIYD-FM Palatka, FL
 *WIYQ Ebensburg, PA
 *WIZO-FM Franklin, TN
 *WIZR-FM Johnstown, NY
 *WJAC-FM Johnstown, PA
 *WJAD Bainbridge, GA
 *WJAG-FM Norfolk, NE
 *WJAI Eaton, OH
 *WJAT-FM Swainsboro, GA
 *WJAX-FM Jacksonville, FL
 *WJBD-FM Salem, IL
 *WJBI Clarksdale, MS
 *WJBL-FM Holland, MI
 *WJBM-FM Jerseyville, IL
 *WJBQ-FM Scarborough, ME
 *WJBR Wilmington, DE
 *WJBW-FM Hampton, SC
 *WJCD-FM Seymour, IN
 *WJCK Rensselaer, IN
 *WJCL-FM Savannah, GA
 *WJCR Washington, PA
 *WJCT-FM Jacksonville, FL
 *WJDB-FM Thomasville, AL
 *WJEE Jacksonville, FL
 *WJEF Lafayette, IN
 *WJEH-FM Gallipolis, OH
 *WJEJ-FM Hagerstown, MD
 *WJEL Indianapolis, IN
 *WJER-FM Dover-New Philadelphia, OH
 *WJFM Grand Rapids, MI
 *WJFR Jackson, MS
 *WJGA-FM Jackson, GA
 *WJGF Romney, WV
 *WJGS Houghton Lake, MI
 *WJHD Portsmouth, RI
 *WJHS Boston, MA
 *WJIG-FM Tullahoma, TN
 *WJIM-FM Lansing, MI
 *WJIV Cherry Valley, NY
 *WJIZ Albany, GA
 *WJJD-FM Chicago, IL
 *WJJM-FM Lewisburg, TN
 *WJJR-FM Mifflinburg, PA
 *WJJS-FM Lynchburg, VA
 *WJJW North Adams, MA
 *WJKL Elgin, IL
 *WJLC-FM South Boston, VA
 *WJLE-FM Smithville, TN
 *WJLK-FM Asbury Park, NJ
 *WJLM Salem, VA
 *WJLO Pensacola, FL
 *WJLY Mayoock, NC
 *WJMA-FM Orange, VA
 *WJMC-FM Rice Lake, WI
 *WJMD Bethesda, MD
 *WJMF Smithfield, RI
 *WJMI Jackson, MS
 *WJMJ Hartford, CT
 *WJML-FM Petoskey, MI
 *WJMM Versailles, KY
 *WJMT-FM Merrill, WI
 *WJMU Decatur, IL
 *WJNJ-FM Atlantic Beach, FL
 *WJNL-FM Johnstown, PA
 *WJNO-FM Palm Beach, FL
 *WJNR-FM Iron Mountain, MI
 *WJNS-FM Yazoo City, MS
 *WJOF Athens, AL
 *WJOI Pittsburgh, PA
 *WJOJ Picayune, MS
 *WJPA-FM Washington, PA
 *WJPD-FM Ishpeming, MI
 *WJRF-FM Detroit, MI
 *WJRE Kewanee, IL
 *WJRH Easton, PA
 *WJRS-FM Jamestown, KY
 *WJSC-FM Johnson, VT
 *WJSK Lumberton, NC
 *WJSM-FM Martinsburg, PA
 *WJSR Athens, GA

*WJSU Jackson, MS
 *WJSV Morristown, NJ
 *WJTO-FM Bath, ME
 *WJVL Janesville, WI
 *WJVM Sterling, IL
 *WJVS Cincinnati, OH
 *WJWF Columbus, MS
 *WJZS Tallahassee, FL
 *WJZZ Detroit, MI
 *WKAIF-FM Macomb, IL
 *WKAJ-FM Saratoga Springs, NY
 *WKAL-FM Rome, NY
 *WKAQ-FM San Juan, PR
 *WKAR-FM East Lansing, MI
 *WKAU-FM Kaukauna, WI
 *WKBB West Point, MS
 *WKBK-FM North Wilkesboro, NC
 *WKBJ-FM Ridgway, PA
 *WKBJ-FM Milan, TN
 *WKBK-FM Covington, TN
 *WKBN-FM Youngstown, OH
 *WKBV-FM Richmond, IN
 *WKBK-FM Hindman, KY
 *WKCC Grayson, KY
 *WKCF Shell Lake, WI
 *WKCI Hamden, CT
 *WKCO Gambier, OH
 *WKCO Saginaw, MI
 *WKCR-FM New York, NY
 *WKCS Knoxville, TN
 *WKCU-FM Corinth, MS
 *WKDA-FM Nashville, TN
 *WKDE-FM Altavista, VA
 *WKDJ Winchester, KY
 *WKDN-FM Camden, NJ
 *WKDO Henderson, KY
 *WKDU Philadelphia, PA
 *WKDZ-FM Cadiz, KY
 *WKEE-FM Huntington, WV
 *WKEB St. Petersburg, FL
 *WKET Kettering, OH
 *WKEU-FM Griffin, GA
 *WKEY-FM Covington, VA
 *WKFM Fulton, NY
 *WKFR-FM Battle Creek, MI
 *WKGK-FM Panama City, FL
 *WKGQ Cumberland, MD
 *WKHM-FM Jackson, MI
 *WKHS Worton, MD
 *WKIR Jackson, TN
 *WKIT Hendersonville, NC
 *WKJB-FM Mayaguez, PR
 *WKJF Cadillac, MI
 *WKJR-FM Muskegon Heights, MI
 *WKKB Manitowoc, WI
 *WKKC Chicago, IL
 *WKKD-FM Aurora, IL
 *WKKJ Green Cove Springs, FL
 *WKKM Harrison, MI
 *WKL-A-FM Ludington, MI
 *WKL-FM St. Albans, VT
 *WKLN Oneonta, AL
 *WKLH Montgomery, AL
 *WKLK-FM Cloquet, MN
 *WKLN Cullman, AL
 *WKL-FM Keyser, WV
 *WKLK Toledo, OH
 *WKLK Atlanta, GA
 *WKME Gardiner, ME
 *WKMO Kokomo, IN
 *WKMS-FM Murray, KY
 *WKMX Enterprise, AL
 *WKNC-FM Raleigh, NC
 *WKNH Keene, NH
 *WKNO-FM Memphis, TN
 *WKNF-FM Kent, OH
 *WKNU Brewton, AL
 *WKOC Kankakee, IL
 *WKOF Hopkinsville, KY
 *WKOG-FM Gordon, GA
 *WKOK-FM Sunbury, PA
 *WKOM Columbia, TN
 *WKOV-FM Wellston, OH
 *WKQZ-FM Kosciusko, MS
 *WKPS New Wilmington, PA
 *WKPT-FM Kingsport, TN
 *WKQO Lexington, KY
 *WKRA-FM Holly Springs, MS
 *WKRG-FM Mobile, AL
 *WKRO Cincinnati, OH
 *WKRT-FM Cortland, NY
 *WKRV Vandalia, IL
 *WKRX Roxboro, NC
 *WKSJ Eidorado, IL
 *WKSJ-FM Mobile, AL
 *WKSJ Greencastle, PA
 *WKSM Tabor City, NC
 *WKSJ Hartford-Meriden, CT
 *WKSU-FM Kent, OH
 *WKSU Cleveland, OH

WKTA McKenzie, TN
 WKTI Milwaukee, WI
 WKUJ-FM Farmington, ME
 WKTK Catonsville, MD
 *WKTJ Struthers, OH
 WKTM Charleston, SC
 WKTN-FM Kenton, OH
 WKTU New York, NY
 WKTZ-FM Jacksonville, FL
 WKUZ Wabash, IN
 WKVI-FM Knox, IN
 WKVO-FM Havelock, NC
 WKVT-FM Brattleboro, VT
 WKWI Kilmarnock, VA
 WKWK-FM Wheeling, WV
 WKWL Belvidere, IL
 *WKWZ Syosset, NY
 WKXA-FM Brunswick, ME
 WKXI Jackson, MS
 WKXL-FM Concord, NH
 WKXR-FM Exeter, NH
 WKYG-FM Parkersburg, WV
 WKYM Monticello, KY
 WKYO-FM Caro, MI
 WKYQ Paducah, KY
 WKYS Washington, DC
 WKYV-FM Vicksburg, MS
 WKYW Frankfort, KY
 *WKWZ Sarasota, FL
 WKZN Zion, IL
 WKZO Myrtle Beach, SC
 WLAC-FM Nashville, TN
 WLAD-FM Danbury, CT
 WLAG-FM La Grange, GA
 WLAK Chicago, IL
 WLAN-FM Lancaster, PA
 WLAP-FM Lexington, KY
 WLAT-FM Conway, SC
 WLAV-FM Grand Rapids, MI
 WLAX Stretator, IL
 WLAY-FM Muscle Shoals, AL
 WLBC-FM Muncie, IN
 WLBG-FM Laurens, SC
 WLBB-FM Mattoon, IL
 WLBJ-FM Bowling Green, KY
 WLBBK-FM De Kalb, IL
 *WLCA Godfrey, IL
 WLCCB-FM Hodgenville, KY
 *WLCC Lincoln, IL
 *WLCH Lebanon, TN
 WLCK-FM Scottsville, KY
 WLCL-FM Lowell, IN
 WLCY-FM St. Petersburg, FL
 WLDM Detroit, MI
 WLDR Traverse City, MI
 WLEC-FM Sandusky, OH
 WLEN Adrian, MI
 WLEQ Bonita Springs, FL
 WLET-FM Toccoa, GA
 WLEV Easton, PA
 WLEW-FM Bad Axe, MI
 *WLFC Findlay, OH
 *WLFM Appleton, WI
 WLFG Crawfordville, IN
 WLG-N-FM Logan, OH
 WLHN Anderson, IN
 WLIF Baltimore, MD
 WLII-FM New London, WI
 WLIL-FM Lenoir City, TN
 WLIN Jackson, MS
 WLIP-FM Kenosha, WI
 WLIR Garden City, NY
 *WLIU Lincoln University, PA
 WLIV-FM Livingston, TN
 WLJC Beatyville, KY
 WLJE Valparaiso, IN
 *WLJS-FM Jacksonville, AL
 WLKE-FM Waupun, WI
 WLKI Angola, IN
 *WLKL Mattoon, IL
 WLKM-FM Three Rivers, MI
 WLKN-FM Lincoln, ME
 WLKR-FM Norwalk, OH
 WLKW-FM Providence, RI
 WLLI-FM Joliet, IL
 WLLS-FM Hartford, KY
 WLMC Oketchobee, FL
 *WLMH Morrow, OH
 WLN-FM Sag Harbor, NY
 WLNH-FM Laconia, NH
 WLNO London, OH
 WLNK Lansing, IL
 *WLNK Lincoln, IL
 WLOA-FM Braddock, PA
 WLOC-FM Munfordville, KY
 WLOL-FM Minneapolis, MN
 WLOO Chicago, IL
 WLOQ Winter Park, FL
 WLOS-FM Asheville, NC
 WLOV-FM Washington, GA
 WLOW-FM Aiken, SC
 WLPL Baltimore, MD
 WLPO-FM La Salle, IL

WLPR Mobile, AL
 WLQA Cincinnati, OH
 WLQR Toledo, OH
 WLOY-FM Fort Pierce, FL
 *WLR A Lockport, IL
 WLRB Rehoboth Beach, DE
 WLRG Roanoke, VA
 *WLRH Huntsville, AL
 *WLRN-FM Miami, FL
 WLRO Whitehall, MI
 WLSR Louisville, KY
 WLRW Champaign, IL
 WLSD-FM Big Stone Gap, VA
 WLSE-FM Wallace, NC
 WLSM-FM Louisville, MS
 WLSR Lima, OH
 WLST Marinette, WI
 *WLSU La Crosse, WI
 WLTA-FM Atlanta, GA
 *WLTJ Lowell, MA
 *WLTJ La Grange, IL
 *WLTJ Columbia, SC
 *WLTJ Lexington, VA
 WLUV-FM Loves Park, IL
 WLVE Baraboo, WI
 WLVI Hartford, CT
 *WLVF-FM Bethlehem, PA
 WLWV Erie, PA
 WLXN Lexington, NC
 WLXR La Crosse, WI
 WLYF Miami, FL
 WLYK Millford, OH
 WLYN-FM Lynn, MA
 WLYT Cleveland Heights, OH
 *WLYZ Memphis, TN
 WMAA-FM Middletown, WI
 WMAA-FM Washington, DC
 WMAA-FM Baltimore, MD
 WMAA-FM Springfield, MA
 WMAZ-FM Macon, GA
 WMBD-FM Peoria, IL
 *WMBI-FM Chicago, IL
 WMBJ Danville, IL
 WMBL-FM Morehead City, NC
 WMBN-FM Petoskey, MI
 *WMBW Chattanooga, TN
 WMC-FM Memphis, TN
 WMCB-FM Michigan City, IN
 WMCJ Statesboro, GA
 WMCJ Stuart, FL
 *WMCN Paris, OH
 *WMCN New Concord, OH
 WMCN-FM Oneida, NY
 *WMCU Miami, FL
 *WMCX West Long Branch, NJ
 WMD-C-FM Hazelhurst, MS
 WMD-FM Fajardo, PR
 *WMDP Milton, WI
 WMDH New Castle, IN
 WMDI McKean, PA
 *WMEA Portland, ME
 *WMEB-FM Orton, ME
 WMEF Fort Wayne, IN
 *WMEH-FM Bangor, ME
 WMER Celina, OH
 WMEV-FM Marion, VA
 WMEZ Pensacola, FL
 WMF-FM Monroeville, AL
 WMF-FM Wilmington, NC
 WMG-FM Hibbing, MN
 WMG-FM Daytona Beach, FL
 *WMPF Medford, MA
 WMPR-FM High Point, NC
 WMGE Danville, KY
 WMGH Vevay, IN
 WMGK Philadelphia, PA
 WMGL Pulaski, TN
 WMGM Atlantic City, NJ
 WMGZ Montgomery, AL
 *WMHB Waterline, ME
 *WMHC South Hadley, MA
 WMHE Toledo, OH
 *WMHK Columbia, SC
 WMHR Syracuse, NY
 *WMHS Morrison, IL
 *WMHT Shenectady, NY
 *WMHW-FM Mount Pleasant, MI
 WMIC-FM Sandusky, MI
 WMIK-FM Middleboro, KY
 *WMPJ Warrenton, NC
 WMIT Black Mountain, NC
 WMIV South Bristol Township, NY
 WMIX-FM Mt. Vernon, IL
 WMJD Grundy, VA
 WMJS Prince Frederick, MD
 WMJW Nanticoke, PA
 WMJX Miami, FL
 WMKC Oshkosh, WI
 *WMKY Morehead, KY
 WMLD Manati, PR
 *WMLN-FM Milton, MA

FM Calls

WMLP-FM Milton, PA
 WMLS-FM Sylacauga, AL
 *WMMC North Andover, MA
 WMMG Brandenburg, KY
 WMMR Philadelphia, PA
 WMS Cleveland, OH
 WNN-FM Gretna, VA
 WNNB-FM North Adams, MA
 WNNC-FM Morgan, NC
 WNNI-FM Columbus, OH
 *WNNR Monroe, CT
 WMOA-FM Marietta, OH
 WMOD Washington, DC
 WMOR-FM Morehead, KY
 *WMOU Murfreesboro, TN
 *WMPG Gorham, ME
 *WMPH Wilmington, DE
 WMPI Scottsburg, IN
 WMPL-FM Hancock, MI
 WMPQ-FM Middleport, OH
 *WMPR Sumter, SC
 WMPSS-FM Memphis, TN
 WMPST-FM S. Williamsport, PA
 WMQT Ishpeming, MI
 *WMRA Harrisonburg, VA
 WMRF-FM Lewiston, PA
 WMRI Marion, IN
 WMRN-FM Marion, OH
 WMRO Brookhaven, MS
 *WMRT Marietta, OH
 WMRV Endicott, NY
 WMRV East St. Louis, IL
 *WMSB Mississippi State, MS
 *WMSC Upper Montclair, NJ
 WMSG-FM Oakland, MD
 WMSK-FM Morganfield, KY
 *WMSF Harrisburg, PA
 WMSR-FM Manchester, TN
 WMSU-FM Mt. Sterling, KY
 WMSU-Hattiesburg, MS
 WMT-FM Cedar Rapids, IA
 WMTF-FM Manistee, MI
 *WMTF Stowe, VT
 *WMTK Park Ridge, IL
 WMTL-FM Leitchfield, KY
 WMTM-FM Moultrie, GA
 WMTQ Mt. Washington, NH
 WMTS-FM Murfreesboro, TN
 *WMUA Amherst, MA
 *WMUB Oxford, OH
 *WMUH Allentown, PA
 *WMUK Kalamazoo, MI
 *WMUL Huntington, WV
 WMUM Marathon, FL
 WMUS-FM Muskegon, MI
 WMUU-FM Greenville, SC
 WMUZ Detroit, MI
 WMVA-FM Martinsville, VA
 WMVB-FM Millville, NJ
 WMVG-FM Milledgeville, GA
 WMVO-FM Mount Vernon, OH
 WMVY-FM Sidney, OH
 *WMXM Lake Forest, IL
 WMYB-FM Myrtle Beach, SC
 WMYK Elizabeth City, NC
 WMYN New Bedford, MA
 WMZK Detroit, MI
 WNAN Demopolis, AL
 WNAP Indianapolis, IN
 *WNAS New Albany, IN
 WNAA-FM New Albany, MS
 WNAV-FM Annapolis, MD
 *WNAZ-FM Nashville, TN
 WNB1-FM Park Falls, WI
 WNBX-FM Keene, NH
 WNCB Burlington, NC
 WNCI Columbus, OH
 WNCN New York, NY
 WNCQ-FM Ashland, OH
 WNCQ Watertown, NY
 WNCU-FM Greenville, NC
 *WNCY Springdale, ME
 WND A Huntsville, AL
 WNDH Napoleon, OH
 WNDU-FM South Bend, IN
 WNDY Crawfordsville, IN
 *WNEC-FM Henniker, NH
 WNES-FM Central City, KY
 WNEW-FM New York, NY
 WNEZ Aiken, SC
 WNFM Dayton, TN
 WNGC Athens, GA
 *WNHS Portsmouth, VA
 *WNHU West Haven, CT
 WNHV-FM White River Junction, VT
 WNI B Chicago, IL
 WNIC-FM Dearborn, MI
 WNIK-FM Arcibo, PR
 WNIL-FM Niles, MI
 WNIS-FM Chicago, IL
 *WNIU-FM De Kalb, IL

*WNJC-FM Senatobia, MS
 WNKO Newark, OH
 WNLA-FM Indiana, MS
 WNLF-FM Norwalk, CT
 WNMB N. Myrtle Beach, SC
 *WNMR Marquette, MI
 WNNN Canton, NJ
 WNNQ-FM Wisconsin Dells, WI
 WNN S Louisville, KY
 WNN T-FM Warsaw, VA
 WNOE-FM New Orleans, LA
 WNOI Flora, IL
 WNOK-FM Columbia, SC
 WNON Lebanon, IN
 WNOR-FM Norfolk, VA
 WNOP-FM Philadelphia, OH
 *WNRC Dudley, MA
 WNRE-FM Circleville, OH
 WNRR Bellevue, OH
 *WN S Cincinnati, OH
 WNSL-FM Laurel, MS
 *WNTE Mansfield, PA
 *WNTH Winnetka, IL
 *WN T Hackettstown, NJ
 *WNUB-FM Northfield, VT
 WNUF New Kensington, PA
 *WNUR Evanston, IL
 WNUW Milwaukee, WI
 WNV A-FM Norton, VA
 *WNWC Madison, WI
 *WNWR Canal Fulton, OH
 WNW S-FM New York, NY
 WNWY-FM Norway, ME
 WNX T-FM Portsmouth, OH
 *WNYC-FM New York, NY
 *WNYE New York, NY
 *WN YU-FM New York, NY
 WOAB Ozark, AL
 *WOAK Royal Oak, MI
 WOAP-FM Owosso, MI
 WOAY-FM Oak Hill, WV
 *WOBC-FM Oberlin, OH
 WOBN Toms River, NJ
 *WOBN Westerville, OH
 WOBR-FM Wanchese, NC
 WOCB-FM West Yarmouth, MA
 *WOCG Huntsville, AL
 WOCH-FM North Vernon, IN
 WOCO-FM Ocoont, WI
 *WOCC Olivet, MI
 WOFM Greeneville, TN
 WOGM Bellefontaine, OH
 WOH S-FM Shelby, NC
 *WOI-FM Ames, IA
 WOIV Deruyter Township, NY
 WOJO Evanston, IL
 WOKA-FM Douglas, GA
 WOKI-FM Oak Ridge, TN
 WOKN Goldsboro, NC
 WOKU-FM Greensburg, PA
 WOKZ-FM Alton, IL
 WOLA-FM Carolina, PR
 WOLD-FM Marion, VA
 WOLI Ottawa, IL
 WOMA Tallahassee, FL
 WOMB Detroit, MI
 WOMP-FM Bellaire, OH
 WONA-FM Winona, MS
 *WONC Napierville, IL
 WONO Syracuse, NY
 WONT Oneonta, NY
 *WONY Oneonta, NY
 WOOD-FM Grand Rapids, MI
 WOOF-FM Dothan, AL
 WOOR Oxford, MS
 *WOPR Oak Park, MI
 WORA-FM Mayaguez, PR
 WORJ-FM Mount Dora, FL
 WOR K Barre, VT
 WORM-FM Savannah, TN
 WORO Corozal, PR
 *WORT Madison, WI
 *WORW Port Huron, MI
 WORX-FM Madison, IN
 WOSH Oshkosh, WI
 WOSM Ocean Springs, MS
 *WOSS Ossining, NY
 *WOSU-FM Columbus, OH
 WOTB Middletown, RI
 WOTW-FM Nashua, NH
 *WOUB-FM Athens, OH
 WOUR Utica, NY
 WOVO Glasgow, KY
 WOVV Fort Pierce, FL
 WOVE Rossville, GA
 WOWI Norfolk, VA
 WOXR Oxford, OH
 WOYE-FM Mayaguez, PR
 *WPAA Andover, MA
 WPAB-FM Pince, PR
 WPAD-FM Paducah, KY

WPAG-FM Ann Arbor, MI
 WPAJ-FM Lancaster, SC
 WPAP-FM Panama City, FL
 WPAT-FM Paterson, NJ
 WPAY-FM Portsmouth, OH
 WPBF Middletown, OH
 WPBS Philadelphia, PA
 WPC H Atlanta, GA
 *WPCR Plymouth, NH
 *WPCS Pensacola, FL
 WPCV Winter Haven, FL
 WPD C-FM Elizabethtown, PA
 WPDH Poughkeepsie, NY
 WPD M-FM Potsdam, NY
 WPDFR-FM Portage, WI
 WPDFX-FM Clarkburg, WV
 *WPEA Exeter, NH
 WPEG Concord, NC
 WPEH-FM Louisville, GA
 *WPEL-FM Montrose, PA
 WPEM Pascagoula, MS
 WPEZ Pittsburg, PA
 *WPL Winter Park, FL
 WPFM Panama City, FL
 WPF R Terre Haute, IN
 *WPFW Washington, DC
 WPGA-FM Perry, GA
 WPGC-FM Morningside, MD
 WPGM Danville, PA
 *WPGT Roanoke Rapids, NC
 WPGU Urbana, IL
 WPGW-FM Portland, IN
 *WPH S-FM Warren, MI
 *WPIO Titusville, FL
 WPI T-FM Pittsburgh, PA
 WPX-FM New York, NY
 WPJB-FM Providence, RI
 *WPKN Bridgeport, CT
 WPKY-FM Princeton, KY
 WPLB-FM Greenville, MI
 WPLJ New York, NY
 WPLM-FM Plymouth, MA
 *WPLN Nashville, TN
 WPL O-FM Atlanta, GA
 WPLR New Haven, CT
 WPLZ Petersburg, VA
 WPM E-FM Punxsutawney, PA
 WPM P-FM Pascagoula, MS
 *WPN E-FM Green Bay, WI
 WPNH-FM Plymouth, NH
 *WPOB Plainville, NY
 WPOC Baltimore, MD
 WPOK-FM Pontiac, IL
 WPOR-FM Portland, ME
 WPOS-FM Holland, OH
 WPPL Blue Ridge, GA
 WPOR-FM Uniontown, PA
 WPRB Princeton, NJ
 WPRC-FM Lincoln, IL
 WPRE-FM Prairie Du Chien, WI
 *WPRK Winter Park, FL
 WPRM-FM San Juan, PR
 WPRO-FM Providence RI
 WPRP-FM Ponca, PR
 WPR T-FM Prestonburg, KY
 *WPSA Paul Smith's, NY
 *WPSL Lehman, PA
 *WPSR Evansville, IN
 WPST Trenton, NJ
 WPTH Fort Wayne, IN
 WPTM Roanoke Rapids, NC
 WPTN-FM Cookeville, TN
 WPTW-FM Piqua, OH
 WPUB-FM Camden, SC
 WPUR Americus, GA
 WPUV-FM Pulaski, VA
 WPV A-FM Petersburg, VA
 WPV R Roanoke, VA
 WPV R St. George, SC
 *WPP T Philadelphia, PA
 WPXI Charleston, SC
 WPXY Rochester, NY
 *WOAB Philippi, WV
 WOAL Cleveland, OH
 *WOAQ Hamden, CT
 WOBE Charleston, WV
 WOBF-FM Rensselaer, NY
 WOBS-FM San Juan, PR
 WOCM Halfway, MD
 WOCR Burlington, VT
 WOCY Quincy, IL
 WODR Raleigh, NC
 WODY-FM Calais, ME
 *WOED-FM Pittsburg, PA
 WOEN Gadsden, AL
 WOEZ Birmingham, AL
 WOFL Rockford, IL
 WQFM Milwaukee, WI
 *WQFS Greensboro, NC
 WQHI Jeffersonville, IN
 WQHL Live Oak, FL
 WQID Biloxi, MS

WQIK-FM Jacksonville, FL
 WQIX Horseheads, NY
 *WQLI Newbury, MA
 WQLK Richmond, IN
 *WQLN-FM Erie, PA
 WQLR Kalamazoo, MI
 WQLT Florence, AL
 WQLX Galion, OH
 WQMC Charlottesville, VA
 WQMG Greensboro, NC
 WQMR New Brunswick, NJ
 WQMS Hamilton, OH
 WQMU Indiana, PA
 WQMV Vicksburg, MS
 WQNZ Natchez, MS
 WQOD Youngstown, OH
 *WQOX Memphis, TN
 WQPM Princeton, MN
 WQPO Harrisonburg, VA
 WQOO Easton, PA
 WQOR Pittsfield, MA
 WQRC Barnstable, MA
 WQRK Norfolk, VA
 WQRS-FM Detroit, MI
 WQRX Benton, IL
 WQSB Albertville, AL
 WQSI Union Springs, AL
 WQSM Fayetteville, NC
 WQSR Sarasota, FL
 WQST Forest, MS
 *WQSU Selingsgrove, PA
 WQTC-FM Two Rivers, WI
 WQTI Dunn, NC
 *WOTO Hartford, CT
 WQUD Memphis, TN
 WQUE New Orleans, LA
 WQUH Defuniak Springs, FL
 WQUJ Johnson City, TN
 WQWK State College, PA
 WQWO-FM Muskegon, MI
 WQXA York, PA
 WQXE Elizabethtown, KY
 WQXI-FM Smyrna, GA
 WQXM Clearwater, FL
 WQXO Munising, MI
 WQXR-FM New York, NY
 WQXY-FM Baton Rouge, LA
 WQYK-FM St. Petersburg, FL
 WQYT Binghamton, NY
 WRAD-FM Radford, VA
 WRAJ-FM Anna, IL
 WRAK-FM Williamsport, PA
 WRAL Raleigh, NC
 WRAR-FM Tappahannock, VA
 *WRAS Atlanta, GA
 WRAY-FM Princeton, IN
 *WRBB Boston, MA
 WRBJ-FM St. Johns, MI
 WRBL-FM Columbus, GA
 WRBN-FM Warner Robins, GA
 WRBQ Tampa, FL
 WRBR South Bend, IN
 WRBS Baltimore, MD
 WRCC Cape Coral, FL
 WRCH-FM New Britain, CT
 *WR C Reading, OH
 WRCK-FM Sheffield, AL
 WRCM Jacksonville, NC
 WRCN-FM Riverhead, NY
 WRCO-FM Richland Center, WI
 WRCP-FM Philadelphia, PA
 WR CR Rustville, IN
 WRCS-FM Ahsokie, NC
 *WRCT Pittsburgh, PA
 *WRCU-FM Hamilton, NY
 WRCV Mercedburg, PA
 WRDB-FM Reedsburg, WI
 *WRDL Ashland, OH
 WRDN-FM Durand, WI
 WRDR Egg Harbor, NJ
 WRDX Salisbury, NC
 WREC-FM Memphis, TN
 WREI Quebradillas, PR
 *WREK Atlanta, GA
 WREM-FM Jenkins, KY
 WREO-FM Ashtabula, OH
 WREZ Buffalo, NY
 WRFE Aguada, PR
 *WRFG Atlanta, GA
 *WRFK-FM Richmond, VA
 WRFL Winchester, VA
 WRFM New York, NY
 *WRFN Nashville, TN
 WRFS Alexander City, AL
 *WRFW River Falls, WI
 WRFY-FM Reading, PA
 WRGA-FM Rome, GA
 WRGI-FM Naples, FL
 WRGT-FM Clarksburg, WV
 WRHL-FM Rochelle, IL
 WRHN Rhinetander, WI

*WRHO Oneonta, NY
 *WRHR Henrietta, NY
 *WRHS Park Forest, IL
 WRHY Starview, PA
 WRIF Detroit, MI
 WRIL Grenada, MS
 WRIO-FM Cape May, NJ
 *WRIU Kingston, RI
 WRJH Brandon, MS
 *WRJR Lewiston, ME
 WRKB-FM Kannapolis, NC
 *WRKC Wilkes-Barre, PA
 WRKD-FM Rockland, ME
 WRKM-FM Carthage, TN
 WRKR-FM Racine, WI
 WRKT-FM Cocoa Beach, FL
 WRKY Steubenville, OH
 WRLB Long Branch, NJ
 WRLM Taunton, MA
 WRLS-FM Hayward, WI
 WRLX Auburn, NY
 *WRMC-FM Middlebury, VT
 WRMF-FM Titusville, FL
 WRMI-FM Morris, IL
 WRMS-FM Beardstown, IL
 *WRMU Alliance, OH
 *WRNE-FM Houllton, ME
 WRNO New Orleans, LA
 WRNS Kinston, NC
 WRNW Briarcliff Manor, NY
 WR OA-FM Guilford, MS
 WR OE Neenah-Nenasha, WI
 WR OCHester, IN
 WR OM-FM Rome, GA
 WR OQ Charlotte, NC
 WR OR Boston, MA
 WR OW-FM Albany, NY
 WR PC San German, PR
 *WRPI Troy, NY
 WRPM-FM Poplarville, MS
 *WRPN-FM Ripon, WI
 *WRPS Rockland, NC
 WRQB Greensboro, NC
 WRQN Westbrock, ME
 WROR Farmville, NC
 WRR-FM Dallas, TX
 *WRRG River Grove, IL
 *WRRH Franklin Lakes, NJ
 WRRN Warren, PA
 WRRZ-FM Clinton, NC
 WRSA Decatur, AL
 *WRSB Weston, MA
 *WRSE-FM Elmhurst, IL
 *WRSF Miamisburg, OH
 *WRSH Rockingham, NC
 WRS L-FM Stamford, KY
 WRS O-FM Geneseo, IL
 *WRST-FM Oshkosh, WI
 *WRSU-FM New Brunswick, NJ
 WRSV Rocky Mount, NC
 WRSW-FM Warsaw, IN
 *WRTC-FM Hartford, CT
 *WRTE Cahokia, IL
 *WRTI Philadelphia, PA
 WRTL-FM Rantoul, IL
 WRTM Blountstown, FL
 *WRUC Schenectady, NY
 WRUF-FM Gainesville, FL
 WRUL Carmi, IL
 WRUM-FM Rumford, ME
 WRUN-FM Utica, NY
 *WRUR-FM Rochester, NY
 WRUT Rutland, VT
 *WRUV Burlington, VT
 *WRUW-FM Cleveland, OH
 *WRVG Georgetown, KY
 WRVM Suring, WI
 *WRVO Oswego, NY
 WRVQ Richmond, VA
 WRVR New York, NY
 *WRVU Nashville, TN
 WRWC Rockton, IL
 WRWR-FM Port Clinton, OH
 WRXL Richmond, VA
 WRXX Centuria, IL
 WRYO Crystal River, FL
 WRYZ-FM Jupiter, FL
 WSAB Mt. Carmel, IL
 WSAC-FM Fort Knox, KY
 *WSAE Spring Arbor, MI
 WSAI-FM Cincinnati, OH
 *WSAJ-FM Grove City, PA
 WSAL-FM Logansport, IN
 WSAQ Port Huron, MI
 WSB-FM Atlanta, GA
 WSB A-FM York, PA
 *WSBF-FM Clemson, SC
 WSBI-FM Brunswick, GA

FM Calls

- *WSBU St. Bonaventure, NY
 *WSCB Springfield, MA
 *WSSC Somerset, KY
 *WSCD-FM Duluth, MN
 WSCB Aurora, IN
 *WSCI Charleston, SC
 WSCQ West Columbia, SC
 WSDM Chicago, IL
 *WSDP Plymouth, MI
 WSEA Georgetown, DE
 WSEC Williamston, NC
 WSEI Olney, IL
 WSEK Somerset, KY
 WSEL-FM Pontotoc, MS
 WSEN-FM Baldwinville, NY
 WSEV-FM Sevierville, TN
 WSEZ Winston-Salem, NC
 WSLF Bridgeton, NC
 WSMF Harrisburg, PA
 WSWF-FM Seneca Falls, NY
 WSGC-FM Elberton, GA
 WSGF Savannah, GA
 WSGH-FM Winston-Salem, NC
 WSGM Staunton, VA
 WSGO-FM Oswego, NY
 *WSGR-FM Port Huron, MI
 WSGS Hazard, KY
 *WSHA Raleigh, NC
 *WSHC Shepherdstown, WV
 WSHC-FM Fort Lauderdale, FL
 WSHG Georgetown, SC
 WSHH Pittsburgh, PA
 *WSHJ Southfield, MI
 *WSHL-FM Easton, MA
 WSHN-FM Fremont, MI
 *WSHR Lake Ronkonkoma, NY
 *WSHS Sheboygan, WI
 *WSHU Fairfield, CT
 WSHV South Hill, VA
 WSHY-FM Shelbyville, IL
 *WSIE Edwarsville, IL
 WSIK Red Bank, TN
 WSIJ-FM Paintsville, KY
 *WSIU Carbondale, IL
 WSIW-FM Pekin, IL
 WSIW-FM Nashville, TN
 WSIJ-FM Magee, MS
 *WSKB Westfield, MA
 *WSKG-FM Binghamton, NY
 WSKP-FM Sebring, NY
 WSKV Stanton, KY
 WSLP Peterborough, NH
 WSLM-FM Salem, IN
 *WSLN Delaware, OH
 WSLT-FM Ocean City-Somers Point, NJ
 *WSLU Canton, NY
 *WSLX New Canaan, CT
 WSLY York, AL
 WSM-FM Nashville, TN
 *WSMC-FM Collegedale, TN
 WSMF-FM La Plata, MD
 WSMF-FM Sanford, ME
 *WSMH-FM Lancaster, NY
 WSMI-FM Litchfield, IL
 WSMJ Greenfield, IN
 WSMN Sault Ste. Marie, MI
 *WSMR Dayton, OH
 WSMT-FM Sparta, TN
 WSMU-FM Starkville, MS
 *WSND-FM Notre Dame, IN
 WSNJ-FM Bridgeton, NJ
 WSNF-FM Sandersville, GA
 WSOC-FM Charlotte, NC
 WSOJ-FM Jesup, GA
 WSOJ-FM Salem, OH
 *WSOR Fort Myers, FL
 *WSOU South Orange, NJ
 WSOY-FM Decatur, IL
 WSPA-FM Spartanburg, SC
 WSPB-FM Sarasota, FL
 *WSPH Baltimore, MD
 WSPK Poughkeepsie, NY
 WSPN La Crosse, WI
 *WSPN Saratoga Springs, NY
 *WSPS Concord, NH
 WSPF-FM Stevens Point, WI
 WSPY Plano, IL
 WSRN San Juan, PR
 WSRK Oneonta, NY
 *WSRN-FM Swarthmore, PA
 WSRW Worcester, MA
 WSRW-FM Hillsboro, OH
 *WSRX Allendale, MI
 WSSH Lowell, MA
 *WSSR Springfield, IL
 *WSSU Superior, WI
- *WSTB Streetsboro, OH
 WSTM St. Matthews, KY
 WSTN Florence, SC
 WSTO Owensboro, KY
 WSTR-FM Sturgis, MI
 WSTS Laurinburg, NC
 WSTW Wilmington, DE
 WSUB-FM Grotton, CT
 *WSUP Platteville, WI
 WSWF Franklin, NJ
 *WSUW Whitewater, WI
 WSUX-FM Seaford, DE
 WSWL-FM Shelbyville, IN
 WSVS-FM Crewe, VA
 WSWG-FM Greenwood, MS
 *WSWM Memphis, TN
 WSWN-FM Belle Glade, FL
 WSWT Peoria, IL
 WSWV-FM Pennington Gap, VA
 WSWW-FM Platteville, WI
 *WSYC-FM Shippensburg, PA
 WSYR-FM Syracuse, NY
 WTAE-FM Pittsburgh, PA
 WTAI-FM Melbourne, FL
 WTAM Gulfport, MS
 WTAN-FM Clearwater, FL
 WTAO Murphysboro, IL
 WTAR-FM Norfolk, VA
 WTAS Crete, IL
 WTAW-FM College Station, TX
 WTAY-FM Robinson, IL
 WTBG-FM Brownsville, TN
 WTBI McComb, MS
 *WTBS Cambridge, MA
 WTCA-FM Plymouth, IN
 *WTCC Springfield, MA
 WTCH-FM Shawano, WI
 WTCM-FM Traverse City, MI
 WTCO-FM Campbellsville, KY
 WTCQ Vidalia, GA
 WTCW-FM Whitesburg, KY
 WTFM Lake Success, NY
 WTGI Hammond, LA
 *WTGM Norfolk, VA
 *WTGN Lima, OH
 *WTGP Greenville, PA
 WTHI-FM Terre Haute, IN
 WTHJ Lobelville, TN
 WTHM-FM Lapeer, MI
 WTHO-FM Thomson, GA
 WTIB Iuka, MS
 WTIK-FM Hartford, CT
 WTIO Charleston, WV
 WTJM Pineville, KY
 *WTJU Charlottesville, VA
 WTKM-FM Hartford, WI
 WTKY-FM Tompkinsville, KY
 WTLB-FM Utica, NY
 WTLI Indianapolis, IN
 WTLN-FM Lake City, FL
 WTLN-FM Apopka, FL
 WTMF-FM Tomah, WI
 WTMJ Miami, FL
 WTNCF-FM Thomasville, NC
 WTNFS-FM Coshocton, OH
 WTOCF-FM Savannah, GA
 WTOF Canton, OH
 WTOFS-FM Skowhegan, ME
 WTOT-FM Marianna, FL
 WTPA-FM Harrisburg, PA
 *WTPC Elsie, IL
 WTPM Aguadilla, PR
 WTPR-FM Paris, TN
 WTQR Winston-Salem, NC
 WTRF-FM Greensburg, IN
 WTRF Wheeling, WV
 WTRS-FM Dunnellon, FL
 *WTRZ Springfield, MA
 WTSA-FM Brattleboro, VT
 WTSB-FM Lumberton, NC
 *WTSF-FM Potsdam, NY
 *WTSJ Drayton Plains, MI
 *WTSR Trenton, NJ
 WTTFC-FM Towanda, PA
 WTTFF-FM Tiffin, OH
 WTTN-FM Watertown, WI
 WTR-FM Westminster, MD
 *WTTU Cookeville, TN
 WTUB Troy, AL
 WTTUE Dayton, OH
 WTTUF Thomasville, GA
 *WTTU New Orleans, LA
 WTTU Selma, AL
 WTVL-FM Waterville, ME
 WTVN-FM Columbus, OH
 WTVR-FM Richmond, VA
 WTVY-FM Dothan, AL
 WTVW Urbana, IL
 WTVW Manning, SC
 WTVW Moncks Corner, SC
 WTVX Guntersville, AL
 WTVW New London, CT
- WTYL-FM Tyertown, MS
 WTZE-FM Tazewell, VA
 *WUAG Greensboro, NC
 *WUJL-FM Tuscaloosa, AL
 WUJL-FM Cincinnati, OH
 *WUEC Eau Claire, WI
 *WUFC Fort Kent, ME
 WUJF Lebanon, PA
 WUJN Albion, MI
 WUJN Midland, MI
 *WUHS Urbana, OH
 *WUHY-FM Philadelphia, PA
 *WUIC Chicago, IL
 *WUJC University Heights, OH
 WULA-FM Eufaula, AL
 *WUMF-FM Farmington, ME
 *WUNC Chapel Hill, NC
 *WUNF-FM Asheville, NC
 *WUNH Durham, NH
 WUOJ Tuscaloosa, AL
 *WUOG Athens, GA
 *WUOM Ann Arbor, MI
 *WUOT Knoxville, TN
 *WUPI Presque Isle, ME
 WUPR-FM Utah, PR
 WURD Georgetown, OH
 *WUSC-FM Columbia, SC
 *WUSF Tampa, FL
 *WUSM North Dartmouth, MA
 *WUSO Springfield, OH
 *WUTM Martin, TN
 *WUTS Sewanee, TN
 WUJN Marquette, MI
 WUUU Oak Ridge, TN
 WUVT-FM Blacksburg, VA
 *WUWM Milwaukee, WI
 *WVAC Adrian, MI
 WVAJ Charleston, WV
 WVAK-FM Paoli, IN
 WVAM-FM Altoona, PA
 *WVBC Bethany, WV
 WVBFB Framingham, MA
 WVBR-FM Ithaca, NY
 WVBFS Burgaw, NC
 *WVBU-FM Lewisburg, PA
 WVCA-FM Gloucester, MA
 WVCC Linesville, PA
 WVCD Hazleton, PA
 WVCM Carrollton, KY
 *WVCR-FM Loudonville, NY
 *WVCS California, PA
 *WVCY Milwaukee, WI
 WVFL-FM Fayette, AL
 WVEM Springfield, IL
 WVEN Franklin, PA
 *WVEP East Montpelier, VT
 WVEF Louisville, KY
 WVFV Lakeland, FL
 WVFV Dundee, IL
 *WVGR Grand Rapids, MI
 *WVGS Statesboro, GA
 *WVHC Hempstead, NY
 WVHF-FM Clarksburg, WV
 WVHI Evansville, IN
 *WVHP-FM Highland Park, NJ
 WVHR Hampton, VA
 *WVIA-FM Scranton, PA
 WVIC-FM East Lansing, MI
 *WVIK Rock Island, IL
 WVIN-FM Hammondsport, NY
 WVIP-FM Mount Kisco, NY
 WVIS Frederickstad, IL
 *WVJC-FM Mt. Carmel, IL
 WVJP-FM Caguas, PR
 *WVKC Galesburg, IL
 WVKO-FM Columbus, OH
 WVLC-FM Orleans, MA
 WVLD Monticello, IL
 WVLF-FM Lexington, KY
 WVLR Sauk City, WI
 *WVLS Jackson, MS
 WVMG-FM Cochran, GA
 *WVMH-FM Mars Hill, NC
 WVMO Monroe, MI
 *WVMW-FM Scranton, PA
 WVNA-FM Tusculumbia, AL
 WVNU-FM Newark, NJ
 WVNO-FM Mansfield, OH
 WVNS Tuskegee, AL
 *WVOF Fairfield, CT
 WVOH-FM Hazelhurst, GA
 WVOI Tisbury, MA
 WVOK-FM Birmingham, AL
 WVOR Rochester, NY
 WVOJ-FM Liberty, NY
 WVOT-FM Wilson, NC
 WVOV-FM Logan, WV
 WVOX-FM New Rochelle, NY
 *WVPB Beckley, WV
 WVPF-FM Monmouth, IL
 *WVPE Elkhart, IN
 WVPO-FM Stroudsburg, PA
 WVRY Waverly, TN
- WVSC-FM Somerset, PA
 *WVSH Huntington, IN
 *WVSS Monomonee, WI
 WVST Bolivar, TN
 *WVSU-FM Birmingham, AL
 *WVTC Randolph Center, VT
 WVTL Monticello, IN
 WVTS Terre Haute, IN
 *WVUB Vincennes, IN
 WVUD-FM Kettering, OH
 *WVUM Coral Gables, FL
 *WVUR-FM Valparaiso, IN
 *WVUS Putney, VT
 *WVVE Norristown, PA
 *WVVS Valdosta, GA
 WVVV Blacksburg, VA
 WVXV-FM Highland Park, IL
 *WVWV Buckhannon, WV
 *WVWR-FM Roanoke, VA
 *WVXU-FM Cincinnati, OH
 WVBA-FM St. Petersburg, FL
 WVBD-FM Bamberg, SC
 WVCK Flint, MI
 *WVCL Wesson, MS
 WVCM-FM Brazil, IN
 WVCT Peoria, IL
 WVWC Albany, GA
 WVDB Philadelphia, PA
 WVDC-FM Washington, DC
 WVDF-FM Scranton, PA
 WVDM-FM Sumter, SC
 WVDR-FM Murrreesboro, NC
 WVEL-FM Medford, MA
 WVEZ Cincinnati, OH
 WVFM Charleroi, PA
 WVGA Waynesboro, GA
 *WVGC Carrollton, GA
 WVGP-FM Sanford, NC
 WVHC Hartford City, IN
 *WVHI Muncie, IN
 *WVHS-FM Hampden-Sydney, VA
 WVIB Ladysmith, WI
 WVID Gainesville, GA
 WVIL Wilmington, NC
 WVJZ Mercer, PA
 WVJW Detroit, MI
 WVJO St. Cloud, MN
 WVJY South Bend, IN
 WVKI Kokomo, IN
 WVKJ Beaver Falls, PA
 WVLM-FM New Orleans, LA
 WVLA La Crosse, WI
 WVLM Canton, MS
 WVMM Minocqua, WI
 WVMM Arlington Heights, IL
 WVMO Reidsville, NC
 WVNO New Orleans, LA
 WVOC Avalon, NJ
 WVOD-FM Lynchburg, VA
 WVOG Boca Raton, FL
 WVOL-FM Buffalo, NY
 WVOM Albany, NY
 WVON-FM Woonsocket, RI
 *WVPH Princeton Junction, NJ
 *WVPT Westport, CT
 *WVPP-FM Colchester, VT
 *WVQC-FM Quincy, IL
 WVRH Columbus, GA
 WVRJ Southampton, NY
 WVRM Gaylord, MI
 WVRN West Palm Beach, FL
 WVRW Wisconsin Rapids, WI
 WVSC-FM Glens Falls, NY
 WVSE Jamestown, NY
 WVSH Philadelphia, PA
 WVSM Bay Minette, AL
 *WVSP Stevens Point, WI
 WVSR-FM St. Albans, VT
 WVST-FM Wooster, OH
 WVTR-FM Bethany Beach, DE
 *WVWJ West Hartford, CT
 WVVA-FM Wheeling, WV
 WVWR West Terre Haute, IN
 *WVWA Walpole, MA
 WVWB-FM Jasper, AL
 WVWJ Johnstown, OH
 WVWM Cleveland, OH
 WVWS Saginaw, MI
 WVWW Detroit, MI
 WVWY Columbus, IN
 WVWZ Summerville, SC
 WVXL-FM Manchester, KY
 WVYD White Plains, NY
 WVYZ Waterbury, CT
- *WXAC Reading, PA
 WXAX Elkhart, IN
 *WXBA Brentwood, NY
 WXBW-FM Milton, FL
 *WXCI Danbury, CT
 WXEL Slidell, LA
- WXEN Cleveland, OH
 WXEZ Sylvania, OH
 WXFM Elmwood Park, IL
 *WXGC Milledgeville, GA
 WXID Mayfield, KY
 WXIL Parkersburg, WV
 WXIS Erwin, TN
 WXIY Bay Springs, MS
 WXXV Allentown, PA
 WXXY Fairmont, NC
 WXXI-FM Dublin, GA
 WXXM Savannah, GA
 WXXO New York, NY
 WXXL Berlin, NH
 WXXR State College, PA
 WXXS Willimantic, CT
 WXXC Henderson, NC
 WXXO Plantation Key, FL
 *WXPB Philadelphia, PA
 WXXR Jacksonville, NC
 WXXA Woodbridge, VA
 WXXC Hickory, NC
 WXXR Woodstock, VA
 WXXR-FM Guayama, PR
 WXXI Norfolk, VA
 WXXI Chicago, IL
 WXXY Columbia, SC
 WXXA Greencastle, IN
 WXXC Charleston, SC
 WXXT Athens, OH
 WXXZ Indianapolis, IN
 WXXS Lafayette, IN
 *WXXI-FM Rochester, NY
 WXXY Montour Falls, NY
 WXXY Bayamon, PR
 WYAN-FM Upper Sandusky, OH
 WYBC-FM New Haven, CT
 WYCA Hammond, IN
 WYCH Hamilton, OH
 WYCR Hanover, PA
 *WYCS Yorktown, VA
 *WYDC Dix Hills, NY
 WYDD Pittsburgh, PA
 WYEN Des Plaines, IL
 *WYEP-FM Pittsburgh, PA
 WYEF Elkhart, IN
 WYFE-FM Winnebago, IL
 WYFI Norfolk, VA
 WYFM Sharon, PA
 WYGO-FM Carbin, KY
 WYII Williamsport, MD
 WYLD-FM New Orleans, LA
 *WYMS Milwaukee, WI
 WYNK-FM Baton Rouge, LA
 WYNO Chattanooga, TN
 WYNR-FM Brunswick, GA
 WYON Grand Rapids, MI
 WYOO-FM Richfield, MN
 WYOR Coral Gables, FL
 WYRL Melbourne, FL
 WYRS Stamford, CT
 WYSL-FM Buffalo, NY
 *WYSO Yellow Springs, OH
 WYSP Philadelphia, PA
 *WYSU Youngstown, OH
 WYTM-FM Fayetteville, TN
 WYVA-FM Yorktown, VA
 WYVW-FM Barboursville, KY
 WYXE Sun Prairie, WI
 WYZZ Raleigh, NC
 WYZZ Wilkes-Barre, PA
- WZAK Cleveland, OH
 WZAR Ponce, PR
 WZAT Savannah, GA
 *WZBC Newton, MA
 WZEE Madison, WI
 WZEE Nashville, TN
 WZFM Charles Town, WV
 WZGC Atlanta, GA
 WZID Manchester, NH
 WZLD Cayce, SC
 WZLE Lorain, OH
 *WZLY Wellesley, MA
 WZMF Monomonee Falls, WI
 WZND Zealand, MI
 WZOK Rockford, IL
 WZOL Luquillo, PR
 WZOT Rockmart, GA
 WZPR Meadville, PA
 WZRO Chicago, IL
 WZRO Pekin, IL
 WZTA Tamaqua, PA
 WZUU-FM Milwaukee, WI
 WZVS-FM Vieques, PR
 WZYO-FM Braddock Heights, MD
 *WZZE Hockessin, DE
 WZZK Birmingham, AL
 WZZM-FM Grand Rapids, MI
 WZZQ Jackson, MS
 WZZW Augusta, GA

Canadian AM Stations By Call Letters

CBA Moncton, N.B.
 CBAF Moncton, N.B.
 CBD Saint John, Ont.
 CBE Windsor, Ont.
 CBEF Windsor, Ont.
 CBF Montreal
 CBG Gander, Nfld.
 CBGA Matane, Que.
 CBTN Ste.-Anne-des-Monts,
 Que.
 CBH Halifax, N.S.
 CBI Sydney, N.S.
 CBJ Chicoutimi, Que.
 CBK Regina, Sask.
 CBL Toronto
 CBM Montreal
 CBN St. John's, Nfld.
 CBNA St. Anthony, Nfld.
 CBNM Marystown, Nfld.
 CBO Ottawa
 CBOF Ottawa
 CBQ Thunder Bay, Ont.
 CBR Calgary, Alberta
 CBT Grand Falls, Nfld.
 CBU Vancouver, B.C.
 CBV Quebec
 CBW Winnipeg, Man.
 CBX Edmonton, Alberta
 CBY Corner Brook, Nfld.
 CBZ Fredericton, N.B.

CFAB Windsor, N.S.
 CFAC Calgary, Alberta
 CFAM Altona, Man.
 CFAN Newcastle, N.B.
 CFAR Fin Flon, Man.
 CFAX Victoria, B.C.
 CFBC Saint John, N.B.
 CFBV Smithers, B.C.
 CFBV Smithers, B.C.
 CFCB Corner Brook, Nfld.
 CFCF Montreal
 CFCH North Bay, Ont.
 CFCL Timmins, Ont.
 CFCH Calgary, Alberta
 CFCH Chatham, Ont.
 CFCH Courtenay, B.C.
 CFCH Tuktoyaktuk, N.W.T.
 CFCH Camrose, Alberta
 CFCH Charlottetown, P.E.I.
 CFCH Victoriaville, Que.
 CFDR Dartmouth, N.S.
 CFED Chapais, Que.
 CFEK Ferris, B.C.
 CFFB Frobisher Bay, N.W.T.
 CFBG Happy Valley, Nfld.
 CFMG Richmond Hills, Ont.
 CFGN Port-aux-Basques, Nfld.
 CFGO Ottawa
 CFGP Grande Prairie, Alberta
 CFGR Gravelbourg, Sask.
 CFGT Alma, Que.
 CFJC Kamloops, B.C.
 CFJR Brockville, Ont.
 CFKC Creston, B.C.
 CFLD Burns Lake, B.C.
 CFLH Hearst, Ont.
 CFLK Kapuskasing, Ont.
 CFLM La Tuque, Que.
 CFLN Goose Bay, Nfld.
 CFLS Levis, Que.
 CFLV Valleyfield, Que.
 CFLW Wabush, Nfld.
 CFMB Montreal
 CFML Cornwall, Ont.
 CFMR Fort Simpson, N.W.T.
 CFNB Fredericton, N.B.
 CFNL Fort Nelson, B.C.
 CFNS Saskatoon, Sask.
 CFNW Port-au-Choix, Nfld.
 CFOB Fort Frances, Ont.
 CFOK Westlock, Alberta
 CFOM Ville Vanier, Que.
 CFOR Orillia, Ont.
 CFOS Owen Sound, Ont.
 CFOX Pointe Claire, Que.
 CFPA Thunder Bay, Ont.
 CFPL Prince Rupert, B.C.
 CFPR London, Ont.
 CFQC Saskatoon, Sask.

CFRA Ottawa
 CFRB Toronto
 *CFRG Kingston, Ont.
 CFRG Gravelbourg, Sask.
 CFRN Edmonton, Alberta
 CFRW Winnipeg, Man.
 CFRY Portage la Prairie, Man.
 CFLS Weyburn, Sask.
 CFSX Stephenville, Nfld.
 CFTJ Cambridge, Ont.
 CFTK Terrace, B.C.
 CFTR Toronto
 CFUN Vancouver, B.C.
 CFVR Abbotsford, B.C.
 CFWB Campbell River, B.C.
 CFWH Whitehorse, Y.T.
 CFYK Yellowknife, N.W.T.
 CHAB Moose Jaw, Sask.
 CHAD Amos, Que.
 CHAK Inuvik, N.W.T.
 CHAL St. Pamphile, Que.
 CHAM Hamilton, Ont.
 CHAP Longiac, Ont.
 CHAT Medicine Hat, Alberta
 CHCL Cold Lake, Alberta
 CHCM Marystown, Nfld.
 CHEC Lethbridge, Alberta
 CHED Edmonton, Alberta
 CHEF Gandy, Que.
 CHER Sydney, N.S.
 CHEX Peterborough, Ont.
 CHFA Edmonton, Alberta
 CHFC Churchill, Man.
 CHGB La Pocatiere, Que.
 CHIC Brampton, Ont.
 CHIN Toronto
 CHLC Hauterive, Que.
 CHLN Trois-Rivieres, Que.
 CHLO St. Thomas, Ont.
 CHLT Sherbrooke, Que.
 CHML Hamilton, Ont.
 CHNC New Carlisle, Que.
 CHNL Kamloops, B.C.
 CHNL-1 Clearwater, B.C.
 CHNO Sudbury, Ont.
 CHNR Simcoe, Ont.
 CHNS Halifax, N.S.
 CHOK Sarnia, Ont.
 CHOO Ajax, Ont.
 CHOV Pembroke, Ont.
 CHOW Wellans, Ont.
 CHPO Parksville-Qualicum,
 B.C.
 CHQB Powell River, B.C.
 CHOM Vancouver, B.C.
 CHOR Calgary, Alberta
 CHQT Edmonton, Alberta
 CHRC Quebec
 CHRD Drummondville, Que.
 CHRL Roberval, Que.
 CHRM Matane, Que.
 CHRS Longueil, Que.
 CHRT St. Elieuthere, Que.
 CHSC St. Catharines, Ont.
 CHSJ Saint John, N.B.
 CHSM Steinbach, Man.
 CHTK Prince Rupert, B.C.
 CHTM Thompson, Man.
 CHTN Charlottetown, P.E.I.
 CHUB Nanaimo, B.C.
 CHUC Cobourg, Ont.
 CHUM Toronto
 CHVD Dobeau, Que.
 CHWK Chilliwack, B.C.
 CHWO Oakville, Ont.
 CHYM Kitchener, Ont.
 CHYR Leamington, Ont.
 CHYR-7 Leamington, Ont.

CIGO Port Hawkesbury, N.S.
 CINL Princeton, B.C.
 CIOK St. Paul, Alberta
 CIVH Vanderhoof, B.C.

CJAD Montreal
 CJAF Cabano, Que.
 CJAN Asbestos, Que.
 CJAR The Pas, Man.
 CJAT Trail, B.C.
 CJAV Port Alberni, B.C.

CJBC Toronto
 CJBK London, Ont.
 CJBW Causapscal, Que.
 CJBQ Belleville, Ont.
 CJBK Rimouski, Que.
 CJCA Edmonton, Alberta
 CJCX Sydney, N.S.
 CJCH Halifax, N.S.
 CJCI Prince George, B.C.
 CJCJ Woodstock, N.B.
 CJCN Grand Falls, Nfld.
 CJCR Gander, Nfld.
 CJCS Stratford, Ont.
 CJDC Dawson Creek, B.C.
 CJDV Drumheller, Alberta
 CJEM Edmundston, N.B.
 CJEN St. Jerome, Que.
 CJFT Smiths Falls, Ont.
 CJFP Riviere-du-Loup, Que.
 CJFX Antigonish, N.S.
 CJGX Yorkton, Sask.
 CJIB Vernon, B.C.
 CJIC Sault Ste. Marie, Ont.
 CJJC Langley, B.C.
 CJKL Kirkland Lake, Ont.
 CJLA Lachute, Que.
 CJLM Joliette, Que.
 CJLS Yarmouth, N.S.
 CJMC Ste.-Anne-des-Monts,
 Que.
 CJMD Chibougamau, Que.
 CJME Regina, Sask.
 CJMR Mississauga, Ont.
 CJMS Montreal
 CJMT Chicoutimi, Que.
 CJNB North Battleford, Sask.
 CJNH Bancroft, Ont.
 CJNL Merril, B.C.
 CJNR Blind River, Ont.
 CJOB Winnipeg, Man.
 CJOC Lethbridge, Alberta
 CJOI Wetaskiwin, Alberta
 CJOK Fort McMurray, Alberta
 CJON St. John's, Nfld.
 CJOR Vancouver, B.C.
 CJOX Grand Bank, Nfld.
 CJOY Guelph, Ont.
 CJPR Blairmore, Alberta
 CJRB Boissevain, Man.
 CJRC Ottawa
 CJRL Kenora, Ont.
 CJRN Niagara Falls, Ont.
 CJRP Quebec
 CJRS Sherbrooke, Que.
 CJRW Summerside, P.E.I.
 CJSR Ste. Agathe des Monts,
 Que.
 CJSJ Estevan, Sask.
 CJSN Shaunavon, Sask.
 CJSO Sorel, Que.
 CJSJ Cornwall, Ont.
 CJTR Trois-Rivieres, Que.
 CJTT New Liskeard, Ont.
 CJVB Vancouver, B.C.
 CJVI Victoria, B.C.
 CJVL Ste.-Marie-de-Beauce,
 Que.
 CJVR Melfort, Sask.
 CJWA Wawa, Ont.
 CJYR Edson, Alberta

CKAC Montreal
 CKAD Middleton, N.S.
 CKAP Kapuskasing, Ont.
 CKAR Huntsville, Ont.
 CKAR-1 Parry Sound, Ont.
 CKAY Duncan, B.C.
 CKBB Barrie, Ont.
 CKBC Bathurst, N.B.
 CKBI Prince Albert, Sask.
 CKBM Montmagny, Que.
 CKBR Brooks, Alberta
 CKBS St. Hyacinthe, Que.
 CKBW Bridgewater, N.S.
 CKBX 100 Mile House, B.C.
 CKCB Collingwood, Ont.
 CKCH Hull, Que.
 CKCK Regina, Sask.
 CKCL Truro, N.S.
 CKCM St. Johns, Nfld.

CKCN Sept-Isles, Que.
 CKCO Quesnel, B.C.
 CKCR Revelstoke, B.C.
 CKCV Quebec
 CKCW Moncton, N.B.
 CKCY Sault Ste. Marie, Ont.
 CKDA Victoria, B.C.
 CKDH Amherst, N.S.
 CKDM Dauphin, Man.
 CKDR Dryden, Ont.
 CKDY Digby, N.S.
 CKEC New Glasgow, N.S.
 CKEK Cranbrook, B.C.
 CKEN Kentville, N.S.
 CKFY Toronto
 CKFH Toronto
 CKFL Lac Megantic, Que.
 CKGA Gander, Nfld.
 CKGB Timmins, Ont.
 CKGF Grand Forks, B.C.
 CKGM Montreal
 CKGO Hope, B.C.
 CKGR Golden, B.C.
 CKGY Red Deer, Alberta
 CKIM Baie Verte, Nfld.
 CKIQ Kelowna, B.C.
 CKJD Sarnia, Ont.
 CKKC Nelson, B.C.
 CKKR Rosetown, Sask.
 CKKW Kitchener, Ont.
 CKLB Oshawa, Ont.
 CKLC Kingston, Ont.
 CKLD Thetford Mines, Que.
 CKLG Vancouver, B.C.
 CKLM Montreal
 CKLR L'Annonciation, Que.
 CKLS La Sarre, Que.
 CKLW Windsor, Ont.
 CKLY Lindsay, Ont.
 CKMK MacKenzie, B.C.
 CKML Mont Laurier, Que.
 CKMP Midland, Ont.
 CKNB Campbellton, N.B.
 CKNL Fort St. John, B.C.
 CKNR Elliott Lake, Ont.
 CKNW New Westminster, B.C.
 CKNX Wingham, Ont.
 CKOB Renfrew, Ont.
 CKOC Hamilton, Ont.
 CKOK Penticton, B.C.
 CKOM Saskatoon, Sask.
 CKOO Osyoogo, B.C.
 CKOT Tilsonton, Ont.

Canadian FM Stations By Call

CBC-FM Charlottetown, P.E.I.
 CBF-FM Montreal
 CBFL-FM Maniwaki, Que.
 CBH-FM Halifax, N.S.
 CBHM-FM Richibucto, N.B.
 CBIM-FM Iles de la Madeleine,
 Que.
 *CBJ-FM Chicoutimi, Que.
 CBJE-FM Chicoutimi, Que.
 CBKO-FM Dawson Creek, B.C.
 CBL-FM Toronto
 CBM-FM Montreal
 CBN-FM St. John's, Nfld.
 CBO-FM Ottawa
 CBOF-FM Ottawa
 CBR-FM Calgary, Alberta
 CBU-FM Vancouver, B.C.
 CBUD-FM Bonnington, B.C.
 CBUF-FM Vancouver, B.C.
 *CBV-FM Quebec, Que.
 CBW-FM Winnipeg, Man.
 CFBC-FM Saint John, N.B.
 CFCA-FM Kitchener, Ont.
 CFCC-FM St. Andrews, Nfld.
 CFDL-FM Deer Lake, Nfld.
 CFDM-FM Drummondville,
 Que.
 CFFM-FM Kamloops, B.C.
 CFGL-FM Laval, Que.
 CFMC-FM Saskatoon, Sask.
 CFMI-FM New Westminster,
 B.C.
 CFMO-FM Ottawa
 CFMQ-FM Regina, Sask.
 CFMS-FM Victoria, B.C.

Canadian Calls

CKOV Kelowna, B.C.
 CKOX Woodstock, Ont.
 CKOY Ottawa
 CKPC Brantford, Ont.
 CKPG Prince George, B.C.
 CKPR Thunder Bay, Ont.
 CKPT Peterborough, Ont.
 CKQR Castlegar, B.C.
 CKRB St. Georges de Beauce,
 Que.
 CKRC Winnipeg, Man.
 CKRD Red Deer, Alberta
 CKRM Regina, Sask.
 CKRN Rouyn, Que.
 CKRS Jonquiere, Que.
 CKRV Drummondville, Que.
 CKRW Weyburn, Y.T.
 CKSA Lloydminster, Alberta
 CKSB St. Boniface, Man.
 CKSL London, Ont.
 CKSM Shawinigan, Que.
 CKSO Sudbury, Ont.
 CKSP Summerland, B.C.
 CKSW Swift Current, Sask.
 CKTA Taber, Alberta
 CKTB St. Catharines, Ont.
 CKTK Kitimondville, B.C.
 CKTL Plessisville, Que.
 CKTS Sherbrooke, Que.
 *CKUA Edmonton, Alberta
 CKVD Val-d'Or, Que.
 CKVL Verdun, Que.
 CKVM Ville-Marie, Que.
 CKVO Clarenceville, Nfld.
 CKVT Temiscaming, Que.
 CKWL Williams Lake, B.C.
 CKWS Kingston, Ont.
 CKWW Windsor, Ont.
 CKWX Vancouver, B.C.
 CKX Brandon, Man.
 CKXL Calgary, Alberta
 CKXR Salmon Arm, B.C.
 CKY Winnipeg, Man.
 CKYL Peace River, Alberta
 CKYR Jasper, Alberta
 VOAR St. John's, Nfld.
 VOAM St. John's, Nfld.
 VOVR St. John's, Nfld.

CFNN-FM St. Anthony, Nfld.
 CFPL-FM London, Ont.
 CFQR-FM Montreal
 *CFRC-FM Kingston, Ont.
 CFRN-FM Edmonton, Alberta
 *CFRW-FM Vancouver, B.C.
 CHEC-FM Lethbridge, Alberta
 CHEX-FM Peterborough, Ont.
 CHFI-FM Toronto
 CHF-FM Calgary, Alberta
 CHFV-FM Halifax, N.S.
 CHGB-FM La Pocatiere, Que.
 CHIC-FM Brampton, Ont.
 CHIN-FM Toronto
 CHIO-FM Winnipeg, Man.
 CHLT-FM Sherbrooke, Que.
 CHOM Westmount, Que.
 (Montreal)
 CHQM-FM Vancouver, B.C.
 CHRC-FM Ste-Foy, Quebec,
 Que.
 CHSC-FM St. Catharines, Ont.
 CHUM-FM Toronto
 CHUT-FM Chicoutimi, Que.
 CHYM-FM Kitchener, Ont.
 CJAT-FM Trail, B.C.
 CJBO-FM Belleville, Ont.
 CJBR-FM Rimouski, Que.
 CJCA-FM Edmonton, Alberta
 CJCB-FM Sydney, N.S.
 CJET-FM Smiths Falls, Ont.
 CJFM-FM Montreal
 CJIC-FM Sault Ste. Marie, Ont.

Canadian Calls, U.S. AM by Frequency

CJOB-FM Winnipeg, Man.
CJOM-FM Windsor, Ont.
CJOV-FM Kelowna, B.C.
CJOY-FM Guelph, Ont.
*CJRT-FM Toronto
CJSD-FM Thunder Bay, Ont.
CJSS-FM Cornwall, Ont.
*CJUS-FM Saskatoon, Sask.

CKCH-FM Hull, Que.
CKCL-FM Truro, N.S.
CKCY-FM Sault Ste. Marie, Ont.
CKDS-FM Hamilton, Ont.
CKFM-FM Toronto
CKGB-FM Timmins, Ont.
CKLA-FM Guelph, Ont.
CKLC-FM Kingston, Ont.
CKLG-FM Vancouver, B.C.
CKLW-FM Windsor, Ont.
CKMF-FM Montreal

CKAT-FM North Bay, Ont.
CKBY-FM Ottawa

CKOK-FM Penticton, B.C.
CKOT-FM Tillsonburg, Ont.
CKPC-FM Brantford, Ont.
CKQN-FM Baker Lake, N.W.T.
CKOS-FM Oshawa, Ont.
CKRD-FM Red Deer, Alberta
*CKRL-FM Quebec, Que.
CKSO-FM Sudbury, Ont.
CKTB-FM St. Catharines, Ont.
*CKUA-FM Edmonton, Alberta
CKVL-FM Verdun, Que.
CKWM-FM Kentville, N.S.
CKWR-FM Kitchener, Ont.
CKWS-FM Kingston, Ont.
CKX-FM Brandon, Man.
CKY-FM Winnipeg, Man.

Station	Power
KUBC Montrose, Colo. (III)	LS-5,000
WDBO Orlando, Fla. (III)	DA-N-1,000
WGAC Augusta, Ga. (III)	DA-N-5,000
	LS-5,000
	DA-N-1,000
KFXD Nampa, Idaho (III)	DA-N-5,000
*WILL Urbana, Ill. (III)	DA-D-5,000
*KSAC Manhattan, Kan. (III)	LS-5,000
	N-500
	ST-WIBW
WIBW Topeka, Kan. (III)	DA-N-5,000
	ST-*KSAC
	LS-5,000
KALB Alexandria, La. (III)	DA-N-1,000
WTAG Worcester, Mass. (III)	DA-2-5,000
WELO Tupelo, Miss. (III)	DA-2-LS-1,000
	N-500
	D-1,000
KANA Anaconda, Mont. (III)	D-500
WAGR Lumberton, N.C. (III)	D-500
WKSJ West Jefferson, N.C.	D-500
KCMX Ashland, Ore. (III)	DA-2-1,000
WHP Harrisburg, Pa. (III)	DA-N-5,000
	D-500
KOBH Hot Springs, S.D. (III)	D-500
WOFE Rockwood, Tenn. (III)	D-1,000
KDAV Lubbock, Tex. (III)	DA-D-500
WLES Lawrenceville, Va. (III)	D-500
WCHS Charleston, W. Va. (III)	DA-N-5,000
WKTY La Crosse, Wis. (III)	DA-2-LS-5,000
	N-1,000
WKAQ San Juan, P.R. (III)	5,000

U.S. A.M. Stations by Frequency

Hours of Operation—Key

CH—Critical hours.
CR—Canadian Restricted.
D—Daytime operation.
L—Limited time; operates night hours only when dominant station is operating in daylight.
LS—Until local sunset.
N—Nighttime operation.
SH—Specified hours.
ST—Shares time.
Where no hours of operation are indicated, station is on unlimited time with the power shown.

Other Abbreviations

CP—Construction permit.
DA-D—directional antenna daytime only.
DA-N—directional antenna nighttime only.
DA-1—directional antenna day and night.
DA-2—directional antenna with changing patterns, day and night.
DA-3—same as DA-2, with an additional pattern change.
Class of station is shown in parentheses. For explanation of classes see FCC Rules, Section A.

Station	Power
540 khz (Canadian) I-A	
KVIP Redding, Calif. (II)	D-1,000
WGTO Cypress Gardens, Fla. (II)	DA-2-D-50,000
	N-(CR)-10,000
WDAK Columbus, Ga. (II)	LS-5,000
	DA-N-500
KWMT Fort Dodge, Iowa (II)	DA-D-5,000
KNOE Monroe, La. (II)	DA-2-LS-5,000
	N-1,000
WDMV Pocomoke City, Md. (II)	D-500
WLIX Islip, N.Y. (II)	D-250
WETC Wendell-Zebulon, N.C. (II)	DA-D-5,000
WARO Canonsburg, Pa. (II)	DA-D-250
WYNN Florence, S.C. (II)	D-250
WDXN Clarksville, Tenn. (II)	D-1,000
KDLT Delta, Utah (II)	D-1,000
WRIC Richlands, Va. (II)	D-1,000
WYLO Jackson, Wis. (II)	DA-D-250

550 khz Regional

KENI Anchorage (III)	5,000
KOY Phoenix (II)	LS-5,000
	N-1,000
KAFY Bakersfield, Calif. (III)	DA-N-1,000
KRAI Craig, Colo. (III)	LS-5,000
	DA-N-500
WAYR Orange Park, Fla. (III)	D-1,000
WGGG Gainesville, Ga. (III)	LS-5,000
	DA-N-500
KMVI Wailuku, Hawaii (III)	5,000
KFRM Salina, Kan. (III)	DA-D-5,000
WCB1 Columbus, Miss. (III)	DA-2-LS-1,000
	N-500
KSD St. Louis (II)	DA-N-5,000
KBOW Butte, Mont. (III)	LS-5,000
	DA-N-1,000
	DA-N-5,000
WGR Buffalo, N.Y. (III)	D-500
WDBM Statesville, N.C. (III)	DA-N-5,000
KFYR Bismarck, N.D. (III)	DA-2-LS-5,000
WKRC Cincinnati (III)	N-1,000
	DA-2-5,000
	DA-2-1,000
*KOAC Corvallis, Ore. (III)	LS-1,000
WHLM Bloomsburg, Pa. (III)	DA-N-500
WNGG Pawtucket, R.I.	DA-N-500
KCRS Midland, Tex. (II)	DA-2-LS-5,000

Station	Power
KTSA San Antonio, Tex. (III)	N-1,000
WDEV Waterbury, Vt. (III)	DA-2-LS-5,000
	N-1,000
WSVA Harrisonburg, Va. (III)	LS-5,000
	DA-N-1,000
KARI Blaine, Wash. (III)	DA-2-LS-5,000
	N-1,000
WSAU Wausau, Wis. (III)	DA-2-5,000
WPAB Ponce, P.R. (II)	LS-5,000
	N-1,000

560 khz Regional

WOOF Dothan, Ala. (III)	D-5,000
KVOK Kodiak, Alaska	CP-1,000
KBLU Yuma, Ariz. (III)	DA-N-1,000
KSFO San Francisco (III)	LS-5,000
	N-1,000
KLZ Denver (III)	DA-5,000
WQAM Miami (III)	LS-5,000
	N-1,000
WIND Chicago (III)	DA-2-5,000
WMIK Middlesboro, Ky. (III)	D-500
WGAN Portland, Me. (II)	DA-5,000
WFRB Frostburg, Md. (II)	D-1,000
WHYN Springfield, Mass. (III)	DA-2-LS-5,000
	N-1,000
WHND Monroe, Mich. (III)	DA-D-500
WEBC Duluth, Minn. (III)	DA-2-5,000
KWTO Springfield, Mo. (III)	DA-N-5,000
KMON Great Falls, Mont. (III)	DA-N-5,000
WCKL Catskill, N.Y. (III)	DA-D-1,000
WGA1 Elizabeth City, N.C. (III)	DA-2-LS-1,000
	N-500
WFIL Philadelphia (III)	DA-2-5,000
WIS Columbia, S.C. (III)	DA-N-5,000
WHBO Memphis (III)	DA-2-LS-5,000
	N-1,000
KLVI Beaumont, Tex. (III)	DA-N-5,000
KPO Wenatchee, Wash. (III)	DA-N-5,000
WJLS Beckley, W. Va. (III)	LS-5,000
	DA-N-500

570 khz Regional

WAAX Gadsden, Ala. (III)	LS-5,000
	DA-N-500
KCNO Alturas, Calif. (III)	D-5,000
KLAC Los Angeles (III)	DA-N-LS-5,000
WFSO Pinellas Park, Fla. (III)	DA-D-500
WACL Waycross, Ga. (III)	LS-5,000
	DA-N-1,000
WKYX Paducah, Ky. (III)	DA-2-LS-1,000
	N-500
WGM5 Bethesda, Md. (III)	DA-2-LS-5,000
	N-1,000
WVMI Biloxi, Miss. (III)	D-1,000
KGRT Las Cruces, N.M. (III)	D-500
WMCA New York (III)	DA-5,000
WSYR Syracuse, N.Y. (III)	DA-2-5,000
WWNC Asheville, N.C. (III)	DA-N-5,000
WLEE Raleigh, N.C. (III)	D-500
WKBN Youngstown, Ohio (III)	DA-N-5,000
WNAX Yankton, S.D. (III)	DA-N-5,000
WFAA Dallas (III)	DA-2-5,000
KLUB Salt Lake City (III)	DA-5,000
KVI Seattle (III)	5,000
WMAM Marinette, Wis. (III)	LS-250
	N-100
KATB Agana, Guam (III)	CP-5,000

580 khz Regional

WBIL Tuskegee, Ala. (III)	D-500
*KYUK Bethel, Alaska (III)	5,000
KIKX Tucson, Ariz. (III)	LS-5,000
	DA-N-500
KMJ Fresno, Calif. (III)	5,000

590 khz Regional

WRAG Carrollton, Ala. (III)	D-1,000
KHAR Anchorage (III)	D-5,000
KBHS Hot Springs, Ark. (III)	D-5,000
KFXM San Bernardino, Calif. (III)	DA-2-1,000
KTHO S. Lake Tahoe, Calif. (III)	LS-1,000
	DA-N-500
KCSJ Pueblo, Colo. (III)	DA-N-1,000
WDLF Panama City, Fla. (III)	DA-N-1,000
WPL0 Atlanta (III)	DA-N-5,000
KGMB Honolulu (III)	5,000
KID Idaho Falls, Idaho (III)	LS-5,000
	DA-N-1,000
WRTH Wood River, Ill. (III)	LS-500
	DA-2-1,000
WVLC Lexington, Ky. (III)	DA-2-LS-5,000
	N-1,000
WEEI Boston (III)	DA-5,000
WJMS Ironwood, Mich.	LS-5,000
	DA-N-1,000
WKZO Kalamazoo, Mich. (III)	DA-N-5,000
KGLE Glendale, Mont. (III)	D-500
WOW Omaha (III)	5,000
WROW Albany, N.Y. (III)	DA-2-LS-5,000
	N-1,000
WCAB Rutherfordton, N.C.	D-500
WGTM Wilson, N.C. (III)	DA-2-5,000
KUGN Eugene, Ore. (III)	LS-5,000
	DA-N-1,000
WARM Scranton, Pa. (III)	DA-2-5,000
WMB5 Uniontown, Pa. (III)	DA-N-1,000
KLBJ Austin, Tex. (III)	LS-5,000
	DA-N-1,000
KSUB Cedar City, Utah (III)	DA-N-1,000
WLVA Lynchburg, Va. (III)	DA-2-1,000
KHQ Spokane, Wash. (III)	5,000

600 khz Regional

WIRB Enterprise, Ala. (III)	D-1,000
KRKM North Pole, Alaska (II)	DA-1,000
KCLS Flagstaff, Ariz. (III)	LS-5,000
	DA-N-500
KINC Independence, Calif. (III)	D-500
KVCV Redding, Calif. (III)	DA-1,000
KOGO San Diego (III)	DA-5,000
KIIX Fort Collins, Colo. (III)	D-1,000
WICC Bridgeport, Conn. (III)	DA-LS-1,000
	N-500
WMBR Jacksonville, Fla. (III)	DA-N-5,000
WMT Cedar Rapids, Iowa (III)	DA-N-5,000
WVOG New Orleans (III)	D-1,000
WFST Caribou, Me. (III)	D-5,000
WCAO Baltimore (III)	DA-5,000
WBDN Escanaba, Mich. (III)	DA-D-1,000
WTAC Flint, Mich. (III)	DA-2-LS-1,000
	N-500
KGEZ Kalispell, Mont. (III)	DA-2-1,000
WCVF Murphy, N.C. (III)	D-1,000
WSJS Winston-Salem, N.C. (III)	DA-2-5,000
KSJB Jamestown, N.D. (III)	DA-5,000
WSOM Salem, Ohio (III)	DA-D-500
WFRM Coudersport, Pa. (III)	D-1,000
WREC Memphis (III)	DA-2,500
KROD El Paso (III)	DA-N-5,000
KERB Kermit, Tex. (III)	DA-D-1,000
KTBB Tyler, Tex. (III)	DA-N-1,000
WVAR Richwood, W. Va.	D-1,000
WAEI Mayaguez, P.R. (III)	DA-1,000

Station Power

610 khz Regional

Table listing stations and power for 610 khz Regional, including WSKN Birmingham, Ala. (II), KAVL Lancaster, Calif. (III), KFRC San Francisco (III), WSNG Torrington, Conn. (III), WIOD Miami (III), WVIX Pensacola, Fla. (III), WCEH Hawkinsville, Ga. (III), WRUS Russellville, Ky. (III), KDAL Duluth, Minn. (III), WDAF Kansas City, Mo. (III), KOJM Havre, Mont. (III), KCSR Chadron, Neb. (III), WGIR Manchester, N.H. (III), KRKE Albuquerque, N.M. (III), WAYS Charlotte, N.C. (III), WTVN Columbus, Ohio (III), WIP Philadelphia (III), KILT Houston (III), KVNU Logan, Utah (III), WSLC Roanoke, Va. (III), WHPL Winchester, Va. (III), KONA Kennewick-Richmond-Pasco, Wash. (III), KUAM Agana, Guam (III).

620 khz Regional

Table listing stations and power for 620 khz Regional, including KTAR Phoenix (III), KNGS Hanford, Calif. (III), KWSM Mt. Shasta, Calif. (III), KSTR Grand Junction, Colo. (III), WSUN St. Petersburg, Fla. (III), WTRP La Grange, Ga. (III), KIPA Hilo, Hawaii (III), KWAL Wallace, Idaho (III), KMNS Sioux City, Iowa (III), WTMK Louisville, Ky. (III), WLBZ Bangor, Me. (III), WJDX Jackson, Miss. (III), WVNJ Newark, N.J. (III), WHEN Syracuse, N.Y. (III), WDNC Durham, N.C. (III), KGW Portland, Ore. (III), WHJB Greensburg, Pa. (III), WCAY Cayce, S.C. (III), WETE Knoxville, Tenn. (III), KWFT Wichita Falls, Tex. (III), WVMT Burlington, Vt. (III), WWNR Beckley, W. Va. (III), WTMJ Milwaukee (III).

630 khz Regional

Table listing stations and power for 630 khz Regional, including WAVU Albertville, Ala. (III), WJDB Thomasville, Ala. (III), KJNO Juneau, Alaska (III), KVMA Magnolia, Ark. (III), KIDD Monterey, Calif. (III), KHOW Denver (III), WMAL Washington (III), WSAV Savannah, Ga. (III), WNEG Toccoa, Ga. (III), KIDO Boise, Idaho (III), WLAP Lexington, Ky. (III), KTiB Thibodaux, La. (III), KDWB St. Paul (III), KXOK St. Louis (III), KGVW Belgrade, Mont. (III), KOH Reno (III), KLEA Lovington, N.M. (III), WIRC Hickory, N.C. (III), WMFD Wilmington, N.C. (III), KWRO Coquille, Ore. (III), WEJL Scranton, Pa. (III), WPRO Providence, R.I. (III), KMAC San Antonio, Tex. (III), KSXX Salt Lake City (III), KGDN Edmonds, Wash. (III), KZUN Opportunity, Wash. (III), WQBS San Juan, P.R. (III).

640 khz Clear

Table listing stations and power for 640 khz Clear, including KFI Los Angeles (I-A) with 50,000 power.

Station Power

Table listing stations and power for 650 khz Clear, including *WOI Ames, Iowa (II) with 5,000 power, WHLO Akron, Ohio (II) with 1,000 power, and WNAD Norman, Okla. (II) with 1,000 power.

650 khz Clear

Table listing stations and power for 650 khz Clear, including KYAK Anchorage (II) with 50,000 power, KORL Honolulu (II) with 10,000 power, WSM Nashville (I-A) with 50,000 power, and KIKK Pasadena, Tex. (II) with 250 power.

660 khz Clear

Table listing stations and power for 660 khz Clear, including KFAR Fairbanks, Alaska (II) with 10,000 power, KOWH Omaha (II) with 1,000 power, WNBC New York (I-A) with 50,000 power, WESC Greenville, S.C. (II) with 10,000 power, and KSKY Dallas (II) with 10,000 power.

670 khz Clear

Table listing stations and power for 670 khz Clear, including *KDLG Dillingham, Alaska with 5,000 power, KPUA Hilo, Hawaii (CP only; now on 970 kHz) (II) with 5,000 power, KBOI Boise, Idaho (II-A) with 50,000 power, and WMAQ Chicago (I-A) with 50,000 power.

680 khz Clear

Table listing stations and power for 680 khz Clear, including KNBR San Francisco (I-B) with 50,000 power, WWBA St. Petersburg, Fla. (II) with 1,000 power, WRNG North Atlanta, Ga. (II) with 25,000 power, WCTT Corbin, Ky. (II) with 1,000 power, WCBM Baltimore (II) with 1,000 power, WRKO Boston (II) with 25,000 power, WDBC Escanaba, Mich. (II) with 25,000 power, KFEQ St. Joseph, Mo. (II) with 5,000 power, KWKA Clovis, N.M. (II) with 500 power, WINR Binghamton, N.Y. (II) with 25,000 power, WNYR Rochester, N.Y. (II) with 250 power, WPTF Raleigh, N.C. (II) with 50,000 power, WMSJ Sylva, N.C. (II) with 1,000 power, WISR Butler, Pa. (II) with 10,000 power, WMP5 Memphis (II) with 10,000 power, KKYX San Antonio, Tex. with 1,000 power, KOMW Omak, Wash. (II) with 1,000 power, WCAW Charleston, W. Va. (II) with 10,000 power, and WAPA San Juan, P.R. (II) with 10,000 power.

690 khz (Canadian) Clear

Table listing stations and power for 690 khz (Canadian) Clear, including WVOK Birmingham, Ala. (II) with 50,000 power, KEOS Flagstaff, Ariz. (II) with 1,000 power, KEVT Tucson, Ariz. (II) with 250 power, KBBA Benton, Ark. (II) with 250 power, KAPI Pueblo, Colo. (II) with 250 power, WADS Ansonia, Conn. (II) with 250 power, WAPE Jacksonville, Fla. (II) with 10,000 power, KKUA Honolulu (II) with 10,000 power, KBLI Blackfoot, Idaho (II) with 1,000 power, KGGF Coffeyville, Kan. (II) with 10,000 power, WTIKX New Orleans (II) with 10,000 power, KTCR Minneapolis (II) with 500 power, KSTL St. Louis (II) with 1,000 power, KEYR Terrytown, Neb. (II) with 1,000 power, KRCO Prineville, Ore. (II) with 1,000 power, *KUSD Vermillion, S.D. (II) with 1,000 power, KHEY El Paso (II) with 1,000 power, KPET Lamesa, Tex. (II) with 250 power, KZEY Tyler, Tex. (II) with 250 power, WZAP Bristol, Va. (II) with 10,000 power, WNNW Warsaw, Va. (II) with 250 power, WELD Fisher, W. Va. (II) with 500 power, WAGO Oshkosh, Wis. (II) with 250 power.

700 khz Clear

Table listing stations and power for 700 khz Clear, including KBYR Anchorage (II) with 1,000 power, and WLW Cincinnati (I-A) with 50,000 power.

710 khz Clear

Table listing stations and power for 710 khz Clear, including WKRK Mobile, Ala. (II) with 1,000 power, KMPC Los Angeles (II) with 1,000 power, and WMBG Williamsburg, Va. (II) with 500 power.

AM by Frequency

Station Power

Table listing stations and power for AM by Frequency, including KERE Denver (II) with 5,000 power, WGBS Miami (II) with 25,000 power, WUFF Eastman, Ga. (II) with 1,000 power, WROM Rome, Ga. (II) with 1,000 power, KEEL Shreveport, La. (II) with 25,000 power, WPA Eupora, Miss. (II) with 500 power, WHB Kansas City, Mo. (II) with 25,000 power, WOR New York (I-B) with 50,000 power, WZOO Asheville, N.C. (II) with 1,000 power, WEGG Rose Hill, N.C. (II) with 250 power, WQKI St. Matthews, S.C. with 1,000 power, WTPR Paris, Tenn. (II) with 250 power, KGNC Amarillo, Tex. (II) with 25,000 power, KURV Edinburg, Tex. (II) with 25,000 power, WQBX Blacksburg, Va. (II) with 5,000 power, KIRO Seattle (II) with 25,000 power, WDSM Superior, Wis. (II) with 5,000 power, WKJB Mayaguez, P.R. (II) with 1,000 power.

720 khz Clear

Table listing stations and power for 720 khz Clear, including *KOTZ Kotzebue, Alaska (II) with 5,000 power, KUAI Eleele, Hawaii (II) with 5,000 power, WGN Chicago (I-A) with 50,000 power, KDWN Las Vegas (II-A) with 50,000 power, and KMAI Agana, Guam (II) with 10,000 power.

730 khz (Mexican) Clear

Table listing stations and power for 730 khz (Mexican) Clear, including WJMW Athens, Ala. (II) with 1,000 power, KSUD West Memphis, Ark. (II) with 250 power, WFOR Thomasville, Ga. (II) with 5,000 power, KLOE Goodland, Kan. (II) with 1,000 power, WFMW Madisonville, Ky. (II) with 500 power, WMTCT Vanceville, Ky. (II) with 1,000 power, KTRY Bastrop, La. (II) with 250 power, WARB Covington, La. (II) with 250 power, WJTO Bath, Me. (II) with 1,000 power, WACE Chicopee, Mass. (II) with 5,000 power, WVIC East Lansing, Mich. (II) with 50,000 power, KWQA Worthington, Minn. (II) with 1,000 power, KWRE Warrenton, Mo. (II) with 1,000 power, KJURL Billings, Mont. (II) with 500 power, KDAB Albuquerque, N.M. (II) with 1,000 power, WDOS Oeonta, N.Y. (II) with 1,000 power, WFMG Goldsboro, N.C. (II) with 1,000 power, WOH5 Shelby, N.C. (II) with 1,000 power, WMG5 Bowling Green, Ohio (II) with 1,000 power, KBOY Medford, Ore. (II) with 1,000 power, WNAK Nanticoke, Pa. (II) with 1,000 power, WPIIT-Pittsburgh (II) with 5,000 power, WPAL Charleston, S.C. (II) with 1,000 power, WLIL Lenoir City, Tenn. (II) with 1,000 power, KKDA Grand Prairie, Tex. (II) with 500 power, KSVN Ogden, Utah (II) with 1,000 power, WPIK Alexandria, Va. (II) with 5,000 power, WMNA Gretna, Va. (II) with 1,000 power, KULE Ephrata, Wash. (II) with 1,000 power, WJMT Merrill, Wis. (II) with 1,000 power.

740 khz (Canadian) Clear

Table listing stations and power for 740 khz (Canadian) Clear, including WBAM Montgomery, Ala. (II) with 50,000 power, KMEC Phoenix (II) with 1,000 power, KBRT Avalon, Calif. (II) with 10,000 power, KCBS San Francisco (II) with 25,000 power, KSSS Colorado Springs (II) with 250 power, KVFC Cortez, Colo. (II) with 1,000 power, WBSR Boca Raton, Fla. (II) with 1,000 power, WKIS Orlando, Fla. (II) with 5,000 power, KYME Boise, Idaho (II) with 500 power, WVLN Oliney, Ill. (II) with 250 power, KBOE Oskaloosa, Iowa (II) with 250 power, WNOP Newport, Ky. (II) with 1,000 power, WCAS Cambridge, Mass. (II) with 250 power, KBAD Carlsbad, N.M. (II) with 1,000 power, WGSN Huntington, N.Y. (II) with 5,000 power, WMBL Moorehead City, N.C. (II) with 1,000 power, WPAQ Mt. Airy, N.C. (II) with 10,000 power, KRMG Tulsa, Okla. (II) with 25,000 power, WVCH Chester, Pa. (II) with 1,000 power, WBAW Barnwell, S.C. (II) with 1,000 power, WIRJ Humboldt, Tenn. (II) with 250 power, WJIG Tullahoma, Tenn. (II) with 250 power, KTRH Houston (II) with 25,000 power, KCMC Texarkana, Tex. (II) with 1,000 power, WMBG Williamsburg, Va. (II) with 500 power, WRNR Martinsburg, W. Va. (II) with 25,000 power.

WSWN Belle Glade, Fla. (II)	D-1,000
WMOP Ocala, Fla. (II)	D-5,000
WCRC Macon, Ga. (II)	D-250
WEAS Savannah, Ga. (II)	D-5,000
KBUL Wichita, Kan. (II)	DA-D-250
WFIA Louisville, Ky. (II)	D-1,000
WLSI Pikesville, Ky. (II)	D-5,000
KREH Oakdale, La. (II)	D-250
WXKA Brunswick, Me. (II)	D-1,000
WLMD Laurel, Md. (II)	DA-D-1,000
WATC Gaylord, Mich. (II)	D-1,000
*KTIS Minneapolis (II)	D-1,000
WDDT Greenville, Miss. (II)	D-1,000
KFAL Fulton, Mo. (II)	D-1,000
KJSK Columbus, Neb. (II)	D-1,000
WOTW Nashua, N.H. (II)	D-1,000
WBRV Boonville, N.Y. (II)	D-1,000
WKAJ Saratoga Springs, N.Y. (II)	D-250
WKJK Granite Falls, N.C. (II)	D-500
WAYN Rockingham, N.C. (II)	D-1,000
WIAM Williamston, N.C. (II)	D-1,000
WHYN Canton, Ohio (II)	D-500
WFRO Fremont, Ohio (II)	DA-D-500
WCPA Clearfield, Pa. (II)	D-1,000
WFLN Philadelphia (II)	DA-D-1,000
WXKX Knoxville, Tenn. (II)	D-1,000
WCOR Lebanon, Tenn. (II)	D-500
KALT Atlanta, Tex. (II)	D-1,000
KIKR Conroe, Tex. (II)	D-500
KFLP Floydada, Tex. (II)	D-250
KCLW Hamilton, Tex. (II)	D-250
WODY Bassett, Va. (II)	DA-D-500
WKDW Staunton, Va. (II)	D-1,000
KUEN Wenatchee, Wash. (II)	D-1,000
WATK Antigo, Wis. (II)	D-250

910 khz Regional

KJJJ Phoenix (III)	DA-N-5,000
KLCN Blytheville, Ark. (III)	D-5,000
KAMD Camden, Ark. (III)	DA-2-LS-5,000
KDEO El Cajon, Calif. (III)	N-500
KNEW Oakland, Calif. (III)	DA-2-1,000
KOXR Oxnard, Calif. (III)	DA-N-5,000
*KPOF Denver (III)	DA-2-LS-5,000
WRCQ New Britain, Conn. (III)	N-1,000
WPLA Plant City, Fla. (III)	DA-2-5,000
WGAJ Valdosta, Ga. (III)	D-1,000
KBGN Caldwell, Idaho (III)	DA-N-5,000
WAKO Lawrenceville, Ill. (III)	D-1,000
*WSUI Iowa City (III)	DA-D-500
KINA Salina, Kan. (III)	DA-2-5,000
WLCB Baton Rouge (III)	DA-D-500
WABI Bangor, Me. (III)	DA-1,000
WDFD Flint, Mich. (III)	DA-2-LS-5,000
WOKK Meridian, Miss. (III)	N-1,000
KOYN Billings, Mont. (III)	LS-5,000
KBIM Roswell, N.M. (III)	N-1,000
WRKL New City, N.Y. (III)	DA-D-1,000
WLAS Jacksonville, N.C. (III)	D-5,000
KCJB Minot, N.D. (III)	DA-2-LS-5,000
WBRJ Marietta, Ohio (III)	N-1,000
WPFB Middletown, Ohio (III)	DA-D-5,000
KGLC Miami, Okla. (III)	LS-1,000
KURY Brookings, Ore. (III)	N-100
WAVL Apollo, Pa. (II)	DA-1,000
WGBI Scranton, Pa. (III)	D-1,000
WSBA York, Pa. (III)	LS-1,000
WNCG N. Charleston, S.C. (III)	N-1,000
WORD Spartanburg, S.C. (III)	DA-2-LS-5,000
WJCW Johnson City, Tenn. (III)	N-1,000
WEPG S. Pittsburg, Tenn. (III)	LS-5,000
KNAF Fredericksburg, Tex. (III)	DA-N-1,000
KRIO McAllen, Tex. (III)	D-500
KIKM Sherman, Tex. (III)	D-1,000
KALL Salt Lake City (III)	DA-2-LS-5,000
WNHV White River Junction, Vt. (III)	N-1,000
WRNL Richmond, Va. (III)	D-1,000
WTOY Roanoke, Va. (III)	DA-N-5,000
KORD Pasco, Wash. (III)	D-1,000
KIXI Seattle (III)	D-1,000
KISN Vancouver, Wash. (III)	DA-2-5,000
WHSM Hayward, Wis. (III)	D-5,000
WDOR Sturgeon Bay, Wis. (III)	D-1,000
WPRP Ponce, P.R. (III)	LS-5,000
	N-500

920 khz Regional	
WCTA Andalusia, Ala. (III)	LS-5,000
WVWR Russellville, Ala. (III)	DA-N-500
KSRM Soldatna, Alaska (III)	D-1,000
KARN Little Rock, Ark. (III)	5,000
KLOC Ceres, Calif. (III)	DA-N-5,000
KDES Palm Springs, Calif. (III)	DA-D-500
KVEC San Luis Obispo, Calif. (III)	DA-2-LS-5,000
KLMR Lamar, Col. (III)	N-500
WTRS Dunnellon, Fla. (II)	LS-1,000
WMEL Melbourne, Fla. (II)	N-500
WGST Atlanta (III)	LS-5,000
WVOH Hazlehurst, Ga. (III)	DA-N-500
WGNU Granite City, Ill. (III)	D-500
WMOK Metropolis, Ill. (III)	DA-N-1,000
*WBAA W. Lafayette, Ind. (III)	LS-5,000
KFNF Shenandoah, Iowa (III)	DA-N-1,000
WTCW Whitesburg, Ky. (III)	N-500
WBOX Bogalusa, La. (III)	D-5,000
KTOC Jonesboro, La. (III)	D-1,000
WPTX Lexington Park, Md. (III)	DA-2-LS-5,000
WMPL Hancock, Mich. (III)	N-1,000
KDHL Faribault, Minn. (III)	D-1,000
KWAD Wadena, Minn. (III)	DA-2-5,000
KWYS W. Yellowstone, Mont. (III)	DA-N-1,000
KORK Las Vegas (III)	D-1,000
KOLO Reno (III)	DA-2-LS-5,000
WTTM Trenton, N.J. (III)	N-500
KQEO Albuquerque, N.M. (III)	LS-5,000
WKRT Cortland, N.Y. (III)	DA-N-1,000
WGHQ Kingston, N.Y. (III)	DA-D-5,000
WIRD Lake Placid, N.Y. (III)	D-5,000
WBBB Burlington-Graham, N.C. (III)	D-5,000
WPTL Canton, N.C. (III)	D-500
WMNI Columbus, Ohio (III)	DA-2-LS-1,000
KGAL Lebanon, Ore. (II)	N-500
WKVA Lewistown, Pa. (III)	DA-1,000
WJAR Providence, R.I. (III)	LS-1,000
WTND Orangeburg, S.C. (III)	DA-N-5,000
KKLS Rapid City, S.D. (III)	D-1,000
WLIV Livingston, Tenn. (III)	D-1,000
KELP El Paso (III)	LS-1,000
KBZB Odessa, Tex. (III)	DA-N-500
KTLW Texas City, Tex. (III)	LS-1,000
KVEL Vernal, Utah (III)	DA-1,000
KITN Olympia, Wash. (III)	D-5,000
KXLY Spokane, Wash. (III)	D-1,000
WMMN Fairmont, W. Va. (III)	5,000
WOKY Milwaukee	DA-N-5,000
	D-5,000
	N-1,000
930 khz Regional	
WJBY Gadsden, Ala. (III)	D-1,000
KTKN Ketchikan, Alaska (III)	LS-5,000
KAPR Douglas, Ariz. (III)	N-1,000
KAFF Flagstaff, Ariz. (III)	D-1,000
KHU Los Angeles (III)	D-5,000
KEWQ Paradise, Calif. (III)	DA-N-5,000
KIUP Durango, Colo. (III)	D-500
WTHD Milford, Del. (III)	LS-5,000
WHAN Haines City, Fla. (III)	DA-N-1,000
WJAX Jacksonville, Fla. (III)	DA-D-500
WKXY Sarasota, Fla. (III)	DA-N-5,000
WMGR Bainbridge, Ga. (III)	DA-2-LS-1,000
KSEI Pocatello, Idaho (III)	N-500
WTAD Quincy, Ill. (III)	LS-5,000
WHON Centerville, Ind. (III)	DA-N-5,000
WKCT Bowling Green, Ky. (III)	DA-D-500
WFMD Frederick, Md. (III)	LS-1,000
WREB Holyoke, Mass. (III)	DA-N-500
WBCK Battle Creek, Mich. (III)	DA-2-LS-5,000
KKIN Aitkin, Minn. (III)	N-1,000
WSLI Jackson, Miss. (III)	D-500
KWOC Poplar Bluff, Mo. (III)	DA-2-LS-5,000
	D-1,000
	DA-N-5,000
	LS-5,000
	DA-N-500

Station	Power
KYSS Missoula, Mont. (III)	D-5,000
KOGA Ogallala, Neb. (III)	D-500
WVNH Rochester, N.H. (III)	DA-N-5,000
WPAT Paterson, N.J. (III)	DA-2-5,000
KCCC Catsbad, N.M. (III)	D-1,000
WBEN Buffalo, N.Y. (III)	DA-N-5,000
WIZR Johnstown, N.Y. (III)	D-1,000
WSOC Charlotte, N.C. (III)	LS-5,000
WITN Washington, N.C. (III)	DA-N-1,000
WEOL Elyria, Ohio (III)	LS-5,000
WKY Oklahoma City (III)	DA-2-1,000
KAGI Grants Pass, Ore. (III)	DA-N-5,000
KSWB Seaside, Ore. (III)	LS-5,000
WCNR Bloomsburg, Pa. (III)	DA-N-1,000
KSDN Aberdeen, S.D. (III)	D-1,000
WSEV Sevierville, Tenn. (III)	DA-N-1,000
KDET Center, Tex. (III)	D-5,000
KITE Terrell Hills, Tex. (III)	D-1,000
WLLL Lynchburg, Va. (III)	LS-5,000
KBFW Bellingham-Ferndale, Wash. (III)	DA-N-1,000
KQOT Yakima, Wash. (III)	D-5,000
WGNT Huntington, W. Va. (III)	D-1,000
*WLBL Auburndale, Wis. (III)	LS-5,000
KROE Sheridan, Wyo. (III)	DA-N-1,000
WEKO Cabo Rojo, P.R. (III)	D-5,000
	D-1,000
	DA-D-500

940 khz (Mexican & Canadian) Clear

KHOS Tucson, Ariz. (II)	DA-2-LS-1,000
KFRE Fresno, Calif. (II)	N-250
WINE Brookfield, Conn. (II)	DA-2-50,000
WLOH Chiefland, Fla. (II)	D-1,000
WINZ Miami (II)	D-500
WMAZ Macon, Ga. (II)	DA-2-LS-50,000
KAHU Waipahu, Hawaii (II)	N-10,000
WMIX Mt. Vernon, Ill. (II)	LS-50,000
KIOA Des Moines, Iowa (II)	DA-N-10,000
WCND Shelbyville, Ky. (II)	N-5,000
WYLD New Orleans (II)	D-250
WIDG St. Ignace, Mich. (II)	DA-2-LS-10,000
WJOR South Haven, Mich. (II)	N-5,000
WCPC Houston, Miss. (II)	D-5,000
KSWM Aurora, Mo. (II)	DA-D-250
KVSH Valentine, Neb. (II)	(CP)DA-2-LS-50,000
WFNC Fayetteville, N.C. (II)	N-250
WCIT Lima, Ohio (II)	D-500
WNAL Nelsonville, Ohio (II)	LS-5,000
KGRB Bend, Ore. (II)	DA-D-250
KWRC Woodburn, Ore. (II)	(CP)DA-D-250
WESA Charleroi, Pa. (II)	D-1,000
WGRP Greenville, Pa. (II)	D-250
New Am Lebanon, Pa.	DA-D-1,000
WECO Wartburg, Tenn. (II)	D-1,000
KIXZ Amarillo, Tex. (II)	DA-2-LS-5,000
KTON Belton, Tex. (II)	N-1,000
KADO Texarkana, Tex. (II)	DA-D-1,000
KBRE Cedar City, Utah (II)	D-1,000
WNRG Grundy, Va. (II)	D-10,000
WEOO Smithfield, Va. (II)	D-5,000
WFAW Ft. Atkinson, Wis. (II)	DA-D-1,000
WCSW Shell Lake, Wis. (II)	DA-D-500
*KUF6 Agana, Guam (II)	D-1,000
*WIPR San Juan, P.R. (II)	10,000
	DA-10,000

950 khz Regional

WRMA Montgomery, Ala. (III)	D-1,000
KRXA Seward, Alaska (III)	SH-1,000
KXJK Forrest City, Ark. (III)	D-5,000
KFSA Fort Smith, Ark. (III)	LS-1,000
KAHI Auburn, Calif. (III)	DA-N-500
KIMN Denver (III)	DA-D-5,000
WLOF Orlando, Fla. (III)	DA-5,000
WGTA Summerville, Ga. (III)	DA-N-5,000
WGOV Valdosta, Ga. (III)	LS-5,000
KBRJ Boise, Idaho (III)	DA-N-1,000
KLER Orofino, Idaho (III)	D-5,000
WJPC Chicago, Ill. (III)	LS-1,000
WXLW Indianapolis	DA-N-500
KOEL Oelwein, Iowa (III)	D-1,000
KJRG Newton, Kan. (III)	DA-2-LS-5,000
	N-500
	D-500

AM by Frequency

Station	Power
WYWY Barbourville, Ky. (III)	D-1,000
WAGM Presque Isle, Me. (III)	DA-5,000
WCTN Potomac-Cabin John, Md. (III)	DA-D-1,000
WRYT Boston (III)	D-5,000
WWJ Detroit (III)	DA-N-5,000
KRSI St. Louis Park, Minn. (III)	DA-2-1,000
WBKH Hattiesburg, Miss. (III)	D-5,000
KLKJ Jefferson City, Mo. (III)	LS-5,000
	DA-N-500
KNFT Bayard, N.M. (III)	D-1,000
WHWV Hyde Park, N.Y. (III)	D-500
WBBF Rochester, N.Y. (III)	DA-2-1,000
WIBX Utica, N.Y. (III)	DA-5,000
WPET Greensboro, N.C. (III)	D-500
WLIT Steubenville, Ohio (IV)	DA-D-500
KYES Roseburg, Ore. (III)	D-1,000
WNCC Barnesboro, Pa. (III)	D-500
WPEN Philadelphia (III)	DA-N-5,000
WBEP Moncks Corner, S.C. (III)	D-500
WSPA Spartanburg, S.C. (III)	DA-N-5,000
KWAT Watertown, S.D. (III)	DA-N-1,000
WAGG Franklin, Tenn. (III)	D-1,000
KDSX Denison-Sherman, Tex. (III)	DA-2-500
KPRC Houston (III)	DA-N-5,000
KSEL Lubbock, Tex. (III)	DA-2-LS-5,000
	N-500
WXGI Richmond, Va. (III)	D-5,000
KJR Seattle (III)	DA-5,000
WKAZ Charleston, W. Va. (III)	LS-5,000
	DA-N-1,000
WERL Eagle River, Wis. (III)	D-1,000
WKT5 Sheboygan, Wis. (III)	DA-D-500
KMER Kemmerer, Wyo. (III)	D-5,000
960 khz Regional	
WERC Birmingham, Ala. (III)	DA-N-5,000
KOOL Phoenix (III)	D-5,000
KAVR Apple Valley, Calif. (III)	D-5,000
KNEZ Lompoc, Calif. (III)	DA-N-500
KABL Oakland, Calif. (III)	DA-5,000
WELI New Haven; Conn. (III)	DA-N-5,000
WGRO Lake City, Fla. (III)	D-500
WJCM Sebring, Fla. (III)	D-1,000
WJAZ Albany, Ga. (III)	DA-D-5,000
WRFC Athens, Ga. (III)	LS-5,000
	DA-N-500
KSRA Salmon, Idaho (III)	D-1,000
*WDLM East Moline, Ill. (III)	DA-D-1,000
WBSB South Bend, Ind. (III)	DA-2-5,000
KMA Shenandoah, Iowa (III)	DA-N-5,000
WPRT Prestonburg, Ky. (III)	D-5,000
KROF Abbeville, La. (III)	D-1,000
WBOC Salisbury, Md. (III)	DA-2-LS-5,000
	N-1,000
WFGL Fitchburg, Mass. (III)	DA-2-1,000
WHAK Rogers City, Mich. (III)	D-5,000
KLTF Little Falls, Minn. (III)	D-5,000
WABG Greenwood, Miss. (III)	LS-1,000
	DA-N-500
WFVS Cape Girardeau, Mo. (III)	LS-5,000
	DA-N-500
KFLN Baker, Mont. (III)	D-5,000
KNEB Scottsbluff, Neb. (III)	DA-2-LS-1,000
	N-500
KWYK Farmington, N.M. (III)	D-1,000
WEAV Plattsburgh, N.Y. (III)	DA-2-5,000
WAAK Dallas, N.C. (III)	D-1,000
WFTC Kinston, N.C. (III)	LS-5,000
	DA-N-1,000
WWST Wooster, Ohio (III)	D-1,000
KGWA Enid, Okla. (III)	DA-1,000
KLAD Klamath Falls, Ore. (III)	D-5,000
WHYL Carlisle, Pa. (III)	DA-D-5,000
WKZA Kane, Pa. (III)	D-1,000
WATS Sayre, Pa. (III)	D-1,000
WBEU Beaufort, S.C. (III)	D-1,000
WBMC McMinnville, Tenn. (III)	D-500
KIMP Mt. Pleasant, Tex. (III)	D-1,000
WKGK San Angelo, Tex. (III)	LS-5,000
	DA-N-1,000
KOVO Provo, Utah (III)	LS-5,000
	DA-N-1,000
WFIR Roanoke, Va. (III)	DA-N-5,000
KALE Richmond, Wash. (III)	DA-N-1,000
WTCH Shawano, Wis. (III)	DA-N-1,000
970 khz Regional	
WERH Hamilton, Ala. (III)	D-5,000
WTFB Troy, Ala. (III)	LS-5,000
	DA-N-500
KIAK Fairbanks, Alaska (III)	5,000
KVWM Show Low, Ariz. (III)	D-5,000
KNEA Jonesboro, Ark. (III)	D-1,000

Station	Power
KBIS Bakersfield, Calif. (II)	DA-2-1,000
KCHV Coachella, Calif. (III)	DA-2-LS-5,000
	N-1,000
KBEE Modesto, Calif. (III)	DA-2-1,000
KFEL Pueblo, Colo. (III)	D-1,000
WOZN Jacksonville, Fla. (III) (CP)	DA-D-1,000
WFLA Tampa, Fla. (III)	DA-N-5,000
WIIJ Atlanta (II)	DA-D-5,000
WVOP Vidalia, Ga. (III)	D-5,000
KPUA Hilo, Hawaii (III)	5,000
KAYT Rupert, Idaho (III)	D-1,000
WMAY Springfield, Ill. (III)	DA-2-LS-1,000
	N-500
WAVE Louisville, Ky. (III)	DA-2-5,000
KSYL Alexandria, La. (III)	DA-N-1,000
WCSH Portland, Me. (III)	DA-N-5,000
WAMD Aberdeen, Md. (III)	DA-2-500
WESO Southbridge, Mass. (III)	D-1,000
WUPY Ishpeming, Mich. (III)	D-5,000
WKHM Jackson, Mich. (III)	DA-2-1,000
KQAO Austin, Minn. (III)	DA-2-LS-5,000
	N-500
WRKN Brandon, Miss. (III)	DA-D-1,000
KOOK Billings, Mont. (III)	DA-N-5,000
KJLT North Platte, Neb. (III)	D-5,000
KVEG Las Vegas (III)	D-500
WWDJ Hackensack, N.J. (III)	D-5,000
	DA-N-5,000
KDCE Espanola, N.M. (III)	D-1,000
WEBR Buffalo, N.Y. (III)	DA-5,000
WCHN Norwich, N.Y. (III)	D-500
WRCS Ahsokie, N.C. (III)	D-1,000
WWIT Canton, N.C. (III)	D-1,000
WDAY Fargo, N.D. (III)	DA-N-5,000
WREO Ashtabula, Ohio (III)	DA-2-LS-1,000
	N-500
KOIN Portland, Ore. (III)	DA-N-5,000
WBLF Bellefonte, Pa. (III)	D-500
WWSW Pittsburgh (III)	DA-2-5,000
WJMX Florence, S.C. (III)	LS-5,000
	DA-N-1,000
KIXL Austin, Tex. (III)	DA-D-1,000
KBSN Crane, Tex. (III)	D-1,000
KNOK Fort Worth (III)	D-1,000
WYPR Danville, Va. (III)	D-1,000
WANV Waynesboro, Va. (III)	DA-2-LS-5,000
	N-1,000
KREM Spokane, Wash. (III)	LS-5,000
	DA-N-1,000
WWYO Pineville, W. Va. (III)	D-1,000
*WHA Madison, Wis. (III)	D-5,000
WAKX Superior, Wis. (III)	D-500
WSTX Christiansted, V.I. (III)	LS-5,000
	N-1,000
980 khz Regional	
WKLF Clanton, Ala. (III)	D-1,000
KFWJ Lake Havasu City, Ariz. (III)	D-500
KCAB Dardanelle, Ark. (III)	D-1,000
KINS Eureka, Calif. (III)	LS-5,000
	DA-N-500
KEAP Fresno, Calif. (III)	D-500
KFWB Los Angeles (III)	5,000
KCTY Salinas, Calif. (III)	DA-D-1,000
KGLN Glenwood Springs, Colo. (II)	D-1,000
WSUB Groton, Conn. (III)	D-1,000
WRC Washington (III)	DA-N-5,000
WDVH Gainesville, Fla. (II)	D-5,000
WTOT Marianna, Fla. (III)	D-1,000
WBOP Pensacola, Fla. (III)	D-1,000
WLOD Pompano Beach, Fla. (III)	DA-D-1,000
WKLY Hartwell, Ga. (III)	D-1,000
WPGA Perry, Ga. (III)	D-1,000
WRIP Rossville, Ga. (III)	DA-D-500
KUPI Idaho Falls, Idaho (III)	D-1,000
KSGM Chester, Ill. (III)	LS-1,000
	DA-N-500
WITY Danville, Ill. (III)	DA-2-1,000
KCJF Shreveport, La. (III)	D-5,000
WCAP Lowell, Mass. (III)	D-1,000
WAOP Otsego, Mich. (III)	D-1,000
WYOO Richfield, Minn. (III)	DA-5,000
WAPF McComb, Miss. (III)	D-5,000
WKOR Starkville, Miss. (III)	D-1,000
KMBZ Kansas City, Mo. (III)	DA-N-5,000
KLYQ Hamilton, Mont. (III)	D-1,000
KLVJ Fallon, Nev. (III)	D-5,000
KICA Clovis, N.M. (III)	DA-N-1,000
KMIN Grants, N.M. (III)	D-1,000
WTRY Troy, N.Y. (III)	DA-N-5,000
WKLM Wilmington, N.C. (III)	D-5,000
WAAA Winston-Salem, N.C. (III)	D-1,000
WONE Dayton, Ohio (III)	DA-N-5,000
WILK Wilkes-Barre, Pa. (III)	LS-5,000
	DA-N-1,000
WAZS Summerville, S.C. (III)	D-1,000
WYCL York, S.C. (III)	DA-D-1,000
KDSJ Deadwood, S.D. (III)	DA-N-1,000

Station	Power
WSIX Nashville (III)	DA-N-5,000
KFRD Rosenberg-Richmond, Tex. (III)	D-1,000
KSVC Richfield, Utah (III)	D-5,000
WFHG Bristol, Va. (III)	LS-5,000
	DA-N-1,000
WMEK Chase City, Va. (III)	D-500
KUTI Yakima, Wash. (III)	D-5,000
HAWW Weston, W. Va. (III)	D-1,000
WCUB Manitowoc, Wis. (III)	D-1,000
WNBI Park Falls, Wis. (III)	D-1,000
WPRE Prairie Du Chien, Wis. (III)	D-1,000
990 khz (Canadian) Clear	
WEIS Centre, Ala. (II)	D-250
WWWF Fayette, Ala. (II)	D-1,000
WTCB Flomaton, Ala. (II)	D-500
KTKT Tucson, Ariz. (II)	DA-2-LS-10,000
	N-1,000
KKYS Pittsburg, Calif. (II)	DA-2-5,000
KTYD Santa Barbara, Calif. (II)	DA-D-1,000
KRKS Denver (II)	D-1,000
WNTY Southington, Conn. (II)	DA-D-500
WFAB Miami-S. Miami (II)	DA-5,000
WHOO Orlando, Fla. (II)	DA-2-LS-50,000
	CH-Non DA-10,000
WDWD Dawson, Ga. (II)	N-5,000
WGML Hinesville, Ga. (II)	D-1,000
WCAZ Carthage, Ill. (II)	D-250
WITZ Jasper, Ind. (II)	D-1,000
WERK Muncie, Ind. (II)	DA-D-250
KAYL Storm Lake, Iowa (II)	D-250
KRSL Russell, Kan. (II)	D-250
WJMR New Orleans (II)	D-250
KRIH Rayville, La. (II)	D-250
WCRM Clare, Mich. (II)	DA-D-250
WABO Waynesboro, Miss. (II)	D-1,000
KRMO Monett, Mo. (II)	D-250
KSVP Artesia, N.M. (II)	LS-1,000
	N-250
WEEB Southern Pines, N.C. (II)	D-5,000
WBTE Windsor, N.C. (II)	D-1,000
WJEH Gallipolis, Ohio (II)	D-1,000
	CH-250
WTIG Massillon, Ohio (II)	DA-D-250
KRKT Albany, Ore. (II)	D-250
WIBG Philadelphia (II)	DA-2-LS-50,000
	N-10,000
WVSC Somerset, Pa. (II)	DA-D-5,000
WLKW Providence, R.I. (II)	DA-D-5,000
WAKN Aiken, S.C. (II)	D-1,000
WNOX Knoxville, Tenn. (II)	DA-N-10,000
KWAM Memphis (II)	DA-D-10,000
KTRM Beaumont, Tex. (II)	DA-1,000
KAML Kenedy-Karnes City, Tex. (II)	D-250
KNIN Wichita Falls, Tex. (II)	DA-2-LS-10,000
	N-1,000
KDYL Tooele, Utah (II)	D-1,000
WNRV Narrows-Pearisburg, Va. (II)	D-5,000
WANT Richmond, Va. (II)	D-1,000
WNNO Wisconsin Dells, Wis. (II)	D-500
WPRA Mayaguez, P.R. (II)	1,000
1000 khz (U.S. & Mexican) Clear	
WVOV Huntsville, Ala. (II)	DA-D-10,000
WQTY Montgomery, Ala. (II)	D-5,000
KMLO Vista, Calif. (II)	DA-D-1,000
WKMK Blountstown, Fla. (II)	D-1,000
WRYZ Jupiter, Fla. (II)	DA-D-1,000
WYOK Soperton, Ga. (II)	D-1,000
WCFL Chicago (I-B)	DA-2-50,000
WREM Jenkins, Ky. (II)	D-1,000
WLM5 Leominster, Mass. (II)	D-1,000
WXTN Lexington, Miss. (II)	D-5,000
KOTD Plattsmouth, Neb. (II)	DA-D-250
KKIM Albuquerque, N.M. (II)	D-10,000
WIQT Horseheads, N.Y. (II)	D-1,000
WKBO Garner, N.C. (II)	D-250
WSPF Hickory, N.C. (II)	D-1,000
WHTH Heath, Ohio (II)	DA-D-250
WSUM Parma, Ohio (II)	DA-D-500
KTKO Oklahoma City (II)	DA-2-5,000
WIOO Carlisle, Pa. (II)	D-1,000
WKYB Hemingway, S.C. (II)	D-10,000-CH-5,000
WGGW Walhalla, S.C. (II)	D-1,000
KXRB Sioux Falls, S.D. (II)	DA-D-10,000
KSTA Coleman, Tex. (II)	D-250
KGRI Henderson, Tex. (II)	D-250
WHWB Rutland, Vt. (II)	D-1,000
WKDE Altavista, Va. (II)	D-1,000
WRAR Tappahannock, Va. (II)	D-500
KOMO Seattle (I-B)	DA-N-50,000
WVWI Charlotte Amalie, V.I. (II)	1,000
1010 khz (Canadian & Cuban) Clear	
KHCS Phoenix (II)	D-500
KLRA Little Rock, Ark. (II)	LS-10,000
	DA-N-5,000

AM by Frequency

Station	Power	Station	Power	Station	Power
KCHJ Delano, Calif. (II)	DA-2-LS-5,000 N-1,000	WBUT Butler, Pa. (II)	D-250	WTIC Hartford, Conn. (I-B)	DA-N-50,000 (DA after Sunset at Dallas)
KCMJ Palm Springs, Calif. (II)	DA-2-LS-1,000 N-500	WSKE Everett, Pa. (II)	D-250	WVCG Coral Gables, Fla. (II)	DA-2-LS-10,000 N-500
KIQI San Francisco (II)	DA-D-10,000	WLYC Williamsport, Pa. (II)	D-1,000	WFIV Kissimmee, Fla. (II)	D-5,000
WCNU Crestview, Fla. (II)	D-1,000	WSMT Sparta, Tenn. (II)	D-1,000	WJQE Port St. Joe, Fla. (II)	D-1,000
WBIX Jacksonville Beach, Fla. (II)	DA-D-10,000	KIXS Kileen, Tex. (II)	D-250	WCOB Marietta, Ga. (II)	DA-D-10,000
WINQ Tampa, Fla. (II)	DA-D-50,000	KPXE Liberty, Tex. (II)	DA-D-250	KIOE Honolulu, Hawaii (II)	5,000
WGUN Atlanta (II)	D-50,000 CR-10,000	KCAS Staton, Tex. (II)	D-250	WPOK Pontiac, Ill. (II)	DA-D-1,000
WCSI Columbus, Ind. (II)	D-500	WGAT Gate City, Va. (II)	D-1,000	WNWI Valparaiso, Ind. (II)	D-250
KSMN Mason City, Iowa (II)	D-1,000	WBRG Lynchburg, Va. (II)	D-1,000	KOAK Red Oak, Iowa (II)	D-250
KIND Independence, Kan. (II)	D-250	WCMS Norfolk, Va. (II)	DA-D-5,000	WKO Louisville, Ky. (II)	DA-2-LS-10,000 N-1,000
KDLA De Ridder, La. (II)	D-1,000	KBLE Seattle (II)	D-5,000	WOAP Owosso, Mich. (II)	D-1,000
WKQT Garyville, La. (II)	D-500	WADC Parkersburg, W. Va. (II)	D-5,000	KYMN Northfield, Minn. (II)	D-1,000
WSD Baltimore (II)	D-1,000	WOKL Eau Claire, Wis. (II)	D-1,000	WCEP Carthage, Miss. (II)	D-250
WITL Lansing, Mich. (II)	DA-D-500	WKAU Kaukauna, Wis. (II)	DA-D-1,000	KYMO East Prairie, Mo. (II)	D-250
WMIN Maplewood, Minn. (II)	DA-D-250	WLIP Kenosha, Wis. (II)	D-250	KJEL Lebanon, Mo. (II)	D-250
WMOX Meridian, Miss. (II)	DA-2-LS-10,000 N-1,000	WCGB Juana Diaz, P.R. (II)	D-1,000	WUFO Amherst, N.Y. (II)	D-1,000
KCHI Chillicothe, Mo. (II)	D-250	1060 khz (U.S. & Mexican) Clear		WEWO Laurinburg, N.C. (II)	D-5,000 CH-1,000
KXEN Festus-St. Louis (II)	DA-D-50,000	KUPD Tempe, Ariz. (II)	DA-500	WKGX Lenoir, N.C. (II)	D-1,000
WCNL Newport, N.H. (II)	D-250	KPAY Chico, Calif. (II)	DA-N-10,000	WDRR Murfreesboro, N.C. (II)	D-1,000
WINS New York (II)	DA-50,000	KLMO Longmont, Colo. (II)	D-10,000	KNDK Langdon, N.D. (II)	D-1,000
WABZ Albemarle, N.C. (II)	D-1,000	WRMF Titusville, Fla. (II)	DA-2-LS-10,000 N-5,000	WMVR Sidney, Ohio (II)	DA-D-250
WFGW Black Mountain, N.C. (II)	DA-50,000 DA-CH-10,000	WXLX Milledgeville, Ga. (II)	D-1,000	KWJJ Portland, Ore. (II)	DA-2-LS-50,000 N-10,000
WELS Kinston, N.C. (II)	D-1,000	WKNG Tallapoosa, Ga. (II)	D-1,000	WEEP Pittsburgh (II)	(CP) D-50,000 CH-25,000
WIOI New Boston, Ohio (II)	D-1,000	WMCL McLeansboro, Ill. (II)	D-250	KRLD Dallas (I-B)	DA-N-50,000
WHIN Gallatin, Tenn. (II)	D-1,000	WRHL Rochelle, Ill. (II)	DA-D-250	WBYK Chatham, Va. (II)	D-1,000
WORM Savannah, Tenn. (II)	D-250	WJKY Jamestown, Ky. (II)	D-1,000	WZTO Hurricane, W. Va. (II)	DA-D-5,000
KDJW Amarillo, Tex. (II)	DA-2-LS-5,000 N-500	WNOE New Orleans (II)	DA-2-LS-50,000 N-5,000	WLEY Cayey, P.R. (II)	250
KODA Houston (II)	SH-DA-D-5,000	WGTR Natick, Mass. (II)	D-1,000	1090 khz (U.S. & Mexican) Clear	
KAWA Waco-Marlin, Tex. (II)	DA-D-10,000	WHFB Benton Harbor-St. Joseph, Mich. (II)	D-5,000	KAAY Little Rock, Ark. (I-B)	DA-N-50,000
WMEV Marion, Va. (II)	D-1,000	WBMB West Branch, Mich. (II)	D-1,000	KNCR Fortuna, Calif. (III)	D-10,000
WPMH Portsmouth, Va. (II)	DA-D-5,000	WKKQ Hibbins, Minn. (II)	D-1,000	KAAAT Denver, Colo. (II)	DA-D-50,000
WCST Berkeley Springs, W. Va. (II)	D-250	KFIL Preston, Minn. (II)	D-1,000	WQIK Jacksonville, Fla. (II)	DA-2-D-50,000 DA-CH-10,000
WSPT Stevens Point, Wis. (II)	D-1,000	WJLJ Tupelo, Miss. (II)	DA-D-250	WBTJ Monticello, Fla. (II)	D-1,000
1020 khz Clear		KBUG Springfield, Mo. (II)	D-500	WBAF Barnesville, Ga. (II)	D-500
KGBS Los Angeles (II)	DA-L-50,000	KNLV Ord, Neb. (II)	D-500	WCRA Effingham, Ill. (II)	D-1,000
WCIL Carbondale, Ill. (II)	D-1,000	WQWX Mebane, N.C. (II)	D-1,000	WGLC Mendota, Ill. (II)	D-250
WPEO Peoria, Ill. (II)	D-1,000	WMAP Monroe, N.C. (II)	D-1,000	WFWR Ft. Wayne, Ind. (II)	DA-D-1,000
KSWS Roswell, N.M. (II)	DA-2-LS-50,000 N-10,000	WLAB St. Paul's, N.C. (II)	D-250	KVDB Sioux Center, Iowa (II)	DA-D-500
KDKA Pittsburgh (I-A)	50,000	WCOK Sparta, N.C. (II)	D-250	*KNWS Waterloo, Iowa (II)	D-1,000
1030 khz Clear		WVOI Canton, Ohio (II)	DA-D-5,000	WSLG Gonzales La. (II)	DA-D-500
WBZ Boston (I-A)	DA-50,000	KYW Philadelphia (I-B)	DA-50,000	WBAL Baltimore (I-B)	DA-N-50,000
KCTA Corpus Christi, Tex. (II)	50,000	WALD Walterboro, S.C. (II)	D-1,000	WILD Boston (II)	D-1,000
KTWO Casper, Wyo. (II)	DA-N-50,000	KGFX Pierre, S.D. (II)	DA-D-10,000	WIID Gaden City, Mich. (II)	DA-D-250
New AM San Juan, P.R. (II)	10,000	WPHC Waverly, Tenn. (II)	D-1,000	WMUS Muskegon, Mich. (II)	D-1,000
1040 khz Clear		KAMA El Paso, Tex. (II)	D-10,000	KEXS Excelsior Springs, Mo. (II)	DA-D-250
KHVV Honolulu (II)	5,000	KCLT Lockhart, Tex. (II)	DA-D-250	KBOZ Bozeman, Mont. (II)	DA-N-5,000
WHO Des Moines, Iowa (I-A)	50,000	KRSP Salt Lake City (II)	D-10,000	WKTE King, N.C. (II)	D-1,000
KPBC Dallas (II)	D-1,000	1070 khz (U.S. & Canadian) Clear		WZBZ Selma, N.C. (II)	D-1,000
1050 khz (Mexican) Clear		WAPI Birmingham, Ala. (II)	LS-50,000	KTGO Tioga, N.D. (II)	D-250
WRFS Alexander City, Ala. (II)	D-1,000	KNX Los Angeles (I-B)	DA-D-LS-50,000	WKFI Wilmington, Ohio (II)	DA-D-1,000
WCRI Scottsboro, Ala. (II)	D-250	WANM Tallahassee, Fla. (II)	D-10,000	WMTY Greenwood, S.C. (II)	DA-D-1,000
KSOH Little Rock, Ark. (II)	D-1,000	WIBC Indianapolis (II)	DA-2-LS-50,000 N-10,000	WKSP Kingstree, S.C. (II)	D-500
KBBV Big Bear Lake, Calif. (II)	DA-D-250	KILR Esterville, Iowa (II)	DA-D-250	WENR Englewood, Tenn. (II)	D-1,000
KOFY San Mateo, Calif. (II)	D-1,000	KFDI Wichita, Kan. (II)	LS-10,000	WJKM Hartsville, Tenn. (II)	D-250
KWSO Wasco, Calif. (II)	D-1,000	KHMO Hannibal, Mo. (II)	DA-N-1,000	WGOC Kingsport, Tenn. (II)	D-1,000
WJSB Crestview, Fla. (II)	D-1,000	KERR Polson, Mont. (II)	DA-2-LS-5,000 N-1,000	KACQ Bellville, Tex. (II)	D-250
WBOX Tampa, Fla. (II)	D-250	KRST Salt Lake City (II)	LS-1,000	KKYN Plainview, Tex. (II)	D-1,000
WAUG Augusta, Ga. (II)	D-5,000	WKMB Stirling, N.J. (II)	DA-N-250	KANN Ogden, Utah (II)	D-1,000
WMNZ Montezuma, Ga. (II)	D-250	WKDR Plattsburgh, N.Y. (II)	D-5,000	KING Seattle (II)	DA-2-50,000
WDZ Decatur, Ill. (II)	D-1,000	WSCP Sandy Creek, N.Y. (II)	D-1,000	WISS Berlin, Wis. (II)	D-250
WTPCA Plymouth, Ind. (II)	DA-D-250	WNCT Greenville, N.C. (II)	DA-2-10,000	WRSR San German, P.R. (II)	250
KJFK Garden City, Kan. (II)	DA-D-5,000	WHPE High Point, N.C. (II)	D-1,000	1100 khz Clear	
WNES Central City, Ky. (II)	D-500	WKOK Sunbury, Pa. (II)	DA-2-LS-10,000 N-1,000	KFAX San Francisco (II)	DA-D-50,000
KLPL Lake Providence, La. (II)	D-250	WHYZ Greenville, S.C. (II)	DA-D-50,000	L-WWWW	1,000
KVPI Ville Platte, La. (II)	D-250	WFLI Lookout Mountain, Tenn. (II)	DA-2-LS-50,000 N-1,000	KREX Grand Junction, Colo. (II)	DA-CH-50,000
WMSG Oakland, Md. (II)	D-500	WDIA Memphis (II)	DA-2-LS-50,000 N-5,000	DA-N-10,000	
WGAY Silver Spring, Md. (II)	D-1,000	KOPY Alice, Tex. (II)	DA-N-1,000	WLBB Carrollton, Ga. (II)	D-1,000
WPAG Ann Arbor, Mich. (II)	DA-D-5,000	KENR Houston (II)	DA-2-LS-10,000 N-5,000	WHLI Hempstead, N.Y. (II)	DA-D-10,000
KLOH Pipestone, Minn. (II)	DA-D-1,000	WINA Charlottesville, Va. (II)	DA-N-5,000	WVWE Cleveland (I-A)	DA-50,000
WACR Columbus, Miss. (II)	D-1,000	WCIR Beckley, W. Va. (II)	D-10,000	WGPA Bethlehem, Pa. (II)	D-250
KMIS Portageville, Mo. (II)	D-1,000	WTSO Madison, Wis. (II)	DA-2-LS-10,000 N-5,000	1110 khz Clear	
KSIS Sedalia, Mo. (II)	D-1,000	WMIA Arcibo, P.R. (II)	500	WBCA Bay Minnette, Ala. (II)	D-10,000
WBNC Conway, N.H. (II)	D-1,000	1080 khz Clear		WBIB Centerville, Ala. (II)	D-1,000
WSCV Peterborough, N.H. (II)	D-1,000	WKAC Athens, Ala. (II)	D-5,000	KRLA Pasadena, Calif. (II)	DA-2-LS-50,000 N-10,000
WSEN Baldwinsville, N.Y. (II)	DA-D-1,000	WLVN Luverne, Ala. (II)	CH-1,000	KPOP Roseville, Calif. (II)	DA-N-500
WYBG Massena, N.Y. (II)	D-1,000	KANC Anchorage, Alaska (II)	D-500	WQYK Tampa, Fla. (II)	DA-D-10,000
WHN New York (II)	DA-50,000	KSCO Santa Cruz, Calif. (II)	LS-10,000	WEBS Calhoun, Ga. (II)	D-250
WFSC Franklin, N.C. (II)	D-1,000	1090 khz (U.S. & Mexican) Clear		*WMBI Chicago (II)	L-WBT-5,000-KFAB
WLON Lincolnton, N.C. (II)	D-1,000	KUPD Tempe, Ariz. (II)	DA-500	WHYT Noblesville, Ind. (II)	DA-D-250
WWGP Sanford, N.C. (II)	D-1,000	KPAY Chico, Calif. (II)	DA-N-10,000	WKDZ Cadiz, Ky. (II)	D-1,000
WZIP Cincinnati (II)	D-1,000	KLMO Longmont, Colo. (II)	D-10,000	WCBR Richmond, Ky. (II)	D-250
KCCO Lawton, Okla. (II)	DA-D-250	WRMF Titusville, Fla. (II)	DA-2-LS-10,000 N-5,000	WFCG Franklinton, La. (II)	D-1,000
KFMJ Tulsa, Okla. (II)	D-1,000	WXLX Milledgeville, Ga. (II)	D-1,000	KPAL Pineville, La. (II)	D-500
KORE Springfield-Eugene, Ore. (II)	D-1,000	WKNG Tallapoosa, Ga. (II)	D-1,000		

AM by Frequency

Station	Power
WGRG Pittsfield, Mass. (II)	D-1,000
*WUNN Mason, Mich. (II)	D-250
WJML Potoskey, Mich. (II)	DA-D-10,000
WKRA Holly Springs, Miss. (II)	D-1,000
KFAB Omaha (I-B)	DA-N-50,000
KCIA Humble City, N.M. (II)	D-1,000
WSFW Seneca Falls, N.Y. (II)	D-1,000
WTBQ Warwick, N.Y. (II)	D-250
WBT Charlotte, N.C. (I-B)	DA-N-50,000
WELX Xenia, Ohio (II)	DA-D-250
KEOR Atoka, Okla. (II)	DA-D-5,000
KBND Bend, Ore. (II)	LS-10,000
	DA-N-1,000
WJSM Martinsburg, Pa. (II)	D-1,000
WNAR Norristown, Pa. (II)	D-500
WKEG Washington, Pa. (II)	DA-D-1,000
WHIM Providence, R.I. (II)	D-1,000
WSLV Ardmore, Tenn. (II)	D-1,000
WUAT Pikesville, Tenn. (II)	LS-1,000
	N-250
KDRY Alamo Heights, Tex. (II)	D-1,000
WZAM Norfolk, Va. (II)	CP-DA-D-50,000
WVJP Caguas, P.R. (II)	250
1120 khz Clear	
WUST Washington (II)	D-1,000
KMOX St. Louis (I-A)	50,000
WFOL Buffalo, N.Y. (II)	D-1,000
KPNW Eugene, Ore. (II)	DA-50,000
KCLE Cleburne, Tex. (II)	D-250
WVUV Leone, A.S. (II)	10,000
1130 khz (U.S. & Canadian) Clear	
KRDU Dinuba, Calif. (II)	DA-1,000
KSDO San Diego (II)	DA-2-LS-5,000
	N-1,000
WPUL Bartow, Fla. (II)	D-1,000
WNRJ Gainesville, Ga. (II)	D-10,000
WMGA Moultrie, Ga. (II)	LS-10,000 (DA-CH)
	N-250
KLEI Kailua, Hawaii (II)	10,000
WVCM Brazil, Ind. (II)	D-500
KKSI Mt. Pleasant, Iowa (II)	D-250
KLEY Wellington, Kan. (II)	DA-D-250
KWKH Shreveport, La. (I-B)	DA-N-50,000
WCAR Detroit (II)	DA-2-LS-50,000
	N-10,000
WDGY Minneapolis (II)	(CP)DA-2-LS-50,000
	N-25,000
WGUF Gulfport, Miss. (II)	(CP)D-500
KBLR Bolivar, Mo. (II)	DA-D-250
WNEW New York (II)	DA-N-50,000
WPYB Benson, N.C. (II)	D-1,000
WCBX Eden, N.C. (II)	D-1,000
KBMR Bismarck, N.D. (II)	D-10,000
WCTM Eaton, Ohio (II)	D-250
WASP Brownsville, Pa. (II)	DA-D-5,000 (CH-1,000)
WEOE Waynesboro, Pa. (II)	DA-D-1,000
WPUB Camden, S.C. (II)	D-1,000
WAMG Gallatin, Tenn. (II)	D-250
WDTM Selmer, Tenn. (II)	D-250
KWBY Edna, Tex. (II)	DA-D-10,000
KBGH Memphis, Tex. (II)	DA-D-1,000
WRRL Rainelle, W.Va. (II)	D-1,000
WISN Milwaukee (II)	(CP)DA-2-LS-50,000
	N-25,000
1140 khz (U.S. & Mexican) Clear	
KRAK Sacramento, Calif. (II)	DA-50,000
KNAB Burlington, Colo. (II)	D-1,000
WQBA Miami (II)	DA-2-LS-10,000
	N-5,000
KGEM Boise, Idaho (II)	DA-10,000
WSIV Pekin, Ill. (II)	D-5,000
	CH-1,000
WAWK Kendallville, Ind. (II)	D-250
KNEI Waukon, Iowa (II)	D-1,000
WKCM Hawkesville, Ky. (II)	D-500
WAKK McComb, Miss. (II)	D-500
KBIL Liberty, Mo. (II)	D-500
KPWB Piedmont, Mo. (II)	D-1,000
KLUC Las Vegas (II)	D-10,000
WCJW Warsaw, N.Y. (II)	DA-D-1,000
WCLW Mansfield, Ohio (II)	DA-D-250
KLPR Oklahoma City (II)	D-1,000
WBZY New Castle, Pa. (II)	DA-D-5,000
KSOO Sioux Falls, S.D. (II)	LS-10,000
	DA-N-5,000
WIXC Fayetteville, Tenn. (II)	D-1,000
KORC Mineral Wells, Tex. (II)	D-250
WRVA Richmond, Va. (I-B)	DA-50,000
WQII San Juan, P.R. (II)	DA-10,000
1150 khz Regional	
WGEA Geneva, Ala. (III)	D-1,000

Station	Power
WJRD Tuscaloosa, Ala. (II)	LS-5,000
	DA-N-1,000
KCKY Coolidge, Ariz. (III)	DA-N-1,000
KXLR N. Little Rock, Ark. (III)	LS-5,000
	DA-N-1,000
KIIS Los Angeles (III)	LS-5,000
	N-1,000
KBAL Morro Bay, Calif. (III)	D-500
KPLS Santa Rosa, Calif. (III)	DA-2-LS-5,000
	N-500
	(CP)D-5,000
KWBZ Englewood, Colo. (III)	D-1,000
WCNX Middletown, Conn. (III)	DA-2-5,000
WDEL Wilmington, Del. (III)	DA-D-1,000
WNDB Daytona Beach, Fla. (III)	DA-N-1,000
WTMP Tampa, Fla. (III)	DA-D-5,000
WFPM Ft. Valley, Ga. (III)	D-1,000
WJEM Valdosta, Ga. (III)	D-1,000
WGGH Marion, Ill. (III)	DA-D-5,000
WYFE Rockford, Ill. (III)	DA-D-1,000
KKUZ Burlington, Iowa (III)	DA-D-500
KWKY Des Moines, Iowa (III)	DA-D-1,000
KSAL Salina, Kan. (III)	DA-N-5,000
WMST Mt. Sterling, Ky. (III)	D-500
WLOC Munfordville, Ky. (III)	D-1,000
WJBO Baton Rouge (II)	DA-5,000
WSKW Skowhegan, Me. (III)	D-5,000
WCOP Boston (II)	DA-2-5,000
WCEN Mount Pleasant, Mich. (III)	LS-1,000
	DA-N-500
KASM Albany, Minn. (III)	D-1,000
KRMS Osage Beach, Mo. (III)	D-1,000
KSEN Shelby, Mont. (III)	DA-2-5,000
KDEF Albuquerque, N.M. (III)	LS-5,000
	DA-N-500
WRUN Utica, N.Y. (III)	DA-2-LS-5,000
	N-1,000
WBAG Burlington-Graham, N.C. (III)	D-1,000
WGBR Goldsboro, N.C. (III)	DA-2-LS-5,000
	N-1,000
WCUE Cuyahoga Falls, Ohio (III)	DA-2-LS-1,000
	N-500
WIMA Lima, Ohio (III)	DA-N-1,000
KNED McAlester, Okla. (III)	DA-N-LS-1,000
	N-500
KAGO Klamath Falls, Ore. (III)	LS-5,000
	DA-N-1,000
KKEY Portland, Ore. (III)	DA-D-5,000
WHUN Huntingdon, Pa. (III)	D-5,000
WYNS Lehighton, Pa. (III)	DA-D-1,000
WKPA New Kensington, Pa. (III)	DA-D-1,000
WDIX Orangeburg, S.C. (III)	DA-2-LS-5,000
	N-500
WTYC Rock Hill, S.C. (III)	D-1,000
WSNW Seneca, S.C. (III)	D-1,000
KIMM Rapid City, S.D. (III)	D-5,000
WGOW Chattanooga (II)	LS-5,000
	DA-N-1,000
WCRK Morristown, Tenn. (III)	LS-1,000
	DA-N-500
WTAW College Station, Tex. (III)	D-1,000
KGCT Corpus Christi, Tex. (III)	DA-D-1,000
KISO El Paso (III)	D-1,000
KVIL Highland Park, Tex. (III)	DA-D-1,000
KJBC Midland, Tex. (III)	D-1,000
KSUZ Port Neches, Tex. (III)	DA-D-500
KOLJ Quannah, Tex. (III)	D-500
KQAM San Antonio, Tex. (III)	DA-D-1,000
WABH Deerfield, Va. (III)	D-1,000
KPUL Pullman, Wash. (III)	D-1,000
KAYO Seattle (III)	LS-5,000
	N-1,000
WELC Welch, W. Va. (III)	D-1,000
WYNE Appleton, Wis. (III)	DA-D-1,000
WAXX Chippewa Falls, Wis. (III)	D-5,000
1160 khz Clear	
WJJD Chicago (II)	DA-50,000-L-KSL
KSL Salt Lake City (I-A)	50,000
WBQN Barceloneta, P.R. (II)	(CP)DA-2-250
1170 khz Clear	
WCOV Montgomery, Ala. (II)	DA-2-LS-10,000
	N-1,000
KJNP N. Pole, Alaska (II)	DA-N-50,000
KCBQ San Diego (II)	DA-2-LS-50,000
	N-5,000
KLOK San Jose, Calif. (II)	DA-LS-50,000
	N-5,000
KUAD Windsor, Colo. (II)	D-1,000
WSNE Cumming, Ga. (II)	D-1,000
KOHO Honolulu (II)	D-1,000
WLBH Mattoon, Ill. (II)	(CP)DA-D-5,000
KSTT Davenport, Iowa (II)	DA-2-1,000
WVLC Orleans, Mass. (II)	DA-D-1,000
KOWO Waseca, Minn. (II)	D-1,000
KJAS Jackson, Mo. (II)	D-250
WHLW Lakewood, N.J. (II)	DA-D-5,000
WBRW Somerville, N.J. (II)	DA-D-500

Station	Power
WWLE Cornwall, N.Y. (II)	DA-D-1,000
WMVI Mechanicville, N.Y. (II)	D-250
WCLN Clinton, N.C. (II)	D-1,000
*KFNW Fargo, N.D. (II)	(CP)D-1,000
KVOO Tulsa, Okla. (I-B)	DA-N-50,000
KPUG Bellingham, Wash. (II)	LS-5,000
	DA-N-1,000
WWVA Wheeling, W. Va. (I-B)	DA-N-50,000
WLKE Waupun, Wis. (II)	D-1,000
WLEO Ponce, P.R. (II)	250
1180 khz Clear	
WLDS Jacksonville, Ill. (II)	D-1,000
KOFI Kalispell, Mont. (II-A)	DA-N-10,000
WHAM Rochester, N.Y. (I-A)	50,000
1190 khz (U.S. & Mexican) Clear	
WAYD Ozark, Ala. (II)	D-1,000
KRDS Tolleson, Ariz. (II)	DA-250
KMCW Augusta, Ark. (II)	D-250
KEZY Anaheim, Calif. (II)	LS-5,000
	DA-N-1,000
KNBA Vallejo, Calif. (II)	D-1,000
KADE Boulder, Colo. (II)	(CP)D-1,000
WAYS Ft. Lauderdale, Fla. (II)	DA-D-5,000
WHHL Pinacastle, Fla. (II)	D-250
WGKA Atlanta (II)	D-1,000
WOWO Ft. Wayne, Ind. (I-B)	DA-N-50,000
WANN Annapolis, Md. (II)	DA-D-10,000
WKOX Framingham, Mass. (II)	D-1,000
WPUP Bay St. Louis, Miss. (II)	D-5,000
KHAD Desoto, Mo. (II)	DA-D-1,000
KAYQ Kansas City, Mo. (II)	LS-1,000
	DA-N-250
KPAR Albuquerque, N.M. (II)	D-1,000
WLBI New York (II)	DA-10,000
WSML Graham, N.C. (II)	DA-D-500
WIXE Monroe, N.C. (II)	D-500
KEX Portland, Ore. (I-B)	DA-50,000
New Am Huron, S.D. (II)	D-500
WHMT Humboldt, Tenn. (II)	D-500
WAMB Nashville (II)	D-250
KLIF Dallas (II)	DA-N-5,000
WBMJ San Juan, P.R. (II)	DA-2-5,000
1200 khz Clear	
WQAI San Antonio, Tex. (I-A)	50,000
1210 khz Clear	
KZOO Honolulu (II)	1,000
WILY Centralia, Ill. (II)	D-1,000
WKNX Saginaw, Mich. (II)	DA-D-10,000
WADE Wadesboro, N.C. (II)	D-1,000
WAVI Dayton, Ohio (II)	D-250
KGYN Guymon, Okla. (II)	DA-N-10,000
WCAU Philadelphia (I-A)	50,000
WHYO Salinas, P.R. (II)	D-1,000
1220 khz (Mexican) Clear	
WBUL Birmingham, Ala. (II)	D-1,000
WABF Fairhope, Ala. (II)	DA-D-1,000
KVSA McGehee, Ark. (II)	D-1,000
KLIP Fowler, Calif. (II)	D-250
KIBE Palo Alto, Calif. (II)	D-5,000
KKAR Pomona, Calif. (II)	DA-D-250
KFCSE Denver (II)	D-1,000
WCDO Hamden, Conn. (II)	DA-D-1,000
WKTZ Jacksonville, Fla. (II)	D-1,000
WACY Kissimmee, Fla. (II)	D-5,000
WCMQ Miami (II)	D-250
WQSA Sarasota, Fla. (II)	DA-D-1,000
WCLB Camilla, Ga. (II)	D-1,000
WPLK Rockmart, Ga. (II)	D-500
WSFT Thomaston, Ga. (II)	D-250
WLPO La Salle, Ill. (II)	DA-D-1,000
WKRS Waukegan, Ill. (II)	DA-D-1,000
WSLM Salem, Ind. (II)	DA-D-5,000
KJAN Atlantic, Iowa (II)	D-250
KOUR Independence, Iowa (II)	D-250
KOFO Ottawa, Kan. (II)	D-250
WFKN Franklin, Ky. (II)	D-250
WEOG Whitley City, Ky. (II)	D-500
WLBI Denham Springs, La. (II)	D-250
KBCL Shreveport, La. (II)	D-250
WSME Sanford, Me. (II)	D-1,000
WBCH Hastings, Mich. (II)	D-250
WAVN Stillwater, Minn. (II)	D-5,000
WMDC Hazlehurst, Miss. (II)	D-250
KBHM Branson, Mo. (II)	D-1,000
KZYM Cape Girardeau, Mo. (II)	D-250
KLPW Union, Mo. (II)	D-1,000
WKBK Keene, N.H. (II)	D-1,000
WGNV Newburgh, N.Y. (II)	DA-D-5,000
WSOO North Syracuse, N.Y. (II)	D-1,000
WKMT Kings Mt., N.C. (II)	D-1,000
WREV Redsville, N.C. (II)	D-1,000

AM by Frequency

<i>Station</i>	<i>Power</i>	<i>Station</i>	<i>Power</i>	<i>Station</i>	<i>Power</i>
KSLV Monte Vista, Colo. (IV)	LS-1,000	WMFG Hibbing, Minn. (IV)	LS-1,000	WJON St. Cloud, Minn. (IV)	LS-1,000
KCRTR Trinidad, Colo. (IV)	N-250	KPRM Park Rapids, Minn. (IV)	N-250	WMPA Aberdeen, Miss. (IV)	LS-1,000
WWCO Waterbury, Conn. (IV)	SH-250	WJON St. Cloud, Minn. (IV)	N-250	WGRM Greenwood, Miss. (IV)	SH-250
WBGC Chipley, Fla. (IV)	LS-1,000	WJON St. Cloud, Minn. (IV)	N-250	WGCM Gulfport, Miss. (IV)	LS-1,000
WLCO Eustis, Fla. (IV)	N-250	WJON St. Cloud, Minn. (IV)	N-250	WMIS Natchez, Miss. (IV)	N-250
WINK Ft. Myers, Fla. (IV)	LS-1,000	WJON St. Cloud, Minn. (IV)	N-250	KFMO Flat River, Mo. (IV)	LS-1,000
WMMB Melbourne, Fla. (IV)	N-250	WJON St. Cloud, Minn. (IV)	N-250	KWOS Jefferson City, Mo. (IV)	LS-1,000
WFOY St. Augustine, Fla. (IV)	LS-1,000	WJON St. Cloud, Minn. (IV)	N-250	KNEM Nevada, Mo. (IV)	250
WBHB Fitzgerald, Ga. (IV)	LS-1,000	WJON St. Cloud, Minn. (IV)	N-250	KBMY Billings, Mont. (IV)	LS-1,000
WDUN Gainesville, Ga. (IV)	N-250	WJON St. Cloud, Minn. (IV)	N-250	KLTZ Glasgow, Mont. (IV)	LS-1,000
WLAG LaGrange, Ga. (IV)	LS-1,000	WJON St. Cloud, Minn. (IV)	N-250	KBLL Helena, Mont. (IV)	N-250
WBML Macon, Ga. (IV)	N-250	WJON St. Cloud, Minn. (IV)	N-250	KFOR Lincoln, Neb. (IV)	LS-1,000
WWNS Statesboro, Ga. (IV)	LS-1,000	WJON St. Cloud, Minn. (IV)	N-250	KODY N. Platte, Neb. (IV)	LS-1,000
WPAX Thomasville, Ga. (IV)	LS-1,000	WJON St. Cloud, Minn. (IV)	N-250	KELK Elko, Nev. (IV)	LS-1,000
WTWA Thomson, Ga. (IV)	LS-1,000	WJON St. Cloud, Minn. (IV)	N-250	WFTN Franklin, N.H. (IV)	250
KVNI Coeur D'Alene, Idaho (IV)	LS-1,000	WJON St. Cloud, Minn. (IV)	N-250	WSNJ Bridgeton, N.J. (IV)	LS-1,000
KMCL McCall, Idaho (IV)	LS-500	WJON St. Cloud, Minn. (IV)	N-250	KAVE Carlsbad, N.M. (IV)	LS-1,000
KFLI Mountain Home, Idaho (IV)	N-250	WJON St. Cloud, Minn. (IV)	N-250	KCLV Clovis, N.M. (IV)	N-250
KWIK Pocatello, Idaho (IV)	LS-1,000	WJON St. Cloud, Minn. (IV)	N-250	WGBB Freeport, N.Y. (IV)	LS-1,000
WCRW Chicago (IV)	N-250	WJON St. Cloud, Minn. (IV)	N-250	WGVA Geneva, N.Y. (IV)	LS-1,000
WEDC Chicago (IV)	LS-1,000	WJON St. Cloud, Minn. (IV)	N-250	WJTN Jamestown, N.Y. (IV)	LS-500
WSBC Chicago (IV)	N-250	WJON St. Cloud, Minn. (IV)	N-250	WVOS Liberty, N.Y. (IV)	LS-1,000
WEBQ Harrisburg, Ill. (IV)	LS-1,000	WJON St. Cloud, Minn. (IV)	N-250	WNBZ Saranac Lake, N.Y. (IV)	LS-1,000
WTAX Springfield, Ill. (IV)	N-250	WJON St. Cloud, Minn. (IV)	N-250	WSNY Schenectady, N.Y. (IV)	LS-1,000
WSDR Sterling, Ill. (IV)	LS-500	WJON St. Cloud, Minn. (IV)	N-250	WATN Watertown, N.Y. (IV)	LS-1,000
WHBU Anderson, Ind. (IV)	N-250	WJON St. Cloud, Minn. (IV)	N-250	WPNF Brevard, N.C. (IV)	LS-1,000
KDEC Decorah, Iowa (IV)	SH-LS-1,000	WJON St. Cloud, Minn. (IV)	N-250	WIST Charlotte, N.C. (IV)	N-250
*KWLC Decorah, Iowa (IV)	N-250	WJON St. Cloud, Minn. (IV)	N-250	WCNC Elizabeth City, N.C. (IV)	LS-1,000
KBIZ Ottumwa, Iowa (IV)	LS-1,000	WJON St. Cloud, Minn. (IV)	N-250	WJNC Jacksonville, N.C. (IV)	LS-1,000
KICD Spencer, Iowa (IV)	N-250	WJON St. Cloud, Minn. (IV)	N-250	WRNC Raleigh, N.C. (IV)	LS-1,000
KIUL Garden City, Kan. (IV)	LS-1,000	WJON St. Cloud, Minn. (IV)	N-250	WWWC Wilkesboro, N.C. (IV)	LS-500
KAKE Wichita, Kan. (IV)	N-250	WJON St. Cloud, Minn. (IV)	N-250	KDLR Devils Lake, N.D. (IV)	250
WINN Louisville, Ky. (IV)	LS-1,000	WJON St. Cloud, Minn. (IV)	N-250	WBBW Youngstown, Ohio (IV)	LS-1,000
WFTM Maysville, Ky. (IV)	N-250	WJON St. Cloud, Minn. (IV)	N-250	WHIZ Zanesville, Ohio (IV)	LS-1,000
WPKE Pikeville, Ky. (IV)	LS-1,000	WJON St. Cloud, Minn. (IV)	N-250	KVSO Ardmore, Okla. (IV)	LS-1,000
WSFC Somerset, Ky. (IV)	N-250	WJON St. Cloud, Minn. (IV)	N-250	KADS Elk City, Okla. (IV)	N-250
KASO Minden, La. (IV)	LS-1,000	WJON St. Cloud, Minn. (IV)	N-250	KBEL Idabel, Okla. (IV)	LS-1,000
KANE New Iberia, La. (IV)	N-250	WJON St. Cloud, Minn. (IV)	N-250	KOKL Okmulgee, Okla. (IV)	LS-1,000
WCOU Lewiston, Me. (IV)	LS-1,000	WJON St. Cloud, Minn. (IV)	N-250	KFLY Corvallis, Ore. (IV)	LS-1,000
WMKR Millinocket, Me. (IV)	N-250	WJON St. Cloud, Minn. (IV)	N-250	KTIX Pendleton, Ore. (IV)	N-250
WCEM Cambridge, Md. (IV)	LS-1,000	WJON St. Cloud, Minn. (IV)	N-250	KPRB Redmond, Ore. (IV)	LS-1,000
WJBJ Hagerstown, Md. (IV)	N-250	WJON St. Cloud, Minn. (IV)	N-250	KQEN Roseburg, Ore. (IV)	LS-1,000
WHAI Greenfield, Mass. (IV)	LS-1,000	WJON St. Cloud, Minn. (IV)	N-250	WRTA Altoona, Pa. (IV)	LS-1,000
WOCB West Yarmouth, Mass. (IV)	N-250	WJON St. Cloud, Minn. (IV)	N-250	WHUM Reading, Pa. (IV)	LS-1,000
WATT Cadillac, Mich. (IV)	LS-1,000	WJON St. Cloud, Minn. (IV)	N-250	WSEW Selingsgrove, Pa. (IV)	LS-1,000
WCBY Cheboygan, Mich. (IV)	N-250	WJON St. Cloud, Minn. (IV)	N-250	WBAX Wilkes-Barre, Pa. (IV)	LS-1,000
WJPD Ishpeming, Mich. (IV)	LS-1,000	WJON St. Cloud, Minn. (IV)	N-250	WWON Woonsocket, R.I. (IV)	LS-1,000
WJIM Lansing, Mich. (IV)	N-250	WJON St. Cloud, Minn. (IV)	N-250	WKDK Newberry, S.C. (IV)	LS-1,000
	LS-1,000	WJON St. Cloud, Minn. (IV)	N-250	WDXY Sumter, S.C. (IV)	LS-1,000
	N-250	WJON St. Cloud, Minn. (IV)	N-250	KCCR Pierre, S.D. (IV)	LS-1,000
	N-250	WJON St. Cloud, Minn. (IV)	N-250		N-250

1240 khz Local

WEBJ Brewton, Ala. (IV)	LS-1,000
WPRN Butler, Ala. (IV)	SH-N-250
WULA Eufaula, Ala. (IV)	LS-1,000
WOWL Florence, Ala. (IV)	N-250
WARF Jasper, Ala. (IV)	LS-1,000
KPPR Globe, Ariz. (IV)	N-250
KNYN Williams, Ariz. (IV)	LS-1,000
KVRC Arkadelphia, Ark. (IV)	250
KTLO Mountain Home, Ark. (IV)	LS-1,000
KWAK Stuttgart, Ark. (IV)	N-250
KPLY Crescent City, Calif. (IV)	250
KOAD Lemoore, Calif. (IV)	250
KMBY Monterey, Calif. (IV)	LS-1,000
KPPC Pasadena, Calif. (IV)	N-250
KLOA Ridgecrest, Calif. (IV)	SH-100
KROY Sacramento, Calif. (IV)	250
KBON San Bernardino, Calif. (IV)	LS-1,000
KSON San Diego (IV)	N-250
KSMA Santa Maria, Calif. (IV)	LS-1,000
KSUE Susanville, Calif. (IV)	N-250
KRDO Colorado Springs (IV)	LS-1,000
KDGO Durango, Colo. (IV)	N-250

Station	Power	Station	Power	AM by Frequency	
WBEJ Elizabethton, Tenn. (IV)	LS-1,000	WFAG Farmville, N.C. (III)	D-500		
	N-250	WKDX Hamlet, N.C. (III)	D-1,000		
WEKR Fayetteville, Tenn. (IV)	LS-1,000	WBRM Marion, N.C. (III)	D-1,000		
	N-250	WCHO Washington Court House, Ohio (III)	D-250		
WBIR Knoxville, Tenn. (IV)	LS-1,000	WLEM Emporium, Pa. (III)	D-1,000		
	N-250	*WPEL Montrose, Pa. (III)	D-1,000		
WKDA Nashville (IV)	LS-1,000	WTAE Pittsburgh (III)	DA-N-5,000	WISO Ponce, P.R. (III)	
	N-250	WNOW York, Pa. (III)	D-1,000	LS-5,000	
WEDG Soddy-Daisy, Tenn. (IV)	LS-1,000	WTMA Charleston, S.C. (III)	LS-5,000	DA-N-1,000	
	N-250		DA-N-1,000	1,000	
WENK Union City, Tenn. (IV)	LS-1,000	WCKM Winnsboro, S.C. (III)	D-500		
	N-250	WKBK Covington, Tenn. (III)	D-1,000		
KVLF Alpine, Tex. (IV)	LS-1,000	WKYZ Madisonville, Tenn. (III)	D-500		
	N-250	WNTT Tazewell, Tenn. (III)	D-500		
KEAN Brownwood, Tex. (IV)	LS-1,000	KPRE Paris, Tex. (III)	D-500		
	N-250	KPAC Port Arthur, Tex. (III)	LS-5,000	1270 khz Regional	
KTAM Bryan, Tex. (IV)	LS-1,000		DA-N-1,000	WGSV Guntersville, Ala. (III)	
	N-250	KUKA San Antonio, Tex. (III)	D-1,000	D-1,000	
KOCA Kilgore, Tex. (IV)	LS-1,000	KIKZ Seminole, Tex. (III)	D-1,000	WKSJ Pritchard, Ala. (III)	
	N-250	WDVA Danville, Va. (III)	DA-N-5,000	D-1,000	
KSOX Raymondville, Tex. (IV)	LS-1,000	WYSR Franklin, Va. (III)	D-1,000	D-5,000	
	N-250	WEER Warrenton, Va. (III)	D-1,000	D-5,000	
KXOX Sweetwater, Tex. (IV)	LS-1,000	*KWSU Pullman, Wash. (III)	L-5,000	D-500	
	N-250	KYAC Seattle (III)	L-5,000	DA-D-1,000	
WSKI Montpelier, Vt. (IV)	LS-1,000	WEMP Milwaukee (III)	DA-2-5,000	D-1,000	
	N-250			5,000	
WSSV Petersburg, Va. (IV)	LS-1,000			LS-5,000	
	N-250	1260 khz Regional		DA-N-1,000	
WROV Roanoke, Va. (IV)	LS-1,000	WCRT Birmingham, Ala. (III)	D-5,000	DA-N-500	
	N-250	KPIN Casa Grande, Ariz. (III)	D-1,000	D-5,000	
WTON Staunton, Va. (IV)	LS-1,000	KCCB Corning, Ark. (III)	D-1,000	DA-N-5,000	
	N-250	KBHC Nashville, Ark. (III)	D-500	(CP)DA-2-LS-5,000	
KXLE Ellensburg, Wash. (IV)	LS-1,000	KGIL San Fernando, Calif. (III)	DA-2-5,000	N-500	
	N-250	KYA San Francisco (III)	LS-5,000	DA-1,000	
KGY Olympia, Wash. (IV)	LS-1,000	KSNO Aspen, Colo. (III)	N-1,000	DA-D-1,000	
	N-250	WMMM Westport, Conn. (III)	D-5,000	DA-D-500	
WKOY Bluefield, W. Va. (IV)	LS-1,000	WNRK Newark, Del. (III)	DA-D-5,000	D-1,000	
	N-250	WWDC Washington (III)	D-1,000	D-1,000	
WTIP Charleston, W. Va. (IV)	LS-1,000	WFTW Ft. Walton Beach, Fla. (III)	DA-2-5,000	D-1,000	
	N-250	WWOK Miami (III)	LS-1,000	DA-2-LS-5,000	
WDNE Elkins, W. Va. (IV)	LS-1,000	WWPF Palatka, Fla. (III)	DA-N-500	N-1,000	
	N-250		D-5,000	DA-2-LS-5,000	
WOMT Maitowoc, Wis. (IV)	LS-1,000	WUFE Baxley, Ga. (III)	D-1,000	N-1,000	
	N-250	WBBK Blakely, Ga. (III)	D-1,000	DA-N-5,000	
WIBU Poyette, Wis. (IV)	LS-1,000	WTJH East Point, Ga. (III)	D-5,000	WXYZ Detroit (III)	
	N-250	KTEE Idaho Falls, Idaho (III)	D-5,000	DA-2-LS-5,000	
WOBT Rhinelander, Wis. (IV)	LS-1,000	KWEI Weiser, Idaho (III)	D-1,000	N-1,000	
	N-250	WIBV Belleville, Ill. (III)	DA-2-5,000	D-1,000	
WJMC Rice Lake, Wis. (IV)	LS-1,000	WNDE Indianapolis (III)	DA-N-5,000	D-5,000	
	N-250	*KFGQ Boone, Iowa (III)	D-1,000	D-1,000	
KFBC Cheyenne, Wyo. (IV)	LS-1,000	KWHK Hutchinson, Kan. (II)	DA-2-LS-1,000	D-1,000	
	N-250		N-500	D-500	
KEVA Evanston, Wyo. (IV)	LS-1,000	WAIL Baton Rouge (III)	D-1,000	D-1,000	
	N-250	WEZE Boston (III)	DA-N-5,000	DA-2-5,000	
KASL Newcastle, Wyo. (IV)	LS-1,000	WALM Albion, Mich. (III)	LS-1,000	DA-D-500	
	N-250		DA-N-500	D-1,000	
KRAL Rawlins, Wyo. (IV)	LS-1,000	WJBL Holland, Mich. (III)	DA-D-5,000	DA-D-5,000	
	N-250	KROX Crookston, Minn. (III)	LS-1,000	D-1,000	
KTHE Thermopolis, Wyo. (IV)	LS-1,000		DA-N-500	LS-1,000	
	SH-250	KDUJ Hutchinson, Minn. (III)	D-1,000	DA-N-500	
WALO Humacao, P.R. (IV)	LS-1,000	WGVM Greenville, Miss. (III)	D-5,000	D-5,000	
	N-250	WNSL Laurel, Miss. (III)	D-5,000	KBOM Smithack-Mandan, N.D. (III)	
		WCSA Ripley, Miss. (IV)	D-500	N-250	
1250 khz Regional		KGBX Springfield, Mo. (III-A)	DA-N-5,000	D-1,000	
WZOB Ft. Payne, Ala. (III)	D-1,000	KIMB Kimball, Neb. (III)	D-1,000	D-500	
WETU Wetumpka, Ala. (III)	D-5,000	WBUD Trenton, N.J. (III)	DA-2-LS-5,000	D-5,000	
KSWW Wickenburg, Ariz. (III)	D-500		N-1,000	DA-2-LS-5,000	
KHIL Wilcox, Ariz. (III)	D-5,000	KVSF Santa Fe, N.M. (III)	1,000	D-1,000	
KFAY Fayetteville, Ark. (III)	D-1,000	WBNR Beacon, N.Y. (III)	DA-D-1,000	D-1,000	
KALO Little Rock, Ark. (III)	LS-1,000	WNDR Syracuse, N.Y. (III)	DA-N-5,000	DA-N-1,000	
	DA-N-500	WGWR Asheboro, N.C. (III)	DA-2-LS-5,000	LS-5,000	
KHOT Madera, Calif. (III)	D-500		N-500	DA-N-500	
KTMS Santa Barbara, Calif. (III)	DA-1,000	WCDJ Edenton, N.C. (III)	D-1,000	DA-N-1,000	
KDHI Twenty-Nine Palms, Calif. (III)	D-1,000	WIXY Cleveland (III)	DA-2-LS-5,000	D-1,000	
WNER Live Oak, Fla. (III)	D-1,000	WNXT Portsmouth, Ohio (III)	DA-2-LS-5,000	D-1,000	
WDAE Tampa, Fla. (III)	DA-5,000		N-1,000	DA-5,000	
WQDE Albany, Ga. (III)	D-1,000	KWSH Wewoka, Okla. (III)	DA-N-1,000	D-1,000	
WYTH Madison, Ga. (III)	D-1,000	KMCM McMinnville, Ore. (III)	DA-N-1,000	D-1,000	
WIZZ Streater, Ill. (III)	DA-D-500	WWYN Erie, Pa. (III)	DA-2-5,000	D-1,000	
WGL Ft. Wayne, Ind. (III)	DA-2-1,000	WPHB Phippsburg, Pa. (III)	D-5,000	D-1,000	
WRAY Princeton, Ind. (III)	D-1,000	WMUU Greenville, S.C. (III)	D-5,000	D-5,000	
KCFI Cedar Falls, Iowa (III)	DA-D-500			D-500	
*KFKU Lawrence, Kan. (III)	DA-N-5,000	WJOT Lake City, S.C. (III)	D-1,000	LS-5,000	
	ST-WREN	KWYR Winner, S.D. (III)	D-5,000	DA-N-1,000	
WREN Topeka, Kan. (III)	DA-N-5,000	WNOO Chattanooga, Tenn. (III)	D-1,000		
	ST-KFKU	WMCH Church Hill, Tenn. (III)	D-1,000		
WNVL Nicholasville, Ky. (III)	D-500	WDKN Dickson, Tenn. (III)	D-1,000		
WLCK Scottsville, Ky. (III)	D-500	WCLC Jamestown, Tenn. (III)	D-1,000		
WGUW Bangor, Me. (III)	D-5,000	KSPL Diboll, Tex. (III)	D-1,000		
WARE Ware, Mass. (III)	DA-N-1,000	KPSO Falfurrias, Tex. (III)	D-500		
WXOX Bay City, Mich. (III)	D-1,000	KIXY San Angelo, Tex. (III)	D-1,000		
KBRF Ferguson Falls, Minn. (III)	DA-N-1,000	KTAE Taylor, Tex. (III)	D-1,000		
KCUE Red Wing, Minn. (III)	D-1,000	KTUE Tulia, Tex. (III)	D-1,000		
WHNY McComb, Miss. (III)	LS-5,000	WCHV Charlottesville, Va. (III)	DA-2-LS-5,000		
	DA-N-1,000		N-1,000		
KBTC Houston, Mo. (III)	D-1,000	WJJJ Christianburg, Va. (III)	D-1,000		
New AM Forsyth, Mont. (III)	D-5,000	KWIQ Moses Lake, Wash. (III)	D-1,000		
WKBR Manchester, N.H. (III)	DA-2-5,000	WVVW Grafton, W. Va. (III)	D-500		
WMTR Morristown, N.J. (III)	DA-D-5,000	WWIS Black River Falls, Wis. (III)	D-1,000		
WIPS Ticonderoga, N.Y. (III)	D-1,000	WEKZ Monroe, Wis. (III)	D-1,000		
		WOCO Oconto, Wis. (III)	D-1,000		

AM by Frequency

Station	Power	Station	Power	Station	Power
WMRO Aurora, Ill. (III)	DA-2-LS-1,000 N-500	KSRC Socorro, N.M. (III)	D-1,000	KOLY Moberidge, S.D. (III)	D-5,000
WGBF Evansville, Ind. (III)	LS-5,000	WGLI Babylon, N.Y. (III)	DA-2-LS-5,000	WMTN Morristown, Tenn. (III)	DA-D-5,000
KCOB Newton, Iowa (III)	D-1,000	WNBF Binghamton, N.Y. (III)	N-1,000	WMAK Nashville (III)	DA-N-5,000
KSKO Arkansas City, Kan. (III)	LS-1,000	WHKY Hickory, N.C. (III)	DA-N-5,000	KVET Austin, Tex. (III)	DA-2-LS-5,000
WCPM Cumberland, Ky. (III)	D-1,000	WBBS Jacksonville, N.C. (III)	LS-5,000	KKUB Brownfield, Tex. (III)	N-1,000
WIXI Lancaster, Ky. (III)	D-1,000	WEYE Sanford, N.C. (III)	DA-N-1,000	KLAR Laredo, Tex. (III)	D-1,000
WGSO New Orleans (III)	DA-5,000	WOMP Bellaire, Ohio (III)	D-1,000	KKAS Silsbee, Tex. (III)	N-500
KWCL Oak Grove, La. (III)	D-1,000	WHIO Dayton, Ohio (III)	D-1,000	KMPC Harrisonburg, Va. (III)	D-5,000
WABK Gardiner, Me. (III)	DA-N-5,000	KUMA Pendleton, Ore. (III)	DA-N-5,000	WKPS Seattle (III)	DA-N-5,000
WEIM Fitchburg, Mass. (III)	DA-2-LS-5,000	KLIQ Portland, Ore. (III)	D-5,000	WCLG Morgantown, W. Va. (III)	D-1,000
WFYC Alma, Mich. (III)	N-1,000	WFBG Altoona, Pa. (III)	LS-5,000	WKLC St. Albans, W. Va. (III)	D-1,000
WVWV Minneapolis (III)	(CP)DA-D-5,000	WQIN Lykens, Pa. (III)	N-1,000	WLOT Marinette, Wis. (III)	D-1,000
KVOX Moorhead, Minn. (III)	DA-N-5,000	WICE Providence, R.I. (III)	D-500	WTLI Mayaguez, P.R. (III)	D-1,000
KDKD Clinton, Mo. (III)	LS-1,000	WFIG Sumter, S.C. (III)	DA-2-LS-5,000		
KYRO Potosi, Mo. (III)	DA-N-500	WATO Oak Ridge, Tenn. (III)	N-1,000		
KCNI Broken Bow, Neb. (III)	D-1,000	KWGH Big Lake, Tex. (III)	N-500	1310 khz Regional	
KVOV Henderson Nev. (III)	D-500	KIVY Crockett, Tex. (III)	D-1,000	WHEP Foley, Ala. (III)	D-1,000
KRZE Farmington, N.M. (III)	D-1,000	KRGV Westaco, Tex. (III)	D-1,000	WJAM Merion, Ala. (III)	D-5,000
WADO New York (III)	D-5,000	KTRN Wichita Falls, Tex. (III)	DA-N-5,000	KBUZ Mesa, Ariz. (III)	LS-5,000
WROC Rochester, N.Y. (III)	DA-N-5,000	WAGE Leesburg, Va. (III)	LS-5,000	KBOK Malvern, Ark. (III)	DA-N-500
WSAT Salisbury, N.C. (III)	DA-N-1,000	WPVA Petersburg, Va. (III)	D-1,000	KIOT Barstow, Calif. (III)	D-1,000
WYAL Scotland Neck, N.C. (III)	D-5,000	WNLB Rocky Mount, Va. (III)	D-1,000	KPOD Crescent City, Calif. (III)	D-1,000
WONW Defiance, Ohio (III)	LS-1,000	KAPY Port Angeles, Wash. (III)	DA-D-1,000	KDIA Oakland, Calif. (III)	DA-5,000
WLMJ Jackson, Ohio (III)	DA-N-500	WVOW Logan, W. Va. (III)	LS-5,000	KTKR Taft, Calif. (III)	D-1,000
KLCO Poteau, Okla. (III)	D-1,000	WZUU Milwaukee (III)	DA-N-1,000	KFKA Greeley, Colo. (III)	LS-5,000
KBDF Eugene, Ore. (III)	D-1,000	WCOW Sparta, Wis. (III)	D-1,000	WICH Norwich, Conn. (III)	DA-N-1,000
WBRX Berwick, Pa. (III)	DA-N-1,000	KOWB Laramie, Wyo. (III)	D-5,000	WKKX Deland, Fla. (II)	DA-2-LS-5,000
WHVR Hanover, Pa. (III)	DA-2-LS-5,000	WRRR Frederiksted, V.I. (III)	N-1,000	WGKR Perry, Fla. (III)	N-1,000
WKST New Castle, Pa. (III)	N-500		DA-D-500	WGAUC Wauchula, Fla. (III)	D-5,000
WANS Anderson, S.C. (III)	DA-N-1,000	1300 khz Regional		WQAK Decatur, Ga. (III)	D-500
WJAY Mullins, S.C. (III)	D-5,000	WBSA Boaz, Ala. (III)	D-1,000	WOKA Douglas, Ga. (III)	D-1,000
WMCP Columbia, Tenn. (III)	D-1,000	WTLN Tallahassee, Ala. (III)	D-1,000	WBRO Waynesboro, Ga. (III)	D-1,000
WDNT Dayton, Tenn. (III)	D-1,000	WEZQ Winfield, Ala. (III)	D-1,000	WBMK West Point, Ga. (III)	D-1,000
KNIT Abilene, Tex. (III)	D-500	KHAC Window Rock, Ariz. (III)	D-1,000	KNUI Kahului, Hawaii (III)	5,000
KTTX Brenham, Tex. (III)	D-1,000	KWCK Searcy, Ark. (III)	D-1,000	KLXI Twin Falls, Idaho (III)	LS-5,000
KLUE Longview, Tex. (III)	D-1,000	KROP Brawley, Calif. (III)	LS-1,000	WIFE Indianapolis (III)	DA-N-1,000
KRAN Morton, Tex. (III)	D-500	KYNO Fresno, Calif. (III)	N-500	KOKX Keokuk, Iowa (III)	LS-1,000
KVWG Pearsall, Tex. (III)	D-500	KMFB Mendocino, Calif. (III)	LS-5,000	KDLS Perry, Iowa (III)	DA-N-500
KNAK Salt Lake City (III)	LS-5,000	KWKK Pasadena, Calif. (III)	DA-2-LS-5,000	KFLA Scott City, Kan. (III)	DA-D-500
WTTX Appomattox, Va. (III)	DA-N-500	KVOR Colorado Springs (III)	N-1,000	WTTL Madisonville, Ky. (III)	LS-1,000
WYVE Wytheville, Va. (III)	D-1,000	WAVZ New Haven, Conn. (III)	LS-5,000	WDOC Prestonburg, Ky. (III)	DA-N-500
KMAS Shelton, Wash. (III)	D-1,000	WRKT Cocoa Beach, Fla. (III)	N-1,000	KEZM Sulphur, La. (III)	DA-D-500
KUDY Spokane, Wash. (III)	DA-D-5,000	WFFG Marathon, Fla. (III)	DA-N-1,000	KUZM W. Monroe, La. (III)	D-1,000
KIT Yakima, Wash. (III)	LS-5,000	WSOL Tampa, Fla. (III)	DA-2-LS-5,000	WLOB Portland, Me. (III)	DA-2-5,000
WNAM Neenah-Menasha, Wis. (III)	DA-2-LS-5,000	WMTM Moultrie, Ga. (III)	N-1,000	WORC Worcester, Mass. (III)	DA-2-LS-5,000
WCMN Arecibo, P.R. (III)	N-1,000	WNEA Newnan, Ga. (III)	D-500	WNIC Dearborn, Mich. (III)	N-1,000
	LS-5,000	WIMO Winder, Ga. (III)	D-1,000	WCCW Traverse City, Mich. (III)	DA-2-5,000
	N-1,000	KOZE Lewiston, Idaho (III)	LS-5,000	KRBI St. Peter, Minn. (III)	D-5,000
		WTAQ La Grange, Ill. (III)	DA-N-1,000	WXXX Hattiesburg, Miss. (III)	DA-D-1,000
			DA-2-LS-5,000	KFSB Joplin, Mo. (III)	DA-2-LS-5,000
1290 khz Regional			N-500	KEIN Great Falls, Mont. (III)	N-1,000
WSHF Sheffield, Ala. (III)	D-1,000	WFRX West Frankfort, Ill. (III)	D-1,000	KGMT Fairbury, Neb. (III)	D-500
WMLS Sylacauga, Ala. (III)	D-1,000	WHLT Huntington, Ind. (III)	D-1,000	WJLK Asbury Park, N.J. (III)	DA-D-LS-1,000
KCUB Tucson, Ariz. (III)	1,000	WAAC Terre Haute, Ind. (III)	D-500		N-250
KDMS El Dorado, Ark. (III)	D-5,000	GLO Mason City, Iowa (III)	DA-N-5,000	WCAM Camden, N.J. (III)	LS-1,000
KUOA Siloam Springs, Ark. (III)	D-5,000	WBLG Lexington, Ky. (III)	DA-N-1,000		N-250
KHSL Chico, Calif. (III)	DA-N-5,000	WIBR Baton Rouge (III)	DA-2-1,000	WPRJ Parsippany-Troy Hills, N.J. (III)	DA-D-1,000
KAZA Gilroy, Calif. (III)	DA-D-5,000	KFLO Shreveport, La. (III)	D-500	WVIP Mt. Kisco, N.Y. (III)	DA-D-5,000
KMEN San Bernardino, Calif. (III)	DA-2-5,000	WFBR Baltimore (III)	DA-5,000	WTLB Utica, N.Y. (III)	LS-1,000
KKIO Santa Barbara, Calif. (III)	D-500	WJDA Quincy, Mass. (III)	D-1,000		DA-N-500
WCCC Hartford, Conn. (III)	D-500	WOOD Grand Rapids, Mich. (III)	DA-N-5,000	WISE Asheville, N.C. (III)	LS-5,000
WTUX Wilmington, Del. (III)	D-1,000	WKPM Princeton, Minn. (III)	D-1,000		DA-N-1,000
WTMC Ocala, Fla. (III)	LS-5,000	WRBC Jackson, Miss. (III)	LS-5,000	WHVN Charlotte, N.C. (III)	D-1,000
	DA-N-1,000		N-1,000	WTIK Durham, N.C. (III)	DA-2-LS-5,000
WSCM Panama City Beach, Fla. (III)	D-500	KMMO Marshall, Mo. (III)	D-1,000		N-1,000
WIRK W. Palm Beach, Fla. (III)	LS-5,000	KBRL McCook, Neb. (III)	DA-D-5,000	KNOX Grand Forks, N.D. (III)	DA-N-5,000
	DA-N-1,000	KPTL Carson City, Nev. (III)	LS-5,000	WFAH Alliance, Ohio (III)	DA-D-1,000
WDEC Americus, Ga. (III)	D-1,000		DA-N-500	KNPT Newport, Ore. (III)	LS-5,000
WCHK Canton, Ga. (III)	D-1,000	WPNH Plymouth, N.H. (III)	D-1,000		DA-N-1,000
WTOC Savannah, Ga. (III)	DA-N-5,000	WTNJ Trenton, N.J. (III)	DA-D-5,000	WBFD Bedford, Pa. (III)	D-5,000
KSNM Pocatello, Idaho (III)	D-1,000	WOSC Fulton, N.Y. (III)	D-1,000	WGSA Ephrata, Pa. (III)	DA-D-5,000
WIRL Peoria, Ill. (III)	DA-2-5,000	WXRL Lancaster, N.Y. (III)	DA-D-1,000	WNAE Warren, Pa. (III)	D-5,000
WREY New Albany, Ind. (III)	DA-D-500	WQBK Rensselaer, N.Y. (III)	DA-D-5,000	WDKD Kingstree, S.C. (III)	D-5,000
KWNS Pratt, Kan. (III)	DA-2-LS-5,000	WKQW Spring Valley, N.Y. (III)	DA-D-500	WDOD Chattanooga (III)	DA-N-5,000
	N-500	WYNG Goldsboro, N.C. (III)	D-1,000	WDXI Jackson, Tenn. (III)	LS-5,000
WCBL Benton, Ky. (III)	D-5,000	WLNC Laurinburg, N.C. (III)	D-500		DA-N-1,000
KJEF Jennings, La. (III)	D-1,000	WSYD Mt. Airy, N.C. (III)	LS-5,000	WBNT Oneida, Tenn. (III)	D-1,000
WHGR Houghton Lake, Mich. (III)	DA-N-5,000		DA-N-1,000	KZIP Amarillo, Tex. (III)	D-1,000
WNIL Niles, Mich. (III)	D-500	WERE Cleveland (III)	DA-5,000	WRR Dallas, Tex. (III)	DA-N-5,000
WNRS Saline, Mich. (III)	DA-D-500	WMVO Mt. Vernon, Ohio	DA-D-500	KOYL Odessa, Tex. (III)	D-1,000
KBMO Benson, Minn. (III)	D-500	KXXO Tulsa, Okla. (III)	DA-2-LS-5,000	KBUC San Antonio, Tex. (III)	DA-D-5,000
WBLE Batesville, Miss. (III)	D-1,000		N-1,000	WEEL Fairfax, Va. (III)	DA-2-LS-5,000
WTYL Tylertown, Miss. (III)	D-1,000	KACI The Dalles, Ore. (III)	D-1,000		N-500
KALM Thayer, Mo. (III)	D-1,000	WWCH Clarion, Pa. (III)	D-500	WGH Newport News, Va. (III)	D-5,000
KGVO Missoula, Mont. (III)	DA-5,000	WLOW Aiken, S.C. (III)	D-500	KARY Prosser, Wash. (III)	D-1,000
KOIL Omaha (III)	DA-N-5,000	WCKI Greer, S.C. (III)	D-1,000	WSLW White Sulphur Springs, W. Va. (III)	D-5,000
WKNE Keene, N.H. (III)	DA-5,000	WKSC Kershaw, S.C. (III)	D-500	WIBA Madison, Wis. (III)	DA-N-LS-5,000

1320 khz Regional

WENN Birmingham, Ala. (III)	D-5,000
WAGF Dothan, Ala. (III)	DA-N-1,000
*KAWC Yuma, Ariz. (III)	D-500
KWHN Ft. Smith, Ark. (III)	DA-N-5,000
KRLW Walnut Ridge, Ark. (III)	D-1,000
KHSJ Hemet, Calif. (III)	DA-D-500
KLAN Lemoore, Calif. (III)	DA-D-1,000
KUDE Oceanside, Calif. (III)	DA-500
KCRA Sacramento, Calif. (III)	DA-2-LS-5,000
	N-1,000
KAVI Rocky Ford, Colo. (III)	D-1,000
WATR Waterbury, Conn. (III)	DA-2-LS-5,000
	N-1,000
WGMA Hollywood, Fla. (III)	DA-2-5,000
WVOJ Jacksonville, Fla. (III)	DA-N-5,000
WAMR Venice, Fla. (III)	D-500
WHIE Griffin, Ga. (III)	D-5,000
WKAN Kankakee, Ill. (III)	LS-1,000
	DA-N-500
KNIA Knoxville, Iowa (III)	DA-D-500
KMAQ Maquoketa, Iowa (III)	D-500
KLWN Lawrence, Kan. (III)	D-500
WBRT Bardstow, Ky. (III)	D-1,000
WCLU Covington, Ky. (III)	DA-D-500
WNGO Mayfield, Ky. (III)	D-1,000
WICO Salisbury, Md. (III)	D-1,000
WARA Attleboro, Mass. (III)	DA-2-1,000
WLS Lansing, Mich. (III)	DA-2-LS-5,000
	N-1,000
WDMJ Marquette, Mich. (III)	DA-N-1,000
WRJW Picayune, Miss. (III)	D-5,000
WVLY Water Valley, Miss. (III)	D-500
KADI Clayton, Mo. (III)	(CP)DA-D-5,000
KOLT Scottsbluff, Neb. (III)	LS-5,000
	DA-N-1,000
KRDD Roswell, N.M. (III)	D-1,000
WHHO Hornell, N.Y. (III)	D-5,000
WAGY Forest City, N.C. (III)	D-1,000
WCOG Greensboro, N.C. (III)	DA-2-LS-5,000
	N-1,000
WKRK Murphy, N.C. (III)	D-5,000
WEEW Washington, N.C. (III)	D-500
KHRT Minot, N.D. (III)	D-1,000
WHOK Lancaster, Ohio (III)	D-1,000
KWOE Clinton, Okla. (III)	D-1,000
KATR Eugene, Ore. (III)	D-1,000
WKAP Allentown, Pa. (III)	DA-2-LS-5,000
	N-1,000
WGET Gettysburg, Pa. (III)	DA-2-LS-1,000
	N-500
WKQT Pittsburgh (III)	DA-N-5,000
WSCR Scranton, Pa. (III)	LS-1,000
	DA-N-500
WOIC Columbia, S.C. (III)	LS-5,000
	DA-N-1,000
KELO Sioux Falls, S.D. (III)	DA-N-5,000
WKIN Kingsport, Tenn. (III)	D-5,000
WMSR Manchester, Tenn. (III)	D-5,000
KVMC Colorado City, Tex. (III)	D-1,000
KXYZ Houston (III)	DA-N-5,000
KCPX Salt Lake City (III)	DA-5,000
WCVR Randolph, Vt. (III)	D-1,000
WLGW Lynchburg, Va. (III)	D-1,000
WEET Richmond, Va. (III)	(CP)DA-D-5,000
KXRO Aberdeen, Wash. (III)	LS-5,000
	DA-N-1,000
KHIT Walla Walla, Wash. (III)	D-1,000
WFHR Wisconsin Rapids, Wis. (III)	LS-5,000
	DA-N-500
WUNO San Juan, P.R. (III)	LS-5,000
	N-1,000

WASA Havre de Grace, Md. (III)

WJET Waltham, Mass. (III)	DA-2-5,000
WTRX Flint, Mich. (III)	DA-2-LS-5,000
	N-1,000
WLOL Minneapolis (III)	DA-2-5,000
WFTO Fulton, Mass. (III)	D-1,000
WJPR Greenville, Miss. (III)	LS-1,000
	DA-N-500
WDAL Meridian, Miss. (III)	D-1,000
KUKU Willow Springs, Mo. (III)	D-1,000
KGAK Gallup, N.M. (III)	LS-5,000
WEVD New York (III)	DA-2-5,000
	SH-WHAZ-WPOW
WPOW New York (III)	DA-5,000
	SH-WEVD-WHAZ
WEBO Owego, N.Y. (III)	D-1,000
WHAZ Troy, N.Y. (III)	DA-1,000
	SH-WEVD-WPOW
WKVO Havelock, N.C. (III)	D-1,000
WHOT Campbell, Ohio (III)	DA-2-LS-1,000
	N-500
WFIN Findlay, Ohio (III)	D-1,000
WKOV Wellston, Ohio (III)	D-500
WELW Willoughby, Ohio (III)	DA-D-500
KPOK Portland, Ore. (III)	DA-5,000
WRIE Erie, Pa. (III)	DA-2-5,000
WLAT Conway, S.C. (III)	LS-5,000
	DA-N-500
WFBC Greenville, S.C. (III)	DA-N-5,000
WAEW Havelock, Tenn. (III)	D-1,000
WTRO Dyersburg, Tenn. (III)	D-500
KMIL Cameron, Tex. (III)	D-500
KSWA Graham, Tex. (III)	D-500
KINE Kingsville, Tex. (III)	D-1,000
KVKM Monahans, Tex. (III)	LS-5,000
	DA-N-1,000
KZAK Tyler, Tex. (III)	1,000
WBTM Danville, Va. (III)	LS-5,000
	DA-N-1,000
WRAA Luray, Va. (III)	D-1,000
WOLD Marion, Va. (III)	D-1,000
WESR Tasley, Va. (III)	D-5,000
*KMBI Spokane, Wash. (III)	D-5,000
WETZ New Martinsville, W. Va. (III)	D-1,000
WHBL Sheboygan, Wis. (III)	DA-2-LS-5,000
	N-1,000
KOVE Lander, Wyo. (III)	LS-5,000
	DA-N-1,000

1340 khz Local

WKUL Cullman, Ala. (IV)	LS-1,000
	N-250
WXOR Florence, Ala. (IV)	LS-1,000
	N-250
WAMA Selma, Ala. (IV)	LS-1,000
	N-250
WFEB Sylcauga, Ala. (IV)	LS-1,000
	N-250
KIKO Miami, Ariz. (IV)	LS-1,000
	N-250
KFBR Nogales, Ariz. (IV)	LS-1,000
	N-250
KPGE Page, Ariz. (IV)	LS-1,000
	N-250
KBTA Batesville, Ark. (IV)	LS-1,000
	N-250
KZNG Hot Springs, Ark. (IV)	LS-1,000
	N-250
KCAT Pine Bluff, Ark (IV)	LS-1,000
	N-250
KBRS Springdale, Ark. (IV)	LS-1,000
	N-250
KATA Arcata, Calif. (IV)	LS-1,000
	N-250
KWXY Cathedral City, Calif. (IV)	LS-500
	N-250
KMAK Fresno, Calif. (IV)	LS-1,000
	N-250
KDOL Mojave, Calif. (IV)	LS-500
	N-250
KSFE Needles, Calif. (IV)	SH-D-1,000
	N-250
KORV Oroville, Calif. (IV)	LS-1,000
	N-250
KATY San Luis Obispo, Calif. (IV)	LS-1,000
	N-250
KIST Santa Barbara, Calif. (IV)	LS-1,000
	N-250
KOMY Watsonville, Calif. (IV)	LS-1,000
	N-250
KDEN Denver (IV)	LS-1,000
	N-250
KQIL Grand Junction, Colo. (IV)	LS-1,000
	N-250
KVRH Salida, Colo. (IV)	SH-LS-1,000
	N-250
WNHC New Haven, Conn. (IV)	LS-1,000
	N-250
WOOK Washington (IV)	LS-1,000
	N-250

Station	Power
WTAN Clearwater, Fla. (IV)	LS-1,000
	N-250
WWFL Clermont, Fla. (IV)	SH-250
WROD Daytona Beach, Fla. (IV)	LS-1,000
	N-250
WDSR Lake City, Fla. (IV)	LS-1,000
	N-250
WTYS Marianna, Fla. (IV)	LS-1,000
	N-250
WPBR Palm Beach, Fla. (IV)	LS-500
	N-250
WSEB Sebring, Fla. (IV)	LS-1,000
	N-250
WFSH Valparaiso-Niceville, Fla. (IV)	LS-1,000
	N-250
WGAU Athens, Ga. (IV)	LS-1,000
	N-250
WIGO Atlanta (IV)	LS-1,000
	N-250
WBBQ Augusta, Ga. (IV)	LS-1,000
	N-250
WGAA Cedartown, GA. (IV)	LS-1,000
	N-250
WOKS Columbus, Ga. (IV)	LS-1,000
	N-250
WBBT Lyons, Ga. (IV)	LS-1,000
	N-250
WTIF Tifton, Ga. (IV)	LS-1,000
	N-250
KSKI Hailey, Idaho (IV)	LS-1,000
	N-250
KAIN Nampa, Idaho (IV)	LS-1,000
	N-250
KPST Preston, Idaho (IV)	LS-5,000
WSOY Decatur, Ill. (IV)	LS-1,000
	N-250
WJPF Herrin, Ill. (IV)	LS-1,000
	N-250
WJOL Joliet, Ill. (IV)	LS-1,000
	N-250
WBIW Bedford, Ind. (IV)	LS-1,000
	N-250
WTRC Elkhart, Ind. (IV)	LS-1,000
	N-250
WLBC Muncie, Ind. (IV)	LS-1,000
	N-250
KROS Clinton, Iowa (IV)	LS-1,000
	N-250
KCKN Kansas City, Kan. (IV)	LS-1,000
	N-250
KSEK Pittsburg, Kan. (IV)	LS-1,000
	N-250
WCMI Ashland, Ky. (IV)	LS-1,000
	N-250
WBGW Bowling Green, Ky. (IV)	LS-1,000
	N-250
WNBS Murray, Ky. (IV)	LS-1,000
	N-250
WEKY Richmond, Ky. (IV)	LS-1,000
	N-250
KVOB Bastrop, La. (IV)	LS-1,000
	N-250
KRMD Shreveport, La. (IV)	LS-1,000
	N-250
WFAU Augusta, Me. (IV)	LS-1,000
	N-250
WDME Dover-Foxcroft, Me	LS-1,000
	N-250
WLVC Fort Kent, ME.	LS-1,000
	N-250
WHOU Houlton, Me. (IV)	LS-1,000
	N-250
WGAW Gardner, Mass. (IV)	LS-1,000
	N-250
WNBH New Bedford, Mass. (IV)	LS-1,000
	N-250
WBRK Pittsfield, Mass. (IV)	LS-1,000
	N-250
WLEW Bad Axe, Mich. (IV)	LS-1,000
	N-250
WLAV Grand Rapids, Mich. (IV)	LS-1,000
	N-250
WCSR Hillsdale, Mich. (IV)	LS-500
	N-250
WMTE Manistee, Mich. (IV)	LS-1,000
	N-250
WAGN Menominee, Mich. (IV)	LS-1,000
	N-250
WMBN Petoskey, Mich. (IV)	LS-1,000
	N-250
WEXL Royal Oak, Mich. (IV)	DA-D-LS-1,000
	N-250
KVBR Brainerd, Minn. (IV)	LS-1,000
	N-250
KDLM Detroit Lakes, Minn. (IV)	LS-1,000
	N-250
WEVE Eveleth, Minn. (IV)	LS-1,000

Station Power

WLYN Lynn, Mass. (III)	D-1,000
WKYO Caro, Mich. (III)	(CP) DA-2-1,000
WKMI Kalamazoo, Mich. (III)	LS-5,000
	DA-N-1,000
KRWC Buffalo, Minn. (III)	D-500
WFFF Columbia, Miss. (III)	D-1,000
KMRN Cameron, Mo. (III)	DA-D-500
KLRS Mountain Grove, Mo. (III)	D-1,000
KICX McCook, Neb. (III)	D-1,000
WNNJ Newton, N.J. (III)	D-1,000
WBBZ Vineland, N.J. (III)	DA-N-1,000
KRRR Ruidoso, N.M. (III)	D-5,000
WKOP Binghamton, N.Y. (III)	DA-2-LS-5,000
	N-500
WMNS Olean, N.Y. (III)	D-1,000
WCHL Chapel Hill, N.C. (III)	DA-N-1,000
KCIZ Williston, N.D. (III)	LS-DA-N-5,000
WSAI Cincinnati (III)	DA-N-5,000
WVOW Conneaut, Ohio (III)	D-500
KOHU Hermiston, Ore. (III)	DA-N-1,000
KUIK Hillsboro, Ore. (III)	D-1,000
WIXZ McKeesport, Pa. (III)	LS-5,000
	DA-N-1,000
WPPA Pottsville, Pa. (III)	DA-2-LS-5,000
	N-500
WELP Easley, S.C. (III)	D-1,000
WLCM Lancaster, S.C. (III)	D-1,000
WBLC Lenoir City, Tenn. (III)	D-1,000
WNAH Nashville (III)	D-1,000
KQIZ Amarillo, Tex. (III)	D-500
KACT Andrews, Tex. (III)	D-1,000
KBUK Baytown, Tex. (III)	DA-2-1,000
KRYS Corpus Christi, Tex. (III)	1,000
KXOL Ft. Worth (III)	LS-5,000
	DA-N-1,000
WBOB Galax, Va. (III)	D-1,000
WHBG Harrisonburg, Va. (III)	D-5,000
KFDR Grand Coulee, Wash. (III)	D-1,000
KMO Tacoma, Wash. (III)	5,000
WHJC Matewan, W. Va. (III)	D-1,000
WMOV Ravenswood, W. Va. (III)	D-1,000
WEGE Green Bay, Wis. (III)	DA-N-5,000
WMNE Menomonee, Wis. (III)	D-1,000
WISV Viroqua, Wis. (III)	D-1,000
KRKK Rock Springs, Wyo. (III)	LS-1,000
	DA-N-500
	DA-D-1,000

1370 khz Regional

WBYE Calera, Ala. (III)	D-1,000
KAWW Heber Springs, Ark. (III)	D-1,000
KTPA Prescott, Ark. (III)	D-500
KREL Corona, Calif. (III)	DA-2-LS-5,000
	N-500
KPCO Quincy, Calif. (III)	D-500
KEEN San Jose, Calif. (III)	DA-2-5,000
KGEN Tulare, Calif. (III)	D-1,000
WWKE Ocala, Fla. (III)	D-5,000
WCOA Pensacola, Fla. (III)	DA-N-5,000
WAXE Vero Beach, Fla. (III)	D-1,000
WLOP Jesup, Ga. (III)	D-5,000
WFDK Mancheset, Ga. (III)	D-1,000
WLOV Washington, Ga. (III)	D-1,000
WPRC Lincoln, Ill. (III)	D-1,000
WTTS Bloomington, Ind. (III)	DA-2-LS-5,000
	N-500
WLTH Gary, Ind. (III)	D-1,000
KDTH Dubuque, Iowa (III)	LS-5,000
	DA-N-1,000
KGNO Dodge City, Kan. (III)	LS-5,000
	DA-N-1,000
KALN Iola, Kan. (III)	DA-D-500
WABD Fort Campbell, Ky. (III)	D-500
WGOH Grayson, Ky. (III)	D-5,000
WTKY Tompkinsville, Ky. (III)	D-1,000
KAPB Marksville, La. (III)	D-1,000
WDEA Ellsworth, Me. (III)	(CP) DA-2-5,000
WZYQ Frederick, Md.	DA-D-500
WKIK Leonardtown, Md. (III)	D-1,000
WWAM Cadillac, Mich. (III)	DA-2-LS-5,000
	N-1,000
WGHN Grand Haven, Mich. (III)	D-500
KSUM Fairmont, Minn. (III)	DA-2-1,000
KDAN Minneapolis, Minn. (III)	DA-D-500
WMGO Canton, Miss. (III)	D-1,000
KWRT Boonville, Mo. (III)	D-1,000
KCRV Caruthersville, Mo.	D-1,000
KXLF Butte, Mont. (III)	5,000
KAWL York, Neb. (III)	D-500
WFEA Manchester, N.H. (III)	DA-5,000
WELV Ellenville, N.Y. (III)	D-500
WALK Patchogue, N.Y. (III)	D-500
WSAY Rochester, N.Y. (III)	DA-N-5,000
WLTC Gastonia, N.C. (III)	D-5,000
WTAB Tabor City, N.C. (III)	D-5,000
*KFJM Grand Forks, N.D. (III)	D-1,000
WSPD Toledo, Ohio (III)	DA-N-5,000
KVYL Holdenville, Okla. (III)	D-500
KAST Astoria, Ore. (III)	DA-N-1,000
KFIR Sweet Home, Ore. (III)	D-1,000

Station Power

WWCB Corry, Pa. (III)	LS-1,000
	DA-N-500
	D-1,000
WPAZ Pottstown, Pa. (III)	D-1,000
WKMC Roaring Spring, Pa. (III)	D-1,000
WKFD Wickford, R. I. (III)	D-500
WDEF Chattanooga (III)	DA-N-5,000
WDXE Lawrenceburg, Tenn. (III)	D-1,000
WRGS Rogersville, Tenn. (III)	D-1,000
KOKE Austin, Tex. (III)	D-1,000
KFRO Longview, Tex. (III)	DA-N-1,000
KPOS Post, Tex. (III)	D-1,000
KSOP Salt Lake City (III)	D-1,000
WBTV Bennington, Vt. (III)	D-1,000
WHEE Martinsville, Va. (III)	D-1,000
WJWS South Hill, Va. (III)	D-5,000
KPOR Quincy, Wash. (III)	D-1,000
WEIF Moundsville, W. Va. (III)	D-1,000
WCCN Neillsville, Wis. (III)	D-5,000
KVVO Cheyenne, Wyo. (III)	D-1,000
WIVV Island of Vieques, PR. (III)	LS-5,000
	N-1,000

1380 khz Regional

WRAB Arab, Ala. (III)	D-1,000
WGYV Greenville, Ala. (III)	D-1,000
WVSA Vernon, Ala. (III)	D-1,000
KZUL Parker, Ariz. (III)	(CP)D-1,000
KEWP N. Little Rock, Ark. (III)	D-1,000
KKZZ Lancaster, Calif. (III)	DA-D-1,000
KGMS Sacramento, Calif. (III)	DA-2-1,000
KTOM Salinas, Calif. (III)	DA-2-5,000
KFLJ Wausenburg, Colo. (III)	D-1,000
WOWW Naugatuck, Conn. (III)	DA-2-LS-5,000
	N-500
WAMS Wilmington, Del. (III)	DA-3-LS-5,000
	N-1,000
WDAT Daytona Beach, Fla. (III)	DA-N-1,000
WLIZ Lake Worth, Fla. (III)	D-1,000
WLCY St. Petersburg, Fla. (III)	DA-N-5,000
WAOK Atlanta (III)	DA-N-5,000
WGUS Augusta, Ga. (III)	D-1,000
WSIZ Ocala, Ga. (III)	D-5,000
KPOI Honolulu (III)	5,000
WMEE Ft. Wayne, Ind. (III)	DA-2-5,000
KCIM Carroll, Iowa (III)	DA-2-1,000
KCII Washington, Iowa (III)	D-500
KUDL Fairway, Kan. (III)	DA-2-LS-5,000
	N-500
WMTA Central City, Ky. (III)	D-500
WWKY Winchester, Ky. (III)	D-1,000
WYNK Baton Rouge (III)	DA-D-5,000
WKTJ W. Farmington, Me. (III)	D-1,000
WPLB Greenville, Mich. (III)	LS-1,000
	N-500
WPHM Port Huron, Mich. (III)	DA-2-5,000
KLIZ Brainerd, Minn. (III)	DA-N-5,000
KAGE Winona, Minn. (III)	D-1,000
WNLA Indianola, Miss. (III)	D-500
KWK St. Louis (III)	DA-2-5,000
KUVR Holdrege, Neb. (III)	D-500
WBBX Portsmouth, N.H. (III)	(CP)DA-N-1,000
*WAWZ Zarephath, N.J. (III)	DA-SH-2-5,000
WVIN Bath, N.Y. (III)	D-500
WBNX New York (III)	DA-LS-5,000
WKKE Asheville, N.C. (III)	LS-5,000
	DA-N-1,000
WGSE New Bern, N.C. (III)	D-5,000
WTOB Winston-Salem, N.C. (III)	LS-5,000
	DA-N-1,000
WLRO Lorain, Ohio (III)	D-500
WPKO Waverly, Ohio (III)	DA-D-1,000
KSWO Lawton, Okla. (III)	DA-2-1,000
KMUS Muskogee, Okla. (III)	LS-1,000
	DA-N-500
KBCH Lincoln City, Ore. (III)	D-1,000
KSRV Ontario, Ore. (III)	LS-5,000
	DA-N-1,000
WACB Kittanning, Pa. (III)	D-1,000
WMML Milton, Pa. (III)	D-1,000
WAYZ Waynesboro, Pa. (III)	D-1,000
WNRI Woonsocket, R.I. (III)	D-1,000
WAGS Bishopville, S.C. (III)	D-1,000
KOTA Rapid City, S.D. (III)	DA-N-5,000
KFCB Redfield, S.D. (III)	DA-D-500
WYSH Clinton, Tenn. (III)	D-1,000
WIZO Franklin, Tenn. (III)	D-1,000
WTNN Millington, Tenn. (III)	D-500
KJET Beaumont, Tex. (III)	D-1,000
KBWD Brownwood, Tex. (III)	LS-1,000
	N-500
KTSM El Paso (III)	LS-5,000
	N-500
KMUL Muleshoe, Tex. (III)	D-1,000
KBOP Pleasanton, Tex. (III)	D-1,000
WSYB Rutland, Vt. (III)	LS-5,000
	DA-N-1,000
WLRV Lebanon, Va. (III)	D-500
WTVR Richmond, Va. (III)	DA-N-5,000
KRKO Everett, Wash. (III)	DA-N-5,000
KEZE Spokane, Wash. (III)	D-5,000

AM by Frequency

Station			Power
WMTD Hinton, W. Va. (III)			D-1,000
WBEL Beloit, Wisc. (III)			DA-N-5,000

1390 khz Regional

WHMA Anniston, Ala. (III)			LS-5,000
			DA-N-1,000
KDON DeQueen, Ark. (III)			D-500
KAMO Rogers, Ark. (III)			D-1,000
KEGR Long Beach, Calif. (III)			DA-N-5,000
KCYR Turlock, Calif. (III)			DA-2-5,000
KFML Denver (III)			D-5,000
WAPR Avon Park, Fla. (III)			D-1,000
WAKA Gainesville, Fla. (III)			D-5,000
WISK Americus, Ga. (III)			D-5,000
New AM Reidsville, Ga. (III)			D-500
WVON Chicago (III)			DA-2-5,000
WFIW Fairfield, Ill. (III)			D-1,000
WJCD Seymour, Ind. (III)			D-1,000
KCLN Clinton, Iowa (III)			DA-D-1,000
KCBC Des Moines, Iowa (III)			DA-1,000
KNCK Concordia, Kan. (III)			D-500
WNY Albany, Ky. (III)			D-1,000
WKIC Hazard, Ky. (III)			D-5,000
KFRA Franklin, La. (III)			D-500
WEGP Presque Isle, Me. (III)			DA-N-5,000
WCAT Orange, Mass. (III)			D-1,000
WPLM Plymouth, Mass. (III)			DA-2-5,000
WCER Charlotte, Mich. (III)			DA-D-5,000
KACH Duluth, Minn. (III)			D-500
KRFO Owatonna, Minn. (III)			D-500
WROA Gulfport, Miss. (III)			D-1,000
KJPW Wainesville, Mo. (III)			D-1,000
KENN Farmington, N.M. (III)			LS-5,000
			DA-N-1,000
KHOB Hobbs, N.M. (III)			D-5,000
WEOK Poughkeepsie, N.Y. (III)			DA-D-5,000
WRIV Riverhead, N.Y. (III)			D-1,000
WFBL Syracuse, N.Y. (III)			DA-N-5,000
WEED Rocky Mount, N.C. (III)			LS-5,000
			DA-N-1,000
WADA Shelby, N.C. (III)			LS-1,000
			DA-N-500
WJRM Troy, N.C. (III)			D-1,000
KLPM Minot, N.D. (III)			LS-5,000
			N-1,000
WTOO Bellefontaine, Ohio (III)			D-500
WMPO Middleport-Pomeroy, Ohio (III)			D-5,000
WFMJ Youngstown, Ohio (III)			DA-N-5,000
KSCM Enid, Okla. (III)			DA-1,000
KSLR Salem, Ore. (III)			LS-5,000
			N-1,000
WLAN Lancaster, Pa. (III)			DA-2-LS-5,000
			N-1,000
WRSC State College, Pa. (III)			D-1,000
WHPB Belton, S.C. (III)			D-1,000
(CP)DA-N-1,000			DA-N-5,000
WCSC Charleston, S.C. (III)			DA-N-5,000
KJAM Madison, S.D. (III)			D-500
WYXI Athens, Tenn. (III)			D-500
WTJS Jackson, Tenn. (III)			LS-5,000
			DA-N-1,000
WMCT Mountain City, Tenn. (III)			D-500
			D-500
KULP El Campo, Tex. (III)			DA-D-500
KBEC Waxahachie, Tex. (III)			LS-1,000
KBWL Logan, Utah (III)			DA-N-500
WEAM Arlington, Va. (III)			DA-2-5,000
WWOD Lynchburg, Va. (III)			LS-5,000
			DA-N-1,000
KBBO Yakima, Wash. (III)			LS-1,000
			DA-N-500
WKLP Keyser, W. Va. (III)			D-1,000
WISA Isabela, PR. (III)			LS-1,000
			N-500

1400 khz Local

WMSL Decatur, Ala. (IV)			LS-1,000
			N-250
WXAL Demopolis, Ala. (IV)			LS-1,000
			N-250
WFPA Fort Payne, Ala. (IV)			LS-1,000
			N-250
WJLD Homewood, Ala. (IV)			LS-1,000
			N-250
WJHO Opelika, Ala. (IV)			LS-1,000
			N-250
KXIV Phoenix (IV)			LS-1,000
			N-250
KTUC Tucson, Ariz. (IV)			LS-1,000
			N-250
KVOY Yuma, Ariz. (IV)			LS-1,000
			N-250
KELD El Dorado, Ark. (IV)			LS-1,000
			N-250
KCLA Pine Bluff, Ark. (IV)			LS-1,000
			N-250

AM by Frequency

<u>Station</u>	<u>Power</u>	<u>Station</u>	<u>Power</u>
KWYN Wynne, Ark. (IV)	LS-1,000 N-250	WALE Fall River, Mass. (IV)	LS-1,000 N-250
KRE Berkeley, Calif. (IV)	LS-1,000 N-250	WLLH Lowell, Mass. (IV)	LS-1,000 N-250
KREO Indio, Calif. (IV)	1,000	WHMP Northampton, Mass. (IV)	LS-1,000 N-250
KKOK Lompoc, Calif. (IV)	DA-D-500	WKNR Battle Creek, Mich. (IV)	LS-1,000 N-250
KQMS Redding, Calif. (IV)	LS-1,000 N-250	WJLB Detroit (IV)	LS-1,000 N-250
KSLS San Luis Obispo, Calif. (IV)	LS-1,000 N-250	WHDF Houghton, Mich. (IV)	LS-1,000 N-250
KAAP Santa Paula, Calif. (IV)	LS-1,000 N-250	WGON Munising, Mich. (IV)	LS-1,000 N-250
KTRT Truckee, Calif. (IV)	LS-1,000 N-250	WSAM Saginaw, Mich. (IV)	LS-1,000 N-250
KUKI Ukiah, Calif. (IV)	LS-1,000 N-250	WSJM St. Joseph, Mich. (IV)	LS-1,000 N-250
KONG Visalia, Calif. (IV)	LS-1,000 N-250	WTCM Traverse City, Mich. (IV)	LS-1,000 N-250
KRLN Canon City, Colo. (IV)	LS-1,000 N-250	KEYL Long Prairie, Minn. (IV)	LS-1,000 N-250
KDŦA Delta, Colo. (IV)	LS-1,000 N-250	KMHL Marshall, Minn. (IV)	LS-1,000 N-250
KFTM Ft. Morgan, Colo. (IV)	LS-1,000 N-250	KEEY St. Paul (IV)	LS-1,000 N-250
KBZZ La Junta, Colo. (IV)	LS-1,000 N-250	WHLB Virginia, Minn. (IV)	LS-1,000 N-250
KPAG Pagosa Springs, Colo.	LS-1,000 N-250	WBIP Booneville, Miss. (IV)	LS-1,000 N-250
WSTC Stamford, Conn. (IV)	LS-1,000 N-250	WMBC Columbus, Miss. (IV)	LS-1,000 N-250
WILI Williamantic, Conn. (IV)	LS-1,000 N-250	WNAG Grenada, Miss. (IV)	LS-1,000 N-250
WFTL Ft. Lauderdale, Fla. (IV)	LS-1,000 N-250	WFOR Hattiesburg, Miss. (IV)	LS-1,000 N-250
WIRA Ft. Pierce, Fla. (IV)	LS-1,000 N-250	WJQS Jackson, Miss. (IV)	LS-1,000 N-250
WNUF Fort Walton Beach, Fla. (IV)	LS-1,000 N-250	KFRU Columbia, Mo. (IV)	LS-1,000 N-250
WERD Jacksonville, Fla. (IV)	LS-1,000 N-250	KJCF Festus, Mo. (IV)	LS-1,000 N-250
WTRR Sanford, Fla. (IV)	LS-1,000 N-250	KSIM Sikeston, Mo. (IV)	LS-1,000 N-250
WPAS Zephyrhills, Fla. (IV)	LS-1,000 N-250	KTTS Springfield, Mo. (IV)	LS-1,000 N-250
WULF Alma, Ga. (IV)	LS-1,000 SH-N-250	KDRG Deer Lodge, Mont. (IV)	LS-1,000 N-250
WSGC Elberton, Ga. (IV)	LS-1,000 N-250	KXGN Glendive, Mont. (IV)	LS-1,000 N-250
WNEX Macon, Ga. (IV)	LS-1,000 N-250	KARR Great Falls, Mont. (IV)	LS-1,000 N-250
WCOH Newnan, Ga. (IV)	LS-1,000 N-250	KBRB Ainsworth, Neb. (IV)	LS-1,000 N-250
WSGA Savannah, Ga. (IV)	LS-1,000 N-250	KCOW Alliance, Neb. (IV)	LS-1,000 N-250
KART Jerome, Idaho. (IV)	LS-1,000 SH-250	KLIN Lincoln, Neb. (IV)	LS-1,000 N-250
KRPL Moscow, Idaho (IV)	LS-1,000 N-250	KBMI Henderson, Nev. (IV)	LS-1,000 N-250
KSPT Sandpoint, Idaho (IV)	LS-1,000 N-250	KWNA Winnemucca, Nev. (IV)	LS-1,000 SH-N-250
KIGO St. Anthony, Idaho (IV)	LS-1,000 N-250	WBRL Berlin, N.H. (IV)	LS-1,000 N-250
WDWS Champaign, Ill. (IV)	LS-1,000 N-250	WTSL Hanover, N.H. (IV)	LS-1,000 N-250
WGIL Galesburg, Ill. (IV)	LS-1,000 N-250	WLTN Littleton, N.H. (IV)	LS-1,000 N-250
WROZ Evansville, Ind. (IV)	LS-1,000 N-250	WOND Pleasantville, N.J. (IV)	LS-1,000 N-250
WBAT Marion, Ind. (IV)	LS-1,000 N-250	KTRC Santa Fe, N.M. (IV)	LS-1,000 N-250
KCOG Centerville, Iowa (IV)	LS-500 N-250 (CP-D-1,000)	KCHS Truth or Consequences, N.M. (IV)	LS-1,000 N-250
KVFD Ft. Dodge, Iowa (IV)	LS-1,000 N-250	KTNM Tucumcari, N.M. (IV)	LS-1,000 N-250
KVOE Emporia, Kan. (IV)	LS-1,000 N-250	WABY Albany, N.Y. (IV)	LS-1,000 N-250
KAYS Hayes, Kan. (IV)	LS-1,000 N-250	WYSL Buffalo, N.Y. (IV)	LS-1,000 N-250
WCYN Cynthiana, Ky. (IV)	LS-500 N-250	WSLB Ogdensburg, N.Y. (IV)	LS-1,000 N-250
WIEL Elizabethtown, Ky. (IV)	LS-1,000 N-250	WBMA Beaufort, N.C. (IV)	LS-1,000 N-250
WFTG London, Ky. (IV)	LS-1,000 SH-N-250	WGBG Greensboro, N.C. (IV)	(CP) LS-1,000 N-250
WFPR Hammond, La. (IV)	LS-1,000 N-250	WSHB Raeford, N.C. (IV)	LS-1,000 N-250
KAOK Lake Charles, La. (IV)	LS-1,000 N-250	WSIC Statesville, N.C. (IV)	LS-1,000 N-250
WRDO Augusta, Me. (IV)	LS-1,000 N-250	WLSE Wallace, N.C. (IV)	LS-1,000 N-250
WIDE Biddeford, Me. (IV)	LS-1,000 N-250	WHCC Waynesville, N.C. (IV)	LS-1,000 N-250
WMCS Machias, Me. (IV)	LS-1,000 N-250	WSMY Weldon, N.C. (IV)	LS-1,000 N-250
WWIN Baltimore (IV)	LS-1,000 N-250	KEYJ Jamestown, N.D. (IV)	LS-1,000 N-250
		WMAN Mansfield, Ohio (IV)	LS-1,000 N-250
		WPAY Portsmouth, Ohio (IV)	LS-1,000 N-250
		KWON Bartlesville, Okla. (IV)	LS-1,000 N-250
		KTMK McAlester, Okla. (IV)	LS-1,000 N-250
		KNOR Norman, Okla. (IV)	LS-1,000 N-250
		KNNC Cottage Grove, Ore. (IV)	LS-1,000 SH-N-250
		KJDY John Day, Ore. (IV)	LS-1,000 SH-N-250
		WEST Easton, Pa. (IV)	LS-1,000 N-250
		WJET Erie, Pa. (IV)	LS-1,000 N-250
		WFEC Harrisburg, Pa. (IV)	LS-1,000 N-250
		WWSF Loretto, Pa. (IV)	LS-1,000 N-250
		WKBI St. Marys, Pa. (IV)	LS-1,000 N-250
		WICK Scranton, Pa. (IV)	LS-1,000 N-250
		WRAK Williamsport, Pa. (IV)	LS-1,000 N-250
		WCOS Columbia, S.C. (IV)	LS-1,000 N-250
		WGTN Georgetown, S.C. (IV)	LS-1,000 N-250
		WKDY Spartanburg, S.C. (IV)	LS-1,000 N-250
		KBJM Lemmon, S.D. (IV)	LS-1,000 SH-250
		WJZM Clarksville, Tenn. (IV)	LS-1,000 N-250
		WHUB Cookeville, Tenn. (IV)	LS-1,000 N-250
		WLSB Copperhill, Tenn. (IV)	LS-1,000 N-250
		WKPT Kingsport, Tenn. (IV)	LS-1,000 N-250
		WGAP Maryville, Tenn. (IV)	LS-1,000 N-250
		WHAL Shelbyville, Tenn. (IV)	LS-1,000 N-250
		KRUN Ballinger, Tex. (IV)	LS-1,000 SH-250
		KBYG Big Spring, Tex. (IV)	LS-1,000 N-250
		KUNO Corpus Christi, Tex. (IV)	LS-1,000 N-250
		KILE Galveston, Tex. (IV)	LS-1,000 N-250
		KGVL Greenville, Tex. (IV)	LS-1,000 N-250
		KEBE Jacksonville, Tex. (IV)	LS-1,000 N-250
		KIUN Pecos, Tex. (IV)	LS-1,000 N-250
		KEYE Perryton, Tex. (IV)	LS-1,000 N-250
		KVOP Plainview, Tex. (IV)	LS-1,000 N-250
		KDWT Stamford, Tex. (IV)	LS-1,000 N-250
		KTEM Temple, Tex. (IV)	LS-1,000 N-250
		KTFS Texarkana, Tex. (IV)	LS-1,000 N-250
		KVOU Uvalde, Tex. (IV)	LS-1,000 N-250
		KIXX Provo, Utah (IV)	LS-1,000 N-250
		WDOT Burlington, Vt. (IV)	LS-1,000 N-250
		WELK Charlottesville, Va. (IV)	(CP)LS-1,000 N-250
		WHHV Hillsville, Va. (IV)	LS-1,000 N-250
		WPCE Portsmouth, Va. (IV)	LS-1,000 N-250
		WHLF South Boston, Va. (IV)	LS-1,000 N-250
		WINC Winchester, Va. (IV)	LS-1,000 N-250
		KEDO Longview, Wash. (IV)	LS-1,000 N-250
		KRSC Othello, Wash. (IV)	LS-1,000 SH-250
		KTNT Tacoma, Wash. (IV)	LS-1,000 N-250
		WBOY Clarksburg, W. Va. (IV)	LS-1,000 N-250
		WRON Ronceverte, W. Va. (IV)	LS-1,000 N-250
		WVRC Spencer, W. Va. (IV)	LS-1,000 N-250
		WKWK Wheeling, W. Va. (IV)	LS-1,000 N-250
		WBTH Williamson, W. Va. (IV)	LS-1,000 N-250
		WATW Ashland, Wis. (IV)	LS-1,000 N-250

AM by Frequency

<i>Station</i>	<i>Power</i>	<i>Station</i>	<i>Power</i>	<i>Station</i>	<i>Power</i>
WSGO Oswego, N.Y. (III)	D-1,000	WSTU Stuart, Fla. (IV)	LS-1,000	KFTW Fredericktown, Mo. (IV)	LS-1,000
WBLA Elizabethtown, N.C. (III)	D-1,000	N-250		N-250	
WBUY Lexington, N.C. (III)	LS-5,000	WTAL Tallahassee, Fla. (IV)	LS-1,000	WMBH Joplin, Mo. (IV)	LS-1,000
	DA-N-1,000	N-250		N-250	
KKXL Grand Forks, N.D. (III)	LS-1,000	WGPC Albany, Ga. (IV)	LS-1,000	KIRX Kirksville, Mo. (IV)	LS-1,000
	N-500	N-250		N-250	
WHHH Warren, Ohio (III)	DA-2-5,000	WBHF Cartersville, Ga. (IV)	LS-1,000	KOKO Warrensburg, Mo. (IV)	LS-1,000
KODL The Dalles, Ore. (III)	DA-N-1,000	N-250		N-250	
KMED Medford, Ore. (III)	LS-5,000	WCON Cornelia, Ga. (IV)	LS-1,000	KWPM West Plains, Mo. (IV)	LS-1,000
	N-1,000	N-250		N-250	
WC DL Carbondale, Pa. (III)	D-5,000	WKEU Griffin, Ga. (IV)	LS-1,000	KXXL Bozeman, Mont. (IV)	LS-1,000
WNPV Lansdale, Pa. (III)	DA-D-500	N-250		N-250	
WGCB Red Lion, Pa. (III)	D-1,000	WMVG Milledgeville, Ga. (IV)	LS-1,000	KUDI Great Falls, Mont. (IV)	LS-1,000
WQOK Greenville, S.C. (III)	DA-N-5,000	N-250		N-250	
WKHJ Holly Hill, S.C. (III)	D-1,000	WQQT Savannah, Ga. (IV)	LS-1,000	KGMY Missoula, Mont. (IV)	LS-1,000
WZYX Cowan, Tenn. (III)	D-1,000	N-250		N-250	
WDM McKenzie, Tenn. (III)	D-500	WVLD Valdosta, Ga. (IV)	LS-1,000	KRBN Red Lodge, Mont. (IV)	LS-1,000
KPUR Amarillo, Tex. (III)	LS-5,000	N-250		N-250	
	DA-N-1,000	KVSI Montpelier, Idaho (IV)	LS-1,000	KVCK Wolf Point, Mont. (IV)	LS-1,000
KEYS Corpus Christi, Tex. (III)	DA-N-1,000	N-250		N-250	
KDNT Denton, Tex. (III)	LS-5,000	KYET Payette, Idaho (IV)	250	KWBE Beatrice, Neb. (IV)	LS-1,000
	DA-N-500	KEEP Twin Falls, Idaho (IV)	LS-1,000	N-250	
	D-5,000	WKEI Kewanee, Ill. (IV)	N-250	KONE Reno (IV)	LS-1,000
KETX Livingston, Tex. (III)	DA-N-500	N-250		N-250	
WKLV Blackstone, Va. (III)	D-5,000	WCVS Springfield, Ill. (IV)	LS-1,000	WKXL Concord, N.H. (IV)	LS-1,000
WOHN Herndon, Va. (III)	DA-D-1,000	N-250		N-250	
KXXR Spokane, Wash. (III)	D-5,000	WLYV Ft. Wayne, Ind. (IV)	LS-1,000	WFPG Atlantic City (IV)	LS-1,000
WHIS Bluefield, W. Va. (III)	LS-5,000	N-250		N-250	
	N-500	WXVW Jeffersonville, Ind. (IV)	LS-1,000	WCTC New Brunswick, N.J. (IV)	LS-1,000
WAJR Morgantown, W. Va. (III)	DA-2-LS-5,000	N-250		N-250	
	N-500	WASK Lafayette, Ind. (IV)	LS-1,000	KRZY Albuquerque, N.M. (IV)	LS-1,000
WNFL Green Bay, Wis. (III)	DA-2-LS-5,000	N-250		N-250	
	N-500	WAOV Vincennes, Ind. (IV)	LS-1,000	KLMX Clayton, N.M. (IV)	LS-1,000
		N-250		N-250	
		KLWW Cedar Rapids, Iowa (IV)	LS-1,000	KOBE Las Cruces, N.M. (IV)	LS-1,000
		N-250		N-250	
		KWBW Hutchinson, Kan. (IV)	LS-1,000	KENM Portales, N.M. (IV)	LS-1,000
		N-250		N-250	
		WTCO Campbellsville, Ky. (IV)	LS-1,000	WCLI Corning, N.Y. (IV)	LS-1,000
		N-250		N-250	
		WWXL Manchester, Ky. (IV)	LS-1,000	WWSC Glen Falls, N.Y. (IV)	LS-1,000
		N-250		N-250	
		WPAD Paducah, Ky. (IV)	LS-1,000	WHDL Olean, N.Y. (IV)	LS-1,000
		N-250		N-250	
		WLKS West Liberty, Ky. (IV)	LS-1,000	WKIP Poughkeepsie, N.Y. (IV)	DA-D-1,000
		N-250		N-250	
		KSIG Crowley, La. (IV)	LS-1,000	WKAL Rome, N.Y. (IV)	LS-1,000
		N-250		N-250	
		KNOC Natchitoches, La. (IV)	LS-1,000	WATA Boone, N.C. (IV)	LS-1,000
		N-250		N-250	
		WNPS New Orleans (IV)	LS-1,000	WGNC Gastonia, N.C. (IV)	LS-1,000
		N-250		N-250	
		WLKN Lincoln, Me. (IV)	LS-1,000	WIZS Henderson, N.C. (IV)	LS-1,000
		N-250		N-250	
		WRKD Rockland, Me. (IV)	LS-1,000	WHKP Hendersonville, N.C. (IV)	LS-1,000
		N-250		N-250	
		WKTP South Paris, Me. (IV)	LS-1,000	WHIT New Bern, N.C. (IV)	LS-1,000
		N-250		N-250	
		WTBO Cumberland, Md. (IV)	LS-1,000	WFBS Spring Lake, N.C. (IV)	LS-1,000
		N-250		N-250	
		WTHU Thurmont, Md. (IV)	LS-500	KGCA Rugby, N.D. (IV)	LS-1,000
		N-250		N-250	
		WMAS Springfield, Mass. (IV)	LS-1,000	WJER Dover-New Philadelphia, Ohio (IV)	LS-1,000
		N-250		N-250	
		WATZ Alpena, Mich. (IV)	LS-1,000	WMOH Hamilton, Ohio (IV)	LS-1,000
		N-250		N-250	
		WHTC Holland, Mich. (IV)	LS-1,000	WLEK Sandusky, Ohio (IV)	250
		N-250		KWHW Altus, Okla. (IV)	LS-1,000
		WMIQ Iron Mountain, Mich. (IV)	LS-1,000	N-250	
		N-250		KGFF Shawnee, Okla. (IV)	LS-1,000
		WIBM Jackson, Mich. (IV)	LS-1,000	N-250	
		N-250		KSIW Woodward, Okla. (IV)	LS-1,000
		WKLA Ludington, Mich. (IV)	LS-1,000	N-250	
		N-250		KEED Eugene, Ore. (IV)	LS-1,000
		WNBY Newberry, Mich. (IV)	LS-1,000	N-250	
		N-250		KFLS Klamath Falls, Ore. (IV)	LS-1,000
		WHLS Port Huron, Mich. (IV)	LS-1,000	N-250	
		N-250		KLBM La Grande, Ore. (IV)	LS-1,000
		KATE Albert Lea, Minn. (IV)	LS-1,000	N-250	
		N-250		*KBPS Portland, Ore. (IV)	LS-1,000
		KBUN Bemidji, Minn. (IV)	LS-1,000	N-250	
		N-250		WWGO Erie, Pa. (IV)	LS-1,000
		KBMW Breckenridge, Minn-Wahpeton, N.D. (IV)	LS-1,000	N-250	
		N-250		WFRA Franklin, Pa. (IV)	LS-1,000
		WELY Ely, Minn. (IV)	LS-1,000	N-250	
		N-250		WDAD Indiana, Pa. (IV)	LS-1,000
		KCLD St. Cloud, Minn. (IV)	LS-1,000	N-250	
		N-250		WPAM Pottsville, Pa. (IV)	LS-1,000
		WROX Clarksdale, Miss. (IV)	LS-1,000	N-250	
		N-250		WMPT S. Williamsport, Pa. (IV)	LS-1,000
		WCJU Columbia, Miss. (IV)	LS-1,000	N-250	
		N-250		WMAJ State College, Pa. (IV)	LS-1,000
		WJXN Jackson, Miss. (IV)	LS-1,000	N-250	
		N-250		WJPA Washington, Pa. (IV)	LS-1,000
		WQIC Meridian, Miss. (IV)	LS-1,000	N-250	
		N-250		WKRI W. Warwick, R.I. (IV)	LS-1,000
		WNAT Natchez, Miss. (IV)	LS-1,000	N-250	
		N-250		WQSN Charleston, S.C. (IV)	LS-1,000
		WROB West Point, Miss. (IV)	LS-1,000	N-250	
		N-250		WCRS Greenwood, S.C. (IV)	LS-1,000
				N-250	

1450 khz Local

WDNG Anniston, Ala. (IV)	LS-1,000
	N-250
WYAM Bessemer, Ala. (IV)	LS-1,000
	N-250
WDIG Dothan, Ala. (IV)	LS-1,000
	N-250
WFIX Huntsville, Ala. (IV)	LS-1,000
	N-250
WLAY Muscle Shoals, Ala. (IV)	LS-1,000
	N-250
KLAM Cordova, Alaska (IV)	SH-250
KAWT Douglas, Ariz. (IV)	LS-1,000
	N-250
KNOT Prescott, Ariz. (IV)	LS-1,000
	N-250
KVSL Show Low, Ariz. (IV)	LS-1,000
	N-250
KOPO Tucson, Ariz. (IV)	LS-1,000
	N-250
KJWH Camden, Ark. (IV)	LS-1,000
	N-250
KENA Mena, Ark. (IV)	LS-1,000
	N-250
KYOR Blythe, Calif. (IV)	DA-D-LS-1,000
	N-250
KAVA Burney, Calif. (IV)	LS-1,000
	N-250
KOWN Escondido, Calif. (IV)	LS-1,000
	N-250
KPSI Palm Springs, Calif. (IV)	LS-1,000
	N-250
KTIP Porterville, Calif. (IV)	LS-1,000
	N-250
KEST San Francisco (IV)	LS-1,000
	N-250
KVML Sonora, Calif. (IV)	LS-1,000
	N-250
KVEN Ventura, Calif. (IV)	DA-D-LS-1,000
	N-250
KOBO Yuba City, Calif. (IV)	LS-500
	N-250
KGIW Alamosa, Colo. (IV)	LS-1,000
	N-250
KYOU Greeley, Colo. (IV)	LS-1,000
	N-250
WNAB Bridgeport, Conn. (IV)	LS-1,000
	N-250
WILM Wilmington, Del. (IV)	LS-1,000
	N-250
WOL Washington (IV)	LS-1,000
	N-250
WWJB Brooksville, Fla. (IV)	LS-1,000
	N-250
WMFJ Daytona Beach, Fla. (IV)	LS-1,000
	N-250
WOCN Miami (IV)	LS-1,000
	N-250
WBSR Pensacola, Fla. (IV)	LS-1,000
	N-250
WSPB Sarasota, Fla. (IV)	LS-1,000
	N-250

AM by Frequency

Station	Power
WJLE Smithville, Tenn. (III)	D-1,000
WAAN Waynesboro, Tenn. (III)	D-1,000
KBOX Dallas (III)	DA-2-LS-5,000
	N-500
KLVL Pasadena, Tex. (III)	LS-1,000
	DA-N-500
KAPE San Antonio, Tex. (III)	DA-D-500
KONI Spanish Fork, Utah (III)	D-1,000
WCFR Springfield, Vt. (III)	D-5,000
*WBBL Richmond, Va. (III)	DA-2-5,000
	SH with WLEE
WLEE Richmond, Va. (III)	DA-2-5,000
	SH with WBBL
	D-5,000
WBLU Salem, Va. (III)	D-1,000
KVAN Vancouver, Wash. (III)	D-1,000
WISM Madison, Wis. (III)	DA-2-5,000
KRAE Cheyenne, Wyo. (III)	D-1,000
WMDD Fajardo, P.R. (III)	5,000
1490 khz Local	
WANA Anniston, Ala. (IV)	LS-1,000
	N-250
WAJF Decatur, Ala. (IV)	LS-1,000
	N-250
WRLD Lanett, Ala.-West Point, Ga. (IV)	LS-1,000
	N-250
WHBB Selma, Ala. (IV)	LS-1,000
	N-250
KCUZ Clifton, Ariz. (IV)	LS-1,000
	N-250
KYCA Prescott, Ariz. (IV)	LS-1,000
	N-250
KAIR Tucson, Ariz. (IV)	CP-LS-1,000-N-250
KXAR Hope, Ark. (IV)	LS-1,000
	N-250
KDRS Paragould, Ark. (IV)	LS-1,000
	N-250
KOTN Pine Bluff, Ark. (IV)	LS-1,000
	N-250
KARV Russellville, Ark. (IV)	LS-1,000
	N-250
KWAC Bakersfield, Calif. (IV)	LS-1,000
	N-250
KPAS Banning, Calif. (IV)	250
KICO Calexico, Calif. (IV)	LS-1,000
	N-250
KRKC King City, Calif. (IV)	LS-1,000
	SH-250
KTOB Petaluma, Calif. (IV)	LS-1,000
	N-250
KBLF Red Bluff, Calif. (IV)	LS-1,000
	N-250
KDB Santa Barbara, Calif. (IV)	LS-1,000
	N-250
KOWL S. Lake Tahoe, Calif. (IV)	LS-1,000
	N-250
KSYC Yreka, Calif. (IV)	LS-1,000
	N-250
KBOL Boulder, Colo. (IV)	LS-1,000
	N-250
KGUC Gunnison, Colo. (IV)	LS-1,000
	N-250
KIIQ Manitou Springs, Colo. (IV)	LS-500
	N-250
WGCH Greenwich, Conn. (IV)	LS-1,000
	N-250
WTRL Bradenton, Fla. (IV)	250
WETO Deland, Fla. (IV)	LS-1,000
	N-250
WKEM Immokalee, Fla. (IV)	LS-1,000
	N-250
WMBM Miami Beach, Fla. (IV)	LS-1,000
	N-250
WCKC Milton, Fla. (IV)	LS-1,000
	N-250
WPXE Starke, Fla. (IV)	LS-1,000
	N-250
WTTB Vero Beach, Fla. (IV)	LS-1,000
	N-250
WSIR Winter Haven, Fla. (IV)	LS-500
	N-250
WMOG Brunswick, Ga. (IV)	LS-1,000
	N-250
WMJM Cordele, Ga. (IV)	LS-1,000
	N-250
WMRE Monroe, Ga. (IV)	LS-1,000
	N-250
WSFB Quitman, Ga. (IV)	SH-250
WSNT Sandersville, Ga. (IV)	LS-1,000
	N-250
WSYL Sylvania, Ga. (IV)	LS-1,000
	N-250
KCID Caldwell, Idaho (IV)	LS-1,000
	N-250
KOFE St. Maries, Idaho (IV)	LS-1,000
	N-250

Station	Power
WKRO Cairo, Ill. (IV)	250
	(CP: LS-1,000, N-250)
WDAN Danville, Ill. (IV)	LS-1,000
	N-250
WESL E. St. Louis, Ill. (IV)	LS-1,000
	N-250
WOPA Oak Park, Ill. (IV)	LS-1,000
	N-250
WZOE Princeton, Ill. (IV)	LS-1,000
	N-250
WKBV Richmond, Ind. (IV)	LS-1,000
	N-250
WNDU South Bend, Ind. (IV)	LS-1,000
	N-250
KBUR Burlington, Iowa (IV)	LS-1,000
	N-250
WDBQ Dubuque, Iowa (IV)	LS-1,000
	N-250
KBAB Indianola, Iowa (IV)	LS-500
	N-250
KRIB Mason City, Iowa (IV)	LS-1,000
	N-250
KKAN Phillipsburg, Kan. (IV)	LS-1,000
	SH-250
KTOP Topeka, Kan. (IV)	LS-1,000
	N-250
WFKY Frankfort, Ky. (IV)	LS-1,000
	N-250
WKAY Glasgow, Ky. (IV)	LS-1,000
	N-250
WOMI Owensboro, Ky. (IV)	LS-1,000
	N-250
WSIP Paintsville, Ky. (IV)	LS-1,000
	N-250
WIKC Bogalusa, La. (IV)	LS-1,000
	N-250
KEUN Eunice, La. (IV)	LS-1,000
	N-250
KJIN Houma, La. (IV)	LS-1,000
	N-250
KRUS Ruston, La. (IV)	LS-1,000
	N-250
WPOR Portland, Me. (IV)	LS-1,000
	N-250
WTVL Waterville, Me. (IV)	LS-1,000
	N-250
WARK Hagerstown, Md. (III)	LS-1,000
	N-250
WHAV Haverhill, Mass. (IV)	LS-1,000
	N-250
WMRC Milford, Mass. (IV)	LS-1,000
	N-250
WTXL W. Springfield, Mass. (IV)	DA-D-LS-1,000
	N-250
WABJ Adrian, Mich. (IV)	LS-1,000
	N-250
WTIQ Manistique, Mich. (IV)	LS-1,000
	SH-250
WMPX Midland, Mich. (IV)	LS-1,000
	N-250
WLRC Whitehall, Mich. (IV)	LS-1,000
	N-250
KXRA Alexandria, Minn. (IV)	LS-1,000
	N-250
KOZY Grand Rapids, Minn. (IV)	LS-1,000
	N-250
KLGR Redwood Falls, Minn. (IV)	LS-1,000
	N-250
WLOX Biloxi, Miss. (IV)	LS-1,000
	N-250
WCLD Cleveland, Miss. (IV)	LS-1,000
	N-250
WHOC Philadelphia, Miss. (IV)	LS-1,000
	N-250
WTUP Tupelo, Miss. (IV)	LS-1,000
	N-250
WVIM Vicksburg, Miss. (IV)	LS-1,000
	N-250
KDMO Carthage, Mo. (IV)	LS-1,000
	N-250
KTRR Rolla, Mo. (IV)	LS-1,000
	N-250
KDRO Sedalia, Mo. (IV)	LS-1,000
	N-250
KDBM Dillon, Mont. (IV)	LS-1,000
	N-250
KLNG Omaha (IV)	LS-1,000
	N-250
WEMJ Laconia, N.H. (IV)	LS-1,000
	N-250
WUSS Atlantic City (IV)	LS-1,000
	N-250
KRSN Los Alamos, N.M. (IV)	LS-1,000
	N-250
KRTN Raton, N.M. (IV)	LS-1,000
	SH-250
WCSS Amsterdam, N.Y. (IV)	LS-1,000
	N-250
WBTA Batavia, N.Y. (IV)	LS-500
	N-250

Station	Power
WKNY Kingston, N.Y. (IV)	LS-1,000
	N-250
WICY Malone, N.Y. (IV)	LS-1,000
	N-250
WDLC Port Jarvis, N.Y. (IV)	LS-1,000
	N-250
WOLF Syracuse, N.Y. (IV)	DA-D-LS-1,000
	N-250
WSSB Durham, N.C. (IV)	LS-1,000
	N-250
WLOE Eden, N.C. (III)	LS-1,000
	N-250
WFLB Fayetteville, N.C. (IV)	LS-1,000
	N-250
WRNB New Bern, N.C. (IV)	LS-1,000
	N-250
WRMT Rocky Mount, N.C. (IV)	LS-1,000
	N-250
WSTP Salisbury, N.C. (IV)	LS-1,000
	N-250
WSVM Valdese, N.C. (IV)	LS-1,000
	N-250
WHSL Wilmington, N.C. (IV)	LS-1,000
	N-250
KNDC Hettinger, N.D. (IV)	LS-1,000
	SH-250
KOVC Valley City, N.D. (IV)	LS-1,000
	N-250
WBEX Chillicothe, Ohio (IV)	LS-1,000
	N-250
WJMO Cleveland Hts., Ohio (IV)	LS-1,000
	N-250
WOHI East Liverpool, Ohio (IV)	LS-1,000
	N-250
WMOA Marietta, Ohio (IV)	LS-1,000
	N-250
WMRN Marion, Ohio (IV)	LS-1,000
	N-250
KOKC Guthrie, Okla. (IV)	LS-500
	N-250
KBIX Muskogee, Okla. (IV)	LS-1,000
	N-250
KBKR Baker, Ore. (IV)	LS-1,000
	N-250
KRNR Roseburg, Ore. (IV)	LS-1,000
	N-250
KBZY Salem, Ore. (IV)	LS-1,000
	N-250
WESB Bradford, Pa. (IV)	LS-1,000
	N-250
WAZL Hazleton, Pa. (IV)	LS-1,000
	N-250
WJNL Johnstown, Pa. (IV)	LS-1,000
	N-250
WGAL Lancaster, Pa. (IV)	LS-1,000
	N-250
WBCB Levittown-Fairless Hills, Pa. (IV)	LS-1,000
	N-250
WMRF Lewistown, Pa. (IV)	LS-1,000
	N-250
WMGW Meadville, Pa. (IV)	LS-1,000
	N-250
WNBT Wellsboro, Pa. (IV)	LS-1,000
	N-250
WSIB Beaufort, S.C. (IV)	LS-500
	N-250
WGCD Chester, S.C. (IV)	LS-1,000
	N-250
WMRB Greenville, S.C. (IV)	LS-1,000
	N-250
WSDC Hartsville, S.C. (IV)	250
KORN Mitchell, S.D. (IV)	LS-1,000
	N-250
WOPI Bristol, Tenn. (IV)	LS-1,000
	N-250
WDXB Chattanooga (IV)	LS-1,000
	N-250
WCSV Crossville, Tenn. (II)	D-250
WROL Knoxville, Tenn. (IV)	LS-1,000
	N-250
WJMM Lewisburg, Tenn. (IV)	LS-1,000
	N-250
WDXL Lexington, Tenn. (IV)	LS-1,000
	N-250
KNOW Austin, Tex. (IV)	LS-1,000
	N-250
KIBL Beeville, Tex. (IV)	LS-1,000
	N-250
KBST Big Spring, Tex. (IV)	LS-1,000
	N-250
KQTY Borger, Tex. (IV)	LS-1,000
	N-250
KNEL Brady, Tex. (IV)	LS-1,000
	N-250
KWMC Del Rio, Tex. (IV)	LS-1,000
	N-250
KSAM Huntsville, Tex. (IV)	LS-1,000
	N-250
KVOZ Laredo, Tex. (IV)	LS-1,000
	N-250

Station	Power	Station	Power	AM by Frequency	
Station	Power	Station	Power	Station	Power
KZZN Littlefield, Tex. (IV)	LS-1,000 N-250	KWFA Merkel, Tex. (II)	D-250	WYFC Ypsilanti, Mich. (II)	D-250
KPLT Paris, Tex. (IV)	LS-1,000 N-250	KTXO Sherman, Tex. (II)	DA-D-1,000	KOLM Rochester, Minn. (II)	D-10,000 CH-1,000
KDOK Tyler, Tex. (IV)	LS-1,000 N-250	KANI Wharton, Tex. (II)	DA-500	WQMA Marks, Miss. (II)	D-250
KVVC Vernon, Tex. (IV)	LS-1,000 N-250	WMNT Manati, P.R. (II)	LS-1,000 N-250	KMPL Sikeston, Mo. (II)	DA-3-LS-5,000 CH-500
KVOG Ogden, Utah (IV)	LS-1,000 N-250	1510 khz Clear		WLSL Ocean City-Somers Pt., N.J. (II)	DA-D-1,000
KWVT Brattleboro, Vt. (IV)	LS-1,000 N-250	KDKB Mesa, Ariz. (II)	D-10,000	KAMX Albuquerque, N.M. (II)	D-500
WFAD Middlebury, Vt. (IV)	LS-1,000 N-250	KIRV Fresno, Calif. (II)	D-500	WKBW Buffalo, N.Y. (I-B)	DA-50,000
WIKE Newport, Vt. (IV)	LS-1,000 N-250	KSOM Ontario, Calif. (II)	DA-2-LS-10,000	WTHE Mineola, N.Y. (II)	D-1,000 CH-250
WCVA Culpeper, Va. (IV)	LS-1,000 N-250	KTIM San Rafael, Calif. (II)	D-1,000	WDSL Mocksville, N.C. (II)	D-5,000 CH-1,000
WVEC Hampton, Va. (IV)	LS-1,000 N-250	KDKO Littleton, Colo. (II)	DA-2-LS-1,000	WARR Warrenton, N.C. (II)	D-1,000
WAYB Waynesboro, Va. (IV)	LS-1,000 N-250	WNLC New London, Conn. (II)	DA-2-LS-10,000	KMAV Mayville, N.D. (II)	D-250
KBRO Bremerton, Wash. (IV)	LS-1,000 N-250	WKAO Boynton Beach, Fla. (II)	D-1,000	WBNO Bryan, Ohio (II)	D-500 CH-250
KVAC Forks, Wash. (IV)	LS-1,000 N-250	WWBC Cocoa, Fla. (II)	D-250	WINW Canton, Ohio (II)	DA-D-1,000
KLOG Kelso, Wash. (IV)	LS-1,000 N-250	WRGI Marco Island, Fla. (II)	DA-D-1,000	WKNT Kent, Ohio (II)	DA-D-1,000
KENE Toppenish, Wash. (IV)	LS-1,000 N-250	WINU Highland, Ill. (II)	DA-D-1,000	WANR Toledo, Ohio (II)	DA-2-1,000
KTEL Walla Walla, Wash. (IV)	LS-1,000 N-250	WJRC Joliet, Ill. (II)	D-500	KOMA Oklahoma City (II)	LS-50,000 DA-N-1,000
WXIT Charleston, W. Va. (IV)	LS-1,000 N-250	WKAJ Macomb, Ill. (II)	D-1,000	KYXI Oregon City, Ore. (II)	DA-2-LS-50,000 N-10,000
WTCS Fairmont, W. Va. (IV)	LS-1,000 N-250	WAYT Wabash, Ind. (II)	D-250	WCHE West Chester, Pa. (II)	D-250
WAEY Princeton, W. Va. (IV)	LS-1,000 N-250	KIFG Iowa Falls, Iowa (II)	D-1,000	WTGR Myrtle Beach, S.C. (II)	D-250
WSGB Sutton, W. Va. (IV)	LS-1,000 N-250	KANS Larned, Kan. (II)	CH-500 D-1,000	WKMG Newberry, S.C. (II)	D-1,000
WGEZ Beloit, Wis. (IV)	LS-1,000 N-250	KAGY Port Sulphur, La. (II)	CH-500	KCHF Sioux Falls, S.D. (II)	D-500
WLCX La Crosse, Wis. (IV)	LS-1,000 N-250	WMEX Boston (II)	DA-2-LS-50,000	WBHT Brownsville, Tenn. (II)	D-250
WIGM Medford, Wis. (IV)	LS-1,000 N-250	WJCO Jackson, Mich. (II)	N-5,000	WIDD Elizabethton, Tenn. (II)	D-1,000
WYTL Oshkosh, Wis. (IV)	LS-1,000 N-250	WLKM Three Rivers, Mich. (II)	DA-D-5,000	WEXM Jamesville, Va. (II)	CH-250 (CP)DA-D-500
KOJO Laramie, Wyo. (IV)	LS-500 N-250	WKPO Prentiss, Miss. (II)	D-1,000	WRAI San Juan, P.R. (II)	DA-10,000
KRTR Thermopolis, Wyo. (IV)	LS-1,000 N-250	KCCV Independence, Mo. (II)	D-1,000	1530 khz Clear	
KGOS Torrington, Wyo. (IV)	LS-1,000 N-250	KEMM Marshfield, Mo. (II)	D-250	WAAO Andalusia, Ala. (II)	D-1,000
WZBS Ponce, P.R. (II)	LS-1,000 N-250	KTTT Columbus, Neb. (II)	D-500	WHYI Moulton, Ala. (II)	D-1,000 CH-250
				WRAN Dover, N.J. (II)	D-250
				WJIC Salem, N.J. (II)	D-250
				WPUT Brewster, N.Y. (II)	D-1,000
				WEAL Greensboro, N.C. (II)	D-1,000
				WYRU Red Springs, N.C. (II)	D-5,000
				WGLN Logan, Ohio (II)	CH-1,000
				WLKR Norwalk, Ohio (II)	LS-1,000
				KBJS Sallisaw, Okla. (II)	CH-250
				WAHT Annville-Cleona, Pa. (II)	DA-D-500
				WPSL Monroeville, Pa. (II)	CP-D-1,000
				WVAP Burnetown, S.C. (II)	CH-500
				WPSC Pageland, S.C. (II)	D-500
				WSJW Woodruff, S.C. (II)	D-1,000
				KMSD Millbank, S.D. (II)	CH-250
				WLAC Nashville (I-B)	D-5,000
				KCTX Childress, Tex. (II)	DA-N-50,000
				KNAM Midland, Tex.	D-250
				KMOO Mineola, Tex. (II)	D-500
				KYKR Port Arthur, Tex. (II)	D-250
				KROB Robstown, Tex. (II)	D-1,000
				KSTV Stephenville, Tex. (II)	D-500
				WBLB Pulaski, Va. (II)	D-250
				KAAR Mountlake Terrace, Wash. (II)	D-1,000
				KGA Spokane, Wash. (I-B)	CH-250
				WAUK Waukesha, Wis. (II)	DA-D-10,000
				1520 khz Clear	
				WAOA Opelika, Ala. (II)	DA-D-5,000
				KMPG Holtister, Calif. (II)	D-500
				KACY Port Hueneme, Calif. (II)	DA-3-50,000
				WTLN Apopka, Fla. (II)	N-1,000
				WGNB Indian Rocks Beach, Fla. (II)	DA-D-5,000
				WEXY Oakland Park, Fla. (II)	DA-D-1,000
				WDGL Douglasville, Ga. (II)	D-1,000
				WXPQ Eatonton, Ga. (II)	D-1,000
				WNMT Garden City, Ga. (II)	CH-500
				WHOW Clinton, Ill. (II)	D-1,000
				WLUV Loves Park, Ill. (II)	D-5,000
				WKVI Knox, Ind. (II)	CH-1,000
				WSVL Shelbyville, Ind. (II)	D-500
				KSIB Creston, Iowa (II)	D-250
				WHIC Hardinsburg, Ky. (II)	D-500
				WRSL Sanford, Ky. (II)	D-500
				KXKW Lafayette, La. (II)	LS-10,000
				WVOB Bel Air, Md. (II)	DA-N-CH-500
				WTRI Brunswick, Md. (II)	D-250
				WKJR Muskegon Hts., Mich. (II)	D-500 CH-250
				WYFC Ypsilanti, Mich. (II)	DA-D-10,000
				KOLM Rochester, Minn. (II)	D-10,000 CH-1,000
				WQMA Marks, Miss. (II)	D-250
				KMPL Sikeston, Mo. (II)	DA-3-LS-5,000 CH-500
				WLSL Ocean City-Somers Pt., N.J. (II)	DA-D-1,000
				KAMX Albuquerque, N.M. (II)	D-500
				WKBW Buffalo, N.Y. (I-B)	DA-50,000
				WTHE Mineola, N.Y. (II)	D-1,000 CH-250
				WDSL Mocksville, N.C. (II)	D-5,000 CH-1,000
				WARR Warrenton, N.C. (II)	D-1,000
				KMAV Mayville, N.D. (II)	D-250
				WBNO Bryan, Ohio (II)	D-500 CH-250
				WINW Canton, Ohio (II)	DA-D-1,000
				WKNT Kent, Ohio (II)	DA-D-1,000
				WANR Toledo, Ohio (II)	DA-2-1,000
				KOMA Oklahoma City (II)	LS-50,000 DA-N-1,000
				KYXI Oregon City, Ore. (II)	DA-2-LS-50,000 N-10,000
				WCHE West Chester, Pa. (II)	D-250
				WTGR Myrtle Beach, S.C. (II)	D-250
				WKMG Newberry, S.C. (II)	D-1,000
				KCHF Sioux Falls, S.D. (II)	D-500
				WBHT Brownsville, Tenn. (II)	D-250
				WIDD Elizabethton, Tenn. (II)	D-1,000
				WEXM Jamesville, Va. (II)	CH-500
				WRAI San Juan, P.R. (II)	(CP)DA-D-500 DA-10,000
				1530 khz Clear	
				WAAO Andalusia, Ala. (II)	D-1,000
				WHYI Moulton, Ala. (II)	D-1,000 CH-250
				KTMN Truman, Ark. (II)	D-250
				KFBK Sacramento, Calif. (I-B)	DA-50,000
				KRYT Colorado Springs (II)	D-1,000
				WDJZ Bridgeport, Conn. (II)	CP-DA-D-10,000
				WENG Englewood, Fla. (II)	D-1,000
				WIAD Jacksonville, Fla. (II)	DA-D-50,000
				WTTI Dalton, Ga. (II)	DA-2-CH-10,000
				WTHO Thomson, Ga. (II)	D-1,000
				WYGM Wyoming, Mich. (II)	CH-500
				WKDC Elmhurst, Ill. (II)	DA-D-250
				KDSN Mynrtle, Iowa (II)	D-500
				KNBI Norton, Kan. (II)	D-1,000
				KWLA Many, La. (II)	D-1,000
				WPNO Auburn, Me. (II)	D-1,000
				WCTR Chestertown, Md. (II)	D-250
				WTHM Lapeer, Mich. (II)	DA-D-5,000
				WYGR Wyoming, Mich. (II)	D-500
				KSMM Shakopee, Minn. (II)	CH-250
				WJRL Calhoun City, Miss. (II)	D-500
				WRPM Poplarville, Miss. (II)	D-10,000
				WYAZ Yazoo City, Miss. (II)	CH-1,000
				KPCR Bowling Green, Mo. (II)	CP-DA-D-250
				WYAZ Yazoo City, Miss. (II)	D-1,000
				KMAM Butler, Mo. (II)	CH-250
				KECK Lincoln, Neb. (II)	D-500
				WJDM Elizabeth, N.J. (II)	DA-D-5,000
				WRBX Chapel Hill, N.C. (II)	DA-D-5,000
				WOBX Wanchese, N.C. (II)	D-250
				WCKY Cincinnati (I-B)	DA-N-50,000
				KJEM Wagoner, Okla. (II)	D-250
				WBCW Jeannette, Pa. (II)	D-1,000
				WHYP North East, Pa. (II)	CH-250 LS-1,000
				WMBT Sheridan, Pa. (II)	N-250
				WASC Sparanago, Pa. (II)	CP-D-250
				WJMJ Marion, Ky. (II)	D-250
				WWRG New Roads, La. (II)	D-1,000
				WVOC Battle Creek, Mich. (II)	DA-D-1,000
				WDEE Detroit (II)	DA-2-LS-50,000
				KSTP St. Paul (I-B)	N-5,000
				WBFN Quitman, Miss. (II)	DA-N-50,000
				KDFN Doniphan, Mo. (II)	D-1,000
				WKER Pompton Lakes, N.J. (II)	D-1,000
				WGMF Watkins Glen, N.Y. (II)	DA-D-1,000
				WLWL Rockingham, N.C. (III)	D-250
				WKBX Winston-Salem, N.C. (II)	D-500 CH-250
				WGIC Xenia, Ohio (II)	DA-D-10,000
				WGFT Youngstown, Ohio	CH-1,000
				KOKN Pawhuska, Okla. (II)	D-500
				WEAC Gaffney, S.C. (II)	CH-500
				WDEB Jamestown, Tenn. (II)	D-1,000
				WTNE Trenton, Tenn. (II)	CH-500 D-250

AM by Frequency

Station	Power
WJGA Jackson Ga. (I)	D-1,000
WOGA Sylvester, Ga. (II)	D-1,000
KISA Honolulu, Hawaii (II)	D-5,000
WSMI Litchfield, Ill. (II)	D-1,000
WBNL Boonville, Ind. (II)	D-250
WADM Decatur, Ind. (II)	D-250
WLOJ La Porte, Ind. (II)	D-250
WCBK Martinsville, Ind. (II)	D-250
KXEL Waterloo, Iowa (I-B)	DA-N-50,000
KNEX McPherson, Kan. (II)	D-250
KLKC Parsons, Kan. (II)	D-250
WKCB Hindman, Ky. (II)	D-1,000
	CH-500
KCTO Columbia, La. (II)	D-1,000
KGLA Gretna, La. (II)	D-500
WDON Wheaton, Md. (II)	D-1,000
WSWG Greenwood, Miss. (II)	D-1,000
KBXM Kennett, Mo. (II)	D-1,000
	CH-500
WKXR Exeter, N.H. (II)	D-1,000
WPTR Albany, N.Y. (II)	DA-50,000
WYRD East Syracuse, N.Y. (II)	D-1,000
WKYK Burnsville, N.C. (II)	D-1,000
WRPL Charlotte, N.C. (II)	D-1,000
WIFM Elkin, N.C. (II)	D-1,000
	CH-500
New AM Whiteville, N.C. (II)	D-1,000
WBGO Bucyrus, Ohio (II)	DA-D-500
WNRE Circleville, Ohio (II)	DA-D-1,000
WABQ Cleveland (II)	D-1,000
WNIO Niles, Ohio (II)	DA-D-500
WBTC Uhrichsville, Ohio (II)	CP-D-250
WRCP Philadelphia (II)	DA-D-50,000
WARD Pittston, Pa. (II)	D-1,000
WPME Punxsutawney, Pa. (II)	D-5,000
	CH-1,000
WADK Newport, R.I. (II)	D-1,000
WKKR Piquets, S.C. (II)	D-1,000
WMLR Hohenwald, Tenn. (II)	D-250
WJJT Jellicó, Tenn. (II)	D-1,000
	CH-500
WBRY Woodbury, Tenn. (II)	D-500
KBUY Fort Worth (II)	DA-2-LS-50,000
	N-1,000
KGBC Galveston, Tex. (II)	LS-1,000
	DA-N-250
KEDA San Antonio (II)	D-1,000
WRGM Richmond, Va. (II)	DA-D-10,000
KZAM Bellevue, Wash. (II)	DA-1,000
WTKM Hartford, Wis. (II)	D-500

1550 khz (Mexican) Clear

WAAY Huntsville, Ala. (II)	LS-5,000
	DA-N-500
WMOO Mobile, Ala. (II)	DA-D-50,000
*KUAT Tucson, Ariz. (II)	D-50,000
KXEX Fresno, Calif. (II)	D-500
KKHI San Francisco (II)	DA-2-10,000
KOXI Arvada, Colo. (II)	D-10,000
WEST West Hartford, Conn. (II)	D-1,000
WRHC Coral Gables, Fla. (II)	DA-D-10,000
WOGO New Smyrna Beach, Fla. (II)	D-250
WYUO Tampa, Fla. (II)	D-10,000
WTHB Augusta, Ga. (II)	D-5,000
WYNX Smyrna, Ga. (II)	D-10,000
WJIL Jacksonville, Ill. (II)	DA-D-1,000
WCSJ Morris, Ill. (II)	D-250
WPDF Corydon, Ind. (II)	D-250
WCVL Crawfordsville, Ind. (II)	DA-N-250
WCTW New Castle, Ind. (II)	DA-2-250
WNDI Sullivan, Ind. (II)	D-250
KIWA Sheldon, Iowa (II)	D-500
KEDD Dodge City, Kan. (II)	DA-D-1,000
KNIC Winfield, Kan. (II)	D-250
WGRK Greensburg, Ky. (II)	D-250
WIRV Irvine, Ky. (II)	D-1,000
WMSK Morganfield, Ky. (II)	D-250
WLUX Baton Rouge (II)	D-5,000
KOKA Shreveport, La. (II)	LS-10,000
	DA-N-500
WSER Elkton, Md. (II)	DA-D-1,000
WNTN Newton, Mass. (II)	D-10,000
WSHN Fremont, Mich. (II)	D-1,000
WOKJ Jackson, Miss. (II)	DA-2-LS-50,000
	N-10,000
WSAO Senatobia, Miss. (II)	D-5,000
KGMO Cape Girardeau, Mo. (II)	DA-D-5,000
KKJO St. Joseph, Mo. (II)	DA-N-5,000
KLKF Springfield, Mo. (II)	D-500
KICS Hastings, Neb. (II)	D-500
KOBY Reno, Nev. (II)	DA-D-10,000
WCGR Canandaigua, N.Y. (II)	D-250
WKOT Kingston, N.Y. (II)	D-500
WBVM Utica, N.Y. (II)	D-1,000
WGNL Greenville, N.C. (II)	D-1,000
WYNA Raleigh, N.C. (II)	D-1,000

Station	Power
WTYN Tryon, N.C. (II)	D-1,000
WPGD Winston-Salem, N.C. (II)	D-1,000
KQWB Fargo, N.D. (II)	D-5,000
WDLR Delaware, Ohio (II)	DA-D-500
KMAD Madill, Okla. (II)	D-250
KXOJ Sapulpa, Okla. (II)	DA-D-500
WLOA Braddock, Pa. (II)	D-1,000
WTTT Towanda, Pa. (II)	500
WBSC Bennettsville, S.C. (II)	LS-10,000
	DA-N-5,000
WKYE Bristol, Tenn. (II)	D-1,000
WPTN Cookeville, Tenn. (II)	D-250
WOKI Oak Ridge, Tenn. (II)	D-1,000
WTBP Parsons, Tenn. (II)	D-500
WPJD Soddy-Daisy, Tenn. (II)	D-250
KCAN Canyon, Tex. (II)	D-1,000
KCOM Commanche, Tex. (II)	D-250
KWBC Navasota, Tex. (II)	D-250
KRGO Salt Lake City (II)	D-10,000
WKBA Vinton, Va. (II)	DA-D-10,000
WVAB Virginia Beach, Va. (II)	D-5,000
KOQT Bellingham, Wash. (II)	D-1,000
KGAR Vancouver, Wash. (I-B)	D-1,000
WXVA Charlestown, W. Ca. (II)	D-5,000
WMIR Lake Geneva, Wis. (II)	DA-D-1,000
WMAD Madison, Wis. (II)	DA-D-5,000
WEVR River Falls, Wis. (II)	D-1,000
WKFE Yauco, P.R. (II)	250

1560 khz (Cuban) Clear

WAGC Centre, Ala. (II)	D-1,000
KDDA Dumas, Ark. (II)	D-500
KBIB Monette, Ark. (II)	D-250
KPMC Bakersfield, Calif. (I-B)	DA-10,000
KIQS Willows, Calif. (II)	D-250
WYSE Inverness, Fla. (II)	DA-1,000
WTAI Melbourne, Fla. (II)	D-5,000
WKOQ Gordon, Ga. (II)	D-5,000
	CH-1,000
WBYS Canton, Ill. (II)	D-250
WSHY Shelbyville, Ill. (II)	DA-D-500
WVAK Paoli, Ind. (II)	D-250
WRIN Rensselaer, Ind. (II)	D-1,000
	CH-500
KRCB Council Bluffs, Iowa (II)	D-1,000
KABI Abilene, Kan. (II)	D-250
WKDO Liberty, Ky. (II)	D-250
WAFI Middlesboro, Ky. (II)	D-1,000
	CH-500
WDXR Paducah, Ky. (II)	(CP)DA-2-LS-10,000
	N-1,000
KAJN Crowley, La. (II)	DA-D-1,000
WSDL Slidell, La. (II)	D-1,000
WSMD LaPlata, Md. (II)	D-1,000
	CH-250
WBUK Portage, Mich. (II)	DA-D-1,000
WMIC Sandusky, Mich. (II)	DA-D-1,000
KBEW Blue Earth, Minn. (II)	D-1,000
KQYX Joplin, Mo. (II)	D-250
KLTI Macon, Mo. (II)	D-250
KTUJ Sullivan, Mo. (II)	D-1,000
WADD Brockport, N.Y. (II)	DA-D-1,000
WQXR New York (I-B)	DA-2-50,000
WTRQ Warsaw, N.C. (II)	D-10,000
WBKC Chardon, Ohio (II)	DA-D-1,000
WTNS Coshocton, Ohio (II)	D-1,000
WCNW Fairfield, Ohio (II)	DA-2-5,000
	CH-1,000
WTOD Toledo, Ohio (II)	DA-D-5,000
KWCO Chickasha, Okla. (II)	LS-1,000
	DA-N-250
KRBB Salisaw, Okla. (II)	D-250
WCCP Clemson, S.C. (II)	D-1,000
	CH-500
WAGL Lancaster, S.C. (II)	DA-CH-10,000
KKAA Aberdeen, S.D. (II)	DA-2-5,000
WBOL Bolivar, Tenn. (II)	D-250
WWGM Nashville (II)	DA-D-10,000
KCAD Abilene, Tex. (II)	D-500
KEGG Daingerfield, Tex. (II)	DA-D-1,000
KHBR Hillsboro, Tex. (II)	D-250
KGUL Port Lavaca, Tex. (II)	D-500
KGHO Hoquiam, Wash. (II)	D-1,000
KDFL Summer-Puyallup, Wash. (II)	D-250
WFSP Kingwood, W. Va. (II)	D-1,000
	CH-250
WGLB Port Washington, Wis. (II)	DA-D-250
WRSJ Bayamon, P.R. (II)	LS-5,000
	N-2,500

1580 khz (Canadian) Clear

WEYY Talladeega, Ala. (II)	D-1,000
KTUF Tempe, Ariz. (II)	D-50,000
	CH-10,000
KPCA Marked Tree, Ark. (II)	D-250
KDFD Van Buren, Ark. (II)	D-1,000
KWIP Merced, Calif. (II)	D-1,000
KDAY Santa Monica, Calif. (II)	DA-2-50,000
KPIK Colorado Springs (II)	D-5,000
WSBP Chattahoochee, Fla. (II)	D-1,000
WSRF Ft. Lauderdale, Fla. (II)	DA-2-LS-10,000
	N-5,000
WGTV Mount Dora, Fla. (II)	D-5,000
WCCF Punta Gorda, Fla. (II)	DA-D-1,000
WCLS Columbus, Ga. (II)	DA-N-1,000
WKIG Glennville, Ga. (II)	D-1,000
WYFZ Jasper, Ga. (II)	(CP) D-250
WKUN Monroe, Ga. (II)	D-1,000
WFRV Aurora, Ill. (II)	DA-D-250
WDQN Duquoin, Ill. (II)	D-250
WBBA Pittsfield, Ill. (II)	D-250
WCCR Urbana, Ill. (II)	D-250
WCNB Connersville, Ind. (II)	D-250
WJVA South Bend, Ind. (II)	D-1,000
WAMW Washington, Ind. (II)	D-250
KCHA Charles City, Iowa (II)	D-500
KWNT Davenport, Iowa (II)	D-500
WAXU Georgetown, Ky. (II)	DA-D-10,000
WMTL Leitchfield, Ky. (II)	250
WPKY Princeton, Ky. (II)	D-250
KLUV Haynesville, La. (II)	D-1,000
KLOU Lake Charles, La. (II)	DA-N-1,000
WPGC Morningside, Md. (II)	DA-D-10,000
WRBJ St. Johns, Mich. (II)	DA-D-1,000
KDOM Windom, Minn. (II)	DA-D-250
WAMY Amory, Miss. (II)	D-5,000

1570 khz (Mexican) Clear

WCRL Oneonta, Ala. (II)	D-1,000
WTOX Selma, Ala. (II)	D-5,000
KBRI Brinkley, Ark. (II)	D-250
KBJT Fordyce, Ark. (II)	D-250
KCYR Lodi, Calif. (II)	DA-D-5,000
KACE Riverside, Calif. (II)	DA-D-5,000
KKEE Salinas, Calif. (II)	D-250

Station	Power
KLOV Loveland, Colo. (II)	D-1,000
WTWB Auburndale, Fla. (II)	D-5,000
WYHI Fernandina Beach, Fla. (II)	D-1,000
WOKC Okeechobee, Fla. (II)	D-1,000
WMES Ashburn, Ga. (II)	D-1,000
WGHC Clayton, Ga. (II)	D-1,000
WGSR Milledgeville, Ga. (II)	D-250
WSSA Morrow, Ga. (II)	D-1,000
WOKZ Alton, Ill. (II)	D-1,000
WFRL Freeport, Ill. (II)	DA-D-5,000
WBEE Harvey, Ill. (II)	DA-D-1,000
WYAY Robinson, Ill. (II)	D-250
WIFF Auburn, Ind. (II)	DA-D-500
WILO Frankfurt, Ind. (II)	D-250
WHML New Albany, Ind. (II)	D-1,000
KMCD Fairfield, Iowa (II)	D-250
KQWC Webster City, Iowa (II)	D-250
WML Marysville, Kan. (II)	D-250
WKYR Burkesville, Ky. (II)	D-1,000
WKKS Samburg, Ky. (II)	D-250
WABL Amite, La. (II)	D-500
KLLA Leesville, La. (II)	D-1,000
KMAR Winnsboro, La. (II)	D-1,000
WTOW Towson, Md. (II)	D-5,000
WMLD Beverly, Mass. (II)	DA-D-500
WPEP Taunton, Mass. (II)	D-1,000
WDEW Westfield, Mass. (II)	D-1,000
WCZN Flint, Mich. (II)	D-1,000
WFUR Grand Rapids, Mich. (II)	D-1,000
KUXL Golden Valley, Minn. (II)	D-1,000
WHII Bay Springs, Miss. (II)	D-1,000
WONA Winona, Miss. (II)	D-1,000
KLEX Lexington, Mo. (II)	D-250
WKOL Amsterdam, N.Y. (II)	D-1,000
WFLR Dundee, N.Y. (II)	D-1,000
WBUZ Fredonia, N.Y. (II)	D-250
WRCN Riverhead, N.Y. (II)	DA-D-1,000
WNCA Siler City, N.C. (II)	D-1,000
WTLK Taylorsville, N.C. (II)	DA-D-500
WGLX Galion, Ohio (II)	DA-D-250
WOBL Oberlin, Ohio (II)	DA-D-250
WPTW Piqua, Ohio (II)	D-250
WTCL Warren, Ohio (II)	DA-D-500
KTAT Frederick, Okla. (II)	D-250
KOLS Pryor, Okla. (II)	D-1,000
WPGM Danville, Pa. (II)	D-1,000
WBUX Doylestown, Pa. (II)	DA-D-5,000
WOTW Latrobe, Pa. (II)	D-1,000
WFGN Galfney, S.C. (II)	D-250
WJES Johnston, S.C. (II)	D-250
WLSC Loris, S.C. (II)	D-1,000
KVRA Vermillion, S.D. (II)	D-500
WHLPL Centerville, Tenn. (II)	D-1,000
WCLE Cleveland, Tenn. (II)	D-1,000
WTRB Ripley, Tenn. (II)	D-1,000
KZOL Farwell, Tex. (II)	D-250
KVLG La Grange, Tex. (II)	DA-D-250
KTER Terrell, Tex. (II)	D-250
WSWV Pennington Gap, Va. (II)	D-1,000
WYTI Rocky Mount, Va. (II)	D-1,000
WAPL Appleton, Wis. (II)	D-1,000
New AM Penuelas, P.R.	D-1,000

FM by Frequency

WHFH Flossmoor, IL
 WGHS Glen Elyn, IL
 WHSD Hinsdale, IL
 WMTD Park Ridge, IL
 KDIC Grinnell, IA
 WFCR Amherst, MA
 WSRX Allendale, MI
 KBEM-FM Minneapolis, MN
 KVSC St. Cloud, MN
 KLJC Kansas City, MO
 KUMR Rolla, MO
 WXBA Brentwood, NY
 WPOB Plainville, NY
 WRUR-FM Rochester, NY
 WKWZ Syosset, NY
 WARY Valhalla, NY
 WFDD-FM Winston-Salem, NC
 KEYA Belcourt, ND
 WMUB Oxford, OH
 WYNS Youngstown, OH
 WRKC Wilkes-Barre, PA
 KSTI Springfield, SD
 WTTU Cookeville, TN
 WQOX Memphis, TN
 KRSM Dallas, TX
 KNTU Denton, TX
 KTEP El Paso, TX
 KPLU-FM Tacoma, WA

*88.7 mhz (ch. 204)

KSPC Claremont, CA
 WNHU West Haven, CT
 WZZE Hockessin, DE
 WCYC Chicago, IL
 WSIE Edwardsville, IL
 WRSE-FM Elmhurst, IL
 WGVE Gary, IN
 WICR Indianapolis, IN
 KIGC Oskaloosa, IA
 KNLU Monroe, LA
 WQLI Newbury, MA
 KUNR Reno, NV
 WRRH Franklin Lakes, NJ
 WRSU-FM New Brunswick, NJ
 WBFO Buffalo, NY
 WHCL-FM Clinton, NY
 WVHC Hempstead, NY
 WCNE Batavia, OH
 WBOC-FM Oberlin, OH
 WESS East Stroudsburg, PA
 WFNM Lancaster, PA
 WLIU Lincoln University, PA
 WSYCFM Shippensburg, PA
 WLCH Lebanon, TN
 KUHF Houston, TX
 WWPV-FM Colchester, VT
 WNHS Portsmouth, VA
 WSHC Shepherdstown, WV
 WERN Madison, WI
 WRFW River Falls, WI

*88.9 mhz (ch. 205)

KUAF Fayetteville, AR
 KXLU Los Angeles, CA
 KUSP Santa Cruz, CA
 WJMJ Hartford, CT
 WDNA Miami, FL
 WPFL Winter Park, FL
 WXGC Milledgeville, GA
 WMXM Lake Forest, IL
 WLCC Lincoln, IL
 WRRG River Grove, IL
 WARG Summit, IL
 WSNF-FM Notre Dame, IN
 KWMR Cedar Rapids, IA
 KNBU Baldwin City, KS
 WEKU-FM Richmond, KY
 WEAA Baltimore, MD
 WERS Boston, MA
 KLUM-FM Jefferson City, MO
 WDWN Auburn, NY
 WYDC Dix Hills, NY
 WSHA Raleigh, NC
 WHEI Tiffin, OH
 WUJC University Heights, OH
 WCSU-FM Wilberforce, OH
 WKPS New Wilmington, PA
 WXPNI Philadelphia, PA
 WMBW Chattanooga, TN
 WNAZ-FM Nashville, TN
 KETR Commerce, TX
 KBYU-FM Provo, UT
 WVUS Putney, VT

VVWC Buckhannon, WV
 WLSU La Crosse, WI
 WYMS Milwaukee, WI

*89.1 mhz (ch. 206)

KCSB Chinle, AZ
 KHDX Conway, AR
 KDBR Redlands, CA
 KUOR-FM Merced, CA
 KBBF Santa Rosa, CA
 KLSH-FM Lewiston, ID
 WVJC-FM Mt Carmel, IL
 WONC Naperville, IL
 WJEL Indianapolis, IN
 KCUI Pella, IA
 KWAR Waverly, IA
 KMUW Wichita, KS
 KLPI Ruston, LA
 WRNE-FM Houlton, ME
 WTRZ Springfield, MA
 KEYA Kalamazoo, MI
 KUMD-FM Duluth, MN
 WMSB Mississippi State, MS
 KCLC St. Charles, MO
 KUFM Missoula, MT
 WKNH Keene, NH
 WFDU Teaneck, NJ
 KANW Albuquerque, NM
 WNYU-FM New York, NY
 WPSA Paul Smith's, NY
 WMHT-FM Schenectady, NY
 WAPS Akron, OH
 WUSO Springfield, OH
 KEPO Eagle Point, OR
 WERG Erie, PA
 WPSI Lehman, PA
 KAUR Sioux Falls, SD
 KBHU-FM Spearfish, SD
 WDNX Olive Hill, TN
 KTUC-FM Fort Worth, TX
 KUIB Vernal, UT
 WNUB-FM Northfield, VT
 WCCM Williamsburg, VA
 WBSD Burlington, WI

*89.3 mhz (ch. 207)

WLRH Huntsville, AL
 KPFB Berkeley, CA
 KOHL Fremont, CA
 KPCC Pasadena, CA
 WRTC-FM Hartford, CT
 WPFW Washington, DC
 WPCS Pensacola, FL
 WFRG Atlanta, GA
 WWGC Carrollton, GA
 KUOI-FM Moscow, ID
 WKKC Chicago, IL
 WNUR Evanston, IL
 WGRN Greenville, IL
 WFCI Franklin, IN
 WFLP Louisville, KY
 WHSN Bangor, ME
 WAMH Amherst, MA
 WBLD Orchard Lake, MI
 WSDP Plymouth, MI
 WOAK Royal Oak, MI
 WSAE Spring Arbor, MI
 WCAL-FM Northfield, MN
 KCUR-FM Kansas City, MO
 KOMR St. Louis, MO
 WSKG-FM Binghamton, NY
 WCSQ Central Square, NY
 WGSU Geneseo, NY
 KFJM-FM Grand Forks, ND
 WCSB Cleveland, OH
 WSMR Dayton, OH
 WCMO Marietta, OH
 WRCJ Reading, OH
 KRRC Portland, OR
 WHHS Havertown, PA
 WQED-FM Pittsburgh, PA
 WSCI Charleston, SC
 WLYX Memphis, TN
 KCBF Dallas, TX
 KSHU Huntsville, TX
 KASB Bellevue, WA
 KUGS Bellingham, WA
 KAOS Olympia, WA
 WPNE-FM Green Bay, WI

*89.5 mhz (ch. 208)

KRPS-FM Phoenix, AZ
 KSMC Moraga, CA
 KPBS-FM San Diego, CA
 KPOO San Francisco, CA
 KSJC-FM Stockton, CA
 KTSF-FM Pueblo, CO

WPKN Bridgeport, CT
 KBGL Pocatello, ID
 WRTE Cahokia, IL
 WNIU-FM De Kalb, IL
 WBKE-FM North Manchester, IN
 WVUR-FM Valparaiso, IN
 KHKE Cedar Falls, IA
 WJWV North Adams, MA
 WCBN-FM Ann Arbor, MI
 WAHS Auburn Heights, MI
 WCMU-FM Mount Pleasant, MI
 KAVS Thief River Falls, MN
 KQAL Winona, MN
 KOPN Columbia, MO
 KCFV Ferguson, MO
 KHCC Helena, MT
 WSOU South Orange, NJ
 WRHO Oneonta, NY
 WDCC-FM Sanford, NC
 WRDL Ashland, OH
 WHSS Hamilton, OH
 WKET Kettering, OH
 KWGS Tulsa, OK
 WSAJ-FM Grove City, PA
 WITF-FM Hershey, PA
 WNTD Mansfield, PA
 WETS Johnson City, TN
 WMOT Murfreesboro, TN
 KMFA Austin, TX
 KEPH Ephraim, UT
 WTGM Norfolk, VA
 KNHC Seattle, WA

*89.7 mhz (ch. 209)

KFJC Los Altos, CA
 KLLU Riverside, CA
 KNHS Torrance, CA
 WMCU Miami, FL
 WUSF Tampa, FL
 WTPC Elsie, IL
 WHWE Howe, IN
 WISU Terre Haute, IN
 KRNL-FM Mount Vernon, IA
 WCVT Towson, MD
 WGBH Boston, MA
 WOCR Olivet, MI
 KUMM Morris, MN
 KMNR Rolla, MO
 KLSR St. Louis, MO
 WGLS-FM Glassboro, NJ
 KTDH Ramoth, NM
 WALF Alfred, NY
 WEOS-FM Geneva, NY
 WITR Henrietta, NY
 WCPE Raleigh, NC
 WOSU-FM Columbus, OH
 WRSU-FM Kent, OH
 WRSF Miami Springs, OH
 WMIU Allentown, PA
 WBMR Telford, PA
 WMHK Columbia, SC
 KUSD-FM Vermillion, SD
 WDYN-FM Chattanooga, TN
 KGCC Denison, TX
 WUEC Eau Claire, WI
 WORT Madison, WI
 WUWM Milwaukee, WI

*89.9 mhz (ch. 210)

KANG Angwin, CA
 KUCI Irvine, CA
 KBHI-FM Modesto, CA
 KCRW Santa Monica, CA
 WJCT-FM Jacksonville, FL
 WPIO Titusville, FL
 WJMU Decatur, IL
 WLCA Godfrey, IL
 WCBU Peoria, IL
 WYNO New Orleans, LA
 WSCB Springfield, MA
 KBDY St. Louis, MO
 WKCR-FM New York, NY
 WRVO Oswego, NY
 WUAG Greensboro, NC
 WVIA-FM Scranton, PA
 WQSU Selingsgrove, PA
 WUSC-FM Columbia, SC
 KACV-FM Amarillo, TX
 KGRV Auburn, WA
 KEWC-FM Cheney, WA
 WHSA Brule, WI
 WMDF Milton, WI
 WWSP Stevens Point, WI

*90.1 mhz (ch. 211)

WOCG Huntsville, AL
 KBPK Buena Park, CA
 KVXJ Crescent City, CA
 KEGH-FM Elk Grove, CA

KAHR Fremont, CA
 KSUL Long Beach, CA
 KCBX San Luis Obispo, CA
 KZSU Stanford, CA
 KSAK Walnut, CA
 KCFR Denver, CO
 WFCS New Britain, CT
 WGTB-FM Washington, DC
 WABE Atlanta, GA
 KRIC Rexburg, ID
 WMBI-FM Chicago, IL
 WLNX Lincoln, IL
 WIAN Indianapolis, IN
 WOI-FM Ames, IA
 KALA Davenport, IA
 KHCC Hutchinson, KS
 WRVG Georgetown, KY
 WMEA Portland, ME
 WNMAR Marquette, MI
 KSJR-FM Collegeville, MN
 WNJC-FM Senatobia, MS
 KTRS Kansas City, MO
 KGLT Bozeman, MT
 KUNM Albuquerque, NM
 WGMC Greece, NY
 WRCU-FM Hamilton, NY
 WCCE Buie's Creek, NC
 WPGT Roanoke Rapids, NC
 NEW-FM Wilkesboro, NC
 WNSD Cincinnati, OH
 WDPS Dayton, OH
 WCMC Paris, OH
 KCSC Edmond, OK
 KSOR Ashland, OR
 KBVR Corvallis, OR
 WRTI Philadelphia, PA
 WEPB Greenville, SC
 KASD Aberdeen, SD
 KCFB Sioux Falls, SD
 KERA-FM Dallas, TX
 KPFT Houston, TX
 KSAU Nacogdoches, TX
 KBBB Beaver, UT
 KUER Salt Lake City, UT
 KDRC-FM St. George, UT
 WRUV Burlington, VT
 WJSC-FM Johnson, VT
 WVWR-FM Roanoke, VA
 KMIH Mercer Island, WA
 KSVR Mt. Vernon, WA
 KOLU Pasco, WA
 KRNB-FM Neah Bay, WA
 WGBF-FM Green Bay, WI
 WRPN-FM Ripon, WI
 KYDZ Cody, WY

*90.3 mhz (ch. 212)

WBHM Birmingham, AL
 KNBS Manteca, CA
 KUSF San Francisco, CA
 WWPT Westport, CT
 WAFG Fort Lauderdale, FL
 WLKL Mattoon, IL
 WWQC-FM Quincy, IL
 WBCL Fort Wayne, IN
 KCOE Cedar Rapids, IA
 WMKY Morehead, KY
 WUFK Fort Kent, ME
 WZBC Newton, MA
 WOPR Oak Park, MI
 KRXL Northfield, MN
 KBFL Buffalo, MO
 KWUR Clayton, MO
 KGSP Parkville, MO
 KRNU Lincoln, NE
 WHPH Hanover, NJ
 WVHP-FM Highland Park, NJ
 WPPH Princeton Junction, NJ
 WMSC Upper Montclair, NJ
 WAMC Albany, NY
 WBAU Garden City, NY
 WHPC Garden City, NY
 WOSS Ossining, NY
 WAFR Durham, NC
 WCDR-FM Cedarville, OH
 WBOE Cleveland, OH
 KLCC Eugene, OR
 KSLC McMinnville, OR
 WARC Meadville, PA
 WUTM Martin, TN
 WEMM Memphis, TN
 WPLN Nashville, TN
 KSYM-FM San Antonio, TX
 KLVR Longview, WA
 WCDE Elkins, WV
 WHLA Holmen, WI
 WRST-FM Oshkosh, WI

*90.5 mhz (ch. 213)

KUAT-FM Tucson, AZ

KLRE Little Rock, AR
 KHSU-FM Arcata, CA
 KVHS Concord, CA
 KDHS Modesto, CA
 KSFH Mountain View, CA
 KCJH Stockton, CA
 KEPC Colorado Springs, CO
 NEW FM Glenwood Springs, CO
 WVUM Coral Gables, FL
 WUOG Athens, GA
 WABR-FM Tifton, GA
 KTUH Honolulu, HI
 WVKC Galesburg, IL
 WKHS Worton, MD
 WMCC North Andover, MA
 WUSM North Dartmouth, MA
 WICN Worcester, MA
 WKAR-FM East Lansing, MI
 KMSU Manokato, MN
 WALP Corinth, MS
 KWWC-Columbia, MO
 KXCV Maryville, MO
 WSPS Concord, NH
 WPEA Exeter, NH
 WCVH Flemington, NJ
 WBJB-FM Lincroft, NJ
 WJSV Morristown, NJ
 WBXL Baldwinville, NY
 WHRW Binghamton, NY
 WBKT Brockport, NY
 WRHR Henrietta, NY
 WASU-FM Boone, NC
 WDAV Davidson, NC
 WVMH-FM Mars Hill, NC
 WCBCE Columbus, OH
 *KAYE-FM Tonkawa, OK
 WJRH Easton, PA
 WVBU-FM Lewisburg, PA
 WDUQ Pittsburgh, PA
 WBCT Columbia, SC
 WFOF Chesapeake, VA
 KCMU Seattle, WA
 KWCV Walla Walla, WA
 WSUP Platteville, WI

*90.7 mhz (ch. 214)

WHCR Montgomery, AL
 KALX Berkeley, CA
 KPFK Los Angeles, CA
 KERS Sacramento, CA
 KSJS San Jose, CA
 KCDC Longmont, CO
 WKGC-FM Panama City, FL
 WACG-FM Augusta, GA
 WPSR Evansville, IN
 WBST Muncie, IN
 KJHK Lawrence, KS
 WCC Somerset, KY
 WMHC South Hadley, MA
 WTCF Springfield, MA
 KEDQ Austin, MN
 WJSU Jackson, MS
 KOBC Joplin, MO
 KVMU St. Louis, MO
 KVNO Omaha, NE
 KRWG Las Cruces, NM
 WFUV New York, NY
 WQFS Greensboro, NC
 WMCO New Concord, OH
 WKTL Struthers, OH
 KALU Langston, OK
 KBOO Portland, OR
 WCLH Wilkes-Barre, PA
 WJHD Portsmouth, RI
 WSMC-FM Collegedale, TN
 KUT-FM Austin, TX
 KSME Manti, UT
 WVTC Randolph Center, VT
 WUVT-FM Blacksburg, VA
 WFGH Fort Gay, WV
 WHAD Deltafield, WI
 WVSS Menomonie, WI

*90.9 mhz (ch. 215)

KRVH Rio Vista, CA
 KAUG Salinas, CA
 KASF Alamosa, CO
 KCSU-FM Fort Collins, CO
 WETA-FM Washington, DC
 WVVS Valdosta, GA
 WEPS Elgin, IL
 WILL-FM Urbana, IL
 WBDG Indianapolis, IN
 KUNI Cedar Falls, IA
 KSLU Hammond, LA
 WMEH-FM Bangor, ME
 WBUR Boston, MA
 WAUS Berrien Springs, MI
 WDTR Detroit, MI

NEW FM Columbus, MS
KCMW-FM Warrensburg, MO
KRUD Las Vegas, NV
WONY Oneonta, NY
WIRG Rochester, NY
WRUC Schenectady, NY
WMIP Warrenton, NC
WNWR Canal Fulton, OH
WGUC Cincinnati, OH
WDUB Granville, OH
KRBM Pendleton, OR
WUHY-FM Philadelphia, PA
KCHU Dallas, TX
KTSU Houston, TX
KPWN Parowan, UT
KPEC-FM Tacoma, WA

***91.1 mhz (ch. 218)**

WEGL Auburn, AL
WVSU-FM Birmingham, AL
KSWH Arkadelphia, AR
KCHO Chico, CA
KCSM San Mateo, CA
KWBI Morrison, CT
WSHU Fairfield, CT
WFAM Jacksonville, FL
WREK Atlanta, GA
WBI Carlinville, IL
WVIK Rock Island, IL
WDHS Gaston, IN
WGCS Goshen, IN
WEDM Indianapolis, IN
WVUB Vincennes, IN
WBOR Brunswick, ME
WMPG Gorham, ME
WUPI Presque Isle, ME
WNCY Springvale, ME
WMUA Amherst, MA
WNRC Dudley, MA
WGGL-FM Houghton, MI
KCCM-FM Moorhead, MN
KSJN St. Paul, MN
WMSU Hattiesburg, MS
WWCL Wesson, MS
KSUW Springfield, MO
KDCV-FM Blair, NE
WFMU East Orange, NJ
KEDP Las Vegas, NM
WTSC-FM Potsdam, NY
WSPN Saratoga Springs, NY
WRSH Rockingham, NC
WRMU Alliance, OH
WRIUW-FM Cleveland, OH
WDEQ-FM De Graff, OH
WSLN Delaware, OH
KWAX Eugene, OR
KEOL La Grande, OR
WDFM State College, PA
WRIU Kingstons, RI
WKCS Knoxville, TN
WKNO-FM Memphis, TN
WRVU Nashville, TN
KWTS Canyon, TX
KOHM Lubbock, TX
KMTP Mt. Pleasant, UT
WDGR Plainfield, VT
WMRA Harrisonburg, VA
KPBX-FM Spokane, WA
WLFM Appleton, WI
WGTD Kenosha, WI

***91.3 mhz (ch. 217)**

WHIL-FM Mobile, AL
KCPR San Luis Obispo, CA
KUOP Stockton, CA
KMSA Grand Junction, CO
NWS FM Ignacio, CO
WUWH West Hartford, CT
NEW-FM Lakeland, FL
WLRN-FM Miami, FL
WVGS Statesboro, GA
WJUM Macomb, IL
WHJE Carmel, IN
KDCR Sioux Center, IA
WBKY Lexington, KY
WKMS-FM Murray, KY
KGRM Grambling, LA
KSCS Shreveport, LA
WSHL-FM Easton, MA
WDJM-FM Framingham, MA
WGAO Franklin, MA
WCWL Stockbridge, MA
WCUW Worcester, MA
WCHW-FM Bay City, MI
WCSG Grand Rapids, MI
WSGR-FM Port Huron, MI

KBIA Columbia, MO
KOVF-FM Kearney, NE
KUCV Lincoln, NE
WUNH Durham, NH
WTSR Trenton, NJ
WETD Alfred, NY
WSMH-FM Lancaster, NY
WCNY-FM Syracuse, NY
WBMU-FM Asheville, NC
WQUB-FM Athens, OH
WGTE-FM Toledo, OH
WLVR-FM Bethlehem, PA
WQLN-FM Erie, PA
WIUP-FM Indiana, PA
WXAC Reading, PA
WDOM Providence, RI
WLTR Columbia, SC
WFMQ Lebanon, TN
KVLU Beaumont, TX
KNCT-FM Killeen, TX
KOCV Odessa, TX
WTJU Charlottesville, VA
KBOS Bellevue, WA
KCED Centralia, WA
KGTS College Place, WA
WQAB Philippi, WV
WHHI Highland, WI
WSSU Superior, WI
WIPR-FM San Juan, PR

***91.5 mhz (ch. 218)**

WEXP Gadsden, AL
KMCR-FM Phoenix, AZ
KUCA Conway, AR
KAHS Arcata, CA
KKUP Cupertino, CA
KDVS Davis, CA
KUSC Los Angeles, CA
KCSB-FM Santa Barbara, CA
KVIK Travis AFB, CA
KRCC Colorado Springs, CO
KUNC-FM Greeley, CO
WCNI New London, CT
WFIT Melbourne, FL
WFSU-FM Tallahassee, FL
WPRK Winter Park, FL
WBEZ Chicago, IL
WMHS Morrison, IL
WEVC Evansville, IN
WGRE Greencastle, IN
WWHI Muncie, IN
WECI Richmond, IN
KANU Lawrence, KS
WKCC Grayson, KY
WTUL New Orleans, LA
KVFG Thibodaux, LA
WRJR Lewiston, ME
WJMB Waterville, ME
WBJC Baltimore, MD
WBIM-FM Bridgewater, MA
WLTJ Lowell, MA
WMFO Medford, MA
WMLN-FM Milton, MA
WRPS Rockland, MA
WWVA Walpole, MA
WZLY Wellesley, MA
WSKB Westfield, MA
WMHW-FM Mount Pleasant, MI
WPHS-FM Warren, MI
KICC International Falls, MN
WVLS Jackson, MS
KSLH St. Louis, MO
KMSM-FM Butte, MT
KIOS-FM Omaha, NE
KIPC Albuquerque, NM
WNYE New York, NY
WXXI-FM Rochester, NY
WRPI Troy, NY
WUNC Chapel Hill, NC
WFAC Columbus, OH
WSTB Streetsboro, OH
WOBW Westerville, OH
WYSO Yellow Springs, OH
KOAP-FM Portland, OR
WYEP-FM Pittsburgh, PA
WMMW-FM Scranton, PA
WSRN-FM Swarthmore, PA
WJMF Smithfield, RI
WFHC-FM Henderson, TN
KWLD Plainview, TX
KUSU-FM Logan, UT
KOH5 Orem, UT
WMTF Stowe, VT
WLUR Lexington, VA
WYCS Yorktown, VA
KUBS Newport, WA
WJGF Romney, WV
WGBW Green Bay, WI
KUWR Laramie, WY

***91.7 mhz (ch. 219)**

WBQM Decatur, AL
WUAL-FM Tuscaloosa, AL
KALW San Francisco, CA
KWHS West Sacramento, CA
KOTO Telluride, CO
WXCI Danbury, CT
WHUS Storrs, CT
WMPH Wilmington, DE
WHRS Boynton Beach, FL
KUID Moscow, ID
WGLT Normal, IL
WEEM Pendleton, IN
KSUI Iowa City, IA
KNWD Natchitoches, LA
WBSF Biddeford, ME
WPAA Andover, MA
WRBB Boston, MA
WAVM Maynard, MA
WBSL Sheffield, MA
WBRS Waltham, MA
WUOM Ann Arbor, MI
KCUM-FM Crookston, MN
KAXE Grand Rapids, MN
KRSW-FM Pipestone, MN
KSLE-FM Rushford, MN
KNOS Marshall, MO
KXOZ Point Lookout, MO
KEMC Billings, MT
WNEC-FM Henniker, NH
WPCR-FM Plymouth, NH
WICB Ithaca, NY
WVXU-FM Cincinnati, OH
WUHS Urbana, OH
KOSU-FM Stillwater, OK
KCHC Central Point, OR
WVVE Norristown, PA
WKDU Philadelphia, PA
WPWT Philadelphia, PA
WARP Due West, SC
WSWM Memphis, TN
KVTT Dallas, TX
KTRU Houston, TX
KRTU San Antonio, TX
KGVH Gunnison, UT
WRMC-FM Middlebury, VT
WVHS-FM Hampden-Sydney, VA
WEMC Harrisonburg, VA
KTOY Tacoma, WA
WVVP Beckley, WV
WSHS Sheboygan, WI
WSUW Whitewater, WI

***91.9 mhz (ch. 220)**

WJLS-FM Jacksonville, AL
KNCC Tsalaie, AZ
KASU Jonesboro, AR
KVCR San Bernardino, CA
KCSS Turlock, CA
KDUR Durango, CO
KWSSB-FM Gunnison, CO
WLSX New Canaan, CT
WCLK Atlanta, GA
KIBO Idaho Falls, ID
WSIU Carbondale, IL
WSSR Springfield, IL
WVSH Huntington, IN
WJEF Lafayette, IN
WETL South Bend, IN
KPGY Ames, IA
KTCC Colby, KS
KBJC Great Bend, KS
WFPK Louisville, KY
WBHS Brunswick, ME
WUMF-FM Farmington, ME
WMEB-FM Orono, ME
WGTS-FM Takoma Park, MD
WAIC Springfield, MA
WCFM Williamstown, MA
WHSR-FM Winchester, MA
WORW Port Huron, MI
KBSS Bemidji, MN
KWPB Liberty, MO
KTLX Columbus, NE
KWSC Wayne, NE
WBGD Bricktown, NJ
WNTI Hackettstown, NJ
WCEB Corning, NY
WVSHR Lake Ronkonkoma, NY
KDSU Fargo, ND
WCWT-FM Centerville, OH
WKCO Gambier, OH
WCWS Wooster, OH
KHIB Durant, OK
KRVM Eugene, OR
WVCS California, PA
WUOT Knoxville, TN
KTAI Kingsville, TX
KTXT-FM Lubbock, TX

KSFC Spokane, WA
WHRM Wausau, WI

92.1 mhz (ch. 221)

WKLN Cullman, AL
WGOK-FM Fairhope, AL
WERH-FM Hamilton, AL
KBAZ Bisbee, AZ
KKEG Fayetteville, AR
KOWN-FM Escondido, CA
KUUL Madera, CA
KDFM Walnut Creek, CA
KBLJ La Junta, CO
KVRH-FM Salida, CO
WCMQ-FM Hialeah, FL
WAMR-FM Venice, FL
WWRN West Palm Beach, FL
WBTR-FM Carrollton, GA
WDWD-FM Dawson, GA
NEW-FM Eastman, GA
WSGC-FM Elberton, GA
WJGA-FM Jackson, GA
WPEH-FM Louisville, GA
WEIC-FM Charleston, IL
WACI Freeport, IL
WJRE Kewanee, IL
WROI Rochester, IN
KTGA Fort Dodge, IA
KRLS Knoxville, IA
KTAV Knoxville, IA
WMOR-FM Morehead, KY
WDHR Pikeville, KY
WTKY-FM Tompkinsville, KY
KVCL-FM Winfield, LA
WSME-FM Sanford, ME
WMSG-FM Oakland, MD
WLEW-FM Bad Axe, MI
WGHN-FM Grand Haven, MI
WKKM Harrison, MI
WCSR-FM Hillsdale, MI
WRBJ-FM St. Johns, MI
WCCW-FM Traverse City, MI
KODE-FM Waseca, MN
WMRQ Brookhaven, MS
WJNS-FM Yazoo City, MS
KSSS-FM Sedalia, MO
WSLE Peterborough, NH
WDVL-FM Vineland, NJ
KBAD-FM Carlbad, NM
WSEN-FM Baldwinville, NY
WLVG-FM Sag Harbor, NY
WDLA-FM Walton, NY
WRCM Jacksonville, NC
WMNC-FM Morganton, NC
WJLY Moyock, NC
WRSV Rocky Mount, NC
WNRR Bellevue, OH
WMPO-FM Middleport, OH
WERM Wapakoneta, OH
KGOW Broken Arrow, OK
WFEM Ellwood City, PA
WAAAT Johnstown, PA
WBPZ-FM Lock Haven, PA
WRCV Mercersburg, PA
WMJW Nanticoke, PA
WCTX Palmyra, PA
WBLR-FM Batesburg, SC
WTWE Manning, SC
WMYB-FM Myrtle Beach, SC
KIJV-FM Huron, SD
WBYQ Hendersonville, TN
KDSE Alice, TX
WTAW-FM College Station, TX
KETX-FM Livingston, TX
KSPA-FM Nacogdoches, TX
KNBT New Braunfels, TX
KROZ Tyler, TX
WDYL Chester, VA
WRLS-FM Hayward, WI
WKKB Manitowoc, WI
WDMW Menomonie, WI
WVNY Racine, WI
WYXE Sun Prairie, WI
WBOZF-FM Hormigueros, PR
WZOL Luquillo, PR

92.3 mhz (ch. 222)

WKLH Montgomery, AL
KXTG Glendale, AZ
KOTN-FM Pine Bluff, AR
KFAC-FM Los Angeles, CA
KSJO San Jose, CA
KREX-FM Grand Junction, CO
KGRE Greeley, CO
WDBO-FM Orlando, FL
KULA Waipahu, HI
KBBK-FM Boise, ID
WGTC Bloomington, IN

FM by Frequency

WYCA Hammond, IN
KOEL-FM Oelwein, IA
KJRG-FM Newton, KS
WKCW La Place, LA
WLPL Baltimore, MD
WVCA-FM Detroit, MI
WJPD-FM Ishpeming, MI
WIL-FM St. Louis, MO
KEZO Omaha, NE
KTRI Las Vegas, NV
KRST Albuquerque, NM
WKTU New York, NY
WFLY Troy, NY
WCSE Asheville, NC
WLYT Cleveland Heights, OH
WCOL-FM Columbus, OH
KGON Portland, OR
WRRN Warren, PA
WPRO-FM Providence, RI
WDEF-FM Chattanooga, TN
WKBJ-FM Milan, TX
KSDL El Paso, TX
KNFM Midland, TX
WLRG Roanoke, VA

92.5 mhz (ch. 223)

KFBK-FM Sacramento, CA
WVWZ Waterbury, CT
WFYN-FM Key West, FL
WPAP-FM Panama City, FL
WLBK-FM De Kalb, IL
WBRK Owensboro, KY
WHAV-FM Haverhill, MA
KQRS-FM Golden Valley, MN
WQST Forest, MS
KSYN Joplin, MO
KPOX Havre, MT
WBFB Rochester, NY
WXNC Henderson, NC
WFAH-FM Alliance, OH
WWEZ Cincinnati, OH
WMHE Toledo, OH
KKNK Oklahoma City, OK
KLAD-FM Klamath Falls, OR
WIFI Philadelphia, PA
WESC-FM Greenville, SC
KELO-FM Sioux Falls, SD
KAFM Dallas, TX
KYND-FM Pasadena, TX
KSUB-FM Cedar City, UT
WRFL Winchester, VA
KZAM-FM Bellevue, WA
WBKV-FM West Bend, WI
WORO Corozal, PR

92.7 mhz (ch. 224)

WULA-FM Eufaula, AL
WHTB Talladega, AL
KZZZ Kingman, AZ
KLYR-FM Clarksville, AR
KWYN-FM Wynne, AR
KJAZ Alameda, CA
KLOM-FM Lompoc, CA
KMFb-FM Mendocino, CA
KCNW Riverside, CA
KROG Sonora, CA
KSUE-FM Susanville, CA
KNJO Thousand Oaks, CA
CKMK Glenwood Springs, CO
WLRB Rehoboth Beach, DE
WKKJ Green Cove Springs, FL
WCCF-FM Punta Gorda, FL
WMCJ Stuart, FL
WXLJ-FM Dublin, GA
KFMA Jerome, ID
WRAJ-FM Anna, IL
WVMM Arlington Heights, IL
WEEE Taylorville, IL
WADM-FM Decatur, IN
WXUS Lafayette, IN
KLGa-FM Algona, IA
WCAK Cattlettsburg, KY
WMIK-FM Middleboro, KY
KJEF-FM Jennings, LA
KBED Lake Providence, LA
KVC Mansfield, LA
KTKC Springhill, LA
WQDY-FM Calais, ME
WNWY-FM Norway, ME
WMJS Prince Frederick, MD

FM by Frequency

WCER-FM Charlotte, MI
 WSMM Sault Ste. Marie, MI
 KXRA-FM Alexandria, MN
 WDLT Cleveland, MS
 WKRA-FM Holly Springs, MS
 KBRX-FM O'Neill, NE
 WOBM Toms River, NJ
 KTNM-FM Tucumcari, NM
 WENY-FM Elmira, NY
 WLIR Garden City, NY
 WIGS-FM Gouverneur, NY
 WALL-FM Middletown, NY
 WBCO-FM Bucyrus, OH
 WJSM-FM Martinsburg, PA
 WRHY Starview, PA
 WWBD-FM Bamberg, SC
 KIVY-FM Crockett, TX
 KINL Eagle Pass, TX
 KVEL-FM Vernal, UT
 WKVT-FM Brattleboro, VT
 WBBI-FM Abingdon, VA
 WVHF-FM Clarksburg, WV
 WAUN Kewaunee, WI
 WDUX-FM Waupaca, WI

92.9 mhz (ch. 225)

WBLX Mobile, AL
 KAFF-FM Flagstaff, AZ
 KWFM Tucson, AZ
 KONG-FM Visalia, CA
 KVOR-FM Colorado Springs, CO
 WZGC Atlanta, GA
 WGOV-FM Valdosta, GA
 WSEI Olney, IL
 WNDU-FM South Bend, IN
 KFMD Dubuque, IA
 WVLK-FM Lexington, KY
 NEW FM Bangor, ME
 WBO5 Brookline, MA
 WKJF Cadillac, MI
 *WSCD-FM Duluth, MN
 KGRK Hannibal, MO
 KWBE-FM Beatrice, NE
 KNEB-FM Scottsbluff, NE
 KSPV-FM Artesia, NM
 KRWN Farmington, NM
 WBUF Buffalo, NY
 KFYR-FM Bismarck, ND
 KKKQ Grand Forks, ND
 WJAI Eaton, OH
 KAKC-FM Tusa, OK
 KDKA-FM Pittsburgh, PA
 WYZZ Wilkes-Barre, PA
 WDSO-FM Dillon, SC
 WZEZ Nashville, TN
 KITY San Antonio, TX
 KBID Wichita Falls, TX
 WEZF Burlington, VT
 WFQG Suffolk, VA
 KISM Bellingham, WA
 KREM-FM Spokane, WA
 WTPM Aguadilla, PR

93.1 mhz (ch. 226)

KJOK Yuma, AZ
 KNX-FM Los Angeles, CA
 KOSO Patterson, CA
 KQIX-FM Grand Junction, CO
 WTMJ Miami, FL
 WEAS-FM Savannah, GA
 KGMO Honolulu, HI
 WXRT Chicago, IL
 WNAP Indianapolis, IN
 KWSN-FM Pratt, KS
 WPOC Baltimore, MD
 WHY-FM Springfield, MA
 WDRO Detroit, MI
 KNUJ-FM New Ulm, MN
 KRVN-FM Lexington, NE
 KUDO Las Vegas, NV
 WPAT-FM Paterson, NJ
 WDDS-FM Syracuse, NY
 WSEZ Winston-Salem, NC
 WZAK Cleveland, OH
 KNSD Springfield, OR
 KBHB-FM Sturgis, SD
 KAMA-FM El Paso, TX
 KZAK-FM Tyler, TX

93.3 mhz (ch. 227)

KDKB-FM Mesa, AZ

*KECR El Cajon, CA
 KYA-FM San Francisco, CA
 KZOO San Luis Obispo, CA
 KTCL Fort Collins, CO
 WFLA-FM Tampa, FL
 WDFR-FM Manchester, GA
 WMBD-FM Peoria, IL
 WAWK-FM Kendallville, IN
 KIOA-FM Des Moines, IA
 WKYO Paducah, KY
 WQUE New Orleans, La
 WRML Tauton, MA
 WPCP-FM Houston, MS
 KWKI Kansas City, MO
 KOYN-FM Billings, MT
 KOB-FM Albuquerque, NM
 WWSE Jamestown, NY
 WBTN-FM Forest City, NC
 WITV-FM Washington, NC
 KSJM Jamestown, ND
 WBEX-FM Chillicothe, OH
 *WAKW Cincinnati, OH
 WOOD Youngstown, OH
 KTEEN-FM Ada, OK
 WMMR Philadelphia, PA
 WJIG-FM Tullahoma, TN
 KIXS-FM Killeen, TX
 KBAT Midland, TX
 KYKR-FM Port Arthur, TX
 KWHO-FM Salt Lake City, UT
 WFLS-FM Fredericksburg, VA
 KBLE-FM Seattle, WA
 WWLA La Crosse, WI
 WQFM Milwaukee, WI
 WPAB-FM Ponce, PR

93.5 mhz (ch. 228)

WGEA-FM Geneva, AL
 KVVW-FM Show Low, AZ
 KBFC Forrest City, AR
 KHBM-FM Monticello, AR
 KXGO Arcata, CA
 KSOM-FM Ontario, CA
 KKOP Redondo Beach, CA
 KPIP Roseville, CA
 KGIW-FM Alamosa, CO
 WSEA Georgetown, DE
 WSWN-FM Belle Glade, FL
 WGLY Vero Beach, FL
 WVOH-FM Hazlehurst, GA
 WAJP Joliet, IL
 WITT Tuscola, IL
 WKMO Kokomo, IN
 WBTO-FM Linton, IN
 KRNA Iowa City, IA
 WYWF-FM Barboursville, KY
 WMMG Brandenburg, KY
 WAIN-FM Columbia, KY
 KFNV-FM Ferriday, LA
 KPVI-FM Ville Platte, LA
 WRKD-FM Rockland, ME
 WATZ-FM Alpena, MI
 WMPL-FM Hancock, MI
 NEW-FM Midland, MI
 KBMO-FM Benson, MN
 WXIJ Bay Springs, MS
 *WHJT Clinton, MS
 KRFG Greenfield, MO
 KRMS-FM Osage Beach, MO
 KTTT-FM Columbus, NE
 KICS-FM Hastings, NE
 KIBC Ogallala, NE
 WBNC-FM Conway, NH
 WHUC-FM Hudson, NY
 WVBR-FM Ithaca, NY
 WVOX-FM New Rochelle, NY
 WAWR-FM Bowling Green, OH
 KWHW-FM Altus, OK
 KSIW-FM Woodward, OK
 WCPA-FM Clearfield, PA
 WYPO-FM Stroudsburg, PA
 WXYR Columbia, SC
 WWWW Summerville, SC
 KCHF-FM Sioux Falls, SD
 WKBL-FM Covington, TN
 WLIL-FM Lenoir City, TN
 KDXJ-FM St. George, UT
 WFCR-FM Springfield, VT
 WLSO-FM Big Stone Gap, VA
 WBBC Blackstone, VA
 WJLM Salem, VA
 WSGM Staunton, VA
 WCST-FM Berkeley Springs, WV
 WJMT-FM Merrill, WI
 WLIH-FM New London, WI

93.7 mhz (ch. 229)

WDJC Birmingham, AL

KXEW-FM Tucson, AZ
 KISR Fort Smith, AR
 KFMM Chico, CA
 KVMJ Coachella, CA
 KFFE Fresno, CA
 KDB-FM Santa Barbara, CA
 KRAI-FM Craig, CO
 WLHV Hartford, CT
 WSTW Wilmington, DE
 WFUO Ocala, FL
 KSNM-FM Pocatello, ID
 WJCD-FM Seymour, IN
 KCIM-FM Carroll, IA
 KYEZ Salina, KS
 WAMX Ashland, KY
 KMBQ Shreveport, LA
 WCGY Lawrence, MA
 WJFM Grand Rapids, MI
 WAYL Minneapolis, MN
 WQID Biloxi, MS
 KCFM St. Louis, MO
 KQNM Gallup, NM
 WBLK-FM Depew, NY
 WMYK Elizabeth City, NC
 WDAY-FM Fargo, ND
 KMOT-FM Minot, ND
 *WFCJ Miamisburg, OH
 WMVO-FM Mount Vernon, OH
 KTMF Medford, OR
 KPPO-FM Portland, OR
 WJOI Pittsburgh, PA
 WFBC-FM Greenville, SC
 KWYR-FM Winner, SD
 KLBJ-FM Austin, TX
 KRLY Houston, TX
 KSEL-FM Lubbock, TX
 KXXR-FM Spokane, WA
 WEKZ-FM Monroe, WI
 WSRSA San Juan, PR

93.9 mhz (ch. 230)

KCTB-FM Flagstaff, AZ
 KPOL-FM Los Angeles, CA
 KPJK-FM Colorado Springs, CO
 WKYS Washington, DC
 WBUS Miami Beach, FL
 WMTM-FM Moultrie, GA
 KEKI Honolulu, HI
 NEW-FM Honolulu, HI
 WLAK Chicago, IL
 WFMW-FM Madisonville, KY
 WCOU-FM Lewiston, ME
 KWPM-FM West Plains, MO
 *WNYC-FM New York, NY
 WCHN-FM Norwalk, NY
 WBAG-FM Burlington, NC
 KSPI-FM Stillwater, OK
 KKLS-FM Rapid City, SD
 KSIX-FM Corpus Christi, TX
 KPAS El Paso, TX
 KBUY-FM Fort Worth, TX
 KWLV San Angelo, TX
 WMEV-FM Marion, VA
 WDROR-FM Sturgeon Bay, WI
 KUAM-FM Agana, GM

94.1 mhz (ch. 231)

WAQT Carrollton, AL
 KEZO Little Rock, AR
 KLYD-FM Bakersfield, CA
 *KPFA Berkeley, CA
 KFSD-FM San Diego, CA
 WYFM Lakeland, FL
 WMEZ Pensacola, FL
 WTOG-FM Savannah, GA
 WQXI-FM Smyrna, GA
 KBXL-FM Caldwell, ID
 WMIX-FM Mt. Vernon, IL
 WGFV-FM Watseka, IL
 KCKN-FM Kansas City, KS
 WHFI Jackson, MI
 WCCA McComb, MS
 KBOW-FM Butte, MT
 KOWH-FM Omaha, NE
 KXTZ Henderson, NV
 KDEF-FM Albuquerque, NM
 KPCE Humble City, NM
 LXNE Lexington, NC
 WHBC-FM Canton, OH
 WSAI-FM Cincinnati, OH
 KXIQ Bend, OR
 WYSP Philadelphia, PA
 WKOK-FM Sundbury, PA
 WHIM-FM Providence, RI
 NEW-FM Aberdeen, SD
 KDJW-FM Amarillo, TX

KBPO Beaumont, TX
 KALL-FM Salt Lake City, UT
 WYVA-FM Yorktown, VA
 KCLK-FM Clarkston, VA
 KEUT Seattle, WA
 WKLP-FM Keyser, WV
 WOAY-FM Oak Hill, WV
 WIAL Eau Claire, WI
 WOYE-FM Mayaguez, PR

94.3 mhz (ch. 232)

WARI-FM Abbeville, AL
 KAMO-FM Rogers, AR
 KORJ Garden Grove, CA
 KNGT Jackson, CA
 KPRA Paso Robles, CA
 KVFM San Fernando, CA
 WYBC-FM New Haven, CT
 WTLD-FM Lake City, FL
 WMUM Marathon, FL
 WGMW Riviera Beach, FL
 WIPE Americus, GA
 WSNT-FM Sandersville, GA
 KADQ Rexburg, ID
 WRMS-FM Beardstown, IL
 WJKL Elgin, IL
 WJVM Sterling, IL
 WXTA Greencastle, IN
 WTCA-FM Plymouth, IN
 WRCR Rushville, IN
 KVDB-FM Sioux Center, IA
 WHIC-FM Hardinsburg, KY
 WREM-FM Jenkins, KY
 KTRY-FM Bastrop, LA
 KLEB-FM Golden Meadow, LA
 WIDE-FM Biddeford, ME
 WICO-FM Salisbury, MD
 KEZZ Aitkin, MN
 KDOM-FM Windom, MN
 WKCU-FM Corinth, MS
 WBAD Leland, MS
 KCLU-FM Roila, MO
 WJLK-FM Asbury Park, NJ
 WWOC Avalon, NJ
 WEHH-FM Elmira, NY
 WBPM Kingston, NY
 WCTO Smiltown, NY
 WRQR Farmville, NC
 WLSE-FM Wallace, NC
 WMER Celina, OH
 WMQA-FM Marietta, OH
 WDFR Marion, OH
 KNFB Nowata, OK
 WCDL-FM Carbondale, PA
 WKSL Greencastle, PA
 WKBI-FM Ridgway, PA
 WPUB-FM Camden, SC
 WATP-FM Marion, SC
 KBRK-FM Brookings, SD
 WPTN-FM Cookeville, TN
 WJJM-FM Lewisburg, TN
 WTHJ Lobelville, TN
 WUUU Oak Ridge, TN
 WSIM Red Bank, TN
 WDBL-FM Springfield, TN
 KDLE-FM Del Rio, TX
 KPJH Fort Stockton, TX
 KPFM Kerrville, TX
 KLIS Palestine, TX
 WERL-FM Eagle River, WI
 WROE Neenah-Nenasha, WI
 WPRE-FM Prairie Du Chien, WI

94.5 mhz (ch. 233)

WAPI-FM Birmingham, AL
 KOOL-FM Phoenix, AZ
 KPAT Gilroy, CA
 KLIL Ukiah, CA
 WDNJ Daytona Beach, FL
 WCVU Naples, FL
 WLRW Champaign, IL
 KKEZ Fort Dodge, IA
 KJCK-FM Junction City, KS
 KFLA-FM Scott City, KS
 WLAP-FM Lexington, KY
 KSMB Lafayette, LA
 KROK Shreveport, LA
 WCOZ Boston, MA
 WJBL-FM Holland, MI
 WCEN-FM Mount Pleasant, MI
 KSTP-FM St. Paul, MN
 KRXL Kirksville, MO
 KPBM-FM Poplar Bluff, MO
 KNUW Great Falls, MT
 WCHR Trenton, NJ
 KGLP Gallup, NM
 WREZ Buffalo, NY

WSYR-FM Syracuse, NY
 WEAF Eden, NC
 KQDY Bismarck, ND
 WRWR-FM Port Clinton, OH
 KBMC Eugene, OR
 WDAC Lancaster, PA
 WPEZ Pittsburgh, PA
 WMMU-FM Greenville, SC
 KGAF-FM Gainesville, TX
 KELT Harlingen, TX
 KLEF Houston, TX
 KLBK-FM Lubbock, TX
 KVVJ Logan, UT
 WRVO Richmond, VA
 KIT-FM Yakima, WA
 WKTI Milwaukee, WI
 KAWY Casper, WY

94.7 mhz (ch. 234)

KMET Los Angeles, CA
 KBVL Boulder, CO
 WDSO Dover, DE
 KUMU-FM Honolulu, HI
 WDAI Chicago, IL
 WFBO Indianapolis, IN
 WXID Mayfield, KY
 WJMD Bethesda, MD
 WMAS-FM Springfield, MA
 WHNE Birmingham, MI
 WKXI Jackson, MS
 KSHS Crestwood, MO
 KTTT-FM Springfield, MO
 *KNIS Carson City, NV
 WFME Newark, NJ
 WQDR Raleigh, NC
 KYTN Grand Forks, ND
 WVKO-FM Columbus, OH
 KEBC Oklahoma City, OK
 KSET-FM El Paso, TX
 KIXY-FM San Angelo, TX
 WEYA Bayamon, PR

94.9 mhz (ch. 235)

WKSJ-FM Mobile, AL
 KAIR-FM Tucson, AZ
 KADL-FM Pine Bluff, AR
 KLRO San Diego, CA
 KSAN-FM San Francisco, CA
 KBOS Tulare, CA
 WINZ-FM Miami Beach, FL
 WLCY-FM St. Petersburg, FL
 WOMA Tallahassee, FL
 WPCW Atlanta, GA
 KFXD-FM Nampa, ID
 KSIH Pocatello, ID
 WAAG Galesburg, IL
 WSAB Mt. Carmel, IL
 KGGO Des Moines, IA
 WOCB-FM West Yarmouth, MA
 WVIC-FM East Lansing, MI
 KAOH-FM Duluth, MN
 KCEZ Kansas City, MO
 KYSS-FM Missoula, MT
 WMTT Mt. Washington, NH
 KBIM-FM Roswell, NM
 WCNW-FM Fairfield, OH
 WDBN Medina, OH
 *WMSP Harrisburg, PA
 WOFM Greenville, TN
 KAMC Arlington, TX
 KOYE Laredo, TX
 KBRE-FM Cedar City, UT
 KRMO Provo, UT
 WPRV Roanoke, VA
 *KQOW Seattle, WA
 WLVE Baraboo, WI

95.1 mhz (ch. 236)

WNDA Huntsville, AL
 KALJ Yuma, AZ
 KAMS Mammoth Spring, AR
 KPAY-FM Chico, CA
 KQLH San Bernardino, CA
 KBBY Ventura, CA
 KRDO-FM Colorado Springs, CO
 WINE-FM Brookfield, CT
 WJAX-FM Jacksonville, FL
 KAOI Wailuku, HI
 WPTH Fort Wayne, IN
 KJCT Wichita, KS
 WGGC Glasgow, KY
 WRBS Baltimore, MD
 *WFBF Flint, MI
 KWQA-FM Worthington, MN
 WQNZ Natchez, MS

FM by Frequency

WGLC-FM Mendota, IL
 WJBD-FM Salem, IL
 WCCI Savannah, IL
 WLKI Angola, IN
 WCRD Bluffton, IN
 WVCN Carrollton, KY
 WQXE Elizabethtown, KY
 WKDJ Winchester, KY
 WHOU-FM Houlton, ME
 WMNB-FM North Adams, MA
 WESO-FM Southbridge, MA
 WSHN-FM Fremont, MI
 WBCH-FM Hastings, MI
 WUUN Marquette, MI
 KMHL-FM Marshall, MN
 WRIL Grenada, MS
 KSWM-FM Aurora, MO
 KJMO Jefferson City, MO
 KYLT-FM Missoula, MT
 KPNW Plentywood, MT
 WPHD-FM Plymouth, NH
 WBXB Edenton, NC
 WKNT-FM Kent, OH
 KYFM Bartlesville, OK
 WVAM-FM Altoona, PA
 WUUF Lebanon, PA
 WDKD-FM Kingstree, SC
 WSCQ West Columbia, SC
 WADL Dyersburg, TN
 WIZO-FM Franklin, TN
 KGRI-FM Henderson, TX
 WIVE-FM Ashland, VA
 WWOD-FM Lynchburg, VA
 WTZE-FM Tazewell, VA
 WCLG-FM Morgantown, WV
 WGLB-FM Port Washington, WI
 WPDPR-FM Portage, WI
 WTCH-FM Shawano, WI

100.3 mhz (ch. 262)

WVNA-FM Tusculumbia, AL
 KIKO-FM Globe, AZ
 KGMR-FM Jacksonville, AR
 KYOR-FM Blythe, CA
 KIQQ Los Angeles, CA
 KBAY San Jose, CA
 KLIR-FM Denver, CO
 WFAN Washington, DC
 WDI2 Orlando, FL
 WXOS Plantation Key, FL
 WCUP Tifton, GA
 WOKZ-FM Alton, IL
 WLOO Chicago, IL
 WCNB-FM Connersville, IN
 KLYH Des Moines, IA
 KXXX-FM Colby, KS
 KTOP-FM Topeka, KS
 WKOF Hopkinsville, KY
 KDBS-FM Alexandria, LA
 WNIC-FM Dearborn, MI
 *WCTS-FM Minneapolis, MN
 WNSL-FM Laurel, MS
 WHEB-FM Portsmouth, NH
 WVNJ-FM Newark, NJ
 KPAR-FM Albuquerque, NM
 WGLD-FM High Point, NC
 WCLT-FM Newark, OH
 KQFM Portland, OR
 WZPR Meadville, PA
 WOKI-FM Oak Ridge, TN
 KDUV Brownsville, TX
 KTLX Dallas, TX
 KILT-FM Houston, TX
 KSAQ San Antonio, TX
 KSL-FM Salt Lake City, UT
 KWIO-FM Moses Lake, WA
 WIVA-FM Aguadilla, PR

100.5 mhz (ch. 263)

WHMA-FM Annisston, AL
 KEBR Sacramento, CA
 KRSD Durango, CO
 WRCH-FM New Britain, CT
 WEAI Jacksonville, IL
 WWKI Kokomo, IN
 WVOR Rochester, NY
 WOMP-FM Bellaire, OH
 WHMO Findlay, OH
 KJAK Oklahoma City, OK
 WLBG-FM Laurens, SC
 WCMS-FM Norfolk, VA
 WKKE-FM Huntington, WV

100.7 mhz (ch. 264)

KDOT-FM Scottsdale, AZ
 KIQO-FM Bishop, CA
 KWYT Salinas, CA
 KFMB-FM San Diego, CA
 KHAY Ventura, CA
 KDZA-FM Pueblo, CO
 WHYI Fort Lauderdale, FL

WJLQ Pensacola, FL
 WAVV Tampa, FL
 WBSI-FM Brunswick, GA
 WYEZ Elkhart, IN
 WYTS Terre Haute, IN
 KICG Iowa City, IA
 WQXY-FM Baton Rouge, LA
 WYTR-FM Westminster, MD
 WCOP-FM Boston, MA
 WITL-FM Lansing, MI
 KCMT-FM Alexandria, MN
 WDMS Greenville, MS
 KGMO-FM Cape Girardeau, MO
 KIEE Harrisonville, MO
 *KGBI-FM Omaha, NE
 WCMC-FM Wildwood, NJ
 WHUD Peekskill, NY
 WFMA Rocky Mount, NC
 WMM5 Cleveland, OH
 *WEEC Springfield, OH
 KICE Bend, OR
 WFMZ Allentown, PA
 WNUW New Kensington, PA
 WCLE-FM Cleveland, TN
 KORQ Abilene, TX
 KASE Austin, TX
 KPXI Mount Pleasant, TX
 WQPO Harrisonburg, VA
 KSEA Seattle, WA
 WBIZ-FM Eau Claire, WI
 WRKR-FM Racine, WI
 WXYX Bayamon, PR

100.9 mhz (ch. 265)

WALX Selma, AL
 WQSI Union Springs, AL
 KTAN-FM Sierra Vista, AZ
 NEW FM Arkadelphia, AR
 KTIM-FM San Rafael, CA
 KSRT Tracy, CA
 WTYD New London, CT
 WTOT-FM Marianna, FL
 WPGA-FM Perry, GA
 WVGVA Waynesboro, GA
 WCJM West Point, GA
 WGSY Peru, IL
 WQFL Rockford, IL
 WBDC Huntingburg, IN
 WNON Lebanon, IN
 WPGW-FM Portland, IN
 WMPI Scottsburg, IN
 WHMK Erlanger, KY
 WJMM Versailles, KY
 WRON Westbrook, ME
 WBRN-FM Big Rapids, MI
 KBEW-FM Blue Earth, MN
 WKLK-FM Cloquet, MN
 KQAD-FM Luverne, MN
 WMD-CF Hazelhurst, MS
 WKBB West Point, MS
 KPCR-FM Bowling Green, MO
 KFUN-FM Las Vegas, NM
 WWOM Albany, NY
 WQIX Horseheads, NY
 WEZG North Syracuse, NY
 WABZ-FM Albemarle, NC
 WIFM-FM Elkin, NC
 WXKY Fairmont, NC
 WMFD-FM Wilmington, NC
 WBNO-FM Bryan, OH
 WIBO Waverly, OH
 KGLC-FM Miami, OK
 WAKM Bedford, PA
 WMLP-FM Milton, PA
 WHYP-FM North East, PA
 WALD-FM Waterboro, SC
 WCVN Middlebury, VT
 WKKEY-FM Covington, VA
 WNNNT-FM Warsaw, VA
 WRCO-FM Richland Center, WI

101.1 mhz (ch. 266)

WFMH-FM Cullman, AL
 KAFI Auburn, CA
 KFIG Fresno, CA
 KRTH Los Angeles, CA
 KOSI-FM Denver, CO
 WWD-CF Washington, DC
 WCKS Cocoa Beach, FL
 WAFT Valdosta, GA
 WNIS-FM Chicago, IL
 WMR9 East St. Louis, IL
 KFJB-FM Marshalltown, IA
 WSGS Hazard, KY
 WAKQ Russellville, KY
 WNOE-FM New Orleans, LA
 KRMD-FM Shreveport, LA
 WRIF Detroit, MI
 KBHP Bemidji, MN
 KAOL-FM Carrollton, MO

KJSK-FM Columbus, NE
 WGR-FM Manchester, NH
 WCBS-FM New York, NY
 WNCB Burlington, NC
 WHOT-FM Youngstown, OH
 KOIN-FM Portland, OR
 WDRV Philadelphia, PA
 WGMR Tyrone, PA
 WCAC Anderson, SC
 WITL-FM Memphis, TN
 WRR-FM Dallas, TX
 KNAF-FM Fredericksburg, TX
 KLOL Houston, TX
 KTEZ Lubbock, UT
 KDAB Ogden, UT
 WIXX Green Bay, WI

101.3 mhz (ch. 267)

KGOT Anchorage, AK
 KIOI San Francisco, CA
 WKCI Hamden, CT
 WEMO East Moline, IL
 WKBV-FM Richmond, IN
 KFDF-FM Wichita, KS
 WFAU-FM Augusta, ME
 WYON Grand Rapids, MI
 WYOO-FM Richfield, MN
 WDAL-FM Meridian, MS
 WEZO Rochester, NY
 WNCO-FM Ashland, OH
 KNE-D-FM McAlester, OK
 WGLA-FM Lancaster, PA
 WGBI-FM Scranton, PA
 WWD-M-FM Sumter, SC
 KMIO Sinton, TX
 WVHR Hampton, VA

101.5 mhz (ch. 268)

KHEP-FM Phoenix, AZ
 KGFN Bakersfield, CA
 KAMB Merced, CA
 KGB-FM San Diego, CA
 WLYF Miami, FL
 WBOP-FM Pensacola, FL
 WKES St. Petersburg, FL
 WYNR-FM Brunswick, GA
 WBIE Marietta, GA
 WBNQ Bloomington, IL
 WCIL-FM Carbondale, IL
 WCSI-FM Columbus, IN
 WWJY South Bend, IN
 KAYL-FM Storm Lake, IA
 WYNK-FM Baton Rouge, LA
 KTXR Springfield, MO
 WBJH Trenton, NJ
 WPDH Poughkeepsie, NY
 WRAL Raleigh, NC
 WJEH-FM Gallipolis, OH
 WLOR Toledo, OH
 KLAU Lawton, OK
 KFLY-FM Corvallis, OR
 WPIT-FM Pittsburgh, PA
 WAYZ-FM Waynesboro, PA
 WLKW-FM Providence, RI
 WQUT Johnson City, TN
 KOXE Brownwood, TX
 KNUE Tyler, TX
 WFVA-FM Fredericksburg, VA
 KETO-FM Seattle, WA
 WIBA-FM Madison, WI
 WISA-FM Isabela, PR

101.7 mhz (ch. 269)

KSQR Mena, AR
 KTOT-FM Big Bear Lake, CA
 KLRB Carmel, CA
 KKIQ Livermore, CA
 KVMN St. Helena, CA
 KSMI Truckee, CA
 KFTM-FM Fort Morgan, CO
 WCNH-FM Quincy, FL
 WWCW Albany, GA
 WTHO-FM Thomson, GA
 WRBN-FM Warner Robins, GA
 KMFE Emmett, ID
 WIXN-FM Dixon, IL
 WTAY-FM Robinson, IL
 WBMP Elwood, IN
 WCMX Fort Wayne, IN
 KSIB-FM Creston, IA
 KXGI-FM Fort Madison, IA
 KIND-FM Independence, KS
 KMKF Manhattan, KS
 WKYM Monticello, KY
 WCBR-FM Richmond, KY
 KEAZ De Ridder, LA
 WLYN-FM Lynn, MA
 WBRK-FM Pittsfield, MA
 WJRS-FM Lansing, MI
 WKJR-FM Muskegon Heights, MI
 WDBI-FM Tawas City, MI

KNCV Rochester, MN
 WMMH-FM Sauk Rapids, MN
 WWLM Canton, MS
 WJBI Clarksdale, MS
 WFTA Fulton, MS
 KLPW-FM Union, MO
 WCNL-FM Newport, NH
 WNNN Canton, NJ
 KLEA-FM Lovington, NM
 WECC Geneva, NY
 WHUG Jamestown, NY
 WFMG-Owego, NY
 WJER-FM Dover-New Philadelphia, OH
 WNKO Newark, OH
 WCOM-FM Urbana, OH
 KTLQ-FM Tahlequah, OK
 WCCS Central City, PA
 WVCC Linesville, PA
 WBAW-FM Barnwell, SC
 WKZO Myrtle Beach, SC
 WKOM Columbia, TN
 WCMT-FM Martin, TN
 WORM-FM Savannah, TN
 WJLE-FM Smithville, TN
 KDSX-FM Denison-Sherman, TX

KSAM-FM Huntsville, TX
 WKWI Kilmarnock, VA
 WJJS-FM Lynchburg, VA
 WRAD-FM Radford, VA
 KACA Prosser, VA

101.9 mhz (ch. 270)

WHHY-FM Montgomery, AL
 KBTM-FM Jonesboro, AR
 KFRY Fresno, CA
 KUTE Glendale, CA
 KRYT-FM Colorado Springs, CO
 WMFJ-FM Daytona Beach, FL
 WHEW Fort Myers, FL
 WCLR Skokie, IL
 WVEM Springfield, IL
 *KNWS-FM Waterloo, IA
 WNES-FM Central City, KY
 KNOE-FM Monroe, LA
 WWL-FM New Orleans, LA
 WPOR-FM Portland, ME
 WLIF Baltimore, MD
 WCIB Falmouth, MA
 *WDET-FM Detroit, MI
 WLDR Traverse City, MI
 KFMQ Lincoln, NE
 KFMS Las Vegas, NV
 WJIV Cherry Valley, NY
 WPX-FM New York, NY
 WGNC Gastonia, NC
 WKRO Cincinnati, OH
 KFNB Oklahoma City, OK
 KINK Portland, OR
 WAWT Pottsville, PA
 KWAS Amarillo, TX
 KQXT San Antonio, TX
 KQPD Ogden, UT
 WVOW-FM Logan, WV
 WAJR-FM Morgantown, WV
 WDEZ Wausau, WI
 WZAR Ponce, PR

102.1 mhz (ch. 271)

WDRM Decatur, AL
 KJZZ Anchorage, AK
 KUDE-FM Oceanside, CA
 KDTF San Francisco, CA
 WZAT Savannah, GA
 WMBJ Danville, IL
 KSKU Hutchinson, KS
 WAQY Springfield, MA
 *WMUK Kalamazoo, MI
 KEEY-FM St. Paul, MN
 KYY5 Kansas City, MO
 WWMO Reidsville, NC
 WDOK-FM Cleveland, OH
 WIMA-FM Lima, OH
 WCED-FM Du Bois, PA
 WIOQ Philadelphia, PA
 WSEV-FM Sevierville, TN
 KLYX Clear Lake City, TX
 KLOZ El Paso, TX
 KFDW Fort Worth, TX
 WRXL Richmond, VA
 KPQ-FM Wenatchee, WA
 WAWA-FM Milwaukee, WI

102.3 mhz (ch. 272)

WAMI-FM Opp, AL
 KBRI-FM Brinkley, AR
 KWKK Dardanelle, AR
 KAVR-FM Apple Valley, CA
 KJLH Compton, CA
 KITA Modesto, CA

KLGT Breckenridge, CO
 KLOV-FM Loveland, CO
 WRTM Bountstown, FL
 WTRS-FM Dunnellon, FL
 WYRL Melbourne, FL
 WUGS-FM Augusta, GA
 WCGO Buford, GA
 WMVG-FM Milledgeville, GA
 WRGA-FM Rome, GA
 WTAS Crete, IL
 WKSI Eldorado, IL
 WRHL-FM Rochelle, IL
 WEFA Waukegan, IL
 WSAL-FM Logansport, IN
 WCBK-FM Martinsville, IN
 WLJC Beattyville, KY
 WYCB-FM Benton, KY
 WCYN-FM Cynthiana, KY
 WGOH-FM Grayson, KY
 WLRS Louisville, KY
 WLOC-FM Munfordville, KY
 WHFS Bethesda, MD
 WBSJ Ellisville, MD
 WTAM Gulfport, MS
 KQCA Canton, MO
 KDEX-FM Dexter, MO
 KYSD Waynesville, MO
 WKXL-FM Concord, NH
 WRIO-FM Cape May NJ
 WSUS Franklin, NJ
 KBSO Espanola, NM
 WBAF-FM Babylon, NY
 WFLC Canandaigua, NY
 WKAJ-FM Saratoga Springs, NY
 WAVR Waverly, NY
 WOKN Goldsboro, NC
 WJSK Lumberton, NC
 WPTM Roanoke Rapids, NC
 WQLX Galion, OH
 WPOS-FM Holland, OH
 WDHK Wilmington, OH
 KRHD-FM Duncan, OK
 KCES Euftalia, OK
 WHYL-FM Carlisle, PA
 WMDI McKean, PA
 WCPL Pageland, SC
 KMIT Mitchell, SD
 KVRP Vermillion, SD
 WRKM-FM Carthage, TN
 WDKN-FM Hickson, TN
 WIRJ-FM Humboldt, TN
 KBIC Alice, TX
 KTXJ-FM Jasper, TX
 KVWC-FM Vernon, TX
 WWSR-FM St. Albans, VT
 WOLD-FM Marion, VA
 WHAW-FM Weston, WV
 WISS-FM Berlin, WI
 WQTC-FM Two Rivers, WI
 WGBM Viroqua, WI

102.5 mhz (ch. 273)

WWWB-FM Jasper, AL
 KNIX Phoenix, AZ
 KBZ Salinas, CA
 KSMA-FM Santa Maria, CA
 KSMF Woodland, CA
 WQSR Sarasota, FL
 WAXY-FM Waycross, GA
 WMDH New Castle, IN
 KRNO Des Moines, IA
 WFMF Baton Rouge, LA
 WCRB Waltham, MA
 WGER-FM Bay City, MI
 KQIC Wilmar, MN
 KPCG Joplin, MO
 KEZK St. Louis, MO
 WBEN-FM Buffalo, NY
 WKIT Hendersonville, NC
 WHIZ-FM Zanesville, OH
 KNPT-FM Newport, OR
 WDV2 Pittsburgh, PA
 WRFY-FM Reading, PA
 WKTM Charleston, SC
 KBBR-FM Hillsboro, TX
 WKBH-FM Texarkana, TX
 WEFW Winchester, VA
 KZOK Seattle, WA
 *WNVC Madison, WI
 WIAF-FM San Juan, PR

102.7 mhz (ch. 274)

KKNU Fresno, CA
 KIIS-FM Los Angeles, CA
 KIIQ-FM Manitow Springs, CO
 WXBW-FM Milton, FL
 WCKO Pompano Beach, FL
 WBXM Oak Park, IL

FM by Frequency

WPFR Terre Haute, IN
WCAO-FM Baltimore, MD
WBRB-FM Mount Clemens, MI
KFOR-FM Lincoln, NE
WNEW-FM New York, NY
WAAV Wilmington, NC
WEBN Cincinnati, OH
WLEC-FM Sandusky, OH
KAFG Oklahoma City, OK
WRAK-FM Williamsport, PA
WREC-FM Memphis, TN
KTFM San Antonio, TX
KORD-FM Richland, WA
WTIO Charleston, WV
WRVM Suring, WI

102.9 mhz (ch. 275)

KHOZ-FM Harrison, AR
KRE-FM Berkeley, CA
KEZL San Diego, CA
WDRS Hartford, CT
WIVY-FM Jacksonville, FL
WRBL-FM Columbus, GA
WSOY-FM Decatur, IL
KQCR Cedar Rapids, IA
KWBW-FM Hutchinson, KS
WGAN-FM Portland, ME
WCUM-FM Cumberland, MD
WIGB Ann Arbor, MI
WFRU-FM Grand Rapids, MI
WCCO-FM Minneapolis, MN
WZZQ Jackson, MS
KFMP Cape Girardeau, MO
KMFL-FM Marshall, MO
WMHR Syracuse, NY
WHKY-FM Hickory, NC
WBLY-FM Springfield, OH
WMGK Philadelphia, PA
WYFM Sharon, PA
WHAL-FM Shelbyville, TN
KDTX Dallas, TX
KQUE Houston, TX
WOWI Norfolk, VA
KELA-FM Centralia, WA
WBSC Milwaukee, WI
KIOZ Laramie, WY
WCHQ-FM Camuy, PR

103.1 mhz (ch. 276)

KEZU El Dorado, AR
KCRI Helena, AR
KWXY-FM Cathedral City, CA
KOCM Newport Beach, CA
KSRF Santa Monica, CA
KTHO-FM South Lake Tahoe, CA
WQUH Defuniki Springs, FL
WLWC Okeechobee, FL
WJZS Tallahassee, FL
WLOQ Winter Park, FL
WZZV Augusta, GA
WVXV-FM Highland Park, IL
WAKO-FM Lawrenceville, IL
WPOK-FM Pontiac, IL
WRWC Rockton, IL
WHLT-FM Huntington, IN
WHME South Bend, IN
KNDY-FM Marysville, KS
WECL Elkhorn City, KY
WAXU-FM Georgetown, KY
WVIC Henderson, KY
WJRS-FM Jamestown, KY
WVXL-FM Manchester, KY
WSTM St. Matthews, KY
WTHM-FM Lapeer, MI
KFIL-FM Preston, MN
WJWF Columbus, MS
WOSM Ocean Springs, MS
KCRV-FM Caruthersville, MO
KCAP-FM Helena, MT
KASK Las Cruces, NM
WHRL Albany, NY
WFMN Newburgh, NY
WONT Oneonta, NY
WQTI Dunn, NC
WWWJ Johnstown, OH
WVNDH Napoleon, OH
KRBS Roseburg, OR
WACM Freeland, PA
WOMU Indiana, PA
WXLR State College, PA
WJBW-FM Hampton, SC
KJAM-FM Madison, SD
KMUL-FM Muleshoe, TX
WCUL Culpener, VA
WKYG-FM Parkersburg, WV

103.3 mhz (ch. 277)

WMGZ Montgomery, AL

KBEE-FM Modesto, CA
KRUZ Santa Barbara, CA
KKTU Ukiah, CA
WDUV Bradenton, FL
WPLD-FM Atlanta, GA
WACL-FM Waycross, GA
WXTZ Indianapolis, IN
New FM Pella, IA
KTFC Sioux City, IA
KJLS Hays, KS
WJTG Hammond, LA
WEEI-FM Boston, MA
WFRF-FM Battle Creek, MI
WDTH Duluth, MN
KBRF-FM Fergus Falls, MN
KPRS Kansas City, MO
KMOX-FM St. Louis, MO
WPRB Princeton, NJ
WYSL-FM Buffalo, NY
*WCRF Cleveland, OH
KKUL Tulsa, OK
WSBA-FM York, PA
WKDA-FM Nashville, TN
KJCS Nacogdoches, TX
KQUL Sinton, TX
KNTG Wichita Falls, TX
WAGO Danville, VA
WESR-FM Tasey, VA
WHEZ Huntington, WV
WVWR Wisconsin Rapids, WI
WVJP-FM Caguas, PR

103.5 mhz (ch. 278)

KOST Los Angeles, CA
KQAO Denver, CO
WGMS-FM Washington, DC
WSHE-FM Fort Lauderdale, FL
WFYR Chicago, IL
WVMU Detroit, MI
WTCM-FM Traverse City, MI
KYSM-FM Mankato, MN
WNAU-FM New Albany, MS
WTFM Lake Success, NY
WYCH Hamilton, OH
WRKY Steubenville, OH
WEZL Charleston, SC
WBRF-FM Knoxville, TN
KRSP-FM Salt Lake City, UT

103.7 mhz (ch. 279)

WQEN Gadsden, AL
KKYK Little Rock, AR
KIOY Hanford, CA
KQZN-FM San Diego, CA
KSFJ San Francisco, CA
WRUF-FM Gainesville, FL
WDBR Springfield, IL
*WFIU Bloomington, IN
KJAN-FM Atlantic, IA
KKKI Davenport, IA
KEYN-FM Wichita, KS
WAAW Murray, KY
KGRA Lake Charles, LA
WHDG Havre De Grace, MD
KPRM-FM Park Rapids, MN
WHER Hattiesburg, MS
KJEL-FM Lebanon, MO
WXLQ Berlin, NH
WNBX-FM Keene, NH
WMGM Atlantic City, NJ
WIXL-FM Newton, NJ
WEIV Ithaca, NY
WSOC-FM Charlotte, NC
WSEC Williamston, NC
WTFI-FM Tiffin, OH
KOMS Lebanon, OR
WOCK Erie, PA
WERI-FM Westerly, RI
KVIL-FM Highland Park, TX
KRMH San Marcos, TX
WEZS Richmond, VA
WCIW-FM Beckley, WV
WWIB Ladysmith, WI
WEZW Wauwatosa, WI

103.9 mhz (ch. 280)

WAYD-FM Ozark, AL
KHAR-FM Anchorage, AK
KMLA Ashdown, AR
KNVA Fayetteville, AR
KPOC-FM Pochontas, AR
KAGB-FM Ingleswood, CA
KCTY-FM Salinas, CA
KHEX Yuba City, CA
KRLN-FM Canon City, CO
KFMO Oak Creek, CO
WRCC Cape Coral, FL
WPLL Blue Ridge, GA
WCEH-FM Hawkinsville, GA
KRPL-FM Moscow, ID
WVFD Dundee, IL
WNOI Flora, IL

WTWC Urbana, IL
WLFQ Crawfordsville, IN
WFLM Crown Point, IN
WRBR South Bend, IN
KNEI-FM Waukon, IA
WTCO-FM Campbellsville, KY
WFTG-FM London, KY
WFIA-FM Louisville, KY
WTCW-FM Whitesburg, KY
WZYQ-FM Braddock Heights, MD
WLEN Adrian, MI
WJNR-FM Iron Mountain, MI
WQAP-FM Owosso, MI
KRAD-FM East Grand Forks, MN
WCLD-FM Cleveland MS
KCHI-FM Chillicothe, MO
KGRD-FM Las Cruces, NM
WRSR Oneonta, NY
WQBK-FM Rensselaer, NY
WRCN-FM Riverhead, NY
WQDX Rochester, NY
WVYD White Plains, NY
WBBY-FM Westerville, OH
WHBM Xenia, OH
WHGM Bellwood, PA
WIBF-FM Jenkintown, PA
WELP Mercer, PA
WVIZ-FM Easley, SC
WHCE-FM Orangeburg, SC
WXIS Erwin, TN
WDEB-FM Jamestown, TN
WBCM-FM McMinnville, TN
KGFH-FM Hoquiam, WA
KTAC-FM Tacoma, WA
WOSH Oshkosh, WI

104.1 mhz (ch. 281)

WATM-FM Altmore, AL
KHOP Modesto, CA
WIOF Waterbury, CT
WRKT-FM Cocoa Beach, FL
WGLF Tallahassee, FL
WLAG-FM La Grange, GA
WJBM-FM Jerseyville, IL
WIKY-FM Evansville, IN
WLBG-FM Muncie, IN
KLFM Ames, IA
KHOM Houma, LA
KMLB-FM Monroe, LA
WSDM-FM La Plata, MD
WBCN Boston, MA
*WVGR Grand Rapids, MI
KFMX St. Louis Park, MN
WVWL-FM Buffalo, NY
WTQR Winston-Salem, NC
WQAL Cleveland, OH
WPAY-FM Portsmouth, OH
KOFM Oklahoma City, OK
WXXW Allentown, PA
WTPA-FM Harrisburg, PA
WLAT-FM Conway, SC
KQHU Yankton, SD
WKIR Jackson, TN
KBFM Edinburg, TX
KRBE Houston, TX
KUTI-FM Yakima, WA
WZEE Madison, WI
WUPR-FM Utuado, PR

104.3 mhz (ch. 282)

WJOF Athens, AL
*KTOO Juneau, AK
KBIG Los Angeles, CA
KLMO-FM Longmont, CO
WBBQ-FM Augusta, GA
WJJD-FM Chicago, IL
KVGB-FM Great Bend, KS
WKME Gardiner, ME
WDMQ Baltimore, MD
WMOJ Detroit, MI
KBEO Kansas City, MO
WNCN New York, NY
WRUN-FM Utica, NY
WPCS-FM Tarboro, NC
WELA East Liverpool, OH
KBBB-FM Borger, TX
KSOP-FM Salt Lake City, UT
KERI Bellingham, WA

104.5 mhz (ch. 283)

KFOG San Francisco, CA
WEAT-FM West Palm Beach, FL
WGPC-FM Albany, GA
WFMB Springfield, IL
*WJAC Indianapolis, IN
*KTOF Cedar Rapids, IA
WFMP Fitchburg, MA
WQWQ-FM Muskegon, MI
WHSY-FM Hattiesburg, MS

KOOO-FM Omaha, NE
KSRN Reno, NV
WVST-FM Wooster, OH
KKMA Pryor, OK
KCIV The Dalles, OR
WRCP-FM Philadelphia, PA
WGRW Wellsville, PA
WHIN-FM Gallatin, TN
WQUD Memphis, TN
KEZT Dallas, TX
KOBBS-FM Orange, TX
KEXL San Antonio, TX
WQRK Norfolk, VA
WHIS-FM Bluefield, WV
WEAU-FM Eau Claire, WI

104.7 mhz (ch. 284)

WZZK Birmingham, AL
*KUAC College, AK
KBUZ-FM Mesa, AZ
KPMJ Oxnard, CA
KDES-FM Palm Springs, CA
KVMY Vail, CO
WRBQ Tampa, FL
WJSR Athens, GA
WRMI-FM Morris, IL
WXAX Elkhart, IN
WITZ-FM Jasper, IN
WJEF-FM Hagerstown, MD
WBOC-FM Salisbury, MD
WVLC-FM Orleans, MA
KCLD-FM St. Cloud, MN
KRES Moberly, MO
WKFM Fulton, NY
WPSK Poughkeepsie, NY
WEZC Charlotte, NC
WTUE Dayton, OH
WIOT Toledo, OH
WYDD Pittsburgh, PA
WNOK-FM Columbia, SC
KIOV Sioux Falls, SD
WVSV-FM Crewe, VA
KDUX-FM Ocean Shores, WA
WTTN-FM Watertown, WI
WKAQ-FM San Juan, PR

104.9 mhz (ch. 285)

WHOD-FM Jackson, AL
WQAB Ozark, AL
KAGH-FM Crossett, AR
KHIG Paragould, AR
KCIZ Springdale, AR
KFMR Fremont, CA
KOCN Pacific Grove, CA
WIHS Middletown, CT
WJNU-FM Atlantic Beach, FL
WAAZ-FM Crestview, FL
WWRH Columbus, GA
WHCG Metter, GA
WKWL Belvidere, IL
WCBW Columbia, IL
WFIW-FM Fairfield, IL
WRSO-FM Geneseo, IL
WTAO Murphysboro, IL
WZRO Pekin, IL
WSHY-FM Shelbyville, IL
WVWY Columbus, IN
WVHC Hartford City, IN
KCHA-FM Charles City, IA
KBOE-FM Oskaloosa, IA
KDSL-FM Perry, IA
KLRP Emporia, KS
WKYW Frankfort, KY
WMTL-FM Leitchfield, KY
WPKY-FM Princeton, KY
WVSK Stanton, KY
KROF-FM Abbeville, LA
KSMI-FM Donaldsonville, LA
KTCC-FM Jonesboro, LA
KCWR Oakdale, LA
WVCA-FM Gloucester, MA
WFCY-FM Alma, MI
WKYO-FM Caro, MI
WELL-FM Marshall, MI
KKWB Breckenridge, MN
KRFO-FM Owatonna, MN
WTIB Iuka, MS
WCIS Pascagoula, MS
KRGK Carthage, MO
KTCH Wayne, NE
KAWL-FM York, NE
WRDR Egg Harbor, NJ
KOPE Mesilla Park, NM
WIZR-FM Johnstown, NY
WXXY Montour Falls, NY
WKVO-FM Havelock, NC
WKSJ Tabor City, NC
*WCVO Gahanna, OH
WLSR Lima, OH
WZLE Lorain, OH
KGOY Bethany, OK
WBEV Okmulgee, OK

WWDL-FM Scranton, PA
WCFA Clinton, TN
WNFM Dayton, TN
WALR-FM Union City, TN
WVRY Waverly, TN
KJDF Beeville, TX
KVLG-FM La Grange, TX
KFRD-FM Rosenberg-Richmond, TX
KPLE Temple, TX
WVVV Blacksburg, VA
WGAT-FM Gate City, VA
KQQQ Pullman, WA
KIAM-FM Wenatchee, WA
WPDV-FM Clarksburg, WV
WATK-FM Antigo, WI
WTKM-FM Hartford, WI
WKAU-FM Kaukauna, WI
WLXR La Crosse, WI
WRDB-FM Reedsberg, WI

105.1 mhz (ch. 286)

WQSB Albertville, AL
KVEE-FM Conway, AR
KBCA Los Angeles, CA
KEWT Sacramento, CA
KADX Denver, CO
WYOR Coral Gables, FL
WBJW-FM Orlando, FL
WUJO Evanston, IL
WGEW-FM Quincy, IL
WTOF-FM Skowhegan, ME
WCBY-FM Cheboygan, MI
WQRS-FM Detroit, MI
WGGW Duluth, MN
WKOZ-FM Kosciusko, MS
KSFT St. Joseph, MO
WOIV Deruyter Township, NY
WRFM New York, NY
WDCG Durham, NC
WUBE-FM Cincinnati, OH
WSOM-FM Salem, OH
KORI Salem, OR
WIOV Ephrata, PA
WILQ-FM Williamsport, PA
WVJB-FM Providence, RI
KNIT-FM Abilene, TX
KLUF-FM Lufkin, TX
WAVA-FM Arlington, VA
WKLK-FM St. Albans, WV
WPRP-FM Ponce, PR

105.3 mhz (ch. 287)

KITT San Diego, CA
KBRG San Francisco, CA
WDEW-FM Macon, GA
WVHI Evansville, IN
WASK-FM Lafayette, IN
KIWI Dubuque, IA
WXEL Slide, IL
WFRB-FM Frostburg, MD
KZNN Rolla, MO
WHHO-FM Hornell, NY
WCLW-FM Mansfield, OH
WDAS-FM Philadelphia, PA
WAGI-FM Gaffney, SC
KOAX Dallas, TX
KWED-FM Seguin, TX
WXRI Norfolk, VA
KBIO Edmonds, WA
KONA-FM Kennewick, WA

105.5 mhz (ch. 288)

WWSM Bay Minette, AL
WLAY-FM Muscle Shoals, AL
WACT-FM Tuscaloosa, AL
KNIK-FM Anchorage, AK
KBFE Casa Grande, AZ
KOKR Newport, AR
KHSJ-FM Hemet, CA
KNAC Long Beach, CA
KOVA Ojai, CA
KWYD Security, CO
WVSB-FM Groton, CT
WVGL Gainesville, FL
WVGL-FM New Port Richey, FL
*WKZM Sarasota, FL
WVSK-FM Sebring, FL
WCHK-FM Canton, GA
WIFO-FM Jesup, GA
WOWE Rossville, GA
WVLI Monticello, IL
WXRK Woodstock, IL
WIFF-FM Auburn, IN
WVBF Bedford, IN
WVJE Vaiparaiso, IN
WVWR West Terre Haute, IN
KILJ Mt. Pleasant, IN
KIWA Sheldon, IA
KTLB Twin Lakes, IA
KKOY-FM Chanute, KS
WSAC-FM Fort Knox, KY

WAYV Atlantic City, NJ
 WMIV South Bristol Township, NY
 WROQ Charlotte, NC
 WRNS Kinston, NC
 WEZV Bethlehem, PA
 WCHM Chambersburg, PA
 WEDA-FM Grove City, PA
 WPXI Charleston, SC
 KTRM-FM Beaumont, TX
 KCMW Victoria, TX
 WXIL Parkersburg, WV
 WLIP-FM Kenosha, WI
 WLST Marinette, WI
 WRPC San German, PR

95.3 mhz (ch. 237)

WELR-FM Roanoke, AL
 WJDB-FM Thomasville, AL
 KRVE Los Gatos, CA
 KEDY Mt. Shasta, CA
 KPGA Pismo Beach, CA
 KUIV Vacaville, CA
 WTLN-FM Apopka, FL
 *WSOR Fort Myers, FL
 WRXX Centralia, IL
 WSIV-FM Pekin, IL
 WRTL-FM Rantoul, IL
 WYFE-FM Winnebago, IL
 WVTL Monticello, IN
 WVAK-FM Paoli, IN
 KOUR-FM Independence, IA
 KIFG-FM Iowa Falls, IA
 KIMI Keokuk, IA
 KMAQ-FM Maquoketa, IA
 KCII-FM Washington, IA
 WMSK-FM Morganfield, KY
 KFRA-FM Franklin, LA
 WJTO-FM Bath, ME
 WHRB-FM Cambridge, MA
 WABJ-FM Adrian, MI
 WDFP Battle Creek, MI
 WCRM-FM Clare, MI
 WNIL-FM Niles, MI
 WLRO Whitehall, MI
 KCPI-FM Albert Lea, MN
 KVLK Detroit Lakes, MN
 KLFD-FM Litchfield, MN
 KNOF St. Paul, MN
 KAGE-FM Winona, MN
 WAFM Amory, MS
 WADI Corinth, MS
 WDRU Drew, MS
 KDKD-FM Clinton, MO
 KNIM-FM Maryville, MO
 KRWS Hardin, MT
 KBHL Lincoln, NE
 KSID-FM Sidney, NE
 WWRJ Southampton, NY
 WOBK-FM Wanchese, NC
 WKTN-FM Kenton, OH
 WLKR-FM Norwalk, OH
 WBZI Xenia, OH
 KBOY-FM Medford, OR
 WISL-FM Shamokin, PA
 WTTT-FM Towanda, PA
 WJPA-FM Washington, PA
 WTBG-FM Brownsville, TN
 WDEH-FM Sweetwater, TN
 KFNE Big Spring, TX
 KMRE Dumas, TX
 KMMK McKinney, TX
 KYUF Uvalde, TX
 WNHV-FM White River Junction, VT
 WQMC Charlottesville, VA
 WIXV Front Royal, VA
 WPVA-FM Petersburg, VA
 KXLE-FM Ellensburg, WA
 WBEV-FM Beaver Dam, WI
 WKCF Shell Lake, WI

95.5 mhz (ch. 238)

WTYY-FM Dothan, AL
 KRFM Phoenix, AZ
 KPHD Fresno, CA
 KLOS Los Angeles, CA
 WOVV Fort Pierce, FL
 WNGC Athens, GA
 WSGF Savannah, GA
 KAIM-FM Honolulu, HI
 WDFH Chicago, IL
 WFMS Indianapolis, IN
 KBGM Sioux City, IA
 KGNO-FM Dodge City, KS
 WDOC-FM Prestonburg, KY
 WPGC-FM Morningside, MD
 WLDM Detroit, MI
 WLIN Jackson, MS

*KILA Henderson, NV
 KNEV Reno, NV
 KSNM Santa Fe, NM
 WROW-FM Albany, NY
 WPLJ New York, NY
 WHPE-FM High Point, NC
 WCLV Cleveland, OH
 WHOK-FM Lancaster, OH
 KWEN Tulsa, OK
 KXL-FM Portland, OR
 WJAC-FM Johnstown, PA
 WBRU Providence, RI
 WSM-FM Nashville, TN
 KOKE-FM Austin, TX
 KZFM Corpus Christi, TX
 KSPL-FM Diboll, TX
 KUOE El Paso, TX
 KEFC Waco, TX
 WIFC Wausau, WI
 KSTO Agana, GM

95.7 mhz (ch. 239)

WUOA Tuscaloosa, AL
 KMYO-FM Little Rock, AR
 KKHJ-FM San Francisco, CA
 KOYN Twenty Nine Palms, CA
 KHOW-FM Denver, CO
 WKSS Hartford-Meriden, CT
 WTAN-FM Clearwater, FL
 WCRA-FM Effingham, IL
 WQHI Jeffersonville, IN
 KOFO-FM Ottawa, KS
 WBYU New Orleans, LA
 WDEA-FM Ellsworth, ME
 WZZM-FM Grand Rapids, MI
 WDMJ-FM Marquette, MI
 KLIZ-FM Brainerd, MN
 KWWR-FM Mexico, MO
 KCGM Scobey, MT
 KROA Grand Island, NE
 WZID Manchester, NH
 KSCR Hobbs, NM
 WEBF Olean, NY
 WYXC Hickory, NC
 WTSB-FM Lumberton, NC
 PWTW-FM Piqua, OH
 KKAJ Ardmore, OK
 WFLN-FM Philadelphia, PA
 KIKK-FM Houston, TX
 WFLO-FM Farmville, VA
 WTRF-FM Norfolk, VA
 KIXI-FM Seattle, WA
 WZUU-FM Milwaukee, WI
 WFID Rio Piedras, PR

95.9 mhz (ch. 240)

WTWX Guntersville, AL
 WVNS Tuskegee, AL
 KBAS Lake Havasu City, AZ
 KEZY-FM Anaheim, CA
 KEWE Camarillo, CA
 KKOS Carlsbad, CA
 KLSB-FM Los Banos, CA
 KAVI-FM Rocky Ford, CO
 WNLK-FM Norwalk, CT
 WYTR-FM Bethany Beach, DE
 WLEO Bonita Springs, FL
 WKKD-FM Aurora, IL
 WHOW-FM Clinton, IL
 WDQN-FM Duquoin, IL
 WIFN Franklin, IN
 WMBC-FM Michigan City, IN
 WMBG Vevay, IN
 WKUZ Wabash, IN
 KILR-FM Estersville, IA
 KLVN Newton, IA
 KQWC-FM Webster City, IA
 KRSL-FM Russell, KS
 WFTM-FM Maysville, KY
 WRSL-FM Stanford, KY
 KMAR-FM Winsboro, LA
 WISZ-FM Glen Burnie, MD
 WYII Williamsport, MD
 WGRQ-FM Pittsfield, MA
 WVOI Tisbury, MA
 WLKM-FM Three Rivers, MI
 KDHL-FM Faribault, MN
 KETU Salem, MO
 KLYQ-FM Hamilton, MT
 KLGM-FM Lewistown, MT
 WADB Point Pleasant, NJ
 WFLR-FM Dundee, NY
 WWSC-FM Glens Falls, NY
 WVOS-FM Liberty, NY
 WKAL-FM Rome, NY

WMBL-FM Morehead City, NC
 WHFD Archbold, OH
 WNPO New Philadelphia, OH
 WYAN-FM Upper Sandusky, OH
 KRBB-FM Sallisaw, OK
 WMRF-FM Lewistown, PA
 WLOW-FM Aiken, SC
 WDXE-FM Lawrenceburg, TN
 WLIV-FM Livingston, TN
 WAZI Morristown, TN
 KXIT-FM Dairhart, TX
 KMWT Mineral Wells, TX
 KNBO-FM New Boston, TX
 WAEY-FM Princeton, WV
 WATW-FM Ashland, WI
 WRDN-FM Durand, WI
 WSPJ La Crosse, WI
 WVMH Minocqua, WI
 WCWC-FM Ripon, WI

96.1 mhz (ch. 241)

WLPR Mobile, AL
 KCEE-FM Tucson, AZ
 KHLB Blytheville, AR
 KCCT Sacramento, CA
 KUNA San Luis Obispo, CA
 KFKZ Greeley, CO
 WKTZ-FM Jacksonville, FL
 WKLS Atlanta, GA
 KQK-FM Idaho Falls, ID
 WLDK Richmond, IN
 KSAJ Clinton, IA
 WSTO Owensboro, KY
 KSNS Lake Charles, LA
 WSRW Worcester, MA
 WHNN Bay City, MI
 WHTC-FM Holland, MI
 KEFM Omaha, NE
 WBNY Buffalo, NY
 WYYD Raleigh, NC
 WOHF-FM Shelby, NC
 KXXY Oklahoma City, OK
 KZEL-FM Eugene, OR
 WLEW Easton, PA
 WTAE Pittsburgh, PA
 WGCB-FM Red Lion, PA
 KWAT-FM Watertown, SD
 KMBS Harlingen, TX
 KMFM San Antonio, TX
 KFMC Provo, UT
 KZUM-FM Opportunity, WA
 WBES Charleston, WV
 WAEL-FM Maricao, PR

96.3 mhz (ch. 242)

KFMI Eureka, CA
 KFSG Los Angeles, CA
 WHUR-FM Washington, DC
 WMJX Miami, FL
 WJIZ Albany, GA
 KKAI Kaiyua, HI
 WBBM-FM Chicago, IL
 WRUM-FM Rumford, ME
 WJR-FM Detroit, MI
 WJFR Jackson, MS
 KADI-FM St. Louis, MO
 KSEN-FM Shelby, MT
 KHFM Albuquerque, NM
 WQXR-FM New York, NY
 WTVN-FM Columbus, OH
 WMTS-FM Murrefreesor, TN
 KEZB El Paso, TX
 KSCS Fort Worth, TX
 KLLL-FM Lubbock, TX
 WMLA-FM Martinsville, VA
 WJMC-FM Rice Lake, WI

96.5 mhz (ch. 243)

WQEZ Birmingham, AL
 KIFM Bakersfield, CA
 KXXY San Diego, CA
 KRON-FM San Francisco, CA
 KKFM Colorado Springs, CO
 WITC-FM Hartford, CT
 WHOO-FM Orlando, FL
 WJCL-FM Savannah, GA
 KMTW Twin Falls, ID
 WMT-FM Cedar Rapids, IA
 KEPT Shreveport, LA
 KXTR Kansas City, MO
 KIVE Glendive, MT
 KRGI-FM Grand Island, NE
 WCMF Rochester, NY
 WSTS Laurinburg, NC

WCUE-FM Akron, OH
 WQMS Hamilton, OH
 KRVA Tulsa, OK
 WJNL-FM Johnstown, PA
 *WPEL-FM Montrose, PA
 WWDB Philadelphia, PA
 *KNWC-FM Sioux Falls, SD
 WDDO-FM Chattanooga, TN
 KIOU Corpus Christi, TX
 KAUM Houston, TX
 WBCI Williamsburg, VA
 KYAC-FM Seattle, WA
 WFMR Milwaukee, WI
 WMDD-FM Fajardo, PR

96.7 mhz (ch. 244)

KDEW-FM De Witt, AR
 KAWW-FM Heber Springs, AR
 KBHS-FM Hot Springs, AR
 KCAL-FM Redlands, CA
 KWIZ-FM Santa Ana, CA
 KAAP-FM Santa Paula, CA
 KBCR Steamboat Springs, CO
 KYOT Sterling, CO
 WYRS Stamford, CT
 WRYZ-FM Jupiter, FL
 WVMG-FM Cochran, GA
 WCOH-FM Newnan, GA
 KOZE-FM Lewiston, ID
 WLLI-FM Joliet, IL
 WLUV-FM Loves Park, IL
 WIHN Normal, IL
 WAZY-FM Lafayette, IN
 WCOE La Porte, IN
 WORX-FM Madison, IN
 WAOV-FM Vincennes, IN
 KANS-FM Larned, KS
 KNEX-FM McPherson, KS
 WLBG-FM Bowling Green, KY
 WBGJ-FM Paris, KY
 WSEK Somerset, KY
 KMRC-FM Morgan City, LA
 KDDI Oak Grove, LA
 WEMD-FM Easton, MD
 WQCM Halfway, MD
 WUFN Albion, MI
 WITW Cadillac, MI
 WMBN-FM Petoskey, MI
 KXGR Grand Rapids, MI
 KWWW Rochester, MN
 WFFF-FM Columbia, MS
 WSEL-FM Pontotoc, MS
 WONA-FM Winona, MS
 KTGR-FM Columbia, MO
 KGVV-FM Belgrade, MT
 *WLSU Canton, NY
 WDLK-FM Port Jervis, NY
 WFSC-FM Franklin, NC
 WKRX Roxboro, NC
 KDLR-FM Devils Lake, ND
 WILE-FM Cambridge, OH
 WCSM-FM Celina, OH
 WFOB-FM Fostoria, OH
 WKOV-FM Wellston, OH
 KWDG Idabel, OK
 WPGM-FM Danville, PA
 WQWK State College, PA
 WZLD Cayce, SC
 WCRS-FM Greenwood, SC
 WVST Bolivar, TN
 WIKa Centerville, TN
 KGTN-FM Georgetown, TX
 KIKM-FM Sherman, TX
 WTSa-FM Brattleboro, VT
 WJMA-FM Orange, VA
 KREW-FM Sunnyside, WA
 WMKC Oshkosh, WI
 WVLK Sauk City, WI

96.9 mhz (ch. 245)

WRSa Decatur, AL
 WIRB-FM Enterprise, AL
 KMEO-FM Phoenix, AZ
 KWAY Monterey, CA
 KROI Sacramento, CA
 WINK-FM Fort Myers, FL
 WVIC-FM Jacksonville, FL
 WLBI-FM Mattoon, IL
 WHTT Moline, IL
 WKZN Zion, IL
 KRIT Clarion, IA
 KMRJ Pittsburg, KS
 WPAJ-FM Paducah, KY
 KSLI Alexandria, LA
 WDPH Presque Isle, ME
 WJIB Boston, MA
 WLAV-FM Grand Rapids, MI

FM by Frequency

WFGP-FM Atlantic City, NJ
 KRAZ Farmington, NM
 WGRQ Buffalo, NY
 WOUR Utica, NY
 WEOB Goldsboro, NC
 WDBM-FM Statesville, NC
 KCRC-FM Enid, OK
 WLOA-FM Braddock, PA
 WLAN-FM Lancaster, PA
 WXTX Charleston, SC
 KDLO-FM Watertown, SD
 WFHG-FM Bristol, TN
 KULP-FM El Campo, TX
 *KVMV-FM McAllen, TX
 KOIP Odessa, TX
 WMLT Jackson, WY
 KMDL Manati, PR

97.1 mhz (ch. 246)

KWEH Camden, AR
 KGBS-FM Los Angeles, CA
 WASH Washington, DC
 WFOG Gainesville, GA
 WNIB Chicago, IL
 WSVL-FM Shelbyville, IN
 WEZB New Orleans, LA
 WBGW Bangor, ME
 WWJ-FM Detroit, MI
 KTCR-FM Minneapolis, MN
 WALT Meridian, MS
 New FM Florissant, MO
 KURL-FM Billings, MT
 KALS Kallispell, MT
 KORK-FM Las Vegas, NV
 WNWG-FM New York, NY
 WQMG Greensboro, NC
 KJCB-FM Minto, ND
 WREO-FM Ashtabula, OH
 WBNB-FM Columbus, OH
 KPAM-FM Portland, OR
 WMPS-FM Memphis, TN
 KWXI Fort Worth, TX
 KLUB-FM Salt Lake City, UT
 WRUT Rutland, VT
 WCOW-FM Sparta, WI

97.3 mhz (ch. 247)

KSON-FM San Diego, CA
 KEAR San Francisco, CA
 KRNW Boulder, CO
 WAlA Miami, FL
 WJAD Bainbridge, GA
 WXLN Savannah, GA
 WRUL Carmi, IL
 WMEF Fort Wayne, IN
 KDMI Des Moines, IA
 KUPK-FM Garden City, KS
 WIBW-FM Topeka, KS
 WGCY New Bedford, MA
 KWFC Springfield, MO
 KKBC Carson City, NV
 WMYB-FM Millville, NJ
 KAFE-FM Santa Fe, NM
 WHCU-FM Ithaca, NY
 WKBC-FM North Wilkesboro, NC
 WWIL Wilmington, NC
 WHP-FM Harrisburg, PA
 KPAT Sioux Falls, SD
 KPLA Plainview, TX
 KEEZ San Antonio, TX
 WGH-FM Newport News, VA
 KTNT-FM Tacoma, WA
 WKWK-FM Wheeling, WV
 WISN-FM Milwaukee, WI

97.5 mhz (ch. 248)

WABB-FM Mobile, AL
 KGUS Hot Springs, AR
 KMYT Merced, CA
 KDUI Riverside, CA
 KTMS-FM Santa Barbara, CA
 WPCV Winter Haven, FL
 KHSS Honolulu, HI
 WDWFS-FM Champaign, IL
 WZOK Rockford, IL
 WNNLS Louisville, KY
 WJIM-FM Lansing, MI
 KNXR Rochester, MN
 WOOR Oxford, MS
 WDNH Dover, NH
 WPST Trenton, NJ
 WALK-FM Patchogue, NY
 WNCQ Watertown, NY
 WAEZ Akron, OH
 KMOD Tulsa, OK

FM by Frequency

WEZK Knoxville, TN
 KAYD Beaumont, TX
 KINT-FM El Paso, TX
 KSJT San Angelo, TX
 KWTX-FM Waco, TX
 WCCV-FM Charlottesville, VA
 WJLC-FM South Boston, VA
 WQBE Charleston, WV
 WESM Martinsburg, WV
 KDLY Lander, WY
 WORA-FM Mayaguez, PR

97.7 mhz (ch. 249)

WFRI Auburn, AL
 WEZZ Clanton, AL
 WKLD Oneonta, AL
 KWJN Lodi, CA
 KPEN Los Altos, CA
 KDOL-FM Mojave, CA
 KSPN Aspen, CO
 WCTY Norwich, CT
 WAFL Milford, DE
 WFOY-FM St Augustine, FL
 WPUR Americus, GA
 WKEU-FM Griffin, GA
 WROM-FM Rome, GA
 WTCQ Vidalia, GA
 KBLI-FM Blackfoot, ID
 WYPC-FM Monmouth, IL
 WBBA-FM Pittsfield, IL
 WLAX Streator, IL
 WFRX-FM West Frankfort, IL
 WWCN-FM Brazil, IN
 WJCK Rensselaer, IN
 KCLN-FM Clinton, IA
 KHBT Humboldt, IA
 KLEE-FM Ottumwa, IA
 KAPB-FM Marksville, LA
 KDBH Natchitoches, LA
 WFST-FM Caribou, ME
 New FM Leonardtown, MD
 WBET-FM Brocton, MA
 WDOV-FM Dowagiac, MI
 WMTE-FM Manistee, MI
 WMIC-FM Sandusky, MI
 KLG-R-FM Redwood Falls, MN
 WRJH Brandon, MS
 WTYL-FM Tylertown, MS
 KOEA Doniphan, MO
 KKCA Fulton, MO
 KMPL-FM Sikeston, MO
 KFBD-FM Waynesville, MO
 KGLM-FM Anaconda, MT
 KUVR-FM Holdrege, NE
 KNCY-FM Nebraska City, NE
 WCSS-FM Amsterdam, NY
 WHVW Hyde Park, NY
 WGGN Castalia, OH
 WURD Georgetown, OH
 WCJD Jackson, OH
 *WTGN Lima, OH
 WOXR Oxford, OH
 KWHP Edmond, OK
 WBUT-FM Butler, PA
 WYSC-FM Somerset, PA
 WGMB Georgetown, SC
 KPUP Kingsville, TX
 WMJD Grundy, VA
 WHBL-FM Sheboygan, WI
 WBRQ Cidra, PR

97.9 mhz (ch. 250)

KUPD-FM Tempe, AZ
 KMJ-FM Fresno, CA
 KNOB Long Beach, CA
 KDQJ Pueblo, CO
 WOXM Clearwater, FL
 WJNO-FM Palm Beach, FL
 KKEA Hilo, HI
 KBOI-FM Boise, ID
 WSDM Chicago, IL
 WLHN Anderson, IN
 KSEZ Sioux City, IA
 KBRA Wichita, KS
 WDSC Portland, ME
 WBAL-FM Baltimore, MD
 WMZK Detroit, MI
 WGRD-FM Grand Rapids, MI
 WBAQ Greenville, MS
 WEVD-FM New York, NY
 WPXY Rochester, NY
 WPEG Concord, NC
 *KFNW-FM Fargo, ND

WNCI Columbus, OH
 KLCO-FM Poteau, OK
 KFMY Eugene, OR
 WVCD Hazelton, PA
 WCOS-FM Columbia, SC
 KYSR Rapid City, SD
 WSIX-FM Nashville, TN
 KGNC-FM Amarillo, TX
 KZEW Dallas, TX
 KFMC Houston, TX
 KOYL-FM Odessa, TX
 WFGM Fairmont, WV
 WSPF-FM Stevens Point, WI
 KFBC-FM Cheyenne, WY
 WBS Charlotte Amalie, VI

98.1 mhz (ch. 251)

WCTA-FM Andalusia, AL
 WVEL-FM Fayette, AL
 KHFO Osceola, AR
 KVIP-FM Redding, CA
 KDIG San Diego, CA
 KABL-FM San Francisco, CA
 WQHL Live Oak, FL
 WRAY-FM Princeton, IN
 KHAK-FM Cedar Rapids, IA
 KUDL-FM Kansas City, KS
 WKQQ Lexington, KY
 WAFB-FM Baton Rouge, LA
 WMYN New Bedford, MA
 WKCC Saginaw, MI
 WWJO St. Cloud, MN
 KSLQ St. Louis, MO
 WQYT Binghamton, NY
 WQMS Fayetteville, NC
 WTOF Canton, OH
 KRLG Lawton, OK
 WFBG-FM Altoona, PA
 WCAU-FM Philadelphia, PA
 WBFM Seneca, SC
 KTLA-FM Texarkana, TX
 WHWB-FM Rutland, VT
 WBOB-FM Galax, VA
 WTVR-FM Richmond, VA
 KING-FM Seattle, WA
 KHQ-FM Spokane, WA
 WISM-FM Madison, WI

98.3 mhz (ch. 252)

WCNA-FM Scottsboro, AL
 WMLS-FM Sylacauga, AL
 KEZH Prescott, AZ
 KTLQ-FM Mountain Home, AR
 KDAR Oxnard, CA
 KOB West Covina, CA
 WLAD-FM Danbury, CT
 WXLN Willimantic, CT
 WSUX-FM Seaford, DE
 WGLY Goulds, FL
 WRMF-FM Titusville, FL
 WFAV Cordele, GA
 WSOJ-FM Jesup, GA
 WJAT-FM Swainsboro, GA
 KBAR-FM Burley, ID
 WBYFS-FM Canton, IL
 WOLI Ottawa, IL
 WARU-FM Peru, IN
 WART Plainfield, IN
 WIUC Winchester, IN
 KWBG-FM Boone, IA
 KABI-FM Abilene, KS
 WDNS Bowling Green, KY
 KYEA West Monroe, LA
 WTVL Waterville, ME
 WHAI-FM Greenfield, MA
 WVMO Monroe, MI
 WQXO Munising, MI
 KFMZ Columbia, MO
 KDBM-FM Dillon, MT
 WLNH-FM Laconia, NH
 WQMR New Brunswick, NJ
 WVIN-FM Hammondsport, NY
 WOIK Hempstead, NY
 WWDR-FM Murfreesboro, NC
 WTNC-FM Thomasville, NC
 WOGM Bellefontaine, OH
 WLGN-FM Logan, OH
 KFMT La Grande, OR
 WWFM Charleroi, PA
 WJRR-FM Milliflinton, PA
 WHUB-FM Cookeville, TN
 WMGL Pulaski, TN
 KHFI-FM Austin, TX
 KORA-FM Bryan, TX
 KULM Columbus, TX
 KMCS Gatesville, TX
 KBOP-FM Pileasanton, TX

KBMF-FM Spearman, TX
 KWWM Stephenville, TX
 WGOL Lynchburg, VA
 WZFM Charles Town, WV
 WDUZ-FM Green Bay, WI
 WZMF Menomonee Falls, WI
 WNBI-FM Park Falls, WI
 WREI Quebradillas, PR

98.5 mhz (ch. 253)

KLAZ Little Rock, AR
 KDNO Delano, CA
 KZAP Sacramento, CA
 KOME San Jose, CA
 KIMN-FM Denver, CO
 WRYO Crystal River, FL
 WGNF-FM Panama City, FL
 WSB-FM Atlanta, GA
 WFRF-FM Freeport, IL
 WACF Paris, IL
 KQKQ-FM Council Bluffs, IA
 WYLD-FM New Orleans, LA
 WROR Boston, MA
 WANG Coldwater, MI
 WJGS Houghton Lake, MI
 *KTI-FM Minneapolis, MN
 WLEO-FM Tupelo, MS
 KBMS Billings, MT
 KSSR Kalispell, MT
 KLUC-FM Las Vegas, NV
 KRSN-FM Los Alamos, NM
 WHLD-FM Niagara Falls, NY
 WLQA Cincinnati, OH
 WGCL Cleveland, OH
 KBJH Tulsa, OK
 KAGM Klamath Falls, OR
 KUPL Portland, OR
 WYCR Hanover, PA
 WDJR Oil City, PA
 WBRE-FM Wilkes-Barre, PA
 WKPT-FM Kingsport, TN
 KQXC McAllen, TX
 KPAC-FM Port Arthur, TX
 WPRM-FM San Juan, PR

98.7 mhz (ch. 254)

KBBC Phoenix, AZ
 KJOI Los Angeles, CA
 WMOD Washington, DC
 WLOY-FM Fort Pierce, FL
 WFMT Chicago, IL
 KCOG-FM Centerville, IA
 WHOP-FM Hopkinsville, KY
 WBFQ Detroit, MI
 KWIM Moorhead, MN
 KLOH-FM Pipestone, MN
 WQMV Vicksburg, MS
 KWTO-FM Springfield, MO
 WXLO New York, NY
 WIBQ Utica, NY
 WRQK Greensboro, NC
 WBEU-FM Beaufort, SC
 KNUS Dallas, TX
 KTSN Victoria, TX
 KCPX-FM Salt Lake City, UT
 WNOR-FM Norfolk, VA
 WWAFA-FM Wheeling, WV

98.9 mhz (ch. 255)

WFMI Montgomery, AL
 KLTA Dubuque, IA
 KCBS-FM San Francisco, CA
 KVMN Pueblo, CO
 WBGW Tallahassee, FL
 WHBF-FM Rock Island, IL
 WSLM-FM Salem, IN
 KCLO-FM Leavenworth, KS
 WSIP-FM Paintsville, KY
 WKXA-FM Brunswick, ME
 WJML-FM Petoskey, MI
 WAKX-FM Duluth, MN
 KTMO Kennett, MO
 KANR Great Falls, MT
 KANR-FM Kearney, NE
 WHFM Rochester, NY
 WERT-FM Van Wert, OH
 WKBN-FM Youngstown, OH
 KFJL Oklahoma City, OK
 WPBS Philadelphia, PA
 WSPA-FM Spartanburg, SC
 WQCR Burlington, VT
 KEZZ Seattle, WA
 KICN Spokane, WA
 WTMB-FM Tomah, WI
 WZVS-FM Viqueas, PR

99.1 mhz (ch. 256)

WAHR Huntsville, AL
 KMAG Fort Smith, AR
 KBBL Riverside, CA
 KSCO-FM Santa Cruz, CA
 KXFM Santa Maria, CA
 KUAD-FM Windsor, CO
 WPLR New Haven, CT
 WQIK-FM Jacksonville, FL
 WEDR Miami, FL
 WMAZ-FM Macon, GA
 KUPI-FM Idaho Falls, ID
 WIAI Danville, IL
 KDEA New Iberia, LA
 WNAV-FM Annapolis, MD
 WPLM-FM Plymouth, MA
 WFMK East Lansing, MI
 KEYC-FM Mankato, MN
 WSWG-FM Greenwood, MS
 WMPM-FM Pascagoula, MS
 *KFUO-FM Clayton, MO
 *WAWZ-FM Zarephath, NJ
 KMTY-FM Clovis, NM
 WAAL Binghamton, NY
 WENC-FM Whiteville, NC
 WHIO-FM Dayton, OH
 WFRQ-FM Fremont, OH
 KPNW-FM Eugene, OR
 WIYQ Ebensburg, PA
 KODA-FM Houston, TX
 WSLQ Roanoke, VA
 WNUW Milwaukee, WI
 WKJB-FM Mayaguez, PR

99.3 mhz (ch. 257)

WMFC-FM Monroeville, AL
 WSLY York, AL
 KRIL El Dorado, AR
 KSER Searcy, AR
 KVRE-FM Santa Rosa, CA
 KJAX Stockton, CA
 WEZY-FM Cocoa, FL
 WFTW-FM Fort Walton Beach, FL
 WCON-FM Cornelia, GA
 WDUK Havana, IL
 WLPO-FM La Salle, IL
 WSCH Aurora, IN
 WKVI-FM Knox, IN
 *KFGQ-FM Boone, IA
 KWAY-FM Waverly, IA
 KOY-FM El Dorado, KS
 WYGO-FM Carbin, KY
 WFUL-FM Fulton, KY
 WBNB-FM Harrodsburg, KY
 WLCK-FM Scottsville, KY
 KJNA Jena, LA
 WKJT-FM Farmington, ME
 WLKN-FM Lincoln, ME
 WHMP-FM Northampton, MA
 WSTR-FM Sturgis, MI
 WZND Zeeland, MI
 NEW FM Trier River Falls, MN
 WBIP-FM Booneville, MS
 KWRT-FM Booneville, MO
 KSCM-FM Houston, MO
 KVLV-FM Fallon, NV
 WFRD Hanover, NH
 WGRF Pleasantville, NJ
 WELY-FM Ellenville, NY
 WPDN-FM Potsdam, NY
 WSWF-FM Seneca Falls, NY
 WRCS-FM Aoshkie, NC
 WTNF-FM Coshocton, OH
 WNXT-FM Portsmouth, OH
 KLOR-FM Ponca City, OK
 WVEN Franklin, PA
 WFSM Harrisburg, PA
 WMPT-FM South Williamsport, PA
 WPQR-FM Uniontown, PA
 WNEZ Aiken, SC
 WCMJ Chester, SC
 WAEW-FM Crossville, TN
 WIDD-FM Elizabethton, TN
 WDXL-FM Lexington, TN
 KFMN Abilene, TX
 KLUK Atlanta, TX
 KLSN Brownwood, TX
 KPLT-FM Paris, TX
 WFFV Front Royal, VA
 WPLZ Petersburg, VA
 WIBZ Parkersburg, WV
 WDMF-FM Dodgeville, WI
 WIGM-FM Medford, WI
 WLKE-FM Waupun, WI

99.5 mhz (ch. 258)

WVOK-FM Birmingham, AL
 KFMM Tucson, AZ
 KHOF Los Angeles, CA
 KVOD Denver, CO

WJBR Wilmington, DE
 WGAY-FM Washington, DC
 WQYK-FM St. Petersburg, FL
 WDMG-FM Douglas, GA
 WICV Chicago, IL
 WQCY Quincy, IL
 WSMJ Greenfield, IN
 KLEM-FM Le Mars, IA
 WKDQ Henderson, KY
 KLCL-FM Lake Charles, LA
 WRNO New Orleans, LA
 WSSH Lowell, MA
 WABX Detroit, MI
 WL0L-FM Minneapoe, MN
 KMYR Albuquerque, NM
 WDCX Buffalo, NY
 *WBAI New York, NY
 WGFN Schenectady, NY
 WMFR-FM High Point, NC
 WKSJW Cleveland, OH
 KHEN-FM Henryetta, OK
 KJIB Portland, OR
 KOLY-FM Moberge, SD
 KPLX Fort Worth, TX
 KWGO-FM Lubbock, TX
 KISS San Antonio, TX
 WVBK Beckley, WV
 WVIV-FM Christiansted, VI

99.7 mhz (ch. 259)

WOOF-FM Dothan, AL
 KIOO Porterville, CA
 KNAI-FM San Francisco, CA
 WLTA-FM Atlanta, GA
 WLO-FM Frankfort, IN
 KFHM Muscatine, IA
 WCSN Louisville, KY
 WIMI Ironwood, MI
 WUGN Midland, MI
 WJMI Jackson, MS
 KMBR Kansas City, MO
 WRKB-FM Kannapolis, NC
 WMNI-FM Columbus, OH
 WSHH Pittsburgh, PA
 WMSR-FM Manchester, TN
 WMC-FM Memphis, TN
 WYFI Norfolk, VA

99.9 mhz (ch. 260)

WKRG-FM Mobile, AL
 KTCS-FM Fort Smith, AR
 KRFD Marysville, CA
 KOLA San Bernardino, CA
 KTYD-FM Santa Barbara, CA
 KPUB-FM Pueblo, CO
 WEZN Bridgeport, CT
 WWOG Boca Raton, FL
 WIYD-FM Palatka, FL
 WBEQ-FM Harrisburg, IL
 WBYG-FM Kankakee, IL
 WTHI-FM Terre Haute, IN
 KSKG Salina, KS
 KPEL-FM Lafayette, LA
 WFRE Frederick, MD
 WQRC Barnstable, MA
 WHFB-FM Benton Harbor, MI
 KAUS-FM Austin, MN
 KIDA Moorhead, MN
 KGOR Omaha, NE
 KTQM-FM Clovis, NM
 WKRT-FM Cortland, NY
 WGFH Plattsburgh, NY
 WLOS-FM Asheville, NC
 WVB5-FM Burgaw, NC
 WYUD-FM Kettering, OH
 WKLR Toledo, OH
 WQQQ Easton, PA
 WLUV Erie, PA
 KTSM-FM El Paso, TX
 KROB-FM Robstown, TX
 KHOO Waco, TX
 KLUR Wichita Falls, TX
 KISW Seattle, WA
 KXLY-FM Spokane, WA
 WYAF Charleston, WV
 WJVL Janesville, WI
 WQBS-FM San Juan, PR

100.1 mhz (ch. 261)

WEIZ Phenix City, AL
 WTUN Selma, AL
 *NEW FM Kodiak, AK
 *KMTE Sitka, AK
 KZST Santa Rosa, CA
 KRLL South Lake Tahoe, CA
 WEEJ Port Charlotte, FL
 WFNE Forsyth, GA
 WMCD Statesboro, GA
 WLOV-FM Washington, GA
 WPRC-FM Lincoln, IL
 WKAI-FM Macomb, IL

WVOV Glasgow, KY
 WMST-FM Mt. Sterling, KY
 WPRT-FM Prestonsburg, KY
 WORB Pittsfield, MA
 WWCK Flint, MI
 KABG Cambridge, MN
 KCUE-FM Red Wing, MN
 KRBI-FM St. Peter, MN
 WHAY Aberdeen, MS
 WNLA-FM Indianola, MS
 WABO-FM Waynesboro, MS
 KMoe Butler, MO
 KHUB-FM Fremont, NE
 WDHA-FM Dover, NJ
 WSGO-FM Oswego, NY
 WQGR Jacksonville, NC
 WWGP-FM Sanford, NC
 WXTQ Athens, OH
 WFIZ Conneaut, OH
 WMVRFM Sidney, OH
 WXEZ Sylvania, OH
 WCHO-FM Washington Court House, OH
 KXXX Chickasha, OK
 KVRO Stillwater, OK
 WPME-FM Punxsutawney, PA
 WZTA Tamaqua, PA
 WDAR-FM Darlington, SC
 WTWf Moncks Corner, SC
 WNMB N. Myrtle Beach, SC
 WYTM-FM Fayetteville, TN
 WBNT-FM Oneida, TN
 WTPR-FM Paris, TN
 WSMT-FM Sparta, TN
 KSTU Centerville, UT
 WKDE-FM Altavista, VA
 WSWV-FM Pennington Gap, VA
 WGH Richlands, VA
 WSHV South Hill, VA
 WRAR-FM Tappahannock, VA
 KLVK Longview, WA
 WCFW Chippewa Falls, WI
 WRFE Aguada, PR

105.7 mhz (ch. 289)

WTUB Troy, AL
 KUOA-FM Siloam Springs, AR
 KARA Santa Clara, CA
 WAUG-FM Augusta, GA
 WWCT Peoria, IL
 WTLN Indianapolis, IN
 KXEL-FM Waterloo, IA
 WKTK Catonsville, MD
 WYBF Framingham, MA
 WOOD-FM Grand Rapids, MI
 WBTI McComb, MS
 KSGM-FM Ste. Genevieve, MO
 KGLR Reno, NV
 WMRV Endicott, NY
 WFMX Statesville, NC
 WWWM Cleveland, OH
 WQXA York, PA
 KHCB-FM Houston, TX
 KYKX Longview, TX
 KEZE-FM Spokane, WA
 WAPL-FM Appletton, WI
 WCAD-FM San Juan, PR

105.9 mhz (ch. 290)

KWST Los Angeles, CA
 KBPI Denver, CO
 WHCN Hartford, CT
 WELE-FM Deland, FL
 WAXY Fort Lauderdale, FL
 WXFm Elmwood Park, IL
 KLWN-FM Lawrence, KS
 WJZZ Detroit, MI
 KKWS Wadena, MN
 WHBI Newark, NJ
 WPBF Middletown, OH
 WAMO-FM Pittsburgh, PA
 WEZI Memphis, TN
 WLAC-FM Nashville, TN
 WXRA Woodbridge, VA

106.1 mhz (ch. 291)

WRFS-FM Alexander City, AL
 KFRF-FM San Francisco, CA
 WLET-FM Toccoa, GA
 WSMI-FM Litchfield, IL
 WOCH-FM North Vernon, IN
 KLSM Mason City, IA
 KLOO Lyons, IA
 KREB Monroe, KS
 WKGO Cumberland, MD
 WCOD-FM Hyannis, MA
 WKHM-FM Jackson, MI
 WECM Claremont, NH
 WCIL-FM Corning, NY
 WBLI Patchogue, NY

WVOT-FM Wilson, NC
 WVNO-FM Mansfield, OH
 KLOO-FM Corvallis, OR
 WWSH Philadelphia, PA
 KDNT-FM Denton, TX
 KJFY Orange, TX
 KLAY-FM Tacoma, WA
 WAUK-FM Waukesha, WI
 WVIS Frederiksted, VI

106.3 mhz (ch. 292)

WKNU Brewton, AL
 WNAN Demopolis, AL
 WRCK-FM Sheffield, AL
 KWAO Sun City, AZ
 KXOW-FM Hot Springs, AR
 KOTE Lancaster, CA
 KMMT Mammoth Lakes, CA
 KYMS Santa Ana, CA
 WSPB-FM Sarasota, FL
 WQRX Benton, IL
 WLNK Lansing, IL
 WFWA Sullivan, IL
 WFDT Columbia City, IN
 WNDY Crawfordsville, IN
 WANY-FM Albany, KY
 WKDZ-FM Cadiz, KY
 WLLS-FM Hartford, KY
 WLCB-FM Hodgenville, KY
 WTJM Pineville, KY
 KXOR Thibodaux, LA
 WJBO-FM Scarborough, ME
 WESP-FM Cambridge, MD
 WKLA-FM Ludington, MI
 WIOG Saginaw, MI
 WMFG-FM Hibbing, MN
 WQPM Princeton, MN
 WGOE Newton, MS
 WPEM Pasagoula, MS
 WJJO Picayune, MS
 WSMU-FM Starkville, MS
 KLTB Bolivar, MO
 KIRK-FM Branson, MO
 KBK Lexington, MO
 KMIS-FM Portageville, MO
 KOPR-FM Great Falls, MT
 KHAT Lincoln, NE
 WOTW-FM Nashua, NH
 WFMV-FM Blairstown, NJ
 WHTG-FM Eatontown, NJ
 WSLT-FM Ocean City-Somers Point, NJ

WVIP-FM Mount Kisco, NY
 WMCR-FM Oneida, NY
 WLNO London, OH
 KGOU Norman, OK
 WHUN-FM Huntingdon, PA
 WCTL Union City, PA
 WYON-FM Woonsocket, RI
 WSTN Florence, SC
 WSHG Georgetown, SC
 WHHR Hilton Head Islands, SC
 KTON-FM Belton, TX
 KWHI-FM Brenham, TX
 KPAN-FM Hereford, TX
 KONI-FM Spanish Fork, UT
 WBDY Bluefield, VA
 WMNA-FM Gretna, VA
 WNVN-FM Norton, VA
 WMAD-FM Middleton, WI
 WEVR-FM River Falls, WI
 KVWO-FM Cheyenne, WY

106.5 mhz (ch. 293)

KWOD Sacramento, CA
 KPRI San Diego, CA
 KEZR San Jose, CA
 WGNU-FM Granite City, IL
 WFML Washington, IN
 KRVR Davenport, IA
 WMAR-FM Baltimore, MD
 WQLR Kalamazoo, MI
 WHSH Albany, NY
 WADV Buffalo, NY
 WSLF Bridgetown, NC
 WRDX Salisbury, NC
 WXEN Cleveland, OH
 WDRK Greenville, OH
 WHLM-FM Bloomsburg, PA
 WYNQ Chattanooga, TN
 KUFO Galveston, TX
 KOOI Jacksonville, TX
 *WRFK-FM Richmond, VA
 KLYN-FM Lynden, WA
 WRGT-FM Clarksburg, WV
 WDLB-FM Marshfield, WI

WNIK-FM Arecibo, PR

106.7 mhz (ch. 294)

WKMX Enterprise, AL
 KWSM Tulare, CA
 KLZ-FM Denver, CO
 WGLF Fort Lauderdale, FL
 WDMG Leesburg, FL
 WOKA-FM Douglas, GA
 WVID Gainesville, GA
 WYEN Des Plaines, IL
 WBZ-FM Boston, MA
 WWWW Detroit, MI
 WWRM Gaylord, MI
 WKYV-FM Vicksburg, MS
 WJAG-FM Norfolk, NE
 WRVR New York, NY
 WSRWF Hillsboro, OH
 KQIV Lake Oswego, OR
 WWWW Beaver Falls, PA
 WPD-CFM Elizabethtown, PA
 WDX-FM Orangeburg, SC
 WEZR Manassas, VA

106.9 mhz (ch. 295)

WERC-FM Birmingham, AL
 KMPX San Francisco, CA
 WCCC-FM Hartford, CT
 WSWT Peoria, IL
 WMRI Marion, IN
 KTPK Topeka, KS
 WVEZ Louisville, KY
 WARK-FM Hagerstown, MD
 WMUS-FM Muskogee, MO
 KRCC-FM Rochester, MN
 KJFF Jefferson City, MO
 KRNO Reno, NV
 *WKDN-FM Camden, NJ
 WRXL Auburn, NY
 WMIT Black Mountain, NC
 WHLO Canton, OH
 WMRN Marion, OH
 KWEO-FM Clinton, OK
 KMMM-FM Muskogee, OK
 WKTA McKenzie, TN
 KNRO-FM Conroe, TX
 KBRF-FM Bremerton, WA
 WXR-FM Guayama, PR

107.1 mhz (ch. 296)

KSTM Apache Junction, AZ
 KAAM Berryville, AR
 KADO-FM Texarkana, AR
 KMAX Arcadia, CA
 KZEN Seaside, CA
 WYAK-FM Lehigh Acres, FL
 WTAI-FM Melbourne, FL
 WCLA-FM Claxton, GA
 WKOG-FM Gordon, GA
 WZOT Rockmart, GA
 WTUF Thomasville, GA
 WSPY Plano, IL
 WPGU Urbana, IL
 WKRV Vandalia, IL
 WBNL-FM Boonville, IN
 WGRD Danville, IN
 WLCL-FM Lowell, IN
 KCCQ Ames, IA
 KDSN-FM Denison, IA
 WCTT-FM Corbin, KY
 WMGE Danville, KY
 WKCB-FM Hindman, KY
 WFPR-FM Hammond, LA
 KCIL Houma, LA
 KSLO-FM Opelousas, LA
 KRUS-FM Ruston, LA
 WPAG-FM Ann Arbor, MI
 WMQT Ishpeming, MI
 WSAQ Port Huron, MI
 WWWW Saginaw, MI
 WIRX St. Joseph, MI
 KEHG-FM Fosston, MN
 KDUZ-FM Hutchinson, MN
 WIRN Virginia, MN
 WROA-FM Gulfport, MS
 WLSM-FM Louisville, MS
 KESM-FM El Dorado Springs, MO
 WKXR-FM Exeter, NH
 WRLB Long Branch, NJ
 WRNW Briarcliff Manor, NY
 WBZA-FM Glens Falls, NY
 WRRZ-FM Clinton, NC

WDDBS Durham, NC
 WIOZ Southern Pines, NC
 WNRE-FM Circleville, OH
 WDOH Delphos, OH
 WITO Ironton, OH
 WLYK Milford, OH
 KSEO-FM Durant, OK
 WOKU-FM Greensburg, PA
 WGRP-FM Greenville, PA
 WEZX Scranton, PA
 WOTB Middletown, RI
 WPAJ-FM Lancaster, SC
 WCIG Mullins, SC
 KSTA-FM Coleman, TX
 KWKO Graham, TX
 *KWBU Waco, TX
 KBUH-FM Brigham City, UT
 WORK Barre, VT
 WPUV-FM Pulaski, VA
 WFON Fond Du Lac, WI
 WIXK-FM New Richmond, WI
 WOCO-FM Oconto, WI
 WSWW-FM Platteville, WI
 WNNO-FM Wisconsin Dells, WI

107.3 mhz (ch. 297)

WQLT Florence, AL
 KSTN-FM Stockton, CA
 WMAL-FM Washington, DC
 WJEE Jacksonville, FL
 WWBA-FM St. Petersburg, FL
 WCGQ Columbus, GA
 WDDD Marion, IL
 WTRE-FM Greensburg, IN
 WRSW-FM Warsaw, IN
 KGRS Burlington, IA
 KARD Wichita, KS
 WAAF Worcester, MA
 WPLB-FM Greenville, MI
 KLIN-FM Lincoln, NE
 WTLB-FM Utica, NY
 WBEA Elyria, OH
 KINB Poteau, OK
 WDBA Du Bois, PA
 WANS-FM Anderson, SC
 WGOR-FM Lebanon, TN
 KGOL Lake Jackson, TX
 KFFM Yakima, WA
 WFAW-FM Fort Atkinson, WI
 WCMN-FM Arecibo, PR

107.5 mhz (ch. 298)

KNEU El Centro, CA
 KKYS Hanford, CA
 KLVE Los Angeles, CA
 KLAK-FM Lakewood, CO
 WIGL Miami, FL
 WGCI Chicago, IL
 WBOQ Terre Haute, IN
 WBLM Lewiston, ME
 WGRD Detroit, MI
 WSJC-FM Magee, MS
 WBSL New York, NY
 WSGH-FM Winston-Salem, NC
 WBYO Boyertown, PA
 WPWR St. George, SC

U.S. FM, Canadian AM Frequencies

KNOK-FM Fort Worth, TX
 KBUC-FM San Antonio, TX
 WEXM-FM Exmore, VA
 WTRF Wheeling, WV
 WCCN-FM Neillville, WI

107.7 mhz (ch. 299)

WENN-FM Birmingham, AL
 KSOL San Mateo, CA
 WORJ-FM Mount Dora, FL
 KICD-FM Spencer, IA
 KWST Topeka, KS
 WHSB Alpena, MI
 KKSS St. Louis, MO
 WSNJ-FM Bridgeton, NJ
 WGN Albany, NY
 WBIV Wethersfield, NY
 WNCT-FM Greenville, NC
 WDAO Dayton, OH
 KAEZ Oklahoma City, OK
 WGET-FM Gettysburg, PA
 WIVK-FM Knoxville, TN
 KWIC Beaumont, TX
 WEER-FM Warren, VA
 *KRAB Seattle, WA
 *WYCY Milwaukee, WI
 WOLA-FM Carolina, PR

107.9 mhz (ch. 300)

KFIN Jonesboro, AR
 KFMV Magnolia, AR
 KUZZ-FM Bakersfield, CA
 KXOA Sacramento, CA
 KAPX San Clemente, CA
 KCOL-FM Fort Collins, CO
 WDJF Westport, CT
 WPFM Panama City, FL
 WIRK-FM West Palm Beach, FL
 WCRY-FM Macon, GA
 WAUR Aurora, IL
 WIFE-FM Indianapolis, IN
 KFMW Waterloo, IA
 WABD-FM Fort Campbell, KY
 WFSI Annapolis, MD
 WWEL-FM Medford, MA
 WGMZ Flint, MI
 KTWN Anoka, MN
 WRPM-FM Poplarville, MS
 KFMG Albuquerque, NM
 WONO Syracuse, NY
 WBT-FM Charlotte, NC
 WDMT Cleveland, OH
 KHPE Albany, OR
 WEEP-FM Pittsburgh, PA
 KCRIR Corsicana, TX
 KESI Edinburg, TX
 *KMBI-FM Spokane, WA
 WEMM Huntington, WV
 WRHN Rhinelande, WI

Canadian AM By Frequency

540 Kilohertz

CBF Windsor, Ont.; 2.5 kw-D, 5 kw-N, DA-1.
 CBK Regina, Sask.; 50 kw-U.
 CBT Grand Falls, Nfld.; 10 kw-U.

550 Kilohertz

CFNB Fredericton, N.B.; 50 kw-U, DA-2.
 CHLN Trois-Rivieres, Que.; 10 kw-D, 5 kw-N, DA-2.
 CHNO Sudbury, Ont.; 10 kw-D, 2.5 kw-N, DA-2.
 CKPG Prince George, B.C.; 10 kw-U, DA-N.

560 Kilohertz

CFOS Owen Sound, Ont.; 1 kw-U, DA-2.
 CHCM Marystown, Nfld.; 1 kw-D, 500 w-N.
 CHTK Prince Rupert, B.C.; 1 kw-D, 250 w-N.
 CJLK Kirkland Lake, Ont.; 5 kw-U, DA-N.
 CKCN Sept-Isles, Que.; 10 kw-D, 5 kw-N, DA-2.
 CKNL Fort St. John, B.C.; 1 kw-U, DA-N.

570 Kilohertz

CFCB Corner Brook, Nfld.; 1 kw-U.

Canadian AM Frequencies

CFWH Whitehorse, Yukon; 1 kw-U.
CJEM Edmonton, N.B.; 5 kw-D, 1 kw-N, DA-N.
CKCQ Quesnel, B.C.; 1 kw-U, DA-2.
CKEK Cranbrook, B.C.; 10 kw-D, 1 kw-N, DA-1.

580 Kilohertz

CFRA Ottawa; 50 w-D, 10 kw-N, DA-2.
CHLC Hauterive, Que.; 5 kw-D, 2.5 kw-N, DA-2.
CJFX Antigonish, N.S.; 10 kw-U, DA-1.
CKAP Kapuskasing, Ont.; 1 kw-U, DA-1.
CKPR Thunder Bay, Ont.; 5 kw-D, 1 kw-N.
*CKUA Edmonton, Alberta; 10 kw-U, DA-2.
CKWW Windsor, Ont.; 500 w-U, DA-1.
CKXR Salmon Arm, B.C.; 1 kw-U, DA-N.
CKY Winnipeg, Man.; 50 kw-U, DA-2.

590 Kilohertz

CFAR Flin Flon, Man.; 10 kw-D, 1 kw-N, DA-D.
CFNL Fort Nelson, B.C.; 250 w-U.
CFTK Terrace, B.C.; 1 kw-U, DA-1.
CKEY Toronto; 10 kw-U, DA-2.
CKRS Jonquiere, Que.; 10 kw-D, 5 kw-N, DA-1.
VOCM St. John's, Nfld.; 10 kw-U, DA-N.

600 Kilohertz

CBNA St. Anthony, Nfld.; 10 kw-U, DA-2.
CFCF Montreal; 5 kw-U, DA-1.
CFCH North Bay, Ont.; 10 kw-D, 5 kw-N, DA-2.
CFCT Tuktoyaktuk, N.W.T.; 1 kw-U.
CFCC Saskatoon, Sask.; 5 kw-U, DA-N.
CJOR Vancouver, B.C.; 10 kw-U, DA-1.
CKCL Truro, N.S.; 1 kw-U, DA-1.

610 Kilohertz

CHNC New Carlisle, Que.; 10 kw-D, 5 kw-N, DA-1.
CHNL Kamloops, B.C.; 10 kw-D, 5 kw-N.
CHTM Thompson, Man.; 1 kw-U.
CJAT Trail, B.C.; 10 kw-D, 1 kw-N.
CJOX Grand Bank, Nfld.; 10 kw-U.
CKML Mont Laurier, Que.; 1 kw-U, DA-N.
CKRW Whitehorse, Y.T.; 1 kw-U.
CKTB St. Catharines, Ont.; 10 kw-D, 5 kw-N, DA-1.
CKYL Peace River, Alberta; 10 kw-U, DA-N.

620 Kilohertz

CFCL Timmins, Ont.; 10 kw-D, 5 kw-N, DA-2.
CJCI Prince George, B.C.; 10 kw-U, DA-N.
CKCK Regina, Sask.; 5 kw-U, DA-N.
CKCM Grand Falls, Nfld.; 10 kw-U, DA-1.

630 Kilohertz

CFCO Chatham, Ont.; 10 kw-D, 1 kw-N, DA-2.
CFCY Charlottetown, P.E.I.; 10 kw-U, DA-2.
CHED Edmonton, Alberta; 10 kw-U, DA-2.
CHLT Sherbrooke, Que.; 10 kw-D, 5 kw-N, DA-2.
CJET Smiths Falls, Ont.; 10 kw-U, DA-2.
CJLA Lachute, Que.; 500 w-D, 1 kw-N.
CKAR Huntsville, Ont.; 1 kw-U, DA-N.
CKOV Kelowna, B.C.; 5 kw-D, 1 kw-N.
CKRC Winnipeg, Man.; 10 kw-U, DA-2.

640 Kilohertz

CBN St. John's, Nfld.; 10 kw-U.

680 Kilohertz

CFTR Toronto; 10 kw-D, 25 kw-N, DA-2.
CHFA Edmonton, Alberta; 5 kw-U, DA-1.
CJCN Grand Falls, Nfld.; 10 kw-U, DA-2.
CJOB Winnipeg, Man.; 10 kw-D, 2.5 kw-N, DA-N.
CKGB Timmins, Ont.; 10 kw-U, DA-2.

690 Kilohertz

CBF Montreal; 50 kw-U.
CBU Vancouver, B.C.; 50 kw-U, DA-1.

710 Kilohertz

CFRG Gravelbourg, Sask.; 5 kw-D.
CHYR Leamington, Ont.; 10 kw-D.
CJRN Niagara Falls, Ont.; 5 kw-D, 2.5 kw-N, DA-2.
CKYM Ville-Marie, Que.; 10 kw-D, 1 kw-N, DA-N.
CKVO Clarenceville, Nfld.; 10 kw-U.

730 Kilohertz

CHYR-7 Leamington, Ont.; 500 w-N.
CJNR Blind River, Ont.; 1 kw-U, DA-N.
CKAC Montreal, 50 kw-U, DA-1.
CKDM Dauphin, Man.; 10 kw-D, 5 kw-N, DA-N.
CKGA Gander, Nfld.; 1 kw-U, DA-1.
CKLG North Vancouver, B.C.; 10 kw-U, DA-2.

740 Kilohertz

CBL Toronto; 50 kw-U.
CBNM Marystown, Nfld.; 10 kw-U, DA-N.
CBX Edmonton, Alberta; 50 kw-U, DA-2.

790 Kilohertz

CFCW Camrose, Alberta; 50 kw-U, DA-2.
CFDR Dartmouth, N.S.; 5 kw-U, DA-1.
CFNW Port au Choix, Nfld.; 1 kw-U, DA-1.
CFAN Newcastle, N.B.; 1 kw-U, DA-1.
CHIC Brampton, Ont.; 5 kw-U.
CKSO Sudbury, Ont.; 10 kw-D, 5 kw-N, DA-2.

800 Kilohertz

CBQ Thunder Bay, Ont.; 10 kw-D, 5 kw-N, DA-1.
CFOB Fort Frances, Ont.; 1 kw-D, 500 w-N.
CHAB Moose Jaw, Sask.; 10 kw-U, DA-N.
CHRC Quebec; 50 kw-U, DA-1.
CJAD Montreal; 50 kw-D, 10 kw-N, DA-2.
CJBQ Belleville, Ont.; 10 kw, DA-2.
CJJC Langley, B.C.; 10 kw-U, DA-2.
CKLW Windsor, Ont.; 50 kw-U, DA-2.
CKOK Penticton, B.C.; 10 kw-D, 500 w-N.
VOWR St. John's, Nfld.; 1 kw-U.

810 Kilohertz

CHQR Calgary, Alberta; 50 kw-U, DA-2.

850 Kilohertz

CKRD Red Deer, Alberta; 10 kw-D, 1 kw-N, DA-N.
CKVL Verdun, Que.; 50 kw-D, 10 kw-N, DA-2.

860 Kilohertz

CBH Halifax, N.S.; 10 kw-U, DA-N.
CFPR Prince Rupert, B.C.; 10 kw-U, DA-1.
CHAK Inuvik, N.W.T.; 1 kw-U.
CJBC Toronto; 50 kw-U.

900 Kilohertz

CFBR Sudbury, Ont.; 10 kw-D, 1 kw-N, DA-2.
CHML Hamilton, Ont.; 5 kw-U, DA-1.
CJBR Rimouski, Que.; 10 kw-U, DA-N.
CJVI Victoria, B.C.; 10 kw-U, DA-1.
CKBI Prince Albert, Sask.; 10 kw-U, DA-2.
CKDH Amherst, N.S.; 1 kw-U, DA-2.
CKDR Dryden, Ont.; 1 kw-D, 250 w-N.
CJEN St. Jerome, Que.; 1 kw-U, DA-1.
CKTS Sherbrooke, Que.; 10 kw-U, DA-2.
CKVD Val d'Or, Que.; 10 kw-D, 2.5 kw-N, DA-1.

910 Kilohertz

CBO Ottawa; 5 kw-U, DA-1.
CFJC Kamloops, B.C.; 10 kw-D, 1 kw-N.
CFSX Stephenville, Nfld.; 500 w-U.
CHRL Roberval, Que.; 10 kw-D, 2.5 kw-N.
CJDV Drumheller, Alberta; 5 kw-U, DA-2.
CKLY Lindsay, Ont.; 10 kw-D, 5 kw-N, DA-2.

920 Kilohertz

CFRY Portage La Prairie, Man.; 10 kw-U, DA-2.
CJCH Halifax, N.S.; 10 kw-D, 5 kw-N, DA-N.
CJCJ Woodstock, N.B.; 1 kw-U, DA-1.
CKCY Sault Ste. Marie, Ont.; 10 kw-D, 5 kw-N, DA-2.
CKNX Wingham, Ont.; 10 kw-D, 1 kw-N, DA-2.
CKWL Williams Lake, B.C.; 1 kw-U.

930 Kilohertz

CFBC Saint John, N.B.; 10 kw-D, 5 kw-N, DA-2.
CJCA Edmonton, Alberta; 10 kw-D, 5 kw-N, DA-N.
CJON St. John's, Nfld.; 25 kw-U, DA-N.

940 Kilohertz

CBM Montreal; 50 kw-U.
CJGX Yorkton, Sask.; 10 kw-U, DA-N.
CJIB Vernon, B.C.; 10 kw-U.

950 Kilohertz

CFAM Altona, Man.; 10 kw-U, DA-2.
CHER Sydney, N.S.; 10 kw-U, DA-1.
CKBB Barrie, Ont.; 10 kw-D, 2.5 kw-N, DA-2.
CKNB Campbellton, N.B.; 10 kw-D, 1 kw-N, DA-2.

960 Kilohertz

CFAC Calgary, Alberta; 50 kw-U, DA-N.
CHNS Halifax, N.S.; 10 kw-U, DA-N.
CKWS Kingston, Ont.; 10 kw-D, 5 kw-N, DA-2.

970 Kilohertz

CFBZ Fredericton, N.B.; 10 kw-U, DA-N.
CJYR Edson, Alberta; 10 kw-U, DA-1.
CKCH Hull, Que.; 5 kw-U, DA-1.

980 Kilohertz

CBV Quebec, Que.; 5 kw-U, DA-1.
CFPL London, Ont.; 10 kw-D, 5 kw-N, DA-2.
CHEX Peterborough, Ont.; 10 kw-D, 5 kw-N, DA-2.
CKGM Montreal; 10 kw-U, DA-1.
CKNW New Westminster, B.C.; 50 kw-U, DA-1.
CKRM Regina, Sask.; 10 kw-D, 5 kw-N, DA-2.

990 Kilohertz

CBW Winnipeg, Man.; 50 kw-U.
CBY Corner Brook, Nfld.; 10 kw-U.

1000 Kilohertz

CKBW Bridgewater, N.S.; 10 kw-U, DA-N.

1010 Kilohertz

CBR Calgary, Alberta; 50 kw-U, DA-2.
CFRB Toronto; 50 kw-U, DA-2.

1050 Kilohertz

CFGP Grande Prairie, Alberta; 10 kw-U, DA-1.
CHUM Toronto; 50 kw-U, DA-2.
CJIC Sault Ste. Marie, Ont.; 10 kw-D, 2.5 kw-N, DA-N.
CJNB North Battleford, Sask.; 10 kw-U, DA-N.
CKSB St. Boniface, Man.; 10 kw-U, DA-N.

1060 Kilohertz

CFCN Calgary, Alberta; 50 kw-U, DA-2.
CJRP Quebec, Que.; 50 kw-D, 10 kw-N, DA-2.

1070 Kilohertz

CBA Moncton, N.B.; 50 kw-U.
CFAX Victoria, B.C.; 10 kw-U, DA-1.
CHOK Sarnia, Ont.; 10 kw-U, DA-2.

1080 Kilohertz

CKSA Lloydminster, Alberta; 10 kw-U, DA-N.

1090 Kilohertz

CHEC Lethbridge, Alberta; 5 kw-U, DA-2.
CHRS Longueuil-St. Jean, Que.; 10 kw-D.
CKKW Kitchener, Ont.; 10 kw-U, DA-2.

1110 Kilohertz

CBD St. John, N.B.; 10 kw-U, DA-2.
CHQT Edmonton, Alberta; 10 kw-U, DA-N.

1130 Kilohertz

CKWX Vancouver, B.C.; 50 kw-U, DA-N.

1140 Kilohertz

CBI Sydney, N.S.; 10 kw-U, DA-N.
CJTR Trois-Rivieres, Que.; 10 kw-U, DA-2.
CKXL Calgary, Alberta; 10 kw-U, DA-N.

1150 Kilohertz

CHSJ St. John, N.B.; 10 kw-D, 5 kw-N, DA-2.
CJRC Ottawa; 50 kw-D, 5 kw-N, DA-2.
CKIQ Kelowna, B.C.; 10 kw-D, 1 kw-N.
CKQC Hamilton, Ont.; 10 kw-U, DA-2.
CKX Brandon, Man.; 10 kw-U, DA-2.

1170 Kilohertz

CFML Cornwall, Ont.; 10 kw-D, DA.
CFNS Saskatoon, Sask.; 1 kw-U, DA-1.
CKGY Red Deer, Alberta; 10 kw-D, 5 kw-N.

1190 Kilohertz

CFSL Weyburn, Sask.; 10 kw-D, 5 kw-N, DA-N.
CHTN Charlottetown, P.E.I.; 10 kw-U.
CJMR Mississauga, Ont.; 10 kw-D.

1210 Kilohertz

CFFB Frobisher Bay, N.W.T.; 250 w-U.

1220 Kilohertz

CHSC St. Catharines, Ont.; 1 kw-D, 500 w-N, DA-1.
CJOC Lethbridge, Alberta; 10 kw-D.
CJRB Boissevain, Man.; 10 kw-D, 5 kw-N, DA-N.
CJRL Kenora, Ont.; 1 kw-U.
CJSS Cornwall, Ont.; 1 kw-U, DA-2.
CKCW Moncton, N.B.; 10 kw-U, DA-N.
CKDA Victoria, B.C.; 50 kw-U, DA-1.
CKSM Shawinigan, Que.; 10 kw-D, 2.5 kw-N, DA-2.

1230 Kilohertz

CFBV Smithers, B.C.; 1 kw-D, 250 w-N.
CFGN Port aux Basques, Nfld.; 250 w-U.
CFGR Gravelbourg, Sask.; 250 w-N.
CFLK Kapuskasing, Ont.; 100 w-U.

Canadian AM, FM Frequencies

CFLN Goose Bay, Nfld.; 1 kw-D, 250 w-N.
CFPA Thunder Bay, Ont.; 1 kw-D, 250 w-N.
CHFC Churchill, Man.; 250 w-U.
CHVD Dolbeau, Que.; 10 kw-D, 250 w-N.
CJNL Merritt, B.C.; 1 kw-D, 250 w-N.
CJOK Fort McMurray, Alberta; 1 kw-D, 500 w-N.
CJSA Ste. Agathe des Monts, Que.; 1 kw-D, 250 w-N.
CJTT New Liskeard, Ont.; 1 kw-D, 250 w-N.
CKLD Thetford Mines, Que.; 1 kw-D, 250 w-N.
CKMP Midland, Ont.; 1 kw-D, 250 w-N.
CKQR Castlegar, B.C.; 1 kw-D, 250 w-N, DA-D.
CKTK Kitimat, B.C.; 1 kw-D, 250 w-N.
VOAR St. John's, Nfld.; 100 w-U.

1240 Kilohertz

CFEK Fernie, B.C.; 1 kw-D, 500 w-N.
CFLM La Tuque, Que.; 1 kw-D, 250 w-N.
CFLS Levis, Que.; 250 w-U.
CFVR Abbotsford, B.C.; 1 kw-D, 250 w-N, DA-N.
CJAF Cabano, Que.; 1 kw-D, 250 w-N.
CJAR The Pas, Man.; 1 kw-D, 500 w-N.
CJAV Port Alberni, B.C.; 1 kw-D, 250 w-N.
CJCS Stratford, Ont.; 500 w-D, 250 w-N.
CJMD Chibougamau, Que.; 1 kw-D, 250 w-N.
CJNH Bancroft, Ont.; 1 kw-U.
CJRW Summerside, P.E.I.; 250 w-U.
CJWA Wawa, Ont.; 1 kw-D, 250 w-N.
CKBS St. Hyacinthe, Que.; 250 w-U.
CKBX 100 Mile House, B.C.; 250 w-U, DA-N.
CKIM Baie Verte, Nfld.; 1 kw-D, 500 w-N.
CKLS La Sarre, Que.; 1 kw-D, 250 w-N.
CKMK Mackenzie, B.C.; 1 kw-D, 250 w-N.
CKOO Osoyoos, B.C.; 1 kw-D, 250 w-N.

1250 Kilohertz

CBGA Matane, Que.; 10 kw-D, 5 kw-N, DA-N.
CBOF Ottawa, Que.; 10 kw-U, DA-1.
CHSM Steinbach, Man.; 10 kw-U, DA-2.
CHWO Oakville, Ont.; 10 kw-D, 5 kw-N, DA-1.
CKJD Sarnia, Ont.; 1 kw-U, DA-2.
CKOM Saskatoon, Sask.; 10 kw-U, DA-N.

1260 Kilohertz

CFRN Edmonton, Alberta; 50 kw-U, DA-N.

1270 Kilohertz

CFGT Alma, Que.; 10 kw-D, 5 kw-N.
CHAT Medicine Hat, Alberta; 10 kw-U, DA-N.
CHWK Chilliwack, B.C.; 10 kw-U, DA-N.
CJCB Sydney, N.S.; 10 kw-U, DA-N.

1280 Kilohertz

CHAM Hamilton, Ont.; 10 kw-U, DA-2.
CHQB Powell River, B.C.; 1 kw-U, DA-1.
CJMS Montreal; 50 kw-U, DA-2.
CJSL Estevan, Sask.; 1 kw-U, DA-1.
CKCV Quebec, Que.; 10 kw-D, 5 kw-N, DA-2.

1290 Kilohertz

CHRM Matane, Que.; 10 kw-U.
CJBK London, Ont.; 10 kw-U, DA-1.

1300 Kilohertz

CBAF Moncton, N.B.; 5 kw-U, DA-1.
CJME Regina, Sask.; 1 kw-U, DA-1.

1310 Kilohertz

CFGM Richmond Hill, Ont.; 50 kw-U, DA-2.
CHGB La Pocatierre, Que.; 10 kw-D, 5 kw-N, DA-N.
CJOK St. Paul, Alberta; 10 kw-U.
CKOY Ottawa; 50 kw-U, DA-2.

1320 Kilohertz

CFTJ Cambridge, Ont.; 1 kw-U, DA-2.
CHOM Vancouver, B.C.; 50 kw-U, DA-2.
CJSO Sorel, Que.; 10 kw-D, 5 kw-N, DA-2.
CKEC New Glasgow, N.S.; 5 kw-U, DA-N.

1330 Kilohertz

CKKR Rosetown, Sask.; 10 kw-U, DA-1.

1340 Kilohertz

CBGN Ste.-Anne-des-Monts, Que.; 1 kw-D, 250 w-N.
CFED Chapais, Que.; 250 w-U.
CFGB Happy Valley, Nfld.; 1 kw-U.
CFKC Creston, B.C.; 250 w-U.
CFLH Hearst, Ont.; 1 kw-D, 250 w-N.
CFLW Wabush, Labrador, Nfld.; 250 w-U, DA-1.
CFOM Ville Vanier, Que.; 250 w-U.
CFYK Yellowknife, N.W.T.; 1 kw-U.
CHAD Amos, Que.; 1 kw-D, 250 w-N.
CIVH Vanderhoof, B.C.; 1 kw-D, 250 w-N.

CJAN Asbestos, Que.; 1 kw-D, 250 w-N.
CJAR The Pas, Man.; 1 kw-D, 250 w-N.
CJLS Yarmouth, N.S.; 5 kw-D, 1 kw-N, DA-2.
CKAR-1 Parry Sound, Ont.; 250 w-U.
CKBR Brooks, Alberta; 1 kw-D, 250 w-N.
CKCR Revelstoke, B.C.; 1 kw-D, 250 w-N.
CKGF Grand Forks, B.C.; 1 kw-D, 250 w-N.
CKNR Elliott Lake, Ont.; 250 w-U.
CKOX Woodstock, Ont.; 1 kw-D, 250 w-N, DA-D.
CKVT Temiscamisque, Que.; 250 w-U.

1350 Kilohertz

CHAL St. Pemiephie, Que.; 1 kw-U.
CHOV Pembroke, Ont.; 1 kw-U, DA-1.
CJCR Gander, Nfld.; 1 kw-U.
CJDC Dawson Creek, B.C.; 1 kw-U.
CJLM Joliette, Que.; 10 kw-D, 1 kw-N, DA-2.
CKAD Middleton, N.S.; 1 kw-U, DA-1.
CKLB Oshawa, Ont.; 10 kw-D, 5 kw-N, DA-2.

1360 Kilohertz

CJVL Ste-Marie de Beauce, Que.; 10 kw-D, 5 kw-N.
CKBC Bathurst, N.B.; 10 kw-U, DA-N.

1370 Kilohertz

CFLV Valleyfield, Que.; 10 kw-D, 5 kw-N.
CFOK Westlock, Alberta; 10 kw-U.
CHPQ Parksville, B.C.; 1 kw-U.

1380 Kilohertz

CFDA Victoriaville, Que.; 1 kw-U, DA-N.
CKLC Kingston, Ont.; 10 kw-U, DA-2.
CKPC Brantford, Ont.; 10 kw-U, DA-2.

1390 Kilohertz

CHOO Ajax, Ont.; 10 kw-U, DA-1.
CKKC Nelson, B.C.; 1 kw-U, DA-1.

1400 Kilohertz

CFLD Burns Lake, B.C.; 250 w-U.
CHNL-1 Clearwater, B.C.; 1 kw-D, 250 w-N.
CINL Princeton, B.C.; 1 kw-D, 250 w-N.
CJJP Riviere du Loup, Que.; 10 kw-D, 5 kw-N.
CKCB Collingwood, Ont.; 250 w-U.
CKFL Lac Megantic, Que.; 1 kw-D, 250 w-N.
CKGR Golden, B.C.; 1 kw-D, 250 w-N.
CKOB Renfrew, Ont.; 250 w-U.
CKRN Rouyn, Que.; 1 kw-D, 250 w-N.
CKRV Drummondville, Que.; 250 w-D, 100 w-N.
CKSW Swift Current, Sask.; 1 kw-D, 250 w-N.

1410 Kilohertz

CFMB Montreal; 10 kw-U, DA-1.
CFUN Vancouver, B.C.; 50 kw-U, DA-2.
CIGO Port Hawkesbury, N.S.; 10 kw-U.
CKSL London, Ont.; 10 kw-U, DA-2.

1420 Kilohertz

CJMT Chicoutimi, Que.; 10 kw-D, 2.5 kw-N.
CJVR Melfort, Sask.; 10 kw-U, DA-N.
CKDY Digby, N.S.; 1 kw-U, DA-1.
CKPT Peterborough, Ont.; 5 kw-U, DA-2.
CKTL Plessisville, Que.; 1 kw-D, 500 w-N, DA-2.

1430 Kilohertz

CKFH Toronto; 50 kw-U, DA-2.

1440 Kilohertz

CFCP Courtenay, B.C.; 1 kw-U, DA-N.
CJOI Wetaskiwin, Alberta; 1 kw-U, DA-1.
CFGO Ottawa; 50 kw-U.

1450 Kilohertz

CBG Gander, Nfld.; 250 w-U.
CFAB Windsor, N.S.; 250 w-U.
CFJR Brockville, Ont.; 1 kw-D, 250 w-N, DA-D.
CHAP Long Lac, Ont.; 40 w.
CHEF Granby, Que.; 10 kw-D, 5 kw-N, DA-1.
CHRT St. Eleuthere, Que.; 250 w-U.
CHUC Cobourg, Ont.; 1 kw-U, DA-2.
CJBM Causapscal, Que.; 1 kw-D, 250 w-N.
CKSP Summerland, B.C.; 1 kw-D, 250 w-N.
CKYR Jasper, Alberta; 100 w-U.

1460 Kilohertz

CJOY Guelph, Ont.; 10 kw-D, 5 kw-N, DA-2.
CKRB Ville St. Georges, Que.; 10 kw-D, 5 kw-N, DA-N.

1470 Kilohertz

CFOX Pointe Claire, Que.; 10 kw-D, 5 kw-N, DA-2.
CFRW Winnipeg, Man.; 10 kw-U, DA-1.
CHOW Welland, Ont.; 1 kw-D, 500 w-N, DA-2.

CJVB Vancouver, B.C.; 10 kw-U, DA-2.

1480 Kilohertz

CHRD Drummondville, Que.; 10 kw-U, DA-2.

1490 Kilohertz

CFMR Fort Simpson, N.W.T.; 50 w-U.
*CFRC Kingston, Ont.; 100 w-U.
CFWB Campbell River, B.C.; 1 kw-D, 250 w-N.
CHYM Kitchener, Ont.; 10 kw-D, 5 kw-N, DA-2.
CJMC Ste. Anne des Monts, Que.; 1 kw-U.
CJPR Blairmore, Alberta; 1 kw-D, 250 w-N.
CJSN Shaunavon, Sask.; 1 kw-D, 250 w-N.
CKBM Montmagny, Que.; 1 kw-D, 250 w-N.
CKEN Kentville, N.S.; 1 kw-D, 500 w-N, DA-1.
CKGO Hope, B.C.; 250 w-U, DA-1.
CKLR L'Annonciation, Que.; 1 kw-D, 250 w-N.

1500 Kilohertz

CKAY Duncan, B.C.; 5 kw-D, 1 kw-N.

1510 Kilohertz

CJRS Sherbrooke, Que.; 10 kw-U, DA-2.
CKOT Tillsonburg, Ont.; 1 kw, DA-D.

1540 Kilohertz

CHIN Toronto; 50 kw, DA-D.

1550 Kilohertz

CBE Windsor, Ont.; 10 kw-U, DA-1.

1570 Kilohertz

CFOR Orillia, Ont.; 10 kw-D, 1 kw-N.
CHLO St. Thomas, Ont.; 10 kw-U, DA-2.
CHUB Nanaimo, B.C.; 10 kw-U, DA-2.
CKLM Montreal; 50 kw-U, DA-2.
CKTA Taber, B.C.; 5 kw-U.

1580 Kilohertz

CBJ Chicoutimi, Que.; 10 kw-U, DA-1.

1600 Kilohertz

CHNR Simcoe, Ont.; 10 kw.

Canadian FM By Frequency

88 Megahertz

88.7 mhz CJOM-FM Windsor, Ont.; 84 kw.

89 Megahertz

89.1 mhz *CKRL-FM Quebec, Que.; 1.4 kw.
89.7 mhz CJUS-FM Saskatoon, Sask.; 3.8 kw.

91 Megahertz

91.1 mhz CJRT-FM Toronto; 27 kw.
91.9 mhz *CFRC-FM Kingston, Ont.; 1.27 kw.

92 Megahertz

92.1 mhz CKPC-FM Brantford, Ont.; 50 kw.
92.1 mhz CKY-FM Winnipeg, Man.; 360 kw.
92.1 mhz CFMQ-FM Regina, Sask.; 6.2 kw.
92.5 mhz CFQR-FM Montreal; 41.4 kw.
92.7 mhz CKSO-FM Sudbury, Ont.; 100 kw.

93 Megahertz

93.5 mhz CBIM-FM Iles-de-la-Madeleine, Que.; 4.5 kw.
93.7 mhz CKAT-FM North Bay, Ont.; 5.86 kw.
93.9 mhz CFMO-FM Ottawa; 95 kw.
93.9 mhz CKLW-FM Windsor, Ont.; 50 kw.

94 Megahertz

94.1 mhz CBL-FM Toronto; 39.8 kw.
94.3 mhz CKMF-FM Montreal; 41.4 kw.
94.3 mhz CHIQ-FM Winnipeg, Man.; 6.5 kw.
94.3 mhz CJSJ-FM Thunder Bay, Ont.; 95 kw.
94.5 mhz CKGB-FM Timmins, Ont.; 425 w.
94.9 mhz CJCB-FM Sydney, N.S.; 675 w.
94.9 mhz CKCH-FM Hull, Que.; 74 kw.
94.9 mhz CKQS-FM Oshawa, Ont.; 50 kw.

95 Megahertz

95.1 mhz CBM-FM Montreal; 24.6 kw.
95.3 mhz *CBV-FM Quebec, Que.; 100 kw.
95.3 mhz CKDS-FM Hamilton, Ont.; 100 kw.

FM Assignments

95.9 mhz CFPL-FM London, Ont.; 179 kw.
 95.9 mhz CHFM-FM Calgary, Alberta; 11 kw.
 95.9 mhz CJFM-FM Montreal; 41.2 kw.

96 Megahertz

96.1 mhz CHFX-FM Halifax, N.S.; 19.5 kw.
 96.1 mhz CKX-FM Brandon, Man.; 55 kw.
 96.3 mhz CKWS-FM Kingston, Ont.; 2.7 kw.
 96.7 mhz CHYM-FM Kitchener, Ont.; 24 kw.
 96.7 mhz CHUT-FM Chicoutimi, Que.; 42 kw.
 96.9 mhz CKVL-FM Verdun, Que.; 307 kw.

97 Megahertz

97.1 mhz CJBQ-FM Belleville, Ont.; 17.4 kw.
 97.1 mhz CKOK-FM Peniticon, B.C.; 1.8 kw.
 97.5 mhz CJOB-FM Winnipeg, Man.; 310 kw.
 97.7 mhz CBUF-FM Vancouver, B.C.; 50 kw.
 97.7 mhz CHOM-FM Montreal; 41.2 kw.
 97.7 mhz CKTB-FM St. Catharines, Ont.; 250 w.
 97.7 mhz CKWM-FM Kentville, N.S.; 18 kw.
 97.9 mhz CFNN-FM St. Anthony, Nfld.; 126 w.

98 Megahertz

98.1 mhz CHFI-FM Toronto; 210 kw.
 98.1 mhz CHRC-FM Quebec, Que.; 81 kw.
 98.1 mhz CKUA-FM Edmonton, Alberta; 352 w.
 98.3 mhz CBWF-FM Winnipeg, Man.; 354 kw.
 98.3 mhz CFM-FM Kamloops, B.C.; 3.9 kw.
 98.3 mhz CKLC-FM Kingston, Ont.; 47 kw.
 98.5 mhz CBHM-FM Richibucto, N.B.; 58.5 w.
 98.5 mhz CFMS-FM Victoria, B.C.; 19 kw.
 98.7 mhz CKWR-FM Kitchener, Ont.; 202 w.
 98.9 mhz CBFL-FM Maniwaki, Que.; 58.5 w.
 98.9 mhz CFBC-FM St. John, N.B.; 5.6 kw.
 98.9 mhz CKRD-FM Red Deer, Alberta; 1.24 kw.

99 Megahertz

99.3 mhz CKLG-FM Vancouver, B.C.; 100 kw.
 99.3 mhz CKQN-FM Baker Lake, N.W.T.; 60 w.
 99.5 mhz CJCA-FM Edmonton, Alberta; 414 w.
 99.9 mhz CKFM-FM Toronto; 100 kw.

100 Megahertz

100.3 mhz CFRN-FM Edmonton, Alberta; 16.2 kw.
 100.5 mhz CJIC-FM Sault Ste. Marie, Ont.; 3.6 kw.
 100.5 mhz CKOT-FM Tillsonberg, Ont.; 1.135 kw.

100.7 mhz CBF-FM Montreal; 100 kw.
 100.7 mhz CHIN-FM Toronto; 50 kw.
 100.9 mhz *CBJ-FM Chicoutimi, Que.; 98 kw.
 100.9 mhz CHEC-FM Lethbridge, Alberta; 245 w.
 100.9 mhz CKCL-FM Truro, N.S.; 360 w.

101 Megahertz

101.1 mhz CFMI-FM New Westminster, B.C.; 100 kw.
 101.1 mhz CJET-FM Smiths Falls, Ont.; 47.2 kw.
 101.3 mhz CKOT-FM Tillsonberg, Ont.; 50 kw.
 101.5 mhz CHEX-FM Peterborough, Ont.; 24 kw.
 101.5 mhz CJBR-FM Rimouski, Que.; 20 kw.

102 Megahertz

102.1 mhz CBR-FM Calgary, Alberta; 100 kw.
 102.1 mhz CHIC-FM Brampton, Ont.; 857 w.
 102.5 mhz CBOF-FM Ottawa; 70 kw.
 102.7 mhz CBH-FM Halifax, N.S.; 100 kw.
 102.7 mhz *CFRO-FM Vancouver, B.C.; 3.7 kw.
 102.7 mhz CHLT-FM Sherbrooke, Que.; 62 kw.
 102.9 mhz CHGB-FM La Pocatiere, Que.; 790 w.

103 Megahertz

103.1 mhz CBC-FM Charlottetown, P.E.I.; 59.2 kw.
 103.3 mhz CBO-FM Ottawa; 70 kw.
 103.5 mhz CHQM-FM Vancouver, B.C.; 100 kw.
 103.9 mhz CFMC-FM Saskatoon, Sask.; 6.02 kw.

104 Megahertz

104.3 mhz CFDM-FM Drummondville, Que.; 50 kw.
 104.3 mhz CKCY-FM Sault Ste. Marie, Ont.; 6.76 kw.
 104.5 mhz CHUM-FM Toronto; 100 kw.
 104.5 mhz CJSS-FM Cornwall, Ont.; 850 w.
 104.7 mhz CJOV-FM Kelowna, B.C.; 3.8 kw.

105 Megahertz

105.3 mhz CFCA-FM Kitchener, Ont.; 100 kw.
 105.3 mhz CKBY-FM Ottawa; 74 kw.
 105.7 mhz CBU-FM Vancouver, B.C.; 100 kw.
 105.7 mhz CFGL-FM Laval, Que.; 100 kw.
 105.7 mhz CHSC-FM St. Catharines, Ont.; 50 kw.

106 Megahertz

106.1 mhz CKLA-FM Guelph, Ont.; 50 kw.
 106.7 mhz CJAT-FM Trail, B.C.; 12.6 kw.

107 Megahertz

107.9 mhz CBJE-FM Chicoutimi, Que.; 98 kw.

Harrison 275
 Heber Springs 244A
 Helena 298
 Hope 285A
 Hot Springs 244A, 248, 292A

Jonesboro 270, 300
 Lake Village 240A
 Little Rock 231, 239, 253, 279
 Magnolia 300
 Maivern 269A
 Mammoth Spring 236
 McGehee 272A
 Mena 269A
 Monticello 228A
 Mountain Home 252A
 Nashville 288A
 Newport 288A
 Osceola 251
 Paragould 285A
 Paris 237A
 Pine Bluff 222, 235
 Pochantans 280A
 Rogers 232A
 Salem 240A
 Searcy 257A
 Siloam Springs 289
 Springdale 285A
 Texarkana 296A
 Walnut Ridge 292A
 Warren 288A
 Wynne 224A

California

Alameda 224A
 Alturas 233
 Anaheim 240A
 Anderson 232A
 Apple Valley 272A
 Arcata 228A
 Arroyo Grande 237A
 Auburn 266
 Bakersfield 231, 243, 268, 300
 Banning 269A
 Barstow 232A
 Berkeley 231, 275
 Bishop 264
 Blythe 262
 Brawley 233, 241
 Burney 291
 Calexico 249A
 Calipatria 265A
 Camarillo 240A
 Carlsbad 240A
 Carmel 269A
 Cathedral City 253
 Chico 229, 236
 Coachella 229
 Crescent City 232A
 Delano 253, 287
 Dinuba 255
 El Cajon 227
 El Centro 298
 Escondido 221A
 Eureka 222, 242
 Fairfield 237A
 Fallbrook 269A
 Fort Bragg 224A, 237A
 Fowler 244A
 Fremont 285A
 Fresno 229, 238, 250, 266, 270, 274, 290
 Garden Grove 232A
 Gilroy 233
 Glendale 270
 Hanford 279, 298
 Hemet 288A
 Hollister 228A
 Holtville 261A
 Imperial 257A
 Indio 276A
 Inglewood 280A
 Jackson 232A
 Kernville 272A
 King City 221A
 Lancaster 292A
 Lemoore 285A
 Livermore 269A
 Lodi 249A
 Lompoc 224A
 Long Beach 250, 272A, 288A
 Los Altos 249A
 Los Angeles 222, 226, 230, 234, 238, 242, 246, 254, 258, 262, 266, 274, 278, 282, 286, 290, 298
 Los Banos 240A
 Los Gatos 237A
 Madera 221A
 Mammoth Lakes 292A
 Manteca 244A
 Mariposa 284
 Marysville 260
 Merced, 248, 268
 Modesto 272A, 277, 281
 Mojave 249A
 Monterey 245
 Monte Rio 249A
 Morro Bay 283
 Mt. Shasta 237A
 Needles 250
 Newport Beach 276A
 Oakdale 236
 Oceanside 271
 Ojai 288A
 Ontario 228A
 Oroville 249A
 Oxnard 252A, 284
 Pacific Grove 285A
 Palm Springs 284
 Paradise 244A
 Pasadena 294
 Paso Robles 232A
 Patterson 226
 Porterville 259
 Quincy 240A
 Red Bluff 240A, 272A
 Redding 251, 282
 Redlands 244A
 Redondo Beach 228A
 Ridgecrest 224A
 Riverside 224A, 248, 256
 Roseville 228A
 Sacramento 223, 241, 245, 253, 263, 286, 293, 300
 Salinas 264, 273, 280A
 San Bernardino 236, 260A
 San Clemente 300
 San Diego 231, 235, 243, 247, 251, 264, 268, 275, 279, 287, 293
 San Fernando 232A
 San Francisco 277, 235, 239, 243, 247, 251, 255, 259, 267, 271, 279, 283, 287, 291, 295
 San Jose 222, 253, 262, 293
 San Luis Obispo 227, 241
 San Mateo 299
 San Rafael 265A
 Santa Ana 244A, 292A
 Santa Barbara 229, 248
 Santa Clara 289
 Santa Cruz 256
 Santa Maria 256, 273
 Santa Monica 276A
 Santa Paula 244A
 Santa Rosa 257A, 261A
 Seaside 296A
 Sierra Madre 296A
 Sonora 224A
 So. Lake Tahoe 251A, 276A
 St. Helena 269A
 Stockton 257A, 261A, 297
 Susanville 224A
 Taft 280A
 Thousand Oaks 224A
 Tracy 265A
 Truckee 269A
 Tulare 235, 294
 Turlock 252A
 Twentynine Palms 239
 Ukiah, 233, 277
 Ventura 236, 264
 Victorville 276A
 Visalia 225
 Walnut Creek 221A
 Wasco 249A
 Weed 257A

Table of FM Assignments

The following table of assignments contains the channels (other than non-commercial educational channels) assigned to the listed communities in the United States, its territories and possessions as of September 1975. Channels designated with "A" are for class A FM stations. All other listed channels are for class B stations in Zones I and I-A and for class C stations in Zone II. (see "FCC Rules," Section A.)

Alabama

Abbeville 232A
 Albertville 286
 Alexander City 291
 Andalusia 251
 Anniston 263
 Arab 224A
 Athens 282
 Atmore 281
 Auburn 249A
 Bay Minette 288A
 Birmingham 229, 233, 243, 258, 284, 295, 299
 Brewton 292A
 Butler 228A
 Carrollton 231
 Clanton 249A
 Cullman 221A, 266
 Decatur 245, 271
 Demopolis 292A
 Dothan 238, 259
 Enterprise 245, 294
 Eufaula 224A
 Evergreen 228A
 Fairhope 221A
 Fayette 251
 Florence 297
 Gadsden 279
 Geneva 228A
 Greenville 240A

Guntersville 240A
 Hamilton 221A
 Haleyville 224A
 Huntsville 236, 256
 Jackson 285A
 Jasper 273
 Mobile 255, 235, 241, 248, 260
 Monroeville 257A
 Montgomery 222, 255, 270, 277
 Muscle Shoals 288A
 Oneonta 249A
 Opelika 265A
 Opp 272A
 Ozark 285A, 280A
 Phenix City 261A
 Prattville 237A
 Roanoke 272A
 Scottsboro 252A
 Selma 261A, 265A
 Sheffield 292A
 Sylacauga 252A
 Talladega 224A
 Thomasville 237A
 Troy 289
 Tuscaloosa 224A, 239, 288A
 Tusculum 262
 Tuskegee 240A

Union Springs 265A
 York 257A

Alaska

Anchorage 263, 267, 271, 280A, 288A
 College 284
 Cordova 265A
 Fairbanks 262, 266
 Juneau 282, 286
 Kenai 261A
 Ketchikan 290, 294
 Kodiak 261A
 Nome 262
 Seward 276A
 Sitka 284

Arizona

Ajo 252A
 Apache Junction 296A
 Benson 249A
 Bisbee 221A
 Bullhead City 272A
 Casa Grande 288A
 Claypool 252A
 Clifton 237A
 Coolidge 280A
 Cottonwood 240A
 Douglas 237A
 Eloy 292A
 Flagstaff 225, 230
 Glendale 222
 Globe 262
 Holbrook 221A
 Kingman 224A
 Lake Havasu City 240A
 Mesa 227, 284
 Miami 276A

Nogales 252A
 Page 228A
 Phoenix 233, 238, 245, 254, 268, 273
 Prescott 252A
 Safford 231, 256
 San Manuel 269A
 Show Low 228A
 Sierra Vista 265A
 Sun City 292A
 Tempe 250
 Tolleson 264
 Tucson 221A, 225, 229, 235, 241, 258
 Wickenburg 288A
 Willcox 252A
 Winslow 236, 247
 Yuma 226, 236

Arkansas

Arkadelphia 265A
 Ashdown 280A
 Benton 296A
 Berryville 296A
 Blytheville 241
 Brinkley 272A
 Camden 246
 Clarksville 224A
 Conway 262, 286
 Corning 228A
 Crossett 285A
 Dardanelle 272A
 DeQueen 224A
 De Witt 244A
 El Dorado 257A, 276A
 Fayetteville 221A, 280A
 Forrest City 228A
 Fort Smith 229, 256, 260, 265A

West Covina 252A
Willows 288A
Woodland 273
Yreka 249A
Yuba City 280A

Colorado

Alamosa 288A
Aspen 249A
Boulder 234, 247
Breckenridge 272A
Canon City 280A
Colorado Springs 225,
230, 236, 243, 270
Cortez 250, 254
Craig 229, 273
Delta 237A
Denver 239, 253, 258
262, 266, 278, 286,
290, 294
Durango 263, 267
Fort Collins 227, 256,
300
Fort Morgan 269A
Glenwood Springs 224A
Grand Junction 222, 226
Greeley 222, 241
Gunnison 252A, 272A
La Junta 221A
Lakewood 298
Lamar 227, 245
Leadville 228A
Littleton 298
Longmont 282
Loveland 272A
Manitou Springs 274
Monte Vista 244A
Montrose, 231, 241
Oak Creek 280A
Pueblo 250, 255, 260,
264
Rocky Ford 240A
Salida 221A
Security 288A
Silverton 280A
Steamboat Springs
244A
Sterling 244A, 288A
Trinidad 224A
Vail 284
Walsenburg 272A

Connecticut

Bridgeport 260
Brookfield 236
Danbury 252A
Darien 240A
Groton 288A
Hamden 267
Hartford 229, 243, 275,
290, 295
Meriden 239
Middletown 285A
New Britain 263
New Haven 232A, 256
New London 265A
Norwich 249A
Stamford 244A
Waterbury 223, 281
Westport 300

Delaware

Bethany Beach 240A
Dover 234
Georgetown 228A
Milford 249A
Rehoboth Beach 224A
Seaford 252A
Willimantic 252A
Wilmington 229, 258

District of Columbia

Washington 230, 242,
246, 254, 258, 262,
266, 278, 297

Florida

Arcadia 252A
Avon Park 292A
Belle Glade 228A
Blountstown 272A
Boca Raton 260
Bonita Springs 240A

Bradentown 277
Cape Coral 280A
Chipley 249A
Clearwater 239, 250
Clewiston 292A
Cocoa 257A
Cocoa Beach 266, 281
Coral Gables 286
Crestview 285A
Crystal River 253
Daytona Beach 233, 270
Defuniak Springs 276A
DeLand 290
Delray Beach 274
Dunnellon 272A
Ft. Lauderdale 264, 278,
290, 294
Ft. Myers 237A, 245, 270
Ft. Pierce 238, 254
Ft. Walton Beach 257A
Gainesville 265A, 279,
288A
Green Cove Springs
224A
Hialeah 221A
Homestead 252A
Jacksonville 236, 241,
245, 256, 275, 283,
297
Jupiter 244A
Key West 223, 238,
296A
Lake City 232A
Lakeland 231
Leesburg 294
Lehigh Acres 296A
Live Oak 251
Marco 266
Madison 285A
Marathon 232A
Marianna 265A
Melbourne 272A, 292A,
296A
Miami 226, 242, 247,
256, 268, 298
Miami Beach 230, 235
Milton 274
Mount Dora 299
Naples 221A, 288A, 233
New Port Richey 288A
Ocala 224A, 229
Okeechobee 276A
Orlando 222, 243, 262,
286
Palatka 260
Palm Beach 250
Panama City 223, 253,
300
Pensacola 231, 264,
268, 297
Perry 288A
Plantation Key 262
Port Charlotte 261A
Port St. Joe 228A
Punta Gorda 224A
Quincy 269A
Riviera Beach 232A
St. Augustine 249A,
288A
St. Petersburg 258, 268,
297
Sanford 237A
Sarasota 273, 288A,
292A
Sebring 288A
Starke 292A
Stuart 224A
Tallahassee 235, 255,
276A, 281
Tampa 227, 235, 264,
284
Titusville 252A
Venice 221A
Vero Beach 288A
West Palm Beach 221A,
283, 300
Winter Haven 248
Winter Park 276A

Georgia

Albany 242, 269A, 283
Americus 232A, 249A
Athens 238, 284
Atlanta 225, 235, 241,
253, 259, 277

Key to FM Channels

Customary FCC terminology identifies FM frequencies by channel numbers from 201 to 300. Channels and frequency equivalents in megahertz are shown below. Asterisks indicate channels reserved for noncommercial use. The letter "A" designates channels set aside for Class A (local service) FM stations, limited to 3kw power and antenna 300 feet above average terrain for signal of comparable strength).

ch	fmhz	ch	fmhz
*201	88.1	251	98.1
*202	88.3	252A	98.3
*203	88.5	253	98.5
*204	88.7	254	98.7
*205	88.9	255	98.9
*206	89.1	256	99.1
*207	89.3	257A	99.3
*208	89.5	258	99.5
*209	89.7	259	99.7
*210	89.9	260	99.9
*211	90.1	261A	100.1
*212	90.3	262	100.3
*213	90.5	263	100.5
*214	90.7	264	100.7
*215	90.9	265A	100.9
*216	91.1	266	101.1
*217	91.3	267	101.3
*218	91.5	268	101.5
*219	91.7	269A	101.7
*220	91.9	270	101.9
221A	92.1	271	102.1
222	92.3	272A	102.3
223	92.5	273	102.5
224A	92.7	274	102.7
225	92.9	275	102.9
226	93.1	276A	103.1
227	93.3	277	103.3
228A	93.5	278	103.5
229	93.7	279	103.7
230	93.9	280A	103.9
231	94.1	281	104.1
232A	94.3	282	104.3
233	94.5	283	104.5
234	94.7	284	104.7
235	94.9	285A	104.9
236	95.1	286	105.1
237A	95.3	287	105.3
238	95.5	288A	105.5
239	95.7	289	105.7
240A	95.9	290	105.9
241	96.1	291	106.1
242	96.3	292A	106.3
243	96.5	293	106.5
244A	96.7	294	106.7
245	96.9	295	106.9
246	97.1	296A	107.1
247	97.3	297	107.3
248	97.5	298	107.5
249A	97.7	299	107.7
250	97.9	300	107.9

Augusta 272A, 276A,
282, 289
Bainbridge 247
Brunswick 264, 268
Buford 272A
Camilla 288A
Carrollton 221A
Cartersville 288A
Chatsworth 257A
Cochran 244A
Columbus 275, 285A,
297
Claxton 296A
Cordele 252A
Cornelia 257A
Covington 221A
Dawson 221A
Donaldsonville, 292A
Douglas 258, 294
Dublin 240A
Eastman 221A
Elberton 221A
Forsyth 261A
Fort Valley 292A
Gainesville 246, 294
Glennville 292A
Gordon 296A
Griffin 249A
Hazelhurst 228A

Hawkinsville 280A
Jesup 252A, 288A
La Grange 281
Louisville 221A
Macon 256, 287, 300
Manchester 227
Marietta 268
Metter 285A
Milledgeville 272A
Moultrie 230
Newnan 244A
Ocilla 249A
Perry 265A
Rockmart 296A
Rome 249A, 272A
Sandersville 232A
Savannah 226, 231, 238,
243, 247, 271
Smyrna 231
Sparta 228A
Statesboro 261A
Swainsboro 252A
Thomasville 296A
Thomson 269A
Tifton 262
Toccoa 291
Valdosta 225, 266, 240A
Vidalia 249A
Warner Robins 269A

Washington 261A
Waycross 273, 277
Waynesboro 265A

Hawaii

Hiilo, Hawaii 246, 250
Kealahou, Hawaii
221A
Honolulu, Oahu 226,
230, 234, 238, 248
Kailua, Oahu 242
Waipahu, Oahu 222
Lihue, Kauai 224A, 228A
Makawao, Maui 232A
Wailuku, Maui 236

Idaho

Alameda 285A
Blackfoot 249A
Boise 222, 250, 282, 286
Burley 252A
Caldwell 231, 276A
Coeur d'Alene 276A
Emmett 269A
Grangeville 224A
Idaho Falls 241, 256
Jerome 275
Lewiston 231, 244A
Moscow 280A
Mountain Home 257A
Nampa 235, 245
Orofino 237A
Payette 261A
Pocatello 229, 235
Preston 244A
Rexburg 232A
Rupert 221A
Salmon 224A
Sandpoint 237A
Soda Springs 261A
Sun Valley 228A
Twin Falls 239, 243
Wallace 274, 282
Weiser 265A

Illinois

Aledo 272A
Alton 262
Anna 224A
Arlington Heights 224A
Aurora 240A, 300
Beardstown 232A
Benton 292A
Bloomington 268
Canton 252A
Carbondale 268
Carmi 247
Carpentersville 280A
Carthage 221A
Centralia 237A
Champaign 233, 248
Charleston 221A
Clinton 240A
Chicago 226, 230, 234,
238, 242, 246, 250,
254, 258, 262, 266,
278, 282, 298

Chillicothe 232A
Clinton 240A
Crest Hill 252A
Danville 256, 271
Decatur 236, 275
DeKalb 223
Dixon 269A
DuQuoin 240A
East Moline 267
E. St. Louis 266
Effingham 239
Eldorado 272A
Elgin 232A
Elmwood Park 290
Evanston 286
Fairfield 285A
Flora 280A
Freeport 221A, 253
Galesburg 224A, 235
Geneseo 285A
Granite City 285A, 293
Harrisburg 260
Havana 257A
Highland Park 276A
Jacksonville 263
Jerseyville 281

FM Assignments

Joliet 228A, 244A
Kankakee 260, 272A
Kewanee 221A
Lansing 292A
LaSalle 257A
Lawrenceville 276A
Lincoln 261A
Litchfield 291
Loves Park 244A
Macomb 261A
Marion 297
Mattoon 245
Mendota 261A
Moline 245
Monmouth 249A
Monticello 288A
Morris 284
Morton 272A
Mount Carmel 235
Mount Vernon 231
Murphysboro 285A
Normal 244A
Oak Park 274
Olney 225
Ottawa 237A
Paris 253
Pekin 237A, 285A
Peoria 227, 289, 295
Peru 265A
Pineyville 280A
Pittsfield 249A
Plano-Sandwich 296A
Pontiac 276A
Quincy 258, 286
Rantoul 237A
Robinson 269A
Rochelle 272A
Rockford 248, 265A,
285A
Rock Island 255
Salem 261A
Savannah 261A
Shelbyville 285A
Skokie 254, 258, 262,
266, 270, 278, 282,
298
South Beloit 276A
Springfield 270, 279,
254
Sterling 232A
Streator 249A
Sullivan 292A
Taylorville 224A
Tuscola 228A
Urbana 280A, 296A
Vandalia 296A
Wasketka 231
Waukegan 272A, 294
West Frankfort 249A
Wilmington 288A
Woodstock 288A

Indiana

Anderson 250
Angola 261A
Aurora 257A
Batesville 280A
Bedford 288A
Berne 228A
Bloomfield 224A
Bloomington 222, 244A,
279
Bluffton 261A
Boonville 296A
Brazil 232A, 249A
Columbia City 292A
Columbus 268, 285A
Connersville 262
Crawfordsville 280A,
292A
Crown Point 280A
Danville 296A
Decatur 224A
Elkhart 264, 284
Elwood 269A
Evansville 281, 287
Fort Wayne 236, 246,
269A, 280A
Fowler 240A
Frankfort 259
Franklin 240A
French Lick 261A
Goshen 249A

FM Assignments

Greenfield 258
Greensburg 297
Hammond 222
Huntingburg 265A
Huntington 276A
Indianapolis 226, 234,
238, 277, 283, 289,
300
Jasper 284
Jeffersonville 239
Kendallville 227
Knox 257A
Kokomo 228A, 263
Lafayette 224A, 244A,
287
Laporte 244A
Lebanon 265A
Linton 228A
Logansport 237A, 272A
Lowell 296A
Madison 244A
Marion 285A, 295
Martinsville 272A
Michigan City 240A
Muncie 281
New Castle 273
North Vernon 291
Paoli 237A
Peru 252A
Plainfield 252A
Plymouth 232A
Portland 265A
Princeton 251
Rensselaer 249A
Richmond 241, 267
Rochester 221A
Rockville 285A
Rushville 232A
Salem 255
Scottsburg 265A
Seymour 229
Shelbyville 246
South Bend 225, 268,
276A, 289A
Sullivan 237A
Terre Haute 260, 264,
274, 298
Valparaiso 288A
Vevay 240A
Vincennes 244A
Wabash 240A
Warsaw 297
Washington 293
West Terre Haute 288A
Winchester 252A

Iowa

Algona 224A
Ames 281, 296A
Anamosa 232A
Atlantic 279
Boone 252A, 257A
Burlington 297
Carroll 224A, 229
Cedar Rapids 243, 251,
275, 283
Centerville 254
Charles City 240A
Cherokee 272A
Clarinda 292A
Clarion 245
Clear Lake 276A
Clinton 241, 249A
Creston 269A
Davenport 279, 293
Decorah 280A
Denison 296A
Des Moines 227, 235,
247, 262, 273
Dubuque 225, 272A, 287
Elkader 261A
Estherville 240A
Fairfield 240A
Forest City 272A
Fort Dodge 221A, 233
Fort Madison 269A
Grundy Center 249A
Hampton 285A
Humboldt 249A
Independence 237A
Iowa City 228A, 264
Iowa Falls 237A
Keokuk 237A

Knoxville 221A
Le Mars 258
Maquoketa 237A
Marshalltown 266
Mason City 252A, 291
Mount Pleasant 288A
Muscatine 259
Newton 240A
Oelwein 222
Onawa 292A
Oskaloosa 285A
Ottumwa 223, 249A
Pella 277
Perry 285A
Rockwell City 288A
Sheldon 288A
Sioux City 232A
Spencer 221A, 299
Storm Lake 268
Washington 237A
Waterloo 270, 289, 300
Waverly 257A
Webster City 240A

Kansas

Arkansas City 293
Chanute 288A
Coffeyville 232A
Colby 262
Concordia 237A
Derby 240A
Dodge City 230, 238
El Dorado 257A
Emporia 285A
Fort Scott 280A
Garden City 247
Goodland 273
Great Bend 282
Hays 277
Hutchinson 271, 275
Independence 269A
Ioia 257A
Junction City 233, 252A
Kansas City 231, 251
Larned 244A
Lawrence 290
Leavenworth 255
Liberal 257A, 288A
Lyons 291
Manhattan 269A
Marysville 276A
McPherson 244A
Newton 222
Oberlin 266
Ottawa 239
Parsons 228A
Phillipsburg 221A
Pittsburg 245
Pratt 226
Russell 240A
Salina 229, 260
Scott City 233
Topeka 247, 262, 295,
299
Wichita 236, 250, 267,
279, 297
Winfield 288A

Kentucky

Albany 292A
Ashland 229, 272A
Barbourville 228A
Bardstown 244A
Beattyville 272A
Benton 272A
Bowling Green 244A,
252A
Brandenburg 228A
Cadiz 292A
Campbellsville 280A
Carrollton 261A
Cattlettsburg 224A
Central City 270
Columbia 228A
Corbin 257A, 296A
Cynthiana 272A
Danville 296A
Elizabethtown 261A
Elkhorn City 276A
Erlanger 265A
Falmouth 237A
Fort Knox 288A
Frankfort 285A

Fullon 257A
Georgetown 276A
Glasgow 236, 288A
Greensburg 276A
Greenville 292A
Hardinsburg 232A
Harrodsburg 257A
Hartford 292A
Hazard 266
Henderson 258, 276A
Hindman 296A
Hodgenville 292A
Hopkinsville 254, 262
Jackson 249A
Jamestown 285A
Jeffersonton 269A
Jenkins 232A
Lancaster 292A
Lawrenceburg 265A
Leitchfield 285A
Lexington 233, 251, 255
Liberty 288A
London 280A
Louisville 248, 259,
272A, 276A, 280A,
295
Madisonville 230
Manchester 276A
Mayfield 234
Maysville 240A
Middlesboro 224A
Monticello 269A
Morehead 221A
Morganfield 237A
Mount Sterling 288A
Munfordville 272A
Murray 279
Neon 261A
Owensboro 223, 241
Paducah 227, 245
Paintsville 255
Paris 244A
Pikeville 221A
Pineville 292A
Prestonsburg 238, 288A
Princeton 285A
Providence 249A
Richmond 269A
Russellville 266
Somerset 244A
Stanford 240A
Stanton 285A
Tompkinsville 221A
Vanceburg 285A
Whitesburg 280A
Winchester 261A

Louisiana

Abbeville 285A
Alexandria 226, 245,
262
Bastrop 232A, 261A
Baton Rouge 251, 264,
268, 273
Bogalusa 300
Crowley 275
DeRidder 269A
Donaldsonville 285A
Eunice 288A
Farmerville 224A
Ferriday 296A
Franklin 237A
Golden Meadow 232A
Hammond 277, 296A
Houma 281, 296A
Jena 257A
Jennings 224A
Jonesboro 285A
Lafayette 233, 260
Lake Charles 241, 258,
279
Lake Providence 224A
Leesville 288A
Mansfield 224A
Many 296A
Marksville 249A
Minden 237A
Monroe 270, 281, 291
Morgan City 244A
Natchitoches 249A
New Iberia 256
New Orleans 222, 227,
239, 246, 253, 258,
266, 270
Oakdale 285A
Oak Grove 244A

Opelousa 296A
Port Sulphur 294
Ruston 298
Shreveport 229, 233,
243, 261A, 266
Slidell 287
Springhill 224A
Sulphur 265A
Tallulah 285A
Thibodaux 292A
Ville Platte 228A
West Monroe 252A
Winfield 221A
Winnsboro 240A

Maine

Auburn 261A
Augusta 267, 282
Bangor 225, 246
Bath 237A
Biddeford 232A
Brunswick 255
Calais 224A
Caribou 249A
Dover-Foxcroft 276A
Ellsworth 232A, 239
Farmington 257A
Houlton 261A
Lewiston 230, 298
Lincoln 257A
Machias 237A
Madawaska 272A
Millinocket 249A
Norway 224A
Portland 226, 250, 270,
275
Presque Isle 237A, 241,
245
Rockland 228A
Rumford 242
Saco 292A
Sanford 221A
Skowhegan 294
South Paris 224A
Waterville 252A
Westbrook 265A

Maryland

Annapolis 256, 300
Baltimore 222, 226, 236,
250, 270, 274, 282,
293
Bethesda 234, 272
Braddock Heights 280A
Cambridge 292A
Catonsville 289
Cumberland 275, 291
Easton 244A
Frederick 260
Frostburg 287
Glen Burnie 240A
Hagerstown 284, 295
Halfway 244A
Havre de Grace 279
Leonardtown 249A
Oakland 238
Oakland (Western) 221A
Ocean City 260, 284
Pocomoke City 273
Prince Frederick 224A
Salisbury 232A
Waldorf 281
Westminster 264
Williamsport 240A

Massachusetts

Amherst 265A
Barnstable 260
Boston 233, 245, 253,
264, 277, 281, 294
Brockton 249A
Brookline 225
Cambridge 237A
Falmouth 270
Fitchburg 283
Framingham 289
Gloucester 285A
Greenfield 252A
Haverhill 223
Hyannis 291
Lawrence 229
Lowell 258
Lynn 269A
Marshfield 240A
Medford 300

New Bedford 247, 251
North Adams 261A
North Attleboro 227
Northampton 257A
Orleans 284
Pittsfield 240A, 269A,
288A
Plymouth 256
Southbridge 261A
Springfield 226, 234,
271
Tisbury 224A
Waltham 273
West Yarmouth 235
Winchendon 249A
Worcester 241, 297

Michigan

Adrian 237A, 280A
Albion 244A, 285A
Alma 285A
Alpena 228A, 299
Ann Arbor 296A
Bad Axe 221A
Battle Creek 237A, 277
Bay City 241, 273
Benton Harbor 260
Big Rapids 265A
Birmingham 234
Boyer City 228A
Cadillac 225, 244A
Caro 285A
Charlottesville 224A
Cheboygan 286
Clare 237A
Coldwater 253
Dearborn 262
Detroit 226, 238, 242,
246, 250, 254, 258,
266, 270, 278, 282,
286, 290, 294, 298
Dowagiac 221A
East Lansing 235, 256
Escanaba 246, 284
Flint 224A, 236, 288A,
300
Fremont 261A
Gaylord 273A, 294
Grand Haven 221A
Grand Rapids 229, 239,
245, 250, 267, 275,
281, 289
Grayling 261A
Greenville 297
Hancock 228A
Harrison 221A
Hastings 261A
Hillsdale 221A
Holland 233, 241
Houghton 249A
Houghton Lake 253
Hutchinson 296A
Ishpeming 222, 296A
Iron Mountain 280A
Iron River 244A
Ironwood 259, 295
Jackson 231, 291
Kalamazoo 271, 293
Lansing 248, 264, 269A
Lapeer 276A
Lincoln Park 222
Ludington 292A
Mackinaw City 232A
Manistee 249A
Marquette 239, 261A
Menominee 292A
Midland 228A, 259
Mt. Clemens 274
Mt. Pleasant 233
Munising 252A
Muskegon 283, 295
Muskegon Heights 269A
Niles 237A
Ostego 265A
Owosso 280A
Petoskey 244A, 255
Port Huron 296A
Rogers City 249A
Saginaw 251, 292A,
296A
St. Helen 288A
St. Ignace 272A
St. Johns 221A
St. Joseph 296A
Saline 275
Sandusky 249A

Sault Ste. Marie 258, 267
South Haven 252A
Sturgis 257A
Tawas City 269A
Three Rivers 240A
Traverse City 221A, 270,
278
Whitehall 237A
Zeeland 257A

Minnesota

Aitkin 232A
Albany 288A
Albert Lea 237A
Alexandria 224A, 264
Anoka 300
Austin 260
 Bemidji 266
Benson 228A
Blue Earth 265A
Brainerd 239
Breckenridge 285A
Cambridge 288A
Cloquet 285A
Crookston 241, 246
Detroit Lakes 237A
Duluth 225, 235, 255,
273, 277, 286
East Grand Forks 280A
Ely 221A
Eveleth 261A
Charlton 293
Faribault 240A
Fergus Falls 243, 277
Fosston 296A
Golden Valley 223
Grand Rapids 244A
Hibbing 292A
Hutchinson 296A
International Falls 232A
Litchfield 237A
Little Falls 221A
Luverne 265A
Mankato 256, 278
Marshall 261A
Minneapolis 229, 246,
253, 258, 262, 267,
275
Montevideo 288A
Moorhead 254, 260
Morris 298
New Ulm 226
Ortonville 292A
Owatonna 285A
Park Rapids 248
Pine City 221A
Pipestone 254
Preston 276A
Princeton 292A
Red Wing 288A
Redwood Falls 249A
Rochester 244A, 248,
269A, 295
St. Cloud 251, 284
St. Louis Park 281
St. Paul 233, 237A, 271
St. Peter 228A
Sauk Centre 232A
Sauk Rapids 269A
Thief River Falls 257A
Virginia 296A
Wadena 290
Waseca 221A
Willmar 273
Windom 232A
Winona 237A
Worthington 236

Mississippi

Aberdeen 288A
Amory 237A
Bay Springs 228A
Biloxi 229
Booneville 257A
Brandon 249A
Brookhaven 221A
Calhoun City 272A
Canton 269A
Carthage 252A
Centerville 285A
Charleston 232A
Clarksdale 269A, 276A
Cleveland 224A, 280A
Clinton 228A

Columbia 244A
Columbus 276A, 280A
Corinth 232A, 237A
Drew 237A
Europa 269A
Forest 223
Fulton 269A
Greenville 250, 264
Greenwood 256
Grenada 261A
Guilford 244A, 272A,
296A
Hattiesburg 221A, 279,
283
Hazelhurst 265A
Holly Springs 224A
Houston 227
Indianola 288A
Iuka 285A
Jackson 234, 238, 242,
259, 275
Kosciusko 286
Laurel 262A, 272A
Leland 232A
Lexington 292A
Louisville 296A
Macon 280A
Magee 298
McComb 231, 289
Meridian 246, 267
Moss Point 285A
Natchez 236
Newton 292A
New Albany 278, 292A
Ocean Springs 276A
Oxford 248
Pascagoula 256, 292A
Philadelphia 272A
Picayune 292A
Pontotoc 244A
Prestiss 252A
Quitman 252A
Ripley 272A
Sardis 240A
Senatobia 237A
Starkville 221A, 292A
Tupelo 253
Tylertown 249A
Vicksburg 254, 294
Waynesboro 288A
West Point 265A
Winona 244A
Yazoo City 212A

Missouri
Aurora 261A
Bethany 240A
Boliva 292A
Boonville 257A
Bowling Green 265A
Branson 292A
Brookfield 249A
Butler 221A
Cabool 292A
Canton 272A
Cape Girardeau 264,
275
Carrollton 266
Carthage 285A
Caruthersville 276A
Chillicothe 280A
Clayton 256
Clinton 237A
Columbia 244A, 252A
Crestwood 234
Dexter 272A
Doniphan 249A
Eldon 224A
Eldorado Springs 288A
Farmington 253
Fulton 249A
Greenfield 228A
Hannibal 225
Harrisonville 264
Houston 257A
Jefferson City 261A, 295
Joplin 223, 273
Kansas City 227, 235,
243, 259, 271, 277,
282
Kennett 255
Kirksville 228A, 233
Lebanon 221A, 279
Lexington 297
Liberty 223
Malden 224A

Marshall 275
Maryville 237A
Mexico 239
Moberly 284
Monett 240A
Mountain Grove 224A
Osage Beach 228A
Poplar Bluff 233, 238
Portageville 292A
Potosi 261A
Rolla 232A, 287
St. Genevieve 289
St. Charles 246
St. Joseph 286

St. Louis 222, 229, 242,
251, 273, 277, 299
Salem 240A
Sedalia 221A
Sikeston 249A
Springfield 234, 247,
254, 268
Sullivan 265A
Thayer 244A
Trenton 221A
Union 269A
Waynesville 249A, 272A
West Plains 230, 272A
Willow Springs 261A

Montana
Anaconda 249A
Baker 265A
Belgrade 244A
Billings 227, 246, 253
Bozeman 229
Butte 231, 238
Dillon 252A
Glasgow 228A
Glendive 243
Great Falls 225, 233,
255, 292A
Hamilton 240A
Hardin 237A
Havre 223, 236
Helena 221A, 276A
Kalispell 246, 253
Lewistown 240A
Libby 269A
Livingston 249A
Miles City 224A
Missoula 227, 235, 261A
Plentywood 261A
Red Lodge 257A
Scobey 239
Shelby 242, 250
Sidney 226, 236
Wolf Point 224A

Nebraska
Alliance 221A
Auburn 288A
Aurora 276A
Beatrice 225
Broken Bow 252A
Chadren 228A, 234
Columbus 228A, 266
Crete 280A
Fairbury 257A
Fremont 288A
Grand Island 239, 243
Hastings 228A
Holdrege 249A
Kearney 255, 272A
Kimball 261A
Lexington 226
Lincoln 237A, 270, 274,
292A, 297
McCook 240A, 276A
Nebraska City 249A
Norfolk 294
North Platte 235, 246
Ogallala 228A
Omaha 222, 231, 241,
253, 260, 264, 283
O'Neill 224A
Ord 280A
Scottsbluff 225, 231
Seward 245
Sidney 237A
Superior 280A
Terrytown 265A
Valentine 241
Wayne 285A
York 285A

Nevada
Carson City 234, 247
Eiko 228A, 237A
Ely 224A
Mountain 257A
Henderson 231, 238
Las Vegas 222, 226,
246, 253, 270
Reno 238, 283, 289, 295
Sparks 252A
Tonopah 224A
Winnemucca 224A

New Hampshire
Berlin 241, 279
Claremont 291
Concord 272A
Conway 228A
Dover 248
Exeter 296A
Hanover 257A
Keene 279
Laconia 252A
Manchester 239, 266
Mt. Washington 235
Nashua 292A
Newport 269A
Peterborough 221A
Plymouth 261A, 287
Portsmouth 262
Rochester 244A

New Jersey
Asbury 232A
Atlantic City 236, 245,
279
Avalon 232A
Blairtown 292A
Bridgeton 299
Camden 295
Canton 269A
Cape May 272A
Dover 288A
Eatontown 292A
Egg Harbor City 285A
Franklin 272A
Long Branch 296A
Millville 247
Newark 234, 262, 290
New Brunswick 252A
Newton 279
Ocean City 292A
Paterson 226
Pleasantville 257A
Point Pleasant 240A
Princeton 277
Ship Bottom 261A
Toms River 224A
Trenton 233, 248, 268
Vineland 221A
Wildwood 264
Zarephath 256

New Mexico
Alamogordo 232A, 288A
Albuquerque 222, 227,
231, 242, 258, 262,
300
Artesia 225
Aztec 235
Belen 249A
Carlsbad 221A
Clayton 228A
Clovis 256, 260
Deming 232A
Española 272A
Eunice 265A
Farmington 225, 245
Gallup 229, 233
Grants 237A
Hobbs 231, 239
Jal 296A
Las Cruces 276A, 280A
Las Vegas 265A
Lordsburg 249A
Los Alamos 253
Lovington 269A
Mesilla Park 285A
Portales 237A
Raton 232A
Roswell, 235, 246
Ruidoso 228A
Santa Fe 238, 247
Santa Rosa 240A
Silver City 224A

Socorro 224A
Taos 257A
Truth or Consequences
244A
Tucumcari 224A
Tularosa 224A

New York
Albany 238, 265A,
276A, 280A, 293, 299
Amsterdam 249A, 285A
Attica 269A
Auburn 295
Babylon 232A, 272A
Baldwinsville 221A
Ballston Spa 244A
Bath 252A
Bay Shore 276A
Binghamton 251, 256
Buffalo 225, 233, 241,
245, 258, 273, 277,
281, 293
Canadaigua 272A
Cazenovia 237A
Cherry Valley (Otsego
Co.) 270
Corning 291
Corlاند 260
Dewey 229
De Ruyter 286
Dundee 240A
Ellenville 257A
Elmira 224A, 232A
Endicott 289
Fulton 284
Garden City 224A
Geneva 269A
Glens Falls 240A, 296A
Gouverneur 224A
Hempstead 252A
Herkimer 224A
Hornell 221A, 287
Horseheads 265A
Hudson 228A
Ithaca 228A, 247, 279
Jamestown 227, 269A
Kingston 232A, 249A
Lake Success 278
Liberty 240A
Little Falls 288A
Middletown 224A
Monticello 252A
Mountour Falls 285A
Mt. Kisco 292A, 296A
Newburgh 276A
New Rochelle 228A
New York 222, 230, 238,
242, 246, 250, 258,
266, 270, 274, 282,
286, 294, 298
Niagara Falls 253
Norwich 230
Ogdensburg 244A
Olean 239, 265A
Oneonta 276A, 280A
Oswego 288A
Owego 269A
Pachogue 248, 291
Patterson 288A
Peekskill 264
Plattsburgh 260
Port Jervis 244A
Potsdam 257A
Poughkeepsie 268, 284
Pulaski 269A
Riverhead 280A
Rochester 223, 243, 250,
255, 263, 267, 280A
Rome 240A
Sag Harbor 221A
Salamanca 261A
Saratoga Lake 237A
Saratoga Springs 272A
Schnechtady 258
Seneca Falls 257A
South Bristol Twp.
(Ontario Co.) 236
Southampton 237A
Southold 269A
Syracuse 226, 233,
265A, 275, 300
Troy 222
Utica 245, 254, 282, 297
Walton 221A

Watertown 248
Weathersfield Twp.
(Wyoming Co.) 299
Wellsville 228A
Westhampton Beach
296A
White Plains 280A

North Carolina
Ahoskie 257A
Albemarle 265A
Asheboro 222
Asheville 260
Belhaven 221A
Black Mountain 295
Burlington 230, 266
Charlotte 236, 279, 284,
300
Clinton 296A
Concord 250
Dunn 276A
Durham 286, 296A
Eden 233
Edenton 261A
Elizabeth City 229
Elkin 265A
Fairmont 265A
Farmville 232A
Fayetteville 251
Forest City 227
Franklin 244A
Fuquay-Varina 280A
Gastonia 270
Goldsboro 245, 272A
Greenville 299
Greensboro 246, 254
Havelock 285A
Henderson 223
Hendersonville 273
Hickory 239, 275
High Point 238, 258, 262
Jacksonville 221A, 288A
Kannapolis 259
Kingston 236, 249A
Kinston 236
Laurinburg 243
Lexington 231
Lumberton 239, 272A
Morehead City-Beaufort
240A, 277
Morganton 221A
Moyock 221A
Murfreesboro 252A
Murphy 280A
New Bern 270, 293
North Wilkesboro 247
Plymouth 240A
Raleigh 234, 241, 268
Reidsville 271
Roanoke Rapids 272A
Rocky Mount 221A, 264
Roxboro 244A
Salisbury 293
Sanford 288A
Shelby 241
Southern Pines 296A
Southport 296A
Statesville 245, 289
Tabor City 285A
Tarboro 282
Thomasville 252A
Wallace 232A
Wanchese 237A
Washington 227
Whiteville 256
Williamston 279
Wilmington 247, 260,
265A, 274
Wilson 291
Winston-Salem 226,
281, 298

North Dakota
Bismarck 225, 233
Bottineau 270
Carrington 249A
Devils Lake 244A
Dickinson 221A
Fargo 229, 250
Grand 265A
Grafton 225, 234
Hettinger 228A
Jamestown 227, 238

Mandan 285A
Mayville 269A
Minot 229, 246
Oakes 252A
Rugby 237A
Tioga 280A
Valley City 265A
Williston 241, 253

Ohio
Akron 243, 248
Alliance 223
Ashland 267
Ashtabula 246
Athens 252A, 288A
Barberton 235
Bellaire 263
Bellevue 252A
Bellefontaine 221A
Bowling Green 228A
Bryan 265A
Bucyrus 224A
Cambridge 244A
Canton 231, 251, 295
Celena 232A, 244A
Chillicothe 227, 232A
Cincinnati 223, 227, 231,
253, 270, 274, 286
Circleville 296A
Cleveland 226, 238, 253,
258, 264, 271, 277,
281, 289, 293, 300
Cleveland Heights 222
Columbus 222, 234, 242,
246, 250, 259, 288A
Conneaut 288A
Coshocton 257A
Dayton 256, 284, 299
Defiance 240A
Delphos 296A
Dover 269A
East Liverpool 282
Eaton 225
Elyria 297
Findlay 263
Fostoria 244A
Fremont 256
Galion 272A
Gallipolis 268
Georgetown 249A
Greenville 293
Hamilton 235, 243, 278
Hillsboro 294
Ironton 296A
Jackson 249A
Johnston 276A
Kent 261A
Kenton 237A
Kettering 260
Lancaster 238
Lima 249A, 271, 285A
London 292A
Lorain 285A
Mansfield 287, 291
Marietta 232A
Marion 232A, 295
Miamisburg 229
Middleport 221A
Middletown 290
Milford 296A
Mt. Vernon 229
Napoleon 276A
New Albany 280A
Newark 262, 269A
New Philadelphia 240A
Norwalk 237A
Oxford 249A
Piqua 239
Port Clinton 233
Portsmouth 257A, 281
Salem 286
Sandusky 249A, 274
Sidney 288A
Springfield 264, 275
Stuebenville 278
Tiffin 279
Toledo 223, 252A, 260,
268, 272A, 284, 288A
Upper Sandusky 240A
Urbana 269A
Van Wert 255
Wapakoneta 221A
Wash. Ct. House 288A

FM Assignments

Waverly 265A
Wellston 244A
Westerville 280A
Wilmington 272A
Wooster 283
Xeniz 237A, 280
Youngstown 227, 255, 266
Zanesville 273

Oklahoma

Ada 227
Altus 228A
Alva 259, 284
Ardmore 221A, 239
Bartlesville 261A
Bethany 285A
Bristow 265A
Broken Arrow 221A
Chickasha 288A
Clinton 237A, 295
Duncan 272A
Durant 296A
Edmond 249A
Elk City 232A
Enid 245
Eufaula 272A
Frederick 240A
Guymon 224A
Henryetta 258
Hobart 257A
Hugo 237A
Idabel 244A
Lawton 251, 268
Madill 285A
McAlester 267
Miami 265A
Muskogee 269A
Norman 292A
Oklahoma City 223, 234, 241, 255, 263, 270, 274, 281, 299
Okmulgee 285A
Pauls Valley 249A
Pawhuska 272A
Ponca City 257A, 265A
Poteau 250, 297
Pryor 283
Sallisaw 240A
Seminole 288A
Stillwater 230, 288A
Sulphur 265A
Tahlequah 269A
Tulsa 225, 238, 243, 248, 253, 277
Weatherford 247
Woodward 228A

Oregon

Albany 300
Ashland 269A
Astoria 225
Baker 237A
Bend 231, 264
Brookings 237A
Burns 224A
Coos Bay 252A, 288A
Coquille 272A
Corvallis 268, 291
Cottage Grove 244A
Enterprise 244A
Eugene 233, 241, 250, 256
Gold Beach 224A
Grant's Pass 245, 260
Hermiston 257A
Hood River 288A
Klamath Falls 223, 253
La Grande 252A
Lakeview 228A
Lebanon 279
Medford 229, 237A
Newport 273
North Bend 265A
Oceanlake 244A
Ontario 226, 241
Oregon City 294
Pendleton 278, 299
Portland 222, 229, 238, 246, 253, 258, 262, 266, 270, 277
Prineville 237A

Redmond 224A
Roseburg 276A
Salem 286
Springfield 226
The Dalles 283
Tillamook 281
Toledo 296A

Pennsylvania

Allentown 264, 281
Altoona 251, 261A, 285A
Beaver Falls 294
Bedford 265A
Bethlehem 236
Chambersburg 236
Bloomsburg 293
Boyerstown 298
Braddock 245
Bradford 280A
Butler 249A
Carbondale 232A
Carlisle 228A
Central City 269A
Chambersburg 236
Charleroi 252A
Clearfield 228A
Columbia 224A
Connellsville 280A
Coudersport 244A
Danville 244A
DuBois 271, 297
Easton 241, 260
Ebensburg 256
Elizabethtown 294
Ellwood City 221A
Emporium 224A
Ephrata 286
Erie 260, 272A, 279, 292A
Franklin 257A
Gettysburg 299
Greensburg 296A
Greenville 296A
Grove City 236
Harrisburg 235, 247, 257A, 281
Hazleton 250
Huntington 292A
Indiana 276A
Jenkintown 280A
Johnstown 221A, 238, 243
Kane 276A
Lancaster 233, 245, 267
Lebanon 261A
Lewistown 240A
Linsville 269A
Lock Haven 221A
Martinsburg 224A
Meadville 262
Media 262
Mercersburg 221A
Mifflinburg 252A
Milton 265A
Montrose 243
Naticoke 221A
New Kensington-Tarentum 264
North East 265A
Oil City 253
Palmyra 221A
Philadelphia 223, 227, 231, 239, 243, 251, 255, 266, 271, 275, 283, 287, 291
Pittsburgh 225, 229, 233, 241, 259, 268, 273, 284, 290, 300
Pottsville 270
Punxsutawney 288A
Reading 273
Red Lion 241
St. Mary's 232A
Sayre 272A
Scranton 267, 285A, 296A
Shamokin 237A
Sharon 275, 280A
Sharpsville 240A
Shenandoah 288A
Shippensburg 232A
Somerset 249A
South Williamsport 257A

State College 244A, 276A
Stroudsburg 228A
Sunbury 231
Towanda 237A
Tyone 266
Uniontown 257A
Warren 222
Washington 237A
Waynesboro 268
Wellsboro 283
White Haven 276A
Wilkes-Barre 225, 253
Williamsport 274, 286
York 253, 277, 289

Rhode Island

Newport 296A
Providence 222, 231, 238, 268, 286
Westerly 279
Woonsocket 292A

South Carolina

Aiken 240A, 257A
Anderson 266, 297
Bamberg 224A
Barnwell 269A
Batesburg 221A
Beaufort 254
Camden 232A
Cayce 244A
Charleston 236, 245, 278
Cheraw 276A
Chester 257A
Columbia 228A, 250, 261A, 284
Conway 281
Dillon 225
Easley 280A
Florence 288A, 292A
Gaffney 287
Georgetown 249A, 292A
Greenville 223, 229, 233
Greenwood 244A
Hampton 276A
Hilton Head Island 292A
Honea Path 276A
Kingstree 252A
Lake City 261A
Lancaster 296A
Laurens 263
Manning 221A
Marion 232A
Moncks Corner 288A
Mullins 296A
Myrtle Beach 221A, 269A
North Charleston 273
North Myrtle Beach 288A
Orangeburg 280A, 294
Pageland 272A
St. George 298
Seneca 251
Spartanburg 255
Summerville 228A
Sumter 267
Walterboro 265A

South Dakota

Aberdeen 231, 235
Belle Fourche 240A
Brookings 232A
Deadwood 226, 236
Gregory 268
Hot Springs 244A
Huron 221A
Madison 276A
Mitchell 272A
Mobridge 258
Pierre 224A, 237A
Rapid City 230, 250, 262
Sioux Falls 223, 228A, 243, 247, 284
Vermillion 272A
Watertown 241, 245
Winner 229
Yankton 262, 281

Tennessee

Athens 252A
Bolivar 244A
Bristol 245
Camden 252A
Carthage 272A
Centerville 244A

Chattanooga 222, 243, 288A, 293
Clarksville 300
Cleveland 264
Clinton 285A
Columbia 269A
Cookeville 232A, 252A
Covington 228A
Crossville 257A
Dayton 285A
Dickson 272A
Donelson 221A
Dyersburg 271A
Elizabethtown 257A
Erwin 280A
Fayetteville 288A
Franklin 261A
Gallatin 283
Germantown 232A
Greeneville 235
Harriman 224A
Humboldt 272A
Huntingdon 265A
Jackson 276A, 281
Jamestown 280A
Jefferson City 257A
Johnson City 268
Kingsport 253, 285A
Knoxville 248, 278, 299
Lafayette 257A
LaFollette 288A
Lawrenceburg 240A
Lebanon 297
Lenoir City 228A
Lewisburg 232A
Lexington 257A
Livingston 240A
Lobelville 232A
Manchester 259
Memphis 246, 259, 266, 274, 283, 290
Morristown 240A
Murfreesboro 242
Nashville 225, 238, 250, 277, 290
Oak Ridge 232A, 262C
Paris 288A
Pulaski 252A
Red Bank City 232A
Ripley 237A
Savannah 269A
Sevierville 271
Shelbyville 275
Smithville 269A
Soddy-Daisy 272A
Sparta 288A
Springfield 232A
Sweetwater 237A
Tulahoma 227
Union City 285A
Waverly 285A

Texas

Abilene 257A, 264, 286, 300
Alice 221A, 272A
Alpine 224A
Alvin 271
Amarillo 226, 231, 250, 254, 270
Andrews 288A
Arlington 235
Atlanta 257A
Austin 229, 238, 252A, 264, 272A
Ballinger 276A
Bay City 245
Beaumont 231, 236, 248, 299
Beeville 285A
Belton 292A
Big Lake 252A
Big Spring 237A
Bishop 296A
Bonham 252A
Borger 282
Brady 237A
Breckenridge 228A
Brenham 292A
Brownfield 280A
Brownsville 226, 262
Brownwood 257A, 268, 281
Bryan 252A
Burnet 296A
Cameron 269A

Canton 244A
Canyon 296A
Carrizo Springs 228A
Center 272A
Childress 244A
Cleveland 295
Coleman 296A
College Station 221A
Colorado City 292A
Columbus 252A
Comanche 232A
Corpus Christi 230, 238, 243, 256, 260
Corsicana 300
Cotulla 249A
Crane 265A
Crockett 224A
Crystal City 272A
Cuero 249A
Dalhart 240A
Dallas 223, 250, 254, 262, 266, 275, 279, 283, 287
Del Rio 232A
Denison 269A
Denton 291
Devine 221A
Diboll 238
Dumas 237A
Eagle Pass 224A
Eastland 244A
Edinburg 281, 300
El Paso 222, 226, 230, 234, 238, 242, 248, 260, 271
Fabens 276A
Fairlurris 292A
Farwell 252A
Floresville 232A
Floydada 237A
Fort Stockton 232A
Fort Worth 230, 242, 246, 258, 271, 298
Fredericksburg 266
Freer 240A
Gainesville 233
Galveston 293
Gatesville 252A
Georgetown 244A
Gonzales 292A
Graham 296A
Greenville 228A
Hamilton 221A
Harlingen 233, 241
Hebbronville 269A
Henderson 261A
Hereford 292A
Hillsboro 273
Houston 229, 233, 239, 243, 250, 256, 262, 266, 275, 281, 289
Huntsville 269A
Jacksonville 293
Jasper 272A
Junction 228A
Kenedy-Karnes 221A
Kermit 292A
Kerrville 232A
Kilgore 240A
Killeen 227
Kingsville 224A, 249A
La Grange 285A
Lake Jackson 297
Lamesa 262, 284
Lampasas 257A
Laredo 224A, 235, 251
Levelland 288A
Livingston 221A
Llano 285A
Longview 289
Lubbock 229, 233, 242, 258, 266, 273
Lufkin 257A, 286
Marfa 228A
Marlin 244A
Marshall 280A
Mathis 252A
McAllen 245, 253
McCamey 237A
McKinney 237A
Memphis 279
Mercedes 292A
Merkel 272A
Mexia 285A
Midland 222, 227, 277
Mineral Wells 240A
Mission 288A

Monahans 260, 271
Mt. Pleasant 264A
Muleshoe 276A
Nacogdoches 221A, 277
New Boston 240A
New Braunfels 221A
Odessa, 245, 250, 256
Orange 283, 291
Ozona 232A
Palestine 232A, 252A
Pampa 262
Paris 257A
Pasadena 223
Pecos 252A
Perryton 240A
Plainview 247
Pleasanton 252A
Port Arthur 227, 253
Port Lavaca 240A, 2
Premon 285A
Quanah 265A
Ralls 252A
Raymondville 269A
Refugio 292A
Rio Grande City 249A
Rockport 272A
Rosenberg 285A
Rusk 249A
San Angelo 225, 230, 234, 248

San Antonio 225, 241, 247, 258, 262, 270, 274, 283, 298
San Marcos 279
San Saba 244A
Seguin 287
Seminole 292A
Seymour 232A
Shamrock 224A
Sherman 244A
Silsbee 269A
Sinton 267, 277
Slaton 224A
Snyder 269A
Sonora 221A
Spearman 252A
Stamford 221A
Stephenville 252A
Sweetwater 244A
Taft 288A
Taylor 221A
Temple 285A
Terrell 296A
Terrell Hills 292A
Texarkana 251, 273
Tulia 285A
Tyler 226, 221A, 268
Uvalde 237A
Vernon 272A
Victoria 236, 254, 300
Waco 238, 248, 260, 296A
Westlake 285A
Wichita Falls 225, 260, 277
Winnsboro 285A

Utah

Blanding 221A
Bountiful 288A
Brightman City 296A
Cedar City 223, 235
Logan 225, 233
Moab 244A
Ogden 238, 250, 266, 270
Orem 296A
Price 252A
Provo 235, 241
Richfield 229
St. George 228A
Salt Lake City 227, 231, 246, 254, 262, 278, 282
Spanish Fork 292A
Tooele 221A
Vernal 224A

Vermont

Barre 296A
Bennington 232A
Brattleboro 224A, 244A
Burlington 225, 255
Middlebury 265A
Montpelier 244A, 276A

Newport 300
Rutland 246, 251
St. Albans 272A
Springfield 228A
Waterbury 269A
White River Junction
237A

Virginia

Abington 224A
Altavista 288A
Appomattox 296A
Arlington 286
Ashland 261A
Big Stone Gap 228A
Blacksburg 285A
Blackstone 228A
Charlottesville 237A,
248
Chesapeake-
Portsmouth-
Virginia Beach 235
City of Nansemond 295
Clarksville 252A
Clifton Forge 280A
Covington 265A
Crewe 284
Culpeper 276A
Danville 277
Exmore 298
Farmville 239
Fredericksburg 227, 268
Front Royal 257A
Galax 251
Gretna 292A
Grundy 249A
Hampton 267
Harrisonburg 282
Hopewell 221A
Kilmarnock 269A
Lawrenceville 288A
Luray 280A, 292A
Lynchburg 252A, 261A,
269A
Manassas 294
Marion 230, 272A
Martinsville 242
Norfolk-Newport News
. 225, 239, 247, 254,
259, 263, 275, 283,
287
Norton 292A
Orange 244A
Pennington Gap 288A
Petersburg 237A, 257A
Pulaski 296A
Radford 269A
Richlands 288A
Richmond 233, 251, 271,
279, 293
Roanoke 222, 235, 256
Salem 228A
South Boston 248

Staunton 228A
Tappahannock 288A
Tasley 277
Tazewell 261A
Warrenton 232A, 299
Warsaw 265A
Williamsburg 243
Winchester 223, 273
Woodbridge 290
Yorktown 231

Washington

Aberdeen 284
Bellingham 225, 282
Bremerton 295
Centralia 275
Chelan 228A
Colfax 272A
Colville 221A
Edmonds 287
Ellensburg 237A
Ephrata 240A
Grand Coulee 253, 266
Hoquiam 280A
Kennewick 287
Longview 288A
Lynden 293
Moses Lake 262
Omak 224A
Opportunity 241
Othello 249A
Prosser 269A
Pullman 285A
Quincy 276A
Richland 274, 292A
Seattle 223, 227, 231,
235, 239, 243, 251,
255, 260, 264, 268,
264, 268, 273, 299
Spokane 225, 229, 251,
255, 260, 289, 300
Sunnyside 244A
Tacoma 247, 280A, 291
Toppenish 224A
Walla Walla 227, 246
Wenatchee 271, 285A
Yakima 233, 252A, 281,
297

West Virginia

Bath (Berkeley Springs)
228A
Beckley 258, 279
Bluefield 283, 292A
Charleston 241, 248,
260, 274
Charles Town 252A
Clarksburg 224A, 285A,
293
Fairmont 250, 276A
Grafton 265A
Huntington 263, 277,
300

Hurricane 292A
Keyser 231
Logan 270
Martinsburg 248
Montgomery 265A
Morgantown 261A, 270
Moundsville 288A
New Martinsville 280A
Oak Hill 231, 290
Parkersburg 236, 257A,
276A
Princeton 240A
Ronceverte 288A
St. Albans 286
Weston 272A
Wheeling 247, 254, 298
Williamson 243

Wisconsin

Antigo 285A
Appleton 289
Ashland 240A
Beaver Dam 237A
Beloit 237A
Berlin 272A
Chippewa Falls 288A
Dodgeville 257A
Durand 240A
Eagle River 232A
Eau Claire 231, 264, 283
Fond du Lac 296A
Fort Atkinson 297
Green Bay 252A, 266
Greenfield Township 235
Hartford 285A
Hayward 221A
Janesville 260
Kaukauna 285A
Kenosha 236, 245
Kewaunee 224A
LaCrosse 227, 240A,
285A
Ladysmith 279
Madison 251, 268, 273,
281
Manitowoc 221A, 272A
Marinette 236
Marshfield 293
Mauston 221A
Medford 257A
Menomonee Falls 252A
Menomonie 221A
Merrill 228A
Middleton 292A
Milwaukee . 227, 233,
239, 243, 247, 256,
271, 275, 299
Minocqua 240A
Monroe 229
Neenah-Menasha 232A,
261A
Neillsville 298

New London 228A
New Richmond 296A
Oconto 296A
Oshkosh 244A, 280A
Park Falls 252A
Platteville 296A
Portage 261A
Port Washington 261A
Prairie du Chien 232A
Racine 221A, 264
Reedsburg 285A
Rhinelander 248, 300
Rice Lake 242
Richland Center 265A
Ripon 240A
River Falls 292A
Sauk City 244A
Shawano 257A, 274
Sheboygan 249A
Shell Lake 237A
Sparta 246
Stevens Point 250
Sturgeon Bay 230, 240A
Sun Prairie 221A
Tomah 255
Tomahawk 261A
Viroqua 272A
Watertown 231
Waupun 257A
Wausau 238, 270
Wauwatosa 279
West Bend 223
Wisconsin Dells 296A
Wisconsin Rapids 277

Wyoming

Buffalo 224A
Casper 233, 238
Cheyenne 250, 292A
Cody 232A
Douglas 221A
Evanston 292A
Gillette 228A
Jackson 245
Lander 248
Laramie 236, 275
New Castle 257A
Powell 255
Rawlins 224A
Riverton 228A
Rock Springs 243, 258
Sheridan 235, 243
Thermopolis 252A, 269A
Torrington 252A
Wheatland 269A
Worland 240A

Guam

Agana 320, 238

Puerto Rico

Adjuntas 275
Aguada 288A

FM Assignments, U.S. International Radio

Aguadilla 225, 262
Arecibo 293, 297
Bayamon 234, 264
Cabo Rojo 221A
Caguas 277
Cayey 249A
Coamo 223
Fajardo 243
Guayama 295
Humacao 299
Isabela 268
Luquillo 221A
Manati 245
Mayaguez 231, 248, 256

Ponce 227, 270, 286
Quebradillas 252A
Rio Piedras 239
San German 236
San Juan 229, 253, 260,
273, 284, 289
Utua 281
Yauco 241

Virgin Islands

Charlotte Amalie 250,
266
Christiansted 258, 291

U.S. International Radio

These stations, located in the U.S. but beaming overseas, operate on various frequencies depending on the seasons of the year. The frequencies (in the 6-25 mhz band): 6-6.200, 9.500-9.775, 11.700-11.975, 15.100-15.450, 17.700-17.900, 21.450-21.750, 25.850-26.100.

Family Stations, 290 Hegenberger Rd., Oakland, Calif. (94621)—**WYFR Scituate, Mass.** Three 100 and two 50 kw transmitters on various frequencies, broadcasting in English to Europe, Africa and the Americas (including Caribbean area), in German to Europe and South America, in Russian to East Europe and South America, in Arabic and French to Europe and North America, and in Spanish to south Europe, Central and South America and Mexico. Harold Camping, pres; Gabriel Otero, prog mgr; Robert A. Thompson, chief engr. Format: Relg.

Far East Broadcasting Co., Friendship Station, Redwood City, Calif. (94063). (415)591-7374.—**KGEI Redwood City, Calif.** with 50 kw and 250 kw, broadcasting in English, Portuguese and Spanish to Mexico, Central America and South America; and in Japanese, Russian, Mandarin and English to U.S.S.R., China, Japan and Southeast Asia. Jim Bowman, mgr; Richard Perry, bus mgr; Jack Brooks, chief engr. Format: Relg.

Trans World Radio Pacific, **KTWR Agana, Guam**—CP for two transmitters broadcasting to Far East and Australia. Paul E. Freed, pres; Fred Wise, chief engr. Format: Relg.

World International Broadcasters, Inc., Box 88, Red Lion, Pa.—**WINB Red Lion, Pa.**, beams programs to North Africa. Dorothy C. Norris, pres and stockholder; John H. Norris, VP, treas and stockholder; Patricia Norris Slaughter, sec and dir; John C. Norris, dir; and Mary Norris Michel, dir. Format: Relg.

You belong in Broadcasting

Radio Billings 1935-1974

Figures for the years 1935 through 1967 are net time sales by stations and networks after all frequency and promotional discounts but before deduction of commissions to agencies and representatives. Figures from 1969 on were computed under a new formula and represent total amounts paid by advertisers for the

use of broadcast facilities. They include commissions paid to advertising agencies and representatives and payments for broadcast time and programs, materials, facilities and services supplied by broadcast stations and networks in connection with the sale of time. Figures are based on FCC data.

Year	National network	% change	Regional network	% change	National non-network	% change	Local	% change	Total	% change
1935 ¹	\$ 39,737,867	\$ 13,805,200	\$ 26,074,476	79,617,543
1936 ²
1937	56,192,396	+41.4	2,854,047	23,117,136	+67.4	35,745,394	+37.1	117,908,973	+48.1
1938	56,612,925	+ 0.7	2.....	28,109,185	+21.6	32,657,349	- 8.7	117,379,459	- 0.6
1939	62,621,689	+10.6	2.....	30,030,563	+ 6.8	37,315,774	+14.2	129,968,026	+10.7
1940*	71,919,428	+13.1	1,869,583	37,140,144	+23.8	44,756,792	+20.0	155,686,247	+20.5
1941	79,621,534	+10.7	2,752,073	+47.2	45,681,959	+23.0	51,697,651	+15.5	179,753,217	+15.4
1942	81,744,395	+ 2.7	3,444,581	+25.2	51,059,159	+11.8	53,898,916	+ 4.2	190,147,052	+ 5.8
1943	99,389,177	+21.6	6,256,508	+81.6	59,352,170	+16.2	64,104,309	+18.9	228,102,164	+20.0
1944	121,757,135	+22.5	7,612,366	+21.7	73,312,899	+23.5	84,960,347	+29.3	287,642,747	+26.1
1945	125,671,834	+ 3.2	8,301,702	+ 9.1	76,696,463	+ 4.6	99,814,042	+17.5	310,484,046	+ 7.9
1946	126,737,727	+ 0.8	8,043,381	- 3.1	82,917,505	+ 8.1	116,380,301	+16.6	334,078,914	+ 7.6
1947	127,713,942	+ 0.8	7,012,689	-12.8	91,581,241	+10.4	147,778,814	+27.0	374,086,686	+12.0
1948	133,723,098	+ 4.5	7,329,255	+ 4.3	104,759,761	+14.4	170,908,165	+15.6	416,720,279	+11.4
1949	128,903,467	- 3.6	5,994,858	-18.2	108,314,507	+ 3.4	182,144,301	+ 6.5	425,357,133	+ 2.1
1950	124,633,089	- 3.3	6,897,127	+15.0	118,823,880	+ 9.7	203,210,834	+11.6	453,564,930	+ 6.6
1951	113,984,000	- 8.5	8,481,000	+23.0	119,559,000	+ 0.6	214,519,000	+ 5.6	456,543,000	+ 0.6
1952	102,528,000	-10.0	7,334,000	-13.5	123,658,000	+ 3.4	239,631,000	+11.7	473,151,000	+ 3.6
1953	92,865,000	- 9.4	5,192,000	-29.2	129,605,000	+ 4.8	249,544,000	+ 4.1	477,206,000	+ 0.9

U.S. Radio Set Sales—1922-1974

1922-1949

Figures compiled by Marketing World Ltd., New York.

Year	Total radio sets manufactured		Automobile sets manufactured		Auto sets in use Number
	Number	Retail value	Number	Retail value	
1922	100,000	\$ 5,000,000
1923	550,000	30,000,000
1924	1,500,000	100,000,000
1925	2,000,000	165,000,000
1926	1,750,000	200,000,000
1927	1,350,000	168,000,000
1928	3,281,000	400,000,000
1929	4,428,000	600,000,000
1930	3,827,000	300,000,000	34,000	\$ 3,000,000
1931	3,420,000	225,000,000	108,000	5,940,000	100,000
1932	3,000,000	140,000,000	143,000	7,150,000	250,000
1933	3,806,000	180,500,000	724,000	28,598,000	500,000
1934	4,084,000	214,500,000	780,000	28,000,000	1,250,000
1935	6,026,800	330,192,480	1,125,000	54,562,500	2,000,000
1936	8,248,000	450,000,000	1,412,000	69,188,000	3,500,000
1937	8,064,780	450,000,000	1,750,000	87,500,000	5,000,000
1938	6,000,000	210,000,000	800,000	32,000,000	6,000,000
1939	10,500,000	354,000,000	1,200,000	48,000,000	6,500,000
1940	11,800,000	450,000,000	1,700,000	60,000,000	7,500,000
1941	13,000,000	460,000,000	2,000,000	70,000,000	8,750,000
1942	4,400,000	154,000,000	350,000	12,250,000	9,000,000
1943	8,000,000
1944	7,000,000
1945	500,000	20,000,000	6,000,000
1946	14,000,000	700,000,000	1,200,000	72,000,000	7,000,000
1947	17,000,000	800,000,000	3,200,000	194,000,000	9,000,000
1948	14,000,000	600,000,000	4,100,000	293,000,000	11,000,000
1949	10,000,000	500,000,000	3,500,000	240,000,000	14,000,000

Radio billings (cont.)

Radio Billings, Set Sales

Year	National network		Regional network		National non-network		Local	Total		
		% change		% change		% change			% change	
1954	78,917,000	-15.0	4,767,000	- 8.2	120,168,000	- 7.3	247,478,000	- 0.8	451,330,000	- 5.4
1955	60,268,000	-23.6	3,809,000	-20.1	120,393,000	+ 0.2	272,011,000	+ 9.9	456,481,000	+ 0.7
1956	44,839,000	-25.6	3,585,000	- 5.9	145,461,000	+20.8	297,822,000	+ 9.5	491,707,000	+ 7.7
1957	47,951,000	+ 6.9	3,709,000	+ 3.5	169,511,000	+16.5	316,493,000	+ 6.3	537,664,000	+ 9.3
1958	42,786,000	-10.8	3,733,000	+ 0.6	171,939,000	+ 1.4	323,207,000	+ 2.0	541,665,000	+ 0.9
1959	35,633,000	-23.4**	188,143,000	+ 9.4	359,138,000	+11.1	582,914,000	+ 7.6
1960	35,026,000	- 1.7	202,102,000	+ 7.4	385,346,000	+ 7.3	622,474,000	+ 6.8
1961	35,837,000	+ 2.3	197,352,000	- 2.4	384,053,000	- 0.3	617,242,000	- 0.8
1962	37,326,000	+ 4.1	208,455,000	+ 5.6	419,468,000	+ 9.2	665,249,000	+ 7.8
1963	41,797,000	+12.5	220,227,000	+ 5.7	449,717,000	+ 7.2	711,741,000	+ 7.0
1964	43,783,000	+ 4.8	232,038,000	+ 5.4	487,947,000	+ 8.5	763,768,000	+ 7.3
1965	44,602,000	+ 1.9	247,942,000	+ 6.9	535,238,000	+ 9.7	827,782,000	+ 8.4
1966	47,217,000	+ 5.9	284,522,000	+12.0	580,210,000	+ 9.7	911,979,000	+10.2
1967	47,600,000	+ 0.8	289,800,000	+ 1.8	602,200,000	+ 5.0	946,600,000	+ 3.8
1968	54,700,000	+12.7	342,200,000	+14.7	733,400,000	+14.4	1,130,300,000	+13.3
1969	50,900,000	- 6.9	349,600,000	+ 2.2	799,900,000	+ 9.1	1,200,400,000	+ 6.2
1970	48,800,000	- 4.1	355,300,000	+ 1.6	852,700,000	+ 6.6	1,256,800,000	+ 4.7
1971	55,100,000	+12.9	378,000,000	+ 6.4	954,600,000	+10.7	1,387,700,000	+10.1
1972	65,000,000	+18.0	384,300,000	+ 1.7	1,098,400,000	+15.1	1,547,700,000	+11.5
1973 ³	59,400,000	- 8.6	382,300,000	- 0.4	1,205,400,000	+10.5	1,647,100,000	+ 7.0
1974	60,300,000	+ 1.5	386,800,000	+ 1.2	1,308,800,000	+ 8.6	1,755,900,000	+ 6.6

¹Nationwide and regional networks combined.

²Data not available.

³Revised figures.

*Figures prior to this date not comparable in all categories

**Regional network calculations discontinued in 1959.

1950-1974 Set Sales

Data compiled by Electronic Industries Association. All figures are in thousands (add 000).

Table. clock and portable radio

Year	Domestic label		Other imports ¹		Total		Total auto radio		Total	
	Units	Dollars	Units	Dollars	Units	Dollars	Units	Dollars	Units	Dollars
1950	9,216	2	9,218	4,740	13,958
1951	6,440	5	6,445	4,544	10,989
1952	7,220	12	7,232	3,243	10,475
1953	7,258	25	7,283	5,183	12,466
1954	6,064	55	6,119	4,124	10,243
1955	7,187	140	7,327	6,863	14,190
1956	8,351	600	8,951	5,057	14,008
1957	8,952	1,000	9,952	5,496	15,448
1958	8,227	\$159,000	2,570	10,797	3,715	\$96,000	14,512
1959	9,947	192,000	5,825	15,772	5,501	130,000	21,273
1960	10,513	190,000	7,518	18,031	6,432	154,000	24,463
1961	11,590	190,000	12,064	23,654	5,568	134,000	29,222
1962	11,811	207,000	12,970	24,781	7,249	181,000	32,030
1963	10,439	179,000	13,163	23,602	7,946	206,000	31,548
1964	10,836	179,000	12,722	\$88,000	23,558	\$267,000	8,313	205,000	31,871	\$472,000
1965	13,812	212,000	17,877	116,000	31,689	328,000	10,037	248,000	41,726	576,000
1966	14,468	231,000	20,311	115,000	34,779	346,000	9,394	267,000	44,173	613,000
1967	12,568	201,000	19,116	132,000	31,684	333,000	9,527	259,000	41,211	592,000
1968	11,660	191,000	22,662	180,000	34,322	371,000	12,510	330,000	46,832	701,000
1969	10,400	166,000	29,014	256,000	39,414	422,000	11,939	316,000	51,353	738,000
1970	7,948	124,000	26,101	256,000	34,049	380,000	10,378	271,000	44,427	651,000
*1971	8,224	131,000	25,811	356,000	34,105	487,000	13,505	315,000	47,610	802,000
1972	9,848	157,000	32,301	449,000	42,149	606,000	13,162	377,000	55,311	983,000
1973	37,652	572,000	12,546	391,000	50,198	963,000
1974	33,231	559,000	10,762	370,000	43,993	929,000

* Prior to 1971, data reflects factory sales by U.S. manufacturers plus those products imported directly by distributors or dealers for resale. All import statistics are based on average value as published by the U. S. Department of Commerce, which is F.O.B., and therefore excludes U.S. import duties, freight charged from the foreign country to the U.S. and insurance.

1971 and years following data reflects products or purchased by U.S. manufacturers plus those products imported directly by distributors or dealers for resale. Import statistics are adjusted to U.S. factory values, including U.S. import duties, freight charged from the foreign country to the U.S. and insurance.

¹Other imports reflect those products imported directly by distributors or dealers for resale.

Broadcast Audiences, Editorializing

Radio and Television Audiences

Radio and television were in more U.S. homes than ever before as 1976 approached.

Television. A total of 69.6 million homes, or 97% of all U.S. homes (excluding Alaska and Hawaii), were TV-equipped as of September 1975, according to the A. C. Nielsen Co.

Color TV. Homes equipped with color TV sets totaled 51.2 million, or 74% of all TV homes, as of September 1975, according to estimates by the A. C. Nielsen Co.

Radio. The Radio Advertising Bureau estimated that 71.4 million U.S. homes, 98.6%, were radio-equipped as of Jan. 1, 1976.

Radio Sets. The number of working-order radio sets in the U.S. totaled 413.1 million in January 1976, according to estimates by the Radio Advertising Bureau. RAB estimated that 299 million of these were home and personal radio sets and 114.1 million were out-of-home receivers.

Viewing and Listening. The extent to which radio and televi-

sion sets were used is indicated in the tables that follow. The television figures were furnished by the Nielsen company and its Nielsen Television Index (NTI). The radio data came from RAB and other sources as noted.

Trend of radio and television ownership

Year	Radio homes (millions)	TV homes (millions)	Year	Radio homes (millions)	TV homes (millions)
1949	40.8	1.6	1962	51.1	49.0
1950	42.1	5.9	1963	52.3	51.3
1951	43.6	12.4	1964	54.0	52.6
1952	44.8	17.3	1965	55.2	53.8
1953	45.0	23.4	1966	57.0	54.9
1954	45.4	28.2	1967	57.5	56.0
1955	46.2	32.3	1968	58.5	57.0
1956	47.2	36.7	1969	60.6	58.5
1957	48.2	40.3	1970	62.0	60.1
1958	48.9	43.0	1971	62.6	62.1
1959	49.5	44.5	1972	64.1	64.8
1960	49.5	45.2	1973	67.4	66.2
1961	49.5	46.9	1974	68.9	68.5
			1975	70.4	69.6

Source: RAB; A. C. Nielsen

TV usage per home per week in hours and minutes

	7am-1pm	1-4:30pm	4:30-7:30pm	7:30-8pm	8-11pm	11pm-1am	1-7am
Mon-Fri	5:47	5:49	7:37	1:33	—	3:09	—
Saturday	1:18	1:06	1:25	:17	—	—	—
Sunday	:59	1:16	1:31	:19	—	—	—
All days	—	—	—	2:10	13:16	4:30	1:46

Seven day 24 hr. total—48:29. Average per day—6:56.

Source: NTI / NAC Audience Demographics Report, February 1975.

Types of network TV shows and their audiences, February 1975 (7:30-11pm)

	Number of programs	% of average audience	% share of programming
General drama	7	20.0	11
Variety	5	19.2	8
Western drama	3	18.7	5
Situation comedy	16	22.6	25
Mystery & suspense drama	21	20.3	33
Feature films	10	19.2	16
All programs 7:30-11pm	63	20.2	100

Source: NTI / NAC Audience Demographics Report, February 1975

TV Audience Composition

Day part	% of U.S. Homes using TV	Number of viewers per 1000 viewing homes	% of audience per average minute			
			Men	Women	Teens	Children
Monday-Friday, 10 am-1 pm	24.5%	1,368	19%	56%	6%	19%
Monday-Friday, 1-4:30 pm	33.2	1,406	17	59	8	16
All nights, 8-11 pm	63.2	2,032	34	42	11	14

Source: NTI / NAC Audience Demographics Report, February 1975.

Broadcast Editorializing

A nationwide survey for the *Broadcasting Yearbook* indicates that over 65% of AM, 54% of FM stations and 58% of TV stations are now editorializing at least occasionally. The editorializing survey data was obtained from the *Yearbook* questionnaire sent to all radio and TV stations. The results are shown in the table.

	U.S.			Canada	
	AM	FM	TV	Radio	TV
Total stations responding	2612	1792	463	83	15
Number editorializing	1813	983	270	54	11
Percent editorializing	69.4%	54.9%	58.3%	65.0%	73.3%
Of stations editorializing percent doing so . . .					
Daily	17.0%	15.1%	22.6%	55.6%	9.1%
Weekly	13.2%	13.3%	19.6%	1.8%	18.2%
Occasionally	69.7%	71.6%	57.8%	42.6%	72.7%

Growth in Broadcasting Stations—1922-1976

Broadcasting Growth, Campus Radio

The following table presents a record of broadcasting growth in the United States before and after the advent of TV. All information is from the records of the FCC.

AM authorizations, Pre-TV

Date	Under construction		Date	Under construction		Total authorized
	Licensed	Total authorized		Licensed	Total authorized	
Jan. 1, 1922		30	Jan. 1, 1939	722	42	764
Mar. 1, 1923		556	Jan. 1, 1940	765	49	814
Oct. 1, 1924		530	June 30, 1941			897
June 20, 1925		571	June 30, 1942			925
June 30, 1926		528	June 30, 1943			912
Feb. 23, 1927		733	June 30, 1944			924
July 1, 1928		677	July 20, 1945	933	23	956
Nov. 9, 1929		618				
July 1, 1930		612				
July 1, 1931	603	9				
Jan. 1, 1932	601	7				
Jan. 1, 1933	599	11				
Jan. 1, 1934	583	8				
Jan. 1, 1935	585	20				
Jan. 1, 1936	616	16				
Jan. 1, 1937	646	39				
Jan. 1, 1938	689	32				

FM authorizations, Pre-TV

Date	Licensed	Experimental	Authorized Total
June 30, 1941	...	69	
June 30, 1942	...	74	
June 30, 1943	...	26	74
June 30, 1944	...	6	58
June 30, 1945	...	3	56

Comparable record of station growth since TV began

Date	AM		FM		TV	
	Authorized	On Air	Authorized	On Air	Authorized	On Air
*Jan. 1, 1946	1,004		456	55	9	6
*June 30, 1946						
*Jan. 1, 1947	1,517				52	7
*June 30, 1947			918	238		
*Jan. 1, 1948	1,962	1,621	926	458	73	17
Jan. 1, 1949	2,127	1,912	966	700	124	50
Jan. 1, 1950	2,234	2,086	788	733	111	97
Jan. 1, 1951	2,351	2,232	703	676	109	107
Jan. 1, 1952	2,408	2,331	650	637	108	108
*Jan. 1, 1953	2,524	2,391			273	129
*June 30, 1953			601	580		
Jan. 1, 1954	2,636	2,521	580	560	567	356
Jan. 1, 1955	2,774	2,669	559	552	576	439 ¹
Jan. 1, 1956	2,935	2,824	557	540	590	482 ²
Jan. 1, 1957	3,125	3,008	554	530	631	511 ³
Jan. 1, 1958	3,295	3,196	590	537	657	544 ⁴
Jan. 1, 1959	3,440	3,326	695	578	666	562 ⁵
Jan. 1, 1960	3,527	3,398	838	688	673	573 ⁶
Jan. 1, 1961	3,667	3,539	1,018	815	634	583
Jan. 1, 1962	3,911	3,693	1,128	960	654	563
Jan. 1, 1963	3,924	3,810	1,128	1,081	662	579
Jan. 1, 1964	4,039	3,937	1,249	1,146	661	582
Jan. 1, 1965	4,077	4,009	1,468	1,270	676	586
Jan. 1, 1966	4,129	4,049	1,657	1,446	702	596
Jan. 1, 1967	4,190	4,121	1,865	1,643	769	623
Jan. 1, 1968	4,249	4,156	2,004	1,753	818	644
Jan. 1, 1969	4,300	4,237	2,114	1,938	834	672
Jan. 1, 1970	4,344	4,269	2,651	2,476	1,038	872
Jan. 1, 1971	4,383	4,323	2,795	2,636	1,025	892
Jan. 1, 1972	4,411	4,355	2,971	2,783	1,004	905
Jan. 1, 1973	4,431	4,382	3,162	2,965	1,001	922
Jan. 1, 1974	4,448	4,395	3,360	3,135	1,002	938
Jan. 1, 1975	4,477	4,432	3,617	3,353	1,010	952
Jan. 1, 1976	4,513	4,463	3,752	3,571	1,030	962

* Comparable figures for all services not available this date.
¹ Includes 23 stations with Special Temporary Authorizations which either had not started operation as of this date, had started but had gone dark or had received authorizations but turned them back with or without operating.
² Includes two licensees which had suspended operation and 37 stations with STAs in same category as footnote 1.
³ Includes 4 licensees which had suspended operation and 34 stations with STAs as in footnote 1 above.
⁴ Includes 7 licensees which had suspended operation and 40 stations with STAs as in footnote 1 above.
⁵ Includes 6 licensees which had suspended operation and 38 stations with STAs as in footnote 1 above.
⁶ Includes 10 licensees which had suspended operation and 38 stations with STAs as in footnote 1 above.

College or University Campus-Limited Radio

College or university campus-limited stations are operated principally by students enrolled in the schools. Their transmission is by carrier current, and reception is usually limited to on-campus listening. (College stations with 10 w or more power are listed in the Directory of AM and FM stations.)

The following directory is based on the membership list of the Intercollegiate Broadcasting System (IBS affiliates are so identified) and other information brought to the attention of the editors. Carrier current stations are not required to register with the FCC, and the directory therefore may not be comprehensive.

Alabama

WVSU IBS Stamford Univ., Birmingham 35209.
WHIL IBS Spring Hill College, Mobile 36608.
WRSD IBS Univ. of Montevallo, Montevallo 35115.
WSBR IBS Saint Bernard College, St. Bernard 35138.

Alaska

KMPS 620 khz, IBS U. of Alaska, Fairbanks 99701.

Arizona

KNAU IBS Northern Arizona U., Flagstaff 86001.
KSUA IBS U. of Ariz., Tucson 85721.
KWKI IBS Cochise College, Douglas 85607.

Arkansas

KHCA, 720 khz, Harding College, Searcy 72143.
KJBU, 600 khz, IBS John Brown University, Siloam Springs 72761.

California

KANG IBS Pacific Union College, Angwin 94508.
KBC IBS Bakersfield Community College, Bakersfield 93304.
KSBS, 880 khz, Cate School, Carpinteria 93013.
KCSC, 95.3 mhz, IBS Chico State University, Chico 95926.
KCMC, 880 khz, IBS Claremont Men's College, Claremont 91711.
KSPC Pomona College, Claremont 91711.
KWEB IBS Webb School of California, Claremont 91711.
KDVS, 880 khz, U. of Calif., Davis 95616.
KFSR, 660 khz, IBS Calif. State U., Fresno 93740.
KLA, 830 khz, IBS U. of Calif., Los Angeles 90024.
KOXY IBS Occidental College, Los Angeles 90041.
KSLA California State College, Los Angeles 90032.
KSCR, 88.7 mhz, U. of Southern Calif., Los Angeles 90007.
KRJC, 660 khz, IBS Modesto Junior College, Modesto 95350.
KNAB IBS Chapman College, Orange 92666.
KBAC, 830 khz, IBS Ambassador College, Pasadena 91123.
KUOR IBS U. of Redlands, Redlands 92373.
KEG, 720 khz, IBS Calif. State U., Sacramento 95819.
KSMC St. Mary's College 94575.
KCR, 550 khz, 98.9 mhz, San Diego State U. 92182.
KUSF, 880 khz, IBS U. of San Francisco 94117.
KSFS, 860 khz, 100.7 mhz, San Francisco State U. 94132.
KBBK IBS Bethany Bible College, Santa Cruz 95062.
KZSU Stanford U., Stanford 94305.
KRHC, 830 khz, IBS Rio Hondo College, Whittier 90608.
KHCR, 830 khz, IBS Los Angeles Harbor College, Wilmington 90744.

Colorado

KAS IBS Adams State College, Alamosa 81101.
KOAS, 670 khz, U. of Denver, Denver 80210.
KWER Loretto Heights College, Denver 80236.
KWSC IBS Western State College, Gunnison 81230.

Connecticut

WPKN, 540 khz, IBS U. of Bridgeport, Bridgeport 06602.

Campus Radio

WXCI, 550 khz, Western Conn. State College, Danbury 06810.
WVOF, 640 khz, IBS Fairfield U., Fairfield 06430.
WESU Wesleyan U., Middletown 06457.
WCCS IBS Central Connecticut State College, New Britain 06050.
WNHU New Haven U., New Haven 06516.
WNCI IBS Connecticut College, New London 06320.
WRMC IBS Mitchell College, New London 06320.

Delaware

WSLY IBS Wesley College, Dover 19901.
WBCR, 640 khz, IBS Brandywine College, Wilmington 19803.

District of Columbia

WAMU, 610 khz, IBS American University, Washington 20016.
WEBS IBS Marjorie Webster Jr. College, Washington 20012.
WRGW IBS George Washington U., Washington 20006.
WRTC IBS Trinity College, Washington 20017.
WTIS, 610 khz, Washington Tech. Institute, Washington 20008.

Florida

WJCR, 740 khz, Jones College, Jacksonville 32211.
WECR, 810 khz, 92.1 mhz, Eckerd College, St. Petersburg 33733.

Georgia

WAUC, 560 khz, IBS Atlanta U. Center, Atlanta 30314.
WEMO IBS Emory U., Atlanta 30322.
WSTB, 1.28 mhz, Southern Technical Institute, Marietta 30060.

Hawaii

KUOH U. of Hawaii, Honolulu 14.

Idaho

KUOI IBS U. of Idaho, Moscow 83843.
KVIK, 650 khz, IBS Ricks College, Rexburg 83440.

Illinois

WIDB, 600 khz, 104 mhz cable FM, IBS Southern Ill. U., Carbondale 62901.
WECH Eastern Illinois U., Charleston 61902.
WIIT, 640 khz, Illinois Institute of Technology, Chicago 60616.
WLUC IBS Loyola U., Chicago 60626.
WNPC IBS North Park College, Chicago 60625.
WRBC IBS Roosevelt U., Chicago 60605.
WRNE IBS Northeastern Ill. U., Chicago 60625.
WUCB IBS Chicago U., Chicago 60637.
WKDI Northern Ill. U., DeKalb 60115.
WEUR IBS Eureka College, Eureka 61530.
WILC, 570 khz, IBS Illinois College, Jacksonville 62650.
WMNC IBS MacMurray College, Jacksonville 62650.
WLNK IBS Lincoln College, Palatine 60266.
WLRA 590 khz, IBS Lewis U., Lockport 60441.
WHEN, 570 khz, Western Ill. U., Macomb 61455.
WDLM Moody Bible Institute, Moline 61244.
WMCR, 640 khz, IBS Monmouth College, Monmouth 61462.
WRSB, 630 khz, Shimer College, Mount Carroll 61503.
WILN, 540 khz, IBS Illinois State U., Normal 61761.
WQXM IBS Harper College, Palatine 60067.
WRBU IBS Bradley U., Peoria 61606.
WWQC IBS Quincy College, Quincy 62301.
WRRC IBS Triton College, River Grove 60171.
WRCR, 640 khz, IBS Rockford College, Rockford 61101.

Indiana

WIUS, 620 khz, 95.1 mhz cable FM, IBS Indiana U., Bloomington 47401.
WQAX IBS Indiana U., Bloomington 47401.
WFCl, 590 khz, Franklin College, Franklin 46131.
WITB Indiana Institute of Technology, Fort Wayne 46803.
WBKE, 630 khz, IBS Manchester College, North Manchester 46962.
WOWI IBS St. Joseph's College, Rensselaer 47978.
WSND, 640 khz, U. of Notre Dame, South Bend 46556.
WTUC IBS Taylor U., Upland 46989.

WVTI, 600 khz, IBS Valparaiso Technical Institute, Valparaiso 46383.
KMRX Purdue U. (Hall H-3), W. Lafayette 47906.
WCCR & WCCR-S Purdue U. (Cary Hall Quadrangle), W. Lafayette 47906.
WHRC & KHRC Purdue U. (Hall H-2), W. Lafayette 47906.
WILY, 580 khz, 90.1 mhz, IBS Purdue U., West Lafayette 47906.
WMRH, 970 khz, 90.1 mhz, Purdue U. (Owen Hall), W. Lafayette 47906.

Iowa

KPGY, 880 khz, IBS Iowa State University, Ames 50012.
KCOE IBS Coe College, Cedar Rapids 52402.
KCRS IBS U. of Northern Iowa, Cedar Falls 50701.
KMC Midwestern College, Denison 51442.
KLOR Loris College, Dubuque 52001.
WGVU, 790 khz, IBS U. of Dubuque, Dubuque 52001.
KRUI, 570 khz, U. of Iowa, Iowa City 52240.
KWAD IBS U. of Iowa, Iowa City 52241.
KAMA, 840 khz, IBS Iowa Wesleyan College, Mt. Pleasant 52641.
KRNL IBS Cornell College, Mount Vernon 52314.
KIGC, 880 khz, IBS William Penn College, Oskaloosa 52577.
KBVC, 89 mhz, IBS Buena Vista College, Storm Lake 50588.

Kansas

KRHA, 660 khz, IBS Emporia Kansas State College, Emporia 66801.
KFHS, 600 khz, Fort Hays Kansas State College, Hays 67602.
KUOK IBS U. of Kansas, Lawrence 66045.
KBCT, 630 khz, Bethel College, North Newton 67117.
Kentucky
WKYU, 580 khz, IBS Western Kentucky U., Bowling Green 42101.
WRVS IBS Georgetown College, Georgetown 40324.
WXKE, 570 khz, IBS U. of Louisville, Louisville 40208.

Louisiana

WLSU, 660 khz, Louisiana State U., Baton Rouge 70803.
KSLU IBS Southeastern Louisiana U., Hammond 70401.
KRVS IBS Southwestern Louisiana U., Lafayette 70506.
WLDC, 640 khz, IBS Loyola University, New Orleans 70118.
WLPI, 770 khz, IBS Louisiana Tech U., Ruston 71270.

Maine

WWAS St. Francis College, Biddeford 04005.
WMMA, 630 khz, IBS Maine Maritime Academy, Castine 04421.
WDUR Bates College, Lewiston 04240.
WSJC IBS St. Joseph's College, North Windham 04062.
WRBA, 640 khz, IBS Berwick Academy, South Berwick 03908.
WRAM IBS Unity College, Unity 04988.

Maryland

WRNV IBS U.S. Naval Academy, Annapolis 21402.
WJHU IBS Johns Hopkins U., Baltimore 21218.
WCCN, 560 khz, IBS Catonsville Community College, Catonsville 21228.
WMUC, 650 khz, IBS U. of Maryland College Park 20742.
WMSM IBS Mt. St. Mary's, Emmitsburg 21727.
WSSC IBS Salisbury State College, Salisbury 21801.
WGTS IBS Columbia Union College, Takoma Park 20012.
WCVT IBS Towson State College, Towson 21204.

Massachusetts

WRWB Babson Institute, Babson Park 02157.
WCSB Graham Junior College, Boston.
WECB, 640 khz, Emerson College, Boston 02116.
WRBU, 560 khz, IBS Northeastern U., Boston 02120.
WTBU IBS Boston U., Boston 02215.
WHRB IBS Harvard U., Cambridge 02138.

WZBC, 640 khz, IBS Boston College, Chestnut Hill 02167.
WUMB, 640 khz, IBS U. of Mass at Boston, Dorchester 02125.
WNRC IBS Nichols College, Dudley 01572.
WMWC Mt. Wachusett Community College, Gardner 01440.
WVAC IBS Curry College, Milton 02186.
WNMH, 540 khz, IBS Northfield Mount Hermon, Mount Hermon 01354.
WRSH IBS Massasoit Commercial College, North Abington 02351.
WVMM, 830 khz, IBS Merrimack College, North Andover 01845.
WUSM IBS Southeastern Mass. U., N. Dartmouth 02747.
WSHL IBS Stonehill College, N. Easton 02356.
WENC 630 khz, Eastern Nazarene College, Quincy 02170.
WSSC, 640 khz, IBS Salem State College, Salem 01970.
WAIC IBS American International College, Springfield 01109.
WTCC, 640 khz, IBS Springfield Technical Community College, Springfield 01105.
WBS Wellesley College, Wellesley 02181.
WCHC, 640 khz, IBS Holy Cross College, Worcester 01610.

Michigan

WRCN, 650 khz, IBS U. of Michigan, Ann Arbor 48104.
WLMC IBS Lake Michigan College, Benton Harbor 49022.
WFRS, 560 khz, IBS Ferris State College, Big Rapids 49037.
WAYN IBS Wayne State U., Detroit 48200.
WMGR IBS Marygrove College, Detroit 48221.
WVOD, 860 khz, IBS U. of Detroit, Detroit 48211.
WBRS, 640 khz, Michigan State U., East Lansing 48824.
WEAK, 640 khz, Michigan State U., East Lansing 48824.
WKME, 640 khz, Michigan State U., East Lansing 48824.
WMCD, 640 khz, Michigan State U., East Lansing 48824.
WMSN Michigan State U., East Lansing 48823.
WFLC IBS Flint Community Jr. College, Flint 48503.
WJBB IBS Lee Lanau School, Glen Arbor 49636.
WCAL IBS Calvin College & Seminary, Grand Rapids 49506.
WTAS, 620 khz, IBS Hope College, Holland 49423.
WIDR, 750 khz, IBS Western Michigan U., Kalamazoo 49001.
WVKV IBS Kalamazoo Valley Community College, Kalamazoo 49002.
WBKV, 600 khz, IBS Northern Michigan U., Marquette 49855.
WCHP IBS Central Michigan U., Mt. Pleasant 48858.
WBSD IBS Olivet College, Olivet 49076.
WKCC IBS Kirtland Community College, Roscommon 48653.
WMJB Macomb County Community College, Warren 48093.
WHUR Eastern Michigan U., Ypsilanti 48197.

Minnesota

KBSB, 670 and 870 khz, Bemidji State U., Bemidji 56601.
KSJU IBS St. John's U., Collegeville 56321.
KGMA IBS Mankato State College, Mankato 56001.
WMMR, 730 khz, University of Minnesota, Minneapolis 55455.
KMCS, 650 khz, IBS Moorhead State U., Moorhead 56560.
KARL IBS Carleton College, Northfield 55057.
KSTO, 590 khz, St. Olaf College, Northfield 55057.
KMAC, 550 khz, IBS Macalester College, St. Paul 55105.
KGSM, 690 khz, IBS Gustavus Adolphus College, St. Peter 56082.
KSMC IBS St. Mary's College, Winona 55987.

Mississippi

WKFB IBS Keesler Technical Training Center, Biloxi 39534.
WMCB, 620 khz, IBS Mississippi College, Clinton 39056.
WSCM Mississippi State College for Women, Columbus 39701.

WJDC, 650 khz, IBS Mississippi Gulf Coast Junior College, Gulfport 39501.
WMSU, 640 khz, IBS U. of Southern Mississippi, Hattiesburg 39401.
WNON Millsaps College, Jackson 39210.
WCBH, 640 khz, IBS U. of Mississippi, University 38677.

Missouri

KFRH IBS Washington U., Clayton 63105.
KMOE, 570 khz, IBS Central Methodist College, Fayette 65248.
KRC, 760 khz, IBS Rockhurst College, Kansas City 64110.
KDLX, 560 khz, 106.1 mhz, IBS Northwest Missouri State U., Maryville 64468.
WKLX Northwest Missouri State College, Maryville 64468.
KMFA, 750 khz, IBS U. of Missouri, Rolla 65401.
KCLC IBS Lindenwood College, St. Charles 63302.
KBIL, 600 khz, St. Louis U., St. Louis 63103.
KCFV IBS Florissant Valley Community College, St. Louis 63135.
KRFM Washington U., St. Louis 63165.
KBCB IBS Central Bible College, Springfield 65802.
KULR, 650 khz, Drury College, Springfield 65802.
KECC, 610 khz, Evangel College, Springfield 65802.
KCMW, 910 khz, IBS Central Missouri State U., Warrensburg 64093.

Montana

KATS Montana State U., Bozeman 59715.

Nebraska

KDCV IBS Dana College, Blair 68008.
KOVF IBS Kearney State College, Kearney 68847.
KOCU, 550 khz, IBS Creighton University, Omaha 68178.

Nevada

KNYE U. of Nevada, Reno 89507.

New Hampshire

WVNB IBS Nathaniel Hawthorne College, Antrim 03440.
WOMB, 570 khz, IBS Franconia College, Franconia 03580.
WNEC IBS New England College, Henniker 03242.
WKNH, 1360 khz, IBS Keene State College, Keene 03431.
WPCR IBS Plymouth State College, Plymouth 03264.
WFPF, 640 khz, Franklin Pierce College, Rindge 03461.

New Jersey

WCCR IBS Camden County College, Blackwood 08012.
WCPE Union College, Cranford 07016.
WGLS IBS Glassboro State College, Glassboro 08088.
WCPR, 740 khz, IBS Stevens Institute of Technology, Hoboken 07030.
WWRC, 640 khz, IBS Rider College, Lawrenceville 08648.
WMCX Monmouth College, Long Branch 07764.
WERD IBS Drew U., Madison 07940.
WFDM, 690 khz, IBS Fairleigh Dickinson U., Madison 07940.
WMSC Montclair State College, Montclair 07053.
WRLC, 640 khz, IBS Livingstone College, New Brunswick 08903.
WRSU IBS Rutgers U., New Brunswick 08903.
WRNU Rutgers U., Newark 07102.
WNCE, 550 khz, IBS Newark College of Engineering, Newark 07102.
WBSB, 640 khz, IBS Bergen Community College, Paramus 07652.
WPSC IBS Paterson State College, Paterson.
WRFB IBS Burlington County College, Pemberton 08068.
WPTN IBS The Pennington School, Pennington 08534.
WRPB, 640 khz, Princeton U., Princeton 08540.
WFDU IBS Fairleigh Dickinson U., Teaneck 07666.
WTSR IBS Trenton State College, Trenton 08625.
WWRC IBS Rider College, Trenton 08609.

WNSC, 590 khz, IBS Kean College of New Jersey, Union 07083.
WPSC, 590 khz, IBS William Patterson College, Wayne 07470.

New Mexico

KNMS, 660 khz, 91.5 mhz cable FM, IBS New Mexico State U., Las Cruces 88003.
KENW, 660 khz, Eastern New Mexico U., Portales 88130.
KTEK IBS New Mexico Institute of Mining, Socorro 87801.
KNMA IBS New Mexico State U., University 88070.

New York

WSUA, 640 khz, IBS State U. of N.Y. at Albany, Albany 12222.
WVAT, 640 khz, IBS Alfred State College, Alfred 14802.
WXBC Bard College, Annandale-On-Hudson 12504.
WQCC, 590 khz, IBS Queensborough Community College, Bayside 11364.
WBSU IBS New York U. College, Brockport 14420.
WHLC, 590 khz, IBS Lehman College, Bronx 10468.
WNYU New York U., Bronx 10453.
WRCM IBS Manhattan College, Bronx 10471.
WSLC Sarah Lawrence, Bronxville 10708.
WBCR, 590 khz, IBS Brooklyn College, Brooklyn 11210.
WKCC, 590 khz, IBS Kingsborough Community College, Brooklyn 11235.
WLIU 590 khz, IBS Long Island University, Brooklyn 11201.
WPIR, 600 khz, 91.9 mhz, IBS Pratt Institute, Brooklyn 11205.
WPRH Pratt Institute, Brooklyn 11205.
WECC IBS Erie Community College, Buffalo 14222.
WSCB, 620 khz, IBS State College at Buffalo 14222.
KSLU St. Lawrence U., Canton 13617.
WHCL IBS Hamilton College, Clinton 13323.
WCOB, 560 khz, IBS S.U.N.Y. Agricultural and Technical College, Cobleskill 12043.
WCSU, 720 khz, IBS State U. of N.Y. College at Cortland, Cortland 13045.
WDTU, 1390 khz, IBS S.U.N.Y., at Delhi, Delhi 13753.
WQMC 590 khz, Queens College, Flushing 11368.
WCVF, 600 khz, IBS State U. College at Fredonia, Fredonia 14063.
WBAU, 640 khz, IBS Adelphi U., Garden City 11530.
WGBC, 640 khz, S.U.N.Y. College at Geneseo, Geneseo 14454.
WEOS IBS Hobart College, Geneva 14456.
WCWP IBS C.W. Post College, Greenvale 11548.
WRCV IBS Colgate U., Hamilton 13346.
WJSL IBS Houghton College, Houghton 14744.
WICB, 610 khz, Ithaca College, Ithaca 14850.
WVBR IBS Cornell U., Ithaca 14850.
WKCS IBS Keuka College, Keuka Park 14478.
WLGC, 590 khz, IBS LaGuardia Community College, Long Island 11101.
WVCR IBS Siena College, Loudonville 12211.
WCVM, 640 khz, IBS S.U.N.Y. at Morrisville, Morrisville 13408.
WNPC, 640 khz, 91.9 mhz, IBS State U. College, New Paltz 12561.
WCAG New York U., New York 10003.
WCCR, 640 khz, IBS City College of New York, New York 10031.
WKCR, 590 khz, Columbia U., New York 10027.
WLGC IBS La Guardia Community College, New York 11101.
WNYU New York U., New York 10012.
WPBC, 640 khz, IBS Pace U., New York 10038.
WYUR IBS Yeshiva College, New York 10033.
WNYT, 640 khz, New York Institute of Technology, Old Westbury 11568.
WONY IBS State U. College, Oneonta 13820.
WOCR, 640 khz, IBS State U. College, Oswego 13126.
WPLT, 650 khz, 90.0 mhz cable FM, State U. College, Plattsburgh 12901.
WNTC, 640 khz, 900 mhz, Clarkson College of Technology, Potsdam 13676.
WRPS, 730 khz, IBS S.U.N.Y. College at Potsdam, Potsdam 13676.
WMCR, 640 khz, IBS Marist College, Poughkeepsie 12601.
WVKR, 620 khz, IBS Vassar College, Poughkeepsie 12601.
WPUK, 590 khz, IBS S.U.N.Y. at Purchase, Purchase 10577.

WITR, 610 khz, IBS Rochester Institute of Technology, Rochester 14623.
WJFR, 540 khz, IBS St. John Fisher College, Rochester 14618.
WRUR, 1090 khz, IBS U. of Rochester, Rochester 14627.
WOFM, 650 khz, IBS St. Bonaventure U., St. Bonaventure 14778.
WSPN Skidmore College, Saratoga Springs 12866.
WRUC 640 khz, IBS Union College, Schenectady 12308.
WUSB, 820 khz, IBS SUNY at Stony Brook, Stony Brook 11790.
WJPZ Syracuse U., Syracuse 13210.
WLMU IBS Lemoyne College, Syracuse 13214.
WHVC IBS Hudson Valley Community College, Troy 12180.
WRPI, 640 khz, Rensselaer Polytechnic Institute, Troy 12181.
WEDJ IBS State Univ. College, Utica 13502.
WRMT IBS Mohawk Valley Community College, Utica 13501.
WKDT, 630 khz, U.S. Military Academy, West Point 10997.
WECC, 570 khz, IBS Erie Community College, Williamsville 14221.

North Carolina

WLMC IBS Lees McRae College, Banner Elk 28604.
WCAR, 550 khz, IBS University of North Carolina, Chapel Hill 27514.
WVFN, 710 khz, U. of North Carolina at Charlotte, Charlotte 28223.
WCAT, 550 khz, IBS Western Carolina U., Cullowhee 28723.
WDAV IBS Davidson College, Davidson 28036.
WDUR, 1600 khz, Duke U., Durham 27706.
WANT IBS Agricultural & Technical College, Greensboro 27411.
WECU East Carolina U., Greenville 27834.
WCCC IBS Coastal Carolina Community College, Jacksonville 28542.
WSAP IBS St. Andrews Presbyterian College, Laurinburg 28352.
WSPC, 580 khz, IBS Pfeiffer College, Misenheimer 28109.
WKNC IBS N.C. State College, Raleigh 27607.
WVPS Wilmington College, Wilmington 28403.

Ohio

WRHA IBS U. of Akron, Akron 44304.
WRMU IBS Mount Union College, Alliance 44601.
WGAM Ohio U., Athens 45701.
WLHD Ohio U., Athens 45701.
WNWG Ohio U., Athens 45701.
WNGR Ohio U., Athens 45701.
WBUF IBS Bluffton College, Bluffton 45817.
WFAL, 680 khz, IBS Bowling Green State University, Bowling Green 43403.
WFIB, 800 khz, IBS U. of Cincinnati, Cincinnati 45219.
WVXU IBS Xavier U., Cincinnati 45207.
WRAR IBS Western Reserve U., Cleveland 44106.
WJUC IBS John Carroll University, Cleveland 44118.
WODR, 540 khz, IBS Ohio Dominican College, Columbus 43216.
WOSR, 540 khz, IBS Ohio State U., Columbus 43210.
WDCW, 580 khz, IBS Defiance College, Defiance 43512.
WVFC IBS Findlay College, Findlay 45840.
WKCO Kenyon College, Gambier 43022.
WDUB IBS Denison U., Granville 43023.
WHRM, 580 khz, IBS Hiram College, Hiram 44234.
WKSU, 750 khz, Kent State U., Kent 44242.
WMOH Western College for Women, Oxford 45056.
WERC, 600 khz, IBS U. of Toledo, Toledo 43606.
WCSU IBS Central State U., Wilberforce 45384.

Oklahoma

KAOS Oklahoma Military Academy, Claremore 74017.
KPSU, 660 khz, IBS Panhandle State U., Goodwell 73939.
KUVY IBS U. of Oklahoma, Norman 73069.
KGBC Oklahoma Baptist U., Shawnee 74801.

Campus Radio

KVRO IBS Oklahoma State U., Stillwater 74074.

Oregon

KBVR IBS Oregon State U., Corvallis 97332.
KPUR, 660 khz, IBS Pacific U., Forest Grove 97116.
KTEC Klamath Falls 97601.
KEOC IBS Eastern Oregon State College, LaGrande 98750.
KLIN IBS Linfield College, McMinnville 97129.
KLC, 860 khz, IBS Lewis and Clark College, Portland 97219.
KDUP, 860 khz, IBS University of Portland, Portland 97203.
KRRC IBS Reed College, Portland 97202.

Pennsylvania

WMUH, 640 khz, IBS Muhlenberg College, Allentown 18104.
WRFT, 640 khz, IBS Temple U., Ambler Campus, Ambler 19002.
WLVR IBS Lehigh U., Bethlehem 18015.
WRMC IBS Moravian College, Bethlehem 18018.
WDCV IBS Dickinson College, Carlisle 17013.
WLCL, 604 khz, IBS Wilson College, Chambersburg 17201.
WDNR IBS Widener College, Chester 19013.
WCS2 IBS Cheyney State College, Cheyney 19319.
WCCB, 640 khz, IBS Clarion State College, Clarion 16214.
WESS, 640 khz, 90.3 mhz, East Stroudsburg State, East Stroudsburg 18301.
WJKB IBS Edinboro State College, Edinboro 16412.
WWEC, 640 khz, IBS. Elizabethtown College, Elizabethtown 17022.
WWGC IBS Gettysburg College, Gettysburg 17325.
WVMM, 640 khz, IBS Messiah College, Grantham 17027.
WTGP IBS Thiel College, Greenville 16125.
WSAJ IBS Grove City College, Grove City 16127.
WHRC, 640 khz, IBS Haverford College, Haverford 19041.
WKSC IBS Kutztown State College, Kutztown 19530.
WFNM IBS Franklin and Marshall College, Lancaster 17604.
WSVC IBS St. Vincent College, Latrobe 15650.
WVBU, 640 khz, IBS Bucknell U., Lewisburg 17837.
KSFC IBS St. Francis College, Loretto 15940.
WNTE IBS Mansfield State College, Mansfield 16933.
WARC IBS Allegheny College, Meadville 16335.
WMSR, 600 khz, IBS Millersville State College, Millersville 17551.
WKDU Drexel U., Philadelphia 19104.
WMAN Drexel Institute of Technology, Philadelphia 19104.
WPWT Philadelphia Wireless Tech. Institute, Philadelphia 19102.
WRTI IBS Temple U., Philadelphia 19131.
WSJR, 640 khz, IBS St. Joseph's College, Philadelphia 19131.
WDUQ Duquesne U., Pittsburgh 15219.
WPGH IBS Pittsburgh U., Pittsburgh 15213.
WPPJ, 670 khz, Point Park College, Pittsburgh 15222.
WRCT IBS Carnegie Institute of Technology, Pittsburgh 15213.
WVMM Mt. Mercy College, Pittsburgh.
WXAC, 91.3 mhz, IBS Albright College, Reading 19604.
WUSV IBS Scranton U., Scranton 18510.
WQSU, 680 khz, IBS Susquehanna U., Selinsgrove 17870.
WSYC, 640 khz, IBS Shippensburg State College, Shippensburg 17257.
WNFT IBS Slippery Rock State College, Slippery Rock 16057.
WCPR IBS Central Pennsylvania Business School, Summerdale 17093.
WEHR IBS Penn State Univ., University Park 16802.
WKVU, 640 khz, IBS Villanova U., Villanova 19085.
WNCB IBS Northeast Christian Jr. College, Villanova 19085.
WKUL, 660 khz, IBS Waynesburg College, Waynesburg 15370.
WCBR IBS West Chester State College, West Chester 19380.
WHAY Penn State U., Wilkes-Barre 18708.
WCLH Wilkes College, Wilkes-Barre 18702.

WLCR IBS Lycoming College, Williamsport 17704.
WYCP, 640 khz, IBS York College of Pennsylvania, York 17405.

Puerto Rico

WIAU IBS Inter American Universities, San German 00753.

Rhode Island

WBCW IBS Barrington College, Barrington 02806.
WRIU IBS Rhode Island U., Kingston 02881.
WBRU Brown U., Providence 02912.
WDOM IBS Providence College, Providence 02908.
WJMF IBS Bryant College, Smithfield 02917.

South Carolina

WSBF IBS Clemson U., Clemson 29632.
WCBC, 830 khz, IBS Columbia Bible College, Columbia 29203.
WUSC IBS U. of South Carolina, Columbia 29208.
WARP IBS Erskine College, Due West 29639.
WFRN, 580 khz, IBS Furman U., Greenville 29613.
WCRO, 640 khz, IBS Winthrop College, Rock Hill 29733.

South Dakota

KTEQ IBS S.D. School of Mines & Technology, Rapid City 57701.

Tennessee

WSMC IBS Southern Missionary College, Collegedale 37315.
WTTU Tennessee Technological U., Cookeville 38581.
WTPL, 600 khz, IBS Tusculum College, Greenville 37743.
WFHC IBS Freed-Hardeman College, Henderson 38340.
WETS, 630 khz, East Tennessee State U., Johnson City 37601.
WUOT U. of Tennessee, Knoxville 37916.
WUTM, 760 khz, IBS Univ. of Tennessee, Martin 38238.
WVBC Bethel College, McKenzie 38201.
WTGR, 640 khz, IBS Memphis State U., Memphis 38111.
WMOT IBS Middle Tennessee State U., Murfreesboro 37130.
WRVU IBS Vanderbilt U., Nashville 37203.
WTSU, 580 khz, IBS Tenn. State U., Nashville 37203.
WNAZ Trevecca Nazarene College, Nashville 37210.

Texas

KACC, 760 khz, IBS Abilene Christian College, Abilene 79601.
KMCM IBS McMurry College, Abilene 79605.
KUTA, 760 khz, U. of Texas at Arlington, Arlington 76019.
KVLU, 93.1 mhz, IBS Lamar U., Beaumont 77710.
KACT IBS Ambassador College, Big Sandy 75755.
KHPC Howard Payne College, Brownwood 76801.
ETSU, cable FM, IBS East Texas State U., Commerce 75428.
KSMU, 640 khz, IBS Southern Methodist U., Dallas 75275.
KVOF, 560 khz, U. of Texas El Paso, El Paso 79968.
KTRU IBS Rice U., Houston 77001.
KSHU IBS Sam Houston State U., Huntsville 77340.
KTAI IBS Texas A&I Univ., Kingsville 78363.
KTXT IBS Texas Tech. Univ., Lubbock 79406.
KSTM IBS St. Mary's Univ., San Antonio 78228.
KWBU IBS Baylor Univ., Waco 76703.

Utah

KCDR IBS Southern Utah State College, Cedar City 84720.
KEPH Utah State Agricultural College, Ephraim 84627.

Vermont

WRUV, 580 khz, IBS U. of Vermont, Burlington 05401.
WJSC IBS Johnson State College, Johnson 05656.
WVM, 640 khz, 91.1 mhz cable FM, IBS Lyndon State College, Lyndonville 05851.
WRMC IBS Middlebury College, Middlebury 05753.
WNUB IBS Norwich U., Northfield 05663.
WWPV IBS St. Michael's College, Winoski Park 05404.

Virginia

WUVT, 640 khz, IBS Virginia Polytechnic Institute and State U., Blacksburg 24061.
WGMB, 600 khz, Bridgewater College, Bridgewater 22812.
WUVA, 640 khz, 89 mhz cable FM, IBS U. of Virginia, Charlottesville 22904.
WLRC, 780 khz, IBS Emory and Henry College, Emory 24327.
WEMC IBS Eastern Mennonite College, Harrisonburg 22801.
WLUR Washington Lee, Lexington 24450.
WWRM IBS Randolph-Macon Women's College, Lynchburg 24501.
WCRC IBS U. of Richmond, Richmond 23173.
WJRB IBS Richmond Professional, Richmond 23220.
WJRB, 820 khz, Virginia Commonwealth U., Richmond.
WBCC IBS Blue Ridge Community College, Weyers Cave 24486.

Washington

KEWC, 665 khz, Eastern Washington State College, Cheney 99204.
KYTS Walla Walla College, College Place 99324.
KCWS IBS Central Washington State College, Ellensburg 98926.
KNCC IBS Northwest College, Kirkland 98033.
KLVR Lower Columbia College, Longview 98632.
KUGR, 670, 760 khz, 95 mhz cable FM, IBS Washington State U., Pullman 99163.
KSSR 660 khz, IBS Seattle Pacific College, Seattle 98119.
KUPS IBS University of Puget Sound, Tacoma 98416.

West Virginia

WVBC IBS Bethany College, Bethany 26032.
WMHC, 630 khz, IBS Morris Harvey College, Charleston 25304.
WCDE IBS Davis & Elkins College, Elkins 26241.
WGSC, 640 khz, IBS Glenville State College, Glenville 26351.
WMUL IBS Marshall Univ., Huntington 25701.
WCAB IBS Alderson-Broaddus College, Philippi 24616.
WVSC, 560 khz, IBS Salem College, Salem 26426.

Wisconsin

WCHT, 580 khz, Lawrence U. of Wisconsin, Appleton 54911.
WCRC IBS Carthage College, Kenosha 53140.
WSRM, 990 khz, IBS U. of Wisconsin, Madison 53706.
WMDF IBS Milton College, Milton 53563.
WMUR, 750 khz, Marquette U., Milwaukee 53233.
WSUP, 630 khz, IBS U. of Wisconsin-Platteville, Platteville 53818.
WRPN IBS Ripon College, Ripon 54971.
WVLC, 640 khz, IBS Lakeland College, Sheboygan 53081.
WSSU IBS Univ. of Wisconsin, Superior 54480.
WCCL, 640 khz, IBS Carroll College, Waukesha 53186.

You belong in Broadcasting

the standard of color excellence:
color-correct[®] now identifies
byron tapes as well as
byron prints

Color-Correct[®] is the trademark registered by Byron Motion Pictures, Inc. in 1945. For nearly three decades, the phrase Color-Correct[®] has been synonymous with quality 16mm film.

Today the identifying trademark, Color-Correct[®] applies not only to Byron motion picture prints, but also includes Byron filmstrips and slides and has been legally extended to include Byron video tapes and transfers. The trademark is registered on the Principal Register of the U.S. Patent Office providing maximum copyright protection for the next twenty years.

That's quite a responsibility—living up to the *Color-Correct[®]* hallmark of excellence. It's a responsibility we gladly accept. Next time, insist on *Color-Correct[®]* tape or film.

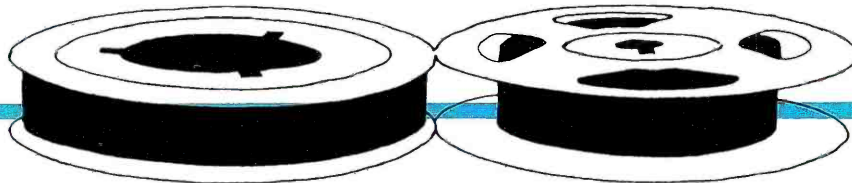

Tape

Fully equipped post production center
Volume ¾" cassette duplication
H.S. 200 computerized editing system
2 inch high speed duplication
Permanently installed long lines for
transmitting and receiving
Digisonics tape coding system
To come: CBS Laser Beam Color Film
Transfer Recorder

Film

Complete post production services
7247/5247 Eastman color negative
developing
High production panel printers—16mm
and Super 8
Eastman and Hazeltine color
analyzers
Liquid gate optical printer—
reductions, blow-ups, 1 to 1 printing
35mm slides and filmstrips—including
negative photography
And of course, Tape to Film transfers

byron COLOR-CORRECT[®]

65 K Street, Northeast Washington, D.C. 20002 202/783-2700
World's Most Sophisticated Video Tape and Film Laboratories

WITHOUT US, YOU'D BE MISSING THIS ...AND A WHOLE LOT MORE



ABC Sports

We're the people who make overseas television via satellite possible for you. But that's just a fraction of what we're doing. We make your overseas satellite phone calls possible, too. And we're the pioneer of international digital satellite communications as well as other new services. . . . Our subsidiary, COMSAT General Corporation soon will launch COMSTAR satellites for AT&T domestic services and MARISAT satellites for

greatly improved maritime communications. We're planning still more new programs, including a U.S. domestic satellite system in partnership with IBM and Aetna Life and Casualty. . . . All this to further improve communications in your home, your office and around the world. For more information on how satellite services can help you, write or give us a call (202/554-6100). We put you in touch—via satellite.

COMSAT



COMMUNICATIONS SATELLITE CORPORATION

950 L'ENFANT PLAZA, S.W., WASHINGTON, D.C. 20024

An Equal Opportunity Employer

D

Broadcast Advertising

Advertising Agencies	D-1
Media Buying/Planning Services	D-8
U.S. Representatives	D-8
Canadian Representatives	D-15
Special Advertising Services	D-15
Commercial Producers	see D-41

Networks & Programming

ABC	D-16
CBS	D-24
NBC	D-27
Mutual	D-30
Hughes Television Network	D-32
National Black Network	D-32
TVS Television Network	D-33
Regional TV Networks	D-33
Regional Radio Networks	D-33
Public Broadcasting	D-38
Canadian Networks	D-39

Radio and TV News Services	D-39
Producers, Distributors and Production Services—For Radio and TV Programs and Commercials	D-41
Closed Circuit TV	D-59
Music Licensing Groups	D-59
Major Awards and Citations	D-60
NAB TV Code	D-61
NAB Radio Code	D-66
Radio Formats	D-68
Special Radio Programming	D-85
World Radio and Television	D-91



Advertising Agencies Handling Major Radio and TV Accounts

A

Burke Dowling Adams Inc. (Division of BBDO Inc.) 1750 Peachtree Road N.W., Atlanta 30309. (404) 875-0121. F. Glenn Verrill, pres; J. Martin Hollinger, med dir; Cherrie Keel, Margie Linder, Penny Linder, Ayn Taylor, Judy Vaughn, media buyers.

Advertising Assoc. Inc. 4515 Harding Rd., Nashville 37205. (615)298-5519. R. Lockin Jones, pres; Steve Kirby, VP.

Radio-TV Media Dept.: Steve Kirby.

Aitkin-Kynett Co. Inc. Four Penn Center, Philadelphia 19103. (215) LO 8-6700. George B. Barnard, chmn bd & chief exec; Michael A. Walsh, VP, med dir.

Radio-Television Dept.: Richard Simmons, radio-TV prod dir.

Carl Ally Inc. 437 Madison Ave., New York 10022. (212) 688-5300. Carl Ally, chief exec officer; James Durfee, chmn of bd; Gerald Shapiro, pres, chief operating officer; Amil Gargano, exec VP, creative dir; Joseph Foran, sr VP, dir of client services.

Radio-TV Dept.: Janine Marjollet, VP, bcstg & prod; Larry Dexeimer, med dir.

Altman Stoller Weiss Advertising Inc. 641 Lexington Ave., New York 10022. (212) 421-6633. David Altman, bd chmn, sec & treas; Max Stoller, pres; Melvin Weiss, exec VP.

Radio-TV Department: Howard Gerber, med dir; Peter Cohen, radio & TV prod dir.

Ammirati Puris AvRutick Inc. 919 3rd Ave., New York 10022. (212)752-8500. Julian AvRutick, pres; Ralph Ammirati, exec VP; Martin Puris, exec VP.

Radio-TV Media Dept.: J. AvRutick.

N.W. Ayer ABH International. 1345 Ave. of the Americas, New York 10019. (212) 974-7400. Neal W. O'Connor, chmn; L.T. Hagopian, vice chmn; Robert T. Zabel, pres; Stuart Minton Jr., exec VP/gen mgr; Hans L. Carstensen Jr., senior VP and dir of mktg, media and rsch; George S. Burrows, VP and dir of media svcs; John L. Decker, senior VP, mgmt supvr and media dir; Howard Lechuk, VP and media dir; Howard Tobias, VP and media dir.

Chicago 60601: 111 E. Wacker Dr. (312) 645-8800. George A. Rink, exec VP and gen mgr; Tom Spasari, VP and media dir.

Los Angeles 90036: 5900 Wilshire Blvd. (213) 937-6211. Tyler Macdonald, chmn, exec VP and gen mgr, Ayer/Pacific; Van Jacobsen, pres; Frederick Olsen, senior VP, media and rsch, Ayer/Jorgensen/Macdonald.

San Francisco 94109: 2151 Sacramento St. (415) 563-5727. Robert C. Pritikin, Jerry Gibbons, plnrs; Pritikin & Gibbons Communications.

Seattle 98104: 216 First Ave., S. (206) 622-1555. Robert W. Castle, pres; Alan H. Chaiet, VP and media dir. Ayer/FE. Baker.

B

E.W. Baker Inc. 55 W. Maple, Birmingham, Mich. 48011. (313) 645-0300. Ernest W. Baker Jr., pres & treas; Jerome K. Abbs, chmn.

Ted Bates & Co. Inc. 1515 Broadway, New York 10036. (212) 869-3131. A. McG. Foster, bd chmn; R.E. Jacoby, pres & chief exec off; Richard A.R. Pinkham, chmn exec com.

Media & Program Dept.: Walter E. Reichel, senior VP exec dir; Isabel Ziegler, senior VP mgr; Fred H. Brandt, VP assoc dir.

Network Broadcast Div.: J.M. Segal, VP in chg; Charles Trubia, VP, negotiations; Miriam Roth, VP, account dir.

Bcst Operations Div.: Vincent J. Bonta, VP Radio/TV Bus. Control Div.: Robert S. Fenton, VP Med. Info & Analysis Div.: Jacqueline Da Costa, VP Media Directors—VPs: T. Focone, F. Gulla, D. Sibley.

Batten, Barton, Durstine & Osborne Inc. 383 Madison Ave., New York 10017. (212) 355-5800.

Thomas C. Dillon, chmn and chief exec off; James J. Jordan Jr., pres; Robert S. Levinson, VP, dir of net progmg; Robert E. Igiel, VP-TV group supvr; Alfred Sanno, VP-TV group supvr; Richard E. Welsh, VP-TV group supvr; Lawrence Fried, VP-TV group supvr; Paul F. Wigand, VP-dir of prog administration; Louis Bullock, dir of new programs; Ann S. Weeks, mgr of daytime TV; Karl M. Fischer, VP, dir TV/radio coml prod;

exec producers: Bernard Haber, VP; Leslie W. Collins, VP; Bertrand Mangel, VP; Thomas Anderson, VP; George Bragg, VP; Robert Conlan, VP; William Clotworthy, dir overscale casting; Carole A. Weinberg, dir of scale casting.

Radio-TV Media Dept.: Robert B. MacDonald, VP, dir media; Edward Tashjian, VP, dir media planning & buying svcs; planning group heads: Jonathan L. Firestone, VP; William Donnelly, VP; Jane Fuller, VP; Richard Borzumato, assoc media dir.

Branch offices:
Atlanta 30327: Burke Dowling Adams, 3290 Northside Parkway. (404) 875-0121. F. Glenn Verrill, pres.
Boston 02199: 2300 Prudential Center. (617) 267-7800. Norman F. Bierman, VP, mgr.

Detroit: 2100 W. Big Beaver Rd., Atrium Bldg., Troy, Mich. 48084. (313) 879-2000. Thomas J. Clark, VP, mgr.

Los Angeles 90036: 5670 Wilshire Blvd. (213) 938-3188. John E. Bernardy, VP, mgr.

Minneapolis 55402: 1640 Northwestern Bank Bldg. (612) 338-8401. William D. Reber, VP, mgr.

San Francisco 94108: 650 California St. (415) 397-1122. William W. Young, VP, mgr.

Behrends & Company Inc. Box 191, High Point, N.C. 27261. (919) 882-4151. Richard D. Behrends, pres; John H. Lockhart Jr., VP; Sylvia Y. Byerly, sec-treas.

Radio-TV Media Dept.: Sylvia Y. Byerly, bcst; Gracie Lank, print.

Walter F. Bennett & Co. 20 N. Wacker Dr., Chicago, Ill. 60606. (312) 372-1131. Jane M. Gunther, radio-TV time buyer.

Philadelphia 19103: 1634 Spruce St. (215) K15-2003.

Hollywood 90028: 1717 N. Highland Ave. (213) HO4-8291.

Benton & Bowles Inc. 909 Third Ave., New York 10022. (212) 758-6200. Victor G. Bloede, chmn bd; John S. Bowen, pres and chief exec off; Al Hampel, exec VP, dir, creative svcs; George J. Simko, senior VP, dir of med mgt; Michael Moore, sr VP, assoc dir, media

Advertising Agencies

mgmt.

Media Dept.: Martin Trapp, Phil Guarascio, Tom McCabe, Frank Massaro, Phil Shiffman, Frank Henderson, assoc media dirs; Charlotte Thompson, VP dir of PR.

Programming Dept.: Michael Lepiner, VP dir progmg; Fred Bartholomew, VP mgr daytime progmg. Hollywood 90028: 1800 N. Highland Ave. (213) 464-9151. T.S. Burnett Jr., sr VP gen mgr; John LaPick, VP creative dir; Max Bryer, sr VP mgr progmg.

New York 10022: Chuo Senko Adv. Inc. 909 3rd Ave. (212) 758-2444. Makoto Namioka, chmn; David Kreinik, pres & chief exec off.

North White Plains, N.Y. 10603: Ted Colangelo Assoc. Inc. 99 Lafayette Ave. (914) 694-2060. Ted Colangelo Jr., pres.

New York 10022: Medicus Communications Inc. (212) 826-0760. V. Edward Dent, pres.

Chicago 60601: 233 N. Michigan Ave. (312) 861-0300. Robert Cohen, Dale E. Landsman, Thomas F. Papenek, John Pavasars, sr VP's.

England: Benton & Bowles Ltd. 197 Knightsbridge, London S. W. 7. 01-589-1444. P. Townsend Griffin, chmn & mgng dir.

Spain: Benton/Bowles & Bowles (Trinidad) Ltd. 119 Abercromby St., Port of Spain, Trinidad. 34-519. Joyce Beston, mgng dir.

Italy: Benton & Bowles Assoc. Pubblicita Italian S.p.a. Corso Quintino Sella 58, 10131 Turin. 877-489. Dr. F. de Barberis, mgng dir.

Belgium: Publiccontrol/Benton & Bowles s.a. Montebellostraat 29, 2000 Antwerp. 38-58-66. Paul Van der Vloet, mgng dir.

Netherlands: Benton & Bowles en Partners B.V. Zwaansleit 3 Amsterdam/Buitenveldert. 44-68-01. Maarten Fels, mgng dir; Thomas E. Hoosen, sr VP & coord of European opns.

France: Benton & Bowles S.A. 33 Rue Marbeuf Paris 75008. 225-73-00. Andre Coutau, pres.

Germany: Brose und Partner/Benton & Bowles GmbH & Co. Freiherr vom-Stein-Strasse 31, 6 Frankfurt am Main. 59-53-61.

Austria: Brose und Partner/Benton & Bowles GmbH & Co. A-1030 Wien 3. Am Bodenapark 1-2, Vienna. 73-55-11.

Canada: Benton & Bowles Canada Ltd. 1235 Bay St. Toronto. (416) 922-2211. H. Donald Borthwick, pres.

Argentina: Johnson/Benton & Bowles S.A.C. de Publicidad. Rivadavia 789 Buenos Aires. Frank E. Johnson, chmn; Hernan Mayer, pres.

Spain: Danis S.A. Avda. Gmo. Franco 512, Barcelona 8. 228-16-05. Juan Fontcuberta, chief exec off. Spain: Danis S.A. Avenida Brasil 6 Madrid 20. 455-72-00.

Spain: Danis S.A. Gran Via 58 Bilbao. 4146-00.

The Biddle Company. 108 E. Market St., Bloomington, Ill. 61701. (309) 827-6161. Everett D. Biddle, chmn; William H. Peltier, pres; Kay Mills, media mgr.

Branch offices: Chicago 60611: 875 N. Michigan Ave. (312) 943-3822. William H. Peltier, pres; Kathy Adams, media mgr.

Westwood, Kan. 66205: 1900 W. 47th Pl. (913) 362-8640. Charles Lahey, VP-mgr; Virginia Schadle, media buyer.

Appleton, Wis. 54910: 4321 W. College Ave. (414) 739-4161. Tom Ramey, senior VP-mgr.

Ralph Bing Advertising Co. 23215 Commerce Park Dr., Beachwood, Ohio 44122. (216) 464-3350. Ralph S. Bing, pres; Barbara C. Bing, VP.

Radio-TV Media Dept.: Ralph S. Bing, time buyer; Susan Orris, prod.

Bruce J. Bloom Inc. 14 Donellan Rd., Scarsdale, N.Y. 10583. (914) 472-3888. Bruce J. Bloom, pres.

Botsford Ketchum Inc. 55 Union St., San Francisco 94104. (415) 982-7211. Robert Savage, pres; David Botsford Jr., chmn of bd.

Los Angeles 90005: 3435 Wilshire Blvd. (213) 385-4011.

Bozell & Jacobs International Inc. One Dag Hammarskjold Plaza, New York 10017. (212) 644-7200. Charles D. Peebler Jr., pres, chief exec off; Alan J. Jacobs, chmn exec comm; Joseph Caggiano, vice chm, finance; Robert Welty, sr VP med dir; John Fisher, VP; William Overmyer, pres.

Chicago 60611: 222 S. Riverside Plaza. (312) 648-1177. Tom Kuhn, exec VP & gen mgr; George Rogers, VP and dir med svcs.

Omaha 68114: 500 Bozell & Jacobs Plaza, 10250 Regency Cir. (402) 397-8660. Don Carlos, exec VP and gen mgr.

Los Angeles 90024: 10850 Wilshire Blvd. (213) 879-1800. Marlene Ubel, med buyer.

Atlanta 30318: 2 Northside 75. (404) 352-1472. Melvin Finkel, VP & mgr; Lee Scheinman, med dir.

Newark, N.J. 07012: 69 Washington St. (201) 623-5100. Donald Mayer, sr VP & gen mgr; Estelle DuJardin, med supvr.

Phoenix 85003: 100 W. Washington. (602) 254-6451. Tove Spofford, med dir.

Trenton, N.J. 08608: 156 W. State St. (609) 396-3880.

Minneapolis 55403: 100 N. 6th St. (612) 339-0071. Ronald H. Oakland, sr VP & creative dir; Jack Griffin, sr VP & dir mgt svcs.

Racine 53405: 4747 Hwy 31 North. (414) 639-5650. Edward Krein, sr VP and mgr; Charles Might, med rsch dir.

Bozell & Jacobs Pacific. 248 Battery St., San Francisco 94111. (415) 982-7878. Jack M. Seigle, pres; John H. Rolfs, exec VP and sec treas; Donald A. Herbers, VP account supvr.

Seattle 98101: 1500 Tower Bldg. (206) 682-1974. Charles Heinrich VP and gen mgr.

Honolulu 96813: Financial Plaza of the Pacific. (808) 531-6211. Martin D. Schiller, VP and gen mgr.

Glenn, Bozell & Jacobs Inc. 1750 Regal Row, Dallas 75235. (214) 630-9100. J. Liener Temerlin, pres; A.L. Bischhorn, sr VP finance; Robert E. Berry, exec VP and gen mgr.

Houston 77002: 2205 Chamber of Commerce Bldg. (713) 224-2761. William H. Fogarty, sr VP and gen mgr.

San Antonio 78215: 1010 McCullough Ave. (512) 227-6311. Glenn Reed, sr VP and mgr.

Oklahoma City 73102: 1420 First Natl. Bank Bldg. (405) 236-8343. Peter B. Rozier, VP and gen mgr.

Monterrey, N.L., Mexico: Apartado Postal No. 4005. 43-30-50. Alan Wipperman, mgr.

Broyles, Allebaugh & Davis Inc. 31 Denver Technological Center, Englewood, Colo. 80110. (303) 770-2000. Frank I. Allebaugh, chmn of bd; George H. Eakins, pres; Donald Hipschman, VP.

Radio-TV Media Dept.: James McCoy, med dir. Radio/TV/Film Prod. Dept.: Bob Geddy.

Buchen/Reincke Inc. 10 South Riverside Plaza, Chicago 60606. (312) State 2-6500. Hill Blackett Jr., chmn of bd; James L. Perry, exec VP; Bruce R. Kelly, sr VP/creative; Lawrence E. March, VP/med; Edwin R. Wentz, VP.

Leo Burnett Co. Inc. and Leo Burnett U.S.A., Prudential Plaza, Chicago 60601. (312) 236-5959. Leo Burnett Co. Inc.: Philip H. Schaff Jr., chmn of bd; C.R. Jack Kopp, pres; Michael J. Rich, financial VP; Clifford H. Irwin, VP-sec; Robert S. Minner, treas.

Leo Burnett U.S.A.: John J. Kinsella, pres; Howard C. Shank, bd chmn; Harold G. Tillson, exec VP; George E. Hamm, exec VP; Eugene Kolkey, exec VP; Gene McKeough, exec VP; Robert Noel, exec VP; Richard Stanwood, exec VP.

Broadcast Business: Peter Weber, mgr; Frank Cimmarusti, mgr, bcst svc; Marla Johnson, mgr, finance section.

Commercial Production: Jack Phelps, mgr TV prod; John A. Donnelly, Wil Fieldhouse, Hooper White, George Zimbelman, all exec prod.

Media-Chicago: William H. Oberholzer, VP in chg; Kenneth E. Lane, VP mgr med; Dr. Seymour Banks, VP med & prog analysis; Ronald Reisman, mgr med & prog analysis; David Arnold, assoc med dir administration & dev; Donald Amos, Lincoln Bumba, Willard Hadlock, Richard Coons, Richard Hobbs, Michael White, Robert Houghtlin, all VP/assoc med dirs.

Program-Chicago: William Eckert, VP in chg; David Seidel, prog supvr.

Program-New York: Gene Accas, VP net rel; Milton Slater, prog supvr.

Program-Hollywood: Walter Ruggles, VP prod mgr; John Christ, VP prod prod.

Media-Detroit: Joseph P. Henry, VP.

Branch offices: New York 10022: 767 Fifth Ave. (212) PL9-5959.

Southfield (Detroit), Mich. 48076: 26555 Evergreen Rd. (313) 355-1900.

Hollywood 90028: 6255 Sunset Blvd. (213) HOLLYWOOD 4-7373.

Leo Burnett Co. of Canada Ltd. 165 University Ave., Toronto M5H 3C1. (416) Empire 6-5801. Harold Johnston, pres; Canada: Arthur Mercet, exec-VP; Kerry Rubie, VP and acct supvr; Marsh Tripp, VP and acct supvr; Adair Gilmour, VP acct supvr; Wayne Hilinski, VP cr dir; Mel Norman, VP admin, fin; Charlie Gamble, VP media dir; Peter Anastasoff, VP ex prod; Gary Doke,

VP art dir; Don Brown, Ernest Trotter, prod mgrs; Jim Rothwell, VP acct supvr; Earl Duffy, VP/treas. Montreal 110: 2055 Peel St. (514) 844-3939. Vancouver V6A 1B2: 1 Alexander St. (604) 680-8866.

Leo Burnett Co. of Michigan Inc. 26555 Evergreen Rd., Southfield, Mich. 48076. (313) 355-1900.

Radio-TV Media Dept.: Joseph P. Henry, VP-med dir.

Leo Burnett Ltd. 48 St. Martin's Lane, London WC2N 4EJ, England. Gordon Barrett, mgng dir.

Byer & Bowman Adv. Agency Inc. 66 S. Sixth St., Columbus, Ohio 43215. (614) 221-7751. E. Ray Wilkin, pres; Charles K. Hartle, exec VP.

Radio-Television Dept.: Keith Shaffer, med dir; Lloyd Sheep, asst media dir.

C

J.M. Camp & Co. Box 968, Wheaton, Ill. 60187. (312) 668-8000. Ruth S. Camp, pres; John R. Linstra, VP. Radio-TV Media Dept.: Martha Thomas, time buyer.

Campbell-Ewald Co. (subsidiary of Interpublic Group) 3044 W. Grand Blvd., Detroit 48202. (313) 872-6200. T.B. Adams, chmn of bd; D.E. Davis Jr., exec VP & agency dir-creative svcs.

Media Dept.: John D. Varnier, sr VP-med dir; Edwin L. Acker, VP dir/multi-products med planning; L.M. Schultz, VP group dir/Chevrolet med planning; Bernard Guggenheim, VP group dir of med support opns; Randall D. Schroeder, VP mgr bcst buying.

Broadcast Production: Molly A. Hudson, senior VP dir of bcstg.

Branch Offices: New York 10020: 620 Fifth Ave. (212) 489-6200. J.J. O'Neal, sr VP & div mgr; Alan R. Dickinson, rgnl account exec.

Chicago 60611: 875 N. Michigan Ave. (312) 751-0800. Bruce W. Perkins, rgnl account exec.

Hollywood 90028: 1717 N. Highland Ave. (213) 461-3211. Robert K. Albright, rgnl account exec/office mgr; Joel T. Squier, sr writer-prod; Douglas A. Mahoney, sr prod specialist.

Atlanta 30303: 100 Peachtree St. N.W. (404) Jackson 4-3858. Randall M. Fraser, rgnl account exec.

Cincinnati 45203: 801B W. 8th St. (513) 621-0500. Michael S. Mitchell, rgnl account exec.

Dallas 75240: 7540 L.B.J. Freeway, Suite 922. (214) 661-3038. Gary L. Andersen, rgnl account exec.

San Francisco 94111: One Maritime Plaza. (415) Yukon 9-5556. R.H. Katerndahl, rgnl account exec.

Chevy Chase, Md. 20015: 5454 Wisconsin Ave. (301) 657-2447. Donald R. Freeman, rgnl account exec.

Kansas City, Mo. 64112: Mid-Continent Bank Bldg. (816) 931-9341. R. David Eick, rgnl account exec.

Campbell-Mithum Inc. Northstar Center, Minneapolis 55402. (612) 339-7383. Stanhope E. Blunt, chmn; George H. Gruenwald, pres.

Chicago 60601: 111 E. Wacker Dr. (312) 565-3800. David R. Seibel, exec VP.

Denver 80206: 200 Fillmore St. (303) 399-2962. E.L. Nelson, VP & gen mgr.

Cargill, Wilson & Acree Inc., Corporate Headquarters: 100 Colony Sq., Atlanta 30361. (404) 892-8790. Edward Acree, chmn of the bd; Charles W. Wray Jr., pres; Don Makowski, exec VP; James Rice, senior VP finance; Jim R. Rogers, senior VP dir prod svcs; Watson Mundy, senior VP; Michael Gaffney, VP co-corporate creative dir; Robert Scott, corporate media dir.

Radio-TV Media Dept.: Jim R. Rogers, dir bcst prod svcs; Peter Friedman, bcst mgr/prod.

Birmingham, Ala. 35202: 2112 11th Ave. South. (205) 251-0287. Donald Dunham, mgt supvr; Ms. Lu Cruce, creative supvr; Linda McRevy, media buyer.

Charlotte, N.C. 28204: 700 Kenilworth Ave. (704) 332-9071. Charles W. Wray Jr., pres; Robert Ward, VP; Augustus G. Torchia, co-corporate creative dir; Sylvia Cope, media dir.

Charney/Levy/George Inc. 770 Lexington Ave., New York 10021. (212) 421-7800. Charles J. Charney, Alvin George, execs.

Chirurg & Cairns Inc. 641 Lexington Ave., New York 10022. (212) Murray Hill 8-5800. W.L. Shepardon, chmn of bd; T.R. Vohs, pres; C.W. Reinhart, VP-gen mgr.

Radio-Television Dept.: Bruce Doll, media dir & VP. Chestnut Hill 67, Mass.: 824 Boylston St. Regent 4-1055. John Nazzaro, VP, gen mgr; Ruth Gaeta, time-buyer.

Hartford, Conn.: Professional Park. (203) 677-1351. R. Carpenter, VP-gen mgr.

Advertising Agencies

The Clyne Company Inc. 245 Park Ave., New York 10017. (212) 983-3800. C. Terrence Clyne, chmn & chief exec off; Henry Kornhauser, pres; John Calene, dir creative svcs; Daniel J. Connolly, dir financial svcs. Radio-TV Media Dept.: Charles Kahao, mgr-med svcs.

Cole & Weber Inc. 3100 S. 176th St. Seattle 98188. (206) 433-6200. Jack L. Sugg, chmn of bd; Lee Jacobi, pres; Hal Dixon, exec VP, chmn of exec com. Radio-TV Media Dept.: Larry Field, VP, Radio/TV dir; Lyn W. Gross, med dir.

Portland, Ore. 97204: 220 S.W. Morrison St. (503) 226-2821. Jack Wagner, VP, creative dir; Kathryn Littlefield, med dir; Rosemary White, sr media buyer.

Colle & McVoy Advertising Agency Inc. 1550 E. 78th St., Minneapolis 55423. Clarence Thompson, chmn of bd.

Radio-TV Media Dept.: Mary Ann Doss, med dir; Joe Feyder, Mary Jane Elander, asst med dirs; Kathy Ray, radio-TV prod.

Waterloo, Iowa: 416 E. Fourth St. (319) ADAMS 4-1583. James Heinz.

Denver 80203: 601 Broadwar Bldg. (303) 825-8253. Jack Snapp.

Sioux Falls, S.D. 57104: 800 W. 11th St. (605) 336-7828. Howard Fitzner.

Coral Gables, Fla. 33134: 2505 Ponce de Leon Blvd. (305) 444-7416. Glen Wilber.

Compton Advertising Inc. 625 Madison Ave., New York 10022. (212) PL 4-1100. C. Stuart Mitchell, chmn of bd; Barton Cummings, chmn exec com; Mill Gossett, pres.

Media Dept.: Bob Liddel, med dir; Maurice Scullor, mgr med dept.; Arnold Behrman, Joe Burbeck, Graham Hay, P. Hendricks, Rick Marino, Larry Nelson, Bob Pape, M. Rosser, Lois Underhill, Jane Twyon, Ethel Wieder, assoc med dir.

Bruce Cox, dir prog dept.; Tom Adams, assoc dir. Los Angeles 90036: 5670 Wilshire Blvd. (213) 937-3610. Shel Stewart, VP.

Comstock Advertising Inc. 70 Niagara St., Buffalo, N.Y. 14202. (716) 856-2100.

James E. Peters, chmn; Joseph H. Radder, pres; Mitchell Owen, exec VP; Howard C. Schellenberg, VP; James Felger, VP.

Radio-Television Dept.: Howard C. Schellenberg, Laurie A. Grace.

The Cramer-Krasselt Co. 733 N. Van Buren St., Milwaukee 53202. (414) 276-3500.

Radio-Television Dept.: John J. Mann, VP & creative dir; Don Pom, radio/TV time buyer.

Crosswell, Munsell, Schubert & Zirbel Inc. (division of Young & Rubicam Int. Inc.) NDP Center-2nd floor, 321 3rd St. S.E., Cedar Rapids, Iowa 52401. (319) 364-9141. E.W. Munsell, pres; R.H. Schubert, exec-VP; R.P. Zirbel, sr VP; L.M. Booton, sr VP; R.D. Meyocks, VP; M.L. White, VP; R.S. Jensen, VP.

Media Director: M.L. White, dir mktg & media svcs; A.M. Huff, media dir; Shirley Karrick, media planner/buyer; J.C. Johnson, media planner/buyer.

Cunningham & Walsh Inc. 260 Madison Ave., New York 10016. (212) 683-4900. Carl W. Nichols Jr., chmn, chief exec off; Anthony C. Chevins, pres; Edward H. Calhoun, exec VP; William T. Brooks, sr VP, dir mktg svcs; Frank P. McDonald, sr VP & dir med svcs; Howard Nass, Richard J. Busciglio, VP, med dir.

San Francisco 94111: 500 Sansome St. (415) 981-7850. Fred Hale, exec VP & dir; Robert Jeremiah, VP, med.

Los Angeles 90067: 1888 Century Park East (213) 556-1600. Robert Kresser, VP, mgr.

D

DKG Inc. 1271 Ave. of the Americas, New York. (212) 489-7300. Shepard Kurnit, chmn & chief exec off; Lawrence Spector, pres; George Rosenkranc, sr VP, med dir.

Dancer Fitzgerald Sample Inc. 347 Madison Ave., New York 10017. (212) 679-0600. Clifford Fitzgerald, founder-chmn; Gordon H. Johnson, chmn, DFS Holdings dir; Stuart B. Upson, bd chmn & chief exec off; Louis T. Fischer, sr VP, media dir; Avram Butensky, sr VP, dir of TV spot buying; Louis Dorkin, sr VP, dir network progmg; Joseph T. Shaw, Jr., VP, dir commercial prod svcs; Arnold Brown, sr VP, director of recording; Ira Weinblatt, VP, dir of media rsch; Melville A. Conner, VP, assoc dir adult TV; William J. Sheehan, VP, assoc dir for Sports TV; Francis J. Mooney Jr., VP for bus and legal affairs.

Hollywood, Calif.: 5670 Wilshire Blvd., Los Angeles. (213) 937-2710. Betty O'Hara, VP, mgr.

San Francisco 94111: 1010 Battery St. (415) 982-8400. Philip S. Boone, sr VP & gen mgr, western opns.

Winter Haven, Fla. 33880: Route 1, No. Lake Winterset Dr., Winterset Acres, John Baldwin, sr VP.

Daniel & Charles Associates Ltd. 261 Madison Ave., New York 10016. (212) 661-0200. Charles Goldschmidt, bd chmn; Daniel S. Karsch, chmn exec com; Laurence Dunst, pres.; Richard Walken, VP, media dir.

Radio-TV Media Dept.: Doris Gould, VP, bcst svcs.

Draper Daniels Inc. John Hancock Center, 875 N. Michigan Ave., Chicago 60611. (312) 751-2244. Draper Daniels, chmn of bd; Myra Janco Daniels, pres; Jack Ragel, VP, med/mktg; Ernest Eversz, VP, creative dir; John E. Matthews, chmn of plans bd; Isabel McCaulay, med mgr.

D'Arcy-MacManus & Masius Advertising. One Memorial Dr., St. Louis 63102. (314) 231-6700. A.J. Amendola, corporate exec VP, mgng dir of St. Louis office; C.J. Prince, senior VP, dir of account service; G. Tintera, VP, dir of client svcs.

Radio-TV Media Dept.: Jerone B. Sexton, VP-media dir; J. Dolan Walsh, VP, H.E. Diekroger, S. Phelps, assoc media dir; Beth Seib, spot buying supvr; Edna Dickinson, Tim Finney, Glenn Hathaway, Dave Kelley, Lee Ludington, Greg Ottersbach, Mary Jo Ziegenfuss, media planners; Lynda McElfresh, Margaret Muse, senior media buyers; Kathleen Clark, Linda Heatherly, Linda Sommers, Barbara Vogt, media buyers.

Bloomfield Hills, Mich. 48013: Woodward at Long Lake Rd. (313) 646-1000. C.F. Adams, corporate exec VP, mgng dir.

Los Angeles 90069: 1801 Century Park East. (213) 277-2888. J.F. Bruemmer, VP, gen mgr.

New York 10022: 437 Madison Ave. (212) 754-2300. W.E. Chambers, exec VP, gen mgr.

Wesley Day Advertising. 1900 Financial Center, Des Moines, Iowa 50309. (515) 243-4135. Len Howe, chmn of bd; Kelley Rucker, exec VP; Robert M. Buckley, pres.

Radio-TV Media Dept.: Darlene Nelson, media planner.

de Garmo Inc. 605 Third Ave., New York 10016. (212) 986-2122. John de Garmo, chmn; Chester L. Posey, pres; Robert S. Berman, exec VP; Steve Semons, VP & med dir; Ivy Stevens, Richard Ruggles, med buyers.

Della Femina, Travisano & Partners Inc. 625 Madison Ave., New York 10022. (212) 421-7180. Jerry Della Femina, pres; Ronald Travisano, exec VP.

Los Angeles 90036: 5900 Wilshire Blvd. (213) 937-8540. Sydney M. Cohen, VP, western reg.

Dentsu Adv. Ltd. 1-11, Tsukiji, Chuo-ku, Tokyo, Japan. Yoshichika Nakahata, pres; Kigoro Shimada, exec VP. 544-5111.

New York: 1114 Ave. of the Americas, New York 10036. (212) 869-8350.

Los Angeles 90036: 5900 Wilshire Blvd. Toyosuke Gamo, VP & gen mgr.

Direct Response Broadcasting Network Inc. Lewis Tower Bldg., Philadelphia 19102. (215) 735-7911. Bernard J. Kramer, pres; Larry Magill, VP television; Lowell Fishman, VP, radio.

Doe-Anderson Advertising Agency Inc. 223 E. Broadway, Louisville, Kentucky 40202. (502) 589-1700. Larry Barker, bd chmn; Robert S. Allison, pres; Robert J. Beggs, sr VP; Joseph V. Rigby, sr VP; Mrs. G.P. Porter, sec & med/mkt coord; John L. Shaw, med dir.

Domain Agency Inc. 465 E. Gundersen Dr., Carol Stream/Wheaton, Ill. 60187. (312) 668-5300. Douglas L. Mains, pres; Faith E. Mains, prod mgr; Orva I. Koenigsberg, account exec; Jeannette Abuhl, account exec.

Wheaton, Ill. 60187: Domain Communications Inc., 805 West Liberty. (312) 682-1460. David Kincheloe, mgr.

Ralph L. Dombrower Co. Inc. 11 E. Franklin St., Richmond, Va. 23219. (804) 643-1113. Ralph L. Dombrower Sr., pres & treas; Ralph L. Dombrower Jr., VP; Malcolm B. Dombrower, VP, sec.

Radio-Television Dept.: Ralph L. Dombrower Jr., mgr.

W.B. Doner & Co. 26711 Northwestern Hwy, Southfield, Mich. 48075. (313) 354-9700. Wilfred B. Doner, chmn exec com; Stanley T. Burkoff, pres; Seymour Roberts, exec VP, acct svcs; Robert G. Urquhart, exec VP, creative dir; M. Kevin Wixted, sec-treas; Emanuel Klein, senior VP, corporate media dir.

Radio-TV Media Dept.: Steven R. Levine, VP, media

dir; Ellen Dryer, Claudia Wickham, media svprs; Marilyn Walsh, Lynn Johnston, asst planners/buyers.

Baltimore 21218: 2305 N. Charles St. (301) 338-1600. Herbert D. Fried, chmn of bd.

Radio-TV Media Dept.: Emanuel Klein, senior VP, corporate media dir; Raymond Dundas, assoc media dir; Fred Hamilton, med supvr; Thomas Healey, med rsch dir; Gary Greenblatt, media supvr/planner; Gerry Rutkowski, asst media planner; Joy Spracklin, Judy Cohan, Ruth Helme, med planners/buyers; Louise MacFarland, outdoor/yellow pages specialist.

Doremus & Co. 120 Broadway, New York 10005. (212) 964-0700. Frank Schaffer, chmn bd; G. Barry McMenamin, pres.

Radio-TV Media Dept.: Robert A. Fearon, exec VP, creative dir; Paula Del Nunzio, VP, radio & TV prod.

Chicago 60604: 208 S. La Salle St. (312) 236-9132.

Boston 02116: 535 Boylston St. (617) 261-2560. Los Angeles 90010: 3520 Wilshire Blvd. (213) 380-5430.

Philadelphia 19102: 106 S. 16th St. (215) 561-0630.

San Francisco 94104: 322 Pine St. (415) 981-4020. Washington 20006: 1701 K St. N.W. (202) 296-5527.

Doyle Dane Bernbach Inc. 20 W. 43rd St., New York 10036. (212) 564-1234. William Bernbach, chief exec off & chmn of the exec committee; Joseph R. Daly, chmn of bd; Thomas A. Gallagher, pres; Ted H. Factor, vice chmn in charge of West Coast opns; Robert Levenson, vice chmn creative; Neil R. Austrian, exec VP, chief financial off, chief admin off & treas; Marvin Honig, exec VP & creative dir; Dorothy Parisi Runkel, senior VP, sec & gen mgr.

Radio-TV Media Dept.: Michael Drexler, senior VP in chg of media; Sy Goldis, VP-dir of media svcs; Sam Haven, John Pansuti, Allan Reed, Conant Sawyer, Herb Schader, Emil Tacovsky, media planning dirs; Ralph Bodle, Scott Clark, Terence Costello, Robert Gass, Robert Gorby, Ron Grimm, George Huelser, Donald Kamens, Lou Kennedy, Shirlyn Mandel, Henry Peterson, Tom Stokas, assoc media planning dirs; John Curran, VP & dir of net TV/radio progmg; Mitchell Lipman, VP & net account supvr; Thomas O'Reilly, net account supvr; Arthur Schreibman, net account exec; Sachi Tasaka, net asst account exec; Janet Sofer, prog coord.

Los Angeles 90036: 5900 Wilshire Blvd. (213) 937-5100.

E

Ehrlich-Harris-Manes & Associates. 4901 Fairmont Ave., Washington 20014. (301) 657-1800. Alvin Q. Ehrlich, pres; Nella C. Manes, exec VP.

Radio-TV Media Dept.: Mary Egan, Donna Webber.

A. Eicoff & Co. 520 N. Michigan Ave., Chicago 60611. (312) 944-2300. Alvin M. Eicoff, pres & mktg dir; Ron Zabka, Margie Zolla, VPs, med.

Eisaman, Johns & Laws. 6255 Sunset Blvd., Los Angeles 90028. (213) 469-1234. Jess M. Johns, pres; J.R. Eisaman, exec VP & account supvr; Robert F. Laws, sr VP & account supvr.

Radio-TV Media Dept.: Ron Phillips, VP & creative dir; bcst; Sherrie Lau, dir, med svcs, western dir; Edith Whaley, med supvr.

Chicago 60601: 333 N. Michigan Ave. (312) 263-3474. Gary Sather, dir, med svcs, eastern dir. New York 10022: 964 3rd Ave. (212) 486-2200.

Elkman Advertising Co. Inc. One Bala Cynwyd Plaza, Bala Cynwyd, Pa. 19004. (215) 835-2400. Stanley Elkman, pres; Donald M. Tuckerman, senior VP; Donald Rosenblit, senior VP.

Radio-TV Media Dept.: Claudia Consiglio, dir; Stephanie Campbell, Karen Culbertson, Judi Goldberg, Ester Poll, buyers.

The Eloise Co. 11 West Main St., Moorestown, N.J. 08057. (609) 235-7900. Eloise M. Kocyan, pres; George H. Kocyan, Jr., VP.

Erwin Wasey. (Subsidiary of Interpublic Group of Companies Inc.) 5455 Wilshire Blvd., Los Angeles 90036. (213) 931-1211. Elliott W. Plowe, chm & chief exec off; Joseph F. Gallagher, pres.

William Esty Co. 100 E. 42nd St., New York 10017. (212) 697-1600. John H. Peace, chmn exec com; Robert B. Betts, chmn bd; Paul R. Dooling, pres; Mark F. Byrne, sr VP, med svcs.

Advertising Agencies

TV Programing Dept.: William Seaman, sr VP, progmg dir.
Santurce, PR. 00908: 1205 Ave. Ponce de Leon. 724-2660-6.

F

Fahlgren & Ferriss Inc. 3100 Carew Tower, Cincinnati 45202. (513)421-2300. David P. Ferriss, chmn; Vincent J. Backley Jr., senior VP; Robert McBride, VP/creative dir; Nita Gwyn, radio & TV prod.

Radio-TV Media Dept.: Thomas Neville, VP/med dir. Parkersburg, W. Va. 26101: Rosemar R. (304)422-3591. H. Smoot Fahlgren, pres.

Pittsburgh 15222: 1414 Oliver Bldg., Mellon Square. (412)391-2270. Ronald J. Koeper, VP-gen mgr.

Fairfax Inc. 260 Madison Ave., New York 10016. (212) 490-7200. Stanley I. Fishel, exec VP & treas.

FCB International Inc. Dr. Edward Grosse, chmn of bd (Chicago); Gerard Iannelli, exec VP (Chicago); Richard B. Bradshaw, sr VP (Toronto); Paul Griffin, sr VP & European opns dir (Frankfurt).

Australia: Foote, Cone & Belding Pty. Ltd., South Yarra, Victoria 3141, Australia. 204 Toorak Rd. 03-240211. John Wardrop, gen mgr.

Australia: Sydney, New South Wales 2010. 9 Commonwealth Street. 02-3573433. M.M. Walker, mgng dir & chmn of Australian bd.

Belgium: Impact-FCB S.A. Brussels 1180. Avenue Brugman 229. (02)345-18-95. Maurice Frydman, gen mgr.

Canada: Foote, Cone & Belding Advertising Ltd., Toronto M4Y 1R1. 10 St. Mary Street. (416) 924-9331. Richard B. Bradshaw, pres & chmn of bd; Robert McBain, exec VP & gen mgr.

Denmark: Foote, Cone & Belding A/S, Copenhagen DK-2100. Ryesgade 53B. (01) 37-11-66. P. Bulow Lehnsby, gen mgr.

England: Foote, Cone & Belding Ltd. London W1M, 2A E. 82 Baker Street. (01) 935-4426. William Kiely, mgng dir.

France: Impact/FCB S.A. 75008 Paris. 30 ave. de Friedland. (01)267-44-22. Pierre Lemonnier, mgng dir.

Germany: Foote, Cone & Belding GmbH. 6000 Frankfurt/Main. Falkensteiner Strasse 75-77. (0611) 15071. Norbert Borsch, mgng dir.

Holland: JB/FCB, b.v. Amsterdam-Buitenveldert. De Boelelaan 16. (020) 44-05-55. Jacques Jessurun, mgng dir.

Italy: Foote, Cone & Belding S.p.A. 20123 Milano. Via della Posta 8/10. (06) 867-851. Gian Luigi Botter, chmn & mgng dir.

00198 Roma: Corso Trieste 42. Franco Farina, gen mgr.

Mexico: Foote, Cone & Belding de Mexico, S.A. Mexico 7, D.F. Salamanca No. 102-10 Piso. 905-511-9713. Ricardo Rubio, mgng dir.

Puerto Rico: Foote, Cone & Belding Adv., Inc., Carribean. GPO 2338 San Juan 00936. (809) 783-5050. Mike Martinez, gen mgr.

South Africa: Lindsay Smithers-FCB Pty. Ltd. Sandton City. (2711) 336821. Len van Zyl, chmn & mgng dir.

Spain: Foote, Cone & Belding, S.A.E. Madrid 1. Serano 27. (01)275-66-06. Antonio Beja, gen mgr.

Sweden: Foote, Cone & Belding AB. Stockholm S-105 62. Kungsgaten 5. (08) 240-240. Christian Preisler, gen mgr.

Fitzgerald Adv. Inc. 615 K&B Plaza, New Orleans 70130. (504) 529-3161. Jos. L. Killeen Jr., pres; Gary Dickson, Martin Manion, Ronald Thompson, account execs; William Conery, Charles Brennan, PR.

Radio-TV Media Dept.: Debbie Reed, med dir; Darryl R. Turgeon, creative dir; Joseph Del Papa, copy chief.

Foltz-Wessinger Inc. 120 N. Shippen St., Lancaster, Pa. 392-2105. David E. Wagenseller Jr.

Foote, Cone & Belding Communications Inc. 200 Park Ave., New York 10017. (212) 973-7000. Arthur W. Schultz, bd chmn; John E. O'Toole, pres & chmn of the exec committee; Robert M. Trump, chmn of the finance committee.

Foote, Cone & Belding Advertising Inc.; Arthur W. Schultz, bd chmn; John E. O'Toole, pres; Charles S. Winston Jr., vice chmn; Louis E. Scott, chmn, exec comm; Robert M. Trump, chmn fin comm; W.R. Wirth, gen mgr.

Broadcast Department: Walter J. Reed, VP dir of

media; Peter M. Bardach, VP dir of bcst.

Creative and Commercial TV Production: Donald J. Pojednic, exec creative dir; Robert Kroll, Edward S. Littleford, Patricia P. Mullen, Susanne G. Townsend, creative dirs; William Hentz, assoc creative dir; Hector Robledo, exec art dir; Richard G. Balian, VP admn; Edward I. Murphy, Herb Blitstein, Judith Stone, Joan Creamer, prod.

Chicago 60611: 401 N. Michigan Ave. (312) 467-9200. David Ofner, gen mgr, Chicago; Thomas Arend, dir opns; Ron Hoff, William S. Baker, exec creative dirs; Robert Mellott, mgr coml svcs; Edward Stern, med dir; Robert Daubensbeck, assoc med dir; Jack Farnell, bcst dir; John Libberton, VP, exec prod; Edward M. Stern, VP, med dir; Robert Daubenspeck, VP, mgr & assoc med dir.

Foote, Cone & Belding/Honig Inc. Louis Honig, chmn; Louis E. Scott, pres; Norman Brown, VP; Thomas Randolph, VP.

Los Angeles 90057: 2727 W. Sixth St. (213) 381-6966. Louis E. Scott, chmn exec comm, West Coast; Norman Brown, gen mgr; John A. Foster, creative dir; Leonard A. Levy, exec prod; Madeline Nagel, med dir.

San Francisco 94111: 55 Francisco St. (415)398-5200. Thomas F. Randolph, gen mgr; Ronald Berman, creative dir; Michael Koelker, Raymond Menzel, assoc creative dirs; Wilton C. Kuffel, med dir.

Albert Frank-Guenther Law Inc. 61 Broadway, New York. (212) 248-5200. John V. McAdams, chmn; Frank W. Hall, pres.

Radio-TV Dept.: Lawrence Butner, sr VP, radio-TV dir. Los Angeles 90036: 5900 Wilshire Blvd. (213) 937-4090. Robert W. Day, sr VP, dir.

San Francisco 94108: 214 Grant Ave. (415) 986-4641. Richard E. Cruickshank, sr VP-mgr.

Chicago 60602: 1 North LaSalle St. (312) 332-6424. John R. Dawson, VP.

Boston 02109: 22 Battery March St. (617) 482-5113. Lane Peacock Jr., mgr.

Philadelphia 19107: Philadelphia National Bank Bldg. (215) Locust 4-2345. James P. Dwyer, senior VP; Robert G. Fest, sr VP.

Clinton E. Frank Inc. 120 S. Riverside Plaza, Chicago 60606. (312) 454-5500. Clinton E. Frank, chmn bd; Donald R. Rutz, pres; Carroll L. Cheverie, exec VP; John E. Mitchell Jr., VP-chief financial off; Leonard B. Gross, vice chmn; Thomas W. Laughlin, sr VP & creative dir.

Radio-Television Dept.: Charles Bauer, dir bcst prod; Kay Hockstad, mgr bcst traf; Richard Matullo, VP-med dir.

New York 10017: 866 Third Ave., (212) 832-6060. Neil Ransick, VP-gen mgr.

Los Angeles 90010: 3550 Wilshire Blvd. (213) 380-3600. Ron Mitchell, sr VP, gen mgr.

Richmond, Va. 23230: 6620 W. Broad St. (804)282-9508. Gene Lightfoot, VP & gen mgr.

Dallas 75205: 5115 McKinney Ave. (214) 521-6400. David B. Ault, VP-gen mgr.

San Francisco 94133: 2351 Powell St. (415) 391-2290. Warren K. Pera, VP-gen mgr.

Fuller & Smith & Ross Inc. 666 Fifth Ave., New York 10019. (212) JU2-9000. Robert E. Allen, chmn; Arthur E. Duram, pres.

Radio-TV prog: William Hunting, VP, med dir.

Chicago 60611: 410 N. Michigan Ave. (312) 467-6800. Paul Brickman, sr VP & mgr.

Toronto 5: 165 Bloor St. E. (416) 925-3804. William A. Willis, mgr.

G

Gardner Advertising Co. Inc. 10 Broadway St. Louis 63102. (314) 444-2000. Warren J. Kratky, pres; Barry F. Loughrane, exec VP & managing dir; C. Kelly O'Neill, VP, med & progmg.

New York 10022: 767 Fifth Ave. (212) 759-8940. Barry Loughrane, VP & mgng dir.

Los Angeles 90028: 1717 N. Highland Ave. (213) 466-8546. Donald T. Forbes, VP, mgr & assoc dir TV/radio progmg.

Gaynor & Ducas Inc. 575 Madison Ave., New York 10022. (212) 688-6900. John J. Thomas, pres; Robert B. Stevens, exec VP, gen mgr; Thomas J. Murray, exec VP; James Holland, dir radio-TV prod; Robert Kutsche, VP, med dir.

George, Gibbs, Hammerman & Myers Advertising. 1515 N. Warson Rd., St. Louis 63132. (314) 428-9850. Irven Hammerman, bd chmn; Henry George, pres; Louis Myers, Harry Gibbs, VPs.

Radio-TV Media Dept.: Barbara Frodeman, med dir;

Carla Manning, asst med dir; Mary Clare Geerling, radio & TV prod.

Gray & Rogers Inc. 1234 Market St., Philadelphia 19107. (215) 864-6800. James W. Finegan, chmn & chief exec off; Donald E. Racer, VP, med dir.

Greah and Kramer Inc. Lewis Tower Bldg., 225 South 15th St., Philadelphia 19102. PE5-7911. B.J. Kramer, pres & creative dir; Karen LePere, VP & media dir.

Grey Advertising Inc. 777 Third Ave., New York 10017. (212) Plaza 1-3500. Edward H. Myer, pres & chief exec off; Arthur C. Fatt, Lawrence Valenstein, founders chmn; Stephen K. Zimmerman, exec VP, acct svcs & administration; Alan B. Fendrick, exec VP, sec & treas; Stephen Novick, senior VP, dir radio-TV coml prod; Bruce Allen, John Green, Catherine Z. Land, Jerome Samuelsohn, VPs, radio-TV prod supvrs.

Stanley Sorance, VP admn radio-TV prod; Ira Lassman, Hal Randelman, Mark Richard, VPs, producers.

Los Angeles 90010: 3435 Wilshire Blvd. (213) 380-0530. Robert L. Humphreys, exec VP, western opns.

Grismer Advertising Agency. 1533 Linden St. Des Moines, Iowa 50309. (515) 282-0455. William B. Grismer, pres; Collette Downey, VP & med dir; Jack Kragie, account supvr.

The Griswold-Eshleman Co. 55 Public Square, Cleveland 44113. (216) 696-3400. R.L. Baumgardner, bd chmn; R. E. Gerbracht, pres & chief exec off; Edmund G. Norwick Jr., VP, dir bus media.

Chicago 60611: 875 N. Michigan Ave. (312) 943-6464. Robert O'Connell, div pres & gen mgr.

Pittsburgh 15222: 223 4th Ave. (412)471-5701. Wynn T. Sullivan, sr VP & gen mgr.

New York 10021: 655 Madison Ave. (212) TE8-7100.

Grubb, Graham & Wilder Inc. Century 21 Plaza, Champaign, Ill. 61820. (217) 344-4334. Robert F. Grubb, bd chmn; John A. Grubb, pres; Patrick Graham, exec VP.

Radio-TV Media Dept.: Cathy Spencer, media dir.

H

Hall, Haerr, Peterson & Harney Inc. 6th Fl. Lehmann Bldg., Peoria, Ill. 61602. (309) 676-8758. J. Philip Harney, bd chmn; Richard A. Hall, pres.

Radio-TV Media Dept.: Mrs. Linda Gregory.

Jefferson City, Mo. 65101: Box 471. (314) 636-3107. Richard A. Hall, pres; Pat Graves, med dir.

Beverly Hills, Calif. 90210: 186 N. Canon Dr. (213) 275-2175. Bob Rose, mgr.

New York 10017: 331 Madison Ave. (212) 867-6633. James C. Seix, mgr.

Halsey, Stakeum & Brown Inc. 333 St. Charles Ave., New Orleans 70130. (504) 524-3282. Donald H. Halsey, pres; P.J. Stakeum Jr., exec VP; Hazel Brown, sec; Jeanne Lausano, media dir.

James Neal Harvey Inc. Advertising. 477 Madison Ave., New York 10022. (212) 759-2800. James N. Harvey, pres; Roger A. Johnson, Gilbert Dannehower, sr VPs.

Radio-TV Media Dept.: Edward Finlay, VP, media dir; Davis Stewart, asst media dir.

Henderson & Roll Inc. 1370 Ave. of the Americas, New York 10019. (212)489-6700. William R. Henderson, chmn, creative dir; I.C. Roll, pres.

Radio-Television Media buyers: William Segal, VP, med dir.

C.J. Herrick Assoc. Inc. 2 W. 45th St., New York 10036. (212) 986-6090. Clarence Herrick, pres; David Crowell, VP.

Radio-Television Dept.: N.G. Marchica.

Hicks & Greist Inc. 850 Third Ave., New York 10022. (212) 421-4200. Charles V. Skoog Jr., chmn of bd; D. Edward Ricchiuto, pres.

Radio-Television Dept.: Richard King, dir radio-TV prod.

Radio-Television Media Dept.: Seymour Parker, VP, med dir.

Hoffmann, York, Baker, & Johnson Inc. 2300 N. Mayfair Rd., Milwaukee 53226. (414) 259-2000. Eugene P. Lawler, pres & chief exec; James A. Baker, chmn bd; Joel Kursel, exec VP & dir acct mgt svcs; Richard A. Garvey, exec VP & creative dir svcs dir; Gordon Sierakowski, controller.

Radio-TV Media Dept.: Robert Geary, VP med and mrktg svcs; Dean Johnson, med and rsh mgr; John Rock, media planning mgr; Lyias Collins, media planning mgr; Joanne Smith, media estimates supvr.

Honig-Cooper & Harrington Inc. 3600 Wilshire

Bldv., Los Angeles 90010. (213)338-3301. Sherman R. Stade, pres.

Hutchins/Darcy Inc. 400 Midtown Tower, Rochester, New York 14604. (716) 546-6480. Frank Hutchins, chmn exec comm; James Morey, pres; Robert MaHarry, sr VP-creative dir.

Radio-TV Media Dept.: Charlotte Weissenberger, VP, media dir.

Infoplan International Inc. (subsidiary of Interpublic Group). 1271 Ave. of the Americas, New York 10020. (212) 697-1222. Leslie T. Harris, pres; Meredith S. Conley, William O. Connors, sr VP-account mgrs; Dorothy P. McGrath, VP-admin mgr.

Chicago 60611: 875 Michigan Ave., Suite 1816. (312) 787-1745. Jerry D. Lawrence, rgnl acct mgr. Pasadena, Calif. 91101: 251 S. Lake Ave. (213)681-6935. John B. Whittles, senior VP.

Coral Gables, Fla. 33134: 250 Catalonia Ave. (305) 448-5040. James R. Kerr, rgnl acct mgr.

Nassau, N.P. Bahamas: Box N3701. (809) 322-7500. William H. Kalis, sr VP. Also offices in Australia, Belgium, Canada, England, Finland, France, Germany.

The Interpublic Group of Companies Inc. 1271 Ave. of the Americas, New York 10020. (212) 867-1122. Paul Foley, chmn of bd & pres. [Also see: McCann-Erickson Inc., McCann-Erickson Advertising of Canada Ltd., Campbell-Ewald Co., Tinker-Dodge & Delano Inc., McCann-Erickson Corp. (International), The Marschak Co. Inc., Infoplan International Inc., Erwin Wasey Inc.]

Arnold E. Johnson Associates Inc. 100 S. Wacker Drive, Chicago 60606. (312) 372-4195. Grace R. Jordan, pres; Thomas Edward Steele, VP.

Radio-TV Media Dept.: Thomas E. Steele, VP, dir; Lenore B. Macafee, TV buyer.

Calvin Jones & Co. 3315 Sul Ross, Houston 77006. (713) 529-4181. B. Calvin Jones, pres; K.C. Benedict, traffic; Wayne Chandler, account exec.

Radio-TV Media Dept.: Don Hougland, prod/dir TV; Mel Coston, chief, photo section.

Ralph Jones Advertising Inc. 3100 Carew Tower, Cincinnati 45202. (513) 421-2300. David Ferriss, bd chmn; Edward C. Eilers, ctrlr; Rosemary Vordenberg, assoc med dir; Willis W. Ward, VP rsch dir; Nita Gwyn, bcst prod mgr.

Kalish & Rice Inc. 1845 Walnut St., Philadelphia 19103. (215) LO 4-3000. Allan S. Kalish, pres; Howard M. Rice, exec VP, creative svcs & sec; George Fischer, med dir.

Kameny Solomon, Sherwood & Gilbert Inc. 110 E. 59th St., New York 10022. (212) 421-5522. Seymour Kameny, chmn exec comm & sec-treas; Nat Kameny, bd chmn; Ray Solomon, exec VP, account supvr; Lew Sherwood, Dave Wiseltier, Marv Schneider, co-creative dirs.

Henry J. Kaufman & Assoc. Inc. 1050 31st St., N.W. Washington 20007. (202) 333-0700. Henry J. Kaufman, chmn; Al Edelson, pres & chief exec officer; Lois Golden, assoc dir, media; Joan Yonker, account exec; Stuart E. Karu, account supvr.

Radio-TV Media Dept.: Finley Hunt, VP, creative svcs; Phil Sabatino, VP, graphics.

Kelly, Nason Inc. 300 E. 42nd, New York 10017. (212) 986-4200. Sheldon Weeks, chmn, treas; Robert J. Palmer, pres, chief exec off; Robert P. Walsh, VP, med dir; Irene Taffel, VP, bcst dir.

Kenyon & Eckhardt Inc. 200 Park Ave., New York 10017. (212) 973-2000. L.A. Kelmenson, pres, chief exec off & chmn exec comm; S. Tannebaum, chmn of bd; Lawrence S. Parker, VP, dir TV-radio & print prod; Bruce Hoenig, VP & mgr med opns.

Boston 02116: 535 Boylston St. (617) 267-8550. Alice Liddell, VP med dir.

Chicago 60606: 10 S. Riverside Plaza (312) 346-4020. Dan Perry, VP & med dir.

Dallas 75219: 2695 Villa Creek Dr., Suite 100. (214)241-5012. William Pearson, VP mgr.

Dearborn, Mich. 48126: One Parklane Blvd. (313) 336-6600. David Gillespie, chmn bd & mgr.

Atlanta 30329: 4 Executive Park E., N.E. (404) 321-3680. John Mitchell, mgr.

Beverly Hills, Calif. 90212: 120 El Camino Dr., Suite 200. (213) 274-7611.

San Francisco 94111: 111 Pine Street. (415) 981-7270. John P. Finneran, VP mgr.

Toronto: 8 King St. (416) 925-8931.

Other offices in Belgium, France, Germany, Italy, Spain, U.K., Dominican Republic, Chile, Venezuela, Jamaica and Trinidad, Argentina, Brazil.

Ketchum International Ltd. 52 Bedford Row, London WC1. 01-242-8123. Peter L. Day, mng dir; William Parker, chmn; David Williams, chmn.

Ketchum MacLeod & Grove Inc. Four Gateway Center, Pittsburgh 15222. (412) 261-5100. Edward T. Parrack, chmn of bd, chief exec off, chmn of exec comm; William H. Genge, pres; William J. Gillilan, vice chmn of bd; Richard H. Connor, exec VP & dir corporate PR; William R. Parker, exec VP; Irving Miller, exec VP & mgr prof opns U.S. adv profit centers; John C. Rennels Jr., VP & treas; Edward L. Graf, VP & sec.

Media Dept.: Joseph M. Coogler, sr VP & dir, opns planning; Herbert D. Gordon, VP med dir; William B. Phillips, VP; Edwin H. Pfund, VP.

New York 10016: 90 Park Ave. (212) 983-8000. Donald J. Moore, exec VP & gen mgr; William H. Lynn, VP & dir TV-radio progmg; Daniel Borg, VP & med dir; Walter Kaprielian, sr VP & creative dir.

Washington 20006: 815 Connecticut Ave. N.W. (202) 296-5520. Roy Wilson, sr VP & gen mgr.

Houston 77006: 3334 Richmond Ave. (713) 532-6811. Anthony D. Wake, sr VP and gen mgr; Donald A. Colvin, sr VP.

Memphis 38131: Directors Plaza, 30-35 Directors Row. (901) 332-4045.

Klemmer Advertising Inc. 1185 Ave. of the Americas, New York 10036. (212) 869-8200. Bradley O. Potter, chmn of bd; Albert P. Molinaro Jr., pres.

Knox Reeves Advertising Inc. Butler Sq., 100 N. 6th St. Minneapolis 55403. (612) 339-0071. David A. Bell, sr VP & gen mgr; Ron Anderson, sr VP & creative dir.

Lando Inc. 39th floor, 600 Grant St., Pittsburgh 15219. (412) 281-5887. Anna M. Cunningham, med buyer; Bernadette McMahon, med dir.

Lang, Fisher & Stashower Advertising Inc. 1010 Euclid Ave., Cleveland 44115. (216) 771-0300. David L. Stashower, pres.

Radio-Television Dept.: Charles D. Knepper Jr., med dir-VP; Thomas S. Case, VP, creative dir; Lou Heckmann, assoc creative radio-TV dir; James A. Reilly, bcst prod mgr; Dorothy Hartrick, assoc med dir; Elaine Johnson, Christine Lockmiller, med buyers.

Lavidge & Assoc. Inc. Bearden Park Circle, Knoxville, Tenn. 37919. (615) 584-6121. Arthur W. Lavidge, pres; Hal Ernest, sr VP; Gerald Golden, exec VP; Pat Dawson, VP.

Radio-TV Media Dept.: Ashleigh Groce, Pat Dawson, Hal Ernest—Knoxville; Don Daniels—Chattanooga; Stew Gardner—Greensboro; Bill Crank—Atlanta.

Greensboro, N.C. 27408: 1400 Battleground Ave., Suite 214. (919)272-5152. Stewart Gardner, mgr.

Chattanooga 37404: 1082 Duncan Ave. (615)698-3366. Don Daniels, mgr.

Atlanta 30329: 4 Executive Park East. (404) 633-6491. Bill Crank, mgr.

LeBow Advertising Co. 100 Merrick Rd., Rockville Centre, N.Y. 11570. (516) 536-4646. Stanley E. LeBow, pres.

Al Paul Lefton Co. Inc., Rohm & Haas Bldg.; Independence Mall West, Philadelphia 19106. (215) 923-9600. Al Paul Lefton, Jr., pres & chief exec off.

Lewis & Gilman Inc. 1700 Market St., Philadelphia 19103. (215) LOcust 8-3775. John C. Belfield, chmn; Robert G. Wilder, pres; Palmer L. Reed, exec VP; Charles M. Lodovico, sr VP, treas.

Radio-TV Media Dept.: Mary Anne Salley, Frank Carvell, VP & med dir; Robert H. Belviso, VP.

Carr Liggett Advertising Inc. 815 Superior Ave., Cleveland 44114. (216) 696-0330. John F. Wilson, pres.

Radio-TV Media Dept.: Natalie Scofield, audio/visual dir; Robert A. Stern, dir of med rsch.

Columbus, Ohio 43229: 1925 E. Dublin Granville Rd. (614)846-3994. Paul L. Myers, gen mgr.

Liller, Neal, Battle & Lindsey Inc. 1300 Life of Georgia Tower, Atlanta 30308. (404) 881-0221. Howard G. Axelberg, chmn; Richard Hodges, pres; Oscar Lewis, vice chmn.

Radio-TV Media Dept.: Mrs. Bobbie Kemp, Mrs. Avrilla Phillips, Mrs. Hughlene Reynolds, Miss Cecilia Armistead, Mrs. Mary Jean Meadows.

Ross Llewellyn Inc. 222 S. Riverside Plaza, Chicago 60606. (312) 648-1339.

Advertising Agencies

Lois Holland Callaway Inc. 745 Fifth Ave., New York 10022. (212) 688-1525. George Lois, chmn & chief exec; Jim Callaway pres; Ron Holland, exec VP; John Cholakis, VP, TV mgr.

Luckie & Forney Inc. 120 Office Park Dr., Birmingham, Ala. 35223. (205) 879-2121. Robert E. Luckie, pres & sec; John Forney, exec VP; Frank Lee, exec VP & treas; Rudy Ward, bcst dir.

Earle Ludgin & Co. 410 N. Michigan Ave., Chicago 60611. (312) 527-4100. Stuart S. Shryer, pres; William W. Thomas, VP charge of media; Richard T. Williamson, VP, med dir.

Vic Maitland & Associates Inc. 2866 E. Oakland Park Blvd., Fort Lauderdale, Fla. 33306. V.I. Maitland, chmn of bd & pres; W.H. Ritenbaugh, exec VP; John Lucinatelli, VP opns; FL. Leistner Jr., VP ctrlr; L. G. Chapman, VP prod; A. R. Davies, VP copy chief; S.M. Walczak, VP graphic arts; K.J. Maitland, dir sls promo. Radio-TV Media Dept.: James Shannon, med dir; R.C. Harvey, VP radio-TV. Pittsburgh 15222: Gateway Towers, Gateway Center. (412) 281-0800.

Mandabach & Simms Inc. 20 N. Wacker Dr., Chicago 60606. (312) CEntal 6-5333. Paul Mandabach, bd chmn; Irwin Simms, pres; VP; Sheldon Kahn, exec VP.

Richard K. Manoff Inc. Advertising. 845 Third Ave., New York 10022. (212) 350-9200. Richard K. Manoff, chmn & chief exec off; Russell K. Shaffer, pres; Wayne Lachman, VP, dir, radio & TV prod; Howard Kamin, VP, med dir.

March Advertising Inc. 15 West 44th St., New York 10036. (212) 867-6683. Sy Levy, pres; Michael R. Fabian, exec VP.

Radio-TV Media Dept.: Marilyn Gottlieb, asst VP & media dir; Barbara Lewis, dir bcst med.

The Marschalk Co. (subsidiary of Interpublic Group) 1345 Ave. of the Americas, New York 10019. (212) 974-7700. Robert L. James, bd chmn & pres. Cleveland 44114: 601 Rockwell Ave. (216) 241-6850. James D. Kuras, exec VP & gen mgr.

Marsteller Inc. 866 Third Ave., New York 10022. (212) PL 2-6500. William A. Marsteller, bd chmn & chief exec off; R.G. Gaulke, exec VP, mgr; Joseph H. Newman, VP, med dir; Pauline Mann, VP, assoc med dir.

Chicago 60601: One East Wacker Drive. (312) 329-1100. Bruce H. Cole, exec VP, gen mgr.

Pittsburgh: One Oliver Plaza. (412) 391-5454. G.B. Richardson, VP, gen mgr.

Los Angeles: 3600 Wilshire Blvd. (213) DU 6-8600.

Masius-Wynne Williams Inc. 437 Madison Ave., New York 10022. (212)754-2300. W.G. Johnson, exec VP chmn opns comm; F.R.D. Tolson, corp exec VP mngg dir; R.A. McArdle, VP, med dir; Gus Spiel, VP assoc med dir.

Radio-TV Dept.: Helen A. Thomas, bcst media.

McCaffrey and McCall Inc. 575 Lexington Ave., New York 10022. (212) 421-7500. David B. McCall, chmn bd; Thomas G. Yohe, exec VP art, TV prod; James J. Tomaney, exec VP, media bcst, res; Joe Sutton, VP net rel; Richard Passanant, asst treas & asst sec; Marion Miller, VP account mgt.

McCann-Erickson Corp. (International) 485 Lexington Ave., New York 10017. (212) OX 7-6000. Eugen Kummel, chmn & chief exec off.

Affiliated companies in Switzerland, Belgium, France, Germany, Great Britain, Italy, Netherlands, Spain, Costa Rica, El Salvador, Guatemala, Mexico, Panama, Puerto Rico, Argentina, Brazil, Colombia, Ecuador, Peru, Uruguay, Venezuela, Australia, Hong Kong, Japan, Philippines.

McCann-Erickson Inc. (subsidiary of The Interpublic Group of Companies Inc.) 485 Lexington Ave., New York 10017. (212) 697-6000. Atlanta 30308: 615 Peachtree St., N.E., (404) 875-0561. Sidney B. McAllister, sr VP & mgr.

Chicago 60606: Gateway Center, 10 South Riverside Plaza. (312) 454-7700. Armella Selsor, VP media dir; Richard Sanborn, Michael Lehman, media supvrs. Detroit 48084: 2401 Big Beaver Rd., Suite 401. (313) 643-4540. Victor Olesen, exec VP & mgr.

Houston 77002: 800 Bell. (713) 225-0061. Jim G. Hetherly, exec VP & mgr.

Advertising Agencies

Los Angeles 90048: 6420 Wilshire Blvd. (213)665-9420. Michael Agate, sr VP & mgr.
Portland, Ore. 97204: 900 S.W. 5th. (503) 224-0621. Prescott T. Lustig, sr VP & mgr.
San Francisco 94104: 44 Montgomery St. (415) 981-2262.

Seattle 98104: 1001 Fourth Ave. (206) 682-6360.
Toronto M5S 1S8: McCann-Erickson Advertising of Canada Ltd., 151 Bloor W. James M. Reeve, bd chmn & pres.

Montreal 110: McCann-Erickson Advertising of Canada Ltd., 2015 Peel St. (514) 849-8341.

Vancouver 5, B.C.: McCann-Erickson Advertising of Canada Ltd., 1018-30 W. Georgia St. (604) 683-5608.
D. Tyerman, mgr.

Meldrum and Fewsmith Inc. 1220 Huron Rd., Cleveland 44115. (216) 241-2141. Arthur E. Earley, pres & chief exec off; Bruce F. Stauderman, exec VP.
Radio-TV Media Dept.: Henry H. Platek, VP, med svcs; Lee Stark, bcst coord.

Southfield, Mich. 48076: 26011 Evergreen Rd. (313) 358-5300. W.D. Neill, exec VP Detroit/Intl opns.

Meltzer, Aron & Lemen Inc. Steuart Street Tower, One Market Plaza, San Francisco 94150. (415) 543-0850. Richard N. Meltzer, bd chmn; Wallace X. Aron, pres; Richard Lemen, exec VP.
Radio-TV Media Dept.: Stan Colberson, VP/med dir. (415) 48226: 1950 First National Bank Bldg. (313)961-4810. Robert D. MacGregor, VP.

New York 10017: 230 Park Ave. (212)753-5055. Wallace Hoffman, gen mgr.
Chicago 60606: 10 S. Riverside Plaza. (312)454-0266. Reginald L. Dellow, mgr.

Arthur Meyerhoff Associates Inc. 410 N. Michigan Ave., Chicago 60611. (312) 337-7860. Roger Mohr, pres; A.E. Meyerhoff, bd chmn; George Taylor, sec; Ernest Stern, treas; Rodger Mitchell, Fred Stroud, sr VPs.
Radio-Television Dept.: Gary Kaney, radio & TV dir; Thomas Merritt, Sharon Pittman, prods; Len Kay, med dir; Francine Goldfine, assoc med dir; Nancy Swiet, June Kemper, Pat Harrington, Sharon McElroy, Rose Marie Snyder, Susan Abramowicz, Carol Spring, Maureen Gorman, Deborah Ross, radio/TV buyers.

Millic/Valenti Advertising Inc. 700 Bishop St., Honolulu 96813. (808) 536-0881. Ray Millic, chmn; Frank Valenti, pres; Mike Roeder, sr VP; Norm Blackburn, sr VP; John Brinck, sr VP; Jerry Huff, sr VP exec art dir.
Radio-TV Media Dept.: J. Fitzgibbon, med dir.

Miller Advertising Agency Inc. 850 Third Ave., New York 10022. (212) 688-1300. Leonard J. Miller, chmn bd; Robert Miller, pres.

John F. Murray Advertising Agency, Inc. 685 Third Ave., New York 10017. (212) 986-1000. Dan Rodgers, chmn, pres; A.C. Cestaro, treas.

W.S. Myers & Associates Inc. Ward Plaza, Honolulu 96814. (808) 531-3531. Jean K. Myers, pres; Robert Chun, VP, creative dir; Richard Lee, VP; Ted Sax, VP radio-TV dir.

N

Nadler & Larimer Inc. 555 Madison Ave., New York 10022. (212) 421-6140. Arch Nadler, chmn of bd; Robert Larimer, pres, creative dir; Irwin Goldberg, exec VP & co-creative dir.

Needham, Harper & Steers Advertising Inc. 909 Third Ave., New York 10022. (212) 758-7600. Paul C. Harper, chmn of bd; Frederick D. Sulcer, pres; J. Jerry Jacobs, VP & TV prod; Annette Mendola, VP & dir bcst buying.

Chicago 60611: 401 N. Michigan Ave. (312) 527-3400. B. Blair Vedder Jr., chmn of bd; Kris R. Schultz, VP & media dir; Marianne Monahan, mgr, spot bcst.

Los Angeles 90024: Kirkey Center, 10889 Wilshire Blvd. (213) 478-6525. Bradley H. Roberts, vice chmn, mgng dir; Bruce Gilbert, VP, med dir; Victoria Gilbert, assoc med dir; John S. Smith, assoc med dir.

Dayton 45402: Suite 2100, Winters Bank Tower. (513) 226-1515. Edward A. Wetzel Jr., VP, mgr.
Washington: 8150 Leesburg Pike Vienna, Va. 22180. (703) 790-1090. Thomas Lambert, VP & gen mgr.

Toronto M5H 1T3: Suite 300, 101 Richmond St. W. (416) 364-1492. Robert L. Miller, chmn; W. Bruce McLean, pres; D.J. Dailleboust, VP.

Montreal H3A 2A5: 2020 University Ave. (514) 282-4178.

Newmark, Posner & Mitchell Inc. 655 Madison Ave., New York 10021. (212) 758-9494. Sidney Posner, chmn and sec; Pearce A. Mitchell, pres and treas.

Noble-Dury & Assoc. Inc. Box 15363, 3814 Cleghorn Ave., Nashville, Tenn. 37215. (615) 297-0931. James M. Elliott Jr., chmn; FW Satterwhite, pres.

Radio-TV Media Dept.: Bill Stejskal, VP med dir. Media Buyers: Martha Perry, Nina Davidson, Melanie Austin; Jim Pocarrelli, assoc med dir; Arnold Witchei, med group head.

Memphis 38117: Box 17723, 803 Mt. Moriah Rd. (901)767-4330. B.H. Gardner, exec VP.

Norman, Craig & Kummel Inc. 919 Third Ave., New York 10022. (212) 751-0900. Norman B. Norman, chmn; Thomas K. Myers, pres.

Radio-TV Media Dept.: Tom Garrabrant, sr VP, med opns.

Norman, Navan, Moore & Baird Inc. 40 Pearl St. N.W., Grand Rapids, Mich. 49502. (616) 774-2900. John B. Norman, pres.

Radio-TV Media Dept.: Mrs. Dorothy Payne, time buyer.

Detroit 48975: 22255 Greenfield Rd. (313) 358-5811. Alton Gabeline.

Northlich, Stolley Inc. 500 Terrace Hilton Bldg., Cincinnati 45202. (513) 421-8840. A. Stolley, pres; R.J. Terbruggen, sec-treas, med dir; Mary A. Whittington, media buyer.

Northlich, Stolley, of Akron Inc., 230 W. Market St., Akron, Ohio 44303. (216) 253-5127. Norman R. Thomas, pres & gen mgr.

O

Ogilvy & Mather Inc. 2 East 48th St., New York 10017. (212) MUrray Hill 8-6100. Andrew Kernshaw, chmn bd; Henry P. Bernhard, vice-chmn.

Radio-TV Media Dept.: Jules Fine, exec VP dir mktg svcs; Howard Eaton, sr VP, dir bcstg; Jack Silverman, sr VP & TV prod head; Phillip L. Tomalin, sr VP & dir bcst prod svcs; Joseph Campion, VP & dir local bcst mgt group.

Los Angeles 90036: 5900 Wilshire Blvd. (213) 937-7900. Ralph Carson, counsel to mgt; Jack Roberts, dir special creative projects; Cy Schneider, sr VP & mgng dir; Ed Smarden, VP, bcst svcs; Norm Olson, med dir.

Houston 77002: 2600 Two Shell Plaza. (713) 225-1841. Michael Turner, sr VP & mgng dir.

Toronto M5H 1V5: 88/100 University Ave. (416) 362-7711.

Montreal H3B 2P6: Place du Canada. (514) 866-6961. Norman Young, VP, mgng dir.

P

Pacific National Advertising Agency. 190 Queen Anne, Seattle 98119. Trevor Evans, bd chmn.

Radio-Television Dept.: Kate Wilson, media dir.
Portland, Ore. 97205: 310 Morgan Bldg. (603) 222-1021. Jack Moys, exec VP mgr; Marjorie Andre, sr VP, radio-TV media dir.

Parkson Advertising Agency Inc. 767 Fifth Ave., New York 10022. (212) 752-3300. Edward Kletter, chmn of the bd; Philip Agisim, vice bd chmn; Albert S. Kesinbaum, pres; Bill Abrams, VP, creative dir.

Radio-Television Dept.: Dick Baiflow, VP radio-TV prod; Michael Kletter, bd chmn; Irv Ross, coml supvr, west coast; Joan Lindquist, dir-bcst opns/traf.

Radio-Television Media Buyers: Herbert Gruber, VP, bcst med dir; Ida Vendetti, bcst med supvr.

Patten Corp. 27200 Lahser, Southfield, Mich. 48076. (313) 353-4520. M.P. Patten, pres; J.A. Castor, exec VP; R.C. Baker, VP radio & TV.

Radio-TV Media Dept.: Dale Peterson, media buyer.

Penzell Associates Inc. 1370 Avenue of the Americas, New York 10019. (212)489-6700. Lawrence Penzell, pres.

Post Keyes Gardner Inc. 875 N. Michigan Ave., Chicago 60611. (312) 943-9400. Freeman Keyes, chmn of bd; Donald Carter, pres; Anthony Hebel, exec VP; Fred Wilson, sr VP, gen mgr.

Radio-TV Media Dept.: Daniel Pearson, assoc med dir.

Q

Quadrant Campbell-Ewald International. (subsidiary of Interpublic Group). 1271 Ave. of the

Americas, New York 10020. (212) TN 7-1122. Also offices in Australia, Belgium, Brazil, England, Finland, France, Germany, Italy, South Africa, Sweden.

R

L.W. Ramsey Advertising Agency. 111 E. 3rd St., Davenport, Iowa 52801. (319)326-0157. A.C. Naekkel, bd chmn.

Raniere, Saslaw, Mohr & Associates Inc. 770 Lexington Ave., New York 10021. (212) Plaza 9-7070. Mel Mohr, pres; Lansing Moore, dir mktg svcs and med.

Radio-TV Media Dept.: Ken Kornbluth, exec VP direct account svcs.

Reilly Brown Inc Advertising. 240 Commercial St., Boston 02109. (617) 723-1740. Robert M. McCracken, pres; Robert P. Vogel, exec VP; Richard P. O'Brien, VP; Robert S. Farrington, sr VP.

Radio-TV Media Dept.: John L. Osborne, med dir/ mgr, med buying svc.
New York 10021: 128 E. 71 St.

Reincke, Meyer & Finn. 10 S. Riverside Plaza, Chicago 60606. (312)782-6500. Charles Fleming, pres & treas.

Radio-Television Dept.: Clyde W. Nelson, med dir.

Religious Media Associates—Fundamental Broadcasters Agency. P.O. Box 246, Knoxville, Tenn. 37901. (615) 525-5442. Art Jones, pres & gen mgr.

Riedl Associates. 1200 Rte. 46, Clifton, N.J. 07013. (201)471-7900. Geo. Riedl, pres; Finlay W. Morrow, sr VP; Joseph Oliveri, gen mgr; Martin Weinberger, VP.
Radio-TV Media Dept.: Jos. Oliveri, media head; Phil Kass, media dir.

Rives, Dyke/Y&R Inc. 6363 Richmond Ave., Houston 77027. (713) 783-7640. Jean Wm Brown, pres & chief exec off; Bertha Tucker, treas.

Ross Roy Inc. 2751 E. Jefferson Ave., Detroit 48207. (313) 568-6000.

Ross Roy, chmn of bd; John S. Pingel, pres; D.C. Graves, H.E. Rumble, sr VPs.

Radio-TV Media Dept.: Alan J. Liebrecht, VP, dir of media; J.J. Walsh, bcst supvr; G.N. Moody, VP mktg svcs.

New York 10017: 555 Fifth Ave. (212)986-6800. F. Henry Larson, pres.

Windsor, Ont. N9A 5N7: 76 University Ave. W. (519)256-2371. K. Fries, VP.

RSM Inc. 770 Lexington Ave., New York 10021. (212)759-7070. Mel Mohr, pres; Ken Kornbluth, exec VP; Herb Hynes, sr VP; Lansing Moore, dir of mktg.
Radio-TV Media Dept.: Ken Kornbluth, dir of bcst svcs.

Rumrill-Hoyt Inc. 380 Madison Ave., New York 10017. (212) MU 2-2000. Gene Novak, pres; John F. Hogan, sr VP, gen mgr; Raymond Tortolani, VP, mktg, media research; John Lamson, VP, media dir; Cliff Greenspan, med supvr; Don Rann, radio-TV prod.

Rochester, New York 14620: 1895 Mt. Hope Ave. (716) BR 1-2150. Joe Valerio, VP, gen mgr; Wm. Mackey, VP, med dir; Don Cramer, Nancy Lopresto, med buyers; Bud McGowan, radio/TV prod supvr.

Buffalo, New York 14202: Statler Hilton Suite 1759. (716) TL 3-6020. Robert Kinnen, VP, gen mgr.

Hollywood, Fla. 33020: 2741 N. 29th Ave. (305)929-1991. William A. Baumert, VP, gen mgr.

Low Runkle Company. 1800 Liberty Tower, Oklahoma City 73102. (405)239-6231. Low Runkle, bd chmn & chief exec off; Howard Neumann, pres.

Radio-TV Media Dept.: Pattie Meis, VP & media dir. Tulsa, Okla. 74135: 5416 S. Yale Ave., Suite 410. (918)663-1050. Vernon Morelock, sr VP.

S

Sachs, Finley & Kaye Inc. 10850 Wilshire Blvd., Los Angeles 90024. (213)879-1800. Bob Finley, VP, creative dir.

Sawdon & Bess Inc., 555 Madison Ave., New York 10022. (212) 751-6660. Frank B. Sawdon, chmn; Jerome Bess, pres; Vic Lewis, sr VP.

Radio-TV Media Dept.: Jerry-Noonan, VP radio/TV; Ding Koehler, creative dir; Russ Finley, VP, media dir.

Charles Schlaifer & Co. 150 E. 58th St., New York 10022. Murray Hill 8-1510. Charles Schlaifer, pres; Herbert Joseph, med dir.

Hollywood 28: 8671 Wilshire Blvd. Mort Craig, timebuyer.

Schwab Beatty, Div. of Marsteller Inc. 866 Third

Advertising Agencies

Ave., New York 10022. (212) 826-9222. Leonard J. Reiss, pres; Ralph T. Siegler, sr VP
Radio-TV Media Dept.: Ruth Klaber, med dir.

Scott & Scott Advertising Inc. 740 N. Rush St., Chicago 60611. (312) 944-6886. R.J. Scott, pres.
Radio-TV Media Dept.: Louise Bunting.

The Shaller Rubin Associates Inc. 909 Third Ave., New York 10022. (212) 758-3600. Milton Shaller, pres; Jack Schwartz, radio-TV dir.

Sheldon Fredericks Adv. Inc. 71 Vanderbilt Ave., New York 10017. (212)686-0170. I.A. Schwartz, pres.
Radio-Television Dept.: Elizabeth Solding, VP

The Sherrill Co. 3200 Maple Ave., Suite 300, Dallas 75201. (214) 741-6375. Webb Sherrill, pres; Jane B. Achor, exec VP; Brenda McHam, VP
Radio-TV Media Dept.: Sally Mayenschein, media dir.

Shima/Passberger Advertising Inc. 1 Rockefeller Plaza, New York 10020. (212)489-6400. John F. Shima, pres; Herb Passberger, VP; Jack Green, VP med dir; Bernard P. Dolan, treas; Helen Nelson, radio/TV prod; Palma D'Orazio, med buyer.

Harold J. Siesel Co. 845 Third Ave., New York. (212) Plaza 9-6500. Alfred J. Siesel, pres; Daniel Siesel, VP & med dir.

The Silton Co. Inc. 320 Statler Office Bldg., Boston 02116. (617) 542-9460. Jason N. Silton, chmn of bd; Ramon H. Silton, pres & treas;
Radio-TV Media Dept.: Sally Stitt, VP/med dir; Linda Klein, med supvr; Laura Smith, med buyer.

Simons Michelson Co. 1126 Lafayette Bldg., Detroit 48226. (313) 963-3000. Leonard N. Simons, Lawrence J. Michelson, Morton Zieve, James A. Michelson, plnrs.
Radio-Television Dept.: Mary George, med supvr; Cora Krisel, Don O'Dell, med buyers.

Smith/Greenland Co. Inc. 1414 Ave. of the Americas, New York 10019. (212) 752-5500. Leo Greenland, chief exec off; Norman Goluskin, pres; Martin L. Smith, treas.
Radio-TV Media Dept.: Beryl Seidenber, Louis Landesman, VPs; Jack O'Connor, Chris Stiglich, Jeanne Massaro, Lynn Davidson.

Smith, Kaplan, Allen & Reynolds Inc. 7000 W. Center Rd., Suite 230, Omaha 68106. (402) 397-7373. H. Wayne Smith, pres, treas; Ronald N. Kaplan, exec VP sec; Helen C. Moeller, VP; LaVon Eby, VP; Dennis Mailliard, VP; Jack Katz, VP.
Radio-TV Media Dept.: LaVon Eby, med dir; Donna Ridgley, asst med dir.

SSC&B Inc. One Dag Hammarskjold Plaza, New York 10017. (212)644-5000. S. Heagan Bayles, chmn of bd; Alfred J. Seaman, pres; Harold Miller, sr VP med & network prod.
Radio-TV Media Dept.: Charles B. Bellante, VP, TV prod control; Donald T. Harrington, VP bcst prod; Frank J. Reed, VP radio/TV bus affairs.
Hollywood 90028: 1800 North Highland Ave. (213) HO4-2119. Peggy Parish, mgr.
Hato Rey, Puerto Rico 00918: Banco de Economias Bldg., Suite 806, Ponce de Leon 221. (809)767-4825. Francisco Alvarez, VP & mgr.

Stern, Walters & Simmons Inc./Advertising 155 E. Huron St., Chicago 60611. (312) 642-4990. Gerald J. Stern, pres; Lee J. Walters, exec VP; William J. Lowney, sr VP & treas; Larry D. Postea, sr VP & creative dir.
Radio-TV Media Dept.: Robert Walters, VP, med dir; Beverly Hills, Calif. 90211: 8383 Wilshire Blvd. (213) 655-1100.

Stevens-Kirkland-Kreer Inc. 111 E. Wacker Dr., Chicago 60601. (312) 644-3580. Henry B. Kreer, pres & treas; Sally A. Wells, med dir.

Sudler & Hennessey, Inc. 130 E. 59th St., New York 10022. (212) 751-1250. Mathew Hennessey, pres, chmn; Vivian Shaknis, dir med prod; Barbara Morano, dir med.

Daniel F. Sullivan Co. Inc. 1266 Soldiers Field Rd., Boston 02135. (617) 783-1150.

T

Tatham-Laird & Kudner. 625 N. Michigan Ave., Chicago 60611. (312) 337-4400. C.R. Standen, chmn of the mgt committee; J. Birn, chief operating off.
Radio-TV Media Dept.: E. Reynold Petray, dir med &

rsch svcs; Leonard F. Materna, Geoff McClelland, assoc media dirs.

New York 10016: 605 Third Ave. (212) 972-9000. T. Williams, mgng ptrn; J. Hughes, med dir.
TLK Direct Mktg Div: 605 Third Ave., New York 10016. (212) 972-9000. Timothy Sharpe, VP & gen mgr; Helen Jensen, med dir.

J. Walter Thompson Co. 420 Lexington Ave., New York 10017. (212) 686-7000. Edward B. Wilson, chmn; Don Johnston, pres & chief exec off, dir; Robert E. Buchanan, sr VP in charge of med; Richard P. Jones, sr VP, med dir; Thomas J. Glynn, VP, U.S. med resources; Thornton B. Wierum, sr VP med svcs.
Chicago 60611: 875 North Michigan Ave. (312) 664-6700. Wayne J. Fickinger, exec VP, mgng dir.
Dearborn, Mich. 48126: 17000 Executive Plaza. (313)336-6900. Glen W. Fortinberry, VP, mgng dir.
Los Angeles 90067: 10100 Santa Monica Blvd. (213)553-8383. Farlan I. Myers, VP, mgr Hollywood office.

San Francisco 94111: 1 Maritime Plaza, Golden Gateway Center. (415) 421-3510. Roy A. Glah, sr VP, mgr.

Tinker, Dodge & Delano Inc. 1345 Ave. of the Americas, New York 10019. (212) 245-1030. Bruce M. Dodge, chmn of bd; Lester A. Delano, pres.

Radio-TV Media Dept.: Roger C. Bumstead, VP, med dir; J. Fraser Tindall, Jules N. Neuberger, Jay E. Cossey

Tracy-Locke Advertising and Public Relations Inc. 1407 Main St., Box 50129, Dallas 75202. (214) 742-3131. Morris Hite, chmn of bd; Norman Campbell, pres; Robert D. Brown, exec VP; Stewart Mitchell, exec VP.

Radio-TV Media Dept.: Jerry Still, VP dir med opns; Lawrence H. Spiegel, VP, med dir; Judy Miller, assoc med dir bcst opns; Warner Klapprodt, VP dir bcst prod.

Denver 80222: 5500 E. Yale Ave. (303) 757-6423. Dan Pollick, VP mgr.

Houston 77027: 5051 Westheimer Ave., Suite 475. (713) 622-6222. Richard Brown, VP mgr.

San Francisco 94111: One California, Suite 600. (415) 956-5125. Willard Moon, VP mgr.

Tucker Wayne & Co. 2700 Peachtree Center Bldg., Atlanta 30303. (404) 522-2383. Matthew Connor, chmn; Robert E. Schaefer, pres; Richard L. Simms Jr, vice chmn; Knox Massey Jr., exec VP; Andrew J. Purcell, sr VP-mktg media dir.
Dobson, med buyers.

V

V & R Advertising Inc. 919 Third Ave., New York 10022. (212) 371-6040. V.D. Lindeman, pres; Herman Liebenson, VP ptrn; Muriel Franco, media buyer.

Van Brunt & Co., Advertising-Marketing Inc. 711 Third Ave., New York 10017. (212) MU 7-0770. Albert D. Van Brunt, pres, chmn exec com; Robert Ricglane, VP, med; William D. Buckley, mgr, bcst dept.
Chicago 60601: 111 E. Wacker Dr. (312)644-4600.

VanSant, Dugdale & Co. Inc. 1 N. Charles St., Baltimore 21201. (301) 539-5100. Harry F. Brian, chmn of bd; Nick VanSant, pres; Daniel J. Loden, exec VP.

Radio-TV Media Dept.: Barry Wiseman, sr bcst prod; Dennis M. Gray, Sherie J. Levin, bcst prods.
Washington 20006: 2021 K St., N.W. (202)872-8870. Raymond J. Sachs Jr., VP.
Philadelphia 19103: 1845 Walnut St., Suite 2330. (215)567-7662. Frank F. Patterson 4th, VP.

Varicom Inc. (see Campbell-Ewald Co.)

W

Waldie & Briggs Inc. 221 North LaSalle St., Chicago 60601. (312)346-7060. Richard M. Bueschel, sr VP; George L. Briggs, sr VP, LaSalle Div.

Waring & LaRosa Inc. 555 Madison Ave., New York 10022. (212) 755-0700. Joseph LaRosa, pres; Saul Waring, exec VP; Morton Grossman, John McCrosky, sr VPs; Martin Narva, Harvey Fishbein, Stuart Hample, Girard Viola, Judy Blumenthal, Vince Salmieri, VPs.

Radio-TV Media Dept.: Martin Narva, VP med dir; Mary Lou Benjamin, assoc med dir; Genevieve Shore, Liz Hecker, Allen Greene, Sheila Roth, buyers; Pat McManamon, exec prod/radio & TV; Marlene Macey, radio/TV bus mgr.

Warren, Muller, Dolobowsky Inc. 747 Third Ave., New York 10017. (212) 754-1600. Robert

Dolobowsky, pres, chief exec off; Keith Fischer, exec VP.

Warwick, Welsh & Miller Inc. 375 Park Ave., New York 10022. (212) 751-4700. John P. Warwick, pres & chief exec off.

Weightman Inc. Advertising 1700 Market St., Philadelphia 19103. (215) 561-6100. S.A. Tannenbaum, chmn of bd & chief exec off; C. Coffey, pres; G.M. Patrizio, exec VP; H. Solomon, VP finance & treas.
Radio-TV Media Dept.: N. Harrison, VP, med dir.

Weiss & Geller Inc. 880 Third Ave., New York 10022. (212) 421-0600. Max A. Geller, chmn; Max Tendrich, pres; Arthur Ross, exec VP; Anne Rothenberg, VP admn.
Radio-Television Media Dept.: Joanne Taub, media buyer.

Wells, Rich, Greene Inc. 767 Fifth Ave., New York 10022. (212) 758-4300. Mary Wells Lawrence, chief exec off & chmn.
Hollywood 90028: 1717 Highland. (213) 462-6347.

Wilson, Haight & Welch Inc. 100 Constitution Plaza, Hartford, Conn. 06103. (203)278-1500.
Branch offices: Boston; Greenwich, Conn.; New York; Tampa, Fla.

Woodard, Voss & Hevenor Inc. 15 Elk St., Albany, N.Y. 12207. (518) 434-8131. Philip Voss, pres.

Wunderman, Ricotta & Kilne Inc. 575 Madison Ave., New York 10022. (212)688-4010. Lester Wunderman, pres; Lewis M. Smith Jr, exec VP & creative dir.

Radio-TV Media Dept.: Si Sanders, VP bcstg; Larry Schneiderman, media dir.
Branch offices: Montreal, London, Paris.

The Wyman Co. Inc. 215 Market St., San Francisco 94105. (415) 397-1826. H. Jack Wyman, pres, creative dir; Ruth J. Wyman, exec VP.
Radio-TV Dept.: Ruth J. Wyman, med dir; Chris Raymond, media buyer.

Wyse Advertising Inc. 2800 Euclid Ave. Cleveland 44115. (216) 696-2424. Marc A. Wyse, pres; Loise Wyse, exec VP corp creative dir; Ron Campana, VP dir acct svcs; David London, VP, assoc creative dir.

New York 10022: 595 Madison Ave. (212) PL2-9880. Richard Voehl, VP creative dir; Alan Saperstein, copy chief.
Oak Brook, Ill. 60521: 2625 Butterfield Rd. (312)654-3344. Van Kaiser, exec art dir; Richard Sanders, copy chief.

Y

Young & Rubicam International Inc. 285 Madison Ave., New York 10017. (212) 953-2000. Edward N. Ney, pres & chief exec off.

Communications Services: Joseph Ostrow, sr VP, dir communications svcs; Theresa Pellegrino, VP, mgr, communications svcs; Polly Langbort, VP, dir communications planning; George W. Sharpe II, Laurence Stoddard Jr, Bruce A. Wager, group suprs; Barbara F. Ames, supvr of opns & bus affairs; Richard H. Low, sr VP, dir bcst progmg & purchasing; Thomas R. Fund, VP, group supvr, net TV nighttime; Charles V. Lavery, VP, group supvr, net TV sports & news; Frank Zingale, VP, group supvr, net TV daytime; Daniel J. Riordan, VP, mgr, net TV nighttime; Patrick J. Broidy, mgr, net TV sports & news; Roger F. Jones, mgr, local bcst & net radio.
Detroit 48826: 211 W. Fort St. (313) 963-1345. Joseph J. Seregny, sr VP, mgr; Eugene J. McCarthy, VP, dir med rel & planning.

Los Angeles 90010: 3435 Wilshire Blvd. (213) 380-6400. Sid Marshall, sr VP, mgr; Selwyn Touber, exec prod, supvr TV prod.
Toronto M4W 1J2: 60 Bloor St. W. (416)961-5111.
Montreal H3B 3T2: 1155 Dorchester Blvd. W. (514) UNiversity 6-8941. James L. Scala, pres, mgng dir, rgnl dir.

Z

W.M. Zemp & Associates Inc. 1213 16th St. North, St. Petersburg, Fla. 33733. (813) 898-0881. W.M. Zemp, pres.

Radio-TV Media Dept.: John Long, assoc media buyer.

Buying Services, Reps

Independent Media Buying/Planning Services

Air Time Inc. 919 Third Ave., N.Y. 10022. (212) 371-4750. Bruce J. Folgel, pres; Kalman S. Liebowitz, exec VP; Fred B. Weiner, exec VP; Mark M. Goldman, VP-treas; Walter R. Hart, VP-acct supvr; Lee Ravdin, VP-med dir; Joel H. Allerhand, VP-mktg; Jerry Levy, VP-acct supvr; Dick Waller, VP-acct supvr; Henry A. Hartwell Jr., exec VP-sls; Anthony R. Cangemi, VP-Chicago; Bruce Kuperschmid, VP; Melane Naiman, VP-assoc med dir; Virginia Daily, VP-med supvr.

American Media Consultants. 6464 Sunset Blvd., Los Angeles 90028. (213)469-3101. Clifford A. Botway, chmn of bd; Milton J. Beckman, pres; Joel Davis, exec VP; Jackie Jackson, VP-media dir.

Atwood Richards Inc. 99 Park Ave., New York 10016. (212)490-9200.
Beverly Hills, Calif. 90210: 9171 Wilshire Blvd. (213)828-8402.

CPM Inc. 919 N. Michigan Ave., Chicago 60611.(312) 944-4650. Norman M. Goldring, pres; Michael Willner, exec VP; L. Roger Casty, VP.

Creative Media Services Inc. Box 451, Wilton, Conn. 06897. (203) 762-9000/9455/9655 (Telecopier: 762-3735). Douglas K. Burch, pres; Christopher A. Burch, media dir; Elton Irby, med coord; Kim Walker, admin asst; C. Gregory Melick, billing mgr.

Gaynor Media Corp. 685 5th Ave., New York 10022. (212) 751-9880. Lee Gaynor, pres.

Independent Media Services Inc. 919 Third Ave., New York 10022. (212) 826-6244. Richard Gershon, pres; Robert Petizon, VP; Neil Aronstam, VP.
Los Angeles 90036: 5900 Wilshire Blvd. (213)930-1984.

inter-Global Communications. VTR Motion Picture Buying and Booking Service. Box 413, Philadelphia 19105. F.O. Pease, gen mgr; A.E. Brammer, foreign mgr; B.E. Pease, assoc; David Rosen, booker.

Media Communications Inc. 3 E. 54th St., New York 10022. (212) 832-6500. Michael Nichter, pres; John Gaskeil, med dir.

Media Corp. of America. 747 Third Ave., New York 10017. (212) 593-0750. Albert B. Shepard, pres; John J. Reidy, exec VP; Lawrence P. Timmins, exec VP; Ray Smolin, VP, gen mgr out-of-home div; Max Bierman, VP/acct mgr; Dolores Marsh, VP media; John E. Curtin, dir media planning; Sandy Aronowitz, media supvr; David Specland, sr med buyer; Dina Weinstein, media supvr; Theresa Gramagna, assoc media buyer; Valerie Adams, assoc media buyer; Florence Ruda, cmprtlr; Joseph Calderon, sec-treas.

The Mediators Inc. 39 W. 55th St., New York 10019. (212) 581-3380. Richard Manney, pres; Patricia McGuinn, exec VP.

The National Media Group Inc. 1150 First Ave., King of Prussia, Pa. 19406. (215)265-1410.

SFM Media Service Corp. 6 E. 43rd St., New York 10017. (212) 682-0760. Walter Staab, pres; Robert A. Frank, exec VP; Stanley H. Moger, exec VP.

S.M.Y. Inc. 360 N. Michigan Ave., Chicago 60601. (312) 332-7910. A.E. Staley III, pres; Virginia L. Shirley, VP.

William B. Tanner Co. Inc. 2714 Union Ave. Ext., Memphis 38112. (901) 320-4212. T.W. 810-591-1066. William B. Tanner, pres; Henry Tanner, VP; William Laffey, VP; Zack Hernandez, VP; Garry Wells, VP.

Vitt Media International Inc. 437 Madison Ave., New York 10022. (212)751-1300. T.W. 710-581-4294. Sam B. Vitt, pres; F. Richard Olsen, sr VP; H.M. LaTerre, sr VP; Lawrence B. Miller, sr VP & chief oper.

Wasserman Media Services Inc. 1501 Broadway, New York 10036. (212) 869-0070. Sanford R. Wasserman, pres; Lois Tartakoff, media dir; Irwin Levine, controller.

467-6111. F. Robert Kalthoff, exec VP, Midwest TV radio sls mgr.

Los Angeles 90005: 633 S. Shatto Place. (213) 385-6394. Jack Devine, mgr.

San Francisco 94104: 155 Montgomery St. (415) 981-2345. William E. Moore, VP.

St. Louis 63102: 10 Broadway. (314) 241-5051. Fred W. Johnson, mgr.

Allanta 30309: 1252 W. Peachtree St. NW. (404) 872-3871. John Del Greco, VP, southeastern mgr.

Dallas 75219: Oakwood Tower, Suite 600, 3626 North Hall St. (214) 528-1741. Wallis Ivy Jr., VP, Dallas mgr.

Detroit: 1017 Naughton, Troy, Mich. 48084. (313) 524-9424. David Brangan, Detroit mgr.

Ayers Inc. of Charlotte. Suite 580, 230 Tryon St., Charlotte, N.C. 28202. Guy Vaughan Jr.

C.K. Beaver & Associates. 2158 Union Ave. Bldg., Memphis 38104. (901) 272-7503. Jack Riley, pres; Marilyn Watson, mgr.

Allanta 30309: 1819 Peachtree St., N.E. (404) 351-5757. Nick Imbornone.

Dallas 75219: 3626 N. Hall. (214) 521-1240. Jack Riley.

Charles Bernard Co. Inc. 730 Fifth Ave., New York 10019. (212) 246-7242. Charles Bernard, pres.

Allanta 30309: 1819 Peachtree Road N.E. (404) 351-9288. Nick Imbornone.

Chicago 60601: 333 N. Michigan Ave. (312) 726-6115. R.M. Duffy.

Detroit 48226: 2140 Book Bldg. (313) 963-6919. Max Goldfarb.

Los Angeles: 21241 Ventura Blvd., Woodland Hills, Calif. 91364. (213) 346-9621. Harlan Oakes.

San Francisco 94131: 199 Crestmont Drive. (415) 731-3620. David Sandeberg, Ward Glenn.

Biddick Co. 18127 Roscoe Blvd., 6 Northridge, Calif. 91324. (213) 349-9526. Guy Biddick, mgr.

John Blair & Co. 717 Fifth Ave., New York 10022. (212) 752-0400. Jack W. Fritz, pres & chief exec off; James A. Jurist, VP & treas; Ellen C. Conlon, sec; William J. Merz, ctrlr.

Blair Radio. (A division of John Blair & Co.) 717 Fifth Ave., New York 10022. (212) 752-0400. Thomas C. Harrison, pres; John Boden, VP & gen mgr; Robert Lobdell, VP & natl sls mgr; Gerald Gibson, VP & NY sls mgr.

Chicago 60611: 645 N. Michigan Ave. (312) 787-2300. Robert Pates, VP & mgr.

Allanta 30308: 600 W. Peachtree St. N.W. (404) 881-1145. William White, VP & mgr.

Boston 02116: 535 Boylston St. (617) 536-6230. Michael C. Horn, VP & mgr.

Dallas 75219: Two Turtle Creek Village, Suite 720. (214) 522-4100. Frank Carter, VP & mgr.

Detroit 48202: 1811 Fisher Bldg. (313) 871-3060. Daniel S. Follis, VP & mgr.

Los Angeles 90036: 5670 Wilshire Blvd., Suite 2415. (213) 937-4620. George Wolfson, VP & mgr.

Philadelphia 19102: Three Girard Plaza. (215) 568-0290. John L. Wellford, VP & mgr.

St. Louis 63102: 10 Broadway. (314) 421-5262. Thomas V. Cinquina, VP & mgr.

San Francisco 94108: 650 California St. (415) 434-3272. Ray Muer, VP & mgr.

Blair Television, Market Divisions. (A division of John Blair & Co.) 717 Fifth Ave., New York 10022. (212) 752-0400. Jack W. Fritz, pres, John Blair and Co; Harry B. Smart, pres, Market Division; Oliver I. Tritter, VP & gen sls mgr; Arthur C. Stringer, VP & NY sls mgr; John T. Bray, sls mgr, American; James R. Bloom, sls mgr, National; William A. Morris, dir of sls strategy; Josef B. Rosenberg, VP, communications; Joseph N.R. Poulin, rsch mgr; Lawrence J. Lynch, prog dir. (Same offices and phone number as Blair Radio above unless otherwise indicated.)

Chicago 60611: Brian P. Hogan, VP, gen sls mgr; Gust J. Theodore, Chicago sls mgr/ABC; Leon Serruys, Chicago sls mgr/NBC; James McGillen, Chicago sls mgr/CBS.

Allanta 30308: H.W. Maier, VP & mgr.

Boston 02116: Floyd Gelini, mgr.

Dallas 75219: Steven F. Beard, VP & mgr.

Detroit 48202: Gabriel P. Dype, VP & mgr.

Jacksonville, Fla. 32207: Gulf Life Tower, Suite 2204. (904)399-1900. John M. Farris, mgr.

Los Angeles 90036: (213) 937-5020. Robert S. Billingsley, VP-mgr.

Philadelphia 19102: Jack F. Satterfield, VP & mgr.

St. Louis 63102: William D. McKinstry, VP & gen mgr.

U.S. Radio and TV Station Representatives



ABC-FM Spot Sales Inc. 1330 Ave. of the Americas, New York 10019. (212) 581-7777. Martin Percival, VP; Stanley J. Cohen, natl sls mgr; Blaise Leonardi, Eastern sls mgr; Bert Goodstadt, Tim Hahnke, Barbara Herman, acct execs; Karen Layland, dir of prom & sls dev; Linda Stern, rsch dir; Vic Corapi, bus mgr.

Chicago 60601: 360 N. Michigan Ave. (312) 372-2267. Jim Smith, Mark Morgan.

Los Angeles 90016: 3321 LaCienega Blvd. (213) 663-3311. Ed Lubin, Mal Klugman.

Detroit 48075: 20777 West Ten Mile Rd. (313) 353-8283. Valerie Tuttle.

Allanta 30308: 600 W. Peachtree St. N.W., Suite 1210. (404) 892-1710. Eilyn Ambrose.

San Francisco 94109: 1177 Polk St. (415) 673-7100. Gloria DeMaria.

ABC Television Spot Sales Inc. 1330 Ave. of the Americas, New York 10019. (212) 581-7777. Richard N. Savage, pres; David Johnson, gen sls mgr; Lawrence S. Perl, bus mgr; Roy Polevoy, dir, rsch & prom; Fred Cohen, Eastern sls mgr; Philip J. Sweeney, Eastern sls mgr; Darrell Anderson, Eastern rgnl sls mgr.

Chicago 60601: Two Illinois Center, Suite 1921. (312) AN 3-0800. Richard B. Taylor, Midwestern sls mgr; Larry Widrig, Midwestern rgnl sls mgr.

Los Angeles 90028: 1313 N. Vine. (213) NO 3-3311. Walt Flynn, sls mgr.

San Francisco 94104: One Jackson Place, 633 Battery St. (415) UN 3-0077. James Sherbert, sls mgr.

Detroit 48075: 24175 Northwestern Highway. (313) 444-1111. Elio Betty Jr., sls mgr.

Paul (Red) Abels. Box 80209, Lincoln, Neb. 68501. (402) 432-6606.

Admiral Repts Inc. 725 S. U.S. 1, Fort Pierce, Fla. 33450. (305)464-6746. Randolph H. Millar, VP, gen sls mgr; J. Kingsley Butt, sls rep.

Advertising Repts Inc. Box 3191, Miami 33101. (305) 361-2122. J. Van Dolen, pres.

Advertising Sales West. 681 Market St., San Francisco 94105. (415)362-7159. Don Pontius, mgr.

Los Angeles: 111 N. LaCienega Blvd., Beverly Hills, Calif. 90211. (213) 655-8326.

New York 10019: 685 Fifth Ave. (212) 759-6020. Henry Cohen.

Chicago 60645: 3322 W. Peterson Ave. (312) 478-5544. Hooper Jones.

Allanta 30309: Box 7201, 131 8th St. (404) 875-8051.

Dallas 75230: 12037 Arbagee Circle. (214) 748-3016. Erie Racey.

Detroit 48226: 2140 Book Bldg. (313) 963-6919. Max Goldfarb.

Alaska Radio-TV Sales. 715 Securities Bldg., Seattle 98101. (206) 624-6333. A.G. Hiebert, pres; Alma Wilson, natl traf mgr.

All-Canada Radio and Television Limited, Suite 550, 1271 Avenue of the Americas, New York 10020. (212) 246-1425. Bill Mitchell, Lynne Hayden.

Chicago 60601: 400 N. Michigan Ave. (312) 263-0491. Rick Kapnick, mgr.

Detroit 48076: 26011 Evergreen Road, Suite 218, Southfield, Mich. (313) 355-0940. Ron Hammer, mgr.

Hollywood 90028: 6922 Hollywood Blvd. (213) 462-8641. Alex Findlay, dir of radio & TV sls.

Arecibo Adv. Agency. Box 1652, Arecibo, PR. 00612. (809)878-1458.

Avery-Knodel Inc. 437 Madison Ave., New York 10022. (212) 421-5600. J.W. Knodel, chmn; Robert J. Kizer, pres; Richard A. O'Donnell, VP & dir of TV; Richard A. Bompante, dir of TV rsch/program svcs;

Patricia Clemency, assoc mktg/prom dir.

Chicago 60601: 2206 Prudential Plaza. (312)

San Francisco 94108: (415) 434-2393. W. Ralph Abell, VP, mgr.

Blair Television, Station Division. (A division of John Blair & Co.) 717 Fifth Ave., New York 10022. (212) 752-0400. Jack W. Fritz, pres, John Blair & Co.; Walter Schwartz, pres, Station Division; Oliver T. Tritler, VP & gen sls mgr; Robert C. Carney, VP & NY sls mgr/ABC; Patrick J. Devlin, NY sls mgr/CBS; Briggs S. Palmer, VP & NY sls mgr/NBC; William A. Morris, dir of sls strategy; Josef B. Rosenberg, VP, communications; Alfred B. Cannarella, rsch mgr/ABC; John J. Scott, rsch mgr/CBS; Andy Coscia, rsch mgr/NBC; Lawrence J. Lynch, prog dir.

(Same offices and phone numbers as Blair Radio above unless otherwise indicated.)

Chicago 60611: Brian P. Hogan, VP, gen sls mgr; Gust J. Theodore, Chicago sls mgr/ABC; Leon Serruys, Chicago sls mgr/NBC; James McGillen, Chicago sls mgr/CBS.

Atlanta 30308: H.W. Maier, VP & mgr.
Boston 02116: Floyd Geline, mgr.
Dallas 75219: Steven F. Beard, VP & mgr.
Detroit 48202: Gabriel P. Dype, VP & mgr.
Jacksonville, Fla. 32207: Gulf Life Tower, Suite 2204. (904)399-1900. John M. Farris, mgr.
Los Angeles 90036: (213) 937-5020. Robert S. Billingsley, VP, mgr.
Philadelphia 19102: Jack F. Satterfield, VP & mgr.
St. Louis 63102: William D. McKinsty, VP & mgr.
San Francisco 94108: (415) 434-2393. Ralph Abell, VP, mgr.

Gene Bolles Co. 663 Fifth Ave., New York 10022. (212) ORegon 5-5058. Gene Bolles, pres.
Chicago 60645: 3322 W. Peterson Ave. (312) 478-5544.

Beverly Hills, Calif.: 111 N. LaCienega Blvd. (213) 652-1313.
San Francisco 94133: 470 Columbus Ave. (415) 885-1436. David Sandeberg.

Bolton/Burchill International Ltd., 645 Madison Ave., New York 10022. (212) 371-6400. Carmen Bolton, pres; Tom Burchill, VP.
Chicago 60601: Suite 805, 360 N. Michigan Ave. (312) 332-4278. Irwin Siegel, dir sls Midwest; Sy Gair, sls mgr.

Los Angeles 90028: Suite 326, 6290 Sunset Blvd. (213) 463-7106. Robin Adrian, dir sls West Coast.
Detroit 48076: 26400 Lahser Road. (313) 353-8050. John Logan, mgr.
Atlanta 30309: 1819 Peachtree Road N.E. (404) 351-9376. Nick Imbornone, mgr.
San Francisco 94115: 1933 Webster St. (415)921-8411. Richard S. Garvin, mgr.

Broadcast Associates. 906 Sunnyside, Chicago 60640. (312) 784-4069. A.J. Polley.

Broadcast Media Sales. 6290 Sunset Blvd., Los Angeles 90028. (213)462-7241. William L. Wallace, pres.

San Francisco 94111: 500 Sansome St. (415)986-5371. William Peavey, mgr.

Broadcast Northwest. 614 Lloyd Bldg., Seattle 98101. (206) 622-7343. Dean Seaton.

Broadcast Representatives. Box 1918, Little Rock, Ark. 72203. (501) 375-2545. Mrs. Pat Wilcox.

Buckley Radio Sales Inc. 3 East 54th St., New York 10022. (212) 832-0404. Robert V. Coppinger, pres; Robert L. Williams, exec VP; Mel Trauner, VP dir rsch; Thomas J. Beauvais, VP-gen sls mgr; Samuel L. Hall Jr., VP; Lloyd McGovern, VP.

Atlanta 30309: Suite 610, 1819 Peachtree Rd. N.E. (404) 352-1287. Thomas R. Blöse, sls mgr.
Boston 06103: 750 Main St., Hartford, Conn. (203)278-1115. William P. Hinds, sls mgr.
Chicago 60611: 520 N. Michigan Ave. (312) 644-4530. Frank S. Mangan, sls mgr.
Dallas 75205: 5327 N. Central Expressway. (214) 528-1315. Ed Robbins, sls mgr.
Detroit 48202: 727 Fisher Bldg. (313) 871-1030. Ronald W. Camillo, sls mgr.

Los Angeles 90028: Suite 915, 6255 Sunset Blvd. (213)461-3313. Cyrus Ostrup, sls mgr.
San Francisco 94104: Rm 426, 220 Montgomery St. (415) 781-0191. Lloyd McGovern, VP, sls mgr.
St. Louis 63102: Equitable Bldg., 10 Broadway. (314) 621-6040/6041. Samuel L. Hall Jr., VP, sls mgr.

Gert Bunchez & Associates Inc. 7730 Carondelet, St. Louis 63105. (314) 862-5250. Gert Bunchez, pres.
New York 10022: 685 Fifth Ave. (212) 755-1339. Gert Bunchez.

San Francisco 94131: 199 Crestmont Dr.

(415)731-3620. Ward Glenn, mgr.
Beverly Hills, Calif. 90211: 111 N. LaCienega Blvd. (213) 652-1441. Chuck Dwyer.
Dallas 75204: 3225 Lemmon Ave., Garden Suite 360. (214)528-7260. Jim Lowenberg, mgr.

Busby, Finch, Latham & Widman. Suite 480, 57 Executive Park S., Atlanta 30329. (404)633-4314. Lanny Finch, pres; Jim Latham.
Dallas 75219: Suite 333, 3141 Hood St. (214) 528-1724. Ralph Widman Jr., mgr.

Caballero Spanish Media Inc. 30 E. 42nd St., New York 10017. (212) 972-1019. Eduardo Caballero.
Chicago 60606: 20 N. Wacker Dr. (312)273-2219.

Canadian Standard Broadcast Sales Inc. 654 Madison Ave., New York 10021. (212) 838-5774. Ted Roberts, pres; Roger O'Connor, VP.
Boston 02116: 129 Newbury St. (617) 262-1145. William A. Queen, mgr.
Dallas 75201: 501 Tower Petroleum Bldg. (214) 748-5239. Clyde B. Melville, mgr.
Los Angeles 90028: 6290 Sunset Blvd. (213) 462-2289. William L. Wallace, mgr.
St. Louis 63102: Room 228 Pierce Bldg., 112 North Fourth St. (314) 231-5143. Bruce W. Schneider, mgr.
San Francisco 94111: 500 Sansome St., Suite 602. (415) 986-5366. W.B. Peavey, TV mgr.
Detroit 48226: 1610 Book Bldg. (313) 961-2685. Bernard Pearse, mgr.
Memphis 38117: Box 17391. (901) 683-2431. Richard Crane, mgr.

David Carpenter Co. 1365 Peachtree St., Atlanta 30309. (404)892-8799. David Carpenter, pres, gen mgr; Laney Gair, exec VP; Linda Seckinger, VP, account exec.

Don Cavitt. 6404 Washburn Ave. S., Minneapolis 55423. (612) 866-7660. Don Cavitt.

CBS/FM Sales. 51 W. 52nd St., New York 10019. (212) 765-4321. Jack Baker, gen mgr; Eli W. Kaufman, Eastern mgr.

Chicago 60611: 630 N. McClurg Ct. (312) 944-6000. Lois Gredell, Midwestern mgr.
Los Angeles 90028: 6121 Sunset Blvd. (213) 469-1212. Bruce Braun, Western mgr.

CBS Radio Spot Sales. 51 W. 52 St., New York 10019. (212)765-4321. John A. Lack, VP & gen mgr; Charles D. Schwartz, New York sls mgr; Don MacFarlane, dir mktg & sls dev; Tom Dawson, VP div svcs.
Chicago 60611: 630 N. McClurg Court. (312) 944-6000. Gary Koester, sls mgr.

Philadelphia 19131: City Line Ave. & Monument Rd. (215) 839-7000. Colin A. Hanna, sls mgr.
Los Angeles 90028: 6121 Sunset Blvd. (213) HOLlywood 9-1212. Dean LeGras, West Coast sls mgr.
San Francisco 94111: 1 Embarcadero Center. (415) YUKon 2-7000. Thomas E. Cosgrove, sls mgr.
Atlanta 30303: Peachtree Center Office Tower, Suite 1412, 230 Peachtree St. N.W. (404) 525-4953. Joseph Sierer, sls mgr.
Detroit 48202: 932 Fisher Bldg. (313) TRinity 2-5500. Don Jumisco, sales mgr.
St. Louis 63102: 1 Memorial Drive. (314) MA 1-2345. David M. Brennan, sls mgr.

CBS Television Stations National Sales 51 W. 52 St., New York 10019. (212) 765-4321. James A. Sowards, gen mgr; Robert Hyland, dir, Eastern natl sls; David Skillman, Eastern sls mgr/WBBM-TV; Jack Rafferty, Eastern sls mgr/WCAU-TV; Frank Gregg, KNXT sls mgr; Bridget McCabe, dir, planning & administration.

Chicago 60611: 630 North McClurg Ct. (312) 944-6000. Carl Carey, dir of Midwest sls.
Detroit 48202: 1910 Fisher Bldg. (313) 872-5500. Stuart Stringfello, office mgr.
Los Angeles 90028: Sunset-Vine Tower, 6290 Sunset Blvd. (213) 469-1212. Robert Fairbanks, sls mgr.
San Francisco 94111: One Embarcadero Center, Suite 3237. (415) 433-0500. Frank Wheeler, office mgr.

Century National Sales. 65 West 54th St., New York 10019. (212) 489-9650. Gordon Potter, pres; Dick Warsaw, VP.
Chicago 60611: 875 N. Michigan Ave. (312) 751-0133.
Detroit 48237: 20760 Collidge, Suite 310. (313) 398-1100. Allan Wilson, mgr.
Los Angeles 90069: 8833 Sunset Blvd. (213) 657-0282. Gordon Potter, pres.
New York 10019: Warwick Hotel, 65 W. 54th St. (212)489-9650. Richard B. Warsaw, natl sls mgr.

Representatives

Albert Chance Co. 5930 Rincon Drive, Oakland, Calif. 94611. (415) 391-1984. Bert Chance, own, mgr; Sam Posner.
Hollywood 90028: 6777 Hollywood Blvd. (213) 463-3201. Bill Warren.

The Christal Co. 919 Third Ave., New York 10017. (212) 688-4414. Philbin S. Flanagan, chmn & chief of; Robert J. Duffy, pres; Keith S. Jackson, VP & New York sls mgr.

Chicago 60601: 333 N. Michigan Ave. (312) 236-6357. Mark G. Day.
Detroit (Troy) 48084: 2100 W. Big Beaver Rd., Suite 214. (313)649-3230. John M. Foutes, VP & mgr Midwest; Walter B. Archer, mgr.

Boston 02116: 607 Boylston St., Rm 216. (617) 267-1180. Ronald H. Wayland, mgr.
Atlanta 30309: 1447 Peachtree St., N.E., (404) 892-1262. Tom Dollif, mgr.

Dallas 75206: Campbell Centre, 8350 N. Central Expressway. (214) 369-2191. Keith Issitt, mgr.
Los Angeles 90010: 3450 Wilshire Blvd. (213) 388-1271. Roland W. Horn, mgr.

San Francisco 94104: 1646 Russ Bldg. (415)982-1390. Bruce Blevins, mgr.
St. Louis 63102: 10 Broadway, Suite 436. (314)231-2272. Linda Stearns, mgr.

Henry S. Cmiel Associates. 35 E. Wacker Drive, Chicago 60601. (312) 726-7713.

Edwin H. Cohen. Box 560222, Miami 33156. (305) 233-3336. Edwin H. Cohen.

Columbia Pictures Industries. 711 Fifth Ave., New York 10022. (212) 751-4400, ext. 200. Heather Lema.

Communications Inc. Stations 2735 Bompert Ave., St. Louis 63144. (314) 968-1900. Richard J. Miller.

Donald Cooke Inc. 17th floor, 521 Fifth Ave., New York 10017. (212) 682-5844. Donald Cooke, pres.
Beverly Hills, Calif. 90211: Suite 108, 111 N. LaCienega Blvd. (213) 652-1441.
Chicago 60645: 3322 W. Peterson Ave. (312) 478-5544.

San Francisco 94131: 199 Crestmont Drive. (415) 731-3620.
St. Louis 63102: 468 Equitable Bldg., 10 S. Broadway. (314) 231-9151.

Charles Cordero. Box 391, Juncos, PR. 00910. (809) 724-1465. Charlie Cordero.

Corlett Associates. Box 5146, Dearborn, Mich. 48128. (313)561-3823. Thomas W. Corlett, owner.
New York 10036: 15 W. 44th St. (212)867-0295. Frederick W. Smith, mgr.
Chicago 60645: 3322 W. Peterson Ave. (312)478-5544. Hooper Jones, mgr.

Country Music Sales. 730 Fifth Ave., New York 10019. (212) 246-7422. Charles Bernard, pres.
Atlanta 30309: 1819 Peachtree Rd. N.E. (404) 351-9288.

Chicago 60601: 333 N. Michigan Ave. (312) 726-6115.
Detroit 48226: 2140 Book Bldg. (313) 963-6919. Max Goldfarb, mgr.
Los Angeles 91413: 14724 Ventura Blvd. (213) 986-8050.

San Francisco 94133: 470 Columbus Ave. (415) 398-1434. David Sandeberg, Ward Glenn, mgrs.

Charles H. Cowling. 9565 Reseda Blvd., No. 128, Northridge, Calif. 91324. (213)886-0472. Charles H. Cowling.

R.S. Crane Co. Inc. 4646 Poplar Ave., Box 17391, Memphis 38117. (901) 683-2431. R.S. Crane, pres; Marijane R. Crane, sec & treas.

Atlanta 30303: 1800 Peachtree Center Bldg., 230 Peachtree St. N.W. (404) 688-3875.
Dallas 75201: 501 Tower Petroleum Bldg. (214) 748-5239. Clyde Melville.
San Francisco 94133: 559 Pacific Ave. (415) 391-1984. Sam Posner.

Creative Communicators Inc. 4125 Victoria Drive, Fort Wayne, Ind. 46805. (219) 483-3882. Gene Pyle.

Creed Associates Inc. 616 Stalter Office Bldg., Boston 02116. (617) 482-4845. Richard A. Keating, pres; Richard P. Luettens, VP; Irene Kelleher, office mgr.

Santo Crupl. 1400 Stalter Bldg., Boston 02116. (617) 542-0478.

Representatives

Bill Dahlisten & Associates. 1680 Vine St. Los Angeles 90028. (213) 464-9263. Bill Dahlisten, proprietor.

New York 10017: 200 E. 42nd St. (212)682-4070. Mike Fulford.

San Francisco 94133: 559 Pacific Ave. (415)397-4512. Sam Posner, rgml mgr.

Seattle 98101: 614 Lloyd Bldg. (206)622-7343. Dean Seaton.

Chicago 60606: 20 N. Wacker Dr. (312)326-8887. Bob Walton.

The Devney Organization Inc. 347 Madison Ave., New York 10017. (212) MU 3-5830. Edward J. Devney, pres.

Boston 02116: 100 Boylston St. 482-4370. George C. Bingham, mgr.

Chicago 60606: 20 N. Wacker Drive. (312) 263-5771. Robert J. Walton, mgr.

Woodland Hills, Calif. 91634: 21241 Ventura Blvd. (213) 346-9621. Harlan Oakes, mgr.

San Francisco 94131: 199 Crestmont Drive. (415) 731-3620. Ward Glenn, mgr.

Atlanta 30309: 1819 Peachtree St. N.E. (404) 351-9288. Nick Imbornone, mgr.

Dallas 75204: 3225 Lemmon Ave. (214)528-7260. Jim Lowenberg, mgr.

Detroit: Enterprise 6525.

Dome & Associates Inc. 1175 Suburban Station Bldg., Philadelphia 19103. (215) LOcust 3-3716. Robert S. Dome, pres.

Pittsburgh 15222: 1704 Investment Bldg. (412) 391-6520. Steve Rooney, VP.

Baltimore 21202: 204 E. Biddle St. (301) 727-6566. Senius Smith, VP.

D-O Sales Service. 347 Madison Ave., New York 10017. (212) MU 3-5830. Edward J. Devney, pres. (offices same as Devney Org. above.)

Doorley & Associates. 119 S. Mansfield Ave., Los Angeles 90036. (213) 936-8009. Marilyn Doorley.

Dora-Clayton Agency Inc. 1252 W. Peachtree NW, Atlanta 30309. (404) 872-8877. 8878. Daniel A. Haight, pres; Arlette G. Haight, VP.

Bob Dore Associates Inc. 25 West 43rd St., New York 10036. (212) 575-5077. Robert M. Dore, pres; Adrian P. Becker, VP-sls mgr.

Chicago 60606: 20 N. Wacker Dr. (312) 332-3613. Robert J. Walton, sls mgr.

Los Angeles 90211: 111 N. LaCienega Blvd. (213)652-1441. Charles P. Dwyer, sls mgr.

Atlanta 30309: 1365 Peachtree St. N.E. (404)892-8799. David Carpenter, sls mgr.

San Francisco 94133: 559 Pacific Ave. (415) 391-1985. Sam Posner.

Boston 02116: 100 Boylston St. (617) 482-4370. George C. Bingham, sls mgr.

Dallas 75219: 3131 Turtle Creek. (214)528-2923. Paul Miller, sls mgr.

Dwyer Broadcast Sales & Services. 111 North La Cienega Blvd., Suite 108, Beverly Hills, Calif. 90211. (213) 652-1441. Charles Dwyer.

Eastman Radio Inc. 1 Rockefeller Plaza, New York 10020. (212) 581-0800. Francis L. Boyle Jr, pres & chief exec off; Charlie Colombo, senior VP/Eastern region; Richard M. Duffy, VP/network; Mark S. Sutter, VP/treas; Maddy Schreiber, rsch dir.

Chicago 60611: 625 N. Michigan Ave. (312) 787-4875. David E. Recher, VP/Midwest mgr.

San Francisco 94111: 517 Washington St. (415) 391-3937. Steve H. Block, VP/mgr.

Dallas 75206: 6060 N. Central Expressway, Suite 224. (214)691-7984. Gary Andon, mgr.

St. Louis 63101: 1015 Locust St., Room 913. (314) 241-7040. Carl Butrum, mgr.

Los Angeles 90010: 4311 Wilshire Blvd. (213) 933-8536. Gerald J. Schubert, senior VP, West Coast region.

Detroit 48202: 2990 West Grand Blvd. (313) 873-2090. William K. Burton, exec VP; David A. Gneiser, VP & mgr.

Atlanta 30309: 1447 Peachtree St. N.E. (404) 892-2484. Richard M. Walker, VP/mgr.

Philadelphia 19103: 1700 Walnut St. (215) 735-0102. Stephen A. Clayback Jr, mgr.

Seattle 98101: 1411 4th Ave. Bldg. (206)624-4191. Mick Tacher, Bob Tacher.

Portland 97205: 1130 S.W. Morrison. (503)226-2911. Richard Gohlman, Jim Cummings.

Denver 80227: 7105 W. Hampden. (303)989-1444. Charlie Vais, Dave Ripley.

Salt Lake City 84111: 312 E. South Temple. (801)355-4641. Doug Wildfoerster, Bennie Williams.

Toronto: 250 Merton St., Ont. M4S 1B1. (416)484-1011. J. Richard Guest.

Montreal: 19 Edison, Box 1074, Place Bonaventure, Que. H5A 1G3. (514)866-2617. Luc Leduc.

Evans Bcstg Corp. TV Sales. 300 Park Ave., New York 10022. (212) 758-7152. Len Ziegel.

St. Louis 63106: 1215 Cole St. (314) 436-3030. Jack Petrik, VP; Tom Koon.

Chicago 60611: 200 E. Ontario. (312) 664-4645. Bill Bannister.

Paul J. Ewing Co. 536 Builders Exchange Bldg., Minneapolis 55402. (612) 333-3660. Paul J. Ewing.

Hugh Feltis & Associates. 3909 51st Ave. N.E., Seattle 98105. (206)523-1283. Hugh Feltis.

Fine Music Hi-Fi Broadcasters. Rm. 413, 10 Fiske Place, Mount Vernon, N.Y. 10550. (914) 468-3534. Kenneth C. Schwartz, owner.

James C. Fletcher Jr. Midnight Sun Broadcasters Inc. 39 W. 46th St., New York 10036. (212)Circle 6-4084.

Florida Media Reps. Box 5038, Daytona Beach, Fla. 32030. (904) 672-2200. William Hunter.

Frontier Advertising Sales. 217 W. 13th St., Pueblo, Colo. 81003. (303)544-3056. B.L. Welch, mgng dir; W.H. Welch, sls consultant.

Michael Fulford Co. 200 E. 42d St., New York 10017. (212) 682-4070. Michael Fulford.

J.C. Gates & Co. 1717 N. Highalnd Ave., Los Angeles 90028. (213) 462-6839. James C. Gates, Juanita Haddy Landon.

GCI Sales Inc. (Div. of Globetrotter Communications Inc.) 10 Rockefeller Plaza, Suite 511, New York 10020. (212) 582-6000. Cooke Bausman, pres; Robert F. Bell, exec VP.

Chicago 60602: 30 N. Michigan Ave. (312)467-4650. Robert F. Bell, mgr.

Atlanta 30309: 1800 Peachtree Road. (404)355-6067. Carter S. Jones, mgr.

Los Angeles 90036: 6010 Wilshire Blvd., Suite 202. (213)938-2021. Doug Grimm, mgr.

San Francisco 94104: 465 California St. (415)956-5970. Dave Murphy, mgr.

Gentle, Larry, Assoc., 288 Fisher St., Grosse Pointe Farms, Detroit 48230. (313) 885-0252.

Gilbreath Associates. 6363 Wilshire Blvd., Los Angeles 90048. (213) 651-0660. George Gilbreath.

San Francisco 94133: 559 Pacific Ave. (415) 391-1984. Sam Posner

Chicago 60606: 20 N. Wacker Dr. (312) 236-8887. Robert Walton.

Gill-Perna Inc. 745 Fifth Ave., New York 10022. (212) 355-0656. Helen Gill, pres; John J. Perna Jr, exec VP.

Chicago 60601: 75 E. Wacker Drive. Financial 6-9393.

Detroit 48226: 2915 Book Bldg. (313) 962-7022.

Los Angeles 90028: 6922 Hollywood Blvd., Suite 508. (213) 462-2371. Hugh Wallace, mgr.

San Francisco 94133: 1331 Columbus Ave. (415) 885-1436. David H. Sandeberg, Ward Glenn.

Max Goldfarb. 2140 Book Bldg., Detroit 48226. (313) 963-6919.

The Gordon Co. 211 E. 43rd St., New York 10017. (212) 986-5445. Arthur Gordon.

Atlanta 30309: 1819 Peachtree Rd. N.E. (404) 355-6432. Barney Ochs.

Los Angeles: Box 703, Woodland Hills, Calif. 91364. (213) 346-9621. Harlan Oakes.

San Francisco: Box 516, Orinda, Calif. 94563. (415) 986-0621. Don Pickens.

Eugene F. Gray Co. 1012 Baltimore Bldg., Kansas City 64105. (816) 471-5502. Gene Gray, Darlene Minx.

St. Louis 63102: 468 Equitable Bldg., 10 S. Broadway (314) 231-9151. Gene Gray, Marty Mitchell, Kathy Brindley.

Denver 80206: Room 306, 280 Columbia St. (303) 321-2080. Box Hix, George Matthews.

Greater New York Radio Sales. 509 Madison Ave., New York 10022. (212) 752-1455. Philip H. Roberts, Alan Silverman.

Herbert E. Groskin and Co. 310 Madison Ave., New

York 10017. (212) 986-4366. Herbert Groskin, pres; D.G. Groskin, VP; M. Garry, bus mgr.

Group One Radio Limited. 3322 W. Peterson Ave., Chicago 60659. (312) 478-5544. Hooper Jones.



Harrington, Righter and Parsons Inc. 280 Park Ave., New York 10017. (212) 687-8777. TWX 710-581-3988. James O. Parsons Jr, chmn of bd; John F. Dickinson, pres; John J. Walters Jr, exec VP, treas; Peter F. Ryan, sr VP natl sls mgr. sec; Pierce H. Foster, VP sls mgr gold team.

Chicago 60611: 233 N. Michigan Ave. (312) 565-1450. Donald O'Connor, sls mgr blue team; Mike Carson, sls mgr gold team; Michael W. Colen, VP Midwestern sls mgr.

Atlanta 30309: 1819 Peachtree Rd., N.E. (404) 355-5612. Frank B. Rice, VP, Southern sls mgr.

Boston 02116: 80 Boylston St. (617) 542-7537. Mary Jane Mitchell, N.E. sls mgr.

Dallas 75231: Two North Park East. (214)369-3925. George L. Pettett, Dallas sls mgr.

Los Angeles 90048: 6420 Wilshire Blvd. (213)655-7244. Thomas W. Carroll, VP, West Coast sls mgr.

Southfield, Mich. 48076: 29200 Northwestern Hwy. (313)353-3370. Roger Alexander, Detroit sls mgr.

Philadelphia 19103: 3 Penn Center Plaza. (215) 665-1170. John Weidman, Philadelphia sls mgr.

St. Louis 63102: Ten Broadway. (314) 231-9797. George Diedrich, St. Louis sls mgr.

San Francisco 94104: 235 Montgomery St. (415) 781-4125. William Wexelblatt, San Francisco sls mgr.

Bob Hix Co. Inc. 280 Columbine St., Denver 80206. (303) 321-2080. TWX 910-931-2581. Robert S. Hix, pres/gen mgr; George Mathews.

Kansas City 64105: 1012 Baltimore Bldg. (816) 471-5502. Gene Gray.

Seattle 98101: 614 Lloyd Bldg. (206) 622-7343. Dean Seaton.

St. Louis: 10 S. Broadway. (314) 231-9151.

George T. Hopewell Inc. Box 1000, Oceanside, N.Y. 11572. (212) 532-3783. Joseph S. Cannon, pres, gen mgr.

Chicago: 3322 W. Peterson Ave., Suite 105. (312) 478-5544. Hooper Jones, mgr.

Detroit: Box 5146, Dearborn, Mich. (313)561-3823. Tom Corlett, mgr.

Beverly Hills, Calif: 111 N. LaCienega Blvd. (213) 655-6055. Jim Walsh, mgr.

San Francisco: 559 Pacific Ave. (415) 391-1984. Sam Posner.

Bernard Howard & Co. Inc. 800 Third Ave., New York 10022. (212) 421-4900. Bernard Howard, pres; Jack Davis, exec VP.

Chicago 60601: 1 E. Wacker Dr. 467-1350. Robert Lazar, VP.

Atlanta 30309: 1800 Peachtree St. N.W. (404) 873-6804. Richard Greener, mgr.

Los Angeles 90069: 8430 Santa Monica Blvd. Oldfield 6-7200. Norman Berk, mgr.

San Francisco 94104: 332 Pine St. (415) 981-3676. Milton Seropan.

St. Louis 64501: 112 N. 4th St. (314) 231-5143. Bruce Schneider.

H-R/Stone Inc. 575 Lexington Ave., New York 10022. (212)758-2323. James M. Alspaugh, pres; Saul F. Frischling, exec VP natl sls mgr; Jack Canning, VP, Eastern sls mgr; Alan Tobkes, dir of rsch.

Chicago 60601: 230 N. Michigan Ave. (312)641-5190. Sy Thomas, sr VP.

Atlanta 30308: 805 Peachtree N.E. (404)873-2228. T. Richard Rawlings, mgr.

Dallas 75219: 3511 N. Hall St. (214)522-5910. Pam Morrison, mgr.

Detroit 48226: 3974 City National Bank Bldg. (313)965-4160. Dave Ayrault, mgr.

Los Angeles 90010: 4311 Wilshire Blvd. (213)930-2040. Don Probst, VP, mgr.

Philadelphia 19102: 225 S. 15th St. (215)732-0117. Carlos Muniz, mgr.

San Francisco 94104: 300 Montgomery St. (415)986-7880. Tom Marks, VP, mgr.

St. Louis 63101: 112 N. 4th St. (314)241-2682. Cheryl Weinstein, mgr.

William L. Hurley. Suite 901, 730 2nd Ave. S., Minneapolis 55402. (612) 333-7725.

Hyett/Ramsland Inc. 630 Baker Bldg., Minneapolis

55402. (612) 339-7179. Harry S. Hyett, pres; James O. Ramslund.

Inter-American Publications Inc. 41 E. 42nd St., New York 10017. (212) MUrray Hill 2-0884. Octavio Gonzalez, VP, gen mgr.

Inter-American Radio Advertising Inc. 313 Pecan St., Del Rio, Tex. 78840. (512) 775-5141.

Intercontinental Services Ltd. 9 E. 46th St., New York 10017. YUKon 6-0820. Harry M. Engel Jr., pres; Jeanette Beaudoin, VP; Elaine Herzstein, asst mgr.

Los Angeles 90028: (Adam Young Inc.) 6290 Sunset Blvd. Hollywood 2-2289. William Wallace. Puerla de Tierra, Santurce, PR.: Schellenberg & Kirwan, Box 8961. 722-5665. James T. Kirwan.

San Francisco 94133: (Radio Time Sales, International) 559 Pacific Ave. (415) 391-1984. Sam Posner, pres.

Ivy Network Corp. 242-A Yale Sta., New Haven 06520. (203) 865-3451. Antony Talaway, chmn; Steven Eckert, pres; R.J. Cerato, sec-treas.

Carter S. Jones Agency 1800 Peachtree Rd. N.W., Atlanta 30309. (404) 355-6067. Carter S. Jones.

Jones, Hooper & Associates. 3322 W. Peterson Ave., Chicago 60659. (312) 478-5544. Herb Alexander, Harper Jones.

W.O. Jones Inc. Box 20052, Atlanta 30325. (404) 325-0757. W.O. Jones.

Kaiser Broadcasting. 300 Park Ave., New York 10022. (212) 832-5700. L. Donald Robinson, VP & gen mgr; Diane L. Sass, VP/finch & mktg; Robert A. Roganli, natl sls mgr; Art Wagner, Eastern sls mgr; Robert M. Darcy, ctrlr.

Chicago 60610: 300 N. State St. (312) 645-0375. Bill Scharlot, Midwest sls mgr.

Los Angeles 90028: 6255 Sunset Blvd., Suite 716. (213) 416-3108. Bruce Fleming, sls mgr.

The Katz Agency Inc. 245 Park Avenue, New York 10017. (212) 972-2100. James L. Greenwald, pres; Oliver T. Blackwell, exec VP; Samuel T. Jones, treas/VP finance; Edward Schnur, ctrlr; Kenneth Mills, sec; Margaret Alcott, asst sec; Dick Mendelson, VP corp dev; Barry Lewis, spec projects dir; Gordon Hastings, dir new bus dev; Douglas Weaver, dir PR/adv.

Katz Radio: 245 Park Avenue, New York 10017. (212) 972-2100. Sal Agovino, pres; Ken Swetz, VP/gen mgr; Geoff Hall, VP mgr Katz Radio Network; Gilbert Miller, VP mgr, sports; Bill McHale, rgnl mgr; Tom Masone, NY sls mgr; Peter R. Goulazian, VP broadcast svcs; Wm. Schrank, dir creative systems; Kenneth A. Mills, dir creative svcs.

Atlanta 30361: 100 Colony Square. (404) 892-3811. Wm. Aaron Jr., mgr.

Chicago 60611: Equitable Bldg., 401 N. Michigan. (312) 670-3200. John Roberts, VP/rgnl mgr; Bob McArthur, mgr.

Dallas 75219: Suite 701, 3626 N. Hall St. (214) 526-7941. Wm. Keys, mgr.

Detroit 48202: Suite 316, 2990W. Grand Blvd. (313) 872-4800. Gene Cloe, div VP mgr.

Los Angeles 90036: Suite 850, 5900 Wilshire Blvd. (213) 937-7470. Winslow Uebel, div VP/mgr; Larry Adams, rgnl mgr.

Philadelphia 19102: Suite 622, 3 Parkway. (215) 567-7950. Jack Marino, mgr.

St. Louis 63102: 10 Broadway. (314) 231-1868. Thomas Kniest, mgr.

San Francisco 94111: Suite 2325, One California Bldg. (415) 362-7534. Pat Hodges, mgr.

Katz Television: 245 Park Ave., New York 10017. (212) 972-2100. David S. Allen, pres; Frank J. McCann, sr VP & gen mgr; Richard A. Goldstein, div VP sls, Len Graziano, sls mgr American; Chips Barabee, div VP sls Atlantic; Michael Raounas, div VP capital; Robert Levenstein, div VP continental; James Keeley, div VP sls pacific; Robert Peyton, VP dir audience dev; Peter R. Goulazian, VP broadcast svcs; Kenneth Mills, dir creative svcs; Wm. Schrank, dir creative systems.

Atlanta 30361: 100 Colony Square. (404) 892-3811. Larry Shrum, mgr.

Boston 02116: 20 Providence St. (617) 542-5458. Edward O'Rourke, mgr.

Charlotte, N.C. 28209: Suite 209, Park Seneca Bldg. (704) 523-5505. Paul Quinn, div VP mgr.

Chicago 60611: 3125 Equitable Bldg., 401 N. Michigan. (312) 670-3200. Victor Ferrante, div VP & mgr; Jerrold Whaley, div VP sls, national; Ed Papazian, div VP sls continental; Gregory Gush, sls mgr, American.

Dallas 75219: 3626 N. Hall St. (214) 526-7941. J.

David Rutledge, div VP, mgr.

Detroit: 1650 W. Big Beaver Road, Troy, Michigan, 48084. (313) 643-4722. Patrick McNew, div VP, mgr.

Los Angeles 90036: 5900 Wilshire Blvd. (213) 937-5250. Gerald Jones, VP/mgr; Rouen Westcott, sls mgr American; Raleigh Fitzpatrick, sls mgr national.

Memphis 38112: 2714 Union Ave. Extended, Suite 110, Tanner Bldg. (901) 454-0168. Swan Burrus III, mgr.

Philadelphia 19102: 3 Parkway, Suite 622. (215) 567-7950. James Carmine Jr., mgr.

St. Louis 63102: 10 Broadway. (314) 231-1868. Richard Epp, div VP/mgr.

San Francisco 94111: One California Bldg. (415) 362-7628. David Abbey, VP; Leonard Warager Jr., mgr.

Kentucky Radio Sales. 102 Tristan Rd., Louisville, Ky. 40222. (502) 426-6116. J. Porter Smith, Don E. Smith, Dorothy Smith.

KERRadio. 41 W. 53d St., New York 10019. (212) 246-7043. Bob Kerr, Lee Novak.

Kettell-Carter Inc. 9 Newbury St., Boston 02116. (617) 262-4760. John D. Kettell, pres; Marjorie Carter, treas-sec.

King Communications Inc. 619 Kenilworth Rd., Bay Village, Ohio 44140. (216) 871-0298.

Nona Kirby Co. Inc. 518 Statter Bldg., Boston 02116. (617) 482-6117. Kay Chile.

Knight Quality Stations Sales. 390 Commonwealth Ave., Boston 02115. (617) 262-1950. Norman Knight, pres; N. Scott Knight, VP; Rich Balsbaugh, Eastern rgnl sls mgr.

John W. Koehn Co. 149 S. Main St., Adrian, Mich. 49221. (517) 263-1039. John W. Koehn; Richard D. Lackie.

Lobster Radio Sales. 638 Congress St., Portland, Me. 04101. (207) 774-6561. Melvin L. Stone, Neal Chamberlain, Robert P. Mooney.

Bangor, Me. 04401: 7 Main St. (207) 947-7354.

Lotus Reps. 6777 Hollywood Blvd., Los Angeles 90028. (213) 466-8119. Richard Kraushaar, VP/gen mgr.

San Francisco 94104: 105 Montgomery St. (415) 398-2164. John Choate, mgr.

Chicago 60606: 20 N. Wacker Dr. S-3412. (312) 263-3340. Howard Weiss, mgr.

New York 10017: 30 E. 42nd St. (212) 972-1046. Joseph Austin Koff, mgr.

Bomar Lowrance & Associates Inc. Life of Georgia Tower, Suite 1211, Atlanta 30308. (404) 881-8975. Bomar A. Lowrance, chmn/chief exec off/treas; Clyde Clem, pres; Helen Keane, sec/asst treas; James P. Lavelle, mgr.

Dallas 75219: Oakwood Tower, Hall at Welborn. (214) 521-1942. Bomar A. Lowrance, pres/treas; James Svehla Jr., mgr.

St. Louis 63102: 10 Broadway. Ron L. Bladon, mgr.

J.A. Lucas Co. 6922 Hollywood Blvd., Los Angeles 90028. (213) 462-6655. James A. Lucas, pres; Sanford L. Kahn, VP.

San Francisco 94105: 681-Market St. (415) Enterprise 1-7441. Jim Lucas, mgr.

Chicago 60606: 20 N. Wacker Dr. (312) 263-5771.

Dallas 75201: Fidelity Union Life Bldg. (214) 742-7952. E. J. Ford, office mgr.

MMT Sales Inc. 747 Third Ave., New York 10017. (212) 758-3838. Gary Scollard, pres; Neil Kennedy, exec VP; Farrell Reynolds, Eastern sls mgr; Marty Mills, dir of rsch; Marty Waters, mktg dir; Robert Lefko, VP corp. planning & dev.

Atlanta 30339: 6400 Powers Ferry Rd., Suite 350. (404) 256-9390. Norman K. Hayes, mgr.

Chicago 60601: Two Illinois Center, 233 N. Michigan Ave. (312) 565-1930. 910-221-0914. Doug Balogh, mgr.

Dallas: Enterprise 62567.

Detroit 48084: 755 West Big Beaver Rd., Suite 414. (313) 362-0430. Thomas Rice, mgr.

Los Angeles 90036: 5900 Wilshire Blvd. (213) 937-6434. Robert Dickenson, mgr.

Minneapolis: Zenith 8752.

Philadelphia 19102: 3 Parkway, Suite 624. (215) 568-6570. Joe Rogers, mgr.

St. Louis 63101: 911 Washington Ave. (314) 421-5360. Martin Ludington, mgr.

San Francisco 94104: 44 Montgomery St. Suite 4024. (415) 986-4404. Sid Gurkin, mgr.

Major Market Radio 415 Madison Ave., New York 10017. (212) 355-1700. George E. Lindman, pres; Donald D. Dalton, VP & dir of sports mktg; Diarmuid

Representatives

White, NY sls mgr.

Chicago 60611: 400 N. Michigan Ave. (312) 321-9850. David K. Winston, mgr.

Southfield, Mich. 48075: Suite 215, 19400 W. 10 Mile Rd. (313) 358-2060. Thomas L. Tiernan, VP & mgr.

Atlanta 30309: 1375 Peachtree St. N.E. (404) 892-7525. Michael B. Disney, mgr.

Los Angeles 90028: 5858 Sunset Blvd. (213) 467-1193. Richard Mahoney, VP & mgr.

San Francisco 94111: One Embarcadero Center, Suite 2103. (415) 433-2181. Frank A. Tessin, mgr.

Market 4 Radio. 1472 Broadway, New York 10036. (212) 354-8244. Jim Smith, pres; Susan Bruno.

Chicago 60606: 20 N. Wacker Dr. (312) 236-8887. Robert Walton.

Dearborn, Mich. 48128: Box 5146. (313) 561-3823. Tom Corlett.

Los Angeles 90028: 1680 N. Vine St. (213) 464-9263. Bill Dahlsten.

San Francisco 94133: 559 Pacific Ave. (415) 391-1984. Sam Posner.

M.A. Sales Company, Inc. 666 Fifth Ave., New York 10019. (212) 489-1250. Jack Masla, pres.

Chicago: 75 E. Wacker Drive. (312) 236-7974. George Maris, mgr.

Dallas: 3626 N. Hall St. (214) 521-1181. Jack Riley, mgr.

Detroit: 1610 Book Bldg. (313) 961-4242. Bernard Pearce, mgr.

Boston: 100 Boylston St. (617) 482-4370. George Bingham, mgr.

Atlanta: 1819 Peachtree Rd. N.E., Suite 607. (404) 351-5757. Nick Imbornone, mgr.

St. Louis: 112 N. 4th St. (314) 231-5143. Bruce Schneider, mgr.

Memphis: 2158 Union Ave. Bldg. (901) 272-7503. Marilyn Watson, mgr.

Los Angeles: Masla/Young, 6290 Sunset Blvd. (213) 462-7351. Bill Wallace, mgr.

San Francisco: Masla/Young, 500 Sansome St. (415) 986-5372. Bill Peavey, mgr.

Jack Masla & Co. 666 Fifth Ave., New York 10019. (212) 489-1250. Jack Masla, pres; Stan Feinblatt, VP & Eastern sls mgr.

Chicago: 75 E. Wacker Drive. (312) CEntal 6-7974. George Maris, mgr.

Dallas: 3626 N. Hall Street. (214) 521-1181. Jack Riley, mgr.

Detroit: 1610 Book Bldg. (313) 961-4242. Bernard Pierce, mgr.

Boston: 100 Boylston St. (617) 482-4370. George Bingham, mgr.

St. Louis: 112 N. 4th St. (314) 231-5143. Bruce Schneider, mgr.

Memphis: 2158 Union Ave. Bldg. (901) 272-7503. Marilyn Watson, mgr.

Los Angeles: Masla/Young, 6290 Sunset Blvd. (213) 462-7351. Bill Wallace, mgr.

San Francisco: Masla/Young, 500 Sansome St. (415) 986-5372. Bill Peavey, mgr.

Atlanta: 1819 Peachtree Bldg. N.E., Suite 607. (404) 351-5757. Nick Imbornone, mgr.

Masla/Young Inc. 6290 Sunset Blvd., Los Angeles 90028. (213) 462-7351. William L. Wallace, exec VP in chg of West Coast ops; Lynn Picadio.

San Francisco 94111: 500 Sansome St. (415) 986-5372. Bill Peavey, mgr.

McClatchy Broadcasting. 21st & Q, Sacramento, Calif. 95816. (916) 442-5011. Richard Belkin, dir of bcstg; Keith B. Collins, mgr of sls.

McGavren-Guild Inc. 400 Park Ave., New York 10022. (212) 826-4200. Ralph Guild, pres & gen mgr; Monte Lang, VP Eastern div mgr; Bob Dwyer, BMS Network, pres; Dick Sharpe, New York sls mgr; Ellen Hulleberg, VP, dir of rsch.

Boston 02116: 224 Clarendon St. (617) 266-0666. Marc Gross, rgnl mgr.

Chicago 60601: 111 E. Wacker Dr. (312) 644-7150. Anthony A. Durpelti, VP, Central div.

Detroit 48202: 2990 W. Grand Blvd. (313) 872-2250. Robert Longwell, rgnl mgr.

Philadelphia 19103: 1700 Spruce St. (215) 732-3380. Vince Benedict, rgnl mgr.

San Francisco 94104: 235 Montgomery St. (415) 986-4112. Jeff Dasher, rgnl mgr.

St. Louis 63102: 10 South Broadway. (314) 321-0000. Gary Ahrens, rgnl mgr.

Representatives

Dallas 75219: 3626 Hall St. (214) 528-5471. Ed Carrell, rgnl mgr.
Atlanta 30305: 2479 Peachtree Rd., N.E. (404) 261-7878. Anthony Maisano, VP, Southern div mgr.
Los Angeles 90048: 6420 Wilshire Blvd. (213) 658-7072. Les Goldberg, VP, Western div mgr.

John L. McGuire Inc. 2829 E. 2nd Ave., Denver 80206. (303) 321-2354. John L. McGuire, own; Del Greenwood, account exec.

McLendon Stations. 1917 Elm St., Dallas 75201. (214) 651-1010. James F. Mackin, B.R. McLendon, Gordon B. McLendon.
Chicago 60610: 24 W. Erie. (312) 943-8400. James F. Mackin.

Media Sales/South. 1819 Peachtree Road N.E., Atlanta 30309. (404) 351-9288. Nick Imbornone, pres.

Baltimore: (301) 263-9211. Marvin Mirvis.
Salisbury, Md.: (301) 742-5400. Charles Stewart.
Philadelphia: (215) 727-1212. Dick Reynolds.
Providence, R.I.: (401) 821-6200. Jim Hooker.
Lancaster, Pa.: (717) 684-2591. Ed Moshler.

The Meeker Co. Inc. 521 Fifth Ave., New York 10017. Murray Hill 2-2170. Robert L. Dudley, pres; William Bee, exec VP; Jack Hardingham, VP & natl sls mgr; John Kriete, Eastern sls mgr.

Chicago: 333 N. Michigan Ave., Central 6-1742. Fred Bauman, Midwest VP.
San Francisco: 50 California St. YUkon 6-4940. Jay Adair, mgr.

Los Angeles: 5670 Wilshire Blvd., 933-5907. Hugh McTernan, West Coast mgr.
Omaha: 1624 Douglas. 341-7535. Harold Soderlund.

Kansas City: 1012 Baltimore Bldg. (816) GR 1-5502. Eugene Gray.

St. Louis: 10 S. Broadway. 231-9151. Eugene Gray.
Atlanta 30308: 615 Peachtree St. N.E. (404) 875-6495. Richard Hughes, mgr.

Dallas 75219: 3141 Hood St. (214) 526-6410. James Cathey, mgr.

Clyde Melville Co. Suite 333, 3141 Hood St., Dallas 75219. (214) 526-0890. Clyde B. Melville, pres.

Mario Messina Co. 3225 Lemmon Ave., Dallas 75204. (214) 528-7260. Jim Lowenberg, gen mgr; Pam Forsgren, asst mgr.

Atlanta 30326: Suite 701, 3384 Peachtree Rd. N.E. (404) 266-2133. Mrs. Mary O'Shields, Ann Benton.
Chicago 60606: 20 N. Wacker Dr. (312) 236-8887. Robert Walton.

Detroit : Box 5146, Dearborn, Mich. 48128. (313) 561-3823. Tom Corlett.
Little Rock, Ark 72203: Box 1918. (501) 375-2545, 376-7067. Mrs. Pat Wilcox.

Los Angeles: Box 703, Woodland Hills, Calif. 91364. (213) 346-9621. Mrs. Harlan Oakes.
Memphis 38104: 2158 Union Avenue Bldg., Suite 520. (901) 278-3908. Bob Chisholm.

New York 10036: 15 West 44th St. (212) 867-0295. Frederick W. Smith.
Raleigh, N.C. 27609: Box 18006. (919) 782-0896. Penn Watson.

San Francisco 94131: 199 Crestmont Dr. (415) 731-3620. Ward Glenn.

Metro Radio Sales (A Metromedia company). 485 Lexington Ave., New York 10017. (212) 682-9100. Richard J. Kelliher, sr VP Metromedia Radio; John Doscher, VP natl sls mgr; Frank Leoce, VP natl sls mgr, New York.

Atlanta 30309: 1365 Peachtree St. N.E. (404) 892-2611. Don Hart, sls mgr.
Chicago 60611: 410 N. Michigan Ave. (312) 467-5200. Gene Werman, VP & Midwest mgr.

Dallas 75219: 3511 North Hall. (214) 322-5651. Patricia Boatright, VP sls mgr.
Detroit 48220: 2201 Woodward Heights. (313) 543-3166. Ronald Yarnick, sls mgr.

Los Angeles 90028: 5746 Sunset Blvd. (213) 464-9266. Steve Courtney, VP, sls mgr.
San Francisco 94111: One Embarcadero Center. (415) 362-1945. Dick Gerken, VP, sls mgr.

Metro TV Sales (A Metromedia Company). 485 Lexington Ave., New York 10017. (212) 682-9100. Thomas J. Tilson, pres; James Jordon, VP, Eastern sls mgr; Dr. Mel Harris, dir of rsch & sls prom; Daniel Greenblatt, VP & sls mgr; Richard Maloney, sls mgr.

Chicago 60611: 410 N. Michigan Ave. (312) 467-5200. William Tynan, VP central region.

Detroit 48220: 2201 Woodward Heights Blvd. (313) 543-2280. Edward M. Shea, mgr.

Los Angeles 90028: 5746 Sunset Blvd. (213) 462-7111. John R. Jones, VP & mgr.
San Francisco 94111: One Embarcadero Center. (415) 362-1947. Anthony Santino, VP & mgr.
Philadelphia 19103: Wellington Bldg., 19th & Walnut. (215) 568-2900. Edward Hardison, mgr.
St. Louis 63102: 10 Broadway. (314) 241-3282. Marion Bock, mgr.

Michigan Spot Sales. Penthouse of Sheraton-Cadillac Hotel, Detroit 48231. (313) Woodward 1-3353. Denman F. Jacobson, Eleanor Krupp, plnrs.

Midwest Radio Reps. 1000 Grand Ave., Des Moines, Iowa 50309. (515) 244-2115. Ross Martin, gen mgr.
San Francisco 94131: 199 Crestmont Drive. (415) 731-3620. Glenn Ward.

Paul Miller & Co. 3131 Turtle Creek, Dallas 75219. (214) 528-2923.
Chicago 60645: 3322 W. Peterson Ave. (312) 478-5544. Hooper Jones.

Detroit 48128: Box 5146, Dearborn, Mich. (313) 561-3823. Tom Corlett.
New York 10036: 25 W. 43rd St. (212) 575-5077. Bob Dore.

Minnesota Star Radio Network. 3415 University Ave., St. Paul 55114. (612) 645-2724. Jack Nugent.

Montana Television Network. Box 2557, Billings, Mont. 59103. (406) 252-5611. Donald G. Bradley, gen mgr; Pete Friden, natl sls mgr.

Art Moore & Associates. Box 1969, Seattle 98111. (206) 682-3377. Jack Clarke, pres; Ed Henry, VP.
Portland, Ore. 97204: 520 S.W. Yamhill. (503) 228-7284. Ed Horny, VP.

Morton Times Sales Inc. 13601 Preston Rd., Suite 910 E., Dallas 75240. (214) 233-1078. D.W. Morton.

Mountain Media Inc. 2695 Alcott St., Suite 334, Denver 80211. (303) 433-6446. Jon McNutt.

William Murphy. 3195 Hull Ave., Bronx, N.Y. 10467.

National Time Sales. 275 Madison Ave., New York 10016. (212) 889-1200. Eugene Bernald, Hank Franklin, Gene R. Bernald.

Chicago 60645: 3322 W. Peterson Ave. (312) 478-5544. Evelyn Kogan, Hooper Jones.
San Francisco 94133: 559 Pacific Ave. (415) 391-1984. Bert Chance.

Atlanta 30309: 1819 Peachtree Rd., N.E. (404) 355-6432. Barney Ochs.
Tulsa, Okla. 74101: Box 1384. (918) 743-9708. Beverly Butler.

Hollywood 90028: 6777 Hollywood Blvd. (213) 463-3201. Bill Warren.

NBC Spot Television Sales. 30 Rockefeller Plaza, New York 10020. (212) 247-8300. Bud Hirsch, VP; Dick Gold, dir Eastern sls; Hilary Hender, Eastern sls mgr.

Chicago: 60654 Merchandise Mart. (312) 644-8300. Donald Douglas, mgr Central div.
Burbank, Calif. 91503: 300 W. Alameda St. (213) 845-7000. Carl Schutz, sls mgr.

San Francisco 94102: Fox Plaza. (415) 626-6700. Robert Anderson, sls mgr.
Washington 20016: 4001 Nebraska Ave., N.W. (202) 362-4000.

Atlanta 30302: 600 W. Peachtree Rd. N.W. (404) 876-3726. Bowmar Lowrance and Associates.

Dallas 75202: First National Bank, Room 1959. (214) 742-8206. Bowmar Lowrance and Associates.
St. Louis 63101: 1015 Locust St. (314) 241-2451. Bowmar Lowrance and Associates.

Toronto: NBC Spot TV Sales, 30 Rockefeller Plaza, N.Y. 10020. (212) 247-8300. Mike Elliott, account exec.
Montreal: NBC Spot TV Sales, 30 Rockefeller Plaza, N.Y. 10020. (212) 247-8300. Mike Elliott, account exec.

Detroit: 1721 Crooks Rd., Troy, Mich. (313) 564-4800. Richard Taylor, sls mgr.

Neidigh Co. 1039 E. 36th, Seattle 98102. (206) 322-4742. Jim Neidigh.

New England Spot Sales Inc. 100 Boylston St., Boston 02116. (617) Hubbard 2-4370. George C. Bingham.

Michael Nichter Associates Inc. Three East 54th St., New York 10022. (212) 832-6500. Michael Nichter, pres.

Northland Stations. 1821½ Logan Ave., S., Minneapolis 55403. (612) 377-6860. Kingsley H. Murphy Jr.

Harlan G. Oakes and Associates Inc. Box 703, Woodland Hills, Calif. 91364. (213) 346-9621. Harlan G. Oakes, pres; Scott Moffett, Marly Costello, account execs.

San Francisco 91364: 199 Crestmont Drive. (415) 731-9621.

Dallas 75204: Garden Suite, 3225 Lemmon Ave. (214) 528-7620. Jim Lowenberg, C. Carmack.

Chicago 60606: 20 N. Wacker Dr. (312) 236-8887. Bob Walton.

Seattle: Tower Bldg. (206) 623-1868.

Bernard I. Ochs So. 1819 Peachtree Rd. N.E., Atlanta 30309. 355-6432. Bernard I. Ochs, pres.

Lee F. O'Connell Co. 111 N. LaCienega Blvd., Beverly Hills, Calif. 90211. (213) 652-1441. Charles Dwyer, owner.
San Francisco: 559 Pacific Ave. (415) 391-1984. Sam Posner, mgr.

Pacific Broadcast Sales. 155 Montgomery St., San Francisco 94104. (415) 397-6187. Paulie Landon, Rick Holmberg.

Los Angeles 90026: 5900 Wilshire Blvd. (213) 937-4500. Robert R. Allen, Robert Maggiore, Barbara Forrest.

Pan American Broadcasting Co. 275 Madison Ave., New York 10016. (212) 889-1200. E. Bernald, pres; Henry Franklin, VP; Eugene R. Bernald, VP.

Atlanta 30309: 1819 Peachtree Rd. (404) 355-7961. Barney Ochs.

Chicago 60645: 3322 Peterson Ave. (312) 478-5544. Hooper Jones.
Hollywood 90028: 6777 Hollywood Blvd. (213) 463-3201. Bill Warren.

San Francisco 94133: 559 Pacific Ave. (415) 391-1984. Sam Posner.
Sacramento 94821: 2600 Auburn St. (916) 483-3469. Jim Hodges.

Seattle 98101: 516 Securities Bldg. (206) 624-6333. Jack Hauser.

Panamericana Television L.A. 1680 N. Vine St., 700, Los Angeles 90028. (213) 469-2277. Richard Ballester, mgr.

Hal Parks Inc. 1819 Peachtree Rd. N.E., Atlanta 30309. (404) 355-4040. Hal Parks, Elsie Hall.

Pearse Sales. 1610 Book Bldg., Detroit 48226. (313) 961-2685.

Peters, Griffin, Woodward Inc. 277 Park Ave., New York 10017. (212) 826-6000. Lloyd Griffin, chmn of the bd/chief exec off; William G. Walters, pres; Theodore D. Van Kirk, exec VP; Lawrence P. Loiello, VP-finance/treas; Dennis K. Gillespie, VP/gen sls mgr; Ron P. Collins Jr., sls mgr, East-Southeast; John C. Lehman, sls mgr, mid-America; Walter E. Harvey, VP/sls mgr, Midwest-Southwest; Roy M. Terzi, VP/sls mgr, West; John E. McGowan, area mgr; Kenneth R. Betteer, rgnl mgr; Lon A. King, VP-creative svcs; John R. Thayer, VP-dir of rsch; David B. Colquhoun, ctrlr.

Atlanta 30308: Life of Georgia Tower. (404) 875-7763. Albert L. Strada, rgnl mgr; James C. Dodgson, sls mgr.

Boston 02116: Statler Office Bldg. (617) 482-4833. Charles S. Smith, sls mgr.

Charlotte, N.C. 28211: 2915 Providence Road. (704) 364-2115. E. Nathan Hale Jr., sls mgr.

Chicago 60601: Prudential Plaza. (312) 372-6373. James R. Seferl, senior VP; Robert F. Buselli, sls mgr, East; J. Barry Weed, sls mgr, mid-America; Thomas R. Will, sls mgr, West.

Dallas 75201: Southland Center. (214) 747-9921. M.C. Via Jr., sls mgr.

Detroit 48226: Penobscot Bldg. (313) 961-4255. Raymond L. Hunter, VP/sls mgr.

Los Angeles 90036: 5455 Wilshire Blvd. (213) 938-3585. Charles R. Kinney, senior VP.

Minneapolis 55402: IDS Center. (612) 333-2425. John J. Cameron, sls mgr.

Philadelphia 19102: 1500 Chestnut St. (215) 568-7290. Frank L. Kreh, sls mgr.

St. Louis 63102: 10 Broadway, Suite 440. (314) 241-3171. Arnold K. Knippenberg, sls mgr.
San Francisco 94111: One California St. (415) 982-9188. Louis J. Hummel Jr., sls mgr.

Petry Television. 3 E. 54th St., New York 10022. (212) 688-0200. Martin F. Connelly, pres; Bob Muth, exec VP; Ed Karlik, group sls mgr-NY; Art Scott VP & group sls mgr; Bill Bee, senior VP & group sls mgr; Steve Bell, VP & dir of progmg; C.W. Schellenger, chief financial officer.

Chicago 60611: 410 N. Michigan Ave. (312) 944-0011. Browning Holcombe, VP & Midwest mgr; Skip Moss, group sls mgr; Jack Carrigan, group sls mgr.

Bill Haight, group s/s mgr.
Atlanta 30309: 1375 Peachtree St. (404) 892-7151.
Richard Hughes, VP s/s mgr.
Boston 02116: 801 Statler Bldg. (617) 482-6440.
Diane Goddardian, s/s mgr.
Detroit 48202: 5-228 General Motors Bldg. (313) 874-2500. Richard Yoder, s/s mgr.
Los Angeles 90036: 5670 Wilshire Blvd. (213) 937-4330. Roger La Reau, VP/WC s/s.
San Francisco 94104: 44 Montgomery St. (415) 434-3631. Paul Sacks, s/s mgr.
St. Louis 63102: 10 Broadway (314) 241-2445.
Lyle Van Valkenburgh, s/s mgr.
Dallas 75219: 3141 Hood St. (214) 528-7862. Jack O'Hern, s/s mgr.
Philadelphia 19102: 1420 Walnut St. (215) 546-4454. Fred Erb, s/s mgr.

Don R. Pickens Co. Box 516, Orinda, Calif. 94563. (415) 986-0621. Don Pickens.
Beverly Hills 90211: 111 N. LaCienega Blvd. Oleander 2-1313. Lee F. O'Connell.

John Andy Potter Co. 3600 Wilshire Blvd., Los Angeles 90010. (213) 388-3407, 388-5121. John A. Potter.
San Francisco 94104: 465 California St. (415) 398-5710. Andy Potter.
Chicago 60606: 20 N. Wacker Drive. (312) 236-8887. Bob Walton.
Dearborn, Mich. 48128: Box 5146. (313)561-3823. Tom Corlett, mgr.
New York 10017: 501 5th Ave. (212)972-0982. Joe Cannon, mgr.

Promotores Asociados Inc. Box 8711, Calle Bolivar No 602, Santurce, PR. 00910. (809) 725-0070. Jorge Fusar, Raphael Fusaro.

Pro/Meeker Radio. 441 Lexington Ave., New York 10017. (212) 687-3380. Sam Brownstein, Fin Hollinger, Susan Kasprzak, Ed Fisher.
Philadelphia 19107: 1015 Chestnut St. (215)922-4387. Richard Harvey.
Chicago 60601: 333 N. Michigan Ave. (312) 368-1644. Tom Hayes, John Nankervis.
Detroit: Enterprise 6085. Emil Lach.
Kansas City, Mo. 64105: 1012 Baltimore Bldg. (816)471-5502. Eugene F. Gray.
Memphis 38104: 2158 Union Ave. (901)272-7503. Marilyn Walton, Jack Biley.
Raleigh, N.C. 27609: Box 18006. (919) 782-0896. Penn Watson.

Seattle 98101: 614 Lloyd Building. (206) 622-7343. Dean Seaton.
Dallas 75219: 3141 Hood. (214)526-6410. Jim Cathey, Louis Cain.
Atlanta 30326: 3384 Peachtree Rd., N.E. (404) 266-2133. Mary O'Shields.
Denver 80206: 2829 E. Second Ave. (303) 321-2354. John L. McGuire, Del Greenwood.
Los Angeles 90028: 6777 Hollywood Blvd. (213) 463-3201. Bill Warren.
San Francisco 94104: 465 California St. (415)956-5972. Dave Murphy.

Quality Broadcasting System. Box 13427, Santurce, PR. 00908. (809) 725-4020. Alfredo R. de Arellano Jr., pres; Alfred D. Herger, prog dir; Wilson Laracuenté, VP, ctrlr; Jose E. Falcon, mgr.

The Queen Company Inc. 163 Newbury St., Boston 02116. (617)262-1145. (800)225-6105. William A. Queen, pres & treas; Esther F. McQueeney, VP & clerk.
New York 10017: 50 E. 42nd St. (212)986-6210.

R & R Representatives Inc. Box 1384, Tulsa Okla. 74101. (918) 587-1491. Beverly Butler, pres; Dwight Nichols, sec-treas.

Erie Racey & Associates. 12037 Arbagee Circle, Dallas 75230. (214) 239-2105.

Radio Advertising Representatives Inc. 90 Park Ave., New York 10016. (212) 692-3227. Michael J. Faherty, pres; Tony Hirsh, gen s/s mgr.
Chicago 60611: 625 N. Michigan Ave. (312) 664-6555. Craig Bachman.
Detroit 48226: 617 City National Bank Bldg. (313) 965-2420. Dan Friel.
Los Angeles 90028: 6725 Sunset Blvd. (213) 469-2923. Jack Kabateck.
San Francisco 94104: 44 Montgomery St. (415) 434-2866. Ed Gardner.

Radio Coast-to-Coast. 106 Scotland Rd., S. Orange, N.J. 07079. (201)762-2132. Bill Masi, pres; John Ondo, rgnl dir.
Winter Park, Fla. 32789. (305)628-4578. John Ondo.

Radio Representatives Inc. Box 2352, Rancho Palos Verdes, Calif. 90274. (213)541-7379. Norwood Patterson.

Radio Time Sales/International 559 Pacific Ave., San Francisco 94133. (415) 391-1984. Sam Posner, own-pres; Bert Chance.

New York 10017: 22 E. 40th St. (212) 889-1200. Hank Franklin, mgr; Sandy Krauss.

Chicago 60606: 20 N. Wacker Dr. (312) 236-8887. Bob Walton, Frank Mangan.

Hollywood 90028: 6777 Hollywood Blvd. (213) 463-3201. Bill Warren.

Dallas 75219: Oakwood Towers, 3626 N. Hall. (214) 521-1240. Jack Riley, Julie Bartholomew.

Tulsa, Okla. 74101: Box 1384. (918) 587-1491. Beverley Butler.

Memphis 38104: 2158 Union Ave., Suite 112. (901) 272-7503. Marilyn Watson.

Detroit 48226: 506 Park Ave. Bldg. (313) 961-3822. Tom Corlett, mgr.

Seattle 98101: 614 Lloyd Bldg. (206) 624-7343. Dean Seaton.

Radio West. 199 Crestmont Dr., San Francisco 94131. (415) 731-3620. David Sandeberg, Ward Glenn.

Seattle 98105: 3909 51st Ave. N.E. (206)523-1283. Hugh Feltis, mgr.

Los Angeles 91364: Box 703, 21243 Ventura Blvd., Woodland Hills, Calif. (213) 346-9621.



Regional Reps Corp. 5340 Central Ave., St. Petersburg, Fla. 33707. (813) 347-9708. Leonard F. Auerbach, pres.

Cleveland 44115: 1220 Huron Road. (216) 781-0035. Norbert J. Kocob, VP; M.C. Carlson.

Cincinnati 45203: 408 Holiday Park Tower, 644 Linn St. (513)651-1511. Don O. Hays, VP; John P. Willinger Jr.

Religious Media Associates. Box 246, Knoxville, Tenn. (615) 525-5442. Art Jones, pres/gen mgr.

Riley Representatives. 3626 N. Hall, Callas 75219. (214) 521-1240. Jack Riley.

Memphis 38104: 2158 Union Avenue Bldg. (901) 272-7503. George Faulder.

Atlanta 30309: 1819 Peachtree Rd. N.E. (404)351-9288. Nick Imbornone.

RKO RADIO REPRESENTATIVES INC.

RKO Radio Representatives Inc. 1440 Broadway, New York 10018. (212) 764-6800. Kathryn Lenard, VP & gen mgr; Peter J. Cleary, VP & Eastern s/s mgr.
Atlanta: 1800 Peachtree Road N.W. (404) 351-0773.

Chicago: 111 E. Wacker Drive. (312) 527-5300. John Hokin, VP & Western s/s mgr.

Detroit: 17117 West Nine Mile Road. (313) 557-4480.

Los Angeles: 6255 Sunset Blvd. (213) 461-8591. Philadelphia: 1617 JFK Blvd. (215) 563-3580.

San Francisco: 425 Bush St. (415) 398-3878.

RKO Television Representatives Inc. 1440 Broadway, New York 10018. (212) 764-6700. Robert L. Glaser, chmn; James V. Marino pres; Pat Servodidio, New York s/s mgr; John Sawhill, dir of rsch.

Chicago 60601: 111 E. Wacker Dr. (312) 527-5300. Bill Ganley, Midwest s/s mgr.

Detroit 48202: 920 Fisher Bldg. (313) 874-4550. Bob Qudeen, Detroit s/s mgr.

Los Angeles 90036: 5670 Wilshire Blvd. (213) 939-1106. Jim Miller, Los Angeles s/s mgr.

San Francisco 94133: 485 Pacific Ave. (415) 982-2041. Jerry Danford, mgr.

Atlanta 30309: 1800 Peachtree Rd. N.W. (404) 876-5743. Giff Eager, Southern s/s mgr.

Rollins Broadcasting. Box 647, Atlanta 30301. (404) 875-3511. Paul H. Downs:

Chicago 60601: 75 E. Wacker Dr. (312) 726-6842. Bill Oldham.

Marv Roslin Inc. 3 E. 54th St., New York 10022. (212)486-0720. Marvin Roslin, pres; Elizabeth L. Hainstock, account exec.

Rounsville Stations. 3220 Peachtree Rd. N.E.,

Representatives

Atlanta 30305. (404) 261-3000. Ralph B. Johnson.

RTV Management Inc. 152 W. 42nd St., New York 10036. (212) 421-0680. John E. Thayer.

Rust Craft Broadcasting Company's Stations. 680 Fifth Ave., New York 10019. (212) 581-4466. Jack N. Berkman, vice chmn; Marshall L. Berkman, pres; Ralph E. Becker, VP/TV; Andrew F. Hoffman, VP/radio.
Pittsburgh 15219: 700 J.K. Porter Bldg. (412)288-0920.

Sandberg-Glenn Co. 199 Crestmont Drive, San Francisco 94131. (415) 731-3620. David Sandeberg, Ward Glenn.

Los Angeles: Box 703, 21241 Ventura Blvd., Woodland Hills, Calif. 91364.

Chicago 60606: 20 N. Wacker Dr. (312) 236-8887. Robert Walton.

New York 10017: 347 Madison Avenue. (212) 683-5530. Ed Devney, mgr.

Dallas 75204: 3225 Lemmon Ave. (214)528-7260. Jim Lowenberg, mgr.

Seattle 98105: 3909 51st Ave. (206)523-1283. Hugh Feltis, mgr.

Dearborn, Mich. 48128: Box 5146. (313)561-3823. Tom Corlett, mgr.

St. Louis 63105: 7730 Carondelet. (314)862-5250. Gert Bunchez, mgr.

Savalli/Gates Inc. 515 Madison Ave., New York 10022. (212) 688-2380. Joseph Savalli, pres; Carmine Patti, VP; William M. Wilson, Michael Maulano, Prem Kapur, Vince Gardino, Joseph Prisco, William Whelan.

Atlanta 30309: 1365 Peachtree St., N.E. (404) 892-8850. Neal Robb.

Chicago 60601: 333 N. Michigan Ave. (312) 782-7494. Robert Tiedje, Thomas Griffin.

Dallas 75219: 3511 N. Hall St. (214) 521-6800. Roger Jacobson.

Los Angeles 90028: 1717 N. Highland. (213) 462-6676. James C. Gates, Tom Papich, Juanita Hadley London.

San Diego 92103: 3368 Second Ave. (714) 297-0314. Dick Thomas, mgr.

San Francisco 94105: 681 Market St. (415) 362-7159. Donald Pontius, mgr.

Seattle 98101: 1007 Lloyd Bldg. (206) 624-2344. Dean Seaton, mgr.

Schellenberg & Kirwan Inc. Box 8961, Santurce, PR. 00910.

San Juan, PR.: Suite 109-110, Condominio San Martin, 1605 Ponce de Leon Ave. (809) 722-5665. James T. Kirwin, pres.

Bruce Schneider & Co. 112 N. 4th St., St. Louis 63102. (314) 231-5143.

Harold S. Schwartz & Associates Inc. 6415 Sheridan Rd., Chicago 60626. (312) 764-1502.
Chula Vista, Calif. 92010: 737 Third Ave. (714)420-6131. Jorge Wilkins.

Selcom Inc. 6922 Hollywood Blvd., Suite 510, Hollywood, Calif. 90028. (213) 462-2371. Hugh Wallace, pres; Bill Smith, VP; John Bradley, Peggy Upton.

San Francisco 94111: One California St./280. (415) 781-3990. Mary Gregg.

Chicago 60611: 400 N. Michigan Ave. (312) 467-0460. Jack Ambrozie, Gina Gallagher, mgrs.

New York 10020: 1271 Avenue of the Americas. (212) 581-0250. Herb Hahn, Linda LaPlant, Bob O'Brien, John Sokolski.

Detroit: 26011 Evergreen Road, Southfield, Mich. 48076. (313) 355-0840. Oliver Street.

Dallas 75219: 3519 Cedar Springs Road. (214) 522-3970. Barbara Cooks.

Atlanta 30305: 3030 Peachtree Rd. N.W. (404)266-9958. John Wilson, mgr.

Selective Broadcast Advertising Inc. 4920 N. Broad St., Philadelphia 19141. (215) 329-6100. Albert C. Lowenstein, pres; Eloise M. Lowenstein, gen mgr.

Simpson/Reilly & Associates. 314 First Ave. W., Seattle 98119. (206) 282-7010. William L. Simpson, pres; Earl F. Reilly Jr., VP & gen mgr; Cam Wilson, VP s/sman; Robert W. Davis, s/sman; Jane E. Gallagher, Ellie Lee, Susie Wilson, Susan Page, s/s assts.

Portland, Ore. 97204: Suite 1000, 620 Bldg., 620 S.W. 5th Ave. (503) 226-3973. Charles L. Burrow, VP-mgr/Portland; Dennis Mahoney, s/sman; Ellen Johnson, Linda Okazaki, Rickey Beckstrom, s/s assts.

SJR Communications Stations. 1370 Ave. of the

Representatives

Americas, New York 10019. (212) 765-3244. Larry Wynn, dir. coml. dev.

Frederick W. Smith Station Representative. 15 W. 44th St., New York 10036. (212) 867-0295.

Soderlund Co. 302 Executive Bldg. 1624 Douglas, Omaha, Neb. 68102. 341-7535. Harold A. Soderlund, pres; Ruth Schmid.

Southern Spot Sales Inc. Box 18006, Raleigh, N.C. 27609. (919) 782-0896. Penn Watson, Lynn Hallock. Atlanta 30326: 3384 Peachtree Rd. N.E., Suite 304. (404) 266-2133. Mary O'Shields. Chicago 60606: 20 N. Wacker Drive. (312) 236-8887. Robert Walton. Dallas 75201: 1537 Fidelity Union Bldg. (214) 747-0135. Jim Lowenberg. Detroit 48226: 2140 Book Bldg. (313) 963-6919. Max Goldfarb.

Memphis 38104: 2158 Union Ave., Suite 520. (901) 278-3908. Bob Chisholm. New York 10036: 15 W. 44th St. (212) 867-0295. Frederick W. Smith.

Philadelphia 19103: 1617 John Kennedy Blvd. (215) 563-3716. Robert Dome. Baltimore 21202: 204 E. Biddle St. (301) 727-6566. Senius Smith. Pittsburgh 15222: 1704 Investment Bldg. (412) 391-6520. Steve Rooney. Hollywood 90028: 6777 Hollywood Blvd. (213) 463-2102. Bill Warren.

Southern Television System Sales. Box 2220, Florence, Ala. 35630. (205) 764-7711. Dick Biddle.

Southwest Radio Representatives. 5327 N. Central Expressway, Dallas 75205. (214) 521-1164.

Spanish International Network. 250 Park Ave., New York 10017. (212) 697-0585. Rene Anselmo, pres; William D. Stiles, VP, sls. Los Angeles 90038: 721 N. Bronson. (213) 466-8131. Chicago 60601: 230 N. Michigan Ave. (312) 782-1129.

San Antonio, Tex. 78204: 411 E. Durango Blvd. (512) 227-4141. Atlanta 30309: 1819 Peachtree Road N.E. (404) 355-4040.

Miami 33129: 2525 S.W. 3rd Ave. (305) 856-3132. San Francisco 94124: 2200 Palou Ave. (415) 826-6990. St. Louis 63102: 112 N. 4th St. (314) 231-5143.

The Starr Broadcasting Group Inc. 3715 Williams Blvd., Kenner, La. 70062. (504) 722-5656. Lou Mahacek Jr.

Stars Inc. Drawer 1207, Valdosta, Ga. 31601. (912) 244-1900. E.D. Rivers, chmn; M.B. Rivers, pres; M.S. Vines, sec.

Steinman Radio Stations. 8 W. King St., Lancaster 17603. (717) 397-5251. Harold E. Miller Jr.

Storer Television Sales Inc. 299 Park Ave., New York 10017. (212) 935-2600. Francis P. Barron, pres; Andrew P. Potos, VP-gen sls mgr; Joseph P. Dowling, VP-rsch; Daniel J. O'Kane, treas; John M. Brigham, Eastern sls mgr. Detroit 48202: New Center Bldg., Suite 521. (313) 873-2383. James E. Goldsmith, sls mgr. Chicago 60601: 333 N. Michigan Ave. Central 6-9550. Charles M. Lieber, Midwest sls mgr. Atlanta 30309: 1375 Peachtree N.E. (404) 892-7202. Bill Mason, Southern mgr.

Los Angeles 90005: 338 S. Western Ave. DUnkirk 9-3138. Joseph P. Mertens, West Coast sls mgr. San Francisco 94104: Russ Blvd. 235 Montgomery. YUkon 1-8860. Shawn McGreevy, San Francisco sls mgr.

E.S. Sumner Corp. 333 E. 55 St., New York 10022. (212) 980-3575. E.S. Sumner, pres; Scott Sumner; Sherwood Sumner, sls mgr. Los Angeles 90069: Ben Conway & Assoc., 999 North Doheny Drive, (213) Crestview 1-8133. Ben F. Conway, pres.

Susquehanna Broadcasting Co. 509 Madison Ave., New York 10022. (212) 421-5640. Eric Bosch, natl sls mgr.

Tacher Co. Inc. 1411 Fourth Ave., Seattle 98101. (206) 624-4191. Mike Tacher, Bob Tacher, Barbara Nelson.

Portland, Ore. 97205: 1130 Southwest Morrison. (503) 226-2911. Richard Gohlman.

Taft Broadcasting Co. 602 Hanna Bldg., Cleveland 44115. (216) 621-3078. Earl Bechtel, mgr, Cleveland s/s office.

Cleveland 44115: 602 Hanna Bldg. (216) 621-3073.

TeleRep Inc. 919 Third Ave., New York 10022. (212) 759-8787. Alfred M. Masini, pres & gen mgr; Richard Brown, VP & gen sls mgr—Lions; Thomas Belviso, gen sls mgr—Tigers.

Atlanta 30308: Life of Georgia Tower. (404) 881-1948. Chicago 60611: 625 N. Michigan Ave. (312) 329-1515.

Detroit 48233: 718 New Center Bldg. (313) 873-3320.

Los Angeles 90036: 5900 Wilshire Blvd. (213) 937-4644.

St. Louis 63102: 10 S. Broadway. (314) 241-7979. San Francisco 94104: 350 Sansome St. (415) 433-1966.

Philadelphia 19102: 1700 Walnut St. (215) 372-2840.

Boston 02116: 607 Boylston St. (617) 247-2555. Dallas 75204: 3225 Lemmon Ave. W. (214) 521-5660.

Television Advertising Representatives Inc. 90 Park Avenue, New York 10016. (212) 692-4175. Stephen D. Seymour, pres; Lloyd A. Wierler, exec VP; Arma E. Andon, VP/mktg & sls dev; George Feldman, VP/creative svcs; Peter F. Yaman, VP/admin sls; Howard Mendelson, NY sls mgr; Dan Cosgrove, group sls mgr; Arnie Kleiner, group sls mgr. Chicago 60611: 625 N. Michigan Ave. (312) 527-4567. William B. Condon, VP/Midwest; Robert Kunath, Midwest sls mgr; Stu Strizak, rgnl sls mgr. Detroit 48226: 617 National Bank Bldg. (313) WO 5-6454. Robert E. Newsham, VP/mgr. Los Angeles 90048: 6420 Wilshire Blvd. (213) HO 6-1144. Doug Clark, mgr.

San Francisco 94104: 44 Montgomery St. (415) 397-5088. E. James Hodggett, mgr.

Philadelphia 19106: Independence Mall East. (215) 238-4966. Thomas J. Hollingshead, mgr.

Thoms Radio-TV Enterprises. 75 Elk Mtn. Scenic Highway, Asheville, N.C. 28804. (704) 255-0111. Harold H. Thoms, pres.

Tie States Ltd. 342 Madison Ave., New York 10036. (212) 697-1996. Michael G. Irving, dir.

T-N Spot Sales. Box 1988, 130 S. Salisbury St., Raleigh, N.C. 27601. (919) 832-8885. Wally Voigt, Paul von Hagel, Allen B. Jones.

Detroit 48226: 1610 Book Bldg. (313) 961-2685. Bernard P. Pearse.

Top Market Television, Inc. 437 Madison Ave., New York 10022. (212) 644-0930. James P. McCann, pres; Richard Williams, VP/Eastern sls mgr; Robert Brady, VP/finance; Dale Paine, VP/rch & sls dev; Thomas Shannon, VP/Western sls mgr. Atlanta 30309: 1819 Peachtree Rd., N.E. (404) 351-8054. Robert J. Bordley. Boston 02116: Tom Market Television. 437 Boylston St. (617) 267-2828. Fred Petrosino. Chicago 60611: 401 North Michigan Ave. (312) 828-0500. Thomas Shannon.

Detroit 48084: 2855 Coolidge Rd. (313) 649-1776. Richard Freeman.

Los Angeles 90048: 6420 Wilshire Blvd. (213) 653-1776. Len Tronick.

Torbet-Lasker Inc. 555 Fifth Ave., New York 10017. (212) 986-2200. Alan Torbett, pres; H. Peter Lasker, VP; Jerry Glynn, Brock Petersen, Ralph Conner, Len Sable, Lee Bell, Paulie Landon, VPs; Ed O'Halloran, head of bus dev; Sandy Kennedy, Peter Moore, Laura LaRosa, Francine Hurwitz, rsch. Branch offices: Chicago, Detroit, Los Angeles, Dallas, San Francisco, Atlanta, Memphis.

TWR Enterprises Ltd. Box 683, Regal Professional Bldg., Spokane, Wash. 99210. (509) 624-6694. Thomas Wilmot Read.

UBC Sales Inc. 30 E. 42nd St., New York 10017. (212) 682-1833. Robert Wittig, VP natl sls. Chicago: 400 N. Michigan Ave. (312) 467-1632. Herb Scharff.

Atlanta 30309: 1819 Peachtree Rd. N.E. (404) 351-9288. Nick Imbornone.

Dallas 75204: 3225 Lemon Garden, Suite 360. (214) 528-7260. James Lowenberg.

Los Angeles 90028: 1680 N. Vine St. (213) 464-9263. Bill Dahlsten.

San Francisco 94133: 559 Pacific Ave., Suite 37. (415) 397-4512. Sam Posner.

United Programming Corp. 600 S. Commonwealth Ave. 1201, Los Angeles 90005. (213) 487-5000. Yasushi Haneda, pres.

Tokyo: 2-D Kitano Bldg., 2-16-15 Hiraikawa-cho, Chiyoda-ku, Tokyo.

Universal Broadcasting Corp. 310 Madison Ave., New York 10017. (212) 661-6096. Marvin B. Kosofsky, pres; Lawrence Brandon, Howard Warshaw, VPs. Minneapolis 54416: 5730 Duluth St. (612) 544-3196.

Hugh Wallace Co. 6922 Hollywood Blvd., Hollywood 90028. (213) 462-2371. Mary Williams.

Walton Broadcasting Sales Corp. 20 N. Wacker Drive, Chicago 60606. (312) 236-8887. Robert J. Walton, pres.

New York 10017: 501 Fifth Ave. (212) 972-0982. Joe Cannon.

San Francisco 94133: 559 Pacific Ave. (415) 391-1984. Sam Posner.

Beverly Hills 90211: 111 N. La Cienega Blvd. (213) 652-1313. Lee F. O'Connell.

Atlanta 30309: 1819 Peachtree N.E. (404) 351-9288. Nick Imbornone, mgr.

Dallas 75204: 3225 Lemmon Ave. (214) 528-7250. Jim Lowenberg, mgr.

Little Rock, Ark. 72203: Box 1918. (501) 376-7607. Pat Wilcox, mgr.

Hal Walton Co. 30 East 42nd St., New York 10017. (212) 682-1834. Richard Eaton, pres; Robert L. Wittig, VP, natl sls; Dennis Powell, acct exec.

Chicago 60611: 400 N. Michigan Ave. (312) 467-1632. Herb Scharff.

Los Angeles 90028: 1680 N. Vine St. (213) 464-9263. Bill Dahlsten.

Dallas 75204: 3225 Lemmon, Garden Suite 360. (214) 528-7260. James Lowenberg.

San Francisco 94133: 559 Pacific Ave., Suite 37. (415) 747-0135. Sam Posner.

Atlanta 30309: 1819 Peachtree Road N.E. (404) 351-9288. Nick Imbornone.

Harley L. Ward Inc. 360 N. Michigan Ave., Chicago 60601. (312) 236-6269.

Wayne-Evans & Associates. 722 Midwest Plaza, Minneapolis 55402. (612) 338-7017. Robert E. Bindeen, exec VP & gen mgr.

Weed/Walton Canadian Representatives. 20 N. Wacker Dr., Chicago 60606. (312) 236-8887. Robert J. Walton, pres.

New York 10017: 501 Fifth Ave. (212) 972-0982. Joe Cannon.

San Francisco 94131: 199 Crestmont Dr. (415) 731-3620. David Sandberg, Ward Glenn.

Los Angeles 90211: 111 N. La Cienega Blvd. (213) 652-1441. Chuck Dwyer.

Boston 02166: 100 Boylston St. (617) 482-4370. George Bingham.

Dallas 75204: 3225 Lemmon Ave. (214) 528-7260. Jim Lowenberg.

Atlanta 30309: 1819 Peachtree Rd. N.E. (404) 351-9288. Nick Imbornone.

Gilbert A. Wellington. 1836 Westlake North—Suite 106, Seattle 98109. (206) Atwater 4-4404.

WGN Continental Sales Co. 2501 Bradley Place, Chicago 60618. (312) 528-2311. Marvin H. Astrin, pres.

New York 10017: 220 E. 42d St. (212) 682-7545. Marvin Rudolph, TV.

New York 10022: 3 E. 54th St., 11th floor. (212) 832-0404. Edward Gerken, radio.

Los Angeles 90067: 1900 Ave. of the Stars. (213) 553-6500. Calvin Copsey, TV.

San Francisco 94104: Wells Fargo Bldg., 44 Montgomery St. (415) 433-2963. Roz Trosley, Lou Fox.

Adam Young Inc. (Television). 3 East 54th St., New York 10022. (212) 836-6900. Adam Young, Chmn; Frank Martin, pres; Arnold M. Kohler, VP, gen sls mgr; Vincent Young, Eastern sts mgr; Michael T. Membrado, exec VP.

Chicago 60601: 111 E. Wacker Dr. (312) 642-6190.

Jeffy Britt, mgr. opns.

San Francisco 94111: 500 Sansome St. (415) 986-5366. William B. Peavey, VP & mgr.



Top Market Television, Inc. 437 Madison Ave., New York 10022. (212) 644-0930. James P. McCann, pres; Richard Williams, VP/Eastern sls mgr; Robert Brady, VP/finance; Dale Paine, VP/rch & sls dev; Thomas Shannon, VP/Western sls mgr. Atlanta 30309: 1819 Peachtree Rd., N.E. (404) 351-8054. Robert J. Bordley. Boston 02116: Tom Market Television. 437 Boylston St. (617) 267-2828. Fred Petrosino. Chicago 60611: 401 North Michigan Ave. (312) 828-0500. Thomas Shannon. Detroit 48084: 2855 Coolidge Rd. (313) 649-1776. Richard Freeman. Los Angeles 90048: 6420 Wilshire Blvd. (213) 653-1776. Len Tronick. Torbet-Lasker Inc. 555 Fifth Ave., New York 10017. (212) 986-2200. Alan Torbett, pres; H. Peter Lasker, VP; Jerry Glynn, Brock Petersen, Ralph Conner, Len Sable, Lee Bell, Paulie Landon, VPs; Ed O'Halloran, head of bus dev; Sandy Kennedy, Peter Moore, Laura LaRosa, Francine Hurwitz, rsch. Branch offices: Chicago, Detroit, Los Angeles, Dallas, San Francisco, Atlanta, Memphis. TWR Enterprises Ltd. Box 683, Regal Professional Bldg., Spokane, Wash. 99210. (509) 624-6694. Thomas Wilmot Read. UBC Sales Inc. 30 E. 42nd St., New York 10017. (212) 682-1833. Robert Wittig, VP natl sls. Chicago: 400 N. Michigan Ave. (312) 467-1632. Herb Scharff. Atlanta 30309: 1819 Peachtree Rd. N.E. (404) 351-9288. Nick Imbornone.

Atlanta 30309: 1819 Peachtree Rd., N.E. (404) 351-9288. Nick Imbornone, mgr.
 Boston 02116: 129 Newbury St. (617) 262-1145. William A. Queen, mgr.
 Detroit 48226: 1610 Book Bldg. (313) 961-2685. Bernard P. Pearse, mgr.
 St. Louis 63102: 112 N. Fourth St. (314) 231-5143. Bruce Schneider, mgr.
 Dallas 75201: 501 Tower Bldg. (214) 748-5239. Clyde B. Melville, mgr.
 Memphis 38117: 536 Poplar Perkins Bldg. (901) 683-2431. Richard Crane, mgr.

Canadian Station Representatives

All-Canada Radio & Television Ltd. 1000 Yonge St., Toronto M4W 2K2. (416)925-9361. Ross A. McCreath, pres; Peter Sisam, gen mgr; Alan C. Butler, natl sis mgr; Dennis Fitz-Gerald, VP, TV.
 Montreal: 925 Dominion Square Bldg. (514)861-5654. R. Gauley, mgr.
 Winnipeg: Suite 407, 180 Smith (House of York). (204)942-6861. Bill Edge, mgr.
 Calgary: 1230 17th Ave. S.W. (403)244-2455. Bob Johnston, mgr.
 Vancouver: The Bentall Centre, Box 49032. (604)684-7461. Arnie Nelson, mgr.
 New York 10020: 1271 Avenue of the Americas. (212) 246-1425. Bill Mitchell, mgr.
 Chicago 60611: Suite 700, 400 N. Michigan Ave. (312)822-9710. Rick Kapnick, mgr.
 Detroit: 26011 Evergreen Rd., Southfield, Mich. 48076. (313)355-0840. Ron Hammer, mgr.
 Los Angeles: Suite 510, 6922 Hollywood Blvd. (213)462-8641. Alex Findlay, mgr.

Canadian Broadcasting Corp. National Selective Sales. U.S. representatives for English & French National Selective TV Sales are: Canadian Standard Broadcast Sales Inc., New York. (212)838-5774. Branch offices in Boston, Chicago, Dallas, Detroit, Los Angeles, San Francisco, Memphis, St. Louis.

Glen-Warren Broadcast Sales Div. 111 Richmond St. W., Toronto M5H 2G9. (416)363-5291. Ian J. Hall, gen mgr.
 Montreal H5A 1A9: 1 Elgin, Place Bonaventure, Box 183. (514)861-9051.
 Vancouver, B.C. V7X 1M4: One Bentall Centre, 505 Burrard St. (604)682-8404.

Independent Communications Sales Ltd. 46 Yorkville Ave. Toronto M4W 1L6. (416)920-9200. T. Atkins, pres.
 Montreal H3B 1H5: 1118 St. Catherine St. W. (514)875-2116. L.A. Mayo, VP
 Winnipeg, Man.: c/o Radio-TV Reps Ltd. (Murray Messner). 802-228 Notre Dame Ave. (204)943-9574.
 Vancouver, B.C.: c/o Radio-TV Reps Ltd. (Frank Jobs). 1131 Richards St. (604)685-0288.
 New York 10022: Bolton-Burchill (Carmen J. Bolton), 645 Madison Ave.

Paul L'Anglais Inc., 2200 Yonge St., Suite 701, Toronto M4S 2C6. (416)487-1551. Maurice D. Malins, mgr.

Andy McDermott Broadcast Sales Ltd. 66 Isabella St. E., Toronto 285. (416)924-4477. TWX: 610-491-4205. Telex: 02-21129. Andy McDermott,

Larry Arnott, Ted Brock, Bill Wallace, D. Jackson.
 Montreal: 1507 Le Cartier, 1115 Sherbrooke W. (514)849-1131. Helen Lanctot, mgr.

A.J. Messner & Co. Ltd. 802-228 Notre Dame Ave., Winnipeg, Man. R3B 1N7. (204)943-9574. A.J. Messner, pres; A.M. Messner, mgr dir.

Paul Mulvihill Ltd. 4 Richmond S. East, Suite 210, Toronto M5C 1M6. (416)363-8814. Paul Mulvihill, pres; Norman Bonnel, exec VP; Rodger Hone, TV sis mgr; Bruce Hawkins, radio sis mgr.
 Montreal: 1500 Stanley St., Suite 426. (514)849-4101. Edward Wood, mgr.

Radio House Ltd. 250 Merton St., Toronto M4S 1B1. (416)484-1011. J. Richard Guest, pres; John D. Gibson, exec VP; L.B. Salnick; R.W. Smith; Santo Mula.
 Montreal: Place Bonaventure, 19 Edison. (514)866-2617. Luc Leduc, mgr.

Radio-Television Representatives Ltd. 1131 Richards St., Vancouver 2, B.C. (604)685-0288. Frank Jobs.

Standard Broadcast Sales Co. Ltd. 2 St. Clair Ave. W., Toronto M4V 1L6. (416)924-5721. Richard R. Moody, pres; Arnold Stinson, VP and gen mgr.
 Montreal H3G 1R8: 1440 St. Catherine St. W. (514)861-3473. Ronald L. Nason, VP and gen mgr.

Stephens & Towndrow Co. Ltd. 808 Carlton Tower,

Canadian Reps Special Ad Services

2 Carlton St., Toronto M5B 1K1. (416)864-9220. James L. Frohlick, VP & gen mgr; Harold F. Abernathy, VP & gen mgr, radio div; Peter J. Jackman, VP & gen mgr, TV div.

Montreal H3A 1V4: Suite 650, 2055 Peel St. (514)844-3975. Maurice Daoust, Montreal mgr; Linda Vallis, Montreal TV mgr.

Vancouver, B.C., V6E 1M7: Suite 410, 1033 Davie St. (604) 684-6277. John Grant, mgr.

Tele-Capital/Unicom Ltd. Suite 935, 1010 St. Catherine St. W., Montreal H3B 3R7. (514)861-5461. Jean-Claude Tremblay, exec VP & gen mgr; Richard A. Sienko, VP admin (Toronto); Jacques Brousseau, VP & Montreal mgr; Jack Hodson, VP radio (Toronto); Doug Bower, VP TV (Toronto); John Fedosoff, mgr (Vancouver).

Toronto M4P 1G8: Suite 600, 55 Eglinton Ave. E. (416)481-5654.

Quebec G1K 7R3: Box 2448, Chemin Ste-Foy. (418)688-8251. Laurent Verret, controller.
 Vancouver: (604)943-1651.

Western Broadcast Sales Ltd. 505 Burrard, Suite 1960, Vancouver, B.C. (604)687-2844.

Special Advertising Services

The companies below provide special advertising and data processing services to radio and television.

BATA (A division of Snider Corporation-KARN) 1001 Spring Street, Little Rock, Ark. 72202. (501)376-9292. Ted Snider, pres; Louise Seymore, VP.

BIAS (Broadcast Industry Automation System, a division of Data Communications Corp.) 3000 Directors Row, Executive Plaza, Memphis 38111. (901)332-3544. Norfleet R. Turner, pres; James E. McKee, senior VP; James L. Thornton, exec VP; Herbert T. Hughes, exec VP.

Sales, traffic, accounting and engineering automation system for radio & TV.

Broadcast Computer Services. (Kaman Sciences Corp.) 1500 Garden of the Gods Rd., Box 7463, Colorado Springs, Colo. 80933. (303)599-1500. Richard E.W. Smith, VP; Jack Finlayson, mgr BCS.

Computerized traffic/operations and accounting systems for TV and radio stations. Interfaces to auto switching from traffic.

Broadcast Data Base Inc. 750 Third Ave., New York 10017. (212)922-2888. Edgar E. White Jr., pres; Leon D. West, VP-treas.

Data processing systems & services.

Broadcast Industry Automation System (BIAS). (See above).

Broadcast Sales Today, Drawer 11370, Pueblo, Colo. 81001. (303)544-3056. W.H. Welch, ed.

Nonprofit quarterly newsletter. Ideas for better spot sales, feedback from broadcasters, agency profiles, rep profiles.

Cable Data, a division of U.S. Computer Systems, Box 13040, 1931 K St., Sacramento, Calif.

95813. Rod Hausen.

Atlanta: (404)636-7080. Dennis F. Garcher.
 Indianapolis: (317)635-2184. David Huw Williams.

Charge-A-Trade. 915 W. Sunrise Blvd., Fort Lauderdale, Fla. 33311. (800)327-3720; in Florida (305)764-6424.

Worldwide credit-card barter system enabling broadcasters to trade advertising for airline tickets, printing, office equipment, carpeting and other products and services.

Compu/Net. 1350 Ave. of the Americas, New York 10019. (212)262-2502. Theodore F. Shaker, chief exec off; Donald Pederson, VP/gen mgr; Joel K. Schwartz, natl sales mgr.

Los Angeles 90045: 8616 La Tijera Blvd. (213)642-2211. Henry Rogers, mgr West Coast opns.

Computerized network offers broadcasters log prep, commercial and log scheduling, inventory reporting, sales analysis, billing on demand, receivables and statements.

Cox Data Systems. 1601 West Peachtree St., N.E., Atlanta 30309. (404)892-3456. Allan Sanders, Dan Roberson.

Computerized information service including avails, processing of orders, scheduling, billing etc. Also cable TV billing and accounts receivable services.

Media Payment Corp. 380 Madison Ave., New York 10017. (212)953-1500. Kenneth P. Donnellon, pres; P.M. Kelly, treas; Dennis E. Robich, dir of business development.

Paperwork Systems Inc. P.O. Box 38, 2000 "A" Street, Bellingham, Wash. 98225. (206)733-8510. Joseph D. Coons, pres; Lee Facto, sec-treas.

Provides "bat" billing, accounting, traffic and payroll minicomputer systems. In-house bat systems provide avails, schedules, invoices, P&L balance sheets.

You belong in Broadcasting

Networks & Programming

ABC

1330 Avenue of the Americas, New York 10019 (212) LT1-7777

American Broadcasting Companies Inc.

Board of Directors: Alger B. Chapman, Mamie Phipps Clark, John A. Coleman, Donald C. Cook, Everett H. Erlick, Leonard H. Goldenson, John Hausman, Leon Hess, George P. Jenkins, Thomas Macioce, Frederick S. Pierce, I. Martin Pompadur, Elton H. Rule, Martin J. Schwab, Simon B. Siegel.

Officers: Leonard H. Goldenson, chmn of the bd & chief exec officer; Elton H. Rule, pres & chief operating off; Everett H. Erlick, senior VP & gen counsel; James Abernathy, VP; Peter Cusack, VP; Richard L. Freund, VP; Jerome B. Golden, VP & sec; Robert T. Goldman, VP; Michael P. Mallardi, VP-chief financial off & treas; Elmer W. Lower, VP; Ellis O. Moore, VP; I. Martin Pompadur, VP; Alfred R. Schneider, VP; Warren D. Schaub, VP-finance & ctrlr; Ronald E. Sappenfield, VP; Franklin Feinstein, asst sec; Ann Maynard Gray, asst treas; William Pierson, asst comptroller; Donald R. Whalen, asst comptroller; John T. Dealey, asst sec.

Legal: Everett H. Erlick, senior VP and gen counsel, ABC Inc.; Jerome B. Golden, VP & sec; Robert J. Kaufman, VP and gen atty, ABC; Mark Roth, VP legal & bus affairs, radio net, owned radio & tv stns; Samuel Antar, dir, legal and bus affairs, ABC News.

Washington 20036: 1124 Connecticut Ave. N.W. (202) 393-7700. Eugene S. Cowen, VP in charge.

Financial: Michael P. Mallardi, VP-chief financial off & treas, ABC Inc.; Ronald E. Sappenfield, VP in chg of corporate dev & planning, ABC Inc.; James L. Abernathy, VP investor relations, ABC Inc.; Edward D. Williams, VP and dir mgt info systems; Warren D. Schaub, VP-finance & ctrlr, ABC Inc.; Edward Tucker, dir, internal audit, ABC Inc.; Arnold Agree, dir of taxes, ABC Inc.

Administration: Robert T. Goldman, VP administration, ABC Inc.; Richard L. Freund, VP in chg of labor rel, ABC Inc.; Irving Novick, VP labor rel, West Coast, ABC; William S. Gennerich, dir of labor rel, East Coast, ABC; Peter Cusack, VP and dir of personnel, ABC Inc.; Dorothy Brincefield, dir, equal opportunity programs; Allan S. Ross, dir, staffing & per dev; Michael R. Scanlon, dir, per, administration & organization; Thomas Wahlrobe, dir, compensation & benefits planning; Robert Sammon, dir of real estate and gen svcs, ABC Inc.; Paul Masterson, VP administration, West Coast; Carole Foster, dir, per, Los Angeles.

Corporate Relations: Elmer W. Lower, VP corporate affairs.

Public Relations: Ellis O. Moore, VP in chg of PR, ABC Inc.; Richard J. Connelly, VP PR, bcstg; William J. Liss, VP PR, leisure activities; Willard J. Dreslin Jr., dir, PR, leisure activities; Hazel Hardy, dir, corporate info; Jim MacGregor, dir, corporate communications projects; Tom Mackin, dir, prog info; Julie T. Hoover, dir, audience info & awards; Steve Strassberg, dir, news info; Charles L. Franke, mgr, nwsptr publ; David Horowitz, mgr, entertainment publ; Susan Lack, mgr, bus info; Susan Mitchell, awards mgr; Ron Najman, mgr, news info; Dan Rustin, mgr, industry & audience rel; Vic Ghidalia, mgr, magazine division; Carmen Anthony,

mgr, PR, leisure activities; Rick Giacalone, dir, photography; Deborah Pierce, mgr, still photography; Hal Garb, mgr, photographic opns, West Coast; Phil Krieglger, dir, PR, bcstg, West Coast, ABC; Joe Maggio, mgr, press rel, West Coast; Robert Wright, mgr, bus info, West Coast; Larry Frank, mgr, spec projects, West Coast PR.

ABC Leisure Group I

John T. Healy, VP, planning & administration.

ABC Records Inc.

Jerold Rubinstein, chm.

Anchor Records

Ian Ralfini, pres.

ABC Record and Tape Sales Corp.

Herbert J. Mendelsohn, pres; R. A. Harlan, exec VP; Ed Rich, treas & comptroller; Chuck Blacksmith, VP, buying; Jack Cohen, gen mgr, retail record division (ABC Wide World of Music).

Word Inc.

Jarrell McCracken, pres.

ABC Farm Publications

Richard E. Albrecht, pres; *Prairie Farmer, Wallace's Farmer, Wisconsin Agriculturist*; Wallace-Homestead Publishing Co. (specialty books).

ABC Leisure Publications

Warren B. Syer, pres; *High Fidelity Magazine, Modern Photography*.

ABC Leisure Group II

ABC Theatre Holdings Inc.

P Harvey Garland, pres; Bernard Levy, VP; ABC Florida State Theatres Inc.; ABC Southeastern Theatres Inc.; ABC Interstate Theatres Inc.

ABC Scenic and Wildlife Attractions

John E. Campbell, pres; Donald F. Keck, VP, mktg; Mary Jean Parson, dir, planning, dev & administration; Silver Springs—Ocala, Fla.; *Weeki Wachee Spring—Weeki Wachee, Fla.*; Historic Towne of Smithville, Smithville, N.J.

ABC Entertainment Center (Los Angeles)

Jack Easton, VP in chg.

American Broadcasting Co.

(The broadcast division of American Broadcasting Companies Inc.)

ABC News

William Sheehan, pres; Avram Westin, exec prod of TV documentaries & exec in chg of *ABC News with Harry Reasoner*; Steve Skinner, senior prod, *ABC News with Harry Reasoner*; Phil Lewis, dir of opns, ABC News TV documentaries; Nicholas Archer, VP, TV news svcs; Ben Blank, dir of graphics; Jack Bush, dir of film; Sydney Byrnes, dir of syndicated news svcs; Charles Novitz, mgr, domestic syndicated news (DEF); Arnold Snyder, mgr, foreign syndicated news service; Don Coe, dir of news opns; William Stone, mgr of news opns; Stan Opatowsky, dir of TV news coverage; Ed Kinney, assignment mgr; Bob Regan, asst assignment mgr; Charles Schuman, asst assignment mgr; Walter J. Piister, Jr., VP, spec TV news programs; John F. Lynch,

dir, political unit; John Thompson, mgr, political unit; Richard Richter, senior prod, news, *Good Morning America*; Robert Siegenthaler, exec prod, spec events unit; Thomas Wolf, VP, TV pub affrs; Lester Cooper, exec prod, *Make A Wish*; Sid Darion, mgr of TV pub affrs & exec prod of *Directions*; James Reina, dir of spec projects; Peggy Whedon, prod, *Issues and Answers*; Martin Rubenstein, VP & gen mgr; Charles Frey, dir of administration; Gerald Amico, mgr of financial analysis; William Nagy, bus mgr; Bernard Osborne, mgr of budget control; Roberta Travis, mgr of administration; Harvey Gersin, dir of rsch & dev; Kitty Lynch, librarian; William Lord, VP, Washington bureau; Thomas A. O'Brien, VP & dir of radio news; Joseph F. Keating, asst dir & exec prod, radio spec events; Mike Stein, mgr of radio news progmg; Dick Dressel, mgr of news, American Contemporary Network; George Phillips, mgr of news, American Information Network; Peter M. Flannery, mgr of news, American Entertainment Network; Clarence Fanto, mgr of news, American FM Network; Mark Richards, assignment mgr, radio news.

ABC Radio

Harold L. Neal Jr., pres; Michael Hauptman, VP

ABC Radio Network

Edward F. McLaughlin, pres; Robert O. Mahlman, VP & gen mgr.

Programming: William MacCallum, dir.

Sales: Michael E. Penzel, VP and dir; Arthur Sulzburgh, natl stls mgr; Lou Severine, New York stls mgr; Frank Boehm, stls mgr, Los Angeles; Art Kriemelman, Chicago stls mgr; Joseph Kelly, Detroit stls mgr.

Marketing svcs: Leo Collins, dir, mktg svcs; Sam Patterson, mgr.

Affiliate affairs: Richard McCauley, VP & dir, affiliate affairs, Alex Smallens, dir, public svcs; Frank Atkinson, dir, stn administration; Michael Weinstock, Western rgnl mgr, stn rel; Calvin Roach, Central rgnl mgr, stn rel; Charles King, Eastern rgnl mgr, stn rel.

Engineering: William Gilmore, dir of engrg & prog opns; Kent Coughlin, mgr, engrg & prog opns; Harry Curtis, mgr, tech opns; Richard Martinez, mgr, tech opns, West Coast.

Research: Alvin Pariser, dir of rsch.

ABC Owned AM Radio Stations

Charles DeBare, pres; Rich Sklar, VP & dir of prog dev; Robert Holmgren, bus mgr; Jeffrey Woodruff, dir, rsch & dev.

ABC Radio Network Rates

Each of the four ABC Radio network services is offered separately and free of any inter-network discounts, and thus the total cost of purchasing more than one of the services is the sum of the individually quoted prices. Advertising rates for each network service are determined in accordance with ABC Radio Network's then current established charges and procedures available from ABC Radio network sales.

WABC New York: Alfred Racco, VP & gen mgr.
KABC Los Angeles: Ben Hoberman, VP & gen mgr.
WXYZ Detroit: Charles Fritz, VP & gen mgr.
KGO San Francisco: Mickey Luckoff, VP and gen mgr.
WLS Chicago: Martin Greenberg, VP and gen mgr.
KXYZ Houston: Nicholas D. Trigony, VP and gen mgr.
ABC Owned FM Radio Stations
 Allen Shaw, VP in chg; Russ King, dir of creative svcs.
WPLJ New York: Willard Löchridge, VP & gen mgr.
KLOS Los Angeles: John Winnaman, VP & gen mgr.
WDAI Chicago: Roger Turnbeaugh, gen mgr.
KSFX San Francisco: Donald H. Platt, gen mgr.
WRIF Detroit: Jack Minkow, gen mgr.
KAUM Houston: James E. Hankins, gen mgr.

ABC-FM Spot Sales Inc.
 Martin Percival, VP in chg; Stanley Cohen, natl sls mgr; Vic Corapi, bus mgr; Blaise R. Leonardi, eastern sls mgr; James F. Smith, Midwest mgr; Ed Lubin, western mgr; Elynn Ambrose, division mgr, Atlanta; Valerie Tuttle, division mgr, Detroit; Gloria DeMaria, division mgr, San Francisco; Karen Layland, dir, sls dev & sls prom; Linda D. Stern, dir of rsch.

ABC Television

Frederick S. Pierce, pres; Charles M. Smith, VP; Leonard E. Maskin, VP administration; Arnold Marfoglia, mgr, affil contract administration.

ABC Television Network
 James E. Duffy, pres; Mary-Jane Raphael, dir, communications/administration; Bertrand M. Fainberg, dir of bus affairs.

Affiliate Relations: Richard L. Beesemyer, VP in chg of affil rel; Robert F. Fountain, VP & dir of stn rel; Gene Klimek, dir of stn administration; Mario Cucinotta, dir of special svcs; Richard Kozak, asst to the VP in chg.

Network Sales: James T. Shaw, VP in chg of sls; Warren J. Boorom, VP and gen mgr, sls; H. Weller Keever, VP and natl sls mgr; Bob Silberberg, VP and dir of sls, eastern division; Douglas Streff, VP, central sls, Chicago; William Gillogly, VP, network sls; Detroit; Vincent Francis, VP, network sls, West Coast; William Firman, VP, mktg; George Newi, VP, daytime sls; John Lazarus, VP, sports sls; William Breen, VP, news sls; Anthony Rocco, dir, sports sls; John Tiedemann, dir, daytime sales; Jon Reed, dir of sls proposals; Charles C. Allen, VP, sls administration; Harold Geary, dir of sls serv nighttime; John McCarthy, dir, sports sls administration & sls proposals; Robert T. Wallen, dir of daytime sls serv.

Advertising & Promotion: Symon B. Cowles, VP, creative svcs; John T. Cuijy Jr., VP, adv; Henry Epstein, art dir; Jerome Zucker, VP, prom & sls dev; Lawrence D. Dupuis, dir of on-air adv, New York; Harry Marks, VP, creative dir, on-air adv; Andre Gebstaedt, dir of sls' adv svcs; Paul W. Barrett, dir, adv; Milton Carney, dir, conference planning; Joel Cohen, dir spec projects; Allen Hirschman, mgr prom; Ralph Broitman, mgr sls dev.

ABC Entertainment
 Fred Silverman, pres; Seymour Amlen, VP & asst to the pres; Michael D. Eisner, VP, prog planning & dev; Bob Boyett, asst to the VP, prog planning & dev, and dir of talent rel; Brandon Stoddard, VP, motion pictures for TV & daytime dev; Lou Rudolph, dir, motion pictures for TV; Jim Green, dir, motion pictures for TV; Sue Cameron, dir, daytime prog dev, West Coast; Stephen Genry, VP, prime-time dramatic prog dev; Dennis Doty, VP, prime-time prog dev, East Coast; Bridget Potter, dir, prime-time prog dev, East Coast; Frank Brill, VP, talent for variety programs; Pam Dixon, VP, talent for comedy & drama; Andrew Siegel, dir, prime-time comedy dev; Edwin T. Vane, VP & natl prog dir; Squire D. Rushnell, VP, children's programs; Lee Polk, dir, children's programs, East Coast; Fulton Lytle, dir, children's programs, West Coast; Anthony D. Thomopoulos, VP, spec programs; James Hay, dir, spec programs; Jeff Reiss, dir of feature films; Michael Brockman, VP, daytime programs; Joseph Stuart, dir of daytime programs, East Coast; Lloyd Gaynes, dir of daytime programs, West Coast; Bob Shanks, VP, early morning & late-night programs; Wally Weltman, dir late night programs, West Coast; William Kelly, dir, early morning prog ops; Anthony Bark, VP, prime-time current programs; Stephen K. Nenko, dir, prog administration; Fred Laffey, dir, prog svcs; Hank Miller, dir, prog administration, West Coast; Tom Day, dir, prog administration, East Coast; Al Luddington, dir, post prod, East Coast.

ABC Sports
 Roone Arledge, pres; Chuck Howard, VP, prog prod; Herb Gránath, VP, prog dev & mktg; James Spence, VP, prog planning; Irwin Weiner, VP, administration & opns; John Fitzgerald, dir of opns; Charles A. Smiley Jr., dir, bus & legal affairs; John Martin, dir, prog planning; Dennis Lewin, coordinating prod, *ABC's Wide World of Sports*; John Wilcox, dir of dev/asst to the pres; Marvin Bader, dir, special projects.

ABC Owned Television Stations
 Richard A. O'Leary, pres; Phil Boyer, VP, prog; Phil Nye, dir, news; Walter Stein, VP, rsch & planning; Joseph L. Rowan, VP, admin.

WABC-TV New York: Kenneth MacQueen, VP & gen mgr.
WLS-TV Chicago: Lewis Erlicht, VP & gen mgr.
KABC-TV Los Angeles: John Severino, VP & gen mgr.

KGO-TV San Francisco: Russ Coughlan, VP & gen mgr.
WXYZ-TV Detroit: James R. Osborn, VP & gen mgr.

ABC Television Spot Sales: Richard N. Savage, pres; David Johnson, gen sls mgr; Kent Fredericks, VP and gen mgr; Walter Flynn, sls mgr, Los Angeles; Fred Cohen, eastern sls mgr; Phil Sweeney, eastern sls mgr; Richard B. Taylor, Midwest sls mgr; James Sherbert, sls mgr; San Francisco; Darrell Anderson, eastern rgnl sls mgr; Lawrence E. Widrig, Midwest rgnl sls mgr; Elio Betty Jr., sls mgr Detroit office; Roy Polevoy, dir of resch and sls prom; Larry Perl, bus mgr.

ABC International Television: Richard A. O'Leary, pres; Jack Singer, prog mgr.

ABC Television Planning: Mark Cohen, VP, finance & planning; Marvin Mord, VP, rsch svcs; George Keramidas, dir, audience resch; Herman Keld, dir, prog & primary rsch, East Coast; Gloria Messina, dir, prog rsch, West Coast; Paul Sonkin, VP, affil rsch; Joseph Giaguinto, VP, stn planning; Albert Rubin, VP, bus analysis and financial planning; P. Thomas Van Schaick, dir; revenue analysis and financial planning; Murray Resnick, bus mgr; Patrick Lofaro, asst bus mgr, East Coast; Edward F. Lerche, asst bus mgr, West Coast; Donal Flynn, VP, bus affairs; Sanford Feldman, VP, live presentations, bus affairs, ABC Entertainment Inc.; Joe Morris, dir, bus affairs, East Coast; George Reeves, VP, bus affairs, West Coast; Stuart Mandell, VP, bus affairs, movies for TV; Richard N. Burns, VP, contracts; Arthur Schimmel, VP, contracts, West Coast, & film & prog mktg svcs; Anthony S. Farinacci, dir, contracts, East Coast; Len Roos, dir, contracts, West Coast; Herbert Jellinek, VP, prod & financial administration, West Coast; Mort Goldstein, dir, prod control, West Coast; Rod Rodomista, dir, prod administration & opns, East Coast; Martin Katz, dir, prod administration & opns—film; Dale Leeson, dir, budgets & prod accounting.

Broadcast Operations and Engineering

Julius Barnathan, VP in charge; Frederick J. Schuhmann, VP, TV facilities and svcs, New York; Norman H. Grant, VP, TV facilities & svcs, Los Angeles; R. L. Pointer, dir of bcst engr; Fraser M. Head, dir of financial planning and controls; Merle Worster, dir of TV opns, New York; John Serafin, mgr, quality control, New York; David Eschelbacher, dir of prod svcs, New York; Edward Messina, dir of film svcs, New York; Charles Baldour, dir of prod planning and controls, New York; John Gilmore, dir of net svcs; Anthony Cusumano, dir of traffic; James Baker, chief engr, WABC-TV New York; Winston Lloyd, chief engr, WABC Radio New York; Robert Trachinger, dir engr, Los Angeles; Louis Sanman, dir of prod svcs, Los Angeles; Robert Hudson, dir of film svcs, Los Angeles; David Loring, dir of prod planning and controls, Los Angeles; William Dryer, chief engr, KABC-TV Los Angeles; Arthur Sterman, chief engr, KABC Radio Los Angeles; Michael Fisher, mgr, equip planning; Max Berry, mgr, audio/video systems; Frank Sirabella, dir, admin svcs; Glen Akins, gen mgr, TV facilities/maintenance, Los Angeles.

ABC Board of Governors

Thomas Goodgame, KTUL-TV Tulsa, Okla., chmn; John Conomikes, WTAE-TV Pittsburgh, vice chmn; Eugene H. Bohi, WGHP-TV High Point, N.C., sec; Robert M. Bennett, WCVB-TV Boston, treas; George U. Lyons, WZZM-TV Grand Rapids, Mich.; William Turner, KCAU-TV Sioux City, Iowa; Lawrence Pollock, WKBW-TV Buffalo, N.Y.; Walter M. Windsor, WFTV(TV) Orlando, Fla.; William Sawyers, KJEO(TV) Fresno, Calif.; Jay Gardner, KRDO-TV Colorado Springs.

Angles; Neil MacLeod, dir, bus administration, Los Angeles.

Broadcast Standards, Merchandising, Music, Quality Control
 Alfred R. Schneider, VP, ABC Inc.

Broadcast Standards & Practices: Grace Johnsen, VP; Richard P. Gitter, dir, East Coast.

ABC Merchandising Inc.: William F. Dennis, VP in chg; Louis Weinberg, mgr of licensing; Donna B. Sessa, mgr educ licensing.

Music: Ronald Schubert, dir.

Quality Control: Vivian Weller, dir.

ABC television network

(183 primary affiliates, 67 secondary affiliates)

Primary stations	Rate
WBRC-TV Birmingham, Ala.	\$1975
WDHN Dothan, Ala.	75
WKAB-TV Montgomery, Ala.	200
KIMO Anchorage	125
KTVK Phoenix	825
KGUN-TV Tucson, Ariz.	375
KTVE-TV El Dorado, Ark.	700
KAIT-TV Jonesboro, Ark.	225
KATV Little Rock, Ark.	800
ZFB-TV Hamilton, Bermuda	—
KBAK-TV Bakersfield, Calif.	675
KVIQ-TV Eureka, Calif.	300
KJEO Fresno, Calif.	600
KABC-TV Los Angeles	5100
KPLM-TV Palm Springs, Calif.	50
KRCR-TV Redding, Calif.	575
KOVR Sacramento, Calif.	1250
KCST San Diego	800
KGO-TV San Francisco	2,700
KNTV San Jose, Calif.	600
KEYT Santa Barbara, Calif.	444
KRDO-TV Colorado Springs	425
KBTV Denver	1,200
WTNH-TV New Haven, Conn.	2550
WMAL-TV Washington	2000
WCJB Gainesville, Fla.	125
WJKS-TV Jacksonville, Fla.	425
WPLG Miami	1425
WEVU Naples, Fla.	75
WFTV Orlando, Fla.	775
WJHG-TV Panama City, Fla.	425
WEAR-TV Pensacola, Fla.	725
WLCY-TV St. Petersburg, Fla.	750
WXLT Sarasota, Fla.	110
WPEC-TV West Palm Beach, Fla.	300
WCTV Tallahassee, Fla.	—
WXIA-TV Atlanta	1,350
WJBF Augusta, Ga.	1,140
WTVM Columbus, Ga.	850
WJCL Savannah, Ga.	250
KHVO Hilo, Hawaii	Satellite to KITV
KITV Honolulu, Hawaii	475
KMVI-TV Wailuku, Hawaii	Satellite to KITV
KIVI-TV Boise, Idaho	300
KPVI Pocatello/Idaho Falls, Idaho	150
KMVT Twin Falls, Idaho	475
WLS-TV Chicago	4900
WAND Decatur, Ill.	525
WSIL-TV Harrisburg, Ill.	350
WQAD-TV Moline, Ill.	950
WRAU-TV Peoria, Ill.	625
WSJV Elkhart, South Bend, Ind.	1135
WTVV Evansville, Ind.	550
WPTA Fort Wayne, Ind.	525
WLWI Indianapolis	1400
WIIL-TV Terre Haute, Ind.	125
KCRG-TV Cedar Rapids, Waterloo, Iowa	825
KAAL Mason City, Iowa	450
KTVO Ottumwa, Iowa	651
KCAU-TV Sioux City, Iowa	900
KUPK-TV Garden City, Kan.	Satellite to KAKE
KAKE-TV Wichita, Kan.	950
WBKO Bowling Green, Ky	175
WTVQ-TV Lexington, Ky	300
WLKY-TV Louisville, Ky.	750
WRBT Baton Rouge	250
KTBS-TV Shreveport, La.	775
WEMT-TV Bangor, Me.	200
WMTW-TV Portland, Me.	750
WJZ-TV Baltimore	1850
WCVB-TV Boston	3450
WTEV New Bedford, Mass.	1350

ABC Affiliates

WHYN-TV Springfield, Holyoke, Mass	625
WUHQ-TV Battle Creek, Mich	250
WXYZ-TV Detroit	3400
WJRT-TV Flint, Saginaw, Bay City, Lansing, Mich	1441
WZZM-TV Grand Rapids, Mich	850
WGTU Traverse City, Mich	100
KAAL-TV Austin, Rochester, Minn	450
WDIO-TV Duluth, Minn	700
WIRT Hibbing, Minn	Satellite to WDIO-TV
KMSP-TV Minneapolis, St. Paul	1600
WLOX-TV Biloxi, Miss	275
WABG-TV Greenwood, Miss	508
WAPT Jackson, Miss	250
KCBJ-TV Columbia, Mo	125
KODE-TV Joplin, Mo	800
KMBC-TV Kansas City, Mo	1600
KPOB Popular Bluff, Mo	—
KQTV St. Joseph, Mo	628
KTVI St. Louis	1800
KMTC Springfield, Mo	225
KULR-TV Billings, Mont	425
KFBB-TV Great Falls, Mont	425
KWNB-TV Hayes Center, Neb	Satellite to KHGI-TV
KHGI-TV Kearney, Neb	600
KETV Omaha	1100
KSNB-TV Superior, Neb	Satellite to KHGI-TV
KSHO-TV Las Vegas	225
KOLO Reno	250
WMUR-TV Manchester, N.H.	300
WMTW-TV Mt. Washington, N.H.	750
WBJA-TV Binghamton, N.Y.	175
WKBW-TV Buffalo, N.Y.	1900
WENY-TV Elmira, N.Y.	125
WABC-TV New York	8800
WOKR Rochester, N.Y.	900
WNYS-TV Syracuse, N.Y.	850
WUTR-TV Utica, N.Y.	125
WLOS-TV Asheville, N.C.	1050
WCCB-TV Charlotte, N.C.	450
WGHP-TV Greensboro, High Point, N.C.	1000
WCTI-TV Greenville, New Bern, N.C.	275
WRAL-TV Raleigh, N.C.	1450
WWAY-TV Wilmington, N.C.	325
KTHI-TV Fargo, Grand Forks, N.D.	450
KDIX-TV Dickinson, N.D.	—
WKRC-TV Cincinnati	1900
WEWS Cleveland	3350
WTVN-TV Columbus, Ohio	1300
WKFE Dayton, Ohio	625
WDHO-TV Toledo, Ohio	625
WYTV Youngstown, Ohio	500

KSWO-TV Lawton, Okla	375
KOCO-TV Oklahoma City, Enid, Okla	1075
KTUL-TV Tulsa, Okla	975
KEZI-TV Eugene, Ore	460
KATU Portland, Ore	1150
WJET-TV Erie, Pa	275
WTPA Harrisburg, Pa	600
WNBP-TV Scranton, Pa	850
Wilkes-Barre, Pa	—
WTEV Providence, R.I.	1350
WCBD-TV Charleston, S.C.	500
WOLO-TV Columbia, S.C.	225
KXON-TV Mitchell, S.D.	300
WTVG Chattanooga	625
WKPT-TV Kingsport, Bristol, Johnson City, Tenn	225
WTVK Knoxville, Tenn	300
WHBQ-TV Memphis	1200
WNGE-TV Nashville	950
KVUE Austin, Tex	300
KBMT Beaumont, Tex	375
KWAB-TV Big Springs, Tex	Satellite to KMOM-TV
KJII-TV Corpus Christi, Tex	400
WFAA-TV Dallas, Ft. Worth	1950
KELP-TV El Paso	325
KTRK-TV Houston	1700
KMCC-TV Lubbock, Tex	200
KTRE-TV Lufkin, Tex	350
KMOM-TV Monahans, Tex	275
KSAT-TV San Antonio, Tex	950
KLTV-TV Tyler, Tex	600
KXIX Victoria, Tex	Satellite to KJII
KTVX Salt Lake City	950
WEZF-TV Burlington, Vt.	100
WSPA-TV Harrisonburg, Va	500
WLVA-TV Lynchburg, Roanoke, Va	350
WVEC-TV Norfolk, Va	975
WXEX-TV Richmond, Va	750
KVEW Kennewick, Wash	Satellite to KAPP
KOMO-TV Seattle	1700
KREM-TV Spokane, Wash	675
KAPP-TV Yakima, Wash	225
WOWK-TV Huntington, W. Va.	1150
WOAY-TV Oak Hill, W. Va.	250
WLUK-TV Green Bay, Marinette, Wis.	750
WXOW La Crosse, Wis	100
WKOW-TV Madison, Wis	400
WITI-TV Milwaukee	1750
WAOW-TV Wausau, Wis	400

Secondary affiliates	Rate
KFAR-TV Fairbanks, Alaska	—
KINY-TV Juneau, Alaska	—
KBLU-TV Yuma, Ariz	175
KFSM Fort Smith, Ark	825

KFPW-TV Fort Smith, Ark	125
KREX-TV Grand Junction, Colo	200
WALB-TV Albany, Ga	750
WMAZ-TV Macon, Ga	650
KUAM-TV Agana, Guam	Bonus
KAYS-TV Hays, Kan	200
WIBW-TV Topeka, Kan	675
KTSB Topeka, Kan	350
KALB-TV Alexandria, La	450
WAGM-TV Presque Isle, Me	200
WBOC-TV Salisbury, Md	375
WLUC-TV Marquette, Mich	450
KCMT Alexandria, Minn	500
WCBT-TV Columbia, Miss	450
WTOK-TV Meridian, Miss	575
WTVW Tupelo, Meridian, Miss	500
KXLF-TV Butte, Mont	600
KTCM-TV Helena, Mont	100
KGVO-TV Missoula, Mont	500
WVNY-TV Watertown, Carthage, N.Y.	475
KXMB-TV Bismarck, N.D.	150
KFYR-TV Bismarck, N.D.	250
KDIX-TV Dickinson, N.D.	—
KXMC-TV Minot, N.D.	225
KMOT-TV Minot, N.D.	150
KUMV-TV Williston, N.D.	150
KXMD-TV Williston, N.D.	75
WLIO-TV Lima, Ohio	—
WSTV-TV Steubenville, Ohio	950
KOBI-TV Medford, Ore	456
KMED-TV Medford, Ore	475
WTAJ-TV Altoona, Pa	—
WJNL-TV Johnstown, Pa	—
WAIM-TV Anderson, S.C.	Bonus
WBTW Florence, S.C.	600
KBTX-TV Bryan, Tex	160
KBGT-TV Harlingen, Tex	475
KGNS-TV Laredo, Tex	50
KCEN-TV Temple, Tex	550
KWTX-TV Waco, Tex	475
KRGV-TV Weslaco, Tex	500
KTWO-TV Casper, Wyo	400
KYCU Cheyenne, Wyo	425
KWRB-TV Thermopolis, Riverton, Wyo	—

ZFB-TV Hamilton, Bermuda, is subject to an additional charge for shipping and handling.

A listing for CBC stations will be made available by ABC on request.

Canadian stations are not subject to ABC discounts or rebate. Special frequency and group discounts allowed by CBC will be given on request. Rate classification and percentage of the hour are not the same as the ABC Television rate and percentages. All other charges (such as microwave, sales tax, distribution, telecine rehearsal, editing, importation, cut-ins, production and facilities services for commercial messages and billboards, etc.) will be billed to the agency by CBC. Canadian telecasts are payable in Canadian currency.

ABC radio networks

Affiliates as of Oct. 1, 1975, for the ABC Contemporary, Entertainment, FM, and Information networks.

City	ABC/C	ABC/E	ABC/FM	ABC/I
Alabama				
Anniston			WHMA-FM	WHMA
Auburn			WAUD	WAUD
Birmingham	WJLD	WVOK	WZZK(FM)	WYDE
Boaz		WBSA		
Centreville	WBIB			
Decatur		WHOS	WDRM(FM)	
Dothan	WDIG		WTVY(FM)	
Enterprise		WIRB		WIRB-FM
Florence	WOWL		WQLT(FM)	WXOR
Ft. Payne	WFPA			
Gadsden		WAAX		
Guntersville	WGSV		WTWX(FM)	
Hartsville			WHRT	WBHP
Huntsville	WVOV		WAHR(FM)	
Lineville	WANL			
Mobile	WABB	WMOB	WKRG-FM	WKSJ AM/FM
Monroeville	WMFC		WMFC-FM	
Montgomery	WHHY	WRMA	WKLH(FM)	WMGY
Opelika		WAOA		
Scottsboro		WCNA-FM		
Selma	WHBB			
Sheffield		WSHF		
Talladega	WEYY	WHTB(FM)		
Tuscaloosa	WTBC			WNPT
Arizona				
Casa Grande		KPIN		
Douglas			KAPR	
Flagstaff			KAFF AM/FM	
Miami			KIKO	
Holbrook			KDJI	

City	ABC/C	ABC/E	ABC/FM	ABC/I
Nogales				KFBR
Page				KPGE
Parker		KZUL		
Phoenix	KBBC	KJJJ	KXTC(FM)	KTAR
Showlow	KVSL			
Tucson	KIKX	KHOS	KWFM(FM)	KTUC
Sierra Vista				KTAN
Willcox				KHIL
Winslow		KINO		
Yuma				KVOY
Arkansas				
Berryville				KAAM(FM)
Blythesville		KHLS(FM)		
Dardanelle				KWKK(FM)
El Dorado	KDMS		KRIL(FM)	
Fayetteville			KKEG(FM)	
Ft. Smith	KWHN		KISR(FM)	KFSA
Helena		KCRI(FM)		
Hot Springs				KBHS
Little Rock	KALO	KXLR	KLAZ(FM)	KDXE
Mountain Home			KTLO-FM	
Newport		KOKR(FM)		
Searcy		KSER(FM)		
Springdale				KBRS
California				
Alturas				KCNO
Anaheim			KAPX(FM)	
Bakersfield	KERN	KLYD		KBIS
Brawley-El Centro				KICO
Chico	KPAY		KFMF(FM)	
Fresno	KEYE	KMAK	KFIG-FM	KFRE
Hanford		KNGS		
Hemet		KHSJ		

City	ABC/C	ABC/E	ABC/FM	ABC/I
Los Angeles	KIIS-FM	KFI KVFM(FM)	KLOS(FM)	KABC
Marysville	KMYC			
Modesto-Turlock	KFIV	KCEY		KOSO(FM)
Mojave		KDOL AM/FM		
Monterey			KWAV(FM)	
Morro Bay	KBAI			
Oroville				KORV
Oxnard-Ventura	KACY	KVEN	KBBY(FM)	KAAP
Palm Springs	KDES			KPSI
Paradise		KEWQ		KPRL
Paso Robles				
Red Bluff		KBLF		
Redding	KRDG			
Ridgecrest		KZIQ		
Sacramento	KROY	KCRA	KXOA(FM)	KCTC
Salinas-Monterey	KDON KRML	KTOM		KKEE KWYT(FM)
San Bernardino	KMEN	KBON	KOLA(FM)	KPRO
San Diego	KDIG	KFMB	KYXY(FM)	KSON
San Francisco	KIQI/ KIOI(FM)	KRE KNEW	KSFY(FM)	KGO
San Luis Obispo				KVEC
Santa Barbara		KRUZ		KKIO
Santa Rosa		KVRE	KZST(FM)	
Sonora			KROG(FM)	
South Lake Tahoe		KTHO		
Stockton	KSTN	KJOY	KJAX(FM)	
Vallejo-Napa		KVON		
Victorville		KCIN		
Visalia			KONG-FM	KONG
Colorado				
Alamosa				KGIW
Aspen			KSPN(FM)	
Boulder				KBOL
Burlington				KNAB
Colorado Springs	KPIK	KRYT AM/FM		KIQI
Denver	KTLK	KLZ	KADX(FM)	KDEN
Ft. Collins				KCOL
Grand Junction				KEXO
Greeley				KYOU
Gunnison				KGUC
Leadville				KBRR
Longmont	KLMO		KLMO-FM	
Pueblo				KPUB
Rifle				KWSR
Salida				KVHR
Sterling				KGEK
Trinidad				KCRT
Vail		KVMT(FM)		
Connecticut				
Bridgeport			WYRS(FM)	WNAB
New London/Groton	WNLC	WSUB AM/FM	WCTY(FM)	
Hartford	WCCC			WEXT
New Britain		WRYM		
New Haven	WCDD		WYBC(FM)	
Stamford		WSTC		WSTC
Waterbury		WIOF(FM)		WATR
Willimantic	WILI			
Delaware				
Dover		WKEN		
Newark	WNRK			
Wilmington	WAMS	WSER		WJIC
District of Columbia				
Washington	WEAM	WWDC	WMAL-FM	WMAL
Florida				
Apopka	WTLN			
Auburndale		WTWB		
Avon Park		WAPR		
Clearwater	WAZE			WQXM(FM)
Cocoa	WEZY			
Daytona Beach	WMFJ	WROD		
Deland			WETO(FM)	
Dunnellon		WTRS AM/FM		
Ft. Lauderdale	WRBD/ WCKO(FM)	WGMA		WFTL
Ft. Myers	WLEQ(FM)	WAYK-AM		WAYK-FM
Ft. Pierce		WFTP		
Inverness				WYSE
Jacksonville	WJAX-FM	WKTZ		WMBR
Lakeland	WGTO	WQPD	WPCV(FM)	WSIR
Lake Wales	WIPC			
Live Oak				WQHL(FM)
Marathon				WFFG
Marco Island				WRGI
Mariana				WTYS
Melbourne		WTAI	WTAI-FM	
Miami	WFUN	WGBS		WIOD

ABC Radio Networks

City	ABC/C	ABC/E	ABC/FM	ABC/I
Milton				WXBM(FM)
Ocala	WWKE			
Orlando		WNBE	WDIZ-FM	WHOO
Panama City	WGNE	WPFM(FM)	WGNE-FM	WPCF
Pensacola	WVIX	WPFA	WMEZ(FM)	
Sarasota	WKXY			WBRD
Tallahassee	WTAL		WGLF(FM)	
Tampa-St. Petersburg	WLCY	WSUN		
Titusville				WRMF
Valparaiso		WFSH		
Vero Beach			WGYL(FM)	
West Palm Beach		WGMW(FM)	WIRK-FM	WEAT
Georgia				
Adel		WBIT		
Albany	WALG		WWCW(FM)	
Alma				WULF
Americus	WDEC			
Atlanta	WIGO	WGST		WPLO
Augusta	WRDW	WTHB	WZZW(FM)	WQAK
Blakely		WBBK		WAUG
Brunswick	WGIG	WSBI(FM)		
Camilla		WCLB		
Carrollton		WLBK		
Clarksville				WIAF
Columbus	WCLS		WWRH(FM)	WDAK
Commerce				WJJC
Cornelia		WCON		
Cumming		WSNE		
Dawson		WDWD		
Gainesville				WDUN
Griffin		WHIE		
Jesup		WLOP		WIFO(FM)
Macon	WNEX		WMAZ-FM	
Marietta	WFOM			
Milledgeville		WXLX		
Moultrie				WMGA
Ocilla-Douglas	WSIZ			
Perry		WPGA	WPGA-FM	
Savannah	WPGA	WNMT		
Thomaston				WTGA
Tifton		WCUP(FM)		
Vidalia	WTCQ(FM)			WVOP
Waycross	WACL		WACL-FM	
Waynesboro		WWGA(FM)		
West Point	WRLD		WCJM(FM)	
Hawaii				
Honolulu	KORL			
Idaho				
Blackfoot	KBLI			
Boise				KGEM
Burley				KBAR
Grangeville	KORT			
Hailey				KSKI
Lewiston	KOZE			
Montpelier				KVSI
Moscow			KRPL(FM)	KRPL
Orofino	KLER			
Payette		KYET		
Pocatello				KWIK
Preston		KPST		
Twin Falls				KLIX
Wallace				KWAL
Illinois				
Beardstown	WRMS			
Belleville				WIBV
Bloomington				WJBC
Canton				WBY5
Casey		WKZI		
Champaign-Urbana	WPGU(FM)	WLRW(FM)	WTWC(FM)	WCCR
Chicago	WLS	WAIT	WDAI(FM)	WJJD
Decatur				WVXX
Du Quoin	WDZ		WSOY-FM	WKDC
El Dorado		WDQN		
Evanston		WKSJ(FM)		
Galesburg		WEAW		
Geneva		WAIK	WAAG(FM)	
Jacksonville		WGSB		
Joliet				WJIL
Kankakee			WBYG(FM)	WJOL
Kewanee	WJRE(FM)			WKEI
La Grange		WTAQ		
Marion				WGGH
Mendota		WGLC AM/FM		

ABC Radio Networks

City	ABC/C	ABC/E	ABC/FM	ABC/I
Monmouth				WRAM
Mt. Carmel		WVMC/ WSAB(FM)		
Olney				WVLN
Ottawa	WOLI(FM)			
Peoria		WWCT(FM)		WXCL
Quincy				WGEM
Rockford	WROK	WLUV(FM)		WRRR
Springfield	WCVS		WVEM(FM)	WFMB(FM)
Streator			WLAX(FM)	WIZZ
Sullivan				WFWA(FM)
Watseka	WGFA			
Indiana				
Anderson	WHUT			
Angola			WLKI(FM)	
Bedford				WBIW
Bloomington		WTTS		WGTC(FM)
Centerville	WHON			
Connersville		WCNB AM/FM		
Crawfordsville	WCVL			
Evansville	WJPS			WROZ
Ft. Wayne		WLYV		WFWR
Gary		WWCA		WAKE/ WLJE(FM)
Greencastle			WXTA(FM)	
Indianapolis	WNDE	WIRE		WNTS
Kokomo				WIOU/ WKMO(FM)
Lafayette	WAZY			
La Porte		WCOE/ WLOI-FM		
Madison				WORX
Marion	WGOM	WMRI(FM)		
Monticello		WVTL(FM)		
Portland	WPGW AM/FM			
Richmond			WQLK(FM)	WKBV
South Bend				WNDU
Terre Haute	WBOW		WPFR(FM)	
Washington				WAMW/ WFML(FM)
Iowa				
Boone				KWBG
Burlington	KBUR		KBUR-FM	
Cedar Rapids	KCRG			
Clinton		KCLN		
Davenport		KWNT AM/FM	WMDR-FM	
Des Moines		KSO		KCBC
		KBAB		
Dubuque	WDBQ			
Fairfield	KMCD			
Fort Dodge	KWMT			
Humboldt			KHBT(FM)	
Keokuk				KOKX
Knoxville				KTAV(FM)
Mason City	KRIB			
Oelwein			KOEL-FM	KOEL
Shenandoah		KMA		
Sioux City		KBCM(FM)	KSEZ(FM)	KSCJ
Waterloo	KXEL			KXEL
Webster City		KQWC		
Kansas				
Chanute				KKOY AM/FM
Coffeyville	KGGF			
Dodge City				KEDD
Emporia				KVOE
Liberal				KSCB
Lyons-Sterling		KLOQ(FM)		
Pratt		KWNS		
Salina	KSKG(FM)			KSAL
Topeka				WREN
Wichita		KAKE	KFDI-FM	
Kentucky				
Berea	WKXO			
Bowling Green		WKCT	WDNS(FM)	
Burkesville		WKYR		
Cave City				WKVE
Corbin	WYGO AM/FM			
Elizabethtown	WIEL			
Ft. Campbell	WABD			
Greensburg				WGRK
Hawesville		WKCM		
Hopkinsville				WKOA
Jackson		WEKG		
Lexington			WKDJ(FM)	WVLK
Louisville	WKLO	WINN	WLRS(FM)	WXVW
Madisonville	WTTL			

City	ABC/C	ABC/E	ABC/FM	ABC/I
Monticello				WKYM(FM)
Murray				WAAW(FM)
Newport		WNOP		
Owensboro	WVJS			WSTO(FM)
Paducah	WKYX			
Paris			WKYQ(FM)	
Pineville			WBGR	
Richmond			WTJM(FM)	
Somerset			WEKY	WSEK(FM)
Stanton			WSFC	
Winchester	WWKY		WSKV(FM)	
Louisiana				
Alexandria	KDBS			
Bastrop		KTRY		
Baton Rouge	WAFB(FM)	WYNK	KSMI(FM)	WLUX
Crowley	KSIG			
Garyville				WKRT/ WCKW(FM)
Haynesville		KLUV		
Jennings				KJEF AM/FM
Lafayette	KSMB(FM)			
Lake Charles	KAOK			
Mansfield		KDXI		
Monroe	KNOE			KNOE-FM
Natchitoches		KNOC		KDBH(FM)
New Iberia		KANE		
New Orleans	WNOE AM/FM	WSMB	WRNO(FM)	WGSO
Oakdale		KREH		
Opelousas				
Shreveport	KOKA			KTAL(FM)
Thibodaux				KEEL AM/FM KXOR(FM)
Maine				
Bangor	WABI	WBGW(FM)		
Biddeford				WIDE
Brunswick				WKXA AM/FM
Dover-Foxcroft				WDME
Lewiston	WLAM			
Lincoln				WLKN
Madawaska				WSJR
Portland	WJBQ AM/FM	WDCS(FM)		
Presque Isle				WDHP(FM)
Rockland				WAGM
South Parks		WKTP		WRKD
Waterville		WTVL		
Maryland				
Aberdeen	WAMD			
Baltimore	WCAO	WCBM	WKTK(FM)	WITH
Bel Air		WVOB		
Cumberland		WCUM		
Glen Burnie		WISZ		
Halfway			WQCM(FM)	
Lexington Park		WPTX		
Thurmont				WTHU
Massachusetts				
Boston	WMEX	WHDH		WEZE
Fall River	WSAR			WNBH
Hyannis	WCOD(FM)			
Lynn		WLYN		
Newburyport		WNBP		
Northampton				WHMP
Pittsfield	WBEC			
Springfield	WAQY(FM)	WMAS		WTYM
West Yarmouth		WOCB		
Worcester	WEIM			WAAF(FM)
	WORC			
Michigan				
Adrian				WABJ
Alpena				WHSB(FM)
Ann Arbor	WAAM	WSDS	WIOB(FM)	WPAG
Battle Creek	WKNR			
Benton Harbor				WHFB-FM
Cheboygan				WHFB
Clare			WCRM AM/FM	WCBY
Coldwater				
Detroit	WWWW(FM)	WXYZ	WRIF(FM)	WTVB
Escanaba				WBRB
Flint	WTAC	WKMF	WWCK(FM)	WTRX
Grand Rapids	WLAV	WLAV-FM	WYON(FM)	WMAX
		WJPW		
Harrison				WKKM(FM)
Hastings		WBCH		
Houghton Lake				WHGR
Ionia		WION		
Iron Mountain		WMIQ		
Jackson	WIBM			
Kalamazoo	WKMI	WBUK		WAOP
Lansing	WVIC	WCER		WFMK(FM)
Marquette		WDMJ		

City	ABC/C	ABC/E	ABC/FM	ABC/I
Menominee			WQWQ(FM)	WAGN
Muskegon	WLRC			WKBZ
Port Huron				WPHM
Rogers City				WHAH
Saginaw-Bay City				WKNX
Sault Ste. Marie				WOOO
South Haven		WJOR		
Tawas City	WIOS			
Wyoming			WYGR	
Zeeland			WZND(FM)	
Minnesota				
Alexandria				KXRA
Breckenridge		KBMW		
Cloquet				WKLK
Duluth	WEBC	WWJC		WAKX AM/FM
Ely				WELY
Grand Rapids	KXGR(FM)			WMFG
Hibbing				KGHS
International Falls				KQAD AM/FM
Luverne				
Marshall	KMHL			
Minneapolis		KRSI	WCCO-FM	WLOL
Montevideo	KDMA			
Pipestone	KLOH			
Redwood Falls				KLGR
Rochester	KWEB		KNXR(FM)	
Virginia				WHLB
Wadena				KWAD
Willmar	KQIC(FM)			
Winona				KWNO
Mississippi				
Bay Springs		WHII(FM)		
Biloxi-Gulfport	WQID(FM)	WROA	WROA-FM	WGCM
Booneville	WBIP			WDSK
Cleveland				
Columbia		WCJU		
Columbus		WCBI		
Drew			WDRU(FM)	
Grenada			WRIL(FM)	
Greenville				WBAQ(FM)
Hattiesburg	WHSY	WBKH	WHSY-FM	
Indianola	WNLA AM/FM			WTIB(FM)
Luka				WWUN
Jackson		WSLI	WJMI(FM)	
McComb	WHNY			
Meridian	WMOX		WALT(FM)	
Natchez	WQNZ(FM)			WNAT
Vicksburg		WQBC		WKYV
Waynesboro				WABO
Missouri				
Cape Girardeau	KGMO AM/FM	KFMP(FM)		
Carthage				WKMO
Columbia			KFMZ(FM)	KFRU
Farmington		KREI		
Fulton		KKCA(FM)		
Hannibal			KGRC(FM)	
Jefferson City	KLIC		KJFF(FM)	
Joplin	KQYX	KFSB	KSYN(FM)	
Kansas City	KUDL-FM	KCMO	KWKI(FM)	WDAF
Kennett			KTMO(FM)	
Kirksville		KIRX	KRXL(FM)	
Poplar Bluff	KLID			KMIS
Portageville				KZNN(FM)
Rolla		KTTR		KSIS
Sedalia	KSIS-FM			
Sikeston	KSIM			
Springfield		KTXR(FM)	KWFC(FM)	KWTO
St. Louis	KIRL	WRTH	KADI(FM)	WIL
		WEW		
Montana				
Billings	KOYN-FM	KOYN		KBMY
Bozeman				KBMN
Butte				KBOW-FM
Dillon				KDMB
Glasgow				KLIZ
Great Falls				KMON
Kalispell				KALS(FM)
Lewiston				KXLO
Libby				KLCB
Livingston				KPRK
Miles City				KATL
Missoula	KYLT-FM			KYSS
Plentywood		KPWD(FM)		
Nebraska				
Alliance				KCOW
Chadron				KCSR
Fairbury		KGMT		
Falls City				KTNC
Fremont				KHUB

ABC Radio Networks

City	ABC/C	ABC/E	ABC/FM	ABC/I
Grand Island		KRGI-FM		KRGI
Hastings	KICS			
Holdrege	KUVR AM/FM			
Kearney	KRNY			
Lexington		KRVN		
Lincoln			KFOR-FM	KFOR
McCook	KICX			
North Platte				KAHL
Ogallala				KOGA
Omaha	WOW	KOWH AM/FM		KLNG
				KEFM(FM)
Scottsbluff				KNEB
Sidney				KSID
Valentine				KVSH
Wayne	KTCH			
Nevada				
Elko				KELK
Las Vegas	KENO	KRAM		KTRI(FM)
Reno	KCBN	KONE	KGLR(FM)	
New Hampshire				
Berlin				WBRL
Franklin				WFTN
Keene	WKBK			
Laconia				WEMJ
Littleton				WLTN
Manchester-Nashua	WFEA	WSMN		
Portsmouth				WBBX
Wolfeboro		WASR		
New Jersey				
Atlantic City	WMID	WOND		
Newark		WVNJ		
Newton			WIXL(FM)	WNNJ
Stirling				WKMB
Trenton		WHWH	WPRB(FM)	WPST(FM)
Vineland	WWBZ			
New Mexico				
Albuquerque	KDEF			KZIA
Belen		KARS		
Clovis	KCLV			
Deming		KOTS		
Farmington				KENN
Gallup				KYVA
Humble City		KCIA	KASK(FM)	
Las Cruces				
Las Vegas		KFUN		
Santa Fe				KTRC
Silver City	KSIL			
Taos				KKIT
New York				
Albany	WPTR	WABY		WOKO
Amsterdam		WCSS		
Auburn				WAUB
Babylon		WGLI		
Binghamton	WENE		WAAL(FM)	WNBK
Brewster		WPUT		
Buffalo	WYSL	WEBR	WGRQ(FM)	WGR
Canandaigua		WCGR AM/FM		
Cornwall				WWLE
Dunkirk				WDOE
Ellenville		WELV		
Elmira		WQIT	WQIX(FM)	
Garden City				WTHE
Geneva	WGVA			
Glens Falls		WWSC		
Hornell		WLEA		
Hudson				WHUC
Ithaca			WVBR(FM)	WTKO
Jamestown		WJTN	WHUG(FM)	
Lockport				WLVL
Massena		WMSA		
Mt. Kisco				WVIP
New York	WABC	WHN	WPLJ(FM)	WMCA
Olean		WHDL		
Oneonta	WSRK(FM)	WDOS		WCNT(FM)
Potsdam				WPDM
Poughkeepsie	WKIP	WBNR		
Riverhead	WRCN AM/FM			
Rochester	WAXC	WNYR	WHFM(FM)	WHAM
Salamanca				WGGO
Saranac Lake				WNBZ
Syracuse	WNDR	WHEN	WDDS(FM)	WSEN AM/FM
Utica-Rome	WTLB	WLFH		WRNY
				WRUN-FM
Watkins Glen	WGMF			
Waverly		WAVR(FM)		
White Plains		WFAS		

ABC Radio Networks

City	ABC/C	ABC/E	ABC/FM	ABC/I	City	ABC/C	ABC/E	ABC/FM	ABC/I
North Carolina					Bend			KICE(FM)	KOOS
Asheville	WISE	WLOS-FM	WMIT(FM)	WFGW	Coos Bay				
Belmont				WCGC	Corvallis	KFLY			
Boone	WATA				Eugene	KPNW	KFMY(FM)	KPNW-FM	KATR
Burgaw	WVBS AM/FM				Lincoln City				KBCB
Charlotte	WRPL	WBT		WSOC-FM	McMinnville				KMCM
Clayton	WHPY				Medford	KYJC	KBOY AM/FM		
Clinton		WCLN			Newport				KNPT
Durham	WSSB	WRBX			Pendleton				KUMA
		WDCG(FM)			Portland	KPAM(FM)	KWJJ	KJIB	KEX
				WIFM AM/FM	Redmond	KGAR			KPRB
Elkin					Roseburg		KRSB(FM)		KQEN
Fayetteville	WFLB	WFAI			Salem		KGAY		
Forest City	WBBO			WFSC	Seaside	KSWB			
Franklin					St. Helens		KOHI		
Gastonia		WGNC			Sweet Home		KFIR		
Goldsboro				WGBR	The Dalles	KACI			
Greensboro	WCOG	WMFR	WMFR-FM	WGBG	Tillamook		KTIL		
Greenville	WOOV			WGNL	Pennsylvania				
Henderson		WHNC/ WXNC(FM)			Allentown		WGPA WHOL		WKAP
Hendersonville			WKIT(FM)		Altoona	WFBG		WFBG-FM	WRTA
Hickory		WHKY	WHKY-FM	WIRC/ WXRC(FM)	Beaver Falls				WBVP
					Bedford	WAYC			
Jacksonville	WBBS				Bloomsburg				WCNR
Kinston	WISP	WFTC			Charleroi	WESA			
Lumberton				WTSB	Chester		WVCH WCVI		
Monroe	WMAP				Connellsville				
New Bern				WRNB	Easton	WEEX			
Raleigh		WYNA		WKBQ	Erie	WCCK(FM)	WRIE		WWGO
Reidsville		WFRC			Everett		WSKE		
Rocky Mount	WEED				Harrisburg	WFEC	WIOO	WSFM(FM)	WCMB
Rosehill				WEGG	Johnstown	WCRO	WWBR	WAAT(FM)	
Sanford	WEYE				Lancaster	WLAN	WGSA	WLAN-FM	
Southern Pines		WEEB			Lebanon				WLBR
Statesville	WSIC				Lewiston				WKVA
Washington					Meadville				WMGW
Weldon	WSMY	WITN			New Castle	WKST		WCTX(FM)	
Wilkesboro		WWWC			Palmyra			WIOQ(FM)	
Wilmington		WKLM			Philadelphia	WIBG	WIBF(FM) WPEN		
Wilson		WLLY			Philipsburg		WPHB		
Winston-Salem			WTOB		Pittsburgh	WPEZ(FM)	WTAE	WDVE(FM)	WEEP
					Reading		WTRA		WBCW
North Dakota					Red Lion		WEEU	WRFY(FM)	
Bismarck			KQDV-FM		Sayre		WATS	WGCB-FM	
Fargo	KVOX		KIDA(FM)		Sharon				WPIC
Jamestown		KSJB			State College	WRSC			
Minot	KCJB		KMOT-FM		Uniontown			WPQR(FM)	
Oaks	KDDR				Waynesboro	WAYZ			
Valley City	KOVC				Wilkes-Barre	WILK	WBAX	WYZZ(FM)	WEJL
Williston				KEYZ	Williamsport	WMPT			WNOW
					York				
Ohio					Rhode Island				
Akron	WCUE	WSLR			Newport				WADK
Ashtabula			WREO-FM	WTOO	Providence		WHIM AM/FM	WBRU(FM)	WLKW AM/FM
Bellefontaine					Woonsocket				WNRI
Bellevue			WNRN(FM)		South Carolina				
Canton	WINW	WHBC		WFAH	Aiken		WLOW AM/FM		
Celina				WCSM	Anderson	WANS			
Cincinnati	WSAI	WKRC	WKRC(FM)	WCKY	Beaufort		WBEU	WBEU-FM	WNCG
Cleveland	WIXY	WGAR	WWWM(FM)	WDOK(FM)	Charleston	WKTM(FM)		WEZL(FM)	
Columbus	WNCI(FM)	WTVN	WBBY(FM)	WRFD	Cheraw	WCRE			
Dayton	WDAO(FM)	WAVI	WBUD(FM)	WONE	Clinton	WPCC			
East Liverpool		WOHI			Columbia	WOIC	WQXL	WZLD(FM)	WCOS-FM
Galion		WGLX			Darlington				WDAR
Hamilton	WMOH		WLSR(FM)		Georgetown	WGMB(FM)			WINH
Kent		WKNT			Greenville	WQOK	WESC		WEAB
Lima		WIMA	WVNO(FM)	WMAN	Hartsville		WSDC		
Lorain-Elyria		WEOL			Greenwood		WGSW		
Mansfield					Kershaw				WKSC
Marion	WDIF(FM)				Lancaster		WAGL		WLSC
Middleport		WMPO AM/FM			Loris				
Napoleon		WNDH(FM)			Myrtle Beach		WMYB		
Portsmouth				WNXT	Newberry		WKMG		
Springfield	WIZE				Orangeburg	WDIX			
Tiffin		WTFE	WMHE(FM)	WTOD	Spartanburg		WKDY		WASC
Toledo	WOHO	WCWA	WIBO(FM)		Sumter				WSSC
Waverly		WPKO			Walhalla				WGOG
Xenia	WGIC				South Dakota				
Youngstown		WBBW		WBBW	Aberdeen	KSDN			
					Hot Springs				KOBH
Oklahoma					Mobridge				KOLY
Enid	KCRC		KCRC-FM		Pierre				KCCR
Lawton	KSWO			KLAW(FM)	Rapid City	KIMM			
Muskogee		KMMM(FM)			Sioux Falls	KISD	KSOO		
Oklahoma City	WKY	KEBC(FM)	KOFM(FM)	KTOK	Watertown	KSDR	KWYR AM/FM		
Poteau		KINB(FM)			Yankton	KQHU(FM)			
Tulsa	KAKC	KTOW/ KGOW(FM)		KXXO					
Oregon									
Astoria				KAST					

City	ABC/C	ABC/E	ABC/FM	ABC/I
Tennessee				
Athens		WYXI		
Bolivar			WKPT-FM	WBOL
Bristol				WFWL
Camden				WEDG
Chattanooga	WFLI	WDOD		
Collierville		WMSO		
Crossville		WCSV		
Dyersburg	WTRO/ WASL(FM)			
Erwin		WEMB/ WXS(FM)		
Fayetteville			WYTM(FM)	WIXC
Greenville		WSMG		
Hohenwald		WMLR		
Humboldt	WIRJ AM/FM			
Jackson		WTJS		
Knoxville	WKGN	WIVK AM/FM		WETE
Lexington				WDXL
Lobelville	WTHJ(FM)			
McKenzie			WKTA-FM	
Memphis	WMPS	KWAM-FM		WWEI
Millington		WTNN		
Nashville	WVOL	WSIX-FM	WLAC-FM	WSIX
Ripley				WTRB
Rogersville				WRGS
Savannah		WORM		
Selmer		WDTM		
Shelbyville		WHAL		
Sparta	WUCR			
Union City				WALR(FM)
Waynesboro				WAAN
Texas				
Abilene	KRBC	KWKC	KFMN(FM)	
Amarillo		KZIP	KDJW-FM	KDJW
Austin	KIXL	KHFI(FM)	KRMH(FM)	
Beaumont	KOLE	KOGT	KWIC(FM)	KTRM AM/FM
Belton				KTON
Big Spring	KBST	KBYG		
Borger	KQTY			
Brownwood	KBWD			
Bryan			KLSN(FM)	
Burnett			KORA(FM)	KTAM
Corpus Christi	KZFM(FM)	KHLB		
Dallas-Ft. Worth	KXOL	KIKN		KRYS
	KVIL	KBOX		KRLD
Dimmitt				
El Paso	KINT	KDHN		
Galveston		KROD		
Houston	KYOK	KXYZ	KUFO(FM)	KHEY
Jacksonville			KAUM(FM)	KGBC
Longview				KNUZ
Lubbock	KLBK			
Marshall	KDOX		KWGO(FM)	KCAS
McAllen-Pharr			KQXX-FM	
Midland				KWEL
Nacogdoches				
Odessa	KOYL-FM	KEEE		
Pampa		KOYL		
Plainview		KGRO		
San Angelo	KPLA(FM)			KKYN
San Antonio	KGKL		KWLW(FM)	
Sherman-Denison	KAPE		KSAQ-FM	KBUS
Texarkana				KDUX
Tyler	KTBB			
Waco	WACO	KEFC(FM)	KHOO(FM)	
Wichita Falls	KNIN	KBID(FM)		KLUR(FM)
Utah				
Blanding				KUTA
Brigham City	KBUH			
Cedar City				KBRE
Logan				KVNU
Moab				KURA
Ogden		KSVN		KLO
Price				KOAL
Provo-Orem				KOVO
Salt Lake City	KNAK	KRGO		KALL
St. George				KDXU
Vernal				KVEL
Vermont				
Burlington	WDOT			
Montpelier		WSKI		
Randolph		WCVR		
Springfield	WCFR AM/FM			
White River Junction				WNHV
Virginia				
Big Stone Gap		WLSD-FM		
Blacksburg	WVVV(FM)			
Bristol	WFHG	WKYE		
Broadway		WBTX		
Charlottesville	WELK			
Chase City				WCHV
				WMEK

ABC Radio Networks

City	ABC/C	ABC/E	ABC/FM	ABC/I
Christiansburg	WJJJ			
Collinsville	WFIC			
Covington		WKEY	WKEY-FM	
Danville	WYPR	WBTM		
Fredericksburg	WFVA			
Front Royal			WFFV(FM)	
Harrisonburg	WHBG			
Hopewell				WHAP
Lynchburg	WTTX	WLGM		WLVA
Marion				WMEV
Norfolk-Portsmouth	WNOR	WKLX	WVHR(FM)	WVEC
Pulaski				WPUV
Richlands		WRIC		
Richmond	WLEE	WEET	WTVR-FM	WRNL
Roanoke	WROV	WLRG(FM)		WBLU
Staunton		WTON		
Tappahannock				WRAR AM/FM
Williamsburg	WMBG			
Winchester	WINC/ WRFL(FM)			
Washington				
Aberdeen				KBKW
Bellingham	KISM(FM)			KGMI
Centralia		KITI		
Chelan	KOZI			
Ellensburg		KXLE		
Ephrata		KULE		
Kelso	KLOG			
Kennewick-Pasco			KONA-FM	KONA
Longview			KLYK(FM)	KEDO
Lynden		KLYN(FM)		
Moses Lake				KSEM
Mount Vernon		KAPS		
Olympia		KITN		
Othello				KRSC
Pasco		KORD AM/FM		
Pullman		KPUL		
Richland	KALE			
Seattle	KAYO	KETO-FM		KOMO
Spokane	KZUN AM/FM	KXXR AM/FM		KGA
Walla Walla				KTEL
Wenatchee			KPO-FM	KPO
Yakima	KQOT	KUTI	KIT-FM	KIT
West Virginia				
Bluefield	WKOY			
Charleston	WKAZ	WCAW	WVAF(FM)	WXIT
Clarksburg	WHAR			
Hinton		WMTD		
Huntington	WKEE	WAMX(FM)		WTCR
Parkersburg			WIBZ-FM	WKYG
Weirton	WEIR			
Welch	WXEE			
Wheeling	WKWK			WVVA
White Sulphur Spgs				WSLW
Wisconsin				
Antigo	WATK AM/FM			
Appleton	WYNE	WAPL AM/FM		WNAM
Baraboo	WBOO			
Beaver Dam			WBEV	
Eau Claire	WBIZ	WOKL		WAXX
Fond Du Lac	KFLZ			
Green Bay	WDUZ		WIXX(FM)	
Hayward				WRLS-FM
La Crosse	WWLA(FM)	WKTY		
Madison	WYXE(FM)			WMAD AM/FM
Milwaukee		WRIT	WZMF(FM)	WISN
Oshkosh		WAGO	WMKC(FM)	
Portage		WPDR		
Racine	WRKR(FM)			WRJN
Reedsburg				WRDB
Richland Center	WRCO			
Sheboygan		WHBL		
Sturgeon Bay				WDOR
Two Rivers	WQTC AM/FM			
Wyoming				
Buffalo				KBBS
Casper				KVOC
Cheyenne			KFBC-FM	KFCB
Jackson				KSGT
Kemmerer				KMER
Laramie	KOWB			
New Castle				KASL
Powell				KPOW
Rawlins				KRAL
Riverton				KVOW
Sheridan				KWYO
Torrington				KGOS
Worland				KWOR

CBS

51 West 52nd St., New York 10019 (212) 975-4321

CBS Inc.

Board of Directors: William S. Paley, chmn; Leon Levy, J. A. W. Inglehart, Frank Stanton, Robert A. Lovett, William A. M. Burden, John A. Schneider, Courtney C. Brown, Roswell L. Gilpatric, Franklin A. Thomas, Henry B. Schacht, Arthur R. Taylor, Marietta Tree, John D. Backe, John Phillips, Donald R. Osborn, Walter R. Yetnikoff.

Officers: William S. Paley, chmn; Arthur R. Taylor, pres; John A. Schneider, VP (CBS/Broadcast Group); Walter R. Yetnikoff, VP (CBS/Records Group); John Phillips, VP (CBS/Columbia Group); John D. Backe, VP (CBS/Publishing Group); David D. Allen, VP, mgt info systems; David M. Blank, VP, chief economist; Drew Brinckerhoff, VP, per; Robert V. Evans, VP & gen counsel; James H. Geer, VP, finance; Clarence H. Hopper, VP, facilities; Richard W. Jencks, VP; J. Grandel Jones, VP, acquisitions; John W. Kiermaier, VP, human resources; Bill Leonard, VP, Washington; Haskell P. MacCawatt, VP & treas; John J. Manion Jr., VP & ctrlr; E. K. Meade Jr., VP, corporate affairs; James F. Sirmons, VP, industrial rel; Harry E. Smith, VP, technology; George F. Staudter, VP & gen auditor; Arthur B. Tourtellot, VP, gen exec; Marilyn Walsh, VP & dir of taxes; Charles T. Bates, sec; John D. Appel, asst sec; Nicole G. Mix, asst sec; Jack B. Purcell, asst sec; Dorothy M. Conway, asst treas; William F. Crean, asst treas; Theodore S. Bache, asst ctrlr.

Department Officers: Noel B. Berman, VP, negotiation svcs department, industrial rel; J. Garrett Blowers, VP, investor rel, corporate affairs; Norman C. Brodessa, VP, facilities engrg & bldg opns; Gilroye A. Griffin Jr., VP, mgr planning, per; Kathryn C. Pelgrift, VP, planning, dev department; Leonard Spinrad, VP, corporate info department, corporate affairs; Simon Volinsky, VP, real estate; Frank J. Welzer, VP, compensation, benefits & per systems department, per.

CBS Laboratories Division: John W. Christensen, senior VP; Otto J. Nichols, VP & ctrlr

CBS Technology Center: Benjamin B. Bauer, VP & gen mgr.

CBS/Records Group

Walter R. Yetnikoff, pres; Robert Altshuler, VP, info svcs; Charles Koppelman, VP, gen mgr, mus publishing; Sheldon M. Wool, VP, administration & chief financial off.

CBS Records Division:

Irwin B. Segelstein, pres; Walter L. Dean, exec VP; Ronald Alexenburg, VP, gen mgr, Epic records & Columbia/Custom labels; John Berg, VP, packaging art & design; Ronald L. Bledsoe, VP, Nashville opns; Samuel Burger, VP, mfg; Marvin Cohn, VP, talent contracts; Jack R. Craig, VP, mktg; Donald A. Dempsey, VP, mdse, Columbia label; Albert B. Earl, VP, opns; Mickey Eichner, VP, East Coast artist & repertoire, Columbia records; Don L. Ellis, VP, West Coast artist & repertoire, Columbia records; William P. Fox, VP & ctrlr; John Hammond, VP, label talent & acquisition; Lawrence K. Harris, VP, bus affairs & administration; Robert E. Kalaidjian, VP, per; Stanley J. Kavan, VP, planning & diversification; Floyd Kershaw, VP, inventory mgt; J. Kenneth Lemry, VP, mfg, Terre Haute; Arnold Levine, VP, adv & sls prom materials; Bruce G. Lundvall, VP, gen mgr, Columbia label; Stephen C. Popovich, VP, artist & repertoire, Epic records; Calvin Roberts, VP, opns mktg; John F. Ryan, VP, mfg administration; Marvin Saines, VP, masterworks, U.S.A.; Billy N. Sherrill, VP, country artist & repertoire; Albert E. Shulman, VP, Columbia spec products; Paul Smith, VP, sls & distribution; Stanford I. Snyder, VP, natl accounts mktg; LeBaron Taylor, VP, spec markets; Jim Tyrrell, VP, natl sls, Epic records & Columbia/Custom labels; Thomas Van Gessel, VP, Columbia record productions. **Subsidiaries:** Marvin Mattis, VP, creative affairs, April/Blackwood.

CBS Records International Division:

M. Richard Asher, pres; Norman Block, VP, European bus affairs; Nicolas J. Cirillo, VP, opns; Allen Davis, VP, European mktg opns; Peter V. de Rougemont, VP, European opns; Bernard Di Matteo, VP, administration & dev; John A. Dolan Jr., VP & ctrlr; Bernice A. Freidus, VP, mktg svcs; Maurice Oberstein, VP; Sol Rabinowitz, VP, mus publishing & artist & repertoire; Vince Romeo, VP,

international artist dev; A. William T. Smith, VP, Australasian opns; Norman S. Stollman, VP, bus affairs; Juan Manuel Villarreal, VP, Latin American opns; Michi Yoshimura, VP, mfg & engrg svcs.

CBS/Columbia Group

John Phillips, pres; William G. Barker Jr., VP; Theodore R. Sullivan, VP

Columbia House Division:

Cornelius F. Keating, pres; Ralph F. Colin Jr., VP, artists and repertoire; Francis A. Datello, VP & ctrlr; Richard Gurian, VP & gen mgr, Columbia House, Canada; Paul A. Harris, VP, creative svcs; Arthur C. Kindler, VP, distribution; Herb Leibovitz, VP, opns & admin svcs; Stephen Levine, VP, mus mktg; Robert R. Luton, VP, planning & dev; Benjamin Orndover, VP, mktg; Oren Testa, VP, opns; Herbert D. Trossman, VP, bus & governmental rel; Richard Wolter, VP, market planning & administration. **X-acto** (a unit of Columbia House Division): John F. Thomas III, VP, gen mgr. **Subsidiary:** James L. Wooters, pres, National Handcraft Institute Inc.; Wayne Adair, VP, gen mgr, National Handcraft Institute Inc.

CBS Musical Instruments Division:

Robert G. Campbell, pres; J. William Anderson, VP, planning & bus dev; Thomas E. Archer, VP, Electro Music; Edmund R. Auer, VP, ctrlr; Monroe R. Brown, VP, opns; Robert P. Bull, VP, Fender/Rogers; Thomas A. Delaney, VP, Gulbransen. **Subsidiary:** Henry Z. Steinway, pres, Steinway & Sons; Henry Bammann, VP, Steinway & Sons; John H. Steinway, VP, Steinway & Sons.

CBS Retail Stores Division:

Thomas C. Anderson, pres; Paul Altman, VP, gen mgr, Pacific Stereo Stores; John Madden, VP & ctrlr.

Creative Playthings Division:

Seymour L. Gartenberg, pres; Sheldon H. Bernstein, VP, natl accounts; John Boland, VP, owned & operated stores; John E. Holtzman, VP, dev & prod; Harry G. Perepeluk, VP & ctrlr; Norman D. Sanders, VP, sls.

CBS/Publishing Group

John D. Backe, pres; Gary J. McCarthy, VP, finance. Beveridge J. Rockefeller, VP, planning & develop.

CBS Educational Publishing Division:

Stanley D. Frank, pres.

Holt, Rinehart and Winston (a unit of CBS Educational Publishing): Stanley D. Frank, pres; William J. Tribe, senior VP, opns; Seibert G. Adams Jr., VP, editor-in-chief, college department; Vincent A. Alexander, VP, editor-in-chief, school department; H. Allen Fernald, VP, gen mgr, college department; Robert D. Fitzgerald, VP, natl sls mgr, school department; Irving Goodman, VP, publisher, gen book department; Thomas M. Kirwan, VP, finance & planning; Joseph Krassner, VP, mktg, school department; Thomas J. Murphy, VP, gen mgr, school department; F. Robert Whitworth, VP, dir of opns, school department; Richard L. Wilty, VP & dir of editorial project administration, college department; Lawrence A. Fornasier, ctrlr.

BFA Educational Media (a unit of CBS Educational Publishing): Lloyd Otis Otterman, VP & gen mgr; Frederic T. Boyer, ctrlr.

Winston Press Inc. (a subsidiary of CBS Inc., operating under jurisdiction of BFA): Thomas C. Wright, VP.

CBS Consumer Publishing Division:

John S. Suhler, pres; Murray Benson, VP, publisher, contract publishing and subsidiary rights dept; Theodore R. Binder, VP, Bond/Parkhurst Publications; Kenneth B. Collins, VP, publisher, Popular Library Books; Robert J. Kretfing, VP, circulation mktg svcs; Michael J. O'Neill, VP and publisher, *Field & Stream*; Bernard Grizer, ctrlr.

CBS International Publishing Division:

James L. Hayes, pres; Richard H. Pippert, VP, mktg; William T. Roland, VP & ctrlr.

CBS Professional Publishing Division:

Theodore vandenBeemt, pres; Robert B. Rowan, exec VP; Jack Hanley, VP & edit, health sciences; Eugene J. Hoguet, VP, prod; Albert E. Meier, VP & edit, serial publications; Gilbert B. Thomas, VP & ctrlr.

CBS Broadcast Group

John A. Schneider, pres; Louis Dorfman, VP, adv & design; Jay Eliasberg, VP, rsc; Gene P. Mater, VP & asst to pres; George E. Shannon, VP, finance & planning; Harvey J. Struthers, VP, mgt dev.

CBS Radio Division

Sam Cook Digges, pres; George J. Arkedis, VP & gen mgr; Richard F. Hyland, rgnl VP, St. Louis.

Division Services: W. Thomas Dawson, VP; Norman S. Ginsburg, dir info svcs; Loren Hollembaek, dir sls prom; Jack Stuppler, dir prog practices; Wini Hall, coord creative svcs; Robert Fuller, mgr press rel.

Engineering: Ralph E. Green, dir.

Finance: Andrew Subbiondo, VP, ctrlr; Richard Fellingner, asst ctrlr; William T. Wilson, asst ctrlr; Donald D. Ducotey, mgr credit & collections.

News Program Services: Joseph P. Durso Jr.; Helen Psaros, exec prod, PLNX.

Network Affiliate Relations: Sherril W. Taylor, VP; Eric H. Salline, dir; Cornelius V. S. Knox Jr., natl mgr; Briggs Baugh, east mgr; Harfield Weedin, western mgr.

Network Operations: Bernard Krause, dir opns and bus aff; Bertrand (Bud) Arnow, mgr tech svcs; Thomas E. McGinn Sr., mgr broadcast opns; Marie Betzig, mgr traf opns.

Network Programs: Frank Miller, dir; Harfield Weedin, dir, Hollywood.

CBS Radio Network Rates

Rate card provides for fixed position, daypart scatter plans and run-of-schedule rates. All commercials are scheduled within network news, features and sports programming. Daytime 60-second rates range from \$980 to \$2,000. Facilities for longer programs are available.

Network Sales: Richard M. Brescia, VP; Benjamin S. Lochridge, VP, dev; Richard Macaluso, eastern sls mgr; John E. Erickson, Jr., Chicago sls mgr; Richard Charlton, Detroit sls mgr; Craig Rogers, West Coast sls; Joe Larsen, dir spec projects; Al Balkin, bus mgr; Susan M. Maricondo, sales service mgr. **Research:** Harper Carraire, dir; Howard Miller, mgr, coverage & mktg resch.

CBS Radio Affiliates Association

Board of Directors 1975-76—Thad M. Sandstrom, WIBW Topeka, Kan., chmn; Gene Eilerman, WWMW Cadillac, Mich., vice chmn; Samuel S. Carey, WBOC Salisbury, Md., sec, treas. Dist dir: Frank B. Estes, WKXL Concord, N.H., dist 1; Fred Bowen, WIBX Utica, N.Y., dist 2; Allen Wannamaker, WBIG Greensboro, N.C., dist 3; Albert H. Sanders Jr., WMAZ Macon, Ga., dist 4; Roger Jeffers, WHOP Hopkinsville, Ky., dist 5; George A. Foulkes, WAAC Terre Haute, Ind., dist 6; Lloyd Loers, KGLQ Mason City, Iowa, dist 7; Frank Stewart, KTRH Houston, dist 8; Richard Butterfield, KOIN Portland, Ore., dist 9. Directors-at-large—Phil Lewis, WCCO Minneapolis; Mike Shapiro, WFAA Dallas; Andy Spheris, WEMP Milwaukee. CBS affiliates as of Dec. 1, 1975: 258.

CBS-Owned AM Stations: J. William Grimes, VP. **CBS Radio Spot Sales:** John A. Lack, VP & gen mgr. **CBS-Owned FM Stations:** J. Robert Cole, VP. **CBS/FM Sales:** John E. Baker, gen mgr.

CBS-Owned AM-FM Stations

WCBS(AM): 51 W. 52nd St., New York 10019. (212) 975-4321. David L. Nelson, VP & gen mgr. **WCBS-FM:** 51 W. 52nd St., New York 10019. (212) 975-4321. James R. McQuade, VP & gen mgr. **WBBM(AM):** 630 N. McClurg Ct., Chicago 60611. (312) 944-6000. William C. O'Donnell, VP & gen mgr. **WBBM-FM:** 630 N. McClurg Ct., Chicago 60611. (312) 944-6000. John Catlett, gen mgr. **KNX(AM):** 6121 Sunset Blvd., Los Angeles 90028. (213) 469-1212. George Nicholaw, VP & gen mgr.

KNX-FM: 6121 Sunset Blvd., Los Angeles 90028. (213) 469-1212. Robert Nelson, gen mgr.

WCAU(AM): City & Monument Aves., Philadelphia 19131. (215) 839-7000. Robert B. Sherman, VP & gen mgr.

WCAU-FM: City & Monument Aves., Philadelphia *9131. (215) 839-7000. Jim Keating, gen mgr.

WEEI(AM): 4450 Prudential Tower, Boston 02199. (617) 262-5900. Eugene Lothery, VP & gen mgr.

WEEI-FM: 4450 Prudential Tower, Boston 02199. (617) 262-5900. John Arbenz, gen mgr.

KMOX(AM): 1 Memorial Dr., St. Louis 63102. (314) 621-2345. Virginia Dawes, stn mgr.

KMOX-FM: 1 Memorial Dr., St. Louis 63102. (314) 621-2345. Howard P. Burnhard, stn mgr.

KBBS(AM): 1 Embarcadero Center, San Francisco 94111. (415) 982-7000. Peter McCoy, VP & gen mgr.

KBBS-FM: 1 Embarcadero Center, San Francisco 94111. (415) 982-7000. Tom Pierce, gen mgr.

CBS Television Stations Division

D. Thomas Miller, pres; Thomas M. Battista, VP, stn svcs; E. Hal Hough, VP, prog & bcst svcs; Gene Jankowski, VP, finance & planning; Vic Donnelly, ctrlr; John McKay, VP, mktg; James Sowards, gen mgr, natl sis; Gilbert Wyland, gen mgr, engr & opns technology; David Cohn, dir, engr & opns technology; Paul Kramer, dir, rsch.

CBS Owned television stations:

WCBS-TV: 51 W. 52nd St., New York 10019. (212) 975-4321. Thomas F. Lerhy, VP & gen mgr.

WBBM-TV: 630 N. McClurg Court, Chicago 60611. (312) 944-6000. Neil E. Derrough, VP & gen mgr.

KMOX-TV: 1 Memorial Dr., St. Louis 63102. (314) Main 1-2345. Christopher P. Desmond, VP & gen mgr.

KXNT(TV): 6121 Sunset Blvd., Los Angeles 90028. (213) 469-1212. W. Russell Barry, VP & gen mgr.

WCAU-TV: City & Monument Aves., Philadelphia 19131. (215) 839-7000. Robert L. Hosking, VP & gen mgr.

CBS Television Stations National Sales: (see listings under Repts. Section D).

CBS News Division

Richard S. Salant, pres; William Small, senior VP, dir of news; Robert Chandler, VP, administration, & asst to the pres; John Sharnik, VP & dir, pub affrs broadcasts; David Fuchs, VP, pub affrs broadcasts; Sanford Socolow, VP, CBS News, Washington; Marshall Davidson, VP, CBS News, ops; Emerson Stone, VP, CBS News, radio; Don Richardson, Sylvia Westerman, deputy dir of news; Joel Hymson, VP, finance, & ctrlr, CBS News; Joseph Bellon, dir, resources dev & prod; Burton Benjamin, exec prod of *CBS Evening News with Walter Cronkite*; Russ Bensley, dir, spec events; George Hoover, dir, info svcs; Donald Hamilton, dir, bus affairs; Robert Little, dir, newfilm syndication; Sid Feders, foreign edit; Peter Sturtevant, natl edit; Samuel Suratt, archivist.

CBS Television Network

Robert D. Wood, pres; John P. Cowden, VP, asst to pres; Louis J. Rauchenberger Jr., VP & ctrlr; Robert Worvet, VP, CBS Studio Center.

Headquarters: 51 W. 52d St., New York 10019. (212) 975-4321. **Broadcast Center:** 524 57th St., New York 10019. (212) 975-4321.

Network Sales: Frank M. Smith Jr., VP, sis; Carl Tillmanns, VP and gen mgr; William M. Materne, VP, natl sis; Robert Bonagura, VP, central sales; Joseph N. Curl, VP-West Coast sis; James Rosenfield, VP, sis admin; Paul Isacson, VP, eastern sis; Dana Redman, dir, daytime sis; Richard G. Sears, VP, Detroit sales; George Zurich, dir, stn clearance; Robert Jamieson, dir, sis admin; Richard Steenberg, dir, specials sis; Herbert Gross, nighttime sis; Michael Peesberg, dir, sports sis.

Programs: Lee Currin, VP, progs; Perry Lafferty, VP, prog, Hollywood; B. Donald Grant, VP, day progs; James V. Hesen, VP, West Coast live opns; Oscar Kalz, VP, progs, N.Y.; Franklin L. Barton, VP, prog dev, Hollywood; Paul D. King Jr., prog prod, Hollywood; Alan Wagner, VP, nighttime programs, N.Y.; Theodore W. O'Connell, VP, prog svcs; Boris B. Kaplan, dir, nighttime progs, Hollywood; Jerry Golod, VP, children's progs; Michael Marden, dir, primetime features; Robert Markell, exec prod, dramatic progs; Jackie Smith, VP, talent & casting, Hollywood; Harvey Shephard, VP, prog planning.

Engineering: David White, VP, opns & engr gen mgr; Joseph Flaherty, gen mgr, eng & dev; Richard S. O'Brien, dir, of engr; J. D. Parker, dir, transmission engr; William Connolly, dir, of devel.

CBS TV Affiliates Assn.

CBS Television Affiliate Board Members— Wayne Kearl, KENS-TV San Antonio, Tex.; Rex Howell, KREX-TV Grand Junction, Colo.; Charles Grisham, WSLA-TV Selma, Ala.; Dave Mintz, KVOS-TV Bellingham, Wash.; George H. Anderson, WGAN(TV) Portland, Me.; Donald P. Campbell, WMAR-TV Baltimore; Paul Raymon, WAGA-TV Atlanta; Charles B. Brakefield, WREG-TV Memphis; Winston Linam, KSLA-TV Shreveport, La.; Earl Hickerson, WCEE-TV Rockford, Ill.; Charles McAbee, KCMO-TV Kansas City, Mo.; Lloyd Cooney, KIRO-TV Seattle.

Program Practices: Thomas J. Swafford, VP; Richard Kirschner, VP, prog practices, Hollywood; Jack Hinton, dir, comcl clearance, N.Y.; Ray Cunell, dir, prog clearance, Hollywood; Don Gotschell, dir, day prog prac, Hollywood; Charles C. Pettijohn, exec edit, prog practices, Hollywood; Thomas W. Downer Jr., dir, primetime prog practices; Mae Helms, dir, prog clearance, N.Y.

Business Affairs: Robert Daly, VP, bus affairs; Sheldon Perry, VP, bus affairs, N.Y.; Gerald Rubin, VP bus affairs, Hollywood; Arnost Horlik, assoc dir bus affrs; Anthony G. O'Malley, dir of sis contracts; John Aggolia, dir adm; James McGowan, dir, research & planning; Alan Levin, dir, talent & prom contracts; Isadore Miller, assoc dir talent & prog negotiations; Ralph Dale, asst dir, research planning; Elizabeth Wellman, assoc dir, N.Y.; Louis Teicher, dir, music opns.

Operations: David White, VP opns & engr; Joseph Flaherty, gen mgr eng & dev; Ira Schackman, dir, broadcast svcs; Robert Hammer, gen mgr CTN opns; Stanley Greene, dir, of tech svcs; Michael Pakalik, dir, design & prod svcs; Leonard Kaufman, dir, prod control.

Affiliate Relations: Carl Ward, VP; Bruce Bryant, VP, dir affil rel; Robert Wood, dir, network coordination; Donald Clancy, dir, administration; John Cosgrove, district mgr; Al Miranda, district mgr; Len Schammel, district mgr; Tom White, district mgr; David Williams, district mgr; Charles Cadley, dir, network transmission facilities.

Press Information: Barrie Richardson, VP, press info; Harry J. Feeney, dir; Sid Garfield, dir, sp projects; Gerald Collins, assoc dir; Harry Cohan, exec edit; Michael Silver, assoc dir; Michael Buchanan, dir, press info, Hollywood.

Sports: Robert Wussler, VP-sports; Clarence Cross, dir sports; William C. Fitts III, adm dir; Sid Kaufman, dir of opns; Martin Cohen, dir, finance & administration.

CBS-TV network by cities

(197 affiliates)

City	Rate
KTXS-TV Abilene-Sweetwater, Tex.	300
WTEN Albany, N.Y.	1,500
KGGM-TV Albuquerque, N.M.	525
WBKB-TV Alpena, Mich.	75
WTAJ-TV Altoona, Pa.	1,000
KFDA-TV Amerrillo, Tex.	500
KTV Anchorage	150
WHMA-TV Anniston, Ala.	100
KXII Ardmore, Okla.	375
WAGA-TV Atlanta	1,500
WRDW-TV Augusta, Ga.	700
KTBC-TV Austin, Tex.	685
KJTV Bakersfield, Calif.	275
WMAR-TV Baltimore	1,750
WABI-TV Bangor, Me.	450
WAFB-TV Baton Rouge	775
KFDM-TV Beaumont, Tex.	650
KVOS-TV Bellingham, Wash.	125
KTVQ Billings, Mont.	350
WBNG-TV Binghamton, N.Y.	1,100
WBMG-TV Birmingham, Ala.	400
KXMB-TV Bismarck, N.D.	150
KBCI-TV Boise, Idaho	475
WNAC-TV Boston	3,250
KBTX-TV Bryan, Tex.	155
WBEN-TV Buffalo, N.Y.	1,800
WCAX-TV Burlington, Vt.	800
KXLF-TV Butte, Mont.	600
WVTV Cadillac-Traverse City, Mich.	500
KFVS-TV Cape Girardeau, Mo.	850
WMT-TV Cedar Rapids, Iowa	925
WCIA Champaign, Ill.	1,250
WCSC-TV Charleston, S.C.	500
WCBS-TV Charleston, W. Va.	1,000
WBTV Charlotte, N.C.	1,975
WDEF-TV Chattanooga	500
KYCU-TV Cheyenne, Wyo.	425
WBBM-TV Chicago	4,750
KHSL-TV Chico, Calif.	350
WCPO-TV Cincinnati	1,750
WJW-TV Cleveland	2,550
KKTV Colorado Springs-Pueblo	350
WNOK-TV Columbia, S.C.	225
WRBL-TV Columbus, Ga.	800
WCBI-TV Columbus, Miss.	450
WBNS-TV Columbus, Ohio	1,375
KZTV Corpus Christi, Tex.	375
KDFW-TV Dallas	1,950
WHIO-TV Dayton, Ohio	1,750
KMGH-TV Denver	1,050
KCCI-TV Des Moines, Iowa	825
WJBK-TV Detroit	3,200
KDIX-TV Dickinson, N.D.	100
WTVY Dothan, Ala.	575
KDAL-TV Duluth, Minn.	700
WTVD Durham, N.C.	1,300
KECC-TV El Centro, Calif.	110
KEKO Elko, Nev.	25
KDBC-TV El Paso	425
KTVF Engin, Kan.	135
WSEE Erie, Pa.	275
KIEM-TV Eureka, Calif.	225
WEHT Evansville, Ind.	425
KTVF Fairbanks, Alaska	150
KXJB-TV Fargo-Valley City, N.D.	450
WBTV Florence, S.C.	600
WINK-TV Fort Myers, Fla.	275
WTVX Ft. Pierce, Fla.	50
KFPV-TV Fort Smith, Ark.	125
WANE-TV Fort Wayne, Ind.	525
KFSN-TV Fresno, Calif.	600
KXGN-TV Glendive, Mont.	50
KLOE-TV Goodland, Kan.	85
KREX-TV Grand Junction, Colo.	300
KRTV Great Falls, Mont.	300
WBAY-TV Green Bay, Wis.	850
WFMV-TV Greensboro-Winston-Salem, N.C.	975
WNCT Greenville, N.C.	600
KGBT-TV Harlingen, Tex.	500
WHP-TV Harrisburg, Pa.	325
WFSB-TV Hartford, Conn.	2,500
KAYS-TV Hays, Kan.	200
KGMB-TV Honolulu	500
KHOU-TV Houston	1,500
WHNT-TV Huntsville, Ala.	500
KID-TV Idaho Falls, Idaho	350
WISH-TV Indianapolis	1,500
WJTV Jackson, Miss.	850
WJXT Jacksonville, Fla.	1,150
KRCG-TV Jefferson City, Mo.	525
WJHL-TV Johnson City, Tenn.	525
WJTV-TV Johnston, Pa.	75
KTVJ Joplin, Mo.	225
WKZO-TV Kalamazoo-Grand Rapids, Mich.	1,400
KCMO-TV Kansas City, Mo.	1,550
KOTI Klamath Falls, Ore.	100
WBIR-TV Knoxville, Tenn.	900
WKBT La. Cross, Wis.	600
WLFJ-TV Lafayette, Ind.	150
KLFY-TV Lafayette, La.	675
WLYH-TV Lancaster-Lebanon, Pa.	190
WJIM-TV Lansing, Mich.	1,050
KVTY Laredo, Tex.	125
KLAS-TV Las Vegas	250
KLEW-TV Lewiston, Idaho	100
WKYT-TV Lexington, Ky.	400
KOLN-TV Lincoln, Neb.	775
KTHV Little Rock-Pine Bluff, Ark.	725
KNXT Los Angeles	5,200
WHAS-TV Louisville, Ky.	1,500
KLKB-TV Lubbock, Tex.	600
WMAZ-TV Macon, Ga.	650
WISC-TV Madison, Wis.	750
KEYC-TV Mankato, Minn.	250
WLUC-TV Marquette, Mich.	450
KGLO-TV Mason City, Iowa	475
KOBI Medford, Oreg.	400
WREG-TV Memphis	1,300
WTOK-TV Meridian, Miss.	575
WTVJ Miami	1,775
WISN-TV Milwaukee	1,500
WCCO-TV Minneapolis	1,700
KXMC-TV Minot, N.D.	250
WKRG-TV Mobile, Ala.	875
KNOE-TV Monroe, La.	950
KMST Monterey-Salinas, Calif.	200
WCOV-TV Montgomery, Ala.	225
WTVF Nashville	1,275
WWL-TV New Orleans	1,200
WCBS-TV New York	9,500
WTAR-TV Norfolk, Va.	1,075
KOSA-TV Odessa, Tex.	425
KWTV Oklahoma City	1,100
WOVT Omaha	950

CBS Affiliates

WBDO-TV Orlando, Fla.	850
KEPR-TV Pasco, Wash.	250
WBBD-TV Peoria, Ill.	575
WCAU-TV Philadelphia	4,000
KOOL-TV Phoenix	950
KDKA-TV Pittsburgh	2,800
WGAN-TV Portland, Me.	6,000
KOIN-TV Portland, Ore.	1,225
WAGM-TV Presque Isle, Me.	200
WPRI-TV Providence, R.I.	1,400
KHQV-TV Quincy-Hannibal, Ill.-Mo.	600
KRSD-TV Rapid City, S.D.	100
KTVN Reno	225
WTVR-TV Richmond, Va.	900
KWRB-TV Riverton, Wyo.	50
WDBJ-TV Roanoke, Va.	950
WHCC-TV Rochester, N.Y.	900
WCCE-TV Rockford, Ill.	325
WHBF-TV Rock Island-Davenport, Ill.	1,050
KBIM-TV Roswell, N.M.	200
KXTV Sacramento, Calif.	1,050
WEYI-TV Saginaw, Mich.	300
KMOX-TV St. Louis	2,000

WBOC-TV Salisbury, Md.	375
KSL-TV Salt Lake City	850
KCTV San Angelo, Tex.	200
KENS-TV San Antonio, Tex.	900
KFMB-TV San Diego	1,400
KPIX San Francisco	2,500
KCOY-TV Santa Maria, Calif.	225
WTOC-TV Savannah, Ga.	450
WDAU-TV Scranton, Pa.	750
KIRO-TV Seattle	1,100
WLSA-TV Selma, Ala.	100
KSLA-TV Shreveport, La.	825
KMEG Sloux City, Iowa	150
KELO-TV Sioux Falls, S.D.	1,250
KIFW-TV Sitka, Alaska	50
WSBT-TV South Bend, Ind.	625
WSPA-TV Spartanburg & Greenville, S.C.	925
KXLY-TV Spokane, Wash.	675
KOLR Springfield, Mo.	525
WSTV-TV Steubenville, Ohio-Wheeling, W. Va.	900
WHEN-TV Syracuse, N.Y.	1,100
WCTV Tallahassee & Thomasville, Fla.	725
WTVT Tampa, Fla.	1,600
WTHI-TV Terre Haute, Ind.	800
WTOL-TV Toledo, Ohio	1,600

WBW-TV Topeka, Kan.	675
KOLD-TV Tucson, Ariz.	375
KOTV Tulsa, Okla.	925
WCFT-TV Tuscaloosa, Ala.	50
KMVT Twin Falls, Idaho	275
KWTX-TV Waco, Tex.	475
KMAU-TV Wailuku, Hawaii	50
WTOP-TV Washington	2,000
WNNY-TV Watertown, N.Y.	475
WSAU-TV Wausau, Wis.	625
WDTV Weston, W. Va.	300
KAUZ-TV Wichita Falls, Tex.	425
KTVH Wichita-Hulchinson, Kan.	750
KXMD-TV Williston, N.D.	75
KIMA-TV Yakima, Wash.	325
WSBA-TV York, Pa.	200
WKBN-TV Youngstown, Ohio	550
Total as of January 1976	\$166,485

Also Available

WAIM-TV Anderson, S.C.	50
KTWV-TV Casper, Wyo.	400

Overseas Group

KAUM-TV Agana, Guam	\$50
ZBM-TV Pembroke, Bermuda	75
WBNB-TV St. Thomas, V.I.	50
Total	\$175

CBS radio network

The following stations, according to CBS, were affiliates as of December 1975. All are AM.

Alabama

WATV Birmingham
WJF Decatur
WFIX Huntsville
WKRQ Mobile
WQTY Montgomery
WAMA Selma
WJRD Tuscaloosa
WVNA Tuscumbia

Alaska

KBVR Anchorage
KFRB Fairbanks
KJNO Juneau
KICY Nome
KIFW Sitka

Arizona

KOOL Phoenix
KOPO Tucson

Arkansas

KFPW Fort Smith
KZNG Hot Springs
KLRA Little Rock

California

KPMC Bakersfield
KHSI Chico
KINS Eureka
KARM Fresno
KNX Los Angeles
KCMJ Palm Springs
KVCV Redding
KFBK Sacramento
KCKC San Bernardino
KSDO San Diego
KCBS San Francisco

Colorado

KSNV Aspen
KVOR Colorado Springs
KLZ Denver
KDGO Durango
KREX Grand Junction

Connecticut

WINF Hartford-Manchester
WQQW Waterbury

District of Columbia

WTOP Washington

Florida

WJSB Crestview
WNDB Daytona Beach
WDBF Delray Beach
WINK Fort Myers
WJAX Jacksonville
WKWF Key West
WDSR Lake City
WML Melbourne
WKAT Miami Beach
WBO Orlando
WCOA Pensacola
WFOY St. Augustine
WSPB Sarasota
WTNT Tallahassee
WDAE Tampa
WJNO West Palm Beach

Georgia

WGPC Albany
WGAU Athens
WRNG Atlanta
WGAC Augusta
WMOG Brunswick
WRBL Columbus
WGGA Gainesville
WMAZ Macon
WLAQ Rome
WTOC Savannah
WPAX Thomasville
WTIF Tifton
WAYX Waycross

Idaho

KBOI Boise
KID Idaho Falls
KRLC Lewiston

Illinois

WDWS Champaign
WBMM Chicago
WDAN Danville
WSOY Decatur
WAKC Normal-Bloomington
WMBD Peoria
WTAD Quincy
WHBF Rock Island
WTAX Springfield

Indiana

WHBU Anderson
WGL Fort Wayne
WXLW Indianapolis
WBAT Marion
WLBC Muncie
WSBT South Bend
WAAC Terre Haute
WAOV Vincennes

Iowa

WMT Cedar Rapids
KRNT Des Moines
KGLO Mason City
KBIZ Ottumwa

Kansas

KXXX Colby
KSEK Pittsburg
WIBW Topeka
KFH Wichita

Kentucky

WCMI Ashland
WSO Henderson
WHOP Hopkinsville
WLAP Lexington
WHAS Louisville
WPAD Paducah
WSP Paintsville
WTCW Whitesburg

Louisiana

KALB Alexandria
WWL New Orleans
KWKK Shreveport

Maine

WFAU Augusta

Massachusetts

WEEI Boston
WHA1 Greenfield
WLMS Leominster
WBRK Pittsfield
WACE Springfield-Chicopee
WAAB Worcester

Maryland

WBFR Baltimore
WUOK Cumberland
WFMD Frederick
WARK Hagerstown
WBOC Salisbury

Massachusetts

WEEI Boston
WHA1 Greenfield
WLMS Leominster
WBRK Pittsfield
WACE Springfield-Chicopee
WAAB Worcester

Michigan

WWAM Cadillac
WJR Detroit
WDBC Escanaba
WKZO Kalamazoo
WGSW Saginaw-Bay City

Minnesota

KDAL Duluth
WCCO Minneapolis

Mississippi

WJOS Jackson
WJFL Vicksburg

Missouri

KWOS Jefferson City
KODE Joplin
KAYO Kansas City
KFEQ St. Joseph
KMOX St. Louis
KDRO Sedalia
KMPL St. Joseph

Montana

KOOK Billings
KBOW Butte
KUDI Great Falls
KCAP Helena
KGEZ Kalispell
KGOV Missoula
KSEN Shelby

Nebraska

KHAS Hastings
KLGW Omaha
KOLT Scottsbluff

Nevada

KLAV Las Vegas
KBET Reno

New Hampshire

WMOU Berlin
WKXL Concord
WTSL Hanover
WKNE Keene
WLNH Laconia
WNNH Rochester

New Jersey

WFPG Atlantic City

New Mexico

KRZY Albuquerque
KWKA Clovis

New York

WROW Albany
WKOP Binghamton
WBEN Buffalo
WELM Elmira
WENT Gloversville
WHCU Ithaca
WKNY Kingston
WCBS New York
WEAV Plattsburgh
WFBL Syracuse
WIBX Utica
WNNY Watertown

North Carolina

WKKE Asheville
WIST Charlotte
WDNC Durham
WFNC Fayetteville
WBIG Greensboro
WNCT Greenville
WMFD Wilmington

North Dakota

KBOM Bismarck
KDIX Dickinson
KFGQ Fargo

Ohio

WCKY Cincinnati
WJW Cleveland
WBNS Columbus
WHIO Dayton
WMOA Marietta
WPAY Portsmouth
WKBN Youngstown

Oklahoma

KWON Bartlesville
KMUS Muskogee
KOCY Oklahoma City

Oregon

KCMX Ashland
KFLS Klamath Falls
KOIN Portland
KRNR Roseburg
KODL The Dalles

Pennsylvania

WCED DuBois
WEST Easton
WVYN Erie
WHP Harrisburg
WDAD Indiana
WJNL Johnstown
WCAU Philadelphia
WVSW Pittsburgh
WGBI Scranton
WKOK Sunbury
WMBS Uniontown
WVPA Williamsport

Rhode Island

WICE Providence

South Carolina

WAIM Anderson
WQSN Charleston
WNOK Columbia
WJMX Florence
WMRB Greenville
WSPA Spartanburg

South Dakota

KKAA Aberdeen
KOTA Rapid City
WNAX Yankton

Tennessee

WDEF Chattanooga
WHUB Cookeville
WJCW Johnson City
WBIR Knoxville
WREC Memphis
WSIX Nashville

Texas

KGNC Amarillo
KLBJ Austin
KSIX Corpus Christi
WFAA Dallas
KISO El Paso
KTRH Houston
KFYO Lubbock
WQAI San Antonio
KWTF Wichita Falls

Utah

KSUB Cedar City
KSL Salt Lake City

Vermont

WSNO Barre
WKVT Brattleboro
WJOY Burlington
WFAD Middlebury
WIKI Newport
WTVN St. Johnsbury

Virginia

WINA Charlottesville
WTAR Norfolk
WTVR Richmond
WFIR Roanoke

Washington

KIXI Seattle
KXLY Spokane
KREW Sunnyside
KUJ Walla Walla
KUEN Wenatchee

West Virginia

WJLS Beckley
WCHS Charleston
WMMN Fairmont
WNEU Wheeling

Wisconsin

WGEE Green Bay
WIBA Madison
WEMP Milwaukee
WXCO Wausau
WFHR Wisconsin Rapids

Wyoming

KATI Casper
KOVE Lander
KROE Sheridan

NBC

30 Rockefeller Plaza, New York 10020 (212) Circle 7-8300

National Broadcasting Co.

NBC is a subsidiary of RCA Corp. (See Section E).

Board of Directors: Julian Goodman, chmn; David C. Adams, vice chmn; Corydon Dunham, Lawrence E. Fouraker, Robert T. Howard, William J. Kennedy III, John R. Petty, Aaron Rubin, Dr. Cecily C. Selby, Donald B. Smiley, Herbert S. Schlosser, Theodore H. Walworth Jr., Richard C. Wald.

Officers: Julian Goodman, chmn; David C. Adams, vice chmn; Herbert S. Schlosser, pres; Richard C. Wald, pres, news; Jack G. Thayer, pres; radio; Theodore H. Walworth Jr., pres, TV stns; Robert T. Howard, pres, TV net; Aaron Rubin, exec VP finance; Arthur Watson, exec VP; Mike Weinblatt, exec VP VP's: Marvin Antonowsky, Deanne Barkley, Perry Bascom, Robert Blackmore, Lin Bolen, Max Buck, Ulrich F. Caro, Donald Carswell, Thomas E. Colfin, Aaron M. Cohen, Robert Conrad, Sara Dempsey, Corydon Dunham, Dick Ebersol, Andrew Ecomomos, Frank Flemming, Stephen Flynn, George Gallup, Robert Galvin, David Gardum, Richard Goldstein, Nicholas C. Gilles, Richard Graham, Stuart Gray, John Hamlin, Weston Harris, Lee Hanna, George Heinemann, Bernard Hirsch, Bettye K. Hoffmann, Larry Hoffner, Robert A. Hurford, Joseph Iaricci, Robert D. Kasmire, John R. Kennedy, Peter B. Kenney, Richard Lindheim, Carl Lindemann Jr., John McMahon, Donald Meaney, Donald J. Mercer, Robert Mulholland, Alfred Ordovery, Tom E. Paro, Richard Raburn, Benjamin Raub, Henry Rieger, Joseph Reilly, Angus Robinson, Roberta Romberg, Gerald E. Rowe, William Rubens, Merryle S. Rukeyser Jr., Al Rush, Robert B. Rush, Walter Saffer, Richard Schade, Lee Schulman, John Scoppo, Chester Simmons, Heber Smith, Marion Stephenson, William F. Storke, Joseph Sutton, Joseph Taritero, David Tebet, Raymond J. Timothy, Russell Tornabene, Mike Trager, Herminio Traviesas, Neal Van Ellis, Arthur Watson, James Way, Herbert Weiss, Richard Welsch, James White.

Departments

Executives: Julian Goodman, chmn of bd; Herbert S. Schlosser, pres; David C. Adams, vice chmn of bd.

Finance

Aaron Rubin, financial exec VP; Richard J. Raburn, VP & treas; James E. Way, VP & ctrlr; Walter Saffer, VP tax admin; David Horowitz, dir, finan planning and budgets; Robert Barnaby, dir, capital planning, material and svcs; Andrew DeSherbinin, dir, auditing; Nicholas Gilles, VP financial planning and treasury opns; William Treloar, mgr, transportation.

West Coast

3000 West Alameda Ave., Burbank, Calif. THornwald 5-7000. Thomas W. Sarnoff, staff exec VP, West Coast; John McMahon, VP, prog; Richard H. Graham, VP, law; Deanne Barkley, VP, prog dev; John Hamlin, VP, special prog opns; Dennis Johnson, mgr, live nighttime prog; Joseph L. Kubin, ctrlr; Seldon Pinchuk, dir, talent & prog admin; Alan H. Raphael, dir, employe relations; Fentor Coe, VP, prog prod; Richard C. Welsch, VP, TV prod & bud affairs; Dean Craig, dir, daytime prog; Henry Rieger, VP, pub info.

Personnel

David J. Gardum, VP, employe relations; Robert Hurford, VP, personnel; Richard Goldstein, VP, labor relations; Robert Romberg, VP, affirmative action; Roy A. Cheney, dir organ planning & develop; Charles Lomax, dir, comp & benefits; Sue-An Krakower, per mgr; Timatha Pierce, dir equal opportunity programs; Bernard J. Handler, compahy physician; Charles J. Boylan, mgr, employe benefits and svcs.

Research and Planning

William Rubens, VP, rsch & corp planning; Thomas Coffin, VP, rsch planning; Stu Gray, VP, rsch; Samson Tuchman, dir economic planning; Gerald Jaffe, dir aud measurement; Alfred Ordovery, VP, corporate planning.

Advertising

Gerald Rowe, VP, design & prom; David Bellin, VP, adv & prom; John Graham, dir design.

Promotion

John Scoppo, VP, creative svcs; Peter M. Tintile, mgr, quest rel.

Station Relations

Donald J. Mercer, VP; Raymond O'Connell, dir stn rel; Charles Hillebrandt, Anthony A. Cervini, Raymond Diaz, Mortimer Dillon, Malcolm R. Laing, William Kelley, Paul Rittenhouse, Marilyn Russell.

Law

Corydon B. Dunham, VP and general counsel; Richard H. Graham, VP law, West Coast; Bernard Gold, asst gen atty; Benjamin Raub, VP & asst gen atty.
Washington, D.C. 20006, 1800 K St. N.W. (202) 833-3600. Peter B. Kenney, VP; Howard Monderer, asst gen atty; Scott Robb, atty; Robert Hynes, Jr., dir, govt rel.

Corporate Affairs

Robert D. Kasmire, VP, corporate affairs.

Public Information: M. S. Rukeyser, Jr., VP, public info; Josh Kane, dir, public info; Al Kroeger, dir, corp communications.

Press & Publicity: Gene Walsh, VP, press & publ; Joe Derby, dir, news pub; Owen Comora, dir, ntl press; Curtis Block, dir, prog and trade publ; Arthur Selby, mgr, photo unit; Til Ferdenzi, mgr, sps info.

Foreign Representatives

25 St. James's St., London SW1, England. Irwin Morgolis, Robert McFarland, George Montgomery, Garrick Utley.

73 Ave. des Champs Elysees, Paris, France. Jack Klein.

Kurfuerstendam 26A, Berlin 15 Germany, Gary Stindt, John Dancy.

Princess Bldg., Des Voeux Rd., Central Hong Kong, BCC, Al Chambers, Jim Laurie, Jack Reynolds.

10 Jain Mandir Rd., New Delhi 1, India, P. K. Khanna.

Kikar Malchei, Israel 19, Tel Aviv, Israel, Avrom Zaritsky, Ken Lucoff, Steve Delaney.

Piazza del Collegio, Rome 1A, Italy, David Teitelbaum, David Burrington.

Sanko Daichi Bldg. 6, Nishikubo Sakuragawa-cho, Shiba, Minato-ku, Tokyo, Japan, Don Oliver, Tom Corpora.

St. Georges Hotel, Beirut, Lebanon, John Palmer. Montevideo 643, Piso 3, Buenos Aires, Argentina. Tom Streithorst.

NBC News

Richard C. Wald, pres; Robert Mulholland, exec VP, news; Joseph Bartelme, VP, news, NBC Owned Stations; Richard Fischer, VP, news opns; Lee Hanna, VP, TV news; Don Meaney, VP, news, Washington; James F. White, VP, news, bus affairs and admin; Reuven Frank, sr exec prod; William Corrigan, gen mgr news; James L. Holton, gen mgr radio news; James Kitchell, gen mgr news svcs; Irwin Margolis, gen mgr/sr prod, Europe.

NBC News and Information Service (NIS)

Robert Mouty, VP & gen mgr; Roy Wetzel, dir; Charles Renwick, dir, licensee rel; Kevin Cox, mgr, eastern sis. *[NOTE—NIS affiliates are shown immediately after the NBC radio network list.]*

NBC Radio Division

Jack G. Thayer, pres; Ulrich F. Caro, VP, bus affairs; Herbert O. Weiss, VP, natl sis, NBC-owned stns; Ronald S. Friedwald, dir, mktg.

NBC Radio Stations

WNBC(AM) & WNNW-FM: 30 Rockefeller Plaza, New York 10020. (212) 247-8300. Perry Bascom, VP & gen mgr.

WMAQ(AM) & WNIS-FM: Merchandise Mart, Chicago 60654. (312) 664-8300. Charles H. Warner, gen mgr.

NBC Radio Affiliates

Executive committee—John Alexander, WFLA(AM) Tampa, Fla., chmn; Jim Caldwell, WAVE(AM) Louisville, Ky., vice chmn; Jim Davidson, KIDO(AM) Boise, Idaho, sec-treas; Lyell Bremser, KFAB(AM) Omaha; Al Burk, WBAL-AM-FM Baltimore; Ted Snider, KARN(AM) Little Rock, Ark.; Alan Andrews WJAR(FM) Providence, R.I.; Dick Barron, Winston-Salem, N.C.; Mike Laureau, WOOD-AM-FM Grand Rapids, Mich.

NBC affiliates as of October 1975: 232.

WRC(AM) & WKYS(FM): 4001 Nebraska Ave. N.W., Washington 20016. (202) 362-4000. Harold L. Green, gen mgr.

KNBR(AM) & KNAI-FM: Fox Plaza, San Francisco 94102. (415) 626-6700. William Dwyer, gen mgr.

NBC Radio Network

Marion Stephenson, VP & gen mgr; Robert B. Rush, VP, sis; Peter Flynn, dir, programs; Stephen T. Lindberg, dir, affil rel; James Holton, gen mgr, radio nws; (vacant), mgr, sis, Eastern office; Robert McNear, mgr, sis; Central office; Dolores Gurr, mgr, sis, Western office; Alan J. Liebrecht, mgr, sis, Detroit office; Wilfred Prather, dir, engrg.

NBC Radio Network Rates

Gross facilities and production charges for Weekday and Weekend areas as follows:

	One Minute	Thirty seconds
Monday-Friday 6 a.m.-10:05 a.m.; 3 p.m.-7:05 p.m.—NYT	\$1,600	\$1,200
Monday-Friday 10:05 a.m.-3 p.m.—NYT	1,250	950
Saturday, Sunday 6 a.m.-7:05 p.m.—NYT	1,250	950
Evenings 7:05 p.m.-11 p.m.—NYT	800	600
Overnight 11 p.m.-6 a.m.—NYT	400	300

Rates are adjusted based on the length of schedules in a year and the amount of weekly expenditures.

Rates are available on request for 1/4 or 1/8 sponsorship of NBC News On the Hour 7:00 AM-11:00 PM Monday-Friday local time and for 1/2 sponsorship of weekday Drive-Time strips.

Rates for fully sponsored programs of 5 minutes or longer are available on request.

NBC Television Stations Division

Theodore H. Walworth Jr., pres; Robert E. Small, dir, bus affrs; George C. Lenfest, dir, opns; George A. Hooper, dir, mktg svcs; Bernard Hirsch, VP, TV spot sis; Weston Harris, VP prog.

NBC Television Stations

WNBC-TV: 30 Rockefeller Plaza, New York, 10020. (212) Circle 7-8300. Arthur Watson, exec VP, gen mgr.

WMAQ-TV: Merchandise Mart, Chicago 60654. (312) 664-8300. Lee Schulman, VP & gen mgr.

WKYC-TV: 1403 East 6th Street, Cleveland (216) 696-1100. Neal Van Ellis, VP & gen mgr.

WRC-TV: 4001 Nebraska Ave., N.W., Washington 20016 (202) 362-4000. Tom Paro, VP & gen mgr.

KNBC-TV: 3000 W. Alameda Ave., Burbank, Calif. 91503. (213) 845-7000. Raymond J. Timothy, VP & gen mgr.

Valley County Cable TV & Nabcatt Inc. 24513 Spruce St. Newhall, Calif. (805) 259-0274. W. R. Rasmussen, gen mgr.

NBC Television Network

Robert T. Howard, pres.

Television Network Business Affairs: Donald Carswell, VP, bus affairs.

Television Sales: Bob Blackmore, VP, sis; Joseph Iaricci, VP, sis, administration; Max Buck, VP, natl sis; Larry Hoffner, VP, eastern sis; Richard Schade, VP, central sis; Sara Dempsey, VP, western sis; George Gallup, VP, spec sis; Robert Conrad, VP, part prog sis; Joseph Sutton, VP, Detroit sis; Stephen A. Flynn, VP, sis svcs.

Television Network Programs: Marvin Antonowsky, VP, prog; Aaron Cohen, VP, programs, East Coast; John J. McMahon, VP, prog opns, West Coast; William F. Storke, VP, spec progmg; Carl Lindemann, Jr., VP, sps; Chester Simmons, VP, sports, opns; Al Rush, VP, talent & prog acquisition; Lin Bolen, VP, day-time prog; John Hamlin, VP, spec prog operations, West Coast; Joseph M. Taritero, VP, variety programs.

NBC Affiliates

George Heinemann, VP special children's programs;
Deanne Barkley, VP prod dev.
Operations and Engineering: John D. Kennedy, VP
operations & engineering; Frank Flemming, VP engrg;
Robert Galvin, VP TV net opns.

NBC-TV network (213 Affiliates)

City	Rate
Alabama	
WAPI-TV Birmingham	\$1,800
WOWL-TV Florence	125
WAAY-TV Huntsville	400
WALA-TV Mobile	675
WSPA-TV Montgomery	700
Alaska	
KENI-TV Anchorage	150
KFAR-TV Fairbanks	150
KINY-TV Juneau	100
Arizona	
KOAI-TV Flagstaff	100
KTAR-TV Phoenix-Mesa	700
KVOA-TV Tucson	375
KBLU-TV Yuma	150
Arkansas	
KFSM-TV Fort Smith	425
KARK-TV Little Rock	700
California	
KERO-TV Bakersfield	450
KMJ-TV Fresno	750
KNBC-TV Los Angeles	5,000
KMIR-TV Palm Springs	75
KCRA-TV Sacramento	1,400
KSBW-TV Salinas-Monterey	800
KGTV San Diego	1,350
KRON-TV San Francisco	2,750
Colorado	
KOAA-TV Denver	1,100
KOAA-TV Pueblo-Colorado Springs (MCF) KOA-TV	325
Connecticut	
WHNB-TV Hartford-New Britain	700
WATR-TV Waterbury	200
District of Columbia	
WRC-TV Washington, D.C.	1,950
Florida	
WESH-TV Daytona Beach-Orlando	775
WBBH-TV Fort Myers	150
WTLV-TV Jacksonville	925
WCKT-TV Miami	1,550
WPTV-TV Palm Beach	375
WDTB-TV Panama City	300
WFLA-TV Tampa-St. Petersburg	1,500
Georgia	
WALB-TV Albany	675
WSB-TV Atlanta	1,700
WATU-TV Augusta	100
WYEA-TV Columbus	150
WCWB-TV Macon	125
WSAV-TV Savannah	500
Hawaii	
KHON Honolulu	400
Wailuku (KAIL)	
Hilo (KHAW)	
Idaho	
KTVB Boise (MCF) KUTV	425
KIFI Idaho Falls	350
Illinois	
WICD Champaign-Danville	250
WMAQ-TV Chicago	4,800
WEEK-TV Peoria	650
WGEM-TV Quincy-Hannibal, Mo.	600
WTVO Rockford	450
WICS Springfield-Decatur	450
Indiana	
WFIE-TV Evansville	425
WKJG-TV Fort Wayne	550
WRTV Indianapolis	1,625
WNDU-TV South Bend-Eikhart	525
WTWO-TV Terre Haute (MCF) WFMB-TV	675
Iowa	
WOC-TV Davenport	1,100
WHO-TV Des Moines	825
KVFD-TV Fort Dodge (OAI) WHO-TV	100
KTIV Sioux City	650
WWL-TV Waterloo-Cedar Rapids	625
Kansas	
KCKT-TV Great Bend	325
Garden City (KGLD-TV)	
McCook, Neb. (KOMC)	
KTSB Topeka	250
KARD-TV Wichita	800
Kentucky	
WPSD-TV Cape Girardeau-Harrisburg-Paducah	700

NBC Television Affiliates

Board of delegates—Ancil Payne, KING-TV Seattle, chmn; Fred Paxton, WPSD-TV Paducah, Ky.; Ralph Jackson, WAVE-TV Louisville, Ky.; Jack Beauchamp, WBAL-TV Baltimore; William Faber, WFLA-TV Tampa, Fla.; Wilson C. Wearn, WFBC-TV Greenville, S.C.; Joseph Sinclair, The Outlet Co., (WJAR-TV), Providence, R.I.; Glenn Flint, KCMT (TV) Alexandria, Minn.; John T. Gelder, Jr., WTWO (TV) Terre Haute, Ind.; Willard Schroeder, WOTV (TV) Grand Rapids, Mich.; Irving Waugh, WSM-TV Nashville; Alan Land, WHIZ-TV Zanesville, Ohio.

WKYH-TV Hazard	Bonus
WLEX-TV Lexington	450
WAVE-TV Louisville	1,650
Louisiana	
KALB-TV Alexandria	425
WBRZ Baton Rouge	775
KPLC-TV Lake Charles	225
KLAA-TV Monroe	100
WDSU-TV New Orleans	1,400
Maine	
WLBS-TV Bangor	400
WCBSH-TV Portland	725
Maryland	
WBAL-TV Baltimore	1,800
WHAG-TV Hagerstown	150
Massachusetts	
WBZ-TV Boston	3,450
WWLP Springfield-Holyoke-Greenfield (WRLP-TV)	625
Michigan	
WWJ-TV Detroit	3,400
WJMN-TV Escanaba	150
WOTV Grand Rapids	1,400
WILX-TV Lansing-Onondaga	700
WNEM-TV Saginaw-Bay City	1,000
WPBN-TV Traverse City (OAI) WOTV or WNEM-TV	350
*Cheboygan (WTOM-TV)	
Minnesota	
KCMT Alexandria-Walker (KNMT)	460
KSTP-TV Minneapolis-St. Paul	1,700
KROC-TV Rochester	425
Mississippi	
WDAM-TV Hattiesburg-Laurel (3)	350
WLBTV Jackson	800
WHTV Meridian	50
WTWV Tupelo	450
Missouri	
KOMU-TV Columbia	475
WGEM-TV Hannibal-(Quincy, Illinois)	600
WDAF-TV Kansas City	1,650
KOAM-TV Pittsburg-Joplin	500
KYTV Springfield	625
KSD-TV St. Louis	2,200
Montana	
KTVQ Billings	250
KTYM Butte	250
KRTV Great Falls (OAI) KUTV	250
KTCM Helena (OAI) KUTV	100
KCFW-TV Kalispell	100
KYUS Miles City	Bonus
KGVO-TV Missoula	250
Nebraska	
KHAS-TV Hastings-Kearney	350
KDUH-TV Hay Springs	200
KNOP-TV North Platte (P)	125
KMTV Omaha	1,050
Nevada	
KORK-TV Las Vegas-Henderson	375
KCRL Reno (MCF) KCRA-TV	275
New Mexico	
KOB-TV Albuquerque	525
KIVA Farmington	Bonus
KSWB-TV Roswell	325
New York	
WICZ-TV Binghamton	260
WGR-TV Buffalo	1,800
WNBC-TV New York	10,000
WROC-TV Rochester	1,000
WRGB Schenectad Syracuse-Elimira (WSYE-TV)	1,625
WKTV Utica	650
North Carolina	
WSOC-TV Charlotte	1,775
WRDU-TV Durham-Raleigh	100
WITN-TV Washington-Greenville	600
WECT Wilmington (MCF) WITN-TV	460
WXII Winston-Salem-Greensboro	1,000
North Dakota	
KFYR-TV Bismarck (OAI) WDAY-TV	250

WDAZ-TV Devils Lake	150
WDAY-TV Fargo	500
*KMOT Minot (MCF) KFVR-TV	125
KUMV-TV Williston (OAI) KMOT-TV	150
Ohio	
WLWT Cincinnati	1,650
WKYC-TV Cleveland	3,300
WLWC Columbus	1,300
WLWD Dayton	1,650
WLIO Lima	200
WSPD-TV Toledo	1,600
WFMJ-TV Youngstown	550
WHIZ-TV Zanesville (OAI) WTRF-TV	140
Oklahoma	
KXII Ardmore (MCF) WBAP-TV	225
WKY-TV Oklahoma City	1,175
KTEW Tulsa	925
Oregon	
KVAL-TV Eugene-Coos Bay (KCBY-TV)	400
KMED-TV Medford-Roseburg (KPIC-TV)	315
KGW-TV Portland	1,225
Pennsylvania	
WICU-TV Erie	750
WJAC-TV Johnstown	1,300
WGAL-TV Lancaster-Harrisburg-York	1,700
KYW-TV Philadelphia-Wildwood, N.J. (WCMC-TV)	4,350
WIC-TV Pittsburgh	2,350
WBRE-TV Wilkes-Barre-Scranton	800
Rhode Island	
WJAR-TV Providence	1,550
South Carolina	
WCIV Charleston	500
WIS-TV Columbia	900
WFBC-TV Greenville-Spartanburg	1,150
South Dakota	
KABY-TV Aberdeen	175
KOTA-TV Rapid City *Lead-Deadwood (KHSD)	500
KSFY-TV Sioux Falls (OAI) KTVI or KCMT	450
Tennessee	
WRCB-TV Chattanooga	650
WCYB-TV Johnson City-Bristol, Va.	650
WATE-TV Knoxville	1,100
WMC-TV Memphis	1,325
WSM-TV Nashville	1,175
Texas	
KRBC-TV Abilene (KACB-TV)	500
San Angelo (KACB-TV)	
KAMR-TV Amarillo	450
KTVV Austin	275
KJAC-TV Beaumont-Port Arthur	510
KRIS-TV Corpus Christi	385
KTSM-TV El Paso	450
KXAS-TV Fort Worth-Dallas	1,500
KPRC-TV Houston	1,700
KGNS-TV Laredo (OAI) WOAI-TV	100
KCBD-TV Lubbock	600
KMID-TV Midland-Odessa	400
KMOL-TV San Antonio	975
KCEN-TV Temple-Waco	525
KTAL-TV Texarkana-Shreveport, La.	650
KRGV-TV Wichita	475
KFDX-TV Wichita Falls	500
Utah	
KUTV Salt Lake City	950
Vermont	
WPTZ Burlington-Plattsburg, N.Y. (MCF) WRGB	700
Virginia	
WVIR-TV Charlottesville	Bonus
WAVY-TV Norfolk	900
WWBT (TV) Richmond	750
WLSL-TV Roanoke	850
Washington	
KING-TV Seattle-Tacoma	1,600
KHO-TV Spokane	725
KNDO Yakima-Richland, Wash. (KNDU)	550

Legend to Station Listing

*Station not available to receive network color telecasts. Combination Rate \$300 if both ordered and available.

()—Unless an advertiser is specifically notified to the contrary, this Associated Station for which no additional time charge is made, will schedule for simultaneous telecast network programs carried by the ordered associated station.

(3)—Station offered on basis of third play Kinescope Recording or Film Print Service.

(N)—Non-Interconnected Station.

(OAI)—Interconnection of this station is by means of off-air pickup. The station or stations whose call letters are shown must also carry program.

(MCF)—Interconnection of this station is via master control of station shown. Such station need not transmit network service but AT&T service must be available at master control.

West Virginia	
WHIS-TV Bluefield.....	400
WBOX-TV Clarksburg (P) (OI) WIIC.....	250
WSAZ-TV Huntington-Charleston.....	1,700
WTAP-TV Parkersburg (OI) WTRF-TV.....	100
WTRF-TV Wheeling.....	950
Wisconsin	
WEAU-TV Eau Claire.....	400
WFRV-TV Green Bay.....	800
WMTV Madison.....	400
WTMJ-TV Milwaukee.....	1,850
WAOE-TV Rhinelander.....	225
KBJR-TV Superior-Duluth, Minn.....	700
Wyoming	
KTWO-TV Casper (OI) WFBC-TV.....	400

Canadian Broadcasting Corp. TV Network Rates for time, facilities and other services will be furnished on request.

NBC radio network

Alabama	Indiana
WAPI Birmingham	WTRC Elkhart
WUNI & WKRQ Mobile	WIFE-FM Indianapolis
WCOV Montgomery	WXUS Lafayette
Arizona	WTHI Terre Haute
KSUN Bisbee	Iowa
KAWT Douglas	WOC Davenport
KCLS Flagstaff	WHO Des Moines
KXIV Phoenix	KDTH Dubuque
KYCA Prescott	Kansas
KCEE Tucson	KARE Atchison
KBLU Yuma	KIUL Garden City
Arkansas	KVGB Great Bend
KELD El Dorado	KWBW Hutchinson
KARN Little Rock	KOAM Pittsburg
California	Kentucky
KGEE Bakersfield	WBLG Lexington
KXO El Centro	WAVE Louisville
KMJ Fresno	WDXR Paducah
KGBS Los Angeles-Palm Springs	Louisiana
KCHV Coachella	KSYL Alexandria
KQMS Redding	WFMF Baton Rouge
KCRA Sacramento	WVOL Lafayette
KBON San Bernardino	KLCL Lake Charles
KOGO San Diego	KMLB Monroe
KNBR San Francisco	WNPS New Orleans
KTMS Santa Barbara	KRMD Shreveport
KBBQ Ventura	Maine
Colorado	WLBZ Bangor
KOA Denver	WCSH Portland
KSTR Grand Junction	Maryland
Connecticut	WBAL Baltimore
WTIC Hartford	WTBO Cumberland
Delaware	Massachusetts
WDEL Wilmington	WCOG Boston
Dist. of Columbia	WTAG Worcester
WKYS Washington	Michigan
Florida	WATZ Alpena
WRKT Cocoa	WBCK Battle Creek
WDAT Daytona Beach	WATT Cadillac
WRUF Gainesville	WJR Detroit
WONN Lakeland	WFDF Flint
WCG Miami	WOOD Grand Rapids
WNOG Naples	WMPL Hancock
WOO-FM Orlando	WIKB Iron River
WPBR Palm Beach	WJPD Ishpeming
WBGM-WONS(FM) Tallahassee	WJIM Lansing
WFLA Tampa	WTRU Muskegon
Georgia	WMBN Petoskey
WSB Atlanta	WSAM Saginaw-Bay City-St. Joseph
WBIA Augusta	WSJM Benton Harbor
WPNX Columbus	WTCM Traverse City
WOKA Douglas	Minnesota
WUFF Eastman	KCMT-FM Alexandria
WKOQ Gordon	KLIZ Brainerd
WBML Macon	WDSM Duluth-Superior
WSAV Savannah	KEHG Fosston
WTHO Thomson	KYSM Mankato
WWGS Tifton	KFMX Minn.-St. Paul
WGAF Valdosta	KPRM Park Rapids
Idaho	KROC Rochester
KIDO Boise	KCLD St. Cloud
KSEI Pocatello	KLLR Walker
KTFI Twin Falls	Mississippi
Illinois	WMPA Aberdeen
WMAQ Chicago	WMBC Columbus
WMAY Springfield	WGRM Greenwood
	WFOR Hattiesburg
	WJDX Jackson

WAML Laurel
WMIS Natchez
WSSO Starkville
Missouri
KHMO Hannibal
KBEA Kansas City
KSD St. Louis
KGXB Springfield

Montana
KGHL Billings
KXLF Butte
KEIN Great Falls
KBLL Helena

Nebraska
KDDY North Platte
KFAB Omaha

Nevada
KORK Las Vegas
KOH Reno

New Hampshire
WGIR Manchester

New Jersey
WLSL Ocean City
WBJH Trenton

New Mexico
KOB Albuquerque
KBCQ Roswell

New York
WINR Binghamton
WWOL-AM-FM Buffalo
WENY Elmira
WNBC New York
WROC Rochester
WGY Schenectady
WSYR Syracuse

North Carolina
WWNC Asheville
WSOC Charlotte
WMNC Morganton
WPTF Raleigh
WSJS Winston-Salem

North Dakota
KFYR Bismarck
WFAR Fargo

Ohio
WLW Cincinnati
WWWE Cleveland
WLIT Steubenville
WSPD Toledo
WFMJ Youngstown
WHIZ Zanesville

Oklahoma
WNAD Oklahoma City

Oregon
KUGN Eugene
KMED Medford
KYXI Portland

Pennsylvania
WSAN Allentown
WHLM Bloomsburg
WCBG Chambersburg
WAZL Hazleton
WJAC Johnstown
WGAL Lancaster
WMRF Lewistown
WKRZ Oil City
WFLN-AM-FM Philadelphia
WEDO Pittsburgh-McKeesport
WHUM Reading
WSCR Scranton
WMAJ State College
WBRE Wilkes-Barre
WRAC Williamsport

Rhode Island
WJAR Providence

South Carolina
WOKe Charleston
WIS Columbia
WFBC Greenville
WCRS Greenwood

South Dakota
KIOV Sioux Falls

Tennessee
WOPI Bristol
WDXB Chattanooga
WKPT Kingsport
WROL Knoxville
WMC Memphis
WSM Nashville

Texas
KBPO Beaumont
KDLK Del Rio
KTSM El Paso
WBAP Fort Worth
KPRC Houston
WOAI San Antonio

Utah
KSXX Salt Lake City

Vermont
WVMT Burlington
WSYB Rutland

Virginia
WSVA Harrisonburg
WLLL Lynchburg
WMVA Martinsville
WCPK Norfolk-Chesapeake
WRVA Richmond
WSLC Roanoke
WHPL Winchester

NBC News & Information Service subscribers

Arizona
KRUX Phoenix

Arkansas
KMYO-FM Little Rock

California
KARM Fresno
KGUY Palm Springs
KFBK Sacramento
KNAI San Francisco
KAAP Ventura

Colorado
KRDO Colorado Springs

Connecticut
WPOP Hartford

Delaware
WILM Wilmington

District of Columbia
WRC Washington

Florida
WINZ Miami
WNBE Orlando
WOSA Sarasota
WMEN Tallahassee
WPOM West Palm Beach

Hawaii
KHVV Honolulu

Idaho
KSPD Boise

Illinois
WNIS-FM Chicago
WITTFM) Tuscola

Kansas
KWBB Wichita

Kentucky
WNNS(FM) Louisville

Louisiana
KJOE Shreveport

Maine
WLBZ Bangor
WCSH Portland

Maryland
WBAL-FM Baltimore

Massachusetts
WNUS Springfield

Michigan
WCAR Detroit
WMAX Grand Rapids

NBC, NIS

Washington
KXRO Aberdeen
KIRO Seattle
KHQ Spokane
KMWX Yakima

West Virginia
WHIS Bluefield
WTIP Charleston
WBOY Clarksburg
WGNT Huntington
WMON Montgomery
WAJP Morgantown
WPAR Parkersburg
WTRF Wheeling

Wisconsin
WEAQ Eau Claire
WNFL Green Bay
WIZM LaCrosse
WMAM Marinette
WTMJ Milwaukee
WOBT Rhinelander
WSAU Wausau

Wyoming
KTWO Casper
KOJO Laramie

You belong in Broadcasting

MBS

1755 S. Jefferson Davis Hwy., Arlington, Va. 22202 (703) 685-2000

Mutual Broadcasting Corp.

60 East 42d St., New York 10017
(212) 277-7575

Board of Directors: Willard W. Garvey, John A. Hardin, Henry W. Meers, Richard A. Stark, Benjamin D. Gilbert, Loren M. Berry.

Mutual Broadcasting Inc.

Washington hqtrs: 1755 S. Jefferson Davis Hwy., Arlington, Va. (703) 685-2000, effective Feb. 1, 1976.

Board of Directors: John A. Hardin, chmn; Benjamin D. Gilbert, C. Edward Little, Richard A. Stark.

Officers: John A. Hardin, chmn of bd; C. Edward Little, pres; Gary J. Worth, exec VP; Jack Clements, VP programs; Bill Greenwood, VP news; Terry Skelton, VP-engrg; Art Okun, VP natl sls; Joseph Hildebrand, VP-Detroit sls; Robert Gordon, VP-finance.

Legal Counsel: General Counsel: Regan, Goldfarb, Powell and Quinn, New York; FCC counsel; Cohn & Marks, Washington.

Station Relations: Milt Komito, dir. Program Clearance & Syndication; Owen Weber, dir. News; Bob Moore, bureau chief. Tom Tiernan, dir, Midwest sls; Steve Van Ophujsen, dir, West Coast sls.

Mutual Black Network

A service of Mutual Reports Inc. (subsidiary of Mutual Broadcasting System Inc.) Washington hqtrs: 1755 S. Jefferson Davis Hwy., Arlington, Va. 22202. (703) 685-2000. 888 Seventh Ave., New York 10019. (212) 977-2780. Thom Gatewood, exec VP; Larry Dean, news dir; Ron Pinkney, sports dir.

Mutual Broadcasting System

Alabama

WYAM Bessemer
WCRT Birmingham
WBYE Calera
WMSL Decatur
WXAL Demopolis
WOOOF Dothan
WOOOF-FM Dothan
WULA Eufaula
WULA-FM Eufaula
WABF Fairhope
WLAY Florence
WLA-FM Florence
WHEP Foley
WJBY Gadsden
WJBB Haleyville
WHOD Jackson
WHOD-FM Jackson
WARF Jasper
WLIQ Mobile
WETU Montgomery (Wetumpka)
WCRL Oneonta
WJHO Opelika-Auburn
WRCK Sheffield
WFEW Sylacauga
WNUZ Talladega
WTBF Troy
WTUG Tuscaloosa

Alaska

*KYAK Anchorage
*KIAC Fairbanks

Arizona

KTAR Phoenix
KNOT Prescott
KHYT Tucson
KTUC Tucson

Arkansas

KAMD Camden
KWEH Camden

KCON Conway
KFFA Helena
KXOW Hot Springs
KBTM Jonesboro
KBTM-FM Jonesboro

California

KPMC Bakersfield
KROP Brawley
KOWN Escondido
KOWN-FM Escondido
KEAP Fresno
KNGT Jackson
KRKC King City
KAVL Lancaster
KFAC Los Angeles
KFAC-FM Los Angeles
KHOT Madera
KUUL Madera
KWIP Merced
KTRB Modesto
KHOP Modesto
KSFE Needles
KSON Ontario
KSON-FM Ontario
*KBBQ Oxnard-Ventura
KPMJ Oxnard-Ventura
KREO Palm Springs (Indio)
KCLM Redding
KACE Riverside-San Bernardino
KCNW Riverside-San Bernardino
KPOP Roseville
KPIP Roseville
KJAY Sacramento
KROY Sacramento
KROI Sacramento
KIDD Salinas-Monterey
KSDO San Diego
KNEW San Francisco-Oakland
KXRX San Jose
KLOM Santa Barbara-Santa Maria-Lompoc

KLOM-FM Santa Barbara-Santa Maria-Lompoc
KPLS Santa Rosa
KWG Stockton
KNJO Thousand Oaks
KTRT Truckee
KCOK Tulare-Visalia
KWSM Tulare-Visalia
KUIC Vacaville
KNBA Vallejo
KOMY Watsonville

Colorado

KSSS Colorado Springs
KDTA Delta
KERE Denver
KIUP Durango
KRSJ Durango
KQIL Grand Junction
KFKA Greeley
KBZZ La Junta
KLOV Loveland
KLOV-FM Loveland
KCSJ Pueblo

Connecticut

WADS Ansonia
WINE Danbury
WINE-FM Danbury
WFIF Milford
WNHC New Haven
WLIS Old Saybrook
WINY Putnam
WNTY Southington
WSNG Torrington
WATR Waterbury

Delaware

WDOV Dover
WSUX Seaford
WSUX-FM Seaford
WTUX Wilmington

District of Columbia

WPIK Washington (Alexandria, Va.)
WXRA Washington (Woodbridge, Va.)

Florida

WSWN Belle Glade
WSWN-FM Belle Glade
WELE Daytona Beach
WELE-FM De Land
WCAI Ft. Myers
WKEM Immokalee
WKEM-FM Immokalee
WLBE Leesburg
WMMB Melbourne
WYRL Melbourne
WWOK Miami
WSBB New Smyrna Beach
WTMC Ocala
WWPF Palatka
WIYD-FM Palatka
WSCM Panama City
WBOP Pensacola
WXOS Plantation Key
WJOE Port St. Joe
WCCF Punta Gorda
WCCF-FM Punta Gorda
WCNH Quincy
WSEB Sebring
WSKP Sebring
WPXE Starke
WMCF Stuart
WQYK Tampa
WQYK-FM Tampa
WTTB Vero Beach
WKAO West Palm Beach (Boynton Beach)
WRYZ West Palm Beach (Jupiter)
WRYZ-FM West Palm Beach (Jupiter)
WZNG Winter Haven

Georgia

WYZE Atlanta
WCOB Atlanta
WBIE Atlanta
WBBQ Augusta
WBBQ-FM Augusta
WFNL Augusta (North Augusta, SC)
WMGR Bainbridge
WBHF Cartersville
WCLA Claxton
WCLA-FM Claxton
WGHC Clayton
WHYD Columbus
WCGQ Columbus
WMJM Cordele
WBLJ Dalton
WBHB Fitzgerald
WKEU Griffin
WGML Hinesville
WJGA Jackson
WJGA-FM Jackson
WLAG La Grange
WBTT Lyons
WCRY Macon
WMVG Milledgeville
WMTM-FM Moultrie
WCOH Newnan
WRGA Rome
WQOT Savannah
WTWA Thomson

Hawaii

*KGU Honolulu

Idaho

KVNI Coeur D'Alene
KPUL Moscow (Pullman, Wash.)
KSPT Sandpoint

Illinois

WMRO Aurora
WIBV Belleville
WEIC Charleston-Mattoon
WEIC-FM Charleston
KSGM Chester (Ste. Genevieve, Mo.)
WVON Chicago
WGCI Chicago
WITY Danville
WIXN Dixon
WLTD Evanston
WNOI Flora
WGIL Galesburg
WJPF Herrin
WJRC Joliet
WAKO Lawrenceville
WAKO-FM Lawrenceville
WSMI Litchfield
WVPC Monmouth
WMIX Mt. Vernon
WMIX-FM Mt. Vernon
WPEO Peoria
WGSY Peru
WYFE Rockford
WYFE-FM Rockford
WKRS Waukegan

Indiana

WBNI Boonville
WBNI-FM Boonville
WVVVY Columbia
WADM Decatur
WADM-FM Decatur
WCMR Elkhart
WBMP Elwood
WVHI Evansville
WIFN Franklin
WLTH Gary
WHLT Huntington
WHLT-FM Huntington
WNIS (Day) Indianapolis
WIBC (Night) Indianapolis
WVVK Kokomo
WSAL Logansport
WCBK Martinsville
WCBK-FM Martinsville
WPCO Mt. Vernon
WRAY Princeton
WRAY-FM Princeton
WRIN Rensselaer
WRCR Rushville
WMPI-FM Scottsburg
WJVA South Bend
WVTS Terre Haute
WKUZ Wabash

Iowa

KXGI Burlington-Keokuk-Fort Madison
KHAK Cedar Rapids
KHAK-FM Cedar Rapids
WSWW Dubuque (Platteville, WI)
WSWW-FM Dubuque (Platteville, WI)
KVFD Fort Dodge
KCOB-FM Newton
KIWA Sheldon
KIWA-FM Sheldon
KMNS Sioux City
KLEU Waterloo

Kansas

KLIB Liberal
KBEA Mission
KTOP Topeka
KTOP-FM Topeka

Kentucky

WLBj Bowling Green

Mutual Network Rates

Hourly, half-hourly, quarter-hourly gross rates available upon request.

Special rates for sports, special events programming available upon request.

MBS five-minute news and sportscasts are available on half-hour between 6:30 a.m. and 11:30 p.m., Monday through Sunday, and on the hour from 12 midnight through 5:00 a.m., Tuesday through Saturday.

Mutual Black Network's five-minute news and sportscasts are available at ten minutes before each hour between 6 a.m. and 9 p.m.

Class AAA—5:30-10:30 a.m.; 3:30-7:35 p.m., Monday through Friday and 7:30 a.m. to 7:35 p.m. Saturday and Sunday. Class AA—11:30 a.m. to 2:35 p.m., Monday through Friday. Class A—8:30-11:30 p.m., Monday through Sunday, Herb Jepko Show and Overnight News—12 midnight through 5:30 a.m., Tuesday through Saturday.

Announcement of less than 30 seconds in length: information and conditions available upon request.

Mutual Affiliates Advisory Council

William R. Mnich, WMNI-AM-FM Columbus, Ohio, chmn; Sam Anderson, KFFA(AM) Helena, Ark., treas; Ross E. Case, KWAT-AM-FM Watertown, S.D., sec; Keith Munger, KCOK(AM) Tulare, Calif., vice chmn; Jay Williams, WVBF(FM) Framingham, Mass.; Michael C. Rice, WINY(AM) Putnam and WNTY(AM) Southington, both Connecticut; Herbert Scott, WPAZ(AM) Pottstown, Pa.; Robert H. Sauber, WFRA(AM)-WVEN(FM) Franklin, Pa.; Jack Prince, WVAB(AM) Virginia Beach, Va.; Eddie Allgood, WDV(A) Danville, Va.; Marshall Rowland, WQIK-AM-FM Jacksonville, Fla.; Robert Pricer, WCLT-AM-FM Newark, Ohio; Arnold Hartley, KATZ(AM) St. Louis; Roger Coleman, WGIL(AM) Galesburg, Ill.; Robert Rock, KTCR-AM-FM Minneapolis; Jack Roth, KONO(AM) San Antonio, Tex.; Warren Hasse, KPND(AM) Pampa, Tex.; Wes Bradley, KSSS(AM) Colorado Springs; Barry Turner, KOIL(AM) Grand Junction, Colo.; Jack Adamson, KIRO-AM-FM Seattle; Jim Arthur, WPIK(AM) Alexandria, Va.; Henry Rau, WNAV(AM) Annapolis, Md.; Edwin Mullinax, WLAG-AM-FM La Grange, Ga.

MBS Affiliates as of Nov. 1, 1975: 685. MBN affiliates as of Nov. 1, 1975: 100.

WCLU Covington (Cincinnati, OH)
 WLLS Hartford
 WLLS-FM Hartford
 WLCB Hodgenville
 WJRS-FM Jamestown
 WAXU Lexington
 WAXU-FM Lexington
 WFTM Maysville
 WNKY Neon
 WPKE Pikeville
 WCBR Richmond
 WCBR-FM Richmond
 WCND Shelbyville

Louisiana
 KVOB Bastrop
 WLBI Baton Rouge (Denham Springs)
 WTGI Hammond
 KXKW Lafayette
 KLIC Monroe
 WSHO New Orleans
 KWCL Oak Grove
 KDDI Oak Grove
 KFLO Shreveport
 WSDL Slidell
 KMAR Winnsboro
 KMAR-FM Winnsboro

Maryland
 WNAV Annapolis
 WDJQ Baltimore
 WASA Havre de Grace
 WHDG Havre de Grace
 WEIT Ocean City
 WTRT Westminster
 WTRR-FM Westminster

Massachusetts
 WKOX Boston
 WYVF Boston
 WOKW Brockton
 WALE Fall River
 WFGL Fitchburg
 WCCM Lawrence
 WSBS Pittsfield (Great Barrington)
 WREB Springfield-Holyoke
 WAAB Worcester

Michigan
 WLEN Adrian
 WVOC Battle Creek
 WDEE Detroit
 WCZN Flint
 WCUZ Grand Rapids
 WHTC Holland
 WKHM Jackson
 WYYY Kalamazoo
 WCEER-FM Lansing (Charlotte)
 WCEN Mt. Pleasant
 WMUS Muskegon
 WMUS-FM Muskegon
 WNIL Niles
 WNIL-FM Niles
 WNRS Saline
 WRBJ St. John's
 WRBJ-FM St. John's
 WLKM Three Rivers
 WYFC Ypsilanti

Minnesota
 KKIN Aitkin
 KAUS Austin
 KAUS-FM Austin
 KROX Crookston

KAOH Duluth
 KRAD E. Grand Forks (Grand Forks, ND)
 WELY Ely
 WEVE Eveleth
 KDHL Faribault
 KBRF Fergus Falls
 KOZY Grand Rapids
 KGMS International Falls
 KTCR Minneapolis
 KTCR-FM Minneapolis
 KMRS Morris
 KLOM Rochester
 KRWB Roseau
 KTRF Thief River Falls

Mississippi
 WAMY Amory
 WLOX Biloxi-Gulfport
 WROX Clarksdale
 WKCU Corinth
 WJPR Greenville
 WJXN Jackson
 WLAU Laurel
 WDAL Meridian
 WDAL-FM Meridian
 WCIS Pascagoula
 WCIS-FM Pascagoula
 WSEL Pontotoc
 WELO Tupelo
 WROB West Point

Missouri
 KCRV Caruthersville
 KCRV-FM Caruthersville
 KJMO Jefferson City
 KBEA Kansas City (Mission, Kan.)
 KXEO Mexico

KWOC Poplar Bluff
 KPBM Poplar Bluff
 KSMO Salem
 KSGM Ste. Genevieve
 KATZ St. Louis
 KOKO Warrensburg
 KJPW Waynesville
 KYSD Waynesville

Montana
 KRBN Red Lodge
 KGCX Sidney
 KVCK Wolf Point

Nebraska
 KLIN Lincoln
 KBRL McCook
 KIBC Ogallala
 KOOO Omaha
 KOOO-FM Omaha

Nevada
 KDWN Las Vegas
 KOLO Reno

New Hampshire
 WKXR Exeter
 WKXR-FM Exeter
 WOTW Nashua
 WOTW-FM Nashua

New Jersey
 WSNJ Bridgeton
 WSNJ-FM Bridgeton
 WTRM Camden
 WRAN Dover
 WSUS Franklin
 WHLW Long Branch-Asbury Pk (Lakewood)
 WTTM Trenton
 WCMC Wildwood

New Mexico
 KALG Alamogordo
 KPAR Albuquerque
 KPAR-FM Albuquerque
 KSVP Artesia
 KCCC Carlsbad
 KMTY Clovis
 KGAK Gallup
 KWEW Hobbs
 KVSF Santa Fe

New York
 WSNY Albany-Schenectady-Troy
 WTRY Albany-Schenectady-Troy
 WKOL Amsterdam
 WMBO Auburn
 WEBO Binghamton (Owego)
 WEBO-FM Binghamton (Owego)
 WADD Brockport
 WXRL Buffalo (Lancaster)
 WCLI Corning
 WCLI-FM Corning
 WEHH Elmira
 WBUZ Fredonia
 WALY Herkimer
 WIRD Lake Placid
 WICY Malone
 WVOX New Rochelle
 WVOX-FM New Rochelle
 WMCA New York
 WJLL Niagara Falls
 WOSC Oswego-Fulton
 WIRY Plattsburgh
 WSPK-FM Poughkeepsie
 WNYR Rochester
 WVOR Rochester
 WLNQ Southampton-Sag Harbor

North Carolina
 WBSM Asheville (Black Mountain)
 WSFL Bridgton
 WBBB Burlington
 WPTL Canton
 WAME Charlotte
 WHVN Charlotte
 WCHL Chapel Hill
 WTIK Durham
 WIDU Fayetteville
 WAKS Fuquay Springs
 WPET Greensboro
 WRGK Greensboro
 WHVL Hendersonville
 WMBL Morehead City
 WMBL-FM Morehead City

WSYD Mt. Airy
 WKBC No. Wilkesboro
 WLLS Raleigh
 WSTP Salisbury
 WOH5 Shelby
 WOH5-FM Shelby
 WMSJ Sylva
 WTAB Tabor City
 WKSM Tabor City
 WHSL Wilmington
 WKBX Winston-Salem

North Dakota
 KDLR Devil's Lake
 KPPO Grand Forks
 KRAD Grand Forks
 KMAV Mayville
 KLPM Minot
 KGCA Rugby

Ohio
 WNCO Ashland
 WATH Athens
 WATH-FM Athens
 WOIO Canton
 WBKC Chardon
 WBEX Chillicothe
 WBEX-FM Chillicothe
 WCNW Cincinnati (Fairfield)
 WCNW-FM Cincinnati (Fairfield)
 WCLU Cincinnati
 WLYK Cincinnati (Milford)
 WERE Cleveland
 WMNI Columbus
 WMNI-FM Columbus
 WONW Defiance
 WIRO Ironton
 WITO Ironton
 WLRO Lorain
 WTIG Massillon
 WCLT Newark
 WIOI Portsmouth (New Boston)
 WLEC Sandusky
 WMVR Sidney
 WMVR-FM Sidney
 WBLV Springfield
 WSTV Steubenville
 WTUU Toledo
 WERT Van Wert
 WERT-FM Van Wert
 WERM Wapakoneta (St. Mary)
 WKFI Wilmington
 WNIO Youngstown

Oklahoma
 KWEO Clinton
 KWEO-FM Clinton
 KJAK Oklahoma City
 KLPR Oklahoma City
 KWHP Oklahoma City (Edmond)
 WBBZ Ponca City
 KSPI Stillwater

Oregon
 KWIL Albany-Corvallis
 KHPE Albany
 KVAS Astoria
 KORE Eugene-Springfield
 KEED Eugene
 KAGI Grants Pass
 KIHRR Hood River
 KFMT La Grahde
 KRDR Portland
 KUIK Portland (Hillsboro)
 KSLM Salem
 KODL The Dalles
 KTDO Toledo

Pennsylvania
 WVAM Altoona
 WBFD Bedford
 WAKM Bedford
 WBLF Bellefonte
 WBRX Berwick
 WEEZ Chester
 WLSW Conneville
 WFRM Coudersport
 WEND Ebensburg
 WMDI-FM Erie
 WFRA Franklin
 WGET Gettysburg
 WHJB Greensburg
 WOKU Greensburg
 WHYL Harrisburg (Carlisle)
 WHYL-FM Harrisburg (Carlisle)
 WAHT Lebanon
 WVCC Linesville
 WJUN Mexico

Mutual Black Network

Alabama
 WJLD Birmingham
 WGOK-FM Fairhope
 WZZA Florence
 WEUP Huntsville
 WGOK Mobile
 WRMA* Montgomery
 WBIL Tuskegee

Arkansas
 KOKY Little Rock
 KCAT Pine Bluff

California
 KAGB-FM Inglewood
 KGFJ Los Angeles
 KZEN Seaside

Colorado
 KDKO Denver (Littleton)

District of Columbia
 WUST Washington

Florida
 WERD Jacksonville
 WWAB Lakeland
 WEDR Miami
 WORL Orlando

Georgia
 WJIZ Albany
 WIGO Atlanta
 WRDW Augusta
 WOKS Columbus
 WIBB Macon
 WFDR-FM Manchester
 WSOX Savannah

Illinois
 WVON Chicago
 WLUV Rockford

Louisiana
 WXOK Baton Rouge
 WNNR New Orleans
 WXEL New Orleans (Slidell)

Maryland
 WEBB Baltimore

Massachusetts
 WILD Boston

Michigan
 WGPR Detroit

Mississippi
 WTAM Gulfport/Biloxi
 WESY Greenville
 WORV Hattiesburg
 WNSL-FM Laurel
 WQIC Meridian

Missouri
 KPRS Kansas City
 KPRT Kansas City
 KATZ St. Louis
 KKSS St. Louis

Nebraska
 KOWH Omaha
 KOWH-FM Omaha

Nevada
 KVOV Las Vegas (Henderson)

New Jersey
 WUSS Atlantic City
 WNJR Newark
 WTNJ Trenton

New York
 WUFO Buffalo
 WLIB* New York
 WBL5* New York

North Carolina
 WIDU Fayetteville Greensboro/Winston-Salem
 WEAL High Point
 WGSE New Bern
 WLLS Raleigh/Durham
 WRSV Rocky Mount
 WWIL Wilmington

Ohio
 WPBF* Cincinnati (Middle-town)
 WABQ Cleveland
 WYKO Columbus
 WYKO-FM Columbus
 WDAO(FM)* Dayton
 WKLR Toledo
 WELX Xenia
 WHBM Xenia
 WGFT Youngstown

Supplementary Mutual Black Network affiliates

Limited Clearance Stations: The following are partially black programmed; there is no completely black programmed station in their markets.

Arizona
 KHYT Tucson

California
 KLIP Fresno (Fowler)

Connecticut
 WYBC New Haven

Georgia
 WLAG LaGrange

Oklahoma
 KFJL Oklahoma City
 KKUL Tulsa

Oregon
 KGAR Portland
 KQIV Portland (Lake Oswego)

Pennsylvania
 WDAS-FM Philadelphia
 WAMO Pittsburgh
 WAMO-FM Pittsburgh

South Carolina
 WPAL* Charleston
 WWDM Columbia (Sumter)
 WCKM Winnsboro

Tennessee
 WNOO Chattanooga
 WJBE Knoxville

Texas
 KJET Beaumont/Pt. Arthur/Orange
 KCOH Houston
 KADO Texarkana

Virginia
 WILA Danville
 WJJS Lynchburg
 WRAP* Norfolk
 WPEC Norfolk/Portsmouth
 WOWI-FM Norfolk/Portsmouth
 WENZ Richmond
 WTOY Roanoke

Washington
 KYAC Seattle
 KYAC-FM Seattle

Wisconsin
 WAWA Milwaukee
 WAWA-FM Milwaukee
 *Partial Clearance

Mutual, Hughes, NBN

WMIM Mount Carmel
 WPEN Philadelphia
 WMGK Philadelphia
 WTMR Philadelphia (Camden, NJ)
 WYDD Pittsburgh
 WMBA Pittsburgh (Ambridge)
 WPVC (WZUM) Pittsburgh (Carnegie)
 WKPA Pittsburgh (New Kensington)
 WPPA Pottsville
 WPAZ Reading (Pottstown)
 WICK Scranton
 WKBI St. Mary's
 WTIV Titusville
 WTTC Towanda
 WTRN Tyrone
 WJPA Washington
 WNBT Wellsboro
 WZIX York

Rhode Island

WJAR Providence
 WKRI Providence (West Warwick)
 WERI Westerly
 WERI-FM Westerly
 WWON Woonsocket
 WWON-FM Woonsocket

South Carolina

WSIB Beaufort
 WBSO Bennettsville
 WTMA Charleston
 WCAY Columbia (Cayce)
 WLAT Conway
 WBRR Greenville (Travelers Rest)
 WMTY Greenwood

WBHC Hampton
 WJBW Hampton
 WHSC Hartsville
 WFNL North Augusta
 WORO Orangeburg
 WHCE Orangeburg
 WRHI Rock Hill
 WSNW Seneca
 WBFM Seneca
 WFIG Sumter
 WCKM Winnsboro

South Dakota

KORN Mitchell
 KCHF Sioux Falls
 KCHF-FM Sioux Falls
 KWAT Watertown
 KYNT Yankton

Tennessee

WLAR Athens
 WSTM Chattanooga (Red Bank)
 WBAC Cleveland
 WAEW Crossville
 WAEW-FM Crossville
 WDNT Dayton
 WEKR Fayetteville
 WIZO Franklin
 WIZO-FM Franklin
 WETB Johnson City
 WSKT Knoxville
 WJIM Lewisburg
 WJIM-FM Lewisburg
 WGPV Maryville
 WCRK Morristown
 WGNS Murfreesboro
 WENO (Night) Nashville (Madison)
 WATO Oak Ridge

WLJH Shelbyville
 WCDT Winchester

Texas

KCAD Abilene
 KQIZ Amarillo
 KIOX Bay City
 KPAC Beaumont-Port Arthur
 KJBL Beeville
 KJDF Beeville
 KOUL Corpus Christi (Sinton)
 KRLD Dallas
 KSET El Paso
 KHYM Gilmer
 KTRH Houston
 KCYL Lampasas
 KPDN Pampa
 KONO San Antonio
 KCMC Texarkana
 KWTX Waco

Utah

KBLW Logan
 KVOG Ogden
 KIXX Provo
 KLAT Salt Lake City (Centerville)
 KMOR Salt Lake City (Murray)
 KRSP Salt Lake City
 KRSP-FM Salt Lake City

Virginia

WBBI Abingdon
 WPIK Alexandria
 WBDY Bluefield
 WZAP Bristol
 WSVS Crewe
 WSVS-FM Crewe
 WDNA Danville
 WFTR Front Royal
 WGAT Gate City
 WGAT-FM Gate City
 WMNA Gretna

WHSV Hillsville
 WWO Lynchburg
 WPRW Manassas
 WOLD Marion
 WSIG Mount Jackson
 WNRV Narrows
 WTID Newport News
 WVAB Norfolk-Portsmouth-VA Beach
 WSSV Petersburg
 WPMH Portsmouth
 WENZ Richmond (Highland Springs)
 WRIS Roanoke
 WJLM Roanoke (Salem)
 WAYB Waynesboro
 WXRA Woodbridge

Washington

KAGT Anacortes
 KPUG Bellingham
 KERI Bellingham
 KELA Centralia-Chehalis
 KVAC Forks
 KOTY Kennewick
 KBAM Longview
 KGY Olympia
 KONP Port Angeles
 KACA Prosser
 KPUL Pullman
 KQQQ Pullman
 KPOR Quincy
 KIRO Seattle
 KSEA Seattle
 KEZE Spokane
 KEZE-FM Spokane
 KENE Toppenish

West Virginia

WCIR Beckley
 WCIR-FM Beckley
 WRDS Charleston
 WKLC Charleston (St. Albans)

WKLC-FM Charleston (St. Albans)
 WELD Fisher
 WVVW Grafton
 WWHY Huntington
 WIRO Huntington (Ironton, Ohio)
 WITO Huntington (Ironton, Ohio)
 WLOG Logan
 WPEM Martinsburg
 WESM Martinsburg
 WADC Parkersburg
 WRON Roanoke
 WEIF Wheeling (Moundsville)
 WBTH Williamson

Wisconsin

WHBY Appleton-Oshkosh
 WGEZ Beloit
 WBIZ Eau Claire
 WAUN Kewaunee
 WRJC Mauston
 WBCS Milwaukee
 WCCN Neillsville
 WCCN-FM Neillsville
 WIXK New Richmond
 WIXK-FM New Richmond
 WSWW Platteville
 WSWW-FM Platteville
 WIBU Poynette
 WJMC Rice Lake
 WCOW Sparta
 WCOW-FM Sparta
 WNNO Wisconsin Dells
 WNNO-FM Wisconsin Dells

Wyoming

KVWO Cheyenne
 KWVO-FM Cheyenne
 KEVA Evanston
 KOJO Laramie

* — Limited affiliation

Hughes Television Network

133 Avenue of the Americas
 New York 10036. (212) 765-6600

Live telecasts of sports and other special events as well as entertainment specials.

Officers

Arthur M. Mortensen, pres; Roylance H. Sharp, exec VP; Thomas Schilling, VP, purchasing; David A. Donnelly, VP, net sts & progmg; John Koushouris, VP & exec prod; Ralph MacFarland, VP engrg; William Hyland, VP & treas; John Lydon, comptroller; Davis & Cox, New York, legal counsel.

Field Office Rutherford, N.J.: 158 E. Passaic Ave. Phone (201) 933-4040.

You belong

in Broadcasting

All year long

National Black Network

1350 Avenue of the Americas
 New York 10019. (212) 586-0610.

Board of Directors: Eugene D. Jackson, Sydney L. Small, Neill H. Brownstein, John Somers, Esq., Arch Whitehead, Charles Stanley, Travers Bell.

Officers: Eugene D. Jackson, pres & chmn of the bd; Sydney L. Small, exec VP & sec; Del Raycey, exec VP
Division heads: Sales: James Harold, natl sls mgr; Research: Robert Lucas, rsch dir. News: Vince Sanders, news dir. Sports: Frank Bannister, dir of sports. Engineering: Eddie Hogan-Bassey, dir of engrg. Affiliate relations: Del Raycey, exec VP in chg. Administration: Sydney L. Small, exec VP in chg.

National Black Network affiliates

Alabama

WENN AM-FM Birmingham
 WBLX(FM) Mobile
 WAPX Montgomery
 WTQX Selma
 WVNS(FM) Tuskegee

Arkansas

KALO Little Rock

California

KDAY Los Angeles
 KSOL(FM) San Francisco
 KZEN(FM) Seaside

Connecticut

WKND Hartford

District of Columbia

WOOK Washington

Florida

WPDQ Jacksonville
 WEDR(FM) Miami
 WOKB Orlando
 WANM Tallahassee
 WTMP Tampa

Georgia

WIPE(FM) Americus
 WAOK Atlanta
 WTHB Augusta
 WOKS Columbus
 WFDR-FM Manchester
 WEAS AM-FM Savannah
 WTUF(FM) Thomasville
 WGOV Valdosta

Illinois

WJPC Chicago
 WBEE Chicago
 WMPP Gary/E. Chicago

Indiana

WTLC(FM) Indianapolis

Kentucky

WLOU Louisville

Louisiana

WBOK New Orleans

Maryland

WWIN Baltimore

Massachusetts

WILD Boston

Michigan

WCHB Detroit
 WAMM Flint
 WWWS(FM) Saginaw

Mississippi

WPAD-FM Greenville
 WKXI(FM) Jackson
 WTBI(FM) McComb
 WTNK Meridian
 WYAZ Yazoo City

Missouri

KPRT Kansas City
 KATZ St. Louis

New Jersey

WUSS Atlantic City
 WNJR Newark
 WTNJ Trenton

New York

WUFO Buffalo
 WBLS(FM) New York
 WLNB New York
 WDKX(FM) Rochester

North Carolina

WVOE Chadbourn

WGIV Charlotte
 WOKN (FM) Goldsboro
 WAAA Greensboro
 Winston-Salem
 WSRG Raleigh/Durham

Ohio

WJMO Cincinnati
 WJMC Cleveland
 WKVO AM-FM Columbus
 WDAO(FM) Dayton

Pennsylvania

WDAS Philadelphia
 WAMO AM-FM Pittsburgh

South Carolina

WPAL Charleston
 WOIC Columbia
 WYNN Florence
 WHYZ Greenville/Spartanburg
 WWDM(FM) Sumter

Tennessee

WLOK Memphis

Texas

KJET Beaumont
 KNOK-AM-FM Dallas Ft. Worth
 KYOK Houston
 KZEY Tyler

Virginia

WRAP Norfolk
 WANT Richmond

Wisconsin

WAWA AM-FM Milwaukee

AM and FM affiliates: 78.

TVS Television Network

280 Park Avenue
New York 10017 (212) 697-0660

A division of Corinthian Broadcasting Corp. Independent network for sports.

Officers: Eddie Einhorn, pres; Alan Lubell, exec VP; Chris Zoulamis, VP; Carl Meyers, eastern sls mgr; Jess Salarfranca, accounting mgr.

Regional TV Networks

Alaska Television Network—Comprising KTVA-TV Anchorage, KTVF-TV Fairbanks, and KIFW-TV Sitka, all Alaska. Hqtrs: 715 Securities Bldg., Seattle 98101. (206)624-6333. A.G. Hiebert, pres; Al Shewe, natl sls mgr; Alma Wilson, traf mgr. Represented by Alaska Radio-TV Sales, Adam Young Inc. and Art Moore & Associates Inc.

Avco Broadcasting Corp.—Comprising WLWC-TV Columbus, WLWD-TV Dayton, and WLWT-TV Cincinnati, all Ohio. Application pending for transfer of WLWT license from AVCO Broadcasting to Multimedia Broadcasting, Greenville, S.C. Hqtrs: 1600 Provident Tower, Cincinnati 45202. (513) 241-1822. Represented by Avco Radio Television Sales Inc.

California-Oregon Broadcasting Inc.—Comprising KRCR-TV Redding, Calif; KOBI-TV Medford and KOTI-TV Klamath Falls, both Oregon. Hqtrs: P.O. Box 5M, Medford, Ore. 97501. (503) 779-5555. Robert Lindstrom, natl sls mgr. TWX 510-757-0607. Represented by The Meeker Co., Northwest, Art Moore & Associates.

Central Educational Network—Comprising WTTW-TV and WXKW-TV both Chicago; WIPB-TV Muncie, WNIT-TV South Bend, WVUT-TV Vincennes, all Indiana; KBIN-TV Council Bluffs, KDIN-TV Des Moines, KIIN-TV Iowa City, KHIN-TV Red Oak, KSID-TV Sioux City, KRIN Waterloo, all Iowa; KTWU-TV Topeka, KPSTS-TV Wichita, both Kansas; WTVS-TV Detroit, WKAR-TV East Lansing, WVCV-TV Grand Rapids, WNPB-TV Marquette, WUCM-TV University Center, all Michigan; KCPT-TV Kansas City, KOZK-TV Springfield, both Missouri; KTNE-TV Hastings, KMNE-TV Bassett, KHNE-TV Hastings, KLNE-TV Lexington, KUON-TV Lincoln, KREN-TV Merriman, KXNE-TV Norfolk, KPNE-TV North Platte, all Nebraska; WEAO-TV Akron, WNEO-TV Alliance, WOUB-TV Athens, WOUUC-TV Cambridge, WOSU-TV Columbus, WOET-TV Dayton, WMUB-TV Oxford, WPBO-TV Portsmouth, all Ohio; KDSD-TV Aberdeen, KESD-TV Brookings, KPSP-TV Eagle Butte, KQSD-TV Lowry, KTSB-TV Pierre, KBHE-TV Rapid City, KUSD-TV Vermillion, all South Dakota; WHWC-TV Eau Claire, WPNE-TV Green Bay, WHLA-TV LaCrosse, WHA-TV Madison, WMVS-TV and WMVT-TV both Milwaukee, WHRM-TV Wausau, all Wisconsin. Hqtrs: 5400 N. St. Louis Ave., Chicago 60625. (312) 463-3040. Raymond C. Giese, exec dir.

Central-Wisconsin Combination—Comprising WSAU-TV Wausau; WMTV-TV Madison, both Wisconsin. Hqtrs: Forward Communications Corp., Box 1088, Wausau 54401. (715)845-4211. James W. Frey, gen sls mgr. Represented by Meeker; Hyatt (Minneapolis-St. Paul).

Dakota Giant Network—Comprising KFJR-TV Bismarck, KMOT-TV Minot, KUMV-TV Williston, all North Dakota. Hqtrs: Box 1738, Fourth & Broadway, Bismarck, N.D. 58501. (701)223-0900. William A. Ekberg, pres. Represented by Blair.

Eastern Educational Television Network—Comprising WETA-TV Washington; WEDH-TV Hartford, WEDN-TV Norwich, WEDW-TV Bridgeport, all Connecticut; WCBB-TV Augusta, WMEB-TV Orono, WMEM-TV Presque Isle, WMED-TV Calais, all Maine; WGBH-TV Boston, WGBX-TV Boston, WGBY-TV Springfield, all Massachusetts; WENH-TV Durham, WEDB-TV Berlin, WLED-TV Littleton, WHED-TV Hanover, WEKW-TV Keene, all New Hampshire; WNJT-TV Trenton, N.J.; WNET-TV New York; WMHT-TV Schenectady, WCNY-TV Syracuse, WXXI-TV Rochester, WNED-TV Buffalo, WNEP-TV Watertown, WNYE-TV Brooklyn and WSKG-TV Binghamton, all New York; WHYI-TV Philadelphia, WLVT-TV Bethlehem-Allentown, WVIA-TV Scranton-

Wilkes-Barre, WPSX-TV Clearfield, WQED-TV Pittsburgh, WQLN-TV Erie and WITF-TV Hershey, all Pennsylvania; WSBE-TV Providence, R.I.; WETK-TV Burlington, WVTB-TV St. Johnsbury, WVTA-TV Windsor, WVER-TV Rutland, all Vermont; WNVF-TV Annandale, Va.; WAPB-TV Annapolis, WMPB-TV Baltimore, WCPB-TV Salisbury, all Maryland.; WVVU-TV Morgantown, WMUL-TV Huntington-Charlestown, WSWP-TV Beckley, all West Virginia. Hqtrs: 1300 Soldiers Field Road, Boston 02135. (617)783-3660. John S. Porter, exec dir.

4X Network—Comprising KXMB-TV Bismarck, KDIX-TV Dickinson, KXMC-TV Minot and KXMD-TV Williston, all North Dakota. Hqtrs: Box 1686, Minot, N.D. 58701. (701) 852-2104. Chester Beiten, pres; H.F. Beuchler, gen mgr. Represented by HR Television; W.L. Hurley, Minneapolis area.

The Kakekand Stations—Comprising KAKE-TV Wichita, KUPK-TV Garden City, both Kansas. Hqtrs: Box 10, Wichita, Kansas. 67201. (316)943-4221. TWX 910-741-6926. Martin Umansky, pres & gen mgr. Rep: Katz Television.

Kansas Broadcasting System—Comprising KTVH-TV Wichita-Hutchinson; KTVCC-TV Ensign; KAYS-TV Hays; KLOE-TV Goodland, all Kansas. Hqtrs: Box 12, Wichita. 67201. (316)838-1411. TWX 910-741-6998. Represented by Blair Television.

Kansas State Network—Comprising KARD-TV-FM Wichita, Kansas; CKCT-TV Great Bend, Kansas; KGLD-TV Garden City, Kansas; KOMC-TV McCook, Nebraska (Oberlin, Kansas). Hqtrs: Box 333, 833 N. Main, Wichita, Kansas 67201. (316)265-5631. TWX 910-741-6976. All television stations affiliated with NBC Television Network. TV represented nationally by Tele Rep. Radio represented nationally by Selcom. CATV ownership: KTVJ-TV Joplin, Mo. CBS Affiliate, Avery-Knodel, natl rep. Charles L. Brown, chmn; Donald Sbarra, corp pres; Frank Chappell, pres bcst div.

Keloland—Comprising KELO-TV Sioux Falls; KDLO-TV Florence; KPLO-TV Reliance, all South Dakota. Hqtrs: Midcontinent Broadcasting Co., KELO Bldg., Phillips at 13th St., Sioux Falls 57102. (605)336-1100. TWX 910-660-0552. Joe Floyd, pres; Evans Nord, exec VP & gen mgr; Represented by H-R; Evans (Minneapolis); McDermott (Canada).

Keystone Network—Comprising WLYH-TV Lancaster-Lebanon; WSBA-TV York, both Pennsylvania. c/o WLYH-TV, Television Hill, R.D. 5, Lebanon, 17042. (717)273-4551. TWX LEB 351. Represented by Blair Television.

Midnight Sun Broadcasters Inc.—Comprising

Alabama Community Network—Comprising WAVU, WQSB(FM) Albertville; WCRI Scottsboro; WCRL, Oneonta; WFMH, Cullman; WBHP Huntsville; WHOS Decatur; WVNA Tusculuma; WWWW Russellville; WWWW Fayette; WRAG Carrollton; WKLF Clanton; WAAX Gadsden; WEIS Centre; WZOB Fort Payne; WJMW Athens; WKLD(FM) Oneonta. Hqtrs: Box 190, Albertville 35950. (205)878-1311. Pat M. Courington, gen mgr.

Alaska Broadcasting System—Comprising KBYR Anchorage, KIFW Sitka, KLAM Cordova, KFRB Fairbanks, KJNO Juneau, KSRM Soldatna, KICY Nome, KCAM Glenallen, KNKIF-FM Anchorage, KRXA Seward. Hqtrs: 715 Securities Bldg., Seattle 98101. (206) Main 4-6333. Representative: Jack Masla & Company Inc., Masla/Young, San Francisco & Los Angeles; Art Moore & Associates, Inc., Seattle & Portland.

Allegheny Mountain Network—Comprising WKBI St. Marys, WFRM Coudersport, WNBT Wellsboro, WTRN Tyrone, WBLF Bellefonte, WGMR Tyrone-State College, WKBI-FM Ridgeway-Johnsonburg, WIYQ(FM) Ebensburg-Johnstown, WGR-FM Wellsboro-Mansfield, all Pennsylvania. Headquarters: Box 247, Tyrone (Altoona) 16886. (814)944-3131. Representative: Dome & Associates. Cary H. Simpson, pres; David Hill, VP; William E. Moses, VP sls; John P. Knorr, VP; James F. Kershner, VP; Paul Bryan, VP; Neal Stevens, VP opns.

All Spanish Network—Comprising KAMX Albuquerque, N.M.; KEVT Tucson, Ariz.; XEJ El Paso, Tex.; XEPZ El Paso, Tex.; XEGNK Laredo, Tex.; XHNK Laredo, Tex.; XEAO, XEAA, XERM, all Calexico, Calif.;

TVS, Regional Networks

KFAR-TV Fairbanks; KENI-TV Anchorage; KINY-TV Juneau, all Alaska. Hqtrs: Box 1160, Fourth Ave., Theatre Bldg., Anchorage 99501. (907)272-7461. A.O. Bramsted, pres & gen mgr; R.D. Jensen, VP; Don Anderson, VP. Represented by Simpson/Reilly (Pacific Coast); Avery-Knodel (New York).

Midwestern Educational Television Inc. (MET)—Comprising KWCM-TV Appleton; WDSE-TV Duluth; KTCa-TV Minneapolis-St. Paul; KTCi-TV Minneapolis-St. Paul; KAVT-TV Austin, all Minnesota; KFME-TV Fargo; KGFE-TV Grand Forks, both North Dakota; KESD-TV Brookings; KUSD-TV Vermillion; KTSB-TV Pierre; KDSD-TV Aberdeen; KBHE-TV Rapid City, all South Dakota. Hqtrs: 1640 Como Ave., St. Paul, Minn. 55108. (612)645-0471. W.D. Donaldson.

Montana Television Network—Comprising KTVO-TV Billings; KXLF-TV Butte; KRTV-TV Great Falls; KPAX-TV Missoula, all Montana. Hqtrs: Box 2557, Billings 59103. (406)252-5611. TWX 910-975-1030. Donald Bradley, gen mgr.

Ohio Educational Television Network Commission. Comprising WCET-TV Cincinnati, WOSU-TV Columbus, WMUB-TV Oxford, WGET-TV Toledo, WOUB-TV Athens, WGSF-TV Newark, WBGU-TV Lima/Bowling Green, WVIZ-TV Cleveland, WOET-TV Kettering, WNEO-TV Alliance, WOUUC-TV Cambridge, WPBO-TV Portsmouth, WEAO-TV Akron, all Ohio. Hqtrs: 2470 North Star Road, Columbus, Ohio 43221. (614)421-1714. Dave L. Fornsshell, exec dir.

Pennsylvania Public Television Network—Comprising WQED-TV Pittsburgh, WHYY Philadelphia, WITF-TV Hershey, WQLN-TV Erie, WPSX-TV Clearfield, WLVT-TV Allentown, and WVIA-TV Scranton, all Pennsylvania. Hqtrs: 169 West Chocolate Ave., Box 397, Hershey, Pa. 17033. (717) 533-2157. TWX 510-657-4012. David H. Leonard, gen mgr.

T.V. Sports Scene Inc.—323 Normandale Office Park, 8200 Normandale Blvd., Minneapolis 55437. (612) 835-4716. Donald L. Herrick, pres; Robert C. Bruce, VP.

Wisconsin Educational Television Network—Comprising WHWC-TV Colfax, WPNE-TV Green Bay, WHLA-TV La Crosse, WHA-TV Madison, WMVS-TV Milwaukee and WHRM-TV Wausau, all Wisconsin. Hqtrs: 732 N. Midvale Blvd., Madison, Wis. 53705. (608) 266-0036. Rep: Don Kates, WHRM-TV and WPNE-TV; James Kissinger, WHLA-TV and WHWC-TV.

Regional Radio Networks

XEMU Eagle Pass, Tex.; XEMS Brownsville, Tex.; XEMW Yuma. Hqtrs: Box 13, Tucson, Ariz. 85702. (602)624-5588. Alvin L. Korngold, pres.

Amigo Group—Comprising KIFN Phoenix, Ariz.; KEVT Tucson, Ariz.; KGST Fresno, Calif.; XEBG San Diego; KBRG San Francisco; KAMX Albuquerque, N.M.; KUNO Corpus Christi, Tex.; KUKA San Antonio, Tex.; XEJ El Paso; KGBT Harlingen, Tex.; XEK Laredo, Tex.; KLFB Lubbock, Tex. Hqtrs: Savalli/Gates, 515 Madison Ave., New York 10022. (212)688-2380. Rep: Savalli/Gates Inc.

Appalachian Network—Comprising WFTG London, Ky.; WCPM Cumberland, Ky.; WNRG Grundy, Va.; WVAR Richwood, W. Va. Hqtrs: Kentucky Radio Sales, 102 Tristram Rd., Louisville, Ky. 40222. (502)426-6116. Elvo Mills, gen mgr. Represented by Kentucky Radio Sales.

Arizona Lotus Network. KRUX Phoenix; KTKT, Tucson. Hqtrs: Lotus Communications Corp., 10850 Wilshire Blvd., Suite 312, Los Angeles 90024. (213) 475-0791. Howard A. Kalmenson, pres; Paul Hill, sec-treas & comptroller; KRUX—Dave Cline, gen mgr; KTKT—Mark Schwartz, VP gen-mgr.

Arizona Network—Comprising KPIN Casa Grande; KVIO Cottonwood; KVSF Show Low; KSWW Wickenburg; KNYN Williams; KINO Winslow. Hqtrs: Contact each station; Sanford L. Kahn Mgr. Representative: J.A. Lucas & Co.

Arkansas Radio Network—Comprising KVRC Arkadelphia, KMLA-FM Ashdown, KMCW Augusta, KTHS Berryville, KLCN and KHL(FM) Blytheville,

Regional Radio Networks

KBRI & KBRI-FM Brinkley, KJWH Camden, KLYR Clarksville, KAGH & KAGH-FM Crossett, KDQN De-Queen, KDEW & KDEW-FM DeWitt, KDDA Dumas, KDMS El Dorado, KNWA(FM) Fayetteville, KBJT For- dyce, KXJK Forrest City, KDFE Ft. Smith/Van Buren, KHOZ Harrison, KAWW & KAWW-FM Heber Springs, KCRIF(FM) Helena, KXAR Hope, KFJN(FM) Jonesboro, KARN & KKYK(FM) Little Rock, KVMA & KFV(FM) Magnolia, KBOK Malvern, KAMS(FM) Mammoth Spring, KZOT Marianna, KPCA Marked Tree, KCGS Marshall, KENA & KSKR(FM) Mena, KBIB Monette, KHBM & KHBM-FM Monticello, KVOM Morrilton, KTLO-FM Mountain Home, KBHC Nashville, KBNBY & KOKR(FM) Newport, KOSE & KHFO(FM) Osceola, KZRK Ozark, KCCFL Paris, KPBA & KCAT Pine Bluff, KTPA Prescott, KAMO & KAMO-FM Rogers, KWAK Stuttgart, KTMN Trumann, KSDU West Memphis, all Arkansas; KDFN & KOEA(FM) Doniphan and KALM Thayer, all Missouri; KADO Texarkana, Tex. Hqtrs: 1001 Spring St., Little Rock 72202. (501) 376-9292. Chuck Gardner, mgr; Tom Longfellow, sales mgr; John Reeder, station rep. Representative: Blair.

Badger Farm & Dairy Network—Comprising WISS Berlin, WWSI Black River Falls, WDMP Dodgeville, WRDN Durand, WOKL Eau Claire, KFIZ Fond du Lac, WTKM Hartford, WLIP Kenosha, WMIR Lake Geneva, WOMET Manitowoc, WLOT Marinette, WMNE Menomonie, WJMT Merrill, WIXX New Richmond, WOCO Oconto, WAGO Oshkosh, WNBI Park Falls, WGLB Port Washington, WPRE Prairie du Chien, WRJN Racine, WVCWC Ripon, WVLR(FM) Sauk City, WTCH Shawano, WHBL Sheboygan, WSPST Stevens Point, WYYS Tomahawk, WGBM(FM) Viroqua, WDXU Waupaca, WXCO Wausau, WBKV West Bend, WNNO Wisconsin Dells, all Wisconsin. Hqtrs: 20 N. Wacker Dr., Chicago 60606. (312) 236-8887. Robert J. Walton, pres. Rep: Walton Bcstg Sls Corp.

Beasley Broadcasting Group—Comprising WFCM Goldsboro, N.C.; WOKN(FM) Goldsboro, N.C.; WHNC Henderson, N.C.; WXNC(FM) Henderson, N.C.; WFAI Fayetteville, N.C.; WASC Spartanburg, S.C.; WGAC Augusta, Ga.; WKGX Lenoir, N.C.; WMOO Mobile, Ala.; WBLX(FM) Mobile, Ala. and WDMT(FM) Cleveland. Hqtrs: Box 1355, Mid Towne Mall, Suite 109, 200 W. Ash St., Goldsboro, N.C. 27530. (919)734-8003. George G. Beasley, pres. Tom Joyner, exec VP.

Beck-Ross Group—Comprising WGLI Babylon, N.Y.; WKMF Flint, Mich.; WGMZ(FM) Flint, Mich.; WBLI-FM Patchogue, N.Y.; WHCN(FM) Hartford, Conn. Hqtrs: 1290 Peconic Ave., Babylon, N.Y. 11704. (516)669-1290. Martin F. Beck, pres; James E. Champin, gen sls mgr. Representative: Jack Masla & Co. except WHCN(FM), ABC-FM Spot Sales.

Beef Empire Radio Group—Comprising WJAG AM-FM Norfolk, Neb., and KCOL & KCOL-FM, Fort Collins, Colo. Hqtrs: 309 Braasch Ave., Norfolk, Neb. 68701. (402)371-0780. Bob Thomas, VP. WJAG represented by McGavren-Guild; KCOL by IMNR/KO Radio Rep.

Beeline, McClatchy—Comprised of KMJ-AM/FM Fresno, KFBK AM & FM Sacramento, KBEE AM & FM Modesto, all Calif. and KOH Reno, Nev. Hqtrs: 21st and Q, Sacramento, Calif. 95816. (916) 442-5011. Eleanor McClatchy, pres; Richard Belkin, dir of bcstg; Keith B. Collins, dir of sls. Rep.: Katz radio.

The Berkshire Group—Comprising WCAT Orange, WSBS Great Barrington and WMNB-AM-FM North Adams, all Mass. Hqtrs: 466 Curran Hwy, North Adams, Mass. 01247. (413)663-6567. Rep.: Nona Kirby Co., Boston.

Big-K Media—KMHT Marshall, KLUE Longview, Texas. Hqtrs: 2323 Jefferson Ave., PO. Box AA, Marshall, Tex. 75670. (214) 758-2222. H.A. Bridge Jr., pres-gen mgr; Mildred J. Mahone, VP. Represented nationally by Jack Masla Assoc.; Southwest, Riley Representatives. Merchandising co-ordinated through Outdoor Marshall Inc.

Brownfield Network—Comprised of KSWM(FM) Aurora, KSOA Ava, KBLR-KLTB(FM) Bolivar, KWRT-KWRT-FM Boonville, KPCR Bowling Green, KGHM Brookfield, KMRRN Cameron, KQCA Canton, KAOL-KAOL-FM Carrollton, KDMO Carthage, KRKG(FM) Carthage, KDKD Clinton, KDFN Doniphan, KEXS Ex-celsior Springs, KRFG Greenfield, KSCM(FM) Houston, KWOS Jefferson City, KTMO(FM) Kennett, KRXL(FM) Kirksville, KBEK(FM) Lexington, KLEX Lexington, KMFL(FM) Marshall, KMMO Marshall, KEMM Marshallfield, KNIM-KNIM-FM Maryville, KRES(FM) Moberly, KBTN Neosho, KSGM-FM Ste. Genevieve, KETU(FM) Salem, KDRO Sedalia, KTTN Trenton,

KOKO Warrensburg, KWRE Warrenton, KWPM West Plains, all Missouri; KTHS Berryville, Ark.; WEIC Charleston, WEIC-FM Charleston, KSGM Chester, WMIX Mount Vernon, WMIX-FM Mount Vernon, all Illinois. Hqtrs: Centertown, Mo. 65023. (314) 584-3317. Clyde G. Lear, mgr; Derry Brownfield, farm dir; Don Osborn, asst farm dir.

Buckeye Farm Network—Comprised of WTOO Bellefontaine, WMGS Bowling Green, WBNO Bryan, WBCO Bucyrus, WWOV Conneaut, WTNS Coshoc-ton, WJER Dover, WFIN Findlay, WDRK(FM) Greenville, WMOH Hamilton, WPFB(FM) Hamilton, WSRW Hillsboro, WKNT Kent, WHOK Lancaster, WCLW Mansfield, WPFB Middletown, WPAV Portsmouth, WSOM Salem, WERM-FM Wapakoneta, WWST Wooster, WLEX Zenia. Hqtrs: 20 North Wacker Dr., Chicago 60606. (312)236-8887. Detroit: Enterprise 7772; Minneapolis: Zenith 7772; St. Louis: Enterprise 41135. Robert J. Walton, pres. Rep: Walton Bcstg Sls Corp.

California Farm Network—Comprising KRAK Sacramento, KBLF Red Bluff, KLBS Los Banos, KPLS Santa Rosa, KXGO Arcata, KBBE Modesto, KMJ Fresno, KPMC Bakersfield, KXO El Centro, KOMY Wat-sonville, KTOB Petaluma, KCHV Coachella, KBLC Lakeport, KDAC Fort Bragg, KRKC King City, KPly Crescent City, KIQS Willows. Hqtrs: 2855 Telegraph Ave., Berkeley, Calif. 94705. (415)644-7086. Milton L. Levy, exec VP; George Green, radio-TV dir.

Carant—The Carolina Radio Network—Comprised of WRCS Ashokie, WRRZ Clinton, WFMC Goldsboro, WISZ Henderson, WELS Kinston, WTSB Lumberton, WEWO Laurinburg, WEED Rocky Mount, WMPM Smithfield, WTAB Tabor City, WEEW Washing-ton, WETC Wendell/Zebulon, WIAM Williamston, WVOT Wilson, all North Carolina; WLAT Conway, WJMX Florence, WKYB Hemmingway, WDX Orangeburg, WDXV Sumter, all South Carolina. Sup-plementary WACS Elizabeth City, N.C.; WFAI Fayette-ville, N.C.; WNCs Fuquay Varina, N.C.; WYRN Louisiana, N.C.; WMAP Monroe, N.C.; WREW Reidsville, N.C.; WKLM Wilmington, N.C.; WLPN Suffolk, Va. Hqtrs: Box 170, Wilson, N.C. 27893. (919) 237-8628. Harry Severance, mgr; Wistar Moore Jr., asst mgr.

Central Main Group—Comprised of WFAU-AM-FM Augusta, WTVL-AM-FM Waterville, WRKD-AM-FM Rockland. Hqtrs: Box 557, 36 Silver St., Waterville, Me. 04901. (207)873-3311. Harold L. Vigue, natl sls dir.

Christian Broadcasting Network—Comprising WMIV(FM) Bristol Center, WJIV(FM) Cherry Valley; WOIV(FM) De Ruyter; WEIV(FM) Ithaca; WBIV(FM) Wetherfield Township. Hqtrs: Drawer G, Ithaca, N.Y. 14850. (607) 272-8080. Bill Freeman, gen mgr; Roger Baerwolf, opns mgr; Jim Wall, sls mgr.

Connecticut State Network—Comprising WSTC Stamford, WATR Waterbury, WSWG Torrington, WICH Norwich, WNLN New London, WINY Putnam, WNTY Southington, WILI Williamantic, WTYD(FM) New Lon-don. Hqtrs: Box 496, Williamantic 06226. (203)423-1612. Herbert C. Rice, pres. Represented by New England Spot Sales Inc., Boston. Jack Masla, New York.

Continental News Service—Comprised of KCAD Abilene, KEAN Brownwood, KCIR-FM Corsicana, KEGG Daingerfield, WFAA Dallas, KFRO Longview, KMWT-FM Mineral Wells, KOYL & KOYL-FM Odessa, KLIS-FM Palestine, KTEO San Angelo, KDSX Sherman, all Texas. Hqtrs: Box 1317, Ft. Worth 76101. (817) 737-6631. Gene Craft, mgr.

Country Music Network—Comprising 79 stations in 29 states. Hqtrs: 730 Fifth Ave., New York 10019. (212) 246-7242. Charles Bernard, pres. Rep: Charles Bernard Co.

Dakota Dynamo Group—Comprised of KGFX Pierre, S.D.; KLOH Pipestone, Minn.; KKLS-AM-FM Rapid City, S.D. Hqtrs: KOVC Inc., Broadcast House, Valley City, N.D. 58072. (701) 845-2531. Robert E. In-gstad Jr., pres. Rep: PRO Time Sls.

Dakota Farm Network—North Dakota—Comprising KBMR Bismarck, KDAK Carrington, KDLR Devils Lake, KGPC Grafton, KNDC Hettinger, KMAV Mayville, KLPM Minot, KEYD Oakes, KGCA Rugby, KOVC Valley City, KBMW Wahpeton. Hqtrs: 20 N. Wacker Dr., Chicago 60606. (312)236-8887. Detroit: Enterprise 7772; Minneapolis: Zenith 7772; St. Louis: Enterprise 41135.

Dakota Farm Network—South Dakota—Comprising KBFS Belle Fourche; KBRK Brookings; KDSJ Deadwood; KBJM Lemmon; KJAM Madison; KORN

Mitchell; KCCR Pierre; KCHF Sioux Falls; KVRA Ver-million; KSDR Watertown; KYNT Yankton. Hqtrs: 20 N. Wacker Dr., Chicago 60606. (312) 236-8887. Detroit: Enterprise 7772; Minneapolis: Zenith 7772; St. Louis: Enterprise 41135. Robert J. Walton, mgr. Rep: Walton Bcstg Sls Corp.

Dakota Salesmaker Stations—Comprised of KDLR Devils Lake, KILLO Grand Forks, KGCC Williston, KXOV Fargo/Moorhead, all North Dakota. Hqtrs: Box 97, Moorhead, Minn. 56560. (218) 233-1522. Richard K. Herbst, mgr. Rep: Masla.

Delta/Net—Comprising KBOA, KTMO(FM) Kennett; KWOC, KPBM(FM) Poplar Bluff; KMPL, KMPL-FM Sikeston, all Mo.; WDSG Dyersburg, Tenn. Hqtrs: Missouri Network Inc., Centertown, Mo. 65033. (314) 584-3317. Clyde G. Lear, sls mgr; Derry Brownfield, farm dir; Don Osborn, asst farm dir.

Eastern Public Radio Network—Comprising WAMU-FM Washington; WMEH-FM Bangor, Me.; WFCR(FM) Amherst, Mass.; WBUR-FM Boston; WGBH-FM Boston; WAMC(FM) Albany, N.Y.; WITF-FM Hershey, Pa.; WUHY-FM Philadelphia; WRFK-FM Rich-mond, Va. Hqtrs: c/o WFRM(FM) Univ of Mass., Amherst, Mass. 01002. (413) 545-0100. Godwin G. Oyewole, pres, bd of dirs; John Beck, Arnold Coda, Peter Darg, Albert Fredette, Susan Harmon, Lester Spencer, and Dr. Walter Sheppard, bd members.

Farm Radio Network—Comprising over 550 stns. Hqtrs: Box 170, Wilson, N.C. 27893. (919)237-8628. Harry Severance, mgr; Wistar Moore, asst mgr.

Fine Music Group—Comprising WTRF-FM Greensburg, Ind.; KMDD(FM) Tulsa, Okla.; WRFY(FM) Reading, Pa.; WMZK(FM) Detroit; WMZK Detroit; WYTS(AM) Terre Haute, Ind.; WCEN-FM Mt. Pleasant, Mich. Hqtrs: 10 Fiske Pl., Mount Vernon, N.Y. 10550. (914)668-3534. Kenneth C. Schwartz, dir of sls. Rep: Fine Music Hi-Fi Bcstrs.

Florida Growers Network—Comprising WTLN Apopka; WAPR Avon Park; WSBP Chattahoochee; WKXX De Land; WAKA Gainesville; WQDI Home-stead; WFIV Kissimmee; WDSR Lake City; WIPC Lake Wales; WNER Live Oak; WKCC Milton; WMOP Ocala; WFUZ-FM Ocala; WOKZ Okeechobee; WPLA Plant City; WCNH Quincy; WAUC Wauchula. Hqtrs: 20 N. Wacker Dr., Chicago 60606. (312) 236-8887. Robert J. Walton, pres; Rep: Walton Bcstg.

Florida Quality Broadcasting Corp. Comprising WDBF Delray Beach, WGGG Gainesville, WDNB Daytona Beach, WDNJ Daytona Beach. Hqtrs: Box 1420, Delray Beach, Fla. 33444. (305)833-1420 or 278-1420. Victor M. Knight, pres; Elsie Mercer, VP-Gainesville; Elliott W. Harris, VP-Daytona Beach.

French Program Group of New England—Comprising WESO Southbridge, WREB Holyoke, both Mass; WZID Manchester, WOTW-AM-FM Nashua, both N.H.; WFAU-AM-FM Augusta, WLAM Lewiston, both Maine; WILI Williamtic, WEXT West Hartford, WINY Putnam, all Conn.; WNRI Woonsocket, R.I. Hqtrs: 10 Center St., Box 333, Chicopee, Mass. 01013. (413)596-6464. Leon J. Alarie, VP. Rep: Leon Alarie.

Georgia Network Inc.—Comprising WBIT Adel; WALG Albany; WDOL & WDOL-FM Athens; WRNG Atlanta; WXAP Atlanta; WBJA Augusta; WAUG Augusta; WAUG(FM) Augusta; WAGX Austell; WAGO Bainbridge; WBSG Blackshear; WDYX & WAGO Buford; WLBB Carrollton; WBBK Blakely; WKRW Car-terville; WGAA Cedartown; WRWH Cleveland; WVMG & WVMG-FM Cochran; WGF5 Covington; WYNE Cumming; WDMG Douglas; WXL1 Dublin; WXL1(FM) Dublin; WUDN Gainesville; WKOG Gor-don; WLAG LaGrange; WMAC & WHCG Metter; WKUN Monroe; WSSA Morrow; WSIZ Ocala; WROM Rome; WROM(FM) Rome; WXLW & WQOT Savannah; WSYL Sylvania; WVNS Statesboro; WRBN Warner Robins; WRBN(FM) Warner Robins; WRBL Colum-bus; WRBL(FM) Columbus; WCOH Newnan; WCOH(FM) Newnan; WNEG Toccoa; WIFO Jesup; WAYX Waycross; WMOG Brunswick; WTFI Tifton; WGAF Valdosta; WGRA Cairo; WCHK & WCHK-FM Canton; WBML Macon; WOGA Sylvester; WLAW Law-renceville; WTHO & WTHO-FM Thomson; WNGA Nashville; WVGVA Waynesboro; WYZE Atlanta; WJJC Commerce; WCON & WCON-FM Cornelia; WMNZ Montezuma; WISK America; WMES Ashburn; WCLB Camilla; WMTM Moultrie; WMTM(FM) Moultrie; WSGC & WSGC-FM Elberton; WFNE Forsyth; WKIG Greenville; WPEH & WPEH-FM Louisville; WLR Thomasville; WDMX Racer; WFLA LaFayette; WFPM Ft. Valley; WCEH & WCEH-FM Hawkinsville; WSPQ Eatonton, all Georgia. Hqtrs: 1447 N.E. Expressway, N.E., Box 29334, Atlanta 30329. (404) 636-8686. Don

Kennedy, pres; Paul Stone, VP; Richard Moore, news dir; Art Collier, sports dir; Jimmy Lee, farm dir.

Golden Crescent Group—Comprising WTIK Durham, WHP High Point, WGW Asheville, WSAT Salisbury, WDBM Statesville, WABZ Albemarle, WGLB Kannapolis, WIST Charlotte, all N.C.; WEAC Gaffney, S.C. Hqtrs: Box 5251, High Point, N.C. 27262. EC. Bryant Jr., ntl sls mgr.

Goldman Group—Comprising WJTN & WWSE(FM) Jamestown, N.Y.; WDOE Dunkirk, N.Y.; WVVY Erie, Pa.; WVMT Burlington, Vt.; WSYB & WRUT(FM) Rutland, Vt.; WLUV(FM) Erie, Pa. Hqtrs: Box 1139, Jamestown, N.Y. 14701. (716)487-1151. Simon Goldman, pres; J. Carl Willems, VP. Regional Reps: Jack Masia.

Greater New York Radio—Comprised of WGBB Freeport/Hempstead, L.I.; WGSW Huntington, L.I.; WCTC, WQMR(FM) New Brunswick, N.J.; WFAS White Plains, N.Y. Hqtrs: Suite 512, 509 Madison Ave., New York 10022. (212) 752-1455. Philip H. Roberts, gen mgr. Rep: Alan Torbet Assoc.

Groskin Group—Comprising 36 stations in 23 states. WLPFR(FM) Mobile, Ala.; KXTC-FM Phoenix; KIBE, KDCC(FM) San Francisco; KRYT, KRYT-FM Colorado Springs; KVOD(FM) Denver; WEEL, WEZR Washington; WMMW Meriden, Conn.; WLOD Ft. Lauderdale, WTM(FM) Miami, both Fla.; WGKA Atlanta, WXLN(FM) Savannah, both Ga.; WEFM(FM) Chicago; WEZB New Orleans; WHRB-FM Boston; WORS(FM) Detroit; KANO, KTVN Minneapolis; KXTR(FM) Kansas City, Mo.; KLVN(FM) Henderson, Nev.; WDH(AFM) Dover, WMTR Morristown, both N.J.; WVOR(FM) Rochester, N.Y.; WCHL Chapel Hill, WEZZ Charlotte, both N.C.; WLYK(FM) Cincinnati; WIFB Philadelphia; WYZZ(FM) Wilkes-Barre, both Pa.; WRR-FM Dallas; KEEE, KJCS(FM) Nacogdoches, all Tex.; WEZS(FM) Richmond, Va.; WFMR Milwaukee, WI. WLVN Madison, WI. WIRU Payette, all Wis. Hqtrs: 310 Madison Ave. New York 10017. (212) 986-4366. Herbert E. Groskin, pres; D.S. Groskin, ntl sls mgr. Rep: Herbert E. Groskin & Co.

Gulf Central Radio Network—Comprising WMPA, WHAY(FM) Aberdeen; WMBC, WJWF(FM) Columbus; WFOR, WHER(FM) Hattiesburg, WVIM Vicksburg, all Miss. Hqtrs: Box 707, Columbus, Miss. 39701. (601) 328-1420. J.W. Furr, owner; Joe Davis, gen mgr. Rep: Messina J.V.

Hawkeye Radio Network—Comprising KCHE Cherokee, KRIT(FM) Clarion, KDTH DuBuque, KMCD Fairfield; KXGI Ft. Madison, KHBT Humboldt, KBAB Indianola, KIMI(AM) Keokuk, KILJ Mt. Pleasant, KLEE Ottumwa, KOAK Red Oak, KNEI Waukon, KLEO Waterloo, all Iowa. Hqtrs: 20 N. Wacker Drive, Chicago 60606. (312)236-8887. Detroit: Enterprise 7772; Minneapolis: Zenith 7772; St. Louis: Enterprise 41135. Robert J. Walton, Rep: Walton Bcstg Sls Corp.

Hildreth Radio & Television Network—Comprising WABI-AM, WABI-TV, WGBW(FM) Bangor, WAGM-AM-TV Presque Isle, all Maine. Hqtrs: 35 Hildreth St., Bangor, Me. 04401. (207)947-8321. Walter L. Dickson, exec VP. Represented nationally by H-R Television Inc.; in New England by Kettell-Carter Inc.; in Canada by Andy McDermott Sales Ltd.

Hukilau Net—Comprising KHLO Hilo, KNUI Maui, and KGU Honolulu, all Hawaii. Hqtrs: KGU Honolulu, 605 Kapiolani Blvd., Honolulu 96813. (808)563-3826. Don Metzger, pres and gen mgr; Bernie Armstrong, ops/prog dir. Rep: Selcom Inc.

Idaho Big Buy—Comprising KIDO Boise, KTFI Twin Falls, KSEI Pocatello, all Idaho. Hqtrs: Box 8087, Boise, Idaho 83707. (208)334-8661. James M. Davidson, sls mgr. Rep: Savalli-Gates.

Illinois Radio Network—Comprising WOKZ-AM-FM Alton, WMRO Aurora, WRMS Beardstown; WBYS Canton, WROY Carmi, WILY Centralia, WCCR Champagne, WHow Clinton, WCBW Columbia; WDAN Danville, WLKB DeKalb, WDOQ DuQuoin, WIXN Dixon, WFRL Freeport, WAIK Galesburg, WGEN Geneseo, WGSB Geneva, KHMO Hannibal-Quincy, WEBO Harrisburg, WJPF Herrin, WINU Highland, WJLL Jacksonville, WJRC Joliet, WMSI Litchfield, WLHB Mattoon, WCSJ-WRMI(FM) Morris, WRAM Monmouth, WYMC Mt. Carmel, WAKC Normal, WVLN Olney, WCMY Ottawa, WPRS Paris, WSVI Pekin, WPEO Peoria, WSPY Plano, WPOK Pontiac, WZOE Princeton, WRHL Rochelle, WYFE Rockford, WCCI Savanna, WSHY Shelbyville, WFMB-FM Springfield, WTIM Taylorville, WPMB Vandalia, WGFA Watska, WKRS Waukegon, WFRX West Frankfort, all Illinois. Hqtrs: 20 North Wacker Drive, Chicago 60606. (312)236-8887. Robert J. Walton, mgr. Rep: Walton Broadcasting Sales Corp.

Indiana Broadcasters Group—Comprising WHUT Anderson; WLKI(FM) Angola; WBIW Bedford; WTTT Bloomington; WCSI Columbus; WFDT(FM) Columbia City; WCNB Connersville; WCVL Crawfordsville; WADM Decatur; WBMP-FM Elwood; WIKY Evansville; WLYV Fort Wayne; WILQ Frankfort; WIFN-FM Franklin; WKAM Goshen; WXIA-FM Greencastle; WSMJ-FM Greenfield; WTRF Greensburg; WJOB Hammond; WWHC-FM Hartford City; WHLT Huntington; WIRE Indianapolis; WXTZ-FM Indianapolis; WITZ Jasper; WXVW Jeffersonville; WIOU Kokomo; WASK Lafayette; WNON-FM Lebanon; WBTO Linton; WORX Madison; WGOM Marion; WYTL(FM) Monticello; WLBC Muncie; WCTW New Castle; WHYT Noblesville; WOCH North Vernon; WVAK Padi; WARU Peru; WPGW Portland; WHON Richmond; WSLM Salem; WMP(FM) Scottsburg; WJCD Seymour; WSVL Shelbyville; WNDI Sullivan; WTCT Tell City; WWCM Terre Haute; WAOV Vincennes; WAYT Wabash; WAMW Washington; WIUC-FM Winchester. Hqtrs: 408 Holiday Park Tower, 644 Linn St., Cincinnati 45203. (513) 651-1511. Don O. Hays, VP. Rep: Regional Reps Corp.

Indiana Radio Network—Comprising WHBU Anderson; WIFF Auburn; WCRD Bluffton; WBNL Boonville; WWCM Brazil; WHON Centerville-Richmond; WFDT Columbia City, WCVL Crawfordsville; WADM Decatur; WCMR Elkhart; WILQ Frankfort; WKAM Goshen; WSMJ(FM) Greenfield; WHLT Huntington; WKVI-AM-FM Knox; WIOU kokomo; WNON(FM) Lebanon; WBTO Linton; WGOM Marion; WMCB(FM) Michigan City; WYTL Monticello; WERK Muncie; WCTW-AM-FM New Castle; WOCH North Vernon; WHYT Noblesville; WARU Peru; WTCA Plymouth; WPGW Portland; WRAY Princeton; WJCK-FM Rensselaer; WSVL Shelbyville; WKCM Tell City; WNWJ Valparaiso, all Ind; WSON, WKDQ(FM) Henderson/Evansville, Ky. Hqtrs: 20 North Wacker Drive, Chicago 60606. (312) 236-8887. Robert J. Walton, mgr. Rep: Walton Broadcasting Sales Corp.

Intermountain Network Inc.—KALL-AM-FM Salt Lake City; KLO Ogden; KOVO-AM-FM Provo; KVVU Logan; KOAL Price; KVEL Vernal; KURA Moab; KUTA Monticello/Blanding; KDXU St. George; KBRE Cedar City; KSCV Richfield; all Utah. KMER Kemmerer; KVOW Riverston; KVOC Casper; KPOW Powell; KWYO Sheridan; KRAL Rawlins; KFBC-AM-FM Cheyenne; KOWB-AM-FM Laramie; KASL Newcastle; KIML Gilette; KBBS Buffalo; KGOS Torrington; KWOR Worland; KSGT Jackson, all Wyoming. KWIK Pocatello, KTEE Idaho Falls; KLIX Twin Falls; KGEM Boise; KSVI Montpelier; KBAR Burley; KSKI Hailey, all Idaho. KGH Billings; KATL Miles City; KPRK Livingston; KBOW-AM-FM Butte; KBLL Helena; KXLO Lewistown; KMON-AM-FM Great Falls; KYSS-AM-FM Missoula; KBMN Bozeman; KALS(FM) Kalispell; KDBM-AM-FM Dillon; KLIZ Glasgow; KLCB Libby; KSEN Shelby all Montana. KELK Eiko, Nev. KNEB-AM-FM Scottsbluff, KSID Sidney; KCOW Alliance; KVSH Valentine; KCSR Chadron; KICS Hastings; KRNY-AM-FM Kearney; KICZ McCook; KAMI Cozad; KOGA Ogallala; KUVR-AM-FM Holdrege, all Nebraska. KPUB Pueblo; KGIW-AM-FM Alamosa; KVRH-AM-FM Salida; KGEK Sterling; KRCT Trinidad; KCOL Fort Collins; KYOU-AM-FM Greeley; KPIK-AM-FM Colorado Springs; KEXO Grand Junction; KBRR Leadville; KLAKE Denver; KBOL-AM-FM Boulder; KGUC Gunnison; KNAB Burlington; KWSR Rifle, all Colorado. KEYZ Williston, KBMR-AM-FM Bismarck, both North Dakota. KIMM Rapid City; KBFS Belle Fourche; KOBH-AM-FM Hot Springs; KCCR Pierre, all South Dakota. KENN Farmington, KYVA Gallup; KKIT Taos, all New Mexico. KPGE Page, Arizona. Hqtrs: 312 East South Temple, Salt Lake City, 84111. (801) 355-4641. Homer L. Peterson, pres; Jack Paige, exec VP; Charlie Vais, Denver mgr. Denver office, 7105 W. Hampden Avenue, Denver, Colo. 80227. (303) 988-1444. Rep: Eastman Radio Inc.

Intermountain-Midwest Radio Network—Comprising KGIW Alamosa, Colo.; KNAB Burlington, Colo.; KVOR Colorado Springs, Colo.; KVFC Cortez, Colo.; KIUP Durango, Colo.; KCOL Fort Collins, Colo.; KFTM Ft. Morgan, Colo.; KEXO Grand Junction, Colo.; KYOU Greeley, Colo.; KGUC Gunnison, Colo.; KBZZ La Junta, Colo.; KPUB Pueblo, Colo.; KVRN Salida, Colo.; KGEK Sterling, Colo.; KBMR Bismarck, N.D.; KEYZ Williston, N.D.; KENN Farmington, N.M.; KELK Eiko, Nev.; KGEM Boise, Idaho; KBAR Burley, Idaho; KTEE Idaho Falls, Idaho; KSVI Montpelier, Idaho; KWIK Pocatello, Idaho; KLIX Twin Falls, Idaho; KBFS Belle Fourche, S.D.; KOBH Hot Springs, S.D.; KCCR Pierre, S.D.; KIMM Rapid City, S.D.; KXRB Sioux Falls, S.D.; KSDR Watertown, S.D.; KYNT Yankton, S.D.; KBRE Cedar City, Utah; KVVU Logan, Utah; KLO Ogden, Utah; KOAL Price, Utah; KVEL Vernal, Utah; KGH Billings, Mont.; KBMN

Regional Radio Networks

Bozeman, Mont.; KBOW Butte, Mont.; KGLE Glendive, Mont.; KMON Great Falls, Mont.; KBLL Helena, Mont.; KGEZ Kalispell, Mont.; KPRK Livingston, Mont.; KXLO Lewistown, Mont.; KATL Mile City, Mont.; KYSS Missoula, Mont.; KSEN Shelby, Mont.; KCOW Alliance, Neb.; KCSR Chadron, Neb.; KAMI Cozad, Neb.; KICS Hastings, Neb.; KUVR-AM-FM Holdrege, Neb.; KRNY-AM-FM Kearney, Neb.; KICX McCook, Neb.; KOGA Ogallala, Neb.; KNEB Scottsbluff, Neb.; KSID Sidney, Neb.; KVSH Valentine, Neb.; KVOC Casper, Wyo.; KFBC Cheyenne, Wyo.; KIML Gilette, Wyo.; KSGI Jackson, Wyo.; KMER Kemmerer, Wyo.; KOWB Laramie, Wyo.; KASL Newcastle, Wyo.; KPOW Powell, Wyo.; KRAL Rawlins, Wyo.; KVOW Riverton, Wyo.; KWYO Sheridan, Wyo.; KGOS Torrington, Wyo.; KWOR Worland, Wyo. Hqtrs: 1565 Elmira St., Box 98, Aurora, Colo. 80010. (303)344-1444. Rep: RKO Radio Representatives.

Iowa Radio Network—Comprising KASI Ames, KJAN Atlantic, KROS Clinton, KCBF Des Moines, WDBQ Dubuque, KILR Estherville, KVFD Fort Dodge, KXIC Iowa City, KOKX Keokuk, KLEM Le Mars, KFJB Marshalltown, KSMN Mason City, KWPC Muscatine, KBQE Oskaaloosa, KAYL Storm Lake, KFJF Shenandoah. Hqtrs: 1000 Grand Ave., Des Moines 50309. (515) 244-2115. Chuck Ney, pres KAYL Storm Lake. Rep: Midwest Radio Reps.

Iowa Town and Country—Comprising KLGA-AM-FM Algona, KJAN-AM-FM Atlantic, KCOG Centerville, KCHA-AM-FM Charles City, KCLN-AM-FM Clinton, KDEC Decorah, KDSN-AM-FM Denison, KGRN Grinnell; KMAO-AM-FM Maquoketa, KCOB-AM-FM Newton, KDLS-AM-FM Perry, KIWA-AM-FM Sheldon, KWAY-AM-FM Waverly. Hqtrs: KMAO, Box 941, Maquoketa, Iowa 52060. Dick Brandt, pres; Wally Stangland, VP; Dennis Voy, sec; John Talbott, treas.

Ivy Network of College Stations—Comprising WTBU (Boston University), WYCB New Haven (Yale), WBRU Providence (Brown), WPRB Princeton (Princeton), WVBR Ithaca (Cornell), WKCR New York (Columbia), WXPB Philadelphia (U. of Penn.), WHRB Cambridge (Harvard), WDCR Hanover (Dartmouth), WZCB Chestnut Hill (Boston College), WMS Williamsstown (Williams), WTBS (MIT), WRSU (Rutgers), WESU (Wesleyan), WLRN (Lehigh), WRUC (Union College), WCHC Worcester (Holy Cross). Hqtrs: 242-A Yale Station, New Haven, Conn. 06520. Ivy Network Sls, 360 Lexington Ave., New York 10017. (212) 867-8073. Steven Eckert, pres; Antony Talalay, chmn; R. Joseph Cerato, sec-treas. Rep: National Educational Advertising Service.

Jaico-No/Cal Group—Comprising KFVY Arroya Grande; KIBS Bishop; KRML Carmel; KHOT, Madera; KMVC Marysville; KWIP Merced; KLOC Modesto; KONG Visalia. Hqtrs: J.A. Lucas, 6922 Hollywood Blvd., Suite M-3, Los Angeles 90028. (213)462-6655. Rep: J.A. Lucas.

Jaico-So/Cal Group—Comprising KWTC Barstow; KYOR Blythe; KXO El Centro; KKOK Lompoc; KSFE Needles; KWXY Palm Springs/Cathedral City; KLOA Ridgecrest; KSEE Santa Maria. Hqtrs: J.A. Lucas Co., 6922 Hollywood Blvd., Suite M-3, Los Angeles 90028. (213)462-6655. Rep: J.A. Lucas.

James Brown Network—Comprising WRDW Augusta, Ga.; WEBB Baltimore; WJBE Knoxville, Tenn. Hqtrs: Clifton & Denison Sts., Baltimore 21216. (301)947-1245. James Brown, pres; Gregory Moses, exec VP; Alan Garner, VP.

Kansas Radio Network—Comprising KSOK Arkansas City; KKOY Chanute; KNCK Concordia; KOY El Dorado; KVOE Emporia; KBWB Hutchinson; KANS Larned; KLWN Lawrence; KNEX McPherson; KNBI Norton; KWNS Pratt; KRSL Russell; KSKG(FM) Salina; KULY Ulysses; KLEY Wellington. Hqtrs: 20 N. Wacker Dr., Chicago (302)236-8887. New York 10017, 501 Fifth Ave. (212)972-0982. Detroit: Enterprise 7772; Minneapolis: Zenith 7772; St. Louis: Enterprise 41135. Robert J. Walton, mgr. Rep: Walton.

Kentucky Radio Network—Comprising WANY Albany, WCMi Ashland, WYVY Barbourville, WBRT Bardstow, WKXO Berea, WBGW Bowling Green, WTCC Campbellsville, WVCM-FM Carrollton, WMTA Central City, WAIN Columbia, WCTT Corbin, WYCN Cynthia, WHIR Danville, WIEL Elizabethtown, WSTL Eminence, WFKY Frankfort, WKAY Glasgow, WGOH Grayson, WHIC Hardinsburg, WHBN Harrodsburg, WHLN Harlan, WLLS Hartford, WKHC Hazard, WSON Henderson, WKCB Hindman, WKOA Hopkinsville, WIRV Irvine, WEKG Jackson, WJKY Jamestown, WIXI

Regional Radio Networks

Lancaster, WLBN Lebanon, WMTL Leitchfield, WAXU Lexington, WKDO Liberty, WVKY Louisa, WFMW Madisonville, WXXL Manchester, WMJL Marion, WNGO Mayfield, WFTM Maysville, WMK Middleboro, WFLW Monticello, WMOR Morehead, WMSK Morganfield, WMST Mt. Sterling, WLOC Munfordville, WNVL Nicholasville, WVJS Owensboro, WDXR Paducah, WSP Paintsville, WPKE Pikeville, WDOC Prestonsburg, WEKY Richmond, WLCK Scottsville, WCND Shelbyville, WSFC Somerset, WTKY Tompkinsville, WLKS West Liberty, WTCW Whitesburg, WEZJ Williamsburg, WWKY Winchester. Hqtrs: 408 Holiday Park Tower, 644 Linn St., Cincinnati 45203. (513) 651-1511. Don O. Hays, VP Reps: Regional Reps Corp.

Keystone Broadcasting System Inc.—Officers & Directors: Nicholas Gordon, pres (director); Charles A. Hammarstrom, VP; George W. Clark, VP

New York: 527 Madison Ave. 10022. (212) 355-3720. Eric Selch, acct exec; George F. Perkins, acct exec; Barbara Reich, office mgr.

Chicago: 111 W. Washington St. 60602. (312) 782-8900. Joseph Lipsitz, ctrlr; George W. Clark, VP; George Caccipio, acct exec; John Zebell, acct exec; Anita Larie, auditor; Jane McFadgen, traf mgr; Holly Shively, dir. stn relations.

Agency Commission: 15% on net station time to accredited agencies; no cash discount.

The stations can be bought separately. Minimum order 20 stations.

Stations may be purchased by state groups, regions or full network. One contract, one itemized invoice and individual station affidavits. Schedules, start dates, copy and/or live tags may vary from station to station. Rates for special combinations available on request.

Rep: Kadetsky Broadcast Properties, Boston; Charles N. Campbell, Detroit; McCintock Assoc. Inc. Los Angeles; Joel Rosenblum, Pittsburgh.

Knight Quality Stations—Comprising WGIR, WGIR-FM Manchester, N.H., WHEB, WHEB-FM Portsmouth, N.H., WSRW Worcester, Mass., WSAR Fall River, Mass., WEIM Fitchburg, Mass. Hqtrs: Room 300, 390 Commonwealth Ave., Boston, Mass. 02215. (617) 262-1950. Officers: Norman Knight, pres; N. Scott Knight, VP Rich Balsbaugh, natl sls mgr; Barbara E. Neale, VP and pub ser dir. Reps: Regionally: Knight Quality Station Sales. Nationally: Alan Torbet Associates.

La Gran Cadena—Comprising WORA-AM-FM Mayaguez, WPRP-AM-FM Ponce and WQBS-AM-FM San Juan, all Puerto Rico. Hqtrs: Box 13427, Sanlurce, PR. 09098. (809) 725-4020. Alfredo R. de Arellano, pres; Jose E. Falcon, mgr; Alfred D. Herger, prod dir.

Laird Group—Comprising KSDN Aberdeen, S.D.; WDXU-AM-FM Waupaca, WDUZ-AM-FM Green Bay, Wis.; 225 N. Adams St., Green Bay, Wis. 54035. (414) 435-5331. Ben A. Laird, pres; Kenneth E. Peterson, VP & gen mgr. Reps: H-R/Stone Rep.

Latin Network—Comprising WBNX New York; KALI Los Angeles; WFAB Miami; WFAN-FM Washington; KXEW-AM-FM Tucson, Ariz.; XERT McAllen, Tex.; XEAM Brownsville, Tex.; KVOZ Laredo, Tex.; XEWG El Paso, Tex.; XEBBC San Diego; KEPS Eagle Pass, Tex. Hqtrs: c/o UBC Sales Inc., 30 E. 42nd St., N.Y. 10017. (212) 682-1833. Rep: UBC Sales, Inc.

Laurel Radio Group—Comprising WOAD, WOMU(FM) Indiana, WCPA, WCPA(FM) Clearfield, WMAJ, WXLRFM) State College, all Penna. Hqtrs: Box 888, State College. (814) 237-4959.

Lazy K Group—Comprising KNUZ Houston; KQUE(FM) Houston; KAYC Beaumont, KAYD(FM) Beaumont. Hqtrs: KNUZ, Box 188, 4701 Caroline, Houston 77001. (713)523-2581. David H. Morris, pres; Forrest Patton, VP, sls. Rep: Katz.

The Linder Group—Comprising KWLM & KQIC(FM) Willmar, KMHL & KMHL(FM) Marshall, KTOE Mankato, KDMA Montevideo. Hqtrs: Box 838, Willmar, Minn. 56201. (612)235-1340. Harry W. Linder, pres; Willard Linder, mgr.

Lobster Network—Comprising WGUY Bangor, Me., WEGP Presque Isle, Me., WRUM-AM-FM Rumford, Me., WDSC(FM) Portland, Me. Hqtrs: 638 Congress St., Portland, Me. 04101. (207)774-6561. Reps: Masla Associates; Northeast Spot Sales, Boston.

Lone Star Farm & Ranch Network—Comprising KCAD Abilene, KBUD Athens, KALT Atlanta, KRUN Ballinger, KFYN Bonham, KKUB Brownfield, KEAN Brownwood, KHLB Burnet, KBEN Carrizo Springs,

KCLE Cleburne, KSTA, KSTA-FM Coleman, KVMC Colorado City, KCIIR(FM) Corsicana, WFAA Dallas, KDDO-KMRE Dumas, KERC Eastland, KGNT Georgetown, KCLW Hamilton, KPAN-FM Hereford, KHBR-KHBR-FM Hillsboro, KSAM Huntsville, KROY Laredo, KLVT Leveland, KCLT Lockhart, KFRO Longview, KMHT Marshall, KMWT Mineral Wells, KWBC Navasota, KGNB-KNBT-FM New Braunfels, KOYL-FM Odessa, KGRQ Pampa, KVWG Pearsall, KIUN Pecos, KVOP Plainview, KTEO San Angelo, KDSX-KDSX-FM Sherman, KSNY Snyder, KBEC Waxahachie, all Texas. Hqtrs: Box 1317, Ft. Worth. 76101. (817) 737-6631. Gene Craft, mgr.

Louisiana Network—Comprising WIKC Bogalusa, KCTO Columbia, WARB Covington, KAJN Crowley, WLBI Denham Springs, KDLA, KDLA-FM DeRidder, KTDL Farmerville, KFNV, KFNV-FM Ferriday, WKQT Garyville, WSLG Gonzales, WTGI Hammond, KCIL, KJIN Houma, KXKV Lafayette, WCKW Laplace, KBED, KLPL Lake Providence; KLLA Leesville, KREB Monroe, WSHO New Orleans, KWRG New Roads, KCWR, KREH Oakdale, KFLO Shreveport, KIKS Sulphur, KTLD Tallulah, KVCL-AM-FM Winnfield, KMAR-AM-FM Winnsboro. Hqtrs: Box 3691, Baton Rouge, La. 70821. Rhett R. McMahon, gen mgr & chief engr; John Brewer, ops dir; Ann McMahon, news dir. Rep: Pro/Meeker Radio.

Magic Circle Network—Comprising KSWM AM-FM Aurora; KSOA Va.; KBLR Bolivar; KBHM Branson, KMAM Butler, KMNR Cameron; KGMO Cape Girardeau, KTGR Columbia; KHAD DeSoto, KDEX Dexter; KDFN Doniphan; KYMO East Prairie, KESM El Dorado Springs; KEXS Excelsior Springs; KREI Farmington, KFTW Federicktown, KRFG-FM Greenfield; KBTC-AM-FM Houston; KPIA Ironton; KJAS Jackson; KODE Joplin, KLWT Lebanon; KTCB Malden; KEMM Marshfield, KNIM Maryville; KRMO Monett; KLRS Mountain Grove; KPWB Piedmont; KLID Poplar Bluff; KMIS Portageville, KYRO Potosi; KCLU Rolla, KETU(FM) Salem; KDRO Sedalia; KSIM Sikeston, KICK Springfield, KALM Thayer, KLPW Union; KOKO Warrensburg; KWRE Warrenton, KFBD Waynesville, KWPM(AM)-WKPM(FM) West Plains, KUKU Willow Springs, all Missouri; KMLA(FM) Ashdown, KBRI Brinkley, KVEE Conway; KCCB Corning, KFAY Fayetteville; KHOZ-AM-FM Harrison; KAMS(FM) Mammoth Springs; KPAC Parked Tree; KTCO Mtn. Home, KDRS Paragould, KCCL Paris; KPOC Pochontas; KAMO Rogers; KARV Russellville, KWCK Searay; KUOA Siloam Springs; KSPR Springdale; KWAQ Stuttgart; KTMN Truman, KRLW Walnut Ridge, KWYN Wynne, all Arkansas. KMDO Ft. Scott, KALN Iola, KLCK Parsons; KSEK Pittsburg, KWNS Pratt, all Kansas; KGCL Miami, KOLS Pryor; KVIN Vinita, all Oklahoma. Hqtrs: 1525 S. Glenstone, Box 3335, Springfield, Mo. 65804. (417)881-4114. M. Richard Bradley, gen mgr; Rep: Tom Corlett (Detroit). (313)961-3822.

Maine Broadcasting System—Comprising WCSH Portland, WLBZ Bangor. Hqtrs: 579 Congress St., Portland, Me. 04101. (207)772-0181. Mary R. Thompson, pres; Herbert W. Crosby, VP & gen mgr. Represented by Avery-Knodel Inc.; Bill Creed, New England.

Masla New York Suburban Plan—Comprising WHLI Hempstead, WHUD(FM) Peekskill, WLNA Peekskill, WGCH Greenwich, Conn.; WGLI Babylon; WVIP Mount Kisco; WBLI(FM) Patchogue. Hqtrs: Jack Masla & Co., 666 Fifth Ave., New York 10019. (212)489-1250. Stanley Feinblatt, eastern sls mgr. Rep: Jack Masla.

Michigan Rural Radio Network—Comprising WALM Albion; WFYC Alma; WLEW Bad Axe; WBCM Bay City-Saginaw; WKYO Caro; WCBY Cheboygan; WTVB Coldwater; WPLB Greenville; WJBL Holland; WHGR Houghton Lake; WHMI Howell; WION Iona; WBUK Kalamazoo; WTHM Lapeer; WKLA Ludington; WMPX Midland; WNL Niles; WAOP Otsego; WCAP Owosso; WJML Petoskey; WHAK Rogers City; WRBJ St. Johns; WMIC Sandusky; WIOS Tawas City; WKLM Three Rivers; WCCC Traverse City; WBMB West Branch; WLRC Whitehall. Hqtrs: 20 N. Wacker Dr., Chicago 60606. (312)236-8887. Detroit: Enterprise 7772; Minneapolis: Zenith 7772; St. Louis: Enterprise 41135. Robert J. Walton, mgr. Rep: Walton.

Mid Atlantic Network—Comprising WINC, WRFL(FM) Winchester, WFVA Fredericksburg, WSGM Mount Jackson, all Va.; WAYZ Waynesboro, WHYL Carlisle, both Pa.; WELD Fisher, W. Va. Hqtrs: Box 605, Winchester, Va. (703)667-2224. John P. Lewis, pres. Represented by Pro/Meeker Radio.

Midnight Sun Broadcasters—Comprising KENI Anchorage, KFAR Fairbanks, KTKN Ketchikan, KINY Juneau, all Alaska. Hqtrs: Box 1160, Anchorage 99510. 272-7461. Alvin O. Bramstedt, pres & gen

mgr; Don Andon, VP; R.D. Jensen, VP Rep: Avery-Knodel, New York; Simpson/Reilly & Assoc., West Coast.

Mid-South Network—Comprising WCBI Columbus, WELO-AM-FM Tupelo, WROX Clarksdale, WNAG Grenada, WONA Winona, all Mississippi. Hqtrs: Radio WELO, Box 410, Tupelo, Miss. 38801. (601) 842-7658. Bob Evans, gen mgr. Represented by Southern Spot Sales.

Minnesota Star Network—Comprising KXRA-AM-FM Alexandria, KQAO Austin, KBVE-AM-FM Blue Earth, KLIZ Brainerd, KROX Crookston, KGHS International Falls, KYSM-AM-FM Mankato, KSTP-AM-FM Minneapolis-St. Paul, KMRS Morris, KPRM-FM Park Rapids, KCUE-AM-FM Redwing, KROC Rochester, KFAM St. Cloud, KTRF Thief River Falls, KWAO-AM-FM Worthington, all Minnesota. Hqtrs: 3415 University Avenue, Minneapolis-St. Paul, 55114. (612)645-2724. Donald F. Jones, pres. Garfield Clark, mgr. Rep: Walton Broadcasting Sales Corp.

Missouri Network Inc. (Missourinet)—Comprising KWSM, KWSM-FM Aurora, KBLR, KLTB(FM) Bolivar; KBHM Branson; KGHM Brookfield, KMNR Cameron, KAOL, KAOL-FM Carrollton, KGMO, KGMO-FM Cape Girardeau; KDMO, KRKG(FM) Carthage; KTGR, KTGR-FM Columbia; KHAD De Soto; KDFN Doniphan; KRFG Greenfield; KSCM(FM), KBTC Houston; KPIA Ironton; KBTN Neosho; KPWB Piedmont; KYRO Potosi; KGBX Springfield; KSOA Va.; KLEX, KBK(FM) Lexington; KEMM Marshfield; KNIM, KNIM-FM Maryfield; KTRR, KZNN(FM) Rolla; KSIS-FM Sedalia; KOKO Warrensburg, KJPW Waynesville; KVSDFM) Waynesville, KBEA Kansas City; KBOA, KTMO(FM) Kennett; KMPL, KMPL(FM) Sikeston, all Missouri. Centertown, Mo. 65023. (314) 584-3317. Clyde G. Lear, mgr; Jim Lipsey, sls mgr; Bob Priddy, news dir; Derry Brownfield, farm dir; Gene Davis, asst farm dir

Missouri Radio Network—Comprising KCRV Charlestown, KCHR Charleston, KCHI Chillicothe, KDKD Clinton, WCBW Columbia/St. Louis, KDEX Dexter, KHMO Hannibal, KWOS Jefferson City, KFBS Joplin, KMMO Marshall, KWIX Moberly, KLID Poplar Bluff, KTRR Rolla, KSIS Sedalia, KMPL Sikeston, KGBX Springfield, KUSN St. Joseph, KTTN Trenton, KOKO Warrensburg, KJPW Waynesville. Hqtrs: 20 N. Wacker Drive, Chicago 60606. (312)236-8887. Detroit: Enterprise 7772; Minneapolis: Zenith 7772; St. Louis: Enterprise 41135. Rep: Walton Broadcasting Sales Corp.

Mountaineer Group—Comprising WSKY Asheville, WYKX Burnsville, WWIT Canton, WCSL Cheryville, WHKP Hendersonville, WKRK Murphy, WCOK Sparta, WMSJ Sylva, WTYN Tryon. Hqtrs: 108 College St., Asheville, N.C. 28801. (704)253-4884. Charles H. Reynolds, sec, treas. Reps: South—Media Sales/South.

National AgRadio Groups—Comprising Milk, Beef, Hog, Broiler, Corn, Soybean, Wheat, Tobacco, Cotton and Egg groups of stations in all parts of the U.S. Hqtrs: 9414 Crosby Rd., Silver Spring, Md. 20910. (301)588-5065. Erny Tannen, pres. Rep: Media America Co.; Radio and TV Sales, Canada.

National Spanish Language Network—Comprising KORJ-FM Garden Grove, KLBS-AM-FM Los Banos, KFAX San Francisco, all Calif.; XEAZ and XEAX San Diego/Tijuana, Mexico; WEDC, WSBC, WXRT-FM all Chicago; WTEL Philadelphia; KRDD Roswell, N.M.; WHBI-FM Newark, N.J.; WZAK-FM Cleveland; KCFH Cuero, KFST Ft. Stockton, KIRT Mission/McAllen; KSTJ-FM San Angelo, KLVL Pasadena/Houston, all Tex.; XEAE Del Rio, XEKD, Del Rio, XEO Reynosa/McAllen, XEOR Matamoros/Brownsville; XEAS Nuevo Laredo/Laredo, XENU Nuevo Laredo/Laredo, XHNOE-FM Nuevo Laredo/Laredo, all Mexican stations. Hqtrs: 275 Madison Ave., New York 10016. (212)889-1200. Rep: National Time Sales.

Nebraska Radio Network—Comprising KCOW Alliance, KCNI Broken Bow, KJSK Columbus, KAMI Cozad, KGMT Fairbury, KTNC Falls City, KICS Hastings, KUVR-AM-FM Holdrege, KRNY Kearney, KECK Lincoln, KBRL McCook, KAHL North Platte, KOGA Ogallala, KBRX O'Neill, KNLV Ord, KOTD Plattsmouth, KEYS Scottsbluff, KFERS Superior, KTCH Wayne, KAWL York. Hqtrs: 20 N. Wacker Drive, Chicago 60606. (312)236-8887. Detroit: Enterprise 7772; Minneapolis: Zenith 7772; St. Louis: Enterprise 41135. Robert J. Walton, mgr. Rep: Walton Bcstg Slc Corp.

New South Radio Network—Comprising WWUN Jackson, WOKK Meridian, WLSM Louisville, WVMI Biloxi, WNSL Laurel, all Mississippi. Hqtrs: Box 5797,

Meridian. (601)693-2661. Joseph W. Carson, gen mgr. Represented nationally by Savalli/Gates.

New York Farm Network—Comprising WKOL Amsterdam, WBTA Batavia, WKOP Binghamton, WDOE Dunkirk, WIGS Gouverneur, WALLY Herkimer, WHHO Hornell, WHCU Ithaca, WJTN Jamestown, WUSJ Lockport, WCHN Norwich, WSGO Oswego, WPDW Potsdam, WADR Remsen, WIPS Ticonderoga, WBVM Utica, WDLA Walton, WAVR Waverly, WLSV Wellsville. Hqtrs: 20 N. Wacker Drive, Chicago 60606. (312)236-8887. Rep: Walton Bcstg Sales Corp.

North Carolina News Network—Western Leg comprised of WZKY Albermarle; WCSE Asheboro; WSKY Asheville; WIST Charlotte; WEGO Concord-Kannapolis; WPEG Concord-Kannapolis; WGSAS Gastonia; WGBG Greensboro; WHKY Hickory; WNOS-AM-FM High Point; WBLY-AM-FM Lexington; WDSL Mocksville; WRDX Salisbury; WSIC Statesville; WFMX Statesville; WTLK Taylorsville; WSVN Valdese; WSEK Winston-Salem; WGPL Winston-Salem; WYDK Yadkinville.

Eastern Leg WRCS-AM-FM Ahsokie; WRRZ Clinton; WCDJ Edenton; WGAI Elizabeth City; WBLA Elizabethtown; WFMO Fairmont-Lumberton; WFAG Farmville; WEGR Goldsboro; WGBR Goldsboro; WNCT-FM Greenville; WIZS Henderson; WRNS Kinston; WEWO Laurinburg; WSTS Laurinburg; WYRN Louisiana; WMBL Morehead City; WHIT New Bern; WRAL Raleigh; WCBT Roanoke Rapids; WCCE Rocky Mount; WFMK Rocky Mount; WRXO Roxboro; WWPB-AM-FM Sanford; WYAL Scotland Neck; WBBZ Selma; WEEB Southwestern Pines; WPCS Tarboro; WLSE-AM-FM Wallace; WITN Washington; WQBR Wanchese; WENC-AM-FM Whiteville; WIAM-AM-FM Williamston; WGNL Wilmington; WGTN Wilson; WBTE Windsor. Hqtrs: 137 S. Salisbury St., Box 1988, Raleigh, N.C. 27602. (919)832-8885. Wally Voight, VP; Paul von Hagel, natl acct exec; Allen B. Jones, regl acct exec.

North Country Stations of Vermont—Comprising WTVN St. Johnsbury, WIKI Newport, both Vermont. Hqtrs: WTVN, Concord Ave. (802)748-2344. St. Johnsbury, E. Dean Finney, pres & gen mgr; Bryan E. Meilleur, asst mgr. Represented nationally by Jack Masla & Co., Inc., New England Spot Sales in New England.

Northern News Network—Comprising WSUF Patchogue; WHRF Riverhead; WRCN(FM) Riverhead. Hqtrs: WPAC, Box 717, Patchogue, N.Y. 11772. James L. Putrese, gen mgr; Richard Saporiti, sls mgr; Don Karnes, news dir. Rep: Masla.

Northern Power Network—Comprising WCCW Traverse City; WHAK Rogers City, WHGR Houghton Lake, WJML Petoskey, all Mich. Hqtrs: 346 East State St., Traverse City, Mich. 49684. (616) Windsor 6-2111. Rep: Walton Radio Slis; Mich. Spot Slis, Detroit.

Ohio Radio Network—Comprising WNCO Ashland, WAQI Ashtabula, WATH Athens, WOMP Belleaire, WTOO Bellefontaine, WMGS Bowling Green, WBNO Bryan, WBEO Bucyrus, WINW Canton, WBKC Columbus, WBEX Chillicothe, WNRE Circleville, WMNI Clardumb, WWOV Conneaut, WVAI, WDAO(FM) Dayton, WONW Defiance, WDLR Delaware, WJER Dover, WEOL, WBEA(FM) Elyria-Lorain, WFIN Findlay WFOB Fostoria, WFRO Fremont, WJEH Gallipolis, WDRK(FM) Greenville, WCNW Hamilton, WSRW Hillsboro, WIRO Ironton, WLMJ Jackson, WKNT Kent, WLN(FM) London, WMAN Mansfield, WBRJ Marietta, WDFI(FM) Marion, WTIG Massillon, WMPD Middleport/Pomeroy, WPFB Middletown, WMVO Mount Vernon, WCLT Newark, WPTW Piqua, WNXN Portsmouth, WLEC Sandusky, WMVR Sidney, WBLY Springfield, WEIR Steubenville/Weirton, WTUU Toledo, WBTC Uhrichsville, WERT Van Wert, WHHH Warren, WCHO Washington C.H., WPKO Waverly, WKFI Wilmington, WWST Wooster, WHOT Youngstown, WHIZ Zanesville. Hqtrs: 9th flr, 1220 Huron Rd., Cleveland 44115. (216) 781-0035. Norbert J. Kocob, gen mgr. Reps: Regional Reps.

Oklahoma Farm Network—Comprising KTEN-FM Ada; KWHW Altus; KEOR Atoka; KWCO Chickasha; KWEO Clinton; KGYN Guymon; KYVL Holonville; KOKL Okmulgee; KXJO Sapulpa. Hqtrs: 20 N. Wacker Dr., Chicago 60606. (312)236-8887. Detroit: Enterprise 7772; Minneapolis: Zenith 7772; St. Louis: Enterprise 41135. Robert J. Walton, mgr. Rep: Walton Bcstg Slis Corp.

Oklahoma News Network—Comprising KADA Ada, KWHW Altus, KALV Alva, KRPT Anadarko, KVSO Ardmore, KYFM Bartlesville, KGOY Bethany, KLTR Blackwell, KXXX Chickasha, KWPR Claremore, KUSH

Cushing, KRHO Duncan, KSEO Durant, KSEO-FM Durant, KADS Elk City, KCRC Enid, KCES Eufaula, KTAT Frederick, KOKC Guthrie, KHEN Henryetta, KHEN-FM Henryetta, KTJS Hobart, KBEL, KWDG Idabel, KSWO Lawton, KMAD Madill, KNED McAlester, KNED-FM McAlester, KGLC Miami, KBIX Muskogee, KGOU, WNAD Norman, KNFB Nowata, KAFG, KTOK Oklahoma City, KOKL Okmulgee, KOKN Pawhuska, KVLH Pauls Valley, KLOK POCOA City, KLCO Poteau, KLCO-FM Poteau, KRBB Sallisaw, KRBB-FM Sallisaw, KXOJ Sapulpa, KGFF Shawnee, KVRO Stillwater, KTLO Tahlequah, KTLO-FM Tahlequah, KRMG Tulsa, KJEM Wagoner, KWEY Weatherford, KWSH Wewoka. Hqtrs: 235-Box 1000, Oklahoma City 73101. (405)235-1671. Rep: Eastman Radio.

Paul Bunyan Network—Michigan regional network comprising WTCM-AM-FM Traverse City; WATT Cadillac; WATZ-AM-FM Alpena; WMBN-AM-FM Petoskey; WATC Gaylord; WPBN-TV Traverse City; WTOM-TV Cheboygan. Hqtrs: Paul Bunyan Bldg, Traverse City 49684. (616)947-7675. Les Biederman, pres; Harry R. Lipson, gen mgr TV stns; Jack Walkmeyer, gen mgr radio stns; Russell H. Loomis, bus mgr; Cordon & Jacob, atty; William H. Kiker, chief engr. Represented nationally by Alan Torbet Associates Inc. (radio); Adam Young Inc. (television).

Pennsylvania Farm Network—Comprising WHOL Allentown, WBVO(FM) Boyertown, WISR Butler, WARO Canonsburg, WCHA Chambersburg, WWCH Clarion, WGS A Ephrata, WHJB Greensburg, WAZL Hazleton, WDAO Indiana, WJAC Johnstown, WKZA Kane, WDAC-FM Lancaster, WQTV Latrobe, WKVA Lewistown, WBPZ Lock Haven, WGBY New Castle, WPPA Pottsville, WATS Sayre, WBTJ Scranton, WPIC Sharon, WVSC Somerset, WETA Tamaqua, WTV Titusville, WMBS Uniontown, WRAC Williamsport. Hqtrs: 20 N. Wacker Drive, Chicago 60606. (312)236-8887. Detroit: Enterprise 7772; Minneapolis: Zenith 7772; St. Louis: Enterprise 41135. Rep: Walton Bcstg.

Pine Tree Radio Network—Comprising WQDY Calais, WHOU Houlton. Hqtrs: 281 Main St., Calais, Me. 04619. (207)454-7545. Buffalo Bob Smith, pres; Daniel F. Hollingdale, gen mgr.

PSA Broadcasting Group—Comprising KLVE(FM) Los Angeles; KEZR(FM) San Jose. Hqtrs: 7919 Sunset Blvd., Los Angeles, Calif. 90046. (213)874-5772. Reps: John A. Potter & Co. (KLVE-FM).

Radio Smiles Group—Comprising WFBS Spring Lake, N.C.; WISP Kinston, N.C.; WRNC Raleigh, N.C.; WSMY Weldon, N.C.; WSMI Graham N.C.; WLPN Suffolk, Va.; WFOG(FM) Suffolk, Va. Hqtrs: PO. Box 622, Fayetteville, N.C. (919)483-1461. N.J. Suttles, pres; Jerry Oakley, VP. Rep: So. Spot Sales.

Rollins Inc.—Comprising KDAY Santa Monica, Calif., WAMS Wilmington, Del., WBEE Harvey, Ill., WCHS-AM-TV Charleston, W. Va., WBES(FM) Charleston, W. Va., WRAP Norfolk, Va., WEAR-TV Pensacola, Fla., WPTZ(TV) Pittsburgh, N.Y. Hqtrs: PO. Box 647, Atlanta 30301. (404)873-2355.

Silver Dollar Network—Comprising KOOK Billings; KXLF Butte; KUDI Great Falls; KOFI Kalispell; KXXL Bozeman; KYLT Missoula; KWYS W. Yellowstone. Hqtrs: Box 1276, Billings, Mont. 59103. (406)248-7827. Reps: Alan Torbet Assoc. John McGuire, Denver. Art Moore, Seattle.

Skyline Network—Comprising WBIP Booneville, Miss.; WBOP Pensacola, Fla.; WBOP-FM Pensacola, Fla.; WGCM Gulfport, Miss.; WTAM-FM Gulfport, Miss.; WOKJ Jackson, Miss.; WTUG Tuscaloosa, Ala.; WTUP Tupelo, Miss. Hqtrs: Box 232, Booneville, Miss. 38829. (601)728-5301. E.O. Roden, gen mgr.

Star Broadcasting System (Western Star Radio Ntwk/American Star Radio Ntwk). PO. Box 11963, Salt Lake City 84111. (801) 966-5627. Richard E. Reep, pres. Rep: Star Broadcasting Sales Division.

Stuart Bcstg Co.—Comprising KRGI, KRGI-FM Grand Island, Neb.; KFOR, KFOR-FM Lincoln, Neb.; WMay Springfield, Ill.; KMNS, KSEZ(FM) Sioux City, Iowa; KSAL, KVEZ-FM Salina, Kan. KOEL-AM-FM Oelwein, Iowa; KWTO, KWTO-FM Springfield, Mo. Hqtrs: 625 Stuart Bldg., Lincoln, Neb. 68508. (402)475-4204. Richard W. Chapin, pres; Orval Koch, asst to pres. Rep: Abels, Omaha.

Suburban Radio Group—Comprising WCGC Belmont, N.C.; WEGO Concord, N.C.; WPEG(FM) Concord, N.C.; WJJJ Christiansburg, Va.; WHVH Hillsville, Va.; WVVV(FM) Blacksburg, Va.; WSVN Valdese, N.C.; WZKY Albermarle, N.C. Hqtrs: PO. Box 888, Belmont, N.C. 28012. (704)825-8224. Robert R. Hilker, pres;

Regional Radio Networks

William R. Rollins, exec VP; Lewis Bagwell, grp VP. Rep: Southern Spot Sales.

Texas Spanish Language Network—Comprising KLVU Houston, XEAX San Diego, XEAX San Diego, XEO Matamoros, Mexico (Brownsville); XEOR Reynosa, Mexico (McAllen); XEAE, XEKD Ciudad Acuna, Mexico (Del Rio); KIRT Mission; XEAS, XENU, XHNOE-FM Laredo/Nuevo Laredo, Mex.; KFST Fort Stockton, and KCFH Cuernavaca. Hqtrs: 275 Madison Ave., New York 10016. (212)889-1200. Represented nationally by National Time Sales Inc. (New York, Chicago, Atlanta, Los Angeles, San Francisco, Tulsa, Dallas, Memphis, Seattle).

Texas State Network—Comprised of interconnected stations KWKC Abilene, KOPY Aine, KBUD Athens, KALT Atlanta, KOKE-AM-FM Austin, KRUN Ballinger, KBUK Baytown, KLVJ Beaumont, KWGH Big Lake, KBST Big Spring, KFYN Bonham, KBBB, KBBB-FM Borger, KBAN Bowie, KNEI Brady, KSTB Breckenridge, KTXB Brenham, KWHI(FM) Brenham, KKUB Brownfield, KBOR Brownsville, KBWD Brownwood, WTAW-AM-FM Bryan, KHLB Burnet, KEBEN Carizo Springs, KGAS Carthage, KDET Center, KCTX Childress, KCLM Cleburne, KSTA Coleman, KVMC Colorado City, KCOM Comanche, KEYS Corpus Christi, KAND Corsicana, KBSN Crane, KCFH Cuero, KXIT-AM-FM Dalhart, KRLD Dallas, KWMC Del Rio, KDNT Denton, KDDD, KMRE-FM Dumas, KERC Eastland, KURV Edinburg, KFST, KPJH-FM Fort Stockton, KFJZ Ft. Worth, KGAF-AM-FM Gainesville; KILE Galveston; KGTN, KGTN(FM) Georgetown; KSWA Graham, KGVJ Greenville, KCLW Hamilton, KWRO Henderson, KPAN-AM-FM Hereford, KHBR-AM-FM Hillsboro, KPRC, KRLY(FM) Houston, KSAM-AM-FM Huntsville, KERB Kermit, KIXS KIXS(FM) Killeen, KINE Kingsville, KPUP(FM) Kingsville, KPET Lamesa, KOYE Laredo, KVOZ Laredo, KLVT Levelland, KPXE Liberty, KZZN Littlefield, KETX-AM-FM Livingston, KCLT Lockhart, KLUE Longview, KRBA Lufkin, KLLM-AM-FM Lubbock, KMHT Marshall, KYAL McKinney, KNAM, KNFM-FM Midland, KMOO Mineola, KORC Mineral Wells, KVKM Monahan, KIMP KPXI-FM Mt. Pleasant, KEEE, KJCS Nacogdoches, KWBC Navasota, KNBO New Boston, KGNB and KNBT-FM New Braunfels, KBZB Odessa, KNET Palestine, KGRG Pampa, KPLT Paris, KVWG Pearsall, KIUN Pecos, KEYE Perryton, KVOP KPLA Plainview, KPOS Post, KTLU Rusk, KIXY-AM-FM San Angelo, KIKM-AM-FM Sherman, KKXX San Antonio, KSEY Seymour, KSNY Snyder, KBMF-FM Spearman, KDWT Stamford, KSTV Stephenville, KSST Sulphur Springs, KXOX Sweetwater, KTER Terrell, KTFS Texarkana, KTUE Tulia, KDOK and KNUE-FM Tyler, KVOU Uvalde, KWTX-AM-FM Waco, KBEC Waxahachie, KZEE Weatherford, KNTO-FM Wichita Falls, all Texas. KBEL Idabel, Okla. Hqtrs: Box 1317, 4801 W. Freeway Fort Worth 76107. (817)737-6631. Gene Craft, mgr.

Tichenor Radio Group—Comprising KGBT Harlingen, Tex., KUNO Corpus Christi, Tex., KIFN Phoenix, KLT-FM Harlingen, Tex., WACO-AM-FM Waco, Tex. WGMA Hollywood, Fla. Hqtrs: KIFN Inc., 147 E. Garfield, Phoenix 85004. (602)257-9363. Willie Harris Jr., VP-gen sls mgr.

Tobacco Radio Network—Comprising stations in N.C., S.C., Ga., Va., Fla., Ala. Hqtrs: 130 S. Salisbury Street, Box 1988, Raleigh, N.C. 27602. (919)832-8885. Wally Voigt, gen mgr; Paul von Hagel, natl acct exec; Allen B. Jones, regional acct exec. Rep: TN Spot Sales.

Viking Radio Network—Comprising KKIN Aitkin, KASM Albany, KBMO Benson, KBEW Blue Earth, KROX Crookston, KDWA Hastings, KDUZ Hutchinson, KLFD Litchfield, KEYL Long Prairie, KOAD Luverne, KYSM Mankato, WMIN Minneapolis/St. Paul, KMRS Morris, KTFM New Prague, KYMN Northfield, KRFO Owatonna, KFIL Preston, KCUE Red Wing, KFAM St. Cloud, KRBI St. Peter, KWAD Wadena, KDOM Windom, KAGE Winona, all Minn. Hqtrs: 20 N. Wacker Dr., Chicago 60606. (312)236-8887. Detroit: Enterprise 7772; Minneapolis: Zenith 7772; St. Louis: Enterprise 41135. Robert J. Walton, mgr. Rep: Walton Bcstg Slis Corp.

Voice of Southwest Agriculture Radio Network—Comprising KCRS Midland, KPET Lamesa, KHEM, KFNE Big Spring, KVMC Colorado City, KIKZ Seminole, KXOX Sweetwater, KNIT-FM Abilene, KGKL San Angelo, KNEI Brady, KOXE(FM), KBWD Brownwood, all Tex. Hqtrs: Box 3610, San Angelo, Tex. 76901. (915)944-1213. Roddy Peoples, farm & ranch dir & own.

Regional Radio, Public Bcstg.

Weatherscan Radio Network—Comprising KOCY, KLPR, KBYE, KOFM, KFJL, all Oklahoma City; KCCO Lawton, KCCO-FM Lawton, KRPT Anadarko, KUSO Ardmore, KTMK McAlester, KEOR Atoka, KWON Bartlesville, KLTR Blackwell, KWEO-AM-FM Clinton, KUSH Cushing, KNOR Norman, KLOR Ponca City, KTEA Ada, and KBJH-FM Tulsa, all Oklahoma. Hqtrs: 1500 Union Founders Tower, Oklahoma City 73112. (405)848-6566. Frank Rees, pres; Ted Mueller, gen mgr. Reps: Walton, Chicago; Messina, Dallas.

Western States Radio Empire—Comprising KBRO Bremerton, KITI Centralia/Chehalis, KCVL Colville, KULE Ephrata, KVAC Forks, KBAM Longview, KITN Olympia, KOMW Omak, KPUL Pullman, KAPA Raymond, KMAS Shelton, KDFL Sumner/Puyallup, KMEL Wenatchee, all Wash.; KGRL Bend, KBBR Coos Bay-North Bend, KEED Eugene, KOHU Hermiston, KMCM McMinnville, KTXI Pendleton, KRCO Prineville, KYES Roseburg, KOHI St. Helens, KACI The Dalles, all Ore. Hqtrs: c/o Jack Masla & Co., 666 Fifth Ave., New York 10019. (212)489-1250. Roger O'Connor, sls mgr. Rep: Masla.

Public Broadcasting

Corporation for Public Broadcasting

Headquarters: 1111 16th St. N.W., Washington 20036. (202) 293-6160.

Board of directors: Dr. James R. Killian Jr. (honorary chmn of CPB bd), M.I.T., Room 9-235, 77 Massachusetts Ave., Cambridge, Mass. 02138. (617) 253-1515; Dr. Gloria L. Anderson, professor & chmn, chemistry dept, Morris Brown College, Atlanta 30314. (404) 525-7831 (term ends 1978); Robert S. Benjamin, chmn, finance committee, United Artists Corp., 729 Seventh Ave., New York 10019. (212) 475-3093 (term ends 1976); Virginia B. Duncan, prod & dir, KOED(TV) San Francisco, 174 Harrison St., Sausalito, Calif. 94965. (415) 332-5786 (term ends 1976); Michael A. Gammino Jr., pres, Columbus National Bank, 33 Weybosset St., Providence, R.I. 02901. (401) 351-9200 (term ends 1978); Lucius Perry Gregg Jr., VP, personal banking dept, The First National Bank of Chicago, One First National Plaza, Chicago 60670 (term ends 1980); Lillie E. Herndon, immediate past pres, National Congress of Parents & Teachers, Box 6213, Columbia, S.C. 29260. (803) 787-0556 (term ends 1980); Amos B. Hostetter, exec VP, Continental Cablevision Inc., 54 Lewis Wharf, Boston 02110. (617) 742-8265 (term ends 1978); Joseph D. Hughes, atty, 1404 Oliver Bldg, Pittsburgh 15222. (412) 281-7854 (term ends 1978); Thomas W. Moore, Thomas Moore Entertainment Inc., 870 United Nations Plaza, Suite 10D, New York 10017. (212) 421-2424 (term ends 1976); Donald E. Santarelli, atty, Amram, Hahn, Sandground & Santarelli, Colorado Bldg, Suite 700, 1341 G St. N.W., Washington 20005. (202) 783-3344 (term ends 1980); Frank E. Schooley, 504 W. Springfield Ave., Champaign, Ill. 61820. (217) 352-8334 (term ends 1976); W. Allen Wallis, chancellor and professor of economics and statistics, University of Rochester, Rochester, N.Y. 14627. (716) 275-2525 (term ends 1980); Jack Wrather, Wrather Corp., 270 N. Canon Drive, Beverly Hills, Calif. 90210. (213) 272-4875 (term ends 1976).

Principal Personnel: Henry Loomis, pres; Scott Miller, exec VP; Donald Quayle, senior VP & dir of bcstg; Ben Posner, VP, finance, planning, and administration, & treas; Thomas Gheradi, gen counsel & sec to the corporation; Paul Mutino, asst gen counsel; Peter Laveths, dir of corporate rel; Douglas Bodwell, dir of educ activities; Philip Rubin, dir of engrg; George D. Ward, dir of external audit; William Simms, dir of financial mgt & accounting; Jon Del Vitto, dir of gen svcs; George Linn, asst to the pres for legislative affairs; Clinton W. Powell, spec asst to the pres for minority affairs; Lily A. Okura, dir of per; Joe Widoff, dir of budget & mgt info; Michael Graham, dir of info systems; Joe Dine, dir of public info; Steve Millard, dir of publications; Robert F. Hostetter, dir of volunteer activities; Thomas Warnock, dir of radio ac-

Wisconsin Educational Radio Network (State of Wisconsin-Educational Communications Board). Comprising WERN Madison, WHAD Delafield, WPNE Green Bay, WLBL Auburndale, WHRM Wausau, WWSA Brule, WHWC Colfax, WHLA Holmen, WHHI Highland, all Wis. 732 North Midvale Boulevard, Madison, Wis. 53705. (608)266-0036. Tony Moe, exec dir; Paul Norton, asst dir, ECB.

Wisconsin Farm Broadcasting Network—Comprising WBEL Beloit, WDMP Dodgeville, WTSO Madison, WCCN Neillsville, WPRE Prairie du Chien, WCWC Ripon, WHBL Sheboygan, WCOW-AM-FM Sparta, WTTN Watertown, WXCO Wausau. Hqtrs: Box 44, Madison, Wis. 53701. (608)274-1440. John B. Zimmerman, gen mgr.

Wisconsin Network Inc.—Comprising WHBY Appleton, WEAQ Eau Claire, KFIZ Fond du Lac, WGEE Green Bay, WCLO Janesville, WIZM La Crosse, WISM Madison, WCUB Manitowish, WEMP Milwaukee, WYTL Oshkosh, WJBU Poynette, WRJN Racine, WSAU Wausau, WBKV West Bend, WFHR Wisconsin Rapids, all Wisconsin. Hqtrs: 220 1st Ave. S., Wisconsin Rapids, Wis. 54494. (715) 424-1300. Jack R. Genaro, gen mgr.

ivities; Leon Rosenbluth, dir of rsch; Calvin Watson, dir of TV activities.

NPACT

National Public Affairs Center for Television (division of WETA-TV Washington) 955 L'Enfant Plaza North S.W., Washington 20024. (202) 484-1500.

Officers: Ward Chamberlin, pres of WETA-TV; Gerald Slater, exec VP of WETA-TV; Al Vecchione, exec dir for pub affrs progmg of WETA-TV/NPACT; Wallace Westfield, exec prod of pub affrs progmg of WETA-TV/NPACT.

NPACT is a national public affairs production center for the Public Broadcasting Service; producer of special events; and producer of *Washington Week in Review* and *Evening Edition with Martin Agronsky*.

Educational Broadcasting Corp.

304 West 58th St., New York 10019. (212) 262-4200. Owner and licensee of WNET New York, channel 13. Local public television station and (having absorbed the functions of the former National Educational Television) major source of programing distributed nationally to 250 public television stations by the Public Broadcasting Service.

Principal personnel: John Jay Iselein, pres & gen mgr; Robert Kotlowitz, VP & dir of progmg; Jerome Toobin, dir of pub affrs; George Marketos, treas; Hudson G. Stoddard, VP & dir for dev; Frank Leicht, VP & dir of opns; Angela N. Solomon, dir of pub info; Shirley B. Gillette, dir, educ div.

Public Broadcasting Service

Headquarters: 485 L'Enfant Plaza West, S.W., Washington 20024. (202) 488-5000.

Principal personnel: Hartford N. Gunn Jr., vice chmn; Lawrence K. Grossman, pres; Michael E. Hobbs, VP, corp planning; Frank Little, VP, progmg; Chalmers H. Marquis, VP, natl affairs; Norman M. Sinel, VP, gen counsel; Charles A. Margetta, VP, finance; William T. Reed, dir member svcs; Jeane R. Young, dir public info.

Board of Governors: M. M. Anderson (1976), retired exec VP, Aluminum Co. of America, Pittsburgh

(representing WCED [TV] Pittsburgh); Edmund F. Ball (1977), chmn, Ball Corp., Muncie, Ind. (representing WIPB [TV] Muncie); Kendrick F. Bellows Jr. (1977), exec VP, Conn. Bank & Trust Co., Hartford, Conn. (representing Conn. Public TV Net); Mrs. Allan E. Charles (1977), VP, bd of trustees, Stanford U. (representing KQED [TV] San Francisco); Mrs. Edward N. Cole (1975) (representing WTVS[TV] Detroit); Dr. William C. Friday (1976), pres, U. of North Carolina, Chapel Hill, N.C. (representing U. of North Carolina TV Net); Alfred C. Galloway (1975), pres, Community Fed Savings & Loan Assn, Nashville (representing WDCN-TV Nashville); Dr. James G. Harlow (1976), pres, West Virginia U., Morgantown, W. Va. (representing WVWU-TV Morgantown); C. Bart Hawley (1975), Central region mgr, Borden Chemical Div, Cincinnati (representing WCET[TV] Cincinnati); Dr. Philip Heckman (1976), pres, Doane College, Crete, Neb. (representing Neb. Educl TV Commission); Ethan A. Hitchcock (1975), Webster, Sheffield, Fleischmann, Hitchcock & Brookfield, New York (representing WNET[TV] New York); Richard E. Hodges Jr. (1976), Liller, Neal, Battle & Lindsey Inc., Atlanta (representing WETV[TV] Atlanta); John Lowell (1977), Welch & Forbes, Boston (representing WGBH-TV Boston); Dr. Donald R. McNeil (1977), dir, Post-Secondary Educ Commission, Sacramento, Calif. (representing KVIE[TV] Sacramento); Newton N. Minow (1976), Sidley & Austi, Chicago (representing WTTW[TV] Chicago); William B. Quarton (1976), retired exec VP, American Bcstg Stns Inc., Cedar Rapids, Iowa (representing Iowa Educl Bcstg Net); Ralph B. Rogers (1975), chmn, Texas Industries Inc., Dallas (representing KERA-TV Dallas); Mrs. Bert E. Roper (1975) (representing WMFE-TV Orlando, Fla.); Leonard H. Rosenberg (1977), chmn, Chesapeake Life Insurance Co., Baltimore (representing Maryland Center for Public Bcstg); Dr. John W. Ryan (1975), pres, Indiana U., Bloomington, Ind. (representing WTIU-TV Bloomington); Dr. John W. Schwada (1976), pres, Arizona State U., Tempe, Ariz. (representing KAET[TV] Phoenix); Mrs. Stephen Stranahan (1975) (representing WGTE-TV Toledo, Ohio); Irby Turner Jr. (1977), city atty, Belzoni, Miss. (representing Miss. Authority for Educl TV); Robert G. Waldo (1977), VP for university relations, U. of Washington, Seattle (representing KCTS-TV Seattle); Don E. Weber (1976) (representing KEDT[TV] Corpus Christi, Tex.).

Board of Managers: Dr. George E. Bair (1975), U. of North Carolina TV Net, Chapel Hill, N.C.; Frank R. Barreca (1976), KUAT-TV Tucson, Ariz.; Ronald C. Bornstein (1976), WHA-TV Madison, Wis.; Martin P. Busch (1975), KUSD-TV/South Dakota ETV Bd., Vermillion, S.D.; Henry J. Cauthen (1977), South Carolina Educl TV Commission, Columbia, S.C.; J. Michale Collins (1977), WNED-TV Buffalo, N.Y.; Miss Betty Cope (1976), WVIZ-TV Cleveland; Miss Dona Lee Davenport (1975), WTVI(TV) Charlotte, N.C.; Robert H. Ellis (1975), KAET(TV) Phoenix; Dennis L. Falk (1977), KFME(TV) Fargo, N.D.; Donley F. Feddersen (1976), WTIU-TV Bloomington, Ind.; Dr. Lawrence T. Fyrmir (1975), New Jersey Public Bcstg Authority, Trenton, N.J.; William S. Hart (1977), WYES-TV New Orleans; David O. Ives (1976), WGBH Educl Foundation, Boston; Lloyd Kaiser (1976), WQED(TV) Pittsburgh; Dr. James L. Loper (1977), KCET(TV) Los Angeles; William J. McCarter (1975), WTTW(TV) Chicago; Dr. Richard J. Meyer (1977), KCTS-TV Seattle; Arthur A. Paul (1977), KVIE(TV) Sacramento, Calif.; Fred J. Rebanman (1975), WJCT(TV) Jacksonville, Fla.; Dr. Otto F. Schlaack (1976), WMVS(TV) Milwaukee; Robert L. Shepherd (1975), WDCN-TV Nashville; Sheldon P. Siegel (1976), WLVT-TV Allentown, Pa.; Paul K. Taff (1976), Conn. Public TV Net, Hartford, Conn.; C. Gregory Van Camp (1977), WWWU-TV Morgantown, W. Va.

National Public Radio

Headquarters: 2025 M St. N.W., Washington 20036. (202) 785-5400.

Personnel: Lee C. Frischknecht, pres; Dr. Presley D. Holmes, VP for progmg; James P. Barrett, dir of public info; Richard Cassidy, dir of engrg; George E. Geesey, dir of opns & prog administration; Wayne A. Gray, dir of bus affairs; Norman Kaderlan, dir of cultural programs; Jack Mitchell, dir of informational programs; Judith Chayes Neiman, dir of dev; C. Robert Zelnick, mgr of natl news & info bureau; Ernest T. Sanchez, gen counsel; Joe Gwathmey, asst to the VP.

Canadian Networks

Canadian Broadcasting Corp.

Head Office: 1500 Bronson Ave., Ottawa; P.O. Box 8478, Ottawa K1G 3J5. (613) 731-3111.

CBC Board of Directors: A.W. Johnson, Dr. S. Bah, Jean-Claude Delorme, Mrs. B.-E. Guay, Frank N. Hansen, Mary Konantz, Andre Lamy, Fernand D. Laverne, Michael Lyпка, Yves J. Menard, James S. Palmer, Mrs. D. Petrie, P.S. Plant, Bernard Trotter.

Principal Officers: A.W. Johnson, pres; Pierre DesRoches, exec VP; Raymond David, VP and gen mgr, French svcs division; D.W. MacPherson, VP and gen mgr, English svcs division; (vacant), VP, special svcs; Jacques Alletyn, Q.C., gen counsel; Guy Coderre, VP, human resources; V.F. Davies, VP, finance; R.C. Fraser, VP, corporate affairs & asst to the pres; N.R. Grover, VP, engrg; N.L. Magnusson, asst VP, human resources; Peter Meggs, VP, PR; Lister Sinclair, VP, prog policy & dev; Andre Ste-Marie, asst VP, engrg; (vacant), VP, planning; Alan Brown, dir of Radio Canada International, Montreal.

CTV Television Network Ltd.

Head Office: 42 Charles St. East, Toronto M4Y 1T5. (416) 924-5454. Telex: administration 02-2678, sales service 02-21646.

Montreal: H5A 1A9 P.O. Box 181; 20 Elmira, Place Bonaventure. (514) 878-3135. Telex: 01-20229.

New York 10020: Intercontinental Communications Inc., 10 Rockefeller Plaza, Room 523. (212) 489-6817.

CTV Principal Officers and Department Executives: Murray H. Chervoer, pres & mgng dir; Donald W. Coyle, exec VP; Raymond Junkin, VP & gen sls mgr; Philip Wedge, VP & dir of progmg; Tom Gould, VP, news, features & info progmg; Arthur Weinthal, VP & dir of entertainment progmg; H. Bruce Parkes, VP & sec-treas; Johnny Esaw, VP, sports Don Cameron, dir, news, features & info progmg; Joseph A. Colson, dir, broadcast svcs; John T. Coleman, dir, info & mktg svcs; Pat Young, dir, prom & PR; Larry Hertzog, asst dir, dev; John D. Murray, mgr, prog administration; Oliver Babirad, asst sports dir & bus mgr; Phil Brown, mgr, prom & presentation; Alice Wert, mgr, sls service.

Global Television Network

Head Office: 81 Barber Greene Rd., Don Mills, Ont. M3C 2A3. (416) 446-5311.

Principal Officers: J.A. Slight, pres; L. Halpert, treas; J. Spalding, prog dir; W. Cunningham, VP-news; P. Viner, gen sls mgr; W. Currie, creative dir; R. Reinhardt, dir, bcst opns; William Givens, mgr, mktg svcs; D. McGuire, prod mgr.

TVA

Head Office: 1405 Alexandre de Seve, Montreal H2L 2V5. (514) 526-9251.

Principal Officer: P. Aumais, admin coord.

Sales: Paul L'Anglais Inc., Montreal (514) 526-9251 and Toronto (416) 487-1551.

Radio and TV News Services

ABC News—See ABC listing in section D.

AP Newsable (a division of Associated Press). 50 Rockefeller Plaza, New York 10020. (212)262-4014. Bob Sundy, dir. A complete news service for CATV. Fully automated reports from the world, nation and state, plus sports, financial news and features 24 hours a day.

Associated Broadcast News Service. 854 National Press Bldg., Washington 20045. (202)628-6397. Robert C. Cody, mgng edit/own.

Services: Washington bureau for radio/TV stations and cable systems, specializing in, but not limited to, localized coverage from Nation's Capitol. ABN correspondents feed sound-on-film, videotaped and audio

reports to stations and systems on per assignment or contract basis. Also produce and syndicate feature reports and public affairs programs: *Washington Open Line, The Future Report, Youth Wants to Know, The American Forum.*

Associated Press—50 Rockefeller Plaza, New York 10020. (212)262-4000. Executives: Wes Gallagher, pres & gen mgr; Keith Fuller, VP & deputy gen mgr; Stanley M. Swinton, Conrad Fink, VP & asst gen mgrs; Roy Steinfort, asst gen mgr; David L. Bowen, VP & dir of communications; Herald G. Buell, exec news photo editor; James Tomlinson, VP and treas; Gerald B. Trapp, gen bcst news edit.

Broadcast Services: Roy Steinfort, asst gen mgr bcst services; Bob Benson, gen exec; Jay C. Bowles, gen bcst exec; Gerald B. Trapp, gen bcst news edit.

Regional Membership Execs—Albany 12211: 645 Albany-Shaker Rd., Box 11010. (518) 458-7821. Richard Shafer.

Atlanta 30303: 30 Pryor St. S.W. (404)522-8971. Doug Kienitz.

Boston 02210: 260 Summer St. (617)357-8100. James Smith.

Charlotte, N.C. 28202: 531 S. Tryon St. (704)334-9115. Ben Avery.

Chicago 60601: 188 W. Randolph St. (312)782-7700. James Farrell.

Columbus, Ohio 43216: 34 S. Third St., Box 1812. (614)228-4306. George Otwell.

Dallas 75202: Times Herald Bldg. (214)742-3447. William F. Greer.

Denver 80201: 650 15th St., Box 1013. (303)825-0123. Robert Kerr.

Detroit 48226: 320 W. Lafayette St. (313)965-9500. George Otwell.

Harrisburg, Pa. 17120: 240 N. Third St. (717)238-9413. Anthony Rizzo.

Houston 77002: c/o Houston Chronicle. (713)220-7391. Thomas B. DeCola.

Kansas City, Mo. 64108: 1715 Grand Ave. (816)421-4844. H. Laurens Genuchi.

Los Angeles 90015: 111 S. Hill St. (213)746-1200. Mark Thayer.

Minneapolis 55415: 426 Portland Ave. (612)335-6741. Terry DeVine.

Nashville 37202: 1100 Broadway, Box 990. (615)344-2205. Nancy Shipley.

New Orleans 70125: 3800 Howard Ave. (318)424-0951. Robert R. Shipley.

Salt Lake City 84111: 143 S. Main. (801)322-3405. Timothy Madden.

San Francisco 94119: 318 Grosvenor Plaza, Box 3554. (415)621-7432. John Morrison.

Seattle 98111: 201 Boren N., Box 2144. (206)682-1812. Alan DenBeste.

Washington 20006: 2021 K St. N.W. (202)833-5300. Anthony Catella.

Services: 24 hours bcst news service via teletype.

Associated Press Radio. 1825 K Street N.W., Washington 20006. (202)833-5300; 833-5910. Edward DeFontaine, managing editor; Bill McCloskey, asst managing editor; George Mayo, chief of communications.

Services: 24-hour AP Radio audio news service via voice lines. Offering live newscasts, business news, sportscasts, agriculture news reports, plus hourly feeds of actuality material for inclusion in newscasts of local stations.

Audio-Video News Bureau. Harbour Sq., 560 N St., S.W., Apt N-303, Washington 20024. (202)554-3434. Constance Lawn, pres.

Services: Cover the main hard news story for 7 international and 3 national radio & TV clients. Other stories on request.

Bay Film Associates. 635 Potrero Ave., San Francisco 94110. (415) 826-5250. Roy Healty, pres.

Services: Produces TV news, public service, industrial, documentary, and educational films.

Black Audio Network Inc. 166 Madison Ave., New York 10016. (212)686-6850. Jay Levy, pres; Roy Thompson, gen mgr; Sam Tucker, chief correspondent; Ronald Bristol, ntl news ed; Jeffrey Portnoy, opns mgr. New York: Donna Munton, bureau mgr. Washington: Charles Hightower, bureau mgr. Atlanta; Ernest Green, bureau mgr. Detroit: Jim Ingram, bureau mgr; Los Angeles: Betty Morris, bureau mgr; San Francisco: Reginald Major, bureau mgr.

Services: Daily audio news twice daily. Transmissions of black and other minority interest for broadcast use. All material consists of actualities with the newsmakers. In addition to daily audio newsfeeds,

Canadian Nets, News Services

syndicated programing, public affairs and special news programs for black-oriented and general market broadcasters is available.

Broadcast News Ltd. (subsidiary of Canadian Press) 36 King St. E., Toronto M5C 2L9. (416)364-3172. John Dauphinee, chief exec; D.V. Covey, gen mgr; Glen Witherspoon, treas. (Worldwide news and features to radio and TV stations by teletype and voice tape circuits.)

Broadcast News Service. (B-N-S) 523 Statler Office Bldg., Boston 02116. (617)426-8414. P.J. Romano, dir.

Services: Daily audio newsfeeds. Accent on actualities. Special features and progs. Spec assignments & service of New England area.

CBS News—See CBS listing in section D.

Capitol Broadcast News. 1337 22nd St., N.W., Washington 20037. (202)785-2889. Carol Kadushin, bureau chief.

Services: Serves as Washington bureau for local stations; investigative and hard news reporting. Radio & TV coverage.

Capitol Hill News Service. 502 National Press Bldg. (202)638-1096. Peter Gruenstein, dir.

Commodity News Services Inc. 4800 Main St., Kansas City, Mo. 64112. (816)753-2020. L. Michael Ridder, pres; Donald Schulte, gen mgr; James Hanson, exec editor; Charles Owens, natl sales mgr.

Services: Farm radio news, grain instant news, LFM news and other commodity services.

Congressional Quarterly Inc. 1414 22nd St. N.W., Washington 20037. (202)296-6800. Nelson Poynter, chmn of bd; Eugene C. Patterson, pres & editor; Paul P. Massa Jr., gen mgr; Robert C. Hur, sls mgr.

Services: Congressional Quarterly Service (news research covering national government and politics with focus on Congress; provides tri-weekly and weekly indexed quarterly, summarized in 1,200-page annual, indexed Almanac.)

Editorial Research Reports (four 6,000-word research reports a month on current major issues; supplemented by daily 500-word backgrounders on spot news developments, weekly reminders of upcoming news events, weekly article service; bound and indexed semi-annually.)

Both services include phone query service and weekly news futures mailings.

Ecumedia News Service. 475 Riverside Drive, Suite 850, New York 10027. (212)870-2255. Roy T. Lloyd, dir; Penny Wilfong, edit; Henry Russell, mktg dir.

Provides audio-feeds of actualities of leading religious news stories, features, commentaries from major religious leaders. Non-sectarian, non-profit. Issued bi-weekly.

Fairchild Broadcast News. 166 Madison Ave., New York. Jay Levy, pres. (Audio news service, domestic and foreign coverage.)

Farm Radio News. 4800 Main St., Suite 118, Kansas City, Mo. 64112. (816)753-2020. L. Michael Ridder, pres. Don Schulte, exec VP.

Chicago 60604: 141 W. Jackson Blvd, Rm. 1790. (312)922-5811. Don Utterback, sls mgr.

New York 10048: Two World Trade Center, Suite 2224. (212)432-5660. Norb Riegel, sls mgr.

Services: Farm Radio News "FRN" is a news wire

**America's Oldest And
Largest Black-Oriented
Broadcast News Service**

**BLACK
AUDIO
NETWORK**

**WITHOUT IT,
YOU'RE NOT WITH IT!**

News Services

service designed to provide farm market news in copy form for broadcast without rewrite.

Independent Television News Ltd. 800 National Press Bldg, Washington 20004. (202)638-2413. Michael Brunson, Washington bureau chief. Suzy Ornstein, editorial assistant.
Services: U.S. bureau of ITN London, the news division of the British commercial television network.

Intermedia News and Feature Service. 229 Seventh Ave., New York 10011. (212)255-5355. Charles B. Yulish, dir; Juliet McGhie, asst dir.
Services: news and features on cultural, entertainment, products, leisure living, and topical information of general interest.

Kiddie Camera (...The Kids Eye Views of the News.) Box 413, Philadelphia 19105. (215) TA8-0502. F. O. Pease, gen mgr; Maurice Zouary, exec prod; Ray Lewis, assoc prod; A. E. Brammer, foreign mgr/children's newsreel.

Mutual Broadcasting System—See MBS listing in section D.

Mutual Black Network News—See MBS listing in section D.

MUTUAL BLACK NETWORK—NUMBER ONE FOR MORE THAN ONE REASON

We produce, program, write, broadcast and present the Black point of view.

We were the first Black network, and that is one of the reasons we continue to be the largest Black network.

Shouldn't you be a part of this exclusive programming? For information contact: Mutual Black Network's Washington, D.C. headquarters: 1755 South Jefferson Davis Highway, Arlington, Virginia 22202 (703) 685-2000.



National Black Network. 1350 Ave. of the Americas, New York 10019. (212)586-0610. Eugene D. Jackson, pres; Sidney L. Small, exec VP; Del Raycey, exec VP; Vince Sanders, natl news dir; Eddie Hogan-Bassey, dir of engr.
Services: Black network news, sports, commentaries, public affairs programs.

NBC News. See NBC listing in section D.

National Public Affairs Center for Television. See listing for NPACT in section D.

National Television News Inc.—560 W. Eight Mile Rd., Detroit 48220. (313)541-1440. James E. O'Donnell, mgng edit; Dave Kelley, prod mgr; (Mrs.) Betty Gunther, opns mgr.
Los Angeles 91364: 6016 Fallbrook Ave., Woodland Hills, Calif. (213) 883-6121. Howard Back, exec edit; Glenn Winters, prod dir.
(Planning, film & videotape production and full na-

tional or regional distribution of newfilm and public svc spots and related audio-visual materials for radio-TV).

Newsfilm Inc. (affiliate of Marathon International Productions Inc.) 10 E. 49th St., New York 10017. Murray Hill 8-3063. Konstantin Kaiser, pres. (Produces news for industry with worldwide coverage and distribution.)

News West. Box 11125, Salt Lake City 84111. (801)467-3740. John Rasmussen, assignment edit.
Services: Produces and shoots TV newfilm, documentaries, and other TV film on assignment primarily in western U.S., Canada and Mexico.

NIS. NBC News and Information Service. See NBC listing in section D.

Press Assn. (Associated Press subsidiary) 50 Rockefeller Plaza, New York (212)262-4000. Wes Gallagher, pres; Robert Euston, VP; Harry T. Montgomery, sec; Roy Steinfort, asst sec.

Progressive Radio Network. Box 172, Bronx, N.Y. 10451. (212)585-2717. Rich Barna, pres.
Services: "News Blimps"—3 minute news features; fast paced and highly produced in stereo, including rock music, comedy and actualities. Current topics of national interest, aimed at youth audience.

Radio News West 333 S. Flower St. No. 190, Los Angeles 90071. (213)765-7581. Joe Quinn, pres; Jim Quinn, VP & gen mgr; Yet Lock, VP-sales; Bill Morgan, edit. (Covers audio news throughout California and serves stations via direct broadcast lines and telephones.)

Radio Pulsebeat News (div. of Pulsebeat News Inc.) 166 Madison Ave., New York 10016. (212)686-6850. Jay Levy, pres & dir of news; Ralph Edwards, VP-sls; Aaron Rich, controller.
Washington: Chris Cutter, bur ch.
Atlanta: Ernest Green.
Chicago: Bill Healy
Los Angeles: Paul Stein.
London: Charles Richards, bur ch.
Paris: Dick Sands, bur ch.
West Berlin: Charles Froelich.

(Offers radio and TV stations actuality news and sports coverage worldwide. Transmits daily actuality feeds and offers weekly actuality news disc service.)

Reuters News Service. 1700 Broadway, New York 10019. (212)582-4030. Glen Renfrew, mgr, North America; Desmond Maberly, J.W. Daffin, Cyril A. Smith, asst mgrs, North America. Mel Beiser, mgng edit.
Chicago 60604: 141 W. Jackson Blvd. (312)427-0793. Eric Hawes.
Los Angeles 90020: 3407 West 6th St. (213)380-2014. Bruce Russell.
Atlanta 30309: 1447 Peachtree St., N.E. (404)872-6893.
San Francisco 94104: 1 Embarcadero Center. (415)956-3636.
Washington 20045: 615 National Press Bldg. (202)628-9212. John Heffernan.
Dallas 75420: Carillon Tower E, 13601 Preston Rd. (214)661-2645.
Toronto M5L 1J1: Box 403 Commerce Court Postal Station. (416)869-3600. Harvey R. Cooper.

Services: News for media, bankers, brokers, and commodity traders.

Trans World Communications Inc. 166 Madison Ave., New York 10016. (212)686-6850. Jay Levy, editor.
Services: News feeds and programs for radio and TV stations. Offers a daily news service featuring actualities and correspondent reports.

Trans World News Service. (a Div. of International Press Service Inc.) Box 2801, Washington 20013. (202)638-5568. Cable address: TWNS, Washington, D.C. A.L. Weintraub, chmn of bd; G. Richard Ward, sec, treas; B. Blazes, acting pres; Edward de R-Pantheon, EVP; E.V. Rotkirch, dir foreign opns & sen ed; K. Nakatsukasa, mgr.
New York 10036: Suite 528, 55 W. 42d St. (212)563-4840. George Fine.

Miami 33131: 13th floor, Dade Federal Bldg., 21 N.E. First Ave. (305)377-8261. Albert L. Weintraub.
Tokyo, Japan: 100-91/C.P.O. Box 1711. K. Nakatsukasa.
Seoul, Korea: C.P.O. Box 6117. C.H. Yim.

Services: Syndicated radio programs on entertainment, politics, travel, personalities, interviews,

women's world, jingles, in Eng, Japanese, Sp & Ger.

UPI Audio Network. 220 E. 42d St., New York 10017. (212)682-0400, ext. 405. Peter S. Willett, VP broadcast svcs; Stan Sabik, coord, broadcast svcs; Frank Sciorlino, audio bureau mgr.
Washington 20004: National Press Bldg., Room 315, 529 14th St., N.W. (202)393-3430. Don Fulsom, bureau mgr.
London ED4Y 8BB: 8 Bouverie St. Tel: 353-1787. Edwin Smith, European audio mgr.

UPITN 7 West 66th St., New York 10023. (212)265-4520. Clarence (Dusty) Rhodes, pres; Kenneth Coyte, exec VP & gen mgr; Roy Berke, dir US operations.

Washington 20003: 1017 N.J. Ave., S.E. (202)488-7313. Paul Sisco, bureau mgr.
London: 48 Wells St. 637-2424. Trevor Jones.
Frankfurt: Kaiserstrasse 16. 0611 293441. Gernot Anderle.
Paris: 2 Rue des Italiens. 824 61 76. Henri Brzoska.
Hong Kong: 1260 New Mercury House. 273221. Nick Quinn.

Services: News film services, international and domestic; film library, electronic feeds; documentaries; industrial films; film clips and distribution.

United Press International. 220 East 42d St., New York 10017. (212)682-0400. Rod Beaton, pres; Frank Tremaine, senior VP; H.L. Stevenson, VP editor; Pete Willett, VP bcstg; Cal Thornton, VP mktg; James F. Darr, VP communications; F.W. Lyon, VP newscaptures. Atlanta 30309: 1211 Williams St., N.W. (404)875-7631. Fred Parker, Southern div mgr.
Boston: 02108: 20 Ashburton Pl. (617)227-4000. Bill Ketter, Northeast div mgr.

Chicago 60611: 430 N. Michigan Ave. (312)467-5050. Donald Brydon, Central div mgr.
Dallas 75201: 1606 Patterson St. (214)741-4085. Bob Crennon, Southwest div mgr.
San Francisco 94102: Fox Plaza, 9th & Market Sts. (415)623-6300. Richard A. Litfin, Pacific div mgr.
Washington 20004: 315 National Press Bldg., 529 14th St., N.W. (202)393-3430. Grant Dillman, VP Washington.

United Press International of Canada Ltd. Suite 432, Place Victoria, 800 Victoria Square, Montreal 115. (514)866-9357. W. Donald MacKay, gen mgr for Canada; John Chartier, exec asst, sls & administration; Dale Morsch, news edit for Canada. (News, news-pictures, newfilm, audio news network.)

United State Catholic Conference, Office for Film and Broadcasting. 1011 First Ave., Suite 1300, New York 10022. (212) 644-1880. Rev. Patrick J. Sullivan, S.J., assoc sec for communications; Richard H. Hirsch, mgr bcstg prod; Henry Herx, coord, film and bcstg educ svcs; Rev. George Byrne, telecommunications specialist; Michael Gallagher, editor, film and bcstg publications.

Vanguard News. Box 1025, Brattleboro, Vt. 05301. (802)257-7131. Dave Calif, pres.
Services: Photo, written, audio & video news gathering. Facilities for broadcast, wire service and company uses.

Westinghouse Broadcasting Co. 90 Park Ave., New York 10016. (212)983-6500. Pat Polillo, VP, exec news prod-Westinghouse Bcstg TV stn group.
Washington 20006: 1625 K St., N.W. (202)783-0907. Sid Davis, bureau chief.

London S.W. 3: 179-181 Brompton Road. Jack Pluntze, chief, Group W foreign news service; Charles Bierbauer, foreign news edit.
Paris 8: 16 rue Christophe Colomb. Bernard Redmont, bureau chief.
53 Bonn 1: Adenauerallee 270. Eliz. Hofmann.
Beirut, Lebanon: Box 564, c/o St. Georges Hotel. Joe Kanalkic, bureau chief.
Tel Aviv: 37 Pinsky. Jay Bushinsky, bureau chief.
Hong Kong: Apt 1-A—Gardena Court, Kennedy Terrace. Leonard Pratt, bureau chief.

World Wide Information Services—660 First Ave., New York 10016. (212)679-7240. Richard W. Hubbell, pres; F. Anthony Dias Blue, VP.
Services: 3,725 reporting offices throughout U.S. and 143 other countries. Specialized reporting in commercial, financial, industrial fields and food industry. Established 1958.

Producers, Distributors and Production Services

Radio-TV program and commercial producers, distributors and syndicators, TV labs and other services

A

Academy Film Productions Inc. 123 W. Chestnut St., Chicago 60610. (312) 642-5877. Bernard Howard, pres & exec prod.

C F G K

Academy Lighting Suite 220, 44 W. 63d St., New York 10023. (212) 582-8101. F. L. Manning, Charles Reinhard.

Hollywood 90028; 6777 Hollywood Blvd. (213) HOLLYWOOD 2-3941. Thomas Schamp, Carl Gibson.

A B

Adco Productions 5050 Biscayne Blvd., Miami 33137. (305) 751-3118. William Wyler, pres; Earl Wainwright, VP.

A B C D E G H K

ADS Audio Visual Productions Inc. 115 Hillwood Ave., Falls Church, Va. 22030. (202) 536-9000. Arthur D. Stamler, pres & exec prod; Charles L. Sayre, VP, mus dir; Carroll James Jr., assoc prod; Wallace T. Bacon, assoc prod; Sidney W. Slapney, assoc prod; Douglas Curran, creative dir; Bert B. Stamler, continuity dir; William O. McElroy, tech dir; Robert Dawson, chief engr; Blake B. Stamler, distribution mgr; Tanya S. Bibber, traf mgr; N. Jeanne Hibner, opns mgr.

Hollywood 90028; 1610 Argyle Ave. (213) 465-3672. Jerry Kisher, opns mgr.

Washington 20008; (202) 462-6078. George Rosenberg, opns mgr.

D E

Advertisers Broadcasting Co. 1700 Broadway, New York 10019. (212) PLaza 7-3560. Sholom Rubinstein, exec prod & plnr.

A B D E G H

Agency Recording Inc. 676 N. La Salle St., Chicago 60610. (312) 236-3632. John Garamoni, pres.

D F K

Roger Ailes & Associates Inc. 230 Central Park South, New York 10019. (212) 765-3022. Roger E. Ailes, pres; Stephen Rosenfield, VP.

A C

AKO Productions Ltd. 32 Front St. W. 5th Floor, Toronto M5J 1C5. (416) 363-1603. Ken Orton, pres.

G

Alan Enterprises Inc. 17366 Sunset Blvd., Pacific Palisades, Calif. 90272. (213) 459-2925. Alan L. Gleitsman, pres; Meg Kellenbeck, opns mgr.

B

Alcare Communications 130 West Lancaster Ave., Wayne, Pa. 19087. (215) 687-5767. Mort Crim, Naomi Crim owners; Jordan Schwartz, gen mgr; Annette Burris, dir of radio; Tom Holland, natl radio sls dir.

A B D E

Allegro Film Productions Inc. 201 W 52d St., New York 10019. (212) 586-3057. Jerome G. Forman, pres; Julius Edelman, VP.

A B C

Allied Artists Television Corp. 15 Columbus Circle, New York 10023. (212) 541-9200. Andrew P. Jaeger, pres; Dean McCarthy, VP-prog dev; Joseph Zaleski, VP-gen sls mgr; Brian O'Daly, dir spec proj; Hank Profenius, Southern division mgr; Leo M. Brody, dir opns; Ralene Levy, mgr print svcs; Virginia Garrison, mgr sls svcs.

A B

Allied Broadcast Equipment/Div of Allied Advertising Corp. 124 South 6th St., Richmond, Ind. 47374. (317) 962-8596. Roy M. Ridge, pres.

E J

Amalgamated Television Services Pty. Ltd. (ATN 7 Sydney) Television Centre, Epping, Sydney, New South Wales, 2121 Australia. 85 0111. J. S. Doherty, gen mgr; N. H. Collier, finance ctrlr; G. E. Healy, mgr-group opns.

New York 10036; Room 405, 1501 Broadway (212) LA 4-9058. Russell Watkins, international dir.

London EC4; 1st Floor, 110 Fleet St. 01 353 5786. Russell Watkins, international dir.

A B C

Amazing But True Inc. 501 Althea Rd., Belleair Es-

Key to service codes

The following codes indicate type of service company offers:

- A - TV program production
- B - TV program distribution
- C - TV commercial production
- D - Radio program production
- E - Radio program distribution
- F - Radio commercial/jingle production
- G - Business/promotion film production
- H - Business/promotion film distribution
- J - Production services
- K - TV processing laboratory

For reader convenience in locating companies by function, each particular code letter always appears in the same place across the width of the column, as shown below:

A B C D E F G H J K

To locate companies that produce radio programs, for instance, simply run your eye down the column. Every firm so engaged will display a "D" about a third of the way in from the left hand margin.

ates, Clearwater, Fla. 33516. (813) 584-7167. Doug Storer, pres-own.

A C D F

American Chiropractic Assn. 2200 Grand Ave., Des Moines, Iowa 50312. (515) 243-1121.

C F

American Diversified Services. 747 Third Ave., New York 10017. (212) 759-7770. Max King, pres. Jud Phillips, music div. Kingsport, Tenn., Los Angeles, branch ofcs.

A B C F G H

American Film Productions Inc. 1540 Broadway, New York 10036. (212) 582-1900. Robert Gross, pres; Sheldon Abromowitz, VP; Ruth Schulman, ctrlr.

Fort Lee, N.J. 07024; (201) 944-2156. Karel Dodal, supr.

C G H

American Foundation for the Blind, Inc. 15 W. 16th St., New York 10011. (212) 924-0420. Loyal E. Apple, exec dir; Patricia Smith, info dir; Arthur Zigouras, dir pub educ div.

C D E F

American International Television Inc. 9033 Wilshire Blvd., Beverly Hills, Calif. 90211. (213) 278-8118. Harold Brown, VP TV & distribution; Noah Jacobs, eastern division mgr; Chad Mason, southern division mgr; Gerald S. Corwin, central division mgr; Alex Horwitz, western division mgr.

A B G H

American Pictronic Corp. 33 W 52d St., New York 10019. (212) 489-8060. M. Milton Schwartz, VP opns; Carolyn Comer, VP administration.

B E H K

America's Productions Inc. 600 Biscayne Blvd., Miami 33132. (305) 373-3393. Louis J. Boeri, pres; Alicia Blanco, treas.

D

American Radio Programs. 524 E. Glenoakes Blvd., Suite C, Glendale, Calif. 91207. (213) 244-2141. Gerald A. Simmonds, pres; Craig B. Simmonds, gen mgr.

D E

AMI Radio News Bureau 68 Post St., San Francisco 94108. (415) 982-1441. John Hamilton, pres.

D

Ken Ansell Films. 450 E. Ohio St., Chicago 60611. (312) 664-2447. Ken Ansell, pres.

C G

Ken Anderson Films. Box 618, Winona Lake, Ind. 46590. (219) 267-5774. Ken Anderson, pres; Walter Olson, bus mgr; Heinz Fussle, exec prod; Lane Anderson, distribution mgr; Max Anderson, prom & adv.

A B G H

Robert Anderson Associates Ltd. Skyridge, Mountain Rd., RR2, Aylmer East, Que. J9H 5E1. (819) 827-2251. Robert Anderson, pres; R. B. Morrison, VP; Douglas E. Wilkinson, sec treas.

G

Animated Productions Inc. 1600 Broadway, New York 10019. (212) CO 5-2942. Al Stahl, pres; Irwin Stahl, VP; Shirley DeBrier, mgr; David Hale, prod supvr.

A B C G H

Animatic Productions Ltd. 2 W. 45th St., New York 10036. (212) 661-7290. Rupert Sterling, pres; Mako Oike, VP; Arthur Jacks, VP.

C G J

Around the World Cassette Programs Inc. 4202 Benedict Canyon Dr., Sherman Oaks, Calif. 91403. (213) 789-5177. Mike Stokey, pres; Michael Stokey II, VP; Burt Wenland, VP; Ethelyn Davis, VP.

A B C G H

Artcom, div LaRue Communications Inc. 708 North Dearborn St., Chicago 60610. (312) 787-8656. G. Doetsch, pres and sls mgr; K. Russell, VP; C. Cummings, prod mgr.

A B G H

Artrana Park Film Studios. Television Centre, Epping, Sydney, N.S.W., 2121 Australia. 85 0155. J. S. Doherty, gen mgr; G. Blackledge, mgr.

New York 10036; Room 405, 1501 Broadway (212) LA 4-9058. Russell Watkins, international dir.

London EC4; 1st Floor, 110 Fleet St. 01-353-5786. Russell Watkins, international dir.

A

Artscope Ltd. 310 W. 53d St., New York 10019. (212) 265-0236. Amin O. Chaudhri, pres; Ginnie L. Music, exec sec; Abida Parveen, sec.

A B C G H

Associated Advertising Productions Inc. Box

alcare

COMMUNICATIONS

creators,
producers and
distributors of
quality features and
programs for
TV and radio

TV

- "Mort Crim: One Moment Please"
- "One Great Moment in Sports"
- "Maintenance Ms."

RADIO

- "Mort Crim: One Moment Please"
- "Bernard Meltzer on Living Better"
- "Family Focus"
- "Update: Where are they Now" (MBS)

Call or write

ALCARE COMMUNICATIONS
130 W. Lancaster Ave., Wayne, Pa. 19087
(215) 687-5767

Producers, Distributors

2612 New Orleans 70176. (504) 586-8444. Jack Weis, dir. Lee Brown, sec-treas.

A C J

Association-Sterling Films 866 Third Ave., New York 10022. (212) 935-5106. Robert D. Mitchell, pres; Tim Wholey, group VP, TV.

New York 10022: (212) 752-4431. Jacqueline S. Keller, mgr.

Dallas 75247: (214) 638-6799. Kenneth A. Ring, mgr.

Atlanta 30340: (404) 458-6253. William O. Fly, mgr.

La Grange, Ill. 60525: (312) 354-7422. Bruce F. Farnsworth, mgr.

Sun Valley, Calif.: (213) 767-0200. Don Sathern, mgr.

Ridgefield, N.J. 07657: (201) 943-3855. Frank Wolf, mgr.

B

Astrafilms Inc. 530 Eighth St., S.E., Washington 20003. (202) 543-1011. Leonard Grossman, pres; Marcelle D. Leet, sec/treas.

A B

Atlantic Commercial Mastering 163 Garfield Rd., Auburn, Me. 04210. (207) 784-5678. Richard P. Daig-nault, pres; David P. Biron, VP.

F J

Atwood-Richards Inc. 99 Park Ave. 15th Floor, New York 10016. (212) 490-9200. Moreton Binn, pres; Jack Fennell, VP.

Beverly Hills, Calif. 9171 Wilshire Blvd., (213) 276-1083. Dinald Quinn, VP; Alan Storm, mgr.

A B C D E F

Audio Circus Inc. 5315 Laurel Canyon Blvd., Suite 200, North Hollywood 91607. (213) 985-3300. Jeff Alan, pres.

D E F G J

Audible Advertising Prods. Inc. 663 Fifth Ave., New York 10022. (212) 873-1238. Mary Hurt, exec prod; Jim Vickers, head of prod.

F

Audio-Video Concepts Inc. 5408 Silver Hill Rd., Suite 501, Suitland, Md. 20028. (301) 568-5836. Edward P. Helvey Jr., pres; John N. Caughman, VP, Cynthia D. Stephanian, corp sec.

D E F J

Aura Recording Inc. 136 W. 52d St., New York 10019. Judson 2-8105. Allan Mirchin, pres. Benjamin Stern, VP.

J

Aurvid Productions/Video Productions, division of International Treasures. Box 413, Philadelphia 19105. (215) 828-0502. F. O. Pease, gen mgr; Harry I. Greene, opns mgr; A. E. Pease, office mgr; J. P. Morgan, vis mgr.

London N. 8: 21 Mountview Court, 648 Green Lanes. A. E. Brammer.

A B

Australian Tourist Commission. 1270 Ave. of the Americas, New York 10029. (212) 489-7550. John I. Richardson, North American mktg dir; Peter Goulding, mgr, Eastern region; Bill Tuck, publ mgr, North America.

Los Angeles 90010: (213) 380-6060. Steve Bowman, mgr, western region.

Chicago 60601: (312) 329-0314. Steve Bowman,

Key to service codes

The following codes indicate type of service company offers:

- A —TV program production
- B —TV program distribution
- C —TV commercial production
- D —Radio program production
- E —Radio program distribution
- F —Radio commercial/jingle production
- G —Business/promotion film production
- H —Business/promotion film distribution
- J —Production services
- K —TV processing laboratory

For reader convenience in locating companies by function, each particular code letter always appears in the same place across the width of the column, as shown below:

A B C D E F G H J K

To locate companies that produce radio programs, for instance, simply run your eye down the column. Every firm so engaged will display a "D" about a third of the way in from the left hand margin.

mgr, central U.S.A.

B

Avco Embassy Pictures Corp./TV. 1301 Ave. of the Americas, New York 10019. (212) 956-5500. E. Jonny Graff, VP TV.

Memphis: Maywood Lake, Olive Branch, Miss. Charles Britt, asst natl sis mgr.

Los Angeles: Sy Shapiro, western div mgr.

A B

Avco Program Sales A Division of Avco Broadcasting Corp. 1600 Provident Tower, Cincinnati 45202. (513) 241-1822. Donald L. Dahlman, VP; Lee Jackoway, sis exec.

A B

A-V Corp. 2518 North Blvd., Box 66824, Houston 77006. (713) 523-6701. J. C. Rebman, pres; W. B. Padon, VP.

A B C G H

Avon Productions Inc. 200 W. 57th St., New York 10019. (212) 581-4460. Ralph Weisinger, pres, Suzy Widawski, exec sec.

A C F G H J

Avpro Inc. 52 Vanderbilt Ave., New York 10017. (212) 686-3830. Lewis M. Marcy, pres.

A B

Award Films 20 N. Wacker Drive, Chicago 60606. (312) 236-8488. Algred D. LeVine, gen mgr; Robert Eirinberg, sec; Jane Carroll, treas.

A B C J

B

Doug Bailey Films Inc. 140 Congressional Lane, Rockville, Md. 20852. (301) 881-0200. Doug Bailey, pres; John E. Parker, VP; Tom Rhoads, dir; Darlinda Zalinski, office mgr.

A C D F G

Bill Baird's Marionettes 59 Barrow St., New York 10014. (212) YU 9-9840. Bill Baird, exec dir.

A B C G H

Ballantine Films Inc. 115 Newbury St., Boston 02116. (617) 267-2160. Jerry T. Ballantine, pres; Judith Ballantine, VP.

C J

Bandeller Films Inc. 2001 Gold SE, Albuquerque, N.M. 87106. (505) 242-2679. Allan Stevens, pres; Robert Stevens, sec-treas.

C G H J

Bandera Enterprises. Box 1107, Studio City, Calif. 91604. (213) 985-5050. Don Flagg, pres; Ethel Taylor, distribution mgr.

B H

G. Banks (in Television) Ltd. 250 Merton St., Toronto M45 1B1. (416) 487-4767. Gyiiney Banks, pres.

A

Barbre Productons Inc. 1089 Bannock St., Denver 80217. (303) 825-5288. John D. Ackelson, creative dir.

C G

Baron Enterprises Inc. 9201 Wilshire Blvd., Beverly Hills, Calif. 90210. (213) 278-0932. Barry Bergsman, pres.

A B

Basch Radio & Television Productions 771 West End Ave., New York 10025. (212) 666-2300. Frances Scott Basch & Buddy Basch, ptrns.

A C D F

Basilean Films. Old Flemingsburg Rd., Morehead, Ky. 40351. (606) 784-9674. John R. Hamilton, dir.

J

Ted Bates & Co. 1515 Broadway, New York 10036. (212) 869-3131. Joel M. Segal, senior VP-bcstg; Mort Zimmerman, dir Colgate progmg unit.

B

Bebell Inc. 416 West 45th St., New York 10036. (212) 245-8900. Norman Lars Bebell, pres; Arthur Frederick Bebell, VP; Herbert J. Braun, sis mgr; Robert F. Eastright, controller.

Motion picture lab division: Marvin Ross, expeditor. Slide lab division: Al Kurtz, expeditor.

K

Beckwith Presentations Inc. 39 W. 55th St., New York 10019. (212) 765-4250. Aaron Beckwith, pres; Sol Kalow, sec.

A B

Jerry Bender Editorial 26 E. 36th St., New York 10016. (212) 686-7407. Jerry Bender, edit; Allen Rozek, edit; Richard Schmeizer, editorial asst; Bonnie Cullen, bus mgr.

A B

Bendick Associates Inc. 360 Grace Church St., Rye, N.Y. 10580. (914) 967-2936. Robert Bendick, pres; Jeanne Bendick, VP.

A

Berkeley Studio, The United Church of Canada, and Interchurch Broadcasting. 315 Queen St. East, Toronto M5A 1S7. (416) 366-9221. Rev. G. Earl Leard, dir med svcs; Rev. Des McCalmont, TV prod supvr; Nancy Edwards, radio prod; Peter Flemington, TV & film prod.

A B

BFC/NCC—Broadcasting & Film Commission, National Council of the Churches of Christ in the U.S.A. 475 Riverside Drive, New York 10027. (212) 870-2567. William F. Fore, exec dir; D. Williams McClurken, dir of bcst opns; Lois J. Anderson, dir of prom & distribution.

A B



ASSOCIATION-STERLING FILMS

FREE FILMS FOR TELEVISION

Prime time, award winning subjects
TV Series—Travel, Social Issues, More

Free catalog and programming service available

866 Third Ave., N.Y. 10022 (212) 752-4431

Libraries in Dallas, Atlanta, Sun Valley, Cal., LaGrange, Ill., Ridgefield, N.J.

BGM International Box 8057, Pensacola, Fla. 32505. (904) 433-7932. Frederic T. C. Brewer, own.

D E

Biddick Co. 18127 Roscoe Blvd. #6, Northridge, Calif. 91324. (213) 349-9526. Guy Biddick, mgr.

C D E F

Big G Productions 16521 Wyoming, Detroit 48221. (313) 862-4350. James C. Guley Sr., chmn of bd; James C. Guley Jr., pres; Samuel Brantley, exec VP.

A B C

Blake Films 104 West Concord St., Boston 02118. (617) 267-7713. Benjamin S. Blake, owner.

C G H J

Blanc Communications Corp. 9454 Wilshire Blvd. Suite 305, Beverly Hills, Calif. 90212. (213) 278-2600. Noel Blanc, pres; Patrick Bailey, exec VP; Bill Baldwin Jr., VP/prod.

A C D E F G H J

Aaron S. Bloom TV Productions. 3993 Washington St., San Francisco 94118. (415) 989-5050. Aaron S. Bloom, own; B. C. Bloom, sec.

A B C D E G J

Blue River Music Inc. Subsidiaries C&B Music Library Inc., Contemporary Creative Services. 6223 Selma Ave., Suite 125, Hollywood 90028. (213) 463-7661. Harry Bluestone, pres; Ross J. Bluestone, VP.

C F G

The Fred Bock Advertising Co. 185 W. Bowery St., Akron, Ohio 44308. (216) 535-2637. Fred C. Bock, pres.

F

Bonneville Broadcast Consultants Box 640, Tenafly, N.J. 07670. (201) 567-8800. Marlin R. Taylor, pres; Loring S. Fisher, VP; Frank Murphy, music dir; David West, mktg assoc.

D E

Bonneville Productions. 130 Social Hall Ave., Salt Lake City 84111. (801) 524-2400. Dick Alsop, mgr; Ross Richins, creative svcs dir; Dave Michelsen, recording and duplicating dir; Mike Collett, engrg dir; Ray Loveless, special services dir; Mike Cannon, prom dir.

A B C D E F G H J

Boston Symphony Orchestra. Boston Pops Symphony Hall, Boston 02115. (617) 266-1492. Thomas D. Perry Jr., exec dir; Thomas W. Morris, mgr.

A B D E

Robert Braverman Productions Inc. 450 Sunrise Highway, Rockville Centre, N.Y. 11570. (516) 536-7400. Robert Braverman, pres; Joan Braverman, prod coord; John J. Ruvolo, exec rep; George C. Williams Jr., prod rep.

A

Bray Studios Inc. 630 Ninth Ave., New York 10036. (212) 245-4582. Paul Bray Jr., pres.

A B G H

Breath of Life 1100 Rancho Conejo Blvd., Newbury Park, Calif. 91320. (805) 498-4561. Charles D. Brooks, speaker; Philip Moores, mgr; Guy G. Stewart, sec-treas; Walter E. Arties, prod-coord.

A B

Brillig Productions Inc. 57 W. 56th St., New York 10019. (212) 541-6161. Barry Brown, pres.

C

British Broadcasting Corp. 630 Fifth Ave., New York 10020. (212) 581-7100. David Webster, dir U.S.; Christopher Jeans, TV prod; Lillian Lang, radio prod; Stephen Christie, chief engr; Yvonne Espina, TV news asst; David McNeil, radio correspondent.

Washington 20036; 2020 M St. N.W. (202) 223-2050. Angus McDermid, John Humphreys. New York 10017: United Nations Office. (212) 688-6266. Brian Saxton.

A B D E

British Information Services. 845 Third Ave., New York 10022. (212) 752-8400. Alan J. Waple, dir, radio & TV division.

A B D E

Broadcast Activities. Box 531, La Porte, Ind. 46350. (219) 362-3682. Michael Sharpless, sls rep; Jan C. Gabriel, TV prod; Charles Sharpless, radio prod.

A B C D E F

The Broadcast Department Inc. 527 Madison Ave., New York 10022. (212) 752-1188. Joseph Danis, pres; Bob Bolbach, prod mgr.

C F

Key to service codes

The following codes indicate type of service company offers:

- A - TV program production
- B - TV program distribution
- C - TV commercial production
- D - Radio program production
- E - Radio program distribution
- F - Radio commercial/jingle production
- G - Business/promotion film production
- H - Business/promotion film distribution
- J - Production services
- K - TV processing laboratory

For reader convenience in locating companies by function, each particular code letter always appears in the same place across the width of the column, as shown below:

A B C D E F G H J K

Broadcasting & Film Commission of National Council of Churches of Christ in the U.S.A. (See National Council of Churches of Christ listing.)

Broadcasting Foundation of America. 52 Vanderbilt Ave., New York 10017. (212) Murray Hill 4-2505. George E. Probst, chmn, bd of trustees; Seymour N. Siegel, pres; Howard L. Kany, VP & exec dir.

D E

Broadcast News Service. 523 Statler Office Bldg., Boston 02116. (617) 426-8414. P. J. Romano, dir.

A D J

Broadcast Productions and Services Inc. 635 National Press Building, Washington 20004. (202) 628-1024. Robert M. Johnson, pres and exec prod. New York 10036: 49 W. 45th St. (212) 586-6778. Alvin Yudkoff.

G H

Broadcast Productions Inc. 960 Time & Life Bldg., New York 10020. (212) Circle 5-2870. Blair Walliser, pres; Samuel Freundel, exec VP; Gloria B. Martin, gen mgr.

D E F

Broadcast Programming International Box 547 Bellingham, Wash. 98225. (206) 676-1400. Kemper Freeman Jr., pres; Tim Waide, product mgr; Mike Bettelli, prog consultant. East Coast 1-800-621-7725. Code A-145. Pat Rowe, prog consultant.

D E

Broadcast Sales Associates 3100 38th Ave. N., Drawer 15236, St. Petersburg, Fla. 33733. (813) 522-0090. George Gothberg, pres; Ozeile G. Gothberg, VP sec-treas; Bob Benson, sls & str rel VP; George Gordon, sls mgr; Forrest Landreth, senior sls exec; Dave Trent, finance & collection officer.

A B C D E F

Brut Productions Inc. 1345 Ave. of the Americas, New York 10019. (212) 581-3114. George Barrie, pres; Dan Goodman, exec VP.

A B

Bryanston Distributors Inc. 630 Ninth Ave., New York 10036. (212) 581-5240. Louis Peraino, pres; Philip Parisi, VP.

A B

Gert Bunchez & Associates Inc. 7730 Carondelet Ave. #134, St. Louis 63105. (314) 862-5250. Gert Bunchez, pres.

New York 10022: 685 Fifth Ave. (212) 755-1339. Gert Bunchez, pres. Dallas: 75219. (214) 522-9749. Dean Cowart, mgr. Los Angeles: 90211. (213) 652-1441. Chuck Dwyer, mgr. Toronto: (416) 465-8570. Donald Dickson, mgr.

A B

Kent Burkhardt and Associates 6500 River Chase Circle East, Atlanta 30328. (404) 252-3037. Kent Burkhardt, pres; Lee Abrams, Beverly Brand and Brad Burkhardt, associates.

D E F

Bill Burrud Production Inc. 1100 S. La Brea Ave., Los Angeles 90019. (213) 937-0300. Bill Burrud, pres; Jon Eichstaedt, VP in chg of mktg; Esther K. Allber, VP & sec-treas.

A B C

Byron Motion Pictures Inc. 65 K St. N.E., Washington 20002. (202) 783-2700. Byron Roudabush, pres;

Producers, Distributors

Dudley Spruill, exec VP; Neal Keehn, VP-sls & svcs.

K

C

California International Productions. 6710 Melrose Ave., Hollywood 90038. (213) Webster 9-1491. Homer O'Donnell, own, K.S. Hedborn, prod asst.

C G

Call for Action Inc. 1785 Massachusetts Ave. N.W., Washington 20036. (202) 797-7800. Virginia R. Stuart, exec dir; Suzanne P. Roosevelt, assoc dir.

A B D E

Call of the Tribes Broadcast. Box 275, North Prairie, Wis. 53153. (414) 968-3405. Les Pederson, exec dir, Robert Gilman, prog dir, Jack DuMars, tech dir.

D

Campbell-Ewald Co. 3044 W. Grand Blvd., Detroit 48202. (313) TR 2-6200. Kird E. Beauregard, VP-dir, radio-TV bcst prod.

C

Campus Radio Voice Inc. 10 E. 39th St., New York 10016. John D. Orr, pres; Lorraine B. Orr, VP.

D E

Candid Productions Inc. 119 West 57th St., New York 10019. (212) LT 1-9450. Paul Feigay, pres; Dick Button, VP.

A B

Alexander Cantwell Associates. 251 E. 51st St., New York 10022. (212) 759-9820. Alexander Cantwell, pres.

A C D F G J

Capital Cities Television Productions. 4100 City Line Ave., Philadelphia 19131. (215) 878-9700. Charles Keller, gen mgr; William G. Muivey, gen sls mgr.

A B C G H

Capital Film Laboratories Inc. 470 E. St. S.W., Washington 20024. (202) 347-1717. Peter Boyko, pres; Robert G. Crane, exec VP; William N. Brooks, VP.

K

Capital Recording Co. Inc. 5400 Carolina Pl., Springfield, Va. 22151. (703) 941-3553. Clarence E. McDaniel, pres; Jacqueline M. McDaniel, sec-treas.

E J

Caravan Productions. 60 School St., Fairfield, Conn. 06430 (203) 336-9721. Peter J. Restivo, exec prod.

A

Carefree Video Company. 801 E. Washington St., Phoenix 85034. (602) 253-4144. Sidney L. Kosowsky, pres; Jerry Kosowsky, VP; Johnny Baron, chief engr.

A C J

George Carlson & Associates. 4106 Arcade Bldg., Seattle 98101. (206) 623-8045. George Carlson, prod.

A B C

Cathedral Teleproductions. 2700 State Road, Cuyahoga Falls, Ohio 44223. (216) 929-1875. Don Caminati, prod mgr; David A. Ginaven, chief engr; Steve McNeal, asst chief engr.

A B G H

Cavalcade Pictures Inc. 959 North Fairfax Ave., Hollywood 90046. (213) 654-4144. Harvey Pergament, pres.

New York 10025: 245 West 107th St. (212) Academy 2-4781.

A B

CaVox Stereo Productions. 502 S. Isis, Inglewood, Calif. 90301. (213) 776-6933. Lee Tate, exec dir; Bob Mayfield, natl prog/sls dir; Lee Arnett, engrg dir.

D E

C & C Syndication. 6381 Hollywood Blvd. Suite 512, Hollywood 90028 (213) 466-3335. Con Hartsock, dir of sls; Charles Alsop, dir of bus affairs.

B

Celebrities Productions. 408 Olive St., St. Louis 63102. (314) 231-3579. Irvin Davis, pres; Adele K. Solit, VP.

A C D F G

Central Sound Productions. 1636 East Michigan Ave., Jackson, Mich., 49202. (517) 782-3445. Carl Fra-

Producers, Distributors

cala, exec prod; Ted Lakomowski, prod mgr.

F

Century Features Inc. Box 597 Pittsburgh 15230. (412) 471-6533. Charles Reichblum, pres.

A D

Bob Cessna's Consultant Services Inc. Box 5356, Daytona Beach, Fla. 32020. (904) 255-1154. Robert W. Cessna, pres; Jane Cessna, sec-treas.

A D J

Channel 8 Color Laboratory. 905 Jackson St., Tampa, Fla. 33601. (813) 229-7781. Bill Faber, pres; Leo Fasselt, color laboratory mgr.

K

Channel Films Inc. 45 W. 45th St., New York 10036. (212) 586-4311. Hal Seeger, exec VP; Leonard Bird, prod. supvr; Susan Blaney, art dir.

J

Channel One Inc. 1727 Clifton Road N.E., Atlanta 30329. (404) 634-3324. Peter G. Kontos, pres; William W. Horlock, VP & treas.

J

The Bruce Chapman Co. Grafton, Vt. 05146. (802) 843-2321. Bruce Chapman, pres; William Chapman, VP.

A C D

Sam Chase Associates Inc. 38 E. 57th St., New York 10022. (212) 755-1668. Sam Chase, pres.

A B D E

Chetwynd Films Ltd. 10 Banigan Dr., Toronto M4H1E9. (416) 421-8820. Arthur Chetwynd, pres; Tom Glynn, VP prod; Robin Chetwynd, VP sis; Marjory Chetwynd, VP sec-treas.

A C G J

Children's Television Workshop. 1 Lincoln Plaza, New York 10023. (212) 595-3456.

A

Chris-Craft Video Tape Production. 915 N. La Brea Ave., Los Angeles 90038. (213) 851-2626. Sherman Fillmore, dir of sis.

A C

Christian Enterprises Duplicators. Box 272, Ashland, Va. 23005 (804) 798-4711. James N. Birkitt, pres & dir; Wes Lund, distributor.

D E

The Christophers. 12 E. 48th St., New York 10017. (212) 759-4050. Richard Armstrong, M.M., exec prod; Jeanne Glynn, prod.

A B D E

Cinecraft Inc. 2515 Franklin Blvd., Cleveland 44113. (216) 781-2300. Paul Culley, pres.

A C G J

Cinema Associate Productions Inc. Box 1542, East Lansing, Mich. 48823. (517) 332-8631. Norman J. Virag, dir; Fred Trost, VP, exec prod.

A C D F G

Cinema 5 Ltd. 595 Madison Ave., New York 10022. (212) 752-3200. Donald S. Rugoff, pres.

A B

Cinema House 3326 Colony Drive, Jamestown, N.C. 27282. (919) 454-3852. Jeffrey O. Clarke, pres.

A C G J

Cinema Processors Inc. Box 13653, Atlanta 30324. (404) 633-1448. Philip Limonciello, laboratory mgr.

K

Cinema/Sound Ltd. 311 W 75th St., New York 10023. (212) 799-4800. Robert Franklin, pres; Joan Franklin, VP.

D E F J

Cinemusic Inc. 30 W. 60th St., New York 10023. (212) 757-3795. Jack Shaindlin, pres; Joan Barry, mgr.

A C D G

Cine-Tele Productions. Box 1565, Palm Desert, Calif. 92260. (213) 465-3376. Harry L. Lehman, owner.

C G

City Film Productions. 64-12 65th Place, Middle Village (Queens county, New York), N.Y. 11379. (212) 456-5050. John R. Gregory, exec prod; Herbert Avvenire, prod; Clarence Schmidt, prod.

A C G J

Dick Clark Teleshows Inc. 9125 Sunset Blvd., Los

Key to service codes

The following codes indicate type of service company offers:

- A -TV program production
- B -TV program distribution
- C -TV commercial production
- D -Radio program production
- E -Radio program distribution
- F -Radio commercial/jingle production
- G -Business/promotion film production
- H -Business/promotion film distribution
- J -Production services
- K -TV processing laboratory

For reader convenience in locating companies by function, each particular code letter always appears in the same place across the width of the column, as shown below:

A B C D E F G H J K

To locate companies that produce radio programs, for instance, simply run your eye down the column. Every firm so engaged will display a "D" about a third of the way in from the left hand margin.

Angeles 90069. (213) 278-0311. Dick Clark, pres; Francis C. La Maina, sec-treas.

A B

Classic Film Museum Inc. 4 Union Square, Dover-Foxcroft, Me. 04426. (207) 564-8371. Carl Andrews Sr., chief exec & chmn of bd; Al Taylor, pres; Dave Andrews, VP; Bruce Andrews, treas; Carl Andrews Jr., dir of non-theatrical.

Port Credit, Ont.; Marlin Motion Pictures. 47 Lakeshore Rd. E. (416) 278-2921. Les Modolo, pres.

B

Claster Television Productions. 660 Kenilworth Drive, Towson, Md. 21204. (301) 825-4576. John Claster, pres; Ken Gelbard, exec VP.

A

CnB Studios. 3415 Beresford Ave., Belmont, Calif. 94002. (415) 592-6149. Alden G. Thompson, ownr/mgr; Carole H. Thompson, exec VP; Orvie A. Steele, recording consultant.

D

CUSTOM TAPES FOR AUTOMATION

OFFERING THE FOLLOWING PROMATS:

- "B" Beautiful Yesteryear
- "C" Contemporary Plush M-O-R
- "N" Nostalgic 78's
- "P" Plus sounds for Adding-A-Flavor. E.G. Big Band Syndrome, Night Touch . . . & Libraries by Artists



3415 BERESFORD AVENUE, BELMONT, CALIFORNIA 94002
TELEPHONE: (415) 592-6149

College Quiz Bowl Co. 572 Madison Ave., New York 10022. (212) 486-9146. Don Reid, creator, owner & pres.

A B

Color-Tech Laboratories Inc. 640 N. Broad St., Philadelphia 19130. (215) CE 6-9100. James K. Anthony, gen mgr.

K

Columbia Pictures Television, division of Columbia Pictures Industries Inc., Colgems Square, Burbank, Calif. 91505. Cable: Columfilm; telex: 23067279. (213) 843-6000. John H. Mitchell, pres; David Gerber, exec VP, prod.

A B

Co Media Productions Ltd. 635 National Press Bldg., Washington 20004. (202) 628-1024. Robert M. Johnson, pres & exec prod.

D E

The Comedy Center Inc. 801 Wilmington Trust Bldg., Wilmington, Del. 19801. (302) 656-2209.

Robert Orben, edit; Lamot Copeland Jr., pres & publisher. Flushing, N.Y. 11365: 6700 192nd St. (212) 454-9090.

A B D E

COMGRO, The Communications Group, A Corporation. 888 7th Ave., New York 10019. (212) 765-0505. Gerald Auerback, pres.

A B C G H

Command Appearance. R.D. 2. Camelot-Florida, Mass. 01247 (413) 663-6060. Robert M. Master, pres.

A D G J

Command Productions. Box 26348, San Francisco 94126. (415) 332-3161. Warren G. Weagant, pres; Kitt Weagant, VP.

A B D E F

Write for FREE Catalog

CUSTOM RADIO PRODUCTION
Contemporary ID's - Logo's - Intros.
All Formats - Lowest Prices.

ALSO - Aircheck Tapes, Production Aids, Wild Tracks, DJ Comedy, Books, FCC Tests, Feature Programs, DJ Promos, and MORE!

COMMAND PRODUCTIONS BOX 26348
(415) 332-3161 - SAN FRANCISCO, CALIF. 94126

Communications Programs International Inc. 685 Fifth Ave., New York 10022. (212) 753-5925. Lawrence F. Mihnol, Chmn. exec committee; Kevin Corrigan, VP; Pat Corrigan, exec asst.

London: 01-944-1269. Alvin Rak off, dir of European opns.

Los Angeles 90069: (213) 652-8628. Fred Hamilton, VP

Washington: (202) 652-8016. Robert F. Corrigan.

A B

Communi-Creations Inc. 2130 S. Bellaire, Denver 80222. (303) 759-1155. Don Spencer, pres; Bruce Johnson, exec VP.

A F G J

Community Club Awards Inc. P.O. Box 151, Westport, Conn. 06880. (203) 226-3377. John C. Gilmore, pres; Bess Gilmore, exec VP & treas; Philip G. Peterson, VP-sis; Keith P. Gilmore, adm asst; Comp-troller.— Frank Smith.

A B D E

Compas Productions Inc. 1801 Ave. of the Stars, Los Angeles 90067. (213) 553-6205. George Schaefer, pres.

A B C

Contact Corp. 1185 Ave. of the Americas, New York 10036. (212) 869-9292. Ed Rasp, pres; Norman A. Lucas, mgr., audio-vis prod.

J

Concept Plus II Productions. 5800 Sunset Blvd., Hollywood 90028. (213) 469-3581. Bill Persky, Sam Denoff.

A

Consolidated Film Industries. 959 Seward St., Hollywood 90038. (213) 462-3161. Sidney P. Solow, pres; Mel Sawelson, exec VP; Ted Fogelman, VP & laboratory supt; James Lawler, VP, finance & bus affairs; Edward H. Reichard, VP & chief engr; Joe Oster, VP & ctrlr.

New York 10023: (212) 541-8080.

Chicago 60611: (312) 641-0028. Bob Burnett, VP.

A B

Contemporary Programming Services Inc. Suite 1707, 1722 S. Carson, Tulsa, Okla. 74119. (918) 583-2398. Jerry Pippin, pres-gen mgr; Jim Parker, VP str rel; G. Lee Jackson, VP-bus.

D E

Continental Recordings Inc. 12 Irving Sq., Framingham, Mass. 01701. (617) 879-2430. L. Daniel Flynn, pres; John F. Flynn, VP; Robert Rose, music dir; John K. Chaisson II, treas; Sonny DuFault, prod dir; Deborah J. Nagle, creative dir.

F

G. Morgan Coote Films—Motion Picture Services. 9 Trailsmoke Cres. Etobicoke M9C 1L9, Ont. (416) 621-2565. G. Morgan Coote, pres; Greta E. Coote, sec-treas.

A B

Corelli-Jacobs Film Music Inc. 25 W. 45th St., New York 10036. (212) 586-6673. Fred Jacobs, pres.

A D

Corporate Communications Inc. 710 Tower Bldg., Seattle 98101. (206) 624-6880. William P. Endicott, pres; Irene M. Endicott, radio prod; John Knight, art dir.

A D F G

The Corporation for Entertainment and Learning Inc. 515 Madison Ave., New York 10022 (212) 421-2030. Merton Y. Koplín, pres; Charles Grinker, exec VP.

A B C G

Countryman-Kiang Inc. 905 Park Ave., Minneapolis 55404. (612) 332-2538. Thomas C. Countryman, pres; Floyd A. Kiang, exec VP; James Sugimura, VP.

C F G J

Douglas S. Cramer Company. Colgens Square, Burbank, Calif. 91505. (213) 843-6000. Douglas S. Cramer.

A G H

Thomas Craven Film Corp. 316 E. 53d St., New York 10022. (212) 688-1585. Thomas Craven, pres; Willis Briley, VP; Fyenne Hamden, VP sec.

A B C F G H

Crawley Films Ltd. Box 3040, Ottawa K1Y 3B5. (613) 728-3513. F. R. Crawley, pres; Graeme Fraser, VP; William O'Farrell, VP, prod; Glenn Robb, gen mgr.

Montreal 215: (514) 933-3642. Henry Strub, Quebec mgr.

Toronto M5V 1K1: (416) 366-0771. Herbert Taylor, mgr.

A B C G H K

CRG World Productions. Box 19902, Dallas 75219. (214) 651-7671. John J. Coyle, pres.

C F

Creative Consultants. Box 820, Hallandale, Fla. 33009. (305) 927-5288. Studios; 249 N.W. 199th St., Miami 33169. (305) 949-7107. Robert D. Buchanan, pres, gen mgr; Jack Schleh, VP, prod mgr.

C

Creative Management Associates Inc. 8899 Beverly Blvd., Los Angeles 90048. (213) 278-8899. Freddie Fields, pres.

New York 10022: (212) 935-4000. Sam Cohn, exec VP.

Los Angeles 90048: (213) 278-8899. Lester Gottlieb, senior VP.

Chicago 60611: (312) 943-7100.

Las Vegas 89102: (702) 734-7666.

Miami 33138: (305) 754-2603.

Rome 00197: 806-041.

London W1: 499-7971.

A B

Creative Marketing & Communications Corp. 3914 Miami Road, Cincinnati 45227. (513) 271-6632. John P. Fields, pres; Chester W. Nerheim, VP.

D E

Creative Productions Inc. 200 Main St., Orange, N.J. 07050. (201) 676-4422. William E. Griffing, pres; Gus J. Nichols, VP.

C F G J

Creative Services. Box 66, Ridley Park, Pa. 19078. (215) WA2-1876. Robert L. Bocchino, principal.

D F G J

Creative Services of the U.S. Catholic Conference. 1312 Mass. Ave., NW, Washington, 20005. (202) 659-6754. Francis P. Frost, dir.

A B D E

Creativision Inc. 295 W. 4th St., New York 10014. (212) 924-3935. Victor F. Kayfetz, pres; Seymour Posner, sec; Micaela Lee, distribution mgr.

B H

Crest National Film Laboratories Inc. 1141 N. Seward St., Hollywood 90038. (213) 462-6696. Maurice M. Stein, pres; Ronald E. Stein, VP; Jeanne Stein, sec-treas.

K

Bing Crosby Productions Inc. 780 North Gower St., Hollywood 90038. (213) 463-0100. Charles Pratt, pres; J. R. Rodgers, VP-finance & bus affairs; John Pommer, VP-prod.

A B

Gordon Crowe Productions Inc. 15 E. 41st St., New York 10017. (212) 867-9437. Gordon Crowe, pres; Stuart Goldsborough, acct exec; Brooks Fountain, prod mgr; Carol Berlin, casting.

A B F G H

Crystal Pictures Inc. 1560 Broadway, New York 10036. (212) 757-5130. F. Feinstein, pres; Sidney

Key to service codes

The following codes indicate type of service company offers:

- A - TV program production
- B - TV program distribution
- C - TV commercial production
- D - Radio program production
- E - Radio program distribution
- F - Radio commercial/jingle production
- G - Business/promotion film production
- H - Business/promotion film distribution
- J - Production services
- K - TV processing laboratory

For reader convenience in locating companies by function, each particular code letter always appears in the same place across the width of the column, as shown below:

A B C D E F G H J K

Tager, gen sis mgr.

B G

Cue Productions. Merchandise Mart Plaza, Chicago 60654. (312) 644-8300. Paul R. Ballantine, mgr.

A B

Cullen Productions Inc. 427 W. 51st St., New York 10019. (212) 581-2740. E. F. Cullen, pres & exec prod; Saul Kasdan, exec VP.

A B C

Cummings Productions, Inc. Dorset, Vt. 05251. (802) 867-2295. Ralph Waldo Cummings, pres.

G

Custom Films Inc. 11 Cob Drive, Westport, Conn. 06880. (203) 226-0300. Lester S. Becker, pres.

A B G H J

D

D'Antoni-Weltz Productions. 1901 Avenue of the Stars, Los Angeles 90067. (213) 277-4455. Barry Weltz, Philip D'Antoni.

A

Gordon M. Day Inc. 256 Hollywood Ave., Douglaston, N.Y. 11363. (212) 687-7040. Gordon M. Day, pres; Carol Bulkley, VP; Leo L. Reich, treas.

C F

DeKko Sound Services Inc. 295 Huntington Ave., Boston 02115. (617) 536-6160. Howard Rothberg, pres.

C G J

DeLuxe Laboratories. 1546 N. Argyle Ave., Los Angeles 90028. (213) 462-6171. Robert T. Kreiman, pres; Stanley Judell, VP & gen mgr; Fred Scobey, VP engr. Fred Austin, VP opns; R. E. Klees, VP mktg.

C G K

Demo-Vox Sound Studio Inc. 1038 Bay Ridge Ave., Brooklyn, N.Y. 11219. (212) 680-7234. Frank J. Grassi, pres/dir of opns; Laura B. Grassi, sec/treas.

D F J

Hal Dennis Productions. 6314 La Mirada Ave., Hollywood 90038. (213) 467-7146. Hal Dennis, pres; Patricia A. Vespoint, sec.

A B C G J

De Wolfe Music Library. 25 West 45th St., New York 10036. (212) 586-6673. Fred Jacobs, pres.

B C E

D4 Film Studios Inc. 109 Highland Ave., Neeldham, Mass. 02194. (617) 444-0226. Stephen Dephoure, pres.

G J

Dialing for Dollars. 407 Court Sq. Bldg., Baltimore 21202. (301) 539-7155. Theodore A. Newhoff.

A B

Diamond P Enterprises Inc. 7715 Sunset Blvd., Suite 230, Los Angeles 90046. (213) 874-1512. Harvey M. Palash, pres; Steve Adler, vp sis; Frank Furino, exec prod.

D E F

D.I.R. Broadcasting Corp. 445 Park Ave., New York 10022. (212) 371-6850. Robert B. Meyrowitz, pres; Alan H. Steinberg, exec VP; Peter Kauff, VP.

A B D E

Producers, Distributors

Directors Group Inc. 410 E. 54th St., New York 10022. (212) 759-8995. Philip Landeck, VP; John F. Ercole, VP; Ben Gradus, VP; Fred Raphael, VP.

A B C

Dirigo Media. 638 Congress St., Portland, Me. 04101 (207) 773-9022. Fred Miller

D E

Discovery Productions Inc. 151 E. 50th St., New York 10022. (212) 752-7575. David Epstein, owner; Rafael Epstein, prod.

A G H

Walt Disney Productions Inc. 500 S. Buena Vista St., Burbank, Calif. 91505. (213) 845-3141. Donn B. Tatum, chrm & chief exec off; E. Cardon Walker, pres & chief operating off.

A B

William Ditzel Productions. 933 Shroyer Rd., Dayton, Ohio 45419. (513) 298-5381. William G. Ditzel, own.

C

G J

DMK Films Inc. 3632 Murphy Rd., Nashville 37209. (615) 383-3044. Dennis M. Kostyk, pres, Michael Castle, sis mgr.

A C

G J

Dolphin Productions Inc. 140 E. 80th St., New York 10021. (212) 628-5930. Allan Stanley, pres; Bruce Davis, prod mgr; Conrad White, opns dir; Bob Blansky, art dir.

C

G J

Doorbell Productions Inc. 41 West 87th St., New York 10024. (212) 877-4308. Bill Britten, pres.

A C

Douglas Film Industries. 10 W. Kinzie, Chicago 60610. (312) 664-7455. Fred C. Raymond, pres; Douglas P. Raymond, VP.

J K

Drake-Chenault Enterprises Inc. 8399 Topanga Canyon Blvd., Suite 300, Canoga Park, Calif. 91304.

Electronic motion graphics for stations and networks with speed and economy



**WTTG-TV
Washington, D.C.**



NBC Sports

Dolphin Productions Inc.

**COMPUTER ANIMATION
(212) 628-5930**

140 East 80th Street/New York, N.Y. 10021

Producers, Distributors

(213) 883-7400. L. E. Chenault, co-owner; Bill Drake, co-owner; Lee Bayley, VP progmg & stn ret; Buddy Scott, James Kelford rgnt mgrs.

D E

Mark Druck Productions. 300 E. 40th St., New York 10016. (212) 682-5980. Mark Druck, pres; Lisa Regal, VP prod.

A C D E F G

Dynamic Films Inc. 888 Seventh Ave., New York 10019. (212) 765-0505. Nathan Zucker, pres.

A B C G H

E

Eagle Film Laboratory Inc. 4971 N. Elston Ave., Chicago 60630. (312) 282-7161. Robert J. Yuskaitis, pres.

K

East Coast Productions Inc. 64-11 99th St. Forest Hills, N.Y. 11374. (212) 459-5216. Joseph Josephson, pres; Blanche Josephson, VP; David Zimmerman, sec.

A B C

E.B.A. Film Distributing. 292 S. La Cienega Blvd., Beverly Hills, Calif. 90211. (213) 659-3350. Bill Andrews, pres; Alvin Eicoff, VP; Seymour Borde, sec-treas.

A B

Arthur Eckstein & Associates Inc. 101 Park Ave., New York 10017. (212) 889-4180. Arthur Eckstein, pres.

C G

Ecumedia News Service. Room 861, 475 Riverside Drive, New York 10027. (212) 749-4440. Warren Day, dir. (212) 870-2485.

A B

Educational Communication Association. 960 National Press Bldg., Washington 20004. (202) 393-6267. Ella F. Harillee, pres.

A B D E

Educational Productions. 8328 Willow Way, Raytown, Mo. 64138. (816) 353-1010. Bill L. Godden, pres.

J

Education Development Center. 55 Chapel St., Newton, Mass. 02160. (617) 969-7100. William T. Dale, dir of educul technology; David Nelson, mgr. media svcs.

A

Ed-Venture Films. 1122 Calada St., Los Angeles 90023. (213) 261-1885. William E. Hines, pres; Robert E. Hines, VP.

A C G J

Charles Elms Production Inc. 163 Highland Ave., North Tarrytown, N.Y. 10591. (914) ME 1-7474, or ME 1-3363. Charles D. Elms, pres; Charles D. Elms Jr., VP; Edward Whitman, VP; Ruth M. Elms, sec-treas.

C G H

The Eloise Co. 11 W. Main St., Moorestown, N.J. 08057. (609) 234-0070. Eloise M. Kocyan, pres; George H. Kocyan Jr., VP. Moorestown, N.J. 08057; (609) 235-0226.

A B G H

Empire Recording Studios Inc. 18 W. 45th St., New York 10036. (212) 757-8855. Ralph Friedman, pres; Larry Roemer, mgr. New York 10036; Magno Sound, 212 W. 48th St.

A D F

Endorsements International Ltd. 111 W. 57th St., New York 10019. (212) 581-7375. Jules Alberti, pres.

C F

Lyle Kenyon Engel Assoc. 211 W. 58th St., New York 10019. (212) 757-9415. Lyle Kenyon Engel, pres; George S. Engel, VP.

A B

Enterprise Productions. Box 7705, Van Nuys, Calif. 91405. (213) 787-1303. Sherman L. Weiss, exec prod.

A B C D E F

Entertainment Media Productions. 999 N. Doheny Drive, Los Angeles 90069. (213) 275-4456. D. Martin Tahse, pres; Fred Bennett, assoc prod.

A B

Entertainment Television Network. 3815 Cleg-

Key to service codes

The following codes indicate type of service company offers:

- A —TV program production
- B —TV program distribution
- C —TV commercial production
- D —Radio program production
- E —Radio program distribution
- F —Radio commercial/jingle production
- G —Business/promotion film production
- H —Business/promotion film distribution
- J —Production services
- K —TV processing laboratory

For reader convenience in locating companies by function, each particular code letter always appears in the same place across the width of the column, as shown below:

A B C D E F G H J K

To locate companies that produce radio programs, for instance, simply run your eye down the column. Every firm so engaged will display a "D" about a third of the way in from the left hand margin.

horn Ave., Nashville 37215. (615) 383-3044. Dennis Kostyk, pres.

A B

The Episcopal Church (Div. of Radio & Television of the Executive Council). 815 Second Ave., New York 10017. (212) 867-8400.

A B D E

Helene Erickson Associates Inc. 84-48 Manton St., Jamaica, N.Y. 11435. (212) 658-1698. Helene Erickson, pres.

A B

ETF Productions Inc. Box 4181, Lexington, Ky. 40504. (606) 277-8018. Floyd A. Kron, pres.

A B C G H

EUE/Screen Gems Video Services. 222 East 44th St., New York 10017. (212) 867-4030. Martin Irwin, VP; Jack Shultis, dir of ops; Phil McEneny, senior account exec; Don Bruck, account exec; Dick Smith, dir of high speed & helical; Darral Romick, dir of syndication; Dominick D'Agostino, dir of prod; Shirley Danko, mgr scheduling; Debbie Ross, Barbara Ruth and Don Sullivan, unit mgrs.

K

Eye View Films Inc. 150 E. 52d St., New York 10022. (212) 838-3329. Bob Schwartz, pres; John Horvath, sec-treas.

A B C G H

F

Marshall Faber Productions. 6412 E. Desert Cove, Scottsdale, Ariz. 85254. (602) 948-8086. Marshall L. Faber, owner.

A C G H J

Mike Fadell Co. Inc. 6101 York South, Minneapolis 55410. (612) 922-5606. Michael J. Fadell, pres; John Brady Benson chmn of board.

A B

Jerry Fairbanks Productions. 826 N. Cole Ave., Hollywood 90038. (213) 462-1101. Jerry Fairbanks, exec prod; Leo S. Rosencrans, head of creative dept.

G H

Faith for Today. 1100 Rancho Conejo Dr., Newbury Park, Calif. 91320. (805) 498-6661. Jim Evans, dir dept. of syndication.

A B

Family Stations Inc. 290 Hegenberger Road, Oakland, Calif. 94621. (415) 568-6200. Harold E. Camping, pres/gen mgr; Scott Smith, VP; George T. Sommerville, communications coord; Robert Rhoads, tech dir; W. Craig Hulsebos, prog mgr. San Francisco 94134: (415) 468-3500. John N. Dick, mgr. Sacramento, Calif. 95821: (916) 483-8191. Carl Auel, mgr. El Cajon, Calif. 92020: (714) 442-4414. Richard Grant, mgr. West Orange, N.J. 07052: (201) 736-2277. Clyde Casto, mgr.

Camden, N.J. 08104: (609) 854-5300. Dane S. Rohm, mgr. Annapolis, Md. 21403: (301) 286-6200. William Sadlier, mgr. Scituate, Mass. 02066: (617) 545-5700. Robert A. Thompson, mgr.

D E

Don Fedderson Productions. 1626 Vine, Hollywood 90028. (213) 461-4537. Don Fedderson, chmn of the bd; Charles Spira, pres; Fred Henry, VP; Jack Arbib, VP.

A B

Irving Feld. 916 Kearny St., #604, San Francisco 94133. (415) 421-6353. Irving Feld.

B E

Dick Feldman Associates Inc. 425 East 51st St., New York 10022. (212) 759-5630. Dick Feldman, pres.

A B C

Toni Ficalora Inc. Film & Tape Productions. 28 E. 29th St., New York 10016. (212) 679-7700. Anthony Ficalora, creative dir; Michael A. Ficalora, exec prod; Bob Mander, exec sls rep; Jane Wasserman, assoc prod.

C G

Film Art Inc. 2436 Vine, Cincinnati 45219. (513) 621-5313. Charles H. Metzger, pres; Ray M. Metzger, VP.

C G J K

Film Associates Inc. 4600 S. Dixie Hwy, Dayton, Ohio 45439. (513) 293-2164. E. Raymond Arn, pres & gen mgr; Mildred G. Arn, VP.

A B C G H

Filmation Associates. 18107 Sherman Way, Reseda, Calif. 91335. (213) 345-7414. Louis Scheimer, pres; Norman Prescott, exec prod; Hal Sutherland, dir.

A B

The Film Factory. 1207 North Western Ave., Hollywood 90029. (213) 461-8281. Gene Weed, pres; Ron Weed, VP gen mgr.

A C G J

Film Service Lab Inc. 58-62 Berkeley St., Boston 02116. (617) 542-1238. George G. Fall, pres; Al Gross, lab mgr.

J K

Film Fair Inc. 10920 Ventura Blvd., Studio City, Calif. 91604. (213) 877-3191. August A. Jekel, chmn of the bd; William D. Jekel, pres; A. Barrie Gable, sec; Kathryn E. Himes, treas; Ted Goetz, VP; Bob Gips, VP; Ben Norman, VP.

New York 10017: (212) 758-6540. Bonnie D'Andrea, sls mgr. Chicago 60610: (312) 822-9200. Dave Oakes, sls mgr.

London W1: 486-5121. Graham Clutterbuck, dir.

C

Film Lab Service Inc. 4019 Prospect Ave., Cleveland 44103. (216) 881-4510. George F. Golden, pres, gen mgr; Edward A. Kuban, VP.

K

Films Five Inc. 42 Overlook Rd., Great Neck, N.Y. 11020. (516) 487-5865. Walter Bergman, VP studio ops.

C G H

Films for Information. 190 California Ave., Palo Alto, Calif. 94306. (415) 328-6516. Paul B. Rich, pres; Ralph B. Chandler, VP.

C G J

Films Inc. 1144 Wilmette Ave., Wilmette, Ill. 60091. (312) 256-4730. Morris Rittenberg, VP TV sls; June Goss, natl dir educul TV sls. New York 10017: 230 Park Ave. Morris Rittenberg, VP TV sls.

A B

Films of India. Box 48303, Los Angeles 90048. (213) 934-3030. R. M. Bagai, pres.

A B G H

Films of the Nations. 7820 20th Ave., Brooklyn, N.Y. 11214. (212) 331-1045. Jerome Schapiro, pres; Sylvia Neches, sls mgr.

B H

Filmsounds Inc. 128 E. 41st St; New York 10017. (212) 867-0330. Norman Kasow, pres.

A D G J

Filmel International Corp. 71 Vanderbilt Ave., New

York 10017. (212) 683-5900. Peter M. Piech, pres; Charles Haydon, VP; George A. Fausel, VP

A B

Filmvideo Releasing Corp. 37 W 57th St., New York 10019. (212) 371-7828. Maurice Zourary, pres.

B

Filmways Inc. 1800 Century Park East, Suite 300, Los Angeles 90067. (213) 552-1133. Richard L. Bloch, chmn, chief exec off & pres; L. Douglas Nolan, exec VP & chief financial off; Edward S. Feldman, senior VP-motion picture prod; Walter C. Schier, senior VP-corporate affairs; Robert Grunburg, controller & asst sec; Lee Moselle, VP & sec; Lawrence H. Manheimer, VP-publishing; John H. Nicolaides, asst sec; David Z. Rosensweig, asst sec; Barbara Shapiro, asst sec.

New York 10022: 540 Madison Ave. (212) 758-5100.

A B

Filmways Motion Pictures Inc. 1800 Century Park East, Suite 300, Los Angeles, 90067. (213) 552-1133. Edward S. Feldman, pres.

A B

Fine Arts Films Inc. 11632 Ventura Blvd., Studio City, Calif. 91604. (213) 980-3034. John Wilson, pres. prod; Steven S. Gluck, dir.

A B C

Flore Films. 128 Mallory Ave., Jersey City, N.J. 07304. (201) 432-4474. Albert A. Fiore, VP prod.

A C D F G H J

Firestone Program Syndication Co. 540 Madison Ave., New York 10022. (212) 593-3013. Len Firestone, pres; Phil Besser, VP sls; Brian Firestone, Alan Whitehouse, rgnl sls mgrs; Jean C. Somers, mgr syndications opns.

B

Alan M. Fishburn Productions. 333 N. Michigan Ave., Chicago 60601. (312) 332-0657. Alan M. Fishburn, own.

A B G H

Five Seas Productions Inc. 433 Beach Ave., Mamaroneck, N.Y. 10543. (914) 381-2730. Imelda Wall Coleman, pres; C. K. Coleman, VP sls; William A. Coleman Jr., exec prod, gen mgr.

A B C D E G H

Flagg Films Inc. Box 1107, Studio City, Calif. 91604. (213) 985-5050. Don Flagg, pres.

A C F G J

Fleischer Wilson Peck Inc. Butler House, Butler, Md. 21023. (301) 771-4444. Edward Fleischer, pres; William A. Peck, VP, creative dir; William Wilson, VP, art dir.

F

Fletcher Films Inc. 73 Rivercourt Blvd., Toronto M4J3A3. (416) 425-4718. Howard D. Fletcher, pres; Marguerite Appleton, VP.

A C G

Florida News Film Feature Service. 1425 Venetia Ave., Coral Gables, Fla. 33134. (305) 448-3204. Marion T. Wilkerson, pres & gen mgr; Edmund Burke Garwood, VP for sls; William B. Wilkinson, VP-creative svcs; D. Eugene Wheeler, mgr still dept; James B. Garrity, accounting mgr.

A B G H

Focal Point Films. 35 Sutton Place, New York 10022. (212) Plaza 9-6222. John P. Strang, pres.

A B

Forde Motion Picture Labs. 306 Fairview Ave. North, Seattle 98109. (206) 682-2510. Edward Watson, pres; Richard E. Vedvick, lab mgr.

Portland, Ore. 97232: 2153 N.E. Sandy Blvd. (503) 234-0553. Arthur Helin, lab mgr.

K

Format Productions Inc. 4253 Reyes Drive, Tarzana, Calif. 91356. (213) 987-3900. Herbert Klynn, pres; M. L. Klynn, exec VP.

A B C G H

Four Star International Inc. 400 S. Beverly Drive, Beverly Hills, Calif. 90212. (213) 277-7444. David B. Charnay, chmn of bd; Arthur M. Frankel, pres; Daniel A. Schiffer, VP bus affairs; John Newland, VP prod; Neil W. Kelly, VP treas; Martha Arnold, sec; Ruth G. Schiffer, asst sec. (A subsidiary, Four Star Entertainment Corp., is located at same address as above.)

New York 10022: 240 E. 55th St. (212) 421-4444. Executives of Four Star Entertainment Corp.: Richard Colbert, pres; John Louis, VP sls; Al Sussman, VP;

Key to service codes

The following codes indicate type of service company offers:

- A —TV program production
- B —TV program distribution
- C —TV commercial production
- D —Radio program production
- E —Radio program distribution
- F —Radio commercial/jingle production
- G —Business/promotion film production
- H —Business/promotion film distribution
- J —Production services
- K —TV processing laboratory

For reader convenience in locating companies by function, each particular code letter always appears in the same place across the width of the column, as shown below:

A B C D E F G H J K

Joseph Doyle, VP, opns; David T. LaFollette, VP, international sls.

A B

Fox & Associates Inc. Northern Ohio Bank Bldg, 1370 Ontario, Cleveland 44113. (216) 621-8520. Aaron S. Fox, pres; Evelyn Allen, corporate sec.

New York 10016: 137 E. 36th St. (212) 889-7250. Aaron S. Fox, pres.

C F G H

Erwin Frankel Productions. 153 W. 82d St., New York 10024. (212) 873-1222. Erwin Frankel, Judith Feldman, exec prod; Paula Weiss Kauffman, creative dir; Bruce Kaiser, broadcast dir; Mitch Donian, film dir; Art Weiner, TV dir; Jules Lokin, childrens prog.

A C D E F J

Sandy Frank Film Syndication Inc. 635 Madison Ave., New York 10022. (212) 628-2770. Sandy Frank, pres; Maury Shields, exec VP; Larry O'Daly, natl sls; Ellen Fuhrmann, dir, opns; Charles Reckitt, comptroller.

B

Freberg Ltd. 8720 Sunset Blvd., Los Angeles 90069. (213) 657-6550. Stan Freberg, pres; Bill Andresen, VP.

A B

Fremantle International Inc. & The Fremantle Corp. 555 Madison Ave., New York 10022. (212) 421-4530. Paul Talbot, pres; Wilbur Freifeld, VP.

A B

French Broadcasting System. 1290 Avenue of the Americas, New York 10019. (212) 581-1771. Michel Anfrol, dir; Charles Greber, asst dir.

Washington 20036: (202) 833-1818. Michel Anfrol, dir.

A B

FunCo Corp. 9046 Sunset Blvd., Los Angeles 90069. (213) 278-8691. Stephen W. Jahn, pres; John R. Mohr, dir of bus affairs.

A

Fun Music Radio. Box 2049, Scottsdale, Ariz. 85252. (602) 946-2093. Howard Greenlee Jr., pres.

D E

G

Dave Gale Productions Ltd. 360 E. 72d St., New York 10021. (212) 628-7813. David L. Gale, pres; William G. Harthorn, VP.

A B

Gamut Productions Inc. Route 2, Box 61A, Barrington, Ill. 60010. (312) 381-3732. Rita Jacobs Willens, pres.

D E

Garnet Films Inc. 322 E. 45th St., New York 10017. (212) 725-8675. George F. Leuck Jr., pres.

Hollywood 90028: 1717 N. Highland Ave. (213) 461-3781.

C G H

General Broadcasting Co. 1167 Tower Rd, Schaumburg, Ill. 60172 (312) 882-3313. Robert E. Potter, pres.

D

General Conference of Seventh-day Adventists. 6840 Eastern Ave., N.W., Washington 20012. (202)

Producers, Distributors

723-0800 ext 813. W. R. L. Scragg, dir; H. L. Reiner, assoc dir.

A B

General Pictures Corp. 2515 Franklin Blvd., Cleveland 44113. (216) 781-2300. George Oliva Jr., pres; Paul Culley, VP.

C

General Television Network. Div. of Meilink Steel Safe Co. 520 W. Eight Mile Road, Ferndale, Mich. 48220. (313) 548-2500. Stanley R. Akers, pres; R. Randolph Hippler, VP.

A B C

Georgetown Productions Inc. 1428 Wisconsin Ave., N.W., Washington 20007. (202) 337-1487. Robert G. McHendrix, pres; Ann C. Brown, sec-treas.

A B C D E G H

Gerald Productions Inc. (Div of COMGRO). 311 W. 43d St., New York 10036. (212) 757-2125. Gerald Auerbach, pres; Henry Traiman, exec VP.

A B

Dan Gibson Prods. 505 Delaware Ave., Buffalo, N.Y. 14202. (716) 883-4749.

A B

Glen-Warren Productions Ltd. Box 9, Toronto M4A 2M9. (416) 291-7571. E. J. Delaney, VP of finance & administration; Allan P. Chapman, gen sls mgr.

New York 10022: (212) 371-7650. Stan Parlan, gen mgr.

Chicago 60611: (312) 321-0494. Joe Tanski, gen mgr.

Detroit: (313) 867-1171. Ed Henry, gen mgr.

A B C G H K

GLL TV Enterprises Inc. 17 Sinclair Martin Dr., Roslyn, N.Y. 11576. (516) 484-2473. Gunther L. Less, pres; Ellen G. Less, sec treas.

A G

Edward H. Goldberger Productions. 210 Tamm Ave., St. Louis 63139. (314) 647-7112. Edward H. Goldberger, own.

C

Melvin L. Gold Enterprises. 301 E. 48th St. New York 10017. (212) 688-0897. Melvin L. Gold, own.

C

Golden West Television Productions. 5800 Sunset Blvd., Los Angeles 90028. (213) 469-3181. John T. Reynolds, pres; Gary Blair, exec prod.

A

Jeff Gold Productions Inc. 300 East 51st St., New York 10022. (212) 759-8785. Jeff Gold, dir-prod; Walter Gold, treas-prod admin; C. Young, prod.

A B C D E F G H

Chuck Goldstein Productions Inc. 1775 Broadway, New York 10019. (212) JU 6-7477-9. Chuck Goldstein, pres; Ruth Goldstein, VP; Philomena Felicione, Jean Maloney.

Toronto: 131 Bloor St. (416) 924-6242. Mairi Brankin.

C

Goodson-Todman Productions. 375 Park Ave., New York 10022. (212) PLaza 1-0600. Mark Goodson and William S. Todman, principals; Giraud Chester, exec VP; Howard Todman, VP & bus affairs dir; Gil Fates, exec prod; Ted Cooper, VP.

Hollywood 90028: Goodson-Todman West, 6430 Sunset Blvd. (213) 461-8211. Frank Wayne, Ira Skutch, Howard Feilsher, Jonathan Goodson, VPs.

A B

Gordon/Glyn Productions Inc. 258 W. 4th St., New York 10014. (212) 255-5156. David Gordon, pres; Michael Glyn, VP.

C

Gordon Newsfilms & Audio-Visual Productions Inc. 1557 Pine St., San Francisco 94109. (415) 776-7484. Gerald D. Gordon, pres.

A B

Gotham Film Productions Inc. 11 E. 44th St., New York 10017. (212) 682-4450. Susan Wayne, pres.

G

Gottlieb/Taffner Programs Inc. 1370 Ave. of the Americas, New York 10019. (212) 245-4680. Ira Gottlieb, pres; D. L. Taffner, sec-treas.

B

Grant & Murtaugh Productions Inc. 140 W. 57th

Producers, Distributors

St., New York 10019. (212) 581-4536. Hal Grant, prod; John Murtaugh, composer/arranger/performer.

F

Graphic Eleven. Box 1084, Louisville, Ky. 40201. (502) 582-7368. Bernard D. Rosenthal, gen mgr.

A B C D E

Gray-Schwartz Enterprises Inc. 425 S. Beverly Drive, Beverly Hills, Calif. 90212. (213) 556-1628. Marv Gray, pres & treas; Enid Schwartz, VP & sec.

B

Greene Inc. Communications. 71 Park Ave., New York 10016. (212) 725-2660. Howard Greene, pres.

D E F

Lewis C. Green Productions. Box 234, Arlington Heights, Ill. 60006. (312) 253-5110. Lewis G. Green, mgr.

F

Sherman Grinberg Productions. (div of Firmite Associates Inc.) 1040 N. McCadden Pl., Hollywood 90038. (213) 464-7491.

New York: 630 Ninth Ave. (212) 765-5170.

A B

Group W Productions Inc. 90 Park Ave., New York 10016. (212) 983-6500. Chet Collier, chmn of the bd; Jack Reilly, pres; George Back, VP s/s; Ralph Cunningham, VP distribution; Dick Perin, dir of s/s dev, Eastern division, s/s (212) 983-6500; Joe Goldfarb, mgr, Central division, s/s (312) 454-6994; Jack Swindell, mgr, Southern division, s/s (214) 254-4455; Jack Foley, mgr, Western division, s/s (805) 969-1950.

A B

Gunn-Vigran Spots Inc. 1137 6th St. Suite 301, Santa Monica, Calif. 90403. (213) 395-0332. Herb Vigran, pres; Johnny Gunn, VP-creative.

F

H

Halvorson Associates. Box 9975, Chevy Chase, Md. 20015. (301) 654-1698. Robert L. Halvorson, head.

D E

Al Ham Music Productions Inc. 90 Morningside Drive, New York 10027. (212) 866-1234. Al Ham, pres. Producers: Rick Shaw, Bill Marino, Frank Marino, Ron Shaw.

F

Handel Film Corp. 8730 Sunset Blvd., West Hollywood, Calif. 90069. (213) 657-8990. Leo A. Handel, pres, Peter Mertens, VP.

A

Hankinson Studio Inc. 20 E. 49th St., New York 10017. (212) 753-4824. Frederick L. Hankinson, pres; Walter Klas, VP.

C

G

Hanna-Barbera Enterprises One E. 57th St., New York 10022. Gary Johnson, mgng dir; Gail Munn, dir of licensing; John Spangler, mchdng rep.

Cincinnati 45202: Donald Stapleton, VP, gen mgr; Donald Warner, dir of sports div.

B

Hanna-Barbera Productions Inc. 3400 Cahuenga Blvd., Hollywood 90068. (213) 851-5000. Joseph Barbera, pres; William Hanna, senior VP; Samuel T. Johnston, exec VP; Bud Getzler, VP & gen mgr; John Michaeli, dir of pub and adv; Dan Rosenthal, dir of bus aff.

A B C

G

Hanna-Barbera Television 3400 Cahuenga Blvd., Hollywood-90068. (213) 851-5000. Herbert F. Solow, pres.

A

Larry Harmon Pictures Corp. 649 North Bronson Ave., Hollywood 90004. (213) HO3-2331. Larry Harmon, pres; Harold M. Alpert, sec-treas.

New York 10019: 60 W. 57th St. (212) C17-6295. Larry Harmon, pres.

A B C

Harris-Tuchman Productions Inc. 751 N. Highland Ave., Hollywood 90038. (213) 936-7189. Ralph G. Tuchman, pres, gen mgr; Fran Harris, VP-creative dir.

G H

Key to service codes

The following codes indicate type of service company offers:

- A —TV program production
- B —TV program distribution
- C —TV commercial production
- D —Radio program production
- E —Radio program distribution
- F —Radio commercial/jingle production
- G —Business/promotion film production
- H —Business/promotion film distribution
- J —Production services
- K —TV processing laboratory

For reader convenience in locating companies by function, each particular code letter always appears in the same place across the width of the column, as shown below:

A B C D E F G H J K

To locate companies that produce radio programs, for instance, simply run your eye down the column. Every firm so engaged will display a "D" about a third of the way in from the left hand margin.

Con Hartssock & Co. 6381 Hollywood Blvd., Suite 512, Hollywood 90028. (213) 466-3335. Con Hartssock, own.

B

Hartwest Productions Inc. 211 E. 51st St., New York 10022. (212) 593-0550. Saul Jaffe, pres.

A B D E

David Haylock Productions. Box 380517, 801 NW 111th St., Miami 33138. (305) 754-4141. David Haylock, dir of opns.

San Francisco 94128: Box 8303.

A B G H

HBO Studio Productions Inc. 120A East 23d St., New York 10010. (212) 777-8390. Gerald M. Levin, pres; Reva Melniker, VP & gen mgr.

A C J

HD Productions Inc. Box 400, Henderson, Nev. 89015. (702) 564-2591. Cy Newman, pres.

A

HEA Productions Inc. 219 East 49th St., New York 10017. (212) 758-4120. Susan Hamilton, pres; Herman Edel, mgng dir; Bernard Drayton, VP.

C F

Hearst Metrotone News. 235 E. 45th St., New York 10017. (212) 682-7690. J. F. D'Angelo, VP; Jerome Berger, VP; Joseph Dowling, admin mgr; Walter de Hoog, prod; Screen News Digest division—Cloyd Aarseth, prod; Martin Kendrick, dir; Norman Turell, s/s dir. Washington 20024: 270 E. St., S.W. (202) 393-8311. Charles E. Shutt, bureau mgr.

A B G H

Arthur Henley Productions. 507 Fifth Ave., New York 10017. (212) 263-0136. Arthur Henley, pres.

A D

Henning & Cheadle Inc. 1000 Greenfield Rd., Detroit 48227. (313) Broadway 2-1000. George A. Cheadle, pres; John D. Joseph, VP; Alan R. Hubbert, sec; Norman Kaplan, eductl dir.

G H

Heritage Enterprises Inc. 445 Park Ave., New York 10022. (212) 421-5323. Skip Steloff, pres; Donald Havens Jr., exec VP; Andrew Besch, s/s & prod administrator.

A B

Highland Laboratories. 90 Tehama St., San Francisco 94105. (415) 986-5480. B. J. Brose, pres.

B C

J K

Hollywood Animators. 7401 Sunset Blvd., Los Angeles 90046. (213) 876-1190. William F. Selleck, Jean M. Selleck.

C

Horizons Communications Corp. 444 Madison Ave., New York 10022. (212) 362-8968. Jerome R. Feniger, pres; William W. Mulvey, chmn exec committee.

D E

Howard Radio-TV Productions. 123 W. Chestnut St., Chicago 60610. (312) 642-5877. Bernard Howard, own.

C F G J

H-R Productions Inc. 251 W. 57th St., New York 10019. (212) 246-5133. Herbert Rosen.

G H J

Hughes Television Network Inc. 1133 Ave. of the Americas, New York 10036. (212) 765-6600. Arthur M. Mortensen, pres; Roylance H. Sharp, exec VP; David A. Donnelly, VP s/s-progmg; John L. Koushouris, VP prod-engr; Ralph A. McFarland, VP str rel; William Hyland, VP bus affairs; Thomas J. Schilling, VP purchasing; Richard Moran, Eastern s/s mgr; John Lydon, comptroller.

Rutherford, N.J.: 158 E. Passaic Ave. (201) 933-4040.

A B

K

I

Image Devices, Inc. Box 610606, 1825 NE 149th St., Miami 33181. (305) 945-1111. David G. Haylock, pres; Will Williams, VP; Harriett E. Pompeo, sec-treas; Sarraa Poster, dir of s/s.

J

Images Presentations Corp. 450 Sunrise Hwy, Rockville Centre, N.Y. 11570. (516) 536-7400. Robert Braverman, pres; Joan Braverman, opns mgr; John E. Vidaver, TV rep.

B

Imagination Inc. 443 Jackson St., San Francisco 94111. (415) 433-5480. Michael Felix, pres; Jeff Hale, VP, dir of animation; Walt Kraemer VP, creative dir.

A B

F

Impact Films Inc. 144 Bleecker St., New York 10012. (212) 674-3375. Lionel Rogosin, pres; Joy Pereths, distribution mgr.

G H

Independent Artists. 16 W. 56th St., New York 10019. (212) 765-4640. Herb Sidel; Paul Rosen.

C

Independent Television Corp. 555 Madison Ave., New York 10022. (212) 826-1555. Abe Mandell, pres; Leonard Kornblum, exec VP finance & adm; Pierre Weis, exec VP of syndication; Tom Sibert, exec VP of foreign s/s; Joseph Fusco Jr., VP adv, publ & prom; Nathan Leipziger, VP progmg & prod; Joseph Fusco, Jr., VP publ & prom.

A B

Infomax, Information Maximizers. Box 38177, Los Angeles 90038. (213) 737-8200. Victor P. Hall, pres.

A B

D E

G

Dan Ingram's No Soap Radio Ltd. 161 W. 54th St., New York 10019. (212) 581-5572. Dan Aron, creative dir; Dan Ingram, creative assoc; Bryan Wells, mus dir; Rob Drasin, assoc prod.

F

Inner City Trade Radio & TV Production. 2630 E. 75th St., Chicago 60649. (312) 734-1232. William C. Tyson, pres; Howard Scott, exec VP.

A

D E F

Inter-American Publications Inc. 41 E. 42d St., Suite 1514, New York 10017. (212) 682-0884. Octavio Gonzalez, VP & gen mgr.

A B

F

Interchurch Broadcasting—See Berkeley Studio.

International Motion Pictures Ltd. Box 3201, Erie, Pa. 16509. (814) 864-2288. Clinton J. Bebell, exec prod.

A B C

G H

K

International Tele-Film Enterprises. 47 Densley Ave., Toronto M6M 5A8. (416) 241-4483. Murray L. Sweigman, mgng dir; Randy Zalken, mktg mgr.

Montreal H2Z 1M7: (514) 861-8053. Bernard J. Maientant, mgr.

Vancouver, B.C. V5Y 2G2: (604) 874-1436. Cameron Varoco, s/s rep.

B

H

International Treasures. Box 413, Philadelphia 19105. (215) 828-0502. FO. Pease, gen mgr; J.P. Morgan, vis dir; A.E. Pease, office mgr; David Rosen, asst vis dir.

London N. 8: 21 Mountview Court, 648 Green Lane. A.E. Brammer, mgr.

A B

G H

Iring Productions Inc. 3202 East 21st, Tulsa, Okla. 74114. (918) 936-2112. John R. Schmitz, pres & ownr.

C D E F

J

Italian Radio TV System (RAI Corp.) 1350 Avenue of the Americas, New York 10019. (212) 757-6987. Renato M. Pachetti, exec VP.
D E

ITC of Canada Ltd. Box 320, Toronto-Dominion Centre, Toronto M5K 1K2. (416) 362-1166. Frank D. Murray, gen mgr.

Montreal H3A 1R3; 1500 Stanley St. (514) 288-4082. William Clapham, mgr.

A B
The It Is Written Telecast. (Division of Adventist Radio-TV Film Center) 1100 Rancho Conejo Blvd. (Box 0) Thousand Oaks, Calif. 91360. (805) 498-3151. Alvin G. Munson, pres; Philip Moores, mgr; George E. Vandeman, dir & speaker; David L. Jones, dir of prod & syndication; George E. Knowles, field coord; Michael D. Fellows, dir of pub rel.
Washington 20012: 6840 Eastern Ave., N.W.

A B C J

J

Riley Jackson Films. 6353 Homewood Ave., Hollywood 90028. (213) 464-4708. Riley Jackson, pres.

A B C D G

Henry Jaffe Enterprises Inc. 200 West 57th St., New York 10019. (212) 245-2400. Henry Jaffe, pres; Rose Blacker, VP.

Los Angeles 90028: 5800 Sunset Blvd.
A B

JAM Creative Productions Inc. 604 Stevens Village Drive, #107, Dallas 75208. (214) 941-9377. Jon Wolfert, pres.

F

Japan Broadcasting Corp. (Nippon Hoso Kyokai). 850 Third Ave., New York 10022. (212) 371-2772. Tadakatsu Seguro, dir.

A B D E

JC Productions Inc. 16 W. 46th St., New York 10036. (212) 575-9611. Joe Conforti, dir; Sal Mallimo, prod mgr; Ted Krysty, audio prod; Shelly Rann, prod rep.

A C D F G

Jefferson Productions. One Julian Price Place, Charlotte, N.C. 28208. (704) 374-3823. E. Grey Hodges Jr., mgng dir; George Booker, opns mgr; Wayne T. Upchurch, sis mgr; Robert Dycus, tech opns mgr.

New York 10022: 300 E. 56th St. (212) 532-0922.
A C G J

Jewell Radio & TV Productions and subsidiary: Talent Phone Instant Auditions. 612 N. Michigan Ave., Chicago 60611. (312) 664-5757. Marion Jewell, pres; Jim Lawrence, script edit; Al Allen, tape edit.

A C D F G J

Calvin Jones and Co. 3315 Sul Ross, Houston 77006. (713) 529-4181. B. Calvin Jones, pres; K. C. Benedict, exec VP; Joseph Sneed, account group chief; Constance Teer, opns-traffic supvr.

A B G H

Tom Jones Recording Studios. Downtown Holiday Inn Bldg., Rochester, Minn. 55901. (507) 288-7711. Thomas H. Jones, pres; Craig S. Rettmer, prod mgr.

D F J

Joshua Tree Productions Inc. 15 W. 46th St., New York 10036. (212) 265-5800. David W. Funt, pres; James A. Kiewel, exec VP.

Paris: 26 Ave Pierre 1er de Serbie. 727-1270. Stephane Tchalgadjieff, dir.
A B

JPI. 1420 Larimer Sq., Denver 80202. (303) 623-0167. Jack E. Carver, pres; Ron Anderson, dir of prod; Mary R. Wolff, dir of syndication.

A B C G H

J.P.L. Productions Inc. 1600 E. Blvd. de Maison-neuve, Montreal (514) 526-2881. J. P. Ladouceur, pres; Paul J. Audette, gen mgr.

A C G J

JWT Syndication—See J. Walter Thompson.

K

KalaMusic. Suite 334, Industrial State Bank Bldg., Kalamazoo, Mich. 49006. (616) 345-7121. Steven C. Trivers, pres; William J. Wertz, VP.

D E

Key to service codes

The following codes indicate type of service company offers:

- A —TV program production
- B —TV program distribution
- C —TV commercial production
- D —Radio program production
- E —Radio program distribution
- F —Radio commercial/jingle production
- G —Business/promotion film production
- H —Business/promotion film distribution
- J —Production services
- K —TV processing laboratory

For reader convenience in locating companies by function, each particular code letter always appears in the same place across the width of the column, as shown below:

A B C D E F G H J K

Victor Kayfetz Productions Inc. 295 W. 4th St., New York 10014. (212) 924-3935. Victor F. Kayfetz pres; Seymour Posner, sec; Micaela Lee, distributor mgr.

C G J

KCRA-TV (Kelly Broadcasting Co.) 310 10th St., Sacramento, Calif. 95814. (916) 444-7300. Jon Kelly Bob Kelly, partners; Bob Grant, natl sts; Harvey Fisher local sts; Paul Thompson, news dir; Dean Cull, prog mgr; Jim Barber, prod mgr.

A C J K

Stacy Keach Productions. 5216 Laurel Canyon Blvd., North Hollywood, Calif. 91607. (213) 877-0472. Stacy Keach, pres; Mary Keach, VP; Andrew Davis, sec; Frankie Newton, exec sec; Robert R. Mulqueen, prod mgr; Dori Schirm, staff sec.

A C D F G H J

Keith Films. 100 E. Hartsdale Ave., Hartsdale, N.Y. 10530. (914) 723-1245. William A. Keith, dir.

G H

M. A. Kempner Inc. International Bldg., Suite 313, 2455 E. Sunrise Blvd., Fort Lauderdale, Fla. 33304. (305) 565-9419. Marvin A. Kempner, pres.

A B

K & H Visual Communications. 3601 Oak Grove, Dallas 75204. (214) 526-5268. Rod Kertz, pres; Tom Young, exec VP; John Bronaugh, VP.

C G J

Killiam Shows Inc. 6 E. 39th St., New York 10016. (212) 679-8230. Paul Killiam, pres; William Perry, sis; Patrick Montgomery, prod supvr.

A B C G H

Rod Kinder Music Organization Inc. 1 Music Circle, Nashville. Rod Kinder, pres; Mary A. Kinder, bus mgr; VP & treas; Max Geiger, chief mixer; Ford Kinder, VP & sec; Wayne Howe, chief eng. mixer.

D F J

King Features/Hearst Metrotone News. 235 E. 45th St., New York 10017. (212) 682-5600. J. F. D'Angelo, pres; Joe Dowling, dir of opns.

A B

King World Productions Inc. 903 Mountain Ave., Berkeley Heights, N.J. 07922. (201) 464-9746. Lucille King, chmn of bd; Charles King, pres; Michael G. King, exec VP; Karen Rabe, sec & treas.

A B

Hal Kirn Associates. 1223 Connecticut Ave. N.W., Washington 20036. (202) 638-4034. Hal Kirn, prod; Carolyn K. Flook, assoc. prod.

A B C D E F G J

Klein &. 155 N. LaPeer Dr., Los Angeles 90048. (213) 278-5600. Robert Klein, pres.

Chicago 60651: Klein & Illinois. (312) 327-3750. Judy Wise.

A B C D E F G H

The Milt Klein Co. 221 S. Maple Drive, Beverly Hills, Calif. 90212. (213) 275-4628. Milt Klein, proprietor.

A B C D E F G H J

Walter J. Klein Co. Ltd. 6301 Carmel Road, Charlotte, N.C. 28211. (704) 542-1403. Walter J. Klein, pres; Robert P. Klein, Elizabeth G. Klein, Richard A. Klein, VPs; Chris Cafegé, dir of prod; Ike McLaughlin, mktg dir; Stanford Levy, distribution dir.

A B C G H J

Producers, Distributors

L

Lakeside Television Co. Inc. 45 W. 45th St., New York 10036. (212) 757-7149. Bernard Schulman, pres.

A B

Lance Productions Inc. 353 W. 57th St., New York 10019. (212) 757-6167. Sherman Ford Jr., pres; Joy G. Ford, VP.

G

Landis/Wolf Inc. 25 West 56th St., New York 10019. (212) 581-8870. Clifford Wolf, pres; Janie Mack, asst prod; Min Ooka, studio mgr; Sybil Hamada, rep.

C

Anthony Lane Film Studios Inc. 5050 W. 78 St., Bloomington, Minn. 55435. (612) 835-5050. Anthony Lane, pres.

A B C

G H

John B. Lanigan & Associates. 2 E. 54th St., New York 10022. (212) PL 1-4484. John B. Lanigan, pres; John C. Ranck, Anthea Masterson.

A B C

Robert Lawrence Productions Inc. 1165 Park Ave., New York 10028. (212) 427-3183. Robert L. Lawrence, pres.

Toronto 5: 38 Yorkville Ave. (416) Walnut 5-5561. John T. Ross, pres.

A B C

G H

Lawren Productions Inc. Box 1542, Burlingame, Calif. 94010. (415) 697-2558. Lawrence A. Williams, pres; Thomas G. Gregory, exec VP.

A C

G H

LBJ Productions. 1214 McCallie Ave., Chattanooga 37415. (615) 629-1481. Gene Michelson, pres; Jim Jenkins, asst VP; Harold Johnson, chief engr; Harold Coe, prod mgr.

A B C

F G H

J. Richard Lee Inc. 5670 Wilshire Blvd., Suite 815, Los Angeles 90036. (213) 939-3147. J. Richard Lee, pres.

A B C

D E F J

Dan Leeds Productions. 45 W. 45th St., New York 10036. (212) Plaza 7-2897. Dan Leeds, pres; P. C. Leeds, VP & sec; Edward Cohen, treas.

A B

Lemorande Film & Tape Production Co. 205 E. Wisconsin Ave., Milwaukee 53202. (414) 271-3358. William Lemorande III, exec prod.

C

F G H J

Le Roy Motion Picture Production Studios. 531 South St., Philadelphia 19147. (215) 925-3769. Charles Roy, pres; Rita Roy, VP.

New York 10001: 213 W. 35th St.

A C

G J

Gene Lester Productions. 4918 Alcove Ave., North Hollywood, Calif. 91607. (213) 769-6160. Gene Lester, prod/dir; Burt Wenland, asst.

A B C

G H

The Lewis Companies. 410 N. Michigan Ave., Chicago 60611. (312) 644-6400. Herschell G. Lewis, pres; Peggy Anderson, creative dir; Ron Muraoka, art dir.

A B

F G H

LowRon Television Inc. 441 W. 53d St., New York 10019. (212) 765-1500. Ron Spangler, pres & chmn bd; Tony Masucci, gen mgr; Steve Walsh, chief engr.

A B C

G H

Liberty Studios Inc. 238 E. 26th St., New York 10010. (212) 532-1865. Anthony Lover, dir/camera-man/pres.

G H

Jack Lieb Productions Inc. 112 North May St., Chicago 60607. (312) 666-1220. Jack H. Lieb, pres; Warren H. Lieb, VP.

A C

G H J

Light, Radio Division. a subsidiary of Light Records Inc., Box 296, Woodland Hills, Calif. 91365. (213) 884-0333. Ralph Carmichael, pres; Mike Trout, dir; Bill Cole, prod.

D E

Linale's Sound Studios. 1995 N.E. 150th St., North Miami, Fla. 33181. (305) 944-1006. Frank Linale, pres; Randy Bird, VP.

D F

Producers, Distributors

Lindberg Productions Inc. 49 W. 46th St., New York 10036. (212) 582-9060. Lawrence W. Lindberg, pres; Murray Frank, treas.

A B C G H

Lindy Productions Inc. 4784 N. High St., Columbus, Ohio 43214. (614) 262-2262. Nils Lindquist, pres; Richard Huntsberger, exec prod; John Fippin, chief engr.

Columbus 43214: Magnetic Studios division. (614) 262-2262.

C F G J

Jack Lloyd Productions. 8440 Sunset Blvd., Hollywood 90069. (213) 656-4607. Jack Lloyd.

A B C D E F

Arthur Lodge Productions Inc. 315 Millwood Road, Chappaqua, N.Y. 10514. (914) 666-5486. Arthur Lodge, pres.

A B

Robt Longenecker Agency. 8438 Meirose Pl., Los Angeles 90069. (213) OLive 3-3770. C. Robert Longenecker, own & pres.

A B C

Lorimar Productions. 4000 Warner Blvd., Burbank, Calif. 91505. (213) 843-6000. Lee Rich.

A

Lori Productions Inc. 6087 Sunset Blvd., Hollywood 90028. (213) 466-7567. Jack Wipper, pres; Ron Grow, VP, Pat Wipper, sec; Mel Kreger, bus mgr; Lyn De Shane, Western regional sls mgr; Bruno Darke, Chicago area sls rep.

Chicago 60603: 67 Madison Ave. (312) 236-2495. Ron Grow, exec VP.

A B

James Love Productions Inc. 51 E. 42d St., New York 10017. (212) 697-8847. James A. Love, pres; Eugene L. York, exec VP.

A B C D E G H J

The Mike Lundy Co. 813 Westbourne Dr., Los Angeles 90069. (213) 652-1018. Mike Lundy, pres; D. L. Carpenter, gen mgr.

A B D E F

Lutheran Church in America, Department of Press, Radio & TV. 231 Madison Ave., New York 10016. (212) 481-9668. R. Marshall Stross, dir; Howard W. Coleman, assoc dir.

A C D F

Lutheran Council in the USA, Film and Broadcast Relations Unit. 315 Park Ave. South, New York 10010. (212) 677-3950. Clement W. K. Lee, dir. San Francisco 94109: (415) 928-7770.

A B D E

Lutheran Television. 2185 Hampton Ave., St. Louis 63139. (314) 647-4900. Martin J. Neeb Jr., exec dir; J. Michael Vincent, distribution dir.

A B C

M

Magic Key. 407 Court Sq. Bldg., Baltimore 21202. (301) 539-7155. Theodore A. Newhoff, chmn.

A B

Magne-Tronics Inc. 93 Broad St., Matawan, N.J. 07747. (201) 566-9600. John H. Bolendz, pres.

A B D E

Manbeck Pictures Corp. 3621 Wakonda Dr., Des Moines, Iowa 50321. (515) 285-8345. Earl Manbeck, Jr., pres, treas; Bonnie Manbeck, VP, sec.

B

Eddy Manson Productions Inc. 2616 N. Beachwood Drive, Hollywood 90068. (213) 465-1894 or 769-8400. Eddy Lawrence Manson, pres & creative dir; Paula Dorne Manson, VP, treas.

C F

Marathon International Productions Inc. 10 E. 49th St., New York 10017. (212) 688-1130. Konstantin Kaiser, pres-exec prod.

A C G H J

Rocky Marciano-Al Falloni Enterprises Inc. 211-16 50th Ave., Bayside Hills, N.Y. 11364. (212) BA4-8491.

A B

Marco Video Systems Inc. 6114 N. 20th St. Philadelphia 19138. (215) 849-9500. George Faulkner,

Key to service codes

The following codes indicate type of service company offers:

A —TV program production
 B —TV program distribution
 C —TV commercial production
 D —Radio program production
 E —Radio program distribution
 F —Radio commercial/jingle production
 G —Business/promotion film production
 H —Business/promotion film distribution
 J —Production services
 K —TV processing laboratory

For reader convenience in locating companies by function, each particular code letter always appears in the same place across the width of the column, as shown below:

A B C D E F G H J K

To locate companies that produce radio programs, for instance, simply run your eye down the column. Every firm so engaged will display a "D" about a third of the way in from the left hand margin.

pres; George Clements, VP & sec; Karl Weger, treas.

A B

Mark Century Corp. 3 E. 57th St., New York 10022. (212) 421-6880. Michael Bogen, VP & gen mgr.

D E F J

Mark Three Studios Inc. 87 Weybosset St., Providence, R.I. 02903. (401) 421-9242. Philip A. Trenn Jr., pres; Tony Petri, VP; Roland J. Maynard, dir of photography.

G H

Mark V Productions. 194 Ridgewood Dr., Boston (617) 537-8686. Dave Navaroli, VP & gen mgr.

D E

Maryknoll Media Relations. Walsh Bldg., Maryknoll, N.Y. 10545. (914) WI 1-7590. Rev. Ronald Saucii, M.M., dir med rel (ext 493).

New York 10016: 123 E. 39th St. (212) Oxford 7-4470.

A B D E

Master Broadcast Services Inc. Box 61, Morrisville, Pa. 19067. (215) 295-0413.

D E

Master Key. 407 Court Sq. Bldg., Baltimore 21202. (301) 539-7155. Theodore A. Newhoff, chmn.

A B

Mattco Associates Inc. 3309 N. Chapel Hill Rd., McHenry, Ill. 60050. (815) 385-5508. Richard J. Matt, pres & exec dir; William M. Fraser, assoc prod.

A C

Maysles Films Inc. 1697 Broadway, New York 10019. (212) 582-6050. Albert Maysles, pres; David Maysles, VP.

A B G H

MBA Music Inc. 8 E. 48th St., New York 10017. (212) 688-2847. Marc Brown, pres, Richard Simon, VP, creative dir.

A B F

MCA TV, a Division of MCA Inc. 445 Park Ave., New York 10022. (212) 759-7500. Lou Friedland, pres; Keith Godfrey, exec VP; Hal Cranton, VP-adv, sls prom & publ; Bob Davis, VP-rsch & sls dev.

Cleveland: 1721 Superior Ave. (216) 241-6010. DeArv Barton, gen consultant; Phillip Conway, Midwest VP.

Universal City, Calif.: 100 Universal City Plaza. (213) 985-4321. Bob Greenberg, VP West Coast.

Chicago: 425 North Michigan Ave. (312) 337-1100. Carl Russell, VP Central.

Dallas: 2906 Maple Ave. (214) RI7-7536. Layton Bailey, VP Southeast.

Atlanta: 205 Walton St. N.W. (404) 525-7521. Carl Runge, VP Southeast.

Minneapolis-St. Paul: 1113 Currie Ave. (612) 335-7037. Dick Cool, VP North Central.

Philadelphia (Cherry Hill, N.J.) 08003: (609) 429-3873. Dick Cignarelli, North East VP.

St. Louis: 11670 Gravois Rd. (314) CE1-8230. Jack Robertson, VP central region.

A B

MCI Productions. (Mobile Color Inc.) Box 1872, Austin, Tex. 78767. (512) 282-1015. Stuart Klein; VP,

Dallas 75207: MCI Productions/Dallas, 2500 Farlington St. (214) 630-1262. Jerry West, mgr. Houston 77042: MCI Productions/Houston, Box 42283. (713) 785-0420. Gerald Oates, mgr.

A B C G H J

MCI Video/Film Productions Inc. 411 Lexington Ave., New York 10017. (212) MU7-8640. Jack Moss, pres.

A B C G H

McGraw-Hill Films. 1221 Ave. of the Americas, New York 10020. (212) 997-2804. Alan Kellock, VP & gen mgr; Norman Slucher, natl sls mgr motion pictures; Grant Robinson, natl sls mgr BLM; Barney Freeman, adv & prom mgr; Donald Breidt, bus mgr.

Hightstown, N.J. 08520: Princeton-Hightstown Rd. (609) 448-1700. Charles Eisenberger, Eastern rgntl mgr.

Manchester, Mo. 63011: Manchester Rd. (314) 227-1600. David Wisely, Western rgntl mgr.

A B G H

Fenton McHugh Productions Inc. 2500 Dempster St., Des Plaines, Ill. 60016. (312) 296-4571. Fenton McHugh, pres.

A B

The McLendon Collection. 1917 Elm St., Dallas 75201. (214) 651-1010. B.R. McLendon, Gordon McLendon, Bart McLendon, partners. Leigh Robertson, natl music dir; Stephen Blackson, natl prod dir.

D E

Kenneth R. Meades. Box 71403, Los Angeles 90071. (213) 666-9056. Kenneth R. Meades, owner-mgr.

F J

Medallion TV Enterprises Inc. 8831 Sunset Blvd., #100 W. Hollywood, Calif. 90069. (213) Oldfield 2-8100. John A. Ettlinger, pres.

A B

Media Features of America. 680 Beach St., Suite 445, San Francisco 94109. (415) 885-2807. Cathy Furniss, pres; Michel Lipman, VP.

B E

Media Productions. 1 Rockefeller Plaza, New York 10020. (212) 265-2772. Burton Zaro, creative dir; Everett Reid Jr., VP-prod; Peter Lussier, dir of prod; Maureen Schulberg, script continuity.

Long Island City, N.Y. 11101: 25-12 Bridge Plaza South. (212) 786-4944.

A B

Media Services Center of the American Lutheran Church. 1568 Eustis St., St. Paul 55108. (612) 645-9173. John L. Brekke, acting coord; Rev. Donald N. Oberdorfer, dir of video services; Carolyn Kay Lindkugel, dir of support svcs; Hal Dragseth, dir of spec svcs; Douglas E. Tuve, dir of audio svcs; Fritz Sinjuschkin, dir of tech svcs; Carol Birkland, str net, prom.

A B C D E F G H J

Mediatech Inc. 528 N. Michigan Ave., Chicago 60611. (312) 644-1314. T. Martin Rennels, VP & gen mgr; Thomas H. Baur, VP mktg.

A B C

K

Don Meier Productions. 520 N. Michigan Ave., Chicago 60611. (312) 222-1755. Don Meier, pres.

A

Bill Melendez Productions Inc. 429 North Larchmont Blvd., Los Angeles 90004. (213) 463-4101. Bill Melendez, prod & pres; Helen Melendez, sec & treas; Ed Levitt, layout & design; Bernard Gruver, stry & design.

Chicago 60601: 221 North La Salle St. (312) 782-2736. Joe Edwards.

A B

Metromedia Producers Corp. 485 Lexington Ave., New York 10017. (212) 682-9100. A. Frank Reel, pres; Kenneth Joseph, exec VP-worldwide syndication; Klaus Lehmann, VP inatl sls.

B

Metrotape West KTTV. 5746 Sunset Blvd., Los Angeles 90028. (213) 462-7111. Richard Stratton, exec VP; Louis S. Steinberg, VP, sls.

A C G J

MG Films Inc. 141 E. 56th St., New York 10022. (212) 371-1622. Marvin M. Grieve, pres; John C. Ranck, VP

A B

MGM Television (div. of Metro-Goldwyn-Mayer Inc.). 10202 W. Washington Blvd., Culver City, Calif. 90230. Harris L. Kattelman, pres TV; John B. Spires, VP international sls; Barry Lowen, VP prog dev; Maurice R. Morton, VP bus affairs; Les Friends, dir of adminis-

tration: Charles R. McLain, dir movies of the week & long-form progs.

New York 10019: 1350 Avenue of the Americas. (212) 977-3400. Edward A. Montanus, VP sls; Ben Wickham, sls mgr; Al Newman, dir of adv & prom; Charles Geusch, mgr & rsch & sls planning.

Culver City, Calif.: 10202 W. Washington Blvd. (312) 836-3000. Joseph Indelli, sls mgr.

Chicago: 333 N. Michigan Ave. (312) 263-1490. Paul Hoffman, sls mgr.

Atlanta: 1718 Peachtree St. N.W., Suite 916. (404) 873-4000. Virgil Wolff, sls mgr.

A B

MHL Productions Inc. 61 Thunderbird Estates, Maryville Mo. 64468. (816) 582-5536. Michael Lazar, pres.

F

Charles Michelson Inc. 444 Madison Ave. New York 10022. (212) 759-3232. Charles Michelson, pres; Vivian D. Michelson, treas.

B D

Richard S. Milbauer Productions/Newsfilm, USA. 21 W. 46th St, New York 10036. (212) 757-4970. Richard S. Milbauer, exec prod.

Chicago 60602: 173 W. Madison. (312) RA 6-8693. Mr. Hathorn.

Washington 20005: 1510 H St. N.W. (202) 628-7668. Mr. Cutler.

A B

Millbeck Broadcasting Corp. 781 58th Ave. South, St. Petersburg, Fla 33705. (813) 866-6545. Arthur Millman, pres.

Cedar Rapids, Iowa 52401: 615 Merchants National Bank Bldg. (319) 364-5182. 364-5182. Gene Kellenberger, prod dir.

A B D

Warren Miller Productions Inc. 505 Pier Ave., Box 536, Hermosa Beach, Calif. 90254. (213) 376-2494. Warren Miller, pres; Curt Dushane, VP; Larry Morrison, prod mgr.

C G

Minicast Productions. Box 1110, Roseville, Calif. 95678. (916) 791-4111. Gene Ragle, mgng partner; Wes Meyers, opns mgr.

E

Mizrachi Women's Organization of America. 817 Broadway, New York 10003. (212) 477-4720. Mrs. Milton S. Jacobson, natl pres.

A B

Mobile Homes Manufacturers Association. Box 201, Chantilly, Va. 22021. (703) 968-6970. Dan L. Butler, dir, PR.

A B

Mode-Art Pictures. 3075 W. Liberty Ave., Pittsburgh 15216. (412) 343-8700. James L. Baker, bd chmn-chief exec off; Robert L. Stone pres; Carl Lindquist, dir of photography.

A B

Modern Sound Pictures Inc. 1402 Howard St., Omaha 68102. (402) 341-8476. Keith T. Smith, pres; Margaret Kell Smith, sec-treas.

A B

Modern Talking Picture Service Inc. 2323 New Hyde Park Rd., New York 11040. (516) 437-6300. Carl H. Lenz, pres; William Oard, exec VP; Dan Kater, VP & gen mgr.

Atlanta 30308: 412 W. Peachtree St. N.W. (404) 524-1311.

Chicago: 1687 Elmhurst Rd., Elk Grove Village, Ill. 60007. (312) 593-3250.

Cincinnati 45202: 9 Garfield Place. (513) 421-2516.

Dallas 75207: 1411 Slocum St. (214) 742-4106.

San Francisco 94105: 16 Spear St. (415) 982-1712.

Summit, N.J. 07901: 315 Springfield Ave.

Don Mills 405, Ont.: 1875 Leslie St. (416) 444-7347. Sheila Andrechuk.

G

Modern Teleservice Inc. 619 W. 54th St., New York 10019. (201) 765-4500. Benjamin DeSio, pres; Richard Russell, exec VP.

Chicago 60611: 201 E. Erie St. (312) 337-3761. Peter Markovich, VP.

Hollywood 90038: 1153 N. McCadden Place. (213) 463-1124. John Lipsky, VP.

A B

More Music Enterprises Inc. 5215 Laurel Canyon Blvd., Suite 200, North Hollywood, Calif. 91607. (213)

Key to service codes

The following codes indicate type of service company offers:

- A —TV program production
- B —TV program distribution
- C —TV commercial production
- D —Radio program production
- E —Radio program distribution
- F —Radio commercial/jingle production
- G —Business/promotion film production
- H —Business/promotion film distribution
- J —Production services
- K —TV processing laboratory

For reader convenience in locating companies by function, each particular code letter always appears in the same place across the width of the column, as shown below:

A B C D E F G H J K

985-3300. Ron Lewis, VP & gen mgr; Jay Stevens, pres.

D E F G

Morgan Productions, a division of Morgan Broadcasting Inc. 6020 S. 45th St., Phoenix 85043. (602) 257-1234. E. Morgan Skinner Jr., exec VP & gen mgr; Earnest M. Skinner, pres & chmn of bd.

D F

Nelson Morris Productions Inc. 11 E. 48th St., New York 10017. (212) Plaza 3-1484. Nelson Morris, pres.

A B

Charles Morrow Associates Inc. 365 West End Ave., New York 10024. (212) 799-0636. Charles G. Morrow, pres.

C F

Moss Communications Inc. 441 Lexington Ave., New York 10017. (212) 687-8640. Jack Moss, pres, exec prod.

A B C G H

Motion Picture Service Co. 125 Hyde St., San Francisco 94102. (415) 673-9162. Gerald L. Karski, pres; Harold A. Zell, VP-prod.

C

MovieLab Inc. 619 W. 54th St., New York 10019. (212) 586-0360. Peter P. Cardasis, Bernie Mackin, Norman Rinehart, Marguerite Blaise.

Hollywood 90038: MovieLab-Hollywood Inc., 6823 Santa Monica Blvd. (213) 469-5981. Harold Hinkle, Corky Morelock, Frank Matera.

K

MRC Films Inc. 71 W. 23d St., New York 10010. (212) 989-1754. Bruce McLaughlin, pres; Lawrence Molloy, exec prod.

A C G J

MTM Enterprises Inc. 4024 Radford Ave., Studio City, Calif. 91604. (213) 763-8411. Grant Tinker.

A

Burt Munk Productions Inc. 56 E. Walton Place, Chicago 60611. (312) 337-0034. Burton M. Munk, pres; Mary Abraham, bus mgr.

G J

Murakami Wolf Films Inc. 1463 Tamarind Ave., Hollywood 90028. (213) 462-6474. Fred Wolf, pres; Charles Swenson, VP; Alex Lucas, exec prod.

A C

Owen Murphy Productions Inc. 11 E. 47 St., New York 10017. (212) 838-1184. Paul Cohen, pres; Helene Cohen, VP; Emmanuel Munos, chief edit.

A C G J

Musical Commercials by Baskerville. 7 Pierpoint Dr., Montclair, N.J. 07042. (201) 746-6163. Charles Baskerville, writer/prod.

C F

Music Makers Inc. 200 Central Park South, New York 10019. (212) 245-3737. Mitch Leigh, creative dir.

C F

The Music Mint 2773 E. Horseshoe Dr., Las Vegas 89120. (702) 451-4273. William G. Mors, owner; Mark S. Mors, prod; Mark Steuert, mus dir; Gene Bernard, audio dir.

D E

Musifex Inc. 1022 Wilson Blvd., Arlington, Va. 22209. (703) 525-6476. E. Robert Velazco, pres.

C F J

Producers, Distributors

N

Narwood Production. 40 E. 49th St., New York 10017. (212) 755-3320. Ted LeVan, pres.

D E

Nassour Productions. 9348 Santa Monica Blvd., Beverly Hills, Calif. 90210. (213) 278-3952. William Nassour, pres, William Nassour, Jr., VP.

C G

National Aeronautics and Space Administration. Office of Public Affairs, Code FAM, Washington 20546. (202) 755-3500. Kenneth Grimm, chief, audio vis branch; H. William Detrich, distribution; Les Gaver, chief, audiovisual news branch (202) 755-8366; Joe Headlee, radio/TV progs. (202) 755-8354.

A B

National Association of Council Broadcast Executives. 233 McClellan Dr., Pittsburgh 15236 (412) 281-1515. The Rev. Harry G. Souders, pres.

A B D E F

National Bird Watching Society. 2519 Maryland Ave., Baltimore 21218. (301) 243-2301. Cas Applestein, pres.

D E

National Council of Churches, Broadcasting & Film Commission. 475 Riverside Drive, Room 856, New York 10027. (212) 870-2567. William F. Fore, exec dir; D. Williams McClurken, dir of broadcast ops; Lois J. Anderson, dir of prom & distribution.

A B D E

National Educational Media Inc. 15250 Ventura Blvd., Sherman Oaks, Calif. 91403. (213) 990-2125. Jack L. Copeland, pres; Andrew M. Perler, VP mktg; Robert M. Stockman, VP international sls; Emil M. Lepp, VP; Eugene J. Seeber, sec-treas.

A B G H

National Film Board of Canada. Studios and offices: 3155 Cote de Liesse Rd., Montreal. (514) 333-3333. Secretary of State, minister responsible for board; Sydney Newman, government film commissioner & chmn of bd; Andre Lamy, asst government film commissioner; Robert Verrall, dir of prod (English); Yves Leduc, dir of prod (French); D. Ruppel, dir of tech & prod svcs; A. Viefflaure, dir of distribution; M. Devlin, dir financial, admin, per svcs; D. Novak, dir info & prom.

New York 10020: 16th Floor, 1251 Ave. of the Americas. (212) 586-2400. J. Boundy, rep.

A B

National General Television Distribution Inc. 600 Madison Ave., New York 10022. (212) 832-3311. Ken Israel, pres; B. Crenshaw Bonner, Southern division mgr; Ben Colman, Eastern division mgr; Samuel Gang, dir, international sls; Beverly J. Partridge, dir of prod svcs; Kathy Matson, sec.

B

National Studios 209 W. 40th St., New York 10018. (212) 695-0550. Arnold Spalter, opns mgr; Lee Dresner, VP sls; Angelo J. Astuto, VP-gen mgr.

C

National Telefilm Associates Inc. 12636 Beatrice St., Los Angeles 90066. (213) 390-3663. TWX 910-343-7417. George C. Hatch, chmn of the bd; Bernard Tabakin, pres; W. Robert Rich, VP & gen sls mgr; Vincente Ramos, VP-international sls; Charles Chaplin, exec VP, Canadian office; Arden D. Moser, dir of sls-Cable Network Television (CNT); John Crocker, dir of natl sls; Rex Waggoner, dir of adv, prom & publ; Burton Rosenburgh, account exec-Eastern division; S. L. (Buddy) Brooks, account exec-Southeast division; Marvin M. Levine, account exec-Midwest division; Barry Bernard, account exec-Western division; Robert S. Mitchell, gen sls rep; Paul Berkowitz, account exec-Eastern division (CNT); James W. Dodd, dir of international bus affairs.

New York 10017: 50 E. 42d St., Suite 301. (212) 972-0056. TWX 710-581-4292.

Toronto M4W 1C8: 175 Bloor St. East. Charles S. Chaplin, exec VP.

London S. W. 1: 2nd Floor South, 47 Victoria St. Bernard Shaw, bus affairs; Peter Rodgers, VP.

Paris 75116: 20 rue Spontini. Charles Denby Wilkes, TV sls rep.

Athens 135: Licavittou II. Dennis Petropoulos, sls rep.

Producers, Distributors

Mexico 17, D.F.T.O.P, S.A.: Apartado Postal 17-770. Col. Granada Dionisio Camacho, sls rep.
Rio de Janeiro 20000: Rua Capitaio Salomao, 31. Raymundo Rodrigues, sls rep.

Buenos Aires: Sarmiento 1714-1er Piso. Alberto Gonzales, sls rep.

Sydney NSW 2060, Australia: Walford House, 273 Alfred St. Robert B. Jones & Tom Francis, TV sls reps.

A B

NCAA Television News Service, 888 7th Ave., New York 10019. (212) 541-8840. Ron Schwartz.

A B C D E

New York Film & Videotape Communications Inc., 450 N. Narberth Ave., Narberth, Pa. 19072. (215) 667-0787. Michael Davis, pres; William Dupertuis, VP.

C G

Nicholson-Muir Productions Inc., 138 Chatsworth Ave., Larchmont, N.Y. 10538. (212) 824-1614. (914) 834-3005. E. Roger Muir, pres; Robert A. Nicholson, exec VP, treas.

A

Nightingale-Conant Corp., 6677 N. Lincoln Ave., Chicago 60645. (312) 478-0050. Bryant W. Gillespie, VP broadcast.

A B D E

Fred A. Niles Communications Centers Inc., 1058 W. Washington Blvd., Chicago 60607. (312) 738-4181. Fred A. Niles, pres; Don Hill, prod mgr; William E. Harder, VP multi media; Norman C. Lindquist, VP sls; Doug Cunningham, prod TV coms; James E. Morgan, VP-finance.

New York 10023: (212) 787-8770. Charles Ticho, VP, gen mgr; Joseph Salzburg, VP.
Los Angeles 90010: (213) 462-7311. Larry Beats, gen mgr.

A B C D E

Nitondo Productions Inc., 38 La Place, Beechwood, Ohio 44122. (216) 831-1383.

New York 10019: 888 8th Ave. (212) 581-3407.

A C D F G J

Noid Productions Inc., 1065 Park Ave., Suite 19C, New York 10028. (212) LO7-1667. Joel Rosenwasser, pres; Richard Hall, Thomas Kennedy, senior VPs; William Holder, VP; Michael Winkler, sec-treas.

A B

Ray Norman Productions Inc., 11 Glenwood Rd., Toms River, N.J. 08753. (201) 349-8569. Ray Norman, pres & exec prod.

D E

North American Broadcasting Corp., Monte Rio Facility, 8900 Bohemian Hwy., Monte Rio, Calif. 95462. (707) 865-2623. Robert J. Booth, chmn; Michael K. Erickson, gen mgr (radio).

New York NABC & N-A Television Inc. Suite 711, 1650 Broadway, Dr. Chesnats.

Monterey, Calif.: NABC, 425 Van Buren St. (International Service of the NABC).

D E

North American Video, 423 E. 90th St., New York 10028. (212) 369-2552. Burton Grodin, pres; Sandy Tirado, VP.

J

Northwest Teleproductions Inc., 4455 W. 77th St., Minneapolis 55435. (612) 835-4455. Robert Mitchell, VP & gen mgr; David Herman, natl sls mgr.

A C G J

Northwestern Inc., 011 S.W. Hooker St., Portland, Ore. 97201. (503) 224-3456. Robert M. Lindahl, pres; Sheldon Goldstein, VP.

A B C D E F

Nostalgia Broadcasting Corp., 781 58th Ave. South, St. Petersburg, Fla. 33705. (813) 867-5845. Arthur N. Millman, pres.

B E

O

Helene Obolensky Enterprises Inc., St. Regis Sheraton Hotel, 2 E. 55th St., New York 10022. (212) 838-4722. Helene Obolensky, pres.

A B

Walter G. O'Connor Co., Box Y, Hershey, Pa. 17033. (717) 534-1000. Walter G. O'Connor, pres.

C F G J

Key to service codes

The following codes indicate type of service company offers:

- A —TV program production
- B —TV program distribution
- C —TV commercial production
- D —Radio program production
- E —Radio program distribution
- F —Radio commercial/jingle production
- G —Business/promotion film production
- H —Business/promotion film distribution
- J —Production services
- K —TV processing laboratory

For reader convenience in locating companies by function, each particular code letter always appears in the same place across the width of the column, as shown below:

A B C D E F G H J K

To locate companies that produce radio programs, for instance, simply run your eye down the column. Every firm so engaged will display a "D" about a third of the way in from the left hand margin.

O'Connor Creative Services, Box 8888, Universal City, Calif. 91608. (213) 769-3500 and (800) 423-2571. Harry O'Connor, pres.

D E

Odyssey Productions Inc., 24 East 51st St., New York 10022. (212) 421-9595. Milton A. Fruchtman, pres.

A B G H

Off Network Productions Inc., 515 Madison Ave., New York 10022. (212) HA 1-4030. Mert Koplin, pres; Charles Grinker, exec VP; Brooke Taylor, VP & gen mgr.

A B

Official Films Inc., 130 E. 40th St., New York 10016. (212) 889-0530. Robert Marcella, dir of sls; Stanley Zalkind, VP; Peter Rodis, dir of prog dev.

Ridgefield, N.J.: Grand & Linden Ave. (212) LO 4-1544.

A B

Lillian Okun, 307 East 44th St., New York 10017. (212) 661-3958. Lillian Okun, pres.

D J

Omega Productions Inc., 711 W. Capitol Dr., Milwaukee 53206. (414) 374-7900. Ervin L. Penkalski, pres; James Rutkowski, sec; Mary Hilbert, treas.

A B F

Omni-Enterprises, 18145 Marilla St., Northridge, Calif. 91324. (213) 886-4457. John N. Heim, pres.

A B

On the Line, With Bon Considine, 501 Althea Rd., Belleair Estates, Clearwater, Fla. 33516. (813) 584-7167. Doug Storer, personal rep.

A C D F

Optimedia Systems Inc., 1080 Route 46 West, Clifton, N.J. 07013. (201) 777-7600. George Hoffman, pres.

C J K

Orbis/Telenews Inc., 2 E. 54th St., New York 10022. (212) 753-5925. Kevin Corrigan, pres; Lawrence F. Mihlor, exec prod.

A B

Orbit Radio/Video, Box 1644, Louisville, Ky. 40201. (502) 584-5535. S. A. Cislser, mgr.

D E

Orr Production Services Inc., 10 E. 39th St., New York 10016. (212) 288-9679. John D. Orr, pres; Lorraine B. Orr, VP.

D E

Overseas Programming Cos. Ltd., 230 Park Ave., New York 10017. (212) Murray Hill 9-5857. Irving Feld, pres; Peaches Beuchler, VP & treas; Sydney Mayer, VP.

A B

P

Palamar Productions Inc., 313 Hempstead Ave., West Hempstead, N.Y. 11552. (516) 486-8240. Alexander J. Buttice, pres; Patricia Buttice, sec-treas.

New York: 415 Lexington Ave. (212) 986-6487.

A B C G H

PAMS Productions & Recording Studios, 4141 Office Parkway, Dallas 75204. (214) 827-0901. William Meeks, Jr., pres; Bruce Collier, Jr., opns dir.

C D J

Panfil Film Production, 271 Madison Ave., New York 10016. (212) 679-6401. Henry E. Knaup, pres; Richard G. Tousey, VP.

C G

Pantomime Pictures Inc., 12144 Riverside Dr., North Hollywood, Calif. 91607. (213) 980-5555. Fred Crippen, creative dir; Darr Hawthorne, prod mgr; R. Peery Forbis, prod; Jana Ginsburg, office mgr; Aaron Crippen, designer.

A C G J

Parade Pictures, 6353 Homewood Ave., Hollywood 90028. (213) 464-4708. Riley Jackson, pres.

A B C

Paramount Television, a division of Paramount Pictures Corp., 5451 Marathon St., Los Angeles 90038. (213) 463-0100. Thomas D. Tannenbaum, senior VP in chg of prod; Emmet G. Lavery Jr., senior VP in chg of bus affairs & administration; Robert M. Newgard, VP sls; Robert C. Peters, VP financial administration; Frank Wright, prom & publ.

Los Angeles 90038: 5451 Marathon St. (213) 463-0100. Con Hartsock.

New York 10023: 1 Gulf & Western Plaza. (212) 333-4890. Louis S. Israel.

St. Louis 63124: 13 Maryhill. (314) 997-5666. Robert F. Neece.

Chicago 60601: 333 N. Michigan Ave. (312) 372-0638. Robert F. Horen, Larry Hutchings.

Marietta, Ga. 30060: 719 Indian Hills Parkway. (404) 971-0266. Michael Mullins.

London W.1: 23 Berkeley House, Hay Hill, 01-499-5837. Chris Towle.

Sydney, Australia: Suite 2958, Australia Square, 27-9367. Bruce Gordon.

Toronto 5: 663 Yonge St. (416) 925-4361. George Harper, VP; Mal Orme.

A

Parkway Productions Inc., 7979 Old Georgetown Road, Washington 20014. (301) 656-0609. Richard Neil Currie, pres.

D E

Jack Partington TV, 435 W. 57th St., New York 10019. (212) 757-0316. Jack A. Partington, pres & exec prod; Jeanne B. Partington, sec & treas.

C F

Passionist Radio and Television Centre, 1089 Elm St., West Springfield, Mass. 01089. (413) 732-4546. Rev. Cyril Schweinberg, C.P., exec dir; Brother Damian Carroll, C.P., assoc dir; Brother John McHale, C.P., dir, Sp progmg.

A B

P.D.S. Productions Inc., Pomfret Center, Conn. 06259. (203) 974-1220. Peter Schachte, pres.

A C G

Peckham Productions Inc., 9 East 48th St., New York 10017. (212) 758-0490. Peter H. Peckham, pres.

G

Performers Services, 1010 Dixie Hwy., Chicago Heights, Ill. 60411. (312) 755-6400. C. M. Billo, pres.

J

Perpetual Motion Pictures Inc., 18 E. 48th St., New York 10017. (212) 759-7990. Hal Silvermintz, pres; Buzz Potamkin, prod.

A C G

H.G. Peters & Co. Inc., 525 Mildred Ave., Primos, Pa. 19018. (215) 626-6500. Hugh G. Peters, pres; Stephen A. Ciechon, exec VP; Dianne S. Peters, sec/ treas; Toni Blunt, dir of PR & sls rep; E. Warren Vosburg, VP sls.

Huntsville, Ala. 35806: (205) 883-0325. Charles Gindhart, project mgr.

A B C

Peters Productions Inc., 8228 Mercury Ct., San Diego 92111. (714) 565-8511. Edward J. Peters, pres; Redd Gardner, rgnl mgr; Michael Larson, opns dir; Geoffrey Williams, creative dir.

D E F J

The Petersen Co., 1330 N. Vine St., Hollywood 90028; 8451 Melrose Ave., Hollywood 90069. (213) 466-9351. Chris Petersen, pres; Alan Belkin, VP; John Williamson, sec-treas.

New York 10022: (213) 758-4060. Lloyd Bethune, VP

A B G H

Philadelphia Flyers Hockey Club. The Spectrum, Philadelphia 19148. (215) 465-4500. Edward M. Snider, chmn; F. Eugene Dixon Jr., vice chmn; Joseph C. Scott, pres; Keith Allen, VP & gen mgr; Louis C. Scheinfeld, VP; Harlan S. Singer, TV & radio mgr.

A B D E

P.M. Piech Associates Inc. 71 Vanderbilt Ave., New York 10017. (212) 683-5900. Peter M. Piech, pres; George A. Fausel, VP.

A B

Pike Productions of Boston. 47 Galen St., Water-town, Mass. 02172. (617) 924-5000. James A. Pike, pres.

C F G H

Pled Piper Films Ltd. Shelburne, Ont. LON 1S0 (519) 925-6558. Allan Wargon, exec prod.

A B G H

Playboy Productions. 8560 Sunset Blvd., Los Angeles 90069. (213) 659-4080. Michael Filerman.

A

Playhouse Pictures. 1401 N. La Brea Ave., Holly-wood 90028. (213) 851-2112. Ted Woolery, prod; Ger-ry Woolery, dir

A C G J

Portafilms Inc. 4180 Dixie Highway, Drayton Plains, Mich. 48020. (313) 674-0489. William H. Murray, pres.

C G

P/R Bcstg Inc. 342 Madison Ave., New York 10017. (212) 661-2315. Lloyd V. Ball, pres.

A B D E G H J

Premiere Artists & Production Agency. 6399 Wilshire Blvd., #505, Los Angeles 90048. (213) 651-3545. Harold Jovien, own.

A B D

Premier Film & Recording Corp. 3033 Locust St., St. Louis 63103. (314) 531-3555. Theodore P. Desloge, chmn of bd; Wilson Datzell, pres.

A C D F G J

Prime TV Films Inc. 526 Madison Ave., New York 10022. (212) 421-2170. Alec Campbell Jr., pres; George W. Campbell, VP; Iola Medd, office mgr.

Miami Beach, Fla. 33141: (305) PL 4-3686. Frank Stone, Southern rep.

Dallas 75240: (214) 826-4475. Frank Parton, Southwestern rep.

Cincinnati 45219: (513) 281-5900. Millard Segal, Midwest rep.

Los Angeles 90069: (213) 273-4018. Jerry Weisfeldt, Art Greenfield, West Coast reps.

A B

Producers Group Ltd. One IBM Plaza, Chicago 60611. (312) 467-1830. Lee W. Gluckman Jr., pres, exec prod; Budd Blume, VP, creative dir.

A C D F G J

Production Center Inc. 221 W. 26th St., New York 10001. (212) Oregon 5-2211. Himan Brown, pres.

A B C D E

The Programme Shoppe Inc. 6362 Hollywood Blvd., Suite 222, Hollywood 90028. (213) 461-3121. Jim Hampton, pres.

D E

Program Syndication Services Inc. 347 Madison Ave., New York 10017. (212) 532-1560. Avram Butensky, VP, gen mgr; Andrew Spitzer, VP, sls dir.

A

Progressive Radio Network. Box 172, Bronx, N.Y. 10451 (212) 585-2717. Rich Barna, pres; Eric Riback, sls mgr; J. Ben Manilla, exec prod.

D E

The Pros Creative Consultants Group Inc. Box 820, Hallandale, Fla. 33009. (305) 927-5288. Robert D. Buchanan, pres; Jack Schleh, prod mgr.

C

Pro Sports Films. 20 N. Wacker Drive, Chicago 60606. (312) 236-8955. Alfred D. LeVine, dir; Jack Paige, sls mgr; Phil Cane, adv.

B G H J

The Protestant Radio and Television Center Inc. 1727 Clifton Road N.E., Atlanta 30329. (404) 634-3324. Peter G. Kontos, pres; William W. Horlock, exec VP & treas.

D E J

Key to service codes

The following codes indicate type of service company offers:

- A -TV program production
- B -TV program distribution
- C -TV commercial production
- D -Radio program production
- E -Radio program distribution
- F -Radio commercial/jingle production
- G -Business/promotion film production
- H -Business/promotion film distribution
- J -Production services
- K -TV processing laboratory

For reader convenience in locating companies by function, each particular code letter always appears in the same place across the width of the column, as shown below:

A B C D E F G H J K

Public Affairs Broadcast Group. 1606 N. Highland Ave., Los Angeles 90028. (213) 462-7223. Mark A. Bragg, pres.

A B D E

Public Broadcasting Associates Inc. 1717 N. Highland Ave., Suite 901, Hollywood 90028. (213) 656-9779. Howard Amacker, pres, gen mgr; Peggy Doyle, VP; Terry Smith, sec-treas.

A D E J

Public Television Library. 475 L'Enfant Plaza West, S.W., Washington 20024. (202) 488-5000. Robert M. Reed, dir; Allan Lewis, supvr of acquisitions; Ralph Schuetz, supvr of distribution; Ken Wilson, assoc dir for non-broadcast activities.

B

Purcell Productions Inc. 300 W. 55th St., New York 10019. (212) 757-5300. Don Purcell, pres; Lou Carter, VP, mus dir; Rosalie Paille, prod coord.

D E F

Q

Q.E.D. Productions Inc. 21 W. 46th St., New York 10036. (212) 582-4291.

A C D G H J

QM Productions. 1041 North Formosa Ave., Los Angeles 90046. (213) 851-1234. Quinn Martin, exec prod; Howard Alston, in chg of prod; Russell Stoneham, supervising prod; John Conwell, asst to exec prod; Richard Brockway, exec editorial supvr.

A

Quadrant Sports Productions Inc. 46 E. Superior, Chicago 60611. (312) 664-4780. Scott Gibbs, pres; Fred J. Huebner Jr., VP.

A B C G H

Quartet Films Inc. 5631 Hollywood Blvd., Hollywood 90028. (213) 464-9225. Michael R. Lah, pres; George Gordon, VP.

C F G

Quality Film Labs Inc. 5800 York Rd., Baltimore 21212. (301) 435-1212. Peter A. Garey, pres.

K

THE BIG DIFFERENCES IN PROGRAMMING SERVICES FOR AUTOMATION

STATION P.D. DECIDES WHAT FORMAT TO AIR. PROMATS TO AUGMENT EXISTING LIBRARIES



R

Radio Bible Class. Box 22, Grand Rapids, Mich. 49501. (616) 241-6771. Richard DeHaan, pres; Carl Ferwerda, exec VP. Toronto M5W 1E9: Box 567, Terminal A. Carnsthorh, Lancashire, England LA6 1LAF: Box 1.

A B C D E

Radio Bible Institute. Box 272, Ashland, Va. 23005. (804) 798-4711. James N. Birkitt, pres & dir; Wes Lund, distributot

D E

Producers, Distributors

Radio Commercial Jingle Production. 161 E. Grand Ave., Chicago 60611. (312) 642-6441. James C. Dolan, pres.

C D F G

The Radio Gospel Fellowship. International hqtrs: Box 72, Denver 80201; 3105 W. Iowa Ave., Denver 80219. (303) 934-5521. Albert H. Salter, dir.

Toronto 210: The Radio Gospel Fellowship (Canada), Box 872, Albert H. Salter, dir.

D E

Radioland Productions Inc. 625 N. Michigan Ave. Chicago 60611. (312) 266-0883. Todd W. Kaiser, pres; Charles L. Schaden, sec-treas.

D E

Radio Programming and Management (RPM) 15552 Arbor Place, Southfield, Mich. 48075. (313) 557-3246. Tom Krikorian, pres & progmg dir; Mark Masters, mus dir.

D E F

Radio Script Services. 301 N. Queen St., Lancaster, Pa. 17603. (717) 393-4337. Estella B. Christman, dir.

F

Radio & TV Roundup Productions. 111 Maplewood Ave., Maplewood, N.J. 07040. New York: (212) 986-5707. New Jersey: (201) 762-2755. Bill Bertenshaw, exec prod; Daniel E. Frercks, radio-TV dir; Betty Janeway, bus mgr; Rev. Dr. Fred Long, rel prog; Dr. Samuel Klein, medical prog dir; W. H. Bertenshaw Jr., dir spec events coverage; Jack Minkowitz, bus news dir.

New York 10036: 18 W. 45th St. (212) 986-5707.

A B C D E F G H K

Carl Ragsdale Associates Ltd. 400 E. 85th St., New York 10028. (212) 861-9290. Carl V. Ragsdale, pres.

G H

RAI Corp. (Italian Radio TV System). 1350 Avenue of the Americas, New York 10019. (212) 757-6987. Renato M. Pachelti, exec. VP.

A B C

Reela Film Laboratories Inc. 65 N.W. Third St., Miami 33128. (305) 377-2611. Stanley Stern, pres; Robert B. Peil, VP & gen mgr; Robert Miele, VP & plant sup't; Thomas Fischer, bus mgr.

New York 10018: (212) OX 5-0550. Edward Hoey, Eastern division sls mgr.

A B C G H K

Reid Ray Films Inc. 2269 Ford Parkway, St. Paul 55116. (612) 699-1393. Howard H. Gelb, pres; Robert H. Winter, dir of prod; Dennis Anderson, communication consultant.

G H

Relevant Productions. 1564 Broadway, 5th Floor, New York 10036. (212) 799-4455. Sam Chase, pres.

A B D E

Reliance Audio-Visual Corp. 619 W. 54th St., New York 10019. (212) 586-0435. S. Sanford Schlitt, pres; Charles S. Spataro, VP, sls & leasing.

A B

Religious Television Associates. 315 Queen St. East, Toronto M5A 1S7. (416) 366-9221. Rev. Des McCalmont, exec prod; Peter Flemington, writer, dir.

A B

Request Records Inc. 66 Memorial Highway, New Rochelle, N.Y. 10801 (914) 633-6055 or 633-6059. H. J. Lengsfelder, pres; Ruth B. Gamba, gen mgr.

D E F

Rhodes Productions Inc. 6535 Wilshire Blvd., Suite A, Los Angeles 90048. (213) 655-2900. Jack E. Rhodes, pres; Roger B. Read, exec VP; Will Tomlinson, Dick Deitsch, David Sifford, Bill Rhodes, VPs; S. L. Brooks, mgr spec projects.

A B

Norm Richards Inc. 45 W. 45th St., New York 10036. (212) 581-8336. Norm Richards, pres.

C F J

Richter McBride Productions Inc. 1 E. 42 St., New York 10017. (212) 687-3840. Robert Richter, pres; Robert McBride, VP.

A B C G J

Riddle Video & Film Productions Inc. Suite 307, 507 Fifth Ave., New York 10017. (212) 697-5895.

Producers, Distributors

William R. Riddle, pres, exec prod; Stuart Ginsberg, VP Sls.

A B C G J

The Riviera Library. 6610 Selma Ave., Hollywood 90028. (213) 462-8585. F. W. Zens, pres.

J

Riviera Productions. 6610 Selma Ave., Hollywood 90028. (213) Hollywood 2-8585. F. W. Zens, exec prod; Jan Elblein, assoc prod.

A C G

Charlie Roberts Advertising & Promotion Inc. R.D. 2, Box 346, Belmar Blvd., Farmingdale, N.J. 07727. (201) 938-4351. Charlie Roberts.

D E F

Robinson Recording Laboratories. 1015 Chestnut St., Philadelphia 19107. (215) 922-1875. Charles J. Metz, owner.

D F J

F. K. Rockett Productions Inc. 5451 Laurel Canyon Blvd., N. Hollywood, Calif. 91607. (213) 985-1090. Thomas H. Cole, pres; Jay Loughrin, VP.

A C G J

Richard H. Roffman Associates Inc. 697 West End Ave., New York 10025. (212) 749-3647, or 662-0410. Richard H. Roffman, pres; T. D. Cohn, pres; Malvina Cohn, VP.

A C D F

Rogosin Films. 144 Bleecker St., New York 10012. (212) 674-3375. Lionel Rogosin, pres; Marilyn Casselman, gen mgr & TV sls; Gordon Lutz, UHF sls.

A B

Romper Room Enterprises Inc. 660 Kenilworth Drive, Towson, Md. 21204. (301) 825-4576. John Claster, pres; Ken Gelbard, exec VP.

A

John Rook & Associates Inc. 19031 Marilla St., Northridge, Calif. 91324. (213) 885-7404. John Rook, pres; Paul Kirby, VP; David Rook, music dir.

D E

Rose-Magwood Productions Inc. 1414 Ave. of the Americas, New York 10019. (212) 751-7000. Jim Rose, Howard T. Magwood, Bob Wolf, David Orr, dirs; David Schermerhorn, gen mgr.

Hollywood 90038; 948 N. Cahuenga Blvd. (213) 466-8561. Howard Magwood, pres/dir.

Toronto: 9 New St. (416) 929-0221. John Bilney, gen mgr; Ron Zacharuk, dir.

Chicago 60611; 410 N. Michigan Ave. (312) 644-4070. Ransom Dunnell, VP/sls.

New York 10019; Print Service Int., 1414 Ave. of the Americas. (212) 751-7004. Rich Mabil, gen mgr; Mike O'Grady, expediting.

A B C

Ross Gaffney Inc. 21 W. 46th St., New York 10036. (212) 582-3744. James Gaffney, pres; Paul Burggraf, VP, exec prod, gen mgr.

G J

Jack Rourke Productions. Box 1705, Burbank, Calif. 91507. (213) 843-4839. Jack Rourke, pres; Bill Hagens, VP sls; Henry Edwards, VP pub rel.

A C D F G J

Danny Rouzer Studio. 7022 Melrose Ave., Hollywood 90038. (213) 936-2494. Danny Rouzer, own.

C G J

Rowe International Inc., Customusic Division. Box 288 (888 Rear Providence Highway), Dedham, Mass. 02026. (617) 326-4446. Russell T. Eckel, dir of mktg, Customusic div; Robert E. Johnson, natl sls coord, Customusic div.

A B

RTV International Inc. 405 Park Ave., New York 10022. (212) 421-0680. Cable ARTEEVIEE New York. William E. Minette, pres; Richard Storm, asst to pres; Scott Charles, sec & treas; William S. Halstead, VP & dir of engrg; John L. Thayer, Jr, coml svcs.

A B

Jack Russell & Associates. Executive Plaza, 1010 Dixie Highway, Chicago Heights, Ill. 60411. (312) 756-7060. Jack Russell, pres.

A B F

Rustad & Robertson Advertising. 802 W. Broadway, Suite 301, Madison, Wis. 53713. (608) 221-3381. John Rustad, pres; John Robertson, VP.

C F G J

Key to service codes

The following codes indicate type of service company offers:

- A —TV program production
- B —TV program distribution
- C —TV commercial production
- D —Radio program production
- E —Radio program distribution
- F —Radio commercial/jingle production
- G —Business/promotion film production
- H —Business/promotion film distribution
- J —Production services
- K —TV processing laboratory

For reader convenience in locating companies by function, each particular code letter always appears in the same place across the width of the column, as shown below:

A B C D E F G H J K

To locate companies that produce radio programs, for instance, simply run your eye down the column. Every firm so engaged will display a "D" about a third of the way in from the left hand margin.

S

Sandler Tape & Film. 1001 N. Poinsettia Pl., Hollywood 90046. (213) 876-2021. Jack Yopp, pres; Patrick Collins, exec prod; Alan Sandler, chmn of bd.

A B C

Alan Sands Productions. 565 5th Ave., New York 10017. (212) Oxford 7-6135. Alan Sands, gen mgr; George Cabere, sls mgr; Carl Diamond, account exec; Murray Marcus, account exec.

A B D E

San Simeon Corp. 44 East Superior St., Chicago 60611. (312) 943-5335. Rudolf M. Orisek, pres; Hal Stein, VP exec prod.

A B

Satori Productions Inc. Box 688, Radio City Station, New York 10019. (212) 581-8450. Ernest G. Sauer, pres; Bill Hughes, VP sls.

A B C G H J

Schnur Appel Television Corp. 87 Woodland Road, Short Hills, N.J. 07078. (201) 375-5300. Mel Appel, pres; Joseph Schackner, VP.

B

Walter Schwimmer Enterprises. 400 N. Michigan Ave., Chicago 60611. (312) 828-9422. Walter Schwimmer, pres; Edward E. Katz, VP; Philip Schwimmer, sec.

A B D E

Scientificom, division of LaRue Communications Inc. 708 N. Dearborn St., Chicago 60610. (312) 787-8656. Gunter H. Doetsch, pres & sls mgr; Katharine A. Russell, VP; Craig S. Cummings, prod mgr.

G H

Screen Entertainment Co. 4440 Lakeside Drive, Burbank, Calif. 91505. (213) VI 9-6666. Henry G. Saperstein, pres.

A B

S.D.A. Productions Ltd. 1103 St. Mathieu St., Montreal, H3H-2H3. (514) 937-3525. R. Harwood, pres; F. Champagne, exec VP.

C G

George Seaman Agency. 441 S. Beverly Dr., Beverly Hills, Calif. 90212. (213) 277-3390. George Seaman, pres; Michael Gordon, VP sls.

B

John H. Secolari Productions Ltd. 745 Fifth Ave., New York 10022. (212) 753-8466. John H. Secolari, pres; Helen J. Secolari, VP.

A B C

Hal Seeger Studios Inc. 45 W. 45th St., New York 10036. (212) 586-4311. Hal Seeger, pres; S. Blaney, prod supvr.

A B

Sentinel Syndications Inc. Box 98810, Seattle 98188. (206) 927-1001. C. B. McNaughton, pres & chmn of bd; Janette Fox, mktg; Mike Chamberlin, sls & bookings; Bryan Buchanan, rsch; Neil Buchanan, mgng dir.

B F

SESAC Inc. 10 Columbus Circle, New York 10019. (212) 586-3450. A. H. Prager, pres; S. B. Candilora, exec VP; Sidney Guber, VP dir mktg svcs.

Nashville 37203; 1513 Hawkins St. (615) 244-1992.

D F

1776 Film Productions. 200 W. 57th St., New York 10019. (212) 736-1776. Ralph G. Weisinger, pres; Suzy Widawski, exec sec.

A B C F G H J

Seventh Day Adventists (See General Conference of.)

William R. Sheekey. 150 Broadway, New York 10038. (212) Cortland 7-2913. William R. Sheekey, own.

B

Sheridan-Elson Communications Inc. 355 Lexington Ave., New York 10017. (212) 661-0500. Robert E. Elson, pres; William R. Sheridan, VP.

A D G H J

Sheridan Elson Communications, Inc.

Serving broadcasting and industry for nearly a decade. We offer topical, informative and entertaining features to radio and television stations... free of charge. Send for information today. 355 Lexington Ave., N.Y.C.

Shield Productions Inc. 161 E. Grand Ave., Chicago 60611. (312) 642-6441. James C. Dolan, pres; Martin M. Rubenstein, VP.

C F G H

Shoe Productions Inc. Box 12025, 485 N. Hollywood, Memphis 38112. (901) 458-4496. Warren Wagner, pres; Wayne Crook, VP; Alan J. Perlman, sec-treas.

F J

The Shooting Gallery Inc. 450 E. Ohio St., Chicago 60611. (312) 664-2447. Ken Ancell, pres & exec dir.

C D E

Show Biz Inc. Box 12594, Nashville 37212. (615) 327-2532. W. S. Graham, chmn bd, pres; Neika Brewer, exec VP; J. R. Dunlap, exec VP; Gary Jones, VP; sls mgr.

A B D E

Show Biz Productions. 137 Kennedy St. N.W., Washington 20011. (202) 723-4215. Hirsch de LaVie, pres; Rod Mendis, Richard Belland, prods.

A C D F

Showcorporation. 91 Franklin St., Westport, Conn. 06880. (203) 227-5105. C. Robert Manby, pres; Robert Manby Jr., VP.

A B

Shuler Productions. Noel Page Bldg., Dallas 75206. (214) 361-0380. Mrs. Linda Shuler, pres; Robert C. Shuler, VP, treas.

A B

Sierra Productions Inc. 500 N.W. 54th St., Miami 33127. (305) 751-2681 or 751-5396. Santiago Sierra, pres; Delia S. Sierra, VP; Juan Sierra, sec.

A C

Signal Productions Inc. 6223 Selma Ave., Hollywood 90028. (213) 463-4600. Kenneth L. Veth, pres.

E

Silvermine Films Inc. 49 W. 45th St., New York 10036. (212) 586-6448. Alvin Yudkoff, pres.

A B C G H

Sixteen Screen Service Co. 6710 Melrose Ave., Hollywood 90038. (213) 939-1491. Homer O'Donnell, own; K. S. Hedburn, prod asst.

C G

Skyline Films Inc. 160 E. 38th St., New York 10016. (212) 490-1668. Joseph McDonough, pres; David Saperstein, exec VP; Bert Saperstein, VP sls.

A C G

David Smith Musical Productions. 27 Colonial Hills Pkwy, St. Louis 63141. (314) 569-0767. David Smith, pres.

F

Walter Harrison Smith Productions. 16 Highview Terrace, New Canaan, Conn. 06840. (203) 966-0225 or 853-7821. Walter Harrison Smith, pres.

A B

Ken Snyder Enterprises. 2032 Alameda Padre Ser-

ra, Santa Barbara, Calif. 93103. (805) 962-8171. Kenneth C. T. Snyder, pres.

A C D F G H

Soundac Color Productions Inc. Box 3454 Norland Branch, Miami 33169. Studios: 249 N.W. 199th St., Miami 33169. (305) 625-3636. Richard H. Ullman, pres; Robert D. Buchanan, exec VP; Jack Schleh, VP-prod mgr; Bob Biddlecom, tech dir.

A B C

Sounds Reasonable Inc. 2000 P St., N.W., Washington 20036. (202) 833-1976. Edmund S. Barnett, pres; Gary Burke, VP; James Freeman, ctrlr.

D F

Sound Stages. 2111 Spencer Rd., Richmond, Va. 23230. (804) 873-5353. W. C. Pulley, pres.

C D F G J

Southeastern Films. 22 Seventh St. N.E., Atlanta 30308. (404) 873-5353. Alva B. Limes, gen mgr.

A C G J

Southern Baptist Radio-TV Commission. Box 12157, Fort Worth 76116. (817) 737-4011. Paul M. Stevens, pres; Alvin O. Huffman, exec VP; Jerome B. Pillow, mktg.

A B D E

Spanish International Network. 250 Park Ave., New York 10017. (212) 697-0585. Rene Anselmo, pres; William D. Stiles, VP-dir of sls.

A B C

Special Features Syndicate. 260 Kearny St., San Francisco 94108. (415) 989-5050. Jonathan P. Edwards, gen mgr; Aaron S. Bloom, owner.

D E

Spectrum Associates Inc. 536 W. 29th St., New York 10001. (212) 524-6266. George Pitt, pres; Alvin H. Perlmutter, VP; Sol Kaplan, VP.

A B C D E F G H

Spelling-Goldberg Productions. 10201 W. Pico Blvd., Los Angeles 90035. (213) 277-2211. Aaron Spelling, Lou Goldberg.

A

Spencer Productions Inc. 507 Fifth Ave., New York 10017. (212) Oxford 7-5895. J. C. Allgeier, pres; Bruce Spencer, gen mgr.

A D

Edgar S. Spizel Advertising Inc. 1782 Pacific Ave., San Francisco 94109. (415) 474-5735. Edgar S. Spizel, pres; Sheila K. Spizel, VP.

A C D G J

Sponsors Film Service Inc. (Div. of COMGRO) 888 Seventh Ave., New York 10019. (212) 765-0505. Gerald Auerbach, pres.

A B

Sport-Films Inc. 1928 N.W. Lovejoy St., Portland, Ore. 97209. (503) 222-3318. Jim Conway, chmn; Fred T. Gaspro, gen mgr.

A B

Sportlife Films. 20 N. Wacker Dr., Chicago 60606. (312) 236-8955. Alfred D. LeVine, pres; Philip Cane, adv; Jack Paige, sls; Bob Krumb, mail order.

A B C G H J

Sports Films & Talents Inc. 4940 Viking Drive, Minneapolis 55435. (612) 835-3565. James W. Thaxton, pres; Daniel G. Endy, exec VP; Arvin B. Zaikaner, VP & treas.

A B G H

Sportsfilm Inc. 317 N. Broad St., Philadelphia 19107. (215) 923-3277. W. William Orr, pres.

A B

Spotmaker Studio. 415 Sixth Ave., 2nd floor, San Diego 92101. (714) 234-8418. Gary Seger, pres.

D F J

Spots Alive Inc. 527 Madison Ave., New York 10022. (212) 355-6486 or 8788. Lincoln Diamant, pres; J. Champion, VP & creative dir.

C F G

Stage Door Studios. R.D. #2, Camelot, Florida, Mass. 01247. (413) 663-6060. Robert M. Master, dir; S. Carson-Denhent, exec asst.

A D G

Stanley-Frank Films Inc. 200 E. 27th St., New York 10016. (212) 689-1150. Frank Lander, pres; Jack Fenimore, VP; Ronnie Sherwood, edit; Kay Fenimore, prod mgr.

C F

Station Syndication Inc. 635 Madison Ave., New

Key to service codes

The following codes indicate type of service company offers:

- A —TV program production
- B —TV program distribution
- C —TV commercial production
- D —Radio program production
- E —Radio program distribution
- F —Radio commercial/jingle production
- G —Business/promotion film production
- H —Business/promotion film distribution
- J —Production services
- K —TV processing laboratory

For reader convenience in locating companies by function, each particular code letter always appears in the same place across the width of the column, as shown below:

A B C D E F G H J K

York 10022. (212) 628-2770. Sandy Frank, pres; Mary Shields, exec VP; Ellen Fuhrmann, dir opns; Charles Reckitt, ctrlr.

A B

Stereo Radio Productions Ltd. 36 East 61st St., New York 10021. (212) 980-3888. James A. Schulke, pres; Phillip S. Stout, VP & creative dir; Dave MacFee, VP, adm asst.

D

Sterling Films Limited. Room 25, King Edward Hotel, 37 King St., E. Toronto M5C1G2. (416) 366-6221. John R. Jackson, pres, Eunice Alcorn, VP.

B

Charles H. Stern Agency Inc. 9220 Sunset Blvd., Suite #218, Los Angeles 90069. (213) 273-6890. Charles H. Stern, pres.

F

Don Stern Productions. 3623 Cahuenga Blvd. West, Hollywood 90068. (213) 851-3675.

C

Steven B. Stevens. 2077 Edinburg La., Fairfield, Ohio 45014. (513) 829-1211.

G

E. J. Stewart Inc. 388 Reed Road, Broomall, Pa. 19008. (215) 543-7600. Eric Address, pres; David Wiggins, VP; Howard Lipman, sec-treas.

A C

The Strachan Co. 666 N. Robertson Blvd., Los Angeles 90069. (213) 659-4307. John Strachan, bd chmn; John E. Ellis Jr., pres; William Swain, exec VP. Seattle 98104; (206) 622-2373. Ann Hallett, corp sec.

A B C

Studioz Sound. 635 Madison Ave., New York 10022. (212) 688-4070 ext. 332. George Agoglia, dir opns; John Hechtman, studio mgr; Kip Kaplan, sls rep.

C

Studio West (Syndicated Programing for Automation). 5929 Tiber Drive, Anaheim, Calif. 92807. (714) 637-8249. Jim C. Meeker, pres.

D E

Sullivan Productions Inc. 919 Third Ave., New York 10022. (212) 758-9103.

A B

Survival Anglia Ltd. 420 Lexington Ave., New York 10017. (212) 889-8739. John Fleming Ball, pres; James deKay, Deita Willis, William Dunne, VP's.

A

Susquehanna Productions, division of Susquehanna Broadcasting Co. 140 E. Market St., York, Pa. 17401. (717) 843-9951. Arthur W. Carlson, VP; Dick Drury, gen mgr; Carl Loucks, sls consultant; Bill Stewart, sls consultant.

D E F

Swedish Broadcasting Corp. (Sveriges Radio), 825 Third Ave., New York 10022. (212) 688-6872. Claes Dahlgren, dir.

A B D E

Allen Swift Inc. 110 W. 57th St., New York 10019. (212) JU 2-8925. Allen Swift, pres-creative dir; Cal A. Stadlen, sec-treas, prod.

A B C F

Syndicated Features Inc. Hotel Picadilly, 227 W. 45th St., New York 10036. (212) 581-6866. Barry Far-

Producers, Distributors

ber, pres; Steven Valensky, gen mgr; Paul Feinstein, prod mgr.

D E

T

Taft, H-B Program Sales. One E. 57th St., New York 10022. Michael Gouid, VP, gen mgr; Richard Cignarelli, Eastern div sls mgr; Andrew Spitzer, mktg mgr.

B

Talco Productions. 279 E. 44 St., New York 10017. (212) Oxford 7-4015. Marty Lawrence, pres; Peter Yung, VP, creative dir.

A D G

Tandem Productions Inc. 1901 Avenue of the Stars, Los Angeles 90067. (213) 553-3600. Norman Lear, Bud Yorkin.

A

William B. Tanner Co. 2714 Union Ave. Extended, Memphis 38112. (901) 320-4212. William B. Tanner, pres; Wilson Northcross Jr., exec VP.

Chicago 60611: (312) 664-3530. Hal Shore, branch mgr.

Los Angeles 90210; (213) 278-5833. Hap Trout, branch mgr.

New York 10022: (212) 758-6776. Arnold Fetbrod, Stanley Grayson, Herbert A. Vitriol, Reynolds Moore, Heagen Baliss, George Nicastro.

Philadelphia (Bala-Cynwyd), Pa. 19004: (215) 839-3078. Howard Seberhagen, branch mgr. San Francisco 94104: (415) 433-1544. Chris Christensen, branch mgr.

C D E F

T.A.T. Communications Co. 1901 Avenue of the Stars, Los Angeles 90067. (213) 553-3600. Norman Lear, Jerry Perenchio.

A

Hal Taylor Productions Inc. 40 Parkway Circle, Scarsdale, N.Y. 10583. (914) 725-3728. Harold V. Taylor, pres; Ruth E. Taylor, VP, sec-treas.

F

Technisonic Studios Inc. 1201 Brentwood Blvd., St. Louis 63117. (314) 727-1055. Charles E. Harrison, pres.

C F J

Tel-Air Interests Inc. 1755 N.E. 149th St., Miami 33181. (305) 944-3268. Grant H. Gravitt, pres; Charles Allen, VP; M. L. Gravitt, sec-treas.

A C D F G H

Telecine Film Studios Inc. 100 S. Northwest Highway, Park Ridge, Ill. 60068. (312) 823-1418. Byron L. Friend, pres.

A B C

Tele-Color Productions Inc. 708 N. West St., Alexandria, Va. 22314. (703) 683-3203. Charles Riley, pgs; Harold Smulian, VP.

A B C

TeleCom Production Inc. 400 N. Michigan Ave., Chicago 60611. (312) 467-5220. Walter Schwimmer, chmn of the bd; Richard Palmer, VP; Edward Katz, VP.

A B

Teledynamics Corp. 202 Mamaroneck Ave., White Plains, N.Y. 10601. (212) 994-1152. Irwin Pizor; Joseph Aranow, sls mgr.

A B

Tele Features Inc. 516 Fifth Ave., New York 10036. (212) 986-4979. Al Odeal, pres.

A B

Telefacts. 165 W. 46th St., New York 10036. (212) 245-0449. Jay Columbus, pres.

A C G J

Telegenic Programs Inc. 250 Merton St., Toronto M4S1B1. (416) 487-4767. Lawrence Fein, pres.

A B

Telegroup Inc. 221 Rockhill Rd., Bala-Cynwyd, Pa. 19004. (215) 667-5006. Barry Nemcoff, pres; Henry Shaw, exec VP.

A C

Telemated Motion Pictures. 8 W. 40th St., New York 10018. (212) 730-1414. Saul S. Taffet, prod dir.

A C

Telemation Productions Inc. 3200 W. Lake Ave., Glenview, Ill. 60025. (312) 729-5215. Robert L.

Producers, Distributors

Flagler, VP, gen mgr; Scott Kane, VP; Michael Theis, oprs mgr; Robert Churchill, chief engr.

A B C J

Telemation Program Services Inc. 50 E. 42d St. New York 10017. (212) 687-0180. Robert Weisberg, pres.

B

Telepak Inc./dba Robert Longenecker Agency. 8438 Melrose Pl., Los Angeles 90069. (213) 653-3770. C. Robert Longenecker, pres.

A C

Teleprompter Corp. 50 West 44th St., New York 10036. (212) 986-7500. James R. Van de Velde, prog dir; Steve Hewitt, assoc dir prog.

A B

TeleScene Inc. 167 Social Hall Ave., Salt Lake City 84111. (801) 322-2505. George C. Hatch, pres; Bob Temple, VP; Bruce Fox, mgr.

A B C

Tele-Tactics. 9 E. 19th St., New York 10003. (212) 673-4800. Barry Drucker, pres; Paul Krupnick, VP.

A B

Teletape Corp. 321 W. 44th St., New York 10036. (212) 582-3400. Richard E. Riedel, chmn of the bd & chief exec off; John J. Natale, pres; William C. Boyd, VP financial & admin; Robert Spicer, treas; Fred C. England, sec; James Hartzler, VP mktg; Donald Redell, VP prog sis & dev; Lucien Lessard, VP prod & creative svcs; Richard Smith, dir post prod; Roy Carlson, gen mgr Real Time division; George Corrin, art dir.

Detroit 48211: (313) 874-4040. Patrick O'Hara, gen mgr.

A B

Televents Ltd. 2450 Virginia Ave., N.W., Washington 20037. (202) 296-0541.

A B D E

Televideo Productions Inc. 60 W. 55th St., New York 10019. (212) 582-8095. Franta G. Herman, pres.

A B

Television Business Inc. 400 N. Michigan Ave., Chicago 60611. (312) 828-9422. Walter Schwimmer, pres; Edward Katz, VP; Philip Schwimmer, sec.

A B

Television & Radio Features Inc. 166 E. Superior St. #2601, Chicago 60611. (312) 944-3700. Morton A. Small, pres; Jack Arden, VP.

A D

Television Productions Center Inc. 445 Melwood St., Pittsburgh 15213. (412) 682-2300. Larry O. Garrett, mktg dir.

Hollywood: (213) 653-2494. Jack E. Rhodes Jr., dir of syndication.

C

Televideo Systems Inc. 2 E. 78th St., New York 10021. (212) 628-8600. Bernard L. Schubert, pres; Saul Reiss, natl sis mgr.

A B

Teleworld Inc. 10 Columbus Circle, New York 10019. (212) 489-9310. Robert Seidelman, pres.

Los Angeles 90069: 9000 W. Sunset Blvd. (213) 278-5115. Dalton Danon, VP.

A B

Tel-Fax, Television Facilities Inc. Box 396, Montgomeryville, Pa 18936. (215) 855-0970. Tony Symanovich, pres; Gregory Symanovich, VP; Michael Burnham, chief engr.

A C

Tellic Inc. 317 W. 89th St., New York 10024. (212) 595-7078. Elwood Siegel, pres.

A B C G H

Tel Ra Productions Inc. 420 E. Lancaster Ave., Wayne, Pa. 19087. (215) 668-9233. William Orr, pres.

A G

Teletar Inc. Box 388, Westport, Conn. 06880. (203) 226-3379. Bess Gilmore, pres; John C. Gilmore exec VP; Keith Gilmore, VP prod; Douglas Gilmore, VP talent; Frank Smith, comptroller.

A D E

Texas Rassin' Films Inc. Cadiz and Industrial Blvd., Dallas 75207. (214) 748-2083. Ed Watt, sis mgr.

A B

Bob Thomas Productions. 23 Broad St., Bloomfield,

Key to service codes

The following codes indicate type of service company offers:

- A - TV program production
- B - TV program distribution
- C - TV commercial production
- D - Radio program production
- E - Radio program distribution
- F - Radio commercial/jingle production
- G - Business/promotion film production
- H - Business/promotion film distribution
- J - Production services
- K - TV processing laboratory

For reader convenience in locating companies by function, each particular code letter always appears in the same place across the width of the column, as shown below:

A B C D E F G H J K

To locate companies that produce radio programs, for instance, simply run your eye down the column. Every firm so engaged will display a "D" about a third of the way in from the left hand margin.

N.J. 07003. (201) 429-9000. Robert G. Thomas exec prod.

A C G

Danny Thomas Productions. 10202 W. Washington Blvd., Culver City, Calif. 90230. (213) 836-3000. Paul J. Witt.

A

J. Walter Thompson/JWT Syndication. 420 Lexington Ave., New York 10017. (212) 686-7000. Thornton B. Wierum, VP, dir of med svcs; Marie G. Luisi, VP, mgr spot bcst & syndication; William C. Cameron, VP, dir of progm.

Atlanta 30309: (404) 892-2321. Frank Carlson, VP & mgr.

Chicago 60611: (312) 664-6700. Larry Olshan, med dir.

Los Angeles 90048: (213) 653-0300. Farlan Myers, VP & mgr.

Detroit 48226: (313) 962-8900. Howard Spokes, VP & dir of med.

San Francisco 94111: (415) 421-3510. Rick Pike, med dir & supvr of bcst unit.

B

339 Focus Inc. 339 E. 48th St., New York 10017. (212) 371-3703. Connor Harris, chmn of bd; Eli Feldman, pres; Dave Wedeck, senior VP; Chris K. Ishii, VP.

A B

Time-Life Films Inc. Time & Life Bldg, New York 10020. (212) 556-7783. Bruce Paisner, pres; William Miller, VP; Wynn Nathan, VP.

Chicago 60611: 401 N. Michigan Ave. (312) 467-9700. Bob Lloyd.

Los Angeles 90010: Equitable Bldg, 3435 Wilshire Blvd. (213) 385-8151. Jack Donahue.

Atlanta 30303: Rhoads-Haverty Bldg., 134 Peachtree St. N.W. (404) 522-9233. Bob Greenstein.

A B

TimeRite Inc. 511 N. Akard, Suite 1300, Dallas 75201. (214) 742-5846. W. C. Woody, pres; John Cobb-Smith, VP.

Wilmington, N.C. 28401: (919) 763-3559. Claud O'Shields, VP.

A B C F

Times Four Productions Inc. 316 Eighth Ave., New York 10001. (212) AL 5-6375. Wiley Hance, pres; John Dapper, VP & art dir; J. Robert DeLaney, exec VP; Earl Barnes, VP & sec.

A B

TM Productions and TM Programming. 1349 Regal Row, Dallas 75247. (214) 634-8511. Tom Merriman, pres; Jim Long, chief exec off.

D E F J

Toddy Pictures Company. Box 150, Atlanta 30327. (404) 355-9654. T. Toddy, pres; C. Small, mgr.

A B

Tomorrow Entertainment Inc. 777 Third Ave., New York 10017. (212) 750-3811. Thomas W. Moore, pres.

Los Angeles 90069: 9200 Sunset Blvd., (213) 273-7610. Roger Gimbel.

A B

Total Communication Systems. 16M Gateway Towers, Pittsburgh 15222. (412) 281-4376. Nelson L. Goldberg, pres; D. M. Devlin, gen mgr.

D E

TPT Manhattan Productions. 5120 Broadway, New York 10034. (212) 942-7200. Peter Hess, prog dir; Joel Willis, dir of studio ops; Jim Miller, adv sis mgr; Sy Yoskowitz, dir of engr.

A B

Training Concepts & Communications Inc. 221 N. LaSalle St., Suite 1038, Chicago 60601. (312) 368-4931. Don L. Glasell, pres; Dan Weller, VP; William Miller, sec.

A B

G H

Trans America Film Corp. Box 975, Kingsport, Tenn. 37662. 246-4000. C. E. Feltner, Jr., chmn; David Bloom, pres; John Dallas, VP southeast region; Claude Hill, VP acquisitions.

Hollywood: Taft Building, Hollywood & Vine. (213) 466-7575.

New York 10019: 888 Seventh Ave. (212) 582-7232.

A B

Trickfilm Studios Ltd. 527 Madison Ave., New York 10022. (212) 355-6486. Charlie Jenkins, pres; Lincoln Diamant, creative rep (U.S.).

C

Trans-American Video Inc. 1541 N. Vine St., Hollywood 90028. (213) 466-2141. George Tompkins, pres; Richard Irvine, VP mktg; Harvey Plotnick, VP prod; Jeff Ross, VP gen mgr.

A B C

Travelux Inc. 1001 Dwight Bldg., Kansas City, Mo. 64105. (816) 221-3420. Donald Dwight Davis, pres; H. T. Davis, VP; Heywood H. Davis, sec-treas.

Tucson, Ariz. 85705: 350 E. Limberlost. (602) 887-1780. Don Davis, syndication, domestic & foreign.

A B C D E F G H

Travelux Television Network Inc. Box 50585, Tucson, Ariz. 85705. (602) 297-4274. Gordon E. (Doc) Hamilton, pres & treas; Don Davis, chmn & sec.

A B

*Where in the world
do you want to go?*

TRAVELUX TELEVISION NETWORK
Box 50585 • Tucson, Arizona 85705

*Managers for
"LET'S GO SEE"
"MARCO POLO SOCIETY"*

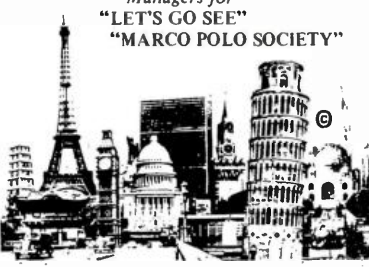

© Communications Satellite Corporation

TRAV-Television, Radio and Audio-Visuals Presbyterian Church in the United States. 341 Ponce de Leon Ave., N.E., Atlanta 30308. (404) 875-8921. Bill Huie, staff dir. for mass media; Sam Wagner, admin asst.

A C D F G

TRC Corp. 1330 N. Illinois St., Indianapolis 46202. (317) 638-1491. R. Gary Schatzlein, pres.

F J

Tri Media Communications Inc. Box 5124, Boise, Idaho 83705. (208) 376-4088. Tom Hotchkiss, pres; Steven Oliver, VP, sis mgr; Gweneth Jamieson, edit supvr.

A C G J

Trio Productions Inc. 144 E. 44th St., New York 10017. (212) 986-3333. Bill Aronson, exec sis; Howard Henkin, exec prod; Newt Miltzman, Tony Arzi, Rollie Guild, Marc Stalter, exec dir; Bob Cohen, Dan Kahn, prod; Linda Kramer, coord.

Hollywood 90038: 932 North La Brea. (213) 874-9400. Barry Elliot, exec prod.

A C G

TR Productions. 1031 Commonwealth Ave., Boston 02115. (617) 783-0200. Oscar H. Cheses, pres; Alfred D. Benjamin, VP.

C F G J

Tulchin Productions Ltd. 107 E. 38th St., New York 10016. (212) 532-3453. Heris Stenzel, exec VP; Lou Georgaras, sls mgr; Ed Babcock, mgr post prod; Hal Tulchin, Richard De Maio, Annette Bachner, prod dirs.

A C G

Tulchin Production Services. 107 E. 38th St., New York 10016. (212) 532-7376. Harold M. Tulchin, pres; Ed Babcock, mgr.

A B

TV Cinema Sales Corp. Suite 212, 434 North Rodeo Dr., Beverly Hills, Calif. 90210. (213) 273-4018. Jerry Weisfeldt, pres; Sue Rashby, exec asst; Alton Whitehouse, southern rep; Richard Ostrander, eastern rep; Ken Weldon, midwest rep.

B

TV Laboratories Inc. 311 W. 43d St., New York 10036. (212) 397-8600. Paul Sulzer, chmn bd; Dan Sandberg, pres; G. David Rosen, exec VP.

K

TV Hollywood. 6325 Santa Monica Blvd., Hollywood 90038. C. J. Vertalen, prod; Charles Gross, sls mgr.

A B

TV Program Distributors. 2 Carlton St., Suite 1720, Toronto M5B 1J3. (416) 363-4033. William F. Wineberg, gen mgr.

B

TV Sports Scene Inc. 323 Normandale Off Pk., 8200 Normandale Blvd., Minneapolis 55437. (612) 835-4716. Donald Herrick, pres; Robert C. Bruce, VP; Norman Greengard, asst to pres; Jolene Normstrom, dir mktg & research; Billy Kidd, assoc prod.

A B C D E

Twelve East Recording Inc. 12 E. 44th St., New York 10017. (212) 986-4747. George E. Stalter Jr., pres; John J. Boyle, exec VP, gen mgr.

C D E

20th Century-Fox Television. 10201 W. Pico Blvd., Los Angeles 90035. (213) 277-2211. Jack Haley Jr., pres; Ron Beckman, exec VP bus affairs; Alan Silverbach, senior VP, world wide syndication; Sy Salkowitz, VP prime time programming; William L. Clarke, VP domestic sls; Richard A. Harper, VP inatl sls.

A B

U

Ukrainian Melody Hour—Radio-TV Programs. Box 2257, Washington 20013. (202) 832-2887. Roman V. Marynowych, prod & dir.

A B D E

United Artists Television Inc. 729 Seventh Ave., New York 10019. (212) 245-6000. Erwin H. Ezzes, chmn & chief exec off; Martin J. Robinson, exec VP & gen sls mgr; Les Furman, dir, sls service; Stephen Elsky, dir, contract department; Lloyd Krause, sls dir, Northeastern division; Paul Kalvin, sls dir, Eastern division.

Chicago 60611: 520 N. Michigan Ave. (312) 527-1030. Selwyn Ginsler, sls dir, Central division. Shreveport, La. 71106: 922 Monrovia St. (318) 865-8144. Fred Watkins, sls dir, Southwestern division.

Culver City, Calif. 90230: United Artists Television Corp. 10202 West Washington Blvd. (213) 559-3450. Murray Oken.

Toronto 2: 2 Carlton St. (416) 363-4033. William Wineberg, gen mgr, UATV of Canada.

Cincinnati 45206: (Print & Stations Service Center) 2904 Woodburn Ave. (513) 751-1323. Jack McLaughlin, VP in chg of stns service.

A B

United Artists Television International Inc. 729 Seventh Ave., New York 10019. (212) 575-4784. Herbert Banquer, senior VP; Joe Levinsohn, asst dir of inatl opns.

Rio de Janeiro: Rua Senador Dantas, 74-30-Andar ZC 06. 224-5322. Francisco Jose Serrador, TV gen mgr, Brazil.

Frankfurt/Main, Germany: Wiesenhuellenstrasse 11. 23427/48/49. Alfred Sorg, mgr.

Mexico 5, D.F.: Presidente Mazarik 61-301. 250-16-99. Raul Lefcovich, dir of Latin American division, TV; Guillermo Cuello, administrator Latin American TV opns.

London W1A2JL: 37-41 Mortimer St. 01-636-1655. Peter Pawsey, dir of European opns (includes Africa & Middle East).

Sydney, Australia: KMS Bldg., 6th Floor, 8124 Kippax St., Surry Hills, 212-1266. Ronald G. Michaels, dir of Far Eastern division.

Key to service codes

The following codes indicate type of service company offers:

- A —TV program production
- B —TV program distribution
- C —TV commercial production
- D —Radio program production
- E —Radio program distribution
- F —Radio commercial/jingle production
- G —Business/promotion film production
- H —Business/promotion film distribution
- J —Production services
- K —TV processing laboratory

For reader convenience in locating companies by function, each particular code letter always appears in the same place across the width of the column, as shown below:

A B C D E F G H J K

Paris 75008: 25-27 Rue d'Astorg. 265-45-90. Mary Jane Fournel, TV sls rep for French-language Cont. countries.

Tokyo: No. 15 Mori Bldg., 16 Akafune-cho, Shiba Nishikubo, Minato-ku. 503-3628/3629.

Buenos Aires: Lavalle 1747-51. 40-3411. Fernando Rodriguez, mgr.

Puerto Rico—Santurce: Suite 223-A, Caribbean Towers Bldg., 760 Ponce de Leon Ave., Miramar, PR: Box 13126. 722-2580. K. K. Poon, mgr.

Bangkok, Thailand: Southeast Insurance Bldg., 6th Floor, 315 Silom Road. 30240. Haman Chuabudhee, TV sls service coord.

Hong Kong: J. Hotung House, Room 222, 5/15 Hankow, Road, Tsimshatsui, Kowloon. K-676744. Doven Chow, mgr.

Manila: Third Floor, PPL Bldg., United Nations Ave. 592-143. Mrs. Leonila L. Cando, TV sls service coord. Bogota, Colombia: Juan Jorge Jaecel (TV Agent), Apartado Aereo 91188. 36-25-18.

Rome: Lionello Torossi (TV Agent), Via Banchi Vecchi 41. 565-766.

Madrid 8: Jose Augustin (TV Agent for Spain & Portugal), Videoprograms, S. A. Martires de Alcala 4. 248-9205.

A B

United Artists Television of Canada. 2 Carlton St., Carlton Towers, Toronto 2. (416) 363-4033. Frank Kowcenuk, gen mgr.

A B

The United Church of Canada. See Berkeley Studio.

United Film Enterprises Inc. 1546 Broadway, New York 10036. (212) JUdon 6-1442. Munio Podhorzer, pres; Nathan Podhorzer, VP.

A B

United Methodist Communications. 475 Riverside Drive, Suite 1370, New York 10027. (212) 663-8900. Curtis A. Chambers, exec dir; Nelson Price, dir, div of pub media.

Nashville 37203: (615) 327-0911. (312) 869-3770.

Evanston, Ill. 60201. Dayton, Ohio 45406: 601 W. Riverview. (513) 222-2531.

A B C D E

United Nations Television & Radio. New York 10017. (212) PL 4-1234. Paul Jankowski, actg dir, radio & vis svcs; Michael Hayward, chief, vis svcs; George Movshon, chief, UN TV & films; Cesar Ortiz Tinoco, chief, radio svcs.

A B

United Presbyterian Church in the U.S.A., Division of Communications. 475 Riverside Drive, New York 10027. (212) 870-3101. Dr. Frank H. Heinze, mngng dir; Rev. Don Roper, dir for pub med; Robert J. Thompson, dir med svcs.

A B C D E F G H

United Sound Systems Inc. 5840 Second Blvd., Detroit 48202. (313) 871-2570. Dan Davis, pres.

C D E F G H J

U.S. Bicentennial Media Group. 2315 E. Broad St., Richmond, Va., 23223. (804) 649-9176. Tom Laughon, exec dir; James F. McDonald Jr., dir of sls; Robert Boyd, dir of mktg.

D E

United Tapes of America. Box 1193, Grand Junc-

Producers, Distributors

tion, Colo. 81501. (303) 242-0405. Stephen W. Schmidt, pres, sls mgr; Robert Anstine, music prod; Edward Brown, chief eng.

D E F

United/Western Records (U.R.P.I.). 6050 Sunset Blvd., Los Angeles 90028. (213) 463-6811. M. T. Putnam, pres; D. F. Morris, exec VP; Jerry Barnes, gen mgr.

San Francisco 94107: Coast Recorders. (415) 397-7676.

A B

U.S. Army Command Information Unit. Office, Chief of Information Washington 20315. (202) 433-2615. Col. Edward Bradford, commander; Edward J. Caputo, chief, broadcast/pictorial branch.

A B

United States Catholic Conference—See Creative Services—U.S. Catholic Conference.

Universal Television, a division of Universal City Studios Inc. 100 Universal City Plaza, Universal City, Calif. 91608. (213) 985-4321. Frank Price, pres.

New York 10022: 445 Park Ave.

A B

University of Chicago, Office of Radio and Television. 1307 E. 60th St., Chicago 60637. (312) 753-4371. Nick Aronson, dir bcstg; Robert Heitsch, radio prog dir.

D E

University of Colorado Radio Service. 313 Stadium Bldg., Boulder, Colo. 80302. Kenneth Prather, coord for radio.

D E

University of Detroit Radio Network. 3800 Puritan, Detroit 48221. Charles A. Dause, exec prod.

D E

UPA Productions of America. 4440 Lakeside Dr., Burbank, Calif. 91505. (213) 849-6666. Henry G. Saperstein, pres; Lee Cannon, Millard Segal, VP's.

A B C G

PUBLIC AFFAIRS PROGRAMMING

FROM THE UNIVERSITY OF DETROIT RADIO NETWORK

Programs available on a weekly basis include:

"Ask the Professor" (:29.30)

"University of Detroit

Town Hall" (:24.30)

"The Law In Your Life" (:14.30)

For a brochure and audition tapes contact:

Radio Traffic Manager
University of Detroit Radio Network
3800 Puritan
Detroit, Michigan 48221

Producers, Distributors

V

Thomas J. Valentino Inc. 151 W. 46th St., New York 10036. (212) 246-4675. Robert Valentino, pres; Thomas J. Valentino Jr., VP; Francis Valentino, VP; Chris Carrino, sound engr.

C F J

Van Coevering Productions. 258 N. 62nd St., Mesa, Ariz. 85205. (602) 985-5573. Jack Van Coevering, pres.

A

Robert Van Dyke Inc. 158 W. 13th St., New York 10011. (212) 741-2989. Robert Van Dyke, pres; Rufus Richardson, chief engr.

J

Van Praag Productions Inc. 250 West 54th St., New York 10019. (212) 245-1050. William Van Praag, exec dir; Ronny Graham, dir.

Hollywood 90028: 1228 North Vine St. (213) HO 2-2341. Don Bernarducci, studio mgr.

C

Vavin Inc. 236 E. 46th St., New York 10017. (212) 682-4624. Richard de Rochemont, pres & chmn of the bd; N.Z. Moreno, VP.

A B

Stephen F. Verona Films Inc. 9233 Doheny Rd., Los Angeles 90069. (213) 278-3846. Stephen F. Verona, pres, prod-dir; Ken Walz, prod; Florence Schlisser, VP; Richard Millman, prod.

A B C G H

Versatile Television Productions Inc. 324 Broadway, Cape Girardeau, Mo. 63701. (314) 335-8816. Robert Hirsch, pres; Jerrold Hollis, mgr.

C G J K

Viacom International Inc. 345 Park Ave., 15th Floor, New York 10022. (212) 371-5300. Ralph M. Baruch, pres & chief exec off. Viacom Enterprises division: Larry Hillford, pres; Henry A. Gillespie, senior VP; Frederick Gilson, VP international sls; Elliott Abrams, VP feature films; Charles Tolep, VP opns; Mort Slakoff, dir creative svcs; Bob Bernstein, dir info svcs; Art Kane, dir international mktg; William Andrews, VP domestic syndication; Jean Goldberg, dir dev & rsch; Todd Gaufocher, dir syndication sls.

Atlanta: 6720 Powers Ferry Rd. N.W. Jack Waldrep, mgr.

Chicago: 625 N. Michigan Ave. Warren Thomassene, mgr.

Dallas: 2 Turtle Creek Village. James McCormick, district mgr.

Los Angeles: 9720 Wilshire Blvd. Robert Donnelly, mgr.

San Francisco: Box 476, Fairfax, Calif. Edward Hewitt, mgr.

Miami: Viacom Latino Americana, 1401 Brickell Ave. Benigno Nosti, VP gen mgr.

6300 Zug, Switzerland: Viacom SA, Chamerstrasse 18. Howard Karshan, mgng dir.

London W1R 9FB: 40 Conduit St. Howard Karshan, mgng dir.

Toronto: Viacom Canada Ltd., 45 Charles St. E. David McLaughlin, VP & gen mgr.

North Sydney, Australia: Colman House, Berry & Walker Sts. William Wells, mgng dir.

Tokyo: Viacom Japan Inc., Mitsuwai Bldg., 7-2, Ginza 6-chome, Chuo-ku. Jiro Sugiyama, pres.

Soa Paulo, Brazil: Caixa Postal 30-544. Jorge Abid, mgng dir.

Beirut, Lebanon: Box 2604. Dr. George Chamas, Middle East rep.

Seoul, Korea: Taiyang Int'l, CPO Box 3769. Mann H. Lee, dir.

Madrid: Velazquez 129. Enrique de Las Casas, mgr.

New Hebrides: Viacom Pacific Inc., National bank House, Rue Bougainville, Port Villa.

B

Jim Victory Television Inc. 45 E. 45th St., New York 10017. (212) 686-8222. James T. Victory, pres; Robert J. Kolb, VP sls.

B

Video-Cinema Films Inc. 510 E. 86th St., New York 10028. (212) 734-1632. Larry Stern, pres & sls mgr.

B

Video City Inc. 12100 N.E. 16th Ave., North Miami, Fla. 33161. (305) 895-6400. Gayford M. Creedon, VP & gen mgr; Gil Stevens, VP opns mgr.

A C J K

Key to service codes

The following codes indicate type of service company offers:

- A —TV program production
- B —TV program distribution
- C —TV commercial production
- D —Radio program production
- E —Radio program distribution
- F —Radio commercial/jingle production
- G —Business/promotion film production
- H —Business/promotion film distribution
- J —Production services
- K —TV processing laboratory

For reader convenience in locating companies by function, each particular code letter always appears in the same place across the width of the column, as shown below:

A B C D E F G H J K

To locate companies that produce radio programs, for instance, simply run your eye down the column. Every firm so engaged will display a "D" about a third of the way in from the left hand margin.

Videocraft International Ltd. 116 E. 30th St., New York 10016. (212) ORegon 9-6030. Arthur Rankin Jr., pres; Jules Bass, exec VP; editorial office: 432 Park Ave., South, New York.

Beverly Hills, Calif.: 325 N. Oakhurst Dr.

A B

Videodetics Corp. 2121 S. Manchester Ave., Anaheim, Calif. 92802. (714) 532-3364; (213) 865-4670. Sheldon Pines, pres; Len Dozier, VP.

A B

Video Enterprises Inc. 8721 Sunset Blvd., Los Angeles 90069. (213) 659-4311. Philip J. Lane, pres; Lawrence Klein, VP; Val Hill, VP sls.

New York 10021: 667 Madison Ave. (212) PL3-9327.

Chicago 60611: 2 E. Oak St.

G

Video Films Inc. 2761 E. Jefferson Ave., Detroit 48207. (313) 259-5900. Clifford Hanna, pres; Hrayr (Peter) Toukhanian, VP.

C G J

Video Tape Center. 1 Gateway Center, Pittsburgh 15222. (412) 391-6260.

A B

Videotel Ltd. 151 Merton St., Toronto M4S 1A7. (416) 486-8632. Richard Rosenberg, pres; Norman Clavir, gen mgr.

A B

Video Distrib. Inc. 6290 Sunset Blvd., Suite 1803, Hollywood, 90028. (213) 466-7273. John Ballinger, pres; Rita Cross, VP.

B K

Viking Films Inc. 850 Seventh Ave., New York 10019. (212) Circle 5-8858. Israel M. Berman, pres.

A B

Visual Projects Ltd. 67 Yale St., Roslyn Heights, N.Y. 11577. (516) 621-5285. Newton E. Meltzer, pres & exec prod; Barbara L. Brilliant, assoc prod, creative dir.

London: 437-4510. John Fletcher.

A B

G H

Vocational Films. 111 Euclid Ave., Park Ridge, Ill. 60068. (312) 823-1418. Byron L. Friend, pres; Blanche Sands, off mgr.

A C G H J

W

Roger Wade Productions Inc. 15 W. 44th St., New York 10036. (212) 375-9111. Roger Wade, pres; Martin McIntyre, VP; Florence Hewitt, sec.

C

Wakeford/Orlorf Inc. 6528 Sunset Blvd., Hollywood 90028. (213) 461-3771. Gary Horowitz, pres; Frank Tuttle, VP & exec prod; Jill Dexter, VP & prod; John Orlorf, dir; Joe Hanwright, dir; Dick Perkins, dir; Bob Reagan, dir; Ron Dexter, cameraman; Steve Faber, supervising edit; Steve Dollinger, tape prod/dir.

New York 10016: (212) 532-2850. Chuck Sloan, pres; Morly Baran, exec prod; Bob Rabinowitz, prod;

Len Foray, sls mgr; Bob Siegler, dir; Mike Gottlieb, dir; Gary Young, dir.

G H

Les Wallwork & Associates. 6255 Sunset Blvd., Suite 1908, Los Angeles 90028. (213) 466-3381. Leslie Wallwork, pres.

B

The Walter Reade Organization Inc. May Fair House, Deal Rd., Oakhurst, N.J. 07755. (201) 531-1600. Sheldon Gunsburg, pres, chief exec off; Edward L. Schuman, senior VP; Christopher W. Preuster, VP, finance & treas; Albert Floersheimer, Jr., sec & asst treas.

B

H

Warner Bros. Distributing (Canada) Ltd. 70 Carlton St., Toronto M5B 1L7. (416) 922-5145. Alastair Banks, dir/Canadian sls; Ma-Shene, mgr/booking dept.

B

Warner Bros. Television. 4000 Warner Blvd., Burbank, Calif. 91505. (213) 843-6000. Gerald J. Leider, pres.

Worldwide distribution: Charles D. McGregor, exec VP, worldwide distribution; Alfred Ashley, VP, administration, TV distribution; Alvin E. Unger, VP, domestic sls mgr; Berry Greenberg, VP, international sls & administration; Gordon A. Hellmann, dir of adv, prom & publ; Carol Levine, film specialist.

New York 10036: 630 Ninth Ave. (212) 246-1000. Erwin Markisch, tech service mgr; Clara Falkoff, booking service mgr; Louis B. Marino, prod info mgr.

Domestic television distribution: New York 10019: 666 Fifth Ave. (212) 246-1000. Peter Alfe, dir of domestic sls.

Chevy Chase, Md. 20015: 127 Hesketh St. (301) 657-4125. Edgar J. Donaldson, Eastern sls dir.

Chicago 60606: 550 W. Jackson Blvd. (312) 372-8089. S. Allen Ash, Midwestern sls dir.

Burbank, Calif. 91505: 4000 Warner Blvd. (213) 843-6000. Sid Cohen, Western sls dir.

Houston 77024: 14302 Chaddbourne Drive. (713) 497-4240. James Delaney, Southern sls dir.

Foreign television distribution:

London W1V, 4AP (U.K., Eire, Europe, Middle East & Africa): 135/141 Wardour St. Harold Breacher, dir of sls; Jack Cook, asst to dir of sls.

Sydney, Australia 2001 (Australia & New Zealand): Box 2661 G.P.O. Matt Brown, sls dir.

Tokyo Central (Japan, Korea, Taiwan & Guam): P.O. Box 762. Louis K. Mizuno, dir of sls; Ken Sugizaki, asst to dir of sls.

Mexico 7, D.F. (Latin America): Calle Acapulco 37. Jorge Sanchez, dir of sls.

Rio de Janeiro (Brazil): Ave. Nossa Senhora de Copacabana 928-GR. 702. Jose de Munsuri, TV sls rep.

Paris 17 (France & colonies, Luxemburg, French-language station Switzerland, Monaco, Belgium, French Equatorial Africa, Senegal): 20, rue Troyon, Michel Lecourt.

Rome 00196 (Italy, Italian-language station Switzerland): 16, Lungotevere Flaminio. Christian Livorness, TV sls rep.

Barcelona-8, Spain (Spain & Portugal): Paseo de Gracia, 77. Xavier Azpiroz, TV sls rep.

Network programming and production:

Burbank, Calif. 91505: 4000 Warner Blvd. (213) 843-6000. Thomas G. Kuhn, VP in chg of TV prod; Edward Blier, VP in chg of net prog & sls (666 Fifth Ave., New York); Barry Meyer, dir of bus affairs; Mark Tuttle, dir of prog dev; Gerald L. Adler, exec prod; Harvey D. Frand, gen prog exec; Rick Rosner, exec prod in chg of video-tape & special projects; Jacqueline Smith, exec prod, family classics; Fredric S. Baum, dir of adv, publ & prom; Enid Moore (New York), mgr of net rel; William L. Hendricks, dir of coml, educ & industrial film prod.

A B

Watermark Inc. 10700 Ventura Blvd., North Hollywood, Calif. 91604 (213) 980-9490. Tom Rounds, pres; Chuck Olsen, prom dir; Lee Hansen, creative svcs dir.

D E F

WBKR Broadcast Service. 15800 South Park, Cleveland 44120. (216) 751-0566. William Baker, mgr; Lawrence Baker, dir of opns & engrg; Brian Telzrow, chief engr; Thomas Quinn, continuity dir.

A B C

Adrian Weiss Productions. 186 North Canon Drive, Beverly Hills, Calif. 90210. (213) 274-9991. Adrian Weiss, pres; Steven Weiss, VP; Tom Corradine, Western div mgr; Richard Ostrander, eastern div mgr;

Hank Profenuis, souther div mgr; Ken Weldon, mid-west div mgr; Marilyn Roth, office mgr.
A B C G H

West Coast Bible College/Media Ministries. 6901 North Maple Ave., Fresno, Calif. 93710. (209) 299-7205. Horace S. Ward, Jr., pres, Henry J. Smith, dean of the college.
D

Western International Syndication. 8732 Sunset Blvd., Los Angeles 91364. (213) 659-5711. (209) Sherwin, pres; Dan Miller, VP sls; William Gargan, VP PR.
A B

WGN Continental Productions Co. (A Division of WGN Continental Broadcasting Co.) 2501 W. Bradley Place, Chicago 60618. (312) 528-2311. Bradley R. Eidmañ, exec VP & gen mgr; Dale Juhlin, VP & exec prod; Harry Miller, VP; Ron McCrae, video-tape & film dir.
C H G 60611 (sls office)L 435 N. Michigan Ave., Room 1929. (312) 329-9104. Dale Juhlin, VP & exec prod.
A B C D E F G H

Alton Whitehouse & Assoc. 7061 Old Kings Rd., S., #137. Jacksonville, Fla. 32217. (904) 733-9565, 733-9566. Alton Whitehouse, pres.
B

Willard Pictures Inc. 45 W. 45th St., New York 10036. (212) JUDson 2-0430. John M. Squiers Jr., pres; Frank Brittain, prod mgr; S.H. Childs, treas.
A B

Willard Productions Inc. 1842 Briarwood Road N.E., Atlanta 30329. (404) 634-2433. Frank H. Willard Jr., pres; Patty H. Willard, VP; Edward J. Wagner, sec.
C F

Daniel Wilson Productions Inc. 300 W. 55th St., New York 10019. (212) 765-7148. Daniel Wilson, pres; Zoey Wilson, sec.
A B C G H

Winik Films Corp. 1619 Broadway, New York 10019. (212) 541-7150. Leslie Winik, pres.
A B C G H

WMAQ-TV (Cue Productions). Merchandise Mart, Chicago 60654. (312) 644-8300. Lee Schulman, VP NBC, gen mgr WMAQ-TV, Robert S. Walsh, stn mgr; Paul R. Ballantine, mgr, Cue Productions.
A B

WNA Music. 1200 Stewart St., Seattle 98101. (206) 623-5934. Wally Nelskog, pres; Anne Nelskog, sec.
A B D E

WNA Video. (Duplicating cassette tapes) 1200 Stewart St., Seattle 98020. (206) 623-5934. Wally Nelskog, pres; James Howell, VP; Edward Birney, treas; Anne Nelskog, sec.
J

Robert Wold Company. 11661 San Vicente Blvd., Los Angeles, Calif. 90049 (213) 820-2668. TWX 910-342-6977.
B

Wometex Film Laboratories Inc. 65 N.W. Third St., Miami 33128. (305) 377-2611. Robert B. Pell, pres; C. Robert Miele, VP, lab mgr; Thomas Fischer, bus mgr.
K

Worldvision Enterprises Inc. 660 Madison Ave., New York 10021. (212) 832-3838. Kevin O'Sullivan, pres & chief operating off; Neil Delman, exec VP; Jerry Smith, senior VP domestic sls; Colin Campbell, senior VP international sls; Howard Lloyd, VP; Scott Moger, VP adv & PR; Bert Cohen, VP ops; Charles Atkins, VP Eastern division; Al Harrigan, VP; special projects; Eric Harfst, VP finance; Larry Gottlieb, treas.
Los Angeles 90028; (213) 462-2315. Howard Lloyd, VP Western division.
Chicago 60601; (312) 346-4569. John Ryan, mgr Central division.
Atlanta 30319; (404) 255-0777. Jim Thomson, VP Southern division.
San Francisco 94920; (415) 435-2577. Ben Okulski, account exec.
A B

World Wide Bingo Inc. Box 1401, Englewood, Colo. 80110. (303) 781-8697. Jack Hampton, gen sls mgr.
A B

Worldwide Films. 395 Main St., Metuchen, N.J. 08840. (201) 494-9500. Hilliard A. Schendorf, pres.
G H

World Wide Video Associates Inc. 80 Central Park

Key to service codes

The following codes indicate type of service company offers:

- A -TV program production
- B -TV program distribution
- C -TV commercial production
- D -Radio program production
- E -Radio program distribution
- F -Radio commercial/jingle production
- G -Business/promotion film production
- H -Business/promotion film distribution
- J -Production services
- K -TV processing laboratory

For reader convenience in locating companies by function, each particular code letter always appears in the same place across the width of the column, as shown below:

A B C D E F G H J K

West, Suite 25 D (Penthouse), New York 10023. (212) 873-5558. Al De Caprio, pres; Sylvia Costa, VP/prod. Beverly Hills, Calif. 90211; 339 S. Robertson Blvd. (213) 652-7332.

Woroner Films Inc. 1995 N.E. 150th St., North Miami, Fla. 33161. (305) 945-5465. Murry Woroner, pres; Marilyn Woroner, sec treas; Robert Hardin, creative dir.
A B

Wrather Corp. 270 N. Canon Dr., Beverly Hills, Calif. 90210. (213) 274-8021. Jack Wrather, pres; Monte E. Livingston, exec VP & gen counsel; Edward D. Tisch, senior VP; Frank L. Bret, VP; Bonita Granville Wrather, VP.
B E

Carter Wright Enterprises. 6533 Hollywood Blvd., Hollywood 90028. (213) 469-0944. Carter Wright, Carla Lestrade, exec sec.
C D F

WRS Motion Picture Laboratory. 210 Semple St., Pittsburgh 15213. (412) 687-3700. F. Jack Napor, pres; Art Rescher, VP; Bob Kalin, prod mgr. Philadelphia 19130; Color Tech Film Laboratories, 640 N. Broad St. (215) 236-9100.
K

WUTV Productions. 951 Whitehaven Rd., Grand Island, N.Y. 14072. (716) 773-7531. Paul Meyer, prod mgr; Herman Pease, gen mgr.
C

Yale Reports. 149 York St., New Haven, Conn. 06511. (203) 436-4631. Trudy Bialic, edit; Betsy Dzwonkoski, admin asst.
D

Yongestreet Program Services Inc. 357 N. Canon Drive, Beverly Hills, Calif. 90210. (213) 273-8290. Alan D. Courtney, pres; Nick Vanoff, VP.
A B

York Enterprises Inc. 45 W. 45th St., (Suite #300), New York 10036. (212) 757-2173. Jack Sobel, pres.
A B

Marvin Young Assoc. 4432 Farndale Ave., North Hollywood 91602. (213) 763-5347. Marvin Young, head assoc.
A J

Youthways Productions Inc. 405 Park Ave., New York 10022. (212) 421-4488. Stephen Kahn, pres; Evelyn G. Kahn, VP; Barbi Sardinas, prod suvr. Los Angeles 90024; (213) 479-0203. Barbara Benson, mgr.
A B

Zachry, Nail & Associates. 901 S. 1st St., Box 1739, Abilene, Tex. 79604. (915) 677-1342. H.C. Zachry, pres; Norman E. C. Nail, exec VP & gen mgr; Robert E. Scott, prog dir.
A B C D E F G J

Felix Zelenka Productions. 818 N. La Brea Ave., Hollywood 90038. (213) 466-3263. Felix Zelenka, pres & prod.
A B C G H

Zounds. 224 Bellevue Ave., Haddonfield, N.J. 08033. (609) 429-4482. Frank Knight, pres; Douglas Knight, VP.
C F

Production, Closed Circuit Music Licensing

Closed Circuit TV

Bramson Telecasting Service. 1440 Broadway, New York 10018. (212)354-9575. E.M. Abramson, pres.
(All phases of closed-circuit television.)

Contact Corp., 1185 Avenue of the Americas, New York 10036. (212)869-9292. Edward C. Rasp, pres; Norman A. Lucas, mgr audio-visual prod. Multi-media producer in the field of education.

Direct Video Corp., Time & Life Building, Rockefeller Center, New York 10020. (212)541-5950. James Nichols, pres.

Subsidiaries: Video Conference Networks Inc. 1271 Ave. of the Americas, New York 10020. (212)541-5950. (Conference TV network, point-to-point and single location svcs.)
Gratton Associates Ltd., 123 East 54th St., New York 10022. (212)486-9052. (Nonbdct productions and 'networks')

Management Television Systems Inc., 1271 Ave. of the Americas, New York 10020 (212)541-5954. (Rental-leasing of color/B&W TV projection equip.)
Amphicon Systems Inc., 1 Graphic Place, Moonachie, N.J. (201)641-3383. (design, mfg, research & devel for MTS, above.)

General Television Network. 13225 Capital, Oak Park, Mich. 48237. (313) 548-2500. R. Randolph Hippler, pres.
(Closed circuit TV, mobile video-tape recording, rent large screen TV projectors, provide closed-circuit TV shows, rent video paging equipment.)

Hughes Television Network Inc. 1133 Ave. of the Americas, New York 10036. (212)765-6600. Arthur M. Mortensen, pres; Roylance H. Sharp, exec VP; David Donnelly, VP (sales/programming); John L. Koushouris, VP & exec prod; William Hyland, VP & treas.; Ralph McFarland, VP-engng; Thomas J. Schilling, VP (purchasing). Tape Editing Center, 20 East 46th St., New York 10017; video tape dubbing and editing facilities, color and black and white. Branch: 158 East Passaic Ave., Rutherford, N.J. 07070. (201)933-4040.
(Specializes in regional networks for all sports and special events. Remote equipment for pickups and taping available.)

Kenneth R. Meades, PO. Box 71403, Los Angeles, Calif. 90071. Kenneth R. Meades, own & mgr.
(Systems design, engineer, repair, technical consulting, management consulting.)

Telecasting Services Inc. 1709 W. Washington Blvd., Chicago 60612. (312)738-1022. H. Walter Thompson, pres; David B. Thompson, VP, prod mgr; Morris Tulskey, sec-treas; John Smolek, chief engr; Jack Gregoris, production.
(Remote and studio facilities for closed-circuit or broadcast color TV, including color cameras, broadcast 1-inch video tape recorders and large-screen video projection. Total programming and engineering services for conventions and other large meetings.)

TNT Communications Inc. 575 Madison Ave., New York 10022. (212)644-0200. Nathan L. Halpern, pres; Frederick J. Cudlipp, dir net ops; Robert Friedman, VP mktg; James W. Johnson, prod mgr.

Music Licensing Groups

American Composers Alliance. 170 W. 74th St., New York 10023. (212) Trafalgar 3-1250. C. Dodge, pres; D. Cooper, exec dir.

American Society of Composers, Authors & Publishers (ASCAP). 1 Lincoln Plaza, New York 10023. (212)595-3050. Stanley Adams, pres; Salvatore T. Chiantia, Ned Washington, VPs; Morton Gould, sec; Ernest R. Farmer, treas; Arthur Schwartz, asst sec; Leon J. Brettler, asst treas; Bernard Korman, counsel; Paul Marks, dir of operations. Directors: Stanley Adams, Harold Arlen, Leon J. Brettler, Arnold Broido, Salvatore T. Chiantia, Cy Coleman, Aaron Copland, Hal David, George Duning, Ernest R. Farmer, Morton Gould, Arthur Hamilton, Gerald Marks, W. Stuart Pope, Irwin Z. Robinson, Wesley H. Rose, Arthur Schwartz, Larry Shayne, Edward Silvers, Michael Stewart, Virgil Thomson, Ned Washington, Norman Weiser.

Music Licensing, Major Awards

Nashville 37203: Number Two Music Square West, (615)244-3936.

Hollywood 90028: 6430 Sunset Blvd, (213)466-7681.

Belwin-Mills Publishing Corp. 16 W 61 St., New York 10023. (212)245-1100. Martin Winkler, pres; Burton L. Litwin, gen mgr, popular and serious music divisions.

Broadcast Music Inc. (BMI). 40 West 57 St., New York 10019. (212)586-2000. Edward M. Cramer, pres & chief exec officer; Sydney M. Kaye, chmn emeritus of bd of directors; G. Richard Shafto, chmn of bd; Edward W. Chapin, counsel and sec; Theodora Zavin, sr VP, performing rights admin; Robert J. Higgins, VP licensing; Richard L. Kirk, VP, California; Edward J. Molinelli, VP, finance and treas; Frances Preston, VP, Nashville; Russell Sanjek, VP, pub rel. Directors: Edward M. Cramer; Don F. DeGroot; John H. DeWitt Jr.; Rex G. Howell; Sydney M. Kaye; Carl E. Lee; Merrill Lindsay; Dwight W. Martin; Richard H. Mason; Robert L. Pratt; Odin S. Ramsland; G. Richard Shafto; Richard S. Stakes; E.R. Vadeboncoeur; Robert Wells.
710 16th Ave. S., Nashville 37203. (615)259-3625.
6255 Suhset Blvd., Hollywood, Calif. 90028. (213)465-2111.
680 Beach St., San Francisco 94109. (415)441-7255.

BMI Canada Ltd. 41 Valleybrook Drive, Don Mills, Ont. M3B 2S6. (416)445-8700. S. Campbell Ritchie, mgng dir.

Composers, Authors & Publishers Assn. of Canada Ltd. 1240 Bay St., Toronto M5R 2C2. (416)924-4427. John V. Mills, Q.C. gen mgr.

The Harry Fox Agency Inc. 110 E 59th St., New York 10022. (212) PLaza 1-1930. Albert Berman, mgng dir.

SESAC Inc. 10 Columbus Circle, New York 10019. (212)586-3450. A.H. Prager, pres; S.B. Candilora, exec VP; W.F. Myers, VP; Norman Odium, VP; Sydney Guber, VP; R.C. Heinecke, treas.
SESAC Bldg., 1513 Hawkins St., Nashville.

Major Awards and Citations

American Baptist Radio/Television Awards by American Baptist Convention, given to networks for programs interpreting Christian concept: sponsors for a program dealing creatively with a controversial subject; stations for an exemplary job of searching out community needs and producing pertinent and creative programing to meet them; to individuals in broadcasting who have communicated the Christian message through innovative use of the media. *Contact:* American Baptist Churches, Valley Forge, Pa. Attn: Rev. Norman DePuy.

American Legion 'Fourth Estate' Awards. Presented to radio or TV stations and other media to "owners, executive heads or staff members" in recognition of "outstanding service to the community, state or nation." *Contact:* National Adjutant, American Legion, 700 N. Pennsylvania, Indianapolis 46206.

American TV and Radio Commercials Festival Awards given annually for best U.S. radio & TV commercials. Clio statuettes, certificates to runners-up & finalists. In 34 product categories and 15 craft categories for TV; 15 product categories and 7 craft categories for radio; International TV/cinema awards presented in 25 categories. Open to all commercials introduced in prior year. Deadline for entries: radio, TV: Feb. 1, 1976. *Contact:* Bill N. Evans, CLIO Awards, 30 E. 60th St., New York 10022.

Major Armstrong Award, given annually for excellence in FM broadcasting by The Armstrong Memorial Research Foundation in four categories: music, education, news and public service for both commercial and noncommercial stations. Deadline: Feb. 23. Administered by Columbia University, School of Engineering and Applied Science. *Contact:* Kenneth Goldstein, executive director, 510 S.W. Mudd Bldg., Columbia Univ., New York 10027.

Howard W. Blakeslee Award, given annually for creative efforts in any medium of mass communication judged to have contributed most to public understanding of progress in research and the prevention,

care and treatment of heart and circulatory diseases; \$500 and citation. Programs must have been broadcast March 1 through Feb. 28. Deadline for entry: May 1. *Contact:* Science Information, Howard W. Blakeslee Awards, American Heart Assn., National Hdqtrs, 7320 Greenville Ave., Dallas 75231.

Broadcasters Promotion Association 'Gold Medal' Awards. Presented to broadcasters for creativity, originality and effectiveness in achieving total audience promotion. *Contact:* Broadcasters Promotion Association, 18 S. Michigan Ave., Chicago 60603.

Heywood Brown Award, \$1,000 award for outstanding journalistic achievement during calendar year "in the spirit of Heywood Brown." Deadline for entry: January 17, 1976. *Contact:* Yetta Riesel, The Newspaper Guild, 1125 15th St., Washington 20005.

Russell L. Cecil Writing Awards in Arthritis, given each year by the Arthritis Foundation for calendar year's outstanding writing about arthritis in television, radio, newspapers and magazines. First (\$1,000) prize in each of the four media categories. Deadline for entries: Jan. 31. *Contact:* Public Information Dept., The Arthritis Foundation, 475 Riverside Dr., New York 10027.

Corporation for Public Broadcasting. CPB presents the following awards annually: "Local Program Awards" single out excellence in local programing in public television. Up to six awards are given. "The Ralph Lowell Medal" is presented to a programing oriented public broadcaster currently active in the field. "The Promotion Award Plaque" recognizes the outstanding Radio or Television promotion during the preceding year. *Contact:* The Information Officer, Corporation for Public Broadcasting, 1111-16th St., N.W., Washington 20036.

Dr. Lee DeForest Award, given at discretion of Board of Directors of NABB to an individual who has made an outstanding contribution for improvement of radio and television. Nominations not solicited. *Contact:* NABB, Box 43640, Los Angeles 90043.

Alfred I. duPont-Columbia Survey and Awards. The survey will report on the performance of broadcast journalism during the preceding year. Awards for outstanding performance in radio and TV journalism will be based on the survey. Time period from July 1 to June 30. Sponsored by Alfred I. duPont Awards Foundation and Columbia U. Graduate School of Journalism. *Contact:* Marvin Barrett, dir., Alfred I. duPont-Columbia Survey and Awards, Graduate School of Journalism, Columbia University, New York 10027.

Financial World Annual Reports, given to corporations making outstanding annual reports to stockholders. *Contact:* Annual Report Survey, Financial World, 919 3rd Ave., New York 10022.

Freedoms Foundation Awards, given annually to radio and TV stations which develop or feature constructive activities to bring about a better understanding of America. Subjects may be drug abuse education, ecology projects, patriotic programs, respect for the law, economic education, moral and spiritual values, human dignity, brotherhood and responsible citizenship. Substantiating materials must include an audio tape, video tape (preferably low band) or a 16 mm kinescope. A script or synopsis must accompany the nomination. Information needed is date aired or released, name of sponsor (station, network and/or company/organization), full address(es) and the chief executive officer. If sponsor is a station, is helpful to know the network affiliation. Nominations must be received by Nov. 1st. Awards are announced on Washington's birthday. *Contact:* Freedoms Foundation at Valley Forge, Valley Forge, Pa. 19481.

Gavel Awards, given annually by the American Bar Association in recognition of outstanding public service by United States newspapers, wire services, magazines, book publishers, radio, television and motion pictures in "increasing public understanding of the American system of law and justice." Awards for media organizations are in the form of individually inscribed gavels. Gavel Award certificates are given to authors, in the case of the print media, and to the producer, director, and writer representing electronic and film media winners. The Gavels are presented at the ABA's annual meeting in August; the Certificates are mailed directly to the winners. Eligible materials must have been published, broadcast or produced during the period of Jan. 1, 1975 and

Dec. 31, 1975, and entries must be postmarked not later than March 1, 1976.

(TV programs considered in four classifications: Network programs; network-owned or affiliated station programs; independent station programs; educational station programs; cable (local origin). A 16mm. film (optical sound track) or 2" quadruplex standard broadcast videotape must be submitted together with three copies of a 200-300 word synopsis. Producer, director, writer and sponsor should be listed on cover page. Radio programs: network programs; network owned or affiliated station programs; independent station programs; educational station programs.) Maximum of 5 entries. *Contact:* Dean Tyler Jenks, staff director, Department of Special Events, American Bar Assn., 1155 East 60th Street, Chicago 60637.

Golden Mike Awards, given annually by the American Legion Auxiliary for best local radio and television programs in the interest of youth, originating over a local station between May 1 and May 1 of succeeding year. A Golden Mike trophy is awarded the sponsors or agency that produced the winning series and a Golden Mike certificate is awarded the winning program series in each state. Deadline for entry: May 1. *Contact:* Layton K. Hurst, American Legion Auxiliary, 1608 K. St., N.W., Washington 20006.

Hall of Fame Award (world-wide in scope) to anyone who had made an outstanding contribution to art of broadcasting. Candidate must have been deceased at least two years prior to annual meeting of Broadcast Pioneers in spring of each year. Nomination must be accompanied by short biography and statement of achievement. *Contact:* M.H. Shapiro, Exec. Sec., Broadcast Pioneers, 40 West 57th St., New York 10019.

Sidney Hillman Foundation Prize Awards, given annually by the Sidney Hillman Foundation for contributions in the fields of daily or periodical journalism, fiction, non-fiction, radio and television. Themes would include the protection of individual civil liberties, improved race relations, a strengthened labor movement, the advancement of social welfare and economic security, greater world understanding, and related problems. Contributions must be published or produced under professional auspices in 1975. Prizes of \$750 are awarded. Deadline for entries is Jan. 31, 1976. *Contact:* Howard D. Samuel, Executive Director, Sidney Hillman Foundation, 15 Union Square, New York 10003.

Roy W. Howard Public Service Award of the Scripps-Howard Foundation. To bring recognition and reward to radio and television stations and newspapers for outstanding public service and urban reporting during 1975. First prize is for \$2,500 and a medallion plaque will be given for stories or broadcasts that exposed and/or corrected situations that directly or indirectly influenced the lives of readers, listeners and viewers. Prizes will be distributed to the individual or among the individuals at the stations or newspapers, who, in the opinion of the editor or station manager contributed significantly to the winning entry. Runner-up prizes of \$1,000 and \$500 may also be awarded. Nominations may be submitted by any station or newspaper and should consist of clippings, a tape of a broadcast, or a reel and soundtrack of a TV program. Entries should be made no later than March 1, 1976. *Contact:* Matt Meyer, pres., Scripps-Howard Foundation, 200 Park Ave., New York 10017.

Hugo Awards of the Chicago International Film Festival. Gold and silver Hugo statues awarded annually in 37 categories, and in TV productions competition for best station and best multi-station documentaries and best station and best multi-station children's programs. Open to all TV film commercials and documentary and entertainment programs telecast worldwide. Annual Chicago International Film Festival: Nov. Deadline: Sept. 20. *Contact:* Michael J. Kutza Jr., director, Chicago International Film Festival Inc., 415 North Dearborn, Chicago 60610.

International Broadcasting Awards, given to "world's best" radio and TV commercials broadcast anywhere in the world in 1975. Competition is sponsored by Hollywood Radio and Television Society. Deadline for entries: December 5. *Contact:* Oliver H. Crawford, executive director, Hollywood Radio and Television Society, 1717 N. Highland Ave., Hollywood 90028. Cable address: HORTSIBA.

International Radio & Television Society "Gold Medal" Award. A gold medal is presented each year

to a person judged to have made "an outstanding contribution to, or achievement in" radio or television. *Contact:* International Radio & Television Society, 420 Lexington Ave., New York 10017.

The Abe Lincoln Awards, are made annually by the Southern Baptist Radio and Television Commission to broadcasters for achievements advancing the quality of life in America and helping the broadcast industry enrich its service to the public. Highest award is the Abe Lincoln Award, a bronze statuette of the Civil War President. Select other broadcasters receive Abe Lincoln Merit awards, mounted bronze medallions. Special awards are also presented. Recipients are chosen from entries submitted throughout the nation. Covers the period of July 1 through June 30 of the following year. Deadline for entries is Sept. 1. *Contact:* James Holcomb, Baptist Radio-TV Commission, Box 12157, 6350 W. Freeway, Fort Worth 76116.

Missouri 'Honor Medals', given annually to broadcast stations, newspapers, magazines and individuals for distinguished service in journalism. *Contact:* Dean of Faculty, School of Journalism, University of Missouri, Columbia, Mo. 65201.

Mortgage Bankers Assn. of America 'Janus' Awards for excellence in financial news programing, given annually by the Mortgage Bankers Association of America, in four categories: Local television, network television, local radio and network radio. Competition recognizes authoritative regularly scheduled programs characterized by comprehensive coverage of financial news. Competition year: Jan. 1-Dec. 31. Submission deadline: Postmarked Jan. 30. *Contact:* R.L. Gray, director of pub rel, Mortgage Bankers Assn. of America, 1125 15th St., N.W., Washington 20005.

National Association of Broadcasters Awards: Distinguished Service plaque awarded annually to the individual who has made a "significant and lasting contribution to the American system of broadcasting by virtue of a singular achievement or continuing service on behalf of the industry." Established in 1953, the award is presented at the annual convention.

Engineering Achievement Award. Annual award presented to an owner, officer or employee of any company, subsidiary or division whose primary business is broadcasting by stations licensed by the FCC, including employees of the Federal Government directly engaged in broadcast engineering work for contributions "which measurably advance the technical state of the broadcasting art."

Harold E. Fellows Memorial Scholarships consist of four annual scholarships of \$1,250 each awarded for study in the junior or senior years in college or for study in graduate school. Applicants must pursue a course of study in a university or college which is an institutional member of the BEA and must be or have been an employee of an NAB member radio or TV station or the child of such an employee.

Contact: NAB, 1771 N St., N.W., Washington 20036.

National Academy of Television Arts & Sciences 'Emmy' Awards recognizes outstanding achievements in all phases of television, including programing, directing, writing, performing etc. *Contact:* Miss Laya Gelff, mgr, National Awards, National Academy of Television Arts and Sciences, 291 S. La-Cienega Blvd., Suite 200, Beverly Hills, Calif. 90211.

National Cowboy 'Western Heritage' Awards made in three television categories: western documentaries, factual TV shows and fictional TV programs. *Contact:* National Cowboy Hall of Fame, 1700 N.E. 63rd St., Oklahoma City 73111.

National Headliners Club Awards, given annually for radio and television network news broadcasting and individual stations' news, public service and editorials; medallions. Deadline for entry: Feb. 15. *Contact:* National Headliners Club, Convention Hall, Miss. Ave. & Boardwalk, Atlantic City 08401.

National Mass Media Brotherhood Awards, given by National Conference of Christians and Jews, to pay tribute to mass media for outstanding creative work promoting better mutual understanding and cooperation among Americans of different religions, races and ethnic origins. Material must have appeared originally between Jan. 1, 1975 and Dec. 31, 1975. *Contact:* Brotherhood Media Awards, National Conference of Christians and Jews, 43 West 57th St., New York 10019. Attn: Harry A. Robinson, VP and director of public information.

National Press Photographers Assn. Award is presented annually for the best news film produced in Spot, General, Sports, Feature, Silent and Documentary classes. News film Station of the Year and News Cameraman of the Year are also included. *Contact:* Hal Lesser, KGW-TV, 1501 S.W. Jefferson St., Portland, Ore. 97201.

Ohio State Awards, given annually for excellence in commercial and noncommercial program fare in both television and radio of an educational and public affairs nature. Period covered: Sept. 1 to Aug. 31. Deadline for entry: Sept. 15. *Contact:* Director, Institute for Education by Radio-TV, 2400 Oentangy River Rd., Columbus, Ohio 43210.

Overseas Press Club Awards, given annually in news media categories including daily newspaper or wire service reporting from abroad, daily newspaper or wire service interpretation of foreign affairs, Robert Capa Gold Medal for best photographic reporting or interpretation from abroad requiring exceptional courage and enterprise, radio spot news from abroad, radio interpretation of foreign news, TV spot news reporting from abroad, TV interpretation or documentary on foreign affairs, magazine reporting from abroad, magazine interpretation of foreign affairs, cartoon on foreign affairs, business news reporting from abroad, book in foreign affairs, Madeline Dane Ross Award for international reporting which demonstrates concern for humanity (any medium), Bob Considine Memorial Award for best reporting from abroad requiring exceptional courage and initiative (any medium). Winners receive illuminated scrolls; winner of best cartoon on foreign affairs receives \$250 from the New York Daily News and National Cartoonist Society; winner of best news reporting from abroad receives \$500 from Bache & Co.; winner of best book in foreign affairs receives \$350; winner of Ross Award receives \$300; winner of Considine Award receives \$1,000. Deadline: mid-February. *Contact:* Robin Moore, awards chmn., Overseas Press Club of America, 55 East 43rd St., New York 10017.

George Foster Peabody Broadcasting Awards, given annually and covering year prior to presentation for radio and television achievement in following fields: news, entertainment, education, youth programs, promotion of international understanding, public service. Deadline for entry or recommendation: Jan. 10. *Contact:* Dr. Worth McDougald, director, Peabody Awards, Henry W. Grady School of Journalism, U. of Georgia, Athens 30601. (404) 542-3785.

George Polk Memorial Awards, given annually for outstanding achievement in reporting, national reporting, writing, editing, photography and production manifested through newspapers, magazines, specialized periodicals, books and radio-television; bronze plaques. Deadline for entry: Jan. 15. *Contact:* Professor Jacob H. Jaffe, Curator, George Polk Memorial Awards, Long Island University, Zeckendorf Campus, Brooklyn, N.Y. 11201.

Psychological Assn. 'Public' Media Awards are given annually to programs on radio and TV aimed at the lay public rather than professionals. Eligible programs deal with a single disability such as blindness, deafness, mental retardation, a crippling orthopedic condition, emotional illness or the overall subject of disability. *Contact:* Awards Committee chairman, American Psychological Assn., Box 1241, Hines, Ill. 60141.

RCA-NBC Fellowships/Scholarships—Fellowships (2): (both for graduate study in Journalism), Columbia University and Northwestern University. Scholarships (4): (undergraduate level), Columbia University, broadcast journalism; Howard University, telecommunications; Kent State University, telecommunications; St. John's University, broadcast journalism. *RCA-NBC Special Scholarships* (2): New School for Social Research (Graduate Department of Urban Affairs and Policy Analysis of the Center for New York City Affairs); Roosevelt University, (Undergraduate

Major Awards, NAB TV Code

level), the Business Occupational Opportunities Studio Trainees Program. *Contact:* Schools.

RTNDA Radio & Television News Awards, given by Radio-TV News Directors Assn. to TV and radio stations for editorializing, for documentaries and reporting of on-the-spot stories and series reporting. Covering calendar year. Deadline for entry: March 1. *Contact:* Prof. Bassett Mosse, Northwestern University, Evanston, Ill. (television); Prof. Richard Yoakam, Indiana University, Bloomington, Ind. (radio).

The Society of Professional Journalists, Sigma Delta Chi Distinguished Service Awards, given annually for meritorious achievement in following categories: Editorializing on radio, editorializing on television, television reporting, radio reporting, public service in radio journalism, public service in television journalism; bronze medallions and certificates. Deadline for entry: Jan. 25. *Contact:* Sigma Delta Chi, 35 E. Wacker Dr., Chicago 60601.

Silver Anvil Awards, given annually by Public Relations Society of America Inc. to recognize outstanding public relations programs of preceding year. Deadline for entry: mid-March. *Contact:* Mrs. Rea W. Smith, Public Relations Society of America Inc., 845 Third Ave., New York 10022.

Society of Motion Picture & Television Engineers Awards. "David Sarnoff Gold Medal"—Awarded to an individual for meritorious achievement in television engineering. "Eastman Kodak Gold Medal"—Presented annually for outstanding achievement in new techniques using television, high-speed photography, etc. "Progress Medal"—Awarded for research inventions or development making a significant advance in TV or film. "The Journal Award" is presented to the author of the most outstanding paper originally published in the Journal of the Society during the preceding calendar year. "Herbert T. Kaimus Gold Medal Award" is awarded for outstanding contributions in the development of color films, processes, techniques or equipment useful in making color motion pictures for TV or theaters. *Contact:* Society of Motion Picture and Television Engineers, 9 E. 41st St., New York 10017.

Television Bureau of Advertising Awards, a yearly joint competition with National Retail Merchants Association. Awards made at Spring NRMA Sales Promotion Conference. Covers department store/specialty store commercials produced calendar year Jan. 1 - Dec. 31. Awards given by market size for both individual spots and campaigns. "Gold Medal Screen" Awards. These awards are presented to broadcasting and advertising industry leaders in recognition of their "outstanding performance in the art of total communication to promote an industry through advertising." *Contact:* Television Bureau of Advertising, 1345 Avenue of the Americas, New York 10019.

Television Director of the Year, given annually by the Directors Guild of America for a live, taped or filmed television program. Award winner chosen by membership from five category winners. Deadline on or about the first of each year. *Contact:* Directors Guild of America Inc., 7950 Sunset Blvd., Hollywood 90046.

Voice of Democracy Scholarship Program, a nationwide broadcast scriptwriting competition for 10th, 11th and 12th grade students. The program is sponsored annually by the Veterans of Foreign Wars of the United States and its ladies auxiliary with the cooperation of broadcasters and secondary school principals during the fall term of each school year. \$22,500 in national scholarship awards are made. The deadline for completion of school competition is Dec. 5. *Contact:* Voice of Democracy Program, VFW National Headquarters, Broadway at 34th St., Kansas City, Mo. 64111.

NAB Television Code

Preamble

Television is seen and heard in nearly every American home. These homes include children and adults of all ages, embrace all races and all varieties of philosophic or religious conviction and reach those of every educational background. Television broadcasters

must take this pluralistic audience into account in programing their stations. They are obligated to bring their positive responsibility for professionalism and reasoned judgment to bear upon all those involved in the development, production and selection of programs.

NAB Television Code

The free, competitive American system of broadcasting which offers programs of entertainment, news, general information, education and culture is supported and made possible by revenues from advertising. While television broadcasters are responsible for the programming and advertising on their stations, the advertisers who use television to convey their commercial messages also have a responsibility to the viewing audience. Their advertising messages should be presented in an honest, responsible and tasteful manner. Advertisers should also support the endeavors of broadcasters to offer a diversity of programs that meet the needs and expectations of the total viewing audience.

The viewer also has a responsibility to help broadcasters serve the public. All viewers should make their criticisms and positive suggestions about programming and advertising known to the broadcast licensee. Parents particularly should oversee the viewing habits of their children, encouraging them to watch programs that will enrich their experience and broaden their intellectual horizons.

Program Standards

I. Principles of Governing Program Content

It is in the interest of television as a vital medium to encourage programs that are innovative, reflect a high degree of creative skill, deal with significant moral and social issues and present challenging concepts and other subject matter that relate to the world in which the viewer lives.

Television programs should not only reflect the influence of the established institutions that shape our values and culture, but also expose the dynamics of social change which bear upon our lives.

To achieve these goals, television broadcasters should be conversant with the general and specific needs, interests and aspirations of all the segments of the communities they serve. They should affirmatively seek out responsible representatives of all parts of their communities so that they may structure a broad range of programs that will inform, enlighten and entertain the total audience.

Broadcasters should also develop programs directed toward advancing the cultural and educational aspects of their communities.

To assure that broadcasters have the freedom to program fully and responsibly, none of the provisions of this Code should be construed as preventing or impeding broadcast of the broad range of material necessary to help broadcasters fulfill their obligations to operate in the public interest.

The challenge to the broadcaster is to determine how suitably to present the complexities of human behavior. For television, this requires exceptional awareness of considerations peculiar to the medium.

Accordingly, in selecting program subjects and themes, great care must be exercised to be sure that treatment and presentation are made in good faith and not for the purpose of sensationalism or to shock or exploit the audience or appeal to prurient interests or morbid curiosity.

Additionally, entertainment programming inappropriate for viewing by a general family audience should not be broadcast during the first hour of network entertainment programming in prime time and in the immediately preceding hour. In the occasional case when an entertainment program in this time period is deemed to be inappropriate for such an audience, advisories should be used to alert viewers. Advisories should also be used when programs in later prime time periods contain material that might be disturbing to significant segments of the audience.

These advisories should be presented in audio and video form at the beginning of the program and when deemed appropriate at a later point in the program. Advisories should also be used responsibly in promotional material in advance of the program. When using an advisory, the broadcaster should attempt to notify publishers of television program listings.

Special care should be taken with respect to the content and treatment of audience advisories so that they do not dissolve their intended purpose by containing material that is promotional, sensational or exploitative. Promotional announcements for programs that include advisories should be scheduled on a basis consistent with the purpose of the advisory.

II. Responsibility Toward Children

Broadcasters have a special responsibility to children. Programs designed primarily for children

should take into account the range of interests and needs of children, from instructional and cultural material to a wide variety of entertainment material. In their totality, programs should contribute to the sound, balanced development of children to help them achieve a sense of the world at large and informed adjustments to their society.

In the course of a child's development, numerous social factors and forces, including television, affect the ability of the child to make the transition to adult society.

The child's training and experience during the formative years should include positive sets of values which will allow the child to become a responsible adult, capable of coping with the challenges of maturity.

Children should also be exposed, at the appropriate times, to a reasonable range of the realities which exist in the world sufficient to help them make the transition to adulthood.

Because children are allowed to watch programs designed primarily for adults, broadcasters should take this practice into account in the presentation of material in such programs when children may constitute a substantial segment of the audience.

All the standards set forth in this section apply to both program and commercial material designed and intended for viewing by children.

III. Community Responsibility

1. Television broadcasters and their staffs occupy positions of unique responsibility in their communities and should conscientiously endeavor to be acquainted fully with the community's needs and characteristics in order better to serve the welfare of its citizens.

2. Requests for time for the placement of public service announcements or programs should be carefully reviewed with respect to the character and reputation of the group, campaign or organization involved, the public interest content of the message, and the manner of its presentation.

IV. Special Program Standards

1. Violence, physical or psychological, may only be projected in responsibly handled contexts, not used exploitatively. Programs involving violence should present the consequences of it to its victims and perpetrators.

Presentation of the details of violence should avoid the excessive, the gratuitous and the instructional.

The use of violence for its own sake and the detailed dwelling upon brutality or physical agony, by sight or by sound, are not permissible.

The depiction of conflict, when presented in programs designed primarily for children, should be handled with sensitivity.

2. The treatment of criminal activities should always convey their social and human effects.

The presentation of techniques of crime in such detail as to be instructional or invite imitation shall be avoided.

3. Narcotics addiction shall not be presented except as a destructive habit. The use of illegal drugs or the abuse of legal drugs shall not be encouraged or shown as socially acceptable.

4. The use of gambling devices or scenes necessary to the development of plot or as appropriate background is acceptable only when presented with discretion and in moderation, and in a manner which would not excite interest in, or foster, betting nor be instructional in nature.

5. Telecasts of actual sports programs at which on-the-scene betting is permitted by law shall be presented in a manner in keeping with Federal, state and local laws, and should concentrate on the subject as a public sporting event.

6. Special precautions must be taken to avoid demeaning or ridiculing members of the audience who suffer from physical or mental affliction or deformities.

7. Special sensitivity is necessary in the use of material relating to sex, race, color, creed, religious functionaries or rites, or national or ethnic derivation.

8. Obscene, indecent or profane matter, as proscribed by law, is unacceptable.

9. The presentation of marriage, the family and similarly important human relationships, and material with sexual connotations, shall not be treated exploitatively or irresponsibly, but with sensitivity. Costuming and movements of all performers shall be handled in a similar fashion.

10. The use of liquor and the depiction of smoking in program content shall be deemphasized. When shown, they should be consistent with plot and character development.

11. The creation of a state of hypnosis by act of detailed demonstration on camera is prohibited and hypnosis as a form of "parlor game" antics to create

humorous situations within a comedy setting is forbidden.

12. Program material pertaining to fortune-telling, occultism, astrology, phrenology, palm-reading, numerology, mind-reading, character-reading, and the like is unacceptable if it encourages people to regard such fields as providing commonly accepted appraisals of life.

13. Professional advice, diagnosis and treatment will be presented in conformity with law and recognized professional standards.

14. Any technique whereby an attempt is made to convey information to the viewer by transmitting messages below the threshold of normal awareness is not permitted.

15. The use of animals, consistent with plot and character delineation, shall be in conformity with accepted standards of humane treatment.

16. Quiz and similar programs that are presented as contests of knowledge, information, skill or luck, must, in fact, be genuine contests and the results must not be controlled by collusion with or between contestants, or by any other action which will favor one contestant against any other.

17. The broadcaster shall be constantly alert to prevent inclusion of elements within a program dictated by factors other than the requirements of the program itself. The acceptance of cash payments or other considerations in return for including scenic properties, the choice and identification of prizes, the selection of music and other creative program elements and inclusion of any identification of commercial products or services, their trade names or advertising slogan within the program are prohibited except in accordance with Sections 317 and 508 of the Communications Act.

18. Contests may not constitute a lottery.

19. No program shall be presented in a manner which through artifice or simulation would mislead the audience as to any material fact. Each broadcaster must exercise reasonable judgment to determine whether a particular method of presentation would constitute a material deception, or would be accepted by the audience as normal theatrical illusion.

20. A television broadcaster should not present fictional events or other non-news material as authentic news telecasts or announcements, nor should he permit dramatizations in any program which would give the false impression that the dramatized material constitutes news.

21. The standards of this Code covering program content are also understood to include, wherever applicable, the standards contained in the advertising section of the Code.

V. Treatment of News and Public Events

General

Television Code standards relating to the treatment of news and public events are, because of constitutional consideration, intended to be exhortatory. The standards set forth hereunder encourage high standards of professionalism in broadcast journalism. They are not to be interpreted as turning over to others the broadcaster's responsibility as to judgments necessary in news and public events programming.

News

1. A television station's news schedule should be adequate and well-balanced.

2. News reporting should be factual, fair and without bias.

3. A television broadcaster should exercise particular discrimination in the acceptance, placement and presentation of advertising in news programs so that such advertising should be clearly distinguishable from the news content.

4. At all times, pictorial and verbal material for both news and comment should conform to other sections of these standards, wherever such sections are reasonably applicable.

5. Good taste should prevail in the selection and handling of news:

Morbid, sensational or alarming details not essential to the factual report, especially in connection with stories of crime or sex, should be avoided. News should be telecast in such a manner as to avoid panic and unnecessary alarm.

6. Commentary and analysis should be clearly identified as such.

7. Pictorial material should be chosen with care and not presented in a misleading manner.

8. All news interview programs should be governed by accepted standards of ethical journalism, under which the interviewer selects the questions to be asked. Where there is advance agreement materially restricting an important or newsworthy area of ques-

tioning, the interviewer will state on the program that such limitation has been agreed upon. Such disclosure should be made if the person being interviewed requires that questions be submitted in advance or if he participates in editing a recording of the interview prior to its use on the air.

9. A television broadcaster should exercise due care in his supervision of content, format, and presentation of newscasts originated by his station, and in his selection of newscasters, commentators, and analysts.

Public Events

1. A television broadcaster has an affirmative responsibility at all times to be informed of public events, and to provide coverage consonant with the ends of an informed and enlightened citizenry.

2. The treatment of such events by a television broadcaster should provide adequate and informed coverage.

VI. Controversial Public Issues

1. Television provides a valuable forum for the expression of responsible views on public issues of a controversial nature. The television broadcaster should seek out and develop with accountable individuals, groups and organizations, programs relating to controversial public issues of import to his fellow citizens; and to give fair representation to opposing sides of issues which materially affect the life or welfare of a substantial segment of the public.

2. Requests by individuals, groups or organizations for time to discuss their views on controversial public issues, should be considered on the basis of their individual merits, and in the light of the contribution which the use requested would make to the public interest, and to a well-balanced program structure.

3. Programs devoted to the discussion of controversial public issues should be identified as such. They should not be presented in a manner which would mislead listeners or viewers to believe that the program is purely of an entertainment, news or other character.

4. Broadcasts in which stations express their own opinions about issues of general public interest should be clearly identified as editorials. They should be unmistakably identified as statements of station opinion and should be appropriately distinguished from news and other program material.

VII. Political Telecasts

1. Political telecasts should be clearly identified as such. They should not be presented by a television broadcaster in a manner which would mislead listeners or viewers to believe that the program is of any other character.

(Ref.: Communications Act of 1934, as amended, Secs. 315 and 317, and FCC Rules and Regulations, Secs. 3.654, 3.657, 3.663, as discussed in NAB's "Political Broadcast Catechism & The Fairness Doctrine.")

VIII. Religious Programs

1. It is the responsibility of a television broadcaster to make available to the community appropriate opportunity for religious presentations.

2. Programs reach audiences of all creeds simultaneously. Therefore, both the advocates of broad or ecumenical religious precepts, and the exponents of specific doctrines, are urged to present their positions in a manner conducive to viewer enlightenment on the role of religion in society.

3. In the allocation of time for telecasts of religious programs the television station should use its best efforts to apportion such time fairly among responsible individuals, groups and organizations.

Advertising Standards

IX. General Advertising Standards

1. This code establishes basic standards for all television broadcasting. The principles of acceptability and good taste within the program standards section govern the presentation of advertising where applicable. In addition, the code establishes in this section special standards which apply to television advertising.

2. A commercial television broadcaster makes his facilities available for the advertising of products and services and accepts commercial presentations for such advertising. However, a television broadcaster should, in recognition of his responsibility to the public, refuse the facilities of his station to an advertiser where he has good reason to doubt the integrity of the advertiser, the truth of the advertising representations, or the compliance of the advertiser with the spirit and purpose of all applicable legal requirements.

3. Identification of sponsorship must be made in all sponsored programs in accordance with the requirements of the Communications Act of 1934, as

amended, and the rules and regulations of the Federal Communications Commission.

4. Representations which disregard normal safety precautions shall be avoided.

Children shall not be represented, except under proper adult supervision, as being in contact with, or demonstrating a product recognized as potentially dangerous to them.

5. In consideration of the customs and attitudes of the communities served, each television broadcaster should refuse his facilities to the advertisement of products and services, or the use of advertising scripts, which the station has good reason to believe would be objectionable to a substantial and responsible segment of the community. These standards should be applied with judgment and flexibility, taking into consideration the characteristics of the medium, its home and family audience, and the form and content of the particular presentation.

6. The advertising of hard liquor (distilled spirits) is not acceptable.

7. The advertising of beer and wine is acceptable only when presented in the best of good taste and discretion, and is acceptable only subject to federal and local laws (See *Television Code Interpretation No. 4*).

8. Advertising by institutions or enterprises which in their offers of instruction imply promises of employment or make exaggerated claims for the opportunities awaiting those who enroll for courses is generally unacceptable.

9. The advertising of firearms/ammunition is acceptable provided it promotes the product only as sporting equipment and conforms to recognized standards of safety as well as all applicable laws and regulations. Advertisements of firearms/ammunition by mail order are unacceptable. The advertising of fireworks is acceptable subject to applicable laws.

10. The advertising of fortune-telling, occultism, astrology, phrenology, palm-reading, numerology, mind-reading, character reading or subjects of a like nature is not permitted.

11. Because all products of a personal nature create special problems, acceptability of such products should be determined with special emphasis on ethics and the canons of good taste. Such advertising of personal products as is accepted must be presented in a restrained and obviously inoffensive manner.

12. The advertising of tip sheets and other publications seeking to advertise for the purpose of giving odds or promoting betting is unacceptable.

13. An advertiser who markets more than one product should not be permitted to use advertising copy devoted to an acceptable product for purposes of publicizing the brand name or other identification of a product which is not acceptable.

14. "Bait-switch" advertising, whereby goods or services which the advertiser has no intention of selling are offered merely to lure the customer into purchasing higher-priced substitutes, is not acceptable.

15. Personal endorsements (testimonials) shall be genuine and reflect personal experience. They shall contain no statement that cannot be supported if presented in the advertiser's own words.

X. Presentation of Advertising

1. Advertising messages should be presented with courtesy and good taste; disturbing or annoying material should be avoided; every effort should be made to keep the advertising message in harmony with the content and general tone of the program in which it appears.

2. The role and capability of television to market sponsors' products are well recognized. In turn, this fact dictates that great care be exercised by the broadcaster to prevent the presentation of false, misleading or deceptive advertising. While it is entirely appropriate to present a product in a favorable light and atmosphere, the presentation must not, by copy or demonstration, involve a material deception as to the characteristics, performance or appearance of the product.

Broadcast advertisers are responsible for making available, at the request of the Code Authority, documentation adequate to support the validity and truthfulness of claims, demonstrations and testimonials contained in their commercial messages.

3. The broadcaster and the advertiser should exercise special caution with the content and presentation of television commercials placed in or near programs designed for children. Exploitation of children should be avoided. Commercials directed to children should in no way mislead as to the product's performance and usefulness.

Commercials, whether live, film or tape, within programs initially designed primarily for children under 12 years of age shall be clearly separated from program

material by an appropriate device.

Trade name identification or other merchandising practices involving the gratuitous naming of products is discouraged in programs designed primarily for children.

Appeals involving matters of health which should be determined by physicians should not be directed primarily to children.

4. Children's program personality or cartoon characters shall not be utilized to deliver commercial messages within or adjacent to the programs in which such a personality or cartoon character regularly appears. This provision shall also apply to lead-ins to commercials when such lead-ins contain sell copy or imply endorsement of the product by program personalities or cartoon characters. (Effective September 1975.)

5. Appeals to help fictitious characters in television programs by purchasing the advertiser's product or service or sending for a premium should not be permitted, and such fictitious characters should not be introduced into the advertising message for such purposes.

6. Commercials for services or over-the-counter products involving health considerations are of intimate and far-reaching importance to the consumer. The following principles should apply to such advertising:

a. Physicians, dentists or nurses or actors representing physicians, dentists or nurses, shall not be employed directly or by implication. These restrictions also apply to persons professionally engaged in medical services (e.g., physical therapists, pharmacists, dental assistants, nurses' aides).

b. Visual representation of laboratory settings may be employed, provided they bear a direct relationship to bona fide research which has been conducted for the product or service. (See *Television Code, X, 11*) In such cases, laboratory technicians shall be identified as such and shall not be employed as spokesmen or in any other way speak on behalf of the product.

c. Institutional announcements not intended to sell a specific product or service to the consumer and public service announcements by non-profit organizations may be presented by accredited physicians, dentists or nurses, subject to approval by the broadcaster. An accredited professional is one who has met required qualifications and has been licensed in his resident state.

7. Advertising should offer a product or service on its positive merits and refrain from discrediting, disparaging or unfairly attacking competitors, competing products, other industries, professions or institutions.

8. A sponsor's advertising messages should be confined within the framework of the sponsor's program structure. A television broadcaster should avoid the use of commercial announcements which are divorced from the program either by preceding the introduction of the program (as in the case of so-called "cow-catcher" announcements) or by following the apparent sign-off of the program (as in the case of so-called trailer or "hitchhike" announcements). To this end, the program itself should be announced and clearly identified, both audio and video, before the sponsor's advertising material is first used, and should be signed off, both audio and video, after the sponsor's advertising material is last used.

9. Since advertising by television is a dynamic technique, a television broadcaster should keep under surveillance new advertising devices so that the spirit and purpose of these standards are fulfilled.

10. A charge for television time to churches and religious bodies is not recommended.

11. References to the results of bona fide research, surveys or tests relating to the product to be advertised shall not be presented in a manner so as to create an impression of fact beyond that established by the work that has been conducted.

XI. Advertising of Medical Products

1. The advertising of medical products presents considerations of intimate and far-reaching importance to the consumer because of the direct bearing on his health.

2. Because of the personal nature of the advertising of medical products, claims that a product will effect a cure and the indiscriminate use of such words as "safe," "without risk," "harmless," or terms of similar meaning should not be accepted in the advertising of medical products on television stations.

3. A television broadcaster should not accept advertising material which in his opinion offensively de-

NAB Television Code

scribes or dramatizes distress or morbid situations involving ailments, by spoken word, sound or visual effects.

XII. Contests

1. Contests shall be conducted with fairness to all entrants, and shall comply with pertinent laws and regulations. Care should be taken to avoid the concurrent use of the three elements which together constitute a lottery—prize, chance and consideration.

2. All contest details, including rules, eligibility requirements, opening and termination dates should be clearly and completely announced and/or shown, or easily accessible to the viewing public, and the winners' names should be released and prizes awarded as soon as possible after the close of the contest.

3. When advertising is accepted which requests contestants to submit items of product identification or other evidence of purchase of products, reasonable facsimiles thereof should be made acceptable unless the award is based upon skill and not upon chance.

4. All copy pertaining to any contest (except that which is required by law) associated with the exploitation or sale of the sponsor's product or service, and all references to prizes or gifts offered in such connection should be considered a part of and included in the total time allowances as herein provided. (See *Television Code, XIV*)

XIII. Premiums and Offers

1. Full details of proposed offers should be required by the television broadcaster for investigation and approved before the first announcement of the offer is made to the public.

2. A final date for the termination of an offer should be announced as far in advance as possible.

3. Before accepting for telecast offers involving a monetary consideration, a television broadcaster should satisfy himself as to the integrity of the advertiser and the advertiser's willingness to honor complaints indicating dissatisfaction with the premium by returning the monetary consideration.

4. There should be no misleading descriptions or visual representations of any premiums or gifts which would distort or enlarge their value in the minds of the viewers.

5. Assurances should be obtained from the advertiser that premiums offered are not harmful to person or property.

6. Premiums should not be approved which appeal to superstition on the basis of "luck-bearing" powers or otherwise.

XIV. Time Standards for Non-Program Material

In order that the time for non-program material and its placement shall best serve the viewer, the following standards are set forth in accordance with sound television practice:

1. Non-Program Material Definition:

Non-program material, in both prime time and all other time, includes billboards, commercials, promotional announcements and all credits in excess of 30 seconds per program, except in feature films. In no event should credits exceed 40 seconds per program. The 40-second limitation on credits shall not apply, however, in any situation governed by a contract entered into before October 1, 1971. Public service announcements and promotional announcements for the same program are excluded from this definition.

2. Allowable Time for Non-Program Material.

a. In prime time on network affiliated stations, non-program material shall not exceed nine minutes 30 seconds in any 60-minute period.

In the event that news programming is included within the three and one-half hour prime time period, not more than one 30-minute segment of news programming may be governed by time standards applicable to all other time.

Prime time is a continuous period of not less than three and one-half consecutive hours per broadcast day as designated by the station between the hours of 6:00 PM and Midnight.

b. In all other time, non-program material shall not exceed 16 minutes in any 60-minute period.

c. Children's Programming Time—Defined as those hours other than prime time in which programs initially designed primarily for children under 12 years of age are scheduled.

Within this time period on Saturday and Sunday, non-program material shall not exceed 10 minutes in any 60-minute period after Dec. 31, 1974 and nine

minutes 30 seconds in any 60-minute period after Dec. 31, 1975.

Within this time period on Monday through Friday, non-program material shall not exceed 14 minutes in any 60-minute period after Dec. 31, 1974 and 12 minutes in any 60-minute period after Dec. 31, 1975.

3. Program Interruptions.

a. Definition: A program interruption is any occurrence of non-program material within the main body of the program.

b. In prime time, the number of program interruptions shall not exceed two within any 30-minute program, or four within any 60-minute program.

Programs longer than 60 minutes shall be pro-rated at two interruptions per half-hour.

The number of interruptions in 60-minute variety shows shall not exceed five.

c. In all other time, the number of interruptions shall not exceed four within any 30-minute program period.

d. In children's weekend programming time, as above defined in 2c, the number of program interruptions shall not exceed two within any 30-minute program or four within any 60-minute program.

e. In both prime time and all other time, the following interruption standard shall apply within programs of 15 minutes or less in length:

5-minute program—1 interruption;

10-minute program—2 interruptions;

15-minute program—2 interruptions.

f. News, weather, sports and special events programs are exempt from the interruption standard because of the nature of such programs.

4. No more than four non-program material announcements shall be scheduled consecutively within programs, and no more than three non-program material announcements shall be scheduled consecutively during station breaks. The consecutive non-program material limitation shall not apply to a single sponsor who wishes to further reduce the number of interruptions in the program.

5. A multiple product announcement is one in which two or more products or services are presented within the framework of a single announcement. A multiple product announcement shall not be scheduled in a unit of time less than 60 seconds, except where integrated so as to appear to the viewer as a single message. A multiple product announcement shall be considered integrated and counted as a single announcement if:

a. the products or services are related and interwoven within the framework of the announcement (related products or services shall be defined as those having a common character, purpose and use); and

b. the voice(s), setting, background and continuity are used consistently throughout so as to appear to the viewer as a single message.

Multiple product announcements of 60 seconds in length or longer not meeting this definition of integration shall be counted as two or more announcements under this section of the code. This provision shall not apply to retail or service establishments.

6. The use of billboards, in prime time and all other time, shall be confined to programs sponsored by a single or alternate week advertiser and shall be limited to the products advertised in the program.

7. Reasonable and limited identification of prizes and donors' names where the presentation of contest awards or prizes in a necessary part of program content shall not be included as non-program material as defined above.

8. Programs presenting women's service features, shopping guides, fashion shows, demonstrations and similar material provide a special service to the public in which certain material normally classified as non-program is an informative and necessary part of the program content. Because of this, the time standards may be waived by the Code Authority to a reasonable extent on a case-by-case basis.

9. Gratuitous references in a program to non-sponsor's product or service should be avoided except for normal guest identification.

10. Stationary backdrops or properties in television presentations showing the sponsor's name or product, the name of his product, his trade-mark or slogan should be used only incidentally and should not obtrude on program interest or entertainment.

Note: From time to time the code authority issues advertising guidelines and clarifications expanding on provisions of the code. Among areas covered are acne, alcoholic beverages, arthritis and rheumatism remedies, bronchitis, comparative advertising, children's premiums and offers, children's TV advertising, disparagement, hallucinogens, hypnosis, men-

in-white, non-prescription medications, personal products, testimonials, time standards, toys and weight reducing products/services. Copies may be obtained from any NAB Code Authority office.

Time Standards for Independent Stations

1. Non-program elements shall be considered as all-inclusive, with the exception of required credits, legally required station identifications, and "bumbers". Promotion spots and public service announcements, as well as commercials, are to be considered non-program elements.

2. The allowed time for non-program elements, as defined above, shall not exceed seven minutes in a 30-minute period or multiples thereof in prime time (prime time is defined as any three continuous hours between 6 p.m. and midnight, local time), or eight minutes in a 30-minute period or multiples thereof during all other times.

3. Where a station does not carry a commercial in a station break between programs, the number of program interruptions shall not exceed four within any 30-minute program, or seven within any 60-minute program, or 13 in any 90-minute program, or 13 in any 120-minute program. Stations which do carry commercials in station breaks between programs shall limit the number of program interruptions to three within any 30-minute program, or six within any 60-minute program, or nine within any 90-minute program, or 12 in any 120-minute program. News, weather, sports, and special events are exempt because of format.

4. Not more than four non-program material announcements as defined above shall be scheduled consecutively. An exception may be made only in the case of a program 60 minutes or more in length, when no more than seven non-program elements may be scheduled consecutively by stations who wish to reduce the number of program interruptions.

5. The conditions of paragraphs three and four shall not apply to live sports programs where the program format dictates and limits the number of program interruptions.

Interpretations

Interpretation No. 1

June 7, 1956, Revised June 9, 1958

"Pitch" Programs

The "pitchman" technique of advertising on television is inconsistent with good broadcast practice and generally damages the reputation of the industry and the advertising profession.

Sponsored program-length segments consisting substantially of continuous demonstrations or sales presentation, violate not only the time standards established in the Code, but the broad philosophy of improvement implicit in the voluntary Code operation and are not acceptable.

Interpretation No. 2

June 7, 1956

Hollywood Film Promotion

The presentation of commentary on film excerpts from current theatrical releases in some instances may constitute commercial material under the Time Standards for Non-Program Material. Specifically, for example, when such presentation, directly or by inference, urges viewers to attend, it shall be counted against the commercial allowance for the program of which it is a part.

Interpretation No. 3

January 23, 1959

Prize Identification

Aural and/or visual prize identification of up to ten seconds duration may be deemed "reasonable and limited" under the language of Paragraph 7 of the Time Standards for Non-Program Material. Where such identification is longer than ten seconds, the entire announcement or visual presentation will be charged against the total commercial time for the program period.

Interpretation No. 4

March 4, 1965

Drinking on Camera

Paragraph 7, Section IX, General Advertising Standards, states that the "advertising of beer and wine is acceptable only when presented in the best of good taste and discretion." This requires that commercials involving beer and wine avoid any representation of on-camera drinking.

Interpretation No. 5

April 8, 1975

The scheduling provisions of Section 1 (Principles Governing Program Content) shall not apply to programs under contract to a station as of April 8, 1975, all episodes of which were then in existence, if such station is unable, despite reasonable good faith efforts, to edit such programs to make them appropriate for family viewing or to reschedule them so as not to occupy family viewing periods. This exception shall in no event apply after Sept. 1, 1977. Any such programs excepted from scheduling provisions shall, of course, bear the required advisory notices. (Effective September 1975)

Regulations and Procedures

The following regulations and procedures shall obtain as an integral part of the Television Code of the National Association of Broadcasters:

I. Name

The name of this code shall be *The Television Code of the National Association of Broadcasters*.

II. Purpose of the Code

The purpose of this code is cooperatively to maintain a level of television programing which gives full consideration to the educational, informational, cultural, economic, moral and entertainment needs of the American public to the end that more and more people will be better served.

III. Subscribers

Section 1. Eligibility

Any individual, firm or corporation which is engaged in the operation of a television broadcast station or network or which holds a construction permit for a television broadcast station within the United States or its dependencies, shall, subject to the approval of the television board of directors as hereinafter provided, be eligible to subscribe to the television code of the NAB to the extent of one subscription for each such station and/or network which it operates or for which it holds a construction permit; provided, that a non-television member of NAB shall not become eligible via code subscription to receive any of the member services or to exercise any of the voting privileges of a member.

Section 2. Certification of Subscription

Upon subscribing to the code, subject to the approval of the television board of directors, there shall be granted forthwith to each such subscribing station authority to use the "NAB Television Seal of Good Practice," a copyrighted and registered seal to be provided in the form of a certificate, a slide and/or a film, signifying that the recipient thereof is a subscriber in good standing to the television code of the NAB. The seal and its significance shall be appropriately publicized by the NAB.

Section 3. Duration of Subscription

Subscription shall continue in full force and effect until thirty days after the first of the month following receipt of notice of written resignation. Subscription to the code shall be effective from the date of application subject to the approval of the television board of directors; provided, that the subscription of a television station going on the air for the first time shall, for the first six months of such subscription, be probationary, during which time its subscription can be summarily revoked by an affirmative two-thirds vote of the television board of directors without the usual process specified below.

Section 4. Suspension of Subscription

Any subscription, and/or the authority to utilize and show the above-noted seal, may be voided, revoked or temporarily suspended for television programing, including commercial copy, which, by theme, treatment or incident, in the judgment of the television board constitutes a continuing, willfull or gross violation of any of the provisions of the television code, by an affirmative two-thirds vote of the television board of directors at a regular or special meeting; provided, however, that the following conditions and procedures shall apply:

A. Preferring of Charges—Conditions Precedent:
Prior to the preferring of charges to the television board of directors concerning violation of the code by a subscriber, the television code review board (hereinafter provided for) (1) Shall have appropriately, and in good time, informed and advised such subscriber of any and all complaints and information coming to the attention of the television code review board and relating to the programing of said subscriber, (2) Shall have reported to, and advised, said subscriber by analysis, interpretation, recommendation or otherwise, of the possibility of a violation or breach of the television code by the subscriber, and (3) Shall have

served upon the subscriber, by registered mail a notice of intent to prefer charges, at least twenty days prior to the filing of any such charges with the television board of directors. During this period the television code review board may, within its sole discretion, reconsider its proposed action based upon such written reply as the subscriber may care to make, or upon such action as the subscriber may care to take program-wise, in conformance with the analysis, interpretation, or recommendation of the television code review board.

(i) Notice of intent

The Notice of intent shall include a statement of the grounds and reasons for the proposed charges, including appropriate references to the television code.

(ii) Time

In the event that the nature of the program in question is such that time is of the essence, the television code review board may prefer charges within less than the twenty days above specified, provided that a time certain in which reply may be made is included in its notice of intent, and provided that its reasons therefor must be specified in its statement of charges preferred.

B. The Charges:

The subscriber shall be advised in writing by registered mail of the charges preferred. The charges preferred by the television code review board to the television board of directors shall include the grounds and reasons therefor, together with specific references to the television code. The charges shall contain a statement that the conditions precedent, herein before described, have been met.

C. Hearing:

The subscriber shall have the right to a hearing and may exercise same by filing an answer within 10 days of the date of such notification.

D. Waiver:

Failure to request a hearing shall be deemed a waiver of the subscriber's right thereto.

E. Designation:

If hearing is requested by the subscriber, it shall be designated as promptly as possible and at such time and place as the television board may specify.

F. Confidential Status:

Hearings shall be closed; and all correspondence between a subscriber and the television code review board and/or the television board of directors concerning specific programing shall be confidential; provided, however, that the confidential status of these procedures may be waived by a subscriber.

G. Presentation; Representation:

A subscriber against whom charges have been preferred, and who has exercised his right to a hearing, shall be entitled to effect presentation of his case personally, by agent, by attorney, or by deposition and interrogation.

H. Intervention:

Upon request by the subscriber-respondent or the television code review board, the television board of directors, in its discretion, may permit the intervention of one or more other subscribers as parties-in-interest.

I. Transcript:

A stenographic transcript record shall be taken and shall be certified by the chairman of the television board of directors to the office of the secretary of the National Association of Broadcasters, where it shall be maintained. The transcript shall not be open to inspection unless otherwise provided by the party respondent in the proceeding.

J. Television Code Review Board; Counsel:

The television code review board may, at its discretion, utilize the services of an attorney from the staff of the NAB for the purpose of effecting its presentation in a hearing matter.

K. Order of Procedure:

At hearings the television code review board shall open and close.

L. Cross-Examination:

The right of cross-examination shall specifically obtain. Where procedure has been by deposition or interrogatory, the use of cross-interrogatories shall satisfy this right.

M. Presentation:

Oral and written evidence may be introduced by the subscriber and by the television code review board. Oral argument may be had at the hearing and written memoranda or briefs may be submitted by the subscriber and by the television code review board. The television board of directors may admit such evidence as it deems relevant, material and competent, and may determine the nature and length of the oral argument and the written argument or briefs.

N. Authority of Presiding Officer; of Television Board of Directors:

The presiding officer shall rule upon all interlocutory matters, such as, but not limited to, the admissibility of evidence, the qualifications of witnesses, etc. On all

other matters, authority to act shall be vested in a majority of the television board unless otherwise provided.

O. Films, Transcriptions, etc.:

Films, kinescopes, records, transcriptions, or other mechanical reproductions of television programs, properly identified, shall be accepted into evidence when relevant.

P. Continuances and Extensions:

Continuance and extension of any proceeding or for the time of filing or performing any act required or allowed to be done within a specific time may be granted upon request, for a good cause shown. The board or the presiding officer may recess or adjourn a hearing for such time as may be deemed necessary, and may change the place thereof.

Q. Findings and Conclusions:

The television board of directors shall decide the case as expeditiously as possible and shall notify the subscriber and the television code review board, in writing, of the decision. The decision of the television board of directors shall contain findings of fact with conclusions, as well as the reasons or bases therefor. Findings of fact shall set out in detail and with particularity all basic evidentiary facts developed on the record (with appropriate citations to the transcript of record or exhibit relied on for each evidentiary fact) supporting the conclusion reached.

R. Reconsideration or Rehearing:

A request for reconsideration or rehearing may be filed by parties to the hearing. Requests for reconsideration or rehearing shall state with particularity in what respect the decision or any matter determined therein is claimed to be unjust, unwarranted, or erroneous, and with respect to any finding of fact shall specify the pages of record relied on. If the existence of any newly-discovered evidence is claimed, the request shall be accompanied by a verified statement of the facts together with the facts relied on to show that the party, with due diligence, could not have known or discovered such facts at the time of the hearing. The request for rehearing may seek:

- a. Reconsideration
- b. Additional oral argument
- c. Reopening of the proceedings
- d. Amendment of any findings, or
- e. Other relief.

S. Time for Filing:

Requests for reconsideration or rehearing shall be filed within ten (10) days after receipt by the respondent of the decision. Opposition thereto may be filed within five (5) days after the filing of the request.

T. Penalty, Suspension of:

At the discretion of the television board, application of any penalty provided for in the decision may be suspended until the board makes final disposition of the request for reconsideration or rehearing.

U. Disqualification:

Any member of the television board may disqualify himself, or upon good cause shown by any interested party, may be disqualified by a majority vote of the television board.

Section 5. Additional Procedures

When necessary to the proper administration of the code, additional rules of procedure will be established from time to time as authorized by the by-laws of the NAB; in keeping therewith, special consideration shall be given to the procedures for receipt and processing of complaints and to necessary rules to be adopted from time to time, taking into account the source and nature of such complaints; such rules to include precautionary measures such as the posting of bonds to cover costs and expenses of processing same; and further provided that special consideration will be given to procedures insuring the confidential status of proceedings relating to code observance.

Section 6. Amendment and Review

Because of the new and dynamic aspects inherent in television broadcast, the television code, as a living, flexible and continuing document, may be amended from time to time by the television board of directors—provided that said board is specifically charged with review and reconsideration of the entire code, its appendices and procedures, at least once each year.

Section 7. Termination of Contracts

All subscribers on the air at the time of subscription to the code shall be permitted that period prior to and including the earliest legal cancellation date to terminate any contracts, then outstanding, calling for program presentations which would not be in conformity with the television code, provided, however, that in no event shall such period be longer than 52 weeks.

NAB TV, Radio Codes

IV. Affiliate Subscribers

Section 1. Eligibility

Any individual, firm or corporation, which is engaged in the production or distribution, lease, or sale of recorded programs for television presentation, subject to the approval of the television code review board as hereinafter provided, shall be eligible to become an affiliate subscriber to the Television Code of the NAB.

Section 2. Certification of Subscription

Upon becoming an affiliate subscriber to the code, subject to the approval of the television code review board, there shall be granted forthwith to each such affiliate subscriber authority to use a copyrighted and registered seal and declaration, in a manner approved by the television code review board, identifying the individual firm or corporation as an affiliate subscriber to the Television Code of the NAB. Such authority shall not constitute formal clearance or approval by the television code review board of specific films, programs or other recorded material.

Section 3. Duration of Affiliate Subscription

The affiliate subscription shall continue in full force and effect until 30 days after the first of the month following receipt of a written notice or resignation. The affiliate subscription to the code shall be effective from the date of application subject to the approval of the television code review board.

Section 4. Suspension of Affiliate Subscription

Any affiliate subscription and the authority to utilize and show the above-noted seal may be voided, revoked, or temporarily suspended for the sale or distribution for television presentation of any film or other recorded material which by theme, treatment, or incident, in the judgment of the television code review board; constitutes a continuing, willful or gross violation of any of the provisions of the television code, by a majority vote of the television code review board at any regular or special meeting. The conditions and procedures applicable to subscribers shall not apply to affiliate subscribers.

Section 5. Representation of Affiliate Subscribers

Any affiliate subscriber or group of affiliate subscribers may authorize an individual or association to act for them in connection with their relations with the television code review board by filing a written notice of such representation with the board. Such representation, however, in no way will limit the right of the television code review board to suspend individual affiliate subscribers in accordance with the provisions of Section 4.

V. Rates

Each subscriber and affiliate subscriber shall pay "administrative" rates in accordance with such schedule, at such time, and under such conditions as may be determined from time to time by the television board (see Article VI, section 8, C. Television Board [3] and [4], By-Laws of the NAB); provided, that appropriate credit shall be afforded to a television member of the NAB against the regular dues which he or it pays to NAB.

VI. The Television Code Review Board

Section 1. Composition

There shall be a continuing committee entitled the television code review board to be composed of not more than nine members, all of whom shall be from subscribers to the television code. They shall be appointed by the president of NAB, subject to confirmation by the television board, and may include one member from each of the subscribing nationwide television networks. Members of the television board shall not be eligible to serve on the review board. Due consideration shall be given, in making the appointments, to factors of diversification of geographical location, market size, company representation and network affiliation.

No person shall continue as a member of the television code review board if the station or entity he represents ceases to subscribe to the television code. In such case a vacancy occurs in the office immediately, and a successor may be appointed to serve out the unexpired term.

All terms shall be for two years, commencing at the close of the annual meeting of the membership following appointment.

A. Limitation of Service:

No person shall serve for more than two terms of two years each, consecutively, as a member of the television code review board; provided, however, this limitation shall not apply to network representatives.

Serving out the unexpired term of a former member shall not constitute a term within the meaning of this

section.

B. Meetings:

The television code review board shall meet at least twice in each calendar year on a date to be determined by the chairman. The chairman, or the code authority director, may, at any time, on at least five days written notice, call a special meeting of the board.

C. Quorum:

For all purposes, a majority of the members of the television code review board shall constitute a quorum.

Section 2. Authority and Responsibilities

The television code review board is authorized and directed:

(1) To recommend to the television board of directors amendments to the television code; (2) to consider, in its discretion, any appeal from any decision made by the code authority director with respect to any matter which has arisen under the code, and to suspend, reverse, or modify and such decision; (3) to prefer formal charges, looking toward the suspension or revocation of the authority to show the code seal, to the television board of directors concerning violations and breaches of the television code by a subscriber; (4) to be available to the code authority director for consultation on any and all matters affecting the television code.

VII. Code Authority Director

Section 1. Director

There shall be a position designated as the code authority director. This position shall be filled by appointment of the president of NAB, subject to approval

of the board of directors.

Section 2. Authority and Responsibilities.

The code authority director is authorized and directed: (1) to maintain a continuing review of all programming and advertising material presented over television, especially that of subscribers to the television code of NAB; (2) to receive, screen and clear complaints concerning television programming; (3) to define and interpret words and phrases in the television code; (4) to develop and maintain appropriate liaison with governmental agencies and with responsible and accountable organizations and institutions; (5) to inform, expeditiously and properly, a subscriber to the television code of complaints or commendations, as well as to advise all subscribers concerning the attitudes and desires program-wise of accountable organizations and institutions, and of the American public in general; (6) to review and monitor, if necessary, any certain series of programs, daily programming, or any other program presentations of a subscriber, as well as to request recorded material, or script and copy, with regard to certain program presented by a subscriber; (7) to reach conclusions and make recommendations to prefer charges to the television code review board concerning violations and breaches of the television code by a subscriber; (8) to recommend to the code review board amendments to the television code.

A. Delegation of Powers and Responsibilities:

The code authority director shall appoint such executive staff as is needed, consistent with resources, to carry out the above described functions, and may delegate to this staff such responsibilities as he may deem necessary.

NAB Radio Code

Preamble

In 1937 a major segment of U.S. commercial radio broadcasters first adopted industry-wide standards of practice. The purpose of such standards, then, as now, is to establish guideposts and professional tenets for performance in the areas of programming and advertising content.

Admittedly, such standards for broadcasting can never be final or complete, because broadcasting is a creative art, always seeking new ways to achieve maximum appeal and service. Therefore, its standards are subject to periodic revision to reasonably reflect changing attitudes in our society.

In 1945 after two years devoted to reviewing and revising the 1937 document, new standards were promulgated. Further revisions were made in subsequent years when deemed necessary. The objectives behind them have been to assure that advertising messages be presented in an honest, responsible and tasteful manner and that broadcasters, in their programming, tailor their content to meet the needs and expectations of that particular audience to which their programming is directed.

The growth of broadcasting as a medium of entertainment, education and information has been made possible by its commercial underpinning. This aspect of commercial broadcasting as it has developed in the United States has enabled the industry to grow as a free medium in the tradition of American enterprise. The extent of this freedom is underscored by those laws which prohibit censorship of broadcast material. Rather, those who own the nation's radio broadcasting stations operate them—pursuant to this self-adopted radio code—in recognition of the needs of the American people and the reasonable self-interests of broadcasters and broadcast advertisers.

The Radio Broadcaster's Creed

We Believe:

That radio broadcasting in the United States of America is a living symbol of democracy; a significant and necessary instrument for maintaining freedom of expression, as established by the First Amendment to the Constitution of the United States;

That its contributions to the arts, to science, to education, to commerce, and therefore to the public welfare have the potential of influencing the common good achievements of our society as a whole;

That it is our obligation to serve the people in such manner as to reflect credit upon our profession and to encourage aspiration toward a better estate for our audiences. This entails making available to them through all phases of the broadcasting art such programming as will convey the traditional stirrings of the U.S. towards goals beneficial to the populace;

That we should make full and ingenious use of the many sources of knowledge, talents and skills and exercise critical and discerning judgment concerning all broadcasting operations to the end that we may, intelligently and sympathetically:

Observe both existing principles and developing concepts affecting our society;

Respect and advance the rights and the dignity of all people;

Enrich the daily life of the people through the factual reporting and analysis of news, and through programming of education, entertainment, and information;

Provide for the fair discussion of matters of public concern; engage in works directed toward the common good; and volunteer our aid and comfort in times of stress and emergency;

Contribute to the economic welfare of all by expanding the channels of trade, by encouraging the development and conservation of natural resources, and by bringing together the buyer and seller through the broadcasting of information pertaining to goods and services.

Toward the achievement of these purposes we agree to observe the following:

I. Program Standards

A. News

Radio is unique in its capacity to reach the largest number of people first with reports on current events. This competitive advantage bespeaks caution—being first is not as important as being accurate. The radio code standards relating to the treatment of news and public events are, because of constitutional considerations intended to be exhortatory. The standards set forth hereunder encourage high standards of professionalism in broadcast journalism. They are not to be interpreted as turning over to others the broadcaster's responsibility as to judgments necessary in news and public events programming.

1. News Sources. Those responsible for news on radio should exercise constant professional care in the selection of sources—on the premise that the integrity of the news and the consequent good reputation of radio as a dominant well-balanced news medium depend largely upon the reliability of such sources.

2. News Reporting. News reporting should be factual, fair and without bias. Good taste should prevail in the selection and handling of news. Morbid, sensational, or alarming details not essential to factual reporting should be avoided. News should be broadcast in such a manner as to avoid creation of panic and unnecessary alarm. Broadcasters should be diligent in their supervision of content, format, and presentation of news broadcasts. Equal diligence should be exer-

cised in selection of editors and reporters who direct news gathering and dissemination, since the station's performance in this vital informational field depends largely upon them.

3. Commentaries and Analyses. Special obligations devolve upon those who analyze and/or comment upon news developments, and management should be satisfied completely that the task is to be performed in the best interest of the listening public. Programs of news analysis and commentary should be clearly identified as such, distinguishing them from straight news reporting.

4. Editorializing. Broadcasts in which stations express their own opinions about issues of general public interest should be clearly identified as editorials.

5. Coverage of News and Public Events. In the coverage of news and public events broadcasters should exercise their judgments consonant with the accepted standards of ethical journalism and should provide accurate, informed and adequate coverage.

6. Placement of Advertising. Broadcasters should exercise particular discrimination in the acceptance, placement and presentation of advertising in news programs so that such advertising is clearly distinguishable from the news content.

B. Controversial Public Issues

1. Radio provides a valuable forum for the expression of responsible views on public issues of a controversial nature. Controversial public issues of importance to fellow citizens should give fair representation to opposing sides of issues.

2. Requests by individuals, groups or organizations for time to discuss their views on controversial public issues should be considered on the basis of their individual merits, and in the light of the contributions which the use requested would make to the public interest.

3. Discussion of controversial public issues should not be presented in a manner which would create the impression that the program is other than one dealing with a public issue.

C. Community Responsibility

1. Broadcasters and their staffs occupy a position of responsibility in the community and should conscientiously endeavor to be acquainted with its needs and characteristics to best serve the welfare of its citizens.

2. Requests for time for the placement of public service announcements or programs should be carefully reviewed with respect to the character and reputation of the group, campaign or organization involved, the public interest content of the message, and the manner of its presentation.

D. Political Broadcasts

1. Political broadcasts, or the dramatization of political issues designed to influence voters, shall be properly identified as such.

2. Political broadcasts should not be presented in a manner which would mislead listeners to believe that they are of any other character.

3. Because of the unique character of political broadcasts and the necessity to retain broad freedoms of policy void of restrictive interference, it is incumbent upon all political candidates and all political parties to observe the canons of good taste and political ethics, keeping in mind the intimacy of broadcasting in the American home.

E. Advancement of Education and Culture

1. Because radio is an integral part of American life, there is inherent in radio broadcasting a continuing opportunity to enrich the experience of living through the advancement of education and culture.

2. Radio broadcasters, in augmenting the educational and cultural influences of the home, schools, religious institutions and institutions of higher education and other entities should:

(a) be thoroughly conversant with the educational and cultural needs and aspirations of the community served;

(b) develop programing consonant with the stations particular target audience.

F. Religion and Religious Programing

1. Religious programing shall be presented by responsible individuals, groups or organizations.

2. Radio broadcasting reaches audiences of all creeds simultaneously. Therefore, both the advocates of broad or ecumenical religious precepts, and the exponents of specific doctrines, are urged to present their positions in a manner conducive to listener enlightenment on the role of religion in society.

G. Responsibility Toward Children

Broadcasters have a special responsibility to children. Programing which might reasonably be expected to hold the attention of children should be presented with due regard for its effect on children.

1. Programing should be based upon sound social concepts and should include positive sets of values which will allow children to become responsible adults capable of coping with the challenges of maturity.

2. Programing should convey a reasonable range of the realities which exist in the world to help children make the transition to adulthood.

3. Programing should contribute to the healthy development of personality and character.

4. Programing should afford opportunities for cultural growth as well as for wholesome entertainment.

5. Programing should be consistent with integrity of realistic production, but should avoid material of extreme nature which might create undesirable emotional reaction in children.

6. Programing should avoid appeals urging children to purchase the product specifically for the purpose of keeping the program on the air or which, for any reason, encourage children to enter inappropriate places.

7. Programing should present such subjects as violence and sex without undue emphasis and only as required by plot development or character delineation.

Violence, physical or psychological, should only be projected in responsibly handled contexts, not used to excess or exploitatively. Programs involving violence should present the consequences of it to its victims and perpetrators.

The depiction of conflict, and of material reflective of sexual considerations, when presented in programs designed primarily for children, should be handled with sensitivity.

8. The treatment of criminal activities should always convey their social and human effects.

H. Dramatic Programing

1. In the design of dramatic programs it is in the interest of radio as a vital medium to encourage those that are innovative, reflect a high degree of creative skill, deal with significant moral and social issues and present challenging concepts and other subject matter that relate to the world in which the listener lives.

2. Radio programing should not only reflect the influence of the established institutions that shape our values and culture, but also expose the dynamics of social change which bear upon our lives.

3. To achieve these goals, radio broadcasters should be conversant with the general and specific needs, interests and aspirations of all the segments of the communities they serve.

4. Radio should reflect realistically the experience of living, in both its pleasant and tragic aspects, if it is to serve the listener honestly. Nevertheless, it holds a concurrent obligation to provide programing which will encourage positive adjustments to life.

In selecting program subjects and themes, great care must be exercised to be sure that treatment and presentation are made in good faith and not for the purpose of sensationalism or to shock or exploit the audience or appeal to prurient interests or morbid curiosity.

5. In determining the acceptability of any dramatic program, especially those containing elements of crime, mystery, or horror, consideration should be given to the possible effect on all members of the listening audience.

In addition, without sacrificing integrity of presentation, dramatic programs on radio shall avoid:

(a) the presentation of techniques of crime in such detail as to be instructional or invite imitation;

(b) presentation of the details of violence involving the excessive, the gratuitous and the instructional;

(c) sound effects calculated to mislead, shock, or unduly alarm the listener;

(d) portrayals of law enforcement in a manner which does not contribute to its proper role in our society.

I. General

1. The intimacy and confidence placed in radio demand of the broadcaster, the networks and other program sources that they be vigilant in protecting the audience from deceptive broadcast practices.

2. Sound effects and expressions characteristically associated with news broadcasts (such as "bulletin," "flash," "we interrupt this program to bring you," etc.) shall be reserved for announcement of news, and the use of any deceptive techniques in connection with

fictional events and non-news programing shall not be employed.

3. The broadcasters shall be constantly alert to prevent inclusion of elements within programing dictated by factors other than the requirements of the programing itself. The acceptance of cash payments or other considerations in return for including the choice and identification of prizes, the selection of music and other creative programing elements and inclusion of any identification of commercial products or services, trade names or advertising slogans within the programing are prohibited unless consideration for such inclusion is revealed to the listeners in accordance with Sections 317 and 508 of the Communications Act.

4. Special precautions should be taken to avoid demeaning or ridiculing members of the audience who suffer from physical or mental afflictions or deformities.

5. The broadcast of gambling sequences deemed necessary to the development of plot or as appropriate background is acceptable only when presented with discretion and in moderation, and in a manner which would not excite interest in, or foster, betting nor be instructional in nature.

6. Quiz and similar programing that is presented as a contest of knowledge, information, skill or luck, must in fact, be a genuine contest and the results must not be controlled by collusion with or between contestants, or by any other action which will favor one contestant against any other.

7. Contests may not constitute a lottery.

8. Listener contests should not mislead as to the nature or value of prizes, likelihood of winning, nor encourage thoughtless or unsafe acts.

9. No programing shall be presented in a manner which through artifice or simulation would mislead the audience as to any material fact. Each broadcast must exercise reasonable judgment to determine whether a particular method of presentation would constitute a material deception, or would be accepted by the audience as normal theatrical illusion.

10. Legal, medical and other professional advice will be permitted only in conformity with law and recognized ethical and professional standards.

11. Narcotic addiction shall not be presented except as a destructive habit. The use of illegal drugs or the abuse of legal drugs shall not be encouraged or be presented as desirable or socially acceptable.

12. Material pertaining to fortune-telling, occultism, astrology, phrenology, palm-reading, numerology, mind-reading, character-reading, or subjects of a like nature is unacceptable if it encourages people to regard such fields as providing commonly accepted appraisals of life.

13. Representations of liquor and smoking shall be de-emphasized. When represented, they should be consistent with plot and character development.

14. Obscene, indecent or profane matter, as proscribed by law, is unacceptable.

15. Special sensitivity is necessary in the use of material relating to sex, race, color, creed, religious functionaries, or rites, or national or ethnic derivation.

16. The presentation of marriage, the family and similarly important human relationships, and material with sexual connotations, should not be treated exploitatively or irresponsibly, but with sensitivity.

17. Broadcasts of actual sporting events at which on-the-scene betting is permitted by law should be presented in a manner in keeping with federal, state and local laws, and should concentrate on the subject as a public sporting event.

18. Detailed exposition of hypnosis or material capable of having an hypnotic effect on listeners is forbidden.

19. Any technique whereby an attempt is made to convey information to the listener by transmitting messages below the threshold of normal awareness is not permitted.

20. The commonly accepted standards of humane animal treatment should be adhered to as applicable in programing.

21. Broadcasters are responsible for making good faith determinations on the acceptability of lyrics under applicable radio code standards.

22. The standards of this code covering programing content are also understood to include, wherever applicable, the standards contained in the advertising section of the code.

23. To assure that broadcasters have the freedom to program fully and responsibly, none of the provisions of this code should be construed as preventing or impeding broadcasts of the broad range of material necessary to help broadcasters fulfill their obligations

NAB Radio Code, Formats

to operate in the public interest.

II. Advertising Standards

Advertising is the principal source of revenue of the free, competitive American system of radio broadcasting. It makes possible the presentation to all American people of the finest programs of entertainment, education, and information.

Since the great strength of American radio broadcasting derives from the public respect for and the public approval of its programs, it must be the purpose of each broadcaster to establish and maintain high standards of performance, not only in the selection and production of all programs, but also in the presentation of advertising.

This code establishes basic standards for all radio broadcasting. The principles of acceptability and good taste within the program standards section govern the presentation of advertising where applicable. In addition, the code establishes in this section special standards which apply to radio advertising.

A. General Advertising Standards

1. A commercial radio broadcaster makes his facilities available for the advertising of products and services and accepts commercial presentations for such advertising. However, he shall, in recognition of his responsibility to the public, refuse the facilities of his station to an advertiser where he has good reason to doubt the integrity of the advertiser, the truth of the advertising representations, or the compliance of the advertiser with the spirit and purpose of all applicable legal requirements.

2. In consideration of the customs and attitudes of the communities served, each radio broadcaster should refuse his facilities to the advertisement of products and services, or the use of advertising scripts, which the station has good reason to believe would be objectionable to a substantial and responsible segment of the community. These standards should be applied with judgment and flexibility, taking into consideration the characteristics of the medium, its home and family audience, and the format and content of the particular presentation.

B. Presentation of Advertising

1. The advancing techniques of the broadcast art have shown that the quality and proper integration of advertising copy are just as important as measurement in time. The measure of a station's service to its audience is determined by its overall performance.

2. The final measurement of any commercial broadcast service is quality. To this, every broadcaster shall dedicate his best effort.

3. Great care shall be exercised by the broadcaster to prevent the presentation of false, misleading or deceptive advertising. While it is entirely appropriate to present a product in a favorable light and atmosphere, the presentation must not, by copy or demonstration, involve a material deception as to the characteristics or performance of a product.

4. The broadcaster and the advertiser should exercise special caution with the content and presentation of commercials placed in or near programs designed for children. Exploitation of children should be avoided. Commercials directed to children should in no way mislead as to the product's performance and usefulness. Appeals involving matters of health which should be determined by physicians should be avoided.

5. Reference to the results of research, surveys or tests relating to the product to be advertised shall not be presented in a manner so as to create an impression of fact beyond that established by the study. Surveys, tests or other research results upon which claims are based must be conducted under recognized research techniques and standards.

C. Acceptability of Advertisers and Products

In general, because radio broadcasting is designed for the home and the entire family, the following principles shall govern the business classifications:

1. The advertising of hard liquor shall not be accepted.

2. The advertising of beer and wines is acceptable when presented in the best of good taste and discretion.

3. The advertising of fortune-telling, occultism, astrology, phrenology, palm-reading, numerology, mind-reading, character-reading, or subjects of a like nature is not acceptable.

4. Because the advertising of all products and services of a personal nature raises special problems, such advertising, when accepted, should be treated with emphasis on ethics and the canons of good taste, and presented in a restrained and inoffensive manner.

5. The advertising of tip sheets and other publications seeking to advertise for the purpose of giving odds or promoting betting is unacceptable.

The lawful advertising of government organizations which conduct legalized lotteries is acceptable provided such advertising does not unduly exhort the public to bet.

The advertising of private or governmental organizations which conduct legalized betting on sporting contests is acceptable provided such advertising is limited to institutional type announcements which do not exhort the public to bet.

6. An advertiser who markets more than one product shall not be permitted to use advertising copy devoted to an acceptable product for purposes of publicizing the brand name or other identification of a product which is not acceptable.

7. Care should be taken to avoid presentation of "bait-switch" advertising whereby goods or services which the advertiser has no intention of selling are offered merely to lure the customer into purchasing higher-priced substitutes.

8. Advertising should offer a product or service on its positive merits and refrain from discrediting, disparaging or unfairly attacking competitors, competing products, other industries, professions or institutions.

Any identification or comparison of a competitive product or service, by name, or other means, should be confined to specific facts rather than generalized statements or conclusions, unless such statements or conclusions are not derogatory in nature.

9. Advertising testimonials should be genuine, and reflect an honest appraisal of personal experience.

10. Advertising by institutions or enterprises offering instruction with exaggerated claims for opportunities awaiting those who enroll, is unacceptable.

11. The advertising of firearms/ammunition is acceptable provided it promotes the product only as sporting equipment and conforms to recognized standards of safety as well as all applicable laws and regulations. Advertisements of firearms/ammunition by mail orders are unacceptable.

D. Advertising of Medical Products

Because advertising for over-the-counter products involving health considerations are of intimate and far-reaching importance to the consumer, the following

principles should apply to such advertising:

1. When dramatized advertising material involves statements by doctors, dentists, nurses or other professional people, the material should be presented by members of such profession reciting actual experience, or it should be made apparent from the presentation itself that the portrayal is dramatized.

2. Because of the personal nature of the advertising of medical products, the indiscriminate use of such words as "safe," "without risk," "harmless," or other terms of similar meaning, either direct or implied, should not be expressed in the advertising of medical products.

3. Advertising material which offensively describes or dramatizes distress or morbid situations involving ailments is not acceptable.

E. Time Standards for Advertising Copy

1. The amount of time to be used for advertising should not exceed 18 minutes within any clock hour. The code authority, however, for good cause may approve advertising exceeding the above standard for special circumstances.

2. Any reference to another's products or services under any trade name, or language sufficiently descriptive to identify it, shall, except for normal guest identification, be considered as advertising copy.

3. For the purpose of determining advertising limitations, such program types as "classified," "swap shop," "shopping guides," and "farm auction" programs etc., shall be regarded as containing one and one-half minutes of advertising for each five-minute segment.

F. Contests

1. Contests shall be conducted with fairness to all entrants, and shall comply with all pertinent laws and regulations.

2. All contest details, including rules, eligibility requirements, opening and termination dates, should be clearly and completely announced or easily accessible to the listening public; and the winners' names should be released as soon as possible after the close of the contest.

3. When advertising is accepted which requests contestants to submit items of product identification or other evidence of purchase of products, reasonable facsimiles thereof should be made acceptable. However, when the award is based upon skill and not upon chance, evidence of purchase may be required.

4. All copy pertaining to any contest (except that which is required by law) associated with the exploitation or sale of the sponsor's product or service, and all references to prizes or gifts offered in such connection should be considered a part of and included in the total time limitations heretofore provided. (See Time Standards for Advertising Copy.)

G. Premiums and Offers

1. The broadcaster should require that full details of proposed offers be submitted for investigation and approval before the first announcement of the offer is made to the public.

2. A final date for the termination of an offer should be announced as far in advance as possible.

3. If a consideration is required, the advertiser should agree to honor complaints indicating dissatisfaction with the premium by returning the consideration.

4. There should be no misleading descriptions or comparisons of any premiums or gifts which will distort or enlarge their value in the minds of the listeners.

Programming on Radio Stations in the United States

Formats

Following, in alphabetical order, by city, state and call letter within each classification, is a listing of program formats and the radio stations that use them.

For convenience the editors have combined the format types indicated by the stations into logical groupings. A station using a

combination of formats may appear under several classifications. Blocks of programming averaging less than some 20 hours per week are considered "special programming"; a list of stations by special programs is presented in a supplementary directory.

In many cases more specific information on format or special programming is given in individual listings in the C section station directory, including addresses for each station.

Adult (See Middle of the Road)

Agriculture & Farm
KLYD Bakersfield, CA
KLYD-FM Bakersfield, CA
WXBM-FM Milton, FL
WPLA Plant City, FL
WFAV(FM) Cordele, GA
WOKA Douglas, GA

WOKA-FM Douglas, GA
KLIX Twin Falls, ID
WRMS Beardstown, IL
WGN Chicago, IL
WSMI Litchfield, IL
WGLC Mendota, IL
WGLC-FM Mendota, IL
WTIM Taylorville, IL
WITTFM Tuscola, IL
WOWO Fort Wayne, IN

WKBV Richmond, IN
WAKE Valparaiso, IN
KKUZ Burlington, IA
KVFD Fort Dodge, IA
KOAK Red Oak, IA
KFNF Shenandoah, IA
KXXX Colby, KS
KFRM Salina, KS
WJPW Rockford, MI
KDHL Faribault, MN

KDHL-FM Faribault, MN
KQAD Luverne, MN
KQAD-FM Luverne, MN
KTOE Mankato, MN
KNUJ New Ulm, MN
KLRG Redwood Falls, MN
KWOA Worthington, MN
WABG Greenwood, MS
KIEE Harrisonville, MO
KMMJ Grand Island, NE

KRVN Lexington, NE
WIGS Gouverneur, NY
WIGS-FM Gouverneur, NY
WMPM Smithfield, NC
WHEX Columbia, PA
WCAY Cayce, SC
KMSD Millbank, SD
KWYR Winner, SD
WBAX Yankton, SD
WNBT Brownsville, TN
KGNC Amarillo, TX
KWMC Del Rio, TX
KGRG Pampa, TX
WQAI San Antonio, TX
KSEY Seymour, TX
KIKM-FM Sherman, TX
KVWC Vernon, TX
*WORT(FM) Madison, WI

WYTL Oshkosh, WI

Alternative
(See Progressive)

American Indian

KHAC Window Rock, AZ
*KIPCF(M) Albuquerque, NM
KGAK Gallup, NM
*KTDB(FM) Ramah, NM

Beautiful Music

Includes station formats characterized as good music and instrumental music.

WCRT Birmingham, AL
WQEZ(FM) Birmingham, AL
WEBJ Brewton, AL
WNAN(FM) Demopolis, AL
WOOV-FM Dothan, AL
WQEN(FM) Gadsden, AL
WLPR(FM) Mobile, AL
WFMI(FM) Montgomery, AL
WEIZ(FM) Phenix City, AL
KHAR Anchorage, AK
KHAR-FM Anchorage, AK
KZZZ(FM) Kingman, AZ
KBUZ Mesa, AZ
KBUZ-FM Mesa, AZ
KMEQ Phoenix, AZ
KMEQ-FM Phoenix, AZ
KRFFM(FM) Phoenix, AZ
KNOT Prescott, AZ
KAZM Sedona, AZ
KAIR Tucson, AZ
KCEE-FM Tucson, AZ
KNYN Williams, AZ
KGUS(FM) Fort Springs, AR
KFIN(FM) Jonesboro, AR
KEZO(FM) Little Rock, AR
KXGO(FM) Arcata, CA
KBRT Avalon, CA
KYOR-FM Blythe, CA
KWXY Cathedral City, CA
KWXY-FM Cathedral City, CA
KPAY-FM Chico, CA
KOWN-FM Escondido, CA
KFRY(FM) Fresno, CA
KKNU(FM) Fresno, CA
KINC Independence, CA
KBIG(FM) Los Angeles, CA
KJOI(FM) Los Angeles, CA
KOST(FM) Los Angeles, CA
KMYT(FM) Merced, CA
KUDE-FM Oceanside, CA
KEWT(FM) Sacramento, CA
KKEE Salinas, CA
KWYT(FM) Salinas, CA
KAPX(FM) San Clemente, CA
KEZL(FM) San Diego, CA
KITT(FM) San Diego, CA
KBAY(FM) San Jose, CA
KDB-FM Santa Barbara, CA
KRUZ(FM) Santa Barbara, CA
KZST(FM) Santa Rosa, CA
KSUE-FM Sanaville, CA
KONG Visalia, CA
KONG-FM Visalia, CA
KOSI Aurora, CO
KBVL(FM) Boulder, CO
KDTA Delta, CO
KCOL-FM Fort Collins, CO
KLMO-FM Longmont, CO
KVMN(FM) Pueblo, CO
WEZN(FM) Bridgeport, CT
WLAD-FM Danbury, CT
WKCI(FM) Hamden, CT
WMMW Meriden, CT
WRCC New Britain, CT
WRCH-FM New Britain, CT
WTYD(FM) New London, CT
WCTY(FM) Norwich, CT
WYVZ(FM) Waterbury, CT
WXLN(FM) Willimantic, CT
WJBR(FM) Wilmington, DE
WSTW(FM) Wilmington, DE
WGAY-FM Washington, DC
WKAO Boynton Beach, FL
WDUV(FM) Bradenton, FL
WQXM(FM) Clearwater, FL
WRKT-FM Cocoa Beach, FL
WVCG Coral Gables, FL
WYOR(FM) Coral Gables, FL
WDNJ(FM) Daytona Beach, FL
WMFJ-FM Daytona Beach, FL
WGLO(FM) Fort Lauderdale, FL
WAKA Gainesville, FL
WRUF-FM Gainesville, FL

WKTZ Jacksonville, FL
WKTZ-FM Jacksonville, FL
WVFM(FM) Lakeland, FL
WAYK Lehigh Acres, FL
WAYK-FM Lehigh Acres, FL
WOHL(FM) Live Oak, FL
WMUM(FM) Marathon, FL
WLYF(FM) Miami, FL
WCVU(FM) Naples, FL
WOOO-FM Orlando, FL
WIYD-FM Palatka, FL
WGNE-FM Panama City, FL
WMEQ(FM) Pensacola, FL
WLOD Pompano Beach, FL
WCCF-FM Punta Gorda, FL
WWBA St. Petersburg, FL
WWBA-FM St. Petersburg, FL
WMC(FM) Stuart, FL
WBG(M) Tallahassee, FL
WAVV(FM) Tampa, FL
WFLA-FM Tampa, FL
WEAT-FM West Palm Beach, FL
WPCH(FM) Atlanta, GA
WSB-FM Atlanta, GA
WGUS-FM Augusta, GA
WCYR Macon, GA
WCYR-FM Macon, GA
WJCL-FM Savannah, GA
WCUP(FM) Tifton, GA
KUMU Honolulu, HI
KUMU-FM Honolulu, HI
KBAR-FM Burley, ID
KID-FM Idaho Falls, ID
KOZE-FM Lewiston, ID
*WBH(FM) Chicago, IL
WLAK(FM) Chicago, IL
WHOW-FM Clinton, IL
WLTD Evanston, IL
WLDS Jacksonville, IL
WAJP(FM) Joliet, IL
WLBH-FM Mattoon, IL
WLSC Mendota, IL
WGLC-FM Mendota, IL
WSIV-FM Pekin, IL
WSWT(FM) Peoria, IL
WZOK(FM) Rockford, IL
WRWC(FM) Rockton, IL
WKZN(FM) Zion, IL
WZBN Zion, IL
WBIF(FM) Bedford, IN
WMEF(FM) Fort Wayne, IN
WATI Indianapolis, IN
WXTZ(FM) Indianapolis, IN
WKMO(FM) Kokomo, IN
WBAT Marion, IN
WMRI(FM) Marion, IN
WOCH-FM North Vernon, IN
WTHI-FM Terre Haute, IN
KRVR(FM) Davenport, IA
KLYF(FM) Des Moines, IA
KKEZ(FM) Fort Dodge, IA
KSEZ(FM) Sioux City, IA
KTLB(FM) Twin Lakes, IA
KFMW(FM) Waterloo, IA
KSKO Arkansas City, KS
KLOO(FM) Lyons, KS
KNEX-FM McPherson, KS
KFLA-FM Scott City, KS
KSWT(FM) Topeka, KS
KARD(FM) Wichita, KS
KBRA(FM) Wichita, KS
WKOF(FM) Hopkinsville, KY
WCSN(FM) Louisville, KY
WVEZ(FM) Louisville, KY
WMST-FM Mt. Sterling, KY
WPAD-FM Paducah, KY
WLUX Baton Rouge, LA
WQXY-FM Baton Rouge, LA
KEAZ(FM) De Ridder, LA
KMLB-FM Monroe, LA
WBYU(FM) New Orleans, LA
WBV(FM) New Orleans, LA
KBCL Shreveport, LA
KMBQ(FM) Shreveport, LA
KEZM Sulphur, LA
WGAN-FM Portland, ME
WLIF(FM) Baltimore, MD
WJMD(FM) Bethesda, MD
WFRF(FM) Frederick, MD
WBOC-FM Salisbury, MD
WGAY Silver Spring, MD
WQRC(FM) Barnstable, MA
WJIB(FM) Boston, MA
WSSH(FM) Lowell, MA
WMNB-FM North Adams, MA
WESO-FM Southbridge, MA
WBAJ-FM Adrian, MI
WATZ-FM Alpena, MI
WDFP(FM) Battle Creek, MI
WGER(FM) Bay City, MI
WHFB-FM Benton Harbor, MI

WITW(FM) Cadillac, MI
WNIC Dearborn, MI
WNIC-FM Dearborn, MI
*WCSG(FM) Grand Rapids, MI
WOOD-FM Grand Rapids, MI
WJGS(FM) Houghton Lake, MI
WHFI(FM) Jackson, MI
WQLR(FM) Kalamazoo, MI
WQVQ-FM Muskegon, MI
WSAQ(FM) Port Huron, MI
WIOG(FM) Saginaw, MI
WDBI-FM Tawas City, MI
*WPHS-FM Warren, MI
KEZZ(FM) Aitkin, MN
KCPJ-FM Aitkin, MN
KAUS-FM Austin, MN
WGGR(FM) Duluth, MN
KQAD Laverne, MN
KQAD-FM Laverne, MN
WALY(FM) Minneapolis, MN
WLWL-FM Minneapolis, MN
KPRM-FM Park Rapids, MN
KLGR-FM Redwood Falls, MN
KEEY St. Paul, MN
KEEY-FM St. Paul, MN
KKWS(FM) Wadena, MN
KAGE-FM Winona, MN
*WHJT(FM) Clinton, MS
WROA-FM Gulfport, MS
WLIN(FM) Jackson, MS
WELO-FM Tupelo, MS
KJMO(FM) Jefferson City, MO
*KOCB(FM) Joplin, MO
KSWFR-FM Mexico, MO
KSTT(FM) St. Joseph, MO
KCFM(FM) St. Louis, MO
KURL-FM Billings, MT
KGLG Glendive, MT
KIVE(FM) Glendive, MT
KPOX(FM) Havre, MT
KALS(FM) Kalispell, MT
KJSK Columbus, NE
KJSK-FM Columbus, NE
KROA(FM) Grand Island, NE
KFOR-FM Lincoln, NE
KBRL McCook, NE
KNCY Nebraska City, NE
KNCY-FM Nebraska City, NE
KEZO(FM) Omaha, NE
KXTZ(FM) Henderson, NV
KORK-FM Las Vegas, NV
WKRX-FM Exeter, NH
WNBX-FM Keene, NH
WMTQ(FM) Mt. Washington, NH
WAYV(FM) Atlantic City, NJ
WPPG-FM Atlantic City, NJ
WMMG(FM) Atlantic City, NJ
WRIO-FM Cape May, NJ
WHTG Eatontown, NJ
WHTG-FM Eatontown, NJ
WVNJ Newark, NJ
WVNJ-FM Newark, NJ
WXLN-FM Newton, NJ
WLSL-FM Ocean City-Somers Point, NJ
WPAT Paterson, NJ
WADB(FM) Point Pleasant, NJ
KOB-FM Albuquerque, NM
KSVP-FM Artesia, NM
KRWN(FM) Farmington, NM
KOPE(FM) Mesilla Park, NM
WHRL(FM) Albany, NY
WVSH(FM) Albany, NY
WROW-FM Albany, NY
WVOM(FM) Albany, NY
WRLX(FM) Auburn, NY
WOYT(FM) Binghamton, NY
WBNY(FM) Buffalo, NY
WENY-FM Elmira, NY
WIOK(FM) Hempstead, NY
WLEA Hornell, NY
WLOT Horseheads, NY
WHVW-FM Hyde Park, NY
WHUG(FM) Jamestown, NY
WTFM(FM) Lake Success, NY
WLVL Lockport, NY
WALL-FM Middletown, NY
WBSL(FM) New York, NY
WEZG(FM) North Syracuse, NY
WSOO North Syracuse, NY
WONT(FM) Oneonta, NY
WEZO(FM) Rochester, NY
WCTO(FM) Smithtown, NY
WWRJ(FM) Southampton, NY
WRUN-FM Utica, NY
WLOS-FM Asheville, NC
WNCB(FM) Burlington, NC
WBT-FM Charlotte, NC
WRRZ-FM Clinton, NC
WBXB(FM) Edenton, NC
WFSC-FM Franklin, NC

WEQR(FM) Goldsboro, NC
WSML Graham, NC
WYVD(FM) Raleigh, NC
WKS(M) Tabor City, NC
WMFD-FM Wilmington, NC
KQDY(FM) Bismarck, ND
KDLR-FM Devils Lake, ND
KYTN(FM) Grand Forks, ND
WOGM(FM) Bellefontaine, OH
WNR(FM) Bellevue, OH
WWEZ(FM) Cincinnati, OH
WDOK-FM Cleveland, OH
WVKO-FM Columbus, OH
WJAI(FM) Eaton, OH
WQLX(FM) Galion, OH
WYCH(FM) Hamilton, OH
WLSR(FM) Lima, OH
WMOA-FM Marietta, OH
WMRN-FM Marion, OH
WLYK(FM) Millford, OH
WLEC-FM Sandusky, OH
*WKTL(FM) Struthers, OH
WWEZ(FM) Sylvania, OH
WKOV-FM Wellston, OH
WKBN-FM Youngstown, OH
KWHW-FM Altus, OK
KYFM(FM) Bartlesville, OK
KKNG(FM) Oklahoma City, OK
KLEC Oklahoma City, OK
KWEN(FM) Tulsa, OK
KATR Eugene, OR
KOMS(FM) Lebanon, OR
KOIN-FM Portland, OR
KUPL(FM) Portland, OR
KCIV(FM) The Dalles, OR
WFMZ(FM) Allentown, PA
WHGM(FM) Bellwood, PA
WEZV(FM) Bethlehem, PA
WPGM Danville, PA
WPGM-FM Danville, PA
WDBA(FM) Du Bois, PA
WQOQ(FM) Easton, PA
WHP-FM Harrisburg, PA
WVCD(FM) Hazleton, PA
WGL-FM Lancaster, PA
WLAN-FM Lancaster, PA
WCTX(FM) Palmyra, PA
WDVR(FM) Philadelphia, PA
WPBS(FM) Philadelphia, PA
WWSH(FM) Philadelphia, PA
WJOI(FM) Pittsburgh, PA
WSHH(FM) Pittsburgh, PA
WRFY-FM Reading, PA
WYZZ(FM) Wilkes-Barre, PA
WOTB(FM) Middletown, RI
WLKW Providence, RI
WLKW-FM Providence, RI
WPJB-FM Providence, RI
WWBD-FM Bamberg, SC
WBEU-FM Beaufort, SC
WXRY(FM) Columbia, SC
WSTN(FM) Florence, SC
WESC-FM Greenville, SC
WATP-FM Marion, SC
KELO-FM Sioux Falls, SD
WYNQ(FM) Chattanooga, TN
WKPT-FM Kingsport, TN
WEZI(FM) Memphis, TN
WREC-FM Memphis, TN
WZEZ(FM) Nashville, TN
WUUU(FM) Oak Ridge, TN
*WDNX(FM) Olive Hill, TN
KBIC(FM) Alice, TX
KGNC-FM Amarillo, TX
KASE(FM) Austin, TX
KHFI-FM Austin, TX
KLB Austin, TX
KBPO(FM) Beaumont, TX
KIOU(FM) Corpus Christi, TX
KSIX-FM Corpus Christi, TX
KOAX(FM) Dallas, TX
KRLD Dallas, TX
KTLC(FM) Dallas, TX
KMRE(FM) Dumas, TX
KESI(FM) Edinburg, TX
KEZB(FM) El Paso, TX
KSET El Paso, TX
KSET-FM El Paso, TX
KANF-FM Fredericksburg, TX
KWKO(FM) Graham, TX
KODA-FM Houston, TX
KNBT(FM) New Braunfels, TX
KYND-FM Pasadena, TX
KQXT(FM) San Antonio, TX
KWED Seguin, TX
KNUE(FM) Tyler, TX
KOPD(FM) Odgen, UT
KLUB Salt Lake City, UT
KLUB-FM Salt Lake City, UT
KSL-FM Salt Lake City, UT
KVEL-FM Vernal, UT
WEZ(FM) Burlington, VT
WRUT(FM) Rutland, VT

Formats

WNHV-FM White River Junction, VT
WLSD-FM Big Stone Gap, VA
WBSD Broadway, VA
WOMC(FM) Charlottesville, VA
WVUL(FM) Culpeper, VA
WFFV(FM) Front Royal, VA
WTAR-FM Norfolk, VA
WPLZ(FM) Petersburg, VA
WTVR-FM Richmond, VA
WPVR(FM) Roanoke, VA
WSGM(FM) Staunton, VA
WFOG(FM) Suffolk, VA
WVAB Virginia Beach, VA
WBCI(FM) Williamsburg, VA
KBIO(FM) Edmonds, WA
WLEC-FM Sandusky, WA
KLYK(FM) Longview, WA
KLYN-FM Lynden, WA
KITN Olympia, WA
KSEA(FM) Seattle, WA
KIXI Seattle, WA
KIXI-FM Seattle, WA
KEUT(FM) Seattle, WA
KXXR Spokane, WA
KIT-FM Yakima, WA
WHIS-FM Bluefield, WV
WBES(FM) Charleston, WV
WTIO(FM) Charleston, WV
WTPJ Charleston, WV
WHEZ(FM) Huntington, WV
WAJR-FM Morgantown, WV
WIAL(FM) Eau Claire, WI
WVUZ-FM Green Bay, WI
WKKB(FM) Manitowoc, WI
WDLB-FM Marshfield, WI
WISN-FM Milwaukee, WI
WROE(FM) Neenah-Nenasha, WI
WCCN-FM Meillsville, WI
WRHN(FM) Rhinelander, WI
WHBL-FM Sheboygan, WI
WDEZ(FM) Wausau, WI
WEYA(FM) Bayamon, PR
WAEL-FM Maicao, PR
WPAB-FM Ponce, PR
WPRM-FM San Juan, PR
WSRA(FM) San Juan, PR

Big Band

WNUP(FM) New Kensington, PA
WICK Scranton, PA
KJIM Fort Worth, TX
KBRR-FM Shillsboro, TX

Black

Includes station formats characterized as rhythm & blues and soul.

WVSM(FM) Bay Minette, AL
WBUL Birmingham, AL
WENN Birmingham, AL
WENN-FM Birmingham, AL
WZZK(FM) Birmingham, AL
WXAL Demopolis, AL
WDIG Dothan, AL
WJLD Homewood, AL
WEUP Huntsville, AL
WBLX(FM) Mobile, AL
WGOK Mobile, AL
WRMA Montgomery, AL
WJHO Opelika, AL
WTQX Selma, AL
WEYV Talladega, AL
WTUG Tuscaloosa, AL
WZZA Tusculumbia, AL
WBIL Tuskegee, AL
WVNS(FM) Tuskegee, AL
WYLS York, AL
KALO Little Rock, AR
KOKY Little Rock, AR
KFMY(FM) Magnolia, AR
KCAT Pine Bluff, AR
KADO-FM Texarkana, AR
KJLH(FM) Compton, CA
KLIP Fowler, CA
KAGB-FM Inglewood, CA
KGER Long Beach, CA
KGF Los Angeles, CA
KHOP(FM) Modesto, CA
*KSMC(FM) Moraga, CA
KDLA Oakland, CA
KPOP Roseville, CA
*KERS(FM) Sacramento, CA
*KQED-FM San Francisco, CA
KSOL(FM) San Mateo, CA

Formats

KDAY Santa Monica, CA
 KZEN(FM) Seaside, CA
 KDKO Littleton, CO
 *WRTC-FM Hartford, CT
 *WNHU(FM) West Haven, CT
 WKND Windsor, CT
 WILM Wilmington, DE
 WHUR-FM Washington, DC
 WOL Washington, DC
 WOOK Washington, DC
 WGGG Gainesville, FL
 WERD Jacksonville, FL
 WCGL Jacksonville, FL
 WWAB Lakeland, FL
 WEDR(FM) Miami, FL
 WMBM Miami Beach, FL
 WORL Orlando, FL
 WBOP Pensacola, FL
 WBOP-FM Pensacola, FL
 WRBD Pompano Beach, FL
 WANM Tallahassee, FL
 WTMP Tampa, FL
 WOKB Winter Garden, FL
 WJZ(FM) Albany, GA
 WIPE(FM) Americus, GA
 WAOK Atlanta, GA
 WIGO Atlanta, GA
 *WRFQ(FM) Atlanta, GA
 WXAP Atlanta, GA
 WRDW Augusta, GA
 WTHB Augusta, GA
 WBAF Barnesville, GA
 WOKS Columbus, GA
 WMJM Cordele, GA
 WSEM Donaldsonville, GA
 WXLJ Dublin, GA
 WXLJ-FM Dublin, GA
 WKEU-FM Griffin, GA
 WIFO-FM Jesup, GA
 WIBB Macon, GA
 WFDL-FM Manchester, GA
 WSNT Sandersville, GA
 WEAS Savannah, GA
 WEAS-FM Savannah, GA
 WTUF(FM) Thomasville, GA
 WGOV Valdosta, GA
 WJPC Chicago, IL
 WESL East St. Louis, IL
 WBEE Harvey, IL
 WBMX(FM) Oak Park, IL
 WOPA Oak Park, IL
 *WRHS(FM) Park Forest, IL
 WWCA Gary, IN
 WTLN(FM) Indianapolis, IN
 WQHI(FM) Jeffersonville, IN
 WLQO Louisville, KY
 WXOK Baton Rouge, LA
 KJEF Jennings, LA
 KLPL Lake Providence, LA
 KLIC Monroe, LA
 WBOK New Orleans, LA
 WYLD New Orleans, LA
 KOKA Shreveport, LA
 WXEL(FM) Stidell, LA
 KYEA(FM) West Monroe, LA
 WANN Annapolis, MD
 WEBB Baltimore, MD
 WSID Baltimore, MD
 WWIN Baltimore, MD
 *WMUA(FM) Amherst, MA
 *WPAA(FM) Andover, MA
 WILD Boston, MA
 WUNR Brookline, MA
 *WAIC(FM) Springfield, MA
 *WSCR(FM) Springfield, MA
 WGPFR(FM) Detroit, MI
 WJLB Detroit, MI
 WAMM Flint, MI
 WCHB Inkster, MI
 WPDN Pontiac, MI
 WWWS(FM) Saginaw, MI
 KMRS Morris, MN
 WXIV(FM) Bay Springs, MS
 MWGO Canton, MS
 WROX Clarksdale, MS
 WCLD Cleveland, MS
 WDLT(FM) Cleveland, MS
 WTAM(FM) Gulfport, MS
 WROV Hattiesburg, MS
 WKXI(FM) Jackson, MS
 WOKJ Jackson, MS
 WNSL-FM Laurel, MS
 WBAD(FM) Leland, MS
 WESY Leland, MS
 WQIC Meridian, MS
 WMLC Monticello, MS
 WNAI Natchez, MS
 WQBC Vicksburg, MS
 WABO Waynesboro, MS

WAZF Yazoo City, MS
 WYAZ Yazoo City, MS
 KADI Clayton, MO
 KPRT Kansas City, MO
 *KGGP(FM) Parkville, MO
 KATZ St. Louis, MO
 KKSS(FM) St. Louis, MO
 KYOV Henderson, NV
 *KRUD(FM) Las Vegas, NV
 *WNEC-FM Henniker, NH
 WUSS Atlantic City, NJ
 WWHI(FM) Newark, NJ
 WNNJ Newark, NJ
 WPRB(FM) Princeton, NJ
 WTNJ Trenton, NJ
 WDLV-FM Vineland, NJ
 WUFO Amherst, NY
 WBKL-FM Depew, NY
 WUCU-FM Ithaca, NY
 WWRL New York, NY
 WDXK(FM) Rochester, NY
 WSAW Rochester, NY
 WSNY Schenectady, NY
 *WBMU-FM Asheville, NC
 WVOE Chadbourn, NC
 WGVF Charlotte, NC
 *WAFR(FM) Durham, NC
 WSRG Durham, NC
 WBLA Elizabethtown, NC
 WIDU Fayetteville, NC
 WOKN(FM) Goldsboro, NC
 WEAL Greensboro, NC
 WIZS Henderson, NC
 WGSNE New Bern, NC
 WLLR Raleigh, NC
 *WSHA(FM) Raleigh, NC
 WRSV(FM) Rocky Mount, NC
 WWIL(FM) Wilmington, NC
 WAAA Winston-Salem, NC
 WAIR Winston-Salem, NC
 WCIN Cincinnati, OH
 WABO Cleveland, OH
 WJMO Cleveland Heights, OH
 WVKO Columbus, OH
 WVKO-FM Columbus, OH
 WDAO(FM) Dayton, OH
 WBBF(FM) Middletown, OH
 WPKL(FM) Toledo, OH
 WELX Xenia, OH
 WBBM(FM) Xenia, OH
 KFJL(FM) Oklahoma City, OK
 KKUL(FM) Tulsa, OK
 KQIV(FM) Lake Oswego, OR
 WDS Philadelphia, PA
 WDS-FM Philadelphia, PA
 WHAT Philadelphia, PA
 *WKDU(FM) Philadelphia, PA
 WAMO Pittsburgh, PA
 WAMO-FM Pittsburgh, PA
 WBSC Bennettsville, SC
 WPAL Charleston, SC
 WGCD Chester, SC
 WOIC Columbia, SC
 WYNN Florence, SC
 WCIG(FM) Mullins, SC
 WQIZ St. George, SC
 *WWWZ(FM) Summerville, SC
 WVOL Berry Hill, TN
 WBOL Bolivar, TN
 WTBG-FM Brownsville, TN
 WMOC Chattanooga, TN
 WNOO Chattanooga, TN
 WMSO Collierville, TN
 WDXJ Jackson, TN
 WJBE Knoxville, TN
 KWAM Memphis, TN
 WDMA Memphis, TN
 WLOK Memphis, TN
 WLAC Nashville, TN
 WDBL Springfield, TN
 WDBL-FM Springfield, TN
 KJET Beaumont, TX
 KNOK Fort Worth, TX
 KNOK-FM Fort Worth, TX
 KGBC Galveston, TX
 KCOH Houston, TX
 *KPFT(FM) Houston, TX
 *KTSU(FM) Houston, TX
 KYOK Houston, TX
 KSEL Lubbock, TX
 KMHHT Marshall, TX
 KPAC Port Arthur, TX
 KAPE San Antonio, TX
 KZEY Tyler, TX
 WKLV Blackstone, VA
 WIKI Chester, VA
 WILA Danville, VA
 WENZ Highland Springs, VA
 WJJS-FM Lynchburg, VA
 WRAP Norfolk, VA
 WANT Richmond, VA
 WTOY Roanoke, VA

KYAC-FM Seattle, WA
 *KTOY(FM) Tacoma, WA
 WZTO Hurricane, WV
 WAWA-FM Milwaukee, WI
 WNOV Milwaukee, WI
 WAWA West Allis, WI
 WKVM San Juan, PR
 WVIS(FM) Frederiksted, VI

Bluegrass

(See Country & Western)

Bright

(See Middle-of-the-Road)

Christian

(See Religious)

Classical

Includes station formats characterized as concert, fine music, semi classical and serious music.

WNSA(FM) Huntsville, AL
 *KUAC(FM) College, AK
 *KAXR(FM) Flagstaff, AZ
 KHFP-FM Phoenix, AZ
 *KUAT-FM Tucson, AZ
 *KSPC(FM) Claremont, CA
 KMJ-FM Fresno, CA
 KFAC Los Angeles, CA
 KFAC-FM Los Angeles, CA
 *KUSC(FM) Los Angeles, CA
 *KXLU(FM) Los Angeles, CA
 KWAV(FM) Monterey, CA
 KOVA(FM) Ojai, CA
 KOCN(FM) Pacific Grove, CA
 KIBE Palo Alto, CA
 KFBK-FM Sacramento, CA
 *KVCR(FM) San Bernardino, CA
 KFSD-FM San Diego, CA
 *KPBS-FM San Diego, CA
 KDFC(FM) San Francisco, CA
 KKHI San Francisco, CA
 KKHI-FM San Francisco, CA
 *KCBX(FM) San Luis Obispo, CA
 *KUOP(FM) Stockton, CA
 KWSO Wasco, CA
 KBVL(FM) Boulder, CO
 KRNV(FM) Boulder, CO
 *KPOF Denver, CO
 KVOD(FM) Denver, CO
 WITC-FM Hartford, CT
 *WETA-FM Washington, DC
 WGM5-FM Washington, DC
 *WHR5(FM) Boynton Beach, FL
 WRYZ-FM Jupiter, FL
 WTMJ(FM) Miami, FL
 *WFSU-FM Tallahassee, FL
 *WPRK(FM) Winter Park, FL
 WGKA Atlanta, GA
 *WVGS(FM) Statesboro, GA
 KAIM Honolulu, HI
 KAIM-FM Honolulu, HI
 *KTUH(FM) Honolulu, HI
 *WBEZ(FM) Chicago, IL
 WFMF(FM) Chicago, IL
 WICV(FM) Chicago, IL
 WNIB(FM) Chicago, IL
 *WSIE(FM) Edwardsville, IL
 WXFM(FM) Elmwood Park, IL
 *WGH5(FM) Glen Ellyn, IL
 *WIUM(FM) Macomb, IL
 WSAB(FM) Mt. Carmel, IL
 *WGLT(FM) Normal, IL
 *WCBU(FM) Peoria, IL
 *WSSR(FM) Springfield, IL
 *WILL Urbana, IL
 *WILL-FM Urbana, IL
 *WFUI(FM) Bloomington, IN
 *WPSR(FM) Evansville, IN
 *WGC5(FM) Goshen, IN
 *WIAN(FM) Indianapolis, IN
 *WNSD-FM Notre Dame, IN
 *WBA5 West Lafayette, IN
 *KCKK-FM Cedar Rapids, IA
 *KWLC Decorah, IA
 *WSUI Iowa City, IA
 *KANU(FM) Lawrence, KS
 *WBKY(FM) Lexington, KY
 *WFPK(FM) Louisville, KY
 WNN5(FM) Louisville, KY
 *WKMS-FM Murray, KY
 *WNOO(FM) New Orleans, LA
 WDC5(FM) Portland, ME
 WCAO-FM Baltimore, MD
 WGM5 Bethesda, MD
 *WGT5-FM Takoma Park, MD
 *WPA5(FM) Andover, MA
 *WBUR(FM) Boston, MA

*WGBH(FM) Boston, MA
 WVCA-FM Gloucester, MA
 WCRB(FM) Waltham, MA
 *WICN(FM) Worcester, MA
 *WAUS(FM) Berrien Springs, MI
 *WCSG(FM) Grand Rapids, MI
 *WCMU-FM Mount Pleasant, MI
 *WMHW-FM Mount Pleasant, MI
 *WSAE(FM) Spring Arbor, MI
 KTNW(FM) Anoka, MN
 *KSJR-FM Collegeville, MN
 *KCCM-FM Moorhead, MN
 *WCAI-FM Northfield, MN
 *KRSW-FM Pipestone, MN
 *WHJT(FM) Clinton, MS
 *KFUO Clayton, MO
 *KFUO-FM Clayton, MO
 *KCUR-FM Kansas City, MO
 KXTR(FM) Kansas City, MO
 *KSOZ(FM) Point Lookout, MO
 *KUMR(FM) Rolla, MO
 KURL-FM Billings, MT
 KANR(FM) Great Falls, MT
 *KRNU(FM) Lincoln, NE
 *KUCV(FM) Lincoln, NE
 *KGBI-FM Omaha, NE
 *KIOS-FM Omaha, NE
 *KWSC(FM) Wayne, NE
 KRCL Reno, NV
 *KUNR(FM) Reno, NV
 WDCR Hanover, NH
 KHFM(FM) Albuquerque, NM
 *KRWF(FM) Las Cruces, NM
 KSNM(FM) Santa Fe, NM
 *WSKG-FM Binghamton, NY
 *WSLU(FM) Canton, NY
 WHCU-FM Ithaca, NY
 *WFUV(FM) New York, NY
 *WNYC-FM New York, NY
 WQXR New York, NY
 WQXR-FM New York, NY
 WHLD-FM Niagara Falls, NY
 WBBF(FM) Rochester, NY
 *WRUR-FM Rochester, NY
 *WMHT-FM Schenectady, NY
 *WASU-FM Boone, NC
 *WUNC(FM) Chapel Hill, NC
 *WKNC-FM Raleigh, NC
 *WFFD-FM Winston-WSalerm, NC
 *WBGU(FM) Bowling Green, OH
 *WCDR-FM Cedarville, OH
 *WGUC(FM) Cincinnati, OH
 WCLV(FM) Cleveland, OH
 *WCMO(FM) Marietta, OH
 *WBOC-FM Oberlin, OH
 *WUSO(FM) Springfield, OH
 *KOSU-FM Stillwater, OK
 *KWGS(FM) Tulsa, OK
 *KSOR(FM) Ashland, OR
 KFLY-FM Corvallis, OR
 *KWAX(FM) Eugene, OR
 *KBOO(FM) Portland, OR
 KOIN-FM Portland, OR
 *WMSF(FM) Harrisburg, PA
 *WITF-FM Hershey, PA
 WFLN Philadelphia, PA
 WFLN-FM Philadelphia, PA
 *WVIA-FM Scranton, PA
 *WVMW-FM Scranton, PA
 *WDFM(FM) State College, PA
 *WSRN-FM Swarthmore, PA
 WYZZ(FM) Wilkes-Barre, PA
 *WJHD(FM) Portsmouth, RI
 *WUSC-FM Columbia, SC
 *WEPR(FM) Greenville, SC
 WMMU Greenville, SC
 WMMU-FM Greenville, SC
 *KESD(FM) Brookings, SD
 *KAUR(FM) Sioux Falls, SD
 *KUSD Vermillion, SD
 *KUSD-FM Vermillion, SD
 *WUOT(FM) Knoxville, TN
 *WFMQ(FM) Lebanon, TN
 WMP5-FM Memphis, TN
 *WPLN(FM) Nashville, TN
 *KACV-FM Amarillo, TX
 *KMFA(FM) Austin, TX
 *KERA-FM Dallas, TX
 WRR-FM Dallas, TX
 *KTEP(FM) El Paso, TX
 KLEF(FM) Houston, TX
 *KTRU(FM) Houston, TX
 *KBYU-FM Provo, UT
 KWHO Salt Lake City, UT
 *WRUV(FM) Burlington, VT
 *WWPV-FM Colchester, VT
 *WRMC-FM Middlebury, VT

*WTJU(FM) Charlottesville, VA
 *WEMC(FM) Harrisonburg, VA
 WGH-FM Newport News, VA
 *WTGM(FM) Norfolk, VA
 *WRFK-FM Richmond, VA
 *KGT5(FM) College Place, WA
 *KOLU(FM) Pasco, WA
 KACA(FM) Prosser, WA
 *KWSU Pullman, WA
 KING-FM Seattle, WA
 *KUOW(FM) Seattle, WA
 KXA Seattle, WA
 *WMUL(FM) Huntington, WV
 *WLSU(FM) La Crosse, WI
 WFMR(FM) Milwaukee, WI
 *WRST-FM Oshkosh, WI

Comedy

WNOP Newport, KY

Concert

(See Classical)

Conservative

(See Middle-of-the-Road)

Contemporary

(See Top-40)

Country & Western

Includes station formats characterized as country, bluegrass, country-politan, contemporary country and modern country.

WARI Abbeville, AL
 WARI-FM Abbeville, AL
 WAAO Andalusia, AL
 WCTA Andalusia, AL
 WCTA-FM Andalusia, AL
 WANA Anniston, AL
 WRAB Arab, AL
 WJMW Athens, AL
 WBCA Bay Minette, AL
 WYAM Bessemer, AL
 WYDE Birmingham, AL
 WKNU(FM) Brewton, AL
 WBTS Bridgeport, AL
 WPRN Butler, AL
 WAGC Centre, AL
 WEIS Centre, AL
 WBIB Centerville, AL
 WKLF Clanton, AL
 WHOS Decatur, AL
 WNNAN(FM) Demopolis, AL
 WELB Eiba, AL
 WIRB Enterprise, AL
 WULA Eufaula, AL
 WULA-FM Eufaula, AL
 WWWW Fayette, AL
 WTCB Florant, AL
 WZOB Fort Payne, AL
 WAAX Gadsden, AL
 WGEA Geneva, AL
 WGVY Greenville, AL
 WJBB Haleyville, AL
 WBHP Huntsville, AL
 WARF Jasper, AL
 WLNV Lurverne, AL
 WK5J-FM Mobile, AL
 WLIQ Mobile, AL
 WUNI Mobile, AL
 WBAM Montgomery, AL
 WHYH-FM Montgomery, AL
 WMMY Montgomery, AL
 WMMGZ(FM) Montgomery, AL
 WHIY Moulton, AL
 WAOA Opelika, AL
 WJHO Opelika, AL
 WAMI Opp, AL
 WAMI-FM Opp, AL
 WYFD Ozark, AL
 WOAB(FM) Ozark, AL
 WPNX Phenix City, AL
 WPID Piedmont, AL
 WPXC Prattville, AL
 WK5J Prichard, AL
 WWSM Rainsville, AL
 WRMG Red Bay, AL
 WELR Roanoke, AL
 WELR-FM Roanoke, AL
 WWWW Russellville, AL
 WCNFA-FM Scottsboro, AL
 WROS Scottsboro, AL
 WTUN(FM) Selma, AL
 WSHF Sheffield, AL
 WMLS Sylacauga, AL
 WEYV Talladega, AL
 WTUB(FM) Troy, AL
 WACT Tuscaloosa, AL
 WACT-FM Tuscaloosa, AL
 WJRD Tuscaloosa, AL
 WVNA-FM Tusculmbia, AL

WVSA Vernon, AL
 WEZQ Winfield, AL
 KANC Anchorage, AK
 KYAK Anchorage, AK
 KIAK Fairbanks, AK
 *KNOM Nome, AK
 KJNP North Pole, AK
 KRXA Seward, AK
 KCUZ Clifton, AZ
 KCKY Coolidge, AZ
 KAPR Douglas, AZ
 KAFF Flagstaff, AZ
 KAFF-FM Flagstaff, AZ
 KDJI Holbrook, AZ
 KBAS(FM) Lake Havasu City, AZ
 KPGE Page, AZ
 KJJJ Phoenix, AZ
 KNIX(FM) Phoenix, AZ
 KTUF Tempe, AZ
 KCUB Tucson, AZ
 KHOS Tucson, AZ
 KSWW Wickenburg, AZ
 KHIL Willcox, AZ
 KINO Winslow, AZ
 KVOY Yuma, AZ
 KMLA(FM) Ashdown, AR
 KMCW Augusta, AR
 KBTA Batesville, AR
 KBBA Benton, AR
 KAAM(FM) Berryville, AR
 KTHS Berryville, AR
 KHLS(FM) Blytheville, AR
 KLCN Blytheville, AR
 KAMD Camden, AR
 KLYR-FM Clarksville, AR
 KVEE Conway, AR
 KVEE-FM Conway, AR
 KAGH Crossett, AR
 KAGH-FM Crossett, AR
 KCBAB Dardanelle, AR
 KDQN De Queen, AR
 KDEW De Witt, AR
 KDEW-FM De Witt, AR
 KRIL(FM) El Dorado, AR
 KFAV Fayetteville, AR
 KBFC(FM) Forrest City, AR
 KTCS Fort Smith, AR
 KTCS-FM Fort Smith, AR
 KHOZ Harrison, AR
 KCRIF(FM) Helena, AR
 KFFA Helena, AR
 KBHS Hot Springs, AR
 KBHS-FM Hot Springs, AR
 KXOW Hot Springs, AR
 KGMR Jacksonville, AR
 KGMR-FM Jacksonville, AR
 KNEA Jonesboro, AR
 KLRA Little Rock, AR
 KAMS(FM) Mammoth Springs, AR
 KZOT Marianna, AR
 KPCC Marked Tree, AR
 KCGS Marshall, AR
 KSKR(FM) Mena, AR
 KBIB Monette, AR
 KVOM Morrilton, AR
 KXLR N. Little Rock, AR
 KBCH Nashville, AR
 KOSE Osceola, AR
 KZKR Ozark, AR
 KADL Pine Bluff, AR
 KADL-FM Pine Bluff, AR
 KUOA Siloam Springs, AR
 KWAQ Stuttgart, AR
 KTMN Trumann, AR
 KRLW Walnut Ridge, AR
 KWYN Wynne, AR
 KFYV Arroyo Grande, CA
 KBIS Bakersfield, CA
 KPCC Bakersfield, CA
 KUZZ Bakersfield, CA
 KUZZ-FM Bakersfield, CA
 KIOT Barstow, CA
 KWTC Barstow, CA
 KBBV Big Bear Lake, CA
 KIBS Bishop, CA
 KROP Brawley, CA
 KLOC Ceres, CA
 KCHJ Delano, CA
 KRED Eureka, CA
 KDAC Fort Bragg, CA
 KEAP Fresno, CA
 KPDM(FM) Fresno, CA
 KFAT(FM) Gilroy, CA
 KNGS Hanford, CA
 KINC Independence, CA
 KZZZ Lancaster, CA
 KKOK Lompoc, CA
 KFOX Long Beach, CA
 KGBS Los Angeles, CA
 KGBS-FM Los Angeles, CA
 KLAC Los Angeles, CA

KHOT Madera, CA
 KDOL Mojave, CA
 KDOL-FM Mojave, CA
 KNEW Oakland, CA
 KGOL Palm Desert, CA
 KPRA(FM) Paso Robles, CA
 KKAR Pomona, CA
 KBFL Red Bluff, CA
 KCLM Redding, CA
 KZIQ Ridgecrest, CA
 KACE Riverside, CA
 KCNW(FM) Riverside, CA
 KRAK Sacramento, CA
 KTMO Salinas, CA
 KCKC San Bernardino, CA
 KQZN-FM San Diego, CA
 KSON San Diego, CA
 KSON-FM San Diego, CA
 KIOA Santa Barbara, CA
 KZON Santa Maria, CA
 KVRE Santa Rosa, CA
 KVRE-FM Santa Rosa, CA
 KSTN-FM Stockton, CA
 KSUE Susanville, CA
 KGEN Tulare, CA
 KCEY Turlock, CA
 KBBO Ventura, CA
 KHAY(FM) Ventura, CA
 KCIN Victorville, CA
 KNAB Burlington, CO
 KPIK Colorado Springs, CO
 KPIK-FM Colorado Springs, CO
 KSSS Colorado Springs, CO
 KVCFC Cortez, CO
 KERE Denver, CO
 KRSJ(FM) Durango, CO
 KFTM Fort Morgan, CO
 KQIL Grand Junction, CO
 KSTR Grand Junction, CO
 *KWSB-FM Gunnison, CO
 KBLJ(FM) La Junta, CO
 KLAK Lakewood, CO
 KLAK-FM Lakewood, CO
 KLMR Lamar, CO
 KUBC Montrose, CO
 KFMU(FM) Oak Creek, CO
 KPUB Pueblo, CO
 KWSR Rifle, CO
 KGEK Sterling, CO
 KFLJ Walsenburg, CO
 KUAD Windsor, CO
 WBIS Bristol, CT
 WFFF Milford, CT
 WIOF(FM) Waterbury, CT
 WEXT West Hartford, CT
 WDSO(FM) Dover, DE
 WTHD Milford, DE
 WAFM(FM) Milford, DE
 WAFR Avon Park, FL
 WBAR Bartow, FL
 WPUL Bartow, FL
 WBRD Bradenton, FL
 WSBP Chattahoochee, FL
 WLQH Chiefland, FL
 WBGC Chipley, FL
 WWBC Cocoa, FL
 WAAZ-FM Crestview, FL
 WCNU Crestview, FL
 WJSB Crestview, FL
 WDCF Dade City, FL
 WGTX Deluniki Springs, FL
 WQUH(FM) Deluniki Springs, FL
 WELE-FM Deland, FL
 WKXX Deland, FL
 WLCO Eustis, FL
 WYHI Fernandina Beach, FL
 WHEW(FM) Fort Myers, FL
 WDVH Gainesville, FL
 WHAN Haines City, FL
 WGMA Hollywood, FL
 WQDI Homestead, FL
 WKEM Immokalee, FL
 WYSE Inverness, FL
 WQIK Jacksonville, FL
 WQIK-FM Jacksonville, FL
 WVOJ Jacksonville, FL
 WKWF Key West, FL
 WFWI Kissimmee, FL
 WDSR Lake City, FL
 WGRG Lake City, FL
 WZST Leesburg, FL
 WWTYS Marianna, FL
 WTAI Melbourne, FL
 WYRL(FM) Melbourne, FL
 WIGL(FM) Miami, FL
 WWOK Miami, FL
 WCKC Milton, FL
 WXBM-FM Milton, FL
 WUGL-FM New Port Richey, FL
 WEXY Oakland Park, FL
 WMOP Ocala, FL

WOKC Okeechobee, FL
 WHOQ Orlando, FL
 WSUZ Palatka, FL
 WPAF-FM Panama City, FL
 WSCM Panama City Beach, FL
 WNNY Pensacola, FL
 WPFA Pensacola, FL
 WPLA Plant City, FL
 WXOS(FM) Plantation Key, FL
 WJOE Port St. Joe, FL
 WELE South Daytona, FL
 WAOC St. Augustine, FL
 WQYK-FM St. Petersburg, FL
 WSUN St. Petersburg, FL
 WPXE Starke, FL
 WOMA(FM) Tallahassee, FL
 WHBO Tampa, FL
 WQYK Tampa, FL
 WYOU Tampa, FL
 WFSH Valparaiso, FL
 WAUC Wauchula, FL
 WEAT West Palm Beach, FL
 WIRK-FM West Palm Beach, FL
 WPCV(FM) Winter Haven, FL
 WJAZ Albany, GA
 WQDE Albany, GA
 WDOL Athens, GA
 WNGC(FM) Athens, GA
 WGUN Atlanta, GA
 WPLU Atlanta, GA
 WYZE Atlanta, GA
 WGAC Augusta, GA
 WUGS Augusta, GA
 WACX Austell, GA
 WMGR Bainbridge, GA
 WBAF Barnesville, GA
 WUFE Baxley, GA
 WBBK Blakely, GA
 WWCC Bremen, GA
 WYNR Brunswick, GA
 WYNR-FM Brunswick, GA
 WDYX Buford, GA
 WGRA Cairo, GA
 WCHK Canton, GA
 WCHK-FM Canton, GA
 WLBB Carrollton, GA
 WBHF Cartersville, GA
 WIAF Clarkesville, GA
 WRWH Cleveland, GA
 WVMG Cochran, GA
 WVMG-FM Cochran, GA
 WHYD Columbus, GA
 WJJC Commerce, GA
 WFAV(FM) Cordele, GA
 WMJM Cordele, GA
 WCUG Cuthbert, GA
 WRCD Dalton, GA
 WDWL Dawson, GA
 WSEM Donaldsonville, GA
 WOKA Douglas, GA
 WOKA-FM Douglas, GA
 WXLI Dublin, GA
 WXLII-FM Dublin, GA
 WUFF Eastman, GA
 WFNE(FM) Forsyth, GA
 WNRJ Gainesville, GA
 WNMJ Garden City, GA
 WKOQ Gordon, GA
 WGRI Griffin, GA
 WCEH Hawkinsville, GA
 WVOH Hazlehurst, GA
 WYYZ Jasper, GA
 WLOP Jesup, GA
 WLAG-FM La Grange, GA
 WPEH Louisville, GA
 WBBT Lyons, GA
 WDEM Macon, GA
 WDEM-FM Macon, GA
 WYTH Madison, GA
 WBIE(FM) Marietta, GA
 WDXM Mc Rae, GA
 WXLX Milledgeville, GA
 WKUN Monroe, GA
 WMNZ Montezuma, GA
 WSSA Morrow, GA
 WMTM Moultrie, GA
 WMTM-FM Moultrie, GA
 WNGA Nashville, GA
 WNEA Newnan, GA
 New AM Reidsville, GA
 WZOT(FM) Rockmart, GA
 WLAQ Rome, GA
 WNST Sandersville, GA
 WQOT Savannah, GA
 WYOK Soperton, GA
 WGTSA Summerville, GA
 WSYL Sylva, GA
 WLOR Thomasville, GA
 WTHO Thomson, GA
 WTHO-FM Thomson, GA
 WTTWA Thomson, GA
 WTIFF Tifton, GA

WWGS Tifton, GA
 WLET Toccoa, GA
 WGOV-FM Valdosta, GA
 WJEM Valdosta, GA
 WVOP Vidalia, GA
 WAYX-FM Waycross, GA
 KAHU Waipahu, HI
 KBLL Blackfoot, ID
 KBRJ Boise, ID
 KGEM Boise, ID
 KORT Grangeville, ID
 KUPI Idaho Falls, ID
 KUPI-FM Idaho Falls, ID
 KART Jerome, ID
 KMCL McCall, ID
 *KUOI-FM Moscow, ID
 KLER Orofino, ID
 KYET Payette, ID
 KPST Preston, ID
 KAYT Rupert, ID
 KBRV Soda Springs, ID
 KIGO St. Anthony, ID
 KLIX Twin Falls, ID
 KWAL Wallace, ID
 WFVR Aurora, ID
 WRMS Beardstown, IL
 WRUL(FM) Carmi, IL
 WKZI Casey, IL
 WRXX(FM) Centralia, IL
 WJJD Chicago, IL
 WJJD-FM Chicago, IL
 *WZRD(FM) Chicago, IL
 WHOW Clinton, IL
 WHOW-FM Clinton, IL
 WIAI(FM) Danville, IL
 WNOI(FM) Flora, IL
 WFRL Freeport, IL
 WFRL-FM Freeport, IL
 WAAG(FM) Galesburg, IL
 WGEN Geneseo, IL
 WGNU Granite City, IL
 WGNU-FM Granite City, IL
 WDUK(FM) Havana, IL
 WJIL Jacksonville, IL
 WLLI-FM Joliet, IL
 WAKO Lawrenceville, IL
 WAKO-FM Lawrenceville, IL
 WSMI-FM Litchfield, IL
 WLUV Loves Park, IL
 WKAI Macomb, IL
 WDDD(FM) Marion, IL
 WLBIH Mattoon, IL
 WMCL McLeansboro, IL
 WVPC-FM Monmouth, IL
 WAKC Normal, IL
 WACF(FM) Paris, IL
 WZRO(FM) Pekin, IL
 WXCL Peoria, IL
 WRHL Rochelle, IL
 WHBF Rock Island, IL
 WCCI(FM) Savanna, IL
 WHCO Sparta, IL
 WFMFB(FM) Springfield, IL
 WLAX(FM) Streator, IL
 WTIM Taylorville, IL
 WFRN Urbana, IL
 WPMB Vandalia, IL
 WXRDI(FM) Woodstock, IL
 WHBU Anderson, IN
 WIFF Auburn, IN
 WGTC(FM) Bloomington, IN
 WWCM Brazil, IN
 WWCM-FM Brazil, IN
 WCSI-FM Columbus, IN
 WCNB Connersville, IN
 WPDF Corydon, IN
 WLFQ(FM) Crawfordsville, IN
 WROZ Evansville, IN
 WFWR Fort Wayne, IN
 WYVY-FM Fort Wayne, IN
 WXTA(FM) Greencastle, IN
 WIRE Indianapolis, IN
 WWKI(FM) Kokomo, IN
 WCOE(FM) La Porte, IN
 WCTW New Castle, IN
 WOCH North Vernon, IN
 WPAK Paoli, IN
 WPAK-FM Paoli, IN
 WART(FM) Plainfield, IN
 WKBV Richmond, IN
 WJVA South Bend, IN
 WTHI Terre Haute, IN
 WLJE(FM)-Valparaiso, IN
 WAOV Vincennes, IN
 WKUZ(FM) Wabash, IN
 KJAN Atlantic, IA
 KJAN-FM Atlantic, IA
 KBUZ Burlington, IA
 KHAK Cedar Rapids, IA
 KHAK-FM Cedar Rapids, IA
 KRIT(FM) Clarion, IA
 KCLN Clinton, IA
 KCLN-FM Clinton, IA

KWNT Davenport, IA
 KSO Des Moines, IA
 WHO Des Moines, IA
 KIWV(FM) Dubuque, IA
 KWMT Fort Dodge, IA
 KOJR Independence, IA
 KOJUR Independence, IA
 KIMIF(FM) Keokuk, IA
 KSMN Mason City, IA
 KKSI Mt. Pleasant, IA
 KWPC Muscatine, IA
 KCOB Newton, IA
 KOEL-FM Oelwein, IA
 KVDB Sioux Center, IA
 KBCM(FM) Sioux Center, IA
 KXEL Waterloo, IA
 KNEI Waukon, IA
 KNEI-FM Waukon, IA
 KWAY Waverly, IA
 KQWC Webster City, IA
 KKOY-FM Chanute, KS
 *KTCC(FM) Colby, KS
 KVOE Emporia, KS
 KUPK Garden City, KS
 KUPK-FM Garden City, KS
 KCVB Great Bend, KS
 KWBF-FM Hutchinson, KS
 KKNK Kansas City, KS
 KCKN-FM Kansas City, KS
 KLIB Liberal, KS
 KNDY Marysville, KS
 KNDY-FM Marysville, KS
 KNBI Norton, KS
 KRFM Salina, KS
 KFLA Scott City, KS
 KTOP-FM Topeka, KS
 KFDI Wichita, KS
 KFDI-FM Wichita, KS
 WTCR Ashland, KY
 WYWY Barbourville, KY
 WBYT Bardstown, KY
 WCBL Benton, KY
 WLBJ Bowling Green, KY
 WLBW Bowling Green, KY
 WMMG(FM) Brandenburg, KY
 WLBC Buffalo, KY
 WVCM(FM) Carrollton, KY
 WCAK(FM) Catlettsburg, KY
 WCTT-FM Corbin, KY
 WCLU Covington, KY
 WSTL Eminence, KY
 WKYWF(FM) Frankfort, KY
 WFKN Franklin, KY
 WAXU Georgetown, KY
 WAXU-FM Georgetown, KY
 WGGC(FM) Glasgow, KY
 WGOH Grayson, KY
 WHIC Hardinsburg, KY
 WHIC-FM Hardinsburg, KY
 WHLN Harlan, KY
 WHBN Harrodsburg, KY
 WHBN-FM Harrodsburg, KY
 WLLS Hartford, KY
 WLLS-FM Hartford, KY
 WKCM Hawesville, KY
 WSGS(FM) Hazard, KY
 WSON Henderson, KY
 WKCB Hindman, KY
 WKCB-FM Hindman, KY
 WHOP-FM Hopkinsville, KY
 WEKG Jackson, KY
 WJRS-FM Jamestown, KY
 WREM Jenkins, KY
 WREM-FM Jenkins, KY
 WIXI Lancaster, KY
 WMTL-FM Leitchfield, KY
 WMTL Leitchfield, KY
 WKDO Liberty, KY
 WINN Louisville, KY
 WTMJ Louisville, KY
 WFMW Madisonville, KY
 WMIK Middleboro, KY
 WFLW Monticello, KY
 WMTS-FM Mt. Sterling, KY
 WRVK Mt. Vernon, KY
 WRVK Neen, KY
 WNVL Nicholasville, KY
 WBRK(FM) Owensboro, KY
 WKYQ(FM) Paducah, KY
 WPAU Paducah, KY
 WBGR Paris, KY
 WBGR-FM Paris, KY
 WDRH(FM) Pikesville, KY
 WLSI Pikesville, KY
 WTJM(FM) Pineville, KY
 WCBR Richmond, KY
 WCBR-FM Richmond, KY
 WLCK Scottsville, KY

Formats

WSEK(FM) Somerset, KY
 WRSL Stanford, KY
 WSKV(FM) Stanton, KY
 WTKY Tompkinsville, KY
 WTKY-FM Tompkinsville, KY
 WLKS West Liberty, KY
 WTCW Whitesburg, KY
 WTCW-FM Whitesburg, KY
 WEQO Whitley City, KY
 WEZJ Williamsburg, KY
 KALB Alexandria, LA
 KTRY Bastrop, LA
 KVOB Bastrop, LA
 WYNK Baton Rouge, LA
 WYNK-FM Baton Rouge, LA
 WBOX Bogalusa, LA
 KCTO Columbia, LA
 KSIG Crowley, LA
 WLBI Denham Springs, LA
 KEUN Eunice, LA
 WFCG Franklinton, LA
 KLEB Golden Meadow, LA
 KLEB-FM Golden Meadow, LA
 WSLG Gonzales, LA
 WFPF Hammond, LA
 KCIL(FM) Houma, LA
 KJEF Jennings, LA
 WCKW(FM) La Place, LA
 KXKW Lafayette, LA
 KLCL Lake Charles, LA
 KLLA Leesville, LA
 KDXI Mansfield, LA
 KAPB-FM Marks, LA
 KREB(FM) Monroe, LA
 KDBH(FM) Natchitoches, LA
 WNPS New Orleans, LA
 WSHO New Orleans, LA
 KWRG New Roads, LA
 KWCL Oak Grove, LA
 KDDI(FM) Oak Grove, LA
 KREH Oakdale, LA
 KPAL Pineville, LA
 KAGY Port Sulphur, LA
 KRIH Rayville, LA
 KWKH Shreveport, LA
 KTIH Thibodaux, LA
 KVPI-FM Ville Platte, LA
 KUZM West Monroe, LA
 KVCL Winnfield, LA
 KMAR Winnsboro, LA
 KMAR-FM Winnsboro, LA
 WFAU Augusta, ME
 WFAU-FM Augusta, ME
 WBGW(FM) Bangor, ME
 WFST-FM Caribou, ME
 WDME Dover-Foxcroft, ME
 WKTJ Farmington, ME
 WKTJ-FM Farmington, ME
 WHOU Houlton, ME
 WHOU-FM Houlton, ME
 WCOU Lewiston, ME
 WCOU-FM Lewiston, ME
 WLKN Lincoln, ME
 WLKN-FM Lincoln, ME
 WMKR Millinocket, ME
 WNNWY-FM Norway, ME
 WPOR Portland, ME
 WPOR-FM Portland, ME
 WAGM Presque Isle, ME
 WPOC(FM) Baltimore, MD
 WTRI Brunswick, MD
 WCCE Cambridge, MD
 WESP-FM Cambridge, MD
 WFMD Frederick, MD
 WFRB Frostburg, MD
 WFRB-FM Frostburg, MD
 WISZ Glen Burnie, MD
 WISZ-FM Glen Burnie, MD
 WHDG(FM) Havre De Grace, MD
 WSDM La Plata, MD
 WSDM-FM La Plata, MD
 WLMD Laurel, MD
 WMJS(FM) Prince Frederick, MD
 WICO Salisbury, MD
 WICO-FM Salisbury, MD
 WTHU Thurmont, MD
 WTRR Westminster, MD
 WDON Wheaton, MD
 WYII(FM) Williamsport, MD
 WCOP Boston, MA
 WCOP-FM Boston, MA
 WFMP(FM) Fitchburg, MA
 WLYN-FM Lynn, MA
 WBNP Newburyport, MA
 WNEB Worcester, MA
 WLEN(FM) Adrian, MI
 WATZ-FM Alpena, MI

WPAG-FM Ann Arbor, MI
 WVOG Battle Creek, MI
 WXOX Bay City, MI
 WCRM Clare, MI
 WCRM-FM Clare, MI
 WANG(FM) Coldwater, MI
 WDEE Detroit, MI
 WKMF Flint, MI
 WJEB Gladwin, MI
 WCUZ Grand Rapids, MI
 WPLB Greenville, MI
 WPLB-FM Greenville, MI
 WKKM(FM) Harrison, MI
 WJPD Ishpeming, MI
 WJPD-FM Ishpeming, MI
 WJCO Jackson, MI
 WITL Lansing, MI
 WITL-FM Lansing, MI
 WTIQ Manistique, MI
 WSMA Marine City, MI
 WMPX Midland, MI
 WYMO(FM) Monroe, MI
 WGOB Munising, MI
 WQXO(FM) Munising, MI
 WMUS Muskegon, MI
 WMUS-FM Muskegon, MI
 WNBW Newberry, MI
 WAOP Otsego, MI
 WPON Pontiac, MI
 WBUK Portage, MI
 WKCO(FM) Saginaw, MI
 WNRS Sainie, MI
 WMIC Sandusky, MI
 WMIC-FM Sandusky, MI
 WIRX(FM) St. Joseph, MI
 WTCM-FM Traverse City, MI
 WYGR Wyoming, MI
 WSDS Ypsilanti, MI
 WZND(FM) Zeeland, MI
 KKIN Aitkin, MN
 KASM Albany, MN
 KCMT-FM Alexandria, MN
 KXRA Alexandria, MN
 KQAO Austin, MN
 KBUN Bemidji, MN
 KBEW Blue Earth, MN
 KBEW-FM Blue Earth, MN
 KLIZ Brainerd, MN
 KRWC Buffalo, MN
 WKLK Cloquet, MN
 KAQH Duluth, MN
 KAQH-FM Duluth, MN
 KRAD East Grand Forks, MN
 KRAD-FM East Grand Forks, MN
 WEVE Eveleth, MN
 KDHL Faribault, MN
 KDHL-FM Faribault, MN
 KBFR Fergus Falls, MN
 KEHG Fosston, MN
 KEHG-FM Fosston, MN
 KDUZ Hutchinson, MN
 KDUF-FM Hutchinson, MN
 KEYL Long Prairie, MN
 KMHL Marshall, MN
 KTCR Minneapolis, MN
 KDMA Montevideo, MN
 KMRS Morris, MN
 KNUJ New Ulm, MN
 KPRM Park Rapids, MN
 KLOH Pipestone, MN
 KFIL Preston, MN
 KFIL-FM Preston, MN
 KLRG Redwood Falls, MN
 KOLM Rochester, MN
 KRWB Roseau, MN
 WVVA Sauk Rapids, MN
 KSMN Shakopee, MN
 WWJO(FM) St. Cloud, MN
 KRSI St. Louis Park, MN
 KRBI St. Peter, MN
 KRBI-FM St. Peter, MN
 KLLR Walker, MN
 KOWO Waseca, MN
 KQDE-FM Waseca, MN
 KDOM Windom, MN
 KAGE-FM Winona, MN
 WHAY(FM) Aberdeen, MS
 WHII Bay Springs, MS
 WVMI Biloxi, MS
 WBIP Boonville, MS
 WRKN Brandon, MS
 WJRL Calhoun City, MS
 WMGO Canton, MS
 WCEP Carthage, MS
 WJBI(FM) Clarksdale, MS
 WCLD-FM Cleveland, MS
 WDSK Cleveland, MS
 WCJU Columbia, MS
 WMBC Columbus, MS
 WADI(FM) Corinth, MS
 WCMA Corinth, MS
 WKCU Corinth, MS

WBSJ(FM) Ellisville, MS
 WEPA Eupora, MS
 WFTO Fulton, MS
 WDMS(FM) Greenville, MS
 WGVW Greenville, MS
 WVBG Greenwood, MS
 WGRM Greenwood, MS
 WRIL(FM) Grenada, MS
 WGFU Gulfport, MS
 WFOR Hattiesburg, MS
 WCPC-FM Houston, MS
 WTI(FM) Iuka, MS
 WVOM Iuka, MS
 WJQS Jackson, MS
 WJXN Jackson, MS
 WWUN Jackson, MS
 WLAU Laurel, MS
 WRBE Lucedale, MS
 WSJC Magee, MS
 WAKK McComb, MS
 WOKK Meridian, MS
 WMLC Monticello, MS
 WNAI Natchez, MS
 WBKN Newton, MS
 WCIS Pascagoula, MS
 WCIS-FM Pascagoula, MS
 WHOC Philadelphia, MS
 WSEL Pontotoc, MS
 WSEL-FM Pontotoc, MS
 WKPO Prentiss, MS
 WBFN Quitman, MS
 WELO Tupelo, MS
 WJLJ Tupelo, MS
 WKYY-FM Vicksburg, MS
 WWIM Vicksburg, MS
 WVLY Water Valley, MS
 WABO Waynesboro, MS
 WABO-FM Waynesboro, MS
 WJNS-FM Yazoo City, MS
 KSOA Ava, MO
 KBLR Bolivar, MO
 KLTB(FM) Bolivar, MO
 KWRT Boonville, MO
 KWRT-FM Boonville, MO
 KPCR Bowling Green, MO
 KPCR-FM Bowling Green, MO
 KGHM Brookfield, MO
 *KBFL(FM) Buffalo, MO
 KMNR Cameron, MO
 KQCA(FM) Canton, MO
 KZYM Cape Girardeau, MO
 KAOL Carrollton, MO
 KAOL-FM Carrollton, MO
 KCRV Caruthersville, MO
 KCHR Charleston, MO
 KHAD De Soto, MO
 KDEX Dexter, MO
 KYMO East Prairie, MO
 KESM El Dorado Springs, MO
 KESM-FM El Dorado Springs, MO
 KEXS Excelsior Springs, MO
 KJCF Festus, MO
 KFMO Flat River, MO
 KFTW Fredericktown, MO
 KFAL Fulton, MO
 KRFG(FM) Greenfield, MO
 KHMO Hannibal, MO
 KIEE(FM) Harrisonville, MO
 KBTC Houston, MO
 KSCM-FM Houston, MO
 KPAA Ironton, MO
 WMBH Joplin, MO
 KTMO(FM) Kennett, MO
 KLEX Lexington, MO
 KBIL Liberty, MO
 KLTi Macon, MO
 KMMO Marshall, MO
 KEMM Marshfield, MO
 KLSR Mountain Grove, MO
 KRMS Osage Beach, MO
 KPWB Piedmont, MO
 KWOC Poplar Bluff, MO
 KMIS Portageville, MO
 KMIS-FM Portageville, MO
 KYRO Potosi, MO
 KZNN(FM) Rolla, MO
 KETU(FM) Salem, MO
 KSMO Salem, MO
 KDRO Sedalia, MO
 KMPL-FM Sikeston, MO
 KTTT Springfield, MO
 KTTT-FM Springfield, MO
 KWTO Springfield, MO
 KFEQ St. Joseph, MO
 KUSN St. Joseph, MO
 KSTL St. Louis, MO
 WIL St. Louis, MO
 WIL-FM St. Louis, MO
 KALI Sullivan, MO
 KTMJ Thayer, MO
 KLPW-FM Union, MO

KOKO Warrensburg, MO
 KFBF Waynesville, MO
 KJPW Waynesville, MO
 KYSD(FM) Waynesville, MO
 KUKU Willow Springs, MO
 KANA Anacosta, MT
 KFLN Baker, MT
 KBMY Billings, MT
 KOYN Billings, MT
 KXXL Bozeman, MT
 KDBM Dillon, MT
 WATN Glasgow, MT
 KMON Great Falls, MT
 KHDN Hardin, MT
 KOJM Havre, MT
 KGEZ Kalispell, MT
 KXLO Lewistown, MT
 KLVB Libby, MT
 KYSS Missoula, MT
 KRBN Red Lodge, MT
 KCGM(FM) Scobey, MT
 KGXC Sidney, MT
 KVCK Wolf Point, MT
 KWBE-FM Beatrice, NE
 KAMI Cozad, NE
 KGMT Fairbury, NE
 KRNV Lexington, NE
 KECK Lincoln, NE
 KHAT(FM) Lincoln, NE
 WJAG Norfolk, NE
 KAHN North Platte, NE
 WMOO Omaha, NE
 KOOO-FM Omaha, NE
 KOTD Plattsmouth, NE
 KNEB Scottsbluff, NE
 KSID Sidney, NE
 KSID-FM Sidney, NE
 KEYS Terrytown, NE
 KPTL Carson City, NV
 KVLV Fallon, NV
 KRAM Las Vegas, NV
 KTRI(FM) Las Vegas, NV
 KBET Reno, NV
 KONE Reno, NV
 WECM(FM) Claremont, NH
 WDNH(FM) Dover, NH
 WOTW-FM Nashua, NH
 WCNL Newport, NH
 WCNL-FM Newport, NH
 WPNH Plymouth, NH
 WPNH-FM Plymouth, NH
 WSNJ Bridgeton, NJ
 WSNJ-FM Bridgeton, NJ
 WSUS(FM) Franklin, NJ
 WJJZ Mount Holly, NJ
 WCRV Washington, NJ
 KALG Alamogordo, NM
 KRZY Albuquerque, NM
 KSVP Artesia, NM
 KHAP Aztec, NM
 KNFT Bayard, NM
 KBAD Carlsbad, NM
 KBAD-FM Carlsbad, NM
 KMTY-FM Clovis, NM
 KOTS Deming, NM
 KRZE Farmington, NM
 KGAK Gallup, NM
 KGLP(FM) Gallup, NM
 KMIN Grants, NM
 KCIA Humble City, NM
 KPOE(FM) Humble City, NM
 KGRD-FM Las Cruces, NM
 KFUN Las Vegas, NM
 KLEA Lovington, NM
 KLEA-FM Lovington, NM
 KENN Portales, NM
 KRSY Roswell, NM
 KRRR Ruidoso, NM
 KAFE Santa Fe, NM
 KSYX Santa Rosa, NM
 KSRC Socorro, NM
 KCHS Truth or Consequences, NM
 KTNM Tucumcari, NM
 WGNA(FM) Albany, NY
 WOKO Albany, NY
 WKOL Amsterdam, NY
 WSEN Baldwinsville, NY
 WSEN-FM Baldwinsville, NY
 WKOP Binghamton, NY
 WBRV Buffalo, NY
 WWOL Boonville, NY
 WWOL-FM Buffalo, NY
 WFLC(FM) Canandaigua, NY
 WELV Ellenville, NY
 WELV-FM Ellenville, NY
 WBZA-FM Glens Falls, NY
 WQIX(FM) Horseheads, NY
 WKOT Kingston, NY
 WXRJ Lancaster, NY
 WLFH Little Falls, NY

WYBG Massena, NY
 WTHE Mineola, NY
 WHN New York, NY
 WKDR Plattsburgh, NY
 WDLG Port Jervis, NY
 WDLG-FM Port Jervis, NY
 WPDH(FM) Poughkeepsie, NY
 WADR Remsen, NY
 WNYR Rochester, NY
 WSCP Sandy Creek, NY
 WHAZ Troy, NY
 WATN Watertown, NY
 WLSV Wellsville, NY
 WCSE(FM) Asheville, NC
 WSKY Asheville, NC
 WWNC Asheville, NC
 WBMA Beaufort, NC
 WPYB Benson, NC
 WBMS Black Mountain, NC
 WBHN Bryson City, NC
 WKYK Burnsville, NC
 WPFL Canton, NC
 WWIT Canton, NC
 WAME Charlotte, NC
 WSOC-FM Charlotte, NC
 WCSL Cherryville, NC
 WCGO Concord, NC
 WQTI(FM) Dunn, NC
 WDCG(FM) Durham, NC
 WEAF(FM) Eden, NC
 WIFM Elkin, NC
 WIFM-FM Elkin, NC
 WFAG Farmville, NC
 WFAI Fayetteville, NC
 WQSM(FM) Fayetteville, NC
 WAGO Forest City, NC
 WBBO-FM Forest City, NC
 WFSO Franklin, NC
 WAKS Fuquay Varina, NC
 WKBO Garner, NC
 WLTC Gastonia, NC
 WFMC Goldsboro, NC
 WKJK Granite Falls, NC
 WGBG Greensboro, NC
 WPET Greensboro, NC
 WRQK(FM) Greensboro, NC
 WNCI Greenville, NC
 WNCI-FM Greenville, NC
 WHNC Henderson, NC
 WIZS Henderson, NC
 WHVL Hendersonville, NC
 WKIT(FM) Hendersonville, NC
 WXRK(FM) Hickory, NC
 WGLD High Point, NC
 WGLD-FM High Point, NC
 WLAS Jacksonville, NC
 WRCM(FM) Jacksonville, NC
 WKTE King, NC
 WKMT Kings Mountain, NC
 WELS Kinston, NC
 WRNS(FM) Kinston, NC
 WKGX Lenoir, NC
 WBRM Marion, NC
 WMMH Marshall, NC
 WQWX Mebane, NC
 WDSL Mocksville, NC
 WIXE Monroe, NC
 WMNC-FM Morgantown, NC
 WDJMS Mount Olive, NC
 WCVF Murphy, NC
 WKRR Murphy, NC
 WHIT New Bern, NC
 WKBC North Wilkesboro, NC
 WYNA Raleigh, NC
 WREV Reidsville, NC
 WPTM(FM) Roanoke Rapids, NC
 WFMFA(FM) Rocky Mount, NC
 WEGG Rose Hill, NC
 WKRX(FM) Roxboro, NC
 WRDX(FM) Salisbury, NC
 WSAT Salisbury, NC
 WWGP Sanford, NC
 WBZB Selma, NC
 WVCC Shallotte, NC
 WADA Shelby, NC
 WOHS-FM Shelby, NC
 WNCA Siler City, NC
 WMPM Smithfield, NC
 WCOK Sparta, NC
 WLAB St. Pauls, NC
 WDBM Statesville, NC
 WDBM-FM Statesville, NC
 WFMX(FM) Statesville, NC
 WTAB Tabor City, NC
 WSTH Taylorsville, NC
 WADE Wadesboro, NC
 WOBR Wanchese, NC
 WOBR-FM Wanchese, NC
 WITN Washington, NC
 WETC Wendell-Zebulon, NC
 WKSK West Jefferson, NC

WENC Whiteville, NC
WENC-FM Whiteville, NC
WWWC Wilkesboro, NC
WIAM Williamston, NC
WSEC(FM) Williamston, NC
WKLW Wilmington, NC
WBTE Windsor, NC
WKBX Winston-Salem, NC
WTQR(FM) Winston-Salem, NC
WYDK Yadkinville, NC
KBMR Bismarck, ND
KDIX Dickinson, ND
KFGO Fargo, ND
KNDC Hettinger, ND
KSJB Jamestown, ND
KNDK Langdon, ND
KMAV Mayville, ND
KDDR Oakes, ND
KCGA Rugby, ND
KTGO Tioga, ND
KEYZ Williston, ND
WSLR Akron, OH
WNCO-FM Ashland, OH
WMGS Bowling Green, OH
WBNO Bryan, OH
WBNO-FM Bryan, OH
WNYN Canton, OH
WBEX-FM Chillicothe, OH
WUBE Cincinnati, OH
WUBE-FM Cincinnati, OH
WZIP Cincinnati, OH
WNRE Circleville, OH
WDMT(FM) Cleveland, OH
WKSJ(FM) Cleveland, OH
WHK Cleveland, OH
WMNI Columbus, OH
WFIZ(FM) Conneaut, OH
WWOW Conneaut, OH
WTNS Coshocton, OH
WTNS-FM Coshocton, OH
WONE Dayton, OH
WONW Defiance, OH
WCNW Fairfield, OH
WCNWF-FM Fairfield, OH
WFOB Fostoria, OH
WFOB-FM Fostoria, OH
WURD(FM) Georgetown, OH
WSRW Hillsboro, OH
WSRW-FM Hillsboro, OH
WITO(FM) Ironton, OH
WLMJ Jacksonville, OH
WHOK-FM Lancaster, OH
WIMA-FM Lima, OH
WLNQ(FM) London, OH
WBRJ Marietta, OH
WMPO-FM Middleport, OH
WPFB Middletown, OH
WMVO-FM Mount Vernon, OH
WNIO Niles, OH
WOBL Oberlin, OH
WPAY Portsmouth, OH
WSPD Toledo, OH
WTOE Toledo, OH
WPKO Waverly, OH
WELW Willoughby, OH
WKBN Youngstown, OH
KADA Ada, OK
KALV Alva, OK
KRPT Anadarko, OK
KEOR Atoka, OK
KLTR Blackwell, OK
KGOW(FM) Broken Arrow, OK
KXXX(FM) Chickasha, OK
KUSH Cushing, OK
KRHD Duncan, OK
KCRC Enid, OK
KQWA Enid, OK
KOKC Guthrie, OK
KGYN Guymon, OK
KVYL Holdenville, OK
KBEL Idabel, OK
KCCO Lawton, OK
KMAD Madill, OK
KNED McAlester, OK
KGLC Miami, OK
KMMM-FM Muskogee, OK
KNAD Norman, OK
KEBC(FM) Oklahoma City, OK
KOKL Okmulgee, OK
KBEV(FM) Okmulgee, OK
KOKN Pawhuska, OK
KINB(FM) Poteau, OK
KRCO-FM Poteau, OK
KRBB-FM Sallisaw, OK
KTOW Sand Springs, OK
KVOO Tulsa, OK
KVIN Vinita, OK
KJEM Wagoner, OK
KWEY Weatherford, OK
KWSH Wewoka, OK
KCMX Ashland, OR

KRKT Albany, OR
KVAS Astoria, OR
KAST Astoria, OR
KXIQ(FM) Bend, OR
KWVR Enterprise, OR
KRDR Gresham, OR
KOHU Hermiston, OR
KLAD Klamath Falls, OR
KLAD-FM Klamath Falls, OR
KQKI Lakeview, OR
KMCM McMinnville, OR
KSHA Medford, OR
KBBR North Bend, OR
*KRBM(FM) Pendleton, OR
KPOK Portland, OR
KWJJ Portland, OR
KRCC Prineville, OR
KPRB Redmond, OR
KRNR Roseburg, OR
KGGY Salem, OR
KORE Springfield, OR
KSND(FM) Springfield, OR
KFIR Sweet Home, OR
KACI The Dalles, OR
KTDO Toledo, OR
WHOL Ailetown, PA
WVAM-FM Altoona, PA
WASP Brownsville, PA
WHYL-FM Carlisle, PA
WCVI Conneville, PA
WCEC-FM Du Bois, PA
WYIQ(FM) Ebensburg, PA
WFEM(FM) Eilwood City, PA
WIOV(FM) Ephrata, PA
WWGO Erie, PA
WSKE Everett, PA
WACM(FM) Freeland, PA
WKSL(FM) Greencastle, PA
WTRA Latrobe, PA
WKVA Lewistown, PA
WIXZ McKeesport, PA
WWIZ(FM) Mercer, PA
WJJR-FM Millifield, PA
WMLP-FM Milton, PA
WHYP North East, PA
WHYP-FM North East, PA
WRCP Philadelphia, PA
WRCP Philadelphia, PA
WPHB Philipsburg, PA
WEEP Pittsburgh, PA
WEEP-FM Pittsburgh, PA
WKBI-FM Ridgway, PA
WKMCM Roaring Spring, PA
WGBI Scranton, PA
WVSC Somerset, PA
WVSC-FM Somerset, PA
WKOK-FM Sunbury, PA
WTTT Towanda, PA
WTTT-FM Towanda, PA
WGMRFM Tyrone, PA
WAYZ Waynesboro, PA
WAYZ-FM Waynesboro, PA
WGCR(FM) Wellsboro, PA
WRAK Williamsport, PA
WRAB-FM Williamsport, PA
WWBR Winder, PA
WNOW York, PA
WHIM Providence, RI
WHIM-FM Providence, RI
WABV Abbeville, SC
WDOG Allendale, SC
WWBD-FM Bamberg, SC
WVBD Bamberg-Denmark, SC
WBLR Batesburg, SC
WBLR-FM Batesburg, SC
WHPB Belton, SC
WVAP Burnetown, SC
WCAY Cayce, SC
WEZL(FM) Charleston, SC
WQSN Charleston, SC
WCRE Cheraw, SC
WCMJ(FM) Chester, SC
WDBU Darlington, SC
WDAF-FM Darlington, SC
WDSC Dillon, SC
WDSC-FM Dillon, SC
WELP Easley, SC
WFFS Fountain, SC
WAGI-FM Gaffney, SC
WSHG(FM) Georgetown, SC
WESC Greenville, SC
WGSW Greenwood, SC
WMTY Greenwood, SC
WCKI Greer, SC
WEAB Greer, SC
WKSC Kershaw, SC
WDDK Kingstree, SC
WJOT Lake City, SC
WLCM Lancaster, SC
WLSC Loris, SC
WTWC(FM) Manning, SC

WATP Marion, SC
WBEB Moncks Corner, SC
WKMG Newberry, SC
WFNL North Augusta, SC
WHCE-FM Orangeburg, SC
WNCN Orangeburg, SC
WCP(LF) Pageland, SC
WKPL Pickens, SC
WBUG Ridgeland, SC
WSNW Seneca, SC
WASC Spartanburg, SC
WKDY Spartanburg, SC
WAZS Summerville, SC
WFIG Sumter, SC
WSJW Woodruff, SC
KAAA Aberdeen, SD
KOBH Hot Springs, SD
KIJV-FM Huron, SD
KBJM Lemmon, SD
KMSD Millbank, SD
KOLY Moberg, SD
KOLY-FM Moberg, SD
KGFV Pierre, SD
KIMM Rapid City, SD
KTOO Rapid City, SD
KFCB Redfield, SD
KIOV(FM) Sioux Falls, SD
KXRB Sioux Falls, SD
KBHB Sturgis, SD
KWAT-FM Watertown, SD
KWYR Winner, SD
WNAAX Yankton, SD
WLAR Athens, TN
WYXI Athens, TN
WBOL Bolivar, TN
WVST(FM) Bolivar, TN
WKYE Bristol, TN
WOPB Bristol, TN
WBHT Brownsville, TN
WFWL Camden, TN
WHLP Centerville, TN
WIKAFM Centerville, TN
WDEF-FM Chattanooga, TN
WDDO Chattanooga, TN
WMCH Church Hill, TN
WDXN Clarksville, TN
WYSH Clinton, TN
WMSO Collierville, TN
WKOM(FM) Columbia, TN
WMCPC Columbia, TN
WPTN Cookeville, TN
WPTN-FM Cookeville, TN
WKBV Covington, TN
WKBV-FM Covington, TN
WDNT Dayton, TN
WDKN Dickson, TN
WDXN-FM Dickson, TN
WDSG Dyersburg, TN
WASL(FM) Dyersburg, TN
WIDD Elizabethton, TN
WEMB Erwin, TN
WIXX Fayetteville, TN
WYTM-FM Fayetteville, TN
WAGG Franklin, TN
WIZO Franklin, TN
WAMG Gallatin, TN
WQFM(FM) Greeneville, TN
WSMG Greenville, TN
WJKM Hartsville, TN
WHHM Henderson, TN
WHMT Humboldt, TN
WIRJ-FM Humboldt, TN
WDXI Jackson, TN
WDEB Jamestown, TN
WDEB-FM Jamestown, TN
WJFC Jefferson City, TN
WJTT Jellico, TN
WJCW Johnson City, TN
WGOC Kingsport, TN
WIVK Knoxville, TN
WIVK-FM Knoxville, TN
WEEN Lafayette, TN
WLAJ Lafayette, TN
WDXE Lawrenceburg, TN
WJLM Lewisburg, TN
WJMM-FM Lewisburg, TN
WDXL Lexington, TN
WLIV Livingston, TN
WLIV-FM Livingston, TN
WENO Madison, TN
WKYZ Madisonville, TN
WMSR Manchester, TN
WGAP Maryville, TN
WKA(FM) McKenzie, TN
WBMC McMinnville, TN
KWAM-FM Memphis, TN
WMC Memphis, TN
WKBJ Milan, TN
WMTN Morristown, TN
WMTCT Mountain City, TN
WMTS Murfreesboro, TN
WKDA Nashville, TN

WSIX-FM Nashville, TN
WSM Nashville, TN
WLK Newport, TN
WBNT Oneida, TN
WBNT-FM Oneida, TN
WTBP Parsons, TN
WUAT Pikesville, TN
WMGL(FM) Pulaski, TN
WRGS Rogersville, TN
WSEV Sevierville, TN
WEDG Soddy-Daisy, TN
WDBL Springfield, TN
WDBL-FM Springfield, TN
WTNE Trenton, TN
WJIG Tullahoma, TN
WECO Wartburg, TN
WPHC Waverly, TN
WAAN Waynesboro, TN
WCDT Winchester, TN
WBRY Woodbury, TN
KCAD Abilene, TX
KOKE-FM Abilene, TX
KOPY Alice, TX
KDJW Amarillo, TX
KGNC Amarillo, TX
KZIP Amarillo, TX
KACT Andrews, TX
KBUD Athens, TX
KALT Atlanta, TX
KOKE Austin, TX
KOKE-FM Austin, TX
KVET Austin, TX
KIOX Bay City, TX
KBUX Baytown, TX
KTRM Beaumont, TX
KIBL Beeville, TX
KACO Belville, TX
KTON Belton, TX
KTON-FM Belton, TX
KHEM Big Spring, TX
KFYN Bonham, TX
KBBB Borger, TX
KQTY Borger, TX
KBAN Bowie, TX
KNEL Brady, TX
KSTB Breckenridge, TX
KTTX Brenham, TX
KEAN Brownwood, TX
KXOE(FM) Brownwood, TX
KORA-FM Bryan, TX
KHLB Burnet, TX
KMIL Cameron, TX
KCAN Canyon, TX
KBEN Carrizo Springs, TX
KCTX Childress, TX
KCAR Clarksville, TX
KJCH Cleveland, TX
KSTA Coleman, TX
WTAW College Station, TX
KVMC Colorado City, TX
KCOM Comanche, TX
KIKR Conroe, TX
KAND Corsicana, TX
KIVY Crockett, TX
KCFH Cuero, TX
KXIT Dahart, TX
KAFM(FM) Dallas, TX
KBOX Dallas, TX
KRLD Dallas, TX
KWMC Del Rio, TX
KSPL Diboll, TX
KSPL-FM Diboll, TX
KDHN Dimmit, TX
KDDD Dumas, TX
KEPS Eagle Pass, TX
KWBY Edna, TX
KHEY El Paso, TX
KISO El Paso, TX
KLOZ(FM) El Paso, TX
KPSO Fallurias, TX
KZOL Farwell, TX
KFLP Floydada, TX
KBUR Fort Worth, TX
WBPB Fort Worth, TX
KNAF Fredericksburg, TX
KBRZ Freeport, TX
KMCS(FM) Gatesville, TX
KGTN Georgetown, TX
KGTN-FM Georgetown, TX
KEES Gladewater, TX
KSWA Graham, TX
KKDA Grand Prairie, TX
KCLW Hamilton, TX
KELT(FM) Harlingen, TX
KGRI Henderson, TX
KHBH Hillsboro, TX
KRME Hondo, TX
KENR Houston, TX
KIKK-FM Houston, TX
KNUJ Houston, TX
KTXJ Jasper, TX
KMBL Junction, TX

KERB Kermit, TX
KPFM(FM) Kerrville, TX
KINE Kingsville, TX
KVLG La Grange, TX
KGO(FM) Lake Jackson, TX
KPET Lamesa, TX
KCYL Lampasas, TX
KETX Livingstone, TX
KETX-FM Livingstone, TX
KCLT Lockhart, TX
KYYX(FM) Longview, TX
KDAV Lubbock, TX
KLLL Lubbock, TX
KLLL-FM Lubbock, TX
KDOX Marshall, TX
KQXX(FM) McAllen, TX
KYAL McKinney, TX
KWFA Merkle, TX
KBUS Mexia, TX
KBAT(FM) Midland, TX
KJBC Midland, TX
KMOO Mineola, TX
KORC Mineral Wells, TX
KRAN Morton, TX
KSAF Nacogdoches, TX
KNBO New Boston, TX
KQYL Odessa, TX
KOGT Orange, TX
KNET Palestine, TX
KPRE Paris, TX
KIKK Pasadena, TX
KVVWG Pearsall, TX
KKNY Plainville, TX
KBOP Pleasanton, TX
KBOP-FM Pleasanton, TX
KYYR Port Arthur, TX
KYYR-FM Port Arthur, TX
KPOS Post, TX
KOLJ Quanah, TX
KCLR Ralls, TX
KSOX Raymondville, TX
KROB Robstown, TX
KROB-FM Robstown, TX
KPEP San Angelo, TX
KTEO San Angelo, TX
KQAM San Antonio, TX
KSAQ(FM) San Antonio, TX
KBUC San Antonio, TX
KBUC-FM San Antonio, TX
KYYX San Antonio, TX
KKNY San Marcos, TX
KIKZ Seminole, TX
KSEY Seymour, TX
KBYP Shamrock, TX
KIKM-FM Sherman, TX
KTXO Sherman, TX
KKAS Silsbee, TX
KIKN Sinton, TX
KSTV Stephenville, TX
KXOX Sweetwater, TX
KTAE Taylor, TX
KTER Terrell, TX
KADO Texarkana, TX
KTLW Texas City, TX
KTUE Tulia, TX
KZAK Tyler, TX
KZAK-FM Tyler, TX
KVOU Uvalde, TX
KYUF(FM) Uvalde, TX
KQVC Vernon, TX
KNAL Victoria, TX
KAWA Waco, TX
KHOO(FM) Waco, TX
KBEC Waxahachie, TX
KZEE Weatherford, TX
KANI Wharton, TX
KLUR(FM) Wichita Falls, TX
KBRE Cedar City, UT
KURA Moab, UT
KMOR Murray, UT
KSVN Ogden, UT
KSCV Richfield, UT
KRGO Salt Lake City, UT
KSOP Salt Lake City, UT
KONI Spanish Fork, UT
KVEL-FM Vernal, UT
WIKL Newport, VT
WCVR Randolph, VT
WHWB-FM Rutland, VT
WNHV White River Junction, VT
WBBI Abingdon, VA
WPIK Alexandria, VA
WKDE Altavista, VA
WKDE-FM Altavista, VA
WIVE Ashland, VA
WODY Bassett, VA
WKEX Blacksburg, VA
WKLK Blackstone, VA

Formats

WBDY(FM) Bluefield, VA
 WZAP Bristol, VA
 WODI Brookneal, VA
 WKBY Chatham, VA
 WKYV Covington, VA
 WSVS Crewe, VA
 WSVS-FM Crewe, VA
 WPED Crozet, VA
 WDVA Danville, VA
 WFLO Farmville, VA
 WGAT Gate City, VA
 WKCY Harrisonburg, VA
 WOHN Herndon, VA
 WHHV Hillsville, VA
 WLRV Lebanon, VA
 WBRG Lynchburg, VA
 WWOD Lynchburg, VA
 WLOD Marion, VA
 WSGM Mt. Jackson, VA
 WTDI Newport News, VA
 WCMNS Norfolk, VA
 WCMNS-FM Norfolk, VA
 WNVVA Norton, VA
 WNVVA-FM Norton, VA
 WPPVA Petersburg, VA
 WPPVA-FM Petersburg, VA
 WPCE Portsmouth, VA
 WBLB Pulaski, VA
 WRIC Richlands, VA
 WEET Richmond, VA
 WTVR Richmond, VA
 WXGI Richmond, VA
 WKBA Vinton, VA
 WSLC Roanoke, VA
 WNLB Rocky Mount, VA
 WYTI Rocky Mount, VA
 WBLU Salem, VA
 WEOO Smithfield, VA
 WKDW Staunton, VA
 WHEO Stuart, VA
 WTZE Tazewell, VA
 WTZE-FM Tazewell, VA
 WKWC Warrenton, VA
 WNNT Warsaw, VA
 WNNT-FM Warsaw, VA
 WHPL Winchester, VA
 WRFL(FM) Winchester, VA
 WXRA(FM) Woodbridge, VA
 KKBW Aberdeen, WA
 KBFV Bellingham-Ferndale, WA
 KBRO-FM Bremerton, WA
 KQIN Burien, WA
 KELA-FM Centralia, WA
 KCLK Clarkston, WA
 KCLK-FM Clarkston, WA
 KCVL Colville, WA
 KWYZ Everett, WA
 KOTY Kennewick, WA
 KBAM Longview, WA
 KWIO Moses Lake, WA
 KWIO-FM Moses Lake, WA
 KAPS Mount Vernon, WA
 KRSC Othello, WA
 KARY Prosser, WA
 KPUL Pullman, WA
 KPUP Puyallup, WA
 KPOR Quincy, WA
 KAYO Seattle, WA
 KETO-FM Seattle, WA
 KMPS Seattle, WA
 KGA Spokane, WA
 KSMO Spokane, WA
 KMO Tacoma, WA
 KENE Toppenish, WA
 KUEN Wenatchee, WA
 KUTI Yakima, WA
 KUTI-FM Yakima, WA
 WJLS Beckley, WV
 WCST Berkeley Springs, WV
 WCST-FM Berkeley Springs, WV
 WBUC Buckhannon, WV
 WCAW Charleston, WV
 WVAF(FM) Charleston, WV
 WPDJ Clarksburg, WV
 WPDJ-FM Clarksburg, WV
 WELD Fisher, WV
 WWHY Huntington, WV
 WHJC Matewan, WV
 WNST Milton, WV
 WKYG Parkersburg, WV
 WKYG-FM Parkersburg, WV
 WAEP Princeton, WV
 WMOV Ravenswood, WV
 WRON Roncheverte, WV
 WRDS South Charleston, WV
 WVRC Spencer, WV
 WKLC St. Albans, WV

WWSB Sutton, WV
 WELC Welch, WV
 WVVVA Wheeling, WV
 WVVVA-FM Wheeling, WV
 WAPL Appletton, WI
 WAPL-FM Appletton, WI
 WBEL Beloit, WI
 WISS Berlin, WI
 WISS-FM Berlin, WI
 WDMP Dodgeville, WI
 WDMP-FM Dodgeville, WI
 WRDN-FM Durand, WI
 WRDN Durand, WI
 WRDN-FM Durand, WI
 WGEF Green Bay, WI
 WYLO Jackson, WI
 WMAD Madison, WI
 WJUB Manitowoc, WI
 WDLB Marshfield, WI
 WMAD-FM Middleton, WI
 WBCS(FM) Milwaukee, WI
 WMMH(FM) Minocqua, WI
 WCCN Neillsville, WI
 WOCO Oconto, WI
 WYTL Oshkosh, WI
 WPLY Plymouth, WI
 WGLB Port Washington, WI
 WGLB-FM Port Washington, WI
 WRDB Reedsburg, WI
 WRCO Richland Center, WI
 WRCO-FM Richland Center, WI
 WCWC-FM Ripon, WI
 WEVR River Falls, WI
 WEVR-FM River Falls, WI
 WTCH Shawano, WI
 WCSW Shell Lake, WI
 WDSM Superior, WI
 WISV Viroqua, WI
 WLKE Waupun, WI
 WXCO Wausau, WI
 KVOC Casper, WY
 KRAE Cheyenne, WY
 KVVO Cheyenne, WY
 KWVO-FM Cheyenne, WY
 KODI Cody, WY
 KEVA Evanston, WY
 KMER Kemmerer, WY
 KOVE Lander, WY
 KOJO Laramie, WY
 KOWB Laramie, WY
 KRAL Rawlins, WY
 KVOW Riverton, WY
 KRKK Rock Springs, WY
 KWYO Sheridan, WY
 KTHE Thermopolis, WY
 KYCN Wheatland, WY
 KWOR Worland, WY

Easy Listening

(See Middle-of-the-Road)

English in Puerto Rico

WORA-FM Mayaguez
 WZAR(FM) Ponce
 WHDA San Juan
 WIAC-FM San Juan
 WRAI San Juan
 WIVV Vieques

Eskimo

*KYUK Bethel, AK

Ethnic/Foreign Language

WIID Garden City, MI
 WBCB Chicago, IL
 WXR(T) Chicago, IL
 WMZK(FM) Detroit, MI
 WXEN(FM) Cleveland, OH
 WZAK(FM) Cleveland, OH
 WJBF(FM) Jenkintown, PA
 KSTJ(FM) San Angelo, TX
 KEDA San Antonio, TX

Farm

(See Agriculture & Farm)

Filipino

KISA Honolulu, HI

Folk

(See Progressive)

Foreign Language

(See Ethnic/Foreign Language)

Free Form

(See Progressive)

French

KSLO Opelousas, LA
 KLUF Lufkin, TX

Golden Oldies

Includes station formats characterized as nostalgia, old gold, solid gold, solid gold rock and classic gold.

WJOF(FM) Athens, AL
 WATM-FM Atmore, AL
 WFR(FM) Auburn, AL
 WCRT Birmingham, AL
 WEBJ Brewton, AL
 WEZZ(FM) Clanton, AL
 KFOD Anchorage, AL
 KAZM Sedona, AZ
 KWAO(FM) Sun City, AZ
 KHAC Window Rock, AZ
 KGKO Benton, AR
 KWUN Concord, CA
 KORJ(FM) Garden Grove, CA
 KIEV Glendale, CA
 KRTH(FM) Los Angeles, CA
 *KDHS(FM) Modesto, CA
 KWOW Pomona, CA
 KFRC-FM San Francisco, CA
 KMPX(FM) San Francisco, CA
 KWIZ Santa Ana, CA
 KWG Stockton, CA
 WCDQ Hamden, CT
 WOVW Naugatuck, CT
 WNTY Southington, CT
 WMOD(FM) Washington, DC
 WKKO Cocoa, FL
 WROD Daytona Beach, FL
 WDCL Dunedin, FL
 WYXF(FM) Fort Lauderdale, FL
 WSRF Fort Lauderdale, FL
 WONS Tallahassee, FL
 *WCLK(FM) Atlanta, GA
 WKUJ Griffin, GA
 WCOB Marietta, GA
 WHCG(FM) Metter, GA
 WMAC Metter, GA
 WRMS Beardstown, IL
 WLRF(FM) Champaign, IL
 WFYR(FM) Chicago, IL
 WYFE Rockford, IL
 WSDR Sterling, IL
 WXVW Jeffersonville, IN
 WLBC-FM Muncie, IN
 WQLK(FM) Richmond, IN
 WNDU South Bend, IN
 KRIB Mason City, IA
 KKSJ Mt. Pleasant, IA
 KCII Washington, IA
 KNEI Waukon, IA
 KNEI-FM Waukon, IA
 KUDL-FM Kansas City, KS
 KSCB Liberal, KS
 WKYR Burkesville, KY
 WYGO-FM Carbin, KY
 WVO(FM) Glasgow, KY
 WAFB-FM Baton Rouge, LA
 WTG(FM) Hammond, LA
 KJVC(FM) Mansfield, LA
 WJMR New Orleans, LA
 WKJT Farmington, ME
 WKJ-FM Farmington, ME
 WNNWY-FM Norway, ME
 WSID Baltimore, MD
 WLMD Laurel, MD
 WROR(FM) Boston, MA
 WACE Chicopee, MA
 WCIB(FM) Falmouth, MA
 *WRSB(FM) Weston, MA
 WHNE(FM) Birmingham, MI
 WCZN Flint, MI
 WHND Monroe, MI
 WGOJ Monroeville, MI
 WQOX(FM) Munising, MI
 *WSDP(FM) Plymouth, MI
 *WORW(FM) Port Huron, MI
 WKNX Saginaw, MI
 *WSHJ(FM) Southfield, MI
 KNUJ New Ulm, MN
 *KRLX(FM) Northfield, MN
 KLOH Pipestone, MN
 KLOH-FM Pipestone, MN
 WYOO Richfield, MN
 WHII Bay Springs, MS
 WGRM Greenwood, MS
 WAML Laurel, MS
 KSD St. Louis, MO
 KNUW(FM) Great Falls, MT
 KGCC Sidney, MT
 KNCY Nebraska City, NE
 KNCY-FM Nebraska City, NE
 KRFS Superior, NE
 KFMS(FM) Las Vegas, NV
 KVEG Las Vegas, NV
 KWRL Sparks, NV
 WXLO(FM) Berlin, NH
 WLTN Littleton, NH
 WOTW Nashua, NH

WFMV-FM Blairstown, NJ
 WSLT Ocean City-Somers Point, NJ
 WGRF(FM) Pleasantville, NJ
 KRAZ(FM) Farmington, NM
 WABY Albany, NY
 WCSS-FM Amsterdam, NY
 WWLE Cornwall, NY
 WBPM(FM) Kingston, NY
 WXXY(FM) Montour Falls, NY
 WCBS-FM New York, NY
 WZZZ(FM) Niagara Falls, NY
 WBLI(FM) Patchogue, NY
 *WRUR-FM Rochester, NY
 WLNG Sag Harbor, NY
 WLNG-FM Sag Harbor, NY
 *WSBU(FM) St. Bonaventure, NY
 WBVM Utica, NY
 WBXB(FM) Edenton, NC
 WRMT Rocky Mount, NC
 WWGP-FM Sanford, NC
 WEEW Washington, NC
 WHSL Wilmington, NC
 KFVR-FM Bismarck, ND
 KDDR Oakes, ND
 WGCL(FM) Cleveland, OH
 WHMQ(FM) Findlay, OH
 WTCL Warren, OH
 WBBY-FM Westerville, OH
 KAFG(FM) Oklahoma City, OK
 KSPI Stillwater, OK
 KSPI-FM Stillwater, OK
 KYNG Coos Bay, OR
 KASH Eugene, OR
 KEED Eugene, OR
 KLIQ Portland, OR
 KLSC Portland, OR
 WRTA Altoona, PA
 WAYC Bedford, PA
 WIOO Carlisle, PA
 WHEX Columbia, PA
 WHJB Greensburg, PA
 WOKU-FM Greensburg, PA
 WUWF(FM) Lebanon, PA
 WEDO McKeesport, PA
 WKST New Castle, PA
 WCAU-FM Philadelphia, PA
 WCDC Chester, SC
 WEAC Gaffney, SC
 WKZQ(FM) Myrtle Beach, SC
 WDX-FM Orangeburg, SC
 WORG Orangeburg, SC
 WBUG Ridgeland, SC
 KQHU(FM) Yankton, SD
 WSLV Ardmore, TN
 WHIN-FM Gallatin, TN
 WBYQ(FM) Hendersonville, TN
 WENO Madison, TN
 WMTS-FM Murfreesboro, TN
 KIXL Austin, TX
 KTSM-FM El Paso, TX
 KSFA-FM Nacogdoches, TX
 KIXY San Angelo, TX
 KVWC-FM Vernon, TX
 KWHO-FM Salt Lake City, UT
 KVEL-FM Vernal, UT
 WCVM(FM) Middlebury, VT
 *WMTF(FM) Stowe, VT
 WABH Deerfield, VA
 WCOL(FM) Lynchburg, VA
 WRGM Richmond, VA
 WVAB Virginia Beach, VA
 KISM(FM) Bellingham, WA
 KUUU Seattle, WA
 KDFL Sumner-Puyallup, WA
 KFFM(FM) Yakima, WA
 WQBE(FM) Charleston, WV
 WRGT-FM Clarksburg, WV
 WEIF Moundsville, WV
 WEIR Weirton, WV
 WGEZ Beloit, WI
 WOKL Eau Claire, WI
 WFO(N) Fond Du Lac, WI
 WLII-FM New London, WI
 WOCO-FM Oconto, WI
 WSAU Wausau, WI
 KWYO Sheridan, WY
 WREI(FM) Quebradillas, PR

Good Music

(See Beautiful Music)

Gospel

(See Religious)

Greek

WCRW Chicago, IL

Hard Rock

(See Progressive)

Hawaiian

KCCN Honolulu, HI

Hit Parade

(See Top-40)

Indian

(See American Indian)

Informational

(See Talk)

Inspirational

(See Religious)

Instrumental

(See Beautiful Music)

Interview

(See Talk)

Italian

WLYN Lynn, MA
 WHBI(FM) Newark, NJ
 WBNX New York, NY

Japanese

KIPA Hilo, HI
 KOHO Honolulu, HI
 KZOO Honolulu, HI

Jazz

WAJF Decatur, AL
 WVNS(FM) Tuskegee, AL
 *KAXR(FM) Flagstaff, AZ
 KXTC(FM) Glendale, AZ
 *KUAT Tucson, AZ
 KJAZ(FM) Alameda, CA
 KRE Berkeley, CA
 KRE-FM Berkeley, CA
 *KSPC(FM) Claremont, CA
 KBCA(FM) Los Angeles, CA
 *KSMC(FM) Moraga, CA
 KOCN(FM) Pacific Grove, CA
 KFSD-FM San Diego, CA
 *KSDS(FM) San Diego, CA
 *KCBX(FM) San Luis Obispo, CA
 KRNW(FM) Boulder, CO
 KADX(FM) Denver, CO
 *WPKN(FM) Bridgeport, CT
 WYBC-FM New Haven, CT
 *WHUS(FM) Storrs, CT
 WFSU-FM Tallahassee, FL
 *WCLK(FM) Atlanta, GA
 WXAP Atlanta, GA
 WWWW(FM) Arlington Heights, IL
 *WESN(FM) Bloomington, IL
 WSDM(FM) Chicago, IL
 *WZRD(FM) Chicago, IL
 WMRY(FM) East St. Louis, IL
 *WVVC(FM) Galesburg, IL
 WBEE Harvey, IL
 *WIUM(FM) Macomb, IL
 *WGLT(FM) Normal, IL
 *WNSD-FM Notre Dame, IN
 *KANU(FM) Lawrence, KS
 *WBKY(FM) Lexington, KY
 WNOP Newport, KY
 *WWNO(FM) New Orleans, LA
 WYLD-FM New Orleans, LA
 *WBUR(FM) Boston, MA
 *WGBH(FM) Boston, MA
 WILD Boston, MA
 *WVSHL-FM Easton, MA
 *WRSB(FM) Weston, MA
 WJLB Detroit, MI
 WJZZ(FM) Detroit, MI
 WILS-FM Lansing, MI
 *WMMH-FM Mount Pleasant, MI
 *WHJT(FM) Clinton, MS
 *KBIA(FM) Columbia, MO
 WUSS Atlantic City, NJ
 KSNM(FM) Santa Fe, NM
 WREZ(FM) Buffalo, NY
 *WLSU(FM) Canton, NY
 WRVR(FM) New York, NY
 *WRUR-FM Rochester, NY
 *WUNC(FM) Chapel Hill, NC
 *WQFS(FM) Greensboro, NC
 *WKNC-FM Raleigh, NC
 *WAUP(FM) Akron, OH
 *WUJ(FM) Springfield, OH
 WELX Xenia, OH
 WHBM(FM) Xenia, OH
 *KLCC(FM) Eugene, OR
 KOIV(FM) Lake Oswego, OR
 *KBOO(FM) Portland, OR
 *WRTI(FM) Philadelphia, PA
 *WVDB(FM) Philadelphia, PA
 *WRSN-FM Swarthmore, PA
 *WRKC(FM) Wilkes-Barre, PA
 *WRIU(FM) Kingston, RI
 *KAUR(FM) Sioux Falls, SD
 WJBE Knoxville, TN
 *KERA-FM Dallas, TX

*KTRU(FM) Houston, TX
 *WRUV(FM) Burlington, VT
 *WVUS(FM) Putney, VT
 *WTJU(FM) Charlottesville, VA
 KIL0 Kirkland, WA
 *WLSU(FM) La Crosse, WI
 WFMR(FM) Milwaukee, WI
 WQFM(FM) Milwaukee, WI
 *WRST-FM Oshkosh, WI
 WZVS-FM Vieques, PR
 WVIS(FM) Fredericksburg, VA

Jewish

WEVD New York, NY

Middle-of-the-Road

Includes station formats characterized as adult, adult contemporary, bright, uptempo, good or easy listening, standards, entertainment and conservative.

WAVU Albertville, AL
 WQSB(FM) Albertville, AL
 WHMA Anniston, AL
 WHMA-FM Anniston, AL
 WKAC Athens, AL
 WSGN Birmingham, AL
 WEBU Brewton, AL
 WCOX Camden, AL
 WKLN(FM) Cullman, AL
 WDRM(FM) Decatur, AL
 WRSA(FM) Decatur, AL
 WXAL Demopolis, AL
 WWOOF Dothan, AL
 WTVY-FM Dothan, AL
 WKMX(FM) Enterprise, AL
 WABF Fairhope, AL
 WHEP Foley, AL
 *WEXP(FM) Gadsden, AL
 WJBY Gadsden, AL
 WJBB Haleyville, AL
 WWWB Jasper, AL
 WKRG Mobile, AL
 WKRG-FM Mobile, AL
 WMOB Mobile, AL
 WCOV Montgomery, AL
 WKLH(FM) Montgomery, AL
 WQTY Montgomery, AL
 WHIY Moulton, AL
 WJHO Opelika, AL
 WAMI Opp, AL
 WAMI-FM Opp, AL
 WOZK Ozark, AL
 WFKH Pell City, AL
 WROS Scottsboro, AL
 WFEB Sylacauga, AL
 WMLS Sylacauga, AL
 WNUZ Talladega, AL
 WNPT Tuscaloosa, AL
 WUOA(FM) Tuscaloosa, AL
 WVNA Tusculoosa, AL
 WSLY(FM) York, AL
 WYLS York, AL
 KBYR Anchorage, AK
 KFOD Anchorage, AK
 KHAR Anchorage, AK
 KHAR-FM Anchorage, AK
 *KNIK-FM Anchorage, AK
 *KYUK Bethel, AK
 KCAM Glennallen, AK
 KJNO Juneau, AK
 *KNOM Nome, AK
 KRXA Seward, AK
 KSRM Soldotna-Kenai, AK
 KSTM(FM) Apache Junction, AZ
 KSUN Bisbee, AZ
 KPIN Casa Grande, AZ
 KCUZ Clifton, AZ
 KAWT Douglas, AZ
 KAFF-FM Flagstaff, AZ
 KCLS Flagstaff, AZ
 KFWJ Lake Havasu City, AZ
 KAAA Kingman, AZ
 KIKO Miami, AZ
 KFBR Nogales, AZ
 KPGE Page, AZ
 KZUL Parker, AZ
 KBBC(FM) Phoenix, AZ
 *KMCR-FM Phoenix, AZ
 KOOL Phoenix, AZ
 KOOL-FM Phoenix, AZ
 KOY Phoenix, AZ
 KXIV Phoenix, AZ
 KNOT Prescott, AZ
 KYCA Prescott, AZ
 KATO Safford, AZ
 KDOT Scottsdale, AZ
 KDOT-FM Scottsdale, AZ
 KVSL Show Low, AZ

KTAN Sierra Vista, AZ
 KWAO(FM) Sun City, AZ
 KCEE Tucson, AZ
 KCEE-FM Tucson, AZ
 KHYT Tucson, AZ
 KOPO Tucson, AZ
 KSWW Wickenburg, AZ
 KNYN Williams, AZ
 KHAC Window Rock, AZ
 KALJ(FM) Yuma, AZ
 KJOK(FM) Yuma, AZ
 KVOY Yuma, AZ
 KBTA Batesville, AR
 KAAM(FM) Berryville, AR
 KTHS Berryville, AR
 KWEH(FM) Camden, AR
 KLYR Clarksville, AR
 KCON Conway, AR
 KAGH Crossett, AR
 KAGH-FM Crossett, AR
 KWKK(FM) Dardanelle, AR
 KDQW De Queen, AR
 KDEW De Witt, AR
 KELD El Dorado, AR
 KEZU(FM) El Dorado, AR
 KNWA(FM) Fayetteville, AR
 KBFC(FM) Forrest City, AR
 KFPW Fort Smith, AR
 KISR(FM) Fort Smith, AR
 KMAG(FM) Fort Smith, AR
 KHOZ-FM Harrison, AR
 KRCI(FM) Helena, AR
 KFFA Helena, AR
 KZNG Hot Springs, AR
 KBTM Jonesboro, AR
 KBTM-FM Jonesboro, AR
 KFIM(FM) Jonesboro, AR
 KARN Little Rock, AR
 KVMA Magnolia, AR
 KBOK Malvern, AR
 KENA Mena, AR
 KTL0 Mountain Home, AR
 KTL0-FM Mountain Home, AR
 KDXE N. Little Rock, AR
 KOSE Osceola, AR
 KDRS Paragould, AR
 KHIG(FM) Paragould, AR
 KPOC Pochontas, AR
 KPOC-FM Pochontas, AR
 KAMO Rogers, AR
 KAMO-FM Rogers, AR
 KWCK Searcy, AR
 KSPR Springdale, AR
 KCIZ(FM) Springdale, AR
 KWAK Stuttgart, AR
 KWRF Warren, AR
 KWYN Wynne, AR
 *KANG(FM) Angwin, CA
 KAVR Apple Valley, CA
 KAVR-FM Apple Valley, CA
 KAFI(FM) Auburn, CA
 KAH1 Auburn, CA
 KGF(M) Bakersfield, CA
 KLYD Bakersfield, CA
 KLYD-FM Bakersfield, CA
 KPMC Bakersfield, CA
 KWTC Barstow, CA
 KBBV Big Bear Lake, CA
 KTOT-FM Big Bear Lake, CA
 KIBS Bishop, CA
 KYOR Blythe, CA
 KAVA Burney, CA
 KICO Calexico, CA
 KEWE(FM) Camarillo, CA
 KKOS(FM) Carlsbad, CA
 KHSL Chico, CA
 KPAY Chico, CA
 KCHV Coachella, CA
 KREL Corona, CA
 KCHJ Delano, CA
 KLTA(FM) Dinuba, CA
 KRDU Dinuba, CA
 KDEO El Cajon, CA
 KNEU(FM) El Centro, CA
 KXO El Centro, CA
 KOWN Escondido, CA
 KINS Eureka, CA
 KRED Eureka, CA
 KDAC Fort Bragg, CA
 KFIG(FM) Fresno, CA
 KFRE Fresno, CA
 KFYE(FM) Fresno, CA
 KIRV Fresno, CA
 KMJ Fresno, CA
 KHSJ Hemet, CA
 KHSJ-FM Hemet, CA
 KINC Independence, CA
 KREO Indio, CA
 KNGT(FM) Jackson, CA
 KRKC King City, CA
 KBLC Lakeport, CA

KOTE(FM) Lancaster, CA
 KLAN Lemoore, CA
 KWNI(FM) Lodi, CA
 KNEZ Lompoc, CA
 KPEN(FM) Los Altos, CA
 KFI Los Angeles, CA
 KIIS Los Angeles, CA
 KIQO(FM) Los Angeles, CA
 KLVE(FM) Los Angeles, CA
 KMPC Los Angeles, CA
 KPOL Los Angeles, CA
 KRVE(FM) Los Gatos, CA
 KUUL(FM) Madera, CA
 KRFD(FM) Marysville, CA
 KMFB Mendocino, CA
 KMFB-FM Mendocino, CA
 *KDH5(FM) Modesto, CA
 KIDD Monterey, CA
 KWAV(FM) Monterey, CA
 KBAI Morro Bay, CA
 KNDW Mt. Shasta, CA
 KVON Napa, CA
 KSFN Needles, CA
 KOCM(FM) Newport Beach, CA
 KABL Oakland, CA
 KUDE Oceanside, CA
 KSDM Ontario, CA
 KSDM-FM Ontario, CA
 KORV Oroville, CA
 KPMJ(FM) Oxnard, CA
 KDES Palm Springs, CA
 KDES-FM Palm Springs, CA
 KPSI Palm Springs, CA
 KUTY Palmdale, CA
 KRLA Pasadena, CA
 KPRL Paso Robles, CA
 KOSO(FM) Patterson, CA
 KTOB Petaluma, CA
 KPGA(FM) Pismo Beach, CA
 KACY Port Hueme, CA
 KTOP Porterville, CA
 KPCO Quincy, CA
 KBLF Red Bluff, CA
 KQMS Redding, CA
 KVCV Redding, CA
 KKOP(FM) Redondo Beach, CA
 KROA Ridgecrest, CA
 *KR VH(FM) Rio Vista, CA
 KDUO(FM) Riverside, CA
 KPRO Riverside, CA
 KPPO Roseville, CA
 KCRSA Sacramento, CA
 KCTC(FM) Sacramento, CA
 KGMS Sacramento, CA
 KJAY Sacramento, CA
 KR0Y Sacramento, CA
 KWOD(FM) Sacramento, CA
 KXOA(FM) Sacramento, CA
 KBON San Bernardino, CA
 KOLA(FM) San Bernardino, CA
 KAPX(FM) San Clemente, CA
 KDIG(FM) San Diego, CA
 KFMB San Diego, CA
 KOGO San Diego, CA
 KPRI(FM) San Diego, CA
 KYXY(FM) San Diego, CA
 KGIL San Fernando, CA
 KVFM(FM) San Fernando, CA
 KABL-FM San Francisco, CA
 KEST San Francisco, CA
 KFOG(FM) San Francisco, CA
 KIOI(FM) San Francisco, CA
 KIQI San Francisco, CA
 KNBR San Francisco, CA
 KRON-FM San Francisco, CA
 KSFO San Francisco, CA
 KEEN San Jose, CA
 KEZR(FM) San Jose, CA
 KLOK San Jose, CA
 KATY San Luis Obispo, CA
 KUNA(FM) San Luis Obispo, CA
 KVEC San Luis Obispo, CA
 *KCSM(FM) San Mateo, CA
 KWIS-FM Santa Ana, CA
 KYMS(FM) Santa Ana, CA
 KDB Santa Barbara, CA
 KIST Santa Barbara, CA
 KIMS Santa Barbara, CA
 KARA(FM) Santa Clara, CA
 KSCO Santa Cruz, CA
 KSCO-FM Santa Cruz, CA
 KUHL Santa Maria, CA
 KSRF(FM) Santa Monica, CA
 KPLS Santa Rosa, CA
 KRSO Santa Rosa, CA
 KVML Sonoma, CA
 KOWL South Lake Tahoe, CA
 KTHO South Lake Tahoe, CA
 KTHO-FM South Lake Tahoe, CA

KSTN Stockton, CA
 KWG Stockton, CA
 KSUE Susanville, CA
 KGOE Thousand Oaks, CA
 KNJO(FM) Thousand Oaks, CA
 KTRT Truckee, CA
 KKTU(FM) Ukiah, CA
 KLIL(FM) Ukiah, CA
 KUJI Ukiah, CA
 KUJC(FM) Vacaville, CA
 KNBA Vallejo, CA
 KVEN Ventura, CA
 KMLO Vista, CA
 KDFM(FM) Walnut Creek, CA
 KSYC Yreka, CA
 KHFX(FM) Yuba City, CA
 KOBO Yuba City, CA
 KUBA Yuba City, CA
 KGIW Alamosa, CO
 KSNO Aspen, CO
 KSPN(FM) Aspen, CO
 KBOL Boulder, CO
 KBRN Brighton, CO
 KNAB Burlington, CO
 KRLN Canon City, CO
 KRLN-FM Canon City, CO
 KRYT Colorado Springs, CO
 KRYT-FM Colorado Springs, CO
 KVOR Colorado Springs, CO
 KVOR-FM Colorado Springs, CO
 KRAI Craig, CO
 KDTA Delta, CO
 KAAT Denver, CO
 KDEN Denver, CO
 KHOW Denver, CO
 KIMN Denver, CO
 KLZ Denver, CO
 KOA Denver, CO
 KIUP Durango, CO
 KCOL Fort Collins, CO
 KFTM Fort Morgan, CO
 KFTM-FM Fort Morgan, CO
 KFOR Grand Junction, CO
 KQIX-FM Grand Junction, CO
 KREX Grand Junction, CO
 KFKA Greeley, CO
 KGRE(FM) Greeley, CO
 KGUC Gunnison, CO
 KBZZ La Junta, CO
 KBRN Leadville, CO
 KLMO Longmont, CO
 KHIQ Manitou Springs, CO
 KHIQ-FM Manitou Springs, CO
 KUBC Montrose, CO
 KFMU(FM) Oak Creek, CO
 KCSJ Pueblo, CO
 KDZA-FM Pueblo, CO
 KFEL Pueblo, CO
 KWSR Rifle, CO
 KAVI Rocky Ford, CO
 KAVI-FM Rocky Ford, CO
 KVRH Salida, CO
 KVRH-FM Salida, CO
 KCRT Trinidad, CO
 KFLJ Walsenburg, CO
 WNAB Bridgeport, CT
 WBIS Bristol CT
 WLAD Danbury, CT
 WGCH Greenwich, CT
 WSUB Groton, CT
 WSUB-FM Groton, CT
 WKSS(FM) Hartford-Meriden, CT
 WINF Manchester, CT
 WCNX Middletown, CT
 WELI New Haven, CT
 WNLK-FM Norwalk, CT
 WNLK Norwalk, CT
 WICH Norwich, CT
 WLIS Old Saybrook, CT
 WNSG Torrington, CT
 WATR Waterbury, CT
 WDJF(FM) Westport, CT
 WMMM Westport, CT
 WXL5(FM) Williamantic, CT
 WWTR-FM Bethany Beach, DE
 WKEN Dover, DE
 WJWL Georgetown, DE
 WSEA(FM) Georgetown, DE
 WTHD Milford, DE
 WTUX Wilmington, DE
 WMAL Washington, DC
 WMAL-FM Washington, DC
 WTLN-FM Apopka, FL
 WTLN Apopka, FL
 WJNJ-FM Atlantic Beach, FL
 WKTX Atlantic Beach, FL
 WSWN-FM Belle Glade, FL
 WBSR Boca Raton, FL
 WWOV(FM) Boca Raton, FL
 WTRL Bradenton, FL

WVJB Brooksville, FL
 WLOH Chieffland, FL
 WTAN Clearwater, FL
 WWFL Clermont, FL
 WCKS(FM) Cocoa Beach, FL
 WRKT Cocoa Beach, FL
 WRKT-FM Cocoa Beach, FL
 WJSB Crestview, FL
 WJST Cypress Gardens, FL
 WND8 Daytona Beach, FL
 WR0D Daytona Beach, FL
 WGTX DeFuniak Springs, FL
 WQUH(FM) DeFuniak Springs, FL
 WETO Deland, FL
 WDBF Delray Beach, FL
 WENG Englewood, FL
 WFTL Fort Lauderdale, FL
 WSHE-FM Fort Lauderdale, FL
 WCAI Fort Myers, FL
 WINK Fort Myers, FL
 WIRA Fort Pierce, FL
 WFTW Fort Walton Beach, FL
 WFTW-FM Fort Walton Beach, FL
 WCMO-FM Hialeah, FL
 WMBR Jacksonville, FL
 WPD0 Jacksonville, FL
 WRYZ Jupiter, FL
 WFFN-FM Key West, FL
 WKWF Key West, FL
 WLTD-FM Lake City, FL
 WDMG(FM) Leesburg, FL
 WLBE Leesburg, FL
 WFFG Marathon, FL
 WMUM(FM) Marathon, FL
 WMEL Melbourne, FL
 WMMB Melbourne, FL
 WAIA(FM) Miami, FL
 WGBS Miami, FL
 WI0D Miami, FL
 WOCN Miami, FL
 WINZ-FM Miami Beach, FL
 WKCK Milton, FL
 WTBJ Monticello, FL
 WGTW Mount Dora, FL
 WNOG Naples, FL
 WGUL New Port Richey, FL
 WOGO New Smyrna Beach, FL
 WBSB New Smyrna Beach, FL
 WFUZ(FM) Ocala, FL
 WTMC Ocala, FL
 WWKE Ocala, FL
 WDBO Orlando, FL
 WDBO-FM Orlando, FL
 WDIZ(FM) Orlando, FL
 WKIS Orlando, FL
 WJNO-FM Palm Beach, FL
 WPCF Panama City, FL
 WCOA Pensacola, FL
 WXOS(FM) Plantation Key, FL
 WCCF Punta Gorda, FL
 WCNH Quincy, FL
 WGMW(FM) Riviera Beach, FL
 WTRR Sanford, FL
 WQSA Sarasota, FL
 WSPB Sarasota, FL
 WSPB-FM Sarasota, FL
 WJCM Sebring, FL
 WSEB Sebring, FL
 WFOY St. Augustine, FL
 WFOY-FM St. Augustine, FL
 WSTU Stuart, FL
 WBG(M) Tallahassee, FL
 WONS Tallahassee, FL
 WTNT Tallahassee, FL
 WDAE Tampa, FL
 WFLA Tampa, FL
 WRMF Titusville, FL
 WRMF-FM Titusville, FL
 WAMR Venice, FL
 WAMR-FM Venice, FL
 WAXE Vero Beach, FL
 WGYL(FM) Vero Beach, FL
 WTTB Vero Beach, FL
 WAUC Wauchula, FL
 WJNO West Palm Beach, FL
 WBJW Winter Park, FL
 WLOQ(FM) Winter Park, FL
 WPAS Zephyrhills, FL
 WGPC-FM Albany, GA
 WWCW(FM) Albany, GA
 WULF Alma, GA
 WISK Americus, GA
 WPU(RM) Americus, GA
 WGAU Athens, GA
 WBSR Atlanta, GA
 WHIN Atlanta, GA
 WLTA-FM Atlanta, GA

Formats

WBBO Augusta, GA
 WBBO-FM Augusta, GA
 WBIA Augusta, GA
 WGAC Augusta, GA
 WZZW(FM) Augusta, GA
 WAZA Bainbridge, GA
 WIGG Brunswick, GA
 WMOG Brunswick, GA
 WBSI-FM Brunswick, GA
 WGRA Cairo, GA
 WKRW Cartersville, GA
 WGAA Cedartown, GA
 WCLS Columbus, GA
 WRBL Columbus, GA
 WRBL-FM Columbus, GA
 WJJC Commerce, GA
 WCOC Cornelia, GA
 WCOC-FM Cornelia, GA
 WDWD-FM Dawson, GA
 WQAK Decatur, GA
 WOKA Douglas, GA
 WOKA-FM Douglas, GA
 WFOX(FM) Gainesville, GA
 WGA Gainesville, GA
 WWHID(FM) Gainesville, GA
 WHIE Griffin, GA
 WKEU Griffin, GA
 WCEH-FM Hawkinsville, GA
 WGML Hinesville, GA
 WJGA Jackson, GA
 WJGA-FM Jackson, GA
 WPEH Louisville, GA
 WPEH-FM Louisville, GA
 WMAZ Macon, GA
 WMAZ-FM Macon, GA
 WLXL Milledgeville, GA
 WMNZ Montezuma, GA
 WMGA Moultrie, GA
 WCOH Newnan, GA
 WCOH-FM Newnan, GA
 WNSN Sandersville, GA
 WSAV Savannah, GA
 WSGF(FM) Savannah, GA
 WTOC Savannah, GA
 WTOC-FM Savannah, GA
 WXLN Savannah, GA
 WZAT(FM) Savannah, GA
 WWNS Statesboro, GA
 WGTA Summerville, GA
 WTGA Thomaston, GA
 WPAX Thomasville, GA
 WTHO Thomson, GA
 WTHO-FM Thomson, GA
 WWGS Tifton, GA
 WLET-FM Toccoa, GA
 WNEG Toccoa, GA
 WGAJ Valdosta, GA
 WVLD Valdosta, GA
 WACL-FM Waycross, GA
 WAYX Waycross, GA
 WBMK West Point, GA
 WCJM(FM) West Point, GA
 WIMO Winder, GA
 KUAI Elelele, HI
 KHLO Hilo, HI
 KIPA Hilo, HI
 KPUA Hilo, HI
 KGMH Honolulu, HI
 KGMQ(FM) Honolulu, HI
 KGU Honolulu, HI
 KLEI Kailua, HI
 KKON Kealahou, HI
 KIVM Lihue, HI
 KMVI Wailuku, HI
 KBLI Blackfoot, ID
 KBOI Boise, ID
 KYME Boise, ID
 KBXL-FM Caldwell, ID
 KCID Caldwell, ID
 KVIN Coeur d'Alene, ID
 KMFE(FM) Emmett, ID
 KORT Grangeville, ID
 KSKI Hailey, ID
 KID Idaho Falls, ID
 KTEE Idaho Falls, ID
 KFMA(FM) Jerome, ID
 KVIS Montpelier, ID
 KRPL Moscow, ID
 KRPL-FM Moscow, ID
 KAIN Nampa, ID
 KFSD-FM Nampa, ID
 KSEI Pocatello, ID
 KRXX Rexburg, ID
 KBRV Soda Springs, ID
 KMTW(FM) Twin Falls, ID
 KTFI Twin Falls, ID
 KWAL Wallace, ID
 *WFVH(FM) Arlington Heights,
 IL

Waur(FM) Aurora, IL
 WKKD-FM Aurora, IL
 WMRO Aurora, IL
 WIBV Belleville, IL
 WKWL(FM) Belvidere, IL
 WQRX(FM) Benton, IL
 *WRTE(FM) Cahokia, IL
 WBYS Canton, IL
 WBYS-FM Canton, IL
 WCIL Carbondale, IL
 WCIL-FM Carbondale, IL
 WRQY Carmi, IL
 WCZA Carthage, IL
 WILY Centralia, IL
 WEIC Charleston, IL
 WEIC-FM Charleston, IL
 *WBHI(FM) Chicago, IL
 WCFI Chicago, IL
 WCRW Chicago, IL
 WFYR(FM) Chicago, IL
 WGN Chicago, IL
 WIND Chicago, IL
 WLOO(FM) Chicago, IL
 WMAQ Chicago, IL
 WVON Chicago, IL
 WGC(FM) Chicago, IL
 WCGO Chicago Heights, IL
 WCBW(FM) Columbia, IL
 WTAS(FM) Crete, IL
 WIVS Crystal Lake, IL
 WDAN Danville, IL
 WITY Danville, IL
 WMBJ(FM) Danville, IL
 WLK De Kalb, IL
 WSOY Decatur, IL
 WSOY-FM Decatur, IL
 WYEN(FM) Des Plaines, IL
 WDQN-FM Du Quoin, IL
 WDQN Du Quoin, IL
 WMRY(FM) East St. Louis, IL
 WKSI(FM) Eldorado, IL
 WRMN Elgin, IL
 WKDC Elmhurst, IL
 WXF(FM) Elmwood Park, IL
 WEAW Evanston, IL
 WAIK Galesburg, IL
 WGIL Galesburg, IL
 WGSB Geneva, IL
 *WGRN(FM) Greenville, IL
 WEBO Harrisburg, IL
 WDUK(FM) Havana, IL
 WJPF Herrin, IL
 WINU Highland, IL
 WEAI(FM) Jacksonville, IL
 WJBM Jerseyville, IL
 WJBM-FM Jerseyville, IL
 WJOL Joliet, IL
 WJRC Joliet, IL
 WBYG-FM Kankakee, IL
 WKAN Kankakee, IL
 WJRE(FM) Kewanee, IL
 WKEI Kewanee, IL
 WLPO La Salle, IL
 WLPO-FM La Salle, IL
 WAKO Lawrenceville, IL
 WAKO-FM Lawrenceville, IL
 WPRC Lincoln, IL
 WSMI Litchfield, IL
 *WLR(AFM) Lockport, IL
 *WIUM(FM) Macomb, IL
 WKAI Macomb, IL
 WKAI-FM Macomb, IL
 WGGH Marion, IL
 WLBB Mattoon, IL
 WHTT(FM) Moline, IL
 WQUA Moline, IL
 WRAM Monmouth, IL
 WVPC-FM Monmouth, IL
 WVLJ(FM) Monticello, IL
 WCSJ Morris, IL
 WRMI-FM Morris, IL
 WSAB(FM) Mt. Carmel, IL
 WVMC Mt. Carmel, IL
 WMIX Mt. Vernon, IL
 WMIX-FM Mt. Vernon, IL
 WINI Murphysboro, IL
 WSEI(FM) Olney, IL
 WVLN Olney, IL
 WCMY Ottawa, IL
 WPRS Paris, IL
 WSPY(FM) Plano, IL
 WPOK Pontiac, IL
 WPOK-FM Pontiac, IL
 WZOE Princeton, IL
 WTAD Quincy, IL
 WTAY Robinson, IL
 WTAY-FM Robinson, IL
 WRHL Rochelle, IL
 WRRR Rockford, IL
 WJBD Salem, IL
 WJBD-FM Salem, IL
 WSHY Shelbyville, IL
 WSHY-FM Shelbyville, IL

WCLR(FM) Skokie, IL
 WHCO Sparta, IL
 WDBR(FM) Springfield, IL
 WMAY Springfield, IL
 WDEM(FM) Springfield, IL
 WIZZ Streator, IL
 WFWA(FM) Sullivan, IL
 WEEE(FM) Taylorville, IL
 WKRV(FM) Vandalia, IL
 WGF Wateka, IL
 WGF-FM Wateka, IL
 WFEA(FM) Waukegan, IL
 WKRS Waukegan, IL
 WFRX-FM West Frankfort, IL
 WXR(D) Woodstock, IL
 WHBU Anderson, IN
 WHUT Anderson, IN
 WLHN(FM) Anderson, IN
 WSC(FM) Aurora, IN
 WTTTS Bloomington, IN
 WBNL Boonville, IN
 WBNL-FM Boonville, IN
 WHON Centerville, IN
 WFDT(FM) Columbia City, IN
 WCSI Columbus, IN
 WWWW(FM) Columbus, IN
 WCNB-FM Connersville, IN
 WPDF Corydon, IN
 WCVL Crawfordsville, IN
 WFLM(FM) Crown Point, IN
 WGR(FM) Danville, IN
 WADM Decatur, IN
 WADM-FM Decatur, IN
 WTRC Elkhart, IN
 WYEZ(FM) Elkhart, IN
 WBM(FM) Elwood, IN
 WJS Evansville, IN
 WCMX(FM) Fort Wayne, IN
 WGL Fort Wayne, IN
 WWO Fort Wayne, IN
 WLTH Gary, IN
 WKAM Goshen, IN
 WXTA(FM) Greencastle, IN
 WSMJ(FM) Greenfield, IN
 WJOB Hammond, IN
 WWHC(FM) Hartford City, IN
 *WHWE(FM) Howe, IN
 WHLT Huntington, IN
 WHLT-FM Huntington, IN
 WFBQ(FM) Indianapolis, IN
 WFMS(FM) Indianapolis, IN
 WIBC Indianapolis, IN
 *WICR(FM) Indianapolis, IN
 WNDI Indianapolis, IN
 WXLN Indianapolis, IN
 WITZ Jasper, IN
 WITZ-FM Jasper, IN
 WXVW Jeffersonville, IN
 WAWK Kendallville, IN
 WAWK-FM Kendallville, IN
 WKVI-FM Knox, IN
 WKVI-FM Knox, IN
 WIOU Kokomo, IN
 *WJEF(FM) Lafayette, IN
 WLOI La Porte, IN
 WNO(FM) Lebanon, IN
 WBTO-FM Linton, IN
 WSAL Logansport, IN
 WSAL-FM Logansport, IN
 WLCL-FM Lowell, IN
 WORX Madison, IN
 WORX-FM Madison, IN
 WBAT Marion, IN
 WIMS Michigan City, IN
 WMCB-FM Michigan City, IN
 WVTL(FM) Monticello, IN
 WPCO Mt. Vernon, IN
 WLBC Muncie, IN
 WREY New Albany, IN
 WCTW New Castle, IN
 WMDH(FM) New Castle, IN
 WHYT Noblesville, IN
 *WEEM(FM) Pendleton, IN
 WARU Peru, IN
 WARU-FM Peru, IN
 WTCA Plymouth, IN
 WJCK(FM) Rensselaer, IN
 WKBV Richmond, IN
 WKBV-FM Richmond, IN
 WRIO(FM) Rochester, IN
 WRCR(FM) Rushville, IN
 WSBT South Bend, IN
 WNDI Sullivan, IN
 WAAC Terre Haute, IN
 WBOQ(FM) Terre Haute, IN
 WBOW Terre Haute, IN
 WAKE Valparaiso, IN
 WNWV Valparaiso, IN
 WAOV Vincennes, IN
 WWAY Wabash, IN
 WKUZ(FM) Wabash, IN
 WRSW-FM Warsaw, IN
 WIUC(FM) Winchester, IN

KASI Ames, IA
 KLFM(FM) Ames, IA
 KJAN Atlantic, IA
 KJAN-FM Atlantic, IA
 KWBG Boone, IA
 KWBG-FM Boone, IA
 KCFI Cedar Falls, IA
 WMT Cedar Rapids, IA
 KCOG Centerville, IA
 KCHE Cherokee, IA
 KRIT(FM) Clarion, IA
 KCLN-FM Clinton, IA
 KROS Clinton, IA
 KRCS Council Bluffs, IA
 WOC Davenport, IA
 KDSN Denison, IA
 KDSN-FM Denison, IA
 KCBC Des Moines, IA
 KIOA-FM Des Moines, IA
 KRNO(FM) Des Moines, IA
 KRNT Des Moines, IA
 WHO Des Moines, IA
 KDTH Dubuque, IA
 KILR Estherville, IA
 KILR-FM Estherville, IA
 KMCD Fairfield, IA
 KVFD Fort Dodge, IA
 KGRN Grinnell, IA
 KBHT(FM) Humboldt, IA
 KBAB Indianola, IA
 KIFG Iowa Falls, IA
 KIFG-FM Iowa Falls, IA
 KOKX Keokuk, IA
 KNIA Knoxville, IA
 KLEM Le Mars, IA
 KFJB Marshalltown, IA
 KFJB-FM Marshalltown, IA
 KGLO Mason City, IA
 KKSI Mt. Pleasant, IA
 KOEL Oelwein, IA
 KBEO Oskaloosa, IA
 KBIZ Ottumwa, IA
 KLEE Ottumwa, IA
 KDLS Perry, IA
 KOAK Red Oak, IA
 KIWA Sheldon, IA
 KIWA-FM Sheldon, IA
 KMA Shenandoah, IA
 KVDB Sioux Center, IA
 KMNS Sioux City, IA
 KSCJ Sioux City, IA
 KAYL-FM Storm Lake, IA
 KTLB(FM) Twin Lakes, IA
 KCII Washington, IA
 KCII-FM Washington, IA
 *KNWS-FM Waterloo, IA
 KWWL Waterloo, IA
 KWAY Waverly, IA
 KWAY-FM Waverly, IA
 KQWC Webster City, IA
 KQWC-FM Webster City, IA
 KARE Atchison, KS
 KGGF Coffeyville, KS
 *KTCC(FM) Colby, KS
 KXXX Colby, KS
 KXXX-FM Colby, KS
 KNCK Concordia, KS
 KNOG Dodge City, KS
 KNOG-FM Dodge City, KS
 KOYV El Dorado, KS
 KOYV-FM El Dorado, KS
 KVOE Emporia, KS
 KUPK Garden City, KS
 KUPK-FM Garden City, KS
 KCVB Great Bend, KS
 KSKU(FM) Hutchinson, KS
 KWBW Hutchinson, KS
 KIND Independence, KS
 KIND-FM Independence, KS
 KALN Iola, KS
 KJCK Junction City, KS
 KANS Larned, KS
 KANS-FM Larned, KS
 KLVN Lawrence, KS
 KSCB Liberal, KS
 KMAN Manhattan, KS
 KMKF(FM) Manhattan, KS
 KNDY Mansville, KS
 KNEX McPherson, KS
 KBEA Mission, KS
 KJRG-FM Newton, KS
 KNBI Norton, KS
 KOFO Ottawa, KS
 KOFO-FM Ottawa, KS
 KCLK Parsons, KS
 KSEK Pittsburg, KS
 KMRJ(FM) Pittsburg, KS
 KINA Salina, KS
 KSAL Salina, KS
 KYEZ(FM) Salina, KS
 KFLA Scott City, KS
 WIBW Topeka, KS
 WREN Topeka, KS

KULY Ulysses, KS
 KAKE Wichita, KS
 KFH Wichita, KS
 KWBB Wichita, KS
 KNIC Winfield, KS
 WDNS(FM) Bowling Green, KY
 WKCT Bowling Green, KY
 WKYR Burkesville, KY
 WKVE Cave City, KY
 WAIN Columbia, KY
 WAIN-FM Columbia, KY
 WCTT-FM Corbin, KY
 WMGE(FM) Danzville, KY
 WQXE(FM) Elizabethtown, KY
 WFKY Frankfort, KY
 WFKN Frankfort, KY
 WFUL Fulton, KY
 WFUL-FM Fulton, KY
 WKAY Glasgow, KY
 WHIC Hardinsburg, KY
 WHIC-FM Hardinsburg, KY
 WHLN Harlan, KY
 WKIC Hazard, KY
 WBI(FM) Henderson, KY
 WHOP Hopkinsville, KY
 WKOA Hopkinsville, KY
 WJKY Jamestown, KY
 WREM Jenkins, KY
 WREM-FM Jenkins, KY
 WBLG Lexington, KY
 WVLK-FM Lexington, KY
 WFTG-FM London, KY
 WAVE Louisville, KY
 WHAS Louisville, KY
 WFMW-FM Madisonville, KY
 WTTL Madisonville, KY
 WMLJ Marion, KY
 WXID(FM) Mayfield, KY
 WMIK-FM Middleboro, KY
 WKYM(FM) Monticello, KY
 WMSK Morganfield, KY
 WMSK-FM Morganfield, KY
 WAAW(FM) Murray, KY
 WPKE Pikeville, KY
 WDOC Prestonburg, KY
 WDOC-FM Prestonburg, KY
 WSTM(FM) St. Matthews, KY
 KALB Alexandria, LA
 KSL(FM) Alexandria, LA
 KSYL Alexandria, LA
 KTRY-FM Bastrop, LA
 WAIL Baton Rouge, LA
 WJBO Baton Rouge, LA
 WARB Covington, LA
 KAJN Crowley, LA
 KSGI Crowley, LA
 KDLA De Ridder, LA
 KTDL Ferrville, LA
 KFRA Franklin, LA
 KFRA-FM Franklin, LA
 WKQT Garyville, LA
 WFRP-FM Hammond, LA
 WTGI(FM) Hammond, LA
 KLUV Haynesville, LA
 KHOM(FM) Houma, LA
 KJEF-FM Jennings, LA
 WCKW(FM) La Place, LA
 KPFL Lafayette, LA
 KPFL-FM Lafayette, LA
 KLCL-FM Lake Charles, LA
 KMLB Monroe, LA
 KVOE New Iberia, LA
 WGSO New Orleans, LA
 WSMB New Orleans, LA
 KRUS-FM Ruston, LA
 KRMD Shreveport, LA
 KRMD-FM Shreveport, LA
 KVCL-FM Winnfield, LA
 KMAR Winsboro, LA
 KMAR-FM Winsboro, LA
 WLBZ Bangor, ME
 WIDE Biddford, ME
 WIDE-FM Biddford, ME
 WKXA Brunswick, ME
 WKXA-FM Brunswick, ME
 WODY Calais, ME
 WDME Dover Foxcroft, ME
 WDEA Ellsworth, ME
 WDEA-FM Ellsworth, ME
 WLVC Fort Kent, ME
 WABK Gardiner, ME
 WHOU Houlton, ME
 WLAM Lewiston, ME
 WLKN Lincoln, ME
 WLKN-FM Lincoln, ME
 WSJR Madawaska, ME
 WMKR Millinocket, ME
 WCSH Portland, ME
 WGAN Portland, ME
 WAGM Presque Isle, ME
 WDHP(FM) Presque Isle, ME
 WRKD Rockland, ME
 WRKD-FM Rockland, ME

WRUM-FM Rumford, ME
 WRUM Rumford, ME
 WSME Sanford, ME
 WSME-FM Sanford, ME
 WTOS-FM Skowhegan, ME
 WTVL Waterville, ME
 WTVL-FM Waterville, ME
 WNAV Annapolis, MD
 WNAV-FM Annapolis, MD
 WBAL Baltimore, MD
 WCBM Baltimore, MD
 WFBF Baltimore, MD
 WITH Baltimore, MD
 WMAR-FM Baltimore, MD
 WYOB Bel Air, MD
 WCTR Chestertown, MD
 WKGO(FM) Cumberland, MD
 WUOK Cumberland, MD
 WSER Elkton, MD
 WFMD Frederick, MD
 WARK Hagerstown, MD
 WARK-FM Hagerstown, MD
 WJEJ Hagerstown, MD
 WJEJ-FM Hagerstown, MD
 WHAG Halfway, MD
 WASA Havre De Grace, MD
 WKIK Leonardtown, MD
 WPTX Lexington Park, MD
 WETT Ocean City, MD
 WDMV Pocomoke City, MD
 WBOC Salisbury, MD
 WTRF-FM Westminster, MD
 WARA Attleboro, MA
 WMLO Beverly, MA
 WCOZ(FM) Boston, MA
 WEEI-FM Boston, MA
 WEZE Boston, MA
 WHDH Boston, MA
 WMEX Boston, MA
 WBET Brockton, MA
 WBET-FM Brockton, MA
 WOKW Brockton, MA
 WBOS(FM) Brookline, MA
 WTYM East Longmeadow, MA
 WALE Fall River, MA
 WCIB(FM) Falmouth, MA
 WFLG Fitchburg, MA
 WFMF(FM) Fitchburg, MA
 WKOX Framingham, MA
 WBSB Great Barrington, MA
 WHAI Greenfield, MA
 WHAI-FM Greenfield, MA
 WREB Holyoke, MA
 WOCM Lawrence, MA
 WLMS Leominster, MA
 WCAP Lowell, MA
 WLYN Lynn, MA
 WRSO Marlboro, MA
 WWEL Medford, MA
 WMRC Milford, MA
 WNBH New Bedford, MA
 WNBH New Bedford, MA
 WNBH North Adams, MA
 WHMP Northampton, MA
 WHMP-FM Northampton, MA
 WCAT Orange, MA
 WVLC Orleans, MA
 WVLC-FM Orleans, MA
 WBRK Pittsfield, MA
 WBRK-FM Pittsfield, MA
 WQRB(FM) Pittsfield, MA
 WPLM Plymouth, MA
 WPLM-FM Plymouth, MA
 WESX Salem, MA
 WESO Southbridge, MA
 WHYN-FM Springfield, MA
 WMAS Springfield, MA
 WMAS-FM Springfield, MA
 WPEP Taunton, MA
 WRLM(FM) Taunton, MA
 WHET Waltham, MA
 WARE Ware, MA
 WOCB West Yarmouth, MA
 WOCB-FM West Yarmouth, MA
 WDEW Westfield, MA
 WSRF(FM) Worcester, MA
 WTAG Worcester, MA
 WABJ Adrian, MI
 WALM Albion, MI
 WFCY Alma, MI
 WATZ Alpena, MI
 WHSB(FM) Alpena, MI
 WPAG Ann Arbor, MI
 WPAG-FM Ann Arbor, MI
 WLEW-FM Bad Axe, MI
 WBCK Battle Creek, MI
 WKFR-FM Battle Creek, MI
 WHFB Benton Harbor, MI
 WHFB-FM Benton Harbor, MI
 WBRN Big Rapids, MI
 WBRN-FM Big Rapids, MI
 WKJF(FM) Cadillac, MI
 WWAM Cadillac, MI

WCER Charlotte, MI
 WCER-FM Charlotte, MI
 WCBY Cheboygan, MI
 WTVB Coldwater, MI
 WGRP(FM) Detroit, MI
 WJR-FM Detroit, MI
 WDM(FM) Detroit, MI
 WOMC(FM) Detroit, MI
 WWJ-FM Detroit, MI
 WXYZ Detroit, MI
 WDWOW Dowagiac, MI
 WDWOW-FM Dowagiac, MI
 WFMK(FM) East Lansing, MI
 WBDN Escanaba, MI
 WDBC Escanaba, MI
 WDFD Flint, MI
 WGMZ(FM) Flint, MI
 WTRX Flint, MI
 WSHN Fremont, MI
 WSHN-FM Fremont, MI
 WJFM(FM) Grand Rapids, MI
 WOOD Grand Rapids, MI
 WYON(FM) Grand Rapids, MI
 WGRY Grayling, MI
 WPLB Greenville, MI
 WBCH Hastings, MI
 WHTC Holland, MI
 WJBL Holland, MI
 WHGR Houghton Lake, MI
 WHMI Howell, MI
 WION Ionia, MI
 WJNR-FM Iron Mountain, MI
 WJPD Ishpeming, MI
 WJPD-FM Ishpeming, MI
 WKHM Jackson, MI
 WKHM-FM Jackson, MI
 WKPR Kalamazoo, MI
 WKZO Kalamazoo, MI
 WYYY Kalamazoo, MI
 WILS Lansing, MI
 WTHM Lapeer, MI
 WKLA Ludington, MI
 WKLA-FM Ludington, MI
 WTIQ Manistique, MI
 WELF-FM Marshall, MI
 WAGN Menominee, MI
 WMPX Midland, MI
 WVMO(FM) Monroe, MI
 *WMHW(FM) Mount Pleasant, MI
 WCEN Mount Pleasant, MI
 WGOX Muskegon, MI
 WQXO(FM) Muskegon, MI
 WKBZ Muskegon, MI
 WQWQ-FM Muskegon, MI
 WNBV Newberry, MI
 WJML Petoskey, MI
 WJML-FM Petoskey, MI
 WMBN Petoskey, MI
 WMBN-FM Petoskey, MI
 *WSDP(FM) Plymouth, MI
 WSPN Pontiac, MI
 WHLS Port Huron, MI
 WJPW Rockford, MI
 WKNX Saginaw, MI
 WSGW Saginaw, MI
 WMIC Sandusky, MI
 WMIC-FM Sandusky, MI
 WSOO Saut Ste. Marie, MI
 WJOR South Haven, MI
 WIDG St. Ignace, MI
 WRBJ St. Johns, MI
 WRBJ-FM St. Johns, MI
 WSTR Sturgis, MI
 WSTR-FM Sturgis, MI
 WIOS Tawas City, MI
 WLKM Three Rivers, MI
 WLKM-FM Three Rivers, MI
 WLDR(FM) Traverse City, MI
 WLRC Whitehall, MI
 WYGR Wyoming, MI
 KXRA Alexandria, MN
 KANO Anoka, MN
 KQAO Austin, MN
 KBHP(FM) Bemidji, MN
 KBUN Bemidji, MN
 KBEW Blue Earth, MN
 KBEW-FM Blue Earth, MN
 KVBR Brainerd, MN
 KBMW Breckenridge, MN
 KKWB(FM) Breckenridge, MN
 KRWC Buffalo, MN
 KABG(FM) Cambridge, MN
 WKLK Cloquet, MN
 KDLM Detroit Lakes, MN
 KVLRF(FM) Detroit Lakes, MN
 WWJC Duluth, MN
 WELY Ely, MN
 WEVE Eveleth, MN
 KSUM Fairmont, MN
 KDHL Fairbault, MN
 KDHL-FM Fairbault, MN
 WMFG Hibbing, MN

WMFG-FM Hibbing, MN
 KDUZ Hutchinson, MN
 KDUZ-FM Hutchinson, MN
 KGHS International Falls, MN
 KLFD Litchfield, MN
 KLFD-FM Litchfield, MN
 KEYL Long Prairie, MN
 KEYC-FM Mankato, MN
 *KMSU(FM) Mankato, MN
 KTOE Mankato, MN
 KYSM Mankato, MN
 KYSM-FM Mankato, MN
 WMIN Maplewood, MN
 KMHL Marshall, MN
 KMHL-FM Marshall, MN
 WCCO Minneapolis, MN
 KDMA Montevideo, MN
 KIDA(FM) Moorhead, MN
 KMRS Morris, MN
 KNUJ New Ulm, MN
 KNUJ-FM New Ulm, MN
 KYMN Northfield, MN
 KROF Owatonna, MN
 KRFO-FM Owatonna, MN
 KLOH-FM Pipestone, MN
 KCUE-FM Red Wing, MN
 KLGR Redwood Falls, MN
 KROC Rochester, MN
 KROC-FM Rochester, MN
 KRWB Roseau, MN
 KSMM Shakopee, MN
 KCLD St. Cloud, MN
 KCLD-FM St. Cloud, MN
 KFMX(FM) St. Louis Park, MN
 KSTP-FM St. Paul, MN
 WAVN Stillwater, MN
 WHLB Virginia, MN
 WIRN(FM) Virginia, MN
 KWAD Wadena, MN
 KOWO Waseca, MN
 KODE-FM Waseca, MN
 KDOM Windom, MN
 KAGE Winona, MN
 KWQA Worthington, MN
 WMPA Aberdeen, MS
 WHII Bay Springs, MS
 WCLD Cleveland, MS
 WFFF-FM Columbia, MS
 WCBF Columbus, MS
 WJWFF(FM) Columbus, MS
 WDRU(FM) Drew, MS
 WBAQ(FM) Greenville, MS
 WGRM Greenwood, MS
 WFOR Hattiesburg, MS
 WHER(FM) Hattiesburg, MS
 WHSY Hattiesburg, MS
 WCPC-FM Houston, MS
 WNLA Indianola, MS
 WNLA-FM Indianola, MS
 WJDX Jackson, MS
 WSLI Jackson, MS
 WAML Laurel, MS
 WSJC Magee, MS
 WQMA Marks, MS
 WHNY McComb, MS
 WDAL-FM Meridian, MS
 WMIS Natchez, MS
 WGTOT(FM) Newton, MS
 WHOC Philadelphia, MS
 WJOJ(FM) Picayune, MS
 *WNJC-FM Senatobia, MS
 WSMU-FM Starkville, MS
 WSSO Starkville, MS
 WTYL Tylertown, MS
 WTYL-FM Tylertown, MS
 WQBC Vicksburg, MS
 WQMV(FM) Vicksburg, MS
 WABO-FM Waynesboro, MS
 WKBB(FM) West Point, MS
 WIGG Wiggins, MS
 KSOA Ava, MO
 KBLR Bolivar, MO
 KLTB(FM) Bolivar, MO
 KIRK-FM Branson, MO
 KBHM Branson, MO
 KGHM Brookfield, MO
 *KBFL(FM) Buffalo, MO
 KMNR Cameron, MO
 KFMP(FM) Cape Girardeau, MO
 KAOL Carrollton, MO
 KAOL-FM Carrollton, MO
 KDMO Carthage, MO
 KRKG(FM) Carthage, MO
 KCRV Caruthersville, MO
 KCHR Charleston, MO
 *KBIA(FM) Columbia, MO
 KESM El Dorado Springs, MO
 KESM-FM El Dorado Springs, MO
 KREI Farmington, MO
 KFMO Flat River, MO
 KJFF(FM) Jefferson City, MO

KJMO(FM) Jefferson City, MO
 KJMO Jefferson City, MO
 KODE Joplin, MO
 KPCG(FM) Joplin, MO
 KAYQ Kansas City, MO
 KCEZ(FM) Kansas City, MO
 KCMO Kansas City, MO
 KMBR(FM) Kansas City, MO
 KMBZ Kansas City, MO
 WDAF Kansas City, MO
 WHB Kansas City, MO
 KBOA Kennett, MO
 KRXL(FM) Kirksville, MO
 KJEL Lebanon, MO
 KJEL-FM Lebanon, MO
 KLWT Lebanon, MO
 KMFL-FM Marshall, MO
 KNIM Maryville, MO
 KNIM-FM Maryville, MO
 KXEO Mexico, MO
 KRES(FM) Moberly, MO
 KWIX Moberly, MO
 KBTN Neosho, MO
 KNEM Nevada, MO
 KPBM-FM Poplar Bluff, MO
 KTTR Rolla, MO
 KETU(FM) Salem, MO
 KSIS Sedalia, MO
 KSIS-FM Sedalia, MO
 KMPL Sikeston, MO
 KSIM Sikeston, MO
 KBUX Springfield, MO
 KGBX Springfield, MO
 KTXR(FM) Springfield, MO
 KMOX-FM St. Louis, MO
 KSD St. Louis, MO
 WEW St. Louis, MO
 KTUI Sullivan, MO
 KLPW Union, MO
 KFBD-FM Waynesville, MO
 KWPM-FM West Plains, MO
 KGLM-FM Anacosta, MT
 KGVW Belgrade, MT
 KURL Billings, MT
 KURL-FM Billings, MT
 KBMN Bozeman, MT
 KBOZ Bozeman, MT
 KBOW Butte, MT
 KBOW-FM Butte, MT
 KXLF Butte, MT
 KDBM Dillon, MT
 KXGN Glendive, MT
 KANR(FM) Great Falls, MT
 KARR Great Falls, MT
 KOPR-FM Great Falls, MT
 KOJM Havre, MT
 KPQX(FM) Havre, MT
 KBLL Helena, MT
 *KHTC(FM) Helena, MT
 KOFI Kalispell, MT
 KXLO Lewistown, MT
 KLCM-FM Lewistown, MT
 KLCB Libby, MT
 KPRK Livingston, MT
 KATL Miles City, MT
 KGVW Missoula, MT
 KYSS-FM Missoula, MT
 KPWD(FM) Plentywood, MT
 KCGM(FM) Scooby, MT
 KSEN Shelby, MT
 KSEN-FM Shelby, MT
 KGCS Sidney, MT
 KVCK Wolf Point, MT
 KCOW Alliance, NE
 KCSR Chadron, NE
 KTTT Columbus, NE
 KTTT-FM Columbus, NE
 KAMI Cozad, NE
 KTNC Falls City, NE
 KHUB Fremont, NE
 KHUB-FM Fremont, NE
 KMMJ Grand Island, NE
 KRGI Grand Island, NE
 KHAS Hastings, NE
 KUVR Holdrege, NE
 KUVR-FM Holdrege, NE
 KGFV Kearney, NE
 *KOVF-FM Kearney, NE
 KIMB Kimball, NE
 KRNV-FM Lexington, NE
 KFMO(FM) Lincoln, NE
 KFOR Lincoln, NE
 KLIN Lincoln, NE
 KLIN-FM Lincoln, NE
 *KRNUL(FM) Lincoln, NE
 KBRL McCook, NE
 KICX McCook, NE
 KNCY Nebraska City, NE
 KNCY-FM Nebraska City, NE
 WJAG Norfolk, NE
 WJAG-FM Norfolk, NE
 KODY North Platte, NE
 KIBC(FM) Ogallala, NE

KOGA Ogallala, NE
 KEFM(FM) Omaha, NE
 KOWH Omaha, NE
 KOWH-FM Omaha, NE
 WOW Omaha, NE
 KNLY Ord, NE
 KOTD Plattsmouth, NE
 KNEB Scottsbluff, NE
 KNEB-FM Scottsbluff, NE
 KOLT Scottsbluff, NE
 KSID Sidney, NE
 KSID-FM Sidney, NE
 KVSH Valentine, NE
 KTCH Wayne, NE
 KTCH-FM Wayne, NE
 KAWL York, NE
 KAWL-FM York, NE
 KPFL Carson City, NV
 KELK Eiko, NV
 KVLV-FM Fallon, NV
 KDOWN Las Vegas, NV
 KLVG Las Vegas, NV
 KORK Las Vegas, NV
 *KRUD(FM) Las Vegas, NV
 KCRL Reno, NV
 KNEV(FM) Reno, NV
 KOBY Reno, NV
 KOLO Reno, NV
 KSRN(FM) Reno, NV
 KRNA Winnemucca, NV
 WKXL Concord, NV
 WKXL-FM Concord, NV
 WKXR Exeter, NH
 WKXR-FM Exeter, NH
 WFTN Franklin, NH
 WTSL Hanover, NH
 WEMJ Laconia, NH
 WLNH Laconia, NH
 WLNH-FM Laconia, NH
 WLTN Littleton, NH
 WGIR Manchester, NH
 WGIR-FM Manchester, NH
 WZID(FM) Manchester, NH
 WSMN Nashua, NH
 WSCV Peterborough, NH
 WSLV(FM) Peterborough, NH
 WPNH Plymouth, NH
 WPNH-FM Plymouth, NH
 WBBX Portsmouth, NH
 WASR Wolfboro, NH
 WJLK Asbury Park, NJ
 WJLK-FM Asbury Park, NJ
 WFPG Atlantic City, NJ
 WMD Atlantic City, NJ
 WSNJ Bridgeton, NJ
 WSNJ-FM Bridgeton, NJ
 *WKDN-FM Camden, NJ
 WTMR Camden, NJ
 WDHA-FM Dover, NJ
 WRDR(FM) Egg Harbor, NJ
 WJDM Elizabeth, NJ
 *WHPH(FM) Hanover, NJ
 *WVHP-FM Highland Park, NJ
 WRLB(FM) Long Branch, NJ
 WMTT Morristown, NJ
 WCTC New Brunswick, NJ
 WQMR(FM) New Brunswick, NJ
 WNNJ Newton, NJ
 WPRJ Parsippany, NJ
 WERA Plainfield, NJ
 WOND Pleasantville, NJ
 WHWH Princeton, NJ
 WJIC Salem, NJ
 WBRW Somerville, NJ
 WKMB Stirling, NJ
 WOBM(FM) Toms River, NJ
 WPST(FM) Trenton, NJ
 WTTM Trenton, NJ
 WCMC Wildwood, NJ
 WCMC-FM Wildwood, NJ
 KDEF Albuquerque, NM
 KDEF-FM Albuquerque, NM
 KKIM Albuquerque, NM
 KOB Albuquerque, NM
 KPAR Albuquerque, NM
 KARS Belen, NM
 KAVE Carlsbad, NM
 KOTS Deming, NM
 KENN Farmington, NM
 KGAK Gallup, NM
 KSCR(FM) Hobbs, NM
 KNEW Hobbs, NM
 KOBE Las Cruces, NM
 KFUIN-FM Las Vegas, NM
 KRTN Raton, NM
 KBIM-FM Roswell, NM
 KSWS Roswell, NM

Formats

KRRR Ruidoso, NM
 KAFE-FM Santa Fe, NM
 KSNM(FM) Santa Fe, NM
 KTRC Santa Fe, NM
 KSIL Silver City, NM
 KSRC Socorro, NM
 WROW Albany, NY
 WCS5 Amsterdam, NY
 WAUB Auburn, NY
 WMBO Auburn, NY
 WGLI Babylon, NY
 *WBXL(FM) Baldwinsville, NY
 WBTA Batavia, NY
 WBNF Binghamton, NY
 WBRV Boonville, NY
 WPUT Brewster, NY
 WADD Brockport, NY
 WADV(FM) Buffalo, NY
 WEBR Buffalo, NY
 WGR Buffalo, NY
 WREZ(FM) Buffalo, NY
 WCGR Canandaigua, NY
 *WLSL(FM) Canton, NY
 WKCL Catskill, NY
 WBCA Corning, NY
 WCLI Corning, NY
 WCLI-FM Corning, NY
 WWLE Cornwall, NY
 WKRT Cortland, NY
 WKRT-FM Cortland, NY
 WFLR Dundee, NY
 WFLR-FM Dundee, NY
 WDOE Dunkirk, NY
 WELV Ellenville, NY
 WELV-FM Ellenville, NY
 WEHM-FM Elmira, NY
 WELM Elmira, NY
 WEHH Elmira Heights, NY
 WMRV(FM) Endicott, NY
 WBUZ Fredonia, NY
 WGBB Freeport, NY
 WOSC Fulton, NY
 WGVV Geneva, NY
 WBZA Glens Falls, NY
 WWSC Glens Falls, NY
 WWSC-FM Glens Falls, NY
 WENT Gloversville, NY
 WIGS Gouverneur, NY
 WIGS-FM Gouverneur, NY
 WHLI Hempstead, NY
 WALY Herkimer, NY
 WHHO Hornell, NY
 WHHO-FM Hornell, NY
 WLIX Islip, NY
 WEIV(FM) Ithaca, NY
 WJTN Jamestown, NY
 WWSE(FM) Jamestown, NY
 WIZR Johnstown, NY
 WIZR-FM Johnstown, NY
 WGHQ Kingston, NY
 WKNY Kingston, NY
 WIRD Lake Placid, NY
 *WSHR(FM) Lake Ronkonkoma, NY
 WVOS Liberty, NY
 WVOS-FM Liberty, NY
 WLFH Little Falls, NY
 WICY Malone, NY
 WMYI Mechanicville, NY
 WVIP Mount Kisco, NY
 WVIP-FM Mount Kisco, NY
 WRKL New City, NY
 WABC New York, NY
 WNBC New York, NY
 WNEW New York, NY
 WRFM(FM) New York, NY
 WACK Newark, NY
 WFMN(FM) Newburgh, NY
 WNGY Newburgh, NY
 WHLD Niagara Falls, NY
 WHLD-FM Niagara Falls, NY
 WJLI Niagara Falls, NY
 WCHN Norwich, NY
 WCHN-FM Norwich, NY
 WDOS Oneonta, NY
 WEBO Owego, NY
 WEBO-FM Owego, NY
 WGF(BM) Plattsburgh, NY
 WDLB Port Jervis, NY
 WDLB-FM Port Jervis, NY
 WPDAM Potsdam, NY
 WPDAM-FM Potsdam, NY
 WEOK Poughkeepsie, NY
 WSPK(FM) Poughkeepsie, NY
 WKIP Poughkeepsie, NY
 WEZO(FM) Rochester, NY
 WHAM Rochester, NY
 WYOR(FM) Rochester, NY
 WRNY Rome, NY
 WLNG Sag Harbor, NY

WLNG-FM Sag Harbor, NY
 WNBZ Saranac Lake, NY
 WKAJ Saratoga Springs, NY
 WKAJ-FM Saratoga Springs, NY
 WGF(FM) Schenectady, NY
 WGY Schenectady, NY
 WSNY Schenectady, NY
 WSWF Seneca Falls, NY
 WSWF-FM Seneca Falls, NY
 WKWQ Spring Valley, NY
 WFBL Syracuse, NY
 WHEN Syracuse, NY
 WFY(FM) Troy, NY
 WIBO(FM) Utica, NY
 WIBX Utica, NY
 WRUN Utica, NY
 WTLB-FM Utica, NY
 WDLA Walton, NY
 WDLA-FM Walton, NY
 WCJW Warsaw, NY
 WTBO Warwick, NY
 WATN Watertown, NY
 WNCQ(FM) Watertown, NY
 WGMF Watkins Glen, NY
 WAFR(FM) Waverly, NY
 WLSV Wellsville, NY
 WFA5 White Plains, NY
 WWDY(FM) White Plains, NY
 WRCS Aoshkie, NC
 WGWR Asheboro, NC
 WZOO Asheboro, NC
 WKKE Asheville, NC
 WCGC Belmont, NC
 WPNF Brevard, NC
 *WCCE(FM) Buie's Creek, NC
 WB2 Charlotte, NC
 WEZC(FM) Charlotte, NC
 WROQ(FM) Charlotte, NC
 WSOC Charlotte, NC
 WCKB Dunn, NC
 WIFM Elkin, NC
 WIFM-FM Elkin, NC
 WFSC Franklin, NC
 WFSC-FM Franklin, NC
 WQMG(FM) Greensboro, NC
 WIRC Hickory, NC
 WJNC Jacksonville, NC
 WKMT Kings Mountain, NC
 WFTC Kinston, NC
 WEWO Laurinburg, NC
 WBUV Lexington, NC
 WLXN(FM) Lexington, NC
 WJSK(FM) Lumberton, NC
 WTSB Lumberton, NC
 WTSB-FM Lumberton, NC
 WBRM Marion, NC
 WMAP Monroe, NC
 WPAQ Mount Airy, NC
 WDDR-FM Murfreesboro, NC
 WKRK Murphy, NC
 WKBC-FM North Wilkesboro, NC
 WPTF Raleigh, NC
 WAYN Rockingham, NC
 WCEC Rocky Mount, NC
 WRXO Roxboro, NC
 WVCB Rutherfordton, NC
 WSAT Salisbury, NC
 WSTP Salisbury, NC
 WADA Shelby, NC
 WMPM Smithfield, NC
 WGAS South Gastonia, NC
 WEEB Southern Pines, NC
 WIOE(FM) Southern Pines, NC
 WOTZ Spruce Pine, NC
 WSIC Statesville, NC
 WCPS Tarboro, NC
 WCPS-FM Tarboro, NC
 WTRQ Warsaw, NC
 WEEW Washington, NC
 WITN Washington, NC
 WHCC Waynesville, NC
 NEW AM Whiteville, NC
 WWWW Wilkesboro, NC
 WIAM Williamston, NC
 WSEC(FM) Williamston, NC
 WAAY(FM) Wilmington, NC
 WHSL Wilmington, NC
 WMFD Wilmington, NC
 WGTM Wilson, NC
 WSEZ(FM) Winston-Salem, NC
 WSJS Winston-Salem, NC
 WTOB Winston-Salem, NC
 KBOM Bismarck-Mandan, ND
 KDAK Carrington, ND
 KDLR Devils Lake, ND
 KPXO Grafton, ND
 KNOX Grand Forks, ND
 KNDC Hettinger, ND
 KEYJ Jamestown, ND
 KSJM(FM) Jamestown, ND

KCJB-FM Minot, ND
 KHRT Minot, ND
 KLPM Minot, ND
 KMOT-FM Minot, ND
 KGCA Rugby, ND
 KOVC Valley City, ND
 WFAH-FM Alliance, OH
 WHFD(FM) Archbold, OH
 WNCO Ashland, OH
 WAQI Ashtabula, OH
 WREO-FM Ashtabula, OH
 WATH Athens, OH
 WAWR-FM Bowling Green, OH
 WBNO Bryan, OH
 WBNO-FM Bryan, OH
 WBCO Bucyrus, OH
 WBCO-FM Bucyrus, OH
 WLE Cambridge, OH
 WILE-FM Cambridge, OH
 WHBC Canton, OH
 WOJO Canton, OH
 WMER(FM) Celina, OH
 WBKC Chardon, OH
 WBEX Chillicothe, OH
 WCKY Cincinnati, OH
 *WJVS(FM) Cincinnati, OH
 WLOA(FM) Cincinnati, OH
 WLW Cincinnati, OH
 WNRE Circleville, OH
 WGAR Cleveland, OH
 WJW Cleveland, OH
 WMM(FM) Cleveland, OH
 WQAL(FM) Cleveland, OH
 WWWW Cleveland, OH
 WBNS Columbus, OH
 WMNI-FM Columbus, OH
 WRFD Columbus, OH
 WTVN Columbus, OH
 WTNS Coshocton, OH
 WTNS-FM Coshocton, OH
 WHIO Dayton, OH
 WHIO-FM Dayton, OH
 WONW Defiance, OH
 WDLR Delaware, OH
 WJER Dover-New Philadelphia, OH
 WJER-FM Dover-New Philadelphia, OH
 WELA(FM) East Liverpool, OH
 WOHI East Liverpool, OH
 WEOL Elyria, OH
 WFIN Findlay, OH
 WFOB Fostoria, OH
 WFOB-FM Fostoria, OH
 WJEH Gallipolis, OH
 WURD(FM) Georgetown, OH
 WHTH Heath, OH
 WSRW Hillsboro, OH
 WSRW-FM Hillsboro, OH
 WIRO Ironton, OH
 *WKET(FM) Kettering, OH
 WHOK Lancaster, OH
 WIMA Lima, OH
 WMAN Mansfield, OH
 WYNO-FM Mansfield, OH
 *WCMO(FM) Marietta, OH
 WMRN Marion, OH
 WITG Massillon, OH
 WDBN(FM) Medina, OH
 WMPO Middleport, OH
 WMPO-FM Middleport, OH
 WPBF(FM) Middletown, OH
 WMOV Mount Vernon, OH
 WNDH(FM) Napoleon, OH
 WNPQ(FM) New Philadelphia, OH
 WCLT Newark, OH
 WCLT-FM Newark, OH
 WNKO(FM) Newark, OH
 WPVL Painesville, OH
 WSUM Parma, OH
 WLEC Sandusky, OH
 WMVR-FM Sidney, OH
 WBLV Springfield, OH
 WLIT Steubenville, OH
 WSTV Steubenville, OH
 *WKT(FM) Struthers, OH
 WTTT Tiffin, OH
 WTTT-FM Tiffin, OH
 WCWA Toledo, OH
 WLOR(FM) Toledo, OH
 WSPD Toledo, OH
 WBTC Uhrichsville, OH
 WYAN-FM Upper Sandusky, OH
 WCOM-FM Urbana, OH
 WTCL Warren, OH
 WCHO Washington Court House, OH
 WCHO-FM Washington Court House, OH
 WIBO(FM) Waverly, OH
 WKOV Wellston, OH

WKFI Wilmington, OH
 WWST Wooster, OH
 WWST-FM Wooster, OH
 WKBN Youngstown, OH
 KADA Ada, OK
 KTFN-FM Ada, OK
 KWHW Altus, OK
 KRPT Anadarko, OK
 KKAJ(FM) Ardmore, OK
 KWON Bartlesville, OK
 KWCO Chickasha, OK
 KWPR Claremore, OK
 KRHD Duncan, OK
 KSEO Durant, OK
 KSEO-FM Durant, OK
 *KSCS(FM) Edmond, OK
 KCRC-FM Enid, OK
 KHEN Henryetta, OK
 KHEN-FM Henryetta, OK
 KTJS Hobart, OK
 KLAW(FM) Lawton, OK
 KRLG(FM) Lawton, OK
 KNED McAlester, OK
 KMMM-FM Muskogee, OK
 KMUS Muskogee, OK
 KNFB(FM) Nowata, OK
 KOCY Oklahoma City, OK
 KOFM(FM) Oklahoma City, OK
 KTOK Oklahoma City, OK
 KVLH Pauls Valley, OK
 KOKN Pawhuska, OK
 WBBZ Ponca City, OK
 KLCO Poteau, OK
 KKMA(FM) Pryor, OK
 KXJO Sapulpa, OK
 KSPI Stillwater, OK
 KSPI-FM Stillwater, OK
 KRAV(FM) Tulsa, OK
 KRMG Tulsa, OK
 KXXO Tulsa, OK
 KWEY Weatherford, OK
 KWSH Wewoka, OK
 KHPE(FM) Albany, OR
 KWIL Albany, OR
 KAST Astoria, OR
 KBKR Baker, OR
 KBND Bend, OR
 KICE(FM) Bend, OR
 KURY Brookings, OR
 KOOS Coos Bay, OR
 KWRO Coquille, OR
 KFLY-FM Corvallis, OR
 KNND Cottage Grove, OR
 KWVR Enterprise, OR
 KPNW-FM Eugene, OR
 KUGN Eugene, OR
 KAJO Grants Pass, OR
 KOHU Hermiston, OR
 KUIK Hillsboro, OR
 KIHR Hood River, OR
 KAGM(FM) Klamath Falls, OR
 KFLS Klamath Falls, OR
 KFMT(FM) La Grande, OR
 KOIK Lakeview, OR
 KBCH Lincoln City, OR
 KMED Medford, OR
 KNPT Newport, OR
 KNPT-FM Newport, OR
 KSRV Ontario, OR
 KXYI Oregon City, OR
 *KRBM(FM) Pendleton, OR
 KEX Portland, OR
 KJIB(FM) Portland, OR
 KOIN Portland, OR
 KQFM(FM) Portland, OR
 KRCC Prineville, OR
 KDUN Reedsport, OR
 KQEN Roseburg, OR
 KRFB(FM) Roseburg, OR
 KSLM Salem, OR
 KFIR Sweet Home, OR
 KACI The Dalles, OR
 KODL The Dalles, OR
 WKXW(FM) Altontown, PA
 WFBG-FM Allentown, PA
 WMBIA Ambridge, PA
 WAHT Anville-Cleona, PA
 WBLF Bellefonte, PA
 WBRX Berwick, PA
 WGPA Bethlehem, PA
 WHLM Bloomsburg, PA
 WHLM-FM Bloomsburg, PA
 WLOA Braddock, PA
 WLOA-FM Braddock, PA
 WBUT Butler, PA
 WBUT-FM Butler, PA
 WISR Butler, PA
 WHYL Carlisle, PA
 WHYL-FM Carlisle, PA
 WCCS(FM) Central City, PA
 WESA Charleroi, PA
 WWF(FM) Charleroi, PA

WVCH Chester, PA
 WWCN Clarion, PA
 WCPA-FM Clearfield, PA
 WCOJ Coatesville, PA
 WCVI Conneville, PA
 WBUX Doylestown, PA
 WEST Easton, PA
 WPDCE Elizabethtown, PA
 WPDCE-FM Elizabethtown, PA
 WGSa Ephrata, PA
 WLVIU(FM) Erie, PA
 WRIE Erie, PA
 WFRa Franklin, PA
 WVEN(FM) Franklin, PA
 WKSL(FM) Greencastle, PA
 WHVR Hanover, PA
 WCMB Harrisburg, PA
 WHP Harrisburg, PA
 WFSM(FM) Harrisburg, PA
 WHPA Honesdale, PA
 WHUN Huntingdon, PA
 WHUN-FM Huntingdon, PA
 WDAW Indiana, PA
 WQMU(FM) Indiana, PA
 WBCW Jeannette, PA
 WJBF-FM Jenkintown, PA
 WJAC Johnstown, PA
 WJAC-FM Johnstown, PA
 WJNL Johnstown, PA
 WJNL-FM Johnstown, PA
 *WFMN(FM) Lancaster, PA
 WLSH Lansford, PA
 WLBK Lebanon, PA
 WBCB Levittown, PA
 WVCC(FM) Linesville, PA
 WWSF Loretto, PA
 WQIN Lykens, PA
 WEDO McKeessport, PA
 WMGW Meadville, PA
 WZPR(FM) Meadville, PA
 WRV(FM) Mercersburg, PA
 WJUN Mexico, PA
 WJUR-FM Mifflinburg, PA
 WPSL Monroeville, PA
 *WPEL-FM Montrose, PA
 WMMT Mt. Carmel, PA
 WMLJ(FM) Nanticoke, PA
 WNAK Nanticoke, PA
 WNBC New Castle, PA
 WKST New Castle, PA
 WIP Philadelphia, PA
 WPN Philadelphia, PA
 WPMG(FM) Philadelphia, PA
 WYSP(FM) Philadelphia, PA
 WPHB Phillipsburg, PA
 KDKA Pittsburgh, PA
 WTAE Pittsburgh, PA
 WTAE-FM Pittsburgh, PA
 WWSF Pittsburgh, PA
 WARD Pittston, PA
 WWMJ Portage, PA
 WPAZ Pottstown, PA
 WAWT(FM) Pottsville, PA
 WPAM Pottsville, PA
 WPPA Pottsville, PA
 WPME Punxsutawney, PA
 WPME-FM Punxsutawney, PA
 WTEU Reading, PA
 WHUM Reading, PA
 WATS Sayre, PA
 WEJL Scranton, PA
 WEZX(FM) Scranton, PA
 WDDL-FM Scranton, PA
 WPIC Sharon, PA
 WSPH Shippensburg, PA
 WVSC Somerset, PA
 WVSC-FM Somerset, PA
 WKBI St. Marys, PA
 WVPO Stroudsburg, PA
 WVPO-FM Stroudsburg, PA
 WKOK Sunbury, PA
 KFIR Sunbury, PA
 WZTA(FM) Tamaqua, PA
 WTVI Titusville, PA
 WTTT Towanda, PA
 WTTT-FM Towanda, PA
 WMB5 Uniontown, PA
 WRRN(FM) Warren, PA
 WJPA Washington, PA
 WJPA-FM Washington, PA
 WKEG Washington, PA
 WANB Waynesburg, PA
 WNBW Wellsboro, PA
 WCHE West Chester, PA
 WBRF Wilkes-Barre, PA
 WBRF-FM Wilkes-Barre, PA
 WRAK Williamsport, PA
 WRAK-FM Williamsport, PA
 WWPAA Williamsport, PA
 WBSA York, PA
 WADK Newport, RI
 WEAN Providence, RI
 WJAR Providence, RI

WKRI West Warwick, RI
 WKFD Wickford, RI
 WWON Woonsocket, RI
 WWON-FM Woonsocket, RI
 WLOW Aiken, SC
 WLOW-FM Aiken, SC
 WNEZ(FM) Aiken, SC
 WDOG Allendale, SC
 WBRL Batesburg, SC
 WBRL-FM Batesburg, SC
 WPUB-FM Camden, SC
 WOSC Charleston, SC
 WOKE Charleston, SC
 WCRE Cheraw, SC
 WCCP Clemson, SC
 WIS Columbia, SC
 WNOK-FM Columbia, SC
 WELP-FM Easley, SC
 WGTN Georgetown, SC
 WINH Georgetown, SC
 WMRB Greenville, SC
 WCRS Greenwood, SC
 WCRS-FM Greenwood, SC
 WJBW-FM Hampton, SC
 WHSC Hartsville, SC
 WSDC Hartsville, SC
 WHHR(FM) Hilton Head Island, SC
 WKHJ Holly Hill, SC
 WJES Johnston, SC
 WKSC Kershaw, SC
 WDKD Kingstree, SC
 WDKD-FM Kingstree, SC
 WJOT Lake City, SC
 WPAJ-FM Lancaster, SC
 WCIG(FM) Mullins, SC
 WJAY Mullins, SC
 WMYB Myrtle Beach, SC
 WMYB-FM Myrtle Beach, SC
 WNCG North Charleston, SC
 WDX Orangeburg, SC
 WORG Orangeburg, SC
 WTND Orangeburg, SC
 WKKR Pickens, SC
 WBUG Ridgeland, SC
 WTYC Rock Hill, SC
 WBFM(FM) Seneca, SC
 WSNW Seneca, SC
 WSPA Spartanburg, SC
 WSPA-FM Spartanburg, SC
 WSSC Sumter, SC
 New FM Aberdeen, SD
 KBFS Belle Fourche, SD
 KJUV Huron, SD
 KORN Mitchell, SD
 KCCR Pierre, SD
 KOTA Rapid City, SD
 KFCE Redfield, SD
 KCHF Sioux Falls, SD
 KCHF-FM Sioux Falls, SD
 KELO Sioux Falls, SD
 KSOO Sioux Falls, SD
 KVRA Vermillion, SD
 KVRP(FM) Vermillion, SD
 KWAT Watertown, SD
 KWAT-FM Watertown, SD
 KWYR Winner, SD
 KWYR-FM Winner, SD
 KYNT Yankton, SD
 WOPI Bristol, TN
 WDEF Chattanooga, TN
 WDXB Chattanooga, TN
 WHUB-FM Cookeville, TN
 WBEJ Elizabethton, TN
 WCPH Etowah, TN
 WIZO-FM Franklin, TN
 WHBT Harriman, TN
 WIRJ Humboldt, TN
 WTJS Jackson, TN
 WKPT Kingsport, TN
 WTE Knoxville, TN
 WEZK(FM) Knoxville, TN
 WCCR-FM Lebanon, TN
 WBLC Lenoir City, TN
 WDXL Lexington, TN
 WDXL-FM Lexington, TN
 WMSR Manchester, TN
 WCMT-FM Martin, TN
 *WUTM(FM) Martin, TN
 WKTA(FM) McKenzie, TN
 WBMCFM McMinnville, TN
 WQUD(FM) Memphis, TN
 WREC Memphis, TN
 WKBJ-FM Milan, TN
 WAZI(FM) Morristown, TN
 WAMB Nashville, TN
 WLAC-FM Nashville, TN
 *WNAZ-FM Nashville, TN
 WSIX Nashville, TN
 WSM Nashville, TN
 WATO Oak Ridge, TN
 WTPR Paris, TN

WMGL(FM) Pulaski, TN
 WSM(FM) Red Bank, TN
 WOFE Rockwood, TN
 WSEV Sevierville, TN
 WHAL Shelbyville, TN
 WHAL-FM Shelbyville, TN
 WTNE Trenton, TN
 WJIG-FM Tullahoma, TN
 WVRY(FM) Waverly, TN
 WCDT Winchester, TN
 KVLV Alpine, TX
 KGNC Amarillo, TX
 KQIZ Amarillo, TX
 KWAS(FM) Amarillo, TX
 KALT Atlanta, TX
 KACO Bellville, TX
 KBYG Big Spring, TX
 KWHI-FM Brenham, TX
 KBOR Brownsville, TX
 KDUV(FM) Brownsville, TX
 KLSN(FM) Brownwood, TX
 KGAS Carthage, TX
 KCLE Cleburne, TX
 KVMC Colorado City, TX
 KNRO-FM Conroe, TX
 KRYV Corpus Christi, TX
 KAND Corsicana, TX
 KIVY-FM Crockett, TX
 KEGG Daingerfield, TX
 KXIT Dalhart, TX
 KEZT(FM) Dallas, TX
 KRLD Dallas, TX
 WFAA Dallas, TX
 KDLK-FM Del Rio, TX
 KDSX-FM Denison-Sherman, TX
 KDNT Denton, TX
 KEPS Eagle Pass, TX
 KBFM(FM) Edinburg, TX
 KRDD El Paso, TX
 KJIM Fort Worth, TX
 KPLX(FM) Fort Worth, TX
 KWXI(FM) Fort Worth, TX
 KGAF Gainesville, TX
 KGAF-FM Gainesville, TX
 KGCB Galveston, TX
 KMCS(FM) Gatesville, TX
 KGVL Greenville, TX
 KMBS(FM) Harlingen, TX
 KWRD Henderson, TX
 KPAN Hereford, TX
 KPAN-FM Hereford, TX
 KVIL Highland Park, TX
 KVIL-FM Highland Park, TX
 KHBR Hillsboro, TX
 KODA Houston, TX
 KXYZ Houston, TX
 KQUE(FM) Houston, TX
 KULF Houston, TX
 KXYZ Houston, TX
 KTXJ-FM Jasper, TX
 KERV Kerrville, TX
 KOCA Kilgore, TX
 *KNCT-FM Killeen, TX
 KPUP(FM) Kingsville, TX
 KVLG-FM La Grange, TX
 KGOL(FM) Lake Jackson, TX
 KVOZ Laredo, TX
 KOYE(FM) Laredo, TX
 KLVT Levelland, TX
 KPXE Liberty, TX
 KCLT Lockhart, TX
 KLUE Longview, TX
 KFYO Lubbock, TX
 KLUF Lufkin, TX
 KMHT Marshall, TX
 KMMK(FM) McKinney, TX
 KCRS Midland, TX
 KNAM Midland, TX
 KNFM(FM) Midland, TX
 KWEL Midland, TX
 KIMP Mount Pleasant, TX
 KPXI(FM) Mount Pleasant, TX
 KMUL Muleshoe, TX
 KJCS(FM) Nacogdoches, TX
 KWBC Navasota, TX
 KGNB New Braunfels, TX
 KBZB Odessa, TX
 KQIP(FM) Odessa, TX
 KQIB Odessa, TX
 KLSI(FM) Palestine, TX
 KGRO Pampa, TX
 KPDN Pampa, TX
 KPLT-FM Paris, TX
 KIUN Pecos, TX
 KEYE Perryton, TX
 KVOP Plainview, TX
 KPAC Port Arthur, TX
 KPAC-FM Port Arthur, TX
 KSUZ Port Neches, TX
 KGKL San Angelo, TX
 KIXY San Angelo, TX
 KIXY-FM San Angelo, TX

KWLW(FM) San Angelo, TX
 KITY(FM) San Antonio, TX
 *KSYM-FM San Antonio, TX
 WQAI San Antonio, TX
 KRMH(FM) San Marcos, TX
 KWED-FM Seguin, TX
 KIKM Sherman, TX
 KKAS Silsbee, TX
 KOUL(FM) Sinton, TX
 KCAS Slaton, TX
 KBMF-FM Spearman, TX
 KXOX Sweetwater, TX
 KTEM Temple, TX
 KPLE(FM) Temple, TX
 KITE Terrell Hills, TX
 KOSY-FM Texarkana, TX
 KNUC(FM) Tyler, TX
 KTBB Tyler, TX
 KCWM(FM) Victoria, TX
 KTXN(FM) Victoria, TX
 KWTX Waco, TX
 KBID(FM) Wichita Falls, TX
 KNTO(FM) Wichita Falls, TX
 KWFT Wichita Falls, TX
 KUTA Blanding, UT
 KBUH Brigham City, UT
 KBUH-FM Brigham City, UT
 KBRE Cedar City, UT
 KSUB Cedar City, UT
 KBLW Logan, UT
 KVLNU Logan, UT
 KMTI Manti, UT
 KURA Moab, UT
 KDAB(FM) Ogden, UT
 KLO Ogden, UT
 *KOH5(FM) Orem, UT
 K5VC Richfield, UT
 KLUB Salt Lake City, UT
 KSL Salt Lake City, UT
 KDXU St. George, UT
 KDXU-FM St. George, UT
 KVEL Vernal, UT
 WSN0 Barre, VT
 WKVT Brattleboro, VT
 WKVT-FM Brattleboro, VT
 WJOY Burlington, VT
 WVMT Burlington, VT
 WFAW Middlebury, VT
 WIKE Newport, VT
 WCVR Randolph, VT
 WHWB Rutland, VT
 WCFR Springfield, VT
 WCFR-FM Springfield, VT
 WWSR St. Albans, VT
 WTVN St. Johnsbury, VT
 *WMTF(FM) Stowe, VT
 WDEV Waterbury, VT
 WNHV White River Junction, VT
 VLSD Big Stone Gap, VA
 WKLV Blackstone, VA
 WCCV-FM Charlottesville, VA
 WCHV Charlottesville, VA
 WINA Charlottesville, VA
 WCPC Chesapeake, VA
 WXCF Clifton Forge, VA
 WDIC Clintwood, VA
 WKCY-FM Covington, VA
 WSVS Crewe, VA
 WCVL Culpeper, VA
 WBTM Danville, VA
 WFLO-FM Farmville, VA
 WBOB Galax, VA
 WBOB-FM Galax, VA
 WGAT Gate City, VA
 WNRG Grundy, VA
 WVEC Hampton, VA
 WVHR(FM) Hampton, VA
 WKCY Harrisonburg, VA
 WWSA Harrisonburg, VA
 WHAP Hopewell, VA
 KWKI(FM) Kilmarnock, VA
 WLRV Lebanon, VA
 WAGE Leesburg, VA
 WLMG Lynchburg, VA
 WLVA Lynchburg, VA
 WEZRF-FM Manassas, VA
 WOLD-FM Marion, VA
 WHEE Martinsville, VA
 WMYA Martinsville, VA
 WMYA-FM Martinsville, VA
 WTAH Norfolk, VA
 WJMA Orange, VA
 WJMA-FM Orange, VA
 WKLX Portsmouth, VA
 WXRI(FM) Norfolk, VA
 WEZS(FM) Richmond, VA
 WRGM Richmond, VA
 WRNL Richmond, VA
 WRVA Richmond, VA
 WFR Roanoke, VA
 WLRG(FM) Roanoke, VA
 WRIS Roanoke, VA

WHLF South Boston, VA
 WJWS South Hill, VA
 WTON Staunton, VA
 WANV Waynesboro, VA
 WAYB Waynesboro, VA
 WYVE Wytheville, VA
 WYVA-FM Yorktown, VA
 KXRO Aberdeen, WA
 KASY Auburn, WA
 *KASB(FM) Bellevue, WA
 KGMI Bellingham, WA
 KBRO Bremerton, WA
 KITI Chehalis, WA
 KCLX Colfax, WA
 KULE Ephrata, WA
 KVAC Forks, WA
 KFDR Grand Coulee, WA
 KONA Kennewick, WA
 KEDO Longview, WA
 KSEM Moses Lake, WA
 KBRC Mount Vernon, WA
 *KUBS(FM) Newport, WA
 KDUX-FM Ocean Shores, WA
 KGY Olympia, WA
 KORD Pasco, WA
 KORD-FM Richland, WA
 KAPY Port Angeles, WA
 KONP Port Angeles, WA
 KACA(FM) Prosser, WA
 KAPA Raymond, WA
 KEZX(FM) Seattle, WA
 KVI Seattle, WA
 KMAS Shelton, WA
 KEZE Spokane, WA
 KEZE-FM Spokane, WA
 KHQ Spokane, WA
 KXLY Spokane, WA
 KXXR-FM Spokane, WA
 KREW Sunnyside, WA
 KREW-FM Sunnyside, WA
 *KPEC-FM Tacoma, WA
 KUJ Walla Walla, WA
 KPO Wenatchee, WA
 KPO-FM Wenatchee, WA
 KIT Yakima, WA
 KMWX Yakima, WA
 WCIR-FM Beckley, WV
 WHIS Bluefield, WV
 WBUC Buckhannon, WV
 WXVA Charles Town, WV
 WZFM(FM) Charles Town, WV
 WCHS Charleston, WV
 WBOY Clarksburg, WV
 WMMN Fairmont, WV
 WTCS Fairmont, WV
 WVWV Grafton, WV
 WGNT Huntington, WV
 WKLP-FM Keyser, WV
 WKLP Keyser, WV
 WVOW Logan, WV
 WVOW-FM Logan, WV
 WETZ New Martinsville, WV
 WOAY Oak Hill, WV
 WOAY-FM Oak Hill, WV
 WADC Parkersburg, WV
 WWOY Pineville, WV
 WMOV Ravenswood, WV
 WKLC-FM St. Albans, WV
 WWSB Sutton, WV
 WELC Welch, WV
 WNEU Wheeling, WV
 WSLW White Sulphur Springs, WV
 WBTH Williamson, WV
 WATK Antigo, WI
 WHBY Appleton, WI
 WATW Ashland, WI
 WATW-FM Ashland, WI
 WLVE(FM) Baraboo, WI
 WBEV Beaver Dam, WI
 WBEV-FM Beaver Dam, WI
 WBEL Beloit, WI
 WCFW(FM) Chippewa Falls, WI
 WERL Eagle River, WI
 WERL-FM Eagle River, WI
 KFIZ Fond Du Lac, WI
 WFON(FM) Fond Du Lac, WI
 WFAW-FM Fort Atkinson, WI
 WNFL Green Bay, WI
 WTKM Hartford, WI
 WTKM-FM Hartford, WI
 WRLS-FM Hayward, WI
 WJAN Janesville, WI
 WLIP Kenosha, WI
 WLIP-FM Kenosha, WI
 WIZM La Crosse, WI
 WIKY La Crosse, WI
 WIBA Madison, WI
 WISM-FM Madison, WI
 WTSO Madison, WI
 WOMET Manitowoc, WI
 WMAM Marinette, WI

WRJC Mauston, WI
 WMNE Menomonee, WI
 WDMW(FM) Menomonee, WI
 WJMT Merrill, WI
 WJMT-FM Merrill, WI
 WEMP Milwaukee, WI
 WISN Milwaukee, WI
 WQFM(FM) Milwaukee, WI
 WTMJ Milwaukee, WI
 WCCN Neillsville, WI
 WIXK New Richmond, WI
 WMKC(FM) Oshkosh, WI
 WNBI Park Falls, WI
 WNBI-FM Park Falls, WI
 WSSW Platteville, WI
 WSSW-FM Platteville, WI
 WBYU Poyntelle, WI
 WFNW(FM) Racine, WI
 WRJN Racine, WI
 WOBT Rhinelander, WI
 WJMC Rice Lake, WI
 WJMC-FM Rice Lake, WI
 WRCO Richland Center, WI
 WRCO-FM Richland Center, WI
 WCWC Ripon, WI
 WEVR River Falls, WI
 WEVR-FM River Falls, WI
 WVLR(FM) Sauk City, WI
 WTCH Shawano, WI
 WKTS Sheboygan, WI
 *WSHS(FM) Sheboygan, WI
 WSCW Shell Lake, WI
 WKCF(FM) Shell Lake, WI
 WCOW Sparta, WI
 WCOW-FM Sparta, WI
 WDR-FM Sturgeon Bay, WI
 WTMB Tomah, WI
 WTMB-FM Tomah, WI
 WGBM(FM) Viroqua, WI
 WVSU Viroqua, WI
 WTTN Watertown, WI
 WAUK Waukesha, WI
 WAUK-FM Waukesha, WI
 WDXU Waupaca, WI
 WDXU-FM Waupaca, WI
 WSAU Wausau, WI
 WEZW(FM) Wauwatosa, WI
 WFHR Wisconsin Rapids, WI
 WWRW(FM) Wisconsin Rapids, WI
 KAWY(FM) Casper, WY
 KTWO Casper, WY
 KNIE Cheyenne, WY
 KSGT Jackson, WY
 KMER Kemmerer, WY
 KASL Newcastle, WY
 KPOW Powell, WY
 KRAL Rawlins, WY
 KVOW Riverton, WY
 KWYO Sheridan, WY
 KRTR Thermopolis, WY
 KGOS Torrington, WY
 KYCN Wheatland, WY
 KWOR Worldway, WY
 KSTO(FM) Agana, GM
 WTPM(FM) Aguadilla, PR
 WLuz Bayamon, PR
 WRSD Bayamon, PR
 WMDD Fajardo, PR
 WMDD-FM Fajardo, PR
 WXR-FM Guayama, PR
 WCGB Juana Diaz, PR
 WMNT Manati, PR
 WPAB Ponce, PR
 WPRP Ponce, PR
 WHOA San Juan, PR
 WQBS San Juan, PR
 WQBS-FM San Juan, PR
 NEW AM San Juan, PR
 WKFE Yaouco, PR
 WVVI Charlotte Amalie, VI
 WIVI-FM Christiansted, VI

Navajo & Pueblo
 *KIPC(FM) Albuquerque, NM

All News
 WATV Birmingham, AL
 WDJC(FM) Birmingham, AL
 KRUX Glendale, AZ
 KPHX Phoenix, AZ
 KTAR Phoenix, AZ
 KTUC Tucson, AZ
 KARY Russellville, AR
 KARM Fresno, CA
 KFWB Los Angeles, CA
 KNX Los Angeles, CA
 KCRA Sacramento, CA

Formats

KFBK Sacramento, CA
 KSDO San Diego, CA
 KGO San Francisco, CA
 KNAI-FM San Francisco, CA
 KXRX San Jose, CA
 KAAP Santa Paula, CA
 WPOP Hartford, CT
 WRC Washington, DC
 WTOP Washington, DC
 WAVS Fort Lauderdale, FL
 WINZ Miami, FL
 WPOM Riviera Beach, FL
 WMEN Tallahassee, FL
 KHVV Honolulu, HI
 KSPD Boise, ID
 WBBM Chicago, IL
 WITTFM Tuscola, IL
 WNTS Indianapolis, IN
 KCLN Clinton, IA
 KRLS(FM) Knoxville, IA
 KUDL Fairway, KS
 KJOE Shreveport, LA
 KWKH Shreveport, LA
 WBAL-FM Baltimore, MD
 WEEL Boston, MA
 WAAB Worcester, MA
 WJJ Detroit, MI
 WMAX Grand Rapids, MI
 WMPL Hancock, MI
 WMPL-FM Hancock, MI
 KDAN Minneapolis, MN
 WWTC Minneapolis, MN
 WRBC Jackson, MS
 KLONG Omaha, NE
 KBMI Henderson, NV
 WBUD Trenton, NJ
 KZIA Albuquerque, NM
 WCBS New York, NY
 WINS New York, NY
 WNW5-FM New York, NY
 WERE Cleveland, OH
 WAVI Dayton, OH
 WANR Toledo, OH
 WBBW Youngstown, OH
 KRMC Midwest City, OK
 KYW Philadelphia, PA
 WCAU Philadelphia, PA
 KQV Pittsburgh, PA
 WERI Westerly, RI
 WERI-FM Westerly, RI
 WSCQ(FM) West Columbia, SC
 KLYX(FM) Clear Lake City, TX
 WRR Dallas, TX
 KURV Edinburg, TX
 KTSM El Paso, TX
 KEYH Houston, TX
 KBBC Centerville, UT
 WAVA Arlington, VA
 WAVA-FM Arlington, VA
 WISG Mount Jackson, VA
 WRIT Milwaukee, WI
 WCOW-FM Sparta, WI

Nostalgia

(See Golden Oldies)

Oldies

(See Golden Oldies)

Personality

(See Talk)

Polish

WZUM Carnegie, PA
 WCCS(FM) Central City, PA

Poika

WMIN Maplewood, MN
 KSMM Shakopee, MN
 WISS Berlin, WI
 WISS-FM Berlin, WI
 WCFW(FM) Chippewa Falls, WI
 WTKM Hartford, WI
 WTKM-FM Hartford, WI

Popular

(See Top-40)

Progressive

Includes station formats characterized as underground, hard rock, folk, alternative, free form and progressive rock.

*WGL(FM) Auburn, AL
 *WVSU-FM Birmingham, AL
 *WUAL-FM Tuscaloosa, AL
 *WVNS(FM) Tuskegee, AL
 *KAXR(FM) Flugstaff, AZ
 KDKB Mesa, AZ
 KDKB-FM Mesa, AZ
 KWFM(FM) Tucson, AZ

*KUAF(FM) Fayetteville, AR
 KEZY-FM Anaheim, CA
 *KALX(FM) Berkeley, CA
 KLRB(FM) Carmel, CA
 KFMF(FM) Chico, CA
 *KSPC(FM) Claremont, CA
 *KKUP(FM) Cupertino, CA
 *KDVS(FM) Davis, CA
 *KUCI(FM) Irvine, CA
 *KUNF(FM) La Canada, CA
 *KFJC(FM) Los Altos, CA
 KMET(FM) Los Angeles, CA
 KWSY(FM) Los Angeles, CA
 *KXLU(FM) Los Angeles, CA
 *KSMMC(FM) Moraga, CA
 *KUOR-FM Redlands, CA
 KROI(FM) Sacramento, CA
 KGB-FM San Diego, CA
 KSAN-FM San Francisco, CA
 KOME(FM) San Jose, CA
 KSJO(FM) San Jose, CA
 *KCPR(FM) San Luis Obispo, CA
 KZOO(FM) San Luis Obispo, CA
 KTIM San Rafael, CA
 KTIM-FM San Rafael, CA
 KTYD Santa Barbara, CA
 KTYD-FM Santa Barbara, CA
 KTYD(FM) Santa Maria, CA
 *KUOP(FM) Stockton, CA
 KSM(FM) Truckee, CA
 *KASF(FM) Alamosa, CO
 KADE Boulder, CO
 KRNV(FM) Boulder, CO
 KLGT(FM) Breckenridge, CO
 KKFV(FM) Colorado Springs, CO
 KBPI(FM) Denver, CO
 KHOW Denver, CO
 KIMN-FM Denver, CO
 KQAO(FM) Denver, CO
 KTCL(FM) Fort Collins, CO
 *KMSA(FM) Grand Junction, CO
 KDJQ(FM) Pueblo, CA
 *WPKN(FM) Bridgeport, CT
 *WVOF(FM) Fairfield, CT
 *WQAO(FM) Hamden, CT
 WHCN(FM) Hartford, CT
 *WFCN(FM) New Britain, CT
 WPLR(FM) New Haven, CT
 WYBC-FM New Haven, CT
 *WHUS(FM) Storrs, CT
 WQQW Waterbury, CT
 *WNHU(FM) West Haven, CT
 *WUHF(FM) West Hartford, CT

*WWPT(FM) Westport, CT
 WILI Willimantic, CT
 *WGTB-FM Washington, DC
 *WVUM(FM) Coral Gables, FL
 WGLV(FM) Gainesville, FL
 WVAI(FM) Jacksonville, FL
 WRYZ-FM Jupiter, FL
 WACY Kissimmee, FL
 WBUS(FM) Miami Beach, FL
 WORJ-FM Mount Dora, FL
 WFSO Pinellas Park, FL
 *WFSU-FM Tallahassee, FL
 *WPRK(FM) Winter Park, FL
 WJSR(FM) Athens, GA
 *WUOG(FM) Athens, GA
 *WCLK(FM) Atlanta, GA
 WKLS(FM) Atlanta, GA
 *WRAS(FM) Atlanta, GA
 *WREK(FM) Atlanta, GA
 *WWGC(FM) Carrollton, GA
 WSGC Elberton, GA
 WSGC-FM Elberton, GA
 WFNE(FM) Forsyth, GA
 *WXGC(FM) Milledgeville, GA
 WOWE(FM) Rossville, GA
 *WVGS(FM) Statesboro, GA
 *WABR-FM Tifton, GA
 *WVVS(FM) Valdosta, GA
 KHSS(FM) Honolulu, HI
 KIKI Honolulu, HI
 *KTUH(FM) Honolulu, HI
 *KUID(FM) Moscow, ID
 *KUOI-FM Moscow, ID

*WESN(FM) Bloomington, IL
 *WZRD(FM) Chicago, IL
 WITY Danville, IL
 WLKB-FM De Kalb, IL
 *WJMU(FM) Decatur, IL
 WVFV(FM) Dundee, IL
 *WNUR(FM) Evanston, IL
 *WVCK(FM) Galesburg, IL
 *WGH(FM) Glen Ellyn, IL
 WVVX Highland Park, IL
 WVVX-FM Highland Park, IL
 *WLT(LF) La Grange, IL

*WVW(FM) Lincoln, IL
 *WIUM(FM) Macomb, IL
 WMIX-FM Mount Vernon, IL
 WTAO(FM) Murphysboro, IL
 *WRHS(FM) Park Forest, IL
 *WARG(FM) Summit, IL
 WPGU(FM) Urbana, IL
 WTW(FM) Urbana, IL
 WXR(D) Woodstock, IL
 *WEVC(FM) Evansville, IN
 WQHI(FM) Jeffersonville, IN
 WQHF(FM) Terre Haute, IN
 *WVUR-FM Valparaiso, IN
 KCCQ(FM) Ames, IA
 *KPGY(FM) Ames, IA
 *KCOE(FM) Cedar Rapids, IA
 KKKQ-FM Council Bluffs, IA
 *KALA(FM) Davenport, IA
 *KDIC(FM) Grinnell, IA
 *KRNL-FM Mount Vernon, IA
 KFMH(FM) Muscatine, IA
 KLRP(FM) Emporia, KS
 *KBJC(FM) Great Bend, KS
 KLWN-FM Lawrence, KS
 KMKF(FM) Manhattan, KS
 WIBW-FM Topeka, KS
 WSAC-FM Fort Knox, KY
 *WRVG(FM) Georgetown, KY
 WKQA(FM) Lexington, KY
 WLRS(FM) Louisville, KY
 WVMF(FM) Baton Rouge, LA
 *KNWD(FM) Natchitoches, LA
 WNOE-FM New Orleans, LA
 WRNO(FM) New Orleans, LA
 *WTUL(FM) New Orleans, LA
 *KLP(LF) Ruston, LA
 *WHSN(FM) Bangor, ME
 *WBOR(FM) Brunswick, ME
 *WUMF-FM Farmington, ME
 WBLM(FM) Lewiston, ME
 *WMEB-FM Orono, ME
 *WMBH(FM) Waterville, ME
 WAYE Baltimore, MD
 WHFS(FM) Bethesda, MD
 WQCM(FM) Halfway, MD
 *WAMH(FM) Amherst, MA
 *WPA(AFM) Andover, MA
 WBCN(FM) Boston, MA
 WCAS Cambridge, MA
 *WVSH-FM Easton, MA
 *WLT(LF) Lowell, MA
 *WMO(FM) Medford, MA
 *WMLN-FM Milton, MA
 WNTN Newton, MA
 *WZBC(FM) Newton, MA
 *WJJW(FM) North Adams, MA

*WMM(CFM) North Andover, MA
 *WUSM(FM) North Dartmouth, MA
 WGRG Pittsfield, MA
 WGRG-FM Pittsfield, MA
 *WMMC(FM) South Hadley, MA
 *WAIC(FM) Springfield, MA
 *WSCB(FM) Springfield, MA
 *WTCC(FM) Springfield, MA
 *WTRZ(FM) Springfield, MA
 *WBR5(FM) Waltham, MA
 *WCFM(FM) Williamstown, MA
 *WHSR-FM Winchester, MA
 WAAF(FM) Worcester, MA
 *WICN(FM) Worcester, MA
 *WRSX(FM) Altitude, MI
 WIQB(FM) Ann Arbor, MI
 *WCHW-FM Bay City, MI
 WABX(FM) Detroit, MI
 *WDET-FM Detroit, MI
 WRIF(FM) Detroit, MI
 WWWW(FM) Detroit, MI
 WVIC East Lansing, MI
 WVIC-FM East Lansing, MI
 WLAV-FM Grand Rapids, MI
 WPLB Greenville, MI
 *WIDR(FM) Kalamazoo, MI
 WLS-FM Lansing, MI
 *WMMH-FM Mount Pleasant, MI
 *WOPR(FM) Oak Park, MI
 *WBLD(FM) Orchard Lake, MI
 *WHSJ(FM) Southfield, MI
 KQRS Golden Valley, MN
 KQRS-FM Golden Valley, MN
 *KUMM(FM) Morris, MN
 *KRLX(FM) Northfield, MN
 WHSY-FM Hattiesburg, MS
 *WMSB(FM) Mississippi State, MS

WNCZ(FM) Natchez, MS
 *WQOU(FM) Columbia, MO
 KSHE(FM) Crestwood, MO

KJCF Festus, MO
 KWKI(FM) Kansas City, MO
 *KGGP(FM) Parkville, MO
 *KSOZ(FM) Point Lookout, MO
 *KMNRF(FM) Rolla, MO
 KADI-FM St. Louis, MO
 *KGLT(FM) Bozeman, MT
 KGVO Missoula, MT
 KRBN Red Lodge, MT
 KICS-FM Hastings, NE
 *KWSC(FM) Wayne, NE
 KKBC(FM) Carson City, NV
 KGLR(FM) Reno, NV
 *WUNH(FM) Durham, NH
 *WNEC-FM Henniker, NH
 *WKNH(FM) Keene, NH
 *WFMU(FM) East Orange, NJ
 *WBJB-FM Lincroft, NJ
 *WRSU-FM New Brunswick, NJ

WPRB(FM) Princeton, NJ
 WBJH(FM) Trenton, NJ
 *WTSR(FM) Trenton, NJ
 *WMCX(FM) West Long Branch, NJ
 KFMG(FM) Albuquerque, NM
 KMYR(FM) Albuquerque, NM
 KRST(FM) Albuquerque, NM
 KASK(FM) Las Cruces, NM
 KKAT Roswell, NM
 *WALF(FM) Alford, NY
 WRNW(FM) Briarcliff Manor, NY

WBUF(FM) Buffalo, NY
 WGRQ(FM) Buffalo, NY
 *WHCL-FM Clinton, NY
 *WECW(FM) Elmira, NY
 WLIR(FM) Garden City, NY
 *WEOS-FM Geneva, NY
 *WRCU-FM Hamilton, NY
 *WITR(FM) Henrietta, NY
 WVBR-FM Ithaca, NY
 *WVCR-FM Loudonville, NY
 WNEW-FM New York, NY
 WNCN(FM) New York, NY
 *WRHO(FM) Oneonta, NY
 *WPOB(FM) Plainville, NY
 *WTS-CFM Potsdam, NY
 WQBK-FM Rensselaer, NY
 *WRUR-FM Rochester, NY
 WSAV Rochester, NY
 *WBSU(FM) St. Bonaventure, NY

WSNY Schenectady, NY
 WKQW Spring Valley, NY
 *WAER(FM) Syracuse, NY
 *WRPI(FM) Troy, NY
 WOUR(FM) Utica, NY
 *WARY(FM) Valhalla, NY
 *WASU-FM Boone, NC
 WIST Charlotte, NC
 WRPL Charlotte, NC
 *WDAV(FM) Davidson, NC
 WDBS(FM) Durham, NC
 WMYK(FM) Elizabeth City, NC
 WRQR(FM) Farmville, NC
 *WQFS(FM) Greensboro, NC
 *WUAG(FM) Greensboro, NC
 WHKY-FM Hickory, NC
 *WKNC-FM Raleigh, NC
 WQDR(FM) Raleigh, NC
 WCUE-FM Akron, OH
 WNRN(FM) Bellevue, OH
 WAWR-FM Bowling Green, OH

WBNO Bryan, OH
 WBNO-FM Bryan, OH
 WCSM Celina, OH
 WCSM-FM Celina, OH
 WWWW(FM) Cleveland, OH
 WCOL-FM Columbus, OH
 WLCF(FM) Findlay, OH
 *WDUB(FM) Granville, OH
 WCJO(FM) Jackson, OH
 WYUD-FM Kettering, OH
 WDF(FM) Marion, OH
 *WBOC-FM Oberlin, OH
 WOXR(FM) Oxford, OH
 *WUSO(FM) Springfield, OH
 WIOT(FM) Toledo, OH
 *KHIB(FM) Durant, OK
 KGOU(FM) Norman, OK
 KMOD(FM) Tulsa, OK

*KBVR(FM) Corvallis, OR
 KFMY(FM) Eugene, OR
 KZEL-FM Eugene, OR
 *KTEC(FM) Klamath Falls, OR
 *KEOL(FM) La Grande, OR
 *WMMU(FM) Allentown, PA
 WSAN Allentown, PA
 *WLRV-FM Bethlehem, PA
 *WVCS(FM) California, PA
 *WESS(FM) East Stroudsburg, PA

*WJR(FM) Easton, PA
 *WTGP(FM) Greenville, PA
 *WSAJ Grove City, PA
 *WSAJ-FM Grove City, PA
 WMDI(FM) McKean, PA
 *WARC(FM) Meadville, PA
 WIOQ(FM) Philadelphia, PA
 *WKDU(FM) Philadelphia, PA
 WMMR(FM) Philadelphia, PA
 WWD(B) Philadelphia, PA
 WDFE(FM) Pittsburgh, PA
 WYDD(FM) Pittsburgh, PA
 *WPRC(FM) Reading, PA
 *WVWV-FM Scranton, PA
 *WVSY-FM Shippensburg, PA
 WRHY(FM) Starview, PA
 WQWK(FM) State College, PA
 *WSRN-FM Swarthmore, PA
 *WJCR(FM) Washington, PA
 *WRKC(FM) Wilkes-Barre, PA
 *WRIU(FM) Kingston, PA
 WFRU(FM) Providence, RI
 *WDOM(FM) Providence, RI
 *WJMF(FM) Smithfield, RI
 WBEU-FM Beaufort, SC
 WSBF-FM Clemson, SC
 WCO5-FM Columbia, SC
 WQOK Greenville, SC
 WWWW(FM) Summerville, SC
 *KASD(FM) Aberdeen, SD
 *KAUR(FM) Sioux Falls, SD
 *KSTI(FM) Springfield, SD
 WQUT(FM) Johnson City, TN
 WROL Knoxville, TN
 WKDA-FM Nashville, TN
 *KASD(FM) Nashville, TN
 *WUTS(FM) Sewanee, TN
 KAMC(FM) Arlington, TX
 KLBJ-FM Austin, TX
 KWIC(FM) Beaumont, TX
 *KWTS(FM) Canyon, TX
 KAFM(FM) Dallas, TX
 KNU5(FM) Dallas, TX
 KBFM(FM) Edinburg, TX
 KAUM(FM) Houston, TX
 KLOL(FM) Houston, TX
 *KPFT(FM) Houston, TX
 *KTRU(FM) Houston, TX
 *KTSU(FM) Houston, TX
 *KTAI(FM) Kingsville, TX
 KSEL-FM Lubbock, TX
 K5FA-FM Nacogdoches, TX
 KBOP-FM Pecos, TX
 KEXL(FM) San Antonio, TX
 KTFM(FM) San Antonio, TX
 *KWBU(FM) Waco, TX
 KANI Wharton, TX
 KBRE-FM Cedar City, UT
 *KCDR-FM Cedar City, UT
 KWVJ(FM) Logan, UT
 *WRUV(FM) Burlington, VT
 *WVPV-FM Colchester, VT
 *WVEP(FM) East Montpelier, VT

*WJSC-FM Johnson, VT
 *WRMC-FM Middlebury, VT
 *WVUS(FM) Putney, VT
 WEAM Arlington, VA
 *WTJU(FM) Charlottesville, VA
 *WHOV(FM) Hampton, VA
 WNOR-FM Norfolk, VA
 WGEO Richmond, VA
 WJWS South Hill, VA
 *WCWM(FM) Williamsburg, VA
 KZAM Bellevue, WA
 KZAM-FM Bellevue, WA
 *KCED(FM) Centralia, WA
 KILO Kirkland, WA
 *KUBS(FM) Newport, WA
 *KAOS(FM) Olympia, WA
 KISW(FM) Seattle, WA
 KREM-FM Spokane, WA
 KLAY-FM Tacoma, WA
 KVAN Vancouver, WA
 *KWCW(FM) Walla Walla, WA
 WVAF(FM) Charleston, WV
 *WCDE(FM) Elkins, WV
 *WMUL(FM) Huntington, WV
 WCLG-FM Morgantown, WV
 *WSHC(FM) Shepherdstown, WV
 WIXX(FM) Green Bay, WI
 *WGBW(FM) Green Bay, WI
 WSPL(FM) La Crosse, WI
 WIBA-FM Madison, WI
 WZMF(FM) Menomonee Falls, WI
 *WMD(FM) Milton, WI
 *WRST-FM Oshkosh, WI
 *WRPN-FM Ripon, WI
 WCMN Arcadio, PR
 WBRO(FM) Cidra, PR

WREI(FM) Quebradillas, PR
 WIAC-FM San Juan, PR
 WKVM San Juan, PR
 WZVS-FM Vieques, PR

Religious

Includes station programing characterized as gospel, sacred, Christian and inspirational.

WYAM Bessemer, AL
 WDJC(FM) Birmingham, AL
 WBTS Bridgeport, AL
 WCOX Camden, AL
 WBIB Centreville, AL
 WKLF Clanton, AL
 *WBQM(FM) Decatur, AL
 WND(AFM) Huntsville, AL
 WLPH Irondale, AL
 WMOO Mobile, AL
 WPID Piedmont, AL
 WTUB(FM) Troy, AL
 WVSA Vernon, AL
 KCAM Giennallen, AK
 KJNP North Pole, AK
 KCTB-FM Flagstaff, AZ
 KASA Phoenix, AZ
 KHCS Phoenix, AZ
 KHPE Phoenix, AZ
 KFMM(FM) Tucson, AZ
 KHAC Window Rock, AZ
 KLYR-FM Clarksville, AR
 KDON De Queen, AR
 KXOW-FM Hot Springs, AR
 KGMR Jacksonvill, AR
 KAAY Little Rock, AR
 KSUD West Memphis, AR
 *KANG(FM) Angwin, CA
 KXGO(FM) Arcata, CA
 KIFM(FM) Bakersfield, CA
 KDNQ(FM) Delano, CA
 KRDU Dinuba, CA
 *KECR(FM) El Cajon, CA
 KFMR(FM) Fremont, CA
 KINC Independence, CA
 KCVR Lodi, CA
 *KEMR(FM) Loma Linda, CA
 KGER Long Beach, CA
 KFSG(FM) Los Angeles, CA
 KHOF(FM) Los Angeles, CA
 KAMB(FM) Merced, CA
 KHOP(FM) Modesto, CA
 KDAR(FM) Oxnard, CA
 KEWQ Paradise, CA
 KVIP Redding, CA
 KBBL(FM) Riverside, CA
 *KLLU(FM) Riverside, CA
 KEBR(FM) Sacramento, CA
 KQLH(FM) San Bernardino, CA
 KLRO(FM) San Diego, CA
 KEAR(FM) San Francisco, CA
 KFAX San Francisco, CA
 KEGL Santa Clara, CA
 KZEN(FM) Seaside, CA
 KWSO Wasco, CA
 KQXI Arvada, CO
 *KPOF Denver, CO
 KFKZ(FM) Greeley, CO
 *KWBI(FM) Morrison, CO
 KFEL Pueblo, CO
 KWYD(FM) Security, CO
 WIHS(FM) Middletown, CT
 WRYM New Britain, CT
 WUST Washington, CT
 WTLN Apopka, FL
 WTLN-FM Apopka, FL
 WAPR Avon Park, FL
 WRHC Coral Gables, FL
 WGTX DeFuniak Springs, FL
 WOUH(FM) DeFuniak Springs, FL
 *WSOR(FM) Fort Myers, FL
 WHAN Haines City, FL
 WOZN Jacksonville, FL
 WBIX Jacksonville Beach, FL
 WLIZ Lake Worth, FL
 WSST Largo, FL
 *WMCU(FM) Miami, FL
 WAYR Orange Park, FL
 *WPCS(FM) Pensacola, FL
 WPPA Pensacola, FL
 *WKZM(FM) Sarasota, FL
 WSKP-FM Sebring, FL
 WINQ Tampa, FL
 WSOL Tampa, FL
 WWCV Windermere, FL
 WODE Albany, GA
 WGUN Atlanta, GA
 WXAP Atlanta, GA
 WGO(FM) Buford, GA
 WRWH Cleveland, GA
 WAVO Decatur, GA

WSEM Donaldsonville, GA
 WTJH East Point, GA
 WYYZ Jasper, GA
 WZOT(FM) Rockmart, GA
 WRIP Rossville, GA
 WYNX Smyrna, GA
 WGTa Summerville, GA
 WOGA Sylvester, GA
 WLET Toccoa, GA
 WAFT(FM) Valdosta, GA
 WAVC Warner Robins, GA
 KAIM Honolulu, HI
 KAIM-FM Honolulu, HI
 KOHO Honolulu, HI
 KBGN Caldwell, ID
 *WMBI Chicago, IL
 *WMBI-MI Chicago, IL
 *WDLM East Moline, IL
 WEAW Evanston, IL
 WGNU-FM Granite City, IL
 *WLCC(FM) Lincoln, IL
 WPEO Peoria, IL
 WQFL(FM) Rockford, IL
 WHCO Sparta, IL
 WVHI(FM) Evansville, IN
 WFWR Fort Wayne, IN
 *WGC(SFM) Goshen, IN
 WYCA(FM) Hammond, IN
 *WHWE(FM) Howe, IN
 WBRI Indianapolis, IN
 WBAT Marion, IN
 WHME(FM) South Bend, IN
 WWVR(FM) West Terre Haute, IN
 *KFGQ Boone, IA
 *KFGO-FM Boone, IA
 *KCOG(FM) Cedar Rapids, IA
 KTOF-FM Centerville, IA
 KDMI(FM) Des Moines, IA
 KTTGA(FM) Des Dodge, IA
 *KNWS Waterloo, IA
 *KNWS-FM Waterloo, IA
 KJWG Newton, KS
 KSKG(FM) Salina, KS
 KFLA Scott City, KS
 WLBJ-FM Bowling Green, KY
 WCTT-FM Corbin, KY
 WHKK(FM) Erlanger, KY
 *WKCC(FM) Grayson, KY
 WRVK Mount Vernon, KY
 WRSL Stanford, KY
 WJMM(FM) Versailles, KY
 KDXI Mansfield, LA
 WVOG New Orleans, LA
 WYLD-FM New Orleans, LA
 KEPT(FM) Shreveport, LA
 KCJ Shreveport, LA
 WDH(PM) Presque Isle, ME
 WFSI(FM) Annapolis, MD
 WRBS(FM) Baltimore, MD
 WHDG(FM) Havre De Grace, MD
 WCTN Potomac-Cabin John, MD
 WTOW Towson, MD
 WUNR Brookline, MA
 *WCVL(FM) Stockbridge, MA
 WUFN(FM) Albion, MI
 WDFP(FM) Battle Creek, MI
 *WAUS(FM) Berrien Springs, MI
 WBFM Detroit, MI
 WMUZ(FM) Detroit, MI
 *WCSG(FM) Grand Rapids, MI
 WJBL-FM Holland, MI
 WMPC Lapeer, MI
 *WUNN Mason, MI
 WUGN(FM) Midland, MI
 WKJR Muskegon Heights, MI
 WEXL Royal Oak, MI
 WJWC Duluth, MN
 KUXL Golden Valley, MN
 *KTIS Minneapolis, MN
 *KTIS-FM Minneapolis, MN
 *WCTS-FM Minneapolis, MN
 KNOF(FM) St. Paul, MN
 WHII Bay Springs, MS
 WRJH(FM) Brandon, MS
 WESY Leland, MS
 WSJC Magee, MS
 WCIS-FM Pascagoula, MS
 WSEL Pontotoc, MS
 WSEL-FM Pontotoc, MS
 *KFUO Clayton, MO
 KCCV Independence, MO
 *KOB(CF) Joplin, MO
 KPCG(FM) Joplin, MO
 *KTSR(FM) Kansas City, MO
 KMIS-FM Portageville, MO
 KLFJ Springfield, MO
 KWFC(FM) Springfield, MO
 KSTL St. Louis, MO
 KXEN St. Louis-Festus, MO

KURL Billings, MT
 KALS(FM) Kalispell, MT
 KJSK Columbus, NE
 *KUCV(FM) Lincoln, NE
 *KGBI-FM Omaha, NE
 KOWH Omaha, NE
 KOWH-FM Omaha, NE
 *KNIS(FM) Carson City, NV
 *KILA(FM) Henderson, NV
 WUSS Atlantic City, NJ
 *WKDN-FM Camden, NJ
 WNNN(FM) Canton, NJ
 WRIO-FM Cape May, NJ
 WWDJ Hackensack, NJ
 WFME(FM) Newark, NJ
 WCHR(FM) Trenton, NJ
 *WAWZ Zarephath, NJ
 *WAWZ-FM Zarephath, NJ
 WEIV(FM) Ithaca, NY
 WMIV(FM) South Bristol Township, NY
 WMHR(FM) Syracuse, NY
 WYRD East Syracuse, NY
 WHAZ Troy, NY
 WBIV(FM) Wethersfield, NY
 WBMS Black Mountain, NC
 WFGW Black Mountain, NC
 WMTI(FM) Black Mountain, NC
 WWIT Canton, NC
 WRBX Chapel Hill, NC
 WHVN Charlotte, NC
 WQTI(FM) Dunn, NC
 WIFM Elkin, NC
 WIFM-FM Elkin, NC
 WAGY Forest City, NC
 KANN Ogden, NC
 WHPE High Point, NC
 WHPE-FM High Point, NC
 WSTS(FM) Lumburg, NC
 WJSK(FM) Lumberton, NC
 WMMH Marshall, NC
 WDSL Mocksville, NC
 WRNC Raleigh, NC
 WWMO(FM) Reidsville, NC
 *WPGT(FM) Roanoke Rapids, NC
 WEGG Rose Hill, NC
 WYAL Scotland Neck, NC
 WPGD Winston-Salem, NC
 WTOF(FM) Canton, OH
 *WCDR-FM Cedarville, OH
 WZIP Cincinnati, OH
 *WCRF(FM) Cleveland, OH
 *WVCO(FM) Galanna, OH
 WQMS(FM) Hamilton, OH
 *WTGN(FM) Lima, OH
 *WFCJ(FM) Miamisburg, OH
 WPBF(FM) Middletown, OH
 WMVO-FM Mount Vernon, OH
 WPAV-FM Portsmouth, OH
 *WEEC(FM) Springfield, OH
 WBZI(FM) Xenia, OH
 KGOV(FM) Bethany, OK
 KELR El Reno, OK
 KHEN-FM Henryetta, OK
 KBYE Oklahoma City, OK
 KOLS Pryor, OK
 KBJH(FM) Tulsa, OK
 KFMJ Tulsa, OK
 KWIL Albany, OR
 KBMC(FM) Eugene, OR
 KPDO Portland, OR
 KPDO-FM Portland, OR
 KCCS Salem, OR
 WHGM(FM) Bellwood, PA
 WBYO(FM) Boyertown, PA
 WARO Canonsburg, PA
 WCCS(FM) Central City, PA
 WVCH Chester, PA
 WPGM Danville, PA
 WPGM-FM Danville, PA
 WDBA(FM) Du Bois, PA
 *WMSP(FM) Harrisburg, PA
 WIBF-FM Jenkintown, PA
 WAAT(FM) Johnstown, PA
 WDAC(FM) Lancaster, PA
 WJSM Martinsburg, PA
 WJSM-FM Martinsburg, PA
 *WPEL-FM Montrose, PA
 WTEL Philadelphia, PA
 WRIB Providence, RI
 WCRE Cheraw, SC
 *WMHK(FM) Columbia, SC
 WOXL Columbia, SC
 WELP Easley, SC
 WAGI-FM Gaffney, SC
 WUUU Greenville, SC
 WUUU-FM Greenville, SC
 WHCC-FM Orangeburg, SC
 WBRR Travelers Rest, SC
 *KNWC Sioux Falls, SC
 *KNWC-FM Sioux Falls, SC
 WSLV Ardmore, TN

WDDO-FM Chattanooga, TN
 *WDYN-FM Chattanooga, TN
 WMOG Chattanooga, TN
 WMCH Church Hill, TN
 WMSO Collierville, TN
 WDSG Dyersburg, TN
 WDEB Jamestown, TN
 WDEB-FM Jamestown, TN
 WJBE Knoxville, TN
 WSKT Knoxville, TN
 WKTA(FM) McKenzie, TN
 WBMC McMinnville, TN
 KWAM Memphis, TN
 WTNN Millington, TN
 WVGW Nashville, TN
 WNAH Nashville, TN
 WBNT-FM Oneida, TN
 WPJD Soddy-Daisy, TN
 KDRY Alamo Heights, TX
 KWAS(FM) Amarillo, TX
 KTRM-FM Beaumont, TX
 KBAN Bowie, TX
 KCTA Corpus Christi, TX
 KDTX(FM) Dallas, TX
 KPBC Dallas, TX
 KSKY Dallas, TX
 KPAS(FM) El Paso, TX
 KHYM Gilmer, TX
 KFMC(FM) Houston, TX
 KHCB-FM Houston, TX
 *KSUC(FM) Keene, TX
 *KVMM-FM McAllen, TX
 KRAN Morton, TX
 KBOP-FM Pleasanton, TX
 KCLR Ralls, TX
 KANN Ogden, UT
 WIVE Ashland, VA
 WIVE-FM Ashland, VA
 WDWL(VF) Chester, VA
 WIKI Chester, VA
 WFAH Falls Church, VA
 *WEMC(FM) Harrisonburg, VA
 WWOD-FM Lynchburg, VA
 WYFI(FM) Norfolk, VA
 WPMH Portsmouth, VA
 WXRI(FM) Norfolk, VA
 WPPW Quantico, VA
 WKBA Vinton, VA
 WJLM(VF) Salem, VA
 KOQT Bellingham, WA
 KARI Blaine, WA
 KGDN Edmonds, WA
 *KOLU(FM) Pasco, WA
 *KMBI Spokane, WA
 KUDY Spokane, WA
 KIAM-FM Wenatchee, WA
 KBBO Yakima, WA
 WBBK(FM) Beckley, WV
 WVAF(FM) Charleston, WV
 WEMM(FM) Huntington, WV
 WSCW S. Charleston, WV
 WWIB(FM) Ladysmith, WI
 *WNWC(FM) Madison, WI
 *WVCY(FM) Milwaukee, WI
 WRVM(FM) Suring, WI
 KYCN Wheatland, WY
 WCGB Juana Diaz, PR
 WIVV Vieques, PR

Request

(See Top-40)

Rhythm & Blues

(See Black)

Rock

(See Top-40)

Sacred

(See Religious)

Serious Music

(See Classical)

Soul

(See Black)

Spanish

Not including Puerto Rico.

KIFN Phoenix, AZ
 KRDS Tullahoma, AZ
 KEVT Tucson, AZ
 KXEW Tucson, AZ
 KXEW-FM Tucson, AZ
 KWAC Bakersfield, CA
 KEWE(FM) Camarillo, CA
 KVIM(FM) Coachella, CA
 KLIP Fowler, CA
 KLIP(FM) Fremont, CA
 KGST Fresno, CA
 KXEX Fresno, CA
 KAZA Gilroy, CA
 KCVR Lodi, CA
 KRVE(FM) Los Gatos, CA
 KXEM McFarland, CA
 KITA(FM) Modesto, CA
 KHOP(FM) Modesto, CA
 KOXR Oxnard, CA

KWKW Pasadena, CA
 KCAL Redlands, CA
 KPFP(FM) Roseville, CA
 *KERS(FM) Sacramento, CA
 KCTY Salinas, CA
 KBRG(FM) San Francisco, CA
 KALI San Gabriel, CA
 KOFY San Mateo, CA
 KEGE Santa Clara, CA
 *KBBF(FM) Santa Rosa, CA
 KSTN-FM Stockton, CA
 KSRT(FM) Tracy, CA
 KCOK Tulare, CA
 KOMY Watsonville, CA
 KFCY Denver, CO
 KAPI Pueblo, CO
 WLVH(FM) Hartford, CT
 WFAN(FM) Washington, DC
 *WHRS(FM) Boynton Beach, FL
 WRHC Coral Gables, FL
 WCMO-FM Hialeah, FL
 WCMQ Miami, FL
 WFAW Miami, FL
 WQBA Miami, FL
 WSOL Tampa, FL
 WCRW Chicago, IL
 WEDC Chicago, IL
 WJOJ(FM) Evanston, IL
 WOPA Oak Park, IL
 WUNR Brookline, IL
 WUSS Atlantic City, NJ
 WDVL Vineland, NJ
 KABQ Albuquerque, NM
 KAMX Albuquerque, NM
 KFUN Las Vegas, NM
 KSRC Socorro, NM
 WADO New York, NY
 WBNX New York, NY
 WHOM New York, NY
 WTEL Philadelphia, PA
 KDSE(FM) Alice, TX
 KOPY Alice, TX
 KOKE-FM Austin, TX
 KIBL Beeville, TX
 KBEN Carrizo Springs, TX
 CCTC Corpus Christi, TX
 KUNO Corpus Christi, TX
 KDMC Del Rio, TX
 KWLK Del Rio, TX
 KPEPS Eagle Pass, TX
 KAMA El Paso, TX
 KAMA-FM El Paso, TX
 KP50 Fallurrias, TX
 KBUY-FM Fort Worth, TX
 KGTN Georgetown, TX
 KGTN-FM Georgetown, TX
 KGBT Harlingen, TX
 KRME Hondo, TX
 KINE Kingsville, TX
 KVOZ Lubbock, TX
 KFLB Laredo, TX
 KQXX(FM) McAllen, TX
 *KVMM-FM McAllen, TX
 KIRT Mission, TX
 KMUL Muleshoe, TX
 KLVL Pasadena, TX
 KVVG Pearsall, TX
 KPLA(FM) Plainview, TX
 KBOP Pleasanton, TX
 KCLR Ralls, TX
 KFRD Rosenberg-Richmond, TX
 KFRD-FM Rosenberg-Richmond, TX
 KCOR San Antonio, TX
 KUKA San Antonio, TX
 KCNY San Marcos, TX
 KWED Seguin, TX
 KMIO(FM) Sinton, TX
 KVOU Uvalde, TX

Standards

(See Middle-of-the-Road)

Talk

Includes station formats characterized as discussion, interview, personality and informational.

WDJC(FM) Birmingham, AL
 WKFV Fayette, AL
 WMOB Mobile, AL
 WQTY Montgomery, AL
 KIFW Stika, AK
 KIKO Miami, AK
 KFBR Nogales, AZ
 KOOL Phoenix, AZ
 KXIV Phoenix, AZ
 KRDS Tullahoma, AZ

Formats

KHYT Tucson, AZ
 *KUAT Tucson, AZ
 KALJ(FM) Yuma, AZ
 KFMV(FM) Magnolia, AR
 KARV Russellville, AR
 KWCK Searcy, AR
 KWYN Wynne, AR
 KGE E Bakersfield, CA
 KLYD Bakersfield, CA
 KLYD-FM Bakersfield, CA
 KPMC Bakersfield, CA
 KNEZ Lompoc, CA
 KABC Los Angeles, CA
 *KUSC(FM) Los Angeles, CA
 KTRB Modesto, CA
 KOON(FM) Pacific Grove, CA
 KWOD(FM) Sacramento, CA
 KGB San Diego, CA
 KGB-FM San Diego, CA
 KLRO(FM) San Diego, CA
 *KQED-FM San Francisco, CA
 KLOK San Jose, CA
 KRUZ(FM) Santa Barbara, CA
 KTMS Santa Barbara, CA
 KHOW Denver, CO
 KOA Denver, CO
 KWAZ Englewood, CO
 WNAE Bridgeport, CT
 *WPKN(FM) Bridgeport, CT
 WICH Norwich, CT
 WSNB Torrington, CT
 WNRK Newark, DE
 *WAMU-FM Washington, DC
 WPDO Jacksonville, FL
 WRYZ-FM Jupiter, FL
 WVFM(FM) Lakeland, FL
 WSTT Largo, FL
 WKAT Miami Beach, FL
 WGUL New Port Richey, FL
 WPBR Palm Beach, FL
 *WPCS(FM) Pensacola, FL
 WPLA Plant City, FL
 *WPIO(FM) Titusville, FL
 WMGA Moultrie, GA
 WCOH Newnan, GA
 WCOH-FM Newnan, GA
 WRNG North Atlanta, GA
 KGMB Honolulu, HI
 KOHO Honolulu, HI
 KLIX Twin Falls, ID
 WMRO Aurora, IL
 WBYS Canton, IL
 WILY Centralia, IL
 *WBEZ(FM) Chicago, IL
 *WGCY(FM) Chicago, IL
 WGN Chicago, IL
 WIVS Crystal Lake, IL
 *WIDG-FM Downers Grove, IL
 *WSIE(FM) Edwardsville, IL
 WEAW Evanston, IL
 WFRF Freeport, IL
 WFRF-FM Freeport, IL
 WGEN Geneseo, IL
 *WLCC(FM) Lincoln, IL
 WPRC Lincoln, IL
 WPRC-FM Lincoln, IL
 WRAM Monmouth, IL
 *WVHS(FM) Morrison, IL
 *WGLT(FM) Normal, IL
 WRRR Rockford, IL
 WHCO Sparta, IL
 *WSSR(FM) Springfield, IL
 WSDR Sterling, IL
 *WARG(FM) Summit, IL
 *WILL Urbana, IL
 WPMB Vandalia, IL
 WKRS Waukegan, IL
 WFRX-FM West Frankfort, IL
 *WHJE(FM) Carmel, IN
 *WGVF(FM) Gary, IN
 WLTH Gary, IN
 WWC A Gary, IN
 WSMJ(FM) Greenfield, IN
 WJOB Hammond, IN
 *WIAN(FM) Indianapolis, IN
 WNTS Indianapolis, IN
 WXLW Indianapolis, IN
 WRCR(FM) Rushville, IN
 WAKE Valparaiso, IN
 *WOI Ames, IA
 KCHE Cherokee, IA
 KWBW Hutchinson, KS
 KIND Independence, KS
 KIND-FM Independence, KS
 *KANU(FM) Lawrence, KS
 KLWN Lawrence, KS
 KNEX-FM McPherson, KS
 KBEA Mission, KS
 KOFO Ottawa, KS
 KOFO-FM Ottawa, KS

WIBW Topeka, KS
 WCAK(FM) Cattlettsburg, KY
 *WRYG(FM) Georgetown, KY
 WCD S Glasgow, KY
 *WBKY(FM) Lexington, KY
 *WFPL(FM) Louisville, KY
 *WWNO(FM) New Orleans, LA
 WBOC-FM Salisbury, MD
 *WGT S-FM Takoma Park, MD
 WTOW Towson, MD
 *WPA A(FM) Andover, MA
 WARA Attleboro, MA
 *WBUR(FM) Boston, MA
 WUNR Brookline, MA
 WACE Chicopee, MA
 WALE Fall River, MA
 WREB Holyoke, MA
 W LMS Leominster, MA
 WCAP Lowell, MA
 WBSM New Bedford, MA
 WAAB Worcester, MA
 *WAUS(FM) Berrien Springs, MI
 WKYO-FM Caro, MI
 WDOV Dowagiac, MI
 WDOV-FM Dowagiac, MI
 WMPL Hancock, MI
 WMPL-FM Hancock, MI
 WHTC Holland, MI
 WMQT(FM) Ishpeming, MI
 WUPY Ishpeming, MI
 *WMUK(FM) Kalamazoo, MI
 WJWP Rockford, MI
 WWW S(FM) Saginaw, MI
 KABG(FM) Cambridge, MN
 *KJSR-FM Collegeville, MN
 KUXL Golden Valley, MN
 *KCCM-FM Moorhead, MN
 *KR S W-FM Pipestone, MN
 KRWB Roseau, MN
 WJON St. Cloud, MN
 *KSJN(FM) St. Paul, MN
 WFOR Hattiesburg, MS
 WHER(FM) Hattiesburg, MS
 *KFUO Clayton, MO
 KHAD De Soto, MO
 KRFG(FM) Greenfield, MO
 *KCUR-FM Kansas City, MO
 KOXE Mexico, MO
 KWIX Moberly, MO
 *KSOZ(FM) Point Lookout, MO
 KYRO Potosi, MO
 *KUMR(FM) Rolla, MO
 KSIM Sikeston, MO
 *KWMU(FM) St. Louis, MO
 KLPW Union, MO
 KBOW Butte, MT
 *KUFM(FM) Missoula, MT
 KLNG Omaha, NE
 KOWH Omaha, NE
 KOWH-FM Omaha, NE
 KORK Las Vegas, NV
 WMOU Berlin, NH
 WXKR Exeter, NH
 WXKR-FM Exeter, NH
 WGIR Manchester, NH
 WGR-FM Manchester, NH
 WSMN Nashua, NH
 WASR Wafersboro, NH
 WULK Asbury Park, NJ
 WULK-FM Asbury Park, NJ
 WFPG Atlantic City, NJ
 WSNJ Bridgeton, NJ
 WSNJ-FM Bridgeton, NJ
 WHLW Lakewood, NJ
 KZIA Albuquerque, NM
 WABY Albany, NY
 WBRV Boonville, NY
 WADV(FM) Buffalo, NY
 WBUZ Fredonia, NY
 WWS C Glens Falls, NY
 WWS C-FM Glens Falls, NY
 WLEA Hornell, NY
 W MVI Mechanicville, NY
 W MCA New York, NY
 *WNYC-FM New York, NY
 WOR New York, NY
 WRRV(FM) New York, NY
 WJLJ Niagara Falls, NY
 WSOQ North Syracuse, NY
 *WPOB(FM) Plainview, NY
 WQBK Rensselaer, NY
 WABZ Albemarle, NC
 WABZ-FM Albemarle, NC
 WIST Charlotte, NC
 WAGY Forest City, NC
 WFSC Franklin, NC
 WMPM Smithfield, NC
 KBOM Bismarck-Mandan, ND
 KTGO Tioga, ND
 WHLO Akron, OH
 *WOUB-FM Athens, OH
 WOMP Belleaire, OH

WOMP-FM Belleaire, OH
 WBCO Bucyrus, OH
 WBCO-FM Bucyrus, OH
 WIXY Cleveland, OH
 WAVI Dayton, OH
 WFOB Fostoria, OH
 WFOB-FM Fostoria, OH
 WDRK(FM) Greenville, OH
 WSUM Parma, OH
 WBTC Uhrichsville, OH
 WERT Van Wert, OH
 WERT-FM Van Wert, OH
 WKOV Wellston, OH
 *KWGS(FM) Tulsa, OK
 KATR Eugene, OR
 *KLCC(FM) Eugene, OR
 KUGN Eugene, OR
 KLAD-FM Klamath Falls, OR
 WHLM Bloomsburg, PA
 WHLM-FM Bloomsburg, PA
 WISR Butler, PA
 WEZ Chester, PA
 W WYN Erie, PA
 WBCW Jeannette, PA
 WQTW Latrobe, PA
 WHUM Reading, PA
 WICK Scranton, PA
 *WRKC(FM) Wilkes-Barre, PA
 WADK Newport, RI
 W W O N Woonsocket, RI
 WJWG Ridgeland, SC
 *W S M C-FM Colledgeale, TN
 WSKT Knoxville, TN
 W WEE Memphis, TN
 WKSR Putasi, TN
 KRBC Abilene, TX
 KBAN Bowie, TX
 *KERA-FM Dallas, TX
 KD S X Denison-Sherman, TX
 KD S X-FM Denison-Sherman, TX
 KG TN Georgetown, TX
 KG TN-FM Georgetown, TX
 KTRH Houston, TX
 *KTSU(FM) Houston, TX
 KGNB New Braunfels, TX
 W OAI San Antonio, TX
 KSX S Salt Lake City, UT
 K AAR Mountlake Terrace, WA
 *KAOS(FM) Olympia, WA
 KIRO Seattle, WA
 KIXI Seattle, WA
 KIXY-FM Seattle, WA
 KYAC Seattle, WA
 *KMBI Spokane, WA
 KPQ Wenatchee, WA
 *W DCE(FM) Elkins, WV
 WBIZ Eau Claire, WI
 KFIZ Fond Du Lac, WI
 WKTY La Crosse, WI
 W TSO Madison, WI
 W NBI Park Falls, WI
 W NBI-FM Park Falls, WI
 WRVM(FM) Suring, WI
 KOWB Laramie, WY
 WIAC San Juan, PR

Top-40

Includes station formats characterized as contemporary, rock, request, popular and hit parade.

WERC Birmingham, AL
 WERC-FM Birmingham, AL
 WVOK Birmingham, AL
 WKNU(FM) Brewton, AL
 WCOX Camden, AL
 WEIS Centre, AL
 WKUL Cullman, AL
 WMSL Decatur, AL
 WDIG Dothan, AL
 WIRB-FM Enterprise, AL
 WULA Eufaula, AL
 WULA-FM Eufaula, AL
 WWWF Fayette, AL
 WOTC Floraton, AL
 W WFL Florence, AL
 W FPA Fort Payne, AL
 WGAD Gadsden, AL
 W VAY Huntsville, AL
 WVOY Huntsville, AL
 WRLD Lanett, AL
 WJAM Marion, AL
 WABB Mobile, AL
 WABB-FM Mobile, AL
 WHYY Montgomery, AL
 W LAY Muscle Shoals, AL
 W LAY-FM Muscle Shoals, AL
 WJHO Opelika, AL
 WAMI Opp, AL
 WAMI-FM Opp, AL
 WAMA Selma, AL

WHBB Selma, AL
 WRCK-FM Sheffield, AL
 WHTB(FM) Talladega, AL
 WTUB(FM) Troy, AL
 WTBC Tuscaloosa, AL
 *WUAL-FM Tuscaloosa, AL
 WOSI(FM) Union Springs, AL
 KENI Anchorage, AK
 KGOT(FM) Anchorage, AK
 KLAM Cordova, AK
 KFAR Fairbanks, AK
 KIFW Sitka, AK
 KCUZ Clifton, AZ
 KEOS Flagstaff, AZ
 KBAS(FM) Lake Havasu City, AZ
 KRIZ Phoenix, AZ
 KUPD Tempe, AZ
 KUPD-FM Tempe, AZ
 KBLU Tucson, AZ
 KTKT Tucson, AZ
 KWFM(FM) Tucson, AZ
 KXEW-FM Tucson, AZ
 KMLA(FM) Ashdown, AR
 KTHS Berryville, AR
 KAGH Crossett, AR
 KAGH-FM Crossett, AR
 KDQD De Queen, AR
 KDMS El Dorado, AR
 KKEG(FM) Fayetteville, AR
 KFS Fort Smith, AR
 KWHN Fort Smith, AR
 KJWZ Harrison, AR
 KAWW Heber Springs, AR
 KAWW-FM Heber Springs, AR
 KBTM-FM Jonesboro, AR
 KAAY Little Rock, AR
 KKYK(FM) Little Rock, AR
 KLAZ(FM) Little Rock, AR
 KFMV(FM) Magnolia, AR
 KDRS Parabol, AR
 KCLA Pine Bluff, AR
 KOTN Pine Bluff, AR
 KOTN-FM Pine Bluff, AR
 KWAK Stuttgart, AR
 KOSY Texarkana, AR
 KEZY Anaheim, CA
 *KAHS(FM) Arcata, CA
 KATA Arcata, CA
 KAFY Bakersfield, CA
 KERN Bakersfield, CA
 KRE Berkeley, CA
 KRE-FM Berkeley, CA
 KEWE(FM) Camarillo, CA
 KAMP El Centro, CA
 KFMI(FM) Eureka, CA
 KDAC Fort Bragg, CA
 KNCR Fortuna, CA
 KYNO Fresno, CA
 KORJ(FM) Garden Grove, CA
 KNGT(FM) Jackson, CA
 KOAD Lemoore, CA
 KKIOM Livermore, CA
 KLOM Lompoc, CA
 KLOM-FM Lompoc, CA
 KNAC(FM) Long Beach, CA
 KHJ Los Angeles, CA
 KIIS-FM Los Angeles, CA
 KLOS(FM) Los Angeles, CA
 KRVE(FM) Los Gatos, CA
 KMYC Marysville, CA
 KYOS Merced, CA
 *KBHI-FM Modesto, CA
 KFIV Modesto, CA
 KHOP(FM) Modesto, CA
 KMBY Monterey, CA
 KRDG Redding, CA
 *KR VH(FM) Rio Vista, CA
 KNDE Sacramento, CA
 KZAP(FM) Sacramento, CA
 *KAUG(FM) Salinas, CA
 KBZF(FM) Salinas, CA
 KDON Salinas, CA
 KFXM San Bernardino, CA
 K MEN San Bernardino, CA
 KCBO San Diego, CA
 KFMB-FM San Diego, CA
 KGB San Diego, CA
 KFRC San Francisco, CA
 *KQED-FM San Francisco, CA
 KSFX(FM) San Francisco, CA
 KYA San Francisco, CA
 KLIV San Jose, CA
 KSLY San Luis Obispo, CA
 KSOL(FM) San Mateo, CA
 KSEE Santa Maria, CA
 KDAY Santa Monica, CA
 *KNHS(FM) Torrance, CA
 *KVIK(FM) Travis AFB, CA
 KUIC(FM) Vacaville, CA
 KBBY(FM) Ventura, CA
 *KSAK(FM) Walnut, CA

KWSO Wasco, CA
 K S F M Woodland, CA
 KADE Boulder, CO
 KVFC Cortez, CO
 KLZ-FM Denver, CO
 KTLK Denver, CO
 KXIX Fort Collins, CO
 KEXO Grand Junction, CO
 KFKA Greeley, CO
 KBZZ La Junta, CO
 KLMR Lamar, CO
 KLMO-FM Longmont, CO
 KLIQ Manitou Springs, CO
 KLIQ-FM Manitou Springs, CO
 KPAG Pagosa Springs, CO
 KDZA Pueblo, CO
 KKAM Pueblo, CO
 KWSR Rifle, CO
 KUAD-FM Windsor, CO
 WADS Ansonia, CT
 WICC Bridgeport, CT
 WINC Brookfield, CT
 WSUB-FM Groton, CT
 *WQAQ(FM) Hamden, CT
 WCCC Hartford, CT
 WCCC-FM Hartford, CT
 WDRC Hartford, CT
 WDRC-FM Hartford, CT
 *WRTC-FM Hartford, CT
 *WCF S(FM) New Britain, CT
 WVAZ New Haven, CT
 W NHC New Haven, CT
 WNLN New London, CT
 WINY Putnam, CT
 WQOQ Waterbury, CT
 W WCO Waterbury, CT
 WDOV Dover, DE
 *WZZE(FM) Hockessin, DE
 WNRK Newark, DE
 WSUX Seaford, DE
 WSUX-FM Seaford, DE
 WAMS Wilmington, DE
 WILM Wilmington, DE
 *WMPH(FM) Wilmington, DE
 *WHUR-FM Washington, DC
 WKYS(FM) Washington, DC
 W WDC Washington, DC
 W WDC-FM Washington, DC
 WLEQ(FM) Bonita Springs, FL
 WLQH Chieffland, FL
 WTAN-FM Clearwater, FL
 WEZY Cocoa, FL
 WEZY-FM Cocoa, FL
 WKKO Cocoa, FL
 WRKT Cocoa Beach, FL
 WGTO Cypress Gardens, FL
 WDAT Daytona Beach, FL
 WMFJ Daytona Beach, FL
 WTRS Dunnellon, FL
 WTRS-FM Dunnellon, FL
 WLCO Eustis, FL
 WHYI(FM) Fort Lauderdale, FL
 WMYR Fort Myers, FL
 WOVV(FM) Fort Pierce, FL
 WNUE Ft. Walton Beach, FL
 WGGG Gainesville, FL
 WRUF Gainesville, FL
 WAPE Jacksonville, FL
 WIVY Jacksonville, FL
 WIVY-FM Jacksonville, FL
 WJAX Jacksonville, FL
 WKIZ Key West, FL
 WGRO Lake City, FL
 WIPC Lake Wales, FL
 WONN Lakeland, FL
 WQPD Lakeland, FL
 WRGI Marco Island, FL
 WTAI-FM Melbourne, FL
 WMJX(FM) Miami, FL
 WOAM Miami, FL
 WTM C Ocala, FL
 WB J W-FM Orlando, FL
 WLOF Orlando, FL
 W WFLP Palatka, FL
 W DLP Panama City, FL
 WPFM(FM) Panama City, FL
 W GNE Panama City Beach, FL
 WBSR Pensacola, FL
 WKLO(FM) Pensacola, FL
 W VIX Pensacola, FL
 WFSO Pinellas Park, FL
 WKXY Sarasota, FL
 WQSR(FM) Sarasota, FL
 WYND Sarasota, FL
 WFUN South Miami, FL
 WILZ St. Petersburg Beach, FL
 W L C Y St. Petersburg, FL
 W L C Y-FM St. Petersburg, FL
 WGLF(FM) Tallahassee, FL
 WTAL Tallahassee, FL
 WRBQ(FM) Tampa, FL
 WTMP Tampa, FL
 WTTB Vero Beach, FL

WIRK West Palm Beach, FL
 WSIR Winter Haven, FL
 WZNG Winter Haven, FL
 WALG Albany, GA
 WDEC Americus, GA
 WRFC Athens, GA
 *WCLK(FM) Atlanta, GA
 WOXL Atlanta, GA
 WZCG(FM) Atlanta, GA
 WAUG Augusta, GA
 WAUG-FM Augusta, GA
 WJAD(FM) Bainbridge, GA
 WCLB Camilla, GA
 WPPI Carrollton, GA
 WBHF Cartersville, GA
 WCGQ(FM) Columbus, GA
 WWRH(FM) Columbus, GA
 WMJM Cordel, GA
 WTTI Dalton, GA
 WDDW Dawson, GA
 WXPO Eatonton, GA
 WFPM Fort Valley, GA
 WDUN Gainesville, GA
 WJGA Jackson, GA
 WJGA-FM Jackson, GA
 WYYZ Jasper, GA
 WIFO-FM Jesup, GA
 WTRP La Grange, GA
 WPEH Louisville, GA
 WPEH-FM Louisville, GA
 WBML Macon, GA
 WNEK Macon, GA
 WFOF Marietta, GA
 WHCG(FM) Metter, GA
 WMAC Metter, GA
 WKUN Monroe, GA
 WNEA Newnan, GA
 WSIJ Ocala, GA
 WPGA Perry, GA
 WSGA Savannah, GA
 WOXL-FM Smyrna, GA
 WMCD(FM) Statesboro, GA
 WGTA Summerville, GA
 WSYL Sylvania, GA
 WLET-FM Toccoa, GA
 WTCO(FM) Vidalia, GA
 WRBN Warner Robins, GA
 WRBN-FM Warner Robins, GA
 WACL Waycross, GA
 KIOE Honolulu, HI
 KKUA Honolulu, HI
 KORL Honolulu, HI
 KPOI Honolulu, HI
 KNUI Kahului, HI
 KBBK-FM Boise, ID
 KFMA(FM) Jerome, ID
 KOZE Lewiston, ID
 KRLC Lewiston, ID
 *KUOI-FM Moscow, ID
 KFXD Nampa, ID
 KLER Orofino, ID
 KSNM Pocatello, ID
 KSNM-FM Pocatello, ID
 KIGO St. Anthony, ID
 KEWP Twin Falls, ID
 KMTW(FM) Twin Falls, ID
 WRMS Beardstown, IL
 WQRX(FM) Benton, IL
 WLRW(FM) Champaign, IL
 WDAI(FM) Chicago, IL
 WJPC Chicago, IL
 WLS Chicago, IL
 WNIS-FM Chicago, IL
 WSDM(FM) Chicago, IL
 WXRT(FM) Chicago, IL
 *WJMU(FM) Decatur, IL
 WESL East St. Louis, IL
 *WRSE-FM Elmhurst, IL
 *WTPC(FM) Elsau, IL
 *WHFH(FM) Flossmoor, IL
 WACI(FM) Freeport, IL
 *WGH(FM) Glen Ellyn, IL
 *WHSD(FM) Hinsdale, IL
 *WLN(FM) Lincoln, IL
 *WLR(FM) Lockport, IL
 *WMHS(FM) Morrison, IL
 *WVJC-FM Mt. Carmel, IL
 WJHN(FM) Normal, IL
 WOLI(FM) Ottawa, IL
 *WRHS(FM) Park Forest, IL
 WIRL Peoria, IL
 WWCT(FM) Peoria, IL
 WHBF-FM Rock Island, IL
 *WVIK(FM) Rock Island, IL
 WROK Rockford, IL
 WCVS Springfield, IL
 *WARG(FM) Summit, IL
 WYFE-FM Winnebago, IL
 WRTH Wood River, IL
 WTKI(FM) Angola, IN
 WIFF-FM Auburn, IN
 *WHJE(FM) Carmel, IN
 WGBF Evansville, IN

WMEE Fort Wayne, IN
 WPTH(FM) Fort Wayne, IN
 WIFN(FM) Franklin, IN
 *WGRE(FM) Greencastle, IN
 *WICR(FM) Indianapolis, IN
 WNAF(FM) Indianapolis, IN
 WQHI(FM) Jeffersonville, IN
 WAZY Lafayette, IN
 WAZY-FM Lafayette, IN
 WYUS(FM) Lafayette, IN
 WGMO Marion, IN
 WPGW Portland, IN
 WNDU-FM South Bend, IN
 WRBR(FM) South Bend, IN
 WTCJ Tell City, IN
 WVTS(FM) Terre Haute, IN
 *WVUR-FM Valparaiso, IN
 WMGH(FM) Vevay, IN
 WAOV-FM Vincennes, IN
 WKUZ(FM) Wabash, IN
 WRSW Warsaw, IN
 KCCQ(FM) Ames, IA
 *KPGY(FM) Ames, IA
 KGRS(FM) Burlington, IA
 KILW Cedar Rapids, IA
 *KWMR(FM) Cedar Rapids, IA
 KCOG Centerville, IA
 KLIK(FM) Davenport, IA
 KSST Davenport, IA
 KGGO(FM) Des Moines, IA
 KIOA Des Moines, IA
 WDBO Dubuque, IA
 *KICB(FM) Fort Dodge, IA
 KFVD Fort Dodge, IA
 KRNA(FM) Iowa City, IA
 KXIC Iowa City, IA
 KIMI(FM) Keokuk, IA
 KLSS(FM) Mason City, IA
 KRIB Mason City, IA
 KCOB Newton, IA
 KMA Shenandoah, IA
 KMNS Sioux City, IA
 KWSL Sioux City, IA
 KTLB(FM) Twin Lakes, IA
 KCII Washington, IA
 KLEU Waterloo, IA
 KXEL-FM Waterloo, IA
 KKOY Chanute, KS
 KEDD Dodge City, KS
 KLR(FM) Emporia, KS
 KJLS(FM) Hays, KS
 KWHK Hutchinson, KS
 KALN Iola, KS
 KJCK-FM Junction City, KS
 KUUL-FM Kansas City, KS
 KCLO Leavenworth, KS
 KMKF(FM) Manhattan, KS
 *KSDB-FM Manhattan, KS
 KSKG(FM) Salina, KS
 KEWI Topeka, KS
 KTOP Topeka, KS
 WIBW-FM Topeka, KS
 KBUL Wichita, KS
 KEYN-FM Wichita, KS
 KLEO Wichita, KS
 *KSWC(FM) Winfield, KS
 WAMX(FM) Ashland, KY
 WCMJ Ashland, KY
 WYWF-FM Barbourville, KY
 WCBL-FM Benton, KY
 WXBQ Berea, KY
 WBSN Bowling Green, KY
 WNES Central City, KY
 WNES-FM Central City, KY
 WCTT Corbin, KY
 WYGO Corbin, KY
 WHIR Danville, KY
 WIEL Elizabethtown, KY
 WEC(FM) Elkhorn City, KY
 WSAC Fort Knox, KY
 WABD Ft. Campbell, KY
 WABD-Ft. Campbell, KY
 *WVVG(FM) Georgetown, KY
 WYXS Glasgow, KY
 WOVO(FM) Glasgow, KY
 WGRK Greensburg, KY
 WHLN Harlan, KY
 WKIC Hazard, KY
 WKDQ(FM) Henderson, KY
 WKCB Hindman, KY
 WKCB-FM Hindman, KY
 WLCB-FM Hodgenville, KY
 WLEK Jackson, KY
 WLAP Lexington, KY
 WLAP-FM Lexington, KY
 WWLK Lexington, KY
 WAKY Louisville, KY
 WKLO Louisville, KY
 WAFI Middletown, KY
 WOMI Owensboro, KY
 WDXR Paducah, KY
 WKYX Paducah, KY
 WPRT Prestonsburg, KY

WPRT-FM Prestonsburg, KY
 WEKY Richmond, KY
 WLCK Shelbyville, KY
 WOND Shelbyville, KY
 *WSCC(FM) Somerset, KY
 WSFC Somerset, KY
 WTLA Somerset, KY
 WSKV(FM) Stanton, KY
 WWKY Winchester, KY
 KROF Abbeville, LA
 KROF-FM Abbeville, LA
 WAFB-FM Baton Rouge, LA
 WIBR Baton Rouge, LA
 WLCS Baton Rouge, LA
 WIKC Bogalusa, LA
 KEUN Eunice, LA
 KTDL Farmerville, LA
 KFNV Ferriday, LA
 KLEB-FM Golden Meadow, LA
 WPRP Hammond, LA
 WGTI(FM) Hammond, LA
 KJIN Houma, LA
 KSMB(FM) Lafayette, LA
 KVOL Lafayette, LA
 KAKO Lake Charles, LA
 KSNS(FM) Lake Charles, LA
 KLOU Lake Charles, LA
 KLLA Leesville, LA
 KNOE Monroe, LA
 KMRC Morgan City, LA
 KMRC-FM Morgan City, LA
 KANE New Iberia, LA
 KNIR New Iberia, LA
 WNOE New Orleans, LA
 WQUE(FM) New Orleans, LA
 WTX New Orleans, LA
 KCLR(FM) Oakdale, LA
 KRUS Ruston, LA
 KEEL Shreveport, LA
 WSDL Slidell, LA
 KTLD Tallulah, LA
 *KVF(FM) Thibodaux, LA
 KXOR(FM) Thibodaux, LA
 KVCL-FM Winnfield, LA
 WPNQ Auburn, ME
 WABI Bangor, ME
 WUGY Bangor, ME
 WJTO Bath, ME
 WJTO-FM Bath, ME
 WBME Belfast, ME
 *WBHS(FM) Brunswick, ME
 WFST-FM Caribou, ME
 WFST Caribou, ME
 WDME Dover Foxcroft, ME
 WKTJ Farmington, ME
 WKTJ-FM Farmington, ME
 *WUMF-FM Farmington, ME
 WLVC Fort Kent, ME
 WABK Gardiner, ME
 WKME(FM) Gardiner, ME
 WYOU-FM Houlton, ME
 WLKN Lincoln, ME
 WLKN-FM Lincoln, ME
 WSJR Madawaska, ME
 WNWY-FM Norway, ME
 WLOB Portland, ME
 WDH(FM) Presque Isle, ME
 WRUM-FM Rumford, ME
 WRUM Rumford, ME
 WJBO-FM Scarborough, ME
 WSKW Skowhegan, ME
 WJBO Westbrook, ME
 WAMD Aberdeen, MD
 WYRE Annapolis, MD
 WCAO Baltimore, MD
 WDJQ(FM) Baltimore, MD
 WLPL(FM) Baltimore, MD
 *WHFC(FM) Bel Air, MD
 WZY-FM Braddock Heights, MD
 WCIUM Cumberland, MD
 WCIUM-FM Cumberland, MD
 WTBO Cumberland, MD
 WZYQ Frederick, MD
 WARK Hagerstown, MD
 WARK-FM Hagerstown, MD
 WQCM(FM) Halfway, MD
 WPGC Morningside, MD
 WPGC-FM Morningside, MD
 WDMV Pocomoke City, MD
 WINX Rockville, MD
 *WKHS(FM) Worton, MD
 *WPAA(FM) Andover, MA
 WBA-FM Boston, MA
 WRKO Boston, MA
 WSAR Fall River, MA
 WEIM Fitchburg, MA
 WVB(FM) Framingham, MA
 WGAW Gardner, MA
 WCOD-FM Hyannis, MA
 WCGY(FM) Lawrence, MA
 WLLH Lowell, MA
 *WMLN-FM Milton, MA

WGTR Natick, MA
 WBSM New Bedford, MA
 WBEC Pittsfield, MA
 WAQY(FM) Springfield, MA
 WHYN Springfield, MA
 WARE Ware, MA
 WTXL West Springfield, MA
 *WRSB(FM) Weston, MA
 WORC Worcester, MA
 WATZ Alpenz, MI
 WAAM Ann Arbor, MI
 WLEW Bad Axe, MI
 WKNR Battle Creek, MI
 WBCM Bay City, MI
 *WCHW-FM Bay City, MI
 WHNN(FM) Bay City, MI
 WATT Cadillac, MI
 WVOY Charlevoix, MI
 WDRQ(FM) Detroit, MI
 WTAC Flint, MI
 WWCK(FM) Flint, MI
 WGHN Grand Haven, MI
 WGRD Grand Rapids, MI
 WGRD-FM Grand Rapids, MI
 WLAW Grand Rapids, MI
 WZZM-FM Grand Rapids, MI
 WPLB Greenville, MI
 WHGR Houghton Lake, MI
 WKPD Ishpeming, MI
 WJPD-FM Ishpeming, MI
 WMQT(FM) Ishpeming, MI
 WJPD Ishpeming, MI
 WIBM Jackson, MI
 WKMI Kalamazoo, MI
 WLS Lansing, MI
 WMTE Manistee, MI
 WMTE-FM Manistee, MI
 WUUN(FM) Marquette, MI
 WJUN Munising, MI
 WQXO(FM) Munising, MI
 WNIL Niles, MI
 WNIL-FM Niles, MI
 *WOPR(FM) Oak Park, MI
 *WSDP(FM) Plymouth, MI
 *WORW(FM) Port Huron, MI
 *WOAK(FM) Royal Oak, MI
 WSAM Saginaw, MI
 *WHSJ(FM) Southfield, MI
 WSJM St. Joseph, MI
 *WPHS-FM Warren, MI
 KAUS Austin, MN
 KBUN Bemidji, MN
 KLIZ-FM Brainerd, MN
 *KJCM-FM Crookston, MN
 WAKX-FM Duluth, MN
 WDTH(FM) Duluth, MN
 WEBC Duluth, MN
 WDGW Minneapolis, MN
 KDMA Montevideo, MN
 KVOX Moorhead, MN
 KWIM(FM) Moorhead, MN
 *KUMM(FM) Mooris, MN
 *KRLX(FM) Northfield, MN
 KLGR Redwood Falls, MN
 WYOO-FM Richfield, MN
 KNCV(FM) Rochester, MN
 KWEB Rochester, MN
 KWWK(FM) Rochester, MN
 WJON St. Cloud, MN
 WWJO(FM) St. Cloud, MN
 KDWB St. Paul, MN
 KSTP St. Paul, MN
 KWNQ Winona, MN
 WMPA Aberdeen, MS
 WQID(FM) Biloxi, MS
 WMRO(FM) Brookhaven, MS
 WKDL Clarksdale, MS
 WROX Clarksdale, MS
 WCLD Cleveland, MS
 WCJU Columbia, MS
 WACR Columbus, MS
 WCBJ Columbus, MS
 WKCU Corinth, MS
 WBSJ(FM) Ellisville, MS
 WDDT Greenville, MS
 WSWG Greenwood, MS
 WSWG-FM Greenwood, MS
 WNAG Grenada, MS
 WROA Gulfport, MS
 WXXX Hattiesburg, MS
 WNLA Indianola, MS
 WNLA-FM Indianola, MS
 WZZO(FM) Jackson, MS
 WAML Laurel, MS
 WNSL Laurel, MS
 WSJ Magee, MS
 WALT(FM) Meridian, MS
 WDAL Meridian, MS
 WMIS Natchez, MS
 WQNZ(FM) Natchez, MS
 WBFN Quitman, MS
 WKOR Starkville, MS
 WTUP Tupelo, MS

WQMV(FM) Vicksburg, MS
 WABO Waynesboro, MS
 *WWCL(FM) Wesson, MS
 KSOA Ava, MO
 KBLL Bolivar, MO
 KLTB(FM) Bolivar, MO
 KGMO Cape Girardeau, MO
 KGMO-FM Cape Girardeau, MO
 KAOL Carrollton, MO
 KAOL-FM Carrollton, MO
 KCHI Chillicothe, MO
 KFMZ(FM) Columbia, MO
 KTGR-FM Columbia, MO
 KGR(CM) Hannibal, MO
 KJAS Jackson, MO
 KLIK Jefferson City, MO
 KFSB Joplin, MO
 KOYX Joplin, MO
 KBEO(FM) Kansas City, MO
 KYS(FM) Kansas City, MO
 KLEX Lexington, MO
 KMFL-FM Marshall, MO
 KLRS Mountain Grove, MO
 KCOL Rolla, MO
 KETU(FM) Salem, MO
 KICK Springfield, MO
 KWTO-FM Springfield, MO
 KIRL St. Charles, MO
 KKJO St. Joseph, MO
 *KLSR(FM) St. Louis, MO
 KSLQ(FM) St. Louis, MO
 KXOK St. Louis, MO
 KOKO Warrensburg, MO
 KOOK Billings, MT
 KOYN-FM Billings, MT
 KBOZ Bozeman, MT
 KXXL Bozeman, MT
 KDBM-FM Dillon, MT
 KLTZ Glasgow, MT
 KEIN Great Falls, MT
 KNUUW(FM) Great Falls, MT
 KUDD Great Falls, MT
 KCAP Helena, MT
 KGYM Missoula, MT
 KILT Missoula, MT
 KHUB Fremont, NE
 KHUB-FM Fremont, NE
 KRGI Grand Island, NE
 *KNCT(FM) Hastings, NE
 KICS Hastings, NE
 KRNY Kearney, NE
 KRNY-FM Kearney, NE
 KLM Lincoln, NE
 *KRN(FM) Lincoln, NE
 KBRL McCook, NE
 KOIL Omaha, NE
 KNLV Ord, NE
 KSID Sidney, NE
 KSID-FM Sidney, NE
 KRFS Superior, NE
 *WSC(FM) Wayne, NE
 KENO Las Vegas, NV
 KFMS(FM) Las Vegas, NV
 KLUC Las Vegas, NV
 KLUC-FM Las Vegas, NV
 KUDDO(FM) Las Vegas, NV
 KCBN Reno, NV
 KWRL Sparks, NV
 WBRL Berlin, NH
 WMOU Berlin, NH
 WXLO(FM) Berlin, NH
 WTSV Claremont, NH
 WBNC Conway, NH
 WBNC-FM Conway, NH
 WTSN Dover, NH
 *WNEC-FM Henniker, NH
 WKBK Keene, NH
 WLNH Laconia, NH
 WLNH-FM Laconia, NH
 *WPCR-FM Plymouth, NH
 WEB Portsmouth, NH
 WEB-FM Portsmouth, NH
 WNNH Rochester, NH
 WJLK Asbury Park, NJ
 WJLK-FM Asbury Park, NJ
 WJLK-FM Asbury Park, NJ
 WJLK-FM Asbury Park, NJ
 WSDS(FM) Franklin, NJ
 *WHPH(FM) Hanover, NJ
 *WHVP-FM Highland Park, NJ
 WHLW Lakewood, NJ
 WMBV Millville, NJ
 WMBV-FM Millville, NJ
 WJNR Newark, NJ
 WDLV Vineland, NJ
 WDLV-FM Vineland, NJ
 WBBZ Vineland, NJ
 KINN Alamogordo, NM

Formats

KRKE Albuquerque, NM
 KSVP Artesia, NM
 KAVE Carlsbad, NM
 KCCC Carlsbad, NM
 KCLV Clovis, NM
 KICA Clovis, NM
 KWKA Clovis, NM
 KRAZ(FM) Farmington, NM
 KWYK Farmington, NM
 KQN(M) Gallup, NM
 KYVA Gallup, NM
 KHOB Hobbs, NM
 KASK(FM) Las Cruces, NM
 KGRT Las Cruces, NM
 KFUN Las Vegas, NM
 KBIM Roswell, NM
 KKAT Roswell, NM
 KVSF Santa Fe, NM
 WPTR Albany, NY
 WCSS-FM Amsterdam, NY
 WNYG Babylon, NY
 WBAB-FM Babylon, NY
 *WBXL(FM) Baldwinsville, NY
 WVIN Bath, NY
 WAAL(FM) Binghamton, NY
 WINR Binghamton, NY
 WBRV Boonville, NY
 WKBW Buffalo, NY
 WYSL Buffalo, NY
 WYSL-FM Buffalo, NY
 *WCEB(FM) Corning, NY
 WENY Elmira, NY
 WENE Endicott, NY
 WKFM(FM) Fulton, NY
 WVIN-FM Hammondsport, NY
 WHUC Hudson, NY
 WHVV Hyde Park, NY
 WTKO Ithaca, NY
 WKSJ Jamestown, NY
 WIZR Johnstown, NY
 WIZR-FM Johnstown, NY
 WBPM(FM) Kingston, NY
 WIRD Lake Placid, NY
 *WSHR(FM) Lake
 Ronkonkoma, NY
 WICY Malone, NY
 WMSA Massena, NY
 WALL Middletown, NY
 WPIX-FM New York, NY
 WPLJ(FM) New York, NY
 WSLB Ogdensburg, NY
 WHDL Olean, NY
 WMSA Olean, NY
 WSRK(FM) Oneonta, NY
 WSGO Oswego, NY
 WBLI(FM) Patchogue, NY
 WSPF Patchogue, NY
 WEAV Plattsburgh, NY
 WRCN Riverhead, NY
 WRCN-FM Riverhead, NY
 WAXC Rochester, NY
 WBFB Rochester, NY
 WCMF(FM) Rochester, NY
 WHFM(FM) Rochester, NY
 WSAW Rochester, NY
 WKAL Rome, NY
 WKAL-FM Rome, NY
 *WSBU(FM) St. Bonaventure,
 NY
 WSNY Schenectady, NY
 WNDR Syracuse, NY
 WOLF Syracuse, NY
 WTRY Troy, NY
 WTLB Utica, NY
 WOTT Watertown, NY
 WLSV Wellsville, NY
 WRCS-FM Ahsokie, NC
 WISE Asheville, NC
 WSL(FM) Bridgeton, NC
 WVBS Burgaw, NC
 WVBS-FM Burgaw, NC
 WBAG Burlington, NC
 WBAG-FM Burlington, NC
 WBBB Burlington, NC
 WWIT Canton, NC
 WCHL Chapel Hill, NC
 WAYS Charlotte, NC
 WPEG(FM) Concord, NC
 WDNC Durham, NC
 WSSB Durham, NC
 WTIK Durham, NC
 WCBX Eden, NC
 WLOE Eden, NC
 WGAI Elizabeth City, NC
 WCNC Elizabeth City, NC
 WMYK(FM) Elizabeth City, NC
 WIFM Elkin, NC
 WIFM-FM Elkin, NC
 WKKO Fair Bluff, NC

WFMO Fairmont, NC
 WROR(FM) Farmville, NC
 WFLB Fayetteville, NC
 WFNC Fayetteville, NC
 WBBO Forest City, NC
 WBBO-FM Forest City, NC
 WGBR Goldsboro, NC
 WYNG Goldsboro, NC
 WBIG Greensboro, NC
 WCOG Greensboro, NC
 WGNL Greenville, NC
 WOOV Greenville, NC
 WKVO Havelock, NC
 WKVO-FM Havelock, NC
 WHKP Hendersonville, NC
 WHKY Hickory, NC
 WSPF Hicory, NC
 WBBS Jacksonville, NC
 WISP Kinston, NC
 WLNC Laurinburg, NC
 WJRI Lenoir, NC
 WBUY Lexington, NC
 WLXN(FM) Lexington, NC
 WLOL Lincolnton, NC
 WYRN Louisburg, NC
 WAGR Lumberton, NC
 WDSL Mocksville, NC
 WMNC Morganton, NC
 WJLY(FM) Moyock, NC
 WRNB New Bern, NC
 WNNC Newton, NC
 WKBC-FM North Wilkesboro,
 NC
 WPNC Plymouth, NC
 WSHB Raeford, NC
 WKIX Raleigh, NC
 WRAL(FM) Raleigh, NC
 WYRU Red Springs, NC
 WFRD Reidsville, NC
 WCBT Roanoke Rapids, NC
 LWLW Rockingham, NC
 WEED Rocky Mount, NC
 WRMT Rocky Mount, NC
 WEYS Sanford, NC
 WOH5 Shelby, NC
 WFBS Spring Lake, NC
 WLAB St. Pauls, NC
 WMSJ Sylva, NC
 WTAB Tabor City, NC
 WTLK Taylorsville, NC
 WTYN Tryon, NC
 WSVM Valdese, NC
 WOBR Wanchese, NC
 WOBR-FM Wanchese, NC
 WSMY Weldon, NC
 WKSK West Jefferson, NC
 WENC Whiteville, NC
 WENC-FM Whiteville, NC
 New Am Whiteville, NC
 WWWC Wilkesboro, NC
 WSGN Wilmington, NC
 WSGH-FM Winston-Salem, NC
 WAIR Winston-Salem, NC
 WTOB Winston-Salem, NC
 KFVR Bismarck, ND
 KQWB Fargo, ND
 KKKL Grand Forks, ND
 KKDO(FM) Grand Forks, ND
 KEYJ Jamestown, ND
 KCBJ Minot, ND
 KDDR Oakes, ND
 WAKR Akron, OH
 WHLO Akron, OH
 WFAH Alliance, OH
 WNCO Ashland, OH
 *WRDL(FM) Ashland, OH
 WREO Ashtabula, OH
 WXTQ(FM) Athens, OH
 *WOUB Athens, OH
 WOMP Bellaire, OH
 WOMP-FM Bellaire, OH
 WTOO Bellefontaine, OH
 WHOT Campbell, OH
 *WNWR(FM) Canal Fulton, OH
 WINW Canton, OH
 WCHI Chillicothe, OH
 WEBN(FM) Cincinnati, OH
 WKRC Cincinnati, OH
 WSAI Cincinnati, OH
 WSAI-FM Cincinnati, OH
 WIXY Cleveland, OH
 WLYT(FM) Cleveland Heights,
 OH
 WCOL Columbus, OH
 WNCI(FM) Columbus, OH
 WCUE Cuyahoga Falls, OH
 *WGX(M) Dayton, OH
 WING Dayton, OH
 WTUE(FM) Dayton, OH
 *WLSN(FM) Delaware, OH
 WDOH(FM) Delphos, OH
 WJER Dover-New
 Philadelphia, OH

WJER-FM Dover-New
 Philadelphia, OH
 WHMQ(FM) Findlay, OH
 *WLFC(FM) Findlay, OH
 WFRO Fremont, OH
 WFRO-FM Fremont, OH
 WDRK(FM) Greenville, OH
 WMOH Hamilton, OH
 WKTN-FM Kenton, OH
 *WKET(FM) Kettering, OH
 WCIT Lima, OH
 WLGJ Logan, OH
 WLGJ-FM Logan, OH
 WLRO Lorain, OH
 WMOA Marietta, OH
 WDI(FM) Marion, OH
 WIOI New Boston, OH
 WLKR Norwalk, OH
 WLKR-FM Norwalk, OH
 WRWR-FM Port Clinton, OH
 WMYR Sidney, OH
 WRKY(FM) Steubenville, OH
 WMHE(FM) Toledo, OH
 WOHO Toledo, OH
 *WUJC(FM) University
 Heights, OH
 WBBY-FM Westerville, OH
 WGIC Xenia, OH
 WFMJ Youngstown, OH
 WHOT-FM Youngstown, OH
 KADA Ada, OK
 KWHP(FM) Edmond, OK
 KSWO Lawton, OK
 KTMC McAlester, OK
 KBIX Muskogee, OK
 KNOR Norman, OK
 KOMA Oklahoma City, OK
 KXXY(FM) Oklahoma City, OK
 KLOOR-FM Ponca City, OK
 KINB(FM) Poteau, OK
 KRBB Sallisaw, OK
 KRBB-FM Sallisaw, OK
 KVRO(FM) Stillwater, OK
 KAKC Tulsa, OK
 KAKC-FM Tulsa, OK
 KELI Tulsa, OK
 KVIN Vinita, OK
 KWSH Wewoka, OK
 KHPE(FM) Albany, OR
 KVAS Astoria, OR
 KGRL Bend, OR
 *KCHC(FM) Central Point, OR
 KOOS Coos Bay, OR
 KYNG Coos Bay, OR
 KFLY Corvallis, OR
 KROW Dallas, OR
 KBDF Eugene, OR
 KPNW Eugene, OR
 *KRVN(FM) Eugene, OR
 KZEL-FM Eugene, OR
 KOHU Hermiston, OR
 *KEOL(FM) La Grande, OR
 KLBM La Grande, OR
 KGAL Lebanon, OR
 KBOY Medford, OR
 KBOY-FM Medford, OR
 KYJC Medford, OR
 KNPT Newport, OR
 KNPT-FM Newport, OR
 KTXI Pendleton, OR
 KGON(FM) Portland, OR
 KGW Portland, OR
 KPAM-FM Portland, OR
 KXL Portland, OR
 KXL-FM Portland, OR
 KYES Roseburg, OR
 KBZY Salem, OR
 KCCS Salem, OR
 KORI(FM) Salem, OR
 KSWB Seaside, OR
 KOHI St. Helens, OR
 KACI The Dalles, OR
 KODL The Dalles, OR
 WAEB Allentown, PA
 WKAP Allentown, PA
 *WMUH(FM) Allentown, PA
 WFBG Altoona, PA
 WVAW Altoona, PA
 *WGEV(FM) Beaver Falls, PA
 WAYC Bedford, PA
 WIOO Carlisle, PA
 WZUM Carnegie, PA
 WCBG Chambersburg, PA
 WCPA Clearfield, PA
 WCPA-FM Clearfield, PA
 WCVI Conellsville, PA
 WFRM Coudersport, PA
 WEEEX Easton, PA
 WLEV(FM) Easton, PA
 WEND Ebensburg, PA
 WCCCK(FM) Erie, PA
 WJET Erie, PA
 WFAF Farrell, PA

WHJB Greensburg, PA
 WOKU-FM Greensburg, PA
 *WSAJ Grove City, PA
 *WSAJ-FM Grove City, PA
 WYCR(FM) Hanover, PA
 WYFC Harrisburg, PA
 WKBO Harrisburg, PA
 WAZL Hazleton, PA
 WHPA Honesdale, PA
 WBCW Jeannette, PA
 WCRO Johnstown, PA
 WKZA Kane, PA
 WLAN Lancaster, PA
 WQTW Latrobe, PA
 WTRA Latrobe, PA
 WYNS Lehighton, PA
 WKVA Lewisport, PA
 WIMG Meadville, PA
 WMPL Milton, PA
 WKPA New Kensington, PA
 WNAR Norristown, PA
 WCAU-FM Philadelphia, PA
 WIBG Philadelphia, PA
 WIF(FM) Philadelphia, PA
 *WKDU(FM) Philadelphia, PA
 KDKA Pittsburgh, PA
 WDTQ Pittsburgh, PA
 WPEZ(FM) Pittsburgh, PA
 WRAW Reading, PA
 WMPT S. Williamsport, PA
 WMPT-FM S. Williamsport, PA
 WARM Scranton, PA
 WGBI-FM Scranton, PA
 WSCR Scranton, PA
 WYFM(FM) Sharon, PA
 WMBT Shenandoah, PA
 WMAJ State College, PA
 WRSC State College, PA
 WNAE Warren, PA
 WJPA Washington, PA
 WJPA-FM Washington, PA
 WEEO Waynesboro, PA
 WNBW Wellsboro, PA
 WBAX Wilkes-Barre, PA
 WILK Wilkes-Barre, PA
 WQXA(FM) York, PA
 WZIX York, PA
 WGNP Pawtucket, RI
 WICE Providence, RI
 WPRO Providence, RI
 WPRO-FM Providence, RI
 WARV Warwick, RI
 WNRI Woonsocket, RI
 WAKN Aiken, SC
 WANS Anderson, SC
 WANS-FM Anderson, SC
 WBAW Barnwell, SC
 WBAW-FM Barnwell, SC
 WBEU Beaufort, SC
 WSIB Beaufort, SC
 WBSC Bennettsville, SC
 WACA Camden, SC
 WUPB-FM Camden, SC
 WKTM(FM) Charleston, SC
 WPAL Charleston, SC
 WMTA Charleston, SC
 WCRC Cheraw, SC
 WGED Chester, SC
 WPCC Clinton, SC
 WCOS Columbia, SC
 WNOK Columbia, SC
 WELP-FM Easley, SC
 WJMX Florence, SC
 WEAC Gaffney, SC
 WFGN Gaffney, SC
 WGM(FM) Georgetown, SC
 WFBC Greenville, SC
 WFBC-FM Greenville, SC
 WHYZ Greenville, SC
 WGSW Greenwood, SC
 WKYB Hemingway, SC
 WKHJ Holly Hill, SC
 WKSP Kingstree, SC
 WLSC Loris, SC
 WYMB Manning, SC
 WTW(FM) Moncks Corner, SC
 WTGR Myrtle Beach, SC
 WKDK Newberry, SC
 WNMB(FM) N. Myrtle Beach,
 SC
 WDIX-FM Orangeburg, SC
 WCPL(FM) Pageland, SC
 WRHI Rock Hill, SC
 WORD Spartanburg, SC
 WPWR(FM) St. George, SC
 WWWW(FM) Summerville, SC
 WDXY Sumter, SC
 WBCU Union, SC
 WGOG Wallahalla, SC
 WCKM Winnsboro, SC
 WYCL York, SC
 KABR Aberdeen, SD
 *KASD(FM) Aberdeen, SD

KKLS Rapid City, SD
 KKLS-FM Rapid City, SD
 KISD Sioux Falls, SD
 KPAT(FM) Sioux Falls, SD
 KSDR Watertown, SD
 KWYR-FM Winner, SD
 KQHU(FM) Yankton, SD
 KYNT Yankton, SD
 WHLP Centerville, TN
 WIK(A) Centerville, TN
 WGOW Chattanooga, TN
 WJZM Clarksville, TN
 WCFM(FM) Clinton, TN
 WKRM Columbia, TN
 WPTN Cookeville, TN
 WPTN-FM Cookeville, TN
 *WTTU(FM) Cookeville, TN
 WAEW Crossville, TN
 WAEW-FM Crossville, TN
 WCSV Crossville, TN
 WTRD Dyersburg, TN
 WENR Englewood, TN
 WHIN Gallatin, TN
 WKMN Hartselle, TN
 WBYQ(FM) Hendersonville,
 TN
 WJAK Jackson, TN
 WKIR(FM) Jackson, TN
 WDEB Jamestown, TN
 WDEB-FM Jamestown, TN
 WJTT Jellico, TN
 WETB Johnson City, TN
 WJSO Jonesboro, TN
 WQUT(FM) Johnson City, TN
 WKIN Kingsport, TN
 WBIR Knoxville, TN
 WBIR-FM Knoxville, TN
 WIVK Knoxville, TN
 WIVK-FM Knoxville, TN
 *WKCS(FM) Knoxville, TN
 WJGN Knoxville, TN
 WNOX Knoxville, TN
 WEEN Lafayette, TN
 WCOR Lebanon, TN
 WBLC Lenoir City, TN
 WDXL Lexington, TN
 WLIV Livingston, TN
 WLIV-FM Livingston, TN
 WFLI Lookout Mountain, TN
 WMSR Manchester, TN
 WHBQ Memphis, TN
 WMC-FM Memphis, TN
 WMPM Memphis, TN
 *WQOX(FM) Memphis, TN
 WGN5 Murfreesboro, TN
 WMTS-FM Murfreesboro, TN
 WLAC Nashville, TN
 WMAK Nashville, TN
 *WNAZ-FM Nashville, TN
 WLIK Newport, TN
 WOKI-FM Oak Ridge, TN
 WKSR Pulaski, TN
 WHAL Shelbyville, TN
 WHAL-FM Shelbyville, TN
 WUCR Sparta, TN
 WJIG Tullahoma, TN
 WBRY Woodbury, TN
 KFMN(FM) Abilene, TX
 KRBC Abilene, TX
 KDJW-FM Amarillo, TX
 KXJZ Amarillo, TX
 KPUR Amarillo, TX
 KNOW Austin, TX
 KLVI Beaumont, TX
 KACO Bellville, TX
 KWGH Big Lake, TX
 KBST Big Spring, TX
 KBBB Borger, TX
 KQTY Borger, TX
 KBWD Brownwood, TX
 KTAM Bryan, TX
 KCXT Childress, TX
 WTAW-FM College Station, TX
 KEYS Corpus Christi, TX
 KZFM(FM) Corpus Christi, TX
 KCIR(FM) Corsicana, TX
 KIVY-FM Crockett, TX
 KLIF Dallas, TX
 KZEW(FM) Dallas, TX
 KDLK Del Rio, TX
 *KGCC(FM) Denison, TX
 KDSX Denison-Sherman, TX
 *KNTU(FM) Denton, TX
 KELP El Paso, TX
 KINT El Paso, TX
 KINT-FM El Paso, TX
 KLOZ(FM) El Paso, TX
 KFJZ Fort Worth, TX
 KFWD(FM) Fort Worth, TX
 KXOL Fort Worth, TX
 KILE Galveston, TX
 KGTTN Georgetown, TX

KGTV-FM Georgetown, TX
 KGVL Greenville, TX
 KHBR Hillsboro, TX
 KILT Houston, TX
 KRBE(FM) Houston, TX
 KRLY(FM) Houston, TX
 KSAM Huntsville, TX
 KEBE Jacksonville, TX
 KTXJ-FM Jasper, TX
 KIXS Killeen, TX
 KIXS-FM Killeen, TX
 KJAR Laredo, TX
 KFRO Longview, TX
 KEND Lubbock, TX
 KLBK Lubbock, TX
 *KOHM(FM) Lubbock, TX
 KSEL Lubbock, TX
 *KTXT-FM Lubbock, TX
 KWGO-FM Lubbock, TX
 KRBA Lufkin, TX
 KRIO McAllen, TX
 KCRS Midland, TX
 KEEE Nacogdoches, TX
 KOYL-FM Odessa, TX
 KOZA Odessa, TX
 KOBS-FM Orange, TX
 KNET Palestine, TX
 KPLT Paris, TX
 KOLE Port Arthur, TX
 KIXY San Angelo, TX
 KIXY-FM San Angelo, TX
 KEEZ(FM) San Antonio, TX
 KISS(FM) San Antonio, TX
 KONO San Antonio, TX
 KTSB San Antonio, TX
 KCNY San Marcos, TX
 KSEY Seymour, TX
 KXOX Sweetwater, TX
 KTEM Temple, TX
 KPLE(FM) Temple, TX
 KDOK Tyler, TX
 KYUF(FM) Uvalde, TX
 KVIC Victoria, TX
 KEFC(FM) Waco, TX
 KRZI Waco, TX
 WACO Waco, TX
 KRGV Weslaco, TX
 KNIN Wichita Falls, TX
 KBRE Cedar City, UT
 KBLW Logan, UT
 KVNJ Logan, UT
 KVVJ(FM) Logan, UT
 KURA Moab, UT
 KDAB(FM) Ogden, UT
 *KOH(S) Ogden, UT
 KEYV Provo, UT
 KFMC(FM) Provo, UT
 KOVO Provo, UT
 KNAK Salt Lake City, UT
 KRSP Salt Lake City, UT
 KWHO-FM Salt Lake City, UT
 WORK(FM) Barre, VT
 WSNB Barre, VT
 WTSB Burlington, VT
 WDOT Burlington, VT
 WJOY Burlington, VT
 *WVEP(FM) East Montpelier, VT
 WEIK Newport, VT
 *WVTC(FM) Randolph Center, VT
 WSYB Rutland, VT
 WCFR Springfield, VT
 WWSR-FM St. Albans, VT
 *WMTF(FM) Stowe, VT
 WBBI Abingdon, VA
 WELK Charlottesville, VA
 WJJJ Christiansburg, VA
 WXCF Clifton Forge, VA
 WFIC Collinsville, VA
 WKCY Covington, VA
 WSVS Crewe, VA
 WYPR Danville, VA
 WEVA Emporia, VA
 WEEL Fairfax, VA
 WFLO Farmville, VA
 WFVA Fredericksburg, VA
 WFVA-FM Fredericksburg, VA
 WFTR Front Royal, VA
 WQPO(FM) Harrisonburg, VA
 WREL Lexington, VA
 WLLL Lynchburg, VA
 WPRW Manassas, VA
 WMVA Martinsville, VA
 WMVA-FM Martinsville, VA
 WGH Newport News, VA
 WQW(FM) Norfolk, VA
 WQRF(FM) Norfolk, VA
 WNOR Norfolk, VA
 WQRF(FM) Norfolk, VA
 WNVA Norton, VA
 WNVA-FM Norton, VA
 WSSV Petersburg, VA

*WNHS(FM) Portsmouth, VA
 WXR(FM) Norfolk, VA
 WPUV Pulaski, VA
 WPUV-FM Pulaski, VA
 WRAD Radford, VA
 WLEE Richmond, VA
 WRVQ(FM) Richmond, VA
 WROV Roanoke, VA
 WSLQ(FM) Roanoke, VA
 WYTI Rocky Mount, VA
 WJLC-FM South Boston, VA
 WJWS South Hill, VA
 WHEO Stuart, VA
 WRAR Tappahannock, VA
 WRAR-FM Tappahannock, VA
 WMBG Williamsburg, VA
 WEFQ(FM) Winchester, VA
 WHPL Winchester, VA
 WINC Winchester, VA
 *KGRG(FM) Auburn, WA
 *KASB(FM) Bellevue, WA
 WKERI(FM) Bellingham, WA
 KPUG Bellingham, WA
 KCVL Colville, WA
 KRKO Everett, WA
 KGHO Hoquiam, WA
 KGHO-FM Hoquiam, WA
 KLOG Kelso, WA
 KSEM Moses Lake, WA
 KBRC Mount Vernon, WA
 *KUBS(FM) Newport, WA
 KRQC Othello, WA
 KRQQ(FM) Pullman, WA
 KALE Richland, WA
 *KCMU(FM) Seattle, WA
 KING Seattle, WA
 KJR Seattle, WA
 KZOK(FM) Seattle, WA
 KHQ-FM Spokane, WA
 KJRB Spokane, WA
 KREM Spokane, WA
 *KSPC(FM) Spokane, WA
 KTAC Tacoma, WA
 KTAC-FM Tacoma, WA
 KTNT Tacoma, WA
 *KTOY(FM) Tacoma, WA
 KGAR Vancouver, WA
 KISN Vancouver, WA
 KHIT Walla Walla, WA
 KTEL Walla Walla, WA
 KUJ Walla Walla, WA
 KMEL Wenatchee, WA
 KPQ Wenatchee, WA
 KFFM(FM) Yakima, WA

KQOT Yakima, WA
 WCIR Beckley, WV
 WWRN Beckley, WV
 WKOY Bluefield, WV
 WKAZ Charleston, WV
 WQBE(FM) Charleston, WV
 WXIT Charleston, WV
 WHAR Clarksburg, WV
 WVRG-FM Clarksburg, WV
 WTCS Fairmont, WV
 WKEE Huntington, WV
 WKEE-FM Huntington, WV
 WZTO Hurricane, WV
 WFSP Kingwood, WV
 WWRN Martinsburg, WV
 WAJR Morgantown, WV
 WCLG Morgantown, WV
 WCLG-FM Morgantown, WV
 WEIF Moundsville, WV
 WIBZ(FM) Parkersburg, WV
 WPAR Parkersburg, WV
 WXIL(FM) Parkersburg, WV
 WMOV Ravenswood, WV
 *WSHC(FM) Shepherdstown, WV
 WEIR Weirton, WV
 WXEE Welch, WV
 WYNE Appletton, WI
 WBOO Baraboo, WI
 WGEZ Beloit, WI
 WBIZ-FM Eau Claire, WI
 WEAU Eau Claire, WI
 WFAW Fort Atkinson, WI
 WDUZ Green Bay, WI
 WKAU Kaukauna, WI
 WKAU-FM Kaukauna, WI
 WLXC La Crosse, WI
 WWLA(FM) La Crosse, WI
 WMIR Lake Geneva, WI
 WISM Madison, WI
 WLST Marinette, WI
 WLST(FM) Marinette, WI
 WDLB Marshfield, WI
 WDMWF(FM) Menomonie, WI
 *WMD(FM) Milton, WI
 WNOV Milwaukee, WI
 WNUW(FM) Milwaukee, WI
 WOKY Milwaukee, WI
 WKTI(FM) Milwaukee, WI
 WZUU Milwaukee, WI
 WZUU-FM Milwaukee, WI
 WMMH Minocqua, WI
 WNAM Neenah-Menasha, WI
 WOCO-FM Oconto, WI

WAGO Oshkosh, WI
 WOSH(FM) Oshkosh, WI
 WPDR Portage, WI
 WPDR-FM Portage, WI
 WRKR Racine, WI
 WRKR-FM Racine, WI
 WRDB Reedsburg, WI
 WRCO Richland Center, WI
 WRCO-FM Richland Center, WI
 WCWC Ripon, WI
 WSPT Stevens Point, WI
 WSPT-FM Stevens Point, WI
 WDOR Sturgeon Bay, WI
 WYXE(FM) Sun Prairie, WI
 WAKX Superior, WI
 WYYS Tomahawk, WI
 WQTC Two Rivers, WI
 WQTC-FM Two Rivers, WI
 WRIG Wausau, WI
 WNNO Wisconsin Dells, WI
 WNNO-FM Wisconsin Dells, WI
 KATI Casper, WY
 KRAE Cheyenne, WY
 KOVE Lander, WY
 KIOZ(FM) Laramie, WY
 KOWB Laramie, WY
 KRKK Rock Springs, WY
 KROE Sheridan, WY
 KYCN Wheatland, WY
 KSTO(FM) Agana, GM
 WABA Aguadilla, PR
 WNEL Caguas, PR
 WCHQ Camuy, PR
 WCOLA-FM Carolina, PR
 WCPR Coamo, PR
 WXRPR Guayama, PR
 WKJB Mayaguez, PR
 WKJB-FM Mayaguez, PR
 WORA Mayaguez, PR
 WLEO Ponce, PR
 WZAR(FM) Ponce, PR
 WRPC(FM) San German, PR
 WAPA San Juan, PR
 WBMJ San Juan, PR
 WKAQ San Juan, PR
 WCII San Juan, PR
 WRAI San Juan, PR
 WUNO San Juan, PR

Underground
 (See Progressive)
Uptempo
 (See Middle-of-the-Road)

Special Programing

WLPO La Salle, IL 3 hrs.
 WPRC-FM Lincoln, IL 6 hrs.
 WPRC-FM Lincoln, IL 6 hrs.
 WMLC McLeansboro, IL 4 hrs.
 WGLC Mendota, IL 7 1/2 hrs.
 WRAM Mornmouth, IL 9 hrs.
 WMIX Mt. Vernon, IL 10 hrs.
 WAKC Normal, IL 7 hrs.
 WPEO Peoria, IL 10 hrs.
 WGSY(FM) Peru, IL 2 hrs.
 WSPY(FM) Plano, IL 10 hrs.
 WHBF Rock Island, IL 5 hrs.
 WCCI(FM) Savanna, IL 5 hrs.
 *WSSR(FM) Springfield, IL 1 hr.
 WFWA(FM) Sullivan, IL 7 1/2 hrs.
 WWWW(FM) Columbus, IN 5 hrs.
 WPDF Corydon, IN 10 hrs.
 WNDY(FM) Crawfordsville, IN 5 hrs.
 WGR(FM) Danville, IN 5 hrs.
 WGBF Evansville, IN 2 hrs.
 WKY Evansville, IN 1 1/2 hrs.
 WKY-FM Evansville, IN 1 1/2 hrs.
 WNEE Fort Wayne, IN 1/2 hr.
 WSMJ(FM) Greenfield, IN 8 hrs.
 WFMS(FM) Indianapolis, IN 1 hr.
 WIBC Indianapolis, IN 5 hrs.
 WNP(FM) Indianapolis, IN 1 hr.
 WCOE(FM) La Porte, IN 6 hrs.
 WLOI La Porte, IN 6 hrs.
 WBAT Marion, IN 1 hr.
 WREY New Albany, IN 1 hr.
 WCTW New Castle, IN 12 hrs.
 WART(FM) Plainfield, IN 3 1/2 hrs.
 WJCK(FM) Rensselaer, IN 10 hrs.
 WROI(FM) Rochester, IN 16 hrs.
 WRCR(FM) Rushville, IN 11 hrs.
 WAAC Terre Haute, IN 1 1/2 hrs.
 WBOW Terre Haute, IN 10 hrs.
 WTHI Terre Haute, IN 6 hrs.
 WNNI Valparaiso, IN 3 hrs.
 *WYUB(FM) Vincennes, IN 6 hrs.
 *WBAW West Lafayette, IN 1 hr.
 KJAN Atlantic, IA 12 hrs.
 KJAN-FM Atlantic, IA 12 hrs.
 KJUR Burlington, IA 14 hrs.
 KCOG Centerville, IA 10 hrs.
 KCHE Cherokee, IA 12 hrs.
 KRIT(FM) Clarion, IA 7 hrs.
 KCLN Clinton, IA 12 hrs.
 KCLN-FM Clinton, IA 12 hrs.
 WHO Des Moines, IA 15 hrs.
 KILR Estherville, IA 6 hrs.
 KILR-FM Estherville, IA 6 hrs.
 KOUR Independence, IA 20 hrs.
 KOUR-FM Independence, IA 20 hrs.
 KBAB Indianola, IA 2 hrs.
 KRNA(FM) Iowa City, IA 1 hr.
 KXIC Iowa City, IA 10 hrs.
 KIM(FM) Keokuk, IA 1 hr.
 KNIA Knoxville, IA 9 hrs.
 KRIB Mason City, IA 10 hrs.
 KXCI Mt. Pleasant, IA 6 hrs.
 KOEL Oelwein, IA 20 hrs.
 KBOE Oskaloosa, IA 4 1/2 hrs.
 KBIZ Ottumwa, IA 9 1/2 hrs.
 KSCJ Sioux City, IA 3 hrs.
 KWVL Waterloo, IA 6 hrs.
 KGNO Dodge City, KS 8 hrs.
 KOYY El Dorado, KS 12 hrs.
 KVGJ Great Bend, KS 6 hrs.
 *KHCC(FM) Hutchinson, KS 3 hrs.
 KSCB Liberal, KS 15 hrs.
 KLOO(FM) Lyons, KS 4 hrs.
 KSEK Pittsburg, KS 9 hrs.
 KMRJ(FM) Pittsburg, KS 9 hrs.
 KULY Ulysses, KS 25 hrs.
 KFPH Wichita, KS 15 hrs.
 WBRF Bardonia, KY 10 hrs.
 WKYR Burkesville, KY 3 hrs.
 WKVE Cave City, KY 1 hr.
 WAFT(FM) Valdosta, GA 1 hr.
 KBOI Boise, ID 7 1/2 hrs.
 KBRJ Boise, ID 1 hr.
 KSPD Boise, ID 6 hrs.
 KCID Caldwell, ID 19 hrs.
 KMFE(FM) Emmett, ID 4 hrs.
 KID Idaho Falls, ID 6 hrs.
 KMCL McCall, ID 2 hrs.
 KAIN Nampa, ID 6 hrs.
 KBRV Soda Springs, ID 10 hrs.
 WJBC Bloomington, IL 13 hrs.
 WKZI Casey, IL 10 hrs.
 WIAI(FM) Danville, IL 8 hrs.
 WLBK De Kalb, IL 12 hrs.
 WSOY Decatur, IL 14 hrs.
 *WNIU-FM De Kalb, IL 2 1/2 hrs.
 WNIU Dixon, IL 11 hrs.
 WNIU-FM Dixon, IL 11 hrs.
 WKSI(FM) Eldorado, IL 1 hr.
 WFIW Fairfield, IL 12 hrs.
 WACI(FM) Freeport, IL 5 hrs.
 WFRL Freeport, IL 15 hrs.
 WFRL-FM Freeport, IL 15 hrs.
 WGIL Galesburg, IL 18 hrs.
 WINU Highland, IL 2 hrs.
 WJBM Jerseyville, IL 12 hrs.
 WJRC Joliet, IL 6 hrs.

Special Radio Programing

The following classifications represent special programming rather than principal formats for the stations listed. All hours are the average for a week.

Agriculture & Farm

WCTA Andalusia, AL 2 hrs.
 WCTA-FM Andalusia, AL 2 hrs.
 WVOK Birmingham, AL 4 hrs.
 WEBJ Brewton, AL 4 hrs.
 WCOX Camden, AL 1 1/2 hrs.
 WEIS Centre, AL 4 hrs.
 WAJF Decatur, AL 1 hr.
 WXAL Demopolis, AL 6 hrs.
 WOOF Dothan, AL 3 hrs.
 WJAM Marion, AL 14 hrs.
 WHBB Selma, AL 6 hrs.
 *KDLG Dillingham, AK 1 hr.
 KAPR Douglas, AZ 3 hrs.
 KZUL Parker, AZ 1 hr.
 KTRR Phoenix, AZ 6 hrs.
 KHL Willcox, AZ 4 hrs.
 KVOY Yuma, AZ 5 hrs.
 KVEE Conway, AR 6 hrs.
 KVEE-FM Conway, AR 6 hrs.
 KCR(FM) Helena, AR 14 hrs.
 KXAR Hope, AR 5 hrs.
 KGUS(FM) Hot Springs, AR 1 hr.
 KZNG Hot Springs, AR 12 hrs.
 KBTM Jonesboro, AR 5 hrs.
 KBFM(FM) Jonesboro, AR 2 hrs.
 KAAY Little Rock, AR 6 hrs.
 KKYK(FM) Little Rock, AR 2 1/2 hrs.
 KZRK Ozark, AR 3 hrs.
 KHIG(FM) Paragould, AR 10 hrs.
 KCLA Pine Bluff, AR 2 hrs.
 KRLW Walnut Ridge, AR 5 hrs.
 KXGO(FM) Arcata, CA 2 1/2 hrs.
 KPAC Bakersfield, CA 11 hrs.
 KICO Calexico, CA 4 hrs.
 *KCHO(FM) Chico, CA 6 hrs.
 KWUN Concord, CA 2 hrs.
 KARM Fresno, CA 5 hrs.
 KFRE Fresno, CA
 KPHE(FM) Fresno, CA 1/2 hr.
 KNYO Fresno, CA 2 1/2 hrs.
 KLSB Los Banos, CA 5 hrs.
 KFV Modesto, CA 2 hrs.
 KHOP(FM) Modesto, CA 2 1/2 hrs.

KORV Oroville, CA 3 hrs.
 KZIO Ridgecrest, CA 1 hr.
 KFBK Sacramento, CA 7 hrs.
 KLOK San Jose, CA 2 hrs.
 KVEC San Luis Obispo, CA 1 1/2 hrs.
 KWG Stockton, CA 3 hrs.
 KSUE Susanville, CA 1 hr.
 KCEY Turlock, CA 2 1/2 hrs.
 KBQO Ventura, CA 1 hr.
 KONG Visalia, CA 2 hrs.
 KGIW Alamosa, CO 8 hrs.
 KIUP Durango, CO 2 1/2 hrs.
 KFKA Greeley, CO 18 hrs.
 KLMO Longmont, CO 5 hrs.
 KPAG Pagosa Springs, CO 1 hr.
 KCSJ Pueblo, CO 10 hrs.
 KAVI Rocky Ford, CO 3 hrs.
 KVRH Salida, CO 2 hrs.
 KVRH-FM Salida, CO 2 hrs.
 *KOTO(FM) Telluride, CO 10 hrs.
 WLLI Williamatic, CT 1/2 hr.
 WKEN Dover, DE 1 hr.
 WSUX Seaford, DE 3 hrs.
 WSUX-FM Seaford, DE 3 hrs.
 WDEL Wilmington, DE 1 hr.
 WAPR Avon Park, FL 6 hrs.
 WGTU Cypress Gardens, FL 1 hr.
 WMTU Daytona Beach, FL 5 hrs.
 WQTH Defuniak Springs, FL 2 hrs.
 WQTH-FM Defuniak Springs, FL 2 hrs.
 WIRA Fort Pierce, FL 1 1/2 hrs.
 WOV(FM) Fort Pierce, FL 1 hr.
 WODI Homestead, FL 2 hrs.
 WRO Lake City, FL 1 1/2 hrs.
 WSS Largo, FL 1 1/2 hrs.
 WLBE Leesburg, FL 5 hrs.
 WYSY Marianna, FL 1 hr.
 WTB1 Monticello, FL 4 hrs.
 WCOA Pensacola, FL 1/2 hr.
 WPFA Pensacola, FL 1/2 hr.
 WBIT Adel, GA 5 hrs.
 WJAZ Albany, GA 14 hrs.
 WULF Alma, GA 2 hrs.

WMGR Bainbridge, GA 1 1/2 hrs.
 WYNR Brunswick, GA 1 hr.
 WYNR-FM Brunswick, GA 1 hr.
 WDYX Buford, GA 1 hr.
 WHYD Columbus, GA 2 hrs.
 WCUG Cuthbert, GA 7 hrs.
 WDMG Douglas, GA 20 hrs.
 WFNE(FM) Forsyth, GA 1 hr.
 WSIZ Ocala, GA 10 hrs.
 WSAV Savannah, GA 1 hr.
 WYOK Soperton, GA 4 hrs.
 WOGA Sylvester, GA 7 hrs.
 WLOR Thomasville, GA 10 hrs.
 WTHO Thomson, GA 2 1/2 hrs.
 WTHO-FM Thomson, GA 2 1/2 hrs.
 WKYR Tifton, GA 5 hrs.
 WNEG Toccoa, GA 1 hr.
 WAFT(FM) Valdosta, GA 1 hr.
 KBOI Boise, ID 7 1/2 hrs.
 KBRJ Boise, ID 1 hr.
 KSPD Boise, ID 6 hrs.
 KCID Caldwell, ID 19 hrs.
 KMFE(FM) Emmett, ID 4 hrs.
 KID Idaho Falls, ID 6 hrs.
 KMCL McCall, ID 2 hrs.
 KAIN Nampa, ID 6 hrs.
 KBRV Soda Springs, ID 10 hrs.
 WJBC Bloomington, IL 13 hrs.
 WKZI Casey, IL 10 hrs.
 WIAI(FM) Danville, IL 8 hrs.
 WLBK De Kalb, IL 12 hrs.
 WSOY Decatur, IL 14 hrs.
 *WNIU-FM De Kalb, IL 2 1/2 hrs.
 WNIU Dixon, IL 11 hrs.
 WNIU-FM Dixon, IL 11 hrs.
 WKSI(FM) Eldorado, IL 1 hr.
 WFIW Fairfield, IL 12 hrs.
 WACI(FM) Freeport, IL 5 hrs.
 WFRL Freeport, IL 15 hrs.
 WFRL-FM Freeport, IL 15 hrs.
 WGIL Galesburg, IL 18 hrs.
 WINU Highland, IL 2 hrs.
 WJBM Jerseyville, IL 12 hrs.
 WJRC Joliet, IL 6 hrs.

Special Programing

KMLB Monroe, LA 7 hrs.
 KMOE Monroe, LA 4 hrs.
 KNOE-FM Monroe, LA 2½ hrs.
 KWKH Shreveport, LA 5 hrs.
 KMAR Winnsboro, LA 14 hrs.
 KMAR-FM Winnsboro, LA 14 hrs.
 WFST-FM Caribou, ME 1 hr.
 WFST Caribou, ME 1 hr.
 WLVC Fort Kent, ME 3 hrs.
 WJSR Madawaska, ME 3 hrs.
 WAGM Presque Isle, ME 1½ hr.
 WBMD Baltimore, MD 1½ hr.
 WSEB Elkton, MD 1 hr.
 WJEU Hagerstown, MD 1 hr.
 WJEU-FM Hagerstown, MD 1 hr.
 WKIK Leonardtown, MD 1 hr.
 WPTX Lexington Park, MD 2 hrs.
 *WMUA(FM) Amherst, MA 2 hrs.
 WABJ Adrian, MI 3½ hrs.
 WFYC Alma, MI 4 hrs.
 WHSB(FM) Alpena, MI 2 hrs.
 WKJF(FM) Cadillac, MI 1 hr.
 WWAM Cadillac, MI 1 hr.
 WCER Charlotte, MI 12 hr.
 WBFQ(FM) Detroit, MI 1 hr.
 WDBC Escanaba, MI 4½ hrs.
 WJEB Gladwin, MI 4 hrs.
 WOOD Grand Rapids, MI 5 hrs.
 WHLT Holland, MI 2 hrs.
 WLS Lansing, MI 2 hrs.
 WMSA Marine City, MI 2½ hrs.
 WJUN(FM) Midland, MI ½ hr.
 WQWQ-FM Mackinac, MI 1 hr.
 WAOP Otsego, MI 9 hrs.
 WKNX Saginaw, MI 1 hr.
 WSSM(FM) Sault Ste. Marie, MI 1 hr.
 WLKM Three Rivers, MI 5 hrs.
 WLKM-FM Three Rivers, MI 5 hrs.
 WBMB West Branch, MI 1½ hr.
 KAUS Austin, MN 12 hrs.
 KABG(FM) Cambridge, MN 3 hrs.
 KSUM Fairmont, MN 12 hrs.
 KEHG Fosston, MN 1 hr.
 KEYL Long Prairie, MN 20 hrs.
 KMRS Morris, MN 12 hrs.
 KTMF New Prague, MN 4 hrs.
 KLOH Pipestone, MN 10 hrs.
 KOLM Rochester, MN 6 hrs.
 WJON St. Cloud, MN 14 hrs.
 KWAD Wadena, MN 10 hrs.
 WMB Aberdeen, MS 3 hrs.
 WHH Bay Springs, MS 3 hrs.
 WODI(FM) Biloxi, MS 6 hrs.
 WYMI Biloxi, MS 1 hr.
 WRJH(FM) Brandon, MS ½ hr.
 WRKN Brandon, MS 1 hr.
 WJBI(FM) Clarksdale, MS 10 hrs.
 WROX Clarksdale, MS 12 hrs.
 WCLD Cleveland, MS 18 hrs.
 WCJU Columbia, MS 5 hrs.
 WDRU(FM) Drew, MS 10 hrs.
 WDMS(FM) Greenville, MS 2 hrs.
 WGVV Greenville, MS 2 hrs.
 WGRM Greenwood, MS 3 hrs.
 WNLA Indianola, MS 14 hrs.
 WNLA-FM Indianola, MS 14 hrs.
 WNAT Natchez, MS 8 hrs.
 WKPO Prentiss, MS 2 hrs.
 WELU Tupelo, MS 14 hrs.
 WIGG Wiggins, MS 10 hrs.
 KPCR Bowling Green, MO 8 hrs.
 KGHM Brookfield, MO 16 hrs.
 KNAM Butler, MO 12 hrs.
 KMOE(FM) Butler, MO 12 hrs.
 KMNR Cameron, MO 10 hrs.
 KAOL Carrollton, MO 7½ hrs.
 KAOL-FM Carrollton, MO 7½ hrs.
 KDMO Carthage, MO 12 hrs.
 *KCFV(FM) Ferguson, MO 4 hrs.
 KRFG(FM) Greenfield, MO 2 hrs.
 KHMO Hannibal, MO 18 hrs.
 KPJA Ironton, MO 10 hrs.
 WMBH Joplin, MO 2 hrs.
 KRXL(FM) Kirksville, MO 7½ hrs.
 KBTN Neosho, MO 6 hrs.
 KWOC Poplar Bluff, MO 4½ hrs.
 KTRR Rolla, MO 2½ hrs.
 KETU(FM) Salem, MO 5 hrs.
 KSIS Sedalia, MO 12 hrs.
 KGBX Springfield, MO 18 hrs.
 KFEO St. Joseph, MO 12 hrs.
 KSTL St. Louis, MO 4 hrs.
 KOYN Billings, MT 2 hrs.
 KBOZ Bozeman, MT 2 hrs.
 KALS(FM) Kalispell, MT 1 hr.
 KKLO Lewistown, MT 18 hrs.
 KGVO Missoula, MT 2½ hrs.
 KPWDFM Plentywood, MT 10 hrs.
 KGXC Sidney, MT 6 hrs.
 KCOW Alliance, NE 5 hrs.
 KWBE Beatrice, NE 4 hrs.
 KCSR Chadron, NE 7 hrs.
 KTTT Columbus, NE 15 hrs.
 KTTT-FM Columbus, NE 15 hrs.
 KROA(FM) Grand Island, NE 2 hrs.
 KHAS Hastings, NE 2 hrs.
 KICS Hastings, NE 15 hrs.

KBRL McCook, NE 8 hrs.
 KAHL North Platte, NE 6½ hrs.
 KOGA Ogallala, NE 10 hrs.
 KNEB Scottsbluff, NE 8½ hrs.
 KRFS Superior, NE 2½ hrs.
 KTCH Wayne, NE 5 hrs.
 KELK Elko, NV 2 hrs.
 KOH Reno, NV 2 hrs.
 WBRL Berlin, NH
 WKXR Exeter, NH ½ hr.
 WSNJ Bridgeton, NJ 10 hrs.
 WSNJ-FM Bridgeton, NJ 10 hrs.
 WSUS(FM) Franklin, NJ 2 hrs.
 WJCS Salem, NJ 1 hr.
 KSNP Arden, NM 2½ hrs.
 KBAD Carlsbad, NM 5 hrs.
 KCLV Clovis, NM 5 hrs.
 KMTY-FM Clovis, NM 2 hrs.
 KOBE Las Cruces, NM 6 hrs.
 KENN Portales, NM 4 hrs.
 PRXS Roswell, NM 6 hrs.
 WOKO Albany, NY 6 hrs.
 WKOL Amsterdam, NY 1 hr.
 WBTA Batavia, NY 15 hrs.
 WADD Brockport, NY 1 hr.
 WENE Endicott, NY ½ hr.
 WOSC Fulton, NY 2 hrs.
 WGVG Geneva, NY 6 hrs.
 WBZA Glens Falls, NY ½ hr.
 WBZA-FM Glens Falls, NY ½ hr.
 WENT Gloversville, NY 2 hrs.
 *WGMCFM) Greece, NY 1 hr.
 WQIX(FM) Horseheads, NY 7 hrs.
 WHCU Ithaca, NY 1 hr.
 WHCU-FM Ithaca, NY 1 hr.
 WGHQ Kingston, NY 1 hr.
 WXRL Lancaster, NY 5 hrs.
 WYOS Liberty, NY 1 hr.
 WLHF Little Falls, NY 3 hrs.
 WALL Middletown, NY 1½ hr.
 WALL-FM Middletown, NY 1½ hr.
 WCHN Norwich, NY 9½ hrs.
 WDSO Oneonta, NY 1 hr.
 WOSG Oswego, NY 1½ hr.
 WQBC Rensselaer, NY 1 hr.
 WQSP Sandy Creek, NY 2 hrs.
 WIND Syracuse, NY 5 hrs.
 WYPS Ticonderoga, NY 6 hrs.
 WTRY Troy, NY 3½ hrs.
 WDLA Walton, NY 6 hrs.
 WDLA-FM Walton, NY 6 hrs.
 KJWJ Warsaw, NY 18 hrs.
 WAVR(FM) Waverly NY 1 hr.
 WBMA Beaufort, NC 2 hrs.
 WPNF Brevard, NC 1 hr.
 WKYK Brevard, NC 1 hr.
 WAME Charlotte, NC 1 hr.
 WCSL Cherryville, NC 1 hr.
 WRZD Clinton, NC 7½ hrs.
 WFAF Farmville, NC 15 hrs.
 WNCT Greenville, NC 14 hrs.
 WNCT-FM Greenville, NC 14 hrs.
 WOOW Greenville, NC 2 hrs.
 WMAP Monroe, NC 1 hr.
 WPAQ Mount Airy, NC 2½ hrs.
 WPCPE(FM) Raleigh, NC 5 hrs.
 WPTM(FM) Roanoke Rapids, NC 10 hrs.
 WCEC Rocky Mount, NC 5 hrs.
 WRXO Roxboro, NC 8 hrs.
 WKRX(FM) Roxboro, NC 4 hrs.
 WCAB Rutherfordton, NC 1 hr.
 WSTP Salisbury, NC 2 hrs.
 WWPQ Sanford, NC 6 hrs.
 WKYK Siler City, NC 5 hrs.
 WLAB SL Pauls, NC 5 hrs.
 WFMX(FM) Statesville, NC 5 hrs.
 WEEW Washington, NC 2 hrs.
 WHCC Waynesville, NC 1 hr.
 WGTM Wilson, NC 10 hrs.
 WBTE Windsor, NC 5 hrs.
 *KEYA(FM) Belmont, ND 2 hrs.
 KDLR Devils Lake, ND 1 hr.
 WATH Athens, OH 3½ hrs.
 WNNR(FM) Bellevue, OH 1½ hr.
 WMGS Bowling Green, OH 4 hrs.
 WBCO Bucyrus, OH 7 hrs.
 WHBC Canton, OH 1 hr.
 WCKY Cincinnati, OH 1½ hr.
 WJAI(FM) Eaton, OH 6 hrs.
 WURD(FM) Georgetown, OH 10 hrs.
 WDRK(FM) Greenville, OH 14 hrs.
 WWWJ(FM) Johnstown, OH 1½ hr.
 WIMA Lima, OH 3 hrs.
 WIMA-FM Lima, OH 1½ hr.
 WMRN Marion, OH 5 hrs.
 WTTT Tiffin, OH 10 hrs.
 WTTT-FM Tiffin, OH 10 hrs.
 WCCM-FM Urbana, OH 6 hrs.
 WKFI Wilmington, OH 16 hrs.
 WWST Woodstock, OH 3 hrs.
 KALV Aledo, OK 10 hrs.
 KRPT Anadarko, OK 1 hr.
 KYSO Ardmore, OK 1 hr.
 KWCE Enid, OK 3½ hrs.
 KTAT Frederick, OK 16 hrs.
 KCCO Lawton, OK 3 hrs.
 *KOSU-FM Stillwater, OK 3 hrs.
 KSPI Stillwater, OK 3 hrs.
 KSPI-FM Stillwater, OK 3 hrs.
 KWRO Coquille, OK 1 hr.

KLHK Hillsboro, OR 1 hr.
 KLAD Klamath Falls, OR 6 hrs.
 KPRB Redmond, OR 3½ hrs.
 KORIFM) Salem, OR 3 hrs.
 KSLM Salem, OR 6 hrs.
 KCVIFM) The Dalles, OR
 KODL The Dalles, OR 2 hrs.
 WFEM(FM) Elwood City, PA 1 hr.
 *WIOV(FM) Ephrata, PA 10 hrs.
 *WQLN-FM Erie, PA 20 hrs.
 WHP Harrisburg, PA 2½ hrs.
 WBCW Jeannette, PA 1 hr.
 WCRO Johnstown, PA 2½ hrs.
 WGAL Lancaster, PA 1 hr.
 WJSM Martinsburg, PA 2 hrs.
 WJSM-FM Martinsburg, PA 2 hrs.
 WRCV(FM) Mercersburg, PA 3 hrs.
 *WPEL Montrose, PA 1½ hr.
 *WPEL-FM Montrose, PA 1½ hr.
 WMIM Mt. Carmel, PA 1 hr.
 WKST New Castle, PA 6 hrs.
 *WVVE(FM) Norristown, PA 2 hrs.
 WDJR(FM) Oil City, PA 2 hrs.
 WKRZ Oil City, PA 2 hrs.
 WOME Punxsutawney, PA 1½ hr.
 WPEU Punxsutawney, PA 1½ hr.
 WEME Reading, PA 5 hrs.
 WKMC Roaring Spring, PA 2 hrs.
 WEJL Scranton, PA 1½ hr.
 WSEW Selingsgrove, PA 1½ hr.
 WKOK Sunbury, PA 2 hrs.
 WNOW York, PA 3 hrs.
 WRIB Providence, RI ½ hr.
 WLOW Aiken, SC 5 hrs.
 WCRE Cheraw, SC 4 hrs.
 WJMX Florence, SC 7 hrs.
 WFGN Gaffney, SC 1 hr.
 *WPRIFM) Greenville, SC 2 hrs.
 WHSC Hartsville, SC 4 hrs.
 WKHJ Holly Hill, SC 1 hr.
 WLCM Lancaster, SC 2 hrs.
 WJAY Mullins, SC 5 hrs.
 WKMG Newberry, SC 2 hrs.
 WHCE-FM Orangeburg, SC 3½ hrs.
 WCPL(FM) Pageland, SC 2 hrs.
 WKRR Pickens, SC 1 hr.
 KAAA Aberdeen, SD 13 hrs.
 KORN Mitchell, SD 7 hrs.
 KCCR Pierre, SD 6 hrs.
 KOTA Rapid City, SD 15 hrs.
 KTOO Rapid City, SD 2 hrs.
 KIOV(FM) Sioux Falls, SD 1 hr.
 KXRB Sioux Falls, SD 10 hrs.
 WBOV Bolivar, TN 4 hrs.
 WYVST(FM) Bolivar, TN 2 hrs.
 WOOD Chattanooga, TN 19 hrs.
 WDXN Clarksville, TN 4½ hrs.
 WKRM Columbia, TN 12 hrs.
 WCSV Crossville, TN 3 hrs.
 WTOW Dyersburg, TN 5 hrs.
 WSMG Greenville, TN 2 hrs.
 WHHM Henderson, TN 15 hrs.
 WDXJ Jackson, TN 2 hrs.
 WEEN Lafayette, TN 5 hrs.
 WREC Memphis, TN ½ hr.
 WREC-FM Memphis, TN ½ hr.
 *WDXN(FM) Olive Hill, TN ½ hr.
 WENK Union City, TN 6 hrs.
 WPHC Waverly, TN 1½ hr.
 WAAN Waynesboro, TN 1 hr.
 KIOX Bay City, TX 1 hr.
 KBAN Bowie, TX 5 hrs.
 KNEL Brady, TX 4 hrs.
 KXEL(FM) Brownwood, TX 2½ hrs.
 KBAM Bryan, TX 1 hr.
 KHLB Burnet, TX 4 hrs.
 WDXN Carrizo Springs, TX 3½ hrs.
 KSTA Columbia, TX 14 hrs.
 WTAW College Station, TX 1 hr.
 WTAW-FM College Station, TX 1 hr.
 WIFA Dallas, TX 3 hrs.
 KESI(FM) Edinburg, TX 7½ hrs.
 KURY Edinburg, TX 10 hrs.
 KWBY Edna, TX 1 hr.
 KPAS(FM) El Paso, TX 2 hrs.
 WBAP Fort Worth, TX 8 hrs.
 KGAF Gainesville, TX 10 hrs.
 KGAF-FM Gainesville, TX 10 hrs.
 KGHM Gilmer, TX 2 hrs.
 KCTI Gonzales, TX 12 hrs.
 KENR Houston, TX 2½ hrs.
 KTRH Houston, TX 12 hrs.
 KAML Kennedy-Karnes, TX 10 hrs.
 KERV Kerrville, TX 1 hr.
 KOKA Kilgore, TX 1 hr.
 KFRO Longview, TX 1 hr.
 KRIO McAllen, TX 5 hrs.
 KMMK(FM) McKinney, TX 3 hrs.
 KOGT Orange, TX 7½ hrs.
 KSYN Plainview, TX 7½ hrs.
 KSUZ Port Neches, TX 2 hrs.
 KSKL San Angelo, TX 4 hrs.
 KWED Seagraves, TX 6 hrs.
 KIKN Sinton, TX 6 hrs.
 KCAS Slaton, TX 7 hrs.
 KXOX Sweetwater, TX 2½ hrs.
 KTER Terrell, TX 3 hrs.
 *KBBDFM) Beaver, UT 1 hr.
 KMTI Maniti, UT 2 hrs.
 KDAB(FM) Ogden, UT 1½ hr.

KSL Salt Lake City, UT 4½ hrs.
 WKVT Brattleboro, VT 2½ hrs.
 *WVEP(FM) East Montpelier, VT 2 hrs.
 WSKI Montpelier, VT 1 hr.
 WIVE Ashland, VA ½ hr.
 WBLT Bedford, VA 5 hrs.
 WZAP Bristol, VA 2 hrs.
 WINA Charlottesville, VA 8½ hrs.
 WPEE Crozet, VA 2½ hrs.
 WHEE Martinsville, VA 5 hrs.
 WJMA Orange, VA 3 hrs.
 WJMA-FM Orange, VA 3 hrs.
 WKDW Staunton, VA 3 hrs.
 WKCW Warrenton, VA 12 hrs.
 WNNT Warsaw, VA 12 hrs.
 WNNT-FM Warsaw, VA 12 hrs.
 WAYB Waynesboro, VA 1½ hr.
 WINC Winchester, VA 2 hrs.
 WYVE Wytheville, VA 12 hrs.
 KARI Blaine, WA 6 hrs.
 *KCED(FM) Centralia, WA ½ hr.
 KCLK Clarkston, WA 1 hr.
 KCLK-FM Clarkston, WA 1 hr.
 KAPS Mount Vernon, WA 2½ hrs.
 KBRC Mount Vernon, WA 1½ hr.
 KPUL Pullman, WA 6 hrs.
 KIRO Seattle, WA 1 hr.
 *KTOY(FM) Tacoma, WA 5 hrs.
 KENE Tappanish, WA 7 hrs.
 WBOY Appleton, WI 5 hrs.
 WAPL Appleton, WI 5 hrs.
 WATW Ashland, WI 3 hrs.
 WATW-FM Ashland, WI 3 hrs.
 WBEV Beaver Dam, WI 10 hrs.
 WBEV-FM Beaver Dam, WI 10 hrs.
 WBEL Beloit, WI 3 hrs.
 WFOV(FM) Fond Du Lac, WI 5 hrs.
 WGEE Green Bay, WI 5 hrs.
 WKTY La Crosse, WI 15 hrs.
 *WNWC(FM) Madison, WI 2 hrs.
 WCUB Manitowish, WI 10 hrs.
 WMNE Menomonie, WI 15 hrs.
 WJMT Merrill, WI 7 hrs.
 WJMT-FM Merrill, WI 7 hrs.
 WCCN Neillsville, WI 5 hrs.
 WNB1 Park Falls, WI 5 hrs.
 WNB1-FM Park Falls, WI 7 hrs.
 WPDR Portage, WI 9 hrs.
 WIBU Poyntette, WI 1½ hrs.
 WJMC Rice Lake, WI 15 hrs.
 WJMC-FM Rice Lake, WI 15 hrs.
 WCWC-FM Ripon, WI 18 hrs.
 WCWC-FM Ripon, WI 18 hrs.
 WHBL Sheboygan, WI 10 hrs.
 WSPT Stevens Point, WI 8½ hrs.
 WSPT-FM Stevens Point, WI 8½ hrs.
 WDUX Waupaca, WI 10 hrs.
 WDUX-FM Waupaca, WI 10 hrs.
 KVOC Casper, WY 1 hr.
 KEVA Evanston, WY 1 hr.
 *KCWC(FM) Riverton, WY
 KGOS Torrington, WY 12 hrs.

Albanian

WORC Worcester, MA ½ hr
 wkly
Alsat
 (See also Eskimo)
 KVOK Kodiak, AK ½ hr wkly.

American Indian (See also Eskimo)

*KAXR(FM) Flagstaff, AZ 1 hr.
 KCLS Flagstaff, AZ 14 hrs.
 KCTB-FM Flagstaff, AZ 2 hrs.
 KDJI Holbrook, AZ 15 hrs.
 KIKO Miami, AZ 3 hrs.
 KZUL Parker, AZ 1½ hr.
 KVSL Show Low, AZ 3½ hrs.
 KINO Winslow, AZ 6 hrs.
 *KERS(FM) Sacramento, CA 1 hr.
 *KPOO(FM) San Francisco, CA 2½ hrs.
 *KCBX(FM) San Luis Obispo, CA 1 hr.
 KIUP Durango, CO ½ hr.
 KAIN Nampa, ID ¼ hr.
 WYNN Baton Rouge, LA 6 hrs.
 *WICN(FM) Worcester, MA 1 hr.
 *WCBN-FM Ann Arbor, MI 1 hr.
 *WDET-FM Detroit, MI 1 hr.
 KBUN Bemidji, MN ¼ hr.
 KORS Golden Valley, MN ¼ hr.
 KORS-FM Golden Valley, MN ¼ hr.
 *KICC(FM) International Falls, MN 4 hrs.
 *KUFM(FM) Missoula, MT 1 hr.
 KCSR Chadron, NE 1 hr.
 KELK Elko, NV ½ hr.
 *KUNM(FM) Albuquerque, NM 3 hrs.
 KENN Farmington, NM 7½ hrs.
 KYVA Gallup, NM 15 hrs.
 KKIT Taos, NM 3 hrs.
 *WKWZ(FM) Sisseton, NY 1 hr.
 *KEYA(FM) Belmont, ND 5 hrs.
 KDLR Devils Lake, ND 1 hr.
 *KJIM Grand Forks, ND ½ hr.
 KRPT Anadarko, OK 1 hr.
 WNAD Norman, OK ½ hr.

KOKN Pawhuska, OK 1 hr.
 KTLQ Tahlequah, OK 3 hrs.
 *WYEP-FM Pittsburgh, PA 2 hrs.
 *KESD(FM) Brookings, SD ½ hr.
 KTOO Rapid City, SD ½ hr.
 *KUSD Vermillion, SD ½ hr.
 KKYR Winner, SD ½ hr.
 *KCHU(FM) Dallas, TX 1 hr.
 KUTA Blanding, UT 5½ hrs.
 *KCCR-FM Cedar City, UT 1 hr.
 *KTOY(FM) Tacoma, WA ½ hr.
 WCSW Shell Lake, WI ½ hr.

Arabic

*KPOF Denver, CO ¼ hr.
 WMUX(FM) Detroit, MI 1 hr.
 *KHUF(FM) Houston, TX 2 hrs.

Armenian

KRDU Dinuba, CA ½ hr.
 WHIM Providence, RI 1 hr.
 WHIM-FM Providence, RI 1 hr.

Asian

*KPOO(FM) San Francisco, CA 2½ hrs.

Assyrian

KHOP(FM) Modesto, CA 6 hrs.

Basque

KBOI Boise, ID ½ hr.
 KELK Elko, NV 1½ hrs.

Big Band

WDMA-FM Dover, NJ 5 hrs.
 WLSH Lansford, PA 1 hr.
 KMBL Junction, TX 10 hrs.

Black

Includes station formats characterized as rhythm & blues and soul

WAAO Andalusia, AL 1 hr.
 *WGLI(FM) Auburn, AL 2 hrs.
 WCOX Camden, AL 16 hrs.
 WEZZ(FM) Clanton, AL 6 hrs.
 WKLF Clanton, AL 4 hrs.
 WAJF Decatur, AL 2 hrs.
 WOOF Dothan, AL 4 hrs.
 *WEXP(FM) Gadsden, AL 12 hrs.
 WJBY Gadsden, AL 1½ hr.
 WJAM Marion, AL 14 hrs.
 WHYY Montgomery, AL 1 hr.
 WAMA Selma, AL 5 hrs.
 WHBB Selma, AL 16 hrs.
 WHTB(FM) Talladega, AL 1 hr.
 WNUT Talladega, AL 6 hrs.
 WJDB Thomasville, AL 8 hrs.
 WJDB-FM Thomasville, AL 8 hrs.
 WJRD Tuscaloosa, AL 1 hr.
 *WUAL-FM Tuscaloosa, AL 15 hrs.
 KXTC(FM) Glendale, AZ 18 hrs.
 KDKB Mesa, AZ 3 hrs.
 KDKB-FM Mesa, AZ 3 hrs.
 KTKT Tucson, AZ 2 hrs.
 *KUCA(FM) Conway, AR 10 hrs.
 KDDA Dumas, AR 13 hrs.
 *KUAF(FM) Fayetteville, AR 12 hrs.
 KBJT Fordyce, AR 2 hrs.
 KFHA Helena, AR 10 hrs.
 KXAR Hope, AR 12 hrs.
 KGUS(FM) Hot Springs, AR 1 hr.
 KZOT Marianna, AR 12 hrs.
 KOBE Osceola, AR 4 hrs.
 KCLA Pine Bluff, AR 12 hrs.
 KWRF Warren, AR 6 hrs.
 KERN Bakersfield, CA 1 hr.
 KGEA Bakersfield, CA 5 hrs.
 KWAC Bakersfield, CA 6 hrs.
 *KALX(FM) Berkeley, CA 20 hrs.
 *KPFA(FM) Berkeley, CA 12 hrs.
 *KPFH(FM) Berkeley, CA 12 hrs.
 *KCHOI(FM) Chico, CA 2 hrs.
 *KKUP(FM) Cupertino, CA 6 hrs.
 *KDV(SF) Davis, CA 6 hrs.
 KTYM Inglewood, CA 7 hrs.
 *KUCI(FM) Irvine, CA 3 hrs.
 KLBS Los Banos, CA 5 hrs.
 KFIV Modesto, CA 1 hr.
 KHOP(FM) Modesto, CA 6 hrs.
 KMBY Monterey, CA 1½ hr.
 *KSMC(FM) Moraga, CA 3 hrs.
 *KCSN(FM) Northridge, CA 2 hrs.
 KPCC Pasadena, CA 11 hrs.
 KKAAR Pomona, CA 4 hrs.
 *KUOR-FM Redlands, CA 12 hrs.
 *KRVH(FM) Rio Vista, CA 1 hr.
 KJAY Sacramento, CA 10 hrs.
 KQLH(FM) San Bernardino, CA 5 hrs.
 *KVCQ(FM) San Bernardino, CA 11 hrs.
 KLRO(FM) San Diego, CA 2½ hrs.
 *KALW(FM) San Francisco, CA 1 hr.
 KFOG(FM) San Francisco, CA ½ hr.
 *KOED-FM San Francisco, CA 3 hrs.
 *KUSP(FM) Santa Cruz, CA 15 hrs.

KVRE Santa Rosa, CA ½ hr.
 KVRE-FM Santa Rosa, CA ½ hr.
 *KJSC-FM Stockton, CA 2 hrs.
 *KUOP(FM) Stockton, CA 6 hrs.
 *KEPC(FM) Colorado Springs, CO 14 hrs.
 KKFM(FM) Colorado Springs, CO 10 hrs.
 KAAT Denver, CO 2 hrs.
 *KCFR(FM) Denver, CO 4 hrs.
 *KPOF Denver, CO ½ hr.
 *KCSU-FM Fort Collins, CO 3 hrs.
 *KWSB-FM Gunnison, CO 9 hrs.
 WGCH Greenwich, CT
 WSUB Groton, CT 2 hrs.
 WDCD Hamden, CT 4 hrs.
 *WOTQ(FM) Hartford, CT 10 hrs.
 WTC Hartford, CT ½ hr.
 WTC-FM Hartford, CT ½ hr.
 WTCN Middletown, CT 1 hr.
 WRFI Milford, CT 3 hrs.
 *WCSM(FM) New Britain, CT 4 hrs.
 WPLR(FM) New Haven, CT ½ hr.
 WYBC-FM New Haven, CT 10 hrs.
 WNLN New London, CT ½ hr.
 WNLK-FM Norwalk, CT 2 hrs.
 WNLK Norwalk, CT 2 hrs.
 WSTC Stamford, CT 1 hr.
 WQOW Waterbury, CT 4½ hrs.
 *WUWH(FM) West Hartford, CT 4½ hrs.
 WDOV Dover, DE 3 hrs.
 *WAMU-FM Washington, DC 10 hrs.
 *WGTB-FM Washington, DC 6 hrs.
 WSWN Belle Glade, FL 2 hrs.
 WSWN Belle Glade, FL 16 hrs.
 WKMK Bountstown, FL 2 hrs.
 *WHRM(FM) Boynton Beach, FL 6 hrs.
 *WVUM(FM) Coral Gables, FL 3 hrs.
 WNFJ Daytona Beach, FL 5 hrs.
 WDFB Delray Beach, FL 8 hrs.
 WYHI Fernandina Beach, FL 3 hrs.
 WIRA Fort Pierce, FL 1 hr.
 WOVV(FM) Fort Pierce, FL 9 hrs.
 WNUF Ft. Walton Beach, FL 13 hrs.
 WRUF Gainesville, FL 4 hrs.
 WQDI Homestead, FL 1 hr.
 WDSR Lake City, FL 5 hrs.
 WGRo Lake City, FL 5 hrs.
 WONN Lakeland, FL 12 hrs.
 WMAF Madison, FL 10 hrs.
 WRGI Marco Island, FL ½ hr.
 WTVS Marianna, FL 5½ hrs.
 *WLRN-FM Miami, FL 1 hr.
 WTBJ Monticello, FL 5 hrs.
 WEXY Oakland Park, FL 4 hrs.
 WMOP Ocala, FL 1 hr.
 WWKE Ocala, FL 2 hrs.
 WWPB Palatka, FL 1½ hr.
 WTRR Sanford, FL 1½ hr.
 *WKZM(FM) Sarasota, FL ½ hr.
 WWSA Sarasota, FL 3 hrs.
 WOSR(FM) Sarasota, FL 2 hrs.
 WSPB Sarasota, FL ½ hr.
 WYND Sarasota, FL 1½ hr.
 WPXE Starke, FL 10 hrs.
 *WFSU-FM Tallahassee, FL 10 hrs.
 *WUSF(FM) Tampa, FL 1 hr.
 WAXE Vero Beach, FL 1 hr.
 WAUC Wauchula, FL 1 hr.
 *WPFL(FM) Winter Park, FL 1 hr.
 WBIT Adel, GA 10 hrs.
 WDOL Athens, GA 2 hrs.
 WGKA Atlanta, GA 1 hr.
 WPCB(FM) Atlanta, GA 1 hr.
 *WRAS(FM) Atlanta, GA 10 hrs.
 WSB Atlanta, GA 1 hr.
 WSB-FM Atlanta, GA 1 hr.
 WMBR Bainbridge, GA 1½ hr.
 WCLB Camilla, GA 4 hrs.
 WLB Carrolton, GA 2 hrs.
 WCLA Claxton, GA 10 hrs.
 WCLA-FM Claxton, GA 10 hrs.
 WUCB Cuthbert, GA 2 hrs.
 WUFF Eastman, GA 5 hrs.
 WXPO Easton, GA 20 hrs.
 WYHB Fitzgerald, GA 12 hrs.
 WPFM Fort Valley, GA 7 hrs.
 WGML Hinesville, GA 3 hrs.
 WTRP La Grange, GA 8 hrs.
 WLAG La Grange, GA 6 hrs.
 WPEH Louisville, GA 6 hrs.
 WPEH-FM Louisville, GA 6 hrs.
 WYTH Madison, GA 13½ hrs.
 WGRS Millen, GA 11 hrs.
 WMNZ Montezuma, GA 12 hrs.
 WCOH Newnan, GA 1¼ hr.
 WRGA Rome, GA 1 hr.
 WRGA-FM Rome, GA 1 hr.
 WSGA Savannah, GA 2 hrs.
 WYNX Smyrna, GA 4 hrs.
 WNN Statesboro, GA 18 hrs.
 WTGA Thomaston, GA 10 hrs.
 WWSG Tifton, GA 6 hrs.
 WNEG Toccoa, GA 3 hrs.
 *WVVS(FM) Valdosta, GA 2 hrs.
 WBRo Waynesboro, GA 10 hrs.
 KBBK-FM Boise, ID 1 hr.
 *WFWH(FM) Arlington Heights, IL 1 hr.

WMRO Aurora, IL 4 hrs.
 WBIV Belleville, IL 1 hr.
 *WESN(FM) Bloomington, IL 14 hrs.
 *WVUP(FM) Champaign, IL 5 hrs.
 *WCYC(FM) Chicago, IL 20 hrs.
 WLS Chicago, IL 1 hr.
 *WUIC(FM) Chicago, IL 5 hrs.
 *WJMU(FM) Decatur, IL 2 hrs.
 *WNUF(FM) Evanston, IL 2 hrs.
 WFRL Freeport, IL 1 hr.
 WFRL-FM Freeport, IL 1 hr.
 WGIL Galesburg, IL 4 hrs.
 *WVVC(FM) Galesburg, IL 5 hrs.
 WJOL Joliet, IL 6 hrs.
 WJRC Joliet, IL 10 hrs.
 WTAQ La Grange, IL 15 hrs.
 *WONCFM Naperville, IL 10 hrs.
 *WVVK(FM) Rock Island, IL 15 hrs.
 *WSSR(FM) Springfield, IL 3 hrs.
 *WARG(FM) Summit, IL 6 hrs.
 WPUJ(FM) Urbana, IL 6 hrs.
 WTWC(FM) Urbana, IL 5 hrs.
 WFA(FM) Waukegan, IL 5½ hrs.
 WVVY(FM) Columbus, IN 1 hr.
 WGL Fort Wayne, IN 2 hrs.
 WJOB Hammond, IN 10 hrs.
 WYCA(FM) Hammond, IN 3½ hrs.
 WIBC Indianapolis, IN 1 hr.
 *WICR(FM) Indianapolis, IN 10 hrs.
 WNPAP(FM) Indianapolis, IN 1 hr.
 WIOU Kokomo, IN 5 hrs.
 WIMS Michigan City, IN 2 hrs.
 WMCB-FM Michigan City, IN 1 hr.
 *WNAS(FM) New Albany, IN ½ hr.
 *WEEM(FM) Pendleton, IN 1 hr.
 *WECI(FM) Richmond, IN 8 hrs.
 WJVA South Bend, IN 1 hr.
 WNDU South Bend, IN 10 hrs.
 *WVUB(FM) Vincennes, IN 2 hrs.
 *KUNIFM Cedar Falls, IA 10 hrs.
 *KCOE(FM) Cedar Rapids, IA 6 hrs.
 KSO Des Moines, IA 1½ hr.
 *KICIA(FM) Grinnell, IA 3 hrs.
 *KRNL-FM Mount Vernon, IA 21 hrs.
 KREL Waterloo, IA 3 hrs.
 KXEL-FM Waterloo, IA 2 hrs.
 *KHCC(FM) Hutchinson, KS 2½ hrs.
 *KANU(FM) Lawrence, KS 4 hrs.
 KCLO Leavenworth, KS 2 hrs.
 WREN Topeka, KS 1 hr.
 KBUL Wichita, KS 6 hrs.
 KEYN-FM Wichita, KS 6 hrs.
 WFKY Frankfort, KY 18 hrs.
 WHBN Harrodsburg, KY ½ hr.
 WBNB-FM Harrodsburg, KY ½ hr.
 WKOA Hopkinsville, KY 5 hrs.
 WXI Lancaster, KY 10 hrs.
 WLBN Lebanon, KY 5 hrs.
 WLOU Louisville, KY 1 hr.
 WTL Madisonville, KY 20 hrs.
 WAFI Middlesboro, KY 1 hr.
 *WMSY(FM) Morehead, KY 1 hr.
 WMT Mt. Sterling, KY 1 hr.
 *WMSY-FM Mt. Sterling, KY 1 hr.
 WPD Paducah, KY 1¼ hrs.
 WANO Pineville, KY 2 hrs.
 KTRY Bastrop, LA 12 hrs.
 KRY Bogalusa, LA 5 hrs.
 KEUG Crowley, LA 5 hrs.
 KEUN Eunice, LA 5 hrs.
 WKQT Garyville, LA 6½ hrs.
 WSLG Gonzales, LA 4 hrs.
 KVOL Lafayette, LA 7 hrs.
 KLCL Lake Charles, LA 10 hrs.
 KDXI Mansfield, LA 10 hrs.
 KOLA Many, LA 4 hrs.
 KNOCC Natchitoches, LA 12 hrs.
 KANE New Iberia, LA 5 hrs.
 *WVNO(FM) New Orleans, LA 4 hrs.
 KRHH Rayville, LA 10 hrs.
 KBSF Springfield, LA 6 hrs.
 KPVI Ville Platte, LA 14 hrs.
 KPVI-FM Ville Platte, LA 14 hrs.
 KMAAR Winnsboro, LA 4 hrs.
 KMAAR-FM Winnsboro, LA 4 hrs.
 *WBOR(FM) Brunswick, ME 10 hrs.
 WBAL Baltimore, MD 1 hr.
 *WSPH(FM) Baltimore, MD 8 hrs.
 WPTX Lexington Park, MD 12 hrs.
 *WFCR(FM) Amherst, MA 12 hrs.
 WBCN(FM) Boston, MA ¼ hr.
 *WBUR(FM) Boston, MA 2½ hrs.
 WCOP Boston, MA 1 hr.
 WCOP-FM Boston, MA 1 hr.
 *WERS(FM) Boston, MA 10 hrs.
 WRKO Boston, MA ½ hr.
 WUNR Brookline, MA 1 hr.
 WVAS Cambridge, MA ½ hr.
 WACE Chicopee, MA 4 hrs.
 WEIM Fitchburg, MA 1 hr.
 *WZBC(FM) North Adams, MA 3 hrs.
 *WJWW(FM) North Adams, MA 3 hrs.
 WBEC Pittsfield, MA ¼ hr.
 WBRK Pittsfield, MA ½ hr.
 WBRK-FM Pittsfield, MA ½ hr.
 *WBSL(FM) Sheffield, MA 4 hrs.
 *WVHC(FM) South Hadley, MA 10 hrs.
 WMAS Springfield, MA ½ hr.

*WTCC(FM) Springfield, MA 20 hrs.
 *WBRF(FM) Waltham, MA 14 hrs.
 WCRB(FM) Waltham, MA 7 hrs.
 WTXL West Springfield, MA 2 hrs.
 *WCFM(FM) Williamstown, MA 1 hr.
 *WICM(FM) Worcester, MA 5 hrs.
 WABJ Adrian, MI ½ hr.
 *WVAC(FM) Adrian, MI 1 hr.
 *WSRX(FM) Alendale, MI 3 hrs.
 *WCBN-FM Ann Arbor, MI 5 hrs.
 WBFM(FM) Detroit, MI 3 hrs.
 *WDET-FM Detroit, MI 6 hrs.
 WVIC East Lansing, MI 2 hrs.
 WVIC-FM East Lansing, MI 2 hrs.
 WMAX Grand Rapids, MI 2 hrs.
 WHLS Port Huron, MI 1 hr.
 *WSGR(FM) Port Huron, MI 1 hr.
 *WQAK(FM) Royal Oak, MI 1½ hr.
 WKXN Saginaw, MI 1 hr.
 WJOR South Haven, MI 2 hrs.
 WYGR Wyoming, MI 1 hr.
 *WBSR(FM) Battle, MN 1 hr.
 KUXL Garden Valley, MN 3 hrs.
 *WCAL-FM Northfield, MN 2½ hrs.
 WELZ Belzoni, MS 15 hrs.
 WJOB Biloxi, MS 6 hrs.
 WVMi Biloxi, MS 2 hrs.
 WJCU Columbia, MS 15 hrs.
 WKCU Corinth, MS 2 hrs.
 WDM5(FM) Greenville, MS 5 hrs.
 WGVW Greenville, MS 5 hrs.
 WABG Greenwood, MS 12 hrs.
 WXXX Hattiesburg, MS 3 hrs.
 WDDC Hazelhurst, MS 10 hrs.
 WMPCC-FM Hazelhurst, MS 10 hrs.
 WCOP Houston, MS 10 hrs.
 WNLA Indianola, MS 4 hrs.
 WNLA-FM Indianola, MS 4 hrs.
 WKOZ Kosciusko, MS 9 hrs.
 WLAU Laurel, MS 4 hrs.
 WAKK McComb, MS 4 hrs.
 WYNY Meric, MS 2 hrs.
 WOKK Meridian, MS 9 hrs.
 WMSI Natchez, MS 14 hrs.
 WNAU New Albany, MS 3 hrs.
 WBKN Newton, MS 4 hrs.
 WHOC Philadelphia, MS 8 hrs.
 WSEL Pontotoc, MS 8 hrs.
 WSEL-FM Pontotoc, MS 8 hrs.
 WKPO Prentiss, MS 1¼ hrs.
 WSAO Senatobia, MS 10 hrs.
 WSMU-FM Starkville, MS 12 hrs.
 WSSO Starkville, MS 12 hrs.
 WTYL Tylertown, MS 9 hrs.
 WTYL-FM Tylertown, MS 9 hrs.
 WIGV Wiggins, MS 15 hrs.
 KRCR Caruthersville, MO 12 hrs.
 KOYX Joplin, MO ½ hr.
 KWKI(FM) Kansas City, MO ¼ hr.
 *KNNOS(FM) Marshall, MO 4 hrs.
 *KNNR(FM) Rolla, MO 14 hrs.
 *KGLT(FM) Bozeman, MT 3 hrs.
 *KJFM(FM) Missoula, MT 2 hrs.
 *KGBI-FM Omaha, NE 2 hrs.
 *KYNVO(FM) Omaha, NE ½ hr.
 KENO Las Vegas, NV
 KUDO(FM) Las Vegas, NV
 WDCR Hanover, NH 14 hrs.
 WFPG Atlantic City, NJ 3 hrs.
 WMG(FM) Atlantic City, NJ 3 hrs.
 WMO Atlantic City, NJ 6 hrs.
 WJDM Elizabeth, NJ 1 hr.
 WHLW Lakewood, NJ 1½ hr.
 WRLB(FM) Long Branch, NJ 15 hrs.
 *WJSV(FM) Morrisston, NJ 2 hrs.
 WCTE New Brunswick, NJ 1 hr.
 WQMR(FM) New Brunswick, NJ 1 hr.
 *WRSU-FM New Brunswick, NJ 19 hrs.
 WJIC Salem, NJ 4 hrs.
 *WSOU(FM) South Orange, NJ 1¼ hrs.
 *WTSR(FM) Trenton, NJ 2 hrs.
 *WAWZ Zarephath, NJ 1¼ hr.
 *KUNM(FM) Albuquerque, NM 5 hrs.
 KWHE Hobbs, NM 1 hr.
 KCIA Humble City, NM ½ hr.
 WAUB Albany, NY 6 hrs.
 WABY Auburn, NY 2 hrs.
 *WDWN(FM) Auburn, NY 3½ hrs.
 WSEN Baldwinsville, NY 4 hrs.
 WSENF Baldwinsville, NY 4 hrs.
 WKOP Binghamton, NY 1 hr.
 WBNF Binghamton, NY 3 hrs.
 *WBOF(FM) Buffalo, NY 8 hrs.
 WELM Elmira, NY 1 hr.
 WEME Endicott, NY ½ hr.
 *WBAU(FM) Garden City, NY 6 hrs.
 *WBO5-FM Geneva, NY 6 hrs.
 WENT Gloversville, NY 1 hr.
 *WVHC(FM) Hempstead, NY 2 hrs.
 *WTR(FM) Henrietta, NY 4 hrs.
 *WVIC(FM) Ithaca, NY 5 hrs.
 WTKO Ithaca, NY 5 hrs.
 WYBR-FM Ithaca, NY 7 hrs.
 WKNY Kingston, NY 1 hr.
 WKOT Kingston, NY 1 hr.
 WLFT Little Falls, NY 1 hr.
 *WVCR-FM Loudonville, NY 12 hrs.

WTHE Mineola, NY 10 hrs.
 WVOX New Rochelle, NY 1 hr.
 *WVUV(FM) New York NY 5 hrs.
 *WNYU-FM New York, NY 4 hrs.
 WACK Newark NY ½ hr.
 WGNV Newburgh, NY ½ hr.
 WEOK Poughkeepsie, NY ½ hr.
 WSPK(FM) Poughkeepsie, NY 4 hrs.
 WPDH(FM) Poughkeepsie, NY 2 hrs.
 *WRO(FM) Rochester, NY 3 hrs.
 *WRUR-FM Rochester, NY 3 hrs.
 WSAY Rochester, NY ½ hr.
 *WXXI-FM Rochester, NY 2 hrs.
 WRNY Rome, NY 7 hrs.
 WGY Schenectady, NY 3 hrs.
 *WVWZ(FM) Syosset, NY 3 hrs.
 WHHR(FM) Syracuse, NY 1½ hr.
 WOLF Syracuse, NY 3 hrs.
 WYRD East Syracuse, NY 2 hrs.
 *WRPI(FM) Troy, NY 4 hrs.
 WCGC Belmont, NC 1 hr.
 WFGW Black Mountain, NC 1 hr.
 WPNF Brevard, NC 8 hrs.
 WSOC-FM Charlotte, NC ½ hr.
 WEGO Concord, NC 1 hr.
 WCKB Dunn, NC 6 hrs.
 WFAG Farmville, NC 3 hrs.
 WBBO Forest City, NC 3 hrs.
 WAKS Fuquay Varina, NC 6 hrs.
 WGNL Greenville, NC 1 hr.
 WHNC Henderson, NC 12 hrs.
 WJNC Jacksonville, NC 6½ hrs.
 WKMT Kings Mountain, NC 3 hrs.
 WELS Kinston, NC 10 hrs.
 WJNC Laurinburg, NC 4 hrs.
 WMBL Morehead City, NC 2 hrs.
 WJJS Mount Olive, NC 2 hrs.
 WSHB Raeford, NC 2½ hrs.
 WCPÉ(FM) Raleigh, NC 3 hrs.
 *WKNCFM Raleigh, NC 6 hrs.
 WREV Reidsville, NC 7 hrs.
 *WPGT(FM) Roanoke Rapids, NC ½ hr.
 WCEC Rocky Mount, NC 14 hrs.
 WRMT Rocky Mount, NC 2 hrs.
 WRXO Roxboro, NC 4 hrs.
 WCAB Rutherfordton, NC 4 hrs.
 WSTP Salisbury, NC 1 hr.
 WBZB Selma, NC 1 hr.
 WADA Shelby, NC 2 hrs.
 WOHs Shelby, NC 8 hrs.
 WGA South Gastonia, NC 5 hrs.
 WCPS Tarboro, NC 8 hrs.
 WPCS-FM Tarboro, NC 8 hrs.
 WSTH Taylorsville, NC 1 hr.
 WADE Wadesboro, NC 6 hrs.
 WLSE Wallace, NC 3½ hrs.
 WGTM Wilson, NC 4 hrs.
 WYOT Wilson, NC 15 hrs.
 WVOT-FM Wilson, NC 15 hrs.
 WBTE Windsor, NC 10 hrs.
 WCUE-FM Akron, OH 3 hrs.
 WHLE Akron, OH 1 hr.
 WHBC Canton, OH 19 hrs.
 WOIO Canton, OH 1½ hr.
 WEBN(FM) Cincinnati, OH 3 hrs.
 WTVN Columbus, OH ½ hr.
 WCUE Cuyahoga Falls, OH 3 hrs.
 *WSMR(FM) Dayton, OH 1 hr.
 WMOH Hamilton, OH 1 hr.
 WYCH(FM) Hamilton, OH 1 hr.
 WIMA Lima, OH 2 hrs.
 WIMA-FM Lima, OH 1 hr.
 WLRO Lorain, OH 3 hrs.
 WMAN Mansfield, OH 1 hr.
 WTIG Massillon, OH 1 hr.
 WPAV Portsmouth, OH 12 hrs.
 *WEEC(FM) Springfield, OH 1 hr.
 WBBW Youngstown, OH 2 hrs.
 KVSQ Ardmore, OK ½ hr.
 KCRC Enid, OK 5 hrs.
 KGWA Enid, OK 4 hrs.
 KSWO Lawton, OK 6 hrs.
 *KOSU-FM Stillwater, OK 1 hr.
 *KTEC(FM) Klamath Falls, OR 3 hrs.
 *KSLC(FM) McMinnville, OR 2½ hrs.
 *KBPS Portland, OR ½ hr.
 WMBM Ambridge, PA 3 hrs.
 *WVCS(FM) California, PA 5 hrs.
 WESA Charleroi, PA ½ hr.
 WVF(FM) Charleroi, PA ½ hr.
 *WVER(FM) Erie, PA 10 hrs.
 WFAF Farrell, PA 6 hrs.
 WKSL(FM) Greencastle, PA ½ hr.
 WCMB Harrisburg, PA 11 hrs.
 WHP Harrisburg, PA ½ hr.
 WKBO Harrisburg, PA 1¼ hrs.
 *WMSP(FM) Harrisburg, PA 2 hrs.
 *WVFN(FM) Lancaster, PA 8 hrs.
 WJAN Lancaster, PA 1½ hrs.
 WDV(FM) Pottsville, PA 1½ hr.
 WDV(FM) Pottsville, PA 1½ hr.
 WYFM Sharon, PA ½ hr.
 WRHY(FM) Starview, PA 2 hrs.
 *WSRN-FM Swarthmore, PA 12 hrs.
 WCTL(FM) Union City, PA ½ hr.
 WZIX York, PA 3 hrs.
 WBRU(FM) Providence, RI 4 hrs.
 WICE Providence, RI 1 hr.

Special Programming

WDOG Allendale, SC 20 hrs.
 WAIM Anderson, SC 3 hrs.
 WANS Anderson, SC 12 hrs.
 WANS-FM Anderson, SC 12 hrs.
 WCA(FM) Anderson, SC 3 hrs.
 WVBBD Bamberg-Denmark, SC 14 hrs.
 WOKE Charleston, SC 3 hrs.
 *WSCI(FM) Charleston, SC 6½ hrs.
 WCRC Cheraw, SC 4 hrs.
 *WBSF-FM Clemson, SC 4 hrs.
 WPCCC Clinton, SC 1 hr.
 WIOC Columbia, SC 15 hrs.
 WDXL Columbia, SC 4 hrs.
 WDCS Dillon, SC 6 hrs.
 WDCS-FM Dillon, SC 6 hrs.
 WOLS Florence, SC 12 hrs.
 WFIS Fountain, SC 18 hrs.
 WFGN Gaffney, SC 2 hrs.
 WGSW Greenwood, SC 10 hrs.
 WKHU Holly Hill, SC 5 hrs.
 WJOT Lake City, SC 4 hrs.
 WLMN Lancaster, SC 1½ hr.
 WLBG Laurens, SC 7 hrs.
 WLSL Loris, SC 10 hrs.
 WYMB Manning, SC 15 hrs.
 WHNC Henderson, SC 6 hrs.
 WKDY Spartanburg, SC 12½ hrs.
 WKMT Sumter, SC 18 hrs.
 WBBR Travelers Rest, SC 12 hrs.
 WALD Walterboro, SC 5 hrs.
 WALD-FM Walterboro, SC 5 hrs.
 WYLB Airdore, TN 6 hrs.
 WBHT Brownsville, TN 15 hrs.
 WDXN Clarksville, TN ½ hr.
 WDCS Cleveland, TN 1 hr.
 WKRM Columbia, TN 1 hr.
 WKML Covington, TN 5 hrs.
 WXC Fayetteville, TN 2 hrs.
 WJAK Jackson, TN 5 hrs.
 WTJS Jackson, TN 2 hrs.
 *WETS(FM) Johnson City, TN 6 hrs.
 *WCCS(FM) Knoxville, TN 5 hrs.
 WSTP Salisbury, TN 1 hr.
 WDXL Lexington, TN 14 hrs.
 WKTA(FM) McKenzie, TN 2 hrs.
 *WSWM(FM) Memphis, TN 3 hrs.
 WHAL Shelbyville, TN 6 hrs.
 WHAL-FM Shelbyville, TN 6 hrs.
 WCDT Winchester, TN 6 hrs.
 KOJZ Amarillo, TX 8 hrs.
 KIXL Austin, TX 1½ hr.
 *KUT-FM Austin, TX 15 hrs.
 KXCF Childress, TX 10 hrs.
 WTAM-FM College Station, TX 16 hrs.
 KNRO-FM Conroe, TX ½ hr.
 *KCHU(FM) Dallas, TX 6 hrs.
 WRR Dallas, TX 4 hrs.
 *KTEP(FM) El Paso, TX 4 hrs.
 KGTN Georgetown, TX 4 hrs.
 KGTM-FM Georgetown, TX
 KCTI Gonzales, TX 2½ hrs.
 KGLV Greenville, TX 2 hrs.
 KSAM Huntsville, TX 3½ hrs.
 KOCA Kilgore, TX 5 hrs.
 *KNOCT-FM Killeen, TX ½ hr.
 KPXE Liberty, TX 3 hrs.
 KFRO Longview, TX 1 hr.
 KLUE Longview, TX 19 hrs.
 *KOHNF(FM) Lubbock, TX 1 hr.
 *KXT-FM Lubbock, TX 3 hrs.
 KFBA Lufkin, TX 5½ hrs.
 KDOX Marshall, TX 2½ hrs.
 KBYL Mexia, TX 6 hrs.
 KOLU Odessa, TX 2 hrs.
 KNET Palestine, TX 1½ hr.
 KLVL Pasadena, TX 11 hrs.
 KRMH(FM) San Marcos, TX 1 hr.
 KXOX Sweetwater, TX 6 hrs.
 KTEA Taylor, TX 14 hrs.
 KTER Terrell, TX 2 hrs.
 KRZI Waco, TX 3 hrs.
 *KCDR-FM Cedar City, UT 1 hr.
 KLO Ogden, UT ½ hr.
 *WVEP(FM) East Montpelier, VT 5 hrs.
 WIVE Ashland, VA 2 hrs.
 *WFO5(FM) Chesapeake, VA 1 hr.
 WSVS Crewe VA 2 hrs.
 WFAF Falls Church, VA 3 hrs.
 WYFR Franklin, VA 15 hrs.
 WFVA Fredericksburg, VA 1 hr.
 WVA-FM Fredericksburg, VA 1 hr.
 WDDY Gloucester, VA 12 hrs.
 WMAA Gretna, VA 10 hrs.
 *WVMA(FM) Harrisonburg, VA 1 hr.
 WHEE Martinsville, VA 15 hrs.
 WHLF South Boston, VA 3 hrs.
 WMBG Williamsburg, VA 2 hrs.
 KLO Kirkland, WA 2 hrs.
 *KAOS(FM) Olympia, WA 7 hrs.
 *KNHC(FM) Seattle, WA 6 hrs.
 KGAR Vancouver, WA 6 hrs.
 KVAN Vancouver, WA 2 hrs.
 *WVPB(FM) Beckley, WV 1 hr.

Special Programming

*VWV-(FM) Buckhannon, WV 2½ hrs.
 *WCDE(FM) Elkins, WV 8 hrs.
 WXEE Welch, WV 3 hrs.
 WBEL Beloit, WI 1 hr.
 *WORT(FM) Madison, WI 10 hrs.
 WUWM(FM) Milwaukee, WI 1 hr.
 *WSSU(FM) Superior, WI 4 hrs.
 *WSSU(FM) Whitewater, WI 5 hrs.
 KAWY(FM) Casper, WY 3 hrs.

Balind

WJAD(FM) Bainbridge, GA ½ hr.
 *KALA(FM) Davenport, 7 hrs.
 WCPDE(FM) Raleigh, NC 3 hrs.
 *WYCS(FM) Yorktown, VA ½ hr.

Bluegrass

*KMSA(FM) Grand Junction, CO 4 hrs.
 *WAMU-FM Washington, DC 13 hrs.
 WSOC-FM Charlotte, NC 1 hr.

British

KXA Seattle, WA 1 hr.

Broadway

WWCB Cory, PA 1 hr.
 KLSN(FM) Brownwood, TX 1 hr.

Cajun French

KOGT Orange, TX 3 hrs.

Calypso

*KMDX(FM) Conway, AR 5 hrs.
 WVVU Charlotte Amalie, VI 5 hrs.

Caribbean

*WFCR(FM) Amhurst, MA 1 hr.
 *WSCR-FM New York NY 2½ hrs.

Children

*KEMR(FM) Loma Linda, CA 2 hrs.
 *KLLU(FM) Riverside CA 2 hrs.
 *KCSU-FM Ft. Collins, CO 1 hr.
 *WDET-FM Detroit, MI 2 hrs.
 *KEMC(FM) Billings, MT 4 hrs.
 *KHSU-FM Arcata, CA 15 hrs.
 *KUFM(FM) Missoula, MT 7 hrs.
 *WOLM-FM Erie, PA 2 hrs.

Chinese

*KPFA(FM) Berkeley, CA 2½ hrs.
 *KPFB(FM) Berkeley, CA 2½ hrs.
 KICO Calexico, CA ½ hr.
 *KERS(FM) Sacramento, CA ¼ hr.
 *KALW(FM) San Francisco, CA 9½ hrs.

WCOP Boston, MA ½ hr.
 *WKCR-FM New York NY 2½ hrs.

Classical

Includes programming characterized as concert, fine music, semi classical, and serious music, opera.

*WEGF(FM) Auburn, AL 6 hrs.
 *WEXP(FM) Gadsden, AL 12 hrs.
 WLPFR(FM) Mobile, AL 3 hrs.
 *WUAL-FM Tuscaloosa, AL 6 hrs.
 *KDLG Dillingham, AK 8 hrs.
 KVOK Kodiak, AK 3 hrs.
 KCTB-FM Flagstaff, AZ 3 hrs.
 KDKB Mesa, AZ 1 hr.
 KDKB-FM Mesa, AZ 1 hr.
 KAZM Sedona, AZ 10 hrs.
 *KUAC(FM) Conway, AR 10 hrs.
 *KUAF(FM) Fayetteville, AR 9 hrs.
 KGUS(FM) Hot Springs, AR 2 hrs.
 KBTM Jonesboro, AR 2 hrs.
 *KHSU-FM Arcata, CA 15 hrs.
 KXGO(FM) Arcata, CA 15 hrs.
 *KALX(FM) Berkeley, CA 15 hrs.
 *KPFA(FM) Berkeley, CA 20 hrs.
 *KPFB(FM) Berkeley, CA 20 hrs.
 *KVHS(FM) Concord, CA 2 hrs.
 *KKUP(FM) Cupertino, CA 4 hrs.
 *KDVS(FM) Davis, CA 10 hrs.
 *KUCI(FM) Irvine, CA 12 hrs.
 *KEMR(FM) Loma Linda, CA 4 hrs.
 *KDH(SF) Modesto, CA 3 hrs.
 KPGA(FM) Pismo Beach, CA 2 hrs.
 *KLLU(FM) Riverside, CA 3 hrs.
 *KERS(FM) Sacramento, CA 10 hrs.
 *KALW(FM) San Francisco, CA 20 hrs.
 *KJSJ(FM) San Jose, CA 5 hrs.
 KRUZ(FM) Santa Barbara, CA 14 hrs.
 *KBBF(FM) Santa Rosa, CA 2½ hrs.
 *KZSU(FM) Stanford, CA 6 hrs.
 *KJSC-FM Stockton, CA 10 hrs.
 KSM(LF) Truckee, CA 2 hrs.
 KSPN(FM) Aspen, CO 14 hrs.

*KEPC(FM) Colorado Springs, CO 12 hrs.
 KKF(M) Colorado Springs, CP 1 hr.
 KIUP Durango, CO 3 hrs.
 *KCSU-FM Fort Collins, CO 15 hrs.
 *KMSA(FM) Grand Junction, CO 9 hrs.
 KFMU(FM) Oak Creek, CO 12 hrs.
 *KTSC-FM Pueblo, CO 2 hrs.
 KVRH Salida, CO 3 hrs.
 KVRH-FM Salida, CO 3 hrs.
 *WXC(FM) Danbury, CT 7 hrs.
 *WQAO(FM) Hamden, CT 15 hrs.
 *WFC(SF) New Britain, CT 3 hrs.
 WYBC-FM New Haven, CT 11 hrs.
 WTYD(FM) New London, CT 3 hrs.
 *WNHU(FM) West Haven, CT 6 hrs.
 *WVPT(FM) Westport, CT 15 hrs.
 WNRK Newark, DE ½ hr.
 *WYUM(FM) Coral Gables, FL 4 hrs.
 WDNJ(FM) Daytona Beach, FL 17 hrs.

WNB(D) Daytona Beach, FL 14 hrs.
 WDBF Delray Beach, FL 7 hrs.
 WMMU(FM) Marathon, FL 2 hrs.
 *WFIT(FM) Melbourne, FL 1½ hrs.
 WPBR Palm Beach, FL 10 hrs.
 WCCF-FM Punta Gorda, FL 3 hrs.
 WMC(FM) Stuart, FL 12 hrs.
 WBG(M) Tallahassee, FL 1 hr.
 WJNO West Palm Beach, FL 2 hrs.
 *WPFL(FM) Winter Park, FL 2 hrs.
 *WUOG(FM) Athens, GA 9 hrs.
 *WRAS(FM) Atlanta, GA 3 hrs.
 *WREK(FM) Atlanta, GA 3 hrs.
 WCOH Newnan, GA 1 hr.
 WCOH-FM Newnan, GA 10 hrs.

*WABR-FM Tilton, GA 3 hrs.
 *WVVS(FM) Valdosta, GA 4 hrs.
 KCID Caldwell, ID 1 hr.
 KID Idaho Falls, ID 2 hrs.
 KID-FM Idaho Falls, ID 7 hrs.
 KAIN Nampa, ID 1 hr.
 *WVFN(FM) Arlington Heights, IL 1 hr.

*WJMU(FM) Decatur, IL 2 hrs.
 *WEP(SF) Elgin, IL 5 hrs.
 *WLT(FM) La Grange, IL
 *WONC(FM) Naperville, IL 2 hrs.
 *WQOC-FM Quincy, IL 15 hrs.
 WDSR Sterling, IL 2 hrs.
 WDCR(FM) Urbana, IL 12 hrs.
 *WNTH(FM) Winnetka, IL 15 hrs.
 *WEVC(FM) Evansville, IN 8 hrs.
 WPTH(FM) Fort Wayne, IN 3 hrs.
 *WEDM(FM) Indianapolis, IN 2 hrs.
 *WBKE-FM North Manchester, IN 12 hrs.

WJCK(FM) Rensselaer, IN 12 hrs.
 WNNW Valparaiso, IN 2 hrs.
 *KALA(FM) Davenport, IA 5 hrs.
 *KIDC(FM) Grinnell, IA 12 hrs.
 KCSI Mt. Pleasant, IA 1 hr.
 *KSNBU(FM) Baldwin City, KS 8 hrs.
 KNGO Dodge City, KS 1½ hr.
 *KHCF(FM) Hutchinson, KS 5 hrs.
 WANO Pineville, KY 5 hrs.
 *KSLU(FM) Hammond, LA 3 hrs.
 *KNLU(FM) Monroe, LA 5 hrs.
 WLVC Fort Kent, ME 2 hrs.
 WSJR Madawaska, ME 2 hrs.
 *WMAU(FM) Amherst, MA 8 hrs.
 WQRC(FM) Barnstable, MA 4 hrs.
 *WAMV(FM) Maynard, MA 1 hr.
 *WJWW(FM) North Adams, MA 6 hrs.
 *WUSM(FM) North Dartmouth, MA 3 hrs.

*WTCC(FM) Springfield, MA 2 hrs.
 WRLM(FM) Taunton, MA 2½ hrs.
 *WCUW(FM) Worcester, MA 5 hrs.
 WUJN(FM) Albion, MI 6 hrs.
 *WSRJ(FM) Allendale, MI 15 hrs.
 WBF(GF) Detroit, MI 1 hr.
 WQWC-FM Muskegon, MI 4 hrs.
 *WORW(FM) Port Huron, MI 1½ hr.
 *WOB St. Ignace, MI 1 hr.
 KSUM Flint, MI 2 hrs.
 KYMN Northfield, MN 2 hrs.
 KNXR(FM) Rochester, MN 4 hrs.
 WGRM Greenwood, MS 3 hrs.
 WSLI Jackson, MS 18 hrs.
 KCHR Chasestown, MO 2 hrs.
 KIE(FM) Harrisonville, MO 2 hrs.
 *KBOC(FM) Joplin, MO 14 hrs.
 KPCG(FM) Joplin, MO 3 hrs.
 *KGPS(FM) Parkville, MO 4 hrs.
 *KGLT(FM) Bozeman, MT 6 hrs.
 KALS(FM) Kalispell, MT 2½ hrs.
 KYSS-FM Missoula, MT 4 hrs.
 KROA(FM) Grand Island, NE 4 hrs.
 KHAS Hastings, NE 2 hrs.
 KELK Elko, NV 2 hrs.
 WDH(A-FM) Dover, NJ 5 hrs.
 *WBJB-FM Lincroft, NJ 18 hrs.
 *WRSU-FM New Brunswick, NJ 16 hrs.

*WTRS(FM) Trenton, NJ 2 hrs.
 KRWN(FM) Farmington, NM 2 hrs.
 KRWN Los Alamos, NM 2 hrs.
 WRL(FM) Albany, NY 3 hrs.
 *WALF(FM) Albany, NY 4 hrs.
 *WDWN(FM) Auburn, NY 4½ hrs.
 *WHCL-FM Clinton, NY 20 hrs.
 *WECW(FM) Elmira, NY 20 hrs.
 *WBAU(FM) Garden City, NY 6 hrs.
 *WGM(CF) Greece, NY 1 hr.
 *WVHC(FM) Hempstead, NY 6 hrs.
 *WSHR(FM) Lake Ronkonkoma, NY 3 hrs.
 *WVCR-FM Loudonville, NY 3 hrs.
 WALL-FM Middletown, NY 2 hrs.
 WCHN Norwich, NY 12½ hrs.
 *WROH(FM) Oneonta, NY 2 hrs.
 *WTSC-FM Potsdam, NY 3 hrs.
 *WKWZ(FM) Syosset, NY 6 hrs.
 WIPS Ticonderoga, NY 2 hrs.
 *WRPI(FM) Troy, NY 3 hrs.
 WFGW Black Mountain, NC 2 hrs.
 WRBX Chapel Hill, NC 4 hrs.
 WMY(FM) Elizabeth City, NC 4 hrs.
 WOMG(FM) Greensboro, NC 8 hrs.
 WDFD-FM Wilmington, NC 1 hr.
 WHF(D) Archbold, OH 1 hr.
 WBN(FM) Cincinnati, OH 2 hrs.
 WLOA(FM) Cincinnati, OH 2 hrs.
 WLSR(FM) Lima, OH 4 hrs.
 WOXR(FM) Oxford, OH 4 hrs.
 WHEN Henryetta, OK 2 hrs.
 KMMM-FM Muskogee, OK 10 hrs.
 KWRO Coquille, OR 1 hr.
 KCVI(FM) The Dalles, OR 5 hrs.
 WFMZ(FM) Allentown, PA 19 hrs.
 WWCB Cory, PA 10 hrs.
 WVCC(FM) Linsville, PA 6 hrs.
 WDJR(FM) Oil City, PA 3 hrs.
 WKRZ Oil City, PA 3 hrs.
 *WRVU(FM) Nashville, TN 6 hrs.
 KLSN(FM) Brownwood, TX 3 hrs.
 KMBL Junction, TX 5 hrs.
 KERV Kerrville, TX 2 hrs.
 KFRO Longview, TX 1 hr.
 KIXY San Angelo, TX 2 hrs.
 KWLW(FM) San Angelo, TX 2 hrs.
 KSL-FM Salt Lake City, UT 1½ hr.
 WFFV(FM) Front Royal, VA 7 hrs.
 WJMA Orange, VA 4 hrs.
 WJMA-FM Orange, VA 4 hrs.
 KGDN Edmonds, WA 5 hrs.
 KACA(FM) Prosser, WA 8 hrs.
 KIAM-FM Wenatchee, WA 5 hrs.
 WKLC-FM St. Albans, WV 2 hrs.
 WAPL Appleton, WI 2 hrs.
 WAPL-FM Appleton, WI 3 hrs.
 WATV Ashland, WI 2 hrs.
 WATW-FM Ashland, WI 2 hrs.
 WCFW(FM) Chippewa Falls, WI 1 hr.

WHBL Sheboygan, WI 2 hrs.
 KIOZ(FM) Laramie, WY 4 hrs.
 KWYO Sheridan, WY 5 hrs.
 WTPM(FM) Aguadilla, PR 2½ hrs.

Concert

(See Classical)

Croatian

WZAK(FM) Cleveland, OH 3½ hrs.
 *WKT(LF) Struthers, OH 1 hr.

Czech

WHEP Foley, AL 2 hrs.
 *WUWU(FM) West Hartford, CT 1 hr.
 KCRG Cedar Rapids, IA 4 hrs.
 WOAP Owasco, MI 2 hrs.
 KTMF New Prague, MN 7 hrs.
 WPOW New York, NY 2 hrs.
 WOMP Belleaire, OH 2 hrs.
 WERE Cleveland, OH 2 hrs.
 WZAK-FM Cleveland, OH 2½ hrs.
 KULP Campo, TX 5 hrs.
 KCTI Gonzales, TX 17 hrs.
 KHBR Hillsboro, TX 2 hrs.
 KVLG La Grange, TX 8 hrs.
 KFRD Rosenberg-Richmond, TX 8 hrs.

Czech Music

KSKY Dallas, TX 2 hrs.

Dutch

KMAX(FM) Arcadia, CA 6 hrs.
 *KCSN(FM) Northridge, CA 1 hr.
 *KCSU-FM Ft. Collins, CO 2 hrs.
 *KDCR(FM) Sioux Center, IA 10 hrs.
 KWHO Salt Lake City, UT 1 hr.

East Indian

*KUAC(FM) College AK 10 hrs.
 WHFS(FM) Bethesda, MD 10 hrs.
 *WRPI(FM) Troy, NY 2 hrs.

English in Puerto Rico

WTPM(FM) Aguadilla 1 hr.
 WCBG Juana Diaz, 2½ hrs.
 WZBS Ponca, 5 hrs.

Esikmo

*KOTZ Kotzebue, AK 10 hrs.
 KICY Nome, AK 4 hrs.

Ethnic
 *WAMP-FM Toledo, OH 10-15 hrs.
 *WDR(FM) Detroit, MI 3 hrs.

Farm
 (See Agriculture & Farm).

Filipino
 (See also Tagalog).
 KCHJ Delano, CA 12½ hrs.
 KHLO Hilo, HI 3 hrs.

KAIM Honolulu, HI 23 hrs.
 KCCN Honolulu, HI 10 hrs.
 KIKI Honolulu, HI 3 hrs.
 KNUI Kahului, HI 11½ hrs.
 KIMV Lihue, HI 10 hrs.
 KMVI Wailuku, HI 7 hrs.
 KAHU Waipahu, HI 11 hrs.

Finnish
 WLIZ Lake Worth, FL ½ hr.
 *WLRN(FM) Miami, FL 1 hr.
 WPBR Palm Beach, FL 1 hr.
 WEFA(FM) Waukegan, IL ½ hr.
 WEIM Fitchburg, MA ¼ hr.
 WJMS Ironwood, MI 1 hr.
 WSOO Saute Ste. Marie, MI ¼ hr.
 WKLK Cloquet, MN ¼ hr.
 WEVE Eveleth, MN 1½ hr.

Folk
 *KUOR-FM Redlands, CA 5 hrs.
 *KCSU(FM) Ft. Collins, CO 3 hrs.
 *WETA-FM Washington, D.C.

Foreign Music
 KAZM Sedona, AZ 10 hrs.

French
 KRDS Tolleson, AZ 6 hrs.
 *KUAF(FM) Fayetteville, AR 2½ hrs.
 KSLY San Luis Obispo, CA 1½ hrs.
 *KCRW(FM) Santa Monica, CA 3 hrs.
 WCCC Hartford, CT 1 hr.
 WCCC-FM Hartford, CT 1 hr.
 WEXT West Hartford, CT 1½ hr.
 WILI Williamantic, CT 1 hr.
 WSOL Tampa, FL ½ hr.
 WDOL Athens, GA 3 hrs.
 KNDJ Honolulu, HI 2 hrs.
 WKWL(FM) Belvidere, IL 4 hrs.
 *WRHS(FM) Park Forest, IL ½ hr.
 *WNTH(FM) Winnetka, IL 1 hr.
 *WICR(FM) Indianapolis, IN 4 hrs.
 *WNAS(FM) New Albany, IN 1 hr.
 *KDIC(FM) Grinnell, IA 3 hrs.
 *KCUI(FM) Peoria, IA 1 hr.
 *KWAR(FM) Waverly, IA 2 hrs.
 KSAL Salina, KS 17½ hrs.
 WHIR Danville, KY 8 hrs.
 *WVPL(FM) Louisville, KY 3½ hrs.
 KROF Abbeville, LA 7 hrs.
 KROF-FM Abbeville, LA 7 hrs.
 WYNK Baton Rouge, LA 1 hr.
 WYNK-FM Baton Rouge, LA 1 hr.
 KSGI Crowley, LA 1 hr.
 KEUN Eunice, LA 6 hrs.
 KLEB Golden Meadow, LA 12 hrs.
 KCIL(FM) Houma, LA 9 hrs.
 KHOM(FM) Houma, LA 9 hrs.
 KJEF Jennings, LA 12 hrs.
 KPFL Lafayette, LA 1 hr.
 KVOL Lafayette, LA ½ hr.
 KXKW Lafayette, LA 2 hrs.
 KLCL Lake Charles, LA 2 hrs.
 *WWNO(FM) New Orleans, LA 4 hrs.
 KWRG New Roads, LA 2 hrs.
 KTIB Thibodaux, LA 4 hrs.
 KPVI Ville Platte, LA 15 hrs.
 KVPI-FM Ville Platte, LA 15 hrs.
 KUZN West Monroe, LA 1 hr.
 WFAU Augusta, ME 1 hr.
 WFAU-FM Augusta, ME 1 hr.
 WCOU Lewiston, ME 3 hrs.
 WCOU-FM Lewiston, ME 3 hrs.
 WLAM Lewiston, ME 3 hrs.
 WD(CS) Portland, ME 1 hr.
 WSME Sanford, ME 1 hr.
 WSME-FM Sanford, ME 1 hr.
 *WMHB(FM) Waterville, ME 3 hrs.
 WTVL Waterville, ME 1 hr.
 WTVL-FM Waterville, ME 1 hr.
 *WSPH(FM) Baltimore, MD 1 hr.
 WHFS(FM) Bethesda, MD 1 hr.
 WCTR Chestertown, MD 5 hrs.
 *WFCR(FM) Amherst, MA 1 hr.
 *WMAU(FM) Amherst, MA ½ hr.
 WALE Fall River, MA 1 hr.
 WALE Fall River, MA 1 hr.
 WGAW Gardner, MA ½ hr.
 WREH Holyoke, MA 5 hrs.
 WLMS Leominster, MA 1 hr.
 *WLT(FM) Lowell, MA 1 hr.
 WESO Southbridge, MA 3 hrs.
 *WSRX(FM) Allendale, MI 1 hr.
 WMGO Canton, MS 1¾ hrs.
 WNSL Laurel, MS 6 hrs.

German
 WBHP Huntsville, AL 1 hr.
 *KHDX(FM) Conway, AR 3 hrs.
 KMAX(FM) Arcadia, CA 1 hr.
 KORJ(FM) Garden Grove, CA 1 hr.
 KTYM Inglewood, CA 5 hrs.
 *KSMC(FM) Moraga, CA ½ hr.
 *KCSN(FM) Northridge, CA 4 hrs.
 KPMJ(FM) Oxnard, CA 4 hrs.
 KTOB Petaluma, CA ½ hr.
 KKOP(FM) Redondo Beach, CA 2 hrs.

Gay
 *WCUW(FM) Worcester, MA 1 hr.
 *WYEP-FM Pittsburgh, PA 2 hrs.

German
 WBHP Huntsville, AL 1 hr.
 *KHDX(FM) Conway, AR 3 hrs.
 KMAX(FM) Arcadia, CA 1 hr.
 KORJ(FM) Garden Grove, CA 1 hr.
 KTYM Inglewood, CA 5 hrs.
 *KSMC(FM) Moraga, CA ½ hr.
 *KCSN(FM) Northridge, CA 4 hrs.
 KPMJ(FM) Oxnard, CA 4 hrs.
 KTOB Petaluma, CA ½ hr.
 KKOP(FM) Redondo Beach, CA 2 hrs.

KLRO(FM) San Diego, CA 4 hrs.
 *KALW(FM) San Francisco, CA 1½ hr.
 *KOED-FM San Francisco, CA 1 hr.
 *KCBX(FM) San Luis Obispo, CA 1 hr.
 *KCRW(FM) Santa Monica, CA 3 hrs.
 KBRN Brighton, CO 1 hr.
 *KRCC(FM) Colorado Springs, CO 1 hr.
 KFML Denver, CO 1 hr.
 *KPOF Denver, CO 1 hr.
 *KCSU-FM Fort Collins, CO ½ hr.
 KLMO Longmont, CO 1 hr.
 WNLK-FM Norwalk, CT 1 hr.
 WNLK Norwalk, CT 1 hr.
 *WHSR(FM) Boynton Beach, FL 2 hrs.
 WFIV Kissimmee, FL 1½ hr.
 *WLRN-FM Miami, FL 12 hrs.
 WCCF-FM Punta Gorda, FL 1 hr.
 WDOL Athens, GA 3 hrs.
 WGKA Atlanta, GA 1 hr.
 KNDI Honolulu, HI 2 hrs.
 *KRIC(FM) Rexburg, ID 1 hr.
 WIBV Belleville, IL 3½ hrs.
 WCBW(FM) Columbia, IL 2 hrs.
 WJ(LF) Elgin, IL 9 hrs.
 WGSB Geneva, IL 5 hrs.
 WGNU Granite City, IL 2 hrs.
 WHBF-FM Rock Island, IL 1 hr.
 WEFA(FM) Waukegan, IL 2 hrs.
 *WNTH(FM) Winnetka, IL 3 hrs.
 WSMJ(FM) Greenfield, IN 1 hr.
 WFSM(FM) Indianapolis, IN 1 hr.
 *WNAS(FM) New Albany, IN 1 hr.
 WIUC(FM) Winchester, IN 1 hr.
 *KCUI(FM) Peoria, IA 1 hr.
 *KWAR(FM) Waverly, IA 2 hrs.
 WBM(D) Baltimore, MD 1 hr.
 WHFS(FM) Baltimore, MD 1 hr.
 WNAS Springdale, MA 1 hr.
 WDEW Westfield, MA 1½ hr.
 WATZ Alpena, MI 1 hr.
 WHFB-FM Benton Harbor, MI 1½ hr.
 *WDET-FM Detroit, MI 2 hrs.
 WMUZ(FM) Detroit, MI ½ hr.
 WHGR Houghton Lake, MI 1 hr.
 KASM-Albany, MN ¼ hr.
 *KBSB(FM) Bemidji, MN ½ hr.
 WMIN Maplewood, MN 1 hr.
 KNUJ New Ulm, MN 3 hrs.

WAVN Stillwater, MN 1 1/2 hr.
 *KEMC(FM) Billings, MT 2 1/2 hrs.
 *KNVO(FM) Omaha, NE 1/4 hr.
 KLAV Las Vegas, NV 2 hrs.
 *WJSV(FM) Morristown, NJ 1/2 hr.
 WTTM Trenton, NJ 1 hr.
 WSEN Baldwinville, NY 2 hrs.
 WSEN-FM Baldwinville, NY 2 hrs.
 WWOL Buffalo, NY 3 hrs.
 WWOL-FM Buffalo, NY 3 hrs.
 WKCL Catskill, NY 1/2 hr.
 WELY Ellenville, NY 2 hrs.
 WELY-FM Ellenville, NY 2 hrs.
 WGHQ Kingston, NY 2 hrs.
 WKNY Kingston, NY 1 hr.
 WVOX New Rochelle, NY 4 hrs.
 WHOM New York, NY 6 hrs.
 WSOQ North Syracuse, NY 1 hr.
 WEOK Poughkeepsie, NY 1/2 hr.
 WZAK(FM) Cleveland, OH 19 1/2 hrs.
 WYCH(FM) Hamilton, OH 5 hrs.
 WMAN Mansfield, OH 1 hr.
 WBPB(FM) Middletown, OH 8 hrs.
 WNDH(FM) Napoleon, OH 10 hrs.
 WIOT(FM) Toledo, OH 1 hr.
 KFNB(FM) Oklahoma City, OK 3 1/2 hr.
 *KOSU-FM Stillwater, OK 1 hr.
 WFMZ(FM) Allentown, PA 1 hr.
 WKSL(FM) Greencastle, PA 5 hrs.
 *WMSFP(FM) Harrisburg, PA 2 hrs.
 WHPA Honesdale, PA 2 hrs.
 WJBF-FM Jenkintown, PA 1 hr.
 WTEL Philadelphia, PA 6 hrs.
 WGCB Red Lion, PA 1/2 hr.
 *WFMQ(FM) Lebanon, TN 1 hr.
 *KERA-FM Dallas, TX 1 hr.
 KINT El Paso TX 1/2 hr.
 *KTEP(FM) El Paso, TX 1 hr.
 *KPTF(FM) Houston, TX 4 hrs.
 KMBL Junction, TX 12 hrs.
 KYLG La Grange, TX 8 hrs.
 KNBT(FM) New Braunfels, TX 4 hrs.
 *KCDR-FM Cedar City, UT 4 hrs.
 KWHO Salt Lake City, UT 1 hr.
 *WFO5(FM) Chesapeake, VA 1/2 hr.
 KARI Blaine, VA 5 hrs.
 KUPY Puyallup, WA 1 hr.
 WERL Eagle River, WI 2 hrs.
 WTKM Hartford, WI 2 1/2 hrs.
 WTKM-FM Hartford, WI 2 1/2 hrs.
 WYLO Jackson, WI 15 1/2 hrs.
 *WORT(FM) Madison, WI 1 hr.
 WDLB Marshfield, WI 1/2 hr.
 WJMT Merrill, WI 1 hr.
 WJMT-FM Merrill, WI 1 hr.
 *WUWM(FM) Milwaukee, WI 1 hr.
 WGLB Port Washington, WI 14 hrs.
 WGLB-FM Port Washington, WI 14 hrs.
 WHBL Sheboygan, WI 1 hr.
 *WHSI(FM) Sheboygan, WI 1 hr.
 *WSSU(FM) Superior, WI 1/2 hr.
 WVRM(FM) Suring, WI 1/2 hr.

Greek
 KGUS(FM) Hot Springs, AR 1 hr.
 KMAX(FM) Arcadia, CA 1 hr.
 KAVA Burney, CA 10 hrs.
 KHOP(FM) Modesto, CA 6 hrs.
 *KERS(FM) Sacramento, CA 1 hr.
 *KJSC-FM Stockton, CA 1 hr.
 WRYM New Britain, CT 1 hr.
 WRHC Coral Gables, FL 1 1/2 hrs.
 WDCL Dunedin, FL 1 1/2 hrs.
 WFSO Pinellas Park, FL 2 hrs.
 WGKA Atlanta, GA 1 hr.
 WYZE Atlanta, GA 1 hr.
 WEDC Chicago, IL 1 hr.
 WJRC Joliet, IL 1 hr.
 WOPA Oak Park, IL 2 1/2 hrs.
 WHBF-FM Rock Island, IL 1 hr.
 WLTH Gary, IN 2 hrs.
 WIDE Biddleford, ME 2 hrs.
 WIDE-FM Biddleford, ME 2 hrs.
 WBMD Baltimore, MD 2 hrs.
 WITH Baltimore, MD 1 hr.
 WHFS(FM) Bethesda, MD 1 hr.
 WMLO Beverly, MA 2 hrs.
 *WRBB(FM) Boston, MA 1 hr.
 WUNR Brookline, MA 4 hrs.
 WACE Chicopee, MA 1/2 hr.
 WLYN Lynn, MA 2 hrs.
 WLYN-FM Lynn, MA 17 hrs.
 WMAS Springfield, MA 1/2 hr.
 WNEB Worcester, MA 1 hr.
 WORC Worcester, MA 1 1/2 hr.
 WID Garden City, MI 4 hrs.
 *KOPN(FM) Columbia, MO 1 hr.
 WOTW Nashua, NH 3 1/2 hrs.
 WRLB(FM) Long Branch, NJ 1 hr.
 *WRSU-FM New Brunswick, NJ 1 hr.
 WDLV Vineland, NJ 1 hr.
 WABY Albany, NY 1 hr.
 WKOP Binghamton, NY 1 hr.
 WWOL Buffalo, NY 2 hrs.
 WWOL-FM Buffalo, NY 2 hrs.
 WTPE Mineola, NY 3 hrs.
 WPOW New York, NY 1 hr.
 *WAUP(FM) Akron, OH 2 hr.

WOMP Bellair, OH 1 hr.
 WYNY Canton, OH 1 1/2 hrs.
 WZAK(FM) Cleveland, OH 4 1/2 hrs.
 WHHH Warren, OH 1 hr.
 WTCL Warren, OH 1 hr.
 WZUM Carnegie, PA 1/2 hr.
 WJBF-FM Jenkintown, PA 2 1/2 hrs.
 WRIB Providence, RI 3 hrs.
 WARV Warwick, RI 1 hr.
 WKRI West Warwick, RI 1 hr.
 *KCHU(FM) Dallas, TX 4 hrs.
 *KUHJ(FM) Houston, TX 1/2 hr.
 WFAF Falls Church, VA 1 hr.
 KXA Seattle, WA 1 hr.
 WEIR Weirton, WV 1 hr.
 *WORT(FM) Madison, WI 2 hrs.
 WGLB Port Washington, WI 1 hr.
 WGLB-FM Port Washington, WI 1 hr.

Haitian
 *WJUV(FM) New York, NY 1 hr.
 *WRCR(FM) New York, NY 2 1/2 hrs.

Hawaiian
 KNDI Honolulu, HI 20 hrs.
 *KTVH-FM Honolulu, HI 8 hrs.

Hebrew
 (See Jewish)

*WRBB(FM) Boston, MA 1 hr.
 KUXL Golden Valley, MN 2 hrs.
 WELY Ellenville, NY 4 hrs.
 WELY-FM Ellenville, NY 4 hrs.

Hindu
 KHOP(FM) Modesto, CA 1/4 hr.
 WZAK(FM) Cleveland, OH 1 1/2 hr.

Homosexual
 (See Gay)

Hungarian
 KREL Corona, CA 2 1/2 hrs.
 WNLK Norwalk, CT 1 hr.
 WNLK-FM Norwalk, CT 1 hr.
 WBSB South Bend, IN 1 hr.
 WRHC Coral Gables, FL 1 hr.
 WCTC New Brunswick, NJ 1 1/2 hr.
 WWMR(FM) New Brunswick, NJ 1 1/2 hr.
 WTTM Trenton, NJ 1 hr.
 WALY Herkimer, NY 1 hr.
 WZAK(FM) Cleveland, OH 6 1/2 hrs.
 WYFM(FM) Sharon, OH 1/2 hr.
 WBBR Winder, PA 1 hr.

Indian (Asian) Music
 *KUTH(FM) Honolulu, HI 1 hr.

Indian
 (See American Indian)

Irish
 WOPA Oak Park, IL 4 hrs.
 WLM5 Leominster, MA 3 hrs.
 *WMMC(FM) N. Andover, MA 3 hrs.
 WMA5 Springfield, MA 2 hrs.
 WNEB Worcester, MA 1 hr.
 WCAM Camden, NJ 1 hr.
 WP5L Monroeville, PA 2 hrs.

Italian
 KMAX(FM) Arcadia, CA 2 hrs.
 KGE6 Bakersfield, CA 1 hr.
 KGFN(FM) Bakersfield, CA 1 hr.
 KTYM Inglewood, CA 3 hrs.
 KRVE(FM) Los Gatos, CA 2 hrs.
 KHOP(FM) Modesto, CA 6 hrs.
 *KSMC(FM) Moraga, CA 1/2 hr.
 *KCSN(FM) Northridge, CA 1 hr.
 *KALW(FM) San Francisco, CA 1 hr.
 *KOED-FM San Francisco, CA 1/2 hr.
 *KCBX(FM) San Luis Obispo, CA 2 hrs.
 KIST Santa Barbara, CA 1 hr.
 *KCRW(FM) Santa Monica, CA 3 hrs.
 *KCSU-FM Fort Collins, CO 1/2 hr.
 WADS Ansonia, CT 1 hr.
 WINE Brookfield, CT 1/2 hr.
 WGCH Greenwich, CT 2 hrs.
 WSUB Groton, CT 1 hr.
 WCCC Hartford, CT 1 hr.
 WCCC-FM Hartford, CT 1 hr.
 *WRTC-FM Hartford, CT 1 hr.
 WFIF Milford, CT 6 hrs.
 WRYM New Britain, CT 12 hrs.
 WNLN New London, CT 1 hr.
 WNLK Norwalk, CT 2 1/2 hrs.
 WNLK-FM Norwalk, CT 2 1/2 hrs.
 WNTY Southington, CT 4 hrs.
 WSTC Stamford, CT 1 hr.
 WEXT West Hartford, CT 2 hrs.
 WMMW Westport, CT 3 hrs.
 WDCL Dunedin, FL 1 hr.
 WSST Largo, FL 1/2 hr.
 *WLRN-FM Miami, FL 4 hrs.
 *WUSF(FM) Tampa, FL 1 hr.
 *KRIC(FM) Rexburg, ID 1/2 hr.

WEDC Chicago, IL 4 1/2 hrs.
 WTAQ La Grange, IL 7 1/2 hrs.
 WOPA Oak Park, IL 1 1/2 hrs.
 WHBF-FM Rock Island, IL 1 hr.
 WHFS(FM) Bethesda, MD 1 1/2 hr.
 WTOW Towson, MD 3 hrs.
 WUNR Brookline, MA 9 hrs.
 WKOX Framingham, MA 1/2 hr.
 WLYN-FM Lynn, MA 18 hrs.
 WNTN Newton, MA 1 hr.
 WDEE Pittsfield, MA 2 hrs.
 WBEW Westfield, MA 1 hr.
 *WICN(FM) Worcester, MA 1 hr.
 WID Garden City, MI 7 1/2 hrs.
 KLAV Las Vegas, NV 3 hrs.
 WRDI Hammondon, NJ 6 hrs.
 *WJSV(FM) Morristown, NJ 1/2 hr.
 WTTM Trenton, NJ 1 1/2 hr.
 WDLV Vineland, NJ 5 hrs.
 WABY Albany, NY 1 hr.
 WKOB Amsterdam, NY 3 hrs.
 WNYG Babylon, NY 5 hrs.
 WJGL Babylon, NY 4 hrs.
 *WBXL(FM) Baldwinville, NY 3 1/2 hr.
 WSEN Baldwinville, NY 2 hrs.
 WSEN-FM Baldwinville, NY 1 hr.
 WBNR Beacon, NY 1 hr.
 WKOP Binghamton, NY 2 hrs.
 WJUF(FM) Buffalo, NY 1 1/2 hr.
 WWOL Buffalo, NY 1 1/2 hr.
 WWOL-FM Buffalo, NY 1 1/2 hr.
 WKCL Catskill, NY 1/2 hr.
 WKRT Cortland, NY 1 hr.
 WKRT-FM Cortland, NY 1 hr.
 WELY Ellenville, NY 1 hr.
 WELY-FM Ellenville, NY 1 hr.
 WENT Gloversville, NY 2 hrs.
 WLIX Islip, NY 4 hrs.
 WJTN Jamestown, NY 1 hr.
 WKOT Kingston, NY 1 hr.
 *W5HR(FM) Lake Ronkonkoma, NY 1 hr.
 WXRL Lancaster, NY 1 hr.
 WLFL Little Falls, NY 3 hrs.
 WVOX New Rochelle, NY 4 hrs.
 WHOM New York, NY 6 hrs.
 WHLD Niagara Falls, NY 6 hrs.
 WSOO North Syracuse, NY 3 hrs.
 WSGO Oswego, NY 1 1/2 hrs.
 WSPK(FM) Poughkeepsie, NY 1 hr.
 WPDH(FM) Poughkeepsie, NY 1/2 hr.
 WOBK Rensselaer, NY 2 hrs.
 WBFM(FM) Rochester, NY 2 hrs.
 *WRO(FM) Rochester, NY 1 hr.
 WNYR Rochester, NY 1 hr.
 W5AY Rochester, NY 2 1/2 hrs.
 W5OR(FM) Rochester, NY 3 hrs.
 *WXXI-FM Rochester, NY 1 hr.
 WSNY Schenectady, NY 1 hr.
 WKQW Spring Valley, NY 1/2 hr.
 WNDR Syracuse, NY 1 hr.
 WHAZ Troy, NY 3 hrs.
 WBYW Utica, NY 1 1/2 hr.
 WGMF Watkins Glen, NY 1 1/2 hr.
 *WAUP(FM) Akron, OH 1 hr.
 WREO Ashtabula, OH 1 1/2 hr.
 WERE Cleveland, OH 1/2 hr.
 WZAK(FM) Cleveland, OH 4 hrs.
 WNPQ(FM) New Philadelphia, OH 1 hr.
 WNI0 Niles, OH 2 hrs.
 WSTV Steubenville, OH 2 hrs.
 *WKTL(FM) Struthers, OH 1 hr.
 WBTC Uhrichsville, OH 1 hr.
 WTCL Warren, OH 1 hr.
 WBBW Youngstown, OH 1 hr.
 WVA0 Alliance, PA 1/2 hr.
 WEEZ Chester, PA 1 hr.
 *WERG(FM) Erie, PA 2 hrs.
 WLVJ(FM) Erie, PA 3 hrs.
 WVG0 Erie, PA 2 hrs.
 WFAF Farrell, PA 3 hrs.
 WBCW Jeannette, PA 1 hr.
 WJBF-FM Jenkintown, PA 13 hrs.
 WMIM Mt. Carmel, PA 1 hr.
 WKST New Castle, PA 1 hr.
 WKPA New Kensington, PA 3 hrs.
 WRCP Philadelphia, PA 1/2 hr.
 WRCP-FM Philadelphia, PA 1/2 hr.
 WTEL Philadelphia, PA 7 hrs.
 WARD Pittston, PA 1 hr.
 WPQR-FM Uniontown, PA 1 hr.
 WYLO-FM Williamsport, PA 1/2 hr.
 WLY5 Williamsport, PA 1/2 hr.
 WHIM Providence, RI 2 hrs.
 WRIB Providence, RI 5 hrs.
 WHWB Rutland, VT 1 hr.
 WABH Deerfield, VA 6 hrs.
 KARI Blaine, WA 2 hrs.
 WTC5 Fairmont, WV 3 hrs.
 WEIR Weirton, WV 1 hr.
 WLIP Kenosha, WI 2 hrs.

Japanese
 KRDU Dinuba, CA 2 1/2 hrs.
 KLIP Fowler, CA 4 hrs.
 *KCRW(FM) Santa Monica, CA 3 hrs.

KSTN-FM Stockton, CA 4 hrs.
 KHLO Hilo, HI 12 hrs.
 KIPA Hilo, HI 42 hrs.
 KPUA Hilo, HI 7 hrs.
 KNDI Honolulu, HI 19 hrs.
 KNUI Kahului, HI 4 hrs.
 KKON Kealahou, HI 7 hrs.
 *KMVI Waiuku, HI 13 hrs.

Jazz
 *WEGL(FM) Auburn, AL 14 hrs.
 *WHIL-FM Mobile, AL 10 hrs.
 *KUAC(FM) College, AK 2 hrs.
 *KDLG Dillingham, AK 4 hrs.
 *KUCA(FM) Conway, AR 3 hrs.
 *KHDX(FM) Conway, AR 10 hrs.
 KBTM Jonesboro, AR 2 hrs.
 KLAZ(FM) Little Rock, AK 1 hr.
 *KALX(FM) Berkeley, CA 20 hrs.
 *KPPA(FM) Berkeley, CA 10 hrs.
 *KPPB(FM) Berkeley, CA 10 hrs.
 *KVVH(FM) Concord, CA 2 hrs.
 *KCUJ(FM) Cupertino, CA 15 hrs.
 *KDCS(FM) Davis, CA 12 hrs.
 *KUCI(FM) Irvine, CA 6 hrs.
 *KDH5(FM) Modesto, CA 6 hrs.
 *KCSN(FM) Northridge, CA 4 hrs.
 *KUOR-FM Redlands, CA 16 hrs.
 *KRHV(FM) Rio Vista, CA 1 hr.
 *KERS(FM) Sacramento, CA 9 hrs.
 *KALW(FM) San Francisco, CA 2 hrs.
 *KPOO(FM) San Francisco, CA 6 hrs.
 *KCPRF(FM) San Luis Obispo, CA 4 hrs.
 *KBBF(FM) Santa Rosa, CA 3 hrs.
 *KZSU(FM) Stanford, CA 6 hrs.
 *KUOP(FM) Stockton, CA 16 hrs.
 KSMIL(FM) Truckee, CA 3 hrs.
 *KEPC(FM) Colorado Springs, CO 14 hrs.
 *KCSU-FM Fort Collins, CO 3 hrs.
 *KMSA(FM) Grand Junction, CO 4 hrs.
 KFMU(FM) Oak Creek, CO 12 hrs.
 *KTSC-FM Pueblo, CO 1 hr.
 *WXCI(FM) Danbury, CT 7 hrs.
 *WSHU(FM) Fairfield, CT 6 hrs.
 *WVOF(FM) Fairfield, CT 6 hrs.
 WGCH Greenwich, CT 2 hrs.
 *WOTO(FM) Hartford, CT 10 hrs.
 *WFCS(FM) New Britain, CT 4 hrs.
 *WNHU(FM) West Haven, CT 6 hrs.
 *WUWH(FM) West Hartford, CT 12 hrs.
 *WVPT(FM) Westport, CT 8 hrs.
 *WAMU-FM Washington, DC 12 hrs.
 *WETA-FM Washington, DC
 *WVUM(FM) Coral Gables, FL 4 hrs.
 *WFIT(FM) Melbourne, FL 1 hr.
 *WLRN-FM Miami, FL 3 hrs.
 *WPFL(FM) Winter Park, FL 1 hr.
 *WUOG(FM) Athens, GA 9 hrs.
 *WRAS(FM) Atlanta, GA 10 hrs.
 *WREK(FM) Atlanta, GA 3 hrs.
 WQAK Decatur, GA
 *WABR-FM Tilton, GA 1 hr.
 *WVVS(FM) Valdosta, GA 2 hrs.
 *KTUH(FM) Valdosta, HI 16 hrs.
 *WVH(FM) Ailington Heights, IL 1 hr.
 *WUIC(FM) Chicago, IL 10 hrs.
 *WJMU(FM) Decatur, IL 2 hrs.
 *WNIU-FM De Kalb, IL 6 hrs.
 WKSJ(FM) Eldorado, IL 3 hrs.
 *WONC(FM) Naperville, IL 5 hrs.
 *WCBU(FM) Peoria, IL 4 hrs.
 WGSY(FM) Peru, IL 1 hr.
 *WRRG(FM) River Grove, IL 4 hrs.
 *WSSR(FM) Springfield, IL 5 hrs.
 *WARG(FM) Summit, IL 6 hrs.
 *WNTH(FM) Winnetka, IL 6 hrs.
 WNDY(FM) Evansville, IN 5 hrs.
 *WEVC(FM) Evansville, IN 5 hrs.
 *WEDM(FM) Indianapolis, IN 1 hr.
 *WECI(FM) Richmond, IN 8 hrs.
 *WVUB(FM) Vincennes, IN 6 hrs.
 *WBAW West Lafayette, IN 1 hr.
 *KPGY(FM) Ames, IA 1 hr.
 *KNBU(FM) Baldwin City, KS 10 hrs.
 *KHCC(FM) Hutchinson, KS 2 hrs.
 KLOO(FM) Lyons, KS 2 hrs.
 WLBK Lebanon, KY 4 hrs.
 WANO Pineville, KY 2 hrs.
 *KNLI(FM) Monroe, LA 5 hrs.
 *KLPJ(FM) Ruston, LA 1 hr.
 *WFCR(FM) Amherst, MA 5 hrs.
 *WMAU(FM) Amherst, MA 8 hrs.
 *WRBB(FM) Boston, MA 10 hrs.
 *WAVM(FM) Maynard, MA 2 hrs.
 *WJWJ(FM) North Adams, MA 6 hrs.
 *WUSM(FM) North Dartmouth, MA 3 hrs.
 *WBSL(FM) Sheffield, MA 10 hrs.
 *WTCC(FM) Springfield, MA 4 hrs.
 WPEP Taunton, MA 1 hr.
 WCRB(FM) Waltham, MA 7 hrs.

Special Programing

*WRSB(FM) Weston, MA 3 hrs.
 *WICN(FM) Worcester, MA 3 hrs.
 *WSRX(FM) Allendale, MI 1 hr.
 *KGLT(FM) Kalamazoo, MI 7 hrs.
 *WORW(FM) Port Huron, MI 1 hr.
 WJG St. Ignace, MI 1 hr.
 KIEE(FM) Harrisonville, MO 1 hr.
 *KSSS(FM) St. Louis, MO 12 hrs.
 *KVMU(FM) St. Louis, MO 13 hrs.
 *WJBF(FM) Bozeman, MT 6 hrs.
 *KUFM(FM) Missoula, MT 10 hrs.
 WDCR Hanover, NH 7 hrs.
 WDMA-FM Dover, NJ 10 hrs.
 *WJBF-FM Lincroft, NJ 18 hrs.
 WRLB(FM) Long Branch, NJ 1 hr.
 *WRSU-FM New Brunswick, NJ 14 1/2 hrs.
 WJIC Salem, NJ 8 hrs.
 *W5OU(FM) South Orange, NJ 2 hrs.
 *WTRF(FM) Trenton, NJ 4 hrs.
 *WALF(FM) Alfred, NY 4 hrs.
 *WJWN(FM) Auburn, NY 3 1/2 hrs.
 *WBXL(FM) Baldwinville, NY 2 hrs.
 *WHCL-FM Clinton, NY 6 hrs.
 *WECW(FM) Elmira, NY 6 hrs.
 WENY-FM Elmira, NY 2 hrs.
 *WBAU(FM) Garden City, NY 4 hrs.
 *WGMCFM Greece, NY 3 hrs.
 *WTRF(FM) Henrietta, NY 8 hrs.
 WYBR-FM Ithaca, NY 4 hrs.
 *W5HR(FM) Lake Ronkonkoma, NY 1 hr.
 WLFL Little Falls, NY 4 hrs.
 *WVCR-FM Loudonville, NY 2 hrs.
 WSOO North Syracuse, NY 3 hrs.
 WCHN Norwich, NY 2 hrs.
 *W5TC-FM Potsdam, NY 3 hrs.
 *WKWZ(FM) Syosset, NY 8 hrs.
 *WRPI(FM) Troy, NY 4 hrs.
 WRPL Charlotte, NC 4 hrs.
 WGMG(FM) Greensboro, NC 5 hrs.
 *WBSU(FM) Bowling Green, OH 12 hrs.
 KMMM-FM Muskegon, OK 7 hrs.
 KICE(FM) Bend, OR 6 hrs.
 KOIN-FM Portland, OR 6 hrs.
 *WMSP(FM) Harrisburg, PA 3 hrs.
 WICK Scranton, PA 6 hrs.
 WRHY(FM) Starview, PA 2 hrs.
 *W5RN-FM Swarthmore, PA 12 hrs.
 WBRU(FM) Providence, RI 4 hrs.
 *WNAZ-FM Nashville, TN 2 hrs.
 *WVUU(FM) Nashville, TN 2 hrs.
 KCOH Houston, TX 2 1/2 hrs.
 *WMRA(FM) Harrisburg, VA 5 hrs.
 WJMA Orange, VA 2 hrs.
 WJMA-FM Orange, VA 2 hrs.
 WGOE Richmond, VA 5 hrs.
 KZAM Bellevue, VA 6 hrs.
 KZAM-FM Bellevue, VA 6 hrs.
 KVAN Vancouver, WA 15 hrs.
 KMTN(FM) Jackson, WY 2 hrs.

Jewish
 (See also Hebrew)

WADS Ansonia, CT 1 hr.
 WHFS(FM) Bethesda, MD 1 1/2 hr.
 WTOW Towson, MD 2 hrs.
 WNEB Worcester, MA 1 hr.
 *WDET-FM Detroit, MI 2 hrs.
 WCTC New Brunswick, NJ 1 hr.
 WQMR(FM) New Brunswick, NJ 1 hr.
 W5AY Rochester, NY 2 1/2 hrs.
 WNDR Syracuse, NY 1 hr.
 WJBF(FM) Jenkintown, PA 13 1/2 hrs.
 WAVA Arlington, VA 2 hrs.

Korean
 *KPOF Denver, CO 1 hr.
 *WEDM(FM) Bethesda, MD 2 hrs.
 KPDO Portland, OR 1/2 hr.
 WJBF-FM Jenkintown, PA 1 hr.

Lithuanian
 WQOW Waterbury, CT 1 hr.
 WZUM Carnegie, PA 1/2 hr.

Medieval
 *WRUR-FM Rochester, NY 1 hr.

Mexican
 (See Chicano, Spanish)

Norwegian
 (See also Scandinavian)

*KWLC Decorah, IA 1 hr.
 *WCAL Northfield, MN 3 hrs.
 KEYZ Williston, ND 2 hrs.

Opera
 *WPCS(FM) Pensacola, FL
 WGKA Atlanta, GA 3 hrs.

Special Programming

Pakistani

WZAK Cleveland, OH 1 hr.

Pennsylvania Dutch

WBYO(FM) Boyertown, PA 1 hr.
WGSa Ephrata, PA ¼ hr.

Persian

*KAYE-FM Tonkawa, OK 1 hr

Polish

KEWE(FM) Camarillo, CA ¼ hr.
*KKUP(FM) Cupertino, CA 2 hrs.
*KEMR(FM) Loma Linda, CA 2 hrs.
*KCSN(FM) Northridge, CA 2 hrs.
*KOED-FM San Francisco, CA 1 hr
WADS Ansonia, CT 4 hrs.
WBIS Bristol, CT 4 hrs.
WGCH Greenwich, CT 1 hr.
WUGB Groton, CT 2 hrs.
WCCC Hartford, CT 1½ hr.
WCCC-FM Hartford, CT 1½ hr
WMMW Meriden, CT 2 hrs.
WCXN Middletown, CT 1 hr.
WVIF Milford, CT 1½ hr.
WRYM New Britain, CT 12 hrs.
WNLK-FM Norwalk, CT 1 hr.
WNLK Norwalk, CT 1 hr.
WNTY Southington, CT 3 hrs.
WSTC Stamford, CT 1½ hr.
WATR Waterbury, CT 2 hrs.
WEXT West Hartford, CT 1 hr.
WILI Willimantic, CT 2 hrs.
*WCYC(FM) Chicago, IL 4 hrs.
WEDC Chicago, IL 6¼ hrs.
*WUIC(FM) Chicago, IL 2 hrs.
WCBW(FM) Columbia, IL 2 hrs.
WTAQ La Grange, IL 5 hrs.
WOPA Oak Park, IL 17 hrs.
WGSY(FM) Peru, IL 3 hrs.
*WARG(FM) Summit, IL 3 hrs.
WZBN Zion, IL 3 hrs.
WLTH Gary, IN 1 hr.
WJOB Hammond, IN 1 hr.
WMSB Michigan City, IN 1½ hr.
*WEEM(FM) Pendleton, IN 4 hrs.
WJVA South Bend, IN 1 hr.
WNDU South Bend, IN 2 hrs.
WSBT South Bend, IN 1 hr.
KRCB Council Bluffs, IA 8 hrs.
*KTCC(FM) Colby, KS 2 hrs.
KLEY Wellington, KS 6 hrs.
WBMD Baltimore, MD 2 hrs.
WTOW Towson, MD 1½ hr.
*WMAU(FM) Amherst, MA ½ hr.
WMLO Beverly, MA 2 hrs.
WUNR Brookline, MA 5 hrs.
WACE Chicopee, MA 8 hrs.
WALE Fall River, MA 2 hrs.
WMAI-FM Greenfield, MA 1 hr.
*WAM(FM) Maynard, MA 2 hrs.
WNEB New Bedford, MA 1½ hr.
WHMP Northampton, MA 3 hrs.
WHMP-FM Northampton, MA 3 hrs.
WBRK Pittsfield, MA 1½ hr.
WBRK-FM Pittsfield, MA 1½ hr.
WESO Southbridge, MA 4 hrs.
WDEW Westfield, MA ½ hr.
*WICN(FM) Worcester, MA 1 hr.
WNEB Worcester, MA 1 hr.
WATZ Alpena, MI 2 hrs.
WHSB(FM) Alpena, MI 2 hrs.
WLEW Bad Axe, MI 2 hrs.
WCZN Flint, MI 1 hr.
WDFD Flint, MI 2 hrs.
WLA V Grand Rapids, MI 1 hr.
WMAX Grand Rapids, MI 1½ hr.
WIKB Iron River, MI 5 hrs.
WJMK Jackson, MI 1½ hr.
WKHM-FM Jackson, MI 1 hr.
WMIC Sandusky, MI 4 hrs.
WMIC-FM Sandusky, MI 4 hrs.
WJOR South Haven, MI 4 hrs.
WMBW West Branch, MI 2½ hrs.
WKLK Clio, MI 1 hr.
KUXL Golden Valley, MN 1 hr.
KWBE Beatrice, NE 5 hrs.
KLAV Las Vegas, NV 1 hr.
WTSV Claremont, NH 1½ hr.
WOTW Nashua, NH 4½ hrs.
WNNH Rochester, NH 2 hrs.
WSNJ Bridgeton, NJ 4 hrs.
WSNJ-FM Bridgeton, NJ 4 hrs.
WCAM Camden, NJ 1 hr.
WDHA-FM Dover, NJ 4 hrs.
WRLB(FM) Long Branch, NJ 4 hrs.
WCTC New Brunswick, NJ 1½ hr.
WQMR(FM) New Brunswick, NJ 1½ hr.
WBHI(FM) Newark, NJ 2 hrs.
*WSOU(FM) South Orange, NJ 2 hrs.
WTTM Trenton, NJ 3 hrs.
WVBZ Vineland, NJ 1 hr.
WCSS Amsterdam, NY 2 hrs.
WKOL Amsterdam, NY 1 hr.

WAUB Auburn, NY 1 hr.
WSEN Baldwinsville, NY 2 hrs.
WSEN-FM Baldwinsville, NY 2 hrs.
WKOP Binghamton, NY 4 hrs.
WWOL Buffalo, NY 3 hrs.
WVWL-FM Buffalo, NY 3 hrs.
WKCL Catskill, NY ½ hr.
WNIA Cheektown, NY 3 hrs.
WELV Ellenville, NY 12 hrs.
WELV-FM Ellenville, NY 12 hrs.
WELM Elmira, NY 1 hr.
WBUZ Fredonia, NY 1½ hr.
WOSC Fulton, NY 2 hrs.
*WBAU(FM) Garden City, NY 1 hr.
*WVHC(FM) Hempstead, NY 2½ hrs.
WALY Herkimer, NY 1 hr.
WHUC Hudson, NY 1 hr.
WHUC-FM Hudson, NY 1 hr.
WKNY Kingston, NY 1 hr.
WXRLL Lancaster, NY 8 hrs.
WLHF Little Falls, NY 5 hrs.
*WVCR-FM Loudonville, NY 1 hr.
WALL Middletown, NY 1½ hr.
WVOX New Rochelle, NY 2 hrs.
WPOW New York, NY 5 hrs.
*WHLN Niagara Falls, NY 6 hrs.
WOOO North Syracuse, NY 3 hrs.
WEOK Poughkeepsie, NY 1 hr.
WPDH(FM) Poughkeepsie, NY 1 hr.
WVOR(FM) Rochester, NY 1 hr.
WKAL Rome, NY 2 hrs.
WKAL-FM Rome, NY 2 hrs.
WRNY Rome, NY 2 hrs.
WGGG Salamanca, NY 1 hr.
WSNY Schenectady, NY 1 hr.
WDRS Syracuse, NY 1 hr.
WBVM Utica, NY 5 hrs.
WIBX Utica, NY 5 hrs.
*WTBO Warwick, NY 1 hr.
*WREO Ashtabuck, OH 1½ hr.
WOMP Bellaire, OH 4 hrs.
WERE Cleveland, OH 2 hrs.
WLRO Lorain, OH 2 hrs.
WNO Niles, OH 4 hrs.
WLIT Steubenville, OH 1 hr.
*WKTL(FM) Struthers, OH 1 hr.
WTD Toledo, OH 3¼ hrs.
WTCL Warren, OH 1½ hr.
WVAM Altoona, PA 1 hr.
WMBAB Erie, PA 5 hrs.
WNCB Barnesboro, PA 3 hrs.
WASP Brownsville, PA 1½ hr.
WARO Caronsburg, PA 1 hr.
WCDL Charbonade, PA 7 hrs.
WESA Erie, PA 2 hrs.
WVFM(FM) Charleroi, PA 2 hrs.
WEEZ Chester, PA 2 hrs.
WCVI Conestoga, PA 2 hrs.
WEND Ebensburg, PA 1 hr.
WVYO(FM) Ebensburg, PA 3 hrs.
*WVERG(FM) Erie, PA 3 hrs.
WJET Erie, PA 2 hrs.
WLVU(FM) Erie, PA 2 hrs.
WFAF Farrell, PA 10 hrs.
WKS(FM) Greencastle, PA 4½ hrs.
WPKB Greensburg, PA 2 hrs.
WOKU-FM Greensburg, PA 2 hrs.
WBCW Jeannette, PA 4 hrs.
WBF-FM Jenkintown, PA 2 hrs.
WCRO Johnstown, PA 1 hr.
WLSH Lansford, PA 2 hrs.
WOTW Latrobe, PA 5 hrs.
WTRA Latrobe, PA 4 hrs.
WMGW Meadville, PA 2 hrs.
WPSL Monroeville, PA 2 hrs.
WMMI Mt. Carmel, PA 2 hrs.
WKST New Castle, PA 2 hrs.
WPKA New Kensington, PA 2 hrs.
WDRJ(FM) Oil City, PA 1 hr.
WKRZ Oil City, PA 1 hr.
WTEL Philadelphia, PA 8 hrs.
WPHB Pittsburgh, PA 2 hrs.
WVWL Portage, PA 8 hrs.
WPAZ Pottstown, PA 2 hrs.
WPAM Pottsville, PA 2 hrs.
WPMF-FM Pottsville, PA 3 hrs.
WPMF-FM Pottsville, PA 3 hrs.
WISL Shamokin, PA 8 hrs.
WISL-FM Shamokin, PA 8 hrs.
WTTT Towanda, PA 1½ hr.
WCTL(FM) Union City, PA ½ hr.
WMBB Uniontown, PA ½ hr.
WVOR-FM Uniontown, PA 4 hrs.
WVBR Windsor, PA 2½ hrs.
WHIM Providence, RI 1 hr.
WHIM-FM Providence, RI 1 hr.
WVRI West Warwick, RI 1 hr.
WNRI Woonsocket, RI 1 hr.
WVON Woonsocket, RI 1 hr.
WVKT Brattleboro, VT 1 hr.
WHWB Rutland, VT 1 hr.
WSYB Rutland, VT 1 hr.
*WVHS-FM Hampden-Sydney, VA 2 hrs.
KILQ Kirkland, WA ½ hr.
WYLO Jackson, WA 1 hr.
*WORT(FM) Madison, WI 3 hrs.
*WUWM(FM) Milwaukee, WI 1 hr.
WGLB Port Washington, WI 1 hr.
WGLB-FM Port Washington, WI 1 hr.

WSPT Stevens Point, WI 1½ hr.
WSPT-FM Stevens Point, WI 1½ hr.
WVVM(FM) Suring, WI ¼ hr.
KROE Sheridan, WI 1½ hr.

Polka

KBRN Brighton, CO 5 hrs.
WJUP Joliet, IL 10½ hrs.
WATC Garford, MI 2 hrs.
WMSA Marine City, MI 2½ hrs.
KTTT Columbus, NE 10 hrs.
KTTT-FM Columbus, NE 10 hrs.
KGMT Fairbury, NE 7½ hrs.
KGMF Fremont, NE 4 hrs.
KHUB-FM Fremont, NE 4 hrs.
KNLV Ord, NE 5 hrs.
KTCH Wayne, NE 1 hr.
WONW DeLancey, OH 4 hrs.
WDOH(FM) Delphos, OH 8 hrs.
WKZA Kane, PA 12 hrs.
WMSL Monroeville, PA 9 hrs.
KTTX Brenham, TX 4 hrs.
KCFH Cuero, TX 3 hrs.
KAWA Waco-Martin, TX 2 hrs.
WAPL-FM Appleton, WI 2 hrs.
WLIH-FM New London, WI 2 hrs.
WGLB Port Washington, WI 3 hrs.
WGLB-FM Port Washington, WI 3 hrs.

Portuguese

KREL Corona, CA 4½ hrs.
KRM(FM) Fremont, CA 11 hrs.
KNGS Hanford, CA 3 hrs.
KOAD Lemoore, CA 1 hr.
KLBS Los Banos, CA 20½ hrs.
KRVS Los Gatos, CA 18 hrs.
KYOS Merced, CA 1 hr.
KTRB Modesto, CA 11½ hrs.
KHOP(FM) Modesto, CA 11½ hrs.
KLO(FM) San Diego, CA 1 hr.
KHL Santa Maria, CA 1½ hr.
KSTN-FM Stockton, CA 16½ hrs.
CKOK Tulare, CA 11 hrs.
KGEN Tulare, CA 8 hrs.
KCEY Turlock, CA 8 hrs.
KOMY Watsonville, CA 2 hrs.
WINE Brookfield, CT 2 hrs.
*WRTC-FM Hartford, CT 10 hrs.
*WFC(FM) New Britain, CT 10 hrs.
WMLV Beverly, MA 2 hrs.
WUNR Brookline, MA 5 hrs.
WACE Chicopee, MA 2 hrs.
WALE Fall River, MA 2 hrs.
WLYN Lynn, MA 2 hrs.
WLYN-FM Lynn, MA 2 hrs.
WSRO Marlboro, MA 2½ hrs.
WVCR Milford, MA 2 hrs.
WVMS(FM) New Bedford, MA 5 hrs.
WNBH New Bedford, MA 11 hrs.
WPEP Taunton, MA 1 hr.
WVRL(FM) Taunton, MA 1 hr.
WARE Ware, MA 2 hrs.
WTLX West Springfield, MA 2 hrs.
WORC Worcester, MA 1½ hr.
WADC Newport, RI 3 hrs.
WHIM Providence, RI 1 hr.
WHIM-FM Providence, RI 1 hr.
WRIB Providence, RI 2 hrs.
WKRI West Warwick, RI 1 hr.
WKFD Wickford, RI 4 hrs.
WNRI Woonsocket, RI 1½ hr.

Programs for the Handicapped

*KUNC-FM Greeley, CO 18 hrs.

Punjabi

KHEX(FM) Yuba City, CA 2½ hrs.
KUBA Yuba City, CA 2½ hrs.

Romanian

*WVUZ(FM) Detroit ½ hr.

Russian

KICY Nore, AK 5 hrs.
WEDC Chicago, IL 3 hrs.
WOPA Oak Park, IL ½ hr.
*WUWM(FM) Milwaukee; WI 1 hr

Scandinavian

(See also Norwegian, Swedish)

WHBF-FM Rock Island, IL 1 hr.
WNEB Worcester, MA 1 hr.
KABG(FM) Cambridge, MN 2 hrs.
KLP Minot, N.D. 1 hr.
KJUN Reedsport, OR 1 hr.
KXA Seattle, WA 1½ hrs.

Serbian

WHLO Akron, OH 1 hr.
WZAK(FM) Cleveland, OH 3 hrs.

Slovak

WOPA Oak Park, IL ½ hr.
*WCAL Northfield, MN 1 hr.
WERE Cleveland, OH 1 hr.
WZAK(FM) Cleveland, OH 1½ hrs.
*WKTL(FM) Struthers, OH 2 hrs.
*WUWM(FM) Milwaukee, WI 2 hrs.

Slovenian

WBKC Chardon, OH 2 hrs.
WZAK(FM) Cleveland, OH 4 hrs.
*WKTL(FM) Struthers, OH 2 hrs.
WBCW Jeannette, PA 2 hrs.

Soul

(See Black)

Spanish

(See also Chicano)

Excludes Puerto Rico.

WHEP Foley AL 7 hrs.
*KUAC(FM) College, AK ½ hr.
KPIN Casa Grande, AZ 3¼ hrs.
KCUZ Clifton, AZ 10 hrs.
KAWT Douglas, AZ 20 hrs.
KAPR Douglas, AZ 2 hrs.
*KAXR(FM) Flagstaff, AZ 1 hr.
KCTB-FM Flagstaff, AZ 2 hrs.
KXTC(FM) Glendale, AZ 4 hrs.
KAAA Kingman, AZ 2 hrs.
KIKO Miami, AZ 8 hrs.
KFBF Nogales, AZ 18½ hrs.
KYCA Prescott, AZ 1 hr.
KATO Safford, AZ 5 hrs.
KHIL Wilcox, AZ 1½ hr.
KNYN Williams, AZ 4 hrs.
*KHDX(FM) Conway, AR 3 hrs.
*KUAF(FM) Fayetteville, AR 2½ hrs.
KWNN Fort Smith, AR 12 hrs.
KFVY Arroyo Grande, CA 3 hrs.
KGEA Bakersfield, CA 13 hrs.
KIOT Barstow, CA 4 hrs.
*KPPA(FM) Berkeley, CA 10 hrs.
*KPPB(FM) Berkeley, CA 10 hrs.
KYOR Blythe, CA 2 hrs.
KROP Brawley, CA 10 hrs.
KICO Calexico, CA 7 hrs.
KXCO(FM) Carlsbad, CA 3 hrs.
*KCHO(FM) Chico, CA 2 hrs.
KACH Coachella, CA 4 hrs.
KWUN Concord, CA 4 hrs.
KREL Corona, CA 17 hrs.
KCHJ Delano, CA 4 hrs.
KLA(FM) Dinuba, CA 12 hrs.
KRDU Dinuba, CA 10 hrs.
KOWN Escondido, CA 2 hrs.
KNGS Hanford, CA 3 hrs.
KMPG Hollister, CA 21 hrs.
KREO Indio, CA 14½ hrs.
KTYM Inglewood, CA 17 hrs.
KRKC King City, CA 7 hrs.
KBLK Lakeport, CA 1 hr.
KLOM Lompoc, CA 1½ hr.
KLOM-FM Lompoc, CA 1½ hr.
*KUSC(FM) Los Angeles, CA 6 hrs.
*KXLU(FM) Los Angeles, CA 8 hrs.
KLBS Los Banos, CA 12 hrs.
KHOT Marysville, CA 7 hrs.
KMVC Madera, CA 9½ hrs.
KYOS Merced, CA 2 hrs.
KFV Modesto, CA 11 hrs.
KFRB Modesto, CA 1 hr.
KHOP(FM) Modesto, CA 1 hr.
KVON Napa, CA 5 hrs.
KUDE Oceanside, CA 2 hrs.
KORV Oroville, CA 2 hrs.
KDES Palm Springs, CA ½ hr.
KDES-FM Palm Springs, CA ½ hr.
KUTY Palmdale, CA 1 hr.
KKAR Pomona, CA 7 hrs.
KTIPT Porterville, CA 18 hrs.
*KRVH(FM) Rio Vista, CA 1 hr.
KPOP Roseville, CA 4 hrs.
KGMS Sacramento, CA 2 hrs.
KJAY Sacramento, CA 6 hrs.
KOLH(FM) San Bernardino, CA 1 hr.
*KVC(FM) San Bernardino, CA 3 hrs.
KLO(FM) San Diego, CA 3 hrs.
*KALW(FM) San Francisco, CA 1½ hr.
*KPOO(FM) San Francisco, CA 14 hrs.
*KJSS(FM) San Jose, CA 5 hrs.
*KCBX(FM) San Luis Obispo, CA 2 hrs.
KKIO Santa Barbara, CA 2 hrs.
KIMS Santa Barbara, CA 2½ hrs.
KSM Santa Maria, CA 4 hrs.
KSM-FM Santa Maria, CA 4 hrs.
KUH Santa Maria, CA 8 hrs.
KZON Santa Maria, CA 2 hrs.
*KCRW(FM) Santa Monica, CA 3 hrs.
KPLS Santa Rosa, CA ½ hr.
*KVRE Santa Rosa, CA 3 hrs.
KVRE-FM Santa Rosa, CA 3 hrs.
*KJSC-FM Stockton, CA 1 hr.
KSTN Stockton, CA 14 hrs.
*KUOP(FM) Stockton, CA 5 hrs.
KGEN Tulare, CA 3 hrs.
KCEY Turlock, CA ½ hr.
KLIL(FM) Ukiah, CA 1 hr.
KUKI Ukiah, CA 2 hrs.
KONG Visalia, CA 10 hrs.
KMLO Vista, CA 2 hrs.
KSF(FM) Woodland, CA 1 hr.
KHEX(FM) Yuba City, CA 15 hrs.

KUBA Yuba City, CA 15 hrs.
KGIW Alamosa, CO 6 hrs.
KBRN Brighton, CO 5 hrs.
KRDO Colorado Springs, CO 1 hr.
*KCFR(FM) Denver, CO 2 hrs.
*KPOF Denver, CO 2 hrs.
KIUP Durango, CO 5 hrs.
KCOL Fort Collins, CO ½ hr.
KTCL(FM) Fort Collins, CO 3 hrs.
KFTM Fort Morgan, CO 3 hrs.
KGLN Glenwood Springs, CO ¼ hr.
KEXO Grand Junction, CO 1½ hr.
KSTRA Grand Junction, CO 1 hr.
KPKA Greeley, CO 6 hrs.
*KUNC-FM Greeley, CO 4 hrs.
KYOU Greeley, CO 9 hrs.
KLMR Lamar, CO 3 hrs.
KLMO Longmont, CO 1 hr.
*KWB(FM) Morrison, CO ¼ hr.
KPA3 Pagosa Springs, CO 2 hrs.
KAVI Rocky Ford, CO 7½ hrs.
KGEK Sterling, CO 1 hr.
*KOTO(FM) Telluride, CO 10 hrs.
KCRTR Trinidad, CO 9 hrs.
KFLJ Walsenburg, CO 10 hrs.
KUAD Windsor, CO 2 hrs.
WVNB Bridgeport, CT 8 hrs.
*WVSHU(FM) Fairfield, CT 1 hr.
WCOO Hamden, CT 4 hrs.
*WOTO(FM) Hartford, CT 10 hrs.
*WRTC-FM Hartford, CT 5 hrs.
WVIC Hartford, CT 1 hr.
WVIC-FM Hartford, CT ½ hr.
WMMW Meriden, CT 1½ hr.
WVIF Milford, CT 3 hrs.
WRYM New Britain, CT 18 hrs.
WNHC New Haven, CT 1 hr.
WNLN New London, CT ½ hr.
WNLK-FM Norwalk, CT 8 hrs.
WNLK Norwalk, CT 8½ hrs.
WEXT West Hartford, CT 2 hrs.
WILI Willimantic, CT 1 hr.
*WAMU-FM Washington, DC 2 hrs.
WHUR-FM Washington, DC 4 hrs.
WBSR Boca Raton, FL 1 hr.
WVFL Clermont, FL 1 hr.
WINK Fort Myers, FL ½ hr.
WKEM Immokalee, FL 18 hrs.
WFIV Kissimmee, FL 2 hrs.
WRGI Marco Island, FL ½ hr.
*WLRN-FM Miami, FL 1 hr.
*WVKZ(FM) Sarasota, FL ¾ hr.
WSPB Sarasota, FL 1 hr.
WYND Sarasota, FL ½ hr.
WRMF Titusville, FL 1 hr.
WRMF-FM Titusville, FL 1 hr.
WJNO West Palm Beach, FL 1 hr.
WJOL Athens, GA 2 hrs.
KBRJ Boise, ID 5 hrs.
KBAR Burley, ID 3 hrs.
KCID Caldwell, ID 12 hrs.
KFLI Mountain Home, ID 2 hrs.
KAIH Nampa, ID 2 hrs.
KFXD Nampa, ID 1½ hr.
KJET Payette, ID 4 hrs.
KSNM-FM Pocatello, ID 2 hrs.
*KRIC(FM) Rexburg, ID 1 hr.
WVFR Aurora, IL 2½ hrs.
WVRO Aurora, IL 4 hrs.
*WCYC(FM) Chicago, IL 4½ hrs.
WLS Chicago, IL ½ hr.
*WUIC(FM) Chicago, IL 5 hrs.
WRMN Elgin, IL 7 hrs.
*WAAG(FM) Galesburg, IL
WGSB Geneva, IL 3 hrs.
WJRC Joliet, IL 2 hrs.
WTAQ La Grange, IL 20 hrs.
*WVOC-FM Quincy, IL 1 hr.
WHBF Rock Island, IL 1 hr.
*WVIF(FM) Rock Island, IL 2 hrs.
WRRR Rockford, IL 1 hr.
*WARG(FM) Summit, IL 12 hrs.
WEFA(FM) Waukegan, IL 9 hrs.
*WNTI(FM) Winnetka, IL 1 hr.
WBMP(FM) Elwood, IN 2 hrs.
WGL Fort Wayne, IN 2 hrs.
WLTH Gary, IN 4 hrs.
WJOB Hammond, IN 2 hrs.
WIBC Indianapolis, IN 1 hr.
*WICR(FM) Indianapolis, IN 2 hrs.
WVNP(FM) Indianapolis, IN 1 hr.
WIOU Kokomo, IN 1½ hr.
WBAT Marion, IN 3 hrs.
*WNAS(FM) New Albany, IN 1 hr.
WJVA South Bend, IN 1 hr.
WSBT South Bend, IN 1 hr.
WRSW Warsaw, IN 1 hr.
WUIC(FM) Winchester, IN 1 hr.
KHUR Burlington, IA 1 hr.
KKBK(FM) Cedar Falls, IA 2 hrs.
*KDIC(FM) Grinnell, IA 3 hrs.
*WSUI Iowa City, IA ½ hr.
KWPC Muscatine, IA 1 hr.
*KCUI(FM) Pella, IA 1 hr.
*KWAR(FM) Waverly, IA 2 hrs.
KKOY Chanute, KS 1 hr.
KUPK Garden City, KS 2 hrs.
KUPK-FM Garden City, KS 2 hrs.
KLOE Goodland, KS 5 hrs.
*KHCC(FM) Hutchinson, KS 2 hrs.
KWHK Hutchinson, KS ½ hr.

KCKN Kansas City, KS 1 hr.
 KCLO Leavenworth, KS 2½ hrs.
 KBFA Mission, KS 1 hr.
 KLCB Parsons, KS 2 hrs.
 KFLA Scott City, KS 3 hrs.
 KULY Ulysses, KS 5 hrs.
 KLEY Wellington, KS 2 hrs.
 *KMUW(FM) Wichita, KS 7 hrs.
 WJMR New Orleans, LA 4 hrs.
 *WSPH(FM) Baltimore, MD 1 hr.
 WTOW Towson, MD 1 hr.
 *WFCR(FM) Amherst, MA 6 hrs.
 *WMAU(FM) Amherst, MA 5 hrs.
 WARA Attleboro, MA 1 hr.
 WCOP Boston, MA
 *WERS(FM) Boston, MA 2 hrs.
 *WRBB(FM) Boston, MA 1 hr.
 WRFB-FM Cambridge, MA 2 hrs.
 WEIM Fitchburg, MA 1 hr.
 WKOX Framingham, MA ½ hr.
 WVB(FM) Framingham, MA ½ hr.
 WCCM Lawrence, MA 1 hr.
 WLLH Lowell, MA 1 hr.
 WBLN Lynn, MA 2½ hrs.
 WLYN-FM Lynn, MA 2 hrs.
 WNTN Newton, MA 1 hr.
 WMA5 Springfield, MA ½ hr.
 WRLM(FM) Taunton, MA 1 hr.
 WHET Waltham, MA ½ hr.
 WCRB(FM) Waltham, MA ½ hr.
 *WICN(FM) Worcester, MA 2 hrs.
 WORC Worcester, MA 1 hr.
 WABU Adrian, MI 4 hrs.
 WLEN(FM) Adrian, MI 3 hrs.
 WUFN(FM) Albion, MI ½ hr.
 *WCBN-FM Ann Arbor, MI 2 hrs.
 *WDET-FM Detroit, MI 1 hr.
 WVIC East Lansing, MI 2 hrs.
 WVIC-FM East Lansing, MI 2 hrs.
 WDFE Flint, MI ½ hr.
 WID Garden City, MI 6 hrs.
 WMAX Grand Rapids, MI 1 hr.
 WHTC Holland, MI 2 hrs.
 WIBM Jackson, MI ½ hr.
 WLS Lansing, MI 1 hr.
 WUGN(FM) Midland, MI ½ hr.
 *WCMU-FM Mount Pleasant, MI 1 hr.
 WKBZ Muskegon, MI ½ hr.
 WQOW-FM Muskegon, MI 2 hrs.
 WAOP Otsego, MI 1 hr.
 WPON Pontiac, MI 1 hr.
 WHLS Port Huron, MI 2 hrs.
 WKNX Saginaw, MI 1 hr.
 WSGW Saginaw, MI 2 hrs.
 WWWW(FM) Saginaw, MI 12 hrs.
 WNRS Saline, MI 1 hr.
 WRBJ St. Johns, MI 8 hrs.
 WYGR Wyoming, MI 1 hr.
 *KBSB(FM) Berthel, MN 2 hrs.
 KUXL Golden Valley, MN 2 hrs.
 WMIN Maplewood, MN 1 hr.
 KRFO Owatonna, MN ½ hr.
 KRFO-FM Owatonna, MN ½ hr.
 *KOPN(FM) Columbia, MO 3 hrs.
 WDAF Kansas City, MO ½ hr.
 *KBDY(FM) St. Louis, MO 3 hrs.
 KBMY Billings, MT 1 hr.
 KHAS Hastings, NE 1 hr.
 KRNY Kearney, NE 2 hrs.
 KRNY-FM Kearney, NE 2 hrs.
 *KRNU(FM) Lincoln, NE ½ hr.

*KJLT North Platte, NE ½ hr.
 *KQVO(FM) Omaha, NE ½ hr.
 KEYR Terrytown, NE 3 hrs.
 *KVOY Henderson, NV 7 hrs.
 KENO Las Vegas, NV
 KLAV Las Vegas, NV 1 hr.
 KUDO(FM) Las Vegas, NV
 *WCAM Camden, NJ 18½ hrs.
 *WRAN Dover, NJ 2 hrs.
 *WJDM Elizabeth, NJ 5 hrs.
 WRDI Hammondtown, NJ 7 hrs.
 *WJBJ-FM Lincoln, NJ 4 hrs.
 *WJSV(FM) Morristown, NJ 1 hr.
 WCTC New Brunswick, NJ 1 hr.
 WQMR(FM) New Brunswick, NJ 1 hr.
 *WRSU-FM New Brunswick, NJ 5 hrs.
 WHBI(FM) Newark, NJ 1½ hr.
 WERA Plainfield, NJ 1 hr.
 *WYOU(FM) South Orange, NJ 3 hrs.
 WTNJ Trenton, NJ 5 hrs.
 WWBZ Vineland, NJ 4 hrs.
 *WAWZ Zarephath, NJ 4 hrs.
 KINN Alamogordo, NM 3 hrs.
 *KINM(FM) Albuquerque, NM 4 hrs.
 KZIA Albuquerque, NM ½ hr.
 KHAP Aztec, NM 3 hrs.
 KARS Belen, NM 17½ hrs.
 KBAD-FM Carlsbad, NM 9 hrs.
 KCCC Carlsbad, NM 14 hrs.
 KOTS Deming, NM 3 hrs.
 KIVA Gallup, NM 9 hrs.
 KWEE Hobbs, NM 2 hrs.
 KOBE Las Cruces, NM 18 hrs.
 *KRWG(FM) Las Cruces, NM 14 hrs.
 KTRC Santa Fe, NM 14 hrs.
 KSYX Santa Rosa, NM 15 hrs.
 KSIL Silver City, NM 13 hrs.
 KRIT Taos, NM 18 hrs.
 KTNM Tucuman, NM 12 hrs.
 WCSS Amsterdam, NY 2½ hrs.
 WBNR Beacon, NY 1 hr.
 *WBFO(FM) Buffalo, NY 2 hrs.
 WGVG Geneva, NY 1 hr.
 *WVHC(FM) Hempstead, NY 1 hr.
 WJTN Jamestown, NY 1 hr.
 *WSHR(FM) Lake Ronkonkoma, NY 1 hr.
 WXRL Lancaster, NY 2 hrs.
 WTHE Mineola, NY 10 hrs.
 *WKCR-FM New York, NY 9 hrs.
 WACK Newark, NY 1 hr.
 WSOO North Syracuse, NY 1 hr.
 WSPK(FM) Poughkeepsie, NY 1 hr.
 WBBF Rochester, NY 1 hr.
 WBF(FM) Rochester, NY 2 hrs.
 *WCMF(FM) Rochester, NY 2 hrs.
 *WIRQ(FM) Rochester, NY 1 hr.
 WSAY Rochester, NY ½ hr.
 WWOR(FM) Rochester, NY 2 hrs.
 *WXXI-FM Rochester, NY 1 hr.
 *WSHA(FM) Raleigh, NC 5 hrs.
 *KFJM Grand Forks, ND ½ hr.
 KMAV Mayville, ND 2½ hrs.
 WHFD(FM) Archbold, OH 1 hr.
 WONW Defiance, OH 3 hrs.
 WEOL Elyria, OH 1½ hr.
 WFIN Findlay, OH 1 hr.
 WFOB Fostoria, OH 5 hrs.

WLRO Lorain, OH 1 hr.
 WNDH(FM) Napoleon, OH 2 hrs.
 *WTKL(FM) Struthers, OH 1 hr.
 WERT Van Wert, OH ½ hr.
 WERT-FM Van Wert, OH ½ hr.
 *KOSU-FM Stillwater, OK ½ hr.
 KJUK Hillsboro, OR 3 hrs.
 KLDAD Klamath Falls, OR 1 hr.
 *KTECFM Klamath Falls, OR 3 hrs.
 KCMC McMinnville, OR 6 hrs.
 *KBPS Portland, OR ½ hr.
 KBZY Salem, OR 1¼ hr.
 KSLM Salem, OR 3 hrs.
 KWRC Woodburn, OR 4 hrs.
 WIOV(FM) Ephrata, PA 1 hr.
 *WOLN-FM Erie, PA 2 hrs.
 WFAF Farrell, PA 3 hrs.
 WJBF-FM Jenkintown, PA 18 hrs.
 WGL Lancaster, PA 1 hr.
 WLAN Lancaster, PA 1½ hr.
 *WYEP-FM Pittsburgh, PA 2 hrs.
 WUEU Reading, PA ½ hr.
 *WFMQ(FM) Lebanon, TN 1 hr.
 *WLYZ(FM) Memphis, TN ½ hr.
 KVLV Alpine, TX 6 hrs.
 KOIZ Amarillo, TX 20 hrs.
 *KUT-FM Austin, TX 10 hrs.
 KRUN Ballinger, TX 4 hrs.
 KIOX Bay City, TX 5 hrs.
 KWGH Big Lake, TX 2 hrs.
 KKUB Brownfield, TX 16 hrs.
 KEAN Brownwood, TX 2 hrs.
 KOX(FM) Brownwood, TX 1 hr.
 KTAM Bryan, TX 3 hrs.
 KML Cameron, TX 5 hrs.
 KSTA Coleman, TX 2 hrs.
 WTAW-FM College Station, TX 16 hrs.
 KVMC Colorado City, TX 5 hrs.
 KCOM Comanche, TX 1 hr.
 KCTA Corpus Christi, TX 14 hrs.
 KCFH Cuero, TX 9 hrs.
 *KCHU(FM) Dallas, TX 4 hrs.
 *KERA-FM Dallas, TX 2 hrs.
 WRR Dallas, TX 1 hr.
 KWBY Edna, TX 12 hrs.
 KULP El Campo, TX 14 hrs.
 KPAS(FM) El Paso, TX 6 hrs.
 *KTEP(FM) El Paso, TX 4 hrs.
 KFST Fort Stockton, TX 10 hrs.
 KGBC Galveston, TX 5 hrs.
 KILE Galveston, TX 2 hrs.
 KCTI Gonzales, TX 6 hrs.
 KPAN Harford, TX 18 hrs.
 KVL Highland Park, TX 1 hr.
 KHCB-FM Houston, TX 8 hrs.
 *KPFT(FM) Houston, TX ½ hr.
 KMBL Junction, TX 4 hrs.
 *KNCT(FM) Killen, TX ½ hr.
 *KTAI(FM) Kingsville, TX ½ hr.
 KPET Lamesa, TX 10½ hrs.
 KYVL Lampasas, TX 3 hrs.
 KLVY Levelland, TX 15 hrs.
 KCLT Lockhart, TX 6 hrs.
 *KOHM(FM) Lubbock, TX 1 hr.
 KSEL Lubbock, TX 15 hrs.
 *KXTX-FM Lubbock, TX 4 hrs.
 KRBA Lufkin, TX 1 hr.
 KWFA Merkel, TX 5 hrs.
 KJBC Midland, TX 6 hrs.
 KNAM Midland, TX 6 hrs.
 *KSAU(FM) Nacogdoches, TX 1 hr.

KGNB New Braunfels, TX 6 hrs.
 KOYL Odessa, TX 1 hr.
 KRIG Odessa, TX 4 hrs.
 KIUN Pecos, TX 12 hrs.
 KKYN Plainview, TX 3 hrs.
 KGUL Port Lavaca, TX 17 hrs.
 KOLJ Quanah, TX ½ hr.
 KPPE San Angelo, TX 8 hrs.
 KTEO San Angelo, TX 4 hrs.
 *KSYM-FM San Antonio, TX 2 hrs.
 KIKZ Seminole, TX 5 hrs.
 KIKM Sherman, TX 10½ hrs.
 KDWT Stamford, TX 2 hrs.
 KXOZ Sweetwater, TX 5 hrs.
 KTAE Taylor, TX 6 hrs.
 KTER Terrell, TX 3 hrs.
 *KTLW Texas City, TX 1½ hr.
 KTUE Tulia, TX 14 hrs.
 KWVC Vernon, TX 5 hrs.
 KTXN(FM) Victoria, TX 3 hrs.
 KRZI Waco, TX 1 hr.
 KBEC Waxahachie, TX 12 hrs.
 KBUH Brigham City, UT 1 hr.
 KBUH-FM Brigham City, UT 1 hr.
 KMOR Murray, UT 4 hrs.
 KSVN Ogden, UT 3 hrs.
 KVOG Ogden, UT 2 hrs.
 *KWCR-FM Ogden, UT 1 hr.
 *KBYU-FM Provo, UT 1 hr.
 *KUIER(FM) Salt Lake City, UT 1½ hr.
 KWHO Salt Lake City, UT 1½ hr.
 KBFV Bellingham-Frondle, WA 2 hrs.
 KARI Blaine, WA 3 hrs.
 KWYZ Everett, WA 1 hr.
 KLYN-FM Lynden, WA 2 hrs.
 KSEM Moses Lake, WA 6 hrs.
 KWIO Moses Lake, WA 6½ hrs.
 KWIO-FM Moses Lake, WA 6½ hrs.
 KAPS Mount Vernon, WA 1 hr.
 KRSC Othello, WA 6 hrs.
 KORD Pasco, WA 1 hr.
 KORD-FM Richland, WA 1 hr.
 KARY Prosser, WA 12 hrs.
 KUPY Puyallup, WA 1 hr.
 KPOR Quincy, WA 4 hrs.
 KALE Richland, WA 2½ hrs.
 *KUOW(FM) Seattle, WA 2 hrs.
 KREW Sunnyside, WA 6 hrs.
 *KTOY(FM) Tacoma, WA 6 hrs.
 KENE Toppenish, WA 20 hrs.
 WBEV Beaver Dam, WI ½ hr.
 WBEV-FM Beaver Dam, WI ½ hr.
 WFO(FM) Fond Du Lac, WI 1 hr.
 *WORT(FM) Madison, WI 5 hrs.
 WPLY Plymouth, WI ½ hr.
 WRJN Racine, WI ½ hr.
 *WRPN-FM Ripon, WI ½ hr.
 *WSHS(FM) Sheboygan, WI 1 hr.
 WAUK Waukesha, WI 1 hr.
 KVOC Casper, WY 1 hr.
 KRAE Cheyenne, WY 2½ hrs.
 KOJO Laramie, WY 2 hrs.
 KPOW Powell, WY ½ hr.
 KGOS Torrington, WY 1 hr.
 WOYE-FM Mayaguez, PR 16 hrs.

Special Programing
World Radio-TV

WKLK Cloquet, MN ½ hr.
 WWJC Duluth, MN ½ hr.
 *WVAL Northfield, MN 3 hrs.
 KUVR Holdrege, NE ½ hr.
 WJTN Jamestown, NY 2 hrs.

Swiss
 KMEO Phoenix, AZ ¼ hr.
 KMEO-FM Phoenix, AZ ¼ hr.
 WJER Dover-New Philadelphia, OH 1 hr.

Tagalog
 (See also Filipino)
 KKON Kaelakokus, HI 1 hr.

Ukranian
 WSGN Birmingham, AL 5½ hrs.
 WLI Willimant, CT 1 hr.
 WJWF-FM Orlando, FL 3 hrs.
 WBJW Winter Park, FL 3 hrs.
 WEDC Chicago, IL 1 hr.
 *WUIC(FM) Chicago, IL 2 hrs.
 WOPA Oak Park, IL 2 hrs.
 WTTM Trenton, NJ ½ hr.
 WAWZ Zarephath, NJ ½ hr.
 WPOW New York, NY 1 hr.
 WIBX Utica, NY 1 hr.
 WDLA Walton, NY 3 hrs.
 WDMA-FM Walton, NY 3 hrs.
 *WTKL(FM) Struthers, OH 1 hr.
 KUPL(FM) Portland, OR
 WJBF-FM Jenkintown, PA 2½ hrs.
 *WPFL Montrose, PA ½ hr.
 *WPEL-FM Montrose, PA ½ hr.
 *WWPV-FM Colchester, VT

Urdu
 *WUWM(FM) Milwaukee, WI 1 hr

Wonen
 *KPA(FM) Berkeley, CA 10 hrs.
 *KPFB(FM) Berkeley, CA 10 hrs.
 *KERS(FM) Sacramento, CA ¾ hr.
 *WGTB-FM Washington, DC 8 hrs.
 WENG Englewood, FL 2½ hrs.
 *WNUR(FM) Evanston, IL 3 hrs.
 *KDIC(FM) Grinnell, IA 3 hrs.
 WBCN(FM) Boston, MA ½ hr.
 *WCUW(FM) Worcester, MA 1 hr.
 *WICN(FM) Worcester, MA 1½ hr.
 *WCBN-FM Ann Arbor, MI 1 hr.
 WENT Gloversville, NY 2 hrs.

Yugoslav
 (see also Serbian, Croatian, Slovenian).
 KOMY Watonsville, CA 1 hr.
 WFA(FM) Waukegan, IL ¼ hr.
 WEVE Eveleth, MN 1 hr.
 KXA Seattle, WA 1 hr.

Yupik
 (See also Eskimo).
 *KDLG Dillingham, AK 8 hrs.

World Radio and Television

The following summarizes domestic radio and television broadcasting around the world. Not included are stations and transmitters used for international or armed forces programs. Transmitter counts for each country are for main transmitters and do not include low power relays, repeaters, satellites or translators. Where current information is not available, radio set counts have been estimated by *Broadcasting*.

Notes: Domestic radio stations in foreign countries often use shortwave and longwave frequencies, as well as the medium wave frequencies corresponding with the standard AM broadcast band in the U.S. Longwave (lw) frequencies below 500 kHz are generally used in Europe, Africa, the Middle East, and Asiatic U.S.S.R. Medium wave (mw) frequencies are between 500 and 1600 kHz and are used on all continents. Shortwave (sw) frequencies are between 1600 and 30,000 kHz and are used for domestic broadcasting on all continents, especially in tropical areas. On long, medium, and shortwave, the mode of transmission is amplitude modulation (AM). Most foreign frequency modulation (FM) radio broadcasting is on the same frequencies as those used in the U.S., although some countries use a band between 60 and 88 MHz.

Unless shown as commercial (com), government broadcasting activity identified below is without advertising. Some independent broadcasting organizations, such as the BBC, operate under statutory authority, and are so identified. Statutory, nongovernmental broadcasting may be supported by receiver license fees, advertising, subsidies, or a combination.

Afghanistan

Radio: 118,000 receivers. Govt bcstg: Radio Afghanistan (Box 544, Kabul). 2 progms svcs using 2 mw & 3 sw freqs.

Albania

Television: 5,000 receivers. One stn, system M, 625 lines. Govt bcstg: Radiodiffusion-Television Albanaise (Rue Ismail Qemali, Tirana).

Radio: 190,000 receivers. 5 stns using 6 mw & 2 sw freqs. Govt bcstg: same as television. Tirana plus four regional stns.

Algeria

Television: 175,000 receivers. 7 stns, system B, 625 lines. Govt. bcstg: Radiodiffusion-Television de la Republique Algerienne

Democratique et Populaire (21 Blvd. des Martyrs, Algiers). **Radio:** 800,000 receivers. 18 mw & 8 sw transmitters. Govt bcstg: Same as television; 3 networks (French, Arabic & Kabyl).

Andorra

Radio: 6,500 receivers. 1 mw stn. Coml bcstg: Radio Andorra (Box 1, Andorra-la-Ville).

Anguilla

Radio: 4,000 receivers. 1 mw stn. Govt bcstg: Radio Anguilla, Anguilla.

Antigua

Television: 12,500 receivers. 1 stn, system M, 525 lines. Coml

bcstg: Leeward Islands Television Svcs Ltd. (Box 159, St. John's). **Radio:** 15,000 receivers. 2 mw 1 FM transmitters. Govt bcstg: Antigua Bcstg Svc (Box 590, St. John's). 1 mw stn. Coml bcstg: Radio ZDK, Box 1100, St. John's. 1 mw 1 FM stn.

Argentina

Television: 4 million receivers. 35 transmitters, system N, 625 lines. Coml bcstg: 34 ind stns.

Radio: 7 million receivers. 143 mw stns, 15 sw stns. Govt bcstg: Radio Nacional de Argentina, Ayacucho 151, Buenos Aires. 22 stns on 22 mw & 4 sw freqs. Also, 10 local stns on mw. Coml bcstg: 107 privately-owned and 4 govt-owned stns using 111 mw & 11 sw transmitters.

Regulatory Agency: Subsecretaría De Comunicaciones, Sarmiento 151, Buenos Aires.

Australia

Television: 4 million receivers. 128 transmitters, system N, 625 lines. Color system PAL. Govt bcstg: Australian Broadcasting Commission (Box 487, G.P.O., Sydney, N.S.W.); R.I. Downing, chmn; Peter Lucas, head of press & pub info; 1 noncoml network with 72 stations plus translators. Coml bcstg: 43 stns. (Federation of Australian Commercial Television Stations, Caltex House, Sydney).

Radio: 12.3 million receivers. 199 mw & 20 sw transmitters. Govt bcstg same as TV. 177 mw stns. 8 sw relay transmitters; 1 natl noncoml network. Independent bcstg: 108 stns using 118 transmitters (all but 4 stns are coml); 2 natl coml networks—Macquarie Broadcasting Service (364 Sussex St., Sydney, N.S.W. 2000); 23 member stns. Major Broadcasting

World Radio-TV

Network of Australia (237 Miller St. North Sydney, N.S.W. 2060), 15 member or affiliated stns. Also, 2 interstate & 10 regional networks.

Cable: 8 CATV systems serving 431 subscribers.
Regulatory Agency: Australian Broadcasting Control Board (562-574 Bourke St., Melbourne 3000).

Azores (Portuguese)

Radio: 65,000 receivers. 3 mw, 1 sw & 1 FM stn. Govt bcstg; Emissor Regional dos Azores (Ponta Delgada, San Miguel), 1 mw, 1 sw & 1 FM transmitter. Coml bcstg: Emissora do Clube Assas do Atlantico (Aeroporto de Santa Maria); 1 mw stn. Radio Clube de Angra (Angra do Heroismo, Terceira); 1 mw stn.

Bahamas

(See Caribbean directory, Section C)
Radio: 100,000 receivers. 3 mw & 2 FM transmitters. Govt bcstg: Broadcasting Corporation of the Bahamas (Box 1347, Nassau).

Bahrain

Radio: 82,000 receivers. 1 mw transmitter. Govt bcstg: Bahrain Bcstg Stn, Manama.

Bangladesh

Television: 1 stn, system B, 625 lines. Govt bcstg: Bangladesh Television, Dacca.
Radio: 7 mw, 4 sw & 5 pm transmitters. Govt bcstg: Radio Bangladesh, Dacca 5.

Barbados

Television: 35,000 receivers (2,500 color receivers), 4 transmitters, system A, 405 lines. Color system NTSC. Govt bcstg (coml): Caribbean Bcstg Corp (Box 900, Barbados); 2 stns with 2 satellites.
Radio: 84,000 receivers. 2 mw transmitters. Govt bcstg (coml): same as television.

Belgium

Television: 2,237,865 receivers (50,702 color), 14 transmitters, system C & H, 625 lines. Color system PAL. Govt bcstg: Radiodiffusion-Television Belge/Belgische Radio en Televisie (B-1050 Bruxelles); 2 French & 2 Dutch networks.
Radio: 4 million receivers. 8 mw & 17 FM transmitters. Govt bcstg: same as TV.

Belize

Radio: 70,000 receivers. 4 mw transmitters. Govt bcstg (coml): Radio Belize (Box 89, Albert Cattohouse Bldg, Belize City).
Regulatory Agency: Ministry of Home Affairs, Belize.

Benin

See Dahomey.

Bermuda

(See separate listings, sections B and C.)
Television: 19,000 receivers (2,000 color), 2 stns system M, 525 lines. Color system NTSC. Coml bcstg: Bermuda Radio & Television Co. Ltd. (Box 452, Hamilton). Capital Bcstg Co. Ltd. (Box 652, Hamilton).

Radio: 40,000 receivers. 3 mw transmitters. Coml bcstg: Bermuda Radio & Television Co. Ltd., 2 mw transmitters. Capital Bcstg Co. Ltd.: 1 mw transmitter.

Bolivia

Television: 45,000 receivers. 2 transmitters, system N, 625 lines. Govt bcstg (coml): Empresa Nacional de Television Boliviana, La Paz.
Radio: 450,000 receivers. 71 mw & approx 58 sw transmitters. Govt bcstg: Radio Illimani (Box 1042, La Paz); 1 mw & 2 sw transmitters. Ind bcstg: 85 stns using 70 mw & approx 56 sw transmitters (all but 3 are coml).

Regulatory Agency: Direccion General de Telecomunicaciones, La Paz.

Botswana

Radio: 53,000 receivers. 1 mw, 4 sw & 1 FM transmitters. Govt bcstg: Radio Botswana (Box 52, Gabarones).

Brazil

Television: 8.8 million receivers (150,000 color), 61 transmitters, system M, 525 lines. Color system PAL. Coml bcstg: 56 ind stns.

Radio: 7 million receivers, 347 mw (250 w, or more) & 167 sw transmitters. Govt bcstg: Radio Nacional do Brasil (Box 1620, Brasilia); 2 mw & 2 sw transmitters. Ind bcstg: 392 stns on mw & sw.

Regulatory Agency: Departamento Nacional De Telecomunicacoes (Brasilia, D.F.).

British Virgin Islands

(See separate listings, sections B & C)
Television: 400 receivers. 1 transmitter, system B, 625 lines. Color system NTSC. Coml bcstg: West Indies Television Network, Tortola.

Radio: 9,000 receivers. 1 mw stn. Coml bcstg: Virgin Islands Bcstg Ltd., Tortola.

Bruni

Television: 3,000 receivers. 1 stn (begins 1975), system B, 625 lines. Color system PAL. Govt bcstg: Department of Broadcasting & Information (Bandar Seri Begawan, Brunei, B.S.B. 3/111).
Radio: 15,000 receivers. 4 mw & 2 sw transmitters. Govt bcstg: Radio Brunei. Bandar Seri Begawan.

Bulgaria

Television: 1.5 million receivers, 8 transmitters plus repeaters, system D, 625 lines. Color system SECAM. Govt bcstg: Committee of Television and Radiodiffusion de la Republique Populaire de Bulgarie, Sofia.

Radio: 1.8 million receivers. 14 mw & 1 sw transmitters. Govt bcstg: same as TV, 2 progmg svcs.

Burma

Radio: 600,000 receivers. 1 mw, 3 sw & 4 FM transmitters. Govt bcstg: Burma Broadcasting Service, Prome Road, Kamayut P.O. Rangoon.

Burundi

Radio: 100,000 receivers. 2 mw, 4 sw & 1 FM transmitters. Govt bcstg: La Voix de la Revolution, Bujumbura; 1 mw & 2 sw transmitters. Relg bcstg: Radio Cordac, Bujumbura; 1 mw, 2 sw & 1 FM transmitters.

Cambodia

Information not available.

Cameroon

Radio: 1,000,000 receivers. 3 mw & 7 sw transmitters. Govt bcstg: Radiodiffusion de la Republique Unie du Cameroun (Box 281, Yaounde); stns at Yaounde, Buea, Douala, & Garoua.

Canada

Television: 8 million receivers (5,000,000 color), 583 transmitters system M, 525 lines. Color system NTSC. Public bcstg: Canadian Broadcasting Corp. (Box 8478, Ottawa) owns 208 TV stns (including rebroadcasting stns). Coml bcstg: 375 privately owned stns (including rebroadcasting stns). (For further information see listing of Canadian television in section B and Canadian networks in section D).

Radio: 21 million receivers, 379 mw, 9 sw & 107 FM stns. Govt bcstg: same as TV; CBC-owned stns: 51 mw, 21 FM & 3 sw. Ind bcstg: 328 mw, 86 FM & 6 sw. (For further information see listing of Canadian radio stns in section C.)

Cable: 562 CATV systems serving 34.7% of all households.
Regulatory Agency: Canadian Radio & Television Commission (Berger Bldg., 100 Metcalf St., Ottawa, Ontario) (613) 995-7949.

Cape Verde

Television: 4,500 receivers. 4 stns, system B, 625 lines. Govt

bcstg: Television Espanola, Santa Cruz de Tenerife.

Radio: 200,000 receivers. 8 mw & 7 FM transmitters. Govt bcstg: Radio Nacional de Espana, Santa Cruz de Tenerife; 1 mw & 1 FM stn. Ind bcstg (incl coml): 8 stns on 7 mw & 6 FM freqs.

Cape Verde Islands

Radio: 30,000 receivers. 5 sw & 1 FM transmitters. Ind bcstg: 3 bcstg organizations—Radio Barlavento, Radio Clube Cabo Verde and Radio Clube Mindelo.

Cayman Islands

Radio: 1 FM transmitter. Educl bcstg: 1 stn.

Central African Republic

Radio: 70,000 receivers. 1 mw, 2 sw & 1 FM transmitters. Govt bcstg: Radiodiffusion Nationale Centrafricaine, Bangui.

Chad

Radio: 75,000 receivers. 1 mw & 2 sw transmitters. Govt bcstg: Radiodiffusion Nationale Tchadienne, Ndjamena.

Chile

Television: 500,000 receivers. 18 transmitters plus relays, system M, 525 lines. Govt bcstg: Television Nacional de Chile, Santiago; 1 network with 17 stns. Educl bcstg: 2 stns.

Radio: 1.6 million receivers. 151 mw & 28 sw transmitters. Ind bcstg: 150 stns.

Regulatory agency: Superintendencia de Servicios Electricos, de Gas y de Telecomunicaciones, Santiago.

China (People's Republic)

Television: 500,000 receivers. 30 transmitters, system D, 625 lines. Govt bcstg: Central People's Bcstg Stn, Peking.

Radio: 2 lw & 287 mw transmitters, 1 FM transmitter. Govt bcstg: same as TV; 2 progmg svcs, progms for national minorities, and regional stns.

Colombia

Television: 900,000 receivers. 30 stns, system M, 525 lines. Govt bcstg (coml): Instituto Nacional de Radio y Television, Bogota; 18 stns plus relays.

Radio: 3 million receivers, 306 mw & 51 sw transmitters. Govt bcstg: Radio Nacional de Colombia, Bogota; 4 mw & 9 sw transmitters. Ind bcstg: 8 coml networks; 302 mw & 42 sw transmitters.

Regulatory agency: Ministerio de Comunicaciones, Bogota.

Comoro Islands

Radio: 36,000 receivers. 2 sw & 1 FM transmitters. Govt bcstg: Office de Radiodiffusion-Television Francaise, Moroni.

Congo

Television: 3,000 receivers. 1 transmitters, system D, 625 lines. Govt bcstg: Radiodiffusion Television Congolaise, Brazzaville.
Radio: 80,000 receivers. 2 mw & 10 sw transmitters. Govt bcstg: same as TV; natl prog from Brazzaville, regional prog from Pointe Noire.

Cook Islands

Radio: 8,000 receivers. 1 mw & 3 sw transmitters. Ind bcstg: Cook Islands Bcstg & Newspaper Corp., Rarotonga.

Costa Rica

Television: 115,000 receivers (10,000 color), 5 transmitters plus relays, system M, 525 lines. Color system NTSC. Coml bcstg: 4 ind stns in San Jose.

Radio: 145,000 receivers. 44 mw & 7 sw transmitters. Ind bcstg: 24 stns (all but 4 are coml).

Regulatory agency: Departamento Control Nacional de Radio, San Jose.

Cuba

(See Caribbean directory, section C.)
Television: 555,000 receivers. 16 transmitters, system M, 525 lines. Govt bcstg: Instituto Cubano de Telecomunicaciones, Havana; 2 networks.

Radio: 2 million receivers. 100 mw transmitters & 1 FM

National Call Sign Allocations, by Country

Note: Call sign prefixes are allocated by international agreement. They constitute the first character, or more often, the first two characters of the station's call sign, and thus indicate the country in which the station is located. Every nation in the world has been assigned one or more of these prefix codes. It should be noted, however, that stations are not required to use call signs, and most Eurasian and African nations do not make extensive use of them. In countries that do use calls, some prefixes may be reserved for services other than broadcasting, or not used at all. The United States, for instance, has been allocated exclusive use of "K", "N", and "W", as well as part of the "A" series, but only "K" and "W" are employed to identify broadcasting stations.

Afghanistan..... YA
Albania..... ZA
Algeria..... 7R, 7T-7Y

Andorra..... C3
Angola..... D2, D3
Argentina..... AY, AZ, LO-LW, L2-L9
Australia..... AX, VH-VN, VZ
Austria..... OE
Bahamas..... C6
Bahrain..... A9
Bangladesh..... S2, S3
Barbados..... 8P
Belgium..... ON-OT
Bhutan..... A5
Bolivia..... CP
Botswana..... A2, 80
Brazil..... PP-PY, ZV-ZZ
Bulgaria..... LZ
Burma..... XY, XZ
Burundi..... 9U
Cambodia..... XU
Cameroon..... TJ
Canada..... CF-CK, CY, CZ, VA-VG, VO, VX, VY, XJ-XO, 3B-3F
Cape Verde..... D4
Central African Republic..... D1

Chad..... TT
Chile..... CA-CE, XQ, XR, 3G
China..... B, XS, 3H-3U
Colombia..... HJ, HK, 5J, 5K
Congo..... TN
Costa Rica..... TE, TI
Cuba..... CL, CM, CO
Cyprus..... 5B, C4
Czechoslovakia..... OK-OM
Dahomey..... TY
Denmark..... OU-OZ; XP, 5P, 5Q
Dominican Republic..... HI
Ecuador..... HC, HD
Egypt..... SSA-SSM, SU, 6A, 6B
El Salvador..... HU, YS
Equatorial Guinea..... 3C
Ethiopia..... ET, 9E, 9F
Fiji..... 3DN-3DZ
Finland..... OF-OJ
France, territories of the French Community..... F, H-W, Y, TH, TK, TM, TO-TQ, TV-TX
Gabon..... TR
Gambia..... CR

Germany..... DA-DT
Ghana..... 9G
Greece..... SV-SZ
Guatemala..... TD, TG
Guinea..... 3X
Guinea Bissau..... CQ
Guyana..... 8R
Haiti..... HH, 4V
Honduras..... HQ, 4H
Hungary..... HA, HG
Iceland..... TF
India..... AT-AW, VT-VW, 8T-8Y
Indonesia..... PK-PO, YB-YH, 8A-8I
West Irian..... JZ
International Civil Aviation Organization..... 4Y
Iran..... EP, EQ, 9B-9D
Iraq..... HN, YI
Ireland..... EI, EJ
Israel..... 4X, 4Z
Italy..... I
Ivory Coast..... TU
Jamaica..... 6Y

transmitter. Govt bcstg: same as TV; 41 stns.
 Regulatory agency: Ministerio de Comunicaciones, Havana.

Cyprus

Television: 85,398 receivers. 5 transmitters, system B, 625 lines. Govt bcstg: Cyprus Bcstg Corp (Box 4824, Nicosia).
 Radio: 205,640 receivers. 9 mw and 8 FM transmitters. Govt bcstg: same as TV.

Czechoslovakia

Television: 3,360,000 receivers. 28 transmitters, system D, 625 lines. Color system SECAM. Govt bcstg: Ceskoslovenska Televize, Prague.
 Radio: 3,900,900 receivers. 1 lw, 26 mw & 33 FM stns. Govt bcstg: Ceskoslovensky Rozhlas (Praha 2, 12099 Vlnohradska 12); 5 progmg svcs, 2 in Czech, 2 in Slovak, 1 in both, plus regional svcs.

Dahomey

Radio: 85,000 receivers. 3 mw, 2 sw & 2 FM transmitters. Govt bcstg: Radiodiffusion du Dahomey, Cotonou.

Denmark

Television: 1,527,170 receivers (216,594 color). 30 transmitters, system B, 625 lines. Color system PAL. Govt bcstg: Danmarks Radio TV-Byen (DK 2860 Sborg); Hans Solhøj, gen mgr; Ernst Trautmann, pub info off.
 Radio: 1.6 million receivers. 1 lw 4 mw & 29 FM transmitters. Govt bcstg: same as TV; 3 natl progmg svcs plus rgnt.

Dominica

Radio: 1 mw stn. Govt bcstg: Radio Dominica, Roseau.

Dominican Republic

(See also Caribbean radio directory, section C.)
 Television: 155,000 receivers. 11 stns, system M, 525 lines. Coml bcstg: 4 TV systems.
 Radio: 200,000 receivers. 99 mw & 22 sw transmitters. Coml bcstg: 93 stns.
 Regulatory agency: Direccion General de Telecomunicaciones, Santo Domingo.

Ecuador

Television: 124,000 receivers. 14 stns, system M, 525 lines. Color system NTSC. Ind bcstg: 6 coml systems, 1 relig system.
 Radio: 350,000 receivers. 231 mw & 73 sw transmitters. Govt bcstg: Radio Nacional del Ecuador, Quito; 1 mw & 1 sw stn. Ind bcstg: 240 stns (most coml, some relig or cultural).
 Regulatory agency: Instituto Ecuatoriano de Telecomunicaciones, Quito.

Egypt

Television: 610,000 receivers. 27 transmitters, system B, 625 lines. Govt bcstg: U.A.R. Broadcasting Corp., Cairo; 3 progmg svcs.
 Radio: 5,250,000 receivers. 20 mw & approx 10 sw transmitters. Govt bcstg: same as TV; 2 natl progmg svcs plus regional and special (including coml) svcs.

Equatorial Guinea

Radio: 2 sw stns. Govt bcstg: Radio Malabo, Malabo. Radio Ecuatorial, Bata (coml).

El Salvador

Television: 120,000 receivers. 5 stns, system M, 525 lines. Govt bcstg: Ministerio de Educacion, San Salvador; 2 stns. Coml bcstg: 3 stns.
 Radio: 1,000,000 receivers. 53 mw & 3 sw transmitters. Govt bcstg: Radio Nacional de El Salvador, San Salvador; 1 mw & 2 sw transmitters. Ind bcstg: 37 stns, all coml except 1 relig stn.
 Regulatory agency: Ministerio del Interior, San Salvador.

Ethiopia

Television: 2,500 receivers. 1 stn, system B, 625 lines. Govt bcstg: Ethiopian Television Svc, Addis Ababa.
 Radio: 200,000 receivers. 4 mw & 5 sw transmitters. Govt bcstg: Radio Ethiopia, Addis Ababa; 3 mw & 3 sw transmitters.

Ind bcstg: Radio Voice of the Gospel, Addis Ababa: 1 mw & 2 sw transmitters (relg & educd progmg).

Falkland Islands

Radio: 600 receivers. 1 mw & 1 sw transmitter. Govt bcstg: Falkland Isl. Bcstg Svc, Stanley.

Feroe Islands

Radio: 12,000 receivers. 1 mw & 3 FM transmitters. Govt bcstg: Ulvarp Foroya, Torshavn.

Fiji

Radio: 150,000 receivers. 10 mw & 2 FM transmitters. Govt bcstg: Fiji Bcstg Commission (Box 334, Suva); Hugh Leonard, gen mgr; 2 mw progmg svcs plus FM progs (all progmg is 50% coml, 50% cultural).

Finland

Television: 1,250,000 receivers (150,000 color). 53 transmitters, systems B & G, 625 lines. Color system PAL. Govt bcstg: Oy Yleisradio Ab, Kesakuu 2, Box 25095, 00250 Helsinki 25. Erkki Raatikainen, dir gen; S. Kiuru, TV-1 prog dir; P. Paloheimo, TV-2 prog dir; V. Zilliacus, dir of foreign svcs.
 Radio: 1.9 million receivers. 2 lw, 11 mw & 86 FM transmitters. Govt bcstg: same as TV; 2 progmg svcs in Finnish & 1 svcs in Swedish.
 Regulatory agency: Ministry of Transportation (Aleksanterinkatn 3D, 00170 Helsinki 17).

France

Television: 13,016,624 receivers (1,765,000 color). 200 transmitters, systems E (819 lines) & L (625 lines). Color system SECAM. Govt bcstg: three networks—TF1 (Jean Cazeneuve, pres), Antenne 2 (Marcel Julian, pres) and TF 3 (Claude Contamine, pres). All three nets transmit in color and carry advertising. TV 1 uses system E and system L and programs for both VHF and UHF stns; Antenne 2 and TF 3 use system L and program for UHF stns. Financed by license fees & advertising.
 Radio: 3,578,000 receiver licenses. 1 lw, 51 mw, 213 FM & 23 sw transmitters. Govt bcstg: Radio France (Jaqueline Baudrier, pres) includes three natl noncommercial nets (France Inter, France Culture & France Musique). Note: Govt bcstg in France operates through seven autonomous societies—TF 1, Antenne 2, TF 3, Radio France, Production (Jean-Charles Edeline, pres), Diffusion (Jean Aulin, pres) and the Audio-Visual Institute (Pierre Emmanuel, pres).
 Cable: Experimental.

French Guiana

Television: 3,000 receivers. 2 transmitters, system K', 625 lines. Govt bcstg: Office de Radiodiffusion Television Francaise, Cayenne.
 Radio: 53,000 receivers. 2 mw, 3 sw & 2 FM transmitters. Govt bcstg: same as TV.

Gabon

Television: 5,000 receivers. 3 stns, system K, 625 lines. Govt bcstg: Radiodiffusion Television Gabonaise, Libreville.
 Radio: 100,000 receivers. 4 mw & 7 sw transmitters. Govt bcstg: same as TV; 1 natl & 1 rgnt network.

Gambia

Television: 60,000 receivers. 1 mw, 1 sw & 1 FM transmitters. Govt bcstg: Radio Gambia, Banjul; 1 sw & 1 FM transmitter. Coml bcstg: Radio Syd. Banjul; 1 mw transmitter.

German Democratic Republic (East Germany)

Television: 5 million receivers. 29 transmitters, system B, 625 lines. Color system SECAM. Govt bcstg: Fernsehen der DDR, Berlin; 2 progmg svcs.
 Radio: 6 million receivers. 1 lw, 21 mw, 2 sw & 43 FM transmitters. Govt bcstg: Staatliches Komitee für Rundfunk beim Ministerrat der DDR (116 Berlin Nalepastrabe 18-50); R. Singer, dir gen; Mathias Muller, dir foreign rel; 3 networks (Stimme der DDR, Radio DDR, Berliner Rundfunk).

Japan	JA-JS, 7J-7N, 8J-8N
Jordan	JY
Kenya	5Y, 5Z
Khmer Republic	XU
Korea	HL, HM, 6K-6N
Kuwait	9K
Laos	XW
Lebanon	OD
Lesotho	7P
Liberia	EL, 5L, 5M, 6Z, A8, D5
Libya	5A
Luxembourg	LX
Malagasy Republic	5R, 5S, 6X
Malawi	7Q
Malaysia	9M, 9W
Maldives Islands	8Q
Mali	TZ
Malta	9H
Mauritania	5T
Mauritius	3B
Mexico	XA-XI, 4A-4C, 6D-6J
Monaco	3A
Mongolia	JT-JV
Morocco	CN, 5C-5G
Mozambique	CR
Nauru	C2

Nepal	9N
Netherlands	PA-PI
Netherlands West Indies	PJ
New Hebrides	YJ
New Zealand	ZK-ZM
Nicaragua	HT, YN
Niger	5U
Nigeria	5N, 5O
Norway	JW, JX, LA-LN, 3Y
Oman	A4
Pakistan	AP-AS, 6P-6S
Panama	HO, HP, 3E, 3F, H-3
Papua New Guinea	P2
Paraguay	ZP
Peru	OA-OC, 4T
Philippines	DU-DZ, 4D-4I
Poland	HF, SN-SR, 3Z
Portugal	CS-CU
Qatar	A7
Romania	YO-YR
Rwanda	9X
San Marino	9A
Saudi Arabia	HZ, 7Z, 8Z
Senegal	6V, 6W
Service abbreviations	Q
Sierra Leone	9L

Singapore	9V, S6
Somali Republic	6O
South Africa	ZR-ZU
Spain	AM-AO, EA-EH
Sri Lanka	4P, 4S
Sudan	SSN-ST, 6T, 6U
Surinam	PZ
Swaziland	3DA-3DM
Sweden	SA-SM, 7S, 8S
Switzerland	HB, HE
Switzerland	YK, 6C
Tanzania	5H, 5I
Thailand	HS
Togo	5V
Tonga	A3
Trinidad & Tobago	9Y, 9Z
Tunisia	TS, 3V
Turkey	TA-TC, 3M
Uganda	5X
United Arab Emirates	A6
United Kingdom	G, M, 2
Territories for which the United Kingdom is responsible for international relations	VP-VS, ZB-ZJ
ZN, ZD, ZQ	

United Nations	4U
United States of America	AA-AL, K, N, W
Upper Volta	XT
Uruguay	CV-CX
USSR	EK, EM-EO, ER, ES, EU-EW, EX-EZ, LY, R, U, YL, 4J-4L
Belorussia	EU-EW
Estonia	ES
Latvia	YL
Lithuania	LY
Ukraine	UR-UT
Vatican State	HV
Venezuela	VY-YY, 4M
Vietnam	XV, 3W
Western Samoa	5W
World Meteorological Organization	C7
Yemen (YAR)	4W
Yemen (PDRY)	7O
Yugoslavia	YT, YU, YZ, 4N, 4O
Zaire	90-9T
Zambia	9I-9J

World Radio-TV

Guyana

Television: 100,000 receivers. 3 mw, 4 sw & 1 FM transmitters. Govt bcstg (coml): Guyana Broadcasting Service (68 Hadfield St., Lodge, Greater Georgetown); 2 mw, 2 sw & 1 FM freqs. Ind coml bcstg: Guyana Bcstg Co Ltd (St. Phillip's Green, High St., Werken-Rust, Georgetown); 1 mw & 2 sw freqs.

Haiti

(See Caribbean directory, section C.)

Radio: 175,000 receivers. 29 mw & 14 FM transmitters. Ind bcstg: 26 stns (all but 4 are coml).

Cable: 1 system, Tele-Haiti, Port-au-Prince; 1 French & 1 English channel serving 13,000 receivers with coml progms.

Honduras

Television: 50,000 receivers. 3 transmitters, system M, 525 lines. Coml bcstg: Compania Televisora Hondurena, Tegucigalpa.

Radio: 175,000 receivers. 94 mw & 12 sw transmitters. Ind bcstg: 73 stns, most coml.

Regulatory agency: Direccion General de Comunicaciones Electricas, Tegucigalpa.

Hong Kong

Television: 700,000 receivers. 2 transmitters, system B, 625 lines. Color system PAL. Coml bcstg: Television Broadcasts Ltd, Kowloon; 1 Chinese & 1 English channel.

Radio: 3 million receivers. 5 mw & 2 FM Transmitters. Govt bcstg: Radio Hong Kong; 2 mw & 2 FM freqs; 1 Chinese & 1 English progms svcs. Coml bcstg: Hong Kong Coml Bcstg Co; 3 mw freqs; 2 Chinese & 1 English progms.

Cable: 1 closed-circuit 405 line system, Redifusion TV Hong Kong, Kowloon; coml progms on 1 Chinese & 1 English channel.

Hungary

Television: 2,085,000 receivers. 9 transmitters, system D, 625 lines. Color system SECAM. Govt bcstg: Magyar Radio es Televizio (Budapest VIII, Brody Sandor 5-7); Istvan Tompe, pres; Valeria Szarka, dir pub affs; financed by license fees & advertising (coml in special blocks).

Radio: 2,542,000 receivers. 12 mw & 10 FM transmitters. Govt bcstg: same as TV; 2 progms svcs on mw, 1 on FM, plus local progms.

Iceland

Television: 48,475 receivers. 9 transmitters, system B, 625 lines. Govt bcstg: State Bcstg Sv (Laugavegur 176, Reykjavik); 2 prog svcs, financed by license fees & advertising.

Radio: 66,500 receivers. 2 lw, 12 mw & 15 FM transmitters. Govt bcstg: same as TV (Box 120, Reykjavik); Andres Bjornsson, dir gen; Inga Dorvaldottir, dir pub info.

India

Television: 75,000 receivers. 3 transmitters, system B, 625 lines. Govt bcstg: All India Radio-Television (Akashvani Bhavan, Parliament St., New Delhi 1).

Radio: 14 million receivers. 112 mw & approx 150 sw transmitters. Govt bcstg: All India Radio, New Delhi; 4 regional progms svcs from New Delhi, Madras, Calcutta & Bombay.

Indonesia

Television: 301,041 receivers. 12 transmitters, system B, 625 lines. Govt coml bcstg: Televisi Republik Indonesia (Senayan, Jakarta); Sumartono Tjitrosodjo, dir of TV; 6 stns.

Radio: 5.3 million receivers. 16 mw, 102 sw & 2 FM transmitters. Govt bcstg: Radio Republik Indonesia, Jakarta; 49 stns broadcast both natl and rgnl progms. Independent bcstg: 44 stns (32 coml & 12 noncoml).

Regulatory agency: Direktorat of Radio-Television & Film, Dept. of Information, Merdeka Barat 9, Jakarta.

Iran

Television: 1,000,000 receivers. 12 transmitters, system B, 625 lines. Govt bcstg: National Iranian Radio & Television (Jame Jam Ave., Box 33-200, Tehran); Reza Gholbi, dir gen; Javad Fekri, dir pub rel; 1 natl network plus progms svcs for Tehran, partially coml.

Radio: 8 million receivers. 33 mw, 3 sw & 5 FM transmitters. Govt bcstg: same as TV; S. Jahانبani, dir radio prod; 1 natl progms svcs plus prog for Tehran & regnl progms.

Iraq

Television: 260,000 receivers. 5 transmitters, system B, 625 lines. Govt bcstg: Baghdad Television, Baghdad.

Radio: 1.3 million receivers. 10 mw & 9 sw transmitters. Govt bcstg: Bcstg Sv of the Republic of Iraq, Baghdad; progms svcs in Arabic & minority languages.

Ireland

Television: 561,000 receivers (50,000 color). 7 transmitters, systems A (405 lines) & 1 (625 lines). Color system PAL. Govt bcstg: Radio Telefis Eireann (Donnybrook, Dublin 4); T.P. Hardiman, dir gen; Louis McRedmond, dir pub info; 1 network financed by license payments & advertising.

Radio: 860,000 receivers. 6 mw & 14 FM transmitters. Govt bcstg: same as TV; 1 English & 1 Irish network.

Cable: Several systems serving 120,000 subscribers.

Regulatory agency: Dept. of Posts & Telegraphs, G.P.O., Dublin 1.

Israel

Television: 450,000 receivers. 14 transmitters, system B, 625 lines. Govt bcstg: Israeli Broadcasting Authority, Jerusalem; 1 progms svcs.

Radio: 450,000 receivers. 21 mw & 19 FM transmitters. Govt bcstg: same as TV; 4 progms svcs. 2 coml

Italy

Television: 11 million receivers. 72 transmitters, systems B &

G, 625 lines. Color system PAL. Govt bcstg: Radiotelevisione Italiana (Viale Mazzini 14, 00195 Rome); 2 progms svcs.

Radio: 13 million receivers. 125 mw, 3 sw & over 400 FM transmitters. Govt bcstg: same as TV; 3 natl progms svcs plus rgnl svcs.

Ivory Coast

Television: 110,000 receivers. 6 transmitters, system K', 625 lines. Govt bcstg: Radiodiffusion Television Ivoirienne, Abidjan.

Radio: 250,000 receivers. 3 mw 4 sw & 4 FM transmitters. Govt bcstg: same as TV.

Jamaica

(See Caribbean radio directory, section C.)

Television: 90,000 receivers. 8 transmitters, 625 lines. Coml bcstg: Jamaica Broadcasting Corp., Kingston.

Radio: 600,000 receivers. 8 mw & 5 FM transmitters. Coml bcstg: Jamaica Bcstg Corp., Kingston; 4 mw & 3 FM stns.

Radio Jamaica Ltd., Kingston, 4 mw & 2 FM stns.

Japan

Television: 25,959,938 receivers (20,958,370 color). 191 transmitters plus low power relays, system M, 525 lines. Color system NTSC. Ind noncoml bcstg: (statutory); Nippon Hoso Kyokai (NHK) (2-2-1 Jinnan, Shibuya-ku, Tokyo 150); Sajujo Ito, chmn; Kichiro Ono, pres; Tadao Nomura, dir pub info; 1 general & 1 educational network of 4,238 stns (including low power relays). Coml bcstg: 87 ind stns (National Association of Commercial Broadcasters, 5H Bungei Shunju Bldg., 3 Kiocho, Chiyoda-ku, Tokyo 102); Takeo Yokota, pres; Tatemichi Omori, chief of pub rel dept.)

Radio: 26 million receivers. 386 mw, 448 FM & 23 sw transmitters. Ind noncoml bcstg: same as TV; 1 general, 1 educational & 1 FM network, plus local progms. 314 mw, 452 FM & 12 sw stns. Coml bcstg: 72 mw, 7 sw & 4 FM stns (see TV).

Cable: 4,200 NHK systems with 320,000 subscribers, plus ind systems.

Regulatory agency: Ministry of Posts & Telecommunications (3-2 Kasumigaseki 1-chome, Chiyoda-ku, Tokyo 100).

Jordan

Television: 100,000 receivers. 2 transmitters, system B, 625 lines. Color system PAL. Govt bcstg (coml): Jordan Television, Amman.

Radio: 200,000 receivers. 2 mw & 3 sw transmitters. Govt bcstg: Broadcasting Service of the Hashemite Kingdom of Jordan, Amman.

Kenya

Television: 38,000 receivers. 1 transmitter, system B, 625 lines. Govt bcstg: Voice of Kenya (Box 30456, Nairobi); J.R. Kangwana, dir of bcstg; J. Musella, dir of pub info.

Radio: 200,000 receivers. 10 mw, 11 sw & 2 FM transmitters. Govt bcstg: same as TV; 1 progms svcs in Swahili, 1 in English & 3 in others.

Korea, Democratic People's Republic (North)

Radio: 25 mw & approx 25 sw transmitters. Govt bcstg: Korean Central Bcstg Stn, Pyongyang.

Korea, Republic (South)

Television: 1.4 million receivers. 19 transmitters, system M, 525 lines. Govt bcstg: Korean Broadcasting System (No. 8, Ye-jangdong, Jung-Gu, Seoul), a public corp.; Kyung-Moh Hong, pres; Sook Han, dir pub info; 10 transmitters. Ind bcstg: Hankuk Munhwa Bcstg Corp., Seoul; 7 transmitters, Tong-yang Bcstg Co. (58-9 Seosomun-Long, Seoul); 2 transmitters.

Radio: 7 million receivers. 81 mw & 4 sw transmitters. Govt bcstg: same as TV; 2 progms svcs. Ind bcstg: 23 stns, most coml.

Regulatory agency: Broadcast Management Bureau, Ministry of Culture & Information (No. 1, Sejongro, Chongno-ku, Seoul).

Kuwait

Television: 120,000 receivers. 4 transmitters, system B, 625 lines. Govt bcstg: Kuwait TV Station (Box 621, Kuwait City); Mohammed N. Sanousi, sec for TV affs; Youfi M. Qulob, head of pub info.

Radio: 500,000 receivers. 3 mw, 4 sw & 1 FM transmitter. Govt bcstg: Kuwait Broadcasting Sv (Box 397, Kuwait); Abdul Aziz M. Jafer, asst undersecretary for bcstg.

Laos

Radio: 125,000 receivers. 14 mw & 11 sw transmitters. Govt bcstg: Radiodiffusion Nationale Lao, Vientiane.

Lebanon

Television: 350,000 receivers. 10 transmitters, system B, 625 lines. Color system SECAM. Coml bcstg: Companie Libanaise de Television, Beirut; 5 transmitters. Tele Orient, Beirut; 5 transmitters.

Radio: 1.5 million receivers. 2 mw, 1 sw & 3 FM Transmitters. Govt bcstg: Lebanese Broadcasting Station, Beirut; Kazem Hagi-Ali, dir; Fouzi Fahmy, dir of pub info. 2 progms svcs plus FM music progms.

Lesotho

Radio: 11,000 receivers. 1 mw, 1 sw & 1 FM transmitter. Govt bcstg (coml): Radio Lesotho (Box 552, Maseru).

Liberia

Television: 10,000 receivers. 1 transmitter, system B, 625 lines. Govt bcstg (coml): Liberia Broadcasting Corp., Box 594, Monrovia; Chauncey Cooper, exec off.

Radio: 150,000 receivers. 5 mw & 4 sw transmitters. Govt bcstg: same as TV. 2 mw & 2 sw transmitters. Ind noncoml bcstg: ELWA, Monrovia; 1 mw & 2 sw transmitters. ELNr, Nimba; 2 mw transmitters.

Libya

Television: 5,000 receivers. 9 transmitters, system B, 625 lines. Govt bcstg: Libyan Broadcasting & TV Service, Tripoli.

Radio: 100,000 receivers. 10 mw & 3 sw transmitters. Govt bcstg: same as TV.

Luxembourg

Television: 88,500 receivers (8,500 color). 2 transmitters, systems C & L, 625 lines. Coml bcstg: Radio-Tele-Luxembourg (Villa Louvigny, Box 1002); Mathias Felten, gen mgr.

Radio: 175,000 receivers. 1 FM transmitters. Coml bcstg: same as TV.

Cable: 100 systems serving 20,000 subscribers.

Macao

Radio: 80,000 receivers. 3 mw & 2 FM transmitters. Govt bcstg: Emissora de Radiodifusao de Macao; 2 mw & 1 FM stns. Coml bcstg: Emissora Vila Verde; 1 mw & 1 FM stn.

Madeira

Television: 7,000 receivers. 1 transmitter, system B, 625 lines. Coml bcstg: Radio Televisao Portuguesa, Funchal.

Radio: 27,236 receivers. 3 mw & 1 FM transmitters. Govt bcstg: Emissor Regional da Madeira, Funchal; 1 mw & 1 FM stn. Independent bcstg: 2 stns on mw.

Malagasy Republic

Television: 7,000 receivers. 1 transmitter, system L, 625 lines. Govt bcstg: Radio Television Malagasy, Tananarive.

Radio: 600,000 receivers. 2 mw & 9 sw transmitters. Govt bcstg (coml): same as TV; 1 network in Malgache, 1 in French.

Malawi

Radio: 200,000 receivers. 6 mw, 4 sw & 3 FM transmitters. Ind noncoml bcstg: Malawi Broadcasting Corp. (Box 30133, Chichiri, Blantyre 3); S.D. Kalyoma, dir gen.

Malaysia

Television: 33,301 license holders. 29 transmitters, system B, 625 lines. Govt bcstg (coml): Radio Television Malaysia (Angkasapuri, Kuala Lumpur 22-10); Doi Ramli, dir gen; 2 networks.

Radio: 41,596 license holders. 34 mw, 23 sw & 1 FM transmitters. Govt bcstg (coml): same as TV; 4 natl networks plus local svcs.

Maldives

Radio: 2,500 receivers. 1 mw & 5 sw transmitters. Govt bcstg: Radio Maldives, Male; progms svcs in Divehi plus English coml prog.

Mal

Radio: 80,000 receivers. 2 mw & 6 sw transmitters. Govt bcstg: Radio Mali, Bamako.

Malta

Television: 61,144 receivers. 1 transmitter, system B, 625 lines. Coml bcstg: Malta Television Service Ltd. (Television House, St. Luke's Road, Gwardamangla).

Radio: 80,000 receivers. 2 mw transmitters. Coml bcstg: Radio Malta, National Road, Blata 1-Bajda, Malta.

Regulatory agency: Malta Broadcasting Authority, National Road, Blata 1-Bajda.

Martinique

Television: 15,000 receivers. 5 transmitters, system K', 625 lines. Govt bcstg: Office de Radiodiffusion Television Francaise, Fort de France.

Radio: 32,000 receivers. 1 mw, 3 sw & 1 FM transmitters. Govt bcstg: same as TV.

Mauritania

Radio: 80,000 receivers. 1 mw & 3 sw transmitters. Govt bcstg: Radiodiffusion Nationale de Mauritanie, Nouakchott.

Mauritius

Television: 26,000 receivers. 1 transmitter plus satellites. Coml bcstg: Mauritius Broadcasting Corp., Forest Side.

Radio: 85,000 receivers. 1 mw & 2 sw transmitters. Coml bcstg: same as TV.

Mexico

(See separate Mexican TV and radio listings, sections B and C.)

Television: 5 million receivers (300,000 color). 104 transmitters, system M, 525 lines. Color system NTSC. Govt bcstg: Television Cultural de Mexico, Secretaria de Comunicaciones y Transportes, Commission de Radiodifusion, Torre de Comunicaciones, Insurgentes Sur, Mexico, D.F.; network of 7 stns plus relays. Coml bcstg: Networks are Cadena Canal 2 (41 stns), Cadena Canal 4 (4 stns), Cadena Canal 5 (4 stns), & Cadena Canal 8 (19 stns), all with main studios in Mexico City.

Radio: 16.9 million receivers. 706 mw, 31 sw & 80 FM transmitters. Ind bcstg: 573 stns, mostly coml.

Regulatory agency: Secretaria de Comunicaciones y Transportes, Mexico, D.F.

Micronesia

Television: 2,600 receivers. 2 transmitters, system M, 525 lines. Coml bcstg: Micronesia Broadcasting Corp., Box 368, Agaña, Guam. H. Scott Kilgore, pres.

Radio: 71,000 receivers. 6 mw transmitters. Govt bcstg: Micronesia Broadcasting Service, Saipan 96950. Elias H. Thomas, dir.

Monaco

Television: 17,000 receivers. 1 transmitter, system E, 819 lines. Coml bcstg: Tele Monte Carlo, Monte Carlo.

Radio: 8,000 receivers. 2 mw, 2 sw & 1 FM transmitters. Coml bcstg: Radio Monte Carlo, Monte Carlo; progms in French & Italian.

Mongolia

Television: 3,000 receivers. 1 transmitter, system D, 625 lines. Govt bcstg: Mongolian Television, Ulan Bator.

Radio: 120,000 receivers. 2 lw & 5 sw transmitters. Govt bcstg: Ulan Bator Radio, Ulan Bator.

Montserrat

Radio: 3 mw transmitters. Govt bcstg: Radio Montserrat 1 mw stn. Coml bcstg: Radio Antilles, 2 mw stns.

Morocco

Television: 230,000 receivers. 9 transmitters, system B, 625

lines. Govt bstg: Radiodiffusion Television Marocaine, Rabat.
Radio: 1.6 million receivers. 26 mw & 6 FM transmitters. Govt bstg: same as TV; 3 networks, 1 in Arabic, 1 in Berber & 1 in English, Spanish & French.

Mozambique

Radio: 176,000 receivers. 20 mw, 34 sw & 2 FM transmitters. Ind bstg (statutory): Radio Clube de Mocambique, Lourenco Marques; 16 mw, 32 sw & 1 FM transmitters, 4 progmg svcs plus rgnl svcs. Ind bstg: 4 mw, 1 FM & 2 sw stns.

Nauru

Radio: 4,000 receivers. 1 mw transmitter. Govt bstg: Nauru Broadcasting Service.

Nepal

Radio: 75,000 receivers. 1 mw & 2 sw transmitters. Govt bstg: Radio Nepal, Katmandu.

Netherlands

Television: 4 million receivers. 22 transmitters, systems B & G, 625 lines. Color system PAL. Ind bstg (statutory): Nederlandse Omroep Stichting, Hilversum; 2 progmg svcs, progs provided by 7 Dutch organizations, financed by license fees & advertising.

Radio: 3.5 million receivers. 10 mw & 31 FM transmitters. Ind bstg (statutory): Nederlandse Omroep Stichting, Hilversum (see TV); 6 mw & 23 FM transmitters, 3 progmg svcs. Regionale Omroep Noord en Oost, Groningen; 2 mw & 3 FM transmitters. Regionale Omroep Zuid, Maastricht, 1 mw & 2 FM transmitters. Ind bstg (regl): Radio Bloemendaal, Bloemendaal; 1 mw transmitter.

Netherlands Antilles

Television: 34,000 receivers. 2 transmitters, system M, 525 lines. Coml bstg: Telecuracao, Curacao. Telearuba, Aruba.
Radio: 140,000 receivers. 10 mw transmitters. Independent bstg: 6 coml & 2 noncoml stns.

New Caledonia

Television: 12,000 receivers. 2 transmitters plus relays, system K, 625 lines. Govt bstg: Radiodiffusion Television Francaise, Noumea.

Radio: 31,000 receivers. 1 mw & 4 sw transmitters. Govt bstg: same as TV.

New Hebrides

Radio: 12,000 receivers. 1 mw & 1 FM transmitter. Govt bstg: Radio Vila (c/o British Information Svc., Vila); James Hastie, sr info off; local advertising accepted.

New Zealand

Television: 800,000 receivers. 4 transmitters, system B, 625 lines. Color system PAL. Ind bstg (statutory): New Zealand Broadcasting Corp. (Box 98, Wellington).

Radio: 2.7 million receivers. 60 mw transmitters. Statutory public bstg: New Zealand Broadcasting Corp., Wellington; 2 noncoml & 1 coml networks. Coml bstg: 8 stns. *Regulatory agency:* Broadcasting Authority, T & G Bldg, Lambton Quay, Wellington.

Nicaragua

Television: 63,000 receivers. 3 transmitters. Coml bstg: Telecadena Nicaraguense. Telecentro de Nicaragua & Television de Nicaragua, all Managua.

Radio: 130,000 receivers. 63 mw & 10 sw transmitters. Govt bstg: Radiodiffusion Nacional, Managua; 1 mw & 1 sw transmitters. Ind bstg: 52 coml & 1 noncoml stns.

Regulatory agency: Direccion de la Radio Nacional y Television, Managua.

Niger

Television: 100 receivers. 1 transmitter, system B, 625 lines. Govt bstg: Office de Radiodiffusion-Television du Niger, Niamey.

Radio: 100,000 receivers. 2 mw & 6 sw transmitters. Govt bstg: same as TV; 4 progmg svcs.

Nigeria

Television: 100,000 receivers. 6 transmitters, system B, 625 lines. Govt bstg (coml): Nigerian Broadcasting Corp., Broadcasting House (Ikoyi, Lagos).

Radio: 5 million receivers. 23 mw & 22 sw transmitters. Govt bstg: same as TV; Lagos natl prog plus rgnl svcs.

Norway

Television: 1,059,997 receivers (71,272 color). 49 transmitters plus relays, system B, 625 lines. Color system PAL. Govt bstg: Norsk Rikskringkasting (Bjornstjerne Bjornsons Plass 1, Oslo 3); Otto Nes, head of TV progs.

Radio: 1,248,252 receivers. 7 lw, 29 mw & 40 FM transmitters. Govt bstg: same as TV; Halldan Hegtun, head of radio progs; Reidar Huseby, dir pub info.

Oman

Radio: 3 mw transmitters. Govt bstg: Oman Broadcasting Corp., Muscat, operates 1 mw transmitter. Ind bstg: BBC Eastern Relay operates 2 mw transmitters.

Pakistan

Television: 147,300 receivers. 3 transmitters, system B, 625 lines. Color system PAL (adopted). Inc bstg: Pakistan Television Corp. Ltd. (1 Tulsia Road, Lalazar Colony, Rawalpindi); Aslam Azhar, managing dir.

Radio: 1.1 million receivers. 21 mw & 16 sw transmitters. Govt bstg: Pakistan Broadcasting Corp., Rawalpindi; progs from 7 cities.

Regulatory agency: Ministry of Information & Broadcasting (Aqaf and Haj, Rawalpindi).

Papua New Guinea

Radio: 100,000 receivers. 6 mw & 23 sw transmitters. Ind statutory bstg: National Broadcasting Commission of Papua New Guinea (Box 1359, Boroko); S. Piniua, chmn; 16 stns broadcasting natl & local progs.

Panama

Television: 180,000 receivers. 11 transmitters, system M, 525 lines. Color system NTSC. Coml bstg: Circuito RPC, Panama. Televisora Nacional, Panama.

Radio: 260,000 receivers. 75 mw transmitters. Coml bstg: 58 stns.

Regulatory agency: Direccion Tecnica de Telecomunicaciones, Panama.

Paraguay

Television: 52,000 receivers. 1 transmitter, system M, 525 lines. Coml bstg: Television Cerro Cora, Asuncion.

Radio: 180,000 receivers. 23 mw & 8 sw transmitters. Govt bstg: Radio Nacional, Asuncion; 1 mw & 2 sw transmitters. Coml bstg: 22 stns.

Regulatory agency: Administracion Nacional de Telecomunicaciones, Asuncion.

Peru

Television: 420,000 receivers. 7 transmitters plus relays, system M, 525 lines. Noncoml bstg: Ministerio de Education & Televisora Universidad, both Lima. Coml bstg: 4 stns in Lima & 1 in Arequipa.

Radio: 2 million receivers. 188 mw & 110 sw transmitters. Coml bstg: approx 200 stns.

Regulatory agency: Ministerio de Comunicaciones, Lima.

Philippines

Television: 584,000 receivers. 18 transmitters plus relays, system M, 525 lines. Color system NTSC. Govt bstg: Bureau of Broadcast, Dept. of Public Information (5th fl. GSIS Bldg., Arroyos St., Manila); Francisco S. Tatad, officer-in-charge; Antonio Bernal, news & pub affrs head; 1 stn, partly coml. Coml bstg: Republic Broadcasting System (E. de los Santos Ave., Diliman, Quezon City), 2 stns. Inter-Island Broadcasting Corp. (Pasong Tamo, Makati, Rizal), 9 stns. Barangay Broadcasting Corp. (Bohol Ave., Quezon City), 1 stn. Kanlaon Broadcasting System (Bohol Ave., Quezon City), 5 stns.

Radio: 5 million receivers. 205 mw & 6 FM transmitters. Govt bstg: National Media Production Center (Gen. Solana St., Intramuros, Manila), 2 stns. Bureau of Broadcasts (see Govt TV), 11 stns. Coml bstg: 75 ind stns.

Regulatory agency: Bureau of Standards for Mass Media, Dept. of Public Information (PHILCOMCEN Bldg., Ortigas Ave., Pasig, Rizal). Radio Control Office, (De los Santos Bldg., Quezon Blvd. Ext., Quezon City).

Poland

Television: 5.2 million receivers. 30 transmitters, system D, 625 lines. Color system SECAM. Govt bstg: Polskie Radio Telewizja, Warsaw; 2 natl progmg svcs.

Radio: 6 million receivers. 1 lw, 28 mw & 48 FM transmitters. Govt bstg: same as TV; 3 progmg svcs.

Portugal

Television: 625,032 receivers. 16 transmitters, systems B & G, 625 lines. Coml bstg: Radiotelevisao Portuguesa. (Apartado 2934, Lisbon); Dr. Ramiro Veladolo, chmn; Dr. Antonio Bivar, dir pub info; 2 progmg svcs.

Radio: 1.5 million receivers. 29 mw, 41 FM & 10 sw transmitters. Govt bstg: Emissora Nacional de Radiodifusao, Rua do Quelhas, Lisboa 2; 2 natl networks plus rgnl svcs. Ind bstg: 37 stns (coml, cultural, religious & private stns).

Qatar

Television: 30,000 receivers. 1 transmitter, system B, 625 lines. Govt bstg: Qatar Broadcasting Service, Doha.

Radio: 40,000 receivers. 2 mw, 1 sw & 1 FM transmitters. Govt bstg: same as TV.

Television System Characteristics

TV Systems are defined by the International Radio Consultative Committee (C.C.I.R.) 10th Plenary Assembly, Geneva, 1963. (The United States for example uses system M.)

System	No. of lines	Ch. width (mhz)	Vision bandwidth (mhz)	Sound separation (mhz)	Vestigial sideband (mhz)	Vision modulation	Sound modulation
A	405	5	3	-3.5	0.75	Pos.	AM
B	625	7	5	+5.5	0.75	Neg.	FM
C	625	7	5	+5.5	0.75	Pos.	AM
D	625	8	6	+6.5	0.75	Neg.	FM
E	819	14	10	+11.15	2	Pos.	AM
F	819	7	5	+5.5	0.75	Pos.	AM
G	625	8	5	+5.5	0.75	Neg.	FM
H	625	8	5	+5.5	1.25	Neg.	FM
I	625	8	5.5	+6	1.25	Neg.	FM
K	625	8	6	+6.5	0.75	Neg.	FM
K'	625	8	6	+6.5	1.25	Neg.	FM
L	625	8	6	+6.5	1.25	Pos.	AM
M	525	6	4.2	+4.5	0.75	Neg.	FM
N	625	6	4.2	+4.5	0.75	Neg.	FM

Field frequency: System M, 60 cycles per second, all other systems 50 cycles per second.

Picture frequency: System M, 30 cycles per second, all other systems 25 cycles per second.

Line frequency: System A, 10.125 khz, systems E and F, 20.475 khz, system M, 15.75 khz, all other systems, 15.625 khz.

World Radio-TV

Emissor Regional de S. Tome e Principe, Caixa Postal 44, Sao Tome.

Saudi Arabia

Television: 125,000 receivers. 8 transmitters, systems B (625 lines) & M (525 lines). Govt bcstg: Broadcasting Service of the Kingdom of Saudi Arabia, Riyadh.

Radio: 300,000 receivers. 14 mw & 4 FM transmitters. Govt bcstg: same as TV; 2 progmg svcs.

Senegal

Television: 2,000 receivers. 1 transmitter, system B, 625 lines. Govt bcstg: Senegal Television, Dakar.

Radio: 300,000 receivers. 8 mw & 8 sw transmitters. Govt bcstg: Radiodiffusion du Senegal, Dakar; 2 natl progmg svcs plus rgnl stns.

Seychelles

Radio: 15,000 receivers. 1 mw transmitter. Govt bcstg: Radio Seychelles, Mahe.

Sierra Leone

Television: 6,000 receivers. 1 transmitter, system B, 625 lines. Govt bcstg (coml): Sierra Leone Television, Freetown.

Radio: 70,000 receivers. 1 mw & 2 sw transmitters. Govt bcstg: Sierra Leone Broadcasting Service, Freetown.

Singapore

Television: 230,000 receivers. 2 transmitters, system B, 625 lines. Govt bcstg: Television Singapore.

Radio: 300,000 receivers. 5 mw, 8 sw & 4 FM transmitters. Govt bcstg: Radio Singapore; progs in English, Chinese, Malay & Tamil.

Solomon Islands

Radio: 7,000 receivers. 1 mw & 2 sw transmitters. Govt bcstg (coml): Solomon Islands Broadcasting Service, Honiara; J.L.O. Tedder, dir.

Somalia

Radio: 60,000 receivers. 1 mw & 5 sw transmitters. Govt bcstg: Somali Broadcasting Service, Mogadishu; stns at Mogadishu & Hargeisa.

South Africa

Television: 250,000 receivers. System I, 625 lines. Color system PAL. Govt bcstg: South African Broadcasting Corp., Johannesburg.

Radio: 2.5 million receivers. 14 sw & 378 FM transmitters. Govt bcstg: South African Broadcasting Corp., Johannesburg; 2 noncoml progmg svcs (1 in English, 1 in Afrikaans). 1 coml svc (English-Afrikaans bilingual), plus svc in African languages.

Spain

Television: 6.8 million receivers. 37 transmitters plus satellites, systems B & G, 625 lines. Govt bcstg: Radiotelevision Espana, Prado del Ray, Madrid. 2 progmg svcs.

Radio: 8 million receivers. 181 mw & 244 FM transmitters. Govt bcstg: same as TV; Juan Jose Roson Peron, dir gen; Luis de Diego Lopez, dir of pub info; 3 natl networks (1 on mw, 2 on FM) plus rgnl & local svcs. Coml bcstg: 6 networks—Red de Emisoras del Movimiento (Avenida Generalisimo 142, Madrid 16); Cadenas Ondas Populares Espanolas (Alfonso XI 4, Madrid 14); Compania de Radiodifusion Continental (Modesto Lafuente 42, Madrid 3); Sociedad Espanola de Radiodifusion (Av. Jose Antonio 32, Madrid 13); Cadena Azul de Radiodifusion (Reina 33, Madrid 4); Cadena de Emisoras Sindicales (Huerfias 73, Madrid 14).

Sri Lanka

Radio: 500,000 receivers. 10 mw, 9 sw & 5 FM transmitters. Govt bcstg: Sri Lanka Broadcasting Corp., Box 574 Torrington Square, Colombo 7; Ridgeway Tillikeratne, dir gen; 1 coml & 1 noncoml progmg svcs each in Sinhalese & Tamil, plus 1 noncoml English svc.

Sudan

Television: 63,000 receivers. 2 transmitters, system B, 625 lines. Govt bcstg (coml): Sudan Television Service, Omdurman.

Radio: 120,000 receivers. 2 mw & 4 sw transmitters. Govt bcstg: Broadcasting Service of the Democratic Republic of the Sudan, Omdurman.

Surinam

Television: 33,000 receivers. 1 transmitter plus relays, system M, 525 lines. Govt bcstg (coml): Surinaamse Televisie Stichting, Paramaribo.

Radio: 110,000 receivers. 5 mw & 1 FM transmitters. Govt bcstg (coml): Stichting Radio Omroep Suriname, Paramaribo; 1 mw & 1 FM transmitters. Ind coml bcstg: Radika, Radio Apin-tie, Radio Paramaribo, all Paramaribo; Radio Rani, Nieuw Nickerie.

Swaziland

Radio: 53,000 receivers. 2 mw, 2 sw & 1 FM transmitters. Govt bcstg: Swaziland Broadcasting Service, Mbabane. Coml bcstg: Swazi Music Radio (Johannesburg, South Africa); progs for Swaziland & southern Africa.

Sweden

Television: 2,889,109 combined TV & radio license holders (1,301,381 color). 111 transmitters and 163 smaller transmitters plus low power relays, systems B & G, 625 lines. Color system PAL. Ind bcstg (statutory): Sveriges Radio, S-105 10

Stockholm. Otto Nordenskiold, dir gen; Herbert Soderstrom, head of pub info; 2 natl networks.

Radio: 228,997 license holders (radio only). 2 lw, 6 mw, 81 FM & 2 sw transmitters. Ind bcstg (statutory): same as TV; 3 networks (1 general).

Cable: Experimental.

Regulatory agency: Central Administration of Swedish Telecommunications (Marbackagatan 11, S-123 86 Farsta).

Switzerland

Television: 1,688,268 receivers (435,518 color). 203 transmitters plus low power relays, systems B & G, 625 lines. Color system PAL. Ind bcstg (statutory): Swiss Broadcasting Corp. (Giacometstrasse 3, 3000, Berne 15); Dr. Stelio Molo, dir gen; Dr. Markus T. Drack, head press & documentation dept; 3 progmg svcs (1 German, 1 French, 1 Italian) plus regular progs in Romansche.

Radio: 2,015,477 receivers. 6 mw & 202 FM transmitters. Ind bcstg (statutory): same as TV; 2 progmg svcs (1 general & 1 music/culture) each in German, French & Italian, plus progs in Romansche & local svcs.

Syria

Television: 140,000 receivers. 5 transmitters. Govt bcstg (coml): Syrian Broadcasting & Television Organization.

Radio: 350,000 receivers. 8 mw & 3 sw transmitters. Govt bcstg: same as TV.

Tahiti

Television: 13,000 receivers. 4 transmitters. Govt bcstg: Office de Radiodiffusion Television Francaise, Papeete.

Radio: 70,000 receivers. 1 mw & 4 sw transmitters. Govt bcstg: same as TV.

Taiwan

Television: 899,538 receivers (52,279 color). 9 transmitters, system M, 525 lines. Color system NTSC. Coml bcstg: 3 systems—Chinese Television Service (100 Kuan-fu S. Rd., Taipei); China Television Company Ltd. (53 Jen-ai Rd., Sec. 3, Taipei); Taiwan Television Enterprise (10 Pa-teh Rd., Sec. 3, Taipei).

Radio: 1,458,569 receivers. 217 mw & 6 FM transmitters. Ind bcstg (statutory): Broadcasting Corp. of China (53 Jen-ai Rd., Sec. 3, Taipei); Lee Shih-feng pres. Coml bcstg: 29 ind stns. **Cable:** 100 CATV systems serving 30,000 subscribers.

Tanzania

Radio: 250,000 receivers. 8 mw & 9 sw transmitters. Govt bcstg: Radio Tanzania, Dar es Salaam; 1 noncoml & 1 coml progmg svcs, both in Swahili.

Thailand

Television: 500,000 receivers. 7 transmitters, system B, 625 lines. Color system PAL. Govt bcstg: Public Relation Dept., Bangkok 2; Prakob Charumani, dir gen; partially coml.

Radio: 3 million receivers. 112 mw & 40 FM transmitters. Govt bcstg: Radio Thailand, Bangkok 2; noncoml.

Togo

Radio: 50,000 receivers. 2 mw & 5 sw transmitters. Govt bcstg: Radiodiffusion du Togo, Lome.

Tonga

Radio: 10,000 receivers. 1 mw transmitter. Govt bcstg: Tonga Broadcasting Commission, Nukualofa.

Trinidad & Tobago

Television: 92,000 receivers. 2 transmitters, system M, 525 lines. Govt bcstg (coml): Trinidad & Tobago Television Co. Ltd., 11 Maraval Rd., Port-of-Spain; F.A. Rawlins, gen mgr.

Radio: 240,000 receivers. 2 mw & 2 FM transmitters. Govt bcstg: National Broadcasting Service, Port-of-Spain; 1 mw & 1 FM. Ind coml bcstg: Trinidad Broadcasting Co., Port-of-Spain; 1 mw & 1 FM.

Tunisia

Television: 90,000 receivers. 7 transmitters, system B, 625 lines. Govt bcstg: Radiodiffusion Television Tunisienne, Tunis.

Radio: 400,000 receivers. 4 mw & 5 sw transmitters. Govt bcstg: same as TV.

Turkey

Television: 269,847 receivers. 11 transmitters, system B, 625 lines. Govt bcstg (coml): Radio & Television Organization of Turkey, (TRT Genel Mudurlugu, Ankara).

Radio: 4,015,199 receivers. 2 mw, 14 mw, 1 sw & 1 FM transmitters. Govt bcstg (coml): same as TV; 2 natl progmg svcs plus rgnl progs.

Uganda

Television: 70,000 receivers. 6 transmitters, system B, 625 lines. Govt bcstg: Uganda Television, Kampala.

Radio: 250,000 receivers. 7 mw & 4 sw transmitters. Govt bcstg: Radio Uganda, Kampala; 2 progmg svcs.

U.S.S.R.

Television: 45 million receivers. 153 transmitters, system D, 625 lines. Color system SECAM. Govt bcstg: State Committee for Broadcasting & Television, Moscow; 4 progmg svcs.

Radio: 100 million receivers. 52 lw, 208 mw transmitters. Rgnl bcstg is sw, on unknown number of transmitters. Govt bcstg: same as TV; 2 natl progmg svcs plus regional & local svcs.

United Arab Emirates

Television: 17,000 receivers. 2 transmitters, system B, 625

lines. Govt bcstg: Voice of the United Arab Emirates, Abu Dhabi.

Radio: 60,000 receivers. 7 mw, 2 sw & 3 FM transmitters. Govt bcstg: same as TV; 2 mw, 1 sw & 1 FM. Also, Radio Dubai, 2 mw, 1 sw & 1 FM stns; Ras al Khaimah Broadcasting Station, mw; Sharjah Broadcasting Station, 2 mw & 1 FM transmitters.

United Kingdom

Television: 22.9 million receivers (5.6 million color), 190 transmitters plus relays, system A, 405 lines (being phased out) system I, 625 lines. Color system PAL. Public bcstg (statutory): British Broadcasting Corp. (Broadcasting House, London W1A 1AA); Sir Charles Curran, dir gen; Huw Wheldon, managing dir TV; 2 natl networks (BBC-1 and BBC-2). Coml bcstg: Independent Broadcasting Authority, 70 Brompton Road, London SW3 1EY; Lady Plowden, chmn; Brian Young, dir gen. The IBA owns and operates a natl TV network, plus all transmitters radiating independent TV programs. Fifteen separate program companies supply IBA with programs in fourteen areas (London is served by two companies, one for weekdays and one for weekends).

Radio: 40 million receivers. 1 lw, 96 mw & 279 FM transmitters. Public bcstg (statutory): BBC; Ian Trethowan, managing dir radio; 4 natl progmg svcs—Radio 1 (popular music), Radio 2 (light music), Radio 3 (general features with emphasis on classical music), Radio 4 (news, documentaries & general features), plus 20 local stns. Coml bcstg: IBA operates 10 AM and 9 FM stns. Manx Radio operates 2 AM and 2 FM stns on the Isle of Man.

Cable: 3 major systems serving 13% of Britain's TV license holders.

Upper Volta

Television: 600 receivers. 1 transmitter, system D, 625 lines. Govt bcstg: Radiodiffusion Television Voltaique, Ouagadougou.

Radio: 100,000 receivers. 2 mw & 2 sw transmitters. Govt bcstg: same as TV.

Uruguay

Television: 350,000 receivers. 16 transmitters, system N, 625 lines. Coml bcstg: 16 ind stns.

Radio: 1.5 million receivers. 76 mw & 19 sw transmitters. Ind bcstg: 71 stns (all but 3 are coml).

Regulatory agency: Direccion Nacional de Comunicaciones, Montevideo.

Vatican City State

Radio: 1 mw transmitter. Govt bcstg: Vatican Radio, Vatican City.

Venezuela

Television: 1.1 million receivers (30,000 color). 42 transmitters, system M, 525 lines. Color system NTSC. Govt bcstg: Televisora Nacional, Caracas; 1 stn. Coml bcstg: 6 ind stns.

Radio: 2 million receivers. 155 mw & 99 sw transmitters. Govt bcstg: Radio Nacional, Caracas, 8 mw & 10 sw transmitters. Ind bcstg: 142 stns (all but 1 are coml).

Regulatory agency: Ministerio de Comunicaciones, Caracas.

Vietnam

Information on Vietnam in 1975 was uncertain; that shown below is the most recent available.

North

Radio: 550,000 receivers. 1 mw & approx 12 sw transmitters. Govt bcstg: Voice of Vietnam, Hanoi; 2 progms svcs plus progs in mountain languages.

South

Television: 500,000 receivers. 1 transmitter, system M, 525 lines.

Radio: 1.5 million receivers. 15 mw & 6 sw transmitters.

Western Samoa

Radio: 10,000 receivers. 1 mw transmitter. Govt bcstg (coml): Samoa Broadcasting Service, Box 200, Apia, Western Samoa; J.W. Moore, dir.

Yemen (People's Democratic Republic)

Television: 25,000 receivers. 3 transmitters, system B, 625 lines. Govt bcstg: Democratic Yemen Broadcasting Service, Aden.

Radio: 100,000 receivers. 1 mw & 2 sw transmitters. Govt bcstg: same as TV.

Yemen Arab Republic

Radio: 90,000 receivers. 3 mw & 1 sw transmitters. Govt bcstg: Radio Sanaa, Sanaa.

Yugoslavia

Television: 2.5 million. 48 transmitters, system B, 625 lines. Color system PAL. Govt bcstg: Jugoslovenska Radiotelevizija, Belgrade; 1 natl network plus rgnl svcs.

Radio: 3.7 million receivers. 117 mw & 98 FM transmitters. Progmg svcs from 8 cities. Coml progmg on some stns.

Zaire

Television: 7,000 receivers. 1 transmitter, system B, 625 lines. Govt bcstg (coml): La Voix du Zaire, Kinshasa.

Radio: 100,000 receivers. 6 mw, 19 sw & 1 FM transmitters. Govt bcstg: same as TV; home svc from Kinshasa plus 9 rgnl stns.

Zambia

Television: 22,000 receivers. 3 transmitters, system B, 625 lines. Govt bcstg: Zambia Broadcasting Service, Lusaka.

Radio: 100,000 receivers. 8 mw, 10 sw & 2 FM transmitters. Govt bcstg: same as TV; 2 progmg svcs.

Collins announces the next generation of FM transmitters. The Generation 4 line.

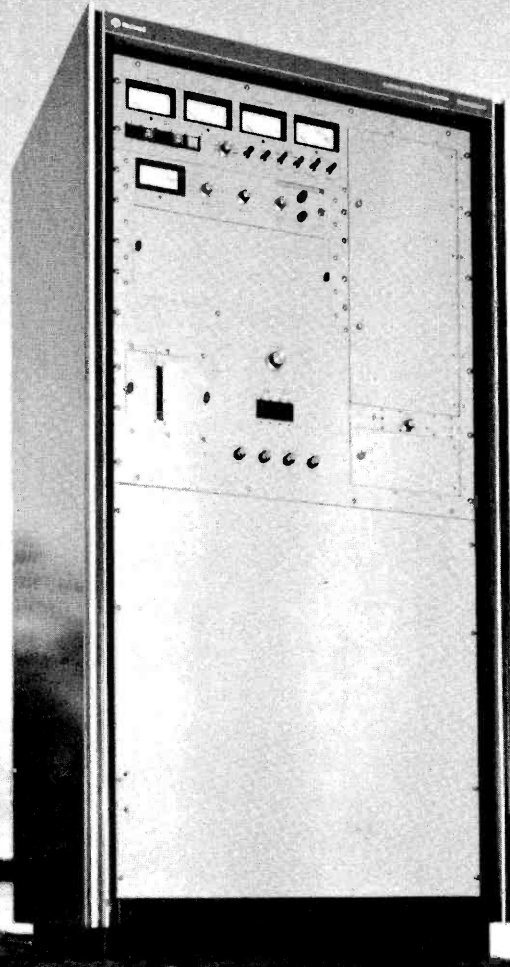

They're here now. Nine new FM transmitters from Collins. Named Generation 4TM because they're a full generation ahead of anything else on the market. And because every feature is the product of 4 decades of Collins broadcast experience.

At the heart of everything is Collins' new, field-proven Phase 4TM Exciter. The best FM exciter available today at any price. Just one part of a system designed to meet the requirements of today's new generation of radio audiophiles . . . with discrete quad compatibility and stringent specifications on all the things that count, like intermod distortion.

Choices? Everything from the big 40-KW

831H-2, the 22½-KW 831G-2B, and 2½-KW 831D-2, to the 10-watt 831A-2. And five more models in between. And they're available right now at prices that are going to be a pleasant surprise. With the same superior Collins quality you've come to expect. Backed with the same unexcelled 24-hour parts and field service.

Act now, while we're still able to hold our current pricing. Contact your local Collins Broadcast salesman. Or Broadcast Marketing, Collins Radio Group, Rockwell International, Dallas, Texas 75207. Phone 214-690-5574 or 214-690-5219.



**Rockwell
International**

...where science gets down to business

Spotmaster[®]

SINGLE DECK
CARTRIDGE MACHINES

Spotmaster[®]

**MULTIPLE DECK
SYSTEMS**

Spotmaster[®]

CARTRIDGE MACHINE
ACCESSORIES

Spotmaster[®]

**TURNTABLES, PRE-AMPS
AND TONE ARMS**

Spotmaster[®]

AUDIO PROCESSING AND
DISTRIBUTION AMPLIFIERS

Spotmaster[®]

**TELEPHONE ANSWERING
INTERFACE SYSTEMS**

Spotmaster[®]

AUDIO CONSOLES

BROADCAST ELECTRONICS, INC.
A FILMWAYS COMPANY
8810 BROOKVILLE ROAD
SILVER SPRING, MARYLAND 20910
PHONE: 301-588-4983

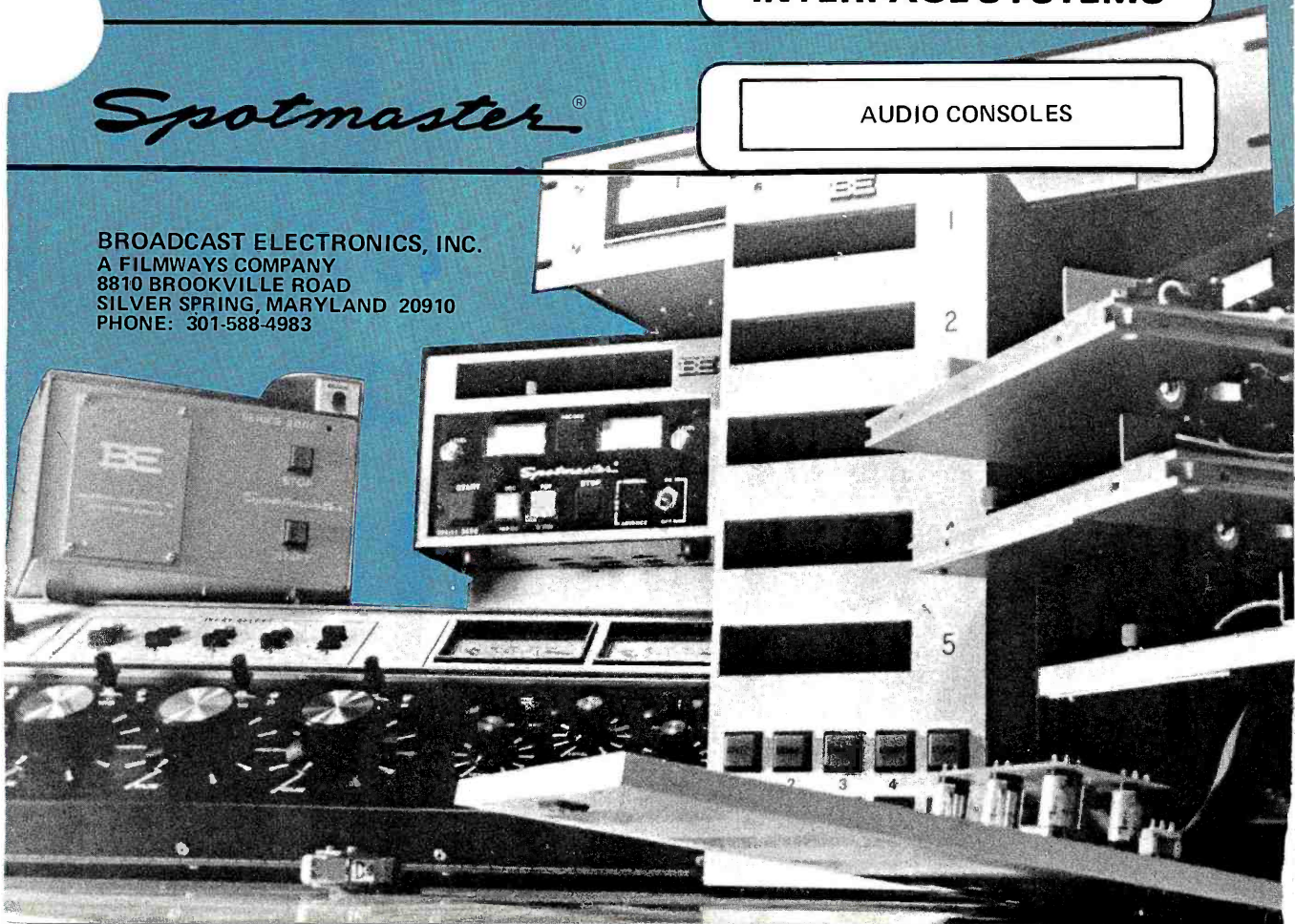

E

Equipment Manufacturers and Distributors	E-1
Consulting Engineers	E-36
Frequency Measuring Services	E-39
Common Carriers	
Land lines (AT&T)	E-39
Microwave	E-39
Satellites	E-40

Broadcasting

Yearbook 1976

Equipment & Engineering

Equipment Makers, Distributors

The following is an alphabetical directory of manufacturers and services involved in the business of broadcasting. Each listing contains company name, headquarters address, telephone, executive personnel, and branch offices. To locate these companies by product, please turn to the Buyer's Guide color pages following this section.

A

AKAI America Ltd. 2139 E. Del Amo Blvd., Compton, Calif. 90220. (213)537-3880. C.E. Phillips, exec VP.

Portable video tape recorder systems and related items for electronic newsgathering.

AKG-Phillips Audio Video Systems. 91 McKee Dr., Mahwah, N.J. 07430. (201) 529-5900. Andrew Brakhan, VP; Robert Miller, dir mktg dev; S. Richard Ravich, mgr; Geoffrey Langdon, tech mgr.

Microphones, headphones, reverberation units, phono cartridges, microphone stands and accessories.

Ace High Tower Co. P.O. Box 55, Greenville, N.C. 27834. (919)752-7323.

Acrodyne Industries Inc. 21 Commerce Dr., Montgomeryville, Pa. 18936. (215)368-2600. Marshall C. Smith, pres; N.S. Ostroff, VP, operations; John D. Parke, dir of mktg.

Television translators, transmitters and peripheral equip.

Addison Division of Muirhead Inc. 1101 Bristol Rd., Mountainside, N.J. 07092. (201)233-6010. D. Semels, pres; J. Verruso, dir of mktg; R. Seelagy, dir of new products.

Advance Industries Inc. 2301 Bridgeport Dr., Sioux City, Iowa 51102. (712) 252-4101. L.J. Tokar, pres; G.S. Chesen, VP.

Designs, manufacturers, installs complete line of towers and pre-assembled buildings for microwave, AM-FM-VHF.

Affiliated Photographic Co. 15 W. 45th St., New York 10036. (212)582-0522. Cye Friedman, pres; A. Charytan, mgr.

Air Space Devices Inc. Box 197, Paramount, Calif. 90723. (213)774-4905. Donald R. Devine, gen mgr; William G. Nussbaum, mktg mgr.

Fall prevention system and perimeter protection system.

Aitken Communications Inc. 701 S. 10th St., Taft, Calif. 93268. (805)765-5403. Kenneth Aitken, pres. Broadcast automation systems.

Alden Electronic & Impulse Recording Equipment Co. Inc. Washington St., Westboro, Mass. 01581. (617)366-8851. John M. Alden, pres; Lawrence A. Farrington, sales mgr; George F. Stafford, VP/ dir of communications.

Alford Manufacturing Co. 120 Cross St., Winchester, Mass. 01890. (617)729-8059. Andrew Alford, pres.

TV antennas, ITFS transmitting antennas, RF measuring instruments.

Allied Electronics. 12311 Industry St., Garden Grove, Calif. 92641. (213) 598-8671. (714)864-7581. TWX 68-5534, 65-5465.

Elgin, Ill. 1355 Sleepy Hollow Rd. (312)697-8200. TWX 72-2466, 72-2465.

Boston, One Century Circle, Campanelli Indus. Pk., Braintree, Mass. 02184. (617)848-4150. TWX 94-0650.

Fort Worth, 401 E. 8th St. 76102. (817)336-5401. TWX 75-8314.

Allied Tower. Box 331, South Houston, Tex. 77587. (713)946-9546.

Vinita, Okla. 74301. (918)256-6113.

See adv, page E-3

Alto Communications Inc. 6362 Hollywood Blvd., Hollywood 90028. (213)466-9261. D. Alan Clark, pres; Bill Ezell, VP; Jim Hampton, VP; Don W. Clark, dir of mktg; John Price, dir of broadcast svcs.

Ameco Inc. Box 13741, Phoenix 85002. (602) 252-5716. Bruce Merrill, pres; Robert Wilson, exec VP. CATV equipment, complete line of active and passive devices.

American Data Corp., an AIRPAX Co. 315 Wynn Dr., Box 5228, Huntsville, Ala. 35805. (205) 837-5180. C.W. Byrd, pres; H. Bjorklund, mktg mgr; M. Wade, eng mgr.

Los Angeles 90020: 425 S. New Hampshire No. 301. (213)387-7756. W.C. Wiseman, western rgnl mgr.

Atlanta 30329: 1729 Wilmont Dr. (404) 633-2100. J. Ryan, rgnl mgr.

Itasca, Ill. 60143: 21W127 Tee Ln. (312) 773-3180. R. Munzner, rgnl mgr.

Rockville, Md. 20853: 5504 Waterway. (301) 460-1454. Wiltronix Inc.

- ITFS/MDS Transmitters and Receivers
- Microwave Path Survey Equipment
- Low-Cost FM Microwave Receivers for Satellite Terminals



varian MICRO-LINK®
beverly, mass. (617) 922-6000



The best rock sound
in Chicago is put
out by an AEL FM-25KD
Stereo Transmitter
Just ask WXRT

AEL stereo transmitters always
send the very best.
FM: 2,500, 15,000, 25,000, 40,000,
50,000 watts.
AM: 5,000, 10,000, 50,000 watts.



Call or Write:



AMERICAN ELECTRONIC LABORATORIES, INC.
P.O. Box 552, Lansdale, PA 19446
Tel: 215/822-2929 • TWX: 510/661-4976

QUALITY TALKS FOR KIRO

Seattle, Washington

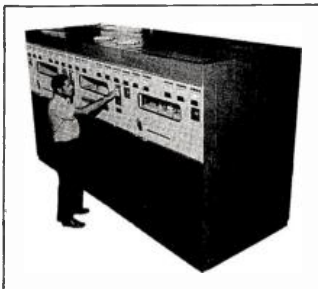

Continental's 317C is the best
measure for any 50 kW AM trans-
mitter purchase. Performance,
125% positive modulation and
reserve power capabilities are
unbeatable. Today's best sound
in 50 kW AM is Continental.

Continental
Electronics

CONTINENTAL ELECTRONICS MFG. CO.
BOX 17040 DALLAS, TEXAS 75217

Equipment

Plaisir, France 78370: Rue Voltaire, Bois Des Cent
Arpents. Claude Cavey.
Montreal H1G 3Y2: 11636 P.M. Favier.
(514)322-4564. Maurice DuPont, P.Q. rgnl mgr.
Production switching, 900 IC routing switcher,
amplifiers, closed circuit systems, special effects
(audio and video), test equipment.



American Electronic Laboratories Inc. P.O. Box
552, Lansdale, Pa. 19446. (215)822-2929. Dr. L. Rieb-
man, pres; C. Fowler, bd chmn and exec VP; B. Ber-
nard, VP mktg; R. Newhook, prod mktg mgr; A. Rosset,
mgr adv.

Broadcast division designs and manufacturers AM
and FM transmitters.

American Electronics Inc. Hwy. 15 S. Box 903-904,
Saint George, S.C. 29477. (803)563-4374. Clarence
Jones, pres; Margaret Jones, VP.

Portable patented remote broadcast telephone
system with integrated circuit and attache case.

American Satellite Corp. 20030 Century Blvd.,
Germantown, Md. 20767. (301)428-0100. Emanuel
Fthenakis, pres; John Puente, exec VP-opns; Dennis T.
Goddard, VP-mktg; John D. Jackson, VP and gen
counsel.

Los Angeles 90291: (213)822-3483. E. Carl
Smedley, dir of west coast region.

New York 10048: (212)775-1234. James J. McKen-
na, dir of eastern region.

Dallas 75250: (214)745-1191. Jerry Edwards, dir of
southwest region.

San Francisco 94111: (415)986-1288. Charles A.
Roberts, mktg mgr, San Francisco area.

**Amperex Electronic Corp., Electro-Optical
Devices Div.** Providence Pike, Slatersville, R.I. 02876.
(401) 762-3800. Norman Neumann, pres; Louis Ar-
pino, mktg mgr; Robert A. Raboin, spv sales.

Elk Grove Village, Ill. 60007: 175 Scott St. (312)
593-8220. Ralph E. Johnson, rgnl sls eng.

N. Hollywood, Calif. 91604: 3760 Cahuenga Blvd.
(213) 762-2118. Robert L. Manahan, rgnl sls eng.

Dallas. (214) 351-6745. Merle E. Arnold.
Camera tubes, vidicons, siviicon, silicon vidicon, im-
age intensifiers, CRT's, intensified silicon vidicons.

Ampex Corp. 401 Broadway, Redwood City, Calif.
94063. (415)367-2011. Arthur H. Hausman, pres &
chief exec off; Charles A. Steinberg, VP-gen mgr,
audio/video systems division; John L. Porter, VP-gen
mgr, magnetic tape division.

Glendale, Calif. 91201: 500 Rodier Drive.
(213)240-5000. Kenneth G. Herring, rgnl sls mgr.

Atlanta 30340: 3135 Chestnut Dr. Suite 101. (404)
451-7112. Paul Hansil, rgnl mgr.

Elk Grove Village, Ill. 60007: 2201 Lunt Ave. (312)
593-6000. Len Hase, rgnl sls mgr.

Hackensack, N.J. 07601: 75 Commerce Way.
(201)489-7400. Al Slater, rgnl sls mgr.

Dallas 75235: 1615 Prudential Drive.
(214)637-5100. Frank Nault, rgnl sls mgr.

Bethesda, Md. 20034: 10215 Fernwood Rd. (301)
530-8800.

Waltham, Mass. 02154: 391 Totten Pond Rd. (617)
890-2040.

Dayton, Ohio 45432: 4130 Linden Ave. (513)
254-6101.

Abington, Pa. 19001: 947 Old York Rd. (215)
887-7650.

Video tape and disc recorders, color cameras, time
base correctors, professional audio recorders.

Ampro Corp. 2220 Maplewood Ave., Willow Grove,
Pa. 19090. (215) 657-3100. Raphael A. Meyer, pres;
Richard F. Grochowski, VP, sec, treas.

Rotary cartridge selector and reproducer, noise
reduction system accessory.

Anderson Electronics International. Box 18,
Black Hawk, S.D. 57718. (605)787-4224. Keith V. An-
derson.

Namarata, B.C.: Box 27.
Port Macquarie, N.S.W., Australia.

Andrew Corp. 10500 W. 153rd St., Orland Park, Ill.
60462. (312)349-3300. H. Woodbury, natl sales mgr;
Richardson, Tex. 75080: Box 938. (214) 235-1279.
R. Hetzler, district mgr.

Los Angeles, Calif. 91711: 771 E. Maryland Ave.
(714) 626-3505. T. Glab, district mgr.

Hawthorne, N.J. 07507: Box 505. (201) 652-1310. J.
Reiner, district mgr.

Palo Alto, Calif. 94304: 701 Welch Rd. (415)
323-1319. W. Sirvatka, rgnl mgr.

Rockville, Md. 20850: Box 1470. (301) 762-1900. T.
Hewlett, district mgr.

Denver 80216: 451 E. 58th Ave. (303) 534-1788.
John Gyurko, district mgr.

Lexington, Mass. 02173: 594 Marrett Rd. (617)
862-0888. Bill Fritz, district mgr.

Hellax coaxial cables and waveguides, microwave
antennas, pressurization equipment, earth station an-
tennas.

Angenieux Corporation of America Inc. Islip Air-
port, Box 340, Ronkonkoma, N.Y. 11779. (516)
567-1800. John Wallace, gen mgr; Ken Rice, bcst TV
sls mgr; Bern Levy, TV optics mgr; Paul C. Foote, tech
dir; Walt David, eastern opns mgr; Bob Jagemann,
western opns mgr; Claus Zedler, dir of tech svcs.

Venice, Calif. 90291: Angenieux Service Corp. of
Calif. (ASCC) - 13381 Beach Ave. (213) 821-5080.

Zoom lenses and color splitting systems for broad-
cast portable, studio, film chain and ENG cameras.

Angle Tower Company. Box 55, Greenville, N.C.
27834. (919) 752-7323. Bill Angle Sr, pres; Bill Angle
Jr, VP.

New and used towers, sale and erection, lighting,
painting, ground systems and general maintenance.

Anlxtel Communications Systems. 5439 W.
Fargo, Skokie, Ill. 60076. (312) 675-1500.

Anlxtel-Pruzan Inc. 1963 First Ave. S. Seattle
98134. (206) 624-6505. Herbert L. Pruzan, pres; Irwin
S. Sylvan, exec VP.

Atlanta 30340: 4303 Pleasantdale Rd. (404)
449-6533. Sandy Smith, district mgr.

Pinebrook, N.J. 07058: Montville Center I, Route 80,
Hook Mtn. Rd. (201) 227-9580. John Egan, district
mgr.

Santa Ana, Calif. 92705: 2228 S. Ritchey St. (714)
556-6270. Gene Robinson, district mgr.

St. Louis 63134: 9449 Aero Space Dr. (314)
423-9555. Tim Rankin, district mgr.

Products for the construction and maintenance of
cable TV systems including studio equipment.

Ann Arbor Terminals Inc. 6107 Jackson Rd. Ann
Arbor, Mich. 48103. (313)769-0926. Michael R.
Levine, pres; Ed Zimmer, VP.

Santa Clara, Calif. 95050: 3000 Scott Blvd, Suite
106. (408) 249-6046. Robert F. Sigal, rgnl sls mgr.

Manufactures CRT display and terminal equipment
directed toward the OEM market.

Applied Electro Mechanics Inc. 2350 Duke Street,
Alexandria, Va. 22314. (703)548-2166. Charles
Banks, pres; Harry Brown, VP & chief engr.

Arriflex Co. of America. 25-20 Brooklyn Queens
Expressway West, Woodside, N.Y. 11377.
(212)932-3403. Paul Klingenstein, pres; Volker W.
Bahnmann, VP & gen mgr.

Burbank, Calif. 91502: 1011 Chestnut St. (213)
843-1883. Wilbur Russell, mgr.

16 and 35 mm motion picture equipment, Arriflex
camera accessories.

Asaca Corp. of America. 1289 Rand Rd. Des
Plaines, Ill. 60016.

Portable color TV camera (three-tube), portable
VTR.

Audio Accessories Inc. 163 Water St., Keene, N.H.
03431. (603) 352-2320. M.B. Hall, pres; D.M. Hall, gen
mgr; G.D. Colburn, plant mgr.

Jack panels, patch cords, telephone jacks and
plugs, pre-wired jack panels.

Audio Designs & Mfg. 16005 Sturgeon, Roseville,
Mich. 48066.

Broadcast production consoles, distribution
amplifiers and rack.

See adv. page E-7

Audio Devices Inc. 100 Research Drive, Glenbrook,
Conn. 06906. (203)327-6500. T. Cunha, pres; W.
Dawson, VP mktg & sls; H. Preston, group product mgr.

New York 10019: (212)757-7470. H. Aronson, rgnl
mgr.

Dedham, Mass. 02026: (617)329-5777. T.
Sancharico, district mgr.

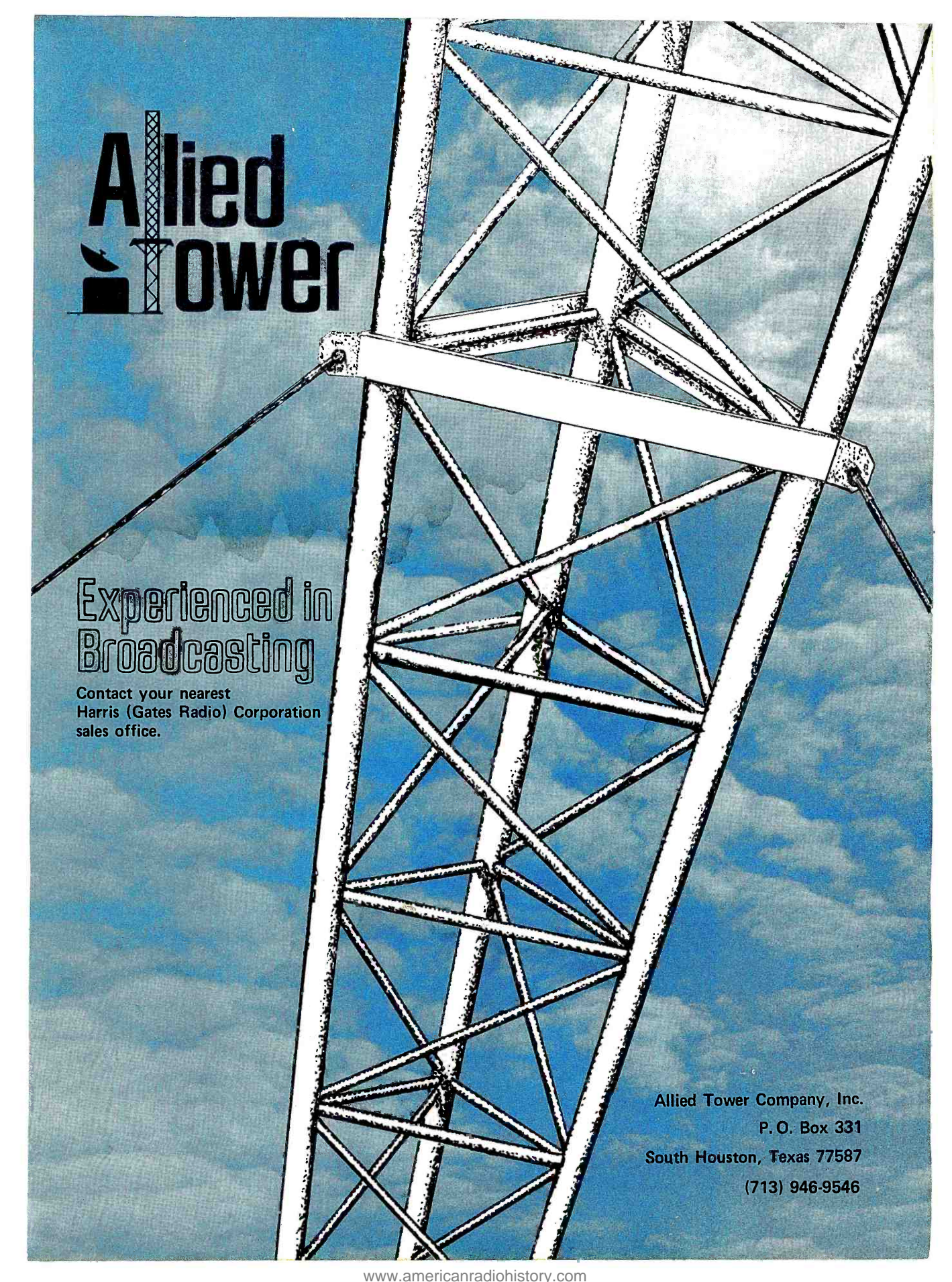

Allied Tower

Experienced in
Broadcasting

Contact your nearest
Harris (Gates Radio) Corporation
sales office.

Allied Tower Company, Inc.
P. O. Box 331
South Houston, Texas 77587
(713) 946-9546

Equipment

Rockville, Md. 20852: (301)881-2430. E. Dougherty, rgnl mgr.

Atlanta 30329: (404)631-5441. L. Longo, district mgr.

Niles, Ill. 60648: (312)583-4161. G. Meyer, rgnl mgr.
Dallas 75235: (214)638-0784. B. Jackson, rgnl mgr.
Los Angeles 90065: (213)255-5103. B. LaGrandeur, rgnl mgr.

Audio Distributors Inc. 2342 S. Division Ave., Grand Rapids, Mich. 49507.

Audio Services Inc. 3140 E. Jefferson, Detroit 48207. (313) 567-0555. Gary C. Schmidt, pres; James A. Zinser, VP-mktg; Jack L. Spiess, VP-engrg; Charles M. Miller, VP-comp sys.

Master clock, EBS, teletype alarm, tone activated equipment controller, audio switcher, custom designs.

Audio/Tek Inc. 503 "F" Vandell Way, Campbell, Calif. 95008. (408)378-5586. Robert W. Kratt, pres; D. Kratt, VP.

Audio-Video Concepts Inc. 5408 Silver Hill Rd., Suite 501, Suitland, Md. 20028. (301)568-5836. Edward P. Helvey, pres; John C. Caughman, VP/gen mgr.

Audio-Video Engineering Co. 65 Nancy Blvd., Merrick, N.Y. 11566. (516)546-4239. Rolf Drucker, own.

Audio/Video Products. 9336 Fostoria St., Downey, Calif. 90241. (213)861-6072. William Carluquist, own.

Audio automation systems and controllers, video digital slating units, digital music production aids, systems engineering.

Audionics Inc. 207 Summit St., Memphis 38104. (901)276-6338. Welton H. Jetton, pres; William Sage, VP, mfg.

Professional audio control consoles for AM, FM, TV multi-track recording and sound reinforcement.

Autogram Corp. Box 456, Plano, Tex. 75074. (214)424-8585. Ernest T. Ankele Jr., pres.

Radio automation and audio consoles.

Automated Processes Inc. 789 Park Ave., Huntington, N.Y. 11743. (516) 427-6024. H. Charles Riker, dir & broadcast mktg mgr.

Audio consoles, amplifiers, equalizers, compressor/limiters, faders, tape synchronizers, audio switching systems.

B

B & K Instruments Inc. 5111 W. 164th St., Cleveland 44142. (216)267-4800. E. John Wooten, pres; Tony Schneider, dir mktg; Bob Farrell, natl sls mgr; Bill Rhodes, dir of communications.

Anaheim, Calif. 92806: 1440 S. State College Blvd. (714) 778-2450. Joe Weatherstone, western sls mgr.

Bensenville, Ill. 60106: 601-D Country Club Dr. (312) 595-7470. Ed Lang, mid-west sls mgr.

Springfield, N.J. 07081: 11 Dundar Rd. (201) 467-3151. John Anderson, eastern sls mgr.

Sound, vibration and data analysis instrumentation.

Bell Brothers Research Corp./Electronic Display Division. 1633 Terrace Drive, St. Paul 55113. (612) 633-1742. Wm. S. Sadler, VP and gen mgr; George H. Wagner, dir of mktg.

Santa Clara, Calif. 95051: Box 2547. (408) 244-1474. Dick Ryan, western mgr.

Upland, Calif. 91786: 1169 Eddington St. (714) 985-7110. Kent Struckhoff, rgnl sls mgr.

Avenel, N.J. 07001: 1150 St. George Ave. (201) 636-2040. Dick Lemke, eastern mgr.

Monochrome and color broadcast monitors, digital display monitors.

Barco U.S. Division of Kallman Associates Inc. 2525 Hyperion Ave., Los Angeles 90027. (213) 660-4900. Alfred M. Kallman, pres.

Precision color television monitors-high and ultra high resolution, monitor alignment generators.

BASF Corp. Crosby Drive, Bedford, Mass. 01730. (617) 271-4000.

Bausch & Lomb. SOPD Div. Dept. 6606. Optics Center, 1400 N. Goodman St., Rochester, N.Y. 14602. (716)338-6470. R.J. Sparling, SOPD, pres; D. Joergel, natl sls mgr; H.G. Lettau, mgr-mktg communications and prod management.

BEAU Motor Division/UMC Electronics Co. 460 Sackett Point Rd., North Haven, Conn. 06473. (203) 288-7731. A.J. Shaftel, pres; C.E. Collett, sls mgr.

Hysteresis synchronous and torque motors, cartridge tape splice finder and eraser.

Belar Electronics Laboratory Inc. Lancaster Ave. at Dorset, Box 826, Devon, Pa. 19333. (215) 687-5550. Arno Meyer, pres; Jesse Maxenchs, mktg mgr; Edward Chien, chief eng.

AM, FM, TV frequency and modulation monitors, accessories and complementary RF amplifiers and antennas.

Berkey Colortran 1015 Chestnut St., Burbank, Calif. 91502. (213) 843-1200. Peter Coe, pres; Ken Boyda, VP, admin; Moe Tawil, VP, eng; Thomas Pinciu, prod mgr; Marion M. Rimmer, VP, sls.

New York 10017: 222 E. 44 St. (212) 721-3434. Bob Benson, dir eastern sls mgr.

Studio/location lighting equipment, accessories, distribution and control systems.

BES Electronics Ltd. 1466 Kalligan Court, Mississauga, Ont. L4X 1A8. (416) 277-0277. William R. Onn, pres & gen mgr.

Broadcast equipment for complete AM/FM from microphone to antenna.

Bird Electronic Corp. 30303 Aurora Road, Cleveland (Solon) 44139. (216)248-1200. Mrs. H.J. Bird, pres; R. Lee, dir of sls.

Ojai, Calif. 93023: (805)646-7255. George Churpek, rgnl sls mgr.

San Francisco: (415) 568-1110. George Churpek, rgnl sls mgr.

Syracuse, N.Y. 13202: (315)422-0494. John Ittel, rgnl sls mgr.

Lancaster, Pa. 17601: (717)569-7018. Richard Tanczos, rgnl sls mgr.

Willowdale, Ont. M2M 3N6: (416)221-7546. David LaFrenais, rgnl mgr.

Watt meters, lab standards, 2w to 50w coaxial loads and attenuators.

BJA Systems Inc. 7819 Deerrun Rd., Philadelphia 19118. (215) 886-1670. Ralph Weinger, pres.

Blonder-Tongue Laboratories Inc. One Jake Brown Road, Old Bridge, N.J. 08857. (201) 679-4000. Isaac S. Blonder, chmn of bd; Ben H. Tongue, pres.

Los Angeles 90039: 3121 Los Feliz Blvd. (213) 666-1511. E. Strassner.

Seattle 98119: 815 W. Ewing St. (206) 284-8020. C. Scott.

Hayward, Calif. 94540: 20698 Corsair Blvd. (415) 785-4531. J. Balash.

TV reception products for home, master antenna systems and CATV systems-commercial grade.

Bogen Division/Lear Siegler Inc. Box 500, Paramus, N.J. 07652. (201) 343-5700. John T. Morgan, pres; Joseph F. Walther, sls mgr, eng sound; Edward H. Sinclair, sls engr, sys appl.

Mixers, studio monitors, equalizers, audio power amplifiers.

Bogner Broadcast Equipment Corp. 99 W. Hawthorne Ave., Valley Stream, N.Y. 11580. (516) 561-9130.

Robert Bosch Corp. 2800 S. 25 Ave., Broadview, Ill. 60153. (312) 681-5000. E.R. Fiene, pres, chief exec; G.L. Bego, pres, sls, svc; H.G. Buerk, VP, fin, admin; G. Weisse, dir orig equip sls & appl eng.

Houston 77018: 4131-A Directors Row. (713) 688-9171. Leonard Wolff.

Saddle Brook, N.J. 07622: 279 Midland Ave. (201) 797-7400. A.R. Pignoni.

Boston Insulated Wire & Cable Co. 65 Bay St., Boston 02125. (617)265-2102. H.B. Burley Jr., chmn of bd; Eli Manchester Jr., pres; Alfred Garshick, VP-engrg; J.L.C. Wagoner, VP-mfg; Wallace A. Chapin, VP-field sls; Leo Gildea, prod sls mgr.

Los Angeles 90061: Electronic Accessories Division. (213)532-9064. John Hathaway, VP West Coast ops.

Hamilton, Ont.: 118 Shaw St. (416)529-7151. Edward McCusker, pres.

Kingston-upon-Thames, England; Boston Insulated Wire (U.K.) Ltd., 1 Canbury Park Rd. 01-546-3384. Hachig A. Aghjayan, pres.

Camera cable and connectors for all broadcast cameras.

Boulevard Recording Studios Inc. 609 N. LaSalle St., Chicago 60610. (312) 944-2752. Hal Kaichuek, pres.

BPI Inc. Box 547, Bellingham, Wash. 98225. Cal Vandegrift.

Broadcast Automation Associates Inc. 5199 N.E. 12th Ave., Fort Lauderdale, Fla. 33334. (305) 776-4762. Ronald Crider, pres; Betsy Ebert, VP; Alan Binus, dir of engr; David Antoniak, TV sls mgr.

Complete line of new and used broadcast equipment.

Broadcast Communications. N. Main St., Warrenton, N.C. 27589. (919) 257-4346. Vern Steed, pres; Jack Butler, sls mgr, bcst products div.

Charlotte, N.C. 28202: Suite 214, 221 S. Church St. (704)332-8530. C. Miller, district mgr.

Broadcast Communications Devices Inc. 5526 E. LaPalma Ave., Anaheim, Calif. 92807. (714) 528-9505. John S. Baumann, pres; Martin Jackson, VP; Nancy T. Baumann, sec.

Santa Clara, Calif. 95050: 1850 Warburton Suite 203. (408) 984-6614. Martin Jackson, VP.

Professional audio and video equipment.

Broadcast Electronics Inc. 8810 Brookville Rd., Silver Spring, Md. 20910. (301)588-4983. Andrew Szegda, pres; Tom Creighton, dir of sls & mktg; Melton J. Black Jr., asst dir of sls & mktg.

Broadcast Supply West. 2607 Bridgeport Way W. 2G, Tacoma, Wash. 98466. (206) 565-2301. Irving D. Law Jr., pres.

Audio automation systems, broadcast studio equipment, cartridge rewind service.

BSC Inc. 8600 W. Sunnyside Ave., Chicago 60656. (312) 625-0265. Carl A. Bergetz, pres; Paul F. Bergetz, VP.

Audio-video recording supplies, custom recording installations.

Buhl Optical. 1009 Beech Ave., Pittsburgh 15233.

Burden Associates. 342 Lexington Ave., Mount Kisco, N.Y. 10549. (914)666-3730. Richard W. Burden, Tom Bethel, George Magnuson.

Canoga Park, Calif. 91303: 20944 Sherman Way. (213)340-4590. Jay O. Baker, Richard W. Burden.

Sunnyvale, Calif. 94086. 1050 E. Evelyn Ave. (408) 738-2100. Leroy C. Granlund.

Aural broadcast engineering service.

Burke & James. 333 W. Lake St., Chicago 60606. (312)372-5422. Jere Benedict, gen mgr.

Burwen Laboratories Inc. 209 Middlesex Turnpike,

- ITFS/MDS Transmitters and Receivers
- Microwave Path Survey Equipment
- Low-Cost FM Microwave Receivers for Satellite Terminals



varian MICRO-LINK[®]
beverly, mass. (617) 922-6000

LIGHTING

**YOU
NEED
IT
?**

**WE
HAVE
IT
!**

STUDIO LIGHTS
LIGHTING CONTROL
DISTRIBUTION EQUIPMENT

Berkey Colortran®

1015 Chestnut Street, Burbank,
California 91502, Tel. 213 843-1200

DIVISION OF
Berkey
Photo Inc.



P.O. Box 5, Burrell Way, Thetford
Norfolk IP24 3RB, U.K., Tel. Thetford 2484



The best MOR sound
in Bend, OR is put
out by an AEL FM-12KD
Stereo Transmitter

Just ask KICE

AEL stereo transmitters always
send the very best.
FM: 2,500, 15,000, 25,000, 40,000,
50,000 watts.
AM: 5,000, 10,000, 50,000 watts.



Call or Write:

AMERICAN ELECTRONIC LABORATORIES, INC.
P.O. Box 552, Lansdale, PA 19446
Tel: 215/822-2929 • TWX: 510/661-4976

QUALITY TALKS FOR KTAC

Tacoma, Washington

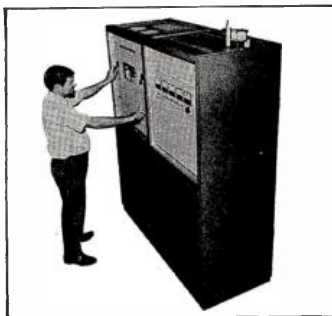

Continental's new 5/10 kW AM transmitter is setting records for acceptance. It has performance and efficiency, with the cleanest sound around. Listen to Continental: quality talks.

**Continental
Electronics**

CONTINENTAL ELECTRONICS MFG. CO.
BOX 17040 DALLAS, TEXAS 75217

Equipment

Burlington, Mass. 01803. (617)273-1488.
Signal controlled dynamic noise filter, news beeper enhancer.

C

CableData, a division of U.S. Computer Systems. 1931 K St., Sacramento, Calif. 95814. (916) 441-4760. Robert J. Mathews, pres; Rodney A. Hansen, VP, mktg & customer service.

Cablevision Construction Corp. 530 N. Belt East Suite 111, Houston 77037. (713) 445-8844. Clifton H. Gardiner, pres.

Construction of aerial and underground cable TV systems.

Cablewave Systems Inc. 60 Dodge Ave., North Haven, Conn. 06473. (203)239-3311. Kenneth Robinson, mktg mgr; William Meola, bcst sls mgr.

Transmission-line systems, elliptical wave-guide systems.

See adv, page E-9

Cal-Tel Construction Co. Inc. Robert G. Owens Inc. 2698 St. Louis Ave., Signal Hill, Calif. 90806. (213)426-7041. Robert G. Owens, pres; Ed. E. Cooper, exec VP; Steve Roberts, engrg mgr.

Raleigh, N.C. 27607: Robert G. Owens Inc. 3087 Medlin Dr. (919)787-8886. Gerald Haisman, exec VP.

Calvert Electronics Inc. 220 East 23rd St., New York 10010. (212)679-1340. Murray Fudim, pres; Bernard Fudim, VP; Fred Samuel, bcst sls; Frank Rodosta, gen mgr.

The Camera Mart Inc. 456 W. 55th St., New York 10019. (212)757-6977. Samuel Hyman, pres; Paul Meistrich, VP; Shelly Brown, gen mgr; Leo Rosenberg, rental mgr; Herb Browning, sls mgr.

See adv, page E-11

Camex Corp. 6362 Hollywood Blvd. Suite 222, Hollywood 90028. (213) 464-0174. Don W. Clark, pres; John Price, VP mktg.

Programming automation systems.

Canon U.S.A. Inc. 10 Nevada Dr., Lake Success, N.Y. 11040. (516)488-6700. Seiichi Takikawa, pres; Yoshifumi Suguri, VP; Jack Keys, mktg mgr of bcst optics; Hiroto Kagami, service dir.

Elmhurst, Ill. 60126: 457 Fullerton Ave. (312)833-3070. Matt Miyazaki, rgnl sls mgr optics.

Costa Mesa, Calif. 90010: 123 Paularino Ave. (714)979-6000. Paul Powers, rgnl sls mgr.

Mississauga, Ont.: 3245 American Dr. (416)678-2730. Tadzuki Sakurai, rgnl sls mgr.

See adv, page E-13

Capitol Magnetic Products/Division of Capitol Records Inc. 1750 North Vine St., Los Angeles 90028. (213) 462-6252. Harry Preston, mktg mgr; Jack Ricci, dir mktg svc; A.P. Cunha, exec VP; W. Bollinger, dir mktg; L. Hockenmeyer, natl sls mgr.

New York 10019: 1370 Ave. of the Americas. (212) 757-7470. Tony Sanchirico, rgnl mgr.

Niles, Ill. 60648: 6401 Gross Point Rd. (312) 775-7101. Dick Dunlavy, rgnl mgr.

Los Angeles 90065: 3117 San Fernando Rd. (213) 255-5103. Bud LaGrandere, rgnl mgr.

Broadcast cartridges.

Catel (division of United Scientific Corp.) 1400 D Stierlin Rd., Mountain View, Calif. 94043. (415) 965-9003. Frank A. Genocchio, pres; Donald R. Lolli, mgr of engrg; Richard Old, sls mgr-CATV; Art Osborn, mgr opns.

TV and FM modulators and demodulators for coaxial cable applications.

CBS Technology Center. 227 High Ridge Road, Stamford, Conn. 06905. (203) 327-2000.

CCA Electronics Corp. 716 Jersey Ave., Gloucester City, N.J. 08030. (609) 456-1716. Jason S. Fox, VP and chief optg officer; Robert Sidwell, VP-sls.

Mexico City: Medellin No. 94B. (905) 525-8074. Carlos Caballero.

Athens: Athens Tower Bldg. B. 779-0602. James Potamos.

Riyadh, Saudi Arabia: Box 1456. 67892. Ghassan Azem.

Binghamton, N.Y. 13903: RFD 1. (607) 724-5608. Charles Hallinan.

Lebanon, Tenn. 37087: Box 609. (615) 444-0305. William Barry.

Fresno, Calif. 93703: 1568 N. Sierra Vista. (209) 251-3008. Robert Sidwell.

Bountiful, Utah 84010: 187 West 3100 South. (801) 295-4823. Morris J. Jones.

Chicago 60631: 6838 N. Ottawa. (312) 774-5115. Gorden DuVal.

Honolulu: Broadcast Services Inc., 2877 Kalakaua Ave. (808) 533-3877. Alan Roycroft.

Toronto: Caldwell A/V Equipment Co., 1080 Bellamy Road, North. (416) 438-6230. William Jones.

AM/FM/TV broadcast transmitters, antennas, related equipment.

C-COR Electronics Inc. 60 Decibel Rd., State College, Pa. 16801. (814) 238-2461. James R. Palmer, pres & dir of mktg; J. Joseph Howe, treas.

CATV distribution systems, trunks, bridgers, extenders, passives, preamplifiers.

Central Dynamics Corp. Box 116, 230 Livingston St., Northvale, N.J. 07647. (201)767-1300. Eric Dalton, pres; Charles Beard, exec VP; Robert Heuffed, VP.

Chicago 60056: (312)259-8099. Robert Faulkner, district sls mgr.

Atlanta 30347: (404)963-3141. Richard DeBaradinis, district sls mgr.

TV station automation equipment, automatic tape editing systems.

Cetec Audio, Division of Cetec Corp. 13035 Saticoy St. Box 3941, N. Hollywood, Calif. 91605. (213) 875-1900. Mort Fujii, gen mgr; Jules Sack, mktg & sls dir; M. Gessaro, cont; E. Wheeler, dir of eng.

London W5 2BP: 15 Uxbridge Rd. (01) 579-9145. Brian Wills, man dir.

Audio consoles, high speed tape duplicators, loudspeakers, equalizers.

Channell Commercial Corp. 620 West Foothill Blvd., Glendora, Calif. 91740. (213)963-1694. William H. Channell, pres.

Pedestal housings and underground housings for directional taps, line extenders, amplifiers.

Chiron Telesystems. 11 Grace Ave., Great Neck, N.Y. 11021. (516) 829-5666. Leon Weissman, pres; Joseph L. Scheuer, VP; David H. Buckley, eastern rgnl sls mgr.

Burlingame, Calif. 94010: 851 Burlway Rd. (415) 348-1144. David S. Siegel, western rgnl sls mgr.

High resolution character and graphics generators.

Chrono-Log Corp. 2583 W. Chester Pike, Broomall, Pa. 19008. (215)356-6771. A. Freilich, pres; D. Biberman, mktg mgr.

Cinema Products Corp. 2037 Granville Ave., Los Angeles 90025. (213)478-0711. Ed DiGuilio, pres; Peter Waldeck, mktg mgr.

Long Beach, N.Y. 11561: 262 Long Beach Blvd. (516) 889-2484. Eric Falkenberg, eastern sls mgr.

16mm motion picture cameras for TV news coverage.

Cohu Inc., Electronics Division. Box 623, San Diego 92112. (714) 277-6700. J.W. Barnes, pres; R.J. Schlicht, VP/mktg; E.V. Dempsey, sls mgr.

Cerritos, Calif. 90701: 13750 Lucas Lane. (213)926-7002.

Florham Park, N.J.: (201) 377-6636. Washington: (301) 656-3061.

Wayne, Pa.: (215) 688-7325. Michigan City, Ind.: (219) 874-3333.

Orlando, Fla.: (305) 896-4881. Huntsville, Ala.: (205) 881-6220.

Lincoln, Neb. 68505: 420 Steinway Rd. (402)467-2900.

Greensboro, N.C.: (919) 273-1918. Denver: (303) 573-8835.

Arlington, Tex. 76013: 2109 Woodside Dr. (817) 461-1707.

San Diego: (714) 278-8931. Costa Mesa, Calif.: (213) 869-5884.

Palo Alto, Calif.: (415) 326-0280. Bedford, Mass. 01730: 12 Lido Lane. (617) 275-0370.

Monochrome and color TV camera systems.

Collins Radio Group/Rockwell International. 1200 N. Alma Rd., Richardson, Tex. 75080. (214) 900-5574. H.L. Kirby Jr., gen mgr, bcst prod; D.A. Senter, mgr of mktg, bcst prod.

Madeira Beach, Fla. 33708: 14018 W. Parsley Dr. (813) 391-8065. R.J. Henry, district mgr.

Maple Plain, Minn. 55359: 200C West Branch Rd. (612) 479-2633. J.L. Littlejohn, district mgr.

Pineville, La. 71360: 8427 Ridgemont Dr. (318) 640-3412. W.J. Monroe, district mgr.

Yuma, Ariz. 85364: 1450 W. Arroyo Dr. (602) 783-6380. Morris Courtright, district mgr.

Rockford, Tenn. 37853: Route 2 Box 12. (615) 573-9717. R.C. Evans, district mgr.

Titusville, N.J. 08560: Fabrow Dr. (609) 737-3691. A.A. Silver, district mgr.

Sterling Heights, Mich. 48077: 38780 Hartwell. (313) 979-6320. D.W. Hill, district manager.



**For TV Sound
at its very best...**

Audio Designs NEW TV 32 Broadcast Production Console

Stringent electronic specifications Flexibility for expansion

ADM's all-new TV 32 Consoles are engineered to meet the most exacting requirements for television production. They are modular, multi-input (up to 32) by 4 submaster busses, TV Studio and Production Center units that will professionally handle any program material in large or small stations.

These full-featured, floor standing consoles incorporate the latest audio production philosophies into broadcast parameters. They are skillfully engineered to provide the professional broadcaster with the most demanded features. TV 32 Series Consoles offer exceptional flexibility for future expansion by plugging in additional modular components. Chances are one of our "stock" units will meet your requirements. If not we will be glad to design a custom console tailored to your exact needs.

ADM is a leading producer of highest quality professional audio consoles. Our key people have had impressive studio broadcast experience, and all of their expertise has been applied to our consoles.

An all-inclusive 5-Year Warranty covers parts and labor, and back-up technical assistance is always available from the factory. Write for Technical Brochure detailing all of the important features of ADM consoles.

BC-5 Broadcast Production Consoles

A table-top version of the TV 32 using the same high quality components. Allows for future expansion through the choice of modular plug-in components.

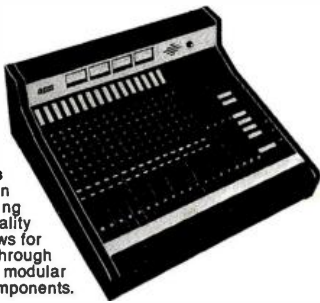

AUDIO DESIGNS AND
MANUFACTURING, INC.
16005 Sturgeon
Roseville, Michigan 48066
Phone: (313) 778-8400, Cable: AUDEX

AMPEX
DISTRIBUTED OUTSIDE U.S.A.
BY AMPEX INTERNATIONAL OPERATIONS, INC.



Equipment

Oak Grove, Mo. 64075: Route 1, Box 217-B. (816) 229-1441. J.C. Shideler, district manager.
Richardson, Tex. 75080: 1200 N. Alma Rd. (214) 690-5424. R.S. Rentfrow, district manager.
Portland, Ore. 97203: 1122 N.E. 122nd Ave. Rm. B-211. (503) 254-2818. R.G. Beattie, district manager.
Richardson, Tex. 75080: 1200 N. Alma Rd. (214) 690-5575. C.A. Fosmark, intl sls coordinator.
Individual components or complete radio stations.

Colorado Video Inc. P.O. Box 928, Boulder, Colo. 80302. (303) 444-3972. Glen Southworth, pres and sls mgr; John Sparks, senior eng.
Thousand Oaks, Calif. 91361: 1562 Devonshire Ave. (213) 889-3653. Darrell Bevan.

Dallas 75240: 13844 Peyton Dr. (214) 233-5497. John Fitzgerald, sls.
Video instruments: digitizers, quantizers, analyzers, data camera, slow scan converters, computer.

ComCoach Corp. Box 843, Setauket, N.Y. 11733. (516) 751-7741. Bruce H. Anderson, pres; Jack C. Kavoukian, VP.

Commercial Electronics Inc. 880 Maude Ave., Mountain View, Calif. 94043. (415) 969-1910. Fred Houwink, chmn of the bd; George Grasso, VP-mktg; Bill Riestler, VP-fin; Marc Broemmelsiek, VP-eng.
Color TV broadcast cameras.

Comm/Scope Co. Box 2406, Hickory, N.C. 28601. (704) 328-5271. Frank Drendel, dir of mktg; James E. Webb, sls mgr.
Coaxial cable.

Communications Technology Inc. 3070 Leeman Ferry Rd., Huntsville, Ala. 35801. (205) 883-7370.

Compu/Net Inc. 8616 La Tijera Blvd., Los Angeles 90045. (213) 642-2211. Edwin J. Stevens, pres; Maurie Webster, exec VP; Ernest E. Holling, VP; Gilbert McCoy, VP/finance; William G. Hunefeld Jr., VP/bcst svcs; G.C. Bustamante, VP/opns; Robert L. Owens, VP/sls-mktg; Robert McCauley, dir/prod grp; Henry C. Rogers, dir instal.
New York 10019: (212) 262-5293. Robert L. Owens, VP/sls-mktg.
Radio and television systems.

QUALITY TALKS FOR KAYO

Seattle, Washington



Continental's new 5/10 kW AM transmitter is setting records for acceptance. It has performance and efficiency, with the cleanest sound around. Listen to Continental: quality talks.

Continental Electronics

CONTINENTAL ELECTRONICS MFG. CO.
BOX 17040 DALLAS, TEXAS 75217

- ITFS/MDS Transmitters and Receivers
- Microwave Path Survey Equipment
- Low-Cost FM Microwave Receivers for Satellite Terminals

varian MICRO-LINK®
beverly, mass. (617) 922-6000

Computer Image Corp. 2475 West Second Ave., Denver 80223.

Vertical interval switchers.

Computer Magnetics Corp. 125 West Providencia Ave., Burbank, Calif. 91502.

Refurbished video head assemblies, audio stacks for VTR's.

Computer Visuals Inc. 3 Westchester Plaza, Elmsford, N.Y. 10523. (914) 592-4646. Phillip S. Mittelman, pres; Robert Goldstein, tech dir; Bo Gehring, creative dir; Larry Elin, account exec.

Comquip Inc. 366 South Maple Ave., Glen Rock, N.J. 07452.

Fixed lens adapter.

Comrex Corp. 56 Union Ave., Sudbury, Mass. 01776.

Wireless microphone system, cue transmitters and receivers.

ComSonics Inc. Box 1106, Harrisonburg, Va. 22801. (703) 434-5965. Warren L. Braun, gen mgr, pres; James Zirk, bus mgr; Richard Shimp, dir of rsch & dev; C.H. Hensley, dir of CATV svcs; Fred Rogers, dir of laboratory support services; Dennis Zimmerman, dir of propagation analysis; Donald Suter, cont.
R&D, CATV equipment, specialized CATV instrumentation products.

Comspace Corp. 350 Great Neck Road, Farmingdale, L.I., N.Y. 11735. (516) 293-5525. Irving Becker, pres.

Conrac Division/Conrac Corp. 600 N. Rimsdale Ave., Covina, Calif. 91722. (213) 966-3511. L.M. Ryan, gen mgr; William A. Fink, mktg mgr, video products; William A. Ems, Western rgnl sls mgr; R.T. Carson, mgr, monitor engng; C.D. Beintema, mgr, display device engng; FF. Heyer, mgr, tech support engng.

Des Plaines, Ill. 60018: 3166 Des Plaines Ave. (312) 298-8577. John F. Keenan, Midwestern rgnl sls mgr.

Elmsford, N.Y. 10523: 122 E. Main St. (914) 592-5522. John McCliment, Eastern rgnl sls mgr.

Video monitors, computer terminals, alphanumeric CRT displays and TV demodulators.

Continental Electronics Mfg. Co. P.O. Box 17040, Dallas 75217. (214) 381-7161. J.O. Weldon, pres; M.W. Bullock, VP mktg; W.D. Mitchell, VP engng; A.V. Collins, mgr bcst sls.

Transmitters and accessories for AM broadcast service.

Control Design Corp. 205 S. Whiting St., Alexandria, Va. 22304. (703) 751-5650. Tom Kitaguchi, chief engr; Eric Wright, export mktg mgr; Ronald L. Rasmus, pres; Ben Abeil, cust eng; William J. Bridges, VP mktg.

Modular broadcast automation systems and components for aural broadcasting.

See adv, page E-15

Control Technology Inc. 2513 Tortugas Lane, Ft. Lauderdale, Fla. 33312. (305) 587-2716. James C. Woodworth, pres.

Broadcast equipment distributor, specializing in automation.

Cooke Engineering Co. 900 Slaters Lane, Alexandria, Va. 22314. (703) 548-3889.

See adv, page E-10

Copperweld Corp.—Copperweld Bimetallics Division. Box 1000, Glassport, Pa. 15045. (412) 664-7131. D.T. Jones, chief-product engng; G.H. Parker, VP and gen mgr; P.J. Komaromy, mktg spec.

Corning Glass Works. 3900 Electronics Dr., Raleigh, N.C. 27604.

Image enhancer, standard and custom-built video delay lines.

Cosmic Optical Co. Ltd. 2-568 Shimochiai Shinjukuku, Tokyo.

Cox Data Systems Inc. 1601 W. Peachtree St., N.E., Atlanta, Ga. 30309. (404) 897-7390. Allan M. Sanders, VP; James E. Minor, VP & gen mgr; James A. Landon, exec VP; Tommy Drum, VP, CATV/Batch svcs; Ron Jones, sls mgr.

Mini-computer, batch and time-sharing data processing systems.

C.R.C. Inc., Visual Aids Division. Box 219, Chatsworth, Calif. 91311. (213) 882-3151. J.J. Marks, pres; J.C. Henderson, VP; C. Hardin, sls mgr.

IBM videowriter, single unit prompters, ribbons, prompter paper.

Creative Electronic Designs. 19 Sicard Ave., New Rochelle, N.Y. 10804. (914) 636-2494. Gregory E. Hyman, pres.

Creative Video Associates Inc. 1542 N. Myers St., Burbank, Calif. 91506. (213) 841-3020. William Carlquist, pres; Robert Minges, exec VP; Douglas Donald, sec-treas.

Portable video production systems.

CRL Electronics. 200 Park Ave. South, New York 10003. (212) 777-5517. Chifra R. Levit, pres.

Crown International. 1718 W. Mishawaka Rd., Elkhart, Ind. 46514. (219) 294-5571. Clarence C. Moore, pres; Max W. Schofield, sr. VP; Clyde W. Moore, VP mktg; Glen Ryman, prod VP.

Power amplifiers, control centers, tape recorders, loudspeakers, distortion analyzers.

CSI Electronics Inc. 835 Industrial Highway, Bldg. 4, Cinnaminson, N.J. 08077. Bernie Gelman, pres; William Moats, VP mktg.

D

Dage-MTI Inc. Box 1033, Michigan City, Ind. 46360. (219) 872-5514. Arthur D. Sterling, pres.

Douglasville, Pa. 19518: Box 416. (215) 582-2716. Paul Thomas, East Coast rgnl mgr.

Redwood City, Calif. 94063: Box 5134. (415) 365-0800. Hank Bogardus, West Coast rgnl mgr.
CCTV accessories.

Data Communications Corp.(BIAS). 3000 Director's Row, Memphis 38131. (901) 332-3544. Norfleet R. Turner, pres; James L. Thornton, exec VP; James E. McKee, senior VP sls.

On-line sales, traffic, accounting and engineering automations system.

Data Disc Inc. 686 W. Maude Ave., Sunnyvale, Calif. 94086. (408) 732-7330. James J. Woo, pres; Esmond C. Lyons Jr., VP mktg.

Elmsford, N.Y. 10523: 249 Saw Mill River Rd. (914) 592-8658. Frank Iazzetta, rgnl sls mgr.

Westwood, Mass. 02090: 5 Barlow Lane Suite 6A.

Cablewave Systems gives you a greater selection of coax construction.

If you're faced with the specifying or purchasing of coaxial cable, here's a complete single source for just about everything you need. We offer four different constructions, air and foam dielectric, smooth wall aluminum or copper corrugated sheathing, in sizes ranging from 1/4 inch to 3 1/2 inches . . . Continuous lengths to 5,000 feet . . . custom cut lengths . . . phase temperature stabilized cable . . . connectors installed on request.

Look to the leaders in coaxial cable. Look to Cablewave Systems. Call or write for literature and prices: Cablewave Systems Inc., 60 Dodge Avenue, North Haven, Connecticut 06473, 203-239-3311. West Coast Office: 790 Lucerne Drive, Sunnyvale, California 94087, 408-735-8500.

Cablewave Systems Inc.



New from Cooke

SMPTE

Video Taping/Editing Accessories

OUR NEW SMPTE TIME CODE SYSTEMS PROVIDE UNIQUE FEATURES AND THE LATEST STATE-OF-THE-ART DESIGNS.

SMPTE TIME CODE GENERATOR



Fully compatible with any SMPTE time code editing system, and meets or exceeds all SMPTE specs. Operates on sync or composite video input. Drop frame mode keeps generator on time when used with NTSC color video sources. Timing is unaffected by momentary power drop outs. Easy time set and large LED display readable at 30 feet. Two isolated outputs at +11 dBm into 600 ohms. Options include 10 outputs and .32 user bits per frame.

SMPTE TIME CODE READER/CHARACTER GENERATOR

Reads SMPTE code, generates 36 line high resolution digital characters, and adds time code characters to video. Valuable quad recorder time can be reduced by making editing decisions off-line on inexpensive helical or cassette machines. Allows time code display on studio or mobile unit monitors during production or VTR playback.



TAPE TIMER

Replaces mechanical counter and motion sensor on RCA and Ampex VTR's. Optical system provides greater accuracy than mechanical counter with the added feature of large easy to read LED digital display. Optional remote readouts and thumbwheel time set switches.



BE SURE WITH COOKE BROADCAST PRODUCTS

MASTER CLOCK SYSTEMS • VIDEO/AUDIO PATCHING EQUIPMENT • VIDEO/AUDIO/PULSE DISTRIBUTION MODULES • VIDEO TAPING/EDITING ACCESSORIES

COOKE ENGINEERING COMPANY

DIVISION OF DYNATECH LABORATORIES, INC.
900 SLATERS LANE, ALEXANDRIA, VA. 22314
TEL: 703-548-3889 TELEX: 89-9454

AVAILABLE IN CANADA FROM:

TELCOM RESEARCH

P. O. Box 271 STONEY CREEK, ONTARIO TEL: (416) 622-1372

(617) 329-6373. Martin J. Fitzgerald, rgnl sls mgr.
Detroit 48239: 9125 Telegraph Rd. (313) 535-2110. Leonard D. Mayers, rgnl sls mgr.
Alexandria, Va. 22314: 421 King St. Tavern Square Suite 217. (703) 765-0224. John W. Sellers, rgnl sls mgr.
Topanga, Calif. 90290: 21253 Chagall Rd. (213) 883-8413. Kurt Zimmerman, rgnl sls mgr.
Broadcast video disc recorder.

Datavision Video Products, Mincom Division, 3M Co. 15932 Shady Grove Road, Gaithersburg, Md. 20670. (301) 948-0460. Frank J. D'Ascenzo, sls mgr. Datavision/Video Products; James N. Mazzoni, mfg mgr; A. Mattia, prod mgr; C. German, engrg mgr.

Full line of television character generators for display of alpha and numeric characters on TV monitor.

Davis & Sanford Co. Inc. 24 Pleasant St., New Rochelle, N.Y. 10802. (914) 632-1636. E. Resk, VP; W. Resk, VP.

DBX Inc. 296 Newtorf St., Waltham, Mass. 02154. (617) 899-8090.

Delta Electronics Inc. 5534 Port Royal Road, Springfield, Va. 22151. (703) 321-9845. Stephen W. Kershner, pres; Charles S. Wright, VP engrg; Russell E. Geiger, exec VP; Joe Novak, sls eng; John Wright, prod mgr.

Antenna monitors, impedance bridges, receiver-generators, remote control equipment.

See adv, page E-17

Desk-Sign Manufacturing Co. 223 S. 61st St., Philadelphia 19139. (215) 747-2565. Stanley E. Stady, pres; Jack Simmons, sls mgr.

Name plates, ID pins, plastic signs.

Diamond Expansion Bolt Co./Division of General Cable Corp. 500 North Ave., Garwood, N.J. 07027. (201) 789-1400. Kenneth Hootnik, gen mgr; Donald Garretson Jr., dir of mktg & sls.

Bell Gardens, Calif. 90201: 7500 S. Garfield Ave. (213) 927-2636. R.A. Stark, rgnl mgr.

Atlanta 30345: 2200 Park Lake Dr. (404) 934-2080. Jack Wright, rgnl mgr.

Des Plaines, Ill. 60018: 1701 Birchwood Ave. (312) 299-7139. E. Ziegler, svc mgr.

Masonry equipment, communications support hardware.

Dielectric Communications. Route 121, Raymond, Me. 04071.

Obstruction lights, wattmeters.

Digital Video Laboratories Inc. 1051 Clinton St., Buffalo, N.Y. 14206.

Digital time base correctors and video processors.

Dipol Electronics Inc. 1051 Clinton St., Buffalo, N.Y. 14206.

Dolby Laboratories Inc. 1133 Ave. of the Americas, New York 10036. (212) 489-6652.

M. Ducommun Co. 580 Fifth Ave., New York 10036. (212) PLaza 7-2540. M. Ducommun Jr., mgr (radio-TV stop watches).

Duncan Electronics Inc. 2865 Fairview Rd., Costa Mesa, Calif. 92626.

Slide controls for audio control equipment.

Durnell Engineering Inc. Highway 4 South, Emmetsburg, Iowa 50536. (712) 852-2611. Morris Durnell, pres; Jack R. Adams, sls mgr.

Aerial personnel lifts.

DYMA Engineering. Route 1 Box 51, Taos, N.M. 87571. (505) 758-2686. C.G. Cunningham, pres; J.A. Cunningham, sec.

Inglewood, Calif. 90302: 505 1/2 Centinela 90302. (213) 674-2806.

San Antonio, Tex. 78229: 5006 Beverly Mae. (512) 696-2619.

Consoles, audio amplifiers and processors, broadcast equipment.

Dynair Electronics Inc. 6360 Federal Blvd., San Diego 92114. (714) 582-9211. W.M. Fischer, VP finance; R.N. Vendeland, VP mktg.

Video and audio routing switchers.

Dynasciences Video Products. Township Line Rd., Blue Bell, Pa. 19422. (215) 643-0250. Joseph Domagala, gen mgr; Joseph Waltrich, video prod mgr.

Image enhancers, processing amplifiers, routing switchers, chroma keyers.

WHAT WE DO FOR YOU IN NEWSFILM,

Newspeople, you're OK.

You're tough. You're smart. You're our most demanding customers. But who can blame you? After all, news happens only once. And when you've drawn a rough assignment, it's difficult enough getting the footage you want, without having to worry about your equipment.

No wonder we're so flattered. You've made us one of the top (if not *the* top) newsfilm equipment dealers in the country. Renting, leasing and buying more CP-16's, Arri's, Scoopics and other cameras. Not to mention Nagras, Uhers, Sennheisers and Moviolas. To name just a few.

And we intend to keep you happy. By doing what we've always done. Checking equipment out, even fresh from the factory box. Keeping our rental stock the youngest and best maintained around. And making sure our pencils stay sharp.

Because the more we do for you, the more you'll do with us.

WE CAN DO FOR YOU IN ENG.

Whether you've cut your teeth on portable video, or you're just beginning to look at it, we've got what it takes to help. Starting with an understanding of what news is all about.

So it's not surprising that we offer a broad line of products from some of the world's leading manufacturers. Including Sony, Hitachi-Shibaden, Ikegami, and Akai. To name just a few. From hand-held cameras to over-the-shoulder plumbicons. Compact portable cassettes to full helical editing and time-base correctors. And much more.

We'll also offer you competent advice, backed by solid technical know-how and experience. So that the investment you make in ENG today doesn't wind up gathering dust tomorrow. Talk to us. You'll see why, when it comes to news in film or video, it pays to come to Camera Mart. For more information, talk to Shelly Brown in Film or Ken Seelig in Video.

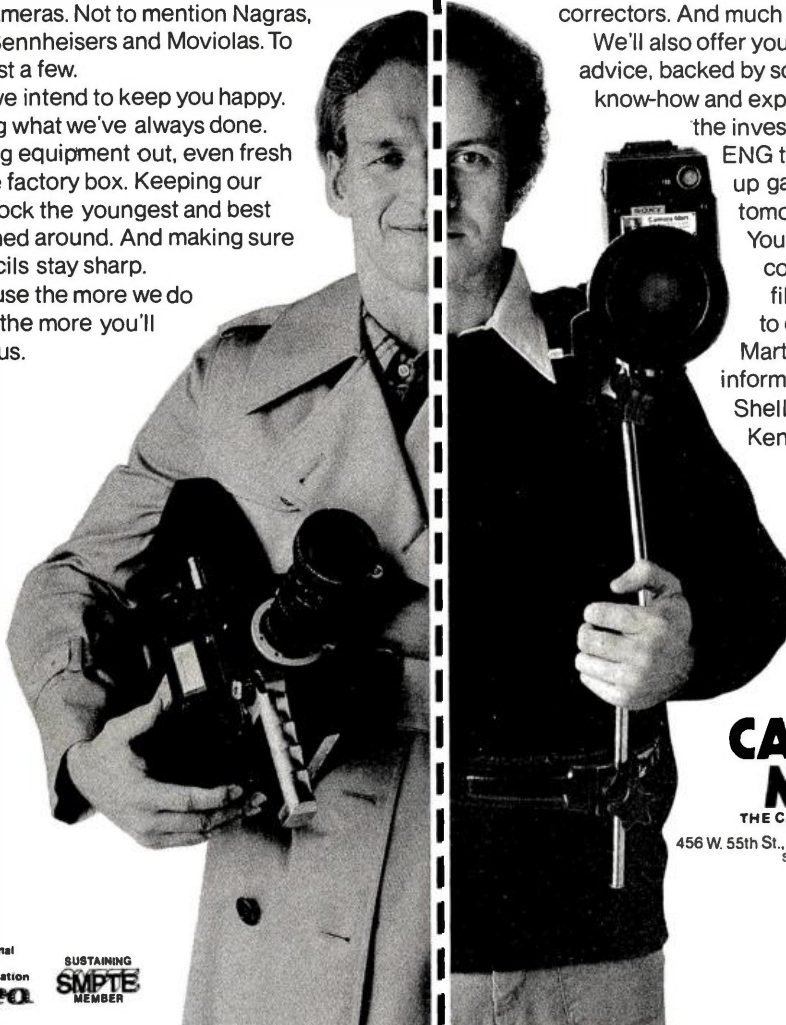

CAMERA MART

THE CAMERA MART, INC.

456 W. 55th St., New York, 10019 (212) 757-6977
SALES SERVICE RENTAL

Member Professional
Motion Picture
Equipment Association
pmpca

SUSTAINING
MEMBER
SMPTE

- **DUMMY LOADS**
100 to 1.5 Million Watts Average Power
- **FM/LOW TV DRY LOADS TO 75KW**
- **AM/VHF DRY LOADS TO 200KW**
- **COAXIAL WATER LOADS**
- **DIRECTIONAL COUPLERS** UP TO 6-1/8 EIA LINE
- **RF POWER METERS** IN LINE/TERMINATING
- **RF ATTENUATORS**
- **RF DRY BALUNS**
- **RF CALORIMETERS**



OUR 26th
YEAR OF
GROWTH

116 CHESTNUT ST., RED BANK, N.J. 07701
TELEPHONE: 201-741-0404

QUALITY TALKS FOR XEQ

Mexico City, Mexico

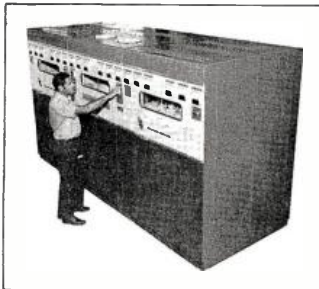

Continental's 317C is the best measure for any 50 kW AM transmitter purchase. Performance, 125% positive modulation and reserve power capabilities are unbeatable. Today's best sound in 50 kW AM is Continental.

Continental Electronics

CONTINENTAL ELECTRONICS MFG. CO.
BOX 17040 DALLAS, TEXAS 75217

Equipment

E

Eastman Kodak Co. 343 State St., Rochester, N.Y. 14650. (716) 325-2000. Kenneth M. Mason, asst VP & gen mgr, motion picture and AV mkt div.

Atlanta 30302: Box 4778 Federal Annex. (404) 351-6510. Edward M. Warnecke, rgnl sls mgr, motion picture & educ markets division.

Dallas 75235: 6300 Cedar Springs Rd. (214) 351-3221. J.M. McDonough, rgnl sls mgr, motion picture & educ markets division.

Hollywood 90038: 6706 Santa Monica Blvd. (213) 464-6131. A.L. Williams, rgnl sls mgr, motion picture & educ markets division.

New York 10036: 1133 Ave. of the Americas. (212) 262-6000. John H. Maynard, rgnl sls mgr, motion picture & educ markets division.

Oak Brook, Ill. 60521: 1901 W. 22nd St. (312) 654-5300. L.F. Coleman, rgnl sls mgr, motion picture & educ markets division.

San Francisco 94109: 3250 Van Ness Ave. (415) 776-6055. Vaughn C. Shaner, rgnl sls mgr, motion picture & educ markets division.

16 and 35mm films, processing chemicals, projection equipment, TV super 8 products.

Echo Science Corp. an Airvin Systems Inc. Co. 485 E. Middlefield Rd., Mountain View, Calif. 94043. (415) 961-7145. J. Robert Burns, pres; Robert J. Walker, VP & gen mgr; Sidney S. Damron, VP engrg & product dev; Ted W. Barger, VP product mgt; William McSweeney, chief engr-coml rotary products.

Dayton, Ohio, 45403: (513) 258-2181. Orie Fritts, VP.

Edison Electronics—A McGraw-Edison Co. Division. Grenier Field, Municipal Airport, Manchester, N.H. 03103. (603) 669-0940. E. Allman, pres; G. McCarthy, VP; E. Nelson, controller; O. Riss, gen mgr; R. Smith, sls mgr; Neel McCullough, adv mgr; M. Zanichowsky, dir of engrg.

Editel Communications Ltd. 5610 Bois Franc, Montreal H4S 1A9. (514) 331-2951. G.R. Jebson, pres; R.E. Belcher, VP.

Mobile equipment, hand held color cameras.

Edutron Inc. 3700 North East 53rd Ave., Gainesville, Fla. 32601. (904) 377-1411. Virgil Lowe, pres.

Video signal processing.

EEDO. 1441 E. Chestnut Ave., Santa Ana, Calif. 92701. (714) 835-6000. PF Cadigan, pres; W.O. Fordiani, VP mktg; G.R. Swetland, prod mgr.

Electronic editing, indexing and synchronizing equipment.

Efratom California Inc. 3303 Harbor Blvd., El Costa Mesa, Calif. 92626. Tom Christensen.

Eidson Electronic Co. P.O. Box 96, Temple, Tex. 76501. (817) 773-3901. Merrill Eidson, own & mgr. Quartz crystals.

EIMAC Division of Varian. 301 Industrial Way, San Carlos, Calif. 94070. (415) 592-1221. R.H. Herdman, VP & gen mgr; J.R. Quinn, mktg mgr; W.I. Orr, adv mgr. Salt Lake City: 1678 S. Pioneer Rd. (801) 487-7561. H.R. Runyon, plant mgr.

Elcom Systems Inc. 127F Brook Ave., Deer Park, N.Y. 11729. (516) 667-5800. Leonard Pollachek, pres.

Coaxial and printed circuit attenuators, terminations, couplers and power dividers.

Electrohome Ltd. 809 Wellington St., Kitchener, Ont. Color and mono video monitors.

Electro Impulse Inc. 116 Chestnut St., Red Bank, N.J. 07701. (201) 741-0404. Mark Rubin, pres.

High power broadcast dummy loads, attenuators, power meters.

Electro Sound Inc. 160 San Gabriel Dr., Sunnyvale, Calif. 95030. (408) 245-6600. David Bain, gen mgr; Robert Cochian, VP mktg and sls.

Tape recorders, duplicators, theatre sound systems.

Electronic Industrial Engineering Inc. 7355 Fulton Ave., North Hollywood, Calif. 91605. (213) 764-2411. J. Thompson, pres; D. Chandler, exec VP; Tyrone Deacon, VP-financing; Vroman Riley, VP.

Cherry Hill, N.J. 08034: (609)663-0079. Ronald Yokes, rgnl sls mgr.

Electrovert Inc. 86 Hartford Ave., Mount Vernon, N.Y. 10553. (914) 664-6090. Richard K. Abercrombie, gen mgr; Hani Tawil, chief eng; Paul J. Bud, tech dir; Joseph Lieberman, natl sls mgr.

Atlanta 30341: 5125 Peachtree Rd. NE. (404) 451-9366. John Gammer, southern rgnl mgr.

Santa Ana, Calif. 92701: 1311 E. Chestnut Ave. Suite D. (714) 835-2033. Ted Donoho, western rgnl mgr.

Irving, Tex. 75060: 111 S. Delaware St. (214) 255-1516. Tom Gill, southwest rgnl mgr.

Franklin Park, Ill. 60131: 3210 Wolf Rd. (312) 455-1003. Ray Schlinder, midwestern rgnl mgr.

Terminal blocks and strips, cable harnesses, markers and accessories.

Electro-Voice Inc. (a subsidiary of Gulton Industries Inc.) 600 Cecil St., Buchanan, Mich. 49107. (616) 695-6831. TWX 810-270-3135. Philip Garnick, pres; C.E. Cobb, exec VP; James Mosier, VP-engrg; Marc Johnson, VP-mktg; Harold Long, mktg mgr-speakers; William Raventos, mktg mgr-microphones; William Sutherland, dir adv & sls prom.

Broadcast monitor speakers, full line of microphones.

Visalia, Calif. 93277: Electro-Voice West. (209)734-8131. Dennis Ehrlicke, mgr.

Freeport, N.Y. 11520: EV/Game inc. (613)382-2141. Jim Rohr, sls mgr.

Gananonque, Ont.: E V of Canada Ltd. (613)382-2141. Mark Simmons, gen mgr.

Nidau, Switzerland 2560: Larry Frandsen, mgt dir. See adv, page E-19

Elpa Marketing Industries Inc. Thoresen and Atlantic Ave., New Hyde Park, N.Y. 11040. Recorders, test equipment.

Emcor-ingersoll Products. 1000 W. 120th St., Chicago. Modular enclosure units.

English Electric Valve North America Ltd. 1 American Drive, Cheektowaga, N.Y. 14225. (716) 632-5871.

Rexdale, Ont. M9V 3Y6: 67 Westmore Drive. (416) 745-9494.

Equipment Manufacturers and Distributors. 220 E. 23rd St., New York 10010. (212) 679-1340. Murray Fudim, pres; Bernard Fudim, VP; Frank Rodesta, gen mgr; Fred M. Samuel, mktg mgr.

Camera tubes, transmitting and other tubes.

ESE. 505½ Centinela, Inglewood, Calif. 90302. (213)

Does your AM off-air monitor sound like quality FM?

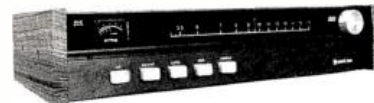

Our Dymek AM5 Does!

- Solid state—FET-IC construction throughout
- Unusually low distortion—less than 1%
- Typical AM "noise and whistles" are 90% eliminated
- Ceramic filters provide remarkable selectivity
- 4 μv sensitivity pulls in the distant stations

Audio Quality comparable to FM!
Order factory direct—\$295.00. Rack mount and 150 or 600Ω impedance output available. We offer 30 day account on your station P/O. Also Mastercharge, BankAmericard and unique rent plan for individuals. For more information, or to place your order, call toll free:

**Nationwide 800/854-7769
California 800/472-1783**



McKay Dymek Co.
675 N. Park Ave., Box 2100
Pomona, CA 91766

IT'S TIME YOU CHANGED THE WAY YOU LOOK AT THINGS.

Broadcast people, you've changed. Over the last few years, you've effectively turned the industry on its ear with a determination to provide your public with more, and *more effective* coverage. Your resolve has brought about vast changes in camera technology—in size, weight, mobility and versatility.



PV10 x 15B.
Lowest-priced
10:1 for major
broadcast cameras.

We've been changing, too. While quietly supplying the broadcast industry with high-quality optics for the last two decades, we've been hard at work, developing a family of lenses to expand the capabilities of broadcast TV equipment... while keeping the economics under control.

You are our requirements. More than any other factor, Canon products are the result of user inputs. So it's no coincidence that we offer the widest, most customized range of optical products for the broadcast field—in terms of function *and* price. From the lightest-weight, most compact (and by the way, most popular) 12-120mm on the market to an enormously-versatile 32-1070mm with

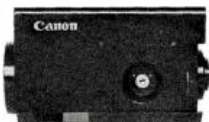

PV25 x 16B-DZ.
Longest low-cost lens
for 1" plumbicons*

continuous zoom and 1.8 meter minimum object distance. Your requirements also inspired our new budget-stretching **Versatility Packages**—

a family of two-lens systems that give one camera the versatility of two at substantial savings. (And we're always listening for new ideas.)

We've invested in you. Because major optical advances don't happen without a lot of expensive thinking and heavy experimentation. While the dividends are visible in every Canon product (for example, for some

years now, we've been pioneers in super spectral coating), they've also won us acclaim in the process. Like a special award from the Motion Picture Academy of Arts and Sciences. No less important, our sizeable investment in manufacture and quality control insures that the advances in our labs aren't diminished on the production line.

You make us look good. Service isn't just a matter of goodwill—it's good business. So we support what we sell with an extensive staff of factory-trained technicians, headquartered in New York, Chicago and Costa Mesa, California. Equipped with the finest, latest test equipment—much of it of our own design. To help insure the consistency of our standards... and facilitate the fastest possible turn-around time.



PV34 x 24B-DZ. Widest
range double-zoom lens.

One demo is worth a thousand claims.

We could spend a lot of time on awe-inspiring technical specs and case-histories. But we'd rather let our lenses do their own talking. More information, or a demonstration are yours for the asking.

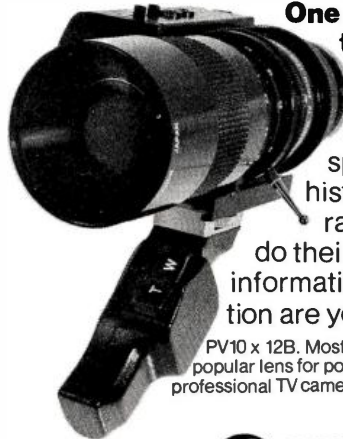

PV10 x 12B. Most
popular lens for portable, hand-held
professional TV cameras.

Canon®

Canon U.S.A. Inc.
Head Office, 10 Nevada Drive,
Lake Success, N.Y. 11040
140 Industrial Drive
Elmhurst, Illinois 60126
123 Paularino Avenue East,
Costa Mesa, Ca. 92626

Canon Optics & Business Machines
Canada, Ltd. 3245 American Drive,
Mississauga, Ontario. L4V 1B8, Can.
Canon Amsterdam N.V.
Industrial Products Division
De Boelelaan 8
Amsterdam, Netherlands
* © N.V. Philips of Holland

Equipment

874-3021. J.D. Johnson, pres; R.M. Mayers, VP.
Solid state digital clocks, timers and programmers.

Essex International Inc. Communications & CATV Division. 6235 S. Harlem Ave., Chicago 60638. (312) 586-3000. D.R. Carpenter, VP & gen mgr; J.W. Holland, gen mgr; D.R. Gust, plant mgr; G. Shemwell, customer service mgr.

E-Z Way Products Inc. P.O. Box 22845, Tampa, Fla. 33622. (813) 677-7144. Cyril B. Rogers, pres.
Communication towers.

F

F&B/Ceco Inc. 315 W. 43d St., New York 10036. (212) 586-1420. John Babb, pres; Walter Druker, VP; Philip Graff, treas.
Los Angeles 90038: (213) 466-9361. Carl Porcello, pres.

Fairchild Sound Equipment Corp. 75 Austin Blvd.,

Commack, N.Y. 11725. (516) 543-5200. Herman D. Post, pres; Warren W. Meuselbach, VP; Jack Friedland, VP (Robins); Samuel C. Jones, sls mgr; Steve Friedman, proj eng.
Broadcast sound and audio equipment.

Farion Electric. 1691 Bayport, Los Altos, Calif. 94070.
FV portable microwave for video relay.

Feller Vacuum Form Studios Inc. 381 Canal Place, Bronx, N.Y. 10451. (212) 993-2999. Mrs. Katherine W. Feller, co-own.

Fernseh-A unit of the Robert Bosch Corp. 279 Midland Ave., Saddle Brook, N.J. 07662. (201) 797-7400. A.R. Pignoni, gen mgr; J.A. Leonard, opns mgr; R.N. Blait, prod mgr.
Los Angeles 90045: 6300 Arizona Circle. (213) 649-4330.
Chicago 60153: 2800 S. 25th Ave. (312) 681-5000.
Houston 77018: 4131 A Directors Row. (713) 688-9171.
Broadcast cameras, film chains, color VTR's.

Fidelpac Div. of Harvel Industries Corp. 109 Gaither Dr., Mt. Laurel, N.J. 08057. (609) 235-3511. Dennis W. Boardman, pres; James P. Rogers, treas; Roger W. Cappello, gen mgr; Gene Bidun, sls and mktg mgr; Dan McCloskey, plant mgr; Arthur Constantine, elec engr; Frank DiLeo, mech engr.
Audio tape cartridges and accessories.

Fimline Corp. 43 Erna St., Milford, Conn. 06463. (203) 878-2433. Edward B. Krause, pres; Jack Grady sls rep; John Koteas, sls mgr.

Florentino Associates Inc. 10 W. 66th St., New York 10023. Imero Florentino.
Production facilities consultants.

Norman Fischer & Associates Inc. Box 5308, Austin, Tex. 78763.

Fixtune Electronics Inc. One W. 30th St., New York 10001. (212) 524-2235. Jack H. Bergman, pres.
Fixed frequency receivers.

Flash Technology Corp. of America. 111 Lock St., Nashua, N.H.
High intensity white obstruction lights.

John B. Fluke Manufacturing Co. Box 7428, Seattle 98133. (800) 426-0361.

Fort Worth Tower. 1901 E. Loop 820 South, Box 8597, Fort Worth 76112. (817) 457-3060. T.W. Moore, pres; Fred Moore, VP; B. Moore, sec-treas.

Freeland Products Co. 3233 Conti St., New Orleans 70119. (504) 822-9223. W.T. Freeland, owner.
Power and transmitting tubes.

Frezzolini Electronics Inc. General Research Laboratory Div. 7 Valley St., Hawthorne, N.J. 07506. (201) 427-1160. James J. Frezzolini, pres; James J. Crawford, VP.
16mm cameras, amplifiers and power packs.

Fuji Photo Film USA Inc., Video Tape Division. 350 Fifth Ave., New York 10001.
Video tape and cassettes.

Fujinon Optical Inc. 420 West End Ave., New York 10024.
Lenses and optical accessories and optical effects system.

G

Garner Industries. 4200 N. 48th St., Lincoln, Neb. 68504. (402) 466-1816. E.D. Garner, pres; Philip Mullin, VP; Jerry L. Williams, sls mgr.
Bulk tape eraser, tape duplicator.

Garron Electronics Inc. 1216 Kifer Road, Sunnyvale, Calif. 94086. (408) 736-8737. Ronald S. DeBry, pres; Ron Eigenmann, dir of mktg; Barbara DeBry, corp sec.
Michigan City, Ind. 46360: Box 269. (219) 879-7333. R. Eigenmann, dir of mktg.
Cartridge tape machines, stereo phase enhancer.

Gates Broadcast Equipment Division—see Harris Corp.

GBC Closed Circuit TV Corp. 74 Fifth Ave., New York 10011. (212) 989-4433. Harry Lefkowitz, pres; Stephen Lefkowitz, VP; Vincent Formicola, VP.
Indianapolis 46220: (317) 257-1337. Michael Ailig, branch mgr.
Oak Park, Mich. 48237: (313) 398-1630. Douglas Mumley, branch mgr.
St. Louis 63132: (314) 994-3211. Philip S. Pagano, branch mgr.
Elk Grove Village, Ill. 60007: (312) 956-1286. John Gray, rgnl mgr.
Boston 02116: (617) 261-2360. Helene Anderson, branch mgr.

General Camera Corp. 471 11th Ave., New York 10018.
16mm cine-sound system, accessories.

General Electrodynamics Corp. 4430 Forest Lane, Garland, Tex. 75042. (214) 276-1161. L.C. Page, pres; F.D. Jackson, VP; Richard Coerver, treas; Ted V. Anderson, mktg mgr; James Cox, contract administrator.

General Television Network. 520 W. Eight Mile Road, Ferndale, Mich. 48220. (313) 548-2500 or 566-2348. Stanley R. Akers, pres; R. Randolph Hippler, VP; Lee Short, chief engr.

Gestetner Corp. Gestetner Park, Yonkers, N.Y. 10703. (914) 968-6666. R.N. Barnett, D. Zealand, G.S. Barnett.
New York 10017: (212) 679-7020. G. Zazza, branch mgr.



Looking for BIG SYSTEM capability in your tower supplier? Fort Worth Tower Company has it. For two decades we've been building high quality communications towers, large and small. Towers for public utilities, railroads, public safety agencies, microwave firms, and the many other communications industries where big system reliability is essential. Towers individually engineered to fit each system's unique requirements.

Fort Worth Tower Co. also offers a complete array of support equip-

ment for your system including microwave reflectors, equipment lifts, and many other related items. You get top performance with a perfect match of equipment and accessories.

For maximum reliability, include a FORT WORTH MOBILT EQUIPMENT BUILDING in your specifications. Designed expressly to house communications electronic equipment, Fort Worth Mobilt's withstand any climate or location problem... house electronic equipment according to the most rigid standards. Your building comes

with supporting I-beams. Simply drop on your site, connect the service inlet, and you're in business. Mobilt's save you time and money because complete wiring is installed at the factory. Many options are available in size, outside finish, wiring and ventilation. You'll find a Mobilt exactly suited to your needs.

We'd like to put our products and experience to work in your system. For full information and a precise quote on your project, please contact us. We'd like the opportunity to serve you.



Fort Worth Tower Co., Inc.

P.O. BOX 8597 / 1901 E. LOOP 820S / FORT WORTH, TEXAS 76112
FORT WORTH PH. (817) 457-3060 // DALLAS PH. (214) 264-2822

AM, FM, SW BROADCAST MODULAR PROGRAM AUTOMATION



CD25G 25 Hz TONE GENERATOR

For production studio use to insert the standard 25 Hz automation actuating tone. Starts tape transport and actuates muting to eliminate bias pops and other start-up noises. Tone button applies 25 Hz tone and stops transport at end of tone.



CD25S 25 Hz TONE SENSOR

Senses the presence of pre-recorded 25 Hz tones on audio material and provides automation control functions. Features tone removal filter, adjustable delayed stop contacts, and fixed tone alarm for automatic tape rewind.



CD60T TIME ANNOUNCE CONTROL UNIT

Adds versatility to your automation system by using two cartridge machines or reel-to-reel transports for automatic time announcements. Contains its own internal IC clock. Power failure interlock disables time announcement until clock reset.

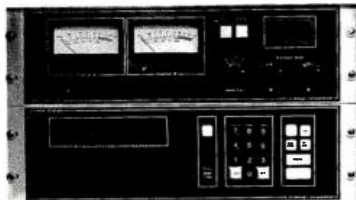

CD28AS SEQUENCER

Low cost way to start automation with easy and economic expansion at a later date. Uses keyboard entry for simplicity of programming. Eighty events of pre-programming provide ample storage for most formats.

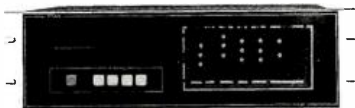

CD12C TIME PROGRAM CONTROLLER

Provides 10 programmable exact time points per hour for real time control of CD28AS and CD28 APM plus digital clock display. 8 relay function outputs for time announcements, transmitter on/off control and other functions. Crystal time base and battery backup.

CDRMD REMOTE CONTROLLER

Provides full entry remote control for traffic department or control room access to automation system. Allows complete programming with display of next-to-run or program-entry.



Control Design provides the total modular approach to AM, FM and Short Wave program automation. Our individual modules may be used alone, assembled into complete automation systems, or used with existing equipment to update and expand automatic programming. All Control Design equipment is manufactured to the highest standards for excellent reliability and easy maintenance. Easily obtained solid state devices are used with printed circuit construction, socket mounted integrated circuits and quick disconnect interface connectors. All equipment is covered by a one year full warranty.

CD24R MULTIPLE CARTRIDGE MACHINE

The CD24R cartridge machine (shown above) is simple and reliable — so reliable it is used by the U.S. Government for flight training. Provides six second access to any one of 24 cartridges.

CD28APM AUDIO CONTROLLER AND PROGRAMMER

The CD28 family of audio controllers is perfect for your new automation system, or for use with present audio sources. Features 2000 pre-programmed events (expandable to 8000) 12 audio sources (expandable to 96), full random select for 9 multiple cartridge players. Accessories include remote control, logging and computer interfaces.



control design corporation 205 S. Whiting St. • Alexandria Virginia 22304 USA
TEL. 703-751-5650
TELEX 899149 • CODECOR

WRITE OR TELEX FOR BROCHURES AND TECHNICAL SPECIFICATIONS

**(217)
222-8200**

**This
number
puts the
Harris
service
team
at your beck
and call**

**The Harris Service Department
is ready to help if broadcast
equipment problems should
arise.**

**Emergency service. Field
service. Technical assistance.
Installation. Check-out.
Parts. Repairs.**

**What we want to do is
make your life easier. And we
mean it when we say Harris
takes "Pride in Service."**

**Remember our number—
24 hours a day—
(217) 222-8200. Harris
Corporation, Broadcast
Products Division,
123 Hampshire Street,
Quincy, Illinois 62301.**



HARRIS
**COMMUNICATIONS AND
INFORMATION HANDLING**

Equipment

Chicago 60610: (312) 467-6411. E. Bowmer, branch mgr.

Los Angeles 90057: (213) 385-9451. T. O'Neill, branch mgr.

San Francisco 94119: (415) 495-4600. J. Rodriguez, branch mgr.

Detroit 48075: (313) 352-5600. A. Van Creveld, branch mgr.

Cleveland 44114: (216) 621-8077. B. Smith Jr, branch mgr.

Miami 33125: (305) 649-3232. A. Munoz, branch mgr.

Houston 77022: (713) 691-2231. M. Pettinger, branch mgr.

Alan Gordon Enterprises Inc. 5362 Cahuenga Blvd., North Hollywood, Calif. 91601. (213) 985-5500. Grant Loucks, pres; Don Sahlein, sr VP; Bob Kuhagen, sr VP; Sylvia Lee, chmn of the bd.

Hollywood, Calif. 90028: 1430 Cahuenga Blvd. (213) 466-3561. Ted Lane, sls mgr.

Motion picture equipment, microfilm, photo instrumentation systems.

Gotham Audio Corp. 741 Washington St., New York 10014. (212) 741-7411. Stephen F. Temmer, pres; Eli Passin, VP; Hugh S. Allen, VP.

Hollywood 90046: 1710 N. La Brea Ave. (213) 874-4444. Hugh S. Allen, VP.

Microphones, disc cutting systems, turntables, tape recorders and input transformers.

The Grass Valley Group Inc. Box 1114, Grass Valley, Calif. 95945. (916) 273-8421. Tom Long, pres; William L. Rorden, sr VP; Robert L. Cobler, mktg VP; Jerry M. Sakai, mfg VP; James M. Ward, exec VP. Sherman Oaks, Calif. 91403: 4419 Van Nuys Blvd. (213) 990-6172. Gordon Sweeley, rgnl mgr.

Great Neck, N.Y. 11021: Station Plaza East (516) 487-1311. Robert Webb, rgnl mgr.

Elkhart, Ind. 46514: 810 W. Bristol St. (219) 264-0931. Louis Swift, rgnl mgr.

Mabank, Tex. 75147: Box 482. (214) 887-1181. W.D. (Bill) Buford, rgnl mgr.

Allanta 30329: 1644 Tully Circle, N.E. (404) 634-0521. Tom Sleeman, rgnl mgr.

TV studio and closed circuit equipment.

Gravco Sales Inc. P.O. Box 1114, Grass Valley, Calif. 95945. (916) 273-8421. Robert L. Cobler, pres.

Los Angeles 90028: 6515 Sunset Blvd. (213) 462-6618. Gordon Sweeley, rgnl mgr.

Great Neck, N.Y. 11021: Station Plaza East. (516) 487-1311. Robert Lynch, district mgr.

Arlington Heights, Ill. 60005: 125 S. Wilke Rd. (312) 394-1344. David Spindle, rgnl mgr.

Dallas 75232: Redbird Airport. (214) 330-1245. Bill Buford, rgnl mgr.

Allanta 30329: 1644 Tully Circle N.E. (404) 634-0521. Charles Moore, rgnl mgr.

Gruber Products Co. P.O. Box 5556, Toledo, Ohio 43613. (419) 476-7200. D.B. Skilliter, pres.

GTE Sylvania Inc. CATV Operations. 114 S. Oregon St., El Paso 79901. (915) 544-7550. P. Kim Packard, gen mgr; R.W. Pawley, mktg mgr; R. Covell, mgr systems engrg.

El Paso 79901: (915) 544-7550. Steve Manly, South Central sls mgr.

Seneca Falls, N.Y. 13148: (315) 568-5881. M. Arnold, Northeast sls mgr.

Decatur, Ala. 35601: (205) 355-6670. M. Hamilton, Southeast sls mgr.

Pekin, Ill. 61554: (309) 347-8556. D. Phillips, North Central sls mgr.

Burlingame, Calif. 94010: (415) 697-3500. C. Awer, Western sls mgr.

GTE Lenkurt Inc. 1105 County Road, San Carlos, Calif. 94070. (415) 591-8461. C.W. Hunter, pres; A. George Ewing, VP mfg; Herbert K. Krengel, VP mktg; Herb Echevarria, VP engrg; Lee Phillips, VP-treas; James W. Tedrow, corporate sec & gen atty; George Griffith, mgr, planning; Fred C. Hill, dir of pub affrs; Daniel Foster, dir of industrial rel.

Falls Church, Va. 22044: 6201 Leesburg Pike. (703) 533-3344. R.E. Ryman, district mgr.

Chicago 60606: 130 N. Franklin. (312) 263-1321. H.F. Jones, district mgr.

Dallas 75225: 8609 Northwest Plaza. (214) 363-0286. Donald R. Herdine, district mgr.

Atlanta 30305: 361 E. Paces Ferry Rd. (404) 261-8282. H.R. Currie, district mgr.

San Carlos, Calif. 94070: 1105 County Road. (415) 591-8461. James Hoover, district mgr.

H

Hamilton Erection Inc. Box 460, York, S.C. 29745. (803) 684-9966. Melvin L. Roberts, pres & mgr.



HARRIS
**COMMUNICATIONS AND
INFORMATION HANDLING**

BROADCAST PRODUCTS DIVISION
123 Hampshire St., Quincy, Ill. 62301 • (217) 222-8200

Harris Corp.-Broadcast Products Division. 123 Hampshire St., Quincy, Ill. 62301. (217) 222-8200. Gene T. Whicker, VP-gen mgr; Eugene O. Edwards, VP-mktg; Joseph M. Engle, dir of domestic sls; John F. Delissio, dir of international sls; Eugene W. Jaeger, dir, contract administration; Edward S. Gagnon, mgr, product mktg; Walter B. Rice, sls mgr, radio broadcast products; Thomas G. Schoonover, sls mgr, TV broadcast products; James E. Barry, mgr, international mktg; Charles B. Patterson, area mgr, international sls; Donald R. Meier, area mgr, international sls; Fernando Perez, area mgr, international sls; Ernest Credgington, area mgr, international sls.

Branch centers:

New York 10016: 130 E. 34th St. (212) 889-0790. Robert Anderman, mgr, Eastern service center; Frank N. Cambria, asst mgr, Eastern service center; Ed Karl, district mgr, radio sls; Dave Spindle, district mgr, TV sls.

Houston 77027: 4019 Richmond Ave. (713) 623-6655. Bernard H. Giesler, mgr Southwestern service center; Mark Murphy, asst mgr Southwestern service center; London T. England, district mgr radio sls; Vern Killion, district mgr TV sls.

Branch offices:

Washington 20005: 730 Federal Bldg. 1522 K St. N.W. (202) 223-5508. Paul Timpe, district mgr radio sls; Lew Page, district mgr TV sls.

Los Angeles 90007: 1945 S. Figueroa. (213) 747-7129. Robert Switzer, district mgr radio sls; Thomas R. O'Hara, district mgr TV sls.

International:

New York 10016: 130 E. 34th St. (212) 725-9800. Joseph R. Guerrero, mgr; Marth Arrue, order service mgr; Carl A. Fosmark, area mgr; Fernando Perez, area mgr.

Montreal: 212 Brunswick Blvd., Pointe-Claire, Que. (514) 695-3751. Leo E. Gilbeau, mgr broadcast products; V.A. Hosquet, mgr customer service.

Toronto: 19 Lesmill Rd., Don Mills, Ont. (416) 447-7234. Robert A. Gauthier, district sls mgr.

Calgary, Alberta: No. 93-4810-40 Ave. S.W. (403) 249-1231. Garry A. Hourie, district sls mgr.

Rio Piedras, Puerto Rico 00928: Box 20079. (809) 766-3239. Jose J. Acosta, rep.

District managers:

Chicago: 1810 N. Ridge Ave., Arlington Heights, Ill. 60004. (312) 255-9230. Vern H. Russell, district mgr, TV sls.

Rocky River, Ohio 44116: Box 2927. (216) 333-6890. Bill Culbertson, district mgr, TV sls.

New York 10016: 130 E. 34th St. (212) 889-0790. Dave Spindle, district mgr, TV sls; Ed Karl, district mgr, radio sls.

Houston 77027: 4019 Richmond Ave. (713) 623-6655. Vern Killion, district mgr, TV sls; London T. England, district mgr, radio sls.

Washington 20005: 730 Federal Bldg. 1522 K St. N.W. (202) 223-5508. Lew Page, district mgr, TV sls; Paul Timpe, district mgr, radio sls.

Los Angeles 90007: 1945 S. Figueroa. (213) 747-7129. Thomas R. O'Hara, district mgr, TV sls; Robert Switzer, district mgr, radio sls.

Atlanta: 3438 Hill Drive, Duluth, Ga. 30136. (404) 476-4136. George I. Hardy, district mgr, TV sls.

Montgomery, Ala. 36106: 1866 Gatewood Drive. (205) 277-4377. Will Bone, district mgr, radio sls.

Rancho Cordova, Calif. 95670: 10521 Malvasia Way. (916) 363-8264. Daniel A. Roberts, district mgr, radio sls.

Macclenny, Fla. 32063: Box 958. (904) 259-6475. Ivey J. Raulerson, district mgr, radio sls.

Adrian, Mich. 49221: 56 S. Crestview Drive, Route 5, Box 240D. (517) 423-4560. David A. Oriente, district mgr, radio sls.

Waverly, Neb. 68462: 1479 19th Ave. (402) 786-2431. Galen L. Hassinger, district mgr, radio sls.

Florissant, Mo. 63031: 2139 Freestone Court. (314) 837-0504. Kin Jones, district mgr, radio sls.

Latham, N.Y. 12110: 11 Ridgcrest. (518) 785-9144. Robert J. Hallenbeck, district mgr, radio sls.

DELTA ELECTRONICS

THE AM BROADCASTER'S SINGLE SOURCE FOR . . .

- DIGITAL ANTENNA MONITORING
- TRANSMITTER/ANTENNA CONTROL
- MEASUREMENT/TEST INSTRUMENTS

Digital Antenna Monitoring

DAM-1 DIGITAL ANTENNA MONITOR – FCC type approved. Provides digital readout of amplitude, ratio and phase. Also available: DAMA-1 Base Current Adapter for remote digital readout of antenna base currents; DAMA-2 Analog Converter to Interface DAM-1 Monitor with existing analog remote control systems; DAMX-1 to extend capacity of DAM-1 to arrays up to 12 towers.

Transmitter/Antenna Remote Control

TMCS-1 TRANSMITTER/ANTENNA REMOTE CONTROL SYSTEM – Provides digital readout and control of the DAM-1 and transmitter over a single voice channel. Other systems available: DAMR-1/DAML-1 for digital readout and control of the DAM-1 only; DAMH-1 for use where the remote control point is close enough to the monitor to permit hardwired inter-connection.



Measurement/Test Instruments

OIB-1 OPERATING IMPEDANCE BRIDGE – For antenna system measurements under transmitter power. May also be used as a conventional bridge.



RG-1 RECEIVER/GENERATOR – Two-watt signal generator with a tracking detector. Built-in rechargeable battery power supply for full portability in making low power impedance measurements. For use with OIB-1 or other RF bridges.



CPB-1 COMMON POINT IMPEDANCE BRIDGE – Monitors common point impedance continuously. Designed for permanent installation.

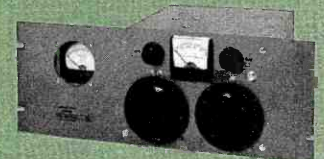

FSM-1 FIELD STRENGTH METER – Single frequency meter for simple, error-free, economical field strength measurements. Plug in modules for multi-frequency and harmonic measurements.

Other Products

TCT-() TOROIDAL CURRENT TRANSFORMER – Provides accurate, stable R. F. samples for phase and amplitude measurements. Available in three sensitivities. Also available: TCTR-1 Compensated Rectifier Circuit to provide DC voltage for remote current measurement when used with TCT-().

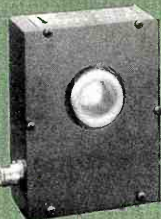

MJ-50 METER JACK – A make-before-break in line jack assembly that permits "hot" insertion of OIB-1 Bridge or Ammeters.

DELTA ELECTRONICS



5534 PORT ROYAL ROAD
SPRINGFIELD, VIRGINIA 22151
TELEPHONE: 703/321-9845 TWX: 710-831-0620



The best album rock sound
in Bay City, Mich. is put
out by an **AEL FM-25 KE**
Stereo Transmitter.

Just ask **WHNN**

AEL stereo transmitters always
send the very best.
FM: 2,500, 15,000, 25,000, 40,000,
50,000 watts.
AM: 5,000, 10,000, 50,000 watts.

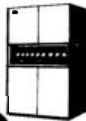

Call or Write:

AMERICAN ELECTRONIC LABORATORIES, INC.
P.O. Box 552, Lansdale, PA 19446
Tel: 215/822-2929 • TWX: 510/661-4976

QUALITY TALKS FOR CBC CBU CBL CBF CBK CBM CBW CJBC

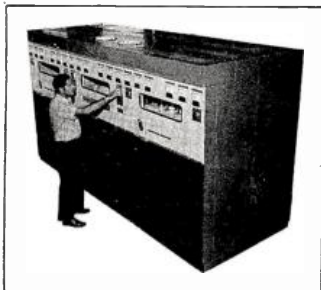

Continental's 317C is the best
measure for any 50 kW AM trans-
mitter purchase. Performance,
125% positive modulation and
reserve power capabilities are
unbeatable. Today's best sound
in 50 kW AM is Continental.

Continental 
Electronics

CONTINENTAL ELECTRONICS MFG. CO.
BOX 17040 DALLAS, TEXAS 75217

Equipment

Greensboro, N.C. 27406: 701 Greenhaven Drive.
(919) 855-1146. Dick Sawicki, district mgr, radio sls.
Bellville, Ohio 44813: Route 3, Rinehart Road. (419)
886-4444. Ed Huber, district mgr, radio sls.

Tulsa, Okla. 74145: Box 45107. (918) 251-8808.
Curtis A. Lutz, district mgr, radio sls.

Columbia, S.C. 29209: 7209 Stonehaven Drive.
(803) 776-2059. E.R. Lowder, district mgr, radio sls.
Oak Harbor, Wash. 98277: Box W. (206) 675-1574.
Neil Armstrong, district mgr, radio sls.

Racine, Wis. 53402: 3320 Ivey Lane. (414)
639-7689. Robert L. Gorjance, district mgr, radio sls.

AM, FM & TV transmitters, TV cameras, monitors, all
broadcast equipment necessary for radio or TV sta-
tions.



HARRIS
COMMUNICATIONS AND
INFORMATION HANDLING

BROADCAST PRODUCTS DIVISION
123 Hampshire St., Quincy, Ill. 62301 • (217) 222-8200

Harwood Mfg. Co. 1800 Fullerton Ave. Chicago
60614. (312) 929-1100. S. Swislow, pres; J. Lippman,
VP; J. Hochberg, VP

Lighting equipment.

Richard Haskey-Broadcast Engineering. 1259
Callens Rd., Ventura, Calif. 93003. (805) 642-2300.
Richard R. Haskey, own.

New and used broadcast equipment. Construction,
turnkey installations.

Hervic Corp. 14225 Ventura Blvd., Sherman Oaks,
Calif. 91403.

Hewlett-Packard Co. 1501 Page Mill Rd., Palo Alto,
Calif. 94304. (415) 493-1501. William R. Hewlett,
pres; William E. Terry, VP, inst group.

Electronic instrumentation and instrument systems,
computer systems.

Highland Associates Inc. Box 99, 80 Garden Office
Center, Broomfield, Colo. 80020. (303) 466-3851.
Hank Broughall, pres; Herb Didier, assoc; Bill Meyers,
assoc.

Broadcast station equipment.

Hitachi Shibaden Corp. of America. 58-25
Brooklyn-Queens Expressway, Woodside, N.Y. 11377.
(212) 898-1261. M. Russin, natl sls mgr; Y. Fujiyoshi,
pres; R. Muto, dir; S. Samejima, treas.

Melrose Park, Ill. 60160: 1725 N. 33 Ave. (312)
344-4020. Mike D'Amore, midwestern rgnl sls mgr.

Carson, Calif. 90745: 21015 S. Figueroa St. (213)
328-2110. Nick Pisciotto, western rgnl sls mgr.

Dallas 75240: 14169 Proton Road. (214) 233-7623.
John Stead, southwestern rgnl sls mgr.

Atlanta 30340: 3610 Clearview Parkway. (404)
451-9453. W.R. Corcoran, southeastern rgnl sls mgr.
Closed circuit TV equipment.

Hologon Optical Systems Corp. 225 Park Avenue
South, New York 10003.

Holt Technical Services Box 111, 428 Brodhead
Ave., Bethlehem, Pa. 18016. (215) 865-3775. Arthur H.
Holt, pres; Arthur K. White, tech dir; Gilbert Ackroyd,
asst tech dir.

AM-FM transmitters, audio processing, studio
equipment.

H.M. Holzberg Associates. Box 322, Totowa, N.J.
07511. (201) 256-0455. Herbert M. Holzberg, pres;
Charles Otto, sls mgr.

Consoles, turntables, cart machines, tape recorders,
switching.

Dave Hovey General Contractor. Route 1, Box 113,
Coffeeville, Miss. 38922. (601) 675-2956. Dave
Hovey, mgr.

Tower painting, sls, site preparation, rigging, mainte-
nance, modification, consulting.

H-R Productions Inc. 251 W. 57th St., New York
10019. (212) 246-5133. Herbert Rosen.

Hughey & Phillips Inc. 3050 N. California St., Bur-
bank, Calif. 91505. (213) 849-1104. J.H. Ganzenhuber,
VP & gen mgr; Chas. E. Stephens, hazard lighting sls
eng.

Lighting equipment, isolation transformers.

Hy-Gain Electronics Corp. 8601 Northeast High-
way 6, Lincoln, Neb. 68505. (402) 464-9151. Andrew

Andros, pres; Ted Andros, VP; Reese Haggott, natl sls
mgr.

Van Nuys, Calif. 91401: 6100 Sepulveda Blvd. No.
322. (213) 785-4532. Kit Kitterer, rep.

Naguabo, PR. 00718: Box 68 State Highway 31.
(809) 874-2175. Normand Pettersen, VP and gen mgr.
Antennas and radios.

ICS Sales & Leasing Inc. Box 281, Ann Arbor, Mich.
48107. (313) 761-1600. B.J. Staal, pres; A. Vermeer,
VP/sec; J. Prince, treas; T. Braun, natl sls mgr; D. Van-
derYacht, VP, prod dev.

New York 10020: 45 Rockefeller Plaza, International
Bldg. (212) 246-2360. Ed McGoldrick, branch mgr.

Ann Arbor, Mich. 48107: 313 N. First, Box 281. (313)
761-1600. Arnold Vermeer, branch mgr.

Chicago 60606: 300 W. Washington, Room 808.
(312) 782-5984. Marlene Moersch, Mike Elliot, branch
mgrs.

Washington 20036: 919 18th St., NW, Room 401.
(202) 452-1115. Paul Ebeltoft, branch mgr.

Word processing and phototype preparation
systems.

IGM (a division of Northwestern Technology Inc.) Box
943, 4041 Home Road, Bellingham, Wash. 98225.
(206) 733-4567. E.C. Burkhart, pres; Steve Grayson,
mktg & sls mgr; Nick Solberg, engrg mgr; Pete Ruesse,
prod mgr; Don Dinsmore, ctrlr.

Broadcast automation systems, multiple cartridge
handling systems, program logging systems, com-
puterized automation systems.

Ikegami Electronics USA Inc. 29-19 39th Ave.,
Long Island City, N.Y. 11101. (212) 932-2577. Hiromi
Nishi, mgr; Y. Sato, chief engr.

TV and radio broadcasting equipment, CCTV equi-
pment, transformers; test and measuring equipment.

Image Devices Inc. 811 N.W. 111 St., Miami 33168.
(305) 751-1818. David Haylock, pres; Will Williams,
VP; Janet Lee Vaingat, sec/treas; H.E. Pompeo,
purchasing coord; David D. Hack, svc mgr.

Imero Fiorentino Associates Inc. 10 W. 66 St.,
New York 10023. (212) 787-3050. Imero Fiorentino,
pres; William Klages, VP; Pete Howard, VP and chief
constnt; Linda Spreen, dir of opns; George Honchar,
dir of spec proj.

Hollywood 90046: 7250 Franklin Ave. (213)
876-6661. Kenneth Palius, VP and dir of tech opns.

Las Vegas 89102: 2781 S. Bronco. (702) 876-6661.
Terry Little, opns mgr.

Color contrast evaluator, TV monitor analyzer.

Industrial Sciences Inc. 3521 SW 42nd Ave.,
Gainesville, Fla. 32608.

Video production switchers, amplifiers.

Innovative Television Equipment. Box 681, Wood-
land Hills, Calif. 91364. (213) 888-9421. Bert I. Rosen-
berg, pres; Stanton Hollingsworth, VP; Richard Crosby,
VP; Robert Gallagher, comp.

TV camera supports, camera accessories.

Inovonics Inc. 1630 Deil Ave., Campbell, Calif.
95008. (408) 374-8300. James B. Wood, pres.

Audio recording and signal processing equipment.

International Tapetronics Corp. Box 241, 2425 S.
Main St., Bloomington, Ill. 61701. (309) 828-1381.
Elmo Franklin, pres; John Jenkins, exec VP; Andrew
Rector, mktg VP; Merle Wilson, VP.

Single and multi-deck audio tape cartridge equi-
pment, reel-to-reel units.

International Video Corp. 990 Almanor Ave., Sun-
nyvale, Calif. 94086. (408) 738-3900. Donald F.
Eldridge, chmn and pres; Ronald H. Fried, exec VP;
Barrett E. Guisinger, Bert H. Dann, VPs and tech ad-
visors to pres; C.C. Snider, VP international; Arie Land-
rum, natl sls mgr; Paul Fletcher, mgr southern region;
Hugh Gillogly, mgr Midwest region; R.N. Henson, mgr,
eastern region.

ITI Electronics Inc. 369 Lexington Ave., Clifton, N.J.
07015. (201) 546-3900. Horace Atwood Jr., pres;
Joseph Weinberg, VP opns; Emil G. Nichols, VP mktg.
Microphones, telephone lines and power amplifiers.

TOWER HAZARD WARNING LIGHTS

300 mm Beacons, Photo-Controls,
Flashers, Obstruction Lights,
Lamp Failure Indicator Systems,
Isolation Transformers

Hughey & Phillips, Inc.
3050 N. California St., Burbank, Calif. 91505

For sheer reliability, few things can beat our RE15 microphone:

And we're conceding only the slightest of edges to the sun.

Because the RE15 is one mike you can always count on to give you the same reliable response at any distance, any angle. It's a Continuously Variable-D® cardioid microphone—an exclusive E-V design*. Once you've set your equalization, all that varies is the level.

Unwanted noise is no problem, either. Not with a super cardioid pattern that provides maximum rejection at 150° off axis. So when the mike is tilted in its most natural position—30° from horizontal—you'll be sure of getting maximum rejection in the horizontal plane. And there's a 100-Hz cutoff "bass tilt" switch for boom use and

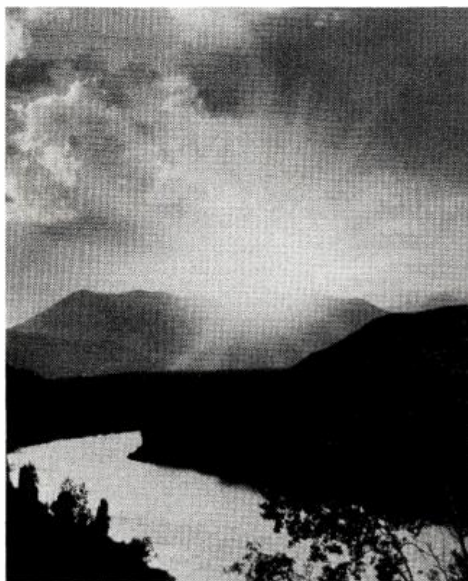

other long reach situations.

Other features abound. Like a "hum buck" coil to supply an extra 25 dB of hum rejection. And a rugged design that stands up to shock and mechanical abuse.

The Electro-Voice RE15. It's a way to keep

your demanding professional customers... asking for more.

RE15...\$180.00. RE16...(with blast filter) \$190.20. And for slightly less demanding situations, RE10...\$110.10. RE11 (with blast filter)...\$120.00. Suggested Resale Net Prices. Slightly higher in Western States.

*U.S. Patent Number 3,115,207. Trade mark registered.

Electro-Voice INC
a **gulton** company

Electro-Voice, Inc., Dept. 161BY, 660
638 Cecil Street, Buchanan, Michigan 49107



Equipment

ITT Cannon Electric. 666 E. Dyer Rd., Santa Ana, Calif. 92702. (714) 557-4700. James H. Anderson, pres; Robert J. Trivison, VP dir of opns; Carl W. Peacock, VP dir of admin; L. Wayne Oliver, VP dir of bus dev; Gerald J. Selvin, VP dir of engrg.

Phoenix 85034: 2801 Air Lane. (602) 275-4792. John M. Phipps, gen mgr.
Solon, Ohio 44139: 29000 Aurora Rd. (216) 248-8800. Herbert E. Quick, gen mgr.
Whitby, Ont. L1N 5V8: Four Cannon Court. (416) 688-8881. Robert C. Enright, gen mgr.
Electrical connectors, lugs and terminals.

ITT Electron Tube Division. Box 100, Easton, Pa. 18042. (215) 252-7331. W.C. Schmitt, pres; J.D. Feehan, VP opns; A.W. McEwan, dir, mktg.
External anode power and traveling wave tubes.

J

Jamieson Film Co. 6911 Forest Park Rd., Dallas 75235. Jack Cobb, dir of mktg.

Jampro Antenna Co., division of Cetec Corp. Box 28425, Sacramento, Calif. 95828. (916) 383-1177. Telex 377321. Peter K. Onnigan, pres; Ross Shelton, sis mgr; Bill Cunningham, customer service mgr.

Toronto M6B 1P8: Canadian General Electric Company Ltd. 97 Wingold Ave. (416) 789-3281. A.F. Stevenson, mgr, mfg & svcs.

Montreal H4P 1X2: Canadian General Electric Company Ltd. 5000 Jean Talon St. W. (514) 733-9911. J. Sardi, sis mgr, TV bcst equip.

Bucks, England HP11 2NA: Computer Equipment Company Ltd. Shaftesbury St. High Wycombe. (0494) 34641. George Angelou, European sis mgr.

Mexico City: Paseo de la Reforma 369. (905) 511-8748.

Jefferson Data Systems, 1 Julian Place, Charlotte, N.C. 28208.

Computer service for TV and radio stations.

Jerrold Electronics Corp. Box 346, Horsham, Pa.

19044. (215)674-4800. Robert D. Eisenhardt, pres; Lee R. Zernick, exec VP; William H. Lambert, VP-CATV systems division; David Brody, VP adv & sis prom; Simon Pomerantz, VP & treas; Joseph A. Wargo, VP-mfg; Michael F. Jeffers, VP-engrg; Joseph D. Romasco, dir of mktg; Bert Wolf, VP-gen mgr, CATV systems division.

Huntingdon Valley, Pa. 19006: 1 Fairway Plaza, Suite 212, Philmont Ave., & Red Lion Rd. (215)674-4800.

Atlanta 30339: 1 Perimeter Place, Suite 101. (404)432-3102.

N. Kansas City, Mo. 64116: 1334 Atlantic Ave. (816)842-1130.

Redwood City, Calif. 94063: 1255 Veterans Blvd. (415)365-5200.

Dedham, Mass. 02026: 850R Providence Hwy U.S. Rt. 1. (617)329-4790.

E.F. Johnson Co. 299 Tenth Ave. S.W., Waseca, Minn. 56093. (507) 835-2050. Richard E. Horner, pres; E.F. Johnson, chmn of the bd; W.A. Zarris, VP-mktg; A.I. Pazera, VP-finance; Richard A. Westrum, VP-mfg; Gai-land Childs, VP-engr.

Houston 77003: 903 Chartres St. (713) 224-3833. Herb Gullberg, gen mgr.

Miami 33122: 3301 N.W. 82nd Ave. (305) 592-5957. Harry Jordan, branch gen mgr.

Coral Gables, Fla. 33134: 300 Greco Ave. Box 520. (305) 445-2671. Jerry Copeland, pres.

Land mobile and CB radios and accessories.

Johnson Electronics Inc. Box 7, S. Highway 17-92, Casselberry, Fla. 32707. (305) 339-2111. Ralph L. Weber, pres and chief exec officer; Joseph M. Lutz, VP mktg; Doris K. Krummenacker, VP fin.

Tuners, receivers, amplifiers and antennas.

JSH Electronics Inc. 8549 Higuera St., Culver City, Calif. 90230. (213) 559-6900. J.S. Harwit, pres; Charles A. Tepper, VP-mktg; Jerry Klaris, exec VP; Len Novin, gen mgr.

New York 10003: 380 Lafayette St. (212) 674-7979. Harold J. Taylor, VP-gen mgr.

Electron tubes, integrated circuits, diodes and transistors.

JVC Industries Inc. 58-75 Queens-Midtown Expressway, Maspeh, N.Y. 11378. S. Hori, pres; D. Sheer, PR/adv.

Videocassette recorders, color cameras, television monitor receivers.

K

Kahn Communications Inc. 74 N. Main St., Freeport, N.Y. 11520. (516) 379-8800. Leonard R. Kahn, pres.
Modulation improvement equipment.

Kalart Victor Corp. Hultenius St., Plainville, Conn. 06062. (203) 747-1663. Morris Schwartz, act pres and chmn; Mort Goldberg, VP-sls; Herb Nettleton, sis mgr-ETV products; J.J. Costag, sis mgr.

Audio-visual and educational TV products.

Kaman Sciences/BCS. 1500 Garden of the Gods Rd., Colorado Springs 80907. (303) 599-1601. R.E.W. Smith, VP Kaman Sciences; Jack Finlayson, mgr, BCS.
Computerized radio/TV traffic and accounting system.

Kansas State Network Inc. Engineering Services Division. Box 333, Wichita, Kan. 67201. (316) 265-5631. Joseph Culver, div mktg dev; Rod Herring, div gen mgr; Rick McEachern, mgr pchsng and material control/sls.

Time base correctors, character generators.

Kappa Networks Inc. 165 Roosevelt Ave., Carteret, N.J. 07008. (201) 541-1600. Stanley L. Pearl, pres; M. Traum, VP.

Cherry Hill, N.J. 08034: (609)779-9282. Vince Benham.

Burlington, Mass. 08103: (617)272-7655. Jim Cauger.

Jupiter, Fla. 33458: (305)262-3966. Dick Cherry.

Minneapolis 55419: (612)861-6051. Ed Harding.

Madison, N.J. 07940: (201)377-3220. Al Livera.

Roslyn Heights, N.Y. 11577: (516)484-1276. Ed Polk.

Alhambra, Calif. 91803: (213)283-7694. M.W. Riedel.

Addison, Tex. 75001: (214)233-8235. Robert R. Thomas.

Scottsdale, Ariz. 85253: (602)994-0401. Jerry Coker.

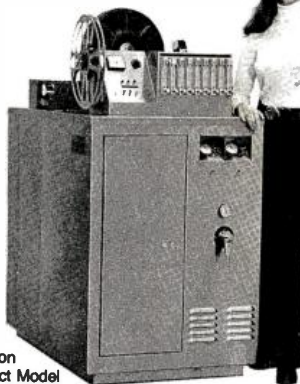

Jamieson Compact Model

Jamieson No. 1 in TV!

Why is the Jamieson Processor No. 1 in TV?
The best answer is from someone who owns one.
Someone you know owns a Jamieson. Probably a lot of people you know. Why not ask them about it? The best way to get an unbiased appraisal of its performance.
Or ask us ... we'll be more than happy to tell you about the Jamieson Processors and give you references.

JAMIESON'S ADVANCED DESIGN TECHNOLOGY FEATURES

- Film advance virtually tension-free. The demand top-overdrive film transport uses no clutches, floating rollers or film sprockets.
- Smaller machines take only half the floor space.
- Solution volumes reduced 15 times over open-tank designs.
- Temperature in primary solutions is controlled to an accuracy of a few hundredths of a degree.
- The elliptical shape of the tube protects the film and provides high induced turbulence.



JAMIESON FILM COMPANY
a division of Kreonite, Inc.

6911 FOREST PARK ROAD • DALLAS, TEXAS 75235
PHONE: 214-350-1283 • TELEX: 73-0932

Please send information on Jamieson Processors and a list of some users.

Name _____ Title _____

Firm _____ Phone _____

Address _____ City _____

State _____ Zip _____ JAMIESON FILM COMPANY

BY76

6911 Forest Park Rd. Dallas, TX 75235

now a color camera coupler... battery operated!

GK-2000U sync coupler weighs
26.4 lbs. with 2 CCU's. Approx.
19" wide, 14" deep, 6" high.



"Let's have a CU on camera 2... hold the LS on camera 1 and now a MCU on 2"... and so goes the direction.

A job for expensive broadcast equipment? Not if you have two JVC portable color cameras, a PV4800 tape deck, headphones, a hand mike and the all new GK-2000U which makes the two camera sync coupling possible.

Now you can get clean, noiseless, vertical interval color switching. Mix and match camera inputs when doing remotes... and all mind you... battery powered.

JVC has done it again. First in the field with a truly fine color portable and now the GK-2000U... the first battery or AC operated sync coupler.

Get a demonstration from your JVC video dealer and learn how you can dazzle the competition or your customers with this new found video capability.

JVC Industries, Inc., 58-75 Queens Midtown Expressway, Maspeth, N.Y. 11378, Tel.: (212) 476-8010. • In Chicago: 3012 Malmo Dr., Arlington Hgts., IL. 60005, Tel.: (312) 593-8997. • In Los Angeles: 1011 W. Artesia Blvd., Compton, CA. 90220, Tel.: (213) 537-8230.

JVC Best by Design

JVC

JVC INDUSTRIES, INC.

**JVC Industries, Inc.,
58-75 Queens Midtown Expwy.,
Maspeth, N.Y. 11378 • (212) 476-8010.**

Please send me information on

- 2 Camera synchronizer BCM-76YB
- Camera
- VTR
- Complete system
- Please arrange a demonstration

Name _____

Title _____

Organization _____

Address _____

City _____

State _____ Zip _____

Telephone _____

NOW ... get all your **ELECTRON TUBES** and **SEMICONDUCTORS** from one source ... and get them fast!

C. M. LEVIT ELECTRONICS
(212) 777-5517

America's top brands shipped to you on the day your order is received. Immediate attention — overnight delivery. Big savings, too!

YOURS FREE

THE MOST COMPLETE ELECTRONIC TUBE AND SEMICONDUCTOR CATALOGUES — A VIRTUAL PURCHASING DIRECTORY OF ACTIVE COMPONENTS

C. M. LEVIT ELECTRONICS

200 Park Avenue South
New York, N.Y. 10003
Phone: (212) 777-5517
Cable Address: "LECIMEX"
NEW YORK
TELEX: 422509



Equipment

Cincinnati 45237: (513)761-7993. Foster Callaghan.
Salt Lake City 84107: (801)266-9617. William Parkstone.
Seattle 98166: (206)248-0090. John Del Vento.
Chicago 60659: (312)588-4535. I. Hirsch.

Don Kent Weather Instruments. 725 Quincy Shore Drive, Wollaston, Mass. 02170. (617) 472-3303. Don Kent, meteorologist, owner.

Remote reading wind speed, direction, temperature instruments; dual scale, metric and regular.

Kings Electronics Co. 40 Marbledale Rd., Tuckahoe, N.Y. 10707.
Coaxial connectors, terminations, attenuators.

Kliegl Brothers Lighting. 32-32 48th Ave., Long Island City, N.Y. 11103. Larry E. Nelson.
Lighting control memory systems.

Kline Iron and Steel Inc. Box 1013, 1225 Huger St., Columbia, S.C. 29202. (803) 254-0301. B.H. Kline, pres; J.R. Trotter, sls mgr, tower dept; E.L. Anderson Jr, chief engr-tower dept; Sol Kline, VP.
TV and FM towers, microwave towers.

L

Laird Telemedia Inc. 2125 South West Temple, Salt Lake City 84115. (801) 487-6251. William G. Laird, pres; Ronald S. Hymas, sls mgr.
TV character generators, TV projectors, filter wheels.

Lampkin Labs Inc. Box 2048, Bradenton, Fla. 33505. (813) 746-4175. Bill Rogers, gen mgr; David Boyers, VP prod.

Landy Associates Inc. 12 Buxton Rd., Cherry Hill, N.J. 08003. (609) 424-4660. James E. Landy, pres; Richard V. Flanagan, VP.
Beltsville, Md. 20705: Box 255. (301) 937-0482. Jerry Kennedy, sls mgr.
Westwood, Mass. 02090: 5 Barlow Lane. (617) 326-6050. Rick Flanagan, VP.
Radio, TV, recording studio equipment.

Laser Link Corp. 303 Crossways Park Drive, Wood-

bury, N.Y. 11797. (516) 364-2200. Ira Kamen, chmn; Kurt Roth, pres; Lowell Smilen, VP-engng.

Latham Associates Inc. 1269 Terrabella Ave., Mountain View, Calif. 94043. (415) 964-5595. Robert A. Latham, pres.

D.N. Latus & Co. Inc. Box 1720, Helena, Mont. 59601. (406) 442-3940. D.N. Latus, pres; S. Coriell, sec-treas.
TV and FM translators.

Lenco Inc., Electronics Div. 319 W. Main St., Jackson, Mo. 63755. Paul J. Leonard, pres:

Leo Diner Films Inc. 332-350 Golden Gate Ave., San Francisco 94102. Roy E. Diner, gen mgr

C.M. Levit Electronics. 200 Park Avenue South, New York 10003. (212) 777-5517. Rose Levit, pres-treas; Michel Levit, dir of sls; Katherine Fulton, exec sec.

Electron tubes, diodes, transistors, integrated circuits, rectifiers.

Lindsay Specialty Products Ltd. 50 Mary St. W., Lindsay, Ont. K9V 4S7. (705) 324-2196. J. Thomas, pres.

Cable TV amplifiers, passives, antennas.

Lipsner-Smith Corp. 6735 N. Honore St., Chicago 60626. (312) 338-3040. J.S. Lipsner, pres; E.A. Smith, VP; E. Werner, exec VP.

Listec Television Equipment Corp. 35 Cain Drive, Plainview, N.Y. 11803. (516) 694-8963. Jack Littler, pres; Joanne Camarda, mgr.
TV studio camera mounting equipment.

LPB Inc. 520 Lincoln Hwy, Frazer, Pa. 19355. (215) 644-1123. Richard H. Crompton, pres and treas; Theodore E. Davey, opns mgr.

Baltimore 21222: Box 9005. (301) 633-7582. William F. Jamison, rgnl sls mgr.
Canoga Park, Calif. 91303: 20944 Sherman Way (213) 340-4590. Richard W. Burden, rgnl sls mgr.

Audio and educational FM and carrier current transmission equipment.

L-W International. 6416 Variel Ave., Woodland Hills, Calif. 91364. (213) 348-8614. R.H. Lawrence, pres; Pat Smith, mgr, mktg svcs.
16mm film chain projectors.

new **LSC** VEDETTE
16mm and 35mm PROFESSIONAL PROJECTORS
for fast, safe, high speed viewing and inspection of motion picture film

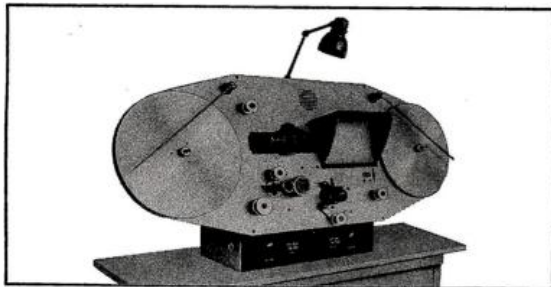

- The ideal machine for film quality control, timing and correction, and release print inspection. Handles negatives, fine grains and prints.
- Visual inspection of both picture and optical sound track. Solid state amplifier for simultaneous monitoring of picture and sound.
- Efficient revolving prism shutter and sharp optics produce bright, clear images without overheating film.

- Smooth, gentle film handling up to 400 ft./min., without intermittent movement of usual claw or Geneva gear drive. Stable, positive focus. 2,000 foot film capacity.

Write for LSC Vedette literature or request a "no obligation" demonstration.



LIPSNER-SMITH CORPORATION
7334 No. Clark St., Chicago, Ill. 60626 • 312-338-3040

CF₂ ULTRASONIC CLEANER

for MOTION PICTURE FILM • MICROFILM • MAGNETIC TAPE

Presented The Academy of Motion Pictures Arts and Sciences Award of Merit for Outstanding Technical Achievement.

Ultrasonic energy is the most effective and economical way to completely clean motion picture film, microfilm and tape without mechanical scrubbing and wiping. Ultrasonic energy performs the entire cleaning operation.

- Restores clarity and sound to maximum quality.
- Enhances the entertainment value of motion picture film and improves commercials.
- Assures static free film with color balance undisturbed.
- Cuts projector maintenance costs ... no dirt or dust carried into gates and orifices ... less breakdowns.
- Completely automatic ... requires only loading and unloading.

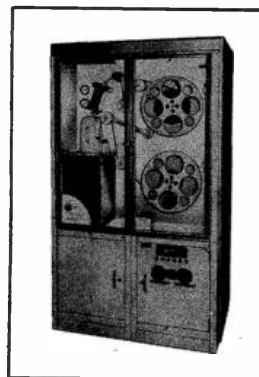

- Costs only 1/20 of a penny per running foot to operate.
- Used by every major motion picture lab in the world.

Descriptive brochure will be sent on request

MARTI . . . THE NAME TO REMEMBER . . .

STEREO STUDIO-TRANSMITTER LINKS INTER-CITY RELAY

Stereo - Mono 950 MHZ FM - AM



STL Transmitter

The Stereo STL with
"Built-in Backup."

Dual Channel System (Stereo) \$4160.00
Single Channel System (Mono) \$2290.00

Antenna or Transmission line cost not included.

FEATURES: • All Solid-State • Direct FM Modulator • Field Proven Varactor Final • Plug-in Modular Construction • Solid-State Ovens • Hi-Accuracy Crystals

Why STL?

1. No "lost air" time due to cut, wet or electrically charged telephone lines.
2. Better Sound Quality Than a Class AAA telephone line.
3. EVENTUAL COST REDUCTION in operating expense.
4. Complete control of entire broadcast system.

Why Dual Channel?

1. A Dual-Channel costs less than a Composite.
2. Better Reliability than a Composite. "Built in Backup."
3. Greater Channel Separation than a Composite.
4. Less Signal Drive Required to Receivers means additional system Fade Margin.
5. Less Test Equipment Necessary and more Positive System Diagnosis.
6. Stereo Generator is away from Studio and Unauthorized Tampering.
7. Stereo Generator and Broadcast Transmitter Compatibility without Interface.
8. Having a Dual-Channel STL is like having a Spare Link.
9. Two Remote Control and Two Sub-Carrier Capability.

Why MARTI?

1. Channel Separation more than 65 db.
2. Channel Response matched to 0.25 db.
3. Distortion less than 0.5%.
4. All Solid State.
5. A Simple, True Direct FM Plug-in Modulator.
6. Complete accessibility to modules without removal from rack.
7. The Marti System Delivers Top Performance with Transmitter manufacturer's Stereo Generator.
8. Marti STL Systems Log over TWO MILLION (2,000,000) Broadcast Hours each Year.
9. AVAILABLE FROM STOCK.

DIGITAL REMOTE CONTROL

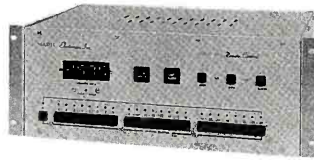

DRC-24 Studio Unit

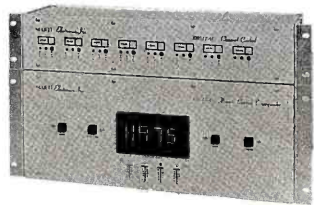

DRT-24 Transmitter Unit

- 8 - Channel — \$2350.00
- 16 - Channel — \$2650.00
- 24 - Channel — \$2950.00

FEATURES: • Single Button, Direct Channel Select • Exceeds All FCC Requirements for Accuracy of Antenna System Data • Studio and Transmitter Units Phase Locked to Common Clock • Telemetry Accuracy 0.1% • Basic 8-Channel System Expandable to 16 or 24 Channels • Status/Tolerance Limit Alarm • Fully Digital for Radio Circuit or Wire-Line Operation • Plug-in Modules for FSK Frequency Change • Adaptable to Multiple Transmitter Control From Multiple Control Points • Status Indication (Optional)

• Compatible with Composite or Dual STL Systems

The Marti DRC-24 is a completely Digital Remote Control, Telemetry and status/alarm system, providing the **ultimate in accuracy, simplicity, and speed of operation.** Channel selection is accomplished simply by pressing a **single** button. The data for the selected channel is then read from the large digital panel display. Raise/Lower commands can be given for the selected channel by pressing the Raise or Lower button.

The integrity of the entire digital process is assured by validation of received data transmission by checking proper start, parity, and stop bits, a **feature found in the most sophisticated data processing equipment.** This advanced design feature virtually eliminates the possibility of error in channel selection, command and telemetry data.

RADIO REMOTE PICKUP 150 - 450 MHZ



RPU
Transmitter

\$975.00 (150 MHZ)
\$1145.00 (450 MHZ)

FEATURES: • All Solid-State • Direct FM Modulator • Broadcast Quality — Continuous Duty • Four Audio Mixing Channels • Plug-in Modular Construction • I.F. Crystal Filter • Taut Band Meters

Radio Remote Pickup Equipment is versatile, dependable and an entree to profitable radio broadcasting. That is the acclaim given to Marti RPU Equipment by American Radio Broadcasters. "How did we ever operate a radio station without it?", is the comment most often heard after equipment has been purchased and put into service.

The progressive minded, community spirited broadcaster, can find many uses for Remote Pickup Equipment. He will do many more remotes than he is presently doing, simply because the equipment is available at a moment's notice. To coin an old cliché, "It doesn't cost — it pays."

Add Color to Your Remotes . . .

PORTABLE BROADCAST REMOTE PICKUP TRANSMITTER

Model RPT-1

\$495.00 (150 MHZ)

FEATURES: • Portable operation on internal rechargeable nickel-cadmium battery. Total weight only 5 1/4 lbs. • All Solid-State • Built-in battery charger • Dual frequency operation (One crystal included) • Meter indicates battery condition and modulation • Whip antenna mounted directly on unit • Broadcast-quality Compressor/Limiter handles toughest remote pickup conditions • Two microphone inputs (one push-to-talk) and one Hi-Level input each with individual mixing gain control

COMPLETE LINE OF ACCESSORIES AVAILABLE



MARTI Electronics, Inc.

P.O. BOX 661 • 1501 N. MAIN
CLEBURNE, TEXAS 76031
817/645-9163



SHORT FORM CATALOG

AURAL STUDIO-TRANSMITTER LINKS



PCL-505 Transmitter

All silicon solid-state circuitry and utilizing **direct FM**, Moseley aural studio-transmitter links offer uncompromised, dependable performance — a **Moseley tradition**. Micro-stripline techniques and true modular construction are but a few of the features typical of the advanced technology used in the PCL-505 and PCL-101 series STL systems.

For AM
PCL-101 or PCL-505

For FM
PCL-101 or PCL-505

For FM Stereo

DUAL STL— Two monaural links conveying left and right audio
COMPOSITE STL— Stereo on a single RF carrier — the PCL-505/C — a **system pioneered by Moseley!**

PCL-101 and PCL-505 Series Studio-Transmitter Links are available for all common bands from 148 MHz to 960 MHz.



PCL-101 Transmitter

REMOTE PICKUP LINKS

RPL-3
148-174 MHz

RPL-4
450-470 MHz



Models RPL-3 and RPL-4 Remote Pickup Links provide unsurpassed audio performance for remote broadcasts. Two full-time microphone and high-level line audio inputs are standard. The RPL-3 and RPL-4 Transmitters are complete with audio mixing and AC/DC power supplies.

REMOTE CONTROL

— DIGITAL —

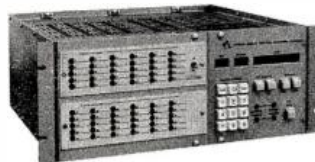

DCS-2 Control Terminal

Fully digital remote control of a remotely located transmitter plant is provided by the **DCS-2 Digital Control System**. Multiple transmitter site operation — a standard option. Command, telemetry, and status provided in groups of thirty

channels. **Automatic parameter logging available.**

Computer-assisted operation of the DCS-2 is another standard option, and can provide **totally automated plant operation**. With CRT display, thirty telemetry or status channels are displayed simultaneously. Tolerances on all telemetry channels and logging are also provided.

The **Model DRS-1A Digital Remote System** provides telemetry, command and status capability at an affordable price. The system is available for operation over telephone or radio interconnecting facilities. Automatic logging is accommodated by the companion **Model DLS-1 Digital Logging System**.



DRS-1A Control Terminal

— ANALOG —

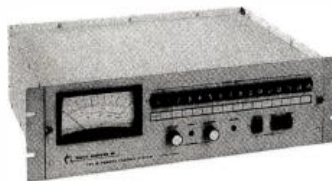

15-Channel

Fifteen telemetry and thirty command functions are provided by the **TRC-15A Remote Control System**. The Model TRC-15AR, when used in conjunction with a Moseley STL will provide totally wireless operation. The Model TRC-15AW is for use on leased telephone, or other wired circuits.

- Model SCG-9 Stereo Generator
- Model SCG-8 Subcarrier Generator

- Remote Control Accessories
- STL Accessories

- Model SCD-8 Subcarrier Demodulator

MOSELEY ASSOCIATES, INC.

Santa Barbara Research Park, 111 Castilian Drive, Goleta, California 93017
(805) 968-9621 TELEX: 658448 CABLE: MOSELEY

M

Mac Panel Co., Audio Tape division. Box 5027, 215 Church St., High Point, N.C. 27262. (919) 882-8138. Joseph L. Craycroft Jr., pres; Billy N. Williams, VP.

Magic for Madison Avenue. 20 E. 46th St., New York 10017. (212) 682-8462. Joseph Kardwell, pres. Magic, illusions and special effects.

Maganavox Video Systems. 1700 Magnavox Way, Fort Wayne, Ind. 46804. (219) 482-4411. J.T. Smith, VP; J. Phillip Stack, mgr of video systems.

New Milford, N.J. 07646: (201) 265-5627. Daniel Batista, rgnl mgr.

Torrance, Calif. 90503: (213) 328-0770. E. Keith Tindall, rgnl mgr.

Arlington Heights, Ill. 60004: (312) 255-4795. Harry Gladwin, rgnl mgr.

Eau Gallie, Fla. 32935: (305) 254-1810. Don Price, rgnl mgr.

Marconi Communications Systems Ltd. Marconi House, New St., Chelmsford, Essex, England CM1 1 PL. 0245-53221. T. Mayer, mgng dir.

Marconi Electronics Inc. 100 Stonehurst Court, Northvale, N.J. 07647. (201) 767-7250. Keith Elkins, exec VP; R.V. Lunniss, area sls mgr.

Stone Mountain, Ga. 30083: 1309-J Stone Mill Court. (404) 469-7471. W. Barry Holland, bcst sls mgr. Broadcast studio and transmitting products.

Marconi Instruments. 100 Stonehurst Court, Northvale, N.J. 07647. (201) 767-7250. Keith Elkins, exec VP.

Marti Electronics Inc. 1501 N. Main, Box 661, Cleburne, Tex. 76031. (817) 645-9163. George W. Marti, pres and gen mgr; Robert E. Richards, dir of mktg; M.E. McClanahan, dir of engrg; Roger I. Bast, dir of mfg.

Aural studio transmitter links, audio amplifiers.

See adv, page E-23

Maze Corp. Box 6636, Birmingham, Ala. 35210. (205) 591-4800. S.R. Maze, pres. Broadcast, TV and recording equipment.

McBee Laboratories Inc. 5151 Wisconsin Ave., Washington 20016. (202) 244-2345. Malcolm M. Burleson, pres; Jack J. Roden, VP; W. Scott Standiford III, sec-treas. TV and radio systems.

McCurdy Radio Industries Inc. 1051 Clinton St., Buffalo, N.Y. 14206. George McCurdy, pres; Ron Mitchell, gen mgr.

Saddle River, N.J. 07458: Box 86. (201) 337-0750. R. Clifford Rogers, eastern sls mgr.

Toronto M1S 3B2: 108 Carnforth Rd. (416) 751-6262. Stan Maruno, sls mgr. Consoles, switchers, intercoms, cartridge machines and speakers.

McGraw-Edison Co., Edison Electronics Division. Grenier Field Municipal Airport, Manchester, N.H. 03103.

McKay Dymek Co. 675 N. Park Ave., Box 2100, Pomona, Calif. 91766. (800) 854-7769, 472-1783. AM off-air monitors, AM antennas.

McMartin Industries Inc. 4500 S. 76th St., Omaha 68127. (402) 331-2000. Ray B. McMartin, pres; Juan Alonso, exec VP; Tom Humphrey, VP mktg; Leonard Hedlund, VP rsch & dev; Jim Lucy, dir sls; Forest Eckhoff, mgr field sls; Bill Ticen, mgr customer svc; Charles E. Goodrich, dir of engrg; Howard W. West, dir of dsng and adv. Transmitters, modulation monitors, amplifiers and receivers.

Kenneth R. Meades, Box 71403, Arco Plaza Station, Los Angeles 90071. (213) 666-9056. Kenneth R. Meades, owner, mgr. Audio, visual systems, console cabinetry.

Memorex Corp. 1200 Memorex Dr., Santa Clara, Calif. 95052. M. Mapes. Video and audio tape.

Merlin Engineering Works Inc. 1880 Embarcadero Rd., Palo Alto, Calif. 94303. Quadruplex VTR's and accessories.

Micmix Audio Products Inc. 9990 Monroe Dr., Suite 222, Dallas 75220. Reverberation chambers.

Micromega/Bunker Ramo Corp. 31717 La Tienda Dr., Box 5009, Westlake Village, Calif. 91359. (213) 889-2211. A.D. Berk, VP gen mgr; E. Strumwasser, VP

Equipment

opns; D.C. Wright, mktg mgr. Amplifiers, oscillators, isolators and circulators.

Micro Record Corp. 487-28 South Ave., Beacon, N.Y. 12508. (914) 831-2750. S. Rose, pres.

Micro-Trak Corp. 620 Race St., Holyoke, Mass. 01040. (413) 536-3551. William E. Stacy, pres; Mahlon C. Stacy, VP. Tone arms, turntables, portable audio equipment, antenna heater controls.

Microwave Associates Inc. Communications Equipment Division. South Ave., Burlington, Mass. 01803. (617) 272-3100. Kenneth R. Evans, VP, Communications Equipment Group; Lawrence J. Cervon, VP and gen mgr, Communications Equipment Division; Curtis Kring, dir of natl mktg; Erik Stromsted, sls mgr; Richard Rearwin, dir of engrg; F. Miani, cust svc mgr; John Van, export mgr; Jack Bourque, contracts mgr.

Atlanta 30341: 14 Perimeter Park. (404) 455-3815. Philip Cass, rgnl sls mgr. Burlington, Mass. 01803: South Ave. (617) 272-3100. Dan McCarthy, rgnl sls mgr. Kansas City, Mo. 64138: 8800 Blue Ridge Blvd. (816) 763-5395. Merton Knold, rgnl sls mgr. Dallas 75234: 4398 Shady Bend Dr. (214) 239-2893. Les Fisher, rgnl sls mgr. Sunnyvale, Calif. 94086: 850A Stewart Dr. (408) 733-0222. John Morrissey, rgnl sls mgr. Mercer Island, Wash. 98040: Box 23. (206) 232-3550. Stan Bennett, northwestern rep. Waterloo, Ont. Box 22. (519) 884-1620. G. James Wilson, sls mgr, Canada. Microwave video systems, heterodyne equipment.

Minicom Division 3M Co.—Video Products. 300 S. Lewis Road, Camarillo, Calif. 93010. (805) 482-1911. Fred J. Hodge, project mgr video products; Bill Curtis, mktg supvr. Chicago 60616: (312) 225-7900. Roger Pryor, area sls mgr.

Dallas 75228: (214) 327-7311. Bob Landingham, area sls rep. San Francisco 94080: (415) 761-1155. Bill Hahn, area sls rep.

Washington 20006: (202) 298-9200. Bill Weston, area sls rep. St. Paul 55101: (612) 733-9037. Scott E. Goff, sls mgr video products.

Minneapolis Magnetics Inc. 8125 Pleasant Ave. S., Minneapolis 55420. (612) 884-7393. Frank Zeman, pres; Eyvand E. Toensing, VP-treas; George M. Stephenson, sec. Audio magnetic tape heads.

Modtec Division Broadcast Electronics Inc. 8810 Brookville Rd., Silver Spring, Md. 20901. (301) 588-4983. Andrew Szegda, pres; Tom Creighton, dir mktg/sls; Mel Black, bcst sls.

Mohawk Wire & Cable Corp. 9 Mohawk Dr., Leominster, Mass. 01453. (617) 537-9961. Richard B. Van Vleck, natl sls mgr. Color camera cable connectors and assemblies.

Mole-Richardson Co. 937 N. Sycamore Ave., Hollywood. Softlights, accessories for Mole products.

Moseley Associates Inc. 111 Castilian Dr., Goleta, Calif. 93017. (805) 968-9621. John A. Moseley, pres; John E. Leonard Jr., VP, mktg; J.D. Thwing, VP-finance & control; T. Arthur Kvaas, VP. Remote control/pickup equipment, stereo generating and SCA equipment.

MSI Television. 4788 S. State St., Salt Lake City 84107. (801) 262-8475.

Multronics Inc. 12307 Washington Ave., Rockville, Md. 20852. (301) 881-5774. M.D. Katz, pres; J.F. Water, VP; C.W. Bonds, mfg mgr.

N

Nagra Magnetic Recorders Inc. 19 W. 44th St., New York 10036. Tape recorders.

National Audio Co. Inc. Box 3657, Glenstone Station, Springfield, Mo. 65804. (417) 883-5377. Steve Stepp, pres; Maxine Bass, sec-treas. Tape equipment accessories.

NBE Inc. 15 Crystal Ave., Derry, N.H. 03038. John H. Ring, pres and sls mgr.



The best instrumental sound in Coral Gables is put out by an **AEL FM-25/25KD Stereo Transmitter**

Just ask **WYOR**

AEL stereo transmitters always send the very best.
FM: 2,500, 15,000, 25,000, 40,000, 50,000 watts.
AM: 5,000, 10,000, 50,000 watts.

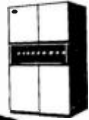

Call or Write:
AMERICAN ELECTRONIC LABORATORIES, INC.
P.O. Box 552, Lansdale, PA 19446
Tel: 215/822-2929 • TWX: 510/661-4976

AM Comes Alive

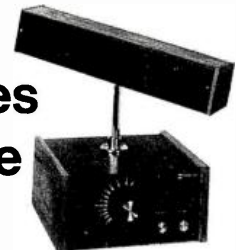

The McKay Dymek DA 5 shielded ferrite loop AM antenna has a solid state preamp with tuning and sensitivity controls. The DA 5 overcomes the two big AM reception problems: strong locals "hiding" weaker distant stations close on the dial, and interference from TV and electrical sources. Eliminate those high cost land lines by using the DA 5 to pick up primary broadcasts for authorized rebroadcast, and for monitoring your EBS primary. Increases signal strength 4 to 8 times—really sharpens up AM performance in your receiver or monitor.

Factory Direct—\$175.00. We offer 30 day account on your station P/O. Also Mastercharge, BankAmericard and unique rent plan for individuals. For more information or to place your order, call toll free:

Nationwide 800/854-7769
California 800/472-1783



McKay Dymek Co.
675 N. Park Ave., Box 2100
Pomona, CA 91766

Equipment, RCA

Westport, N.Y. 12993: (518) 962-4567. John H. Ring, area sls mgr.

Neff Electronics Inc. 11511 Maryland Ave., Box 257, Beltsville, Md. 20705. (301) 937-4776. John L. Neff, pres; Robert F. Richards, VP; Wayne L. Hetrich, dir of engr.

Alert generator and detector, amplifiers, cartridges.

Neumade Products Corp. 720 White Plains Rd., Scarsdale, N.Y. 10583. (914) 725-4900. L.E. Jones, exec VP; R.N. Jones, VP; Warren W. Clements, sec treas.

Buffalo, N.Y. 14225: (716)684-0050. W.K. Mix, plant mgr.

Rupert Neve Inc. Berkshire Industrial Park, Bethel, Conn. 06801. (203) 744-6230. Rodney D. Titcomb, VP-mktg; B.J. Roche, VP, engr; T.B. Nordahl, VP, sls.

Hollywood 90028: Suite 614, 1800 N. Highland Ave. (213) 465-4822. Tore B. Nordahl, sls mgr.

Malton, Ont. L4T 3K1: Rupert Neve of Canada Ltd., 2721 Rena Rd. (416) 677-6611. Gary C. Caruthers, VP sls.

Melbourn, Royston, Hertfordshire, England: Rupert Neve & Co. Ltd., Cambridge House (0763) 60776. Derek A. Tilsley, mktg dir.

Consoles, equalizers.

New England Tower Construction Co. Inc. R.F.D. 2, Brandon, Vt. 05733. (802) 247-5725. Curtis Prescott, pres; Louise Prescott, VP; Deborah Prescott, sec; Clara Hayes, bookkeeper.

Nippon Electric Co. Ltd. c/o Telemation Inc. Box 15068, Salt Lake City 84115.

Northwest Monitoring Service. Box 1042, Pendleton, Ore. 97801. (503) 276-2281. J.H. Platz, mgr. Frequency standards.

Nortronics Co. Inc. 8101 10th Ave. N., Minneapolis 55427.

Magnetic tape heads and tape recorder accessories.

Nurad Inc. 2165 Druid Park Dr., Baltimore 21211. (301) 462-1700. Gordon Neuberth, pres; Glenn H.

Helme, VP; Harry C. Quast, treas; Leslie K. Lear, dir of mktg; George F. Fike, chief engr. Antenna systems.

O

Gunnar A. Olsen Corp. 22 S. Maryland Ave., Port Washington, N.Y. 11050. (516) 883-3820. Alf W. Olsen, pres; Walter J. Clarke, VP

Opamp Labs Inc. 1033 N. Sycamore Ave., Los Angeles 90038. (213) 934-3566. B.J. Losmandy, pres. Audio consoles, amplifiers, controls, power supplies.

Optasound Corp. 25 E. 26th St., New York 10010.

Optek Inc. 5526 E. La Palma Ave., Anaheim, Calif. 92807. (714) 528-2321. John S. Baumann, pres.

Time code editing systems, computerized automation equipment.

Optical Systems Co. Star-D Division, 18436 Topham St., Tarzana, Calif. 91356. (213) 343-7183. C. Skora, own.

Slide binders, film equipment.

Otari Corp. 981 Industrial Rd., San Carlos, Calif. 94070.

Tape recorders, automation systems.

P

Pacific Tower Co. 6100 N.E. Columbia Blvd., Portland, Ore. 97218. (503) 287-7303. Gilbert Nielsen, pres.

Towers, lighting and ground systems.

Pallard Inc. 1900 Lower Road, Linden, N.J. 07036. (201) 381-5600. Jerry J. Kovanda, exec VP; Walter Braun, VP, mktg svcs.

Los Angeles 90066: (213) 391-6385. Lida Novacek.

Pako Corp. 6300 Olson Memorial Hwy, Minneapolis 55418. (612) 540-6011.

Panasonic Video Systems, Matsushita Electric Corp. of America, One Panasonic Way, Secaucus, N.J. 07094. (201) 348-7000.

Paperwork Systems Inc. 2000 A St., Box 38, Bellingham, Wash. 98225. (206) 733-8510. Joseph D. Coons, pres; Lee Facto, sec treas; Christopher M. Young, VP field ops.

Accounting systems for broadcast stations.

Paulmar Inc. 3336 Commercial Ave., Northbrook, Ill. Film cleaning, viewing and inspecting equipment.

Peerless Electronics Inc. 12011 Coit Rd., Suite 103, Dallas 75230. (214) 661-9558.

Pentagon Industries Inc. 4751 N. Olcott Ave., Chicago 60656. (312) 867-9200. T. Horton, pres; Joe Briedis, VP engr; Charles Wheeler, VP opns; Bill Holtane, sls mgr tape products.

Permadyne Electronics Corp. 2927-29 N. Southport Ave., Chicago 60657. (312) 525-5559. Paul H. Dunakin, pres; Robert Fox, VP; R. Dunn, sec; Robert Smith, sls.

Phelps Dodge Communications Co. Plant 1, Route 79, Marlboro, N.J. 07746.

Antennas, coaxial transmission line and accessories.

Phillips Audio Video Systems Corp., Broadcast Equipment Division. 91 McKee Drive, Mahwah, N.J. 07430. John S. Auld, pres; James Wilson, VP mktg; Warren Anderson, mgr, adv & PR.

Photo Research Division, Kollmorgen Corp. 300 N. Hollywood Way, Burbank, Calif. 91505. (213) 849-6017. James K. Branch, pres; Fred Clover, dir of mktg; Richard A. Walker, dir of engr.

Potomac Instruments Inc. 932 Philadelphia Ave., Silver Spring, Md. 20910. (301) 589-3125. Robert H. Ellenberg, pres; Clifford C. Hall, chief engr; David G. Harry, dir of mktg; William H. Casson, staff engr.

Antenna monitors, field strength monitors, audio test equipment.

Power-Optics Inc. Box 266, Fairview Village, Pa. 19409. (215) 539-5300. D. Lesner, pres; Thomas N. Streeter, VP and gen mgr; Richard Fordham, service mgr.

Digital remote control system for broadcast cameras.

Prodelin Inc. Box 131, Hightstown, N.J. 08520. (609) 448-2800. L.A. Bondon, pres; J.B. James, exec VP. Bridgeview, Ill. 60455: 9707 S. 76th Ave. (312) 598-2900. P.L. Caffrey, VP.

Santa Clara, Calif. 95050: 1350 Duane Ave. (408) 244-4720. A. Haselman, VP.

Microwave antennas, transmission line systems.

Pro-Tex Reel Band Co. 200 Film Bldg., Cleveland 44114. (216) 861-2624. Thomas S. Kulka, pres.

Pulse Dynamics Manufacturing Corp. Depot & Fulton Sts., Box 355, Colchester, Ill. 62326. (309) 776-4544. R.D. Zimmer, gen mgr, sls mgr; M.C. Kerber, chief engr.

QUALITY TALKS FOR WLW

Cincinnati, Ohio



Continental's 317C is the best measure for any 50 kW AM transmitter purchase. Performance, 125% positive modulation and reserve power capabilities are unbeatable. Today's best sound in 50 kW AM is Continental.

Continental Electronics

CONTINENTAL ELECTRONICS MFG. CO.
BOX 17040 DALLAS, TEXAS 75217

RCA Corporation

30 Rockefeller Plaza, New York 10020
(212) 598-5900

Board of Directors Thorton F. Bradshaw, Anthony L. Conrad, Stephen M. DuBrui, Jr., Lawrence E. Fouraker, George H. Fuchs, Julian Goodman, Edgar H. Griffiths, Howard R. Hawkins, William C. Hittinger, William J. Kennedy III, John R. Petty, Cecily C. Selby, Donald B. Smiley, Robert L. Werner.

Officers Anthony L. Conrad, pres; Kenneth W. Bilby, exec VP, pub affrs; George H. Fuchs, exec VP, industrial relations; Edgar H. Griffiths, exec VP; Howard R. Hawkins, exec VP; William C. Hittinger, exec VP; Irving K. Kessler, exec VP, government & commercial systems; Robert L. Werner, exec VP & general counsel; Charles C. Ellis, senior VP, finance; Stephen S. Barone, VP licensing; Lester Bernstein, VP corporate communications; Eugene E. Beyer Jr., VP & gen atty; Herbert T. Brunn, VP, consumer affairs; Robert C. Butler, VP, financial analysis; Joseph W. Curran, VP, marketing services; George C. Evanoff, VP, corporate development; George A. Fadler, VP, manufacturing services & materials; Laurence J. Farley, VP, financial resources; J. Thomas Kennedy, VP & controller; Roy H. Pollack, VP & General Manager, Consumer Electronics; Raymond L. Scherer, VP, Washington; Eugene A. Sekulow, VP, international; Bernard V. Vonderschmitt, VP & gen mgr, solid state div; William M. Webster, VP, Laboratories; Warren E. Hendrickson, treasurer; George E. Morris, secretary.

Washington: 1800 K St. N.W. 20006. (703) 558-4242. Raymond L. Scherer, VP.

RCA Commercial Communications Systems Division. Bldg 2-2, Front & Cooper St., Camden, N.J.

08102. (609) 963-8000. C.J. Gaydos, N.J. Hudak, J.L. Preston, R.C. Tyrrel.

Atlanta 30329: 14 Executive Park Dr. N.E. (404) 634-6131. P.G. Walters, P. Higginbotham.

Austin, Tex. 78731: 3409 Executive Center Dr., Suite 213. (512) 345-2224. D. Forbes.

Birmingham, Ala. 35223: Office Park Bldg. 10, Office Park Circle. (205) 871-1155. A. Nobo.

Boston: Wellesley, Mass. 02181. Wellesley Office Park, 40 Williams St. (617) 237-6050.

Burlingame, Calif. 94010: 330 Primrose Rd., Suite 305. (415) 343-2741. R.J. Newman.

Charlotte, N.C. 28210: 6230 Fairview Rd., Suite 104. (704) 366-0626. L. White.

Chicago 60606: Gateway II Bldg., Suite 1400, 120 S. Riverside Plaza. (312) 782-0700. O.G. Bjerke, R.J. Gibbs, F. Timberlake.

Cincinnati 45231: 11430 Hamilton Ave. (513) 825-1550. C.E. Raasch.

Dallas 75247: 8700 Stemmons Freeway. (214) 638-6200. E.H. Hoff, G. McClanathan, L. Pinski.

Denver 80211: 2695 Alcott St., Suite 231-S. (303) 433-8484. J.H. Butts.

Detroit: Southfield, Mich. 48075. 42333 Southfield Rd., Suite 209. (313) 357-0080. W.P. Happel.

Hollywood 90028: 6363 Sunset Blvd. (213) 461-9171. H.W. Dover, G. Dato.

Indianapolis 46205: 2511 E. 46th. (317)546-4001. J.L. Ayers.

Jacksonville, Fla. 32207: 2747 Art Museum Dr., Suite 5. (904) 398-4588. E.C. Fitch.

Kansas City: Overland Park, Kan. 66207. 5750 W. 95th St., Suite 111. (913)642-3185. G. Thursty.

McMurray, Pa. 15347: 761 N. Washington Rd., Nationwide Office Bldg. (412) 941-5570. C. Koriwchak.

Minneapolis 55416: 4522 Excelsior Blvd. (612) 920-6395. W.G. Eberhart.

New York 10036: 1133 Ave. of the Americas. (212) 586-3000. R.F. Varda, J.P. Shipley.

St. Louis 63105: 7701 Forsyth Blvd., Suite 455. (314) 862-3660. D.B. Freeman.

Remote broadcasting originating consoles and accessories.

Equipment, RCA

Q

QRK Electronic Products Inc. (A subsidiary of CCA Electronics Corp.) 1568 North Sierra Vista, Fresno, Calif. 93707. (209) 251-4213.

Quick-Set Inc. 3650 Woodhead Drive, Northbrook, Ill. 60062. (312) 498-0700. RC. Mooney, pres; M.J. Stolman, VP; Ron Wiseheart, VP; Bill Thomas, VP. Instrument positioning equipment.

Q-TV Telesync. 342 W. 40th St., New York 10018. (212) 695-2775. George Andros, VP s/s; Bob Swanson, gen s/s mgr.

Los Angeles: 7350 Beverly Blvd. (213)936-6195. Bob Anderson, mgr.

R

Jules Racine & Co. Inc. 85 Executive Blvd., Elmsford, N.Y. 10523. (914) 277-3070. Morgan F. Smith, pres; Roger B. Smith, VP. Stopwatches and chronographs.

Radio & TV Publicizers. Box 534, Scottsboro, Ala. 35768. (205) 845-3492. Jim Trippe, own/mgr.

Rank Precision Industries Inc. 411 Jarvis Ave., Des Plaines, Ill. 60018. (312) 297-7720. J.M. Campbell, pres; Richard E. Putman, eastern s/s mgr. West Nyack, N.Y. 10994: 260 N. Route 303. (914) 358-4450.

Broadcast zoom lenses and optics.

Raven Screen Corp. 124 E. 124th St., New York 10035. (212) Lehigh 4-8408. Fred Rose, pres; Eleanor Landes, sec-treas. Projection screens.

Raychem Corp. 300 Constitution Drive, Menlo Park, Calif. 94025. (415) 329-3466. Vince Walsh, mktg mgr. Phoenix 85014: 5045 N. 12th St., Suite 102. (602) 266-8429.

Sherman Oaks, Calif. 91403: 14011 E. Ventura Blvd., Suite 207E. (213) 788-9872. Irvine, Calif. 92664: 2182 Dupont Drive, Suite 17. (714) 833-3630.

San Diego 92120: 3435 Camino Del Rio South, Suite 211. (714) 280-5990.

Norwalk, Conn. 06851: 111 East Ave., Suite 325. (203) 853-2700.

Orlando, Fla. 32809: 7040 Lake Ellenor Drive, Suite 101, Orlando Central Park. (305) 855-4214.

Seattle 98119: 408 Second Ave. W. (206) 285-2375. B. Lloyd.

Washington: Arlington, Va. 22209: 1901 N. Moore St. (703) 558-4212. R.S. Emch, R.C. Parkhill. West Palm Beach, Fla. 33403: 3900 RCA Blvd. (305) 622-1100. R.E. Giles.

RCA Community Television Systems/Electronic Industrial Engineering Division. 7355 Fulton Ave., North Hollywood, Calif. 91605. (213) 764-2411. Henry Duszak, ops mgr; Peter A. Weston, dir, finance; John Ovnick, chief engr; Robert Schoenbeck, staff tech advisor.

Cherry Hill, N.J. 08034: 811 Church Rd., Suite 110. (609) 663-0079. Ronald R. Yokes, rgnl s/s mgr. CATV products and services.

RCA Consumer Electronics Div.: 600 N. Sherman Drive, Indianapolis 46201. (317) 635-9000. Roy H. Pollack, VP and General Manager.

RCA Distributing Corp.: 600 N. Sherman Dr., Indianapolis 46201. (317) 635-9000. M.E. Kramer, pres.

Distribution Offices: Atlanta, Ga. 30318: 1500 Marietta Blvd., N.W.; Des Plaines, Ill. 60018: 424 E. Howard Ave.; Detroit (Taylor, Mich. 48180: 27000 Trolley Dr.); Kansas City, Shawnee-Mission, Kan. 66201: PO. Box 295; Los Angeles 90022: 6051 Telegraph Rd.; San Antonio, Tex. 78219: 1903 Hornel Dr.; San Francisco 94080: 233 East Harris Ave., South San Francisco.

RCA Electronic Components. 415 S. Fifth St., Harrison, N.J. 07029. (201) 485-3900. H.C. Hittinger, exec VP; J.A. Haines, division VP; distributor products; M.S. Lewis, mgr, distributor s/s.

Atlanta 30329: RCA Building, 14 Executive Park Drive N.E. (404) 834-6131. W.F. Cornelius.

Edison, N.J.: RCA-36 Talmadge Rd. (201) 485-3900. J.M. Lunney.

Des Plaines, Ill. 60018: RCA, 446 E. Howard Ave. (312) 827-0033. J.T. Houlihan.

Atlanta 30305: 2970 Peachtree Road N.W. (404) 261-3657.

Doverland Park, Kan. 66212: 7500 West 95th St. (913) 649-6930.

Burlington, Mass. 01803: Schaal Assoc., 4-A St. (617) 272-3250.

Maple Shade, N.J. 08052: 1000 Maplewood Drive. (609) 667-4280.

Dix Hills, N.Y. 11746: 3 East Deer Park Road. (516) 864-4400.

Ithaca, N.Y. 14850: Deanco Inc., 714 W. Clinton St. (607) 272-2198.

Warren, Ohio 44484: 1310 Niles-Cortland Road N.E. (216) 856-4979.

Chadds Ford, Pa. 19317: Box 199. (215) 459-4300. Johnstown, Pa. 15905: 1027 Calvin Drive. (814) 255-1142.

Denver 80222: (303) 758-1936.

Des Plaines, Ill. 60018: (312) 298-1100.

Bethesda, Md. 20014: (301) 652-9057.

Hingham, Mass. 02043: (617) 749-6850.

Minneapolis 55422: (612) 529-9114.

Berkely, Mo. 63134: (314) 521-5111.

Bloomfield, N.J. 07003: (201) 744-6261.

Dallas 75229: (214) 350-8871.

Bellevue, Wash. 98004: (206) 455-0903.

Dorval 760, Que.: Raychem Canada Ltd., 9565 Cote de Liesse. (514) 636-1680.

Toronto 392: Raychem Canada Ltd., 3089 Bathurst St., Suite 207. (416) 789-7425.

Mexico, 11 D.F.: Raychem S.A., Yucatan 20, Suite 302. 564-00-66.

Recortec Inc. 777 Palomar Ave., Sunnyvale, Calif. 94086. (408) 735-8821. Lester H. Lee, pres; Eldon A. Corl, VP; William Lawless, prog mgr.

Video tape timers, programers, evaluators and conditioners.

Redding Radio, a division of SJ Industries Inc. Box 344, Fairfield, Conn. 06430. (203) 579-0284. Jeffrey N. Tellis, gen mgr; Sascha Deale, s/s mgr; R.F. Bourne, dir of engr; Eugene A. Roure Jr, dir, rsch and dev.

Microphone call-letter plates, telephone coupling devices, promotional items, studio equipment and accessories.

Rediaco. 1815 Guilford Ave., Baltimore 21202. (301) 727-6420.

Overland Park, Kan. 66207: RCA, 5750 W. 95th St., Suite 111. (913) 642-2852. A.K. Mallard.

Hollywood 90028: RCA, 6363 Sunset Blvd. (213) 461-9171. R.F. Kreuzer.

RCA Global Communications: 60 Broad St., New York 10004. (212) 363-2121. Eugene F. Murphy, pres. (See also Satellite Communications, this section.)

RCA Government and Commercial Systems: Marne Highway & Borton Landing Rd., Moorestown, N.J. 08057. (609) 963-8000. Irving K. Kessler, exec VP.

RCA Laboratories: David Sarnoff Research Center, Princeton, N.J. (609) 452-2700. W.M. Webster, VP; Systems Research Laboratory, Integrated Circuit Technology, Microwave Technology Center, Solid State Technology Center, Communications Research Laboratory, Information Sciences, Process and Applied Materials Research Laboratory, Materials Research Laboratory; Zurich, Switzerland; Tokyo.

RCA Picture Tube Division: New Holland Ave., Lancaster, Pa. 17604. (717) 397-7661. William C. Hittinger, exec VP.

RCA Records: 1133 Ave. of the Americas, New York 10036. (212) 598-5900. Kenneth Glancy, pres.

RCA Sales Corp.: 600 N. Sherman Drive, Indianapolis 46201. (317) 635-9000. Jack S. Sauter, pres.

RCA Service Co. Building 204-2, Cherry Hill offices, Camden, N.J. 08101. (609) 779-4152. Julius Koppelman, pres.

Jersey City, N.J.: (201) 451-2222; Philadelphia: (215) 467-3300; Atlanta: (404) 355-6110; Cleveland: (216) 238-9555; Chicago: (312) 965-7550; Dallas: (214)631-8770; Los Angeles: (213) 685-3092.

RCA Solid State Div.: Route 202, Somerville, N.J. 08876. (201) 722-3200. Bernard V. Vonderschmitt, VP & gen mgr.

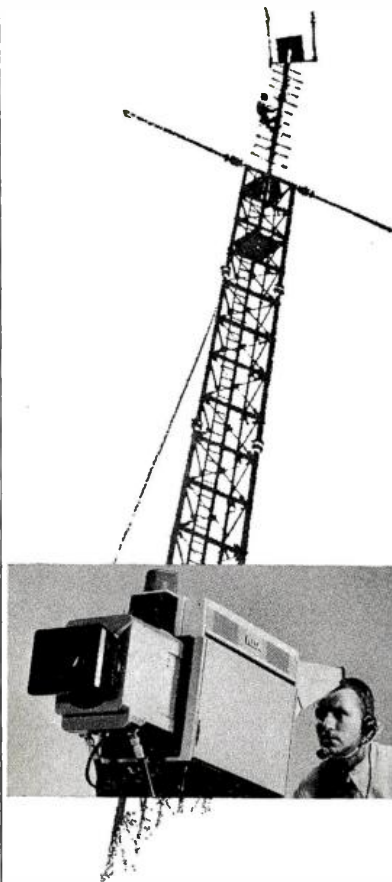

Command Performance? RCA SERVICE DELIVERS Expert Repair and Overhaul Service

FOR:

- Video tape recorders
- TV Cameras
- Antennas
- Microphones
- Transmitters
- Installation
- Console
- TV Projectors
- Microwave

Dial either of these offices for full information about fast, dependable broadcast equipment maintenance service from RCA:

Chicago (312) 298-7980
Philadelphia (215) 467-3300

Or contact:

RCA Service Company
A Division of RCA
Technical Products Service
Bldg. 204-2, Camden, N.J. 08101
Phone (609) 779-4129

RCA



Broadcasters: Before you blow thousands of dollars on transmission troubles, check this out.

Interference from tower guywires can mess up the finest transmitting system.

So before you look for expensive solutions, check out Shakespeare Saf-Glass® guy insulators.

These high strength fiberglass insulators isolate your antenna from guywire interference, while maintaining the stability of your tower.

Guy insulator lengths up to 20'. Strength ratings from 15,000 to 35,000 lbs. For further information, write or phone Lewis Mitchell, Special Products Group, Shakespeare Electronics and Fiberglass Division, P.O. Box 246, Columbia, S.C. 29202 (803) 779-5800.

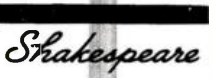

WE DO MORE WITH FIBERGLASS



We also have available solid fiberglass rod from 1/8" to 13/16" in diameter. Call for current prices.

Equipment

Reliable Electric, 11333 W. Addison, Franklin Park, Ill. 60131. (312) 455-8010. J.B. Cook, chmn; R.J. Rodday, pres; J.P. Wehle, VP, engrg; PK. Kolestos, VP, intl; J.C. Mitchell, VP, foreign.
Service drop accessories, lightning protection devices, pole guying equipment.

Repro Products Corp., 7400 State Road, Philadelphia 19136. (215) 338-1110. W.S. Wisniewski, senior VP-communications division; J.P. Fannelli Jr., pres.
CATV cable closures for two way systems or multi-taps.

Revox Corp., 155 Michael Drive, Syosset, N.Y. 11791. (516) 364-1900. Colin Hammond, pres; Peter Giddings, mktg dir.
Hollywood 90068: (213) 876-1200. Derek Allen, Western division mgr.

R.F. Systems Inc., 155 King St., Cohasset, Mass. 02025. (617) 383-1200. A.K. Fowler, pres; J.E. Hayes, VP; R.E. Gallinger, VP, admin.
Mountain View, Calif. 94040: Microwave Marketing Associates, 2680 Bayshore Frontage Rd. (415) 969-3355. Donald F. Kojiane.
Old Bethpage, N.Y. 11804: Box 70. (516) 938-5595. Burt Walker.

Antenna needs for troposcatter, radar, communications and satellite systems.

Richmond Hill Laboratories Inc., 142 Central Ave., Clark, N.J. 07066. (201) 381-5955. Peter C. Hess, sls mgr; J. Kennedy, rgnl mgr.

Riker Communications Inc., 142 Central Ave., Clark, N.J. 07066. (201) 382-3700. Gerald Fahringer, chmn of the bd & chief financial off; Leon J. Knize, pres & chief exec; Irving Horowitz, senior VP-engrg.

Rivers Associates, 112 Bonnydale Road, Leominster, Mass. 01453. (617) 537-4821. Norman L. Rivers, pres.
Encoders/decoders, silence sensors, tone detectors and control units.

Robert Bosch Corp., 2800 S. 25th Ave., Broadview, Ill. 60153. H.P. Lachner, mktg svcs mgr.

Robins/Fairchild, 75 Austin Blvd., Commack, N.Y. 11725. (516) 543-5200. Herman D. Post, pres; George Alexandrovich, VP; Sam Jones, sls mgr.

Rodelco Electronics Corp., 356A Comac Rd., Deer Park, N.Y. 11729.
Television translators.

Roh Corp., 107 Technology Park, Norcross, Ga. 30071. (404) 449-0873. James B. Godwin, pres.
Broadcast audio components, remote attenuation, switching and control systems.

Rohde & Schwarz Sales Co., 14 Gloria Lane, Fairfield, N.J. 07008. (201) 575-0750. Ulrich L. Rohde, pres; Sam Rich, treas; C.E. Barlow, mktg dir, West; A. Freeland, mktg dir, East.

Electronic measuring and communications test equipment.

Rohn Manufacturing, division of Unarco Industries Inc., Box 2000, Peoria, Ill. 60601. (309) 697-4400. Dwight Rohn, pres; Donald Rohn, VP; Richard Kleine, VP-mktg; Phil Haugens, traf mgr; Grady Rooker, microwave mgr; James Duncan, credit mgr; Al Repsumer, Midwestern division sls mgr; J.M. Fleissner, sls engr; Gene Francis, Western division sls mgr; Larry Grimes, Central division sls mgr.

Turnersville, N.J. 08012: Box 681. (609) 589-8032. Ken Cordrey, Eastern division sls mgr.

Dallas 75229: (214) 241-7791. Bill Davis. Reno 89502: (702) 322-9300. Bill Parker. Frankfort, Ind. 46041: (317) 654-4494. Boyd Lambert.

Birmingham, Ala. 35217: (205) 841-1789. Walker Bragan.

Russco Electronics Mfg. Inc., 1070 Brookhaven Drive, Clovis, Calif. 93612. (209) 299-2167. Russell C. Friend, pres/gen mgr; Victor Kearney, VP; Gary Kearney, sec.
Broadcast turntables, amplifiers, mixing consoles.

Sanyo Electric Inc., 1200 W. Artesia Blvd., Compton, Calif. 90220. (213) 537-5830.

Scala Radio Corp., 1970 Republic Ave., San Leandro, Calif. 94577. (415) 351-3792. Bruno Zucconi, pres.

Schafer Electronics Corp, subsidiary of Cetec Corp., Santa Barbara Research Park, 75 Castilian Drive, Goleta, Calif. 93017. (805) 968-0755. Robert M. Ward, pres; Frank Roide, exec VP; Andrew McClure, VP, sls; Earl Bullock, VP, engrg; Dwight Herbert, sls pgm mgr; Dallas Barnard, spec prod mgr.

Grand Junction, Colo. 81501: Communications West Inc., Box 1193. (303) 243-5373. Dick Maynard, Mike Shafer.

Dallas 75218: 10523 Maplegrove. (214) 328-4944. Tom Copeland, southern rgnl mgr.

Leominster, Mass. 01453: 42 Main St. (617) 534-0441. Ron Dagenais, northeastern rgnl mgr.

Altamonte Springs, Fla. 32701: 255 Whooping Loop. (305) 831-8458. Gordon Lund, southeastern rgnl mgr.

Bethlehem, Pa. 18017: 401 Carver Dr. (215) 691-8574. George Pupala, mid-Atlantic rgnl mgr.

Butte des Morts, Wis. 54927: Box 87. Bud Thomas, midwestern rgnl mgr.

Radio automation systems, tape recorders, cartridge machines, logging systems.

Schafer International, 1355 Harbor Drive, San Diego 92101. (714) 236-1200. Paul C. Schafer, pres.

Scheinman-Neaman Co., 2900 Liberty Ave., Pittsburgh 15201. (412) 566-1022. Lewis J. Scheinman, sls mgr.

Scientific Atlanta Inc., 3845 Pleasantdale Rd., Atlanta 30340. (404) 449-2000. Sid Topol, pres; Jack Kelly, exec VP; Howard Crispin, VP mktg; J.H. Levergood, mktg dir, cable communications div; Henry Marron, engrg dir, cable communications div.

Bladensburg, Md. 20710: (301) 779-1515. Ed Pietras, rgnl mgr.

Burlington, Mass. 01803: (617) 272-1256. Dan Pioli, rgnl mgr.

Long Beach, Calif. 90807: (213) 428-7515. Roy Schaub, rgnl mgr.

Leonia, N.J. 07605: (201) 461-5340. John King, area mgr.

Belleville, Ill. 62223: (618) 397-9251. Barney Geolat, rgnl mgr.

Atlanta 30340: (404) 449-2000. Ben Forrester, rgnl mgr.

Scully/Metrotech, division of Dictaphone Corp., 575 Ellis St., Mountain View, Calif. 94043. (415) 968-8389. William Krehbiel, pres; Homer Hull, sls mgr. Los Angeles 90005: 548 Kingsley Dr. (213) 387-4252. Chuck Broneer, mgr.

Nashville 37203: 1005 8th Ave. (615) 244-1546. William Shute, mgr.

Chicago 60645: 3434 W. Peterson Ave. (312) 583-7878. Gareth Nelson, mgr.

Tenafly, N.J. 07670: 285 County Rd. (201) 568-4414. Gerald Terdiman, mgr.

Broadcast logging recorders, tape recorders, bidirectional reproducers.

Sennheller Electronic Corp., 10 W. 37th St., New York 10018. (212) 239-0190.

Seton Name Plate Corp., 592-BY Blvd., New Haven, Conn. 06505. (203) 772-2520. Fenmore R. Seton, pres; M.R. Crespo, VP; R.F. Rackliff, VP.
Microphone name plates, badges, signs.

SGL Homalite, 11 Brookside Dr., Wilmington, Del. 19804. (302) 652-3686. N.E. Whitcomb, pres; R.G. Eastman, sls mgr.

Cherry Hill, N.J. 08002: (609) 235-4878. Bernard R. Sherer, pres.

Newton, Mass. 02166: (617) 969-5478. Norman A. Seifert, pres.

Lynbrook, N.Y. 11563: (516) 599-3351. Harold B. Helf, pres.

Minneapolis 55431: (612) 831-8423. John Melhoff, pres.

San Mateo, Calif. 94401: (415) 342-7057. John Latimer, pres.

Pasadena, Calif. 9105: (213) 684-2000. James Luscombe, pres.

Seattle 98136: (206) 938-4166. Jon B. Jolly, pres.

Wilmette, Ill. 60091: (312) 256-5202. R.J. Wilson, pres.

SGL Plastics, a division of SGL Industries. Rte. 248, Nazareth, Pa. 18064. (215) 759-0280. James D. Guiducci, pres; John R. Gardner, plant mgr.

SGL Printed Circuits Inc., 825 Black Oak Ridge Rd., Wayne, N.J. 07470. (201) 835-2765.

Shakespeare Electronics and Fiberglass Division, Box 246, Columbia, S.C. 29202. (803) 779-5800. Lewis Mitchell, spec products group.

Transmitter guy wire insulators.

Shallico Inc., Box 1089, Smithfield, N.C. 27577. (919)

S

Silent Partners



Now that the FCC have approved the use of a 25 microsecond characteristic on Dolby transmission, more and more FM stations will be taking advantage of this ruling to effect even better quality for their listeners.

Obviously now, more than ever, source quality is of paramount importance and in tape the Revox/Dolby B is the obvious answer.

Already most manufacturers of automated programming equipment have come to rely on Revox—such prestigious names as Schafer Electronics Corporation, CCA, Gates Division of Harris-Intertype, Sparta Electronics Corporation, IGM/NTI and SMC Systems Marketing Incorporated (Sonomag) all employ Revox tape recorders as an integral part of their installations.

If your application depends on ultra-reliable, high performance and outstanding signal to noise, shouldn't you be using Revox too?

"More proof that Revox delivers what all the rest only promise."

Dolby is the trademark of Dolby Laboratories, Inc. Illustrations may contain optional extras.

Revox Corporation in USA: 155 Michael Drive, Syosset, N.Y. 11791
Revox in England: Lamb House, Church Street, Chiswick, London W4 2PB.
Revox International: Regensdorf 8105 ZH Althardstrasse 146, Switzerland.

As for the Beyer DT109

microphone/headphones, they are in a class by themselves. Highly sensitive and capable of withstanding immensely high sound pressure without overload or distortion, they feature modular construction with a unique multi-pin plug in lead allowing separate wiring of left and right headphone channels, independently of the microphone.

Add featherweight comfort and effective ear sealing together with a wide frequency, true cardioid, broadcast quality microphone specially designed to work under extremes of temperature and humidity, and it is easy to understand why the DT109 has become so popular for live remote broadcasting, studio, film, television, disc jockey and language laboratory applications.

Together or separately, our remarkable Silent Partners will open your ears to recording and broadcasting possibilities you never knew existed.

Your nearest Revox/Beyer dealer will be delighted to arrange an introduction.

Once you have met them, you will wonder how you ever did without them.

Please tell me where I can see and buy Revox A77 Dolby B
 Revox Good used machines*
 Beyer DT109

Name _____
 Street _____
 City _____ State _____ Zip _____
 BSI/3 *As and when available from our dealers

Equipment

934-3135. J.S. Shallcross, pres; M.D. Sutton, VP. Attenuators, switches, resistors.

Sharp Electronics Corp. 10 Keystone Place, Paramus, N.J. 07652. (201) 265-5600.

Shintron Co. Inc. 144 Rogers St., Cambridge, Mass. 02142. (617) 491-8700. Shintaro Asano, pres.

Thousand Oaks, Calif. 91360: 1234 Uppingham. (805) 492-5422. Ronald F. Scaggs, rgnl mgr. Video studio equipment: spec effects generators, switchers and sync generators.

Shure Brothers Inc. 222 Hartrey Ave., Evanston, Ill. 60204. (312) 679-5830. S.N. Shure, gen mgr; V. Machin, VP, mktg, mfg; R. Kelley, VP, fin. Components, microphones, sound systems.

Sigmaform Corp. 2401 Walsh Ave., Santa Clara, Calif. 95050. (408) 247-6510. W.D. Weagant, pres; K.C. Monroe, sls and mktg mgr; M.J. Stanek, VP, rsch & dev. Tubing and molded shapes, windproof torches, sealing tape.

Sintronic Corp. 705 Haverford Rd., Bryn Mawr, Pa. 19010. (215) LA5-3700. Arthur A. Singer, pres; Peter A. Tyrell Jr., gen mgr; Gerald Meier, prod mgr.

Claremore, Okla. 74017: Box 622. (918) 341-5240. Claude H. Hill, sls rep.

Lafayette Hills, Pa. 19444: Box 257. (215) 828-5847. Fred Chassey, sls rep.

New York 10048: One World Trade Center, Suite 2365. (212) 432-1400. John Hayes, VP. AM-FM transmitters, line surge protectors.

Sitco Antennas. 10330 N.E. Marx, Portland, Ore. 97220. (503) 253-2000. Gustave Berliner, pres; Axel B. Tyle, ant engr; Robert Hillyer, adv mgr.

Skipran Lighting Control Corp. 61-03 32nd Ave., Woodside, N.Y. 11377. (212) 274-7222. Stephen J. Skipran, pres; Frank Brenner, VP; Terry H. Wells, sls mgr. Studio lighting control systems.

Smith Electronics Inc. 8200 Snowville Rd., Cleve-

land 44141. (216) 526-4386 or 526-3843. Carl E. Smith, pres.

Soil Inc. 401 E. 74th St., New York 10021. (212) 988-0290. J.M. Soil, pres. Broadcast facilities, switching systems.

Sony Corp. of America. 9 W. 57th St., New York 10019. (212) 371-5800.

Brisbane, Calif. 94005: 230 W. Hill Place, Crocker Industrial Park. (415) 467-4900.

Compton, Calif. 90220: 700 W. Artesia Blvd. (213) 537-4300.

Atlanta 30341: 20 Perimeter Park, Suite 109. (404) 451-7501.

Niles, Ill. 60648: 6801 W. Jarvis St. (312) 792-3600. Langley Park, Md. 20783: 1358 Holton Lane. (301) 439-3500.

Ferndale, Mich. 48220: 10610 Galaxie Ave. (313) 548-9325.

Long Island City, N.Y. 11101: 47-47 Van Dam St. (212) 361-8600.

Dallas 75247: 9004 Ambassador Row. (214) 631-3431.

Electronic newsgathering equipment.

SOS Photo Cine Optics Inc. 315 W. 43rd St., New York 10036. (212) 586-1420. Ronald H. Groen, VP sls; Michael Sloun, sls engr; Klaus Strode, video engr.

Hollywood 90038: (213) HO6-9361. Phil Dewald, sls mgr.

Sound Dynamics Inc. Box 1335, Sunnyvale, Calif. 94088. (408) 926-3588. Ronald W. Golick, pres, gen mgr. Broadcast studio equipment.

Sparta/Division of Cetec Corp. 5851 Florin-Perkins Road, Sacramento, Calif. 95828. (916) 383-5353. Telex 377-488. Frank Bogusz, pres and gen mgr; Jack J. Lawson, senior VP; Don C. Laws, ctrlr. Audio AM-FM transmitters, accessories.

Spindler & Sauppe Inc. 13034 Saticoy St., North Hollywood, Calif. 91605. (213) 764-1800. Norman A. Sauppe, pres; James W. Hulfish Jr., dir of mktg; Don Schafer, treas. TV slide projectors and background projection systems.

Stage Equipment and Lighting Inc. (Studio Equipment & Lighting Dept.) 12231 N.E. 13th Court, North Miami, Fla. 33161. (305) 891-2010. Telex 51-2606. George Gill, tech consultant; Janet Gill, customer service; Muriel Gill, pres; Vivian Gill, VP. Studio lamps.

Stahl Metal Products Division, The Scott & Fetzer Co. 4750 W. 160th St., Cleveland 44135. (216) 267-0330. T.O. York, pres; J.I. Mitchell, sls mgr-utility sls; R.E. Suhoff, sls mgr-distributor sls.

Cardington, Ohio 43315: (419) 864-6871. Robert Sparks, plant mgr.

Durant, Okla. 74701: (405) 924-5575. David Norman, plant mgr.

Atlanta 30336: (404) 691-7612. Richard Edgell, plant mgr.

Stainless Inc. Third St., North Wales, Pa. 19454. (215) 699-4871. Henry J. Guziewicz, pres; Richard J. Eberle, VP; Jess C. Rodriguez, VP mktg; Owen F. Ulmer, Howard E. Balshukat, sls engr. Microwave and CATV towers.

Stancil-Hoffman Corp. 921 N. Highland Ave., Hollywood 90038. (213) 464-7461. W.V. Stancil, pres; M.D. Custer, VP. Recorder/reproducer for logging channels, instant replay, repetitive playback.

Stanton Magnetics Inc. Terminal Drive, Plainview, N.Y. 11803. (212) 445-0063. W.O. Stanton, pres; Pete Bidwell, sls mgr-professional products; George Alexandrovick, professional products mgr. Magnetic phonograph cartridges.

State Labs Inc. 215 Park Ave. S., New York 10003. (212) 677-8400. Mark Schindler, pres; Manny Blumberg, sls mgr; Syd Bird, pchsng mgr.

Step Corp. 8699 West Chester Pike, Upper Darby, Pa. 19083. (215) 446-1515. Saul Meyer, pres. Computerized sales, traffic and accounting system for radio.

Stereotronics Television Co. 13720 Riverside Drive, Sherman Oaks, Calif. 91403. (213) 783-7770. James F. Butterfield, pres; James W. Lucas, tech dir.

Edwin J. Stevens. 8616 La Tijera Blvd., Los Angeles 90045. (213) 642-2211. Edwin J. Stevens, pres; Don Pederson, gen mgr. New York 10019: 1350 Avenue of the Americas.



Creation of the new Calibration Standard filled a need.. the acceptance of Stanton's 681 TRIPLE-E is unprecedented!

It was no accident! The Recording Industry needed a new calibration standard because it had been cutting discs with higher accuracy to achieve greater definition and sound quality.

So, the engineers turned to Stanton for a cartridge of excellence to serve as a primary calibration standard in recording system check-outs.

The result: the new calibration standard, the Stanton 681 TRIPLE-E.

The rest is history! Major recording studios adopted it . . . as did many of the smaller producers. Radio stations across the world put the 681 TRIPLE-E on all of their turntables, both for on-the-air broadcasting and for disc-to-tape transfer.

And, audiophiles by their purchases have voted it the outstanding stereo cartridge available.

The Stanton 681 TRIPLE-E offers improved tracking at all frequencies. It achieves perfectly flat frequency response beyond 20 kHz. Its ultra miniaturized stylus assembly has substantially less mass than previously, yet it possesses even greater durability than had been previously thought possible to achieve.

Each 681 TRIPLE-E is guaranteed to meet its specifications within exacting limits and each one boasts the most meaningful warranty possible. An individually calibrated test result is packed with each unit.

As Julian D. Hirsch of Hirsch-Houck Labs wrote in Popular Electronics Magazine in April, 1975: "When we used the cartridge to play the best records we had through the best speaker systems at our disposal, the results were spectacular".

Whether your usage involves recording, broadcasting, or home entertainment, your choice should be the choice of the professionals . . . the STANTON 681 TRIPLE-E.

Write today for further information to Stanton Magnetics, Inc., Terminal Drive, Plainview, New York 11803



All Stanton cartridges are designed for use with all two and four-channel matrix derived compatible systems.

Sintronic
the classic choice
for all
power levels
AM . . . 1KW - 50KW
FM . . . 10W - 50KW

Sintronic Transmitters have been installed in over 27 countries. For over 10 years, they have performed optimally under severe environmental conditions. All Sintronic Transmitters are conservatively designed and constructed. Quality components are used throughout.

Sintronic manufactures a complete line of AM and FM broadcast transmitters to satisfy every broadcast requirement. Detailed information and comprehensive product brochures on request.

Sintronic Corporation is a subsidiary of Singer Products Co., Inc. Integrity and dependability since 1937.

Sintronic
CORPORATION
Main Office and Plant:
705 Haverford Ave., Bryn Mawr, Pa. 19010
(215) 525-3700
Administrative & Export Offices:
One World Trade Center, Suite 2365, N.Y., N.Y. 10048
(212) 432-1400

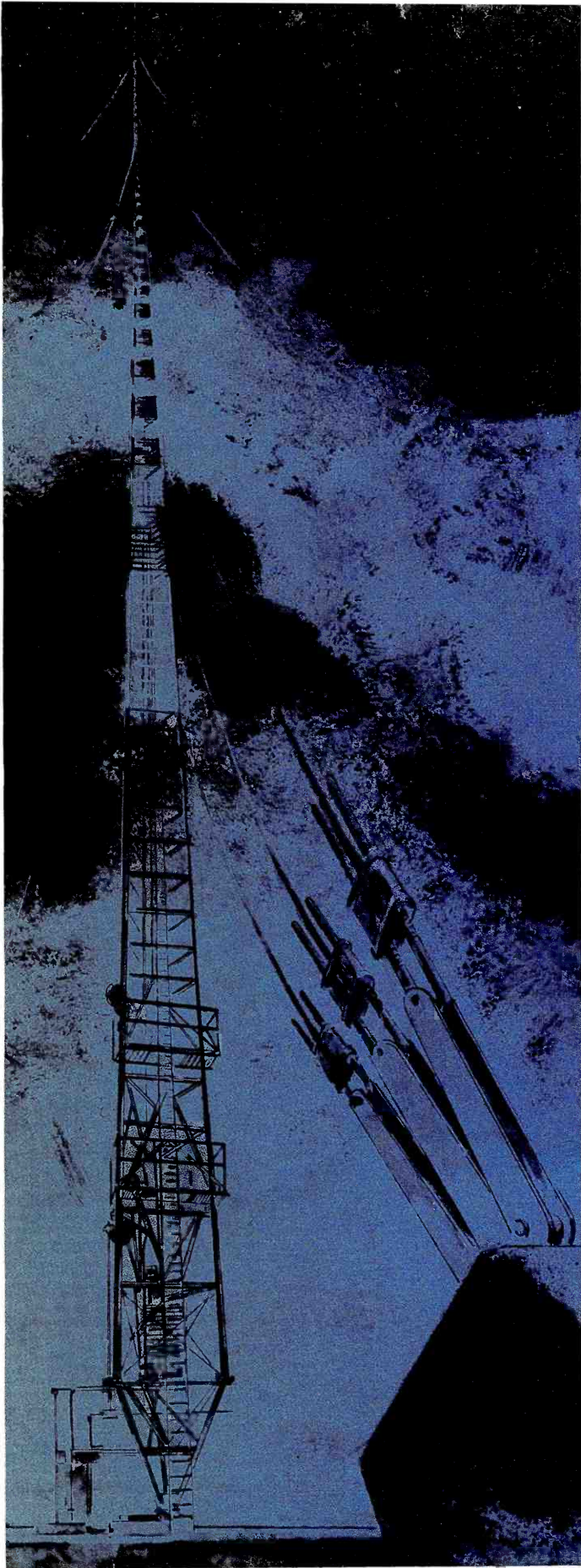

towers that talk back to the weather

When nature's warnings come on the wings of brutal winds with ice as an exclamation point, broadcasting towers must listen respectfully.

Stainless towers aren't intimidated by such messages and their accompanying conditions. Our towers talk back to the weather in no-nonsense language. This is the language of strength—the strength of construction achieved by experts with vast experience in building towers for the broadcasting industry.

These Stainless experts, using computer analysis of design and materials, soil studies for site suitability and strict adherence to Stainless quality and fabrication standards have earned us our reputation for reliable AM/FM and TV towers.

Tell us your requirements—our people (and towers) talk your language.



North Wales, Pennsylvania 19454 • (215) 699-4871

Equipment

(212) 262-2502. Joel Schwartz, dir of sls and mktg. Computer services.

Stevens Tower Service. Box 281, Laurel, Miss. 39440. (601) 425-5145.

Storeel Corp. Box 80523, 4993 New Peachtree Rd., Atlanta 30341. (404) 458-3280. Ruth E. Schaeffer, pres.

Film, tape and cassettes storage and transportation systems.

Strand Century Inc. 20 Bushes Lane, Elmwood Park, N.J. 07407.

Memory system, lighting control.

Strong Electric. 87 City Park Ave., Box 1003, Toledo, Ohio 43697. (419) 248-3741. A.J. Hatch, gen mgr; Nelson Alexander, mktg mgr.

Spotlights, projection light sources.

Willi Studer America Inc. 1819 Broadway, Nashville 37203. Raymond Updike, mktg mgr. Recorder/reproducers, microphones.

Superscope Inc. 8150 Vineland Ave., Sun Valley, Calif. 91352. (213) 767-9750. Joseph S. Tushinsky, pres; Irving Tushinsky, exec VP; Fred C. Tushinsky, VP sls mktg & new product dev; Nathan Tushinsky, sr VP prod; Edward Duggan, VP finance; Paul A. Markoff, VP corporate sls; Alan Hirshfeld, VP adv.

Glendale, Ariz. 85301: (602) 938-4820. Donn Bangs, mgr.

Troy, Mich. 48084: (313) 588-7200. Richard Isola, mgr.

Woodside, N.Y. 11377: (212) 446-7227. Joe Deo, mgr.

Bellevue, Wash. 98005: (206) 454-5162. Dave Pedrick, mgr.

Itasca, Ill. 60143. (312) 569-2147. Stan DeSzameit, mgr.

Woburn, Mass. (617) 879-5792. Mario Cannata, mgr.

Swager Tower Corp. Box 656, Fremont, Ind. 46737. (219) 495-5165. William Swager, pres; Dan J. Swager, VP.

Towers, safety climbing device.

Switchcraft Inc. 5555 N. Elston Ave., Chicago 60630. (312) 792-2700. Will Larson, pres; Clyde Schultz, VP mktg; Charlie Giesow, VP prod; Fred O. Dumke, sec-treas; William E. Dumke, VP.

Jacks, plugs, switches and audio connectors.

System-Matics Inc. 510 N. Sheridan, Tulsa, Okla. 74115. (918) 835-2368. Ed Covington, pres; Mike Richardson, exec VP; Mel Williams, sls mgr.

Systems Marketing Corp. 1011 W. Washington St., Bloomington, Ill. 61701. (309) 829-6377. L. Eugene Striegler, pres; William A. Earman, VP; Allan Mapel, sec. treas.

Columbia, S.C. 29204: Box 4468. (803) 788-5683. Joe Toher, mgr.

Weatherford, Tex. 76086: 491 Elbow Court. (817) 441-8052. Pete Charlton, mgr.

Sacramento, Calif. 95481: 4614 Freeway Circle. (916) 334-2659. Jim Quarles.

Akron, Pa. 17501: 33 Dawn Ave. (717) 859-1011. David May, mgr.

Highland Park, Ill. 60035: 850 Yale Lane. (312) 433-1253. Bob Popke, mgr.

Cartridge equipment, radio automation.

Systems Resources Corp. 223 Newtown Road, Plainview, N.Y. 11803. (516) 249-3018.

Systems Wire & Cable Inc. 3500 S. 30th St., Box 21007, Phoenix 85036. (602) 268-8744. John R. Woods, pres; Nathaniel M. Marshall, exec VP; William Witzigman, VP ops; John W. Elsasser, sls mgr; P.J. Thompson, sls rep.

Coaxial cables.

T

Taber Manufacturing & Engineering Co. 2081 Edison Ave., San Leandro, Calif. 94577. (415) 635-3831. William D. Taber, pres; Robert H. Kearns, VP; P. Taber, treas.

Hollywood 90038: 1227 N. Vine St. (213) 464-5108.

Replacement audio heads, bulk tape eraser, test tapes.

Joel Tall Inc. (trade marks EditAll, Editabs). 158 South Terrace Ave., Mount Vernon, N.Y. 10550. (914) MO8-0388. Joel Tall, pres.

Joel Tall Inc. is represented by Elpa Marketing Industries, Thorens & Atlantic Ave., New Hyde Park, N.Y. P16-3002. Richard W. Walter, sls mgr.

Tape-Athon Corp. 502 S. Isis Box 814, Inglewood, Calif. 90301. (213) 776-6933. David J. Anthony, pres; H.J. Halvorson, pres, music; Thomas L. Anthony, VP; Wally Rubin, VP sls.

Reel-to-reel playbacks, multi-transport systems.

Tapescart TCM Inc. 12326 Wilkins Ave., Box 662, Rockville, Md. 20851. (301) 881-8888. Paul L. Shore, pres.

Tascam. 7733 Telegraph Rd., Montebello, Calif. 90640. George Derado, pres; Larry Phillips, mktg dir; John Boyle, sls mgr; Charles Overstreet, adv mgr.

T-C Specialties Co. Inc. Box 192 (15-17 S. Main St.), Coudersport, Pa. 16915. (814) 274-8060. William J. Ayers, pres.

Coupon billing systems, office products.

TEAC Corp. of America. 7733 Telegraph Rd., Montebello, Calif. 90640. (213) 726-0303.

Technology Inc., HF Photo Systems Division. 11801 W. Olympic Blvd., Los Angeles 90064. (213) 479-3941. W. Lewis, VP and gen mgr; Derrill Macho, dir, com mktg; M.S. Lee, cntrlr; G. Henshaw, gp mktg mgr; I. Ryman, engrg mgr; W. Schutram, cust svc mgr; R. Arlen, mfg mgr.

Elm Grove, Wis. 53122: Box 598. (414) 782-2514. Ralph Winkler, mgr, natl sls.

Film processors, silver recovery units.

Tektronix Inc. Box 500, Beaverton, Ore. 97077. (503) 644-0161.

Field engineer offices:

Orlando, Fla. 32803: 1040 Woodcock Rd., Suite 109. (305) 894-3911.

Rockville, Md. 20850: 1335 Piccard Dr. (301) 948-7151.

Syracuse, N.Y. 13212: 1 Northern Concourse. (315) 455-6661.

Philadelphia 19034: 165 Indiana Ave., Fort Washington, Pa. (215) 542-1440.

Dallas 75240: 4455 Sigma Rd. (214) 233-7791.

Atlanta 30341: Suite 3, 2251 Perimeter Park. (404) 451-7241.

Santa Clara, Calif. 95051: 3200 Coronado Dr. (408) 249-5500.

Irvine, Calif. 92705: 16601 Hale Ave. (714) 556-8080.

Hazelwood, Mo. 63042: 422 Anglum Rd. (314) 731-4696.

Van Nuys, Calif. 91406: 16930 Sherman Way. (213) 987-2600.

Springfield, N.J. 07081: 964 S. Springfield Ave. (201) 379-1670.

Indianapolis 46219: 6121 E. 30th St. (317) 546-2408.

Chicago 60007: 1541 Elmhurst Rd., Elk Grove Village, Ill. (312) 593-2830.

Long Island, N.Y. 11797: 100 Crossways Park West. (516) 364-9060.

Boston 02154: 244 Second Ave., Waltham, Mass. (617) 890-4550.

Telcom Inc. 8027 Leesburg Pike, McLean, Va. 22101. (703) 893-7700. Peter J. Schenk, pres; Gail E. Boggs, chmn; Roger N. Crummer, Robert N. Dehart, Kenneth Owen, William H. Wilson, VPs.

St. Louis 63017: Telcom Engineering Inc.—Telcom Construction Corp. (314) 532-3535. J.C. Barnard, VP.

Las Vegas 89109: Telcom-Nevada. (702) 732-3186. J.S. Stotsky, VP.

Telcine Inc. 294 East Shore Dr., Massapequa, N.Y. 10758. (516) 798-2828. Donald R. Collins, pres.

Telecommunications Industries Ltd. 6335 Home-wood Ave., Suite 204, Los Angeles 90028. (213) 461-3561. Ed Ries, pres.

Test charts, slides, films.

Teledyne Camera Systems. 131 N. Fifth Ave., Arcadia, Calif. 91006. (213) 359-6691. D.B. Tidus, pres; R.J. Deterville, VP mktg.

Motion picture cameras, recording systems, optical products, night vision equipment.

Telemation Inc. Box 15068, Salt Lake City 84115. (801) 487-5399. Lydie O. Keys, pres; R.T. Hoffman, VP admin; K.D. Lawson, VP mktg; Paul Warnock, VP fin; Donald Smith, bcst sls mgr.

Burlingame, Calif. 94010: 375 Beach Rd. (415) 348-3322. Michael Goddard, sls.

Inglewood, Calif. 90301: 401 E. Manchester. (213) 674-1453. Don Dunbar, sls mgr.

Salt Lake City 84115: Box 15068. (801) 487-5399. Sam Kichas, sls.

Denver 80211: 3501 Kalamath St. (303) 433-8603. Gary Atkins, sls.

Dallas 75229: 2609 Tarna Dr. (214) 247-9684. Mike Richardson, sls.

Glenview, Ill. 60025: 1948-B Lehigh Rd. (312) 729-5210. Dennis Fraser, sls.

New York 10036: 25 W. 43rd St., Suite 606. (212) 575-1466. Jerry Cudlipp, rgnl bcst sls mgr.

Beltsville, Md. 20705: 10768 Tucker St. (301) 937-8700. Don Rhodes, sls.

Atlanta 30340: 3684 Wilton Ave. (404) 451-1801. Tommy Thompson, sls.

Holliston, Mass. 01746: 19 Francine Dr. (617) 429-5858. Don LeFebvre.

Omaha 68137: 5110 S. 125th Court. (402) 895-1947. Ken Schneider.

Amplifiers, components, cameras, generators, switching equipment.

Tele-Measurements Inc. 145 Main Ave., Clifton, N.J. 07014. (201) 473-8822. J.R. Poppele, pres; William Endres, VP.

Springfield/Chicopee, Mass.: Box 1 (WACE). Phil Zoppie, mgr.

Telemet, division of Geotel Inc. 185 Dixon Ave., Amityville, N.Y. 11701. (516) 541-3600. K. Schwenk, mktg mgr; A. Bolletino, asst mktg mgr; R.G. Griffiths, rgnl mgr; Atlanta: (404) 294-5809. W.G. Robinson, rgnl mgr; Riverside, Calif.: (714) 683-0641. R. Lawrence, rgnl mgr; Lombard, Ill.: (714) MA7-6026. D. Chapman, rgnl mgr; Dallas: (214) 241-0928. L. Caput, rgnl mgr.

Group delay test set, demodulator, routing switches.

TelePro Industries Inc. 2 Echelon Plaza, Suite 100, Voorhees, N.J. 08043. (609) 772-1000. Dennis Boardman, pres; James Rogers, treas; Roger Cappello, gen mgr; Gene Bidun, sls mgr.

Sunnyvale, Calif. 94086: 816 San Aleso Ave. (408) 734-3714. James Chittester, gen mgr.

Kansas City, Mo. 64120: 830 N. Agnes. (816) 241-8668. Robert Schenck, gen mgr.

Telescript Inc. 20 Insley St., Demarest, N.J. 07627. (201) 567-2220. Robert P. Swanson, pres; A. Petzbobby, VP engr.

Chatsworth, Calif. 91311: California Retyping Co., Lurline Ave. (213) 882-3151. Jim Henderson, VP.

Monitor prompting services, front projection systems.

Television and Computer Division, Frontier Engineering Corp. Box 265, Florham Park, N.J. (201) 822-3030. C.V. Girod Jr., pres.

Television Equipment Associates Inc. Box 1391, Bayville, L.I., N.Y. 11709. (516) 628-8068. Bill Pegler, pres.

Video tape cleaner/evaluator, video and pulser delays, microphone, headsets.

Television Microtime Inc. (subsidiary of Andersen Laboratories Inc.) 1280 Blue Hills Ave., Bloomfield, Conn. 06002. (203) 242-0761. A. Norman Into Jr., pres; Elmer J. Dahl, VP; David E. Acker, VP.

Time base correctors, VTR system.

Television Research International Inc. 1988 Leghorn St., Mountain View, Calif. 94043.

Video-tape editing system.

Television Technology Corp. 9150 Brookville Rd., Silver Spring, Md. 20904. (301) 565-0770.

TV and FM rebroadcast translators.

Telex Communications Inc. 9600 Aldrich Ave., S., Minneapolis 55420. (612) 884-4051. Ansel Kleiman, pres; James Arrington, VP; Sidney Kitzell, dir of mktg.

Recorders/reproducers, headsets, tape equipment.

Teltron Inc. 2 Riga Lane, Box 416, Douglassville, Pa. 19518. (215) 582-2711. A.H. Mengel, pres; P.L. Thomas, mktg mgr.

Redwood City, Calif. 94063: Box 5134. (415) 365-0800. H. Bogardus, western rgnl mgr.

TV image tubes, vidicons, orthicons, and vikons.

Texas Electronics Inc. Box 7225, Inwood Stn, Dallas 75209. (214) 631-2490. J.R. Tozer, pres; Sam F. Eason, chief engr; David DeGraff, sls mgr; J. Young, prod.

Weather instruments for broadcast use.

Thomson-CSF Electron Tubes Inc. 750 Bloomfield Ave., Clifton, N.J. 07015. (201) 779-1004. Ernest L. Stern, pres; Stuart Hesselton, prod mgr; Alain Delaye, tech mgr.

There is more to picture quality than one Volt and 75 Ohms.

Setting your video at One volt across 75-ohms is just the beginning of the achieving ity. That's Tektronix Tel-



Engineers to help you with products to time, test, measure, correct and display the composite video signal. These Field Engineers are experienced in the day-to-day use of our Television Products and they can be especially helpful when you need assistance with a tough application. To get assistance from these highly qualified people, call the nearest Tektronix office in the listing in this section. To get a Television Catalog write: Tektronix, Inc., Box 500A, Beaverton,

OR 97077.



TEKTRONIX®
committed to
technical excellence

- Sync Generators • Test Signal Generators • Automatic Video Correctors • Picture Monitors •
- Waveform Monitors • Vectorscopes • Spectrum Analyzers • Sideband Analyzers •

Equipment

Thomson-CSF Laboratories Inc. 37 Brownhouse Rd., Stamford, Conn. 06902. (203) 327-7700. Renville H. McMann, pres; Langdon A. Cook, exec VP; John Camarda, sls mgr; Harvey Caplan, Midwest rgnl sls mgr; Thomas Hindle, Southeast rgnl sls mgr; James A. Smith, western rgnl sls mgr; Robert J. Estony, dir info svcs; John Dawson, camera sls.

La Canada, Calif. 91011: Box 36. (213) 790-4393. James A. Smith, rgnl mgr.
St. Louis 63129: 4233 Barcelos Dr. (314) 487-2450. Harvey Caplan, Midwest rgnl mgr.
Color broadcast equipment, audio peak controllers, test generators.

Time & Frequency Technology Inc. 3000 Olcott St., Santa Clara, Calif. 95051. (408) 246-6365. Joseph Wu, pres; Rich Walsworth, VP engrg; Tim Worny, cntrlr. Frequency and modulation monitors, clock systems, receivers, encoder/decoder.

TOCOM Inc. Box 47066, Dallas 75247. (214)

259-7691. John Campbell, pres; Jim Smith, VP; Charles Lowe, VP; Charles Powell, VP.

Topaz Electronics. 3855 Ruffin Rd., San Diego 92123. (714) 279-0831. Gerald P. Williams, dir of mktg; Richard Wheelock, sls mgr; Kenneth Olson, pres; Tom McGuire, VP, mfg.
Transformers, regulators, inverters, powermakers.

Tower Erection Inc. N86 W14041 Beacon Road, Menomonee Falls, Wis. 53051.

Tracor Inc. 6500 Tracor Lane, Austin, Tex. 78721. (512) 926-2800. Frank W. McBee Jr., pres; R.E. Olyphint, division VP; Harry L. Thomas, sls mgr, industrial instruments.

Waltham, Mass. 02154: (617) 890-5300. Warren Rathbun.

Garden City, N.Y. 11530: (516) 248-4858. Paul Milazzo.

Rockville, Md. 20850: (301) 340-0303. Jimmie L. Toms.

Orlando, Fla. 32803: (305) 843-1510. William P. Bivins.

Greensboro, N.C. 27408: (919) 273-1918. Thomas C. Kirkman.

Huntsville, Ala. 35807: (205) 881-6220. F. Douglas Severage.

Dallas 75240: (214) 233-5535. W. Russell Martin. Milford, Mich. 48042. (313) 685-2560. Mike Dyer. Evergreen, Colo. 80439: (303) 674-6000. Herb Didier.

Yorba Linda, Calif. 92686: (714) 528-9505. John Baumann.

Sunnyvale, Calif. 94087: (408) 739-1941. Vern Behlen.

Treise Engineering Inc. 1941 First St., San Fernando, Calif. 91340. (213) 365-3124. J. Carl Treise, pres; Thomas C. Treise, gen mgr; Robert Palmatier, sls mgr.

Tri-Ex Tower Corp. 7182 Rasmussen Ave., Visalia, Calif. 93277. (209) 732-8383. Edward R. Borges, gen mgr; Clyde C. Blyleven, VP/mktg.

Triplet Corp. 286 Harmon Rd., Bluffton, Ohio 45817. (419) 358-5015. Ropp Triplet, pres; Norm Triplet, exec VP, mktg.

Panel instruments and test equipment.

Trompeter Electronics Inc. 8936 Comanche Ave., Chatsworth, Calif. 91311. (213) 882-1020.

TT Electronics Inc. 2214 S. Barry Ave., Los Angeles 90064. (213) 478-8224. J.F. Sodaro, sls mgr; S.J. Sodaro, prod mgr.
Electronic filters.

TV Cable Supply Co. Box 38, Carlisle, Pa. 17013. (717) 243-4918. George F. Gardner, mgr; Carl E. Richard, sls mgr.

U

Ultra Audio Products/Pixtec. Box 921, Beverly Hills, Calif. 90213. (213) 849-1433.

Unarco-Rohn, Division of Unarco Industries Inc. Box 2000, Peoria, Ill. 61601. (309) 697-4400. Dwight Rohn, pres; R.A. Kleine, VP, mktg; Donald Rohn, VP. Birmingham, Ala. 35217: Box 6537. (205) 841-1789. Nick Nichols, off mgr.

Frankfort, Ind. 46041: Box 365. (317) 654-4494. Boyd Lambert, gen mgr.

Communications towers and accessories.

Unimedia Inc. 2301 Industrial Pkwy West, Hayward, Calif. 94545. (415) 782-2600.

Unimedia Corp. 22525 Kingston Lane, Auburn, Calif. 95603. (916) 272-1971. William J. McLaughlin, pres.

Video color monitors and monitor/receivers. Tuner and speaker amplifiers.

United Recording Electronics Industries. 11922 Valerio St., North Hollywood, Calif. 91605. (213) 764-1500. M.T. Putnam, pres; D.F. Morris, VP.

Utility Tower Co. Box 12027, Oklahoma City 73112. (405) 946-5551. C.E. Nelson, own; V.G. Bud Duvall, gen mgr; Ron Nelson, sls mgr; M.N. Nate Sholar, Eastern division mgr.

Mayfield, Ky. 42066: Box 163. (502) 247-3642. M.N. Sholar, eastern division mgr.

Towers, base insulators and lighting kit.

V

Varian Associates. 611 Hansen Way, Palo Alto, Calif.

Power grid tubes, megawatt tetrode, triodes.

Varian/Micro-Link. 8 Salem Rd., Beverly, Mass. 01915. (617) 922-6000.

Vedco Inc. 2320 North Woodlawn Ave., Metairie, La. 70001.

Program/routing switcher, distribution amplifiers.

Vega Division of Cetec Corp. 9900 Baldwin Place, El Monte, Calif. 91731. (213) 442-0782. Ernie Pappenfus, gen mgr; Ken L. McKenzie, natl sls mgr.
Wireless microphones.

Video Data Systems Inc. 657 Old Willets Path, Hauppauge, N.Y. 11787. Gerald Goldman, natl sls mgr.

Vidronics Company Inc. 855 N. Cahuenga Blvd., Hollywood 90038. (213) 466-9741. Harold Goldman, chmn of the bd; Milton J. Raynor, exec VP; Michael L. Weisbarth, VP of sls.

New York 10022: 711 Fifth Ave. (212) 486-9116.

Videotape production and post-production.

VIF International. Box 1555, Mountain View, Calif. 94042. (408) 739-9740. Gordon MacKechnie, pres; Eric Breeze, dir of video engrg; Alden G. Thompson, dir of progmg; Ken Aitken, dir automation equip, engr.

Magnetic tape recording equipment, radio automation and programming services.

Utility Tower Supports Your Profit Potential

From the base to the beacon, Utility Towers are engineered and erected to the exacting requirements of reliability and stability of the broadcast industry.

Utility Tower combines computer accuracy in the design and specification of towers with Utility Tower's own experienced erection crews to give you the best engineered and erected tower available.

Call Utility Tower for an estimate, let the tower of strength support your profit potential.

Utility Tower
COMPANY

HOME OFFICE: Ron Nelson
Box 12027
Oklahoma City, Okla. 73112
(405) 946-5551
Night: (405) 942-8164

EASTERN DIVISION: Nate Sholar
Box 163
Mayfield, Ky. 42066
(502) 247-3642
Night: (502) 247-5657

- ITFS/MDS Transmitters and Receivers
- Microwave Path Survey Equipment
- Low-Cost FM Microwave Receivers for Satellite Terminals

varian MICRO-LINK[®]
beverly, mass. (617) 922-6000

A hand is shown holding a black business card. The card features a white logo consisting of three stylized, overlapping shapes forming a triangle. Below the logo, the text "THOMSON-CSF LABORATORIES, INC." is printed in white, uppercase letters. The card is being held over a surface that appears to be a laptop keyboard, with another card partially visible underneath it.

One good name becomes another.

CBS Laboratories Professional Products Department, responsible for the development, manufacturing and marketing of broadcast products, has become Thomson-CSF Laboratories, Inc., a wholly owned subsidiary of Thomson-CSF, S.A.

Thomson-CSF, S.A., one of the world's leading professional electronics companies with over 48,000 employees, has, with this acquisition, further increased its commitment to the American broadcasting industry.

Although our name is new, we will continue to offer the very finest in broadcast equipment including Audimax[®], Volumax[®], Vidifont[®], Image Enhancer, Color Correction Systems and the complete line of Thomson-CSF products including the revolutionary TTV 1515 triax camera.

And we will continue to expand our research effort in the same tradition of professional excellence that has made CBS Laboratories the standard for the industry. We also will maintain the same professional development, engineering and marketing management staff.

You will continue to find the same innovative thinking and the same dedication to quality. We've got it all together under one great new name... Thomson-CSF Laboratories, Inc.



THOMSON-CSF LABORATORIES, INC.

37 Brownhouse Road, Stamford, Connecticut 06902
(203) 327-7700 / TWX (710) 474-3346

Equipment, Engineers

Vikron. 4918 W. 35th St., Minneapolis 55416. (612) 927-7716. David Dalquist, pres; Donald Puls, gen mgr/sls mgr.

Analog and digital magnetic tape heads.

Visual Educom Inc. 4333 S. Ohio St., Michigan City, Ind. 46460. (219) 879-8311. Kenneth R. Anderson, pres; Carl Bixby Jr., VP & dir of mktg; Eugene A. Reich, VP, DAGE TV product group.

Visual Electronics Corp. 356 W. 40th St., New York 10018. (212) 736-5840. James B. Tharpe, pres; Joseph M. Trachtenberg, VP; Charles E. Spicer, VP-engr.

La Grange Park, Ill.: 337 N. Dover Ave. (312) 354-3124. Felix D. Bonvouloir, salesman.

Bethesda, Md.: 5940 Avon Drive. (301) 530-1767. Ed Clammer, salesman.

Pasadena, Calif.: 400 Daisy Ave. (213) 449-6176. Gary Mitchell, gen mgr.

Sunnyvale, Calif.: 1208A Kifer Road. (408) 736-8737. Ron DeBry, gen mgr.

Clifton, N.J.: 10 Roberts St. (201) 667-5100. Peter Magg, gen mgr.

Greensboro, N.C.: 219 Homewood Ave. (919) 292-1791. A.W. Greeson, salesman.

Winston-Salem, N.C.: 2550 Weymouth Road. (919) 765-3157. P.D. Thompson, salesman.

Audio cartridge and cassette equipment.

Vital Industries Inc. 3700 N.E. 53rd Ave. Gainesville, Fla. 32601. (904) 378-1581. Nubar Donoyan, pres; Dale Buzan, VP engr.

Atlanta 30327: 3620 Ridgewood Rd. N.W. (404) 233-9459. N. Donoyan, mktg mgr.

Video and audio switching equipment, routing switcher.

W

Wallach & Associates Inc. 5701 Euclid Ave., Cleveland 44103. (216) 361-7616. Charles E. Wallach.

Ward-Beck Systems Ltd. 841 Progress Ave., Scarborough, Ont. M1H 2X4. (416) 438-6550.

Buffalo, N.Y. 14210: Ward-Beck Systems Inc., 290 Larkin St.

Audio mixing consoles, modular components.

Westinghouse Electric Corp. 1111 Schilling Rd., Hunt Valley, Md.

Solid-state broadcast transmitter.

Wilkinson Electronics Inc. 701 Chestnut St., Trainer, Pa. 19013. (215) 497-5100. Guffy P. Wilkinson, pres; William H. Johnson, chief engr; Catherine C. Wilkinson, sec; William G. Shaw, sls engr.

Broadcast transmitters and accessories, line surge protectors, rectifiers.

Woodward Associates Inc. Box 22, Fayetteville, N.Y. 13066.

World Video Inc. Box 117, Boyertown, Pa. 19512. (215) 367-6055. John P. Koser, pres; Jack Taylor, gen sls mgr; Ted Dames, prod mgr; Donald Stelta, dir of engr; Lynn Wagner, ofr mgr.

Atlanta 30319: 3203 Lanier Dr. (404) 237-6097. Lew Radford.

Garden City, N.Y. 11530: 83 Russel Rd. (516) 248-4858. Paul Milazzo.

Totowa, N.J. 07512: 115 Sandra Dr. (201) 256-0455. Herb Holzberg, rgnl sls mgr.

Rockville, Md. 20853: 5504 Waterway. (301) 460-1454. Dwight Wilcox.

Louisville, Ky. 40201: Box 1644. (502) 584-5535. Steve Cisler.

Farmington Hills, Mich. 48024: 31185 10 Mile Rd. (313) 478-2157. Mike Dyer.

Evergreen, Colo. 80439: Box 158. (303) 674-6000. Herb Didier.

Taos, N.M. 87571: Route 1, Box 51. (505) 758-2686. Carroll Cunningham.

Color video monitors.

World Wide Bingo Inc. Box 1401 Englewood, Colo. 80110. (303) 781-8697. James R. Hampton.

Y

York Cablevision Inc. Box 460, York, S.C. 29745. (803) 684-9967. Melvin L. Roberts, pres.

Cable TV.

Z

H. Zolberg Associates. 702 E. 58th St., Brooklyn, N.Y. 11234. (212) 752-3690.

Video system.

Consulting Engineers

*Indicates membership Association of Federal Communications Consulting Engineers.

Advanced Technology Systems, Inc. 2425 Wilson Blvd., Arlington, Va. 22201. (703) 525-2664. John J. Renner, pres; A.D. Owen, VP engr; H.F. DeFrancesco, prin engr.

Akerman, Ben. 2436 Shady Valley Dr., N.E., Atlanta 30324. (404) 261-3125. Ben Akerman, own.

Anderson, Harry R. See Hammett & Edison.

Anderson, R. See Atlantic Research.

Anderson Radio Engineering Co. PO. Box 1671, Greenville, S.C. 29602. (803) 277-2876. Burton S. Anderson, owner.

***Alvin H. Andrus.** See Steel, Andrus & Adair, 351 Scott Drive, Silver Spring, Md. 20904. (301) 384-5374.

Applied Video Electronics, Inc. Box 25, Brunswick, Ohio 44212. (216) 225-4443. G. Alfred Dodds, pres; Peter S. Magg, VP.

Armentrout, Gary. See Warren L. Braun.

Associated Communications. 4032 W. Krall, Phoenix 85019. (602) 934-8522. Walter J. Stiles, pres; Luke O. Hodges, VP (Dallas: [214] 351-3820).

Atlantic Research Corp., Jansky & Bailey Consulting Dept. 5390 Cherokee Ave., Alexandria, Va. 22314. (703) 354-3400. Dr. Coleman Raphael, pres; W.H. Borten, exec VP/treas. *Stuart L. Bailey, consultant. James E. Reeve, *Oscar Reed Jr., N. Butz, G. Daugherty, J. Landoll, B. Sparks, H. Turnage, K. Uhl, W. Weakley, R. Robertson.

Augustitus, Frank G. See A.D. Ring & Assoc.

Aviation Systems Associates. 1650 S. Pacific Coast Highway, Suite 214, Redondo Beach, Calif. 90277. (213) 378-2281. John Chevalier Jr., mngng ptrn.

Los Angeles; James Lampl, mngng ptrn, Alexandria, Va.; Charles Carmody, mngng ptrn, Honolulu.

***Bailey, Stuart L.** See Atlantic Research.

Ball, William G. See Gautney & Jones.

Barnwell, M.J. See Vir James Consulting Radio Engineers.

John H. Battison and Associates. Consulting Radio Engineers. 10073 Echo Hills Drive, Cleveland 44141. (216) 526-3906. Dr. John H. Battison, Mel Walk, S. Bennett, Mark Battison.

JOHN H. BATTISON & ASSOCIATES

Consulting Broadcast & Communications Engineers

10073 Echo Hills Drive, CLEVELAND, OHIO

216-526-3906 44141

FCC-AM, FM, TV Applications, Field Work

DIRECTIONAL ANTENNA DESIGN & PROFS

Battison, Mark. See John H. Battison and Associates.

***Beecher, Willis C.** 1730 M St., N.W., Suite 910, Washington 20036. (202) 393-5621.

Begue, George P. See Atlantic Research.

Bennett, S. See John H. Battison and Associates.

Benne, Barbara. See Silliman, Moffet & Kowalski.

***Benns, William E. Jr.** c/o WFLI Radio, O'Grady Drive, Chattanooga 37409.

***Bergen, Serge.** 10828 Fairchester Drive, Fairfax, Va. 22030. (703) 273-2191. Serge Bergen, consulting engineer.

Bernard Assoc. 237 E. 39th St., New York 10016.

(212) Murray Hill 6-7445. Bernard Eichwald, senior partner; associate: Gerard C. Sharpe.

Berseneff, Alex. See Silliman, Moffet & Kowalski.

Bidlack, Cecil S. See Carl E. Smith.

***Bitzer, Ralph J.** Arcade Bldg., St. Louis 63101. (314) 421-4954. Assoc.: Theodore A. Giles.

Bixby, Jeffrey M. See John H. Mullaney.

Blanton, K.G. See A. Earl Cullum Jr.

***Blumberg, Marvin.** See A.D. Ring & Assoc.

Boggs, Gail E. See Telcom.

Bond & Oakley. Box 7136, Reno 89510. (702) 322-9145. Ron Oakley, Clyde H. Bond. Assocs: Chris Miller, Norvel Seyler.

Bower, L.W. See Vir James Consulting Radio Engineers.

William H. Bradley, PE. 300 W 41 St., Sand Springs, Okla. 74063. (918) 245-5444. William H. Bradley, PE., consulting radio engineer.

Braun, Cyril M. 14628 Claude Lane, Silver Spring, Md. 20904. (301) 384-1529.

Warren L. Braun, PE. Consulting Engineers. Box 1106, 680 NY Ave., Harrisonburg, Va. 22801. (703) 434-4331. Warren L. Braun, PE., owner; William Edmonson, PE., prin engr; Staff (ComSonic Corp.): James Zirk, bus mgr; Don Suter, ctrlr; Jack Hensley, dir CATV; Dennis Zimmerman, dir syst design; Dick Shimp, dir R&D; Fred Rogers, dir lab svcs. Engineers: Bob Yancey, Glenn Shomo, Wayne Craun, Gary Neff, Gary Armentrout, Stanley Harpine, Mario Williams. Technicians: Lynn Hill, Dowl Sherman, Gilbert Counts, Dave Trissel, Don Hogshead, Ted Bockman, Virgil Whitmire, Don Strickler, G. David Blake. Office Staff: Ely Moyers, Sandra Munns, Lillian Braun VP.

Bridges, Loren F. See Carl E. Smith.

Brown, Margie C. See Kershner & Wright.

Browne, John FX. & Associates Inc. 25 W. Long Lake Rd., Bloomfield Hills, Mich. 48013. (313) 642-6226. John FX. Browne, pres; Warren P. Happel, PE.; Jan Dicks, off mgr.

Bullock, Robert E. 1957 Hilldale Drive, La Canada, Calif. 91011. (213) 790-2857. Robert E. Bullock, own.

Burgess, Harold D. See Hoyles, Niblock Associates Ltd.

Burleson Associates. Metromedia Bldg., 5151 Wisconsin Ave., Washington 20016. (202) 244-2345. Malcolm M. Burleson, Edmond Ciejek, Roger Penn, Raymond Rohrer.

Burleson, Malcolm M. See Burleson Associates.

Butz, H. See Jansky & Bailey.

William B. Carr & Associates Inc. Box 13287, Ft. Worth 76118. (817) 284-9311. *William B. Carr, pres dir.

Cavegn, Ambrose J. See A.D. Ring & Assoc.

Christean, Roy E. See Carl E. Smith.

Chu Associates Inc. 800 Fesler St., El Cajon, Calif. 92020. (714) 442-9459. TWX 910-331-1178.

Churchill, Daniel W. See Commercial Radio Co. Inc./C.A. Service.

Ciejek, Edmond. See Burleson Associates.

Ciccoricco, Francis A. 169 North West St., Homer, N.Y. 13077. (607) 749-4400.

Closser, P.D. 3875 Dunhaven Rd., Dallas 75220. (214) 352-9090.

Cobb, Mariana Woodson. See Silliman, Moffet & Kowalski.

Jules Cohen & Associates. 1730 M St. N.W., Washington 20036. (202) 659-3707. Partners: *Jules Cohen, *Bernard R. Segal, *Paul L. Wimmer. Associates: *L.R. du Treil, W.C. King Jr. PE., Alan E. Gearing, Albert F. Crider.

Cohen & Dippell PC. 527 Munsey Bldg., Washington 20004. (202) 783-0111. *Julius Cohen, pres; *Ralph E. Dippell Jr., VP; *Donald G. Everist, scy-treas; Engrs: John R. Uram Jr., Robert W. Guill, Sudnir K. Khanna.

***Cohen, Julius.** See Cohen & Dippell.

Commercial Radio Co. Inc. Box 43, Cavendish, Vt. 05142. (802) 226-7582. Daniel W. Churchill, gen mgr;

Beth E. Scannell, shop mgr; Karl E. Hass & Michael D. Scannell, engrs.

Construct Consultants Inc. 25 West Long Lake Rd., Bloomfield Hills, Mich. 48013. (313) Midwest 5-2688. John FX. Browne, PE, pres; William H. Gillette, PE, VF; Harold Turner, PE, structural engr.

Courtright Engineering Inc. 1450 W. Arroyo Dr., Yuma, Ariz. 85364. (602) 783-6380. M. Courtright, PE; P. Courtright.

Craun, Wayne. See Warren L. Braun.

Crawford, Susan. See Silliman, Moffet & Kowalski.

Cross Communications Consultants. 5416 Audobon Rd., Bethesda, Md. 20014. (301) 652-7817; or 300 Spring St., Eureka Springs, Ark. 72632. (501) 253-8367. John S. Cross, pres.

C.P. Crossno & Associates. PO. Box 18312, Dallas 75218. (214)321-9140. Charles P. Crossno, Charles E. Shoemaker.

***Cuellar, Oscar Leon.** 1563 South Hudson St., Denver 80222. (303) 756-8456. *Oscar Leon Cuellar, PE.

***A. Earl Cullum Jr. and Associates.** Consulting Engineers, Inwood Post Office, Box 7004, Dallas 75209. (214)631-8360. Partners: D.A. Peterson, T.A. Wright, C.M. Daniell; Associates: DeWolf Schatzel, L.F. Heithecker, K.G. Blanton.

Culver, Robert D. See Lohnes & Culver.

***Culver, Ronald H.** See Lohnes & Culver.

***Dahlberg, Elizabeth L.** See Lohnes & Culver.

Daniell, C.M. See A. Earl Cullum Jr.

Daugherty, G. See Atlantic Research.

John J. Davis Consulting Engineers. PO. Box 644, Sierra Madre, Calif. 91024. (213) 355-6909. John J. Davis, pres.

DeLauder, Douglas B. See Silliman, Moffet & Kowalski.

Dettra, John E. See Steel, Andrus & Adair.

Dickinson, Robert V.C. See Carl E. Smith.

Diehl, Leon. See Warren L. Braun.

Dillard, Everett L. See Edward F. Lorentz & Assoc.

***Dippell, Ralph E. Jr.** See Cohen & Dippell.

***Duncan, Virgil D., PE.** 1908 Ridge Rd., Raleigh, N.C. 27607. (919) 787-3377. Virgil D. Duncan, pres.

S.C. Dutka. See Vir James Consulting Radio Engineers.

L.J.N. du Treil & Associates Inc. 200 Nelson Drive, Haraahan, La. 70123. (504) 737-8877. L.J.N. du Treil, pres.

***du Treil, L.R.** See Jules Cohen & Assoc.

***Edison, Edward.** See Hammett & Edison.

Edmonson, William H. Jr. See Warren L. Braun.

Eichwald, Bernard. See Bernard Assoc.

Ellis, Larry. See Vir James Consulting Radio Engineers.

Englehart, Terence W. See Hoyles, Niblock Assocs. Ltd.

Espy, Dawkins. Box 3127, Olympic Station Beverly Hills, Calif. 90212. (213) 272-3344. Dawkins Espy, consultant. Engrs: T.L. Snyder, R. Black. Staff: P. Richards.

Evans, Margaret E. See Silliman, Moffet & Kowalski.

Evans, R. Peter. See Hoyles, Niblock Associates.

Ralph E. Evans Associates. 3500 N. Sherman Blvd., Milwaukee 53216. (414)442-4210. Ralph E. Evans PE, *Ralph E. Evans III, ptnrs; E. Ray Cooke, Byron B. Evans.

***Everist, Donald G.** See Cohen & Dippell.

Flinker, David B. See Gautney & Jones.

Ford, Paul Dean. R.R. 12, Box 379, West Terre Haute, Ind. 47885. (812) 535-3831. Paul Dean Ford, own.

Foster, L.B. See Floyd Hall.

Freedman, Mel. 1479 Mountain View Rd., Hughson, Calif. 95326. (209)883-2611.

***Frese, George M.** 1011 Denis Court, East Wenatchee, Wash. 98801. (509)884-4558.

Friedman, Thomas B. 164-63rd Ave., Playa Del Rey, Calif. 90291. (213) 823-7798. Thomas B. Friedman, own.

Gallagher, Charles I. See Edward F. Lorentz & Assoc.

Gautney & Jones. 2922 Telear Ct., Falls Church, Va. 22042. (703)560-6800. Partners: *George E. Gautney, *Carl T. Jones. Staff: Donald E. Pauley, William G. Ball, David B. Flinker, John E. Hidle.

Gehman, Robert. See Edward F. Lorentz & Assoc.

Gilbo, Arnold W. See Peter B. Gureckis & Assoc.

***Giles, Theodore A.** See Ralph J. Bitzer.

Gillette, William H. See Construct Consultants.

Paul Godley Co. PO. Box 798, Upper Montclair, N.J. 07043. (201) 746-3000. *Paul F. Godley Jr., pres; Carson W. Kauffman, assoc.

B.F. Goldberg & Associates. 1440 Knox Abbott Dr., W. Columbia, S.C. 29169. (803) 796-7282. Barnett F. Goldberg, PE., pres; F. Steve Watters Jr., EIT, engr assoc, Betsey Griffith, sec.

Grandmason, R. See Atlantic Research.

Grant, Julie A. See Silliman, Moffett & Kowalski.

Gray, Claude M. Box 602, Birmingham, Ala. 35201. (205) 822-1132.

***Griffin, Frederick G.** 7212 Timberlake Rd., Lynchburg, Va. 24502. (703) 237-2044.

Grobowski & Assoc. 1500 Massachusetts Ave., N.W. Washington 20005. (202)293-1131. Zig Grobowski, Kaz Shimabukuro.

Grover, Ralph G. See Hammett & Edison.

Peter V. Gureckis & Associates. 1910 K St. N.W., Washington 20006. (202) 223-1180. *Peter V. Gureckis, Harold B. Rohlock, Arnold W. Gilbo, Edward R. Osborne, Normando Diaz.

Gullil, Robert W. See Cohen & Dippell.

***Guy, Raymond F.** 2320 N.E. 34th Court, Lighthouse Point, Fla. 33064. (305)942-5847.

Hall, Floyd E.E., Consulting Radio Engineers. Box 1017, Crestline, Calif. 92325. (714)338-3338. Floyd Hall, prop; L.B. Foster, assoc.

Hamman, Wm. A. See Silliman, Moffet & Kowalski.

Hammett & Edison. Box 68, International Airport, San Francisco 94128. (415)342-5208. *Robert L. Hammett, pres; *Edward Edison, VP; Robert P. Smith, F. Paul Monaco Jr., Jerome E. Partch, Ralph G. Grover, Harry R. Anderson.

Hannel, F.W. 7304 North Oxford Place, Peoria, Ill. 61614. (309)691-3426. B. Gurney, C.L. Hannel.

Hannel, C.L. See F.W. Hannel.

Hartley, John T. See Hoyles, Niblock Assocs. Ltd.

Haskey, Richard. 1259 Callens Road, Ventura, Calif. 93003. (805) 642-2300.

Hatfield and Dawson. 906 36th Ave., Seattle 98122. (206) 324-7860. James B. Hatfield, PE.; Benj. F. Dawson III, PE.; Mairy L. Hatfield, PE.; partners.

Havens, Daniel B. See Kershner & Wright.

***Head, Howard T.** See A.D. Ring & Assoc.

Heffelfinger, J.B. 9208 Wyoming Pl., Kansas City, Mo. 64114. (816) Hiland 4-7010.

Heithecker, L.F. See A. Earl Cullum Jr.

Holiday, Don. See Vir James Consulting Radio Engineers.

Hoyles Niblock Associates Ltd. 4664 Lougheed Highway, Burnaby, Vancouver B.C. V5C 5R7. (604) 294-3401. Telex 043-54623. Eastern Canada office: 1 Dawson, Mart D., Box 186, Place Bonaventure, Montreal. (514) 395-8733. Principals: Herbert A. Hoyles, Peter A. Niblock, R.N. Peter Evans. Assoc: T. Negoro, William R. Tracey, Harold S. Lindberg, Grant McCormick, Roy B. Sandberg, Harold C. Peerenboom, Barry W. Mrazek, John A. Hartley, Terence G. Englehart, Eugene Janssens, David Hansen, David Brothers, Harold D. Burgess, Hugo M. Louis, Charles D. Surnick, Lloyd G. Collison, Allan Thomas, Jean-Guy Bruneau, David A. Morris, Robert C. Rolfe, Robert W. Bultitude.

Hutcheson, Guy C. Box 808, Arlington, Tex. 76010. (817)261-8721.

J. Boyd Ingram & Associates. Box 2154, Jackson,

Consulting Engineers

Miss. 39205. (601)362-7637. J. Boyd Ingram, pres; James Lee Martin, Jody Jarrell, associates.

Isberg, R.A. 1215 Henry St., Berkeley, Calif. 94709. (415) 526-1446.

Jacker, Edward W. 420 S. Chase Ave., Lombard, Ill. 61048. (312) 629-0942. Edward W. Jacker, PE, own.

Vir James Consulting Radio Engineers. Box 6590, Denver 80206. (303) 333-5562. *Vir N. James, PE, tech dir; Ihor (Slim) Sulyma, L.W. Bower, CE PE, Steve Dutka, EE, Don Holiday, PE, Taylor Shreve, PE., Stanley W. Leslie, AEROE, JD, Margarete Ralston, B.A.M.C. Staff: Phylliss Baker, Marie Stauter, Sheryl Asche, Bruce Chambers.

VIR JAMES
CONSULTING RADIO ENGINEERS
Applications and Field Engineering
Computerized Frequency Surveys
Box 6590—80206
(303) 333-5562
DENVER, COLORADO
Member AFCEE

Jetton, Ronald. See Donald L. Markley.

***Jones, Carl T.** See Gautney & Jones.

Jones, Robert A., 633 S. La Grange Rd., LaGrange, Ill. 60525. (312) 352-2275. R.A. Jones, D.C. McDonnell.

***Kassens, Harold.** See A.D. Ring and Associates.

Kaufman, Carson W. See Paul Godley Co.

***Keane, Walter F. PO.** Box 5355, Santa Fe, N.M. 87501. (505) 983-5175.

***Kear, Frank G.** 3913 Leland St., Chevy Chase, Md. 20015. (202) 652-2128.

***Keel, John J.** 1121 E. Capitol St. S.E., Washington 20003. (202) 544-7943. *John J. Keel, PE, George Wilson, Fred Kendig.

Kemman, James H. See Silliman, Moffett & Kowalski.

Kershner & Wright. 5526 Port Royal Rd., Springfield, Va. 22151. (703) 321-8830. Partners: *Stephen W. Kershner, *Charles S. Wright. Boynton G. Haggaman, sr engr.

W.J. Kessler Associates. 3700 N.E. 53rd Ave., Gainesville, Fla. 32601. (904) 376-3157. William J. Kessler, own; Michael J. Wilhelm, assoc; Neff Cox, staff engr.

Khanna, Sudhir K. See Cohen & Dippell.

Terrell W. Kirksey. 5210 Avenue F, Austin, Tex. 78751. (512)454-7014.

Komai, Dan. See Lohnes & Culver.

***Kowalski, Carl L.** See Silliman, Moffet & Kowalski.

A.W. Kramer Associates. DeFuniak Springs, Fla. 32433. (904) 892-3100. A.W. Kramer, M.E. Kramer.

Kramer, M.E. See A.W. Kramer Associates.

Kuykendall, David S. See Malarkey, Taylor & Assoc.

Landoll, James R. See Atlantic Research.

Stanley Lapin Consultants. 12 Bushy Ridge Road, Westport, Conn. 06880. (203) 227-4788. Stanley P. Lapin, PE., pres.

Lappas & Lindberg Co. 141 W. Jackson, Chicago 60604. (312) Wabash 2-4123. Frank G. Lappas, pres; Carl A. Lindberg, assoc.

Larson, H. Drew Jr. See Silliman, Moffett & Kowalski.

Lautz, Robert F. See A.D. Ring & Assocs.

Ledford, Donald F. See A.D. Ring & Assocs.

Lee, Paul H. Associates Inc. Box 1575, Thousand Oaks, Calif. 91360. (805) 492-4045 and (213) 889-7769. Paul H. Lee, pres; John H. Poole, VP

Leslie, Stanley W. See Vir N. James Consulting Radio Engineers.

Linburg, Harold S. See Hoyles, Niblock Associates.

Lindberg, Carl. See Lappas & Lindberg Co.

Consulting Engineers

- Littlefield, J.G.** See Paul Godley Co.
- Lohnes & Culver.** 1156 15th St., N.W., Suite 606, Washington 20005. (202) 296-2722. Ptnrs: *George M. Lohnes, *Ronald H. Culver, *Elizabeth L. Dahlberg, Frederick D. Viehmeyer, Robert D. Culver. Associates: LaVerne M. Poast, Dan Komai.
- Edward F. Lorentz & Associates, Consulting Radio Engineers.** 1334 G St., N.W., Suite 500, Washington 20005. (202)347-1319. *Edward F. Lorentz, PE. Associates: Charles I. Gallagher and Robert Gehman Jr. Consultant: Everett L. Dillard, PE.
- Lubcke, Harry R.** 2443 Creston Way, Hollywood 90068. (213) 469-3266; (714) 337-2029.
- Lundin, John A.** See A.D. Ring & Assoc.
- Lynch, Cecil.** 2460 Illinois Ave., Modesto, Calif. 95351. (209) 523-3955.
- Malarkey, Taylor & Associates.** 1225 Connecticut Ave., N.W., Washington 20036. (202)223-2345. Martin F. Malarkey, pres; Archer S. Taylor, VP; David S. Kuykendall.
- Mann, Pebworth & Associates Inc.** Box 9011, Richmond, Va. 23225. (804) 272-1953; (804) 977-5745. Principals: Thomas L. Mann, pres; Richard A. Pebworth, VP; John W. Mills, treas. Consultants: Kemper W. Miller, facilities consultant.
- Markley, Donald L.** 1802 W. Moss, Peoria, Ill. 61606. (309) 673-7511. Donald L. Markley, Ronald Jetton, Richard Bisping.
- *May, Russell P.** 351 N. Shannon Ave., Indianalantic, Fla. 32903. (305) 727-7405. Russell P. May, proprietor.
- Maybre, Manuel Jr.** See Steel, Andrus & Adair.
- McClanathan & Assoc.** P.O. Box 750, Portland, Ore. 97207. (503)246-8080. Bob McClanathan.
- McCormick, H. Grant.** See Hoyles, Niblock.
- McDoneli, D.C.** See Robert A. Jones.
- Frank H. McIntosh & Assoc.** McIntosh Laboratory Inc., 2 Chambers St., Binghamton, N.Y. 13903. RA3-3512.
- *McNary, James C.** 6500 River Rd., Bethesda, Md. 20034. (301)229-6600.
- Meades, Kenneth R.** Box 71403, Los Angeles 90071. (213) 666-9056.
- Microwave Services Inc. Consulting Engineers.** 266 W. Main St., Denville, N.J. 07834. (201) 627-7400. *V.J. Nexon, pres; *Victor Nexon Jr., VP.
- Midwest Engineering Associates.** 6934A N. University Peoria, Ill. 61614. (309) 691-3426. F.W. Hannel, PE., BSEE, MSEE; H. Roger Schaver, BSME; Byron Bunch, PE., BSCE; Leslie Storm, ASEE; Barbara Gurney, office mgr.
- Robert L. Miers.** P.O. Box 12, Rolla, Mo. 65401. (314) 265-3148. Robert L. Miers, chief engr; Arnold Lee Mitchell.
- Miller, Chris.** See Bond & Oakley.
- *Moffet, John A.** See Silliman, Moffett & Kowalski.
- Monaco, F. Paul Jr.** See Hammett & Edison.
- T.G. Morrissey Consulting Engineer.** Box 15214, Lakewood (Denver), Colo. 80215. (303) 237-5261.
- Mrazek, Barry W.** See Hoyles, Niblock Associates Ltd.
- John H. Mullaney, Consulting Radio Engineers.** 9616 Pinkney Ct., Potomac, Md. 20854. (301) 299-3900. *John H. Mullaney, PE. own; Joseph B. Ragan, assoc engr; John J. Mullaney, assoc engr; Jeffrey M. Bixby, assoc engr.
- Mullaney, John J.** See John H. Mullaney.
- Munn, C.E.** See E. Harold Munn Jr. & Associates.
- Munn & Associates, E. Harold Jr.** Box 220, 100 Airport Rd., Coldwater, Mich. 49036. (517) 278-7339. E.H. Munn, Jr., pres; C.E. Munn, VP; Virgil Royer, Wayne Reese, Dane Juber. Associates: L.E. Munn, James A. Chase.
- Munn, H.D.** See E. Harold Munn Jr. & Associates.
- Musseiman, John D.** See Carl E. Smith.
- Myse, Daryal A.** 1737 H St., N.W., Washington 20006. (202) 298-6010.
- Nafzger, Lester H.** 85 E. Gay St., Columbus, Ohio 43215. (614)228-2560.
- Charles Neenan Associates.** 315 E. 69th St., New York 10021. (212)988-5557.
- Neff, Gary.** See Warren L. Braun, PE.
- Negoro, Takashi.** See Hoyles, Niblock.
- *Nexon, Victor J.** See MSI Telecom.
- Niblock, Peter A.** See Hoyles, Niblock.
- Oakley, Ron.** See Bond & Oakley.
- Ocko Associates.** 14 S. Bryn Mawr Ave., Bryn Mawr, Pa. 19010. (215) 525-8610. Richard Ocko, pres; Robert McCabe, Nelson Cochran, Frank Hartwick.
- Oursler, Leonard L. Jr., E.E.** 109 Old Meadow Rd., Canonsburg, Pa. 15317. (412)746-2750.
- Owen, A.D.** See Advanced Technology Systems Inc.
- Owen, Kenneth.** See Telcom.
- Parshley, Richard J.** See Norman L. Rivers Assoc.
- Partch, Jerome E.** See Hammett & Edison.
- Pauley, Donald E.** See Gautney & Jones.
- Peerenboom, Harold C.** See Hoyles, Niblock Associates Ltd.
- Penn, Roger.** See Burleson Associates.
- Donald A. Perry & Associates Inc.** 14801 Warwick Blvd., Box 1275, Newport News, Va. 23601. (804)877-4367.
- *Peters, Arthur K.** 2725 N.W. 32nd Place, Gainesville, Fla. 32601. (904) 378-0149.
- Peterson, D.A.** See A. Earl Cullum Jr.
- Pinkham, James F.** See John H. Mullaney.
- Poast, LaVerne M.** See Lohnes & Culver.
- *Prestholdt, Ogdan.** See A.D. Ring & Assoc.
- Ragan, Joseph B.** See John H. Mullaney.
- *Reed, Oscar Jr.** See Atlantic Research.
- Reese, Wayne.** See E. Harold Munn Jr.
- Reeve, James.** See Atlantic Research.
- A.D. Ring & Assoc.** 1771 N St., N.W., Washington 20036. (202) 296-2315. Partners: *Frank G. Kear, *Howard T. Head, *Marvin Blumberg, *Ogdan Prestholdt, *Harold L. Kassens. Associates: Frank S. Colligan, Earl Judy, Peter W. Lechman, Donald F. Ledford, John A. Lundin, Joseph W. Stielper, Frank G. Augustitus, Ambrose J. Cavegn, Robert F. Lautz.
- Ritch, Robert E.** See Silliman, Moffett & Kowalski.
- Rivers, Carolyn L.** See Norman L. Rivers Assoc.
- Norman L. Rivers Associates.** 112 Bonnydale Rd., Leominster, Mass. 01453. (617)537-4821. Norman L. Rivers, David Blomquist, Edward Soome, Donald Hinsky, Frank Klokota.
- *Raymond E. Rohrer.** See Burleson Associates.
- Roliff, Carl E.** 515 S. Virginia, Reno, Nev. (702) 786-1047.
- Roaner Television Systems Inc.** 250 W. 57th St., New York 10019. (212)246-3967. I.S. Rosner, pres; R. Striker, J. Ciulla, S. Chup.
- Throckold, Harold B.** See Peter V. Gureckis & Assoc.
- Rountree, J.G., P.E.** Box 9044, Austin, Tex. 78766. (512) 452-3073.
- Royer, Virgil.** See E.H. Munn Jr.
- Sandberg, Roy B.** See Hoyles, Niblock.
- Saxon, Merl,** Consulting Radio Engineer. Box 575, Lufkin, Tex. 75901. (713) 634-9558, 632-2821.
- Schatzel, DeWolf.** See A. Earl Cullum Jr.
- Schenk, Peter J.** See Telcom.
- Seabrooke, Harry R.** See Silliman, Moffett & Kowalski.
- *Segal, Bernard R.** See Jules Cohen.
- Seyler, Norvel.** See Bond & Oakley.
- Sharpe, Gerard C.** See Bernard Assoc.
- Shimabukuro, Kaz.** See Grobowski & Assoc.
- Shoemaker, Charles E.** See C.P. Crossno & Associates.
- Shomo, Glen.** See Warren L. Braun.
- Shreve, Taylor.** See Vir N. James Consulting Radio Engineers.
- Silliman, Moffet & Kowalski, Radio Consulting Engineers.** 711 14th St., N.W., Suite 503, Washington 20005. (202) 737-6646. *Robert M. Silliman, ptnr; *John A. Moffett, ptnr; *Carl L. Kowalski. Senior staff: Barbara Bennis, Marianna Woodson Cobb, Douglas B. DeLawder, James H. Kemman, Geoffrey L. Lampshire, H. Drew Larson, Robert E. Ritch, Harry R. Seabrooke. Staff: Alexander Berseneff, Susan Crawford, Margaret E. Evans, Julie A. Grant, William A. Hamman, Cathy Ozdany, Fran Rogers, Renee Snipe, Stella Varley.
- Singleton & Barnard.** 4856 Mahalo Dr., Eugene, Ore. 97405. (503) 484-1376. Harold C. Singleton, mgr and chief engr.
- Smalling, E.** See Rosner Television Systems.
- Carl E. Smith Consulting Radio Engineers and Smith Electronics Inc.** 8200 Snowline Rd., Cleveland 44141. (216) 526-4386. *Carl E. Smith, PE.; Cecil S. Bidlack, PE.; Robert V.C. Dickinson, PE.; Robert S. Kirby, PE.; Marion L. Sneedeker, PE.; Roy E. Christen, Larc A. Smith, Al Warmus.
- Smith, Frederick A.,** Suite One-I, The Ashley House, Box 2432, Charleston, S.C. 29403. (803) 723-4775. Frederick A. Smith, PE.; William D. Rohe Jr., PE.; Allen E. Crandall.
- Smith, Robert P.** See Hammett & Edison.
- Sparks, B.** See Atlantic Research.
- Steve Speheger.** 50 La Crosse Ct., Lafayette, Ind. 47905.
- *Spragg, Leonard A.** Storer Broadcasting Co., 1177 Kane Concourse, Miami Beach 33154. (305) 866-0211.
- Steel, Andrus & Adair.** 2029 K St., N.W., Washington 20006. (301) 827-8725, (202) 223-4664. *David L. Steel Sr., *Alvin H. Andrus, *George P. Adair. Associate engineers: *John E. Dettra Jr., Manuel Mayobre Jr.
- *David L. Steel Sr.,** Steel, Andrus & Adair, Rd. 1, Box 276, Greenwood Point, Grasonville, Md. 21638. (301) 827-8725. Principal office: 2029 K St., N.W., Washington 20006. *George P. Adair, *John E. Dettra Jr., Manuel Mayobre Jr. *David L. Steel Sr.; *Alvin H. Andrus.
- Stelper, Joseph W.** See A.D. Ring.
- Stiles, Walter J.** Suite 1621, Tucson House, Tucson, Ariz. 85705. (602)792-2108. Walter J. Stiles. Assoc: Luke Hodges, 3040 Woodwind Lane, Dallas 75229. (214)351-3820.
- Stotaky, James S.** See Telcom.
- Strain, Charles E.** 4556 Northside Dr., N.W., Atlanta 30327. (404) 255-4556.
- Sulyma, Thor.** See Vir James Consulting Radio Engineers.
- T & T Radio Measurements.** Box 1575, Thousand Oaks, Calif. 91360. (213) 889-7769, (805) 492-5055. Paul H. Lee, chief engr.
- Taylor, Archer S.** See Malarkey, Taylor & Associates.
- Telcom Inc.** 8027 Leesburg Pike, Vienna, Va. 22180 (703) 893-7700. Peter J. Schenk, pres; John G. MacKie, exec VP; Harry E. Taber, exec VP; Robert Bloom, VP; Robert N. De Hart, VP; J.D. Ahlgren, VP.
- Templeton, Lawrence W.** See Hammett & Edison.
- Tendick, Cullen B.** 912 Roderick Ave., Oxnard, Calif. 93032. (805)483-5243.
- Thomforde, C.J.,** 2615 4th Ave., Grand Forks, N.D. 58201. (701)775-7084.
- Todd, Ronald H.** See Hammett & Edison.
- Alfred E. Towne.** Box 647, Belmont, Calif. 94002. (415) 593-6706.
- Towner, Orrin W.** 11208 Beech Rd., Anchorage, Ky. 40223. (502)245-4673. Orrin W. Towner, PE.
- Tracey, William R.** See Hoyles, Niblock Associates Ltd.
- Turnage, H.** See Atlantic Research.
- Turner, Harold.** See Comstruct Consultants Inc.
- Uhl, K.** See Atlantic Research.
- Uram, John R. Jr.** See Cohen & Dippell.
- Van Wagenen, H.W.** See Carl E. Smith.

Varley, Stella. See Silliman, Moffett & Kowalski.

Thomas J. Vaughn and Associates. Grenier Field, RFD No.3, Manchester, N.H. 03103. (603)624-4351. *T.J. Vaughn, pres.

Viehmeier, Fred D. See Lohnes & Culver.

***Vilasiates, Matthew J.** 7601 Burford Drive, McLean, Va. 22101. (703) 365-9504, 356-6445.

Volkman, Donald F. RR No. 8, Box 149-B, Parkshire Pl., Muncie, Ind. 47302. (317) 284-1124.

Volkman, Speheger, Williams. 1010 S. A. St., Richmond, Ind. 47374. Richard Williams, pres.

Wall, John. 1001 Picket Pl., Vienna, Va. 22180.

Weakley, William C. See Atlantic Research.

Webster, Clive W. See Hoyles, Niblock Associates Ltd.

Weiss, Vern A. II. Box 1664, Kankakee, Ill. 60901. (815) 939-0036. Vern A. Weiss II, pres; Robert Kemper O'Hara, VP

Welch, William H. Drawer 11370, Pueblo, Colo. 81001. (303) 544-3056.

Louis A. Williams Jr. & Associates. 2092 Arrowood Pl., Cincinnati 45231. (513) 851-4964. Louis A. Williams Jr., PE.

Williams, Mario. See Warren L. Braun.

Williams, Martin R. 7401 E. 14th St., Indianapolis 46219. (317) 356-0388.

Williams, Nathan. 110 Algoma Blvd., Oshkosh, Wis. 54901. (414)235-3590.

***Wimmer, Paul L.** See Jules Cohen.

Wolk, Mel. See John H. Battison and Associates.

Wrathall, Grant R. 517 Vista Del Mar Dr., Aptos, Calif. (Santa Cruz) 95003. (408) 688-3352.

***Wright, Charles S.** See Kershner & Wright.

Wright, Lowell R., Aeronautical Consultant. P.O. Box 1706, Winter Park, Fla. 32789. (305)323-3600. Lowell R. Wright, owner; Lee Wright, assoc.

Wright, T.A. See A. Earl Cullum Jr.

Yancey, Bob. See Warren L. Braun.

Frequency Measuring Services

Anderson Radio Engineering Co. Box 1671, Greenville, S.C. 29602. (803) 277-2876. Burton S. Anderson, owner.

Apple Frequency Measuring Service. Box 997, Burlington, N.C. 27215. (919)584-0448. Helen Apple, Homer Apple.

Broadcasting Frequency Monitoring Service. 2122 Laurel, Texarkana, Ark. 75501. (501) 772-2225. E.B. Hurst, owner, B.L. Hurst, mgr.

Cambridge Crystals (Div. of Cambridge Thermionic Corp.) 445 Concord Ave., Cambridge, Mass. 02138. (617) 876-2810. Clarence Cheney, dir.

Commercial Radio Monitoring Co. 103 S. Market St., Lee's Summit, Mo. 64063. (816) 524-3777. Leo G. Andrews, mgr; Walter H. Campbell, Walter V. Nitcher, Dale M. Crawford, William R. Thorsen, Gary L. Lush, Robert F. Wolfskill, John M. McComas, associates.

Electronic Service Co. 2912 East Mabel St., Tucson, Ariz. 85716. (602) 325-2225. Ray Hofslciaw.

George W. Ewing. 201 E. 10th St., San Bernardino, Calif. 92410. (714) 884-0548. George W. Ewing.

Frequency Measuring Service. Box 6590, Denver 80206. (303) 288-1482. Howard S. Eldridge, supervisor; Valerie E. Eldridge, asst; Vir James, tech dir; C.B. James, sec-treas.

Frequency Measuring Services. 528 Ravine Ave., Lake Bluff, Ill. 60044. (312) 234-0953. Irene H. Knaack, owner; Howard S. Knaack, Harold F. Knaack, associates.

Claude M. Gray. Box 602, Birmingham, Ala. 35201. (205) 822-1132. Claude M. Gray, consulting radio eng.

Floyd Hall E.E., Consulting Radio Engineers. Box 1017, Crestline, Calif. 92325. (714) 338-3338. Floyd Hall, prop.

Hutton Monitoring Service. 2010 Westchester

Ave., Catonsville, Md. 21228. (301) 747-9078. J.W. Hutton, owner.

J. Boyd Ingram and Associates. Box 2154, Jackson, Miss. 39205. (601) 362-2790. J. Boyd Ingram, pres.

Kelly Bcstg. Co. 310 Tenth St., Sacramento, Calif. 95814. 444-7300. Bill Karpisek, chief.

Newman-Kees Measurements. 3326 Oak Hill Rd., Evansville, Ind. 47711. (812) 476-5104. Walter E. Newman, mgr.

Northwest Monitoring Service. Box 1042, Pendleton, Ore. 97801. (503) 276-2281. J.H. Platz; D.J. Morris.

NORTHWEST MONITORING SERVICE

AM, FM, TV, CATV, Microwave, Stereo Pilot, SCA. Color Burst.

Mobile Unit servicing five states.

Harmonic field strength measurements for AM, FM, TV.

Frequency Standards meeting FCC requirements for measurements available on attractive lease basis.

INQUIRIES INVITED

503-276-2281

Common Carriers

Land Lines (AT&T)

American Telephone & Telegraph Co. 1776 On the Green, Morristown, N.J. 07960. Robert Ogden, natl bcstg market coord (201) 540-6758; J.A. Calderwood (201) 540-6646. Ronald E. West, 110 Belmont Drive, Somerset, N.J. 08873. (201) 885-2872.

Coordinators:

Bell of Pa. & Diamond State Tel.: C.H. John, One Parkway, 11th Fl., Philadelphia 19102. (215) 466-2593.

C. & P. Company: WB. Viperman, 1710 H St. N.W., Rm. 215, Washington 20006. (202) 392-3928.

Cincinnati Bell: R.A. Sander, 309 Vine St., Rm. M60, Cincinnati 45202. (513) 397-2585.

Illinois Bell: A. Willard, 225 W. Randolph St., 11th Fl., Chicago 60606. (312) 727-3366.

Indiana Bell: J.E. Brake, 220 N. Meridian St., Indianapolis 46204. (317) 265-7548.

Michigan Bell: Jim Pepper, 882 Oakman Blvd., Rm. 525, Detroit 48238. (313) 883-9900 ext 391.

Mountain Bell: E. Tabor, 1020 Fifteenth St., Rm. 2A, Denver 80202. (303) 624-7086.

New England Tel. Co.: E.J. Kiley, 185 Franklin St., Rm. 1402, Boston 02107. (617) 743-3303.

New Jersey Bell: C.J. Kryda, 540 Broad St., Rm. 305, Newark, N.J. 07101. (201) 649-2673.

New York Tel.: J. Von Welgen, 1411 Broadway, 36th Fl., New York 10018. (212) 394-2981.

Northwestern Bell: H.L. Rush, 8420 Dodge St., Omaha 68114. (402) 399-5089.

Ohio Bell: R.G. Mallory, 100 Erieview Plaza, Rm. 1536, Cleveland 44114. (216) 822-4271.

Pacific Northwest Bell: K.R. Schultz, 821 Second Ave., Rm. 1701, Exchange Bldg., Seattle 98104. (206) 345-6030.

Pacific Tel & Tel Co.: R.K. Carlson, 140 New Montgomery St., Room 918, San Francisco 94105. (415) 542-0265.

South Central Bell: H.L. Scheinert, Box 771, Birmingham, Ala. 35201. (205) 321-3396.

Southern Bell: R.C. Clayton, Hurt Bldg., Rm. 834, Atlanta 30303. (404) 529-6743.

Southern New England Tel.: S. Lewis, 300 George St., 9th Fl., New Haven, Conn. 06510. (203) 771-5552.

Southwestern Bell: J.C. Smith, 112 N. Fourth St., St. Louis 63102. (314) 247-5149.

Wisconsin Tel.: F.J. Harper, 741 N. Milwaukee St., Milwaukee 53202. (414) 678-2977.

Long Lines Coordinators:

Northeastern & New York City area: E. Skubis, 32 Ave. of the Americas, Rm. 2451, New York 10013. (212) 393-6359.

Eastern area: Mary Ensminger, 2000 L St. N.W., Rm.

Engineers, Frequency Svcs AT & T, Microwave

Southwest Frequency Measurements Inc. Box 1542, Austin, Tex. 78767. (512) 459-6012. C.M. Bartholomew, mgr.

Standard Frequency Measuring Service, 1005 Ellingsworth Lane, Middletown, Ky. 40243. (502) 245-5555. Louis A. Williams, engr in charge.

Strain Engineering Service. 4556 Northside Drive, N.W., Atlanta 30327. (404) 255-4556.

T & T Radio Measurements. Box 1575, Thousand Oaks, Calif. 91360. (213) 889-7769, (805) 492-5055. Paul H. Lee, chief engr.

Van Nostrand Radio Engineering Service. Box 32245, Decatur, Ga. 30032. (404) 241-5551. W.L. Van Nostrand, co-owner. Also Box 458, Melbourne Beach, Fla. 32951. (305) 723-1250. Samuel B. Boor, co-owner.

Martin R. Williams, 7401 E. 14th St. Indianapolis, Ind. 46219. (317) 356-0388. Martin R. Williams, owner.

Nathan Williams. 110 Algoma Blvd., Oshkosh, Wis. 54901. (414) 235-3590.

Woodward Measurement Lab, 9108 New Delaware Rd., Mt. Vernon, Ohio 43050. (614) 392-0841. R.O. Woodward, owner.

Ziehl Electronics Service. 199 Ontario St., Lockport, N.Y. 14094. (716) 434-3500. Richard Ziehl, mgr.

707, Washington 20036. (202) 466-3055.

Southern area: P. Cox, 100 Edgewood Ave., Atlanta 30303. (404) 529-7014.

Central area: L.A. Melicci, 10 S. Canal St., 25th Fl., Chicago 60606. (312) 855-4776.

Midwestern area: N.A. Boland, 811 Main St., Rm. 670, Kansas City, Mo. 64141. (816) 391-2831.

Western area: C.G. Gillespie, Box 3288, San Francisco 94119. (415) 442-2352.

Microwave

Alabama Microwave Inc. Box 163, Tupelo, Miss. 38801. Frank K. Spain, pres.

Serves NBC for WQWL-TV Florence, Ala.

American Microwave & Communications Inc. 105 Kent St., Iron Mountain, Mich 49801. James A. Klungness, pres. Serves Mich. with three TV networks and NBC radio network.

Cablecom-General Inc. Subsidiary of General Tire & Rubber Co., Akron, Ohio. 4705 Kingston, Box 7251 Denver 80207, (303) 373-0280. Richard A. Forsling, chmn of bd; Robert Manby, dir dev; Gerald Cahill, VP finance.

CPI Microwave Inc. 1015 City National Bank Bldg. Austin, Tex. 78701. George M. Batsche, pres. Carries three TV networks to stations in Texas.

East Texas Transmission Co. P.O. Box 989, Tyler, Tex. 75701. Serves KLTV(TV) Tyler and Texas State Network KDOK(FM).

Eastern Microwave Inc. 1010 James St., Syracuse, N.Y. 13203. A. J. Eicholzer, VP.

Serves Pennsylvania Public Television Network and update New York and Massachusetts stations with New York City sports events.

Grayson Enterprises Inc. 1403 Slocum St., Dallas, 75207.

Carries ABC-TV to Lubbock, Tex.

MCI Telecommunications Corp. Subsidiary of MCI Communications Corp., 1150 17th St. N.W. Washington (20036) (202) 872-1600. 1301 Avenue of the Americas, New York (10019), (212) 582-6520. William G. McGowan, bd chmn and pres; Kenneth A. Cox, Thomas L. Leming, V. Orville Wright, Carl M. Vorder Bruegge, sr. VPS.

Business Long Distance voice grade, data, teleprinter, and facsimile services among 34 cities.

Microwave Transmission Corp. 2460 Garden Rd., Monterey, Calif. 93940. Noel S. Young, VP and gen mgr.

Serves KEY-TV Santa Barbara and KSBY-TV San

Microwave, Satellites

Luis Obispo, both Calif, with ABC; serves various school districts in Washington with educational TV.

Mid-Kansas Inc. 140 W. 8th St., Junction City, Kan. 66441. Robert K. Weary, sec-treas.
Serves Kansas TV stations.

Midwestern Relay Co. Subsidiary of The Journal Co., 720 E. Capitol Dr., Milwaukee 53201 (414) 332-9611. Robert James, gen. mgr.; Sprague Vonier, mktg mgr.

Serves all of Wisconsin and Minnesota, parts of Michigan, Illinois and Iowa.

Newhouse Alabama Microwave Inc. Box 10502, Birmingham, Ala. 35202. Henry S. Balch, asst sec-treas.

Carries CBS-TV to WHMA-TV Anniston Ala.

Pacific Telatronics Inc. Box SM, Medford, Ore. 97501. Edward A. Malone, pres.

Carries California Educational Network to stations in northern California.

Western Tele-Communications Inc. Box 10727, University Park Station, Denver 80210. (303) 771-8200. Carter F. Page, pres; Larry Romrell, exec VP; Douglas G.J. Johnson, VP-mktg; Russell F. Johnson, VP-engrg.

Long haul microwave trunking system throughout Pacific, Rocky mtn, and Central Plains states, providing full range of TV transmission, program audio, high speed data and wholesale carrier to carrier transmission services. Operates 62,000 channel miles of microwave. Serves 52 TV and 72 radio stations.

West Texas Microwave Co. Box 1149, Del Rio, Tex. 78840. Jack R. Crosby, pres. R.O. Mosher, exec VP.

Serves various Texas radio stations with Texas State Network feed, ABC radio and provides sports pickups to KMID(TV) Odessa, Tex.

Satellites

Three companies offer domestic satellite communications services with rates depending on type of service and whether service is part-time, full time, scheduled or unscheduled. The three companies—American Satellite Corp., RCA Global Communications Inc. and Western Union Telegraph Co.—are using Westar and Satcom satellites with backup service provided on Canadian Anik satellites. Terrestrial links connect the various earth stations scattered across the country with regional carrier operation centers, from which customer feeds originate.

In addition, Comsat General Corp., CML Satellite Corp. and GTE Satellite Corp. are planning domestic operations. However, specialized telecommunications services like audio and video may not be provided on all systems initially.

The International Telecommunications Satellite Organization offers international service.

For information on FCC fees pertaining to satellite communications services, see "FCC Rules," section A.

American Satellite Corp.

(A wholly-owned subsidiary of Fairchild Industries Inc.)

20301 Century Boulevard, Germantown, Md. 20767.

(301) 428-6040. TWX 710-828-0489. Emanuel Fthenakis, pres; John A. Keyes, VP-mktg; Dennis T. Goddard, sr VP; Dr. Eugene Cacciamani, VP technical; John D. Jackson, VP, gen counsel.

American Satellite provides private line voice, data, facsimile and wideband communications services to broadcasters, to business, industrial and financial communities and to government agencies. Nationwide service is provided via the Westar satellite with operating centers at Los Angeles, New York, Dallas, Chicago, Pittsburgh, Houston, San Francisco and Washington.

Communications Satellite Corp. (COMSAT)

950 L'Enfant Plaza SW, Washington 20024. (202) 554-6000. Joseph H. McConnell, chmn of bd; Joseph V. Charyk, pres; Lucius B. Battle, VP corporate affairs; John V. Harrington, VP-rsch & engrg; James J. McTer-

counsel; John L. Martin Jr., VP system engrg develop; Joseph H. O'Connor, VP & treas; Donald R. Owen, VP opns; Robert C. Barthle, asst VP ground systems; Robert D. Briskman, asst VP fixed systems; Edward J. Martin, asst VP, mobile systems; John G. Gant, sec & asst gen counsel.

Comsat General was established to provide domestic, maritime and aeronautical services using Comstar satellites.

CML Satellite Corp.

1750 K St., N.W., Washington 20006. (202) 466-2660.

Joint venture to establish domestic satellite system involving Comsat General, IBM Corp. and Aetna Life and Casualty. Not yet operational.

GTE Satellite Corp.

(A wholly owned subsidiary of General Telephone and Electronics)

One Stamford Forum, Stamford, Conn. 06904. (203) 357-2000. James L. Clark, pres; David F. Piske, VP opns; Joel P. Mellis, sec; Richard F. Hardy, treas; Edward A. Fanelli, asst sec; James M. Dunn Jr., asst treas.

GTE plans to provide message toll service (phone) for AT&T and GTE telephone systems via Comsat General's satellite. Under FCC order, GTE Satellite will be prohibited from providing specialized telecommunications services during its initial three years of operation.

International Telecommunications Satellite Organization (INTELSAT)

490 L'Enfant Plaza SW, Washington 20024. (202) 488-2300. Telex: 892707. Santiago Astrain, sec gen; F. Latapie, dir of admin and conference affrs; R. Westlake, dir of finance; E. Podraczky, dir of technical opns; D. Leive, sr legal advisor.

INTELSAT provides in-space facilities for international public telecommunications systems operating on commercial principles and available on a non-discriminatory basis to all areas of the world. There are 91 member countries in INTELSAT, with COMSAT representing the U.S. Service is provided by seven INTELSAT IV satellites, with the later generation IV-A satellite scheduled to replace existing systems over the next several years. Plans for INTELSAT V satellites with even greater channel capacity are already on the drawing boards.

RCA Global Communications Inc.

(A wholly-owned subsidiary of RCA)

60 Broad St., New York 10004. (212) 363-3986 (East Coast); (212) 485-8761 (West Coast). Philip Schneider, exec VP, Satcom system; Harold Rice, VP special projects; Walter Puoli, dir mktg, planning and administration; Jay Mehrhoff, sls dir.

RCA Global and RCA Alaska Communications Inc. own and operate the RCA Satcom domestic communications satellite system, which offers private line voice-grade circuits, television and CATV transmission, full transponder systems and custom systems for government and industry. Nationwide service is provided from operating centers at New York, Valley Forge (Pa.), Washington, Los Angeles and San Francisco. Until mid-1976, RCA service will be provided on Western Union's Westar satellite and Telesat Canada's Anik satellite. Later, RCA will have its own, 24-transponder satellites: Satcom I launched December 1975, and Satcom II scheduled for launch March 1976.

The Western Union Telegraph Co.

One Lake Street, Upper Saddle River, N.J. 07458 (201) 825-5000. Dow C. Pruitt, VP Westar satellite and transmission service; Edward L. Taylor, VP Westar sales and marketing development; R.B. Smith, asst VP Westar sales.

Western Union owns and operates two 12-transponder satellites, Westar I and Westar II. Five earth stations serve New York, Atlanta, Chicago, Dallas and Los Angeles, all with television operation centers except Atlanta. Audio, video, data and facsimile service is available.

Satellites planned and aloft

Anik I, Anik II, Anik III

The first two of three 24-transponder satellites are satellites, each with 12-transponder capacity. The Canadian Broadcasting Corp. uses video and audio circuits on the satellite systems, with U.S. carriers leasing transponder time for backup to primary service provided on the Westar satellites. The first Anik was launched in November 1972. Satellite service is provided over all of Canada and most of the U.S.

Comstar I, Comstar II

The first two of three 24-transponder satellites are expected to be operational by end of 1976. Comsat General Corp. will own and operate the satellites, which will be leased to phone companies for full-time use. Depending on FCC action, AT&T alone or in joint venture with General Telephone and Electronics will use satellites. Specialized nontelephone uses are prohibited for the first three years of operation by FCC order.

Satcom I

RCA's satellite, launched Dec. 12, 1975 and expected to be available for customer use by March 1976. It provides 24 transponder capability, serves all 50 states and is in geostationary orbit at 119 degrees West. Satcom II is expected to be launched March 1976 and will have same capacity and capability.

Westar I, Westar II

Owned and operated by Western Union—although leased to other carriers—each satellite provides 12-transponder capability. Service is available in all 50 states from geostationary orbit. Fully operational since 1973.

nan Jr., VP finance; William H. Berman, VP gen counsel; Martin J. Votaw, VP Intelsat mgmt div.; H. William Wood, VP U.S. Intelsat div.; Richard R. Colino, asst VP Intelsat div.; Burton I. Edelson, asst VP & dir, Comsat laboratories; Eugene T. Jilig, asst VP engrg; Sydney Metzger, asst VP & chief scientist; Lewis C. Meyer, asst VP procurement; Dennis V. Neill, asst VP satellite opns; James B. Potts, asst VP comm. opns; Carl J. Reber, asst VP fin admin; Harry L. Van Trees, asst VP advanced systems; Frederic M. Mead, treas; Robert B. Schwartz, sec & dir pub info.

Comsat is the U.S. representative to the international consortium that provides satellite service world-wide via Intelsat-IV satellites. Currently there are seven satellites including one second generation Intelsat IV-A.

Comsat General Corp. (A wholly-owned subsidiary of Communications Satellite Corp.)

John A. Anderson, pres; William D. English, VP & gen

You belong in Broadcasting

1976 Buyer's Guide

Radio and television broadcast equipment and services are listed here at the special request of each company in an easy-to-use alphabetical directory. Products or services are listed with the companies supplying them following in alphabetical order.

To locate the headquarters, or nearest sales office, of any listed manufacturer or service, simply turn to the company's alphabetical listing in section E, the Broadcast Equipment Directory. That listing includes address, principal executives, branch offices and telephone numbers.

Names of firms appearing in bold face are advertisers in the 1976 BROADCASTING YEARBOOK.

AMPLIFIERS, AUDIO, VIDEO, RF

American Data
Audio Designs & Mfg. Inc.
Audio Distributors Inc.
Belar Electronics Labs Inc.
Broadcast Supply West
Collins Radio
Control Technology Inc.
CSI Electronics Inc.
Dyma Engineering Inc.
 Dynasciences
Harris Corp.
Landy Associates
 Lenco Inc.
LPB Inc.
Marti Electronics Inc.
Moseley Associates Inc.
Pulse Dynamics Mfg. Corp.
RCA-Communications Systems Division
Revox Corp.
Robins/Fairchild

Roh Corp.
 Shintron
 Telex
Wilkinson Electronics Inc.

ANTENNAS & ACCESSORIES

Allied Tower Co.
Cablewave Systems Inc.
Collins Radio
Control Technology Inc.
CSI Electronics Inc.
Delta Electronics Inc.
Dyma Engineering Inc.
Ft. Worth Tower
Harris Corp.
LPB Inc.
Marti Electronics Inc.
RCA-Communications Systems Division
Sintron Corp.
Utility Tower Co.
Wilkinson Electronics Inc.



The best soft music sound
 in Toledo is put
 out by an **AEL FM-25KD**
Stereo Transmitter

Just ask **WMHE**

AEL stereo transmitters always
 send the very best.
 FM: 2,500, 15,000, 25,000, 40,000,
 50,000 watts.
 AM: 5,000, 10,000, 50,000 watts.



Call or Write:

AMERICAN ELECTRONIC LABORATORIES, INC.
 P.O. Box 552, Lansdale, PA 19446
 Tel: 215/822-2929 • TWX: 510/661-4976

Landy Associates inc.

manufacturers rep
 and broadcast
 products distributor

representing the finest in
 Television, Radio, and
 Recording Equipment
 for Broadcast, Closed Circuit
 Production, and
 Recording Studio
 Applications

Landy Associates, Inc.
 12 Buxton Road
 Cherry Hill, New Jersey 08003
 609 - 424-4660

READY!

LPB's [®] mini-studio systems come complete and ready for on-air, recording studio or remote operation. Every system is tops in value . . . unmatched even by higher priced systems! Included are:

- Console.
- 2 Professional 3-speed 12-inch Turntables.
- 2 12-inch Tone Arms.
- 2 Stanton Cartridges with styli.
- Turntable Equalizer/Preamplifier . . . 2 for stereo.

There's a full range of complete systems to choose from . . . each with sturdy, handsome, white Formica[®] top furniture over chromed steel legs and supports.

LPB offers a complete line of broadcast audio equipment. Call or write us for all your audio needs, from mike stands to headphones.

LPB[®] LPB Inc.
 520 Lincoln Highway, Frazer, PA 19355
 (215) 644-1123



ROH MEANS AUDIO SYSTEMS

Offering superior quality and lowest maintenance, our products provide the greatest value

year after year!

Ask one of our customers in your area or call Jim Godwin at Roh: (404) 449-0873



ROH CORPORATION
107 Technology Park
Norcross, GA 30071

WBNS TV
WCBB TV
WCCB TV
WCVB TV
WCIX TV
WFRV TV
WGAN TV
WGHP TV
WHCT TV
WKAB TV
WWL TV
WNEO TV
WNEW TV
WPTZ TV
WTVT TV
WNDU TV
WYEA TV
KGEN TV
KCRG TV
KDUH TV
KGMB TV
KHMA TV
KOAM TV
KOAT TV
KOTA TV
KTEH TV
KYW TV

AUDIO SYSTEMS & COMPONENTS

Ampro Corp.
Audio Designs & Mfg. Inc.
Audio Distributors Inc.
Broadcast Automation Associates
Broadcast Supply West
The Camera Mart Inc.
Collins Radio Co.
Control Technology Inc.
Dyma Engineering Inc.
Electro-Voice Inc.
Harris Corp.
Landy Associates
LPB Inc.
Philips Audio Video Systems
Pulse Dynamics Mfg. Corp.
Revox Corp.
Robins/Fairchild

Roh Corp.
Shalco Inc.
Shintron
Sintronic Corp.
Stanton Magnetics Inc.
Telex
Wilkinson Electronics Inc.

AUTOMATIC LOGGING & ACCES.

Moseley Associates Inc.

AUTOMATION, BROADCAST

Audio Distributors Inc.
Broadcast Automation Associates
Broadcast Supply West
Camex Corp.
Collins Radio

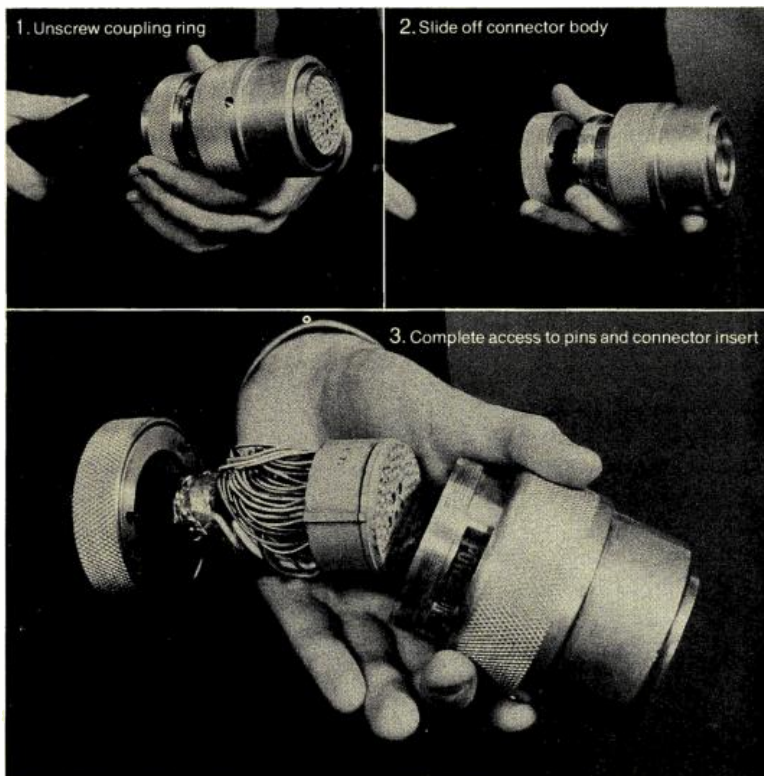

Field-repairable

A damaged TV cable connector can put a camera out of action just when you need it most. But BIW cable with the new 85C Field-Repairable Connectors can be fixed on the spot.

These unique connectors are easily disassembled for fast access to damaged pins or other

problems. No special tools required. Available in mini and standard sizes. Both East and West Coast facilities assure prompt supply and fast service on BIW cable and cable assemblies—the line preferred by local TV stations and every major TV network.

Boston Insulated Wire & Cable Company

65 Bay Street, Boston, Mass. 02125 • Tel: 617-265-2102
Court Street, Plymouth, Mass. 02360 • Tel: 617-746-7650
12902 South Spring Street, Los Angeles, Calif. 90061 • Tel: 213-532-9064

Other Plants and Sales Offices: Hamilton, Ontario, Canada (416-529-7151)
• Kingston-upon-Thames, U.K. (01-546-3384) • Singapore (374797)



EQUIPMENT?

NEW and PRE-OWNED

- Complete Station Packages
- Broadcast Equipment, Furniture, Cart Racks
- Proven Music Services
- Full Financing

Stocking Distributor for:

**AMPEX • SCULLY • AKG
REVOX • CBS • BELAR
ELECTRO-VOICE • TFT
SPOTMASTER • MOSELEY
ELECTROSOUND • JAMPRO
RUSSCO • BEYER • SHURE**

BA BROADCAST
AUTOMATION
ASSOCIATES

1599 N.E. 12th Avenue
Fort Lauderdale, Florida 33334
Collect (305) 776-4762

CONTROL TECHNOLOGY INC.

QUALITY BROADCAST EQUIPMENT
Automation Specialists

- IGM AUTOMATION
- THOMPSON CSF AUDIO-VIDEO
- ELECTROSOUND TAPE RECORDERS
- MOSELEY REMOTE CONTROLS
- TFT AM-FM TV MONITORS
- RUSSCO TURNTABLES-CONSOLES
- ROH AUDIO SYSTEMS
- AUDIOPAX TAPE CARTRIDGES
- ORBAN PARASOUND EQUALIZERS

(305) 587-2716

Jim Woodworth, Pres.
2513 Tortugas Lane
Ft. Lauderdale, Fla. 33312

Rigged for Silent Running



Shallco

Beneath the surface, Shallco attenuators quietly raise and lower signals for broadcast applications.

Request Catalog 102

SHALLCO, INC. P. O. BOX 1089
SMITHFIELD, N. C. 27577
919/934-3135

Control Design Corp.
Control Technology Inc.
Moseley Associates Inc.
RCA-Communications Systems Division
Revox Corp.
Sintronic Corp.

BOOMS, MICROPHONE

Audio Distributors Inc.
Beyer Dynamic
Broadcast Supply West
The Camera Mart Inc.
Collins Radio
CSI Electronics Inc.
Harris Corp.
LPB Inc.
RCA-Communications Systems Division
Revox Corp.

CABINETS, RACKS, PANELS

Broadcast Supply West
Collins Radio
CSI Electronics Inc.
Dyma Engineering Inc.
Harris Corp.
LPB Inc.
RCA-Communications System Division

CABLES & ACCESSORIES

Audio Distributors Inc.
Boston Insulated Wire & Cable
The Camera Mart Inc.
Collins Radio
Harris Corp.
Mohawk Wire & Cable
RCA-Communications Systems Division

CALIBRATORS, TV CAMERAS/MONITORS

McGraw-Edison Co.
Also see "Test Equipment"

CAMERA CABLE & CONNECTORS

Boston Insulated Wire & Cable
Mohawk Wire & Cable

CAMERAS, PROJECTORS & ACCESSORIES

Amperex Electronic Corp.
Buhl Optical
The Camera Mart Inc.

Fernseh Div., Robert Bosch
Harris Corp.
JVC Corp.
Landy Associates
Lenco Inc.
Lipsner-Smith Corp.
Marconi Electronics
Meteor Light & Sound
Philips Audio-Video Systems
RCA-Communications Systems Division
Teleamation Inc.
Thomson CSF Labs

CAMERA SUPPORT EQUIPMENT & ACCESSORIES

Innovative Television Equip. Co.
Quick-Set Inc.

BUHL

A FILM CHAIN WITHOUT A DEDICATED CAMERA

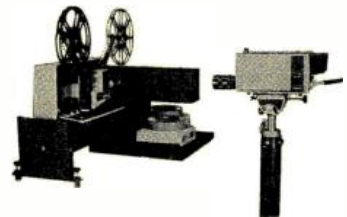

MOBILE MULTIPLEXER!

Save the high cost of an extra color camera
Studio camera adapts to film chain
use in seconds

Use standard TV zoom lens
Input: Two 35mm slide projectors in
dissolve mode plus 16mm or Super-8
Mobile Multiplexer saves studio space
At \$975.00,
out performs units at twice the price!

For complete technical details---
Contact Buhl.

BUHL OPTICAL
1009 Beech Avenue
Pittsburgh, Pa. 15233
Phone 412-321-0076

BUHL

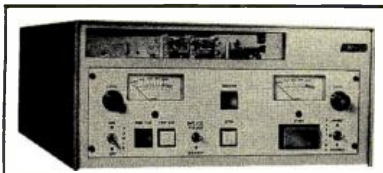

Stereo Recorder/Reproducer
with Splice Finder Option

Top of the line automatic tape cartridge recorder/reproducers. 34 models to choose from directly from stock.

Financing available to qualified buyers. Call collect or write today for details.



AMPRO CORPORATION

850 PENNSYLVANIA BLVD.
FEASTERVILLE, PA 19047
(215) 322-5100

Professional Equipment For Broadcasting Professionals

FIDELIPAC® CARTRIDGES

EMPTY • TAPE LOADED
24 HOUR ORDER DESK



MASTER CARTRIDGE

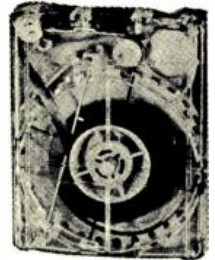

STANDARD FIDELIPAC CARTRIDGE

- ① HIGHEST QUALITY
- ② LOWEST PRICES
- ③ IMMEDIATE DELIVERY
- ④ AMPEX TAPE & ACCESSORIES
- ⑤ TELEX-VIKING-MAGNECORD EQUIPMENT

NATIONAL AUDIO COMPANY

"The Cartridge People"

P.O. Box 3857 Glenstone Station • Springfield, Mo. 65804 • Phone 417-883-5377

CARTRIDGE, AUTOMATIC TAPE

- Ampro Corp.
- Audio Distributors Inc.
- Broadcast Automation Associates
- Broadcast Electronics Inc.
- Broadcast Supply West
- Collins Radio
- Control Technology Inc.
- CSI Electronics Inc.
- Dyma Engineering Inc.
- Fidelipac
- Garron Electronics Inc.
- Harris Corp.
- International Tapetronics Corp.

- Landy Associates
- LPB Inc.
- National Audio Co.
- RCA-Communications Systems Division
- Sintronic Corp.
- Telex

- The Camera Mart Inc.
- Dyma Engineering Inc.
- Harris Corp.
- JVC Corp.
- RCA-Communications Systems Division
- Telex

CARTRIDGE REWIND SERVICE

Broadcast Supply West

CASSETTES, AUDIO TAPE EQUIPMENT AND ACCESSORIES

Audio Distributors Inc.

CASSETTES, AUDIO & VIDEO

- Broadcast Automation Associates
- The Camera Mart Inc.
- Dyma Engineering Inc.
- JVC Corp.
- National Audio Co.

FREE

(THIS IS NO BOOK FOR AMATEURS.)



It's crammed with pictures, poop, and prices. Features top grade electronics from around the world. Strictly for professional audio, broadcast, television, recording and motion picture moguls. We specialize in fast, off-the-shelf delivery on recorders. Duplicators. Micro-

phones. Turntables. Reverbs. Amplifiers. Attenuators. Equalizers. Compressors. Speakers. Broadcast and recording consoles. Write for your free copy of our catalog today.



AUDIO DISTRIBUTORS, INC.
2342 S. Division Avenue
Grand Rapids, Michigan 49507

RAPID-QTM
CART MACHINES

RQ 71 Series for all size cartridges
Custom 3000 Series for "A" size cartridges



- Record/Playback
- Playback Only
- Single Units
- Multiple Units
- Monaural
- Stereo

Automatic fast-forward standard

GARRON ELECTRONICS, INC.
1216 Kifer Road
Sunnyvale, California 94086
(408) 736-8737

The MASTER CART from FIDELIPAC®



For the cleanest cart sound your station can broadcast, Master Cart is the answer. Engineered to use natural tape flow patterns that eliminate erratic tape behavior and assure repeatability both from cartridge to cartridge and usage to usage. Provides that added edge in stereo performance that conventional cartridges *can't* deliver. Fewer parts for simpler maintenance . . . and greater reliability.

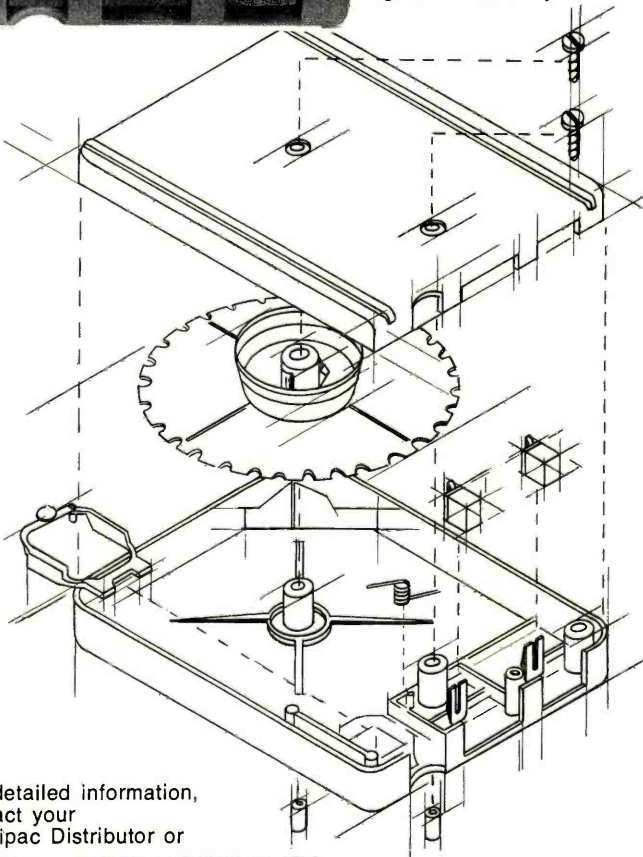

For detailed information, contact your Fidelipac Distributor or



FIDELIPAC®

109 Gaither Drive • Mt. Laurel, NJ 08057
(609) 235-3511

® Trademark

FIDELIPAC® ACCESSORIES & CARTRIDGES

CART-A-ROUND CARTRIDGE STORAGE RACKS

Each WR-25 Modular Rack holds 25 Type A Cartridges . . . eight can be mounted on our Mobile Carousel Base to make up the MR-200.

WR-25 \$13.25
MR-200 \$145.95

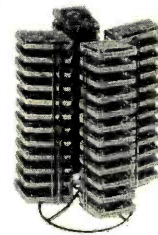
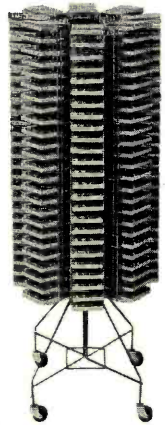

TABLE TOP CARTRIDGE RACK

Model TR-96 holds 96 Type A cartridges, Model TR-48 holds 48.
TR-96 \$73.85
TR-48 \$38.55



STUDIO ON AIR LIGHT

brilliant red lettering on jet black background can be seen even in the brightest ambient light conditions. \$29.95



CART-E-RASE DEMAGNETIZER

can be used for erasing cartridges, reel-to-reel tape, film sound stripping, etc. \$34.50



ALIGNMENT PROBLEM?

Keep your cart equipment in perfect working order with:

- 350 STA Alignment Cartridge \$38.50
- 350 STF Wow and Flutter Cartridge \$24.50
- 350 STQ Cue Test Cartridge \$35.00
- Head Insertion Gage \$3.35
- Height Gage \$12.95
- Right Angle Zenith Gage \$21.75



Contact your Fidelipac Distributor or

FIDELIPAC®

109 Gaither Drive, Mt. Laurel, NJ 08057
(609) 235-3511

® Trademark

THE QUADZILLION MODEL 7×10^{-23}

HAS A ZILLION INPUTS,
A ZILLION OUTPUTS,
A ZILLION CONTROLS...
... TAKES A
ZILLIPIUS
TO RUN IT!

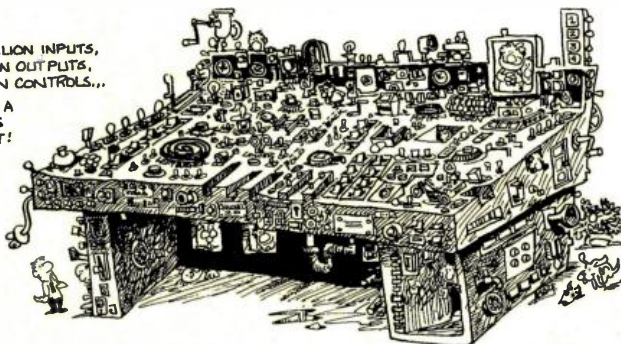

WHY WOULDN'T IT BE THE ULTIMATE BROADCAST CONSOLE?

DYMA KNOWS!!

RT. 1, Box 5, TAGS, NEW MEXICO 875 71 PHONE (505) 768-2686

CLOSED CIRCUIT SYSTEMS

American Data
Fernseh Division, Robert Bosch
Phillips Audio Video Systems
Quick-Set Inc.
RCA-Communications Systems Division

COAXIAL CABLE

Cablewave Systems Inc.
Calvert Electronics Inc.
Collins Radio
Dyma Engineering Inc.
Ft. Worth Tower
Harris Corp.
Mohawk Wire & Cable
RCA-Communications Systems Division
Telemation Inc.

COILS

Collins Radio
Delta Electronics
Harris Corp.
Also see 'Transformers'

CHARACTER GENERATORS

Chiron Telesystems
Control Technology Inc.
Cooke Engineering Co.
Datavision Video Products
Landy Associates Inc.
RCA-Communications Systems Division
Telemation Inc.
Thomson CSF Labs
Video Data Systems Inc.

CHRONOMETERS, CLOCKS

Broadcast Electronics Inc.
Collins Radio
Control Technology Inc.
Dyma Engineering Inc.
Harris Corp.
Landy Associates Inc.
LPB Inc.

COLOR TELEVISION TEST CHART

Fernseh Div., Robert Bosch
Harris Corp.
Landy Associates Inc.
RCA-Communications Systems Division
Telecommunications Industries Ltd.

COLOR TV EQUIPMENT

Canon USA Inc.

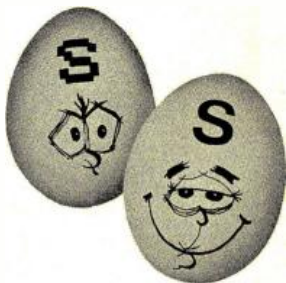

Datavision D-3000 Generates Characters ...Smooth on the Curves!

The most significant feature of any character generator is the quality of the characters it generates. Simple. Character quality shows in the smoothness of curved letters and numerals. An obvious "stair-step" tells you that the manufacturer skimped by using less elements in the matrix.

The Datavision D-3000 has 1120-element character resolution, as good as the most expensive equipment on the market, and at significant cost saving. Plus, the D-3000 is loaded with other features: two character sizes; two independent output channels; 3 speed roll and crawl; character edging; word flash; automatic centering; and optional D-4000 Random Access Storage System.

For all the facts, and a free on-site demonstration, phone (301) 948-0460 or write: Datavision Video Products, Mincom Division, 3M Company, 15932 Shady Grove Road, Gaithersburg, MD 20760.



D-3000...you're a smoothie!

Datavision Video Products **3M**
MINCOM DIVISION COMPANY

THE RIGHT MIXER

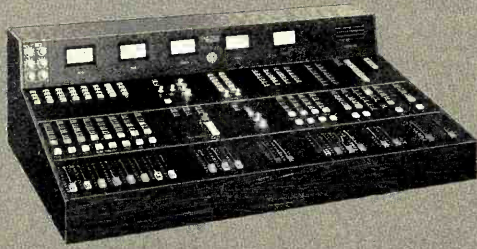

Now there's reason to celebrate!

For as low as \$9995 you can have the ROBINS FAIRCHILD Model 1632 Audio Mixing Console. With such outstanding features as 16 input channels, which handle 64 sources, three submaster mixing channels, dual program output channels, plug-in I.C. op-amp circuitry and illuminated push button switching. Plus many options to make the Model 1632 ideally suited to your specific needs.

FOR COMPLETE DETAILS CALL OR WRITE SAM JONES

ROBINS & FAIRCHILD

A Robins Industries Corporation

75 Austin Boulevard, Commack, N.Y. 11725
(516) 543-5200

RELIABILITY FLEXIBILITY PERFORMANCE... ECONOMY TOO!



RELIABILITY - advanced state-of-the-art technology, I.C. op-amp circuitry and high quality components throughout.
FLEXIBILITY - through multiple input preselect switches and a broad selection of optional plug-in modules, to suit your individual requirements.
PERFORMANCE - with features like microphone input limiters which prevent overload, "Human Engineering" which provides maximum operator visibility, efficiency and comfort, to minimize operator error.
... readily available in 5 or 8 channel models, mono or stereo ... all sensibly priced.

THE ROBINS/FAIRCHILD
30000 Series Broadcast Consoles

FOR COMPLETE DETAILS CALL OR WRITE SAM JONES

ROBINS & FAIRCHILD

A Robins Industries Corporation

75 Austin Boulevard, Commack, N.Y. 11725
(516) 543-5200

Dyma Engineering Inc.
Fernseh Div., Robert Bosch
Harris Corp.
JVC Corp.
Landy Associates Inc.
Lenco Inc.
Philips Audio Video Systems
Quick-Set Inc.
RCA-Communications Systems Division
Telemation Inc.
Thomson CSF Labs

COMMUNICATIONS SYSTEMS

Audio Distributors Inc.
Delta Electronics Inc.
Dyma Engineering Inc.
Harris Corp.
LPB Inc.
Moseley Associates Inc.



MOSELEY
ASSOCIATES, INC.
111 CASTILIAN DRIVE, GOLETA, CALIFORNIA 93017

**ALL SOLID-STATE
REMOTE CONTROL SYSTEMS
AM-TV-FM...WIRE AND WIRELESS**

RCA-Communications Systems Division
Robins/Fairchild

CONSOLES

Ampro Corp.
Audio Designs and Mfg. Inc.
Audio Distributors Inc.
Broadcast Automation Associates
Broadcast Electronics Inc.

Broadcast Supply West
Collins Radio
Control Technology Inc.
CSI Electronics Inc.
Dyma Engineering Inc.
Harris Corp.
LPB Inc.
Robins/Fairchild
Rupert Neve Inc.
RCA-Communications Systems Division
Shintron
Sintronics Corp.
Wilkinson Electronics Inc.

CONSULTING SERVICES

Control Technology Inc.
Dyma Engineering Inc.
RCA-Communications Systems Division

CONVERTERS, TV

Marconi Electronics

CRYSTAL UNITS

See "Transmitters"

DEFLECTION COMPONENTS

Calvert Electronics Inc.
RCA-Communications Systems Division

DEHYDRATORS & ACCESSORIES

Cablewave Systems Inc.
Collins Radio
Harris Corp.

DESIGN

Collins Radio
Dyma Engineering Inc.
Lenco Inc.
Telemation Inc.
Also see 'Consulting Services'

DESK NAME PLATES

Audio Distributors Inc.

DEVELOPMENT, EQUIPMENT

Lenco Inc.
Telemation Inc.



40 Input, 10 Channel
Stereo Console

6, 8, 10 and 12 channel
mono, dual mono, stereo and dual
stereo/simulcast audio consoles
available from stock in either
rotary or slide fader versions.
Financing available to qualified
buyers. Call collect or
write today for details.



AMPRO CORPORATION
850 PENNSYLVANIA BLVD.
FEASTERVILLE, PA 19047
(215) 322-5100

Professional Equipment For Broadcasting Professionals

DIRECTIONAL COUPLERS

Electro Impulses Inc.

DOLLIES, INSTRUMENT CARTS, ETC.

Harris Corp.

Innovative Television Equipment
Quick-Set Inc.

DUMMY LOADS

Electro Impulses Inc.
Harris Corp.

EDITING, FILM & TAPE

The Camera Mart Inc.
Cooke Engineering Inc.
JVC Corp.
Lipsner-Smith
RCA-Communications Systems Division

E.N.G. EQUIPMENT & ACCESSORIES

JVC Corp.
Landy Associates

ENGINEERING, SYSTEM

Collins Radio
Control Technology Inc.
Fernseh Div., Robert Bosch
Landy Associates
RCA-Communications Systems Division
Telemation Inc.

EQUALIZERS

Audio Designs & Mfg. Inc.
Collins Radio
Control Technology Inc.
Dyma Engineering Inc.
Robins/Fairchild
Rupert Neve Inc.
Roh Corp.
Wilkinson Electronics

ERASERS, MAGNETIC TAPE

Audio Distributors Inc.
Broadcast Electronics Inc.
Broadcast Supply West
The Camera Mart Inc.
Collins Radio

Control Technology Inc.
Dyma Engineering Inc.
Fidellpac
Harris Corp.
International Tapetronics Corp.
Landy Associates
National Audio Co.
Robins/Fairchild
Taber Mfg. and Engrg. Co.

FACILITIES PLANNING

Collins Radio
Dyma Engineering Inc.
Fernseh Div., Robert Bosch
LPB Inc.

FIELD STRENGTH METERS

Potomac Instruments

FILM CHAINS

Buhl Optical
Fernseh Div., Robert Bosch

FILM PROCESSORS

Jamieson Film Co.

FILTERS

Collins Radio
The Camera Mart Inc.

GENERATORS, SIGNAL

Broadcast Supply West
Collins Radio
Delta Electronics
Dyma Engineering Inc.
Landy Associates Inc.
Lenco Inc.
Marconi Instruments
McGraw-Edison Co.
Potomac Instruments
Telemation Inc.

HEADS, MAGNETIC FILM, MAGNETIC TAPE, DISK RECORDING AND PLAYBACK

Audio Distributors Inc.
Beyer Dynamics
Broadcast Electronics
Broadcast Supply West

The Camera Mart Inc.
Canon USA Inc.
Control Technology Inc.
CSI Electronics Inc.
Electro-Voice Inc.
Garron Electronics
RCA-Communications Systems Division
Stanton Magnetics Inc.
Taber Mfg. and Engrg. Co.

HEADSETS, HEADPHONES

Audio Distributors Inc.
Broadcast Supply West
The Camera Mart Inc.
Collins Radio
Control Technology Inc.
Dyma Engineering Inc.
Harris Corp.
LPB Inc.
National Audio
Phillips Audio Video Systems
Pulse Dynamics Mfg. Corp.
RCA-Communications Systems Division
Revox Corp.
Stanton Magnetics Inc.
Television Equipment Associates
Telex

IMAGE ENHANCERS, TV

Dynasciences

INDICATORS

Moseley Associates Inc.
Also see 'Test Equipment'

INSTALLATION

Collins Radio
Telemation Inc.

JACK PANELS AND ACCESSORIES

Audio Distributors Inc.
Collins Radio
Cooke Engineering Inc.
CSI Electronics Inc.
Harris Corp.
LPB Inc.
Potomac Instruments
RCA-Communications Systems Division

LENSES, OPTICAL & CAMERA

Angenieux Corp. of America
Buhl Optical
The Camera Mart Inc.
Canon USA Inc.
Phillips Audio Video Systems
RCA-Communications Systems Division

LIGHTNING PROTECTORS

Wilkinson Electronics Inc.

LIGHTS AND LIGHTING

Berkey Colortran
The Camera Mart Inc.

angēnieux service corporation of california
13381 BEACH AVE., VENICE, CALIF. 90291 • (213) 821-5080
FACTORY SERVICE
CENTERS
REPAIRS • PARTS
ACCESSORIES
angēnieux service corporation of new york
1500 OCEAN AVE., BOHEMIA, N.Y. 11716 • (516) 567-2424



Meteor Light & Sound
National Audio Co. Inc.
RCA-Communications Systems Division
Revox Corp.

LINE SURGE PROTECTORS

Sintronics Corp.
Wilkinson Electronics Inc.

LINKS, RELAY

Harris Corp.
Marti Electronics Inc.
Moseley Associates Inc.

MOSELEY ASSOCIATES, INC.
111 CASTILIAN DRIVE, GOLETA, CALIFORNIA 93017

ALL SOLID-STATE AURAL STL SYSTEMS
All U.S. and foreign bands

Sintronics Corp.
Wilkinson Electronics Inc.

LOUDSPEAKERS & ACCESSORIES

Audio Designs & Mfg. Inc.
Audio Distributors Inc.
Broadcast Automation Associates
Broadcast Supply West
Collins Radio
CSI Electronics Inc.
Dyma Engineering
Electro-Voice Inc.
Harris Corp.
LPB Inc.
RCA-Communications Systems Division
Sintronics Corp.

METERS

Audio Designs & Mfg. Inc.
Audio Distributors Inc.
Collins Radio
Delta Electronics
Harris Corp.
Potomac Instruments
Pulse Dynamics
Also see 'Test Equipment'

MICROPHONES & ACCESSORIES

Audio Distributors Inc.
Beyer Dynamics
Broadcast Automation Associates
Broadcast Electronics Inc.
Broadcast Supply West
The Camera Mart Inc.
Collins Radio
Control Technology Inc.
CSI Electronics Inc.
Dyma Engineering Inc.
Electro-Voice Corp.
Harris Corp.
LPB Inc.
Philips Audio Video Systems
Pulse Dynamics Mfg. Corp.
RCA-Communications Systems Division
Revox Corp.
Sintronics Corp.
Wilkinson Electronics Inc.

MICROWAVE

Cablewave Systems Inc.
Collins Radio

Broadcast Supply
is the Place to Buy!

IGM Automation Systems and the largest selection of Broadcast Studio Equipment in the industry!

For FAST DELIVERY at SENSIBLE PRICES

call Collect
206-565-2301

BROADCAST SUPPLY WEST
2607 Bridgeport Way West
Tacoma, Washington 98466

Dyma Engineering Inc.
Marti Electronics Inc.
Moseley Associates Inc.

MOSELEY ASSOCIATES, INC.
111 CASTILIAN DRIVE, GOLETA, CALIFORNIA 93017

SINGLE LINK STEREO STL SYSTEM
ALL SOLID-STATE

Quick-Set Inc.
RCA-Communications Systems Division
Unarco-Rohn

MOBILE COMMUNICATIONS

Audio Distributors Inc.
The Camera Mart Inc.
Collins Radio
Dyma Engineering Inc.
Marti Electronics Inc.

MOSELEY ASSOCIATES, INC.
111 CASTILIAN DRIVE, GOLETA, CALIFORNIA 93017

160 MHz and 450 MHz
REMOTE BROADCAST PICKUP SYSTEMS

Moseley Associates Inc.
RCA-Communications Systems Division

MOBILE EQUIPMENT BUILDINGS

Fort Worth Tower

Now, in our corner the world heavyweight champions...



Introducing, from Quick-Set, the professional champs in television and microwave support equipment. We've acquired the Houston Fearless product line of studio pedestals, heads, tripods and dollies. These popular heavy duty units accommodate a complete range of studio/remote requirements.

Stability, smooth action and quality are the key ingredients in every Quick-Set product. This is why we can offer a lifetime guarantee against defects in materials and workmanship. We back this with worldwide distribution and service to give you the professional support you deserve.

Send for our complete catalog.

QUICK-SET INCORPORATED

instrument positioning equipment
3650 Woodhead Drive, Northbrook, Illinois 60062
312/498-0700 Telex: 72-4362



**Recorder/Reproducer \$775
(Reproducer \$550)**

So Much For So Little PD-II SERIES

A machine that records and plays mono tapes in the "A" size cartridge, stops automatically on the 1 kHz cue tone and offers you longer life, less maintenance and better performance than any other cartridge machine at an economy price.

Compare For Yourself

- Quiet air-damped solenoid
- Flat, stable 1/2 inch solid aluminum deck
- Micro-adjustable head assembly
- Direct-drive capstan motor
- Trim design - 3 units fit side-by-side in a 19 inch equipment rack
- Latest solid state components
- Plug-in circuit cards
- No relays

**CALL US AND WE'LL
PROVE IT TO YOU**

For complete information call us collect at 309/828-1381. You'll be talking to experienced broadcasters who not only know what ITC can do—but know what you want it to do.

IT INTERNATIONAL
TAPETRONICS
CORPORATION

—P.O. Box 241•2425 South Main Street
Bloomington, IL. 61701
Marked Exclusively in Canada by
McCurdy Radio Industries Ltd.

MOBILE VIDEO TAPE EQUIPMENT

The Camera Mart Inc.
Fernseh Div., Robert Bosch
Philips Audio Video Systems
RCA-Communications Systems Division

MODULATORS

Collins Radio
CSI Electronics Inc.
Harris Corp.
Sintronics Corp.

MONITORS, AUDIO & VIDEO

Audio Designs & Mfg. Inc.
Ball Brothers Research Corp.
Belar Electronics Laboratory Inc.
Broadcast Automation Associates
Broadcast Electronics Inc.
The Camera Mart Inc.
Collins Radio
Control Technology Inc.
Dyma Engineering Inc.
Fernseh Div., Robert Bosch
Harris Corp.
Marconi Instruments
RCA-Communications Systems Division
Roh Corp.
Shintron
Sintronics Corp.
Thomson CSF Labs
Wilkinson Electronics

MONITORS, FREQUENCY MODULATION & PHASE

Belar Electronics Lab Inc.
Collins Radio
Control Technology Inc.
CSI Electronics Inc.
Delta Electronics
Dyma Engineering Inc.
Harris Corp.
Landy Associates
Moseley Associates Inc.
Potomac Instruments Inc.
RCA-Communications Systems Division
Sintronics Corp.

Wilkinson Electronics Inc.

OSCILLATORS

Audio Designs & Mfg. Inc.
Broadcast Supply West
Collins Radio
Delta Electronics
Dyma Engineering Inc.
Potomac Instruments
Robins/Fairchild
Also see 'Test Equipment'

PANELS

Audio Distributors Inc.
Collins Radio
Harris Corp.
Also see 'Cabinets, Racks, Panels'

PATCH CORDS

Audio Distributors Inc.
Collins Radio
Harris Corp.
Potomac Instruments
Also see 'Jack Panels'

PAY-TV EQUIPMENT

Fernseh Div., Robert Bosch

PHASING EQUIPMENT

Audio Distributors Inc.
Collins Radio
CSI Electronics Inc.
Dyma Engineering Inc.
Garron Electronics Inc.
Harris Corp.
Sintronics Corp.

PICKUPS

Audio Distributors Inc.
Broadcast Supply West
Collins Radio
CSI Electronics Inc.
Landy Associates
Stanton Magnetics
Also see 'Heads'

**When accuracy Counts... Count on Belar
for AM/FM/TV MONITORS**

BELAR
AM MODULATION MONITOR

BELAR CALL ARNO MEYER (215) 687-5550
ELECTRONICS LABORATORY, INC.
LANCASTER AVENUE AT DORSET, DEVON, PA. 19333 • BOX 826 • (215) 687-5550

PLAYBACK TAPE EQUIPMENT

Audio Distributors Inc.
Broadcast Automation Associates
Broadcast Electronics Inc.
Broadcast Supply West
The Camera Mart Inc.
Collins Radio
CSI Electronics Inc.
Control Technology Inc.
Dyma Engineering Inc.
Fernseh Div., Robert Bosch
Garron Electronics
Harris Corp.
International Tapetronics Corp.
Landy Associates
LPB Inc.
National Audio Co.
RCA-Communications Systems Division
Revox Corp.
Telex
Wilkinson Electronics Inc.

PLUGS AND CONNECTORS

Collins Radio
CSI Electronics Inc.
Mohawk Wire and Cable

POWER SUPPLIES

The Camera Mart Inc.
Collins Radio
Dyma Engineering Inc.
Harris Corp.
Lamb Labs
RCA-Communications Systems Division
Revox Corp.
Robins/Fairchild
Wilkinson Electronics Inc.

PROJECTORS, PROJECTION UNITS

Buhl Optical
Harris Corp.
Revox Corp.
Also see 'Cameras, Projectors'

PUBLIC ADDRESS SYSTEMS

Audio Distributors Inc.
Collins Radio
Pulse Dynamics Mfg. Corp.
Robins/Fairchild
Roh Corp.
Also see 'Loudspeakers & Accessories'

RACKS

Audio Distributors Inc.
Broadcast Supply West
Collins Radio
Dyma Engineering Inc.
Fidelipac
Harris Corp.
Landy Associates
National Audio Co.
Also see 'Cabinets, Racks, Panels'

RECEIVERS, AM-FM-TV-MULTIPLEX

Collins Radio
Moseley Associates Inc.

Revox Corp.
Wilkinson Electronics Inc.

RECORD PLAYER UNITS

Broadcast Electronics Inc.
Broadcast Supply West
Collins Radio
CSI Electronics Inc.
Dyma Engineering Inc.
Harris Corp.
LPB Inc.
Stanton Magnetics Inc.

RECORDERS, AUDIO & VIDEO (AND ACCESSORIES)

Broadcast Automation Associates
Broadcast Supply West
The Camera Mart Inc.
Collins Radio
Control Technology Inc.
Dyma Engineering Inc.
Fernseh Div., Robert Bosch
Fidelipac
Garron Electronics
Harris Corp.
International Tapetronics Corp.
Landy Associates
LPB Inc.
National Audio Co.
Philips Audio Video Systems
RCA-Communications Systems Division
Revox Corp.
Telemation Inc.
Telex
Wilkinson Electronics Inc.

RECORD CLEANING EQUIPMENT

Bib Inc.
Collins Radio
Revox Corp.

REELS, MAGNETIC TAPE

Audio Distributors Inc.
Broadcast Electronics
Broadcast Supply West
The Camera Mart Inc.
Collins Radio
Control Technology Inc.
Dyma Engineering Inc.
Fidelipac
Harris Corp.
International Tapetronics Corp.
RCA-Communications Systems Division

RF BRIDGING EQUIPMENT

Delta Electronics
Potomac Instruments

REMOTE BROADCAST EQUIPMENT

Pulse Dynamics Mfg. Corp.

REMOTE CONTROL

Audio Distributors Inc.
Collins Radio
Control Technology Inc.
CSI Electronics Inc.



The best beautiful
music sound in
Columbia, SC is put out
by an **AEL FM-2.5KD**
Stereo Transmitter

Just ask **WXYR**

AEL stereo transmitters always
send the very best.
FM: 2,500, 15,000, 25,000, 40,000,
50,000 watts.
AM: 5,000, 10,000, 50,000 watts.



Call or Write:

AMERICAN ELECTRONIC LABORATORIES, INC.
P.O. Box 552, Lansdale, PA 19446
Tel: 215/822-2929 • TWX: 510/661-4976

Remote Broadcast

Complete Line of Remote
Broadcasting Equipment
Using Standard Telephone Lines



- ✦ Direct Distance Dialing
- ✦ Built in Voice Couplers
- ✦ Line Lock Features
- ✦ Many Options & Accessories
- ✦ Single & Multi
Channel Mixers
- ✦ Consoles
- ✦ AC/DC
- ✦ Sports Network System

Ask For Catalog
Unconditional 5 year guarantee



PULSE DYNAMICS MFG. CORP.
P. O. Box 355
Colchester, Illinois 62326
(309) 776-4544, 776-4575

Delta Electronics
Dyma Engineering Inc.
Harris Corp.
Marti Electronics
Moseley Associates Inc.
Roh Corp.
Sintronics Corp.
Wilkinson Electronics Inc.
 Also see 'Communications Systems'

RF ATTENUATORS

Electro Impulses Inc.

RF BALUNS

Electro Impulses Inc.

RF CALORIMETERS

Electro Impulses Inc.

SCA EQUIPMENT

Colorado Video Inc.

**SERVICE, REPAIRS
 AND MAINTENANCE**

The Camera Mart Inc.
Collins Radio
Harris Corp.
**RCA - Communications
 Systems Division**
RCA Service Co.

FM/SCA/TV

Transmit still TV pictures
 on the 67 kHz subcarrier
 channel for:

- instructional programming
- community services
- storecasting

Contact us for hardware
 specifications.

cvi

Colorado Video Inc.
 P. O. Box 928
 Boulder, CO 80302
 (303) 444-3972
 TWX 910-940-3248
 COLO VIDEO BDR

Pioneers in
 compressed video

SILICON RECTIFIERS
Wilkinson Electronics Inc.

SOUND RECORDING EQUIPMENT

Audio Designs & Mfg. Inc.
Audio Distributors Inc.
Broadcast Automation Associates
Broadcast Supply West
The Camera Mart Inc.
Collins Radio
Dyma Engineering Inc.
Garron Electronics
Harris Corp.
International Tapetronics Corp.
Landy Associates
Philips Audio Video Systems
Revox Corp.
Robins/Fairchild
 Telex

SPEAKERS

Audio Designs & Mfg. Inc.
Audio Distributors Inc.
Broadcast Supply West
Collins Radio
CSI Electronics Inc.
Electro-Voice Inc.
Harris Corp.
Landy Associates
Philips Audio-Video Systems
RCA-Communications Systems Division

SPECIAL EFFECTS, AUDIO & VIDEO

American Data
Audio Designs & Mfg. Inc.
The Camera Mart Inc.
Collins Radio
Dyma Engineering Inc.
Garron Electronics
Landy Associates
RCA-Communications Systems Division
 Shintron
Telemation Inc.

SPLICING EQUIPMENT, FILM, TAPE

Broadcast Supply West
The Camera Mart Inc.
Collins Radio
Fidellpac
International Tapetronics Corp.
National Audio Co.

Revox Corp.

**STANDS, MICROPHONE, PROJEC-
 TOR**

Broadcast Supply West
The Camera Mart Inc.
Dyma Engineering Inc.
Electro-Voice Inc.
Harris Corp.
RCA-Communications Systems Division
Revox Corp.

STEREO EQUIPMENT, AUDIO

Audio Design & Mfg. Inc.
Collins Radio
CSI Electronics Inc.
Control Technology Inc.
Dyma Engineering Inc.
Garron Electronics Inc.
Harris Corp.
Revox Corp.
Wilkinson Electronics Inc.

SWITCHES & ACCESSORIES

Collins Radio
C.M. Levit Electronics
 McGraw-Edison Co.
RCA-Communications Systems Division

SWITCHING EQUIPMENT

American Data
Broadcast Supply West
Collins Radio
Control Technology Inc.
Dyma Engineering Inc.
 Dynasciences
Landy Associates
RCA-Communications Systems Division
Roh Corp.
 Shintron
Telemation Inc.

SYNC. GENERATORS

Shintron

TAPE, AUDIO & VIDEO

Audio Distributors Inc.
Broadcast Automation Associates
Broadcast Electronics
Broadcast Supply West

A "SOUND" COMPETITIVE EDGE!

The **STE-100 STEREO PHASE ENHANCER** . . .
 can minimize "Phase nulling" in "Mono-sum" signals,
 and ensure your "Sound quality" in todays competitive markets! ! !



GARRON ELECTRONICS, 1216 Kifer Rd, Sunnyvale, CA, 94086, Call (408) 736-8737

Utility Tower Supports Your Profit Potential

From the base to the beacon, Utility Towers are engineered and erected to the exacting requirements of reliability and stability of the broadcast industry.

Utility Tower combines computer accuracy in the design and specification of towers with Utility Tower's own experienced erection crews to give you the best engineered and erected tower available.

Call Utility Tower for an estimate, let the tower of strength support your profit potential.



Utility Tower
COMPANY

HOME OFFICE: Ron Nelson
Box 12027
Oklahoma City, Okla. 73112
(405) 946-5551
Night: (405) 942-8164

EASTERN DIVISION: Nate Sholar
Box 163
Mayfield, Ky. 42066
(502) 247-3642
Night: (502) 247-5657

CSI Electronics Corp.
Dyma Engineering Inc.
Harris Corp.
Martl Electronics Inc.
RCA-Communications Systems Division
Wilkinson Electronics Inc.

Moseley Associates Inc.
RCA-Communications Systems Division
Shintron
Wilkinson Electronics Inc.

TRIPODS, PEDESTALS & ACCESSORIES

TRANSMITTERS

Audio Distributors Inc.
Collins Radio
Control Technology Inc.
CSI Electronics Inc.
Dyma Engineering Inc.
Harris Corp.
LPB Inc.

Landy Associates
Quick-Set Inc.

TUBES & TUBE REBUILDING

Audio Distributors Inc.
Amperex Electronic Corp.
Calvert Electronics Inc.
CECO Communications Inc.

WILKINSON ELECTRONICS MAKES

A 10 WATT FM TRANSMITTER
A 100 WATT FM TRANSMITTER
A 250 WATT FM TRANSMITTER
A 1 KW FM TRANSMITTER
A 2.5 KW FM TRANSMITTER
A 5 KW FM TRANSMITTER
A 7.5 KW FM TRANSMITTER
A 10 KW FM TRANSMITTER
A 20 KW FM TRANSMITTER
A 25 KW FM TRANSMITTER
A 50 KW FM TRANSMITTER
AN FM RELAY RECEIVER
A STEREO GENERATOR
AN SCA GENERATOR
A BIG STEREO CONSOLE
A LITTLE STEREO CONSOLE
A 1 KW AM TRANSMITTER
A 5 KW AM TRANSMITTER
A 10 KW AM TRANSMITTER
A 50 KW AM TRANSMITTER
A MONAURAL AUDIO CONSOLE
AN AM MODULATION MONITOR
AN AM RF AMPLIFIER
A MONO LIMITING AMPLIFIER
A STEREO LIMITING AMPLIFIER
A MONAURAL AGC AMPLIFIER
A STEREO AGC AMPLIFIER
A TURNTABLE PREAMPLIFIER,
MONAURAL & STEREO
A MONITORING AMPLIFIER
A REMOTE AMPLIFIER
A DISTRIBUTION AMPLIFIER
A LINE AMPLIFIER
LIGHTNING PROTECTORS
SILICON RECTIFIER STACKS
CUSTOM PRODUCTS

TRANSLATORS

DESIGNERS AND MANUFACTURERS OF VHF, UHF, FM. ALSO REPAIR
PARTS AND UP DATING KITS FOR ALL ADLER, LITTON,
AND KEITH ANDERSON TRANSLATORS

FOR FULL INFORMATION:

Television Technology Corporation

5970 West 60th Ave., Arvada, Colo. 8003
(303) 423-1652

WILKINSON
ELECTRONICS, INC.

Telephone: (215) 497-5100

701 Chestnut St.
Trainer, Pa. 19013
CABLES WILEC

CALVERT BROADCAST CAPABILITY

• Camera Tubes

Plumbicon* Vistacon
Leddicon Vidicon

• Transmitting Tubes

TV-AM-FM-Translator

• Microwave Tubes

Klystron UHF
Traveling Wave Tube

• Special Tubes

Photo Multiplier
CRT Instrumentation

Broadcast product availability
at lowest cost.

**EIMAC RCA EEV
AMPEREX VARIAN**

For literature make this
Toll-Free call: 800-221-6845.

BROADCAST/CATV/CCTV Division
CALVERT ELECTRONICS, INC.
220 East 23rd St., New York, N.Y. 10010
(212) 679-1340

*Reg. Trademark N.V. Philips of the Netherlands

PAY WHOLESALE PRICES for your TUBES & SEMICONDUCTORS

Celco is an established
franchised
super distributor
of major lines & offers:



- Largest stocking inventory
- 24-hour usual shipping service
- 24-hour emergency phone service.

Call collect on
your requirements.

212-646-6300



COMMUNICATIONS, Inc.
2115 AVENUE X
BROOKLYN, NEW YORK 11235

Collins Radio
CSI Electronics Inc.
Dyma Engineering Inc.
English Electric Valve
Freeland Products Co.
Harris Corp.
C.M. Levit Electronics
Wilkinson Electronics Inc.

TUNERS, RF

Collins Radio

TUNING & PHASING

Audio Distributors Inc.
Collins Radio
CSI Electronics Inc.
Harris Corp.

TURNTABLES

Audio Distributors Inc.
Broadcast Automation Associates
Broadcast Electronics Inc.
Broadcast Supply West
Collins Radio
Control Technology Inc.
CSI Electronics Inc.
Dyma Engineering Inc.
Harris Corp.
Landy Associates
LPB Inc.
McMartin Industries Inc.
Micro-Trak
Phillips Audio Video Systems
RCA-Communications Systems Division
Revox Corp.
Sintronics Corp.
Stanton Magnetics
Wilkinson Electronics Inc.

TV TEST SLIDES

Telecommunications Industries Ltd.

VIDEO TAPE

C.M. Levit Electronics
Landy Associates

Also see 'Tape, Audio & Video'

VIDEO TAPE CLEANERS & EVALUATORS

Television Equipment Associates

VIDEO TAPE RECORDERS

Fernseh Div., Robert Bosch
Phillips Audio Video Systems
RCA-Communications Systems Division

VOLTAGE REGULATORS

RCA-Communications Systems Division

WEATHER INSTRUMENTS

Alden Electronic Equipment
Collins Radio
Dyma Engineering Inc.
Telemation Inc.

Broadcast Services

The following directory is a service to those interested in particular types of programs or other services. It shows where to obtain desired services, and is made possible through the cooperation of companies who have asked to be spotlighted in this way. For further information on an individual program supplier see its alphabetical listing in the appropriate division of section D, under programing or advertising. For other services, refer to section F.

Suppliers whose names are in bold face are advertisers in the 1976 BROADCASTING YEAR-BOOK.

BROKERS, STATION & CATV

Blackburn & Company Inc.
R.C. Crisler & Co. Inc.
Norman Fischer & Assoc. Inc.
Hamilton/Landis & Associates Inc.
The Keith W. Horton Company Inc.
Richard A. Shaheen
Howard Stark
Edwin Tornberg & Company Inc.

CONSULTANTS

Norman Fischer & Assoc. Inc.
New York Film & Video Tape Comm. Inc.
Edwin Tornberg & Company Inc.

EMPLOYMENT SERVICES

Norman Fischer & Assoc. Inc.

ENGINEERS

Oscar Leon Cuellar, P.E.

Oscar Leon Cuellar, P.E.

Consulting Engineer
Member AFCEE

1563 South Hudson
(303) 756-8456

DENVER, Colorado 80222

FINANCIAL CONSULTANTS

Firstmark Financial Corporation

MOTION PICTURE LABS

Leo Diner Films Inc.

PROGRAM PRODUCTION SERVICE

TV Sports Scene Inc.

PROMOTION SERVICES

New York Film & Video Tape Comm. Inc.

REGIONAL NETWORK PROMOTION

TV Sports Scene Inc.

STATION FINANCING

Norman Fischer & Assoc. Inc.
Edwin Tornberg & Company Inc.

TV PRODUCERS-DIST.

Alcare Communications
TV Sports Scene Inc.

Clean up your image with EEV camera tubes.



8572V 1 inch magnetic Vidicon[®]
for use in color film
chain operation



P8130 to P8133 30mm Coaxial
Leddicon[®] series with coaxial
light bias. Replaces most integral
or separate mesh color camera
tubes. Available in standard layer
as well as extended red or green.



P858 4 1/2 inch Image Orthicon[®]
for use as the luminance tube
in color cameras.



B134V1 1 inch electrostatic
focus Vidicon for color film
chain broadcast applications.
B480V1 1 1/2 inch tube for use
in luminance channel.

Clean, precise, consistent—EEV Leddicon[®] camera tubes are made to last. They can be used as replacements for Plumbicon[®] and Vistacon tubes.

Hundreds of stations in the USA and throughout the world use Leddicons to down costs and up quality.

From the same one-stop source you can also specify EEV Image Orthicons—we're the world's biggest makers—and Vidicons.

All EEV tubes are available for immediate delivery with fast service back-up. Contact us now for type lists and prices.



EEV NORTH AMERICA

ENGLISH ELECTRIC VALVE NORTH AMERICA LTD.

1 American Drive • Cheektowaga, NY 14225

(716) 632-5871 • TWX: (710) 523-1862

67 Westmore Drive • Rexdale, Ontario M9V 3Y6

(416) 745-9494 • Telex: 06 965864

A member of the GEC - English Electric Group of Companies

Leddicon[®] is a registered trademark of English Electric Valve Company Limited

Plumbicon[®] is a registered trademark of N. V. Philips' of Holland

RESULTS!

To measure the level of success of a company you look at their achievement in past performances, their list of satisfied clients, and the end results of their efforts. When you want a professional to do the job for you in buying, selling, or appraisals...

Hamilton-Landis & Associates, Inc.
Media Brokers

WASHINGTON, D.C.:
1730 K Street, N. W., 20006
(202) 393-3456

DALLAS, TEXAS:
6060 N. Central Expressway, 75206
(214) 691-2345

CHICAGO, ILLINOIS:
1429 Tribune Tower, 60611
(312) 337-2754

SAN FRANCISCO, CALIFORNIA:
111 Sutter Street, 94104
(415) 392-5671

F

Professional Services

Station and CATV Brokers.....	F-1
Station Financing.....	F-3
Consultants.....	F-4
Law Firms and Attorneys Active in Communications Law.....	F-6
Research Services.....	F-16
Employment Services.....	F-18
Public Relations, Publicity and Pro- motion Services.....	F-18
Talent Agents and Managers.....	F-19

Associations

National Assn. of Broadcasters.....	F-20
Television Bureau of Advertising.....	F-21
Radio Advertising Bureau.....	F-22
Television Information Office.....	F-22
Radio Information Office.....	F-22
Broadcast Rating Council.....	F-22
National Assn. of Farm Broadcasters....	F-22
National Assn. of TV Program Execu- tives.....	F-23
Radio-Television News Directors Assn..	F-25
Radio-TV Galleries of Congress.....	F-27
State Broadcasters Associations.....	F-29
Other National Associations.....	F-30

Miscellaneous

U.S. Government Agencies of Interest to Broadcasting.....	F-36
Congressional Committees.....	F-36
Armed Forces Radio & TV Service.....	F-38
Voice of America.....	F-38
Radio Free Europe/Radio Liberty.....	F-38
Canadian Radio-Television Commission.	F-38
Unions and Labor Groups.....	F-39
Books.....	F-40
Schools Specializing in Radio and TV....	F-45
Colleges Offering Degrees in Radio and TV.....	F-46

Broadcasting®

Yearbook 1976

Professional Services

Brokers

Action Sales Inc. 217 West 13th St. Pueblo, Colo. 81003. (303)544-3056. B.L. Welch, owner, W.H. Welch, consultant.

Adams Broadcast Services Inc. Box 1287, FDR Stn, New York 10022. (212)260-1658. Robert F. Adams, pres.

American Media Associates Inc. 305 Degree of Honor Bldg., St. Paul 55101. (612)227-7577. M.D. Price Jr.

Harry W. Alexander Organization. 230 Park Ave., New York 10017. (212)532-1048. Harry W. Alexander, pres; Reese Brown, VP; Joey W. Alexander, sec.

Avpro Inc. 8 Briar Wood Lane, Suffern, N.Y. 10901. (914) 425-2066. Lewis M. Marcy, pres; Max M. Friedman.

Bedford, Mass. 01730: 2 Sunset Road. (617)275-6285. Ansel Chaney.

Beckerman Associates. 14001 Miramar Ave., Madeira Beach, Fla. 33708. (813)391-2824. Bernice S. Beckerman, Milton B. Beckerman.

Blackburn & Co. Inc. 1725 K St., N.W., Washington 20006. (202)331-9270. James W. Blackburn, Jack V. Harvey, Joseph M. Sitrick, Frank H. Nowaczek, James W. Blackburn Jr., Richard F. Blackburn.

Atlanta 30361: 400 Colony Square, Suite 510. (404)892-4655. Clifford B. Marshall, Robert A. Marshall.

Chicago 60601: 333 N. Michigan Ave. (312)346-6460. Hub Jackson, Wendell W. Doss, Roger O'Sullivan.

Beverly Hills, Calif. 90212: Bank of America Bldg., 9465 Wilshire Blvd. (213)274-8151. Colin M. Selph, Roy Rowan.

See second cover.

Robert W. Breckner. 1014 N. Bundy Dr., Los Angeles 90049. (213) 472-2132.

CATV Associates Inc. PO. Box TV, Casanova, Va. 22017. (703)788-4101. William T. Stubblefield Sr., pres; Barbara D. Stubblefield, sec-treas.

Chapman Associates. 5 Dunwoody Park, Atlanta 30341. (404)394-9244. Paul H. Chapman, pres; J. William Chapman, VP; Frances H. Chapman, sec-treas.

Boston 02050: 2153 Main St., Marshfield. (617)837-6711. Arthur H. Simmers.

Cleveland 44140: Box 9722. (216)871-0614. John A. King.
Dallas 75234: 2655 Villa Creek. (214)243-6043. William A. Hammond.

Detroit 48226: 1115 Penobscot Building. (313)963-5035. Robert H. McKendrick.
Nashville 37204: Box 40411. (615)298-4986. G. Paul Crowder.

San Francisco (San Rafael, Calif.) 94903: Holiday Plaza Building. (415)461-9499. E. Kerst Walters, Jr.

Communications Capital Corp. 960 Time Life Bldg., New York 10020. (212) Circle 5-2870. Blair Walliser, pres; Samuel Freundel, exec VP; G.B. Martin, gen mgr.

R.C. Crisler & Co. Suite 801, 580 Walnut St., Cincinnati 45202. (513)381-7775. Richard C. Crisler, pres; Ted Hepburn, VP; Alex Howard, VP.

Tucson, Ariz. 85717: Box 4008. (602)795-1050. Edwin G. Richter Jr, VP.

See adv., next page.

Daniels & Assoc. Inc. 2930 E. Third Ave., Denver 80206. (303)321-7550. John Saemen, pres.

Lincoln Dellar & Co. Box 5385 Santa Barbara, Calif. 93108. (805)969-3819. Lincoln Dellar, pres.

Doubleday Media. Carillon Tower West, 13601 Preston Rd., Suite 417, Dallas 75240. (214)233-4334. David G. Scribner, pres; Richard A. Anderson, VP. Bob Dalchau, John R. Lego, rgnl mgrs.

Phoenix 85014: 1202 E. Maryland Ave. (602)264-7459. Neil Sargent, rgnl mgr.

San Antonio: (512)824-5528. Conway Craig, rgnl mgr.

William A. Exline Inc. 31 Carroll Court, San Rafael, Calif. 94903. (415)479-0717. William A. Exline, pres.

William A. Exline, Inc.

31 CARROLL COURT
SAN RAFAEL, CALIFORNIA 94903
(415) 479-0717

MEDIA BROKERS - CONSULTANTS

Norman Fischer & Associates Inc. Box 5308, Austin, Tex. 78763. (512)478-1703. Norman Fischer, pres.

Frazier, Gross & Clay, Inc. 5028 Wisconsin Ave., N.W., Suite 333, Washington 20016. (202)966-2280. Horace W. Gross, pres; Howard S. Frazier, VP; E.H. Clay, VP.

W.B. Grimes & Co. National Press Bldg., Washington 20045. (202)628-1133. Walter Grimes, owner.

Wilt Gunzendorfer & Assoc. 1421 South Reeves St., Los Angeles 90035. (213)878-5678; (213) CR5-5678. Wilton Gunzendorfer, assoc pres-own; Natalie Gunzendorfer, asst mgr.

Howard J. Haman & Co. 8 Hidden Valley Rd., Lafayette, Calif. 94549. (415)284-9681. Howard J. Haman, pres.

Hamilton-Landis and Associates Inc. 1730 K St., N.W., Washington 20006. (202)393-3456. Ray V. Hamilton, chmn of bd; Milton Q. Ford, exec VP.
Dallas 75206: 6060 North Central Expy. (214)691-2345. Daniel D. Hayslett, pres.

Chicago 60611: 1429 Tribune Tower. (312)337-2754. Howard J. Stasen, VP.
San Francisco 94104: 111 Sutter St. (415)392-5671. John H. Bone, senior VP.

R. Miller Hicks & Co. 1011 West 11th St., Austin,

Brokers

Tex. 78703. (512)477-9696. R. Miller Hicks, pres; C. Brunner Smith, controller.

Hogan-Feldmann Inc. 16255 Ventura Boulevard, Suite 415, Encino, Calif. 91436. (213) 986-3201. Arthur B. Hogan, pres; Jack Feldmann, sec.

The Holt Corp. Box 111, 428 Brodhead Ave., Bethlehem, Pa. 18016. (215)865-3775. Arthur H. Holt, pres; Arthur K. White, assoc.

Charlotte, Mich. 48813: 1122 South Clinton. Edward Christian, assoc.

The Keith W. Horton Co. 1705 Lake St., Elmira, N.Y. 14902. (607)733-7138. Keith W. Horton, pres; Richard L. Kozacko, VP.

St. Albans, Vt. 05478: Box 270. (802)524-5963. Robert I. Kimel, VP.
Syracuse, N.Y. 13211: 1100 Malden Rd. (315)454-4144. Kenneth R. Chapin, assoc.

Hudson Investment Corp. 1150 17th St., N.W., Washington 20036. (202) 296-8995. Edward R. McKenna, VP.

HUDSON INVESTMENT CORPORATION

Brokers
WASHINGTON

1150 - 17th Street, N.W. Phone: 202-296-8995

Kelley Associates Inc. 4525 Shady Lane, Wichita Falls, Tex. 76308. (817)692-7722. Boyd Kelley, pres.

Philip L. Kelsner & Associates. 133 East 64th St., New York 10021. (212) Yukon 8-2266. Philip L. Kelsner, partner.

William Kepper Associates. 1615 Orrington Ave., Evanston, Ill. 60204. (312)869-3468. Kenneth D. Anderson, William L. Kepper, Dorothy K. Landry, C.A. Ross, H. Lex Walters.

william Kepper associates
MEDIA BROKERS
1615 Orrington Ave.,
Evanston (Chicago) Ill. 60201
(312) 869-3468

Larson Walker & Co. Suite 508, 1725 DeSales St., N.W., Washington 20036. (202)223-1553. G. Bennett Larson, pres; William L. Walker, VP.
Pacific Palisades, Calif. 90272: Box 654. (213)277-1567. Christian Larson, assoc.

LARSON/WALKER & COMPANY

Brokers, Consultants & Appraisers
Los Angeles Washington
G. Bennett Larson, President

Please write or call (collect):

William L. Walker Vice President Suite 508 1725 DeSales Street, N.W. Washington, D.C. 20036 202/223-1553	Chris Larson Associate P.O. Box 654 Pacific Palisades California 90272 213/277-1567
---	--

LaRue Media Brokers Inc. 116 Central Park South, New York 10019. (212)265-3430. Hugh Ben LaRue, pres.

Joe M. Leonard Jr. 4255 LBJ Freeway, Suite 282, Dallas 75234. (214)661-5748.

Vincent J. Manno. "October Hill." Box 1253, Weston, Conn. 06880. (203)226-9591.

Reggie Martin, Media Broker. 731 S. Mashta Dr., Key Biscayne, Fla. 33149. (305)361-2181. Reggie Martin, owner.

Patt McDonald Co. 1601 North Fielder Rd., Arlington, Tex. 76012. (817)277-8550. Patt McDonald, owner-mgr.

Ralph E. Meador. Box 36, Lexington, Mo. 64067. (816)259-2544. Ralph E. Meador, owner.

George Moore & Associates. Suite 712, 6116 No. Central Expressway, Dallas 75206. (214)361-8970. George W. Moore, W. James Moore, Monta L. Hall.

George MOORE & ASSOCIATES

BROKERS AND APPRAISERS

6116 N CENTRAL EXPRESSWAY SUITE 712
DALLAS, TEXAS 75206 214/361-8970

Mountain States Broadcast Properties Inc. 80 Garden Office Center, Box 99, Broomfield, Colo. 80020. (303)466-3851. (Mountain States Media Brokers, Ltd.) Henry S. Broughall, pres; Elizabeth G. Broughall; Arthur J. Smith.

New York Securities Co. 1290 Ave. of the Americas, New York 10019. (212)977-9500. John E. Palmer.

John A. Park Jr. and Co. Box 17127, Raleigh, N.C. 27609. (919)782-3131. John A. Park Jr., pres.

Donald A. Perry & Associates Inc. Box 1275, Newport News, Va. 23601. (804)877-4367. Donald A. Perry, pres.

Radio's Reliable Resources. Box 413, Philadelphia 19105. (215) TA 8-0502. Franklin O. Pease, gen mgr; Harry I. Greene, ops mgr; A.E. Pease, off mgr; John P. Morgan, vis mgr; David Rosen, asst vis mgr.
London, England. 21 Mountain Court, 648 Green Lanes. OL-889-2704. A.P. Brammer, mgr, European office.

Cecil L. Richards Inc. Box 19306, Washington 20036. 1625 Eye St., N.W., Washington 20006. (202)296-2310. C.L. (Lud) Richards, pres.

CECIL L. RICHARDS, INC.

Media Brokers

1625 Eye St. N.W.
Washington, D.C. 20006
202/296-2310

"Lud" Richards, Pres.

Robert Ellis Rudolph Corp. 1119 S.W. Park Ave., Portland, Ore. 97205. (503)223-7518. Robert Ellis Rudolph, pres; PT. Rudolph, VP.

Richard A. Shaheen Inc. 435 N. Michigan Ave., Suite 2219, Chicago 60611. (312)467-0040. Richard A. Shaheen, pres.

Sovran Associates Inc. 11300 North Central Expressway, No. 217, Dallas 75231. (214)369-9545. Robert O. Magruder, pres.

Howard E. Stark. 50 East 58th St., New York 10019. (212)355-0405. Howard E. Stark, mgr.

John D. Stebbins Co. Box 30, Lake Forest, Ill. 60045. (312)234-4534-5. John D. Stebbins, pres.

Jack L. Stoll & Assoc. 9010 Reseda Blvd., Northridge, Calif. 91324. (213)886-2250. Jack L. Stoll, pres; Bruce A. Stoll, VP.

William T. Stubblefield Co. Inc. Box TV, Casanova, Va. 22017. (703)788-4101. William T. Stubblefield Sr., pres; William T. Stubblefield Jr., VP; John S. Stubblefield, VP; James R. Stubblefield, VP; Thomas L. Stubblefield, VP.

Edwin Tornberg & Co. 5530 Wisconsin Ave., Suite 1150, Washington 20015. (301)652-3766. Edwin Tornberg, pres.

R. C. CRISLER & CO., INC.

Business Brokers Specializing in
Television, Radio & CATV
Licensed Securities Dealers
Underwriting—Financing

CINCINNATI

Richard C. Crisler—Ted Hepburn—Alex Howard

580 Walnut Street 45202

Phone (513) 381-7775

TUCSON

Edwin G. Richter, Jr.—Frank Kalil

P.O. Box 4008. 85717

Phone (602) 795-1050

Brokers, Station Financing

W.R. (Ike) Twining, Box 87, Carmel, Calif. 93921.
(408)624-7710.

TWINING & COMPANY
WESTERN MEDIA INVESTMENTS

P.O. Box 87
CARMEL, CALIFORNIA 93921
(408) 624-7710 (415) 981-5510

John H. Vondell Jr. Box 12186, Charlotte, N.C. 28205. (704)374-1135.

J.N. Wells & Co. Box 2040, Oak Park, Ill. 60301. (312)386-6133. Joe N. Wells, pres; Joe E. Wells, senior VP; Charles C. Wells, exec VP.

Western Business Brokers, 773 Foothill Blvd., San Luis Obispo, Calif. 93401. (805)544-1310. W. John Grandy, pres.

John Grandy
Western Business Brokers
773 Foothill Boulevard
San Luis Obispo, California
805-541-1900

Edward Wetter & Co. Inc. 1000 Chesapeake Dr., Havre de Grace, Md. 21078. (301)939-5555.

Carl M. Williams & Associates Inc. 1660 So. Al-
bion St., Suite 1021, Denver 80222. (303)758-7221.
Carl M. Williams.

ACTION

That's what you want, when you decide to move your broadcast property.

That's what you get, when you list with The Horton Company.

And when you're looking for an acquisition, you want meaningful action — complete information on properties that fulfill your requirements, and no "time-wasters."

Call on us for action . . . every member of our staff will work on your behalf with skill, discretion and dispatch.



Brokers & Consultants
to the
Communications Industry

THE KEITH W. HORTON COMPANY, INC.
1705 Lake Street • Elmira, New York 14902
(P.O. Box 948) • (607) 733-7138
Keith W. Horton
Richard L. Kozacko • Robert D. S. Condit

Associate Robert I. Kimel/Box 270/St. Albans, Vt. 05478 (802) 524-5963
Associate Kenneth R. Chapin/1100 Malden Rd./Syracuse, NY 13211 (315) 454-4144
Associate William S. Cook/Box 425/Newark, Del. 19711 (302) 737-4772

MEDIA BROKERS • APPRAISERS

AT YOUR SERVICE WITH OVER
20 YEARS EXPERIENCE

RICHARD A.

SHAHEEN, INC.

435 NORTH MICHIGAN AVE. • CHICAGO 60611

312/467 • 0040



EDWIN TORNBURG & COMPANY, INC.

Negotiators For The Purchase And Sale Of
Radio And TV Stations • CATV
Appraisers • Financial Advisors

5530 Wisconsin Avenue, Washington, D.C. 20015
301-652-3766

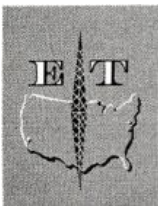

Station Financing

Allied Capital Corp. 1625 Eye St., N.W., Washington 20006. (202)393-4276. Curtis S. Steuart, chmn of bd; George C. Williams, pres.

Becker Communications Associates. 1800 North Meridian St., Suite 410, Indianapolis 46202. (317)923-2353. Jim Ackerman, exec dir.

Chicago: 60603: 2 First National Plaza, 17th fl. (312)630-5035. Harold Ewen, asst. dir.
New York 10041: 55 Water St. (212)747-4440. David O. Wicks.

Los Angeles 90067: 1901 Building, Century City. (213)553-1574. Wm. M. Cockrum, dir.

Cable Funding Corp. 39 Broadway, New York 10006. (212)425-9044. Harold Ewen, pres.

Communications Fund Inc. 960 Time-Life Bldg., New York 10020. (212) 245-2870. Blair Walliser, pres; Samuel Freundel, exec VP; G.B. Martin, gen mgr.

Firstmark Financial Corp. 110 E. Washington St., Indianapolis 46204. (317)638-1331. William K. Van Huss, asst VP.

See adv, next page.

First Midwest Capital Corp. 1636 IDS Center, Minneapolis 55402. (612)339-9391. Alan K. Ruvelson, pres; Andrew J. Greenshields, VP; Lyle T. Walker, treas and asst sec.

First National Bank of Chicago. One First National Bank Plaza, Chicago 60670. (312)732-6248. Benjamin T. Lenhardt Jr., VP.

Norman Fischer & Associates Inc. Box 5308, Austin, Tex. 78763. (512)452-6489. Norman Fischer, pres.

Heiler-Oak Communications Finance Corp. 105 West Adams St., Chicago 60690. (312)346-2300. Samuel L. Eichenfield, VP; Loren N. Young, VP.

R. Miller Hicks & Co. 1011 West 11th St., Austin, Tex. 78703. (512)477-9696. R. Miller Hicks, pres; C. Brunner Smith, controller.

Financing, Consultants

Jeff-Craig Associates Inc. 40 E. 34th St., New York 10016. (212)679-4300. Richard Farkas, pres.
Hollywood 90028: 6725 Sunset Blvd. (213)465-7133. Irving Miller, VP.

Paul Kagan Associates Inc. 100 Merrick Rd., Rockville Centre, N.Y. 11570. (516)764-5516. Paul Kagan, pres.

Lexington International Inc. 445 Park Ave., New York 10022. (212) 752-1818. Herbert L. Golden, pres; David Edell, exec VP.

Radio's Reliable Resources. Box 413, Philadelphia 19105. (215)828-0502. Franklin O. Pease, gen mgr; Harry I. Greene, opns mgr; A.E. Pease, off mgr; John P. Morgan, vis mgr; David Rosen, asst vis mgr.
London: 21 Mountview Court, 648 Green Lanes: (01)889-2704. A.P. Brammer, mgr European opns.

Reynolds & Co. 120 Broadway, New York 10005.

(212)558-6000. Robert E. Palmer.

John D. Stebbins Co. Box 30, Lake Forest, Ill. 60045. (312)234-4534-5. John D. Stebbins, pres.

Thomas Funding Corp. 40 E. 34th St., New York 10016. (212)679-4300. Richard Farkas, pres.
Hollywood 90028: (213)465-6666. Zoltan Farkas.

Edwin Tornberg & Co. 5530 Wisconsin Ave., N.W., Suite 1150, Washington 20015. (301)652-3766. Edwin Tornberg, pres.

Consultants

Adams Broadcast Services Inc. Box 1287, FDR Stn, New York 10022. (212)260-1658. Robert F. Adams, pres.

(Mgt, fin, prog, per, ad, sls and prom planning. Specialists in stn bldg opn, capitalization, eco, feasibility studies.)

Aircasters Inc. Box 182, Scottsdale, Arizona 85252. (602)959-1763. Dick Gilbert, pres; Alma Gilbert, VP. (FCC and FAA app.; AM, FM turnkey facilities; studies, surveys, analysis; planning for sale, acquisition or merger).

American Station Services. 217 W. 13th St., Pueblo, Colo. 81003. (303)544-3056. W.H. Welch, consultant. (Studies on stn progmg ascertainment, pre-application investment, relicensing ascertainment; audience telephone coincidental studies.)

Austin Co. 3650 Mayfield Rd., Cleveland 44121. (216)382-6600. (Design, eng, consulting and construction svcs for bcstg facilities; feasibility and facility studies; cost analysis.) Offices in principal North American cities. London, Paris, Amsterdam, Milan, Madrid, Buenos Aires, Sydney, Melbourne, Brisbane, Dusseldorf, Brussels, Rome, and Tokyo. Charles A. Shirk, pres, chief exec officer; T.J. Judge, VP and gen sls mgr; B.R. Sayer, VP, per mgr; T.B. Sweeney, VP, eng rsch; C.B. Utley, VP, treas, gen aud; A.A. Wilhelm, VP, sec-comp.

Becker Communications Associates, 1800 N. Meridian St. No. 410, Indianapolis 46202. (317)923-2353. Jim Ackerman, exec dir; Harold Ewen, David O. Wicks.

New York 10041: Warburg-Paribas-Becker, 55 Water St. (Financial consultants to CATV industry).

Lambert B. Beeuwkes Organization. 4596 Mountain Creek Dr., Roswell, Ga. 30075. (404)993-8722. Lambert B. Beeuwkes, pres; M.E.B. Beeuwkes, sec-treas. (Consulting for bcst sls dev, progmg format, audience prom.)

Lawrence Behr Assoc. Inc. 1129 S. Evans St., Box 3313, Greenville, N.C. 27834. (919)758-4509. Lawrence Behr, pres; Tom D. Keith, assoc; Malcolm Green, P.E. assoc.

Thousand Oaks, Calif.: 125 W. Avenida de las Flores 91360. (805)492-5055. Paul Lee, P.E., VP.

(Bcst, cable, communications systems, dev, mgt, construction).

BFM Associates. Box 101, Westtown, N.Y. 10998. (914)355-1393, 726-3927. Joseph J. Madden, mngng ptrn.

BGM Associates. Box 85, New Haven, Conn. 06501. (203)248-2198. Fred Walker, pres; Richard L. Geismar, VP; Ralph L. Nelson, VP. (Radio, TV and CATV. Mgt, per, operational, progmg, sls. Bcst financial planning.)

Booz, Allen & Hamilton Inc., 135 South LaSalle St., Chicago 60603. (312)346-1900.

New York: 245 Park Ave. 10017. (212)697-1900.
Washington: 1025 Connecticut Ave., N.W. 20036. (202)293-3600.

Cleveland: 925 Euclid Ave. 44115. (216)696-1900.
Detroit: 1617 Penobscot Bldg. 48226. (313)961-1900.

Dallas: 325 No. St. Paul St. 75201. (214)741-5011.
Los Angeles: 611 W. Sixth St. 90017. (213)620-1900.

San Francisco: 555 California St. 94104. (415)391-1900.

Toronto: Box 127, Dominion Center, 1. (416)363-2112.

Earl J. Bradsher Jr. 670 Virginia Ave., N.E., Atlanta 30306. (404)873-1110. (FM assignments, South-eastern U.S., classical mus progmg).

Robert W. Breckner. 1014 North Bundy Dr., Los Angeles 90049. (213) 472-2132. (TV, radio, cable management.)

Broadcast Advisory. Suite 2102, 2222 Ave. of the Stars, Los Angeles (90067). (213)277-4980. Raymond I. Kandel. (Consultant to radio stn buyers providing projections, financing help, negotiations, staffing and mgt analysis.)

Broadcast Marketing Corp. 17 Drumm St., San Francisco 94111. (415)986-3517. William L. McGee, pres. (Radio/TV local sls training progs/seminars, including customized stn/mkt audio/vis presentations, and co-op adv svc.)

Buckley Radio Sales Inc. 3 E. 54th St., New York 10022. (212)832-0404. Robert V. Coppinger, pres; Robert L. Williams, exec VP; Thomas J. Beauvais, VP, gen sls mgr; Mel Trauner, VP, rsch. (Spot radio natl sls rep.)

Kent Burkhart and Associates Inc. 6500 River Chase Circle E., Atlanta 30328. (404)252-3037. Kent Burkhart, pres; Lee Abrams, dir; Pat Burkhart, sec-treas; Jean B. Hobel, rsch dir. (Progmg and gen radio

DIAL US!

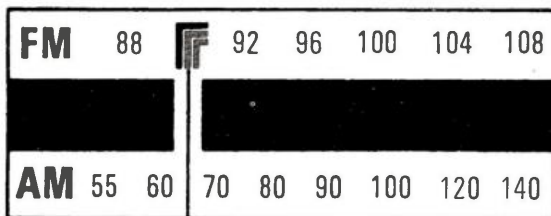

FOR MONEY

(Music to your ears)

Searching for radio facility financing? Stop here. You'll like our format.

It's a pleasant combination of expertise and easy-to-live-with extended payment plans.

We're professionals in broadcast financing. We've been financing broadcasting facilities since 1959. Accordingly, with all due modesty, we're quite good at it. If you need \$100,000 or more to finance a radio or television facility, phone us at (317) 638-1331 and ask Bill Van Huss to explain our individualized flexible financing, competitive rates and confidential analysis of your financing needs.

Firstmark Financial

Firstmark Financial Corporation
Communications Finance Division
110 E. Washington Street
Indianapolis, Indiana 46204
(317) 638-1331

and TV consultation; syndicated "superstars" and "mellow rock" formats.)

Central Broadcast Corp. 1115 1st Natl Bank Bldg., Cincinnati 45202. (513)421-4950. Irv Schwartz, pres. (Mgmt & progm).

Century 21 Productions Inc. 8383 Stemmons, Suite 233, Dallas 75247. (214)638-3222. Dick Starr, VP & gen mgr; Tom McIntyre, VP. (Mkt analysis, progm formats, prom, automated format, mus consultation.)

Bob Cessna's Consultant Services Inc. P.O. Box 5356, Daytona Beach, Fla. 32020. (904)255-1154. Bob Cessna, pres. (Gen evaluation, motivation, format suggestions.)

Clark-Mann & Associates. 203 Columbus Ave., San Francisco 94133. (415)421-0220. William D. Clark, pres; Mal Rivkins, VP. (Full svcc adv agency & PR firm with background in bcst and print.)

Robert L. Coe. 11 E. 78th St., New York 10021. (212)737-4554. Robert L. Coe, owner.

The Comedy Center Inc. 801 Wilmington Trust Bldg., Wilmington, Del. 19801. (302)656-2209. Robert Orben, edit; Lamont Copeland Jr., publisher. (Publishers of Orben's Current Comedy humor services.)

Communications Capital Corp. 960 Time-Life Bldg., New York 10020. (212) 245-2870. Blair Walliser, pres; Samuel Freundel, exec VP; Gloria Martin, gen mgr. (Svcs to owners, buyers and sellers regarding appraisal, financing, opn, progm, expansion and diversification in all branches of communications.)

Concerned Marketing Co. 8350 N. Central Expressway, Suite M-1050, Dallas 75206. (214)691-7898. James B. Luck, exec VP; James C. Gray, sec-treas; Harry S. Hagan Jr., rgnl VP-South. (301)929-1032; Richard C. Ar buckle, rgnl VP-East. (914)381-2744; Ronald F. Johnson, rgnl VP-West. (503)485-1161; Herbert Miller, rgnl VP-Midwest. (913)362-8375. (Broadcast marketing firm, provides revenue billing promotions to TV and radio.)

Bud Connell Associates, Broadcast Consultants. 4600 Via Marina, Suite 209, Marina del Rey (Los Angeles), Calif. 90291. (213)823-0363. Bud Connell, pres; Ann Pursell Mare, market rsch dir. (Consultants to mgt, on progm, sls, stn opns, prom planning, mus, pub affrs, demographics, automation, syndication, jingles, appraisals, corporate planning, acquisition, facility design, feasibility studies, market & audience rsch.)

Roger N. Cooper & Associates. 5885 Sycamore Hill Rd., Newcastle, Calif. 95658. (916)663-2828. Roger N. Cooper, pres. (dev mktg and med-rsch oriented sls aids for budget dev and adv sls. Economic studies.)

Sol Cornberg. Ballymacahara, Wicklow, County Wicklow, Ireland. Wicklow 4119. Also Box 487, Holmes, N.Y. 12531. (914)878-9933. Sol Cornberg. (Communication system and facilities design and consultation.)

Corron & Black, Russell Inc. 5225 Wisconsin Ave., N.W., Washington 20015. (202) 244-7600. William G. Russell, pres. (Radio-TV insurance; consultation & broker.)

William Kenneth Cumming & Assocs. 707 N. Carolina Ave., Cocoa, Fla. 32922. (305)632-2769. (CATV pgmg, public TV stns, closed circuits; learning ctrs, audio-visual; communications media, curricula). Dr. Cumming, pres.

Ron Curtis & Co. O'Hare Plaza, 5725 E. River Rd., Chicago 60631. (312)693-6171. Carl Youngs, pres; Mike Walker, VP; Fred Harms, senior consultant; Rick Davenport, consultant; Jim Mishler, consultant; Dave Boylan, consultant. (Exec and air talent recruitment.)

The Dalton Group Assn., Consultants. 917 15th St., N.W., Washington 20005. (202)347-7773. William Dalton, chmn. (Consultation and assistance svcs for voluntary nonprofit trade and professional organizations.)

Daniels & Assoc. Inc. 2930 E. Third Ave., Denver 80206. (303)321-7550. Bill Daniels, chmn; John Saeman, pres; Jerry Buford, exec VP; Tom Johnson, Keith Burcham, Dick Zell, Hugh McCulloh, Vern Milligan, Frank Griggs, Bob Holman.

Dirgo Media. 638 Congress St., Portland, Me. 04101. (207)773-9022. Fred Miller, gen mgr; Melvin Stone, dir

stn affils; Cynthia Pierce, admin asst.

Richard P. Doherty Television-Radio Management Corp. 10 Ezra Lane, Dennis, Mass. 02638. (617)385-3946. Richard P. Doherty, pres; Judith D. Eyanson, sec-treas. (Confidential stn appraisals for buyers, sellers, lending institutions; asset appraisals for new buyers; economic feasibility studies; internal mgt efficiency.)

Warren Earl Associates Inc. P.O. Box 2248, Toluca Lake Station, N. Hollywood, Calif. 91602. (213)763-4353. Warren Earl, pres.

Electro and Optical Systems Ltd. 3015 Kennedy Rd., Scarborough, Ont. M1V 1E7. (416)293-9404. Michael L. Paull, pres; A. Maurice Evans, VP.

Employers Reinsurance Corp. Insurance Exchange Bldg., Kansas City, Mo. 64105. (816) Victor 2-9160. James R. Mather Jr. (Insurance: libel, slander, plagiarism, piracy, violation of copyright, invasion of privacy.)

William A. Exline Inc. 31 Carroll Ct., San Rafael, Calif. 94903. (415)479-0717. William A. Exline, pres. (Gen mgt, finances, per search, appraisals. Receiverships and bankruptcies.)

Imero Fiorentino Associates Inc. 10 W. 66th St., New York 10023. (212)787-3050. Imero Fiorentino, pres; Bill Klages, PE, VP; Pete Howard, chief consultant & VP; Kenneth Palius, VP & dir of tech opns, West Coast; Jim Washburn, dir admin opns, West Coast; Linda Spreen, dir opns, East Coast; George Honchar, dir of spec projects.

Hollywood, Calif.: 7250 Franklin Ave. 90046. (213)876-6661.

Las Vegas: 2781 S. Bronco 89102. (702)876-6661. (Lighting designers & consultants for TV, theatre, & industry; TV studio/prod systems design; TV lighting & staging seminars.)

Norman Fischer & Associates Inc. Box 5308, Austin, Tex. 78763. (512)478-1703. Norman Fischer, pres. (Mgt consulting, appraisals, sls proms, mkt rsch, expert testimony, FCC applications, brokerage.)

FM. International. 3601 Park Center Blvd., Minneapolis. (612)920-6677. Jim Coursolle, Gene Loffer, sls mgt consultants. (Establish turnkey FM stations, aids management in selling out station for one year.)

Robert H. Forward & Assoc. 550 S. Barrington Ave., Los Angeles 90049. (213)476-3605. Robert H. Forward, pres. (Stn sls, prod & gen mgt consultants.)

Frazier, Gross & Clay Inc., 5028 Wisconsin Ave., N.W., Suite 333, Washington 20016. (202)966-2280. Horace W. Gross, pres; Howard S. Frazier, VP; E.H. Clay, VP. (Mgt consultants, economic studies, audience analysis, appraisals, financing, media brokers.)

Martin J. Friedman. 1710 Daytonia Rd., Miami Beach 33141. (305)861-8342. Martin J. Friedman, pres.

Billy Glason (Fun-Master Comedy Service). 200 W. 54th St., New York 10019. (212)265-1316. Billy Glason, own. (Professional comedy material. Professional training in art of stand-up comedy.)

Jerry Graham, Stockbridge, Mass. 01262. (413)499-1531. Jerry Graham, exec officer.

Greenebaum & Assoc. 135 S. LaSalle St., Chicago 60603. (312) Financial 6-2137. Edgar N. Greenebaum Jr., sr plnr; W.L. Manson, William H. Schield Jr. (Financial & mgt.)

Robert F. Grubb. 5 Regent Court, Champaign, Ill. 61820. (217)359-7527. (Negotiations of sale and purchase of communication companies. Mktg consultant and broker.)

Wilt Gunzendorfer & Assoc. 1421 S. Reeves St., Los Angeles 90035. (213)878-5678 or CR5-5678. Wilt Gunzendorfer, owner-mgr; Natalie Gunzendorfer, asst mgr. (Fin mgt, media broker, appraisals, mkt surveys, sls consulting, expert court witness, applications, all phases radio-TV and CATV opns.)

R. Miller Hicks & Co. 1011 West 11th St., Austin, Tex. 78703. (512)477-9696. R. Miller Hicks pres; C. Brunner Smith, controller. (Management consulting, appraisals, sales promotions, market research, FCC applications and brokerage.)

James C. Hirsch Communications Services. 447 Westover Road, Stamford, Conn. 06902. (203)324-4747. (Bcstg/communications consulting svcs for adv & mktg progs, pub affrs, surveys & special projects, planning-dev-implementation.) New York 10022: 685 5th Ave. (212)421-2266.

Consultants

The Holt Corp. 428 Brodhead, Box 111, Bethlehem, Pa. 18016. (215)865-3775. Arthur Holt, pres; Art White, tech dir; Bob Wolken, opns dir; Harrison Kner, rsch dir. (Feasibility studies, capitalization planning, prog consulting and planning, tech facility sls and planning, opns studies, mus formats, rsch projects.)

David Honig. 1816 T St. N.W., Washington 20009. (202)667-0585. (Consultant in communications and systems analysis.)

The Keith W. Horton Co. Inc. 200 William St., Elmira, New York 14902. (607)733-7138. Keith W. Horton, pres; Richard L. Kozaco, VP; Robert I. Kimmel, assoc.

Humor Societies of America. 74 Pullman Ave., Elberon, N.J. 07740. (201)229-9472. George G. Lewis, exec dir. (Comedy & humor material, laughmaking proms, happy publ prom, special events, jokes, gags.)

Intermedia Analyses Inc. P.O. Box 294, Harrington Park, N.J. 07640. (201)767-3621. Carol G. Mayberry, pres.

Paul Kagan Associates Inc. 100 Merrick Rd., Rockville Centre, N.Y. 11570. (516)764-5516. Paul Kagan, pres. (Station appraisals & Financial analysis.)

Jonathan Karas & Assoc. Science House, Manchester, Mass. 01944. (617)526-1120. Dr. Jonathan Karas, pres. (Science & engrg consultants for mktg, mass communications.)

Kearney, Donald L. c/o The Commsuit Group, 17 E. 96th St., New York 10028. (212)369-0328. (Mgt, prog, sls, news, personnel & prom for radio & TV bcstrs. Media evaluations for advertisers/agencies.)

K-H Associates. Suite 315, 2121 P St. N.W., Washington 20037. (202)833-8433. Theodore F. Koop, John V. Horner, co-owners. (Consultants on pub affrs problems with govt or med.)

A. Lewis King. Shorefront Park, South Norwalk, Conn. 06854. (203)853-0585. (Radio stn & TV opns analysis, prog analysis, sls analysis.)

Kubicki, Iams & Partners Inc. Box 135, Rosele, Ill. 60172. (312)529-1001. Alan S. Kubicki, pres; Paul F. Iams Jr., VP & dir of creative svcs; Jerry Atchley, VP & sls mgr; Edward J. Giab, eng & design consultant.

R. H. Lee Associates Inc. Box 1575, Thousand Oaks, Calif. 91360. (805)492-5055. (213)889-7769. Paul H. Lee, pres; John H. Poole, VP. (Propagation studies, antenna systems design, planning, installation supervision, for AM, FM, TV bcst, commercial and military communication systems.)

Joe M. Leonard Jr. 4255 LBJ Freeway, Suite 282, Dallas 75234. (214)661-5748.

The Mike Lundy Co. 1606 N. Argyle, Hollywood, Calif. 90028. (213)464-8268. Mike Lundy, pres; D.L. Carpenter, gen mgr.

Frank N. Magid Associates Inc. 1 Research Center, Marion, Iowa 52302. (319)377-7345. Frank N. Magid, pres; Dallas Murphy Miller, exec VP-rsch division. (Bcst journalism, banks, other commercial concerns.)

Malarkey, Taylor & Associates Inc. 1225 Conn. Ave., N.W., Suite 700, Washington 20036. (202)223-2345. Martin F. Malarkey, pres; Archer S. Taylor, VP. (Offers total capability in all aspects of CATV including engineering, financial, and mgt disciplines.)

Management/Programming Consultants. Box 24, Traverse City, Mich. 49684. (616)947-1538. David H. Forster, VP-opns; John A. Weiszer, VP-sls & rsch. (Management and programming consultants.)

Marketing Survey & Research Corp. Research Park, Box 2030, Princeton, N.J. 08540. (609)924-3800. Dr. Herbert Greenberg, pres; Jeanne Greenberg, exec VP; David A. Moss, VP dir communications industries. (Personnel testing-primarily sls & mgt; consulting for special research projects.)

McHugh & Hoffman Inc. 7900 Westpark Dr., Suite 805, McLean, Va. 22101. (703)790-5050. Philip L. McHugh, pres; Peter S. Hoffman, VP; Dorris H. Reed, sec & treas. (Consultants to networks, major stn groups and independent TV and radio stns, particularly in areas of news and specialized progm.)

Thomas McMurray Ideas. 610 Shelton St., Charlotte, N.C. (704)364-4798. Thomas H. McMurray,

Consultants, Law Firms

pres; David Hedrick, exec VP (Consultants in progmg, mgt, financial, sls, research, per recruitment, pension fund, graphics, custom jingles.)

Kenneth R. Meades. Box 71403, Los Angeles 90071. (213)666-9056. Kenneth R. Meades, own & mgr. (Financial, progmg, tech.)

Media Development Corporation. 19525 Ventura Blvd., Tarzana, Calif. 91356. (213)881-7017. Kevin B. Sweeney, pres. (Dev of retail/natl sls for major-mkt bcstres via in-mkt svcs.)

Hudson Miller & Assoc. Box 3032, Ft. Pierce, Fla. 33450. (305)464-1400. Hudson Miller Jr., pres; Jerdan Ballard, VP (Mgt systems, profit & loss control, sls plans & salesman orientation, FCC compliance, copy & traffic procedures, cost controls.)

Moss Assoc. Inc. 415 Lexington Ave., New York 10017. (212) 687-7377. Joseph H. Moss, pres; Murray Brauman, exec VP (Consultant to ind TV producers, packagers & synd.)

Motherwell Bcstg Systems Corp. 777 3rd Ave., New York 10022. (212) PLaza 5-1621. Roger Coleman, pres; Lee Coleman & John Keljikan, VP's. (Progmg, engrg, mgt.)

Paul B. Mowrey. 7½ E. 81st St., New York 10028. (212) Yukon 8-7171. (TV mgt consultant.)

Natl Laugh Enterprises. Box 835, Grand Central Station, N.Y. 10017. (201)229-9472. George Q. Lewis, exec dir. (Prog dev, gagwriting svcs, humor svcs, sp events, humor proms.)

Jack Neff Associates. 4234 Howard Ave., PO. Box 46, Kensington, Md. 20795. (301)942-4434. John L. Neff, pres. (Consultant on broadcast equip, prod marketing and sls mgt.)

New York Film & Videotape Comm. Inc. 450 N. Narberth Ave., Narberth, Pa. 19072. Michael Davis, pres.

George Norman Broadcasting. 2501 Olympus Dr, Salt Lake City 84117. (801)277-3905. George I. Norman Jr., pres; (Business, sls, prog, engrg.)

Salt Lake City: 53 E. 4th St., Suite 201. (801)322-1074.

M.S. Novik. 300 W. 23d St., New York 10011. (212) ALgonquin 5-4385. M.S. Novik, own. (Pub svc bcst consultant.)

Donald A. Perry & Associates Inc. PO. Box 1275, Newport News, Va. 23601. (804)877-4367. Donald A. Perry, pres. (Appraisal/financial and brokerage.)

The Personnel Laboratory Inc. 733 Summer St, Stamford, Conn. 06901. (203)325-4348. King Whitney Jr., pres; Irene Salese, VP; Joanna Steinberg, VP; Bruce Muller, Ph.D.-Psychologist. (Personnel.)

Professional Programing Inc. 7011 N. Jan Mar Dr, Dallas 75230. (214)691-8846. Dick Starr, pres; Carole Starr, VP. (Progmg and opns mgt rsch & consultation. Formats, sound hours, contests, prom & mus.)

Provandie Eastwood & Lombardi Inc. The Pilot House, Lewis Wharf, Boston 02110. (617)523-2200. Thomas A. Ferraro, bcst dir; Thomas G. Matzell, bcst prod. (Full prod capabilities including writing and creation of TV and radio adv and progmg.)

Radio Programming & Management (RPM). 15552 Arbor Place, Southfield, Mich. 48075. (313)557-3246. Tom Krikorian, pres; Mark Masters, mus dir. (Complete mgt and progmg consultation svcs prog; specializes in converting a live operation to automation.)

Radio's Reliable Resources. Box 413, Philadelphia 19105. (215)828-0502. Franklin O. Pease, gen mgr; Harry I. Greene, opns mgr; A.E. Pease, off mgr; John P. Morgan, vis mgr; David Rosen, asst vis mgr. London: 21 Mountview Ct., 648 Green Lane (01) 889-2704. A.P. Brammer, mgr European office.

Raymar Associates Inc. 203 Columbus Ave., San Francisco 94133. (415)397-7491. Frank Raymond, pres; F. Paul Schwab, VP.

Reymer & Co. 29551 Greenfield Rd., Suite 119, Southfield, Mich. 48076. (313)557-3663. Arnold S. Reymer, pres. (TV news consultant and in-depth attitudinal aud rsch.)

Eric Riback. 1700 Albemarle Rd., Brooklyn, N.Y. 11226. (212)287-0436. (Progmg, PR, and mgt consultant to noncommercial radio stns.)

Rierson Broadcast Consultants. 156 E. 52d St., New York 10022. (212)688-7275. Robert L. Rierson, pres; Barbara B. Reisenbach, VP.

Wm. A. Roberts, Broadcast Consultant. 1110 No. Oak Cliff Blvd., Dallas 75208. (214)948-6760.

John Rook & Associates Inc. 19031 Marilla St., Northridge, Calif. 91324. (213)885-7404. John H. Rook, pres; Paul Kirby, VP.

(Total radio progmg consultation in top 40, news conversation, country & MOR. Personnel placement for clients only, engrg consultation.)

RTV International Inc. 405 Park Ave., New York 10022. (212)421-0680. William Minette, pres; Scott Charles, treas; John L. Thayer, dir coml svcs; William S. Halstead, VP engrg.

Robert Ellis Rudolph Corp., 1119 S.W. Park Ave., Portland, Ore. 97205. (503)223-7518. Robert Ellis Rudolph, pres. (Consultants in acquisitions, divestitures, mergers.)

Science House. Box 1469, Manchester, Mass. 01944. (617)526-1120. Dr. Jonathon Karas, dir. (Creative svcs in dev demonstrations for TV comls, films exhibits.)

Sound Advice. 422 S. Western Ave., Los Angeles 90020. (213)388-2586. Eamon O'Duibhir, gen mgr; Philip Rothman, natl mktg dir; Richard Maulhardt, computer opns dir; Sean O'Duibhir, prom dir; Rachelle Guzman, exec sec; Bob Phoono, record svcs dir. (Prog & mktg services.)

Soundplan Broadcasting Services Limited, World Trade Centre, 52 St. Katherine's Way, London E1 9LB. Peter Petts, M.J. Curnow.

Jack Steck Assoc. 1527 Dorchester Road, Havertown, Pa. 19083. (215)789-0966. Jack Steck, pres. (Broadcast program consultants, stage production, public relations.)

Stone Enterprises Inc. 638 Congress St., Portland, Me. 04101. (207)774-6561. Melvin L. Stone, pres; Robert P. Mooney, exec VP. (Financial mgt svcs, acquisitions, progmg, religious progmg placement.)

Stoneland Research. P.O. Drawer D, Chesapeake, Va. 23320. (804)421-2126. Paul F. Rule, pres & dir, rsch svcs. (Progmg and sls dev, ici, rgnl and natl audience and mktg rsch.)

Jack Strang. 35 Sutton Pl., New York 10022. (212) PLaza 9-6222. Jack Strang, pres & own. (Consultation on and supervision of all phases of film and TV prod.)

S.S. Street & Associates Inc. 1830 Cassamia Pl., Charlotte, N.C. 28211. (704)364-1687. S.S. Street, pres-treas; N. Street, VP-sec. (CATV mgt, brokerage and prom.)

Tape Networks Inc. dba AIR Network, 819 Eleventh Ave., Box 489, Delano, Calif. 93215. (805)725-2599. R.H. Palmquist, pres. (Sacred mus automation with bus guidance.)

TelCom Associates. 215 East 51 St., New York 10022. (212)751-0123. Herb Jacobs, pres.

Telecommunications Consultants Inc. 212 Fair St., UPO Box 858, Kingston, N.Y. 12401 (914)339-5505. Edwin A. Bernstein, pres; Robin B Martin, VP.

New York 10022: 880 Third Ave. (212)421-8575. Albany 12211: Box 11-098. (518)783-7383. (Mgt, prmg, sls, fin, consultants to bcstns.)

Tele-Measurements Inc. 145 Main Ave., Clifton.

N.J. 07014. (201)473-8822. New York: (212)581-9020. J.R. Poppele, pres; W.E. Endres, VP; Jude Poppele, sec-treas. (Tele-Pat light boxes and slides, color coded labels for audio cartridge identification, design rsch installation for color TV studios.)

John Thorwald. 1026 N. Winnetka Ave., Dallas 75208. (214)943-1625. (Mgt, per, opns, prod, sls & financial consultant.)

TM Broadcasting Marketing Corp. 17 Drumm St., San Francisco 94111. (415)986-3517. William L. McGee, pres; Jerry Atchley, VP sls; Jim Long, chmn. (Sales training and marketing research.)

Edwin Tornberg & Co. 5530 Wisconsin Ave., Washington 20015. (301)652-3766. Edwin Tornberg, pres.

TR Enterprises. 1606 N. Argyle, Hollywood, Calif. 90028. (213)464-8268. Mike Lundy, pres.

Hubert E. Ulmer. 2854 N. Thompson Rd., N.E., Atlanta 30319. (404)458-0411. (Radio-TV fin & accounting, mgt consultants.)

John R. Ulmer, CPA. Box 10347, Atlanta 30319. (404)993-2138. (Accounting, auditing & tax return preparation & other financial services in connection with FCC filings.)

Harry R. Wagner. 404 Sunset Dr., S., St. Petersburg, Fla. 33707. (813)345-3182. (TV mgt, FCC applications, license renewals, mkt surveys, stn opns, pgm prod, hearing exhibit preparation, stn mgmt.)

Norman Wain. 55 Erieview Plaza, Cleveland 44114. (216)781-3600. (Business, administrative and sales consulting for radio.)

William L. Walker (Larson, Walker & Co.). Suite 508, 1725 DeSales St., N.W., Washington 20036. (202)223-1553. (Mgt consulting, trouble shooting, per selection and utilization, labor relations, stn planning and opns, mkt surveys, asset evaluations, appraisals.)

Robert Ward Associates Ltd. 110 Vincennes Rd., Charlottesville, Va. 22901. (804)296-2476. Robert Ward, pres. (Farm and state net organization and mgt; sls consultant; agricultural, natl, rgnl, loc special proms.)

The Webster Group. 35 Sutton Pl., New York 10022. (212)371-4828. Maurice Webster, pres. (Radio mgt consulting-marketing, sls, strategy, performance analysis, prom, presentations, genl mgt.)

The Welsh Co. Box 51066, Tulsa, Okla. 74151. (918)836-3908. James R. Williams, own. (Consultant svcs in radio sls, sls mgt mgt including group and private study progs using rsch and training systems.)

Edward Wetter & Company Inc. 1000 Chesapeake Dr, Havre de Grace, Md. 21078. (301)939-5555. Edward Wetter, pres. (Appraisals.)

Charles Woodward Associates Inc. 60 Edgars Lane, Hastings-on-Hudson, N.Y. 10706. (914)478-2029. Charles C. Woodward, pres. (Mgt consultants, all aspects of acquisition and opn of CATV systems, appraisals.)

Lowell R. Wright. Box 1706, Winter Park, Fla. 32789. (305)678-6060. Lowell R. Wright, aeronautical consultant. (Aeronautical studies, tall structures, [radio & TV towers], airspace utilization, accident investigation & litigation assistance.)

Young Adult Marketing Inc. 19525 Ventura Blvd., Tarzana, Calif. 91356. (213)881-7017. Kevin B. Sweeney, pres. (Sls and prom strategies and svcs for young-adult media.)

Law Firms Active in Communications Law

The following law firms are involved in practice before the FCC. Individual attorneys are listed in the directory immediately following.

A

Alk & Lubic: 4710 41st St., N.W., Washington 20016. (202) 362-6311.

Amram, Hahn & Sandground: Colorado Bldg., Washington 20005. (202) 783-3344.

Anderson & Goldman: 295 Madison Ave., New York 10017. (212) 679-2400.

Arent, Fox, Kintner, Plotkin & Kahn: Federal Bar Bldg., Washington 20006. (202) 347-8500.

Arnold & Porter: 1229 19th St., N.W., Washington 20036. (202) 872-6700.

B

Barnes & Neilson: 434 Munsey Bldg., 1329 E St., N.W., Washington 20004. (202) 783-7670.

Barrick, Jackson & Switzer: 228 S. Main St., Rockford, Ill. 61101. (815) 962-6611.

Becker & London: 15 Columbus Circle, New York 10023. (212) 541-7070.

Becker & Silberberg: Pennsylvania Bldg., Washington 20004. (202) 393-3003.

Bergson, Barkland, Margolis & Adler: 11 Dupont Circle, N.W., Washington 20036. (202) 462-5930.

Bilger & Blair: 1730 M St., N.W., Washington 20036. (202) 659-4230.

Black, Kendall, Tremaine, Boothe & Higgins:

3100 First National Bank Tower, Portland, Ore. 97201. (503) 221-0550.

Booth & Freret: 1302 18th St., N.W. Washington 20036. (202) 296-9100.

Brice & Barron: 2001 Bryan Tower, Suite 3858, Dallas 75201. (214) 748-6412.

Brown & Effros: 1523 O St. N.W., Washington 20005. (202) 387-3100.

Brown, Herman, Scott, Dean & Miles: Suite 203, Fort Worth Club Bldg., Fort Worth 76102. (817) 332-1391.

Burns, Van Kirk, Greene & Kafer: 521 Fifth Ave., New York 10017. (212) 972-0500.

C

Cahill, Gordon & Reindel: 80 Pine St., New York 10005. (212) 944-7400.

Cahill & Kaswell: 2030 M St. N.W., Washington 20036. (202) 833-8161.

Carr, Bonnor, O'Connell, Kaplan & Thompson: 900 17th St., N.W. Washington. (202) 659-4660.

Chadbourne, Parke, Whiteside & Wolff: 1150 17th St., N.W., Washington. (202) 872-8050.

Christensen & Shelesky: 4084 University Dr., Suite 102, Fairfax, Va. 22030. (703) 273-4573.

Cohen & Berfield: 1129 20th St., N.W., Washington 20036. (202) 466-8565.

Cohn & Marks: 1920 L St., N.W., Washington 20036. (202) 293-3860.

Cole, Zylstra & Raywid: 2011 I St., N.W., Washington 20006. (202) 785-1777.

Cordon & Jacob: 2000 L St., N.W., Suite 616, Washington 20036. (202) 293-2300.

Covington & Burling: 888 16th St., N.W., Washington 20006. (202) 293-3300.

D

Daly, Joyce, Borsari & George: 1830 Jefferson Place, N.W., Washington 20036. (202) 296-8900.

Dempsey & Koplovitz: 821 15th St., N.W., Washington 20005. (202) 737-6363.

Denechaud & Denechaud: 1412 Pere Marquette Bldg., New Orleans 70112. (504) 525-1334.

Dow, Lohnes & Albertson: 1225 Connecticut Ave., N.W., Washington 20036. (202) 659-8200.

E

English, Bowler & Jenks: 162 W 6th St., Erie, Pa. 16501. (814) 454-4533.

F

Farrand, Malti, Spillane & Cooper: Suite 2985, Bank of America Ctr., 555 California St., San Francisco 94104. (415) 989-0680.

Farrow, Schildhouse & Dent: 1120 Connecticut Ave., N.W., Washington 20036. (202) 659-8746.

Fisher, Wayland, Southmayd & Cooper: 1100 Connecticut Ave., N.W., Washington 20036. (202) 659-3494.

Fletcher, Heald, Rowell, Kenehan & Hildreth: 1225 Connecticut Ave., N.W., Washington 20036. (202) 659-9100.

Fly, Shuebruk, Blume & Gaguine: 1211 Connecticut Ave., N.W., Washington 20036. (202) 293-1282.

G

Gammon & Tierney: 1925 K St. N.W., Washington 20006. (202) 293-7979.

Glaser & Fletcher: 1150 17th St., N.W., Washington 20036. (202) 872-0200.

Greeley, Bernard & Tierney: 1990 M St., Suite 660, Washington 20036. (202) 785-2690.

H

Haley, Bader & Potts: 1730 M St., N.W., Washington 20036. (202) 659-7676.

Hamel, Park, McCabe & Saunders: 1776 F St., N.W., Washington 20006. (202) 785-1234.

Harrison, Greene, Mann, Davenport, Rowe & Stanton: The Tenth Floor, First Federal Bldg., St. Petersburg, Fla. 33701. (813) 896-7171.

Hedrick & Lane: 1211 Connecticut Ave., N.W., Washington 20036. (202) 628-5923.

Hogan & Hartson: 815 Connecticut Ave., N.W., Washington 20006. (202) 331-4500.

J

Jackson, Parkinson & Jackson: 1828 L St., N.W., Suite 1111, Washington 20036. (202) 466-8850.

Janklow & Traum: 375 Park Ave., New York 10022. (212) 421-1700.

Jones, Day, Reavis & Pogue: 1100 Connecticut Ave., N.W., Washington 20015. (202) 452-5800.

K

Kaler, Worsley, Daniel & Hollman: 710 Ring Bldg., Washington 20036. (202) 331-9100.

Keller & Heckman: 1150 17th St., N.W., Suite 1000, Washington 20036. (202) 296-2700.

Kirkland, Ellis & Rowe: 1776 K St., N.W., Suite 1100, Washington 20006. (202) 833-8400.

Kohn, Harold E.: 1776 K St., N.W., Washington 20006. (202) 293-7110.

Koteen & Burt: 1000 Vermont Ave., N.W., Washington 20005. (202) 737-5566.

L

Layton & Perry: 140 East Division Road, Box 461, Oak Ridge, Tenn. 615. (615) 483-8474.

Lyon & Nellis: 640 Federal Bar Bldg., 1819 H St., N.W., Washington 20006. (202) 223-6300.

M

Mallyck & Bernton: 1900 L St., N.W., Washington 20036. (202) 466-2350.

Marmet Professional Corp.: 1822 Jefferson Pl., N.W., Washington 20036. (202) 331-7300.

McClendon & McClendon: 903 Deposit Guaranty Bank Bldg., Jackson, Miss. 39201. (601) 948-5656.

McKenna, Wilkinson & Kittner: 1150 17th St., N.W., Washington 20036. (202) 296-1600.

Midlen & Reddy: 1990 M St., N.W., Washington 20036. (202) 659-5700.

Miller, Cassidy, Larroca & Lewin: Suite 500, 1320 19th St., N.W., Washington 20036. (202) 293-6400.

Miller & Schroeder: 1225 Connecticut Ave., N.W., Suite 514, Washington 20036. (202) 659-4400.

Misegades, Douglas & Levy: Suite 304, 1126 16th St., N.W., Washington 20036. (202) 638-3833.

Mitchell, Silberberg & Knupp: 1800 Century Park East, Los Angeles 90067. (213) 553-5000.

Moore, Berson & Lifflander: 555 Madison Ave., New York 10022. (212) 838-0600.

Morgan, Lewis & Bockius: 1140 Connecticut Ave., N.W., Washington 20036. (202) 872-5000.

Moses & Singer: 51 W. 51st St., New York 10019. (212) 581-9000.

Mulcahy & Gefke, S.C.: 811 E. Wisconsin Ave., Milwaukee, Wis. 53202. (414) 278-7110.

Mullin, Connor & Rhyne: 1000 Connecticut Ave., N.W., Washington 20036. (202) 659-4700.

Munter, Adams & Thomson: National Press Bldg., Washington 20004. (202) 628-0055.

Myse, Daryal A.: 1737 H St., N.W., Washington 20006. (202) 298-6010.

O

O'Connor & Hannan: 1747 Pennsylvania Ave., N.W., Suite 600, Washington 20006. (202) 785-8700.

Ogden, Ogden & Murphy: 1411 Fourth Ave. Bldg., Seattle 98101. (206) 622-2991.

Law Firms, Attorneys

P

Patton, Boggs, Blow: 1200 17th St., N.W., Washington 20036. (202) 223-4040.

Peabody, Rivlin, Lambert & Meyers: 1150 Connecticut Ave., N.W., Washington 20036. (202) 457-1000.

Pierson, Ball & Dowd: 1000 Ring Bldg., Washington 20036. (202) 331-8566.

Pittman, Lovett, Ford & Hennessy: 1819 H St., N.W., Washington 20006. (202) 293-7400.

Powell & Becker: 1156 15th St., N.W., Washington 20005. (202) 872-0190.

Prather, Levenberg, Seeger, Doolittle, Farmer & Ewing: 1101 16th St., N.W., Washington 20036. (202) 296-0500.

Prince & Paul: 815 Bowen Bldg., Washington 20005. (202) 737-8154.

R

Reavis, Pogue, Neal & Rose: 1100 Connecticut Ave., N.W., Washington 20036. (202) 293-2030.

Renouf, McKenna & Polivy: 1532 16th St., N.W., Washington 20036. (202) 265-1807.

Rhyne & Rhyne: 839 17th St., N.W., Washington 20006. (202) 347-1380.

S

Schwartz & Woods: 1325 18th St., N.W., No. 206, Washington 20036. (202) 833-2350.

Sells & Gregory: 2000 L St., N.W., Washington 20036. (202) 659-3840.

Shack & Mendenhall: Suite 413, 1730 Rhode Island Ave., N.W., Washington 20036. (202) 293-5900.

Shipley, Ackerman, Stein & Kaps: 1108 National Press Bldg., 529 14th St., N.W., Washington 20004. (202) 783-1647.

Sidley & Austin: 1730 Pennsylvania Ave., N.W., Suite 1100, Washington 20006. (202) 872-1730.

Smith & Pepper: 1776 K St., N.W., Washington 20006. (202) 296-0600.

Smithwick & Bond: 1036 National Press Bldg., Washington 20045. (202) 737-0300.

Sollinger & Gordon: 250 Park Ave., New York 10017. (212) 687-1140.

Stambler & Shinsky: 1737 DeSales St., N.W., Washington 20036. (202) 347-0883.

Surrey, Karasik & Morse: 1156 15th St., N.W., Washington 20005. (202) 331-4000.

V

Verner, Lipfert, Bernhard & McPherson: 1660 L St., N.W., Washington 20006. (202) 296-6515.

Voelker & Jeffers: 620 First Nat'l Bank of Commerce Bldg., New Orleans 70112. (504) 581-7471.

W

Wald, Harkrader & Ross: 1320 19th St., N.W., Washington 20036. (202) 296-2121.

Weich, Morgan & Kleindienst: 900 17th St., N.W., Washington 20006. (202) 296-5151.

Wheeler & Wheeler: 704 Southern Bldg., Washington 20005. (202) 347-7117.

Wilkinson, Cragun & Barker: 1735 New York Ave., N.W., Washington 20006. (202) 833-9800.

Wilmer, Cutler & Pickering: 1666 K St., N.W., Washington 20006. (202) 872-6000.

Wilner & Scheiner: 2021 L St., N.W., Washington 20036. (202) 293-7800.

Attorneys Active in Communications Law

A

Abrahams, Howard: Meredith Corp., 747 Third Ave., New York 10017. (212) 688-7300.

Abrams, Floyd: Cahill, Gordon & Reindel, 80 Pine St., New York 10005. (212) 944-7400.

Adams, Efa: 4201 Cathedral Ave., N.W., Washington 20016. (202) 964-2133.

Affleck, Gordon B.: 50 East North Temple, Salt Lake City 84150. (801) 363-8022.

Agress, Ellen Shaw: 555 Madison Ave., New York

Attorneys

10022. (212) 838-0600.

Albert, Felix: GTE Service Corp., 730 Third Ave., New York 10007. (212) 551-8663.

Albertson, Fred W.: 310 Harbor Dr., Key Biscayne, Fla. 33149.

Aldrich, C. Duane: American Telephone & Telegraph, 195 Broadway, New York 10007. (212) 393-4811.

Aleinikoff, Eugene N.: Corp. for Public Broadcasting, 1345 Ave. of the Americas, New York 10019. (212) 582-2020.

Alk, Isadore G.: Alk & Lubic, 4710 41st St., N.W. Washington 20016. (202) 362-6311.

Anderson, Arthur A.: Anderson & Goldman, 295 Madison Ave., New York 10017. (212) 679-2400.

Anderson, David R.: Wilmer, Cutler & Pickering, 1666 K St., N.W., Washington 20006. (202) 872-6156.

Anderson, Howard C.: 1710 H St., N.W., Washington 20006. (202) 392-5111.

Arak, Sidney F.: Finklestein & Firestone, 1725 K St., N.W., Washington 20006. (202) 223-2445.

Archerd, William F.: Oppenheimer, Brown, Wolff, Leach & Foster, First National Bldg., St. Paul, Minn. 55101. (612) 227-7271.

Archilla-Roig, Efrain: Box C, Humacao, PR. 00661.

Arlow, Alan J.: Cohn & Marks, 1920 L St., N.W., Washington 20036. (202) 293-3860.

Arnovich, Sylvia: Rosenman Colin Kay Petschek, Freund & Emil, 575 Madison Ave., New York 10022. (212) 644-7000.

Asher, Thomas R.: Media Access Project, 1910 N St., N.W., Washington 20036. (202) 785-2613.

Ashley, George E.: New York Telephone Co., 1095 Ave. of the Americas, New York 10036. (212) 395-2311.

B

Babler, Wayne E.: 101 Pine St., St. Louis 63101. (314) 247-4492.

Bader, Michael H.: Haley, Bader & Potts, 1730 M St., N.W., Suite 700, Washington 20036. (202) 659-7676.

Baisely, James M.: GTE Automatic Electric Inc., 400 North Wolf Rd., Northlake, Ill. 60164. (312) 562-7100.

Baker, Philip M.: 4515 Willard Ave., Washington 20015. (301) 652-8919.

Baker, Raymond E.: Communications Systems Div. GE, Lynchburg, Va. 24505. (703) 846-7311.

Baker, Warren E.: United Utilities Inc., Box 11315, Plaza Station, Kansas City, Mo. 64112. (913) 236-9900.

Bankson, John R. Jr.: Hamel, Park, McCabe & Saunders, 1776 F St., N.W., Washington 20006. (202) 785-1234.

Baraff, B. Jay: Stambler & Shrinky, 1737 DeSales St., N.W., Washington 20036. (202) 347-0883.

Barfield, William B.: C&P Telephone Co. of Maryland, 201 N. Charles St., Baltimore, 21201. (301) 393-3371.

Barker, Robert W.: Wilkinson, Cragun & Barker, 1735 New York Ave., N.W., Washington 20006. (202) 833-9800.

Barnard, William M.: Miller & Schroeder, 1225 Connecticut Ave., N.W., Washington 20036. (202) 659-4400.

Barnes, Maurice R.: Barnes & Neilson, Munsey Bldg., Washington 20004. (202) 783-7670.

Baron, Theodore: 1926 I St., N.W., Washington 20006. (202) 337-6313.

Barrick, William H.: Barrick, Jackson & Switzer, 228 South Main St., Rockford, Ill. 61101. (815) 962-6611.

Bartlett, John L.: Kirkland, Ellis & Rowe, 1776 K St., N.W., Suite 100, Washington 20006. (202) 833-8400.

Bechtel, Gene A.: Arent, Fox Kintner, Plotkin & Kahn, 1200 Federal Bar Bldg., 1815 H St., N.W., Washington 20006. (202) 347-8500.

Becker, A. Harry: 1730 M St., N.W. Washington

20036. (202) 833-9400.

Becker, Mortimer: Becker and London, 15 Columbus Circle, New York 10023. (212) 541-7070.

Becker, Richard Sanford: 1156 15th St., N.W., Washington 20005. (202) 872-0190.

Beelar, Donald C.: 24 St. Andrews Place, Hilton Head Island, South Carolina 29928.

Begley, Dennis F.: Midlen & Reddy, 1990 M St., N.W., Washington 20036. (202) 659-5700.

Beizer, Robert A.: Kirkland, Ellis & Rowe, 1776 K St., N.W., Suite 1100, Washington 20006. (202) 833-8400.

Bell, James F.: Reavis, Pogue, Neal & Rose, 1100 Connecticut Ave., N.W., Washington 20036. (202) 293-2030.

Bell, Stephen R.: Wilkinson, Cragun & Barker, 1735 New York Ave., Washington 20006. (202) 833-9800.

Bellon, Joseph P.: 19 Leeds Dr., Port Washington, N.Y. 11050. (516) 767-4897.

Bender, Raymond G. Jr.: Dow, Lohnes & Albertson, 1225 Connecticut Ave., N.W. Washington 20036. (202) 659-8200.

Berfield, Morton L.: Cohen & Berfield, 1129 20th St., N.W., Washington 20036. (202) 466-8565.

Berkman, Myles P.: 320 Market St., Steubenville, Ohio 43952. (614) 282-0911.

Berman, William H.: Communication Satellite Corp., 950 L'Enfant Plaza, S.W., Washington 20024. (202) 554-6000.

Bernard, Lawrence J. Jr.: Greeley, Bernard & Tierney, 1990 M St., Suite 660, Washington 20036. (202) 785-2690.

Bernstein, Robert Alfred: Pittman, Lovett, Ford & Hennessey, 1819 H St., N.W., Suite 1000, Washington 20006. (202) 293-7400.

Bernthal, Eric L.: Fox, Kintner, Plotkin & Kahn, 1200 Federal Bar Bldg., 1815 H St., N.W., Washington 20006. (202) 347-8500.

Bernton, William P.: Mallyck & Bernton, 1900 L St., N.W., Washington 20036. (202) 466-2350.

Besing, Ray: Geary, Barron & Stahl, 2500 LTV Tower, Dallas 75201. (214) 748-9901.

Betley, Leonard J.: Ice, Miller, Donaldio & Ryan, 111 Monument Circle, 10th floor, Indianapolis 46204. (317) 635-1213.

Bierlein, Lawrence W.: Powell & Becker, 1156 15th St., N.W., Washington 20005. (202) 872-0190.

Bigelow, Robert P.: Hennessy, McCluskey, Earle & Kilburn, 28 State St., Boston 02109. (617) 742-8300.

Bilger, Donald E.: Bilger & Blair, 1730 M St., N.W., Washington 20036. (202) 659-4230.

Blair, Forbes W.: Bilger & Blair, 1730 M St., N.W., Washington 20036. (202) 659-4230.

Blooston, Arthur: 2120 L St., N.W., Washington 20037. (202) 833-3050.

Blume, Jack P.: Fly, Shuebruk, Blume & Gaguine, 1211 Connecticut Ave., N.W., Washington 20036. (202) 293-1282.

Blumenfeld, Seth D.: Western Union International Inc., 26 Broadway, New York 10004. (212) 363-6400.

Blumenthal, Martin: Stambler & Shrinky, 1731 DeSales St., N.W., Washington 20036. (202) 347-0883.

Boiler, Charles Albert: The Public Bcstg Center, Pittston, Pa. 18640. (717) 655-4561.

Bolton-Smith, Carlie Jr.: MCI Communications Corp., 1301 Avenue of the Americas, New York 10019.

Bond, Clifford J. III: Smithwick & Bond, 1036 National Press Bldg., Washington 20045. (202) 737-0300. (919) 727-1255, 766-8325 (North Carolina).

Booth, Robert M. Jr.: Booth & Freret, 1302 18th St., N.W., Washington 20036. (202) 296-9100.

Borchardt, Kurt: 8 Doubloon Drive, Hilton Head Island, S.C. 29928. (803) 785-4349.

Borghesani, W.H. Jr.: Keller & Heckman, 1150 17th St., N.W., Suite 1000, Washington 20036. (202) 296-2700.

Boros, Jerome S.: Fly, Shuebruk, Blume & Gaguine, 45 Rockefeller Plaza, New York 10020. (212)

247-3040.

Borsari, George R. Jr.: Daly, Joyce, Borsari & George, 1830 Jefferson Place, Washington 20036. (202) 296-8900.

Borsari, John A.: Daly, Joyce, Borsari & George, 1830 Jefferson Place, Washington 20036. (202) 296-8900.

Bowers, Jonathan S.: Cordon & Jacob, 2000 L St., N.W., Washington 20036. (202) 293-2300.

Bowie, Nolan A.: Citizens Communications Center, 1914 Sunderland Place N.W., Washington 20036. (202) 296-4238.

Boyce, Roy W.: Cohen & Berfield, 1129 20th St., N.W., Washington 20036. (202) 466-8565.

Bradley, Samuel M.: Welch & Morgan, 900 17th St., N.W. Washington 20006. (202) 296-5151.

Branscomb, Anne W.: 245 Milton Rd., Rye, N.Y. 10580. (914) 967-4742.

Braun, Howard Jay: Fly, Shuebruk, Blume & Gaguine, 1211 Connecticut Ave., N.W., Washington 20036. (202) 293-1282.

Braverman, Burt A.: Cole, Zylstra & Raywid, 2011 I St., N.W., Washington 20006. (202) 659-9750.

Breit, A. Thomas: 722 North Broadway, Milwaukee 53202. (414) 393-2151.

Brice, Bill E.: Brice & Barron, 2001 Bryan Tower, Suite 3858, Dallas 75201. (214) 748-6412.

Brod, Ernest: Western Union International Inc., 26 Broadway, New York 10004. (212) 363-5812.

Brooks, Robert D.: 466 Lexington Ave., New York 10017. (212) 340-3011.

Brophy, Theodore F.: General Telephone & Electronics Corp., One Stamford Forum, Stamford, Conn. 06904.

Brown, Darwin C.: Suite 528, Barr Bldg., 910 17th St., N.W., Washington 20006. (202) 223-2770.

Brown, Richard L.: 1156 15th St., N.W., Suite 516, Washington 20005. (202) 785-3945.

Bruce, Robert R.: Hogan & Hartson, 815 Connecticut Ave., N.W., Washington 20006. (202) 331-4500.

Bucher, H.I.: 350 Royal Palm Way, Palm Beach, Fla. 33480. (305) 833-6110.

Buckmaster, Robert: Beecher, Buckmaster, Beecher & Lindemann, 300 Court Square Bldg., Waterloo, Iowa 50703. (319) 234-1766.

Buenzie, Robert J.: Smith & Pepper, 1776 K St., N.W., Washington 20006. (202) 296-0600.

Buchholz, Bernard: Graubard, Moskovitz, McGoldrick, Dannett & Horowitz, 345 Park Ave., New York 10022. (212) 593-3000.

Buffone, Samuel J.: Moore, Nathan & Buffone, 1921 Penn. Ave., N.W., Washington 20006. (202) 452-8300.

Buikley, Lewis E.: 208 S. LaSalle St., Chicago 60604. (312) 372-5600.

Bullivant, Rupert R.: 527 Pacific Bldg., Portland, Ore. 97204. (503) 228-6351.

Burch, Dean: Pierson, Ball & Dowd, 1000 Ring Bldg., Washington 20036. (202) 331-8566.

Burch, Richard Kurt: NAB, 1771 N St., N.W., Washington 20036. (202) 293-3500.

Burns, George D.: Cable Communications Resource Center, 1900 L St., N.W., Washington 20036. (202) 296-5810.

Burstein, Herbert: 1 World Trade Center, Suite 2373, New York 10048. (212) 432-0940.

Bustard, R. David: Sidley & Austin, 1730 Pennsylvania Ave., N.W., Washington 20006. (202) 872-1730.

Byrnes, William J.: Haley, Bader & Potts, 1730 M St., N.W., Washington 20036. (202) 659-7676.

C

Cahill, Robert Vincent: Cahill & Kaswell, 2030 M St. N.W., Washington 20036. (202) 8338161.

Callaghan, Richard L.: 1828 L St., N.W., Suite 1001, Washington 20036. (202) 296-2300.

Campbell, Alan C.: Dow, Lohnes & Albertson, 1225 Connecticut Ave., N.W., Washington 20036. (202) 659-8200.

Cangelosi, Carl H.: RCA Global Communications

Inc. 60 Broad St., New York 10004.

Caplicki, Dennis P.: Bilger & Blair, 1730 M St., N.W., Washington 20036.

Carideo, James V.: GTE Data Services Inc., 5422 Bay Center Drive, Tampa, Fla. 33609. (813) 877-8021.

Carr, John Richard: Dempsey & Koplowitz, 938 Bowen Bldg., Washington 20005. (202) 737-6363.

Carroccio, A. Thomas: Berliner, Maloney, Gimer & Muir, 1100 Conn. Ave., N.W., Washington 20036. (202) 293-1414.

Carson, Virginia S.: McKenna, Wilkinson & Kittner, 1150 17th St., N.W., Washington 20036. (202) 296-1600.

Cassidy, Kevin H.: DATRAN, 8130 Boone Blvd., Vienna, Va. 22180. (703) 893-2450.

Chaffee, Walter B.: Launer, Chaffee & Hanna, 131 W. Wilshire Ave., Box 112, Fullerton, Calif. 92632. (714) 871-8600.

Chopnick, Max: 9 East 46th St., New York 10017. (212) 697-8130.

Christensen, Gary L.: Hogan & Hartson, 815 Connecticut Ave., N.W., Washington 20006. (202) 331-4518.

Christensen, Thomas M.P.: Christensen & Shelesky, 4084 University Dr., Suite 102, Fairfax, Va. 22030. (703) 273-4573.

Church, Abiah A.: Storer Bcstg Co., 1177 Kane Concourse, Bay Harbor Island, Miami Beach, Fla. 33154. (305) 866-0211.

Cinciotto, Linda A.: Arent, Fox, Kintner, Plotkin & Kahn, 1200 Federal Bar Bldg., Washington 20006. (202) 347-8500.

Clancy, Donald E.: 51 West 52d St., New York 10019. (212) 765-4321.

Clarke, Donald F.: Bell Telephone Co. of Pa., One Parkway, Philadelphia 19102. (215) 466-5481.

Claro, John A.: Barefoot, Moler & Claro, 3000 City Nat'l. Bank Tower, Oklahoma City 73102. (405) 232-3566.

Close, Elmer Harry: Box 466, Keene, N.H. 03431. (603) 352-9230.

Coffman, Gordon C.: Wilkinson, Cragun & Barker, 1735 New York Ave., N.W., Washington 20006. (202) 833-9800.

Cohen, Harold David: Pierson, Ball & Dowd, 1000 Ring Bldg., Washington 20036. (202) 331-8566.

Cohen, Harold J.: American Tel & Tel, Rm 2519, 195 Broadway, New York 10007. (212) 393-3002.

Cohen, Lewis I.: Cohen & Berfield, 1129 20th St., N.W., Washington 20036. (202) 466-8565.

Cohen, Stanley B.: Cohn & Marks, 1920 L St., N.W., Washington 20036. (202) 293-3860.

Cohen, Wallace M.: 1910 Sunderland Place, N.W., Washington 20036. (202) 462-6010.

Cohn, Lawrence N.: Cohn & Marks, 1920 L St., N.W., Washington 20036. (202) 293-3860.

Cohn, Marcus: Cohn & Marks, 1920 L St., N.W., Washington 20036. (202) 293-3860.

Colby, Lauren A.: Box 19335, Washington 20036. (202) 296-7631.

Colby, Richard E.: Metromedia Producers Corp., 5746 Sunset Blvd., Los Angeles 90028.

Cole, John P. Jr.: Cole, Zylstra & Raywid, 2011 I St., N.W., Washington 20006. (202) 659-9750.

Cole, Marshal L.: Wilner & Scheiner, 2021 L St., N.W., Washington 20036. (202) 293-7800.

Coleman, James J.: 321 St. Charles Ave., New Orleans 70130. (504) 529-5652.

Collin, John A.: 4626 Park Ave., Ashtabula, Ohio 44004. (216) 998-2323.

Collin, Ralph F.: Rosenman, Colin, Kaye, Petschek, Freund & Emil, 575 Madison Ave., New York 10022. (212) 644-7000.

Coll, Robert Wilson: McKenna, Wilkinson & Kittner, 1150 17th St., N.W., Washington 20036. (202) 296-1600.

Collier, Robert A.: Collier, Shannon, Rill and Edwards, 1666 K St., N.W., Washington 20006. (202) 785-1777.

Coney, Byron D.: Dodd, Russell, Hamlin & Coney, Room 312, 1400 Fourth Ave. Bldg., Seattle 98101. (206) 632-5306.

Conn, Robert E.: Western Union International Inc., 26 Broadway, New York 10004. (212) 363-6406.

Connor, J. Parker: Mullin, Connor & Rhyne, 1000 Connecticut Ave., N.W., Washington 20036. (202) 659-4700.

Cooke, James R.: McKenna, Wilkinson & Kittner, 1150 17th St., N.W., Washington 20036. (202) 296-1600.

Cooper, Grover Collins: Fisher, Wayland, Southmayd & Cooper, 1100 Connecticut Ave., N.W., Washington 20036. (202) 659-3494.

Cooper, Wayne B.: Farrand, Malli, Spillane & Cooper, Suite 2985, Bank of America Center, 555 California St., San Francisco 94104. (415) 989-0680.

Corazzini, Robert F.: Smith & Pepper, 1776 K St., N.W., Washington 20006. (202) 296-0600.

Cordon, Alfred C. Jr.: Cordon & Jacob, 2000 L St., N.W., Suite 616, Washington 20036. (202) 293-2300.

Cottone, Benedict P.: 1730 M St., N.W., Suite 908, Washington 20036. (202) 296-1901.

Coulter, William Kirk: Communications Satellite Corp., 950 L'Enfant Plaza, S.W., Washington 20024.

Courtney, Jeremiah: 2120 L St., N.W., Washington 20037. (202) 833-3050.

Courtney, Jerrold: Title Insurance & Trust Bldg., 309 South Third St., Suite 226, Las Vegas 89101. (702) 384-5832.

Cowan, Geoffrey: Center for Law and Social Policy, 1600 20th St., N.W., Washington 20009. (202) 387-4222.

Cowan, John J.: 1500 MacCorkle Ave., S.E., Charleston, W. Va. 25301. (304) 344-6302.

Cox, Kenneth A.: Haley, Bader & Potts, 1730 M St., N.W., Washington 20036. (202) 659-7676.

Coy, Wayne: WETA/NPACT, 3620 27th St. S., Arlington, Va. 22206. (703) 820-4500.

Crocker, Richard J.: United Telecommunications Inc., 1800 K St., N.W., Suite 102, Washington 20006. (202) 659-4600.

Curtis, Vincent J.: Fletcher, Heald, Rowell, Kenehan & Hildreth, 1225 Connecticut Ave., N.W., Washington 20036. (202) 659-9100.

Cutcliffe, Lee S.: AT&T, 32 Avenue of the Americas, New York 10013. (212) 393-7535.

Cutler, Charles R.: Kirkland, Ellis & Rowe, 1776 K St., N.W., Suite 1100, Washington 20036. (202) 833-8400.

Cutler, Lloyd N.: Wilmer, Cutler & Pickering, 1666 K St., N.W., Washington 20006. (202) 872-6100.

Czarra, Edgar F. Jr.: Covington & Burling, 888 16th St. N.W., Washington 20006. (202) 452-6066.

D

Dannett, Eammanuel: Graubard, Moskowitz, McGoldrick, Dannett & Horowitz, 345 Park Ave., New York 10022. (212) 593-3000.

Davis, Hal C.: National Bank of Topeka Bldg., Topeka, Kan. (913) 232-7207.

Davis, John I.: Dow, Lohnes & Albertson, 1225 Connecticut Ave., N.W., Washington 20036. (202) 659-8200.

Davis, John R.: New England Tel & Tel Co., 185 Franklin Street, Boston, Mass. 02107. (617) 743-7031.

Davison, Calvin: Jones, Day, Reavis & Pogue, 1100 Connecticut Ave., N.W., Washington 20015. (202) 452-5871.

Davlin, Zalman O.: Hennessy, McCluskey, Earle & Kilburn, Room 2200, 28 State St., Boston 02109. (617) 742-8300.

Dealy, John Francis: Sherman Fairchild Technology Center, Germantown, Md. 20767. (301) 948-9600.

Delaney, Paul L.: 115 North Fairfax, Alexandria, Va. 22314. (703) 683-4200.

DeLynn, Hubert J.: RKO General Inc., 1440 Broadway, New York 10018. (212) 564-8000.

Dempsey, John J.: Dempsey & Koplowitz, 821 15th St., N.W., Washington 20005. (202) 737-6363.

Dempsey, William J.: Dempsey & Koplowitz, 821

15th St., N.W., Washington 20005. (202) 737-6363.

Denechoud, Charles I. Jr.: Denechoud & Denechoud, 1412 Pere Marquette Bldg., New Orleans 70112. (504) 525-1344.

Denny, Charles R.: 1800 K St., N.W., Suite 810, Washington 20006. (202) 338-6666.

Denslow, L. Alton: Washington Bldg., Washington 20005. (202) 737-0727.

DeRosa, Francis J.H.: RCA Global Communications Inc., 60 Broad St., New York 10004. (212) 363-2070.

DeVore, Lawrence M.: Communications Satellite Corp., 950 L'Enfant Plaza South, S.W., Washington 20024. (202) 554-6133.

Diamond, Marvin J.: Hogan & Hartson, 815 Connecticut Ave., N.W., Washington 20006. (202) 331-4532.

DiPrima, Frank P.: Plough Inc., 303 Jackson Ave., Memphis 38101. (901) 320-2234.

Diuguid, John P.: Carr, Bonner, O'Connell, Kaplan, Thompson & Diuguid, 900 17th St., N.W., Washington 20036. (202) 659-4660.

Do bin, Paul: Cohn & Marks, 1920 L St., N.W., Washington 20036. (202) 293-3860.

Doolittle, J. William: Prather, Levenberg, Seeger, Doolittle, Farmer & Ewing, 1101 16th St., N.W., Washington 20036. (202) 296-0500.

Dougherty, Thomas J.: Metromedia Inc., 5151 Wisconsin Ave., N.W., Washington 20016. (202) 244-5151.

Douglas, George R. Jr.: Misegades, Douglas & Levy, P.C., Suite 304, 1126 16th St., N.W., Washington 20036. (202) 638-3833.

Dowd, Thomas N.: Pierson, Ball & Dowd, Ring Bldg., Washington 20036. (202) 331-8566.

Doyle, Stephen E.: Office of Telecommunications Policy, Executive Office of the President, Washington 20504. (202) 395-3375.

Dreyer, Robert A.: 6 Park Rd., Short Hills, N.J. 07078. (201) 376-7111.

Drury, John E.: Welch & Morgan, 900 17th St., N.W., Washington 20006. (202) 296-5151.

Dunbar, Frank C. Jr.: 250 East Broad St., Midland Bldg., Columbus, Ohio 43215. (614) 228-4371.

Dunbar, James V. Jr.: Cosmos Bcstg Corp., Box 367, Columbia, S.C. 29202. (803) 253-6431.

Dunham, Corydon B. Jr.: National Bcstg Co., 30 Rockefeller Plaza, New York 10020. (212) 247-8300.

Dunlap, James A.: Hughes Aircraft Co., Box 92919, Los Angeles 90009. (213) 648-2795.

Duty, John M.: Gammon & Tierney, 1925 K St., N.W., Washington 20006. (202) 293-7979.

Dvorski, Bernard M.: 1710 H St., N.W., Washington 20006. (202) 392-8653.

Dwyer, Albert Hayden: 188 Engle St., Tenafly, N.J. 07670. (201) 567-0335.

Dwyer, James Aloysius: Airsignal International, 201 East Ogden Ave., Hinsdale, Ill. 60521.

Dyk, Timothy: Wilmer, Cutler & Pickering, 1666 K St., N.W., Washington 20006. (202) 872-6000.

Dyke, James Webster Jr.: Covington & Burling, 888 16th St., N.W., Washington 20006. (202) 452-6000.

E

Eagan, R. Russell: Kirkland, Ellis & Rowe, 1776 K St., N.W., Suite 1100, Washington 20036. (202) 833-8400.

Edge, Joe Dixon: Hamel, Park, McCabe & Saunders, 1776 F. St., N.W., Washington 20006. (202) 785-1234.

Edmundson, James K. Jr.: Fly, Shuebruk, Blume & Gaguine, 1211 Connecticut Ave., N.W., Washington 20036. (202) 293-1282.

Effros, Stephen R.: Brown & Effros, 1523 O St., N.W., Washington 20005. (202) 387-3100.

Eggmann, Horace J. Jr.: 400 First Federal Bldg., East St. Louis, Ill. 62201. (618) 873-0200.

Elardo, Donald J.: RCA Global Communications, 2030 M St., N.W., Washington 20036. (202) 558-4433.

Attorneys

Emery, Walter B.: 3297 Leighton Rd., Columbus, Ohio 43221. (614) 451-8117.

Emmons, Nathaniel F.: Mullin, Connor & Rhyne, 1000 Connecticut Ave. N.W., Washington 20036. (202) 659-4700.

English, John W.: English, Bowler & Jenks, 162 W. 6th St., Box 1560, Erie, Pa. 16501. (814) 454-4533.

English, William deShay: Communications Satellite Corp., 950 L'Enfant Plaza South, S.W., Washington 20024. (202) 554-6000.

Epstein, Gary M.: Arent, Fox, Kintner, Plotkin & Kahn, 1200 Federal Bar Bldg., 1815 H St., N.W., Washington 20006. (202) 347-8500.

Esbensen, Eric T.: Pittman, Lovett, Ford & Hennessey, 1819 H St., N.W., Washington 20006. (202) 293-7400.

Estes, Robert M.: 570 Lexington Ave., New York 10022. (212) 751-1311, (ext. 2508).

Ewing, Samuel E.: 1800 K St., N.W., Washington 20006. (202) 558-4244.

F

Faber, Michael W.: Peabody, Rivin, Lambert & Meyers, 1150 Connecticut Ave. N.W., Washington 20036. (202) 457-1000.

Faber, Norman L.: Hall, Dickler & Howley, 460 Park Ave., New York 10022. (212) 838-4600.

Fanelli, Joseph A.: Corcoran, Foley, Youngman & Rowe, 1511 K St., N.W., Washington 20005. (202) 783-7900.

Farrand, Stephen R.: Farrand, Malti, Spillane & Cooper, Bank of America Center, Suite 2985, 555 California St., San Francisco 94104. (415) 989-0680.

Feen, A. Pearley: 119 S. Winooski Ave., Burlington, Vt. 05402. (802) 864-9891.

Fels, Nicholas W.: Covington & Burling, 888 16th St., N.W., Washington 20006. (202) 293-3300.

Feldstein, Stuart: National Cable Television Association, 918 16th St., N.W., Washington 20006. (202) 466-8111.

Feele, John R. Jr.: Dow, Lohnes & Albertson, 1225 Connecticut Ave., N.W., Washington 20036. (202) 659-8200.

Ferrall, Victor E. Jr.: Jones, Day, Reavis & Pogue, 1100 Connecticut Ave., N.W., Washington 20015. (202) 452-5992.

Field, John D. III: Dow, Lohnes & Albertson, 1225 Connecticut Ave., N.W., Washington 20036. (202) 659-8200.

Fields, Mark Edward: Miller & Fields, 1901 Pennsylvania Ave., N.W., Suite 300, Washington 20006. (202) 785-2720.

Fine, Joseph J.: 456 Hurt Bldg., Atlanta 30303. (404) 688-1210.

Finkelstein, Michael: Finkelstein & Firestone, 1725 K St., N.W., Washington 20006. (202) 223-2945.

Florini, John Eugene III: Smith & Pepper, 1776 K St., N.W., Washington 20006. (202) 296-0600.

Firestone, Charles M.: Citizens Communications Center, 1914 Sunderland Pl., N.W., Washington 20036. (202) 296-4238.

Firestone, Michael E.: Finkelstein & Firestone, 1725 K St., N.W., Washington 20006. (202) 223-2945.

Fisher, Ben C.: Fisher, Wayland, Southmayd & Cooper, 1100 Connecticut Ave., N.W., Suite 730, Washington 20036. (202) 659-3494.

Fisher, Thomas George: Meredith Corp., Des Moines, Iowa 50336. (515) 284-9166.

Fitz, William H.: Pierson, Ball & Dowd, 1000 Ring Bldg., Washington 20036. (202) 331-8566.

Fletcher, Francis E. Jr.: Glaser & Fletcher, 1150 17th St., N.W., Washington 20036. (202) 872-0200.

Fletcher, Frank U.: Fletcher, Heald, Rowell, Kenahan & Hildreth, 1225 Connecticut Ave., N.W., Washington 20036. (202) 659-9100.

Fletcher, Thomas W.: Cole, Zylstra & Raywid, 2011 I

St., N.W., Washington 20006. (202) 659-9750.

Foley, Robert Matthew: Shack & Mendenhall, 1730 Rhode Island Ave., N.W., Suite 413, Washington 20036. (202) 293-5900.

Ford, Frederick W.: Pittman, Lovett, Ford & Hennessey, 1819 H St., N.W., Washington 20006. (202) 293-7400.

Forester, James G.: Forester & Carroll, S.C., 735 North Water St., Milwaukee 53202. (414) 271-4740.

Forrest, Herbert E.: Sleptoe & Johnson, 1250 Connecticut Ave., N.W., Washington 20036. (202) 223-4800.

Foulls, Ronald J.: 4432 Edmunds St., N.W., Washington 20007.

Fowler, Cody: Box 1438, 220 Madison St., Tampa, Fla. 33601. (813) 228-7411.

Fox, Brenda Lee: National Association of Broadcasters, 1771 N St., N.W., Washington 20036. (202) 293-3560.

Frank, Theodore David: Arent, Fox, Kintner, Plotkin & Kahn, 1200 Federal Bar Bldg., 1815 H St., N.W., Washington 20006. (202) 347-8500.

Frankl, Kenneth R.: RKO General Inc., 1440 Broadway, New York 10018. (212) 564-8000.

Freeman, James J.: Pierson, Ball & Dowd, 1000 Ring Bldg., Washington 20036. (202) 331-8566.

French, R.H.S.: Collier, Shannon, Rill & Edwards, 1615 Eye St., N.W., Washington 20006. (202) 393-1050.

Freret, Julian P.: Booth & Freret, 1302 18th St., N.W., Washington 20036. (202) 296-9100.

Friedell, Gerald H.: 2100 1st National Bank Bldg., Minneapolis 55402. (612) 339-0381.

Frohock, Thomas N.: McKenna, Wilkinson & Kittner, 1150 17th St., N.W., Washington 20036. (202) 296-1600.

Frost, Norman C.: Box 771, Birmingham, Ala. 35223. (205) 321-8205.

G

Gaguine, Benito: Fly, Shuebruk, Blume & Gaguine, 1211 Connecticut Ave., N.W., Washington 20036. (202) 293-1282.

Gallagher, Peter John: Dow, Lohnes & Albertson, 1225 Connecticut Ave., N.W., Washington 20036. (202) 659-8200.

Gallopy, Vincent: GTE Service Corp., One Stamford Forum, Stamford, Ct. 06904.

Gammon James A.: Gammon & Tierney, 1925 K St. N.W., Washington 20006. (202) 293-7979.

Gaynes, Martin J.: Cohn & Marks, 1920 L St., N.W., Washington 20036. (202) 293-3860.

Geller, Alfred: 575 Madison Ave., New York 10022. (212) 752-2900.

Geller, Henry: Aspen Institute, 1755 Mass. Ave., N.W., Washington 20036. (202) 462-2011.

George, Carl E.: 3636 Traynham Rd., Cleveland 44122. (216) 561-4245.

George, Leo I.: Daly, Joyce, Borsari & George, 1830 Jefferson Place, Washington 20036. (202) 296-8900.

Gerlach, Gary G.: Arnold & Porter, 1229 19th St., N.W., Washington 20036. (202) 872-6828.

Getzendaner, Mark A.: 17430 Ballinger Way, N.E., Seattle 98155. (206) 363-7456.

Gillespie, Gardner F. III: Hogan & Hartson, 815 Connecticut Ave., N.W., Washington 20006. (202) 331-4500.

Glaser, Michael L.: Glaser & Fletcher, 1150 17th St., N.W., Washington 20036. (202) 872-0200.

Gold, Stephen A.: Law Offices of Samuel Miller, 944 Washington Bldg., Washington 20005. (202) 783-6811.

Goldberg, Henry: Verner, Lipfert, Bernhard & McPherson, 1660 L St., N.W., Washington 20006. (202) 296-6515.

Goldey, Michael J.: AT&T Long Lines, 32 Avenue of the Americas, New York 10013.

Goldfarb, Aaron: 2828 First City National Bank Bldg., Houston 77002. (713) 223-4417.

Goldman, Donald H.: Anderson & Goldman, 295 Madison Ave., New York 10017. (212) 679-2400.

Goldstein, David: 601 Bangs Ave., Asbury Park, N.J. 07712. (201) 775-3242.

Goldstein, Ira J.: Moses & Singer, 51 West 51 St., New York 10019. (212) 581-9000.

Goldstein, Irving: Comsat, 950 L'Enfant Plaza, S.W., Washington 20024.

Golub, William W.: Rosenman, Colin, Kaye, Pelschek, Freund & Emil, 575 Madison Ave., New York 10022. (212) 688-7800.

Gomes, Gary C.: Fairchild Industries Inc., Fairchild Drive, Germantown, Md. 20767. (301) 948-9600.

Goodkind, Arthur B.: Koteen & Burt, 1000 Vermont Ave., N.W., Washington 20005. (202) 737-5566.

Gould, Judson A.: Wilfert & Gould, 1735 New York Ave., N.W., Suite 715, Washington 20006. (202) 833-1046.

Gray, John W. Jr.: American Telephone & Telegraph Co., 2000 L St., N.W., Washington 20036.

Greeley, James E.: 1990 M St., N.W., Suite 660, Washington 20036. (202) 785-2690.

Green, Michael B.: Wilkinson, Cragun & Barker, 1735 New York Ave., Washington 20006. (202) 833-9800.

Green, Robert N.: Western Union Telegraph Co., Suite 1001, 1828 L St., N.W., Washington 20036. (202) 624-0145.

Green, William S.: Pierson, Ball & Dowd, 1000 Ring Bldg., Washington 20036. (202) 331-8566.

Greene, William D.: Burns, Van Kirk, Greene & Kafer, 521 Fifth Ave., New York 10017. (212) 972-0500.

Gregory, L. Weston: Sells & Gregory, 2000 L St., N.W., Washington 20036. (202) 659-3480.

Grenier, Edward J. Jr.: Sutherland, Asbill & Brennan, 900 17th St., N.W., Washington 20006. (202) 296-4800.

H

Hadi, Robert D.: Wilner & Schneiner, 2021 L St., N.W., Washington 20036. (202) 293-7800.

Hamburg, Morton I.: 767 Fifth Ave., Suite 3809, New York 10022. (212) 838-0424.

Hankins, Robert B.: Pierson, Ball & Dowd, 1000 Ring Bldg., Washington 20036. (202) 331-8566.

Hannon, John S.: Communications Satellite Corp., 950 L'Enfant Plaza, S.W., Washington 20024. (202) 554-6000.

Hardy, Ralph Williams Jr.: Dow Lohnes & Albertson, 1225 Connecticut Ave., N.W., Washington 20036. (202) 659-8200.

Hargrove, Wade H.: Tharrington, Smith & Hargrove, Suite 300, BB&T Bldg., Raleigh, N.C. 27602. (919) 821-4711.

Harkins, James L. Jr.: City Hall, Room 204, Cleveland 44114. (216) 621-7135.

Harkrader, Carleton A.: Wald, Harkrader & Ross, 1320 19th St., N.W., Washington 20036. (202) 296-2121.

Harrington, John C.: Fletcher, Heald, Rowell, Kenahan & Hildreth, Suite 400, 1225 Connecticut Ave., N.W., Washington 20036. (202) 659-9100.

Harrington, Robert F.: 1400 Public Service Bldg., Portland, Ore. 97204. (503) 224-3920.

Harris, Laurence E.: MCI Telecommunications Corp., 1150 17th St., N.W., Washington 20036. (202) 872-1600.

Harrison, Baya M.: Harrison, Greene, Mann, Davenport, Rowe & Stanton, 10th floor, First Federal Bldg., St. Petersburg, Fla. 33701. (813) 896-7171.

Harrison, Donald: Covington & Burling, 888 16th St., N.W., Washington 20006. (202) 293-3300.

Harrison, Pegram: 100 Colony Square, Suite 2126, 1175 Peachtree St., N.E., Atlanta 30309. (404) 892-8988.

Harter, L. Mason: 1400 Balltown Rd., Schneckady, N.Y. 12309. (518) 377-2261.

- Hartman, John A. Jr.:** ITT, 320 Park Ave., New York 10022. (212) 752-2600.
- Harvey, Arthur:** Metromedia Inc., 5746 Sunset Blvd., Hollywood, Calif. 90028. (213) 462-7111.
- Harvey, Edmund E.:** Chadbourne, Parke, Whiteside & Wolff, 1150 17th St., N.W., Washington 20036. (202) 872-8050.
- Hathaway, Merrill F. Jr.:** Koteen & Burt, 1000 Vermont Ave., N.W. Washington 20005. (202) 737-5566.
- Hawkins, Howard R.:** RCA Global Communications Inc., 60 Broad St., New York 10004. (212) 363-4200.
- Hayes, Edward Jr.:** 1705 Irving St. N.W., Washington 20010. (202) 234-3920.
- Heald, Robert L.:** Fletcher, Heald, Rowell, Kenehan & Hildreth, 1225 Connecticut Ave., N.W., Washington 20036. (202) 659-9100.
- Healy, Robert W.:** Gordon & Healy, 1821 Jefferson Place, N.W., Washington 20036. (202) 785-5020.
- Hearne, John P.:** 15215 Sunset Blvd., Pacific Palisades, Calif. 90272. (213) 454-7505.
- Hecker, Stuart:** 500 Fifth Ave., New York 10036. (212) 391-1050.
- Heckman, Jerome H.:** Keller and Heckman, 1150 17th St., N.W., Washington 20036. (202) 296-2700.
- Helein, Charles H.:** Dow, Lohnes & Albertson, 1225 Connecticut Ave., N.W., Washington 20036. (202) 659-8200.
- Helmick, Richard A.:** Cohn & Marks, 1920 L St., N.W., Washington 20036. (202) 293-3860.
- Hennessey, Joseph F.:** Pittman, Lovett, Ford & Hennessey, 1819 H St., N.W., Washington 20036. (202) 293-7400.
- Henry, E. William:** Ginsburg, Feldman & Bress, No. 300, 1700 Pennsylvania Ave., N.W., Washington 20006. (202) 223-3800.
- Herbits, Charles G.:** National Public Radio, 2025 M St., N.W., Washington 20036. (202) 785-5477.
- Herman, A.M.:** Brown, Herman, Scott, Dean & Miles, Suite 203, Fort Worth Club Bldg., Ft. Worth 76102. (817) 332-1391.
- Herman, Morton L.:** Brown, Herman, Scott, Dean & Miles, Suite 203, Fort Worth Club Bldg., Ft. Worth 76102. (817) 332-1391.
- Hester, Thomas P.:** American Tel & Tel, 2000 L St., N.W., Washington 20036. (202) 466-5575.
- Hickey, Robert John:** Morgan, Lewis & Bockius, 1140 Connecticut Ave., N.W., Suite 1100, Washington 20036. (202) 466-2300.
- Hildreth, Richard:** Fletcher, Heald, Rowell, Kenehan & Hildreth, 1225 Connecticut Ave., N.W., Washington 20036. (202) 659-9100.
- Hill, David L.:** Keller & Heckman, 1150 17th St., N.W., Suite 1000, Washington 20036. (202) 296-2700.
- Hill, Dean George:** 7809 Greentwig Rd., Bethesda, Md. 20034. (301) 365-0517.
- Hilliard, Carl B.:** 400 United Calif Bank Bldg., 1010 N. Main St., Santa Ana, Calif. 92701. (714) 547-6075.
- Hilmer, Lucien:** 1156 15th St., N.W., Washington, D.C. 20005. (202) 659-9050.
- Hird, Frederick S. Jr.:** Kaler, Worsley, Daniel & Hollman, 710 Ring Bldg., Washington 20036. (202) 331-9100.
- Hochberg, Philip R.:** O'Connor & Hannan, Suite 600, 1747 Pennsylvania Ave., N.W., Washington 20006. (202) 785-8700.
- Hodson, Robert E.:** Pierson, Ball & Dowd, 1000 Ring Bldg., Washington 20036. (202) 331-8566.
- Hoffman, Joel E.:** Wald, Harkrader & Ross, 1320 19th St., N.W., Washington 20036. (202) 296-2121.
- Holt, Thaddeus:** 815 Connecticut Ave., N.W., Washington 20006. (202) 785-5230.
- Holtz, Edgar W.:** Hogan & Hartson, 815 Connecticut Ave., N.W., Washington 20006. (202) 331-4500.
- Horne, Michael S.:** Covington & Burling, 888 16th St., N.W., Washington 20006. (202) 293-3300.
- House, Arthur G.:** Fly, Shuebruk, Blume & Gaguine, 1211 Connecticut Ave., N.W., Washington 20036. (202) 293-1282.
- House, Thomas J.:** Sidley & Austin, 1730 Pennsylvania Ave., N.W., Washington 20006. (202) 872-1730. One First National Plaza, Chicago 60670. (312) 329-5400.
- Houston, Ray B.:** RCA Corp., Camden, N.J. 08102. (609) 963-8000, ext 5696.
- Howard, Benjamin C.:** Miles and Stockbridge, 10 Light St., Baltimore 21202. (301) 727-6464.
- Howard, G.M. Esq.:** Box 7689, Dallas 75209. (214) 369-2095. 49 Green St., Marietta, Ga. 30060. (404) 422-1228.
- Hudgens, James A.:** Fly, Shuebruk, Blume & Gaguine, 1211 Connecticut Ave., N.W., Washington 20036. (202) 293-1282.
- Hummers, Edward W. Jr.:** Fletcher, Heald, Rowell, Kenehan & Hildreth, 1225 Connecticut Ave., N.W., Washington 20036. (202) 659-9100.
- Humphrey, Margot Smiley:** Koteen & Burt, 1000 Vermont Ave., N.W., Washington 20005. (202) 737-5566.
- Hutcheson, Mark A.:** Davis, Wright, Todd, Riese & Jones, 4200 Seattle 1st Natl. Bank Bldg., Seattle 98104. (206) 622-3150.
- Hyde, Rosel H.:** Wilkinson, Cragun & Barker, 1735 New York Ave., N.W., Washington 20006. (202) 833-9800.
- I**
- Irwin, David A.:** American Satellite Corp., 20030 Century Blvd., Germantown, Md. 20767. (301) 428-0100.
- J**
- Jackson, Thomas P.:** Jackson, Parkinson & Jackson, 1828 L St., N.W., Washington 20036. (202) 466-8850.
- Jackson, Thomas S.:** Jackson, Parkinson & Jackson, 1828 L St., N.W., Washington 20036. (202) 466-8850.
- Jackson, William P.:** 919 18th St., N.W., Washington 20006. (202) 833-1310.
- Jacob, John B.:** Cordon & Jacob, 2000 L St., N.W., Suite 616, Washington 20036. (202) 293-2300.
- Jacobi, Robert B.:** Cohn & Marks, 1920 L St., N.W., Washington 20036. (202) 293-3860.
- James, Robert L.:** Cole, Zylstra & Raywid, 2011 Eye St., N.W., Washington 20006. (202) 659-9750.
- James, W. Ervin:** Hofheinz & James, First National Life Bldg., Main at Rusk, Houston 77002. (713) 228-0835.
- Janklow, Morton L.:** Janklow & Traum, 375 Park Ave., New York 10022. (212) 421-1700.
- Jatlow, David C.:** Smith & Pepper, 1776 K St., N.W., Washington 20006. (202) 296-0600.
- Jencks, Richard W.:** CBS, 1990 M St., N.W., Washington 20036. (202) 296-1234.
- Jennes, Ernest W.:** Covington & Burling, 888 16th St., N.W., Washington 20006. (202) 452-6000.
- Jensen, J. Allen:** Box 2008, Idaho Falls, Idaho. (208) 522-6684.
- Johnson, Brian Allan:** Pierson, Ball & Dowd, 1000 Ring Bldg., Washington 20036. (202) 331-8566.
- Johnson, M. Scott:** Glaser & Fletcher, P.C., 1150 17th St., N.W., Washington 20036. (202) 872-0200.
- Johnston, Everett D.:** 1302 18th St., Washington 20036. (202) 296-9103.
- Jones, Charles E.:** 301 American Savings Bldg., 201 North Main, Wichita, Kan. 67202. (316) 265-8591.
- Jones, Douglas N.:** 2525 North Tenth St., Arlington, Va. 22201. (703) 522-5749.
- Jones, John Robert:** 100 East Broad St., Columbus, Ohio 43215. (614) 221-7863.
- Jorgensen, Norman E.:** 1926 Eye St., N.W., Washington 20006. (202) 331-9313.
- Joyce, Leonard S.:** Daly, Joyce, Barsari & George, 1830 Jefferson Place, N.W., Washington 20036. (202) 296-8900.
- K**
- Katzen, Sally:** Wilmer, Cutler & Pickering, 1666 K St., N.W., Washington 20006. (202) 872-6207.
- Kaye, Sydney M.:** Roser man, Colin, Kay, Petschek, Freund & Emil, 575 Madison Ave., New York 10022. (212) 688-7800.
- Karasik, Monroe:** Surrey, Karasik, Greene & Hill, 1156 15th St., N.W., Washington 20005. (202) 659-9050.
- Katz, George A.:** 299 Park Ave., New York 10017.
- Kaye, Sydney M.:** Rosenman, Colin, Kaye, Petschek, Freund & Emil, 575 Madison Ave., New York 10022. (212) 644-7000.
- Keith, M. Langhorne:** Hogan & Hartson, 815 Connecticut Ave., N.W., Washington 20006. (202) 331-4736.
- Keithley, Carter E.:** Bilger & Blair, 1730 M St., N.W., Washington 20036. (202) 659-4230.
- Kelleher, John Michael:** 1710 H St., N.W., Washington 20006. (202) 637-9900.
- Keller, Joseph E.:** Keller & Heckman, 1150 17th St., N.W., Washington 20036. (202) 296-2700.
- Keller, Thomas J.:** Office of Telecommunications Policy, 1800 G St., N.W., Washington 20504. (202) 395-5616.
- Kendall, John W.:** Black, Kendall, Tremaine, Booth & Higgins, 3100 First National Bank Tower, Portland, Ore. 97201. (503) 221-0550.
- Kenehan, Edward F.:** Fletcher, Heald, Rowell, Kenehan & Hildreth, 1225 Connecticut Ave., N.W., Washington 20036. (202) 659-9100.
- Kenkel, John Bonaventure:** Miller & Schroeder, 1225 Connecticut Ave., N.W., Washington 20036. (202) 659-4400.
- Kennedy, Richard F.:** Putbren & Kennedy, 6800 Fleetwood Dr., McLean, Va. 22101. (703) 790-8844.
- Kenny, John V.:** National Cable Television Assn., 918 16th St., N.W., Washington 20006. (202) 466-8111.
- Kessler, Lorence L.:** 1325 18th St., N.W., Suite 206, Washington 20036. (202) 833-2350.
- Kimball, Raymond J.:** Shack & Mendenhall, P.C., 1730 Rhode Island Ave., N.W., Suite 413, Washington 20036. (202) 293-5900. (Admitted in Massachusetts only).
- King, John W.:** Haley, Bader & Potts, Suite 700, 1730 M St., N.W., Washington 20036. (202) 659-7676.
- Kistler, H. Donald:** Jackson, Laskey & Parkinson, 1828 L St., N.W., Washington 20036. (202) 466-8850.
- Kittner, Joseph M.:** McKenna, Wilkinson & Kittner, 1150 17th St., N.W., Washington 20036. (202) 296-1600.
- Kleinberg, Kenneth A.:** Mitchell, Silberberg & Knupp, 1800 Century Park East, Los Angeles 90067. (213) 553-5000.
- Kleindienst, Richard G.:** Welch, Morgan & Kleindienst, 900 17th St., N.W., Washington 20006. (202) 296-5151.
- Knauer, Leon Thomas:** Wilkinson, Cragun & Barker, 1735 New York Ave., N.W., Washington 20006. (202) 833-9800.
- Knight, Louise Osborne:** Kury and Kury, 800 North 4th St., Sunbury, Pa. 17801. (717) 286-5866.
- Koerner, James A.:** Stambler & Shinsky, 1737 DeSales St., N.W., Washington 20036. (202) 347-0883.
- Kolevzon, Peter S.:** 919 Third Ave., New York 10022. (212) 688-1100.
- Koplovitz, William C.:** Dempsey & Koplovitz, 938 Brown Bldg., Washington 20005. (202) 737-6363.
- Koteen, Bernard:** Koteen & Burt, 1000 Vermont Ave., N.W., Washington 20005. (202) 737-5566.
- Kramer, Albert H.:** 1346 Conn. Ave., N.W., Washington 20036. (202) 466-8407.
- Krasnow, Erwin G.:** Kirkland, Ellis & Rose, 1776 K St., N.W., Suite 1100, Washington 20036. (202) 833-8400.
- Kraus, Rainer K.:** Koteen & Burt, 1000 Vermont Ave., N.W., Washington 20005. (202) 737-5566.
- Krause, Jeffrey Darwin:** 10929 Howland Dr., Reston, Va. 22091. (703) 960-0225.

Attorneys

Kreutzer, Arthur C.: 79 West Monroe St., Chicago 60603. (312) 372-5484.

Kuhmann, Edward J.: Renouf, McKenna & Polivy, 1532 16th St., N.W., Washington 20036. (202) 265-1807.

L

Lane, John D.: 1211 Connecticut Ave., N.W., Suite 700, Washington 20036. (202) 628-5923.

Lankler, Alexander: 3526 K St., N.W. Washington 20007. (202) 333-6500.

Laskey, John L.: Jackson, Laskey & Parkinson, 1828 L St., N.W., Washington 20036. (202) 466-8850.

Launer, Leland C.: 131 W. Wilshire Ave., Fullerton, Calif. 92632. (714) 871-8600.

Leader, Martin R.: Fisher, Wayland, Southmayd & Cooper, 1100 Connecticut Ave., N.W., Suite 730, Washington 20036. (202)659-3494.

Leadbetter, A. Dale: Stambler & Shrinky, 1737 DeSales St., N.W., Washington 20036. (202)347-0883.

LeDuc, Don R.: 305 Cheyenne Trail, Madison, Wisc. 53706.

Lehrhaupt, Charles M.: RCA Global Communications Inc., 60 Broad St., New York 10004. (212)363-2073.

Lerman, Steven Alman: McKenna, Wilkinson & Kitner, 1150 17th St., N.W., Washington 20036. (202) 296-1600.

Lessenco, Gilbert B.: Wilner & Scheiner, 2021 L St., N.W., Washington 20036. (202) 293-7800.

Leventhal, Norman P.: McKenna, Wilkinson & Kitner, 1150 17th St., N.W., Washington 20036. (202) 296-1600.

Levetown, Robert A.: AT&T, Room 2531, 195 Broadway, New York 10007. (212) 393-4268.

Levine, Robert E.: Gordon & Healy, 1821 Jefferson Place, N.W., Washington 20036. (202) 785-5020.

Levinson, Louis: 14 Overhill Rd., Bala-Cynwyd, Pa. 19004. (215)664-0180.

Levy, Harold S.: AT&T, 195 Broadway, New York 10007. (212) 393-9800.

Levy, Isaac D.: 1845 Walnut St., Philadelphia 19103. (215) 561-8800.

Levy, Joel H.: Cohn & Marks, 1920 L St., N.W., Washington 20036. (202) 293-3860.

Levy, Sherman: Misegades, Douglas & Levy, 1126 16th St., N.W., Washington 20036. (202)638-3833.

Lewis, Sandra J.: Cole, Zylstra & Raywid, 2011 Eye St., N.W., Washington 20006. (202)659-9750.

Lightstone, Ronald: Viacom International Inc., 345 Park Ave., New York 10022. (212)371-5300.

Lipton, Martin: Wachtell, Lipton, Rosen, Katz & Kern, 230 Park Ave., New York 10017. (212)889-4300.

Litvin, Fanny N.: 2800 Quebec St., N.W., Apt. 1022, Washington 20008. (202) 362-6614.

Lloyd, David H.: Arnold & Porter, 1229 19th St., N.W., Washington 20036. (202)872-6868.

Lloyd, Frank W.: Citizens Communications Center, 1914 Sunderland Place, N.W., Washington 20036. (202)296-4238.

Lockwood, Corwin R.: Hogan & Hartson, 815 Connecticut Ave., N.W., Washington 20006. (202)331-4522.

Loeffler, Robert H.: Covington & Burling, 888 16th St., N.W., Washington 20006. (202)293-3300.

Loevinger, Lee: Hogan & Hartson, 815 Connecticut Ave., N.W., Washington 20006. (202)331-4530.

Loftus, William Robert: Wilkinson, Cragun & Barker, 1735 New York Ave., N.W., Washington 20006. (202)833-9800.

Lothschuetz, John M.: United Telecommunications Inc., 1800 K St., N.W., Suite 1102, Washington 20006. (202)659-4600.

Lovett, Bruce E.: American Television & Communications, 1990 M St., N.W., Suite 680, Washington 20036. (202)872-0790.

Lovett, Lee G.: Pittman, Lovett, Ford & Hennessey, 1819 H St., N.W., Washington 20006. (202)293-7400.

Lubic, Robert Bennett: Alk & Lubic, 4710 41st St., N.W., Washington 20016. (202)362-6311.

Luedtke, J. Peter: Covington & Burling, 888 16th St., N.W., Washington 20006. (202)293-3300.

Lutzker, Arnold Paul: Dow, Lohnes & Albertson, 1225 Connecticut Ave., N.W., Washington 20036. (202)659-8200.

Lyon, Richard K.: 640 Federal Bar Bldg., 1819 H St., N.W., Washington 20006. (202)223-6300.

M

Mackes, John H.: Welch & Morgan, 900 17th St., N.W., Washington 20006. (202)296-5151.

Magee, James E.: Wilkinson, Cragun & Barker, 1735 New York Ave., Washington 20006. (202) 833-9800.

Maher, David W.: Kirkland & Ellis, 2900 Prudential Plaza, Chicago 60601. (312)726-2929.

Mahony, Sheila: Cable Television Information, 2100 M St., N.W., Washington 20037. (202)872-8888.

Mailoux, Pierre E.: 815 Bowen Bldg., Washington 20005. (202) 737-8154.

Malick, Gordon R.: Marmet Professional Corp., 1822 Jefferson Place, N.W., Washington 20036. (202)331-7300.

Mallyck, E. Theodore: Mallyck & Bernton, 1900 L St., N.W., Washington 20036. (202)466-2350.

Malone, William: 1120 Connecticut Ave., N.W., Suite 900, Washington 20036. (202)293-2837.

Malti, George M.: Farrand, Malti, Spillane & Cooper, Suite 2985, 555 California St., San Francisco 94104. (415)989-0680.

Manelli, Daniel J.: 4445 Yuma St., N.W., Washington 20016. (202)244-1711.

Marcus, Daniel: Wilmer, Cutler & Pickering, 1666 K St., N.W., Washington 20006. (202)872-6150.

Markel, Robinson: Skadden, Arps, Slate, Meagher & Flom, 919 Third Ave., New York 10017. (212) 371-6000.

Marks, Herbert E.: Wilkinson, Cragun & Barker, 1735 New York Ave., N.W., Washington 20006. (202) 833-9800.

Marks, Leonard H.: Cohn & Marks, 1920 L St., N.W., Washington 20036. (202)293-3860.

Marks, Richard D.: Dow, Lohnes & Albertson, 1225 Connecticut Ave., N.W., Washington 20036. (202)659-8200.

Marmet, Robert A.: Marmet Professional Corp., 1822 Jefferson Place, N.W., Washington 20036. (202)331-7300.

Marple, Jon: Dow, Lohnes & Albertson, 1225 Connecticut Ave., N.W., Washington 20036. (202)659-8200.

Martin, Charles F.: 32 Ave. of the Americas, New York 10013. (212)393-5345.

Martin, Frank J. Jr.: Sutherland, Asbill & Brennan, 1666 K St., N.W., Washington 20006. (202)872-7833.

Martin, George B.: 1725 K St., N.W., Washington 20006. (202)296-8285.

Martin, Harlan: Box 256, Hendersonville, Tenn. 37075. (615)824-6534.

Martin, Harry C.: Fletcher, Heald, Rowell, Kenehan & Hildreth, 1225 Connecticut Ave., N.W., Washington 20036. (202)659-9100.

Massie, William J. Jr.: 1900 Pennsylvania Ave., N.W., Washington 20006. (202)872-3486.

Matthews, John Duff: Dow, Lohnes & Albertson, 1225 Connecticut Ave., N.W., Washington 20036. (202)659-8200.

Matthews, Thomas C. Jr.: Wald, Harkrader, Nicholson & Ross, 1320 19th St., N.W., Washington 20036. (202)296-2121.

Maulson, Vernon C.: 1312 East Empire St., Bloomington, Ill. 61701. (309)829-8911.

May, Jerry C.: Glaser & Fletcher, 1150 17th St., N.W., Washington 20036. (202)872-0200.

McCabe, Thomas J.: Western Union International, 2100 M St., N.W., Suite 305, Washington 20037.

(202)872-0439.

McCarthy, G. Daniel: Bilger & Blair, 1730 M St., N.W., Washington 20036. (202) 659-4230.

McCarthy, Michael J.: Dow, Lohnes & Albertson, 1225 Connecticut Ave., N.W., Washington 20036. (202) 659-8200.

McClendon, B.B. Jr.: McClendon & McClendon, 903 Deposit Guaranty Bank Bldg., Jackson, Miss. 39201. (601)948-5656.

McCollister, Rolfe H.: McCollister, Belcher, McCleary & Fazio, 352 Florida, Baton Rouge, La. 70801. (504)348-5961.

McConaughy, George C.: George, Greek, King, McMahon & McConaughy, Columbus Center, 100 East Broad St., Columbus, 43215. (614)228-1541.

McCormick, Donald P.: GT&E Corp., 730 Third Ave., New York 10017. (212)551-1638.

McCoy, Craig S.: Cole, Zylstra & Raywid, 2011 Eye St., N.W., Washington 20006. (202)659-9750.

McCoy, John E.: Storer Bcstg Co., 1177 Kane Concourse, Bay Harbor Island, Miami Beach, Fla. 33154. (305)866-0211.

McDonald, Joseph F. Jr.: 1095 North Maddux Drive, Reno 89502. (702)322-0848.

McDowell, C. Blake: 500 First National Tower, Akron, Ohio 44308. (216)535-5711.

McFadden, Douglas Bruce: AT&T, 2000 L St., N.W., Suite 710, Washington 20036. (202)466-5554.

McGonagle, John Joseph Jr.: Mudge, Rose, Guthrie & Alexander, 1701 Pennsylvania Ave., N.W., Washington 20006. (202)298-5970.

McGuire, Timothy S.: RCA Global Communications Inc., 60 Broad St., New York 10004. (212) 363-2072.

McKaig, J. Carter: Hedrick & Lane, 1211 Connecticut Ave., N.W., Washington 20036. (202) 628-5923.

McKay, Lawrence J.: Cahill, Gordon & Reindell, 80 Pine St., New York 10005. (212)944-7400.

McKee, Robert E.: ITT Corp., 320 Park Ave., New York 10004. (212)752-6000.

McKenna, Francis G.: Renouf, McKenna & Polivy, 1532 16th St., N.W., Washington 20036. (202)265-1807.

McKenna, James A. Jr.: McKenna, Wilkinson & Kitner, 1150 17th St., N.W., Washington 20036. (202)296-1600.

McKenna, Robert B. Jr.: Wilkinson, Cragun & Barker, 1735 New York Ave., Washington 20006. (202) 833-9800.

McKerns, Charles J.: Dow, Lohnes & Albertson, 1225 Connecticut Ave., N.W., Washington 20036. (202) 659-8200.

McLeod, George R.: 2000 N St., N.W., Washington (202)223-2877.

McLeod, W.J. Jr.: Jefferies Blvd. & Washington St., Walterboro, S.C. 29488. (803) 549-6811.

McNelis, Charles A.: Welch & Morgan, 900 17th St., N.W., Washington 20006. (202) 296-5151.

McShane, James E.: 2436 Fontenelle Blvd., Omaha 68104. (402)553-0957.

Mellis, Joel P.: GT&E Service Corp., 730 Third Ave., New York 10017. (212)551-1618.

Mendenhall, Gregory B.: Shack & Mendenhall, 1730 Rhode Island Ave., N.W., Suite 413, Washington 20036. (202)293-5900.

Meurer, Raymond: 138 Duffield, Detroit 48201. (313)966-3327.

Meyer, Suzanne: Dow, Lohnes & Albertson, 1225 Connecticut Ave., N.W., Washington 20036. (202) 659-8200.

Meyers, Tedson J.: Peabody, Rivlin, Lambert & Meyers, 1150 Connecticut Ave. N.W., Washington 20036. (202) 457-1000.

Middlekauff, Roger D. Jr.: Carr, Bonner, O'Connell, Kaplan, Thompson & Diuguid, 1001 Connecticut Ave., N.W., Washington 20036. (202)659-4660.

Midlen, John H.: Midlen & Reddy, 1990 M St., N.W., Washington 20036. (202)659-5700.

Midlen, John H. Jr.: Midlen & Reddy, 1990 M St., N.W., Washington 20036. (202)659-5700.

- Millenbauch, Lew A.:** Cohen & Berfield, 41 State St., Albany, N.Y. 12207. (518) 434-6162.
- Miller, Charles A.:** Covington & Burling, 888 16th St., N.W., Washington 20006. (202) 293-3300.
- Miller, Glen L.:** Miller, Tolbert & Hirschauer, 216 Fourth St., Logansport, Ind. 46947. (219) 753-3195.
- Miller, Herbert D. Jr.:** Koteen & Burt, 1000 Vermont Ave., N.W., Washington 20005. (202) 737-5566.
- Miller, Herbert J. Jr.:** Miller, Cassidy, Larroca & Lewin, Suite 500, 1320 19th St., N.W., Washington 20036. (202) 293-6400.
- Miller, Lawrence M.:** Schwartz & Woods, 1325 18th St., N.W., Washington 20036. (202) 833-2350.
- Miller, Neville:** Miller & Schroeder, 4715 Berkeley Terrace, N.W., Washington.
- Miller, Reed:** Arnold & Porter, 1229 19th St., N.W., Washington 20036. (202) 872-6826.
- Miller, Samuel:** 944 Washington Bldg., Washington 20005. (202) 783-6811.
- Miller, Thormund A.:** Southern Pacific Communications Center, 1914 Sunderland Place, N.W., Washington 20036.
- Miller, William E.:** Steptoe & Johnson, 1250 Connecticut Ave., N.W., Washington 20036. (202) 223-4800.
- Minow, Newton N.:** Sidley & Austin, 1730 Pennsylvania Ave., N.W., Washington 20006. (202) 872-1730. One First National Plaza, Chicago 60670. (312) 329-5400.
- Mitchell, Lee M.:** Sidley & Austin, 1730 Pennsylvania Ave., N.W., Suite 1100, Washington 20006. (202) 872-1730.
- Mitnick, Judith A.:** Storer Broadcasting Co., 1220 19th St., N.W., Washington 20036. (202) 296-3340.
- Moates, G. Paul:** Sidley & Austin, 1730 Pennsylvania Ave., N.W., Washington 20006. (202) 872-1730. One First National Plaza, Chicago 60670. (312) 329-5400.
- Mode, Douglas G.:** 824 Connecticut Ave., N.W., Washington 20006. (202) 783-5646.
- Molovinsky, Gale:** National Association of Educational Broadcasters, 1346 Connecticut Ave., N.W., Washington 20036. (202) 667-6000.
- Monahan, James D.:** Dow, Lohnes & Albertson, 1225 Connecticut Ave., N.W., Washington 20036. (202) 659-8200.
- Monderer, Howard:** NBC, 1800 K St., N.W., Suite 610, Washington 20006. (202) 833-3600.
- Moore, Bruce P.:** 1633 Connecticut Ave., N.W., Washington 20009.
- Moore, Earle K.:** Moore, Berson & Lifflander, 555 Madison Ave., New York 10022. (212) 838-0600.
- Mordkofsky, Harold:** 2120 L St., N.W., Washington 20037. (202) 833-3050.
- Morgan, Edward P.:** Welch, Morgan & Kleindienst, 900 17th St., N.W., Washington 20006. (202) 296-5151.
- Morgan, William Vance:** Welch, Morgan & Kleindienst, 300 Farragut Bldg., 900 17th St., N.W., Washington 20006. (202) 296-5151.
- Moring, Frederick:** Morgan, Lewis & Bockius, 1140 Connecticut Ave., N.W., Washington 20036. (202) 872-5000.
- Morrell, Michael X.:** 600 New Hampshire Ave., N.W., Washington. (202) 965-4150.
- Morrissey, Joseph M.:** Welch, Morgan & Kleindienst, 900 17th St., N.W., Washington 20006. (202) 296-5151.
- Moser, John B.:** 875 N. Michigan Ave., Chicago 60611. (312) 266-8140.
- Mott, Harold E.:** Greyhound Tower, Suite 216, 111 West Clarendon Ave., Phoenix 85013. (602) 248-9111.
- Mott, William C.:** U.S. Independent Federal Assn., 1801 K St., N.W., Suite 1201, Washington 20006. (202) 872-1200.
- Moulton, Horace P.:** 1 Wall St., New York 10005. (212) 425-3000.
- Mulcahy, Charles C.:** Mulcahy & Gefke, S.C., 811 East Wisconsin Ave., Milwaukee 53202. (414) 278-7110.
- Mull, Archibald M. Jr.:** Mull & Mull, 715 Crocker Citizens Bank Bldg., 1007 7th St., Sacramento, Calif. 95814. (916) 443-4626.
- Mullen, William G.:** National Newspaper Assn., 491 National Press Bldg., Washington 20004. (202) 783-1651.
- Mullin, Eugene F.:** Mullin, Connor & Rhyne, 1000 Connecticut Ave. N.W., Washington 20036. (202) 659-4700.
- Mulvihill, Donald J.:** Cahill, Gordon & Reindel, 1819 H St., N.W., Washington 20006. (202) 223-3350.
- Muntzing, L. Manning:** LeBoeuf, Lamb, Leiby & MacRae, 1757 N St. N.W., Washington 20036. (202) 872-8668.
- Murphy, Eugene F.:** RCA Global Communications Inc., 60 Broad St., New York 10004. (212) 363-2071.
- Murphy, James A.:** Ogden, Ogden & Murphy, 1411 Fourth Ave. Bldg., Seattle 98101. (206) 622-2991.
- Murphy, Ronald A.:** Ogden, Ogden & Murphy, 1411 Fourth Ave. Bldg., Seattle 98101. (206) 622-2991.
- Murray, E.K.:** 512 Washington Bldg., Tacoma, Wash. 98402. (206) 383-1656.
- Murray, Michael Laurence:** 16 Rue Jean Jaures, F8 Versailles, Paris.
- Murray, Richard H.:** Oppenheimer, Brown, Wolff, Leach & Foster, W-1781 First National Bank Bldg., St. Paul 55101. (612) 227-7271.
- Murrell, William Jr.:** 1904 West Colonial Drive, Orlando, Fla. 32804. (305) 841-4174.
- Muscio, Umberto V.:** Muzak Corp., 100 Park Ave., New York 10017. (212) 889-1330.
- Myse, Daryal A.:** 1737 H St., N.W., Washington 20006. (202) 298-6010.

N

- Naftain, Alan Y.:** Koteen & Burt, 1000 Vermont Ave., N.W., Washington 20005. (202) 737-5566.
- Nalley, Lorie Molnar:** Economic Development Administration, Dept. of Commerce, 14th St. & Constitution Ave., Washington 22203. (202) 967-4867.
- Neu, James H.:** Kizer & Neu, 309 Legal Bldg., Plymouth, Ind. 46563. (219) 936-2160.
- Neustadt, Stanley S.:** Cohn & Marks, 1920 L St., N.W., Washington 20036. (202) 293-3860.
- Newell, Roger P.:** Wester Union International Inc., 26 Broadway, New York 10014. (212) 363-6400.
- Nomkin, Milton C.:** Communications Satellite Corp., 950 L'Enfant Plaza South, S.W., Washington 20024. (202) 554-6000.
- North, Ernest D.:** 51 Monte Vista Ave., Ridgewood, N.J. 07450. (201) 445-3670.

O

- Ockershausen, Harry J.:** Dempsey & Koplovitz, 938 Bowen Bldg., Washington 20006. (202) 737-6363.
- O'Connell, Peter D.:** Combined Communications Corp., Box 25518, Phoenix 85002. (602) 254-1333.
- O'Connell, Quinn:** 1000 Connecticut Ave., N.W., Washington 20036. (202) 659-5740.
- O'Hare, Richard C.:** 1511 K St., N.W., Washington 20005. (202) 783-7900.
- Olender, Robert L.:** Stambler & Shrinky, 1737 DeSales St., N.W., Washington 20036. (202) 347-0883.
- Oliver, Joseph M. Jr.:** Reavis, Pogue, Neal & Rose, 1100 Connecticut Ave., N.W., Washington 20036. (202) 293-2030.
- Oltarsh, Kenneth S.:** Solinger & Gordon, 250 Park Ave., New York 10017. (212) 687-1140.
- O'Neill, Edward S.:** Wilner & Scheiner, 2021 L St., N.W., Washington 20036. (202) 293-7800.
- Oppenheimer, Monroe:** Surrey, Karasik, Green & Hill, 1156 15th St., N.W., Washington 20005. (202) 659-9050.
- O'Reilly, Thomas J.:** Chadbourne, Parke, Whiteside & Wolff, 1150 17th St., N.W., Washington 20036. (202) 872-8050.
- Overgaard, Cordell J.:** One First National Plaza, Suite 5200, Chicago 60670. (312) 786-6638. •
- Overton, George W.:** 105 West Adams St., Chicago 60603. (312) 236-6954.
- Oyster, James L.:** Smith & Pepper, 1776 K St., N.W., Washington 20006. (202) 296-0600.

P

- Pantzer, Kurt F.:** 1313 Merchants Bank Bldg., Indianapolis 46204. (317) 638-1313.
- Papajohn, John N.:** Pittman, Lovett, Ford & Hennessy, 1819 H St., N.W., Washington 20006. (202) 293-7400.
- Parker, Ellis Jackson III:** Mount Pleasant, Upper Marlboro, Md. 20870. (301) 627-4487.
- Parker, Norman C.:** Flynn, Parker & Badaracco, 319 North Fourth St., St. Louis 63102. (314) 231-8282.
- Partoll, Alfred C.:** AT&T, 195 Broadway Room 2555, New York 10007.
- Paul, Ray R.:** Prince & Paul, 815 Bowen Bldg., Washington 20005. (202) 737-8154.
- Peck, Myron C.:** Law Offices of Daryal A. Myse, 1737 H St., N.W., Washington 20006. (202) 298-6010.
- Pellegrin, John D.:** Fletcher, Heald, Rowell, Kenehan & Hildreth, 1225 Connecticut Ave. N.W., Washington 20036. (202) 659-9100.
- Pepper, Vincent A.:** Smith & Pepper, 1776 K St., N.W., Washington 20006. (202) 296-0600.
- Perkins, Roy F. Jr.:** 1400 20th St., N.W., Washington 20036. (202) 872-0234.
- Perlberg, Jules M.:** Sidley & Austin, 1730 Pennsylvania Ave., N.W., Washington 20006. (202) 872-1730. One First National Plaza, Chicago 60670. (312) 329-5400.
- Perry, B. Dwight:** Dow, Lohnes & Albertson, 1225 Connecticut Ave., N.W., Washington 20036. (202) 659-8200.
- Perry, Larry D.:** Layton & Perry, 140 E. Division Rd., Box 461, Oak Ridge, Tenn. 37830. (615) 483-8474.
- Petrich, Louis P.:** Youngman, Hungate & Leopold, 1901 Avenue of the Stars, Suite 1530, Los Angeles 90067. (213) 277-3333.
- Pettit, John W.:** Hamel, Park, McCabe & Saunders, 1776 F St., N.W., Washington 20006. (202) 785-1234.
- Petty, Don:** Darling, Shattuck, Hall & Call, Box 817, Carpinteria, Calif. 93013. (805) 684-2829.
- Piemonte, Gabriel F.:** 231 Hanover St., Boston 02108. (617) 227-8380.
- Pierson, W. Theodore:** Pierson, Ball & Dowd, 1000 Ring Bldg., Washington 20036. (202) 331-8566.
- Pilafian, James:** Pilafian Bldg., 200 S.W. 2d Ave., Miami 33130. (305) 371-2773.
- Plotkin, Harry M.:** Arent, Fox, Kintner, Plotkin & Kahn, 1200 Federal Bar Bldg., 1815 H St., N.W., Washington 20006. (202) 347-8500.
- Polivy, Margot:** Renouf, McKenna & Polivy, 1532 16th St., N.W., Washington 20036. (202) 265-1807.
- Pollock, James C.:** 2600 Virginia Ave., N.W., Washington 20037 (202) 333-4500.
- Pond, Walter:** GT&E Service Corp., 730 Third Ave., New York 10017. (212) 551-1618.
- Popham, James J.:** NAB, 1771 N St., N.W., Washington 20036. (202) 293-3560.
- Posner, Gene:** 152 West Wisconsin Ave., Milwaukee 53203. (414) 276-7440.
- Potts, William J. Jr.:** Haley, Bader & Potts, 1730 M St., N.W., Washington 20036. (202) 659-7676.
- Powell, Robert D.:** Powell & Becker, 1156 15th St., N.W., Washington 20005. (202) 872-0190.
- Preston, John F. Jr.:** American Tel & Tel, 2530 195 Broadway, New York 10007. (212) 393-3721.
- Price, Milton D. Jr.:** Oliver, Gearin, Price & Melzarek, 305 Degree of Honor Bldg., St. Paul 55101. (612) 277-7577.
- Prokop, Ruth L.:** Tiber Island, 1257 Fourth St., S.W., Washington 20036. (202) 293-2800.
- Putbress, Keith E.:** 6800 Fleetwood Dr., McLean, Va. 22101. (703) 790-8844.

Attorneys

Putz, C. Deios Jr.: U of San Francisco, School of Law, San Francisco 94117. (415)665-4932.

Q

Quale, John C.: Kirkland, Ellis & Rowe, 1776 K St, N.W., Washington 20006. (202) 833-8400.

Quenstedt, Warren D.: 1212 LaRonde Court, Alexandria, Va. 22307. (703)765-5171.

Quisenberry, John T.: 372A Heritage Village, Southbury, Conn. 06488. (203)264-8018.

R

Rafter, John A.: Dow, Lohnes & Albertson, 1225 Connecticut Ave., N.W., Washington 20036. (202)659-8200.

Raish, L.R.: 8705 Waterford, Alexandria, Va. 22308. (703)360-4455.

Ramey, Carl R.: McKenna, Wilkinson & Kittner, 1150 17th St, N.W., Washington 20036. (202)296-1600.

Rawson, Robert J.: Fletcher, Heald, Rowell, Kenehan & Hildreth, 1225 Connecticut Ave., N.W., Washington 20036. (202)659-9100.

Raywid, Alan: Cole, Zylstra & Raywid, 2011 Eye St, N.W., Washington 20006. (202)659-9750.

Reams, Frazier: WCWA, 604 Jackson St., Toledo, Ohio 43604. (419) 248-2627.

Reams, Frazier Jr.: 604 Jackson St., Toledo, Ohio 43604. (419)248-2627.

Reddy, Edward B.: Midlen & Reddy, 1990 M St., N.W., Washington 20036. (202)659-5700.

Redmond, Daniel M.: Dow, Lohnes & Albertson, 1225 Connecticut Ave., N.W., Washington 20036. (202)659-8200.

Reed, Marjorie S.: Fletcher, Heald, Rowell, Kenehan & Hildreth, 1225 Connecticut Ave., N.W., Washington 20036. (202) 659-9100.

Reifer, Joseph R.: Cole, Zylstra & Raywid, 2011 Eye St., N.W., Washington 20006. (202)659-9750.

Reis, Harold F.: Lowenstein, Newman & Reis, 1100 Connecticut Ave., N.W., Washington 20036. (202) 296-7585.

Reiss, Philip S.: 500 Fifth Ave., New York 10036. (212) 564-3530.

Rennekamp, Kenneth E.: 304 Ross St., Pittsburgh 15219. (412)281-1365.

Renouf, Katrina: Renouf, McKenna & Polivy, 1532 16th St, N.W., Washington 20036. (202)265-1807.

Resnick, Leo: Board of Trade Bldg., 1129 20th St, N.W., Washington 20036. (202)659-9636.

Reyner, William S. Jr.: Hogan & Hartson, 815 Connecticut Ave., N.W., Washington 20006. (202)331-4510.

Rhyné, Charles S.: 839 17th St., N.W., Washington 20006. (202)331-4510.

Rhyné, S. White Jr.: Mulin, Connor & Rhyné, 1000 Connecticut Ave. N.W., Washington 20036. (202) 659-4700.

Ricks, Jay E.: Hogan & Hartson, 815 Connecticut Ave., N.W., Washington 20006. (202)331-4518.

Riley, James Patrick: Fletcher, Heald, Rowell, Kenehan & Hildreth, 1225 Connecticut Ave., N.W., Washington 20036. (202)659-9100.

Rivkin, Steven Robert: 910 17th St., N.W., Suite 608, Washington 20006. (202) 872-8172.

Robb, Scott Hall: NBC, 1800 K St., N.W., Washington 20006. (202)833-3600.

Roberge, William H. Jr.: Powell & Becker, 1156 15th St, N.W., Washington 20005. (202)872-0190.

Robbins, Charles E.: 1086 National Press Bldg., Washington 20004. (202)223-5554.

Roberts, John C.: Yale Law School, 127 Wall St, New Haven, Conn. 06520. (203)436-2211.

Roberts, L. Adrian: Dow, Lohnes & Albertson, 1225 Connecticut Ave., N.W., Washington 20036. (202)659-8200.

Robertson, Charles J.: Richard H. Chamberlain & Assocs, 3400 Spruce St., Philadelphia 19104. (215)662-3000.

Robinson, C. Ray: Box 2248, Merced, Calif. 95341. (209)722-6244.

Rocha, Juan Jr.: Herrera, Rocha & Segura Inc., 712 San Antonio Savings Bldg., San Antonio, Tex. 78205. (512)225-6191.

Rodgers, William Paul Jr.: National Association of Regulatory Utility Commissioners, 1102 ICC Bldg., Box 684, Washington 20044. (202)628-7324.

Rodin, Richard S.: Hogan & Hartson, 815 Connecticut Ave., N.W., Washington 20006. (202)331-4532.

Roessler, Ronald J.: The C&P Telephone Co. of W. Va., Room 208, 1500 MacCorkle Ave., S.E., Charleston, W. Va. 25314. (304)343-9911.

Roff, Frank: AT&T, 195 Broadway, Room 2555, New York 10007. (212)393-4811.

Roff, J. Hugh Jr.: 32 Ave. of the Americas, New York 10013. (212)393-6708.

Romanelli, Rosario P.: Western Union International Inc., 26 Broadway, New York 10004. (212) 363-6407.

Rosen, Jay M.: GT&E Information System Inc., Four Corporate Park Dr., White Plains, N.Y. 10604. (914)694-8840.

Rosenberg, Marvin: Fletcher, Heald, Rowell, Kenehan & Hildreth, 1225 Connecticut Ave., N.W., Washington 20036. (202)659-9100.

Rosenbloom, Joel: Wilmer, Cutler & Pickering, 1666 K St., N.W., Washington 20006. (202)872-6216.

Rosenbloom, Michael H.: Wilner & Scheiner, 2021 L St., N.W., Washington 20036. (202) 293-7800.

Ross, Wm. Warfield: Waid, Harkrader & Ross, 1320 19th St., N.W., Washington 20036. (202) 296-2121.

Rourke, Gerald S.: Welch & Morgan, 900 17th St., N.W., Washington 20006. (202)296-5151.

Rowell, Russell: Fletcher, Heald, Rowell, Kenehan & Hildreth, 1225 Connecticut Ave., N.W., Washington 20036. (202)659-9100.

Roycroft, Howard F.: Hogan & Hartson, 815 Connecticut Ave., N.W., Washington 20006. (202)331-4525.

Ruddy, Francis S.: Exxon Co., U.S.A., P.O. Box 2180, Houston 77001.

Russell, Percy H.: Kirkland, Ellis & Rowe, 1776 K St, N.W., Suite 1100, Washington 20006. (202)833-8400.

Russe, Roy R.: Cohn & Marks, 1920 L St., N.W., Washington 20036. (202)293-3860.

S

Samuelson, Derrick W.: ITT Corp., 320 Park Ave., New York 10022. (212) 752-6000.

Sandberg, John A.: Litton Systems Inc., 1770 Walt Whitman Rd., Melville, N.Y. 11746. (516)694-8300.

Sandoval, Ruben: 500 N. Main Ave., San Antonio, Tex. 78215. (215)224-1061.

Santorio, Edward J.: 304 Maple Ave., South Plainfield, N.J. 07080. (201)765-0785.

Saponaro, Frank P. Jr.: The Superior Oil Co., 909 R.C.A. Bldg., Washington 20006. (202)338-6663.

Sarver, James W.: C&P Telephone Co., 320 St. Paul Place, Baltimore 21202. (301)393-3408.

Satterfield, Lee A.: AT&T, 930 H St, N.W., Washington 20005. (202)392-5188.

Scalia, Antonin: Administrative Conference, 2120 L St., N.W., Washington 20037. (202)254-7020.

Scharff, J. Laurent: Pierson, Ball & Dowd, 1000 Ring Bldg., Washington 20036. (202)331-8566.

Schattenfield, Thomas: Arent, Fox, Kintner, Plotkin & Kahn, 1200 Federal Bar Bldg., 1815 H St., N.W., Washington 20006. (202)347-8500.

Scheiner, Arthur: Wilner & Scheiner, 2021 L St., N.W., Washington 20036. (202)293-7800.

Scheinman, Stanley B.: MCI Communications Corp., 1301 Ave. of the Americas, New York 10019. (212)582-6520.

Scher, Gerald: Amram, Han & Sundlun, 700 Colorado Bldg., Washington 20005. (202)783-3344.

Schildhouse, Sol: Farrow, Schildhouse & Dent, 1120 Connecticut Ave. N.W., Washington 20036. (202) 659-8746.

Schmidt, Richard M. Jr.: Cohn & Marks, 1920 L St., N.W., Washington 20036. (202)293-3860.

Schneider, Edwin R. Jr.: Main St., Blue Hill, Maine 04614. (207)374-2893.

Schochor, Jonathan: McKenna, Wilkinson & Kittner, 1150 17th St., N.W., Washington 20036. (202)296-1600.

Schoemer, John R. Jr.: Townley, Updike, Carter & Rogers, 200 East 42d St., New York 10017. (212)682-4567.

Schroeder, Arthur H.: Miller & Schroeder, 1225 Connecticut Ave., N.W., Washington 20036. (202)659-4400.

Schulhof, Hugh T.: American Tel & Tel, 2000 L St., N.W., Washington 20036. (202)466-3000.

Schulkind, Herbert M.: Fly, Shuebruk, Blume & Gaguine, 1211 Connecticut Ave., N.W., Washington 20036. (202)293-1282.

Schwartz, Alfred L.: Metromedia Inc., 277 Park Ave., New York 10017. (212)682-9100.

Schwartz, Lois Siegel: 1015 20th St. N.W., Washington 20036. (202) 296-3022.

Schwartz, Louis: Schwartz & Woods, 1325 18th St., N.W., Suite 206, Washington 20036. (202)833-2350.

Schwartzman, Andrew Jay: Office of Communication, United Church of Christ, 289 Park Ave. South, New York 10010. (212) 475-2121.

Score, John M.: Data Transmission Co., 1920 Aline Ave., Vienna, Va. 22180. (703)893-2450.

Scott, William Ralph: Box 2057, Stuart, Fla. (305)287-3303.

Seaks, Robert G.: 704 Southern Bldg., Washington 20005. (202)347-7117.

Sedky, Cherif: Hill, Christopher & Phillips, 2000 L St., N.W., Washington 20036. (202)833-3990.

Segal, Bernard G.: Schnader, Harrison, Segal & Lewis, 1719 Packard Bldg., Philadelphia 19102. (215)491-0405.

Segal, Irving R.: Schnader, Harrison, Segal & Lewis, 1719 Packard Bldg., Philadelphia 19102. (215)491-0420.

Seligman, Harold: Parkway Towers, Suite 1704, 404 James Robertson Parkway, Nashville 37219. (615)244-7996.

Sells, Harry G.: Sells & Gregory, 2000 L St., N.W., Washington 20036. (202) 659-3480.

Semler, H. Michael: Wilkinson, Cragun & Barker, 1735 New York Ave., N.W., Washington 20006. (202)833-9800.

Shack, Thomas G. Jr.: Shack & Mendenhall, Suite 413, 1730 Rhode Island Ave., N.W., Washington 20036. (202)293-5900.

Shannon, Charles V.: 1700 K St., N.W., Washington 20006. (202) 296-4150.

Shapiro, George H.: Arent, Fox, Kintner, Plotkin & Kahn, 1200 Federal Bar Bldg., 1815 H St., N.W., Washington 20006. (202)347-8500.

Shelesky, Raymond J.: Christensen & Shelesky, 10560 Main St., Fairfax, Va. 22030. (703)273-4573.

Sherl, Bernard: 342 Madison Ave., New York 10017. (212)986-6282.

Shertzer, George Edwin: GT&E Corp., 730 Third Ave., New York 10017. (212)551-1636.

Shields, Daniel W.: Tele-Communications Inc., Box 10727, Univ. Park Stn., Denver 80210. (303)771-8200.

Shmanda, Theodore A.: 801 N. Pitt St., Apt. 1104, Alexandria, Va. 22314. (703)548-6891.

Shott, Ned E.: 412 Bland St., Bluefield, W. Va. 24701. (304)327-6171.

Shrinsky, Jason L.: Stambler & Shrinsky, 1737 DeSales St., N.W., Washington 20036. (202) 347-0883.

Shubert, Lee W.: Bilger & Blair, 1730 M St., N.W., Washington 20036. (202) 659-4230.

Shuebruk, Peter: Fly, Shuebruk, Blume & Gaguine, 45 Rockefeller Plaza, New York 10020. (212)247-3040.

Shute, John V.: NBC, 30 Rockefeller Plaza, New York 10020. (212)247-8300.

Siegel, Ronald A.: Cohn & Marks, 1920 L St., N.W., Washington 20036. (202)293-3860.

Silva, James R.: Highways License Bldg., Olympia, Wash. 98504.

Silver, Harry R.: Arent, Fox, Kintner, Plotkin & Kahn, 1200 Federal Bar Bldg., 1815 H St., N.W., Washington 20006. (202) 347-8500.

Sims, William P.: Dow, Lohnes & Albertson, 1225 Connecticut Ave., N.W., Washington 20036. (202)659-8200.

Sinel, Norman Mark: Public Bcstg Svcs, 955 L'Enfant Plaza S.W., Washington 20004. (202)484-9500.

Singman, Julian H.: 1910 Sunderland Place, N.W., Washington 20036. (202)785-2020.

Skall, Gregg P.: Office of Telecommunications Policy, Washington 20504. (202) 395-5615.

Slater, Terrence L.: ITT, 1707 L St., N.W., Washington 20036. (202)296-6000.

Slaughter, Harrison T.: Pierson, Ball & Dowd, 1000 Ring Bldg., Washington 20036. (202)331-8566.

Sletteiland, Greggar P.: Zenith Radio Corp., 1900 North Austin Blvd., Chicago 60639. (312)745-5137.

Smith, Eric H.: Public Broadcasting Service, 485 L'Enfant Plaza West, S.W., Washington 20024. (202)488-5057.

Smith, E. Stratford: Smith & Pepper, 1776 K St., N.W., Washington 20006. (202)296-0600.

Smith, Eugene T.: National Press Bldg., 1346 F St., N.W., Washington 20004. (202)347-2363.

Smith, George S.: Marmet Professional Corp., 1822 Jefferson Place, N.W., Washington 20036. (202)331-7300.

Smith, John Gordon: 815 15th St., N.W., Washington 20005. (202) 737-8154.

Smith, John J.: McKenna, Wilkinson & Kittner, 1150 17th St., N.W., Washington 20036. (202) 296-1600.

Smithwick, Gary S.: Smithwick & Bond, 1036 National Press Bldg., Washington 20045. (202) 737-0300. 409 First Center Bldg., 2000 W. First St., Winston-Salem, N.C. 27104. (919) 724-3975, 727-1255.

Socolow, A. Walter: 660 Madison Ave., New York 10021. (212) 757-2112.

Solinger, David M.: Solinger & Gordon, 250 Park Ave., New York 10017. (212)687-1140.

Solomon, Henry A.: Haley, Bader & Potts, 1730 M St., N.W., Suite 700, Washington 20036. (202)659-7676.

Solomon, Richard A.: Wilner & Scheiner, 2021 L St., N.W., Washington 20036. (202)293-7800.

Southmayd, John P.: Fisher, Wayland, Southmayd & Cooper, 1100 Connecticut Ave., N.W., Suite 730, Washington 20036. (202)659-3494.

Sovick, Laurence: 200 Empire Bldg., Syracuse, N.Y. 13202. (315)474-2911.

Sparks, Kenneth R.: Federal City Council, 1155 15th St., N.W., Washington 20005. (202)223-4560.

Spawn, Coy U. Jr.: 733 Bankers Mortgage Bldg., Houston 77002. (713)222-0105.

Spencer, Lewis D.: 9401 West Grand Ave., Franklin Park, Ill. 60131. (312) 451-1000.

Spievak, Edwin B.: Cohn & Marks, 1920 L St., N.W., Washington 20036. (202)293-3860.

Spillane, Lester W.: Suite 2985, Bank of America Center, 555 California St., San Francisco 94104. (415) 989-0680.

Sprague, E. Stuart: Heritage 212B, Southbury, Conn. 06488. (203)264-6492.

Sprinkle, Dane O.: GT&E Service Corp., 1120 Connecticut Ave., N.W., Room 900, Washington 20036. (202)337-6600.

Stambler, Arthur: Stambler & Shinsky, 1737 DeSales St., N.W., Washington 20036. (202)347-0883.

Stanley, Earl R.: Dow, Lohnes & Albertson, 1225 Connecticut Ave., N.W., Washington 20036. (202) 659-8200.

Steen, John W.: Westinghouse Broadcasting Co., 200 Park Ave., New York 10017. (212) 692-7822.

Steadman, Frank M. Jr.: Chesapeake & Potomac Telephone Cos., 1710 H St., N.W., Washington 20006.

Stegemann, Edward J.: Welch & Morgan, 900 17th St., N.W., Farragut Bldg., Washington 20006. (202)296-5151.

Stein, Abe L.: 1129 Munsey Bldg., 1329 E St., N.W., Washington 20004. (202)737-7944.

Stein, Robert J.: Citizens Communications Center, 1812 N St., N.W., Washington 20036. (202)296-4238.

Sternbach, Paul N.: Burns, Van Kirk, Greene & Kafer, 521 5th Ave., New York 10017. (212)972-0500.

Stevens, David S.: McKenna, Wilkinson & Kittner, 1150 17th St., N.W., Washington 20036. (202)296-1600.

Stewart, John I.: Jones, Day, Reavis & Pogue, 1100 Connecticut Ave., N.W., Washington 20015. (202) 452-5835.

Stich, Lawrence R.: IBM Corp., 18100 Frederick Park, Gaithersburg, Md. 20760. (301)840-7465.

Strauss, Samuel W.: 115 North Fourth St., Camden, N.J. 08102. (609)963-3006.

Strodel, Richard H.: Wheeler & Wheeler, 704 Southern Bldg., Washington 20005. (202)347-7117.

Struck, William L.: 501 Harries Bldg., Dayton, Ohio 45402. (513)224-7058.

Sujack, Edwin T.: 130 East Randolph St., Chicago 60601. (312)726-2929.

Summers, John B.: NAB, 1771 N St., N.W., Washington 20036. (202)293-3500.

Sunderland, Louise A.: 1776 F St. N.W., Washington 20006. (202) 785-1234.

Sundlun, Bruce G.: Amram, Hahn & Sandground, 700 Colorado Bldg., Washington 20005. (202)783-3344.

Sutton, George O.: 1038 National Press Bldg., Washington 20004. (202)628-7949.

Swados, Robert: 70 Niagara St., Buffalo, N.Y. 14202. (716)856-4600.

Sweeney, Walter H.: Welch & Morgan, 900 17th St., N.W., Washington 20006. (202) 296-5151.

Swezey, Robert D.: Route 1, Purcellville, Va. 22132. (703)668-5492.

Swift, Richard F.: Dow, Lohnes & Albertson, 1225 Connecticut Ave., N.W., Washington 20036. (202) 659-8200.

T

Tannenwald, Peter: Arent, Fox, Kintner, Plotkin & Kahn, 1200 Federal Bar Bldg., 1815 H St., N.W., Washington 20006. (202)347-8500.

Taptich, Edward R.: McKenna, Wilkinson & Kittner, 1150 17th St., N.W., Washington 20036. (202) 296-1600.

Taylor, Ray L.: 11608 Chayote St., Los Angeles 90049. (213) 476-6493.

Taylor, Willis H.: 330 Madison Ave., New York 10017. (212) 986-8686.

Thornton, Gerald D.: Meredith Corp., 1716 Locust St., Des Moines, Iowa 50303. (515)284-9397.

Throop, Allen E.: Suite 1120, Investment Bldg., 1511 K St., N.W., Washington 20005. (202)738-7900.

Tierney, John L.: Gammon & Tierney, 1925 K St. N.W., Washington 20006. (202) 293-7979.

Tiffany, Curran C.: AT&T, 2000 L St., N.W., Washington 20036. (202)466-5593.

Tighe, M. Joan: 454 North Oakhurst Dr., Beverly Hills, Calif. 90210.

Tijerina, Pete: 302 International Bldg., San Antonio, Tex. 78205. (512)224-6552.

Tillotson, David F.: Arent, Fox, Kintner, Plotkin & Kahn, 1200 Federal Bar Bldg., 1815 H St., N.W., Washington 20006. (202)347-8500.

Timberg, Sigmund: 815 15th St., N.W., Washington 20005. (202)392-1074.

Toohy, Daniel Weaver: Dow, Lohnes & Albertson, 1225 Connecticut Ave., N.W., Washington 20036. (202)659-8200.

Traum, Jerome S.: Janklow & Traum, 375 Park Ave., New York 10022. (212)421-1700.

Tresnor, James Aloysius: Dow, Lohnes & Albertson,

1225 Connecticut Ave., N.W., Washington 20036. (202) 659-8200.

Trionens, Howard J.: Sidley & Austin, 1730 Pennsylvania Ave., N.W., Washington 20006. (202) 872-1730. One First National Plaza, Chicago 60670. (312) 329-5400.

Trufelli, Arthur W.: RCA Global Communications, 60 Broad St., New York 10004. (212)363-7434.

Trunk, Carl F. Jr.: NBC, Room 626, 30 Rockefeller Plaza, New York 10020. (212) 247-8300.

Tuft, Leonard W.: RCA Global Communications Inc., 2030 M St., N.W., Washington 20036. (202) 558-4422.

Tumulty, Joseph Jr.: RCA Global Communications, 2030 M St., N.W., Washington 20036. (202) 558-4422.

Turner, John Alfred Jr.: 1700 Walnut St., Suite 200, Philadelphia.

U

Ulman, Lewis H.: Southern New England Telephone Co., 227 Church St., New Haven, Conn. 06506. (203)771-2191.

V

Valder, Michael J.: Antioch School of Law, Suite 509, 1145 19th St., N.W., Washington 20036. (202)833-1700.

Valentine, Franklin R. Jr.: 245 Park Ave., New York 10017. (212)972-6716.

Veeder, Peter G.: Thorp, Reed & Armstrong, 2900 Grant Bldg., Pittsburgh 15219. (412)391-1780.

Verrill, Charles O. Jr.: 1200 17th St., N.W., Washington 20036. (202)223-4040.

Voelker, Richard L. Jr.: Voelker & Jeffers, 620 First National Bank of Commerce Bldg., New Orleans 70112. (504)581-7471.

Vogel, George T.: Western Union Telegraph Co., 70 Parkway North, Yonkers, N.Y. 10704. (914)476-0874.

Volner, Ian David: Cohn & Marks, 1920 L St., N.W., Washington 20036. (202)293-3860.

W

Wadlow, Raymond C.: Hogan & Hartson, 815 Connecticut Ave., N.W., Washington 20006. (202) 331-4500.

Wald, Robert L.: Wald, Harkrader & Ross, 1320 19th St., N.W., Washington 20036. (202)296-2121.

Wall, Thomas H.: 1830 Jefferson Place N.W., Washington 20036. (202) 833-1717.

Wallach, Don H.: Seeburg Industries Inc., 767 Fifth Ave., New York 10022. (212)751-5300.

Walsh, Francis Richard: School of Law, U. of San Francisco, Golden Gate & Parker Ave., San Francisco 94117. (415)752-1000.

Walton, Frederick H. Jr.: Dempsey & Koptovitz, 938 Bowen Bldg., Washington 20005. (202)737-6363.

Ward, Donald E.: Fly, Shuebruk, Blume & Gaguine, 1211 Connecticut Ave., N.W., Washington 20036. (202)293-1282.

Warner, Harry P.: 1900 Ave. of the Stars, Suite 2440, Los Angeles 90067. (213) 277-3528.

Wasilewski, Vincent T.: NAB, 1771 N St., N.W., Washington 20006. (202) 293-3500.

Watson, Keith S.: Wald, Harkrader & Ross, 1320 19th St., N.W., Washington 20006. (202)296-2121.

Watson, William Wood: 1710 H St., N.W., Washington 20006. (202)392-8511.

Wayland, Charles V.: Fisher, Wayland, Southmayd & Cooper, 1100 Connecticut Ave., N.W., Washington 20036. (202)659-3494.

Weaver, Henry B. Jr.: Atlantic Richfield Co., 717 Fifth Ave., New York 10022. (212)758-2345.

Webber, Paul R. III: Dolphin, Branton, Stafford and Webber, 666 11th St., N.W., Washington 20001.

Wegmann, Edward F.: 1047 National Bank of Commerce Bldg., New Orleans 70112. (504)524-0732.

Weinberg, Arthur V.: Smith & Pepper, 1776 K St., N.W., Washington 20006. (202) 296-0600.

Attorneys, Research Services

Weissman, William R.: Wald, Harkrader & Ross, 1320 19th St., N.W. Washington 20036. (202) 296-2121.

Weisswasser, Stephen A.: Wilmer, Cutler & Pickering, 1666 K St., N.W., Washington 20006. (202)872-6153.

Welch, Francis X.: Suite 502, 1828 L St., N.W., Washington 20036. (202)628-3080.

Welch, Vincent B.: Welch, Morgan & Kleindienst, 900 17th St., N.W., Washington 20006. (202) 296-5151.

Wels, Richard H.: 18 East 48th St., New York 10017. (212)689-6450.

Werner, Jack: Suite 1001, 1828 L St., N.W., Washington 20036. (202)296-5321.

Werner, Robert L.: RCA, 30 Rockefeller Plaza, New York 10020. (212)265-5900.

Weston, Tracy Andrew: Public Communications Inc., 10203 Santa Monica Blvd., Fifth Floor, Los Angeles 90067. (213)879-5268.

Wheeler, George Y. III: Koteen & Burt, 1000 Vermont Ave., N.W., Washington 20005. (202) 737-5566.

White, Curtis T.: Citizens Communications Center, 1914 Sunderland Pl., N.W., Washington 20036. (202)296-4238.

White, Howard A.: ITT World Communications, 67 Broad St., New York 10004. (212)797-3300.

Whitesell, John P.: Box 1034, Iowa Falls, Iowa 50126. (515)648-2547.

Whittaker, Alfred W.: C&P Tel. Co. of Va., 703 East Grace St., Richmond, Va. 23219. (804)772-3104.

Whol, Edward R.: AT&T, 32 Ave. of the Americas, New York 10013. (212)393-6617.

Wilkinson, Glen A.: Wilkinson, Cragun & Barker, 1735 New York Ave., N.W., Washington 20006. (202)833-9800.

Wilkinson, Vernon L.: McKenna, Wilkinson & Kiltner, 1150 17th St., N.W., Washington 20036. (202)296-1600.

Wilner, John R.: Wilner & Scheiner, 2021 L St., N.W., Washington 20036. (202)293-7800.

Wilner, Morton H.: Wilner & Scheiner, 2021 L St., N.W., Washington 20036. (202)293-7800.

Wilson, James I.: Price & Paul, 815 15th St., N.W., Washington 20004. (202)737-8154.

Wilson, Thomas W.: Dow, Lohnes & Albertson, 1225 Connecticut Ave., N.W., Washington 20036. (202) 659-8200.

Winkler, Ronald L.: Sutherland, Asbill & Brennan, 1666 K St., N.W., Washington 20006. (202)872-7800.

Wittenberg, Ralph K.: First National Bank Bldg., 1 East First St., Reno 89501. (702)323-1311.

Wollenberg, J. Roger: Wilmer, Cutler & Pickering, 1666 K St., N.W., Washington 20006. (202) 872-6220.

Woods, Robert A.: 1325 18th St., N.W., Suite 206, Washington 20036. (202) 833-2350.

Woods, Warren: Wilson, Woods & Villalun, Suite 1032, Pennsylvania Bldg., 425 13th St., N.W., Washington 20004. (202)628-4600.

Woodworth, Ramsey L.: Hedrick & Lane, 1211 Connecticut Ave., N.W., Washington 20036. (202) 628-5923.

Wyatt, Wilson W.: Marion E. Taylor Bldg., Louisville, Ky. 40202. (502)582-1881.

Y

Yaroschuk, Michael S.: Harold E. Kohn, P.A., 1776 K St., N.W., Washington 20006. (202) 293-7110.

Yarrington, Hugh James: Wilkinson, Cragun & Barker, 1616 H St., N.W., Washington 20006. (202)628-4400.

Young, Francis Leo: National League of Cities/I.S. Conference of Mayors, 1620 Eye St., N.W., Room 222, Washington 20006. (202)293-7570.

Young, Lloyd D.: Chadbourne, Parke, Whiteside & Wolff, 1150 17th St., N.W., Washington 20036. (202)872-8050.

Z

Zaragoza, Richard R.: Fisher, Wayland, Southmayd & Cooper, 1100 Connecticut Ave., N.W., Washington 20036. (202)659-3494.

Zeger, Warren Yale: RCA Global Communications Inc., 60 Broad St., New York 10004. (212) 363-7436.

Zeglis, John D.: Sidley & Austin, 1730 Pennsylvania Ave., N.W. Washington 20006. (202) 872-1730. One First National Plaza, Chicago 60670. (312) 329-5400.

Zelfang, Donald P.: National Assn. of Broadcasters, 1771 N St., N.W., Washington 20036. (202)293-2152.

Zorbaugh, Geraldine: 61 West 9th St., New York 10011. (212) 477-7517.

Zwicky, Warren C.: Storer Broadcasting Co. 1220 19th St. N.W., Washington 20036. (202) 296-3340.

Zylstra, Roger E.: Cole, Zylstra & Raywid, 2011 Eye St., N.W., Washington 20006. (202)659-9750.

Research Services

Arbitron, American Research Bureau. 1350 Ave. of the Americas, New York 10019. Theodore F. Shaker, pres. (212)262-5032; A.J. Aurichio, VP mktg planning & dev (212)262-5017; John A. Fawcett, VP Arbitron radio stn sls & mktg (212)262-5164; Gerald Flesher, VP adv. prom. PR (212)262-5133; Norman S. Hecht, VP gen mgr Arbitron TV (212)262-5180; William T. McClenaghan, VP gen mgr Arbitron radio (212)262-5020; Pierre Megroz, VP Arbitron TV stn sls & mktg (212)262-5161; Joel K. Schwartz, VP Arbitron radio agency/advertiser sls (212) 262-5175; Richard Weinstein, VP Arbitron agency/advertiser sls & mktg (212)262-5288.

Chicago 60611: 1408 Tribune Tower (312)467-5750. Barbara C. Czachorski, midwest mgr Arbitron agency/advertiser sls; James E. Mocaraki, midwest mgr, Arbitron TV stn sls; Steve Templeton, midwest mgr, Arbitron radio stn sls.

Atlanta 30309: 1375 Peachtree St., N.E. (404)892-7866. Douglas M. Grimm, southern mgr Arbitron TV; G. William Sheridan, southern mgr Arbitron radio.

Dallas 75205: 5327 N. Central Expressway. (214)522-2470. Paul Kelly, southern dir Arbitron TV/radio sls.

San Francisco 94104: 425 California St. (415)391-1702. Ronald H. Laufer, northwest mgr Arbitron TV/radio sls.

Los Angeles 90010: 4311 Wilshire Blvd. (213)937-6420. William N. Shafer, VP western Arbitron TV stn sls; Clay Braun, western mgr Arbitron radio stn sls; Gary B. Lieberthal, western mgr Arbitron agency/advertiser sls.

Beltville, Md. 20705: 4320 Amundale Rd. Larry E. Manuet, VP gen mgr opns/prom (301)595-4611; Rupert R. Ridgeway, VP rsch (301)595-4617; Sherm Brodey, dir communications (301)595-4667; Richard Gaspell, mgr client svcs (301)595-4644.

Audit Bureau of Circulations. 123 N. Wacker Dr., Chicago 60606. (312) CEntal 6-7994. Alan T. Wolcott, pres-mngn dir; Howard W. Kutz, VP-asst mngn dir.

New York: 420 Lexington Ave. 10017. (212)532-8992. C.H. Hudders Jr., VP-mgr, eastern member svc ofc.

Toronto: 335 Bay St. M5H 2R3. (416)366-6340.

Cooperative association of 4,000 advertisers, advertising agencies and publishers for verification and reporting of circulation and other data of newspapers and periodicals.

Axiom Market Research Bureau Inc. 420 Lexington Ave., New York 10017. (212)725-2265. Timothy Joyce, pres; Alain Tessier, dir client svcs; Sylvia Cassel, computer svcs; Avery Gibson, TV & radio svcs; Don McGlathery, rsch & dev svcs; Martha Riesen, opns; Usha Mirchandani, admin.

Measures viewing audience, viewer involvement, covers adult network programs; measures viewing by dayparts. Furnishes year-around measurements.

BBM Bureau of Measurement 120 Eglinton Ave. East, Toronto M4P 1E3 (416) 486-5055. Peter R. Jones, pres; Don Harwood, VP & Dir of Surveys; Ken J. Purdy, VP rsch & dev; Charles J. Follett, sec-treas.

Measures radio-TV in Canada; locally, regionally and nationally using personal diary only.

Broadcast Advertisers Reports Inc. 500 Fifth Ave., New York 10036. (212)221-2630. Robert W. Morris, pres; Pro Sherman, VP bcst rel; David Thurston, exec VP.

Production and sls svc center: Darby, Pa. 19023. Chestnut at Fifth St. (212)221-2362 or (215)534-3030. Phil Edwards, chmn, publisher; Marion Dempsey, VP, sls svc.

Monitors TV and radio networks, plus spot TV in 75 markets. Industry source of broadcast expenditures by advertiser. Provides transcript service.

Broadcast Economic Trends 1234 Board of Trade Bldg., Kansas City, Mo. 64105. (816) 471-1979.

Computerized monitoring of advertising economy and forecasting future trends in radio-TV are offered; in addition a newsletter analyzing key activity in advertising and broadcasting is planned.

Broadcast Information Bureau Inc. 30 E. 42 St., New York 10017. (212) 687-1668. Harvey Sestowski, publisher & pres; Avra Fliegelman, VP & editor-in-chief.

Broadcast News Service. 523 Statler Ofc. Bldg., Boston 02116. (617)426-8414. R.J. Romano, dir. Public opinion research.

Broadcast Pro-File. Box 982, Hollywood 90028.

Researches and writes broadcast station history profiles. Also provides other broadcasting research information.

Broadcast Service Bureau Inc. Box 5974, Washington 20014. (301) 654-8531. Burr N. Edwards, pres.

Supplies rules and standards to radio and TV.

R.H. Bruskin Assoc. 303 George St., New Brunswick, N.J. 08903. (201)249-1800; New York (212)944-7023. Richard Bruskin, chmn; Marvin Baiman, pres; Fred Boyes, VP; Robert Golden, VP; Charles Lemonick, VP; Joel Brown, VP; Sidney Rowland, proj dir; Rae Feldman, proj dir; Jeff Scott, proj dir; Louise Sheridan, proj dir.

Major media studies, radio-TV station image studies, diary listening studies, before and after effectiveness studies, program evaluation studies, license renewal public interest studies, program concept studies, news program research, performance evaluation.

Bruskin International. Same headquarters as R.H. Bruskin Assoc. (above).

Canadian Facts Co. Ltd. 160 Bloor St. East, Toronto M4W 1C2. (416)924-5751. G.R. Enns, pres; FS. Lyman, chmn; J.A. Lynn, Miss P. Gray, M.A. LoPresti, D.G. McGrath, all VPs.

Montreal: 1375 Sherbrooke St. W. (512)842-1734. FS. Lyman, chmn.

Vancouver: Regional Marketing Services Limited, 510 W. Hastings St. (604)688-9588. RC. Forward, VP.

Ottawa: 130 Albert St., Suite 416, Ottawa. (613)232-0812. Miss Susan O'Hara.

Canadian marketing and opinion research.

Mark Clements Research Inc. 516 Fifth Ave., New York 10036. (212) Murray Hill 2-7455. Mark Clements, pres; E.L. Reiter, VP.

Marketing, management, sales & product research consultants; economic and programing studies for TV and radio.

ComQuest Corp. 1000 Elwell Court, Palo Alto, 94303. (415) 969-4040. Susan Gale, pres.

Provides information services in telephone and telegraph, data communications, CATV and CCTV, specialized common carriers, satellite communications interconnect, broadband radio and TV and mobile radio and paging.

Dr. Charles Connolly. 1204 Arizona Ave., Ames, Iowa 50010. (515)292-4384. Dr. Charles Connolly, exec dir; Anne H. Connolly, gen mgr; Fran Comstock, audience analysis supvr.

License renewal public ascertainment of community needs; audience & program analysis; "spot ratings" of selected programs (7 day results); cable surveys.

Roger Cooper & Associates 5885 Sycamore Hill Rd., Newcastle, Calif. 95658. (916)663-2828. Roger N. Cooper, pres.

Marketing and research counsel to broadcasters. Development and implementation of research-oriented marketing strategy. Economic studies.

Crossley Surveys Inc. 909 Third Ave., New York 10022. (212) 752-4100. Franklin B. Leonard, pres; Robert D. Cabell, exec VP; Staats M. Abrams, sr VP.

Marketing, opinion, media research services. Consumer, industrial, commercial surveys. Nationwide

employe interviewing staff available separately. National probability sample experimental design, statistical analysis, sales auditing.

Dimensions Unlimited 2816 Rowena Ave., Los Angeles 90039. (213) 666-1406. Deborah Gonderit, pres; Terry D'Angona, exec VP; Ed Poole, VP s/nr; Peggy Deming, field supvr.

Full service media/marketing research, local and national. Station audience profiles, attitudinal studies, license renewals, customized research. Publishers of *The Source*, syndicated radio audience measurement.

The Eloise Co. 11 West Main St., Moorestown, N.J. 08057. (609) Belmont 4-0070. Eloise M. Kocyan, pres; George H. Kocyan Jr., VP. Moorestown, N.J. 08057; (609)235-7999. Kingston, Pa. 18704; (717)288-0813.

Essary Research Assoc. (ERA) Box 3656, Los Angeles 90028. (213) 876-5974. Dr. Roderick A. Bell, pres; Gayle Essary, dir; Bernice Borak, assoc. dir.

Community ascertainment surveys for FCC license renewal; public opinion polls for news departments; audience and marketing survey projects.

Melvin A. Goldberg, Inc./Communications 347 Madison Ave., New York 10017. (212)685-8868. Melvin A. Goldberg, pres; Norma N. Goldberg, VP.

Consultation and research, radio, TV, CATV. Program testing, news and personalities, station image. Qualitative and quantitative research. Economic analyses and forecasting.

Guide-Post Research Inc. 301 Fifth Ave. Bldg., Pittsburgh 15222. (412)281-6332. Mary Ann Krem-pasky, dir; Tom Bigelow, VP mktg.

William R. Hamilton & Staff Inc. 4000 Albermarle St., N.W., Washington 20016. (202)362-8566. William R. Hamilton, pres; Anne Thibault, exec VP.

New York 10002. 215 E. 51st St. (212) 751-0134. Ed Matteson, mgr. Denver 80202. 1407 Larimer St. (303) 825-6199. Glenn Newkirk, mgr.

Surveys of radio-TV station images, news personalities and newscast elements, programing preferences, audience flow and loyalty, community ascertainment, program concepts; survey research techniques applied to on-air coverage of issue concerns; quarterly National Opinion Survey of U.S. public and leadership; custom marketing and opinion research.

C.E. Hooper, Inc. 566 E. Boston Post Rd., Mamaroneck, N.Y. 10543. (914)698-0800. Robert S. Kniffin, gen mgr.

Radio audience research for programing and sales; audience ratings and custom studies; telephone custom broadcast research and low cost screening.

Human Factors. Camelot Rd 2, Florida, Mass. 01247. (413)663-6060. Joseph L. Levit, PhD, dir; Robert A. Levit, PhD, consult.

Research, design, development & testing of behaviorism, acceptance & compatibilities of earth humans with manufactured and natural products.

I.D.C. Services Inc. 150 E. Huron St., Chicago 60611. (312)943-7500. Paul Roth, pres; John Fletcher, tech dir; Sterling "Red" Quinlan, dir bcast svcs; Lee Weston, VP mktg; Donald Crosslet, VP financing. New York: 600 Madison Ave., 10022. (212)758-7220.

Digiconics offers information to the television industry: Teleprof services, broadcast services and talent and residuals service.

The Information Source. 1709 West Eighth St., Los Angeles 90017. (213)484-1464. Les Estrin, pres; Catherine Tyrrell, mgr. info consults.

Efficient research of existing info. Comprehensive, on-premise collection of published and non-published marketing, adv and bus info covering full spectrum of business world.

Herbert Kay Research Inc. 33 North Fullerton Ave., Montclair, N.J. 07042. (201)746-3303. Dr. Herbert Kay, pres.

Market Data Associates 217 W. 13th St., Pueblo, Colo. 81003. (303) 544-3056. W.H. Welch, dir; B.L. Welch, statistician.

Non-participation total-market concept studies for major advertisers where stations are only permitted to buy published results. Audience telephone coincidental studies where stations do participate. All studies open to BRC audit.

Market Facts—New York Inc. 201 E. 42d St., New York 10017. (212)661-6050. B. Sherak, chmn; G. Spagna, pres; P. Geiss, M. Gottlieb, I. Povlin, A. Koff, VPs.

Marketing Evaluations Inc. 14 Vanderventer Ave., Port Washington, L.I., N.Y. (516) 944-8833; (212)357-7405; Jack Landis, chmn; Henry Brenner, vice chmn; Steven Levitt, pres, chief exec officer; Herb Altman, VP.

TV Q: performer Q: concept testing new shows, movies; entertainment & commercials rsch.

Marketing Facts & Sales. Box 92, Stevensville, Mont. 59870. T. Norman Tvetter, pres.

Products, markets, sales & media research/analysis. Plans for distribution advertising and sales.

Market Research Corp. of America. 122 E. 42nd St., New York 10017. (212) 697-3540. Donald W. Connel, pres; Daniel F. Connel, senior VP.

Chicago: 624 S. Michigan Ave. 60605. (312)939-1500. Fred Kleiderer, dir, mktg, West. National and local consumer panels, custom and conventional store audits, interviewing surveys.

Medianalysis Monitoring and Reports Co. 35 Wisconsin Circle, Washington 20015. (301) 986-1593. James R. Bonfils, pres.

Radio commercial monitoring reports published twice a month for Washington, Chicago, Baltimore and Philadelphia.

Media Records Inc. 370 Seventh Ave., New York 10001. (212)736-7490. Sal Lane, VP & gen mgr.

Measuring and reporting newspaper advertising lineage and investments in over 200 daily and Sunday papers.

Mediastat (Media Statistics, Inc.) 8120 Fenton St., Silver Spring, Md. 20910. (301) 588-4878. James W. Seiler, pres; John Landreth, exec VP; George Arnold, VP; Pam Person, natl radio s/s mgr.

Syndicated radio audience surveys nationwide, ascertainment surveys for license renewal, cable surveys for significantly viewed stations.

National Research Institute Inc. 8585 N. Stemmons Freeway, Suite 922, Dallas 75247. (214)630-2521. Joseph P. Driscoll, bd chmn; D.P. Welborne, pres. (Telephone station evaluation surveys.)

A.C. Nielsen Co. Nielsen Plaza, Northbrook, Ill. 60062. (312) 498-6300. A.C. Nielsen Jr., bd chmn; N.E. Harden, pres; W.S. Ahrbeck, VP Nielsen TV Index; James D. Lyone, exec VP and mgr. media rsch div.

Chicago: 410 N. Michigan Ave. 60611. (312) 828-1170. W.L. Miller, VP. New York: 1290 Avenue of the Americas 10019. (212) 956-2500. G.E. Blechta, VP & mgr. NSI; W.S. Hamill, VP & mgr. NTI.

Dallas: 2665 Villa Creek Dr. 75234. (214) 620-0225. K.O. Wylar, VP. Hollywood: 6922 Hollywood Blvd., 90028. (213) 466-4391. C.C. Carter, VP.

Menlo Park, Calif.: 70 Willow Rd. 94025. (415) 321-7700. W.M. Chesney, VP.

Nielsen Television Index-national audience measurement service. Nielsen Station Index-local audience measurement service. Also additional marketing and custom research services.

Edward J. Noonan Marketing and Opinion Research. 8 Highland Rd., Atkinson, N.H. 03811. (603) 362-5274. Edward J. Noonan, pres; Evelyn B. Walsh, fld supvr.

Radio and TV audience studies, marketing and opinion research, telephone surveys, bank surveys, political polls, advertising research, consumer/executive interviewing.

Pike & Fischer Inc. Suite 522, 2000 L St., N.W., Washington 20036. (202)223-4880. John W. Willis, pres; Charles E. Thompson, VP, sec & treas.

Publisher of "Pike & Fischer Radio Regulations," the standard, comprehensive reference work, maintained to date with weekly reports on all phases of the regulation of radio and TV by federal agencies and the courts.

Alfred Politz Media Studies. 300 Park Ave. South, New York 10010. (212) Plaza 9-5200. David Branerman, VP & dir of client svcs; Henry D. Ostberg, chief exec off.

Designs and conducts studies of media contributions to advertising performance; measures audience, advertising exposures and advertising influence.

J.D. Power & Assoc. 5455 Wilshire Blvd., Los Angeles 90036. (213)938-5151. Dave Power, pres; Barry Robertson, exec VP; Jim Brennan, VP.

Mkt planning, rsch & commun svcs. National, international, local, regional.

Public Pulse Worldwide (formerly Roper Research Assoc.) Boston Post Road, Mamaroneck, New York

Research Services

10543. (914) OWens 8-0800. Oscar Lubow, pres; Charles Jacobson, asst to the pres; Bruce Gershfield, VP; Beverly Weber, VP; Ed Spar, VP.

Publishers Information Bureau. 575 Lexington Ave., New York 10022. (212)752-0055. Stephen E. Kelly, pres; Robert C. Gardner, VP.

Monthly reports on advertising space and revenue in magazines and Sunday newspaper supplements.

The Pulse Inc. 730 5th Ave., New York 10036. Judson 6-3316. Dr. Sydney Roslow, dir; Laurence Roslow, assoc dir; George Sternberg, VP; Richard Roslow, service dir.

6404 Wilshire Blvd., Los Angeles 90048. Olive 3-7733. Kenneth Gross, Pacific Coast director.

435 N. Michigan Ave., Chicago. Superior 7-7140. Paul Gillette, Great Lakes dir.

Audience research in radio, TV & other media, market research, public opinion research, ad research.

Radio Research. 80 Main St., Warwick, N.Y. 10990. (914)986-4871. Robert M. Richmond, mgr.

In-depth analyses of audience measurement surveys by ages/sexes/day parts. Monitors, sales slogans, graphs, charts, promo suggestions, presentations.

Radio TV Reports Inc. 41 East 42nd St., New York 10036. (212) 697-5100. David Fins, pres.

Detroit: 24416 West Nine Mile Rd., Southfield 48075. (313)444-5477.

Los Angeles: 1680 N. Vine St. 90028. (213) HO 6-6124.

Washington: 4435 Wisconsin Ave., N.W. 20016. (202)244-3540.

Chicago: 1723 West Howard St., Evanston 60202. (312)869-0811.

Provides transcripts, digests and analyses of radio and TV news and comment; surveys of program content; monitoring of commercials; tape and cassette recordings; photoboards; film conversions; kinescopes.

Research Consultants Inc. 83 East Ave., Norwalk, Conn. 06852. Dr. John Peatman, pres & dir; M.M. Peatman, VP.

Market research in radio and TV.

Research Information Center Inc. (A subsidiary of The Greyhound Corp.) Greyhound Tower, Phoenix 85077. Hilda Barnes, pres.

Revens Systems Corp. 110 Walnut St., Evansville, Ind. 47705. (812) 425-4562. Reginald B. Collier, chmn; Margaret Henderson Blair, pres; Michael von Gonten, Sr VP.

Television research, program scheduling research, program promo research, rating predictions, new product predictive models.

Roper Research Associates Inc. (see Public Pulse Worldwide).

Rules Service Co. 5530 Wisconsin Ave., Suite 1225, Chevy Chase, Md. 20015. (301) 657-3023. M.B. Spaulding Jr., ed & pub.

Loose leaf subscription service on FCC parts 0, 1, 2, 17, 73, 74, 76, 78, & 87 and FAA and CAR regulations.

Herschel Shostack Associates Inc. 10 Old Post Office Road, Silver Spring, Md. 20910. (301) 589-2259. Dr. Herschel Shostack, pres.

Jerusalem, Israel: 15 Habanay St. Beit Hakerem. (02) 533-660. Ehud Neiger, dir, intl mktg.

Applied survey research in mass communications, and marketing focusing on audience perceptions of and response to news and editorial programs.

W.R. Simmons & Associates Research, a division of Stanton-Grudin-Chook Inc. 1180 Avenue of the Americas, New York 10036. (212) 575-1400. Frank Stanton, chmn; Paul H. Chook, pres; Shm Grudin, exec VP & treas.

Sindlinger & Co., Inc. Harvard & Yale Aves., Swarthmore, Pa. 19081. (215) Kingswood 4-8260. Albert E. Sindlinger, pres.

Detroit: 14900 Stahlman Ave. 48223.

Weekly reports on media exposure, entertainment and leisure time activity, consumer attitudes and finances.

The Source See Dimensions Unlimited.

Southwest Research Inc. 1750 Regal Row, Suite 126, Dallas 75235. (214)638-7305. Mary H. Winters, pres; Jack D. Winters, exec VP; Charlotte White, sec-treas.

Research, Employment, PR

Fort Worth-Wedgewood Village: 5280 Trail Lake Drive, Suite 12, 76133.

Houston: 112 Meyerland Plaza Mall, Suite 32-34, 77035.

Mesquite, Tex: Test Kitchen 932 Big Town shopping center, 75149.

Sherman, Tex: 460-C Sher-Den Mall, 75090.

Daniel Starch & Staff. 566 E. Boston Post Rd., Mamaroneck, N.Y. 10543. (914)698-0800. (212)532-7725. William J. Wilson, pres; Charles E. Wilson, exec VP; Richard Vincent, VP; Peter Toso, VP; Eleanor Blanc, VP.

Marketing, advertising, product, opinion media research; national, regional and local surveys, radio-TV-magazine-newspaper research.

Stoneland Research. Drawer D, Chesapeake, Va. 23320. (804) 421-2126. Paul F. Rule, pres & dir, research svcs.

Local, regional and national audience and marketing research, image studies, copy and program testing, consultation in programing and sales development.

The Sullivan Letter. 888 Seventh Ave., Suite 400, New York 10019. Information about records and recording artists.

Survey and Marketing Services. 184 South Hotel St., Suite 517, Honolulu 96813. (808) 537-3356. Lee A. Weigle, exec dir; Dr. Jeffrey M. Smith, rsch dir.

Media research, TRACE radio rating service, market research.

Television Testing Co. One Park Ave., New York 10016. (212)679-8440. Paul Murphy, pres.

Pre-testing of TV commls, product concepts and progms using cable TV facilities.

Trendex Inc. 15 Riverside Ave., Westport, Conn. (general office). (203) 227-0851. 509 Madison Ave., New York (N.Y. office). (212)752-7160. Edward G. Hynes, pres; Robert B. Rogers, exec VP; James S. Bacharach, VP chief opns off; Louis J. Pappalardo, VP; John P. List, VP-treas; Richard J. Montesano, exec VP bcst div; Elsie Pratt, VP.

Consumer, market and industrial research by telephone. Telephone coincidental and other audience surveys.

Videodex Inc. 342 Madison Ave. New York 10017. (212) 687-8837. Allan V. Jay, dir.

Local television audience analysis; test market audience penetration research and evaluation.

World Wide Information Services Inc. 660 First Ave., New York 10016. (212) 679-7240. Richard W. Hubbell, pres; Anthony D. Blue, VP.

3725 field reporting offices throughout U.S. and 143 countries offering customized research and market intelligence using staff of 14,000 newspaper editors and reporters primarily.

Employment Services

The AMPS Agency (All Media Placement Service) 6331 Hollywood Blvd., Los Angeles 90028. (213)462-7301. Jay Murley, chmn; Bob Laza, pres; LeRoy Thompson, VP.

Broadcast Personnel, Inc. 527 Madison Ave., New York 10022. (212) 355-2672. Sherlee Barish, pres.

Ron Curtis & Co. O'Hare Plaza, 5725 East River Rd., Chicago 60631. (312)693-6171. Ron Curtis, pres; Mike Walker, VP; Fred Harms, senior consultant; Rick Davenport, consultant; Jim Mishler, consultant; Dave Boylan, consultant.

Norman Fischer & Assoc. Box 5308, Austin, Tex. 78703. (512)478-1703. Norman Fischer, pres.

Kovas Communications Inc. 2100 Lee St., Evanston, Ill. 60202. (312) 475-1590. Frank S. Kovas Jr., pres; Ernest P. Anastos, VP, gen mgr.

Job Leads Publishing Co. Box 61, Lincolndale, N.Y. 10540. Paul Kass, editor; Bob DiBella, ad mgr; Lynn Barna, circulation mgr; Stephen Baily, prod mgr. (Publication listing radio-TV jobs.)

Public Relations, Publicity and Promotion Services

Action Printers. Drawer 11370, Pueblo, Colo. 81001. (303) 544-3056. B.L. Welch, owner, gen mgr; Grant B. Anderson, prod mgr; W.H. Welch, sls consultant. (Specializing in all types of station operation forms including contracts, affidavits, statements, letterheads, continuity sheets, logforms, promo sheets, personality sheets, bumper-strips. [1952].)

David O. Alber Assoc. 509 Madison Ave., New York 10022. (212) TEmpleton 8-8300. Mike Alber, pres. Los Angeles: 9255 Sunset Blvd. CR 8-1993.

Atlas Flag Corp. of America. 1311 E. Jackson, Eldorado, Ill. 62930. (618) 273-3376. Solway C. Fierberg, pres; L. Tucker, sls; Libby Fierberg, sec. (Manufacturer of American flags, flag kits and flag desk sets.)

Banner & Greif Ltd. 369 Lexington Ave., New York 10017. (212) 687-7730. Ed Greif, pres. (General public relations consulting service for the broadcast-industry.)

Barash Advertising. 403 S. Allen St., State College, Pa. 16801. (814) 238-5051. Sy Barash, pres; Mimi Barash, VP; Ronald Shroyer, creative dir. (Complete mktg, advertising and sales promotion for cable television companies; all media.)

Buddy Basch Office. 25 E. 26th St., New York 10010. (212) 666-2300. Buddy Basch, owner. (Publicity, public relations, promotion and related writing and communications area services [brochures, books, pamphlets, research].)

Aleon Bennett and Assoc. 8272 Sunset Blvd., Los Angeles 90046. (213) 656-1616. Aleon Bennett, pres; Vonne Godfrey, VP; Beth Lisa, account exec. (Public relations/promotion/advertising for entertainment industry, financial community, tie-ins, endorsements.)

Bentley & Livingstone Inc. 410 N. Michigan Ave., Wrigley Bldg., Chicago 60611. (312) 828-0797. George Livingstone, pres; E.W. Welch, sec-treas.

Bergen and Lee Inc. 1533 Wilshire Blvd., Los Angeles 90017. (213) 483-8866. Burns W. Lee, pres; Roger G. Kee, VP; Lois B. Gaines, VP (PR counsel).

Bingo Cards and Equipment. 5035 Bedford Ave., Omaha 68104. (402) 453-2689. B.A. Tracy. (Personalized bingo cards for TV, cable and radio.)

Robert W. Bloch Public Relations. 1 E. 57th St., New York 10022. (212) 755-8047. Robert W. Bloch, owner, mgr. (Corporate public relations specializing in finance, communications, and foreign trade firms.)

Bruce J. Bloom Inc. 14 Donellan Rd., Scarsdale, N.Y. 10583. (914) 472-3888. Bruce J. Bloom, pres. (Advertising, sales, promotion, public relations.)

Bridal Fair Inc. 8901 Indian Hills Dr., Omaha, Neb. 68114. (402) 391-7800. Jerry L. Johnson, VP, gen mgr. (Broadcast syndication sales.)

H.A. Bruno & Assoc. Inc. 30 Rockefeller Plaza, New York 10020. (212) Circle 6-8040. Ralph J. Ianuzzi, pres. (PR, publicity, promotion.)

Carl Byoir & Assoc. Inc. 800 2d Ave., New York 10017. (212) 986-6100. George Hammond, brd chmn; Robert Wood, pres; James H. Porterfield, exec VP; Muriel Fox, VP for radio-TV. (Public relations consulting.)

Washington: 225 Natl Press Bldg. (202) STerling 3-6565. Ray Courage, mgr.

Chicago: Suite 2430, Prudential Plaza. (312) DE2-6300. Willis L. Helmantoler, mgr.

Los Angeles: Suite 1114, 900 Wilshire Blvd. (213)627-6421. H.D. Harvey, mgr.

San Francisco: 100 Bush St., Suite 1801. (415)362-6971. Robert Richelson, mgr.

Detroit-Cleveland: Buhl Bldg., Room 942, Griswold & Congress Sts., Detroit. (313)965-3366. William G. Hayward, mgr.

Atlanta: Life of Georgia Tower, Suite 1004, 600 W. Peachtree St., N.W. (404)581-1353. William Waddell, mgr.

Houston: Suite 300, 3 Greenway Plaza East. (713)626-5560. Larry Goldman, mgr.

Chartmakers, Inc., 25 W. 45th St., New York 10036. (212) 247-7200. Edward A. Linker, pres; Charles F. Rutzler, sec-treas; Clarence L. LePeer, VP; Joseph

O'Heir, VP. (Designers-producers for management communications: audio-visual training aids, multi-media presentations, motion picture and videotape production.)

Chip Cleary & Co. Ltd. Security Bank Bldg., P.O. Box 447, Santa Ana, Calif. 92701. (714)547-7331. Chip Cleary, pres; John Collins, VP, govt affairs; James T. Workman, VP, mgt counseling section; Dr. Charles Huegy, VP, fin affairs. (Government affairs, PR, management counselors.)

New York: Cleary, Hitt & Collins. 333 E. 69th St. Sacramento, Calif.: Forum Bldg. Washington: 3131 Woodley Rd., N.W. Honolulu: 116 S. King St.

Harry Coleman & Co. P.O. Box 3032, Tucson, Ariz. 85702. (602)298-1013. Harry M. Coleman, pres. (Spot surveys, polls, special assignments, market research.)

Communication Planners Inc. Atrium Bldg., 98 Cutter Mill Rd., Great Neck, N.Y. 11021. (212) 895-7560 or (516) 487-1221. Martin G. Waldman, pres; Sandra Nemser Waldman, VP, editorial. (Public relations and communications counseling for corporations and organizations, public affairs and campaign planning.)

Community Club Awards Inc. P.O. Box 151, Westport, Conn. 06880. (203) 226-3377. John C. Gilmore, pres; Bess Gilmore, exec VP; Philip Peterson, VP sls; Paul Cowley, west coast sls mgr. (Radio/TV sales promotion campaigns involving nonprofit clubs and service organizations using exclusive advertiser premiums.)

Compass Inc., P.O. Box 12436, Las Vegas, Nev. 89112. (702) 458-2154. Mark A. Parr, pres; Eli S. Jenkins, VP; Bob W. Richards, VP-sls dir. (Broadcast travel incentive. Packages, travel programs to be used as station sales promotion, sales incentive to station clients, etc.)

Concerned Marketing Co., 8350 North Central Expressway, Dallas 75206. (214) 691-7898. James B. Luck, exec VP; James C. Gray, sec-treas; Harry S. Hagan Jr., rgnl VP-South. (301) 929-1032; Richard C. Ar buckle, rgnl VP East, (914) 381-2744; Ronald F. Johnson, rgnl VP-West, (503) 485-1161; Herbert Miller, rgnl VP-Midwest, (903) 362-8375. (Full service marketing organization with services that include broadcast promotions.)

The Hal Copeland Co. 528 Meadows Bldg., Dallas 75206. (214) 361-8788. Hal Copeland, pres; Ann Bryan Copeland, creat dir; Kay C. Ellis, copy chief. (Client Speakers Bureaus for interview shows; publicity, promotion and public relations services.)

James A. Cowan. Box 308, Station Q, 27 St. Clair Ave., East, Toronto, Can. (416) 962-2365. (PR.)

Dan Daniel. 162 West 56th St., Suite 301, New York 10019. (212) 247-5782. (New ideas in programing, audience programing, sales promotion and development.)

Davis Public Relations Inc. 280 Madison Ave., New York 10016. (212) 889-6990. Stephen Davis, pres; Irving Mandell, senior assoc. (General public relations services specializing in travel, leisure time, sports, consumer products and business services.)

Phil Dean Assoc. Inc. 271 N. Ave., New Rochelle, N.Y. 10807. (914) 576-0010. Phil Dean, pres; Rosemary Marra, acct exec. (PR, promotions, advertising.)

Irwin H. Diamond & Assoc. 7380 N. Lincoln Ave., Lincolnwood, Ill. 60464. (312) 675-2430. Irwin H. Diamond, pres. (Sls promotion activities surrounding Tenna Topper promotions.)

Dougherty Assoc. Inc. 32 Nassau St., Princeton, N.J. 08540. (609) 924-7616. Joseph A. Dougherty, pres. (Complete public relations services in all media. Specializations: sciences, medicine, health care products/services, education, business, industry.)

Arthur Eddy Public Relations. 1405 North Foothill Rd., Ojai, Calif. 93023. (805) 646-5834. Arthur Eddy, owner.

The Eloise Co. 11 W. Main St., Moorestown, N.J. 08057. (609) 234-0070. Eloise M. Kocyan, pres; George H. Kocyan Jr., VP (Rsch, counseling, publ, photography, annual reports, brochures, catalogs, internal & external company publications, audio-visual prod, adv, sls prom.)

Lyle Kenyon Engel. 211 W. 58th St., New York 10019. (212) 757-9415. George S. Engel.

Milton Fenster Assoc. 540 Madison Ave., New York 10019. (212) Plaza 9-3540. Milton Fenster, pres; Hy

Hollinger, Cecilia Lewis, Fred Rayfield, Leonard Arnow, acct execs. (Corporate, finan, pdt counseling.)

Edward Gottlieb & Assoc. 485 Madison Ave., New York 10022. (212) 421-9220. Edward Gottlieb, chmn and pres; William Kaduson, exec VP; Renee Wachs, dir TV and radio.

Washington: 1145 19th St. Federal 8-5020. Gordon Smith, VP

Los Angeles: 6253 Hollywood Blvd. Don Scoggins, dir.

Heather Enterprises Inc. 2064 S. Carr St., Denver 80227. (303) 985-7437. Stanley Wasserman, pres. (Mail order specializing in country music products for television and radio.)

Hill & Knowlton Inc. 633 Third Ave., N.Y. 10017. (212) 697-5600. Richard W. Darrow, chmn of bd; John W. Hill, chmn of exec com; James J. Cassidy, pres; William A. Durbin, Loet A. Velmans, vice chmn. (International PR and pub affrs counsel.)

Dallas: 2001 Bryan St. 75201. (214) 651-1761. Honolulu: 1600 Kapiolani Blvd. 96814. (808) 955-1789.

Houston: 2500 Dunstan, Suite 312. 77005. (713) 237-9383.

Los Angeles: 5900 Wilshire Blvd. 90036. (213) 937-7460.

San Francisco: 44 Montgomery St. 94104. (415) 392-1810.

Washington, D.C.: One McPherson Sq., Vermont at K. St., N.W. 20005. (202) 638-2800.

ICPR. 9255 Sunset Blvd., Los Angeles 90069. (213) 550-8211. Rupert Allan, Rene A. Henry Jr., Rick Ingersoll, Frank McFadden, Morton Segal, Constance L. Stone, John Strauss, exec officers. (Public relations.)

New York 10022: 545 Madison Ave. (212) 644-0440. Roger Ahrens, exec VP in chg of Eastern opns.

Infoplan International Inc. 1271 Avenue of the Americas, New York 10020. (212) 697-1222. Leslie T. Harris, pres & chief operating off. (PR counsel & svc.)

Inter-Global Communications/Perception Plus. Box 413, Philadelphia, 19105. (215) 828-0502, 647-8296. Franklin O. Pease, gen mgr; Joseph Sperling, exec dir; Maurice Zouary, dir; Ray Lewis, consultant; H.I. Greene, admin asst; A.E. Brammer, foreign mgr. (Product endorsement, PR, publ, prom, tie-ins, contests, trade adv campaigns, direct mail, films in-store displays, mkt rsch, all med.)

The Kalmus Corp. The Waldorf-Astoria, 301 Park Ave., New York 10022. (212) 421-1122. Allan H. Kalmus, pres. (PR counselors.)

S.W. Lee and Associates. 782 W. Greenbelt Pkwy., Holbrook, L.I., N.Y. 11741. (516) 472-9263. Samuel W. Lee, Pres. (Communications consulting and public relations.)

The Philip Lesly Co. 33 N. Dearborn St., Chicago 60602. (312) 236-9520. Philip Lesly, pres; Veronica Woerner, ctr. (Counsel, creative input and major services in mass communications and public relations.)

King Louie International Inc. 311 W. 72d St., Kansas City, Mo. 64114. (816) 363-5212. Victor Lerner, pres; George Jenne, stn mgr.

Magnity-Kane Advertising/Public Relations. 18 S. 8th St., Terre Haute, Ind. 47807. (812)232-1885. Harry Magnity pres; Michael Kane, VP; Jerry Phillips, creative dir; Rod Bradfield, art dir; Rose Baker. (Adv. PR, mdse progs, film & distribution, radio series & distribution.)

Manning, Salvage & Lee Inc. 666 Fifth Ave., New York 10019. (212) 586-2600. Farley Manning, chmn; Ruth Altman, radio/TV dept.

St. Louis 63101: Wright & Manning Inc. 515 Olive St. Arthur E. Wright Jr.

Chicago 60601: Beveridge, Kraus, Robbins & Manning Inc., 75 E. Wacker Dr.

Washington 20006: Manning, Salvage & Lee Inc. 1750 Pennsylvania Ave., N.W. John T. Rainey, VP.

Market International Inc. Phillips 66 Petroleum Bldg., Suite 508, 68 S. Main St., Salt Lake City, Utah 84101. (801)521-9444. Anthony V. Ragozzine, pres; David Lichfield, VP; David Hannah, finance dir; Sara Coleman, new bus. (Promotion, surveys, direct mail.)

Jack McGuire/Associates Inc. 20 N. Wacker Dr., Chicago 60606. (312)782-0706. Jack McGuire, pres. (PR, including counseling, publicity, product promotion.)

Frank McNaughton & Assoc. 2615 Lake Ave., Wilmette, Ill. 60091. (312) 256-5066. Frank and Florence A. McNaughton, ptrns. (Free lance writers, editing; public relations.)

Howard Mendelsohn & Co. 620 N. Michigan Ave., Chicago 60611. (312) Michigan 2-0244.

Reg Mitchell & Assoc. 15 Sunrise Ave., Ormond Beach, Fla. 32074. (904)672-5744. Reginald P. Mitchell, pres. (PR, pub affairs.)

FP Model & Company Inc. 37 Riverside Dr., New York 10023. (212) 362-5141. F. Peter Model, managing dir; Jack Kish, VP graphics. (Complete range of corporate public relations and editorial services, including speechwriting, reports and brochures, magazine development.)

National Media Consultants. 6464 Sunset Blvd., Hollywood. (213)462-6935. Milton J. Beckman, pres; Joel Davis, VP. (Media planning & buying.)

New York Film & Videotape Comm. Inc. 450 N. Narberth Ave., Narberth, Pa. 19072. Michael Davis, pres.

Noyes, Moran & Co. P.O. Box 606, Downers Grove, Ill. 60515. (312)969-5553. Stan Noyes, pres; Robert O. Moran, VP; David S. Sutton, exec VP; Don Szymanski, art dir; John J. Scott, creative dir. (Sales assistance, coordinated design, sales & management studies; composite-week log analysis for Section IV-A license renewal plus narrative exhibits written for license-renewal application.)

Padilla and Speer Inc. Beverage and Robbins Inc., subsidiary. 75 E. Wacker Dr., Chicago 60601. (312) 332-7229. H. Zane Robbins, pres; Oscar M. Beverage, chmn. (General public relations/public affairs services with special capabilities in corporate and financial relations, marketing publicity, sports management and promotion.)

Al Petker. 9201 Wilshire Blvd., Beverly Hills, Calif. 90210. (213) 287-2331. Al Petker, pres; Ace Ochs, VP. (Publicity for radio stations and national advertisers.)

Prizes For Stations. 565 Fifth Ave., New York 10017. (212) OXford 7-6135. P. Sands, pres; George Cabare, VP; George Comtois, sls mgr. (Offers prizes and merchandise in exchange for cash and/or station time.)

Promotional Items, Flags. Atlas Flag Corp. of America, 1311 E. Jackson St., Eldorado, Ill. 62930. (618) 273-3376. Solway C. Fierberg, pres-treas; Libby Fierberg, sec-VP. (Manufacturer of United States & bi-centennial flags and flag kits for sale to radio and television stations.)

Publici-Tips. 5395 South Miller St., Littleton, Colo. 80123. (303)973-2337. Pauline J. Thompson, pres; Sidney R. Thompson, EVP; Elizabeth Brooks, sec. (Trade press clippings for broadcast industry.)

Martin Roberts & Associates Inc. 9171 Wilshire Blvd., Suite 310, Beverly Hills, Calif. 90121. (213)273-0381. Martin Roberts, pres and chief exec off. (Advertising, publicity, promotion, promotional aids, brochures, research.)

Richard H. Roffman Assoc. 697 West End Ave., New York 10025. (212) Riverside 9-3647. Richard H. Roffman, bd chmn. (General public relations.)

Rogers, Cowan & Brenner Inc. 250 N. Canon Dr., Beverly Hills, Calif. (213) 275-4581. Henry C. Rogers, bd chmn; Warren J. Cowan, pres; Constance L. Stone, Craig W. Moodie, senior VP.

A.A. Schechter & Associates Inc. (wholly owned subsidiary of Hill & Knowlton Inc.) 633 Third Ave., New York 10017. (212) 687-1150. A.A. Schechter, pres; George Glazer, exec VP; Elizabeth M. Rich, senior VP; Sandy Black, VP; Ilene Campbell, off mgr; account execs: Len Chaimowitz, Mimi Shorr, Carol Jennings, Bruce Cassidy, Marti Jones. (Public relations and public affairs consultants, TV and film production for industry, business and associations.)

Lawrence Laurie & Assoc. Los Angeles: 8899 Beverly Blvd. 90048. (213) 274-0851

Earnest Wittenberg Assoc. Washington, D.C.: 1616 H. St. N.W. 20006. (202) 783-2080.

Jay Sharp Promotions. 3436 Goldendale Dr., Dallas 75234. (214) 214-5683. Jay Sharp, pres. (Record promotion, artists relations, artist appearance publicity, bookings.)

Peter Simone and Associates. 1717 N. Highland Ave., Suite 1210, Hollywood 90028. (213) 461-4559. Peter Simone, pres; Michele Cohen, press agent; Toni Diorgio, asst. (National & industrial publicity and promotion for all artists in the music and film industry.)

Small Market Promotions. 5430 Central Ave., St. Petersburg, Fla. 33707. (Promotion packages for small market radio stations.)

The Wayne Smith Co. Inc. 500 12th St., S.W., Suite 810, Washington 20024. (202)484-5620. Wayne J. Smith, pres; Paul Nagle, Patricia Days, Bernard Burt, account execs. (Adv. PR, publ.)

The Softness Group Inc. 635 Madison Ave., New York 10022. (212) 752-7770. Don Softness, chmn; John Softness, pres; Adele Adelson, VP; William Falk, broadcast dir/acct supervisor; Charles Sinclair, creative dir; senior acct execs: Connie Meehan, Aliston Stoker, Caryn F. Fullerman, Bonnie Devine, Glida Brown; acct execs: Wendy Koller, Annemarie Cairns, Maureen O'Brien. (Public relations, public services to broadcast groups, stations, program producers, syndication sales representatives.)

Samuel E. Stavisky & Assoc. Inc. Suite 302, 1100 17th St., N.W., Washington 20036. (202)296-8844. Samuel F. Stavisky, pres; William S. Frank, exec VP; Jose A. Gemeil, VP. (Domestic & internat PR.)

William B. Tanner Co. 2714 Union Ave., Extended, Memphis 38112. (901) 320-4212. William B. Tanner, pres; Wilson Northcross, exec VP; Mars Mdse. Co., Henry Tanner, VP; Mars Automotive Div., Roy Key, mgr; Joe Bankhead, VP & dir libraries; Zack Hernandez, VP & sls mgr, ID Div.; Scott Blake, VP & mgr. Airplay Intl Div.; Bill Laffey, VP Time Credit Div. (Library services, sales promotions, custom ID's & commercials, TV library service & commercials.)

Vanguard Dasca. Box 1025, Brattleboro, Vt. 05301. (802) 257-7131. David S. Calef, pres.

Vibrations Sales Promotion & Advertising Inc. 301 E. 63rd St., New York 10021. (212) 593-0065. Ronald M. Cohen, pres; Max Cohen, VP. (Promotional tee shirts, time buying, bart services. Specialists in youth marketing.)

Tony Visk Creative Broadcasting. 3802 Greenrock Ct., N.E., Atlanta 30340. (404) 934-1956. Tony Visk, pres and own. (Radio programs & promotions, commercial concepts, consultant concepts.)

Vonco Products Inc. 201 Park Ave., Box 275, Lake Villa, Ill. 60046. (312)356-2323. W. Von Stoesser, pres; L.L. Laske, VP. (Antenna go-go balls, hand puppets, litter bags, misc plastic polyethylene shapes.)

Morton D. Wax & Assoc. 200 W. 51st St., New York 10019. (212) 247-2159. Morton Wax, pres; acct execs: Neal Whitton, Ronnie Grishman, Ellis Nassour, Randy Garelick. (Consumer & trade publicity and promotion, direct mail, tie-ins, contests.)

Welch Datamaps. Drawer 11370, 217 W. 13th St., Pueblo, Colo. 81001. (303) 544-3056. B.L. Welch, owner-gen mgr; Sharon K. Welch, ptrn; W.H. Welch, sls consultant. (Comprehensive visual sales aids with coverage maps/forms, demographics complete production facilities.)

Joe Wolhandler. 211 E. 51st St., New York 10022. (212) Plaza 9-2050.

ZBS Media Inc. R.D. 1, Ft. Edward, N.Y. 12828. (518)695-6406. Bob Durand, pres; Tom Lopez, VP & creative dir; Michael Roach, sls dir; Bob Bielecki, head engr; Richard Shanks, farm dir; Max Sufi, dir of PO rsch. (Radio programs designed for progressive, contemporary, college radio, adv, promotional, consultant svcs.)

Talent Agents/Managers

Miles Bohm Auer, Artists' Manager. 8344 Melrose Ave., Suite 29, Hollywood 90069. (213) 462-6416. Miles Bohm Auer, sole owner.

Beckwith Presentations Inc., Beckwith Casting Co. 39 West 55 St., New York 10019. (212) 765-4250. Aaron Beckwith, pres; Sol Kalow, sec-treas.

CMA-TV; CMA Corp; CMA Artists Inc. (see Creative Management Associates.)

Chartwell Artists Ltd. 9720 Wilshire Blvd., Beverly Hills, Calif. 90212. (213) 273-6700. A.J. Perenchio, pres.

Gerard Cloutman Agency. 10850 Riverside Dr., Suite 602, North Hollywood, Calif. (213) 877-0768. Gerard Cloutman, owner.

Command Appearance. RD No. 2, Camelot, Florida,

Talent Agents, NAB

Mass. 01247. (413) 663-6060. Robert Miles Master, talent mgr.

Creative Management Associates Inc. 8899 Beverly Blvd., Los Angeles 90048. (213) 278-8899. Freddie Fields, pres & chief exec officer.

New York: 600 Madison Ave. (212)935-4000. Buddy Howe, bd chmn; Sam Cohn, sr VP.

London: W1, 22 Grafton St., 499-7971. Dennis Selinger.

Rome: 38 via Siacci. 805-558. Roger Beaumont.

Diamond Artists Ltd. 8400 Sunset Blvd., Hollywood 90069. (213) Oldfield 4-5960. A.J. Greshler, pres; R. Guy Steiner, mngng dir.

New York: 119 W. 57th St. (212)Circle 7-3025. Fred Harris, dir.

ERA Associates. 308 Westwood St., Norristown, (Phila.) Pa. 19401. (215) 279-7384. Ken Schreffler, talent exec.

Jack Fields & Associates. 9255 Sunset Blvd., Hollywood 90069. (213)278-1333. Jack X. Fields.

Frieda Fishbein. 353 W. 57th St., New York 10019. (212)247-4398. Frieda Fishbein, owner.

Erwin Frankel Productions. The Communications Center, 153 West 82d St., New York 10024. (212)873-1222. Erwin Frankel, exec prod; Isidore Silver, legal dir; Paula Weiss Kauffman, talent dir.

Reece Halsey Agency. 8733 Sunset Blvd., Los Angeles 90069. (213) 652-2409. Reece Halsey, Dorris Halsey, owners.

Shirley Hamilton. 500 N. Michigan Ave., Chicago. (312)644-0300. Shirley Hamilton.

George B. Hunt & Assoc. 8350 Santa Monica Blvd., Suite 104, Los Angeles 90069. (213) 654-6600. George B. Hunt, owner.

Sacramento, Calif. 95816: 1009 22nd St. (916) 447-3489. Jackie O'Dell, talent coord.

George Ingersoll Agency. 7167½ Sunset Blvd., Hollywood 90046. (213)874-6434. George R. Ingersoll, owner; Teddy O'Toole, sec.

International Famous Agency. 1301 Ave. of the Americas, New York 10019. (212)556-5600. Marvin Josephson, pres; Ralph Mann, senior exec VP; Irwin Moss, exec VP.

Los Angeles 90069: 9255 Sunset Blvd. (213)237-8811. Marvin Josephson, pres; Donald Sipes, senior exec VP; Franklin Konigsberg, senior exec VP; Sam Kaplan, exec VP.

Marvin Josephson Associates Inc. 9255 Sunset Blvd., Los Angeles 90069. (213) CRestview 3-8811. Marvin Josephson, Don Sipes, Frank Konigsberg, Sam Kaplan.

New York 10019: 1901 Ave. of the Americas. (212)956-5800. Ralph Mann, Robert Chuck, Irwin Moss.

TelePak Inc. DBA Robert Longenecker Agency. 8438 Melrose Pl., Los Angeles 90069. (213)653-3770. Robt. Longenecker, pres-owner.

The Mishkin Agency Inc. 9255 Sunset Blvd., Los Angeles 90069. (213)272-5688. Meyer Mishkin, pres.

Moeller Talent Inc. P.O. Box 15364, Nashville 37215. (615)244-4292. W.E. Moeller, pres; Jack B. Andrews, VP & sec.

William Morris Agency. 1350 Avenue of the Americas, New York 10019. (212)586-5100. Nat Lelkowitz, pres; Howard Hausman, VP; Lee Stevens, VP. TV reps: Sol Leon, Lou Weiss, Tony Ford, Larry Auerbach, Ron Yatter, Leon Memoli, Steve Pinkus, Pat Tourk, Bob Goodman, Paul Heller, Steve Weiss, Leonard Kramer.

Beverly Hills, Calif.: 151 El Camino Dr. (213) CRestview 4-7451. Abe Lastfogel, bd chmn; Samuel Weisbord, exec VP; Roger Davis, VP; Walter Zifkin, VP; Morris Stoller, exec VP. TV reps: Sam Weisbord, Fred Apollo, Norman Brokaw, Lee Cohen, Herb Karp, Martin Michelson, Tony Fantozzi, Bill Haber, Stan Kamen, Mike Rosenfeld, Arnold Sank, Robert Stein, Mike Ovitz, Rowland Perkins, Barry Salomon, Elliot Wax, Fred Westheimer.

New York School of Announcing & Speech. 165 W. 46th St., New York 10036. (212) LT1-3471. Sidney J. DuBroff, pres & dir; Michael DuBroff, VP & treas.

Roffman Assoc. 697 West End Ave., New York 10025. (212) 749-3647. Richard H. Roffman, pres; Malvina Cohn, VP; Dr. Theodore D. Cohn, sec-treas.

Jack Russell & Associates. Executive Plaza, 1010 Dixie Hwy, Chicago Heights, Ill. 60411. (312) 756-7060. Jack Russell, pres.

Mort Schwartz Agency. 156 E. 52 St., New York 10022. (212) PLaza 3-1529. Mort Schwartz.

Screen Children's Guild Agency. 12444 Ventura Blvd., Studio City, Calif. 91604. (213) 985-6131. Arthur F. Roscoe, gen mgr; Katie Russell, casting dir.

Melville A. Shauer. 9110 Sunset Blvd., Los Angeles 90069. (213) CRestview 1-1103. Melville A. Shauer, owner.

Glenn Shaw Agency. 8440 Sunset Blvd., Los Angeles 90069. (213) 654-6110. Glenn E. Shaw, owner.

SIBA Inc. Box 10068, Baltimore 21204. (301) 426-8639. Richard Fay, pres.

Charles H. Stern Agency Inc. 9220 Sunset Blvd., Los Angeles 90069. (213) 273-6890. Charles H. Stern, pres; Eleanor Ross, dir of on-camera casting; Don Pitts, dir of voice-over performers.

Harold Swoverland Personal Management. 3246 Isabella Dr., Oceanside, Calif. 92054. (714) 757-6220.

Talent Phone Instant Auditions (division of Jewell Radio & TV Productions) 612 N. Michigan Ave., Chicago 60601. (312) 664-5757. Marion P. Jewell, pres.

Telepak Inc. (see Robert Longenecker Agency).

Vanguard Productions. 8 Winter St., Brattleboro, Vt. 05301. (802)257-7131. Dave Calef, pres.

Herman Zimmerman Agency. 12077 Ventura Pl., Studio City, Calif. 91604. (213) Popular 6-8119. Herman and Nellie H. Zimmerman, co-owners.

Broadcasting: Yearbook 1976

Associations

National Association of Broadcasters

Headquarters: 1771 N St. N.W.
Washington 20036
Phone: (202) 293-3500

Officers and Staff

President's Office

Vincent T. Wasilewski, pres; Harold Niven, VP for planning and dev and asst to the pres.

Government Relations

Donald P. Zeifang, exec VP; Roy Elson, VP; William Carlisle, VP; T. Michael Barry, David Markey, legislative counsels; Richard T. Wartell, broadcast liason.

Public Relations

James H. Hulbert, exec VP; Charles T. Jones Jr., VP and R/O dir; Broadcast Bureau: Robert E. Hallahan, dir; Community Affairs: Patricia Grace, dir. Employment Clearing House; Alice Hayes, dir. Librarian: Susan M. Hill, Publications Bureau: Milton Magruder, dir.

Station Relations

Burns Nugent, exec VP; George W. Bartlett, VP,

engineering. John A. Dimling, VP research. (New York office—485 Madison Ave., New York 10022; Russell B. McKennan, asst to VP.)

Broadcast Management: Ron Irion, dir.

Regional Managers: John Duckers (South Central states); Steven Farabi (Mid-Atlantic); Jim Moren (Northeast); Curt Mackey (West); Lynn W. Renne (North Central); Daniel M. Valentine (Southeast).

Code Subscription: George Dorrington, mgr.

Legal

John B. Summers, gen counsel; James Popham, Brenda Fox, asst gen counsels; Richard Wycoff, attorney.

Office of Administration

John G. Kinzer sec-treas.
Donald B. Pearce, asst treas.
LaRue M. Courson, VP admin svcs.

NAB Code Authority

Stockton Helffrich, dir. 485 Madison Ave., New York 10022. (212) 752-8050. Jerome G. Lansner, asst dir.

Washington office: Richard K. Burch, mgr; Henry J. Roeder, asst mgr.

New York office: Lorne G. Williamson, mgr; William E. Schulte, asst mgr.

Hollywood office: 1717 N. Highland Ave., Hollywood 90028. (213) HOLLYWOOD 2-6909. Roger Field, mgr.

Distinguished Service Award Recipients.

1953: David Sarnoff; 1954: William S. Paley; 1955: former NAB President Mark Ethridge; 1956: Robert E. Kintner; 1957: Herbert Hoover; 1958: Frank Stanton; 1959: Robert W. Sarnoff; 1960: Clair R. McCollough; 1961: former NAB President Justin Miller; 1962: Edward R. Murrow; 1963: Bob Hope; 1964: Donald H. McGannon; 1965: Leonard H. Goldenson; 1966: Sol Taishoff; 1967: Chet Huntley and David Brinkley; 1968: Lowell Thomas; 1969: John Fetzer; 1970: Rosel Hyde; 1971: former NAB President Neville Miller; 1972: Billy Graham; 1973: Ward Quaal; 1974: Richard Chapin; 1975: George Storer; 1976: Julian Goodman.

Boards

Board of Directors

Chairman: Wilson C. Wearn, Multimedia Broadcasting, Greenville, S.C.

Executive Committee: Wilson C. Wearn, Multimedia, Greenville, S.C.; Harold Krelstein, Plough Broadcasting, Memphis; V. Kay Melia, KLOE Goodland, Kan.; Kathryn Broman, Springfield TV, Springfield, Mass.; Robert D. Gordon, WCPO-TV Cincinnati; William Leonard, CBS Inc., Washington; Andrew M. Ockershausen, Evening Star Stations, Washington; Vincent T. Wasilewski, NAB pres.

Radio Board

Harold R. Krelstein, Plough Broadcasting Co., Memphis, chmn; V. Kay Melia, KLOE Goodland, Kan., vice chmn.

Dist. 1: Donald A. Thurston, WMNB North Adams, Mass.

Dist. 2: William F. O'Shaughnessy, WVOX New Rochelle, N.Y.

Dist. 3: Victor C. Diehm, WAZL Hazleton, Pa.

Dist. 4: Robert R. Hilker, WCGC Belmont, N.C.

Dist. 5: Paul E. Reid, WBHB Fitzgerald, Ga.

Dist. 6: Len Hensel, WSM Nashville

Dist. 7: Walter E. May, WPKE Pikeville, Ky.

Dist. 8: John R. Anderson, WCCW Traverse City, Mich.

Dist. 9: Donald G. Jones, KFIZ Fond du Lac, Wis.

Dist. 10: Robert E. Thomas, WJAG Norfolk, Neb.

Dist. 11: George L. Brooks, KCUE Red Wing, Minn.

Dist. 12: V. Kay Melia, KLOE Goodland, Kan.

Dist. 13: Stan Wilson, KFJZ Ft. Worth.

Dist. 14: Jack B. Chapman, KGAK Gallup, N.M.

Dist. 15: Frank W. McLaurin, KSRO Santa Rosa, Calif.

Dist. 16: Joseph C. Drilling, KOGO San Diego.

Dist. 17: Wally N. Nelskog, KIXI Seattle.

Class A: Harold R. Krelstein, Plough Bcstg, Memphis; Virginia Pate Wetter, WASA Harve de Grace, Md.

Class B: Thad M. Sandstrom, WIBW Topeka, Kan.; Ben A. Laird, WDUZ Green Bay, Wis.

Class C: Dick Painter, KYSM Mankato, Minn.

Class D: Jack S. Younts, WEEB Southern Pines, N.C.; Edward D. Allen Jr., WDOR Sturgeon Bay, Wis.

Networks: Harold L. Neal Jr., ABC Radio, New York; Sherril Taylor, CBS Radio, New York; C. Edward Little, MBS, New York; Eugene D. Jackson, National Black Network; Jack G. Thayer NBC Radio, New York.

Television Board

Walter E. Bartlett, Avco Bcstg, Cincinnati, chmn. Robert D. Gordon, WCPO-TV, Cincinnati, vice chairman.

Charles A. Batson, Cosmos Broadcasting, Columbia, S.C.; Bill Bengtson, KOAM-TV Pittsburg, Kan.; Thomas E. Bolger, WMTV Madison, Wis.; Kathryn F. Broman, Springfield, (Mass.) TV Broadcasting Corp.; A. James Ebel, KOLN-TV Lincoln, Neb.; Ray Johnson, KMED-TV Medford, Ore.; Robert B. McConnell, WISH-TV Indianapolis; Daniel T. Pecaro, WGN-TV Chicago; Mike Shapiro, WFAA-TV Dallas.

Networks: Eugene S. Cowen, ABC, Washington; William Leonard, CBS, Washington; Peter B. Kenney, NBC, Washington.

Television Code Review Board

Wayne Kearl, KENS-TV San Antonio, Tex., chmn; Wallace Jorgenson, WBTV(TV) Charlotte, N.C.; Michael S. Kieyman, Cox Broadcasting, Atlanta Burton LaDow, KTVK(TV) Phoenix; Robert J. Rich, WDSM-TV Duluth, Minn.; Alfred R. Schneider, ABC, New York; Thomas J. Swafford, CBS-TV, New York; James R. Terrell, KTVT(TV) Ft. Worth; Herminio Travesas, NBC, New York.

Radio Code Board

Robert H. Harter, WHO Des Moines, Iowa, chmn; Ross Case, KWAT Watertown, S.D.; Jack Clements, MBS, New York; Ralph Daniels, NBC, New York; Hal J. Davis, KITE San Antonio, Tex.; Michael O. Lareau, WOOD Grand Rapids, Mich.; Steve Shannon, KCMC Kansas City, Mo.; Carl V. Venters Jr., WPTF Raleigh, N.C.; James M. Ward, WLAC Nashville; James Wesley Jr., KFI Los Angeles.

Board Committees

By-Laws—Donald A. Thurston, WMNB North Adams, Mass., chmn; George L. Brooks, KCUE Red Wing, Minn.; Ray Johnson, KMED-TV Medford, Ore.; Ben A. Laird, WDUZ Green Bay, Wis.; Wally N. Nelskog, KIXI Seattle.

Convention—Robert D. Gordon, WCPO-TV Cincinnati, co-chmn; V. Kay Melia, KLOE Goodland, Kan.,

co-chmn; John R. Anderson, WCCW Traverse City, Mich.; Thomas E. Bolger, WMTV Madison, Wis.; Kathryn F. Broman, Springfield (Mass.) TV Bcstg Corp.; Donald G. Jones, KFIZ Fond du Lac, Wis.; Frank W. McLaurin, KSRO Santa Rosa, Calif.; Daniel T. Pecaro, WGN-TV Chicago; Paul E. Reid, WBHB Fitzgerald, Ga.—Virginia Pate Wetter, WASA Harve de Grace, Md.

Membership—Robert B. McConnell, WISH-TV Indianapolis, chmn; Eugene B. Dodson, WTVT Tampa, Fla.; Victor C. Diehm, WAZL Hazleton, Pa.; Ben A. Laird, WDUZ Green Bay, Wis.; William A. O'Shaughnessy, WVOX New Rochelle, N.Y.; Robert E. Thomas, WJAG Norfolk, Neb.; Stan Wilson, WFJZ Fort Worth; Jack S. Younts, WEEB Southern Pines, N.C.

Standing Committees

Broadcast Engineering Conference—Daniel H. Smith, Capital Cities, Philadelphia, chmn; Robert J. Butler, NBC, New York; William B. Honeycutt, KDFW-TV Dallas; Ralph L. Hucaby, WLAC Nashville; Eldon Kanago, KICD Spencer, Iowa; Leslie S. Learned, MBS, Centerport, N.Y.; James D. Parker, CBS, New York; R. LaVerne Pointer, ABC, New York; Russell B. Pope, Golden Empire Broadcasting Co., Chico, Calif.; Doyle D. Thompson, Landmark Communications, Greensboro, N.C.

Engineering Advisory—Robert W. Flanders, McGraw-Hill Bcstg, chmn; Charles F. Abel, KFMB-TV San Diego; Ernest L. Adams, Cox Broadcasting Corp.; Ralph F. Bait, WGN Continental Bcstg Co.; Albin R. Hillstrom, KOOL Radio & TV Inc.; John R. Kennedy, NBC-TV New York; Leslie S. Learned, Mutual Bcstg System Inc.; James D. Parker, CBS-TV, New York; R. LaVerne Pointer, ABC, New York; Benjamin Wolfe, Post-Newsweek Stns, Washington; A. James Ebel, KOLN-TV Lincoln, Neb.

Radio Information—Robert R. Hilker, Suburban Radio Group, chmn; Len Hensel, WSM-AM-FM Nashville; Bruce Johnson, RKO General Inc.; Don Jones, KFIZ Fond du Lac, Wis.; Dick McKee, KOB Albuquerque, N.M.; Philip Spencer, WCSX Amsterdam, N.Y.; Sherril Taylor, CBS Radio, New York.

Hundred Plus Markets Television—Bill Bengtson, KOAM-TV Pittsburg, Kan., chmn. Ray Butterfield, WLOX-TV Biloxi, Miss.; Samuel S. Carey, WBOC-TV Salisbury, Md.; Jay E. Gardner, KRDO-TV Colorado Springs; Howard Green, WENY-TV Elmira, N.Y.; Richard Reed, Gilmore Broadcasting Corp., Kalamazoo, Mich.; John Shott, WHIS-TV Bluefield, W.Va.; Sheldon Storrier, WKTV(TV) Utica, N.Y.

Small Market Radio—Wayne C. Cornis, KFSD Nampa, Idaho, chmn; Edward O. Fitts, WNLA Indianola, Miss.; Dick Painter, KYSM Mankato, Minn.; Sherwood R. Parks, KINA Salina, Kan.; David E. Par-

Television and Radio Political Action/Education Committees

Executive Trustees: Richard D. Dudley, Forward Communications, Wausau, Wis., chmn; Jim Caldwell, WAVE(AM) Louisville, Ky.; Tom Chauncy, KOOL-TV Phoenix; Douglas Manship, WBRZ(TV) Baton Rouge; Jack Rosenthal, Harriscope Broadcasting, Casper, Wyo.; Vincent Wasilewski, NAB Washington; William Carlisle, NAB, Washington.

Advisory Trustees: Walter E. Bartlett, Avco Broadcasting, Cincinnati; John Behnke, KOMO-TV Seattle; Kathryn Broman, Springfield (Mass.) TV Broadcasting Co.; Richard W. Chapin, Stuart Broadcasting, Lincoln, Neb.; Charles R. Dickoff, WEAQ(AM) Eau Claire, Wis.; Karl Eller, Combined Communications, Phoenix; Victor Ferral Jr., Jones, Day, Reavis & Co., Washington; Jack W. Fritz, Blair Television, New York; Otis T. Gatson, WKZO(AM) Kalamazoo, Mich.; Wendell Mayes Jr., KNOW(AM) Austin, Tex.; Clair R. McCollough, Steinman Stations, Lancaster, Pa.; James C. Richdale Jr., Corinthian Broadcasting, Houston; David A. Rock, WSMN(AM) Nashua, N.H.; Walter L. Rubens, KOBE(AM) Las Cruces, N.M.; Don Scheil, KLGK-AM-FM Redwood Falls, Minn.; Lester M. Smith, KJR(AM) Seattle; E. R. Vadeboncoeur, WSYR-TV Syracuse, N.Y.; Robert Wells, KIUL(AM) Garden City, Kan.

Executive Director: Spencer Denison, Washington.

NAB, TVB

ngoni, WKVT Brattleboro, Vt.; William R. Rollins, WSVM Valdese, N.C.; Robert W. Tobey, KOTS Deming, N.M.; Jack S. Younts, WEEB Southern Pines, N.C.

Television Information—Peter Storer, Storer Bcstg Co., Miami Beach, Fla., chmn, Leslie Arries, WBEN-TV Buffalo, N.Y.; Thomas E. Bolger, WMTV Madison, Wis.; Kathryn Broman, Springfield (Mass.) TV Bcstg Corp.; John Cowden, CBS-TV, New York; Robert Gordon, WCPO-TV Cincinnati; Robert Kasmire, NBC, New York; Ellis Moore, ABC, New York; John Murphy, Avco Bcstg Corp., Cincinnati; (ex-officio) A. Louis Read, WDSU-TV New Orleans.

Television Bureau of Advertising

Headquarters: 1345 Avenue of the Americas, New York 10019.
Phone (212) 397-3456

Central Division: 410 N. Michigan Ave. Chicago 60611
Phone (312) 644-1215

Detroit Office: 1017 Fisher Bldg., 3011 W. Grand Blvd., Detroit 48202
Phone (313) 873-7070

Western Division: 444 N. Larchmont Blvd., Los Angeles 90004
Phone (213) 469-8231

Officers

Roger D. Rice, pres.
Norman E. Cash, vice chmn of bd.
George G. Huntington, exec VP & gen mgr.
Joseph J. Sullivan Jr., exec VP s/s.
Harvey Spiegel, Sr VP, isch & mktg.
Richard Severance, VP, natl s/s.
Murray Gross, VP, communications.
John Sheehan, VP, stn svcs.
Beverly Keene, VP, creative svcs.
Walter M. Vetter, VP, tech svcs.
Jack O'Mara, VP, Western div.
Jacob Evans, VP, Central div.
W. Eldon (Hap) Hazard, VP, Detroit.
Henry P. Hayes, VP, bus affairs.
Seymour Bernstein, dir of survey rsch.
Harold Simpson, dir of info svcs.

Board of Directors: Walter E. Bartlett, Avco Broadcasting Corp., Cincinnati; Norman E. Cash, TVB, New York; Tom Cookerly, WMAL-TV Washington; Robert Dudley, The Meeker Co., New York; William B. Faber, WFLA-TV Tampa, Fla.; David E. Henderson, The Outlet Co., Providence, R.I.; Kenneth M. Johnson, KTRK-TV Houston; Albert P. Krivin, Metromedia Television, Los Angeles; James Marino, RTVR Inc., New York; A. red M. Masini, TeleRep Inc., New York; James P. McCann, Top Market Television, New York; Bruce McGorin, WCSH-TV Portland, Me.; D. Thomas Miller, CBS Television Stations Division, New York; Wynn Nathan, Time-Life Films, New York; Richard A. O'Leary, ABC Television Stations, New York; Thomas M. Percer, WHNT-TV Huntsville, Ala.; C. P. Persons Jr., WKRG-TV Mobile, Ala.; Robert Rice, WRAU-TV Peoria, Ill.; Roger D. Rice, TVB, New York; James C. Richdale Jr., KHOU-TV Houston; Marvin L. Shapiro, Westinghouse Broadcasting Co., New York; Norman E. Wait, McGraw-Hill Broadcasting Co., New York; William G. Walters, Peters, Griffin, Woodward Inc., New York; Arthur A. Watson, WNBC-TV New York.

Committees

Executive Committee (board of directors): Walter E. Bartlett, chmn; Norman E. Cash, vice chmn; Roger D. Rice, pres.; Alfred M. Masini, VP; Marvin L. Shapiro, sec; Arthur A. Watson, treas; Kenneth M. Johnson, ex-officio.

Research Advisory Committee: Chmn: Ken Mills, Katz Television, New York; Bill Alexander, WFMY-TV Greensboro, N.C.; Richard Bompane, Avery-Knodel Inc., New York; Dave Henderson, The Outlet Co., Providence, R.I.; Mark Mandala, KGO-TV San Francisco; Mary McKenna, Metromedia Inc., New York; Al Ordo- ver, NBC, New York; Paul Ryan, TVB of Canada Inc., Toronto; Diane Sass, Kaiser Broadcasting Corp., New York; Walter Stein, ABC Owned TV Stations, New York; Adam Young, Adam Young Inc., New York; Bernhard F. Ziegler, WTVJ(TV) Miami.

Sales Advisory Committee: Co-chmn: Thomas G.

RAB, TIO, RIO, BRC, NAFB

Maney, WCVB-TV Boston, and Richard Appletton, WPVI-TV Philadelphia; Jim Blake, KSTP-TV St. Paul; Jon Campbell, KPRC-TV Houston; James Joe Golden, KDAL-TV Duluth, Minn.; Arnold M. Kohler, Adam Young Inc., New York; George Lilly, WBEN-TV Buffalo, N.Y.; Ray C. Senate, WIBW-TV Topeka, Kan.; Jay Walters, Harrington, Righter & Parsons, New York; John Behnke, KOMO-TV Seattle; Robin Brumett, KIRO-TV Seattle; James D. Freeman, WSBT-TV South Bend, Ind.; Jack E. Harris, KREM-TV Spokane, Wash.; Les Lindvig, KOOL-TV Phoenix; Ron Philips, WTAR-TV Norfolk, Va.; Andrew Potos, Storer Television Sales, New York; William S. Ritchie, KTEW-TV Tulsa, Okla.; Douglas Smith, WFBC-TV Greenville, S.C.; Lloyd Werner, Television Advertising Representatives Inc., New York; Marty Colby, XETV-TV Tijuana, Mexico; Hap Ealon, WJBK-TV Detroit; Frank Flynn, WCTV-TV Thomasville, Ga.; Patrick Gmitter, Cox Broadcasting Corp., Atlanta; Robert Headlee, WBRZ-TV Baton Rouge; Mark Mandala, KGO-TV San Francisco; Richard McCloskey, KMEG-TV Sioux City, Iowa; Henry J. O'Neill, WFOS-TV Hartford, Conn.; Robert E. Rice, WRAU-TV Peoria, Ill.; Richard Wexo, WDSU-TV New Orleans; Gerard Mulderrig, WPIX-TV New York; representing board of directors: Robert Wiegand, WKRC-TV Cincinnati; representing research advisory committee; Ken Mills, The Katz Agency, New York.

National Sales Advisory Committee: Francis P. Barron, Storer Television Sales Inc., New York; Oliver S. Blackwell, Katz Television, New York; Carman J. Bolton, Bolton/Burchill International Ltd., New York; John F. Dickinson, Harrington, Righter & Parsons Inc., New York; Robert L. Dudley, The Meeker Co., New York; Bernard Hirsch, NBC Spot Television Sales, New York; Neil Kennedy, MMT Sales Inc., New York; Robert J. Kizer, Avery-Knodel Inc., New York; James Marino, RTVR Inc., New York; Alfred M. Masini, TeleRep Inc., New York; James P. McCann, Top Market Television, New York; John McKay, CBS Television Stations National Sales, New York; Robert Muth, Petry Television Inc., New York; L. Donald Robinson, Kaiser Broadcasting Spot Sales Inc., New York; Marvin Rudolph, WGN Continental Television Sales Co., New York; Richard N. Savage, ABC Television Spot Sales, New York; Stephen D. Seymour, Television Advertising Representatives Inc., New York; Edward P. Shurick, H-R Television Inc., New York; Thomas J. Tilson, Metro TV Sales, New York; Oliver T. Tritter, Blair Television, New York; Theodore D. Van Erk, Peters, Griffin, Woodward Inc., New York; Adam Young, Adam Young Inc., New York; Len Ziegel, Evans Broadcasting Corp., New York.

Radio Advertising Bureau

Headquarters: 555 Madison Ave. New York, 10022
Phone (212) 688-4020

Western Office: 1900 Avenue of the Stars, Suite 765, Los Angeles 90067
Phone (213) 553-9470

Midwestern Office: 333 N. Michigan Ave., Chicago 60601
Phone (312) 372-4620

Detroit Office: 6735 Telegraph Rd., Birmingham, Mich. 48010
Phone (313) 647-8110

Officers

Harold L. Neal Jr., chmn.
Miles David, pres.
Robert H. Alter, exec VP
Albert Heck, VP, natl sts, East.
Lee Morgenlander, VP, dir of rsch.
George G. Waltheus, VP-Midwest.
Allen Hundley, VP-Southwestern region.
William Kennedy, VP-Detroit, dir of automotive adv.
James Ingraham, VP-Western region.
Joseph Vincent, VP rgnl sts.
William Peterson, VP communications.
Larry Ostrow, VP, natl retail chain sts.
Joyce Reed, VP, co-op svcs.
Jack Ackerman, VP, membership opns.
Stephen Bellinger, treas.
Cary Simpson, sec.

Board of Directors: Sal Agovino, Katz Radio, New York; James P. Arcara, Capital Cities Communications Inc., New York; George W. Armstrong, Storz Broadcasting, Omaha; Marvin Astrin, WGN Chicago; Ralph

Beaudin, Combined Communications, Phoenix; Stephen Bellinger, WJZ Decatur, Ill.; Roger G. Berk, Group One Broadcasting, Akron, Ohio; Paul F. Braden, WFPB Middletown, Ohio; Richard Buckley, Buckley Radio Sales Inc., New York; Arthur W. Carlson, Susquehanna Broadcasting, York, Pa.; Richard Carr, Meredith Broadcasting, Atlanta; Dwight Case, RKO General, Los Angeles; Richard W. Chapin, Stuart Enterprises, Lincoln, Neb.; Miles David, RAB, New York; Sam Cook Digges, CBS Radio, New York; George Duncan, Metromedia Radio, New York; Elmo Ellis, Cox Broadcasting, Atlanta, Ralph Guild, McGavren-Guild Inc., New York; L. G. Bob Jones, Southern Broadcasting, Winston-Salem, N.C.; Joe Kjar, Bonneville International Stations, Salt Lake City; Michael O. Lareau, WOOD-AM-FM Grand Rapids, Mich.; Leon Lowenthal, WKRC Cincinnati; Richard J. Monahan, Kops-Monahan Communications, New Haven, Conn.; David Morris, KNUZ Houston; John T. Murphy, Avco Broadcasting, Cincinnati; Harold L. Neal Jr., ABC Radio, New York; Don M. Nelson, Mid-America Radio Inc., Indianapolis; Donald A. Pels, Lin Broadcasting, New York; Marvin L. Shapiro, Westinghouse Broadcasting, New York; Cary H. Simpson, WTRN Tyrone, Pa.; Lee Allan Smith, WKY Oklahoma City; John Thayer, NBC Radio, New York; Harold H. Thoms, Thoms Radio/TV Enterprises, Asheville, N.C.; Bert West, Golden West Broadcasters, San Francisco; George Wilson, Bartell Broadcasters, New York.

Board Committees

Executive Committee:—Arthur W. Carlson, chmn.; George W. Armstrong, Sam Cook Digges, Joseph Kjar, John Murphy, John Thayer, Harold H. Thoms

Past Chairmen Advisory Committee:—Lester M. Smith, Kaye-Smith Enterprises, Bellevue, Wash., chmn.; Roger W. Clipp, WAYK-AM-FM Lehigh Acres, Fla.; George R. Comte, WTMJ-AM-TV and WKTI(FM) Milwaukee; Victor C. Diehm, WAZL(AM) and WVCD(FM) Hazleton, Pa.; Harold Krelstein, Plough Broadcasting, Memphis.

Finance Committee:—Elmo Ellis, chmn.; Marvin Astrin, Stephen Bellinger, Paul Braden, George Duncan, Richard Monahan, Lee Allan Smith.

Local Sales Committee:—Lee Allan Smith, chmn.; Marvin Astrin, Stephen Bellinger, Paul Braden, Dwight Case, Roger Clipp, Victor Diehm, Michael Lareau, David Morris, Cary Simpson.

National Sales Committee:—Leon Lowenthal, chmn.; Sal Agovino, James P. Arcara, Ralph Beaudin, Richard Buckley, Dick Carr, George Duncan, Ralph Guild, L.G. "Bob" Jones, Don Nelson, Marvin L. Shapiro, Lester Smith, Bert West.

Industry Problems Committee:—Richard W. Chapin, chmn.; James P. Arcara, George W. Armstrong, Marvin Astrin, Roger G. Berk, Richard Buckley, Dwight Case, Roger W. Clipp, Elmo Ellis, Harold Krelstein, Richard J. Monahan, Donald Nelson, Donald Pels, Cary Simpson, George Wilson.

Television Information Office

Headquarters: 745 Fifth Ave. New York 10022.
Phone (212) Plaza 9-6800.

Personnel

Roy Danish, dir.
Bert R. Brill, exec dir.
Managers of station services:
Henry W. Levinson
James Folsom
Louis B. Ames
James Poteat, librarian.
Elliot Ames, assoc editor.

Radio Information Office

Headquarters: 1771 N St. N.W., Washington 20036.
Phone (202) 293-3568.

Personnel

Charles T. Jones Jr., VP-dir.
Jonathan O. Hall, asst dir.
Valerie Waddelove, admin asst.

Broadcast Rating Council

Headquarters: 420 Lexington Ave., Room 2347,
New York 10017.
Phone (212) 679-7730

Officers

Peter Akizer (WWJ Stations), chmn.
Hugh M. Beville Jr., exec dir-sec treas.
John A. Dimling Jr. (National Association of Broadcasters), asst treas.
Brenda Fox, asst sec.

Board of directors. Chmn: Wilson C. Wearn, Multimedia Broadcasting; Peter A. Kizer, WWJ Stations; Donald H. McGannon, Westinghouse Broadcasting Co.; Jay Eliasberg, CBS/Broadcast Group; Thomas Coffin, NBC; Marvin Mord, ABC; Roger Rice, TVB; Miles David, RAB; James Greenwald, Katz Agency; Don B. Curran, Kaiser Broadcasting.

Liaison Observers

Association of National Advertisers: Charles Benesch, General Foods; William Kistler, VP, ANA.

American Association of Advertising Agencies: Gerald Baldwin, Young & Rubicam; Jack Hill, Ogilvy and Mather.

National Association of Farm Broadcasters

Officers

Royce Bodiford, KGNC Amarillo, Tex., pres.
Marvin Vines, KAAY Little Rock, Ark., pres-elect.
George Logan, KGNC Amarillo, Tex., sec-treas.
Ray Kremer, Box 533, Mount Dora, Fla., sls mktg dir.
Richard Hult, WIBW Topeka, Kan., VP, editor of "Chats."
Bob Buice, KARN Little Rock, Ark., historian.
Bill Alford, Orion Broadcasting, Cedar Rapids, Iowa, chmn, associates.
George Atkins, Canadian Broadcasting Corporation, Ontario, parliamentarian.
Bill Mason, WGN Chicago, immediate past pres.

National VPs: Ed Johnson, Agri-Broadcasting Network, Columbus, Ohio (Northeast); Gene Williams, WNAX Yankton, S.D. (North Central); Roddy Peoples, Voice of Southwest Agriculture, San Angelo, Tex. (South Central); Buddy Sanders, WMC Memphis (Southeast); Bill Allison, KMJ Fresno, Calif. (West).

Voting Members

Adair, Lynn, KSL-AM-TV Salt Lake City.
Allison, Bill, KMJ-AM-TV Fresno, Calif.
Andrews, Harry, WIBC Indianapolis.
Arnold, Barney, WHAS-AM-TV Louisville, Ky.
Atkins, George S., Canadian Broadcasting Corp., Toronto.
Ausley, Wally, WPTF Raleigh, N.C.
Balvanz, Richard, KMMJ Radio Grand Island, Neb.
Bateman, Dave, WDAY Radio Fargo, N.D.
Bazyn, Wallace, KVSH Valentine, Neb.
Bealy, Layne R., U.S. Dept. of Agriculture, Washington.
Behrens, Ken, WJBC Radio Bloomington, Ill.
Bishea, Albert M., WGBF Radio Evansville, Ind.
Bodiford, Royce, KGNC Amarillo, Tex.
Bradley, Dan, Rural Radio Network Inc., New Palestine, Ind.
Branham, David, Agri-Broadcasting Network, Columbus, Ohio.
Brown, Joe, KDAV Radio Lubbock, Tex.
Brownfield, Derry, Missouri Network Inc., Centertown, Mo.
Buice, Bob, KARN-Arkansas Radio Network, Little Rock, Ark.
Burns, Colleen, WMBD AM TV Peoria, Ill.
Burrow, John, KGNC Radio, Amarillo, Tex.
Burtenshaw, Bob, KID Idaho Falls, Idaho.
Childs, Rex, KFID Radio Wichita, Kan.
Compton, Dewey, KTRH Houston.
Compton, Ronnie, KTRH Houston.
Conger, Charles, KBIZ-KTVO Ottumwa, Iowa.
Cox, Forrest, WLBT-TV Jackson, Miss.
Cox, Murray E., WFAA Dallas.
Crowner, Jack M., WAVE Louisville, Ky.
Dahlberg, Darrel, KRNV Radio Lexington, Neb.
Davis, Harold, WILO Radio Frankfort, Ind.

Davis, Lew, Ohio Farm Network, Jackson, Ohio.
Davis, Red, KOLT Radio Scottsbluff, Neb.
Dillard, Jack, KWKH Shreveport, La.
Dillman, Bruce, KECK Lincoln, Neb.
Duncan, James, KWKH Shreveport, La.
Duncan, Steve, WTCR Radio Ashland, Ky.
Emby, Col. Dink, WHOP Hopkinsville, Ky.
Etheredge, Bob, KCB-D-TV Lubbock, Tex.
Flesher, Mike, KFKA Radio Greeley, Colo.
Frazier, Kendal, WIBW-TV-FM Topeka, Kan.
Glazebrook, Leland, Sullivan, Ill.
Gould, Jay, WOWO Ft. Wayne, Ind.
Grunert, Ron, WVAL Radio Sauk Rapids-St. Cloud, Minn.
Guenther, Karl, WKZO-AM-TV Kalamazoo, Mich.
Gustin, Al, Meyer Bcstg Inc., Bismarck, N.D.
Hansen, Dale, KWVWL Radio-TV Waterloo, Iowa.
Hare, W. R., KWTV Oklahoma City.
Hawkins, Richard S., KXXX Colby, Kan.
Haynes, Harrington Jr., WSOY Decatur, Ill.
Hare, W. R., KWTV Oklahoma City.
Heath, Howard E., WPAG & Michigan Farm Ann Arbor, Mich.
Heinz, Al, KGLO-AM-TV Mason City, Iowa.
Hoefing, Steve, KMA Shenandoah, Iowa.
Hoffman, Dan, WIBW-AM-TV Topeka, Kan.
Houdashell, Ernie, KGNC Radio Amarillo, Tex.
Hull, Richard C., WFRV-TV-FM Green Bay, Wis.
Hunter, Earl, WKTY Radio LaCrosse, Wis.
Hutchcraft, Bruce, WTVT-TV Tampa, Fla.
Jefferies, C.B., KENR Radio Houston.
Jenkins, Wayne, Wabash Valley Bcstg, Terre Haute, Ind.
Jewell, Roy, CFPL-AM-TV London, Ont.
Johnson, Ed, Agri-Broadcasting Network, Columbus, Ohio.
Kellher, Pat, WAXX(AM), WEAU-TV Eau Claire, Wis.
Kendrick, Jim, KWTO Radio Springfield, Mo.
King, David E., KSEL AM-TV Lubbock, Tex.
Kirkpatrick, Keith, WHO Des Moines, Iowa.
Kline, Lee, WHO Des Moines, Iowa.
Knauf, Dave, WHO Des Moines, Iowa.
Kuppler, Charles, WTAD Radio & KHQA-TV Quincy, Ill.
Lavinghousez, Bill, WFTV Orlando, Fla.
Lease, Bruce L., KWQA Radio Worthington, Minn.
Lee, Roy, KGBX Springfield, Mo.
Liles, Wayne C., KWTV Oklahoma City.
Lilligren, Chuck, WCCO Radio Minneapolis.
Luepke, Frank, KIWA Sheldon, Iowa.
McDonald, Bob, KRGV-TV Westaco, Tex.
McDonald John A., WSM Nashville.
McHargue, Dick, KHMO Hannibal, Mo.
McQueen, Horace F., KLTV-TV-KTRE-TV Tyler, Tex.
McReynolds, Bill, WQOI San Antonio, Tex.
Martin, Harry, Rural Radio Network, Inc., New Palestine, Ind.
Mason, Bill, WGN-AM-TV Chicago.
Mayfield, Frank G., WIBA Madison, Wis.
Messersmith, Rex, KRVN Lexington, Neb.
Michaelsen, Ron J., WMT Cedar Rapids, Iowa.
Millard, Gene, KFEO Radio St. Joseph, Mo.
Miller, Robert C., AVCO Bcstg Corp., Cincinnati.
Miller, Earle, KDHL Radio Faribault, Minn.
Moore, Vern, KIDO Radio Boise, Idaho.
Muller, Chuck, KOA-AM-TV Denver
Nelson, Don, KLZ Radio Denver
Nelson, Ed, WNAX Radio, Yankton, S.D.
Nielson, Warren, KFAB, KMTV Omaha.
Oliver, Lloyd, KOLN Lincoln, Neb. and KGIN-TV Grand Island, Neb.
Oppold, Mark, WMT Cedar Rapids, Iowa.
Osborn, Don, Missouri Network Inc., Centertown, Mo.
Gskarsen, Davonna L., WRFD Radio Columbus.
Oviatt, Denny, KSOO Radio Sioux Falls, S.D.
Passer, Jerry, WMT Cedar Rapids, Iowa.
Paul, Cletus, KBUR Radio Burlington, Iowa
Peebles, Larry, WCVL-WLFO Crawfordsville, Ind.
Peebles, Roddy, Voice of Southwest Agriculture, San Angelo, Tex.
Peterson, Arnold W., WOW-TV Omaha.
Pierson, Russell, WKY-AM-TV Oklahoma City.
Pippert, Paul, WKMO-AM-TV Kansas City, Mo.
Plambeck, Herb, Herb Plambeck and Associates, Des Moines, Iowa.
Powers, Ron, WIMA Radio Lima, Ohio.
Ragan, Gene, WOOF Radio Dothan, Ala.
Rankin, Charlie, KURV, KESI Edinburg, Tex.
Ray, Bill, Agrinet Farm Network, Charlottesville, Va.
Roberts, Marty, WTAX Springfield, Ill.
Robinson, Wip, III, WWSA Harrisonburg, Va.
Rodgers, Raymond L., KFBK, Sacramento, Calif.
Root, Ken, WKY-AM-TV, Oklahoma City
Roquemore, Crawford, WTUB Radio Troy, Ala.

Rothgeb, Wayne P., WMEE(AM)-WKJG-TV Ft. Wayne, Ind.

Samuelson, Mike, WJAG Norfolk, Neb.
Samuelson, Orion, WGN-AM-TV Chicago.
Sanders, E. W. (Buddy), WMC-AM-TV Memphis.
Sargent, Earl E., KWFT Wichita Falls, Tex.
Schoen, Ralph R., WGIL Radio Galesburg, Ill.
Schuman, Larry, WCMR Elkhart, Ind.
Shaw, Walt, Hercules Broadcasting, KRAK Sacramento, Calif.
Sheppard, Verne, KOTA-AM-TV Rapid City, S.D.
Simpson, Weymeth M., KHO-AM-TV Spokane, Wash.
Slack, J. Evan, Intermountain Farm Network, Denver.
Slater, Sonny, KSAL Radio Salina, Kan.
Slusarczyk, Edwin L., WIBX Utica, N.Y.
Sparks, Harold L., WLKM Three Rivers, Mich.
Speece, Maynard A., WCCO Radio Minneapolis.
Stearns, John A., U.S.A. Productions, Pacific Palisades, Calif.
Steckline, Larry, KFRM, KICT Radio, Wichita, Kans.
Stone, David P., Hubbard Bcstg Inc. St. Paul.
Stone, Rob, WIRE Radio Indianapolis.
Strickland, Verne, WRAL-TV Raleigh, N.C.
Sturmer, Les, WBAY-AM-TV Green Bay, Wis.
Sylvester, Dave, KWMT Radio Ft. Dodge, Iowa.

Underwood, J. R., WOC Broadcasting Co., Davenport, Iowa.
Urdahl, Jerry K., WAXX(FM)-WEAU-TV Eau Claire, Wis.

Vines, Marvin, KAAY Little Rock, Ark.

Walters, Beverly, KFGO Fargo, N.D.
Wangness, Mel, KOEL Radio Oelwein, Iowa.
Ward, Roger, WJIL Radio Jacksonville, Ill.
Wideman, Spike, KFYO Lubbock, Tex.
Wilkes, Ed, KFYO Lubbock, Tex.
Wilkinson, Ray S., WRAL-TV Raleigh, N.C.
Williams, Gene, WNAX Yankton, S.D.
Williams, Wally, WSJS Radio Winston-Salem, N.C.
Yaws, Dick, WBAP-FM-TV Ft. Worth.
Ziegler, Bob, WRFD Radio Columbus.
Zimmerman, John B., Wisconsin Farm Bcstg Network, Madison, Wis.

National Association of Television Program Executives

Address: Box 5272, Lancaster Pa. 17601. (717) 569-0181.

Officers

Martin Chauvin, WOTV(TV) Grand Rapids, Mich., pres.
 Phil Boyer, ABC, New York, 1st VP.
 Jim Major, WJBK-TV Detroit, 2nd VP.
 Betty Woodland, Lancaster, Pa., sec-treas.
 James Ferguson, WAGA-TV Atlanta, immediate past pres.

Directors: Harry Francis, Meredith Broadcasting, New York; William Wuerch, Avco Broadcasting Corp., Cincinnati; Joe Sands, KNXT(TV) Los Angeles; Jack Markham, WFMY-TV Greensboro, N.C.; Henry Gillespie, Viacom International, New York; Seymour Horowitz, WABC-TV New York; A.R. Van Cantford, WSB-TV Atlanta; Jayne Boyd, WKYC-TV Cleveland; Chuck Sorien, WCCO-TV Minneapolis; Steve Currie, WCBD-TV Charleston, S.C.; Lew Klein, Gateway Communications Inc., Cherry Hill, N.J.; Jack Jacobson, WGN Continental Broadcasting Co., Chicago; Bill Hillier, KPX San Francisco.

Membership

Jim Abbott, WTVW Evansville, Ind.
Gary Adler, WJKS-TV Jacksonville, Fla.
Richard A'Hearn, WFLG-TV Miami Fla.
Edward G. Alken, KPHO-TV Phoenix Ariz.
Raymond E. Alexander, WBRZ-TV Baton Rouge
Elmer Alley, WSM-TV Nashville
Robert M. Allingham, KSTAR-TV Phoenix
Herb Altman, Marketing Evaluations Inc., Port Washington, N. Y.
Charles S. Alvey, WUHO-TV Battle Creek, Mich.
Forest Amsden, KGW-TV Portland, Ore.
James N. Armistead, WRDW-TV North Augusta, S. C.
Betty Asherman, WCKT-TV Miami

John Atkinson, WNAC-TV Boston
Becky Averyt, KOA-TV Denver
Gus Bailey, Jr., WKRC-TV Cincinnati
Joe H. Baker, KMTV Omaha
Walt Baker, KHJ-TV Los Angeles
William F. Baker, KMTV Omaha
Winthrop P. Baker, Westinghouse Broadcasting Co., New York
David M. Baltimore, WBRE-TV Wilkes-Barre, Pa.
Alvin H. Barcheski, WHO-TV Des Moines, Iowa
Wayne Barrington, WISN-TV Milwaukee
Ted Baze, WPHL-TV Philadelphia
Earl Beall, WGR-TV Buffalo, N. Y.
David Beddow, KDKA-TV Pittsburgh
Jim Behling, WITI-TV Milwaukee
John Behnke, KOMO-TV Seattle
Chester T. Behrman, WFIE-TV Evansville, Ind.
Douglas G. Bell, WCCB-TV Charlotte, N. C.
Norman Berger, WKBN-TV Youngstown, Ohio
Paul T. Berry, WRBL-TV Columbus, Ga.
Jerrell Birdwell, KTLA Los Angeles
Jon F. Boettcher, WBRA-TV - WSVN-TV, Roanoke, Va.

Cal A. Bollwinkel, KXTV-TV Sacramento, Cal.
Jack Bomar, KTHV Little Rock, Ark.
Hendrik Booraem, Jr., WPIX-TV New York
Jayne Boyd, WKYC-TV Cleveland
Phil Boyer, American Broadcasting Co., New York
Carl A. Bracale, KIMO-TV Anchorage
Clayton H. Brace, KGTV San Diego
Charles Bradley, WPVI-TV Philadelphia
James A. Bradley, KWLL-TV Waterloo, Iowa
Tom Breen, KTVU Oakland, Calif.
Jean Brousseau, CKMT-TV Trois-Rivieres, Quebec, Canada
Paul G. Brown, KATC-TV Lafayette, La.
Arnold Brustin, WBBM-TV Chicago
Bruce R. Bryant, CBS Television Network, New York
Richard S. Burdick, WCVB-TV Needham, Mass.
Curtis W. Butler, WCHS-TV Charleston, W. Va.
Richard J. Butterfield, KOIN-TV Portland, Oregon
David T. Butts, WSEE-TV Erie, Pa.
Conrad Cagle, WAVE-TV Louisville, Ky.
Clem Candelaria, KTVT Fort Worth
Joseph F. Carney, KMSP-TV Minneapolis
Jerry Carr, WOKR-TV Rochester, N. Y.
Larry Cazavan, WXYZ-TV Detroit
David Chase, WIIC-TV Pittsburgh
Marvin Chauvin, WOTV Grand Rapids, Mich.
Murray Chercover, CTV Television Network Ltd., Toronto M4Y 1T4 Canada
Ray J. Chumley, WSTV-TV Steubenville, Ohio
Lawrence M. Clamage, WWJ-TV Detroit
Scott R. Clawson, KSL-TV Salt Lake City
Gene Cless, KMBC-TV Kansas City, Mo.
Kent L. Colby, KAUS-TV Austin, Minn.
John Comas, WXII-TV Winston-Salem, N. C.
Jerry Condra, KCRG-TV Cedar Rapids, Iowa
Sheldon Cooper, WGN Continental Broadcasting Co. Chicago
Jo Corey, WBBH-TV Ft. Myers, Fla.
Michael J. Corken, WAST-TV Albany, N. Y.
A. Philip Corvo, KGTV San Diego
Paul D. Coss, KABC-TV Hollywood
Patricia Cramer, WTVN-TV Columbus, Ohio
Kenneth R. Croes, KOCC-TV Oklahoma City
Harold C. Crump, WLAC-TV Nashville
Dean C. Cull, KCRV-TV Sacramento, Cal.
Gifford Cummings, NET Television, Inc., Ann Arbor, Mich.
Donald A. Cunningham, WOWK-TV Huntington, W. Va.
Gene Cunny, KDFW-TV Dallas
C. Stephen Currie, WCBD-TV Charleston, S. C.
George M. Curry, WSAS-TV Huntington, W. Va.
Ray Dantzler, WTVT Tampa, Fla.
Jerry Danziger, KOB-TV Albuquerque, N. M.
Ed Davis, WLEX-TV Richmond, Va.
Jack Decker, WHEC-TV Rochester, N. Y.
Milt DeReyna, WEAR-TV Pensacola, Fla.
Rodger E. Divens, WLVA-TV Lynchburg, Va.
Ralph J. Dolan, KSTP-TV Minneapolis
John Dorkin, WLKY-TV Louisville, Ky.
Robert D. Doubleday, KATV Little Rock, Ark.
James C. Dowdle, WTOG-TV St. Petersburg, Fla.
Gary Dreispul, WJAR-TV Providence, R. I.
Chris Duffy, WLS-TV Chicago
James H. Duncan, WTVJ Durham, N. C.
Wallace L. Dunham, KTEW-TV Tulsa, Okla.
Doug Duperrault, WFLA-TV Tampa, Fla.
M. A. Durea, WOSU Radio & Television, Columbus, Ohio

NATPE

John Duvall, WLEX-TV Lexington, Ky
J. Michael Early, WWL-TV New Orleans
William E. Eckstein, WTVK-TV Knoxville, Tenn.
Lee S. Eden, Corinthian Broadcasting Corp., New York
John Edgerton, WBTV Charlotte, N. C.
Julius P. Efflandt, KTVH Wichita, Kansas
Ramsey Elliott, KOVR-TV Sacramento, Cal.
Jeff Evans, WLCY-TV St. Petersburg, Fla.
Ben Falber, Jr., WIIL-TV Terre Haute, Ind.
Chet Falzerano, WBRC-TV Birmingham, Ala.
Maurry J. Farrell, WYEA-TV Columbus, Ga.
Peter Fennelly, WBIR-TV Knoxville, Tenn.
James Ferguson, WAGA-TV Atlanta
Jeanne Findlater, WXYZ-TV Southfield, Mich.
Bill Fouch, KCST-TV San Diego
Dave L. Fornshell, Ohio Educational Television Network, Columbus, Ohio
Keith H. Fowles, WAGM-TV Camden, Maine
Carl Fox, KYTV Springfield, Mo.
Harry Francis, Meredith Broadcasting, New York
John P. Frankenfield, WBAL-TV Baltimore
Alan Frank, WBZ-TV Boston
Bill Franks, WVTU Milwaukee
Nick Freeman, KIRO-TV Seattle
John Froome, KAKE-TV Wichita, Kansas
John W. Fuller, WTLV Jacksonville, Fla.
Joe Galvan, KTVO Ottumwa, Iowa
Phil Ganyon, XETV San Diego
Art Garland, WRGB-TV Schenectady, N.Y.
Barrett Geoghegan, WAND-TV Decatur, Ill.
William A. Gietz, WTAR-TV Norfolk, Va.
Samuel Gifford, WHAS-TV Louisville, Ky.
Jack Gilbert, KCAU-TV Sioux City, Iowa
Albert J. Gillen, WJRT-TV Flint, Mich.
Raymond A. Givlard, WGAN-TV Portland, Maine
Chuck Gindgold, KATU-TV Portland, Ore.
Judy Girard, WBNG-TV Binghamton, N. Y.
Patrick J. Gmlter, Cox Broadcasting Corp., New York
Berl Golub, WKCF-TV Dayton, Ohio
George J. Gonyar, WABI-TV Bangor, Maine
James F. Goodman, WRAL-TV Raleigh, N. C.
Robert J. Gould, KXAS-TV Fort Worth
David M. Graves, WWNY-TV Watertown, N. Y.
John Greene, WWBT Richmond, Va.
Hewitt Griffin, WLBT-TV Jackson, Miss.
Richard T. Grimm, KTVI Honolulu
John M. Grubbs, Storer Broadcasting Co., Miami
Keith Gunther, KSD-TV St. Louis
Monte Gurwit, KOMU-TV Columbia, Mo.
George B. Hagar, KHON-TV Honolulu
John Haldi, WBNS-TV Montgomery, Ala.
William R. Hall, KREM-TV Spokane, Wash.
E. L. Hambleton, CFCF Television, Montreal, H3N 1M4 Quebec, Canada
Dave Handy, WSPA-TV Spartanburg, S. C.
Jeffrey Hark, WTAJ-TV Altoona, Pa.
John Harkrader, WDBJ-TV Roanoke, Va.
Charles P. Harper, Jr., WTVQ-TV Lexington, Ky.
Richard Harris, General Electric Broadcasting Co., Denver
Weston J. Harris, NBC Owned Stations Div., New York
William E. Harris, WSBK-TV Boston
Elizabeth Hayter, WCAU-TV Philadelphia
Stuart S. Hazard, WLIX-TV Jackson, Mich.
Don Elliot Heald, WSB-TV Atlanta
William J. Helms, WCIA-TV Champaign, Ill.
Al Helton, KVUE-TV Austin, Texas
David E. Henderson, WJAR-TV Providence, R. I.
Ed Herbert, WGR-TV Buffalo, N. Y.
James C. Herzog, KOLO-TV Reno, Nevada
Richard A. Heuer, WJCT Jacksonville, Fla.
Ben Hevel, WCPO-TV Cincinnati
Kathleen Higgins, WHP Harrisburg, Pa.
Bill Hillier, KPX-TV San Francisco
Bill Hippee, KCCI-TV Des Moines, Iowa
Mickey L. Hooten, WTAE-TV Pittsburgh
Seymour Horowitz, WABC-TV New York
Juanita Hostettler, WHP-TV Harrisburg, Pa.
E. Hal Hough, CBS Television Stations, New York
Mel House, KBMA-TV Kansas City, Mo.
Dena Howell, KBCI-TV Boise, Idaho
John Hrubesky, WMTV Madison, Wis.
Ray Hubbard, Post-Newsweek Stations, Inc., Washington, D. C.
Robert Huber, WJW-TV Cleveland
Joe Hudgens, KCCI-TV Des Moines, Iowa
Everett H. Hughes, WDBO-TV Orlando, Fla.
Paul M. Hughes, WTEN Albany, N. Y.
Mack Humplidge, WSAV-TV Savannah, Ga.
Edward A. Hutchings, WEAU-TV Eau Claire, Wisc.
John L. Hutchinson, Jr., WNED-TV Buffalo, N. Y.

Thomas A. Hutchison, WLUK-TV Green Bay, Wisc.
John P. Irvin, KOTV Tulsa, Okla.
Wayne Jackson, WECT Wilmington, N. C.
Jack Jacobson, KGUN-TV Tucson, Ariz.
Jack Jacobson, WGN Continental Broadcasting Co., Chicago
Kenneth H. James, KETV Omaha
Frank Jank, KVOS-TV Bellingham, Wash.
Lee Jason, KFNS-TV Fresno, Cal.
Elmer F. Jaspán, WDRB-TV Louisville, Ky.
Bill Jay, WLAC-TV Nashville
Paul Jensen, KOLN-TV/KGIN-TV, Lincoln, Neb.
Joe Jerkins, WKY-TV Oklahoma City
Earl Johnson, WRTV Indianapolis, Ind.
Bob Jones, WLEX-TV Lexington, Ky.
David J. Jones, KARK-TV Little Rock, Ark.
Tak Kako, WABC-TV New York
Mel J. Kampmann, KXJB-TV Fargo, N. D.
Mal Kasanoff, KGBT-TV Harlingen, Texas
Arvo O. Katajisto, WPTV Palm Beach, Fla.
John J. Keenan, WEYI-TV Saginaw, Mich.
Charles Keller, Capital Cities Broadcasting Corp., Philadelphia
Ken Kennedy, WDAY-TV Fargo, N. D.
Tom Kenney, KFMB-TV San Diego
John T. Ketterer, WMBD-TV Peoria, Ill.
Ron Klayman, WQAD-TV Moline, Ill.
Lewis Klein, Gateway Communications Inc., Cherry Hill, N. J.
L. W. Kiewer, WVEC-TV Hampton, Va.
Douglas Knight, WSPD-TV Toledo, Ohio
A. George Koplów, WBF-TV Rock Island, Ill.
Al Korn, RKO Television, New York
Neil Kuvín, WXIA-TV Atlanta
Michael J. Labonia, Iowa Educational Broadcasting Network, Des Moines, Iowa
Ed Lackner, KOMO-TV Seattle
Kenneth Ladage, WOW-TV Omaha
Jack LaForest, WLUK-TV Marquette, Mich.
Ed Lamy, WAFB-TV Baton Rouge
Charles Larsen, WLWC Columbus, Ohio
Boyd W. Lawlor, KSBW-TV Salinas, Cal.
Charles T. Leaseur, KBTU Denver
Lon Lee, WJXT Jacksonville, Fla.
Roger Lefkon, WNBC-TV New York
Robert L. Lewis, KGW-TV Portland, Ore.
Bruce R. Liljegren, WAOW-TV Wausau, Wisc.
Walter C. Liss, Jr., WKWB-TV Buffalo, N. Y.
Jay W. Lloyd, KSL-TV Salt Lake City
Bill Logan, WMTV Cedar Rapids, Iowa
Don Long, KRDO-TV Colorado Springs, Colo.
Dixon C. Lovorn, Cosmos Broadcasting Corp., Columbia, S. C.
Art Ludwig, WTCN-TV Minneapolis
Charles McAbee, KCMO-TV Kansas City, Mo.
Kevin McAndrews, KOLR-TV Springfield, Mo.
Amy McCombs, WFSB-TV Hartford, Conn.
F. Robert McCourt, WSOC-TV Charlotte, N. C.
E. James McDonald, WSYR-TV Syracuse, N. Y.
Gerald McGrath, WTMJ-TV Milwaukee
Jim Major, WJBK-TV Southfield, Mich.
Jack Markham, WFMY-TV Greensboro, N. C.
Bob Martin, KOOL-TV Phoenix
Emil W. Martin, McClatchy Broadcasting, Sacramento, Cal.
Lou Martin, KOAM-TV Pittsburg, Kansas
Homer C. Mason, KHQ-TV Spokane, Wash.
Larry H. Massoli, KORR-TV Las Vegas
Jack F. Matranga, KTXL-TV Sacramento, Cal.
Philip Mayer, KNBC Burbank, Cal.
Howard W. Meagle, Jr., WVIR-TV Charlottesville, Va.
Don Merl, KMOX-TV St. Louis
Ed Metcalf, WPTA-TV Fort Wayne, Ind.
Jack Michael, WREC-TV Memphis
Dave Miller, WIS-TV Columbia, S. C.
Frank M. Miller, WTJF Miami
Robert Mitchell, KGO-TV San Francisco
Ruth Ann Modestitt, WTHI-TV Terre Haute, Indiana
Jack Moffitt, WUAB-TV Cleveland
William G. Moll, KENS-TV San Antonio, Texas
Edward A. Montanus, MGM-TV New York
Jules Moreland, KOIN-TV Portland, Ore.
George Moynihan, Westinghouse Broadcasting Co., New York
Robert R. Nelson, WXLTV Sarasota, Fla.
Glenn Nickell, KVAL-TV Eugene, Ore.
Gary R. Nielsen, KETV Omaha
Robert E. O'Connor, KTTV Los Angeles
E. LeRoy Olliger, KWGN-TV Denver
Charles E. Osburn, WLIO-TV Lima, Ohio
Roger C. Ottenbach, WEEK-TV East Peoria, Ill.
W. Paul Oughten, WITN-TV Washington, N. C.
John Palmer, WHNB-TV West Hartford, Conn.
Michael Palmer, KOCC-TV Oklahoma City
Harry J. Pappas, KMPH-TV Visalia, Cal.
Stewart B. Park, KNTV San Jose, Cal.

Jack A. Parris, KMEG-TV Sioux City, Iowa
Erwin Parthe, WNEM-TV Saginaw, Mich.
Sandra Pastoor, WXIX-TV Cincinnati
Robert O. Paxson, WPTZ Plattsburgh, N. Y.
Herman Pease, WUTV Buffalo, N. Y.
Daniel T. Pecaro, WGN Continental Broadcasting Co., Chicago
Tom M. Percer, WHNT-TV Huntsville, Ala.
Joseph C. Perkins, Jr., WTAR-TV Norfolk, Va.
Alan E. Perris, Post-Newsweek Stations, Washington
Marvin L. Perry, Jr., KTBS-TV Shreveport, La.
C. P. Persons, Jr., WKRG-TV Mobile, Ala.
William E. Pfeiffer, WLOS-TV Asheville, N. C.
Sidney Pike, WTCC-TV Atlanta
Clifford S. Pine, WFTV Orlando, Fla.
James A. Plant, CFPL-TV London, Ontario, Canada N6A 4H9
Dave Polrier, WIDIO-TV Duluth, Minn.
Malcolm D. Potter, WVUE-TV New Orleans
Don Powers, WCSH-TV Portland, Maine
John Proffitt, KCMO-TV Kansas City, Mo.
Harold Protter, KPLR-TV St. Louis
Zev Putterman, KOED-TV San Francisco
John Radeck, WJBF Augusta, Ga.
Buddy Ragan, WNGE-TV Nashville
Dan Rainger, KCPX-TV Salt Lake City
Robert I. Ratcliff, WKPT-TV Kingsport, Tenn.
Rick Ray, WCSC-TV Charleston, S. C.
James H. Reese, WATE-TV Knoxville, Tenn.
Jim Reid, WDCAT-TV Washington
Tom Reiff, KPRC-TV Houston
Quintin E. Renner, WBEN-TV Buffalo, N. Y.
John T. Reynolds, KTLA Los Angeles
Harry Riegert, WFRV-TV Green Bay, Wis.
Robert P. Rimes, McGraw-Hill Broadcasting Co., San Diego
Lenart Ringquist, WNEW-TV New York
William S. Ritchie, KTEW Tulsa, Okla.
Gary Robinson, WGHP-TV High Point, N. C.
John L. Robinson, WTEV Providence, R. I.
Mort Rosenthal, WDAU-TV Scranton, Pa.
Stanley A. Rudick, WTTG Washington
Squire D. Rushnell, ABC Owned Television Stations, New York
Jack Rye, KTSM-TV El Paso, Texas
Jack Sallaska, KWTW-TV Oklahoma City
Elbert Sampson, WKBS-TV Philadelphia
Joe Sands, KNXT Los Angeles
Bob Savage, WMAZ-TV Macon, Ga.
W. "Buzz" Sawyer, WWLP-TV Springfield, Mass.
Lionel Schaen, KHJ-TV Los Angeles
R. M. Schafbuch, KOA-TV Denver
Peter Schlesinger, KCOP-TV Hollywood
Jeff Schiffman, WJZ-TV Baltimore, Md.
John Schmuhi, WSAF-TV Montgomery, Ala.
Allen H. Scollay, KRON-TV San Francisco
James R. Searer, Channel 3 Inc., Muskegon, Mich.
Stu Selbei, KYCU-TV Cheyenne, Wyoming
Jack Shafer, McGraw-Hill Broadcasting Co., San Diego
Don Sharon, CKLW-TV Detroit
Robert Shay, WCBS-TV New York
Tom Sheeley, KELO-TV Sioux Falls, S. D.
William J. Shock, WTOL-TV Toledo, Ohio
Zvi Shoubin, WMAQ-TV Chicago
Vic Skaggs, KTVI St. Louis
Max Sklower, KOAT-TV Albuquerque, N. M.
Philip Slavick, WWC-TV Memphis
David Smart, Jr., WHIO-TV Dayton, Ohio
Kenneth W. Smith, WESH-TV Orlando, Fla.
LaMar Smith, KUTV Salt Lake City
George Snowden, WOR-TV New York
Charles J. Sorlien, WCCO-TV Minneapolis
Gary E. Spears, WICS-TV Springfield, Ill.
George A. Sperry, WKBD-TV Southfield, Mich.
Bill Spiegel, WLWT Cincinnati
Ed Spray, WBBM-TV Chicago
Ronald St. Charles, WUAB-TV Cleveland
Ken Staaf, WCEE-TV Rockford, Ill.
Irwin P. Starr, WMAL-TV Washington
Allen Sternberg, WCKT Miami
George A. Stevens, WRCB-TV Pittsburgh
Monty G. Stock, WLUK-TV Green Bay, Wis.
Lyn P. Stoyer, KTVI-TV Sioux City, Iowa
Peter Strand, WSNS-TV Chicago
Albert Sturges, WFLD-TV Chicago
Frank Struzzi, WCKT Miami
Bob Sutton, KYW-TV Philadelphia
Leonard A. Swanson, WLIC-TV Pittsburgh
Dick Sweeney, WHAS-TV Louisville, Ky.
Henry A. Taylor, KCBD-TV Lubbock, Texas
James Al Taylor, WKYT-TV Lexington, Ky.
Bill Thrash, WKY-TV Oklahoma City
Barry H. Thurston, Kaiser Broadcasting Co., San Francisco
Don L. Tillman, WTTV-TV Indianapolis

Thomas N. Todd, WFBC-TV Greenville, S. C.
 Harry D. Trigg, WGN-TV Chicago
 Nat Tucker, WTNH-TV New Haven, Conn.
 Buddy Turner, WDAF-TV Kansas City, Mo.
 Jim Tuveson, Jr., KGO-TV San Francisco
 John P. Twaddle, WCVB-TV Needham, Mass.
 Dave J. Uhrich, WRET-TV Charlotte, N. C.
 Henry G. Urrich, WLYH-TV Lebanon, Pa.
 A. R. Van Cantfort, WSB-TV Atlanta
 T. J. Vaughn, WAND-TV Decatur, Ill.
 Herb Victor, KBHK-TV San Francisco
 Frederick H. Von Stade, WTVN-TV Columbus, Ohio
 Garry Vorhees, WTRF-TV Wheeling, W. Va.
 Russell F. Vossen, WZZM-TV Grand Rapids, Mich.
 Tay Voye, WTVJ Miami
 George Wallace, KGUN-TV Tucson, Ariz.
 George Walsh, WHEN-TV Syracuse, N. Y.
 Paul E. Walton, Jr., WNDU-TV South Bend, Ind.
 W. Carroll Ward, WTVM Columbus, Ga.
 Ralph Webb, KWTX-TV Waco, Texas
 Phillip (Pip) Wedge, CTV Television Network Ltd., Toronto M4Y 1T4 Canada
 Arthur Weinthal, CTV Television Network Ltd., Toronto M4Y 1T4 Canada
 Don West, CKLW-TV, Windsor, Ontario, Canada
 Gordon West, WCAU-TV Philadelphia
 Lee Weston, IDC Services, Chicago
 Gordon F. White, KPTV Portland, Ore.
 Charles A. Whitehurst, WFMY-TV Greensboro, N. C.
 Barbara Wigham, WPTA-TV Ft. Wayne, Ind.
 Jerry L. Williams, WCTV Tallahassee, Florida
 W.R. Williamson III, WKBN Broadcasting Corp., Youngstown, Ohio
 Robert C. Wisniewski, WDSU-TV New Orleans
 Dean Woodring, KREM-TV Spokane, Wash.
 Dick Woolfen, Metromedia Television, Los Angeles
 William E. Wuerch, WLWT-TV Cincinnati
 Ed Zack, WOC-TV Davenport, Iowa
 Derk Zimmerman, KBHK-TV San Francisco
 Chris Zoulamis, Corinthian Broadcasting Corp., New York

land, Calif. Career information: Roger Allan, WRKO(AM), Boston. Scholarship: Barney Oldfield, Litton Industries, 9370 Santa Monica Blvd., Beverly Hills, Calif. 90213. Freedom of information: Norman Wagdy, Storer Broadcasting Co., 1725 K st. N.W., Suite 601, Washington 20006. Convention Sites: Ralph Renick, WTVJ, 30 N.W. 4th St, Miami 33128. Awards: Dave Partridge, WFBC & TV, Greenville, S.C. Long range planning: Wayne Vriesman, KWGN-TV, Denver. Management relations: Ed Godfrey, KGW-TV, 1501 S.W. Jefferson, Portland, Ore. 97201. Nominations: Ron Mires, KGTV-TV, Box 81047, San Diego, 92138. Special projects: Curtis Beckmann, WCCO(AM), Minneapolis. Equal employment opportunity: Pat Stevens, KGUN-TV, Tucson, Ariz. 85703. Professional services: Dick Westbrook, WAND-TV, Box 631, Decatur, Ill. 62525. Public relations: George Ruge, Pacific Gas & Electric, 77 Beale St, San Francisco 94106. Consultants: Ray Miller, KPBC-TV, Box 2222, Houston 77001. Historian: Jack Shelley, Iowa State University, Press Bldg., Rm. 212, Ames, Iowa 50010. Placement: Howard Back, National Television News, 6016 Fallbrook, Woodland Hills, Calif. 91364. International: Bruce Hogle, CFRN & TV, Broadcast House, Edmonton, Alberta. Research: Vernon A. Stone, University of Georgia, School of Journalism, Athens, Georgia 30601. Educational liaison: Steve Murphy, WOW-TV, 3501 Farnam St., Omaha 68131. Chairman for Washington affairs: Tom Frawley, Cox Broadcasting. Conference arrangements: Robert Vaughn, Special Programs, Chrysler Corp., Box 1919, Detroit 48104. Exhibits: Eddie Barker, 8435 N. Stemmons Freeway, Suite 880, Dallas 75247. Local arrangements: Ralph Renick, WTVJ, 30 N. 4th St, Miami 33128, Paul White Award: Tom Frawley, Cox Broadcasting. Technical: Chris Clark (Botsaris), WLAC-TV, 474 James Robertson Pkwy, Nashville, Tenn. 37219.

Active Members

As of November 1975

Adler, Louis C., WCBS-AM New York.
 Allan, Roger, WRKO Boston.
 Alpert, A., WJAR AM-TV Providence, R.I.
 Ammerman, D.S., KULF-AM Houston.
 Anderson, G.L., KVOA-TV, Tucson, Ariz.
 Armour, T., CJAD-AM, CJFM Montreal.
 Arnold, R., KOLR-TV Springfield, Ill.
 Ashbridge, J.E.; CKNW-AM New Westminster, B.C.
 Ashworth, F.W., WXII-TV Winston-Salem.
 Aspinwall, Everett H. Jr., WPBR-AM Palm Beach, Fla.
 Avery, B., KELO-TV Sioux Falls, S.D.
 Aycrigg, B.; WDBO-TV Orlando, Fla.
 Baker, Harold, WTLV-TV Jacksonville, Fla.
 Ballard, W.T. Jr., WBTV-TV Charlotte, N.C.
 Barker, E., Eddie Barker Assoc Dallas.
 Barnako, Frank R., WRC-AM, WKYS-FM Washington.
 Bazell, S., KTVU-TV Oakland, Calif.
 Becherer, T., WWJ-TV Detroit.
 Beck, Warren, CHML/CKDS Hamilton, Ont, Can.
 Beckman, Curtis J., WCCO Minneapolis.
 Berk, S., WTTG-TV Washington.
 Bernstein, Mel, WNAC-TV Boston.
 Bethel, E.E., Radio Bahamas, Nassau.
 Bleser, R.O., WHIO-TV Dayton, Ohio.
 Bloom, H., WCVB-TV Boston.
 Blumberg, R., Rockville, Md.
 Bogaards, H.W. Jr., Modern Talking Pictures New Hyde Park.
 Boland, J., WREC AM-FM Memphis.
 Borden, Cliff, WFHR-AM, WWRW-FM Wisconsin Rapids, Wis.
 Botsaris, Chris C., WLAC-TV Nashville.
 Boyes, H.E., Michigan Educational Association East Lansing, Mich.
 Bradbury, J.W., KBON-AM San Bernardino, Calif.
 Brassfield, R., WCHS-TV Charleston, S.C.
 Breitkreutz, D.R., WTAG Radio, Worcester, Mass.
 Brice, D., KIRO-TV Seattle.
 Bridgman, Austin, KSD-TV St. Louis.
 Brigandi, S.P., WSMJ-FM Greenfield, Ind.
 Brigham, A., WHEN-TV Syracuse, N.Y.
 Brooks, G.L., WSOC-TV Charlotte, N.C.
 Brown, E., WSIU-TV Carbondale, Ill.
 Brown, K.P., CBC, Ottawa.
 Brush, D.R., Mobil Oil Corp. N.Y.
 Bryant, R., KOIN-TV Portland, Ore.
 Bryson, Paul Thomas, WTEM-TV New York.
 Buch, A., KMJ-TV Fresno, Calif.
 Buchanan, P.K., WBEN AM-FM Buffalo, N.Y.
 Bundlie, C.K., WDAZ-TV Grand Forks, N.D.
 Burden, Anthony C., WVEC-AM-TV Norfolk, Va.
 Burgess, C., WJMA AM-FM Orange, Va.
 Burke, E.E. Jr., KTRK-TV Houston.

Burnett, James P., WHBC AM-FM Canton, Ohio.
 Burton, B., WOOD AM-FM Grand Rapids, Mich.
 Burton, R.H., KMGH-TV Denver.
 Bushnell, C.S., Exxon Co. U.S.A. Houston.
 Butler, Thomas A., WPSD-TV Paducah, Ky.
 Butz, Robert Fred, KLZ-AM-FM Denver.
 Byron, Jim, WBAP-AM-TV Fort Worth.
 Cain, R.P., WWSA AM-FM Wheeling, W. Va.
 Calcutt, Ernie, CFRA Radio Ottawa.
 Caldwell, Durham, WHYV-TV Springfield, Mass.
 Callaway, J.D., WTTW-TV Chicago.
 Callaghan, P., WSPY-FM Plano, Ill.
 Capener, Ted R., Bonneville International Corp., Washington.
 Carlson, Walter B., WMBI Chicago.
 Carmean, N.C., WSPD-AM Toledo, Ohio.
 Carney, C.A., WKMI-AM Kalamazoo, Mich.
 Casey, T.P., WCJB-TV Gainesville, Fla.
 Casselman, Chet, KSFO San Francisco.
 Chalfant, J.W., WOUB-TV Athens, Ohio.
 Chase, Bob, KWJJ-AM Portland, Ore.
 Cheifert, S.D., KHVV-AM Honolulu.
 Chenevey, F.P., WOWO/KEZO FM Omaha.
 Close, William J. Sr., KOOL Radio-TV Phoenix.
 Cockerham, M.N., WRBT-TV Baton Rouge.
 Cogan, P.S., KTW-AM Seattle.
 Cohen, L.D., WCFR AM-FM Springfield, Vt.
 Cokely, D., WHEB AM-FM Portsmouth, N.H.
 Coker, Robert Dane, WIRE-AM, WXTZ-FM Indianapolis.
 Connolly, T., WAST-TV Albany, N.Y.
 Conway, G.C., WOR-AM New York.
 Cooke, D., KFRC AM-FM San Francisco.
 Cooper, L.L., KGVO/KTYM Missoula, Mont.
 Corporon, John, WPIX-TV New York.
 Crafton, W.D., WNTS-AM Indianapolis.
 Craig, Michael T., WGAN-TV Portland, Me.
 Crane, Thomas P., WNEM-TV Saginaw, Mich.
 Croke, W.B., WFTV-TV Orlando, Fla.
 Cronkite, Walter, CBS News, New York.
 Crump, G.A., WCMS AM-FM Norfolk, Va.
 Cryan, W.F., WPRI-TV Providence, R.I.
 Cummings, Keith, WILS Lansing, Mich.
 Dadd, B.E., KEYH-AM Houston.
 Davis, M., WTRF FM-TV Wheeling, W. Va.
 Dean, William H. Jr., WLVI-TV Indianapolis.
 Deaner, F.E., WHIZ-TV Zanesville, Ohio.
 DeCamp, E., KGBX, Springfield, Mo.
 Decker, Donald J., WGY-AM, WRGB-TV Schenectady, N.Y.
 deForest, Ed, KWKH AM-FM Shreveport, La.
 deHaro, A., KRIS-TV Corpus Christi, Tex.
 Delaney, K., ABC News, Washington.
 Denney, L., WTVW-TV Evansville, Ind.
 Dennison, D., KSTR Radio, Grand Junction, Colo.
 Dent, C.L., WIOD-AM Miami.
 Dermody, Edward B., KMA-AM Shananduah, Iowa.
 Dewey, H.M., KCMO-AM Kansas City, Mo.
 Dexter, J.I., KOSU-FM/KVRO-FM Stillwater, Okla.
 Dillard, G., WLVI-TV Boston.
 Dorsey, Claude P., KMBC-TV Kansas City.
 Douglas, E., WKLO-AM, WCSN-FM Louisville, Ky.
 Douglas, Fred C. Sr., WKZO-AM-TV Kalamazoo, Mich.
 Douglas, Robert C., WHBN-TV Hartford, Conn.
 Doyle, George H., KFH-AM-FM Wichita, Kan.
 Doyle, J.M., WAGA-TV Atlanta.
 Drake, George, WALK AM-FM Patchogue, N.Y.
 Drennan, Jim, KXTV-TV Sacramento, Calif.
 Dressel, Richard, ABC Radio, New York.
 Drosselhuys, T., KIOA AM-FM Des Moines, Iowa.
 Eaton, Tom, WTIC-AM-TV Hartford, Conn.
 Eclaubre, M., WGSAM-AM, WCTO-FM Huntington Station, N.Y.
 Edel, A., KSFY-TV Sioux Falls, S.D.
 Edwards, G., WSOC AM-FM Charlotte, N.C.
 Edwards, Michael, WBBM-FM Chicago.
 Ehrlich, Paul, WABC-AM New York.
 Esther, J.R., WEHT TV Evansville, Ind.
 Evans, C., RKO General Broadcasting, Washington.
 Faulder, G.B., WXEX-TV Richmond, Va.
 Feldman, J.R., WBBM-TV Chicago.
 Ferguson, G.J., CFQC-AM, CFQR-FM Montreal.
 Ferguson, J., Bermuda Broadcasting Company, Hamilton, Bermuda.
 Fetherston, R., WISC-TV Madison, Wis.
 Fiegel, Frank J., CKCK-TV Regina, Sask.
 Ford, R., WBT AM-FM Charlotte, S.C.
 Foster, Robert, WGN Chicago, Washington.
 Foulk, E. Karl, WNCI-FM Columbus.
 Frawley, Thomas J., Cox Broadcasting, Washington.
 Frey, Harry E., WTHI-TV Terre Haute, Ind.

Radio-Television News
 Directors Association

Headquarters: 1735 De Sales St, NW, Washington 20036. (202)737-8657.

Officers

John Salisbury, KXL-AM-FM, Box 22106, Portland, Ore., pres. Wayne Briesman, KWGN-TV, 550 Lincoln St., Denver 80203., VP. Rob Downey, WKAR, Mich. State U., East Lansing, Mich. 48824, exec sec. Paul M. Davis, WCIA-TV, 509 South Neil, Champaign, Ill. 61802, treas.

Rob Hughes, mgr, Washington office.

Ray Hiebert, editor, RTNDA Communicator.

Tom Frawley, Cox Broadcasting, 1735 DeSales St, N.W., Washington 20036., past pres. Larry Walklin, (Head, AEJ Radio-TV Div) KRNU-FM/KUON-TV, University of Nebraska, ex-officio; Dick Hughes (pres, Nat'l Bcst Editorial Assn), 11 WPix Place, New York 10017, ex-officio. Karl M. Sepkowski, CJIC & TV, Box 370, Sault Ste. Marie, Ont., pres, RTNDA Canada.

Directors. West: Mrs. Pat Stevens, KGUN-TV, 2175 N. Sixth Ave., Tucson, Ariz. 85703. Sherman Bazell, KTVU-TV, 1 Jack London Square, Oakland, Calif. 94607. Midwest: Harry Kevorjian, WNDU & TV, Box 16, South Bend, Ind. 46624. James S. Marshall, WBAY & TV, 115 S. Jefferson, Green Bay, Wis. 54301. Northeast: Paul G. Kuntz, WTIC-AM-FM, 1 Financial Plaza, Hartford, Conn. 06103. Roger Allen, WRKO-AM, RKO General Building, Government Center, Boston 02114. Southeast: Walter W. Hawer, KTRK-TV, Box 12, Houston 77001. Dave Partridge, WFBC & TV, Box 788, Greenville, S.C. 29602. Canada: Karl M. Sepkowski, CJIC & TV, Sault Ste. Marie, Ont. Directors-at-large: Mike Parker, KFI-AM, Box 74607, Los Angeles 90004. Tom Peterson, KWLL & TV, Fourth & Franklin, Waterloo, Iowa 50703. Curtis Beckmann, WCCO-AM, 625 2nd Ave. S., Minneapolis 55402. Ed deForest, KWKH-AM-FM, Box 1130, Shreveport, La. 71102.

Committee Chairmen. Membership: Lou Prato, WMAQ-TV, Merchandise Mart, 19th Fl., Chicago 60654. Publicity: Bob Gilmartin, WKRC-TV, 1906 Highland Ave., Cincinnati 45219. Publications: Ted Landphair, WMAI-AM, 4400 Jenifer St., N.W., Washington 20015. Ethics: Sherman Bazell, KTVU-TV, Oak-

RTNDA

Froehlick, Donald H., WISN Milwaukee.
Froyd, John H., KCMT-AM-FM Alexandria, Minn.
Fyffe, William C., KABC-TV Los Angeles.
Gage, Frederick H., WLAM Lewiston, Me.
Gamache, J. Ronald, WLLH-AM, WSSH-FM Lowell, Mass.
Gamble, Robert F., WRTV Indianapolis.
Gamer, Greg, KARD-TV Wichita, Kan.
Gardner, L., KDTH-AM, KFMD-FM Radio Dubuque, Iowa.
Garrett, L., WSLV-TV Roanoke, Va.
Garry, William G., UPI, Watertown, N.Y.
Gautier, Mark O., KMTV-TV Omaha.
Gaydos, Ken, KGDN-AM, KBIO-FM Seattle.
Geraghty, Larry, WCSH-TV Portland, Me.
Gifford, Alex, WVUE-TV New Orleans.
Giles, R. Lee, WISH-TV Indianapolis.
Gill, W.B., WOTV-TV Grand Rapids, Mich.
Gilmartin, R.L., WKRC-TV Cincinnati.
Godfrey, Ed, KGW-TV Portland, Ore.
Goodman, J., NBC, New York.
Gordon, J., WNEW AM-FM New York.
Gordon, Lloyd P., WBIG Greensboro, N. C.
Gordon, William S., WPTV-TV West Palm Beach, Fla.
Graf, Richard C., WJBK-TV Southfield, Mich.
Gray, C.W., WDAF-AM Kansas City.
Green, J.R., WATI Radio-TV, Indianapolis.
Green, Earl K., WTVN-TV Columbus, Ohio.
Greene, John L. Jr., WBT-TV Charlotte, N.C.
Griffiths, T.A., Provo, Utah.
Grove, Williams D., WJXT-TV Jacksonville, Fla.
Guthrie, W.V., WCLR-FM Skokie, Ill.
Haggerty, J., ABC New York.
Hale, E.A. Jr., WNEP-TV, Avoca, Pa.
Haley, S., WSB-TV Atlanta.
Hammond, M.L., WIVK AM-FM Knoxville, Tenn.
Handberg, Ronald N., WCCO-TV Minneapolis.
Hanson, J.J., KDUH-TV Scottsbluff, Neb.
Hardt, R. D., WABC AM-FM New York.
Harp, D.A., KXTX Radio, Lubbock, Tex.
Harrington, Robert P., WBTV-AM Bennington, Vt.
Harris, C.P., KMUV-TV Sacramento.
Harris, J.C. Jr., KYW-TV Philadelphia.
Harrison, Charles F. Jr., WGN-TV Chicago.
Hart, Edwin, WLWD-TV Dayton, Ohio.
Hartman, N.S., KOVR-TV Sacramento, Calif.
Hartnett, B., WGR-AM Buffalo.
Hawver, Walter W., KTRK-TV Houston.
Hayes, Parke D., WXYZ-TV Southfield, Mich.
Hayman, S.E., KCRG-AM-TV Cedar Rapids, Iowa.
Hebert, G., WNOG-AM, WCVU-FM Naples, Fla.
Heffron, Norman, KING-TV Seattle.
Heggen, D., KFYY-TV Bismarck, N.D.
Henry, William P., WFLA-TV Tampa, Fla.
Henson, K., KQTV-TV St. Joseph, Mo.
Herford, P.M., CBS News New York.
Hickox, K., Focus Cable TV, Oakland, Calif.
Hicks, Henry H., WNY5-TV Dewitt, N.Y.
Hicks, J.C., KAKE-TV Wichita, Kan.
Hickson, T.M., KTVQ-TV Billings, Mont.
Higby, G. Robert, WFLA-AM-FM Tampa, Fla.
Higgins, Terence L., CFQC-TV Saskatoon, Sask., Can.
Hodges, G., WWAY-TV Wilmington, Del.
Hogle, Bruce W., CFRN-TV Edmonton, Alberta.
Holton, James L., NBC News, New York.
Horne, R.M., KTWB-AM-TV Casper, Wyo.
Howe, Jim, KEX Portland, Ore.
Howe, J.H., KOLO-TV Reno, Nev.
Huddy, William P., KEYT-TV Santa Barbara, Calif.
Hudson, R., KOCO-TV Oklahoma City.
Huff, D.E., WHIM AM-FM East Providence, R.I.
Hultman, John H., WBBM-AM Chicago.
Husak, John, KEYC-FM-TV Mankato, Minn.
Hyland, John J., WFIL-AM Philadelphia.
Ihrle, J., KCMO-AM, KCEZ-FM Kansas City, Mo.
Johnson, Bos, WSZA-TV Huntington, W. Va.
Johnson, J., WHTH-AM, WNKO-FM Heath, Ohio.
Johnson, N.L., WCMU-FM Mt. Pleasant, Mich.
Johnson, Phil, WWL-TV New Orleans.
Johnston, Don, CRFB Toronto, Ont., Can.
Jones, A., WRCS-TV Chattanooga, Tenn.
Jordan, B., WKRG-TV Mobile, Ala.
Kamenske, B.H., Washington.
Karon, Roy L., WMT-TV Cedar Rapids, Iowa.
Keeler, J., WAVE-AM, Louisville, Ky.
Keeping, Max, CJOH-TV Ottawa, Ont., Can.
Keeton, J.W., KFKA-AM Greeley, Colo.
Keller, K.R., WDAF-TV Kansas City, Mo.
Kennedy, Edward M., WWLP-TV Springfield, Mass.
Kent, Arthur, KCPX-TV Salt Lake City.
Keough, D.L., WROC-TV Rochester, N.Y.

Kershaw, R., WBAL-TV Baltimore.
Ketchersid, R.M., WSB AM-FM Atlanta.
Kevoorian, Harry James, WNDU-TV South Bend, Ind.
Kinard, J. Spencer, KSL-TV Salt Lake City.
Klein, E.G., WJDM-AM Elizabeth, N.J.
Knapp, David G., CBC/CBMT-TV Montreal.
Kramer, Joe, KCMO-TV Kansas City, Mo.
Kuntz, P.G., WITC AM-FM Hartford, Conn.
Kurtz, Kenneth R., WKYT-TV Lexington, Ky.
Laidlaw, Ron W., CFPL-TV London, Ont.
Lamachia, J.J., WNDR-AM, Syracuse, N.Y.
Landphair, T., WMAL-AM Washington.
Larson, Tony, KOSI AM-FM Aurora, Colo.
Laseter, Frank, WQDR-FM Raleigh, N.C.
Lawhon, J., WRAL-TV Raleigh, N.C.
Ledbetter, M., WTVW-TV Tupelo, Miss.
Ledoux, J., CKVL Verdun, Que.
Lee, Robert M. D., WWTV-TV Cadillac, Mich.
Lengyel, P.E., WTRC/WYFZ/WSJV Elkhart, Ind.
Levin, J., WBRC-TV Birmingham, Ala.
Lewis, F., KLAS-TV Las Vegas.
Lewis, Gene, WHBF-AM-FM Rock Island, Ill.
Liebmann, S.J., Radio 2UE-AM North Sidney, Australia.
Lively, Gene, KMOL-TV San Antonio, Tex.
Lobo, R.M., NBC News c/o WKYC Cleveland.
Lockwood, J.G., WTVV-TV Indianapolis.
London, R.L., WCUZ-AM Grand Rapids, Mich.
Loose, Donald F., WTMJ-TV Milwaukee.
Lord, W.E., ABC News, Washington.
Lynch, Wesley E., KREM-TV Spokane, Wash.
MacGregor, Byron, CKLW-AM-FM Windsor, Ont.
Maisel, L.E., WTVL-TV Toledo, Ohio.
Mann, A., WIIC-TV Pittsburgh.
Mann, Roger, WANE-TV Fort Wayne, Ind.
Manuel, G.R., WABI AM-TV, WBGW-FM Bangor, Me.
Margles, S., Standard Broadcast News, Ottawa, Ont.
Margolis, I., NBC News, London.
Markiewicz, R., Depew, N.Y.
Marshall, James, WBAV-TV Green Bay, Wis.
Martin, J.G., KBCM-FM Sioux City, Iowa.
Martin, Len., KSD-AM St. Louis.
Marvel, Theodore P., WRIV-AM Riverhead, N. Y.
Masterton, M.S., NBN-3 TV Newcastle, N.S.W., Australia.
Matthews, A.R., WFMY-TV Greensboro, N.C.
Maynard, John, KSRO-AM Santa Rosa, Calif.
Mays, James E., WTAR-TV Norfolk, Va.
McCall, R.W., WLWT-TV Cincinnati.
McCarty, M.J., WSMW-TV Worcester, Mass.
McClure, S.R., WGUL-AM-FM New Port Rickey, Fla.
McGonigle, Paul J., KOY-AM Phoenix.
McGowan, W.R., WRVA-AM Richmond, Va.
McKenna, Harry V., WEAN, WPJB(FM) Providence, R. I.
McMichael, Dick., WRBL-AM-FM-TV Columbus, Ga.
McMullen, Robert, WFRV-TV Green Bay, Wis.
McMullin, D., KTVI-TV St. Louis.
McQuate, J.E., WBST-FM Muncie, Ind.
McSherry, William P., ABC Los Angeles.
Mell, D., KHQ-TV Spokane, Wash.
Melrose, R., Vallejo, Calif.
Merryman, Walker, KGHl-TV Kearney, Neb.
Micek, B.J., WTOG-TV St. Petersburg, Fla.
Mies, John, WLS-TV Chicago.
Miller, Bud, WLS-AM Chicago.
Miller, Larry D., KLRN-TV, KUT-FM Austin, Tex.
Miller, R., KPRC-TV Houston.
Miller, R.W., WDBJ-TV Roanoke, Va.
Milner, S.A., KNAC-FM Long Beach, Calif.
Mires, R.E., KGTV San Diego.
Mitchell, J.W., NPR, Washington.
Mitchell, Wm. R., KOSA-TV Odessa, Tex.
Mobilia, P.A. Jr., WNHC Radio, New Haven, Conn.
Moffield, W.R., WKMS Radio, Murray, Ky.
Monroe, W.B., NBC News, Washington.
Monsen, J., KBYU-TV Provo, Utah.
Moore, Bob S., WTAJ-TV Altoona, Pa.
Moore, Jim, WGH Newport News, Va.
Moore, R., KERO-TV Bakersfield, Calif.
Moore, Rick, WLKY-TV Louisville, Ky.
Moring, J.C., WMAL-TV Washington.
Morris, A.R., WSB-AM Atlanta.
Morris, Jack, KTEW-TV Tulsa, Okla.
Morse, Robert, WCAU-TV Philadelphia.
Mueller, P.R., KSL AM-FM Salt Lake City.
Mulloy, C.J., KRNA-FM Iowa City.
Myers, Richard A., WKIK-AM Leonardtown, Md.
Nance, Bo, WKL-AM, Oklahoma City.
Nixon, D., KCAU-TV Sioux City, Iowa.
Nye, P., WABC-TV New York.
O'Brien, Tom, ABC News AM/FM Network, New York.
Oellermann, W. L., WSEI-FM Edwardsville, Ill.
Opatowsky, S., ABC-TV New York.
Owen, Don, KSLA-TV Shreveport, La.

Parker, Mike, KFI-AM Los Angeles.
Parrmley, Tom, WIBW-AM-TV Topeka, Kan.
Parramore, J.H., KTXS-TV Abilene, Tex.
Partridge, Dave, WFBC-AM-TV Greenville, S. C.
Patterson, William, WTVN Columbus, Ohio.
Patton, L.H., WBRZ-TV Baton Rouge, La.
Peladeau, Francois, Maison Radio Can., Montreal.
Pennington, J., WEAR-TV Pensacola, Fla.
Pennybacker, J. Edmund, KOEO Albuquerque, N.M.
Perkins, R.E., WDAS AM-FM Philadelphia.
Peterson, T., KWVL-AM-TV Waterloo, Iowa.
Peterson, W.B., KCST-TV San Diego.
Patrick, Richard, KOEL Oelwein, Iowa.
Phillips, George T., ABC Radio, New York.
Phillips, W.D., WROK AM-FM Rockford, Ill.
Pickard, Lawrence, WCVB-TV Needham, Mass.
Pierson, W.T., Pierson, Ball & Dowd, Washington.
Piggott, J.M., WASK AM-FM Lafayette, Ind.
Pike, J.S., WCIX-TV Miami.
Pinnock, Frank S., KOBE-AM Las Cruces, N.M.
Planner, Edward G., WMAQ-TV Chicago.
Pond, Larry E., WFIE-TV Evansville, Ind.
Powell, J.P., WREC-TV Memphis.
Powell, M.A., WTVD-TV Durham, N.C.
Powell, Thomas, WDAU Scranton, Pa.
Price, Grant, KWWL-TV Waterloo, Iowa.
Richard, M.C., KLMS-AM Lincoln, Neb.
Pruitt, S.F., WALG-AM Albany, N.Y.
Radebaugh, W.H., Kennett.
Ramsey, D.A., KSAT-TV San Antonio, Tex.
Reid, J., KSTT-AM Davenport, Iowa.
Reilly, J., WHEC-TV Rochester, N.Y.
Reiman, Jim, KRON-TV San Francisco.
Renick, Ralph A., WTVJ(TV) Miami.
Resnick, M., KTBS-TV Shreveport, La.
Richardson, B., KRGV-TV Westlaco, Tex.
Robinson, K., KPHO-TV Phoenix.
Roby, M., KSD-TV St. Louis.
Rockwell, D.W., KITV-TV Honolulu.
Rogers, George F., WMAR-TV Baltimore.
Rogers, Robert M., KENS-TV San Antonio, Tex.
Rosenbaum, Richard D., ABC News, Los Angeles.
Ryan, B., KARK-TV Little Rock, Ark.
Sabik, S., UPI Audio, New York.
Safer, M., CBS News, New York.
Salisbury, John, KXl AM-FM Portland, Ore.
Sanders, V., National Black Network, New York.
Scarlano, M.J., KTVS-TV Sterling, Colo.
Schaefer, Robert, KMOX-TV St. Louis.
Schanzer, Howard Jerome Jr., KXJB-TV Fargo, N.D.
Schmitt, Don, WMTV(TV) Madison, Wis.
Schmitt, H.L., WLEE-AM Richmond, Va.
Schmitz, L.V., KLEM AM-FM Le Mars, Iowa.
Schottelkotte, Albert J., WCPO-AM-TV Cincinnati.
Schroder, Norman C., WDAY-TV Fargo, N.D.
Schultz, Ernest J. Jr., WKY-TV Oklahoma City.
Schwinn, J.E., WDIO-TV Duluth, Minn.
Scott, C.L., KHTV-TV Houston.
Scott, H., KOMO-TV Seattle.
Scott, Kenneth J., ABC Radio News, Washington.
Scott, R., WISN-TV Milwaukee.
Sears, D.W., KOAA-TV Pueblo, Colo.
Segal, Z., CBS News, Atlanta.
Seibel, Stuart D., KYCU-TV Cheyenne, Wyo.
Seidel, E.M., WGST-AM Atlanta.
Sepkowskl, Karl, CJIC-TV Sault Ste. Marie, Ont.
Shafnan, Joseph E., WYTV-TV Youngstown, Ohio.
Shanin, M., KCKN Radio, Kansas City, Kan.
Shaw, C., Sidney, NSW, Australia.
Shaw, John P., WPEP-AM Taunton, Mass.
Sheehan, W., ABC New York.
Sher, Richard L., KNBR-AM-FM San Francisco.
Showalter, N., WCTW-AM, WMDH-FM New Castle, Ind.
Shusman, B.J., Newsweek Bcstg Service, New York.
Simerly, T.L., KOA-TV Denver.
Simon, Jim, KABC-AM Los Angeles.
Simon, R.G., WJNC-AM, WRCM-FM Jacksonville, N.C.
Sims, Wes, WPTA-TV Ft. Wayne, Ind.
Sinclair, W., KITE-AM Terrell Hills, Tex.
Small, William, CBS News, Washington.
Smith, H.K., ABC News, Washington.
Smith, Hugh L., WTVT-TV Tampa, Fla.
Smith, Max Lee, KGLO-AM-TV Mason City, Iowa.
Smyth, Dick, CHUM Toronto.
Snyder, J.L., WTOP-TV Washington.
Solomon, J.R., WCOL AM-FM Columbus, Ohio.
Spaulding, J.A. Jr., KMMJ-AM Grand Island, Neb.
Stacey, Charles B., KTEEN-TV Ada, Okla.
Stanley, J.M., WTVL Radio, Waterville, Me.
Stanton, F. Dr., New York.
Stelges, Donald F., KPVT-TV Portland, Ore.
Stephenson, Ronald J., WJAC-TV Johnsonstown, Pa.
Stevens, Pat, KGUN-TV Tucson, Ariz.

Stout, M., WPVL-AM Painesville, Ohio.
Strul, Eugene M., WCKT-TV Miami.
Stuart, Kenneth J., KIXI-AM-FM Seattle.
Stuchell, C.W., KPSI-AM Palm Springs, Calif.
Steuber, R.P., WSPD-TV Toledo, Ohio.
Sullivan, M.P., WICC-AM Bridgeport, Conn.
Sullivan, R.J., WADK-AM Newport, R.I.
Sweezy, R.D., Purcellville, Va.
Taishoff, S., Broadcasting, Washington.
Tallerico, J.A. Jr., WJCO-AM. WILX-TV Jackson, Miss.
Tannen, D.B., WGAC-AM Augusta, Ga.
Taylor, Robert W., KOLN, KGIN-TV, Lincoln, Neb.
Taylor, Truman, WTEV-TV New Bedford, Mass.
Taylor, William W., WREX-TV Rockford, Ill.
Terry, H., KLZ-TV Denver.
Thomas, D., KSIR-AM Estes Park, Colo.
Thomas, N., CKWW-AM Windsor, Ont.
Thomas, W., KDFW-TV Dallas.
Thompson, P.A., KCRA-TV Sacramento, Calif.
Thomsen, J.A., WOC-TV Davenport, Iowa.
Thornton, Russell G., KXAS-TV Fort Worth.
Tindiglla, R., WPVI-TV Philadelphia.
Tornabene, R.C., NBC News, New York.
Townley, R., WGR-TV Buffalo, N.Y.
Trudel, M., WLBT-TV Bangor, Me.
Trunzo, R., WRKL-AM New York.
Turley, T., TV News Inc., New York.
Tyler, George R., KSAL-AM Salina, Kan.
Ubell, E., WNBC-TV New York.
Vance, William L., WBNS-TV Columbus, Ohio.
Vaughn, C., KOTV Tulsa, Okla.
Voecks, Albert E., WSM-AM-FM Nashville.
Vogel, S., WJBC-AM, WBNO-FM Bloomington, Ind.
von Ende, M.E., WFSB-TV Hartford, Conn.
Vriesman, Wayne R., KWGN-TV Denver.
Wagy, Norman O., Storer Bcstg., Washington.
Walt, D., KTVI-TV Sioux City, Iowa.
Wald, Richard C., NBC, News New York.
Walden, A.R., WNBC Radio, New York.
Walker, H.B., Judge, Glendale, Calif.
Waters, W. Ben, WTOL-TV Toledo, Ohio.

Watson, D., KRPC-AM Houston.
Wayman, T.E., KMPC-AM Hollywood.
Webb, Donald L., Cincinnati.
Weil, R.A., KJUU-AM Phoenix.
Weisenfeld, P.A., WVIC AM-FM Lansing, Mich.
Weiss, M., KHOU-TV Houston.
Westbrook, Dick, WAND-TV Decatur, Ill.
Westman, John R., WLAV-AM-FM Grand Rapids, Mich.
Wheeler, R., WGBF-AM Evansville, Ind.
White, David L., WJR-AM-FM Detroit.
White, Joe Tom, KWFT Wichita Falls, Tex.
White, L.F., Clinton, Iowa.
White, Robert F., WVOY-AM Charlevoix, Mich.
White, S.R., WKIX-AM, WYYD-FM Raleigh, N.C.
Whitehead, Gordon A., CFPL AM-FM London, Ont.
Whitman, D.F., KITN-AM, KITI-AM Olympia, Wash.
Wice, P.C., KGFW-AM Kearney, Neb.
Wilbanks, Robert K., WHO Des Moines, Iowa.
Willett, Peter S., UPI New York.
Williams, Ronald, WDWS-AM-FM Champaign, Ill.
Willson, W.H., KCET-TV Los Angeles.
Wilson, D., KJAC-TV Port Arthur, Tex.
Wilson, J. Edward, WDAK Columbus, Ga.
Wilson, Raymond A., KFMB-TV San Diego, Calif.
Winkler, K.O., WOI-TV Ames, Iowa.
Wise, R., KWKH-AM, KROK-FM Shreveport, La.
Wood, W.M., WINA-WQMC Charlottesville, Va.
Woodward, Tyll, KJRB-AM Spokane, Wash.
Woodsley, Kenneth L., KXLF-AM-TV Butte, Mont.
Wright, R.E., KLOL-FM Houston.
Wright, T.E., KXYZ-AM Houston.
Wrye, William M., CKLW-TV Detroit.
Wygant, T., KGO-AM San Francisco.
Yadon, R.S., WAKY-AM Louisville, Ky.
Yeager, B., WDHO-TV Toledo, Ohio.
Yoakam, Richard D., WFUI Bloomington, Ind.
Young, Fred, WTAE-TV Pittsburgh.
Zaillian, James, KNX-AM Hollywood.
Zechman, W.H., WBMC AM-FM McMinnville, Tenn.
Zelich, Marko, WSAU-TV Wausau, Wis.
Zimmerman, Carl G., WITI-TV Milwaukee.
Zimmerman, W.A., WLUK-TV Green Bay, Wis.

Mayer, Elizabeth Midgley, Harriet Moidel, Bruce A. Morton, Roger H. Mudd, Thomas Novak, Robert C. Pierpoint, Terrell S. Plantinga, Martin Plissner, Ann L. Reilly, Ralph A. Santos, Bob Schieffer, Daniel Schorr, Barry Serafin, Eric Seavreid, Bernard Shaw, Jeanne Slavin, Sanford Socolow, Joan S. Spiegel, Lesley R. Stahl, Neil E. Stawser, Anthony Streuli, Charles C. Thompson II, Lane B. Venardos, Robert E. Vitarelli, Ellen Wadley, Harold W. Walker, Mary O. Yates, Susan Zirinsky.

CBS Radio Group—296-1234, 2020 M St. N.W.: James J. F. McCarthy, Wes Vernon.

CBS Television Stations—296-1234, 2020 M St. N.W.: Charles Crawford, Dan Cryor, Robert Fromm, George Groce, Grant Holcomb, Orlando Mingarelli, Richard O'Donnell, Antoinette W. Rodes, Floyd T. Rose.

Cox Broadcasting Corp.—737-0277, 1735 DeSales St. N.W.: Kenneth R. Bridgham, Andrew Cassells, Harold M. Cessna, Thomas H. Frawley, Raymond J. Goddard, Malvyn H. Johnson.

Eastern Educational Television Network—820-4500: 3620 27th, Arlington, Va. Elizabeth Brownstein, Richard W. Wilson Jr.

Evening News Association—371-5250, Route 2 Box 59-C, Middletown, Md.: John Chambers, Joe Tomko.

Fuji Telecasting Co.—347-6070, 274 National Press Building, Yutaka Matsumoto.

German Broadcasting and TV Systems—338-6965, 3132 M St. N.W.: Rolf Menzel.

German Television Network ARD—298-6535, 3132 M St. N.W.: Holger Faber, Hans J. Fraedrick, Edward H. Franke, Marylou Humphrey, Hans Kirchmann, Werner Kohn, Guenter Mueggenburg, Gerd H. Pelletier, Bela Perlaky, Ulrich Schiller, Rolf H. Schmechel, Heinz Soete.

German Television-ZDF—333-3909, 2914 M St. N.W.: Kurt Zengler, Hermann Feicht, Gerd Helbig, Rolanda S. Johnson, Werner Lelle, Gerd Ramsbrock, Hans J. Schmitt, Carl Weiss, Ingeborg Wurster.

Goldwest Broadcasters—347-4158, White House Press Room: Jeffrey R. Skov.

Group W-TV—783-0907, 1625 K St. N.W.: Valerie B. Hymes, Paul L. Moviton.

Hearst Metrotone News Inc.—393-8311, 470 E St. N.W.: Gary P. Fookes, John O. May, Edmund H. Reek Jr., Salvatore P. Salvia, Charles E. Shutt.

Israel Radio and Television—8201 16th St., Silver Spring, Md.: Jacob S. Ahimeir.

Jack Williams Washington News Service—370-5378, 52 South French St., Alexandria, Va.: Jack Williams.

Japan Broadcasting Corp. (NHK)—393-1077, 935 National Press Building: Mikio Arai, Satoru Kuwabara, Takashi Suetone, Hatsuhsu Takashima.

KCBS Radio, San Francisco—296-1234, 2020 M St. N.W.: James J. F. McCarthy, Wes Vernon.

KDKA, KDKA-TV, Pittsburgh—783-0907, 1625 K St. N.W.: James P. Anderson, Richard Brasie, Matthew Cooney, Richard Neil Currie, Sid Davis, Eric J. Engberg, Thomas E. Girard, James McManus, Roderick MacLeish, James J. Snyder, Gerald E. Udwin.

KFI Radio, Los Angeles—737-0277, 1735 DeSales St. N.W.: Kenneth R. Bridgham, Andrew Cassells, Harold M. Cessna, Thomas J. Frawley, Raymond J. Goddard, Malvyn H. Johnson.

KFWB Los Angeles—783-0907, 1625 K St. N.W.: James P. Anderson, Richard Brasie, Matthew Cooney, Richard Neil Currie, Sid Davis, Eric J. Engberg, Thomas E. Girard, James McManus, Roderick MacLeish, James J. Snyder, Gerald E. Udwin.

KGBS Los Angeles—331-9884, 1725 K St. N.W.: Norman O. Wady, Thomas Spaight, Fay Gillis Wells.

KMOX-AM-TV St. Louis—296-1234, 2020 M St. N.W.: George W. Grace, James J. F. McCarthy, Wes Vernon.

KNX Radio Los Angeles—296-1234, 2020 M St. N.W.: James J. F. McCarthy, Wes Vernon.

KPIX-TV San Francisco—783-0907, 1625 K St. N.W.: James P. Anderson, Richard Brasie, Matthew

Radio-Television Galleries of Congress

Senate: Max M. Barber, supt; Philip A. Regan, first asst supt; Jane Ruyle, second asst supt; Lawrence Janezich, third asst supt. **Phone:** 224-6421. **Room:** S-312, Capitol, Washington 20511.

House: Mike Michaelson, supt; Ruth M. Tate, first asst supt; Robert J. Murphy Jr., second asst supt; Eloise Poretz, third asst supt. **Phone:** 225-5214. **Room:** H-320, Capitol, Washington 20510.

Executive Committee

Robert F. Foster, WGN Continental Broadcasting Co., chmn; Sam A. Donaldson, ABC, vice chmn; Paul Duke, PBS, sec; Christie R. Basham, NBC, treas; Harold W. Walker, CBS; Chales E. Van Dyke, AP Radio; and G. Bradford Kress, NBC, all members at large; William Greenwood, Mutual Broadcasting System, member ex-officio.

Networks, Stations and Services

City is Washington unless otherwise designated.

ABC News—393-7700, 1124 Connecticut Ave. N.W. David B. Allen, Murray Alvey, Richard B. Armstrong, John M. Arrowsmith, Ted Barry, Stephen S. Bell, Leslie A. Blatt, Kenneth L. Blaylock, Jane Capet, Tom Capra, Robert E. Clark, A.E. Cremedas, Kevin Delaney, Sam A. Donaldson, Arestides Dounis, William R. Downs, Michael G. Duffy, J. Fisch Jr., Robert E. Frye, Vasil R. Furnad, James David Garcia, Marianne Greeker, George R. Geriach, William Gill, Edward M. Gilman, Edward M. Harris, Katherine A. Harting, Robert H. Heming, Eddie L. Henderson, Herbert S. Holmes, Gordon Hoover, Charles R. Huges, William R. Johnson III, David Kaplan, Herbert E. Kaplow, William L. Knowles, Earl Robert Lissit, Arthur V. Lodovichetti, William E. Lord, Robert M. Lukeman, John F. Lynch, Lewis C. Madco, John P. Magee, David P. Malenofski, Sharon L. Metcalf, Edward P. Morgan, David P. Newman, Harold W. Patnode, Roger Peterson, William E. Pettit, Victor Ratner, Frank Reynolds, Carl Rochelle, Beverly H. Roger, George P. Romilly, Charles J. Roppolo, Richard R. Sanders, Linda H. Schatz, David E. Schoumacher, Kenneth J. Scott, Virginia Sherwood, Howard K. Smith, Eric Van Speights, Earl Joseph Steiner, Charles M. Stone, Joseph W. Templeton, W. D. Tomlinson, Ann M. Trainor, William S. Weisel, Melvin J. Wertz, Helen I.

Westwood, Peggy Whedon.

Associated Press Radio—833-5910, 1825 K St. N.W.: Norman R. Beebe, Robert Benson, Robert S. Berkowitz, Edward J. Delontaine, Joseph H. Ewalt, John W. Hewitt III, John Holliman, Edwin J. Kane, L. J. Lancer, Tom Martin, James Newman, John O'Malley, Paula Quick, Walter C. Rodgers, Jerome A. Smith, Charles E. Van Dyke, Shelby A. Whitfield.

Associated Press Radio Washington Bureau Broadcast Desk—833-5300, 2021 K St. N.W.: D. Randy Allen, Anthony Catella, Gladys C. Echols, Edward M. Fishell II, Doris Newcomb, Ira Rosenfield, William H. Sautter, Charles E. Warder.

Audio-Video News Bureau—554-3434, 560 N St. S.W.: Constance E. Lawn.

Australian Broadcasting Commission—466-8575, 2020 M St. N.W.: Peter L. Barnett.

Bonneville International Corp.—393-6077, 1735 DeSales St. N.W.: Theodore R. Capener, Brian L. Moran.

British Broadcasting Corp.—223-2050, 2020 M St. N.W.: John Humphreys, Angus McDermid, Christopher H. Mylverton-Drake.

Canadian Broadcasting Corp.—638-3286, 566 National Press Building: Richard Ayo, Michael A. Carnell, Leonard C. Cathart, J.P. Champagne, Ron Collister, Patrica K. Massenet, Lucien B. Millet, John T. Rutherford, Rene Raoul Torre.

Capital Broadcast News—659-2978, 1337 22nd St. N.W.: Carol A. Kaduskin.

CBS News—296-1234, 2020 M Street: Benjamin J. Adams, Lee E. Adler, Herbert Alston, John A. Armstrong, Robert M. Armstrong, Nelson Benton, John Bessor, Milton Bittenbrender, Donald E. Bowers, Edward R. Bradley Jr., Rita Braver, Luther Brown Jr., Paul H. Byers, Robert B. Camford, Catherine Chodorow, Connie Chung, Alfred Colby, William B. Crawford, Karan L. Danaher, James E. Duvall, Charles Franks, William H. Galbraith Jr., Michael George, Marion F. Goldin, Fred Graham, Mary E. Green, Mark H. Harrington III, William W. Headline, George E. Herman, Bruce G. Hoertel, Bernard Kalb, Marvin Kalb, Barry Lando, Stephanie Levinson, Paul E. Liebler, William E. Linden Jr., Marya McLaughlin, Cal A. Marlin, John B.

Radio-TV Galleries

Cooney, Richard Neil Currie, Sid Davis, Eric J. Engberg, Thomas E. Girard, James McManus, Roderick MacLeish, James J. Snyder, Gerald E. Udwin.

KPLX Fort Worth-Dallas—751-8855, 4801 Kenmore Ave., Alexandria, Va.; Jeffrey S. Lubar.

KTVU-TV Oakland, Calif.—737-0277, 1735 DeSales St. N.W.; Kenneth R. Bridgham, Andrew Cassells, Harold M. Cessna, Thomas J. Frawley, Raymond J. Goddard, Malvyn H. Johnson.

KYW, KYW-TV Philadelphia—783-0907, 1625 K St. N.W.; James P. Anderson, Richard Brasie, Matthew Cooney, Richard Neil Currie, Sid Davis, Eric J. Engberg, Thomas E. Girard, James McManus, Roderick MacLeish, James J. Snyder, Gerald E. Udwin.

Korean Broadcasting System—750-1988, 4906 Fran Place, Alexandria, Va.; Sung Yum Park.

Meet the Press (NBC)—332-4477, Sheraton-Park Hotel; Betty Cole Dukert, Lawrence E. Spivak.

Metromedia Radio News—244-6220, 5151 Wisconsin Ave. N.W.; Jeffrey J. Beauchamp, Robert S. Hainey, William J. McCloskey, Amy R. Sabin, Edward L. Tobias.

Mignon Smith Washington—Alabama Report Birmingham, WATV Birmingham, WJBY Gadsden, WMSL Decatur, WCOV Montgomery, WKRG Mobile, WFIX Huntsville, WNPT Tuscaloosa, WAUD Auburn-Opekila, WHEP Foley, WOOF Dothan 333-0579, 700 New Hampshire Ave. N.W.; Mignon C. Smith.

Mountain States News Service—462-7767, 1603 19th St. N.W.; James C. Benfield, Lee Catterall.

Mutual Broadcasting System—785-6300, 918 16th St. N.W.; Julian Barber, Jon Bascom, Forrest J. Boyd, Robert D. Burns, Jack B. Clements, Candy Crowley, John J. Deighan, Martin A. Edwards, Pamela M. Evans, Peter Gamble, William Greenwood, Steven I. Guggenheim, Daniel R. Hackett, James T. Hall, Millard D. Hansen Jr., Robert F. Hurlleigh, Alfred R. LaVie Jr., Elizabeth H. Levy, Frederic D. Lowery II, Peter J. Michaels, Bob S. Moore, Amata Patton, Glen Rutherford, Duff Thomas, Thomas R. Wats.

NBC News—686-4000, 4001 Nebraska Ave. N.W.; Joel R. Asman, Arthur F. Barriault, Christie Basham, Robert Bender, Barry Berk, Lewis H. Bernhardt, Robert L. Borgness, David Brinkley, Tom Brokaw, Herbert M. Brubaker, Scott B. Bruns, Dorothy Byckner, Arch M. Campbell, George Cheely, John J. Cochran, John G. Cox, Audrey Dillman, Herbert J. Dudnick, Betty Cole Dukert, Betty Wolsten Endicott, Robert T. Endicott, Wallace R. Fanning Jr., B. Ray Farkas, Sheldon Fielman, Robert Goralski, Wilson Gordon Graham, Peter Hackes, Wilson Hall, Charles A. Hoagland, John F. Hofen, John F. Holland, Susan L. Hoover, Peter J. Jeffries, Albert S. Johnson, Charles O. Jones, Frank J. Jordan, Douglas Kiker, G. Badford Kress, Robert Kur, Ben Lacy, John R. Levy, Bruce MacDonell, Catherine Mackin, Mary Ann Maskrey, Robert W. Matthews, Lee McCarthy, Robert McCormick, Michael D. McKinley, Donald V. Meany, Dina Madianot, William B. Monroe Jr., Fred Montague, Michael D. Mosegitt, Lessandra G. Murtha, David Nuell, Angela B. Owens, Ralph H. Peterson, Brander M. Pettway, Kathleen M. Pinkard, Charles Quinn, Bryson B. Rash, James W. Rhodes, Glenn Rinker, Carl Robinson, Marilyn Robinson, Robert Rogers, Ford Rowan, Stephen Royce, David L. Rush, Raymond L. Scherer, Max A. Schindler, Maureen Sharpe, Lloyd Siegel, Carole Simpson, Frank D. Slingland, George A. Sozio, Lawrence E. Spivak, Carl L. Stern, Janie L. Taylor, Lee Thompson, John Travieso, James R. Upshaw, Richard G. Valeriani, James H. Vance III, John F. Walsh, Russell H. Ward, Vernon G. Womble.

Net-Science Program Group—484-1526, 955 L'Enfant Plaza S.W.; David Prowitz.

National Public Affairs Center for Television—484-1500, 955 L'Enfant Plaza S.W.; Tom Angell, Carol Ann Blakeslee, Angele Cundell, Paul Duke, Lincoln M. Furber, Christopher R. Gaul, Alvin H. Goldstein, Cheryl Lynn Gruver, David L. Haase, Jim Karayn, James C. Lehrer, Carolyn Lewis, Susan B. Malin, Frank B. Phillippi, Audrey Rasmussen, Milbrey T. Rennie, Frank B. Phillippi, Elvera Ruby, Mary Frances Sirianne, James E. Solt Jr., Kathie Test, Al Vecchione, Linda A. Winslow.

National Public Radio—785-5400, 2025 M St. N.W.; David M. Creagh, Joshua Darsa, Todd M. Easton, Robert A. Edwards, Richard D. Firestone, Ira S. Flatow, William R. Green, Martha M. Griffin, Richard N. Holwil, Thomas R. Mahoney, Jack W. Mitchell, David L. Molpus,

Barbara P. Newman, Cathy Primus, Jeffrey A. Rosenberg, James B. Russell, Layton J. Waters, Linda C. Wertheimer.

Nippon Television Network Corp.—638-0890, 765 National Press Building; Masanobu Fujimoto.

Orion Broadcasting, Inc.—544-8709, 13 Fourth St. N.E.; Dean E. Norland.

Pacific Radio (WBAI-FM)—628-4620, 868 National Press Building; Paz Cohen, Robert Krulwich.

RKO General Broadcasting—965-1500, 1701 Pennsylvania Ave. N.W.; Clifford Evans.

SWF German Radio & TV Network—356-1746, 6211 Lock Raven Dr., McLean, Va.; Robert E. Roentgen.

Soviet Radio and TV—587-8769, 1401 Blair Mill Rd., Silver Spring, Md.; Peter N. Fyodorov, Ioury V. Solton.

Spot News—Stephen Banker, 5078 Fulton St. N.W. 20016, 362-4585; Wendy Blair, 2480 16th St. N.W. 20009, 234-7181; Robert H. Cirace, 4100 North 40th Street, Arlington, Va. 22207, 527-2113; Robert F. Funk, 7019 Sheridonna Lane, Alexandria, Va. 22310, 971-1759; Norman Gaines, 504 East Capitol St. N.E. 20030, 543-7139; Richard V. Norling, 8809 Tallyho Trail, Potomac, Md. 20854, 299-5360; Gary M. Parker, 9314 Cherry Hill Rd., College Park, Md. 20740, 474-8455; Murray E. Ward, 9004 Beatty Dr., Alexandria, Va. 22308, 780-2704; Harold William Yates II, 112 Granville Dr., Silver Spring, Md. 20901, 588-0561.

Stephen J. McCormick Communications—628-2735, 635 National Press Building; Stephen J. Cormick.

Storer Broadcasting Co.—331-9884, 1735 K St. N.W.; Thomas N. Spaight, Norman O. Wagy, Fay Gillis Wells.

Susquehanna Broadcasting Co.—751-8855, 4801 Kenmore Ave., Alexandria, Va.; Jeffrey S. Lubar.

Swedish Broadcasting Corp.—347-2022, 1200 National Press Building; Bjorn H. P. Bondeson, Bo N.G. Holmquist, Sven G. Stromberg.

Swiss Broadcasting Corp.—347-1255, 1033 National Press Building; Raul Carlos Lautenschutz.

Telemedia—869-8330, 31 Cullinan Dr., Gaithersburg, Md.; Pierre Tabarly.

Tokyo Broadcasting System Inc.—223-5562, 2020 M St. N.W.; Tamotsu Kuki.

UPI Audio—628-2688, 315 National Press Building; Pye Chamberlayne, Merrilee Cox, Gene Gibbons, Roger O. Giltines.

UPI Radio—628-2688, 315 National Press Building; Richard Brenner, George J. Marder.

UPITN Corp.—488-7313, 1017 New Jersey Avenue S.E.; Fred Lawrence, Roy J. Louis, Jack Schelzy, Paul C. Sisco.

WAGA-TV Atlanta—331-9884, 1725 K St. N.W.; Thomas N. Spaight, Norman O. Wagy, Faye Gillis Wells.

WARM Wilkes-Barre, Scranton, Pa.—751-8855, 4810 Kenmore Ave., Alexandria, Va.; Jeffrey S. Lubar.

WATV Birmingham, Ala.—333-0579, 700 New Hampshire Ave. N.W.; Mignon C. Smith.

WAUD Auburn-Opekila, Ala.—333-0579, 700 New Hampshire Ave. N.W.; Mignon C. Smith.

WAVA—522-1111, 1901 Fort Myer Dr., Arlington, Va.; Carl R. Kasell, James Limbach, Pat Mochel, Carol Rieke, Paul M. Ruslow.

WAVE, WAVE-TV Louisville, Ky.—544-8709, 13 Fourth St. N.E.; Dean E. Norland.

WBBM Radio, Chicago—296-1234, 2020 M St. N.W.; J. F. McCarthy, Wes Vernon.

WBZ, WBZ-TV Boston—783-0907, 1625 K St. N.W.; James P. Anderson, Richard Brasie, Matthew Cooney, Richard Neil Currie, Sid Davis, Eric J. Engberg, Thomas E. Girard, James McManus, Roderick MacLeish, James J. Snyder, Gerald E. Udwin.

WCAU Radio, Philadelphia—296-1234, 2020 M St. N.W.; James J. F. McCarthy, Wes Vernon.

WCAU-TV Philadelphia—296-1234, 2020 M St. N.W.; Dan Cryot.

WCBS Radio, New York—296-1234, 2020 M St. N.W.; James J.F. McCarthy, Wes Vernon.

WBS-TV New York—296-1234, 2020 M St. N.W.; Charles B. Crawford.

WCOV Montgomery, Ala.—333-0579, 700 New Hampshire Ave. N.W.; Mignon C. Smith.

WEEI Boston—296-1234, 2020 M St. N.W.; James J. F. McCarthy, Wes Vernon.

WFIE Evansville, Ind.—544-8709, 13 Fourth St. N.E.; Dean E. Norland.

WFIX Huntsville, Ala.—333-5079, 700 New Hampshire Ave. N.W.; Mignon C. Smith.

WFMS Indianapolis—751-4801 Kenmore Ave., Alexandria, Va.; Jeffrey S. Lubar.

WFRV Green Bay, Wis.—544-8709, 13 Fourth St. N.E.; Dean E. Norland.

WGBB Freeport, Hempstead, N.Y.—751-8855, 4801 Kenmore Ave., Alexandria, Va.; Jeffrey S. Lubar.

WGSB Miami—331-9884, 1725 K St. N.W.; Thomas N. Spaight, Norman O. Wagy, Fay Gillis Wells.

WGN Continental Broadcasting Co., Chicago—393-6077, 1735 DeSales St. N.W.; Robert F. Foster, Kazuo C. Uchima.

WHEP Foley, Ala.—333-0579, 700 New Hampshire Ave. N.W.; Mignon C. Smith.

WHIO, WHIO-TV Dayton, Ohio—737-0277, 1735 DeSales St. N.W.; Kenneth R. Bridgham, Andrew Cassells, Harold M. Cessna, Thomas J. Frawley, Raymond J. Goddard, Malvyn H. Johnson.

WHLO Akron, Canton, Ohio—751-8855, 4801 Kenmore Ave., Alexandria, Va.; Jeffrey S. Lubar.

WHLQ Canton, Ohio—757-8855, 4801 Kenmore Ave., Alexandria, Va.; Jeffrey S. Lubar.

WHN New York—338-9884, 1725 K St. N.W.; Thomas N. Spaight, Norman O. Wagy, Fay Gillis Wells.

WHUR-FM Washington—636-7825, 2600 Fourth St. N.W.; Charles E. Cobb Jr., Benjamin J. Dudley, R.O. Montague Paul, Robert N. Taylor.

WIICTV Pittsburgh—737-0277, 1735 DeSales St. N.W.; Kenneth R. Bridgham, Andrew Cassells, Harold M. Cessna, Thomas J. Frawley, Raymond J. Goddard, Malvyn H. Johnson.

WIND Chicago—783-0907, 1625 K St. N.W.; James P. Anderson, Richard Brasie, Matthew Cooney, Richard Neil Currie, Sid Davis, Eric J. Engberg, Thomas E. Girard, James McManus, Roderick MacLeish, James J. Snyder, Gerald E. Udwin.

WINS New York—783-0907, 1625 K St. N.W.; Richard Neil Currie, Sid Davis, Eric J. Engberg, Thomas E. Girard, James McManus, Roderick MacLeish, James J. Snyder, Gerald E. Udwin.

WIOD Miami—737-0277, 1735 DeSales St. N.W.; Kenneth R. Bridgham, Andrew Cassells, Harold M. Cessna, Thomas J. Frawley, Raymond J. Goddard, Malvyn H. Johnson.

WITI-TV Milwaukee—331-9884, 1725 K St. N.W.; Thomas N. Spaight, Norman O. Wagy, Faye Gillis Wells.

WJBK-TV Detroit—331-9884, 1725 K St. N.W.; Adam Gallan, Kristin S. Gulland, Thomas N. Spaight, Norman O. Wagy, Fay Gillis Wells.

WJBY Gadsden, Ala.—333-0579, 700 New Hampshire Ave. N.W.; Mignon C. Smith.

WJW, WJW-TV Cleveland—331-9884, 1725 K St. N.W.; Thomas N. Spaight, Norman O. Wagy, Fay Gillis Wells.

WJZ-TV Baltimore—783-0907, 1625 K St. N.W.; James P. Anderson, Richard Brasie, Matthew Cooney, Richard Neil Currie, Sid Davis, Eric J. Engberg, Thomas E. Girard, James McManus, Roderick MacLeish, James J. Snyder, Gerald E. Udwin.

WKIS Orlando, Fla.—751-8855, 4801 Kenmore Ave., Alexandria, Va.; Jeffrey S. Lubar.

WLQA Cincinnati—751-8855, 4801 Kenmore Ave., Alexandria, Va.; Jeffrey S. Lubar.

WLOR Toledo, Ohio—751-8855, 4801 Kenmore Ave., Alexandria, Va.; Jeffrey S. Lubar.

WLTA Atlanta—751-8855, 4801 Kenmore Ave., Alexandria, Va.; Jeffrey S. Lubar.

WMSL Decatur, Ala.—333-0579, 700 New Hampshire Ave. N.W.; Mignon C. Smith.

WMAL Radio—686-3000, 4400 Jenifer St. N.W.; John N. Alexander, Betsy F. Ashton, Joy B. Epps, Robert H. Gneiser, Kurt A. Henschen, Dorothy M. Jones, Lewis P. Jones, Lawrence Krebs, Ted Landphair, Edwin Meyer,

Joseph F. McCaffrey, W. Westley Moore Jr., Gary J. Reals, Harold M. Steele, Stephen K. Thompson, Mary T. Wright.

WMAL-TV—686-3000, 4461 Connecticut Ave. N.W.: Gary L. Axelson, Maralee Beck, Paul L. Berry, Jr., Ronald Canada, James D. Clarke, Warren P. Corbett, Leonard R. Deibert, Stefany Grimes, John R. Harter, George F. Humphreys II, Robert J. Jordan, Frances Carol Martin, William E. McDougall, Joan Pinkerton, Thomas F. Reynolds, Wes Sarginson, John Spiropoulos, Edgar W. Turney.

WMT Cedar Rapids, Iowa.—544-8709, 13 Fourth St. N.E.: Dean E. Norland.

WNPT Tuscaloosa, Ala.—333-5079, 700 New Hampshire Ave. N.W.: Mignon C. Smith.

WOOF Dothan, Ala.—333-5079, 700 New Hampshire Ave. N.W.: Mignon C. Smith.

WOWO Fort Wayne, Ind.—783-0907, 1625 K St. N.W.: James P. Anderson, Richard Basie, Matthew Cooney, Richard Neil Currie, Sid Davis, Eric J. Engberg, Thomas G. Girard, James McManus, Roderick McLeish, James J. Snyder, Gerald E. Udwin.

WOWA Miami—751-8855, 4801 Kenmore Ave., Alexandria, Va.: Jeffrey S. Lubar.

WSB, WSB-TV Atlanta—737-0277, 1735 DeSales St. N.W.: Kenneth R. Bridgman, Andrew Cassells, Harold M. Cessna, Thomas J. Frawley, Raymond J. Goddard, Malvyn H. Johnson.

WSBK-TV Boston—331-9884, 1725 K St. N.W.: Thomas N. Spaight, Norman O. Wagy, Fay Gillis Wells.

WSOC, WSOC-TV Charlotte, N.C.—737-0277, 1735 DeSales St. N.W.: Kenneth R. Bridgman, Andrew Cassells, Harold M. Cessna, Thomas J. Frawley, Raymond J. Goddard, Malvyn H. Johnson.

WSPD, WSPS-TV Toledo, Ohio—331-9884, 1725 K St. N.W.: Thomas N. Spaight, Norman O. Wagy, Fay Gillis Wells.

WTAE-TV Pittsburgh—244-1334, 3001 Veazey Terrace N.W.: Maria Falter Gwaltney.

WTOP News—686-6000, 40th and Brandywine Sts. N.W.: Richey D. Adams, Britton M. Arrington Jr., Ralph J. Begleiter, Bruce W. Bookholtz, Robert D. Boyer, Michael C. Buchanan, Maureen Bunyan, Carroll M. Bush, Milburn G. Butler, Patrick J. Collins, Thomas V. Dukehart Jr., David T. French, Stephen B. Gendel, Norman Hicks, Harold Hoiland, Frank D. McDermott, Patrick E. McCrath, David L. Moubrey, Michael M. Murphy, Gordon W. Peterson, Leo A. Pitts, Eldridge Spearman, Judith P. Sigler, James L. Synder, Henry L. Tenenbaum, William M. Thompson.

WTTG-TV News—244-5151, Wisconsin Ave. N.W.: Marilyn Brooks Berry, Meryl Comer, Madhu V. Damania, Gary Dubin, Marcus M. Dulmage, Barton M. Eckert, Robert G. Henry Jr., William R. Huttenloch, Deborah F. Mathis, Maury Povich, Burton K. Resnick, James J. Schultz, Alan B. Smith, Wayne Wood.

WWDG Capitol Broadcasting Co.—589-7100, 8800 Brookville Rd., Silver Spring, Md.: Robert J. Means.

Washington Radio and Television News—978-6411, 5536 Kendrick Lane, Burke, Va.: James R. Eury Jr., Richard D. Eury, Richard W. Zobon.

Westinghouse Broadcasting Co., Inc.—783-0907, 1625 K St. N.W.: James P. Anderson, Richard Brasie, Matthew Cooney, Richard Neil Currie, Sid Davis, Eric J. Engberg, Thomas G. Girard, James McManus, Roderick MacLeish, James J. Synder, Gerald E. Udwin.

State Associations

Alabama Broadcasters Assn. C.P. Persons Jr., WKRG-TV Mobile, pres.; Earl Manning Jr., WELR AM-FM Roanoke, pres.-elect; Richard Deason, exec dir. Box 6246, University 35486. (205) 758-6240.

Alaska Broadcasters Assn. Dick Lobdell, KIAK Fairbanks, pres.; Bill Wally, VP; Carl Bracale KIMO Anchorage, sec.-treas, 3910 Seward Hwy, Anchorage 99503. (907) 279-9437.

Arizona Broadcasters Assn. Charles Olson, KOLD-TV Tucson, pres.; Robert Allingham, KTAR-TV Phoenix, VP; Ray Odom, KJZZ(AM) Phoenix, sec.-treas; FA, "Jake" Higgins, exec dir, Box 7429, Phoenix 85011.

Arkansas Broadcasters Assn. Glen O'Neal, KWNN (AM) Fort Smith, pres.; Phil Phillips, KBRS (AM) Springdale, 1st VP; Lynn Farr, KFIN(FM) Jonesboro, 2nd VP; Pat Walsh, KAAY(AM) Little Rock, sec.-treas; Dale E. Wilson, exec dir, 2311 Biscayne Dr., Cantrell Place, Little Rock 72207. (501) 375-2545.

California Broadcasters Assn. Joseph Drilling, KJEO Fresno, chmn; Frank McLaurin, KSRO Santa Rosa, vice-chmn; Russ Coughlan, KGO-TV San Francisco, vice chmn-TV; George Nicholas, KNX Los Angeles, vice chmn-radio; Theodore J. Wolf, KGMS Sacramento, sec.-treas; Howard J. Smiley, pres, 1107 Ninth St., Suite 907, Sacramento 95814. (916) 444-2237.

Colorado Broadcasters Association. Al Perry, KOSI Aurora, pres.; Carl Anderson, KREX Grand Junction, pres.-elect; John J. Miller, KCOL Fort Collins, sec.-treas; John E. Morrill, exec dir, 7138 West Frost Dr., Littleton, Colo. 80123. (303) 979-8787.

Connecticut Broadcasters Assn. Michael C. Rice, WILI Willimantie, pres.; Ento De Dominicis, WRCH New Britain, VP; Patrick Crafton, WLAD Danbury, sec.-treas; Peter K. Orne, WTNH-TV New Haven, asst sec.-treas, 15 Highland Park Rd, North Haven 06473. (203) 771-6433.

Florida Assn. of Bcstrs. Robert Olson, WTVT Tampa, pres.; Donald Clark, WDAE Tampa, pres.-elect; Kenneth F. Small, exec VP; Duperrault, VP-TV; Herbert Levin, VP-radio; Duane McConnell, WVMF Lakeland, sec.-treas; Carl Hallberg, immed past pres, 3131 N.W. 13th Street, Suite 37, Gainesville, Fla. 32601. (904) 372-0708.

Georgia Assn. of Broadcasters. William K. Sanders, exec dir; Eve Brandon, exec asst, 6065 Roswell Rd., Suite 815, Atlanta 30328. (404) 252-0964.

Hawaiian Assn. of Broadcasters. George Hagar, KHON-TV Honolulu, pres.; Don Metzger, KGU (AM) Honolulu, VP; Fred Constant, KPOI (AM) -KHSS (FM) Honolulu, sec; Jim Ownby, KNDI(AM) Honolulu, treas, 1060 Bishop St., Honolulu 96813. (808) 537-3991.

Idaho State Broadcasters Assn. Dale Peterson, KCID(AM) Caldwell, pres.; Harold Hirte, KMVT(TV) Twin Falls, VP; Dale Smith, KSRA(AM) Salmon, sec.-treas; Ron Grisham, exec dir, Box 884, Boise 83701. (208) 375-7277.

Illinois State Broadcasters Assn. Jack Mazzie, WREX-TV Rockford, pres.; Shelby Harbison, WTAX(AM) Springfield, pres.-elect; Lee Schulman, WMAQ-TV Chicago, VP-TV; Robert Farrow, WICS(TV) Springfield, sec.-treas; James G. Turpin, exec dir, 726 S. College, Springfield 62704. (217) 789-0590.

Indiana Broadcasters Assn. Kelly H. Atherton, pres.; Dave McGhee, exec VP, 300 Board of Trade Bldg, Indianapolis 46204. (317) 636-0724.

Iowa Broadcasters Assn. Robert H. Harter, WHO-AM-TV, KLYF (FM) Des Moines, pres.; Forrest Mitchell, KGRN (AM) Grinnel, VP; Edwin Lasko, KCRG-AM-TV Cedar Rapids, treas; Jack Shelley, exec sec, 1230 Marston Ave., Ames 50010. (515) 294-4340.

Kansas Assn. of Broadcasters. H. Pat Powers, KTPK(FM) Topeka, pres.; Ken Jennison, KSAL(AM) Salina, pres.-elect, Bill Miller, KGGF(AM) Coffeyville, sec.-treas; Tony Jewell, KIU(AM) Garden City, past pres, 408 Petroleum Bldg., Wichita 67202. (316) 265-8901.

Kentucky Broadcasters Assn. Ernest Sparkman, WKIC(AM) Hazard, pres.; J.T. Whitlock, exec dir; Alvis H. Temple, treas, Box 930, Bowling Green 42101; Garland West, WKJC Bowling Green, Box 680, Lebanon 40033. (502) 692-3126.

Louisiana Association of Broadcasters. Bruce Rainey, KALB Alexandria, pres.; John Penny-Backer, exec sec, Box 16078, Louisiana State U., Baton Rouge 70803. (504) 388-6188.

Maine Assn. of Broadcasting. Raymond A. Gilvard, WGAN-AM-FM-TV Portland, pres.; Turner Porter Jr., WJTO-AM-FM Bath, 1st VP; Robert Joyce, WMTW-TV Poland Spring, 2nd VP; Norman G. Gallant, WFAU-AM-FM Augusta, exec dir, Box 307, Augusta 04330. (207) 623-3878.

Maryland-District of Columbia-Delaware Broadcasters Assn. Harry Shriver, WFBR(AM) Baltimore, pres.; Samuel S. Carey, WBOC-AM-FM-TV Salisbury, Md., VP; Thomas J. Dougherty, Metromedia, Washington, sec; Sally Hawkins, WILM(AM) Wilmington, Del., treas.

Massachusetts Broadcasters Assn. Lawrence Shane, WMRC Millis, pres.; Douglas J. Rowe, exec dir, 16 W. Main St., Marlboro 01752. (617) 485-5555.

Michigan Assn. of Broadcasters. O.T. Gaston, WKZO Kalamazoo, pres.; Richard Q. DeAngelis, WNEM-TV Saginaw, VP; John D. Degroot, WWRM Gaylord, sec.-treas; Thomas J. Cleary, exec dir, Box 1335, Lansing 48904. (517) 371-1729.

Minnesota Broadcasters Assn. Stanley S. Hubbard, KSTP Minneapolis-St. Paul, pres.; Frank Befera, VP; Richard Painter, KYSM Mankato, VP; Henry L. Sampson, WAVN Stillwater, sec; Ray Foslid, KSMM Shakopee, treas; James H. Adams, exec dir, 825 Sibley Memorial Hwy, St. Paul 55118. (612) 224-5829.

Mississippi Broadcasters Assn. Ken Bailey, WBKH Hattiesburg, pres.; Bob McRaney Jr., exec sec, Box 758, West Point 39773. (601) 494-7334.

Missouri Broadcasters Assn. Charles Earls, KBOA (AM)-KTMO (FM) Kennett, pres.; Robert McKune, KTRT(AM)-KZNN(FM) Rolla, pres.-elect; Charles McAbee Jr., KCMO-TV Kansas City, sec.-treas, 1800 S.W. Blvd., Jefferson City 65101. (314) 636-6692.

Montana Broadcasters Assn. Fred Hunnes, KATL Miles City, pres.; Lynn Koch, KGVO-TV Missoula, VP; Burt Oliphant, KDBM Dillon, sec.-treas; Bob Hoene, exec sec, 213 Fifth Ave., Box 503, Helena 59601. (406) 442-3961.

Nebraska Broadcasters Assn. Joe Stavas, KTTT-AM-FM Columbus, pres.; Norman Williams, KMTV Omaha, pres.-elect; L.J. Walklin, KRNU-FM Lincoln, treas; Frank P. Fogarty, exec VP, Box 31802, Omaha 68131. (402) 551-4360.

Nevada Broadcasters Assn. James C. Herzig, KOLO-TV Reno, pres.; Mark Smith KLAS-TV Las Vegas, VP; Ray Gardner, KELK Elko VP-AM radio; Lorraine Walker, KRNO (FM) Reno, VP-FM radio; Emma Addis, KVEG Las Vegas, sec.-treas; Julie Day, KRNO (FM) Reno, exec sec, Box 2427, Reno 89505.

New Hampshire Assn of Bcstrs. Talbot R. Hood, WKBK Keene, pres.; John Scott, WSCV Peterborough, 1st VP; Gary Howard, WEMJ Laconia, 2nd VP; Bob Connelly, WWHN Rochester, sec.-treas.

New Jersey Broadcasters Association. James Rodio, WRDI Hammonton, pres.; Arnold Zucker, exec dir; Paul Most, WOBN Toms River, VP Radio Center, Rutgers University, New Brunswick, N.J. 08903. (201) 247-3337.

New Mexico Broadcasters Assn. Gerry Martin, Las Cruces, pres; 1st VP (vacant); Bernie Bustos, KMIN Grants, 2d VP; Bill Brooks, KARS Belen, treas. Dick McKee, KOB Albuquerque; Bill Torbert, KIVA Clovis; Jim Guber, KWYK Farmington; Jack Chapman, KGAK Gallup; dirs. Ed Pigeon, exec dir, 709 Fruit Ave., Albuquerque 87102. (505) 242-2211.

New York State Broadcasters Assn. Inc. Philip Spencer, WCSS-AM-FM Amsterdam, pres.; Leavitt J. Pope WPIX-FM-TV New York, VP; Perry B. Bassom, WNBC New York, sec; Joseph A. Reilly, WWOM(FM) Albany, treas; John W. Tabner Albana, counsel; Ellen S. Coby, exec sec, 9 Herbert Dr., Latham, N.Y. 12110. (518) 783-5821.

North Carolina Assn. of Broadcasters. James G. Babb WBTV (TV) Charlotte, pres.; James A. Heavner, WCHL (AM) Chapel Hill, pres.-elect; Eugene H. Bohi, WGHP-TV High Point, VP for TV; Ralph M. Lambeth, WGBG (AM) Greensboro, VP for radio; Jack Starnes, WBAG-AM-FM Burlington, sec.-treas; Wade H. Hargrove, exec dir, gen counsel, Box 790, Raleigh 27602. (919) 821-7300.

North Dakota Broadcasters Assn. John Von Rueden, KXMB-TV Minot, pres.; Dave Beach, KF5M-AM-FM Grand Forks, pres.-elect; C. H. Logan, KDSU(FM) sec.-treas, North Dakota State U., Univ. Sta., Ceres Hall, Fargo 58102. (701) 237-8321.

Ohio Assn. of Broadcasters. Stephen T. Joos, WIZE Springfield, pres.; Thomas C. Sawyer, exec dir, 41 S. High St., Columbus 43215. (614) 228-4052.

Oklahoma Broadcasters Assn. Glen Burke, KSEO-AM-FM Durant, pres.; Ron Blue, KRMG (AM) Tulsa, pres.-elect; Tom Reddell, KOMA (AM) Oklahoma City, VP; Leon H. Rogers, exec dir, Box 457, Shawnee 74801. (405) 273-4404.

Oregon Assn. of Broadcasters. Bruce Kerr, KSLM Salem, pres.; Henry Florip, KYJC Medford, VP; Vern Mueller, gen mgr, Box 3236, Eugene 97403. (503) 686-3900.

Pennsylvania Assn. of Broadcasters. Robert H.

State & National Associations

Maurer, counsel and exec dir. 407 N. Front St., Harrisburg 17101. (717) 233-3511.

Rhode Island Broadcasters Assn. Alan Andrews, WJAR-TV Providence, pres; John Franks, VP; John Robinson, WTEV(TV) New Bedford, Mass., treas; David Russell, WWOON Woonsocket, sec. c/o David Russell, WWOON, Woonsocket 02895. (401) 762-1240.

Rocky Mountain Broadcasters Assn. Claude Cain, KID-TV Idaho Falls, pres; Henry Fletcher, KSEI(AM) Pocatello, Idaho, exec dir. Box 191, Pocatello, Idaho 83201. (208) 233-5020.

South Carolina Broadcasters Assn. A.P. Skinner, WOLS Florence, pres; Dr. Richard M. Uray, exec mgr. U. of South Carolina College of Journalism. Columbia 29208. (803) 777-4102.

South Dakota Broadcasters Assn. E.C. Strangland, pres; Lenore Thompson, sec-treas; Verli Thomas, exec dir. 4609 W. 12th St., Sioux Falls 57106. (605) 336-7110.

Tennessee Assn. of Broadcasters. Jack Hoskins, WLEA-AM-FM Cleveland, pres; Reggie Honey, WRKM Carthage, sec-treas; James Dick, WIVK-AM-FM Knoxville; Harold Crump, WLAC-TV Nashville; James Bedwell, WHBQ (AM) Memphis, VPs; Paul L. Ruhle, exec dir; Judy Chandler, office mgr. Box 2688, Nashville 37202. (615) 254-5761.

Texas Assn. of Broadcasters. Rush Evans Jr., KTBC-TV Austin, pres; Rodger Bill Watkins, WTAW Bryan, VP; Bonner McLane, exec VP 901 W. 19th, Austin 78701. (512) 476-3061.

Utah Broadcasters Assn. Hal Colliprest, KLUB Salt Lake City, past pres; Earl J. Glade Jr., exec dir; Larry Bell, KEYY, pres; Frank McIntyre, KQPD, dir; Margaret

Hemmert, KVLE, dir. Box 401, Provo 84601. (801) 374-1121 ext 4392.

Vermont Assn. of Broadcasters. William Graham, WIFE(AM) Newport, pres; Belva Keyworth, WBTN(AM) Bennington, VP; Robert Harrington, WBTN(AM) Bennington, treas; Peter Martin, WCAX-TV Burlington, sec. Box 608, Burlington 05401. (802) 862-5761.

Virginia Assn. of Broadcasters. William L. Eure Jr., WSSV-WPLZ(FM) Petersburg, pres; Bob McRaney Jr., WWBT Richmond, pres-elect; J. William Poole, WFLS-AM-FM Fredericksburg; Dr. William W. Greer, exec sec. Box 648, Petersburg 23803. (804) 733-3807.

Washington State Assn. of Broadcasters. J. Birney Blair, KHO-AM-FM-TV Spokane, chmn of bd; Jack Bankson, KVI Seattle, vice chmn; James A. Murphy, pres; Gordon Tuell, KWSU-AM-TV, Pullman, sec-treas. Suite 1015, 1411 Fourth Ave. Bldg., Seattle 98101. (206) 622-2991.

West Virginia Broadcasters Assn. Frank J. Lee, WMMN(AM) Fairmont, pres; George Andrick, WSAZ-TV Huntington, VP; J. Ross Felton, WVVVA-AM-FM Wheeling, sec-treas; Jack Williams, exec sec. 1910 Parkview St., Huntington 25701. (304) 522-2905.

Wisconsin Broadcasters Assn. Robert O. Southland, WFRV-TV Green Bay, pres; Bernie Strachote, WRIT, WBOS Milwaukee, VP-radio; Richard D. Dudley, Forward Comm. Inc. Wausau, VP-TV; Dr. Ruane B. Hill, WUWM Milwaukee, sec; Nathan L. Goetz, Koetz Bcstg Corp., Monroe, treas; Hugh Dickie, WTMB-AM-FM Tomah, immed past pres; Joe Killeen, exec dir. Box 41725, Shorewood 53211. (414) 332-8270.

Wyoming Assn. of Broadcasters. Larry Wakefield, KATI Casper, pres; Kerm Kath, KGOS Torrington, 1st VP; Bill Hart, 2nd VP; Ray Lansing, exec sec treas; Tony Kohl, Fred Hildebrand, Bill Luzmoor, Bob Price dirs. Box 1873, Cheyenne 82001. (307) 634-5871.

National Associations and Professional Societies

AAF/ADS. College Chapters—Academic Division of the American Advertising Federation, 1225 Connecticut Ave. N.W., Washington 20036. (202) 659-1800. Howard H. Bell, pres of AAF; Jonah Giltitz, exec VP; Professor Frank L. Dobyns, Univ of Missouri, chmn, academic div; J. David Schwartz, mgr of educi svcs.

Acoustical Society of America. 335 East 45th St., New York 10017. (212) 685-1940. Robert S. Gales, pres; Betty H. Goodfriend, admin sec.

Action for Children's Television (ACT). 46 Austin St., Newtonville, Mass. 02160. (617) 527-7870. Peggy Charen, pres; Maureen Harmon, PR; Debbie First, exec dir.

Advertising Council. 825 Third Avenue, New York 10022. (212) 758-0400. Thomas B. Adams, chmn (chmn, Campbell—Ewald Co.); Gibson McCabe, honorary chmn (retired); W. Leonard Evans, vice chmn (publisher & editor, Tuesday Magazine); Edgar H. Latspeich, vice chmn (VP Procter & Gamble Co.); Leonard S. Matthews, vice chmn; Robert P. Keim, pres; Dean H. Fritchman, VP; Gordon C. Kinney, VP; A. C. Podesta, VP; Lewis W. Shollenberger, VP; John H. Drichton, sec (pres, American Association of Advertising Agencies); Peter W. Allport, treas (pres, Association of National Advertisers). Branch offices: Washington, D.C.—Los Angeles, Ca.

Advertising Research Foundation Inc. Three East 54th St., New York 10022. (212) 751-5656. George H. Allen, Fawcett Publications, chmn; Arthur S. Pearson, Bristol-Myers' Clair division, vice chmn; Edgar A. Roll, pres; Dr. E. L. Deckinger, Grey Advertising, treas; Gilbert H. Weil, gen counsel; James Becknell, exec dir. Directors: Peter W. Allport, Assn. of Natl. Advertisers; John R. Andrews, General Foods Corp.; Dr. Seymour Banks, Leo Burnett Co.; S. Heagan Bayles, SSC&B; Dr. David M. Blank, CBS Broadcast Group; Dr. Leo Bogart, Newspaper Adv Bureau; Robert A. Burnett, Meredith Corp.; Richard F. Casey, Benton & Bowles; John Crichton, AAAA; Thomas H. Dunkerton, Compton Advertising; George S. Fabian, Chesebrough-Ponds; Frank J. Gromer Jr.; Foote, Cone & Belding; John D. Henry, Procter & Gamble; Dr. Herbert E. Krugman, General Electric Co.; A. Edward Miller, Downe Publishing Co.; A. C. Nielsen Jr., A. C. Nielsen Co.; William S. Rubens, NBC; Edwin H. Sonneck, Goodyear Tire &

Rubber Co.; John I. Taylor, Globe Newspaper Co.; Dr. Robert A. Wachsler, BBDO.

Affiliated Advertising Agencies International 116 Fifth Ave., New York 10036. (212) 661-5776.

Alabama Assn. of Educational Broadcasters. 2101 Magnolia Ave., Birmingham, Ala. 35205. (205) 328-8756. Denis N. Stork, pres.

Alpha Epsilon Rho (national honorary broadcasting society), College of Journalism, U. of South Carolina, Columbia, S.C. 29208. (803) 777-4102. Andrew Orgel, natl student pres; Paul Boscarino, natl student VP; Rebecca Mestelle, IPAC; Dr. Richard M. Uray, natl exec sec; Betty Girling, natl honorary advisor.

Los Angeles 90007: Dept. of Telecommunications, U. of Southern California. Stuart Brower, Southwest rgnl advisor.

Coral Gables, Fla. 33124: Dept. of Mass Communications, U. of Miami. Paul Nagel Jr., Florida regional advisor.

Carbondale, Ill. 62901: Broadcasting Service, Southern Illinois U. Dr. John Kurtz, Dr. Charles Lynch, Mideastern regional co-advisors.

Monroe, La. 71201: Dept. of Speech, Northeast Louisiana U. Dr. V. J. Smith, Gulf Coast regional advisor.

Mt. Pleasant, Mich. 48858: Dept. of Speech and Dramatic Arts, Central Michigan U. Dr. Louis Day, Great Lakes regional advisor.

Lincoln, Neb. 68508: Dept. of Journalism, U. of Nebraska. Dr. Larry Walkin, Central Plains regional advisor.

Flushing, N.Y. 11367: Dept. of Communication Arts and Sciences, Queens College. Mark Rosenblatt, Northeast regional advisor.

Stillwater, Okla. 74074: Dept. of Radio-TV-Film, Oklahoma State U. Dr. James Rhea, Oklahoma regional advisor.

Memphis 38152: Dept. of Speech and Drama, Memphis State U. Dr. Marvin Bensman, Southeastern regional advisor.

Lubbock, Tex. 79409: Dept. of Mass Communications, Texas Tech U. Dr. Dennis Harp, South Central regional advisor.

Salt Lake City 84112: Speech-Communication Dept., U. of Utah. Dr. Robert Tieman, Mountains regional advisor.

Norfolk, Va. 23504: Dept. of Mass Communications,

Norfolk State College. Dr. Stan Tickton, East Central regional advisor.

Pullman, Wash. 99163: Dept. of Communications, Washington State U. Val Limberg, Northwestern regional advisor.

Oshkosh, Wis. 54903: Radio-TV-Film Dept., U. of Wisconsin-Oshkosh. Dr. Robert Snyder, North Central regional advisor.

American Advertising Federation Inc. 1225 Connecticut Ave. N.W., Washington 20036. (202) 659-1800. Howard H. Bell, pres; Jonah Giltitz, exec VP; Roderick A. Mays, senior VP; F. Dale Howard, dir-club mgr services; Raymond Barville, VP admin/membership; Robert Hilton, immediate past chmn of bd; Carl W. Nichols Jr., chmn of bd; James S. Fish, sr vice chmn of bd; Sherwin Block, vice chmn, western region; Robert F. DeLay, chmn. Inter-Assoc Council; Lois Nelson, chmn, women's advertising activities. San Francisco 94111: 50 California St. (415) 421-6867.

American Association of Advertising Agencies (AAAA). 200 Park Ave., New York 10017. (212) 682-2500. John Elliott Jr., Ogilvy & Mather Inc., chmn; Neal W. O'Connor, N.W. Ayer ABH International, vice chmn; Robert M. Davis, Davis, Johnson, Mogul & Colomatto Inc., sec-treas; John Crichton, pres.

Beverly Hills, Calif. 90211; 8500 Wilshire Blvd. (213) 657-3711. Robert P. Stephens, VP. Washington 20036; 1730 M St. N.W. (202) 331-7345. Lawrence D. Reedy, VP; Kate Black.

Media policy committee: Leonard Matthews, Leo Burnett Co., chmn; Robert Liddell, Compton Advertising Inc., vice chmn; Joseph Ostrow, Young & Rubicam International Inc.; Robert E. Buchanan, J. Walter Thompson Co.; Hans L. Carstensen Jr., N.W. Ayer ABH International; Michael Drexler, Doyle Dane Bernbach Inc.; Jules Fine, Ogilvy & Mather Inc.; Gene DeWitt, Rosenfeld, Sirowitz & Larson Inc.; Martin Narva, Waring & LaRosa Inc.; Louis Fischer, Dancer-Fitzgerald-Sample Inc.; Frank J. Gromer Jr., Foote, Cone & Belding; Harold Miller, SSC&B Inc.; Robert MacDonald, Batten, Barton, Durstine & Osborn Inc.; Sanford E. Reisenbach, Grey Advertising Inc.; George J. Simko, Benton & Bowles Inc. Julian Sloan, AAAA sec to the committee.

Broadcaster relations: Thornton B. Wierum, J. Walter Thompson Co., chmn; Lois Underhill, Compton Advertising Inc., vice chmn; Gerald Baldwin, Young & Rubicam International Inc.; George Burrows, N.W. Ayer & Son Inc.; Frank McDonald, Cunningham & Walsh Inc.; Walter Reichel, Ted Bates & Co.; Robert L. Turner, McCann-Erickson Inc.; Kent Vlautin, Foote, Cone & Belding; Peter Berla, Keenan & McLaughlin Inc.; Patricia Foley, AAAA sec to the committee.

Broadcast administration: Phillip L. Tomalin, Ogilvy & Mather Inc., chmn; Marion Preston, J. Walter Thompson Co., vice chmn; Peter Weber, Leo Burnett Co., Central region vice-chmn; Julian Armistead, Young & Rubicam International Inc.; Ted Bird, Doyle Dane Bernbach Inc.; William Clotworthy, Batten, Barton, Durstine & Osborn Inc.; William Cotton, Wells Rich, Green Inc.; Bruce Cox, Compton Advertising Inc.; Robert Finn, William Esty Co.; Gina Gaylord, McCann-Erickson Inc.; Sidney Hertzell, Grey Advertising Inc.; May Kohler, Gardner Advertising Inc.; Bertrand M. Lanchner, N.W. Ayer ABH International; Marianne McDermott, Ketchum, MacLeod & Grove Inc.; Frank Mooney, Dancer-Fitzgerald-Sample Inc.; Frank J. Reed, SSC&B Inc.; Mimi Wallace, Ted Bates & Co.; Patricia Foley, AAAA sec to the committee.

Representing AAAA on ANA-AAAA joint policy committee on broadcast talent union relations: Phillip L. Tomalin, Ogilvy & Mather Inc., co-chmn; Mr. Armistead, Mr. Bird, Mr. Clotworthy, Mr. Cotton, Mr. Finn, Mrs. Gaylord, Miss McDermott, Mr. Mooney, Miss Preston, Mr. Reed, Mr. Schneider, Mrs. Wallace, Mr. Weber.

Representing AAAA on industry-TV talent union standing committees: Mr. Bird, Miss Preston, Mrs. Wallace; Phillip L. Tomalin, Ogilvy & Mather Inc.

Representing AAAA on industry-AFTRA (transcription code) standing committee: Mr. Armistead, Mr. Finn, Miss Preston, Mr. Tomalin, Mrs. Wallace.

Subcommittee on talent union affairs: New York: Julian Armistead, Young & Rubicam International Inc., chmn; Linda Beakler, Kenyon & Eckhardt Inc.; Bernadette Naughton, Batten, Barton, Durstine & Osborn Inc.; Cornelia Fairly Doyle Dane Bernbach Inc.; Rosalie Kleinberg, Dancer-Fitzgerald-Sample Inc.; Cynthia Krauss, Grey Advertising Inc.; Carole Laguzzi, J. Walter Thompson Co.; Georgette McCarthy, McCaffrey and McCall Inc.; Myrna Omang, Compton Advertising Inc.; Sandra Oncay, William Esty Co.; Anne Serra, McCann-Erickson Inc.; Geraldine Weiss, Norman, Craig & Kummel Inc.; Judy Williams, Needham,

National Associations

Harper & Steers Inc.; Carole Ann Smith, Ted Bates & Co.; Alma Zipkin, Ogilvy & Mather Inc.; Dallas: Eugene Jacobson, Bloom Advertising Agency Inc.; Denver: Robert Geddy, Broyles, Allebaugh & Davis Inc.; Los Angeles: Joyce Stevens, Foote, Cone & Belding/Honig; James O. Baier, Batten, Barton, Durstine & Osborn Inc.; Sylvia Seymour, Erwin Wasey Inc.; Minneapolis: Richard Stevens, Campbell-Mithun Inc.; Pittsburgh: Marianne McDermott, Ketchum, MacLeod & Grove Inc.; San Francisco: Yvonne Walker, Honig-Cooper & Harrington.

Subcommittee on casting and talent agent problems: Catherine White, SSC&B Inc., chmn; Mimi Wallace, Ted Bates & Co.; Max Fryer, Benton & Bowles Inc.; Doris Gravert, Dancer-Fitzgerald-Sample Inc.; Evelyn Pierce, J. Walter Thompson Co.; Margaret Sala, Doyle Dane Bernbach Inc.

Subcommittee on cable TV, and technical developments: Mr. Cox, chmn; Mr. Armistead, Mr. Bird, Mr. Cotton, Miss McDermott, Miss Preston.

Subcommittee on TV business operations: Mrs. Gaylord, chmn; Mr. Tomalin, ex-officio; Mr. Bird; Mr. Clotworthy; Mr. Finn; Mr. Lanchner; Mrs. Wallace; James Carroll, Benton & Bowles Inc.; William Duryea, Young & Rubicam International Inc.; Selwyn Shillinglaw, J. Walter Thompson Co.; Stanley Slorance, Grey Advertising Inc.

Subcommittee on broadcast traffic: Dorothy Giannone, Young & Rubicam International Inc., chmn; Donald McIntosh, Compton Advertising Inc., chmn; Sally Biele, Ogilvy & Mather Inc.; Diana Deane, Ketchum, MacLeod & Grove Inc.; Michael Dvoretz, Batten, Barton, Durstine & Osborn Inc.; Mary Franklin, McCann-Erickson Inc.; Marion Lennox, Benton & Bowles Inc.; Thomas McTigue, Ted Bates & Co.; Patricia Stevin, J. Walter Thompson Co.; Harry Watson, William Estly Co.; Peter Weber, Leo Burnett Co.

Broadcast administration (Chicago): Peter Weber, Leo Burnett Co., chmn; Virginia Dalton, J. Walter Thompson Co.; Genevieve Dolinko, Needham, Harper & Steers Inc.; Diana Ealmea, Earle Ludgin & Co.; Kay Hockstad, Clinton E. Frank Inc.; John Marsh, Tatham-Laird & Kudner Inc.; Robert Mellott, Foote, Cone & Belding; Carol Rogers, D'Arcy-MacManus & Masius, vice chmn; Peggy Shane, Grey-North Advertising Inc.

Broadcast programming: Lewis S. Wechsler, Wells, Rich, Greene Inc., chmn; Howard Eaton, Ogilvy & Mather Inc., vice chmn; Gene Accas, Leo Burnett Co.; Peter Bardach, Foote, Cone & Belding; Louis Dorkin, Dancer-Fitzgerald-Sample Inc.; Hugh Lucas, Campbell-Ewald Co.; Joel Segal, Ted Bates & Co.; Robert Levinson, Batten, Barton, Durstine & Osborn Inc.; Richard H. Low, Young & Rubicam International Inc.; Werner Michel, SSC&B Inc.; Thomas O'Reilly, Doyle, Dane, Bernbach Inc.; William Seaman, William Estly Co. Inc.; Patricia Foley, AAAA sec to the committee.

Advertising legal affairs: Elhanan Stone, Ted Bates & Co., chmn; Elaine Reiss, Ogilvy & Mather Inc., vice chmn; Michael Breslin, Leo Burnett Co.; J. Byron Hackett, J. Walter Thompson Co.; Frank Mooney, Dancer-Fitzgerald-Sample Inc.; James Moore, Norman, Craig & Kummel Inc.; Robert G. Simon, McCann-Erickson Inc.; Philip Stringer, Young & Rubicam International Inc.; Bertrand M. Lanchner, N.W. Ayer ABH International; Lionel Wernick, Batten, Barton, Durstine & Osborn Inc.; Mahlon Perkins, Donovan Leisure Newton & Irvine, AAAA counsel, ex-officio; Patricia Foley, AAAA sec to the committee.

American Cinema Editors Inc. 422 South Western Ave., Los Angeles 90020. (213) 386-1946. Axel R. Hubert, pres; Eve Newman, VP; John M. Woodcock, sec; Bill W. Garst, treas.

Directors: Richard Greer, George Grenville, David Newhouse, Peter Parasheles, Rita Roland, Herbert L. Stock, Maury Winetrobe.

American Council for Better Broadcasts. 120 E. Wilson St., Madison, Wis. 53703. (608) 257-7712. Dr. Gene W. Carter, pres; Susan Dreyfus Fosdick, VP; Dr. Clinton W. Bradford, sec.

American Guild of Authors and Composers. 40 W. 57th St., New York 10019. (212) 757-8833. Ervin Brake, pres; Alex Kramer, exec VP; Leonard Whitcup, 1st VP; Lew Spence, 2nd VP; Sheldon Harnick, sec; Bernie Wayne, asst sec; Sheila Davis, treas; Donald Kahn, asst treas; Lewis M. Bachman, exec dir. Hollywood 90028: 6430 Sunset Blvd, Suite 1113. (213) 462-1108. Lauren Lucier, rgnl dir.

American Marketing Assn. 222 S. Riverside Plaza, Chicago 60606. (312) 648-0536. Arnold Corbin, New York, VP; Robert H. Egger, RCA Corp., immediate past pres; Al B. Blankenship, Bowling Green State U., sec-treas; Vern J. McGinnis, FS Services Inc., VP, assn sec-treas; Ann Ives, AMR International Inc., VP, conferenc;

lan MacFarlane, MacFarlane & Co. Inc., VP, industrial mktg; Charles S. Mayer, York University, VP, international mktg; Keith K. Cox, U. of Houston, VP, mktg educ; Henry J. Claycamp, International Harvester Co., VP, mktg mgt; Marshall G. Greenberg, National Analysts, VP, mktg rsch; Dorothy Cohen, Hofstra U., VP, public policy & issues; John S. Wright, Georgia State U., VP, publications.

American Medical Assn. 535 North Dearborn St., Chicago 60601. (312) 751-6000. Frank Campion, dir, communications division; Dick DuMont, dir, radio-TV department.

American Meteorological Society. 45 Beacon St., Boston 02108. (617) 227-2425. David S. Johnson, pres; David Atlas, pres-elect; Dr. William Kellogg, past pres; Dr. Kenneth C. Spengler, exec dir; David F. Landrigan, sec-treas.

American Newspaper Publishers Association (ANPA). Box 17407, Dulles International Airport, Washington 20041. (703) 620-9500. Jerry W. Friedheim, gen mgr.

American Radio Relay League. 225 Main St., Newington, Conn. 06111. (203) 666-1541. Harry J. Dannels, pres; Victor C. Clark, 1st VP; Noel B. Eaton, Carl L. Smith, VPs; D. H. Houghton, treas; John Huntoon, sec; R. L. Baldwin, gen mgr.

American Society of Composers, Authors & Publishers (ASCAP). 1 Lincoln Plaza, New York 10023. (212) 595-3050. (See listing under Music Licensing Groups).

American Society of Magazine Photographers Inc., The Society of Photographers in Communications. 60 East 42d St., New York 10017. (212) 661-6450. Arie Kopelman, exec dir; Lawrence Fried, pres.

San Francisco 94103: 1041 Folsom St., Jeremiah Bragstad.

Southern Calif chapter: 6515 Wilshire Blvd, Los Angeles 90048, Suite 7. (213) 553-5532. Ben Biggs, pres.

Chicago 60302: Box 2007, Oak Park, Bill Rogers, pres.

Northwest: 155 Water St., Vancouver 3, B. C. Bill Staley, chmn.

Boston 02114: 42 West Cedar, Lynn McLaren.

American Society of Newspaper Editors. c/o Gene Giancarlo, exec sec. Box 551, 1350 Sullivan Trail, Easton, Pa. 18042. (215) 252-5502.

American Women in Radio and Television Inc. 1321 Connecticut Ave. N.W., Washington 20036. (202) 296-0009. Jane E. Cohen, WRC-TV Washington, pres; Saidie Adwon KTUL-TV, Tulsa, Okla., pres-elect; Wilma H. Kriner, W.M. Zemp & Assoc. Inc., St. Petersburg, Fla., sec-treas VPs; Mary Jean Parson, ABC Scenic Attractions, New York, Northeast area; Nikki Caccia, T.L. Reimel Advertising, Philadelphia, Midwest area; Joan Perry, Perry Hoyle Advertising Inc., Birmingham, Ala., Southern area; Carol Green, WSAU-TV Wausau, Wis., East Central area; Doris A. Graham, May Broadcasting Co., KMTV Omaha, West Central area; Jean Sprague, Media Consultants Inc., Oklahoma City, Southwest area; Catherine Clymer, Nielsen/Clymer & Assoc., Beverly Hills, Calif., Western area.

Directors-at-large: Dona Clark, Information Inc., Los Angeles; Marianne Faulkner WXIX-TV Cincinnati; Margaret Kalmbach, S.C. Educational TV Network, Columbia; Francine P. Proulx, exec dir.

Armed Forces Communications and Electronics Assn. 5205 Leesburg Pike, Falls Church, Va. 22041. (703) 820-5028. Thomas A. Campobasso, Collins Radio Group, Rockwell International Corp., pres. VPs: Jack Albright, W. Earl Fisher, William H. Graham, George A. Harter, Howard R. Hawkins and James R. Mellor. Lt. Gen. George E. Pickett, USA (ret), exec VP & gen mgr; Scott Rigby, gen counsel; R.J. Whelan, natl sec.

Associated Press Broadcasters (APB). 50 Rockefeller Plaza, New York 10020. (212) 262-4011. Tom Frawley, Cox Broadcasting, Washington, pres; Walter Rubens, KQBE Las Cruces, N.M., 1st VP

Board of directors: Frank Balch, WJOY Burlington, Vt., past pres; Rex Davis, KMOX St. Louis; Charles Whitehurst, WFMY-TV Greensboro, N.C.; Harry McKenna, WEAN Providence, R.I.; Roy Morgan, WILK Wilkes-Barre, Pa.; Breck Harris, WBAP Fort Worth; John Howard, KRCC Council Bluffs, Iowa; Curtis Beckmann, WCCO Minneapolis; Hal Kennedy, KKTU Colorado Springs; Robert Tobey, KAT5 Deming, N.M.; Thad Sandstrom, WIBW Stations, Topeka, Kan.; Ken

Booth, KEEL Shreveport, La.; W. Jack Brown, WLON Lincolnton, N.C.; Anthony Gonzalez, WWNR Beckley, W.Va.; John Salisbury, KXL Portland, Ore.; Dave Kelly, WIIC-TV Pittsburgh.

Assn. for Broadcast Engineering Standards Inc. 1730 M St. N.W., Suite 700, Washington 20036. (202) 659-7676. Jay W. Wright, KING Seattle, pres; Hamilton Shea, WSWA Harrisonburg, Va., VP; Col. John Bowman, Evening Star Broadcasting Co., treas; William J. Potts Jr., Haley, Bader & Potts, Washington sec Directors: James Wulliman, WTMJ Milwaukee; James M. Caldwell, WAVE Louisville, Ky; Col. John Bowman, Evening Star Broadcasting Co., Washington; Jay W. Wright, KING Seattle; Leslie G. Aries, WBEN Buffalo, N.Y.; Oscar Hirsch, KFVS Cape Girardeau, Mo.; Robert W. Booth, WTAG Worcester, Mass; John E. McCoy, Storer Broadcasting Co., Miami; Harry J. Shaub Jr., Lancaster, Pa.; Hamilton Shea, WSWA Harrisonburg, Va.; James W. Ward, WLAC Nashville; Peter A. Kiser, WWJ Detroit.

Assn. of American Railroads. American Railroads Building, Washington 20036. (202) 293-4000. Stephen Ailes, pres; Richard E. Briggs, asst to pres and dir of office of information & pub affrs; Joe W. Grotte, asst dir; John N. Ragsdale, mgr of industry rel.

Directors: D.L. Lang, mgr of editorial svcs; R.V. Poos, mgr of news service; J.R. Shamute, mgr Information Letter and photographic svcs; Woodrow W. Thompson, mgr of spec svcs; Lawrence H. Kaufman, mgr of media rel.

Association of Black Broadcast Executives (ABBE). George Norford, Group W, New York, pres; David Heppburn, WNEW-TV New York, VP; Stanley Robertson, NBC-TV Los Angeles, VP; Mal Johnson, Cox Broadcasting, Atlanta, sec; Tyrone Brown, Post-Newsweek Stations, Washington, gen counsel.

Association of Broadcast Executives of Texas. Box 1833, Dallas 75221. (214) 634-1080 Ext 27. Lynn Hapeman, Bloom Agency, Dallas, pres; Chuck Baker, Sears, Dallas, VP; Jane Whitehurst, Bloom Agency, Dallas, sec; Mike Stephens, KXAS-TV Fort Worth, treas.

Assn Canadienne de la Radio et de la Television de Langue Francaise Inc. C.P. 627 Succ. "B," Ottawa K1P 5S2. (613) 233-4035. (800) 267-9558. Francois Bastien, Poste CFDA, Victoriaville, pres.

Association of Canadian Advertisers Inc. Suite 620, 159 Bay St, Toronto, Ontario M5J 1J7. (416) 363-8046. J. Foss, Canadian Cannors Ltd., chmn of bd; A. J. Hodges, Sterling Drug Ltd; immediate past chmn of board; Marcel Poirier, General Foods Ltd., senior vice chmn; Jack V. Dampy, Canada Packers Ltd, vice-chmn and treas; vice-chmn: Ralph S. Davis, Kellogg Co. of Canada; R. J. Galloway, Cambell Soup Co. Ltd.; W. J. Harris, Imperial Tobacco Products Ltd.; Roger Lhoumeau, Petrofina Canada Ltd.; W. T. Blakely, Assn. of Canadian Advertisers Inc., pres; W. D. Buller, Assn. of Canadian Advertisers Inc., sec; dirs: R. M. Bricker, Dominion Textile Ltd.; C. D. Clarence, Du Pont of Canada Ltd.; W. D. H. Davis, The Canada Starch Co. Ltd.; Best Foods Division; W. D. Fotlis, Dominion Foundries and Steel Ltd.; A. C. Goetz Jr., Pepsi-Cola Canada Ltd.; E. G. Hirst, Irwin Toy Co.; P. D. G. Hopkins, The Procter & Gamble Co. of Canada; A. T. Lennox, Labatt Breweries of Canada Ltd.; J. J. McHardy, Canadian Imperial Bank of Commerce; P. E. Priestman, American Airlines Inc.; John P. Sauter, Kraft Foods Ltd.; R. T. Stewart, Scott Paper Ltd.; J. V. Tittley, Canada Cement Lafarge Ltd.; Walter Trudeau, Corby Distilleries Ltd.; I. Williamson, Nabisco Foods.

Assn of Cinema & Video Laboratories Inc. Suite 607, 901 N. Washington St., Alexandria, Va. 22314. (703) 548-7502. Frank M. McGeary, pres; Robert M. Smith, VP; William H. Smith, sec-treas; Preston B. Bergin, exec sec.

Assn of Electronic Manufacturers Inc. Suite 1600, 222 South Riverside Plaza, Chicago 60606. (312) 649-1600. Jay J. Greengard, pres; Herbert E. Taylor, VP; Gerald Damsky, sec; Kenneth C. Prince, exec VP; David L. Fisher, sec central division.

New York 10017: 551 Fifth Ave. (212) 661-6500. Stanley I. Lehrer, exec. VP, eastern division.

Assn. of Federal Communications Consulting Engineers. 1156 15th St. N.W., Suite 606, Washington 20005. (202) 296-2722. Ogden L. Prestholdt, pres; Carl E. Smith, VP; Donald G. Eversit, sec; L.R. duTrail, treas.

Association of Independent Television Stations

National Associations

Inc. (INTV). 19 W. 44th St., New York 10036. (212) 575-0577. James R. Terrell, chmn of bd; Herman W. Land, pres; Herman Pease, sec; Leavitt J. Pope treas.

Board: Gene Adelstein, KZAZ(TV) Tuscon; Don B. Curran, Kaiser Bcstg Co., Oakland; Robert L. Glaser, RKO General Television Inc., New York; Albert P. Krivim, Metromedia Television, Los Angeles; Herman W. Land, INTV; Herman Pease, WUTV(TV) Buffalo, N.Y.; Leavitt J. Pope, WPXI Inc., New York; Harold E. Protter, KPLR-TV St. Louis; John T. Reynolds, KTLA(TV) Los Angeles; James R. Terrell, KTVT(TV) Ft. Worth-Dallas; R. E. Turner, Turner Communications Corp., Atlanta; Naomi Goldstein, dir of administration; Robert J. Somerville, dir of sls.

Assn. of Maximum Service Telecasters Inc., 1735 DeSales St., N.W. Washington 20036. (202) 347-5412. Lester W. Lindow, exec dir; Roy W. Easley, asst exec dir; Paul R. Jeannin, admin asst. Bd of dirs: Arch L. Madsen, Bonneville Communications Corp., Salt Lake City, pres; Franklin C. Snyder, The Hearst Corp., Pittsburgh, 1st VP; Robert F. Wright, WTKO-TV Meridian, Miss., 2nd VP; Ralph S. Jackson, Orion Bcstg Inc., Louisville, Ky., sec-treas; Lester W. Lindow, AMST, Washington, asst sec-treas; Norman P. Bagwell, WKY-TV Oklahoma City; A. James Ebel, KOLN-TV Lincoln, Neb.; Jack Harris, KPCC-TV Houston; Wallace J. Jorgenson, Jefferson—Pilot Broadcasting Co., Charlotte, N.C.; C. Howard Lane, KOIN-TV Portland, Ore.; Terry H. Lee, Storer Bcstg Co., Miami Beach; August C. Meyer, WCIA Champaign, Ill.; James M. Moroney, Jr., Belo Broadcasting Corp., Dallas; John T. Murphy, Avco Broadcasting Corp., Cincinnati; Fred Paxton, WPSD-TV Paducah, Ky.; C. Wrede Petersmeyer, Corinthian Broadcasting Corp., New York; A. Louis Read, WDSU-TV New Orleans; Lawrence H. Rogers II, Taft Broadcasting Corp., Cincinnati; Willard Schroeder, WOTV Grand Rapids, Mich; Willard E. Walbridge, Capital Cities Communications Inc., Houston; Mort C. Watters, Scripps-Howard Bcstg Co., Cincinnati; Charles H. Crutchfield, Jefferson-Pilot Broadcasting Co., Charlotte, N.C., emeritus; Joseph B. Epperson, Scripps-Howard Bcstg Co., Cleveland, dir emeritus; A. M. Herman, Fort Worth, emeritus. Executive Committee: Terry H. Lee, Storer Broadcasting Co.; Arch L. Madsen, Bonneville Communications Corp., Salt Lake City; Robert F. Wright, WTKO-TV Meridian, Miss.; Frank Snyder, The Hearst Corp.; Jack Harris, KPCC-TV Houston; C. Wrede Petersmeyer, Corinthian Broadcasting Corp.; Lawrence H. Rogers II, Taft Broadcasting Co. Engineering Committee: Clyde Haehle, Avco Bcstg Corp., Cincinnati, chmn; James E. Bloyd, Scripps-Howard Broadcasting Co., Cleveland; Albert Chismark, WHEN-TV Syracuse, N.Y.; A. James Ebel, KOLN-TV Lincoln, Neb.; Robert W. Flanders, McGraw-Hill Broadcasting Co., Indianapolis; Ralph Hucaby, WLAC-TV Nashville; Carl G. Nopper, WMAR-TV Baltimore; Daniel H. Smith, Capital Cities Communications Inc., Philadelphia; Leonard A. Spragg, Storer Broadcasting Co., Miami Beach.

Assn of Motion Picture & Television Producers Inc. 8480 Beverly Blvd., Hollywood 90048. (213) 653-2200. Jack Valenti, pres; Marshall Wortman, VP; Billy Hunt, exec VP; Alfred P. Charmie, VP; K. William O'Connor, VP-sec; W. R. Holm, VP; Robert T. Watkins, treas.

Assn of National Advertisers Inc., 155 E. 44th St., New York 10017. (212) 697-5959. Officers: Peter W. Allport, pres; Samuel Thurm, senior VP-Washington; William D. Kistler, VP; William F. Heimlich, VP; Herbert A. Ahlgren, VP; Harry L. Darling, VP; James R. Cosgrove, asst treas & sec; Gilbert H. Weil, gen counsel. Dirs: F. Kent Mitchell, General Foods, chmn; Ross Garrett, 3M Co., vice chmn; Earl A. Clasen, Pillsbury Co.; Del C. Bowman, Hughes Aircraft Co.; David W. Burke, General Electric Co.; William M. Claggett, Ralston Purina Co.; Joseph W. Curran, RCA Corp.; Peter A. Dow, Chrysler Motors Corp.; Robert L. Ficks Jr., Ethan Allen Inc.; R. Ross Garrett, 3M Co.; Chester R. Green, Fraitec Corp.; Lee J. Lent, American Cyanamid Co.; James H. Pearce, The Dow Chemical Co.; George F. Tyrrell, Johnson & Johnson; Sanford Buchsbaum, Revlon; Blair R. Rettig, Aluminum Co. of America; John T. McLoughlin, Vick Chemical Co.

Television advertising committee: A. B. Priemer, S. C. Johnson & Son, chmn; Philip Agisim, J. B. Williams Co.; Jack J. Bard, Purex Corp.; Robert G. Berry, Sterling Drug; Glenbrook Laboratories Div; Robert Bodeau, General Mills Inc.; Sanford Buchsbaum, Revlon Inc.; Richard C. Butler, LeVey Brothers; C. Buell Culver, R. T. French Co.; Robert A. Dobbins, Best Foods Div, CPC International Inc.; S. A. Foreman, Standard Brands Sales

Co.; L. C. Hall, Noxell Corp.; Gordon G. Hurt, Zenith Sales Co.; Robert M. Lukovics, Westinghouse Electric Corp.; J. T. McLoughlin, Vick Chemical Co., Div of Richardson-Merrell; G. A. McMullen, Morton-Norwich Products Inc.; Jack Murphy, Prudential Insurance Co. of America; Alfred L. Plant, Block Drug Co. Inc.; E. L. Richmond, American Motors Corp.; G. O. Ringling, Oscar Mayer & Co.; Louis Rubinacci, Nabisco Inc.; John E. Ruhaak, United Airlines; R. H. Schirmer, Chrysler Motors Corp.; E. Christian Schoenle, Pillsbury Co.; F. L. Smawley, Jos. Schlitz Brewing Co.; Peter Spengler, Bristol-Meyer Co.; M. B. Streicker, Miles Laboratories Inc.; T. E. Tinsley, Kellogg Co.; Harry Way, Colgate-Palmolive Co.; G. L. Young, Procter & Gamble Co.

Radio adv com: Samuel F. Melcher Jr., Lehn & Fink Products Co., chmn; A. G. Atwater Jr., Wm. Wrigley Jr. Co.; William B. Bishop, Household Finance Corp.; J. D. Elgin, Mobile Oil Corp.; James P. Felton, Avco Financial Services; Henry Hayes, Pepsi-Cola Co.; Raymond C. Keck, Cities Service Oil Co.; Dean R. Lind, Sun Oil Co.; W. V. Linn, Texaco Inc.; Daniel F. McNertney, State Farm Mutual Automobile Insurance Co.; A. P. Meaume, Amoco Oil Co.; Bob A. Newmark, The F. & M. Schaefer Brewing Co.; T. E. Tinsley, Kellogg Co.; T. W. Wilson, Exxon Co.; F. L. Wuellner, Ford Motor Co.; W. D. Yeager, Nestle Co. Inc.

ANA members of ANA-AAAA joint policy com on broadcast talent union let: Alfred L. Plant, Block Drug Co., chmn; James E. Cochran, Procter & Gamble Co.; Darrough Diamond, McDonald's Corp.; Robert Dobbins, Best Foods Div of CPC International; Richard Dube, Lever Brothers Co.; George W. Feld, Revlon Inc.; Hugh Goodman, Warner-Lambert Co.; Frank Harvey, General Foods Corp.; George Lenox, The Goodyear Tire & Rubber Co.; John E. Ruhaak, United Airlines; Carole Rezabek, Ralston Purina Co.; Bob Newmark, The F. & M. Schaefer Brewing Co.; Peter Spengler, Bristol-Myers Co.; Mitchell Streicker, Miles Laboratories Inc.; George Sullivan, Colgate Palmolive Co.; A. C. Thompson, Chrysler Motors Corp.; Guy Farmer, Patterson, Belknap, Farmer & Shibley, counsel for committee.

Association of Public Radio Stations. 1730 Pennsylvania Ave., Washington 20006. (202) 785-4616. Matthew B. Coffey, pres; William H. Kling, bd chmn.

Audio Engineering Society. 60 E. 42d St., New York 10017. (212) 661-8528. Dr. Duane H. Cooper, pres; Rex Isom, pres elect; Donald W. Powers, sec; Arthur E. Gruber, treas; Donald J. Plunkett, exec dir.

Directors: Hugh S. Allen Jr., Dr. Robert Ashley, John J. Bubbers, John T. Mullin, Donald L. Richter, Willi Studer, Richard Burwen, Raymond E. Cooke.

Bedside Network of the Veterans Hospital Radio & TV Guild. 1841 Broadway, New York 10023. (212) PL 7-8657. Robert J. Higgins, pres; Terry Ross, 1st VP; William R. Potts Jr., 2d VP; Hope Martinez, 3rd VP; Joel B. Mayer, treas; Jean Houston, sec.

Brand Names Foundation Inc. 477 Madison Ave., New York 10022. (212) 753-4131. H. Ford Perine, pres.

Broadcast Credit Assn. Inc. 360 N. Michigan Ave., Chicago 60601. (312) 263-1668. Arno W. Mueller, Storer Broadcasting, Miami Beach, Fla., chmn of bd; Lawrence P. Loiello, Peters, Griffin, Woodward Inc., New York, pres; Howard Brandt, WGN Continental Broadcasting Co., Chicago, VP; Fred Cige, Metromedia Inc., New York, sec; Alan Lajtay, ABC TV network, New York, treas; Robert E. McAuliffe, IBFM, Chicago, exec VP; Andrew J. Numziata, BCA, Chicago, VP/administration.

Directors: W. Martin Wingren, Kaiser Broadcasting, San Francisco; Harold Poole, Gilmore Broadcasting, Kalamazoo, Mich.; Gene R. Anderson, Forward Communications Corp., Wausau, Wis.; Joseph J. McCabe, KPLR-TV St. Louis; William G. Mueller, KTVU(TV) Oakland, Calif.; Cecil Walker, KBTU(TV) Denver; Barbara Goodstein, WPXI Inc., New York; Joseph E. Seaver, KRON-TV/FM San Francisco; Marvin Schragar, John Blair & Co., New York; V. William Montuori, Harrington, Righter & Parsons, New York.

Broadcast Education Association (formerly Assn. for Professional Broadcasting Education). 1771 N. Street, N.W., Washington 20036. (202) 293-3518. Rod Rightmire, Ohio U., Athens, Ohio, pres; Wallace Dunlap, Westinghouse Broadcasting Co., Washington, VP; Robert Snyder, U. of Wisconsin, Madison, Wis., sec-treas; Harold Niven, NAB, Washington, exec sec.

Directors: Frank Balch, WJOY Burlington, Vt.; Clayton Brace, KGTV San Diego; Ruane Hill, U. of Wisconsin, Milwaukee; Stuart Hyde, San Francisco State U., San Francisco; Edward Luck, Georgia State

U., Atlanta; Wendell Mayes Jr., KNOW Austin, Tex.; Philip Marella, LIN Broadcasting Corp., New York; Worth McDougald, U. of Georgia, Athens, Ga.; Clark Pollock, Nationwide Communications Inc., Columbus, Ohio.

Broadcasters Foundation Inc. 40 West 57th St., New York 10019. (212) 586-2000. Edwin W. Pfeiffer, pres; Robert W. Ferguson, VP; Betty Luster Prentiss, sec; M. H. Shapiro, exec sec; Robert J. Higgins, treas.

Broadcasters Promotion Assn. Box 5102, Lancaster, Pa. 17601. (717) 569-7611. Tom Cousins, WCCO-TV Minneapolis, pres; Lynne Grasz, KOLN-TV/KGIN-TV Lincoln, Neb., pres-elect; Roger Ottenbach, WEEK-TV Peoria, Ill., VP; Ken Taishoff, WTMJ-TV Milwaukee, sec; Terry Simpson, WTTV(TV) Bloomington, Ind., treas.

Broadcasting Foundation of America. Suite 1810, 52 Vanderbilt Ave., New York. (212) 684-2505. George E. Probst, bd chmn; Seymour N. Siegel, pres; Howard L. Kany, VP & exec dir. (Nonprofit educational organization distributing international radio programs to U.S. radio stations, schools, colleges and universities.)

Broadcast Music Inc. (BMI). 40 West 57th Street, New York 10019. (212) 586-2000. (See listing under Music Licensing Groups).

Broadcast Pioneers, 40 West 57th St., New York 10019. (212) 586-2000. Harold R. Kreinstein, Plough Broadcasting Co. Inc., Memphis, pres; Betty Prentiss, sec; Robert J. Higgins, treas; M. H. Shapiro, exec sec.

Broadcast Pioneers Library. 1771 N. St. N.W., Washington 20036. (202) 223-0088. Endowed by Broadcast Pioneers Educational Fund Inc. Joseph E. Baudino, pres; Catharine Heinz, VP; Harold Niven, VP; Robert J. Higgins, sec-treas; William S. Hedges, chmn emeritus. Directors: Joseph E. Baudino, Roger W. Clipp, Robert L. Coe, John F. Dille Jr., Arthur Hull Hayes, Ernest Lee Jahncke Jr., Carl E. Lee, John T. Murphy, Harold Niven, Ward L. Quaag, G. Richard Shafto, Virginia Pate Wetter, Catharine Heinz, dir.

Broadcast Rating Council (See separate listing).

Bureau of Advertising of The American Newspaper Publishers Assn. Inc. 485 Lexington Ave., New York 10017. (212) 687-9300. James F. Chambers Jr., chmn of bd; Jack Kauffman, pres.

Chicago: 400 North Michigan Ave. (312) 644-1290. Dwight I. Skinner.

Detroit: 1657 Guardian building. (313) 963-4353. L. M. Rich.

Los Angeles: 5670 Wilshire Boulevard. (213) 933-8526. Howard M. Keefe.

San Francisco: 400 Montgomery St. (415) 981-8118. George Hooper.

Business Exchange Inc. 8217 Melrose Ave., Los Angeles 90046. (213) 651-4200. M. J. McConnell, pres; J. L. Janssen, VP; M. D. Yasmineh, sec-treas. Orange County/Santa Ana, Calif. 92705: 10522 Brier Lane.

San Bernardino-Riverside/Loma Linda, Calif. 92354: 25566 Barton Rd.

San Diego 92109: 2180 Garnet, Suite 3C.

Santa Barbara, Calif. 93101: 1727 State St., Ste. 6.

South Bay-Long Beach/Torrance, Calif. 90504: 18436 Hawthorne Blvd.

Ventura County-Oxnard/Oxnard, Calif. 93030: 135 W. Magnolia Ave., No. 13.

Phoenix 85016: 4747 N. 16th St., No. A-112.

Boston/Stonham, Mass. 02180: 52 Main St. Hialeah, Fla. 33010: 546 E. 25th St.

Las Vegas 89104: 1111 Las Vegas Blvd., S. No. 228.

Pompton Plains, N.J. 07444: 917 Route 23.

Albuquerque, N.M. 87100: 6400 Uptown N.E., 362W.

New York 10022: 220 E. 51st St.

Peoria, Ill. 61602: 232 S. West Jefferson.

Salt Lake City 94111: 316 S. 4th East.

Canadian Advertising and Sales Association. Suite 369, Queen Elizabeth Hotel, Montreal. (514) 866-2124. A. G. Solosky, Bell Canada, Ottawa, pres; Mac Lindsay, CHML Radio, Hamilton, Ont., past pres; Donald Fraser, D. E. Fraser Co., Windsor, Ont., exec VP; Ken McKee, Bell Canada, Montreal, VP; Blanche Evans, The Distillers Co. (Canada) Ltd., Toronto, VP-finance; Les Pasis, Paris Sales Co. Ltd., Hamilton, Ont., VP; Fred Walker, Walker Real Estate, St. Catharines, Ont., VP; R. C. Marvin, Canadian Advertising Advisory Board, Toronto, exec dir; R. E. (Ed) Gourlay (at CASA Montreal hqtrs), mgng dir.

Canadian Association of Broadcast Consultants. 1550 West de Maisonneuve, Room 402,

Montreal H3G-1N2. (514) 935-7447. D. E. M. Allen, pres; Peter A. Hiblock, VP; V. Lattaro, sec-treas.

The Canadian Association of Broadcasters. 85 Sparks St., Box 627, Station B, Ottawa (613) 233-4035. Dr. Pierre Camu, pres; Allan Waters, CHUM Ltd., Toronto, chmn; Ed Prevost, Radiomutuel Ltd., Montreal, vice chmn; radio; Ron Mitchell, Moffat Communications, Winnipeg, Man., vice chmn; television; Philippe de Gaspé Beaubien, Telemedia Ltee., Montreal, immediate past chmn.

Directors: Dennis Barkman, CHWK Chilliwack, B. C.; Francois Bastien, CFDA Victoria/Ville, Que.; Gaston Belanger, CFTM-TV Montreal; George Gallagher, CKRM Regina, Sask.; Don Hartford, CFRB Toronto; Tom Laing, CFSL Weyburn, Sask.; C. Jamieson, CJON-AM-TV St. John's, Nfld.; D. Lawrie, Kawartha/Frontenac Bcstg Ltd., Toronto; Andre Mercier, CHLT-TV Sherbrooke, Que.; J. A. Peters, CHAN/CHEK-TV Vancouver, B.C.; J. A. Radford, CFRJ Brockville, Ont.; J. Schoone, CKCW Moncton, N.B.; A. Shortell, CKSA-TV Lloydminster, Sask.-Alberta; Allan Slight, IWC Communication Ltd., Toronto; Ted Soskin, CHQR Calgary, Alta. Officers: Dr. Pierre Camu, pres; Flora Love, dir admin svcs; Gerry Acton, dir industry and PR; M. Robin Quinn, dir gov't & PR; Danielle Langlais, coord, rsch & publications.

Canadian Cable Television Association. 85 Albert St., Suite 405, Ottawa K1P 6A4. (613) 232-2631. Michael Hind-Smith, pres; J. Roger Hebert, VP; Glenys Parry, dir of rsch; K. E. Hancock, dir of engrg; E. G. Wimberley, dir of administration.

Directors: John O. Graham, chmn; C. William Stanley, vice chmn, Atlantic; Omer Girard, vice chmn, Quebec; P.B. Lind, vice chmn, Ontario; Hugh Comack, vice chmn, Prairies; W. Garth Plither, vice chmn, Pacific; Pierre Levesseur, immediate past-chmn; W.D. B. Aiton, sec-treas.

Catholic Apostolate of Radio, Television & Advertising (CARTA). 1011 1st Ave., No. 1920, New York 10022. (212) 371-6100, ext. 269. Anthony A. Cervini, pres; Frank McGarey, VP; Jane Ann McGettrick, VP; Rita Donworth, treas; John Martino, asst treas; Joan Hennessey, sec.

Clear Channel Broadcasting Service. 1776 K St. N.W., Washington 20006. (202) 296-4855. Joseph A. Kjar, KSL Salt Lake City, pres; Irving C. Waugh Jr., WSM Nashville, VP; A. M. Herman, WBAP Fort Worth, treas; Daniel D. Calibraro, WGN Chicago, sec; William C. Hunter, WHAS Louisville, chmn of engrg committee; Barney Arnold, WHAS Louisville, chmn of farm service committee.

Executive committee: Joseph A. Kjar, Irving C. Waugh Jr., A. M. Herman, Daniel D. Calibraro, Arch L. Madsen, KSL Salt Lake City; Dr. David D. Palmer, WHO Des Moines, Iowa; Elmo Ellis, WSB Atlanta; William F. Rust, WHAM Rochester, N.Y.

Commonwealth Broadcasting Association. Broadcasting House, London W1A 1AA. 01-580 4468 ext. 5022. Alva Clark, sec-gen. Members of Standing Committee: James Kangwana, Voice of Kenya, Nairobi, Kenya, VP progs & administration; James Redmond, BBC, London, engrg VP; P.C. Chatterji, All India Radio; Sir Charles Curran, BBC; Talbot Duckmanton, Australian Broadcasting Commission; Joseph Grima, Malta Broadcasting Authority; Christopher Kolade, Nigerian Broadcasting Corp.; Mrs. Wong-Lee Siok Tin, Radio and Television Singapore; Dwight Whyllie, Jamaica Broadcasting Corp.

Community Broadcasters Assn. 3219 West State Rd., Olean, N.Y. 14760. (716) 372-0161. F. Ernest Lackey, WHOP Hopkinsville, Ky., bd chmn; Roger Jeffers, WHOP Hopkinsville, Ky., pres; John R. Henzel, WHDL Olean, N.Y., vice-chmn & treas; Ronal Bonebrake, KOCY Oklahoma City, VP-sec.

Council for UHF Broadcasting (CUB). Box 23640, L'Enfant Plaza Station, Washington 20024. (202) 488-5211. Richard C. Block, chmn; Thomas E. Bolger, WMVT Madison, Wis., asst chmn-com'l stations; Frederick Breitenfeld Jr., Ph.D., Maryland Center for Public Broadcasting, asst chmn-public stations; William Reed, sec.

Council members: Carlo Anneke, WTAJ-TV Philadelphia; Betty Cope, WVIZ-TV Cleveland; Arthur Dorfner, WDOH-TV Toledo, Ohio; Robert Donovan, KMEG-TV Sioux City, Iowa.

Council of Better Business Bureaus Inc. 1150 17th St. N.W., Washington 20036. (202) 467-5200. Terrance Hanold, chmn of bd; William H. Tankersley, pres; Gene King, dir of bcstg.

Country Music Association Inc. 1511 Sigler St., Suite 111, Nashville 37203. (615) 244-2840. Wesley

H. Rose, Acuff-Rose Publications Inc., pres; Irving Waugh, WSM Inc., exec VP; Goddard Leiberson, CBS Records Group, VP; Bhaskar Menon, Capitol Industries-EMI Inc., VP; John K. Mailland, MCA Records Inc., VP; Jim Foglesong, DOT Records, VP; Bill Farr, Phonodisc Inc., VP; Dennis Brown, Joe Brown Enterprises, VP; Frank Mancini, RCA Records, sec; A. Torio, Victor Music Publishing Co., asst sec; Bob Austin, Record World, treas; Jerry Bradley, RCA Records, asst treas; Janet Gavin, The Gavin Report, sergeant at arms; Directors: Joe Talbot, Precision Record Pressing, chmn; Bob McIntyre, Wolf A. Popper Inc.; Bill Lucas, Grey Advertising Inc.; Hank Williams Jr., artist; Charley Pride, artist; Don Light, Don Light Talent Inc.; Bob Neal, William Morris Agency Inc.; Bob Tubert, composer; Bill Anderson, composer; Ralph Emery, The Ralph Emery Show; Charlie Douglas, WWL New Orleans; Harold Moon, POBIAO Canada; Gary Buck, Broadland Music Inc.; Harry "Hap" Peebles, Harry Peebles Agency; Don Romeo, Don Romeo Agency Inc.; Bob Woltering, Clairmont Corp.; Bill Williams, Billboard; Mary Reeves Davis, Tuckahoe Music Inc.; J. William Denny, Cedarwood Publishing Co.; Dan McKinnon KSON San Diego; Bud Wendell, Grand Ole Opry-Opryland; C. W. (Chic) Doherty, MGA Records Inc.; Wade Pepper, Capitol Records Inc.; Jim Schwartz, Schwartz Brothers; Hutch Carlock, Music City Record Distributors. Directors-at-large: Stanley Adams, ASCAP; Ron Bledsoe, CBS Records; Roy Horton, Peer-Southern Organization; Frances Preston, Broadcast Music Inc.; Charles Scully, SESAC Inc. Richard H. Frank, Barksdale, Whalley Leaver, Gilbert & Frank counsel; Mike Milom, Barksdale, Whalley Leaver, Gilbert & Frank, asst counsel.

Direct Mail/Mktg Assn. 6 East 43d St., New York 10017. (212) 689-4977. Robert F. DeLay, pres; John Jay Daly, senior VP; Celia Wallace, VP, PR; Raymond F. Brennan, VP mktg.
Washington 20006: 1703 K St., Suite 905. (202) 347-1222.

Division of Radio-Television of the Assn. for Education in Journalism. 206 Avery Hall, U. of Nebraska, Lincoln, Neb. 68508. (402) 472-3054. Larry Walklin, head; David Dary, vice head; James Hoyt, sec.

Educational Communication Assn. 906 National Press Bldg., Washington, 20045. (202) 393-6267. Ella F. Hartlee, pres and dir; James H. Boren, bd chmn; Charles Talley, vice chmn; Anna May Moinihan, sec-treas.

Electronic Industries Assn. 2001 I St. N.W., Washington 20006. (202) 659-2200. Glen R. Solomon, chmn bd; V. J. Adduci, pres; J. E. Padgett, treas; Raymond E. Johnson, gen counsel; Norman F. Sharp, VP administration; Tyler Nourse, VP parts; J. T. Mack, VP dis prod div & tube; Jack Waymam, sr VP cons elect grp; A.M. Wilson, VP engrg dept & solid state prod div; John Sodolski, VP comml & ind elect div; J.A. Caffiaux, VP gov prod div; A.M. Wilson, VP engrg dept; C.S. Lee, VP mktg svcs dept; Norman F. Sharp, dir PR.

Electronic Industries Assn of Canada. 77 Metcalfe St., Ottawa K1P 5L6. (613) 237-6847. E. G. Wright, chmn of bd; J. K. Carman, vice chmn of bd; L. Balcer, pres; B. N. Pollick, vice chmn; E. Walton, assoc vice chmn; A. Ainlay, dir of engrg; C. Harris, gen mgr.

Electronic Representatives Association. 233 E. Erie St. (suite 1002), Chicago, Ill. 60611. (312) 649-1333. Raymond J. Hall, exec VP; Paul C. Mazzacano, communications dir; Gail C. Carter, consultant on distribution.

Federal Communications Bar Association. Box 32251, Washington 20007. (202) 872-6826. Reed Miller, pres; John P. Bankson, 1st VP; Edgar W. Holtz, 2nd VP; Edward Hayes Jr., sec; Lois Siegal Schwartz, asst sec; James P. Riley, treas.

Film Producers Assn. of New York. 165 W. 46th St., New York 10036. (212) Circle 5-2545. George Cooney, pres; Charles Ticho, VP; Irving Hecht, sec; Robert Cross, treas; Harold Klein, exec dir.

FM Rock Broadcasters Assn. Contact: Joseph M. Costello, WRNO(FM) Box 6071, New Orleans 70114.

The Ford Foundation. 320 E. 43rd St., New York 10017. (212) 573-5000. McGeorge Bundy, pres; Fred W. Friendly, advisor on communications; David M. Davis, off in chg, communications.

Independent Motion Picture Producers Assn. 6110 Santa Monica Blvd., Hollywood 90038. (213) 656-0200. Edward Finney, pres; Henry Sucher, sec-treas; Morris M. Landers, VP; Jack Coyle, VP; Paul Levinson, legal counsel & VP.

Independent Television News Association. 225

National Associations

E. 42d St., New York 10017. John Corporon, pres; Sherm Bazell, VP; John Healy, treas.

Institute of Broadcasting Financial Management Inc. 360 N. Michigan Ave., Chicago 60601. (312) 332-1295. Arno W. Mueller, Storer Broadcasting, Miami Beach, Fla., chmn of bd; W. Martin Wingren, Kaiser Broadcasting, San Francisco, pres; Harold Poole, Gilmore Broadcasting, Kalamazoo, Mich., VP; Gene Anderson, Forward Communications, Wausau, Wis., sec; Joseph McCabe, KPLR-TV St. Louis, treas.

Directors: Glen B. Banks, KTAR Phoenix; William J. Key, WHBO-AM-TV Memphis; Peter K. Nelson, WISN-AM-FM-TV Milwaukee; Michael M. Schreter, Golden West Broadcasters, Los Angeles; Raymond J. Tucker, Cox Bcstg Corp., Atlanta; George E. Castrucci, Taft Bcstg Co., Cincinnati; Harold A. Christiansen, Metromedia Television, Los Angeles; Roland L. Filiatut, Springfield TV Bcstg, Springfield, Mass.; Aubrey G. Jenkins, WFAA-AM-TV Dallas; John G. Reynolds, WXVZ Southfield, Mich.; Ronald J. Doerfler, Capital Cities Communications, New York; Eunice Hollomon, Plough Bcstg Co., Memphis; Gerald King, Jefferson Bcstg Co., Charlotte, N.C.; Daniel L. Monroe, WNEM-TV Saginaw, Mich.; Celest Regenber, Badger Bcstg Co., Madison, Wis.

Robert E. McAuliffe, Chicago, exec dir; Carlene E. Krantz, Chicago, admin sec.

Institute of Canadian Advertising. 8 King Street East, Suite 401, Toronto M5C 1B5. (416) 368-2981. G.S.L. Anderson, Ronalds-Reynolds & Co. Ltd., Toronto, pres; R. W. Collington, Cockfield, Brown & Co. Ltd., Toronto, 1st VP; F.W. Convery, FH, Hayhurst Co. Ltd., Toronto, 2nd VP; D.C. Robertson, J. Walter Thompson Co. Ltd., Toronto, treas; D.L. Armstrong, Institute of Canadian Advertising, sec.

Directors: E.J. Borra, Doyle Dane Bernbach Advertising Ltd., Toronto; M.E. Buckstein, Sturman, Buckstein & Co. Ltd., Don Mills, Ont.; A.S. Collins, Foster Advertising Co. Ltd., Toronto; J.I. Hamilton, Base Hamilton Edwards Ltd., Toronto; P.W. Hunter, McKinnell Advertising Co. Ltd., Toronto; B.F. Johnston, McCom Advertising Ltd., Toronto; T.J. Marsil, Media Advertising Ltd., Montreal; T.J. O'Malley, Vickers & Benson Ltd., Toronto; H.M. Turner, MacLaren Advertising Ltd., Toronto; A.B. Yeates, Baker, Lovick Ltd., Toronto; P.T. Zarry, Spitzer, Mills & Bates Ltd., Toronto.

Institute for Education by Radio-Television. Ohio State Awards, Ohio State U. 2400 Olentangy River Rd., Columbus, Ohio 43210. (614) 421-2540. Richard B. Hull, dir; Martha Hausen, assoc dir.

Institute of Electrical and Electronics Engineers Inc. 345 East 47th St., New York 10017. (212) 644-7910. Dr. Herbert A. Shulke Jr., exec dir and gen mgr.

Directors: Arthur P. Stern, pres; Joseph K. Dillard, exec VP; T.F. Jones, VP; R.M. Saunders, VP; R.F. Coleiessa, VP; F.S. Barnes, VP; H.S. Goldberg, VP; G.H. Schneider, sec-treas; J.J. Guarrera, H. Chestnut, R.C. Hansen, J. Zaborzsky, J.E. Barkie, R.D. Briskman, R.A. Rivers, A.S. Hoagland, R.W. House, R.C. Benoit, W.W. Middleton, W.L. Sullivan, P.F. Carroll, R.M. Shuffer, C.A. Bayless, G. Sinclair, F.L. Stumpers, J.R.C. Lacerda, H. Shinkawa, D.G. Fink, E.B. Robertson, H.A. Schulke Jr.

Institute of High Fidelity Inc. 489 Fifth Ave., New York 10017. (212) Murray Hill 2-5131. George De Rado, pres; Gertrude Nelson Murphy, exec sec.

Inter-American Assn. of Broadcasters. Calle Y1, 1264-Montevideo, Uruguay 8-44-56 and 8-00-53. Jose de Almeida Castro, Brazil, pres; Felix Cardona Moreno, Venezuela, 1st VP; Hector Amengual, Uruguay, 2nd VP; Arch Madsen, USA, treas; Guillermo Perrone, Argentina, sec; Luis Alberto Sola, Uruguay, dir-gen.

Intercollegiate Broadcasting System (Member services office), Box 592, Vails Gate, N.Y. 12584. (914) 565-8740. Don Grant, chmn; Jeff Tellis, pres; Fritz Kass, treas; Richard Askoff, exec dir.
Providence, R.I. 2005 Industrial Bank Bldg 02903. Corporate office IBS.

International Advertising Assn. Inc., 475 Fifth Ave., New York 10017. (212) 684-1583. Alfred L. Hollender, chmn; Joseph Novas Jr, pres; Roberto Bissone, VP; Rein Rijkens, VP; Tsuneji Hibino, VP; Edw. Van Brunt, treas; John S. W. Wasley, exec sec; Hugh I. Holker, sec.

International Broadcasters Society. 22 East 40 St., New York 10016. (212) 889-1200. Eugene Ber-

National Associations

naid, rgni dir; Edward Bernald, station communications; Henry Franklin, publ dir.

International Christian Broadcasters, Box 6516, Clearwater, Fla. 33518. (813) 726-7173. Rulus Dodrill, pres; Abe Thiessen, exec dir; C. Richard Shumaker, assoc dir.

The International Council of the National Academy of Television Arts and Sciences, c/o The National Academy of Television Arts and Sciences, Suite 209, 1270 Ave. of the Americas, New York 10020. (212) 582-0910.

International Frequency Registration Bd. (IFRB), International Telecommunication Union, Place des Nations, 1211 Geneva, Switzerland. Geneva 346021. The IFRB is a five-member board elected at the Plenipotentiary Conference, Montreux 1965, responsible for management of the radio frequency spectrum according to international radio regulations.

International Radio and Television Foundation Inc., 420 Lexington Ave., New York 10017. (212) 532-4546. Howard S. Meighan, The Catalyst Group Inc., bd chmn; Avram Butensky, Dancer-Fitzgerald-Sample Inc., pres; Joseph P. Dougherty, Capital Cities Communications Inc., VP; Robert D. Kasmir, NBC, VP; Sherill W. Taylor, CBS Radio Network, VP; Mary L. McKenna, MetroMedia Inc., sec; M.S. Kellner, Station Representatives Assoc., treas.

Directors: W. Russell Barry, KNXT(TV) Los Angeles; Robert M. Bennett, WCVB-TV Boston; Robert E. Buchanan, J. Walter Thompson Co.; Robert L. Coe, Ohio U., professor emeritus; Jacqueline DeCosta, Ted Bates & Co.; Roy Danish, Television Information Office; Lewis H. Erlich, American Broadcasting Co.; Jerome Feniger, Horizons Communications Corp.; F. Charles Graves, The Church of Jesus Christ of Latter-day Saints; Stephen B. Labunski, Merv Griffin Group Radio; Elmer W. Lower, American Broadcasting Companies Inc.; John L. McClay, Taft Broadcasting Co.; T.J. McDermott, retired, N.W. Ayer & Son Inc.; Edward F. McLaughlin, ABC Radio Network; Hope Martinez, Hope Martinez Media Co.; John H. Mitchell, Columbia Pictures Television; Jack Moffit, WUAB-TV Lorain, Ohio; Andrew M. Ockershausen, Washington Star Stations; Kevin O'Sullivan, Worldvision Enterprises Inc.; Sol J. Paul, *Television Radio Age*; Daniel T. Pecaro, WGN Continental Broadcasting Co.; Edwin W. Pfeiffer, WPRI-TV Providence, RI.; A. Louis Read, Cosmos Broadcasting of Louisiana Inc.; James M. Rupp, Cox Broadcasting Corp.; Mike Shapiro, Belo Broadcasting Corp.; Roylance H. Sharp, Hughes Television Network; Albert B. Shepard, Media Corporation of America; Edward P. Shurick, Broadcast Data Base Inc.; John V. B. Sullivan, WNEW Radio, New York; Robert H. Teter, WLSL-TV Roanoke, Va.; Hermínio Traviesas, NBC Inc.; Willard E. Walbridge, Capital Cities Communications Inc.; Maurie Webster, Compu/Net Inc.; Robert H. Boulware, exec sec.

International Radio and Television Society Inc., 420 Lexington Ave., New York 10017. (212) 532-4546. Jerome Feniger, Horizons Communications Corp., pres; Giraud Chester, Goodson-Todman Productions, VP; Eleanor S. Applewhite, CBS Inc., VP; Roy Danish, Television Information Office, VP; Richard A. O'Leary, ABC-owned TV Stations, VP; Jerome S. Boros, Fly, Shuebruk, Blume & Gaguine, sec; John C. Moler, WRFM(FM) New York, treas.

Directors: Gene A. Accas, Leo Burnett U.S.A.; Elizabeth Bain, Katz Television; Ralph M. Baruch, Viacom International Inc.; Edward Bleier, Warner Bros. Television; Avram Butensky, Dancer-Fitzgerald-Sample Inc.; Charles A. DeBare, ABC; Joseph P. Dougherty, Capital Cities Communications Inc.; Eugene D. Jackson, National Black Network; A. O. Knowlton, General Foods Corp.; Michael E. Marcovics, W.T. Grant Co.; Donald J. Mercer, National Broadcasting Co.; D. Thomas Miller, CBS Television Stations Division; Stanley H. Moger, SFB Media Service Corp.; Alfred L. Plant, Block Drug Co.; Charles H. Tower, Corinthian Broadcasting Corp.; Arthur A. Watson, WNBC-TV; Kenneth M. Weinstock, Grey Advertising Inc.; Maurie Webster, Compu/Net Inc. ex officio; Robert H. Boulware, exec dir.

International Tape Association (ITA), World Tape Center, Box 11070, Tucson, Ariz. 85734. (602) 889-6338. Larry Finley, exec dir.

Iota Beta Sigma, 2261 Palmer Ave., Suite 3J, New Rochelle, N.Y. 10801. (914) 235-8862. Chris Knoller, grand pres; Jerry Williams, grand sec treas; Dic Allen, grand exec sec.

Joint Council on Educational Telecommunications, 1126 Sixteenth St. N.W., Washington 20036. (202) 659-9740. H. H. Riddleberger and Jeremy W. Birkbeck, prog associates; J. Russell Burke, communications satellite consultant.

The Joint Technical Advisory Council (JTAC), 345 East 47 Street, New York 10017. (212) 752-6800. Stuart L. Bailey, Atlantic Research Corp., chmn; Sidney Metzger, COMSAT, vice chmn; John M. Kinn, sec; Audrey L. van Dort, admin asst.

League of Advertising Agencies, 79 Madison Ave., New York 10016. (212) 689-8533. Dorothy Olim, Krone-Olim Advertising Inc., pres; Edward Caroe, Caroe Marketing Inc., VP; Don Greene, Don Greene Associates Inc., VP; Sy Levy, March Advertising Inc., VP; Nat Roth, Furman, Roth & Co., treas; Stanley Schwartz, The Stanley Schwartz Co. Inc., sec; Ted Kaufman, exec dir.

Board of governors: Marvin Asch, Asch Seidenbaum Ltd.; Emmanuel Berger, Berger Nechamkin & Associates Inc.; Gerald Keller, Keller Haver Inc.; Harry Lamper, The Lampert Agency Inc.; Robert Lipman, Lipman Advertising Co.; John McManus, The McManus Co.; Robert M. Miller, Lee-Myles Associates Inc.; Irving Pastarnack, Pastarnack Associates Inc.; Jules Rabin, Jules Rabin Associates Inc.; Louis Reinhold, Richmond Advertising/Reinhold Assoc. Inc.; Max Sinowich, Chelsea Advertising Inc.; Joseph I. Sonnenreich, Joseph I. Sonnenreich Advertising; Harry C. Waterston, Harry C. Waterston Inc.; Robert J. Weill, Leiber-Harrison Inc.; William G. Wolfe, Doubleday Advertising Co. Inc.

Mortgage Bankers Association of America (MBA), 1125 15th St. N.W., Washington 20005. (202) 785-8333. Robert L. Gray, dir of PR.

Motion Picture Assn. of America Inc., 1600 Eye St. N.W., Washington, 20006. (202) 293-1966. Jack J. Valenti, pres; G. Griffith Johnson, exec VP; William H. Fineshriber, Jr., VP.

New York office: 522 Fifth Ave., N.Y. 10036 (212) 867-1200; Hollywood office: 8480 Beverly Blvd 90048 (213) 653-2200.

Motion Picture Expor' Assn. of America, 522 Fifth Ave., New York J.036. (212) TN7-1200. Jack Valenti, pres; G. Griffith Johnson, exec VP; William H. Fineshriber, Jr., VP in charge of TV; George Viethere, VP; S.F. Gronich, VP, Continental European office; Marc Spiegel, VP, South Europe and Middle East; Robert Corbery, VP, Latin America; Harry Stone, Latin America, VP; Robert Perkins, VP, Australia. Branch offices: Washington, Paris, Rome, London, Mexico City, Rio de Janeiro, Manila, Nigeria.

The National Academy of Television Arts & Sciences, 291 South La Cienega Blvd, Beverly Hills, Calif. 90211. (213) 659-0990. Robert F. Lewine, pres; John Cannon, chmn of the bd; Richard Rector, vice chmn; David Lawrence, sr VP; Jules Power, sec; True Boardman, treas; Laya Gelfin, mgr natl awards; Patricia Uhley, mgr natl admin.

Atlanta: 1601 W. Peachtree St. Don Elliot Heald, pres.

Chicago: Merchandise Mart. Jim Ruddle, pres. Cleveland: 8443 Day Drive, Parma Ohio. Jack Moffitt, pres.

Columbus: 2470 N. Star Rd. Ed Eakins, pres. Hollywood: 14032 Cantlay St. Van Nuys, Calif. Larry Stewart, pres.

Miami: 316 N. Miami Ave. William Brazzil, pres. New York: 119 W. 57th St. Jules Power, pres.

Phoenix: 511 W. Adams St. Bob Martin, pres. St. Louis: 4140 Lindell Blvd. Rev. Joseph M. O'Brien, pres.

San Diego: 3404 Hawk St. Jonathan Dunn-Rankin, pres.

San Francisco: 735 Montgomery St., No. 200. Robert W. O'Connor, pres.

Seattle: 100 4th Ave. N. Don McCune, pres.

Washington: 7509 Park Mill Crt., Rockville, Md. Robert Adams, pres.

National Alliance of Television & Electronic Service Assns. 5908 S. Troy St., Chicago 60629. (312) 476-6363. Frank J. Moch, exec dir; Philip E. Holt Jr., pres; George J. Weiss, VP; Leo P. Shumavon, sec-gen; Richard Ebare, treas.

National Assn. for Better Broadcasting, P.O. Box 43640, Los Angeles 90043. James V. Bennett, pres; Frank Orme, exec VP; Elizabeth Longstreet, cor sec; Gertrude Blackstock, rec sec.

National Association of Broadcasters, 1771 N St. N.W., Washington 20036. (See listing, this section)

National Assn. of Council Broadcast Execu-

tives. 233 McClellan Dr., Pittsburgh 15236 (412) 281-1515. The Rev. Harry G. Souders, pres.

National Assn. of Educational Broadcasters, 1346 Connecticut Ave. NW, Washington 20036. (202) 785-1100.

Directors: James A. Fellows, Mary Lynn Moody, William G. Suckles, David Gilmore, Eva Archer, mgng edit; Sharon Greenwell, per svcs coord.

National Assn. of Farm Directors. See listing, this section

National Assn. of Gagwriters, Box 835, Grand Central Station, New York 10017. (201) 229-9472. George Q. Lewis, exec dir.

National Association of Independent Television Producers and Distributors (NAITPD) 375 Park Ave., New York 10022. (212) 751-0600. Giraud Chester, chmn.

National Assn. of Manufacturers, 277 Park Ave., New York 10017. (212) 826-2100. E. J. Dwyer, chmn of bd; W. P. Gullander, pres; John McGraw, sec; A. F. Ambrose, treas; W. H. McGaughey, VP (Public Relations).

Washington: 1133 15th St., N.W. Eugene Hardy, VP Gov't. Relations.

Eastern Division: 199 Cherry Hill Rd., Parsippany, N.J. R.P. Rathbun, VP.

Atlanta: 1421 Peachtree Ave. N.E. 30309. (404) 892-0530. Frank Steingruge, VP.

San Francisco: 532 Emerson St., Box 880 PaJo Alto, (415) Davenport 3-0291. James Hammond, VP.

Detroit: 801 Northland Towers, Southfield, Mich. 48073. (313) 353-3300. William Grier, VP.

Chicago: 205 W. Wacker Dr., Suite 1822. C. C. Rorie.

National Association of Retail Dealers of America, 318 West Randolph St., Chicago 60606. (312) 726-5583. Pete Vrontikis, pres; James Renier, chmn of bd; VPs: Len Geiser, Peter Hart, Mel Landow, H. B. Price III; F. Hardy Rickbeil, sec; Walter C. Fox, treas; Jules Steinberg, exec VP.

Directors: Lou Gallin Jr., Paul Goldenberg, Julius Kretzer, James Barrett, Phil Blank, Robert A. Bond, Jerry Duck, John Fisher, Morris Glielich, Sam Gordon, Bud Green, John Hackett, Michael Jaret, Robert E. Kenison Jr., George Littman, Jack Luke, Carolyn Mennier, Dan Peterson, Jerry Plavin, Larry Quigley, C. D. Reinhard, Charles Robinette, John Sperry, Martin Wolf.

Past presidents: Sam Boyd, C. W. Conn Jr., Earl Holst, George Johnston, H. B. Price Jr., Ken Stucky, Billy Yates.

National Association of State Radio Networks, Box 1000, Oklahoma City 73101. Tom Longfellow, pres; Clyde Lear, 1st VP; Gene Craft 2nd VP; Don Kennedy, sec-treas.

National Assn. of Television and Radio Announcers, 1408 S. Michigan Avenue, Chicago 60605. (312) 939-5170. Curtis Shaw, pres; Georgie Woods, chmn of bd; Lucky Cordell, exec dir.

National Association of Television Program Executives Inc. (See separate listing, this section.)

National Assn. of Theatre Owners Inc. (NATO): 1500 Broadway, New York 10036. (212) 730-7420. T. G. Solomon, pres; Paul Roth, chmn of bd; Joseph G. Alterman, VP exec dir.

National Black Media Coalition 1816 T St., N.W., Washington 20009. Rochester, N.Y. (716) 325-5116. James McCuller, chmn; Warren Graves, Washington coord.

National Broadcast Assn. for Community Affairs, 4400 Jenifer St., N.W., Washington 20015. (202) 686-6999. Eddie L. Madison, Jr., pres; J. Sydney King, WBAL-TV Baltimore, prog coord; Pat Cramer, WTVN-TV Columbus, Ohio, exec VP; Sandra M. Johnson, WJW-TV Cleveland, sec; Doug Stone, WTRF-TV Wheeling, W.Va., treas.

National Broadcast Editorial Association, 514 West 57th St., New York 10019. (212) 765-4321, ext 6345. Peter C. Kohler, WCBS-TV, pres; Fred Dressler, KBTU, VP; James Johnson, KHOL-TV, sec-treas.

National Broadcasters Club, 1737 DeSales St. N.W., Washington 20036. (202) 638-3535. Wallace Dunlap, pres; James R. Price, VP and treas; Catharine Heinz, VP and sec.

National Cable Television Assn., 918 16th St., N.W., Washington 20006. (202) 466-8111. Robert L. Schmidt, pres; Beverly J. Murphy, VP operator rel;

National Associations

Rochelle A. Nezin, convntn coord; Wally Briscoe, senior VP for assn affairs; Stuart F. Feldstein, VP, legal & govt affairs; Delmer Ports, VP-engrg; Donald M. Andersson, VP of statistical services; Charles Lipsen, VP, congressional rel; Rob Stengel, VP pub affrs; David Roudybush, controller.

National Citizens Committee for Broadcasting. 1346 Connecticut Ave., N.W., Suite 415, Washington 20036. (202) 466-8407. Nicholas Johnson, chmn; Ted Carpenter, exec dir.

National Committee for UHF Television Scott Hessek, chmn. c/o CBN Television Box 111, Portsmouth, Va. 23705. (804) 499-8201. Patrick Arnoux, treas.

National Education Assn. 1201—16th St., N.W., Washington 20036. (202) 833-4484. Terry E. Herndon, exec sec; Robert H. Chanin, deputy exec dir; Susan Lowell, dir, communications svcs; Philip King, mgr public info; Ahron Leichtman, media rel coord.
New York 10020: Editorial Information Center, 1270 Avenue of the Americas. Linley M. Stafford.

National Electrical Manufacturers Assn. (NEMA), 155 East 44th St., New York 10017. (212) 682-1500. Chris J. Wittling, Crouse-Hinds Co., bd chmn; W. H. Dennier, General Electric; M. P. Kartalia, Square D Co.; W. H. Satterfield, Midland-Ross Corp., VP, gen mgr; Bernard H. Falk, pres; Edgar P. Eaton Jr., Carbone Corp., treas.

National Federation of Advertising Agencies. (NFAA), Suite 1115, Sarasota Bank Bldg., Sarasota, Fla. 33577. (813) 366-2902. George P. Crumbley Jr., Crumbley Robertson Riley Advertising, Atlanta, pres; James S. Wattenmaker, Wattenmaker Advertising, Cleveland, exec VP; John A. Garrigues, Ross, Jurney and Associates, Salt Lake City, VP; Joel Freedman, J. S. Freedman Advertising, Cincinnati, treas.

National News Council. 1 Lincoln Plaza, New York 10023. (212) 595-9411. Ned Schnurman, assoc dir; William B. Arthur, exec dir; Stanley H. Fuld, chmn.

National Press Club. National Press Bldg., Washington 20004. (202) 737-2500.

National Radio Broadcasters Association. 500 Fifth Ave., Suite 1450, New York 10036. (212) 869-8873. Robert Herpe, WPLR(FM) New Haven, Conn., chmn; James Gabbert, KIOI(FM) San Francisco, pres; Steve Trivers, WQLR(FM) Kalamazoo, Mich., VP East; John Winnaman, KLOS(FM) Los Angeles, VP West; Abe Voron, exec dir; Elena Slovinac Saldan, admin dir.

National Religious Broadcasters. Box 2254, Morristown, N.J. 07960. (201) 540-8500. Dr. Ben Armstrong, exec sec; Dr. Abe Van Der Puy, Miami, Calif., pres; Dr. Thomas F. Zimmerman, Springfield, Mo., 1st VP; E. Brandt Gustavson, Chicago, 2d VP; Rev. Richard Canfield, Lancaster, Pa., sec; Rev. Melvin Jones, Lincoln, Neb., treas.

National Retail Merchants Assn. 100 W. 31st St., New York 10001. (212) 244-8780. James R. Williams, pres. Joseph R. Rowen, edit and publisher.
Washington 20004: 1317 F St., N.W.

Newspaper Advertising—Bureau. 485 Lexington Ave., New York 10017. (212) 687-9300. Frank Batten, chmn of bd; Jack Kauffman, pres.

Chicago: 400 North Michigan Ave. (312) 644-1290. Dwight I. Skinner.
Detroit: 1657 Guardian Building. (313) 963-4353. Sheldon Moyer.

Los Angeles: 5670 Wilshire Blvd. (213) 933-8526. Howard M. Keefe.
San Francisco: 400 Montgomery St. (415) 981-8118. John Temple-Reston.

New York Market Radio Broadcasters Association (NYMRAD). Daniel K. Griffin, WOR(AM) New York, chmn; William S. Jaeger, WNCN(FM) New York, vice chmn; Don Lewis, WHBI(FM) Newark, N.J., sec/ treas.

Premium Advertising Assn. of America. 420 Lexington Ave., New York 10017. (212) 679-0524. Kenneth R. Baumbusch, pres.

Production Managers Association. c/o Ralph T. Kuehn, WISN-TV Milwaukee, pres. Chuck McConnell, WXXI(TV) Rochester, N.Y., VP; Ray Drago, WBRZ-TV Baton Rouge, sec; Cari Kochman, KRTV(TV) Great Falls, Mont., treas; Alvin A. L. Dompke, WBNS-TV Columbus, Ohio, newsletter editor.

Proprietary Assn. 1700 Pennsylvania Ave., N.W., Washington 20006. (202) 223-5866. O. G. Kennedy,

Morton-Norwich Products Inc., chmn.; John T. McLoughlin, vice chmn.; James D. Cope, pres and chief exec officer; Michael R. Schrauth, sec; Joseph M. Pisani, VP medical and scientific affairs; Daniel J. Manelli, VP, legal affairs.

Public Radio in Mid-America. (PRIMA) c/o R.W. Thomas KVMU Radio, 8001 Natural Bridge, St. Louis 63121. Hugh Cordier, WSUI Iowa City, pres; Richard Wright, KANU Lawrence, Kan., VP; Kenneth Garry, WSIU Carbondale, Ill., sec-treas; Sam Scott, KCUR Kansas City, Mo., past-pres.

Public Relations Society of America Inc. 845 Third Ave., New York 10022. (212) 751-1940. James F. Fox, pres; Jay Rockey, pres-elect; J. Kenneth Clark, treas; Dr. Kenneth O. Smith, sec; Rea W. Smith, exec VP; Leo J. Northart, editor Public Relations Journal.

Publishers Information Bureau. 575 Lexington Ave., New York 10022. (212) 752-0055. Stephen E. Kelly, pres; Robert C. Gardner, VP.

Radio Advertising Bureau. 555 Madison Ave., New York 10016. (See listing this section).

Radio and Television Research Council. c/o Tom N. Zoler, Bristol-Myers, 345 Park Ave., New York 10022. (212) 644-2100. Jon Zoler, pres; Stuart Gray, pres-elect; Richard Montesanto, sec-treas.

Radio Bureau of Canada. 43 Eglington Ave East, Toronto M4P 1A2. (416) 482-2222. James L. Adam, pres; Peter N. Harricks, exec VP; E. Larry Heywood, VP creative svcs; Robert C. Sheppard, mktg dir.
Montreal H3G 1G8: 1110 Ouest, rue Sherbrooke, Suite 1008. (514) 849-9131. J. Sylvio Belisle, mgr, Quebec opns.

The Radio Club of America Inc. Box 2112, Grand Central Station, New York 10017. (201) 982-2420, 755-3093. Fred M. Link, pres; Samuel N. Hartmaluk, VP; Francis H. Shepard, Jr., sec; David Talley, treas; Fred Shunaman, exec sec.

Radio Television News Directors Assn. (See listing, this section).

Radio-TV Correspondents' Assn. The Capitol, S 312, Washington 20510. William Greenwood, Mutual Broadcasting System, pres; Robert F. Foster, WGN Continental Broadcasting Co., VP; Sam A. Donaldson, ABC News, sec; Paul Duke, Public Broadcasting Service, treas; Ted Capener, Bonneville International Corp., member at large; G. Bradford Kress, NBC News, member at large; Marya McLaughlin, CBS News, member ex officio.

Radio Television News Directors of Canada. Box 370, Sault Ste. Marie, Ont. (705) 253-1121. Karl Sepkowski, pres; David Knapp, VP television; Dick Smyth, VP radio; Don Covey, treas; David Rogers, sec.

Directors: Elmer Harris, William Jessome, Maritimes; Claude LaPointe, J. C. Asselin, Quebec; Warren Beck, Brian Wrobel, Central Canada; Steve Halinda, Frank Flegel, Prairies; Terry Spence, Doug Collins, British Columbia.

Radio and Television Research Council. c/o Helen B. Johnston, Grey Advertising Inc., 777 Third Ave., New York 10017. (212) 751-3500. Helen B. Johnston, pres; Jon Zoler, pres-elect; Stuart Gray, sec-treas.

Recording Industry Assn. of America Inc. 1 E. 57th St., New York 10022. (212) Murray Hill 8-3778. Stanley M. Gortikou, pres; Henry Brief, exec dir.

Retail Advertising Conference. 32 W. Randolph St., Chicago 60601. (312) 782-5932.

Screen Composers Assn. (See Unions, Labor Groups).

Sigma Delta Chi. Professional Journalistic Society, 35 E. Wacker Drive, Chicago 60601. (312) 236-6577. William J. Small, CBS News, New York, pres; Robert S. McCord, Arkansas Democrat, Little Rock, 1st VP; Professor James L. Julian, San Diego State University, VP for campus charter affairs; Richard H. Leonard, Milwaukee Journal, sec; Alf Goodykoontz, treas; Russell E. Hurst, exec officer.

Sesac Inc. (See listing under Music Licensing Groups).

Society of Broadcast Engineers Inc. Box 88123, Indianapolis 46208. (317) 842-0836. Glenn Lahman, KDKA Pittsburgh, pres; Eugene Hill, Kaiser Broadcasting, Oakland, Calif., VP; James E. Hurley, WTAE Pittsburgh, sec-treas; Vincent Flanders, asst sec-treas; Jeanne Smith, c/o Smith & Powstenko, 2000 N St. N.W., Suite 210, Washington 20036, editor SBE Signal.

Dunmore, Pa 18512: Box 131. Joseph A. Risse, edit dir, SBE Journal.

Society of Motion Picture and Television Engineers. 862 Scarsdale Ave., Scarsdale, N.Y. 10583. (914) 472-6606. Denis A. Courtney, exec dir; Alex E. Alden, staff engr; Kenneth M. Mason, pres; William D. Hedden, exec VP; Byron S. Roudabush, past-pres; William T. Wintrigham, VP, engr; Gerald G. Graham, VP, editorial; Joseph T. Dougherty, VP, financial; Harry Teitelbaum, VP, conference; Herbert R. Pilzer, VP, sections; Herbert E. Farmer, VP, educational affairs; A. Earl Quinn, VP, photo-instrumentation affairs; Edward H. Reichard, VP, motion-picture affairs; Roderick T. Ryan, VP, photo-science affairs; Joseph A. Flaherty, VP, television affairs; Richard O'Brien, sec; Robert M. Smith, treas; Thomas King, editor.

Society of Motion Picture Art Directors. (See Unions, Labor groups).

Southern California Broadcasters Assn. 1800 N. Highland Ave., Hollywood 90028. (213) 466-4481. Robert M. Light, pres.

Spokane Broadcasters Assn. Box 8037, Manito Station, Spokane, Wash. 99203. (509) 534-0423. Steve Dean, pres; Robert Swartz, VP; Dean Woodring, sec; Dan Doleman, treas.

Station Representatives Assn. 230 Park Ave. New York 10017. (212) 689-6084. James Greenwald, pres; Adam Young, VP; Jack Masla, sec; Ted Vanerik, treas; M. S. Kellner, mgng dir, Directors: John Dickinson, Don Saraceno, Bob Muth, Joe Savalli, Bob Dudley.

Station Representatives of Canada Inc. Box 251, Station F, Toronto M4I 2L5. (416) 924-4477. Peter Sisam, pres; Rick Gest, past-pres; Rodger Hone, exec VP; Harold Abernethy, VP radio; Robert Alexander, VP television; Andy McDermott, sec-treas.
Montreal: 1440 St. Catherine St. W., Suite 1020. Peter Graham, pres.

Television Bureau of Advertising. 1345 Ave. of the Americas, New York 10019. (212) 397-3456. (See separate listing).

Television Film Assn. 3701 W. Oak St., Burbank, Calif. 845-8371.

Television Information Office. NAB (See separate listing).

Television Pioneers. Box 1475, Lubbock, Tex. 79408. (806) 762-0404. W. D. (Dub) Rogers, pres; John E. Feltzer, 1st VP; Glenn Marshall, sec-treas.

Television Programers Conference. Lee Waller, WTVJ(TV) Miami, pres; Bill Thrash, WKY-TV Oklahoma City, 1st VP; Dick Story, KATV(TV) Little Rock, 2nd VP; Conrad Cagle, WAVE-TV Louisville, Ky., treas; Ed Whatley, WKRG-TV Mobile, Ala., sec.

Theatre Authority Inc. 485—5th Ave., New York 10017. (212) Murray Hill 2-4215. Beverly Roberts, exec sec; Harold M. Hoffman, 1st VP; Elizabeth Morgan, rec sec; DelLoyd Tibbs, treas.

6255 Sunset Blvd., Hollywood 90028. (213) Hollywood 2-5761. Julian Christenson, exec sec.

(TA has jurisdiction over performances at benefits of members of participating unions and guilds. TA officers are representatives of Actors Equity Assn., American Guild of Musical Artists, American Guild of Variety Artists, American Federation of Television & Radio Artists, Screen Actors Guild and other organizations and theatrical charities.)

UNDA-USA. (Catholic Broadcasters Assn.) 305 Michigan Ave., Detroit 48226. (313) 961-2234. Sister Maureen Rodgers, O.P., Detroit, pres; Fr. Stephen Umhoefer, Madison, Wis., 1st VP; Fr. George Schroeder, Duluth, Minn., treas; Sister Pat Kowalski, O.S.M., Omaha, sec.

University Film Association, c/o Don Staples, Dept of Cinema Studies, New York University, New York 10003. (212) 598-3364. Don Staples, pres; Robert W. Wagner, Ohio State U., editorial VP; Dennis Lynch, Memphis State U., exec VP; Larry Silverman, Wayne State U., conference VP; Sol Wrienn, Va. State Bd. of Ed, treas; Peter Bukalski, Ohio State U., sec.

U. S. Catholic Conference. Office for Film and Broadcasting, 1011 First Ave., Suite 1300, New York 10022. (212) 644-1880. Rev. Patrick J. Sullivan, S. J., assoc sec for communication; Richard Hirsch, mgr, bctst prod.

Associations, Government

Videotape Production Assn., 23 Park Ave., New York. Morton Dubin, chmn of bd of directors. Branch offices: West Coast, Los Angeles; Hugh Hole; Chicago: Dave Herman; Montreal/Toronto: Babs Pitts.

Washington Area Broadcasters Association. 5151 Wisconsin Ave. N.W., Washington 20016. (202) 244-9700. William Dalton, chmn; Harold Green, vice chmn; Tom Cookerly, sec-treas.

Directors: Ted Dorf, Jim Arthur, Tom Paro, Jim Kelsey, Larry Kirby, Jerry Lyman.

Western Educational Society for Telecommunications. 2001 Associated Rd., Fullerton, Calif. 92631. (714) 870-7226, ext. 266. Richard B. Elliott, pres; Anne Murdoch, sec-treas; Donel Price, newslet-

ter edit; Robert Sherwood, Anaheim convention chmn; Allan Zeltzer, membership chmn.

WEMA (Western Electronics Mfrs Assn). 2600 El Camino Real, Palo Alto, Calif 94306. (415) 327-9300. Earl Wantland, Tektronix Inc., chmn; E. E. Ferrey, pres; William E. Terry, Hewlett-Packard Co, treas; James E. Rhodes, Becton, Dickinson, sec.

Los Angeles 90045, 9841 Airport Blvd. (213) 641-8910.

Western States Advertising Agencies Association Inc., 5900 Wilshire Blvd., Los Angeles 90036. (213) 933-7337. Ruth Oreck, exec dir.

Women in Communications Inc. WICI 8305-A Shoal Creek Blvd., Austin, Tex. 78758. (512) 452-0119. Mary Utting, exec dir; Ernestine Wheelock, PR dir.

Directors: Christy Bulkeley, pres; Linda Winkler, pres-elect; Ann Daly, 1st VP; Karen Brown, 2nd VP.

World Association for Christian Communication. 600 Palms Bldg., Detroit 48201. (313) 962-0340. Rev. Ed Willingham, bus mgr.

Steering committee: Rev. Clement W. K. Lee, Lutheran Council in the USA, chairperson; Rev. Bert Akers, S.J., Sacred Heart Programs, St. Louis; Lois J. Anderson, National Council of Churches, New York; Dr. David Augsburg, Mennonite Broadcasts Inc., Oak Brook, Ill.; Rev. George Conkin, Pacific School of Religion, Berkeley, Calif.; Sonia Francis, Episcopal Church, New York; Mrs. Patti Johnson, Ohio Council of Churches, Columbus, Ohio; J. Jerome Lackamp, Dept. of Radio & Television, Catholic Diocese of Cleveland; Carolyn K. Lindekugel, American Lutheran Church, St. Paul; Rev. Des McCalmont, Religious Television Associates, Toronto; Nelson Price, United Methodist Communications, New York; Tommy P. Thompson, Lutheran Laymen's League, St. Louis; Karl Holtsinger, Franciscan Communications Center, Los Angeles.

Broadcasting

Yearbook 1976

Miscellaneous

Government Agencies of Interest to Broadcasting

Executive Office of the President

The White House. 1600 Pennsylvania Ave., N.W., Washington 20500. (202) 456-1414.

Ronald H. Nessen, press secretary to the President; William I. Greener, principal deputy press secretary to the President; John W. Hushen, deputy press secretary to the President; Robert Mead, television advisor to the President; Margita E. White, assistant press secretary and director, Office of Communications; James B. Shuman, associate director, Office of Communications; Larry M. Speakes, assistant press secretary; J. William Roberts, assistant press secretary; Randall L. Woods, deputy director, Office of Communications.

Office of Telecommunications Policy. Executive Office of the President, Washington 20504. (202)395-5800.

John M. Eger, acting dir; Col. Charles S. Shepherd, military asst; Thomas J. Keller, gen counsel; Ralph Griffith, asst to the dir for congressional and media affairs; Bromley Smith, asst dir for administration and exec direction; William Fishman, asst dir for international communications; Samuel E. Probst, acting asst dir for frequency mgt; Charles C. Joyce Jr., asst dir for government communications; Roland S. Homet, chief, office of studies and analysis.

Interdepartment Radio Advisory Committee (IRAC). Executive Office of the President, Washington 20504. S.E. Probst, chmn (202) 395-5623; A. Colorado, exec sec (202) 967-4931.

Senate Committee on Commerce

Headquarters: Room 5202 New Senate Office Bldg., Washington 20510. (202) 224-5115. Members: Warren G. Magnuson (D-Wash.), chmn; John O. Pastore** (D-R.I.), Vance Hartke* (D-Ind.), Philip A. Hart* (D-Mich.), Howard W. Cannon* (D-Nev.), Russell B. Long* (D-La.), Frank E. Moss* (D-Utah), Ernest F. Hollings* (D-S.C.), Daniel K. Inouye* (D-Hawaii), John V. Tunney (D-Calif.), Adlai E. Stevenson (D-Ill.), Wendell H. Ford (D-Ky.), John A. Durkin* (D-N.H.), James B. Pearson (R-Kan.), Robert P. Griffin* (R-Mich.), Ted Stevens* (R-

Alaska), J. Glenn Beall Jr.* (R-Md.), Lowell P. Weicker Jr.* (R-Conn.), James L. Buckley (C-R-N.Y.) Howard H. Baker Jr.* (R-Tenn.) (committee membership as of Dec. 2, 1975).

Joseph Fogarty, communications counsel; Michael Pertschuk, chief counsel; S. Lynn Sutcliffe, gen counsel; Arthur Pankopf Jr., minority counsel.

House Committee on Interstate & Foreign Commerce

Headquarters: Room 2125, Rayburn House Office Bldg., Washington 20515. (202)225-2927. Members: Harley O. Staggers† (D-W.Va.), chmn; Torbert H. Macdonald** (D-Mass.), John E. Moss † (D-Calif.), John D. Dingell (D-Mich.), Paul G. Rogers (D-Fla.), Lionel Van Deerlin (D-Calif.), Fred B. Rooney (D-Pa.), John M. Murphy* (D-N.Y.), David E. Satterfield III (D-Va.), Brock Adams (D-Wash.), W.S. (Bill) Stuckey Jr† (D-Ga.), Bob Eckhardt (D-Tex.), Richardson Preyer (D-N.C.), James W. Symington (D-Mo.), Charles J. Carney* (D-Ohio), Ralph H. Metcalfe (D-Ill.), Goodloe E. Byron* (D-Md.), James H. Scheuert (D-N.Y.), Richard L. Ottingert (D-N.Y.), Henry A. Waxman*† (D-Calif.), Robert (Bob) Kreuger† (D-Tex.), Timothy E. Wirth* (D-Colo.), Philip R. Sharp† (D-Ind.), William M. Brodhead (D-Mich.), W.G. (Bill) Hefner† (D-N.C.), James J. Florio (D-N.J.), Anthony (Toby) Mofett† (D-Conn.), Jim Santini† (D-Nev.), Gene A. Maguire† (D-N.J.), Samuel L. Devine*† (R-Ohio), James T. Brody† (R-N.C.), Tim Lee Carter (R-Ky.), Clarence J. Brown (R-Ohio), Joe Skubitz (R-Kan.), W. Henson Moore*† (R-La.), James M. Collins† (R-Tex.), Louis Frey, Jr.* (R-Fla.), John Y. McCollister (R-Neb.), Norman F. Lent† (R-N.Y.), H. John Heinz III (R-Pa.), Edward R. Madigan (R-Ill.), Carlos J. Moorhead (R-Calif.), Matthew J. Rinaldot† (R-N.J.) (committee membership as of Dec. 2, 1975).

W.E. Williamson, chief clerk, (225-2927).

* Member of Communications Subcommittee.

** Chairman, Communications Subcommittee.

† Member of Special Subcommittee on Investigations.

U.S. Supreme Court

Headquarters: 1 First St., N.E., Washington 20543.

(202)393-1640. Chief Justice: Warren E. Burger. Associate Justices: William J. Brennan Jr., Potter Stewart, Byron R. White, Thurgood Marshall, Harry A. Blackmun, Lewis F. Powell Jr., William H. Rehnquist, John Paul Stevens.

Barrett McGurn, dir pub info; Mark W. Cannon, admin asst to the Chief Justice; Michael Rodak Jr., clerk; Frank M. Hepler, marshal.

U.S. Court of Appeals for the District of Columbia Circuit

Headquarters: Third St. and Constitution Ave., N.W., Washington 20001. (202)426-7182. Chief Judge: David L. Bazelon. Circuit Judges: J. Skelly Wright, Carl McGowan, Edward A. Tamm, Harold Leventhal, Spotswood W. Robinson III, George E. MacKinnon, Roger Robb, Malcolm R. Wilkey. Senior Circuit Judges: Wilbur K. Miller, Charles Fahy, John A. Danaher. Hugh E. Kline, clerk; Charles E. Nelson, circuit exec.

Dept. of Agriculture

Headquarters: 14th & Independence Ave. S.W., Washington 20250. (202)655-4000. Earl J. Butz, sec. Off of Comm: Claude W. Clifford, dir; Hal R. Taylor, deputy dir; David Granahan, asst dir (vis media); Layne R. Beaty, supvr, radio & TV; Larry A. Quinn, TV prod specialist; Joseph T. McDavid, press division; Theodore R. Crane, special reports division; Bryon Schumaker, photos & slides; Martin H. Lobdell, motion pictures; Nelson Fitton, publications; David A. Sutton, design division.

Dept. of Commerce

Headquarters: 14th & Constitution Ave., N.W., Washington 20230. (202)967-4901. Elliot L. Richardson, sec.

Office of Communications: William F. Rhatican, asst to the sec and dir of communications; Earl G. Cox, bcst media dir; Tony Scinta, news director.

Bureau of Census: (301) 763-5227. Vincent P. Barabba, dir; Henry Smith, public information officer.

Domestic and International Business Administration: (202) 967-3808. Travis Reed, asst sec; Robert Amdur, public info officer.

Economic Development Administration: (202) 967-5113. William D. Mizell, asst sec for economic

development; Barbara Estabrook, dir of public affairs.

Maritime Administration: (202)967-2746. Robert J. Blackwell, asst sec for maritime affairs; Walter Oates, pub affairs officer.

National Bureau of Standards: (301)921-3181. Dr. Richard W. Roberts, dir; William E. Small, spec asst for pub affairs.

National Fire Prevention and Control Administration: (202) 634-7722. Howard Tipton, administrator; Peg Maloy, public info officer.

National Oceanic and Atmospheric Administration: (301) 496-8243. Dr. Robert M. White, administrator; Stanley B. Eames, dir of pub affairs.

Bureau of Economic Analysis: (202) 523-0777. George Jaszi, dir; Ago Ambre, info officer.

Patent Office: (703)557-3428. C. Marshall Dann, commissioner; Isaac Fleischmann, dir of office of info svcs.

U.S. Travel Service: (202) 967-4987. Creighton D. Holden, asst sec for tourism; Robert Jackson, dir of info svcs.

Office of Minority Business Enterprise: (202) 967-4597. Alex Armendaris, dir; Lyman Bryan, public info officer.

Office of Telecommunications: (202) 967-5578. John M. Richardson, dir; Lois Adams, public info officer.

Dept. of Defense

Headquarters: Pentagon, Washington 20301. (202) 545-6700. Donald H. Rumsfeld, sec; Joseph Laitin, asst sec (pub affrs), OXford 7-9312; Norman T. Hatch, chief, audiovisual division, OXford 7-4162; Russell W. Wagner, chief, documentary branch, OXford 5-0168; Donald E. Baruch, chief, prod branch, OXford 7-4596; Major Peter K. Friend, chief, acquisitions branch, OXford 7-6161.

Dept. of the Army: Martin R. Hoffman, sec; Major General L. Gordon Hill, chief of info, OXford 5-5135; Colonel Perry G. Stevens, chief, pub info div, OXford 5-5136; Lieutenant Colonel Gordon Waite, chief, news branch, OXford 7-7550; Major Raymond Smith, chief, audio-vis branch, OXford 5-3007.

Dept. of the Navy: J. William Middendorf II, sec; Captain D.E. Cooney, chief of info, OXford 7-7391; CDR Thomas Caldwell, dir, public info division, OXford 7-4627; CDR Jack Mayo, dir, prod svcs division, OXford 7-0866.

Dept. of the Air Force: vacant, sec; Colonel Harry J. Dalton Jr., acting dir of info, OXford 7-6061; Colonel Robert Herrmann, chief, public info division, OXford 5-5554; Lieutenant Colonel J. Robert King, chief, pictorial/bcst branch, OXford 5-9664.

Marine Corps: General Louis H. Wilson, commandant; B Gen William R. Malony, dir of info, OXford 4-2958; Lt Col J.D. McNamara, head, info branch, OXford 4-1492.

Dept. of Health, Education & Welfare

Headquarters: 330 Independence Ave. S.W., Washington 20201. (202) 245-6296. David Mathews, sec (202) 245-6306.

Office of the Secretary: Edward J. McVeigh, actg asst sec for pub affairs (202) 245-1850.

Social and Rehabilitation Service: Robert A.H. Wilson, asst administrator for pub affairs (202) 245-0381.

Office of Education: Jack L. Billings, actg asst commissioner for pub affairs (202) 245-8387.

National Institute of Health (Public Health Service): Storm Whaley, assoc dir for communications (301) 496-4461.

Food and Drug Administration (Public Health Service): John T. Walden, asst commissioner for pub affairs (301) 443-4177.

Health Services Administration (Public Health Service): Patricia Q. Schoeni, assoc administrator for communications & pub affairs (301) 443-2086.

Health Resources Administration (Public Health Service): Morton Lebow, assoc administrator for communications, HRA (301) 443-1620.

Social Security Administration: Wallace E. Kendall, actg dir, office of information (301) 594-1995.

Office for Civil Rights: Lou Mathis, asst dir for pub affairs (202) 245-6671.

Office of Child Development: Mrs. Pauline Tait, chief, public education division (202) 755-7724.

Dept. of Justice

Headquarters: 9th & Pennsylvania Ave., N.W., Washington 20530. (202) 739-8200. Edward H. Levi, attorney general; Harold R. Taylor Jr., deputy attorney general; Robert H. Bork, solicitor general; Robert J. Havel, dir of public info; Thomas E. Kauper, asst atty gen, antitrust division; Glen E. Pommerening, asst atty gen, office of mgt & finance; Rex E. Lee, asst atty gen, civil division; J. Stanley Pottinger, asst atty gen, civil rights division; Richard L. Thornburgh, asst atty gen, criminal division; Walter Kiechel Jr., deputy asst atty gen, land & natural resources division; Antonia Scalia, asst atty gen, office of legal counsel; Michael M. Uhlmann, asst atty gen, office of legislative affairs; Scott P. Crampton, asst atty gen, tax division. Clarence M. Kelley, dir, FBI: Lawrence M. Traylor, pardon atty; Maurice H. Sigler, chmn, board of parole; David L. Milhollan, chmn, board of immigration appeals; Richard W. Velde, administrator, law enforcement assistance administration; Norman A. Carlson, dir, bureau of prisons; Benjamin F. Holman, dir, community relations service; Henry S. Dogin, administrator, drug enforcement administration; Leonard F. Chapman Jr., commissioner, immigration & naturalization service; Gerald D. Fines, dir, executive office for U.S. attorneys; Wayne B. Colburn, dir, United States marshals service.

Dept. of Labor

Headquarters: 3rd & Constitution Ave., N.W., Washington 20210. (202) 655-4400.

Office of info, publications & reports, 523-7316. John W. Leslie, dir.

Dept. of State

Headquarters: 2201 C St., N.W., Washington 20520. (202) 655-4000. Henry A. Kissinger, secretary of state; Robert S. Ingersoll, deputy secretary; Lawrence S. Eagleburger, deputy under sec for mgt; Ambassador John E. Reinhardt, asst sec for pub affrs; Paul E. Auerswald, dir, office of med svcs, (Bureau of Public Affairs), 632-3656; Ambassador Robert Anderson, special asst to the sec for press rel, 632-9590; Willis E. Naeher, deputy asst sec for communications (Bureau of Administration), 632-1000.

Dept. of Transportation

Headquarters: 400 7th St., S.W., Washington 20590. (202) 426-4000. William T. Coleman Jr., sec; C. Ramon Greenwood, asst to the sec & dir of pub affrs. (202) 426-4570.

Federal Highway Administration: (202)426-0648. Norbert Tiemann, administrator; Werner A. Siems, dir of pub affrs.

Federal Aviation Administration: (202) 426-3883. James E. Dow, actg administrator; Dennis S. Feldman, actg asst administrator for info svcs.

Urban Mass Transportation Administration: (202) 426-4043. Robert E. Patricelli, administrator; Ronald C. Kane, dir of pub affrs.

United States Coast Guard: (202)426-1587. Admiral Owen W. Siler, commandant; Captain Adrian Lonsdale, chief, pub affrs division.

Saint Lawrence Seaway Development Corporation: (202)426-3574. David W. Oberlin, administrator.

Federal Railroad Administration: (202) 426-0881. Asaph H. Hall, administrator; Paul D. Young, pub affrs off.

National Highway Traffic Safety Administration: (202)426-9550. Dr. James B. Gregory, administrator; John Knievet, dir of pub affrs & consumer svcs.

Dept. of the Treasury

Headquarters: 15th St. & Pennsylvania Ave., N.W., Washington 20220. (202)393-6400. William E. Simon, secretary of the treasury.

Info office, 2041: James N. Sites, special asst to sec; John O. Mongoven, deputy special asst to the sec (public affairs); Charles Arnold, dir, news svcs; Alvin M. Hattal, dir bcst svcs.

Internal Revenue Service: 964-4743. Al J. Golato, asst to the comm pub affrs; E. Neil Patton, deputy asst to the comm, 964-4744; Leon H. Levine, chief, pub info, 964-4037.

U.S. Savings Bond Division: Robert E. Harper, dir of pub affairs, 634-5377; F. Crawford Smith, asst dir, pub affairs, 634-5389.

U.S. Customs Service: Richard J. McGowan, dir, pub info division, 964-2475.

Government Agencies

U.S. Secret Service: Jack Warner, asst to the dir (office of public affairs), 964-8221; Kenneth W. Lynch, 964-8221.

Comptroller of the Currency: William B. Foster Jr., special asst to the comptroller, 447-1798.

Bureau of the Mint: James A. Parker, special asst to the dir for pub affairs, 964-5011.

Bureau of Alcohol, Tobacco, & Firearms: Warren H. McConnell, asst to the dir, pub affairs, 961-7135; Howard D. Criswell, pub info, 961-7268.

U.S. Information Agency

Headquarters: 1776 Pennsylvania Ave., N.W., Washington 20547. (202)632-4963. James Keogh, dir; Eugene Kopp, deputy dir; R. Kenneth Towery, deputy dir (Policy & Plans); Andrew T. Falkiewicz, asst dir (Office of Public Information); Charles R. Beecham, asst dir (Press & Publications); Robert S. Scott, asst dir (Motion Pictures and Television Service); Harold F. Schneiderman, asst dir (Information Centers); Kenneth Giddens, asst dir (Broadcasting).

Advisory Commission on Information, United States

Headquarters: 1750 Pennsylvania Ave., Washington 20547. (202)632-5210. Hobart Lewis, chmn; Dr. George Gallup, J. Leonard Reinsch, Arthur C. Nielsen Jr., John M. Shaheen, Louis T. Olom, staff dir.

Energy Research & Development Administration

Headquarters: 20 Massachusetts Ave., Washington 20545. (202) 376-4000.

Office of Pub Affrs: John W. King, dir (202) 376-4070; Robert W. Newlin, asst dir (202) 376-4070; Alfred P. Alibrando, asst dir for public info (202) 376-4055; Philip D. Keif, chief, general news branch (202) 376-4058; Penny Adams (radio-TV), (202) 376-4058; Charles W. Pelzer, asst dir for communication svcs (301) 973-4357; James S. Cannon, chief, nuclear & natl security news (301) 973-3335; James Lyman (nuclear), (301) 973-3446; Ed Westcott (photographer), (301) 973-5476; Sid L. Schwartz, motion picture & audiovisual officer (301) 973-5365; Jon Fogel, TV, motion picture & radio officer (301) 973-5365; Jack C. Moser, TV, motion picture & radio officer (301) 973-5365.

Federal Communications Commission

Headquarters: 1919 M St., N.W., Washington 10554. (202) 655-4000 (For full listing of commissioners and staff see section A).

Federal Trade Commission

Headquarters: 6th St. & Pennsylvania Ave., N.W., Washington 20580. (202)963-1110. Members: Paul Rand Dixon, M. Elizabeth Hanford, Stephen A. Nye, R.T. McNamar, exec dir; Calvin J. Collier, gen counsel; Charles A. Tobin, sec; James T. Halverson, dir of Bureau of Competition; J. Thomas Rosch, dir of Bureau of Consumer Protection; Frederic M. Scherer, dir of Bureau of Economics; Wesley J. Liebler, dir of Office of Policy Planning & Evaluation; Daniel H. Hanscom, dir of Office of Admin Law Judges; Arthur L. Amolsch, dir of Office of Public Information.

National Aeronautics & Space Administration (NASA)

Headquarters: 400 Maryland Ave., S.W., Washington 20546. (202)755-2320. Dr. James C. Fletcher, administrator; Herbert Rowe, assoc administrator for external affairs; John P. Donnelly, asst administrator for pub affrs; Dr. Fred B. Tuttle, dir, office of educat progs; Les Gaver, chief, audio-visual branch; Joseph L. Headlee, chief, radio-TV branch; O.B. Lloyd Jr., dir of public services; Miles Waggoner, dir of public info.

National Industry Advisory Committee (NIAC)

Headquarters: Federal Communications Commission, Room A-201, 1229 20th St., N.W., Washington 20554. (202) 632-7232. Charlotte Reid, defense commissioner; R.D. Lichtwardt, exec dir, FCC; Raymond W. Seddon, chief, emergency communications division; Donald S. Aines, exec sec, NIAC; National Industry Advisory Committee: William R. Stump, AT&T, co-vice

Government, AFRTS, VOA, Radio Free Europe, CRTC

chmn; Vincent T. Wasilewski, National Association of Broadcasters, co vice chmn; J. Francis Taylor Jr., Aeronautical Radio Inc, chmn.

National Labor Relations Board

Headquarters: 1717 Pennsylvania Ave., N.W. Washington 20570. (202)655-4000. Members: Betty Southard Murphy, chmn; John H. Fanning, Howard Jenkins Jr., Peter D. Walther, John A. Penello. John S. Irving, gen counsel.

Office of pub info: 254-9033. Thomas W. Miller Jr, dir.

Federal Preparedness Agency (under General Services Administration)

Headquarters: General Services Bldg., 18th & F Sts., N.W., Washington 20405. (202) 343-1100. Leslie W. Bray Jr., dir; Thomas J. Simmons, exec asst; Gaston L. Choiniere, actg exec dir; Daniel J. Cronin, asst dir for conflict preparedness; Lawrence Y. Goldberg, civil crisis preparedness.

Securities & Exchange Commission

Headquarters: 500 N. Capitol St., Washington 20549. (202) 755-4833. Members: Roderick M. Hills, chmn; Philip Loomis Jr., John Evans, A.A. Sommer, Irving M. Pollack, Harvey Pitt, gen counsel; Bernard Wexler, office of opinions & review; Lee Pickard, division of market regulation; John Burton, chief accountant; S. James Rosenfeld, dir of public info.

Office of the secretary: (202)755-1160. George A. Fitzsimmons, sec; Alan Levenson, dir, corporation finance; Aaron Levy, dir, corporate regulations; Stanley Sporkin, dir of division of enforcement.

AFRTS

Armed Forces Radio and Television Service

AFRTS operates 300 AM and FM radio stations and 118 television stations around the world. Some are broadcast operations and some carried on closed circuit systems of various types. AFRTS stations broadcasting in U.S. territory (primarily Alaska and the Pacific), in Canada and in the Caribbean are individually listed under the appropriate headings of the YEARBOOK.

AFRT. 1117 N. 19th St., 4th Fl., Arlington, Va. 22209. (202) 694-1810. Robert Cranston, chief, directorate for electronic media; LTC Howard A. Myrick, chief, field ops; Kirk H. Logie, chief, information prog dev.

AFRTS-Washington. 1117 N. 19th St., 3rd Fl., Arlington, Va. 22209. (202) 694-4821. LTC Felix L. Casipit, commander, AFRTS-W; Hoyt L. Wertz, chief, broadcast service; Enrico F. Bove, chief tech service.

AFRTS-Los Angeles. 1016 N. McCadden Pl., Los Angeles 90038. Colonel Oliver A. Willey Jr., commander; C. de la Torre, deputy; John J. Brown, chief, radio service; Robert J. Vinson, chief television service.

Voice of America

Headquarters: 330 Independence Ave. S.W., Washington. (202) 755-4744. Kenneth R. Giddens, dir; Serban Vallimarescu, deputy dir; Jack H. Schellenberger, deputy dir, programs; W. Russell Cox, deputy dir, administration; Kenneth Langenbeck, deputy dir, engrg & tech. Public info office: 755-4744.

Policy

The Voice of America, a part of the U.S. Information Agency, has the following directive: "The long-range interests of the United States are served by communicating directly with the peoples of the world by radio. To be effective, the Voice of America must win the attention and respect of listeners. These principles will govern VOA broadcasts:

Radio in the American Sector

In West Berlin the USIA operates RIAS (Radio in the American Sector), which broadcasts an average of 245 hours per week in German over medium and short wave facilities as well as FM. Its main purpose is to reach the population of East Berlin and East Germany, but it also has a sizable audience in West Berlin.

"1. VOA will establish itself as a consistently reliable and authoritative source of news. VOA news will be accurate, objective and comprehensive.

"2. VOA will represent America, not any single segment of American society. It will therefore present a balanced and comprehensive projection of significant American thought and institutions.

"3. As an official radio, VOA will present the policies of the United States clearly and effectively. VOA also will present responsible discussion and opinion on these policies."

To implement this directive, these broadcasts present news and news-related items of American and world events, news analyses, commentaries, correspondents' reports, editorial roundups, and feature material such as documentaries, roundtable discussions, interviews and special events all of which provide overseas audiences with a balanced and accurate concept of the many facets of American life and clear information regarding U.S. policies.

Facilities

The Voice of America has a network of 113 transmitters, of which 41 are in the continental United States. These are short and medium wave stations ranging in power from 35 kw to 1,000 kw. The largest transmitter complex is at Greenville, N.C. There, 18 transmitters feed programs received via microwave from the Washington studios to audiences and relay stations abroad over 73 directional antennas. Total power at Greenville is 4,800 kw. Other domestic facilities are at Bethany, Ohio; Marathon, Fla. (MW); Delano and Dixon, both California.

Overseas relay stations are at: Munich, Germany; Kavala and Rhodes, Greece; Tangier, Morocco; Monrovia, Liberia; Okinawa; Tinang and Poro, The Philippines; Woolferton, England; Colombo, Sri Lanka; Bangkok, Thailand. These include short and medium wave transmitters, among which are three one-megawatt transmitters.

In addition to its network of fixed transmitters, the Voice has seven transportable transmitters. These are all 50 kw, six shortwave and one medium wave, designed to be moved quickly. The medium wave transportable transmitter is on Marathon Key, Fla., broadcasting Spanish language programs. The six shortwave transportables are in The Philippines, where they augment existing facilities in relaying Voice programs to Southeast Asia and the Far East. VOA's total power is now 23,010 kw.

Local Placement

Many VOA tapes, music recordings and script materials are furnished by U.S. Information Agency offices overseas for local distribution and broadcast. Other relays and rebroadcasts are made through arrangements with local broadcasters in West Europe, Africa, the Near East, South Asia, the Far East and Latin America. For example, VOA's Spanish-language correspondents feed of 90 minutes, Mondays-Fridays, is rebroadcast by more than 800 Latin American radio stations.

Jamming

USSR jamming of VOA vernacular language broadcasts to the USSR and East Europe began in 1948 and continued until 1963. Other East European countries began jamming in 1950. Except for Poland (which stopped jamming in 1956) and Bulgaria (which continued to jam until September 1974), Czechoslovakia, Hungary and Romania ceased jamming VOA broadcasts shortly after the USSR stopped. Coincident with the invasion of Czechoslovakia (Aug. 21, 1968), the Soviet Union resumed jamming of VOA's broadcasts in Armenia, Georgian, Russian and Ukrainian. When VOA broadcasts in Uzbek began in September 1972, jamming also was instituted on these programs. In September 1973 all Soviet jamming of VOA broadcasts again was stopped without explanation.

The People's Republic of China began jamming the VOA Chinese-language broadcasts in 1956. At the present time (October 1975) it is the only country jamming VOA programs.

Voice of America Weekly Language Broadcasts (hours and minutes per week)

Albanian 7:00
Arabic (Near East & North Africa) 49:00
Armenian 7:00
Bengali 7:00
Bulgarian 10:30
Burmese 7:00
Chinese 59:30
Czech-Slovak 14:00
English (inclusive to all areas) 202:00
Estonian 7:00
French (Africa) 37:00
Georgian 7:00
Greek 3:30
Hindi 7:00
Hungarian 17:30
Indonesian 21:00
Khmer 14:00
Korean 10:30
Lao 7:00
Latvian 7:00
Lithuanian 7:00
Polish 17:30
Portuguese (Brazil) 14:00
Romanian 10:30
Russian 98:00
Serbo-Croatian 7:00
Spanish (Latin America) 35:00
Swahili 7:00
Thai 3:30
Turkish 3:30
Ukrainian 28:00
Urdu 7:00
Uzbek 7:00
Vietnamese 28:00
Total
Broadcasts 774:30

Radio Free Europe Radio Liberty

Radio Free Europe/Radio Liberty

1201 Connecticut Ave. N.W., Washington 20036. Sig Mickelson, pres; Walter K. Scott, exec VP, One English Garden, 8005 Munich 22, West Germany.

Broadcasts to East Europe in Bulgarian, Czech, Slovak, Hungarian, Polish and Rumanian; broadcasts to the Soviet Union in Russian, Ukrainian, Belorussian, Armenian, Azerbaijani, Georgian, Lithuanian, Estonian, Latvian, Tatar-Bashkir, Kazak, Kirghiz, Tadjik, Turkmen, Uzbek, Azygei, Avar, Chechen-Ingush, Ossetic.

The Board for International Broadcasting

1030 15th St. N.W., Suite 430, Washington 20005. (202) 254-8040. Established by Congress in 1973, the board evaluates and makes grants to Radio Free Europe and Radio Liberty and assures that funds are applied consistently with U.S. foreign policy. Board members are: David M. Abshire chmn; Foy D. Kohler, John T. Murphy, Thomas Henry Quinn, John P. Roche, ex officio, Sig Mickelson, pres RFE/RL. Staff: Walter R. Roberts, exec dir; Barry F. Gidley, budget & admin off; Anatole Shub, prog off; Carol Curric Gidley, asst. to exec. dir.

Canadian Radio- Television Commission

Executive Offices: 100 Metcalfe St., Ottawa KIA ON2. (613) 995-7949. Five full-time members: Harry J. Boyle, actg chmn; John Hyllton, Mrs. Pat Pearce, Real Therrien. (Note: one position is vacant.)

Part-time Members: Jacques de la Chevrotiere, Quebec City, Que.; Armand H. Cormier, Moncton, N.B.; Northrop Frye, Toronto; Rosalie Gower, Vernon, B.C.; Harry Bower, Regina, Sask.; Brian Land, Downsview, Ont.; John Shanski, Winnipeg, Man.; Dr. Gordon Thomas, St. Anthony, Nfld.; Jacques Hebert, Montreal; Donald M. McDougal, Halifax, N.S.

Unions/Labor Groups

*Organizations affiliated with Associated Actors & Artists of America.

**Organizations affiliated with International Alliance of Theatrical Stage Employees & Moving Picture Operators.

Actors' Equity Assn.* (AEA) (AFL-CIO)—165 West 46th St., New York 10036. (212) Plaza 7-7660. Donald Grody, exec sec.

Los Angeles 90028: 6430 Sunset Blvd. (213) HO-2-2334. Edward Weston, asst exec sec.

San Francisco 94104: 110 Bush St. (415) YUkon 6-4060. Harry Pollard.

Chicago 60601: 75 E. Wacker Dr. (312)641-0393. Paul Bowers, asst exec sec.

Toronto M5B 1B1: 64 Shuter St. (416) 869-1334. Burnard Chadwick, Canadian representative.

Affiliated Property Craftmen Local 44**, (AFL-CIO)—7429 Sunset Blvd., Hollywood 90046. (213)876-2320.

American Communications Assn.—Communications Trade Division, International Brotherhood of Teamsters (ACA-IBT) (Ind.)—1 Park Row, New York. (212)267-1374. Joseph P. Selly, pres; William Bender, sec-treas.

Local No. 1: 12 N. 21st St., Philadelphia 19103. (215) LO4-1251. Mort Borrow, pres.

American Federation of Labor & Congress of Industrial Organizations (AFL-CIO)—Hqtrs: 815 16th St., N.W., Washington, D.C. 20006. (202)293-5000. George Meany, pres.

American Federation of Musicians (AFM) (AFL-CIO)—Headquarters: 641 Lexington Ave., New York 10022. (212) Plaza 8-0600. Hal C. Davis, pres.

American Federation of Television and Radio Artists (AFTRA) (AFL-CIO)—1350 Avenue of the Americas, New York 10019. (212) 265-7700. Sanford I. Wolff, natl exec sec; Louis Nunley, natl VP; Kenneth Harvey, pres; Joe Stattery, 1st VP; Bill Baldwin, 2nd VP; Jim Axel, Atlanta VP; George Herman, Washington VP; Bill Hillman, San Francisco VP; Jonathan Dunn-Rankin VP, San Diego; Peter Leeds, Los Angeles VP; Brad Phillips, New York VP; Mel Brandt, treas; Hugh William, sec.

American Guild of Musical Artists (AGMA) (AFL-CIO)—Headquarters: 1500 Broadway, New York 10036. (212) 869-0358. Frederick O'Neal, pres; Sanford I. Wolff, exec sec; Gene Boucher, 1st VP; Henry Butler, 2nd VP; Frank Guarrera, 3rd VP; Murial Cofta-Greenspan, 4th VP; Thomas Pyle, 5th VP; Lawrence Davidson, treas; Edmond Karlsrud, recording sec.

Canada: Burnard Chadwick, 64 Shuter St., Toronto M5B 1B1. (416) 869-1334.

Los Angeles: Francis Barnes, 6430 Sunset Blvd., Suite 603, 90028. (213) 461-3714.

San Francisco: Beeson, Tayer, & Kovach, Suite 1500, 100 Bush St. 94104. (415) YUkon 6-4060.

Philadelphia: Edward Davis, 925 Lafayette Bldg., 5th and Chestnut Sts. (215)629-1234.

Chicago: Herb Neuer, 307 N. Michigan Ave. 60611. (312) FR2-8081.

Northwest: George Peckham, 704 Bellevue East, Seattle, EAst 3-0438, MA2-8199.

New Orleans: Kay Long, 34 San Jose Ave. 70121. Boston: Robert Segal, 11 Beacon St., RI 2-0208.

Washington: Evelyn Freyman, Suite 210, Chevy Chase Center Bldg. (202)657-2560.

Texas: Benny Hopper, 4745 Shands Drive, Mesquite, Tex. 75149.

American Guild of Variety Artists (AFL-CIO)—1540 Broadway, New York 10036. (212)765-0800.

Associated Actors & Artistes of America* (AFL-CIO)—1500 Broadway, New York 10036. (212) 869-0358. Frederick O'Neal, pres; Sanford I. Wolff, exec sec (AFTRA); Chester Migden, 1st VP (natl exec sec SAG); De Lloyd Tibbs, 2nd VP (exec sec AGMA); H. O'Neil Shanks, 3rd VP (exec sec SEG); Penny Singleton, 4th VP (exec pres AGVA); Donald Grody, 5th VP (exec sec AEA); Harold Hoffman, treas. National affiliates: Actor's Equity Association, 1500 Broadway, N.Y. 10036; Donald Grody, exec sec. American Federation of TV and Radio Artists, 1350 Ave. of the Americas, N.Y. 10019; Sanford I. Wolff, exec sec. American Guild of Musical Artists, 1841 Broadway, N.Y. 10023; DeLloyd Tibbs, ex sec. American Guild of Variety Artists, 1540 Broadway, N.Y. 10036; Hebrew

Actors Union, 31 East 7th St., N.Y. 10003; Herman Yablokoff, pres. Italian Actors Union, 1674 Broadway, N.Y. 10019; Sal Carollo, exec sec. Screen Actors Guild, 7750 Sunset Blvd., Hollywood, Calif. 90046; Chester L. Migden, exec sec. Screen Extras Guild, 3629 Cahuenga Blvd. West, Hollywood, Calif. 90028; H. O'Neil Shanks, exec sec. Asociacion Puertorriquena de Artistas y Tecnicos del Espectaculo. (APATE). 804 Ponce de Leon, Oficina 404, Santurce, PR. 00907. William Valentin, sec gen.

Broadcast-Television Recording Engineers Local 45 (IBEW), 3518 Cahuenga Blvd. West, Suite 307, Hollywood 90068. (213) 851-5515. Andrew J. Draghi, bus mgr.

Cinema Lodge 1185, International Assn. of Machinists (IAM) (AFL)—214 South Loma Dr., Los Angeles 90026. Hubbard 3-6630.

Communications Workers of America (CWA) (AFL-CIO)—1925 K St., N.W., Washington 20006. (202)Federal 1-7711.

Composers & Lyricists Guild of America Inc. (CLGA)—6565 Sunset Blvd., Suite 420, Los Angeles 90028. (213) HOLlywood 2-6068.

Elmer Bernstein, pres; Jack Elliott, VP; Marilyn Bergman, sec; Lyn Murray, treas.

New York 10016: 270 Madison Ave. (212)683-5320.

Directors Guild of America Inc. (DGA)—7950 Sunset Blvd., Hollywood 90046. (213) 656-1220. Joseph C. Youngerman, natl exec sec.

New York 10019: 110 W. 57th St. (212) 581-0370. Ernest D. Ricca, Eastern exec sec.

Chicago 60611: 40 East Oak St. (312) 787-5050. E. Shields Dierkes, Midwest exec sec.

Film Technicians Local 683** (AFL)—6721 Melrose Ave., Hollywood 90038. 935-1123. Don Hagerly, exec sec; Carl A. Schmieder, bus rep.

Hollywood Film Council—3629 Cahuenga Blvd., W., Los Angeles 90068. (213) 851-4301. Wm. K. Howard, pres; Max Herman, VP; Chester Migden, VP; Gerald Smith, VP; Gene Allen, treas; O'Neil Shanks, sec.

Illustrators & Matte Artists of the Motion Picture, Television & Amusement Industries. Local 790** (AFL-CIO)—Los Angeles 90046. 7715 Sunset Blvd., Suite 210. 876-2010. Josef Bernay, bus rep.

International Alliance of Theatrical Stage Employees and Moving Picture Machine Operators of the United States and Canada—1270 Avenue of the Americas, New York 10020. (212) Circle 5-4369. Walter F. Diehl, pres; Harold Chadwick, gen sec-treas.

Local 33: 4605 Lankershim Blvd., Suite 833, North Hollywood 91602. (213) 985-0633. Adrian J. Swope, pres; Nick Long, recording sec; William Trinklely, financial sec-treas; Franklin L. Barnhart Jr., bus rep.

International Brotherhood of Electrical Workers (IBEW) (AFL-CIO)—1125 15th St., N.W., Washington 20005. (202) 833-7000. John E. Kain, dir of Broadcasting and Recording Dept.

Local 45: 3518 W. Cahuenga Blvd., Suite 307, Hollywood 90028. (213) 851-5515. Andrew J. Draghi, bus mgr.

Local 40: 3353 Barnham Blvd., Hollywood 90068. (213) 851-4004. Russel J. Bartley, bus mgr; John Setnick, pres.

Local 202: 210 Mississippi St., San Francisco 94107. (415) 864-0202. E.J. Bird.

Local 1200: (Washington-Baltimore) Miles Bldg., Rm 309, 2401 Blueridge Ave., Wheaton, Md. 20902. (301)933-0450. Laurence J. Rimshaw, bus mgr.

Local 1212: 230 W. 41st St., New York 10036. (212)354-6770. Vincent Bartilucci, bus mgr.

Local 1220: 203 N. Wabash Ave., Chicago 60601. (312)332-1908. Norman F. Rugen, pres.

International Photographers Local 659** (AFL-CIO)—7715 Sunset Blvd., Hollywood 90046. (213) 876-0160. Gerald K. Smith, edit; George J. Toscas, mgng edit; Terry M. Burley, bus mgr.

International Sound Technicians Local 695** IATSE & MPMO (AFL-CIO)—15840 Ventura Blvd., Suite 303, Encino, Calif. 91316. (213)872-0452, 981-0452. John L. Coffey, bus rep.

International Union of Electrical, Radio & Machine Workers, 1126 16th St., N.W., Washington 20036. (202)296-1200. Paul Jennings, pres; David J. Fitzmaurice, sec, treas.

Make-Up Artist & Hair Stylists Local 706**

Unions

(AFL-CIO)—11519 Chandler Blvd., North Hollywood, Calif. 91601. (213)877-2776. Harry Maret, pres; Monty Westmore, sec, treas; Howard J. Smit, bus rep.

Motion Picture Costumers Local 705 IATSE** (AFL-CIO)—1427 N. La Brea Ave., Hollywood 90028. (213)851-0220. William K. Howard, bus rep; Bob Ellsworth, sec-treas; Bert Henrikson, pres.

Motion Picture Editors Guild Local 776** (AFL-CIO)—7715 W. Sunset Blvd., Hollywood 90046. (213) 876-4770.

Motion Picture Screen Cartoonists Local 841** (AFL-CIO)—12441 Ventura Blvd., Studio City, Calif. 91604. Irving Dressler, pres; Cliff Augustson, VP; Alex Shapiro, bus agent.

Motion Picture Screen Cartoonists Local 839** (AFL-CIO)—12441 Ventura Blvd., Studio City, Calif. 91604. (213)766-7151. Harry Hester, pres; Morris Gollub, VP; Charlotte Gable, sec-treas; Louis Appet, bus rep.

Motion Picture Screen Cinetechnicians Local 789** (IATSE)—4545 Santa Monica Blvd., Los Angeles 90029. (213) 666-2952. PE. O'Bryant, bus mgr; Jules J. Weisberg, pres.

Motion Picture Studio Electrical Technicians (IATSE & MPMO) Local 728** (AFL-CIO)—3400 Barham Blvd., Hollywood 90068. (213)851-3300. Art Melli, bus rep-sec; Robert L. Allen, call steward-treas.

Motion Picture Studio Grips IATSE Local 80** (AFL-CIO)—6926 Melrose Ave., Los Angeles 90038. WEBster 1-1419.

Motion Picture Studio Projectionists Local 165 IATSE & MPMO. (AFL-CIO)**—6640 Sunset Blvd., Suite 110, Hollywood 90028. (213) 461-2985. Stephen R. Flint, bus rep; Donald R. Brown, sec-treas; Max Lulla, pres.

Motion Picture Studio Set Painters Local 729** (AFL-CIO)—12753 Ventura Blvd., North Hollywood 91604. (213)877-0671. Raiph W. Peckham, bus resp; Edward E. Verga, local pres; Richard T. Norris, VP; Don Robinson, rec sec.

Musicians Union, Local 47, American Federation of Musicians (AFM) (AFL-CIO)—817 N. Vine St., Hollywood 90038. (213) 462-2161. Max Herman, pres; Vince Di Bari, VP; Marl Young, sec; Bob Manners, treas.

National Assn. of Broadcast Employees & Technicians (NABET) (AFL-CIO)—Intl President's Office, Suite 420, 1601 Connecticut Ave., N.W., Washington 20009. (202) 265-3501. Edward M. Lynch, intl pres; James D. Harvey, intl VP; Clifford Gorsuch, intl rep; Roy W. Davis, intl rep; Dorr C. Wilson, admin asst to intl pres; Harry Coyle, intl rep; Duane R. Corder, intl sec-treas. Rm. 711, 80 E. Jackson Blvd., Chicago 60604. (312) 922-2462.

San Francisco 94102: 126 Hyde St. (415) 771-5350. Robert Lenihan, intl rep.

The Newspaper Guild (TNG) (AFL-CIO-CLC)—1125 15th St., N.W., Washington 20005. (202)296-2990. Barney Peterson, intl chairperson; Charles A. Perlik Jr., pres; Robert M. Crocker, sec-treas.

Ottawa: 2841 Riverside Drive, Rm. 302. (613) 731-7584. William H. McLeman, Canadian dir.

Office and Professional Employees International Union Local 174 (OPEIU) (AFL-CIO)—9056 Santa Monica Blvd., Suite 301, Hollywood 90069. (213)278-5880. Herman W. Pope, local pres; Max J. Krug, bus rep; Howard Woolfan, asst bus rep.

Scenic & Title Artists Local 816 (IATSE)**—7429 W. Sunset Blvd., Hollywood 90046. (213) 876-1440-1. William Anderson, pres; Joseph E. Johnston, sec-treas; Marvin J. DeChellis, bus rep.

Screen Actors Guild* (SAG) (AFL-CIO)—Headquarters: 7750 Sunset Blvd., Hollywood 90046. (213)876-3030. Dennis Weaver, pres; Chester Migden, natl exec sec.

New York: 551 Fifth Ave., 10017. (212) Murray Hill 7-4623. John T. McGuire, exec sec.

Chicago: 307 N. Michigan Ave. 60601. (312) Frankin 2-8081. Herbert Neuer, exec.

Detroit: 1150 Griswold, Ste. 3200. 48226. (313) 963-0269. Tomi Thurston, exec.

Florida: 3226 Ponce de Leon Blvd., Coral Gables, Fla. 33134. (305) 444-7677. Melvin Karl, asst natl exec sec.

San Francisco: 100 Bush St. 94104.

ions, Books

(415)391-7510. Don Tayer, exec.
Boston: 11 Beacon St., Rm. 1103. 02108.
(617)Richmond 2-0258. Robert M. Segal, exec.
Dallas: 5025 N. Central Expwy. Ste. 2026. 75205.
(214)522-2080. Ciinta Dayton, exec.
Philadelphia: 1405 Locust St., Rm. 1620. 19102.
(215) 545-3150. W. Melvin Evans, exec.
San Diego: 3045 Rosecrans Blvd., Rm. 206. 92110.
(714)222-3996. Jackie Walters, exec.

Screen Cartoonists Guild (SCG) Division of Teamsters Local 986—1616 W. 9th St., Los Angeles 90015. (213)380-9860. Dotson Bennett, bus agt.

Screen Composers Assn. (independent) 9250 Wilshire Blvd., Beverly Hills, Calif. 90212. (213)276-3123. Nathan Scott, pres; Herschel Gilbert, VP; Frank DeVol, sec; George Dunning, treas; Miklos Rozsa, Eur. rep.
c/o Zissu, Marcus & Stein, 270 Madison Ave., New York 10016. (212)683-5320.

Screen Extras Guild (SEG) (AFL-CIO)—3629 Cahuenga Blvd. W., Los Angeles 90068. (213) 851-4301. Murray Pollack, pres; H. O'Neil Shanks, natl exec sec.

San Francisco 94106: 100 Bush St. (415) 391-7510. Donald Tayer, exec sec.
Honolulu 96815: 1888-H Kalakaua Ave. (808) 949-1112. Keokekalea Hughes, bus rep.

Script Supervisors Local 871**—7715 Sunset Blvd., Hollywood 90046. (213)876-4433. George A. Rutter, bus rep.

New York: Motion Pictures Script Supervisors, Production Office Coordinator & Production Auditors of Local 161 (IATSE). 250 W. 57th St. 10019. (212) 245-4526. Olga Barrekette, bus agent; Noni Rock, pres; Renata Stoia, VP; Barbara Defina, treas.

Service Employees International Union—Local

278—740 So. Western Ave., Suite 212, Los Angeles 90005. (213)386-4815. George Hardy, intl pres.

Set Designers & Model Makers of the Motion Picture Television & Amusement Industry Local 847** (AFL-CIO)—7715 Sunset Blvd., Hollywood 90046. 876-2010. Josef Bernay, bus rep.

Society of Motion Picture & Television Art Directors, Local 876 (IATSE)**—7715 Sunset Blvd., Hollywood 90046. (213) 876-4330. Gene Allen, exec dir.

Stagehands, Local 33** 2858 West 8th St., Los Angeles 90005. (213)380-1648. Nick Long, sec; Franklin L. Barnhart Jr., bus rep.

Story Analysts Local 854** (AFL-CIO)—7715 Sunset Blvd., Suite 210, Los Angeles 90046. (213) 876-1600. Bruce Bradbury, pres; Joan Orihuela, exec sec.

Studio Electricians Sound Technicians & Air Conditioning Engineers Local 40 (IBEW) (AFL-CIO)—3353 Barham Blvd., Hollywood 90068. (213)851-4004. Charles H. Pillard, intl pres; Joseph D. Keenan, intl sec; Harry Van Arsdale Jr., intl treas; Russell J. Bartley, bus mgr.

United Electrical, Radio & Machine Workers of America, 11 E. 51st St., New York 10022. (212)753-1960. Albert J. Fitzgerald, gen pres; James J. Mattes, gen sec, treas; Hugh Harley, dir of org.

United Scenic Artists, Local 829. 268 West 47th St., New York 10036. (212)246-4491. Andy Clores and Abe Kanter, bus reps.

Writers Guild of America, East Inc. (WGAE)—22 West 48 St., New York 10036. (212) 575-5060. Leonard Wasser, exec dir.

Writers Guild of America West, Inc. (WGA)—8955 Beverly Blvd., Los Angeles 90048. (213) 550-1000. Michael H. Franklin, exec dir; David W. Rintels, pres; Allan Manings, VP; William Ludwig, sec-treas.

by Charles S. Steinberg. Hastings House, New York. 315 pp. \$13.50, 1974.

Dr. Steinberg, professor of communications for Hunter College and former vice president-information services for CBS-TV, offers an academic appraisal of eight media issues, including news, counteradvertising, children's TV, the esthetics of criticism and public and educational TV.

Broadcasting and Cable Television: Policies for Diversity and Change, by the Committee for Economic Development. CED, New York. 120 pp. \$4.00/2.50.

Based on studies begun in late 1971 by a research and policy committee consisting of people inside broadcasting and cable as well as outside observers, critics and researchers. The report contains an introduction and summary of recommendations and sections on the public responsibilities of commercial broadcasting, a policy for public broadcasting, the potential of cable and organizing regulation for change.

Cavalcade of Broadcasting by Curtis Mitchell. Follett. 254 pp. \$9.95/\$4.95, 1971.

This history of American radio and TV is about half pictorial, including some historic early photos of considerable merit.

Cavett, by Dick Cavett and Christopher Porterfield. Harcourt Brace Jovanovich, New York. 373 pp. \$8.95, 1974.

Mr. Porterfield, who roomed with Mr. Cavett at Yale and later joined his staff, reviews the performer's earlier life and analyzes a typical program taping schedule. Mr. Cavett dissects the talk show phenomenon.

CBS: Reflections in a Bloodshot Eye, by Robert Metz. Playboy Press; Chicago. 428 pp. \$13.50, 1975.

A chronology of CBS's almost 50 years of development. Mr. Metz, reporter for the *New York Times*, presents a series of vignettes stressing the roles of various individuals in CBS's past and present, with chapters on the creation of the network, the development of TV.

Children's Television: The Economics of Exploitation, by William Melody. Yale University Press, New Haven, Conn. 139 pp. \$7.95 (cloth), \$1.95 (paper).

The book is an update of an Action for Children's Television report submitted as part of the FCC's inquiry into the subject of children's TV—an inquiry initiated largely by ACT itself. Mr. Melody is associate professor of communications at the Annenberg School of Communications at the University of Pennsylvania.

The Deejays, by Arnold Passman. Macmillan, New York 320 pp. \$7.95, 1971.

A history of music on radio from the beginning up to the present. The author has known many of his subjects personally and this lends a lighter and more interesting touch to the subject.

Economic Aspects of Television Regulation, by Roger G. Noll, Merton J. Peck and John J. McGowan. Brookings Institution, Washington. \$8.95, 1973.

The study describes itself as a "comprehensive economic analysis of the television broadcasting industry, its interaction with the FCC, and the prospects for change."

The Early Window: Effects of Television on Children and Youth, by Robert M. Liebert, John M. Neale and Emily S. Davidson. Pergamon Press, Elmsford, N.Y. 193 pp. \$9.50/\$6.50, 1973.

The three authors were active on the surge-general's research program on TV and Social Behavior and much of what is reported comes from that massive research. The result is an attempt to explore all such research and chapters include the overall growth process, production and content in TV today, TV and aggressions, the prosocial effects of TV, the commercial interests, government and industry role and an overview.

The Electric Mirror: Politics in an Age of Television, by Sig Mickelson. Dodd, Mead, New York. 304 pp. \$8.95, 1972.

The former head of CBS News reviews the past two decades' TV reporting and advertising and analyzes the medium's key problems in politics. A chapter deals with the use of TV abroad, one is on political debates, one on costs and one on the relations between government and television.

Fear in the Air: Broadcasting and the First Amendment—the Anatomy of a Constitutional Crisis, by Harry S. Ashmore. Norton, New York. 180pp. \$6.95, 1973.

Books

Editor's Note: This bibliography supplements other listings that have been published in BROADCASTING YEARBOOKS. It is intended to be representative of publications related to the broadcasting industry and not to be all inclusive.

Directories and Dictionaries

The Big Broadcast: 1920-1950, by Frank Buxton and Bill Owen. Viking Press, New York. 301 pp. \$12.95, 1972.

An alphabetical listing of network radio programs providing program type, key personalities, program opening and closing and sometimes bits of scripts. Some include the network and year the program started and some description of the programs carried. There is also information on announcers, reporters, interviewers, comedy shows, soap operas, sound effects etc. About 150 photos of radio personalities are included as is an extensive index with more than 5,000 entries.

Index to Characters in the Performing Arts—Part IV, Radio and Television, by Harold S. Sharp and Marjorie Z. Sharp. Scarecrow Press, Metuchen, N.J. 700 pp. \$15, 1973.

The fourth and final work of a series, the index covers some 2,500 programs and about 20,000 characters. As a research aid it is invaluable since by knowing one character in a drama the researcher may trace down everyone else who took part. A guide to the characters, not to the actors who played each character.

Television and Human Behavior, by George Costock et al. Rand Corp., Santa Monica, Calif. Three volumes. \$27.00, 1975.

Annotated bibliography of the post-1960 research into most aspects of TV's impact on society. The volumes, which can be purchased separately, include "A Guide to the Pertinent Scientific Literature," "The Key Studies" and "The Research Horizon, Future and Present."

World Directory of Religious Radio and Television Broadcasting. William Carey Library, 305 Pasadena Ave., South Pasadena, Calif. 91030. 808 pp. \$8.50, 1973.

A country-by-country survey by the International Christian Broadcasters of the present status of religious broadcasting over the world. A map, general data on the country and a detailed listing of stations is included.

The World Encyclopedia of the Film, edited by John M. Smith and Tim Cawkwell. World. 303 pp. \$25, 1972.

Biographical material on persons in film, including film makers and performers. More than 2,000 biographical entries, some 500 pictures. Some 20,000 films are listed by title with year, credits and length as well as whether color or wide-screen.

General

About Television, by Martin Mayer. Harper & Row, New York. 433 pp. \$10, 1972.

A readable and sympathetic survey of the industry including technical problems, ratings, selling time, prime time shows, daytime programming, sports, evening newscasts, politics and documentaries, examples of local television. A good introduction to the problems in the field.

The Age of Television, by Leo Bogart. Frederick Ungar, New York. 549 pp. \$14.50, 1972.

Update of the 1956 and 1958 editions of the same name, with 125 pages of updated notes, keyed by letters to the pertinent portions of the original text. There is a new introduction, appendix on broadcast research and bibliography covering the 1958-1971 period. The entire book is indexed. One of the best early books on television the book deals with TV's role, programming, patterns of viewing, radio listening in the TV age, TV's relationship to reading, movies, sports etc.

Armstrong's Fight for FM Broadcasting: One Man vs Big Business and Bureaucracy, by D. H. V. Erickson. U. of Alabama Press, University, Ala. \$7.75, 1973.

The title not only outlines the book but reveals the approach of the author—that the inventor was thwarted by almost the entire broadcasting industry, spearheaded by RCA and the FCC.

Broadcasting: The Critical Challenges, edited

BOOKS FOR BROADCASTERS

403. AM-FM BROADCAST STATION PLANNING GUIDE by Harry A. Etkin. A comprehensive guide to planning, building, and operating a radio broadcast facility—AM, FM, or combined operation. Based on a lifetime of experience and intimate association in broadcasting. 8½ x 11", illustrated. **\$12.95**

405. BROADCAST STATION OPERATING GUIDE by Sol Robinson. This comprehensive reference encompasses every level of broadcasting. The secret to success in broadcasting, as in any other business, is knowing what to do and how to do it. This book tells it like it is. 256 pages. **\$12.95**

406. THE BUSINESS OF RADIO BROADCASTING by Edd Routh. How to operate a station as a profitable business and serve the public interest as well. This is the first text to deal with broadcast station operation from beginning to end. Clearly explains proven techniques to follow, and cautions to observe. 400 pages, illustrated. **\$12.95**

404. THE ANATOMY OF LOCAL RADIO-TV COPY by William A. Peck. Leading station executives have called this book the one that sets the standard for radio-TV copy at the local level. Loaded with hundreds of ways to increase station billing with sales-proven copy. 104 pages. **\$5.95**

417. GUIDE TO PROFESSIONAL RADIO & TV NEWSCASTING by Robert C. Siller. A practical, self study guide for those who want to get started or get ahead in broadcast journalism. 224 pages, illustrated. **\$9.95**

418. HANDBOOK OF RADIO PUBLICITY & PROMOTION by Jack Macdonald. This handbook is a virtual promotion encyclopedia—includes over 250,000 words, over 1500 on-air promo themes adaptable to any format; and over 350 contests, stunts, station and personality promos! One idea alone of the hundreds offered can be worth many times the small cost of this indispensable sourcebook. 372 pages, 8½ x 11" bound in long-life 3-ring binder. **\$29.95**

419. HOW TO BECOME A RADIO DISC JOCKEY by Hal Fisher. Essentially a course in showmanship, this book teaches all the techniques needed to become a successful broadcast announcer (or disc jockey). 256 pages, illustrated. **\$7.95**

420. HOW TO PREPARE A PRODUCTION BUDGET FOR FILM & VIDEO TAPE by Sylvia Allen Costa. A complete guide to determining finances for any video tape or film production, from TV commercials to feature-length films. Jammed with facts covering every aspect of estimating costs.

Tells how to estimate every cost associated with any size production, including the production location, cameras and accessories, sound equipment, light gear, raw film stock or video and sound recording tape, lab developing, printing and processing fees, personnel—(creative, technical, and talent), scenic elements, location expenses, surveys of remote shooting locations, film and tape editing, optical effects and animation, plus a host of miscellaneous expenses such as writer fees, animals, special effects requirements, and insurance. Also included are typical rate listings and eight sample budgets, representing TV commercials, documentaries, and feature-length films. 192 pages. **\$12.95**

421. HOW TO SELL RADIO ADVERTISING by Si Willing. The right formula for sales depends on the individual and the prospective advertiser. Therein lies the secret as Si Willing illustrates it by theory and by practice. You'll hear all sorts of objections (including a few you haven't heard!) and how they've been successfully countered. From the dialog between salesman and prospect you'll learn the approaches and the clinchers, how to use available sales tools to the best advantage and how to deal with competition. You'll learn ways to sidestep objections, how to recognize the "opportunity moment", and how to convert a "No" to a "Yes". 320 pages. **\$12.95**

434. RADIO PRODUCTION TECHNIQUES by Jay Hoffer. Here's an all-round book for everyone in radio—performers, producers and directors, and sales and engineering personnel. Covers every phase of radio production from announcements to the overall station "sound"—in fact, every creative aspect of today's radio...with special emphasis on sales. Tells how to produce results for an advertiser, and how to develop production expertise, and how to use the elements of pacing and timing in every production. Covers record screening, jingle use, news, on-air promotion, public service, contests, public affairs, remotes, talk and farm shows, etc. Practical data on sales includes idea development, writing, and how to create more effective commercials. 204 pages, illustrated. **\$12.95**

437. RADIO STATION SALES PROMOTIONS by Jack Macdonald. 300 merchandise-moving ideas! A compendium of creative selling ideas designed exclusively for radio stations—sales tools that work. A vast supply of ready-to-use ideas for producing sales in 43 categories, from air conditioners to washing machines. 72 pages, 8½" x 11" **\$10.00**

Broadcasting Book Division

1735 DeSales Street, N.W. Washington, D.C. 20036

Send me the books whose numbers I've indicated at left. Payment for the full amount is enclosed.

Name _____

Address _____

T City _____ State _____ Zip _____

Book No.	Price
Total	\$ _____

A discussion of the major pressures on broadcasting, especially in news and special events programming. Mr. Ashmore believes the major problem is a public feeling that broadcasters are somehow to blame for many of the nation's problems.

The Film Buff's Bible, of Motion Pictures (1915-1972), edited by the Hollywood Film Archive, 8344 Melrose Ave., Dept. BC, Hollywood, Calif. 90069. \$24. 1973.

Over 13,000 titles of the most popular films including year of release, running time, critical rating from three sources, distributor or studio, country of origin.

The Image Empire: A History of Broadcasting in the United States from 1953 by Erik Barnouw. Oxford University Press. 416 pp. \$9.75. 1970.

This third volume in Mr. Barnouw's history of American radio and television (following *A Tower in Babel*, 1966 and *The Golden Web*, 1968) concerns broadcasting's development following the rise of TV. Much of the book concerns programing trends. He discusses news management by the government in the 1960's and TV's intimate portrayal of assassinations, wars, rioting, man on the moon and other events.

Jones Dictionary of CATV Terminology. Jones International Ltd., 880 Continental Bank Bldg., Englewood, Colo. 80110. \$19.95. 1973.

Over 800 CATV definitions in both French and English.

Marcconi, by W. P. Jolly. Stein & Day. 293 pp. \$7.95. 1972.

A solid chronological approach and analysis of the inventor from his unhappy childhood to his death as an honored citizen.

Mass Media, Violence and Society, by Dennis Howitt and Guy Cumberbatch. John Wiley/Halstead Press, New York. 167 pp. \$12.50. 1975.

The authors of this review of studies done on the subject to date contend that the mass media have no significant effect on the level of violence in society. Chapters discuss the general issue and the public debate over it, examine it as a psychological problem, and explore experimental studies, mechanisms of media effects, and correlated field studies.

Maverick Inventor: My Turbulent Years at CBS, by Peter C. Goldmark and Lee Edson. Saturday Review Press, with distribution by E. P. Dutton, New York. 278 pp. \$7.95. 1973.

Inventor-engineer Goldmark tells his story of the 36 years he spent at CBS, many years as head of CBS Labs. His story is that of CBS's losing battle to establish its color TV system, the pioneering of the long-playing phonograph record and, more recently his Electronic Video Recording system.

NBC Handbook of Pronunciation. Compiled by James F. Bender. Thomas Y. Crowell Company, 201 Park Ave., N.Y. 10003, Third Edition, \$4.95.

This well known handbook has been completely revised and enlarged. In it, you will find the correct way to say 20,000 words and proper names frequently mispronounced.

News from Nowhere: Television and the News, by Edward Jay Epstein. Random House, New York. 321 pp. \$7.95. 1973.

Mr. Epstein's book first made news as a 27-page article in the *New Yorker*. It's the result of a 1968-69 investigation of network news, with emphasis on how organization affects product.

The \$100 Million Dollar Lunch, by Sterling (Red) Quintan. J. Phillip O'Hara Inc., Chicago. \$6.95.

A background account on the 25-year legal controversy that ended, ultimately, in the loss of license to WHDH-TV Boston—and the end of a major daily newspaper. The author was once ABC's vice president for Chicago.

The Politics of Broadcast Regulation, by Erwin G. Krasnow and Lawrence D. Longley. St. Martin's Press, 175 Fifth Ave., New York. 160 pp. \$8.50 cloth; \$3.95 paper. 1972.

An examination of the regulation of broadcasting as a political process. It deals with the basic political questions of who gets what, when, and how and takes into account the importance of courts in broadcast regulation, development of the right of citizens' groups to enter into administrative review and the increasing influence of the presidency on regulatory activity. Part

one examines basic characteristics of the regulatory process. Part two comprises four case studies of broadcast regulatory policies.

Presidential Television, by Newton Minow, John Bartlow Martin and Lee M. Mitchell. Basic Books, New York. 232 pp. \$8.95. 1973.

Dealing with the President's political, but mostly noncampaign, uses of television. The rise of the political use of television is reviewed, as is the law as it deals with the subject and the hopes of the congressional and judicial branches of government for as much opportunity to use the medium. Newton Minow is the former FCC chairman, Mr. Martin a writer and former ambassador and Mr. Mitchell a communications lawyer.

Radio, Television and American Politics by Edward W. Chester. Sheed & Ward, New York. \$7.50. 1969. paperback Sheed & Ward. \$3.95. 1971.

This volume examines the influence of the broadcast media on local and national politics from a historical viewpoint, starting with KDKA and Harding returns et seq.

Rebel in Radio: The Story of WQXR, by Elliott M. Sanger. Hastings House, New York. \$7.50.

The story of the New York fine-music station, told by the man who managed it for 29 years.

David Sarnoff, a biography. By David Lyons. Harper & Row, New York. \$6.95.

Say It Safely by Paul P. Ashley, University of Washington Press, Seattle. 180 pp. \$3.95. 1966.

Mr. Ashley, a Seattle attorney, has been interested in libel cases for 40 years. This is his third book on the subject.

Television: The Business Behind the Box, by Les Brown. Harcourt, Brace, Javanovich, New York. 365 pp. \$8.95. 1971.

The role of network television as seen by the then radio-TV editor of *Variety* (now of the *New York Times*) with particular attention to programing and management.

Television and Growing Up: The Impact of Televised Violence, a report to the surgeon general from the surgeon general's scientific advisory committee on television and social behavior. Government Printing Office, Washington. 279 pp. \$2.25 paper. 1972.

The study includes both special reports done for the commission and the group's own findings about television and its possible effect on children, particularly in the area of violence on television.

Television and Radio, by Giraud Chester, Garnet Garrison, Edgar Willis. Appleton-Century-Crofts, New York. 613 pp. \$11.95. 1971.

A revision of the earlier editions with Part 1 devoted to a discussion of radio and TV in society and Part 2 covering studio operations. A new chapter on politics and broadcasting and revisions in studio discussions are the principal changes. Some third of the volume is reported as new material.

Television and Presidential Politics, by Robert E. Gilbert. Christopher Publishing House, Quincy, Mass. 335 pp. \$9.75. 1972.

An analysis of the role of TV in presidential policies. The book deals with the increasing role of television in making presidential elections a truly national effort. Chapters deal with the visual medium's function in obtaining a major political nomination, trends in campaign expenditures and giving more detailed information in particular campaigns concluding with the Nixon-Humphrey campaign in 1968. The author believes that since 1952 television has dominated the political scene.

Television and the Public, by Robert T. Bower. Holt, Rinehart & Winston, New York. 205 pp. \$7.95. 1973.

An updating of the 1963 Gary A. Steiner report, *The People Look at Television*, this report was backed by CBS research and is based on 1970 data. About a third of the same questions are used. The overall conclusion is that more people are watching more television. It is almost impossible to summarize but is a careful audience examination, probably the most important since the Steiner report.

The Television Commercial: Creativity and Craftsmanship by Norman D. Cary. Decker. 150 pp. Paperback \$6.95. 1971.

A guide to selling, structure of ads, institutional ads, public service announcements, use of the storyboard, length factors, research and testing and production.

Television Economics, by Bruce Owen, Jack Beebe

and Willard Manning Jr. Lexington Books, Lexington, Mass. 218 pp. \$15.00. 1974.

In two parts, it explores economics of television program markets and looks into questions of public policy toward television. It presents data on current economic problems and, based on that data, presents a variety of policy options.

The Television Years, by Arthur Shulman and Roger Youman. Popular Library, New York. 320 pp. \$1.50 (paper). 1973.

Well-illustrated review of TV from 1948 through 1972 with heavy emphasis on network shows.

The Tin Kazoo—Television, Politics and the News, by Edwin Diamond. The MIT Press, Cambridge, Mass. 269 pp. \$9.95. 1975.

Deals with news formats and the audience and, more specifically, with the content of public news. Mr. Diamond focuses on several case studies of TV news, including the Vietnam war coverage, the *Pentagon Papers*, several chapters on former President Nixon (including Watergate coverage) and TV as a political tool.

To Kill a Messenger: Television News and The Real World by William Small. 602 pp. \$8.95. 1970.

Mr. Small, now the senior vice president of CBS News, was CBS news chief in Washington when he wrote this book covering in detail news problems from the television newsmen's point of view.

Tube of Plenty: The Evolution of American Television, by Erik Barnouw. Oxford University Press, New York. 518 pp. \$14.95. 1975.

Illustrated social history, through early 1975, of American TV, covering, in most part, network-level broadcasting, and dealing more with the documentary and news aspects of TV than with the entertainment programs.

TV: The Most Popular Art, by Horace Newcomb. Anchor Books, New York. 272 pp. \$2.50. 1974.

Dissects and analyzes the major kinds of popular network television programing, concentrating on prime-time examples, with chapters on comedies, westerns, mysteries, doctors and lawyers, adventure shows, soap operas, news, sports and documentaries.

The Universal Eye: The World of Television, by Timothy Green. Stein & Day, New York. 276 pp. \$10. 1972.

A review of television around the world, the 21 chapters take up Western Europe, the Communist world, the Arab countries and Israel, Asia, Australia, Africa and an overview of the whole. Timothy Green is the former head of *Time* magazine's London bureau.

Vintage Radio: A Pictorial History of Wireless and Radio, 1887-1929, by Morgan E. McMahon. McMabon's Vintage Radio, Box 2045, Palos Verdes Peninsula, Calif. 90274. 263 pp. \$6.95/\$4.95. 1973.

A well-illustrated guide to early radio receivers and parts thereof. The text deals with radio history, microphones and other broadcast equipment, a review of brands of radio receivers, the scanning disk TV and a directory of radio broadcast receivers.

We're Going to Make You a Star, by Sally Quinn. Simon and Schuster, New York. 256 pp. \$7.95. 1975.

The one-time co-host of CBS Morning News attributes her less-than-successful debut and subsequent failure, in large part, to CBS News and to a *New York* magazine cover story, which she says, was "written in a snide way." Contending she was "vastly over-promoted" and "painfully under-prepared," she emphasizes the absence of help from CBS News.

Educational

The Breakthrough Course of Radio Selling, conceived by Bruce Johnson, edited by Art Mandelbaum. RKO General Radio, New York. \$2.50.

This is more than a book; it's a complete do-it-yourself kit in radio education, with the aim of creating salesman who know the medium they're selling. The text is duplicated in 12 audio cassettes. Mr. Johnson is a former president of the RKO Radio division. Mr. Mandelbaum is vice president for advertising and promotion.

Audio Control Handbook for Radio and Television Broadcasting, by Robert S. Orlingel. Hastings House, New York. 192 pp. \$10/\$6.50. 1972.

A revision of a book issued in 1956 and revised in 1963 and 1968. Although organization is nearly identical with earlier editions the format has changed

as has the page size. Useful for beginners and experienced broadcasters alike.

Broadcast Journalism: An Introduction to News Writing, by Mark W. Hall. Hastings House, New York. 159 pp. \$6.95 cloth, \$4.95 paper. 1971.

Discussions of news writing, sources of news, police and criminal news, disaster and civil disturbance coverage, libel and slander, good taste. An appendix discusses style and writing errors.

Broadcasting and Government: Responsibilities and Regulations, by Walter Emery. Michigan State University Press, East Lansing. \$12.50, 1971.

A revision of the 1961 edition the book covers the scope of government controls, character, classification and utilization of radio frequencies, problems of going on the air etc. Appendices include many basic FCC papers including the Communications Act of 1934 plus revisions up to date, a study of FCC-FTC relations, regulations on fairness, a report on the 1960 programing inquiry and other pertinent matters.

Broadcasting in America: A Survey of Television and Radio, by Sydney W. Head. Houghton-Mifflin, Boston. \$9.95, 1972.

A revision of the classic first issued in 1956, this nearly complete rewrite deals with physical bases of broadcasting, its origin and growth, its economics, its regulation and an assessment of the influence broadcasting has on the nation.

Commercial FCC License Handbook, by Harvey F. Swearer. Tab Books, Blue Ridge Summit, Pa. 432 pp. \$8.95 cloth, \$5.95 paper, 1971.

A review of the elements necessary to taking examinations for the FCC's 1st, 2d and 3d phone licenses. It includes illustrations and sample questions.

The Communicative Arts and Sciences of Speech. Edited by Keith Brooks. Charles E. Merrill Books, Columbus, Ohio. 610 pp., indexes. \$7.95, 1967.

A good introduction to the many areas, including radio-TV, that make up most college and university departments of speech and dramatic art. Designed chiefly for undergraduate use in such a department.

Documents of American Broadcasting, edited by Frank J. Kahn. Appleton-Century-Crofts, 684 pp. \$11.95, 1973.

A revised format for an important reference work and classroom text. Five sections are included—regulation of broadcasting, regulation of programing, freedom of expression, broadcast journalism and public interest. There are updated reading lists for each major section.

How to Get into Show Business, by Merrill E. Joels. Hastings House, New York. 157 pp. \$5.95, 1970.

Business sense is an important talent, according to this expansion of an earlier work. **Acting Is a Business.**

Introduction to Mass Communications, by Edwin Emery, Philip H. Ault and Warren K. Agee. Dodd, Mead and Co., New York. 444 pp. \$7.95, 1970.

This is the third edition of a work designed to acquaint students with all areas of media, including current issues and problems.

Making TV Pay Off: A Retailer's Guide to Television Advertising, by Howard P. Abrahams. Fairchild Publications, New York. 144 pp. \$6.95, 1975.

A workbook covering such area as determining company and television goals and budget, what people to reach and when, what to promote and how, actual writing and production of the TV commercial, buying time on the air and tie-ins with other means of promotion.

Mediability: A Guide For Nonprofits, by Len Biegel and Aileen Lubin. Taft Products Inc., Washington. 110 pp. \$6.50.

A how-to handbook in laymen's terms for intelligent use of media by public service, nonprofit organizations. The authors discuss sophisticated methods of ad presentation and choosing a medium and a target audience. The primer is part of the "NonProfit-Ability Series" published by Taft.

The Medium Is the Message, by Marshall McLuhan with Quentin Fiore. Bantam Books Inc., New York. 160 pp. \$1.45.

This is the economy version of the \$10.95 Random House book that helped to popularize the 1960's medium-message dialogue whose echoes still linger. Dr. McLuhan is professor of Humanities at Fordham University.

Structures and Organization of Broadcasting in the Framework of Radiocommunications, by Albert Namurois. European Broadcasting Union, Geneva, Switzerland, Centre International. 1 Rue de Varemé, CH-1211 Geneva 20. 211 pp. 1972.

A review of the world legal system of telecommunications, radio and TV services, including a 20-page bibliography. Detailed information, presented in a highly organized fashion.

Television and Radio Announcing, by Stuart W. Hyde. Houghton-Mifflin. \$9.95, 1971.

A revision of an old favorite with over 100 pages added since the old edition 13 years ago. Part I deals with announcing, Part II with practice assignments.

Television News, by Irving E. Fang. Hastings House \$12.95/\$7.50, 1972.

An expanded and revised edition of a standard text first issued in 1968. Deals with the problems of TV news, how to handle them, editorials and fairness, election coverage, libel, access, section 315, privacy etc. New are a glossary, reference notes and a bibliography. Examples and illustrations throughout.

Writing News for Broadcast, by Edward Bliss Jr. and John M. Patterson. Columbia University Press, New York 298 pp., \$13.50, 1971.

A well-written analysis of all angles of writing news for radio and television. Many descriptive examples add to the value of the book. Included is a word and picture presentation of the evening newscasts of the three networks on March 19, 1971, an interesting study in comparative techniques.

Technical

Communications Satellites for the 1970's: Technology, edited by Nathaniel E. Feldman and Charles M. Kelly. MIT Press, Cambridge, Mass. 614 pp. \$18.50, 1971.

Volume 25 in the series "Progress in Astronautics and Aeronautics, this is a collection of technical papers selected from the AIAA Third Communications Satellite Systems conference held in 1970

How to Prepare a Production Budget for Film and Video Tape, by Sylvia Allen Costa. Tab Books, Blue Ridge Summit, Pa. 192 pp. \$12.95, 1973.

Chapters on estimating, studio costs, equipment, raw stock, lab charges, sound, production personnel, talent, scenic elements, location expenses, etc.

The Invisible Resource: Use and Regulation of the Radio Spectrum, by Harvey J. Levin Johns Hopkins Press, Baltimore. 432 pp. \$12, 1971.

The book is divided into four parts. One, the spectrum system—including the major users of the spectrum. Two, alternatives in the allocation and management of the spectrum. Three, the level of spectrum development. Four, examining the potential of competition as a means of preserving resources of the spectrum.

The Radio Amateur's Handbook 1972, edited by Doug DeMaw. American Radio Relay League, Newington, Conn.

This is the 49th edition of the widely used guide.

Radio Handbook, by William I. Orr, Editors and Engineers Ltd., Howard W. Sams & Co., New Augusta, Ind. 896 pp. \$13.50, 1970.

Though chiefly aimed at the radio amateur, this work would interest anyone dealing with shortwave communication. This is the 18th edition.

The Spaghetti City Video Manual, by Videofreex. Praeger Publishers, New York. 116 pp. \$7.95.

Considering that the authors specialize in non-Establishment television, this is a relatively straight technical manual that's designed for those working their way up from the bottom in television, as opposed to working their way down from more sophisticated technology. The core of its wisdom is how to operate, and keep operating, half-inch videotape equipment.

The Technique of Lighting for Television and Motion Pictures, by Gerald Millerson. Hastings House, New York 366 pp. \$17.95, 1972.

Includes drawings and photos (8-pages in color) and chapters on lighting, the eye and the visual world, tools of lighting, portraiture, television techniques, effects and the like.

The Technique of Special Effects Cinematography, by Raymond Fielding. Hastings House, New York. 425 pp. \$18.50, 1972.

Books

Revision and expansion of 1965 encyclopedia is illustrated with 283 photos and 41 diagrams. Chapters deal with techniques available, camera equipment, glassshots, mirror-shots, in the camera matte shots, printing, rear projection, front projection and miniatures.

Management, Production and Techniques

Accounting Manual for Broadcasters, edited by the Institute for Broadcasting Financial Management, Suite 308, 360 N. Michigan Ave., Chicago 60601. \$20, 1972.

Indexed heavy duty sheets in vinyl-covered hard binder. Prepared in cooperation with Ernst & Ernst. 50 pages text and guidelines, plus financial reporting forms. Covers depreciation and amortization, intangible assets, film contracting accounts, operating income accounts, accrued music license fees.

An Alphabetical Guide to Motion Picture, Television and Videotape Production by Eli L. Levitan. McGraw Hill Book Co., New York. \$24.50, 1970.

This all-inclusive practical source of information about every facet of film and tape production is an essential tool of the trade for everyone associated with communication. It should become a basic text as well for the student and teacher. Well illustrated.

AM/FM Broadcast Station Planning Guide, by Harry A. Etkin. Tab Books, Blue Ridge Summit, Pa. 192 pp. \$12.95, 1970.

Chapters are offered on planning, frequency search and channel allocation, preparing engineering data for Form 301, basic floor plans, transmitter plant, wire and power needs, towers and antenna systems, studio and monitoring equipment, program automation, mikes, preventive maintenance tips, proof-of-performance tests and description of some sample operations. Many diagrams accompany the text.

Broadcast Management, by Ward L. Quaal and Leo A. Martin. Hastings House, New York. 251 pp. \$8.95, 1968.

A comprehensive study of the management of radio and television in America by two leading experts. Part of a series.

Broadcasting and Bargaining: Labor Relations in Radio and Television, edited by Allen E. Koenig, University of Wisconsin Press, Madison. 344 pp. \$8, 1970.

Total of 22 authors explore that aspect of broadcasting too long left only to personal conversation.

Business of Radio Broadcasting, by Edd Roulff. Tab Books, Blue Ridge Summit, Pa. 400 pp. \$12.95, 1972.

Divided into six major divisions the book covers the role of the station in the community, sales, programing, administration, technical operations, legal aspects including licensing, fairness etc.

Case Studies in Broadcast Management by Howard W. Coleman. Hastings House, 95 pp. \$4.95, 1970.

Studies of 13 radio and television station management decisions taken from actual experience.

Designing & Maintaining the CATV & Small TV Studio, by Kenneth Kenech. Tab Books, Blue Ridge Summit, Pa. 252 pp. \$12.95, 1972.

Writing in non-technical terms although dealing with technical subjects this is a helpful book for those entering this field with little experience. Chapters include study of the studio pulse system, switching systems and video effects, cameras and lighting equipment, RF and video monitors, video terminals, distribution systems, audio mixing consoles, audio program sources, maintenance shop etc.

Guide to Understanding Broadcast License Applications and Other FCC Forms, by Ralph M. Jennings. Office of Communication of United Church of Christ, 289 Park Ave., South, New York 10010.

An explanation of the basic tenets of license granting including special attention to Section IV, the program statement, intended for both broadcasters and for those who file competing license applicants, it is a detailed simplification of a critical process.

Modern Radio Station Practices, by Joseph S. Johnson and Kenneth K. Jones. Wadsworth, Belmont, Calif. 268 pp. \$7.95, 1972.

Books

includes 14 station profiles that provide an in-depth analysis of different kinds of stations in varied markets as examples of lessons discussed in earlier portions of the books.

The Technique of the Film Cutting Room by Ernest Walter, Hastings House, New York. 282 pp. \$11.50, 1970.

A book for motion picture professionals by a professional.

The TV Director/Interpreter by Colby Lewis, Hastings House, New York. 225 pp. \$8.95, 1969.

The Michigan State University professor gives practical explanation of the role of the TV director.

Video Tape Production and Communication Techniques, by Joel Lawrence Efrein. TAB Books, Blue Ridge Summit, Pa. 17214. 256 pp., 125 illus. \$12.95, 1971.

A TV tape production handbook covering lighting, graphics, sets and props, sound, direction, editing, dubbing-duplicating of tape copies, elements of program production etc.

CATV

CATV: A History of Community Antenna Television, by Mary Alice Mayer Phillips, Northwestern University Press, Evanston, Ill. 209 pp. \$9.75, 1972.

Examines the regulatory aspects of cable on the national, state and municipal levels. Divided into three parts, the first offers an examination of a few selected cable systems in the 40's and 50's; the second traces federal regulation of cable, and the third examines the probable future of the CATV industry.

Cable Television, a 10-volume series published by the Rand Corp., 1700 Main St., Santa Monica, Calif. 90406. Titles are listed individually below. Each may be obtained from the Santa Monica address.

Cable Television: Applications for Municipal Services, by Robert K. Yin, Rand Corp. 43 pp., \$3, 1973.

Includes sections on operating a single municipal channel, cable characteristics relevant to municipal applications and a review of such applications.

Cable Television: A Guide for Education Planners, Rand Corp. 89 pp. \$4, 1973.

A more technical discussion than the volume by the same author listed above, this book has sections on

cable as a means of distribution, overview of implementing a system using cable, planning an in-school and an out-of-school project and development and operation of each.

Cable Television: A Guide to Federal Regulations, by Steven R. Rivkin, Rand Corp. 1700 Main St., Santa Monica, Calif. 90406. 343 pp. \$6 paper, 1973.

An analysis of federal laws and regulations that apply to cable television. Includes explanation of the six key federal regulatory areas—carriage of television, program exclusivity and copyright, cablecasting and channel capacity, role of state and local authorities, technical standards and operating requirements. Also included are a number of important cable legal cases, key FCC forms etc.

Cable Television: A Guide to the Technology, by Carl Pilnick and Walter S. Baer, Rand Corp. 65 pp. \$3, 1973.

A discussion of the basic needs for a cable system, capacity of different types of systems, cablecasting, interconnection of systems, two-way communications, technology for new services and technical standards.

Cable Television: Citizen Participation After the Franchise by Monroe E. Price and Michael Botein, Rand Corp., 1700 Main St., Santa Monica, Calif. 90406. 34 pp. \$2 paper 1973.

Certificates of compliance as a pressure point for citizens participation, FCC procedures are described.

Cable Television: Citizen Participation in Planning by Robert K. Yin, Rand Corp., 1700 Main St., Santa Monica, Calif. 90406. 37 pp. \$2, 1973.

A discussion of citizens interest and the actions they may take on proposed cable television.

Cable Television: Making Public Access Effective, by Richard C. Kletter, Rand Corp. 1700 Main St., Santa Monica, Calif. 90406. 74 pp. \$3, 1973.

Mr. Kletter deals with the promise of public access, limitations of FCC rules on the access issue, organizing for public access, models for access, programing costs and equipment and final summary suggestions.

Cable Television: The Process of Franchising, by Leland L. Johnson and Michael Botein, Rand Corp., 1700 Main St., Santa Monica, Calif. 90406. 97 pp. \$3.

Divides the process of franchising into ten steps with detail on terms and conditions of franchise.

Cable Television: Technical Considerations in Franchising Major Market Systems, by Carl Pilnick, Rand Corp., 1700 Main St., Santa Monica, Calif. 90406. 76 pp. \$3 paper, 1973.

Why technical factors are important to the franchising process.

Cable Television: Uses in Education, by Polly Carpenter, Rand Corp. 57 pp. \$3, 1973.

Discusses the potential of cable for education, barriers to the use of TV in education and the educator's stake in the cable franchise.

Cable Television in the Cities: Community Control, Public Access, and Minority Ownership, edited by Charles Tate, The Urban Institute, 2100 M St., N.W., Washington. 184 pp. \$3.95 paper, 1972.

Aimed at getting the community involved in operations and policies of cable this book tells about commercial control of CATV, local origination problems and prospects, municipal regulations, minority opportunities etc.

Cable Television and the FCC: A Crisis in Media Control, Temple University Press, Philadelphia. 289 pp. \$7.95, 1973.

A study of the development of cable and of the approaches to cable regulation.

Cable Television U.S.A.: An Analysis of Government Policy, by Martin H. Seiden, Praeger Special Studies. 253 pp. \$16.50, 1972.

The author of an economic analysis of cable published by the FCC in 1965 now criticizes its efforts in that field describing his study as "an analysis and detailed description of how the FCC has altered the concept of governmental regulation by involving itself unnecessarily in the innermost workings of a minor part of the communications industry." A detailed description of the FCC's steps toward CATV regulation presented from the partisan viewpoint of the writer.

On the Cable, the Television of Abundance, Report of the Sloan Commission on Cable Communications' 18-month study, McGraw-Hill Book Co., New York. 272 pp. \$7.95 cloth, \$2.95 paper, 1972.

The study analyzes cable TV and shows that it is much more than an extension of conventional TV—it is a brand new communications complex. The report compares cable's potential impact on the communications industry to the invention of the printing press and the telephone.

The Wired Nation: The Electronic Communications Highway, by Ralph Lee Smith, Harper Colophon Books, New York. 128 pp. \$1.95 paper 1972.

Covers the definition of cable, rise of CATV, role of regulation, effect on and part played by AT&T and local community action.

You
belong
in
Broadcasting

Schools Specializing in Radio-TV

Note—This list includes only those schools which specialize in professional or technical courses in broadcasting. Many colleges and universities also offer courses in radio and television. Current information on colleges and universities which offer degrees in radio-TV is covered in a separate listing.

American Broadcasting School: International Latino American Escuela de Locucion: Internacional. 6290 Sunset Blvd., 8th floor, Hollywood 90028. (213)463-5665. Hal Farnell, pres; Hank O'Neill, VP; Phillip Edwards, admin dir; Tito Alvarez, Latin dir.

Courses offered: (In both Spanish and English) radio/TV announcing, production, time sales, broadcast writing, news writing, traffic management, FCC first class license.

Ron Bailie School of Broadcast. 170 Denny Way, Seattle 98109. (206)682-3696. Ronald L. Bailie, pres; James R. Thomas, dir; Nancy O. Becker, registrar.

Colorado Springs 80902: 323 S. Nevada Ave. (303)473-2333.

Denver 80202: 1020 15th St., Suite 4-C. (303)573-1040. Dennis Johnson, dir; Ginger Johnson, registrar.

Phoenix 85004: 2303 N. Central. (602)258-2930. Mike Scott, dir; Camille Tyra, registrar; Tom Summers, electronics dir.

Portland, Ore. 97205: 949 S.W. Oak St. (503)222-1400. Harley Youngblood, dir.

Salt Lake City 84111: 364 S. State St. (801)355-3632. Paul Droubay, dir; La Rae Meier, registrar.

San Diego 82112: Box 14. (714)233-1170. San Jose: Brian Van Hovel, dir.

San Francisco: 420 Taylor. (415)441-0707. Del Chapman, dir; Lexie Rosbary, registrar; Bruce R. Black, electronics dir.

Spokane, Wash. 99202: East 2022 Sprague. (509)MA4-6878. Bob Summers, dir; Gena Wikstrom, registrar.

Courses offered: Announcing-production-copywriting and FCC license preparation.

Bell & Howell Schools. (Administrative offices for home study and resident schools) 209 West Jackson Blvd., Chicago 60606. (312)939-8200. L.D. Dunlap, pres; W.C. Carson, exec VP educ; T.L. Hammond, VP student affairs; J.J. Gershon, senior VP accreditation & state govt relations; D.L. Walls, VP dir resident school opns; S. Cohen, VP sls; D. MacFarlane, natl dir of admissions; G. Dean, dir electronic prog develop & home study ed.

Chicago 60641: DeVry Institute of Technology (home study), 4141 W. Belmont Ave. W.C. Carson, exec VP.

Chicago 60618: DeVry Institute of Technology (resident), 3300 N. Campbell. S.R. Edmonds, pres; R. Renor, dean of faculty; G.A. Murphy, dean of students; R. Allwood, dir of admissions.

Atlanta 30308: DeVry Institute of Technology, 828 W. Peachtree St. N.W. K.H. Breeden, pres; H.B. Overton, dean of faculty; P. Shearer, dean of students; J.W. Hull, dir of admissions.

Dallas 75235: DeVry Institute of Technology, 5353 Maple Ave. D.A. Jerr, pres; J.R. Swann, dean of students; M. Schledorn, dir of admissions.

Phoenix 85016: DeVry Institute of Technology, 4702 N. 24th St. R. Hess, pres; D.H. Aughinbaugh, dean of students; A.L. Geiger, dir of admissions.

Woodbridge, N.J. 07095: DeVry Technical Institute, 479 Green Street. G.C. Kiesel, pres; R. Chruslinsky, dean of faculty; R.M. Bocchino, dean of students; G. Vance, dir of admissions.

Columbus, Ohio 43209: Ohio Institute of Technology, 1350 Alum Creek Dr. R.A. Czerniak, pres; M. Forrest, dean of faculty; J.B. Ganz, dean of students; K. Suid, dir of admissions.

Kansas City, Mo. 64108: Missouri Institute of Technology, 1644 Wyandotte St. C.R. LeValley, pres; E. Wilson, dean of faculty; T. Davison, dean of students; J. Coon, dir of admissions.

Toronto 19: DeVry Institute of Technology, 970 Lawrence Ave., West. P. Dykstra, pres; D.P. Charran, dean of faculty; M. Maskowitz, dean of students; J. Williams, dir of admissions.

Courses offered: Resident school programs in radio, TV, communications, computer electronics and automation systems. Home study programs in

electronic communications, digital industrial electronics, home entertainment electronics systems, audio technology.

Broadcast Training Center, d/b as Announcer Training Studios. 152 W. 42nd St., New York 10036. (212)221-3700. Morris Brownstein, pres; Moya Phillips, dir.

Courses offered: Radio announcing, programing and production for newscasters, sportscasters, disk jockeys and staff announcers. FCC 1st class license preparation.

Broadcasting Institute of America Inc. 3230 Patterson Dr., New Orleans 70114. (504)362-4624. Joseph M. Costella III, admin dir; Todd Bauer, instructor.

Courses offered: Professional radio and TV broadcasting, 390 hours of instruction, 30 hours per week, for 13 weeks, in music formats, programing, announcing, console operations, news, continuity and traffic. Third phone license preparation. Lifetime placement service for graduates. Subsidiary of WRNO New Orleans.

Brown Institute. 3123 E. Lake St., Minneapolis 55406. (612)721-2481. Richard C. Brown, dir; John MacKnight, dir of bcstg division.

Fort Lauderdale, Fla.: 111 N.E. 44th St. Ty Mack, dir. Courses offered: 800 hours of training in all phases of broadcasting including disc jockey, news, sports, sp events, sales, writing, stn mgt. Twelve sets of studios occupying four buildings. Complete TV training studios. First class FCC license.

Career Academy International Headquarters. 611 E. Wells St., Milwaukee 53201. (414)272-4822. Malcolm Houghton, pres.

Atlanta 30309: 2045 Peachtree Road. (404)351-1550. Sandra Lockwood, administrator.

Boston 02215: 70 Brookline Ave. (617)536-6662. Doug Springman, administrator.

Columbus, Ohio 43215: 71 S. High St. (614)221-4481. C.J. Harris, administrator.

Houston 77002: 1221 Pierce St. (713)222-1224. Larry Nero, administrator.

Milwaukee 53201: 825 N. Jefferson St. (414)271-0300. Seymour Koltin, administrator.

Washington 20007: 2233 Wisconsin Ave. (202)965-5100. Fred Busch, administrator.

Toronto: 8 King St. E. (416)363-6914. James McSween, administrator.

Courses offered: Training includes interpretive commercial announcing, newscasting, disc jockeying, sportscasting and play-by-play, diction, pronunciation, and vocabulary, programing and timing, interviews, speech, emceeing, panel shows, special events coverage, news and commercial writing, FCC third class license, radio code, international reporting, farm news. Complete home study course also available.

Carolina School of Broadcasting. 516 Fenton Place, Charlotte, N.C. 28207. (704)376-1619. William A. Vaughn, dir; Susan B. Hedrick, dir.

Courses offered: Two eight-month courses: Broadcasting—non-technical; and combination broadcasting (in-station training plus group sessions). Announcing, production, copywriting, news, commercial production, sales, administration, job placement. In either course, "Group Sessions" two nights per week or Saturdays for 35 weeks. Optional in-station training: full or part time for indefinite number of months as determined by station and student. Closed-circuit TV facilities and stereo control room. Residential training in studio and station operations at commercial radio and TV stations in N.C., S.C., Va., and Tenn.

Central Institute of Technology. 1644 Wyandotte St., Kansas City, Mo. 64108. (816)421-5852. FR. Hess, pres; E.A. Wilson, dean of faculty; D.I. Mills Sr., dean of students; H.D. Van Sickle, dean of financial affairs.

Courses offered: Assoc degree in electronic engineering technology, 108 weeks; bachelor of electronics engineering technology, 144 wks; electronics technician program, 72 wks.

Cleveland Institute of Electronics. 1776 E. 17th St., Cleveland 44114. (216)781-9400. G.O. Allen, pres; Dr. B. Pfeifer, exec VP; J. Snediker, VP industrial dir.

Courses offered: Broadcast engineering, first class FCC license, electronics engineering and ten additional home study electronics career courses.

Columbia College. 925 N. LaBrea Ave., Hollywood 90038. (213)851-0550. Ernest M. Baumeister, pres; Joseph Bluth, chmn of bd; Andre F. Stojka, dean, department of cinema; Bruce H. Shoemaker, dir of admissions. Board of trustees: Robert F. Lewine, Gail Patrick Jackson, Dr. Frank Baxter, David Nowinson,

Schools

Andre F. Stojka.

Courses offered: A four-year non-profit degree-granting institution. Undergraduate and graduate studies offered in all aspects of broadcasting. Courses include TV prod., TV camera operation, video-tape recording, FCC license, announcing, writing, acting, entertainment law, stn administration, cinematography, film editing, lighting, TV stn operation, film prod, TV directing, market rsch, news reporting, journalism, adv, PR, cable TV, video control, documentary film prod.

**Television and
Motion Picture Production
COLUMBIA COLLEGE**
925 N. LaBrea Ave.
Los Angeles, Calif. 90038
Phone: (213) 851-0550

Columbia School of Broadcasting. 1902 Van Ness Ave., San Francisco 94109. (415)441-5700. Sullivan Barnes, pres; Roy E. Gruenwald, Senior VP; Walter D. Rogers, VP financial; Richard Good, admin dir & placement dir; William S. Dodd, dir of instruction-radio announcing course; Ralph Holmstad, dir of instruction-radio-TV coml writing course.

Anchorage 99510: Box 1801. (907)274-2222.

Atlanta 30309: Peachtree Palisades West Bldg., 1800 Peachtree Road N.W., Suite 814. (404)351-9100.

Babylon, N.Y. 11704: WBAB Radio Bldg., Route 109. (516)661-4000.

Carlsbad, Calif. 92008: c/o KARL-FM, Box 949. (714)729-7955.

Cincinnati 45203: Holiday Park Tower, Bldg. C, 644 Linn St., Suite 127. (513)721-0066.

Cleveland 44115: 3101 Euclid Ave., Suite 309. (216)431-5750.

Colorado Springs 80906: 2860 S. Circle Drive, Suite 414, Garden Valley Center. (303)576-1870.

Dallas 75207: 311 Stemmons Tower South. (214)634-9880.

Denver 80206: Box 6285. (303)399-6400.

Hollywood 90028: 6565 Sunset Blvd. (213)469-1677.

Honolulu 96813: 677 Ala Moana Blvd., Suite 605. (808)521-1811.

Houston 77006: 3777 Kirby Drive. (713)529-4711.

Indianapolis 46205: 3969 Meadows Drive, Suite 103. (317)542-1211.

Jacksonville, Fla. 32202: 233 W. Adams St., Florida National Bank Bldg. (904)356-8351.

Kansas City, Mo. 64111: 4140 Broadway. (816)756-0777.

Memphis 38117: 5050 Poplar Ave., Suite 1500. (901)682-0606.

Minneapolis 55402: WCCO Bldg., Suite 103, 625 Second Ave. S. (612)332-4441.

Philadelphia: 6784 Market St., Upper Darby, Pa. 19082. (215)734-1710.

Phoenix 85016: 5251 N. 16th St., Suite 311. (602)264-9967.

Pittsburgh 15220: Seven Parkway Center, Suite 105. (412)922-8010.

Portland, Ore. 97205: 1219 SW Main St., Suite A. (503)222-3511.

San Diego 92101: 4111 Broadway. (714)238-1700.

San Francisco 94109: 1902 Van Ness Ave. (415)441-5700.

Seattle 98121: 2200 Sixth Ave., Suite 1. (206)623-2800.

Sioux Falls, S.D. 57102: Box 585. (605)338-4551.

Washington 20014: 7315 Wisconsin Ave., Suite 300W. (301)656-4707.

Courses offered: Radio announcing and radio-TV commercial writing course.

Connecticut School of Broadcasting Inc. 750 Main St., Hartford, Conn. 06103. (203)232-9988. Dick Robinson, pres; Jeff Menzel, dir.

Stratford, Conn. 06497: 2874 Main St. (203)378-5155. Dick Robinson, pres; Mike Beringer, dir.

Courses offered: History of communications, copywriting, broadcast performance, broadcast management, control room procedures, FCC regulations, news, production, sales.

Schools, Universities

Continental Broadcasting Academy. 12 Irving St. Framingham, Mass. 01701. (617)237-0568. Herbert A. Black II, pres; Daniel Flynn, bursar and gen mgr. Courses offered: Radio-TV announcing.

Elkins Institute. 2727 Inwood Road, Dallas 75235. (214)357-4001. Bill Elkins, chm of bd; B.B. Elkins, pres; Charles Feistkorn, VP opns; Leonard Hancock, course dev & training svpr.

Atlanta 30309: 51 Tenth St. at Spring N.W. (404)872-8844. Phil Eastabrooks.

Dallas 75235: 2603 Inwood Road. (214)350-1211. Frank Elkins.

Denver 80209: 420 S. Broadway. (303)744-7311. Bill Berry.

Hartford 06118: 800 Silver Lane. (203)568-1110. Ed Gleason.

Houston 77002: 3518 Travis. (713)526-7637. Ralph Cousins.

Memphis 38104: 1362 Union Avenue. (901)726-9762. Gil Gilbert.

Minneapolis 55406: 4103 East Lake Street. (612)721-1687. Vic Kissal.

Nashville 37204: 2106-A Eighth Avenue, South. (615)297-5396. Ed Gleason.

New Orleans 70119: 2940 Canal. (504)822-7510. Nick Alfonso.

Oklahoma City 73105: 501 N.E. 27th Street. (405)521-1426. Rick Buttrum.

San Antonio 78204: 503 South Main. (512)223-1848. Clyde Wilson.

Courses offered: 8-week theory and laboratory training in radio, TV, electronics, terminated by acquisition of a 1st class radio telephone FCC license; 16-week course in fundamental broadcasting encompassing announcing, scriptwriting, sportscasting, newscasting, control room operation, recording, programming, production, voice training; 24-week course in radio and television repair with emphasis on color TV and solid state circuitry; 48-week electronic technician course covering theory and lab work in basic electricity, power control and servomechanisms, logic and computer circuits and communications; 25-week course in professional photography including basic black and white photography, color photography, news and accident photography, black and white and color lab work and industrial photography.

Grantham Electronics Institute. 5884 Leesburg Pike, Falls Church, Va. 22041. (703)820-4417. Claude C. Miller, dir.

Courses offered: Communications electronics.

Grantham School of Engineering. 2000 Stoner Ave., Los Angeles 90025. (213)477-1901. Donald J. Grantham, pres; W.I. Denny, dean of students; John J. Dulin, dean of faculty.

Courses offered: Electronics engineering by correspondence and communications electronics by correspondence.

ICS School of Electronics. ICS Division of INTEXT. Scranton, Pa. 18515. (717)342-7701. Joseph A. Risse, dir of electronics curriculum; Edward A. Skies, asst dir; Robert Donovan, VP, education.

Courses offered: FCC licenses, practical radio and TV engineering, cable TV installer, telephone technology, communications technology, radio, TV-hi-fi servicing; industrial electronics, writing, sales advertising, and accounting, special custom tailored courses for industry and bcstg.

Institute of Broadcast Arts. 75 E. Wacker Dr., Chicago 60601. (312)236-8105. Arthur J. Mansavage, pres, dir; Mary M. Mansavage, VP; Daniel J. Baran, asst dir; Joe Edwards, education dir.

Milwaukee 53216: 4730 W. Fond du Lac Ave. (414)445-3090. Terry L. Mansavage, sec-treas; Barbara Du Bois, administrative asst; James Kagan, education dir.

Courses offered: Day and evening classes available for a total of 12½ hrs per week. Ten month "Licensed Broadcaster" course: Board & prod, commercials, format, sports & interviewing, news, sales & management, TV, FCC first class radiotelephone licensing.

J-R Radio Announcer School. Box 356, Salem, Ohio 44460. (216)337-7930. Roger H. Luscombe, owner, instructor.

Courses offered: Private and classroom in-person training in private studio. Correspondence course, 3rd class FCC license preparation, fundamentals of delivery, articulation, pronunciation, ad libbing, interviewing, writing and editing of news, writing commercials,

program log, commercial production, disk jockey practice.

Kansas Midwestern School of Broadcasting. 1726 South Seneca, Wichita, Kan. 67213. (316)267-2891. Tony L. Creamer, pres, gen mgr; Bruce Bertsch, asst mgr; Roger L. McFerrin, student dir.

Courses offered: Phase I, broadcast orientation; Phase IA, on-air station operation; Phase II, news gathering, writing, editing and reporting; Phase III, sports, play by play, casting and reporting; Phase IV, FCC; Phase V, commercial writing and production. Lifetime placement assistance.

Don Martin School of Communications. 5th Floor, 7080 Hollywood Blvd., Los Angeles 90028. (213)462-3281. Howard G. Townsend, pres & dir; Bob J. Gage, dir of operations; Nancy A. Nance, registrar.

Courses offered: Radio prod, TV prod, CATV, electronics, FCC 1st class license, practical transmitter application.

Midwestern Broadcasting School. 228 S. Wabash Ave., Chicago 60604. (312) 922-0712. Fred Robbins, dir.

Courses offered: Radio/television announcing course (day and evening classes) and comprehensive broadcasting course. Includes disk jockey, newscasting, commercials, ad-libbing, copy writing, sportscasting, programming, station routing, producing/directing, time selling, control board operation, microphone techniques, diction, vocabulary building, station management, FCC regulations.

National Institute of Communications. 11488 Oxnard St., North Hollywood, Calif. 91606. (213)980-5212. Henry C. Kurn, dir; Kenneth E. Roberts, dir admissions.

Courses offered: Broadcast arts, FCC 1st class license.

National Radio Institute. 3939 Wisconsin Ave., Washington 20016. (202)244-1600.

New School for Social Research. 66 W. 12th St., New York 10011. (212)741-5600. Dr. John R. Everett, pres; Dr. Harry D. Gideonse, chancellor; Allen Austill, dean; Dr. Joseph J. Greenbaum, dean, the graduate faculty; Howard L. Levine, dir PR.

Courses offered: TV writing workshop, writing for TV, films and radio; TV production workshop; voice and speech for theater and TV; seminars on TV commercials; and writing television commercials.

Northeast Broadcasting School. 282 Marlboro St., Boston (617)267-7910.

Courses offered: Programs in disc jockeying, announcing, newscasting, TV production and directing.

Northwest Schools. 1221 N.W. 21st Ave., Portland, Ore. 97209. (503)226-4811. W.A. Sawyer, pres.

Courses offered: Radio-TV announcing.

Northwestern Electronics Institute. 3800 Minnehaha Ave., S., Minneapolis 55406. (612)721-2469. C.L. Larson, pres.

Courses offered: Associate in electronics technology degree, computer technician, radio-television, industrial electronics technician, digital electronics specialists, electronics technician, television specialist, certificate programs.

Omega State Institute (division of Omega Services Inc.) Box 11500, Chicago 60611. (312)649-0927. Eric Thurman, pres; James Ehrhart, educational dir; Linda McIntyre, financial aid; John Kiley, placement dir; Glen Visser, sales mgr.

Courses offered: Electives from four subject categories: engineering (including training for FCC first class license); sales; business operations (such as commercial traffic); programming (including air talent work, radio and TV production, and electronic news gathering). Nationwide placement. Licensed by Illinois Office of Education. Approved for veterans.

Phoenix College. 1202 W. Thomas Rd., Phoenix 85013. (602)253-6108. Donald J. Richardson, professor of mass communications.

Courses offered: Fundamentals of radio-TV, introduction to broadcast engineering, radio-TV announcing, broadcast advertising & continuity writing, broadcast sales (radio & TV), cooperative education in broadcasting (internship), radio news, broadcast engineering (FCC first class license), radio programming, broadcast production, broadcast station management.

Leland Powers School of Radio, Television & Theatre Inc. 452 Beacon St., Boston 02115. (617)247-1300. Donald V. Baker III, pres; Robert Johnston, exec dir.

Courses offered: Radio-TV announcing, writing, production, newscasting, sales, sports, speech, television acting, theatre, stage acting, make up, movement, directing, script writing.

Radio Engineering Inc. Schools. 61 N. Pineapple Ave., Sarasota, Fla. 33577. (813)955-6922. Dwain Glenn, pres; Joseph A. Shields, VP.

Fredericksburg, Va. 22401: 2402 Tidewater Trail. (703)373-1441.

Courses offered: FCC license training, radio announcing.

School of Broadcasting and Announcing. 1697 Broadway, Suite 607, New York 10019. (212) Circle 5-2640. Michael Woloson, dir.

Courses offered: Disk-jockey, newscasting, announcing, combo operation, TV commercials, TV news, TV weather.

Signal Radio-TV Career School. 2314 Broadway, Denver 80205. (303)255-8667. William S. Pierson, pres & educational dir; Roland Newman, opns mgr & registrar.

Courses offered: Radio-television announcing/station operations. Full course in radio-television performing arts and all facets of commercial radio and television station operations. Live audio and video studios and production facilities.

Technical Career Institutes. 320 W. 31st St., New York 10001. (212)594-4000. Samuel Steinman, pres; Nathan Buch, dir.

Courses offered: Electronics technology, electronics circuits and systems, radio-television and electronics servicing, air conditioning and refrigeration, radio-television receivers, color TV, communications electronics and FCC license, home and auto air-conditioning and refrigeration.

Television Studio School of New York (formerly RCA Institutes). 1600 B'way, New York 10019. (212)541-6238. Murray Dick, dir.

Courses offered: TV production, directing, & studio operation.

Valparaiso Technical Institute (station WVTI). Box 490 (Center St.), Valparaiso, Ind. 46383. (219) 462-2191. G. Edward Hershman, pres; Arthur L. Hershman, VP; R. Cloid Patton, dean of engineering.

Courses offered: In the fields of guided missiles, computers, microwaves, communications, industrial electronics, space satellites, atomic energy, solid state electronics, medical electronics, automation, basic and advanced programs leading to an Associate and B.S. degree in engineering electronics.

Bill Wade School of Radio and Television. 7080 Hollywood Blvd., Suite 711, Hollywood 90028. (213)463-5665. Owned and operated by Creative Broadcast Services Inc. Tom Schaefer, pres; Ed Wickey, VP; Gerald B. Hassman, admin dir.

Courses offered: Radio and television announcing, production and sales and FCC first-class license (through correspondence).

Colleges and Universities

Colleges offering degrees in broadcasting

Schools are listed in alphabetical order by state.

Alabama

Alabama, U. of; University Ala. 35486. BA-MA.
Auburn U.; Auburn, Ala. 36830. BA-MA.

Alaska

Alaska, U. of; Fairbanks, Alaska 99701. BA.

Arizona

Arizona State U.; Tempe, Ariz. 85281. BA.
Arizona U.; Tucson, Ariz. 85721. BA.
Northern Arizona U.; Flagstaff, Ariz. 86001. BA.

Arkansas

Arkansas State U.; Jonesboro, Ark. 72401. BA.

John Brown U.; Siloam Springs, Ark. 72761. BA.

California

California Institute of the Arts; Valencia, Calif. 91355. BA-MA.
California Polytechnic State U.; San Luis Obispo, Calif. 93407. BA.
California State U., Chico; Chico, Calif. 95926. BA.
California State U., Fresno; Fresno, Calif. 93740. BA-MA.
California State U., Fullerton; Fullerton, Calif. 92634. BA-MA.
California State U., Long Beach; Long Beach, Calif. 90840. BA.
California State U., Los Angeles; Los Angeles 90032. BA.
California State U., Northridge; Northridge, Calif. 91324. BA-MA.
California State U., Sacramento; Sacramento, Calif. 95819. BA.
San Diego State U.; San Diego 92115. BA-MA.
San Francisco State U.; San Francisco 94132. BA-MA.
San Jose State U.; San Jose 95192. BA-MA.
Southern California, U. of; Los Angeles 90007. BA-MA.
Stanford U.; Stanford, Calif. 94305. BA-MA-PhD.
UCLA; Los Angeles 90014. BA-MA.

Colorado

Colorado State U.; Fort Collins, Colo. 80521. BA-MA.
Colorado, U. of; Boulder, Colo. 80302. BA-MA-PhD.
Denver, U. of; Denver 80210. BA-MA.
Southern Colorado State College; Pueblo, Colo. 81001. BA.

Connecticut

Bridgeport, U. of; Bridgeport, Conn. 06602. BA-MA.

Delaware

Delaware, U. of; Newark, Del. 19711. BA-MA.

District of Columbia

American U.; Washington 20016. BA-MA.
Howard U.; Washington 20001. BA.

Florida

Florida State U.; Tallahassee, Fla. 32306. BA-MA-PhD.
Florida Technological U.; Orlando, Fla. 32816. BA-MA.
Florida, U. of; Gainesville, Fla. 32611. BA-MA.
Miami, U. of; Coral Gables, Fla. 33124. BA.
South Florida, U. of; Tampa, Fla. 33620. BA.
West Florida, U. of; Pensacola, Fla. 32504. BA-MA.

Georgia

Clark College; Atlanta, Ga. 30314. BA.
Georgia, U. of; Athens, Ga. 30602. BA-MA.

Hawaii

Hawaii, U. of; Honolulu 96822. BA.

Idaho

Idaho State U.; Pocatello, Idaho 83201. BA.
Idaho, U. of; Moscow, Idaho 83843. BA.

Illinois

Eastern Illinois U.; Charleston, Ill. 61920. BA.
Illinois State U.; Normal, Ill. 61761. BA.
Illinois, U.; Urbana, Ill. 61801. BS-MS.
Northern Illinois U.; DeKalb, Ill. 60115. BA-MA.
Northwestern U.; Evanston, Ill. 60201. BA-MA-PhD.
Southern Illinois U.; Carbondale, Ill. 62901. BA-MA.
Southern Illinois U.; Edwardsville, Ill. 62025. BA-MA.
U of Illinois, Chicago Circle; Chicago 60680. BA-MA.
Western Illinois U.; Macomb, Ill. 61455. BA-MA.
Wheaton College; Wheaton, Ill. 60187. BA-MA.

Indiana

Ball State U.; Muncie, Ind. 47306. BA-MA.
Butler U.; Indianapolis, Ind. 46208. BA-MA.
Evansville, U. of; Evansville, Ind. 47702. BA.
Indiana State U.; Terre Haute, Ind. 47809. BA-MA.
Indiana U.; Bloomington, Ind. 47401. BA-MA-PhD.
Purdue U.; West Lafayette, Ind. 47907. BA-MA-PhD.

Iowa

Drake U.; Des Moines, Iowa 50311. BA.
Iowa State U.; Ames, Iowa 50010. BA-MA.
Iowa, U. of; Iowa City Iowa 52242. BA-MA-PhD.
Northern Iowa, U. of; Cedar Falls, Iowa 50613. BA.

Kansas

Fort Hays Kansas State College; Hays, Kan. 67601. BA.
Kansas State U.; Manhattan, Kan. 66506.
Kansas, U. of; Lawrence, Kan. 66045. BA-MA-PhD.
Washburn U.; Topeka, Kan. 66621. BA.
Wichita State U.; Wichita, Kan. 67208. BA.

Kentucky

Eastern Kentucky U.; Richmond, Ky 40475. BA.
Kentucky, U. of; Lexington, Ky. 40506. BA-MA.
Murray State U.; Murray, Ky. 42071. BA-MA.
Western Kentucky U.; Bowling Green, Ky. 42101. BA.

Louisiana

Grambling State U.; Grambling, La. 71245. BA.
Louisiana State U.; Baton Rouge 70803. BA-MA-PhD.
Loyola U.; New Orleans 70118. BA-MA.
Northeast Louisiana U.; Monroe, La. 71201. BA.
Southwestern Louisiana, U. of; Lafayette. La. 70501. BA-MA.

Maine

Maine, U. of; Orono, Me. 04473. BA.

Maryland

Maryland, U. of; College Park, Md. 20742. BA-MA.
Towson State College; Baltimore 21204. BA.

Massachusetts

Boston U.; Boston 02215. BA-MA.
Emerson College; Boston 02116. BA-MA.
Massachusetts, U. of; Amherst, Mass. 01002. BA-MA-PhD.

Michigan

Central Michigan U.; Mt. Pleasant, Mich. 48859. BA-MA.
Detroit, U. of; Detroit 48221. BA.
Eastern Michigan U.; Ypsilanti, Mich. 48197. BA-MA.
Michigan State U.; East Lansing, Mich. 48824. BA-MA-PhD.
Michigan, U. of; Ann Arbor, Mich. 48104. BA-MA-PhD.
Northern Michigan U.; Marquette, Mich. 49885. BA.
Wayne State U.; Detroit 48202. BA-MA-PhD.
Western Michigan U.; Kalamazoo, Mich. 49008. BA-MA.

Minnesota

Bemidji State College; Bemidji, Minn. 55601. BA.
Minnesota, U. of; Duluth, Minn. 55812. BA.
Minnesota, U. of; Minneapolis 55409. BA-MA-PhD.

Mississippi

Mississippi State U.; Mississippi State, Miss. 39762. BA.
Mississippi, U. of; University, Miss. 38677. BA-MA-Edd-PhD.
Southern Mississippi, U. of; Hattiesburg, Miss. 39401. BA-MA-PhD.

Missouri

Central Missouri State U.; Warrensburg, Mo. 64093. BA-MA.
Lindenwood Colleges; St. Charles, Mo. 63301. BA.
Missouri, U. of; Columbia, Mo. 65201. BA-MA-PhD.
Missouri, U. of; Kansas City, Mo. 64110. BA.
Park College; Suburban Kansas City, Mo. 64152. BA.
St. Louis U.; St. Louis 63103. BA-MA.
Stephens College; Columbia, Mo. 65201. BA.

Montana

Montana State U.; Bozeman, Mont. 59715. BA.
Montana, U. of; Missoula, Mont. 59801. BA-MA.

Nebraska

Creighton U.; Omaha 68178. BA.
Nebraska, U. of; Lincoln, Neb. 68508. BA-MA.
Nebraska, U. of; Omaha 68106. BA-MA.
Wayne State College; Wayne, Neb. 68787. BA.

Nevada

Nevada, U. of; Reno 89507. BA.

New Jersey

Seton Hall U.; South Orange, N.J. 07079. BA.
Trenton State College; Trenton, N.J. 08619. BA.
William Paterson College; Wayne, N.J. 07470. BA-MA.

Colleges, Universities

New Mexico

New Mexico State U.; Las Cruces, N.M. 88003. BA.

New York

Brooklyn College; Brooklyn, N.Y. 11210. BA-MA.
Columbia U.; New York 10027. MA-PhD.
Cornell U.; Ithaca, N.Y. 14850. BA-MA.
Fordham U.; Bronx, N.Y. 10485. BA-MA.
Hofstra U.; Hempstead, N.Y. 11550. BA.
Ithaca College; Ithaca, N.Y. 14850. BA.
Herbert H. Lehman College; Bronx, N.Y. 10468. BA.
New Rochelle, College of; New Rochelle, N.Y. 10801. BA.
New York U.; New York 10003. BA.
Queens College; Flushing, N.Y. 11367. BA-MA.
St. John's U.; Jamaica, New York 11439. BA.
State U. at Brockport; Brockport, N.Y. 14420. BA.
State U. of New York at Geneseo; Geneseo, N.Y. 14454. BA-MA.
State U. of New York at Oswego; Oswego, N.Y. 13126. BA.
State U. of New York at Plattsburgh; Plattsburgh, N.Y. 12901. BA.
Syracuse U.; Syracuse, N.Y. 13210. BA-MA-PhD.

North Carolina

North Carolina, U. of; Chapel Hill, N.C. 27514. BA-MA.
Shaw U.; Raleigh, N.C. 27602. BA.
Wake Forest U.; Winston-Salem, N.C. 27109. BA.

North Dakota

North Dakota, U. of; Grand Forks, N.D. 58201. BA-MA.

Ohio

Akron, U. of; Akron, Ohio 44325. BA-MA.
Ashland College; Ashland, Ohio 44805. BA.
Bowling Green State U.; Bowling Green, Ohio 43402. BA-MA-PhD.
Cincinnati, U. of; Cincinnati, Ohio 45219. BA-MA.
Dayton, U. of; Dayton, Ohio 45409. BA-MA.
Kent State U.; Kent, Ohio 44242. BA-MA.
Marietta College; Marietta, Ohio 45750. BA.
Miami U.; Oxford, Ohio 45056. BA-MA.
Ohio State U.; Columbus, Ohio 43210. BA-MA-PhD.
Ohio U.; Athens, Ohio 45701. BA-MA-PhD.
Otterbein College; Westerville, Ohio 43081. BA.
Wooster, College of; Wooster, Ohio 44691. BA.
Xavier U.; Cincinnati 45207. BA-MA.

Oklahoma

Central State U.; Edmond, Okla. 73034. BA-MA.
Oklahoma City U.; Oklahoma City 73106. BA.
Oklahoma State U.; Stillwater, Okla. 74074. BA-MA-PhD.
Oklahoma, U. of; Norman, Okla. 73069. BA-MA-PhD.
Tulsa, U. of; Tulsa, Okla. 74104. BA.

Oregon

Oregon State U.; Corvallis, Ore. 97331. BA.
Oregon, U. of; Eugene, Ore. 97403. BA-MA-PhD.
Pacific U.; Forest Grove, Ore. 97116. BA.
Southern Oregon College; Ashland, Ore. 97520. BA.

Pennsylvania

Clarion State College; Clarion, Pa. 16214. MA.
Duquesne U.; Pittsburgh 15219. BA.
Geneva College; Beaver Falls, Pa. 15010. BA.
Kutztown State College; Kutztown, Pa. 19530. BA.
Pennsylvania State U.; University Park, Pa. 16802. BA-MA-PhD.
Point Park College; Pittsburgh 15222. BA.
Temple U.; Philadelphia 19122. BA-MA-MFA-PhD.
Westminster College; New Wilmington, Pa. 16142. BA.

South Carolina

South Carolina, U. of; Columbia, S.C. 29208. BA-MA.

South Dakota

South Dakota State U.; Brookings, S.D. 57006. BA.
South Dakota, U. of; Vermillion, S.D. 57069. BA-MA.

Tennessee

Memphis State U.; Memphis 38152. BA-MA.
Southern Missionary College; Collegedale, Tenn. 37315. BA.

Colleges, Universities

Tennessee, U. of; Knoxville, Tenn. 37916. BA-MA-PhD.

Texas

Abilene Christian College; Abilene, Tex. 79601. BA-MA.
Baylor U.; Waco, Tex. 76703. BA.
East Texas State U.; Commerce, Tex. 75428. BA.
Houston, U. of; Houston 77004. BA.
Lamar U.; Beaumont, Tex. 77710. BA.
North Texas State U.; Denton, Tex. 76203. BA-MA-PhD.
Sam Houston State U.; Huntsville, Tex. 77340. BA.
Southern Methodist U.; Dallas 75275. BA-MA.
Texas Christian U.; Fort Worth 76129. BA-MA.
Texas Tech U.; Lubbock, Tex. 79409. BA-MA.
Texas, U. of; Austin, Tex. 78712. BA-MA-PhD.
Texas, U. of at Arlington; Arlington, Tex. 76019. BA.
Texas, U. of at El Paso; El Paso, Tex. 79968. BA.
Texas Woman's U.; Denton, Tex. 76204. BA-MA.
West Texas State U.; Canyon, Tex. 79015. BA.

Utah

Brigham Young U.; Provo, Utah 84601. BA-MA.
Utah State U.; Logan, Utah 84321. BA-MA.
Utah, U. of; Salt Lake City 84112. BA-MA-PhD.
Weber State College; Ogden, Utah 84403. BA.

Vermont

Vermont, U. of; Burlington, Vt. 05404. BA-MA.

Virginia

Hampton Institute; Hampton, Va. 23668. BA.
Madison College; Harrisonburg, Va. 22801. BA.

Norfolk State College; Norfolk, Va. 23504. BA.
Virginia Commonwealth U.; Richmond, Va. 23284. BA.
Washington & Lee U.; Lexington, Va. 24450. BA.

Washington

Eastern Washington State College; Cheney, Wash. 99004. BA.
Washington State U.; Pullman, Wash. 99163. BA-MA.
Washington, U. of; Seattle 98105. BA-MA.
Western Washington State College; Bellingham, Wash. 98225. BA.

West Virginia

Fairmont State College; Fairmont, W. Va. 26554. BA.
Marshall U.; Huntington, W. Va. 25701. BA-MA.
West Virginia U.; Morgantown, W. Va. 26506. BA.

Wisconsin

Marquette U.; Milwaukee 53233. BA-MA.
Wisconsin, U. of-LaCrosse; LaCrosse, Wis. 54601. BA.
Wisconsin, U. of; Madison, Wis. 53706. BA-MA-PhD.
Wisconsin, U. of; Milwaukee 53201. BA-MA.
Wisconsin, U. of-Oshkosh; Oshkosh, Wis. 54901. BA.
Wisconsin, U. of; Platteville, Wis. 53818. BA.
Wisconsin, U. of-Stevens Point; Stevens Point, Wis. 54481. BA-MA.
Wisconsin, U. of-Superior; Superior, Wis. 54880. BA.
Wisconsin, U. of; Whitewater, Wis. 53190. BA.

Wyoming

Wyoming, U. of; Laramie, Wyo. 82071. BA.

Iowa

Iowa Central Community College; Fort Dodge 50501.

Kansas

Barton County Community College; Great Bend 67530.
Garden City Community College; Garden City 67846.

Kentucky

Ashland Community College; Ashland 41101.
Somerset Community College; Somerset 42501.

Maryland

Baltimore, Community College of; Baltimore 21215.
Harford Community College; Bel Air 21014.

Massachusetts

Graham Junior College; 632 Beacon St., Boston 02215.
Mt. Wachusett Community College; Gardner 01440.

Michigan

Delta College; University Center 48710.
St. Clair County Community College; Port Huron 49060.

Minnesota

Duluth Area Vocational Technical Institute; Duluth 55811.
Rochester Community College; Rochester 55901.

Mississippi

Mississippi Gulf Coast Jr. College/Jefferson Davis Campus; Gulfport 39501.

Nebraska

Northeast Nebraska Technical Community College; Norfolk 68701.

North Carolina

Lenoir Community College; Kingston 28501.

New York

Alfred State College; Alfred 14802.
Nassau Community College; Garden City 11530.
Onondaga Community College; Syracuse 13215.
Staten Island Community College; New York 10301.
Suffolk County Community College; Seiden 11784.

Ohio

Ohio U.; Zanesville 43701.

Oregon

Blue Mt. Community College; Pendleton 97801.
Portland Community College; Portland 97219.

Pennsylvania

Penn State U.-Wilkes Barre Campus; Wilkes-Barre 18708.

South Carolina

Tri County Technical College; Pendleton 29670.

South Dakota

Black Hills State College; Spearfish 57783.

Tennessee

Jackson State Community College; Jackson 38301.

Texas

Central Texas College; Lillien 76541.
Odessa College; Odessa 79760.
San Antonio College; San Antonio 78284.

Virginia

Virginia Western Community College; Roanoke 24015.

Washington

Lower Columbia College; Longview 98632.
Yakima Valley College; Yakima 98902.

Wisconsin

Milwaukee Area Technical College; Milwaukee 43203.

Wyoming

Central Wyoming College; Riverton 82501.

Colleges and universities offering broadcasting courses

California

Humboldt State U.; Arcata 98521.

Connecticut

Western Connecticut State College; Danbury 06810.

District of Columbia

George Washington U.; Washington 20006.

Georgia

Georgia State U.; Atlanta 30342.

Maryland

Morgan State College; Baltimore 21239.

Montana

Eastern Montana College; Billings 59103.

New Hampshire

New Hampshire, U. of; Durham 03824.

New York

Fredonia State U. College; Fredonia 14063.
Rochester Institute of Technology; Rochester 14623.

St. John's U.; Jamaica 11439.
St. Lawrence U.; Canton 13617.

North Carolina

Duke U.; Durham 27706.
North Carolina State U.; Raleigh 27607.

Ohio

Capital U.; Columbus 43209.
Toledo, U. of; Toledo 43606.

Oregon

Linfield College; McMinnville 97128.

Pennsylvania

Geneva College; Beaver Falls 15010.
Villanova U.; Villanova 19085.

Washington

Central Washington State College; Ellensburg 98926.
Walla Walla College; College Place 99324.

Wisconsin

Beloit College; Beloit 53511.
St. Norbert College; DePere 54115.
Wisconsin, U. of-Eau Claire; Eau Claire 54701.

Two year colleges offering programs in broadcasting

Alabama

Gadsden State Junior College; Gadsden 35903.

Arizona

Phoenix College; Phoenix 85013.

California

Butte College; Oroville 95926.
College of the Desert; Palm Desert 92260.
Consumes River College; Sacramento 95823.
Fullerton College; Fullerton 92634.
Grossmont College; El Cajon 92020.
Long Beach City College; Long Beach 90808.
Merced College; Merced 95340.
Moorpark College; Moorpark 92021.
Orange Coast College; Costa Mesa 92626.
Pasadena City College; Pasadena 91106.
Rio Hondo College; Whittier 90608.
San Bernardino Valley College; San Bernardino 92403.
San Diego City College; San Diego 92101.

San Francisco, City College of; San Francisco 94112.
San Mateo, College of; San Mateo 94402.
Santa Rosa Junior College; Santa Rosa 95401.
Shasta College; Redding 96001.

Florida

Pensacola Junior College; Pensacola 32504.

Idaho

Ricks College; Rexburg 83440.

Illinois

Black Hawk College; Moline 61265.
College of DuPage; Glen Ellyn 60137.
Lake Land College; Mattoon 61938.
Parkland College; Champaign 61820.
Illinois Eastern Community Colleges/Campus of Wabash Valley College; Mt. Carmel 62863.

Indiana

Vincennes U.; Vincennes 47591.

RCA

Call your RCA field man to solve today's equipment needs.

Atlanta, Ga. 30341
3395 Northeast Expressway
404.455.3400
P. G. Walters—P. Higginbotham

Austin, Texas 78731
3409 Executive Centre Dr.
Suite 213, 512.345.2224 & 5
D. Forbes

Birmingham, Ala. 35223
Office Park Bldg. #10
Office Park Circle, 205.871.1155
A. Nabo

Boston, Wobessee, Mass. 02181
Wellesley Office Park
40 Williams Street, 617.237.6050
J. F. Morse

Burlingame, Calif. 9401D
330 Primrose Rd., Suite 305
415.344.2741
R. J. Newman

Camden, N. J. 08102
Bldg. 2-2, Front & Cooper Sts.
609.963.8000
N. J. Hudak—R. C. Tyrrell

Charlotte, N. C. 28210
5230 Fairview Rd., Suite 104
704.366.0626
L. White

Chicago, Ill. 60606
Gateway II Bldg., Suite 1400
120 S. Riverside Plaza
312.782.0700

O. G. Bjerke
F. Timberlake

Cincinnati, Ohio 45231
11430 Hamilton Ave., 513.825.1550
C. E. Raasch

Dallas, Texas 75247
8700 Stemmons Freeway, 214.638.6200
E. H. Hoff—G. McClanathan
L. Pinski

Denver, Colo. 80211
2695 Alcott St., Suite 231-S
303.433.8484
J. H. Butts

Detroit, Southfield, Mich. 48075
24333 Southfield Rd., Suite 209
313.357.0080
J. L. Preston

Hollywood, Calif. 90028
RCA Corp., Suite 531
6363 Sunset Blvd., 213.461.9171
H. W. Dover—C. Cookson

Indianapolis, Ind. 46205
RCA Broadcast Sales, Bldg. Q-1
2511 East 46th Street
317.546.4001

J. L. Ayers

Jacksonville, Fla. 32207
2747 Art Museum Drive, Suite 5
904.398.4588
F. C. Fitch

Kansas City Area:
Overland Park, Kansas 66207
5750 West 95th St., Suite 111
913.642.3185, 6, 7

G. Thursby

McMurray, Pa. 15317
761 N. Washington Road
Nationwide Office Bldg., 412.941.5570

C. Koriwchak

Minneapolis, Minn. 55416
4601 Excelsior Blvd., Suite 307
612.920.6395, 6

W. G. Eberhart

New York, N. Y. 10036
1133 Avenue of the Americas
3rd Floor, 212.598.5900

R. F. Varda—J. P. Shipley
C. J. Gaydos

St. Charles, Mo. 63301
Noah's Ark, Suite 340
314.723.2525 & 946.7755

D. B. Freeman

Seattle, Washington 98109
1818 Westlake Ave. N., Suite 222
206.285.2375

B. Lloyd

Washington, D. C. Area:
Arlington, Virginia 22209
1901 North Moore St., 703.558.4212
R. S. Emch—R. C. Parkhill

West Palm Beach, Fla. 33410
3900 RCA Blvd., Palm Beach Gardens
305.622.1100

R. E. Giles

RCA International Marketing Subsidiaries

Canada
RCA Limited
21001 North Service Road
Trans-Canada Highway
Ste. Anne de Bellevue (PQ) H9X3L3
Telephone: (514) 457-9000
W. H. Holroyd

Canada

RCA Limited
1450 Castletown Avenue
Toronto 15, Ontario
Telephone: (416) 551-6550
J. P. Watson

Canada

RCA Limited
2876 Rupert Street
at Grandview Highway
Vancouver, British Columbia
Telephone: (604) 433-0541
R. L. Harlow

Mexico

RCA S.A. de C.V.
Avenida Cuifahuac 2519
Apartado Postal 17-570
Mexico DF
Telephone: 5-27-60-20 Ext. 104
C. P. Perez

Argentina

RCA International Limited
Casilla de Correo 4400
Buenos Aires
Telephone: 70-4171
H. T. Magno

Brazil

RCA Telesistemas Ltda.
Rua. Correa Dutra, 126-4° and.
Rio de Janeiro-GB.
Telephone: 245-9209
L. Scheiner

England

RCA International Ltd.
Lincoln Way, Windmill Road
Sunbury-on-Thames, Middlesex
Telephone: Sunbury-on-Thames 8.5511
J. M. Boatman

West Germany

RCA GmbH
2085 Quickborn-Hamburg
Schillerstrasse 14
Telephone: 04106/612-1
S. König

Switzerland

RCA International Marketing S.A.
118 rue du Rhone
CH 1204 Geneva
Telephone: 35-82-00
J. Gibson

Hong Kong

RCA International Ltd.
1927 Prince's Building
Chater Road, G.P.O. 112
Telephone: 5-234181
P. J. Foody/T. F. Newman

Australia

RCA Limited
6th Floor
608 St. Kilda Road
Melbourne, Vic.
Telephone: 224-1475
A. R. Gibbs

Australia

RCA Limited
ADC House, 7th Floor
99 Elizabeth Street
Sydney, N.S.W.
Telephone: 231-4699
R. D. Walsh