

BROADCASTING TELECASTING

1954

**BROADCASTING
YEARBOOK -
MARKETBOOK
ISSUE**

Quick Index

Advertising Analysis	131
Agencies	379
Audience	16
Awards	474
Equipment	396
FCC Directory	30
FCC Rules	418
Highlights of '53	65
NARTB	59
Networks	35
Newspaper Owners	454
Regional Nets	467
Representatives	21
Stations	
Am by States	67
Am Call Letters	444
Am Frequencies	435
Fm by States	67
Fm Call Letters	452
Transcription	362

**Facts on Tv, See
TELECASTING
YEARBOOK**

CONTENTS COPYRIGHTED
1954 by BROADCASTING
PUBLICATIONS, INC.

public favorite No.

in the Nation's No. 1 *income* market

WDEL 5,000 WATTS
day and night

Wilmington, Delaware

Overwhelming station favorite in the nation's richest income market, WDEL delivers an audience that buys with the highest per capita income in the United States.



Steinman Station

Represented by

ROBERT MEEKER Associates

New York

Chicago

Los Angeles

San Francisco

The Tape That Mirrors the Original Sound

SOUND RECORDING



irish

BRAND

GREEN BAND Professional



THE FINEST TAPE YOUR RECORDER CAN USE

Just as the reflection of a perfect mirror is faithful to the original image, in every detail, so too does IRISH Green Band RECORD, RETAIN and REPRODUCE the original sound with flawless fidelity.

This can be confirmed by tests. Instruments will reveal that IRISH Green Band offers lower noise level, uniform sensitivity, minimum amplitude variation, less distortion.

But instrument tests are only the landmarks

of good design and production. The final proof is in the hearing. Therefore, to know and appreciate the quality of IRISH Green Band Tape, it must be used, listened to, and compared with other tapes on the same recorder.

You will find that the only limitation to IRISH Green Band quality is the limitation of the tape recorder itself: it is the finest tape your recorder can use.

irish
BRAND
GREEN BAND
Professional

is fast becoming the choice of audio engineers in broadcast stations, recording studios and wherever sound quality is of paramount importance.

1200 feet on plastic reel.....\$ 5.50
2400 feet on metal reel..... 12.85

One day you will surely use IRISH... so write today for free test sample reel.

irish BROWN BAND for Popular Priced Recorders: IRISH Brown Band, expressly designed for home and office recorders. Reproduces with true fidelity the frequency range from 100 to 8000 cycles. A high quality, plastic base tape for the price of ordinary paper tape!

1200 feet, plastic base, on plastic reel.....\$3.75

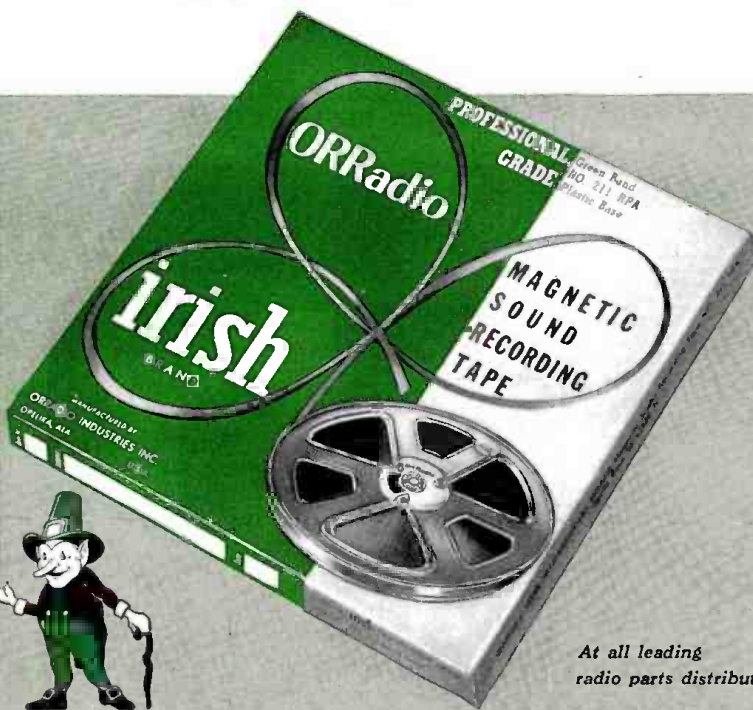

At all leading radio parts distributors

ORRADIO INDUSTRIES, INC.

OPELIKA 9, ALABAMA

World's Largest Exclusive Magnetic Tape Manufacturer

EXPORT DIVISION: Morhan Exporting Corp., New York, N. Y.

Television

THE AMERICAN TOBACCO CO., INC.

Lucky Strike Cigarettes
"Private Secretary,"
starring Ann Sothern
"Robert Montgomery Presents—
Your Lucky Strike Theatre"
(Alternate Weeks)
"The Jack Benny Program"
"Your Hit Parade"
(Alternate Weeks)
"Make Room for Daddy,"
starring Danny Thomas
(Alternate Weeks)

ARMSTRONG CORK COMPANY

Floor Covering, Building Material
"Armstrong's Circle Theatre"

CHRYSLER CORPORATION

*Plymouth, Dodge, De Soto,
Chrysler Automobiles*
"Medallion Theatre"

**CROSLEY DIVISION
OF AVCO MANUFACTURING CORP.**

Radio and Television Sets
"Your Hit Parade"
(Alternate Weeks)

DE SOTO-PLYMOUTH DEALERS OF AMERICA

"The Groucho Marx Show
—You Bet Your Life"

E. I. DU PONT DE NEMOURS & CO. (INC.)

"Cavalcade of America"

GEMEX COMPANY

Watchbands
"The George Jessel Show"
(Alternate Weeks)

GENERAL ELECTRIC COMPANY

"The Fred Waring Show"
"The General Electric
Theater"

**GENERAL ELECTRIC COMPANY,
LAMP DIVISION**

"The Jane Froman Show"

GENERAL MILLS, INC.

*Betty Crocker Cake Mix,
Cheerios*
"The Stu Erwin Show"

THE B. F. GOODRICH COMPANY

Life-Saver Tubeless Tires
"The George Burns &
Gracie Allen Show"
(Alternate Weeks)

LEVER BROTHERS COMPANY

Surf, All-Purpose Detergent
"Art Linkletter's House
Party"

U. S. STEEL CORPORATION

"United States Steel Hour"
(Alternate Weeks)

BBDO NATIONAL PROGRAMS

Radio

THE AMERICAN TOBACCO CO., INC.

Lucky Strike Cigarettes
"The American Way"
"The Jack Benny
Program"

CREAM OF WHEAT CORPORATION

Cream of Wheat
"Theatre of Today"

CONSOLIDATED COSMETICS, INC.

Lanolin Plus Products
"The Edgar Bergen-
Charlie McCarthy Show"
(Alternate Weeks)

**DE SOTO-PLYMOUTH DEALERS
OF AMERICA**

"The Groucho Marx Show
—You Bet Your Life"

GENERAL ELECTRIC COMPANY

"The Bing Crosby Show"

GEO. A. HORMEL & COMPANY

Canned Meat Products
"Music With the
Hormel Girls"

LEVER BROTHERS COMPANY

Surf, All-Purpose Detergent
"Art Linkletter's
House Party"

THOMAS NELSON & SONS

*Revised Standard
Version of the Bible*
"The Evening Comes"

REXALL DRUG COMPANY

Drug Products
"Amos 'n' Andy"

BATTEN, BARTON, DURSTINE & OSBORN, INC.

NEW YORK • BOSTON • BUFFALO • CHICAGO • CLEVELAND • PITTSBURGH
MINNEAPOLIS • SAN FRANCISCO • HOLLYWOOD • LOS ANGELES • DETROIT

INDEX TO CONTENTS OF 1954 BROADCASTING YEARBOOK

(For Facts on Television See 1953-54 TELECASTING Yearbook & Marketbook)

A	Bahakel, Cy N., Stations..... 62	tions..... 62	Stations by Provinces..... 351
Academy of Television Arts & Sciences..... 468	Baldwin & Mermey..... 471	Broadcasting Corp. of America's Network..... 62, 467	Canadian Assn. of Radio & Tv Broadcasters..... 468
John B. Adams..... 471	J. Patrick Beacom Stations..... 62	Broadcasting, Related Services..... 468	Canadian Broadcasting Corp.—Executives & Staff..... 460
Advertest Research..... 471	Bell Telephone Labs..... 469	Brown School Stations..... 62	Canadian Facts Ltd..... 471
Advertisers Index..... 482	A. S. Bennett—Cy Chaikin..... 471	H. A. Bruno & Assoc..... 471	Canadian International Stations..... 64
Advertisers, Network Billings... 49	Bentley & Livingstone Inc..... 471	Paul Bunyan Network..... 467	Canadian National Telegraphs... 469
Advertising—	Edward L. Bernays..... 471	Bureau of Advertising..... 468	Carriers, in Communications... 469
Agencies..... 379	George Biderman..... 471	Bureau of Broadcast Measurement..... 471	Censorship, FCC Rules..... 429
Agency Billings..... 52	Billings—	Walter P. Burn..... 471	Clear Channel Bcstg. Ser..... 468
Network Billings..... 49	Agency..... 52	William Burnett Radio Lab... 470	Clefield Broadcasters..... 62
Radio Analysis..... 13	Network..... 49	Business, 1953 Radio Analysis.. 13	Cleveland Plain Dealer Stations 62
Advertising Assn. of the West... 468	Bitner, H. M., Stations..... 62	Carl H. Butman..... 470	Coll & Freedman Inc..... 471
Advertising Council Inc..... 468	Ivan Black Assoc..... 471	Carl Byoir & Assoc..... 471	College Networks..... 469
Advertising Fed. of America... 468	Blackburn-Hamilton Co..... 469	C	Colorado—
Advertising Research F'ndation 471	Books, Relating to Radio..... 475	California—	Am, Fm Stations..... 93
Affiliation, Network, FCC Rules 424	Booth Stations..... 62	Am, Fm Stations..... 81	Market Data by Counties.... 98
Agencies—Handling Radio..... 379	Booz, Allen & Hamilton..... 469	Market Data by Counties.... 80	Colorado Broadcasters Assn.... 360
Agency Billings..... 52	Brand Names Foundation..... 468	California Northern Group.... 467	Columbia Broadcasting System Inc. Executives & Staff..... 62
Agriculture, Dept. of..... 472	Rudy Bretz..... 470	California State Radio & Television Broadcasters Assn.... 360	CBS Radio Division—
Air Trails Network Stations.... 62	British Columbia Stations... 353	Call Letters—	Executives & Staff..... 39
Alabama—	British United Press Ltd..... 49	Canadian Am Stations by.... 452	Map of Network..... 40
Am, Fm Stations..... 67	Broadcast Advertising Bureau 44, 468	Fm Stations by..... 452	Owned Stations..... 62
Market Data by Counties.... 67	Broadcast License, How to Apply 434	U. S. Am Stations by..... 444	Columbia Pacific Network.... 467
Alabama Broadcasters Assn.... 360	Broadcast Management Services Co..... 470	Cambridge Thermionic..... 470	Columbine Network..... 467
Alaska, Am, Fm Stations..... 348	Broadcast Music Inc..... 470	Canada—	Commerce Department..... 473
Alaska Broadcasting System... 467	Broadcast News Ltd..... 49	Am Stations by Call Letters.. 452	Committees, Related to Radio.. 468
David O. Alber Assoc. Inc..... 471	Broadcast Service Bureau Inc.. 470	Am Stations by Frequencies.. 443	Comm'l Radio Monitoring Co... 470
Alberta, Radio Stations..... 351	Broadcast Stations—(See Listing: Radio Stations)	International Stations..... 64	Communications Carriers..... 469
W. Gordon Allen Stations.... 62	Broadcasters' State Associations 360	Station Representatives..... 29	Composers, Authors & Publishers Assn. of Canada Ltd... 470
Allied Arts, Consultants..... 469	Broadcasting Co. of South Sta-		Congress, Radio Galleries..... 469
Allied States Assn. of Motion Picture Exhibitors..... 468			Robert S. Conlan Assoc..... 471
Allocations, FCC Rules..... 418			Connecticut—
Aloha Network..... 467			Am, Fm Stations..... 96
Am Stations—			Market Data by Counties.... 95
By Call Letters, Canada..... 452			Connecticut State Network... 467
By Call Letters, U. S..... 444			Consultants, Allied Arts..... 469
By Frequencies, Canada..... 443			Consulting Engineers..... 461
By Frequencies, U. S..... 435			Controlled Circulation Audit.. 471
By States..... 67			Correspondents Galleries..... 469
American Assn. of Adv. Agencies 468			Cotton Belt Group..... 62
American Broadcasting Co.—			Courington, Pat M..... 62
Executives & Staff..... 35			Covington Stations..... 62
Map of Network..... 38			James A. Cowan..... 471
Owned & Managed Stations.. 62			James M. Cox Stations..... 62
American Marketing Assn.... 468			Ed Craney Stations..... 62
American Newspaper Pub. Assn. 468			Cuba Stations..... 477
American Radio Publications... 469			Gano F. Culwell Corp..... 471
Analysis, Radio Advertising... 13			Curtis Radiocasting Corp.... 62
American Radio Relay League.. 468			D
American Research Bureau..... 471			Dairyland Network..... 467
American Telephone & Tel. Co.. 469			Daytime Broadcasters Assn.... 468
American Women in Radio & Tv 468			Defense Department..... 473
Analysis, Radio Advertising... 13			Definitions, FCC Rules..... 418
Arizona—			Delaware—
Am, Fm Stations..... 74			Am, Fm Stations..... 100
Market Data by Counties.... 74			Market Data by Counties.... 100
Arizona Broadcasters Assn.... 360			Vic Diehm Assoc. Stations... 62
Arizona Broadcasting System... 467			Dine & Kalmus..... 471
Arizona Network..... 467			Direct Mail Advertising Assn.. 468
Arkansas—			District of Columbia—
Am, Fm Stations..... 76			Am, Fm Stations..... 101
Market Data by Counties.... 76			Market Data..... 101
Arkansas Broadcasters Assn.... 360			Dominican Republic..... 478
Arkansas Network..... 467			Don Lee Bcstg. System..... 467
Arktek Stations..... 62			Reuben H. Donnelly Corp.... 470
Arrow Assoc..... 471			duPont Awards..... 474
Arrowhead Network..... 467			L. J. N. duTreil & Assoc.... 470
ASCAP..... 470			E
Assignments, FCC Rules..... 429			Educational Stations, Fm..... 483
Assn. of Canadian Advertisers.. 468			Electronics Mfrs. Assn..... 469
Assn. of Federal Communications Consulting Engineers..... 468			Elliot-Haynes Ltd..... 471
Assn. of National Advertisers.. 468			Engineers, Consulting..... 461
Associated Press..... 49			Lyle Kenyon Engel..... 470
Associations, Related to Radio. 468			Equipment Manufacturers..... 396
Associations, State Broadcasters 360			European Station Frequencies 443
Atomic Energy Commission... 472			Executive Office of President.. 472
Attorneys, Dealing with Radio. 463			Executives Radio-Tv Service.. 471
Audience Analysis, Radio..... 16			F
Audit Bureau of Circulations.. 471			Facsimile, FCC Rules Governing 424
Authorizations of Sta..... 39, 63, 361			Fair Tv Practices Committee... 469
Aupry, Gene, Stations..... 62			The Faught Co..... 470
Awards, 1953..... 474			(Continued on page 6)
B			
Bahamas Stations..... 477			



1954 Yearbook-Marketbook
 Executive and Publication Headquarters
 Broadcasting • Telecasting Bldg., 1735 DeSales St., N.W.,
 Washington 6, D. C. • Telephone: Metropolitan 8-1022

SOL TAISHOFF
 Editor and Publisher

EDITORIAL

ART KING, Managing Editor
EDWIN H. JAMES, Senior Editor
J. Frank Beatty, Earl B. Abrams, Associate Editors; Fred Fitzgerald, Assistant Managing Editor; Lawrence Christopher, Technical Editor; David Berlyn, Harold Hopkins, Don West, Assistant Editors; Patricia Kiely, Special Issues; Staff: Ray Ahearn, Jonah Gitlitz, Louis Rosenman; Editorial Assistants: Anna Campbell, Kathryn Ann Fisher, Joan Sheehan, Harriet Sinrod; Gladys L. Hall, Secretary to the Publisher.

BUSINESS
MAURY LONG,
Vice President & General Manager; Ed Sellers, Southern Sales Manager; George L. Dant, Advertising Production Manager; Harry Stevens, Classified Advertising Manager; Eleanor Schadi, Fred Reidy, Shirley Harb, Mary Jeffries, Betty Bowers; B. T. Taishoff, Treasurer; Irving C. Miller, Auditor and Office Manager; Eunice Weston, Assistant Auditor.

ART AND LAYOUT: Duane McKenna.
CIRCULATION AND READERS' SERVICE
JOHN P. COSGROVE, Manager
Elwood M. Slee, Subscription Manager; Robert Deacon, Anne Fliedner, Doris J. Frazier, Joel H. Johnston, Loel Miller.

NEW YORK BUREAU
 444 Madison Ave., Zone 22, Plaza 5-8355. **EDITORIAL: Rufus Crater, New York Editor; Bruce Robertson, Senior Associate Editor; Florence Small, Agency Editor; Rocco Famighetti, Joyce Barker, Selma Gersten.**
BUSINESS: Winfield R. Levi, Sales Manager; Eleanor R. Manning, Sales Service Manager; Kenneth Cowan, Eastern Sales Manager; Dorothy Munster.

CHICAGO BUREAU
 360 N. Michigan Ave., Zone 1, Central 6-4115. **Warren W. Middleton, Midwest Sales Manager; Barbara Kolar, John Osborn, News Editor.**

HOLLYWOOD BUREAU
 Taft Building, Hollywood & Vine, Zone 28, Hollywood 3-8181. **David Glickman, West Coast Manager; Leo Kovner, Marjorie Ann Thomas.**

TORONTO
 32 Colin Ave., Hudson 9-2694. **James Montagnes.**

BROADCASTING* Magazine was founded in 1931 by Broadcasting Publications Inc., using the title: BROADCASTING*—The News Magazine of the Fifth Estate. Broadcast Advertising* was acquired in 1932 and Broadcast Reporter in 1933.

*Reg. U. S. Patent Office
 Contents Copyrighted 1953 by Broadcasting Publications, Inc.
 Published every Monday, 53rd issue (Yearbook Number) published in January by BROADCASTING PUBLICATIONS, INC., Broadcasting • Telecasting Building, 1735 DeSales St., N.W., Washington 6, D. C. Entered as second class matter March 14, 1933, at Post Office at Washington, D. C., under act of March 3, 1879.

Annual subscription for 52 weekly issues \$7.00.
 Annual subscription including BROADCASTING Yearbook (53rd issue) \$9.00, or TELECASTING Yearbook (54th issue) \$9.00.
 Annual subscription to BROADCASTING • TELECASTING including 54 issues \$11.00. Add \$1.00 per year for Canadian and foreign postage. Regular issue 35¢ per copy; 53rd and 54th issues \$5.00 per copy.

NO OTHER PLAN OFFERS SUCH COVERAGE AT SUCH SAVINGS!

Get Discounts up to 55%--Plus Coverage of 1/6 of America--
with the Westinghouse Group Station Plan

Compare the advantages of the Westinghouse Group Station Plan
with those of any other advertising media, for...

Greatest Coverage →

Reach 1/6 of America--26,600,000 buyers--via the 50,000-watt clear channel voice of Westinghouse in Boston, Philadelphia, Pittsburgh, Ft. Wayne and Portland (plus the 1000-watt voice of WBZA in Springfield).

Lowest Cost →

Discounts from 10% to 55% assure lowest possible cost per thousand selling impressions.

Complete flexibility →

Tailor your campaign to meet your budget; choose between fixed position or floating schedules; use chainbreaks, a combination of chainbreak and 1-minute announcements, Class "A" programs--or a combination of all three; run 13 weeks or longer; select two or more markets.

Test purposes →

Westinghouse radio stations serve six important, widely varied markets across the nation--New England, mid-Atlantic, Midwest, Pacific Northwest--offering ideal test facilities for new products, new packages, new copy themes, new advertising and/or sales techniques.

In 1/6 of America, no other combination of stations or media offers the low-cost coverage, dominance and penetration available with the Westinghouse Group Station Plan.

Call your nearest Free & Peters "colonel" for complete details.

You can be sure if it's



WESTINGHOUSE BROADCASTING COMPANY, Inc.

WBZ • WBZA • KYW • KDKA • WOWO • KEX • WBZ-TV • WPTZ

National Representatives: Free & Peters

INDEX

<p>Newton L. Fausey..... 470 Federal Civil Defense Adm. 472 Fed. Com. Bar Assn..... 463, 469 Federal Communications Commission— Executives & Staff..... 30 Field Offices 34 Former Members 30 How to Apply for Station..... 434 Rules-Regulations (Selected) 418 Federal Radio Commission, Former Members 30 Federal Trade Commission..... 472 Hugh Feltis & Assoc..... 470 John E. Fetzer Stations 62 Financial Public Relations Assn. 469 E. Dean Finney Stations..... 62 Florida— Am, Fm Stations..... 104 Market Data by Counties... 104 Florida Assn. of Broadcasters... 360 Fm Stations— Authorized in U. S..... 63 By Call Letters..... 452 By States 67 Educational 433 Equipment Manufacturers... 396 Foreign Language Qual. Network 467 Forrest, Wm. C., Stations 62 Harry Fox 470 Howard S. Frazier..... 470 Freedom Awards 474 Frequencies— Canadian Am Stations by... 443 European Stations 443 U. S. Am Stations..... 435 Frequency Measuring Services. 470 Friendly Group 62</p> <p style="text-align: center;">G</p> <p>Galleries, Radio Correspondents 469 J. A. Gallimore Stations 62 Theodore R. Gamble Stations... 62 Guy Gannett Broadcasting 467 Gannett Newspapers Stations... 62 Withers Gavin Stations..... 62 Dixon Gayer, Public Rel..... 471 General Services Administration 472 General TeleRadio Inc..... 62 Georgia— Am, Fm Stations..... 112 Market Data by Counties... 112 Georgia Assn. of Local Stations 467 Georgia Assn. of Broadcasters... 360 Georgia Major Market Trio... 467 Gila Broadcasting Co. Stations. 62 Globe Wireless Ltd..... 469 Edward Gottlieb & Assoc..... 471 Government Agencies 472 Graham Research Service..... 472 Granite State Broadcasting Co. 62 Granite State Network..... 467 Claude M. Gray..... 470 Great Northern Broadcasting... 467 Greer Stations 62 Gross Billings, Radio Networks 49 Group Ownership 62 Guam, Am, Fm Stations 349 Guide-Post Research 472</p> <p style="text-align: center;">H</p> <p>Hait Stations 478 Hal K. Halpern 471 Michael R. Hanna 470 Steve Hannagan 471 Harris Stations 62 Hawaii, Am, Fm Stations..... 349 Hawaiian Assn. of Radio & Tv Broadcasters 360 Health, Education & Welfare, Dept. of 472 Hearst Stations 62 Highlights of 1953, Radio..... 65 Oscar C. Hirsch Stations..... 62 Roy Hofheinz Stations 62 C. E. Hooper Inc..... 472 Hoosier Network 467 Hood Assoc. 470 How to Apply for Station..... 434 Hutton Monitoring Service..... 470</p> <p style="text-align: center;">I</p> <p>Idaho— Am, Fm Stations..... 121 Market Data by Counties... 121</p>	<p>Idaho Broadcasters Assn..... 360 Illinois— Am, Fm Stations..... 124 Market Data by Counties... 123 Illinois Broadcasters Assn..... 360 Imes, Birney Jr..... 63 Indecent Language, FCC Rules. 429 Index of Advertisers..... 482 Edward T. Ingle 470 Indiana— Am, Fm Stations..... 134 Market Data by Counties... 134 Indiana Broadcasters Assn..... 360 Inland Radio Inc. Stations... 63 Institute for Education by Radio-Tv 469 Institute of Radio Engineers... 469 Intercollegiate Bcstg. System... 469 Intermountain Network 467 International Monitoring Service 470 International News Service.... 49 International Stations— Canadian 64 United States 64 International Tel. & Tel. Corp.. 469 Iowa— Am, Fm Stations..... 141 Market Data by Counties... 140 Iowa Broadcasters Assn..... 360</p> <p style="text-align: center;">J</p> <p>Jamaica Stations 478 Joint Technical Advisory Comm. 469 Justice Department 472</p> <p style="text-align: center;">K</p> <p>Kansas— Am, Fm Stations..... 149 Market Data by Counties... 148 Allen Kander 470 Kansas Assn. of Radio Broadcasters 361 Robert S. Keller Inc..... 471 Kentucky— Am, Fm Stations..... 154 Market Data by Counties... 152 Kentucky Broadcasters Assn.... 361 Keystone Broadcasting System— Executives & Officers 41 Map of Network 42 Stations Affiliated with... 41 A. Lewis King..... 470 Edward M. Kirby 471 Kriedt & Myers 471</p>	<p style="text-align: center;">L</p> <p>Labor Department 473 Labor Groups in Radio..... 473 Edward Lamb Enterprises Inc.. 63 Mark Larkin 471 Lawyers, Radio 463 Austin C. Lescarboua & Staff. 471 Philip Lesley Co..... 471 Latin American Stations 477 Bernard L. Lewis 471 Lewis, Richard Field Jr..... 63 Hal Leyshon & Assoc..... 471 License, How to Apply for..... 434 License Renewals, FCC Rules... 426 Licensing Groups, Music..... 470 Long Radio Enterprises 467 J. G. Long Stations..... 63 Jessica L. Longston Stations... 63 Lotteries, FCC Rules Governing 428 John J. Louis Stations..... 63 Louisiana— Am, Fm Stations..... 159 Market Data by Counties... 159 Louisiana Assn. of Broadcasters 361</p> <p style="text-align: center;">M</p> <p>M & N Broadcasting Co. 63 MacKay Radio & Telegraph Co. 469 Maine— Am, Fm Stations..... 163 Market Data by Counties... 163 Maine Radio & Tv Bcstrs. Assn. 361 Maine Bcstg. System..... 467 Manitoba Radio Stations 353 Manufacturers, Equipment.... 396 Richard Manville Research..... 472 Maps—(See Network listings) Market Research 471 Market Research Corp. of America 472 Market Research of Cleveland... 472 Marketscope Research Co..... 472 Maryland— Am, Fm Stations..... 166 Market Data by Counties... 165 Maryland-D. C. Radio-Tv Assn... 361 Massachusetts— Am, Fm Stations..... 168 Market Data by Counties... 168 Mayes, Wendell, Stations..... 63 McCaw-Keating Stations..... 63 McClatchy Beeline 467 McClatchy Broadcasting Co.... 63</p>	<p>McClung Stations 63 Howard J. McCollister Co..... 471 J. Bernard McDonnell..... 471 McKinsey & Co..... 470 George McKittrick & Co..... 470 Measuring Services, Frequency. 470 Media Records Inc..... 472 Meredith Pub. Co. Stations... 63 Philip Merryman & Assoc..... 485 Metropolitan Network 467 Mexico 478 Michigan— Am, Fm Stations 174 Market Data by Counties... 174 Michigan Assn. of Broadcasters 361 Michigan Radio Network..... 467 Midnight Sun-Aurora Bcstg. ... 63 Mid-South Network 467 Midwestern Broadcasting Co. Sta. 63 Arthur H. Miller..... 471 Minnesota— Am, Fm Stations..... 188 Market Data by Counties... 186 Minnesota Assn. of Broadcasters 361 Mississippi— Am, Fm Stations 193 Market Data by Counties... 193 Mississippi Broadcasters Assn.. 361 Mississippi Bcstg. Co. 467 Missouri— Am, Fm Stations..... 197 Market Data by Counties... 196 Missouri Broadcasters Assn.... 361 Reg Mitchell & Assoc..... 471 Modifications, FCC Rules.... 428 Moffett Research Co..... 472 Montana— Am, Fm Stations..... 206 Market Data by Counties... 206 Montana Radio Stations Inc.... 361 Multiple Ownership, Rules.... 420 Murphy-Bridges Stations 63 Music Licensing Groups..... 470 Music Pub. Protective Assn.... 470 Mutual Broadcasting System— Executives & Staff..... 44 Map of Network..... 46</p> <p style="text-align: center;">N</p> <p>National Appliance & Radio-Tv Dealers Assn. 469 Natl. Assn. for Better Radio & Tv 469 National Assn. of Educ. Bcstrs. 469 National Assn. of Manufacturers 469 Natl. Assn. Performing Artists. 470 National Assn. Radio Farm Directors 469 National Assn. of Radio-Television Broadcasters— Officers & Committees 59, 469 Standards of Practice 64 National Better Business Bureau 469 National Broadcasting Co.— Executives & Staff 47 Map of Network 48 Owned & Operated Stations... 63 National Council of the Churches of Christ in USA 469 National Electrical Mfrs. Assn. 469 National Exhibitors Theatre 469 Television Committee 469 National Headliners Awards 474 National Labor Relations Board 473 National Register Pub. Co. 470 National Representatives, List of 21 National Dry Goods Assn. Awards 474 National Retail Dry Goods Assn. 469 National Safety Awards 474 National Tv Film Council 469 Nebraska— Market Data by Counties... 208 Am, Fm Stations 208 Nebraska Broadcasting Assn.... 361 Ted Nelson Assoc. 470 Wayne M. Nelson Sta. 63 Network Affiliation, FCC Rules. 424 Network Radio Gross 49 Networks— ABC Executives and Staff ... 35 CBC Executives & Staff 460 CBS Inc. Executives & Staff... 62 CBS Radio Executives & Staff 39</p> <p style="text-align: right;">(Continued on page 8)</p>
--	--	---	---

ABBREVIATIONS IN 1954 YEARBOOK

EXECUTIVE PERSONNEL

Administrative	adm.
Assistant	asst.
Associate	assoc.
Business Manager	bus. m.
Chairman of the Board	chmn. of bd.
Chief Bookkeeper	chief bkpr.
Chief Engineer	ce
Co-Engineer	co-engr.
Co-Owner	co-o
Commercial Manager	cm
Commercial Production Manager	coml. pdm
Comptroller	comp.
Continuity Editor	continuity ed.
Controller	cont.
Copy Director	copy d.
Director	d
Director of Engineering	d. of engr.
Director of Operations	d. of opers.
Educational Director	educ. d
Executive Officer	exec. officer
Executive Owner	exec. o
Executive Director	exec. d
Executive Producer	exec. prod.
Executive Vice President	evp
Facility Director	facility d
Farm Director	fd
Film Director	film d
General Manager	gm
General Sales Manager	gen. sim
Local Sales Manager	loc. sim
Manager	m
Manager of Tv Operations	m of tv opers.
Managing Director	mngng. d
Merchandising Manager	merc. m
Music Director	music d
National Commercial Manager	natl. cm
News Director	nd
News Editor	news ed.
Office Manager	office m
Operations Manager	opers. m
Owner	o
Partner	ptrn.
President	p
Production Coordinator	prod. coordinator
Production Director	prod. d
Production Manager	prod. m

Program Director	pd
Program Manager	prog. m
Program Supervisor	prog. sup.
Promotion	prom.
Public Affairs Director	pub. affairs d
Public Relations Director	pub. rel. d
Public Service Director	pub. serv. d
Publicity Director	publ. d
Regional Manager	reg. m
Research Director	research d
Resident Manager	res. m
Sales Director	sls. d
Sales Manager	slm
Secretary-Treasurer	secy.-treas.
Special Events Director	sp. events d
Sports Director	sd
Station	sta.
Studio Supervisor	studio sup.
Supervising Engineer	sup. engr.
Technical Director	tech. d
Traffic Manager	traffic m
Transmitter Supervisor	trans. sup.
Vice President	vp
Women's Director	wd

TRANSCRIPTION LIBRARIES

Associated	Assoc.
Capitol	Cap.
Cole	Cole
Lang-Worth	L-W
MacGregor	Mac.
SESAC	SES
Standard	St.
Thesaurus	Thes.
World	Wld.

TRANSMITTER MAKES

Collins	Col.
Crosley	Cros.
DuMont	DuM.
Federal	Fed.
Gates	G.
General Electric	GE
Marconi	Marc.
Northern Electric	NE
RCA	RCA
REL	REL
Raytheon	Ray.
Temco	Tem.
Western Electric	WE
Westinghouse	WH

A carbon copy is never quite as good as the ORIGINAL

A carbon copy is never quite as good as the ORIGINAL

the original...

WNEW

1130 | ON YOUR DIAL

565 Fifth Avenue, New York 17, N. Y.

1914

1954

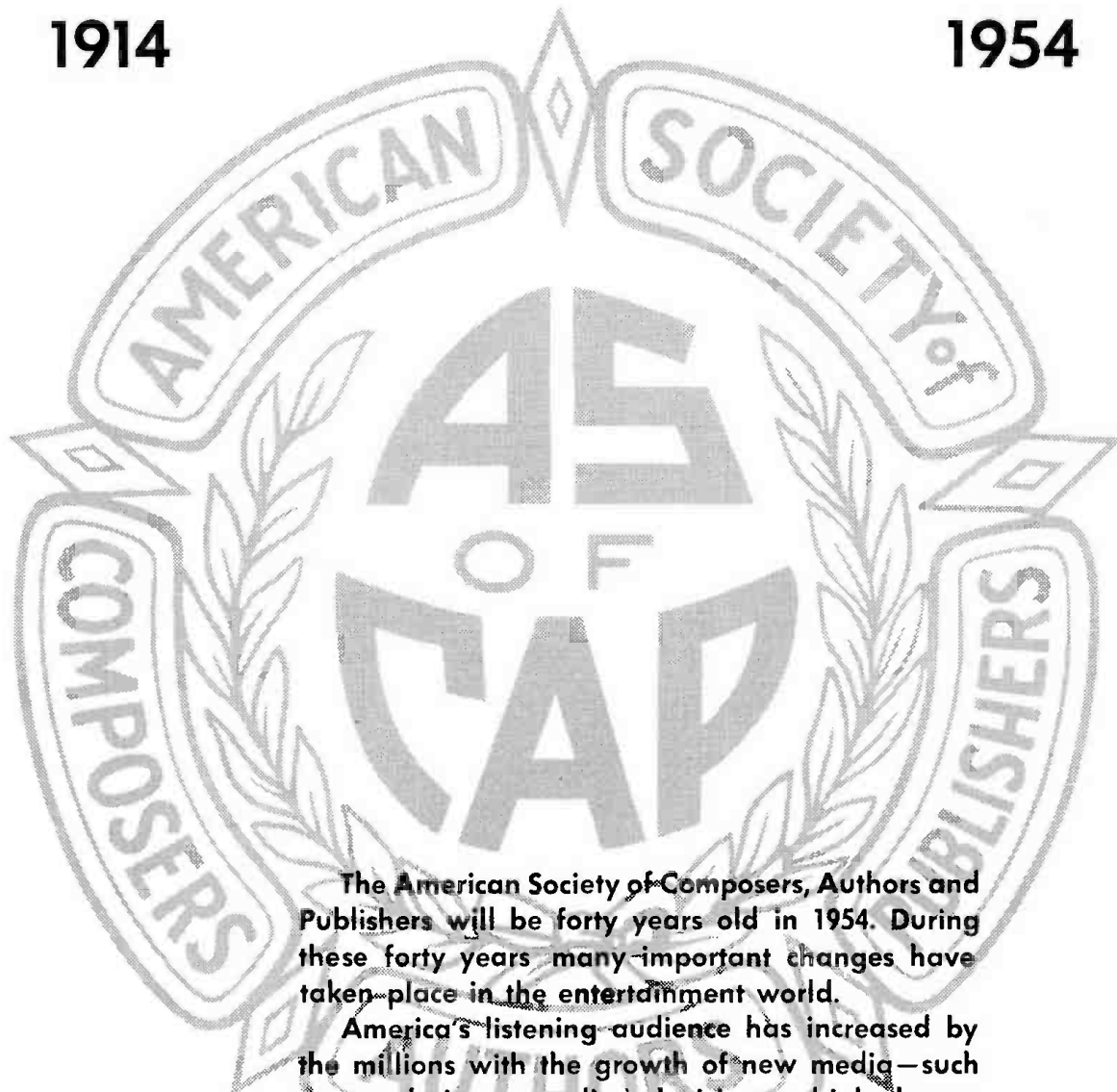

The American Society of Composers, Authors and Publishers will be forty years old in 1954. During these forty years many important changes have taken place in the entertainment world.

America's listening audience has increased by the millions with the growth of new media—such as sound pictures, radio, television and juke boxes. And the one ingredient in the field of entertainment which has survived all technological changes—not only survived, but has increased and expanded—is Music! It has remained a basic requirement for all phases of show business. For a good song always is good entertainment!

ASCAP—entering its forty-first year—is justly proud of the repertory of its more than 3,000 song-writers and composers. ASCAP also is proud of its many years of service to its licensees, and pledges itself to a continuation of making available to the entertainment world the best in music.

AMERICAN SOCIETY OF COMPOSERS, AUTHORS AND PUBLISHERS

575 MADISON AVENUE, NEW YORK 22, N. Y.

are you selling

a 10-inch idea...

on a 21-inch screen?



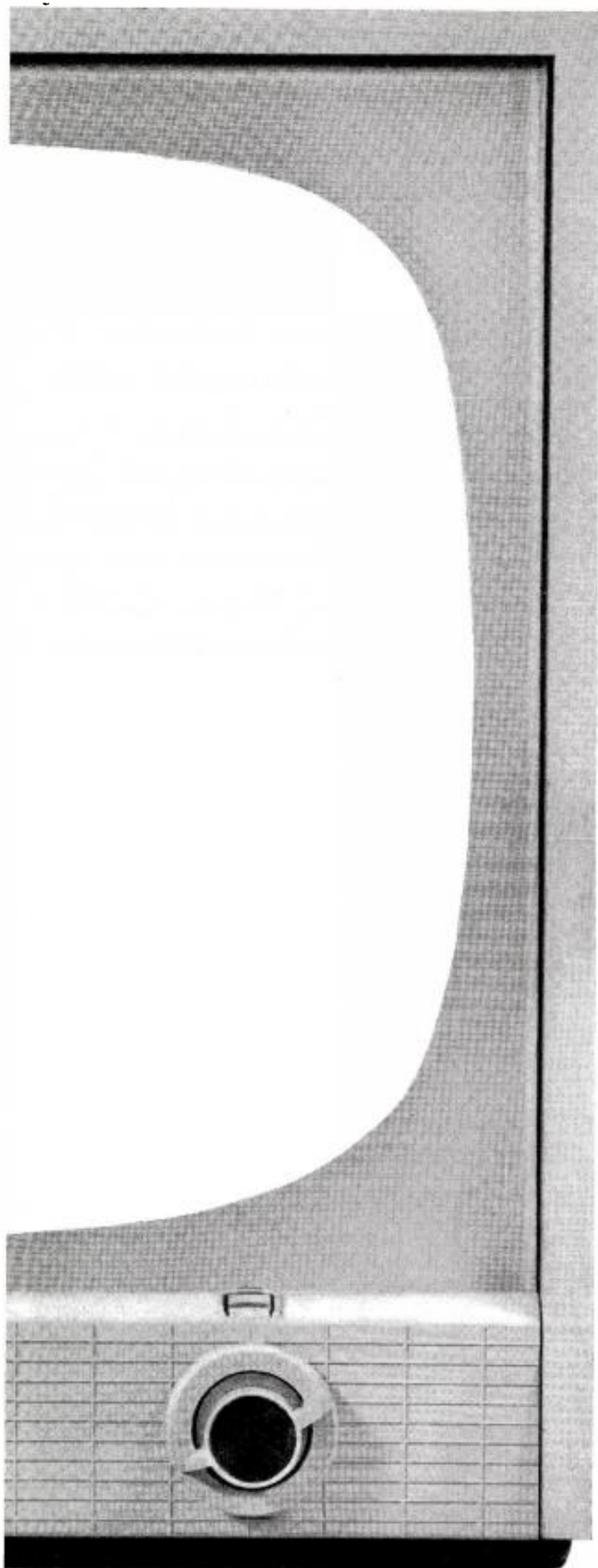

TV moves fast.

Are your commercials giving you the jump on competition—or are they lagging a couple of years behind? Think it over. Could be your sales curve is caught in a creative backwater.

McCANN-ERICKSON, Inc.

Advertising

New York • Boston • Cleveland • Detroit • Chicago
Cincinnati • San Francisco • Los Angeles • Hollywood
Portland and offices throughout the world



FREE & PETERS

INC.

Pioneer Station Representatives Since 1932

FOR LATEST INFORMATION, CALL

NEW YORK
444 Madison Ave.
Plaza 1-2700

CHICAGO
230 N. Michigan Ave.
Franklin 2-6373

ATLANTA
Glenn Bldg.
Main 5667

HOLLYWOOD
6331 Hollywood Blvd.
Hollywood 9-2151

DETROIT
Penobscot Bldg.
Woodward 1-4255

FT. WORTH
406 W. Seventh St.
Fortune 3349

SAN FRANCISCO
Russ Building
Sutter 1-3798

EXCLUSIVE NATIONAL RADIO REPRESENTATIVES:

EAST SOUTHEAST

WBZ-WBZA	Boston-Springfield	NBC	51,000
WGR	Buffalo	CBS	5,000
KYW	Philadelphia	NBC	50,000
KDKA	Pittsburgh	NBC	50,000
WFBL	Syracuse	CBS	5,000
.....			
WCSC	Charleston, S. C.	CBS	5,000
WIST	Charlotte	MBS	5,000
WIS	Columbia, S. C.	NBC	5,000
WGH	Norfolk-Newport News	ABC	5,000
WPTF	Raleigh-Durham	NBC	50,000
WDBJ	Roanoke	CBS	5,000

MIDWEST SOUTHWEST

WHO	Des Moines	NBC	50,000
WOC	Davenport	NBC	5,000
WDSM	Duluth-Superior	ABC	5,000
WDAY	Fargo	NBC	5,000
WOWO	Fort Wayne	NBC	50,000
WIRE	Indianapolis	NBC	5,000
KMBC-KFRM	Kansas City	CBS	5,000
KFAB	Omaha	CBS	50,000
WMBD	Peoria	CBS	5,000
.....			
KFDM	Beaumont	ABC	5,000
KRIS	Corpus Christi	NBC	1,000
WBAP	Ft. Worth-Dallas	NBC-ABC	50,000
KXYZ	Houston	ABC	5,000
KTSA	San Antonio	CBS	5,000

MOUNTAIN AND WEST

KDSH	Boise	CBS	5,000
KVOD	Denver	ABC	5,000
KGMB-KHBC	Honolulu-Hilo	CBS	5,000
KEX	Portland	ABC	50,000
KIRO	Seattle	CBS	50,000

Analysis of 1953 Radio Advertising

TOTAL time sales by U. S. radio stations and networks were nearly half a billion dollars in 1953. The \$498,428,000 volume was \$25 million bigger than volume in 1952 and was an all-time record for annual radio business.

These were net time sales, after all frequency and promotional discounts but before deduction of commissions to agencies, national sales representatives and others.

Following the pattern of every year since 1948, national network sales were down, spot and local sales up. A 16.9% increase in spot volume over 1952 and 5.3% increase in local business were far more than enough to overcome the 12.7% decrease in network volume. The 1953 record: National network: \$89,528,000; spot: \$144,595,000; local: \$257,254,000. Regional network business, which has never been substantial compared with other categories, was \$7,051,000.

Radio's biggest boom occurred despite television competition that was increasing daily. In the first calendar year after the FCC freeze, 114 tv stations went into operation. That radio could do so well against such formidable opposition confounds predictions a few years ago.

What television has done to radio is to force a redistribution of volume in the three major business categories. Since 1948, network business has steadily declined, both in actual dollar volume and in proportion to total time sales. Network business accounted for 32.1% of total sales in 1948, 30.3% in 1949, 27.5% in 1950, 24.9% in 1951, 21.7% in 1952 and 18% in 1953.

Spot and Local Up

In those same years spot and local dollar volumes have risen annually and the proportions of their contributions to total volume have also increased, with the single exception of spot in 1952. Spot business accounted for 25.1% of total sales in 1948, 25.5% in 1949, 26.2% in 1950, 26.3% in 1951, 26.1% in 1952 and 29% in 1953. Local business was 41.1% of total sales in 1948, 42.8% in 1949, 44.8% in 1950, 47% in 1951, 50.6% in 1953 and 51.6% in 1953.

Regional network business has amounted to between 1% and 2% of total volume. Regional figures include revenue from special networks arranged for such events as sports broadcasts, as well as from permanent regional organizations.

As it was for most segments of

EDITOR'S NOTE: Estimated radio net time sales for 1953 are based on data gathered in a survey of a large and statistically reliable sample of all classes of stations. The formula for computing totals was originally developed for BROADCASTING by Dr. Herman S. Hettinger, nationally-known economist. Statistical information was audited by Sinrod & Tash, Washington certified public accountants, who delivered to BROADCASTING only weighted averages in each station and business category, in conformity with the canons of the American Institute of Certified Public Accountants. This method of estimating net time sales has been proved highly accurate through the years.

TABLE I
RADIO NET TIME SALES 1952-1953

Class of Business	1952	% Total	1953 (Estimated)	% Total
National Network	\$102,528,000	21.7	\$89,528,000	18.0
Regional & Miscellaneous Network	7,334,000	1.6	7,051,000	1.4
National & Regional Non-Network	123,658,000	25.1	144,595,000	29.0
Local	239,631,000	50.6	257,254,000	51.6
Total	\$473,151,000	100.0	\$498,428,000	100.0

the economy 1953 was a boom year for all advertising media.

Television: No official figures are available for 1953, but Richard P. Doherty, NARTB vice president, has estimated that the total tv revenue for that year was around \$448 million. That figure pertains to total revenue, including time sales and sale of talent and other services, and hence is not com-

parable to the B•T estimate of radio net time sales.

Magazines: Publishers Information Bureau estimates that gross billings in the leading 100 general and farm magazines were \$599 million in 1953, as compared with \$553.9 million in 1952. These figures are in no way comparable with radio and television net time sales quoted above. The PIB mag-

azine estimates are gross, figured at the one-time space rate. A closer comparison for radio is with the BROADCASTING YEARBOOK's estimate of gross radio billings of \$767.4 million for 1953, for which see below.

Newspapers: The Bureau of Advertising of the American Newspaper Publishers Assn. estimated that national advertising volume was \$600 million in 1953, compared with \$526 million in 1952. The bureau would make no estimate of total newspaper volume, including local business, beyond saying that it would be "well ahead" of 1952.

Outdoor: The Outdoor Advertising Assn. estimated that national sales in 1953 were \$106 million, compared to \$96.7 million for 1952. The association would not estimate total volume.

Direct Mail: The Direct Mail Advertising Assn. estimated that national sales in 1953 were 5% bigger than the \$1.1 billion in 1952.

(Note: Figures for newspapers, outdoor and direct mail should not be compared with net time sales

RADIO NET TIME SALES, 1935-53

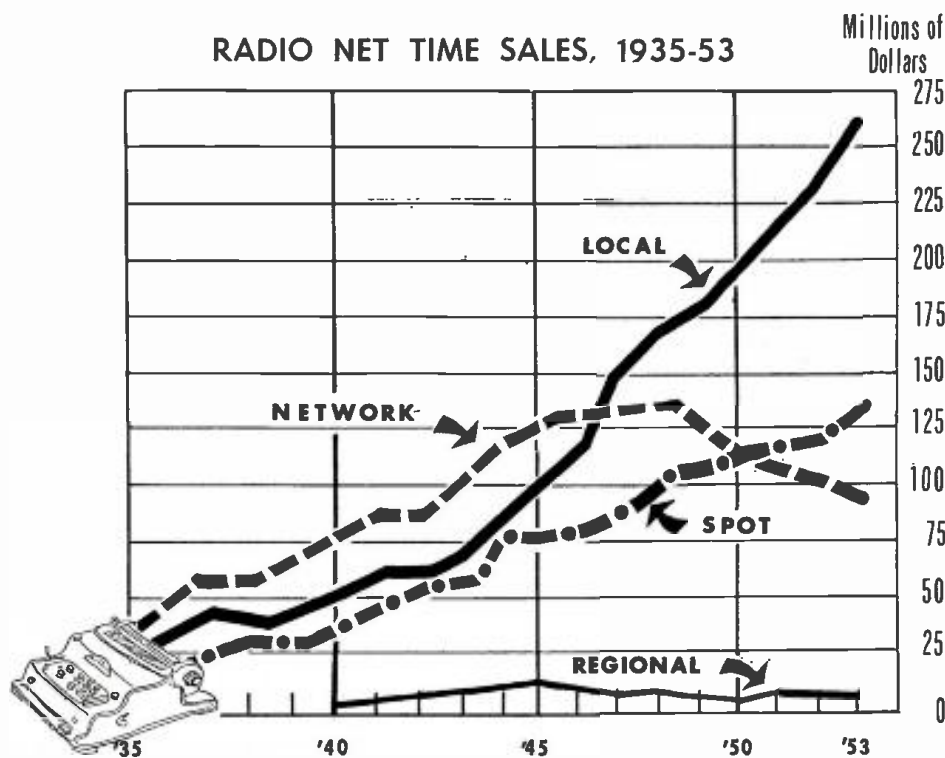

HERE'S the way time sales in the four major categories—national network, regional network, spot and local—have fared year by year. For specific figures, see Table II, page 14.

for radio and television. Net time sales estimates do not include the substantial expenditures in production and related activities. Newspaper, outdoor and direct mail estimates do.)

If 1953 were a boom year what will 1954 bring? To judge by all available economic indicators, it will be for radio and other advertising media what *Fortune* magazine has predicted it would be for the whole U. S. economy—the second biggest year in history.

In a memorandum circulated to the NARTB membership, Mr. Doherty reported on a recent conference of 14 leading business economists who attempted to outline the business outlook for 1954. Of these experts, according to Mr. Doherty, two believed business activity in 1954 would be at about the same history-making level of 1953. The other 12 forecast lower levels. Of the 12, one believed business would take a 15-17% slide this year. The consensus of the others, however, was that business would slip about 8-10%.

Such a slip would hardly mean recession. Indeed if the slip were only slightly less than 8% it would be, as *Fortune* predicts, the second best year on record.

Mr. Doherty submitted three general conclusions in his report:

1. Fears of a sharp recession getting under way in 1954 seem to be without foundation.

2. Conversely, there doesn't appear to be any logical basis for assuming that 1954 will extend the peak boom levels of 1953. However, this could occur if sharply revived military activities developed during the next six or seven months.

3. Most manufacturing and distributive groups will probably find that 1954 will be a year during which they are faced with a slower rate of activity (as compared with 1953) and with a higher rate of market competition.

These three conclusions can be translated into meaning for advertising. For intelligent advertisers, a market which is tightening but still big and rich should suggest invigorated promotion and sales effort. Indications are that forward-looking advertisers are making just such plans.

Last November the Assn. of National Advertisers reported the results of a poll of 170 member companies as to 1954 intentions [BoT,

TABLE III
ESTIMATED RADIO GROSS BILLINGS—1953

Class of Business	Estimated Gross Billings
National Network	\$158,910,000
Regional & Miscellaneous Network	10,492,000
National Non-Network	215,171,000
Local	382,818,000
TOTAL	\$767,391,000

TABLE II
RADIO NET TIME SALES—1935-1953
Class of Business

Year	Change from previous year		Change from National previous year		Change from previous year		Change from previous year		Change from previous year	
	National Network	%	Regional Network	%	Local	%	Total	%	Total	%
1935 ¹	\$39,737,867	\$13,605,200	\$26,074,476	\$79,617,543
1936 ²
1937	56,192,396	41.4	2,854,047	23,117,136	67.4	35,745,394	37.1	117,908,973	48.1
1938	56,612,925	0.7	28,109,185	21.6	32,657,349	(-8.7)	117,379,459	0.6
1939	62,621,689	10.6	30,030,563	6.8	37,315,774	14.2	129,968,026	10.7
1940*	71,919,428	13.1	1,869,583	37,140,444	23.8	44,756,792	20.0	155,686,247	20.5
1941	79,621,534	10.7	2,752,073	47.2	45,681,959	23.0	51,697,651	15.5	179,753,217	15.4
1942	81,744,396	2.7	3,444,581	25.2	51,059,159	11.8	53,898,916	4.2	190,147,052	5.8
1943	99,389,177	21.6	6,256,508	81.6	59,332,170	16.2	64,104,309	18.9	228,102,164	20.0
1944	121,757,135	22.5	7,612,366	21.7	73,312,899	23.5	84,960,347	29.3	287,642,747	26.1
1945	125,671,834	3.2	8,301,702	9.1	76,696,463	4.6	99,814,042	17.5	310,484,046	7.9
1946	126,737,727	0.8	8,043,381	-3.1	82,917,505	8.1	116,380,301	15.6	334,078,914	7.6
1947	127,713,942	0.8	7,012,689	-12.8	91,581,241	10.4	147,778,814	27.0	374,086,686	12.0
1948	133,723,098	4.5	7,329,255	4.3	104,759,761	14.4	170,908,165	15.6	416,720,279	11.4
1949	128,903,467	-3.6	5,994,858	-18.2	108,314,507	3.4	182,144,301	6.5	425,357,133	2.1
1950	124,633,089	-3.3	6,897,127	15.0	118,823,880	9.7	203,210,834	11.6	453,564,930	6.6
1951	113,984,000	-8.5	8,481,000	23.0	119,599,000	0.6	214,519,000	5.6	456,543,000	0.6
1952	102,528,000	-10.0	7,334,000	-13.5	123,658,000	3.4	239,631,000	11.7	473,151,000	3.6
1953†	89,528,000	-12.7	7,051,000	-3.8	144,595,000	16.9	257,254,000	7.4	498,428,000	5.3

¹ Nation-wide and regional networks combined.
² Data not available.
* Figures prior to this date not comparable in all categories.
† 1953 figures estimated.

Nov. 9, 1953]. The companies were asked whether they planned to enlarge or contract their spending in each of 12 media.

Of the companies that used radio in 1953, 34% said they expected to spend more in radio in 1954, 39% planned to spend about the same, 27% planned to reduce radio expenditures.

Of those using television in 1953, 80% planned to build up their tv budgets in 1954, 15% expected to spend about the same, and 5% anticipated a reduction of tv spending.

Overall, the 1954 picture looked good, according to the ANA survey. Increased expenditures in all but two of the 12 media were anticipated. Consumer magazines, Sunday supplements, newspapers, point-of-purchase, outdoor, direct mail, business papers and farm magazines—in addition to radio and television—will receive increased appropriations from more of the reporting companies than the number planning to spend less. Only Sunday comics and car cards were in for

reduced appropriations from more advertisers than those planning to spend more in those media.

Radio time sales since World War II have increased more than \$164 million in annual volume. But the size of the radio broadcasting industry has also expanded. In the same period the number of am stations in operation has more than doubled, from 1,062 on the air at the end of 1946 to 2,509 at the end of 1953. With the station population rising faster than the total business volume, the post-war years have seen a decline in "average" per-station revenue.

At the end of 1946, with 1,062 am stations operating and with total time sales of \$334 million, the "average" station sales were \$314,575. (This, of course, ignores the fact that both national and regional networks take sizable chunks of the total volume. These computations are used only to indicate how, though the pot has grown larger

year by year, the number of stations dipping into it has also grown, with individual portions getting smaller.)

On this basis, average per-station time sales have looked like this: 1947, \$245,786; 1948, \$223,442; 1949, \$207,693; 1950, \$206,714; 1951, \$195,857; 1952, \$197,888; and 1953, \$193,656.

Fm revenues are not treated independently in these estimates since the total fm volume of time sales is not large enough to be accurately estimated by the sample method.

Gross time billings (value of time sold, figured at the one-time rate with no deductions) as estimated by BROADCASTING YEARBOOK were \$767,391,000 in 1953 compared with \$714,975,000 in 1952.

Of that total, \$158,910,000 was for national network time, \$10,492,000 for regional network, \$215,171,000 for spot and \$382,818,000 for local.

TABLE V
RADIO NETWORK GROSS EXPENDITURES BY PRODUCT GROUP

Product Groups	1952		1953	
	Gross Billings	% Total	Est. Gross Billings	% Total
1. Agriculture & Farming	\$ 754,765	.5	\$ 1,203,780	.8
2. Apparel, Footwear & Accessories	420,187	.3	1,170,132	.7
3. Automotive, Automotive Equip. & Accessories	4,376,300	2.7	7,314,744	4.6
4. Beer, Wine & Liquor	2,203,316	1.3	1,846,572	1.2
5. Building Material, Equip. & Fixtures	1,023,408	.6	1,548,300	1.0
6. Confectionery & Soft Drinks	5,296,820	3.2	3,113,736	2.0
7. Consumer Services	2,264,301	1.4	2,330,928	1.5
8. Drugs & Remedies	21,029,955	12.9	20,833,332	13.1
9. Entertainment & Amusements	6,090	.0	9,000	.0
10. Food & Food Products	36,833,737	22.5	35,148,744	22.1
11. Gasoline, Lubricants & Other Fuels	5,179,888	3.2	4,751,568	3.0
12. Horticulture	114,086	.0	107,324	.0
13. Household Equipment & Supplies	6,561,099	4.0	7,052,964	4.4
14. Household Furnishings	1,435,115	.9	1,893,284	1.2
15. Industrial Materials	2,114,852	1.3	750,000	.5
16. Insurance	3,335,753	2.0	2,232,504	1.4
17. Jewelry, Optical Goods & Cameras	1,006,903	.6	963,456	.6
18. Office Equipment, Writing Supplies & Stationery	642,675	.4	606,252	.4
19. Political	1,700,569	1.0	800	.0
20. Publishing & Media	536,884	.3	247,728	.2
21. Radios, Tv Sets, Phonographs, Musical Instruments & Access.	2,876,575	1.8	2,348,604	1.5
22. Retail Stores & Shops	33,234	.0	15,450	.0
23. Smoking Materials	15,959,995	9.8	14,786,796	9.3
24. Soaps, Cleaners & Polishes	18,325,951	11.2	15,612,324	9.8
25. Sporting Goods & Toys	83,427	.0
26. Toiletries	23,215,160	14.2	26,503,620	16.7
27. Transportation, Travel & Resorts	883,428	.5	817,284	.5
28. Miscellaneous	5,148,995	3.2	5,700,804	3.6
TOTAL	\$163,453,466		\$158,910,010	

* % will not necessarily add to 100 because of rounding.

UP

1400 radio stations from coast to coast receive from United Press an average of more than 40 news programs and news features every day--in addition to scores of extra shows of seasonal and special topical interest throughout the year. And some 200 kinds of sponsors buy them. The U.P. bureau nearest you is ready to present further information promptly.

United Press news programs for radio

United Press news programs for radio

TYPE	TITLE	MINUTES	DAYS
BASIC NEWS	World News Roundup	15	Weekdays, 7 times; Sun., 6 times
	The World in Brief	5	Weekdays, 14 times; Sun., 11 times
	The World in a Nutshell	1	Weekdays, 7 times; Sun., 6 times
SPORTS	Speaking of Sports	5	Monday through Saturday
	The Sports Lineup	5	Every day
	The Sports Roundup	5	Twice daily
	Great Moments in Sports	5	Monday through Saturday
	Sizing Up Sports	15	Sunday
FOR WOMEN	In the Woman's World	5	Monday through Friday
	Mainly for Women	5	Monday through Friday
	Women in the News	5	Monday through Friday
HUMAN INTEREST	Your Home	5	Saturday
	Names in the News	5	Monday through Friday
	Time Out	5	Monday through Friday
	In Your Neighborhood	5	Monday through Saturday
	In Movieland	5	Saturday
	Flashback	1	Monday through Friday
	United Press Almanac	1	Every day
	Do Tell	5	Sunday
FARMING	In Their Own Words	5	Sunday
	Let's Take a Trip	5	Saturday
	On the Farm Front	5	Monday through Saturday
	Daily Farm Market Survey	5	Monday through Saturday
	Rural Roundup	5	Tuesday through Saturday
COMMENTARY & REVIEW	R-F-D Review	5	Sunday
	Today's United Press Commentary	5	Every day
	Under the Capitol Dome	5	Monday through Saturday
	United Press News Analysis	5	Monday through Friday
	Highlights of the Week's News	15	Sunday
BUSINESS & SCIENCE	This is Washington	15	Sunday
	United Press Reporting	15	Sunday
	Weekly Business Review	5	Sunday
	Tomorrow's Business	5	Saturday
	Today in Science	5	Monday through Friday
Calling All Drivers	5	Sunday	

The Radio Audience

By Arthur C. Nielsen
President, A. C. Nielsen Company

(Chart 1)

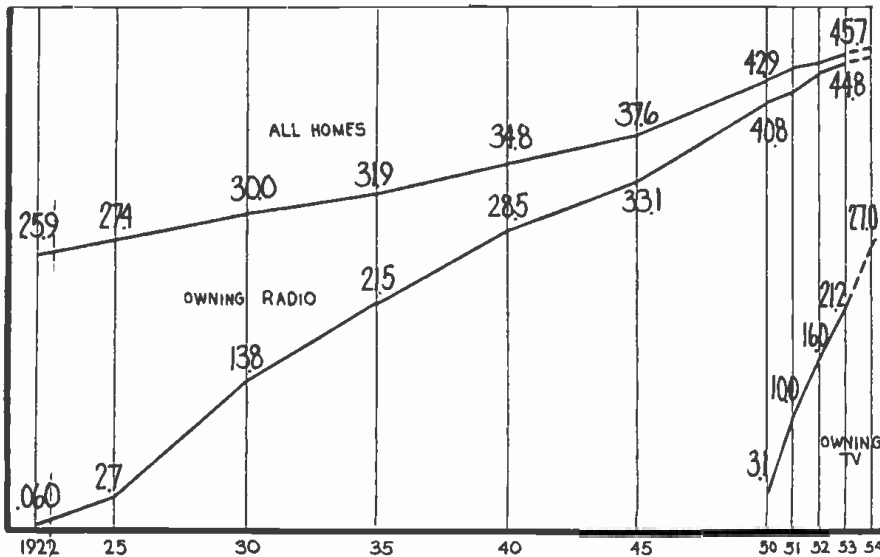

CHART 1—GROWTH OF RADIO-TV OWNERSHIP. Still growing in 1953, radio approached virtual saturation of U. S. homes—44,800,000 homes, or 98.1 per cent of the total—keeping it still unequalled in potential among media. Television ownership grew to 25,690,000 homes, as of October, which gave it 57.4 per cent saturation. Of importance to broadcast advertisers was the fact that over 19,000,000 homes in the country could only be reached by radio. In this chart, estimates of future growth are projected.

Radio, in the year just past, must have confounded some of the prophets of doom in our midst. Thirty-three years or so after its birth, the medium had the highest home saturation in its history, continued to provide advertisers with a larger potential than that of any other medium, continued to perform a sizable job of moving products off shelves, and, in general, met the challenge of mushrooming television outlets with continuing strength, scope and vitality.

As television service was spreading to more and more markets, the senior medium gave all indications of being not the victim, but the vigorous competitor.

It's interesting to examine the size, proportions and performance of radio during the year, using data from the Nielsen Radio Index.

CHART 2—RADIO AND TV HOMES BY TERRITORIES AND COUNTY SIZE. Radio still follows population distribution evenly in its regional pattern. Television does not, showing a variation in degree of saturation that ranged from 77 per cent in the Northeast to 36 per cent in the South. Similarly, radio's distribution by county size is far more even than tv's, the latter tending to concentrate in the large, metropolitan counties and being relatively weak in the small, rural ones. This contrast between the two is of vital significance for advertisers in matching media to product distribution patterns.

(Chart 2)

SEPTEMBER 1, 1953

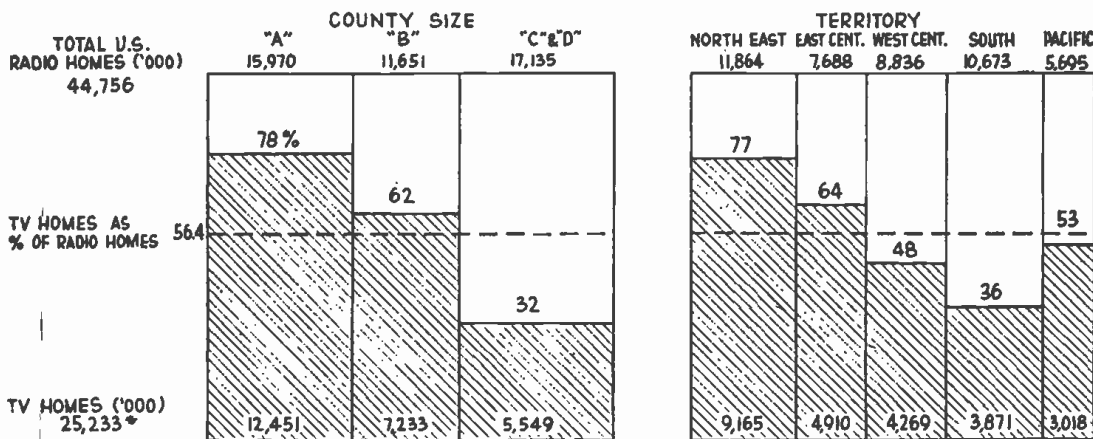

* NBC ESTIMATES
(1) INCLUDING ADJACENT COUNTIES BELONGING TO SOME METRO AREA

in 1953

CHART 3—VOLUME OF RADIO USAGE PER DAY. During the first half of 1953, the average radio home listened 17 minutes less per day than in the comparable period of 1952. This was less of a decline than in the three previous years. At the same time, it was to a certain extent compensated for by the growth in ownership. Looking at the grand total of home-hours per day, a good measure of the potential for the advertiser, we see 129 million for this year, 10 million below the '52 figure.

JANUARY - JUNE 1953 — AVERAGE PER DAY (Chart 3)

	EST. NO. RADIO HOMES (MILLIONS)	HOURS RADIO USAGE PER DAY	TOTAL HOME HRS. PER DAY (MILLIONS)
1946	34.0	4:13	143.1
1947	35.9	4:33	163.3
1948	37.6	4:41	176.5
1949	39.3	4:32	178.3
1950	40.7	4:10	169.7
1951	41.9	3:38	152.1
1952	43.8	3:10	139.0
1953	44.8	2:53	129.5

CHART 4—U. S. HOMES USING RADIO BY HOURS. Turning to radio usage in terms of numbers of homes, it may be seen that peak listening occurred at mid-day; that the early morning hours showed increases over '52; that evening listening activity was substantially lower than last year's; and that afternoon and evening hourly totals tended to match each other for the first time. Still, the absolute size of the daily audience was in itself quite substantial.

TOTAL U. S. RADIO HOMES (000) USING RADIO BY HOURS OF DAY—SEPTEMBER (Chart 4)

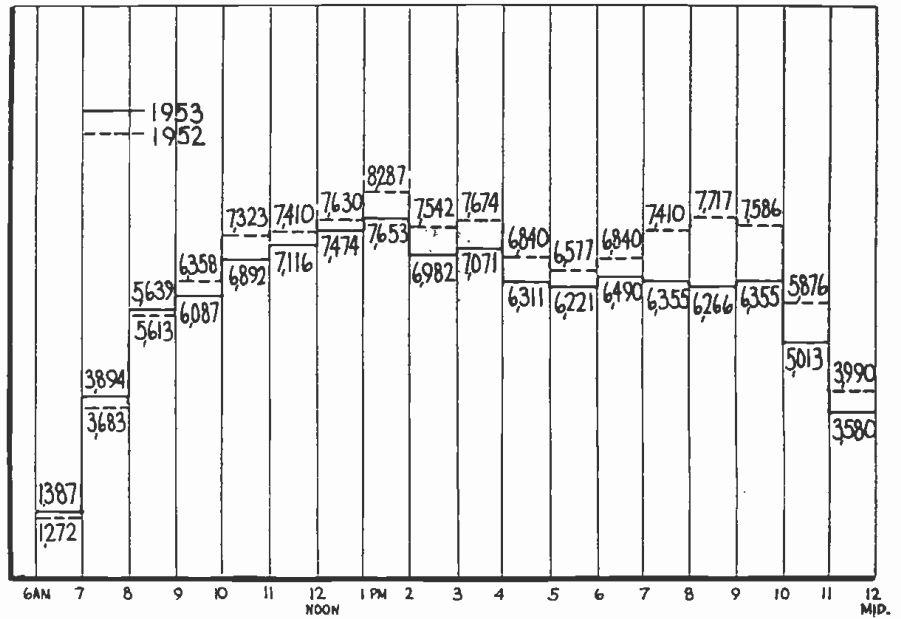

WEEK ENDING SEPTEMBER 26, 1953 (Chart 5)

CHART 5—AVERAGE RATINGS, BY PROGRAM TYPES. At the start of the season, variety-comedy shows had the highest average rating among evening once-a-week shows, with general drama second. In the daytime categories, serials were the most popular. This follows the pattern of the same period in 1952, when comedy and serials also led, although at higher average levels.

ONCE-A-WEEK EVENING (25 MIN. OR MORE DURATION) MULTI-WEEKLY DAYTIME

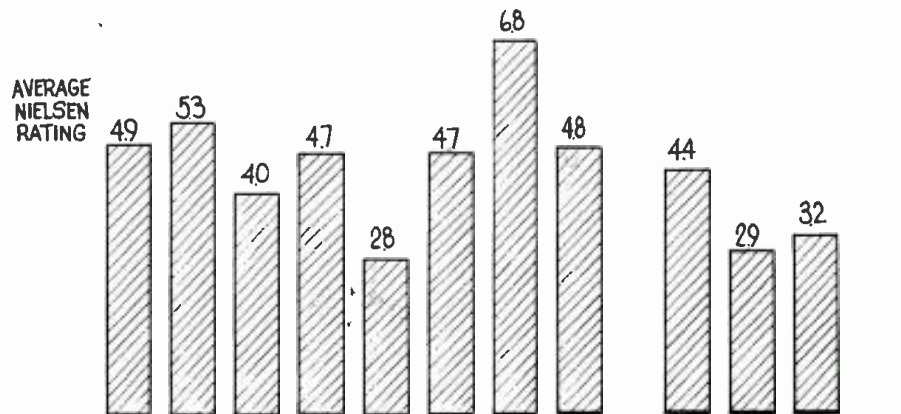

(Continued on page 20)

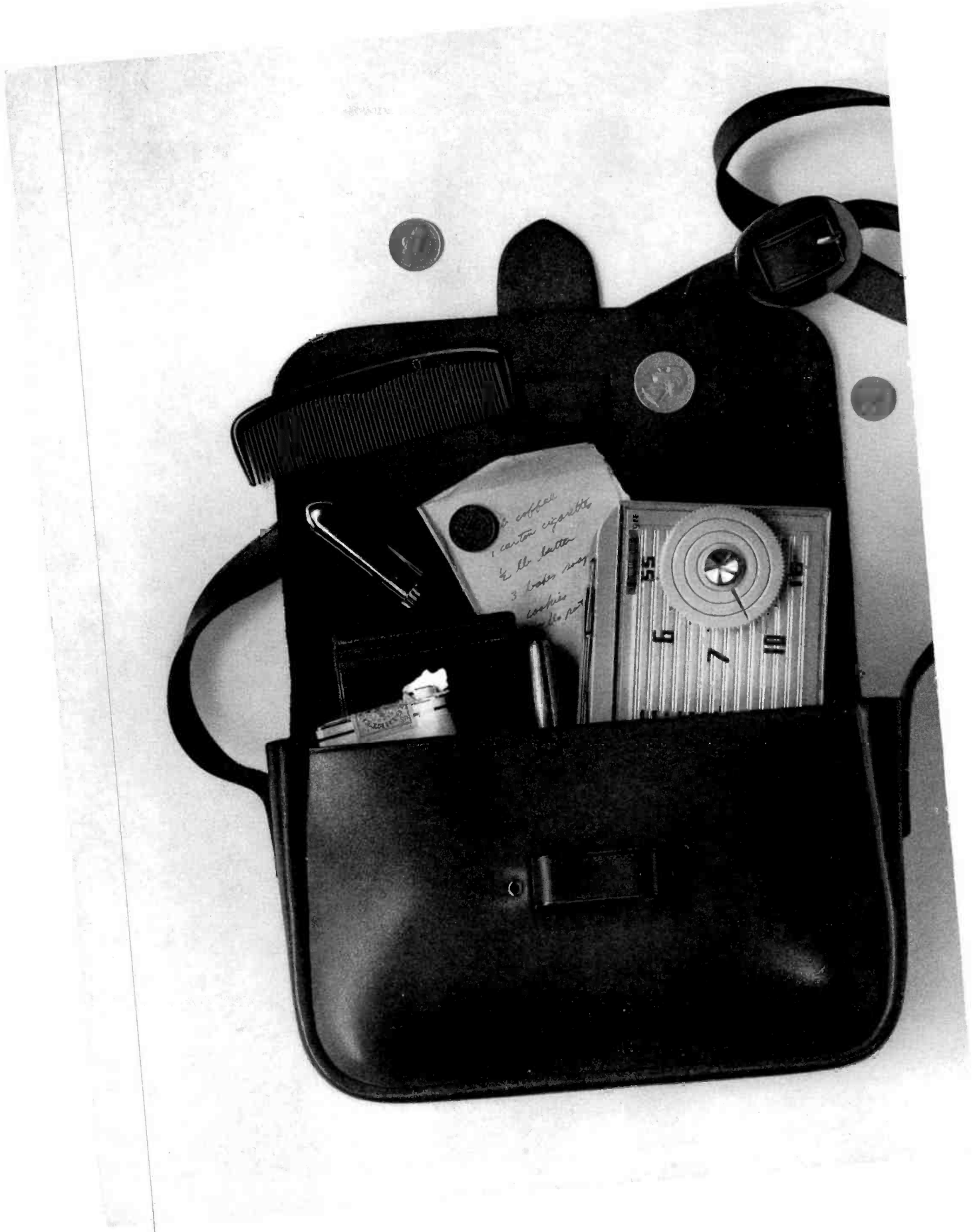

1 coffee
1 carton cigarettes
1/2 lb butter
3 books soap
1 book
1/2 lb pot

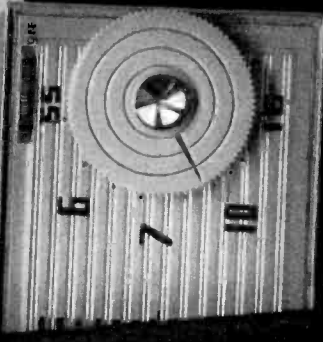



... She shall
have radio
wherever
she goes

Funny about radio: the lighter it gets,
the more weight it carries.

For no other advertising medium turns
up in so many different shapes and
sizes, to reach out to so many different
customers. And no other's on such
intimate terms that it goes wherever
the customer goes—from home
to car to pocketbook, *right up to the
point of sale.*

All because of one thing: wherever they
go, whatever they're doing, Americans
like to listen to radio.

What else explains the 110 million new
sets people have bought in the last
eight years. And the 14 million *more*
they're buying this year.

What else explains the demand for a set
so light it can ride along with the
shopping list... The customer enthusiasm
that's got the set-maker turning out
more than a thousand a day... And
the public's eagerness for lighter and
even smaller sets that transistors
promise for tomorrow.

*Today—by adding a new outlet every
3 seconds—radio is growing faster than
any other advertising medium.*

Radios now fit any pocket... *Radio*
always has.

CBS RADIO NETWORK

... where America listens most

ONCE-A-WEEK EVENING (25 MINUTES OR MORE DURATION)

MULTI-WEEKLY DAYTIME

SITUATION GENERAL MYSTERY CONCERT POPULAR VARIETY VARIETY QUIZ & ADULT CHILD QUIZ & COMEDY DRAMA DRAMA MUSIC MUSIC MUSIC COMEDY AUDIENCE PARTICIPATION SERIALS PROGRAMS AUDIENCE PARTICIPATION

CHART 6—COST PER THOUSAND HOMES REACHED, BY PROGRAM TYPES. As was the case in the same period of '52, quiz and audience participation shows were the most economical among evening program types, with mysteries second. Both types, incidentally, averaged lower costs-per-thousand than they did the year before. Among daytime shows, the serials as a group were again the best bargains to sponsors, showing their continuing leadership in that respect.

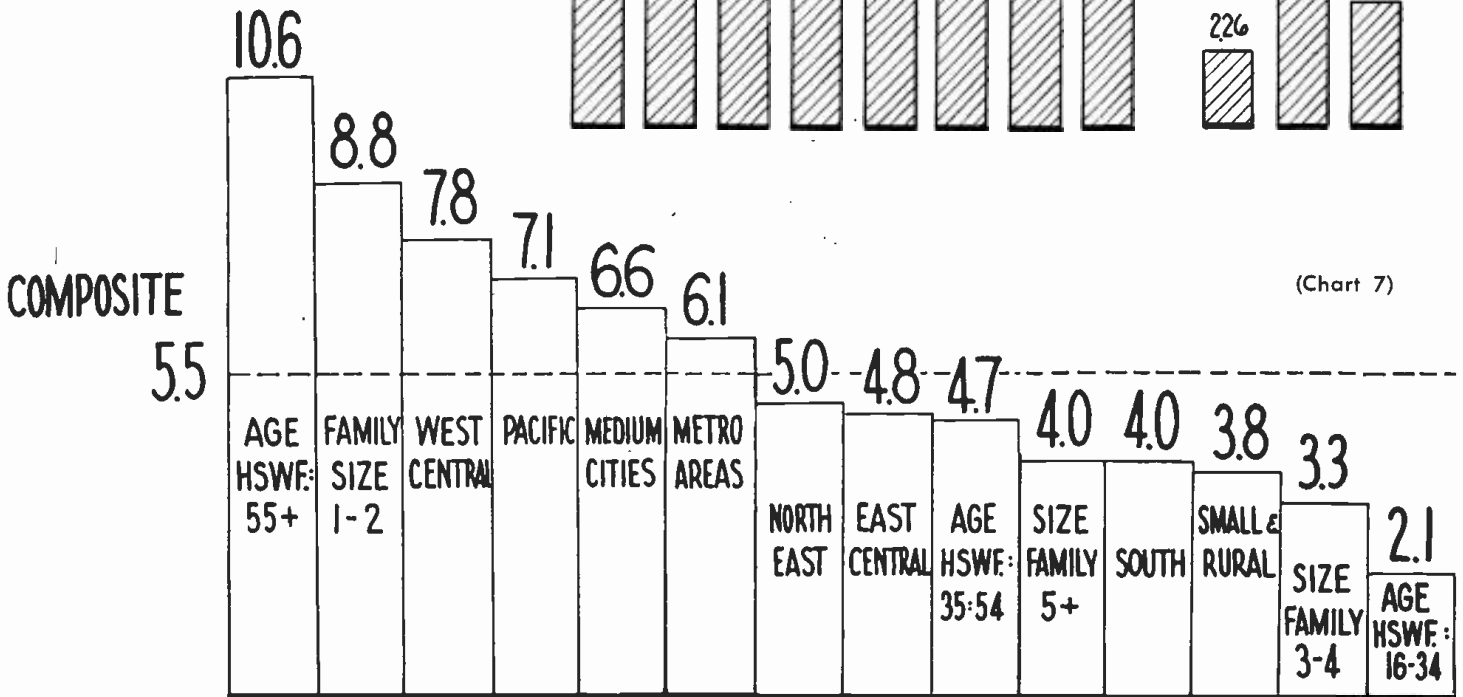
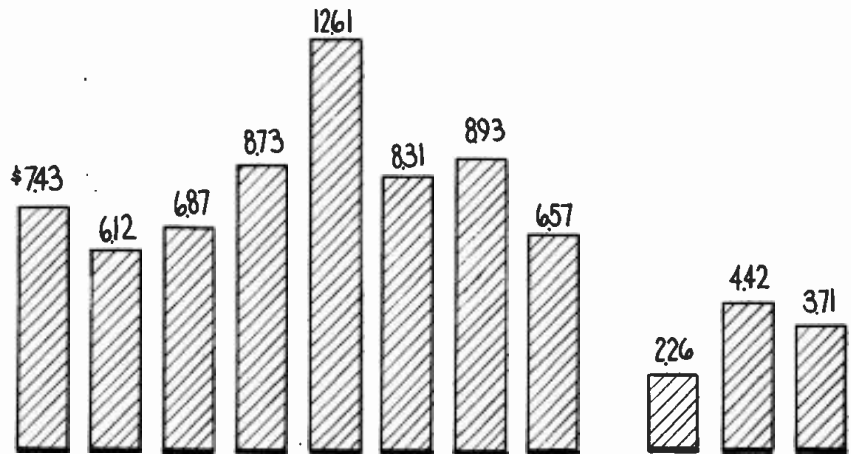

(Chart 7)

CHART 7—AUDIENCE CHARACTERISTICS OF A MUSICAL SHOW. The wide variation in a program's appeal among homes of different characteristics is typified here. At one time last season, the show had a national rating of 5.5. But it was nearly twice as popular—with a 10.6 rating—among older families as a group, only half as popular among younger families, and so on. It may be seen that this program, like so many others, shows large differences in its appeal to homes of different locations, family size, age, and market size. These variations continue to affect the advertiser's choice of vehicle.

CHART 8—AUDIENCE SIZE COMPARISONS, TWO-PROGRAM COMBINATIONS. Since many advertisers use two or more programs to promote a brand, it's pertinent to examine the extent of audience size and degree of duplication achieved by various combinations in four weeks in terms of per cent of homes reached. Here we see, typically, that using radio and tv shows to complement each other can mean larger audiences, with very little duplication. Combinations of radio shows alone tend more toward duplicated audiences.

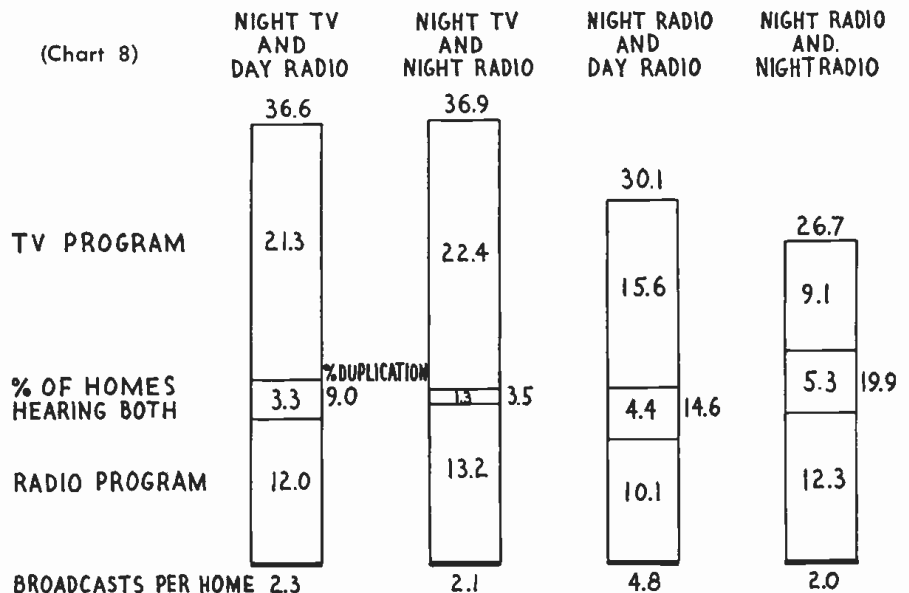

(Chart 8)

RADIO STATION REPRESENTATIVES AND STATIONS REPRESENTED

(Editor's Note: Reproduced here is a directory of radio station representatives. The listing of a firm does not necessarily mean that it presently is handling radio station representation. Where a firm actually is the designated representative of a radio station or stations, the listings so indicate. Dagger (†) indicates firm is also a newspaper representative.)

AIRSPOT SALES

Chicago 1—64 E. Lake St. Tel.: Franklin 2-0961.
State 2-0460. Gen. Mgr.: Joseph Kapps.
(Stations represented not reported)

ALASKA RADIO SALES

New York 17—17 E. 42d St. Tel.: Murray Hill
2-0813. Network Sales Mgr.: Charles E. Soden;
Spot Sales Mgr.: Roy V. Smith.

Represents:

KFQD Anchorage KINY Juneau
KFRB Fairbanks KTKN Ketchikan
KIBH Seward KIFW Sitka

AM RADIO SALES

New York—WMCA Bldg., 1657 Broadway. Mgr.:
Willmot H. Losee.
Chicago—400 N. Michigan Ave. John Carey, Jerry
Glynn.
Los Angeles—5939 Sunset Blvd.

Represents:

WIND Chicago WLOL Minneapolis
WMCA New York KMPC Los Angeles

AMERICAN SALES AND SERVICING AGENCY

New York 17—17 E. 42nd St. Tel.: Murray Hill
2-0810. Pres.: Guy Bolam.

Represents:

Radio Luxembourg "One" and "Two"

AVERY-KNODEL INC.

New York 20—608 Fifth Ave. Tel.: Judson 6-5536.
Mgr.: Lewis H. Avery.
Chicago 1—75 E. Wacker Dr. Tel.: Andover 3-4710.
Mgr.: J. W. Knodel.
San Francisco 4—235 Montgomery St. Tel.: Yukon
2-3877. Mgr.: David H. Sandeberg.
Los Angeles 48—6399 Wilshire Blvd. Tel.: Web-
ster 3-9583. Mgr.: Edwin Cahn.
Atlanta 3—41 Marietta St., N.W. Tel.: Cypress
7545. Mgr.: Charles C. Coleman.
Dallas 1, Tex.—1915 Elm St. Tel.: Sterling 1558.
Mgr.: Clyde B. Melville.

Represents:

WGAC Augusta, Ga. WIBA Madison, Wis.
KERO Bakersfield, Calif. WDCY Minneapolis
WGUY Bangor, Me. KOMA Oklahoma City
WSGN Birmingham, Ala. WOOO Orlando, Fla.
WKBW Buffalo WIRL Peoria, Ill.
WAPO Chattanooga, Tenn. WGAN Portland, Me.
WSAI Cincinnati KOIN Portland, Ore.
KSO Des Moines, Iowa WLSL Roanoke, Va.
KDAL Duluth, Minn. WHBF Rock Island, Ill.
KEPO El Paso, Tex. KROY Sacramento, Calif.
KFPW Fort Smith, Ark. KALL Salt Lake City
KFRF Fresno, Calif. KCBQ San Diego, Calif.
KILO Grand Forks, N. D. KSOO Sioux Falls, S. D.
WJEF Grand Rapids, Mich. KTUL Tulsa, Okla.
WFBC Greenville, S. C. WRUN Utica-Rome, N. Y.
WKZO Kalamazoo, Mich. WBRY Waterbury, Conn.
WROL Knoxville, Tenn. KXEL Waterloo, Iowa
WILK Wilkes-Barre, Pa.

Rural Radio Network The Intermountain Network

WILLIAM A. AYRES CO.

San Francisco 4—233 Sansome St. Tel.: Yukon
6-2981. Owner-Mgr.: William A. Ayres.

Represents:

Donald Cooke Inc.

WALTER BIDDICK CO.

Los Angeles 15—1151 S. Broadway. Tel.: Rich-
mond 6184. Mgr.: Guy Biddick.

Represents:

WIBW Topeka, Kan. KCKN Kansas City, Mo.
WIBX Utica, N. Y. WOKZ Alton, Ill.
KGFH Cuero, Tex. KVOS Ogden, Utah
KJSK Columbus, Neb. KMUR Murray, Utah
KJAN Atlantic, Iowa KRPL Moscow, Idaho
KJRG Newton, Kan. KCLX Colfax, Wash.
KNBR North Platte, Neb.

LOUIS J. BORGATTI INC.

Boston 16—419 Boylston St. Tel.: Commonwealth
6-0718. Pres.-Treas.: Louis J. Borgatti.

Represents:

Connie Stackpole Show

Granite State Network: WTXL Springfield, Mass.
WKBR Manchester, N. H. WARE Ware, Mass.
WNNH Rochester, N. H. WWON Woonsocket, R. I.
WTSV Claremont, N. H. WPJB Providence, R. I.
WTSL Lebanon, N. H. Lobster Network:
WTA Brattleboro, Vt. WFOR Portland, Me.
WMOU Berlin, N. H. WCOU Lewiston, Me.
WHOB Gardner, Mass. WFAU Augusta, Me.
WIDE Biddeford, Me. WTVD Waterville, Me.
WRK Rockland, Me.
WRK Rumford, Me.

BERTHA BANNAN

Boston—Little Bldg. Tel.: Hubbard 4370. Bertha
Bannan.

New England Radio Representation:

WJAR Providence WOCB Cape Cod, Mass.
WLBZ Bangor, Me. WDEV Waterbury, Vt.
WHA1 Greenfield, Mass. WSYB Rutland, Vt.
WCSH Portland, Me. WWSR St. Albans, Vt.
WIBX Utica, N. Y. WELI New Haven, Conn.
WRDO Augusta, Me. WBET Brockton, Mass.
WFGM Fitchburg, Mass. WCRB Waltham, Mass.
WSPR Springfield, Mass. WLYN Lynn, Mass.
WNBH New Bedford, Mass. WJOY Burlington, Vt.
WERI Westerly, R. I.
WTHT Hartford, Conn.

WATR Waterbury, Conn. Mass.
WRJM Newport, R. I.
WNAB Bridgeport, Conn. WOTW Nashua, N. H.
WTOR Torrington, Conn. WHEC Rochester, N. Y.
WTRY Troy, N. Y.
WARA Attleboro, Mass. WHAY New Britain, Conn.
WALE Fall River, WTSA Brattleboro, Vt.
Maine Broadcasting System

HIL F. BEST CO.

Detroit 26—Park Ave. Bldg. Tel.: Woodward
2-7298.
New York 17—101 Park Ave. Tel.: Lexington
2-3783.
Chicago 1—228 N. LaSalle St. Tel.: State 2-5096.
Atlanta—Mortgage Guarantee Bldg. Tel.: Alpine
5-084.
San Francisco 3—15 Harriet St. Tel.: Underhill

Why Do

more radio stations choose

HIL F. BEST CO.

than any other radio representative?

Here are a few reasons:

- ☆ Six Sales Offices
- ☆ 100% AM-FM selling—No TV's
- ☆ Selling only at card rates—no deals
- ☆ No P.I.'s—only straight radio selling
- ☆ Billing and collecting service for all stations
- ☆ Largest and the BEST small radio representative

Ask any station manager that co-operates and gets HIL F. BEST payment checks every month! ! !

If you will agree to work hand-in-hand with my SIX sales offices we can help you sell more spots in the national field; if interested: *Write — Wire — Phone*

Hil F. Best Co.

Radio Station Representative

Park Ave. Bldg.

Detroit 26, Mich.

RADIO REPRESENTATIVES

3-6480.
Los Angeles 36—5225 Wilshire Blvd. Tel.: York
8-812.

Represents:

TEXAS:
KVLF Alpine
KALT Atlanta
KRUN Ballinger
KIOX Bay City
KTXC Big Spring
KNEL Brady
KSTB Breckenridge
KBOR Brownsville
KORA Bryan
KDET Center
ECTX Childress
KCLE Cleburne
KVMC Colorado City
KCFH Cuero
KXIT Dalhart
KDDD Dumas
KNAF Fredericksburg
KSJG Gladewater
KGRH Henderson
KPAH Hereford
KHBR Hillsboro
KMBC Junction
KERV Kerrville
KINE Kingsville
KHIT Lampasas
KJBC Midland
KVKM Monahans
KRIG Odessa
KOGT Orange
KODD Pampa
KFTV Paris
KIUN Pecos
KBOP Pleasanton
KCNV San Marcos
KQED Seguin
KSEV Seymour
KEVA Shamrock
KTAN Sherman
KXOX Sweetwater
KTLW Texas City
KNAL Victoria

FLORIDA:
WTRL Bradenton
WKKO Cocoa
WCNU Crestview
WBRD Fort Lauderdale
WGGG Gainesville
WJVB Jacksonville
Beach
WLEB Leesburg
WSEB New Smyrna
Beach
WCNH Quincy
WTRR Sanford
WKXY Sarasota
WPLA Plant City

KANSAS:
KCRB Chanute
KCLO Leavenworth
KSCB Liberal

MISSOURI:
KCHI Chillicothe
KREI Farmington
KNEM Nevada

ILLINOIS:
WAVA Ava
WKEI Kewanee
WSMI Litchfield
WVMC Mt. Carmel
WIZZ Streator

INDIANA:
WCDC Anderson
WLO Frankfort
WINL Lebanon
WLRP New Albany
WSRK Shelbyville
WFML Washington

MICHIGAN:
WKNK Muskegon
WTVB Coldwater
WSTR Sturgis
WABJ Adrian
WALM Albion
WMPZ Flint
WION Ionia
WHTC Holland
WMTE Manistee
WMDN Midland
WSDC Marine City

OHIO:
WPRO Fremont
WAND Canton
WJER Dover

KENTUCKY:
WLCK Campbellsville
WAIN Columbia
WCPM Cumberland
WIEL Elizabethtown
WFUL Fulton
WKIC Hazard
WKTW Mayfield
WSP Paintsville
WERT Prestonburg
WSFC Somerset

TENNESSEE:
WAGG Franklin

WALTER BIDDICK CO.

Los Angeles 15—1151 S. Broadway. Tel.: Rich-
mond 6184. Mgr.: Guy Biddick.

Represents:

WIBW Topeka, Kan.
WIBX Utica, N. Y.
KJSK Columbus, Neb.¹
KJAN Atlantic, Iowa¹
KCID Caldwell, Idaho
KRPL Moscow, Idaho²
KSPT Sandpoint, Idaho
KSUB Cedar City, Utah
KMUR Murray, Utah²
KJSK-KJAN—One contract, 10% discount.
KRPL-KCLX—One contract, 25% discount.
Tri-City Network.
Missouri Network—20% discount.

JOHN BLAIR & CO.

New York—Chrysler Bldg. East. Tel.: Murray
Hill 2-6900. Chairman: John P. Blair; Presi-
dent: Richard D. Buckley.
Chicago—520 N. Michigan Ave. Tel.: Superior
7-8659. Mgr.: Charles F. Dilcher.
Boston 16—Statler Office Bldg., 20 Providence
St. Tel.: Hubbard 2-3163. Mgr.: Bruce G. Patty-
son.
St. Louis—1037 Paul Brown Bldg. Tel.: Chestnut
3688. Mgr.: J. Chris Hetherington.
Los Angeles—6331 Hollywood Blvd. Tel.: Holly-
wood 7-6103. Mgr.: Carleton E. Coveny.
San Francisco—3010 Russ Bldg. Tel.: Douglas 2-
3188. Mgr.: B. James Richards.
Detroit—524 Book Bldg. Tel.: Woodward 1-6030.
Mgr.: Charles D. Fritz.
Dallas—Rio Grande Nat'l Bldg. Tel.: Riverside
4228. Mgr.: Clarke R. Brown.

Represents:
Don Lee Broadcasting System
The Arizona Radio Network
Texas State Network

KOY Phoenix, Ariz.
KTUC Tucson, Ariz.
KHJ Los Angeles
KFXM San Bernardino,
Calif.
KGB San Diego, Calif.
KFRC San Francisco
KQDM Stockton, Calif.
KFEL Denver
WJAX Jacksonville,
Fla.
WQAM Miami
WDBO Orlando, Fla.
WFLA Tampa, Fla.
WGST Atlanta
KIDO Boise, Idaho
WXYZ Detroit
WLS Chicago
WIBC Indianapolis
WKLO Louisville
WDSU New Orleans
WFBR Baltimore
WHDH Boston
KXOK St. Louis
WHB Kansas City, Mo.
WOW Omaha, Neb.
WNEW New York
KFYR Bismarck, N. D.

WENS Columbus, Ohio
KRMG Tulsa, Okla.
KPOJ Portland, Ore.
WWSW Pittsburgh
WGBI Scranton, Pa.
WSPA Spartanburg,
S. C.
WTMA Charleston,
S. C.
WRR-KFJZ Dallas, Ft.
Worth, Tex.
KLYN Amarillo, Tex.
KWFT Wichita Falls,
Tex.
KTRH Houston, Tex.
KGBS San Antonio
KDYL Salt Lake City
KING Seattle, Wash.
WVDC Washington
WVVA Wheeling,
W. Va.
WSAV Savannah, Ga.
WENR Chicago
WHBQ Memphis, Tenn.
WTCN Minneapolis
WPRO Providence, R. I.
KFH Wichita, Kan.

HASKELL BLOOMBERG

Lowell, Mass.—39 Kearney Square. Tel.: Lowell
9-815. Gen. Mgr.: Haskell Bloomberg.
Lawrence, Mass.—Cregg Bldg. Tel.: Lawrence
2-2148.
Cambridge, Mass.—28 Carleton St. Tel.: Kirk-
land 7-2355.

Represents:

WLLH-AM-FM Lowell, Mass.

THE BOLLING CO. INC.

New York 17—480 Lexington Ave. Tel.: Plaza
9-8150. Mgr.: George W. Bolling.
Boston—80 Boylston St. Tel.: Hubbard 2-0346.
Mgr.: Richard G. Koenig.
Chicago 1—360 North Michigan Ave. Tel.: Dear-
born 2-5277. Mgr.: John D. Stebbins.
Los Angeles 5—2978 Wilshire Blvd. Tel.: Dun-
kirk 8-8158. Mgr.: George W. Bolling III.
San Francisco 3—5 Third St. Tel.: Garfield 1-6740.
Mgr.: John T. Coy.

Represents:

WROW Albany, N. Y.
WHBU Anderson, Ind.
WBNB Binghamton,
N. Y.
KFGO Fargo, N. D.
WANE Fort Wayne,
Ind.
WHP Harrisburg, Pa.
WISH Indianapolis
WKDA Nashville,
Tenn.
KOWH Omaha, Neb.
WQAN Scranton, Pa.
WHOT South Bend,
Ind.
WTHI Terre Haute,
Ind.
WNEB Worcester,
Mass.
WBIR Knoxville, Tenn.
KFAC Los Angeles
WMBG Richmond, Va.

WVET Rochester, N. Y.
KOL Seattle, Wash.
WHKK Akron, Ohio
WISE Asheville, N. C.
WCOP Boston, Mass.
WVVS Charlotte, N. C.
WKNE Hartford-New
Britain, Conn.
KVAN Portland, Ore.
KSON San Diego, Calif.
KREM Spokane, Wash.
WILM Wilmington, Del.
WBSM New Bedford,
Mass.
KEAR San Mateo,
Calif.
KARM Fresno, Calif.
KFMJ Tulsa, Okla.
WJMR New Orleans
WCOG Greensboro,
N. C.

†THE BRANHAM CO.

Chicago—360 N. Michigan Ave. Tel.: Central
6-8728. Mgr.: C. B. Peterson.
New York—230 Park Ave. Tel.: Murray Hill
6-1860. Mgr.: Joseph F. Timlin.
Atlanta—Rhodes-Haverty Bldg. Tel.: Walnut
3025. Mgr.: H. L. Rails.
St. Louis—Arcade Bldg. Tel.: Chestnut 6192
Mgr.: J. E. Nicholson.
Dallas—1005 Fidelity Union Life Bldg. Tel.:
Riverside 4884. Mgr.: George Harding.
Detroit—General Motors Bldg. Tel.: Trinity
1-0440. Mgr.: Fred Weber.
Charlotte, N. C.—Commercial National Bank
Bldg. Tel.: 8639. Mgr.: E. C. Finch.
San Francisco—703 Market St. Tel.: Yukon 2-1582.
Mgr.: Walter F. Patzlaiff.
Los Angeles—6399 Wilshire Blvd. Tel.: Webster
1-1551. Mgr.: Norman E. Noyes.
Memphis—Sterick Bldg. Tel.: 8-2344. Mgr.: Sid-
ney Nichols.

Represents:

WABB Mobile, Ala.
KTHS Hot Springs,
Ark.
KFWE Los Angeles
WGBA Columbus, Ga.
WNEK Macon, Ga.
WTPS New Orleans
KWKH Shreveport, La.
WTEO Cumberland,
Md.
WHYN Springfield-
Holyoke, Mass.
WRBC Jackson, Miss.
KOB Albuquerque,
N. M.
WCPO Cincinnati
WDEF Chattanooga,
Tenn.

WTJS Jackson, Tenn.
WNOX Knoxville,
Tenn.
WMC Memphis
WFC Amarillo, Tex.
KRIC Beaumont, Tex.
KIT Yakima, Wash.
KMO Tacoma, Wash.
KWBU Corpus Christi,
Tex.
KRLD Dallas
KROD El Paso, Tex.
WCHS Charleston,
W. Va.
WBLK Clarksburg,
W. Va.
WPAR Parkersburg,
W. Va.

HOWARD C. BROWN CO.

Hollywood 46—7165 Torreyson Dr. Tel.: Holly-
wood 2-3460. Mgr.: Howard C. Brown.
(Stations represented not listed.)

BULMER & JOHNSON INC.

Minneapolis 2—WCCO Bldg. Tel.: Lincoln 7017.
(Stations represented not listed)

BURN-SMITH CO. INC.

New York 18—19 W. 44th St. Tel.: Murray Hill
2-3124. Mgr.: C. Stanley Bailey.
Chicago 1—307 N. Michigan Ave. Tel.: Central
6-4437. Mgr.: John A. Toothill.

Represents:

KRIZ Phoenix, Ariz.
KFOK Long Beach,
Calif.
KLK Oakland, Calif.
KSEW Salinas, Calif.
WVUF Gainesville, Fla.
WALB Albany, Ga.
WJVA South Bend,
Ind.
KCRI Cedar Rapids,
Iowa
WLEJ Bowling Green,
Ky.
WFKY Frankfort, Ky.
WHLN Harlan, Ky.
WYLK Lexington-
Versailles, Ky.
WKYV Louisville, Ky.
WOMI Owensboro, Ky.
WBOC Salisbury, Md.
WKLA Ludington,
Mich.
WCMA Corinth, Miss.
WCNC Elizabeth City,
N. C.
WFLB Fayetteville,
N. C.
WGBB Greensboro,
N. C.

†CAPPER PUBLICATIONS INC.

New York—420 Lexington Ave. Tel.: Lexington
2-1250. Mgrs.: Philip Zach, K. H. Constant,
W. L. McKee.
Chicago—333 N. Michigan Ave. Tel.: Central
6-5977. Mgrs.: Frank Gaughen, Bernard Clark.
Kansas City—21 W. Tenth St. Tel.: Harrison
4700. Mgr.: Joe Story.
San Francisco—Russ Bldg. Tel.: Douglas 5220.
Mgr.: Fred Jameson.

Represents:

KCKN Kansas City, Kan.
WIBW Topeka, Kan.

CBS RADIO SPOT SALES

A SERVICE OF CBS RADIO

Radio Station Representatives

New York—485 Madison Ave. Tel.: Plaza 1-2345.
Gen. Sales Mgr.: Henry Flinn; Eastern Sales
Mgr.: Milton Allison.
Chicago—410 N. Michigan Ave. Tel.: Whitehall
4-6000. Western Sales Mgr.: Gordon F. Hayes.
Los Angeles—Columbia Sq. Tel.: Hollywood
9-1212. Mgr.: George Hurst.
San Francisco—Palace Hotel. Tel.: Yukon 2-7000.
Mgr.: Bert West.
Atlanta—31 Third St. N.E. Tel.: Elgin 0727. Mgr.:
Dave Kittrell.
Detroit—902 Fisher Bldg. Tel.: Trinity 2-5500.
Mgr.: Ralph H. Patt Jr.

Represents:

KMOX St. Louis
KNX Los Angeles
KSL Salt Lake City
WAPI Birmingham
WBEM Chicago
WBT Charlotte
WCSB New York
WCAU Philadelphia
WCCO Minneapolis

Columbia California
Network
Columbia Pacific
Network
WBEI Boston
WVA Richmond
WTOP Washington
KCBS San Francisco
WMBR Jacksonville
Fla.

HENRY I. CRISTAL CO.

New York—270 Park Ave. Tel.: Murray Hill
8-4414. Mgr.: Henry I. Cristal.
Chicago—333 N. Michigan Ave. Tel.: Central
6-6357. Mgr.: James L. Thompson.
Boston—581 Boylston St. Tel.: Copley 7-1180.
Mer. Richard Charlton.
Detroit—2107 Book Bldg. Tel.: Woodward 3-2365.
Mgr.: Joseph R. Spadea.
San Francisco—Russ Bldg. Tel.: Yukon 2-1204.
Mgr.: Richard E. Green.

Represents:

WBEN Buffalo
WGAR Cleveland
WJR Detroit
WDAF Kansas City
KFI Los Angeles
WHAS Louisville

WTMJ Milwaukee
WGY Schenectady
WBAL Baltimore
WTC Hartford, Conn.
WTAG Worcester,
Mass.

GEORGE W. CLARK INC.

Chicago—333 N. Michigan Ave. Tel.: Central
6-2884. Mgr.: George W. Clark.
New York—11 W. 42d St. Tel.: Oregon 5-7457.
Mgr.: William Wyatt.
Los Angeles—11 N. LaCienega, Beverly Hills.
Tel.: Crestview 5-2022. Mgr.: Lee O'Connell.
San Francisco—233 Sansome St. Tel.: Yukon
6-2981. Mgr.: William Ayres.

TEN BRANHAM OFFICES COAST TO COAST

ATLANTA
DALLAS
DETROIT
NEW YORK
CHICAGO

ST. LOUIS
MEMPHIS
CHARLOTTE
SAN FRANCISCO
LOS ANGELES

representing RADIO

WABB	Mobile, Alabama	WNOX	Knoxville, Tennessee
KTHS	Little Rock, Arkansas	WMC	Memphis, Tennessee
KFWB	Los Angeles, California	KFDA	Amarillo, Texas
WNEX	Macon, Georgia	KRIC	Beaumont, Texas
WTPS	New Orleans, Louisiana	KWBU	Corpus Christi, Texas
KWKH	Shreveport, Louisiana	KRLD	Dallas, Texas
WTBO	Cumberland, Maryland	KROD	El Paso, Texas
WHYN	Springfield-Holyoke, Mass.	KMO	Tacoma, Washington
WRBC	Jackson, Mississippi	KIT	Yakima, Washington
KOB	Albuquerque, New Mexico	WCHS	Charleston, West Virginia
WCPO	Cincinnati, Ohio	WBLK	Clarksburg, West Virginia
WDEF	Chattanooga, Tennessee	WPAR	Parkersburg, West Virginia
WTJS	Jackson, Tennessee		

representing TELEVISION

KJEO	Fresno, California	WMCT	Memphis, Tennessee
WHYN-TV	Springfield-Holyoke, Mass.	KFDA-TV	Amarillo, Texas
KOB-TV	Albuquerque, New Mexico	KRLD-TV	Dallas, Texas
WCPO-TV	Cincinnati, Ohio	KROD-TV	El Paso, Texas
WEWS	Cleveland, Ohio	KMO-TV	Tacoma, Washington

national advertising representatives

BRANHAM

RADIO REPRESENTATIVES

Represents:
 KYA San Francisco
 WFOC Milwaukee, Wis.
 WHAM Marinette, Wis.
 WNAM Neenah-Menasha, Wis.
 WBEV Beaver Dam, Wis.
 Evergreen Group of Washington State

THOMAS F. CLARK INC.

New York 17-1 E. 54th St. Tel.: Eldorado 5-5666.
 Mgr.: Thomas F. Clark.
 Chicago-35 E. Wacker Dr. Tel.: State 2-1663.
 Mgr.: Paul Elsberry.
 Detroit-3049 E. Grand Blvd. Tel.: Trinity 1-8981.
 Mgr.: Paul Pequinot.

Represents:
 KGIW Alamosa, Colo.
 KBNZ La Junta, Colo.
 KVRH Salida, Colo.
 WFM Colorado, Ga.
 KLVK Leadville, Colo.
 WWGS Tifton, Ga.
 WVIV Jacksonville, Fla.
 KVBC Farmington, N. M.
 WCRS Greenwood, S. C.
 WLET Toccoa, Ga.
 WKTG Thomasville, Ga.

CLARK-WANDLESS-MANN INC.

New York-205 E. 42d St. Tel.: Murray Hill 4-1910.
 (Stations represented not reported)

COLLEGE RADIO CORP.

New York 17-14 W. 45th St. Tel.: Oxford 7-0890
 Pres.: Edwards R. Hopple; Treas.: Robert R. Vance Jr.
 (Represents 105 campus radio stations.)

LIONEL COLTON

New York 17-527 Lexington Ave. Tel.: Eldorado 5-7609.

Represents:
 WIBX Utica, N. Y.
 WBET Brockton, Mass.
 WREB Holyoke, Mass.

CONTINENTAL RADIO SALES

Philadelphia-Drexel Bldg. 111 S. 5th St., Tel.: Lombard 3-0882. Mgr.: Roberta Butche.
 New York-285 Madison Ave. Tel.: Lexington 2-2450. Mgr.: Stephanie Matyas.
 Chicago-228 N. LaSalle St. Tel.: Franklin 2-2095. Mgr.: Mrs. Ruth Olsen.

Represents:
 WGYV Greenville, Ala.
 KXJK Forrest City, Ark.
 KWSD Mt. Shasta, Calif.
 KSEF Needles, Calif.
 KFRH Riverside, Calif.
 KVRB Warren, Mo.
 WCFM (FM) Washington, D. C.
 WBLJ Dalton, Ga.
 WSGC Elberton, Ga.
 KASI Ames, Iowa
 WMTG Vanclue, Ky.
 WJMB Brookhaven, Miss.
 WRJW Picayune, Miss.
 KDMO Carthage, Mo.
 KWRE Warren, Mo.
 WIFM Elkin, N. C.
 KAGH Crossett, Ark.
 KDIA Auburn, Calif.
 KRDU Dinuba, Calif.
 WVOP Vidalia, Ga.
 KRXK Rexburg, Idaho
 WCHI (FM) Chicago Heights, Ill.
 WTAQ LaGrange, Ill.
 WEAW Evanston, Ill.
 WMRI Marion, Ind.
 WVFV Fuquay Springs, N. C.
 WGNL Gastonia, N. C.
 WBUY Lexington, N. C.
 WTSB Lumberton, N. C.
 WMAP Monroe, N. C.
 WHED Washington, N. C.
 KWCO Chickasha, Okla.
 WKPA New Kensington, Pa.
 WKOK Sunbury, Pa.
 WPRM Mayaguez, P. R.
 WTYC Rock Hill, S. C.
 KGFX Pierre, S. D.
 WHUB Cookeville, Tenn.
 WHBT Harriman, Tenn.
 WJJM Lewisburg, Tenn.
 WJGJ Tullahoma, Tenn.
 KRBA Lufkin, Tex.
 KBUB Brigham City, Utah

WGLC Centreville, Miss.
 WAPP McComb, Miss.
 WHOC Philadelphia, Miss.
 KGMO Cape Girardeau, Mo.
 KCHR Charleston, Mo.
 KIMO Independence, Mo.
 KRMO Monett, Mo.
 KOBE Las Cruces, N. M.
 KCBS Truth or Consequences, N. M.

THE CONWELL CO.

Kansas City 6-1002 Walnut Tel.: Victor 1120.
 Owner: John O. Conwell.

Represents:
 KCHI Chillicothe, Mo.
 KWRE Warrenton, Mo.
 KNEM Nevada, Mo.
 KREI Farmington, Mo.
 KCLO Leavenworth, Kan.

DONALD COOKE INC.

New York 17-331 Madison Ave. Tel.: Murray Hill 2-7270. Mgr.: Donald Cooke.
 Chicago 1-228 N. LaSalle St. Tel.: State 2-5096. Mgr.: Fred R. Jones.
 Los Angeles 36-111 N. LaCienega Blvd. Tel.: Crestview 5-2022. Mgr.: Lee F. O'Connell.
 Detroit-1076 Penobscot Bldg. Tel.: Woodward 2-3080. Mgr.: Charles J. Sheppard.
 San Francisco-233 Sansome St. Tel.: Douglas 2-4586. Mgr.: William Ayres.

Represents:
 KTOP Porterville, Calif.
 KBOW Butte, Mont.
 KASH Eugene, Ore.
 WCMB Harrisburg, Pa.
 KFRO Longview, Tex.
 KPAS Banning, Calif.
 KWTC Barstow, Calif.
 KRNO San Bernardino, Calif.
 WINK Fort Myers, Fla.
 KSEK Pittsburg, Kan.
 WGVV Geneva, N. Y.

Canadian Stations:

CJAV Port Alberni, B. C.
 CKKL Calgary, Alta.
 CJYJ Guelph, Ont.
 CJRL Kenora, Ont.
 CKWS Kingston, Ont.
 CKJL Kirkland Lake, Ont.
 CFCH North Bay, Ont.
 CHEX Peterborough, Ont.
 CHOK Sarnia, Ont.
 CHLO St. Thomas, Ont.
 CB Timmins, Ont.
 CKEY Toronto, Ont.
 Quebec French Radio Group

HARRY E. CUMMINGS

Jacksonville, Fla.—Barnett Bank Bldg. Tel.: 6-5770. Mgr.: Harry E. Cummings.

Southeastern Representative:

WTMA Charleston, S. C.
 WHBS Huntsville, Ala.
 WJAX Jacksonville, Fla.
 WQAM Miami, Fla.
 WDBO Orlando, Fla.

DEVNEY & CO.

New York 17-535 Fifth Ave. Tel.: Murray Hill 7-5365. Pres.: E. J. Devney.
 Chicago-64 E. Lake St. Tel.: Franklin 2-0016. Mgr.: Hal Holman.

Represents:

KDMS El Dorado, Ark.
 WCXN Middletown, Conn.
 WPCF Panama City, Fla.
 WSIR Winter Haven, Fla.
 WGMV Greenville, Miss.
 WATN Watertown, N. Y.
 WELS Kingston, N. C.
 WLAY Muscle Shoals, Ala.
 WONW Defiance, Ohio
 WRJM Newport, R. I.

DORA-CLAYTON AGENCY INC.

Southern Regional Representatives
 Atlanta 3-502 Mortgage Guarantee Bldg. Tel.: Alpine 7841. Operated by Dora C. Cossé and Clayton J. Cossé.

Represents:

Forjoe & Co. Palmetto Network (S.C.)
 WSPC Anniston, Ala.
 WBCO* Bessemer-Birmingham, Ala.
 WEBT Brewton, Ala.
 WHOS* Decatur, Ala.
 WWO* Dothan, Ala.
 WOWL* Florence, Ala.

WCBT Roanoke Rapids, N. C.
 WTNC Thomasville, N. C.
 WATH Athens, Ohio
 KOLS Pryor, Okla.
 WMUU Greenville, S. C.
 WNAH Nashville, Tenn.
 WDBL Springfield, Tenn.
 KPAT Pampa, Tex.
 WDNE Elkins, W. Va.
 WFPF Park Falls, Wis.

* Indicates stations with all or part Negro programs.

EVERETT-MCKINNEY INC.

New York 17-40 E. 49th St. Tel.: Plaza 9-3747.
 Chicago 11-400 N. Michigan Ave. Tel.: Superior 7-9052.
 Beverly Hills-111 N. LaCienega Blvd. Tel.: Crestview 5-2022.
 San Francisco-233 Sansome St. Tel.: Yukon 6-2396.

Represents:

WTHT Hartford, Conn.
 WSTC Stamford, Conn.
 W DAN Danville, Ill.
 KWHK Hutchinson, Kan.
 WLAM Lewiston, Me.
 WBEK Pittsfield, Mass.
 WENY Elmira, N. Y.
 WHDL Olean, N. Y.
 WHEC Rochester, N. Y.
 WNXT Portsmouth, Ohio
 KFLW Klamath Falls, Ore.
 KORE Eugene, Ore.
 KSLM Salem, Ore.
 WPAM Pottsville, Pa.
 WRAK Williamsport, Pa.

HUGH FELTIS & ASSOC.

Seattle 4-Central Bldg. Tel.: Eldorado 4489

Represents:

KBKW Aberdeen, Wash.
 KVOS Bellingham, Wash.
 KBRO Bremerton, Wash.
 KELS Longview-Kelso, Wash.
 KGAL Corvallis Albany-Lebanon, Ore.
 KSGA Redmond, Ore.
 KGAE Salem, Ore.
 KHQ Spokane, Wash.
 KPQ Wenatchee, Wash.
 KTV A Anchorage, Alaska
 KIT Yakima, Wash.

FORJOE & CO. INC.

New York 19-29 West 57th St. Tel.: Plaza 5-8501.
 Pres.: Joseph Bloom; V. P.: Zangwill Golobe; Gen. Mgr.: Joseph Ruggiero.
 Chicago 11-435 N. Michigan Ave. Tel.: Delaware 7-1874. Gen. Mgr.: Tom Cinquina.
 Los Angeles 14-127 Wilshire Blvd. Tel.: Madison 6-8329. Mgr.: Lawrence Krasner.
 San Francisco 5-583 Market St. Tel.: Sutter 1-7569. Mgr.: Zonabelle Samson.
 Atlanta 3-405 Mortgage Guarantee Bldg. Tel.: Alpine 7841. Mgr.: Clayton Cossé.
 (Stations represented not reported)

FREE & PETERS INC.

New York 22-444 Madison Ave. Tel.: Plaza 1-2700. Pres.: H. Preston Peters; Eastern Radio Sales Mgr.: Jones Scovern.
 Chicago 1-230 N. Michigan Ave. Tel.: Franklin 2-8373. Mgr.: John A. Cory; Midwest Radio Sls. Mgr.: Arthur Bagge.
 Atlanta 3-Glenn Bldg. Tel.: Main 5667. Mgr.: James M. Wade.

Detroit 26—Penobscot Bldg. Tel.: Woodward 1-4255. Mgr.: W. W. Bryan. Fort Worth 2—406 W. 7th St. Tel.: Fortune 3349. Mgr.: Dean Milburn. Hollywood 28—8331 Hollywood Blvd. Tel.: 9-2151. Mgr.: Hal W. Hoag. San Francisco 4—Russ Bldg. Tel.: Sutter 1-3798. Mgr.: F. Thos. Boise Jr.

Represents: WBZ-WBZA Boston-Springfield WGR Buffalo KYW Philadelphia KDKA Pittsburgh WFBL Syracuse WCSB Charleston, S. C. WIST Charlotte WIS Columbia, S. C. WGH Norfolk-Newport News WPTF Raleigh-Durham WDBJ Roanoke WHO Des Moines WOC Davenport WJZ Decatur, Ill. WDSM Duluth-Superior WDAY Fargo, N. D.

GILL-PERNA INC.

New York 21—654 Madison Ave. Tel.: Templeton 8-4740. Pres.: Helen Gill; Exec. V.P.: John J. Perna Jr. Chicago—75 E. Wacker Dr. Tel.: Central 6-2420. Los Angeles—2330 W. Third St. Tel.: Dunkirk 7-4388. San Francisco—57 Post St. Tel.: Sutter 1-5568. (Stations represented not reported)

PAUL GIRARD CO.

Dallas 1—314 Thomas Bldg. Tel.: Sterling 1037. (Stations represented not reported)

GENE GRANT & CO.

Los Angeles 36—5225 Wilshire Blvd. Tel.: York 8812. San Francisco 3—15 Harriet St. Tel.: Underhill 3-8480. (Stations represented not reported)

W. S. GRANT CO. INC.

San Francisco—703 Market St. Tel.: Exbrook 2-6685. Los Angeles—1127 Wilshire Blvd. Tel.: Madison 9-2653. New York—33 W. 42d St. Tel.: Bryant 9-1374. Chicago—612 N. Michigan Ave. Tel.: Superior 7-8177. (Stations represented not reported)

IRENE GRIFFITH

Hollywood 28—1341 No. Cahuenga Blvd. Tel.: Hillside 3912. San Francisco 4—681 Market St. Tel.: Douglas 4475. (Stations represented not reported)

MELCHOR GUZMAN CO. INC.

New York—45 Rockefeller Plaza. Tel.: Circle 7-0624. V. P. in Charge: A. M. Martinez. (Represents stations in Cuba, Mexico, Puerto Rico, Central and South America)

ARTHUR H. HAGG & ASSOC. INC.

Chicago 1—360 N. Michigan Ave. Tel.: Central 6-7553. Mgr.: Arthur H. Hagg. New York 17—366 Madison Ave. Tel.: Murray Hill 2-8865. Mgr.: Phil Broderick. Kansas City—P. O. Box 182. Tel.: Hedrick 2818. Mgr.: Robert D. Hagg. Omaha 5—3222 Center St. Tel.: Jackson 2620. Mgr.: Howard Harvey. Minneapolis 17—5615 41st Ave. So. Tel.: DR 8732. Mgr.: Jan E. Woll.

Represents:

KGNO Dodge City, Kan. KSWI Council Bluffs, Iowa

HEADLEY-REED CO.

New York—420 Lexington Ave. Tel.: Murray Hill 5-8701. Pres.: Frank W. Miller Sr.; Sec.-Treas.: Frank W. Miller Jr.; V. P.: W. B. Faber; V. P. Sales & Gen. Mgr.: Sterling B. Beeson. Chicago—230 N. Michigan Ave. Tel.: Franklin 2-4886. V. P.-Mgr.: John H. Wrath. Atlanta—Palmer Bldg. Tel.: Cypress 4311. Mgr.: E. W. Sweatman Jr. San Francisco—300 Montgomery St. Tel.: Yukon 6-1265. Mgr.: Ralph W. Mitchell. Hollywood—Taft Bldg. Tel.: Hillside 7738. Mgr.: Clark Barnes. New Orleans—Lee Circle Bldg. Tel.: Tulane 3363. Mgr.: Milton De Reyna Jr. Philadelphia—1216 Lincoln Liberty Bldg. Tel.: Locust 4-0678. Mgr.: Robert S. Dome.

Represents:

WALA Mobile, Ala. WSAF Montgomery, Ala. WDAK Columbus, Ga. WGL Ft. Wayne, Ind. WSAR Fall River, Mass. WSAM Saginaw, Mich. XFEQ St. Joseph, Mo. WHLD Niagara Falls, N. Y. WSJS Winston-Salem, N. C. WKOW Madison, Wis.

WFMJ Youngstown, Ohio WSAJ Allentown, Pa. WORE Boston, Mass. WKOP Binghamton, N. Y. WBCK Battlecreek, Mich. WTIK Durham, N. C. WHAN Charleston, S. C. WSYR Syracuse, N. Y. WTRY Troy, N. Y. WONE Dayton, Ohio WLAN Lancaster, Pa. WEEK Peoria, Ill. WEMP Milwaukee, Wis. WEEU Reading, Pa. WFAS White Plains, N. Y. WRDW Augusta, Ga. WKMH Dearborn, Mich. WTKO Meridian, Miss. KOTA Rapid City, S. D. WHIM Providence, R. I. WBML Macon, Ga. KWWL Waterloo, Iowa WORC Worcester, Mass. WKHM Jackson, Mich. WHK Cleveland, Ohio WCOS Columbia, S. C. KSFQ San Francisco, Calif. WBRE Wilkes-Barre, Pa. WSCR Scranton, Pa. WKAT Miami, Fla. WWSB New Orleans, La.

GEORGE P. HOLLINGBERRY CO.

Chicago 1—307 N. Michigan Ave. Tel.: Dearborn 2-6060. Mgr.: George P. Hollingbery. New York 18—500 Fifth Ave. Tel.: Bryant 9-3960. Mgr.: F. E. Spencer Jr. Atlanta 3—223 Peachtree St. Tel.: Cypress 1489. Mgr.: Richard N. Hunter. San Francisco 4—400 Montgomery St. Tel.: Douglas 2-1792. Mgr.: Kory LaRue. Los Angeles 13—411 W. Fifth St. Tel.: Madison 6-3633. Mgr.: Harry H. Wise Jr.

Represents:

WADC Akron, Ohio WGPC Albany, Ga. KOAT Albuquerque, N. M. WABE Allentown, Pa. WQXI Atlanta, Ga. WJFB Augusta, Ga. KPNC Bakersfield, Calif. WJBO Baton Rouge, La. WBCM Bay City, Mich. WNNR Binghamton, N. Y. KGEM Boise, Idaho WGN Chicago, Ill. KVOR Colorado Springs, Colo. WRBL Columbus, Ga. WBTV Danville, Va. WHIO Dayton, Ohio WWJ Detroit, Mich. WECB Duluth, Minn. KTSM El Paso, Tex. WEAU Eau Claire, Wis. WPS Evansville, Ind. KYNO Fresno, Calif. WBIG Greensboro, N. C. KPOA Honolulu, Hawaii WDXJ Jackson, Miss. KORK Las Vegas, Nev. KGH Little Rock, Ark. WLVA Lynchburg, Va. WISC Madison, Wis. WIOD Miami, Fla. WOL Moline, Ill. WSIX Nashville, Tenn. WVEZ New Orleans, La. KOOL Phoenix, Ariz. WJAS Pittsburgh, Pa. KOLO Reno, Nev. WHAM Rochester, N. Y. KUTA Salt Lake City, Utah KITO San Bernardino, Calif. KIST Santa Barbara, Calif. WARM Scranton, Pa. KOMO Seattle, Wash. KSCJ Sioux City, Iowa WORD Spartanburg, S. C. WSPR Springfield, Mass. KGBX Springfield, Mo. KSTN Stockton, Calif. KCNA Tucson, Ariz. WTRF Wheeling, W. Va. KOLD Yuma, Ariz. WAAB Worcester, Mass. WTMA Charleston, S. C. Arrowhead Network

* Except in Chicago, New York, Boston, Philadelphia.

HAL HOLMAN CO.

Chicago 1—64 E. Lake St. Tel.: Franklin 2-0016. Mgr.: Hal Holman. New York—535 Fifth Ave. Tel.: Murray Hill 7-5365. Mgr.: Ed Devney. Los Angeles 28—6381 Hollywood Blvd. Tel.: Hollywood 5048. Mgr.: Tracy Moore.

Represents:

WTCM Traverse City, Mich. WATT Cadillac, Mich. WATZ Alpena, Mich. WMBN Petoskey, Mich. WATC Gaylord, Mich. WFBE Benton Harbor, Mich. WBFB Jackson, Mich. WMUS Muskegon, Mich. WCEN Mt. Pleasant, Mich. WCZA Carthage, Ill. WHOW Clinton, Ill. WLHB Mattoon, Ill. WLDS Jacksonville, Ill. WJOL Joliet, Ill. WFLN Olney, Ill. WPEO Peoria, Ill. WLBC Muncie, Ind. WKAM Warsaw, Ind. KFIZ Fond du Lac, Wis. WBNB Beaver Dam, Wis. WAUX Waukesha, Wis. WSPJ Stevens Point, Wis. WGNS Murfreesboro, Tenn. WCRK Morristown, Tenn. WTPR Paris, Tenn. KIUP Durango, Colo. KGLN Glenwood Spring, Colo. KFJX Grand Junction, Colo. KFKA Greeley, Colo. KGAR Garden City, Kan. KNEB Scottsbluff, Neb. KGFV Kearney, Neb. KVAL Wallace, Idaho WLSB Birmingham, Ala. WGWG Selma, Ala. WHIR Danville, Ky. WMK Middlesboro, Ky. WAYX Waycross, Ga. KDSJ Deadwood, S. D. KICA Clovis, N. M. WLEC Sandusky, Ohio KXGI Fort Madison, Iowa

DON HOWARD & CO.

Del Rio, Tex.—Roswell Hotel. Tel.: 5-2431. Owner: Don Howard.

Represents:

XEDM Hermosillo XEFW Tampico XEMU Piedras Negras

H-R REPRESENTATIVES INC.

New York 17—405 Lexington Ave. Tel.: Murray Hill 9-2606. Pres.-Treas.: Frank M. Headley; Exec. V.P.: Dwight S. Reed; V.P.-Sec.: Frank E. Pellegrini; V.P.: Paul R. Weeks; V.P.: James W. LeBaron; Lou Faust; Joseph Amaturro; Walter Dunn; John E. Soell; Larry Hasbrouck. Chicago 9—79 W. Monroe St. Tel.: Randolph 6-0113. Dwight S. Reed, Carlin S. French, Bernard Salvin. San Francisco—110 Sutter St. Tel.: Exbrook 2-3407. James M. Alspaugh, John T. Bradley. Hollywood—710 Equitable Bldg. Tel.: Granite 1480. V.P.: Harold Lindley.

Represents:

KMPC Los Angeles WRKC Rockford, Ill. WFBG Altoona, Pa. WJIM Lansing, Mich. WMSC Columbia, S. C. WCOL Columbus, Ohio KMMJ Grand Island, Ala. WLOK Lima, Ohio WHUM Reading, Pa. KJBS San Francisco WTSP St. Petersburg, Fla. KNOE Monroe, La. WNOE New Orleans WJW Cleveland WONS Hartford, Conn. WSOC Charlotte, N. C. * West Coast only. WWNC Asheville, N. C. KXXX Colby, Kan. WIKK Erie, Pa. WNAC Boston WEAN Providence, R. I. WILD Birmingham, Ala. WING Dayton, Ohio KTHT Houston, Tex. WIZE Springdale, Ohio WELI New Haven, Conn. WOR New York* WMAS Springfield, Mass. KVI Seattle, Wash. Yankee Network

INDIE SALES INC.

New York 17—80 E. 42d St. Tel.: Murray Hill 2-4813. Mgr.: Jack Koste. Chicago 1—228 N. LaSalle St. Tel.: State 5096. Detroit 26—Park Avenue Bldg. Tel.: Woodward 2-7298. Los Angeles 36—5225 Wilshire Blvd. Tel.: York 8812. San Francisco 13—15 Harriet St. Tel.: Underhill 3-6480. Mgr.: Eric Braswell. (Stations represented not reported)

INTER-AMERICAN PUBLICATIONS INC.

New York 17—41 E. 42d St. Tel.: Murray Hill 2-0884. Pres.: Angel Ramos; V.P.-Treas.: Jose Oviedo; Sec.: Frank Navarro.

Represents:

WKAQ San Juan, P. R. WPAB Ponce, P. R. WKJB Mayaguez, P. R.

INTER-STATE UNITED NEWSPAPERS

New York—545 Fifth Ave. Tel.: Murray Hill 2-5452. Chicago—25 E. Jackson Blvd. Tel.: Webster 9-7260. Detroit—2146 St. Antoine St. Tel.: Cadillac 4497. Los Angeles—4822 S. Avalon Blvd.

Represents:

WNOP Newport, Ky.—WRHC Jacksonville, Fla. WUSN Charleston, S. C. WKSK Dallas, Tex. KCNC Fort Worth, Tex. WDX Orangeburg, S. C. WRFC Miami, Fla. WWRL New York WERD Atlanta, Ga. WAUG Augusta, Ga. WJLD Birmingham, Ala.

FRED R. JONES & SON

Chicago—228 N. LaSalle St. Tel.: State 2-5096

Represents:

Donald Cooke, Inc. Indie Sales Inc. Hil F. Best Co.

THE KATZ AGENCY

New York 22—488 Madison Ave. Tel.: Plaza 9-4460. Radio Sales Mgr.: M. S. Kellner. Chicago 1—307 N. Michigan Ave. Tel.: Central 6-7343. Mgr.: Gerald H. Gunst. Detroit 26—Penobscot Bldg. Tel.: Woodward 3-8420. Mgr.: Ralph Bateman. Kansas City 6—Bryant Bldg. Tel.: Victor 7095. Mgr.: Thomas J. Flanagan Jr. Atlanta 3—22 Marietta St. Tel.: Alpine 1637. Mgr.: Keith Byerly. Dallas 1—2006 Bryan St. Tel.: Riverside 4036. Mgr.: David Rutledge. San Francisco 4—Russ Bldg. Tel.: Sutter 1-7434. Mgr.: Stanley J. Reulman. Los Angeles 14—530 W. 6th St. Tel.: Tucker 8167. Mgr.: Richard Hasbrouck.

Represents:

KLZ Denver WLCB Nashville WGBS Miami, Fla. KHQ Spokane, Wash. WDAE Tampa WMMN Fairmont, W. Va. *WMAZ Macon, Ga. WISN Milwaukee *WTOC Savannah WJBK Detroit WEOA Evansville, Ind. WFDF Flint, Mich. WFBM Indianapolis WOOD Grand Rapids, Mich. WMT Cedar Rapids KRNT Des Moines KWK St. Louis WNHK New Haven WEBS Buffalo, N. Y. WNXA Sioux City, Mo. KCMO Kansas City, Mo. WYU New Orleans KGHJ Billings, Mont. D. C. WKRC Cincinnati WSPD Toledo, Ohio WSAZ Huntington, W. Va. WFIL Philadelphia WFAE Pittsburgh KFSN San Diego, Calif. WRC Memphis * The Georgia Trio.



Nothing unusual, things are always poppin' at **NBC SPOT SALES!**

RADIO REPRESENTATIVES

Los Angeles 5-2978 Wilshire Blvd. Tel.: Dunkirk 8-8158. Mgr.: V. E. Atkinson.
San Francisco 3-5 Third St. Tel.: Garfield 1-6740. Mgr.: George D. Close.

Represents:
WCOA Pensacola, Fla. WDNB Daytona Beach, Fla.
WJHP Jacksonville, Fla. WTMC Ocala, Fla.
WVPG Palm Beach, Fla. WDLF Panama City, Fla.

EDWARD PETRY & CO. INC.
New York 22-488 Madison Ave. Tel.: Murray Hill 8-0200. Mgr.: Lawrence Field.
Chicago 11-400 N. Michigan Ave. Tel.: Whitehall 4-0011. Mgr.: Edward E. Voynow.
Detroit 2-General Motors Bldg. Tel.: Trinity 5-1035. Mgr.: William Cartwright.
San Francisco 4-Russ Bldg. Tel.: Yukon 2-3631. Mgr.: Earle H. Smith.
Los Angeles 14-523 W. Sixth St. Tel.: Michigan 9227. Mgr.: Chester G. Matson.
St. Louis 3-915 Olive St. Tel.: Chestnut 7191. Mgr.: George Kercher.
Dallas 2-Life of America Bldg., Wood & Akard Sts. Tel.: Prospect 3593. Mgr.: Buell Herman.

Represents:
WSB Atlanta KGW Portland, Ore.
WFAA Dallas-Ft. Worth WRNL Richmond
KPRC Houston WOAI San Antonio
KARK Little Rock, Ark. KVOO Tulsa, Okla.
KFAA Los Angeles KTBS Shreveport, La.
KOA Denver WTP Philadelphia
KSTP St. Paul WABC New York
WSM Nashville KFMB San Diego
WTAR Norfolk KMA Shreveport, La.
Texas Quality Network

RADIO REPRESENTATIVES INC.
New York-480 Lexington Ave. Tel.: Murray Hill 8-4340. Pres.: Harry S. Goodman; V.P. Chg. New York: Peggy Stone.
Chicago-75 E. Wacker Drive. Tel.: Financial 6-9982. Gen. Mgr.: Ed Niekay.

Represents:
WVOK Birmingham, Ala. WENE Binghamton, N. Y.
WBAM Montgomery, Ala. WMGM New York
KPLN Denver WDOS Oneonta, N. Y.
WCFL Chicago WCRO Johnstown, Pa.
KAKE Wichita, Kan. WBG Philadelphia
WNN Louisville, Ky. WPO Stroudsburg, Pa.
WDYK Cumberland, Md. WBSA York, Pa.
WMOU Berlin, N. H. WMPM Memphis, Tenn.
WMAK Nashville, Tenn.

RADIO-TV PROMOTION SYNDICATE
New York 16-245 Fifth Ave. Tel.: Murray Hill 5-0588. Exec. Dir.: Irwin J. Breslauer; Sls. Dir.: Alvin H. Perlmutter.

Represents:
WALL Middletown, N. Y. WNRC New Rochelle, N. Y.
KDUZ Hutchison, Minn. WFGN Gaffney, S. C.

WILLIAM G. RAMBEAU CO.
New York 17-347 Madison Ave. Tel.: Murray Hill 6-5940. Pres.: William G. Rambeau; Vice Pres. in Chg. N. Y. Office: James A. Wethington.
Chicago 1-333 N. Michigan Ave. Tel.: Anderson 3-5566. Mgr.: Alfred A. Brown.
Los Angeles 5-1746 N. Las Palmas Ave. Tel.: Hillside 0388. Mgr.: Jack Porter.
Minneapolis 2-825 Second Ave., Suite 326-327. Tel.: Lincoln 7017. Mgr.: Vivian Bulmer.
San Francisco 5-607 Market St. Tel.: Garfield 1-0426. Mgr.: Roy D. Soderlind.
(Stations represented not listed.)

PAUL H. RAYMER CO. INC.
New York 22-444 Madison Ave. Tel.: Plaza 9-5570. Pres.: Paul H. Raymer; Exec. V.P. in charge AM operations: Fred C. Brokaw; Dir. Sales Research & Prom.: Carl W. Tillmanns.
Chicago 17-435 N. Michigan Ave. Tel.: Superior 7-4473. V.P.-Mgr.: G. C. Packard.
Detroit 26-2949 Penobscot Bldg. Tel.: Woodward 3-0764. Mgr.: Robert B. Rains.
Atlanta 3-Glenn Bldg. Tel.: Cypress 5304. Mgr.: Arch B. Ragan.
San Francisco 4-Russ Bldg. Tel.: Douglas 2-8909. Mgr.: L. Ray Rhodes.
Hollywood 28-1680 Vine St. Tel.: Hollywood 9-2376. Mgr.: John D. Gale.
Dallas 4-Life of America Bldg. Tel.: Riverside 5663. Mgr.: Robert E. Stuart.

Represents:
McClatchy Beeline
Arizona Broadcasting System
WBRC Hartford WBRC Birmingham
KTAR Phoenix WDOO Chattanooga
KVOA Tucson WTAC Flint, Mich.
KIMS Santa Barbara, Calif. WTOL Toledo
KOH Reno
KROY Santa Maria, Calif. WSBT South Bend, Ind.
WKBN Youngstown, Ohio KXO El Centro, Calif.
WLOF Orlando, Fla. WHKC Columbus, Ohio
WDNC Durham, N. C. WKJG Fort Wayne, Ind.
WQXR New York
KPBK Sacramento, Calif. WARC Rochester, N. Y.
KERN Bakersfield, Calif. KLRN Little Rock, Ark.
KMJ Fresno, Calif. KROW Oakland, Calif.
KJWG Stockton, Calif. WINZ Miami, Fla.
WCAO Baltimore WNOK Columbia, S. C.

KFOR Lincoln, Neb. KTBC Austin, Tex.
KRVN Lexington, Neb. KEYS Corpus Christi, Tex.
KOIL Omaha, Neb. KRCV Weslaco, Tex.
WVLA Boston KFDX Wichita Falls, Tex.
KANS Wichita, Kan. WKBH La Crosse, Wis.
KTOK Oklahoma City
KELO Sioux Falls, S. D.

O. J. REISS
New Orleans 12-904 Maritime Bldg. Tel.: Magnolia 2917.
(Stations represented not reported)

DONALD RICH
New York-Suite 903, 1564 Broadway. Tel.: Judson 6-5547.
(Stations represented not reported)

ALEX ROSENMAN
New York-347 Madison Ave. Tel.: Murray Hill 3-7340. Owner: Alex Rosenman.
Chicago-122 N. Clark St. Tel.: Financial 6-5450. Mgr.: Hal Tate.
San Francisco-Penthouse, Mills Bldg. Rep.: Duncan A. Scott.

Represents:
WCAN Milwaukee

SCHEERER & CO.
Chicago-35 E. Wacker Dr. Tel.: State 2-7942.
(Stations represented not reported)

THE SCHEPP-REINER CO.
New York-18 E. 43d St. Tel.: Murray Hill 2-8540. S. J. Reiner.
(Stations represented not listed.)

DUNCAN A. SCOTT & CO.
San Francisco-Penthouse, Mills Bldg. Tel.: Garfield 1-7950. Owner: Duncan A. Scott.
Los Angeles-2978 Wilshire Blvd. Tel.: Dunkirk 8-4151. Mgr.: A. O. Dillenbeck Jr.

Represents:
KLAC Los Angeles KIBH Seward, Alaska
KINY Juneau, Alaska KFRB Fairbanks, Alaska
KTKN Ketchikan, Alaska
KIFW Sitka, Alaska
KFQD Anchorage, Alaska
KLX Oakland, Calif.

SEARS & AYER
Chicago-612 N. Michigan Ave. Tel.: Superior 7-8177, 8178.
New York-295 Madison Ave. Tel.: Murray Hill 9-2556.
San Francisco-631 Market St. Tel.: Yukon 6-0621.
Los Angeles-5225 Wilshire Blvd. Tel.: York 8812.
St. Louis-316 N. 8th St. Tel.: Central 2391.

Represents:
WKTM Mayfield, Ky. WRAC Racine, Wis.
KSLO Opelousas, La. KSPR Casper, Wyo.
WGRO Bay City, Mich. WFRS Alexander City, Ala.
WPBC Mineapolis, Minn. WHMA Anniston, Ala.
WGM Gulfport, Miss. WOLF Dothan, Ala.
WJFR Greenville, Miss. WFUN Huntsville, Ala.
WQBC Vicksburg, Miss. WTBC Tuscaloosa, Ala.
KWOS Jefferson City, Mo. WLCR Torrington, Conn.
WFTL Ft. Lauderdale, Fla.
WMBH Joplin, Mo. WOKZ Alton, Ill.
KIRX Kirksville, Mo. WRQY Carmi, Ill.
KTTS Springfield, Mo. WTMV East St. Louis, Ill.
WFNS Burlington, N. C. WEAV Evanston, Ill.
KBHS Hot Springs, Ark. WFRL Freeport, Ill.
KARE Atchison, Kan. WKAN Kankakee, Ill.
KRGJ Grand Island, Neb. WGGH Marion, Ill.
WPUV Pulaski, Va. WCMY Ottawa, Ill.
WLFM Suffolk, Va. WTVH Peoria, Ill.
Magic Circle Network WCVS Springfield, Ill.
KSTT Davenport, Iowa

SOUTHERN RADIO REPRESENTATIVES
Atlanta 3-Peters Bldg., Rm. 617. Tel.: Cypress 0053. Pres.: Otis Parker.

Represents:
WRFs Alexander City, Ala. WWWW Jasper, Ala.
WAUD Auburn, Ala. WRB Enterprise, Ala.
WATM Atmore, Ala. WRMA Montgomery, Ala.
WULA Eufaula, Ala. WMOZ Mobile, Ala.
WRAG Carrollton, Ala. WPBB Jackson, Ala.
WLD Lanet, Ala. WJBB Haleyville, Ala.
WFD Piedmont, Ala. WKAL Demopolis, Ala.
WGYV Greenville, Ala. WALB Albany, Ga.
WNPT Tuscaloosa, Ala. WMLT Dublin, Ga.
WPHF Cartersville, Ga.
WKLF Clanton, Ala. WLBa Carrollton, Ga.
WZOB Ft. Payne, Ala. WFPM Ft. Valley, Ga.
WMSL Decatur, Ala. WRHT Griffin, Ga.
WBHP Huntsville, Ala. WTWA Thomson, Ga.
WMLS Sylacauga, Ala. WWNS Statesboro, Ga.
WAVU Albertville, Ala. WIMO Winder, Ga.
WCLL Oneonta, Ala. WGAA Cedaratown, Ga.
WCRI Scottsboro, Ala. WMVG Milledgeville, Ga.
WJAM Marion, Ala. WGRB Dalton, Ga.
WWRW Russellville, Ala. WMGR Bainbridge, Ga.
WLAY Muscle Shoals, Ala.

WPAX Thomasville, Ga. WWO Laurinburg, N. C.
WBHB Fitzgerald, Ga. WFMO Fairmont, N. C.
WCCA Calhoun, Ga. WLTC Gastonia, N. C.
WTRF LaGrange, Ga. WCRB Cheraw, S. C.
WGNB Murfreesboro, Tenn. WLBG Laurens, S. C.
WLAR Athens, Tenn. WBCU Union, S. C.
WJBS DeLand, Fla. WAKN Aiken, S. C.
WSIS Statesville, N. C. WELP Easley, S. C.
WBRM Marion, N. C. WGSW Greenwood, S. C.
WTNC Thomasville, N. C. WSNW Seneca, S. C.
WKBC North Wilkesboro, N. C. WHSC Hartsville, S. C.
WGWV Asheboro, N. C. WEAB Greer, S. C.
WEYE Sanford, N. C. WANS Anderson, S. C.
WNNC Newton, N. C. WEAB Barnwell, S. C.
WKMT Kings Mtn., N. C. WKDK Newberry, S. C.
WSTP Salisbury, N. C. WSSC Sumter, S. C.
WTSB Lumberton, N. C. WRMA Myrtle Beach, S. C.
WBWY Lexington, N. C. WBCS Bennettsville, S. C.
WATA Boone, N. C. WCGD Chester, S. C.
WLON Lincoln, N. C. WLSL Florence, S. C.
WTCY Rock Hill, S. C. WTNC Orangeburg, S. C.
WAGS Bishopville, S. C.

STORER BROADCASTING CO.
New York 22-Storer House, 118 E. 57th St. Tel.: Eldorado 5-7690.

Owned Stations:
WWVA Wheeling, W. Va. WERC Birmingham, Ala.
WSPD Toledo, Ohio WAGA Atlanta, Ga.
KABC San Antonio, Tex. WGBS Miami, Fla.
WJBK Detroit, Mich.

TALLCORN NETWORK
Sioux City, Iowa-% KOMC. Pres.: D. K. Dirks

Represents:
John Pearson Co. Iowa Stations
KDTH Dubuque KWPC Muscatine
KWGB Boone KRB Mason City
KOL Oelwein KFB Marshalltown
KBOE Keokuk KVID Fort Dodge
KFNF Shenandoah KFCD Spencer
KDEC Decorah KCOM Sioux City
KICM Carroll KSIB Creston
KROS Clinton

W. M. TEMPLE & ASSOC.
Kansas City 6, Mo.-1012 Baltimore, 806-7. Tel.: Victor 0021. Mgr.: W. M. Temple.

Represents:
The Walker Representation Co.

TRANSIT RADIO INC.
Cincinnati 2-1109 Union Trust Bldg. Tel.: Dunbar 7775. Board Chairman: Hulbert Taft Jr.; Pres.: Richard C. Crisler.

Represents:
KCMO-FM Kansas City, Mo. WBUZ (FM) Bradbury Heights, Md.
KTNT (FM) Tacoma, Wash. WTOA (FM) Trenton, N. J.

UNITED BROADCASTING CO.
New York 17-507 Fifth Ave. Tel.: Murray Hill 7-4758. Mgr.: Robert L. Wittig.
Washington 1-8th & Eye Sts. N.W. Tel.: Republic 7-8000. Mgr.: Richard Eaton.
Baltimore 1-912 N. Charles St. Tel.: Saratoga 7-8250. Mgr.: Marvin Mirvis.
Richmond, Va.-513 E. Main St. Tel.: 3-8368. Mgr.: Richard C. Scheele.
Cleveland-2157 Euclid Ave. Tel.: Superior 1-4424.

Represents Owned Stations:
WOOX Washington WARK Hagerstown, Md.
WFAN (FM) Washington WANT Richmond, Va.
WINX Rockville, Md. WJMO Cleveland
WSID Baltimore WBUD Trenton, N. J.

VENARD INC.
New York-444 Madison Ave. Tel.: Murray Hill 8-1088. Pres.: Lloyd George Venard.
Chicago-35 E. Wacker Drive. Tel.: State 2-5260. Mgr.: Howard B. Meyers.
San Francisco-Mills Bldg. Tel.: Garfield 1-7950. Mgr.: Duncan A. Scott.
Atlanta-Glenn Bldg. Tel.: Alpine 3080. James
Boston-419 Boylston St. Tel.: Commonwealth 6-0718.

Represents:
WHBC Canton, Ohio KBUR Burlington, Iowa.
WERE Cleveland KMLB Monroe, La.
WAGE Syracuse KTRT Sioux City, Iowa
WFDQ Jacksonville, Fla. WBRZ Orlando, Fla.
WHHM Memphis, Tenn. WBSR Pensacola, Fla.
WCOV Montgomery, N. Y. WJTN Jamestown, N. Y.
WLOS Asheville, N. C.

(Continued on page 65)

CANADIAN RADIO REPRESENTATIVES

JAMES L. ALEXANDER

Toronto—100 Adelaide St., W. Tel.: Empire 3-9594.
 Mgr.: J. L. Alexander.
 Montreal—Drummond Bldg. Tel.: Harbour 6448.
 Mgr.: Frank Edwards.

Represents:
 CKPC Brantford, Ont.
 CKFT Fort Frances, Ont.
 CHVC Niagara Falls, Ont.
 CKLB Oshawa, Ont.
 CFPA Port Arthur, Ont.
 CJCJ Sault Ste. Marie, Ont.
 CKNX Wingham, Ont.
 CHLP Montreal, Ont.
 CKEN Kentville, N. S.
 CFAB Windsor, N. S.

ALL-CANADA RADIO FACILITIES LTD.
 Toronto—Victory Bldg. Tel.: Empire 6-7691. Mgr.: G. F. Herbert.

Montreal—Dominion Square Bldg. Tel.: University 6-9868. Mgr.: Burt Hall.
 Winnipeg—Galt Bldg. Tel.: 926-861. Mgr.: M. V. Chesnut.
 Calgary, Alta.—Taylor, Pearson & Carson Bldg. Mgr.: H. R. Carson.
 Vancouver, B. C.—198 W. Hastings St. Tel.: Tatlow 7461. Mgr.: J. E. Baldwin.

Represents:
 CJVI Victoria, B. C.
 CKWV Vancouver, B. C.
 CHWK Chilliwack, B. C.
 CKPG Prince George, B. C.
 CFJC Kamloops, B. C.
 CKOV Kelowna, B. C.
 CJAT Trail, B. C.
 CFCP Grand Prairie, Alta.
 CJCA Edmonton, Alta.
 CFAC Calgary, Alta.
 CJOC Lethbridge, Alta.
 CHAT Medicine Hat, Alta.
 CKBI Prince Albert, Sask.
 CKCK Regina, Sask.
 CKRC Winnipeg, Man.
 CFPL London, Ont.
 CKSO Sudbury, Ont.
 CKOC Hamilton, Ont.
 CFRE Toronto, Ont.
 CKLW Windsor, Ont.
 CJCS Stratford, Ont.
 CFRA Ottawa, Ont.
 CFCE Montreal, P. E. I.
 CFNB Fredericton, N. B.
 CFCE Charlottetown, P. E. I.
 CJLS Yarmouth, N. S.
 CHNS Halifax, N. S.
 CJCB Sydney, N. S.
 CJON S. John's, Nfld.

ASSOCIATED BROADCASTING CO. LTD.
 Toronto—1139 Bay St. Tel.: Princess 1111. Mgr.: M. Maxwell. Radio-TV Dir.: Gordon Allen.
 (General Canadian station representation non-exclusive.)

CANADIAN BROADCASTING CORP.
 Toronto—354 Jarvis St. Tel.: Midway 5481. Commercial Mgr.: W. E. Powell.
 Montreal—Radio Canada Bldg. Tel.: Plateau 5111. Commercial Mgr.: French Network: M. Valiquette.

Represents CBC-owned stations:
 CBN St. John's, Nfld.
 CBG Gander, Nfld.
 CBT Grand Falls, Nfld.
 CBV Corner Brook, Nfld.
 CBI Sydney, N. S.
 CBH Halifax, N. S.
 CBA Sackville, N. B.
 CEJ Chicoutimi, Que.
 CBV Quebec, Que.
 CBM Montreal, Que.
 CBF Montreal, Que.
 CBO Ottawa, Ont.
 CBL Toronto, Ont.
 CJB Toronto, Ont.
 CBW Manitoba, Nfld.
 CBK Watrous, Sask.
 CBX Alberta, Nfld.
 CBR Vancouver, B. C.
 CFPR (leased) Prince Rupert, B. C.
 CBE Windsor, Ont.

JOS. A. HARDY & CO. LTD.

Quebec—39 St. John St. Tel.: 5-7373. Mgr.: Roland Seguin.
 Montreal—1489 Mountain, Apt. 20. Tel.: Plateau 1101. Mgr.: Mrs. B. Wells.
 Toronto—67 Yonge St. Tel.: Empire 3-6009. Mgr.: W. Bruce Butler.

Represents:
 CHRC Quebec, Que.
 CKNB Cambellton, N. B.
 CKRS Jonquiere, Que.
 CHNC New Carlisle, Que.
 CKLD Thetford Mines, Que.
 CHLT Sherbrooke, Que.
 CKLB Matane, Que.
 CKVM Ville-Marie, Que.
 CFGT St. Joseph d'Alma, Que.
 Trans-Quebec Radio Group

JOHN N. HUNT & ASSOC.

Vancouver, B. C.—198 W. Hastings St. Tel.: Tatlow 6277. Mgr.: John Hunt.

Represents:
 CHUB Nanaimo, B. C.
 CKSB St. Boniface, Man.
 CHNO Sudbury, Ont.
 CKCH Hull, Que.
 CKCV Quebec, Que.
 CHGB St. Anne de la Pocatiere, Que.
 CKVD Val d'Or, Que.
 CKEY Toronto, Ont.
 CKOY Ottawa, Ont.
 CJCH Halifax, N. S.
 CKOK Penticton, B. C.
 CKFI Fort Frances, Ont.
 CKNX Wingham, Ont.
 CHLP Montreal, Que.
 CKRN Rouyn, Que.
 CKMR Newcastle, N. B.
 CKCL Truro, N. S.
 CJAV Port Alberni, B. C.
 CHML Hamilton, Ont.
 CKOX Woodstock, Ont.
 CJAD Montreal, Que.
 CKST Sherbrooke, Que.
 CJSC Sorel, Que.
 CFEC St. John, N. B.
 CFAB Windsor, N. S.

PAUL MULVIHILL

Toronto—21 King St. E. Tel.: Empire 8-6554. Mgr.: Paul Mulvihill.
 Montreal—1434 St. Catherine St. W. Mgr.: Murray MacIvor.

Represents:
 CJCH Halifax, N. S.
 CHOK Sarnia, Ont.
 CJFX Antigonish, N. S.
 CKT St. Catherines, Ont.
 CKBB Barrie, Ont.

NATIONAL BROADCAST SALES LTD.
 Toronto—222 Simcoe St. Tel.: Empire 6-3718. Gen. Mgr.: R. A. Leslie.
 Montreal—1396 St. Catherine St. W. Tel.: UN. 6-1538 V.P.-Mgr.: E. F. Kavanagh.

Represents:

CFCH North Bay, Ont.
 CKGB Timmins, Ont.
 CKLK Kirkland Lake, Ont.
 CKWS Kingston, Ont.
 CHEX Peterborough, Ont.
 CKOY Ottawa, Ont.
 CKEY Toronto*
 CHML Hamilton*
 CKNW New Westminster, B. C.
 CFBC St. John, N. B.

* Montreal only.

RADIO AND TELEVISION SALES INC.
 Toronto—10 Adelaide St. E. Tel.: Empire 6-8944. Mgr.: A. A. McDermott.
 Montreal—211 Gordon Ave. Verdun. Tel.: Pontiac 6-4112. Mgr.: Andy Wilson.

Represents:
 CKVL Verdun-Montreal, Que.
 CJSO Sorel, Que.
 CHEF Granby, Que.
 CFDA Victoriaville, Que.
 CJCQ Quebec City (English)
 French Radio Assoc. Ltd. (network)

RADIO REPRESENTATIVES LTD.
 Toronto—4 Albert St. Tel.: Empire 8-6151. Mgr.: J. Slatter.
 Montreal—Dominion Sq. Bldg. Tel.: University 6-8058. Mgr.: W. Dipie.
 Vancouver, B. C.—198 W. Hastings St. Tel.: Tatlow 6277. Mgr.: John Hunt.
 Winnipeg—Lindsay Bldg. Tel.: 9-6374. Mgr.: A. J. Messner.
 Toronto, Montreal, Winnipeg and Vancouver Representation:

CJTB Vernon, B. C.
 CKFH Toronto, Ont.
 CKDM Dauphin, Man.
 CKRM Regina, Sask.
 CKX Brandon, Man.
 CHLO St. Thomas, Ont.
 CJOY Guelph, Ont.
 CKBW Bridgewater, N. S.
 CKDA Victoria, B. C.
 CKOK Penticton, B. C.
 CFN Calgary, Alta.
 CFRN Edmonton, Alta.
 CFQC Saskatoon, Sask.
 CJRW Summerside, P. E. I.
 CKRD Red Deer, Alta.
 CKPR Fort William, Ont.
 CJOB Winnipeg, Man.
 CJDC Dawson Creek, B. C.

RADIO TIMES SALES (ONT.) LTD.
 Toronto—147 University Ave. Tel.: Empire 6-8680. Mgr.: Norm Brown.

Represents:
 CJAD Montreal, Que.
 WJR Detroit, Mich.
 CKEC New Glasgow, N. S.
 CKTS Sherbrooke, Que.
 WGAR Cleveland, Ohio

RADIO TIME SALES (QUE.) LTD.
 Montreal—1231 St. Catherine St. W. Tel.: Marquette 4684. President: Ralph J. Judge.

Represents:
 CJAD Montreal, Que.
 CKEC New Glasgow, N. S.
 WJR Detroit, Mich.
 CKTS Sherbrooke, Que.
 WGAR Cleveland, Ohio

OMER RENAUD & CO. LTD.

Montreal—1411 Stanley St. Tel.: Belair 9541. Mgr.: Omer Renaud.
 Toronto—170 Bay St. Tel.: Empire 4-1197-8. Mgr.: Omer Renaud.

Represents:
 CKCH Hull, Que.
 CHGB Ste. Anne de la Pocatiere, Que.
 CJFP Riviere du Loup, Que.
 CKSM Shamingan Falls, Que.
 CKCR Kitchener, Ont.
 CHLN Three Rivers, Ont.
 CFCL Timmins, Ont.
 CKRB Beauce, Ont.
 CHUM Toronto, Ont.
 CKCL Truro, N. S.
 CKAC Montreal, Que.
 CHNO Sudbury, Ont.
 CKOX Woodstock, Ont.
 CKMO Vancouver, B. C.
 CKMR Newcastle, N. B.
 CKRN Rouyn, Que.
 CKVD Val d'Or, Que.
 CHAD Amos, Que.
 CKCV Quebec, Que.
 CKLS La Sarre, Que.
 CKSB St. Boniface, Man.
 CHFA Edmonton, Alta.
 CHRL Roberval, Que.
 CFRG Gravelbourg, Sask.
 CFNS Saskatoon, Sask.

STEPHENS & TOWNDROW

Toronto—35 King St. W. Tel.: Empire 6-4221. Mgrs.: Bill Stephens, Ernie Towndrow.

Represents:
 CHML Hamilton, Ont.
 CHLO St. Thomas, Ont.
 CHUB Nanaimo, B. C.
 CJAV Port Alberni, B. C.
 CFRA Ottawa, Ont.

HORACE N. STOVIN & CO.

Toronto—Victory Bldg. Tel.: Empire 3-9184. Pres.: H. N. Stovin. Gen. Sales Mgr.: George W. Hellman.
 Montreal—Keefer Bldg. Tel.: University 6-6291. Mgr.: T. C. Maguire.
 Winnipeg—Childs Bldg. Tel.: 92-5097. Mgr.: Godfrey Tudor.
 Vancouver—517 Crown Bldg. Tel.: Tatlow 4831. Mgr.: J. W. Stovin.

Represents:
 CJOR Vancouver, B. C.
 CFPR Prince Rupert, B. C.
 CKLN Nelson, B. C.
 CKXL Calgary, Alta.
 CHED Edmonton, Alta.
 CJGX Yorkton, Sask.
 CKY Winnipeg, Man.
 CJRL Kenora, Ont.
 CJBC Toronto, Ont.
 CFOR Orillia, Ont.
 CFOS Owen Sound, Ont.
 CHOV Pembroke, Ont.
 CJBQ Belleville, Ont.
 CFJR Brockville, Ont.
 CKLV Moose Jaw, Sask.
 CJNB North Battleford, Sask.
 CKOM Saskatoon, Sask.
 CFAR Flin Flon, Man.
 CKSF Cornwall, Ont.
 CJBR Rimouski, P. Q.
 CJEM Edmundston, N. B.
 CKCW Moncton, N. B.
 CHSJ Saint John, N. B.
 VOXM Newfoundland (St. John's)
 CKPR Fort William*

* Winnipeg only.

Pepys

COMMENTS

Do, from day to day, meet various waggish souls who comment that the phrase which we do proudly display—"A Stovin Station is a Proven Station" does not jingle in its syllables! To such we do reply that it is no jingle, it is a Guarantee that the value of every Stovin Station is fully proven by its listener-loyalty, its services to its community, its planned programming and merchandising services. And these will gladly be applied to your sales problems if you will consult any of our four offices.

"A STOVIN STATION
 IS
 A PROVEN STATION"

HORACE N. STOVIN

& COMPANY

MONTREAL TORONTO WINNIPEG VANCOUVER



*Representative for
 these live Radio
 Stations*

KVOS Bellingham
 CJOR Vancouver
 CFPR Prince Rupert
 CKLN Nelson
 CKXL Calgary
 CHED Edmonton
 CJGX Yorkton
 CHAB Moose Jaw
 CJNB North Battleford
 CKOM Saskatoon
 CFAR Flin Flon
 CKY Winnipeg
 CJRL Kenora
 CJBC Toronto
 CFOR Orillia
 CFOS Owen Sound
 CHOV Pembroke
 CJBQ Belleville
 CFJR Brockville
 CKLV Moose Jaw
 CKLC Kingston
 CKSF Cornwall
 CJBR Rimouski
 CJEM Edmundston
 CKCW Moncton
 CHSJ Saint John
 VOXM Newfoundland
 ZBM Bermuda
 ZNS Nassau

EXECUTIVE AND STAFF PERSONNEL OF THE FEDERAL COMMUNICATIONS COMMISSION

Headquarters Office: New Post Office Bldg., Washington 25, D. C., Phone: Executive 3-3620

Commissioners and Assistants

ROSEL HERSCHEL HYDE, Chairman
(Republican: Term expires June 30, 1959)
Assumed office April 17, 1946
Legal Assistant: Dee W. Pincock
Engineering Assistant: Paul D. Miles
Administrative Assistant: Vera F. Nordness
Administrative Assistant: Mollie V. Burgess
Secretaries: Iona Wickham and Jane T. Hungerford
Office: Room 6107

ROBERT T. BARTLEY
(Democrat: Term expires June 30, 1958)
Assumed office March 6, 1952
Legal Assistant: Max D. Paglin
Confidential Assistant: Farrell McGonigal
Engineering Assistant: Kenneth W. Miller
Secretary: Isolene Corbett
Clerk: Alice Watson
Office: Room 6207

FRIEDA BARKIN HENNOCK
(Democrat: Term expires June 30, 1955)
Assumed office July 6, 1943
Legal Assistant: Arthur Blooston
Administrative Assistant: Naomi E. L. O'Leary
Secretaries: Kathryn Chester and Mahala Johnson
Office: Room 7111

JOHN CARL DOERFER
(Republican: Term expires June 30, 1954)
Assumed office April 15, 1953
Confidential Assistant: Patricia C. Siemien
Legal Assistant: Evelyn F. Eppley
Secretary: Mary L. Moose
Office: Room 7207

GEORGE EDWARD STERLING
(Republican: Term expires June 30, 1957)
Assumed office Jan. 2, 1948
Confidential Assistant: Neva Bell Perry
Clerk: Irene Cline
Office: Room 7241

EDWARD MOUNT WEBSTER
(Independent: Term expires June 30, 1956)
Assumed office April 10, 1947
Legal Assistant: Robert M. Koteen
Engineering Assistant (Acting): Everett G. Henry
Confidential Assistant: Ruth Kopplialy
Secretaries: Elizabeth Lindsley and Mary Jo Rice
Office: Room 6239

ROBERT EMMETT LEE
(Republican: Term expires June 30, 1960)
Assumed office as recess appointee, Oct. 6, 1953
Legal Assistant: David C. Williams
Confidential Assistant: Elizabeth L. Dannelly
Secretaries: K. Lois Welch, Josephine Curren
Office: Room 7255

Patent Advisor to Commission
William Bauer
Office: Room 1617 Temporary T Bldg.

Office of Formal Hearing Examiners

Temporary T Building

Administrative Assistant: Lillian Watson
Room 1707

J. D. BOND
Secretary: Joan C. Knobloch
Office: Room 1083

WILLIAM G. BUTTS
Secretary: Frances E. Armstrong
Office: Room 2089-A

BASIL P. COOPER
Secretary: Jennie Citro
Office: Room 1285

JAMES D. CUNNINGHAM
Secretary: Anne F. Janco
Office: 1087-A

THOMAS H. DONAHUE
Secretary: Ellen P. Morton
Office: Room 2091

CHARLES J. FREDERICK
Office: Room 1620

MILLARD F. FRENCH
Secretary: Bernice Hase
Office: Room 2085

CLAIRE W. HARDY
Secretary: Myrtle Bergheim
Office: Room 1091

ISADORE A. HONIG
Office: Room 1602

ANNIE N. HUNTING
Secretary: Anne O'Donohue
Office: Room 2087

HUGH B. HUTCHISON
Secretary: Violet Waddington
Office: Room 1702

H. GIFFORD IRION
Secretary: Helen O'Dea
Office: Room 1706

FANNEY N. LITVIN
Secretary: Lelia C. Kreps
Office: Room 1079

JOHN B. POINDEXTER
Secretary: J. Phyllis Hancock
Office: Room 1614

HAROLD L. SCHILZ
Office: Room 1610

HERBERT SHARFMAN
Secretary: Alice Brody
Office: Room 1714

ELIZABETH C. SMITH
Secretary: Valborg F. Bernhard
Office: Room 1089

Office of Opinions and Review

SOL SCHILDHAUSE, Acting Chief
Secretary: Yolanda Goldenberg
Assistant Chief: Horace E. Slone
Staff: Charles S. Borum, Hideyuki Noguchi, Donald J. Berkemeyer, Paul R. Conway, Julian S. Egre, Gerald F. Hadlock, Richard M. Hartscock, Edith M. Klein, Vernon B. Romney, Walter W. Guenther, Edward C. McKenzie.
Office: Room 7302

Office of Reports and Information

GEORGE O. GILLINGHAM, Chief
Office: Room 7232

INFORMATION BRANCH
Salina M. Lindo

REPORTS BRANCH
Mary O'Leson, Eva O. Melton

Office of the General Counsel

WARREN E. BAKER, General Counsel
Secretary: Mary J. Garrison
Office: Room 7334

LEGISLATION, TREATIES AND RULES DIVISION
Richard A. Soloman, Assistant General Counsel in Charge

Members of Former FEDERAL RADIO COMMISSION

Feb. 23, 1927 — July 10, 1934

Admiral W. H. G. Bullard, Pennsylvania
March 15, 1927—November 24, 1927 (Deceased)

Orestes H. Caldwell, New York
March 15, 1927—February 23, 1929

Eugene O. Sykes, Mississippi
March 15, 1927—July 10, 1934 (Deceased)

Henry A. Bellows, Minnesota
March 15, 1927—October 31, 1927 (Deceased)

Colonel John F. Dillon, California
March 15, 1927—October 8, 1927 (Deceased)

Sam Pickard, Kansas
November 1, 1927—January 31, 1929

Harold A. Lafount, Utah
November 14, 1927—July 10, 1934 (Deceased)

Ira E. Robinson, West Virginia
March 29, 1928—January 15, 1932 (Deceased)

General C. McK. Saltzman, Iowa
May 2, 1929—July 19, 1932 (Deceased)

William D. L. Starbuck, New York
May 2, 1929—February 23, 1934

Thad H. Brown, Ohio
January 21, 1932—July 10, 1934 (Deceased)

James H. Hanley, Nebraska
April 1, 1933—July 10, 1934 (Deceased)

Former Members of FEDERAL COMMUNICATIONS COMMISSION

Hampson Gary, Texas
July 11, 1934—December 24, 1934 (Deceased)

Anning S. Frall, New York
January 17, 1935—July 23, 1937 (Deceased)

Iryin Stewart, Kentucky
July 11, 1934—June 30, 1937

Frank R. McNinch, North Carolina
October 1, 1937—August 31, 1939 (Deceased)

Eugene O. Sykes, Mississippi
July 11, 1934—April 5, 1939 (Deceased)

Thad H. Brown, Ohio
July 11, 1934—June 30, 1940 (Deceased)

Frederick I. Thompson, Alabama
April 8, 1939—June 30, 1941

George H. Payne, New York
July 11, 1934—June 30, 1943 (Deceased)

T. A. M. Craven, District of Columbia
August 21, 1937—June 30, 1944

Norman S. Case, Rhode Island
July 11, 1934—June 30, 1945

James Lawrence Fly, Texas
September 1, 1939—November 13, 1944

William H. Willis, Vermont
July 1, 1945—March 6, 1946 (Deceased)

Fair A. Porter, Kentucky
December 21, 1944—February 25, 1946

Charles R. Denny Jr., District of Columbia
March 30, 1945—October 31, 1947

Ewell K. Jett, Maryland
February 15, 1944—December 31, 1947

Ray C. Wakefield, California
March 22, 1941—June 30, 1947 (Deceased)

Clifford J. Durr, Alabama
November 1, 1941—June 30, 1948

Albert Wayne Coy, Indiana
December 29, 1947—February 21, 1952

Robert Franklin Jones, Ohio
September 5, 1947—September 19, 1952

Eugene H. Merrill
October 14, 1952—April 15, 1953 (Recess Appointee)

Paul Atlee Walker
July 11, 1934—June 30, 1953

Secretary: Bessie H. Trice
Office: Room 7334
Attorneys: Erich Saxl and Robert D. Greenburg

LITIGATION DIVISION
J. Roger Wollenberg, Assistant General Counsel in Charge
Secretary: Bertha J. Meister
Office: Room 7334
Attorneys: Mary Jane Morris, Daniel R. Ohlbaum, Stanley S. Neustadt

Office of the Chief Engineer

EDWARD W. ALLEN JR., Chief Engineer
Administrative Assistant: Ruby Floyd
Office: Room 7515

VIRGIL R. SIMPSON, Assistant Chief Engineer
Secretary: Mary E. Nalls
Office: Room 7515

JOHN O. WILLOUGHBY, Assistant to the Chief Engineer
Secretary: Nancy Rich
Office: Room 7515

CONELRAD

RALPH J. RENTON, U. S. Supervisor
Secretary: Margaret Fox
Office: Room 7516
(Vacancy) Eastern Zone Supervisor
Ernest C. Thelemann, Central Zone Supervisor
Robert D. Linx, Western Zone Supervisor
Coordinating Engineers: Carl A. Johnson, Senior; Roger B. Carey, Thomas Cave, David O. Cooper, Joseph Eichel, Vernon Esgar, James Fernane, Frank J. Burris, Kenneth Hedrick, Donald Holaday, Frederick Holliday and James A. Homsy.

FREQUENCY ALLOCATION & TREATY DIVISION

Albert L. McIntosh, Chief
Secretary: Jane Rudy
Office: Room 7509
Engineers: William Bradley, Charles A. Brooks, Louis De LaFleur, Albert Evangelista, Merle E. Glunt, Thomas L. Heron, Saul M. Myers, William L. North, Emile Reniere, George Steizenmuller and Robert L. Tosch.

LABORATORY DIVISION

Edward W. Chapin, Chief
Secretary: Wanda Palmer
Clerk: Nellie Wehland
Office: Laurel, Md. Telephone: Laurel 585
Engineers: Irl Ball, Albert Craig, Andrew R. Gabor, Joseph Hanyok, John E. Knight, L. C. Middlekamp, Milton Mobley, Willmar Roberts and Everett Shinn.

TECHNICAL RESEARCH DIVISION

William C. Boese, Chief
Secretary: Ida M. Young
Office: Room 7500
Engineers: Jack Damelin, Jules Deltz, Harry Fine, Herman Garlan, Elton Dairs, Albert L. Kreis, Braxton L. Peele, Arnold Skirveth, John Taff, George Waldo and Glenn West.

Office of the Secretary

(Vacancy), Secretary
Administrative Assistant: Laura L. Hollingsworth
Secretary: Ethel M. Richardson
Office: Room 6149

WILLIAM P. MASSING, Acting Secretary
Secretary: Catherine M. Lunders
Office: Room 6149

DOCKETS DIVISION

Jessie R. Blaine, Chief
Office: Room 6516

MINUTE DIVISION

Annette E. Hutterly, Chief
Office: Room 6518

LIBRARY DIVISION

Helen A. Clark, Chief
Office and Library: Room 2346

TECHNICAL ASSISTANCE DIVISION

Gordon Kent, Chief
Joseph G. Thomas, Assistant Chief
Office: Room 1703 Temporary T Bldg.

INTERNATIONAL TELECOMMUNICATIONS SETTLEMENTS DIVISION

Charlotte S. Smith, Chief
Office: Room 1147

MAIL AND FILES DIVISION

Mary E. Sprague, Chief
Office: Room 7226

MESSENGER BRANCH

J. W. Brown, Chief
Office: Room 7202

The
Association of
FEDERAL COMMUNICATIONS
CONSULTING
Engineers

Members

George P. Adair
George P. Adair

Stuart L. Bailey
Jansky & Bailey

William E. Benns, Jr.
William E. Benns, Jr.

Lester H. Carr
Weldon & Carr

T. A. M. Craven
Craven, Lohnes & Culver

John Creutz
Page, Creutz, Garrison and
Waldschmitt

A. Earl Cullum, Jr.
A. Earl Cullum, Jr.

Ronald H. Culver
Craven, Lohnes & Culver

George C. Davis
George C. Davis

Everett L. Dillard
Commercial Radio Equip. Co.

Millard M. Garrison
Page, Creutz, Garrison and
Waldschmitt

George E. Gautney
George E. Gautney

Glenn D. Gillett
Glenn D. Gillett

Paul F. Godley
Paul Godley Co.

C. M. Jansky, Jr.
Jansky & Bailey

Frank G. Kear
Kear & Kennedy

Robert E. L. Kennedy
Kear & Kennedy

Worthington C. Lent
On military duty

George M. Lohnes
Craven, Lohnes & Culver

Frank H. McIntosh
Frank H. McIntosh

James C. McNary
James C. McNary

Russell P. May
Russell P. May

E. C. Page
Page, Creutz, Garrison and
Waldschmitt

William E. Plummer
On government duty

A. D. Ring
A. D. Ring & Co.

Robert M. Silliman
Robert M. Silliman

Carl E. Smith
Carl E. Smith

James O. Weldon
Weldon & Carr

Raymond M. Wilmotte
Raymond M. Wilmotte

Grant R. Wrathall
Grant R. Wrathall

Associate Members

Rodney D. Chipp
Allen B. DuMont Laboratories,
Inc.

William S. Duttera
National Broadcasting Co.

J. B. Epperson
Scripps-Howard Radio, Inc.

Raymond F. Guy
National Broadcasting Co.

Andrew F. Inglis
Radio Corporation of America

Earl M. Johnson
Mutual Broadcasting System

L. E. Littlejohn
Radio Station WHUM

William B. Lodge
Columbia Broadcasting System

Frank L. Marx
American Broadcasting Co.

George A. Mayoral
General Electric Company

John G. Preston
American Broadcasting Co.

Philip F. Siling
Radio Corporation of America

Jay W. Wright
Columbia Broadcasting System



BROADCASTERS...if you are considering television...

Compare!

**...in important matters
such as the purchase of
TV broadcast equipment...**

COMPARE BEFORE YOU DECIDE

If your station plans to begin television service, or go to high power . . . Standard Electronics invites you to compare and decide on a basis of cold facts.

Compare circuitry . . . tube replacement costs . . . power consumption . . . ability to transmit color signals . . . operating simplicity . . . eye appeal . . . maintenance . . . deliveries . . . comparative factors that truly decide which transmitter best serves your needs.

Comparison Chart of VHF High Power Transmitters (50 KW)

	SE Transmitter	Transmitter B	Transmitter C	Transmitter D
AMPLIFIER DRIVES WITH 5 KW	★ YES	NO	YES	YES
AMPLIFIER WILL OPERATE WITH ANY MAKE DRIVER	★ YES	NO	NO	NO
TUBE COST } COMPLETE SET FCC SPARES	★ \$6,138 \$1,495	\$11,625 \$4,237	\$13,230 (est) \$6,429 (est)	\$9,250 (est) \$5,050 (est)
AIR COOLED	★ YES	YES	NO	NO
POWER LINE REQUIREMENTS (at black level)	★ 208/230 V 60 cy, 3 φ 145 KW	460 V 60 cy, 3 φ 193 KW	208/230 V 60 cy, 3 φ 150 KW (est)	208/230 V 60 cy, 3 φ 165 KW (est)
FLOOR AREA (including power equipment, blowers, etc.)	★ 152 sq. ft.	154 sq. ft.	160 sq. ft. (est)	—
ALL TUBES VISIBLE FROM FRONT	★ YES	NO	NO	NO
SELF CONTAINED (no separate enclosures, vaults, pumps, etc.)	★ YES	NO	NO	NO
INDIVIDUAL CHASSIS CONSTRUCTION	★ YES	NO	NO	NO
INTERUNIT CABLING WITHOUT TRENCHES	★ YES	NO	NO	NO



SE's BLUE STAR STATIONS

(SE equipped—maximum power authorized by FCC)

- ★ **THE BIRMINGHAM NEWS CO.** • WABT, Birmingham, Channel 13
40 KW—316 KW ERP
- ★ **CROSLY BROADCASTING CORP.** • WLW-A, Atlanta, Channel 11
50 KW—316 KW ERP
- ★ **GENERAL TELERADIO** • WOR-TV, Empire State Bldg., New York, Channel 9
50 KW—130 KW ERP

Transmitter room of WOR-TV's new Empire State 50 KW transmitter, 130 KW ERP. 100% air cooled. Completely self-contained. Equipment throughout by Standard Electronics.

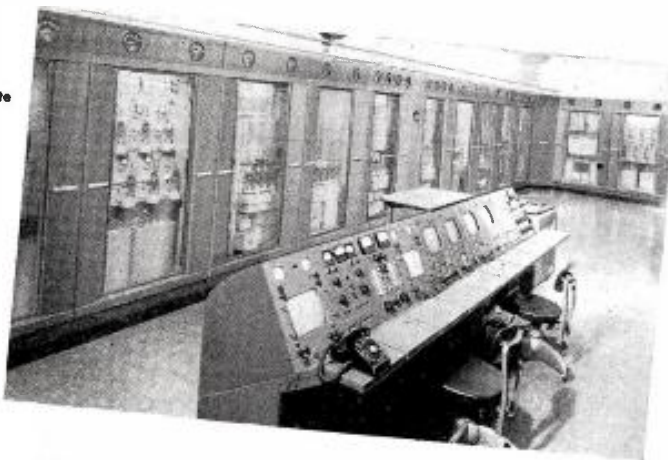

TO DELIVER TOMORROW'S EQUIPMENT TODAY.

standard electronics corporation

A SUBSIDIARY OF CLAUDE NEON, INC.
285-289 EMMETT STREET • NEWARK 5, N. J.

*devoted exclusively to the
engineering, manufacturing, and servicing of equipment
for the broadcast and television industry*

ONLY
STANDARD ELECTRONICS
has these
exclusive features



ADD-A-UNIT DESIGN

Lets you go from 500 watts to 50 KW without scrapping or even modifying a single piece of equipment.



VERSATILE AMPLIFIERS

SE's Add-A-Unit amplifiers can be added to existing station equipment regardless of make. Any 5 KW transmitter will drive a 50 KW S-E amplifier.



ECONOMICAL INSTALLATION

Fewer building alterations. Units fit any station layout.



SELF-CONTAINED

Compact, no external blowers or external vaults needed.



LOWER TUBE COSTS

Similar types throughout. Low emission visual tubes interchangeable with aural section where power requirements are less. Lower initial tube cost, too.



ACCESSIBLE

All tubes visible and accessible from the front via full length glass doors.



COLOR ADAPTABLE

Elimination of back porch clamp insures proper operation with color signals.

Office of the Chief Accountant

WILLIAM J. NORFLEET, Chief Accountant
 Secretary: Lily M. Marshall
 Office: Room 7315
 HUGO REYER, Assistant Chief Accountant
 Secretary: Elizabeth N. Harris

ACCOUNTING SYSTEMS DIVISION

John J. Nordberg, Assistant Chief Accountant in Charge of Division
 Secretary: Lois L. Liston
 Assistant Chief of Division: Harland Morris
 Office: Room 7315

ECONOMICS DIVISION

Hyman H. Goldin, Assistant Chief Accountant in Charge of Division
 Secretary: Pearl P. Cook
 Assistant Chief of Division: James B. Sheridan
 Office: Room 7312

Office of Administration

ROBERT W. COX, Executive Officer
 Secretary: Ozella Drake
 Administrative Assistant: Richard Solan
 Office: Room 7347

BUDGET AND FISCAL DIVISION

Robert W. Cox, Acting Budget Officer

ORGANIZATION AND METHODS DIVISION

Eric G. Stewart, Planning Officer
 Office: Room 7405
 Walter S. Davis, Records Officer
 Office: Room 7407

PERSONNEL DIVISION

Gilbert H. Hatfield, Personnel Officer
 Office: Room 7351

ADMINISTRATIVE SERVICES DIVISION

Paul H. Sheehy, Chief
 Office: Room 6148

Broadcast Bureau

CURTIS B. PLUMMER, Chief
 Secretary: Estelle J. Bunn
 Office: Room 7530
 JOSEPH M. KITTNER, Assistant Chief
 Secretary: Frances R. Jarvis
 Office: Room 7530
 LAVELLE W. HUGHES, Administrative Assistant
 Secretary: Betty N. Wargo

BROADCAST FACILITIES DIVISION

James E. Barr, Chief
 Office: Room 7526
 Secretary: Helena C. Osman
 Office: Room 7454

(AM and FM)

New and Changed Facilities Branch

(Vacancy), Chief
 Secretary: Hazel S. Cherry
 Office: Room 7443
 Engineers: Edward H. Hackman, Harold L. Kassens, Ralph H. Garrett, Harold D. Russell, E. O. Ansell, Cedric C. Morris, Harold Anderson, George K. Ashenden Jr., Robert H. Deiler, Frank Togh, Earl G. Coston, Chester R. Kirkevold.
 Attorneys: E. Theodore Mallick, Philip S. Cross, Benton C. Tolley Jr.
 Accountant: Joseph Giammatteo

Existing Facilities Branch

Wallace E. Johnson, Chief
 Secretary: Mary P. Bailey
 Office: Room 7445
 Engineers: Herbert L. Beury, Edward P. Lynch, John A. Roseborough.
 Accountant: Viola Slattery

FIELD ENGINEERING AND MONITORING BUREAU REGIONAL OFFICES

Chief of the Field Engineering and Monitoring Bureau: George S. Turner
 415 22nd St. N. W., Washington, D. C.

Region	Headquarters	Districts
North Atlantic Region	954 Federal Bldg. New York 14, N. Y.	1, 2, 3, 4, 5 & 24
Paul H. Herndon Jr.	411 Federal Annex Atlanta 3, Ga.	6, 7, 22
South Atlantic Region	332 U. S. Appraisers Bldg. Houston 11, Tex.	8, 9, 10
Joe H. McKinney	323-A Customhouse San Francisco 28, Calif.	11, 12, 15
Gulf States Region	802 Federal Office Bldg. Seattle 4, Wash.	13, 14
Kenneth G. Clark	832 U. S. Court House Chicago 4, Ill.	16, 17, 18
South Pacific Region	1029 New Federal Bldg. Detroit 26, Mich.	19, 20
Geo. V. Witse	P. O. Box 1142 Lanikai, Oahu, Hawaii	21
North Pacific Region	Room 52, U.S. P.O. & Courthouse, Anchorage, Alas.	23
William J. McDonell		
Central States Region		
Emery H. Lee		
Great Lakes Region		
Lee R. Dawson		
Hawaiian Region		
Charles T. Manning		
Alaskan Region		

Allocations Branch
 Bruce S. Longfellow, Chief
 Secretary: Verna R. Friedland
 Office: Room 8433
 Engineers: Donald C. Kanode
 Record Unit: Vernald E. Kley, chief; Rose E. Bettick, assistant chief.

(Television)

Applications Branch
 Joseph N. Nelson, Chief
 Secretary: Ethel J. Loneragan
 Office: Room 8511
 Engineers: Daniel Jacobson, McIvor L. Parker, Willard J. Beale, Paul B. Duncan, Clayton W. Hanson, Ernest D. Herider, Harold G. Kelley, Rex Wilson, Lewis Terry, Harry Mills, Joseph Rose.
 Attorneys: Earl R. Stanley, William Jensen, David W. Warren, Arthur S. Feld, Martin I. Levy, Samuel Saady, David H. Deibler.
 Accountants: William H. Hunter Jr., Joseph J. Berezney, Nelson C. Carlisle, John W. Griffin, Glenn F. Murphy, F. Richard Stuart, Douglas S. George, George Johnson, Peter Gerlanto, Irwin Fine, Muriel Jones.

Technical Branch

Hart S. Cowperthwait, Chief
 Office: Room 8511
 Secretary: Mary D. Carnahan
 Engineer: Julian T. Dixon

HEARING DIVISION

(Vacancy), Chief
 Secretary: Emma C. Burke
 Office: Room 7440
 Robert J. Rawson, Assistant Chief
 Secretary: Frankie L. Fox
 Office: Room 7440
 Engineers: John E. Doane, Louis Light, Jerome F. Padberg, John P. McCullin, Daniel B. Hutton.
 Attorneys: David I. Kraushaar, Pasquale Valicente, Stanley B. Cohen, Bernard M. Williamson.

RENEWAL AND TRANSFER DIVISION

Walter R. Powell Jr., Chief
 Secretary: Wanda L. Haag
 Office: Room 7522

Transfer Branch

Robert H. Alford, Chief
 Secretary: Kathryn J. Roos
 Office: Room 7449
 Attorney: Thomas B. Fitzpatrick, Max Aronson.
 Accountants: Guy E. Douglas, John D. Stephenson.

Renewal Branch

Forest L. McClennig, Acting Chief
 Secretary: Elizabeth B. Blumberg
 Office: Room 7522
 Accountants: Robert F. Braden, John B. Foret, George W. Phillips, Agnes T. Martin.

Compliance Branch

LeRoy Schaff, Chief
 Secretary: Shirley M. Henderson
 Office: Room 7522
 Attorney: Maurice W. Whitton
 Accountants: Robert D. J. Leahy, John W. O'Donnell.

Control Section

Melba Z. Templeman, Chief
 Office: Room 7523
 Legal Examiners: Mildred K. Roberts, Helen K. Huber, Doris L. Nutt, George M. Eisenberger.

RULES AND STANDARDS DIVISION

Arthur Scheiner, Chief
 Secretary: Mildred B. Nesterak
 Office: Room 7434
 Engineers: Robert G. Weston, Louis H. Rein, Otis T. Hanson.
 Attorneys: Herbert M. Schulkind, Henry Geller.
 Secretary: Florence I. Stretch

LICENSE DIVISION

Clara M. Iehl, Chief
 Office: Room 8449
 Marguerite F. Hubbard, Assistant Chief

AM Branch

Quentin S. Proctor, Chief
 Legal Examiners: Margaret R. Walsh, Jean S. Berberich, Betty J. Barkley, Adeline Frizelle, Elizabeth E. McMichael, Zell M. Witt, Patricia Stubbs and Mary A. Lawrenson.

FM Branch

Helen A. Marston, Chief
 Legal Examiners: Mary Hopp, Kathryn M. Johnson, Sylvia B. Rardin.

TV Branch

Marguerite M. Van Dyke, Chief
 Legal Examiners: Robert W. Loehne, Jeanne C. Barrows, Wynelle Leonardo, Marie Fish, Pauline Stanley, Marjorie Vain.

Records and Files

Lillian T. Ricker, Chief
 Clerks: Doris Shea, William Alston, Naomi Smith, Charlotte Campbell.

Public Reference Room

For AM, FM and TV Dockets and Files
 Room 8450, George W. Simcoe, James Martin.

Common Carrier Bureau

CURTIS M. BUSHNELL, Acting Chief
 Secretaries: Sylvia Prytulak, Vivian F. Fishman.
 Office: Room 7119
 Administrative Assistant: Irene Durgin
 Office: Room 7117

Safety and Special Radio Services Bureau

Temporary T Bldg.
 14th St. & Constitution Ave., N. W.
 EDWIN L. WHITE, Chief
 Secretary: Elizabeth K. Valicenti
 Office: Room 2069

Field Engineering and Monitoring Bureau

Address: 415 22d St., N.W., Washington, D. C.

GEORGE S. TURNER, Chief
 Secretary: Anne M. Ignatowich
 Office: Room 205
 Attorney Advisor: John H. McAllister
 Administrative Assistant: (Vacancy)
 Office: Room 203
 FRANK M. KRATOKVIL, Assistant Chief
 Office: Room 203

FIELD OPERATING DIVISION

Frank M. Kratokvil, Chief
 Secretary: Carolyn B. Pemberton
 Office: Room 202

ENGINEERING DIVISION

George L. Jensen, Chief
 Secretary: Ida Goldberg
 Office: Room 103

ANTENNA SURVEY BRANCH

Noble C. Shumway Jr., Chief

INSPECTION AND EXAMINATION DIVISION

S. W. Norman, Chief
 Secretary: Elva Mae Parks
 Office: Room 102

MONITORING DIVISION

Irving L. Weston, Chief
 Secretary: (Vacancy)
 Office: Room 201

DISTRICT OFFICES

District No.	City	Address	Engineer in Charge
1	Boston 9, Mass.	1600 Customhouse	Nathan A. Hallenstien
2	New York 14, N. Y.	748 Federal Bldg.	Arthur Batcheller
3	Philadelphia 6, Pa.	1005 U.S. Customhouse	Roger E. Phelps
4	Baltimore 2, Md.	508 Old Town Bank Bldg.	Hyman A. Cohen
5	Norfolk 10, Va.	Room 402, New P.O. Bldg.	Edward Bennett
	Newport News, Va.	200 U.S. P.O. Bldg. (Vacancy)	
		(Ship Office)	
6	Atlanta 3, Ga.	411 Federal Annex	W. D. Johnson
	Savannah, Ga.	214 P.O. Bldg.	Andrew R. Bahlay
		(Sub-Office)	
7	Miami 1, Fla.	312 Federal Bldg.	Arthur S. Fish
	Tampa 2, Fla.	409-410 P.O. Bldg.	Chalmer H. Neeb
		(Sub-Office)	
8	New Orleans 16, La.	400 Audubon Bldg.	Theodore B. Deiler
	Mobile 10, Ala.	419 U.S. Courthouse & Custom Bldg.	Geo. E. Franklin
		(Sub-Office)	
9	Houston 11, Tex.	324 U.S. Appraisers Bldg.	Louis L. McCabe
	Beaumont, Tex.	329 P.O. Bldg.	Eric D. Coburn
		(Sub-Office)	
10	Dallas 22, Tex.	500 U.S. Terminal Annex	John H. Homsy

AMERICAN BROADCASTING COMPANY

(A Division of American Broadcasting-Paramount Theatres Inc.)

7 West 66th Street, New York 23, N. Y. Telephone: Susquehanna 7-5000

For Executives of Television Division, see Telecasting Yearbook

AMERICAN BROADCASTING-PARAMOUNT THEATRES, INCORPORATED

Board of Directors

Earl E. Anderson	Robert L. Huffines Jr.
John Balaban	William T. Kilborn
A. H. Blank	Robert E. Kintner
John A. Coleman	Walter F. Marshall
Charles T. Fisher Jr.	Edward J. Noble
E. Chester Gersten	Robert H. O'Brien
Leonard H. Goldenson	Herbert Schwartz
Walter W. Gross	R. B. Wilby
Robert H. Hinckley	Owen D. Young

AMERICAN BROADCASTING COMPANY

(A Division of American Broadcasting-Paramount Theatres, Inc.)

Officers

Robert E. Kintner, *President*
 Robert H. O'Brien, *Executive Vice President*
 Earl E. Anderson, *Vice President*
 Charles T. Ayres, *Vice President*
 James H. Connolly, *Vice President*
 Slocum Chapen, *Vice President*
 John Daly, *Vice President*
 Robert H. Hinckley, *Vice President*
 Earl Hudson, *Vice President*
 Ernest Lee Jahncke Jr., *Vice President*
 Frank Marx, *Vice President*
 John Mitchell, *Vice President*
 Harold Morgan, *Vice President and Comptroller*
 Theodore I. Oberfelder, *Vice President*
 George Shupert, *Vice President*
 Alexander Stronach, *Vice President*
 Charles Underhill, *Vice President*
 Thomas Velotta, *Vice President*
 Robert M. Weltman, *Vice President*
 Paul Whiteman, *Vice President*
 Geraldine B. Zorbaugh, *Secretary & General Counsel*
 Walter C. Tepper, *Controller*
 Aaron Rubin, *Asst Treasurer & Asst Secretary*
 Omar Elder, *Asst Secretary & Asst General Counsel*

NEW YORK

7 West 66 Street
 New York 23, New York
 Charles T. Ayres, *Vice President in charge of Radio Network*
 Oliver Treyz, *Director of Radio Network*

Engineering & General Services

Frank Marx, *Vice President in charge*
 John Bourcier, *Operations Supervisor*
 Thomas F. Foy, *Purchasing Agent*
 Richard Hamilton, *Supervisor of Communications*
 Clure Owen, *Administrative Assistant*
 John Preston, *Director of Engineering Facilities & General Services*
 Lawrence A. Ruddle, *Recording Director*
 Joseph J. Spagnola, *Office & Studio Services Director*
 William Trevarthen, *Director of Engineering Operations*
 Reginald Willcocks, *Traffic Manager*
 Merle Worster, *Eastern Engineering Operations Manager*

Finance, Personnel

Harold Morgan, *Vice President and Comptroller*
 Marie McWilliams, *Director of Personnel*
 Walter C. Tepper, *Chief Accountant*
 Mortimer Weinbach, *Director of Labor Relations*

Legal

Geraldine B. Zorbaugh, *Secretary & General Counsel*
 Omar Elder, *Assistant Secretary & Assistant General Counsel*

News & Special Events

Thomas Velotta, *Vice President in charge*
 Donald Coe, *Director of News & Special Events Program*

Robert M. Weltman, *Vice President in charge of Programming & Talent*
 Raymond Diaz, *National Program Director*
 Addison Amor, *Director of Program Sales*
 Walter A. Gustafson, *Supervisor of Sound Effects*
 William Hamilton, *Eastern Program Manager*
 Helen Hedeman, *Supervisor of Casting*
 Anne Kelly, *Announcing Office Manager*
 J. Ward Mitchell, *Manager of Script & Program Promotion*

George Sax, *National Director of Program Operations*

Clayton Shields, *Business Manager*
 Ruth B. Smith, *Supervisor of Production Control Unit*

Frank Vagnoni, *Manager of Music Division*
 Public Relations, Advertising & Promotion, and Continuity Acceptance

John Facey, *Director of Public Relations & Special Features*

Ruth Crawford, *Librarian*
 Ellen Heagerty, *Supervisor of Audience Information*

Grace Johnsen, *Director of Continuity Acceptance*
 Ernest G. Stern, *Acting Manager of Publicity*

Ruth Trexler, *Executive Producer of Religious and Educational Programs*

Sales Promotion

Eugene Accas, *Director of Radio Network Sales Promotion*

Sales

Norman E. Cash, *Assistant Sales Manager*
 William Fairbanks, *Eastern Sales Manager*
 George Huelsner, *Network Sales Service Manager*
 Station Relations, Operations for Sales & Station Traffic, Research & Sales Development

Ernest Lee Jahncke Jr., *Vice President & Assistant to the President*

Frank Atkinson, *Manager of Co-operative Program Department*

Stewart Barthelmess, *Manager of Station Clearance*
 Alfred Beckman, *National Director of Station Relations Department*

Donald G. Buck, *Director of Operations for Sales and Station Traffic*

Edmund C. Casarella, *Art Director, Sales Promotion*
 William M. Materne, *Coordinator of Owned Stations*

Dean Shaffner, *Director of Network Radio Research*
 Alice Stamatis, *Manager of Order Processing*

Eugene Accas, *Director of Network Radio Sales Development*

William A. Wylie, *Manager of Station Relations Department*

CENTRAL DIVISION

20 North Wacker Drive

Chicago 6, Illinois

Elliot Henry Jr., *Publicity Director*
 W. Donald Roberts, *Director of Network Radio*

Matthew Vieracker, *Treasurer*

HOLLYWOOD

1539 North Vine Street

Hollywood 28, California

Earl Hudson, *Vice President, Western Division*
 J. Clifford Anderson, *Program Business Manager*

Jon Barkhurst, *Director of Radio-Promotions-Publicity Department*
 Amos Baron, *Network National Sales Manager—Pacific Coast*

Matthew E. Barr, *Los Angeles Sales Manager—KECA ABC Pacific Network*

Dorothy L. Brown, *Continuity Acceptance Editor, Western Division*

Philip G. Caldwell, *Manager, Engineering & General Services, Western Division*

Francis Conrad, *Director of Radio, Western Division*

Dresser Dahstead, *Program Manager, Western Division*

Ralph Denechaud, *Engineering Operations Supervisor*

Florence T. Shiro, *Personnel Director*
 C. Merwin Travis, *Director, Department of Promotion—Public Services*

John C. Wagner, *Controller, Western Division*
 Sam Zeiman, *News Editor, Western Division*

SAN FRANCISCO

420 Taylor Street

San Francisco 2, California

James Connolly, *Vice President in charge*
 Lorraine Duchene, *Continuity Acceptance Editor*

A. E. Evans, *Business Manager of San Francisco Office*

William Grandy, *Program Director for Radio*
 Harry Jacobs, *Chief Engineer*

Edith Kirby, *Traffic Manager*
 Victor Reed, *Director of News & Special Events*

Henry A. Saroyan, *Auditor*
 William E. Williams, *Manager, Publicity Advertising and Promotion*

NEW YORK

Theodore I. Oberfelder, *Vice President & General Manager of WABC*

Michael Renault, *Commercial Manager of WABC*
 Myrtle Tower, *Program Director of WABC*

CHICAGO

Sterling C. Quinlan, *General Manager of WENR*
 William F. Kusack, *Director of Engineering, WENR*

HOLLYWOOD

Amos Baron, *Station Manager of KABC*
 Matthew Barr, *Sales Manager of KABC*

SAN FRANCISCO

Paul Scheiner, *Station Manager of KGO*
 John Hansen, *Sales Manager of KGO*

DETROIT

(WXYZ, INC.)

James G. Riddell, *President, WXYZ Inc.*
 Harold Christian, *Commercial Manager of WXYZ*

Station Representatives for WABC, KABC & KGO
 Edward Petry & Company

488 Madison Avenue
 New York, New York

Station Representatives for WENR & WXYZ
 John Blair & Company

150 East 43rd Street
 New York, New York

RADIO STATIONS ADVISORY COMMITTEE

Roger W. Clipp, *WFL Philadelphia, Pa., District 1*

J. P. Williams, *WING Dayton, Ohio, District 2*

Verl Bratton, *WKTY La Crosse, Wisconsin, District 3*

T. B. Lanford, *KRMD Shreveport, La., District 4*

Harold V. Hough, *WBAP Fort Worth, Texas, District 5*

Frank C. Carman, *KUTA Salt Lake City, Utah, District 6*

Steve Connolly, *KEX Portland, Ore., District 7*
 A. D. Willard Jr., *WGAC Augusta, Ga., District 8*

FCC EXECUTIVES

District No.	City	Address	Engineer in Charge
11	Los Angeles 12, Calif.	539 U.S. P.O. & Courthouse Bldg.	Bernard H. Linden
	San Diego 1, Calif.	15-C U.S. Customhouse (Sub-Office)	Ney R. Landry
	San Pedro, Calif.	326 U.S. P.O. & Courthouse Bldg. (Ship Office)	J. Lee Smith
12	San Francisco 26, Calif.	323-A Customhouse	Francis V. Sloan
13	Portland 5, Ore.	307 Fitzpatrick Bldg.	Joseph H. Hallock
14	Seattle 4, Wash.	802 Federal Bldg.	Herbert H. Arlowe
15	Denver 2, Colo.	521 Customhouse	William E. Clyne
16	St. Paul 2, Minn.	208 Uptown P.O. & Federal Bldg.	Donald A. Murray
17	Kansas City, Mo.	3200 Federal Office Bldg.	Harold T. Gallaher
18	Chicago 4, Ill.	826 U.S. Customhouse	H. D. Hayes
19	Detroit 26, Mich.	1029 New Federal Bldg.	Edwin S. Heiser
20	Buffalo 3, N. Y.	328 Federal Bldg.	Paul A. Holloway
21	Honolulu 1, T. H.	502 Federal Bldg.	Paul R. Fenner
22	San Juan 13, P. R.	322-323 Federal Bldg.	Arthur T. Cline Jr.
23	Juneau, Alaska	7-8 Shattuck Bldg.	Harold D. DeVoe (Vacancy)
	Anchorage, Alaska	53 U.S. P.O. & Courthouse (Sub-Office)	
24	Washington, D. C.	104 Brigs Bldg. 415 22d St. N.W.	Alfred H. Kleist

BROADCASTING • TELECASTING

PRIMARY MONITORING STATIONS

Allegan, Mich.	P.O. Box 89	J. Patrick Scanlon
Grand Island, Nebr.	P.O. Box 788	Arthur A. Johnson
Kingsville, Tex.	P.O. Box 632	William R. Foley
Laurel, Md.	P.O. Box 31	Adolph Andersen
Livermore, Calif.	P.O. Box 989	George R. McLeod
Mills, Mass.	P.O. Box 458	Edward W. Sanders
Portland, Ore.	P.O. Box 5165	Robert A. Landsburg
Powder Springs, Ga.	P.O. Box 4	Henry B. Dumphrey Jr.
Santa Ana, Calif.	P.O. Box 744	William J. Hoffer
Lanikai, Oahu, Hawaii	P.O. Box 1142	Lee R. Dawson (Acting)

SECONDARY MONITORING STATIONS

SearsPort, Me.	P.O. Box 44	Vernon K. Wilson
	Belfast, Me.	
	P.O. Box 191	Adelbert C. Lawrence
Spokane, Wash.		
Twin Falls, Idaho	P.O. Box 499	John L. Kurdeka
Fort Lauderdale, Fla.	P.O. Box 5098	Homer V. Thompson
Lexington, Ky.	P.O. Box 89	James E. Gilfoy
Muskogee, Okla.	P.O. Box 1448	Harry E. Garoutte
Fairbanks, Alaska	P.O. Box 810	Kenneth V. Preston
Anchorage, Alaska	P.O. Box 719	Raymond L. Tardif

1954 BROADCASTING Yearbook-Marketbook • Page 35

ABC radio is



The usual...and usually the safest...indication of how a network is doing is the amount of money that advertisers are spending there.

By this standard, the present is pleasant on ABC Radio, and the future looks even better.

Some of the biggest sales of the past year in network radio were made on ABC; our over-all billings are on the rise and have been since early fall. And no other radio network can make that statement. These figures from the Publishers Information Bureau show the situation.

growing!

NETWORK-BY-NETWORK COMPARISON

Gross radio billings

	November 1952	November 1953	Per cent change
ABC	\$2,659,934	\$2,798,532	+5%
Network B	5,506,172	5,403,351	-2%
Network C	2,172,485	2,090,007	-4%
Network D	4,138,979	3,372,330	-19%

This gratifying trend is the result of many things that have been happening and are going to happen here at ABC.

Our network coverage has expanded to include 363 stations. New stars, new programs, new ideas have been introduced, and many more will make their appearance early this year. There have been some significant rating gains. We signed a record amount of new business for the fall... in fact, it was the biggest, busiest fall we've had in years. Yes, ABC is really *on the move*. And if you're a cost-conscious advertiser, it might be a smart move to ask us about some of the availabilities on ABC Radio.

ABC Radio Network

American Broadcasting Company

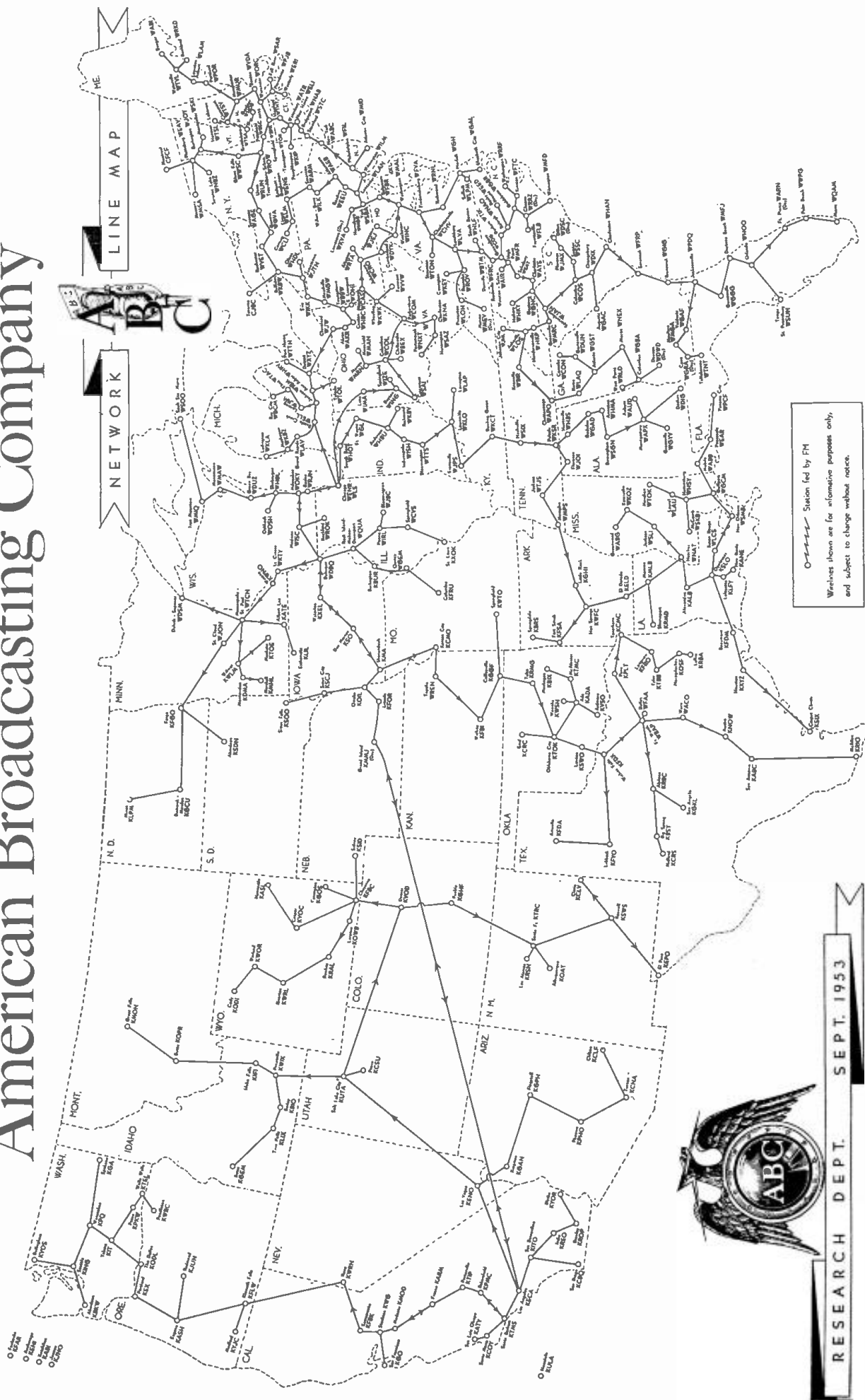

RESEARCH DEPT. SEPT. 1953

CBS RADIO
A DIVISION OF COLUMBIA BROADCASTING SYSTEM INC.
485 Madison Ave., New York 22, N. Y. Telephone: Plaza 1-2345
 For executives of parent company, Columbia Broadcasting System Inc., see page 62.

Officers

Adrian Murphy, *President*
 James M. Seward, *Administrative Vice President*
 J. Kelly Smith, *Administrative Vice President*
 H. Leslie Atlass, *Vice President in Charge of Central Division*
 Guy della Cloppa, *Vice President in Charge of Network Programs, Hollywood*
 Charles L. Glett, *Vice President in Charge of Network Services, Hollywood*
 Lester Gottlieb, *Vice President in Charge of Network Programs*
 Arthur Hull Hayes, *Vice President in Charge of San Francisco Office*
 John J. Karol, *Vice President in Charge of Network Sales*
 William B. Lodge, *Vice President in Charge of Engineering*
 William A. Schudt Jr., *Vice President in Charge of Station Relations*

Accounting

Merle Wick, *Director of Accounting*
 Claude Boydston, *Chief Accountant*

Business Affairs, Network Programs

Henry Howard, *Director of Business Affairs*
 Kenneth Craig, *Director of Business Affairs, Hollywood*
 Anne Nelson, *Associate Director, Business Affairs, Hollywood*
 W. C. Harrington, *Manager, Music Copyright Division*

Editing

Don Ball, *Director*

Engineering Department

William B. Lodge, *Vice President in Charge of Engineering*
 A. B. Chamberlain, *Chief Engineer*
 H. A. Chinn, *Chief Audio Engineer*
 J. W. Wright, *Chief Radio Engineer*

Legal

Robert Dunne, *Senior Attorney*

Network Programs

Lester Gottlieb, *Vice President, Network Programs*
 Gerald Maulsby, *Manager of Network Broadcasts*
 Norman Frank, *Program Supervisor*
 James Fasset, *Director of Serious Music*
 Charles S. Monroe, *Manager, Program Writing*

Network Sales

John Karol, *Vice President in Charge of Network Sales*
 Eldon Hazard, *Sales Manager*
 Dudley Faust, *Eastern Sales Manager*
 Gilson Gray, *Administrative Manager*
 E. E. Hall, *Sales Service Manager*

Pacific Coast Office

Bok Reitzel, *Sales Manager*
 Chicago Office, 410 Michigan Avenue
 Roger K. Huston, *Manager*

Detroit Office, Fisher Bldg.

Ben Lochridge, *Manager*

News

Wells Church, *Director of News*
 Helen J. Sioussat, *Director of Talks*
 Red Barber, *Counselor on Sports*
 John Derr, *Director of Sports*
 George Crothers, *Director of Religious Broadcasts*
 Theodore Koop, *Director of News and Public Affairs, Washington*
 Robert Skedgell, *Director of Special Events*
 Lewis Shollenberger, *Director of Special Events, Washington*

Public Affairs

Stuart Novins, *Director, Public Affairs*

Operations

Horace Guillotte, *Director of Operations*
 Austin E. Joscelyn, *Director of Operations, Hollywood*
 James Sirmons, *Manager of Network Operations*
 Davidson Vorhies, *Manager, Technical Operations and Chief Engineer, WCBS*
 Hugh Cowham, *Traffic Manager*
 Julius Mattfeld, *Director of Music Library*
 Lucile Singleton, *Manager of Record and Script Library*

Press Information

George Crandall, *Director*
 Irving Fein, *Director of Public Relations, Hollywood*
 Lloyd Brownfield, *Director of Press Information, Hollywood*
 Sidney Garfield, *Director of Exploitation*
 Michael Boscia, *Executive Assistant*
 Edward Reynolds, *Manager*
 Harry J. Feeney, *Assistant to the Director and Trade News Editor*
 Anne Harding, *Manager, Service Division*
 Raymond Hughes, *Manager, Magazine Division*

CBS-OWNED STATIONS

WCBS and WCBS-FM, 485 Madison Avenue, New York 22

Carl Ward, *General Manager*
 Henry Untermeyer, *Sales Manager*
 Sam Slate, *Program Manager*
 Don Foley, *Promotion Manager*
 Milton Rich, *Manager, Press Relations*

KCBS and KCBS-FM, Palace Hotel, San Francisco 5

Arthur Hull Hayes, *Vice President in Charge San Francisco Office, General Manager of KCBS and KCBS-FM*
 Jules Dundes, *Sales Manager*
 Pede Worth, *Program Manager*
 Evelyn Clark, *Promotion Manager*

KMOX, 401 S. Twelfth Boulevard, St. Louis 2

Eugene Wilkey, *General Manager*
 Robert Hyland, *Sales Manager*
 Mark Russell, *Program Manager*
 Foster Brown, *Program Manager*

KNX and KNX-FM and Columbia Pacific Network
 6121 Sunset Boulevard, Los Angeles 28

William Shaw, *General Manager*
 Bert West, *Assistant General Manager and Sales Manager*
 Robert Sutton, *Program Manager*
 James Frost, *Promotion Manager*

WBBM and WBBM-FM, 410 N. Michigan Avenue, Chicago 11

H. Leslie Atlass, *Vice President in Charge of Central Division, General Manager of WBBM*
 E. H. Shomo, *Assistant General Manager*
 Bill Miller, *Sales Manager*
 Thomas A. Bland, *Program Manager*
 C. W. Doebler, *Promotion Manager*

WEEI and WEEI-FM, 182 Tremont Street, Boston 12

Harvey Struthers, *General Manager*
 Emmett J. Heerd Jr., *Sales Manager*
 Eugene King, *Program Manager*
 Jack Curry, *Promotion Manager*

HOUSEWIFE'S PROTECTIVE LEAGUE PRODUCTIONS

Edward W. Wood Jr., *General Sales Manager and General Manager, HPL Program Services, Inc.*

CBS RADIO SPOT SALES

Henry Flynn, *General Sales Manager*
 Milton Allison, *Eastern Sales Manager*
 George Castleman, *Manager, Sales Development*
 Richard Hess, *Research Manager*
 Sherril Taylor, *Promotion Manager*

Chicago Office, 410 North Michigan Avenue

Gordon F. Hayes, *Western Sales Manager*

Memphis Office, 83 S. Main Street

David Kittrell, *Sales Manager*

Detroit Office, Fisher Bldg.

Ralph Patt, *Sales Manager*

Los Angeles Office, Columbia Square

George Hurst, *Sales Manager*

San Francisco Office, Palace Hotel

Al Donahue, *Sales Manager*

Research

Harper Carraine, *Director of Research*
 Edward Reeve, *Sales and Promotion Research Manager*
 Howard Miller, *Manager, Coverage and Marketing Research*
 Gerhart Wiebe, *Research Psychologist*

Sales Promotion and Advertising

George Bristol, *Director*
 Charles Oppenheim, *Administrative Manager*
 Louis Dorfsman, *Associate Director and Art Director*
 Murry Salberg, *Program Promotion Manager*
 Thomas Means, *Director, Promotion Service, CBS-Owned Stations*
 Frank Nesbitt, *Director, Network Sales Presentations*
 William Jayme, *Director, Network Copy*
 Irving Miller, *Director, Art Service, CBS-Owned Stations Promotion*
 Joseph Tole, *Production Manager*
 Edward Kaylen, *Sales Analysis and Special Reports*

Station Administration

Wendell B. Campbell, *Vice President in Charge*

Station Relations

William A. Schudt Jr., *Vice President in Charge of Station Relations*
 Edward DeGray, *Director*
 Ole Morby, *Western Division Manager, Columbia Square, Los Angeles 28*

CBS, INC., BROADCAST SERVICE DEPARTMENTS
Building Operations and Ticket Division

James Swenson, *Manager of Building Operations*
 Jack Page, *Assistant Manager of Building Operations*
 Laurette Banks, *Supervisor of Ticket Division*

General Purchasing

John E. Forsander, *Director of Purchases*
 Edward Drewes, *Purchasing Agent*

Office Services Department

A. H. Bryant, *Manager*
 Maude Stubner, *Supervisor of Program Typing*
 Emily Schiener, *Supervisor of Program Transcripts*

Personnel Relations

Robert Kalaidjian, *Director*
 Dr. Jack Nelson, *Director of Medical Office*
 Charles Burt, *Personnel Administrator*
 John Anderson, *Personnel and Labor Research Manager*
 Richard Stanley, *Employment Manager*

Photographic

Walter I. Sigal, *Manager*

Reference

William C. Ackerman, *Director*
 May Dowell, *Manager, General Information Division*
 Agnes Law, *Librarian*
 Esther Dobbins, *Manager, Program Information Division*
 Dorothy Boyle, *Manager, Program Statistics Division*

AM STATIONS AUTHORIZED IN U. S.

(From records of FCC)

Date	Licensed	Under Construction	Total Authorized
Jan. 1, 1922			30
Mar. 1, 1923			556
Oct. 1, 1924			530
June 20, 1925			571
June 30, 1926			528
Feb. 23, 1927			733
July 1, 1928			677
Nov. 9, 1929			618
July 1, 1930			612
July 1, 1931	603	9	612
Jan. 1, 1932	601	7	608
Jan. 1, 1933	599	11	610
Jan. 1, 1934	583	8	591
Jan. 1, 1935	585	20	605
Jan. 1, 1936	616	16	632
Jan. 1, 1937	646	39	685
Jan. 1, 1938	689	32	721
Jan. 1, 1939	722	42	764
Jan. 1, 1940	765	49	814
June 30, 1941			897
June 30, 1942			925
June 30, 1943			912
June 30, 1944			924
July 20, 1945	933	23	956
Jan. 1, 1946	940	64	1,004
Jan. 1, 1947	1,062	458	1,520
Jan. 1, 1948	1,522	440	1,762
Jan. 1, 1949	1,865	262	2,127
Jan. 1, 1950	2,048	186	2,234
Jan. 1, 1951	2,199	152	2,351
Jan. 1, 1952	2,300	108	2,408
Jan. 1, 1953	2,371	153	2,524
Jan. 1, 1954	2,500	136	2,636

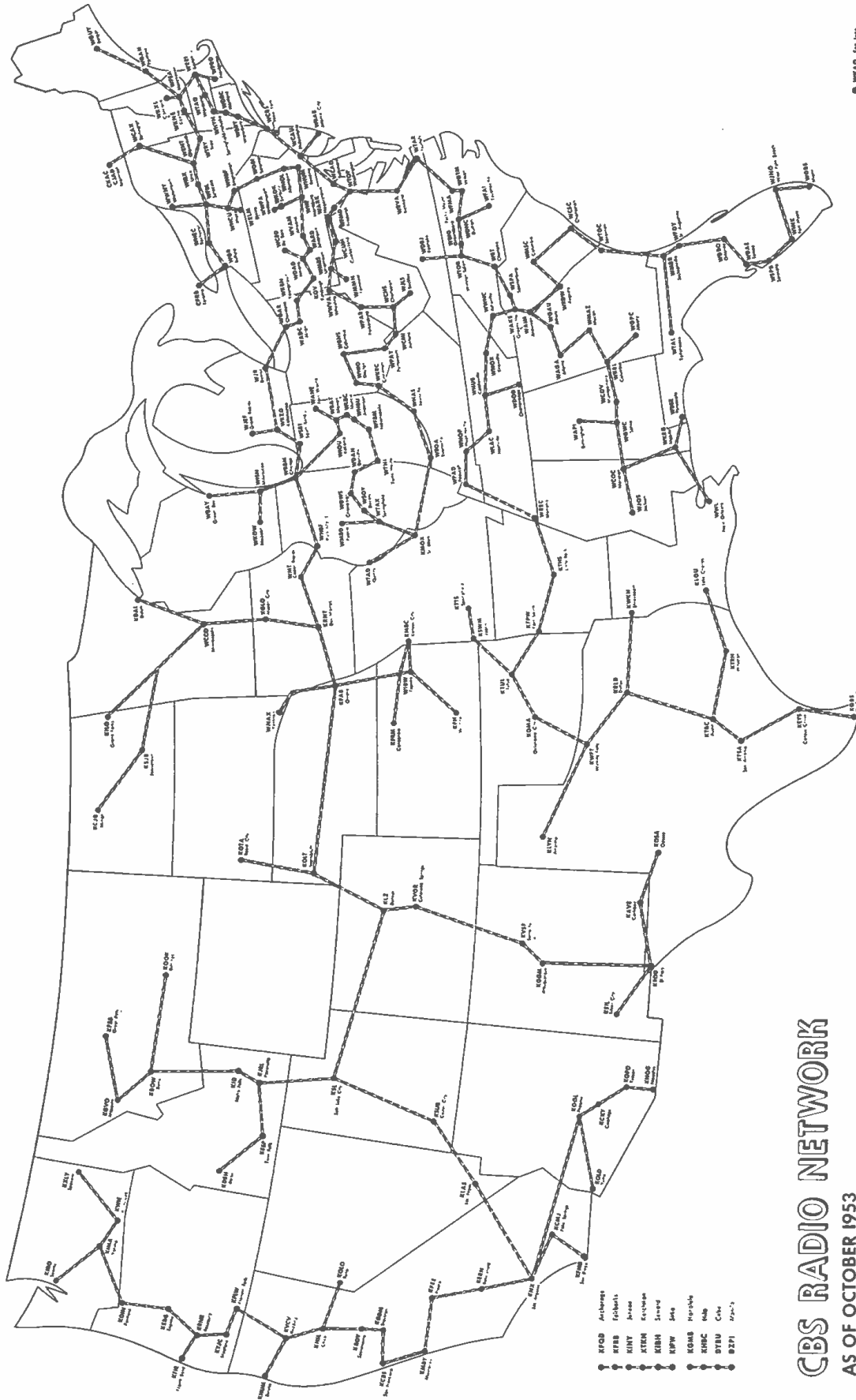

© WEAQ, Inc. 1953

CBS RADIO NETWORK AS OF OCTOBER 1953

- KTOB Arkansas
- KBBB Colorado
- WFTS Florida
- WTTN Indiana
- KBNH Iowa
- KSPW Kansas
- KMOB Kentucky
- KZNC Louisiana
- WTUU Michigan
- WZTV Minnesota

KEYSTONE BROADCASTING SYSTEM

NOVEMBER, 1953

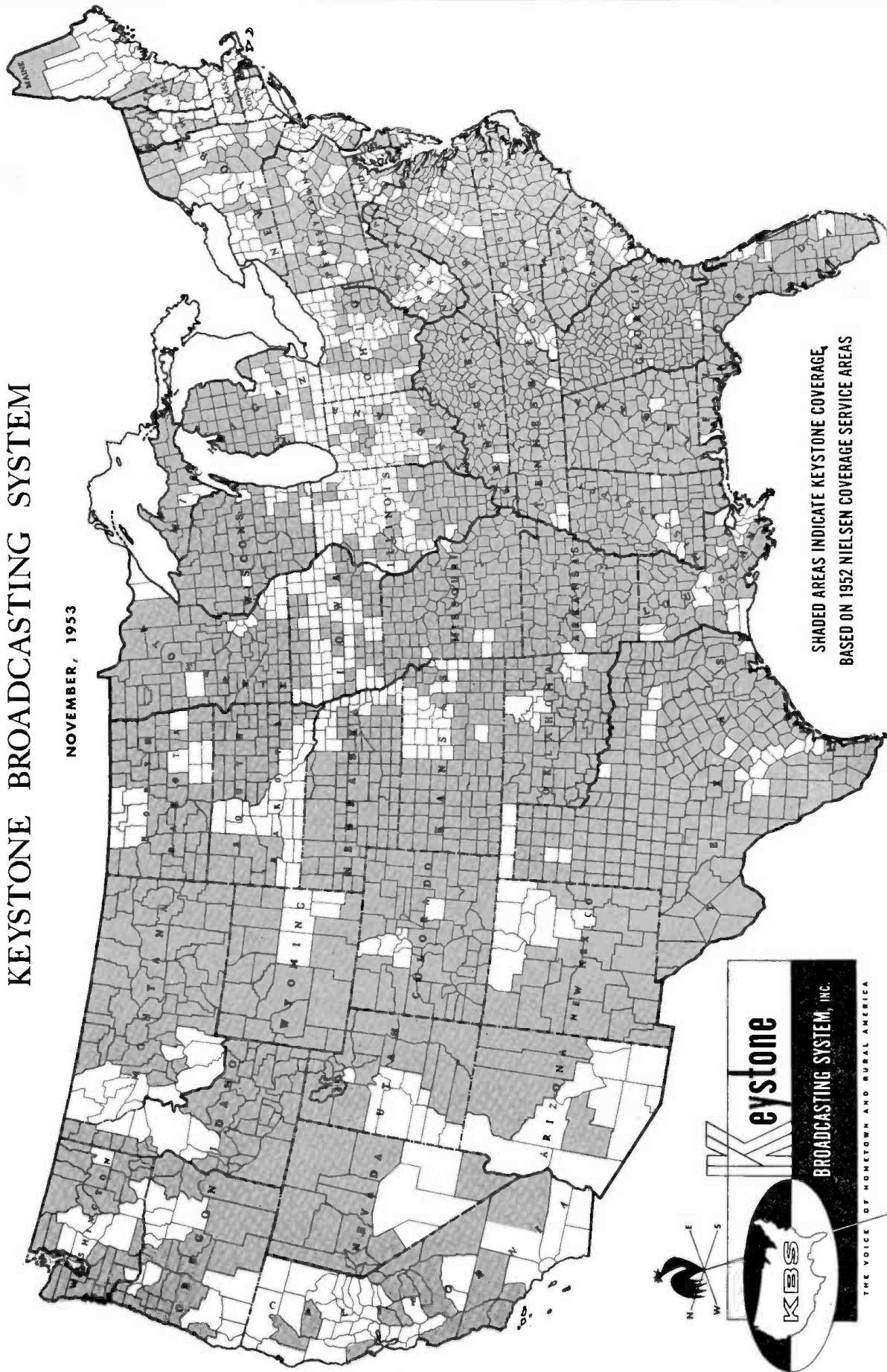

SHADED AREAS INDICATE KEYSTONE COVERAGE,
BASED ON 1952 NIELSEN COVERAGE SERVICE AREAS

Keystone
BROADCASTING SYSTEM, INC.
THE VOICE OF HOMETOWN AND RURAL AMERICA



Extra Arms and Hands in Your Sales Department?

There is nothing at all mysterious about what it takes to move a product—in volume! The answer is **ENERGY . . .** all kinds, at all levels. When you decide to tell your story to Hometown and Rural America via the 687 **KEYSTONE** radio stations, you are hooking yourself onto lots more than just a radio network.

You and your product are going to get the *full treatment* which is typical of **KBS** sales drives. Ex-

tra hands to send letters to your dealers—extra hands to get displays up in windows and on counters—extra hands to get your merchandise **UP FRONT** at the point of sale . . . and lots more!

Lots of people *talk about* **MERCHANDISING EXTRAS!** **KEYSTONE DELIVERS!** We'll be glad to show you case histories that will make you green with envy! What'll you bet?

● **WRITE, WIRE OR PHONE FOR COMPLETE MARKET INFORMATION AND RATES**

CHICAGO
111 West Washington St.
STate 2-6303

NEW YORK
580 Fifth Avenue
PLaza 7-1460

LDS ANGELES
1330 Wilshire Blvd.
DUnkirk 3-2910

SAN FRANCISCO
57 Post Street
SUtter 1-7440

✓ **TAKE YOUR CHOICE**

A handful of stations or the network . . . a minute or a full hour . . . it's up to you, your needs.

✓ **MORE FOR YOUR DOLLAR**

No premium cost for individualized programming. Network coverage for less than "spot" cost for some stations.

✓ **ONE ORDER DOES THE JOB**

All bookkeeping and details are done by **KEYSTONE**, yet the best time and place are chosen for you.

Keystone
BROADCASTING SYSTEM, INC.

THE VOICE OF HOMETOWN AND RURAL AMERICA

MUTUAL BROADCASTING SYSTEM EXECUTIVES AND STAFF

1440 Broadway, New York 18, N. Y., Phone: Longacre 4-8000

BOARD OF DIRECTORS

Thomas F. O'Neil, Chairman
Elbert M. Antrim, WGN Chicago, Vice-Chm.
James E. Wallen, MBS, N. Y., Secy.
Willett H. Brown, Don Lee Network, Hollywood
H. K. Carpenter, WHK Cleveland
Gordon Gray, General Teleradio, Inc. (WOR and WOR-TV Divisions)
Benedict Gimbel Jr., WIP Philadelphia
Adolf N. Hult, MBS, N. Y.
Ward D. Ingram, Don Lee, Hollywood
Earl M. Johnson, MBS, N. Y.
Robert A. Schmid, MBS, N. Y.
Frank Schreiber, WGN Chicago
J. Glen Taylor, General Teleradio, Inc.
Linus Travers, Yankee Network, Boston

OFFICERS

Thomas F. O'Neil, President
J. Glen Taylor, Administrative Vice President, Policy
E. M. Johnson, Administrative Vice President, Production, Engineering, Station Relations
Robert A. Schmid, Administrative Vice President, Sales, Advertising
James E. Wallen, Secretary & Administrative Vice President, Finance
Gordon Gray, Vice President, General Teleradio, in charge of WOR and WOR-TV Division.
B. J. Hauser, Vice President in charge of Co-op Programs
Adolf N. Hult, Vice President in charge of Sales
Herbert Rice, Vice President in charge of Programs
Julius F. Seebach, Vice President in charge of Program Productions
George Ruppel, Treasurer
Elisha Goldfarb, Assistant Secretary

OFFICE MANAGEMENT

George Ruppel, Treasurer
Elisha Goldfarb, Legal Counsel
R. Groome, Assistant Controller

Beatrice M. Marschner, Personnel Director
Adolph Oppinger, Labor Negotiations
Galle Dody, Supervisor, Central Steno
Margaret Lanigan, Supervisor, File & Reception
Audrey Zelner, Supervisor, Listeners Service
Ruth Hendler, Manager, Mail & Purchasing
Augusta Hall, Telephone Supervisor
Margaret Riordan, Supervisor, Wire Communications

LEGAL COUNSEL

Keith Masters, Andrew C. Hamilton, Percy H. Russell Jr., of Kirkland, Fleming, Green, Martin & Ellis, Washington, D. C. & Chicago
Emmanuel Dannett, of McGoldrick, Winn, Dannett & Horowitz, New York
Elisha Goldfarb, MBS, New York

PROGRAM

Herbert Rice, V.P. in charge of Programs
Julius F. Seebach, V.P. in charge of Program Productions
B. J. Hauser, V.P. in charge of Co-op Programs
Harold Wagner, Manager of Program Operations
Don Hamilton, Assistant to Program Production Vice President
Dorothy Kemble, Director of Radio and TV Clearance
Ermeron Buckley, Associate Music Director
John Bogue, Music Librarian
Nathan Abramson, Manager of Entertainment Bureau
Milton Burgh, Director of News
Arthur Feldman, Director of Special Events
Paul Jonas, Director of Sports
George Brown, Manager of News Operations

STATION RELATIONS AND ENGINEERING

Earl M. Johnson, Vice President in Charge of Station Relations and Engineering
Charles Godwin, Director of Station Relations
Robert Carpenter, Asst. Director of Station Relations
Robert Kennett, Station Contact Representative
Jean Engel, Supervisor of Station Information

Roy Danish, Director of Commercial Operations
Alma Graef, Manager of Sales Service
T. E. Danley, Manager of Sales Traffic
Sara Joseph, Supervisor of Contracts
John Hayes, Office Manager—Recording
Chester Cheek, Sales Manager—Recording
Leslie Learned, Engineering Operations Manager
James Chapman, Assistant Manager, Engineering Operations
Charles Singer, Chief Engineer
Robert O'Connor, Chief Plans and Allocations Engineer

SALES

Adolf N. Hult, Vice President in charge of network Sales
John Overall, Eastern Sales Manager
Sidney Allen, Administrative Manager—network Sales

ADVERTISING, PUBLIC RELATIONS & RESEARCH

Robert A. Schmid, Vice President in charge of Advertising, Public Relations and Research
James Tyler, Director of Advertising
F. Carleton McVarish, Director of Audience Promotion & Merchandising
Richard Puff, Director of Research & Planning
Francis X. Zuzolo, Director of Press Information
Arnold Roston, Art Director
Nathan Sakolsky, Production Manager
Henry Foster, Manager of Presentations
Walter Stein, Manager of Research
R. Jackson Foster, Manager of Art Presentations

WASHINGTON

Everett Holles, Director of Washington Operations

CHICAGO

Carroll Marts, Director of Midwest Operations
Virgil Reiter, Midwest Sales Manager
Dorothy Reynolds, Midwest Sales Service Manager
Myrtle Goulet, Office Manager and Program Traffic
George Herro, Promotion and Press Information Representative

BROADCAST ADVERTISING BUREAU

Headquarters: 270 Park Avenue, New York 17, New York. MUrray Hill 8-4020

Officers

Charles C. Caley, Chairman of the Board, WMBD, Peoria, Illinois
Kevin B. Sweeney, President BAB, Inc., New York, N. Y.
Simon Goldman, Secretary, WJTN, Jamestown, N. Y.
John Patt, Treasurer, WGAR, Cleveland, Ohio
William L. Morrison, Asst. Secretary-Treasurer, BAB, Inc., New York, N. Y.

Board of Directors

Charles T. Ayres, ABC
7 W. 86 Street, New York, N. Y.
Joseph E. Baudino
Westinghouse Broadcasting Co., 1625 K Street, N.W., Washington, D. C.
John Blair
John Blair & Co., 150 E. 43rd St., New York
Kenyon Brown, KWFT
Wichita Falls, Texas
Charles C. Caley, Chairman, WMBD
Peoria, Illinois
Martin B. Campbell, WFAA
Dallas, Texas

KBS STATIONS

(Continued from Page 41)

WEST VIRGINIA—WHAR Clarksburg; WDNE Elkins; WKYR Keyser; WVOW Logan; WEPM Martinsburg; WMJC Matewan; WMOD Moundsville; WLOH Princeton; WBRW Welch; WHAW Weston.

WISCONSIN—WATW Ashland; WLDY Ladysmith; WDLB Marshfield; WIGM Medford; WMNE Menomonie; WNAM Neenah; WFPF Park Falls; WIBU Poynette; WRAC Racine; WOBT Rhinelander; WRCO Richland Center; WKLJ Sparta; WSPT Stevens Point; WOKW Sturgeon Bay; WTRW Two Rivers; WTTN Watertown; WAUX Waukesha; WOSA Wausau (formerly WLIN Merrill, Wis.).

WYOMING—KVVO Cheyenne; KLUK Evanston; KOVE Lander; KPWO Powell; KRAL Rawlins; KVR5 Rock Springs; KWYO Sheridan.

John C. Cohan, KSBW
Salina, Calif.
Robert Dunville, WLW
Cincinnati, Ohio
Wm. H. Fineshruber Jr., NBC
30 Rockefeller Plaza, New York, N. Y.
Simon Goldman, WJTN
Jamestown, New York
John S. Hayes, WTOP
Washington, D. C.
George J. Higgins, KMBC
Kansas City
J. Herbert Hollister, KCOL
Fort Collins, Colorado
Ward D. Ingram, KHJ
Los Angeles, California
Edgar Kobak, WTWA
Thomson, Georgia (341 Park Ave., N. Y.)
Howard Lane, KOIN
Portland, Ore.
William McGrath, WHDH
Boston, Massachusetts
Arch L. Madsen, KOVO
Provo, Utah

John Meagher, KYSM
Mankato, Minnesota
James H. Moore, WSLS
Roanoke, Virginia
Adrian Murphy, CBS
485 Madison Avenue, New York, N. Y.

John Patt, WJR
Detroit, Mich.
H. Preston Peters
Free & Peters, 444 Madison Ave., New York, N. Y.

William B. Quarton, WMT
Cedar Rapids, Iowa
Robert A. Schmid, Mutual
1440 Broadway, New York, N. Y.
George B. Storer
Storer Broadcasting Co., 1005 Kane Concourse,
Miami Beach, Fla.

Robert D. Swezey, WDSU
New Orleans, Louisiana
Donald Thornburgh, WCAU
Philadelphia, Pennsylvania
Allen M. Woodall, WDAK
Columbus, Georgia

Board Committees

Executive Committee—Joseph E. Baudino, Chairman, Westinghouse Broadcasting Co., Washington, D. C.; Simon Goldman, WJTN, Jamestown, N. Y.; William H. Fineshruber Jr., NBC, New York, N. Y.; Adrian Murphy, CBS, New York, N. Y.; William B. Quarton, WMT, Cedar Rapids, Iowa; Kenyon Brown, KWFT, Wichita Falls, Texas; Allen M. Woodall, WDAK, Columbus, Georgia.

Finance Committee—Ward D. Ingram, Chairman, KHJ, Los Angeles, California; Charles T. Ayres, ABC, New York, N. Y.; Robert A. Schmid, MBS, New York, N. Y.; H. Preston Peters, Free & Peters, New York, N. Y.; Robert Dunville, WLW, Cincinnati, Ohio; John S. Hayes, WTOP, Washington, D. C.

Membership Committee—William McGrath, Chairman, WHDH, Boston, Massachusetts; John Meagher, KYSM, Mankato, Minnesota; George J. Higgins, KMBC, Kansas City, Missouri; Arch L. Madsen, KOVO, Provo, Utah; James H. Moore, WSLS, Roanoke, Virginia.

By-Laws Committee—Robert D. Swezey, Chairman, WDSU, New Orleans, Louisiana; Howard Lane, KOIN, Portland, Oregon; Donald W. Thornburgh, WCAU, Philadelphia, Pennsylvania.

Plans Committee

From Stations—Donald W. Thornburgh, Chairman, WCAU Philadelphia; Edward Breen, KVFD, Fort Dodge, Iowa; Al Cadwell, KOAT, Albuquerque, N. M.; Charles H. Crutchfield, WBT, Charlotte, N. C.; George J. Higgins, KMBC, Kansas City, Mo.; Howard Lane, KOIN, Portland, Ore.; Winslow Leighton, WSNY, Schenectady, N. Y.; Henry Johnston, WAPI, Birmingham, Ala.; Robert J. McAndrews, KBIG, Avalon, Calif.; William A. McGuineas, WGN, Chicago, Ill.; Daniel C. Park, WIRE, Indianapolis, Ind.; F. C. Sowell, WLAC, Nashville, Tenn.; Ben Strouse, WWDC, Washington, D. C.; Owen F. Uridge, WQAM, Miami, Fla.; Walter E. Wagstaff, KIDO, Boise, Idaho; Ralph N. Weil, WOV, New York, N. Y.

From Networks—George Bristol, Columbia Broadcasting System; Oliver Treyz, American Broadcasting Company; James Tyler, Mutual Broadcasting System; Ridgway Hughes, National Broadcasting Company.

From Station Representatives—Eugene Katz, The Katz Agency; Robert Meeker, Robert Meeker Associates, Inc.

TO OPEN NEW DOORS

in all the 48 states for profitable selling throughout '54:



the 560 stations of **MUTUAL** *the network for radio...* **PLUS!**

NATIONAL BROADCASTING COMPANY, INC.

RCA Building, New York 20, New York—Telephone CI 7-8300

Registered Telegraphic Address: NATBROCAST, New York

For Executives RCA see page 58

BOARD OF DIRECTORS

David Sarnoff, *Chairman*
Cahill, John T. Ingles, Harry C.
Denny, Charles R. Jolliffe, Charles B.
Folsom, Frank McGrady, Edward F.
Hagerty, Harry C. Robinson, William E.
Harrison, George L. Sarnoff, Robert W.
Heffernan, Joseph V. Weaver, Sylvester L., Jr.
Horton, Mrs. Douglas West, John K.

OFFICERS

Sarnoff, David, *Chairman of the Board*
Weaver, Sylvester L., Jr., *President*
Sarnoff, Robert W., *Executive Vice President*
Adams, David C., *Vice President*
Bannister, Harry, *Vice President*
Barry, Charles C., *Vice President*
Clifford, John M., *Vice President*
Cott, Ted, *Vice President*
Denny, Charles R., *Vice President*
Elges, Sydney H., *Vice President*
Ervin, Thomas E., *Vice President*
Fineshriber, William H., Jr., *Vice President*
Frey, George H., *Vice President*
Hanson, O. B., *Vice President*
Hedges, William S., *Vice President*
Heffernan, Joseph V., *Vice President*
Kopf, Harry C., *Vice President*
Margraf, Gustav B., *Vice President*
McAvity, Thomas, *Vice President*
Russell, Frank M., *Vice President*
Sacks, Emanuel, *Vice President*
Smith, Carleton D., *Vice President*
Stanton, Carl M., *Vice President*
West, John K., *Vice President*
Wile, Frederic W., Jr., *Vice President*
Canon, John Q., *Secretary*
McDonald, Joseph A., *Treasurer*
Matson, George D., *Controller*
Lynch, Paul B., *Assistant Secretary*
Simonds, Raymond E., *Assistant Secretary*
Williams, William A., *Assistant Treasurer*

ORGANIZATION UNDER THE PRESIDENT AND VICE PRESIDENT

Weaver, Sylvester L., Jr., *President*
Sarnoff, Robert W., *Executive Vice President*

FINANCE AND SERVICES

Heffernan, Joseph V., *Vice President in charge of Finance and Services*
Adams, David C., *Administrative Vice President*
Chotzinoff, Samuel, *General Music Director*

ENGINEERING

Hanson, O. B., *Vice President and Chief Engineer*
Clark, William A., *Administrative Assistant*
Cullen, Edward R., *Liaison Engineer*
D'Agostino, Joseph, *Liaison Engineer*
Guy, Raymond F., *Manager of Radio and Allocation Engineering*
Nixon, George M., *Manager of Engineering Development*
Rackey, Chester A., *Manager of Audio-Video Engineering*
Wood, James Jr., *Manager of Technical Services*

STATION RELATIONS

Bannister, Harry, *Vice President in charge of Station Relations*
Hickox, Sheldon B., *Director of Station Relations*
Knode, Thomas, *Manager of Station Relations*
Woodman, Harry A., *Manager of Traffic Department*

TREASURERS

McDonald, Joseph A., *Treasurer*
Williams, William A., *Assistant Treasurer*
McKeon, Harry F., *Director of the Tax Department*
Bloxham, William D., *Manager of Purchasing*

INTEGRATED SERVICES

Hedges, William S., *Vice President for Integrated Services*
Hayes, Henry Patrick, *Manager Radio Recording Sales*
Lowell, Edward M., *Manager Building and General Services Department*
Miller, William B., *Night Executive Officer*
Tintle, Peter M., *Manager of Guest Relations*
Joy, Mildred, *Chief Librarian*

LEGAL

Ervin, Thomas E., *Vice President and General Attorney*
Shute, John V., *Assistant General Attorney*
Denning, James E., *Senior Attorney*
Heilfrich, Stockton, *Manager of Continuity Acceptance*

CONTROLLERS

Matson, George D., *Controller*
Young, Hamilton, *Director of Auditing and Systems*
O'Shea, Francis X., *Chief Accountant*
Gilles, Nicholas, *Budget Manager*

PERSONNEL

Clifford, John M., *Vice President in charge of Personnel*
Jacobsen, B. Lowell, *Director of Personnel*
Souhami, Edmund, *Labor Relations Administrator*
Tower, Lewis R., *Labor Relations Administrator*
Wankel, Ferdinand, *Labor Relations Administrator*
Tufts, Robert, *Organization Development Administrator*
Rutledge, Donald A., *Manager, Training, Policy, Benefits and Communications*
Mackenzie, Donald H., *Manager, Employment, Records and Health*
Broadfoot, David, *Manager, Salary Administration*

PRESS AND PUBLICITY ORGANIZATIONS SERVING RADIO NETWORK

Elges, Sydney H., *Vice President for Press and Publicity*
Connelly, Richard T., *Director of Press Department*
Bishop, Don, *Manager of Program Publicity*
Moore, Ellis, *Manager of Radio-Television Business Publicity*
McTigue, John D., *Supervisor, Radio Network Publicity*
Cole, Kathryn, *Manager of Information*
Sullivan, Cornelius, *Public Relations Representative*

RESEARCH AND PLANNING

Beville, Hugh M., *Director of Research and Planning*
Coffin, Dr. Thomas E., *Manager of Research*
Cooper, Allen R., *Manager of Markets and Media*
Cornell, James H., *Manager of Audience Measurement*
Rumple, Barry T., *Manager of Plans*

PUBLIC AFFAIRS

Taylor, Davidson, *Director of Public Affairs*
McAndrew, William R., *Manager of News and Special Events*
Gallery, Thomas S., *Manager of Sports*
Stanley, Edward, *Manager of Public Service Programs*
Corwith, Doris, *Supervisor of Religious Broadcasts and Talks*
Meyers, Joseph O., *Chief of the Central News Desk*

TECHNICAL OPERATIONS

McElrath, George, *Director of Technical Operations*
Gallant, Paul V., *Supervisor of Radio Broadcasting Operations*
Sellar, Gerald M., *Radio Operations Supervisor*
Knopfke, Frederick G., *Manager of Sound Effects*

RADIO NETWORK

Fineshriber, William H., Jr., *Vice President in charge of the Radio Network*
Cott, Ted, *Operating Vice President of the Radio Network*

PROGRAMS

Cleary, John P., *National Program Director, Radio Network*
Wogan, Robert L., *Supervisor Radio Network Operations*
Mueller, Merrill, *Radio News and Features Executive*

SALES

Horton, Fred L., *Director of Radio Network Sales*
Gardner, Howard, *Director of Radio Network Sales Development*
Diefenderfer, George W., *Radio Network Sales Manager, Central Division*
Williams, John K., *Radio Network Sales Manager, Pacific Division*
Miles, Sackett, *Manager, Radio Sales Service and Traffic*

ADVERTISING & PROMOTION

Hughes, Ridgway, *Director of Advertising & Promotion, Radio Network*
Nelson, James, *Advertising Manager, Radio Network*
Hitchens, Robert, *Sales Promotion Manager, Radio Network*
Van Bellen, Walter, *Art Director, Radio Network*
McMahon, Frank, *Copy Supervisor, Radio Network*

BUSINESS MANAGER

Zaer, Theodore, *Business Manager, Radio Network*
Stephenson, Marion, *Divisional Budget Manager, Radio Network*

CHICAGO OFFICE—RADIO NETWORK

Merchandise Mart, Chicago 54, Illinois
Tel. Superior 7-8300
Diefenderfer, George W., *Radio Network Sales Manager, Central Division*

NBC OWNED STATIONS AND NBC SPOT SALES

Denny, Charles R., *Vice President in charge of NBC Owned Stations and NBC Spot Sales*
Sjogren, Henry T., *Divisional Business Manager*
Collidge, Charles H., *Director of Technical Operations*
Bevis, Charles C., Jr., *General Executive*
Blake, Robert F., *Publicity Director, WNBC*
WNBC, WNBC-FM, New York
Shea, Hamilton, *General Manager of WNBC, WNBC-FM*
de la Ossa, Ernest, *Station Manager*
Pack, Richard M., *Director of Programs and Operations*
Afe, Peter, *Manager of Operations*
Buck, Max, *Director of Advertising, Sales Promotion and Merchandising*
Leder, Robert J., *Radio Sales Manager*
WMAQ, WMAQ-FM, Chicago
Kopf, Harry C., *Vice President and General Manager of WMAQ, WMAQ-FM*
Herbuveaux, Jules, *Assistant General Manager*
Dresser, Charles, *Director of Sales*
Heinemann, George, *Director of Programming*
Whalley, John F., *Director of Operations*
Luttgens, Howard C., *Engineer in Charge*
WTAM, WTAM-FM, Cleveland
Yoder, Lloyd E., *General Manager for WTAM, WTAM-FM*
Leonard, Samuel E., *Engineer in Charge*
Taylor, Brooks, *Program Director*
KNBC, KNBC-FM, San Francisco
Greaves, George, *General Manager for KNBC, KNBC-FM*
McDaniel, William K., *Sales Manager*
Peck, Curtis D., *Manager of Radio Technical Operations and Integrated Services*
Thompson, John, *Program Manager*
WRC, WRC-FM, Washington
Smith, Carleton D., *Vice President and General Manager WRC, WRC-FM*
Goodfellow, Joseph, *Director of Sales*
Kovach, James, *Program Director*
McClelland, Lefferts A., *Director of Operations*
Rogers, John G., *Engineer in Charge*

NATIONAL SPOT SALES

McFadden, Thomas B., *Director of National Spot Sales*
Close, Richard H., *Manager for Represented Stations*
Davidson, William N., *National Manager for Radio Spot Sales*
Shepard, Harold, *Sales Development Advertising and Promotion Manager*
Herbert, Caroline, *Sales Service Manager*

WASHINGTON AND PACIFIC DIVISION OFFICES

WASHINGTON

1625 K. St., N.W.

Russell, Frank M., *Vice President, Washington*
Wheeler, George, *Assistant Vice President*

PACIFIC DIVISION

Sunset Boulevard and Vine Street, Hollywood 28, Calif.
Tel. Hollywood 9-6161

West, John K., *Vice President for the Pacific Division*

McCray, Thomas C., *Director of Radio Network, Pacific Division*

Frost, Lewis S., *Director of Public Relations*
Delleit, Frank, *Business Manager, Pacific Division*

Bubeck, Harry, *Radio Network Program Manager, Pacific Division*

Graham, Richard H., *Attorney*
Raddatz, Leslie, *Manager of Press and Publicity*
Saxton, Alfred, *Manager of Technical Operations*
Williams, John K., *Network Sales Manager, Pacific Division*

FOREIGN OFFICES

England: Wheeler, Romney
National Broadcasting Company, Inc.
2 Mansfield Street, London W1, England

France: Archinard, Paul
Frye, William
52 Avenue des Champs Elysees, Room 533,
Paris 8, France

Japan-Korea: Folster, George Thomas
Hall, Wilson
Rich, John
Robinson, James G.

Nikkatsu Building, Number 1-1 Chome, Yura
Kuchō Chiyodaku Tokyo, Japan

Germany: McCormick, Robert
Press Center (American)
APO 757, c/o PM
New York, New York

Italy: Begon, Jack
54 Via Della Mercede
Rome, Italy

NBC RADIO NETWORK FACILITIES

JANUARY 1, 1954

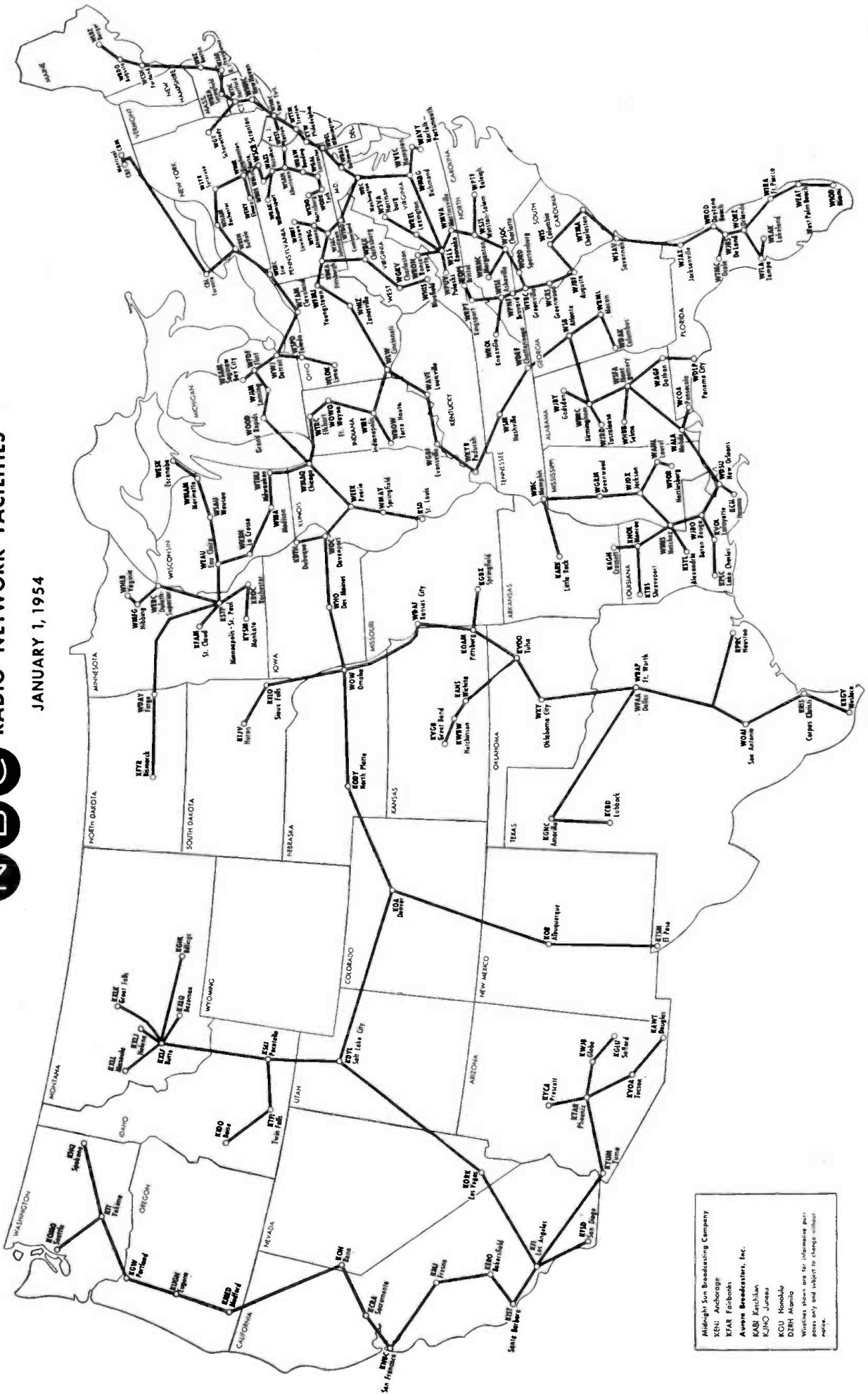

Midnight Sun Broadcasting Company
 KENT Anchorage
 KEAR Fairbanks
 Auvre Broadcasters, Inc.
 KABI Ketchikan
 KJNO Juneau
 ECU Hoonah
 DZRH Haines
 Stations shown are for information pur-
 poses only and subject to change without
 notice.

Network Gross Drops Again in 1953

IN 1953, the four nationwide radio networks showed a downward trend in time sales that had persisted since 1948, when they registered an all-time high combined gross of \$198,995,742.

The following year, the combined gross had dropped to \$187,800,329; in 1950 it was \$183,519,037; in 1951 it fell off again to \$174,718,594; in 1952 it was down to \$163,453,466.

Last year, according to B*T estimates the radio networks had gross time sales of approximately \$169 million. (See story page 14.)

Actually, the networks' 1953 record compares better with 1952 than the figures indicate, so far as regular business is concerned. The 1952 total includes \$1,700,569 worth of time sold to 57 political groups during the 1952 Presidential campaign; the 1953 total (through October) includes one

political account which purchased \$779 worth of network time.

Otherwise, the two years—1952 and 1953—look pretty similar for the radio networks. There were 235 non-political advertisers buying time during the first ten months of 1953, compared to 234 in 1952, indicating that 1953 should at least come up to the 247-advertiser total achieved by the four radio networks in 1952.

Radio network clients in 1952 included 37 advertisers who spent more than \$1 million apiece for network time, at gross rates. This is a little ahead of 1953, which, according to B*T projections, showed 33 million dollar network clients.

These top purchasers of radio network time were just about the same in both years. The 1952 list includes seven companies which dropped beneath the \$1 million radio network time mark in 1953, with one—American Chiclé Co.—leaving the

medium entirely. Almost as spectacular changes were made by two of the three advertisers who joined the \$1 million radio network time purchasers last year—Kaiser Motors, which rose from \$228,000 gross time billing in 1952 to \$2,232,000 in 1953, and General Electric, which jumped its radio network time buying from \$312,000 in 1952 to \$1,612,000 last year. The third new \$1 million spender the networks got last year—Chrysler Corp.—was just under that mark in 1952, with \$945,000, and just over, with \$1,050,000, in 1953.

Procter & Gamble Co. was the radio networks' No. 1 client in 1953, as in the year before, although its gross time purchases were last year roughly 10% below its 1952 level. Miles Labs again ranked second and the entire top ten radio network advertisers were the same in both years, although in altered order (see table).

MILLION DOLLAR RADIO NETWORK ADVERTISERS GROSS TIME PURCHASES

Rank Order	1953*	Rank Order	1952**	Rank Order	1953*	Rank Order	1952**
(1)	Procter & Gamble	\$14,354,000	(1)	\$16,235,025	(22)	Philip Morris & Co.	\$1,928,000
(2)	Miles Labs	7,157,000	(2)	7,021,901	(23)	General Electric Co.	1,612,000
(3)	General Foods Corp.	6,833,221	(4)	6,199,430	(24)	William Wrigley Jr. Co.	1,575,000
(4)	Sterling Drug	5,861,000	(3)	6,370,822	(25)	Rexall Drug	1,487,000
(5)	Gillette Co.	5,732,000	(8)	4,184,685	(26)	Quaker Oats Co.	1,377,000
(6)	Colgate-Palmolive Co.	5,622,000	(9)	4,135,687	(27)	Kellogg Co.	1,314,000
(7)	Lever Brothers	4,962,000	(6)	5,759,817	(28)	Pet Milk Co.	1,238,000
(8)	General Mills	4,419,000	(5)	6,151,026	(29)	Standard Oil Co. of Indiana	1,231,000
(9)	Liggett & Myers Tobacco Co.	4,279,000	(10)	4,027,962	(30)	Armour & Co.	1,221,000
(10)	American Home Products Co.	4,253,000	(7)	4,304,592	(31)	Ex-Lax Inc.	1,216,000
(11)	Swift & Co.	3,396,000	(13)	3,147,860	(32)	American Federation of Labor	1,196,000
(12)	R. J. Reynolds Tobacco Co.	3,134,000	(12)	3,374,806	(33)	Chrysler Corp.	1,050,000
(13)	P. Lorillard Co.	2,756,000	(15)	2,692,058		Bristol-Myers Co.	468,000
(14)	Manhattan Soap Co.	2,561,000	(23)	1,442,346		Nat'l Dairy Products Corp.	981,000
(15)	General Motors Corp.	2,542,000	(31)	1,221,289		National Biscuit Co.	794,000
(16)	American Tobacco Co.	2,418,000	(18)	2,332,334		American Chiclé Co.	302,000
(17)	Campbell Soup Co.	2,308,000	(11)	3,489,936		Gulf Oil Corp.	302,000
(18)	Pillsbury Mills	2,240,000	(17)	2,344,985		Prudential Insurance Co. of America	847,000
(19)	Kaiser Motors Corp.	2,232,000		228,278		Coca-Cola Co.	977,000
(20)	S. C. Johnson & Son	2,123,000	(20)	2,035,414			
(21)	Philco Corp.	2,104,000	(16)	2,518,698			

* Estimates, based on PIB figures for first ten months, 1953
 ** Actual gross time purchases, according to PIB for full year, 1952

RADIO NEWS SERVICES

ASSOCIATED PRESS—50 Rockefeller Plaza, New York 20. Tel.: Plaza 7-1111. Executives: Frank J. Starzel, general manager; Oliver Gramling, assistant general manager; Lloyd Stratton, secretary; John Aspinwall, radio news editor; Ernest B. Vaccaro, executive representative, Washington. (Continuous worldwide news; business and market reports; specialized feature scripts; sports news, spot and commentary; for TV, AP Wirephoto for spot picture coverage.)

BRITISH UNITED PRESS LTD.—231 St. James St. W., Montreal, Que. Tel.: Plateau 9947. Phil R. Curran, managing director; Dennis Landry, executive news editor; N. M. MacLeod, assistant general manager and chief correspondent at Ottawa; Fred A. Darrell, chief accountant; Willard D. Eberhart, bureau manager; T. G. McQuaid, radio editor.

BROADCAST NEWS LIMITED—Subsidiary of Canadian Press, 55 University Ave., Toronto 1, Ont., Tel.: Empire 4-2692; Gillis Furcell, chief executive; Charles Edwards, manager; C. A. Day, treasurer. (Worldwide news and features to radio stations by teletype.)

INTERNATIONAL NEWS SERVICE—235 E. 45th St., New York. Tel.: Murray Hill 7-8800. Executives: Seymour Berkson, general manager;

Barry Faris, editor; Robert W. Brown, business manager; Frank J. Nicht, general sales manager; Robert H. Reid, manager, INS-IMP-TV Dept.; John M. Cooper, radio-tv news director. (Worldwide news and news feature coverage by 24-hour teletype printer; special facsimile circuit for tv stations carrying spot news and photos, maps, weather maps, features, cartoons and sports photos; daily tv news film; weekly tv newsreel; weekly sports reel; Super Projectall.)

PRESS ASSOCIATION (Associated Press subsidiary)—50 Rockefeller Plaza, New York. Tel.: Plaza 7-1111; Frank J. Starzel, president; Oliver Gramling, vice president; Lloyd Stratton, secretary.

REUTERS LTD. OF LONDON—Times Building, 229 W. 43 St., New York. Tel.: Bryant 9-8558. D. K. Rogers, manager.

UNITED PRESS ASSOCIATIONS—220 East 42d St., New York 17. Tel.: Murray Hill 2-0400. Officers, New York: Hugh Ballie, president and general manager; Earl J. Johnson, vice president and general news manager; Jack Bisco, vice president and general business manager; LeRoy Keller, vice president and general sales manager; Mims Thomason, vice president and general newspictures manager. New York execu-

tives: John J. Madigan, radio news manager; William C. Payette, television manager. Regional executives: Atlanta, James R. Russell, southern division radio editor; Jack Young, southern division newspictures editor; Boston, Alan B. Wade, New England radio editor; David Wurzel, New England division newspictures editor; Chicago, Charles E. Ahrens, central division radio editor; Paul Sisco, central division television editor; Harold Gully, central division newspictures editor; Los Angeles, LeRoy Hansen, Pacific division television editor; Dallas, Charles J. McCarty, southwest division newspictures editor; San Francisco, W. C. McDowell, Pacific division newspictures editor; Washington, Robert J. Serling, Washington radio bureau manager, W. R. Higginbotham, Washington television editor, A. F. Harrison, special representative. (Services, for radio: news, news features on sports, women's interests, of general human interest, farming, business and science, commentary and review of outstanding news events, national and international affairs; for television, motion picture news film, spot newspictures by Telephoto and facsimile, teletyped scripts for motion picture film, around-the-clock news wire, sports and weather shows, weekend sports and sports reviews.)

STORER LEADS IN MERCHANDISING TOO!

Based on years of successful experience, advertisers have come to expect top coverage, top ratings and top returns in all of the markets which are served by Storer radio and television stations.

Remember that Storer produces still more dollars for you through intense, aggressive merchandising support.

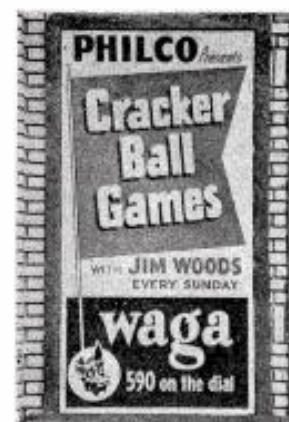

THREE SHEET POSTERS



COUNTER DISPLAYS



TRADE BULLETINS



POINT OF PURCHASE DISPLAYS



CONSUMER SURVEYS



POSTERS



WINDOW DISPLAYS



STOCK CHECKING

ADDITIONAL MERCHANDISING SERVICES

INCLUDE THE FOLLOWING: *

- Personal calls on retailers, wholesalers, etc.
- Truck signs
- Distribution checkups
- Product exploitation
- Publicity
- Mailings to retailers, jobbers, brokers, wholesalers etc.
- Newspaper advertisements
- On-the-air promotions
- Sales meetings for dealers, jobbers, distributor salesmen
- Car cards
- Client follow-up reports
- Promotion consultation service
- Window streamers
- House organs
- Sales bulletins
- Illuminated billboards
- Ads in drug and grocery publications
- Personal appearances by station personalities
- Easel displays
- Use of products on give-away shows
- Booths at fairs
- Sampling
- Airplane towing

* For further details contact your nearest Storer office



STORER BROADCASTING COMPANY

WSPD-TV Toledo, Ohio	WJBK-TV Detroit, Mich.	WAGA-TV Atlanta, Ga.	KGBS-TV San Antonio, Texas	WBRC-TV Birmingham, Ala.
WSPD Toledo, Ohio	WJBK Detroit, Mich.	WAGA Atlanta, Ga.	KGBS San Antonio, Texas	WBRC Birmingham, Ala.
			WWVA Wheeling, W. Va.	WGBS Miami, Fla.

NATIONAL SALES HEADQUARTERS:

TOM HARKER, V. P., National Sales Director **BOB WOOD**, Midwest National Sales Mgr.
118 East 57 Street, New York 22, ELdorado 5-7690 • 230 N. Michigan Ave., Chicago 1, FRanklin 2-6498

TOP AGENCY RADIO-TV BILLINGS UP 25% IN '53

RADIO-TV billing among the top 32 agencies in the country increased approximately 25% in 1953 with BBDO and Young & Rubicam leading the B•T survey list again with an annual expenditure of \$49.5 million and \$49 million, respectively, in the combined broadcast media. Total am-tv estimated billing of the 32 leading agencies came to \$563.6 million compared to \$451.9 million for the 30 leaders in 1952.

Radio's share of the 1953 agency billing totalled \$191.4 million, \$9 million more than recorded in 1952 when 30 agencies checked in with a total of \$182.4 million.

Television meanwhile rose this year to \$372.2 million from 1952's tally of \$269.5 million, a dollar gain of more than \$102 million and a percentage increase of about 38%.

Young & Rubicam, as in 1952, was second to BBDO in combined radio-tv outlay this year with billings of \$49 million, while J. Walter Thompson took over third place, spending \$35 million in am and tv in 1953.

BBDO was first in expenditures for television alone, its tv billing in 1953 totalling \$35 million, with Y & R a close second in tv billing with \$34 million.

In radio, Dancer-Fitzgerald-Sample was again the leader with a 1953 disbursement of \$18 million in that category.

The seven remaining agencies constituting this year's Big Ten in combined am-tv billing were: Benton & Bowles, \$32 million; Biow Co., \$32 million; William Esty, \$29 million; Dancer-Fitzgerald-Sample, \$27 million; McCann-Erick-

son, \$25.5 million; Ted Bates & Co., \$24 million, and Leo Burnett Co., \$24 million.

The figures in all cases in this survey include expenditures for time and talent in both network and spot. The list embraces all agencies billing \$6 million or more in radio and television during 1953 and the estimate in each instance from responsible officials of the agency involved.

A survey of the 1953 record of each of the 32 agencies in the survey follows.

BATTEN, BARTON, DURSTINE & OSBORN:

Radio-tv billing, \$49.5 million; \$14.5 million in radio, \$35 million in tv. Radio-tv share of agency's overall billing, 40%.

BBDO, first in combined radio and television billing, increased its front-ranking 1952 total by \$9.5 million. Accounting for the gain were the following new television shows sponsored by these advertisers: *The George Jessel Show* on ABC-TV for Gemex; American Tobacco Co.'s *Make Room for Daddy* on ABC-TV, and *Private Secretary*, on CBS-TV; Crosley Corp.'s *Your Hit Parade* on NBC-TV; Vitamin Corp. of America's *Paul Dixon Show* on DuMont; Chrysler Div.'s *Chrysler Medallion Theatre* on ABC-TV; General Electric's *Jane Froman Show*, and U. S. Steel's *U. S. Steel Theatre*, both on ABC-TV; Lever Bros.' *Houseparty* and duPont's *Cavalcade of America*, also on ABC-TV. During the year the agency dropped *Keep Posted* on DuMont for *Saturday Evening Post* as well as American Tobacco's *Biff Baker* on CBS-TV, and Gemex's participation on the *Stork Club* on CBS-TV.

In radio, General Electric took on Bing Crosby on CBS; Lanolin signed to sponsor Edgar Bergen, also on CBS; American Tobacco purchased *Houseparty* on CBS; and Vitamin bought *American Way* on CBS; Lever Brothers Corp. of America sponsored Gabriel Heatter on Mutual. Losses in radio included the following: Armstrong dropped its *Theatre of Today* on CBS; Wildroot cancelled three Mutual network shows and put the money into radio and tv spots, U. S. Steel dropped *Theatre Guild* on NBC and duPont cancelled *Cavalcade of America*.

YOUNG & RUBICAM: Radio-tv billing, \$49 million; \$15 million in radio, \$34 million in tv. Radio-tv share of agency's overall billing, 35%.

Y&R ran a very close second for top combined billing, a mere half a million dollars below first place, and a million below in television. It achieved the most spectacular gain of the year percentagewise, adding \$13 million over last year's figure, jumping three million in radio and ten million in television. It was the proud claim of the agency that almost all of its major accounts are represented on tv. Among the new programs placed by the agency during the year in television were: *My Favorite Husband* on CBS-TV, sponsored by International Silver and the Simmons Co.; *Jamie* on ABC-TV, sponsored by Duffy-Mott Co., and *Meet Mr. McNutley* alternately on CBS-TV for General Foods. Among the programs continued from the year before were Johnson & Johnson's *All Star Revue* on NBC-TV; General Foods' *Bob Hope Show* on NBC-TV; Singer Sewing Machine's *Four Star Playhouse* on CBS-TV; T. J. Lipton's

KIEM 5000 AM WATTS 4600 FM KRED 1954 - 21st Year

SERVING NORTHERN CALIFORNIA AND SOUTHERN OREGON SINCE 1933



REDWOOD BROADCASTING COMPANY, INC., WM. B. SMULLIN, PRESIDENT, PHONE HILLSIDE 3-1621, EUREKA, CALIFORNIA

TOPS IN:

Local News, Sports and Music!

FIRST IN:

Coverage, Listening and Service!

Ask John Blair & Co., or Blair-TV

Affiliated with KIEM-TV-Channel 3 and Mutual Don Lee Broadcasting System

DON LEE

is

Pacific Coast Radio

With 45 stations located within each of the 45 important marketing areas, Don Lee is the only network to reach Pacific Coast people where they live and buy.

And remember... on Don Lee low, low daytime rates apply to nighttime, too.

Two reasons why Don Lee is STILL the best, the most economical, the most effective medium to reach the nearly 16 million responsive people on the Pacific Coast.

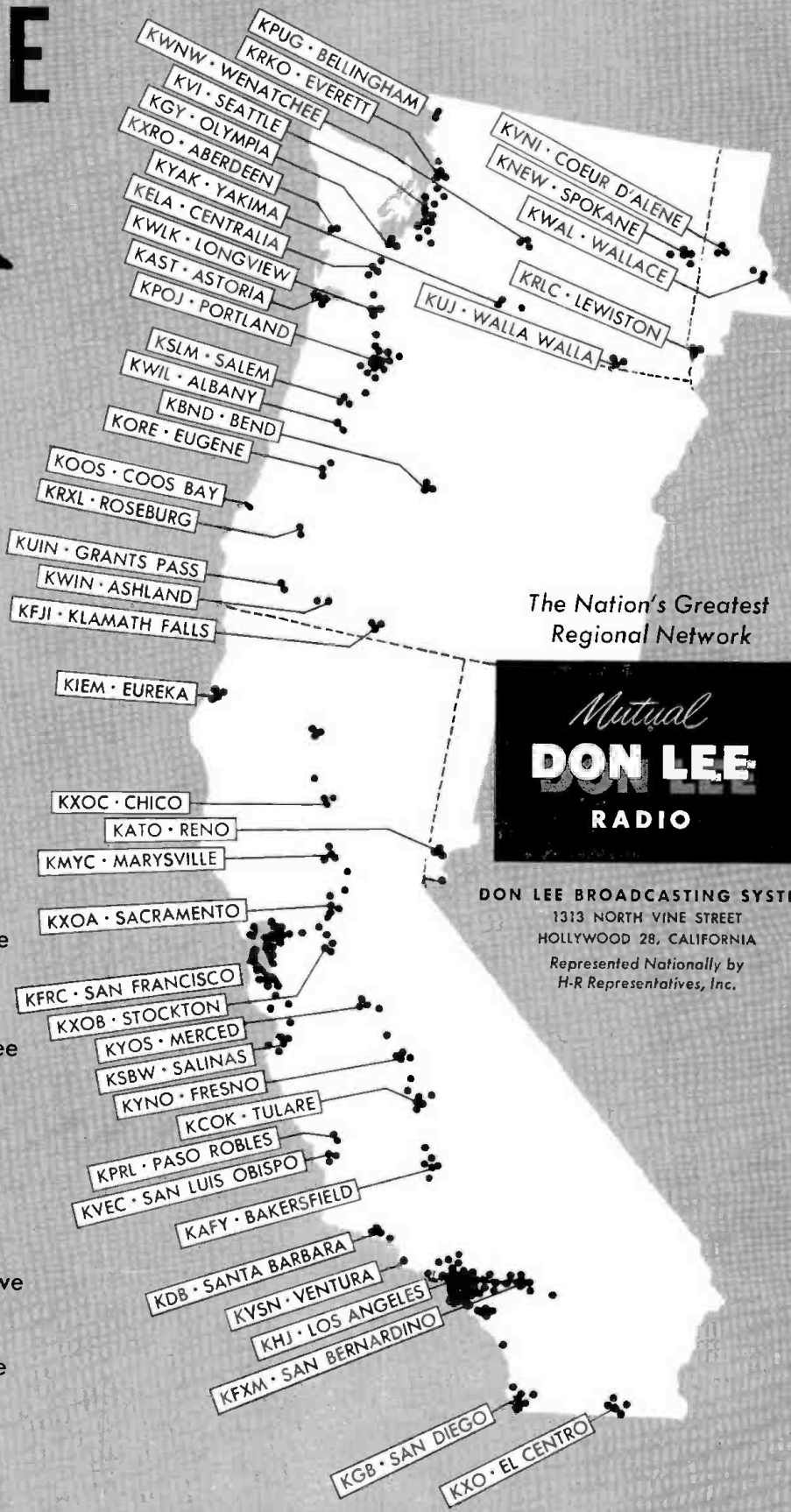

The Nation's Greatest Regional Network



DON LEE BROADCASTING SYSTEM
 1313 NORTH VINE STREET
 HOLLYWOOD 28, CALIFORNIA
 Represented Nationally by
 H-R Representatives, Inc.

AGENCY BILLINGS

Godfrey Talent Scouts on CBS-TV; General Electric's *I Married Joan* on NBC-TV; Gulf Oil's *Life of Riley* on NBC-TV; General Food's *Our Miss Brooks* on CBS-TV; Procter & Gamble's *Paul Winchell Show* on NBC-TV and Goodyear Tire & Rubber's *Television Playhouse* on NBC-TV.

J. WALTER THOMPSON CO.: Radio-tv billing \$35 million: \$13.5 million in radio, \$21.5 million in tv. Radio-tv share of agency's overall billing, 24%.

This agency, with an \$8 million rise in billing over 1952, soared from sixth to third place in the survey. The gain is attributable in large part to the increased television action of Kraft Foods and Scott Paper Co. Kraft doubled its television budget during the year, sponsoring another and separate *Tv Theatre* on ABC-TV while maintaining its original *Kraft Theatre Show* on NBC-TV. Scott Paper Co. now sponsors part of *Omnibus* on CBS-TV, and *My Little Margie* and *Ding Dong School* on NBC-TV. Pan American Airlines began sponsoring *Meet The Press* on NBC-TV during 1953, while the agency's other advertisers remained largely steadfast in their radio and television commitments. The agency suffered no loss of accounts in 1953.

BENTON & BOWLES: Radio-tv billing, \$32 million: \$11.8 million in radio, \$20.2 million in tv. Radio-tv share of agency's overall billing, 60%.

B&B rang up a \$2 million gain over 1952. Among the new tv programs placed during the year were *A Letter From Lovetta* and *On Your Account*, both for P&G's Tide. Procter & Gamble also expanded *Welcome Travelers* on NBC Radio. Benson & Hedges began sponsorship of *Pantomime Quiz* on tv, and General Foods continued with its *Red Buttons* show. The agency also placed heavy spot campaigns during the year for, among others, Best Foods, General Foods and Procter & Gamble. Effective Feb. 1, Best Foods will move to Dancer-Fitzgerald-Sample.

BIOW CO.: Radio-tv billing, \$32 million: \$8 million in radio, \$24 million in tv. Radio-tv share of agency's overall billing, 60%.

Biow registered a \$2 million gain in 1953, having placed two new network shows in television: Philip Morris cigarettes sponsored the recent Ezio Pinza program, *I, Bonimo*, on NBC-TV for a portion of the year, and Dunhill cigarettes underwrote a half-hour on NBC-TV for 39 weeks. Effective Jan. 1 the agency

lost the Dunhill account to Hewitt, Ogilvy, Benson & Mather. Philip Morris continued its sponsorship of *I Love Lucy* on CBS-TV, and Bulova figured importantly with massive radio and tv spot campaigns. The agency lost two other accounts during the year: P&G's Lava soap and Gunther beer. It continued to service four other P&G products on a spot basis: Spic and Span, Lilt, Joy and Fluffo.

WILLIAM ESTY: Radio-tv billing, \$29 million: \$8 million in radio, \$21 million in tv. Radio-tv share of billing, 50%.

The overall billing here is up \$1 million over 1952. Camels added *Topper* on CBS-TV, Cavalier underwrote *I've Got a Secret* on CBS-TV, General Mills bought a new cartoon strip on CBS-TV, and Coca-Cola Bottlers of New York returned to sponsor *Sense and Nonsense* on NBC-TV. Camels continued with its before-and-after-baseball schedule on radio and tv, its tv news coverage with John Cameron Swayze and the television program *Man Against Crime*. The cigarette firm dropped *My Friend Irma* and Bob Hawk in radio but

HOW THEY RANKED IN '53

Agency	Comparative Rank		Am-Tv Billing (In Millions)		Radio Only (In Millions)		Tv Only (In Millions)		Am-Tv Share Of-Overall Billings	
	1953	1952	1953	1952	1953	1952	1953	1952	1953	1952
BBDQ	1	1	\$ 49.5	\$ 40	\$ 14.5	\$ 13.5	\$ 35	\$ 26.5	40%	40%
Young & Rubicam	2	2	49	36	15	12	34	24	35%	35%
J. W. Thompson Co.	3	6	35	27	13.5	13.5	21.5	13.5	24%	24%
Benton & Bowles	4	3	32	30	11.8	10.5	20.2	19.5	60%	60%
Biow Co.	5	4	32	30	8	10.5	24	19.5	60%	50%
William Esty & Co.	6	5	29	28	8	10	21	18	50%	50%
Dancer-Fitzgerald-Sample	7	7	27	26	18	17.5	9	8.5	55%	55%
McCann-Erickson	8	8	25.5	25	8	8.7	17.5	16.3	40%	40%
Ted Bates & Co.	9	12	24	15	6	6	18	9	60%	50%
Leo Burnett Co.	10	10	24	18	7.2	9	16.8	9	50%	50%
Foote, Cone & Belding	11	9	18	20	8	10	10	10	30%	30%
Lenzen & Newell	12	11	18	15	4	3	14	12	55%	50%
Kenyon & Eckhardt	13	13	15.2	14.5	5.6	5.5	9.6	9	28%	27%
Kudner Agency	14		15	15	4.8	4.8	10.2	10.2	35%	35%
Cunningham & Walsh	15	17	14	10	4	4	10	6	33%	33%
Maxon Inc.	16	15	14	11	4.2	4.4	9.8	6.6	40%	40%
N. W. Ayer & Son	17	14	13.4	12	6.5	6	6.9	6	14%	14%
Sullivan Stauffer, Colwell & Bayles	18	16	13	10	3	4	10	6	50%	50%
Compton Adv.	19	20	12.5	8	5	4.5	7.5	3.5	30%	26%
Needham, Louis & Brorby	20	18	11	8	4.5	3	6.5	5	45%	40%
Sherman & Marquette	21	21	11	7.5	3.5	2.5	7.5	5	50%	50%
Geoffrey Wade	22		10		6.5		3.5		90%	
(Not listed in 1952.)										
Ruthrauff & Ryan	23	22	10	7.5	5	3.2	5	4.3	23%	25%
Cecil & Presbrey	24	19	9.5	8	1.5	3.6	8	4.4	50%	50%
Campbell-Ewald	25	23	8.5	7	1.8	1.8	6.7	5.2	25%	25%
Warwick & Legler	26	25	7	7	1.5	3	5.5	4	50%	50%
D'Arcy Adv	27	24	6.5	7	2.5	3.5	4	3.5	25%	25%
Doherty, Clifford, Steers & Shenfield	28		6		1.5		4.5		55%	
(Not listed in 1952.)										
Fuller & Smith & Ross	29	30	6	3.4	1.5	0.9	4.5	2.5	15%	15%
MacManus, John & Adams	30		6		2		4		33%	
(Not listed in 1952.)										
Ward Wheelock Co.	31	26	6	6	2.5	3.5	3.5	2.5	55%	50%
Weiss & Geller	32		6		2		4		50%	
(Not listed in 1952.)										
TOTALS			\$563.6	\$451.9	\$191.4	\$182.4	\$372.2	\$269.5		



ANYWAY YOU LOOK AT IT — IN PROVIDENCE IT'S
TOP LOCAL AUDIENCE + TOP TALENTS = RESULTS

DIAL 1110



PROVIDENCE

REPRESENTED BY HEADLEY-REED

YOUR OPERATING COSTS CAN BE CUT THOUSANDS OF DOLLARS A YEAR!

When you operate your transmitter by remote control

The addition of Hammarlund Remote Control Equipment to broadcast transmitters can mean thousands of dollars a year in reduced operating costs, as well as the solution to the growing shortage of engineers in the broadcast field.*

Hammarlund offers the *only* system available that incorporates the basic principles of time-proven long-distance telephone dialing. It is the one system based on modern principles using audio tones to continuously hold your line rental costs at a minimum while giving maximum dependability.

Specific advantages of the Hammarlund System

- Only a *single* telephone circuit is required. VHF or microwave may be used. No D.C. loop needed. *You may use your present service line.*
- Full control of up to nine separate functions. Plenty of room to expand without additional line rentals even including a second complete transmitter, for full time program operation or emergency standby.
- Telemetering of nine separate electrical quantities. True AC telemetering! Not just a potentially expensive remote DC metering circuit requiring frequent recalibration.
- Up to four emergency alarm indications.
- Fail-safe operations assured at all times.
- Incorporates standard Hammarlund units, which have been thoroughly proven over years of service.
- Fulfills all requirements of the Federal Communications Commission Rules and Regulations.

Low Long-run costs

Obtain the maximum benefits from remotely controlling your transmitter by carefully selecting the control equipment. A few more dollars invested now in the very best will mean trouble-free, less-costly operations for many years to come. Hammarlund equipment is backed by a reputation of highest quality for more than 40 years. Month-in-month-out telephone line costs will be less. Maintenance expenditures will be at a minimum.

 **HAMMARLUND**

SINCE 1910

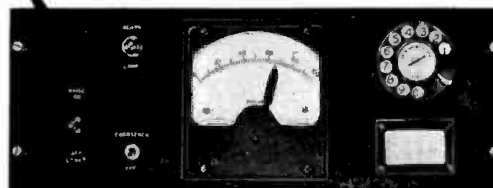

Control panel for installation in station operator's console.

*Here's how your costs can be reduced!...

1. No longer will your station need continuous attendants at the transmitter. If you have an engineer shortage, this is an economical way to overcome that problem.
2. Hours of the present operating staff can be arranged to reduce overtime.
3. Qualified personnel will be released for remote pickup and emergency coverage.

For detailed information on Remote Control Equipment for Broadcast Transmitters write for Bulletin B100.

THE HAMMARLUND MANUFACTURING COMPANY, INC.
Main Plant and Offices: 460 W. 34th ST., N. Y. 1, N. Y.

Midwest Sales Office: 605 N. Michigan, Chicago 11, Ill. • Export Sales Office: 13 E. 40th St., N. Y.

active year for D'Arcy. The agency placed the *Eddie Fisher* series on NBC-TV for Coca-Cola, continued with Gerber Products' and James Lees & Sons' participations on the *Kate Smith Show* on NBC-TV, and bought *Tom Corbett* on DuMont for International Shoe Co. In radio Budweiser Brewing sponsored the *Bill Stern Show* on ABC Radio.

DOHERTY, CLIFFORD, STEERS & SHEN-FIELD: Radio-tv billing, \$6 million: \$1.5 million in radio, \$4.5 million in tv. Radio-tv share of agency's overall billing, 55%.

Bordens and Bristol-Myers raised this agency to its position of importance this year. Bristol-Myers began sponsorship of *Man Behind the Badge* on CBS-TV, and Bordens' undertook *Treasury Men in Action* on NBC-TV, finally dropping the program toward the end of the year. Bristol-Myers participated also on the *Jackie Gleason Show* on CBS-TV and *Show of Shows* on NBC-TV. The agency also places spot campaigns for Bordens and Bristol-Myers products. Until September 1953, it handled the Welch Grape Juice Co.'s representation on the *Howdy Doody Show*, the account moving to Kenyon & Eckhardt at the start of the fall season.

FULLER & SMITH & ROSS: Radio-tv billing, \$6 million: \$1.5 radio, \$4.5 million in tv. Radio-tv share of agency's overall billing, 15%.

This agency virtually doubled its billing in television during 1953. Super-Kem-Tone took over co-sponsorship of the *Ray Bolger Show* on ABC-TV and Commercial Solvents bought Red Barber on CBS-TV. Aluminum Co. of America continued its sponsorship of *See It Now* on CBS-TV and Fiberglass bought a portion of the Godfrey morning show on CBS Radio and CBS-TV. During the season the agency lost the Westinghouse sponsorship of *Freedom Rings*.

MACMANUS, JOHN & ADAMS: Radio-tv billing, \$6 million: \$2 million in radio, \$4 million in tv. Radio-tv share of agency's overall billing, 33%.

MacManus, John & Adams is another among the few major agencies which have more than doubled in billing in 1953. The agency achieved its leap onto the survey list by placing two network shows during the year for the Pontiac division of General Motors: the *Dave Garroway* program on NBC-TV, and the *Football Scoreboard* on NBC-TV. In addition, the

agency spotted Dow Chemical Co. on three network participating shows.

WARD WHEELOCK CO.: Radio-tv billing, \$6 million: \$2.5 million in radio, \$3.5 million in tv. Radio-tv share of agency's overall billing, 55%.

The agency's combined billing remained the same in 1953 as in 1952 but there was an internal shift of a million dollars from its radio to its television budget. Campbell Soup, the agency's major radio-tv account, continued to sponsor two network shows in television, *Campbell Sound Stage* on NBC-TV and *Double or Nothing* on CBS-TV, and one show in radio, *Double or Nothing* on ABC.

WEISS & GELLER: Radio-tv billing, \$6 million: \$2 million in radio, \$4 million in tv. Radio-tv share of agency's overall billing, 50%.

Weiss & Gueller, too, has more than doubled its radio-tv billing in 1953 with the acquisition of the Toni account, which sponsors *Godfrey and His Friends* on CBS-TV, the Godfrey simulcast on the same network and *Nora Drake* on CBS Radio. Additionally, the agency in 1953 bought *Dollar a Second* on DuMont for Mogen David Wine and *Come Back* on ABC-TV for Sealy Mattress.

RADIO CORPORATION OF AMERICA

30 ROCKEFELLER PLAZA, NEW YORK 20, N. Y. Tel.: Columbus 5-5900. For NBC listing see page 47.

BOARD OF DIRECTORS

David Sarnoff, Chairman

Walter A. Buck	Mrs. Douglas Horton
John T. Cahill	Harry C. Ingles
Frank M. Folsom	Charles B. Jolliffe
Harry C. Hagerly	Edward F. McGrady
John Hays Hammond Jr.	William E. Robinson
George L. Harrison	

OFFICERS

David Sarnoff, Chairman of the Board
 Frank M. Folsom, President
 Joseph B. Elliott, Executive Vice President in Charge of Consumer Products Division
 Elmer W. Engstrom, Executive Vice President in Charge of RCA Laboratories Division
 Charles M. Odorizzi, Executive Vice President in Charge of Corporate Staff Functions
 L. W. Teegarden, Executive Vice President
 W. Walter Watts, Executive Vice President in Charge of Electronic Products Division
 Robert A. Seidel, Vice President, Sales and Service Subsidiaries Division
 Ewen C. Anderson, Vice President, Commercial Department
 Meade Brunet, Vice President and Managing Director of RCA International Division
 Walter A. Buck, Vice President, General Planning
 Conway P. Coe, Vice President, Patents
 Orrin E. Dunlap Jr., Vice President, Press Relations and Institutional Advertising
 Charles B. Jolliffe, Vice President and Technical Director
 Emanuel Sacks, Staff Vice President
 E. M. Tuft, Vice President in Charge of Personnel
 Robert L. Werner, Vice President and General Attorney
 Ernest B. Gorin, Vice President and Treasurer
 H. Baker, Vice President, Home Instruments
 P. A. Barkmeier, Vice President, Regional Operations
 J. S. Carter, Vice President, Financial Administration
 E. D. Foster, Vice President, Economic Planning
 V. De P. Goubeau, Vice President, Materials
 R. T. Orth, Vice President, Tubes
 D. F. Schmit, Vice President, Product Engineering
 T. A. Smith, Vice President, Engineering Products
 H. R. Maag, Vice President and Western Manager
 A. F. Watters, Vice President, Personnel Administration
 John Q. Cannon, Secretary
 Walter S. Holmes Jr., Acting Controller

RCA LABORATORIES DIVISION

Dr. E. W. Engstrom, Executive Vice President in Charge
 Dr. V. K. Zworykin, Vice President and Technical Consultant

MANUFACTURING PLANTS

Bloomington, Ind., 1300 So. Rogers Street
 Cambridge, Ohio
 Camden, N. J., Front & Cooper Streets

Canonsburg, Pa., Adams Avenue
 Cincinnati, Ohio, 5040 Lester Road
 Detroit, Mich., 6545 St. Antoine Street
 Harrison, N. J., 415 So. Fifth Street
 Hollywood, Calif., 1016 N. Sycamore Avenue
 Indianapolis, Ind., 501 N. LaSalle Street
 Lancaster, Pa., Box 1140, New Holland Pike
 Los Angeles, Calif., 11819 West Olympic Blvd.
 Marlon, Indiana, 3301 S. Adams Street
 Monticello, Ind., Box 242, Hanawalt Road
 New York, N. Y., 155 E. 24th Street
 Hamilton, Ohio
 Moorestown, N. J.
 *Findlay, Ohio
 *Rockaway, N. J.

RCA SERVICE CO. INC.

Front & Cooper Sts., Camden, N. J.
 C. M. Odorizzi, Chairman of Board
 E. C. Cahill, President

Vice Presidents

P. B. Reed, Government Service
 W. L. Jones, Technical Products
 D. H. Kunsman, Consumer Products
 D. R. Creato, Law

RCA ESTATE APPLIANCE CORP.

Hamilton, Ohio
 R. A. Seidel, Chairman of the Board
 C. M. Dunn, President
 Ellsworth Simms, Vice President, Manufacturing
 Robert E. Ireland, Controller
 Loretta V. Walsh, Secretary

RCA VICTOR DISTRIBUTING CORP.

666 N. Lake Shore Drive, Chicago 11, Ill.
 W. M. Norton, President
 John Holzman, Vice President and Sales Director

RCA EXHIBITION HALL

40 West 49th Street
 New York, New York
 H. P. O'Brien, Manager

RCA COMMUNICATIONS INC.

66 Broad Street, New York City
 Telephone: Hanover 2-1811
 Board of Directors: John T. Cahill, Ernest B. Gorin, George L. Harrison, Joseph V. Heffernan, Harry C. Ingles, Charles B. Jolliffe, Edward F. McGrady, Thompson H. Mitchell, David Sarnoff. Officers: David Sarnoff, Chairman of the Board; Thompson H. Mitchell, President; Thomas D. Meola, Vice President in Charge of Operations; Harold H. Beverage, Vice President in Charge of Research & Development; Lon A. Cearley, Vice President & Controller; Howard R. Hawkins, Vice President and General

Attorney; Chester W. Latimer, Vice President and Chief Technical Consultant; John H. Muller, Vice President in Charge of New York District; David S. Rau, Vice President and Chief Engineer; W. Sidney Sparks, Vice President in Charge of Commercial Activities; Cyril J. Rennie, District Manager, Washington Office, Assistant Vice President in Charge of Washington District; Harry E. Austin, Vice President in Charge of Pacific Coast District; Frederick J. Sager, Treasurer and Assistant Secretary; Robert Gilfillan, Assistant Treasurer; John Q. Cannon, Secretary; Raymond E. Simonds, Assistant Secretary.

RCA INSTITUTES INC.

350 West 4th Street, New York City
 Telephone: Watkins 4-7845

Board of Directors: E. C. Cahill, J. M. Clifford, O. E. Dunlap Jr., F. H. Kirkpatrick, G. F. Maedel, T. D. Meola, G. L. Van Deusen, T. P. Wynkoop. Officers: T. P. Wynkoop, Chairman of the Board; George F. Maedel, President; William F. Vogt, Treasurer; Charles F. Valentine, Assistant Treasurer; John Q. Cannon, Secretary; Robert C. Proppe, Assistant Secretary.

RCA INTERNATIONAL DIVISION

30 Rockefeller Plaza, New York City
 Telephone: Judson 6-3800

Meade Brunet, Vice President and Managing Director.

RADIOMARINE CORPORATION OF AMERICA

75 Varick Street, New York City
 Telephone: Walker 5-3716

Board of Directors: Ewen C. Anderson, Meade Brunet, Walter A. Buck, John S. Carter, Vincent De P. Goubeau, George F. Shecklen, Lindsey W. Teegarden, W. Walter Watts, Thomas P. Wynkoop. Officers: Lindsey W. Teegarden, Chairman of the Board; Thomas P. Wynkoop, President; George F. Shecklen, Executive Vice President; Bruce W. Dold, Vice President and Controller; William F. Vogt, Vice President and Treasurer; I. F. Byrnes, Vice President in Charge of Engineering; A. J. Costigan, Vice President in Charge of Communications; H. A. Saul, Vice President in Charge of Production; G. P. Aldridge, Vice President in Charge of Sales and Government Contracts; Robert C. Proppe, Secretary; Charles A. Carney, Assistant Controller; Charles F. Valentine, Assistant Treasurer and Assistant Secretary; William F. Aufenanger, Assistant Secretary; Gerald Gouldrup, Assistant Secretary (for FCC licenses).

* Start operations in 1954.

NATIONAL ASSOCIATION OF RADIO AND TELEVISION BROADCASTERS: 1954 OFFICERS AND COMMITTEES

Headquarters Office: 1771 N Street, N.W., Washington 6, D. C. Phone Decatur 2-9300
West Coast Office: Suite 915, Two Ten Post, San Francisco 8, Calif. Phone Garfield 1-5084

OFFICERS

President **HAROLD E. FELLOWS**
Chairman of Board & General Counsel
JUSTIN MILLER
Secretary-Treasurer **C. E. ARNEY JR.**

DEPARTMENT EXECUTIVES

Robert K. Richards
Administrative Vice President
Employee-Employer Relations Dept.
Richard P. Doherty, *Vice President*
Charles H. Tower, *Assistant to Vice President*
Robert J. Gormley, *Labor Economist*

Engineering Dept.
A. Prose Walker, *Manager*

Government Relations Dept.
Ralph W. Hardy, *Vice President*
Oscar Elder, *Assistant to Vice President*

Information Dept.
Fran Riley, *Manager*
Sally Kean, *Assistant Manager*

Legal Dept.
Justin Miller, *General Counsel*
Vincent T. Wasilewski, *Chief Attorney*
Abiah A. Church, *Attorney*

Promotion & Fm Dept.
John H. Smith Jr., *Manager*

Research Dept.
Richard M. Allerton, *Manager*
Louise K. Aldrich, *Librarian*

Station Relations Dept.
William K. Treynor, *Manager*
Jack L. Barton, *Assistant Manager and West Coast Representative*
Gregory Reeser, *Field Representative*

Television
Thad H. Brown, *Vice President and Counsel to Tv Board*
Howard H. Bell, *Assistant to Vice President*
Betty Doolittle, *Administrative Assistant*

Television Code Affairs
Edward H. Bronson, *Director*

Auditor
William L. Walker

BOARD OF DIRECTORS 1953-1954

RADIO BOARD

		<i>Term Expires</i>
Chmn.	Justin Miller	
Pres.	Harold E. Fellows	
Sec.-T.	C. E. Arney Jr.	
Dist. 1	Herbert L. Krueger, WTAG Worcester, Mass.	1955
Dist. 2	E. R. Vadeboncoeur, WSYR Syracuse	1954
Dist. 3	George H. Clinton, WPAR Parkersburg, W. Va.	1955
Dist. 4	Harold Essex, WSJS Winston-Salem, N. C.	1954
Dist. 5	John Fulton, WQXI Atlanta	1955
Dist. 6	Henry B. Clay, KWKH Shreveport, La.	1954
Dist. 7	F. Ernest Lackey, WHOP Hopkinsville, Ky.	1955
Dist. 8	Stanley R. Pratt, WSOO Sault Ste. Marie, Mich.	1954
Dist. 9	Hugh K. Boice Jr., WEMP Milwaukee	1955
Dist. 10	E. K. Hartenbower, KCMO Kansas City, Mo.	1954
Dist. 11	John F. Meagher, KYSM Mankato, Minn.	1955
Dist. 12	Jack Todd, KAKE Wichita, Kan.	1954
Dist. 13	Kenyon Brown, KWFT Wichita Falls, Texas	1955
Dist. 14	William C. Grove, KFBC Cheyenne, Wyo.	1954
Dist. 15	William D. Pabst, KFRC San Francisco, Calif.	1955
Dist. 16	Albert D. Johnson, KOY Phoenix, Ariz.	1954
Dist. 17	Richard M. Brown, KPOJ Portland, Ore.	1955

Directors-at-Large

Large Stations	John H. DeWitt Jr., WSM Nashville	1955
	Paul W. Morency, WTIC Hartford	1954
Medium Stations	G. Richard Shafto, WIST Charlotte, N. C.	1955
	A. D. Willard Jr., WGAC Augusta, Ga.	1954
Small Stations*	Edgar Kobak, WTWA Thomson, Ga.	1955
FM Stations	Ben Strouse, WWDC-FM Washington	1955
	Michael R. Hanna, WHCU-FM Ithaca, N. Y.	1954
Network	Earl M. Johnson, MBS New York	1955

* One Vacancy

PRESIDENTS

Eugene F. McDonald Jr. (WJAZ)	1923-1925
Frank W. Elliott (WHO)	1925-1926
Earle C. Anthony (KFI)	1926-1928
William S. Hedges (WMAQ)	1928-1930
Walter J. Damm (WTMJ)	1930-1931
*Harry Shaw (WMT)	1931-1932
Alfred J. McCosker (WOR)	1932-1934
J. Truman Ward (WLAC)	1934-1935
Leo J. Fitzpatrick (WJR)	1935-1936
*Charles W. Myers (KOIN)	1936-1937
John Elmer (WCBM)	6-23-37-2-16-38
Mark Ethridge (WFAS)	3-30-38-7-1-38
Neville Miller	7-1-38-3-1-44
J. Harold Ryan (WSPD)	4-15-44-9-30-45
Justin Miller	10-1-45-6-4-51
Harold E. Fellows (WEEI)	6-4-51-

* Deceased

TELEVISION BOARD

Chmn.	Robert D. Swezey, WDSU-TV New Orleans	1954
Vice Chmn.	Clair R. McCollough, WGAL-TV Lancaster	1954
	Harold Hough, WBAP-TV Fort Worth	1954
	Paul Raibourn, KTLA (TV) Los Angeles	1954
	George B. Storer, Storer Broadcasting Co. Miami Beach, Fla.	1954
	Campbell Arnoux, WTAR-TV Norfolk, Va.	1953
	Kenneth L. Carter, WAAM (TV) Baltimore	1953
	William Fay, WHAM-TV Rochester	1953
	Ward L. Quaal, WLWT (TV) Cincinnati, Ohio	1955
Network:	Alexander Stronach, ABC New York	1953
	Merle S. Jones, CBS New York	1955
	Frank M. Russell, NBC Washington	1953

NARTB COMMITTEES

1953-1954 Board committees are as follows:
By-Laws Committee—E. K. Hartenbower, KCMO Kansas City, chairman; Kenneth L. Carter, WAAM (TV) Baltimore; Herbert L. Krueger, WTAG Worcester, Mass.; Stanley R. Pratt, WSOO Sault Ste. Marie, Mich.; Robert D. Swezey, WDSU-TV New Orleans.

Finance Committee—Harold Essex, WSJS Winston-Salem, N. C., chairman; Campbell Arnoux, WTAR-TV Norfolk, Va.; Kenyon Brown, KWFT Wichita Falls, Texas; William Fay, WHAM-TV Rochester; John F. Meagher, KYSM Mankato, Minn.; A. D. Willard Jr., WGAC Augusta, Ga.

Membership Committee—Henry B. Clay, KWKH Shreveport, La., chairman; Richard M. Brown, KPOJ Portland, Ore.; John H. DeWitt Jr., WSM Nashville; F. Ernest Lackey, WHOP Hopkinsville, Ky.; Clair R. McCollough, WGAL-TV Lancaster, Pa.; Ward L. Quaal, WLWT (TV) Cincinnati, O.; Jack Todd, KAKE Wichita, Kan.

Chairman and members of standing committees for current fiscal year follow:

Am Radio Committee—G. Richard Shafto, WIS Columbia, S. C., chairman; J. J. Bernard, KOMA Oklahoma City; Grover C. Cobb, KFBC Great Bend, Kan.; William C. Grove, KFBC Cheyenne, Wyo.; James L. Howe, WCTC New Brunswick, N. J.; Lester W. Lindow, WFDF Flint, Mich.; Paul W. Morency, WTIC Hartford; William D. Pabst, KFRC San Francisco; F. C. Sowell, WLAC Nashville; William H. Fineshriver Jr., NBC; E. M. Johnson, MBS.

Fm Committee—Ben Strouse, WDWC-FM Washington, D. C., chairman; Walter J. Brown, WDXY (FM) Spartanburg, S. C.; Carl George, WGAR-FM Cleveland, Ohio; Michael R. Hanna, WHCU-FM Ithaca, N. Y.; Richard Field Lewis, WRFM (FM) Winchester, Va.; Edward A. Wheeler, WEAW (FM) Evanston, Ill.; Robert E. Williams, WFML (FM) Washington, Ind.

Sports Committee—George J. Higgins, KMBC Kansas City, chairman; Ben Strouse, WWDC Washington; Ben Laird, WDUZ Green Bay, Wis.; John Fulton, WQXI Atlanta; William B. McGrath, WHDH Boston; Harold Hough, WBAP-TV Fort Worth; M. C. Watters, WCPO-TV Cincinnati; D. L. Provost, WBAL-TV Baltimore; Robert T. Tinscher, KVTY (TV) Sioux City, Ia.; Robert B. Hanna, WRGB (TV) Schenectady, N. Y.; Gene Trace, WBBW, Youngstown; Charles Mallory, KSJO San Jose, Calif.

Standards of Practice Committee—John F. Meagher, KYSM Mankato, Minn., chairman; Carleton D. Brown, WTVL Waterville, Me.; William B. McGrath, WHDH Boston; William D. Pabst, KFRC San Francisco; Clyde

W. Rembert, KRDL Dallas; E. R. Vadeboncoeur, WSYR Syracuse; Walter E. Wagstaff, KIDO Boise, Idaho.

Copyright Committee—Edward Breen, KVFD Fort Dodge, Ia., chairman; George H. Clinton, WPAR Parkersburg, W. Va.; Donald G. Graham, KOMO Seattle; Joseph McDonald, NBC New York, N. Y.; A. J. Mosby, KGVO Missoula, Mont.; Lawrence H. Rogers II, WSAZ Huntington, W. Va.; James W. Woodruff Jr., WRBL Columbus, Ga.

Insurance Committee—Gilmore N. Nunn, WLAP Lexington, Ky., chairman; Harold Essex, WSJS Winston-Salem, N. C.; Roger Clipp, WFIL Philadelphia, Pa.; Frank P. Fogarty, WOV Omaha; C. T. Lucy, WRVA Richmond, Va.

Public Events Committee—Edgar Kobak, WTWA Thomson, Ga., chairman; Joseph K. Close, WKNE Keene, N. H.; Victor C. Diehm, WAZL Hazelton, Pa.; Merrill Lindsay, WSOY Decatur, Ill.; Richard A. Moore, KTTV (TV) Hollywood; John F. Patt, WGAR Cleveland; Paul Raibourn, KTLA (TV) Los Angeles; Victor A. Sholis, WHAS-TV Louisville; P. A. Sugg, WKY-TV Oklahoma City; Hugh B. Terry, KLZ-TV Denver; E. R. Vadeboncoeur, WSYR Syracuse.

Labor Advisory Committee—Robert D. Swezey, WDSU-TV New Orleans, chairman; John M. Clifford, NBC-TV New York; Frank Falknor, CBS-TV New York; Leslie C. Johnson, WHBF-TV Rock Island, Ill.; Philip G. Lasky, KPIX (TV) San Francisco; Donald H. McGannon, DuMont TV Network, New York; Richard A. Moore, KTTV (TV) Los Angeles; Donald W. Thornburgh, WCAU-TV Philadelphia; Mort Weinbach, ABC-TV New York; Edwin K. Wheeler, WWJ-TV Detroit; George Cook, WLS Chicago.

Television Information Committee—Harold E. Fellows, NARTB, chairman; Richard A. Borel, WBNS-TV Columbus; Howard Chernoff, WTAP (TV) Parkersburg, W. Va.; Sidney Eiges, NBC-TV New York; Jack Harris, KPRC-TV Houston; David J. Jacobson, CBS-TV New York; Gerald Lyons, DuMont, New York; John W. Pacey, ABC-TV, New York; Henry W. Slavick, WMCT (TV) Memphis; Charles Vanda, WCAU-TV Philadelphia.

Subscription Television Study Committee—Paul Raibourn, KTLA (TV) Los Angeles, chairman; Clair R. McCollough, WGAL-TV Lancaster, Pa.; Ward L. Quaal, WLWT (TV) Cincinnati.

Television Finance Committee—Campbell Arnoux, WTAR-TV Norfolk, chairman; William Fay, WHAM-TV Rochester; George B. Storer, Storer Broadcasting Co., Miami Beach, Fla.; Robert D. Swezey, WDSU-TV New Orleans.

Tv Engineering Advisory Committee—Raymond F. Guy, NBC New York, chairman; Rodney Chipp, DuMont, New York; John Leitch, WCAU-TV Philadelphia; William Lodge, CBS New York; J. E. Mathiot, WGAL-TV Lancaster, Pa.; Carlton G. WMAZ-TV Baltimore; R. J. Rockwell, Crosley Broadcasting Corp., Cincinnati; Frank Marx, ABC.

Television Code Review Board—John E. Fetzer, WKZO-TV Kalamazoo, Mich., chairman; J. Leonard Reinsch, WSB-TV Atlanta, vice chairman; Ewell K. Jett, WMAZ-TV Baltimore; Mrs. A. Scott Bullitt, KING-TV Seattle; Walter J. Damm, WTMJ-TV Milwaukee.

Convention Committee—Kenyon R. Brown, KWFT Wichita Falls, Texas, chairman; Hugh K. Boice Jr., WEMP Milwaukee; C. L. McCarthy, KROY Sacramento; W. D. Rogers Jr., KDUB-TV Lubbock, Texas; Owen F. Uridge, WQAM Miami; James D. Russell, KKTU (TV) Colorado Springs; Clair R. McCollough, WGAL-AM-TV Lancaster, Pa.

Television Film Committee—Harold P. See, KRON-TV San Francisco, chairman; Paul Adant, WHEN-TV Syracuse; Martin B. Campbell, WFAA-TV Dallas; Klaus Landsberg, KTLA (TV) Los Angeles; Marshall Pengra, KSTM (TV) St. Louis; Elaine Phillips, WSPD-TV Toledo; Irving Rosenhaus, WATV (TV) Newark; Dan Shields, WEEU-TV Reading, Pa.; Raymond W. Welpott, WRGB (TV) Schenectady.

Television Circulation Study Committee—Robert D. Swezey, WDSU-TV New Orleans, chairman; Campbell Arnoux, WTAR-TV Norfolk; Kenneth L. Carter, WAAM (TV) Baltimore; Clair R. McCollough, WGAL-TV Lancaster, Pa.; J. Leonard Reinsch, WSB-TV Atlanta; Donald W. Thornburgh, WCAU-TV Philadelphia; Lee B. Wailes, Storer Broadcasting Co.; Richard A. Borel, WBNS-TV Columbus.

Engineering Conference Committee—Raymond Guy, NBC, chairman; Frank Marx, ABC; William B. Lodge, CBS; Rodney D. Chipp, DuMont; Earl M. Johnson, MBS; Carl Mey-DuMont; Earl M. Johnson, MBS; Fritz Leydord, WJR Detroit; Willard J. Purcell, WGY Schenectady; Karl E. Hoffman, WGR Buffalo; A. James Ebel, WMBD Peoria, Ill.; James D. Russell, KKTU (TV) Colorado Springs, Convention Committee liaison.



BMI

**OFFERS
THESE
PROGRAM
AIDS
TO THE
BROADCASTER**



CONTINUITY

Music programs that sell . . . ready for immediate use . . . smooth, well-written scripts for a variety of program purposes:

- ACCORDING TO THE RECORD** (five minutes, daily)
- THE BOOK PARADE** (quarter hour, weekly)
- MUSIC AND SPORTS** (quarter hour, 3 times weekly)
- MILESTONES** (half hour, periodically)

CONCERT MUSIC

Monthly Pin Up Sheet, listing new recordings of outstanding contemporary and standard compositions.

YOUR CONCERT HALL—a series of half-hour radio scripts, three times weekly.

TODAY IN MUSIC—dates and facts about the important music events of the month.

PIN UP SHEETS

Convenient and timely reference to the current song leaders . . . pop hits, folk favorites, standards, rhythm and blues successes . . . issued monthly.

COPYRIGHT RESEARCH

Thorough, up-to-the-minute information on music clearance . . . a complete basic catalog and regular weekly supplements of newly published music with consolidated indexes provided semi-annually.

NEWSLETTER

Personal monthly message to the broadcasters. An exchange of radio and music ideas.

BMI services are all designed to aid the broadcaster and are available to every BMI-licensed station. Check with your program director or music librarian for this material.

MUSIC MEMO

Monthly informational bulletin . . . the radio man's guide to BMI music . . . contains helpful feature articles, the Platter Spinners Parade and Tips on Tunes.

MEET THE ARTIST

Valuable reference of vital statistics on 144 of the nation's popular recording artists.

CHECK LIST

Digest of trade press ratings of the newest record releases.

HOLIDAY MUSIC

Timely suggestions of appropriate music for seasonal and holiday occasions.

MUSIC DISTRIBUTION

Music of every type, published by BMI and affiliated publishers, mailed to stations frequently.

PERFORMINDEX

Handy, time-saving catalog of most-performed BMI-licensed titles.

CATEGORICAL INDEX

Provides immediate reference to a wide variety of song titles, arranged for selecting appropriate music in countless script situations.

BROADCAST MUSIC, INC.

580 FIFTH AVENUE • NEW YORK 36, N.Y.

NEW YORK • CHICAGO • HOLLYWOOD • TORONTO • MONTREAL

continued to underwrite these radio shows: *Phrase that Pays*, *Walk a Mile*, *Camel Caravan*, and *Grand Ole Opry*. Colgate-Palmolive Co. continues to sponsor *Lorenzo Jones* and *Strike It Rich* on NBC Radio.

DANCER-FITZGERALD-SAMPLE: Radio-tv billing, \$27 million: \$18 million in radio, \$9 million in tv. Radio-tv share of agency's overall billing, 55%.

D-F-S, first in radio and seventh in combined radio-tv billing this year, exceeded its 1952 total by \$1 million, mainly as a result of its acquisition of the Bab-O account and the remainder of the American Chiclé budget. These more than offset the agency's loss of a portion of its General Mills business to BBDO during the year. Bab-O is a particularly heavy spot advertiser in both radio and tv, and American Chiclé sponsors *Rocky King* on DuMont. Moreover, the agency acquired two new accounts as the year drew to an end, both of which will influence greatly the firm's billing in 1954. The new additions are Best Foods, formerly handled by Benton & Bowles, and Peter Paul Inc., serviced previously by Maxon Inc.

McCANN-ERICKSON: Radio-tv billing, \$25.5 million: \$8 million in radio, \$17.5 million in tv. Radio-tv share of agency's overall billing, 40%.

Total radio-tv billing increased a half million over 1952. Lever Brothers broke its national campaign for Shadow Wave and increased its expenditures for Pepsodent. The products are represented on the Godfrey morning simulcast on CBS-AM-TV and on *Big Town* in radio. The Chesebrough Mfg. Co. was added by the agency to *Your Show of Shows* while 20 Mule Team Borax continues

with *Death Valley Days* on television, regionally. Westinghouse carries on with its sponsorship of *Studio One* on CBS-TV.

TED BATES: Radio-tv billings, \$24 million: \$6 million in radio, \$18 million in tv. Radio-tv share of agency's overall billing, 60%.

The agency added \$9 million over last year's figure and doubled its television expenditure of 1952. These were the new shows added in 1953: *Colgate Comedy Hour* on NBC-TV for Colgate-Palmolive Co.; *My Friend Irma* on

Face and *Valiant Lady* on CBS-TV, *Whispering Streets* and *Wizard of Odds* on ABC Radio, and *Family Skeleton* on CBS Radio. The Kellogg Co. sponsors a portion of *Howdy Doody* on NBC-TV; *Wild Bill Hickok* on a regional basis, *Arthur Godfrey Show* (morning) on CBS and *Superman* on NBC-TV. In addition, the agency represents Pillsbury on the Godfrey morning show and on the Art Linkletter daily program; Mars Inc. and Kellogg continue to sponsor *Super Circus* on ABC-TV while Con-

For the second year BBDO and Young & Rubicam were the heaviest spenders in broadcast media among leading advertising agencies, according to annual survey by B*T's agency editor, Florence Small. Thirty-two leaders spent \$191.4 million in radio and \$372.2 million in tv for a grand total of \$563.6 million.

CBS-TV for Brown & Williamson Tobacco Co., and *Orchid Award* on ABC-TV for the same cigarette sponsor; Continental Bakery's *Make Up Your Mind* on CBS-TV and, for Colgate again, *Our Miss Brooks* on CBS-TV. In addition, the agency spends a formidable sum of spot money for Colgate, Carter Products, Standard Brands, and Anahist Co., among others.

LEO BURNETT CO: Radio-tv billing, \$24 million: \$7.2 million in radio billing, \$16.8 million in tv. Radio-tv share of agency's overall billing, 50%.

Leo Burnett increased its radio-tv billing \$6 million over 1952, adding the Toni Co. and the Kellogg Co. to its roster of accounts. For Toni the agency now handles *Place the*

verted Rice and Hoover Vacuum are participating on the Garry Moore CBS-TV show.

FOOTE, CONE & BELDING: Radio-tv billing, \$18 million: \$8 million in radio, \$10 million in tv. Radio-tv share of agency's overall billing, 30%.

FC&B dropped off approximately \$2 million during 1953 in combined radio and tv billing, mainly as a result of its resignation of the Toni account. The agency did, however, gain two new accounts during the year; part of the Johnson's Wax business and the Paper-Mate account. Rheingold continues its spot radio and tv coverage and Hall Brothers Inc. is still underwriting its NBC-TV show.

LENNEN & NEWELL: Radio-tv billing, \$18 million: \$4 million in radio, \$14 million

"FOUR OF A KIND" IS HARD TO BEAT!

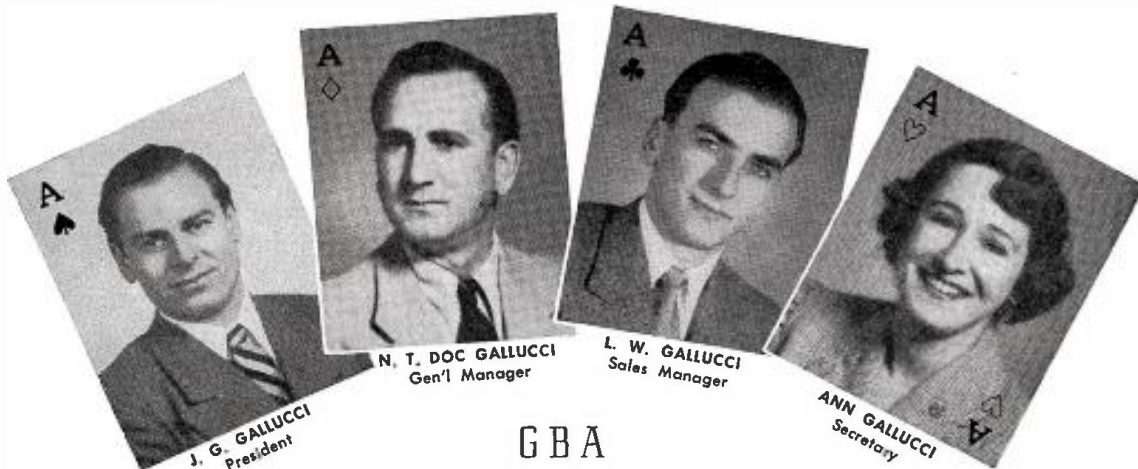

GBA PRODUCTIONS

And when they're all *aces*, the blue chips are yours! Deal yourself this winning combination! America's largest radio special feature sales organization, The Gallucci Brothers and Associates, specialize in a package promotion, complete from sales to copy, which means EXTRA business, EXTRA income for your station. Contact:

727 MERIDEN ROAD, WATERBURY, CONNECTICUT • WEST OF THE ROCKIES: P.O. BOX 1224, DENVER, COLORADO

in tv. Radio-tv share of agency's overall billing, 55%.

L&N gained three million dollars over its 1952 billing. Accounting chiefly for the rise was the radio-tv expansion of P. Lorillard & Co. with two new shows, *Judge for Yourself*, starring Fred Allen on NBC-TV, and *Two for the Money* on CBS-TV. Also, Schlitz Brewing expanded its network dramatic show, *Schlitz Playhouse*, on CBS-TV, and Tidewater added some stations to its list. P. Lorillard continued to sponsor *Chance of a Lifetime* on DuMont.

KENYON & ECKHARDT: Radio-tv billing, \$15.2 million: \$5.6 million in radio, \$9.6 million in tv. Radio-tv share of agency's overall billing, 28%.

Radio and tv billing at K&E was up \$700,000 over 1952. The agency gained one tv account during the year, Welch Grape Juice Co., which sponsors a portion of *Howdy Doody* on NBC-TV. In addition it expanded the number of stations carrying its *Toast of the Town* show for Lincoln-Mercury on CBS-TV. The agency also participated during the year in the historic Ford Anniversary show which ran on two networks for two hours. Lincoln-Mercury, Amazo, Repperidge Farms and Spool Cotton are among the agency's principal radio and television spot advertisers.

KUDNER AGENCY: Radio-tv billing, \$15 million: \$4.8 million in radio, \$10.2 million in tv. Radio-tv share of agency's overall billing, 35%.

Kudner's radio-tv figures remained substantially the same as in 1952. The agency continued to handle the Buick and Texaco accounts—the latter underwrote the *Milton Berle Show* on NBC-TV until summer and the former took over in the fall—and still services Texaco's *Metropolitan Opera* broadcasts on ABC Radio. General Motors continues to sponsor *Henry J.* Taylor News on Mutual.

CUNNINGHAM & WALSH: Radio-tv billing, \$14 million: \$4 million in radio, \$10 million in tv. Radio-tv share of agency's overall budget, 33%.

Chesterfield increased its budget this year, accounting in good part for the \$4 million advance of this agency over the 1952 tally. In addition to the huge Chesterfield schedule the agency handles spot activity in radio and television for such advertisers as Sunshine Biscuit, Northwest Airlines, Pan American coffee, Squibb Co., Narragansett beer, Diamond hosiery, and McCall's patterns.

MAXON INC.: Radio-tv billing, \$14 million: \$4.2 million in radio, \$9.8 million in tv. Radio-tv share of agency's overall billing, 40%.

In 1953 Maxon recorded an increase of over \$3 million in television. For General Electric it added alternate sponsorship of *Meet Mr. McNutley* on CBS-TV, while Hot Point continued with its *Ozzie and Harriet* show on ABC-TV, and Gillette proceeded with its heavy radio and tv sports schedule including sponsorship of the World Series, the fights, the Rose Bowl game, and All Star and Orange Bowl games. Peter Paul (Mounds), which figured importantly with its newscasts for the greater part of 1953, was lost by the agency in November. The account has moved to D-F-S.

N. W. AYER & SON: Radio-tv billing, \$13.4 million: \$6.5 million in radio, \$6.9 million in tv. Radio-tv share of agency's overall billing, 14%.

Ayer billing in 1953 was up almost \$1.5 million over last year with most of the increase going into spot radio and television. The agency continued to place, for Electric Light & Power Co., *Meet Corliss Archer* on ABC Radio and *You Are There* on CBS-TV.

Lever Bros. continues with *Houseparty* on CBS-AM-TV; Bell Telephone Co. remains with the *Telephone Hour* on NBC Radio, and Atlantic Refining maintains its annual football telecasts on DuMont and on a regional basis.

SULLIVAN, STAUFFER, COLWELL & BAYLES: Radio-tv billing, \$13 million: \$3 million in radio, \$10 million in tv. Radio-tv share of agency's overall billing, 50%.

Radio-tv billing at SSC&B was up \$3 million over 1952. American Cigar & Cigarette Co. began sponsoring *Where's Raymond* on ABC-TV, Speidel Corp. started alternate-week sponsorship of *Make Room for Daddy* on ABC-TV, and Carter Products took on *Place The Face* on CBS-TV. Meanwhile American Cigar & Cigarette Co. continued to sponsor *Big Story* on NBC-TV and NBC Radio, and *Doug Edwards and the News* on CBS-TV. Carter Products retained *City Hospital* on CBS-TV and *Down You Go* on DuMont.

COMPTON ADV.: Radio-tv billing, \$12.5 million: \$5 million in radio, \$7.5 million in tv. Radio-tv share of overall billing, 30%.

Compton increased its radio-tv billing \$4.5 million over 1952, principally as a result of a vast spot outlay for such accounts as Procter & Gamble, Standard Brands, and Goodyear Tire & Rubber Co. In addition P & G continued sponsorship of *Fireside Theatre* on NBC-TV and *Guiding Light* on CBS-TV. In radio P & G continues to underwrite four daytime serials: *Guiding Light* on CBS Radio, *Right to Happiness* on NBC, *Road of Life* on both CBS and NBC, and *Young Dr. Malone* on CBS. In 1953 Compton placed an expanded spot campaign for Gleem, a P & G product.

NEEDHAM, LOUIS & BRORBY: Radio-tv billing, \$11 million: \$4.5 million in radio, \$6.5 million in tv. Radio-tv share of agency's overall billing, 45%.

The agency hiked its radio-tv billing \$3 million over last year, a \$1.5 million rise in radio and a similar increase in television. In television S. C. Johnson & Son added sponsorship of *Life With Father* on CBS-TV while continuing with alternate-week sponsorship of *Robert Montgomery Presents* on NBC-TV, *Saturday Night Fights* on ABC-TV, and *Name's The Same* on ABC-TV. The agency also handled some Kraft participations on *Kraft TV Theatre* on NBC-TV, plus Quaker Oats sponsorship of *Zoo Parade* and Derby Foods on *Sky King*, both on ABC-TV. In radio, Derby Foods sponsors *Sky King* on MBS, Kraft Foods underwrites *The Great Gildersleeve* on NBC, and S. C. Johnson & Son and State Farm Mutual combine to sponsor *Cecil Brown Newscasts* on Mutual.

SHERMAN & MARQUETTE: Radio-tv billings, \$11 million: \$3.5 million in radio, \$7.5 million in tv. Radio-tv share of agency's overall billings, 50%.

Sherman & Marquette finished the year with a \$4 million increase over its 1952 radio-tv billing. The rise is due mainly to acquisition of a larger share of the Colgate business. In 1953 the agency began placing, for Colgate, *The Comedy Hour* on NBC-TV and *Mr. & Mrs. North* on CBS-TV. It continued to service *Strike It Rich* on CBS-TV for the same sponsor. Additionally, S & M expanded proportionally its spot placements for Colgate. Also, for Nestle's Chocolate, the agency bought into a portion of the *Jackie Gleason Show* on CBS-TV. Quaker Oats sponsored continuously the *Gabby Hayes Show* until Dec. 3, 1953.

GEOFFREY WADE ADV.: Radio-tv billing, \$10 million: \$6.5 million in radio, \$3.5 million in tv. Radio-tv share of agency's overall billing, 90%.

Traditionally strong in radio, Wade found 1953 no exception in that respect. The agency services the following radio programs for Miles Labs: *Curt Massey Time* on CBS Radio and Mutual; *Hilltop House* on CBS Radio; *News of the World*, *One Man's Family*, and *Break the Bank* on NBC. In television, Miles Labs spends its budget in a large spot announcement campaign for Alka-Seltzer.

RUTHRAUFF & RYAN: Radio-tv billing, \$10 million: \$5 million in radio, \$5 million in tv. Radio-tv share of agency's overall billing, 23%.

Following a staggering loss of accounts at the end of 1952, R & R began this past year to pick up steam and clients. It acquired the Sun Oil account, which sponsors *Three Star Extra* on NBC Radio; Glamorene, which is represented on NBC-TV's *Today*, as well as Bosco, Clearsil and Scratch X, the latter three spot advertisers. Moreover, the firm enlisted Frostee for a part sponsorship of the *Arthur Godfrey Show* and for five months handled the *Arthur Murray Show* on DuMont. On Dec. 1 Motorola undertook alternate sponsorship with U. S. Steel of a dramatic show on ABC-TV. Wrigley Co. continues its sponsorship of the *Gene Autry Show* on CBS-TV. Effective Jan. 1, R & R lost Blue Coal, a spot advertiser, to SSC&B and the recently-gained Glamorene account to Hicks & Greist.

CECIL & PRESBREY: Radio-tv billing, \$9.5 million: \$1.5 million in radio, \$8 million in tv. Radio-tv share of agency's overall billing, 50%.

Cecil & Presbrey vaulted a million and a half over its 1952 mark. Benrus Watch Co. began a participation on *Your Show of Shows* on NBC-TV and underwrote a heavy tv spot campaign. Block Drug Co. took over sponsorship of *Gabriel Heatter* on MBS. Electric-Auto-Lite continued with its sponsorship of *Suspense* on CBS-AM-TV, and Sylvania Electric carried on with its *Beat the Clock* program on CBS-TV. Block Drug Co. held to its two network tv programs, *Danger* on CBS-TV and *Name That Tune* on NBC-TV.

CAMPBELL-EWALD CO.: Radio-tv billing, \$8.5 million: \$1.8 million in radio, \$6.7 million in television. Radio-tv share of agency's overall billing, 25%.

Campbell-Ewald increased its billing approximately a million and a half over 1952. The agency placed the new Chevrolet Dealers' *Chevrolet Showcase* on ABC-TV, and presided over Chevrolet's expanded spot budget in both radio and television. Chevrolet Dealers continued sponsorship of *Chevrolet News* on ABC Radio and the *Dinah Shore Show* on NBC Radio and NBC-TV.

WARWICK & LEGLER: Radio-tv billing, \$7 million: \$1.5 million in radio, \$5.5 million in tv. Radio-tv share of agency's overall billing, 50%.

The agency held firm this year to its overall pace in 1952. For ExLax Inc., the firm placed *Leave It to the Girls* on DuMont, and bought into a portion of *Plainclothesman*, also on DuMont, for Larus & Bros. Co. Hoffman Beverages continued to sponsor *Children's Hour* on NBC-TV, and R. J. Caruso, Chrysler-Plymouth dealer in Los Angeles, carried on a television campaign. Pabst Blue Ribbon continued, as before, to sponsor the fights on radio and tv as well as carry on a radio spot campaign.

D'ARCY ADV.: Radio-tv billing, \$6.5 million: \$2.5 million in radio, \$4 million in tv. Radio-tv share of agency's overall billing, 25%.

This agency dropped perhaps a half-million dollars from its 1952 figure. Still it was an



BMI

PRODUCT and SERVICE REACH A NEW HIGH!

With each succeeding year BMI's products and services attain new highs in volume and value.

The large and growing catalog of BMI-licensed music in all classes—popular, folk, standard, symphonic, operatic, educational—gives continuing evidence of the quality and ability of the composers and publishers affiliated with BMI.

BMI Service, too, is reaching new highs. BMI not only serves its broadcast licensees—AM, FM and TV—with a steady flow of practical program aids, but provides its repertoire and facilities to every user of music . . . ballrooms, night clubs, motion pictures, hotels, restaurants, skating rinks, amusement parks, wired music, industrial plants, symphony orchestras, chamber music groups, choirs and choruses, motion picture exhibitors using intermission music and many others.

BMI-licensed pop song hits are maintaining leading positions in all of the music trade popularity charts—the Hit Parade, the Variety scoreboard, Billboard charts, Downbeat polls, the everyday best-seller lists—and, for the past four consecutive years, were voted Number One in all categories by the nation's juke box operators in the Annual Cash Box Popularity Poll.

In the field of Concert Music, BMI continues to foster composition and encourage public interest through its annual Student Composers Radio Awards, its support of the American Composers Alliance, and the extensive publication of Concert Music through its wholly owned subsidiary, Associated Music Publishers, Inc.

Similar BMI services and efforts in the entire field of music are being conducted throughout the Provinces of Canada by BMI Canada Limited.

BROADCAST MUSIC, INC.

580 FIFTH AVENUE • NEW YORK 36, N.Y.

NEW YORK • CHICAGO • HOLLYWOOD • TORONTO • MONTREAL

COLUMBIA BROADCASTING SYSTEM INC.

485 Madison Ave., New York 22, N. Y. Telephone Plaza 1-2345
(For Executives of CBS Radio Division, see page 39)

BOARD OF DIRECTORS

William S. Paley, Chairman
Leon Levy
Samuel Paley
J. A. W. Iglehart
Dorsey Richardson
Ralph F. Colin
Frank Stanton
Edward R. Murrow
James B. Conkling
Frederick L. Chapman
Bruce A. Coffin
Lloyd H. Coffin
David H. Cogan
Adrian Murphy
J. L. Van Volkenburg
Robert A. Lovett

OFFICERS

William S. Paley, Chairman of the Board
Frank Stanton, President
Bruce A. Coffin, Vice President
Lloyd H. Coffin, Vice President
David H. Cogan, Vice President
James B. Conkling, Vice President
Earl H. Gammons, Vice President
William C. Gittinger, Vice President
Lawrence W. Lowman, Vice President
Howard S. Melghan, Vice President
Adrian Murphy, Vice President
Daniel T. O'Shea, Vice President
Richard S. Salant, Vice President
J. L. Van Volkenburg, Vice President
Julius F. Brauner, Secretary
Samuel R. Dean, Treasurer
Arthur S. Padgett, General Auditor
Edward L. Saxe, Controller
Herbert C. Hamilton, Assistant Secretary
Milton Neaman, Assistant Secretary
Richard W. Jencks, Assistant Secretary

CBS-COLUMBIA

3400 47th Ave., Long Island City, N. Y.
Telephone: Exeter 2-3000

OFFICERS

Bruce A. Coffin, Chairman of the Board & Executive Vice President
David H. Cogan, President
Mario A. Gardner, Vice President in Charge of Purchases

Leopold M. Kay, Vice President in Charge of Engineering
J. Albert Stobbe, Vice President in Charge of Operations
Louis Hausman, Vice President
Charles J. Kayko, Administrative Vice President
Arthur S. Padgett, General Auditor in Charge of Auditing & Taxes
Julius F. Brauner, Secretary
Samuel R. Dean, Treasurer
Joseph H. Seider, Assistant Secretary
John Ward, Controller, Assistant Treasurer

CBS LABORATORIES DIVISION

OFFICERS

Dr. Peter C. Goldmark, Vice President in Charge of Engineering Research & Development

CBS RADIO DIVISION

OFFICERS

Adrian Murphy, President
James M. Seward, Administrative Vice President
J. Kelly Smith, Administrative Vice President
William A. Schudt Jr., Vice President in Charge of Station Relations
H. Leslie Atlass, Vice President in Charge of Central Division
Guy della Cioppa, Vice President in Charge of Network Programs—Hollywood
Charles L. Glett, Vice President in Charge of Network Services—Hollywood
Lester Gottlieb, Vice President in Charge of Network Programs
Arthur Hull Hayes, Vice President in Charge of San Francisco Office
John Karol, Vice President in Charge of Network Sales
William B. Lodge, Vice President in Charge of Engineering

CBS TELEVISION DIVISION

OFFICERS

J. L. Van Volkenburg, President
Harry S. Ackerman, Vice President in Charge of Network Programs—Hollywood
H. V. Akerberg, Vice President in Charge of Station Relations

H. Leslie Atlass, Vice President in Charge of Central Division
Frank Falknor, Vice President in Charge of Operations
Charles L. Glett, Vice President in Charge of Network Services—Hollywood
W. Spencer Harrison, Vice President in Charge of Legal and Business Affairs
Merle S. Jones, Vice President in Charge of Stations and General Services
William B. Lodge, Vice President in Charge of Engineering
Hubbell Robinson Jr., Vice President in Charge of Network Programs
William H. Hylan, Vice President in Charge of Network Sales
William J. Flynn, Comptroller

COLUMBIA RECORDS INC.
799 Seventh Ave., New York 19, N. Y.
Telephone: Circle 5-7300

OFFICERS

James B. Conkling, President
Goddard Lieberman, Executive Vice President
James H. Hunter, Vice President in Charge of Production Engineering & Research
A. J. Schrade, Vice President in Charge of West Coast Operations
Paul J. Wexler, Vice President in Charge of Sales and Merchandising
Kenneth E. Raine, Secretary, Director of Industrial Relations
W. G. Wilkins, Treasurer
Arthur S. Padgett, General Auditor

CBS-HYTRON

100 Endicott Street
Danvers, Mass.
Telephone: 2360

OFFICERS

Bruce A. Coffin, President
Lloyd H. Coffin, Treasurer and Chairman of the Board
John Q. Adams, Vice President in Charge of Sales
David H. Cogan, Vice President
Charles F. Stromeyer, Executive Vice President
Herbert C. Hamilton, Assistant Secretary
Robert W. Hill, Clerk and Secretary

GROUP OWNERSHIP OF RADIO STATIONS IN THE UNITED STATES

AIR TRAILS NETWORK STATIONS (Charles Sawyer)—WING Dayton, WCOL Columbus, WIZE Springfield, (52%), all Ohio, and WCMT-AM-FM Ashland, Ky. (70%).
W. GORDON ALLEN STATIONS—KRGa Springfield, KGAL Lebanon (60%), KSGA Cottage Grove (60%), KGAE Salem (33½%), all Oregon. Headquarters: KGAE Salem, Ore.
AMERICAN BROADCASTING CO. OWNED AND MANAGED STATIONS—WABC, WABC-FM, New York; WENR, WENR-FM, Chicago; KGO, KGO-FM, San Francisco; KECA, KECA-FM, Los Angeles; WXYZ, WXYZ-FM, Detroit. All affiliates of American Broadcasting Co., WABC, WABC-FM, KECA-AM-FM and KGO-AM-FM represented by Edward Petry & Co., Inc. WENR-AM-FM and WXYZ-AM-FM by John Blair & Co.
ARETEX STATIONS—KCMC Texarkana, KWFC Hot Springs, and KAMD Camden, all Arkansas. Controlled by Walter Hussman, C. E. Palmer and Frank O. Myers.
GENE AUTRY STATIONS—KOOL Phoenix (85% ownership), KOPO Tucson (48%), KNOG Nogales (48%), KOLD Yuma (85%), all Ariz., and KMPC Los Angeles (51%).
CY N. BAHAKEL STATIONS—WKOZ Kosciusko, WABG Greenwood, Miss.; WRIS Roanoke, Va., and WKIN Kingsport, Tenn.
J. PATRICK BEACON STATIONS—WVWV Fairmont and WETZ New Martinsville, W. Va., and WBUT Butler, Pa.
H. M. BITNER STATIONS—WFDF Flint and WOOD Grand Rapids, Mich.; WEOA Evansville and WFBM Indianapolis, Ind.
BOOTH STATIONS—WJLB, WERI(FM), Detroit; WBFC Flint; WSGW Saginaw, Mich.
BROADCASTING CO. OF THE SOUTH STATIONS (Surety Life Insurance Co.)—WIS, WIS-FM, Columbia; WSPA, WSPA-FM, Spartanburg, both South Carolina; WIST, WIST-FM, Charlotte, N. C. G. Richard Shafto, general manager, WIS, Columbia, S. C.
BROADCASTING CORP. OF AMERICA—KPRO, KPRO(FM) Riverside; KREO, Indio; KYOR, Blythe; KRCP Brawley, all California, Fred E. Carr, trustee.
BROWN SCHOOLS STATIONS—KOME, Tulsa; KGBR, Long Beach, Calif.; KUOA, KUOA-FM, Siloam Springs, Ark. John E. Brown Jr., president; Clinton Fowler, executive vice president.
CBS OWNED STATIONS—WCBS, WCBS-FM, New York; KCBS, KCBS-FM, San Francisco; KMOX, St. Louis; KNX, KNX-FM, Los Angeles; WBBM, WBBM-FM, Chicago; WEEL, WEEL-FM, Boston; KQV Pittsburgh, Pa. (45% owned by CBS); WCCO, Minneapolis (53% owned by Midwest Radio-

TV, Inc., 47% owned by CBS); WTOP, WTOP-FM, Washington (55% owned by Washington Post, 45% owned by CBS). All affiliates of CBS Radio networks: all represented nationally by CBS Radio Spot Sales.
CLEARFIELD BROADCASTERS—WCPA Clearfield, WAKU Latrobe and WDAW Indiana, all Pa., and WJCM Sebring, Fla.
CLEVELAND PLAIN DEALER STATIONS—WHK, Cleveland; WHKC, Columbus; WKBN, Youngstown (minority interest).
COTTON BELT GROUP—KTFB, Texarkana, Tex.; KDMS, El Dorado, Ark.; WGVN, Greenville, Miss.; KDKD, Clinton, KUDL, Kansas City, KOKO, Warrensburg, Mo. All owned or controlled by David M. Segal.
PAT M. COURTINGTON STATIONS—WGRI, Scottsboro, WCRL, Oneonta and WAVU, Albertville, all Alabama.
COVINGTON STATIONS—WCOV, Montgomery; WGWG, Selma and WGWG, Gadsden. All in Alabama.
JAMES M. COX STATIONS—WSB, WSB-FM, Atlanta; WIOD, WIOD-FM, Miami; WHIO, WHIO-FM, Dayton, Headquarters; WSB, James M. Cox Jr., vice president; J. Leonard Reinsch, managing director of radio and television.
ED CRANEY STATIONS—KXLF, Butte, Mont.; KXL, Portland, Ore.; KXLJ Helena, Mont.; KXLQ Bozeman, Mont.; KXLL Missoula, Mont.; KXLK, Great Falls, Mont.
CURTIS RADIOCASTING CORP. STATIONS—WGBF, Evansville, Ind.; WBOW, Terre Haute, Ind.; WTMV, East St. Louis, Ill.
VIC DIEHM ASSOC. STATIONS—WVDA Boston; WAZL-AM-FM Hazleton, Pa.; WIDE Biddeford, Maine; WHOL Altoona, Pa.
JOHN E. FETZER STATIONS—WKZO Kalamazoo and WJEF-AM-FM Grand Rapids, Mich.; KOLN Lincoln Neb., and WMBD-AM-FM Peoria, Ill. (33½%).
E. DEAN FINNEY STATIONS—WTWN St. Johnsbury, WIKE Newport and EBC Springfield, all Vermont.
WILLIAM C. FORREST STATIONS—WIBU Poynette; WWCF(FM) Baraboo, and WRDB Reedsburg, all Wisconsin.
FRIENDLY GROUP—WSTV, Steubenville, Ohio; WFPG, Atlantic City; WPIT, Pittsburgh; WBMS, Boston, Mass. and their FM affiliates. John J. Laux, managing director.
J. A. GALLIMORE STATIONS—WSNW-AM-FM

Seneca and WSSC Sumter, both South Carolina, and WLFA Lafayette and WBAW Barnwell, both Georgia.
THEODORE R. GAMBLE STATIONS—KJR Seattle, Wash.; KCMJ Palm Springs, Calif.; KOIN-AM-FM Portland, Ore. (50%); KLZ-AM-FM Denver, Colo. (20.4%).
GANNETT NEWSPAPERS STATIONS—WHEC, Rochester; WENY, Elmira, N. Y.; WHDL, Olean, N. Y. (minority); WTHT, Hartford; WDAW, Danville, Ill. All holdings through newspaper. Headquarters: Rochester, N. Y. Frank E. Tripp, chairman; Paul Miller, executive vice president; Herbert W. Cruikshank, general manager; Lynn N. Bitner, general business manager; Glover Delaney, managing director, radio group.
WITHERS GAVIN STATIONS—WJQS, Jackson; WACR, Columbus; WMBC, Macon and WCOG, Meridian, all in Mississippi.
GENERAL TELERADIO INC. (owned by General Tire & Rubber Co.)—Yankee Network Div.: WNAZ Boston; WCTR-FM Worcester; WEAN Providence; WONS Hartford, Don Lee Network Div.: KHJ, KHJ-FM Los Angeles; KFRC San Francisco; KGB San Diego. WOR Div.: WOR, WOR-FM New York. Thomas F. O'Neil, president, General Teleradio Inc. Linus Travers, vice president-general manager, Yankee Network Div. Willet H. Brown, vice president-general manager, Don Lee Network Div. William H. Fineshriver Jr., vice president-general manager, WOR Div.
GILA BCSTG. CO. STATIONS—KCKY Coolidge, KWJB Globe, KGLU Safford, KVNC Winslow, all Arizona. Lewis F. Long, president.
GRANITE STATE BROADCASTING CO.—WKBR, WKBR-FM Manchester, N. H.; WTSV, WTSV-FM Claremont, N. H.; WTSL Hanover-Lebanon, N. H. Headquarters: 155 Front St., Manchester, W. J. Barkley, president; W. F. Rust Jr., treasurer.
AGNES JANE REEVES GREER STATIONS—WJER Dover, Ohio; WAJR Morgantown and WDNE Elkins, W. Va.
JOHN P. and SIDNEY HARRIS STATIONS—KFBI Wichita, KSAL Salina, KIUL Garden City, all Kan., and KBUR Burlington, Iowa.
HEARST STATIONS—WBAL Baltimore; WISN, WISN-FM Milwaukee; WCAE, WCAE-FM Pittsburgh; WBAL and WISN, WISN-FM licensed to Hearst Corp. WCAE, WCAE-FM licensed to WCAE Inc. D. L. Provost, vice president and general manager for radio and television, Hearst Corp. Leonard Kapner, president, WCAE Inc.

OSCAR C. HIRSCH STATIONS—WKRO Cairo, and WHCO Sparta, Ill.; KFVS Cape Girardeau, Mo.; KFMO Flat River, Mo., and minority interest in KSIM Sikeston, Mo.

ROY HOFHEINZ STATIONS — KTHH Houston, KACE Dallas, all Texas; WILD Birmingham (minority interest).

BIRNEY IMES JR. STATIONS—WCBI Columbus, WMOX Meridian, WELO Tupelo, WNAG Granada, WROX Clarksdale, all Mississippi.

INLAND RADIO INC. STATIONS—KBKR, Baker, KLEB, LaGrange, and KSRV, Ontario, all in Oregon. Principal owner: Olive B. Cornett, 50%. Headquarters: KBKR, Baker, Ore.

EDWARD LAMB ENTERPRISES INC. — WHOO Orlando, Fla.; WIOD and WTRT(FM) Toledo, Ohio; WIKK Erie, Pa. Edward Lamb, president; Frank Oswald, vice president. Headquarters: 500 Edward Lamb Bldg., Toledo. Washington Office: 1177 National Press Bldg.

RICHARD FIELD LEWIS JR. STATIONS—WINC, WRFL(FM) Winchester, WISG Mt. Jackson, and WFWA Fredericksburg (60%), Virginia; WAYZ Waynesboro and WHYL Carlisle, both Pennsylvania.

J. G. LONG STATIONS—KIOX Bay City, KVIC Victoria and KTLW Texas City, all in Texas. (Long Texas Group, a package unit.)

JESSICA L. LONGSTON STATIONS—KBO Burley, Ida. (86%); KSEM Moses Lake, Wash. (58%); KAYO (formerly KRSC) Seattle, Wash. (52%); KPUG Bellingham, Wash. (50%).

JOHN J. LOUIS STATIONS—KTAR, Phoenix, KVOA Tucson, KYUM, Yuma, KYCA, Prescott, all in Arizona. Dick Lewis, general manager.

M&N BROADCASTING CO. STATIONS—WIGM Medford, WFPF Park Falls, WLDY Ladysmith, all Wis. Charles Nelson, director, WIGM Medford, Wis.

WENDELL MAYES STATIONS—KBWD Brownwood, KNOV Austin and 50% of KSNY Snyder, all Texas; 25% interest in KTOK Oklahoma City, and KFDA Amarillo, Tex.

MEREDITH PUBLISHING CO. STATIONS—KCMO-AM-FM Kansas City, Mo.; KPHO Phoenix, Ariz.; WOW Omaha, Neb.

MCCAW-KEATING STATIONS — J. Elroy McCaw and John D. Keating own (50% each) KPOA Honolulu and KILA Hilo, Hawaii, and KYA San Francisco. Mr. McCaw also owns KORC Mineral Wells, Tex., half interest in KELE Centralia, Wash., and minority interests in KYAK Yakima and KALE Richland, Wash., and KLZ Denver.

MCCATCHY BROADCASTING CO.—(Owned by McClatchy Newspapers, publisher of the Sacramento Bee, Fresno Bee, and Modesto Bee): KFBK, KFBK-FM, Sacramento; KMJ, KMJ-FM, Fresno; KWG, Stockton; KERN, KERN-FM, Bakersfield; KBEI (FM), Modesto; KOH, Reno, Nev. Headquarters: 21st & Q Sts., Sacramento 4. President: Eleanor McClatchy.

MCLUNG STATIONS — KHSL, Chico; KYOS, KYME(FM), Merced; KVCV, KVRE(FM), Redding, all California.

MIDNIGHT SUN-AURORA BROADCASTING SYSTEM—KFAR Fairbanks, KENI Anchorage, KJNO Juneau, KABI Ketchikan, all Alaska. Miriam Dickey, president, Midnight Sun Broadcasting Co. Austin G. Cooley, president, Aurora Broadcasters Inc.

MIDWESTERN BROADCASTING CO. STATIONS—(Controlled by Les Biederman) WTCM Traverse City, WATT Cadillac, WATC, Gaylord, WATZ Alpena, and WMBN Petoskey, all in Michigan.

MORGAN MURPHY-WALTER C. BRIDGES STATIONS—WEBC, Duluth; WMPG, Hibbing, Minn.; WHLB, Virginia, Minn.; WEAU, Eau Claire, Wis.; WISC, Madison, Wis. Mr. Murphy also has an interest in KVCV, Lafayette, La. Mr. Bridges has interest in WJMC, Rice Lake, Wis.

NBC OWNED AND OPERATED STATIONS — WNBC, WNBC-FM, New York; WRC, WRC-FM, Washington; WMAQ, WMAQ-FM, Chicago; WTAM, WTAM-FM, Cleveland; KNBC, KNBC-FM, San Francisco. All members of NBC Radio network; all represented by NBC Spot Sales.

WAYNE M. NELSON STATIONS—WPET Greensboro, WHIP Mooresville and WAYN Rockingham, all North Carolina.

JAMES NOE STATIONS—KNOE Monroe, WNOE New Orleans, La.; KOTN Pine Bluff, Ark.

JAMES H. OTTAWAY STATIONS—WENE, Binghamton-Endicott, N. Y.; WDOS Oneonta, N. Y.; WVPO Stroudsburg, Pa.

PAGLIN-RAY STATIONS—WBOK New Orleans, KAOK Lake Charles, WXOK Baton Rouge, all Louisiana. Owned jointly by Jules J. Paglin and Stanley W. Ray Jr.

PEOPLES BROADCASTING STATIONS (Farm Bureau Insurance Co.)—WRFD Worthington, Ohio; WTTM Trenton, N. J.; WMMN Fairmont, W. Va.; WGAR-AM-FM Cleveland, Ohio.

JOHN H. PERRY STATIONS—WCOA, Pensacola, Fla.; WHP, Jacksonville, Fla.; WTMC, Ocala, Fla.; WDLF, Panama City, Fla., and 40% in WNDB Daytona Beach.

LOU POLLER STATIONS—WCAN Milwaukee; WPWA Chester, Pa.; WARL-AM-FM Arlington, Va.

RAHALL STATIONS — WKAP, Allentown, Pa.; WNAE, Norristown, Pa.; WNNR, Beckley, W. Va.; N. Joe Rahall, president.

ADELINE B. RINES STATIONS—WRDO Augusta, WLBZ Bangor, and WCSH Portland, all in Maine.

DEE RIVERS STATIONS — WEAS, Decatur; WJIV, Savannah; WGOV, Valdosta, all in Georgia; KWEM, West Memphis, Ark. E. D. Rivers Jr., chairman; W. H. Keller Jr., president.

E. D. RIVERS SR. STATIONS—WLBS, Birmingham; WOBBS, Jacksonville; WMIE, Miami.

JAMES RIVERS STATIONS — WMJM, Cordele; WJAZ, Albany; WTJH, East Point; WACL, Waycross, all in Georgia. Latter two stations are controlled by Mr. Rivers. William Blizzard, WMJM, Cordele, Ga.

CECIL W. ROBERTS STATIONS — KCLO Leavenworth, Kan.; KREI Farmington, Mo.; KCHI Chillicothe, Mo., and KCRB Chanute, Kan.

AARON B. ROBINSON STATIONS—WDXE Lawrenceburg, Tenn. (owner); WDXI Jackson, WTPR Paris and WENK Union City, Tenn. (majority stockholder); WMCA Corinth, Miss. (45.84% owner).

W. WAYNE & JOHN R. ROLLINS STATIONS—WNJR Newark, N. J.; WRAD Radford and WRAP Norfolk, Va.; WJWL Georgetown, Del., and WFAI Fayetteville, N. C.

ROUNSAVILLE STATIONS—WQXI Atlanta, Ga.; WLOU Louisville, Ky.; WCIN Cincinnati, Ohio; WMBM Miami Beach, Fla.; WBAC Cleveland, Tenn. R. W. Rounsaville, WQXI Atlanta, Ga.

RURAL RADIO NETWORK STATIONS (all FM)—WRRL Wethersfield, WRRE Bristol Center, WRRR Ihaca, WRDD Deuyter, WRRR Cherry Valley, WRRR Beacon, all New York.

SHELDON F. SACKETT STATIONS—KROW Oakland, Calif.; KVAN Vancouver, Wash.; KOOS Coos Bay, Ore.

SCRIPPS-HOWARD GROUP—Scripps-Howard Radio Inc. is licensee of WCPO-AM-FM, Cincinnati, WNOX, Knoxville. Memphis Publishing Co., is licensee of WMC, WMCF(FM), Memphis, all of which are operated separately. Officials: Jack R. Howard, 230 Park Ave., New York, president; Richard B. Westergaard, vice president and general manager, WNOX; Mortimer C. Watters, vice president and general manager, WCPO, WCPO-FM, Henry W. Slavick is general manager of WMC, WMCF(FM).

SEATON STATIONS — KMAN, Manhattan and KGGF, Coffeyville, Kans.; KHAS, Hastings, Neb. Owned by Fred A. and Richard M. Seaton.

STAUFFER PUBLICATIONS STATIONS — KSEE Pittsburg and KSOK Arkansas City, Kan.; KGFF Shawnee, Okla.

STEINMAN STATIONS—WGAL, WGAL-FM, Lancaster; WKBO, Harrisburg; WORK, York; WRAW, Reading; WEST, WEST-FM Easton, all Pa.; WDEL, WDEL-FM, Wilmington, Del. Headquarters: 8 West King St., Lancaster, Pa. Clair R. McCollough, general manager.

STORER BROADCASTING CO. STATIONS—WJBK, WJBK-FM, Detroit; WSPD, WSPD-FM Toledo; WWVA, WWVA-FM Wheeling, W. Va.; KGBS San Antonio, Tex.; WAGA, WAGA-FM Atlanta; WGBS, WGBS-FM Miami; WBRC Birmingham, Ala. George B. Storer, president; J. Harold Ryan, vice president and treasurer; Lee B. Wallis, executive vice president; Stanton P. Kettler, Southern District vice president; William E. Rine, Northern District vice president; John E. McCoy, secretary; Glenn G.

Boundy, director of engineering. Headquarters: 199 Pierce St., Birmingham, Mich. New York office: 488 Madison Ave. Tom Harker, vice president and national sales director; Arthur C. Schofield, advertising and sales promotion manager. Chicago office: 230 N. Michigan Ave. Robert C. Wood, midwest national sales manager.

TEDESCO STATIONS—WKLJ Sparta, Wis.; WCOW St. Paul, WKLK Cloquet, NEW Hutchinson, all Minn. Headquarters: WCOW St. Paul. Albert S. Tedesco.

TEXAS STATE NETWORK OWNED STATIONS—KFJZ Fort Worth, KRIO McAllen, WACO Waco, all in Texas. Headquarters: Fort Worth. Gene Cagle, president and general manager.

B.F.J. TIMM STATIONS — WMFS Chattanooga, Tenn.; WDMG Douglas, Ga.; WGAA Cedartown, Ga. Mr. Timm has controlling interest in all stations.

TOWN & FARM STATIONS (Don Searle)—KIOA Des Moines, Iowa; KMMJ Grand Island, Neb.; Colby, Kan.

UNITED BROADCASTING CO. — WOOK, WFAN(FM), Washington; WANT, Richmond, Va.; WARK, Hagerstown, Md.; WSID, Baltimore; WINX, Rockville, Md.; WJMO Cleveland, Ohio. Richard Easton, president. New York office: 507 Fifth Ave. Robert L. Wittig, manager.

UNIVERSAL BROADCASTING CO. — WISH, Indianapolis; WHBU, Anderson; WANE, Ft. Wayne; WHOT, South Bend, all in Indiana. C. Bruce McConnell, president.

UPPER MICHIGAN-WISCONSIN BCSTG. STATIONS—WJMS Ironwood, Mich.; WATW Ashland, Wis.; WIKB Iron River, Mich.

WM. J. WAGNER STATIONS—KFQD, Anchorage; KFRB, Fairbanks; KINY, Juneau; KTKN, Ketchikan, KIFW Sitka, and KIBH, Seward, all in Alaska.

WINSTON O. WARD STATIONS — KIMP Mt. Pleasant, Tex.; KBEL Idabel, Okla., and (NEW) Alexandria, La.

WESTINGHOUSE BROADCASTING CO. STATIONS—WBZ, WBZ-FM, Boston; WBZA, WBZA-FM, Springfield, Mass.; KDKA, KDKA-FM, Pittsburgh; KYW Philadelphia; WOWO Fort Wayne; KEX, KEX-FM, Portland, Ore. A subsidiary of Westinghouse Electric Corp. Headquarters: 1625 K St., N. W., Washington 6, D. C. Telephone: Sterling 3-0903. Officers: Chris J. Witting, president; Joseph E. Baudino, vice president and general manager; Eldon Campbell, general sales manager; D. G. Partridge, advertising manager; Gordon Hawkins, program and educational director; J. O. Schertler, industrial relations manager; I. C. Ruby, auditor; Ralph N. Harmon, engineering manager; George E. Harkerty, asst. engineering manager; D. A. Myer, technical-field director; John W. Steen, legal representative.

J. W. WOODRUFF STATIONS — WATL Atlanta, WRBL, Columbus, WGFC, Albany, all Georgia.

FM STATIONS AUTHORIZED IN U. S.

(Based upon records of FCC)

Date	Under Licensed	Construction	Cond'l. Grant	Experim. mental	Total Authorized	On the Air
June 30, 1940	50
June 30, 1941	69
June 30, 1942	74
June 30, 1943	26	74	...
June 20, 1944	6	58	...
June 30, 1945	3	56	...
July 1, 1946	456	55
July 1, 1947	918	238
Dec. 31, 1947	84	703	223	...	926	458
May 1948	1,035	...
June 30, 1949	377	488	865	737
Dec. 31, 1949	478	315	788	733
June 30, 1950	493	237	2	...	732	691
Dec. 31, 1950	519	183	1	...	703	676
June 30, 1951	534	124	1	...	659	649
Jan. 1, 1952	564	86	650	637
June 30, 1953	551	50	601	580
Jan. 1, 1954	533	47	580	560

NARTB STANDARDS OF PRACTICE FOR AMERICAN BROADCASTERS

(Effective July 1, 1948)

THE BROADCASTERS' CREED

We Believe:

That American Broadcasting is a living symbol of democracy; a significant and necessary instrument for maintaining freedom of expression, as established by the First Amendment to the Constitution of the United States;

That its influence in the arts, in science, in education, in commerce and upon the public welfare, generally, is of such magnitude that the only proper measure of its responsibility is the common good of the whole people;

That it is our obligation to serve the people in such manner as to reflect credit upon our profession and to encourage aspiration toward a better estate for all mankind; by making available to every person in America, such programs as will perpetuate the traditional leadership of the United States in all phases of the broadcasting art;

That we should make full and ingenious use of man's store of knowledge, his talents and his skills and exercise critical and discerning judgment concerning all broadcasting operations to the end that we may, intelligently and sympathetically:

¶ Observe the proprieties and customs of civilized society;

¶ Respect the rights and sensitivities of all people;

¶ Honor the sanctity of marriage and the home;

¶ Protect and uphold the dignity and brotherhood of all mankind;

¶ Enrich the daily life of the people through the factual reporting and analysis of the news, and through programs of education, entertainment and information;

¶ Provide for the fair discussion of matters of general public concern; engage in works directed toward the common good; and volunteer our aid and comfort in times of stress and emergency;

¶ Contribute to the economic welfare of all, by expanding the channels of trade; by encouraging the development and conservation of natural resources; and by bringing together the buyer and seller through the broadcasting of information pertaining to goods and services.

Therefore:

As a guide for the achievement of our purpose, we subscribe to the following:

PROGRAM STANDARDS*

News

News reporting should be factual, fair and without bias. Commentary and analysis should be clearly identified as such.

Good taste should prevail in the selection and handling of news. Morbid, sensational or alarming details not essential to the factual report, especially in connection with stories of crime or sex, should be avoided. News should be broadcast in such a manner as to avoid panic and unnecessary alarm.

Broadcasters should exercise due care in their supervision of content, format, and presentation of news broadcasts originated by them; and in their selection of newscasters, commentators and analysts.

Broadcasters should exercise particular discrimination in the acceptance and placement of advertising in news programs. Such advertising should be appropriate to the program, both as to content and presentation, and should be distinctly set apart from the news content.

In programs of news, news commentary and news analysis which are less than ten minutes in length, no more than two commercial announcements should be used and they should be given at or near the beginning and end of the program.

Agricultural and market newscasts should be governed by the same general standards applicable to news broadcasts.

Political Broadcasts**

Political broadcasts, or the dramatization of political issues designed to influence an election should, if accepted, be properly identified as such.

* Standards for broadcasting can never be final or complete. Broadcasting is a creative art, still in the process of development, and as such it must always seek new ways to achieve greater results. Therefore, any standards promulgated must be subject to change.

** Because of the present confusion concerning the laws with respect to political broadcasts, broadcasters are advised to consult their lawyers in all cases where they have the least doubt as to the proper method of handling.

Public Affairs and Issues

A broadcaster, in allotting time for the presentation of public questions, including those of a controversial nature, should use his best efforts to insure fair presentation. Such time should be allotted with due regard to all other elements of balanced program schedules, and to the degree of interest on the part of the public in the question to be presented.

Discussions of controversial public issues should be presented on programs specifically intended for that purpose, and they should be clearly identified as such.

The presentation of controversial public issues should be made by properly identified persons or groups.

Freedom of expression of opinion in broadcasts of controversial public issues should be carefully maintained, but the right should be reserved to refuse them for noncompliance with laws such as those prohibiting defamation and sedition.

Religious Programs

Broadcasting, which reaches men of all creeds simultaneously, should avoid attacks upon religion. Religious programs should be presented respectfully and accurately, and without prejudice or ridicule.

Religious programs should be presented by responsible individuals, groups and organizations.

Religious programs should place emphasis on broad religious truths, excluding the presentation of controversial or partisan views not directly or necessarily related to religion or morality.

Children's Programs

Children's programs should be based upon sound social concepts and should reflect respect for parents, law and order, clean living, high morals, fair play and honorable behavior.

They should convey the commonly accepted moral, social and ethical ideals characteristic of American life.

They should contribute to the healthy development of personality and character.

There should be no appeals urging children to purchase the product in order to keep the program on the air, or which for any purpose encourage children to enter strange places or to converse with strangers.

Educational

Every radio program performs an educational function. Broadcasters should recognize the great responsibilities thus imposed, in planning their programs, to insure the most beneficial service to all listeners.

Broadcasters should cooperate with educators and with educational groups in developing improved techniques of broadcasting, as well as those processes of education best calculated to produce expert and skillful personnel.

Crime and Mystery Programs

In determining the acceptability of any program containing any element of crime, horror or mystery, due consideration should be given to the possible effect on all members of the family.

If the techniques and methods of crime are presented it should be done in such a way as not to encourage imitation; criminals should be punished, specifically or by implication; and programs which tend to make the commission of crime attractive should not be permitted.

Such programs should avoid the following subject matter:

¶ Detailed presentation of brutal killings, torture or physical agony, horror, the use of supernatural or climactic incidents likely to terrify or excite unduly.

¶ Episodes involving the kidnapping of children.

¶ Sound effects calculated to mislead, shock or unduly alarm the listener.

¶ Disrespectful portrayal of law enforcement; and characterization of officers of the law as stupid or ridiculous.

¶ Suicide as a satisfactory solution to any problem.

General

Sound effects and expressions characteristically associated with news broadcasts (such as "bulletin," "flash," etc.) should be reserved for announcement of news, and the use of any deceptive techniques in

connection with fictional events and non-news programs should be unacceptable.

When plot development requires the use of material which depends upon physical or mental handicaps it should be used in such a way as to spare the sensibilities of sufferers from similar defects.

The regular and recurrent broadcasting, in advance of sports events, of information relating to prevailing odds, the effect of which could be expected to encourage gambling, should not be permitted.

Simulation of court atmosphere or use of the term "Court" in a program title should be done only in such a manner as to eliminate the possibility of creating the false impression that the proceedings broadcast are vested with judicial or official authority.

In cases of programs broadcast over multiple station facilities, the originating station should assume responsibility for conforming such programs to these Standards of Practice.

ADVERTISING STANDARDS

Advertising is the life blood of the free, competitive American system of broadcasting. It makes possible the presentation, to all the American people, of the finest programs of entertainment, information and culture.

Diligence should be exercised to the end that advertising copy accepted for broadcasting complies with pertinent federal, state and local laws. Acceptance of advertising should be predicated upon such considerations as the integrity of the advertiser, the quality of the product, the value of service, and the validity of claims made.

In accepting advertising the broadcaster should exercise great care that he is not conveying to his audience information which is misleading, dangerous to health or character, distasteful or contrary to the proprieties and customs characteristic of his audience, or in violation of business and professional ethics.

Advertising copy should contain no claims intended to disparage competitors, competing products, or other industries, professions or institutions.

Advertising copy should contain no claims that a product will effect a cure.

Good taste should always govern the content, placement and presentation of announcements. Disturbing or annoying sound effects and devices, blatant announcing and over-repetition should be avoided.

Time Standards for Advertising Copy

As a guide to the determination of good broadcast advertising practice, the time standards for advertising copy are established as follows:

The maximum time to be used for advertising, allowable to any single sponsor, regardless of type of program, should be:

Between 6:00 p.m. and 11:00 p.m.

5 minute programs	1:00
10 minute programs	2:00
15 minute programs	2:30
25 minute programs	2:50
30 minute programs	3:00
45 minute programs	4:30
60 minute programs	6:00

All Other Hours

5 minute programs	1:15
10 minute programs	2:10
15 minute programs	3:00
25 minute programs	4:00
30 minute programs	4:15
45 minute programs	5:45
60 minute programs	7:00

The time standards allowable to a single advertiser do not affect the established practice of allowance for station breaks between programs.

All multiple sponsorship or announcement programs, except as hereinafter provided, are subject to the limitation of a maximum of three minutes of advertising per fifteen minute segment, excluding station breaks. Such programs of half hour, three-quarter hour and hour duration are subject to appropriate multiples of that limitation.

Recognizing that such programs as shopping guides, market information, rural news, and the like render a definite service to the listening public, time standards for such programs may be waived for a total of one hour a broadcast day, but care should be exercised to preserve proper program balance in their distribution.

While any number of products may be advertised by a single sponsor within the specified time standards, advertising copy for these products should be presented within the framework of the program structure. Accordingly the use on such programs of simulated spot announcements which are divorced from the program by preceding the introduction of the program itself, or by following its apparent sign-off should be avoided. To this end the program itself should be announced and clearly identified before the use of what have been known as "cow-catcher" announcements and the program should be signed off after the use of what have been known as "hitch-hike" announcements.

Any casual reference in a program to another's

INTERNATIONAL STATIONS IN THE U. S.

INTERNATIONAL BROADCAST STATIONS Of the United States

(Operating in 6-25 mc band with powers up to 200 kw)

CBS—WDSI, six installations at Brentwood, N. Y., and Wayne, N. J.

KCBR, five installations at Delano, Calif.

NBC—WRCA, six installations at Bound Brook, N. J.

KRCA, five installations at Dixon, Calif.

General Electric Co.—WGEQ, three installations at Schenectady, N. Y.

KEGI, two installations at Belmont, Calif.

Crosley Corp.—WLWO, eight installations at Mason and Bethany, Ohio.

Associated Broadcasters Inc.—KWID, two installations at San Francisco.

World Wide Broadcasting Corp.—WRUL, five installations at Scituate, Mass.

Note: Up until last year, the U. S. international shortwave stations were programmed under contract to the Voice of America. Some continue to be programmed by the International Broadcasting Service of the U. S. Information Agency, but World Wide, Associated and General Electric's Belmont installations are no longer under government contract.

Canadian Stations

Canadian Broadcasting Corp.—Has some two dozen international installations, mostly at Vercheres, Que., and Sackville, N. B.

Privately Owned Installations—Canadian Marconi Co., Montreal; Rogers Radio Broadcasting Co., Toronto; Voice of the Prairies Ltd., Calgary, Alta; Maritime Broadcasting Co., Halifax, N. S.; Eastern Broadcasters Ltd., Sydney, N. S.; Transcanada Communications Ltd., Winnipeg, Man.; Western Broadcasting Co., Vancouver, B. C.; Edmonton Journal Ltd., Edmonton, Alta.

product or service under any trade name, or language sufficiently descriptive to identify it, should, except for normal guest identifications, be avoided. If used, it should be considered as advertising copy and, as such a part of and included in the total time allowances as herein provided.

The placement of more than one commercial announcement between two commercial programs should not be permitted except in those instances when one of the two announcements is a sponsored time signal, weather report, station promotion or location announcement of not to exceed a total of ten seconds in length.

Contests

Any broadcasting designed to "buy" the radio audience, by requiring it to listen in hope of re-

ward, rather than for the quality of its entertainment, should be avoided.

Contests should offer the opportunity to all contestants to win on the basis of ability and skill, rather than chance.

All contest details, including rules, eligibility requirements, opening and termination dates should be clearly and completely announced or easily accessible to the listening public, and the winners' names should be released as soon as possible after the close of the contest.

When advertising is accepted which requests contestants to submit items of product identification or other evidence of purchase of product, reasonable facsimiles thereof should be made acceptable.

All copy pertaining to any contest (except that which is required by law) associated with the exploit-

ation or sale of the sponsor's product or service, and all references to prizes or gifts offered in such connection should be considered a part of and included in the total time allowances as herein provided.

Premiums and Offers

Full details of proposed offers should be submitted to the broadcaster for investigation and approval before the first announcement of the offer is made to the public.

A final date for the termination of an offer should be announced as far in advance as possible.

If a consideration is required, the advertiser should agree to honor complaints indicating dissatisfaction with the premium by returning the consideration.

There should be no misleading descriptions or comparisons of any premiums or gifts which will distort or enlarge their value in the minds of the listeners.

RADIO REPRESENTATIVES

(Continued from page 28)

WLS Lansing, Mich. KWBE Hutchinson, Kan.
 WMAN Mansfield, Ohio Kan.
 WPAY Portsmouth, Ohio KTXL San Angelo, Tex.
 WPJB Providence, R. I. KTBB Tyler, Tex.
 KCMC Texarkana, Tex. KWKC Abilene, Tex.
 The Oklahoma Network

THE WALKER REPRESENTATION CO. INC.

New York 17-347 Madison Ave. Tel.: Murray Hill 3-5830. Pres.: Wythe Walker; V.P.: C. Otis Rawait.
 Chicago 1-360 N. Michigan Ave. Tel.: Andover 3-5771. Mgrs.: Wythe Walker, Ralph C. Kelley.
 Kansas City-1012 Baltimore St. Tel.: Victor 0021. Mgr.: William Temple.
 Los Angeles 5-872 S. Lafayette Park Pl. Tel.: Fairfax 3200. Mgr.: Harlan Oakes.
 San Francisco-Russ Bldg. Mgr.: Norm Cunningham.
 Atlanta-1128-A Mortgage Guarantee Bldg. Tel.: Alpine 1241. Mgr.: Tom Atkinson.
 Minneapolis-1687 N.W. National Bldg. Tel.: Geneva 9631. Mgr.: Orville Lawson.

Represents:

WOLF Syracuse, N. Y. KXL Portland, Ore.
 WELM Elmira, N. Y. KXLF Butte, Mont.
 WSAW Rochester, N. Y. WSPC Anniston, Ala.
 WBRK Pittsfield, Mass. WBBQ Augusta, Ga.
 WNBH New Bedford, Mass. WJEM Quincy, Ill.
 WLEC Muncie, Ind. WJER Hagerstown, Md.
 WJAG Norfolk, Neb. WJBR Winston-Salem, N. C.
 KLPB Minot, N. D. WJMK Florence, S. C.
 WRJN Racine, Wis. WNOR Norfolk, Va.
 WATW Ashland, Wis. WFNC Fayetteville, N. C.
 WGRS Louisville, Ky. WPLH Huntington, W. Va.
 WDEV Waterbury, Vt. WPLH Huntington, W. Va.
 WATC Nashua, N. H. KGRH Fayetteville, Ark.
 KAKC Tulsa, Okla. WJMS Ironwood, Mich.
 WKBB Iron Mountain, Mich. WJEB Fitchburg, Mass.
 WDBC Escanaba, Mich. WTXL Springfield, Mass.
 WHDF Calumet, Mich. WGTM Wilson, N. C.
 WWOD Lynchburg, Va. WJAR Norristown, Pa.
 KENT Shreveport, La. WWRN Beckley, W. Va.
 WAPX Montgomery, Ala. WWRV Ann Arbor, Mich.
 WJRD Tuscaloosa, Ala. WATL Atlanta, Ga.
 KXLY Spokane, Wash. WFCB Dunkirk, N. Y.

Pacific Northwest Broadcasters Z-Bar Network, Montana

GRANT WEBB

New York 17-270 Park Ave. Tel.: Murray Hill 8-4254. Owner: Grant Webb.
 Stations represented not listed

WEED & CO.

New York-350 Madison Ave. Tel.: Murray Hill 7-7772. Mgr.: Joseph J. Weed.
 Chicago-203 N. Wabash Ave. Tel.: Randolph 6-7730. Mgr.: C. C. Weed.
 Detroit-Book Bldg. Tel.: Woodward 1-2685. Mgr.: Bernard Pearse.
 San Francisco-625 Market St. Tel.: Douglas 2-1451. Mgr.: Don Staley.
 Boston-Stallier Bldg. Tel.: Hubbard 2-5677. Mgr.: Robert Reardon.
 Hollywood-6331 Hollywood Blvd. Tel.: Hillside 8611. Mgr.: Lincoln Simonds.
 Atlanta-Glenn Bldg. Tel.: Cypress 4081. Mgr.: George Swearingen.

Represents:

WARD Johnstown, Pa. WKWK Wheeling, W. Va.
 KIMA Yakima, Wash. WBAV Green Bay, Wis.
 WTAD Quincy, Ill. WJWJ Montgomery, W. Va.
 WKNA Charleston, S. C. WJWW St. Petersburg, Fla.
 WSUN St. Petersburg, Fla.
 KTFI Twin Falls, Idaho WIOU Kokomo, Ind.
 WSOY Decatur, Ill. KPLC Lake Charles, La.
 WTAX Springfield, Ill. KRMD Shreveport, La.
 WGBF Evansville, Ind. WIMA Lima, Ohio
 WBOW Terre Haute, Ind. WKAP Allentown, Pa.
 KGLO Mason City, Iowa WKAM Altoona, Pa.
 KSDN Aberdeen, S. D.

KGGF Coffeyville, Kan.
 KALB Alexandria, La. WRDO Augusta, Me.
 WLBZ Bangor, Me. WSLH Portland, Me.
 WJSS Jackson, Miss. KFBB Great Falls, Mont.
 WMUR Manchester, N. H.
 KGCM Albuquerque, N. M.
 WWNY Watertown, N. Y.
 WAKR Akron, Ohio KQV Pittsburgh
 WJAR Providence, R. I.
 WACO Waco, Tex. WCAX Burlington, Vt.
 New England Regional Network
 Marjorie Mills Hour
 Canadian Stations:
 CFAC Calgary, Alta. CHAB Moose Jaw, Sask.
 CJCA Edmonton, Alta. CKCK Regina, Sask.
 CFGP Grand Prairie, Alta. CKNB Campbellton, N. B.
 CJOC Lethbridge, Alta. CFNB Fredericton, N. B.
 CJAT Trail, B. C. CFCF Montreal, Que.
 CKWV Vancouver, B. C. CFCY Charlottetown, P. E. I.
 CJVI Victoria, B. C. CHAT Medicine Hat, Alta.
 CFBC St. John, N. B. CFPL London, Ont.
 CFPA Port Arthur, Ont. CFRA Ottawa, Ont.
 CHNS Halifax, N. S. CKCV Quebec City
 CJCB Sydney, N. S. CFJC Kamloops, B. C.
 CKRC Winnipeg, Man. CKVO Kelowna, B. C.
 CKSO Sudbury, Ont. CJCS Stratford, Ont.
 CKOC Hamilton, Ont. CKOM Saskatoon, Sask.

GILBERT A. WELLINGTON

Seattle-5546 White-Henry-Stuart Bldg. Tel.: Seneca 6682.

Represents:

Midnight Sun-Aurora Broadcasting System
 KFAR Fairbanks KJNO Juneau
 KENI Anchorage KABI Ketchikan

WESTERN RADIO SALES

Hollywood 28-1540 N. Highland Ave. Tel.: Hollywood 9-8229. Mgr.: Carl Schuele.
 San Francisco-79 Post St. Tel.: Yukon 6-4112. Mgr.: Daren F. McGavren.

Represents:

KAFP Petaluma, Calif. KRNO San Bernardino, Calif.
 KAJO Reno, Nev. KTKR Taft, Calif.
 KAVL Lancaster, Calif. KUKI Ukiah, Calif.
 KCMJ Palm Springs, Calif. KWSD Mt. Shasta, Calif.
 KGYW Vallejo, Calif. KWSO Wasco, Calif.
 KTHM Eureka, Calif. KXOA Sacramento, Calif.
 KIBS Bishop, Calif. KXOC Chico, Calif.
 KJRL Pocatello, Idaho
 KMOD Modesto, Calif.

WGN CHICAGO

New York-220 E. 42d St. Tel.: Murray Hill 2-3033. Mgr.: Ben H. Berentson.

WLW CINCINNATI

Chicago-360 N. Michigan Ave. Tel.: State 2-6693. Mgr.: Harry F. Albrecht.
 New York-630 Fifth Ave. Tel.: Circle 6-1616. Mgr.: Bernard Musnik.

ADAM J. YOUNG JR. INC.

New York 16-22 East 40th St. Tel.: Murray Hill 9-0006. Mgr.: Adam J. Young Jr.
 Chicago 2-55 East Washington St. Tel.: Andover 3-5448. Mgr.: William J. Reilly.
 St. Louis-7 North 7th St. Tel.: Maine 5020. Mgr.: Jack Hetherington.
 Los Angeles 28-Guaranty Bldg., 6331 Hollywood Blvd. Tel.: Hollywood 9-0965. Mgr.: William L. Wallace.

Represents:

CKLW Detroit, Mich. WJAC Johnstown, Pa.
 KCIJ Shreveport, La. WKRG Mobile, Ala.
 KLAC Los Angeles, Calif. WKXL Concord, N. H.
 KTRM Beaumont, Tex. WICC Bridgeport, Conn.
 WKMI Kalamazoo, Mich. WPIC Youngstown, Ohio
 WLEU Erie, Pa. KULA Honolulu, Hawaii
 WAFB Baton Rouge, La. WABI Bangor, Me.

WFEA Manchester, N. H. WBNY Buffalo, N. Y.
 WIL St. Louis

Canadian Stations:

CFAB Windsor, N. S. CJCH Halifax, N. S.
 CFAR Flin Flon, Man. CJEM Edmundston, N. B.
 CFCN Calgary, Alta. CJFP Riviere de Loup, Que.
 CFRJ Brockville, Ont. CJFX Antigonish, N. S.
 CFOS Owen Sound, Ont. CJGX Yorkton, Sask.
 CFQC Saskatoon, Sask. CJOB Winnipeg, Man.
 CFRB Toronto, Ont. CJOR Vancouver, B. C.
 CFRN Edmonton, Alta. CKBB Barrie, Ont.
 CHTL Sherbrooke, Que. CKAC Montreal, Que.
 CKTS Sherbrooke, Que. CKCR Kitchener, Ont.
 CHML Hamilton, Ont. CKCW Moncton, N. B.
 CHNC New Carlisle, Que. CKDM Dauphin, Man.
 CHV Sudbury, Ont. CKLD Thetford Mines, Que.
 CHOV Pembroke, Ont. CKLN Nelson, B. C.
 CFPF Prince Rupert, B. C. CKLW Windsor, Ont.
 CKBL Matane, Que. CKRM Regina, Sask.
 VOXM St. John's, Newfoundland. CKRS Jonquiere, Que.
 CHRC Quebec, P. Q. CKX Brandon, Man.
 CHSJ Saint John, N. B. CKVM Ville Marie, Que.
 CJAD Montreal, Que. CHLO St. Thomas, Ont.
 CJRO Belleville, Ont.
 CJBR Rimouski, Que.

ADAM YOUNG INTERNATIONAL LTD.

New York 16-22 East 40th St. Tel.: Murray Hill 3-6196. Pres.: Adam J. Young Jr.; Gen. Mgr.: Stephen A. Mann.
 Chicago 2-55 E. Washington St. Tel.: Andover 3-5448. Mgr.: William J. Reilly.
 St. Louis-7 North 7th St. Tel.: Maine 5020. Mgr.: Jack Hetherington.
 Los Angeles 28-Guaranty Bldg., 6331 Hollywood Blvd. Tel.: Hollywood 9-0965. Mgr.: William L. Wallace.

Export Stations

U. S. Territories and Possessions
 PUERTO RICO VIRGIN ISLANDS
 WKVM San Juan WSTA St. Thomas

Foreign Stations:

BAHAMAS
 ZNS Nassau
 BARBADOS
 "Rediffusion" Bridgetown
 BERMUDA
 ZBM Pembroke
 BRITISH GUIANA
 ZFY Georgetown
 COSTA RICA
 TIGPH "Alma Tica" San Jose
 TIBAS "Radio Monumental" San Jose
 TIGPH2 "Nueva Alma Tica" San Jose
 GUAM
 KUAM, Agana Foreign Stations
 HAITI
 4VW-4VMV Port-au-Prince
 4VW-4VRW Port-au-Prince
 HONDURAS
 HRLP "Radio America" Tegucigalpa
 HONG KONG
 "Rediffusion" Hong Kong
 JAMAICA
 "Radio Jamaica," Cross Roads
 MALAYA
 "Rediffusion" Penang
 MALTA
 "Rediffusion" Valetta
 MEXICO
 XEX "La Voz de Mexico" Mexico City
 NICARAGUA
 YNW-YNWA "Radio Mundial" Managua
 YNWW "Radio Sport" Granada
 PANAMA
 Spanish Only:
 HOA-HOB-HP5G "Radio Panamericana" Panama City
 HOW "Radio Panamericana" Col'or
 English Only:
 HOG Panama City
 PERU
 OBX4X-OBX4Q "Radio El Sol" Lima
 SALVADOR
 YSDF San Salvador
 YSDR Santa Ana
 SINGAPORE
 "Rediffusion" Singapore
 TANGIER
 "Radio Africa" Tangier
 TRINIDAD
 "Radio Trinidad" Port of Spain

MEREDITH STATIONS

Give You COMPLETE COVERAGE Of These Three "SUPER" Markets!

- Population: 2,660,300
Retail Sales: \$2,927,737,000
Counties: 170 in Nebraska, Iowa, Kansas,
South Dakota, Minnesota and
Missouri

Truly a "SUPER" Market sold by WOW,
5000 watts on 590. NBC for 26 years.
Represented by John Blair.



- Population: 683,500
Retail Sales: \$749,749,000
Counties: 7 in Arizona

Truly a "SUPER" Market sold by KPHO,
5000 watts on 910. ABC. Best buy in
Phoenix radio! Represented by The Katz
Agency.



- Population: 5,663,200*
Retail Sales: \$5,354,424,000*
Counties: 213 in Missouri, Iowa, Illinois,
Nebraska, Kansas and Okla-
homa.*

Truly a "SUPER" Market sold by KCMO,
Greater Kansas City's only 50,000 watt
station (10,000 watts nighttime). 810 kc.,
ABC. Represented by The Katz Agency.

*DAYTIME COVERAGE AREAS



It's Good to Know "It's a Meredith Station"

WOW & WOW-TV, Omaha . . . WHEN, Syracuse . . . KPHO & KPHO-TV, Phoenix . . . KCMO & KCMO-TV, Kansas City

Affiliated with Better Homes and Gardens . . . Successful Farming Magazines

SOURCE: SALES MANAGEMENT'S "SURVEY OF BUYING POWER", MAY 10, 1953

DIRECTORY OF AM AND FM STATIONS AND MARKET DATA FOR THE UNITED STATES

(For complete listing of TV Stations see TELECASTING Yearbook)

ALABAMA

MARKET DATA BY COUNTIES

County	Population 1950	Radio Families 1953	Retail Sales 1952(000)	Food Sales 1952(000)	Drug Sales 1952(000)	Passenger Cars 1953	County	Population 1950	Radio Families 1953	Retail Sales 1952(000)	Food Sales 1952(000)	Drug Sales 1952(000)	Passenger Cars 1953
Autauga	18,186	3,600	\$ 6,306	\$ 2,716	\$ 203	2,849	Jefferson	558,928	156,220	586,202	144,185	14,583	126,208
Baldwin	40,997	10,200	28,458	8,235	885	10,160	Lamar	16,441	3,710	4,893	1,391	141	2,409
Barbour	28,892	5,680	13,757	4,258	396	3,940	Lauderdale	54,179	13,850	41,667	9,777	1,129	11,987
Bibb	17,987	3,770	8,160	2,067	161	2,286	Lawrence	27,128	5,690	7,434	2,732	322	3,083
Blount	28,975	6,850	11,104	3,189	230	3,908	Lee	45,073	9,630	29,285	8,504	1,129	7,603
Bullock	16,054	2,590	5,024	1,529	178	1,544	Limestone	35,766	8,070	18,002	5,035	485	5,756
Butler	29,228	5,960	16,723	4,599	398	4,399	Lowndes	18,018	2,970	5,241	1,145	34	1,555
Calhoun	79,539	20,300	66,496	19,559	1,964	20,432	Macon	30,561	5,420	10,914	3,881	275	3,678
Chambers	39,528	9,250	11,755	4,089	652	8,049	Madison	72,903	18,140	58,331	12,250	1,285	16,420
Cherokee	17,634	3,840	4,967	1,290	101	3,349	Marion	29,494	5,290	14,976	3,406	369	3,203
Chilton	26,922	6,280	11,716	3,225	339	4,140	Marshall	27,264	6,410	12,329	3,414	298	4,005
Choctaw	19,152	3,540	6,774	1,499	77	2,026	Mobile	45,090	11,280	35,997	7,499	984	9,124
Clarke	26,548	5,460	21,069	2,963	480	4,104	Montgomery	231,105	64,030	214,662	57,177	9,763	56,525
Clay	13,929	3,090	5,351	1,696	207	2,407	Monroe	25,732	4,970	11,421	3,008	206	3,531
Cleburne	11,904	2,780	3,344	1,141	66	2,230	Morgan	138,965	35,550	139,582	30,379	3,708	32,319
Colbert	30,720	6,730	13,013	4,007	395	6,624	Perry	52,924	13,820	44,309	12,263	917	10,834
Conecuh	39,561	9,940	32,392	9,500	1,053	9,520	Pickens	20,439	3,340	8,531	2,032	232	2,028
Coosa	21,776	4,070	7,601	2,296	166	2,398	Pike	24,349	4,690	10,329	2,601	287	3,058
Covington	11,766	2,490	4,183	1,683	140	2,067	Randolph	30,608	6,510	15,680	4,502	565	4,668
Crenshaw	40,373	9,300	23,614	6,984	871	8,283	Russell	22,513	4,940	10,672	3,155	224	3,672
Cullman	18,981	3,910	8,212	2,187	154	2,599	St. Clair	40,364	8,490	10,455	3,511	300	7,686
Dale	49,046	11,650	20,946	6,415	556	8,270	Shelby	26,687	6,160	10,618	3,959	367	4,620
Dallas	20,828	4,640	8,716	3,676	380	4,905	Sumter	30,352	6,970	12,432	5,681	334	4,781
DeKalb	56,270	11,640	38,189	9,465	1,239	9,897	Talladega	23,610	4,110	9,252	1,683	157	2,310
Elmore	45,048	10,990	19,160	5,085	420	7,183	Tallapoosa	63,639	14,730	43,587	14,081	1,285	12,011
Escambia	31,649	6,850	14,493	4,905	452	5,895	Tuscaloosa	35,074	8,140	21,654	6,501	900	6,945
Fayette	31,443	6,540	24,136	5,972	587	6,383	Walker	94,092	21,550	61,236	17,263	2,206	17,490
Franklin	93,892	25,560	80,321	21,431	2,180	22,668	Washington	63,769	14,940	39,176	14,856	958	9,848
Geneva	19,388	4,430	8,422	2,083	171	3,228	Wilcox	15,612	3,460	4,536	1,639	30	2,036
Greene	16,482	2,780	7,822	1,682	189	1,502	Winston	23,476	3,810	6,347	1,644	87	1,776
Hale	20,832	3,690	7,336	2,014	221	2,072		18,250	4,230	8,016	2,010	235	2,684
Henry	18,674	3,620	8,098	1,733	251	2,878							
Houston	46,522	11,340	42,733	9,460	1,102	10,948							
Jackson	38,998	8,500	14,958	3,117	356	5,632							

Total: 3,061,743 734,790 \$2,141,464 \$563,974 \$61,829 777,285
 Note: Population 1950 Census; radio families Standard Audit & Measurement Services Inc.; food, drug and retail sales, copyright 1953 Sales Management; further reproduction unlicensed; automobiles supplied by state.

DIRECTORY OF AM AND FM STATIONS

City	Call Letters	Chan. or Freq. Power	Established	Licensee Headquarters Telephone	Network Representative	Owner or Pres. p; Exec. up exp; Gen. Mgr. gm; Sta. Mgr. sm; Coml. Mgr. cm; Sales Mgr. slm; Prog. Dir. pd; Chief Eng. ce; Prom. Mgr. pmm; Prod. Mgr. pdm; News, Farm, Sports or Women's Dir. nd, fd, sd, wd.	Executive Abbreviations	Market Data For Primary Area (Supplied by station)	Library, News Serv. Transmitter
ALBERTVILLE									
	WAVU	630	1948	Sand Mt. Bcstg. Co. P. O. Box 250 630	Alabama	Pat M. Courington, o gm & m Bob H. Riseling, cm	Mel Evans, pd & sd Robert Finney, fd	Bill Hoffman, ce Jesse Culp, fd	Wid. AP G
	WAVU-FM	Ch. 286 (B) 105.1mc 4.5kw	1949						
ALEXANDER CITY									
	WRFS	1050	1947	Piedmont Service Corp. 12 Main St. Adams 4-2566	KBS Sears & Ayer	James L. Coley, p James W. Whately, gm, cm, pmm & ce	Bob McKinnon, pd, nd & fd	Bill Buchanan, sd Charlene Price, wd	Pop.: 54,000 Rad. Hms.: 14,500 Wid. UP Ray.
	WRFS-FM	Ch. 291 (B) 106.1mc 4.6kw	1949						Wid., Thes. UP REL
ANDALUSIA									
	WCTA	1340	1946	Andalusia Bcstg. Co. P. O. Box 29 1100	MBS. KBS Walker, Dora-Clayton	J. Dige Bishop, p & gm Donald Cooke, cm	Christine Hardage, pd Bart Pryor, pmm & fd Wes Gardner, ce	Howell Pebworth, nd & sd Barbara Nicholson, wd	Pop.: 30,000 Rad. Hms.: 1,500 Ret. Sis.: \$25,000,000 Wid. AP RCA
	WCTA-FM	Ch. 251 (B) 98.1mc 10.5kw	1950						Pop.: 200,000 Rad. Hms.: 25,000 Ret. Sis.: \$50,000,000 Wid., Thes. AP Col.
	WLSA (CP)	920	1,000-D	Montezuma Bcstg. Co. Box 806 995		Marion S. Davis, gm	Chas. J. Ward, ce		Pop.: 113,542 Rad. Hms.: 23,654 Ret. Sis.: \$27,032,627
ANNISTON									
	WANA (CP)	1490	250	Anniston Radio Co. P. O. Box 937 Gadsden, Ala.		C. L. Graham, co-o	E. H. Estes, co-o		Pop.: 100,000 Rad. Hms.: 38,000
	WHMA	1450	250	Anniston Bcstg. Co. Radio Bldg. 2380	ABC. Alabama Bcstg. Sears & Ayer	Harry M. Ayers, p Malcolm B. Street, gm, cm & sd	Rosamond Ponder, pd Teena Taylor, pmm & wd James A. Hudson, ce	E. Cody Hall, nd Sam Jones, fd	Wid. UP Col.
	WHMA-FM	Ch. 263 (B) 100.5mc 3.65kw	1947						Thes. UP GE
	WSPC	1390	1,000-D	Model City Bcstg. Co. Jefferson Davis Hotel 1850	MBS. Walker, Dora-Clayton	W. S. Weatherly, p & gm John M. Orrison, cm Rosebud Waldrop, pd	Carroll B. Keith, pmm Winfred B. Kennedy, ce Bill Nash, nd	S. A. Matthews, fd Buddy Rutledge, sd Sara F. Jackson, wd	Pop.: 150,000 Rad. Hms.: 37,800

Data corrected to Dec. 10, 1953. If executives or services for FM are same as AM affiliate names are not repeated. Market Data supplied by stations.
 FM's in italic. *—Non-Commercial Station. CP—Construction Permit issued. D—Day. DA—N—Directional Antenna, night only. DA-1—Directional Antenna, same pattern day and night. DA-2—Directional Antenna, different pattern day and night. L—Limited Time with Dominant Station. LS—Local Sunset. N—Night. SA—Special Authorization. SH—Specified Hours. ST—Share Time. Complete key to abbreviations, page 6.

ALABAMA

City	Call Letters Established TV Affiliate	Chan. or Freq. Power	Licensee Headquarters Telephone	Network Represent- ative	Executive Abbreviations Owner o; Pres. p; Exec. vp evp; Gen. Mgr. gm; Sta. Mgr. sm; Coml. Mgr. cm; Sales Mgr. sim; Prog. Dir. pd; Chief Eng. ce; Prom. Mgr. pmm; Prod. Mgr. pdm; News, Farm, Sports or Women's Dir. nd, fd, sd, wd.	Market Data For Primary Area (Supplied by station)	Library, News Serv. Transmitter	
ATHENS								
	WIMW 1944	730 500-D	Athens Bcstg. Co. Hine St. 585	Alabama- Dixie, Alabama Bcstg., North Alabama	Homer F. Dunnivant, p, gm & cm	Robert V. Dunnivant, pd, pmm, nd & sd William G. Mitchell, ce	Marg Jones, wd John Fisher, fd Pop.: 402,000 Rad. Hms.: 95,000 Ret. Sls.: \$109,331,000 AP G
ATMORE								
	WATM 1949	1580 250-D	Southland Bcstg. Co. P. O. Box 59 50	Tom Miniard, co-o, gm, ce & fd	Grady L. Ingram, co-o Sam B. Ford, cm	Julia E. Miniard, pd & wd Jim Campbell, nd & sd Pop.: 42,500 Rad. Hms.: 9,900 AP RCA
AUBURN								
	WAUD 1947	1230 250	Auburn Bcstg. Co. Tuskegee Hwy. 1240	ABC, Alabama Bcstg.,	Elmer G. Salter, p, gm, cm & sd Lowell Earl Takles, pd, pmm & fd	Marion Hyatt, ce Nancy Brown, wd	Marion Bayard, traffic m Tony Carter, nd Pop.: 155,500 Rad. Hms.: 32,390 Ret. Sls.: \$50,450,000	Assoc. AP G
BESSEMER								
	WBCO 1950	1450 250	Bessemer Bcstg. Co. P. O. Box 606 Bessemer 5-5241 ForJoe, Dora- Clayton	Jesse Lanier, p Robert D. Williams, gm	Hal Falter, cm Erskine Faush, pd	Jack Warden, ce Lora Walker, wd Pop.: 590,000 Rad. Hms.: 150,750	L-W Ray.
BIRMINGHAM								
	WAPI 1925 WABT (TV)	1070 10,000-D 5,000-N DA-N	The Television Corp. P. O. Box 2553 4-2466	CBS, Alabama Bcstg. CBS Radio Spot Sales	Henry P. Johnston, p & mgng. d Herbert Martin, cm & radio opers. m	James Chenoweth, pmm J. V. Sanderson, ce	Arnold Sartain, asst. ce Ray Furr, asst. to p Pop.: 1,122,300 Rad. Hms.: 255,590 Ret. Sls.: \$807,352,000	Wld. UP RCA
	WAFM (FM) 1946	Ch. 253 (B) 99.5mc 72kw	(WAPI, AM Affiliate)					AP UP RCA
	WBRC 1925 WBRC-TV	960 5,000 DA-N	Birmingham Bcstg. Co. 1727 1/2 2d Ave. N. 4-7741	NBC Raymer	J. Robert Kerns, vp & mgng. d	James E. Bailey, sm & cm Fox Lightfoot, pd	Davenport Smith, nd Mary Badham, wd Pop.: 671,000 Rad. Hms.: 187,335 Ret. Sls.: \$664,132,000	Cap. INS RCA
	WCRT 1953	1260 1,000-D	Chapman Radio & Television Co. 725 S. 22d St. 7-3019	George K. Chapman, p & pd William A. Chapman, vp & ce	Rudy C. Clark, gm, cm & pmm Ray Shader, nd	Bill Kennedy, sd Arlene Maze, wd Pop.: 1,000,000 UP Ray.
	WEDR 1949	1220 1,000-D	Magic City Bcstg. Co. 1417 4th Ave. N. 4-0925 McGillivra	J. L. Doss, p	John A. Thompson, secy.-treas., gm, cm, pd & pmm	John F. Cram, ce Mrs. R. J. Pope, wd Pop.: 750,000 Rad. Hms.: 200,000 UP Ray.
	WILD 1946	950 10,000-D 1,000-N DA-N	Pilot Bcstg. Corp. Essex House 53-4977	MBS H-R Reps.	George A. Mattison Jr., p Don D. Campbell, gm J. B. Roberts, cm	Chas. White McGehee, pd Wm. E. Mattison, pmm H. R. Lowery, ce	Sam Benton, nd George Bell, sd Sue McMillan, wd Pop.: 572,000 Rad. Hms.: 143,570 Ret. Sls.: \$670,498,000 AP Col.
	WJLD 1942 WJLN-TV	1400 250	Johnston Bcstg. Co. P. O. Box 5767 54-3466 Interstate United News- papers	George Johnston Jr., p James Connolly, gm	Jane Martindale, pd Maurice McKinney, ce	Hardrock Gunter, fd Pop.: 1,182,400 Rad. Hms.: 390,970 Ret. Sls.: \$508,792,000 AP Col.
	WJLN (FM) 1948	Ch. 284 (B) 104.7mc 23kw	(WJLD, AM Affiliate)				 AP RCA
	WLBS 1946	900 1,000-D	WLBS Inc. 212 N. 13th St. 54-2541 Stars	E. D. Rivers, p William R. Randall, gm Jim Macri, cm	Steve Hunter, pd & nd Jim Atkins, pmm	Gordon Bishop, ce Laura Rogers, wd Pop.: 1,123,660 Rad. Hms.: 376,430 Col.-G Thes. AP RCA
	WSGN 1928 WSGN-TV	610 5,000-D 1,000-N DA-N	Jemison Bcstg. Co. 202 Protective Life Bldg. 4-3434	ABC Avery- Knodel	Bascom H. Hopson, p, gm & natl. sim G. O. Privett, cm Dave Campbell, pd	Mary F. Childers, pmm Jack Shea, ce J. E. Kolter, secy.	Ed Lake, nd & fd John Forney, sd Carol Wood, wd Pop.: 5,000,000 Rad. Hms.: 905,000	Cap., UP
	WSGN-FM 1947	Ch. 229 (B) 93.7mc 29kw						
	WVOK 1947	690 50,000-D DA-D	Voice of Dixie Inc. P. O. Box 2468 6-2924 Radio-TV Reps.	Iralee W. Benns, p, gm & wd	Ira Leslie, natl. std & pd	George Blaskow, ce Dan Brennan, nd & fd Pop.: 96,700 Rad. Hms.: 22,350 Ret. Sls.: \$44,653,000	Cap., AP G
BREWTON								
	WEBJ 1947	1240 250	Brewton Bcstg. Co. P. O. Box 870 1000	MBS, KBS Dora- Clayton	W. Emmett Brooks, p & gm J. Bolling Brooks, vp & asst. gm	Charles E. Land, pd Joseph A. Sikes, ce Ruby Lanton, traffic m	Wm. E. Brooks Jr., sd Mary Moore, wd Pop.: 700,000 Rad. Hms.: 250,000 UP G
CARROLLTON								
	WRAG 1951	590 1,000-D	Pickens Co. Bcstg. Corp. P. O. Box 71 2364	R. E. Hook, co-o W. E. Farrar, co-o Douglas Reeh, gm & sd	Earl H. Johnson, cm, ce & nd Gladys S. Estis, pd & wd	W. L. Ashcraft, pmm Carl Sauceman, fd Pop.: 700,000 Rad. Hms.: 250,000 UP G
CLANTON								
	WKLF 1947	980 1,000-D	Southeastern Bcstg. Co. Selma Hi-way 448 KBS, Alabama Bcstg.,	J. Kelly Robinson, p Leland Hudson, gm & cm	Helen Parrish, pd, pmm & wd	Lester Carter, ce Pop.: 700,000 Rad. Hms.: 250,000	Wld. AP G
	WHLF-FM 1953	Ch. 265 (A) 100.1mc .37kw						Wld. AP Col.

Data corrected to Dec. 10, 1953. If executives or services for FM are same as AM affiliate names are not repeated. Market Data supplied by stations. FM's in italic. *—Non-Commercial Station. CP—Construction Permit issued. D—Day. DA-N—Directional Antenna, night only. DA-1—Directional Antenna, same pattern day and night. DA-2—Directional Antenna, different pattern day and night. L—Limited Time with Dominant Station. LS—Local Sunset. N—Night. SA—Special Authorization. SH—Specified Hours. ST—Share Time. Complete key to abbreviations, page 6.

CULLMAN

WFMH 1950	1300 1,000-D	The Voice of Cullman 206 Second Ave. E. 910	Alabama	B. C. Eddins, ptrn. & gm	Lon Waters, pd	J. D. Hardeman, fd		Assoc., Thes. AP Ray.
WFMH-FM 1949	Chan. 266 (B) 101.1mc 5.3kw							
WKUL 1946	1340 250	Cullman Bcstg. Co. P.O. Box 211 863	MBS, KBS	Hudson C. Millar Jr., p, gm & cm Ralph Mann, pd, pmm & sd	Arthur Bachmann, ce & nd	Leon Murphree, fd Eunice Gorff, wd	Pop.: 125,000 Rad. Hms.: 36,000	UP WE

DECATUR

WAJF 1953	1490 250	J. B. Falt Jr. 112 Grant St. 4016	Alabama	J. B. Falt Jr., o Cletus Quick, sm, cm, pd & nd	Peter H. Hoffman, ce Mitchell Self, fd	Blackie Brent, sd Nettie K. Quick, wd	Pop.: 50,000 Rad. Hms.: 13,000 Ret. Sis.: \$36,000,000	
WHOS 1948	800 1,000-D	North Alabama Bcstg. Co. 212 Jackson St. 991	Alabama Bcstg.	Barrett C. Shelton, co-o John H. Jones, co-o	Louis C. Blizzard, gm, cm & nd Jerry Greigs, pd & sd	Jim Fouts, pmm & fd G. Upton, ce	Pop.: 975,200 Rad. Hms.: 215,170 Ret. Sis.: \$78,000,000	Assoc., Thes. AP, UP WE
WHOS-FM 1951	Ch. 223 (B) 92.5mc 8.6kw							Thes. AP RCA
WMSL 1935 WMSL-TV	1400 250	Tennessee Valley Bcstg. Co. Bank St. 802	MBS, KBS	Frank Whisenant, p & gm	Bob Gleason, pd Garlan Sandlin, ce	Dick Pettet, sd	Pop.: 100,000 Rad. Hms.: 24,000	AP G

DEMOPOLIS

WXAL 1947	1400 250	The Demopolis Bcstg. Co. 400	MBS, KBS	William M. Jordon, p, gm & pmm	Henry J. Bley, cm Marsha James, pd	Barry W. Collins, ce	Pop.: 75,000 Rad. Hms.: 24,000	Wid. AP RCA
--------------	-------------	---------------------------------	----------	--------------------------------	---------------------------------------	----------------------	-----------------------------------	-------------------

DOTHAN

WAGF 1932	1320 1,000 DA-N	Dothan Bcstg. Co. 204 1/2 E. Main St. 2-9100	NBC McGillvra	Julian C. Smith, gm Fred C. Moseley, cm	Lamar Trammell, pd & sd Jimmy Acree, pmm	Harvard T. Rawlinson, ce Pat Elliott, wd		Wid. AP G
WDIG 1947	1450 250	Houston Bcstrs. 107 E. Adams St. 3-4100	ABC Schep- Reiner, Cummings	Jess Swicegood, p, gm & cm	Earl Hutto, pd & sd Charles Lawshe, ce	Wayne Moseley, nd Joe H. Holloway, fd	Pop.: 217,960 Rad. Hms.: 51,000 Ret. Sis.: \$32,900,000	Thes. UP Ray.
WOOF 1948	560 5,000-D	The Wool Trust 110 S. Foster 30-560	Alabama Bcstg. Clark	R. A. Dowling, p, cm, pd & pmm	Agatha Gay, gm	Earl Williford, ce		UP G

ENTERPRISE

WIRB 1948	1230 250	Wiregrass Bcstg. Co. 30		R. E. James, co-o & gm	Ralph M. Stanford, co-o Fred S. Watson, cm	Eugene E. Vinson, pmm		L-W AP G
--------------	-------------	----------------------------	--	------------------------	---	-----------------------	--	----------------

EUFULA

WULA 1948	1240 250	Ala-Ga Bcstrs. Radio Bldg., U.S. Hwy. 241 744	KBS Southern Radio Pro- ductions	E. B. Fussell, co-o & gm Jessie B. Fussell, co-o	H. G. Chastain, pd & ce	R. E. Stephens, nd & sd Sara Bush, wd	Pop.: 67,339 Rad. Hms.: 12,742	UP Col.
--------------	-------------	--	---	---	-------------------------	--	-----------------------------------	------------

FAYETTE

WWWF 1949	990 1,000-D	Bankhead Bcstg. Co. Jasper, Ala. 2-3462	KBS	W. W. Bankhead, p James E. Reese, gm	Jack Black, cm, pd & pmm	Hugh Hughes, ce	Pop.: 55,000 Rad. Hms.: 22,000	UP Col.
--------------	----------------	---	-----	---	--------------------------	-----------------	-----------------------------------	------------



there isn't time to read them all

Let's not kid ourselves. No advertiser, no account executive, no agency time buyer has either the hours or the physical stamina to read all the trade publications that stream across his desk.

BROADCASTING • TELECASTING is the journal that gives everybody concerned with radio and television the fullest coverage of everything new, everything significant, everything affecting radio-tv and the allied arts. And BROADCASTING • TELECASTING has been covering this beat for more than 23 years.

Annual subscription to BROADCASTING • TELECASTING including the 1954 BROADCASTING and TELECASTING YEARBOOKS—\$11.00.

ALABAMA

City	Call Letters	Chan. or Freq.	Licensee Headquarters Telephone	Network Representative	Owner o; Pres. p; Exec. up exp; Gen. Mgr. gm; Sta. Mgr. sm; Coml. Mgr. cm; Sales Mgr. slm; Prog. Dir. pd; Chief Eng. ce; Prom. Mgr. pmm; Prod. Mgr. pdm; News, Farm, Sports or Women's Dir. nd, fd, sd, wd.	Executive Abbreviations	Market Data For Primary Area (Supplied by station)	Library, News Serv. Transmitter
FLORENCE								
	WJOI 1946	1340 250	Florence Bcstg. Co. 850 S. Court 2608	ABC, Alabama Bcstg.	Joe T. Van Sandt, p & gm Tom York, cm	Don Spry, pd, pmm, nd, sd & fd Paul Shannon, ce Joy Day, wd	Pop.: 121,800 Rad. Hms.: 27,285 Ret. Slis.: \$88,197,000 G
	WJOI-FM 1951	Ch. 252 (A) 93.3mc 250kw					 GE
	WOWL 1945	1240 250	Radio Muscle Shoals P. O. Box 634 3-800	Alabama Bcstg. Rambeau, Clayton	Richard B. Biddle, p Jim Garrett, asst. m Dora M. Biddle, cm & pmm	Bill Mapes, pd & nd Larry Rohling, ce Bill Wynne, sd Jean Scott, wd	Pop.: 93,626 Rad. Hms.: 20,016 AP G
FOLEY								
	WHEP 1953	1310 1,000-D	Alabama Gulf Radio Inc.					
FORT PAYNE								
	WFPA 1950	1400 250	George A. Gothberg Jr. 102 S. Gault Ave. 1440	Alabama Bcstg. Continental	George A. Gothberg Jr., o & nd Jerry B. Carr, gm & pd	Ted Kirby, cm & fd Nat Kirby, pmm Edward Pierce, ce	Pop.: 60,000 Rad. Hms.: 13,000 Ret. Slis.: \$9,000,000 AP Col.
	WZOB 1950	1250 1,000-D	Glenn M. Gravitt P. O. Box 255 1096	Alabama Bcstg. Southern Radio Productions	Glenn M. Gravitt, o & gm	Joe Liber, cm Jess Moore, ce, nd & fd	Virginia Lankford, wd Pop.: 176,510 Rad. Hms.: 48,241 Ret. Slis.: \$61,500,000	Thes. UP WE
GADSDEN								
	WETO 1949	930 1,000-D	Gadsden Radio Co. 722 S. 12th St. 6-9201	KBS	C. L. Graham, co-o E. H. Estes, co-o & gm	Mort Lloyd, cm Ray Estes, pd	D. Vowell, pmm Julius Vessels, ce Pop.: 100,000 Rad. Hms.: 40,000	Cap. AP WE
	WGAD 1947	1350 5,000-D 1,000-N DA-N	Coosa Bcstg. Co. Philipson Bldg. 5641	ABC	Curtis DeLamar, p, gm, cm & pmm June DeLamar, vp & pd	Mrs. Curtis DeLamar, secy.-treas. Halley D. Williams, ce Jack Werley, nd	Boyd Parsons, fd Basil Gilchrist, sd Frances Brown, wd Rad Hms.: 75,000 UP WE
	WGWD 1948	570 1,000-D	Etowah Bcstrs. Inc. 750 Forest Ave. 6-6301		Oscar P. Covington, p J. P. Kirby, gm	Curtis Blair, cm Frances Seale, pd	Jerry Bleich, pmm W. G. Anderson, ce UP G

Data corrected to Dec. 10, 1953. If executives or services for FM are same as AM affiliate names are not repeated. Market Data supplied by stations. FM's in italic. *—Non-Commercial Station. CP—Construction Permit issued. D—Day. DA-N—Directional Antenna, night only. DA-1—Directional Antenna, same pattern day and night. DA-2—Directional Antenna, different pattern day and night. L—Limited Time with Dominant Station. LS—Local Sunset. N—Night. SA—Special Authorization. SH—Specified Hours. ST—Share Time. Complete key to abbreviations, page 6.

OVER 70%
of the
National Advertisers
Who Bought
Spot Radio
in the
Muscle Shoals
Market in 1953
Bought **WOWL**

REPRESENTED BY
William G. Rambeau Company
Dora-Clayton Agency (Southeast)

WOWL

**THE WISE BUY IN THE
MUSCLE SHOALS MARKET**



DICK BIDDLE
President
Radio Muscle Shoals, Inc.

"The Owl"

Serves the Multiple Market*
of Florence, Sheffield, Tuscum-
bia and Muscle Shoals City
(contiguous) and the Muscle
Shoals area

Lauderdale and Colbert Coun-
ties Population, 101,547

ALABAMA's 4th Market
THE NATION'S 230th Market*

Planned Merchandising Campaigns

Ask about our
Bonus Blitz

* Sales Management 1953

WOWL

**THE VOICE THAT SELLS
IN MUSCLE SHOALS**

ALABAMA

WJBY 1927	1240 250	Gadsden Bcstg. Co. 108 Broad St. 6-3381	NBC Avery-Knodel	B. H. Hopson, p Sterling Brewer, gm Joe Brewer, cm	Bill Cornelius, pd, nd fd & sd	Dawson Bearden, ce Betty Jenkins, wd	Pop.: 60,000 Rad. Hms.: 30,000 Ret. Sls.: \$68,901,000 INS Col.
WJBY-FM 1948	Ch. 279 (B) 103.7mc 2.45kw						Pop.: 93,892 Rad. Hms.: 52,560 Ret. Sls.: \$80,321,000	Wld. Fed.
GENEVA								
WGEA 1953	1150 1,000-D	Geneva County Reaper Westville Rd. 456	Robert Sidwell, sm, ce & nd	Gene Free, cm & sd Junior Walker, pd	Jean Powell, wd	Pop.: 279,873 Rad. Hms.: 63,980 Ret. Sls.: \$153,437,000	Wld. Col.
GREENVILLE								
WGYV 1948	1400 250	Greenville Bcstg. Co. Box 227 585	ABC. KBS. Alabama Bcstg.	W. H. Miller, gm, cm, pd & pmm	J. D. Bell, ce		Pop.: 100,000 Rad. Hms.: 25,000	Wld. AP G
GUNTERSVILLE								
WGSV 1950	1270 1,000-D	Guntersville Bcstg. Co. Box 32 4131	KBS	E. L. Roberts, co-o Albert Rains, co-o Ed Carrell, gm, cm & pmm	Roy McClendon, pd, nd & sd Lavelle Jackson, ce & fd	Margaret Henderson, wd	Pop.: 100,000 Rad. Hms.: 25,000 Ret. Sls.: \$30,000,000	Thes. UP Ray.
HALEYVILLE								
WJBB 1949	1230 250	Haleyville Bcstg. Co. 389	MBS, Alabama Bcstg. Indie	W. P. Thelands, p John L. Slatton, gm & cm	Pat Slatton, pd Jack K. McNutt, pmm & nd	Paul Kelly, ce Mitch Seif, sd	Pop.: 186,000 Rad. Hms.: 43,725 UP RCA
HAMILTON								
WERH 1950	970 5,000-D	Marion County Bcstg. Co. U.S. Hwy. 78 3481	Alabama Bcstg. McGillivra Dora- Clayton	Hugh J. Fite, p & gm Charles B. Tucker, cm, pd, pmm & ce	Edgar Clayton, nd	Johnie Lott, fd & sd	Pop.: 978,754 Rad. Hms.: 205,212 Ret. Sls.: \$497,311,567	L-W AP Ray.
HOMEWOOD								
WEZB 1953	1320 1,000-D	Voice of Home- wood Hollywood Coun- try Club 2-8211	Gene Newman, p & gm David Higgenbotham, cm	Ganus Scarborough, pd Johnny Sap, pmm Verl Ciseró, ce Rita Klein, wd	Leroy Garrett, fd	Pop.: 1,206,300 Rad. Hms.: 1,200,000 Ret. Sls.: \$719,733,000	—
WJLD 1942	1400 250	(See Birmingham listing)						

WERH THE STRONGEST

1950 POPULATION 978,754

1950 HOME COUNT 259,794

1950 RADIO HOMES 205,212

1951 AUTOMOBILES 172,551

1949 FARM INCOME ... \$118,381,890

1951 RETAIL SALES \$497,311,567

regional representatives,
DORA-CLAYTON AGENCY
Mortgage Guaranty Building,
Atlanta, Georgia
New York representative:
ROBERT S. KELLER, INC.
72 Barow Street,
New York 14, N. Y.



STRONGEST SIGNAL IN NORTHWEST
ALABAMA AND NORTHEAST MISSISSIPPI
STRONGEST IN LISTENERS
STRONG ON ENTERTAINMENT AND
STRONGEST AS THE ADVERTISING VALUE
IN THIS FAST DEVELOPING FARM
AND INDUSTRIAL AREA. WERH
DOMINATES THE 14,695 SQUARE MILES
OF OUR 0.1 MV/M CONTOUR.

WERH

HAMILTON, ALABAMA

5000 WATTS 970 KC



ALABAMA

City Call Letters Established TV Affiliate	Chan. or Freq. Power	Licensee Headquarters Telephone	Network Representative	Executive Abbreviations	Market Data For Primary Area (Supplied by station)	Library, News Serv. Transmitter
				<i>Owner o; Pres. p; Exec. op evp; Gen. Mgr. gm; Sta. Mgr. sm; Coml. Mgr. cm; Sales Mgr. slm; Prog. Dir. pd; Chief Eng. ce; Prom. Mgr. pmm; Prod. Mgr. pdm; News, Farm, Sports or Women's Dir. nd, fd, sd, wd.</i>		
HUNTSVILLE						
WBHP 1937	1230 250	Wilton H. Pollard Fifth Ave. 5000	MBS, KBS	W. H. Pollard, p & gm James Tripp, cm	Kathryn Moore, pd Grady M. Reeves, pmm, nd & sd	James Potter, ce UP G
WFUN 1946	1450 250	Huntsville Bcstg. Co. 410 W. Holmes St. 2424 Sears & Ayer	J. B. Falt Jr., p, gm & pmm	John Garrison, secy.- treas., sm, pd & ce Bob Dean, nd	Jerome Hughey, fd Glenn Slayton, sd Janet Lane, wd Pop.: 80,000 Rad. Hms.: 20,000 Ret. Sls.: \$42,000,000 AP G
WHBS 1946	1550 5,000-D 500-N DA-2	Huntsville Times Box 988 2345	ABC, Alabama Bcstg. Gill- Ferna, Cummings	Henry P. Johnston, p Jack F. Neal, gm	Reuben T. Miller, pd Victor Bankowski, ce	Fred Digeau, sd Lucia Lull, wd Pop.: 323,824 Rad. Hms.: 70,000 AP RCA
WHBS-FM 1947	Ch. 236 (B) 95.1mc 16kw					
JACKSON						
WPBB 1950	1290 1,000-D	Jackson Bcstg. Co. P. O. Box 128 2413	MBS, KBS	T. H. Gaillard Jr., p, gm & ce Guy R. Hester, cm	Charles Ballas, pd & nd Ben Briggs, fd	Ben Haskeu, sd Dora Lee Clay, wd Pop.: 250,000 Rad. Hms.: 64,290 Ret. Sls.: \$84,538,000
JASPER						
WWWB 1946	1240 250	Bankhead Bcstg. Co. Inc. Bankhead-Long Bldg. 2-3461	KBS	W. W. Bankhead, p, James E. Ruse, gm & nd William C. Edgemon, cm	J. L. Sartain Jr., pd & sd David J. Vansandt, ce Dabney Ramsaur Jr., pmm	J. C. Bullington, fd Jean Jones, wd Veneta Phillips, secy. Cap. UP WE
WWWB-FM 1953	Ch. 273 (B) 102.5mc 17.5kw					
LANETT						
WRLD 1943	1490 250	Valley Bcstg. Co. Inc. P. O. Box 312 2-2711	ABC, KBS McGillivra	J. C. Henderson, p C. Jim Murphy, gm & cm	Aileen H. Love, pd & pmm	Albert L. Stancel Jr., ce Pop.: 30,000 Rad. Hms.: 10,000 Thes. AP WE
WRLD-FM 1949	Ch. 275 (B) 102.9mc 10kw					
MARION						
WJAM 1951	1310 1,000-D	Neely Bcstg. Co. P. O. Box 221 7111	Alabama Bcstg. Southern Radio Pro- ductions	L. M. Neely Jr., p & gm Earl Hanna, sm, cm & sd	Sara White, pd & wd Virgil Moore, pmm & ce	Wayne Vowell, nd Oliver Jackson, fd Pop.: 114,368 Rad. Hms.: 92% Ret. Sls.: \$56,442,000 Cap. AP G
MOBILE						
WABB 1948	1480 5,000 DA-N	Mobile Press- Register Inc. 304 Government St. 3-1551	ABC, MBS Branham	R. B. Chandler, p W. J. Hearin Jr., evp	Dewey H. Long, gm Robert C. Walker, pd	Phil Forrest, pmm William H. Murphree, ce Wld. UP WE
WABB-FM 1948	Ch. 271 (B) 102.1mc 51kw					
WALA 1930 WALA-TV	1410 5,000 DA-N	Pape Bcstg. Co. 210 Government St. 3-3756	NBC Headley- Reed	W. O. Pape, p H. K. Martin, gm	Al Treadway, cm H. Holman, pd	R. B. Hurley, ce W. B. Pape, pmm St. AP RCA
WKAB 1947 WKAB-TV	840 1,000-D	Pursley Bcstg. Serv. Box 1306 7-6345 ForJoe, Dora- Clayton	Louise P. Pursley, p Robt. H. Moore, vp & gm J. C. Smith, cm	J. T. Jackson, pd H. E. Miller, ce Ed Chapman, pmm	Paul Dubose, nd Hubert Grant, sd Janice Latham, wd Pop.: 617,547 Rad. Hms.: 148,255 Ret. Sls.: \$460,778,000 AP
WKRK 1946	710 1,000-D 500-N DA-N	Giddens & Rester Radio Telegraph Rd., Box 1184 2-6789	CBS Young	Kenneth R. Giddens, p Frank Conwell, gm Dick McMullen, pd & sd	Shirley Lane Rester, pmm F. E. Couey, ce Carl Haug, slm	Charles E. Tapley, nd T. J. Rester Jr., fd Barbara Kaye, wd Pop.: 365,000 Rad. Hms.: 88,567 L-W AP RCA
WKRK-FM 1946	Ch. 260 (B) 99.9mc 3kw					
WMOZ 1953	960 1,000-D	Gadsden Radio Co. 1638 St. Stephens Rd. 6-7618 Pearson	C. L. Graham, co-o E. H. Estes, co-o Walter V. Turner, gm	Mac M. Thomas, cm Camille F. Rouse, pd Vernon C. Floyd, ce	James Bivens, sd Dorothy Lee, wd Pop.: 579,133 Rad. Hms.: 167,697 Ret. Sls.: \$437,687,996 Col.
MONROEVILLE						
WMFC 1952	1220 250-D	Monroe Bcstg. Co. 1220	KBS	William M. Stewart, co-o Jimmy Faulkner, co-o	George C. Shurden, gm, cm & pmm Jim Aycock, pd Chuck Smith, ce & fd	Riley Kelly, nd Jimmy Quinn, sd Betty Gulsby, wd Pop.: 55,200 Rad. Hms.: 16,500 Ret. Sls.: \$34,106 Wld. AP RCA
MONTGOMERY						
WAPX 1947	1600 1,000 DA-N	United Bcstg. Co. 116 Catoma St. 3-7569	ABC Walker	Thomas E. Martin, p Hoke S. Williford, cm & pmm	Lee Stockfelt, pd Owen A. Lehr, ce Lou Benton, nd	Crawford Rice, fd Dave Manners, sd Lucy Pope, wd St. AP RCA
WEAM 1953	740 50,000-D	Deep South Bcstg. Co. 2-3851 Radio Reps.	Mrs. J. F. Richardson, p	W. J. Brennan, gm & secy.-treas. Ira Leslie, natl. slm	Fred U. Wamble, pd Cyril G. Brennan, ce
WCOV 1938 WCOV-TV	1240 250	Capitol Bcstg. Co. Exchange Hotel 2-5781	CBS Taylor	Oscar P. Covington, p Hugh M. Smith, gm Joe Petranka, sm	Walter Spiro, pd & sd O. M. Teate, pmm	W. D. Weatherly, ce Tom Doron, nd Dot Armand, wd Pop.: 350,000 Rad. Hms.: 75,000 UP Col.
WCOV-FM 1948	Ch. 233 (B) 94.5mc 4.1kw					
WJJJ 1948	1170 10,000-D 1,000-N DA-2	Southern Bcstg. Co. Inc. 135 Commerce St. 3-4471	MBS Weed	Joseph G. Mathews, p John C. Hughes, gm E. Caldwell Stewart, pd	Fred Wright, ce Martha Hall, traffic m	Jay Alldredge, nd Bill Slaton, sd UP GE

Data corrected to Dec. 10, 1953. If executives or services for FM are same as AM affiliate names are not repeated. Market Data supplied by stations. FM's in italic. *—Non-Commercial Station. CP—Construction Permit issued. D—Day. DA-N—Directional Antenna, night only. DA-1—Directional Antenna, same pattern day and night. DA-2—Directional Antenna, different pattern day and night. L—Limited Time with Dominant Station. LS—Local Sunset. N—Night. SA—Special Authorization. SH—Specified Hours. ST—Share Time. Complete key to abbreviations, page 6.

ALABAMA

WMGY 1946	800 1,000-D	Dixie Bcstg. Co. 4 S. Perry St. 2-5245 Forjoe, Dora- Clayton	Dr. S. D. Suggs, p Frances Sewell, vp Thomas W. Sewell, gm, cm & secy.-treas.	C. L. Brown, pd Clint Brown, pmm John Lamar, ce Red Ryan, nd	Crawford Roquemore, fd Chuck Elliott, sd Josie Williams, wd	Pop.: 353,462 Rad. Hms.: 65,812 Ret. Sis.: \$450,000,000 UP G	
WRMA 1953	950 1,000-D	Southland Bcstg. Co. 26 N. Lawrence St. 2-1475 McGillivra	Ralph M. Allgood, co-o & gm Grover Wise, co-o	Walter B. Stevenson, ce	Carl P. Wallace, sd Bertha Bailey, wd	Pop.: 250,000 Rad. Hms.: 92,104 Ret. Sis.: \$270,566,000	Assoc. G	
WSFA 1930	1440 5,000-D 1,000-N DA-N	Montgomery Bcstg. Co. P. O. Box 1031 8361	NBC Headley- Reed	David E. Dunn, p William W. Hunt, cm Charlie Davis, pd	Julia C. Looney, pmm & natl. adv. m C. I. Shelhofsky, ce John Allen Wolf, nd	Leland Childs, fd Dick Reid, sd Camille Brown, wd	Pop.: 106,525 Rad. Hms.: 24,534 Ret. Sis.: \$144,520,000	Wid. AP Cont.	
MUSCLE SHOALS									
WLAY 1933	1450 250	Muscle Shoals Bcstg. Corp. 620 E. 2d St. 1450	MBS Devney	Frank M. Farris Jr., o & p Eulus O. Whitehead, gm & nd	George Manush, pd & sd Imogene Stack, pmm & wd	Lynn V. McMoran, ce Ronald S. Walker, fd	Pop.: 65,000	Wid. AP G	
ONEONTA									
WCRL 1952	1570 250-D	Blount County Bcstg. Service 4871	Alabama Southern Radio Reps.	E. Glenn Abercrombie, gm				Cap. AP Col.	
OPELIKA									
WJHO 1940	1400 250	Opelika-Auburn Bcstg. Co. 1400 Auburn Rd. 612	MBS, KBS Indie, Dora- Clayton	John C. Cooper Jr., gm & p E. Jere Turk, cm	Gordon E. Snyder, sd John E. Smollon, ce	Mercer L. King Jr., nd Gall S. Whatley, wd	Pop.: 30,000 Rad. Hms.: 17,000	Wid., Thes., SES, UP Col.	
OPP									
WAMI 1952	860 1,000-D	Opp Bcstg. Co. P. O. Box 169 659	H. N. Lee, p	Beri Moore, gm & cm	Joe Osgatharp, ce	Pop.: 300,000 UP Col.	
OZARK									
WQZK 1953	900 1,000-D	Ozark Bcstg. Corp							
PHENIX CITY									
WPNX 1948	1460 1,000 DA-1	Community Bcstg. Co., Inc. Phenix-Girard Bank Bldg. 8-8787	ABC, MBS Forjoe	Roy M. Greene, p & o Don C. Price, cm	Jay H. Lamb, pd & ce Robert H. Mann, pmm & nd	Jim Dillard, sd V. R. Greene, fd Earline Duncan, wd	Pop.: 400,000 Rad. Hms.: 140,000 AP WE	
PIEDMONT									
WPID 1953	1280 1,000-D	Piedmont Radio Station 2231	C. L. Graham, p Curt Blair, gm & cm	Frances Kerns, pd J. D. Carter, pmm	Hamilton Masters, ce	Pop.: 12,000 Rad. Hms.: 3,000 Ray.	
ROANOKE									
WELR 1950	1360 1,000-D	J. W. Buttram 801 N. Main St. 3811	KBS	J. W. Buttram, o. gm & cm	John Hodges, pd, fd & sd Richard Killebrew, pmm & nd	Leverne Foster, ce	Pop.: 125,000 Rad. Hms.: 80,000 Ret. Sis.: \$125,000,000 WE	
RUSSELLVILLE									
WWWR 1949	920 1,000-D	Bankhead Bcstg. Co. Underwood Rd. 647	KBS, Tri-W Southern Radio Pro- ductions	W. W. Bankhead, p Hal Kirby, gm & cm	Carl Van Sittert, pd & ce	James E. Reese, net- work d of opers.	Pop.: 553,721 Rad. Hms.: 128,100 Ret. Sis.: \$228,197,000 UP Col.	



Town and Country with WMGY

19 COUNTIES WITH TOTAL POPULATION OF 666,778

County	Population	Radio Homes
MONTGOMERY	138,129	30,556
ELMORE	34,546	5,832
COOSA	13,460	2,099
TALLAPOOSA	35,270	6,406
MACON	27,454	4,976
LEE	36,455	6,562
RUSSELL	39,500	3,640
BARBOUR	32,722	5,221
BULLOCK	19,810	3,221
PIKE	32,493	5,558
CRENSHAW	23,631	3,803
BUTLER	32,447	5,018
LOWNDES	22,661	3,398
AUTAUGA	20,977	3,243
CHILTON	23,400	4,685
DALLAS	55,245	10,218
WILCOX	26,279	4,094
CONECUM	25,489	3,685
PERRY	26,910	3,771
Total	664,778	115,986

800 KC - Clear Channel

1000 Watts MontGomeryY

If your message is directed at the Magnificent Montgomery Market or at the greater agriculture community of central 'Bama Florida and Georgia it's WMGY (one buy will deliver both for you)

WMGY

ALABAMA

City Call Letters Established TV Affiliate	Chan. or Freq. Power	Licensee Headquarters Telephone	Network Representative	Executive Abbreviations	Owner o; Pres. p; Exec. up evp; Gen. Mgr. gm; Sta. Mgr. sm; Coml. Mgr. cm; Sales Mgr. sim; Prog. Dir. pd; Chief Eng. ce; Prom. Mgr. pmm; Prod. Mgr. pdm; News, Farm, Sports or Women's Dir. nd, fd, sd, wd.	Market Data For Primary Area (Supplied by station)	Library News Serv. Transmitter
SCOTTSBORO							
WCRI 1950	1050 250-D	Pat M. Courington P. O. Box 394 123	Alabama	Pat M. Courington, o & p	Eaton P. Govan Jr., gm & cm Jo Anne Hale, pd & wd	James G. Wallace, ce & fd Charles Pruitt, pmm	Wid. AP G
WROS 1952	1330 1,000-D	Scottdboro Bcstg. Co. 717 Scott St. 156		Hugh T. Kirby, p	Rose M. Kirby, gm, cm & wd	Clyde R. Varner, pd, pmm & sd Bill Prickett, ce, nd & fd	
SELMA							
WGWC 1946	1340 250	Dallas Bcstrs. Inc. P. O. Box 686 4-6687	CBS Holman	Oscar Covington, p	John F. Townshend, gm, cm & ce	Stan Hendricks, pd G
WHBB 1935	1490 250	Selma Bcstg. Co. 209 Washington St.	NBC Avery-Knodel	B. H. Hopson, p Julien Smith Jr., gm	Erin Reynolds, pd	W. D. Powers Jr., ce	Pop.: 162,937 Rad. Hms.: 31,750 Ret. Sis.: \$36,464,000
SYLACAUGA							
WFEB 1945	1340 250	Alabama Bcstg. Co. 527 N. Broadway 2-3281	MBS, KBS, Alabama Bcstg.	E. E. Forbes Sr., p	George W. Carr, gm, cm, pd, pmm & sd	Conrad B. Pickren, ce & nd	Pop.: 75,535 Rad. Hms.: 21,320 Ret. Sis.: \$64,000,000
WMLS 1948	1290 1,000-D	Marble City Bcstg. Co. 11 1/2 W. 2d St. 2-4354	Alabama Bcstg.	Curtis O. Liles, p & gm M. W. McEwen, cm	Robert M. Duck, pd & pmm	Walter Welch, ce Gertrude Tyson, wd	Pop.: 150,000 Rad. Hms.: 24,820 Ret. Sis.: \$55,000,000
TALLADEGA							
WHTB 1945	1230 250	Voice of Tallade- ga Inc. Sylacauga Hwy. 2205	MBS, KBS, Alabama Bcstg. Conti- nental	R. A. Davidson, p & gm Myron T. Snoddy, cm	W. B. Dorriety, pd	David Andrews, ce	Wid. AP Col.
WHTB-FM 1953	Ch. 246 (B) 97.1mc 9.2kw						
TALLASSEE							
WTLS (CP)	1300 1,000-D	Tallassee Bcstg. Co. P. O. Box 18 Tuscaloosa, Ala.					
TROY							
WTBF 1947	1490 250	Troy Bcstg. Corp. College Dr. 980	MBS, South- eastern	J. Roy Crow, p Jess Jordan, gm & nd	Robert Tolbert, cm Joe Gilchrist, ce	Ace Dudley, sd Cathy Grantham, wd	WLD AP WE
TUSCALOOSA							
WJRD 1936	1150 5,000-D 1,000-N DA-N	Wilhelmina Echols 2216 Broad St. 4464	NBC Rambeau. Dora- Clayton	Wilhelmina Echols, o Gene Tibbett, gm & pmm Lehman Mayer, cm	Roy McAllister, pd & sd Dave Livingston, ce Star Smith, asst. cm	Roy Lamont, nd Jack Hamm, fd Idalia Hollingsworth, wd	Pop.: 1,641,311 Rad. Hms.: 269,917 Ret. Sis.: \$635,436,000
WNPT 1951	1280 1,000-D	West Alabama Bcstg. Co. P. O. Box 181 3311	Alabama Bcstg. System Indie	W. P. Thielens, p T. H. Todd, gm & ce Bill Harris, asst. m	Ruth Harris, cm & pmm Keith Barze, pd	Joe Langston, nd Clyde Price, sd	
WTBC 1946	1230 250	Tuscaloosa Bcstg. Co. City Hall Bldg. 5523	MBS, KBS Sears & Ayer	Bert Bank, gm & pmm Donald H. Sams, cm	Jack Mock, pd J. A. Ward, ce		
WTBC-FM 1953	Ch. 239 (B) 95.7mc 17.5kw						
TUSKEGEE							
WTUS 1952	580 500-D	Radio Tuskegee Inc. Union Springs Rd. 580	KBS, Alabama Bcstg.	James Honey, gm John Andrew Bowers, cm	Gerald Burton White, pd & nd Johnnie Hartzog, pmm & sd	Julian Alvie Duncan, ce Sylvia Fralic, wd	Pop.: 229,108 Rad. Hms.: 76,369

ARIZONA

MARKET DATA BY COUNTIES

County	Population 1950	Radio Families 1953	Retail Sales 1952(000)	Food Sales 1952(000)	Drug Sales 1952(000)	Passenger Cars 1952	County	Population 1950	Radio Families 1953	Retail Sales 1952(000)	Food Sales 1952(000)	Drug Sales 1952(000)	Passenger Cars 1952
Apache	27,767	2,380	\$ 7,535	\$ 1,224	\$ 155	2,998	Pinal	43,191	10,440	43,226	14,296	1,763	16,239
Cochise	31,488	8,759	32,137	8,705	1,012	17,466	Santa Cruz	9,344	2,350	14,666	3,002	827	3,632
Cocconino	23,910	5,640	26,887	4,408	623	9,355	Yavapai	24,991	7,150	27,422	6,434	982	11,056
Gila	24,158	6,440	22,447	5,931	904	9,730	Yuma	28,006	7,900	42,162	9,608	1,223	18,749
Graham	12,985	3,080	14,196	2,549	364	5,696	Total	749,587	214,440	\$898,747	\$202,989	\$ 33,311	330,054
Greenlee	12,805	3,450	8,530	2,874	198	4,995	Note: Population 1950 Census; radio families Standard Audit & Measurement Services Inc.; food, drug and retail sales, copyright 1953, Sales Management; further reproduction unlicensed; automobiles supplied by state.						
Maricopa	331,770	103,630	435,643	92,264	15,155	170,857							
Mohave	8,510	2,410	10,935	2,366	237	3,497							
Navajo	29,446	4,570	20,129	3,943	756	7,399							
Pima	141,216	46,250	192,832	45,385	9,112	71,156							

DIRECTORY OF AM AND FM STATIONS

BISBEE								
KSDN 1933	1230 250	Carleton W. Morris Drawer C Lowell 9	MBS, Arizona Net. Blair	Carleton W. Morris, p Arlo Woolery, gm & cm	Ray Helgesen, pd Leo Bernard, pmm	John Harris, ce Lou Evans, nd	Pop.: 14,800 Rad. Hms.: 4,200 Ret. Sis.: \$18,000,000	Wid., SES, UP
CLIFTON								
KCLF 1950	1400 250	Saguaro Bcstg. Co. Box 548 321	ABC	Dwight Harkins, p Hari Barnett, gm & cm	Jim Currie, pd & sd	Odoriso Pannoza, ce	Pop.: 15,000 Rad. Hms.: 600 Ret. Sis.: \$10,000,000	Assoc., Thes. UP Col.

COOLIDGE

KCKY 1948 1150 1,000 DA-N Gila Bcstg. Co. Roosevelt at Main St. 4451 CBS, Radio Net. of Arizona ForJoe Louis F. Long, p William F. Parady, gm & cm Jim Murdock, pd & nd Jim Doyle, pmm & fd Jeff Lapping, ce Virginia Belden, wd Pop.: 100,000 SES., L-W UP WE

DOUGLAS

KAWT 1946 1450 250 Carleton W. Morris Box 1118 173 NBC, Ariz. Bcstg. Carleton W. Morris, p Robert Whitaker, gm & sd Sidney H. Manette, pd & nd Oliver Grieve, ce James Bruns, fd Terry Williams, wd Pop.: 18,000 Rad. Hms.: 4,500 Cap., Mac. AP, UP WE

FLAGSTAFF

KCLS 1950 1360 5,000-D Charles J. Saunders Box 1677 946 MBS, Don Lee, Arizona Net. Charles J. Saunders, o & gm Harry Becker, cm & pd Len Benson, ce Jay Saunders, nd & sd Bill Brechen, fd Dorothy Saunders, wd Pop.: 48,100 Rad. Hms.: 12,290 Ret. Sls.: \$58,150,000 Cap. AP GE

KGPH 1950 690 1,000-D 500-N DA-N Frontier Bcstg. Co. Weatherford Hotel 51 ABC McGillvra A. S. Holm, gm Clair Hill, cm Mary Jane Phillippi, pd & wd Eugene C. Phillippi, pmm & ce John More, nd Pop.: 48,100 Rad. Hms.: 12,290 Ret. Sls.: \$58,150,000 Cap. AP GE

GLOBE

KWJB 1938 1240 250 Gila Bcstg. Co. Box 2343 41 NBC, Arizona Bcstg. Raymer Willard Shoecraft, sm, pmm & nd Eric L. Manola, pd & cm Earl Hickman, ce Darrell Tucker, sd Harryette Weinberg, wd Pop.: 15,000 Rad. Hms.: 5,000 Ret. Sls.: \$18,000,000 Theg. AP

KINGMAN

KGAN 1949 1230 250 J. J. Glancy Box 1208 Blue 462 ABC J. J. Glancy, o Mrs. A. L. Payne, pd Leroy O'Laughlin, ce Pop.: 14,000 Ret. Sls.: \$10,935,000 RCA

MESA

KTYL 1946 1310 1,000-D 500-N DA-N Harkins Bcstg. Inc. P. O. Box 885 Woodland 4-5737 Dwight Harkins, p & gm Lorenzo Lisonbee, cm Jack Harris, pd Dick Gilbert, pmm Ben Smith, ce Bob Vache, sd Kay Foster, wd Pop.: 300,000 St. UP G

KTYL-FM 1951 Ch. 284 (A) 104.7mc 50kw St. UP Col.

NOGALES

KNOG 1949 1340 250 Old Pueblo Bcstg. Co. 770 CBS ForJoe E. S. Mittendorf, p Jack Martin, gm Dorothy E. de Rivera, cm Nancy Soto, traffic m George Lewis, sd Frank Wilson, fd Elta Derrick, wd Pop.: 75,000 Ret. Sls.: \$11,440,077 Wld. UP WE

PHOENIX

KIFN 1949 860 1,000-D Western Bcstg. Co. 1975 S. Central Ave. Alpine 3-6155 Frank P. Redfield, p & gm John K. Redfield, cm & pmm Jose D. Alvarado, pd Edgar B. Pool, ce Pedro Moraga, nd & sd Grace Gil, co-wd Rosita Aguillar, co-wd Pop.: 425,000 Rad. Hms.: 97.6% Ret. Sls.: \$1,000,103,901 SES. UP G

KOOL 1947 960 5,000 DA-N Maricopa Bcstrs. Adams Hotel Alpine 8-6421 CBS, Arizona Net. Hollingbery Gene Autry, p Charles H. Garland, gm Thomas Kelland, sm William Connelly, cm Homer Lane, pd Miles Shepherd, ce Frank Pollack, nd Dee Junker, wd Pop.: 320,000 Rad. Hms.: 120,000 Ret. Sls.: \$880,000,000 St. UP RCA

KOY 1922 550 5,000-D 1,000-N KOY Bcstg. Co. 840 N. Central Ave. Alpine 4-4144 MBS, Don Lee, Arizona Net. Blair John L. Hogg, p & cm Albert D. Johnson, m & pmm John R. Williams, pd Edward R. Janney, ce William J. Lester, pdm & loc. sm Paul Gribben, nd Ernie Douglas, fd Ed DeForest, co-sd Bill Close, co-sd Pop.: 500,000 Ret. Sls.: \$600,000,000 Wld. UP WE

KPHO 1940 910 5,000 DA-N Meredith Engineering Co. 631 N. 1st St. ABC Katz E. T. Meredith, p Richard B. Rawls, gm Charles Schlueter, asst. cm Gene Spry, pd George McClanathan, ce Wayne Center, nd Pop.: 400,000 Rad. Hms.: 200,000 AP WE

KRIZ 1950 1230 250 Howard M. Loeb 2345 Westward Blvd. Alpine 4-8436 KBS Burn-Smith Howard M. Loeb, p, gm & nd Sheldon Engel, cm & sd Bill Bailey, pd James Groll, ce Pop.: 300,000 Rad. Hms.: 76,000 UP GE

KRUX 1947 1340 250 Radio Arizona Inc. Goodrich Bldg. Alpine 2-2371 Tee Pee Net. L. O'Connell, Indie Stanley Schultz, p Stan Norman, gm Frank Barc, cm Timothy Sparkman, pd Robert Heiberg, pmm Gene Boos, ce Gene Burris, nd Gerry Heck, fd Ray Odom, sd Madeline Wise, wd Pop.: 221,412 Rad. Hms.: 56,571 Ret. Sls.: \$117,000,000

KTAR 1922 620 5,000 DA-N KTAR Bcstg. Co. 1101 N. Central Ave. Alpine 4-4161 NBC, Arizona Bcstg. Raymer John J. Louis, chmn. of bd. Richard O. Lewis, p & gm E. W. Harvey, vp & cm B. R. Fulbright, secy.-treas. A. C. Anderson, vp & ce Rol Laughner, pd & fd Ted Edwards, pub. service d John Snow, nd John Harrington, sd Shirley Johannesma, wd Pop.: 652,500 Rad. Hms.: 171,689 Ret. Sls.: \$839,183,328 Thes., St., Cap. AP WE

PRESCOTT

KYCA 1940 1490 250 Southwest Bcstg. Co. P. O. Box 1631 244 NBC, Arizona Bcstg. Raymer Harold Ritter, p & gm Hollis Hill, pd Ric Williamson, pmm George Eitel, ce Pop.: 18,000 Ret. Sls.: \$25,960,231 Cap., Thes. AP RCA

SAFFORD

KGLU 1938 1480 1,000 Gila Bcstg. Co. 520 Main St. 15 NBC, Arizona Bcstg. Raymer Louis F. Long, p Paul Merrill, gm Edward E. Furman, cm Lester McBride, pd Russ Wonnacott, pmm & nd John E. Hickman, ce Les McBride, sd Bonita McBride, wd Pop.: 25,000 Rad. Hms.: 8,000 Ret. Sls.: \$30,000,000 AP, UP WE

TUCSON

KCNA 1947 580 5,000-D 500-N DA-N Catalina Bcstg. 1511 E. 16th St. 2-4664 ABC Hollingbery Erskine Caldwell, p Wayne Sanders, gm, pd & pmm Harry Chambers, cm Peter Trowbridge, p, gm & ce Helen Wray, vp Tomm Epperson, ce Robert O. Black, bus. m Jim Maize, nd Bob McKeehan, fd Wally Lindberg, sd Jan Maize, wd Pop.: 278,000 Rad. Hms.: 65,870 AP G

KEVT 1953 690 250-D Tucson Radio Inc. 400 N. Shawnee 4-5588 Oakes DeWitt Wray, cm Hector Le Desma, pd Linn R. Trowbridge, vp & traffic m Fernando Rubio, nd Anita Edgerton, wd Pop.: 160,000

ARKANSAS

BLYTHEVILLE

KLCN 1922	910 5,000-D	Harold L. Sudbury Sudbury Bldg. 2093 Pearson	Harold L. Sudbury, p gm & cm	Carl Frame, pd J. T. Sudbury, pmm	Neal McCormick, ce Don Whitney, fd	 AP G
KLCN-FM 1948	Ch. 241 (B) 96.1mc 21kw							

CAMDEN

KAMD 1946	1450 250	Camden Radio Inc. 647 California Ave., S.W. 6-5091	MBS, KBS, Arkansas, Razorback Gill-Perna	Walter E. Hussman, p Frank O. Myers, gm Donald Cathey, cm	Cal Carter, pd, pmm, nd & sd	Dorris C. Hunter, ce Freda Carter, wd	Pop.: 200,000 Rad. Hms.: 50,000	Assoc. AP RCA
KPLN 1953	1370 1,000-D	D. R. James Jr. Stephens Rd. 6-9334	D. R. James Jr., p C. T. Mullins, gm & pmm	J. Andrew Wright, sm, pd, nd, ce & wd L. J. Smith, cm	Charles Christie, fd John Garner, sd	Pop.: 156,550 Rad. Hms.: 36,355 Ret. Sls.: \$112,274,000	

CONWAY

KCON 1950	1230 250	Conway Bcstg. Co. 903½ Front St. 189	Razorback	James E. Clayton, p, gm, cm & nd Muriel Cobb, pd	Herman G. Stermer, ce Charles Buice, pmm E. W. Bauer, fd	Grant Hazelwood, sd Rita Hicks, wd		Wld., SES UP Col.
--------------	-------------	---	--------------------	--	--	---------------------------------------	--	-------------------------

CROSSETT

KAGH 1951	1340 250	Julian Haas 900 Main St. 750	NBC, Arkansas, Razorback Best, Melville	Julian Haas, o	Charles Buice, ce	Ken Johnston, nd & sd	Pop.: 40,000 Rad. Hms.: 7,900 AP Ray.
--------------	-------------	------------------------------------	---	----------------	-------------------	-----------------------	----------------------------------	---------------------

EL DORADO

KDMS 1950	1290 1,000-D	Radio Station KDMS Randolph Hotel Bldg. 3-9190	KBS, Razorback, Arkansas Devney, Melville, Dora- Clayton	David M. Segal, p Virgil E. Stone, gm & sd	Paul E. Norton, cm Elizabeth P. Perdue, pd	E. C. Gresham, ce	Pop.: 342,182 Rad. Hms.: 78,244 Ret. Sls.: \$254,629,000	L-W UP Col.
KELD 1935	1400 250	Radio Enterprises Inc. Radio Center Bldg. 3-6126	ABC	W. N. McKinney, p, gm, pmm & natl. cm J. R. Duerson, loc. cm	Mrs. D. Pondrom, pd John H. Long, ce Edward R. Hall, nd	William G. Darland, fd & sd Sarah McLarty, wd	Pop.: 100,000 Rad. Hms.: 30,000 Ret. Sls.: \$76,506,000	Assoc. AP Col.

FAYETTEVILLE

KGRH 1946	1450 250	Fayetteville Bcstg. Co. 922 N. Leverett 2-2322	MBS Walker	Hayden McIlroy, p Fred J. Stevenson, gm	Edwin G. Gideon, cm & pmm Wallie Ingalls, pd & sd	Harold R. Lindsey, ce Richard W. Evans, nd Mary Ingalls, wd	Pop.: 50,400 Rad. Hms.: 13,350 Ret. Sls.: \$49,700,000 AP G
--------------	-------------	---	---------------	--	---	---	--	------------------

FORREST CITY

KXJK 1949	950 1,000-D (CP: 5,000-D)	Forrest City Bcstg. Co. National Bank Bldg. 950	KBS, Razorback, Arkansas	William Fogg, p & gm James Pearson Jr., cm Lloyd Denney, pd	Larry Parker, pmm, nd & sd	Walter Smith Jr., ce Bob Weber, fd	Pop.: 400,000 Rad. Hms.: 104,000 Ret. Sls.: \$643,000,000	Wld. AP G
--------------	---------------------------------	---	---	---	-------------------------------	---------------------------------------	---	-----------------

FORT SMITH

KFPW 1930	1230 250	Tulsa Bcstg. Co. Station "B" Box 98 3-4105	CBS, Razorback Avery- Knodel	John Griffin, p L. A. Blust, vp, gm & cm J. Paul McCaslin, sm	Harlan Judkins, pd George Ketcham, pmm Gene Gregory, ce	Pat Garner, nd & fd Dorothy Gibson, wd Joe Roppolo, sd	Pop.: 199,700 Rad. Hms.: 53,130 Ret. Sls.: \$131,334,000	L-W UP WE
KFPW-FM 1947	Ch. 235 (B) 94.9mc 14kw							
KFSA 1947	950 1,000-D	Southwestern Pub. Co. 920 Rogers Ave. 2-9126	ABC, Gross Roots Net, Pearson	Donald W. Reynolds, p Weldon Stamps, gm D. L. Johnson, cm Paschal Forta, pd	Richard Bentley, pmm Robert W. Platt Jr., ce Pat Forta, nd	Carl West, fd Harry Freeman, sd Jerry Winner, wd	Pop.: 230,280 Rad. Hms.: 55,852 Ret. Sls.: \$155,548,200 AP Col.
KFSA-FM 1948	Ch. 296 (A) 107.1mc 0.32kw						 GE
KWHN 1947	1320 5,000 DA-N	KWHN Bcstg. Co. 421-423 Garrison 3-8967	MBS Rambeau	H. S. Nakdimen, o & secy.-treas. Parkman R. Feezor, sm & cm	Glenn O'Neal, pd, pmm & nd Bruce Dennis, ce	Marvin McCullough, fd Don V. Archer, sd Eloise Quinn, wd	Pop.: 428,635 Rad. Hms.: 97,032 Ret. Sls.: \$230,746,000 AP WE

HARRISON

KHOZ 1946	1240 250	Harrison Bcstg. Corp. Radio City Addition 1240	MBS, KBS	Bob Wheeler, o & gm Mel Lynn, cm	Bruce Washburn, pd Fred Ward, ce	Leon Shaddox, nd, fd & sd Lillian Bell, wd		Thes. UP G
--------------	-------------	--	-------------------	-------------------------------------	-------------------------------------	--	--	------------------

HELENA

KFFA 1941	1360 1,000 DA-N	Helena Bcstg. Co. 215 York St. 4-2361	MBS, KBS Best	Sam W. Anderson, gm George Caven, cm	Larry Parker, pd & sd Katherine Kizer, pmm	Earl Hodges, ce	Pop.: 149,300 Rad. Hms.: 28,860 Ret. Sls.: \$28,000,000	Wld. AP G
--------------	-----------------------	---	------------------	---	---	-----------------	---	-----------------

HOPE

KXAR 1948	1490 250	Hope Bcstg. Co. PR-7-3601	MBS, KBS Best	A. H. Washburn, p L. B. Tooley, gm & ce	W. E. Ninemire, cm Carroll Winn, pd	Haskell Jones, pmm, nd & sd Florence Tooley, wd	Pop.: 103,000 Rad. Hms.: 26,000 Ret. Sls.: \$49,000,000 AP Col.
--------------	-------------	------------------------------	------------------	--	--	---	---	---------------------

ARKANSAS

City	Call Letters Established TV Affiliate	Chan. or Freq. Power	Licensee Headquarters Telephone	Network Represent- ative	Owner o; Pres. p; Exec. cm; Sales Mgr. slm; Prod. Mgr. pdm; News, Farm. Sports or Women's Dir. nd, fd, sd, wd.	Executive Abbreviations vp vvp; Gen. Mgr. gm; Sta. Mgr. sm; Coml. Mgr. Prog. D. r; Chief Eng. ce; Prom. Mgr. pmm; Chief of Eng. ce; Chief of Eng. ce; Chief of Eng. ce	Market Data For Primary Area (Supplied by station)	Library, News Serv. Transmitter
HOT SPRINGS								
KBHS 1953	590 1,000-D	Resort Bcstg. Co. 113 3d St. 3888	Sears & Ayer	I. A. Cain, p Marvin Hull, gm Ed. C. Appler, cm	Dud Stallings, pd & nd Steve Nichols, pmm Clint Norman, ce	Lynn Bayless, sd Bonnie Jean Brooks, wd	Pop.: 350,000 Rad. Hms.: 91,000 Ret. Sls.: \$239,785,000	Wld. UP G
KBLO 1953	1470 1,000-D	National Park Bcstg. Co. 1011 Central Ave. 5365	Razorback	Robert S. Bielow, co-o & gm	J. W. Bowie Meredith, co-o Jesse Pate, cm	Jack Nash, pd Robert G. King, ce		SES, AP G
KRCH 1953	1270 1,000-D	Garland Radio & Tv Corp. 873 1/2 Park Ave. 2102	KBS McGillvra	Leonard P. Frankel, p Randall L. McCarrell, gm	A. E. Simmons, cm & pmm Dorothy E. Foley, pd & wd	A. R. Garrett, ce David Black, nd Wayne Harper, fd & sd	Pop.: 80,500 Rad. Hms.: 22,060	
KWFC 1941	1340 250	Spa Bcstg. Co. Malco Music Hall Bldg. 412	MBS	W. E. Hussman, p Patt McDonald, gm C. J. Dickson, cm	Jack Ridgeway, pd & sd Dalton Sanders, ce	Ernest Watson, pmm Walter Ebel, nd Joyce Cook, wd		Thes. AP Col.
JONESBORO								
KBTM 1930	1230 250	Regional Bcstg. Co. 603 Madison St. Webster 5-5597	MBS, KBS	Jay P. Beard, p, gm & pmm Bernard Hargreaves, cm	Veda Beard, pd Cecil Clark, ce Clarence Adams, nd & fd	Al Hazelwood, sd Kit Hargreaves, wd	Pop.: 288,000 Rad. Hms.: 68,670 Ret. Sls.: \$102,160,000	Wld. AP G
<i>KBTM-FM</i> 1948	Ch. 270 (B) 101.9mc 8.1kw							
KNEA 1950	970 1,000-D	Radio Jonesboro Inc. Webster 2-8381	Razorback Gill- Perna	Dick Crane, gm Harold Gregson, cm Jay Roberts, pd & nd	Charles Quinton, pmm Wesley Bell, ce Chad Lassiter, fd	Bob Houston, sd Kay Norman, wd	Pop.: 361,800 Rad. Hms.: 92,700 Ret. Sls.: \$215,700,000	Assoc. UP RCA
LITTLE ROCK								
KARK 1928	920 5,000 DA-N	Ark. Radio & Equipment Co. 112-14 E. Capitol Ave. LD 99	NBC, Arkansas Petry	T. H. Barton, chmn. of bd. T. K. Barton, vp & gm Douglas J. Romine, sm	A. C. Dowden, cm Ernest M. Howard, pd Carol Vinson, pmm Dan L. Winn, ce	Edgar Chestnutt, nd Bob Buice, fd Wilson Hurst, sd Anne Allen, wd	Pop.: 854,700 Rad. Hms.: 190,660 Ret. Sls.: \$584,044,000	Wld. AP, UP RCA
KGHI 1927	1250 1,000-D 500-N DA-N	KGHI Bcstg. Service 306 1/2 W. 3d St. Franklin 2-0166	ABC Holling- bery	A. L. Chilton, ptrn. L. H. Chilton, ptrn. S. C. Vinsonhaler, ptrn. & gm	Kermit L. Richardson, cm	Betty Jo McNealy, pd V. O. Vandusen, ce	Pop.: 413,676 Rad. Hms.: 110,590 Ray.
KLRA 1927	1010 10,000-D 5,000-N DA-N	Arkansas Bcstg. Co. P. O. Box 557 2-5427 Taylor	J. N. Heiskell, p W. V. Hutt, gm R. J. Myers, cm Harris Owen, pd Robert Hicks, pmm	Kermit F. Tracy, ce Hugh B. Patterson Jr., secy.-treas. Oscar Alagood, loc. slm	John R. Holmes, fd Herbert Byrd, sd Mrs. Mescal Johnson, wd	Pop.: 818,200 Rad. Hms.: 221,600 Ret. Sls.: \$610,162,000	St. AP, UP RCA
KTHS 1928	1090 50,000 DA-N	Radio Bcstg. Inc. 313 Main 4-2293	CBS Branham	W. H. Bronson, p H. B. Clag, evp B. G. Robertson, gm Hugh R. Murphy, cm	Mark Weaver, nd Cecil Bland, pd Robert Brown, pmm Cecil Suitt, ce	Wm. Neel, nd Marvin Vines, fd Mike Murphy, sd		L-W RCA
KVLC 1948	1050 1,000-D	Southwestern Bcstg. Co. Southern Natl. Ins. Bldg. 5-5321	KBS McGillvra	R. M. Saxon, p Ray Dexter, m Wally Geiger, cm	Dale Mahurin, ce	Kitty V. LaCall	Pop.: 822,301 Ret. Sls.: \$873,350,000	Assoc. UP G.
KXLR 1946	1150 5,000-D 1,000-N DA-N	Arkansas Airwaves Co. 217 E. 3d St. 2-2155	MBS, Razorback Rambeau	John F. Wells, p Emil J. Pouzar, gm Melton Lancaster, cm	Roy Nichols, pd & pmm Earl Butler, ce	William H. Hadley, nd Peter Hawkins, sd Bobby Forster, wd	Pop.: 470,345 Rad. Hms.: 111,954 Ret. Sls.: \$367,057,000	Thes. UP G
MAGNOLIA								
KVMA 1948	630 1,000-D	Magnolia Bcstg. Co. 212 N. Jefferson 630	MBS, Razorback Pearson	Dr. Joe F. Rushton, p W. M. Bigley, gm	W. D. Waller, slm Ray Wells, ce	Les Rogers, nd		Wld. AP Ray.
MALVERN								
KDAS 1951	1420 1,000-D	Malvern Bcstg. Co. Young Insurance Bldg. 1584 Devney, Melville	Thomas Alford, p, gm & cm	Jim Faulkner, pd & sd John Williams, ce	Ed Stanfield, nd	Pop.: 123,177 Rad. Hms.: 30,647 Ret. Sls.: \$89,622,000	Wld. UP G
KGRO (CP)	1380 1,000-D	Malvern Bcstg. Co. 321 School St.						
McGEHEE								
KVSA 1953	1220 1,000-D	S. E. Arkansas Bcstrs. Inc. P. O. Box 1220 20	KBS, Arkansas, Razorback Best	Abbott F. Kinney, p, gm, pmm, sd & pd	Frank H. Ross, slm Herschell E. Parent, pd & nd Thomas O. Graves, ce	Mrs. M. F. Kinney, cm Lillian Cohen, wd	Pop.: 171,641 Rad. Hms.: 37,028 Ret. Sls.: \$90,530,000	Cap. AP G
MENA								
KENA 1950	1450 250	R. B. Bell S. Reene St. 878	MBS, KBS	R. B. Bell, p Bernice Bell, pd	O. D. Frederick, ce Claud Hill, nd	Mary Lou Carter, wd		St. UP Col.
MORRILTON								
KVOM 1953	800 250-D	Morrilton Bcstg. Co. c/o C. R. Horne Radio Station KXRJ Russellville, Ark.						
MOUNTAIN HOME								
KTLO 1953	1490 250	Mountain Home Bcstg. Corp. P. O. Box 1471 1490	MBS	Robert S. Wheeler Jr., p	Bruce C. Washburn, gm	Everett Horton, cm Fred E. Ward, ce		

Data corrected to Dec. 10, 1953. If executives or services for FM are same as AM affiliate names are not repeated. Market Data supplied by stations. FM's in *italic*. *—Non-Commercial Station. CP—Construction Permit issued. D—Day. DA-N—Directional Antenna, night only. DA-1—Directional Antenna, same pattern day and night. DA-2—Directional Antenna, different pattern day and night. L—Limited Time with Dominant Station. LS—Local Sunset. N—Night. SA—Special Authorization. SH—Specified Hours. ST—Share Time. Complete key to abbreviations, page 6.

NEWPORT

KNBY 1290 Newport Bcstg. Razorback Harold Sudbury, p Gene Howe, cm & nd Mary Ellen McDonald, UP
1949 1,000-D Co. Best Anson Clark, ce wd RCA
Box 218
749

OSCEOLA

KOSE 860 Osceola Bcstg. KBS. Harold F. Ohlendorf, p Betty G. Woods, cm Harold M. Jones, ce Pop.: 1,000,000 Wid.
1949 1,000-D Corp. Razorback Best Ted Woods, gm Hobson Daws, pd & sd Rad. Hms.: 281,000 AP
P. O. Box 311 Best Ret. Sis.: \$890,000,000 RCA
860

PARAGOULD

KDRS 1490 Progressive KBS T. M. Self, co-o & Doayne F. Bateman, cm George Kirby, fd Pop.: 90,000
1947 250 Bcstg. Co. bus, m Hugh Frizzell, pd & sd Wilma Wheelis, traffic Rad. Hms.: 18,000 AP
Box 491 Cedar 2-7627 & gm Russell Schwamb, ce m & wd Ret. G
Cedar 2-7627

PINE BLUFF

KCLA 1400 Radio Engineer- Ken Kesterson, gm Charles Penix, pd Dave Wallis, sd Pop.: 75,873 L-W
1947 250 ing Service Clyde Martin, cm Rad. Hms.: 17,190 AP
2900 W. 28th Ret. Sis.: \$77,000,000 G
1900

KOTN 1490 Universal Bcstg. MBS, KBS B. J. Parrish, p, gm Joe Wallace, loc, cm Pop.: 133,100 Thes.
1934 250 Corp. & ce Lois Palmer, pd Rad. Hms.: 29,093 AP
P. O. Box 957 Ret. Sis.: \$80,760,000 RCA
721

POCAHONTAS

KPOC 1420 Pocahontas Radio KBS, Ark. Adrian L. White, gm Bill Nichol森, pd, nd Pop.: 50,000 Wid.
1950 1,000-D Inc. Indian Hiram Mayo, cm & sd Jack Wilson, ce UP
P. O. Box 250 Razorback, Magic Circle G

KPOC-FM Ch. 249
1952 97.7mc
0.390kw

RUSSELLVILLE

KXRJ 1490 The Valley MBS, KBS C. R. Horne, p & gm William C. McKenney, Kermit Womack, nd Pop.: 89,790
1947 250 Bcstrs. L. L. Bryan, cm pd & ce Don Sammons, pmm Marjorie Crabaugh, wd Rad. Hms.: 23,112 AP
Fine Arts Bldg. Ret. Ray

SEARCY

KSCY 1450 Edith Wood Sweezy
(CP) 250 c/o Arkansas Recorder
215 E. Third St.
Little Rock, Ark.

KWCB 1300 White County MBS, KBS Carl N. Dodd, p & gm Don P. Jones, sim John Argo, sd SES.,
1951 1,000-D Bcstg. Co. Inc. Homer M. Harris, pd & ce Thes.
P. O. Box 95 1281 AP
G

SILOAM SPRINGS

KUOA 1290 KUOA Inc. MBS, Magic D- John E. Brown Cecil E. Smith, gm Ralph Kennedy, pd Pop.: 250,000
1923 5,000-D Siloam Springs, Ark. Circle Sr. p cm & ce Rad. Hms.: 50,000 Thes.
777 WE

KUOA-FM Ch. 289 (B)
1948 105.7mc
2.6kw

SPRINGDALE

KBRS 1340 Southwestern ABC, Magic Donald W. Reynolds, p Roy J. Bowman, gm Bill Ussery, ce Pop.: 110,000
1949 250 Pub. Co. Circle Pearson cm & pd Rad. Hms.: 29,125 AP
P. O. Box 29 675 G

STUTTGART

KWAK 1240 Stuttgart Bcstg. MBS, KBS Melvin P. Spann, vp Ross Beard, vp & June Spann, pd, traffic St. Wid.
1948 250 Corp. Best gm & secy. treas. m & wd Richard Stuart, fd UP
Box 271 Ret. N. W. Biddulph, cm Marvin Heffington, ce & fd Ret. Sis.: \$22,000,000 G

TEXARKANA

KCMC (See Texarkana, Tex., listing)
KCMC-FM
KOSY (See Texarkana, Tex., listing)
KTFS (See Texarkana, Tex., listing)

WALNUT RIDGE

KRLW 1320 Southern College Razorback Dr. H. E. Williams, p Mitch Odum, loc, sim Dave Godwin, nd Pop.: 254,300
1951 1,000-D Bcstg. Service Best Neal B. Bunn, gm & sd Bill Thornton, pd Leonard Ringle, ce Rad. Hms.: 63,310
Drawer 30 980 Ret. Sis.: \$31,868,000

WARREN

KWRF 860 Pines Bcstg. Co. Paul Fiser, co-o Lee Reaves, gm Norman Jones, ce Pop.: 98,134
1953 250-D 353 John Rye, co-o Deno Nichols, cm Virginia Nichols, traffic Rad. Hms.: 83,414

WEST MEMPHIS

KWEM 990 KWEM, Inc. For Joe E. D. Rivers Jr., p William Riley, pd Thomas Roane, nd
1947 1,000-D 463 J. E. Nobles, gm Edward Beck, ce Richard Stuart, fd UP
Spencer Bedsole, cm Matty Brescia, pmm & Patricia Raymond, wd G





**MORE LISTENERS
PER
DOLLAR
THAN FROM
ANY**



CALIFORNIA

MARKET DATA BY COUNTIES

County	Population 1950	Radio Families 1953	Retail Sales 1952(000)	Food Sales 1952(000)	Drug Sales 1952(000)	Automobile Ownership 1952
Alameda	740,315	259,120	\$990,503	\$257,807	\$29,904	334,765
Alpine	241	*	150	29	218
Amador	9,151	2,820	8,992	2,845	243	5,228
Butte	64,930	23,110	87,589	24,496	2,107	38,582
Calaveras	9,902	3,140	8,662	2,356	198	5,644
Colusa	11,651	3,720	18,927	3,986	528	7,402
Contra Costa	298,984	99,380	287,174	104,931	8,590	138,729
Del Norte	8,078	2,670	11,275	3,177	333	6,739
El Dorado	16,207	** 5,730	16,467	6,352	287	10,189
Fresno	276,515	88,710	369,371	86,982	10,200	157,414
Glenn	15,448	4,770	22,638	4,650	374	10,345
Humboldt	69,241	23,270	104,396	26,715	1,927	43,510
Imperial	62,975	15,370	87,642	20,765	2,367	33,829
Inyo	11,658	3,910	19,320	5,092	580	7,608
Kern	228,309	71,180	292,646	74,041	6,128	125,753
Kings	46,768	13,490	61,563	13,927	1,432	27,978
Lake	11,481	4,240	13,422	4,565	494	7,720
Lassen	18,474	5,850	19,676	5,716	712	9,936
Los Angeles	4,151,687	1,516,980	5,683,608	1,364,165	199,501	2,225,938
Madera	36,964	10,920	42,654	12,495	813	19,718
Marin	85,619	29,120	89,882	29,113	2,961	40,822
Mariposa	5,145	1,470	3,411	1,177	51	2,968
Mendocino	40,854	12,840	48,974	12,274	876	23,643
Merced	69,780	21,080	92,581	20,640	2,517	38,227
Modoc	9,678	2,760	15,733	3,378	319	5,698
Mono	2,115	640	1,887	540	1,018
Monterey	130,498	42,000	169,820	41,105	4,419	64,979
Napa	46,603	14,970	49,046	13,208	1,106	22,221

CALIFORNIA

City	Chan. or Freq. Power	Licensee Headquarters Telephone	Network Representative	Owner o; Pres. p; Exec. up evp; Gen. Mgr. gm; Sta. Mgr. sm; Coml. Mgr. cm; Sales Mgr. sim; Prog. Dir. pd; Chief Eng. ce; Prom. Mgr. pmm; Prod. Mgr. pdm; News, Farm. Sports or Women's Dir. nd, fd, sd, wd.	Executive Abbreviations	Market Data For Primary Area (Supplied by station)	Library, News Serv. Transmitter
BAKERSFIELD—(Continued)							
KPMC 1933	1560 1,000	Pioneer Mercantile Co. P. O. Box 1709 8-8157	ABC Hollingbery	Frank Schamblin, p Leo Schamblin, gm C. C. Sturm, cm & pd	Paul Biermann, pmm, nd & fd L. F. Jarvis, ce	Art Mason, sd Eleanor Strauss, wd	Pop.: 459,000 Rad. Hms.: 129,939 Thes. UP RCA
BANNING							
KPAS 1947	1490 250	Darwin Bcstg. Co. Box 1394 Banning 515	Chet Darwin, p, gm & cm	Jack Campbell, pd	Drew Walker, ce	Pop.: 66,000 Rad. Hms.: 2,460 Ret. Sls.: \$73,000,000 Thes. AF Ray.
BARSTOW							
KWTC 1947	1230 250	Mojave Valley Bcstg. Inc. Box 697 4001	L. O'Connell, Cooke, McGavren	W. T. Brown, p Harry S. White, sm & em, nd	Jim Harvey, pd & nd Don Hetzel, ce	Pop.: 28,500 Rad. Hms.: 8,000 Ret. Sls.: \$29,346,323 Wld. UP WE
BERKELEY							
KRE 1923	1400 250	Central California Bcstrs. 601 Ashby Ave. Ashberry 3-7715	Arthur Westlund, p & gm	Don Hambly, cm & pmm	Les Avery, pd	Pop.: 1,680,675 Rad. Hms.: 540,000 AP WE
KRE-FM 1945	Ch. 275 (B) 102.9mc 9.9kw
BEVERLY HILLS							
KCBH (FM) (CP)	Ch. 254 (A) 98.7mc 50kw	A. A. Crawford 458 N. Rodeo Dr. Crestview 1-8124	A. Arthur Crawford, o, p & ce Jean E. Crawford, pd	Pop.: 4,540,500 Rad. Hms.: 1,551,100 Ret. Sls.: \$5,683,608,000 GE
BISHOP							
KIHS 1953	1230 250	Inyo Bcstg. Co. P. O. Box 757 Bishop 4411	Western Radio Sales	James R. Oliver, ptrn., gm & pmm S. A. Cislser, ptrn.	R. S. Deming, cm John Drozd, pd	Alva Wilt, ce & nd Howard Frost, sd	Pop.: 13,000 Rad. Hms.: 4,000 Cap. UP G
BLYTHER							
KYOR 1948	1450 250	Bcstg. Corp. of America Box 668 2231	ABC Calif. Rural Pearson	Paul Nelson, gm Glen Sines, cm	Bill Donahoe, pd Bill Blaisey, ce	Charles Bigler, sd Marie Jannes, wd
BRAWLEY							
KROP 1948	1300 1,000-D 500-N	Bcstg. Corp. of America P. O. Box 238 Brawley 1300	ABC Calif. Radio Pearson	Fred E. Carr, trustee Bill Williams, gm, pd & pmm	Carol Williams, cm & wd Ray Casey, nd	Dwight Drumm, fd Bob Reynolds, sd	Pop.: 50,000

DIRECTORY OF AM AND FM STATIONS

City Call Letters Established TV Affiliate	Chan. or Freq. Power	Licensee Headquarters Telephone	Network Represent- ative	Owner o; Pres. p; Exec. vp evp; cm; Sales Mgr. sm; Prog. Dir. pd; Prod. Mgr. pdm; News, Farm, Sports or Women's Dir. nd, fd, sd, wd.	Executive Abbreviations Gen. Mgr. gm; Sta. Mgr. sm; Coml. Mgr. Chief Eng. ce; Prom. Mgr. pmm; Chief of News, Farm, Sports or Women's Dir. nd, fd, sd, wd.	Market Data For Primary Area (Supplied by station)	Library, News Serv. Transmitter	
ALTURAS KCNO 1951	570 1,000-D	CONR Inc. P. O. Box 207 2531 Forjoe	Rowland H. Dow, p, pd & pmm	Philip N. Good, vp, gm, cm & fd Ralph W. Powers, ce	Ralph Powers, nd Bessie M. Dow, wd Rand Garrett, sd	Pop.: 145,944 Rad. Hms.: 45,019 Ret. Sls.: \$200, 907, 000	St., SES., Cap. UP G.
AUBURN KDIA 1950	1490 250	Charles E. Halstead P. O. Box 992 1078	KBS Ayres	Charles E. Halstead Jr., p, gm & ce	Mrs. Charles Halstead, wd	 G.	
AVALON KBIG 1952	740 10,000-D DA-D	John Poole Bcstg. Co. 6540 Sunset Blvd. Hollywood 28 Hollywood 3-3205 Meeker	John H. Poole, p, gm & ce Robert J. McAndrews, cm & pmm Cliff Gill, opers. m	Alan Lisser, pd Stu Wilson, pdm & pub sev d Beull H. Dalton, d of enrg	Don Callen, Avalon m Larry Berrill, nd & sd Margee Phillips, wd	Pop.: 6,281,800 Rad. Hms.: 2,049,001 Ret. Sls.: \$7,573,155,000	Cap. UP G
BAKERSFIELD KAFY 1946 KAFY-TV	550 1,000-DA-N	Bakersfield Bcstg. Co. 2013 Chester Ave. 4-6421	MBS, Don Lee Forjoe	Sheldon Anderson, p & gm Naum Healy, sm	Joe Kinser, pd & sd Ted Froming, ce Bea Waldon, pmm	Hal Laffoon, nd Jim Garner, ce Mary Gregg, wd John Greensmith, fd	Pop.: 257,000 Rad. Hms.: 67,050 Ret. Sls.: \$292,646,000	Cap. UP Col.
KBIS 1950	970 1,000-DA-2	Marmat Radio Co. 957 Oak St. 4-6093 Grant	Hal Brown, p & gm Frank Wilbur, cm Jim Hayden, pd	Dick Daggett, pmm Jack Duemler, ce	Ernest Ferguson, loc. sm Bob M. Elias, sd & /nd	Pop.: 426,000 Rad. Hms.: 410,664 Ret. Sls.: \$411,348,000	Assoc., SES. AP Col.
KERN 1938	1410 1,000	McClatchy Bcstg. Co. Elks Bldg. 8-8431	CBS McClatchy Raymer	Eleanor McClatchy, p Walter L. Bazluk, m	Verne Shatto, ce Paul McElroy, nd	Lawrence Martin, fd		Cap. AP GE
KERN-FM 1948	Ch. 231 (B) 94.1mc 9.1kw							
KERO 1946 KERO-TV	1230 250	Kern County Bcstrs. Inc. 1420 Truxtun Ave. 4-4548	NBC Avery- Knodel	Gene De Young, p & gm Edward Urner, cm	Leslyn Day, pd John Parker, pmm & sd	Edwin Andress, ce Ken Croes, nd Rayleen Merman, wd	Pop.: 246,000 Rad. Hms.: 71,000 Ret. Sls.: \$456,000,000	Wid. UP RCA

Data corrected to Dec. 10, 1953. If executives or services for FM are same as AM affiliate names are not repeated. Market Data supplied by stations. FM's in italic. *—Non-Commercial Station. CP—Construction Permit issued. D—Day. DA-N—Directional Antenna, night only. DA-1—Directional Antenna, same pattern day and night. DA-2—Directional Antenna, different pattern day and night. L—Limited Time with Dominant Station. LS—Local Sunset. N—Night. SA—Special Authorization. SH—Specified Hours. ST—Share Time. Complete key to abbreviations, page 6.

Keep your eye on KBIG!



Our advertisers report sales increases, which are reflected in increased schedules.

Increase your sales in ALL Southern California.



Business is Good!

KBIG last quarter sales were 72% more than same period last year.

Good Availabilities do go fast!



Call your KBIG sales representative or Robert Meeker Associates, Inc., for costs and schedules.

740

This is the "high-traffic" point on the dial where advertisers and listeners meet. The powerful KBIG signal is boomed from Catalina Island across salt water (best conductor of radio waves) to reach all Southern California... Los Angeles, San Diego, Long Beach, Pasadena and 103 other incorporated cities PLUS the vast rural populations of 8 big counties. This is truly the Giant Economy Package of Southern California Radio.

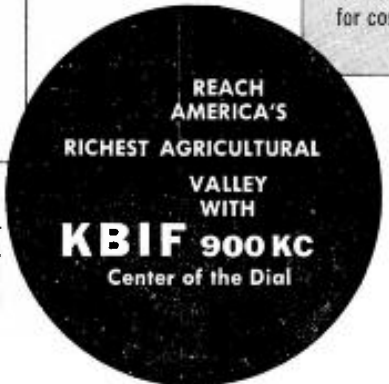

REACH AMERICA'S RICHEST AGRICULTURAL VALLEY WITH **KBIF 900 KC** Center of the Dial

John Poole
Broadcasting Co.
KBIG KBIF KBID-TV
KBIC-TV
6540 Sunset Boulevard
Hollywood 28
Hollywood 3-3205

KBIF Transmitter: Sanger
Office: 1412 Fulton St., Fresno

Advertisers use KBIF independently or in combination with KBIG to reach Fresno County and its adjoining counties—KINGS, MADERA, MERCED and TULARE—all in the prosperous San Joaquin Valley of Central California.

CALIFORNIA

City	Call Letters Established TV Affiliate	Chan. or Freq. Power	Licensee Headquarters Telephone	Network Represent- ative	Executive Abbreviations Owner o; Pres. p; Exec. op evp; Gen. Mgr. gm; Sta. Mgr. sm; Coml. Mgr. cm; Sales Mgr. slm; Prog. Dir. pd; Chief Eng. ce; Prom. Mgr. pmm; Prod. Mgr. pdm; News, Farm. Sports or Women's Dir. nd, fd, sd, wd.	Market Data For Primary Area (Supplied by station)	Library. News Serv. Transmitter		
BAKERSFIELD—(Continued)									
	KPMC 1933	1580 1,000	Pioneer Mercantile Co. P. O. Box 1709 8-8157	ABC Holling- bery	Frank Schamblin, p Leo Schamblin, gm C. C. Sturm, cm & pd	Paul Biermann, pmm, nd & fd L. P. Jarvis, ce	Art Mason, sd Eleanor Strauss, wd	Pop.: 459,000 Rad. Hms.: 129,939	Thes. UP RCA
	BANNING								
	KPAS 1947	1490 250	Darwin Bcstg. Co. Box 1394 Banning 515	Chet Darwin, p, gm & cm	Jack Campbell, pd	Drew Walker, ce	Pop.: 66,000 Rad. Hms.: 2,460 Ret. Sis.: \$73,000,000	Thes. AP Ray.
	BARSTOW								
	KWTC 1947	1230 250	Mojave Valley Bcstg. Inc. Box 697 4001 L. O'Connell, Cooke, McGavren	W. T. Brown, p Harry S. White, sm & em, nd	Jim Harvey, pd & nd Don Hetzel, ce		Pop.: 26,500 Rad. Hms.: 8,000 Ret. Sis.: \$29,346,323	Wld. UP WE
	BERKELEY								
	KRE 1923	1400 250	Central California Bcstrs. 601 Ashby Ave. Ashberry 3-7715	Arthur Westlund, p & gm	Don Hambly, cm & pmm	Les Avery, pd	Pop.: 1,680,675 Rad. Hms.: 540,000 AP WE
	KRE-FM 1948	Ch. 27.5 (B) 102.9mc 9.9kw							
	BEVERLY HILLS								
	KCBH (FM) (CP)	Ch. 25.4 (A) 98.7mc 50kw	A. A. Crawford 456 N. Rodeo Dr. Crestview 1-8124	A. Arthur Crawford, o, p & ce Jean E. Crawford, pd			Pop.: 4,540,500 Rad. Hms.: 1,551,100 Ret. Sis.: \$5,683,608,000 GE
	BISHOP								
	KIES 1953	1230 250	Inyo Bcstg. Co. P. O. Box 757 Bishop 4411 Western Radio Sales	James R. Oliver, ptrn., gm & pmm S. A. Cisler, ptrn.	R. S. Deming, cm John Drozd, pd	Alva Wilt, ce & nd Howard Frost, sd	Pop.: 13,000 Rad. Hms.: 4,000	Cap. UP G
	BLYTHER								
	KYOR 1948	1450 250	Bcstg. Corp. of America Box 668 2231	ABC, Calif. Rural Pearson	Paul Nelson, gm Glen Sines, cm	Bill Donahoe, pd Bill Blaisey, ce	Charles Bigler, sd Marie Jahnes, wd	
	BRAWLEY								
	KROP 1948	1300 1,000-D 500-N	Bcstg. Corp. of America P. O. Box 238 Brawley 1300	ABC, Calif. Radio Pearson	Fred E. Carr, trustee Bill Williams, gm, pd & pmm	Carol Williams, cm & wd Ray Casey, nd	Dwight Drumm, fd Bob Reynolds, sd	Pop.: 50,000
	BURBANK								
	KBLA 1952	1490 250	Bcstrs. of Burbank Inc. 11516 Oxnard St. N. Hollywood Sunset 2-1195	Gordon A. Rogers, p & sd	Robert S. Marshall, gm Henry May, pd & nd	William Robinson, ce Mildred Carr, wd	Pop.: 558,000	L-W UP WE
	CALEXICO								
	KICO 1947	1490 250	Charles R. Love 722 Main St. El Centro, Calif. 3250 L. O'Connell	Charles Love, p W. A. Geddes, gm Don Gillette, cm	Chap Rollins, pd, pmm & co-sd Hub Herbert, ce	Bob Temple, nd Sid Greenbaum, co-sd	Pop.: 220,000 Rad. Hms.: 50,000 Ret. Sis.: \$90,687,000	AP Ray.
	CHICO								
	KHSL 1935 KHSL-TV	1290 5,000 DA-N	Golden Empire Bcstg. Co. 336 Broadway Fireside 2-0141	CBS, CPRN Grant	Mrs. Hugh McClung, p M. F. Woodling, gm J. A. Pero, cm	Ed Parker, pd Russell B. Pope, ce Bud Hanna, sd	Tommy Nelson, nd Jeri Bowen, wd	Pop.: 935,432 Rad. Hms.: 312,000 Ret. Sis.: \$897,920,000	St. UP RCA
	KXOC 1949	1150 5,000-DA-N CP: 1060 10,000-DA-N	KXOC Inc. Radio Lane Fireside 2-4211	MBS, Don Lee Pearson	Lincoln Dellar, p Jack L. Powell, gm & cm	Neil McIntyre, pd, pmm & fd E. W. Berger, ce	Charlotte Graber, office m David Armitage, nd Martin Cantisano, sd	Pop.: 500,000 UP Col.
	COALINGA								
	KBMX 1950	1470 500-D	Pleasant Valley Radio Co. P. O. Box 715 136	KBS	Benjamin M. Bowman, p & ptrn. Rea B. Bowman, m, ptrn., ce & nd	Hilton T. Johnson, cm Faye Bowman, pd & wd	Dick Brown, pmm, fd & sd	Pop.: 25,000 Rad. Hms.: 8,000 Ret. Sis.: \$12,000,000	L-W, SES. UP G
	CORONA								
	KBUC 1948	1370 1,000-D 500-N DA-N	Radion Bcstg. Inc. Box 368 1370 McGillvra	Elmer J. Bucknum, p & gm Chas. L. Eubanks, cm	Cliff Miller, pd & nd Chas. Ferguson, pmm Chas. Billyew, ce	Mary A. Bucknum, sm & wd	Pop.: 665,000 Rad. Hms.: 217,000 UP GE
	CRESCENT CITY								
	KCRE 1950	1400 250	Del Norte Bcstg. Co. P. O. Box 248 3061-502	Robert E. Grey, p, gm & pd	Peggy Burke Grey, cm, pmm & nd	Jerry Clausen, fd & sd	Pop.: 15,500	St., SES. AP GE

Data corrected to Dec. 10, 1953. If executives or services for FM are same as AM affiliate names are not repeated. Market Data supplied by stations.
 FM's in italic. *—Non-Commercial Station. CP—Construction Permit issued. D—Day. DA-N—Directional Antenna, night only. DA-1—Directional Antenna, same pattern day and night. DA-2—Directional Antenna, different pattern day and night. L—Limited Time with Dominant Station. LS—Local Sunset. N—Night. SA—Special Authorization. SH—Specified Hours. ST—Share Time. Complete key to abbreviations, page 6.

DELANO

KCHJ 1951	1010 1,000-D	Charles H. Johnes Cty. Line Rd. at Melcher 8676	Charles H. Johnes, p. gm & ce	Jean G. Johnes, pd & wd	Bill Moyer, nd & fd Harold Gann, sd	Rad. Hms.: 150,000	SES. UP
---------------------	-----------------	--	-------	----------------------------------	----------------------------	--	--------------------	----------------------------

DINUBA

KRDU 1946	1240 250	Radio Dinuba Co. P. O. Box 157 Dinuba 500	Egon A. Hofer, p. gm & cm	Harold Sparks, pd Warren Nystrom, ce	John L. Hofer, nd & fd	Pop.: 520,000 Rad. Hms.: 133,500 AP
---------------------	-------------	---	-------	------------------------------	---	------------------------	-------------------------------------	-----------------------------

EL CENTRO

KXO 1927	1230 250	Valradio Inc. P. O. Box 140 1100	MBS. Don Lee Raymer	Paul A. Jenkins, p Riley R. Gibson, gm	Belle Hovey, cm Doug Fishel, asst. m	Bob Weaver, sd & fd Mary Francisco, wd	Pop.: 245,000 Rad. Hms.: 24,500 Ret. Sls.: \$136,462,000	Cap., SES. UP RCA
--------------------	-------------	--	---------------------------	---	---	---	--	---------------------------------------

EUREKA

KHUM 1947	1240 250	Carroll R. Hauser Vance Hotel Hillside 2-5744	ABC, CBS Pearson	Carroll R. Hauser, p & gm	Frank M. Smith, cm & sd	Bill Kelso, pd & pmm Dean Elliott, ce Mabel Zabel, traffic m	Pop.: 100,000 Rad. Hms.: 33,000 Ret. Sls.: \$100,000,000	Cap. AP Col.
---------------------	-------------	--	---------------------	------------------------------	----------------------------	--	--	----------------------------------

KIEM 1933	1430 5,000	Redwood Bestg. Co. Box 1021 Hillside 3-1621	MBS. Don Lee Blair	William B. Smullin, p Donald H. Telford, gm Robert Stach, cm Pearl Jacobsen, pd	Violet Susan, pmm Larry King, ce Eddy Arnold, pdm	Newt Steward, nd Harry Howard, sd Marion Graham, wd	Pop.: 110,000 Rad. Hms.: 33,000 Ret. Sls.: \$155,000,000	Wid. UP WE
---------------------	---------------	--	--------------------------	--	---	---	--	-------------------------

KRED(FM) Ch. 242 (B) (KIEM, am Affiliate)
1947 96.3mc
4.6kw

FORT BRAGG

KDAC 1948	1230 250	Edward Mertle P. O. Box 616 3251	United Pacific Forjoe	Edward A. Mertle, o	Craig N. Smith, gm & ce Dick Holt, pd	Mathew V. Huber, pm	Pop.: 45,000 AP Col.
---------------------	-------------	--	-----------------------------	---------------------	---	---------------------	--------------	-----------------------------------

To reach ALL of SOUTHERN CALIFORNIA you must include

**SOUTHERN CALIFORNIA'S
THIRD MARKET
IMPERIAL
VALLEY**

LOS ANGELES

SAN DIEGO

EL CENTRO

KXO

**COVERS THE ENTIRE
IMPERIAL VALLEY**

(There are no holes
in our coverage)

SOUTHERN CALIFORNIA'S THIRD MARKET

\$122,597,000 Cash Farm Income*
7th Farm County in entire U. S.*

Mountains block out nearly all non-valley radio and TV

THIS LUSH MARKET CAN BE REACHED ONLY FROM WITHIN!

KXO enjoys 59% share-of-audience, day and night
average, including all cities in the Imperial Valley.**

*Sales Management 1953 **J. W. Ward, Inc. Feb. 1953

CALIFORNIA

City	Call Letters Established TV Affiliate	Chan. or Freq. Power	Licensee Headquarters Telephone	Network Represent- ative	Owner; Pres. D; Exec. vp cm; Sales Mgr. slm; Prog. Dir. pd; Prod. Mgr. pdm; News, Farm, Sports or Women's Dir. nd, fd, sd, wd.	Executive Abbreviations vp; Gen. Mgr. gm; Sta. Mgr. sm; Coml. Mgr. Harold O'Donnell, pd Helen Johnson, office m	Market Data For Primary Area (Supplied by station)	Library, News Serv. Transmitter
FRESNO								
KARM	1430	5,000-DA-1	KARM, The George Harm Station 1333 Van Ness Ave. 4-2966	ABC Bolling	Hattie Harm, p Clyde F. Coombs, gm Lou Lampe, pd	Eldora Roth Cooney, pmm Elbert H. Dean, ce Hap Haggard, nd & fd		St. AP, INS RCA
<i>KARM-FM</i>	Ch. 270 (B)	101.9mc 7.4kw						AP, INS GE
KFRE	940	50,000 DA-2	California Inland Bcstg. Co. T. W. Patterson Bldg. 4-5001	CBS Avery- Knodel	Paul R. Bartlett, p & gm Frank D. Woody, slm Ed J. Frech, pvp Keith L. Mealey, engrg vp	Harry H. Burum, pmm Harold O'Donnell, pd Helen Johnson, office m Russell Powell, nd Wally Erickson, fd Flo Hansen, wd	Pop.: 896,900 Rad. Hms.: 268,000 Ret. Sls.: \$1,125,362,000	Wld. UP GE
<i>KRFM (FM)</i>	Ch. 229 (B)	93.7mc 70kw	(KFRE, Am Affiliate)				Pop.: 505,000 Rad. Hms.: 157,000 Ret. Sls.: \$505,974,000 GE
KGST	1600	1,000-D	Delle Bcstg. Plaza Shopping Center 6-6526 Rambeau	Morris Mindel, cm Jeanne Bacher, pd & wd	Andy Kay, nd Roy Storey, sd Barney Lee, fd	Pop.: 325,000 Rad. Hms.: 31,000 Ret. Sls.: \$370,000,000 UP Col.
KMAK	1340	250	McMahan Bcstg. Co. 2020 McKinley 6-9448 Grant	R. O. McMahan, p Coyle Chambers, gm	Ed Nickels, ce Denny Whitney, asst. m	Pop.: 307,700 Ret. Sls.: \$369,371,000 UP
KMJ	580	5,000	McClatchy Bcstg. Co. 1515 Van Ness Ave. 3-8277	NBC Raymer	Eleanor McClatchy, p David T. Harris, sm Roy Swanson, cm	Ramsey Elliott, pd Richard Ebbert, pmm William Wallace, ce Andrew Patterson, traffic m Chet Castleman, nd Edward Sturgeon, fd		Assoc. AP, UP RCA
<i>KMJ-FM</i>	Ch. 250 (B)	97.9mc 7.8 kw						
KVNO	1300	1,000 DA-2	Schuler, William- son, Chenault P. O. Box 407 Fresno 2-4163	MBS, Don Lee Holling- bery	Mrs. Amelia Schuler, p L. E. Chenault, gm Les Daggett, cm	Leo Goldman, pd Jack Grady, pmm Bert Williamson, ce Ed Piston, nd & fd George Bryson, sd Frances Quinn, wd	Pop.: 450,000 Rad. Hms.: 96,000	Thes. UP Ray.
GLENDALE								
KIEV	870	250-D	Cannon System Ltd. 102 N. Glendale Ave. Citrus 1-1133 L. O'Connell	David H. Cannon, p Cal Cannon, gm	Charles N. Whitten Jr., ce	 UP WE
<i>KUTE (FM)</i>	Ch. 270 (B)	101.9mc 11.6kw	Robert P. Adams P. O. Box 729 Citrus 4-1414	Robert P. Adams, p & ce		 Fed.
<i>KFMU (FM)</i>	Ch. 246 (B)	97.1mc 58kw	Nicholas M. Brazy					
HANFORD								
KNGS	620	1,000 DA-N	Hanford Bcstg. Co. P. O. Box 620 620 L. O'Connell	Earl J. Fenston, p & o Don C. Reeves, gm & ce	John Haslam, cm Lloyd Chappel, pd	Pop.: 900,000 Rad. Hms.: 880,000	St. UP, INS Ray.
INDIO								
KREO	1400	250	Bcstg. Corp. of America P. O. Box 697 Indio 7-3403	ABC Pearson	Richard T. Sampson, gm Lyle Shuman, sm Douglas Caplette, cm	Patricia Gordon, pd Bill Howard, pmm Cliff Lantz, ce Don Retz, nd Maurie Solt, fd Alex Alexander, sd Peggy Pasty, wd	Pop.: 17,855 Ret. Sls.: \$64,812,000 Ray.
LANCASTER								
KAVL	1340	250	Antelope Bcstg. Co. P. O. Box 1192 1000 Western Radio	Whitford B. Carter, p & gm	Herbert L. Comstock, cm James B. French, ce Lew Shank, nd & sd Wilma Lewis, wd	Pop.: 25,000 Rad. Hms.: 7,500	Wld., SES. UP RCA

Data corrected to Dec. 10, 1953. If executives or services for FM are same as AM affiliate names are not repeated. Market Data supplied by stations. FM's in italic. *—Non-Commercial Station. CP—Construction Permit issued. D—Day. DA-N—Directional Antenna, night only. DA-1—Directional Antenna, same pattern day and night. DA-2—Directional Antenna, different pattern day and night. L—Limited Time with Dominant Station. LS—Local Sunset. N—Night. SA—Special Authorization. SH—Specified Hours. ST—Share Time. Complete key to abbreviations, page 6.

KARM

Fresno, California

ABC's Station for Central California

Represented Nationally by

THE BOLLING CO. INC.

New York
480 Lexington Ave.

Boston
80 Boylston St.

Chicago
360 N. Michigan Ave.

Los Angeles
2978 Wilshire Blvd.

San Francisco
5 Third Street

LODI									
KCVR 1946	1570 1,000-D	Central Valley Radio P. O. Box 600 8-0628	KBS	Herbert W. Brown, co-o David A. Brown, co-o	Clyde C. Casto, gm, cm & pmm	Dedah M. Corlett, pd George L. Sampson, ce	Pop.: 750,000 Rad. Hms.: 200,000 UP Ray.	
LONG BEACH									
KFOX 1924	1280 1,000	Nichols & Warin- ner Inc. 220 East Anaheim 672-81 Burn- Smith	Lawrence W. Mc- Dowell, gm & cm	Robert Lamb, pmm	Albert Mutter, tech. sup.		L-W, Wid. UP WE	
KFOX-FM 1951	Ch. 272 (A) 102.3mc 1kw								
KGER 1926	1390 5,000 DA-N	John Brown Schools of Calif. 3745 Atlantic Ave. 40-7907 Gill- Perna	Dr. John E. Brown Sr., p Clinton H. Fowler, gm, cm & pd	Luther H. Crumbaugh, ce Finis Bell, nd	Maj. Harry Bateson, fd Robert Klosterman, sd Irene Cook, wd		Thes. AP RCA	
KNOB(FM) 1949	Ch. 276 (A) 103.1mc 0.32kw	Cerritos Bcstg. Co. 1120 Pine Ave. 8-5519	Ray Torian, p, gm, cm, pd & ce			Pop.: 1,500,000 Rad. Hms.: 125,000 Ray.	
LOS ANGELES									
KABC 1929 KABC-TV	790 5,000 DA-N	American Bcstg.- Paramount The- atres Inc. 1539 N. Vine St. Hollywood 2-3141	ABC Petry	Leonard H. Goldenson, p (AB-PT) Robert E. Kintner, p (ABC) Earl J. Hudson, vp, W. Div. (ABC)	William Phillipson, gm, W. Div. (ABC) Amos Baron, sm Matt Barr, slm	Dresser Dahlstead, pd Jon Barkhurst, pmm Phillip Caldwell, ce Sam Zelman, nd & sd	Pop.: 4,915,100 Rad. Hms.: 1,841,700 Ret. Sls.: \$6,086,182,000	L-W AP, UP RCA	
KABC-FM 1948	Ch. 238 (B) 95.5mc 3.8kw								
KCBH (FM) 1953	Ch. 254 (B) 98.7mc 50kw	A. A. Crawford							
KFAC 1931	1330 5,000 DA-N	Los Angeles Bcstg. Co. 5773 Wilshire Webster 0161 Bolling	Calvin J. Smith, p, gm & cm Howard M. Rhines, pd	Ron Oakley, ce Lucile Blake, traffic m Dick Joy, nd & sd	Eileen Wheatley, office m Grace Sperry, mus. lib.	Pop.: 4,785,500 Rad. Hms.: 1,611,610	Assoc. AP RCA	
KFAC-FM 1948	Ch. 282 (B) 104.3mc 3.8kw								
KFI 1922	640 50,000	Earle C. Anthony Inc. 141 N. Vermont Ave. Dunkirk 2-2121	KBS Christal	Earle C. Anthony, p & gm Charles E. Hamilton, asst. to p	Pat Kelly, pd Ron Manders, pmm H. L. Blatterman, co-ce Curtis W. Mason, co-ce	Jack Littleton, pub. d Pat Bishop, nd Rollie Thomas, sd Nelson McInich, fd	Pop.: 7,000,000 Rad. Hms.: 2,500,000	Wid. Cap. AP, UP RCA	
*KFSG 1924	1150 2,500-D 1,000-N ST-KRKD	Echo Park Evangelistic Assn. 1100 Glendale Dunkirk 9-1141	Dr. Rolf K. McPher- son, p	M. D. Buchen, gm & pd	Oval Wylie, pmm Donald K. Horton, ce	 WE	
KFVD 1925	1020 5,000-L	Standard Bcstg. 338 S. Western Ave. Dunkirk 8-2345 McGillvra	Frank Burke Jr., p & gm Vern Lindblade, cm	Carl Brewster, pd & pmm Leonard Reeves, ce	Bob Stone, nd Violet Schram, wd	Pop.: 5,174,775 AP, UP Ray.	

"SOLID" BLOCK PROGRAMMING

explains the trend to Los Angeles' "Twenty-Four Hour Station"

DAYTIME —

MUSIC and NEWS—11 Hours SOLID

Presenting uninterrupted vocal and orchestral stylings balanced with latest wire news hourly.

NIGHT OWL —

Pops, Premieres and Personalities—6 Hours SOLID

Beamed to the enormous Los Angeles nighttime audience of 650,000—more than the combined populations of Dallas and El Paso.

NEGRO —

Rhythm and Blues—2½ Hours SOLID

The ONLY Los Angeles evening program styled for the big Negro and foreign markets—an audience of 500,000, more than the entire population of Indianapolis.

The Original

KGFI

Twenty-Four Hour Station

Hollywood 4-0201

6314 SUNSET BOULEVARD, Los Angeles 28, Calif.

CALIFORNIA

City	Call Letters Established TV Affiliate	Chan. or Freq. Power	Licensee Headquarters Telephone	Network Represent- ative	Owner o; Pres. p; Exec. op evp; Gen. Mgr. gm; Sta. Mgr. sm; Coml. Mgr. cm; Sales Mgr. slm; Prog. Dir. pd; Chief Eng. ce; Prom. Mgr. pmm; Prod. Mgr. pdm; News, Farm, Sports or Women's Dir. nd, Id, sd, wd.	Executive Abbreviations	Market Data For Primary Area (Supplied by station)	Library, News Serv. Transmitter
LOS ANGELES—(Continued)								
	KFWB 1925	980 5,000	Union Bcstg. Corp. 6419 Hollywood Blvd. Hempstead 3-5151 Branham	Harry Maizlish, p Morton Siddey, gm	Sydney Yallen, opr d Dan Russell, pd Harry Myers, ce	David Ballard, nd Mark Scott, sd AP, UP
	KFWB-FM 1948	Ch. 234 (B) 94.7mc 58kw			Harry Maizlish, p & gm			
	KGfJ 1926	1230 250	Ben S. McGlashan 6314 Sunset Blvd. Hillside 4-0201		Ben S. McGlashan, o Thelma Kirchner, gm & cm	Homer Obuchon, ce	Juanita McCurdy, traf- fic m	Pop.: 3,903,338 Rad. Hms.: 1,240,279 Assoc. UP WE
	KHJ 1922	930 5,000	General Tele- radio Inc. 1313 N. Vine St. Hollywood 2-2133	MBS, Don Lee Blair	Willet H. Brown, p Ward D. Ingram, evp	Norman Boggs, slsvp Robert M. Light, pmm	Robert Arne, ce	Wid. AP, INS WE
	KHJ-FM 1943	Ch. 266 (B) 101.1mc 16.8kw						
	KLAC 1946	570 5,000-D	KMTR Radio Corp. 1000 N. Cahuenga Blvd. Hollywood 2-7311 Young, Scott	Dorothy Schiff, o & chmn. of bd. M. W. Hall, p & gm	Larry Buskett, asst. slm Sam Benson, p sup. Warren Earl, pmm	Marvin Wentworth, ce Ed Lyon, nd Sam Balter, sd	Pop.: 4,785,500 Rad. Hms.: 1,594,383 Ret. Sis.: \$11,994,565,000 UP RCA
	KLAC-TV	1,000-N						
	KMPC 1927	710 50,000-D 10,000-N DA-N	KMPC, The Sta- tion of The Stars 5939 Sunset Blvd. Hollywood 9-5341 AM Radio Sales	Gene Autry, p Robert O. Reynolds, gm & vp L. C. Sigmon, vp, asst. gm, cm & ce	Mark Haas, bcstg. d Oren Mattison, treas. Charles Cowling, slm	Harry Golder, nd Bob Kelley, sd Charles Stone, fd	Pop.: 5,472,411 Rad. Hms.: 2,119,276 UP, AP RCA
	KNX 1922	1070 50,000	Columbia Bcstg. System Inc. 6121 Sunset Blvd. Hollywood 9-1212	CBS, Columbia Pacific Radio CBS Radio Spot Sales	William D. Shaw, gm Bert West, sm Robert P. Sutton, pd Les Bowman, ce	James W. Frost, pmm Marie Webster, opr d David Showalter, pub aff. d.	John F. Beck, nd Robert Wilson, fd Tom Harmon, sd Ruth Ashton, wd	Pop.: 5,536,100 Rad. Hms.: 1,818,090 UP AP RCA
	KNX-TV							
	KNX-FM 1948	Ch. 226 (A) 93.1mc 67kw						
	KPOL 1952	1540 10,000-D	Coast Radio Bcstg. Corp. 5087 Huntington Dr. Capitol 1-6101	Hugh R. Murchison, p Fred D. Custer, gm Robertson C. Scott, pd	Floyd Hall, ce Jack Stanley, prog. sup.	Jack Withington, slm AP G
	KRKD 1927	1150 5,000-D 1,000-N ST: KFSG	Radio Bcstrs. Inc. 541 S. Spring St. Madison 2121	Ned Connor, gm & cm	Charles Clifton, pd, nd & sd	Willis O. Freitag, ce	SES., Wid. AP, INS RCA
	KRKD-FM 1949	Ch. 242 (B) 96.3mc 15kw						
	KSRT(FM) 1953	Ch. 230 (B) 93.9mc 6.4kw	School of Radio Arts 1655 N. Cherokee Hollywood 2-3281	Don C. Martin, p & cm	James L. Fitch, pd Walter Bradish, ce	Hal Kornell, nd	Pop.: 2,000,000 Rad. Hms.: 400,000 Cap., SES. AP REL
MARYSVILLE								
	KMYC 1940	1410 1,000 DA-2	Marysville-Yuba City Bcstrs. Inc. P. O. Box 631 2-2396	MBS, Don Lee Grant	H. E. Thomas, p Joe D. Carroll, gm & cm	Bill Cleveland, pd Ned Liebman, pmm & sd	Loyd McQueary, ce John Mayer, nd	Wid. AP WE
	KMYC-FM 1947	Ch. 260 (B) 99.9mc 4.9kw						
MERCED								
	KYOS 1936	1480 5,000 DA-N	Merced Bcstg. Co. P. O. Box 717 Randolph 2-6252	MBS, Don Lee Grant & McClung	Mrs. Hugh McClung, p & gm Charles H. Kinsley Jr., sm & fd	Edward Blakesley, cm Stanley Evans, pd & sd Russell Pope, ce	Robert Garrett, pmm Richard Watry, nd Louise Jackson, wd	Pop.: 621,000 Rad. Hms.: 206,930 St. UP RCA
	KVME(FM) 1948	Ch. 248 (B) 97.5mc 8.9kw	(KYOS, Am Affiliate)					
MODESTO								
	KBEE(FM) 1948	Ch. 277 (B) 103.3mc 11.5kw	McClatchy Bcstg. Co. 14th & Eye Sts. 2-2061 Raymer	Eleanor McClatchy, p	Albert Schneider, sta. exec. & ce		Pop.: 60,000 Cap., Assoc. UP RCA
	KBOX 1951	970 1,000 DA-2	Stanislaus County Bcstrs. 1507 10th St. 3-7756 Rambeau	Milton L. Hibdon, p & gm Fran Abell, cm	Richard Nicholson, pd & sd Dave Jacobs, pmm	Paul S. Farrelle, ce Red Crow, fd Norma Alamsha, wd	Pop.: 788,500 Rad. Hms.: 262,800 Ret. Sis.: \$871,275,000 L-W AP Col.
	KMOD 1950	1360 1,000 DA-N	Radio Modesto Inc. P. O. Box 941 2-1051	ABC Meeker, Moore, Western Radio	John Schacht, p & gm Jud Sturtevant, cm	Gene D'Accardo, pd & nd Frank Soares, pmm	Peter Onnigian, ce Maxine Boren, office m	Pop.: 120,000 Rad. Hms.: 35,000 Wid. AP GE
	KTRB 1933	860 10,000-D 1,000-N DA-2	KTRB Bcstg. Co. Inc. P. O. Box 593 3-0737 Grant	William H. Bates Jr., p, gm & ce Lee Roddy, cm	Donald E. Lapan, pd & pmm Charles McEwen, nd	Phil Barber, sd Leonard Anderson, fd Hilda Higbee, wd	St., Cole UP, INS GE
	KTRB-FM 1949	Ch. 281 (B) 104.1mc 4.7kw						
MONTEREY								
	KMBY 1939	1240 250	Monterey Radio- TV Co. 468 Calle Principal 2-4541	Grant	Kenyon Brown, p S. M. Aston, gm & cm	Bruce Ariss, pd Galynd Hammond, ce		Pop.: 250,000 Rad. Hms.: 70,000
	KMBY-TV							
	KXXL (CP)	630 500-D	S. A. Cisler 546 Hartnell Plaza 5-6302	S. A. Cisler, p & pd	J. R. Oliver, gm & cm		Pop.: 200,000 Rad. Hms.: 60,000

Data corrected to Dec. 10, 1953. If executives or services for FM are same as AM affiliate names are not repeated. Market Data supplied by stations. FM's in italic. *—Non-Commercial Station. CP—Construction Permit issued. D—Day. DA—Directional Antenna, night only. DA-1—Directional Antenna, same pattern day and night. DA-2—Directional Antenna, different pattern day and night. L—Limited Time with Dominant Station. LS—Local Sunset. N—Night. SA—Special Authorization. SH—Specified Hours. ST—Share Time. Complete key to abbreviations, page 6.

MT. SHASTA

KWSD 1340 Shasta Cascade Arthur Adler, co-o & David H. Rees, co-o, Iola Huntingdon, pd Pop.: 30,000 Thes. AP
1947 250 Bcstg. Corp. Continental gm sm & ce Bob Laverty, sd Rad. Hms.: 7,500 RCA
E. Alma St.
Mt. Shasta 2124

NAPA

KVON 1440 Gibson Radio & Luther E. Gibson, p Wyman Riley, nd David Wortman, ce Pop.: 200,000 Wld. UP
1947 500 Pub. Co. J. L. L. Gibson, gm J. L. L. Gibson, gm Dave Beronio, sd Rad. Hms.: 196,000 Col.
DA-1 P.O. Box 911 O'Connell David Boise, sm Robert E. Scott, cm
Vallejo, Calif. Nolan Cruise, pd
Vallejo 2-7127

NEEDLES

KSFE 1340 Needles Bcstg. KBS B. J. Fitzpatrick, ptrn. L. A. Newsome Jr., Tom Cass, mus. d Pop.: 12,000 Thes. AP
1952 250 Co. & cm ptrn., pd & pmm Buck Newsome, sd Rad. Hms.: 4,200 INS
P. O. Box C-2 Albert Lincoln, ce Ret. Sis.: \$4,678,000 RCA
1234 & 4455

OAKLAND

KLX 910 Tribune Building J. R. Knowland Jr., p Earl M. Phillips, office Bert Buzzini, fd Pop.: 2,968,500 Thes., St.
1922 5,000 Co. Milton L. Levy, gm m Bill Laws, sd Rad. Hms.: 2,897,256 AP
DA-1 Tribune Tower Burn-Smith Jerry Morton, pd John K. Chapel, nd Anne Truax, wd Ret. Sis.: \$3,498,256,000 WE
Glencourt 1-0660 Roswell, S. Smith, ce

KLX-FM Ch. 267 (B) Thes., St.
1947 101.3mc AP
20kw GE

KROW 960 KROW Inc. Sheldon F. Sackett, p Jack Grant, sm Harry Bartolomei, ce Pop.: 2,372,600 St.
1922 1,000 464 19th St. Raymer J. G. Paltridge, gm & Ray A. Yeager, pd Jim Young, nd Rad. Hms.: 1,021,725 AP, UP
Twinoaks 3-9600 Russ Coughlan, asst. Mercedes Prosser, Frank Sobrero, sd Wanda Ramey, wd Ret. Sis.: \$3,108,641,000 Col.

KWBR 1310 Warner Bros. S. W. Warner, gm Jeane K. Fisher, pd E. N. Warner, treas. Pop.: 2,651,394 UP
1920 1,000 327 22d St. Forjoe F. Wellington Morse, Paul E. Gregg, ce RCA
Higate 4-1212

ONTARIO

KOCS 1510 Daily Report Co. Harry Allen, gm & cm Tom Nobles, pmm & sd Glenn Clark, ce Pop.: 175,000 Cap., SES.
1947 250 222 E. "B" L.O'Connell Louise Meter, pd & wd Bill Hesson, nd Rad. Hms.: 115,000 UP
DA-2 Yukon 627-54 (KOCS, Am Affiliate) GE

KEDO(FM) Ch. 228 (A)
1947 93.5mc
0.31kw

OROVILLE

KMOR 1340 Oroville Bcstrs. H. S. Fearnhead, p Louis Coppola, pd & Nick Chames, co-sd Pop.: 70,000 Thes.
1948 250 Inc. Ayres James R. Bird, gm, cm co-sd Bob Pearl, fd UP
P. O. Box 1032 & ce Wally Kunkle, nd La Velle Joy, wd Ret. Sis.: \$46,775,000 RCA
1340-1341

PALM SPRINGS

KCMJ 1340 Palm Springs CBS Joseph E. Gamble, Thelma Roberts, pd (Miss) Phil Stone, nd Pop.: 20,000 Thes.
1946 250 Bcstg. Co. L.O'Connell p & gm N. Vincent Parsons, ce Art Sipherd, sd Rad. Hms.: 6,750 AP
P. O. Box KK 2253 McGavren Norman Lofthero, cm

KPAL 1450 Desert Radio & TV Co. (CP) 174 N. Palm Canyon Dr.

PALO ALTO

KIBE 1220 Sundial Bcstg. William R. Crocker, p Claire Barskey, pd Pop.: 652,500 St.
1949 1,000 Corp. Grant, Best Edward Davis, vp & gm Ben K. Wright, ce Rad. Hms.: 204,545 AP
KDFC(TV) P.O. Box 1151 Peter A. Cuneo, cm & Ret. Sis.: \$616,629,000

PASADENA

KALI 1430 Consolidated Henry Fritzen, p & gm Ernesto Cervera, pd & Harvey Fritch, ce Pop.: 4,142,000 Assoc.
1950 5,000-D Bcstg. Co. pmm Rad. Hms.: 1,434,945 UP
DA-D 758 E. Colorado St. Ryan 1-7148

*KPPC 1240 Pasadena Pres- byterian Church Clayton M. Blake, ce Pop.: 4,142,000 UP
1924 100-SH 54 N. Madison St. Sycamore 3-3069 L.O'Connell Marshall S. Neal, p Mel Winters, pmm Andy James, sd Rad. Hms.: 1,434,945 RCA
Southern Calif. William J. Beaton, gm & cm Claire Hughes, asst. m & wd Gordon Baker Lloyd, fd

KWKW 1300 800 Sierra Madre Villa Ryan 1-6744 Pop.: 2,485,200
1942 1,000-DA-N Bcstg. Co. L.O'Connell Bill Garr, pd & nd Rad. Hms.: 313,876
0.33kw GE

KWKW-FM Ch. 252 (A) Pop.: 4,500,000
1947 98.3mc Rad. Hms.: 313,876
0.33kw GE
KXLA 1110 Pacific Coast Loyal K. King, p & Jack Reeder, ce Lou Stevens, fd Wld. AP
1942 10,000-DA-2 Bcstg. Co. M. Atkinson, pd Carl Saunders, nd Marlon Atkinson, wd RCA
1401 S. Oak Knoll Rd. Ryan 16991

PASO ROBLES

KPRL 1230 Dale J. & Bernard MBS, Dale J. Schwartz, Bernard Schwartz, Dorothy Schwartz, cm Pop.: 70,000
1946 250 Schwartz KBS, ptrn., gm, fd & ce ptrn., pd, nd, sd & wd Henry May, fd Rad. Hms.: 69,300 AP
32nd & Oak Sts. Don Lee Grant RCA
204

PETALUMA

KAFP 1490 Warner Bros. KBS Stafford W. Warner, p Elaine Avila, nd Ted Kennessey, sm & Wld., Cap.
1950 250 P.O. Box 590 Western Radio Wellington Morse, gm Sam Zentner, pmm & nd John Spears, nd sd John Spears, nd John Goforth, pd & fd Paul Gregg, ce Ret. Sis.: \$31,000,000 UP
2-9787 RCA

PITTSBURG

KECC 990 KECC Inc. Mel D. Marshall, gm Art Knott, pd & sd M. R. Scott, ce Pop.: 326,543 Wld., L-W
1949 1,000 235 Railroad Ave. Grant John C. MacFarland, George Y. Spelvin, E. B. Fagens, nd Rad. Hms.: 324,267 UP
DA-N 2-2964 cm pmm Ret. Sis.: \$306,875,403 WE

CALIFORNIA

City	Call Letters Established TV Affiliate	Chan. or Freq. Power	Licensee Headquarters Telephone	Network Represent- ative	Executive Abbreviations Owner o; Pres. p; Exec. vp evp; Gen. Mgr. gm; Sta. Mgr. sm; Coml. Mgr. cm; Sales Mgr. slm; Prog. Dir. pd; Chief Eng. ce; Prom. Mgr. pmm; Prod. Mgr. pdm; News, Farm, Sports or Women's Dir. nd, fd, sd, wd.	Market Data For Primary Area (Supplied by station)	Library, News Serv. Transmitter		
POMONA									
	KPMO 1947	1600 500	Valley Bcstg. Co. 1240 E. Holt Lycoming 2-1293	Dean H. Wickstrom, co-o & cm	Florence E. Wick- strom., pd	Susan Moore, pmm Buck Rogers, ce Tom Nobles, nd & sd	Pop.: 300,000 Rad. Hms.: 100,000 Ret. Sis.: \$150,000,000 UP Ray.
PORTERVILLE									
	KTIP 1946	1450 250	J. F. Tighe Bcstg. Co. P. O. Box 1312 1450	ABC Cook Grant	J. F. Tighe, p Frank R. Brown, gm Richard L. Hubbs, cm	Barbara Jean Snowden, pd & wd Dalton Coke, pmm	Alan P. Snowden, ce Les Gorn, nd Hank Waltz, fd Bill White, sd	Pop.: 25,000 Rad. Hms.: 21,000 Ret. Sis.: \$175,000,000	Thes. UP Ray.
RED BLUFF									
	KBLF 1946	1490 250	Hal K. Shade 737 Main St. 880	KBS Tracy Moore	Hal K. Shade, p Bill Baumgarten, gm, cm, pmm & sd	Barbara Smith, pd & wd Harry A. Shelby, ce	Tim Armstrong, nd Don Reichling, fd	Pop.: 89,399 Rad. Hms.: 31,247 Ret. Sis.: \$109,116,000	Cap. UP G
REDDING									
	KVCV 1939	600 1,000 DA-1	Golden Empire Bcstg. Co. P. O. Box 511 1646	CBS Grant	Mickey McClung, p Fred M. Stuepnagel, gm H. E. McCarty, cm	Lyle Mathys, pd Ted Dooley, pmm, nd & sd Russell Pope, ce	George Wussow, res. e Stan Garvey, fd Fran Bruce, wd	Pop.: 39,000 Rad. Hms.: 12,300	St. UP RCA
	KVRE(FM) 1949	Ch. 280 (A) 103.9mc 1kw	(KVCV, Am Affiliate)						
REDLANDS									
	KCAL (CP)	1410 1,000	Southwest Bcstg. Co.		Bernard Corren, p	Saul Levine, evp	Milton Miller, secy- treas.	Pop: 300,000	
RIVERSIDE									
	KPRO 1941	1440 1,000	Bcstg. Corp. of America 3401 Russell St. 6290	Calif. Radio Net. Pearson	Fred E. Carr, Trustee Richard T. Sampson, gm & pmm	Dale Peterson, cm & sd Jim Fisher, pd Manuel Barrazo, ce	Ray Spencer, nd Walt Abbott, fd Virginia Blackman, wd	Pop.: 549,190 Rad. Hms.: 171,620 Ret. Sis.: \$547,395,000 AP Col.
SACRAMENTO									
	KCRA 1945	1320 5,000-D 1,000-N DA-2	KCRA Inc. 1010 11th St. Gilbert 2-0758	NBC Meeker	Ewing C. Kelly, p & gm Fred Beckwith, cm	John Kuhlman, pd Irma Davis, pmm W. Herbert Hartman, ce	Howard J. Smiley, sm Mal MacIntyre, nd Bill Conlin, sd	Pop.: 516,792 Rad. Hms.: 122,560 Ret. Sis.: \$529,428,000	Wld. UP WE
	KCRA-FM 1947	Ch. 241 (B) 96.1mc 11kw							Wld. UP GE
	KFBK 1922	1530 50,000	McClatchy Bcstg. Co. 708 Eye St. Gilbert 3-1745	ABC McClatchy Beeline Raymer	Eleanor McClatchy, o Keith B. Collins Arthur C. Williams, cm Harry Warren, pd	Stam Sronce, ce Victor Blanks, nd	Ray Rodgers, fd Tony Koester, sd Jacqueline Daniel, wd		Thes. AP, UP
	KFBK-FM 1947	Ch. 245 (B) 96.9mc 3.2kw							
	KGMS 1952	1380 1,000-D DA-1	Capitol Radio Enterprises Hotel Senator Hudson 1-3133 Grant	Irving J. Schwartz, gm Stephen George, cm & sd	Jack Matranga, pd, pmm & nd	Richard Hinz, ce	Pop.: 500,000 Rad. Hms.: 200,000 Ret. Sis.: \$801,138,000	Cap. AP Col.
	KROY 1937	1240 250	KROY Inc. Sacramento Hotel Gilbert 3-2525	CBS Avery- Knodel	C. L. McCarthy, p & gm Joseph E. Hinman, cm	John Z. Ickes, pd William J. Karpisek, ce	Henry Thornley, nd & pub. affairs d Scotty Mortland, fd	Pop.: 300,000 Rad. Hms.: 100,000	Assoc., UP INS RCA
	KXOA 1945	1470 1,000 DA-1	Sacramento Bcstrs. Inc. P. O. Box 94 Wabash 5-2717	MBS, Don Lee Pearson, McGavren	Lincoln Dellar, p Robert W. Dumm, gm Ralph Guild, cm	Dean Seaton, pd, nd & fd Don Quinn, pmm	Ewald Berger, ce Doug Montell, sd Beth Shelby, wd	Pop.: 522,600 Rad. Hms.: 163,170 Ret. Sis.: \$875,656,000	St. UP Ray.
	KXOA-FM 1949	Ch. 300 (A) 107.9mc 13kw							

Data corrected to Dec. 10, 1953. If executives or services for FM are same as AM affiliate names are not repeated. Market Data supplied by stations. FM's in italic. *—Non-Commercial Station. CP—Construction Permit issued. D—Day. DA—N—Directional Antenna, night only. DA-1—Directional Antenna, same pattern day and night. DA-2—Directional Antenna, different pattern day and night. L—Limited Time with Dominant Station. LS—Local Sunset. N—Night. SA—Special Authorization. SH—Specified Hours. ST—Share Time. Complete key to abbreviations, page 6.

KROY

Sacramento, California

CBS

The Nation's 51st Retail Market

What Will You Buy? . . . It's up to you . . . But . . . Here's
our ten month record for 1953 . . . LOCAL up 59.6%
NATIONAL up 21.2%

Best Network—Best Personalities—Best Ratings—Best Increase
These make **KROY** the **LEADING STATION** and the **TOP
BUY** in the Sacramento Market

National Representatives — Avery-Knodel, Inc.

SALINAS

KDON 1935	1460 5,000 DA-1	(See Santa Cruz listing)								
KSBW 1947	1380 1,000 DA-1	Salinas Bcstg. Corp. P. O. Box 1651 8071	MBS Burn- Smith, Western	John C. Cohan, p & gm William M. Oates, cm Neal Edmundson, pd	George Freeman, ce Virgil Mitchell, nd & fd	Raymond McFarland, sd Cay Hillegas, wd	Pop.: 235,000 Rad. Hms.: 77,270 Ret. Slis.: \$258,270,000	Cap. AP RCA		

SAN BERNARDINO

KCSB 1947	1350 500 DA-N	F. P. D'Angelo 770 Mill St. 8-2245 Forjoe	Fred P. D'Angelo, p, gm & cm Jim Tracewell, pd, ce & nd	Jack Frew, pmm Darlean Cole, office m Nick Jordan, rec. lib. & sd	Red Britton, fd Mary-Ellen Martin, wd	Pop.: 300,000	Thes., SES. AP WE
KFXM 1929	590 1,000 DA-2	Lee Bros. Bcstg. Corp. 512 5th St. 4761	MBS, Don Lee Blair	J. Clifford Lee, p E. W. Lee, vp & gm Paul H. Martin, gen. slm	Gene W. Lee, pd Rod Masters, pmm George Ewing, ce Phil Stewart, nd	Howard Bailey, sd Howard Baichly, fd Marion McCook Moody, wd	Pop.: 710,150 Rad. Hms.: 229,085 Ret. Slis.: \$708,917,000	Wid. UP RCA
KITO 1947	1290 5,000 DA-2	KITO Inc. 569 4th St. San Bernardino 7807	ABC Holling- bery	J. J. Flanagan, p & gm Arnold Benum, cm	Fred Reinhardt, pd, pmm & fd Richard Klitzing, ce	Marjorie Sharpe, wd Bob Van Roy, nd		Cap. UP RCA
KRNO 1948	1240 250	Western Empre Bcstrs. 990 Colton Ave. 8-2771 Cook	Norman H. Rogers, p & gm George W. Brock, sm & ce	Chuck Palmer, pd & nd John Staples, pdm	John Harder, pub. rel. d	Pop.: 368,000 Rad. Hms.: 130,000 Ret. Slis.: \$534,646,000 AP RCA

SAN BRUNO

KSBR(FM) 1947	Ch. 263 (B) 100.5mc 63kw	Radio Diablo Inc. 798 San Mateo Ave. Juno 8-1212	H. Leslie Hoffman, p	O. H. Brown, acting gm		Pop.: 3,370,362	St.
------------------	--------------------------------	---	----------------	----------------------	------------------------	--	-----------------	-----------------------

SAN BRUNO MT.

KNBC-FM (See San Francisco listing)

SAN DIEGO

KCBQ 1946	1170 5,000-D 1,000-N DA-N	Charles E. Salik P. O. Box 1829 Woodcrest 5-4103	ABC Avery- Knodel	Charles E. Salik, p & gm Graham H. Moore, cm	Robert S. Regan, pd & nd Suzanne M. Bower, pmm Charles J. Sherburne, ce	Lorena B. James, bus. m Jim O'Leary, sd Howard Keddie, fd Zetta Jewel, wd	Pop.: 1,079,584 Rad. Hms.: 337,370 Ret. Slis.: \$1,278,812,000	L-W UP RCA
KFMB 1941	550 1,000 DA-1	Wrather-Alvarez Bcstg. Co. 1405 5th Ave. Main 2114	CBS, CPRN Petry	Jack D. Wrather Jr., co-o Helen Alvarez, co-o George Whitney, gm	Hobby Myers, sm Jerry Lee Pecht, pd William Miller, pmm Charles F. Abel, ce	Louis Meiers, cont. Paul White, exec. n ed. Molly Morse, wd	Pop.: 865,500 Rad. Hms.: 217,610 Ret. Slis.: \$932,976,000	Cap., SES. AP, UP GE
KFSD 1926	600 5,000 DA-1	Airan Radio Corp. Ltd. 326 Broadway Franklin 8353	NBC Katz	Thomas E. Sharp, p John C. Merino, gm	Peter D. Murphy, pd	LeRoy Bellwood, ce	Pop.: 710,000 Rad. Hms.: 174,430 Ret. Slis.: \$700,570,000	Wid. INS RCA
KFSD-FM 1948	Ch. 231 (B) 94.1mc 33.3kw							
KGB 1927	1360 1,000	General Teleradio Inc. 1017 1st Ave. Franklin 6151	MBS, Don Lee Blair	Willet H. Brown, p Marion R. Harris, gm	Matt Long, pd Joe D. Kline, ce	Johnny Black, nd Martha Shorten, wd	Pop.: 710,000 Rad. Hms.: 217,600 Ret. Slis.: \$717,687,000 AP, UP Col.
KSDO 1947	1130 5,000-D 1,000-N	San Diego Bcstg. Co. U. S. Nat'l Bank Bldg. Main 2041 Stubbins, Pearson, McGavran	Jack Heintz, vp & gm Wilson Edwards, asst. m	Norman Kay, sm Frederick Stubbins, res. m	Vern Milton, ce	Pop.: 705,000 Rad. Hms.: 215,000 AP, UP WH
KSON 1947	1240 250	Fred & Dorothy Rabell 630 F St. Franklin 5175	Good Music Bolling	Fred Rabell, p, gm & cm	Dorothy Rabell, pd & pmm	Charles Mowatt, ce	Pop.: 681,900 Rad. Hms.: 215,696	Assoc. AP RCA

SAN FERNANDO

KGIL 1947	1280 1,000 DA-1	San Fernando Valley Bcstg. Co. 4919 Van Nuys Blvd. State 4-6291	E. P. Franklin, p Howard P. Gray, gm, secy. & cm	Allan McKee, pd	Jay I. Rice, ce		Cap. AP
--------------	-----------------------	--	----------------	--	-----------------	-----------------	--	---------------------

SAN FRANCISCO

KCBS 1912	740 50,000 DA-2	CBS Inc. of Calif. Palace Hotel Yukon 2-7000	CBS, CPRN CBS Radio Sales	Frank Stanton, (CBS) p Arthur H. Hayes, (CBS) vp & gm Jules Dundes, d of sl & adv.	Fred Ruegg, pd Alan Cormack, ce Evelyn Clark, pmm William Cullenward, d of press info	Carroll Hansen, nd Gordon Roth, fd Carroll Hansen, sd Jane Todd, wd		SES. AP, UP, INS GE
KCBS-FM 1948	Ch. 255 (B) 98.9mc 35kw							
KDFC(FM) 1948	Ch. 271 (B) 102.1mc 33kw	Sundial Bcstg. Corp. 369 Pine St. Yukon 2-6271 (KIBE Palo Alto Am Affiliate) Grant, Best	William R. Crocker, p Edward Davis, gm	Peter A. Cuneo, cm Claire Barskey, pd	Hartley J. Richards, ce		Wid. WE
KFRC 1926	610 5,000	General Tele- radio 1000 Van Ness Ave. Prospect 6-0500	MBS, Don Lee Blair	William D. Pabst, gm Merwyn McCabe, cm Melvyn Venter, pd	Robert Templeton, pmm & sd Ernest Underwood, ce Enes Canata, office m	Marianne Crumpacker, nd Josephine Martin, wd	Pop.: 3,700,000 Rad. Hms.: 1,160,000	Wid. AP, UP WE
KGO 1923	810 50,000 DA-1	American Bcstg.- Paramount The- atres Inc. 420 Taylor Graystone 4-8585	ABC Petry	James Connolly, vp Paul T. Scheiner, gm John Hansen, cm	Vic Reed, pd, nd & sp. events Gordon Grannis, pmm	Harry Jacobs, ce Bill Adams, fd Ann Holden, wd	Pop.: 4,310,720 Rad. Hms.: 1,659,600 Ret. Slis.: \$4,359,165,000	Assoc., Cap., St. AP, INS L-W AP, INS GE
KGO-FM 1947	Ch. 291 (B) 106.1mc 50kw							
KJBS 1924	1100 1,000-L	KJBS Bcstrs. 1470 Pine St. Ordway 3-4148 Avery- Knodel	E. P. Franklin, ptrn. Stanley G. Breyer, cm	Charles F. Pendleton, pd, pmm & nd Roger L. Roberts, ce	Virginia M. May, office m Ruth Thompson, wd	Pop.: 2,681,322 Rad. Hms.: 858,559 Ret. Slis.: \$3,498,258,000	Assoc., Thes. Cap. UP, INS GE

CALIFORNIA

City	Call Letters	Chan. or Freq.	Licensee Headquarters Telephone	Network Representative	Owner	Executive Abbreviations	Market Data For Primary Area (Supplied by station)	Library, News Serv. Transmitter	
SAN FRANCISCO (Cont'd)									
	KNBC 1922	680 50,000	NBC 420 Taylor St. Graystone 4-8700	NBC NBC Spot Sales	Sylvester L. Weaver Jr., p (NBC)	William K. McDaniel, cm Robert W. Sarnoff, evp (NBC) George Greaves, gm	Bill Cothran, nd Henry Schacht, fd Ira Blue, sd Marjorie King, wd	Rad. Hms.: 1,617,260 Ret. Sls.: \$4,700,000,000	AP, UP, INS RCA
	KNBC-FM 1949	Ch. 259 (B) 99.7mc 45kw	Grant R. Wrathall Aptos. Calif. 3352		Grant R. Wrathall, p			Pop.: 2,300,000 Rad. Hms.: 680,000	
	KPOO (CF) 1949	1010 1,000-D	Chronicle Pub. Co. 901 Mission St. Garfield 1-1112		Charles Thieriot, vp Harold P. See, sm	Norman Louvau, cm Douglas Elleson, pd	Lee Berryhill, ce Lucia Edwards, mus. d	Rad. Hms.: 927,180	AP RCA
	KRON-TV 1949	Ch. 243 (A) 96.5mc 13kw	Golden Gate Bcstg. Corp. 1355 Market St. Market 1-9171	McGillivra	S. H. Patterson, p Norwood J. Patterson, gm & ce	Richard P. Bott, cm Susan Alex. pd, pmm & wd	H. H. Wickersham, tech. sup. Frank Arthur, nd & sd	Pop.: 2,941,600 Rad. Hms.: 269,100 Ret. Sls.: \$3,498,258,000	UP RCA
	KSAN 1922	1450	The Associated Ecstrs. Inc. 2855 Van Ness Ave. Prospect 6-5100	Headley-Reed	Wesley I. Dumm, p R. C. D. Bell, asst. to p Frank M. Dumm, secy.-treas.	Alan L. Torbet, gm Gareth Garland, cm Robert Hansen, pd Gene DeAlessi, pmm	A. E. Towne, ce Bob Colvig, nd Wally King, fd Faye Stewart, wd	Pop.: 3,682,654 Rad. Hms.: 1,187,953	St. Wid. UP, INS WE
	KKFX (FM) 1947	Ch. 247 (A) 97.3mc 10kw	Electronic Service Corp. 1000 27th St. Atwater 8-0510		Stephen A. Cisler, p George C. Atkinson, gm & cm	George F. Schafer, pd & sm	Doug Mariska, ce		Assoc. AP GE
	KYA 1928	1260 5,000-D 1,000-N	Radio Station KYA Inc. Fairmont Hotel Douglas 2-2536	Clarke	J. Elroy McCaw, p H. E. Fearnhead, gm	Irv Phillips, asst. m Paul Beck, ce	Less Keiter, sd Beth Norman, wd		UP RCA
SANGER									
	KBLF 1947	900 1,000-D	John Poole Bcstg. Co. 1412 Fulton St. Fresno, Calif. 6-4702 or 2-8223	Meeker	John H. Poole, p David C. Camp, gm & cm	Walter K. Novell, pd Russell C. Friend, ce Bob Ulrich, pdm	Doug Keene, nd Jim Bailey, sd	Pop.: 611,503 Rad. Hms.: 175,498 Ret. Sls.: \$638,955,000	Wid. UP Col.
SAN JOSE									
	KEEN 1947	1370 1,000 DA-1	United Bcstg. Co. Hotel De Anza Cypress 4-0344	Grant	George M. Mardikian, p B. Floyd Farr, vp & gm Bob Blum, slm & sd	George Snell, pd & secy.-treas.	Ray Hollingsworth, pmm Willis M. Green, ce Ken Wilhelm, fd Jean Martin, wd	Pop.: 355,500 Rad. Hms.: 100,000 Ret. Sls.: \$374,873,000	UP Ray.
	KLOK 1946	1170 5,090-D 1,000-N DA-N	Valley Bcstg. Co. P. O. Box 967 Cypress 3-3445	Pearson	E. L. Barker, p & gm Richard E. Ryan, cm	Ruth Poindexter, pd & wd	Billy G. Cunningham, ce Bob Custer, sd	Pop.: 450,000 Rad. Hms.: 125,000	AP RCA
	KSJO 1946	1590 1,000-D 500-N DA-N	Santa Clara Bcstg. Co. P. O. Box 995 Cypress 3-8030	Rambeau	Patrick H. Peabody, p Charles F. Mallory, vp & gm	Norman Paul, pd & nd Edward W. Meece, ce	Earle Russell, sd Mary Rhodes, wd	Pop.: 359,000 Rad. Hms.: 353,256 Ret. Sls.: \$374,873,000	Wid. UP WE GE
	KSJO-FM 1947	Ch. 237 (A) 95.3mc 1kw							
	KXRX 1948	1500 1,000 DA-1	San Jose Bcstg. Co. P. O. Box 167 Cypress 2-5080	Tracy Moore, McGavren	Joseph E. Levitt, p Gordon Graham, cm Frank Kilpatrick, pd & nd	Oscar Bradley, slm Frank Glass, ce	Helen McDonald, mus. lib.	Pop.: 350,000 Rad. Hms.: 117,000 Ret. Sls.: \$374,873,000	UP RCA
SAN LUIS OBISPO									
	KATY 1949	1340 250	KATY, Sweetheart of San Luis Obispo Inc. 981 Monterey St. 3171	ABC Meeker	Maynard Marquardt, p & gm Don Macleod, cm & sd	Barbara Brydia, pd & wd Gloria Heinz, pmm Clayton Coldwell, ce	G. O. Porter, vp & tech. d Don Bowden, nd & fd	Pop.: 63,000 Rad. Hms.: 17,000 Ret. Sls.: \$80,000,000	UP Ray.
	KVEC 1937	920 1,000-D 500-N	The Valley Electric Co. 851 Higuera St. San Luis Obispo 1100	MBS, KBS, Don Lee Grant	Christina M. Jacobson, p Les Hacker, gm Jack Wasson, cm	Arthur Hapgood, pd & nd Nancy Mills, pmm & wd	Robert Schoffeld, ce Hugh Harling, sd & fd	Pop.: 76,976 Rad. Hms.: 21,584 Ret. Sls.: \$52,064,962	St. AP RCA
	KVEC-TV 1949	Ch. 237 (A) 95.3mc 1kw							
SAN MATEO									
	KEAR 1948	1550 1,000 DA-N CP: 10,000 DA-2	Bay Radio Inc. 3 West 37th Ave. Fireside 5-4837	Bolling	Stephen A. Cisler, p & gm George C. Atkinson, cm	William Agee, pd Charles Lynn, pmm D. F. Mariska, ce Margaret Dougherty, office m	Jane Hoffman, mus. lib. Jerry Janes, nd	Pop.: 3,000,000	Assoc. St. Mac. AP Ray.
	KVSM 1946	1050 1,000-D	Hugh H. Smith Jr. 279 Baldwin Ave. Diamond 4-2541	Walker	Hugh H. Smith, o Gilbert L. Bond, gm	Merwyn F. Planting, ce	Barbara Allen, wd		Cole UP, INS Col.
SAN RAFAEL									
	KTLM 1947	1510 1,000-D	Marin Bcstg. Co. Inc. 1117 5th Ave. Gl 3-6880		Roy A. Brown, p Hugh Turner, gm	Ed Ohmstead, ce John Clahan, sd	Kitty Oppenheimer, wd	Pop.: 200,000 Rad. Hms.: 60,000 Ret. Sls.: \$197,450,000	UP Ray.
SANTA ANA									
	KVOE 1926	1480 1,000 DA-1	The Voice of the Orange Empire Inc. Ltd. 105 E. 5th St. Kimberly 3-8321	Pearson	Ernest L. Spencer, p & gm Donn Spencer, cm & sd	Deane S. Long, pd Hal Davis, pmm	Stanley G. Guenther, ce Marsh Dewey, nd & fd	Pop.: 758,756 Rad. Hms.: 239,306 Ret. Sls.: \$866,521,827	Mac. Cap. UP RCA
	KVOE-FM 1949	Ch. 244 (A) 96.7mc 1kw							UP GE
SANTA BARBARA									
	KDB 1921	1490 250	F. Robert Bauer Radio Square 4131	MBS, Don Lee Pearson	F. Robert Bauer, p & gm Harry C. Butcher, o & gm Michael J. McKeogh, vp	Joe W. Benes, cm, pd & nd	Robert Carter, ce & sd Bobbie Lee, wd		UP WE
	KIST 1946	1340 250	Radio KIST Inc. Balboa Bldg. 3981	NBC Hollingbery	James S. Blomfield, cm Darleen M. Levinson, pd & traffic d Gordon L. Stafford, prod. d	Gordon R. Phillips, pd, pmm & nd Leo G. DeCunnick, ce	Gene Forssell, ce Robert Jones, sd Dorothy Davis, wd		Thes. UP RCA
	KTMS 1937	1250 1,000 DA-1	News-Press Pub. Co. De La Guerra Plaza 3911	ABC Raymer	T. M. Storke, p C. A. Storke, vp Albert R. Albinger, gm & cm	Gordon R. Phillips, pd, pmm & nd Leo G. DeCunnick, ce	Edgar A. Sprague, sd Thos. Kleveland, fd Pat Dayton, wd	Pop.: 200,000 Rad. Hms.: 50,000 Ret. Sls.: \$56,500,000	SES. AP RCA

Data corrected to Dec. 10, 1953. If executives or services for FM are same as AM affiliate names are not repeated. Market Data supplied by stations. FM's in italic. *—Non-Commercial Station. CP—Construction Permit issued. D—Day. DA-N—Directional Antenna, night only. DA-1—Directional Antenna, same pattern day and night. DA-2—Directional Antenna, different pattern day and night. L—Limited Time with Dominant Station. LS—Local Sunset. N—Night. SA—Special Authorization. SH—Specified Hours. ST—Share Time. Complete key to abbreviations, page 6.

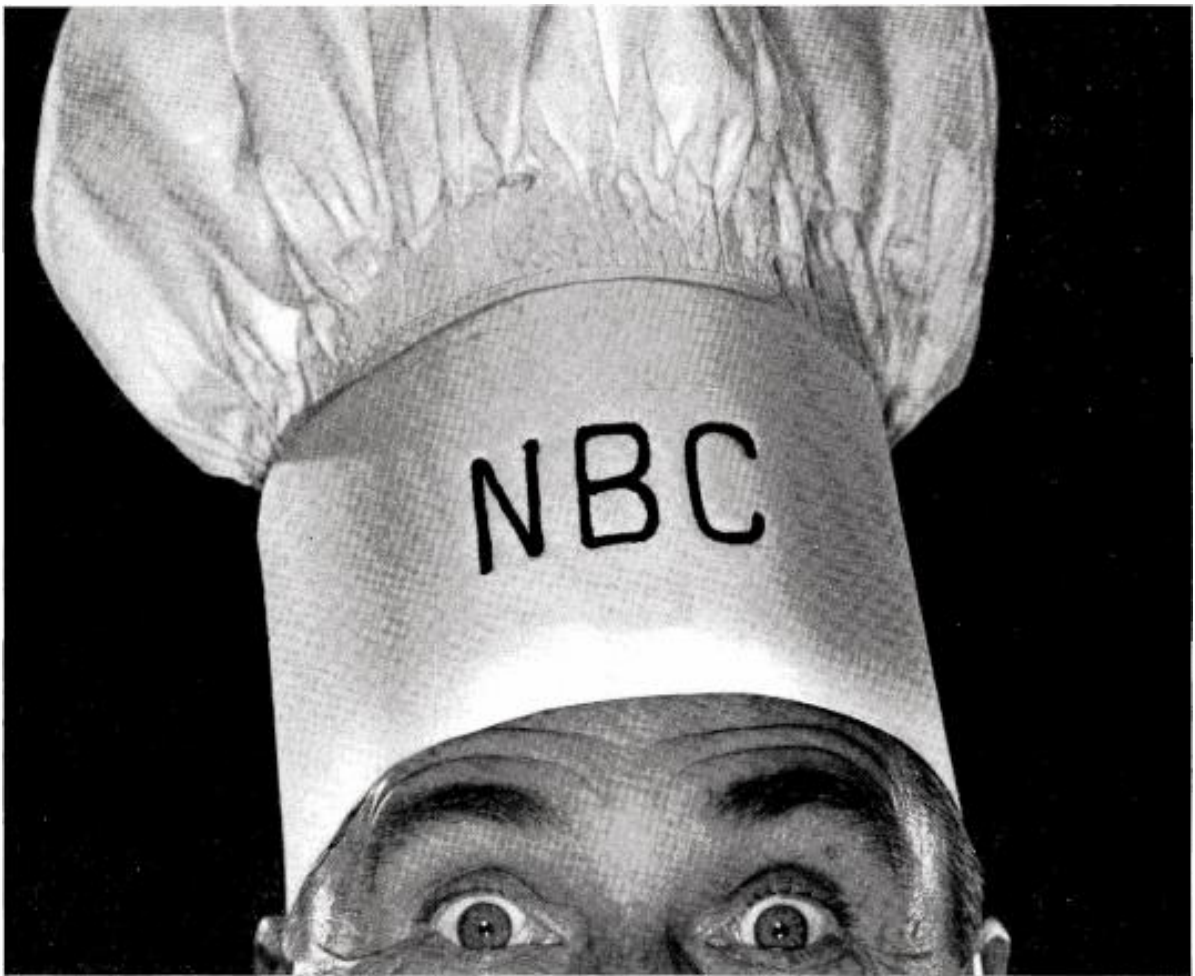

Top coverage . . . to cook up Western sales for you!



Yes, it's a recipe for top coverage that's always successful:

INGREDIENTS

*Combination of NBC stations in the Far West
Outstanding NBC programs over these stations*

Mix these two potent ingredients together and you get the No. 1 audience — top coverage of *your* prospects — whatever you sell!

83.5% of all radio homes in Washington, Oregon and California listen regularly to NBC Pacific Coast Network.

No other network delivers such sales impact!

Radio homes in this fast-growing, fast-buying area have increased 53% in the past decade. More people now listen to radio in the Far West than ever before.

Choice network time is available on NBC Pacific Coast Network, the No. 1 network in the Far West. Consult your nearest NBC Sales Office for details.

NBC

Western Radio Network

A service of Radio Corporation of America

HOLLYWOOD • SAN FRANCISCO

CALIFORNIA

City Call Letters Established TV Affiliate	Chan. or Freq. Power	Licensee Headquarters Telephone	Network Represent- ative	Owner o; Pres. p; Exec. vp eyp; Gen. Mgr. gm; Sta. Mgr. sm; Coml. Mgr. cm; Sales Mgr. slm; Prog. Dir. pd; Chief Eng. ce; Prom. Mgr. pmm; Prod. Mgr. pdm; News, Farm, Sports or Women's Dir. nd, fd, sd, wd.	Executive Abbreviations	Market Data For Primary Area (Supplied by station)	Library, News Serv. Transmitter	
SANTA CATALINA ISLAND								
KBIG 1952	740 10,000 DA-1	John H. Poole Bcstg. Co.	(See Avalon listing)					
SANTA CRUZ								
KDON 1935	1460 5,000 DA-1	Charles Black- wood Grant P. O. Box 1490 Salinas, Calif. 2-0294 Weed	Charles Blackwood Grant, p & gm Ann B. Knowlton, cm	Omer N. Wright, ce James Lyons, pd Johnny Lamb, sd Henry Seiver, fd	Pop.: 277,170 Rad. Hms.: 74,428 Ret. Sis.: \$294,203,000	Wid., Cap. UP	
KSCO 1947	1080 1,000-D 500-N DA-N	Radio Santa Cruz P. O. Box 1080 1080	Charles V. Berlin, p, gm, cm, pd, pmm & ce	Dorothy Hartin, nd	Pop.: 356,630 Rad. Hms.: 349,498 Ret. Sis.: \$456,887,000	St., Thes. AP RCA	
SANTA MARIA								
KCOY 1947	1400 250	News-Press Pub. Co. 114 W. Cook St. Santa Maria 5-2644	ABC, 101 Net. Raymer	T. M. Storke, p William A. Cook, gm Louise Haggood, pd & wd	John Clowes Jr., ce Charles A. Storke, vp B. D. Lane, treas.	Bertram Willoughby, secy. Bob Stewart, nd Jack Colom, sd	Pop.: 27,000 Rad. Hms.: 8,500	SES, AP Ray.
KSMA 1945	1240 250	James Hagerman- John I. Groom 510 W. Morrison 5-2582	KBS L. O'Connell	James Hagerman, co-o, co-gm & co-cm John I. Groom, co-o, co-gm & co-cm	Tony Kent, pd Gale Brady, ce Edm. L. Feeley, co-slm	H. J. Neiggemann, co-slm	Pop.: 59,192 Rad. Hms.: 20,717 Ret. Sis.: \$25,026,000	Wid UP RCA
SANTA MONICA								
KOWL 1947	1580 5,000-D CP: 10,000-D	KOWL Bcstg. Co. Pico at the Ocean Exbrook 4-8761 Clark, McGavren	J. D. Funk, p George A. Baron, gm & cm	Paul Compton, pd Robert D. Funk, pmm & cm	Robert Dye, ce	Pop.: 4,700,000 Rad. Hms.: 1,515,327 Ret. Sis.: \$5,683,608,000 WE
SANTA PAULA								
KSPA 1948	1400 250	Santa Paula Bcstrs. Inc. 940	KBS L. O'Connell	C. Harvey Haas, p, gm & ce	Chas. Martin, cm & pmm Harvey Loomis, pd	Rudi Marini, nd & sd Carrie Lane, wd	Wid AP Col.	
SANTA ROSA								
KSRO 1937	1350 1,000 DA-1	Finley Bcstg. Co. Finley & Fresno Sts. 110 Grant	Ruth E. Finley, p Charles P. Scott, gm & cm	Al Pearson, pd & nd Hilmar Cann, ce	Dan Galvin, sd Harriet Barnes, wd	Pop.: 250,000 Rad. Hms.: 139,240 RCA
SONORA								
KROG 1949	1450 250	Brewster E. Ferrel Box 996 Jefferson 2-7898	KBS	Brewster E. Ferrel, o & gm	G. E. Manley, ce C. W. Mitchell, ce	L. E. Ferrel, pd Wm. P. Keasbey, nd	Pop.: 12,800 Rad. Hms.: 10,100 Ret. Sis.: \$14,000,000	St., SES, AP Ray.
STOCKTON								
KGDM 1926	1140 5,000-DA-N	E. F. Pepper 519 E. Market St. 4-4551	CBS Blair	E. F. Pepper, p E. Smith, gm & cm M. Humphreys, pd	A. Stover, pmm J. Tryon Kelley, ce Bill Hill, nd	B. Lange, fd Irv Schwartz, sd Elsie Flower, wd	Wid, UP WH	
KSTN 1949 KTUV(TV)	1000 1,000-DA-1	San Joaquin Bcstg. Co. Hotel Clark 4-7338 Holling- bery	Knox LaRue, p Donald T. Ralph, gm	Ellis Lind, pd Carl McGee, ce	Joan Sorge, pmm Robert Bernasconi, nd	Pop.: 275,000 UP, INS Col.
KWG 1921	1230 250	McClatchy Bcstg. Co. 612 E. Market St. 5-5728	ABC Raymer	Eleanor McClatchy, p James Ranger, gm & nd	James Longe, prog. m	Frank Nesmith, ce Paul Huebner, nd John MacKenzie, fd	Rad. Hms.: 69,000	Thes. AP
KXOB 1947	1280 1,000-DA-N	KXOB Inc. Hotel Stockton 4-7313	MBS, Don Lee Western Radio Sales, Pearson, McGavren	Joseph E. Gamble, p Ort J. Lofthus, gm & cm H. Van Derwerker, pd	Carolyn Pribyl, pmm James Johnson, ce Ford Warner, nd	Del Goodin, fd Dale Phillips, sd Ruby Barnett, wd	Pop.: 220,000 Rad. Hms.: 71,841 Ret. Sis.: \$324,017,000 UP Ray.
SUSANVILLE								
KSUE 1948	1240 250	Nolan Hallowell & James E. McKahan KSUE Bldg. 2020 Tracy Moore	Nolan Hallowell, ptrn., gm & cm James E. McKahan, ptrn.	Gerald A. Oliver, pd & sd Harold C. Houston, ce, nd & fd	Gwen W. Burr, traffic m & wd	Pop.: 27,553 Rad. Hms.: 7,250 Ret. Sis.: \$25,000,000	St., Cap. UP
TAFT								
KTKR 1949	1310 500-D	Taft Bcstg. Co. P. O. Box "WW" 5-3101	KBS	Kenneth Aitken, p, gm & ce	John A. Smith, cm	Blaine Worrell, pd George J. Tschumy Jr., nd	Pop.: 30,000 Rad. Hms.: 7,800 Ret. Sis.: \$15,000,000 UP
TULARE								
KCOK 1945 KCOK-TV	1270 1,000-DA-N	Sheldon Ander- son 6-2866	MBS, Don Lee ForJoe	Sheldon Anderson, p & gm Don Weldon, sm	Jean Hixson, comm. d Richard Scudder, prom. d	Don Ferguson, ce Alan Rinehart, m Ken Clifford, nd & fd Marcia Drake, wd	Pop.: 219,850 Rad. Hms.: 56,400 Ret. Sis.: \$218,970,000 UP
TURLOCK								
KTUR 1949	1390 1,000-DA-N	Turlock Bcstg. Corp. P. O. Box 526 4-3430	KBS L. O'Connell	W. N. Lindskoog, p H. Ansell McMillen, gm	Herb Lindgren, office coord. & fd B. McMillen, pd	Maxon B. Sayre, ce Jane Lindenberg, nd Ed Klein, sd	Pop.: 278,000 Rad. Hms.: 60,000 Ret. Sis.: \$200,000,000 UP Ray.
UKIAH								
KUKI 1950	1400 250	Marguerite E. Sims P. O. Box 638 Homestead 2-4771 McGavren	Marguerite E. Sims, p & gm Lou DuMoulin, cm John Franklin, pd	John Oliveira, pmm & fd Stanley Ryno, ce Jack Hasling, nd	Philip Trine, sd Dorothy McCorquodale, wd	Pop.: 62,335 Rad. Hms.: 15,635	St. AP RCA
VALLEJO								
KGJW 1947	1190 250-D	Vallejo Bcstg. Co. P. O. Box 1112 Vallejo 8-8944 McGavren	Ellsworth Peck, co-o, co-m & pd A. J. Krisik, co-o, co-m & cm	Robert Wade, pmm William Roberts, ce Hal Engebretsen, nd, sd & fd	Mamie Graf, office m Olive Fowles, wd	Pop.: 304,742 Rad. Hms.: 98,304 Ret. Sis.: \$75,000,000 UP

Data corrected to Dec. 10, 1953. If executives or services for FM are same as AM affiliate names are not repeated. Market Data supplied by stations. *RM's in italic.* —Non-Commercial Station. CP—Construction Permit issued. D—Day. DA-N—Directional Antenna, night only. DA-1—Directional Antenna, same pattern day and night. DA-2—Directional Antenna, different pattern day and night. L—Limited Time with Dominant Station. LS—Local Sunset. N—Night. SA—Special Authorization. SH—Specified Hours. ST—Share Time. Complete key to abbreviations, page 6.

CALIFORNIA

VENTURA

KVEN 1948	1450 250	Coast Ventura Co. P. O. Box 1611 Miller 3-8675	MBS McGavren Webb	Harry Engel, p Sid Held, gm Roy Winkelmann, cm	Fred Hall, pd & pmm Frank Haines, ce	Jerry Thomas, nd Ed Walden, fd John McCormick, sd Jane Smith, wd	Pop.: 125,000 Rad. Hms.: 41,125	UP Col.
KVVC 1948	1590 1,000-DA-1	KVVC, The Voice of Ventura County P. O. Box 1411 Miller 3-6185	KBS Wythe Walker	William H. Haupt, p Karl A. Rembe, sm Bob Brown, cm & sd	Bob Wagner, pd Charles Farmer, ce	Carol Callaway, off. m. traffic m & wd	Pop.: 250,000 Rad. Hms.: 68,671 INS RCA

VICTORVILLE

KAVR (CP)	960 5,000-D	Apple Valley Ecstg. Co.						
--------------	----------------	----------------------------	--	--	--	--	--	--

VISALIA

KONG 1948	1400 250	Tulare Co. Ecstg. Rt. 6, Box 205 4-5811 Holling- bery	Knox LaRue, p Jim Carroll, gm	Mike Kirmeyer, pd & sd	Gorman Brown, ce	Pop.: 211,900 Rad. Hms.: 60,000 Ret. Sis.: \$229,155,000 AP
--------------	-------------	---	---------------------------	----------------------------------	---------------------------	------------------	--	----------------------

WASCO

KWSO 1950	1050 1,000-D	Maple Leaf Ecstg. Co. Box 366	E. J. Peters, p Theo. G. Heirichs, gm	James Hodges, cm Bob Bann, pd E. L. Robertson, ce	Norman Berg, fd Don Rodewald, nd Doris Rosales, wd	Pop.: 35,000 Rad. Hms.: 32,298	L-W, SES, UP Col.
--------------	-----------------	-------------------------------------	----------------	---	---	--	-----------------------------------	-------------------------

WATSONVILLE

KHUB 1937	1340 250	Patrick H. Pea- body Atkinson Lane 4-5641 Rambeau	Patrick H. Peabody, p Hal E. Chase, gm	Mark F. DeLaunay, cm Tom Martin, pd & nd Merle Rossman, ce	Ed Hall, sd H. Washburn, fd Kay Hubbard, wd	Pop.: 200,000	L-W AP WE
--------------	-------------	--	------------------	--	--	---	---------------	-----------------

YREKA

KSYC 1947	1490 250	Siskiyou County Ecstg. Co. Lawrence Lane 624 Tracy Moore	Ernest Millbourn, p D. C. Hoflinger, gm	Jack A. Mitchell, sm D. M. Comstock, pd	Wm. R. Maginnis, ce	Pop.: 30,517 Rad. Hms.: 9,699	Wid. AP RCA
--------------	-------------	---	-------------------------	--	--	---------------------	----------------------------------	-------------------

YUBA CITY

KAGR (CP) KAGR-TV	1450 100	John Steventon						
KUBA 1947	1600 500-D 1,000-N- DA-N	Peachbowl Ecstgs. Inc. Hotel Marysville Marysville, Calif. 3-7309 Ayres, L.O'Connell	C. V. Ullom, p Roger R. Hunt, gm Lloyd H. Klemp, cm	Ric Ryan, pd & wd Ray Davenport, pmm John J. Rollh, ce	Hedley Hall, nd Lonnie Simmons, sd Don Brown, fd	Pop.: 68,300 Rad. Hms.: 20,210 Ret. Sis.: \$68,668,000	Thes. AP G

COLORADO

MARKET DATA BY COUNTIES

County	Population 1950	Radio Families 1953	Retail Sales 1952(000)	Food Sales 1952(000)	Drug Sales 1952(000)	Passenger Cars 1952	County	Population 1950	Radio Families 1953	Retail Sales 1952(000)	Food Sales 1952(000)	Drug Sales 1952(000)	Passenger Cars 1950
Adams	40,234	12,550	\$28,248	\$6,517	\$975	17,406	Logan	17,187	4,930	25,326	4,431	580	7,058
Alamogosa	10,531	2,800	15,647	3,212	487	2,960	Mesa	38,974	12,580	42,902	9,652	1,311	13,608
Arapahoe	52,125	17,740	54,314	18,914	2,456	26,192	Mineral	698	1	433	157	35	180
Archuleta	3,030	660	2,088	387	259	650	Monte	5,946	1,680	11,581	2,771	447	1,986
Baca	7,964	2,480	13,427	3,203	499	2,316	Montezuma	9,991	2,850	12,466	2,947	572	2,645
Bent	8,775	2,160	7,004	1,911	246	2,268	Montrose	15,220	4,400	13,882	3,068	406	4,458
Boulder	48,296	15,990	54,869	13,589	1,823	18,241	Morgan	18,074	5,070	25,212	4,485	737	6,776
Chaffee	7,168	2,200	7,769	2,122	191	2,556	Otero	25,275	7,330	26,327	6,322	831	7,715
Cheyenne	3,453	1,050	4,440	832	141	1,044	Ouray	2,103	670	1,329	393	164	668
Clear Creek	3,289	1,160	3,703	875	159	1,237	Park	1,870	570	1,560	287	95	757
Conejos	10,171	1,990	5,042	1,269	177	1,814	Phillips	4,924	1,450	8,280	1,414	326	1,904
Costilla	6,067	980	1,725	400	103	840	Pitkin	1,646	440	1,460	392	73	674
Crowley	5,222	1,330	4,555	1,042	175	1,584	Prowers	14,836	4,520	28,173	4,187	1,329	4,581
Custer	1,573	570	810	240	48	517	Pueblo	90,188	27,020	97,251	22,356	2,286	30,502
Delta	17,365	5,410	15,250	3,679	450	4,983	Rio Blanco	4,719	1,510	7,595	2,250	490	1,668
Denver	415,788	141,960	644,916	121,021	26,037	148,960	Rio Grande	12,832	**4,480	11,996	2,592	470	3,371
Dolores	1,986	1,180	1,405	467	67	614	Routt	8,940	2,570	7,794	1,741	372	2,634
Douglas	3,507	1,200	2,287	613	109	1,495	Saguache	5,664	1,330	4,817	801	200	1,359
Eagle	4,488	1,140	3,131	961	133	1,572	San Juan	1,471	**920	920	271	98	396
Elbert	4,477		3,121	719	174	1,444	San Miguel	2,693	720	1,387	587	100	659
El Paso	74,523	26,160	93,290	20,661	4,423	32,315	Sedgwick	5,095	1,440	7,128	1,438	284	1,737
Fremont	18,366	5,390	15,439	3,834	546	6,109	Summit	1,135	380	537	175	45	482
Garfield	11,825	3,710	14,639	3,401	631	3,752	Teller	2,754	740	2,148	604	112	1,060
Gilpin	850	170	373	155	34	462	Washington	7,520	2,330	8,947	2,340	298	2,665
Gunnison	3,963	1,120	5,996	751	405	1,588	Weid	67,504	19,140	72,333	13,907	1,787	23,123
Hinsdale	263	↑	137	55	38	81	Yuma	10,827	3,420	13,444	2,443	556	3,792
Huerfano	10,549	2,660	7,486	2,036	204	2,449	Total	1,325,089	419,190	\$1,618,945	\$347,150	\$61,596	621,627
Jackson	1,976	590	1,542	448	97	684							
Jefferson	55,887	19,940	44,665	12,925	2,064	26,619							
Kitowa	3,003	850	3,488	839	136	937							
Kit Carson	8,600	2,590	14,844	2,403	633	2,707							
Lake	6,150	1,800	6,444	1,709	265	2,513							
La Plata	14,890	4,110	18,143	3,559	500	4,348							
Larimer	43,554	14,290	50,448	11,315	1,762	18,671							
Las Animas	25,902	6,280	18,560	5,695	475	5,859							
Lincoln	5,909	1,800	10,050	1,589	455	2,149							

↑ See San Juan. † See Rio Grande.
* Mineral figure included in Rio Grande County figure.
** Hinsdale figure included in San Juan County figure.
Note: Population 1950 Census; radio families Standard Audit & Measurement Services Inc.; food, drug and retail sales, copyright 1953, Sales Management; further reproduction uncensored; automobiles supplied by state.

DIRECTORY OF AM AND FM STATIONS

ALAMOSA

KGIW 1929	1450 250	E. L. Allen 26	Inter- mountain	E. L. Allen, o D. L. Allen, gm & ce	Lola Ortega, pd & wd Dick Frink, pmm	C. L. Dynes, nd- Bud De Santelle, sd	Pop.: 60,000	SES, UP G
--------------	-------------	-------------------	-----------------------------	--	---	---	--------------	-----------------

BOULDER

KBOL 1947	1490 250	Boulder Radio KBOL 1617 Pearl 1490 H-R Reprs.	Russel Shaffer, p & gm Gene Palm, cm	Bob Butz, pd & nd Blair Dobbins, ce	Don Roper, sd Robin Arnett, wd	Pop.: 52,000 Rad. Hms.: 15,990 Ret. Sis.: \$82,213,000	Thes., UP Col.
--------------	-------------	---	---------------------	---	--	-----------------------------------	--	----------------------

BROADCASTING • TELECASTING

COLORADO

City	Call Letters Established TV Affiliate	Chan. or Freq. Power	Licensee Headquarters Telephone	Network Represent- ative	Owner o; Pres. p; Exec. up evp; Gen. Mgr. gm; Sta. Mgr. sm; Coml. Mgr. cm; Sales Mgr. slm; Prog. D.r. pd; Chief Eng. ce; Prom. Mgr. pmm; Prod. Mgr. pdm; News, Farm, Sports or Women's Dir. nd, fd, sd, wd.	Executive Abbreviations	Market Data For Primary by station) Area (Supplied)	Library, Transmitter News Serv.
CANON CITY								
	KRLN 1947	1400 250	Royal George Bcstrs. P. O. Box 846 1100	Colum- bine. Inter- mountain	Raymond M. Beckner, p, gm & nd	Ed Wood, ce Q. Bryan, sd	Pop.: 136,880 Rad. Hms.: 26,720 Ret. Slis.: \$65,000,000 UP
COLORADO SPRINGS								
	KCMS(FM) 1953		[See Manitou Springs Listing]					
	KRDO 1947	1240 250	Pikes Peak Bcstg. Co. 399 S. 8th St. Melrose 2-1515	McGillivra	Joe Rohrer, p & gm Harry Hoth, cm Jean Gitz, pd & wd	Pat Colt, pmm Herbert Schubarth, ce Paul Crozier, bus. m	Pop.: 87,000 Rad. Hms.: \$102,000,000	L-W, St., Thes. AP RCA
	KRDO-TV 1947	1300 1,000	Voice of the Rockies Inc. 512 S. Tejon Melrose 4-2844	CBS Holling- bery	James D. Russell, gm Isabelle McClung, sm & pd	John Hanssen, cm H. Cozine Strang, ce Dick Lee, prod. d	Pop.: 70,000 Rad. Hms.: 23,000 Ret. Slis.: \$90,000,000	Wld., Assoc. UP RCA
CRAIG								
	KRAI 1948	1230 250	Northwestern Colo. Bcstg. Co. 707	KBS Inter- mountain	Miles Barrett, o George Cory, gm Gene Wilburn sm & sd	Carr Pecknold, cm Wm. M. Jack, pmm, p, n & fd	Pop.: 20,000 Rad. Hms.: 7,980 Ret. Slis.: \$26,582,000	Cap. UP G
DENVER								
	KFEL 1923	950 5,000	Eugene P. O'Fallon Inc. Albany Hotel Alpine 4681	MBS Blair	Gene O'Fallon, gm Frank Bishop, mgng. d John McEniry, cm Dale Morgan, pd	Gene O'Fallon Jr., pmm Rhean Cunningham, ce	Pop.: 1,052,000 Rad. Hms.: 303,430 Ret. Slis.: \$1,152,114,000	Assoc. INS WH
	KFEL-FM 1948	Ch. 247 (B) 97.3mc 23.5kw						
	KFSC (CP)	1220 1,000-D	Francisco V. Sanchez 3036 Elm St. [See Englewood Listing]					
ENGLEWOOD								
	KGMC							
	KLIR 1953	990 1,000-D	Denver Bcstg. Co. 6535 W. Jewell Westwood 1313		F. Donald Hall, o & gm L. L. Tracy, cm Ernest E. Mark, pd, nd & sd	Lloyd L. Wilson, asst. m & ce	Pop.: 1,000,000 Rad. Hms.: 150,000	
	KLZ 1922	560 5,000	Aladdin Radio & Television Inc. 17th & Lincoln Main 4271	CBS Katz	Hugh B. Terry, p & gm Lee Fcndren, natl. slm Dudley Tichenor, loc. slm	Charlie Roberts, pd Art Gow, mus. d Bill Day, sl, pm d L. Thomas, pmm	Pop.: 1,477,200 Rad. Hms.: 414,430 Ret. Slis.: 1,797,922,000	St., Cap., Wld. AP, INS RCA
	KLZ-FM 1945	Ch. 231 (B) 94.1mc 5.3kw						Cap., Wld., St. INS, AP WE
	KMYR 1941	1340 250	KMYR Bcstg. Co. 422 Security Life Bldg. Main 4161	Columbine Forjoe	F. W. Meyer, p & gm A. G. Meyer, sm Edwin Koepke, cm	Lowell Switzer, pd James Brown, pmm Walter Willson, ce	Pop.: 3,538,400 Rad. Hms.: 966,460 Ret. Slis.: \$4,028,526,000	Thes. AP, UP INS GE
	KOA 1924	850 50,000	Metropolitan Tv Co. 1625 California Main 6211	NBC Petry	William Grant, p Don Searle, evp Robert Hix, cm Judd Woods, ex. asst.	Jim Atkins, pd Dick Harris, pmm Robert Owen, ce	Pop.: 854,200 Rad. Hms.: 265,000 Ret. Slis.: \$1,012,707,000	Thes., SES, AP, INS RCA
	KOA-FM 1948	Ch. 239 (B) 95.7mc 23.5kw						
	KKPF 1928	910 5,000-D 1,000-N	Pillar of Fire 1845 Champa St. Tabor 3733		Arthur K. White, p & gm	Kathleen M. White, co-m	Pop.: 1,100,000 Rad. Hms.: 375,000	Thes., SES, AP, INS RCA
	KTLN 1948	1150 1,000-D CP: 1280 5,000 DA-2	Radio Station KTLN Inc. 431 W. Colfax Acoma 4811	Radio Reps.	Leonard Coe, p John L. Buchanan, gm Dean Jarvis, cm	Jack Helling, pd Del Wood, pmm Orin E. Kelly, ce	Pop.: 1,100,000 Rad. Hms.: 375,000	Cap., UP G
	KVOD 1925	F30 5,000 DA-1	Colorado Radio Corp. Midland Savings Bldg. Tabor 2291	ABC Free & Peters	W. D. Pyle, p & co-e T. C. Ekrem, gm & co-ce	Con Hecker, cm V. W. Corbett, pd	Pop.: 85,000 Rad. Hms.: 18,850 Ret. Slis.: \$19,500,000	Assoc., L-W UP RCA
DURANGO								
	KIUP 1935	930 1,000 DA-N	San Juan Bcstg. Co. P. O. Box 641 117	MBS, Western Slope Net. Holman	R. E. O'Brien, gm Lindsey Becker, cm Lee O'Brien, pd	Al Gare, pmm Henry Pollman, ce Frank Toomey, nd	Pop.: 85,000 Rad. Hms.: 18,850 Ret. Slis.: \$19,500,000	Wld., Thes., SES, UP G
ENGLEWOOD								
	KGMC 1952	1220 1,000-D CP: 1150	Grady Franklin Maples and R. B. McAlister 3355 S. Broadway SU 1-4481		Grady Franklin Maples, co-o. co-gm, cm & co-pmm	R. B. McAlister, co-o, co-gm, co-pmm & pd	Pop.: 625,300 Rad. Hms.: 180,300 Ret. Slis.: \$772,143,000 UP G
FORT COLLINS								
	KCOL 1947	1410 1,000 DA-N	The Northern Colorado Bcstg. Co. 1600 La Porte 2600	Columbine, Inter- mountain H-R Rep.	Herb Hollister, p Ellis Atteberry, gm Bob McClary, cm	Hollis Hoff, pd Dan Coltrane, ce Mark Mahan, fd	Pop.: 124,000 Rad. Hms.: 31,000 Ret. Slis.: \$157,012,000	Thes. UP Col.
FORT MORGAN								
	KFTM 1949	1260 500-D	Morgan Co. Bcstg. Box 431 1000	KBS, Columbine, Inter- mountain	Don K. Smith, gm Mac McGraw, cm & sd	Johanna Hanson, pd Richard E. Oldfield, ce & nd	Pop.: 124,000 Rad. Hms.: 31,000 Ret. Slis.: \$157,012,000	Cap. UP G
GLENWOOD SPRINGS								
	KGLN 1950	1340 250	KGLN Inc. Box C 777	MBS, Western Slope Holman	Rex G. Howell, p Jerry Fitch, co-o, gm & nd	Gene Curtis, pd, fd & sd Bonner Z. Baker, ce	Pop.: 10,000 Rad. Hms.: 3,500 Ret. Slis.: \$13,229,000 UP G
GOLDEN								
	KFML(FM) (CP)	Ch. 253 (B) 98.5mc 2.25kw	E. A. Banckner Box 364, Rt. 3					

Data corrected to Dec. 10, 1953. If executives or services for FM are same as AM affiliate names are not repeated. Market Data supplied by stations. FM's in italic. *—Non-Commercial Station. CP—Construction Permit issued. D—Day, DA-N—Directional Antenna, night only. DA-1—Directional Antenna, same pattern day and night. DA-2—Directional Antenna, different pattern day and night. L—Limited Time with Dominant Station. LS—Local Sunset. N—Night. SA—Special Authorization. SH—Specified Hours. ST—Share Time. Complete key to abbreviations, page 6.

COLORADO

GRAND JUNCTION

KEXO 1948	1230 250	Voice of Western Colorado 2508 N. Ave. 1230	Columbine Oakes	D. Spencer Grow, p H. Abbott Tessman, gm & cm	Robert Collins, pd Mildred Fuller, pmm Compton Mitchell, ce	William Orr, nd James Elcher, fd Olive Taylor, wd	Pop.: 65,000 Rad. Hms.: 24,350	Thes., Wid., INS	Cap. INS
KFXJ 1926 KFXJ-TV	920 1,000-D 500-N	Western Slope Bcstg. Co. 445 Hillcrest Manor 1300	MBS, Western Slope Holman	Rex Howell, p & gm E. Anson Thomas, sm & cm Peg Thomas, pd	Ed Lewis, pdm & sd Cecil Witchurch, ce Roy Adamson, secy.- treas.	Reed Hixon, nd Lyle Marriner, fd June Lee, wd	Pop.: 112,000 Rad. Hms.: 28,000 Ret. Sis.: \$128,000,000		L-W UP G

GREELEY

KFKA 1921	1310 1,000 DA-N	Midwestern Radio Corp. 620 8th Ave. 450 Holman	H. E. Green, p Wm. G. Stewart, sm & cm	Jack Redus, pd & sd Harry Brewer, ce Jerry Ryan, nd	Fred Clark, fd Sue Mosier, wd	Pop.: 750,000 Rad. Hms.: 200,000 Ret. Sis.: \$400,000,000	Thes., SES., Cole UP WE	Wid. AP WE
KYOU 1948	1450 250	Meroco Bcstg. Co. 3275	KBS, Columbine, Inter- mountain McGillvra	Elwood H. Meyer, p & gm	John T. Roscoe, sm & ce				

LA JUNTA

KBNZ 1937	1400 250	Otero Bcstg. Co. Radio Bldg. 42	MBS, KBS Clark	R. D. Gerken, p, gm & pmm	R. D. McGregor, cm & ce J. C. Gerken, pd & wd	John C. Lee, nd & sd John Doenges, fd	Pop.: 50,000 Rad. Hms.: 15,000 Ret. Sis.: \$50,000,000		UP G
--------------	-------------	---------------------------------------	-------------------	------------------------------	---	--	--	--	---------

LAMAR

KLMR 1948	1340 250 CP: 1920 1,000-D 500-N DA-N	Southeast Bcstg. Co. P. O. Box 632 804	Inter- mountain Continental	Ralph Eaton, p Everett Shupe, gm & pmm	Dennis Behan, cm & sd Kenneth Roberts, ce, nd & fd	Claire Behan, pd & wd	Pop.: 30,000 Rad. Hms.: 10,210		Wid. AP GE
--------------	---	---	-----------------------------------	--	---	-----------------------	-----------------------------------	--	------------------

LEADVILLE

KLVC 1951	1230 250	Leadville's Top of the Nation Station Inc. 520 W. 6th 70	KBS, Columbine Palmer	Vir N. James, p & ce	James L. Littlejohn, gm, cm, pd, nd & sd	Marilyn Coleman, pmm & wd	Pop.: 15,000 Rad. Hms.: 5,000 Ret. Sis.: \$7,500,000		Wid. INS WE
--------------	-------------	--	-----------------------------	----------------------	---	------------------------------	--	--	-------------------

LONGMONT

KLMO 1949	1050 250-D	Longmont Bcstg. Co. 301 Main St. 1050	KBS	Irving T. Ludlow, p Russell T. Palmer, secy.-treas. P. Reed Walker, vp & gm	Dick Lee, pd Walter Robinson, ce	Jackie Walker, wd	Pop.: 308,250 Rad. Hms.: 97%		L-W UP G
--------------	---------------	--	-----	---	-------------------------------------	-------------------	---------------------------------	--	----------------

MANITOU SPRINGS

KCMS(FM) 1953	Ch. 285 (A) 104.9mc 0.75kw	Garden of the Gods Bcstg. Co. Box 592 Mulberry 5-5776	C. M. Edmonds, p, o & ce	Mrs. C. M. Edmonds, cm		Pop.: 85,643 Rad. Hms.: 28,000 Ret. Sis.: \$74,523,000	GE
------------------	----------------------------------	--	----------------	-----------------------------	---------------------------	--	--	----------------	----

MONTROSE

KUBC 1947	1240 1,000-D 500-N DA-N	Uncomahgre Bcstg. Co. P. O. Box 279 199	Communi- ty Net.	F. J. Hartman, p George O. Cory, gm Dale G. Moore, asst. to gm	Harley Pryor, m, Delta studio Ed DeJulio, pd & nd	Thomas Weir, ce Lorraine Kretschman, wd	Pop.: 46,600 Rad. Hms.: 15,730 Ret. Sis.: \$39,000,000		Cap. UP WE
--------------	----------------------------------	--	------------------------------	---	---	---	--	--	------------------

PUEBLO

KCSJ 1947 KCSJ-TV	590 1,000 DA-N	Star Bcstg. Co. 211 W. 5th 8522	MBS, Inter- mountain Avery- Knodel	Douglas D. Kahle, p & gm Robert L. Clinton Jr., cm	Larry Gordon, pd Tim O'Connell, pmm Dale Redlingshafer, ce	Bob Billman, nd Cliff Hendrix, fd Ross Beatty, sd	Pop.: 350,000 Rad. Hms.: 105,000 Ret. Sis.: \$300,000,000	Thes., AP WE	
KDZA 1947 KDZA-TV	1230 250	Pueblo Radio Co. 3011 Elizabeth 1255 McGillvra	Dee B. Crouch, p, gm, cm, pd, pmm & ce	Bill Beck, sd	Mary Smith, wd	Pop.: 100,000 Rad. Hms.: 25,000 Ret. Sis.: \$120,000,000		L-W AP G
KGHF 1928	1350 5,000-D 1,000-N DA-N	Colorado Bcstg. Co. P. O. Box 293 3877	ABC Gil-Perna	Gifford Phillips, p Robert D. Ellis, gm William Mahoney, cm	Gregory Chancellor, pd Willis Shanks, ce	John H. McGill, sm Robert A. Mott, nd Irwin M. Cunningham, fd			Wid., SES, UP G

SALIDA

KVRH 1948	1340 250	Vir N. James Salida, Colo. 30	KBS, Columbine, Inter- mountain Clark	Vir N. James, p, gm & cm	Clo B. James, asst. m Jack Diehl, nd Fred Alber, fd	Bob Ryer, sd V. Koess, wd	Pop.: 7,000 Rad. Hms.: 2,300 Ret. Sis.: \$8,000,000		INS RCA
--------------	-------------	-------------------------------------	---	-----------------------------	---	------------------------------	---	--	------------

STERLING

KGEK 1925	1230 250-D	Elmer G. Beehler Fleming Rd. 879	Elmer G. Beehler, p, gm, fd & ce	Al Ross, cm, pd, pmm nd & sd		Pop.: 45,200 Rad. Hms.: 11,317	Mac., Cole UP G	
--------------	---------------	--	----------------	-------------------------------------	---------------------------------	--	-----------------------------------	-----------------------	--

TRINIDAD

KCRT 1946	1240 250	KCRT Inc. Box 772 338	MBS, KBS, Inter- mountain Indie	E. M. Cooper, p, gm & ce Bob Loehr, cm	Vince Brascia, pd John O'Connor, nd	Pete DeLuca, sd Mildred Cooper, wd	Pop.: 42,000 Rad. Hms.: 13,251 Ret. Sis.: \$31,000,000	Wid., L-W UP G	
--------------	-------------	-----------------------------	--	--	--	---------------------------------------	--	----------------------	--

CONNECTICUT

MARKET DATA BY COUNTIES

County	Population 1950	Radio Families 1953	Retail Sales 1952(000)	Food Sales 1952(000)	Drug Sales 1952(000)	Automobile Ownership 1952	County	Population 1950	Radio Families 1953	Retail Sales 1952(000)	Food Sales 1952(000)	Drug Sales 1952(000)	Automobile Ownership 1952
Fairfield	504,342	151,010	\$726,709	\$210,853	\$21,598	204,648	Tolland	44,709	12,530	34,078	11,315	640	19,753
Hartford	539,661	159,790	743,110	189,396	23,555	205,881	Windham	61,759	18,430	85,658	21,868	1,700	25,040
Litchfield	98,872	29,760	114,114	35,120	3,796	45,042	Total	2,007,280	593,600	\$2,639,850	\$728,305	\$79,478	789,483
Middlesex	67,332	19,500	89,568	24,810	2,850	28,963	Note: Population 1950 Census; radio families Standard Audit & Measurement Services Inc.; food, drug and retail sales, copyright 1953, Sales Management; further reproduction unlicensed; automobiles supplied by state.						
New Haven	545,784	160,820	674,062	184,192	20,648	192,962							
New London	144,821	41,760	172,551	50,747	4,683	52,478							

CONNECTICUT

DIRECTORY OF AM AND FM STATIONS

City	Chan. or Freq. Power	Licenses Headquarters Telephone	Network Representative	Executive Abbreviations	Market Data For Primary Area (Supplied by station)	Library News Serv. Transmitter
Call Letters Established TV Affiliate				Owner o; Pres. p; Exec. up evp; Gen. Mgr. gm; Sta. Mgr. sm; Coml. Mgr. cm; Sales Mgr. slm; Prog. Dir. pd; Chief Eng. ce; Prom. Mgr. pmm; Prod. Mgr. pdm; News, Farm, Sports or Women's Dir. nd, fd, sd, wd.		
BRIDGEPORT						
WICC 1928	600 1,000-D	Bridgeport Bcstg. Co. P. O. Box 9140 Trumbull 8-1601	MBS, Yankee Young	Philip Merryman, p & gm Manning Slater, cm, pmm & sd	Robert Crane, pd Jim Elliott, nd Beulah Bestor, wd	Thes. AP Ray
WICC-TV	500-N DA-1				Pop.: 1,386,000 Rad. Hms.: 393,228 Ret. Sls.: \$1,731,547,000	
WNAB 1941	1450 250	Harold Thomas 991 Broad St. Bridgeport 3-3112	ABC, Conn. State Net. Rambeau. Bannan	Harold Thomas, o, gm & ce Ray Colonari, cm Jack Dahlby, pd	Dick Bertelmann, nd Bob Ritzert, sd	Pop.: 180,000 Rad. Hms.: 45,920 Ret. Sls.: \$249,838,000
BRISTOL						
WBIS 1949	1440 500-D	Bristol Bcstg. Corp. 183 Main St. 9265	McGillivra	Frederick W. Beach, p Robert H. Gillespie, gm	Ameleto Ciccarelli, cm Richard L. Ricci, ce	Elliott K. Stein, nd Pop.: 45,000
DANBURY						
WLAD 1947	800 250-D	Berkshire Bcstg. Corp. 207 Main St. 8-3565	Indie	John J. Previdi, p Sol Robinson, gm, cm & pmm Eleanor Kemble, pd	Rudolf Cehak, ce James B. Lee, secy.-treas. Frank Comer, nd	Hal Brundage, fd Paul Baker, sd Ann Rundie, wd Pop.: 27,000 Rad. Hms.: 7,000
HARTFORD						
WCCC 1947	1290 500-D	Greater Hartford Bcstg. Co. Hotel Bond 5-6848	Walker. Kettell- Carter	William M. Savitt, p Max Savitt, secy.-treas. Ralph H. Klein, gm & cm	Burt LaCoe, pd Everett Seltzer, pmm Michael Cookish, ce	Jack Brooks, nd John Brubaker, sd Pop.: 500,000 Rad. Hms.: 136,000
WDRG 1922	1360 5,000 DA-1	The Conn. Bcstg. Co. 750 Main St. 7-1188	CBS Raymer	Franklin M. Doolittle, p Walter B. Haase, gm	William F. Malo, cm & pmm Harvey H. Olson, pm & nd Henry M. Broderick, ce	Pop.: 1,170,300 Rad. Hms.: 337,400 Ret. Sls.: \$1,440,202,000
WDRG-FM 1939	Ch. 229 (B) 93.7mc 7kw					Pop.: 2,000,000 Rad. Hms.: 600,000 Ret. Sls.: \$1,750,000,000
WGTH 1935	1410 5,000 DA-2	General-Times Tv Corp. 54 Pratt St. 7-9131	MBS, Yankee H-R Reprs.	William O'Neill, p Fred W. Wagenvoord, gm	Seymour Kaplan, cm C. P. Patterson, pd	Alan Henry, pmm Rogers B. Holt, ce Assoc. UP WH
WGTH-TV						
WHTT 1936	1230 250	The Hartford Times Inc. 555 Asylum St. 2-0237	ABC, Conn. State Everett- McKinney. Bannan	Glover De Laney, gm Richard K. Blackburn, asst. m & tech. d	Leonard Schoenfeld, cm Mitchell Betters, pd	Charles Masini, ce Sereno Gammell, nd Una King, wd AP RCA
WTIC 1925	1080 50,000 DA-N	Travelers Bcstg. Service Corp. 26 Grove St. 5-0801	NBC, New England Regional Net. Christal	Paul W. Morency, gm Walter Johnson, cm Loeonard J. Patricelli, pd	Bernard Mullins, pmm Herman D. Taylor, ce Irvin C. Cowper, asst. sim	N. T. Eaton, nd Frank Atwood, fd Robert Steele, sd Jean Colbert, wd L-W, SES. AP, INS WH
WTIC-FM 1940	Ch. 243 (B) 96.5mc 20kw					L-W, SES. AP, INS Ret
MERIDEN						
WMMW 1947	1470 1,000-D	Silver City Crystal Co. 8 W. Main St. 5-5747	Rambeau	C. A. Schultz, p & o G. A. Kruttschnitt, gm	Leo P. Finn, pd John Roache, ce	George Tomlinson, nd Jim MacGovern, wd Pop.: 1,890, 820 Rad. Hms.: 313,170 Ret. Sls.: \$1,200,200,000
WMMW-FM 1948	Ch. 239 (B) 95.7mc 7kw			Lester Fox, sm		Pop.: 3,500,000 Ret. Sls.: \$2,000,000,000
MIDDLETOWN						
WENX 1948	1150 500-D	The Middlesex Bcstg. Co. 460 Main St. Diamond 7-2565	Devney	Richard J. O'Brien, p William J. O'Brien Jr., gm	Robert E. Claunch, cm William J. Glynn, pd Kenneth Bishop, ce	Thes. UP Ray.

Data corrected to Dec. 10, 1953. If executives or services for FM are same as AM affiliate names are not repeated. Market Data supplied by stations. FM's in *italics*. *—Non-Commercial Station. CP—Construction Permit issued. D—Day. DA-N—Directional Antenna, night only. DA-I—Directional Antenna, same pattern day and night. DA-2—Directional Antenna, different pattern day and night. L—Limited Time with Dominant Station. LS—Local Sunset. N—Night. SA—Special Authorization. SH—Specified Hours. ST—Share Time. Complete key to abbreviations, page 6.



"There's TNT on 'CCC"

TNT is Time, News, Temperature every fifteen minutes all day, every weekday. It helped us win Variety's Showmanship award, attracts many "fractional" listeners.

HARTFORD'S only station

offering **MUSIC and NEWS**
all day, every day.

1290 Kilocycles — 500 Watts

WCCC means . . . "We Create Cash Customers" . . . throughout Central Connecticut by reaching your potential customers for as little as 50¢ per thousand families.

Represented nationally by The Walker Representation Company
Represented in New England by Kettell-Carter

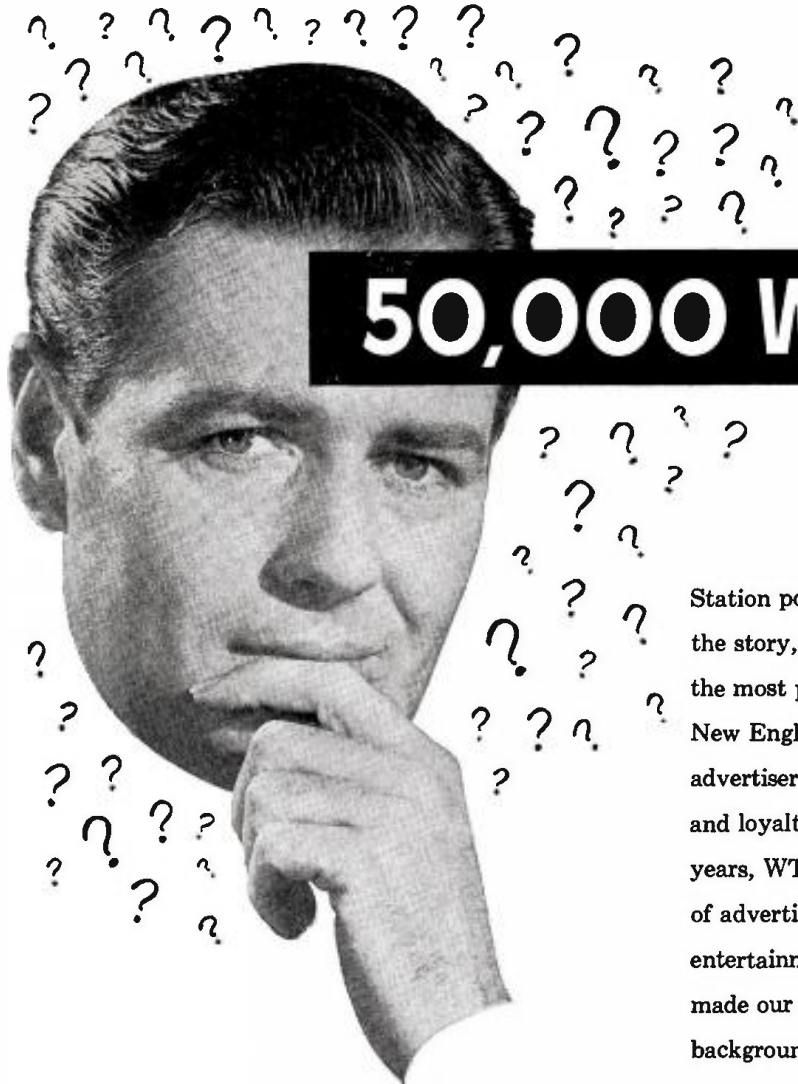

50,000 WHATS ?

Station power by itself is only part of the story, and the fact that WTIC is the most powerful station in Southern New England would not interest an advertiser were it not for the confidence and loyalty of our listeners. Over the years, WTIC's policy of careful screening of advertisers, high standards of entertainment and public service has made our programs unexcelled backgrounds for messages that sell.

FOR YOUR SELLING . . .
USE **WTIC**

WTIC DOMINATES THE PROSPEROUS
SOUTHERN NEW ENGLAND MARKET

CONNECTICUT

City	Call Letters Established TV Affiliate	Chan. or Freq. Power	Licensee Headquarters Telephone	Network Represent- ative	Executive Abbreviations Owner o; Pres. p; Exec. vp evp; Gen. Mgr. gm; Sta. Mgr. sm; Coml. Mgr. cm; Sales Mgr. sim; Prog. Dir. pd; Chief Eng. ce; Prom. Mgr. pmm; Prod. Mgr. pdm; News, Farm, Sports or Women's Dir. nd, fd, sd, wd.	Market Data For Primary Area (Supplied by station)	Library, News Serv. Transmitter
NEW BRITAIN							
	WHAY 1949	910 5,000 DA-2	The Central Conn. Bcstg. Co. 22 Grove Hill 3-2721	Conn. State Net. Young	Patrick J. Goode, p Edward D. Taddel, evp Aldo DeDominicis, gm	Leo Borin, sm Charles Bell, cm Pete Stoner, pd	Hillis Holt, ce L-W UP RCA
	WKNB 1946 WKNB-TV	840 1,000-D	The New Britain Bcstg. Co. 213 Main St. Baldwin 3-3603	Bolling	Julian Gross, p Peter B. Kenney, gm Gustave Nathan, cm	Robert W. Andrews, pd Dean Bafford, pmm John P. Shipley, ce William H. Ray, secy.	Robert Regan, nd Phil Hale, fd Bob Ahearn, sd Betty Pattee, wd Wld. AP Ray.
NEW HAVEN							
	WAVZ 1947	1260 1,000-D	The WAVZ Bcstg. Corp. 152 Temple St. Spruce 7-4761	Forjoe, Kettell- Carter	Victor W. Knauth, p & co-o Daniel W. Kops, vp, co-o & gm	Richard J. Monahan, cm Erwin J. Markle, pd Samuel Barstein, pmm Ralph Carrano, ce	Albert DeFilippo, secy. Samuel Nielsen, loc. sim George Phillips, nd & sd Joyce Swanchak, wd Rudy Frank, pmm Fred King, ce Pop.: 543,600 Rad. Hms.: 163,070 Ret. Sls.: \$1,150,000,000 AP Ray.
	WELI 1935 WELI-TV	960 1,000 DA-N	Connecticut Radio Founda- tion Inc. 221 Orange St. University 5-1133 (WELI, Am Affiliate)	ABC H-R Reprs., Bannan	Richard W. Davis, p & gm	Edwin H. Schweitzer, cm Charles H. Wright, pd	L-W UP RCA
	WEIB (FM) 1949 WELI-TV	Ch. 264 (B) 100.7mc 7.6kw					
	WNHC 1944 WNHC-TV	1340 250	Elm City Bcstg. Corp. 1110 Chapel St. Spruce 7-3611	NBC, Conn. State Net. Katz	Patrick J. Goode, p Edward D. Taddel, evp Aldo DeDominicis, secy.-treas. & gm Edward C. Obrist, sm & pd	J. Vincent Callanan, cm James W. Evans, pmm	Vincent DeLaurentis, ce Rockwell Clark, nd Dorothy Coleman, wd Wld. AP, INS Col.
	WNHC-FM 1948 WNHC-TV	Ch. 256 (A) 99.1mc 19.5kw					AP, INS GE
NEW LONDON							
	WNLC 1936 WNLC-TV	1490 250	Thames Bcstg. Corp. 281 State St. 2-4365	MBS, Yenkee Conn. State Net. McKinney	Gerald J. Morey, p & gm Leo B. Keegan, cm	Nelson C. L. Brown, pd Sheila O'Byrne, pmm	Randolph Barrett, ce Warren F. Haas, loc. sid Dave Connors, nd Pop.: 181,423 Rad. Hms.: 59,362 Ret. Sls.: \$236,498.208
NORWALK							
	WNLK 1948	1350 500 DA-N	Norwalk Bcstg. Co. Main & Wall St. Temple 8-5566	McGillvra	James Stolcz, p & gm John Naylor, pd	Nick Yalowey, ce John Ferguson, nd	Dick Bounerba, sd Pop.: 1,012,000 Wld., SES, UP Ray.

Data corrected to Dec. 10, 1953. If executives or services for FM are same as AM affiliate names are not repeated. Market Data supplied by stations. FM's in italic. *—Non-Commercial Station. CP—Construction Permit issued. D—Day. DA-N—Directional Antenna, night only. DA-1—Directional Antenna, same pattern day and night. DA-2—Directional Antenna, different pattern day and night. L—Limited Time with Dominant Station. LS—Local Sunset. N—Night. SA—Special Authorization. SH—Specified Hours. ST—Share Time. Complete key to abbreviations, page 6.

WELI
in the MAJOR MARKET of New Haven...

ST with listeners
with local advertisers
with national advertisers
with local personality shows

WELI
by every yardstick-TODAY
and for over 18 years...
NEW HAVEN'S MOST
POPULAR STATION!

1000 W - 960 KC - ABC - HR REPRESENTATIVES

New England Rep.
BERTHA BANNAN

No. 1 RADIO BUY

... in New Haven

MERCHANDISING ←

More guaranteed in-store food display than any other
New Haven station

PROGRAMS ←

live wire local plus NBC affiliation-proven audience.

SATURATION ←

run of station • day and night • 20 spots a week
1-13-26 week package • \$45 - \$48 - \$60 per week.

— three steps cover — New Haven's ultra-rich market on

WNHC radio

→ ask KATZ

CONNECTICUT

City	Call Letters Established TV Affiliate	Chan. or Freq. Power	Licensee Headquarters Telephone	Network Represent- ative	Owner o; Pres. p; Exec. vp evp; Gen. Mgr. gm; Sta. Mgr. sm; Coml. Mgr. cm; Sales Mgr. sim; Prog. Dir. pd; Chief Eng. ce; Prom. Mgr. pmm; Prod. Mgr. pdm; News, Farm, Sports or Women's Dir. nd, fd, sd, wd.	Executive Abbreviations	Market Data For Primary Area (Supplied by station)	Library, News Serv. Transmitter	
NORWICH									
WICH	1946	1400 250	Eastern Conn. Bcstg. Co. Cuprak Rd. Turner 7-1613	J. K. Lasser, p Donald Lasser, gm Richard Reed, cm	Jack MacAdie, pd Edward Adler, pmm Alexander Dubenetsky, ce	Ed Leonard, nd & sd Alvin Lawrence, fd Joy Somerville, wd	Pop.: 148,000 Rad. Hms.: 49,200 Ret. Sis.: \$142,000,000	Wid. UP Ray.
PUTNAM									
WPCT	1953	1350 500-D	Isreal Putnam Bcstg. Co. 42 Main St. 8-2721	Roland A. Gayette, p Daniel J. Hyland, gm & cm	William Winne, pd James Bonney, ce	Thomas Hynes, nd Dick Gaumont, sd	Pop.: 125,000	
STAMFORD									
WSTC	1941	1400 250	The Western Conn. Bcstg. Co. 270 Atlantic St. 4-7575	ABC, Conn. State Everett-McKinney, O'Connell	Kingsley Gillespie, p Julian Schwartz, gm & nd	Walter Dibble, pd Robert A. Reynolds, ce	Harry Downie, sd	Pop.: 155,358 Rad. Hms.: 44,859 Ret. Sis.: \$217,159,750	L-W UP RCA
WSTC-FM	1947	Ch. 244 (A) 96.7mc 0.55kw							
TORRINGTON									
WLCR	1947	990 1,000-D	Litchfield County Radio Corp. 23 Main St. 4173	Sears & Ayer	C. O. Scott, p & gm Joe Storm, cm & pmm Ken Mudgett, pd	Hal Norman, nd & sd Ray Atherton, fd Alfred Pallokat, ce	Roberta Grunskay, wd		Wid. UP
WTOR	1948	1490 250	Torrington Bcstg. Co. 93 Perkins St. 4181	ABC, Conn. State Net. Rambeau	Harold Thomas, p Edmund Waller, gm John J. Morris, cm	Richard Kilbourn, pd & pmm Edward Michelski, ce	Al Eyre, sd Louise Easton, wd		Wid. UP
WATERBURY									
WATR	1934	1320 1,000	WATR Inc. 440 Meadow St. 5-1121	ABC, Conn. State Net. Rambeau	Harold Thomas, p Sam Elman, gm & cm Wallace King, pd	Wallace Gordon, pmm Russell Jensen, ce Phil Corvo, nd	Al Vestro, sd Marion Budwell, wd	Pop.: 175,000 Rad. Hms.: 55,000 Ret. Sis.: \$228,000,000 UP Col.
WATR-TV	1934	DA-1							
WBRY	1934	1590 5,000 DA-1	American-Republican Inc. 136 Grand St. 3-1125	CBS, Nutmeg Knodel, Kettell-Carter	J. Maxim Ryder, m Harry A. Devorken, cm Walter O. Howard, pd	Robert S. Holczer, pmm Frank B. Hales, ce E. Christy Erk, nd	Robert Stewart, fd John A. Cluney, sd Grace Galvin, wd	Pop.: 190,000 Rad. Hms.: 57,000 Ret. Sis.: \$135,000,000	Wid. AP RCA
WWCO	1946	1240 250	Mattatuck Bcstg. Co. 119 W. Main St. 4-5141	MBS, Yankee McGillvra	William G. Wells, p James Shoemaker, gm Al Simmons, cm	Robert Cramer, pd William Goldstein, ce	Marinus Koster, secy.-treas.	Pop.: 250,000 AP Col.

DELAWARE

MARKET DATA BY COUNTIES

County	Population 1950	Radio Families 1953	Retail Sales 1952(000)	Food Sales 1952(000)	Drug Sales 1952(000)	Automobile Ownership 1952-1953
Kent	38,870	11,640	\$62,117	9,975	\$1,306	27,638
New Castle	218,879	64,450	288,730	67,882	7,398	78,264
Sussex	61,336	18,370	126,662	17,302	1,815	27,205
Total	318,085	94,460	\$477,509	\$95,159	\$10,519	122,232

Note: Population 1950 Census; radio families Standard Audit & Measurement Services Inc.; food, drug and retail sales, copyright 1953, Sales Management; further reproduction unlicensed; automobiles supplied by state.

DIRECTORY OF AM AND FM STATIONS

DOVER									
WDOV	1947	1410 1,000-D	Del. State Capitol Bcstg. Corp. Denny Rd. Dover 5816 Rambeau	C. F. Freed, p Cliff Goodman, gm William Freed, cm	John Adkins, pd Bennett Brownell, ce Harry McSherry, nd	Pat Knight, sd George Vappa, fd Virginia Bracket, wd	Pop.: 136,000 Rad. Hms.: 37,700	Wid. AP G
GEORGETOWN									
WJWL	1953	900 1,000-D	Rollins Bcstg. Inc. Georgetown 2567 Pearson	John Rollins, p Norman Glenn, gm, cm & pm	Bill Jaeger, pd Ed Marzoo, ce & fd Les Coleman, nd	Bill German, sd Edna Moore, wd	Pop.: 550,500 Ret. Sis.: \$712,000,000	Thes. GE
MILFORD									
WKSB	1953	930 500-D DA-D	The Kent-Sussex Bcstg. Co. Box 444 Milford 8881 & 8981	Herbert M. Griffith, Jr., co-o, co-m, cm & pmm	Charles V. Lundstedt, co-o, co-m & ce	Borden E. Smith, pd & nd Ellie Higgons, wd	Pop.: 175,000 Rad. Hms.: 50,000 Ret. Sis.: \$225,000,000	L-W UP
WILMINGTON									
WAMS	1948	1380 1,000-DA-1	Wilmington Tri-State Bcstg. Co. 321 Delaware Ave. 4-8882	MBS Hollingbery	Frank Carrow, p Edwin A. McKeon, gm	William S. Ewing, cm & pmm Tim Crow, pd, nd & sd	Perley Tribou, ce Eleanor Landon, traffic m	Pop.: 277,100 Rad. Hms.: 75,920 Ret. Sis.: \$297,030,000	
WDEL	1921	1150 5,000 DA-2	WDEL Inc. 10th & King Sts. 7268	NBC Meeker	Clair R. McCollough, sta. exec.	Harvey C. Smith, sm J. Robert Gulick, sim	Richard V. Avdelotte, pd		Wid. UP
WDEL-TV	1950	Ch. 227 (B) 93.7mc 20kw							
WELM	1922	1450 250	Del Bcstg. Co. 920 King St. 4-7771	ABC Bolling	Ewing B. Hawkins, p & gm Jackson F. Lee, cm & pmm	Warren Keyser, pd H. Edwin Kennedy, ce Harry Thernal, nd	Robert V. Kelley, sd Richard Bair, fd Marjorie Price, wd	Pop.: 400,000	Wid. WE
WTUX	1947	1290 500-D	Port Frere Bcstg. Co. 1326 Market St. 5-8821 Indie	Gordon K. MacIntosh, p Howard R. Robinson, gm	John M. Talley, cm William Gehlert, pd & nd Edward Piering, Jr., pmm	Seymour Toberlsky, ce Jim Termine, sd Justina Spagnolo, wd	Pop.: 297,715 Rad. Hms.: 75,000	Thes. AP Ray.

Data corrected to Dec. 10, 1953. If executives or services for FM are same as AM affiliate names are not repeated. Market Data supplied by stations. FM's in italic. *—Non-Commercial Station. CP—Construction Permit issued. D—Day. DA-N—Directional Antenna, night only. DA-1—Directional Antenna, pattern day and night. DA-2—Directional Antenna, different pattern day and night. L—Limited Time with Dominant Station. LS—Local Sunset. N—Night. SA—Special Authorization. SH—Specified Hours. ST—Share Time. Complete key to abbreviations, page 6.

MARKET DATA

County	Population 1950	Radio Families 1953	Retail Sales 1952(000)	Food Sales 1952(000)	Drug Sales 1952(000)	Automobile Ownership 1953
Washington	802,178	232,970	\$1,399,882	\$284,573	\$51,479	216,000
Total	802,178	232,970	\$1,399,882	\$284,573	\$51,479	216,000

Note: Population 1950 Census; radio families Standard Audit & Measurement Services Inc.; food, drug and retail sales, copyright 1953, Sales Management; further reproduction unlicensed; automobiles supplied by D. C.

DIRECTORY OF AM AND FM STATIONS

WASHINGTON

WARL-AM-FM		(See Arlington, Va. listing)							
WASH(FM) 1945	Ch. 246 (B) 97.1mc 15kw	Commercial Radio Equipment Co. 810 International Bldg. District 7-1319	MBS Continental	Everett L. Dillard, p & gm	James A. Gustafson, cm Eugene V. Jrasinski, ce	Robert E. Best, traffic m Doug Bailey, pmm	Pop.: 2,200,000	RCA
WBUZ(FM)		(See Bradbury Heights, Md., listing)						RCA
WCFM(FM) 1948	Ch. 258 (B) 99.5mc 20kw	Cooperative Bcstg. Assoc. 1120 Connecticut Ave. Republic 7-8688	Continental	C. Edward Behre, p William M. Blaisdell, gm	Imogene Putnam, pd H. Edward Behre, ce	Harold W. Schanagel, asst. pd Louis Brown, mus. d	Pop.: 3,411,200 Rad. Hms.: 2,080,000 Ret. Sls.: \$2,811,079,000	Assoc. Fed.
WDON		(See Wheaton, Md., listing)							
WEAM		(See Arlington, Va. listing)							
WFAX		(See Falls Church, Va. listing)							
WGAY-AM-FM		(See Silver Spring, Md. listing)							
WGMS 1947	570 1,000-D	The Good Music Station Inc. Hotel Harrington Executive 3-8676	Continental Good Music Bcstrs.	M. Robert Rogers, p & gm	Dan R. Cavalier, cm & pmm Pierson Underwood, pd	Nick Chaconas, ce Anne Blair, wd	Pop.: 1,500,000 Rad. Hms.: 400,000 Ret. Sls.: \$1,500,000,000	AP Col.
WGMS-FM 1948	Ch. 278 (B) 103.5mc 20kw							Assoc. AP Col.

WGMS

the Good Music Station

BROADCASTING
Magazine and Telecasting

NATIONAL PRESS BLDG.
WASHINGTON, D. C.

October 27, 1952

SOL TAISHOFF
Editor & Publisher

Mr. M. Robert Rogers
President-General Manager
Radio Station WGMS
Washington's Good Music Station
Washington, D. C.

Dear Bob:

That was a wonderfully magnificent note
on our ad pull. And it's going into
our Joy Book.

Many thanks, Mister. It was beyond the
usual call.

**It could also mean
We Get More Sales*

Sincerely,
Sol Taishoff

"could also mean

We Get More Sales"

*With thanks to Sol Taishoff,
Editor and Publisher, Broadcasting Magazine
for his gracious interest and ingenuity.*

**M. Robert Rogers
Pres. Gen. Mgr.**

WGMS Washington, D.C.

AM-FM

Member Good Music Broadcasters % WQXR New York City

DISTRICT OF COLUMBIA

City	Call Letters	Chan. or Freq. Power	Licenses Headquarters Telephone	Network Representative	Owner: Pres. p; Exec. vp evp; Gen. Mgr. gm; Sta. Mgr. sm; Coml. Mgr. cm; Sales Mgr. slm; Prog. Dir. pd; Chief Eng. ce; Prom. Mgr. pmm; Prod. Mgr. pdm; News, Farm, Sports or Women's Dir. nd, fd, sd, wd.	Executive Abbreviations	Market Data For Primary Area (Supplied by station)	Library, News Serv. Transmitter	
WASHINGTON—(Continued)									
	WINK		(See Rockville, Md. listing)						
	WMAL	630	Evening Star Bcstg. Co.	ABC	S. H. Kauffman, p	Charles Bishop, pd	Bryson Rash, features d	Pop.: 2,589,400	SES.
	1925	5,000	4461 Conn. Ave. N. W.	Katz	K. H. Berkeley, vp & gm	Haywood Meeks, pub. d & pmm	James Gibbons, sd Ruth Crane, wd	Rad. Hms.: 765,476	AP
	WMAL-TV	DA-1	Kellogg 7-1100		C. L. Kelly, asst. gm	Frank Harvey, ce		Ret. Sis.: \$2,403,732,000	RCA
	WMAL-FM	Ch. 297 (B)							
	1948	107.3mc							
	20kw								
	WOL	1450	Washington Bcstg. Co.		Henry Rau, p	Patrick H. Kelly, bus. m.	Maxwell Marvin, cm, pd		UP
	1924	250	1000 Connecticut Ave. Metropolitan 8-0010		Charles Dillon, vp & gm				WE
	WOL-FM	Ch. 254 (B)							
	1946	98.7mc							
	20kw								
	WOOK	1340	United Bcstg. Co. 8th & I Sts., N. W. Republic 7-8000	UBC	Richard Eaton, p, gm	Arthur A. Snowberger, cm & sm	Joe Quinn, sd & pmm E. E. Stevens, ce		UP
	1940	250	(WOOK, Am Affiliate)						RCA
	WFAN(FM)	Ch. 262 (B)							
	1948	100.3mc							
	20kw								
	WPKK		(See Alexandria, Va. listing)						
	WRC	980	National Bcstg. Co. Sheraton Park Hotel Adams 4-5400	NBC NBC Spot Sales	Sylvester L. Weaver Jr., p (NBC)	Joseph Goodfellow, sales dir.	James E. Kovach, pd Robert Adams, pmm Nancy Osgood, wd Kenneth French, prog. mgr.	Pop.: 1,914,300	AP, UP
	1923	5,000-DA-N			Robert W. Sarnoff, evp (NBC)	Kenneth French, pd John Rodgers, ce		Rad. Hms.: 496,930	INS
	WNBW(TV)				Frank M. Russell, vp in chg. of Wash. off.		Arthur J. Bergman, sd	Ret. Sis.: \$2,229,157,000	RCA
	WRC-FM	Ch. 230 (B)			Carleton D. Smith, gm				
	1947	93.9mc							
	20kw								
	WTOP	1500	WTOP Inc. 40th & Brandywine Sts. N.W. Emerson 2-9300	CBS CBS Radio Spot Sales	John S. Hayes, p	Clyde M. Hunt, vp in charge of engrg. & ops.	Warren Booram, sls. prom. d Patricia Searight, pd Ted Koop, nd Claude Mahoney, fd Arch McDonald, sd Elinor Lee, wd	Pop.: 1,178,300	Cap.
	1926	50,000-DA-2			George F. Hartford, vp in charge of sis.	Laurence E. Richardson, exec. asst.		Rad. Hms.: 467,200	AP, UP
	WTOP-TV				Lloyd W. Dennis, vp in charge of progs.	Robert A. J. Bordley, gen. slm		Ret. Sis.: \$2,066,659,000	INS WE
	WTOP-FM	Ch. 242 (B)			Cody Pfanstiehl, press info. & aud. prom. d				
	1949	96.3mc							
	20kw								
	WUST-AM-FM		(See Bethesda, Md. listing)						
	WWDC	1260	WWDC Inc. 1627 K St. N. W. Sterling 3-3800	MBS Blair	Joseph Katz, p	Norman Reed, pd	Bob Wolff, sd	Pop.: 1,464,000	St., L-W,
	1941	5,000-DA-1			Ben Strouse, vp & gm	Irv Lichtenstein, pmm	Hazel Markel, wd	Rad. Hms.: 433,240	Thes. Wid
					Herman M. Paris, cm	Ross H. Beville, ce		Ret. Sis.: \$1,670,000,000	AP
	WWDC-FM	Ch. 266 (B)							UP
	1946	101.1mc							WE
	20kw								Thes., Wid., St., L-W
									AP, UP
									WH

Data corrected to Dec. 10, 1953. If executives or services for FM are same as AM affiliate names are not repeated. Market Data supplied by stations. FM's in italic. *—Non-Commercial Station. CP—Construction Permit issued. D—Day. DA—Day. DA-N—Directional Antenna, night only. DA-1—Directional Antenna, same pattern day and night. DA-2—Directional Antenna, different pattern day and night. L—Limited Time with Dominant Station. LS—Local Sunset. N—Night. SA—Special Authorization. SH—Specified Hours. ST—Share Time. Complete key to abbreviations, page 6.

1340 ON YOUR DIAL

THE AMAZING STORY OF WOOK!

A UBC STATION

In Washington they say look to WOOK and everything is double okay

They Know

WOOK has more listeners than ANY of the nine other Washington area independents during the entire 24 hour period.

WOOK leads Washington in Sales Growth by getting solid results for its advertisers.

WOOK is Washington's most popular independent station.

Here's the Proof

The most talked about station in the nation! Continually SOLD OUT because of audience, market, sales and results.

WOOK, the UBC voice of the nation's Capital City, broadcasts to the more than 1,474,200 people with more than 1,631,634,000 dollars to spend in the greater Washington area . . . and through brilliant programming reaches the loyal *plus audience* of 339,066 Negroes with more than 375,000,000 retail dollars to spend!

WOOK, Washington's FIRST Independent station, has more listeners than any of the nine other Washington area independents during the entire twenty-four hour period surveyed by The Pulse, Incorporated!

WEEKEND SPECIAL

Pop.: 1,464,000

Rad. Hms.: 433,240

Ret. Sis.: \$1,670,000,000

St., L-W, Thes. Wid

AP

UP

WE

Thes., Wid., St., L-W

AP, UP

WH

WOOK—WASHINGTON'S FIRST INDEPENDENT STATION

ASK BOB WITTIG AT UBC'S N. Y. OFFICE—MURRAY HILL 7-4758

or UBC, 8th & Eye Sts., N. W., Washington, D. C.

you can get all this...

plus...

results,

when you buy

WASHINGTON'S

PIONEER

MERCHANDISING

STATIONS!

Plus these merchandising features . . .

- ★ Air Announcements
- ★ Newspaper Ads
- ★ TV Guide Ads
- ★ Lobby Displays
- ★ Billboard Windows
- ★ Planned Publicity
- ★ Give-Away Prizes
- ★ Dealer Mailings
- ★ Special Promotions

WMAL *am*
fm
tv

THE EVENING STAR STATIONS ★ ABC IN WASHINGTON, D. C.
REPRESENTED BY KATZ

**GROCERY STORE
DISPLAYS**



**DRUG STORE
DISPLAYS**

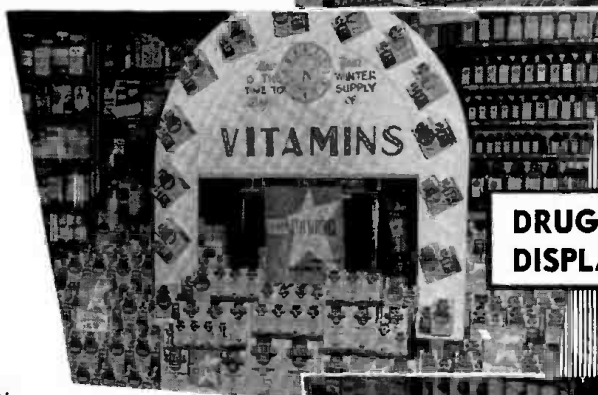

DEALER CALLS



FLORIDA

MARKET DATA BY COUNTIES

County	Population 1950	Radio Families 1953	Retail Sales 1952(000)	Food Sales 1952(000)	Drug Sales 1952(000)	Automobile Ownership 1952	County	Population	Radio Families Radio	Retail Sales Retail	Food Sales	Drug Sales	Passenger Cars Passenger
Alachua	57,026	14,050	\$ 55,007	\$ 14,663	\$ 1,717	19,266	Leon	51,590	12,410	46,654	11,169	1,557	11,317
Baker	6,313	1,200	3,192	957	85	2,223	Levy	10,637	2,270	5,582	1,851	163	3,397
Bay	42,689	13,320	46,314	12,949	1,546	18,020	Liberty	3,182	830	1,370	404		863
Bradford	11,457	2,680	7,794	2,588	133	4,078	Madison	14,197	2,700	5,419	2,005	189	3,742
Brevard	23,653	7,460	21,002	6,854	658	15,948	Manatee	34,704	11,150	34,591	9,779	1,353	20,878
Broward	83,933	31,050	137,878	31,725	5,385	58,746	Marion	38,187	10,070	41,845	9,758	1,217	15,280
Calhoun	7,922	1,710	4,313	1,385	119	1,998	Martin	7,807	2,450	6,967	2,533	279	4,557
Charlotte	4,286	1,310	3,526	1,122	121	2,598	Monroe	29,957	8,740	23,820	7,549	934	10,270
Citrus	6,111	1,600	4,824	1,587	239	2,969	Nassau	12,811	3,030	9,639	2,816	233	3,873
Clay	14,323	3,330	9,275	3,359	380	5,333	Okaloosa	27,333	6,610	15,698	4,591	678	11,926
Collier	6,488	1,580	2,583	657	81	3,109	Okeechobee	3,454	800	2,898	859	74	1,929
Columbia	18,216	4,070	15,085	3,951	378	6,058	Orange	114,950	38,860	147,838	33,671	5,559	66,672
Dade	495,084	176,310	779,170	158,176	37,948	262,598	Osceola	11,406	3,680	10,551	3,654	328	6,211
De Soto	9,242	2,150	6,915	2,248	321	3,615	Palm Beach	114,688	36,750	168,110	36,743	5,590	62,158
Dixie	3,928	890	2,128	582	50	1,251	Pasco	20,529	6,400	14,724	5,440	460	10,169
Duval	304,029	89,210	363,505	89,404	13,633	114,783	Pinellas	159,249	63,330	221,644	40,133	6,980	91,963
Escambia	112,706	31,120	104,054	26,434	3,213	43,737	Polk	123,997	36,170	103,983	30,984	3,793	58,731
Flagler	3,367	770	2,039	522	38	1,968	Putnam	23,615	6,190	22,365	6,058	482	9,549
Franklin	5,814	1,340	2,392	1,133	126	1,446	St. Johns	24,998	6,920	21,497	7,306	947	9,423
Gadsden	36,457	6,330	21,981	5,319	534	7,624	St. Lucie	20,180	6,040	25,925	6,760	398	10,778
Gilchrist	3,499	650	2,122	524	77	1,464	Santa Rosa	18,554	4,300	8,032	3,287	153	5,405
Glades	2,189	500	1,507	373	79	805	Sarasota	28,827	10,660	47,109	12,331	1,615	22,520
Gulf	7,460	1,800	5,038	1,382	202	2,945	Seminole	26,883	7,320	22,867	6,444	684	12,089
Hamilton	8,981	1,680	4,079	1,295	134	2,012	Sumter	11,330	2,850	6,855	2,230	224	3,634
Hardee	10,073	2,540	8,572	2,334	243	4,907	Suwannee	16,986	3,710	11,323	3,120	322	4,709
Hendry	6,051	1,450	7,091	1,318	98	3,392	Taylor	10,416	2,430	8,443	2,308	229	3,230
Hernando	6,693	1,620	5,679	1,569	185	3,256	Union	8,906	910	2,273	1,027	85	1,093
Highlands	13,636	4,120	11,290	3,961	397	6,581	Volusia	74,229	24,420	83,552	22,749	3,553	37,288
Hillsborough	249,894	76,280	281,434	66,929	9,517	115,408	Wakulia	5,258	1,060	1,109	546	30	1,316
Holmes	13,988	2,850	4,403	1,197	165	2,962	Walton	14,725	3,550	9,376	2,442	263	5,283
Indian River	11,872	3,500	11,703	3,651	493	8,625	Washington	11,888	2,740	3,935	1,326	148	2,788
Jackson	34,645	7,340	19,715	4,349	519	8,613	Total	2,771,305	846,240	\$3,157,493	\$754,810	\$119,801	1,178,682
Jefferson	10,413	1,950	4,738	1,728	126	2,587	Note: Population 1950 Census; radio families Standard Audit & Measurement Services Inc.; food, drug and retail sales, copyright 1953, Sales Management; further reproduction unlicensed; automobiles supplied by state.						
Lafayette	3,440	690	1,688	548	-	1,095							
Lake	36,340	10,890	30,134	8,741	1,253	19,445							
Lee	23,404	7,640	29,313	7,423	1,112	13,893							

DIRECTORY OF AM AND FM STATIONS

City	Chan. or Freq.	Licensee Headquarters Telephone	Network Representative	Owner; Pres. p; Exec. vp evp; Gen. Mgr. gm; Sta. Mgr. sm; Coml. Mgr. cm; Sales Mgr. slm; Prog. Dir. pd; Chief Eng. ce; Prom. Mgr. pmm; Prod. Mgr. pdm; News, Farm, Sports or Women's Dir. nd, fd, sd, wd.	Executive Abbreviations	Market Data For Primary Area (Supplied by station)	Library, News Serv. Transmitter
BARTOW							
WBAR 1953	1460 1,000-D	William Avera Wynne Box 820, Lakeland Hwy. 3-5111	W. A. Wynne, p Ted Leeper, gm	John Burgreen, cm Edward St. Clair, ce & sd Bob Coe, nd	Pop.: 123,000	
BELLE GLADE							
W\$WN 1947	900 1,000-D	Seminole Bcstg. Co. Box 8 2063	Dr. Robert G. Nelson, p (Mrs.) Mary M. Foy, gm	Marvin Smith, slm Don Day, pd Eva Johnson, traffic m		Thes., Wid., SES, UP G
BRADENTON							
WTRL 1947	1490 250	Trail Bcstg. Corp. Memorial Pier 3-1531 Best	H. D. McClelland, p Howard A. Donahoe, evp	George W. Manning, sm Don McKellar, pd George McGougan, ce		Wid., St. AP G
CLEARWATER							
WTAN 1948	1340 250	* Clearwater Radio Bcstrs. P. O. Box 1109 3-3084	KBS McGillvra	Otis E. Pruitt, p H. Dennison Parker, gm Frank L. Parker, cm	L. Harnoid Falconnier, pd & pmm Leslie E. Freedom, ce		Wid., UP Col.
COCOA							
WKKO 1953	860 250-D	Brevard Bcstg. Co. P. O. Box 387 1020	KBS	Emerson W. Browne, gm	Carl Collins, Jr., pd Davis E. Wilson, ce	Pop.: 222,488 Rad. Hms.: 67,897 Ret. Sis.: \$239,000,000 UP G
CORAL GABLES							
WAHR (CP)	1490 250	Alan H. Rosenson 420 Lincoln Rd. Miami Beach 58-6334	Alan H. Rosenson, p			
WVCG 1948	1070 1,000-D	Peninsular Bcstg. Corp. 223 Aragon Ave. 48-7411 Clark	George W. Thorpe, p & gm T. Hooke McCallie, cm	Robert S. Stevens, pd Barbara S. Binns, pmm & wd	Pop.: 600,000 Rad. Hms.: 162,000 Ret. Sis.: \$750,000,000	Assoc. AP RCA

Data corrected to Dec. 10, 1953. If executives or services for FM are same as AM affiliate names are not repeated. Market Data supplied by stations. FM's in italic. *—Non-Commercial Station. CP—Construction Permit issued. D—Day. DA—Directional Antenna, night only. DA-1—Directional Antenna, same pattern day and night. DA-2—Directional Antenna, different pattern day and night. L—Limited Time with Dominant Station. LS—Local Sunset. N—Night. SA—Special Authorization. SH—Specified Hours. ST—Share Time. Complete key to abbreviations, page 6.

CRESTVIEW

WCNU 1948	1010 1,000-D	Gulfshores Bcstg. Co. P. O. 518 3511	KBS, Alabama Bcstrs.	D. G. O'Neal, p & pmm Sam F. Townsend, gm & cm	Vernon Cooper, pd & sd Judson Ward, ce	W. D. Douglas, nd Carolyn Townsend, wd	Pop.: 200,000 Rad. Hms.: 38,000 Ret. Slis.: \$77,000,000	Wld., SES, AP G
--------------	-----------------	---	-------------------------------------	--	--	---	--	-----------------------

DAYTONA BEACH

WMFJ 1935	1450 250	W. Wright Esch 444 N. Beach St. 6491-3	ABC McGillvra	W. Wright Esch, o Ray Clancy, sm	John S. Pitts, cm Mildred Mullins, pd	W. K. Ellenwood, ce		SES, UP
WNDB 1948	1150 1,000 DA-N	News-Journal Corp. 128 Orange Ave. 2-0531	MBS Perry	Jerry Stone, gm R. Y. Huffman, cm	Wm. L. Steadman, pd F. A. Scott, ce	Bob Patillo, sd Jo Bledsoe, wd	Pop.: 77,100 Rad. Hms.: 27,610 Ret. Slis.: \$72,402,000	Wld., AP GE
WNDB-FM 1947	Ch. 233 (B) 94.5mc 8.5kw							AP GE
WROD 1947	1340 250	Daytona Beach Bcstg. Corp. Wilder Blvd. & S. Beach St. 4626	NBC Rambeau	E. J. Sperry, p & gm	W. C. Collier, pd & ce			Cap. UP Col.

DE LAND

WJBS 1948	1490 250	John B. Stetson U. Hubbard Ave. (P. O. Box 808) 1490	NBC	J. Ollie Edmunds, p C. L. Menser, gm & pd Robert Walton, cm, pmm & nd	James Miller, ce Dick Westerveidt, sd	Georgiana Bushnell, wd	Pop.: 25,000 Rad. Hms.: 6,500 Ret. Slis.: \$33,000,000	Theg. AP Col.
--------------	-------------	---	--------------	--	--	---------------------------	--	---------------------

DELRAY BEACH

WDBF (CP)	1420 500-D	Delray Bcstrs. 2006 James St. Durham, N. C.						
--------------	---------------	---	--	--	--	--	--	--

FORT LAUDERDALE

WBRD 1950	1580 250-D	Broward Bcstg. Co. P. O. Box 78 2-2563	KBS Best	L. C. Judd, p	Charles H. Gravett, gm	Theodore Dudas, ce	Pop.: 105,000 Rad. Hms.: 98%	St. UP WE
WITV(TV)	CP: 1,000 DA-2							
WFTL 1946	1400 250	Tri-County Bcstg. Co. P. O. Box 131 3-2511	Sears & Ayer	J. W. Dickey, p R. L. Bowles, gm & cm	Jack Swart, pd Richard Nonthey, ce	Orville Revelle, nd Mack Ansbaugh, sd		L-W, Wld. AP Col.

FORT MYERS

WINK 1939	1240 250	Fort Myers Bcstg. Co. 54 E. First St. 4-1341	CBS, Florida State Net. Cooke	Daniel Sherby, p A. J. Bauer, gm & cm	Frank Nodine, pd, pmm & nd	James E. Lacy, ce Ward Goodrich, sd	Pop.: 58,600 Rad. Hms.: 17,290 Ret. Slis.: \$54,837,000	AP RCA
WINK-TV								
WMYR 1952	1410 1,000-D	Robert Hecksher 33 E. Hanson St. 5-1175	Robert Hecksher, o, gm, ce & pd	Kenneth M. Parke, cm			L-W UP G

FORT PIERCE

WARN 1952	1330 1,000-D	Hurricane Bcstg. Service P. O. Box 1343 1330	ABC, KBS	Murray C. Tillmon, co-o & gm C. C. Tillman Jr., co-o & pmm	E. Fisher Darden, cm Willis M. Shawver Jr., pd, nd & fd	John E. Palmer, ce Don Thursten, sd Harriet Langdon, wd	Pop.: 73,000 Rad. Hms.: 12,500 Ret. Slis.: \$42,000,000	
WIRA 1946	1400 250	Indian River Bcstg. Co. County Park 1400	MBS, NBC	James L. Howe, p & gm	J. Kingsley Butt, cm Anne Wilder, pd & nd	James Sowinski, ce Bill Strickland, sd	Pop.: 38,928 Rad. Hms.: 10,135 Ret. Slis.: \$43,036,000	Wld. UP G

FORT WALTON

WFTW (CP)	1260 1,000-D	Vacationland Bcstg. Co. P. O. Box 87 3-2601	Wilbur R. Powell, p Milford A. Reynolds, gm	Richard E. Darby, pd Frank Prestwood, ce	Percy Hamilton, nd		
--------------	-----------------	--	----------------	---	---	--------------------	--	--

VACATION LAND SUMMER AND WINTER

WMFJ

FIRST RADIO STATION IN

DAYTONA BEACH, FLA.

Affiliated with the American Broadcasting Company

JOSEPH HERSHEY McGILLVRA, INC.
NATIONAL REPRESENTATIVES

ROBERT S. KELLER
AGENCY COORDINATOR

FLORIDA

City	Call Letters Established TV Affiliate	Chan. or Freq. Power	Licensee Headquarters Telephone	Network Represent- ative	Owner o; Pres. p; Exec. vp evp; Gen. Mgr. gm; Sta. Mgr. sm; Coml. Mgr. cm; Sales Mgr. sim; Prog. D.r. pd; Chief Eng. ce; Prom. Mgr. pmm; Prod. Mgr. pdm; News, Farm, Sports or Women's Dir. nd, fd, sd, wd.	Executive Abbreviations	Market Data For Primary Area (Supplied by station)	Library, News Serv. Transmitter
GAINESVILLE								
	WGCG 1948	1230 250	Alachua County Bcstg. Co. 1230 Waldo Rd. 5791	ABC, KBS Best	R. M. Chamberlin, p. gm & ce L. E. Mims, cm	Pierre Bejano, pd Scott Sutton, pmm Morrow S. Krum, nd	Jack Herring, fd Herman Shonbrun, sd Edith M. Cameron, wd	Wid. AP
	WFUF 1928	850 DA-N	U. of Florida University Campus 3261, ext. 467	MBS Burn- Smith	Garland Powell, gm Ray Dantzler, asst. m John Dunnivant, cm A. B. Blackburn, of. m Bob Leach, pd	Charles Murdock. pmm Bertram McNamara, ce Lelia K. Yarbrough. traffic m	Bob Smith, nd Clyde Beal, fd Otis Boggs, sd Miriam Andrews, wd	Pop.: 877,500 Rad. Hms.: 214,150 Ret. Sls.: \$531,192,000 L-W AP RCA
	WFUF-FM 1948	Ch. 281 (B) 104.1mc 12kw					Pop.: 850,000 Rad. Hms.: 45% Ret. Sls.: \$500,000,000	L-W, Thes. AP
HOLLYWOOD								
	WHWD 1953	1320 500-D	Circle Bcstg. Co. First National Bank Bldg. 2-2989 (See Miami listing) McGillvra	Roy M. Greene, o	Robert L. Bowles, gm	George Ralston, ce	Cap. UP G
	WINZ 1946	940 50,000-D 10,000-N DA-2						
JACKSONVILLE								
	WIVY 1948	1050 1,000-D	Edw. J. Oberle Rt. 9 Box 228 A 4-7722 Clark	Edw. J. Oberle, o & gm Arman Reinke, cm	Dick Webb, pd	James Stephens, ce	Pop.: 460,000 Rad. Hms.: 190,000 INS REL
	WJAX 1925	Ch. 229 (B) 93.7mc 3kw 930 5,000 DA-N	City of Jacksonville 1 Broadcast Pl. 4-1681	NBC Blair, Cummings	John T. Hopkins, III, gm & ce	J. W. Douglas, cm	Marion D. Trowell, pt & pmm	Thes. AP WE
	WJAX-FM 1948	Ch. 236 (B) 95.1mc						
	WJHP 1940	1320 5,000 DA-N	Jacksonville Journal Co. 500 Laura St. 4-7711	MBS Perry	John H. Perry Jr., p T. S. Gilchrist Jr., gm Willard Fraker, cm C. Speed Veal, pd & nd	Martha Thomas, pmm Beecher Hayford, ce Jewell Hill Hoover, traffic d	C. Wesley Hunt, office m Marshall Rowland, fd Fred Schilling, sd Alice Withee, wd	Pop.: 456,800 Rad. Hms.: 133,470 Ret. Sls.: \$442,303,000 L-W AP RCA
	WJHP-FM 1948	Ch. 245 (B) 96.9mc 32kw						
	WMBR 1934	1480 5,000 DA-N	Washington Post Co. 605 S. Main St. 9-4475	CBS CBS Radio Spot Sales	Philip L. Graham, p, Wash. Post Co. John S. Hayes, vp. Wash. Post Co.	Glenn Marshall Jr., p. WMBR Div. Charles Stone, cm Roger Langston, pmm	Ernest Vordermark, ce Bill Terry, pd Bill Grove, nd Dick Stratton, sd Virginia Atter, wd	Pop.: 403,400 Rad. Hms.: 104,640 Ret. Sls.: \$407,108,000 Wid. UP CoL

Data corrected to Dec. 10, 1953. If executives or services for FM are same as AM affiliate names are not repeated. Market Data supplied by stations. FM's in italic. *—Non-Commercial Station. CP—Construction Permit issued. D—Day. DA-N—Directional Antenna, night only. DA-1—Directional Antenna, same pattern day and night. DA-2—Directional Antenna, different pattern day and night. L—Limited Time with Dominant Station. LS—Local Sunset. N—Night. SA—Special Authorization. SH—Specified Hours. ST—Share Time. Complete key to abbreviations, page 6.

**FIRST
IN LISTENER PREFERENCE
IN
FABULOUS FLORIDA'S
FIRST
CITY OF YEAR-ROUND SALES, AND
FIRST
IN COVERAGE IN NORTH FLORIDA AND SOUTH GEORGIA**

W - J - A - X

930 kc — 5,000 watts

JACKSONVILLE, FLORIDA'S MUNICIPAL STATIONS



J. D. Kennedy
Commissioner in Charge

John T. Hopkins III
Manager & Chief Engineer

NATIONAL REPRESENTATIVES: JOHN BLAIR & CO. — SOUTHEAST: HARRY E. CUMMINGS

WMBR-FM 1948	Ch. 241 (B) 96.1mc 63kw						Pop.: 619,000 Rad. Hms.: 157,100 Ret. Sls.: \$575,181,000	UP WE	
WOBS 1948	1360 1,000-D	Southern Radio & Equipment Co. P. O. Box 5648 98-3411	Stars National	E. D. Rivers Sr., p Jim Macri, gm R. L. McQuage, cm	Harry Talbert, asst. m & sd Guy Crumpley, pd Fred Murphy, pmm	W. F. Askew, ce Jack Hayward, nd Mark Thompson, fd Rhetta Lackey, wd		G	
WPDQ 1942	600 5,000 DA-N	Jacksonville Bcstg. Corp. Gulf Life Bldg. 4-4421	ABC Taylor	James R. Stockton, p Robert R. Feagin, gm Kenneth F. Small, asst. gm	Charles E. Edward, pd Gordon W. Pierce, pmm James R. Donovan, ce	Hugh Batey, nd Glenn Reeves, fd Jack Wheeler, sd Anne Daly, wd	Pop.: 560,000 Rad. Hms.: 141,670 Ret. Sls.: \$507,079,000	UP RCA	
WRHC 1950	1400 250	WRHC Inc. 247 Margaret St. 6-0461	Interstate, Forjoe Dora- Clayton	Harold S. Cohn Sr., p Harold S. Cohn, II, gm	Kenneth Knight, co-pd Mrs. E. Stein, co-pd	Frank Theis, ce Elsie J. Cohn, wd	Pop.: 350,000 Rad. Hms.: 94.2%	L-W RCA	
JACKSONVILLE BEACH									
WJVB 1947	1010 1,000-D	Jacksonville Beach Bcstg. 201 Professional Bldg. 5-3674	KBS Best	J. Lyle Williams Jr., p, gm & cm Ted Booth, pd & nd	Jack Evans, pmm Daniel M. Long, ce Joe Grawet, sp. events	Bill Williams, sd Mary Mason, wd	Pop.: 300,000	AP Ray.	
KEY WEST									
WKWF 1945	1600 500	John M. Spottswood Stock Island 2-7777	MBS	John M. Spottswood, o, gm & cm	Mary S. Spottswood, pd & pmm	Kermit H. Lewin, sm Charles R. Lowe, ce		St. RCA	
LAKE CITY									
WDSR 1946	1340 250	Deep South Radioways 126 N. Marion St. 525		Alfred H. Temple, o & gm	Alma H. Temple, treas. Ben Decker, m & cm	Armine Wood, pd Richard E. Dyer, ce		Assoc. UP	
LAKELAND									
WLAK 1936	1430 1,000	Lakeland Bcstg. Corp. 1430 E. Line St. Mutual 2-1271	NBC Pearson	S. O. Ward, p, gm & pmm	Powell Adams, cm William P. Lee, pd & ce	Garland Burt, lib. & nd Earl Rahrer, sd	Pop.: 141,827 Rad. Hms.: 43,542 Ret. Sls.: \$103,983,000	Assoc. UP RCA	
WONN 1949	1230 250	Coastal Bcstg. Co. P. O. Box 2038 Mutual 5-1171	MBS Cooke	Robert S. Taylor, p, gm & pmm Duane F. McConnell, secy.-treas., ce & bus. m	Thomas R. Barber, cm Ted Covington, vp, pd & nd	Bill Snyder, sd Gloria Revels, wd Graham Mela, fd	Pop.: 164,890 Rad. Hms.: 41,860 Ret. Sls.: \$147,525,000	Cap. AP G	
LAKE WALES									
WIPC 1951	1280 1,000-D	Imperial Polk Bcstg. Corp. P. O. Box 712 2-9831	KBS	Sarkes Tarzian, p S. W. Keen, vp	G. Max Kimbrel, gm, cm & ce	John Haughee, pd, nd & sd Joan C. Kimbrel, wd	Pop.: 140,000 Rad. Hms.: 35,000 Ret. Sls.: \$112,000,000	Wid. AP G	

WRHC

JACKSONVILLE'S ONLY FULL TIME INDEPENDENT!

WRHC
Jacksonville
P. O. Box 2467
247 Margaret Street
Phone 6-0461

KEN KNIGHT
Jacksonville's ONLY Negro Announcer and Program Director. Formerly P.D. of WERD, Atlanta. First Negro Program Director in the Nation to be Listed with the FCC.

Second in the Nation . . . Jacksonville, Fla., is second only to Nashville, Tennessee in the Sale of Hillbilly Records.

WRHC Saturates this responsive audience with 8 Hours of Hillbilly Music Daily . . . Twice as Much as the Nearest Competitor and 8 times more than Jacksonville's five other AM & FM Stations.

WRHC is Exclusive in the Field for Nighttime Negro Programming (when the Negro can Listen Most)—8 PM to 1 AM.

A Tremendous, Profitable Market—36.2% of Total Population

Total Negro Population (Jacksonville)	75,115
Total Negro Population (Duval Co.)	81,840
Average Annual Income (Duval County)	(Negro) \$1,313
Percentage of Radio Homes	94.2% (White & Negro)

250 watts
1400 kc.

Represented by
FORJOE & CO.

FLORIDA

City	Call Letters Established Tv Affiliate	Chan. or Freq. Power	Licensee Headquarters Telephone	Network Represent- ative	Owner o; Pres. p; Exec. cm; Sales Mgr. slm; Prog. Prod. Mgr. pdm; News, Farm, Sports or Women's Dir. nd, fd, sd, wd.	Executive Abbreviations Exec. up exp; Gen. Mgr. gm; Sta. Mgr. sm; Coml. Mgr. pmm; Chief Eng. ce; Prom. Mgr. pmm; News, Farm, Sports or Women's Dir. nd, fd, sd, wd.	Market Data For Primary Area (Supplied by station)	Library, News Serv. Transmitter
LAKE WORTH								
WEAT 1948	1490 250 CP; West Palm Beach 850 1000 DA-1	James Robert Meachem P. O. Box 791 4422	NBC Walker	James Robert Meachem, o & gm Clifford H. Gluck, cm	Bill Gordon, pd, nd, fd Wayne Stump, ce	Charles Bryan, sd Mrs. Aino Carlson, wd	Pop.: 130,000 Rad. Hms.: 36,750 Ret. Sis.: \$168,000,000	Cap. AP Ray.
LEESBURG								
WLBE 1949	790 1,000 DA-1	WLBE Inc. Box 297 552	MBS Best	Paul A. Husebo, co-o Wendell F. Husebo, co-o, gm & cm	Richard R. Coleman, pd	J. Allen Brimmer, ce Bill Rudy, sd	Pop.: 358,867 Rad. Hms.: 95,688 Ret. Sis.: \$168,500,000	Wid. UP Col.
LIVE OAK								
WNER 1949	1450 250	Norman O. Protsman P. O. Box 655 1450	KBS	Norman O. Protsman, o & gm John Lee Alford, cm & fd	Faith M. Protsman, pd & wd	Clarence S. Parker, ce & sd E. K. Hamilton, nd	Pop.: 18,000 Rad. Hms.: 4,500 Ret. Sis.: \$14,236,000 UP RCA
MARIANNA								
WTYS 1948	1340 250	John H. PIPPS 650	MBS	John H. PIPPS, o L. H. Graves, gm Guy Hamilton, sm	Berta Hamilton, pd & wd	W. A. Snowden Jr., ce Karl Richards, fd	Pop.: 35,000
MELBOURNE								
WMMB 1948	1240 250	Melbourne Bcstg. Co. Drawer 790 574	MBS	Frederick H. Kury, p	A. V. Catterton, gm	Hugh Tyler, ce		SES. UP Col.
MIAMI								
WFEC 1949	1220 250-D	David Haber 350 N. E. 71st St. 89-7534 Interstate	David Haber, o Herbert Schorr, gm Charles Higgins, cm	Milton Oshins, pd, pmm & sd William Reeder, ce Barbara Lyles, traffic d	Edwina Nicholas, exec. secy. George Hutton, nd	 UP WE
WGBS 1943	710 50,000-D 10,000-N DA-2	Storer Bcstg. Co. 1605 Biscayne Blvd. 9-2401	CBS Katz	George B. Storer, p Miller N. Babcock, gm Francis J. Riordan, cm	Ewald Kockritz, pd Robert Bingham, nd Don Butler, fd	Stan Ornest, sd Jane Butler, wd Edward Lockwood, ce	Pop.: 1,000,000 Rad. Hms.: 298,000 Ret. Sis.: \$1,274,381,000	L-W UP, INS WE
WGBS-FM 1952	Ch. 242 (B) 96.3mc 1.5kw							
WINZ 1946	940 50,000-D 10,000-N DA-2	Hollywood Bcstg. Co. Biscayne Terrace Hotel 82-6641 Raymer	Rex Rano, p & gm B. Petzoldt, natl. slm Peter Cole, loc. slm	Bob Landers, prod. m James L. Sawyer, ce	Lee Taylor, nd Dennis Kerwin, sd	Pop.: 1,656,000 Rad. Hms.: 855,040 Ret. Sis.: \$1,262,510,000 AP, INS RCA
WIOD 1926	610 5,000 DA-2	Isle of Dreams Bcstg. Corp. 600 Biscayne Blvd. 3-6444	NBC Holling- bery	Daniel J. Mahoney, p James M. LeGate, gm Robert L. Fidler, cm Scott Bishop, pd	Martha Henriquez, pmm M. C. Scott Jr., ce Wilton Chiles, asst. ce	Gene Strul, nd Wm. Bischoff, fd Billie O'Day, wd	Pop.: 871,900 Rad. Hms.: 265,700 Ret. Sis.: \$1,108,978,000	Thes. AP, UP INS WE RCA
WIOD-FM 1946	Ch. 247 (B) 97.3mc 15kw							
WLRD(FM) 1948	Ch. 230 (B) 93.9mc 13kw	Mercantile Bcstg. Co. 420 Lincoln Rd. Miami Beach 58-6334 Indie	Alan H. Rosenson, o, gm & ce	Marshall J. Simmons, cm		Pop.: 707,900 Ret. Sis.: \$917,084,000	Wid., L-W WE
WMIE 1948	1140 10,000-D 5,000-N DA-2	Sun Coast Bcstg. Co. Hotel Everglades 3-5556 National	E. D. Rivers Sr., p. K. A. Meer, gm & cm	J. A. Boling, pd & pmm	R. Bennett, ce		Assoc. AP RCA
WQAM 1920	560 5,000-D 1,000-N	Miami Bcstg. Co. 1723 duPont Bldg. 2-6121	ABC, Florida- American Blair, Cummings	John S. Knight, p Owen F. Uridge, gm & cm	Don Fischer, pd Gene Rider, ce	Gordon Shaw, nd Marshall Parsons, sd		Wid. AP GE
WQAM-FM 1946	Ch. 235 (B) 94.9mc 8.2kw							
WWPB 1947	1450 250	Paul Brake 414 S. W. 2d Ave. 3-7405	KBS Walker	Paul Brake, o & m Bert Johnson, cm & pmm	Peggy Newman, pd Jack Wilson, ce W. E. Davenport, nd & sd	Cal Carter, fd Libby Poor, wd	Pop.: 700,000 AP WE
WWPB-FM 1948	Ch. 268 (B) 101.5mc 8.5kw						Pop.: 1,000,000 Ret. Sis.: \$350,000,000	WH
MIAMI BEACH								
WKAT 1937	1360 5,000-D 1,000-N	WKAT Inc. 1759 Bay Rd. 5-5711	MBS Headley- Reed	A. Frank Katzentine, o John I. Prosser, evp. gm & pd	Walter A. Callahan, cm A. P. Smith, Jr., ce	C. A. Wampler, bus. m John Price, nd Bob Evans, sd		Cole, St. UP WE Wid., L-W
WKAT-FM 1947	Ch. 226 (B) 93.1mc 285kw							
WMBM 1947	800 1,000-D	R. W. Rounsaville MacArthur Causeway 5-5586 Forjoe, Dora- Clayton	R. W. Rounsaville, o & gm J. E. Vaughn, sm Arnold Kaufman, cm	Ed Cook, pd, nd & sd Art Selley, sls. prom. m Charles Hartwick, ce	Bill Kimbro, pub. rel. d Mayme Bondu, wd Dave Bondu, fd	Pop.: 625,000 Rad. Hms.: 196,200 Ret. Sis.: \$500,000,000	St. UP Col.
NEW SMYRNA BEACH								
WSBB 1951	1230 250	Beach Bcstg. Co. New Smyrna Hotel 760		Walter T. Slattery, gm & cm	James D. King, pd	Roland Jordan, ce		Thes. UP Tem.
OCALA								
WMOP (CP)	900 1,000-D	A. B. Letson 311 Robertson Bldg. Marion 2-4118	A. B. Letson, o & gm	Jim Kirk, pd & asst. m		Pop.: 80,000 Rad. Hms.: 21,000 Ret. Sis.: \$86,000,000	
WTMC 1939	1290 1,000 DA-N	Ocala Bcstg. Co. 14 S. Magnolia St. Marion 2-4127	NBC Perry	John H. Perry, p Thomas S. Gilchrist Jr., gm	James B. Smith, sm C. T. Catalano, cm	Ruth Brumball, pd William P. Callahan, ce	Pop.: 40,030 Rad. Hms.: 10,070	L-W AP Col.

Data corrected to Dec. 10, 1953. If executives or services for FM pre same as AM affiliate names are not repeated. Market Data supplied by stations. FM's in italic. *—Non-Commercial Station. CP—Construction Permit issued. D—Day. DA—Directional Antenna, night only. DA-1—Directional Antenna, same pattern day and night. DA-2—Directional Antenna, different pattern day and night. L—Limited Time with Dominant Station. LS—Local Sunset. N—Night. SA—Special Authorization. SH—Specified Hours. ST—Share Time. Complete key to abbreviations, page 6.

ORLANDO

WDBO 1924 WDBO-TV	580 5,000 DA-N	Orlando Bcstg. Co. 30 S. Ivanhoe Blvd. E 6181	CBS Blair, Cummings	Harold P. Danforth, p & gm Wm. G. McBride, sld	Rosalind Boggs, pd James E. Yarbough, ce Carter Scofield, nd & fd	Don McAllister, sd Jas. L. Berry, wd	Assoc., Thes., Wid. AP, UP
WDBO-FM 1948	Ch. 222 (B) 92.3mc 34kw						Wid., Assoc., Thes. AP, UP GE
WHOO 1947	990 10,000-D 5,000-N DA-N	WHOO Inc. Ft. Gatlin Hotel Bldg. 5-3591	ABC Avery- Knodel	Edward Lamb, p Carl F. Hallberg, gm & cm	Walter Sickles, pd Walter Mitchell, pmm	Donald Compton, ce	Pop.: 544,000 Rad. Hms.: 175,060 Ret. Sis.: \$515,092,000 St. AP RCA
WHOO-FM 1947	Ch. 243 (B) 96.5mc 59kw						Fed.
WLOF 1940	950 5,000 DA-N	Hazlewood Inc. P. O. Box 1991	MBS	Joseph L. Brechner, p John W. Kluge, secy.- treas. Donn R. Collee, vp & gm Thomas H. Donohue, cm	Ernest Legge, pd Freda M. Hilton, prom. d W. Dodd Daniel, ce Forrest Clark, nd	Charles Batchelder, sp. events d R. B. Smith, sd Mrs. Ruth Donahue, wd	L-W UP RCA
WORZ 1947	740 5,000-D 1,000-N DA-2	Central Florida Bcstg. Co. 790 N. Orange Ave. 2-2451	NBC Taylor	Naomi T. Murrell, p John E. Surrick, gm & cm Happy Ison, pd	Harry Gaines, pmm & fd Jim Moore, ce Don James, nd	Bill Dawson, sd Mary Lou Edwards, wd	Pop.: 750,000 Rad. Hms.: 500,000 Cap. AP WE
WORZ-FM 1952	Ch. 262 (B) 100.3mc 16kw						Cap. AP RCA
PALATKA							
WWPF 1947	1260 500 DA-N CP: 800 250-D	Palatka Bcstg. Co. 900 River St. East 5-4555	KBS	J. E. Massey, ptrn. L. C. McCall, ptrn., gm & ce	Herb Young, cm Johnny W. Gillis, pd	Bruce E. Wilson, prod. m & fd Bob James, sd	Pop.: 38,100 Rad. Hms.: 11,540 Wid. UP Col.
PALM BEACH							
WWPG 1941	1340 250	Palm Beach Bcstg. Corp. 3000 S. Ocean Blvd. 2-1515		Charles E. Davis, o, gm & cm	Florence Hicks, pd	Clyde Walkden, ce	Thes., L-W UP G
WWPG-FM 1946	Ch. 250 (B) 97.9mc 22kw						Fed.
PANAMA CITY							
WDLP 1940	590 1,000 DA-N	Panama City Bcstg. Co. W. Beach Dr. Poplar 3-1777	NBC, KBS Perry	John H. Perry Jr., p C. B. Kelley, gm	Byron Hayford, cm, pd & asst. to gm	Calvin Howrigan, ce Don Brookins, nd	Pop.: 42,000 Rad. Hms.: 13,320 L-W AP Ray.
WDLP-FM 1950	Ch. 255 (B) 98.9mc 5kw						L-W AP RCA
WPCF 1949	1400 250	Bay County Bcstg. Co. P. O. Box 387 Sunset 5-8176	ABC, MBS Devney	E. L. Dukate, p W. D. Lanier, vp, gm & cm	Martha Ann Heath, pd & wd Jack DuMars, ce & sd	John McMullen, nd	Pop.: 48,000 Rad. Hms.: 12,000 Ret. Sis.: \$21,931,000
PENSACOLA							
WBSR 1946	1450 250	WBSR Inc. WBSR Bldg. 6173	CBS Taylor	Patt McDonald, p Don J. Lynch, vp & gm	Boris Mitchell, cm Tony Chastain, pd	Glenn Nichols, ce	Wid. AP
WCOA 1926	1370 5,000 DA-N	WCOA Inc. 118 E. Intendencia 4111	NBC Perry	John H. Perry Jr., p J. Holliday Veal, gm Irving F. Welch, cm & fd	R. C. Wolfe Jr., pd & nd Ralph Rogers, pmm Harold L. Heath, ce	Don Griffith, sd Clarine S. Porter, wd	Pop.: 238,600 Rad. Hms.: 97,450 Ret. Sis.: \$165,619,000 L-W AP RCA
WEAR 1947 WEAR-TV	1230 250	Gulfport Bcstg. Co. P. O. Box 1188 8-4449	ABC, MBS Holling- bery	Mel Wheeler, p & gm Milt DeReyna, cm Dick Darby, pd	Jerry Williams, pmm Jim Smith, ce	Dave Fulton, nd Gordy Glen, sd	Pop.: 160,000 Rad. Hms.: 40,000 Ret. Sis.: \$174,988,000 Thes., Assoc. AP G
PERRY							
WPRY (CP)	1220 250-D	Palatka Bcstg. Co. P. O. Box 86		J. E. Massey, ptrn. L. C. McCall, ptrn.			

SERVING THE SUN EMPIRE Since 1924



WDBO

580K.C. 5000 WATTS WDBO-FM 92.3 MCS 34000 WATTS

STILL WAY AHEAD! *Central Florida's Pioneer Radio Station*

1952 Retail Sales in the 17 WDBO counties totaled \$526,948,000*. All programs on WDBO are duplicated on WDBO-FM.

More families listen regularly (6 or 7 days or nights a week) to WDBO, than all 3 other Orlando stations combined**.

Pulse Radio Index—Morning 41.0, afternoon 46.0***.

*1952 Sales Management **S.A.M.S. 1952 ***Pulse December 1952

WDBO, Orlando, Florida . . National Representatives BLAIR . . CUMMINGS . .

FLORIDA

City	Call Letters Established TV Affiliate	Chan. or Freq. Power	Licensee Headquarters Telephone	Network Represent- ative	Executive Abbreviations Owner o; Pres. p; Exec. up evp; Gen. Mgr. gm; Sta. Mgr. sm; Coml. Mgr. cm; Sales Mgr. slm; Prog. Dir. pd; Chief Eng. ce; Prom. Mgr. pmm; Prod. Mgr. pdm; News, Farm, Sports or Women's Dir. nd, fd, sd, wd.	Market Data For Primary Area (Supplied by station)	Library, News Serv. Transmitter	
PLANT CITY								
WPLA 1949	1570 250-D	W. A. Smith Hopewell Rd. 526 Best	W. A. Smith, o George Friend, gm & cm	Frankie Blackwelder, pd & pmm James L. Derrick, ce	Joseph J. Wilson, nd Jim Shumway, fd Gordon Solie, sd	Pop.: 213,757 Rad. Hms.: 79,316 Cole UP	
QUINCY								
WCNH 1948	1230 250	Quincy Bcstg. Corp. Box 190 300	MBS	A. B. Letson, p, gm & ce	Jerry Melvin, cm & pmm	Dewey C. Newton, pd	Pop.: 40,000 Rad. Hms.: 10,000 Ret. Sls.: \$23,000,000 Thes. UP WE	
ST. AUGUSTINE								
WFOY 1936	1240 250	Fountain of Youth Bcstg. Co. Magnolia Ave. 1622	CBS	Mary E. Bell, p John E. Bernhard Jr., evp, gm, cm, pmm & nd	Frankie C. Walker, secy.-treas. & pd Ernest Raistrick, ce	R. J. Sheppe, fd Julian Fant, sd Alberta Dillin, wd	Wid. UP Col.	
WSTN (CP)	1420 1,000-D	St. Augustine Bcstg. Co. 66 Treasury St. 815	Southern Radio	Thomas S. Carr, gm & pmm	Oliver Thornburg, cm & pd	Harold Spengler, ce	
ST. PETERSBURG								
WFIN 1947	680 1,000-D	Florida West Coast Bcstrs. Inc. Royal Palm Hotel 7-0511 Indie	Dr. Charles L. Far- rington, p Arthur Mundorff, gm & cm	James Carley, pd Bill Wright, pmm & nd Manly St. Jean, ce	Dick Baker, fd Bob Clayton, sd Marge Blank, wd	Pop.: 641,400 Ret. Sls.: \$852,257,000 AP G	
WSUN 1928	620 5,000	City of St. Petersburg Recreation Pier 7-4747	ABC Weed	George D. Robinson, gm	Vera New, cm Louis J. Link, pd	Jeff Moshier, sd	Assoc. UP RCA	
WSUN-TV	DA-N							
WSTP 1939	1380 5,000 DA-N	Pinellas Bcstg. Co. Times Bldg. 7-8108	MBS H-R Reps.	Nelson P. Poynter, p F. J. Kelley, gm Leona Wildman, cm	Jack Faulkner, pd & pmm William Mangold, ce	Lewis Brewer, fd Bob Hoffer, sd Beth McNeeley, wd	Pop.: 1,275,000 Rad. Hms.: 190,892 Ret. Sls.: \$744,359,000 Wid., Cap. UP, INS RCA	
WSTP-FM 1948	Ch. 273 (B) 102.5mc 37kw							
SANFORD								
WTRR 1947	1400 250	Myron A. Reck P. O. Box 1541 999	KBS Best	Myron A. Reck, o & gm Roy D. Green, cm	J. Marion Harman Sr., pd, nd & wd James S. Williamson, Jr., ce & pd	Ralph Spotts, fd	Pop.: 61,900 Rad. Hms.: 24,570 Ret. Sls.: \$17,756,000 UP Col.	
SARASOTA								
WKXY 1949	1540 1,000-D	Sarasota Bcstg. Co. P. O. Box 2431 Ringling 6-6651	KBS Best	A. G. Fernandez, p & gm	Red Ermisch, sd		Pop.: 70,000 Rad. Hms.: 98% Ret. Sls.: \$90,000,000 L-W AP G	
WSPB 1939	1450 250	WSPB Inc. City Island Ringling 6-8811	CBS Pearson	Robert C. Jones Jr., p John B. Browning, gm J. McCarthy Miller, cm	David C. Hale, pd James E. Grant, ce	Don Priest, sd Jeanne King, wd	Pop.: 182,100 Rad. Hms.: 58,650 Ret. Sls.: \$184,154,325 Wid., Thes. UP RCA	
SEBRING								
WJCM 1950	1340 250	Clearfield Bcstg. Inc. Box 233 81-811	MBS	W. K. Ulerich, p W. J. Thomas, gm	Al Frank, m, pd & sd Robert Goshorn, ce	Betty Frank, wd	Pop.: 14,000 Rad. Hms.: 4,000 Ret. Sls.: \$12,000,000 St. UP Ray.	
SULPHUR SPRINGS								
WBBO 1948	1050 250-D	(See Tampa, listing)						
TALLAHASSEE								
WMEN (CP)	1330 1,000-D	WASP Inc. 1713 Prince St.						
WTAL 1935	1270 5,000 DA-N	John H. Phipps P. O. Box 989 2-1270	CBS Meeker	John H. Phipps, p L. Herschel Graves, gm	Joe Hosford, pd Bill Snowden, ce	Bob Delaney, sd Peggy Flynn, wd	Wid. AP RCA	
WTAL-FM 1947	Ch. 280 (A) 103.9mc 0.72kw							
WTNT 1946	1450 250	Tallahassee Appliance Corp. Hotel Duval 2-1450	ABC, Florida- American Dora- Clayton	Frank W. Hazelton, p & gm Emanuel Joanos, vp	Charles Clifton, ce Jack Sutor, nd	Jack Edger, sd Helen Hulick, wd	Pop.: 50,000 Thes. UP G	
TAMPA								
WALT 1946	1110 1,000-D	W. Walter Tison Box 1077 2-7921 Pearson	W. Walter Tison, p, gm & cm Sandy Geer, pd & fd	W. J. Rennie, pmm J. B. Tison, ce	Guy Bagli, nd & sd Eva Byron, wd	L-W AP RCA	
WDAE 1922	1250 5,000 DA-1	Tampa Times Co. 114 N. Franklin 2-2911	CBS Katz	David E. Smiley, p L. S. Mitchell, gm & cm C. Jack King, ce	K. W. Skelton, pd Sol Fleischman, pmm & sd	Wm. Pharr Moore, ce Mark E. Swingley, fd Kay Dowst, wd	Pop.: 417,780 Ret. Sls.: \$503,078,000 Assoc. AP GE	
WDAE-FM 1947	Ch. 264 (B) 100.7mc 65kw						Pop.: 666,044	
WEBK 1950	1590 1,000-D	Hillsboro Bcstg. Co. 1521 E. Broadway 4-4177	KBS Dora- Clayton	Elmo B. Kitts, ptrn., gm & ce E. P. Martin, ptrn.	Alpha Martin, ptrn. Bob Chambers, pd & nd	Larry Lane, sd	Pop.: 500,000 Rad. Hms.: 100,000 INS Col.	
WFLA 1926	970 5,000 DA-N	Tribune Co. 312 Morgan St. 2-4747	NBC Blair, Cummings	J. C. Council, p George W. Harvey, gm Paul M. Jones, pd	Tom Matthews, pmm Joe Mitchell, ce Sam Latimer, nd	Mardi Liles, fd Milton Spencer, sd Emily Moody, wd	Pop.: 757,000 Rad. Hms.: 187,430 Ret. Sls.: \$740,766,000 Thes., L-W UP RCA	
WFLA-FM 1948	Ch. 227 (B) 93.3mc 53kw						Thes. UP UP AP G	
WBBO 1948	1050 250-D	Sulphur Springs Bcstrs. 11011 Florida Ave. 91-1711	Harold A. Dunlap, p & gm	Ellen M. Sauls, pd	John W. Herb, ce AP G	

Data corrected to Dec. 10, 1953. If executives or services for FM are same as AM affiliate names are not repeated. Market Data supplied by stations. FM's in italic. *—Non-Commercial Station. CP—Construction Permit issued. D—Day. DA-N—Directional Antenna, night only. DA-1—Directional Antenna, same pattern day and night. DA-2—Directional Antenna, different pattern day and night. L—Limited Time with Dominant Station. LS—Local Sunset. N—Night. SA—Special Authorization. SH—Specified Hours. ST—Share Time. Complete key to abbreviations, page 6.

TARPON SPRINGS

WBOY 1470
(CP) 5,000-D

WBOY Inc.
Box 276
21461

.....
.....

A. H. Turner, p & gm
Gail D. Griner, secy-
treas.

Roe P. Turner, cm &
fd
Frank Sims, pd & sd
Harry J. Pisapia, pmm
& nd

Clarence C. Gosey,
religious d
Signe Carlson, wd

Pop.: 100,000
Rad. Hms.: 85%

UP, AP
G

VERO BEACH

..... 1490
(CP) 100
WNTM 1370
(CP) 1,000-D

Indian River
Bcstg. Co.
Central Florida
Bcstg. Co.

WEST PALM BEACH

WEAT 850
1948 1,000
DA-1
WIRK 1290
1947 5,000-D
WIRK-TV 1,000-N
DA-N

(See Lake Worth, Fla. listing)

Ken-Sell Inc.
711 S. Flagler
Dr.
2-1744

MBS
CBS,
Florida
Meeker

Joseph S. Field Jr.,
p & gm
Rome Hartman, pd &
sd

William Heitzman, ce
Bob Ray, nd

Bernadine Webster,
wd

Pop.: 192,500
Rad. Hms.: 54,400
Ret. Sis.: \$215,000,000

Assoc.
INS
Col.

WJNO 1230
1936 250

WJNO Inc.
1500 N. Flagler
Dr.
2-3638

Cooke

Sydney King Russell,
p
H. V. McMillan, evp.
gm & cm

Vernon Crawford, pd
Warren Spencer, ce
Elizabeth Miller, traffic
m

Robert Hawkey, nd
Dave Webster, fd
Keyes Perrin, sd
Ann Wharton, wd

Pop.: 150,000

Wid.
UP
RCA

WWPG
1941

(See Palm Beach listing.)

WINTER HAVEN

WSIR 1490
1947 250

Citrus Belt
Bcstrs.
665 W. Lake
Howard Dr.,
S.W.
32-561

MBS
Devney

Frederick L. Allman, p
Lawrence A. Rollins,
gm

Earl Sturgeon, cm
Richard Eyrich, pd

L. Orden Craig, ce
Larry Rollins, nd

Pop.: 122,801
Rad. Hms.: 35,030
Ret. Sis.: \$105,686,000

UP
Ray.

WINTER PARK

WABR 1600
(CP) 1,000-D

Orange County
Bcstrs.
13 S. Ridgewood
3-1488

.....
.....

Charles Wolf, p, gm
& cm

Richard C. Fellows,
pd, pmm, ce & sd

Pauline M. Fellows,
wd

Pop.: 250,000
Ret. Sis.: \$175,000,000

buy the **BIG** audience!

Latest PULSE figures show WFLA way out in front in Class B time* audience in the 11-county, Tampa-St. Petersburg trade area.

Of the 54 quarter-hour time segments, WFLA has the highest rating in 31, and has second highest rating in 12 others. This simply means that during 79% of the Class B time, WFLA is either first or second in audience rating—in competition with 15 other stations serving the area.

When you buy the Tampa-St. Petersburg market, buy the station with the programs that more people listen to—more of the time. Buy WFLA!

*Before 6 p.m. and after 10:30 p.m.

WFLA

The Tampa Tribune Stations • AM and FM



National Representative JOHN BLAIR & CO. • Southeastern Representative HARRY E. CUMMINGS, Jacksonville, Fla.



If you're looking for coverage which umbrella would you choose?

Measure dollars expended. Measure audience obtained. POWER is radio's *only* successful answer to the competition of television.

In Georgia, Atlanta's WSB is your clear channel 50,000-watt voice. This one *power* station gives you the major share of the Atlanta audience; it delivers for you a worthwhile audience in Georgia's secondary markets—and a tremendous number of listeners elsewhere.

No other Georgia station or combination of Georgia stations gives you as many listeners per dollar as you can get on WSB.

Clear channel *power* alone gives you this complete, low cost umbrella-type coverage.

Get more for your radio dollar in Georgia . . . *get on WSB*. One rate, day and night, 7 a.m. to 11 p.m., class B all other.

wsb

The Voice of the South

*Georgia's only 50,000 watt
clear channel station
Atlanta, Georgia*

Affiliated with The Atlanta Journal and Constitution • Represented by Petry

GEORGIA

City	Call Letters	Chan. or Freq. Power	Licensee Headquarters Telephone	Network Representative	Executive Abbreviations Owner o; Pres. p; Exec. up evp; Gen. Mgr. gm; Sta. Mgr. sm; Coml. Mgr. cm; Sales Mgr. slm; Prog. Dir. pd; Chief Eng. ce; Prom. Mgr. pmm; Prod. Mgr. pdm; News, Farm, Sports or Women's Dir. nd, fd, sd, wd.	Market Data For Primary Area (Supplied by station)	Library, News Serv. Transmitter
AMERICUS	WDRC 1947	1230 250	The Americus Bcstg. Co. Windsor Ave. 3681	MBS, KBS Indie, Dora-Clayton	Charles C. Smith, vp, gm, pd, pmm, nd & fd J. E. Gilstrap Jr., cm & sd John L. Rivard, ce Sue Marshall Smith, wd	Pop.: 24,208 Rad. Hms.: 6,409	Wld. UP Ray.
ATHENS	WGAU 1938	1340 250	J. K. Patrick & Co. Bobbin Mill Rd. 1741	CBS, KBS, Ga. Assn. of Local Stations	C. A. Rowland Sr., p R. Lewis Doster, gm Burl Womack, cm & nd Mary L. Betts, pd Bill Evans, ce & sd	Rad. Hms.: 9,840 Ret. Sis.: \$50,000,000	AP Col.
	WGAU-FM 1949	Ch. 258 (B) 99.5mc 4.4kw					AP GE
	WRFC 1948	960 1,000-D 500-N DA-N	Radio Athens Inc. 279½ N. Lumpkin St. 446		L. H. Christian, p & gm C. A. McClure, cm Rhett Turnipseed, pd Ed Thilenius, pmm & sd H. Randolph Holder, nd Ronnie Stephens, fd Mary Anne Martin, wd L. D. Drewry, ce	Pop.: 226,000 Rad. Hms.: 87,470 Ret. Sis.: \$110,950,000	Assoc. UP
ATLANTA	WAGA 1937	590 5,000 DA-N	Storer Bcstg. Co. 1018 W. Peachtree Vernon 3553	CBS Katz	George B. Storer, p Glenn C. Jackson, mgng. d Claude Frazier, slm Don Naylor, pd Charles E. Trainor, publ. m Hugo Bondy, ce R. David Mayo, merc. m Dale Clark, nd & fd Les Henrikson, sd Helen Parris, wd	Pop.: 730,000 Rad. Hms.: 435,050 Ret. Sis.: \$875,000,000	Thes. AP WH
	WAGA-FM 1948	Ch. 277 (B) 103.3mc 43kw				Pop.: 850,000 Rad. Hms.: 600,000 Ret. Sis.: \$900,000,000	AP WE
	WATL 1931	1380 5,000 DA-N	Atlanta Bcstg. Co. 201 Henry Grady Bldg. Alpine 1515	MBS, GALS Walker	J. W. Woodruff Sr., p G. C. Livingston Jr., gm & ce Lee Nance, cm, pd & nd Paul Jones, sd Elspeth Simmons, wd	Pop.: 899,900 Rad. Hms.: 216,765 Ret. Sis.: \$930,022,000	UP WE
	WATL-FM 1948	Ch. 248 (B) 97.5mc 44kw				Pop.: 1,124,875 Rad. Hms.: 260,906 Ret. Sis.: \$1,162,527,500	UP GE
	WBGE 1947	1340 250	General Bcstg. Co. Inc. Georgian Terrace Hotel Vernon 1194		Robert N. Pinkerton, p & gm Howard Parrish Jr., ce		AP GE
	WBGE-FM 1948	Ch. 238 (B) 95.3mc 1.83kw	(See Decatur, Ga. listing)				
	WEAS 1947						
	WERD 1949	860 1,000-D	Radio Atlanta Inc. 274½ Auburn Ave., N.E. Lamar 0666	Interstate United News-papers Inc.	J. B. Blayton Sr., p J. B. Blayton Jr., gm Albert H. Saddler, cm Robert H. Brisendine, pd William F. Kennedy, ce Dr. William M. Boyd, nd Mrs. Freddye Henderson, wd	Pop.: 871,603 Rad. Hms.: 212,690 Ret. Sis.: \$917,696,000	UP WE

THE ROUNSAVILLE CHAIN

Your key to some of the nation's most concentrated . . . most profitable markets! Backed by years of successful operation, they're your best bet for high profits on low-cost-per-thousand listeners!

3

TV STATIONS

Now Under Construction!

WCIN-TV Cincinnati, Ohio

WLOU-TV Louisville, Kentucky

WQXI-TV Atlanta, Georgia

3

NETWORK STATIONS

WQXI Mutual, Atlanta, Georgia

WBAC Mutual, Cleveland, Tenn.

WBEJ Mutual, Elizabethton-Johnson City, Tennessee

3

NEGRO-PROGRAMMED STATIONS

WCIN Cincinnati, Ohio

WLOU Louisville, Kentucky

WBMB Miami Beach, Florida

ROUNSAVILLE Radio Stations
Peachtree at Mathieson Dr., Atlanta, Ga.

National Reps.: Geo. P. Hollingberry (WQXI)

National Reps.: Forjoe and Company (WCIN - WLOU - WBMB)

Southeastern: Dora-Clayton Agency (All Stations)

**OUT-OF-HOME
LISTENING IN ATLANTA
GIVES YOU A WHOPPING
20% BONUS**

**and
waga gives you**

- * 50% MORE OUT-OF-HOME LISTENERS THAN STATION "B"
—AND TWICE AS MANY OR MORE THAN ANY OTHER STATION
- * 42% MORE QUARTER HOUR FIRSTS THAN ALL OTHER STATIONS COMBINED

Out of a total of 502 quarter-hour periods Sunday through Saturday, WAGA had 295 firsts. Station "B" had 61; Station "C" 57; Station "D" 43; Station "E" 19; and all others had a total of 27.



**WRITE FOR
THIS FOLDER**



Out-of-home or in-the-home—WAGA gives you more listeners per dollar than any other Atlanta station! Get the facts and you'll put WAGA Radio to work for you in the billion-dollar Atlanta market.

*Data based on Pulse of Atlanta Out of Home Radio Audience, July 1953

590
on the dial
5,000
watts

waga

CBS-Radio in Atlanta

Represented Nationally by the KATZ AGENCY, Inc. Tom Harker, V.P. and Nat'l Sales Director, 118 E. 57th St., New York 22
Bob Wood, Midwest National Sales Manager, 230 N. Michigan Ave., Chicago



GEORGIA

City	Call Letters Established TV Affiliate	Chan. or Freq. Power	Licensee Headquarters Telephone	Network Represent- ative	Owner o; Pres. p; Exec. vp evp; Gen. Mgr. gm; Sta. Mgr. sm; Coml. Mgr. cm; Sales Mgr. slm; Prog. D.r. pd; Chief Eng. ce; Prom. Mgr. pmm; Prod. Mgr. pdm; News, Farm, Sports or Women's Dir. nd, fd, sd, wd.	Executive Abbreviations	Market Data For Primary Area (Supplied by station)	Library, News Serv. Transmitter
ATLANTA—(Continued)								
WGST	1943	920 5,000-D 1,000-N	Georgia Institute of Technology Forsyth Bldg. Walnut 8441	ABC Blair	Ben Ackerman, gm Jim Hicks, cm	Jack Kelly, pd Ivan Miles, ce	Bob Siegrist, nd Ken Wilson, sd Dean Dickens, wd	Pop.: 1,700,000 Rad. Hms.: 400,000 AP RCA
WGST-FM	1949	Ch. 231 (B) 94.1mc 78kw					 GE
WQXI	1948	790 5,000-D 1,000-N DA-N	Robert W. Rounsaville 3165 Mathieson Dr., N.E. Cherokee 2196	MBS Holling- bery	Robert W. Rounsaville, o John Fulton, gm Don Mitchell, cm	Bob Corley, pd & fd Elton Chick, ce Paul B. Cram, tech. d	Herb Harris, nd Stan Raymond, sd Reba Clayton, wd	St., Wld. AP, UP WE
WSB	1922	750 50,000	Atlanta Newspapers Inc. Biltmore Hotel Elgin 6711	NBC Petry	James M. Cox Jr., o J. Leonard Reinsch, mng. d John M. Outler Jr., gm	Frank Gaither, sm Elmo Ellis, pd	Walter Paschall, pmm D. C. Daugherty, ce	St., Wld. AP, UP WE
WSB-FM	1948	Ch. 253 (B) 98.5mc 32kw				Frank Gaither, cm & pd	R. A. Holbrook, asst. ce RCA
WTJH	1949		(See East Point, Ga. listing)				 RCA
AUGUSTA								
WAUG	1951	1050 250-D	Garden City Bcstg. Co. Bon Air Hotel 3-4441		Geo. Nicholson, ptnr. Chester Jones, ptnr.	T. L. Morgan, gm Gordon Anderson, sls. m	Robert White, pd James W. Faulkner, ce	Cap. AP Ray.
WAUG-FM	1952	Ch. 289 (B) 105.7mc 9.2kw					 GE
WEBQ	1947	1340 250	Savannah Valley Bcstg. Co. Inc. 515 Jefferson Davis Ave. 4-5441	MBS Walker, Dora- Clayton	George G. Weiss, p John W. Watkins, gm & cm	Edward H. Dunbar, pd John Lyon, pmm & nd Marvin Tarpley, ce	Bill Riddle, sd Dottie Miller, wd	Pop.: 220,000 Rad. Hms.: 67,400 Ret. Sis.: \$300,701,000 AP G
WGAC	1941	580 5,000-D 1,000-N DA-N	Twin States Bcstg. Co. 664 Broad St. 2-2692	ABC Avery- Knodel	A. D. Willard Jr., p & gm D. MacDonald, vp Martin E. White, cm	Warren Hites, pd Jack Jopling, ce John Barnes, nd	Ed Kobak, sd J. W. Chambers, fd Joyce Hayward, wd	Pop.: 450,000 Rad. Hms.: 107,000 Thes. UP RCA
WJBF	1947	1230 250	Georgia-Carolina Bcstg. Co. WJBF Bldg. 4-2421	NBC Holling- bery	J. B. Fuqua, p & o D. M. Kelly, gm & pmm	Steve Manderson, cm James Armistead, pd	John P. Jopling, ce	Pop.: 281,000 Rad. Hms.: 70,000 Ret. Sis.: \$190,000,000 UP Ray.
WRDW	1930	1480 5,000 DA-N	Radio Augusta Inc. Eighth & Broad Sts. 2-8805	CBS Headley- Reed	Grover C. Maxwell, p W. Ray Ringson, gm & pmm	M. C. Gregory, cm Richard Warner, pd & nd Rabun F. Bobo, ce	Raymond Culpepper, fd Bob Ruckle, sd Eileen Stubb, wd	Wld. AP RCA
BAINBRIDGE								
WMGR	1946	1490 250	Decatur Bcstg. Co. P. O. Box 375 776	MBS	Thomas R. Hanssen, gm, ce & sd Charles W. Dowdy, cm & fd	Joe Hill, pd John A. Dowdy, pmm	Ray Reed, nd Jane Hall, wd	Pop.: 80,000 Rad. Hms.: 2,860 Ret. Sis.: \$25,350,000 Wld. AP G
BRUNSWICK								
WGIG	1949	1440 1,000 DA-N	Brunswick Bcstg. Corp. 1514 Union St. 2714	ABC, GALS McGillivra	Hugh K. Tollison, gm John Lane, cm	John Harmon, pd & sd Herman Lange, ce	Marvin Massey, pmm Caroline Stuckey, wd	Cap. AP G
WMOG	1940	1490 250	Radio Brunswick, Inc. St. Simons Causeway 1503	MBS, KBS Indie Dora- Clayton	Allen M. Woodall, p Albert H. Haack Jr., gm	Ben R. Wills, cm Lew Carter, pd	Cecil Tankersly, ce Jack Garrison, nd	Pop.: 63,011 Rad. Hms.: 15,930 Ret. Sis.: \$36,000,000
CAIRO								
WGRA	1950	790 1,000-D	Grady-Mitchell Bcstg. Co. Bainbridge Road 2-4392	ABC, KBS, GALS Indie	Ed Stevens, p Jim Honey, gm	Ed Whitehead, cm Glenn Felham, pd	Gregg Strang, ce Sara Crew, nd	Pop.: 235,095 St. UP Col.
CALHOUN								
WCGA	1953	900 1,000-D	Gordon County Bcstg. Co. P. O. Box 312 West Point, Georgia					
CAMILLA								
WCLB (CP)		1540 250-D	Capel Bcstg. Co.					
CARROLLTON								
WLBB	1947	1100 250-D	Carroll Bcstg. Co. P. O. Box 569 980	KBS So. Radio	Thos. K. Vassy, p, pm, gm, pmm	J. O. Norton, cm Charles M. Angley, pd	Chessley Hooper, ce Will Sinclair, nd, fd	Pop.: 65,000 Rad. Hms.: 20,000 Ret. Sis.: \$36,000,000 Wld. UP Ray.
CARTERSVILLE								
WBHF	1946	1450 250	W. R. Frier	MBS, KBS	W. R. Frier, p & gm	Martha Sullins, pd	H. E. Bridges, ce	L-W UP G
CEDARTOWN								
WGAA	1941	1340 250	Timm Inc. Box 807 777	KBS Stars National	John R. Barlett, gm	James Schliestet, ce		Cap. AP RCA

Data corrected to Dec. 10, 1953. If executives or services for FM are same as AM affiliate names are not repeated. Market Data supplied by stations. FM's in italic. *—Non-Commercial Station. CP—Construction Permit issued. D—Day. DA—Day. DA-N—Directional Antenna, night only. DA-1—Directional Antenna, same pattern day and night. DA-2—Directional Antenna, different pattern day and night. L—Limited Time with Dominant Station. LS—Local Sunset. N—Night. SA—Special Authorization. SH—Specified Hours. ST—Share Time. Complete key to abbreviations, page 6.

COLUMBUS

WDAK 1943 WDAK-TV	1340 250	Radio Columbus Inc. Martin Bldg. 5447	NBC Headley- Reed	Allen M. Woodall, p Miles H. Ferguson, sm	W. S. Massie, cm Joe Byars, pd & pmm Max F. Harper, ce	Bill Henry, nd Jim Harding, sd Loretta Ekum, wd	Pop.: 250,000 Rad. Hms.: 50,000	Wld. AP RCA
WGBA 1947	1270 1,000-D	Christian & McClure 1213½ Broadway 3-3603	Ayers	C. A. McClure, ptnr, gm & cm L. H. Christian, ptnr	Rhett Turnipseed, pd Ralph Burgess, pmm, nd & sd	Keith Brown, ce Truman Darnell, fd	Pop.: 318,789 Rad. Hms.: 69,000 Ret. Sis.: \$194,377,000	Thes. L-W UP RCA
WPNX 1952		Community Bcstg. Co. P. O. Box 687 (See Phenix City, Ala. listing)						
WRBL 1928 WRBL-TV	1420 5,000-DA-N	Columbus Bcstg. Co. 1350 13th Ave. 2-0601		Jim Woodruff Jr., p, gm Walter Graham, cm Bill Gramer, pd	George Jenkins, pmm Joe A. Gamble, tech. d Noel Moore, ce	Boyd Hinton, nd Jeff Stuart, fd Hugh Coburn, sd Rose Flournoy, wd	Pop.: 575,100 Rad. Hms.: 135,812 Ret. Sis.: \$303,709,000	Assoc. UP, INS WE
WRBL-FM 1946	Ch. 227 (B) 93.3mc 48kw						Pop.: 1,966,239 Rad. Hms.: 266,404 Ret. Sis.: \$577,047,000	GE

CORDELE

WMJM 1940	1490 250	Southeastern Bcstg. System 20 Ave B St. 866	MBS, Ga. Assn. of Local Stations Clark	James S. Rivers, p William E. Blizzard, Jr., gm, pmm & fd	O'Grady Cooper, Jr., slm & nd Clark Standard, pd & sd	Freddie Albert, ce Arnold Walker, wd	Pop.: 77,000 Rad. Hms.: 18,275 Ret. Sis.: \$52,000,000 UP RCA
--------------	-------------	--	--	---	--	---	--	--------------------

CORNELIA

WCON 1953	1450 250	ABC Indie	Habersham Bcstg. Co. 1 Burrell St. 1450	Jack Bradley, gm Bob Kilgore, cm Hoyt Dillard, pd	S. Y. Sosbee, pmm Warren G. Gilpin, ce	Mrs. Janet Davison, nd Jim Marlowe, sd	Pop.: 150,000	AP G
--------------	-------------	--------------	--	---	---	--	---------------	---------

COVINGTON

WMOC 1946	1430 1,000-D	Georgia Bcstg. Svc. Inc. 2275	KBS, Ga. Assn. of Local Stations	George Mooney, p William P. Williams, gm & nd	Derel Morris, cm Lew Banks, pd	Russell Caldwell, ce	Pop.: 100,000	Wld., SES, UP Col.
--------------	-----------------	-------------------------------------	--	---	-----------------------------------	----------------------	---------------	--------------------------

DALTON

WBLJ 1940	1230 250	Dalton Bcstg. Corp. 111 S. Pentz St. 1180	KBS, MBS	H. C. Kenemer, p William B. Davies, gm	Olin H. Kenemer, cm Marthel Ewton, pd	John S. Andrews, ce James Clark, nd	Pop.: 70,000 Rad. Hms.: 92.9%	Thes. UP G
--------------	-------------	--	-------------------	---	--	--	----------------------------------	------------------

DAWSON

WDWD 1948	990 1,000-D	Dawson Bcstg. Co. 416	ABC, Indie Sales	Ed Stevens, p W. C. Woodall Jr., gm & cm Owen Parnacott, pd	Joseph Stephens, ce	Carolyn Wall, wd	Pop.: 85,107 Rad. Hms.: 33,410 UP RCA
WDWD-FM 1948	Ch. 266 (B) 101.1mc 11.6kw						 RCA

DECATUR

WEAS 1947	1010 10,000-D CP: 50,000-D	WEAS Dearborn 2521 Stars National	E. D. Rivers Jr., chmn. of bd. W. H. Keller Jr., p Warren Roberts, sta. d	Joe Robkin, cm Ned Lukens, pd Kurt Alexander, pmm & nd	Bill Loudermilk, ce Les Gradick, tech. d H. W. Field, fd	Pop.: 885,000 Rad. Hms.: 220,050 Ret. Sis.: \$174,100,000 INS RCA
WGLS 1949	970 1,000-D	DeKalb Bcstg. Co. 526 Church St. Crescent 6471 Rambeau	Guy W. Rutland Sr., p Sam W. Kane, gm	Al Ciraldo, cm, pd, pmm, nd & sd	Lawson Leake, ce Jim Wesley, fd	Pop.: 800,000 Ret. Sis.: \$957,000,000	St. UP G

DOUGLAS

WDMG 1947	860 1,000-D	WDMG Inc. P. O. Box 590 564	Dora- Clayton	B. F. J. Timm, p Mary M. Jarrard, gm	Edward Lund, nd Stanley H. Strickland, ce & pd	Jimmy Dunnaway, sd June Mosely, wd		Wld. UP
--------------	----------------	-----------------------------------	------------------	---	--	---------------------------------------	--	---------------------

DUBLIN

WMLT 1945	1340 250	Dublin Bcstg. Co. Franklin St. 871-872	MBS, KBS	George T. Morris, p W. Newton Morris, gm W. C. Courson, cm	George Tellmann, pd Lawrence L. Henry, ce	Sarah Orr Williams, nd	Pop.: 114,218 Rad. Hms.: 28,621 Ret. Sis.: \$55,389,000	Wld. AP G
--------------	-------------	--	-------------------	--	--	---------------------------	---	-----------------

EAST POINT

WTJH 1949	1260 5,000-D	James S. & Doris R. Rivers Dodson Dr. Franklin 1473	KBS	James S. Rivers, o William B. Hill, gm & ce	Tom Loe, nd	Claude Jones, fd	Pop.: 1,564,730 Rad. Hms.: 413,940 Ret. Sis.: \$1,437,316,000	UP Ray.
--------------	-----------------	--	--------------	---	-------------	------------------	---	------------

ELBERTON

WGGC 1946	1400 250	Elberton Bcstg. Co. Elberton			Melvin C. Gorman, m			
--------------	-------------	---------------------------------	--	--	---------------------	--	--	--

FITZGERALD

WBHB 1946	1240 250	Ben Hill Bcstg. Corp. West Roanoke Drive 2077	MBS, KBS, Ga. Assn. of Local Stations	Otto Griner, p Al H. Evans, gm, cm, pmm, nd & sd	Daphne L. Newsome, pd & wd	Ed Durham, ce Jim Collier, fd		Wld. AP G
--------------	-------------	---	---	--	-------------------------------	----------------------------------	--	-----------------

FORT VALLEY

WFBM 1951	1150 1,000-D	Peachbelt Bcstg. Co. 64	KBS, Ga. Assn. of Local Stations Indie	Ed Stevens, p Hugh Birdsong, gm, ce & sd	Kenneth Flynt, cm Lee Mathis, pd & nd	Tex Beverly, fd Madeline Upchurch, wd	Rad. Hms.: 30,000 UP Col.
--------------	-----------------	-------------------------------	--	--	--	---	-------------------	---------------------

GAINESVILLE

WDUN 1949	1240 250	Northeast Georgia Bcstg. Co. 217½ South Main St. Lenox 4-7331	ABC, Ga. Assn. of Local Stations Indie	John W. Jacobs Jr., p & gm Jim Hartley, sm & fd	Doris Smith, cm & wd Jay Still, pd & nd	Les Brooks, ce Drane Watson, sd	Pop.: 42,000 Rad. Hms.: 10,000 Ret. Sis.: \$46,000,000	Wld. AP GE
--------------	-------------	--	--	---	--	------------------------------------	--	------------------

WDUN-FM

WDUN-FM 1949	Ch. 280 103.9mc 0.3kw							
WGGA 1941	550 5,000-D 500-N DA-N	Blue Ridge Bcstg. Co. Press-Radio Center Lenox 2-6211	MBS, KBS, Palmetto, Cracker Dora- Clayton	Charles Smithgall, p Robert O. Moran, gm Robert Schwab, cm	Billie L. Kinsey, pd Keith Brown, ce	Sylvan Meyer, nd George Porter, fd	Pop.: 246,900 Rad. Hms.: 53,000 Ret. Sis.: \$16,733,000 UP RCA

GEORGIA

City Call Letters Established TV Affiliate	Chan. or Freq. Power	Licensee Headquarters Telephone	Network Represent- ative	Owner o; Pres. p; Exec. vp evp; Gen. Mgr. gm; Sta. Mgr. sm; Coml. Mgr. cm; Sales Mgr. slm; Prog. Dir. pd; Chief Eng. ce; Prom. Mgr. pmm; Prod. Mgr. pdm; News, Farm, Sports or Women's Dir. nd, fd, sd, wd.	Executive Abbreviations	Market Data For Primary Area (Supplied by station)	Library, News Serv. Transmitter
GRIFFIN							
WKEU 1933	1450 250	Radio Station WKEU P. O. Box 155, Macon Rd. 5507	MBS, KBS	A. W. Marshall Jr., p & gm	William F. Westmore- land, ce		L-W AP G
WKEU-FM 1953	Ch. 271 (B) 102.1mc 1.8kw						
WRHT 1952	1320 1,000-D	Griffin Bcstg. System Cherokee Rd. 9451 Dora- Clayton	R. H. Thompson Sr., o, gm & pmm James Watson, sm, sd & nd	Johnny Williams, cm R. H. Thompson Jr., pd	Charles Player, ce & fd Ceile Sealy, wd	Pop.: 201,600 Rad. Hms.: 55,490 Wld. UP G
HARTWELL							
WKLY 1947	980 1,000-D	Louie L. Morris Box 189 71	Louie L. Morris, o Max G. Pfaender, evp & m Burch Griffin, asst. m	Caroline Stults, cd Eugene Holden, ce Virginia Bailey, secy. & wd	Jim Stevenson, nd & sd Bill Nash, fd	Pop.: 492,920 Rad. Hms.: 123,230 Ret. Sis.: \$210,886,000 Cap., Wld. UP G
HAWKINSVILLE							
WCEH 1952	610 500-D	Tri-County Bcstg. Co. Box 184 498	KBS Dora- Clayton	R. T. Ragan, p & gm Henry Griffin, vp D. R. Jackson, secy.- treas.	Paul E. Reid, gm, cm, pmm & sd James Popwell, pd & fd	Mike Pelton, ce Glen Weber, nd Frances Jones, wd	Pop.: 100,000 Rad. Hms.: 20,000 Wld. UP G
JESUP							
WBGR 1949	1370 1,000-D	Altamaha Bcstg. Co. Box 147 2444	KBS	W. Glenn Thomas, o & gm Dennis N. Brown, sm & cm	T. N. Oglesby, pd Arthur Manning, ce	W. Glenn Thomas Jr., asst. ce Mrs. Pansy Surrency, wd	Pop.: 40,000 Rad. Hms.: 15,000 Cap. UP Ray.
LA FAYETTE							
WLFA (CP)	1590 5,000-D	Radio Dixie					
LaGRANGE							
WLAG 1941	250 1240	LaGrange Bcstg. Co. 305-307 Broome St. 2-3505	MBS, KBS Indie, Dora- Clayton	Roy C. Swank, p & gm Edwin Mullinax, gm & cm	John Boggess, pd & sd Patricia Smith, pmm J. M. McKay, ce	Linda McKee, wd Henry East, nd Joe Hawkins, fd	Pop.: 109,000 Rad. Hms.: 38,569 Ret. Sis.: \$64,000,000 Wld. UP G
WLAG-FM 1948	Ch. 281 (B) 104.1mc 2.3kw						Pop.: 145,000 Rad. Hms.: 43,258 Ret. Sis.: \$72,000,000 Assoc. UP G
WTRP 1953	620 500-D	Chattahooche Bcstg. Co. Ltd. Hammett Bldg.		Byron H. Hurst, ptrn. & gm Ralph C. Freeman, ptrn.	Cecil Crew, ptrn. Jim Martin, cm, pd & sd Ray Relihan, ce	Frank Cordell, pmm Weyman Brooks, nd Emily Rutland, wd Bill Brittain, fd	Thes. AP G
MACON							
WBML 1940	1240 250	Middle Georgia Bcstg. Co. 230 Second St. 3-5454	NBC Headley- Reed	Allen M. Woodall, p E. F. MacLeod, gm	Geo. W. Patton, cm James M. Wilder, ce	Dick Wiethan, nd & fd	Pop.: 190,400 Rad. Hms.: 45,110 Ret. Sis.: \$138,136,000 Wld. AP RCA
WIBB 1948	1280 1,000-D	Peach State Bcstg. Co. Inc. Professional Bldg. 2-2505 Walker, Dora- Clayton	Thomas H. Maxwell, p & gm	Donald C. Frost, cm	Gordon Price, pd UP Ray.
WMAZ 1922	940 10,000	Southeastern Bcstg. Co. Bankers Bldg. 2-7373	CBS Katz	Geo. P. Rankin, p & o Wilton E. Cobb, gm Frank Crowther, cm	E. G. Pendleton, pmm Albert Sanders, loc. slm Ben Chatfield, nd Herb Johnson, fd	James Lawhon, ce Bob Savage, sd Helen Farmer Popejoy, wd	Pop.: 700,100 Rad. Hms.: 176,900 Ret. Sis.: \$395,035,000 L-W UP RCA
WMAZ-FM 1946	Ch. 256 (B) 99.1mc 3kw						
WNEX 1945	1400 250	Macon Bcstg. Co. Bibb Bldg. 5-3301	MBS, ABC Branham	Edward M. Lowe, p Alfred Lowe, gm Marlon Bragg, cm	Emory G. Stroberg, bus. m Emanuel Farber, ce	Lem Clark, sd Ted Arnold, fd Margaret Heck, wd	Pop.: 114,000 Ret. Sis.: \$109,874,000 Thes. AP Thes. AP WE
WNEX-FM 1945	Ch. 245 (B) 96.9mc 4.1kw						
MARIETTA							
WFOM 1946	1230 250	Fred B. Wilson & Albert Jones P. O. Box 131 8-3396	Fred B. Wilson, ptrn. Albert L. Jones, ptrn., gm & pmm	John K. Williams, slm Chuck Strauss, pd & ce	John Williams, nd Dudley McCaskill, sd Channing Cope, fd	Rad. Hms.: 25,000 UP Ray.
MILLEDGEVILLE							
WMVG 1946	1450 250	Jere N. Moore Milledgeville, Ga. 250	MBS, KBS, GALS Griffith	Jere N. Moore, o Michael T. Landy, gm	Josephine Ragsdale, ce pd	Robbie O. Hattaway, ce Joe Boone, sd	Pop.: 30,000 Rad. Hms.: 4,000 Cap. UP G
MONROE							
WMRE (CP)	1490 250	Walton Bcstg. Co. P. O. Box 25 Gainesville, Ga.		Warren G. Gilpin, gm			
MOULTRIE							
WMGA 1939	1400 250	John F. Pidcock	ABC	John F. Pidcock, p Roy F. Zess, gm & cm	Robert J. Lenihan, pd. fd, sd & wd	Homer W. Sloan, ce	Pop.: 45,000 Rad. Hms.: 9,600 Ret. Sis.: \$36,000,000 UP RCA
WMTM (CP)	1300 1,000-D	Colquitt Bcstg. Co.					
NEWNAN							
WCOH 1947	1400 250	Newnan Bcstg. Co. P. O. Box 581 1400	MBS Hunter	James O. Hardin Jr., p, gm, cm, pd, nd & fd	William E. Davis Jr., ce Johnny Brown, sd	Joyce Coggin, wd	Pop.: 145,600 Rad. Hms.: 31,582 Ret. Sis.: \$107,451,000 Wld. AP Col.
WCOH-FM 1952	Ch. 244 (B) 96.7mc 0.33kw					 RCA

Data corrected to Dec. 10, 1953. If executives or services for FM are same as AM affiliate names are not repeated. Market Data supplied by stations.
 FM's in italic. *—Non-Commercial Station. CP—Construction Permit issued. D—Day. DA—N—Directional Antenna, night only. DA-1—Directional Antenna, same pattern day and night. DA-2—Directional Antenna, different pattern day and night. L—Limited Time with Dominant Station. LS—Local Sunset. N—Night. SA—Special Authorization. SH—Specified Hours. ST—Share Time. Complete key to abbreviations, page 6.

*Only a combination of stations
can cover Georgia's
major markets.*

The Georgia Trio

WAGA
5000 w
590 kc
CBS Radio

WMAZ
10,000 w
940 kc
CBS Radio

WTOG
5000 w
1290 kc
CBS Radio

ATLANTA

MACON

SAVANNAH

*represented
individually and
as a group by*

**The TRIO
offers advertisers
at one low cost:**

- CONCENTRATED COVERAGE
- MERCHANDISING ASSISTANCE
- LISTENER LOYALTY BUILT BY LOCAL PROGRAMMING
- DEALER LOYALTIES

The KATZ AGENCY, INC.

In 3 major markets

NEW YORK CHICAGO DETROIT ATLANTA DALLAS KANSAS CITY LOS ANGELES SAN FRANCISCO

GEORGIA

City	Call Letters Established TV Affiliate	Chan. or Freq. Power	Licenses Headquarters Telephone	Network Represent- ative	Owner o. Pres. p. Exec. vp exp; Gen. Mgr. gm; Sta. Mgr. sm; Coml. Mgr. cm; Sales Mgr. slm; Prog. Dir. pd; Chief Eng. ce; Prom. Mgr. pmm; Prod. Mgr. pdm; News. Farm, Sports or Women's Dir. nd, fd, sd, wd.	Executive Abbreviations	Market Data For Primary Area (Supplied by station)	Library, News Serv. Transmitter
ROME								
WLAQ	1410 1,000 DA-N	News Pub. Co. 209 Broad St. 7787	ABC	Mrs. Jane Mooney, p Lee Mowrv Jr., gm, pmm, nd & sd	Martha Daniel, ce Elizabeth Hardin, pd	Daniel B. Scott, ce D. Franklin, fd	Pop.: 100,000	Wid. UP AP
WRGA	1470 5,000 DA-N	Rome Bcstg. Corp. 501 Broad St. 2-2411	MBS Walker	Charles Smithgall, o Mather Payne, gm L. B. Talley, cm	James F. Roberts, pd R. A. Starr, ce "Cap" Hicks, nd	Al Kirby, fd Cecil Kerce, sd Fran McSpadden, wd	Pop.: 112,462 Rad. Hms.: 99,800	L-W UP WH
WRGA-FM	Ch. 293 (B) 106.5mc 1.15kw						Pop.: 40,051 Rad. Hms.: 23,000	L-W UP GE
WROM	710 1,000-D	Coosa Valley Radio Co. 121 1/2 Broad St. 2-0833	Southern	Dean Covington, p Edward McKay, gm Charles Doss, cm, pd & sd	Thos. Robertson, ce Blair Jessee, prod. m & nd	Avery Means, pmm Clyde Varner, fd Dorothy McKay, wd	 AP Ray.
SAVANNAH								
WCCP	1450 250	Dixie Bcstg. Co. P. O. Box 943 2-4182	MBS Walker	Carter C. Peterson, p & gm Weldon Herrin, cm & sm	Charles Beresford, pd Al Jennings, pmm & sd William Moats, ce	Richard Lantz, nd Jesse Mooney, fd Charles Lipton, sls pmm Faye Hancock, wd	Pop.: 180,000 Rad. Hms.: 40,000 Ret. Sls.: \$160,000,000	St. UP G
WDAR	1400 250	WDAR Inc. 34 E. Bryan St. 3-8807	H. Blair Minick, p & gm	Robert Radecki, cm Danny Clark, pd, pmm & nd Sol Ratner, sd	C. Joseph Testo, ce Stella G. Minick, vp & wd	Pop.: 275,000 Ret. Sls.: \$146,872,000
WFRP	1230 250	Georgia Bcstg. Co. 219 E. Charlton St. 3-9642	ABC McKin- ney, Ayers	John F. Pidcock, p, gm & pd John G. Williams, cm & pmm	Bennett McKnight, ce Dick Hull, nd & sd	Dave Hart, fd Addine Leitch, wd	Pop.: 455,000 Rad. Hms.: 54,300 AP Ray.
WJIV	900 1,000-D	WJIV Inc. 128 West Taylor St. 4-7264 National	W. H. Keller, Jr., p James L. Woods, gm Abram Eisenman, cm L. R. Picus, pd & nd	Frank Freeman, pmm Heyward Tuten, ce Shirley J. Collins, traffic m	Rex England, sd Denzil Mixon, fd Mary McDew, wd	 AP Ray.
WSAV	630 5,000 DA-N	WSAV Inc. Liberty National Bank Bldg. 3-0234	NBC Blair	Harben Daniel, p & gm Donald K. Jones, cm Duane Hatch, pd & nd	Susan Perry, pmm Meredith E. Thompson, ce Robert W. Ward, loc. adv. m	Douglas Strohbehn, fd Clarence Garnes, sd Betty Broughton, wd	Pop.: 773,537 Rad. Hms.: 167,729 Ret. Sls.: \$437,884,000	Thes. AP RCA
WSAV-FM	Ch. 252 (B) 100.3mc 15.5kw						
WTOC	1290 5,000 DA-N	Savannah Bcstg. Co. 516 Abercorn St. 2-0127	CBS, Ga. Trio Katz	Wm. T. Knight, Jr., p, treas. & gm S. F. Driscoll, vp F. Schley Knight, vp	Ben Williams, cm Kyle E. Goodman, ce Dwight J. Bruce, pmm & fd	Wm. D. Randall, nd W. O. King, sd Ruth M. Goodman, wd		L-W UP RCA
WTOC-FM	Ch. 247 (B) 97.3 mc 5kw						 GE
STATESBORO								
WWNS	1490 250	R. H. Thompson & Virginia P. Bowen E. Olliff St. 502	MBS, KBS. Ga. Assn. Local Stations	R. H. Thompson, Sr., p & gm Edwin H. Bass, sm, ce, cm & slm	Shirley T. Dyer, pd John R. Morris, pmm & pdm	Dean Baxter, sd & fd Martha Mixon, nd Mrs. Ernest Brannen, wd	Pop.: 30,000 Rad. Hms.: 12,950 Ret. Sls.: \$48,000,000	Wid. UP Ray.
SUMMERVILLE								
WGTA	950 1,000-D	Tri-State Bcstg. Co. Inc. Holland Rd. 295	Ga. Assn. of Local Stations	William B. Farrar, gm & o	Lawrence Keown, pd & nd	Charles M. Lowry, Jr., ce	Pop.: 289,772 Rad. Hms.: 98,912 Ret. Sls.: \$101,824,000	Cap. UP WE
SWAINSBORO								
WJAT	800 1,000-D	Jack A. & Nancy M. Thompson P. O. Box 371 2011	Jack A. Thompson, p & gm	Jack Wiseley, sm & ce Doris Lewis, pd & wd	Bill Polk, fd	Pop.: 880,000 Rad. Hms.: 220,000	Cap., L-W UP G
WJAT-FM	Ch. 269 (A) 101.7mc 0.97kw						Pop.: 71,200 Rad. Hms.: 15,900	Wid., L-W UP Col.
THOMASTON								
WSFT	1220 250-D	Thomaston Bcstg. Co. Thomaston 2187	MBS, Ga. Assn. of Local Stations	J. B. Hardy, p S. J. Carswell, gm C. D. Thames, cm	Bill Heule, pd & nd Craig Wills, ce Jim O'Donnel, sd	Guy Sharpe, fd Lillian Turner, wd	Pop.: 55,000 Rad. Hms.: 9,000	Wid. AP WE
THOMASVILLE								
WKTG	730 1,000-D	Southern Bcstg. System Inc. 1501	W. F. Scott, Jr., p & gm Louie T. Porter, cm & sm	Roger Mansfield, sd Mary Jean Crew, office m	Bruce E. Singleton, ce Nancy Anderson, nd & wd	Pop.: 209,100 Rad. Hms.: 46,380	Wid., Thes. UP Ray.
WPAX	1240 250	H. Wimpy 117 Remington Ave. 909	H. Wimpy, p & gm Bob Willis, pd	Al Feinberg, cm	James Poole, ce		Cap. UP G
THOMSON								
WTWA	1240 250	Hickory Hill Bcstg. Co. Inc. 127 Journal St. 141	MBS, KBS Southern Radio	Edgar Kobak, o Frank H. Hash, gm Richard J. Roche, cm	Mrs. Doris McNease, pd	William P. Dickson, ce		Wid. UP RCA
TIFTON								
WWGS	1340 250	Tifton Bcstg. Corp. Graham Bldg. 921	MBS, Ga. Assn. of Local Stations	W. A. Graham, p J. E. Graham, vp Carl Wendell, gm & cm	W. F. Crutchley, pd Frank Proctor, ce Gerald R. Hunter, nd	D. A. Osborn, sd Donald Smith, fd Carrie P. Boyd, wd	Pop.: 48,000 Rad. Hms.: 10,620 Ret. Sls.: \$28,851,000	Cap. UP WE
TOCCOA								
WLET	1420 5,000-D	R. G. LeTourneau 423 Prather Bridge Rd, 544	MBS, KBS Clark	R. G. LeTourneau, p Virgie E. Craig, gm	Roy E. Gaines, cm Charles H. Gaines, pd, pmm, nd & sd	C. H. Sutton, ce Joy Simpson, wd	Pop.: 100,000 Rad. Hms.: 23,000	Thes. UP GE
WLET-FM	Ch. 291 (B) 106.1mc 7.3kw						Pop.: 100,000 Rad. Hms.: 10,000

Data corrected to Dec. 10, 1953. If executives or services for FM are same as AM affiliate names are not repeated. Market Data supplied by stations. FM's in italic. *—Non-Commercial Station. CF—Construction Permit issued. D—Day. DA—Day. DA-N—Directional Antenna, night only. DA-1—Directional Antenna, same pattern day and night. DA-2—Directional Antenna, different pattern day and night. L—Limited Time with Dominant Station. LS—Local Sunset. N—Night. SA—Special Authorization. SH—Specified Hours. ST—Share Time. Complete key to abbreviations, page 6.

VALDOSTA

WGAF 1951	910 5,000 DA-N	Valdosta Bcstg. Co. 116 West Hill Ave. 910	ABC Pearson. Dora-Clayton	George B. Cook, p. gm & cm Willard Belot, pd & sd	Ernest Green, ce & fd Byrant Lane, nd Faye Jackson, wd	Mary Virginia McDonald, wd	Pop.: 395,342 Rad. Hms.: 106,020 Ret. Sis.: \$223,937,000	Thes. AP WH
WGOV 1940	950 5,000-D 1,000-N DA-2	WGOV Inc. Daniel Ashley Hotel 1420	MBS Stars National	Ed Rivers Jr. chmn. of bd. W. H. Keller Jr., p A. B. Smith, sta. d	James A. Wood, cm Vince Randolph, pd & nd Ben G. Porter, pmm	Lester Q. Hall, ce Les Gradick, tech. d Bob Bonifay, sd Inez McDonald, wd	Pop.: 360,000 Rad. Hms.: 70,000 Ret. Sis.: \$160,000,000	UP Ray.
WGOV-FM 1948	Ch. 223 (B) 92.5mc 7kw							

VIDALIA

WVOP 1946	970 1,000-D	Vidalia Bcstg. Co. Highway 280 3029	MBS, KBS, GALS Southern Sales	Howard C. Gilreath, bus. m & gm R. S. Bryant, pd	R. E. Ledford, pmm Loren Dorrough, ce	Jack Sasser, sd Ruby Bryant, wd	Pop.: 200,000	UP Ray.
--------------	----------------	---	-------------------------------------	--	--	------------------------------------	---------------	------------

WAYCROSS

WACL 1951	570 1,000 D	Teletronics Inc. 3068	James S. Rivers, p L. H. Thesmar, gm & cm	Robert C. Lay, pd & nd Lloyd McKinney, ce	Walter Kizer, sd John Williams, fd Neil Penland, wd	Pop.: 376,030 Rad. Hms.: 118,722 Ret. Sis.: \$362,883,000	L-W AP Col.
WAYX 1936	CP: 1,000 DA-N 1230 250	Jack Williams 1600 Carswell Ave. 965	MBS, KBS, GALS Holman	Jack Williams, o John J. Tobola, m & cm Mrs. Gwen Higgs, pd	Curtis Frazier, ce Charles Witt, pmm Dean Bragg, nd	Malcomb Thomas, fd Tommy Edwards, sd Mrs. Geraldine Griffin, wd	Pop.: 60,000 Rad. Hms.: 11,500	Wid., UP RCA

WAYNESBORO

WBRO 1953	1310 1,000-D	Burke County Bcstg. Co.	MBS, KBS, GALS Georgia Sales	William Fulgham, gm Howard C. Gilreath, bus. m & cm	Roy Chalker, pmm & nd	Billy Fulgham, ce	Pop.: 175,000 Ret. Sis.: \$2,000,000	
--------------	-----------------	-------------------------	------------------------------------	---	-----------------------	-------------------	---	--

WEST POINT

WRLD 1940	(See Lanett, Ala. listing)							
--------------	----------------------------	--	--	--	--	--	--	--

WINDER

WIMO 1952	1300 1,000-D	Winder-Monroe Bcstg. Co. P. O. Box 526 4831		W. C. Woodall Jr., p C. H. Grider, gm & cm	O. G. Swindle Jr., pd, fd & sd W. R. Powell, ce	Royce A. Jones, nd Sara T. Pope, wd	Pop.: 103,000 Rad. Hms.: 24,300 Ret. Sis.: \$59,500,000	UP G
--------------	-----------------	---	--	---	---	--	---	---------

IDAHO

MARKET DATA BY COUNTIES

County	Population 1950	Radio Families 1953	Retail Sales 1952(000)	Food Sales 1952(000)	Drug Sales 1952(000)	Automobile Ownership 1952	County	Population 1950	Radio Families 1953	Retail Sales 1952(000)	Food Sales 1952(000)	Drug Sales 1952(000)	Automobile Ownership 1952
Ada	70,649	23,250	\$ 90,828	\$ 16,623	\$ 2,319	40,317	Jerome	12,080	3,340	15,327	3,337	354	6,555
Adams	3,347	860	2,558	992	82	1,653	Kootenai	24,947	7,750	26,700	7,897	717	15,530
Bannock	41,745	12,070	48,732	11,556	1,420	20,090	Latah	20,971	5,890	18,629	4,267	578	10,177
Bear Lake	6,834	1,850	7,360	1,238	237	3,583	Lemhi	6,278	1,750	5,715	1,686	111	3,162
Benewah	6,173	1,720	5,836	1,544	42	3,405	Lewis	4,208	1,140	4,199	639	162	2,162
Bingham	23,271	5,640	22,034	4,741	582	11,112	Lincoln	4,256	1,050	3,317	765	74	1,903
Blaine	5,384	1,330	6,355	1,420	151	3,056	Madison	9,156	2,280	12,425	2,060	294	4,245
Boise	1,776	560	1,065	387		754	Minidoka	9,785	2,560	8,874	1,808	216	5,445
Bonner	14,853	4,260	13,100	3,416	308	8,281	Nez Perce	22,658	7,110	41,536	7,050	999	13,276
Bonneville	30,210	8,770	52,683	9,008	1,019	16,760	Oneida	4,387	1,190	4,765	863	79	2,748
Boundary	5,908	1,490	6,706	1,834	79	3,077	Owyhee	6,307	1,580	5,606	1,675	92	3,494
Butte	2,722	840	2,002	456	31	1,799	Payette	11,921	3,730	10,951	2,714	265	6,851
Camas	1,079	290	871	150	35	700	Power	3,988	940	4,923	876	41	2,048
Canyon	53,597	15,960	65,340	13,298	1,742	29,513	Shoshone	22,806	6,710	22,513	7,386	661	10,463
Caribou	5,576	1,870	9,837	1,572	57	3,159	Teton	3,204	680	2,760	576	90	1,528
Cassia	14,629	3,780	19,854	3,417	459	7,083	Twin Falls	40,979	12,660	58,519	8,934	1,334	24,422
Clark	918	*	794	172	630	4,315	Valley	4,270	1,160	5,325	1,425	98	2,094
Clearwater	8,217	1,980	5,799	1,296	266	4,313	Washington	8,576	2,540	13,806	1,781	205	4,711
Custer	3,318	920	2,570	758	71	1,727							
Elmore	6,687	2,060	7,269	823	69	4,563	Total	588,637	169,680	\$698,317	\$143,127	\$ 16,831	290,529
Franklin	9,867	2,490	9,862	1,848	265	5,026	* See Jefferson.						
Fremont	9,351	2,340	9,533	1,907	288	4,315	** Clark included in Jefferson County figures						
Gem	8,730	2,430	7,131	1,806	73	4,704	Note: Population 1950 Census; radio families Standard Audit & Measurement Services Inc.; food, drug and retail sales, copyright 1953, Sales Management; further reproduction uncensored; automobiles supplied by state.						
Gooding	11,101	3,210	15,500	3,354	375	5,957							
Idaho	11,423	2,960	10,886	1,898	208	6,082							
Jefferson	10,495	**2,720	7,922	1,874	283	4,783							

DIRECTORY OF AM AND FM STATIONS

City	Call Letters Established	Chan. or Freq. Power	Licensee Headquarters Telephone	Network Representative	Owner o; Pres. p; Exec. up exp; Gen. Mgr. gm; Sta. Mgr. sm; Coml. Mgr. cm; Sales Mgr. slm; Prog. Dir. pd; Chief Eng. ce; Prom. Mgr. pmm; Prod. Mgr. pdm; News, Farm, Sports or Women's Dir. nd, fd, sd, wd.	Executive Abbreviations	Market Data For Primary Area (Supplied by station)	Library News Serv. Transmitter	
BLACKFOOT									
KBLI	1490 250		William I. Palmer Yellowstone Highway 780	William I. Palmer, p Carl A. Winther, gm	Reed Monson, cm & sd Evangeline R. Winther, pd & wd	Donald Clark, ce	AP WE	
BOISE									
KDSH	950 5,000 DA-N		Boise Valley Bcstrs. Inc. 311 N. 10th St. 3-2511	CBS, Bonneville Free & Peters	Westerman Whillock, p & gm Earl Glade Jr., sm, cm, pd & pmm	James A. Johntz Jr., ce George Ganz, loc. slm	Dave Johnson, nd Al Bodney, sd Bill Gratton, fd Anne Schofield, wd	Pop.: 285,000 Rad. Hms.: 81,000 Ret. Sis.: \$360,537,000	L-W UP WH
KGEM	1140 10,000 DA-1		Idaho Bcstg. & Tv Co. 5601 Cassia 4-3511	ABC, KBS, Rocky Mountain Hollingbery	Frank C. Carman, p	Milo J. Petersen, gm & vp	Howard McDonald, asst. m	Pop.: 168,000 Rad. Hms.: 44,000 Ret. Sis.: \$300,000,000	Wid. UP
KIDO	630 5,000 DA-2		KIDO Inc. 709 Idaho St. 2-4611	NBC, Great Western Blair	Mrs. Georgia M. Davidson, p Walter E. Wagstaff, gm	John Young, cm George Walton, pd	Harold Toedtemeyer, ce Wiff Janssen, sd	Pop.: 208,425 Rad. Hms.: 59,550 Ret. Sis.: \$253,011,000	Thes. UP RCA

IDAHO

City Call Letters Established TV Affiliate	Chan. or Freq. Power	Licensee Headquarters Telephone	Network Represent- ative	Owner o; Pres. p; Exec. up evp; cm; Sales Mgr. sm; Prog. Dir. pd; Chief Eng. ce; Prom. Mgr. pmm; Prod. Mgr. pdm; News, Farm, Sports or Women's Dir. nd, fd, sd, wd.	Executive Abbreviations Gen. Mgr. gm; Sta. Mgr. sm; Coml. Mgr. cm; Sales Mgr. sm; Prog. Dir. pd; Chief Eng. ce; Prom. Mgr. pmm; Prod. Mgr. pdm; News, Farm, Sports or Women's Dir. nd, fd, sd, wd.	Market Data For Primary Area (Supplied by station)	Library, News Serv. Transmitter
BURLEY							
KBAR 1947	1230 250	KBIO Inc. Box 461 10	ABC, Rocky Mt. Bcstg. Moore & Lund	Jessica Longston, p K. Clark, gm & nd George Mac Donald, cm & sd	George D. Carter, pd & fd	Donald R. Lockwood, ce Jean Wallerl, wd	Pop.: 25,000 Wid. UP WE
CALDWELL							
KCID 1947	1490 250	Caldwell Bcstg. Co. P. O. Box 1052 9-7444 Oakes	Clair B. Hull, p, cm & pmm F. H. Booton, gm, pd & nd	Richard E. Lewis, ce Ken Waddell, sd	Dick Nafsinger, fd Martha Hull, wd	Pop.: 80,000 Rad. Hms.: 28,500 UP RCA
COEUR D'ALENE							
KVNI 1946	1240 250	Coeur d'Alene Bcstg. Co. Blackwell Island 1250	MBS, Don-Lee	Burl C. Hagadone, p & gm Wayne E. Olsen, sm	Bernard V. Merriman, pd, pmm, nd & fd Vince Hoffart, ce	Bob Hough, sd Barbara Earin, wd	Pop.: 55,000 Cap. RCA
IDAHO FALLS							
KID 1928	590 5,000-D	Idaho Radio Corp. Box 701 4	CBS, Bonneville	A. W. Schwieder, p C. N. Layne, gm Leonard Wasden, cm	Leo Higham, pd & pmm Carroll Secrist, ce	Claude Cain, sd Roy Southwick, fd Myrtle Asper, wd	Pop.: 100,000 Rad. Hms.: 28,000 UP RCA
KID-TV 1946	1,000-N DA-N	Eastern Idaho Bcstg. & Tv Corp. P. O. 581 N. Yellowstone Hwy. 1054	ABC, MBS, KBS, Inter- mountain Avery- Knodel	J. M. Brady, p & gm John R. Taylor, sm	Hal Simmons, pd Wayne Davis, pmm & nd	Jim Kithcart, sd	Pop.: 45,000 Rad. Hms.: 17,000 Ret. Sls.: \$90,000,000 St. AP G
LEWISTON							
KLER 1953	740 250-D	Cole E. Wylie 2829 Country Club Dr. 3-5558	Cole E. Wylie, p William C. Rhodes, gm Martin D. Rockey, nd, fd & sd	Robert O. Edwards, pd	Rose Ann Spring, traffic m Gene Wilson, ce	Pop.: 100,000
KRLC 1935	1350 1,000 DA-N	H. E. Studebaker Lewis-Clark Hotel 3-1551	MBS, Don Lee Weed, Moore & Lund	H. E. Studebaker, p Donald Thomas, gm	Tom Decker, asst. m Alben Nelson, pd	Bill Neumann, ce Jack Clifford, nd	Pop.: 114,028 Rad. Hms.: 37,070 Ret. Sls.: \$122,898,000 Thes. Assoc. UP RCA
MOSCOW							
KHPL 1947	1400 250	Latah County Bcstrs. P. O. Box 396 Moscow 2283	KBS	Roy Anderson, o Bert McAllister, gm	H. D. Young, ce	Ruth McAllister, wd	Pop.: 15,360 Rad. Hms.: 15,360 SES. AP
NAMPA							
KFXD 1935	580 5,000 DA-N	Frank E. Hurt & Son Inc. Box 891 6-4611	MBS, Inter- mountain Avery- Knodel	Edward Hurt, p Doyle Cain, gm & cm	Shirl Black, pd	Gilbert Rose, ce	Pop.: 335,664,000 Rad. Hms.: 86,450 Cap. AP G
POCATELLO							
KJRL 1946	1240 250	Radio & Tv Bcstg. Co. of Idaho 1140 Yellowstone Ave. 1240	CBS, Bonneville CBS Radio Spot Sales, Cooke, McGavren, Moore	Burl C. Hagadone, p Roger L. Hagadone, sm, cm & pmm	Dick Wright, pd Jerry Fennell, loc. slm Bob Paulos, nd	Jullian Dennis, ce & fd Phil Neiswanger, sd Elaine Childs, wd	Pop.: 80,000 Cap. Col.
KSEI 1926	930 5,000 DA-N	Radio Service Corp. Box 31 122 S. Main 4000	NBC, Great Western Weed	Henry H. Fletcher, p, gm & cm	Ruthe A. Fletcher, pd Olive M. Leeney, pmm	Ellis W. Call, ce Jim Tyne, nd & sd	Pop.: 170,680 Rad. Hms.: 50,200 Ret. Sls.: \$211,143,000 St., L-W, Thes. UP RCA
KSEI-FM 1946	Ch. 243 (B) 96.5mc 1.8kw						
KWIK 1946	1440 1,000 DA-1	Eastern Idaho Bcstg. & Television Co. Bannock Hotel 3400	ABC, MBS, KBS, Inter- mountain Avery- Knodel	James M. Brady, p John R. Taylor, gm	Robert Weggeland, pd & nd Joy Morrison, pmm Dean McCurdy, ce	Bruce Twerrell, sd Norma Adamson, wd	Wid. AP
PRESTON							
KPST 1948	1340 250	Voice of the Rockies Inc. Box 192 600	KBS Continental	Leon Smith, p Ruion Dunn, gm	M. S. Stocking, cm & wd	D. A. Nash Jr., ce & sd	Pop.: 50,000 Rad. Hms.: 12,000 Ret. Sls.: \$23,000,000 Assoc. Col.
REXBURG							
KRKK 1950	1230 250	Snake River Radio & Tv Co. Inc. 445 S. 2d East 700	Dr. M. F. Rigby, p Merrill Skinner, gm, cm & sd	James Clawson, pd, pmm & nd Merrill Andrus, ce	Dawna Merrill, traffic m & wd S. K. Stuart, fd	Pop.: 85,000 Rad. Hms.: 24,000 Ret. Sls.: \$90,000,000 Cap., Thes. AP G
KRKK-FM 1950	Ch. 229 (B) 93.7mc 16.5kw						
SANDPOINT							
KSPT 1949	1400 250	Bauer Bcstg. Co. Sandpoint 555	KBS Continental	Norman E. Bauer, p, gm, pmm & sd	Watt Moreland Jr., pd Wm. R. Frey, ce & pd Jack Quinn, cm	Ione Rossmiller, wd Tom Brackney, fd	Pop.: 18,000 Rad. Hms.: 5,250 Ret. Sls.: \$24,000,000 St. UP WE

Data corrected to Dec. 10, 1953. If executives or services for FM are same as AM affiliate names are not repeated. Market Data supplied by stations.
 FM's in italic. *—Non-Commercial Station. CP—Construction Permit issued. D—Day. DA-N—Directional Antenna, night only. DA-1—Directional Antenna, pattern day and night. DA-2—Directional Antenna, different pattern day and night. L—Limited Time with Dominant Station. LS—Local Sunset. N—Night.
 SA—Special Authorization. SH—Specified Hours. ST—Share Time. Complete key to abbreviations, page 6.

TWIN FALLS

Table listing radio stations in Twin Falls, Idaho, including call letters, frequencies, owners, and technical details.

WALLACE

Table listing radio stations in Wallace, Idaho, including call letters, frequencies, owners, and technical details.

WEISER

Table listing radio stations in Weiser, Idaho, including call letters, frequencies, owners, and technical details.

ILLINOIS

MARKET DATA BY COUNTIES

Large table with 6 columns: County, Population 1950, Radio Families 1953, Retail Sales 1952(000), Food Sales 1952(000), Drug Sales 1952(000), Automobile Ownership 1952. Includes a total row and a note about population 1950 census data.

ILLINOIS

City	Call Letters Established TV Affiliate	Chan. or Freq. Power	Licensee Headquarters Telephone	Network Represent- ative	Owner o; Pres. p; Exec. up evp; Gen. Mgr. gm; Sta. Mgr. sm; Coml. Mgr. cm; Sales Mgr. slm; Prog. Dir. pd; Chief Eng. ce; Prom. Mgr. pmm; Prod. Mgr. pdm; News, Farm, Sports or Women's Dir. nd, fd, sd, wd.	Executive Abbreviations	Market Data For Primary Area (Supplied by station)	Library, News Serv. Transmitter
ALTON								
	WOKZ 1948	1570 1,000-D	WOKZ Inc. Hotel Stratford 3-5506	Edward N. Palen, p & gm	W. Eccles Huff, asst. gm, cm & pmm Clyde Wiseman, pd & sd Ben Ruyle, ce	Pop.: 1,500,000	St. UP Col.
AURORA								
	WMRO 1938	1280 250-D	WMRO Inc. 184 S. River St. 4215		Martin O'Brien, o & m Vincent G. Cofey, cm J. M. Doran, pd	John R. Kitner, ce Jim O'Brien, pmm & nd	Bill Randalls, fd Bob Lauer, sd	L-W INS RCA
BELLEVILLE								
	WIBV 1947	1060 250-D	Belleville Bcstg. Co. 2100 W. Main Belleville 5000 Indie	John W. Lewis Jr., p & treas. Clarence J. Keller, cm & pmm	William C. Bailey, pd Marvin M. Mollring, ce Edward Hutchins, nd	Jos. Wesley, fd & sd Ruth Schaefer, wd	Pop.: 1,250,000 Rad. Hms.: 300,000 Ret. Sis.: \$15,000,000 AP G
BLOOMINGTON								
	WJBC 1924	1230 250	Bloomington Bcstg. Corp. 209 E. Washington 5281	ABC Rambeau	Loring C. Merwin, p Warner C. Tidemann, gm	Harry B. Swift, cm Fred Muxfeld, pd Fred L. Bailey, ce	Keith Bright, nd Phil Cole, sd	Pop.: 694,000 Rad. Hms.: 204,950 Ret. Sis.: \$783,000,000 Thes., Wid. UP RCA
	WJBC-FM 1947	Ch. 268 (B) 101.5mc 15.5kw						
CAIRO								
	WKRO 1942	1490 250	Oscar C. Hirsch P. O. Box 311 1490	MBS Pearson	Oscar C. Hirsch, p & ce	Merrill C. Currier, gm & cm	 Col.
CANTON								
	WBYS 1947	1560 250-D	Fulton County Bcstg. Co. E. Linn Limits 1877	KBS	Dale S. Phares, o & gm Gene Mayall, cm	Jerry Bidle, pd, nd & fd Henry Meyers, pmm	Vernon LaBrayere, ce & sd Pernila Junell, wd	Pop.: 60,000 Rad. Hms.: 16,000 Ret. Sis.: \$50,000,000 Wid. AP G
	WBYS-FM 1948	Ch. 265 (A) 100.9mc 0.65kw						
CARBONDALE								
	WCIL 1946	1020 1,000-D	Southern Illinois Bcstg. Partner- ship 218 W. Main 167	Paul F. McRoy, p, gm, pd & ce	Walter C. Schafer, cm Roy Freeman, fd	Pop.: 992,100 Rad. Hms.: 273,380	Thes. AP Col.
CARMI								
	WROY 1948	1460 1,000-D	Carmi Bcstg. Co. 101 S. Walnut 4161	KBS, Abe Lincoln Sears & Ayer	Roy Clippinger, p Howard M. Reedy, gm & nd	Jack Weidemann, cm Bill Baker, pd, fd & sd	John Greenwood, ce Betty Hillyard, wd	Pop.: 368,696 Rad. Hms.: 102,050 Ret. Sis.: \$301,247,807 L-W, SES. UP Col. L-W, SES. UP G
	WROY-FM 1950	Ch. 247 (B) 97.3mc 11.2kw						
CARTHAGE								
	WCAZ 1921	990 1,000-D	Superior Bcstg. Service 502 Wabash Ave. 520		Zola N. Compton, p			
CENTRALIA								
	WCNT 1946	1210 1,000-D	Southern Ill. Bcstg. Corp. Box 428 5151	KBS	Carson W. Rogers, p Merle G. Rogers, gm	Don Brown, pmm C. G. Swanzy, ce	Jack Holt, nd Ted W. Atwood, sd	Pop.: 390,000 Rad. Hms.: 100,000 Ret. Sis.: \$220,000,000 St. UP G Pop.: 110,000 Rad. Hms.: 36,650 Ret. Sis.: \$98,000,000 Thes., St. UP RCA
	WCNT-FM 1948	Ch. 243 (B) 96.5mc 3kw						
CHAMPAIGN								
	WDWS 1937	1400 250	The Champaign News-Gazette Inc. 48 Main St. 6-1855	CBS Meeker	J. A. McDermott, gm	Larry Stewart, cm & pd	Robert Brown, ce	Pop.: 467,000 Rad. Hms.: 115,000 Ret. Sis.: \$500,000,000 Wid. UP GE
	WDWS-FM 1949	Ch. 248 (B) 97.5mc 27kw						
CHICAGO								
	WAAF 1922	950 1,000-D	Corn Belt Publishers 221 N. LaSalle St. Randolph 6-1932 Rambeau	Ward A. Neff, p W. E. Hutchinson, vp Thomas L. Davis, sm & cm	William Bauer, pd & nd	Carl Ulrich, ce Mike Rapchak, sd	Pop.: 7,000,000 Rad. Hms.: 2,000,000 St. UP RCA
	WAAF-FM 1950	Ch. 230 (B) 93.9mc 28kw						
	WAIT 1941	820 5,000-D	Radio Station WAIT 75 E. Wacker Dr. Franklin 2-0660	Gene T. Dyer, p Stanley Matos, cm	Earl Withrow, gm Rosemary Stinson, pd	E. W. Jacker, ce	St. UP

Data corrected to Dec. 10, 1953. If executives or services for FM are same as AM affiliate names are not repeated. Market Data supplied by stations.
 FM's in italic. *—Non-Commercial Station. CP—Construction Permit issued. D—Day. DA—N—Directional Antenna, night only. DA-1—Directional Antenna, same pattern day and night. DA-2—Directional Antenna, different pattern day and night. L—Limited Time with Dominant Station. LS—Local Sunset. N—Night. SA—Special Authorization. SH—Specified Hours. ST—Share Time. Complete key to abbreviations, page 6.

CHICAGO—(Continued)

WBBM 1923 WBBM-TV	780 50,000	Columbia Bcstg. System Inc. 410 N. Michigan Ave. Whitehall 4-8000	CBS	H. Leslie Atlass, vp & gm E. H. Shomo, asst. gm William F. Miller, cm	Al Bland, pd	C. W. Doebler, pmm J. F. Novy, ce Bill Garry, nd Bill Oliver, fd John Harrington, sd Virginia Renaud, wd	Pop.: 2,994,350 Rad. Hms.: 2,852,630 Ret. Sis.: \$11,988,340,500	Assoc. AP, UP WH
WBBM-FM 1940	Ch. 242 (B) 96.3mc 10.5kw							
WCBD 1947	820 5,000-SH	(See Zion listing)						
WCFL 1926	1,000 50,000 DA-2	Chicago Fed. of Labor 688 Lake Shore Dr. Mohawk 4-2400	ABC Bolling	Arthur R. Harre, p & gm Marty Hogan, cm	Robert Platt, pd Charles E. Willett, ce	Victor Barnes, nd Joe Boland, sd		St. UP RCA
WCRW 1926	1240 100-SH	Clinton R. White 2756 Pine Grove Ave. Eastgate 7-6860		Clinton R. White, o & ce	J. A. White, gm	Vince Garrity, sd		
WEDC 1926	1240 250-SH	Emil Denmark Inc. 3860 W. Ogden Ave. Crawford 7-4100		Emil Denmark, p Frank J. Kotnour, gm & cm Bill Mack, pd, pmm & nd	Gene Thede, ce William P. Brady, mus. d	Tony Ventrella, sd Serena Notari, wd	Pop.: 3,000,000	UP RCA
WFBM(FM) 1940	Ch. 258 (B) 99.5mc 30kw	Zenith Radio Corp. 6601 W. Dickens Berkshire 7-7500		Cmdr. E. F. McDonald Jr., p.	Ted Lettzell, gm Violet Kmety, pd	Ross Utter, ce		SES., Thes., St. Zenith
WENR 1925 WBKB(TV)	890 50,000 ST-WLS	American Bcstg.-Paramount Theatres Inc. 20 N. Wacker Dr. Andover 3-0800	ABC Blair	Sterling Quinlan, gm Edward Lynch, cm	Maurice Murray, pd Ell Henry, pmm	William Kusak, ce Con O'Dea, nd & sd	Pop.: 2,955,800 Rad. Hms.: 2,847,740 Ret. Sis.: \$9,500,000,000	AP, UP RCA
WENR-FM 1948	Ch. 234 (B) 94.7mc 25kw						Pop.: 5,500,000 Rad. Hms.: 1,670,000 Ret. Sis.: \$6,945,000	St. AP, INS RCA
WFMF(FM) 1944	Ch. 262 (A) 100.3mc 33kw	WFMF Inc. 230 N. Michigan Ave. Franklin 2-3885		Harry Berg, gm & ce	Terry Miller, pd			RCA, Cap., St., Wid. UP WH
WFMT(FM) 1951	Ch. 254 (B) 98.7mc 34kw	Gale Bcstg. Inc. 4000 Wash. Blvd. Nevada 2-2240		Bernard Jacobs, p, gm & cm	Norman Pellegrini, pd Rita Jacobs, asst. m	Michael Nichols, asst. pd	Pop.: 4,600,000	GE Assoc. UP WE
WGES 1924	1390 5,000 DA-2	Radio Station WGES 2708 Wash. Blvd. Sacramento 2-1700		John A. Dyer, p & gm Elizabeth M. Hinzman, cm	Herbert Rudolph, pd K. P. Freda, pmm	William A. Shunk, ce		
WGN 1924 WGN-TV	720 50,000	WGN Inc. 441 N. Michigan Ave. Superior 7-0100	MBS Hollingbery	Col. Robert R. McCormick, p Frank P. Schreiber, gm Wm. A. McGuineas, cm	Bruce Dennis, pd Charles A. Wilson, pmm Carl J. Meyers, ce James Hanlon, pub. d	Spencer Allen, nd Jack Brickhouse, sd Norman Kraeft, fd Myrtle Stahl, educ. d	Pop.: 11,986,020 Rad. Hms.: 3,483,260	St. AP, UP

94% of Illinois' Retail Sales
92% of Illinois' Food Store Sales
94% of Illinois' Drug Store Sales
98% of Illinois' General Merchandise Store Sales
93% of Illinois' Household Product Sales
92% of Illinois' Automotive Sales

in

WGN's Coverage Area

WGN . . . reaching more homes per week than any other Chicago station.

Sales Management Survey of Buying Power

Nielsen Coverage Service

A Clear Channel Station
Serving the Middle West

MBS



Chicago 11
Illinois
50,000 Watts
720
On Your Dial



Chicago Office: 441 N. Michigan Ave., Chicago 11
Eastern Sales Office: 220 E. 42nd Street, New York 17, N. Y. for New York City, Philadelphia and Boston
Geo. P. Hollingsbery Co.
Advertising Solicitors for All Other Cities
Los Angeles—411 W. 5th Street • New York—500 5th Avenue • Atlanta—223 Peachtree Street
Chicago—307 N. Michigan Avenue • San Francisco—625 Market Street

ILLINOIS

City	Call Letters Established TV Affiliate	Chan. or Freq. Power	Licensee Headquarters Telephone	Network Represent- ative	Owner o; Pres. p; Exec. cm; Sales Mgr. slm; Prog. Dir. pd; Chief Eng. ce; Prod. Mgr. pdm; News, Farm. Sports or Women's Dir. nd, fd, sd, wd.	Executive Abbreviations up evp; Gen. Mgr. gm; Sta. Mgr. sm; Coml. Mgr. mgr. Prom. Mgr. pmm; Chief Eng. ce; Chief Mgr. cm; Chief Sales Mgr. slm; Chief Production Mgr. pdm; News, Farm. Sports or Women's Dir. nd, fd, sd, wd.	Market Data For Primary Area (Supplied by station)	Library, News Serv. Transmitter	
CHICAGO—(Cont'd)									
WHFC	1450	250	WHFC 3350 S. Kedzie Townhall 3-6305						
WEHS-TV	Ch. 250 (A)	99.7mc 21kw	(WHFC, Am Affiliate)						
WIND	560	5,000	WIND Inc. 400 N. Michigan Ave. Whitehall 4-2170 A.M. Radio Sl.	Ralph L. Atlass, p & gm John T. Carey, cm	H. Leslie Atlass Jr., pd Robert Peel, pmm	Kenneth Shirk, ce James Dale, nd Bert Wilson, sd	Pop.: 9,537,975 Rad. Hms.: 2,884,070 Ret. Sl.: \$9,876,730,000	St. AP, UP RCA
WJJD	1160	50,000-L DA-1	Plough Bcstg. Co. Inc. 230 N. Michigan Ave. State 2-5466 Radio-TV Reps.	Abe Plough, p & o Frederick G. Harm, vp, gm & pd Louis (Tex) Frankel, sls. adm.	Robert W. Ward, cm Walter Myers, ce Ralph Blank, mus. d Carl Warner, nd	Ed Short, sd Randy Blake, fd Rosemary Wayne, wd	Pop.: 11,000,000 Rad. Hms.: 3,675,000	Thes. Wid., St. Cap. UP RCA
WLS	890	50,000 ST-WENR	Agricultural Bcstg. Co. 1230 W. Washington Blvd. Monroe 6-9700	ABC Blair	James E. Edwards, p Glenn Snyder, gm Charles M. Freeman, cm	Harold Safford, pd Betty G. Howard, pmm	Thomas Rowe, ce William Small, nd	Rad.: Hms.: 2,404,840	St. AP, UP RCA
WMAQ	670	50,000	National Bcstg. Co. Merchandise Mart Superior 7-8300	NBC NBC Spot Sales	Sylvester L. Weaver Jr., p (NBC) Robert W. Sarnoff, evp (NBC) Harry C. Kopf, vp & gm Charles Dresser, sls. d	Rudi Neubauer, cm George Heinemann, pd John Keys, pmm Howard C. Luttgens, ce Jules Herbuveaux, asst. gm	Neil Murphy, cont. John F. Whalley, d. of opers. William Ray, nd John Erp, sd Everett Mitchell, fd Judith Waller, wd	Pop.: 9,217,100 Rad. Hms.: 2,524,000 Ret. Sl.: \$9,059,100,000	Thes. AP, UP, INS WH
WMAQ-FM	Ch. 266 (B)	101.1mc 24kw						Pop.: 7,406,000 Rad. Hms.: 2,200,000 Ret. Sl.: \$9,206,611,000	Thes. AP, UP, INS RCA
*WBMI	1110	5,000-L	The Moody Bible Institute of Chicago 153 Institute Pl. Michigan 2-1570	Dr. Wm. Culbertson, p L. E. Johnson, cont. H. C. Crowell, evp R. L. Constable, gm	Robert H. Parsons, pd John H. Raymond, pmm	A. Paul Frye, ce Don Turner, nd Frances Youngren, wd	Pop.: 4,000,000	Wid. UP RCA
WSBC	1240	250-SH	WSBC 2400 W. Madison St. Monroe 6-9060 Stars National	Robert O. Miller, gm & pd	Julius Miller, cm	Mary V. Baker, wd	Pop.: 4,000,000	
WSEL(FM)	Ch. 282 (B)	104.3mc 40kw	Chicago Skyway Bcstg. Co. 188 W. Randolph St. Andover 3-6767	William Irvin, p D. Irvin, gm & pd	Richard W. Phillips, cm	Robert Boyd, ce	Pop.: 5,000,000	St. WE

Data corrected to Dec. 10, 1953. If executives or services for FM are same as AM affiliate names are not repeated. Market Data supplied by stations. FM's in italic. *—Non-Commercial Station. CP—Construction Permit issued. D—Day. DA-N—Directional Antenna, night only. DA-1—Directional Antenna, same pattern day and night. DA-2—Directional Antenna, different pattern day and night. L—Limited Time with Dominant Station. LS—Local Sunset. N—Night. SA—Special Authorization. SH—Specified Hours. ST—Share Time. Complete key to abbreviations, page 6.

DECATUR...

... IS THIS KIND OF COMMUNITY. IN 1953 the generous folks of Decatur voluntarily subscribed over \$300,000 for a new Science Hall at James Millikin University and nearly \$1,200,000 for expansion of the Decatur and Macon County Hospital. In addition the franchised voters of Decatur by referendum approved a \$4,200,000 sewer modernization project and they voted \$7,200,000 to provide new buildings for the Decatur Public Schools. BECAUSE DECATUR IS THIS KIND OF COMMUNITY, because it has had the foresight to provide these facilities, tremendous new industrial expansion has been announced for Decatur since June 12, 1953. The Caterpillar Tractor Company will spend \$45,000,000 for a new plant that will employ 3,000 people. The Marvel-Schebler Products division of the Borg-Warner Corporation is expanding their plant to employ another 1,200 workers. Lincoln Laboratories has bought a new 162 acre

plant site, the Decatur General Electric Plastic plant is adding 17,000 square feet to their plant. The A. E. Staley Company announces a start date for a new \$1,000,000 feed-mixing mill. Morgan Sash & Door Co. and Illinois Bell Telephone Co. are building new warehouses and the Irwin-Neisler pharmaceutical manufacturing firm has a new \$250,000 plant under construction. And the Wabash Railroad has purchased a 227 acre industrial tract and is now working with a number of new industries which contemplate coming to Decatur. WSOY is proud of this community and market, and proud to be a part of it. WSOY has been a Decatur station since 1925.

The ONLY way you can reach this market is with WSOY, your CBS station. Consistently WSOY has almost 50% of the available audience. WSOY, and only WSOY, gives you both circulation and high ratings

WSOY

THE SOYBEAN CAPITAL OF THE WORLD

ILLINOIS BROADCASTING COMPANY

CBS

DECATUR, ILLINOIS

WSOY-FM

REPRESENTED NATIONALLY BY WEED & COMPANY

CHICAGO HEIGHTS

WCHI(FM) Ch. 240 (A) Chicago Hts. Bcstg. Co. Continental Anthony Santucci, p, Henry E. Burns, cm Joseph Perez, sd Pop.: 400,000
 1950 95.9mc 164 E. 232 St. gm & ce & pd Rad. Hms.: 97,000
 0.255kw Skyline 5-7448 GE

CICERO

WHFC 1450 (See Chicago listing)
 1926 250

CLINTON

WHOW 1520 Cornbelt Bcstg. Abe J. R. Livesay, p Jim Williams, cm Bill Ward, nd & sd
 1947 1,000-D Co. Lincoln Roland O. Looper, vp, Frank C. Jennings, sd John Barton, fd
 401½ S. Side Sq. Net. gm & ce pd & secy-treas. RCA
 305 Holman

DANVILLE

WDAN 1490 Northwestern CBS Robert J. Borow, gm, Honore Ronan, pd & Max Shaffer, sd & sp. Pop.: 183,240
 1938 250 Pub. Co. Everett-McKinney cm & pmm wd Theodora Magin, ce Rad. Hms.: 43,417
 WDAN-TV 1700 events d Ret. Sis.: \$115,000,000 AP
 RCA

WITY 980 Vermillion Bcstg. G. E. Metzger, p Ward White, cm Max Winter, nd & fd Pop.: 894,800
 1953 1,000 Corp. F. A. Higgins, gm Ken Early, pd Elzer Marks, sd Rad. Hms.: 212,515
 DA-1 Box 551 & pmm Jack Brookhank, ce Fran Early, wd Ret. Sis.: \$932,119,000

DECATUR

WDZ 1050 WDZ Bcstg. Co. Charles C. Caley, p William F. Miller, pd A. James Ebel, ce Rad. Hms.: 111,517 Wids.,
 1921 1,000-D 265 S. Park St. Frank C. Schroeder Jr., vp & gm & nd Russell W. Pierce, fd Theas.
 3-9744 Peters Howard G. Bill, cm James L. Wood, sd UP
 Nancy Norman, wd G

WSOY 1340 Ill. Bcstg. Co. F. W. Schaub, p Eugene D. Dorsey, pd Tom Schoendienst, sd Rad. Hms.: 38,000 L-W, Cap.
 1925 250 Route 48 at N. Weed Merrill Lindsay, gm Allan N. Doyle, ce Carol Tuschhoff, wd AP
 Jasper St. Charles F. Bruce, cm & pmm Al Rowe, nd G

WSOY-FM Ch. 271 (B) St., Cole
 1946 102.1mc 31kw RCA AP

DEKALB

WLBK 1360 DeKalb Radio George C. Biggar, p Robert Zirk, ce Pop.: 1,345,264 Cap.
 1947 500-D Studios Inc. gm & fd Lois Montgomery, continuity ed. & wd Rad. Hms.: 382,428 AP
 153½ N. 3d St. Richard Meier, cm Herb Carroll, nd & sd Ret. Sis.: \$1,473,399,000
 2877 R. C. Brown, pd & pmm

DIXON

WSDR 1240 (See Sterling listing)
 1949 100

DU QUION

WDQN 1580 Leonard M. & Leonard F. Best Leonard M. Johnson, Raymond Steele, cm Philip Richardson, nd Pop.: 116,000
 1951 250 Johnson co-o & pmm Catherine Johnson, pd Bob Armstrong, sd Rad. Hms.: 25,000
 30½ W. Main St. Leonard F. Johnson, co-o & gm Julian Emlen, ce UP
 1399 G

EAST ST. LOUIS

WTMV 1490 On The Air Inc. Alvin Eads, p E. W. Willrich, pmm Dan Stengel, nd Pop.: 1,681,447
 1935 250 Broadview Hotel Sears & Ayer F. J. Prendergast, gm Erle White, ce Neil Norman, sd Rad. Hms.: 502,448
 Bridge 4625 R. S. Holcomb, pd Martin L. Leich, oper. m Byron Scott, fd UP
 Thelma Currat, wd Ret. Sis.: \$1,555,300,000 RCA

EFFINGHAM

WCRA 1090 Effingham Bcstg. Co. Joseph McNaughton, Jack Armel, gm, cm, Geo. Kregotis, ce Cap.
 1947 250-D 110 N. Banker St. p Curt Brady, pd Zona B. Davis, nd UP
 1090 G



AM • FM

ADVERTISERS
 pay only 1.7 cents
 PER THOUSAND listening RADIOS
 in the ROCKFORD, ILLINOIS area

918,646 RADIOS ARE IN DAILY USE IN THIS AREA

A
 MILLION
 DOLLAR
 MARKET
 Nat'l Reps.
 H-R

ILLINOIS

City	Call Letters Established TV Affiliate	Chan. or Freq. Power	Licensee Headquarters Telephone	Network Represent- ative	Owner o; Pres. p; Exec. vp e; Gen. Mgr. gm; Sta. Mgr. sm; Coml. Mgr. cm; Sales Mgr. slm; Prog. Dir. pd; Chief Eng. ce; Prom. Mgr. pmm; Prod. Mgr. pdm; News, Farm, Sports or Women's Dir. nd, fd, sd, wd.	Executive Abbreviations	Market Data For Primary Area (Supplied by station)	Library, News Serv. Transmitter
ELGIN								
WRMN 1949	1410 500-D	Elgin Bcstg. Co. Fox Hotel 7700 McGillvra	J. Richard Sutter, p, gm & cm John Mason, pd & pmm	George Merker, ce & fd Phyllis Warner, nd	Ron Miller, sd Fern Samples, wd	Pop.: 960,000 Rad. Hms.: 260,000 Ret. Sls.: \$60,000,000	L-W UP
ELMWOOD PARK								
WLEY(FM) 1947	Ch. 296 (A) 107.1mc 0.95kw	Elmwood Park Bcstg. 2526 N. Harlem Ave. Tuxedo 9-1133	Zeb Zarnecki, p & gm Robert Brandt, cm	W. Corvine, pd	William Kemnitz, ce	Pop.: 2,500,000 Rad. Hms.: 300,000	SES. GE
EVANSTON								
WEAW (CP)	1330 500-D DA-D
WEAW (FM) 1947	Ch. 286 (B) 105.1mc 36kw	North Shore Bcstg. Co. 2425 Main St. University 4-4606 Sears & Ayer	Edward A. Wheeler, p & gm	J. Collins, cm Robert Conrad, pd	August Sparo, ce	Pop.: 4,100,000 Rad. Hms.: 2,000,000	Wld. UP Col.
WNMP 1947	1590 1000-D	Evanston Bcstg. Co. 2201 Oakton St. Greenleaf 5-1590	Fred Newton, p Angus D. Pfaff, vp, gm & cm	James M. MacTaggart, treas. John Horton, pdm & nd	Albert Griffin, ce Joyce Kaye, wd	Pop.: 3,000,000	Cap. INS
FAIRFIELD								
WFIW 1953	1390 500-D	Wayne County Bcstg. Co. P. O. Box 148 Fairfield 2159	Thomas S. Land, co-o, gm & fd	Bryan Davidson, co-o, asst. m, pd & ce Dick Berry, nd	Garnet Williams, cm & sd Irene Murphy, wd	Pop.: 189,757 Rad. Hms.: 58,112 Ret. Sls.: \$168,911,000
FREEPORT								
WFRL 1947	1570 1,000-D	Freeport Bcstg. Co. Inc. 9 N. Chicago Ave. State 436 Sears & Ayer	Vincent S. Baker, p, gm & ce	Dave Taylor, cm & pmm	Ralph Reynolds, pd	Pop.: 399,828 Rad. Hms.: 120,129 Ret. Sls.: \$467,946,000 AP
GALESBURG								
WGIL 1936	1400 250	Galesburg Bcstg. Co. 312 Hill Arcade Bldg. 4626	Midwest, Rambeau	Mrs. O. N. Custer, p Robert W. Frudeger, gm & vp Roger Hoffman, cm	George F. Thoma, pd Capps Sutherland, pmm Howard Frederick, ce	David Loring, nd Bob Dixon, sd A. R. Kemp, fd	Pop.: 200,000 Rad. Hms.: 98.6% Ret. Sls.: \$68,000,000	Cap. AP Col.
HARRISBURG								
WEBQ 1923	1240 250	Harrisburg Bcstg. Co. 100 E. Poplar St. Harrisburg 2-8	KBS	Inglis M. Taylor, gm & cm Dorice Turner, pd	Ken Hamilton, pmm & sd Elmer Gladson, ce	Earl Killman, nd Eddie Wise, fd Norma Slaton, wd	Pop.: 500,000 Rad. Hms.: 165,000 UP WE
WEBQ-FM 1947	Ch. 260 (B) 99.9mc 4.2kw UP Fed.
HERRIN								
WJPF 1940	1340 250	O. W. Lyerla P. O. Box 179 381	MBS, KBS, Pearson	O. W. Lyerla, p Charles R. Cook, gm & cm	Louise Piantanida, pd Ben E. Orf, ce	Chet Townsend, nd & sd	Pop.: 157,114 Rad. Hms.: 47,043 Ret. Sls.: \$122,016,000	L-W UP RCA
JACKSONVILLE								
WLDS 1941	1180 1,000-D	Jacksonville Radio & Tv Bcstg. Corp. Ill. Theatre Bldg. 1180 Holman	Robert A. Fay, p R. Karl Baker, vp, gm, cm & pmm T. J. Fairburn, pd & nd	G. J. Cassens, ce William L. Fay, secy.- treas.	Barney Lewis, sd E. Garlich, fd Jo Caldwell, wd	Pop.: 752,400 Rad. Hms.: 231,650 Ret. Sls.: \$820,573,000	Thes. AP G
WLDS-FM 1941	Ch. 263 (B) 100.5mc 9kw	Wld. AP G
JOLIET								
WJOL 1924 WJOL-TV	1340 250	Joliet Bcstg. Co. 601 Walnut St. Joliet 4761	Willard Erwin Jr., o Joseph J. Garvey, gm Richard Leidig, cm Eileen Caron, pd	Marion W. Philbin, pmm Les DeCosta, ce Glen Logan, nd	Bob Philbin, sd Wayne Churchill, fd Lois Zarley, wd	Pop.: 180,000 Rad. Hms.: 52,000 Ret. Sls.: \$200,000,000	Thes. UP
KANKAKEE								
WKAN 1946	1320 1,000-D	Kankakee Daily Journal Co. 183 N. Schuyler Ave. 3-6633 Sears & Ayer	Leslie C. Small, p Burrell L. Small, gm Bruce Brown, sm	Robert J. Hawkins, asst. sm Orren Allain, pd & sd	Monty Moncrieff, slm Richard Eckels, ce James Preston, nd	Wld. AP Ray.
KEWANEE								
WKEI 1952	1450 100	Kee Bcstg. Co. 207 Baker Bldg. 4471 Best	E. D. Scandrett, p, gm & ce Paul Messplay, pd	L. S. Mohnen, fd Phillip Miler, sd	Bert Jackson, nd Roberta Farrell, wd	Pop.: 80,000 Rad. Hms.: 20,000 Ret. Sls.: \$500,000	L-W AP Col.
LA GRANGE								
WTAQ 1950	1300 500-D	La Grange Bcstg. Co. Box 408 Fleetwood 2-1300	Russ Salter, co-o & gm Charles Sebastian, co-o	Ralph Faucher, cm & sd	Vincent Essig, pd & nd William Wardle, ce	Pop.: 5,000,000 Col.
LA SALLE								
WLPO 1947	1220 250-D	La Salle County Bcstg. Corp. P. O. Box 215 La Salle 3100	Peter Miller, p William Holm, gm & cm	Donald Frost, pd & fd Lawrence McCann, ce Laverne Waltman, nd	Skip Erwin, sd Lura Marie, wd	Pop.: 221,010 Rad. Hms.: 65,920 Ret. Sls.: \$269,718,000	Thes. AP G
LINCOLN								
WPRC 1951	1370 500-D	Prairie Radio Corp. P. O. Box 37 1370 Rambeau	Ray F. Knochel, p & gm Lee N. Hamm, sls. vp Saunders A. Devine, cm	William Brady, pd & nd John H. Deal, prom. d Donald E. Thompson, ce	Earle W. Layman, sd John E. Clark, fd Mimi Gordon, wd	Pop.: 666,200 Rad. Hms.: 208,150 Ret. Sls.: \$784,900,000	L-W AP Col.

Data corrected to Dec. 10, 1953. If executives or services for FM are same as AM affiliate names are not repeated. Market Data supplied by stations. FM's in italic. *—Non-Commercial Station. CP—Construction Permit issued. D—Day. DA-N—Directional Antenna, night only. DA-1—Directional Antenna, same pattern day and night. DA-2—Directional Antenna, different pattern day and night. L—Limited Time with Dominant Station. LS—Local Sunset. N—Night. SA—Special Authorization. SH—Specified Hours. ST—Share Time. Complete key to abbreviations, page 6.

LITCHFIELD

WSMI 1540 Mid-Illinois Hayward L. Talley, p, Clark O. Whitman, slm Orin Coddington, pmm Pop.: 394,127
 1950 1,000-D Bcstg. Co. Best gm & ce Evelyn M. Smith, wd Ed Johnson, sd Ret. Slis.: \$358,757,000
 Box 72 Litchfield 100 RCA

MACOMB

WKAI 1510 Macomb Bcstg. William E. Schons, p Howard Welty, ce Donald Newberg, sd L-W
 1947 250-D Co. Allen M. Fobes, sm, Caryl Carstens, nd UP
 113 E. Carroll St. cm, pd & pmm G
 1350

MARION

WGGH 1150 Marion Bcstg. Co. George W. Dodds, p Ray Hatley, cm Frank Elders, nd & sd Pop.: 172,000
 1949 500-D P. O. Box 311 Sears & Orville D. Jackson, ce Don Ritter, fd & wd Rad. Hms.: 57,040 Assoc.
 824 Ayer & pmm G

MATTOON

WLBH 1170 Mattoon Bcstg. Abe J. R. Livesay, p & gm Robert Guess, pd & nd Howard Miller, fd Pop.: 500,000
 1948 250-D Co. Ken Wooddell, cm & Ray Livesay, ce Phyllis Knight, wd Rad. Hms.: 98.2% St.
 1632½ Broadway Net. Lincoln AP
 6464 Holman sd Dwight Bower, pmm Ray.
 WLBH-FM Ch. 245 (B) Pop.: 500,000
 1949 96.9mc 23kw Rad. Hms.: 60% AP
 G

METROPOLIS

WMOK 920 Fort Massac KBS James H. Firmin, p J. R. Wetherington, pd E. E. Hill, nd Pop.: 783,000
 1951 500-D Bcstg. Co. Indie gm & pmm Carlos Steele, ce Gilbert Webb, fd Rad. Hms.: 314,000 Thes.
 Nat'l State Bank Bldg. & sd Philip A. Roewe, cm Dixie Smith, office m Pat Kidd, wd Ret. Slis.: \$598,000,000 UP
 2106 G

MOLINE

WQUA 1230 Quad City Bcstg. ABC Dalton Lemasurier, p William J. Archer, cm Wilbur L. Mason, Pop.: 232,533
 1948 250 Corp. G. Laverne Flambo, gm Antoinette Glewwe, co-nd Frederick Hohl, co-nd Rad. Hms.: 71,986 Cap.
 1319 5th Ave. bery Benne Alter, pd Harold W. Higby, ce pmm AP
 4-6727 Col.

MT. CARMEL

WVMC 1360 Radio Station KBS Stephen P. Bellinger, Gilbert T. Wallace, pd Evelyn G. Meier, nd & Pop.: 320,000
 1948 500-D WVMC mgng. ptr., gm Eugene D. Garrett, ce Harold Richardson, fd UP
 N. Cherry St. Rd. Charles H. Green, cm G
 1360

MT. VERNON

WMIX 940 Mt. Vernon Radio John R. Mitchell, D Jim Purser, asst. m Alva Hulbert, ce Pop.: 618,160
 1947 1,000-D & Tv Co. Pearson Raymond J. Cheney, gm & sd & sd Rad. Hms.: 154,540 AP
 Radio Center 3500 gm WE
 WMIK-FM Ch. 231 (B) L-W
 1948 94.1mc 15.2kw AP
 GE

OAK PARK

WOPA 1490 Village Bcstg. Co. Egmont Sonderling, p, Martin Bouhan, pd & Sidney Schneider, ce Pop.: 2,500,000
 1950 250 408 S. Oak Park Forjoe gm, cm & pmm nd Wayne Osborne, sd Assoc.
 Village 8-5760 UP
 WOPA-FM Ch. 272 (A) St.
 1950 102.3mc 1kw RCA
 UP

OLNEY

WVLN 740 Olney Bcstg. Co. Marshall H. Poole, p Bert DeBarr, pd & nd Ed Barnes, fd Pop.: 587,615
 1947 250-D 302½ E. Main St. Holman & gm Paul Hartsey, ce Norm Lamkin, sd Rad. Hms.: 212,993 SES., St.
 WVLN-FM Ch. 225 (B) AP
 (CP) 92.9mc 18.5kw Col.

OTTAWA

WCMY 1430 Carl H. Meyer Carl H. Meyer, p & Dorothy M. Meyer, cm Sam Potter, ce Pop.: 180,000
 1952 500-D 118 W. Madison gm Wm. A. Sweda, pd, nd & fd Rad. Hms.: 41,800 SES.
 551 UP
 Ret. Slis.: \$181,000,000 G

PARIS

WPRS 1440 Paris Bcstg. Corp. Adlai C. Ferguson Jr., Carl E. Sunkel, pd & Pop.: 300,000
 1951 500-D 3-1440 p, gm, cm & pmm nd AP
 WPRS-FM Ch. 252 (A) G
 1952 98.3mc 1kw Cap.
 AP
 G

PEKIN

WSIV 1140 Pekin Bcstg. Co. W. Kenneth Patterson, George C. Udry, pmm John Myers, sd Pop.: 1,173,747
 1948 1,000-D Inc. Rambeau p & gm & ce Fearn Wilson, fd Rad. Hms.: 344,960 AP
 15 S. Capitol St. James T. Butler, cm Phil Strand, nd Mabel Delaney, wd Ret. Slis.: \$1,195,118,700 G
 3400 Robert R. Snow, pd

ILLINOIS

City	Call Letters	Chan. or Freq.	Licensee Headquarters Telephone	Network Representative	Executive Abbreviations	Market Data For Primary Area (Supplied by station)	Library, News Serv. Transmitter
Established	Power				Owner o; Pres. p; Exec. vp evp; Gen. Mgr. gm; Sta. Mgr. sm; Comd. Mgr. cm; Sales Mgr. slm; Prog. Dir. pd; Chief Eng. ce; Prom. Mgr. pmm; Prod. Mgr. pdm; News, Farm, Sports or Women's Dir. nd, fd, sd, wd.		
PEORIA							
WEEK	1350		W. Central Bcstg. Co.	NBC	Fred C. Mueller, gm	F. R. Oakley, pmm	Hank Fisher, sd
1947	1,000			Reed	Don D. Kynaston, cm, pd & sm	Wayne Lovely, ce	Sidney Baldwin, wd
WEEK-TV	DA-2		Commercial Bank Bldg. 3-3688			Phil Wilson, nd	Pop.: 500,000 Rad. Hms.: 59,900 Ret. Sis.: \$500,000,000
WIRL	1290		Illinois Valley Bcstg. Co.	ABC, MBS	Timothy W. Swain, p	Lloyd K. Harvey, pd & pmm	Paul C. Brines, asst. m
1948	5,000		115 N. Jefferson 4-9239	Avery-Knodel	Tom Gavin, gm	Rudolph T. Luukinen, ce	Ralph F. Smith, nd
WMBD	1470		WMBD Inc.	CBS	Charles C. Caley, p & gm	Robert M. Riley Jr., pmm	R. Brooks Watson, nd
1927	5,000		212 S. Jefferson 6-0711	Free & Peters	Harold V. Phillips, cm	A. James Ebel, ce	John Rayburn, sd
WMBD-FM	Ch. 224 (B)				Marvin H. Hult, pd & asst. m	Gerald W. Swank, cont.	Emil Bill, fd
1947	92.5mc				Charles Miller, asst. pd		Florence Luedeke, wd
	16kw						Pop.: 534,762 Rad. Hms.: 127,870
WPEO	1020		WPEO Inc.	John R. Livingston, p & gm	Gordon Joyner, pd & nd	Gerry DeVore, ce
1946	1,000-D		225 Main St. 4-9249	Holman	William Rogers, cm		Dick Herm, fd
WTVH	1590		Hilltop Bcstg. Co.	MBS	Hugh R. Norman, p, gm & pd	O. H. Duewall, cm	Dick Defay, nd
1946	1,000		410 Fayette St. 6-8771	Sears & Ayer		Wallace Wurz, ce	John O'Hard, sd
WTVH-TV	DA-2						Pop.: 400,000 Rad. Hms.: 125,000 Ret. Sis.: \$278,000,000
QUINCY							
WGEM	1440		Quincy Bcstg. Co.	ABC	T. C. Oakley, p	Paul J. McClelland, pd	Charlie Griffith, nd
1948	1,000		Hotel Quincy 6840	Walker	Joseph S. Bonansinga, gm	Ted Austin, pdm	Rick Weaver, sd
WGEM-TV	DA-2				James E. Muse, cm	Frank E. Laughlin, ce	Donald Brohan, fd
WGEM-FM	Ch. 286 (B)						Mary Harvey, wd
1947	105.1mc						Rad. Hms.: 80,460 Ret. Sis.: \$179,483,000
	8.9kw						Pop.: 1,080,000 Rad. Hms.: 330,270 Ret. Sis.: \$1,098,288,000

Data corrected to Dec. 10, 1953. If executives or services for FM are same as AM affiliate names are not repeated. Market Data supplied by stations. FM's in italic. *—Non-Commercial Station. CP—Construction Permit issued. D—Day. DA-N—Directional Antenna, night only. DA-1—Directional Antenna, same pattern day and night. DA-2—Directional Antenna, different pattern day and night. L—Limited Time with Dominant Station. LS—Local Sunset. N—Night. SA—Special Authorization. SH—Specified Hours. ST—Share Time. Complete key to abbreviations, page 6.

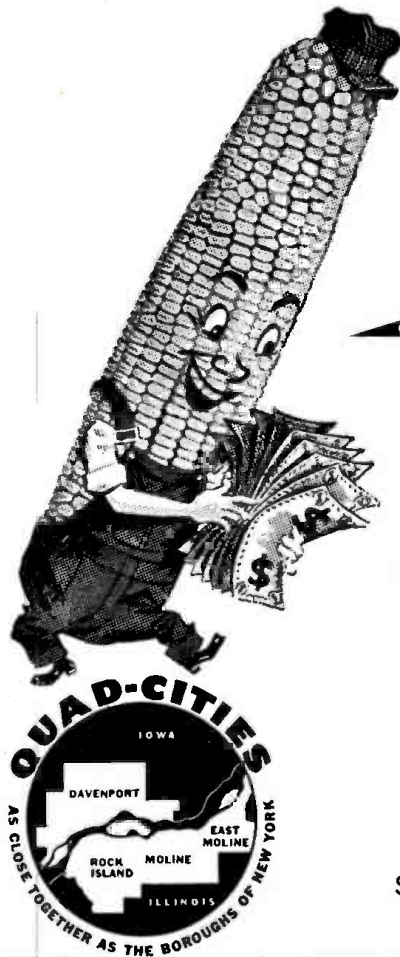

In the 10 Iowa-Illinois Counties circling the Quad-Cities there are:

21,220 FARMS

with an average acreage of

160 ACRES per FARM

and a gross cash farm income of

\$14,400 per FARM

- Three of these counties were among the nation's top ten for hog raising
- Four of these counties were among the nation's 100 leading counties in Gross Cash Farm Income.
- And in all 10 counties that circle the Quad-Cities the farmers who live there averaged over \$14,000 a year income.
- Huge acreages of grain and hay crops as well as top production of cattle, hogs, and sheep bring in the money.

Figures from Sales Management and U. S. Census

Quad-Cities' favorite

WHBF AM FM TV

TELCO BUILDING, ROCK ISLAND, ILLINOIS

Represented by Avery-Knodel, Inc.

SELL THIS GOOD QUAD-CITY FARM MARKET WITH

WTAD 1927	930 5,000-D 1,000-N DA-N	Lee Bcstg. Inc. W. C. U. Bldg. 8200	CBS Weed	Lee P. Loomis, p Walter Rothschild, gm & nat'l. slm John DeBow, cm Merritt Milligan, pd & asst. m	Gene Terry, pmm J. E. Gray, ce Wayne Cribb, asst. nat'l. slm Ralph Lewis, pdm	Don Nicholson, nd Dick Faier, fd Bill Crews, sd Marion Sexton Milligan, wd	St. AP, UP G	
WTAD-FM 1948	Ch. 258 (B) 99.5mc 27kw					 RCA	
ROCKFORD								
WBEL 1948		(See Beloit, Wis. listing)						
WROK 1929	1440 1,000-D 500-N	Rockford Bcstrs. Inc. News Tower 2-8621	ABC H-R Reps.	E. K. Todd, p Walter M. Koessler, gm John J. Dixon, cm	Maurice P. Owens, pd & sd Maurice Nelson, ce Betty L. Thro, pmm	Bob Edell, nd Don Bowton, fd Florence Shugars, wd	Pop.: 460,965 Rad. Hms.: 98.4% Ret. Sl.: \$449,822,000 Thes. AP RCA	
WROK-FM 1949	Ch. 243 (B) 97.5mc 16kw							
WRRR (CP)	1330 1,000-D DA-D	Rock River Bcstg. Co. 113 S. Court St. 8-2263	Boyd Phelps, vp & gm Dick Wells, cm John Rhodes, pd	H. Georgeann Stemler, pmm Marvin Moberly, ce	Mike Simon, nd		
ROCK ISLAND								
WHBF 1925	1270 5,000 DA-N	Rock Island Bcstg. Co. Telco Bldg. Rock Island 6-5441	CBS Avery- Knodel	Ben H. Potter, p Leslie C. Johnson, gm Maurice Corken, asst. gm Ted Arnold, slm	Frank Hicks Jr., prog. m & sd Fern Hawks, pmm	Robert J. Sinnett, ce William E. Ellison, nd Paul Liggitt, news & sp. events d	Pop.: 513,800 Rad. Hms.: 150,460 Ret. Sl.: \$617,059,000 Wid. UP Col	
WHBF-FM 1947	Ch. 255 (B) 98.9mc 37kw						Wid. UP WE	
SPRINGFIELD								
WCVS 1924	1450 250	WCBS Inc. 523 E. Capitol Ave. 9855	MBS Sears & Ayer	Harold L. Dewing, p C. W. Neeld, gm, cm & pmm John Geil, pd	Richard L. Ashenfelter, ce James H. Mitchell, nd & sd	Kenneth E. Spengler, fd Miriam Hill, wd	Pop.: 412,000 Rad. Hms.: 71,190 Ret. Sl.: \$180,000,000 Wid. AP RCA	

IN

Springfield, Illinois

WCVS

SPRINGFIELD'S FIRST IN PROMOTION AND MERCHANDISING
(Proven by 8 National Contest Awards)

Affiliated with ABC and MBS ❖ Sears & Ayer - Nat'l. Reps.

ILLINOIS

City	Call Letters Established	Chan. or Freq. Power	Licensee Headquarters Telephone	Network Representative	Owner o; Pres. p; Exec. up evp; Gen. Mgr. gm; Sta. Mgr. sm; Coml. Mgr. cm; Sales Mgr. slm; Prog. Dir. pd; Chief Eng. ce; Prom. Mgr. pmm; Prod. Mgr. pdm; News, Farm, Sports or Women's Dir. nd, fd, sd, wd.	Executive Abbreviations	Market Data For Primary Area (Supplied by station)	Library, News Serv. Transmitter
SPRINGFIELD—(Continued)								
WMAV	1950	970 1,000-D 500-N DA-2	Lincoln Bcstg. Co. Inc. 711 Myers Bldg. 6963	NBC Pearson	Gordon Sherman, p, gm & cm Syl Binklin, pd	Mel Kampe, pmm Melvin Feldman, ce Robert Brown, nd	Bernie Waterman, sd Peggy Irving, wd	Thes. UP RCA
WTAX	1930	1240 250	WTAX Inc. US 66 & E. Cook St. 2-4441	CBS Weed	Oliver J. Keller, p & gm O. J. Keller Jr., cm John W. Midgley, pd	Bill Miller, pmm E. C. Swaringen, ce Glen Farrington, nd	Shelby Harbison, sd Spizz Singer, fd Laverne Best, wd	Pop.: 443,200 Rad. Hms.: 97% Ret. Sls.: \$512,833,000 L-W AP RCA
WTAX-FM	1948	Ch. 279 (B) 103.7mc 6.7kw						
STERLING								
WSDR	1949	1240 100	Blackhawk Bcstg. Co. 218 1st Ave. Main 3400		Sam Bartlett, p, gm & fd Lillian Bartlett, cm Johnny Rohwer, pd	Gerald W. Gamel, pmm Edward Fisher, ce	Al Anderson, nd Jack Ferris, sd Jean Hickey, wd	Pop.: 175,000 Rad. Hms.: 35,000 L-W, Cap. UP G
STREATOR								
WIZZ	1953	1250 500-D DA-D	Streator Bcstg. Co. Hwy. 23 North 4147	Best	Stephen P. Bellinger, mngng. ptrn.	Vernon R. Nunn, gm Jack A. Dill, cm	Harold I. Peters, ce Jean Marconnet, nd	Pop.: 500,000
TAYLORVILLE								
WTIM	1952	1410 1,000-D DA-D	Moyer Bcstg. Co. 1410	Continental	Roger Moyer, co-o Russell Armentrout, co-o	Keith Moyer, evp James C. Hilderbrand, gm	Tom Mathis, sm & ce Kes Pollock, sd Joan Scott, wd	Pop.: 500,000 Ret. Sls.: \$750,000,000 St., Thes. G

Data corrected to Dec. 10, 1953. If executives or services for FM are same as AM affiliate names are not repeated. Market Data supplied by stations.

FM's in italic. *—Non-Commercial Station. CP—Construction Permit issued. D—Day. DA-N—Directional Antenna, night only. DA-1—Directional Antenna, same pattern day and night. DA-2—Directional Antenna, different pattern day and night. L—Limited Time with Dominant Station. LS—Local Sunset. N—Night. SA—Special Authorization. SH—Specified Hours. ST—Share Time. Complete key to abbreviations, page 6.

**FOR
MAXIMUM
AUDIENCE
AT
MINIMUM
COST!**

WTAX

CBS RADIO AFFILIATE

For Five years in a row

Hooper* has shown WTAX far in front in Springfield, Illinois.

For Five Years in a row

Hooper* has shown that WTAX has steadily INCREASED its margin of LEADERSHIP.

Here are share of audience percentages in all rated time periods as reported in most recent *Radio INDEX:

WTAX	48.2%
Station B	18.5%
Station C	17 %

(Other stations reported ranged from 2.7% to 4.6%)

*October, 1953 index—released mid-November.

Represented Nationally by Weed & Company

URBANA

*WILL 1922	580 5,000-D DA-D	U. of Ill. 1010 S. Wright 7-6611	NAEB Tape Net	Lloyd Morey, p Frank E. Schooley, gm Harold E. Hill, pd	Abe Zaiden, pmm John R. Brugger, ce Donald E. Brown, nd	Elzer Marx, sd Bob Jarnigan, fd Jessie Heathman, wd	Pop.: 2,000,000 Assoc. Cap. AP, UP RCA
WKID 1948	1580 250-D	Sterling Bcstg. Co. Box 192 7-5431 McGillvra	Gene W. Phillippe, co-o & pd Bob Snyder, co-o & cm	Earl J. Kumpel, pmm Dick Williams, ce & fd	Hal Nettleship, nd Steve Austin, sd Katie Scheurich, wd	Pop.: 350,000 Rad. Hms.: 120,000 Ret. Slis.: \$150,000,000 UP G
WKID-FM 1948	Ch. 277 (A) 103.3mc 2.4kw					 UP G

WAUKEGAN

WKRS 1949	1220 1,000-D DA-D	News-Sun Bcstg. Co. P. O. Box 500 Delta 6-7900 McGillvra	F. Ward Just, p Joseph B. Kirby, gm, cm & sd	A. F. Sorenson, pd Stanley Chadwick, ce	Donald Reddicliffe, nd Christine Brown, wd	Pop.: 247,600 Rad. Hms.: 66,400 Ret. Slis.: \$259,340,000 Thes. AP G
--------------	-------------------------	---	--------------------	--	--	---	---

WEST FRANKFORT

WFRX 1951	1300 1,000-D	Pyramid Radio Bcstg. & Tv Co. Indie Inc. Box 359 1300	G. W. Lambert, p Robert O. Veach, gm & cm Bill E. Spangler, pd & pmm	Everett T. Kennedy, ce Doug Matthews, nd	Charles Blair, sd Ken Kennedy, fd Mary Jane Box, wd	Pop.: 882,439 Rad. Hms.: 248,408 Ret. Slis.: \$680,703,000 Thes. UP G
--------------	-----------------	---	-------	--	--	---	--

ZION

WCBD 1947	820 5,000-SH	Michael J. Mintern 2714 Enoch Ave. 521	M. J. Mintern, mng. d	Carl Q. Lee, cm
--------------	-----------------	---	-----------------------	-----------------

more people listen to

WMAY

than to any other

Springfield, Illinois, Station

Don't miss the greatest slice
of ILLINOIS' SECOND MARKET
THE SPRINGFIELD TRADING AREA!

The Total Weekly DAYTIME Circulation of WMAY is—
85% LARGER than Springfield Station B
35% LARGER than Springfield Station C

The Total Weekly NIGHTTIME Circulation of WMAY is—
37% LARGER than Springfield Station B
27% LARGER than Springfield Station C
—according to figures compiled and affirmed by
the A. C. NIELSEN COMPANY

more people listen to

970 on your dial

1000 watts, day
500 watts, night

WMAY

than to any other Springfield Station



Affiliate

Four Times As Powerful As Any Other Springfield Station By Day—Twice As Powerful At Night!

CONNERSVILLE

WCNE 1948	1580 250-D	News-Examiner Co. 408 Central Ave. 1950 Gill- Perna	G. S. Tatman, secy. E. M. Jackson, gm & cm	Ralph T. Underwood, pd, & asst. m & sd	Earl Thompson, ce	Pop.: 134,203 Rad. Hrs.: 43,000 Ret. Sis.: \$115,000,000	Wid. UP GE
WCNE-FM 1948	Ch. 262 (B) 100.3mc 10kw							Wid. UP GE

CRAWFORDSVILLE

WBBS (FM) (CP)	Ch. 292 (A) 106.3mc 1kw	First Baptist Church						
-------------------	-------------------------------	----------------------	--	--	--	--	--	--

ELKHART

WTRC 1931	1340 250	Truth Pub. Co. 116 S. 2d St. 3-1960	NBC Pearson	John F. Dille Jr., p Don R. McFall, gm Don Freed, cm	Jerry Maloney, pd Mary Anne Witman, pmm	Lester Zellmer, ce Phill Haines, nd Eldy Lundquist, sd	Pop.: 110,000 Rad. Hrs.: 32,000 UP RCA
WTRC-FM 1947	Ch. 264 (B) 100.7mc 33kw						Pop.: 740,000 Rad. Hrs.: 210,000 UP Fed.

EVANSVILLE

WEOA 1936	1400 250	WFBM Inc. 24 N. W. Third St. 4-9215	CBS Katz	Harry M. Bitner Jr., p Don Menke, gm & cm Michael Finn, pd	Carolyn Bosse, pmm & wd William Schultz, ce Alex Monahan, pub. service d	F. Courtney Smith, nd Dick Anderson, sd Robert Eaton, fd	Pop.: 393,400 Rad. Hrs.: 111,300 Ret. Sis.: \$372,480,000	L-W INS RCA
WGBF 1923	1280 5,000-D 1,000-N DA-N	On The Air Inc. 1001 Diamond Ave. 2-1171	NBC Weed	Martin L. Leich, gm (Mrs.) Pat Roper, pd Del Greenwood, pmm	Erwin P. Schoeny, ce Fred Rollinson, nd	Marvin Bates, sd Lois Freeman, wd	Pop.: 703,600 Rad. Hrs.: 286,230 Ret. Sis.: \$622,027,000 UP Col.
WMLL(FM) 1941	Ch. 233 (B) 94.5mc 25kw	(WGBF, Am affiliate)					Pop.: 655,595 Rad. Hrs.: 200,411 Ret. Sis.: \$656,363,000 UP
WIKY 1947	820 250-D	South Central Bcstg. Corp. P. O. Box 148 4-8284 Pearson	John A. Engelbrecht, p, gm, cm & pd Charles Palmisano, pmm	George F. Stoltz, ce Don Sherwood, nd John Taylor, sd	Ken McCutchan, fd Joy Young, wd	Pop.: 500,000	Thes., Cap. AP Col.
WIKY-FM 1948	Ch. 281 (B) 104.1mc 19.1kw							Thes., Cap. AP Fed.

OUTSTANDING . . .

- ✓ NEWS COVERAGE
EMPHASIS ON LOCAL NEWS, FEATURING
DON O'MEARA, NEWS EDITOR ON-THE-SPOT.
- ✓ FARM COVERAGE
FULL TIME FARM DIRECTOR COVERS ALL
AGRICULTURAL FUNCTIONS IN AN AREA WHERE
FARM INCOME IS 36% HIGHER THAN NATIONAL
AVERAGE.
- ✓ CBS NETWORK AFFILIATION
ALL OUTSTANDING NETWORK SHOWS.
- ✓ MARKET COVERAGE
40.8% GREATER TOTAL PENETRATION OF TRADING
AREA THAN LOCAL NEWSPAPER

1000 WATTS
REPRESENTED BY
WEED & CO.

WIOU
KOKOMO, INDIANA

CBS AFFILIATE
JOHN CARL JEFFREY
GENERAL MANAGER

INDIANA

City	Call Letters Established TV Affiliate	Chan. or Freq. Power	Licensee Headquarters Telephone	Network Represent- ative	Owner; Pres. p; Exec. up evp; Gen. Mgr. gm; Sta. Mgr. sm; Coml. Mgr. cm; Sales Mgr. slm; Prog. Dir. pd; Chief Eng. ce; Prom. Mgr. pmm; Prod. Mgr. pdm; News, Farm, Sports or Women's Dir. nd, fd, sd, wd.	Executive Abbreviations	Market Data For Primary Area (Supplied by station)	Library, News Serv. Transmitter
EVANSVILLE—(Cont'd)								
WJPS 1948	1330 5,000-D 1,000-N DA-2	WJPS Inc. 206 Main St. 5-2221	ABC Holling- bery	Robert S. Davis, p Robert J. McIntosh, gm	Jack McLean, cm, pd James Voors, pmm Phillip Landman, pmm James Jared, ce	Chuck Miller, fd Verne Paule, nd Marilou Maddox, wd Clara Henry, bus. m	Pop.: 491,576 Rad. Hms.: 139,864 Ret. Sis.: \$420,966,000	St., Wid. AP Fed.
FT. WAYNE								
WANE 1948	1450 250	Radio Ft. Wayne 1205 Ft. Wayne Bank Bldg. Anthony 6212	CBS Boiling	C. Bruce McConnell, p Robert McConnell, gm Charles E. Kennedy, sm	Robert Hill, pd & sd Doug Hadley, nd Eugene Humphreys, ce	Merlin Smith, loc. cm Sharon Lane, wd	Pop.: 186,800 Rad. Hms.: 54,880	St. AP
WGL 1924	1250 1,000 DA-2	News-Sentinel Bcstg. Co. Inc. 201 W. Jefferson St. Eastbrook 3368	ABC Headley- Reed	Helene R. Foellinger, p Merrill C. Johnson, gm & cm	Norman C. Widenhofer, pd & asst. m Dorsey Holzappel, ce	Roy Harvey, nd Len Davis, sd Mary McDonald, wd	Pop.: 471,900 Rad. Hms.: 139,680 Ret. Sis.: \$527,696,000	L-W UP RCA
WKJG 1947 WKJG-TV	1380 5,000 DA-2	Northeastern Indiana Bcstg. Co. 220 E. Jefferson St. Anthony 2295	MBS Raymer	Clarence L. Schust, p Edward G. Thoms, gm Carleton B. Evans, cm	Calo Mahlock, pd Eugene A. Chase, ce	Hilliard Gates, asst. m & sd Wayne Rothgeb, fd	Pop.: 797,500 Rad. Hms.: 243,900 Ret. Sis.: \$827,757,000	Wid. UP RCA
WKJG-FM 1948	Ch. 291 (B) 106.1mc 30kw							
WOWO 1925	1190 50,000 DA-N	Westinghouse Bcstg. Co. 124 W. Washington Anthony 2136	NBC Free & Peters	Chris Witting, p J. E. Baudino, evp C. W. Vandagriff, gm H. D. Longworth, slm Guy S. Harris, pd G. H. Abels, pmm	B. H. Ratts, ce Hilda C. Woehrmeyer, sis. service d J. H. Ackley, traffic sup.	R. J. Stone, studio tech. sup. Leo Yoder, trans. sup. Ernie Ashley, sd Jay Gould, fd Jane Weston, wd	Pop.: 3,701,800 Rad. Hms.: 1,085,370 Ret. Sis.: \$4,186,274,000	Thes. UP
FRANKFORT								
WLO (CP) 1948	1570 250-D	Radio Frankfort 52½ E. Washington St. 3338 Best	Stephen P. Bellingier, mgng. ptrn. Wm. Rhinesmith, gm	Wayne Hall, cm Rob't. E. Ewing, ce	Max Cockley, Lebanon m	Pop.: 296,600 Ret. Sis.: \$315,000,000
GARY								
WGRY 1950	1370 500-D	WGRY Inc. 734 Washington St. 5-5151	George M. Whitney, p, gm & cm	Robert Dietz, pd William Murphy, pmm	Quintette McDuffie, ce Lucile Becker, wd	Pop.: 560,000 Rad. Hms.: 154,000 Ret. Sis.: \$610,000,000	SES. UP RCA
WWCA 1949	1270 1,000 DA-1	Lake Bcstg. Co. Inc. 578 Broadway 9171 Pearson	Dee O. Coe, p & gm Joseph R. Fife, cm & pmm Todd Branson, pd & sd	Victor H. Voss, ce Dale Cobble, office m Ted Thorne, nd	Russ Honeyman, fd Stacey Evans, wd	Pop.: 500,000 Rad. Hms.: 175,000 Ret. Sis.: \$500,000,000 AP Col.
HAMMOND								
WJOB 1928	1230 250	South Shore Bcstg. Co. 449 State St. Sheffield 8400 (WJOB, Am Affiliate) McGillvra	Robert C. Adair, p Edward J. Rozhon, gm Len Ellis, cm	Wilbert Wobus, pd Jess Peters, Jr., ce Harold Harris, nd	Hugh Hill, sd Jerold Mitchell, fd	Pop.: 1,125,200 Rad. Hms.: 305,600 Ret. Sis.: \$1,038,790,000 UP Ray.
WJIZ (FM) 1948	Ch. 222 (B) 92.3mc 3.1kw						 UP
INDIANAPOLIS								
WFBM 1923 WFBM-TV	1260 5,000 DA-N	WFBM Inc. 1330 N. Meridian St. Lincoln 8521	CBS Katz	Harry M. Bitner, co Harry M. Bitner Jr., gm William F. Kiley, cm	Frank O. Sharp, pd Bernard W. Carney, pmm Harold S. Holland, ce Hugh L. Kibbey, sis. service m	Gilbert Forbes, nd Tom Carnegie, sd Harry Martin, fd	Pop.: 1,375,000 Rad. Hms.: 437,000 AP, INS
WIBC 1938	1070 50,000-D 10,000-N DA-2	WIBC Inc. 30 W. Washington St. Lincoln 2305	MBS Blair	Richard M. Fairbanks, p & gm Gilbert I. Berry, cm & gen. slm	William L. Dean, pd & pmm Robert Minton, ce Robert Myers, asst. to p	Gordon Graham, nd William F. Fox Jr., sd William Mason, fd Alice Bayne, wd	Pop.: 2,419,760 Rad. Hms.: 698,240 Ret. Sis.: \$2,501,282,000	SES., Cole, Thes. AP, UP, RCA
WIRE 1924	1430 5,000 DA-N	Indianapolis Bcstg. Inc. 307 N. Penn. St. Plaza 1541	NBC Free & Peters	Eugene C. Pulliam, p Willard C. Worcester, vp & gm Daniel C. Park, cm	M. Wayland Fullington, pd Richard L. Higgs, pmm	Eugene E. Alden, ce Donald Bruce, co-nd Allen Jeffries, co-nd Charles Brockman, sd Paula Carr, wd	Pop.: 1,703,800 Rad. Hms.: 525,400 Ret. Sis.: \$1,825,622,000	Wid. AP, UP RCA
WISH 1941	1310 5,000-D 1,000-N DA-N	Universal Bcstg. Co. 1440 N. Meridian St. Plaza 4595	ABC Boiling	C. Bruce McConnell, p Robert B. McConnell, gm William H. Spencer, sm	William Frosch, pd Reid Chapman, pmm Stokes Gresham Jr., ce	Gene Allison, co-nd & fd John Fraim, co-nd Luke Walton, sd Catherine Daniels, wd	Pop.: 1,555,745 Rad. Hms.: 459,833	Thes. AP RCA
WXLW 1948	1590 1,000-D	Radio Indianapolis Inc. 3003 Kessler Blvd. Hickory 6494 Pearson	Lyman S. Ayres, p Robert D. Enoch, gm	Golden A. Smith Jr., pd	Norbert Goetzinger, ce John Randall, nd	Pop.: 650,000 Rad. Hms.: 167,800	Cap. UP RCA
JASPER								
WITZ 1948	990 1,000-D	Jasper On The Air Inc. Box 167 678	Dr. G. E. Metzger, p Dennis J. Keller, gm Dick Witty, cm Betty Parks, pd	Joseph Salvi, pmm Jim Young, ce Dick Sherman, nd	Jack Brandt, sd Peter L. Russo, fd Beverly Chism, wd	Pop.: 1,510,900 Rad. Hms.: 349,758 Ret. Sis.: \$650,552,000	Wid. UP
KOKOMO								
WIOU 1948	1350 1,000 DA-2	North Central Indiana Bcstg. Corp. 212½ N. Main St. 6194	CBS Weed	R. H. Blackledge, p John Carl Jeffrey, vp & gm	William Randolph Cox, pd & bus. m Chester V. Rector, ce	William Pipher, sd William Hitt, fd Dorothy Barnes, wd	Pop.: 311,100 Rad. Hms.: 95,620 Ret. Sis.: \$321,200,000	Thes. AP GE
LAFAYETTE								
WASK 1942 WFAM-TV	1450 250	WFAM Inc. McCarty Lane 2-4300	MBS, Midwest Rambeau	O. E. Richardson, p David F. Milligan, m cm & pmm	Richard W. Long, pd Richard Cochran, ce K. C. Strange, nd	Earl Richardson, fd & sd Harry Bradley, sd Jane Ransome, wd	Pop.: 239,782 Rad. Hms.: 68,501 Ret. Sis.: \$140,000,000 UP Ray.
WFAM(FM) 1948	Ch. 236 (B) 95.1mc 12kw						 UP Ray.

Data corrected to Dec. 10, 1953. If executives or services for FM are same as AM affiliate names are not repeated. Market Data supplied by stations. FM's in *italics*. *—Non-Commercial Station. CP—Construction Permit issued. D—Day. DA-N—Directional Antenna, night only. DA-1—Directional Antenna, same pattern day and night. DA-2—Directional Antenna, different pattern day and night. L—Limited Time with Dominant Station. LS—Local Sunset. N—Night. SA—Special Authorization. SH—Specified Hours. ST—Share Time. Complete key to abbreviations, page 6.

WFBM

leads all Indianapolis stations in

city audience

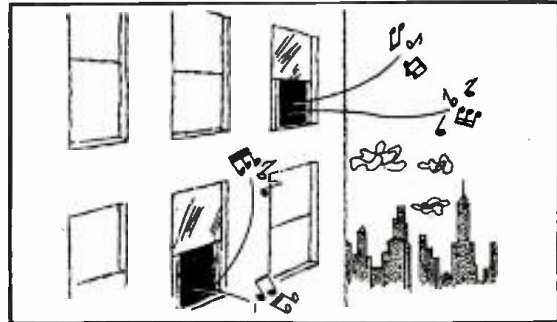

suburban and
farm audience



total weekly
nighttime
audience

(based on SAMS).

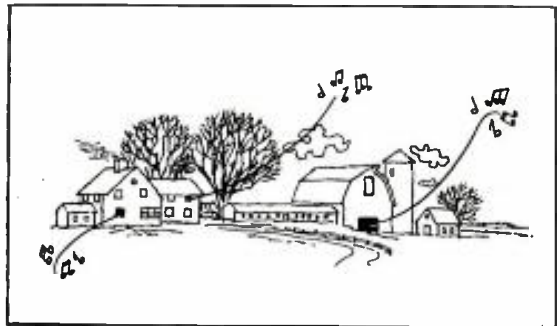

WFBM is the top station in over-all listening in Indianapolis.

WFBM's talent roster includes personalities who are as familiar to Indiana listeners as the top-notch network stars.

WFBM follows through on its advertisers' on-the-air campaigns with helpful merchandising and promotion assistance.

In short, when your advertising dollars go to work on WFBM, they earn a bonus in audience, listener-loyalty, and sales. For complete data get in touch with our national reps, the Katz Agency.

WFBM

Indianapolis • CBS

Represented by the Katz Agency

Affiliated with WFBM-TV; WEOA, Evansville;
WFDF, Flint; WOOD AM & TV, Grand Rapids

INDIANA

City	Call Letters Established TV Affiliate	Chan. or Freq. Power	Licensee Headquarters Telephone	Network Represent- ative	Executive Abbreviations Owner o; Pres. p; Exec. vp evp; Gen. Mgr. gm; Sta. Mgr. sm; Coml. Mgr. cm; Sales Mgr. slm; Prog. Dir. pd; Chief Eng. ce; Prom. Mgr. pmm; Prod. Mgr. pdm; News, Farm, Sports or Women's Dir. nd, fd, sd, wd.			Market Data For Primary Area (Supplied by station)	Library, News Serv. Transmitter
LA PORTE									
	WLOI 1948	1540 250-D	LaPorte Bcstg. Co. Rumely Hotel 3734		Hoyt Scott, p & sm				Cap. AP
LEBANON									
	WJNL(FM) 1953	Ch. 296 (A). 107.1mc 0.59kw	Radio Lebanon 117 S. Lebanon St. 17 Best	Stephen P. Bellinger, mgng. ptrn.	Charles M. Cockley, gm, cm & ce	Hildreth Doyall Cockley, pd	Pop.: 23,993 Rad. Hms.: 7,412 UP RCA
LINTON									
	WBTO 1953	1600 500-D	The Linton Bcstg. Co. c/o WBNL Boonville, Ind.		Henry C. Sanders, o				
LOGANPORT									
	WSAL 1949	1230 250	Loganport Bcstg. Corp. Box 399 4261	MBS, KBS	Glen L. Miller, p Raymond W. Baker, gm & secy.	Joseph A. Wiler, cm Ira G. McCormack Jr., pd & fd	Raymond A. Olson, ce Richard E. Jackson, sd	Pop.: 195,000 Rad. Hms.: 57,800 Ret. Sis.: \$153,000,000	Assoc. AP RCA
MADISON									
	(CP) WORX(FM) 1950	1440 500-D DA-D Ch. 244 (A) 96.7mc 0.35kw	Knight-Cutler System Knight-Cutler System Telegraph Hill 1037		Frances Knight, p & gm Dodd Gorman, cm	Charles N. Cutler, pd & ce Joan Sibenthal, wd	Bill Birket, sd & nd Leo Waltz, fd	Pop.: 276,869 Rad. Hms.: 63,634 Ret. Sis.: \$25,673,600	SES. UP G
MARION									
	WBAT 1947	1400 250	Marion Radio Corp. 303½ S. Adams St. 5500	CBS Rambeau	John L. Ramp, p William C. Fowler, gm & sd	William J. Emard, cm & pmm John R. Anderson, pd	Charles F. Stinson, ce William Shannon, nd Guy Harris, fd	Pop.: 181,900 Rad. Hms.: 56,500 Ret. Sis.: \$165,900,000	
	WMRI(FM) 1948 WMRI-TV	Ch. 295 (B) 106.9mc 34kw	Chronicle Pub. Co. 610 S. Adams 5705	Hooster	Gardener J. Thomas, Lloyd V. Smith, gm & ce	Bob Finacannon, asst. gm & cm	Bob Michels, pd Toni Horning, traffic d	Pop.: 181,900 Rad. Hms.: 25,000 Ret. Sis.: \$52,000,000	Cap., Thes.
MICHIGAN CITY									
	WIMS 1947	1420 1,000-D 500-N DA-N Ch. 228 (A) 93.5mc 1kw	Northern Ind. Bcstrs. 415 Franklin 5-5245 Rambeau	William N. Udell, p & gm Al Halus, co-cm Jay Schoff, co-cm	Richard S. Olson, pd Robert J. Schilling, ce John H. Gleason, nd Paul Schroeder, co-sd	Howard Murdick, co-sd Stew McDonnell, fd Ruth Bleck, wd	Pop.: 1,000,000 UP Ray.
MUNCIE									
	WLBC 1926 WLBC-TV	1340 250	Tri-City Radio Corp. Radio Center 4403 (WLBC, Am Affiliate)	CBS Holman, Walker	D. A. Burton, p & gm W. F. Craig, vp, cm & pmm	Lee Allerton, pd M. M. Crain, ce	F. M. Hinshaw, nd		St. AP GE
	WMUN(FM) 1947	Ch. 281 (B) 104.1mc 7.4kw							
NEW ALBANY									
	WLRP 1949	1570 1,000-D	Ohio Valley Bcstg. Inc. P. O. Box 285 1570 Clifton Ave. 4-2235 Best	Roy L. Hickox, p & gm Milton Lamm, cm Keith L. Reising, pd	Joe Gillum, pmm Eugene A. Fischer, ce	Joe Piggott, nd, fd & sd Rita Loesch, wd	Pop.: 128,210 Rad. Hms.: 36,125 Ret. Sis.: \$124,000,000	L-W UP Ray.
NEW CASTLE									
	WCY(FM) 1947	Ch. 273 (B) 102.5mc 4kw	Courier-Times Inc. 202½ S. 14th St. 2600 Scheerer	Scott B. Chambers, p Edwin D. Ogborne, gm	Howard A. White, cm Stanley A. Bock, pd	Francis A. Thompson, ce Jack E. Van Hoose, sd	Pop.: 63,000 Rad. Hms.: 19,000 Ret. Sis.: \$41,000,000	Wid., Cap. AP GE
PORTLAND									
	WPGW 1951	1440 500-D DA-D	Glenn West P. O. Box 608 1094		Glenn West, o, gm, cm, pmm & ce Ron Miller, pd	Harold K. Rippey, fd Kester D. Pollock, sd	Eldrew Cissell, nd Mrs. Glenn West, wd		Wid., SES. UP G
PRINCETON									
	WRAY 1950 WRAY-TV	1250 1,000-D	Princeton Bcstg. Co. Outer West Broadway 1250	M. R. Lankford, p Gene Peterson, gm & sd	Dennis Critchfield, cm Harold Bass, ce	Ray Harry, nd & fd	Pop.: 723,559 Rad. Hms.: 187,011 Ret. Sis.: \$700,000,000	St. AP G
RICHMOND									
	WKBV 1926	1490 250	Central Bcstg. Corp. 25 S. 9th St. 2-1156	ABC Meeker	Paul R. Quigg, p Lester G. Spencer, gm Roland Nusbaum, cm & pmm	C. L. Mitchell, pd Louis Duning, ce Spencer Danes, sd	Ted Westbrook, nd Geneta Kern, wd Cedric Miller, co-fd Mary Elizabeth Miller, co-fd	Pop.: 200,000 Rad. Hms.: 57,500 Ret. Sis.: \$215,946,000	Thes., SES. UP
SALEM									
	WSLM 1953	1220 250-D	Don H. Martin Radio Ridge 700	KBS Continental	Don H. Martin, p & gm Herbert L. Arms, cm	Margaret Martin, pd & wd Darrell Dixon, ce	Tommy Allison, nd "Copper" Davis, sd Erwin Eisert, fd	Pop.: 748,400 Rad. Hms.: 249,467	Thes. Mac AP G
SEYMOUR									
	WJCD 1949	1390 500-D	Azra C. Baker 1534 Ewing St. 1212	KBS	Azra C. Baker, p & gm Robert E. Shippee, cm	Roger W. Bradley, pd Arnold Haun, ce	Johnny W. Otte, sd		Wid. AP G

Data corrected to Dec. 10, 1953. If executives or services for FM are same as AM affiliate names are not repeated. Market Data supplied by stations. FM's in *italics*. —Non-Commercial Station. CP—Construction Permit Issued. D—Day. DA-N—Directional Antenna, night only. DA-1—Directional Antenna, same pattern day and night. DA-2—Directional Antenna, different pattern day and night. L—Limited Time with Dominant Station. LS—Local Sunset. N—Night. SA—Special Authorization. SH—Specified Hours. ST—Share Time. Complete key to abbreviations, page 6.

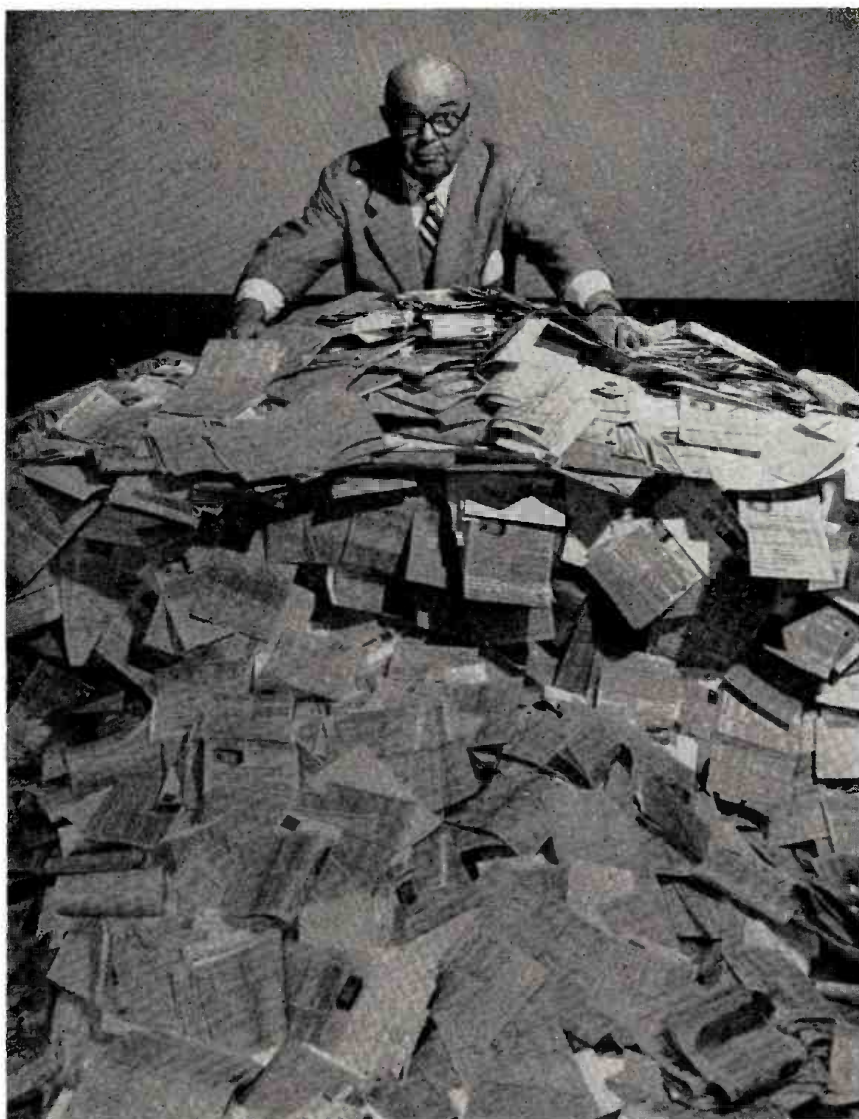

CHARLIE BROCKMAN
WIRE's Sports Director



ROBIN BRIGHT
WIRE's Chief Announcer

WIRE GETS **KING SIZE** RESULTS FOR KINGAN INC.

BEAT THE SPONSOR football contest pitted contestants against the sponsor, Hal Ranck, Advertising Director of Kingan Inc. shown in photo above. Mr. Ranck picked the scores and winning teams in a weekly 10-game football contest.

In a 10-week period WIRE shattered all previous mail count records. Approximately 50,000 entries poured into WIRE to vie for radios and Kingan's **MEAT OF THE WEEK**.

Kingan Inc. sponsored **BIG 10 FOOTBALL GAMES** over WIRE. Robin Bright, WIRE's Chief Announcer, teamed with Charlie Brockman, WIRE's Sports Director, for the coverage.

Free & Peters, Inc., Exclusive National Representatives



WIRE

YOUR BEST SALESMAN IN THE GREAT HOOSIER MARKET

INDIANA

City	Call Letters Established	Chan. or Freq. Power	Licenses Headquarters Telephone	Network Representative	Owner	Executive Abbreviations	Market Data For Primary Area (Supplied by station)	Library, News Serv. Transmitter
SHELBYVILLE								
WSRK(FM)	1952	Ch. 267 (B) 101.3mc 5kw	Shelby Radio Service 125 E. Washington St. 1108 Best	Bernard M. Dabney, Jr., p, gm & cm	G. Wayne Harris, pd L. H. Estes, ce	Pop.: 52,000 Rad. Hms.: 12,620 Ret. Sis.: \$30,000,000	Wid., SES. UP GE
SOUTH BEND								
WHOT	1944	1490 250	South Bend Bcstg. Corp. 434 S. St. Joseph St. 7-1566	ABC Bolling	C. Bruce McConnell, p Frank Crosiar, gm	C. J. Pajakowski, cm Bill Etherton, pd	Pop.: 226,000 Rad. Hms.: 62,900	Assoc. AP
WJVA	1947	1580 250-D	St. Joseph Valley Bcstg. Corp. P. O. Box 179 4-1111	KBS Burn-Smith	F. R. Householder, p & gm Vince Doyle, cm & sd	Owen Lackey Jr., pd & Francis Böck, ce	Pop.: 263,100 Rad. Hms.: 62,100 Ret. Sis.: \$262,640,000 UP Col.
WSBT	1922	960 5,000 DA-2	South Bend Tribune 3-6161	CBS Raymer	F. A. Miller, p Neal B. Welch, gm & cm Robert J. Drain, pd	Robert H. Swintz, pmm Arthur O'Neil, ce	Pop.: 1,624,500 Rad. Hms.: 465,920 Ret. Sis.: \$1,675,918,000	St., Thes. UP RCA
WSBT-TV	1922	5,000 DA-2						
TELL CITY								
WTCJ	1948	1230 250	Tell City Bcstg. Co. 740	James R. Brewer, o & m			
TERRE HAUTE								
WBOW	1927	1230 250	Banks of the Wabash Inc. 303 S. 6th St. Crawford 5034	NBC Weed	Alvin Eades, p William F. Rippetoe, gm & cm Harry E. Frey, pd	Ralph McHargue, pmm Howard Stewart, ce Leo Baxter, mus. d	Pop.: 108,500 Ret. Sis.: \$122,200,000	Thes. AP, UP
WBOW-FM	1947	Ch. 266 (B) 101.17mc 20kw						
WTHI	1948	1480 1,000 DA-2	Wabash Valley Bcstg. Corp. 120 S. 7th St. Crawford 9481	CBS Bolling	Anton Hulman Jr., p Joseph M. Higgins, gm Ben Falber Jr. pd	Robert F. Crawford, pmm Don E. Pettit, ce	Pop.: 105,700 Rad. Hms.: 32,100 Ret. Sis.: \$125,851,000	Wid., L-W UP RCA
WTHI-TV	1948	1,000 DA-2						
WTHI-FM	1948	Ch. 260 (B) 99.9mc 7.2kw						
VINCENNES								
WAOV	1940	1450 250	Vincennes Sun Co. Grand Hotel 787	MBS Free & Peters	Eugene C. Pulliam, p A. C. Bernstein, gm & cm	Russell Hart, pd & fd Roy Stanley, pmm Ralph Baldwin, ce	Pop.: 182,330 Rad. Hms.: 80,433 Ret. Sis.: \$36,279,000	Wid. UP WE
WARSAW								
WKAM	1949	1220 250-D	Kosciusko Bcstg. Corp. R. F. D. #1 65	KBS. Midwest Holman	J. W. Autenrieth Jr., p	Howard Wheelock, ce	Pop.: 50,000 AP
WRSW	1952	1480 500 DA-2	Reub Williams & Sons Inc. Times Bldg. 155	R. B. Williams, p C. Reuben Williams, gm & nd	W. Mollenhour, cm & bus. m Marje Snyder, pd & wd	Pop.: 139,836 Ret. Sis.: \$136,627,200	L-W, Cap. Wid. UP Col. WH
WRSW-FM	1948	Ch. 297 (B) 107.3mc 34kw						
WASHINGTON								
WFML(FM)	1948	Ch. 293 (B) 106.5mc 14kw	Washington Radio Inc. Box 89 1810 Best	Joseph Floerke, cm	Joseph Edwards, pd & sd Paul M. Davis, ce Emily Osman, wd	Pop.: 125,000	Cap. AP GE
WEST LAFAYETTE								
*WBAA	1922	920 5,000-D 1,000-N DA-N	Purdue U. Hall of Music 92-2385	F. L. Hovde, p Jim Miles, gm John DeCamp, pd & sd	Ralph R. Townsley, ce John Henderson, educ. sup. Robert Moore, nd		Assoc., SES. UP Col.

Data corrected to Dec. 10, 1953. If executives or services for FM are same as AM affiliate names are not repeated. Market Data supplied by stations. FM's in italic. *—Non-Commercial Station. CP—Construction Permit issued. D—Day. DA-N—Directional Antenna, night only. DA-1—Directional Antenna, same pattern day and night. DA-2—Directional Antenna, different pattern day and night. L—Limited Time with Dominant Station. LS—Local Sunset. N—Night. SA—Special Authorization. SH—Specified Hours. ST—Share Time. Complete key to abbreviations, page 6.

IOWA

IOWA MARKET DATA BY COUNTIES

County	Population 1950	Radio Families 1953	Retail Sales 1952(000)	Food Sales 1952(000)	Drug Sales 1952(000)	Automobile Ownership 1952	County	Population 1950	Radio Families 1953	Retail Sales 1952(000)	Food Sales 1952(000)	Drug Sales 1952(000)	Passenger Cars 1950
Adair	12,292	3,920	\$9,438	\$1,602	\$226	5,912	Delaware	17,734	4,980	13,716	2,764	319	8,247
Adams	6,753	2,760	6,850	724	97	4,229	Des Moines	42,056	13,340	56,536	13,296	1,843	19,944
Allamakee	16,351	4,540	17,992	3,419	225	6,790	Dickinson	12,756	3,860	15,429	2,753	351	6,931
Appanoose	19,683	6,110	14,412	3,289	381	7,302	Dubuque	71,337	19,090	89,579	18,165	1,423	25,303
Audubon	11,579	3,340	15,728	2,446	222	5,801	Emmet	14,102	4,140	15,769	3,185	402	7,631
Benton	22,656	6,880	21,626	4,299	344	11,092	Fayette	28,294	8,270	24,578	4,843	446	12,985
Black Hawk	100,448	31,320	132,030	25,729	3,450	43,381	Floyd	21,505	6,530	21,912	4,905	547	10,367
Boone	28,139	8,310	24,550	4,869	608	12,722	Franklin	16,268	5,030	15,865	2,777	223	9,434
Bremer	18,884	5,560	22,436	3,858	275	10,282	Freemont	12,323	3,560	11,704	2,518	262	5,547
Buchanan	21,927	5,640	17,925	3,220	246	8,775	Greene	15,544	4,820	17,190	3,233	366	8,762
Buena Vista	21,113	6,840	26,980	5,050	522	11,756	Grundy	13,722	4,220	13,094	2,171	315	8,209
Butler	17,394	5,250	20,888	3,082	297	9,505	Guthrie	15,197	4,490	13,406	2,424	275	6,932
Calhoun	16,925	5,190	15,600	3,099	382	8,794	Hamilton	19,680	6,070	13,328	4,108	502	10,963
Carroll	23,065	6,300	32,086	4,840	498	11,065	Hancock	15,077	4,310	13,328	2,712	265	8,269
Cass	18,532	5,970	24,748	4,363	310	9,333	Hardin	22,218	7,180	30,658	5,427	537	12,113
Cedar	18,910	5,200	18,358	2,808	210	9,033	Harrison	19,580	5,630	18,366	3,534	533	7,874
Cerro Gordo	46,053	14,090	66,027	13,078	1,496	21,504	Henry	18,708	5,320	19,203	3,694	480	8,644
Cherokee	19,052	5,120	20,827	3,363	522	9,206	Howard	13,105	3,660	14,705	2,709	202	6,228
Chickasaw	15,228	4,310	18,332	4,219	199	7,100	Humboldt	13,117	3,920	13,881	2,666	225	7,418
Clarke	9,369	2,900	9,494	2,564	317	4,147	Ida	10,697	3,120	15,678	2,708	325	5,855
Clay	18,103	5,490	27,642	5,038	509	10,170	Iowa	15,835	4,740	16,964	2,873	296	7,491
Clayton	22,522	6,450	21,697	3,941	420	10,263	Jackson	18,622	5,400	18,052	3,499	414	8,772
Clinton	49,664	15,140	61,207	12,827	1,182	21,702	Jasper	32,305	4,870	31,981	8,180	756	14,908
Crawford	19,741	5,570	19,529	3,978	401	8,792	Jefferson	15,696	4,850	14,655	3,200	345	7,174
Dallas	23,661	7,530	26,310	5,865	653	11,783	Johnson	45,756	12,370	47,639	8,865	1,531	16,495
Davis	9,959	2,950	5,210	1,393	177	4,530	Jones	19,401	5,500	22,351	3,726	443	8,817
Decatur	12,601	3,610	9,301	2,442	261	4,980	Keokuk	16,797	5,360	17,149	2,510	230	7,812
							Kossuth	26,241	7,150	24,975	4,524	487	13,861

County	Population 1950	Radio Families 1952	Retail Sales 1952(000)	Food Sales 1952(000)	Drug Sales 1952(000)	Passenger Cars 1952	County	Population 1950	Radio Families 1952	Retail Sales 1952(000)	Food Sales 1952(000)	Drug Sales 1952(000)	Passenger Cars 1949
Lee	43,102	12,930	45,777	10,589	1,535	17,910	Sac	17,518	5,280	19,303	3,589	381	9,919
Linn	104,274	33,520	146,705	25,467	4,837	46,098	Scott	100,698	31,150	141,506	25,919	3,896	45,238
Louisia	11,101	3,140	14,714	2,295	327	5,403	Shelby	15,942	4,540	17,577	2,183	329	7,737
Lucas	12,069	3,720	13,611	3,040	275	5,586	Sioux	26,381	7,220	26,270	4,937	583	12,800
Lyon	14,697	4,070	14,626	2,284	272	7,738	Story	44,294	12,750	44,583	10,814	1,220	17,785
Madison	13,131	4,100	12,756	2,283	317	6,267	Tama	21,688	6,660	25,569	4,104	336	10,732
Mahaska	24,672	7,820	27,639	4,502	732	11,208	Taylor	12,420	3,900	8,794	1,759	185	5,513
Marion	25,930	7,340	18,161	4,820	482	10,082	Union	15,651	4,970	16,468	3,385	456	7,054
Marshall	35,611	10,870	46,416	9,677	1,017	16,349	Van Buren	11,007	3,550	7,731	1,482	115	4,954
Mills	14,064	3,590	12,500	2,239	295	5,557	Wapello	47,397	14,510	47,804	10,887	1,584	18,092
Mitchell	13,945	4,020	17,827	2,904	184	7,154	Warren	17,758	5,300	12,195	2,856	202	8,009
Monona	16,303	4,820	14,904	2,847	343	7,495	Washington	19,557	5,930	25,997	3,689	597	9,659
Monroe	11,814	3,270	8,537	2,219	173	4,618	Wayne	11,737	3,830	9,447	2,071	267	5,087
Montgomery	15,685	5,120	19,393	3,502	470	7,741	Webster	44,241	13,300	59,689	10,651	1,113	21,196
Muscatine	32,148	10,210	41,749	7,767	658	14,670	Winnebago	13,450	3,850	16,069	2,841	332	7,281
O'Brien	18,970	5,790	24,528	4,282	421	10,364	Winneshiek	21,639	5,900	18,363	3,518	335	9,177
Oseola	10,181	2,830	11,074	1,933	96	5,855	Woodbury	103,917	33,020	144,508	27,278	4,511	43,223
Page	23,921	7,080	37,546	4,766	836	10,618	Worth	11,068	3,100	9,023	2,083	157	5,741
Palo Alto	15,891	4,410	16,102	2,796	358	7,752	Wright	19,652	6,100	22,381	4,778	584	10,690
Plymouth	23,252	6,470	26,589	4,627	533	11,039	Total	2,621,073	790,060	\$3,039,460	\$ 583,885	\$ 73,400	1,090,358
Pocahontas	15,496	4,570	14,695	2,939	380	9,264	Note: Population 1950 Census; radio families Standard Audit & Measurement Services Inc.; food, drug and retail sales, copyright 1953, Sales Management; further reproduction unlicensed; automobiles supplied by state.						
Polk	226,010	72,890	325,593	62,076	9,787	92,091							
Pottawattamie	69,662	20,850	71,029	16,833	2,055	29,024							
Poweshiek	19,344	5,590	19,840	4,207	424	8,730							
Ringgold	9,526	3,100	7,082	1,013	181	4,346							

DIRECTORY OF AM AND FM STATIONS

City	Station	Frequency	Class	Owner	Manager	Notes
AMES	KASI	1430	D	Ames Bcstg. Co.	KBS	W. S. Rupe, p
	1948	1,000-D		328½ Main St.	Midwest	A. A. Skinner, gm & Doyle Kelso, ce
	*WOI	640		Iowa State	Continental	Dean Albert, nd
	1922	5,000-D		College	NAEB	Richard F. Vogl, pd
AMES	WOI-TV			Service Bldg.	Tape Net.	Marguerite Theobold, pmm
				2500 ext. 831		George Halsey, nd
ATLANTIC	KJAN	1220	D	Nishna Valley Bcstg. Co.	KBS	Al Hansen, p
	1953	250-D		Atlantic		Franklin G. Miller, vp & gm
				1717		Federick Clark, ce & fd
						H. A. Preston, pmm & sd
						Pop.: 323,000
						Rad. Hms.: 95,000
						Ret. Sls.: \$22,000,000
						Wld., SES
						AP
						Ray.
						Wld., St.
						AP, UP
						RCA



This Is the Quint-Cities

Five cities, with three bridges carrying 10-million automobiles a year, and binding the Illinois side to the Iowa side in ONE COMMERCIAL Unit...

THIS IS A MANUFACTURING CENTER... 56th largest in the nation; 54,000 industrial workers... and the location of such big names as International Harvester, John Deere, J. I. Case, Alcoa, Bendix Aviation—and the Rock Island Arsenal...

THIS IS AN AGRICULTURAL CENTER... six of the nation's seven largest hog-raising counties are located within a 60-mile radius of the Quint-Cities...

THIS IS A THRIVING RETAIL CENTER... 242,200 people with an annual effective buying income of \$439,261,000... \$1,814 per capita... \$337 per person above the national per capita average. These people spend \$302,327,000 in Quint Cities retail outlets annually... \$1,248 per capita... or \$201 per person above the national per capita average. (Figures in this paragraph—1953 Sales Management Survey of Buying Power.)

HERE IS A MAJOR MARKET... the largest between Minneapolis and St. Louis, between Chicago and Omaha...

It is the centric point of an even larger market... all knit into one BIG CUSTOMER for your product or services by Radio Station WOC. For complete information about this 32-year old station... which has delivered the Quint-Cities' favorite radio listening since 1922... SEE YOUR NEAREST F & P man.

Col. B. J. Palmer, president
Ernest C. Sanders, manager

NBC Affiliate
5000W - 1420 KC
DAVENPORT,
IOWA
Free & Peters, Inc.
Exclusive National
Reps.



IOWA

City	Call Letters Established TV Affiliate	Chan. or Freq. Power	Licensee Headquarters Telephone	Network Represent- ative	Owner o; Pres. p; Exec. vp evp; Gen. Mgr. gm; Sta. Mgr. sm; Coml. Mgr. cm; Sales Mgr. slm; Prog. Dir. pd; Chief Eng. ce; From. Mgr. pmm; Prod. Mgr. pdm; News, Farm, Sports or Women's Dir. nd, fd, sd, wd.	Executive Abbreviations	Market Data For Primary Area (Supplied by station)	Library, News Serv. Transmitter	
BOONE									
	*KFGQ 1927	1260 250-D	Boone Biblical College						
	KFGQ-FM 1950	Ch. 237 (A) 99.3mc 0.31kw							
	KWBG 1950	1590 1,000-D 500-N DA-N	Boone Bcstg. Co. P. O. Box 36 1590	Iowa Tall Corn Net. Pearson	Mary Goldthwaite Garvey, p Paul E. Miller, gm & pd	Robert W. Erickson, cm & sd Daniel Garretson, ce Tom Quinlan, nd	Pop.: 255,146 Rad. Hms.: 76,640 Ret. Sls.: \$240,959,000	Wld., Thes. UP, INS GE	
BURLINGTON									
	KBUR 1941	1490 250	Burlington Bcstg. Co. Roosevelt & Mt. Pleasant St. 7680	ABC Taylor	G. B. McDermott, p & gm David H. Steinle, cm & pmm	Richard Mosena, pd & nd John F. Gallino, ce	Pop.: 153,447 Rad. Hms.: \$2,834	St. AP RCA	
CARROLL									
	KCIM 1950	1380 1,000 DA-2	Carroll Bcstg. Co. 520 N. Adams 3586 Pearson	Morris W. McPherson, gm	Eugene H. Reiff, asst. m & ce R. C. Johnson, nd	Dale Barton, sd & fd Edna G. Collins, wd Pop.: 256,277 Rad. Hms.: 80,134 Ret. Sls.: \$261,317,000	L-W, Thes. AP, INS	
CEDAR RAPIDS									
	KCRI 1947	1600 5,000	Cedar Rapids Tv Co. 1st St. & 1st Ave., S.W. 4-4194	MBS Burn- Smith	Sutherland Dows, p Wade S. Patterson, gm & cm	Ralph D. Willey, pd Edna Herbst, pmm & wd Carl Rollert, ce Dick Yoakam, nd Bob Brooks, sd	Pop.: 382,500 Rad. Hms.: 112,540 Ret. Sls.: \$355,570,000	Wld. RCA Col.	
	KPIG 1949	1450 250	Cedar Rapids Bcstg. Co. 211 1st St., S.W. 3-8265 Pearson	Allen H. Embury, vp, gm & cm Don Ramsell, pd	Al Morse, ce Jay Alexander, nd & sd Sally Wing, wd	Pop.: 165,000 Rad. Hms.: 36,875 Ret. Sls.: \$141,000,000	Cap. UP Col.	
	WMT 1922	600 5,000	American Bcstg. Stations Inc. Paramount Theatre Bldg. 6127	CBS Katz	William B. Dolph, p Helen S. Mark, chmn. of bd. William B. Quarton, vp & gm	Lew Van Nostrand, slm Douglas B. Grant, pd Leo Cole, pmm George Hixenbaugh, ce	Dick Cheverton, nd Tait Cummins, sd Chuck Worchester, fd Bob Nance, f. ed. Helen Roberts, wd	Pop.: 3,645,715 Rad. Hms.: 993,677 Ret. Sls.: \$3,513,276,000	L-W, Thes. AP, UP, INS RCA
	WMT-TV	DA-N							
CENTERVILLE									
	KCOG 1949	1400 100	Centerville Bcstg. Co. 1910 S. Main St. 131 McGillvra	Robert K. Beck, p A. M. Farber, gm & cm	Margaret Ashby, pd & nd Walter H. Lemen, ce	Harold L. Wanzer, sd Warren R. Langfitt, fd Pop.: 73,700 Rad. Hms.: 22,800 Ret. Sls.: \$49,743,000	L-W AP RCA	
CHARLES CITY									
	KCHA 1949	1580 250-D	Radio Inc. 300½ N. Main St. 787	KBS Upper Midwest Lawson	Charles J. Ellis, p & pmm Charles E. Wright, chmn. of bd. & gm Vern Bromberg, cm & sd	Wayne Mack, pd Loren B. Koesling, ce Doris La Bounty, bus. m John Whitsel, nd Virgil Fortner, fd Dorothy MacFarland, wd	Pop.: 122,000 Rad. Hms.: 32,800 UP Col.	
CHEROKEE									
	KCHE 1953	1440 500-D	Cherokee Bcstg. Co. 219½ W. Main St. 51	Russell A. Hickmon, gm & cm Charles Reznikov, pd & pmm	Sterling Heil, ce June Ames, nd Robert Lanxon, sd Carl McIntyre, fd	Pop.: 142,639 Rad. Hms.: 35,659 Ret. Sls.: \$378,034,367	Thes. AP Col.	
CLINTON									
	KROS 1941	1340 250	Clinton Bcstg. Corp. Jacobsen Bldg. 448	MBS Iowa Tall Corn Pearson	W. S. Jacobsen, p Bernard M. Jacobsen, gm Darline Gordon, cm	Ralph Stoeckel, pd Gerald A. Parker, ce Lee White, nd Henry Dihlmann, sd Don Ballinger, fd Gwen Johnson, wd	Pop.: 200,000 Rad. Hms.: 60,000 Ret. Sls.: \$210,000,000	Thes. UP Col.	
	KROS-FM 1947	Ch. 242 (B) 96.1mc 13kw					Pop.: 260,000 Rad. Hms.: 120,000 Ret. Sls.: \$260,000,000	Wld. UP RCA	
COUNCIL BLUFFS									
	KSWI 1947	1580 500-D	Nonpareil Bcstg. Co. 120 S. Main 4041 Haag	Robert R. O'Brien, p	Robert H. O'Brien, gm & ce Had Hughes, cm	Robert Hallgren, pd Marge Morris, pmm Pop.: 736,000 Rad. Hms.: 220,000 Ret. Sls.: \$822,000,000	Assoc., Thes. AP Col. GE	
CRESTON									
	KSIB 1946	1520 1,000-D	Southwest Iowa Bcstg. Co. Radio Center Creston 55	KBS Iowa Tall Corn Pearson	Mrs. Arthur Horning, chief o E. M. Horning, gm, pd & fd	Dave Melton, cm & pmm William S. Zollman, ce	Jack Mills, nd Dutch Horning, sd Vera Hansell, wd Pop.: 225,000 Rad. Hms.: 42,000 Ret. Sls.: \$103,000,000	Thes. INS Ray.	

Data corrected to Dec. 10, 1953. If executives or services for FM are same as AM affiliate names are not repeated. Market Data supplied by stations.
 FM's in italic. *—Non-Commercial Station. CP—Construction Permit issued. D—Day. DA-N—Directional Antenna, night only. DA-1—Directional Antenna, same pattern day and night. DA-2—Directional Antenna, different pattern day and night. L—Limited Time with Dominant Station. LS—Local Sunset. N—Night. SA—Special Authorization. SH—Specified Hours. ST—Share Time. Complete key to abbreviations, page 6.

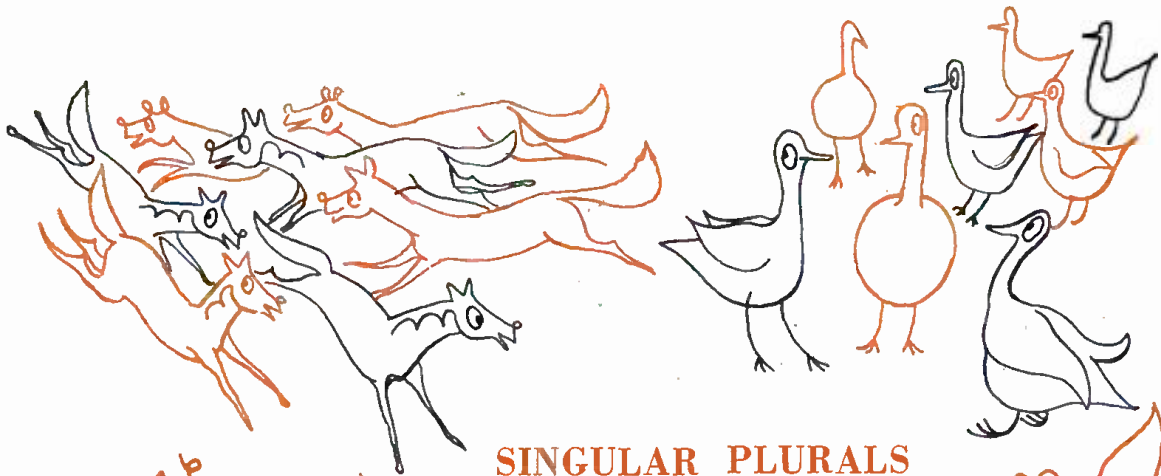

SINGULAR PLURALS

(including clowder,
murmuration and gaggle)

We have been investigating group designations for the animal kingdom. In the interest of keeping you informed, we publish a passel of our findings.

A bunch of cats is a clowder; one speaks of a cover of coots, a stud of mares, a tribe of goats, a bale of turtles, a murmuration of starlings, a raft of turkeys and a gang of elk. There are also a dray of squirrels, a pace of asses, a barren of mules, a crash of rhinoceroses, a gaggle of geese.

In a certain part of the Midwest, where consumers herd and listeners muster, there's a plural for human being which gives point to our prose: *WMTlisteners*. This is a collective term for 338,480 families who listen to WMT every week, the pluralest assemblage that ever.

For a clutch of data (a group of datum), see the Clowder* man.

WMT and WMT-TV
CEDAR RAPIDS

600 kc 5,000 watts
Basic CBS Network

*The Katz Agency, our national reps.

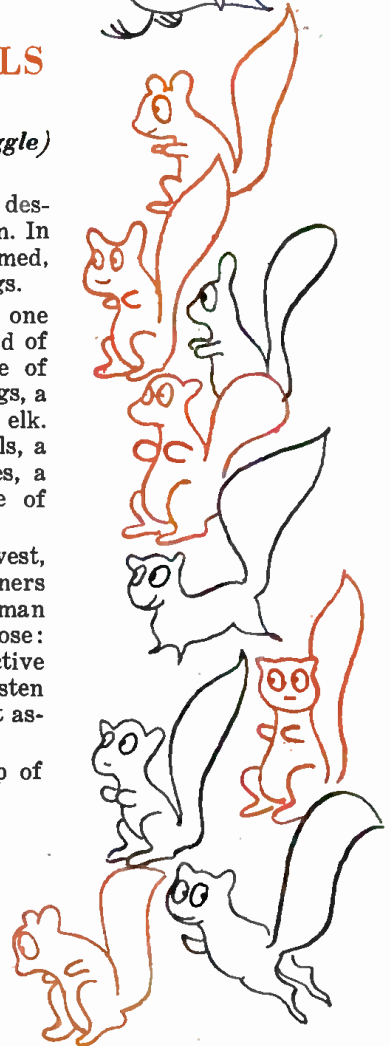

IOWA

City	Chan. or Call Letters Established TV Affiliate	Chan. or Freq. Power	Licensee Headquarters Telephone	Network Represent- ative	Executive Abbreviations Owner o; Pres. p; Exec. vp evp; Gen. Mgr. gm; Sta. Mgr. sm; Coml. Mgr. cm; Sales Mgr. slm; Prog. Dir. pd; Chief Eng. ce; Prom. Mgr. pmm; Prod. Mgr. pdm; News, Farm, Sports or Women's Dir. nd, fd, sd, wd.	Market Data For Primary Area (Supplied by station)	Library, News Serv. Transmitter
DAVENPORT							
KFMA 1952	1580 250-D	KFMA Bcstg. Co. 415 Perry St. 6-4407 ForJoe	A. D. Peirce, p, gm & cm	Gene Larsen, pd, nd & fd Doris Hanner, pmm	Francis B. Shawver, ce	Pop.: 234,256 Rad. Hms.: 71,650 Ret. Sl.: \$246,605,000 RCA
KSTT 1946	1170 1,000 DA-2	Davenport Bcstg. Co. Inc. 310 Harrison St. 6-2541	MBS Sears & Ayer	Hugh R. Norman, p Jerry Dunphy, gm Nell Conklin, cm Bruno Olson, pd	A. M. McGregor, ce & treas. Bill Merchant, nd	Ellis Marvin, sd Bill Allan, fd Lois Snively, wd	Pop.: 250,000 Rad. Hms.: 592,010 Ret. Sl.: \$250,000,000 Col.
WOC 1922 WOC-TV	1420 5,000-DA-2	Tri City Bcstg. Co. 805 Brady St. 3-3661	NBC Free & Peters	Col. B. J. Palmer, p D. D. Palmer, vp & treas. Ralph Evans, evp William Wagner, secy. Ernest C. Sanders, m	Fred A. Reed, asst. m Mark Wodlinger, slm Charles R. Freburg, pd Paul H. Ives, prog. m & pmm	Paul Arvidson, ce Bob Frank, nd & fd Hal Hart, sd Mary Louise Marshall, wd	Pop.: 447,200 Rad. Hms.: 136,461 Ret. Sl.: \$538,342,000 L-W, Thes. UP Col.
WOC-FM 1948	Ch. 279 (B) 103.7mc 47kw						NBC, Thes. UP RCA

Data corrected to Dec. 10, 1953. If executives or services for FM are same as AM affiliate names are not repeated. Market Data supplied by stations. FM's in italic. *—Non-Commercial Station. CP—Construction Permit issued. D—Day. DA—N—Directional Antenna, night only. DA-1—Directional Antenna, same pattern day and night. DA-2—Directional Antenna, different pattern day and night. L—Limited Time with Dominant Station. LS—Local Sunset. N—Night. SA—Special Authorization. SH—Specified Hours. ST—Share Time. Complete key to abbreviations, page 6.

The Music & News Station the Quint-Cities' Listen to Most

Our Low Rates and Good Programming get results in this preferred market among the 162 standard metropolitan areas.



KFMA—Davenport
The Quint-Cities' Music & News Station
covering . . .

- The HOG CAPITAL of the World
- The Richest CATTLE Raising County in the World—
In the Heart of the CORN BELT!
- THIS IS A MANUFACTURING CENTER
- 59,000 Industrial Workers—
- 12th in Effective Buying Income per capita . . .
- 56th Largest Manufacturing Center in the Nation . . .
- 65th in Buying Power . . .
- 74th in Retail Sales . . .
- 79th in Population . . .

HERE IS A MAJOR MARKET
The largest between Minneapolis and St. Louis;
between Chicago and Omaha.

YES, Some SPOTS are better than others
and in the Quint-Cities, the best SPOTS are on
KFMA—a natural test market!

One of America's leading Independent
Radio Stations—
The only Independent Radio Station in
the Quint-City Area!



For
RECORD
SALES . . .
it's

KFMA BROADCASTING COMPANY
A. D. Peirce, President
DAVENPORT, IOWA

or
Ask any FORJOE COMPANY Representative
National Reps.

DECORAH



KDEC 1947	1240 250	Scenic Bcstg. Co. Inc. State Rd. 1240	MBS Iowa Tall Corn Pearson	Verne Koenig, p & gm	Kenneth Bjerke, cm	Arnie Zaruba, ce		Assoc. AP G
*KWLC 1926	1240 250-D	Luther College 600 Leiv Eiriksson Dr. 687 ext. 13	NAEB	Dr. J. W. Ylvisaker, p Leslie G. Rude, pd	Oliver M. Eittrheim, ce Nolan Johannes, nd	Elliot Christian, sd Jean Tucker, wd	G

DES MOINES

KCBC 1947	1390 1,000-DA-1	Majestic Bcstg. Co. 3512 Ingersoll 7-4483	Karl Peters, p Rollo H. Bergeson, gm	Claire E. Grant, cm Robert S. Brown, ce	Don Purdy, slm	Pop.: 420,000 Rad. Hms.: 110,000 Ret. Sls.: \$183,635,000 INS
KIOA 1948	940 10,000-D 5,000-N- DA-2	Town & Farm Co. Onthank Bldg. 2-9191	MBS AM Radio Sales	Don Searle, p Rex Lathen, vp & gm	Lee Harris, pd Ruth Reed, pmm Lyle Amoo, ce	R. Jay Nash, nd Bob Elston, sd Betty Wells, wd	Pop.: 2,283,600	Wid. UP, INS RCA
KRNT 1935	1350 5,000-DA-N	Cowles Bcstg. Co. 715 Locust St. 3-2111	CBS Katz	Gardner Cowles, p Bob Dillon, gm Paul Elliott, cm	Dick Covey, pd Joe Hudgens, pmm Charles Quentin, ce	Russ Van Dyke, nd Al Coupee, sd Lols Carty, wd	Pop.: 860,000 Rad. Hms.: 266,710 Ret. Sls.: \$957,773,000	Stan. AP, UP RCA
KRNT-FM 1952	Ch. 283 (B) 104.5mc 50kw							Stan. AP, UP WH
KSO 1922	1460 5,000-DA-N	Murphy Bcstg. Co. 800 Farm Bureau Bldg. 3-0571	ABC Avery- Knodel	Kingsley H. Murphy Jr., p B. C. Baldwin, vp & sm A. E. Shumate, vp & cm	Lou Cooke, pd Gloria Frumkin, pmm Floyd E. Bartlett, ce Ove Strandskov, comp.	Glenn Goodwin, nd Dale Ellsworth, fd Helen Marsh, wd	Pop.: 922,669 Rad. Hms.: 320,000 Ret. Sls.: \$1,056,895,000	Cap. AP RCA
KSO-FM 1949	Ch. 247 (B) 97.3mc 15.5kw						Pop.: 900,000 Rad. Hms.: 300,000 Ret. Sls.: \$1,056,895,000	Cap. AP, INS RCA
KWDM 1948	1150 1,000-DA-2	Des Moines Bcstg. Co. 407 5th Ave. 2-8363	Iowa Tall Corn	George W. Webber, p & cm Robert L. Webber, gm	Edith L. Webber, pd & wd Les Gates, pmm	Werner Schwartz, ce Dick Nesbitt, nd & sd	Pop.: 527,000	Assoc.. Cole. SES. INS Ray.

Let's talk about RATINGS!

KSO likes to talk about its long public-service record in Central Iowa. We like to talk about our local personalities and give careful attention to both spot buyer and program buyer. We like to talk about the results this good listener-relationship, production, promotion and attention produce. BUT . . .

TIME BUYERS IN  Bangor  Hollywood  New York  Dallas 

— aren't close enough to know the local flavor. He buys with statistics — FACTS — in mind. SO, Mr. and Miss Timebuyer, *wherever* you are

LET'S TALK ABOUT RATINGS! The true rating is the one labeled "Cost Per Thousand." Choosing seven spot times at random . . . and using KSO's highest one-time spot rate (\$14.00), **the cost per thousand is 67¢** . . . and carrying this on down to KSO's Spot Announcement Package highest-frequency discount rate, **the cost per thousand is 40¢** . . . and this compares to 96c and 58c on the next high-rated Central Iowa station.

LET'S TALK ABOUT RATINGS! We like to . . . and so do the Avery-Knodel people. They represent us nationally. Ask them . . . or us . . . for our recent coverage map and complete survey figures of above results.

KEYS TO SALES OPPORTUNITIES
DES MOINES 9, IOWA ABC for CENTRAL IOWA

KINGSLEY H. MURPHY, JR., President
BILL BALDWIN, Station Mgr.
GENE SHUMATE, Comm. Mgr.

Represented by
AVERY-KNODEL Inc.
NEW YORK • CHICAGO • SAN FRANCISCO
LOS ANGELES • ATLANTA • DALLAS

IOWA

City	Call Letters Established TV Affiliate	Chan. or Freq. Power	Licensee Headquarters Telephone	Network Represent- ative	Executive Abbreviations Owner o; Pres. p; Exec. up evp; Gen. Mgr. gm; Sta. Mgr. sm; Coml. Mgr. cm; Sales Mgr. sim; Prog. Dir. pd; Chief Eng. ce; Prom. Mgr. pmm; Prod. Mgr. pdm; News, Farm, Sports or Women's Dir. nd, fd, sd, wd.	Market Data For Primary Area (Supplied by station)	Library, News Serv. Transmitter		
DES MOINES (Continued)									
WHO	1924	1040 50,000	Central Bcstg. Co. 914 Walnut St. 3-7147	NBC Free & Peters	Col. B. J. Palmer, p Ralph Evans, evp D. D. Palmer, vp & treas. P. A. Loyet, vp & res. m	William D. Wagner, secy. Wilfred W. Woods, asst. res. m Harold Fulton, sim	Jack Kerrigan, pd Reed E. Snyder, ce Jack D. Shelley, nd Jim Zabel, sd Herb Plambeck, fd	Pop.: 3,570,100 Rad. Hms.: 1,082,960 Ret. Sls.: \$4,016,000,000	SES., Thes. AP, UP, INS WH
WHO-FM	1948	Ch. 262 (B) 100.3mc 400kw						Pop.: 1,373,600 Rad. Hms.: 425,861 Ret. Sls.: \$1,577,399,000	
DUBUQUE									
KDTH	1941	1370 1,000-DA-N	Telegraph Herald 8th & Bluff 3-7351	NBC, Iowa Iowa Tall Corn Pearson	F. W. Woodward, p K. S. Gordon, gm Al Newburgh, cm	Arnold Stierman, pd Gerald MacAleese, pmm, fd & sd	Robert Hancock, ce George Freund, nd Esther Martin, wd	Pop.: 225,010 Rad. Hms.: 63,652 Ret. Sls.: \$213,782,446	Assoc., Wid. AP
WDBQ	1933	1490 250	Dubuque Bcstg. Co. 505 Main St. 3-8241	ABC, MBS Meeker	James D. Carpenter, evp & gm Harry Hatzenbuehler, loc sim. Gleason Kistler, pd & fd	Robert E. Carpenter, pmm Don Heim, trans. chief Fran Barker, studio chief	Vaughn Gayman, asst. m & nd John Husak, sd Sr. Mary St. Clara, BVM, wd	Pop.: 97,965 Rad. Hms.: 26,000 Ret. Sls.: \$107,221,000	Thes. UP RCA
WDBQ-FM	1948	Ch. 277 (B) 103.3mc 15kw						Pop.: 196,715 Rad. Hms.: 54,350 Ret. Sls.: \$201,088,000	
ESTHERVILLE									
KLIL	1952	1340 100	Estherville Bcstg. Corp. Box 173 1800	ABC	William E. Schons, p & gm	Jack Turnbull, cm Gene Randolph, pd & ce	Mavis Peterson, pmm	Pop.: 100,000	L-W, SES. AP Col.
FAIRFIELD									
KFAD	1953	1570 250-D	The Fairfield Bcstg. & TV Corp. Hwy. 34 W. 345	KBS	Carl D. Boyer, p James D. Mortwedt, vp & gm	Don Mortwedt, pd Eugene Spiker, cm	Tom Kleckner, ce	Pop.: 111,000	
FORT DODGE									
KVFD	1939	1400 250	Northwest Bcstg. Co. 912 1st Ave. S. Walnut 3761	MBS, Iowa Tall Corn Pearson	Ed Breen, p & gm Max Landes, cm Drexel Peterson, pd Dave Sinclair, ce	Virginia Fisher, office m Ken Peterson, nd	Bob Roderick, sd Verne Gielow, fd Mary Rankin, wd	Pop.: 194,700 Rad. Hms.: 57,950 Ret. Sls.: \$383,427,000	L-W UP, INS RCA
KQTV(TV)									
KFMY(FM)	1947	Ch. 274 (B) 102.7mc 10kw	(KVFD, Am Affiliate)						
FORT MADISON									
KXGI	1948	1360 500-D	KXGI Inc. Marquette Bldg. 1360 Holman	W. E. Walker, p Greg Rouleau, gm & pmm Paul Oye, cm	Lloyd Mallette, pd N. P. Colwell, fd Harold Hackbarth, ce Gloria Naatgeboren, nd	Dick Specht, sd Tish Cook, wd	Pop.: 568,367 Rad. Hms.: 171,893 Ret. Sls.: \$237,538,000	L-W AP Ray.
IOWA CITY									
KKIC	1948	800 1,000-D- DA	Johnson County Bcstg. Corp. Box 751 8-1181	Iowa Tall Corn Rambau	A. James Ebel, p Gene Claussen, gm & sd	F. M. Broeders, cm Hershell Weakley, pd & pmm Elliott Full, ce	Bob Hutchison, nd G. M. Ludwig, fd Rita Frey, wd	Pop.: 1,000,000 Rad. Hms.: 290,000	Wid., Cap. UP, INS Col.
*WSUI	1919	910 5,000-DA-1	State U. of Iowa Iowa City 8-0511 ext. 2171	Carl H. Menzer, gm & d	Lee Eitzen, pd S. J. Ebert, ce	Arthur Barnes, nd Bob Zenner, sd		Wid., Cap. UP, INS Col.
KEOKUK									
KOKX	1948	1310 1,000-D 500-N-DA-2	Keokuk Bcstg. Co. 4 So. 5th St. 235	H. W. Stadler, p Herb Nelson, g, c & pmm	Virgil Fortner, pd James L. Mott, ce Harley Melton, nd	George Lasley, fd Chet Andrews, sd Kay Gredell, wd		Wid., Cap. AP G
KOKX-FM	1948	Ch. 274 (B) 102.7mc 3.7kw							
MARSHALLTOWN									
KFJB	1923	1230 250	Marshall Electric Co. 133 E. Main St. 3361	MBS, Iowa Tall Corn Pearson	Paul G. Norris Jr., pub., Times- Republican William P. White, gm	William C. Doll, cm Allan N. Schrock, pd & pmm Keith Pfeiffer, fd	Herbert G. Anderson, sd Byron Gosden, nd Dale Smith, sd	Pop.: 155,000 Rad. Hms.: 55,000 Ret. Sls.: \$32,250,000	Thes. UP RCA
MASON CITY									
KGLO	1937	1300 5,000 DA-N	Lee Radio Inc. Mason City 2800	CBS Weed	Lee P. Loomis, p Herbert R. Ohrt, evp & gm Lloyd L. Loers, cm Bud Suter, pd & sd	Don Harrer, pmm Roger Sawyer, ce Walter Rothschild, natl sim	Ken Kew, nd Al Heinz, fd Ann Good, wd	Pop.: 435,000 Rad. Hms.: 125,830 Ret. Sls.: \$453,630,000	Wid. AP, UP RCA
KGLO-FM	1948	Ch. 266 (B) 101.1mc 16kw							
KRIB	1948	1490 250	Mason City Bcstg. Co. 5 Second St., S.W. 5400	MBS, Tall Corn Pearson	Louis, Abbott, George & Wm. B. Wolf, co-o Joseph S. Simon, gm & pmm	Edward Lamson, cm Bob Cavanaugh, pd, nd & fd Richard J. Kelley, ce	Tom O'Connor, sd Mary Jane Anderson, wd		Thes. AP
KSMN	1948	1010 1,000-D	Mohawk Bcstg. Co. Weir Bldg. 5420	Robert M. Carson, p & gm	Steve M. Hoff, cm Milten H. Cohen, pd	Hubert J. Marshall, ce	Pop.: 500,000 Rad. Hms.: 125,000	Assoc. UP G
MUSCATINE									
KWPC	1947	860 250-D	Muscataine Bcstg. Co. Mulberry & Houser 860	KBS, Iowa Tall Corn Pearson	George J. Volger, gm & cm	Mrs. Marion Temple- man, pd & wd Darrell Dorsey, ce	Jim Ryan, nd & sd John Williamson, fd	Pop.: 455,500 Rad. Hms.: 138,000 Ret. Sls.: \$469,000,000	Wid., Assoc. UP Col.
KWPC-FM	1948	Ch. 259 (B) 99.7mc 0.78kw						Pop.: 100,000 Rad. Hms.: 10,000 Ret. Sls.: \$469,000,000	
OELWEIN									
KOEL	1950	950 500-DA-1	Northwest Iowa Radio Corp. 4½ W. Charles St. Oelwein 120	Iowa Tall Corn Pearson	C. W. Crahan, p W. J. Teich, gm Don L. McKee, cm Ed Jenkins, pd	Len Bjella, pmm Burt N. Murphy, ce Dick Petrik, nd	Robert Zimmerman, sd Paul Ruse, fd Chrystal Julien, wd	Pop.: 400,000 Rad. Hms.: 115,000 Ret. Sls.: \$343,000,000	Thes., SES., L-W

Data corrected to Dec. 10, 1953. If executives or services for FM are same as AM affiliate names are not repeated. Market Data supplied by stations. FM's in *italics*. *—Non-Commercial Station. CP—Construction Permit issued. D—Day. DA—Day. DA-N—Directional Antenna, night only. DA-1—Directional Antenna, same pattern day and night. DA-2—Directional Antenna, different pattern day and night. L—Limited Time with Dominant Station. LS—Local Sunset. N—Night. SA—Special Authorization. SH—Specified Hours. ST—Share Time. Complete key to abbreviations, page 6.

Buy **WHO**

and Get Iowa's Metropolitan Areas..

Plus the Remainder of Iowa!

TAKE FOOD SALES, FOR INSTANCE!

4.4%	CEDAR RAPIDS . . .	█
10.7%	TRI-CITIES . . .	█
10.7%	DES MOINES . . .	█
3.1%	DUBUQUE . . .	█
4.7%	SIOUX CITY . . .	█
4.3%	WATERLOO . . .	█
65.4%	REMAINDER OF STATE	█



Figures add to more than 100%, because Rock Island County, Illinois is included in Tri-Cities.

THE "REMAINDER OF IOWA" ACCOUNTS FOR THESE SALES: (Which You MISS Unless You Cover the Entire State)

- 65.4% Food Stores
- 61.6% Eating and Drinking Places
- 44.8% General Merchandise Stores
- 55.6% Apparel Stores
- 60.7% Home Furnishings Stores
- 65.1% Automotive Dealers
- 73.2% Filling Stations
- 79.6% Building Material Groups
- 60.4% Drugstores

Source: 1952-'53 Consumer Markets

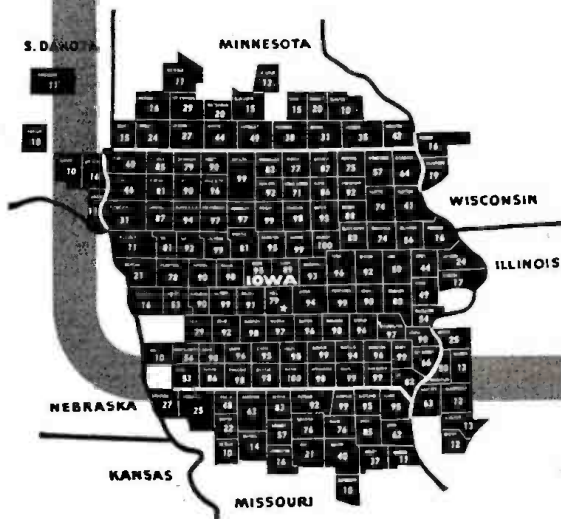

**BUY ALL of IOWA—
Plus "Iowa Plus"—with**

WHO

Des Moines . . . 50,000 Watts

Col. B. J. Palmer, President

P. A. Loyet, Resident Manager

County	Population 1950	Radio Families 1953	Retail Sales 1952(000)	Food Sales 1952(000)	Drug Sales 1952(000)	Automobile Ownership 1952	County	Population 1950	Radio Families 1953	Retail Sales 1952(000)	Food Sales 1952(000)	Drug Sales 1952(000)	Automobile Ownership 1952
Lincoln	5,643	1,940	5,979	1,317	160	3,854	Russell	13,406	4,180	16,066	3,874	385	8,259
Linn	10,053	3,340	6,404	1,122	201	4,311	Saline	33,409	11,120	56,921	9,631	1,226	17,521
Logan	4,206	1,160	7,541	1,546	191	2,354	Scott	4,921	1,440	8,360	2,291	137	3,512
Lyon	28,576	8,380	29,034	6,047	1,037	11,745	Sedgwick	222,290	86,730	337,039	63,693	10,701	124,037
McPherson	23,670	7,350	26,614	5,477	848	12,967	Seward	9,972	3,650	23,798	4,808	590	5,590
Marion	16,307	5,010	17,625	3,637	408	8,557	Shawnee	105,418	34,870	123,795	26,957	3,736	47,776
Marshall	17,926	5,740	16,938	3,966	528	8,696	Sheridan	4,607	1,070	5,476	991	85	2,823
Meade	5,710	1,650	8,470	1,514	252	3,707	Sherman	7,373	2,270	14,715	2,379	353	4,477
Miami	19,698	5,900	14,547	3,734	485	8,226	Smith	8,846	2,590	7,648	2,076	246	4,769
Mitchell	10,320	3,290	16,909	2,869	517	5,799	Stafford	8,816	2,710	8,107	2,143	252	5,399
Montgomery	46,487	15,500	50,722	13,094	1,695	21,201	Stanton	2,263	"	3,197	556	84	1,652
Morris	8,485	2,540	6,723	1,648	189	4,483	Stevens	4,516	1,370	8,180	1,856	112	2,988
Morton	2,610	1,380	4,856	1,145	238	1,847	Sumner	23,646	7,730	20,192	4,343	667	14,264
Nemaha	14,341	4,190	13,810	2,953	559	6,007	Thomas	7,572	2,320	14,093	2,202	508	4,716
Neosho	20,348	6,480	19,181	4,837	526	9,431	Trego	5,865	1,720	6,526	1,157	114	3,424
Ness	6,322	2,090	8,366	1,626	295	4,184	Wabaunsee	7,212	2,080	4,853	1,440	158	3,630
Norton	8,808	2,670	13,230	2,218	361	4,909	Wallace	2,508	690	4,271	704	45	1,568
Osage	12,811	4,100	8,606	2,215	222	6,121	Washington	12,977	4,070	8,004	1,378	197	6,398
Osborne	8,558	2,720	10,242	2,359	309	4,891	Wichita	2,640	1,250	7,615	1,260	50	1,932
Ottawa	7,265	2,310	6,426	1,542	170	4,128	Wilson	14,815	4,860	11,687	2,918	260	7,373
Pawnee	11,041	2,850	14,438	2,497	378	5,796	Woodson	6,711	2,100	5,295	1,304	127	3,172
Phillips	9,273	3,070	9,443	1,965	180	5,112	Wyandotte	165,318	52,350	143,902	38,817	6,037	61,673
Pottawatomie	12,344	3,630	12,196	2,315	357	5,673	Total	1,905,299	613,570	\$2,160,969	\$467,522	\$66,037	921,476
Pratt	12,156	3,830	16,781	3,366	469	7,189	*Morton included in Stanton County figure. *See Morton. *See Haskell. *See Wichita. *Haskell figure included in Grant. *Greeley is included in Wichita County figure. Note: Population 1950 Census; radio families Standard Audit & Measurement Services Inc.; food, drug and retail sales, copyright 1953, Sales Management; further reproduction unlicensed; automobiles supplied by state.						
Rawlins	5,728	1,550	8,294	1,448	244	3,760							
Reno	84,058	17,440	72,361	14,215	2,244	27,377							
Republic	11,478	3,720	8,677	2,001	295	6,107							
Rice	15,635	5,200	14,714	3,587	538	9,121							
Riley	33,405	9,520	32,252	6,788	1,125	11,900							
Rooks	9,043	2,810	13,514	2,611	504	5,300							
Rush	7,231	2,210	10,568	1,899	298	4,642							

DIRECTORY OF AM AND FM STATIONS

ARKANSAS CITY	KSOK 1280 1947 1,000-D 100-N	KSOK Bestg. Co. P. O. Box 455 2666	KBS	Oscar S. Stauffer, p S. C. Thompson, vp & gm	C. E. Archer, cm Richard Moore, pd & nd	Edward H. Howe, ce Dan Kahler, sd	Pop.: 827,371 Rad. Hms.: 335,160 Ret. Sls.: \$937,638,000	L-W AP Ray.
ATCHISON	KARE 1470 1939 DA-1	Griffith-Buening Co. 5th & Kansas 2477	Sears & Ayer	James M. Griffith, co-o, gm & fd Paul H. Buening, co-o & cm	James Shaddock, pd Robert Nelson, pmm & nd	Larry Winegardner, ce Edna Shelley, wd Bill Ervin, sd	Pop.: 253,458 Rad. Hms.: 65,624 Ret. Sls.: \$249,742,000	St. AP Col.
CHANUTE	KCRB 1480 1953 1,000-D	Cecil W. Roberts Beach & Plumber 434	KBS Best	Cecil W. Roberts, o Duane W. Hoisington, gm, cm & ce	Paula Hoisington, pd & wd	Joe Young, pmm, nd & sd Bill Penner, fd		UP Col.
COFFEYVILLE	KGGF 1930 690 10,000-D 5,000-N DA-2	The Midwest Bestg. Co. 8th & Elm 1843	ABC Weed	Richard M. Seaton, p Robert L. Pratt, gm & pmm	E. B. Spoonamore, cm Richard S. Embody, pd	J. S. Jaminet, ce Vic Lindsey, nd Joe Cook, fd	Pop.: 2,700,000 Rad. Hms.: 775,850 Ret. Sls.: \$2,392,057,000	Wld. AP WH

look
what's
cooking in
Coffeyville!



WEED & CO., National Representatives.

KGGF GIVES PRIMARY COVERAGE TO 87 COUNTIES IN KANSAS, OKLAHOMA, MISSOURI AND ARKANSAS, WHERE 2,700,000 PEOPLE SPEND \$2,400,000,000 ANNUALLY. THE POPULATION AND RETAIL SALES OF THIS MARKET ARE GREATER THAN THE ENTIRE STATE OF KANSAS.

The 10 counties in extreme southeast Kansas and northeast Oklahoma have a combined population of 271,300. Montgomery County (KGGF's home county) has the greatest population and retail sales.

KGGF has been the "home town" station to these folks for 23 years.

Ask Weed & Co. about KGGF's 10,000 watts (d) and 5,000 watts on 690 KC.

KANSAS

City	Call Letters Established TV Affiliate	Chan. or Freq. Power	Licensee Headquarters Telephone	Network Represent- ative	Executive Abbreviations Owner: Pres. p; Exec. up evp; Gen. Mgr. gm; Sta. Mgr. sm; Coml. Mgr. cm; Sales Mgr. slm; Prog. Dir. pd; Chief Eng. ce; Prom. Mgr. pmm; Prod. Mgr. pdm; News, Farm, Sports or Women's Dir. nd, fd, sd, wd.	Market Data For Primary Area (Supplied by station)	Library, News Serv. Transmitter
COLBY							
KKXX 1947	790 5,000-D	Western Plains Bcstg. Co. Inc. 380 W. 4th St. 790	H-R Reprs.	Don Searle, p Ed Mason, gm & fd Wm. A. Martin, cm	Don Secord, pd & nd V. L. Lynch, ce Pete Howard, sd	Helen Clark, wd	Thes., SES. UP Col.
CONCORDIA							
KFRM 1948	550 5,000-D DA-D	Midland Bcstg. Co. KMBC Building Kansas City, Mo. Harrison 2850 General Bcstg. Co.	CBS Free & Peters	Arthur B. Church, p George J. Higgins, vp & mgng. d Arthur B. Church Jr., adm. asst.	Roderick B. Cupp, pd C. E. Moler, ce Harold W. Storm, pmm	John Farmer, nd Phil Evans, fd Sam Molen, sd	L-W AP, UP RCA
KNCK (CP)	1390 500-D						
DODGE CITY							
KGNO 1930	1370 5,000-D 1,000-N DA-N	Dodge City Bcstg. Co. 785½ Second Ave. 1370		Wendell Elliott, cm Ruth Peterson, cm	Herschel Holland, pd Frank Miller, ce Gray Graham, nd	Gail Hamilton, fd Bob Harper, sd Frances Elliott, wd	Pop.: 109,528 Wid. G
EL DORADO							
KBTO 1953	1360 500-D	O. A. Tedrick P. O. Box 168 130		O. A. Tedrick, o	B. E. Brown, gm & cm	Jay H. Williams, ce	
EMPORIA							
KTSW 1938	1400 250	Emporia Bcstg. Co. Broadview Hotel 133	Gill- Perna	G. F. Reed, p Robert L. Palmer, gm & sd	Harold Servey, cm Wilma Slattery, pd Everett A. Thompkins, ce	Tex Smiley, nd Connie Manahan, wd	Pop.: 92,000 Rad. Hms.: 30,000 Ret. Sis.: \$89,000,000 Wid., Thes. AP Col.
GARDEN CITY							
KGAR 1948	1050 1,000-D	Ark. Valley Bcstg. Co. RR #1 3044	Holman	Ellsworth Sherman, p M. R. Pearce, gm	Lorraine L. Pearce, cm & pd	Robert Breeding, ce	Assoc. UP G
KIUL 1935	1240 250	KIUL Inc. 509½ N. Main 3251	MBS	Robert Wells, p & gm Bob Emery, cm	Tony Jewell, pd, fd & sd Ann Conard, pmm & wd	Joe Tennesen, ce Wes Cook, nd	Wid. AP G
GOODLAND							
KWGB 1947	730 1,000-D	Goodland Bcstg. Co. Hotel Howard Box 569 331	MBS, KBS	James E. Blair, o & gm	Bert Blair, cm	Lyle E. Fick, ce	Cap., Cole UP G
GREAT BEND							
KVGB 1937	1590 5,000 DA-N	KVGB Inc. 2103 Forest 4317	NBC Pearson	Helen T. Coogan, p Grover C. Cobb, vp & gm	Sherwood R. Parks, asst. m Ray H. Beals, pd	Gilbert Hanzlicek, ce Bill Jarvis, slm & sd James F. Heaton, nd & fd	Thes. AP Ray.
HAYS							
KAYS 1948	1400 250	KAYS Inc. 2450 Hall St. 4-2578	KBS	Frank Motz, p Bob Schmidt, gm & cm Max Bicknell, pd	Glen Barnett, ce Bud Ryan, pmm		Thes., L-W AP RCA
HUTCHINSON							
KWBW 1935 KTVH(TV)	1450 250	Nation's Center Bcstg. Co. 17th & Harding Sts. 2-4486	NBC, KBS, Kansas Quality Group Taylor	Bess Marsh Wyse, p Harold E. King, gm Kainor Carson, cm	Marguerite MacMorris, pmm & wd Bill Hart, ce & fd	Ed Welch, nd Wilma Perics, office m	Pop.: 101,000 Rad. Hms.: 29,000 Ret. Sis.: \$100,000,000 Wid. AP Col.
KWHK 1946	1280 1,000-D 500-N DA-2	KWHK Bcstg. Co. 18 W. 5th 5-4461	Everett- McKinney	James E. Murray, p Vern Minor, secy.- treas. & gm	Dan Salmon, cm Jim Murray Jr., pd Gren Darling, pmm	M. H. Clary, ce Jack Lynch, sd	Pop.: 600,000 Rad. Hms.: 175,000 AP G
INDEPENDENCE							
KIND 1947	1010 250-D	Central Bcstg. Inc. 1010	MBS, KBS	J. Nelson Rupard, p Jo Randall, cm	James Teats, ce Neale Rowland, nd	Phil Atkisson, sd Frances Rupard, wd	Pop.: 216,900 Rad. Hms.: 70,422 Ret. Sis.: \$207,668,000 AP GE
KIND-FM 1953	Ch. 22 1/2 (A) 93.5mc 0.325kw						
JUNCTION CITY							
KJCK 1949	1420 1,000-D	Junction City Bcstg. Co. 724½ N. Washington St. 8-3165	Kansas Net. Indie	R. L. Weir Jr., p, gm & ce James P. Platt, cm Jack Horner, pd	Robert D. Snyder, pmm Gene Cless, nd	Dick Shagool, sd Chuck Nichols, fd Shirley Webster, wd	Pop.: 220,000 Rad. Hms.: 75,000 Ret. Sis.: \$232,000,000 Wid. UP Col.
KANSAS CITY							
KCKN 1930	1340 250	KCKN Bcstg. Co. 300 Waltower Bldg. Kansas City, Mo. Victor 3864	Capper	W. A. Bailey, p Ben Ludy, gm Joe Story, m	George Stump, pd Gladys Richardson, office m	Louis Dickensheets, ce Allen Smith, nd	Pop.: 925,900 Rad. Hms.: 231,475 Ret. Sis.: \$1,218,461,000 St., L-W AP, UP RCA
LAWRENCE							
*KFKU 1924	1250 5,000 DA-N ST: WREN	U. of Kansas 2700, ext. 382	NAEB Tape Net.	Franklin D. Murphy, chancellor R. Edwin Browne, d	Mildred Seaman, pd R. P. Stringham, ce	Jackie Jones, nd Merle Harmon, sd	Pop.: 758,571 Rad. Hms.: 209,740 Assoc. AP, UP
KLWN 1951	1320 500-D	Lawrence Bcstrs. Inc. 3431	Grant	Arden Booth, p, gm, cm & fd	Ed Hundley, pd & sd Hal Carlson, ce	Jack Hines, nd Bette Booth, wd	Pop.: 318,248 Rad. Hms.: 87,350 Ret. Sis.: \$448,062,000 L-W, Thes. UP WE
LEAVENWORTH							
KCLO 1948	1410 500-D	Cecil W. Roberts P. O. Box 809 3620	Best	Cecil W. Roberts, o Chester Kozak, gm	Delmas Rush, ce		L-W UP Col.

Data corrected to Dec. 10, 1953. If executives or services for FM are same as AM affiliate names are not repeated. Market Data supplied by stations. FM's in italic. *—Non-Commercial Station. CP—Construction Permit issued. D—Day. DA—Directional Antenna, night only. DA-1—Directional Antenna, same pattern day and night. DA-2—Directional Antenna, different pattern day and night. L—Limited Time with Dominant Station. LS—Local Sunset. N—Night. SA—Special Authorization. SH—Specified Hours. ST—Share Time. Complete key to abbreviations, page 6.

Sell the Kansas Farm Market



Here is America's "sleeper" market . . . Kansas farm families and the folks in surrounding agricultural communities.

Just look at these figures from the latest *Kansas Business Review*. Farm Income up 9.4%. Hog prices up 27.4% over a year ago and eggs up 17.5%. Wheat is bringing the farmer \$1.97 a bushel and corn sells at \$1.51.

Finally, the farmers themselves feel prosperous. In addition to bulging bank accounts there's a big demand for land itself—so great that the price per acre and the total value of all farm real estate has hit an all time high.



...use the Kansas Farm Station



WIBW



Mass selling depends on mass exposure . . . and that's just what WIBW gives you. From sign-on to sign-off, Kansas farm homes report that they listen to WIBW more than twice as much as any other station. In this same statewide, personal survey,* WIBW continued to rank an outstanding *first* for the best farm news, weather, and market reports. Let us prove WIBW's selling ability with **FAST RESULTS FOR YOU!**

* Kansas Radio Audience, '53

WIBW—CBS Radio in Topeka

Ben Ludy, Gen. Mgr.

WIBW, WIBW-TV, KCKN

Rep.: Capper Publications, Inc.

KANSAS

City	Call Letters Established TV Affiliate	Chan. or Freq. Power	Licensee Headquarters Telephone	Network Represent- ative	Owner o; Pres. p; Exec. up evp; Gen. Mgr. gm; Sta. Mgr. sm; Coml. Mgr. cm; Sales Mgr. slm; Prog. Dir. pd; Chief Eng. ce; Prom. Mgr. pmm; Prod. Mgr. pdm; News, Farm, Sports or Women's Dir. nd, fd, sd, wd.	Executive Abbreviations	Market Data For Primary Area (Supplied by station)	Library, News Serv. Transmitter
LIBERAL								
KSCB 1948	1270 1,000-D	Seward County Bcstg. Co. E. 8th St. P. O. Box 311 3891	Best	Alf M. Landon, p Leon S. Salathiel, gm Roy Pearce, cm	Bill Scott, pd, nd & sd	J. A. Seegars, ce Virginia Knos, wd	Pop.: 90,000 Rad. Hms.: 30,000	L-W UP Col.
MANHATTAN								
KMAN 1950	1350 500-D	Manhattan Bcstg. 114 N. 4th Prescot 8-4451	Fred A. Seaton, p Warren L. Mowder, gm	Paulson E. Leighton, cm Samuel C. Blessing, pd & fd	Herbert P. Lavin, ce Herb Tuttle, nd Chas. Howe, sd Willa Carey, wd Kenneth L. Thomas, asst. d	Pop.: 274,000 Rad. Hms.: 91,400 Ret. Sls.: \$346,589,699	Thes., SES. AP G
*KSAC 1924 KSAC-TV	580 5,000-D 500-N ST-WIBW	Kansas State College 6-8811, ext. 219	James A. McCain, p L. L. Longsdorf, gm	Robert D. Hilgendorf, d Bernard P. Holbert, ce		Pop.: 5,000,000	AP RCA
McPHERSON								
KNEK 1949	1540 250-D	K. R. Krehbiel Box 186 1540	Henry J. Dais, gm Robert E. Perkins, cm	Claude L. Hughes Jr., ce & fd Jim Farley, nd	Bob Bartter, sd Betty Jo Donham, wd	Pop.: 400,000 Rad. Hms.: 100,000	Thes. AP G
NEWTON								
KJRG 1953	950 500-D	Geo. Basil Anderson 3240	Geo. Basil Anderson, o Robert Kent, gm, pmm & ce	William Fellner, cm Ken Stobaugh, pd, nd & fd	Dean Curfman, sd Alice Erlanson, wd		
OTTAWA								
KOFO 1949	1220 250-D	Ottawa Bcstg. Co. 20th & S. Main 1045	James N. Jobs, ptrn., gm, pd, pmm, ce & nd	Herbert M. Jobs, ptrn., m & fd	Thomas F. Ruble, cm Jim McCrossen, sd		Cap., L-W UP G
PARSONS								
KLKC 1948	1540 250-D	Community Bcstg. Co. Inc. 1904 Broadway 4050	Clyde M. Reed Jr., p Raeburn D. Drenner, gm, cm & pmm	Gene Joslin, pd Charles Neer, ce Dave Wright, nd & sd	Jay Pratt, fd Neta Barnes, wd	Pop.: 220,400 Rad. Hms.: 50,996 Ret. Sls.: \$184,311,000	Thes., Assoc. AP Col.
PITTSBURG								
KOAM 1937 KOAM-TV	860 10,000-D 5,000-N DA-N	Pittsburg Bcstg. Professional Bldg. 2165	E. V. Baxter, p, gm & cm	Paul Hudson, pmm & Leo Stafford, ce	Glen Harold, nd Bill Cramer, sd	Pop.: 3,164,542 Rad. Hms.: 912,362 Ret. Sls.: \$3,250,777,000 AP WH
KSEK 1947	1340 250	KSEK Bcstg. Co. 1340 E. Quincy 742	Oscar Stauffer, p	Thad M. Sandstrom, gm	Paul A. Winders, ce	Pop.: 250,000 Rad. Hms.: 67,000	Thes. AP GE
PRATT								
KWSK 1952	1570 250-D	Pratt Bcstg. Co. 207 1/2 S. Main 1570	Clem Morgan, o, gm & nd John Wright, cm	Bud Pratt, pd, pmm & sd	Clarence Evans, ce M. H. Morgan, wd	Pop.: 55,000 Ret. Sls.: \$53,000,000	
SALINA								
KSAL 1937	1150 5,000 DA-N	KSAL Inc. 201 W. Iron Ave. 3701	R. J. Laubengayer, p Ray V. Jensen, m & cm	Alfred Thompson, pd & nd C. R. Lamer, pmm Donald Engelhardt, ce	Sonny Slater, fd Laurence Sundquist, sd	Pop.: 1,025,222 Rad. Hms.: 329,192 Ret. Sls.: \$1,136,507	L-W, St. AP WE
TOPEKA								
KJAY 1949	1440 5,000-D 1,000-N DA-2	S. H. Patterson 908 Kansas Ave. 3-1336	S. H. Patterson, o Norwood J. Patterson, gm & ce	A. Jack Stewart, asst. m, cm & pmm Hal McWilliams, pd & sd	Gordon Sanders, nd & fd	Pop.: 646,400 Rad. Hms.: 162,380 Ret. Sls.: \$584,660,000 INS G
KTOP 1947	1490 250	Charles B. Axton N. Buchanan St. 4-3444	Bailey Axton, o, p & gm Allan Curnutt, cm	Jack Warren Ostrode, pd Floyd A. Griffiths, ce	Marie M. McKinney, asst. m Charlie Christian, sd	Pop.: 428,368 Rad. Hms.: 86,690 Ret. Sls.: \$287,108,000	Assoc. AP Col.
WIBW 1928 WIBW-TV	580 5,000 DA-N ST: KSAC	Topeka Bcstg. Assn. Inc. 1035 Topeka Blvd. 3-2377	H. S. Blake, p Ben Ludy, gm Hilton Hodges, cm	Maude Carlson, pd Allan Young, pmm	Lewis Dickensheets, ce Wes Seyler, fd	Pop.: 55,787,940 Rad. Hms.: 1,549,665	L-W, St. AP, UP RCA
WREN 1927	1250 5,000 DA-N ST: KFKO	WREN Bcstg. Co. 411 W. 10th St. 2-0505	Alf M. Landon, p Fred L. Conger, bus. m Gerald K. Barker, slm	Max Falkenstien, prog. m & sd Dorothy Paramore, pmm	Alfred Meyer, tech. sup. Frank Jones, nd & fd Dottie Paige, wd	Pop.: 758,751 Rad. Hms.: 209,740 Ret. Sls.: \$691,652,000	Wid. UP WH
WICHITA								
KAKE 1947	1240 250	KAKE Bcstg. Co. 420 W. Douglas 4-9369	Jack Todd, vp & gm Martin Umansky, cm	Graeme Fletcher, pd & nd Harold Newby, ce	Bill Young, sd Bill McLean, fd	Pop.: 497,632 Rad. Hms.: 142,651 Ret. Sls.: \$604,849,000	Wid. AP RCA
KANS 1936	1480 5,000-D 1,000-N DA-2	Taylor Radio & Tele. Corp. 1015 N. Broadway 4-2387	O. L. (Ted) Taylor, p Archie J. Taylor, gm & cm Vernon Reed, pd	Russel L. Lowe, pmm Ted Heithecker, ce George Gow, nd	Dave Wilson, sd Mel Haines, fd Joan Fillingham, wd	Pop.: 606,800 Rad. Hms.: 190,570 Ret. Sls.: \$671,586,000	Assoc. AP, UP Col.
KFBI 1922	1070 10,000-D 1,000-N DA-N	KFBI Inc. 42d & Broadway Temple 6-3377	R. J. Laubengayer, chmn. of bd. Howard Lane, p Hale Bondurant, gm & natl. cm	Clarence Sewell, loc. cm George Wells, pd Lew Hunter, pmm K. W. Pyle, ce	Lynn Sucher, nd Jack Campbell, sd Lester Weatherwax, fd Marie MacDonald, wd	Pop.: 1,661,300 Rad. Hms.: 627,200 Ret. Sls.: \$1,764,453,000	Wid. AP RCA
KFH 1922	1330 5,000 DA-N	Radio Station KFH Co. KFH Bldg. 2-4491	Frank V. Webb, vp & gm Bryce Benedict, slm Lawrence V. Cotton, regl. slm Thomas P. Bashaw, pd	Virgil G. Hinshaw, gm Dick Gavitt, nd	Jack Munley, sd Bruce Belymer, fd Ethel Jane King, wd	Pop.: 936,600 Rad. Hms.: 300,700 Ret. Sls.: \$1,049,971,000	Cap. AP, UP WE
KFH-FM 1948	Ch. 262 (B) 100.3mc 11kw							Cap. AP, UP GE
KWBB 1951	1410 1,000 DA-2	Wichita Beacon Bcstg. Co. 2829 Salina Ave. Temple 8-3331	O. E. Bradley, p Milt Hall, gm John Merrill, cm Virginia Welch, pd	Dale E. Kern, pmm Gene T. Williams, ce Jim Setters, nd	Bob Mays, sd "Jumps" Cauthorn, fd Lucille Almon, wd	Pop.: 630,000 Rad. Hms.: 198,360 Ret. Sls.: \$750,000,000	Cap., Thes. AP GE

Data corrected to Dec. 10, 1953. If executives or services for FM are same as AM affiliate names are not repeated. Market Data supplied by stations. FM's in italic. *—Non-Commercial Station. CP—Construction Permit issued. D—Day. DA—Day. DA-N—Directional Antenna, night only. DA-1—Directional Antenna, same pattern day and night. DA-2—Directional Antenna, different pattern day and night. L—Limited Time with Dominant Station. LS—Local Sunset. N—Night. SA—Special Authorization. SH—Specified Hours. ST—Share Time. Complete key to abbreviations, page 6.

KENTUCKY

MARKET DATA BY COUNTIES

County	Population 1950	Radio Families 1953	Retail Sales 1952(000)	Food Sales 1952(000)	Drug Sales 1952(000)	Automobile Ownership 1952	County	Population 1950	Radio Families 1953	Retail Sales 1952(000)	Food Sales 1952(000)	Drug Sales 1952(000)	Automobile Ownership 1952
Adair	17,603	4,050	\$ 5,989	\$ 1,196	\$ 256	2,930	Anderson	8,984	2,480	7,412	1,728	78	3,002
Allen	13,787	3,740	6,728	1,545	208	3,002	Ballard	8,545	2,910	4,020	1,323	99	3,598

Another **KANS** *SUCCESS STORY!!*

**Killion's
Business Increased
155.38%
IN 3 YEARS
USING KANS EXCLUSIVELY**

NO OTHER STATION
NO OTHER MEDIA



one of KILLION'S 5 High Volume Stations

Phenomenal Results!! With Seven Newscasts Per Week

Killion's "Fresh-Gas," heard first on KANS, is a household word in Wichita. Starting with only two newscasts, Killions now enjoy the greatest gallonage in Wichita, thru five high-speed service stations—A good product well sold on KANS.

Whatever the product, KANS does a great selling job because programing is beamed to the home, for home listening. You can penetrate the Wichita market quicker, easier, more economically by using KANS. Results in all fields prove it.

Now Try

KANS NBC IN WICHITA . . .

Represented Nationally by Paul H. Raymer Co.

HERE'S WHY WAVE IS KENTUCKY'S GREATEST RADIO VALUE!

5000-watt WAVE is powered, priced and programmed for the Louisville Trading Area exclusively — covers it thoroughly, *without waste circulation!*

The Louisville Trading Area accounts for:

**55.3% OF THE STATE'S
TOTAL RETAIL SALES!**

**59.8% OF THE STATE'S
DRUG SALES!**

**57.5% OF THE STATE'S
AUTOMOTIVE SALES!**

**51.3% OF THE STATE'S
FOOD SALES!**

To cover the rest of Kentucky, you need many of the State's 50 *other* radio stations.

Let NBC Spot Sales give you all the facts on WAVE, the Blue-Chip Buy in the Bluegrass State.

5000 WATTS

NBC AFFILIATE

WAVE
LOUISVILLE

NBC SPOT SALES, Exclusive National Representatives

KENTUCKY

City Call Letters Established TV Affiliate	Chan. or Freq. Power	Licensee Headquarters Telephone	Network Representative	Executive Owner o; Pres. p; Exec. vp epp; Gen. Mgr. gm; Sta. Mgr. sm; Coml. Mgr. Cm; Sales Mgr. sm; Prog. Dir. pd; Chief Eng. ce; Prom. Mgr. pmm; Prod. Mgr. pdm; News, Farm, Sports or Women's Dir. nd, fd, sd, wd.	Abbreviations	Market Data For Primary Area (Supplied by station)	Library, News Serv. Transmitter
COVINGTON							
WZIP 1947	1050 250-D	WZIP Inc. Juniper 5300	KBS Indie	Arthur L. Ellerman, p, gm & cm Edd C. Toleman, pd & ce	Walter R. Rehbaum, pmm & nd Raymond L. Scott, sd	Wallace E. Stein, fd Carmen G. Ellerman, wd	Pop.: 1,250,000 Rad. Hms.: 400,000 AP RCA
CUMBERLAND							
WCMP 1950	1490 250	Blanco Radio Co. Inc. Harlan 700	MBS, KBS, Good Coal Best	R. B. Helms, p & gm Lew Boehm, cm Charles Esposito, pd & pmm	J. Francke Fox, ce Al Cash, nd & sd	Clyde Beal, fd Margie Couch, wd	Thes. UP Col.
DANVILLE							
WEIR 1947	1230 250	Commonwealth Bcstg. Corp. P. O. Box 234 Danville 1230	MBS, KBS, Holman	W. T. Isaac, p & cm	David B. Highbaugh, vp, pd, nd, fd & sd	Henry C. Lovell, ce	Pop.: 98,000 Rad. Hms.: 29,800 Ret. Sls.: \$45,000,000 Wid. UP Col.
ELIZABETHTOWN							
WIEL 1950	1400 250	Elizabethtown Bcstg. Co. 5151	KBS Best	J. W. Hodges, p Walter Huddleston, gm & cm	Clement Cockrell, pd Thomas A. Baldwin, ce	Ed Booher, nd Doreen Banninger, wd	Pop.: 117,300 Rad. Hms.: 25,850 Ret. Sls.: \$53,532,000 Assoc. UP Col.
FRANKFORT							
WFKY 1947	1490 250	Frankfort Bcstg. Co. Kentucky Ave. Extended 4-8281	MBS, KBS, Burn- Smith	Ken Hart, p & gm Charles Drew, cm	Robert Beasley, pd & nd	Wally Roach, ce Jack Perkins, sd	Pop.: 77,650 Rad. Hms.: 24,960 Ret. Sls.: \$58,630,000 Wid. UP We
FULTON							
WFUL 1951	1270 1,000-D	Ken-Tenn Bcstg. Corp. 1270 Best	R. W. Bushart, p J. O. Lewis, gm	John Latham, gm & ce	Leon Howard, pd	Pop.: 216,998 Rad. Hms.: 55,263 Ret. Sls.: \$149,246,000 SES., Thes. UP G
WFUL-FM 1953	Ch. 285 (A) 104.9mc 0.5kw						Pop.: 217,000 Rad. Hms.: 55,263 Ret. Sls.: \$149,246,000
GLASGOW							
WKAY 1948	1490 250	Glasgow Bcstg. Co. 2141	KBS	Jack Pedigo, p Clovis Sadler, gm & ce Freeman Cherry, cm	Caroline Biggers, pd & nd John M. Barrick, pmm	William D. Atkinson, fd Opal E. Cherry, wd	Pop.: 100,000 SES. UP WE
HARLAN							
WHLN 1941	1230 250	Blanco Radio Co. Inc. 625	MBS, KBS, Good Coal Burn- Smith	R. B. Helms, p, gm & pmm James T. Morgan, cm & nd	Nell Bradford, pd James Macklin, ce	Clayton Miracle, sd Lois Barthel, wd	Pop.: 75,336 Rad. Hms.: 15,845 Ret. Sls.: \$18,985,000 Thes. UP G
HAZARD							
WKIC 1947	1340 250	BMG Bcstg. Corp. Peoples Bank Bldg. 720	MBS Best	Fred B. Bullard, p Richard H. Goodlette, secy.-treas. & gm	Chas. W. Metcalf, nd Bob Mansfield, cm, sd & pmm	Marvin E. Young, ce	Wid. AP Col.
HENDERSON							
WSON 1941	860 500-D	Henderson Bcstg. Co. Zion Rd. 3923	MBS Meeker	Hecht S. Lackey, p, gm, cm & nd Martin E. Schaeffer, pd	Dorothy McCormick, pmm & wd	Jerry Tolbert, sd Tom Southwood, fd Kay Morris, music lib.	Wid. AP UP G
WSON-FM 1946	Ch. 258 (B) 99.5mc 20kw						
HODGENVILLE							
WFLW (CP)	1320 1,000-D DA-2	Lincoln Memorial Bcstg. Co.	T. M. Stearman, p	Clifford Spurlock, gm & pd		Pop.: 250,000 Rad. Hms.: 10,000
HOPKINSVILLE							
WHOP 1940	1230 250	Hopkinsville Bcstg. Co. Cadiz Rd. Tuxedo 5-5331	CBS, Ashland- Aetna Meeker	F. Ernest Lackey, p & gm Katherine Peden, cm Margaret Wyatt, pd & wd	Bonnie B. Lackey, pmm Leo Y. Wilson, ce Virginia Cornette, secy.-treas.	John G. Wolfe, nd George W. Gray Jr., sd	Pop.: 42,300 Rad. Hms.: 8,910 Ret. Sls.: \$30,321,000 Thes. UP
WHOP-FM 1948	Ch. 254 (B) 98.7mc 8.8kw						Pop.: 464,100 Rad. Hms.: 89,220 Ret. Sls.: \$221,877,000 RCA, Thes. UP GE
LEBANON							
WLBN 1953	1590 500-D	Lebanon- Springfield Bcstg. Co. Box 647	C. H. Hulse, co-o, gm & ce	Charles Shuffett, co-o, cm & pd		
LEXINGTON							
WLAP 1922	630 5,000-D 1,000-N DA-2	American Bcstg. Corp. Radio Bldg. 3-2727	ABC Pearson	Gilmore N. Nunn, p J. E. Willis, vp & gm Miller A. Welch, cm & asst. m	Jack Brooks, pd Joe DeLong, pmm H. C. Locklar, ce Sue Ann Fenimore, nd	J. B. Faulconer, sd Paul Everman, fd Bette Maxwell, wd	Pop.: 782,700 Rad. Hms.: 185,820 Ret. Sls.: \$463,441,000 Wid. UP WE
WLAP-FM 1950	Ch. 233 (B) 94.5mc 3.5kw						
WLEX 1946	1300 1,000 DA-N	Central Ky. Bcstg. Co. Campbell House 3-0433	KBS Forjoe	J. D. Gay Jr., p H. G. Bell, secy.-treas.	J. L. Brownell Sr., gm & cm	J. L. Brownell Jr., pd William Yount, ce	L-W, Mac. AP WE
WVLK 1947	590 1,000 DA-1	Bluegrass Bcstg. Co. Phoenix Hotel 4-6470	MBS Burn- Smith	Donald J. Horton, p Ted Grizzard, vp & gm	George T. Webb, cm Claude Sullivan, pd & sd Cavin Barnette, pmm	Paul Dunbar, ce Ray Holbrook, nd Mimi Chandler, wd	Pop.: 666,500 Rad. Hms.: 163,400 Ret. Sls.: \$453,500,000 Thes. AP G
LOUISVILLE							
WAVE 1933	970 5,000 DA-1	WAVE Inc. 334 E. Broadway Wabash 2201	NBC NBC Spot Sales	George W. Norton Jr., p Nathan Lord, gm LeVel Waltman, cm	James Caldwell, pd Charles Hill, pmm Wilbur Hudson, ce Cyrus Crites, research d	Hugh Sutton, nd Ed Kallay, sd Chester Brown, fd Ann Hubert, wd	Rad. Hms.: 622,000 Ret. Sls.: \$731,839,000 St., Thes. AP
WAVE-TV							
WGRC 1936	790 5,000-LS 1,000-N DA-2	Northside Bcstg. Co. Kentucky Home Life Bldg. Wabash 8871 Walker	J. Porter Smith, p Charles L. Harris, gm Tom Underwood, cm & pmm	Ward Hatcher, p W. J. Morrison, ce Jack Donnell, nd	Jerry East, fd Gerald Brown, sd Agnes Burke, wd	L-W UP Fed.
WHAS 1922	840 50,000	WHAS Inc. 525 W. Broadway Wabash 2211	CBS Christal	Barry Bingham, p Victor A. Sholis, vp & d Neil D. Cline, sm John M. Fouts, sls. d	Samuel Gifford, pd William Loader, pmm Orrin W. Towner, d of engrg. Richard Oberlin, nd	James Finegan, sd Barney Arnold, fd Dorcas Ruthenburg, wd	Pop.: 2,806,900 Rad. Hms.: 659,190 Ret. Sls.: \$2,024,764,000 L-W AP WE
WHAS-TV							

Data corrected to Dec. 10, 1953. If executives or services for FM are same as AM affiliate names are not repeated. Market Data supplied by stations. FM's in italic. *—Non-Commercial Station. CP—Construction Permit issued. D—Day. DA-N—Directional Antenna, night only. DA-1—Directional Antenna, same pattern day and night. DA-2—Directional Antenna, different pattern day and night. L—Limited Time with Dominant Station. LS—Local Sunset. N—Night. SA—Special Authorization. SH—Specified Hours. ST—Share Time. Complete key to abbreviations, page 6.



Still ...

THE ONLY RADIO STATION
SERVING AND SELLING
THE RICH KENTUCKIANA MARKET



50,000 WATTS . . . 1A CLEAR CHANNEL

ASSOCIATED WITH THE LOUISVILLE COURIER-JOURNAL AND TIMES

VICTOR A. SHOLIS, Director • NEIL D. CLINE, Station Manager

Represented Nationally by Henry I. Christol Co., New York,
Chicago, San Francisco, Detroit, Boston.

KENTUCKY

City	Call Letters Established TV Affiliate	Chan. or Freq. Power	Licensee Headquarters Telephone	Network Represent- ative	Executive Abbreviations Owner o; Pres. p; Exec. vp evp; Gen. Mgr. gm; Sta. Mgr. sm; Coml. Mgr. cm; Sales Mgr. slm; Prog. Dir. pd; Chief Eng. ce; Prom. Mgr. pmm; Prod. Mgr. pdm; News, Farm, Sports or Women's Dir. nd, fd, sd, wd.	Market Data For Primary Area (Supplied by station)	Library, News Serv. Transmitter	
LOUISVILLE—(Continued)								
WINN 1940	1240 250	Ky. Bcstg. Corp. Earle Hotel Wabash 5148	KBS. Universal Radio-TV Reps.	Harry McTigue, p & gm Jesse L. Chambers, treas.	Chas. A. Schacht Jr., cm George S. Partridge, pd & nd	Helen E. Roberts, pmm Melvin Scarsdale, ce Jim McIntyre, sd Louise Weiler, wd	Pop.: 381,700 Rad. Hms.: 113,120 Ret. Sls.: \$115,000,000 UP Col.
WKLO 1948 WKLO-TV	1080 5,000-D 1,000-N DA-2	Mid-America Bcstg. Corp. Henry Clay Hotel Clay 4441	ABC Blair	Joe Eaton, p & gm	Russell J. Pirkey, cm M. L. Moore, pd	D. C. Summerford, ce Kay Lowe, wd UP WE	
WKYW 1947	900 1,000-D	Radio Ky. Inc. 431 W. Jefferson St. Clay 4811 Burn- Smith	F. Eugene Sandford, p & treas.	Edwin E. S. Weldon, vp & sm	H. Parker Smith, cm Paul Ruhle, pd	Pop.: 1,000,000	Cap., St. AP WE
WLOU 1948 WLOU-TV	1350 1,000-D	Robert W. Rounsaville 2549 S. 3d St. Caihoun 3680 ForJoe. Dora- Clayton	Robert W. Rounsaville, o Lee R. Smith, m J. T. Starr Jr., cm	Johnny Martin, pd & nd Steve Dawson, ce	Paul B. Cram, tech. d Cliff Butler, sd Patricia Bell, wd AP	
MADISONVILLE								
WFMW 1950	730 250-D	Messenger Bcstg. Co. Main & Center Sts. 1885	KBS Continental	Edgar Arnold Sr., p H. W. Wells, gm & fd E. L. Kelley Jr., cm, pmm & sd	Richard T. Harris, pd Evers Mick, ce	John Gatlin, nd Helen Oldham, wd	Pop.: 300,000 Rad. Hms.: 94%	Cap., St., The. UP G
WFMW-FM 1949	Ch. 230 (B) 93.9mc 2.85kw						Pop.: 250,000 Rad. Hms.: 72%	Cap., St., The. RCA
MAYFIELD								
WKTM 1946	1050 1,000-D	Mayfield Bcstg. Co. Mayfield Hotel 46 West Kentucky Bcstg. Co. 1597	MBS Best	Mike Layman, p Al Hendershot, gm & secy.-treas. Frank Richardson, cm H. M. Suthard, p T. E. Brewer, gm & cm	Joe McNeilly, pd, nd, sd & fd Thomas F. Nagle, pmm Otis L. Davis, pd & fd Ben Dixon, ce	Joe Hargrove, ce Hallie Vandergriff, wd Bob Lee, pmm, nd & sd Mrs. Betty Shelton, wd	Pop.: 323,255 Rad. Hms.: 86,280 Ret. Sls.: \$154,197,000	The. UP G
WNGO 1947	1320 1,000-D						Pop.: 304,050 Rad. Hms.: 53,310	Cap. AP G
MAYSVILLE								
WFTM 1948	1240 250	Standard Tobacco Co. 1400	MBS KBS	Charles P. Clarke, co-o J. M. Finch Jr., co-o John W. Betts, gm	James Neuhart, cm Gene A. Waters, pd Harvey L. Cross, ce Harold Sagraves, nd	Lawrence McGill, sd J. Scott True, fd Dorothy Wood, wd	Pop.: 52,800 Rad. Hms.: 10,741 Ret. Sls.: \$27,413,300	Wid. UP G
MIDDLESBORO								
WMK 1948	560 500-D	Cumberland Gap Bcstg. Co. 980 Hoiman	Dr. U. G. Brummett, p Webster Taylor, gm	Maurice K. Henry, cm & pmm Bill Baker, pd & sd	Tal England, ce Lee Wilder, nd & fd	Pop.: 129,000 Rad. Hms.: 28,111 Ret. Sls.: \$53,919,000	The. UP G
MURRAY								
WNBS 1948	1340 250	Murray Bcstg. Co. Inc. P. O. Box 548 1340	H. T. Waldrop, o & p Ed Griffin, m	Troy Glidwell, cm, pd & sd	Otis Cohoon, ce AP WE	
NEWPORT								
WNOP 1948	740 1,000-D DA-D	Tri-City Bcstg. Co. 606 Monmouth St. Juniper 7100	James G. Lang, p Ann R. Lang, sm	R. Douglas Nunn, pd & nd	Chuck Moore, fd	Pop.: 2,264,000 Rad. Hms.: 750,000 UP Ray.
OWENSBORO								
WOMI 1938	1490 250	Owensboro Bcstg. Co. Byers Ave. & Livermore Rd. 3-1558	MBS Burn- Smith	Lawrence W. Hafer, p Hugh O. Potter, gm & cm	Cliffordean Potter, pd & wd	Marshall Bruner, pmm & co-sd Jim Wilkinson, co-sd	Pop.: 156,452 Rad. Hms.: 52,890	The. AP RCA
WOMI-FM 1948	Ch. 223 (B) 92.5mc 60kw							The. AP GE
WVJS 1947	1420 1,000 DA-2	Owensboro On The Air Inc. 324 Allen St. 3-3521 Rambeau	V. J. Steele, p Malcolm Greep, vp & gm John T. Rutledge, asst. gm & cm	Larry Adams, pd Leola C. Hayden, pmm & wd Robert Earl Jagoe, ce N. C. Milwee, asst. pd	Charles C. Steele, Prod. d J. Walter Greep, nd Le Roy Woodward, sd Earl Fisher, fd	Pop.: 212,400 Rad. Hms.: 61,100 Ret. Sls.: \$146,100,000	Wid. UP GE
WVJS-FM 1948	Ch. 241 (B) 96.1mc 45kw						 UP GE
PADUCAH								
WKYB 1946	570 1,000-D 500-N DA-2	WKYB Inc. 504 Kentucky Ave. 2-1878	NBC Pearson	E. J. Paxton, p & gm Sam Livingston, secy.- treas., bus. m & sd	John W. Polk Jr., slm Joe Pat Knight, pd, fd & nd	Ernest J. Pell, ce Patricia Ann Paxton, wd	Pop.: 952,500 Rad. Hms.: 218,120 Ret. Sls.: \$711,097,000	Wid. AP RCA
WKYB-FM 1947	Ch. 227 (B) 93.3mc 31kw							
WPAD 1930	1450 250	Paducah Bcstg. Co. Taylor Bldg. 4th & Broadway 2-8231	CBS Meeker	Pierce E. Lackey, p Prewitt Lackey, gm	Ray Mofield, asst. m, pd, pmm, nd, fd & sd U. C. Morris, ce	Linn Wolf, slm Martha Ward, wd	Pop.: 155,000 Rad. Hms.: 41,000 Ret. Sls.: \$135,000,000	L-W UP G
WPAD-FM 1946	Ch. 245 (B) 96.9mc 17kw						Pop.: 806,247 Rad. Hms.: 97,842 Ret. Sls.: \$450,000,000	L-W UP Fed.
PAINTSVILLE								
WSIP 1949	1490 250	Big Sandy Bcstg. Co. Meade Bldg. 1196	MBS	Escom Chandler, ptrn. Ted Arnold Silvert, ptrn. & gm	Jack Welch, asst. m Eugene Baldridge, ce Bill Barker, fd	Larry Draper, sd Jacqueline Rule, wd	Pop.: 105,194 Rad. Hms.: 24,982 Ret. Sls.: \$27,769,000	The. UP Ray.
PIKEVILLE								
WLSI 1949	900 1,000-D	Cumberland Pub. Co. 456	Mrs. W. J. Ward Jr., p Roy E. Alexander, gm & cm	Charles T. Snowden, pd & pmm	Stewart O'dell, fd & pd Edna Mae Aders, wd L-W UP G	
WPKE 1949	1240 250	East Ky. Bcstg. Corp. 1280	MBS, KBS, Continental	Clyde Childers Jr., p Al Kahn, m	Guy Ferrrell, ce Edwin L. Meek, ce	Imogene Owens, wd	Wid., SES. AP RCA	

Data corrected to Dec. 10, 1953. If executives or services for FM are same as AM affiliate names are not repeated. Market Data supplied by stations.
 FM's in italic. *—Non-Commercial Station. CP—Construction Permit issued. D—Day. DA—Day. DA-N—Directional Antenna, night only. DA-1—Directional Antenna, same pattern day and night. DA-2—Directional Antenna, different pattern day and night. L—Limited Time with Dominant Station. LS—Local Sunset. N—Night. SA—Special Authorization. SH—Specified Hours. ST—Share Time. Complete key to abbreviations, page 6.

LOUISIANA

City	Call Letters	Chan. or Freq. Power	Licenses Headquarters Telephone	Network Representative	Owner o; Pres. p; Exec. vp evp; Gen. Mgr. gm; Sta. Mgr. sm; Coml. Mgr. cm; Sales Mgr. sm; Prog. Dir. pd; Chief Eng. ce; Prom. Mgr. pmm; Prod. Mgr. pdm; News, Farm, Sports or Women's Dir. nd, fd, sd, wd.	Executive Abbreviations	Market Data For Primary Area (Supplied by station)	Library, News Serv. Transmitter
BATON ROUGE								
	WAFB	1480	Modern Bcstg. Co. of Baton Rouge Inc.	MBS Young	Jack S. Burk, p Tom E. Gibbens, gm & vp Ron C. Litteral, cm	John Ferguson, pd & sd Pat Curtin, pmm Don Allan, ce	Grace McElveen, office in John C. Coburn, nd Gordon Loudon, fd	Pop.: 500,000 Rad. Hms.: 101,867 RCA
	WAFB-TV	1,000-N DA-N	929 Government St. 4-8571					
	WAFB-FM	Ch. 282 (B) 1948						Thes. AP
	WIBR	1300	Community Bcstg. Co.	Walker	G. T. Owen, p Robert Earle, gm	Scott W. Erwin, pd E. E. Case, ce	Bernard Zuccaro, nd J. C. Politz, sd	Pop.: 297,400 Rad. Hms.: 75,400 Ret. Sis.: \$239,800,000 UP Col.
	WJBO	1150	Baton Rouge Bcstg. Co.	NBC Louisiana	Douglas L. Manship, p J. Roy Dabadie, vp & gm Charles P. Manship Jr., secy.-treas.	Charles C. Garvey, sim Don Perrie, pd, prom. d & sd	J. Patrick Weathersby, ce Bill Slatter, nd	Pop.: 500,000 Rad. Hms.: 108,490 Ret. Sis.: \$394,737,000 Wid. AP, UP RCA
	WJBO (FM)	Ch. 251 (B) 1941	(WJBO, Am Affiliate)					Pop.: 400,000 Ret. Sis.: \$250,000,000 Wid. AP, UP WE
	WLCS	910	Air Waves Inc.	ABC Rambeau	R. F. Cangelosi, p Earl H. Smith, vp, gm & pd	Lamar Simmons, cm Olas Olsen, pmm Ed Van Valkenburg, ce	Gene Nelson, nd Jerry Breaux, sd Helen Jennings, wd	Pop.: 326,000 Rad. Hms.: 58,000 Ret. Sis.: \$235,000,000 Assoc. AP, INS G
	WLCS-FM	Ch. 266 (B) 1946						
	WXOK	1290	WXOK Inc.	Forjoe	Jules Paglin, co-o	Stanley W. Ray Jr., co-o	Herb Pearson, gm Ed Bishop, pd Charles Hogue, ce	Pop.: 330,000 Rad. Hms.: 84,000 Ret. Sis.: \$147,872,000 Wid. AP
	WXOK	1,000-D	243 Convention St. 4-7604					
BOGALUSA								
	WEKY (CP)	920	Bogalusa Bcstg. Co.					
	WIKC	1490	Enterprise Publ. Co.		Curt Siegelin, gm			
	WIKC	250	605 N. Rio Grande St. 1490					
COVINGTON								
	WARB	730	A. R. Blossman Inc.		A. R. Blossman, o & p William H. Bland Jr., gm & ce	Roy Hebert, cm & sd Winford McDaniel, pd & sd	Tom Landry, fd Mildred Bland, pmm & wd	Pop.: 1,000,000 Rad. Hms.: 850,000 Ret. Sis.: \$650,000,000
	WARB	250-D	P. O. Box 568 1600					
CROWLEY								
	KSIG	1450	Acadia Bcstg. Co.	Louisiana	Maxwell J. Thomas, p gm & pmm Dan Harper, cm & fd	Neal Warner, pd Chester P. Ruffner, ce	Alden C. Sonnier, nd Gene Griffin, sd Kathleen Sonnier, wd	Pop.: 258,932 Rad. Hms.: 68,140 Ret. Sis.: \$188,696,000 AP G
	KSIG	250	101 N. Parkerson Ave. 1450					
DE RIDDER								
	KDLA	1010	Sabine Bcstg. Co.	KBS	Cyril W. Reddoch, p Ralph L. Hooks, gm & cm	Ted Thompson, pd Roy Burnett, pmm & nd	Pete Sanders, sd	Pop.: 543,260 Rad. Hms.: 131,960 Ret. Sis.: \$353,519,000 UP G
	KDLA	1,000-D	Box 46 7600					
EUNICE								
	KEUN	1490	Tri-Parish Bcstg. Co.	MBS	Vincent Riehl, p John A. Chauvin, gm, nd & sd	Milton S. David, pmm & fd	J. L. Sylvester, ce Ella V. Granfer, wd	Pop.: 11,600 Rad. Hms.: 11,600 Ret. Sis.: \$45,374,000 Wid. AP Col.
	KEUN	250	Box 789 3041					
HAMMOND								
	WIHL	1400	Cefalu Radio Station	KBS	Nicholas Cefalu, co-o Anthony V. Cefalu, co-o	J. K. Ferris, gm & cm George Bonnell, pd, nd, sd & fd	Warren Adams, ce Alice Terry, traffic m	Pop.: 58,802 Rad. Hms.: 11,600 Ret. Sis.: \$45,374,000 AP G
	WIHL	250	P. O. Box 432 960					
HOUMA								
	KCIL	1490	KCIL Inc.	NBC Louisiana	Denver T. Brannen, p	Paul T. Hayes, vp & gm		Wid., SES. AP G
	KCIL	250	Bayou Black Dr. 6828					
JENNINGS								
	KJEF	1290	Jennings Bcstg. Co. Inc.		Max Thomas, p Clovis L. Bailey, gm Jerry Dugas, cm	Paul Lejeune, pmm Ed Barton, ce	Howard Hoag, sd Jackie Todd, wd	Pop.: 11,600 Rad. Hms.: 11,600 Ret. Sis.: \$75,000,000 UP G
	KJEF	500	1521 Lake Arthur Ave. 1155					
LAFAYETTE								
	KLFY	1420	Camellia Bcstg. Co.	ABC Louisiana	Paul H. DeClouet, p William A. Patton, gm & sd	Bill Corcoran, cm Bob Castellon, pd & nd	Carroll Crew, ce Garland Bonin, fd Toni Coons, wd	Pop.: 325,600 Rad. Hms.: 84,100 Ret. Sis.: \$183,000,000 Cap., Wid. UP GE
	KLFY-TV	1,000-D	Box 367 8-9494					
	KVOL	1330	Evangeline Bcstg. Co. Inc.	NBC Meeker	George H. Thomas, gm Evan H. Hughes, sm, pmm & nd Tom Pears, cm	Donald E. Metz, pd & sd Louis P. Pilcher, ce Al Terry, fd	Rita Mae T. Bourliea, wd	Pop.: 151,000 Rad. Hms.: 89,390 Ret. Sis.: \$32,000,000 L-W AP Col.
	KVOL	1,000	P. O. Box 1070 5-6426					
	KVOL-FM	Ch. 241 (B) 1949						Thes. AP RCA
	KVOL-FM	96.1mc 15kw						
LAKE CHARLES								
	KAOK	1400	KAOK Inc.	MBS Forjoe	Jules Paglin, p Stanley Ray Jr., mgng. d	Tom A. Gresham, co-m Roy K. Rhodes, co-m, pd & sd	Walter A. Jones, ce Rose Weimar, wd	Pop.: 70,000 Assoc. UP Ray.
	KAOK	250	1 Mill St. 6-7541					

Data corrected to Dec. 10, 1953. If executives or services for FM are same as AM affiliate names are not repeated. Market Data supplied by stations. FM's in *italics*. L—Non-Commercial Station. CP—Construction Permit issued. D—Day. DA—Directional Antenna, night only. DA-1—Directional Antenna, same pattern day and night. DA-2—Directional Antenna, different pattern day and night. L—Limited Time with Dominant Station. LS—Local Sunset. N—Night. SA—Special Authorization. SH—Specified Hours. ST—Share Time. Complete key to abbreviations, page 6.

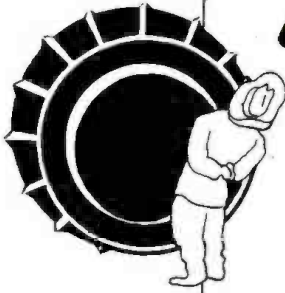

LOOK UP -

Head and shoulders above other stations in the market is WJBO, by reason of full NBC programming, full 5 Kilowatts day and night. Popular DJ shows; chockful-of-news-casts; hot sports and special events; all these serve to bring NBC home to the home folks.

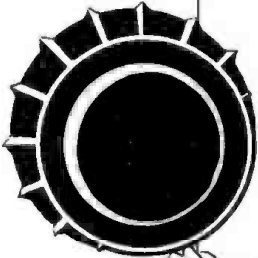

LOOK UNDER -

Lift the coverage map and see what's beneath. Oil wealth; industrial wealth from refining and chemicals; agricultural wealth from sugar and rice and cattle. High per family income (24th in the US) high effective buying income (69th in the US). Retail sales in the coverage area are over half a billion dollars.

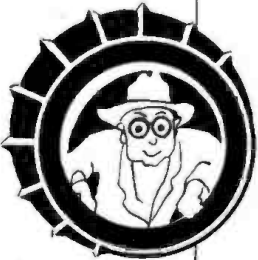

LOOK OUT -

The whole market is jumping with increases, even in the face of downward national trends. Population increases, sales increases, other increases, all highly rated by Sales Management.

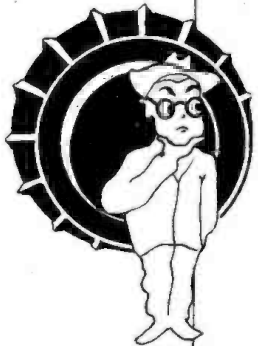

LOOK WISE -

... when your George P. Hollingbery man tells you the WJBO story. It's strong, it's true, and it's an introduction to a good buy in a rich market.

LOOK FOR

WJBO

BATON ROUGE, LA.

ON YOUR NEXT SPOT SCHEDULE

LOUISIANA

City	Chan. or Freq. Power	Licensee Headquarters Telephone	Network Representative	Owner o; Pres. p; Exec. vp evp; Gen. Mgr. gm; Sta. Mgr. sm; Coml. Mgr. cm; Sales Mgr. sm; Prog. Dir. pd; Chief Eng. ce; From. Mgr. pmm; Prod. Mgr. pdm; News, Farm, Sports or Women's Dir. nd, fd, sd, wd.	Executive Abbreviations	Market Data For Primary Area (Supplied by station)	Library News Serv. Transmitter	
LAKE CHARLES—(Continued)								
KLOU 1947	1580 1,000 DA-1	The Pelican Bcstg. Co. 203 W. Clarence 6-7277	CBS, Louisiana Pearson	Sara M. Anderson, o & mgng. d John L. Vath, gm Harper L. Clark, cm	Sidney H. Morse, pd & sd Eleanor W. Shirley, pmm & wd	Ernest J. Vincent, ce Bill Anderson, nd Jerry Barlow, fd	Pop.: 147,958 Rad. Hms.: 42,060 Ret. Sls.: \$112,061,000	Thes. AP
KPLC 1935 KPLC-TV	1470 5,000-D 1,000-N DA-N	Calcasieu Bcstg. Co. Majestic Hotel 2713	NBC, Louisiana Weed	T. B. Lanford, p David Wilson, gm Pelham E. Mills Jr., cm	Robert E. Weimar, pd Lucille Storer, pmm A. B. Craft Jr., ce	Robert Thompson, sd Eleanor Wagner, wd	Pop.: 699,460 Rad. Hms.: 170,663 Ret. Sls.: \$476,188,000	Wld. AP, UP RCA
MANSFIELD								
KDBC (CP)	1360 1,000-D	De Soto Bcstg. Corp.						
MINDEN								
KAPK 1952	1240 100	Parish Bcstg. Corp. 1985	Martin Kirsch Jr., p & gm Reginald M. Ward, cm, pmm & fd	Carl W. Goulden, ce M. E. Brown, asst. m Carl Roberts, nd	Sammy David, sd Billye Sue Bryant, wd	Pop.: 60,000 Rad. Hms.: 15,000 Ret. Sls.: \$91,260,000 UP Col.
MONROE								
KLIC 1950	1230 250	Dr. Frank P. Cerniglia Strauss Bldg. 3-4617	MBS, KBS Dora- Clayton	Dr. Frank P. Cerniglia, p & gm Robert Fowlkes, cm	John Lacy, pd, ce & sd	Lloyd Goodin, pmm & nd Mary Ruth Smith, wd	Pop.: 450,000	Cap. UP Col.
KMLB 1930	1440 5,000-D 1,000-N DA-N	Liners Bcstg. Co. Inc. Frances Hotel 7161	ABC Taylor	Mrs. Robert Gaston Jr., p Charles Price, gm	J. R. Plaisance, pd & pmm O. L. Morgan, ce	Paul Kingsley, nd Lawrence Gibbs, sd Chas. Morn, fd Jackie Voorhees, wd	Pop.: 65,000	Thes. AP G
KMLB-FM 1947	Ch. 281 (A) 104.1mc 17kw							
KNOE 1944 KNOE-TV	1390 5,000 DA-N	James A. Noe Bernhardt Bldg. 8155	NBC H-R Reps.	James A. Noe, p Paul H. Goldman, vp & gm	John Allen, cm Harry Arthur, pd	Jack Ratliff, ce Mac Ward, nd Beth Breese, wd		L-W AP RCA
MORGAN CITY								
KMRC (CP)	1430 500-D	Tri-City Bcstg. Co.						
NATCHITOCHE								
KWCJ 1947	1450 250	Natchitoches Bcstg. Co. P. O. Box 232 2353		Dr. Wm. H. Pierson, p				
NEW IBERIA								
KANE 1946	1240 250	New Iberia Bcstg. Co. 101 W. St. Peter 2-6726	ABC, Louisiana	George H. Thomas, gm Dierrell Hamm, m A. Hall Allen, cm	Al Viguerie, pd Donald Bonin, pmm & sd Myrle Case, ce	Jo Elyn Chambers, nd & wd Harriet Prosper, fd	Pop.: 196,932 Rad. Hms.: 47,870 Ret. Sls.: \$140,202,000	Cap. AP Col.
KVIM 1951	1360 1,000-D	Queen City Bcstg. Co. P. O. Box 50 2-5826	Paul M. Cochran, p John Coco, gm & pd	Jack Guerin, cm Jim Drake, pmm, sim & sd	Lynn Hargreaves, ce Jim Wynn, nd	Pop.: 70,000 Rad. Hms.: 19,000 Ret. Sls.: \$50,000,000	Assoc. UP We
NEW ORLEANS								
WBOK 1951	800 1,000-D DA	WBOK Inc. 505 Baronne Tulane 5363 Forjoe	Jules J. Paglin, co-o Stanley W. Ray Jr., co-o Fred Schwarz, cm	Edward Prendergast, asst. m & pd Lou Peneguy, pmm John Rhodes, ce	Moon Mullins, nd & sd Red Smith, fd Kathy Wells, wd	Pop.: 783,000 Rad. Hms.: 227,300 Ret. Sls.: \$725,674,000 UP G
WDSU 1923 WDSU-TV	1280 5,000 DA-1	WDSU Bcstg. Corp. 520 Royal St. Tulane 4371	NBC Blair	Edgar B. Stern Jr., p Robert D. Swezey, evp & gm Louis Read, cm	Lester E. Kabacoff, secy.-treas. Don Howell, pd Marion Annenberg, pmm	Lindsey Riddle, ce Tom Hicks, prog. m Pat Michaels, nd Mel Leavitt, sd		Wld., Cap. AP, UP RCA
WDSU-FM 1949	Ch. 287 (B) 105.3mc 17kw							
WJBW 1926	1230 250 DA-N	Louise C. Carlson Cigali Bldg. Magnolia 3488 Rambeau	(Mrs.) Louise C. Carlson, p, o & gm Edward C. Carlson, cm	Johnny Nickols, pd & nd George Stimmel, pmm F. J. Reely, ce	Harry Nigocia, fd John Parrish, sd J. Till, wd	Pop.: 586,400 Rad. Hms.: 154,300 AP GE
WJMR 1946 WJMR-TV	990 250-D	Supreme Bcstg. Co. Inc. Jung Hotel Canal 0356 Bolling	Chester F. Owens, p George A. Mayoral, evp	James E. Gordon, gm & pmm	Patrick J. Shannon, cm Tom Abbott, pd		
WRCM(FM) 1946	Ch. 246 (B) 97.1mc 61kw							
WMRY 1950	600 500-D	Southland Bcstg. Co. 2107 Dryades St. Tulane 4841 Perna	Lester Kamin, p Mort Silverman, gm & cm	Larry McKinley, pd, nd & sd Mary Potter, pmm	Samuel Perkins, ce John Revisore, loc. sim Laura Lane, wd	Pop.: 900,000 Rad. Hms.: 270,000 Ret. Sls.: \$788,463,000 UP Col.
WNOE 1925	1060 50,000-D 5,000-N DA-2	James A. Noe St. Charles Hotel Express 2173	MBS H-R Reps.	James A. Noe, p Benton Paschall, vp & gm Paul Beville, cm	Eldon Durand, pd George A. Smith, pmm A. J. Bourgeois, ce	Betty Underwood, wd Bill Elliott, nd James Steele, sd Bill Stanley, fd	Pop.: 2,012,300 Rad. Hms.: 98.6% Ret. Sls.: \$1,812,423,000	St., SES. AP RCA
WSMB 1925	1350 5,000 DA-N	WSMB Inc. Maison Blanche Bldg. Magnolia 5921	ABC Headley- Reed	Gaston Dureau Jr., p John R. O'Meallie, gm T. J. Fontelieu, cm	Irving Paley, pmm	H. G. Nebe, ce Maida Tabor, wd	Pop.: 954,820 Rad. Hms.: 241,748 Ret. Sls.: \$817,341,000	
WTIX 1951	1450 250	Mid-Continent Bcstg. Co. 624 Canal St. Magnolia 3211 Continental	Robert H. Storz, p Todd Storz, evp George Wm. Armstrong, vp & gm	Fred Berthelson, cm Larry Wilson, pd C. Warren Kennedy, pmm	Morris Jones, ce Les Stein, pdm Harry Gage, nd Don Nicol, sd		Cap. UP G
WTSP 1948	940 1,000-D 500-N DA-N	The Times- Picaune 615 Howard Ave. Canal 5561 Branham	John F. Tims, p H. F. Wehrmann, gm	Robert Smith, pd	Martin Burke, pmm George W. DeBlieux, ce		Assoc. WE
WWEZ 1947	890 5,000 DA-2	WWEZ Radio Inc. New Orleans Hotel Canal 3521 Holling- bery	A. J. Chilton, p C. A. Oswald, gm	Ken Elliott, pd	Harrison C. Mondy, ce	 UP WH
WWL 1922	870 50,000 DA-1	Loyola U. Roosevelt Hotel Raymond 2194	CBS Katz	Rev. W. Patrick Donnelly, S.J., p W. H. Summerville, gm Larry Baird, cm	Ed Hoerner, pd Ray Liuzza, pmm & merc. m J. D. Bloom, ce	W. D. O'Leary, S.J., faculty d Don Lewis, nd Bill Brenkel, sd Jill Jackson, wd	Pop.: 10,941,800 Rad. Hms.: 2,680,902 Ret. Sls.: \$6,551,929,000 AP, UP RCA
WWMT(FM) (CP)	Ch. 239 (B) 95.7 mc 48kw	Fidelity Bcstg. 813 Chartres St. Canal 4120		George R. Montgom- ery, p & gm	Peter H. Walmsley, vp James M. Hibun, ce	Macy O. Teetor Jr., secy.-treas.	 RCA

Data corrected to Dec. 10, 1953. If executives or services for FM are same as AM affiliate names are not repeated. Market Data supplied by stations. FM's in italic. *—Non-Commercial Station. CP—Construction Permit issued. D—Day. DA—Day. DA-N—Directional Antenna, night only. DA-1—Directional Antenna, same pattern day and night. DA-2—Directional Antenna, different pattern day and night. L—Limited Time with Dominant Station. LS—Local Sunset. N—Night. SA—Special Authorization. SH—Specified Hours. ST—Share Time. Complete key to abbreviations, page 6.

LOUISIANA

OAKDALE

KREH 900 Louisiana Bcstg. KBS Cyril W. Reddoch, p La Vance Carson, cm Mel Bennett, nd & sd Pop.: 325,000
1953 250-D Service Raloh L. Hooks, gm & ce Bart Ferris, fd Rad. Hms.: 123,196
900

OPELOUSAS

KSLO 1230 KSLO Bcstg. Co. ABC, KBS William E. Jones, p & Lloyd Wandell Floyd J. Cormier, nd Pop.: 200,000
1947 250 P. O. Box 392 Sears & gm Allegood, pd & sd & fd Wid.
2633 Ayer A. B. Reed Jr., cm Richard M. Cole, ce UP
WE

RUSTON

KRUS 1490 Ruston Bcstg. Co. MBS, KBS Clarence E. Faulk, p Kenneth L. Whitaker, William S. Carter, pd Pop.: 15,000
1947 250 Box 533 gm Charles Gandy, ce Rad. Hms.: 4,127
1490 UP
CoL

SHREVEPORT

(CP) 1480 Shreveport Bcstg. Co. Co.

KCIJ 980 Southland Bcstg. Co. Lester Kamin, p L. H. Brandao, pd, nd Mitchell Hodges, pmm
1950 5,000-D Co. Young John H. Pace, gm & cm N. L. Keys, ce UP
Col.

KENT 1550 Frank H. Ford MBS Frank H. Ford, p William F. Ford, slm Tony Barrett, nd Pop.: 503,300
1947 1,000-D 311 Milam Bldg. Walker Frank H. Ford Jr., Bill Monroe, pmm Bill Merrill, sd Ret. Hms.: \$452,089,000
500-N 3-3681 gm & cm L. J. Carlson, ce Bill Rutledge, fd AP
DA-N Ray.

KRMD 1340 Radio Station ABC T. B. Lansford, p Elizabeth V. Alford, E. R. Bernstein Jr., sd Pop.: 15,000
1928 250 KRMD Weed Glenn V. Wilson, gm pd Carl W. Goulden, ce Rad. Hms.: 4,127
New Jefferson Hotel 6171 William L. Switzer, sd Wid., Cap.
ST
AP
CoL

KRMD-FM Ch. 266 (B) 101.1mc 11.5kw

KTBS 980 KTBS Inc. NBC, E. Newton Wray, p & William B. Barnes, C. H. Maddox, ce Pop.: 1,272,800
1922 10,000-D 312 E. Kings Texas gm natl. slm Carroll Hill, nd Rad. Hms.: 296,820 AP, UP
5,000-N Hghwy. Quality, Michael Roppolo, pd Vern Stierman, sd Ret. Hms.: \$990,964,000
DA-2 7-3644 Louisiana (Mrs.) Dorothy Golds- James V. Bonnette, fd Alan Hart, wd RCA

KTBS-FM Ch. 243 (B) 96.5mc 14kw Pop.: 684,300
1952 Rad. Hms.: 158,310 Ret. Hms.: \$573,813,000

KWKH 1130 Internat'l Bcstg. CBS W. H. Bronson, p James T. Briggs, pmm James VanSickle, nd Pop.: 1,816,502
1925 50,000 Corp. 509 Market St. 2-8711 Henry Clay, vp & gm W. E. Antony, tech, d Jack Fiser, sd Jack Timmons, fd L-W
DA-N Fred A. Watkins, cm O. S. Droke, ce Jack Timmons, fd AP, UP
RCA

KWKH-FM Ch. 233 (B) 94.3mc 13.5kw Pop.: 508,782
1948 Rad. Hms.: 127,921 L-W, ST
Ret. Hms.: \$449,984,000 AP, UP
WH

SPRINGHILL

(CP) 1460 Springhill Bcstg. Co. Co.

THIBODAUX

KTIB 630 Delta Broad- casters, Inc. Ferd Block, p Ed Jackson, secy.-
(CP) 500-D 701 W. 5th St. Sam Lawrason, vp treas. Arthur Bachmann, m
5348 & ce AP
G

VILLE PLATTE

KVPI 1050 Ville Platte Bcstg. Co. Inc. Lionel B. Deville, p Guy Mitchell, sls. rep. J. S. Fontenot, pd &
1953 250-D P. O. Box 566 5888 Chris Duplechain, gm ce

MAINE

MARKET DATA BY COUNTIES

County	Population 1950	Radio Families 1953	Retail Sales 1952(000)	Food Sales 1952(000)	Drug Sales 1952(000)	Automobile Ownership 1952	County	Population 1950	Radio Families 1953	Retail Sales 1952(000)	Food Sales 1952(000)	Drug Sales 1952(000)	Automobile Ownership 1952
Androscoggin	83,594	23,280	\$ 90,472	\$ 26,641	\$ 1,817	1,817	Penobscot	108,198	27,330	115,581	30,250	2,625	2,625
Aroostook	98,039	21,630	101,695	27,186	2,251	2,251	Piscataquis	18,617	5,080	14,989	4,845	555	555
Cumberland	169,201	48,020	189,164	55,680	5,017	5,017	Sagadahoc	20,911	5,920	15,519	6,118	333	333
Franklin	20,682	5,280	17,370	5,618	413	413	Somerset	39,785	10,420	27,447	9,615	771	771
Hancock	32,105	9,250	24,107	9,375	430	430	Waldo	21,687	5,880	14,824	4,707	289	289
Kennebec	83,881	22,210	82,623	23,434	1,991	1,991	Washington	35,187	9,400	22,214	7,829	606	606
Knox	28,121	8,270	26,881	8,238	546	546	York	93,541	26,210	72,868	26,455	2,013	2,013
Lincoln	18,004	5,050	19,215	5,963	286	286	Total	674,468	244,570	\$869,239	\$264,274	\$20,805	287,525
Oxford	44,221	11,340	34,250	12,320	902	902							

DIRECTORY OF AM AND FM STATIONS

AUGUSTA

WFAU 1340 Twin City Bcstg. Co. MBS, Faust Couture, p Harry Simons, cm Gregory Evans, pmm St., Wld.
1946 250 160 Bangor St. 3-3878 Norman G. Gallant, gm Mona Toothaker, pd Catherine Rice, wd AP
Ray.

WRDO 1400 WRDO Inc. NBC, New Adeline B. Rines, p Leslie R. Hubley, pd Don Kelly, nd Thes.
1932 250 175 Water St. 3-4735 Regional England Donald K. Powers, gm & cm Harold T. Dinsmore, ce Linwood Brotee, fd Jean Murray, wd UP
RCA

BANGOR

WABI 910 Community ABC, Horace Hildreth, p Milton C. Chapman, Bob Patten, pd Pop.: 99,000
1925 5,000-DA-N Bcstg. Serv. Leon P. Gorman Jr., loc. cm Richard Bronson, Walter L. Dickson, ce Ret. Hms.: 98,000
WABI-TV 6446 57 State St. 6446 gm prof. m George Hale, nd Paul Dugas, sd Ret. Hms.: \$288,000,000

WGUY 1230 Murray Carpenter CBS Murray Carpenter, o Clifton E. Reynolds, George C. Tuck, fd Pop.: 150,000
1947 250 P. O. Box 732 Samuel G. Henderson Jr., gm pd & nd Larry Colton, sd Ret. Hms.: 38,000
7354 Foster Roger W. Hodgkins, ce Margo Floyd, wd Ret. Hms.: \$63,485,000

WGUY-FM Ch. 226 (A) 93.1mc 11kw Pop.: 250,000
1947 Rad. Hms.: 63,000 Ret. Hms.: \$63,485,000 UP
GE

MAINE

City	Call Letters Established TV Affiliate	Chan. or Freq. Power	Licensee Headquarters Telephone	Network Represent- ative	Owner; Pres. p; Exec. vp evp; Gen. Mgr. gm; Sta. Mgr. sm; Coml. Mgr. cm; Sales Mgr. slm; Prog. Dir. pd; Chief Eng. ce; Prom. Mgr. pmm; Prod. Mgr. pdm; News, Farm, Sports or Women's Dir. nd, fd, sd, wd.	Executive Abbreviations	Market Data For Primary Area (Supplied by station)	Library, News Serv. Transmitter
	WLBZ 1926	620 5,000-DA-N	Maine Bcstg. Co. 100 Main St. 2-4656	NBC, Maine Bcstg., New England Weed, Bannan	Adeline Rines, p Edward E. Guernsey, gm	Irving S. Hunter, pd George Chapman, pmm	John Wibby, ce William Mincher, nd Edward Owen, sd	Pop.: 351,600 Rad. Hms.: 90,000 Thes. UP WE
BIDDEFORD	WIDE 1948	1400 250	Biddeford Bcstg. Corp. 234 Main St. 4-4566	MBS, Yankee Raymer	Victor C. Diehm, o Arthur Deters, gm, cm & ce	Chris Drivas, asst. m, pd, pmm & wd George Friary, nd	Bill Petit, fd Carl Swanson, sd	Pop.: 95,088 Rad. Hms.: 27,020 Ret. Slis.: \$90,872,000 UP G
HOULTON	WABM 1950	1340 250	Aroostook Bcstg. Corp. 1340 North Rd. 2257	MBS, Yankee, Maine Bcstg.	Harry E. Umbhrey, p H. D. Glidden, gm	Ted Coffin, cm R. W. MacIntosh, ce	Dewey Dewitt, sd	Thes. AP RCA
LEWISTON	WCOU 1938	1240 250	Twin City Bcstg. Co. 223 Lisbon St. 4-6921	MBS, Yankee, Lobster O'Connell, Borgatti	Faust Couture, p John C. Libby, gm & cm	Herbert Fontaine, pd & pmm Herbert Wiles, ce	Oscar J. Normand, office m Linn Wells, nd & sd Hal Alberghini, fd Connie Coury, wd	Pop.: 89,061 Rad. Hms.: 25,430 Ret. Slis.: \$84,197,000 St. SES., Wld. AP RCA
	WCOU-FM 1948	Ch. 230 (B) 93.9mc 13.7kw						Wld., SES. AP WH
	WLAM 1947 WLAM-TV	1470 5,000-DA-1	Lewiston- Auburn Bcstg. Co. 129 Lisbon St. 4-5401	ABC Everett- McKinney, Kettell- Carter	Elden H. Shute Jr., p & sm Frank S. Hoy, gm	Gerald T. Higgins, cm & pmm Harold W. Dutch, pd	Henry Root, ce Parker Hoy, nd	Ret. Slis.: \$90,472,000 Thes. AP RCA
PORTLAND	WCSH 1925 WCSH-TV	970 5,000-DA-N	Congress Square Hotel Co. 157 High St. 2-0181	NBC, New England, Maine Weed, Bannan	Mrs. Adeline B. Rines, p Donald K. Powers, gm & cm Leslie R. Hubley, pd & pmm	Daniel H. Smith, ce Philip N. Johnson, nd	Jake Brofee, fd J. Donald MacWilliams, sd Arnes Gibbs, wd	Pop.: 433,200 Rad. Hms.: 120,240 Ret. Slis.: \$421,508,000 Thes. AP, UP RCA

Data corrected to Dec. 10, 1953. If executives or services for FM are same as AM affiliate names are not repeated. Market Data supplied by stations. FM's in *italic*. *—Non-Commercial Station. CP—Construction Permit issued. D—Day. DA-N—Directional Antenna, night only. DA-1—Directional Antenna, same pattern day and night. DA-2—Directional Antenna, different pattern day and night. L—Limited Time with Dominant Station. LS—Local Sunset. N—Night. SA—Special Authorization. SH—Specified Hours. ST—Share Time. Complete key to abbreviations, page 6.

BUY 5000 WATT

W L A M

ABC NETWORK "MAINE'S VOICE OF PROGRESS"

**1st IN SHARE
OF AUDIENCE**

MORNINGS
8:00 a.m. to 12 Noon
43.1%

AFTERNOONS
12 Noon to 6:00 p.m.
43.0%

EVENINGS
6:00 p.m. to 8:00 p.m.
40.9%

Represented Nationally
by **Everett-McKinney, Inc.**

C. E. HOOPER, INC. Survey
LEWISTON-AUBURN, ME., FEB., MAR., APR. 1951

Represented
in New England by
Kettell-Carter

WGAN 1938 WGAN-TV	560 5,000-DA-1	Guy Gannett Bcstg. Serv. 390 Congress St. 2-7423	CBS Avery- Knodel	Guy P. Gannett, p Creighton E. Gatchell, gm	Francis H. Farnum, Jr., pd, pmm & nd Roger W. Hodgkins, ce	H. Duncan Oliphant, educ. d Jane Lauten, wd	Pop.: 379,349 Rad. Hms.: 124,522 Ret. Sis.: \$614,760,000	SES. AP, UP RCA
WPOR 1947	1490 250	Oliver Bcstg. Corp. 477 Congress St. 3-8111	ABC MBS, Yankee, Lobster O'Connell, Borgatti	Richard E. Bates, cm Harold H. Meyer, p & William J. Mullen, cm Raymond Mercier, pd	George Hunter, fd Roster Perry, ce Harry J. Dowd, Jr., office m	Bill Williams, nd Hugh Babb, sd Martha Standish, wd	Pop.: 223,000 Rad. Hms.: 51,000 Ret. Sis.: \$175,000,000 AP GE
PRESQUE ISLE								
WAGM 1931	1450 250	Aroostook Bcstg. Corp. 155 State St. 8821	MBS, Yankee- Maine Bcstg.	Harry E. Umphrey, p H. D. Glidden, gm	Dick Marshall, cm, pd, pmm & fd Lester E. Hughes, ce	Forrest J. Craig, slm Dewey Dewitt, sd Dick Meyer, nd		Thes. AP
ROCKLAND								
WRKD 1952	1450 250	Knox Bcstg. Co. 493 Main St. 1800	ABC O'Connell, Borgatti	Carleton D. Brown, p Paul R. Huber, m	Vere B. Crockett, cm Donald S. Winslow, ce	Frank S. Knight, fd Margaret Dana, wd	Pop.: 47,000 UP RAY
RUMFORD								
WRUM 1953	1450 250	Rumford Publ. Co. Prospect Ave. 1057	KBS, Lobster O'Connell	Melvin L. Stone, p Kenneth J. Ellis, gm & pd	George B. Cunningham, cm Edward J. Tremblay, ce	Ben Pike, nd Hal Andrews, fd Woodrow Mercier, sd Madelaine McLean, wd	Pop.: 35,000 Rad. Hms.: 9,000	
WATERVILLE								
WTVL 1946	1490 250	Kennebec Bcstg. Co. 36 Silver St. 2700	ABC, Lobster O'Connell, Borgatti	Carleton D. Brown, p & gm Harold L. ViQue, cm Fred Preble, pd	Neil Collar, pmm Don Sutherland, ce John Maguire, nd	Ken Chase, fd Hugh Rawlinson, sd Evalyn Paikc, wd	Pop.: 50,000 Rad. Hms.: 12,500 Ret. Sis.: \$75,000,000 AP RCA

MARYLAND

MARKET DATA BY COUNTIES

County	Population 1950	Radio Families 1953	Retail Sales		Food Sales 1952(000)	Drug Sales 1952(000)	Automobile Ownership		County	Population 1950	Radio Families 1953	Retail Sales		Food Sales 1952(000)	Drug Sales 1952(000)	Automobile Ownership	
			1952(000)	1952(000)			1953	1953				1952(000)	1953				
Alleghany	89,556	25,790	\$ 81,159	\$ 25,300	\$ 2,515	25,549	2,515	25,549	Montgomery	164,401	51,610	172,076	42,638	4,745	80,528	1953	80,528
Anne Arundel	117,392	31,520	72,943	24,904	2,563	40,806	2,563	40,806	Prince Georges	194,182	59,780	112,332	42,479	3,982	82,873	1953	82,873
Baltimore	270,273	358,660	1,403,605	382,451	48,483	107,322	48,483	107,322	Queen Annes	14,579	4,060	11,283	3,357	207	5,434	1953	5,434
Calvert	12,100	2,900	8,546	2,395	124	4,494	124	4,494	St. Marys	29,111	6,740	19,918	7,433	223	7,984	1953	7,984
Caroline	18,234	5,340	25,398	4,781	466	8,573	466	8,573	Somerset	20,745	5,550	23,045	6,423	477	5,847	1953	5,847
Carroll	44,907	11,640	39,429	7,985	903	19,055	903	19,055	Talbot	19,428	5,840	29,240	6,002	1,106	8,519	1953	8,519
Cecil	33,356	8,820	25,685	8,794	365	13,114	365	13,114	Washington	78,886	22,800	74,256	20,630	1,980	29,325	1953	29,325
Charles	23,415	5,200	18,285	4,545	234	8,670	234	8,670	Wicomico	39,641	11,940	49,768	9,241	945	16,370	1953	16,370
Dorchester	27,815	7,760	22,607	6,741	468	10,460	468	10,460	Worcester	23,148	6,790	39,088	6,378	573	9,116	1953	9,116
Frederick	62,287	17,560	57,583	13,747	1,292	23,964	1,292	23,964	Total	2,343,001	680,230	\$2,370,151	\$647,756	\$73,517	779,545		779,545
Garrett	21,259	4,930	14,597	3,270	235	6,738	235	6,738	Note:	Population 1950 Census; radio families Standard Audit & Measurement Services Inc.; food, drug and retail sales, copyright 1953, Sales Management; further reproduction unlicensed; automobiles supplied by state.							
Harford	51,782	14,930	45,322	12,507	1,037	21,033	1,037	21,033									
Howard	23,119	6,140	10,737	2,201	279	9,613	279	9,613									
Kent	13,677	3,940	13,249	3,574	313	6,015	313	6,015									

AMERICAN BROADCASTING COMPANY
YANKEE NETWORK

WPOR | LAND

1. 25.5% of State's population
2. 37.9% of State's retail sales
3. WPOR is strong on local impact, news, weather, music, sports
4. Growing acceptance—WPOR local business up 106%—national business up 238%

REPRESENTED BY—
NEW YORK—Richard O'Connell
BOSTON—Lou Borgatti
CHICAGO—Hal Holman
PACIFIC COAST—Duncan Scott

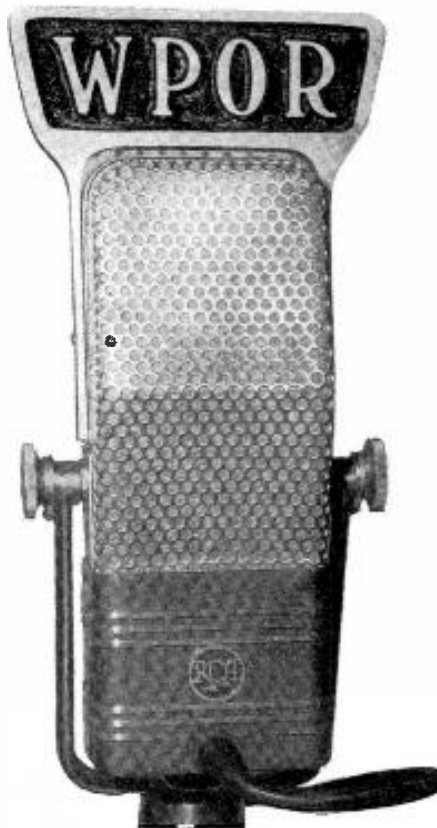

PORTLAND, MAINE

MUTUAL BROADCASTING SYSTEM
LOBSTER NETWORK

*Portland's
favorite
station—
ask
anyone!*

Hal Meyer, President

MARYLAND

City	Call Letters	Chan. or Freq. Power	Licensee Headquarters Telephone	Network Representative	Executive Abbreviations	Market Data For Primary Area (Supplied by station)	Library, News Serv. Transmitter		
ANNAPOLIS									
WANN	1190	1,000-D	Annapolis Bcstg. Corp. Pearson, Dora-Clayton	Morris H. Blum, p & gm	Arthur P. Dietz, ce Ray.		
WASL	810	250-D	The Chesapeake Radio	Robert L. Blalock, p & gm	John Drew, pd & fd Jos. H. Griscom, ce	Bill Earle, nd & sd Muriel E. Blalock, wd	Wid. AP Col.	
WNAV	1430	1,000-DA-N	Capital Bcstg. Co.	KBS McGillvra	Albert H. MacCarthy, p	Richard Rudolph, operator	Helga Pfefferman, pd Alan B. Laffier, ce	Thes. AP GE	
WNAV-FM	Ch. 256 (B)	99.1mc 16.6kw	Store Radio	R. C. Embry, operator	Norman V. Bergholm, sm WH	
BALTIMORE									
WBAL	1090	50,000-DA-N	The Hearst Corp. 2610 N. Charles St.	NBC Christal Hopkins 7-3000	Charles B. McCabe, vp & exec. d	Freeman W. Cardall, bus. m	J. M. Kennedy, sm Thomas J. White Jr., nd & publ. m	AP, UP INS WE	
WBMD	750	1,000-D	Key Bcstg. Co. 879 Park Ave. McGillvra	George E. Hull, p	Thomas O'Connor, pd, nd, fd & sd	Polly Dorsey, wd	Pop.: 1,796,960 Rad. Hms.: 466,038 Ret. Sls.: \$1,480,318,000	AP RCA
WCAO	600	5,000-DA-1	The Monumental Radio Co.	CBS Raymer	L. Waters Milbourne, p & gm	Robert M. Richmond, cm & pmm	Wm. Conhurst, nd Roger Griswold, sd	Pop.: 1,427,000 Rad. Hms.: 577,000 Ret. Sls.: \$1,988,979,000	Wid. AP WH
WCAO-FM	Ch. 274 (B)	102.7mc 20kw	H. Shelton Earp Jr., gm	Russell H. Morgan, ce	Betty McCall, wd
WCBM	680	10,000-D	Baltimore Bcstg. North & Harford Aves.	MBS Taylor	John Elmer, p & cm	Charles A. Roeder, pd & nd	John MacLean, sd Newell Warner, fd	L-W AP, INS RCA
WFBR	1300	5,000-DA-1	Belmont 8400	ABC Blair	George H. Roeder, gm	G. Porter Houston, ce	Myrth Riefner, wd
WITH	1230	250	The Baltimore Radio Show Inc.	Robert S. Maslin, p	J. H. L. Trautfelder, vp & treas.	William Q. Ranft, ce John W. Steele, nd	Pop.: 1,625,003 Rad. Hms.: 432,050	Wid. AP, UP RCA
WITH-TV	1941	250	10 E. North Ave. Mulberry 5-1300	Robert S. Maslin Jr., vp, secy. & publ. d	William S. Pirie Jr., sis. d	C. Nelson Baker, sd Helen K. Neel, wd
WITH-FM	Ch. 282 (A)	104.3mc 20kw	Maryland Bcstg. 7 E. Lexington Lexington 7808	Forjoe	Robert B. Jones Jr., vp & gm	W. Bert Hanauer, pd	James S. Duff, ce Chuck Thompson, sd	St. AP WE
WSID	1010	1,000-D	The United Bcstg. 912 N. Charles St. Saratoga 8250	Thomas G. Tinsley Jr., p & gm	Robt. C. Embry, cm Nedra Berryman, pd	Lee Reckling, ce UP
WWIN	1400	250	Belvedere Bcstg. 1119 N. Charles Saratoga 7-3555	Richard Eaton, p & nd	Helen Wherley, pd	Joseph R. Sporney, ce Ralph Pennewell, sd	Pop.: 949,708 Rad. Hms.: 275,000 Ret. Sls.: \$1,282,101,000	Assoc. AP WE

Data corrected to Dec. 10, 1953. If executives or services for FM are same as AM affiliate names are not repeated. Market Data supplied by stations. FM's in italic. *—Non-Commercial Station. CP—Construction Permit issued. D—Day. DA-N—Directional Antenna, night only. DA-1—Directional Antenna, same pattern day and night. DA-2—Directional Antenna, different pattern day and night. L—Limited Time with Dominant Station. LS—Local Sunset. N—Night. SA—Special Authorization. SH—Specified Hours. ST—Share Time. Complete key to abbreviations, page 6.

In
Baltimore's
Metropolitan Area, 1st in sales in Md.

IT'S
WSID that gets the bid Baltimore's Favorite Independent

WSID has more listeners during the entire afternoon period than the COMBINED LISTENING AUDIENCE OF ANY TWO INDEPENDENT STATIONS.

In Baltimore **WSID** has more listeners per dollar cost than any other independent station.
SOON—WSID-TV

U
B
C

CBS
In
Hagerstown,
Capital of Western Maryland
2nd in sales in Md.

IT'S WARK-CBS that leads the entire area.

'Mark WARK' on your list
Auxiliary Studio, Waynesboro, Pa.

Leads any
TWO other stations in
listening audience according to
all surveys available.

For more listeners and more value
Call UBC, 912 N. Charles St. Baltimore, Saratoga 7-8250
or 507 Fifth Ave., N. Y. City, Murray Hill 7-4758

BETHESDA

WUST 1951	1120 250-D	Broadcast Management Inc. 1343 U St., NW Washington, D. C. Hobart 2-0011	McGillivra	Harold E. Sheffers, p & gm	Vernon Ward, cm & pmm Georgette Leighton, pd	Robert Carnine, ce Roy Snyder, nd John Bandy, sd Frances White, wd	Pop.: 1,474,200 Rad. Hms.: 418,570 Ret. Sis.: \$1,631,634,000	UP Col.
WUST-FM 1951	Ch. 292 (A) 106.3mc 0.5kw						Pop.: 1,500,000 Rad. Hms.: 430,960 Ret. Sis.: \$1,631,634,000	

BRADBURY HEIGHTS

WBUZ-FM (See Washington, D. C. Listing)
1948

CAMBRIDGE

WCEM 1947	1240 100	Shore Bcstg. Co. P. O. Box 333 1580	MBS	G. P. Richards, p & cm	Thomas H. Maguire, Jr., sm & nd	Bette B. Robbins, pd Anna Flowers, pmm Arthur Coburn, ce	Pop.: 66,000 Rad. Hms.: 20,150 Ret. Sis.: \$48,157,000	Wld. AP Col.
---------------------	-------------	---	-----	---------------------------	------------------------------------	--	--	--------------------

CUMBERLAND

WCUM 1948	1490 250	Tower Realty Co. Williams Road & East City Line 5400	CBS ForJoe	Karl F. Steinmann, p Eldred Steinmann, vp in chg.	Malcolm A. Campbell Jr., gm, pd & sd Roy H. Knotts, cm	Paul Custer, ce Wm. Criswell, nd Russ Reynolds, fd Katherine Flora, wd	Pop.: 100,000 Rad. Hms.: 32,000 Ret. Sis.: \$80,000,000	Thes. AP RCA
---------------------	-------------	---	---------------	---	--	---	---	--------------------

WCUM-FM Ch. 275 (B)
1948 102.9mc
1.29kw

WDYK 1953	1230 250-DA-N	Western Md. Bcstg. Co. P. O. Box 510 5001	ABC, MBS Radio-Tv Reps.	Richard A. Raese, p James M. Martinson, gm	Floyd V. Cozad, cm Edwin Meyer, pd & nd	George Sokol Jr., ce Chad Riley, sd	Pop.: 175,000 Rad. Hms.: 58,000 Ret. Sis.: \$84,000,000	St. UP Col.
---------------------	------------------	--	-------------------------------	--	---	--	---	-------------------

WTBO 1928 WTBO-TV	1450 250	Maryland Radio Corp. 31 Frederick St. 299	NBC Branham	Charles E. Smith, p & gm	P. H. Cunningham, cm & pmm Michael Hurst, pd, nd & sd	David W. Jefferies, ce Robert Rosamond, fd M. Virginia Rosenbaum, wd	Pop.: 165,046 Rad. Hms.: 43,200 Ret. Sis.: \$116,265,000	Wld. UP WE
--------------------------------	-------------	--	----------------	-----------------------------	--	---	--	------------------

ESSEX

WSID (See Baltimore listing)
1947

FREDERICK

WFMD 1936	930 1,000-DA-N	Monocacy Bcstg. Co. Corner Market & 7th St. Monument 3-4181	CBS Meeker	Laurence Leonard, p Alan W. Long, gm & cm	Evelyn Leonard, pd Howard C. Fisher, ce Joe Eisenhaur, nd Harold Keats, pmm	Lawrence Crickenberger, fd Al Cooper, sd Mary M. Long, wd	Pop.: 417,803 Rad. Hms.: 113,989 Ret. Sis.: \$333,511,000	AP RCA
---------------------	-------------------	---	---------------	---	--	--	---	-----------

WFMD-FM Ch. 260 (B)
1947 99.9mc
2kw

TODAY, AS 10 YEARS AGO, INDUSTRY LEADERS SAY:

WBOC

ONE OF AMERICA'S FINER RADIO STATIONS

At RADIO PARK, SALISBURY, MD.

OUT-OF-TOWN STUDIOS: SEAFORD, DEL., POCOMOKE CITY, MD.

SHARE OF AUDIENCE
(Mon. thru Fri. Average)
Source: J. A. Ward, Inc.
9 AM - 12 Noon 69.5%
12 Noon - 6 PM 71.6%
6 PM - 10 PM 72.0%

MARKET DATA
Source: Sales Management
Population 301,700
Radio Homes 82,500
Retail Sales \$333,484,000

AT THE CENTER OF THE STORIED DEL-MAR-VA PENINSULA

John W. Downing, President
Charles J. Truitt, Gen. Mgr.

National Representatives:
Burn-Smith Co., Inc.

MARYLAND

City	Call Letters	Chan. or Freq.	Licenses Headquarters Telephone	Network Representative	Executive Abbreviations	Market Data For Primary Area (Supplied by station)	Library, News Serv. Transmitter	
HAGERSTOWN								
WARK	1490	250	United Bcstg. Co. 128 S. Prospect St. 4500	CBS United	Richard Eaton, p S. E. Phillips, gm & cm	Hunter Reams, pd & G. Harold Brewer, ce Dick Collyer, nd Stan Roberts, sd Betty Bupp, wd	Pop.: 225,000 Rad. Hms.: 64,300 UP	
WJEJ	1240	250	Hagerstown Bcstg. Co. Franklin Court 2323	ABC, MBS Walker	Grover C. Crilley, p & gm Wm. H. Paulsgrove, cm & pmm	Robert Leshar, pd George McIntire, ce Glenn Thomas, nd & sd	Pop.: 125,000 Rad. Hms.: 29,000 Ret. Sis.: \$99,400,000 L-W AP	
WJEJ-FM	Ch. 284 (B)	104.7mc 9.36kw					Pop.: 300,000 Thes. AP GE	
HAVRE de GRACE								
WASA	1330	1,000-D	The Chesapeake Bcstg. Corp. P. O. Box 97 800	Jason T. Pate, p & gm Charles W. Irwin, cm	H. Robert Gray Jr., pd & nd Gerald D. Johnson, ce Allen Anderson, sd Jane Emery, wd	Pop.: 236,800 Rad. Hms.: 61,000 Ret. Sis.: \$229,000,000 Wid. UP Ray.	
LEONARDTOWN								
WKIK	1370	1,000-D	Southern Md. Inc. Greenwood 5-2211	Charles E. Springer, p, pd & nd	James L. Bittner, vp, gm & ce William C. Redd, cm & pmm Loren Hiddleston, fd	Pop.: 65,000 Rad. Hms.: 2,033 Col.	
LEXINGTON PARK								
WPTX	1570	1,000-D	Patuxent Radio Great Mills Rd. Great Mills 2-1031	KBS	Harry J. Daly, p John M. Naylor, gm	Lou Douglas, pd J. Frank Raley, fd Molly Chaplin, wd	Pop.: 50,000 Rad. Hms.: 18,000 Ret. Sis.: \$40,000,000	
MORNINGSIDE								
WPGC (CP)	1580	250-D	Harry Hayman					
ROCKVILLE								
WINX	1600	1,000-D	Montgomery County Bcstg. Co. Poplar 2-4357	United	Richard Eaton, gm Arthur A. Snowberger, ce Gene Andrews, pd	 UP Col.	
SALISBURY								
WBOC	960	1,000-DA-N	The Peninsula Bcstg. Co. Radio Park 6131	MBS Burn-Smith	John W. Downing, p Charles J. Truitt, gm, cm & pmm	John W. Downing Jr., pd Jack W. Ward, ce	Pop.: 300,100 Rad. Hms.: 82,250 Ret. Sis.: \$333,484,000 Wid. L-W AP RCA	
SILVER SPRING								
WGAY	1050	1,000-D	Tri-Suburban Bcstg. Corp. 11306 Kemp Mill Rd. Juniper 9-1050	Metro-politan Indie	John W. Kluge, p Joseph L. Brechner, gm Ernie Tannen, cm	Chuck Dulane, pd, nd & fd John Drew, pmm	Arthur McDougall, ce Beverly C. Costello, traffic m & wd Val Thomas, sd	Pop.: 1,600,000 Wid. AP Col.
WESTMINSTER								
WTTR	1470	1,000-D	Carroll County Bcstg. Corp. Uniontown Road 1171	Russell H. Morgan, vp & gm	E. E. Divers, cm John H. Little, pd	Charles T. Buffington, ce Gladys Wimert, wd	Pop.: 100,000 Rad. Hms.: 30,000 Ret. Sis.: \$110,000,000
WHEATON								
WDON	1540	250-D	Commercial Radio Equip. Co. 1319 F. St., N. W. Washington, D. C. District 7-1319	Everett L. Dillard, p & gm James G. Gustafson, cm	Douglas Bailey, pmm Eugene V. Jurasinski, ce	Robert E. Best, traffic m Pop.: 1,300,000	

MASSACHUSETTS

MARKET DATA BY COUNTIES

County	Population 1950	Radio Families 1953	Retail Sales 1952(000)	Food Sales 1952(000)	Drug Sales 1952(000)	Automobile Ownership 1952	County	Population 1950	Radio Families 1953	Retail Sales 1952(000)	Food Sales 1952(000)	Drug Sales 1952(000)	Automobile Ownership 1952
Barnstable	46,805	15,410	\$ 79,229	\$ 24,310	\$ 2,717		Norfolk	392,308	115,300	355,519	113,994	12,655	
Berkshire	132,866	39,100	154,634	42,094	3,506		Plymouth	189,468	58,470	202,851	61,462	5,456	
Bristol	381,569	114,420	384,889	111,936	12,204		Suffolk	896,615	251,220	1,375,513	315,256	37,454	
Dukes	5,633	1,750	7,656	3,211	411		Worcester	546,401	157,820	608,145	175,306	15,499	
Essex	522,384	158,210	545,974	172,164	16,659		Total	4,690,514	1,362,560	\$5,217,684	\$1,481,175	\$158,372	1,376,058
Franklin	52,747	16,220	60,003	16,444	1,226		Note: Population 1950 Census; radio families Standard Audit & Measurement Services Inc.; food, drug and retail sales, copyright 1953, Sales Management; further reproduction unlicensed; automobiles supplied by state.						
Hampden	367,971	109,300	439,738	116,526	14,343								
Hampshire	87,594	23,340	72,582	18,530	2,164								
Middlesex	1,064,569	300,910	943,266	307,457	33,781								
Nantucket	3,484	1,090	7,685	2,485	297								

DIRECTORY OF AM AND FM STATIONS

ATTLEBORO								
WARA	1320	1,000-DA-2	Attleboro Radio Assn. Inc. 8 N. Main St. Attleboro 1-1320	Walker, Bannan	Keith S. Field, gm Wm. A. Dawson Jr., cm	Dave Mohr, pd Charles W. Lynch, ce Charles Mahan, nd	Howard Tozier, sd Stan Morgan, fd Jo Sherman, wd UP RCA
BOSTON								
WBMS	1090	1,000-D	WBMS Inc. Hotel Shelton Copley 7-3005	Rambeau	John Laux, p Norman Furman, gm Dorothea Mann, pd	Harry Paul, pmm Don Snider, ce William Marlowe, nd	Harry Clark, sd Anna Yona, wd	Pop.: 3,870,000 Rad. Hms.: 2,543,000 Ret. Sis.: \$2,803,000,000 AP UP

Data corrected to Dec. 10, 1953. If executives or services for FM are same as AM affiliate names are not repeated. Market Data supplied by stations. FM's in *italics*. *—Non-Commercial Station. CP—Construction Permit issued. D—Day. DA—N—Directional Antenna, night only. DA-1—Directional Antenna, same pattern day and night. DA-2—Directional Antenna, different pattern day and night. L—Limited Time with Dominant Station. LS—Local Sunset. N—Night. SA—Special Authorization. SH—Specified Hours. ST—Share Time. Complete key to abbreviations, page 6.

MASSACHUSETTS

WBZ 1921 WBZ-TV	1030 51,000 DA-1	Westinghouse Bcstg. Co. Inc. 1170 Soldiers Field Rd. Algonquin 4-5670	NBC, New England Regional Free & Peters	Chris J. Witting, p Paul E. Mills, gm C. M. Meehan, sim Avner Rakov, prog. m C. Lud Richards, adv. m & sis. pmm	W. H. Hauser, ce & asst. m J. McNamara, nd	Leo Egan, sd Malcolm McCormick, fd Mildred Carlson, wd	Pop.: 4,856,300 Assoc. Thes. Rad. Hms.: 1,362,895 AP, UP Ret. Sis.: \$5,285,946,000 INS WH
WBZ-FM 1940	Ch. 225 (B) 92.9mc 20kw	(See Springfield listing)					
WBZA 1924							
WCOP 1935	1150 5,000-DA-2	WCOP Bcstg. Co. 489 Boylston St. Copley 7-0123	Bolling	T. B. Baker Jr., co-o Alvin Beaman, co-o Roy V. Whisnand, co-o & gm	Irvin E. Dierdorff Jr., pd & nd A. N. Armstrong Jr., cm	Roland C. Hale, ce Johnny Most, sd	Rad. Hms.: 887,000 AP, INS
WCOP-FM 1948	Ch. 264 (B) 100.7mc 20kw						
WEEI 1924	500 5,000-DA-1	Columbia Bcstg. System 182 Tremont St. Hubbard 2-2323	CBS, New England Regional Net. CBS Radio Spot Sales	Frank Stanton, p Harvey J. Struthers, gm Emmett J. Heerd Jr., sim	Eugene M. King, pd John T. Curry Jr., sis. prom. d Harold A. Dorschug, ce Marie H. Houlahan, publ. d	Charles Ashley, nd Fred Cusick, sd Louis A. Webster, fd Heloise Parker Broeg, co-wd Priscilla Fortescue, co-wd	L-W AP, UP GE
WEEI-FM 1948	Ch. 277 (B) 103.3mc 20kw						
WHDH 1929	850 50,000-DA-2	Matheson Radio Co. 6 St. James Ave. Hancock 6-5500	Blair	Robert B. Choate, p William B. McGrath, mngng. d Alexander M. Tanger, cm	George M. Perkins, pd William E. Shea, pmm Philip K. Baldwin, ce John Day, nd	Curt Gowdy, sd Joseph Kelly, fd Christine Evans, wd	Pop.: 5,319,518 Rad. Hms.: 1,423,500 AP WH
WHDH-FM 1949	Ch. 233 (B) 94.5mc 20kw						
WMEX 1934	1510 5,000-DA-N	The Northern Corp. 70 Brookline Ave. Commonwealth 6-3900	William S. Pote, gm Lawrence J. Flynn, cm	John E. Reilly, pd George Kaplan, pmm William Ferruzzi, ce	Frank Fallon, sd Marie Mason, wd	Ret. Sis.: \$2,628,195,489 L-W, SES. AP WE INS RCA
WNAC 1937 WNAC-TV	680 50,000-DA-1	General Teleradio Inc. Yankee Network Division 21 Brookline Ave. Commonwealth	MBS Yankee H-R Reps.	Tom O'Neill, p Linus Travers, evp & gm George Steffy, vp	Tom Bateson, cm John D. Maloy, pd George Hallberg, pmm	Phyllis Doherty, publ. d I. B. Robinson, ce Leland Bickford, nd Les Smith, sd Louise Morgan, wd	UP, INS Rev. WE
WNAC-FM 1948	Ch. 253 (B) 98.5mc 20kw	6-0800					

REACH THE NATION'S 6th METROPOLITAN MARKET *plus*

WITH THE PRIMARY COVERAGE OF

WBZ-WBZA

51,000 WATTS

BOSTON. The nation's sixth metropolitan market—retail sales, \$3,220,272,000 with WBZ!

SPRINGFIELD. The nation's forty-fourth metropolitan market—retail sales, \$512,320,000 with WBZA!

21 COUNTIES in New Hampshire, Maine, Vermont and Massachusetts with WBZ and WBZA—retail sales, \$1,625,936,000! (An area equal in size to the nation's twelfth metropolitan market, Minneapolis-St. Paul—and more than equal in retail sales.)

REMEMBER, THIS IS ONLY PRIMARY COVERAGE. Secondary and tertiary coverage account for an additional 30 counties. Send for our Audience Action Mail Map, based on a sample of 100,000 actual pieces of audience mail. And for all-over coverage in New England, be sure to get our rates. No obligation, of course.

WESTINGHOUSE BROADCASTING COMPANY

WBZ • WBZA • KYW • KDKA • WOWO
KEX • WBZ-TV • WPTZ

National Representatives: Free & Peters, except for TV; for WBZ-TV and WPTZ, NBC Spot Sales

MASSACHUSETTS

City	Call Letters	Chan. or Freq. Power	Licensee Headquarters Telephone	Network Representative	Owner o; Pres. p; Exec. vp evp; Gen. Mgr. gm; Sta. Mgr. sm; Coml. Mgr. cm; Sales Mgr. sim; Prog. Dir. pd; Chief Eng. ce; Prom. Mgr. pmm; Prod. Mgr. pdm; News, Farm, Sports or Women's Dir. nd, fd, sd, wd.	Executive Abbreviations	Market Data For Primary Area (Supplied by station)	Library, News Serv. Transmitter
WORL 1950	950 5,000-D	Pilgrim Bcstg. 92 State St. Lafayette 3-4000 Headley- Reed	Joseph A. Dunn, p Arthur E. Haley, gm & cm	Norman Prescott, pd Polly E. Haddad, pmm John Parker, ce	Claire Crawford, asst. slm Arthur Hume, nd & sd	Pop.: 3,570,917 Rad. Hms.: 939,715 Ret. Sls.: \$4,100,000,000 AP Ray.
BROCKTON								
WBET 1946	1480 1,000-DA-N	Enterprise Pub. Co. 60 Main St. 7062	Charles A. Fuller, gm & nd Earle G. Clement, cm	William W. Pierce 3rd, pd Arthur Jones, pmm & fd	Charles Nowell, ce Walter Dunbar, sd	Pop.: 167,733 Rad. Hms.: 47,923 Ret. Sls.: \$216,526,926	SES., Thes. AP Col.
WBET-FM 1948	Ch. 249 (A) 97.7mc 0.8kw						 AP GE
BROOKLINE								
WVOM 1948	1600 5,000-DA-1	The Boston Bcstg. Corp. 790 Common- wealth Ave. Beacon 2-5650	KBS	Benjamin Bartzoff, vp & gm	Ken Strong, cm James Fitzgerald, pd	Jerome Bartzoff, ce	 UP Ray.
CAMBRIDGE								
WTAO 1948	740 250-D	Middlesex Bcstg. Corp. 439 Concord Ave. Eliot 4-0500 Indie	Frank J. Lyman Jr., p Frederick S. Bailey, gm	John H. Kimball Jr., cm	Edward J. Penney Jr., pd Bob Mehrman, nd	Pop.: 3,250,000 Ret. Sls.: \$3,449,812,000
WTAO-TV								
WXHR(FM) 1946	Ch. 245 (B) 96.9mc 6.9kw	(WTAO, Am Affiliate)	Continental Good Music Bcstrs.	John R. Thornton, gm C. Stuart Grover, cm	John Cameron, pd Leonard Pray, ce	Pauline C. Stiness, publ. d	Pop.: 3,053,500 Rad. Hms.: 895,800 Ret. Sls.: \$216,526,926 UP
CHICOPEE								
WACE 1946		(See Springfield listing)						
FALL RIVER								
WALE 1948	1400 250	Narragansett Bcstg. Co. 374 Central St. 4-1400	MBS, Yankee Walker, Bannan	George L. Sisson Jr., p & gm J. Roger Sisson, loc. slm	Markey Gosciminski, reg. slm Walter Johnson, pmm Roland Berube, ce Madeline Hamel, wd	Madeleine Hamel, bus. m & wd Ann Kenney, traffic m James Arkison, nd & sd Jerry Jerome, fd	Pop.: 200,000 UP Ray.
WSAR 1921	1480 5,000 DA-2	Fall River Bcstg. Co. Academy Bldg. Fall River 7-9477	ABC Headley- Reed, Kettell- Carter	Frank W. Miller Jr., p Lincoln W. N. Pratt, gm & treas.	Cornelius D. Sullivan, cm J. Joseph Welch, pd, nd & fd	John Pavao, ce Bill O'Brien, sd Gladys Bramblett, wd	Pop.: 379,335 Rad. Hms.: 215,903 Ret. Sls.: \$400,000,000	Thes. UP WH
FITCHBURG								
WEIM 1941	1280 1,000-DA-N	WEIM Fitchburg Inc. 717 Main St. 3-3766	MBS Yankee Walker Kettell- Carter	Henry G. Molina Jr., p Lewis F. Sargent, gm	James Chalmers, cm & sd David Rodman, pd Theodore Kalin, ce	Leslie Levinson, nd Walter Viewig, fd Dorothy McKittrick, wd	 AP GE
WFGM 1950	1580 1,000-D	Wachusett Bcstg. Corp. 455 Main St. 3-4897 Rambeau, Bannan	David M. Myers, p, gm & cm Talbot R. Hood, pd	Joseph Rich, pmm Donald L. Coleman Jr., ce	Martha Meadows, exec. secy. Kirk Anderson, nd, fd & sd	Pop.: 155,500 Rad. Hms.: 42,710 Ret. Sls.: \$124,500,000 INS Ray.
FRAMINGHAM								
WKOX 1947	1190 1,000-D	WKOX Inc. Mt. Wayte Ave. Framingham 7409 Webb, Kettell- Carter	Albert A. Anderson, p Richard E. Adams, gm, vp & treas.	Lewis F. Sargent, cm William B. Sherman, pd	Francis W. Bartol, ce James B. Robbins, nd	Pop.: 361,917 Rad. Hms.: 112,759 Ret. Sls.: \$116,551,000	Wld. UP Ray.

Data corrected to Dec. 10, 1953. If executives or services for FM are same as AM affiliate names are not repeated. Market Data supplied by stations. FM's in italic. *—Non-Commercial Station. CP—Construction Permit issued. D—Day. DA-N—Directional Antenna, night only. DA-1—Directional Antenna, same pattern day and night. DA-2—Directional Antenna, different pattern day and night. L—Limited Time with Dominant Station. LS—Local Sunset. N—Night. SA—Special Authorization. SH—Specified Hours. ST—Share Time. Complete key to abbreviations, page 6.



ANYWAY YOU LOOK AT IT — IN PROVIDENCE IT'S
TOP LOCAL AUDIENCE + TOP TALENTS = RESULTS



REPRESENTED BY HEADLEY-REED

GARDNER									
WGAW 1946	1340 250	Gardner Bcstg. Co. 3 Pleasant St. 1490	ABC, KBS Webb, Borgatti	William F. Rust, Jr., p	William C. Engel, gm & cm	William Martin, ce		 AP GE
GREENFIELD									
WHAI 1938	1240 250	John W. Haigis 354 Main St. Greenfield 4301	MBS, Yankee Walker, Bannan	John W. Haigis, p John W. Haigis, Jr., gm Horace W. Nichols, cm	Ira I. Hewey, pd & sd Thomas J. Kelly, pmm Leland F. Wheeler, ce	Graydon H. Spragg, nd Woodbridge B. Brown, fd June K. Greene, wd	Pop.: 55,000 Rad. Hms.: 16,000 Ret. Sis.: \$80,000,000	Wid. AP Col.	
WHAI-FM 1948	Ch. 252 (A) 98.3mc 1kw						Pop.: 150,000 Rad. Hms.: 50,000 Ret. Sis.: \$100,000,000	Wid. AP REL	
HAVERHILL									
WHAU 1947	1490 250	Haverhill Gazette Co. 30 How St. Haverhill 4-4733 Kettell- Carter	John T. Russ, p & gm Robert I. Kimel, sm	John J. Kirby, cm Kenneth D. Ash, pd	David E. Cate, ce Eileen Kneeland, wd	Pop.: 218,569 Rad. Hms.: 98.4% UP Ray.	
HOLYOKE									
WHYN 1941 WHYN-TV	560 1,000-DA-1	The Hampden- Hampshire Corp. 1300 Liberty St. Springfield 4-1126	CBS Branham, Weed	Charles N. DeRose, gm Patrick J. Montague, cm	A. J. Paley, ce Bill Keating, sd	Helen Hope, wd	Pop.: 350,000 Rad Hms.: 150,000	L-W UP RCA	
WHYN-FM 1948	Ch. 261 (B) 93.1mc 3.2kw			Charles Tamm, ce				L-W UP GE	
WREB 1950	930 500-D	Valley Bcstg. Co. 323 High St. 2-3296	Colton	Sigward O. Holmes, p John H. Vondell Jr., sm & pd	Emil R. Werner, cm Warren F. Craig, nd Dr. A. D. King, ce	Tom Eaton, sd Mildred Chase, co-wd Ruth Mason, co-wd	Pop.: 444,000	Assoc. SES. AP G	
LAWRENCE									
WCCM 1947	800 1,000-D	The Lawrence Bcstg. Co. 278 Essex St. Lawrence 3-7171 Indie, Foster	George H. Jaspert, p & gm Daniel B. Ruggles, III, cm	Pete Ward, pd John D. Bodell, ce Harold Bishop, nd John O'Connell, sd	Forrest N. Morgan, Jr., fd Christine Cartwright, wd	Pop.: 472,256 Rad. Hms.: 120,000 AP GE	
LOWELL									
WCAP 1951	980 1,000-D	Northeast Radio Inc. 243 Central St. 4-0404 Kettell- Carter	Israel Cohen, p William J. Warren, gm & cm	Ugo San Antonio, pd Theodore Cohen, ce Reg Cox, nd	Duke Savitt, sd G. Alexakos, fd Kay Brogan, wd	Rad. Hms.: 510,090 UP Ray.	
WLLH 1934	1400 250	Merrimac Bcstg. Co. Inc. 39 Kearney Sq. Lowell 8715	MBS, Yankee Bloomberg	Gerald Harrison, p Carl S. Wheeler, vp Dana W. Fitzgerald, sm	Haskell Bloomberg, cm Tom Clayton, pd & sd A. G. Michaels, ce	R. B. Newton, asst. ce Fred Simmonds, nd Ann Bradford, wd		Assoc. UP WE	
WLLH-FM 1948	Ch. 258 (B) 99.5mc 12.2kw						 WE	

WHAI

INSTEAD OF THE USUAL PLEONASM WE
SUGGEST YOU CONTACT BERTHA BANNAN
IN BOSTON OR THE WALKER COMPANY IN
NEW YORK

WHAI

GREENFIELD
MASSACHUSETTS

MASSACHUSETTS

City	Call Letters Established TV Affiliate	Chan. or Freq. Power	Licensee Headquarters Telephone	Network Represent- ative	Owner o; Pres. p; Exec. up evp; Gen. Mgr. gm; Sta. Mgr. sm; Coml. Mgr. cm; Sales Mgr. slm; Prog. Dir. pd; Chief Eng. ce; Prom. Mgr. pmm; Prod. Mgr. pdm; News, Farm, Sports or Women's Dir. nd, fd, sd, wd.	Executive Abbreviations	Market Data For Primary Area (Supplied by station)	Library, News Serv. Transmitter	
LYNN									
	WLYN 1947	1360 1,000-D	Puritan Bcstg. Service Inc. 7 Willow St. 5-6200	Indie Sales	Theodore Feinstein, p Hank Forbes, gm, cm & pd	Milton Jaffee, pmm Russell Bassett, ce	Bob McLean, nd UP Col.	
	WLYN-FM 1949	Ch. 288 (A) 105.5mc, 0.52kw							
MEDFORD									
	WHIL 1951	1430 500-D	Conant Bcstg. Co. Inc. 99 Revere Beach Mystic 8-2250	Sherwood J. Tarlow, p & gm Joseph Kruger, cm David H. Maynard, pd	Allan W. Roberts, pmm & prod. m Sal Fulchino, ce	Arthur Stamler, nd Al Frezza, sd Marilyn, wd	Pop.: 2,166,615 Rad. Hms.: 547,096 Ret. Sls.: \$2,459,054,000	Thes. UP G
NEW BEDFORD									
	WBSM 1949	1230 100	Bay State Bcstg. Pope's Island 3-1767 Boiling	Joseph P. Duchaine, p Otto F. A. Arnold, gm Richard Evans, cm	Chris Clark, pd & sd Brownell Brightman, ce	Jerry Jerome, nd Harriet Hall, wd	Pop.: 144,204 Rad. Hms.: 40,500 Ret. Sls.: \$141,000,000 UP RCA
	WBSM-FM 1949	Ch. 247 (B) 97.3mc 2.5kw							
	WNBH 1921	1340 250	E. Anthony & Sons Inc. 432 County St. 8-5228	MBS, Yankee Walker	Basil Brewer, p J. Thomas Mathers, gm	Arnold Briden, cm Jim Gleason, pd & sd	Bob Sayre, nd Betty Barton, wd	Pop.: 115,000 Rad. Hms.: 98.2%	Wld. AP RCA
	WTEV(TV)		(WNBH, Am Affiliate)						
	WFMR(FM) 1948	Ch. 251 (B) 98.1mc, 20kw						SES. AP RCA	
NORTH ADAMS									
	WMNB 1947	1230 250	Northern Berkshire Bcstg. Co. 466 Curran Hghwy, Mohawk 3-8567 McGillvra	J. Gordon Keyworth, p, treas., gm & ce Richard J. O'Brien, coml. rep.	Lawrence G. Truesdale, prog. m	Belva C. Keyworth, office m Bernard Bullett, sd	Pop.: 60,000 Rad. Hms.: 15,000 Ret. Sls.: \$54,000,000	Wld. AP Ray.
	WNAW 1952	860 250-D	Cecil F. Clifton Box 193 Mohawk 3-5356	Cecil F. Clifton, p Robert E. Dain, gm	Ralph Haneman, ce Raymond Gordon, sd	Dick Brown, fd Joseph Tubby, wd	Assoc., Cole UP RCA	
NORTHAMPTON									
	WHMP 1950	1400 250	Pioneer Valley Bcstg. Co. 78 Main St. 4275 Borgatti	John H. Williams, p Alexander W. Milne, gm & cm	Joseph T. Fennessey, pd & nd Harold Schumacher, ce	Mark Layne, sd Dorothy Drewsen, wd	Pop.: 80,000 Rad. Hms.: 22,800 Ret. Sls.: \$78,000,000	St. AP RCA
PITTSFIELD									
	WBEC 1947	1490 250	Western Mass. Bcstg. Co. 30 Eagle St. 8292	ABC, New England Kettell- Carter Everett- McKinney	Lawrence K. Miller, p W. Wendell Budrow, gm, cm & pmm	Robert Henaberry, pd Walton T. Ayer, ce Ed Farrell, Jr., nd	Dana Jones, fd John Lyons, sd Alice O'Meara, wd	Cap. AP GE	
	WBEC-FM 1948	Ch. 232 (A) 94.3mc 1kw						Ray.	
	WBK 1938	1340 250	Greylock Bcstg. Co. 8 Bank Row Pittsfield 2-1553	MBS, Yankee Borgatti, Walker	Leon Podolsky, p Walter Kearsy, gm & cm	Richard Bolender, pd Ed Merritt, pmm Ed Taffet, ce	Larry Vaber, nd Dan Healy, sd	Pop.: 74,200 Rad. Hms.: 22,850 Ret. Sls.: \$85,300,000	Assoc. UP WH
	WMGT(TV)								
QUINCY									
	WJDA 1947	1300 1,000-D	South Shore Bcstg. Co. 29 Brackett St. Mayflower 9-1300 Webb	James D. Asher, p, gm, cm & pmm	Charles Glass, pd Fred Lane, ce	Bill Edwards, nd Len Ringquist, sd	Pop.: 1,200,000	Wld. AP Col.
SALEM									
	WESX 1939	1230 250	North Shore Bcstg. Corp. 49 Washington St. Salem 5670 Webb	James D. Asher, o cm William C. Asher, p, gm & pmm	Norman Durkee, pd & ce William Lamprey, comp.			
SPRINGFIELD									
	WACE 1946	730 1,000-D	Regional Bcstg. Co. Hotel Bridgway 6-1323 Indie, Kettell- Carter	John S. Begley, co-o & treas. David Hayes, p	Ralph J. Robinson, gm & cm C. J. O'Malley, pd	H. R. Glinka, ce Ruth Batcheller, wd	Pop.: 885,500 Rad. Hms.: 252,000 Ret. Sls.: \$890,000,000 AP RCA
	WBZA 1924	1030 1,000	Westinghouse Bcstg. Co. Inc. Hotel Kimball 6-8336	NBC, New England Regional Net. Free & Peters	Chris J. Witting, p. Paul E. Mills, gm C. M. Meehan, slm Aver Rakov, prog. m	C. Lud Richards, adv. m & sls. pmm W. H. Hauser, ce & asst. m J. McNamara, nd	Leo Egan, sd Malcolm McCormick, fd Mildred Carlson, wd	Assoc., Thes. AP, UP WH	
	WBZA-FM 1940	Ch. 246 (B) 97.1mc 8.2kw							
	WHYN 1941		(See Holyoke listing)						
	WJKO 1949	1600 5,000-DA	Springfield Bcstg. Co. 137 State St. 2-7487	Gill-Perna	C. M. Manitsas, gm, cm, pd & ce	Mrs. Olga Lake, asst. pd	Joseph Daboul, nd & sd (Mrs.) G. Baacke, wd Ben Bonkosky, fd	Pop.: 751,509 Rad. Hms.: 227,730 UP RCA
	WJKO-FM 1948	Ch. 270 (B) 101.9mc, 10kw							
	WMAS 1932	1450 250	WMAS Inc. 101 West St. 7-1414	MBS, Yankee H-R Reps.	Gerald Harrison, p Robert Donahue, gm & cm	Paul Peltier, pd & pmm John Michnovetz, ce	Noah LaMountain, nd Roland Dumas, sd Mae Brown, wd	Pop.: 421,500 Rad. Hms.: 114,900 Ret. Sls.: \$477,100,000	Assoc. UP RCA
	WMAS-FM 1947	Ch. 234 (B) 94.7mc 1.35kw							
	WSPR 1936	1270 1,000-DA-N	WSPR Inc. 63 Chestnut St. 2-4181	ABC Holling- bery, Bannan	Alan C. Tindal, p & gm James H. Ferguson, Jr., cm	Milton R. Slater, pd George R. Townsend, ce	Kristian Solbert, treas. Carrie Porter, wd Jack Labrie, nd & pmm UP WE L-W AP	
	WSPR-FM 1949	Ch. 250 (B) 97.9mc 13kw							
TAUNTON									
	WPEP 1949	1570 1,000-D	Silver City Bcstg. Corp. 174 Broadway Taunton 4-7528	J. Marshall McGregor, p & ptrn. J. Milton Hammond, treas. & ptrn.	Joseph G. Quill, sm & pd Edwin Stawniak, cm Larry Prado, ce	Don Parks, fd & ch. ann. Ed Litchfield, nd & sd Marguerite McGregor, wd	Pop.: 120,000 Rad. Hms.: 40,000 Ret. Sls.: \$36,668,000	L-W G

Data corrected to Dec. 10, 1953. If executives or services for FM are same as AM affiliate names are not repeated. Market Data supplied by stations. FM's in italic. *—Non-Commercial Station. CP—Construction Permit issued. D—Day. DA-N—Directional Antenna, night only. DA-1—Directional Antenna same pattern day and night. DA-2—Directional Antenna, different pattern day and night. L—Limited Time with Dominant Station. LS—Local Sunset. N—Night. SA—Special Authorization. SH—Specified Hours. ST—Share Time. Complete key to abbreviations, page 6.

WALTHAM

WCRB 1948	1330 1,000-D	Charles River Bestg. Co. 834 Main St. 5-7080	Ted Jones, p & gm Wm. J. Fitzpatrick, cm	David B. Tucker, pd David S. McNeill, nd Thomas Shea, ce	Arthur Johnson, sd Fred L. Bosworth, publ. d Midge Rooney, wd	Pop.: 416,623 Rad. Hms.: 410,103 Ret. Sis.: \$301,252,000	UP Ray.
--------------	-----------------	---	-------	---	--	--	---	------------

WARE

WARE 1948	1250 1,000-D	Central Bestg. Corp. Off East St. Ware 1250	John B. Poor, p William R. Sweeney, gm	Frank Knight, pd	David C. Pryce, ce Pauline Campbell, wd	Pop.: 170,000 Rad. Hms.: 168,000 Ret. Sis.: \$195,000,000	L-W AP Ray.
--------------	-----------------	--	-------	--	------------------	--	---	-------------------

WEST SPRINGFIELD

WTXL 1949	1490 250	Telecolor Corp. 34 Sylvan St. 9-4768	Lawrence A. Reilly, p & gm	Holland D. Cameron, cm	James L. Spates, opers. m & ce Harris Bond, sd	Pop.: 454,000 Rad. Hms.: 131,200 Ret. Sis.: \$447,000,000	Wld. INS G
--------------	-------------	--	-------	-------------------------------	---------------------------	--	---	------------------

WEST YARMOUTH

WOCB 1940	1240 250	E. Anthony & Sons Inc. So. Sea Ave. Hyannis 502	MBS, Yankee Walker, Bannan	Basil Brewer, p Paul W. Stiles, m, cm & pmm	Joyce Johnson, pd Frank L. Lynch, ce Edger H. Semprini Jr., nd & sd	Blanche Robinson, wd	Pop.: 55,922 Rad. Hms.: 17,500 Ret. Sis.: \$90,986,000 RCA
WOCB-FM 1948	Ch. 232 (A) 94.3mc 1kw							

WORCESTER

WAAB 1931 WAAB-TV	1440 5,000 DA-1	WAAB Inc. 34 Mechanic St. 2-5611	MBS, Yankee Everett- McKinney	George F. Wilson, p & gm Wayne Teeter, cm	Robert Kreiger, pmm George Capalbo, ce Mary Cahill, office m	Robert Nims, nd Miss Lace, wd	Pop.: 630,000 Rad. Hms.: 171,290 AP RCA
-------------------------	-----------------------	--	--	---	--	----------------------------------	-------------------------------------	--------------------

WNEB 1946	1230 250	New England Bestg. Co. 405 Main St 6-4672	Paul C. Lytle, p & bus. m John J. Hurley, gm & treas.	Edward T. McCann Jr., cm Thomas J. Decker, pd & sd	Vernon P. Wilson, ce Thomas C. Phillips, nd Jeanne Connelly, wd	Pop.: 450,000 Rad. Hms.: 111,640 Ret. Sis.: \$672,720,000 UP Ray.
--------------	-------------	--	-------	--	---	---	---	---------------------

WORC 1925	1310 1,000-DA-1	Radio Worcester Inc. 4 Walnut St. 5-3101	ABC Headley- Reed Kettell- Carter	C. George Taylor, p & gm Kenneth M. Cooper, gm	Thomas M. Donlin, cm Richard D. Smith, pd	Carroll Philbrooke, ce William Crowley, sd	
--------------	--------------------	---	---	---	--	---	-------------------------	--

WTAG 1924	580 5,000-DA-2	WTAG Inc. 18 Franklin St. 5-4321	CBS Christal	Robert W. Booth, vp & gm Herbert L. Krueger, vp & sm	Robert J. Brown, cm Richard L. Gravel, loc. slm A. J. Brissette, prog. m & pdm	Bernard J. LaPlante, sls. pmm E. A. Browning, ce James G. Little, nd John V. Ambrose, sd	Assoc., Wld. AP RCA
--------------	-------------------	--	-----------------	---	--	--	-------------------------	---------------------------

WTAG-FM 1940	Ch. 241 (B) 96.1mc 10kw							Assoc. AP GE
-----------------	-------------------------------	--	--	--	--	--	--	--------------------

IN SPRINGFIELD * **MORE** LOCAL ADVERTISERS USE

WACE THAN ANY OTHER STATION IN THE MARKET!

GET THE FACTS!

Call Jack Koste, Indie Sales, N.Y.C.; Kettell-Carter, Boston;
Hil Best, Detroit; Hooper Jones, Chicago; Gene Grant,
Los Angeles or CALL COLLECT RALPH ROBINSON, WACE,
SPRINGFIELD 6-1323. *(Springfield-Holyoke Met. District)

WACE

SELLS AT LOCAL LEVEL—YOUR BEST NATIONAL BUY!

730 KC

One of the Nation's Busiest Stations

1,000 W.



In Detroit, America's 5th Market, this is the proved "success formula":

Take the overwhelming popularity and community acceptance of radio station WWJ. . . . plus the prestige and network programming of its NBC affiliation. Add the 3¼-million Auto Radios, and the 1½-million Home Radios in the primary listening area.

A multitude of successful advertisers, during the past 32 years, have followed this formula for doing BIG business in a market with the largest income per family of any major market in the U.S.A.

Through WWJ, you reach more of those families in the middle income group and above, than other Detroit stations do . . . for *less* than the average cost-per-thousand-listeners for radio time in Detroit.

**The time to sell Detroit is now . . .
the time to buy is . . .**



Associate Television Station WWJ-TV

AM—950 KILOCYCLES—5000 WATTS
FM—CHANNEL 246—97.1 MEGACYCLES

WORLD'S FIRST RADIO STATION. Owned and Operated by THE DETROIT NEWS • National Representatives: THE GEORGE P. HOLLINGBERRY CO.

MICHIGAN

City	Call Letters Established TV Affiliate	Chan. or Freq. Power	Licensee Headquarters Telephone	Network Represent- ative	Owner o; Pres. p; Exec. up evp; Gen. Mgr. gm; Sta. Mgr. sm; Coml. Mgr. cm; Sales Mgr. slm; Prog. Dir. pd; Chief Eng. ce; Prom. Mgr. pmm; Prod. Mgr. pdm; News. Farm, Sports or Women's Dir. nd, fd, sd, wd.	Executive Abbreviations	Market Data For Primary Area (Supplied by station)	Library, News Serv. Transmitter
ANN ARBOR								
WHRV 1947 WHRV-TV	1600 1,000-DA-1	Huron Valley Bcstrs. Inc. 4230 Packard 2-4573	Walker	J. F. Hopkins, p & cm Steve Filliak, gm Richard Harner, pd	Otis Hardy, pmm & nd James Allen, ce	O. Wardel, fd Bob Brown, sd Bonnie Haig, wd	Rad. Hms.: 36,040	Wid. AP WE
WPAG 1945 WPAG-TV	1050 1,000-D	Washtenaw Bcstg. Co. Inc. 3d Floor Hutzel Bldg. 2-5517	McGillvra	Arthur E. Greene, p Edward F. Baughn, vp & gm	Kenneth MacDonald, cm Roger Shepard, pd Donald N. Bowdish, ce	Al Samborn, nd Howard Heath, fd Bob Ufer, sd	Pop.: 2,688,434 Rad. Hms.: 652,357	St. AP WE
BAD AXE								
WLEW 1950	1540 250-D	Port Huron Bcstg. Co. 935 S. Van Dyke Rd. 1010	Great Lakes Gill-Perna	John F. Wismer, gm James Muehlenbeck, sm	Richard Estell, pd & nd	Donald Cloutier, ce		St. UP RCA
BATTLE CREEK								
WBCK 1948 WBCK-TV	930 1,000 DA-2	Michigan Bcstg. Co. Security Natl. Bank Bldg. 3-5555	MBS Headley- Reed	Robert H. Holmes, p & gm	Whitney Jones, slm E. F. Cahill, pd	Robert Willbur, ce		Wid. UP RCA
WELL 1925	1400 250	Federated Publications Inc. Mich. Natl. Bank Bldg. Woodward 4-1173	ABC Meeker	D. E. Jayne, gm	F. F. Owen, cm & pd	Earl J. Stone, ce	Pop.: 104,500 Rad. Hms.: 33,300 Ret. Sis.: \$161,148,964 AP
BAY CITY								
WBCM 1925	1440 1,000-D 500-N	Bay Bcstg. Co. Inc. 100 Center Ave. 7551	ABC Holling- bery	Harley D. Peet, p H. A. Giesel, gm & cm	Charles E. Anthony, pd Ralph H. Carpenter, ce	Frank J. Walsh, nd & sd G. Edward Vallender, fd	Pop.: 375,000 Rad. Hms.: 90,000 Ret. Sis.: \$400,000,000	Wid. UP WE
WBCM-FM 1946	Ch. 241 (B) 96.1mc 41kw							
BENTON HARBOR								
WHFB 1947 WHFB-TV	1060 1,000-D	Palladium Pub. Co. Fairplain Ave. 5-2113	Holman	Stanley R. Banyon, p J. P. Scherer, gm Ted Vernasco, cm	John Chase, pd & fd Munson Robinson, ce	Ed Backus, nd Ray Mittan, sd		Wid. AP RCA
WHFB-FM 1947	Ch. 260 (B) 99.9mc 9.2kw							

Data corrected to Dec. 10, 1953. If executives or services for FM are same as AM affiliate names are not repeated. Market Data supplied by stations. FM's in *italics*. *—Non-Commercial Station. CP—Construction Permit issued. D—Day. DA-N—Directional Antenna, night only. DA-1—Directional Antenna, same pattern day and night. DA-2—Directional Antenna, different pattern day and night. L—Limited Time with Dominant Station. LS—Local Sunset. N—Night. SA—Special Authorization. SH—Specified Hours. ST—Share Time. Complete key to abbreviations, page 6.

WELL

BATTLE CREEK

Battle Creek's top-rated station

and the best buy because . . .

- 28 years of making friends — and sales
- Covers retail trading area of 198,299
- Affiliated with American Bcstg. Company

Represented nationally by

ROBERT MEEKER ASSOCIATES, INC., ★ 250W • 1400 WELL

521 5th Avenue, New York City

BIG RAPIDS

WBRN 1460 Paul A. Brandt Paul A. Brandt. o Spencer Denison, gm Pop.: 50,000 L-W, SES.
1953 500-D 13804 Northland Holman & cm AP
648

CADILLAC

WATT 1240 Midwestern MBS, Les Biederman, p M. L. Chandler, sim Bill Kiker, ce SES.
1945 250 Bestg. Co. Buñyan Art Nyhus, sm M. L. Chandler, sim Bill Kiker, ce AP
U. S. 131 South Holman Prospect 5-7831

COLDWATER

WTVB 1590 Twin Valley Southern George A. Hosek, p E. Harold Munn Jr., George Lasley, cm Pop.: 600,000 Thes., Wld.
1949 5,000-D Bcstrs. Inc. Michigan sd & ce Rad. Hms.: 125,000 AP
500-N-DA-2 Box 32 Net. Best Ret. Sis.: \$559,000,000 G

WTVB-FM Ch. 252 (A) Pop.: 225,000 Wld., Thes., Cole
1950 98.3mc 0.25kw Rad. Hms.: 56,250 AP
0.25kw RCA

DEARBORN

WKMH (See Detroit listing)

DETROIT

CKLW 800 Essex Bcstrs. Inc. MBS J. E. Campeau, p A. R. Gloster, pmm Art Lank, sd Pop.: 10,573,080 Thes.
1931 50,000 3300 Guardian Young E. Wilson Wardell, cm W. J. Carter, ce Myrtle Labbitt, co-wd Rad. Hms.: 2,949,486 INS.
CKLW-TV Bldg. Campbell S. Ritchie, W. H. Gatfield, treas. Marv Moran, co-wd Ret. Sis.: \$12,390,353,000 BUP
(Windsor, Ont.) pd fd RCA

CKLW-FM Ch. 230 (A)
1949 93.9mc 0.25kw

(See Pontiac listing)

WCAR 1939 (See Pontiac listing)
WJBK 1490 Storer Bestg. Co. George B. Storer, p Harry Lipson, asst. Paul Frincke, ce
1926 250 500 Temple Ave. Katz Gayle V. Grubb, vp mngng. d Al Nasler, sd AP, INS
WJBK-TV CP: 1500 Richard Fischer, pd Peter Storer, pmm RCA
10,000-D 5,000-N-DA-2

CKLW Gives Advertisers the **LOWEST RATE**
GREATEST COVERAGE at the **LOWEST RATE**
of any Major Station in the **DETROIT AREA**
50,000 WATTS 800 KC.

Guardian Bldg. Detroit, Adam J. Young, Jr. Inc. National Rep. J. E. Campeau President MUTUAL

MICHIGAN

City Call Letters Established TV Affiliate	Chan. or Freq. Power	Licensee Headquarters Telephone	Network Represent- ative	Owner o; Pres. p; Exec. vp evp; Gen. Mgr. gm; Sta. Mgr. sm; Coml. Mgr. cm; Sales Mgr. slm; Prog. Dir. pd; Chief Eng. ce; Prom. Mgr. pmm; Prod. Mgr. pdm; News, Farm, Sports or Women's Dir. nd, fd, sd, wd.	Executive Abbreviations	Market Data For Primary Area (Supplied by station)	Library, News Serv. Transmitter
DETROIT—(Cont'd)							
WJLB 1926	1400 250	Booth Radio & TV Stations Inc. 3100 David Broderick Tower Woodward 5-2000 (WJLB, Am Affiliate) ForJoe	John L. Booth, p mngng. d & gm	E. E. Nyy, sm George Kendall, pd	Eric V. Hay, sls. vp E. H. Clark, engrg. vp	Pop.: 2,817,600 Rad. Hms.: 851,400 Wld. AP
WBRI(FM) 1941	Ch. 250 (B) 97.9mc 3.3kw						Wld. AP RCA
WJR 1927	760 50,000	WJR, The Goodwill Station Inc. Fisher Bldg. Trinity 5-4440	CBS Christal Radio Time Sales	John F. Patt, p Worth Kramer, vp & gm William G. Siebert, secy.-treas. F. Sibley Moore, vp George Cushing, vp	Elmer O. Wayne, slm Franklin C. Mitchell, pd James H. Quello, d of pub. rel. & adv. George F. Leydorf, enrg. vp	F. A. McPhillips, sls. serv. d Jack White, nd Marshall Wells, fd Bob Reynolds, sd Agnes May, wd	Pop.: 13,134,700 Rad. Hms.: 3,434,440 Ret. Sl.: \$14,896,838,000 Wld., Thes. AP, UP INS WE
WJR-FM 1948	Ch. 242 (B) 96.3mc 24kw						
WKMH 1946	1310 5,000-D 1,000-N- DA-2	WKMH Inc. WKMH Bldg. 15001 Michigan Ave. Tiffany 6-8500	Mich. Bcstg. Radio Headley- Reed	Fred A. Knorr, p & gm George M. Miller, vp & cm	Bob Seymour, pd Jerrod Martin, vp & ce	Richard Buller, nd Frank Sims, sd	L-W UP, INS RCA
WKMH-FM 1950	Ch. 262 (B) 100.3mc 7kw						
WLDM(FM) 1949	Ch. 238 (B) 95.5mc 20kw	Lincoln Bcstg. Co. 15401 West Ten Mile Rd. Jordan 4-5835	Harold I. Tanner, p & gm	Russell H. Matson, cm Frank Gaal, pd	Jerome F. Steadley, ce	Pop.: 4,000,000 Rad. Hms.: 500,000 Assoc., Wld., Thes., St. AP REL.
WWJ 1920 WWJ-TV	950 5,000-DA-N	The Evening News Assn. 815 W. Lafayette Woodward 2-2000	NBC Holling- bery	Edwin K. Wheeler, gm Don DeGroot, asst. gm Thomas Warner, cm Melvin C. Wissman, pd	James G. Eberle, pub. affairs m Edgar J. Love, gen. enrg. m Carl Wesser, ce	Henry C. Rogers, bus. m John Merrifield, fd Fran Harris, wd	Pop.: 5,333,830 Rad. Hms.: 1,500,000 Ret. Sl.: \$6,031,139,000 Thes., L-W WE
WWJ-FM 1941	Ch. 246 (B) 97.1mc 48kw						Thes., L-W REL.
WXYZ 1925 WXYZ-TV	1270 5,000-DA-N	WXYZ Inc. 1700 Mutual Bldg. Woodward 3-8321	ABC, Mich. Radio Blair	James G. Riddell, p & gm Harold S. Christian, cm Phil Brestoff, pd	Charles Kocher, ce William E. Morgan, adv. & pmm Harold L. Neal, asst. sim	Tom A'Hearne, nd Don Wattrick, sd Edythe Fern Melrose, wd	St. AP, INS RCA
WXYZ-FM 1948	Ch. 266 (B) 101.1mc 30kw					 GE

Data corrected to Dec. 10, 1953. If executives or services for FM are same as AM affiliate names are not repeated. Market Data supplied by stations. FM's in italic. *—Non-Commercial Station. CP—Construction Permit issued. D—Day. DA-N—Directional Antenna, night only. DA-I—Directional Antenna, same pattern day and night. DA-2—Directional Antenna, different pattern day and night. L—Limited Time with Dominant Station. LS—Local Sunset. N—Night. SA—Special Authorization. SH—Specified Hours. ST—Share Time. Complete key to abbreviations, page 6.

Get
the most
out of
radio
television
and the
allied arts

BROADCASTING • TELECASTING
is the one journal that gives you the most
reliable, most complete news of radio, tele-
vision and the allied arts. If you are new
to radio/tv, or if you plan to enter the field
—don't take chances on a buck-slip copy—
start your own subscription today. Read
the latest news while it is still news.
Annual subscription \$7.00.*

**BROADCASTING
TELECASTING**

1735 DeSales Street, N.W., Washington 6, D. C.

* BROADCASTING and TELECASTING Yearbooks may be ordered as part of a year's subscription at the additional cost of \$2.00 per Yearbook. Apart from a subscription Yearbooks are \$5.00 per copy.

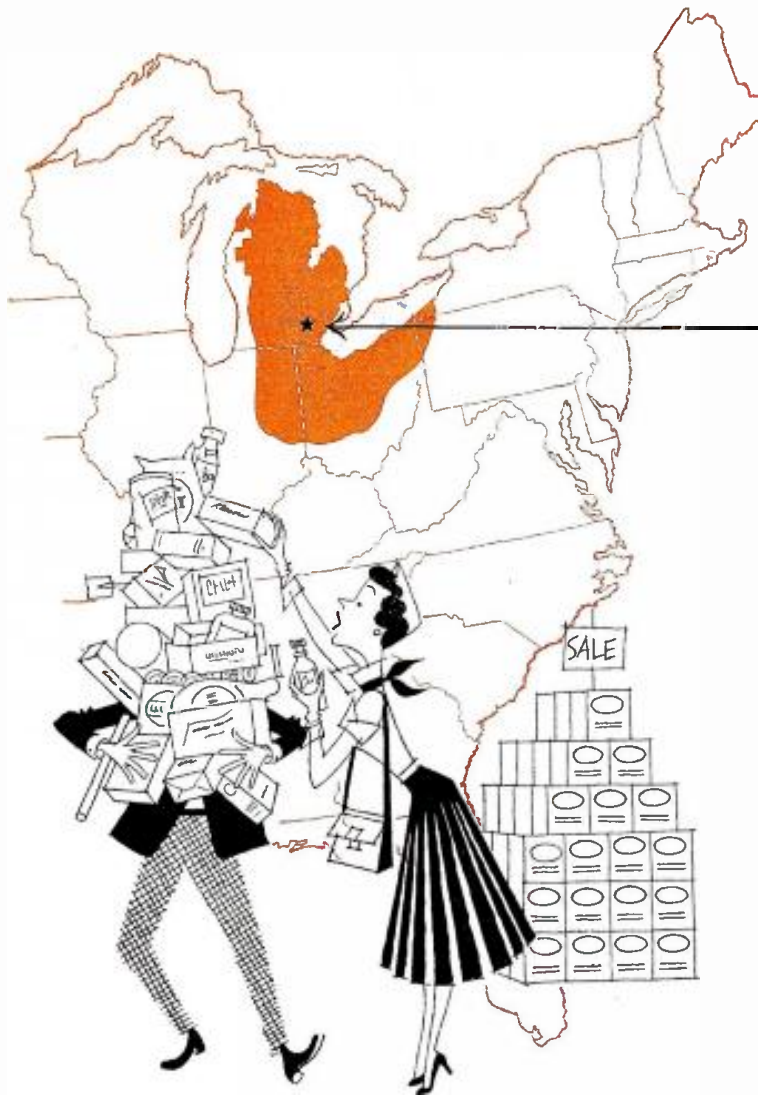

almost 10% of the nation's sales takes place

HERE

in *WJR's* primary coverage area!

**W
J
R**

the great voice of the great lakes

WJR MARKET DATA

		% of total U. S. market
Population	12,601,300	8.3
Radio Homes	3,785,540	8.6
Farm Radio Homes	328,990	5.9
Drug Sales	\$ 464,447,000	10.3
Food Sales	\$ 3,266,766,000	9.4
Retail Sales	\$13,613,431,000	9.3
Filing Station Sales	\$ 739,614,000	10.1
Passenger Car Registrations	4,116,934	10.2

WJR is the one salesman that can effectively and economically increase your volume in *all* of this rich market area. Every single day of the year WJR, the most influential voice in the Great Lakes region, will carry your advertising message to millions of buyers in Michigan, Ohio, Indiana, Pennsylvania and Ontario. Let WJR's success and popularity do a real selling job for you!

Contact WJR or your Christal representative today to get the most for your advertising dollar in one of the nation's richest markets.



WJR, Detroit, The Goodwill Station
1285 Radio Network
50,000 watts

AN IMPORTANT AREA FOR YOU
—A FAMILIAR AREA TO US



WJR, Fisher Building, Detroit 2, Michigan
WJR, Eastern Office: 665 Fifth Avenue, New York 22
Represented Nationally by the Henry I. Christal Company
Canadian Representatives: Radio Time Sales, (Ontario) Ltd.

MICHIGAN

City	Call Letters Established TV Affiliate	Chan. or Freq. Power	Licensee Headquarters Telephone	Network Represent- ative	Executive Abbreviations Owner o; Pres. p; Exec. vp evp; Gen. Mgr. gm; Sta. Mgr. sm; Coml. Mgr. cm; Sales Mgr. slm; Prog. Dir. pd; Chief Eng. ce; Prom. Mgr. pmm; Prod. Mgr. pdm; News, Farm, Sports or Women's Dir. nd, fd, sd, wd.	Market Data For Primary Area (Supplied by station)	Library, News Serv. Transmitter
------	---	----------------------------	---------------------------------------	--------------------------------	--	---	---------------------------------------

EAST LANSING

MICHIGAN

City	Call Letters Established TV Affiliate	Chan. or Freq. Power	Licensee Headquarters Telephone	Network Represent- ative	Executive Abbreviations Owner o; Pres. p; Exec. vp evp; Gen. Mgr. gm; Sta. Mgr. sm; Coml. Mgr. cm; Sales Mgr. slm; Prog. Dir. pd; Chief Eng. ce; Prom. Mgr. pmm; Prod. Mgr. pdm; News, Farm, Sports or Women's Dir. nd, fd, sd, wd.	Market Data For Primary Area (Supplied by station)	Library, News Serv. Transmitter
------	---	----------------------------	---------------------------------------	--------------------------------	--	---	---------------------------------------

GRAND RAPIDS—(Contd)

WJEF 1945	1230 250	Fetzer Bcstg. Co. 187 Monroe, N. W. Glendale 6-8512	CBS Avery- Knodel	John E. Fetzer, p Carl E. Lee, mgng. d Martin Glaimo, sm & cm	Michael Joseph, pd Bruce M. Glycadgis, ce	Donald Hoylman, nd Dick Miller, sd Rosemary Phoenix, wd	Pop.: 288,292 Rad. Hms.: 88,160 Ret. Sis.: \$296,140,000	Thes. AP RCA
WJEF-FM 1951	Ch. 229 (B) 93.7mc 550kw						Pop.: 1,084,084 Rad. Hms.: 603,546 Ret. Sis.: \$1,886,820,000	Thes. AP Fed.
WLAV 1940	1340 250	Versluis Radio & TV Inc. 6 Fountain St. N. E. Glendale 6-5461	ABC Michigan Radio Pearson	Leonard A. Versluis, p Hy M. Steed, vp, gm & cm	Lee G. Stevens, ce Bob Greenhoe, nd	Jack Harrison, sd Joan Randall, wd	Pop.: 286,000 Rad. Hms.: 88,000	St. UP RCA
WLAV-FM 1946	Ch. 245 (B) 96.9mc 3kw						Pop.: 360,000 Rad. Hms.: 101,000	St. UP Fed.
WOOD 1924 WOOD-TV	1300 5,000-DA-N	Grandwood Bcstg. Co. Grand Rapids Natl. Bank 9-4125	NBC Katz	H. M. Bitner, p Harry M. Bitner Jr., vp Willard Schroeder, gm Art Swift, gen. slm	Frank Sisson, pd John Dragomier, pmm Louis Bergenroth, ce Jack Clay, sis. serv. m	Bob Runyon, nd Eddie Chase, fd Bob Kirby, sd Carol Duvall, wd	Pop.: 598,600 Rad. Hms.: 170,420 Ret. Sis.: \$1,216,530,000	Wid. AP RCA

HOLLAND

WHTC 1948	1450 250	Holland Bcstg. Co. 5 E. 8th St. 9482 Best	William A. Butler, p Sandy Meek, gm	William Gargano, pd John Klungle, ce Al Ackerman, sd	Mary Emma Young, wd	Pop.: 120,000 Rad. Hms.: 43,000 Ret. Sis.: \$117,000,000	Thes., Wid. L-W AP Col.
--------------	-------------	---	---------------	--	--	------------------------	--	----------------------------------

HOUGHTON

WHDF 1929	1400 250	Upper Michigan Bcstg. Co. Douglass Hotel	NBC Walker	George L. Burgan, o & ce Albert W. Payne, gm	Earl Norden, pd & nd Peter Fausone, sd	Myrtle Barrette, wd		Wid. AP Cont.
--------------	-------------	--	---------------	--	---	---------------------	--	---------------------

HOUGHTON LAKE

WHGR (CP)	1290 1,000-D	Sparks Bcstg. Co.						
--------------	-----------------	-------------------	--	--	--	--	--	--

IONIA

WION 1953	1430 500-D	Ionia Bcstg. Co. P. O. Box 143 1537 Best	Monroe MacPherson, o Al LaGuire, gm & cm Kenneth Chapin, slm	William M. & MacPherson, pd Donald Seaman, pmm & sis. serv. rep. J. Irving Grove, ce	Bernice Hammond, adm. asst. Ellis Shotwell, nd & fd Frank Imburg, sd Charlotte Foohey, wd	Pop.: 90,000 Rad. Hms.: 24,000	Thes. AP
--------------	---------------	---	---------------	---	--	---	-----------------------------------	----------------------

IRON MTN.

WMIQ 1947	1450 250	Iron Mtn. Kingsford Bcstg. Co. 211 E. Ludington St. 2031	ABC, Northern	Frank Russell Jr., p Russell J. Staffeld, gm William C. Johnson, cm	Donald Burdick, pd, pmm & nd Paul Anick, ce	Conrad Nelson, sd Beryl Miench, wd	Pop.: 65,520 Rad. Hms.: 15,120
--------------	-------------	---	---------------------------	--	---	---------------------------------------	-----------------------------------	-------------------------

IRON RIVER

WIKB 1949	1230 250	WIKB Inc. 234 W. Genesee St. 102	MBS, KBS Upper Midwest Walker	H. H. Frailing, p J. F. Kauper, gm & cm	Len Johnson, pd, pmm, fd & sd Lester Patten, ce	Bud Shields, nd Alfreda LaBoki, wd	Pop.: 20,000 Rad. Hms.: 6,500 Ret. Sis.: \$19,000,000	Thes. G
--------------	-------------	---	--	--	---	---------------------------------------	---	---------------------

IRONWOOD

WJMS 1931	630 1,000 DA-N	Upper Mich.-Wis. Bcstg. Co. 124 E. McLeod Ave. 20	MBS Walker	William L. Johnson, p Donald R. Hoover, m	Laura Johnson, pd Arne Dahlbacka, ce	Rose Isaac, wd	Pop.: 87,400 Ret. Sis.: \$77,100,000	Thes. UP Col.
--------------	----------------------	---	---------------	--	---	----------------	---	---------------------

ISHPEMING

WJPD 1947	1240 250	Ishpeeming Bcstg. Co. Jenks Block 1892	KBS, Bunyan, Upper Midwest	James P. Deegan, p, gm & cm Paul C. Crowley, pd & sd	Carl B. Tupala, pmm & nd Bernard R. Maloney, ce	Robert R. Rennie, fd Lois Ruth Holmgren, wd	Pop.: 49,986 Rad. Hms.: 12,665	Wid. AP Ray.
--------------	-------------	---	-------------------------------------	---	--	---	-----------------------------------	--------------------

JACKSON

WIBM 1928	1450 250	WIBM Inc. 2511 Kibby Rd. 6121	ABC Forjoe	Roy Radner, p & gm Wm. Cizek, sm Wm. Hall, cm	Jack Underwood, pd Betty Carris, traffic m	Chas. Wirtanen, ce Usla Mollenkopf, office m	Pop.: 120,000	L-W AP RCA
WKHM 1951	970 1,000-DA-2	Jackson Bcstg. & TV Corp. 441 Wildwood 4-7181	MBS, Michigan Bcstg. Headley- Reed	Fred A. Knorr, p Walter Patterson, sls. d mgng. d Robert G. Wright, asst. mgng. d	Richard Schueler, pd John O. Gilbert II, pmm	Paul Wright, ce Ron Milton, nd, fd & sd	Pop.: 622,085 Rad. Hms.: 176,000 Ret. Sis.: \$132,000,000	Wid. UP WE

KALAMAZOO

WKMI 1947	1360 1,000-DA-N	Steere Bcstg. State Theatre Bldg. 4-0111 Young	Howard D. Steere, p & cm	E. J. Popke Jr., gm Carl Stephens, ce	Ron Bontsema, nd Joe Wright, sd Ann Lee, wd	Pop.: 128,000 Rad. Hms.: 38,500 Ret. Sis.: \$23,765,000	St. UP Ray.
WKZO 1930 WKZO-TV	590 5,000-DA-N	Fetzer Bcstg. Co. 124 W. Michigan Ave. 3-1223	CBS Avery- Knodel	John E. Fetzer, p Carl E. Lee, mgng. d John W. O'Harrow, sls. d Otis T. Gaston, asst. sls. d & pmm	Charles T. Lynch, pd Arthus E. Covell, ce Dr. Willis F. Dunbar, pub. affairs d	Ellsworth L. Tait, comp. Frank Benesh, nd Carleton W. Collin, fd Leonard Colby, sd Mary Fontanne, wd	Pop.: 857,900 Rad. Hms.: 242,698 Ret. Sis.: \$876,809,000	Thes. AP RCA

LANSING

WILS 1947 WILS-TV	1320 5,000-D 1,000-N DA-2	Lansing Bcstg. 407 N. Washington Ave. 2-1655 Venard	W. A. Pomeroy, p & sd Walter Dennis, cm James Pollack, pd	Dave Froh, asst. pd & sd Walter Braeger, pmm John C. Pomeroy, ce	John Maters, nd Jerry Haskell, fd Dorothy Abbanat, wd	Pop.: 369,200 Rad. Hms.: 112,000 Ret. Sis.: \$385,000,000	L-W, Cap. AP RCA
WJIM 1934 WJIM-TV	1240 250	WJIM Inc. Bank of Lansing Bldg. 2-1333	ABC, NBC, Michigan Radio Net. H-R Reps.	Harold F. Gross, p Willard E. Walbridge, vp & gm	Howard K. Finch, vp. pd & sd Charles E. Wallace, ce	Ray Marcus, nd	Pop.: 500,000 Rad. Hms.: 110,000 Ret. Sis.: \$500,000,000	Wid., St. UP RCA

LAPEER

*WMPC 1926	1230 250-SH	The Liberty Street Gospel Church of Lapeer 455J		Frank S. Hemingway, p & gm	Hollis F. Hayes, ce			
---------------	----------------	---	--	-------------------------------	---------------------	--	--	--

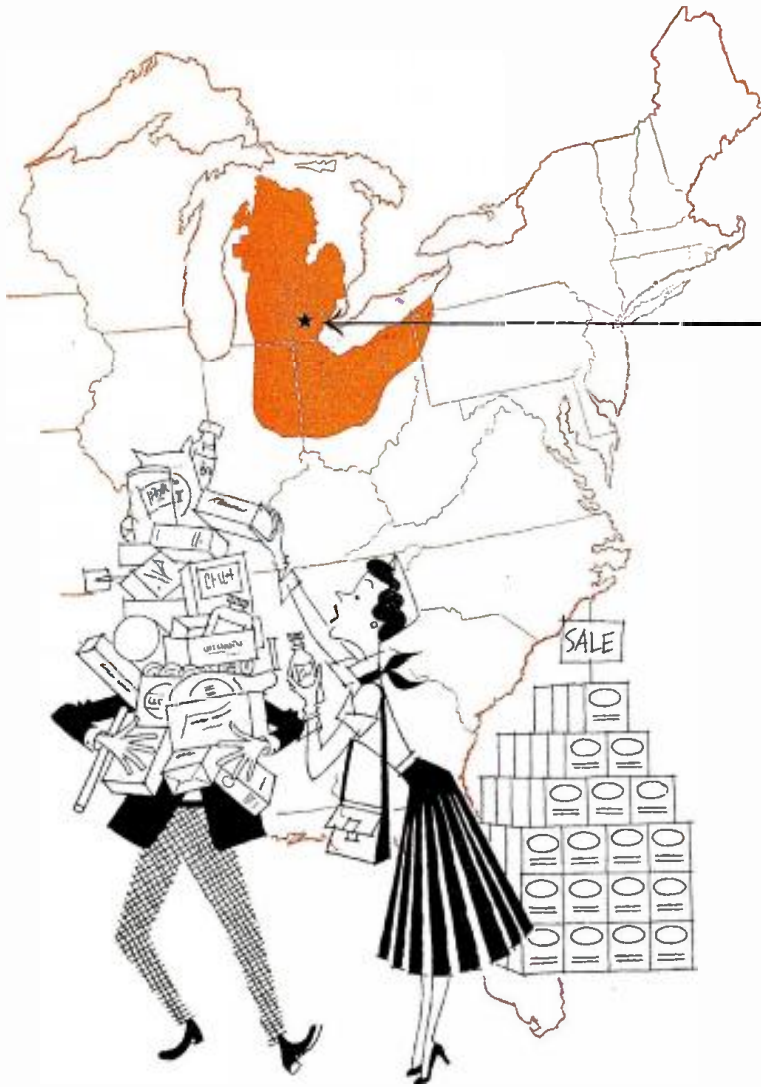

almost 10% of the nation's sales takes place

HERE

in **WJR's** primary coverage area!

W
J
R

the great voice of the great lakes

WJR MARKET DATA

		% of total U. S. market
Population	12,601,300	8.3
Radio Homes	3,785,540	8.6
Farm Radio Homes	328,990	5.9
Drug Sales	\$ 464,447,000	10.3
Food Sales	\$ 3,266,766,000	9.4
Retail Sales	\$13,613,431,000	9.3
Filling Station Sales	\$ 739,614,000	10.1
Passenger Car Registrations	4,116,934	10.2

WJR is the one salesman that can effectively and economically increase your volume in *all* of this rich market area. Every single day of the year WJR, the most influential voice in the Great Lakes region, will carry your advertising message to millions of buyers in Michigan, Ohio, Indiana, Pennsylvania and Ontario. Let WJR's success and popularity do a real selling job for you!

Contact WJR or your Christal representative today to get the most for your advertising dollar in one of the nation's richest markets.



AN IMPORTANT AREA FOR YOU
—A FAMILIAR AREA TO US



WJR, Fisher Building, Detroit 2, Michigan
WJR, Eastern Office: 665 Fifth Avenue, New York 22
Represented Nationally by the Henry I. Christal Company
Canadian Representatives: Radio Time Sales, (Ontario) Ltd.

MICHIGAN

City	Call Letters Established TV Affiliate	Chan. Or Freq. Power	Licensee Headquarters Telephone	Network Represent- ative	Executive Abbreviations Owner o; Pres. p; Exec. vp evp; Gen. Mgr. gm; Sta. Mgr. sm; Coml. Mgr. cm; Sales Mgr. slm; Prog. Dir. pd; Chief Eng. ce; Prom. Mgr. pmm; Prod. Mgr. pdm; News, Farm, Sports or Women's Dir. nd, fd, sd, wd.			Market Data For Primary Area (Supplied by station)	Library, News Serv. Transmitter
EAST LANSING									
*WKAR 1922 WKAR-TV	870 5,000-D	Michigan State College Edgewood 2-1511 ext. 488	John A. Hannah, p Robert J. Coleman, gm Lawrence T. Frymire, pd	Norris E. Grover, ce Rob Downey, nd Howard Hass, fd	Robert Shackleton, sd Mary Collopy, wd	Pop.: 4,994,985	Thes., SES AP WE	
ESCANABA									
WBBC 1941	680 1,000-DA-2	Delta Bcstg. Co. 604-06 Ludington St. 3190	MBS Walker	Geo. D. Lindenthal, p, gm & cm	R. E. Wagner, pd & sd H. C. Olsen, ce	W. J. Duchaine, nd Edith Bell, wd	Pop.: 111,700 Rad. Hms.: 139,700 Ret. Sl.: \$97,000,000	Thes. UP RCA	
WESK 1953	1490 250	M & M Bcstg. Co. Inc. 712½ Ludington St. 3750	NBC Clark	William E. Walker, p Barclay Conley, gm	Lee Morrison, cm Paul Ryan, pd	Alister Alexander, ce John Bell, fd	 UP Temco	
FLINT									
WBBC 1947	1330 1,000-DA-2	Booth Radio & Television Stations Inc. G-3076 E. Bristol Rd. 9-8686	MBS Weed	John Lord Booth, p W. Gerald Schroeder, gm & cm	Edward Berryman, pd & sd James Rush, pmm & nd	G. E. Ryan, ce Maude Beagle, wd	Pop.: 506,300 Rad. Hms.: 139,460 Ret. Sl.: \$562,783,000	Wld. AP Col.	
WFDF 1922	910 1,000-DA-1	Trebit Corp. Garland at First Ave. 2-7158	NBC Katz	H. M. Bitner Sr., p Lester W. Lindow, gm Elmer Knopf, pd	Marvin Levey, sis. Gerald C. Wolpert, ce	Donald Cameron, nd Dan Hunter, sd	Pop.: 706,400 Rad. Hms.: 192,760 Ret. Sl.: \$743,652,000	St., Thes. AP RCA	
WKMF 1952	1470 1,000-DA-1	WKMF Inc. 1623 Utica Ave. Tulsa, Okla.		William H. Morford, . gm	Richard Carter, cm	Homer Blumerick, ce	Pop.: 278,000 Ret. Sl.: \$196,610,000	St. UP Tem.	
WMRP 1946	1510 250-D	Methodist Church 3217 Lapeer 3-5112	William H. Morford, . gm	Richard Carter, cm	Homer Blumerick, ce	Pop.: 278,000 Ret. Sl.: \$196,610,000	St. UP Tem.	
WTAC 1946 WTAC-TV	600 1,000-D 500-N DA-1	Trendle- Campbell Bcstg. Corp. 740 S. Saginaw St. 2-1136	ABC Raymer	George W. Trendle, p H. Allen Campbell, gm	J. R. McKinley, sm Laurence Arnold, pd	James Gimbel, ce	Pop.: 1,005,097 Rad. Hms.: 290,730	L-W UP RCA	
GAYLORD									
WATC 1950	900 1,000-D	Midwestern Bcstg. Co. Paul Bunyan Bldg. 2700	Paul Bunyan Holman	Les Biederman, p & gm C. O. Reed, cm	Robert Fritz, pd Wm. H. Kiker, ce			St. AP G	
GRAND RAPIDS									
WFUR 1947	1570 1,000-D	Furniture City Bcstg. Corp. 399 Garfield SW. Glendale 6-9541 McGillvra	William Kuiper Sr., p, gm, cm & pd	John D. Timmer, ce Gordon Kibby, nd	Bob Beukema, fd	Pop.: 200,000	Assoc. UP Ray.	
WGRD 1947	1410 1,000-D	Music Bcstg. Co. 35 Lafayette Ave., NE 94-111 Gill-Perna	Paul F. Eichhorn, p & gm Glenn R. LePard, pd	Fred Stover, pmm Richard Groenevelt, ce Tom Van Tol, nd	Dirk Nebbeling, fd Bruce Grant, sd Norma Brink, wd	Pop.: 502,000 Rad. Hms.: 100,000	St. AP WE	

Data corrected to Dec. 10, 1953. If executives or services for FM are same as AM affiliate names are not repeated. Market Data supplied by stations. FM's in italic. *—Non-Commercial Station. CP—Construction Permit issued. D—Day. DA-N—Directional Antenna, night only. DA-1—Directional Antenna, same pattern day and night. DA-2—Directional Antenna, different pattern day and night. L—Limited Time with Dominant Station. LS—Local Sunset. N—Night. SA—Special Authorization. SH—Specified Hours. ST—Share Time. Complete key to abbreviations, page 6.

YES, THERE IS ONLY ONE

RADIO/TV WEEKLY BUSINESS PAPER—

THE NEWSWEEKLY OF RADIO AND TELEVISION **BROADCASTING • TELECASTING.**

ANNUAL SUBSCRIPTION PRICE IS \$7.00

WITH YEARBOOKS \$11.00.

First in Flint

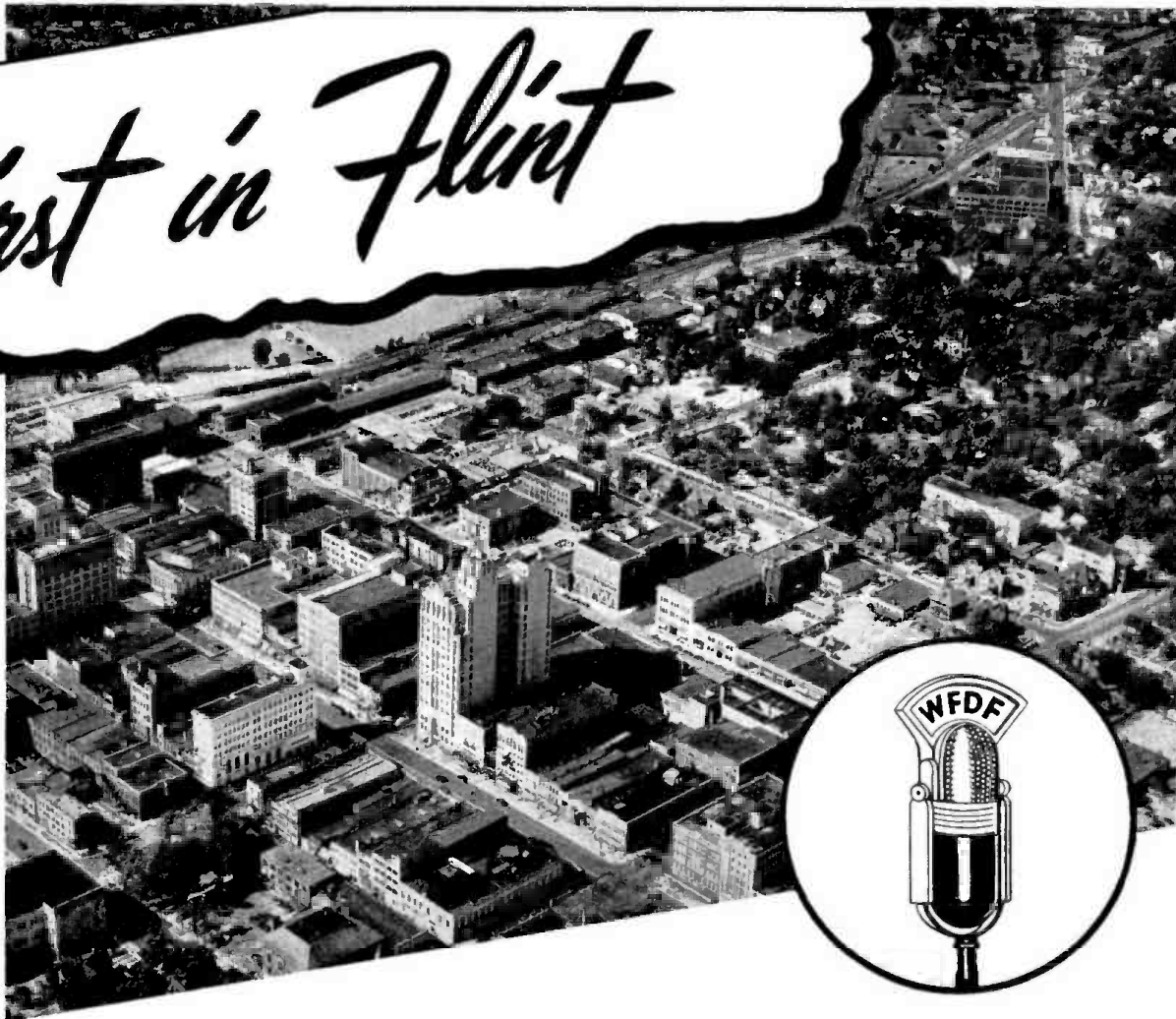

The birthplace of General Motors Corporation and still the largest General Motors Plant City in the world—that's busy, bustling, "FABULOUS FLINT"—home of Buick, Fisher Body and AC Spark Plug Divisions and with three of Chevrolet's largest plants as well.

But Flint is STILL growing! In 1953 a new Buick Jet Plant was added, a new Ternstedt Plant began to operate and a huge new Chevrolet Plant is scheduled to begin production in 1954. The City of Flint is keeping pace with a \$35,000,000 civic improvement program that is providing new schools, a new City Hall, wider streets, bridges, hospitals, and an improved park system.

And WFDF IS FIRST IN FLINT . . . FIRST in a BIG (287,200 people) market . . . FIRST in an ACTIVE (\$325,184,000. retail sales last year) market . . . FIRST in a RICH market where effective family buying income is MORE THAN 40% HIGHER THAN THE NATIONAL AVERAGE!

. . . tell YOUR sales story over WFDF and make SURE of a share in the RICH FLINT MARKET.

NBC AFFILIATE

WFDF

**910 KILOCYCLES
FLINT, MICHIGAN**

REPRESENTED BY THE KATZ AGENCY

Associated with: WOOD and WOOD-TV Grand Rapids—WFBM and WFBM-TV Indianapolis
—WEOA Evansville

MICHIGAN

City Call Letters Established Tv Affiliate	Chan. or Freq. Power	Licensee Headquarters Telephone	Network Representative	Owner: Pres. p; Exec. up evp; Gen. Mgr. gm; Sta. Mgr. sm; Coml. Mgr. cm; Sales Mgr. sim; Prog. Dir. pd; Chief Eng. ce; Prom. Mgr. pmm; Prod. Mgr. pdm; News, Farm, Sports or Women's Dir. nd, fd, sd, wd.	Executive Abbreviations	Market Data For Primary Area (Supplied by station)	Library, News Serv. Transmitter
GRAND RAPIDS—(Contd)							
WJEF 1945	1230 250	Fetzer Bcstg. Co. 187 Monroe, N. W. Glendale 6-8512	CBS Avery-Knodel	John E. Fetzer, p Carl E. Lee, mgng. d Martin Gialmo, sm & cm	Michael Joseph, pd Bruce M. Glycagdis, ce	Donald Hoylman, nd Dick Miller, sd Rosemary Phoenix, wd	Pop.: 288,292 Rad. Hms.: 88,160 Ret. Sis.: \$286,140,000 Thes. AP RCA
WJEF-FM 1951	Ch. 229 (B) 93.7mc 550kw						Pop.: 1,084,084 Rad. Hms.: 603,546 Ret. Sis.: \$1,886,820,000 Thes. AP Fed.
WLAV 1940	1340 250	Versluis Radio & Tv Inc. 6 Fountain St. N. E. Glendale 6-5461	ABC Michigan Pearson	Leonard A. Versluis, p Hy M. Steed, vp, gm & cm	Lee G. Stevens, ce Bob Greenhoe, nd	Jack Harrison, sd Joan Randall, wd	Pop.: 286,000 Rad. Hms.: 88,000 St. UP RCA
WLAV-FM 1946	Ch. 245 (B) 96.9mc 3kw						Pop.: 360,000 Rad. Hms.: 101,000 St. UP Fed.
WOOD 1924 WOOD-TV	1300 5,000-DA-N	Grandwood Bcstg. Co. Grand Rapids Natl. Bank 9-4125	NBC Katz	H. M. Bitner, p Harry M. Bitner Jr., vp Willard Schroeder, gm Art Swift, gen. slm	Frank Sisson, pd John Dragomier, pmm Louis Bergenroth, ce Jack Clay, sls. serv. m	Bob Runyon, nd Eddie Chase, fd Bob Kirby, sd Carol Duvall, wd	Pop.: 598,600 Rad. Hms.: 170,420 Ret. Sis.: \$1,216,530,000 Wid. AP RCA
HOLLAND							
WHTC 1948	1450 250	Holland Bcstg. Co. 5 E. 8th St. 9482	Best	William A. Butler, p Sandy Meek, gm	William Gargano, pd John Klungle, ce Al Ackerman, sd	Mary Emma Young, wd	Pop.: 120,000 Rad. Hms.: 43,000 Ret. Sis.: \$117,000,000 Thes., Wid. L-W AP Col.
HOUGHTON							
WHDF 1929	1400 250	Upper Michigan Bcstg. Co. Douglass Hotel	NBC Walker	George L. Burgan, o & ce Albert W. Payne, gm	Earl Norden, pd & nd Peter Fausone, sd	Myrtle Barrette, wd	Wid. AP Cont.
HOUGHTON LAKE							
WHGR (CP)	1290 1,000-D	Sparks Bcstg. Co.					
IONIA							
WION 1953	1430 500-D	Ionia Bcstg. Co. P. O. Box 143 1537	Best	Monroe MacPherson, o Al LaGuire, gm & cm Kenneth Chapin, slm	William M. MacPherson, pd Donald Seaman, pmm & sls. serv. rep. J. Irving Grove, ce	Bernice Hammond, adm. asst. Ellis Shotwell, nd & fd Frank Imburg, sd Charlotte Poohy, wd	Pop.: 90,000 Rad. Hms.: 24,000 Thes. AP
IRON MTN.							
WMIQ 1947	1450 250	Iron Mtn. Kingsford Bcstg. Co. 211 E. Ludington St. 2031	ABC, Northern	Frank Russell Jr., p Russell J. Staffeld, gm William C. Johnson, cm	Donald Burdick, pd, pmm & nd Paul Anick, ce	Conrad Nelson, sd Beryl Miench, wd	Pop.: 65,520 Rad. Hms.: 15,120
IRON RIVER							
WIKB 1949	1230 250	WIKB Inc. 234 W. Genesee St. 102	MBS, KBS Upper Midwest Walker	H. H. Frailing, p J. F. Kauper, gm & cm	Len Johnson, pd, pmm, fd & sd Lester Patten, ce	Bud Shields, nd Alfreda LaBoki, wd	Pop.: 20,000 Rad. Hms.: 6,500 Ret. Sis.: \$19,000,000 Thes. AP G
IRONWOOD							
WJMS 1931	630 1,000 DA-N	Upper Mich.-Wis. Bcstg. Co. 124 E. McLeod Ave. 20	MBS Walker	William L. Johnson, p Donald R. Hoover, m	Laura Johnson, pd Arne Dahlbacka, ce	Rose Isaac, wd	Pop.: 87,400 Ret. Sis.: \$77,100,000 Thes. UP Col.
ISHPEMING							
WJPD 1947	1240 250	Ishpeeming Bcstg. Co. Jenks Block 1892	KBS, Bunyan, Upper Midwest	James P. Deegan, p, gm & cm Paul C. Crowley, pd & sd	Carl B. Tupala, pmm & nd Bernard R. Maloney, ce	Robert R. Rennie, fd Lois Ruth Holmgren, wd	Pop.: 49,986 Rad. Hms.: 12,665 Wid. AP Ray.
JACKSON							
WIBM 1926	1450 250	WIBM Inc. 2511 Kibby Rd. 6121	ABC Forjoe	Roy Radner, p & gm Wm. Cizek, sm Wm. Hall, cm	Jack Underwood, pd Betty Carris, traffic m	Chas. Wirtanen, ce Usla Mollenkopf, office m	Pop.: 120,000 Rad. Hms.: 176,000 Ret. Sis.: \$132,000,000 L-W AP RCA Wid. UP WE
WKHM 1951	970 1,000-DA-2	MBS, Michigan Bcstg. 441 Wildwood 4-7181	Headley-Reed	Fred A. Knorr, p Walter Patterson, mgng. d Robert G. Wright, asst. mgng. d	Richard Schueler, pd John O. Gilbert II, pmm	Paul Wright, ce Ron Milton, nd, fd & sd	Pop.: 622,085 Rad. Hms.: 176,000 Ret. Sis.: \$132,000,000
KALAMAZOO							
WKMI 1947	1360 1,000-DA-N	Steere Bcstg. State Theatre Bldg. 4-0111	Young	Howard D. Steere, p & cm	E. J. Popke Jr., gm Carl Stephens, ce	Ron Bontsema, nd Joe Wright, sd Ann Lee, wd	Pop.: 128,000 Rad. Hms.: 38,500 Ret. Sis.: \$23,765,000 St. UP Ray.
WKZO 1930 WKZO-TV	590 5,000-DA-N	Fetzer Bcstg. Co. 124 W. Michigan Ave. 3-1223	CBS Avery-Knodel	John E. Fetzer, p Carl E. Lee, mgng. d John W. O'Harrow, sls. d Otis T. Gaston, asst. sls. d & pmm	Charles T. Lynch, pd Arthus E. Covell, ce Dr. Willis F. Dunbar, Pub. affairs d	Ellsworth L. Tait, comp. Frank Benesh, nd Carleton W. Collin, fd Leonard Colby, sd Mary Fontanne, wd	Pop.: 857,900 Rad. Hms.: 242,698 Ret. Sis.: \$876,809,000 Thes. AP RCA
LANSING							
WILS 1947 WILS-TV	1320 5,000-D 1,000-N DA-2	Lansing Bcstg. 407 N. Washington Ave. 2-1655	Venard	W. A. Pomeroy, p & gm Walter Dennis, cm James Pollack, pd	Dave Froh, asst. pd & sd Walter Braeger, pmm John C. Pomeroy, ce	John Maters, nd Jerry Haskell, fd Dorothy Abbanat, wd	Pop.: 369,200 Rad. Hms.: 112,000 Ret. Sis.: \$385,000,000 L-W, Cap. AP RCA
WJIM 1934 WJIM-TV	1240 250	WJIM Inc. Bank of Lansing Bldg. 2-1333	ABC, NBC, Michigan Radio Net. H-R Reps.	Harold F. Gross, p Willard E. Walbridge, vp & gm	Howard K. Finch, vp, pd & sd Charles E. Wallace, ce	Ray Marcus, nd	Pop.: 500,000 Rad. Hms.: 110,000 Ret. Sis.: \$500,000,000 Wid., St. UP RCA
LAPEER							
*WMPC 1926	1230 250-SH	The Liberty Street Gospel Church of Lapeer 455J		Frank S. Hemingway, p & gm	Hollis F. Hayes, ce		

Data corrected to Dec. 10, 1953. If executives or services for FM are same as AM affiliate names are not repeated. Market Data supplied by stations. FM's in italic. *—Non-Commercial Station. CP—Construction Permit issued. D—Day. DA—Day. DA-N—Directional Antenna, night only. DA-1—Directional Antenna, same pattern day and night. DA-2—Directional Antenna, different pattern day and night. L—Limited Time with Dominant Station. LS—Local Sunset. N—Night. SA—Special Authorization. SH—Specified Hours. ST—Share Time. Complete key to abbreviations, page 6.



YOU MIGHT SKATE FIVE MILES IN 14½ MINUTES*—

**BUT . . . YOU NEED WKZO-WJEF RADIO
TO BREAK RECORDS
IN WESTERN MICHIGAN!**

GRAND RAPIDS—KALAMAZOO AREA PULSE
SHARE OF AUDIENCE—MON.-FRI.—FEB., 1953

	6 a.m.—12 noon	12 noon—6 p.m.	6 p.m.— 12 midnight
WKZO-WJEF	41% (a)	41%	40%
STATION "B"	13%	13%	17%
STATION "C"	11%	7%	12%
STATION "D"	9%	7%	9%

(a) Does not broadcast for complete period and the share of audience is unadjusted for this situation.

If you want to break sales records in Western Michigan, just remember this:

1. The March, 1953 Nielsen Report credits WKZO, Kalamazoo, and WJEF, Grand Rapids, with a 12-county audience of 151,050 *daytime* homes, 130,530 *nighttime* homes!
2. WKZO-WJEF give you 70.8% more morning listeners, 105.0% more afternoon listeners and 37.9% more evening listeners, than the next-best two-station combination in Kalamazoo and Grand Rapids!
3. On a per-thousand basis, WKZO-WJEF cost 48.5% less in the morning, 54.7% less in the afternoon and 23.9% less at night, than the next-best two-station choice!

Ask your Avery-Knodel man for all the WKZO-WJEF facts.



The Feltzer Stations

WKZO — KALAMAZOO
WKZO-TV — GRAND RAPIDS-KALAMAZOO
WJEF — GRAND RAPIDS
WJEF-FM — GRAND RAPIDS-KALAMAZOO
KOLN — LINCOLN, NEBRASKA
KOLN-TV — LINCOLN, NEBRASKA
Associated with
WMBD — PEORIA, ILLINOIS

WKZO-WJEF

**CBS RADIO
KALAMAZOO**

**CBS RADIO
GRAND RAPIDS**

Avery-Knodel, Inc., Exclusive National Representatives

* Ross Robinson set this record on February 12, 1927, at Lake Placid, New York.

MICHIGAN

Call Letters Established TV Affiliate City	Chan. or Freq. Power	Licensee Headquarters Telephone	Network Represent- ative	Owner o; Pres. p; Exec. up evp; Gen. Mgr. gm; Sta. Mgr. sm; Coml. Mgr. cm; Sales Mgr. slm; Prog. Dir. pd; Chief Eng. ce; Prom. Mgr. pmm; Prod. Mgr. pdm; News, Farm, Sports or Women's Dir. nd, fd, sd, wd.	Executive Abbreviations	Market Data For Primary Area (Supplied by station)	Library, News Serv. Transmitter	
LUDINGTON								
WKLA 1944	1450 250	Ludington Bcstg. Co. E. Ludington Ave. 1450	ABC, KBS Burn- Smith	Raymond A. Plank, p. gm & ce	Donald M. Hack, cm, fd & sd Charles J. Hagerman, pd & pmm	Tom Roy, nd Fay Hull, wd	Pop.: 42,308 Rad. Hms.: 10,900 Ret. Sls.: \$46,861,000 UP WH
MANISTEE								
WMTE 1951	1340 250	Manistee Radio Corp. Radio Rd. 1340	KBS Best	T. A. Manwell, p Stephen P. Cole, gm & ce	Eddie Owens, cm Lou Blake, pd	Marshall Hanson, pmm & sd Crystine Emunson, wd	Pop.: 23,300 Rad. Hms.: 17,310 Ret. Sls.: \$29,000,000	L-W AP G
MARINE CITY								
WDOG 1950	1590 1,000-D- DA-2	Radio St. Claire Inc. Box 12 3471 Weed	Jerry W. Coughlin, p Jack Hazlett, gm	John Bell, pd	Jim Duryea, ce	Pop.: 3,174,337 Rad. Hms.: 863,822 INS Ray.
MARQUETTE								
WDMJ 1931	1320 1,000-DA-N	Lake Superior Bcstg. Co. Mining Journal Bldg. 616	MBS, KBS Northern	Leo. G. Brott, gm Eldon W. Wallace, sm, pd & nd	Robert J. Luke, cm & pmm	Gordon H. Brozek, ce		Thes. UP G
MENOMINEE								
WMAW 1952	1340 100	Green Bay Bcstg. Co. 980 1st St. 4651	ABC Pearson	Martin Geertz, gm, cm & pd	Robert Reimers, pmm, ce & sd	Jack DuBlon, nd Dick Peterson, fd Miriam Benson, wd	Pop.: 95,000 Rad. Hms.: 91,412 Ret. Sls.: \$45,000,000	L-W, Thes. UP
MIDLAND								
WMDN 1948	1490 250	Rich Pub. House 298 S. Swede Rd. Temple 9-9988 Best	Phillip T. Rich, p Jerry Breen, gm & cm	Tom Matthews, pd, pmm, nd & sd	Peter A. Wolf, ce & fd Bette Studer, wd	Pop.: 356,200 Rad. Hms.: 89,050 Ret. Sls.: \$373,159,000	L-W, Thes. AP G
MT. CLEMENS								
WMLN(FM) 1947	Ch. 292 (A) 106.3mc 0.34 kw	Macomb Pub. Co. 67 Cass Ave. Howard 3-1501 Continental	Paul W. McKee, p	Mark T. McKee, Jr., gm	Wilburn A. Schattler, ce	Pop.: 227,000 Rad. Hms.: 20,000 Ret. Sls.: \$155,105,000 UP GE
MT. PLEASANT								
WCEN 1949	1150 1,000-D 500-N-DA-N	Paul A. Brandt 112½ E. Broadway 33-171		Paul A. Brandt, o Georgia Martin, cm & wd	James Bailey, pd Peter Fronezak, ce	Chester Regoza, nd & fd Dan Baxter, sd	Pop.: 150,000	St., SES. AP G

Data corrected to Dec. 10, 1953. If executives or services for FM are same as AM affiliate names are not repeated. Market Data supplied by stations. FM's in italic. *—Non-Commercial Station. CP—Construction Permit issued. D—Day. DA-N—Directional Antenna, night only. DA-1—Directional Antenna, same pattern day and night. DA-2—Directional Antenna, different pattern day and night. L—Limited Time with Dominant Station. LS—Local Sunset. N—Night. SA—Special Authorization. SH—Specified Hours. ST—Share Time. Complete key to abbreviations, page 6.

WESTERN UNION

W. P. MARSHALL, PRESIDENT

DL = Day Letter

NL = Night Letter

LT = Inc'l Letter Telegram

VL = Inc'l Victory Ltr.

CLASS OF SERVICE

This is a full-rate Telegram or Cablegram unless its deferred character is indicated by a suitable symbol above or preceding the address.

The filing time shown in the date line on telegrams and day letters is STANDARD TIME at point of origin. Time of receipt is STANDARD TIME at point of destination.

WTTT PORT HURON, MICHIGAN

WTTT PORT HURON MICHIGAN TO ALL TIMEBUYERS USA

1000 AGGRESSIVE WATTS SERVING PORT HURON AND THE ENTIRE THUMB AREA OF MICHIGAN TOP INDUSTRIAL AND AGRICULTURAL AUDIENCE OFFERING YOU AND OUR LISTENERS PROMPT FACTUAL NEWS COMPLETE SPORTS COVERAGE AND A LISTENER APPEALING SCHEDULE OF PROGRAMS AND PUBLIC SERVICE PROGRAMMING THAT SELLS WEED AND COMPANY NATIONAL REPRESENTATIVES ABC NETWORK.

WILLIAM WEIL, GEN'L. MANAGER
WTTT 606 Water Street,
PORT HURON, MICHIGAN

Ken Blevins, Station Relations
WTTT Port Huron, Michigan, for further information

WTTT PORT HURON, MICHIGAN

MUSKEGON

WKBZ 1928	850 1,000-DA-1	Ashbacker Radio Corp. 432 Apple Ave. 26-051	ABC. Mich. Radio Meeker	Arch Shawd, p & gm Helen Duvall, cm Joseph J. Herget, pd	Bill Bennett, pmm George Krivitzky, ce	Martin Whelan, nd Robert Johnson, sd	Pop.: 528,000 Rad. Hms.: 175,600 Ret. Sis.: \$500,000,000	Thes. AP Ray.
WKBZ-FM 1948	Ch. 225 (B) 98.9mc 4.7kw							
WKNK 1949	1600 5,000-DA-N	N K Bcstg. Co. Federal Square 32-126	MBS Best	Nicholas W. Kuris, p John S. Bell, gm, sd	Henry Veenstra, cm, pmm Evelyn Johnson, pd	Perd Reynolds, ce Paul Elliott, nd, fd		Wld. UP Gates
WMUS 1946	1090 1,000-D	Greater Muskegon Bcstrs. 517 W. Giles Rd. 4-1872	KBS	Dalton Hille, vp Harley Lucas, m Sam Lombardi, ce	Bob McKendrick, nd & sd	Emily Kadlec, wd	 UP WE

OAK PARK

WJDM (FM) Ch. 238 (B)
1949 95.5 mc
20 kw
Lincoln Bcstg. Co.

OWOSSO

WOAP 1948	1080 250-D	Owosso Bcstg. Co. 2301 N. Shiawassee St. 980	Great Lakes McGillvra	J. E. Campbell, p M. H. Wirth, gm Merrill Walker, cm, pd & nd	Clem Sellers, pmm Fran Bowles, ce	Ed Fitzpatrick, sd Edwina Orser, wd	Pop.: 141,050 Rad. Hms.: 34,908 Ret. Sis.: \$162,068,000	L-W AP GE
--------------	---------------	---	-----------------------------	--	--------------------------------------	--	--	-----------------

PETOSKEY

WMBN 1946	1340 250	Midwestern Bcstg. Co.	MBS, KBS Bunyan Holman	Les Beiderman, p	Ralph Pierson, gm Merton Carter, sim	Johnny Cossens, pd		
--------------	-------------	--------------------------	------------------------------	------------------	---	--------------------	--	--

PONTIAC

WCAR 1938	1130 1,000-D CP: Detroit 50,000-D 10,000-N DA-2	WCAR Inc. P.O. Box 55 Federal 3-7141 Pearson	H. Y. Levinson, p & gm	Wayne N. Cook, engrg. vp & ce	William G. Lenhard, cm		Assoc. AP, INS RCA
--------------	--	--	------------------	---------------------------	----------------------------------	---------------------------	--	--------------------------

WCAR-FM Ch. 258 (B)
1948 99.5mc
20kw

WPON (CP) 1460
500w-DA-N
James L. Gerity Jr.

PORT HURON

WHLS 1938	1450 250	Port Huron Bcstg. Co. 932 Military St. Yukon 2-8536	MBS Gill- Perna, Mich. Spot Sales ABC Weed	John F. Wismer, gm John J. Shepard, asst. gm & cm	Ned S. Hubbell, pd & sd Eugene W. Miller, pmm	George E. Carroll, ce Richard A. Whitford, nd		St., Wld. UP RCA
WTHH 1947	1380 1,000-DA-1	The Times Herald Co. 606 Water St. Yukon 5-5171		F. Granger Weil, evp William L. Weil, gm Gaylord Forbes, cm	Richard Sommerville, pd & nd Kenneth Blevins, pmm	Kenneth Kunze, ce Edwin F. Forbes, fd Edward Senyczko, sd	Pop.: 173,286 Rad. Hms.: 84,606	Thes., St. AP G

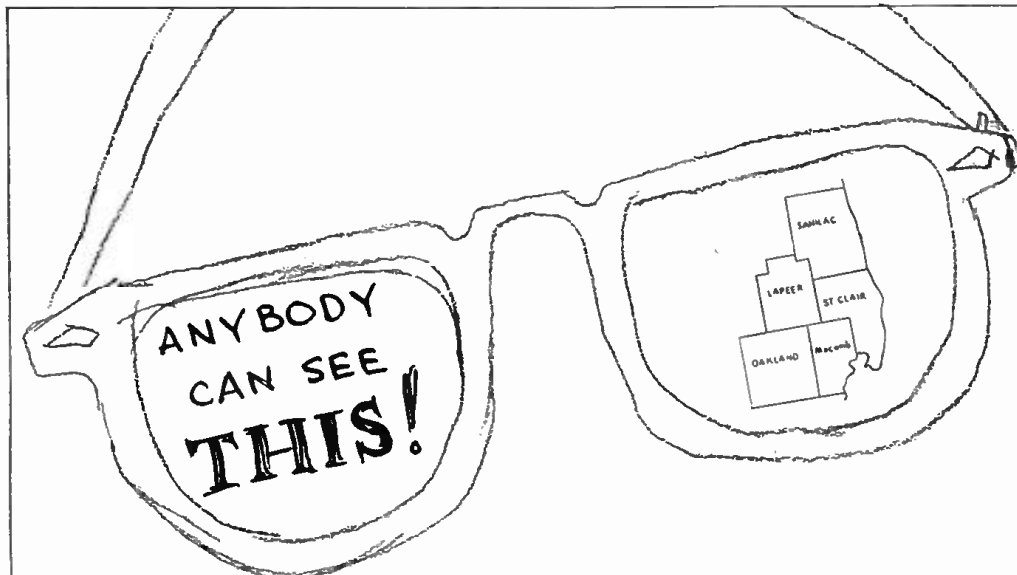

WHLS is the most-listened-to station in Port Huron. Fifty out of 100 shoppers surveyed prefer its great programs, love its grand personality. And remember, WHLS is sold as a package with WLEW, the dominant station of Bad Axe, a prosperous community that receives no primary radio signal from any other station in Northeastern Michigan. The retail sales in the area WLEW covers amount to more than \$32,642,000 a year. That's buying for you! That's a market for you.

Here's one of the greatest combination buys in America today; a radio station buy that brings you 225,075 radio families and \$584,855,-750 and more year in and year out in retail sales! Ask for more facts. Do it now, today. Also remind us to send you our latest Pulse survey.



Yes, anybody can see that WHLS is the voice of Port Huron, Michigan. No matter how you measure WHLS-and it's been measured and measured scientifically and accurately-it's the station to cover "Michigan's Thumb", a rich industrial and urban area containing 556,220 potential customers; people who spend \$100,584,000 for retail goods; a station which not only saturates the great counties seen here in the map, but Western Ontario, too.

Gill-Perna, Inc., nat'l representatives
New York Chicago Los Angeles San Francisco

Michigan Spot Sales — Michigan state representative
15001 Michigan Avenue, Dearborn, Mich. Tiffany 68500

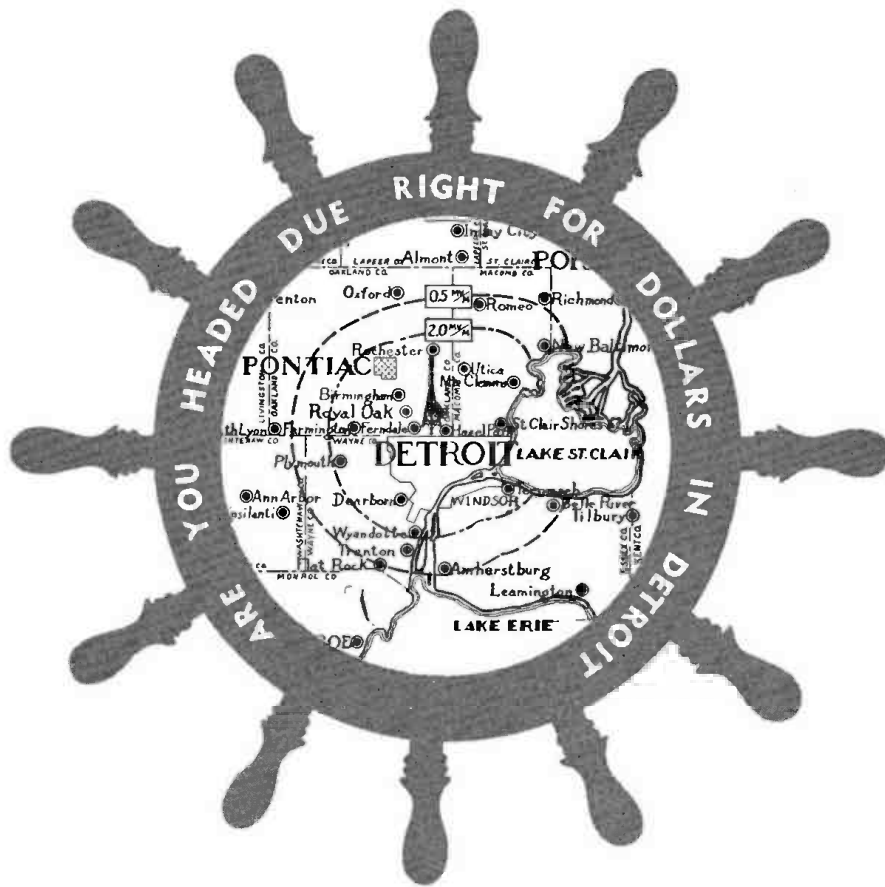

Let's face it, you're not headed right if you're not headed into the great Detroit market covered intensively by WEXL. Glance up at that map again. There's Detroit coverage where it *counts!*

Remember, it's WEXL in Royal Oak-Detroit—TOPS in sports, news and music. WEXL's low spot rate will amaze you. Check with Gill-Perna, Inc. or check direct for all the details. JORDAN 4-6523 does it.



Jacob B. Sparks, Pres. & Gen. Mgr.
 Gordon A. Sparks, Sec'y & Treas. & Mgr.
 Garnet G. Sparks, Vice Pres. & Ch. Eng.

for 29 years Michigan's oldest independent serving 856,640 homes.

GILL-PERNA, INC.

NATIONAL REPRESENTATIVES

MINNESOTA

City	Call Letters Established	Chan. or Freq. Power	Licensee Headquarters Telephone	Network Representative	Owner; Pres. p; Exec. up evp; Gen. Mgr. gm; Sta. Mgr. sm; Coml. Mgr. cm; Sales Mgr. sim; Prog. Dir. pd; Chief Eng. ce; Prom. Mgr. pmm; Prod. Mgr. pdm; News, Farm, Sports or Women's Dir. nd, fd, sd, wd.	Executive Abbreviations	Market Data For Primary Area (Supplied by station)	Library, News Serv. Transmitter
ALBANY								
KASM 1950	1150 500-D	Stearns County Bcstg. Co. 1150	KBS Continental. Lawson	William H. Blattner, p Urban J. Keppers, gm & pd	Arthur Boss, cm & pmm Dale Howard, ce	Cliff Mitchell, nd & fd Steve Gleason, sd Sally Hanauska, wd	Pop.: 289,693 Rad. Hms.: 77,054 Ret. Sis.: \$253,849,000	L-W UP G
ALBERT LEA								
KATE 1937	1450 250	Albert Lea-Austin Bcstg. Co. Inc. 332 S. Broadway 2338	ABC. Southern Minn. Meeker, & Bulmer & Johnson	Bennett O. Knudson, p E. A. Van Alstyne, gm Tom Golden, cm	Robert Holt, ce Trace Goddard, nd & sd	Cliff Cairns, fd Marie Prosser, wd	Pop.: 253,000 Rad. Hms.: 75,300 Ret. Sis.: \$284,000,000	Thes., SES. UP Col.
ALEXANDRIA								
KXRA 1949	1490 250	Alexandria Bcstg. Corp. 1000	Lawson	R. C. Brown, gm Everette Walters, cm Kenneth Bechtel, pd	Kenneth Olson, ce Wayne Moody, nd & sd	Kenneth Tessmer, fd Frances Anderson, wd		Thes. Col.
AUSTIN								
KAUS 1948 KMMT(TV)	1480 1,000-DA-2	Cedar Valley Bcstg. Co. 405A N. Main St. 8838	MBS. Dairyland Pearson	Martin Bustad, p L. L. McCurnin, gm Ken Soderberg, cm Tom Steensland, pd	Bob Abbott, pmm Glen Klein, ce Ken Cessna, nd	Rollie Dain, sd Don Sheetz, fd Joice Bank, wd	Pop.: 150,000 Rad. Hms.: 40,000 Ret. Sis.: \$160,000,000	Wid. AP GE
BEMIDJI								
KBUN 1946	1450 250	Butler Bcstg. Co. Inc. 419½ Beltrami Ave. 1900	MBS. KBS. Upper Minn. Lawson	Edward W. Butler, p, gm, cm, pmm & sd	Gwenyth Butler, pd & wd Del Grage, ce	Aldy Swanson, nd Norm Rick, fd	Pop.: 33,000 Rad. Hms.: 8,422 Ret. Sis.: \$19,453,000	SES. UP RCA
BRAINERD								
KLIZ 1946	1400 250	Brainerd Bcstg. Co. E. Oak St. 2853	MBS. Upper Midwest Walker	Ed Tom O'Brien, p & gm Earl R. Johnsen, sm, cm & pd	James Peterson, ce Robert Chasteen, nd & fd	Al Leighton, sd Miriam Hylland, wd	Pop.: 47,575 Rad. Hms.: 12,772 Ret. Sis.: \$15,000,000	Cap. AP G
BRECKENRIDGE								
KBMW 1948	1450 250	Interstate Bcstg. Corp. 519 Dakota Ave. Wahpeton, N. D. 2-5567	KBS Lawson	Harry M. Griffith, gm George Kaufmann, cm & sd	Clayton J. Kulseth, pd Harold G. Unkenholz, ce	LaVore Freeborn, office m R. M. Johnson, nd	Pop.: 100,000 Ret. Sis.: \$53,000,000	St. UP Col.
CLOQUET								
WKLK 1950	1230 250	Cloquet Bcstg. Co. 124½ Ave. C 1450	KBS	Albert S. Tedesco, p Dale R. Peterson, gm & sd Richard A. Rall, cm	Marlene Beauchene, pd Darrel Gander, ce Beverly Norgren, pmm & wd	Burt Oien, nd Dean Cates, co-fd Nancy Anderson, co-fd		L-W UP Col.
CROOKSTON								
KROX 1949	1260 1,000-D 500-N DA-N	Crookston Bcstg. Co. Eagles Bldg. 1050 Cooke, Lawson, Grant	Jerome A. Dahlberg, p, pd & sd William J. Kiewel, m & secy.-treas.	Garfield L. Cox, vp & cm Earl L. Handyside, ce	John Kalin, nd Evelyn Bausitan, wd	Pop.: 1,500,000 Rad. Hms.: 300,000 Ret. Sis.: \$12,500,000	Thes., Wid. UP Ray.
DETROIT LAKES								
KDLM 1951	1360 1,000-D	Detroit Lakes Bcstg. Corp. 1360 Riechwood Rd. 1100 Lawson	R. C. Brown, p Gordon Hutton, gm & nd	Phil Solberg, cm Eric Munro, ce	Tom Mee, sd Jan Solberg, wd		Wid. AP G

Data corrected to Dec. 10, 1953. If executives or services for FM are same as AM affiliate names are not repeated. Market Data supplied by stations. FM's in *italics*. *—Non-Commercial Station. CP—Construction Permit issued. D—Day. DA-N—Directional Antenna, night only. DA-I—Directional Antenna, same pattern day and night. DA-2—Directional Antenna, different pattern day and night. L—Limited Time with Dominant Station. LS—Local Sunset. N—Night. SA—Special Authorization. SH—Specified Hours. ST—Share Time. Complete key to abbreviations, page 6.

K R O C
K A T E
K Y S M

Concentrated Coverage of the Fabulous Farmlands of SOUTHERN MINNESOTA

IN THIS 32-COUNTY MARKET:

POPULATION	774,100
RADIO HOMES	211,350
RETAIL SALES	\$856,245,000
FARM INCOME	\$772,032,000
INCOME PER FARM	\$ 11,705

Sell Southern Minnesota from the "inside" with the area's favorite stations.

Southern Minnesota Network

KROC (NBC)
ROCHESTER

KATE (ABC)
ALBERT LEA

KYSM (NBC)
MANKATO

National Representatives: ROBERT MEEKER ASSOCIATES Regional Representatives: BULMER & JOHNSON

MINNESOTA

DULUTH									
KDAL 1936	610 5,000-DA-N	Red River Bcstg. Co. Inc. 218 Bradley Bldg. 2-2828 (See Superior, Wis., listing)	CBS Avery- Knodel	Dalton A. LeMasurier, p & gm Odin S. Ramsland, cm	Jack Gordon, pd Dale Cowle, pmm R. A. Dettman, ce	Bill Krueger, nd Don Dahl, sd Elizabeth Brown, wd	Rad. Hms.: 111,233	L-W AP RCA	
WDSM									
WEBC 1924	1320 5,000-DA-N	Head of the Lakes Bcstg. WEBC Bldg. 2-2873	NBC, Arrow- head Bulmer & Johnson, Holling- bery	Morgan Murphy, p W. C. Bridges, vp & Clifford Lue, cm	M. J. Flaherty, pd & pmm N. P. Gill, ce Charles Persons, engrg. d	Thomas Kelly, nd & sd Deke Grussendorf, fd Sally Gleason, wd		Wid., SES. UP	
- WEBC-FM (CP) Ch. 222 (B) 92.3mc 74kw									
EVELETH									
WEVE 1947	1340 250	Carl Bloomquist 1340	MBS, KBS Lawson	Carl Bloomquist, p Art Nelson, gm	Bob Daniels, pd Joe Cerar, ce	Rose Ullman, traffic m Al Williams, sd	Pop.: 68,300 Rad. Hms.: 20,470 Ret. Sis.: \$61,451,000	St. Col.	
FAIRMONT									
KSUM 1949	1370 1,000-DA-2	Fairmont Bcstg. Co. 306 N. Park St. 1370	MBS, Upper Midwest Rambeau	Leo J. Seifert, p Frank Endersbe, gm James L. Barkley, pd	William W. Small, pmm & office m Larry Lawson, ce George Brooks, nd	Dick Mahar, sd Jim Barkley, fd Annabel Webb, wd	Pop.: 456,700 Rad. Hms.: 109,650 Ret. Sis.: \$423,609,000	Thes. AP RCA	
FARIBAULT									
KDHL 1948	920 1,000-DA-2	KDHL Bcstg. Co. 213 Central Ave. 2312	Herbert H. Lee, ptrn. & gm Palmer Dragsten, ptrn. & cm	J. E. Hyde, ptrn. & ce	Francis Robbins, nd Tom Bachrach, sd Dean Curtiss, fd		Cap. AP RaY.	
FERGUS FALLS									
KGDE 1926	1250 1,000-D 500-N-DA-N	Fergus Radio Corp. 6996	MBS, Great Northern Walker	Harold L. Dell, evp & gm	Frederic T. Dell, asst. m & nd	Norman C. Haagenen, sm & cm Harold E. Allen, ce	 AP Col.	
GRAND RAPIDS									
KBZY 1948	1490 250	Itasca Bcstg. Co. 198	MBS	Robert D. Kennedy, p, gm & cm	Bud Germ, pd Ross Fesenmeyer, ce	Bill Lane, sd	Pop.: 36,000 Rad. Hms.: 9,320 Col.	
HIBBING									
WMFG 1935	1240 250	Head of the Lakes Bcstg. Co. 5th Ave. & Howard Sts. 3-7531	NBC, Arrow- head Holling- bery, Bulmer & Johnson	Morgan Murphy, p Walter C. Bridges, gm O. H. Peterson, cm	Ruth E. Coe, pd, pmm & wd Norman Gill, ce	George W. Johnson, nd Bud Johnson, sd		Wid., SES. UP Col.	
HUTCHINSON									
KDUZ 1953	1260 1,000-D	McLeod County Bcstg. Co. Radio City 1555	Albert Tedesco, ptrn., gm & sd Victor Tedesco, ptrn. Nicholas Tedesco, ptrn.	Hienz Fruck, cm Ted Hanson, pd Howard Nordine, pmm & nd	Darrel Gander, ce Don Wheeler, fd Jane Haugen, wd			
LITTLE FALLS									
KLTF 1950	960 500-D	Little Falls Bcstg. Co. 105½ E. Broadway 367	KBS	John H. Lemme, p John J. Nugent, gm	Richard J. Rudeck, cm Sumner Sabean, pd	Gordon Lommen, ce	Pop.: 85,000 Rad. Hms.: 89,201 Ret. Sis.: \$301,755,000	L-W UP Col.	
MANKATO									
KTOE 1950	1420 5,000-D 1,000-N- DA-N	Minnesota Valley Bcstg. Co. Box 550 4537	ABC, Pearson	H. W. Linder, p D. O. Linder, gm & cm	Wayne Will, pd Steve Wolf, ce	Thomas White, nd Bill Smith, sd	Pop.: 379,017 Rad. Hms.: 108,340 Ret. Sis.: \$361,600,000	Cole UP G	
KYSM 1938	1230 250	Southern Minn. Supply Co. 101 N. 2d St. 4673	NBC, Northwest, Southern Minn. Meeker	John F. Meagher, gm & cm	Eugene Bouchier, pd Robert Cosgrove, pmm	James Houts, ce		Thes. AP RCA	
-KYSM-FM 1948 Ch. 272 (B) 103.5mc 47kw									
MARSHALL									
KMHL 1946	1400 250	Harry Willard Linder KMHL Bldg. 2282	ABC Pearson	Harry W. Linder, o	Gilmore F. Frayseth, gm	Russell Nelson, ce Ben Dickmeyer, pd	 UP RaY.	
MINNEAPOLIS									
KEYD 1948	1440 5,000-D	Family Bcstg. Corp. 15 N. 9th St. Lincoln 8451 (See St. Paul listing) Rambeau	Henry C. Klages, p Lee L. Whitink, gm	Rav Tenpenny, cm & pd	Harvey V. Headen, ce Bob Kaye, nd Fred Vant Hull, sd	Pop.: 1,789,218 Rad. Hms.: 461,110	St. AP RCA	
KSTP 1928 KSTP-TV									
*KTIS 1949	900 1,000-D	Northwestern Schools 50 Willow St. Lincoln 3244	Dr. Richard Elvee, p	Loren F. Bridges, gm	Clarence LaBonte, ce	Pop.: 1,500,000	SES. UP WE	

Mighty Mover!

Paul Bunyan was so strong, it's said, that when it came time to move his logging camp to a new location, he simply picked up the whole camp at one swoop.

Quite a feat, that. Brings to mind the *real-life* exploits of WCCO RADIO, the Northwest's 50,000-watt giant—which is so powerful it can move merchandise en masse for you throughout *109 primary counties* in four Northwest states (an area of some 86,700 square miles)! Fact is, WCCO RADIO delivers a bigger weekly audience of potential customers in 82 of these counties than any of the more than 200 other radio stations heard throughout the entire area.* And does all this at an astonishingly low cost per thousand circulation—*6¢ per thousand families daytime, 11¢ nighttime!*

If you want to move a mighty lot of your product in the Northwest, call CBS Radio Spot Sales or Phil Lewis, sales manager of ... **WCCO RADIO**

*Minneapolis—St. Paul
The Northwest's 50,000-watt Giant*

•SAMS 1962



MINNESOTA

*KUOM 1922	770 5,000-D ST-WCAL	Univ. of Minn. Main 8177	James Lewis Morrill, p Burton Paulu, gm Northrop Dawson Jr., pd Berten A. Holmberg, ce	Irving Fink, prod. d Sheldon Goldstein, script sup. Dorothy Greenwood, adult pd	Ray Christensen, mus. d & sd Ralph Mauseth, nd Ray Wolf, fd Jo Nelson, wd	Pop.: 1,000,000 UP RCA
WCCO 1924 WCCO-TV	830 50,000	Midwest Radio- Television Inc. 625 Second Ave S Main 1202	CBS, CBS Radio Spot Sales	Robert Ridder, p F. Van Konyenburg, evp & gm Larry Haeg, gm Phil Lewis, slm Bob McKinsey, pd	Fred Heywood, publ. d, pmm & prog. prom. J. J. Beloungy, ce Charles Smith, d of sls. prom.	Jim Bormann, nd Stew MacPherson, sd Maynard Speece, fd	Pop.: 3,356,200 Rad. Hms.: 952,470 Ret. Sls.: \$3,766,015,000	L-W AP, UP, INS WE
WDGY 1923	1130 50,000-D 25,000-N- DA-2	Twin Cities Bcstg. Corp. Nicollet Hotel Bridgeport 2271 Avery- Knodel	C. T. Hagman, p & gm Sam N. Nemer, cm Don O'Brien, nd	Kenneth Olson, co-ce Kenneth Larson, co-ce	Dean Sherman, fd Wes Fesler, sd Rosemary Canfield, wd	Rad. Hms.: 674,500 AP WH
WLOL 1940	1330 5,000-DA-1	Independent Bcstg. Co. 1730 Hennepin At. 0408	MBS AM Radio Sales	Ralph L. Atlass, p H. W. Cassill, opr. sup. Wayne Williams, cm Edward Wiebe, pd	Gene Brautigam, control sup. Merle Bjork, trans. sup.	Lloyd M. Hallett, asst. secy. & office m Donald Kelly, nd Richard Enroth, sd Kathleen Runyon, wd	Pop.: 1,338,200 Rad. Hms.: 406,010 UP RCA
WMIN 1936 WMIN-FM 1948	(See St. Paul listing)							
WPBC 1949	980 1,000-D	People's Bcstg. 1133 Stinson Blvd. Granville 4356	William V. Stewart, p, gm & pmm Merle Forland, cm	Becky Ann Stewart, pd & wd Clinton Barstad, ce	Jack Hastings, nd & sd		L-W UP Col.
WTCN 1935 WTCN-TV	1280 5,000-D 1,000-N	Minnesota Television Public Service Corp. 2925 Dean Blvd. Mohawk 9-6771	ABC Blair	Robert Butler, p Edward G. Smith, gm Kendall M. Light, cm Judy Bryson, pd & wd	Myron Fleming, ce George Hudak, pmm	John Ford, nd Robert Carlson, fd Frank Buettel, sd	Pop.: 1,697,600 Rad. Hms.: 453,900 Ret. Sls.: \$1,142,562,000	Assoc. AP, UP WE
WTCN-FM 1951	Ch. 246 (B) 97.1mc 2.5kw						Pop.: 1,100,600 Rad. Hms.: 370,000 Ret. Sls.: \$1,142,562,000	AP, UP WE
MONTEVIDEO								
KDMA 1951	1450 100	Midwest Bcstg. Corp. 7212	ABC, Dairyland Pearson	Bill Linder, gm Bill Farrell, cm	Jim Wood, pd	Richard Beekman, ce	
MOORHEAD								
KVOX 1937	1340 250	KVOX Bcstg. Co. Inc. 403 Center Ave. 3-1522	MBS, Great Northern Walker	E. J. McKellar, p & co M. M. Market, gm & sd	R. L. Owens, asst. m. cm & pmm Mike Gurney, slm	Don Geiken, ce T. P. Hannafer, nd	Pop.: 193,200 Rad. Hms.: 51,270 Ret. Sls.: \$219,000,000	Wld. UP WE
NEW ULM								
KNUJ 1949	860 1,000-D	KNUJ Inc. 304½ N. Minn. St. 904	KBS	Walter K. Mickelson, p Stanley B. Whitman, gm, cm & ce	Roger Russell, pd Warren Asher, pmm George Korenchen, sd	Denny Hayes, nd Bob Christianson, fd Patti Smith, wd	Pop.: 591,000 Rad. Hms.: 165,170 Ret. Sls.: \$632,241,000	Wld., L-W AP G
NORTHFIELD								
*WCAL 1918	770 5,000-D ST-KUOM	St. Olaf College 500	Milford C. Jensen, gm & ce James V. Anderson, pd & nd	Carl B. Helgen, pmm	Phillip Overlund, fd (Mrs.) Hilde Howden, wd	Pop.: 1,250,000	
OWATONNA								
KOBK 1950	1390 500-D	Owatonna Bcstg. Co. Box 250 2359	KBS	Myles H. Johns, p Ted Nelson, vp Bob Frye, gm	Jim Sweeney, cm Marie Gockowski, pd & nd	Jerry Dvorachek, ce Ted Hedstrom, sd Jim Larson, fd	Pop.: 82,000 Rad. Hms.: 24,800	L-W UP Col.
RED WING								
KAAA 1949	1250 1,000-D	Red Wing Bcstg. Co.	Maxine Jacobs, gm H. D. Cary, cm & pmm	Peter Lyman, pd Donald M. Willie, ce	James Bailey, sd Harley Flathus, fd		Assoc., Cap. AP G
ROCHESTER								
KROC 1935 KROC-TV	1340 250	S. Minn. Bcstg. Co. 100 1st Ave. Bldg. 3924	NBC, Southern Minn. Meeker	Mrs. Gregory P. Gentling, p G. David Gentling, gm & cm	Cal Smith, sm & pd Warren Miller, pmm Robert Cross, ce Ray Thompson, nd	Bernie Lusk, sd Jerry Boyum, fd Mary Miller, wd	Pop.: 250,000 Rad. Hms.: 70,000 UP Col.
ST. CLOUD								
KFAM 1938	1450 250	Times Publ. Co. Weber Bldg. 3330	NBC Northwest Pearson	Frederick C. Schilplin, gm	John F. Green, cm & pmm			Thes. AP RCA
*KFAM-FM 1948	Ch. 284 (B) 104.7mc 15kw							
WJON 1950 WJON-TV	1240 250	Granite City Bcstg. Co. Hotel St. Cloud 1240	ABC Rambeau	Max H. Lavine, p Herman Schneider, m Wallace N. MacBriar Jr., pd	Paul Zahorik, slm Charles Williams, ce Harold Zahorik, continuity d	Bud Lynott, nd Dick Statz, sd	Pop.: 100,000 Rad. Hms.: 30,000 Ret. Sls.: \$90,000,000	Wld. UP G
ST. PAUL								
KEYD 1948	(See Minneapolis listing)							
KSTP 1928 KSTP-TV	1500 50,000- DA-2	KSTP Inc. 3415 University Ave. Prior 2717	NBC, Northwest Petry	Stanley E. Hubbard, p & gm K. M. Hance, vp Marvin L. Rosene, cm	Karl A. Plain, slm Wm. S. Sadler, ce Joseph C. Cook, pmm	D. Brooks Henderson, prod. sup. & nd Jack Horner, sd Carl Kannstedt, fd		Wld., Thes. AP, UP
*KTIS 1949	(See Minneapolis listing)							
*KTIS-FM 1949	(See Minneapolis listing)							
*KUOM 1922	(See Minneapolis listing)							
WCCO 1924 WCCO-TV	(See Minneapolis listing)							

MINNESOTA

City	Call Letters	Chan. or Freq. Power	Licensee Headquarters Telephone	Network Representative	Owner; Pres. p; Exec. vp evp; Gen. Mgr. gm; Sta. Mgr. sm; Coml. Mgr. cm; Sales Mgr. slm; Prog. Dir. pd; Chief Eng. ce; Prom. Mgr. pmm; Prod. Mgr. pam; News, Farm, Sports or Women's Dir. nd, fd, sd, wd.	Executive Abbreviations	Market Data For Primary Area (Supplied by station)	Library, News Serv. Transmitter
ST. PAUL—(Cont'd.)								
WDGY	1923							
WLOL	1940							
WMIN	1400		WMIN Bcstg. Co.		N. L. Bentson, p	Frank M. Devaney,	Tom Letcher, pmm	Pop.: 1,167,800
1936	250		811 Frontenac Pl.	Clark	Norman Page, radio	vp in charge of sls.	Warren Fritze, ce	Rad. Hms.: 337,928
WMIN-TV			Prior 7757		opers. d & nd	Clifford Borgstrom,	Hal Newell, sd	Ret. Sis.: \$1,530,470,000
WMIN-FM	Ch. 258 (B)							AP
1947	99.5mc							WE
WPBC	1949							AP
WTCN	1934							Fed.
WTCN-FM	1951							
WCOW	1590		South St. Paul	Gopher	Victor J. Tedesco, gm	Jack Douglas, pd	Gene Taylor, nd	Pop.: 1,500,000
1951	5,000-D		Bcstg. Co.	Pearson	Nicholas Tedesco, asst.	Ken Nordstrom, slm	Bert Olsen, fd	Rad. Hms.: 500,000
WCOW-TV			8 W. 9th St.		Arne Peterson, cm &	Larry Lennette, ce	Faye Christianson, wd	SES.
			Garfield 4717		sd			UP
								G
STILLWATER								
WSHB	1220		St. Croix Bcstg.		Wm. F. Johns, p	Roger Erickson, pd &	Dewey Campbell,	L-W
1949	250-D		Co.	Cooke	Richard K. Power, gm	fd	pmm	UP
			126 Main		James H. McLaughlin,	Eimer Christenson, ce	Anita Albrecht, wd	GE
			46 & 47		cm, n & sd			
THIEF RIVER FALLS								
KTRF	1230		Henry K.		Henry K. Arneson, p	Henry J. Bothman, ce	John Dunicliff, fd	Pop.: 97,405
1946	250		Arneson	Bulmer &	Don Olson, gm	Doug Tegmeier, sd &	Lois Udstrand, wd	Rad. Hms.: 29,470
			1313 N. Main Ave.	Johnson	Ormond Johnson,	nd		Ret. Sis.: \$62,000,000
			13		pmm			L-W, Wid.
								UP
								G
VIRGINIA								
WHLB	1400		Head of the	NBC,	Morgan Murphy, p	Harry Wills, pd & nd	Alys Mae McBride, wd	Wid. SES.
1936	250		Lakes Bcstg.	Arrow-	W. C. Bridges, gm	Norman Gill, ce	Mundo DeYoannes, sd	UP
			Co.	head, N.W.	Harold J. Parise, m			Col.
			2000	Holling-				
				bery				
WADENA								
KWAD	920		Assoc. Bcstrs.	MBS	Carl E. Holt, gm	Jim Buchan, pd & nd	Milt LaDue, ce	Wid.
1948	1,000-DA-N		1st Nat'l Bank	Bulmer &				UP
			Bldg.	Johnson				G
			920					

Data corrected to Dec. 10, 1953. If executives or services for FM are same as AM affiliate names are not repeated. Market Data supplied by stations. FM's in italic. *—Non-Commercial Station. CP—Construction Permit issued. D—Day. DA-N—Directional Antenna, night only. DA-1—Directional Antenna, same pattern day and night. DA-2—Directional Antenna, different pattern day and night. L—Limited Time with Dominant Station. LS—Local Sunset. N—Night. SA—Special Authorization. SH—Specified Hours. ST—Share Time. Complete key to abbreviations, page 6.

THE Linder STATIONS

in MINNESOTA'S billion-dollar farm area...

reach more people.....cover more homes

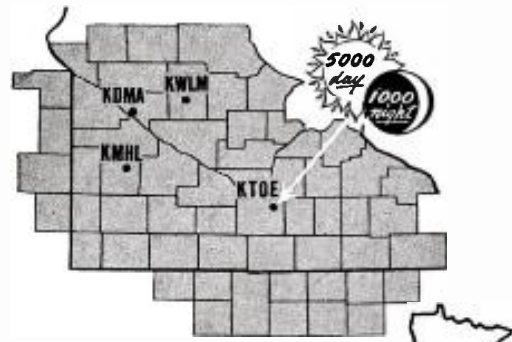

Counties Covered by Linder Stations	1,229,000	Counties Covered by Linder Stations	360,941
Cities of Saint Paul & Minneapolis	827,900	Cities of Saint Paul & Minneapolis	257,010

than there are in both Minneapolis & St. Paul!
(and no TV)

The Linder Group of stations covers 48.8% of the farm population, households and radio homes—23% of Minnesota's total population. Their area has 59.5% of the total farm income and 27.8% of the state's total retail sales. Big audiences mean big sales in this prosperous area of the Linder Group of stations.

Available individually or in combination. Ideal for test campaigns.

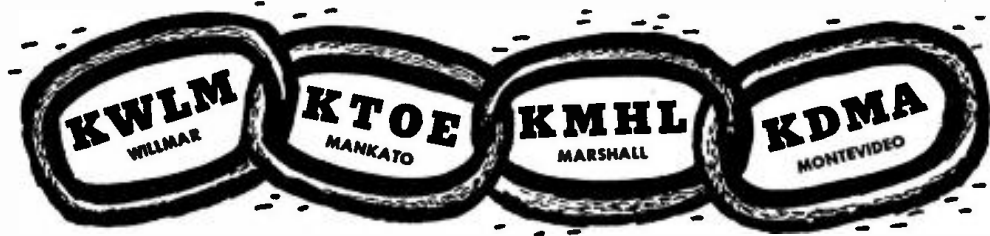

HARRY W. LINDER
THE Linder STATIONS
WILLMAR, MINNESOTA

WILLMAR

KWLM 1340 Lakeland Bcstg. Co. ABC, Dairyland Pearson H. W. Linder, p Jack Lynch, cm Joe Martinson, pd Jim Peck, pmm Francois Peterson, ce

WINONA

KWNO 1230 Winona Radio Service 216 Center 3314 ABC, Dairyland Pearson M. H. White, p Ken Marsh, gm H. Rod Hurd, cm Joe Rizzardi, pmm Lewis Denes, ce Gordon Holte, nd Chuck Williams, sd Ethel Holte, wd Pop.: 226,600 Rad. Hms.: 61,880 Ret. Sls.: \$195,828,000 St. AP RCA

WORTHINGTON

KWOA 730 1947 1,000-D Worthington Bcstg. Co. Hotel Thompson 2-7301 Bulmer & Johnson R. W. Olson, p Ralph E. Shepard, gm Arne Karhu, cm Ty Mack, pd Clint Knapp, ce George Michealson, nd Myron Heuer, sd Merv Gardner, fd Tiny Taylor, wd Pop.: 1,136,913 L-W, Thes. Rad. Hms.: 267,509 Ret. Sls.: \$1,594,413,000 UP

MISSISSIPPI

MARKET DATA BY COUNTIES

Table with 14 columns: County, Population 1950, Radio Families 1953, Retail Sales 1952(000), Food Sales 1952(000), Drug Sales 1952(000), Passenger Cars 1952, County, Population 1950, Radio Families 1953, Retail Sales 1952(000), Food Sales 1952(000), Drug Sales 1952(000), Passenger Cars 1952. Includes counties like Adams, Alcorn, Alcorn, Attala, Benton, Bolivar, Calhoun, Carroll, Chickasaw, Choctaw, Claiborne, Clarke, Clay, Coahoma, Copiah, Covington, De Soto, Forrest, Franklin, George, Greene, Grenada, Hancock, Harrison, Hinds, Holmes, Humphreys, Issaquena, Itawamba, Jackson, Jasper, Jefferson, Jeff Davis, Jones, Kemper, Lafayette, Lamar, Lauderdale, Lawrence, Leake, Lee, Leflore, Lincoln, Lowndes, Madison, Marion, Marshall, Monroe, Montgomery, Neshoba, Newton, Noxubee, Oktibbeha, Panola, Pearl River, Perry, Pike, Pontotoc, Prentiss, Quitman, Rankin, Scott, Sharkey, Simpson, Smith, Stone, Sunflower, Tallahatchie, Tate, Tippah, Tishomingo, Tunica, Union, Walthall, Warren, Washington, Wayne, Webster, Wilkinson, Winston, Yalobusha, Yazoo.

Note: Population 1950 Census; radio families Standard Audit & Measurement Services Inc.; food, drug and retail sales, copyright 1953, Sales Management; further reproduction unlicensed; automobiles supplied by state.

DIRECTORY OF AM AND FM STATIONS

ABERDEEN

WMPA 1240 1952 250 Prairie Bcstg. Co. P. O. Box 402 1050 KBS Mid-South McGillvra T. A. Richardson, p William Felton, gm, cm. nd & fd Grace Felton, pd Eddie Lane, ce George Thompson, sd Jo Boyd, wd Pop.: 36,543 Rad. Hms.: 7,633 Ret. Sls.: \$15,015,000 L-W UP G

BATESVILLE

WBLE 1290 1953 1,000-D Panola Bcstg. Co. P. O. Box 247 Travis A. Palmer, co-o Harold B. McCarley, co-o & gm James E. Hartness, co-o Thes. AP G

BILOXI

WLOX 1490 1948 250 WLOX Bcstg. Co. Buena Vista Hotel 5581 MBS Rambeau James S. Love Jr., p Ray Butterfield, gm & sd Thomas B. Majure, cm & ce Hugh W. Smith, pd Richard Kettering, pmm Suzanne Strangi, nd Claire Wood, wd Pop.: 126,737 Rad. Hms.: 12,140 St. UP WE

BOONEVILLE

WBIP 1400 1950 250 Booneville Bcstg. Co. Highway 45 South 678 KBS Continental E. D. Roden, p V. Keith Wroten, gm, cm. ce & nd Wynez Wroten, pd & wd Jack Gardner, pmm Irwin Feldman, sd Albert Boyd, fd Pop.: 46,806 Rad. Hms.: 11,033 Ret. Sls.: \$24,549,000 UP G

MISSISSIPPI

City	Call Letters Established TV Affiliate	Chan. or Freq. Power	Licensee Headquarters Telephone	Network Represent- ative	Owner o; Pres. p; Exec. up evp; Gen. Mgr. gm; Sta. Mgr. sm; Coml. Mgr. cm; Sales Mgr. slm; Prog. Dir. pd; Chief Eng. ce; Prom. Mgr. pmm; Prod. Mgr. pdm; News, Farm, Sports or Women's Dir. nd, fd, sd, wd.	Executive Abbreviations	Market Data For Primary Area (Supplied by station)	Library, News Serv. Transmitter
BROOKHAVEN								
	WJMB 1949	1340 250	Brookhaven Bcstg. Co. W. Chicasaw 1298	MBS	Tullius Brady, p, gm & cm	Bill Jones, asst. gm, pd & pmm		Wld. AP G
CANTON								
	WDOB 1953	1370 500-D	Madison County Bcstg. Co. P. O. Box 182 1370	KBS Dora- Clayton	J. D. Bishop, co-o J. T. Ownby, co-o Anne Dee Davis, co-o	Robert L. Statham, gm Harold Harris, cm	Ozella Westbrook, pd Buddy Thames, fd Pop.: 744,000 Rad. Hms.: 154,450	Thes. UP Ray.
CENTREVILLE								
	WGLC 1951	1580 250-D	Southern Bcstg. Co. 4001	KBS. Mississippi Net. Continental.	Alvin Sansing, p Paul Simpkins, gm W. L. Walker, cm & sd	David Thornhill, pd Maxwell Bramlette, pmm Bob Basett, ce	Thelma McCraime, nd Carl Treppendahl, fd Clara Simpkins, wd	Cap. UP
CLARKSDALE								
	WROX 1943	1450 250	Mrs. Birney Imes Sr. Delta Ave. 1568	MBS. Mid-South McGillvra	(Mrs.) Birney Imes Sr. Bob McRaney, gm	P. B. Hinman, sm Helen Sugg, cm & wd	Jack Cristil, pd & sd C. D. Graves, ce Pop.: 300,000 Rad. Hms.: 49,380 Ret. Sls.: \$27,955,000	Thes. AP RCA
CLEVELAND								
	WCLD 1949	1490 250	Cleveland Bcstg. Hghwy. 61 South 1115	McGillvra	Lowry Tims, p C. W. Capps, gm & cm	Elizabeth Bradley, pd Richard Bullock, ce	Larry Feduccia, sd Marcia Pemberton, wd Pop.: 346,400 Rad. Hms.: 69,710 Ret. Sls.: \$50,000,000 AP Col.
COLUMBIA								
	WABL (CP)	980 500-D	Southwestern Bcstg. Co. of Miss.		c/o Louis Alford P. O. Box 604 McComb			
	WCJU 1946	1450 250	WC-JU Inc. Hghwy. 24 South 755	MBS, KBS	Lester Williams, p, gm & cm Bill Barrett, pd, nd & sd	Charles Newman, sm & pmm	Ray Tolar, ce B. A. Sharp, fd Pop.: 35,000 Rad. Hms.: 6,500	Wld. AP G
COLUMBUS								
	WACR 1950	1050 250-D	Miss. Bcstg. Co. WACR Bldg. 768		Withers Gavin, p & gm			St. UP
	WCBI 1940	1340 250	Columbus Bcstg. Gilmer Hotel 1313	MBS, Mid-South McGillvra	Birney Imes Jr., p Bob McRaney, gm & pmm	J. W. Eatherton, cm Janice Frantz, pd & wd	Tom McFerrin, ce Dick Crago, sd Pop.: 150,000 Rad. Hms.: 52,000	Thes. AP RCA
	WHER (CP)	1540 10,000-D	J. W. Furr Main & 4th S. 1198		J. W. Furr, p	Hal Benson, gm		
CORINTH								
	WCMA 1946	1230 250	Corinth Bcstg. Co. Ray Bldg. 5575	MBS, Dixie Burn- Smith, Dora- Clayton	Aaron B. Robinson, vp John E. Bell, gm & pmm	Joe P. Van Dyke, cm Vincent Lawrence, pd James D. Anderson, ce	Lenore Reynolds, nd & wd Fred Dillon, sd Pop.: 57,000 Rad. Hms.: 17,500 Ret. Sls.: \$40,000,000	Wld. UP WE
GREENVILLE								
	WGVM 1949	1260 1,000-D	Cottonbelt Bcstg. Corp. of Miss. 118 S. Broadway 4559 Melville	David M. Segal, p Edward M. Guss, gm Jack Stull, cm & pmm	Wallace D. Hoy, pd & nd Wayne McChristian, ce	Gene Harrington, sd Bill Tyler, fd Letitia Boyles, wd Pop.: 436,000	L-W UP Col.
	WJPR 1939	1330 1,000-D 500-N-DA-N	Radio Services Co. 120 S. Poplar 9049	MBS, KBS, Miss. Net. Sears & Ayer	Emmett H. McMurry Sr., p	Emmet H. McMurry Jr., gm	Frank W. Baldwin, cm Tommy Tiller, pd Percy L. Kuhn, ce	Wld. AP G
GREENWOOD								
	WABG 1950	960 1,000-D 500-N-DA-2	Greenwood Bcstg. Co. Inc. Howard St. 3010	ABC	Cy N. Bahakel, p	Tom Reardon, m Andy Graver, cm	Jane Prevost, pd Clifford Greené, ce Pop.: 400,000 Rad. Hms.: 100,000	Wld. AP Col.
	WGRM 1937	1240 250	P. K. Ewing Walnut St. 1900	NBC, KBS	P. K. Ewing, p	F. C. Ewing, gm	Don Neil, cm UP
GRENADE								
	WNAG 1949	1400 250	Birney Imes Jr. Barwin Hotel 1400	MBS, Mid- South McGillvra	Birney Imes Jr., o Robert L. McRaney, gm	Monroe Looney, sm, cm & pmm	Jimmie Pinnix, ce RCA
GULFPORT								
	WGCM 1928	1240 250	WGCM Bcstg. Co. 1110	ABC, KBS Mississippi Rebel Sears & Ayer	Hugh O. Jones, p & gm C. E. Vann, asst. m, pd	(Mrs.) O. L. Owens, cm Walter Trautman, pmm	Charles T. Hook, ce	Wld. AP RCA WE
	WGCM-FM 1948	Ch. 268 (B) 101.5mc 3kw						
HATTIESBURG								
	WFOR 1925	1400 250	Forrest Bcstg. Co. Inc. 302 Hemphill St. Juniper 4-5432	NBC, KBS, Rebel Holling- bery	C. J. Wright Sr., p Charles J. Wright Jr., vp & gm Edwin M. Jenkins, cm	David L. Waite, pd, nd & sd B. B. McLemore, ce	Mrs. B. M. Wright, secy.-treas. Chuck Thompson, fd Cile Waite, wd Pop.: 83,424 Rad. Hms.: 21,050 Ret. Sls.: \$81,650,000 UP
	WRFM(FM) 1949	Ch. 250 (B) 97.9mc 2.5kw	(WFOR, Am Affiliate)				Pop.: 241,397 Ret. Sls.: \$203,870,000 RCA
	WHSY 1948	1230 250	Hub City Bcstg. Hghwy. 11 North Box 1008 Juniper 3-1741	ABC Rambeau	Charles W. Holt, p & gm Robert N. Robinson, cm	Olga Hagler, pmm Charles T. Sharpling, ce	Connie I. Holt, sm William C. Veidt, sd Alice E. Bivin, wd Pop.: 100,000 Rad. Hms.: 25,000 Ret. Sls.: \$103,000,000	AP G

Data corrected to Dec. 10, 1953. If executives or services for FM are same as AM affiliate names are not repeated. Market Data supplied by stations. FM's in *italics*. *—Non-Commercial Station. CP—Construction Permit issued. D—Day. DA—Day. DA-N—Directional Antenna, night only. DA-1—Directional Antenna, same pattern day and night. DA-2—Directional Antenna, different pattern day and night. L—Limited Time with Dominant Station. LS—Local Sunset. N—Night. SA—Special Authorization. SH—Specified Hours. ST—Share Time. Complete key to abbreviations, page 6.

HAZLEHURST

WMDC 1220 Southwestern 1220 KBS Louis Alford, gm Malcolm Jones, pd Jack Stevens, fd Pop.: 60,000
1953 250-D Bcstg. Co. of 869 A. M. Smith, sm & ce pmm & nd Rad. Hms.: 15,000
Miss. Ret. Sis.: \$35,000,000

INDIANOLA

WNLA 1380 Central Delta 1380 W. L. Kent, ptnr. Paul Artman, pd & sd Robert Meador, ce & Pop.: 384,370
1953 500-D Bcstg. Co. John M. McClendon, J. Stuart Hough, pmm nd Rad. Hms.: 76,848
P. O. Box 575 Indianola 500 Chuck Allen, gm & cm Helen Neill Henry, wd Ret. Sis.: \$271,845,000

JACKSON

WJDX 620 Lamar Life 1929 5,000-D NBC, Rebel Fred L. Beard, gm Percy G. Root, ce Forrest Cox, fd Pop.: 1,622,200 Cap., Wld.
WJDT(TV) 1,000-N- DA-N 2-1183 Bcstg. Co. of 2171 Howard Langfitt, pd Woodie Assaf, sd June King, wd Ret. Sis.: \$932,990,000 UP

WJDX-FM Ch. 275 (B) 102.9mc 50kw Withers Gavin, p & gm UP
1948 WE

WJQS 1400 Miss. Bcstg. Co. 1947 250 Edwards Hotel P. O. Box 34 3-9681 James T. Ownby, p & gm Pop.: 250,000
St. UP Rad. Hms.: 45,000 RCA

WJXN 1450 Jackson Bcstg. Co. 1945 250 Forjoe, Radio Ranch Moody & Foley Sts. 2-6673 J. W. Carlier, gm G. G. Benson, ce Percy Powers, sd Pop.: 1,200,000 Assoc.
WRBC 1947 1300 5,000-D MBS Branham 125 S. Lamar St. 5-1562 Bub Leonard, pd & nd Dick Miller, fd Marjorie Lee, wd Rad. Hms.: 295,000 AP
1,000-N Ret. Sis.: \$425,000,000 Ray.

WSLI 930 Standard Life 1938 5,000-DA-N ABC Weed W. R. Newman, p B. K. Smith, pd Lyman Hellums, sd Pop.: 525,700 Wld.
WSLI-TV 5,000-DA-N P. O. Box 1847 F. E. Wilkerson Jr., cm F. M. Files Jr., cont. Jeff Hester, nd Dorothy Dawley, wd Rad. Hms.: 110,841 AP
Ret. Sis.: \$291,352,000 RCA

KOSCIUSKO

WKOZ 1340 Kosciusko Bcstg. Co. 1947 250 P. O. Box 392 782 ABC McGilvra Cy N. Bahakel, p & gm Mims Boswell Jr., cm Wayne A. Oliver, ce Pop.: 108,050 Wld.
Erlene Leach, sm Rad. Hms.: 23,885 AP
Ret. Sis.: \$66,783,000 Ray.

LAUREL

WAML 1340 New Laurel 1932 250 Radio Station Inc. Box 950 5737 NBC, KBS, Rebel Hollingbery Harold M. Matison, p Morris Caver, cm Ed Breland, nd Pop.: 108,050 Wld.
Granville Walters, gm & pmm Stanley Walters, pd & sd Patty Overstreet, wd Rad. Hms.: 23,885 AP
Ret. Sis.: \$66,783,000 Ray.

WLAU 1490 Southland Bcstg. Co. 1946 250 437 N. Magnolia St. 8-7227 ABC, MBS McGilvra Chalmers T. McCallum, p & co-o Teck Jones, cm Hal Harris, sd Pop.: 78,400
Norma H. Leggett, secy.-treas., co-o & gm Dave Kane, pd & nd Carroll Jackson, fd Rad. Hms.: 17,800 UP
Nancy Allen, wd Ret. Sis.: \$44,700,000 WE

LOUISVILLE

WLSM 1270 Louisville Bcstg. Corp. 1953 1,000-D P. O. Box 111 1000 William R. Parkes, sm Herb Guthrie, ce

MACON

WMBC 1400 Miss. Bcstg. Co. 1947 250 Inc. WMBD Bldg. 310 Mississippi Withers Gavin, p & gm

McCOMB

WAPF 1010 Southwestern 1948 1,000-D Bcstg. Co. of 1884 Miss. Hotel Pike 1884 KBS Continental Louis Alford, p Phillip D. Brady, gm Cindy Gardner, pmm James Hemphill, nd Pop.: 154,131 L-W, Wld.
Ollie Bales, cm Leo Freeman, ce Matt Goodall, sd George Mullendore, fd Rad. Hms.: 138,717 UP
Ret. Sis.: \$90,000,000 RCA

WAPF-FM Ch. 261 (A) 100.1mc 27kw Pop.: 121,091 L-W, Wld.
1952 Rad. Hms.: 30,273 UP
Ret. Sis.: \$60,000,000 GE

WSKB 1250 WSKB Inc. 1952 5,000-D 500-N-DA-N 2080 ABC Rambeau, Dora-ClaYton Lester Williams, p Robert Louis Sanders, Bill Tracy, fd Pop.: 305,800 Cap.
Jack H. Sanders, gm ce Rosemary Q. Jackson, wd Rad. Hms.: 75,700 AP
Herbert M. Taylor, pd, pmm & nd Matt Goodall, sd Ret. Sis.: \$158,500,000

MERIDIAN

WCOC 910 Miss. Bcstg. Co. 1928 5,000-D Inc. Threefoot Bldg. 7714 CBS, Mississippi Withers Gavin, p & gm St.
WCOC-TV 1,000-N UP

WMOX 1240 Birney Ines Jr. 1946 250 P. O. Box 1511 2-0171 MBS, Mid-South McGilvra Birney Ines Jr., p Joseph W. Carson, sm Ed Holladay, cm The.
AP
RCA

WTOK 1450 Southern Tv 1946 250 Corp. Southern Bldg. 3-1441 ABC Headley-Reed Robert F. Wright, p & gm William B. Crooks, cm Jerry Joiner, pmm Joe Saxon, ce SES.
INS
WE

NATCHEZ

WMIS 1240 Natchez Bcstg. Co. 1941 250 City Bank Bldg, 8211 NBC, Miss. Net., Louisiana Net. P. K. Ewing, p George Wilson, ce Charles L. Barry, fd Pop.: 350,000
P. K. Ewing Jr., gm & pmm Carleton Adams, nd Irene Griffey, wd

WNAT 1450 Old South Bcstg. Co. 1949 250 Eola Hotel 4621 ABC, Miss. Net. Laurie G. Ratcliffe, p Val Jensen, pd Martin Tyronne, ce Pop.: 350,000
Paul Schilling, gm Lou Garris, pmm & sd Elliott Trimble, nd UP
GE

PASCAGOULA

WPMP 1580 Crest Bcstg. Co. 1951 250-D Inc. P. O. Box 348 83 KBS, Miss. Net. W. R. Guest Jr., p & pmm Floyd W. Hess, sm & Fred Strothers, ce Pop.: 50,000 Wld., Cap.
M. P. Lewis, fd Rad. Hms.: 5,970 UP
WE

PHILADELPHIA

WHOC 1490 William H. Cole 1948 250 P. O. Box 26 740 KBS Continental William H. Cole, o & m Mrs. William H. Cole, Paul M. Miller, ce Rad. Hms.: 5,970 Cap.
UP
Col.

MISSISSIPPI

Table of Mississippi radio stations including columns for City, Call Letters, Chan. or Freq., Power, Licensee Headquarters Telephone, Network Representative, Executive Abbreviations, Market Data, and Library.

Data corrected to Dec. 10, 1953. If executives or services for FM are same as AM affiliate names are not repeated. Market Data supplied by stations.

MISSOURI

MARKET DATA BY COUNTIES

Large table showing Market Data by Counties in Missouri. Columns include County, Population 1950, Radio Families 1953, Retail Sales 1952(000), Food Sales 1952(000), Drug Sales 1952(000), and Automobile Ownership 1952. Includes a summary row for Total and explanatory notes.

Delivery from

The **KMBC** *Team* **KFRM**

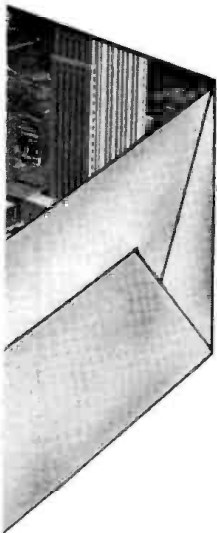

Delivery of the great Kansas City primary trade area by The KMBC-KFRM Team is *not* a special package. It is a regular occurrence—and *has been for years!* Hour after hour, day after day, KMBC-KFRM remains the chief single convenient source of news, sports, special events, farm and women's information, and entertainment for the folks in the Heart of America.

Today, The KMBC-KFRM Team has more listeners than ever before. And nowadays these listeners spend more time with their radio than ever before. That means more impacts for the advertiser – and **MORE SALES.** By the same token, these folks have more buying power – so they buy more often—*again* more sales—an economic evolution which becomes a very delightful cycle for the wise advertiser who places his schedule on The KMBC-KFRM Team.

Regular delivery of the nation's seventeenth market by KMBC-KFRM is accom-

plished through a combination of facilities, know-how, the CBS Radio Network, outstanding local programming with outstanding local personalities, experience and the very finest in administration.

These factors have maintained a consistent leadership for The Team. And, recognition of this leadership is firmly fixed in the minds of hundreds of thousands of loyal listeners in the Kansas City primary trade area. They know that their "regular" delivery from The Team will be a very "special" delivery – every time. So, they buy the products and services advertised on KMBC-KFRM.

The KMBC-KFRM Team has the entire Kansas City primary trade area to offer as a "regular" delivery. Make sure your product or service is in the package. Call, wire or phone KMBC-KFRM, Kansas City, or your nearest Free & Peters colonel today!

KFRM *Team*

KANSAS FARM STATION
HEART OF AMERICA

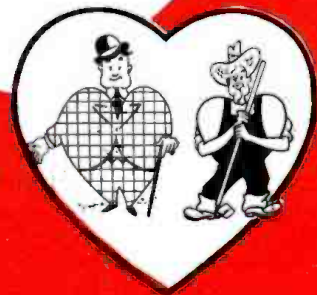

MISSOURI

City Call Letters Established Tv Affiliate	Chan. or Freq. Power	Licensee Headquarters Telephone	Network Represent- ative	Executive Abbreviations Owner o; Pres. p; Exec. up evp; Gen. Mgr. gm; Sta. Mgr. sm; Coml. Mgr. cm; Sales Mgr. sim; Prog. Dir. pd; Chief Eng. ce; Prom. Mgr. pmm; Prod. Mgr. pdm; News, Farm, Sports or Women's Dir. nd, fd, sd, wd.	Market Data For Primary Area (Supplied by station)	Library, News Serv. Transmitter		
FULTON								
KFAL 1950	900 1,000-D	Mo. Central Bcstrs. 5th & Market St. 1400		Robert W. Nickles, ptrn., gm & pmm Roger P. Fox, ptrn., pd, fd & sd	L. Reed Holt, cm Jack Patterson, ce	Brooks Ann Cole, nd Kathryn Lynn, wd	Pop.: 605,300 Rad. Hms.: 186,323 Ret. Sis.: \$462,359,000	St. UP Col.
HANNIBAL								
KHMO 1941	1070 5,000-D 1,000-N- DA-2	Bolling Bcstrg. Co. 410 E. Capitol 102½ S. Main St. 3450	MBS Pearson	James P. Bolling, ptrn. Ada A. Bolling, ptrn. William H. Shaw, gm & cm	Paul E. Harvey, pd Gene Hoenes, pmm A. S. Ben Parrish, ce	Dale Wilson, nd Pat Harvey, fd Lorraine Croft, wd	Pop.: 613,200 Rad. Hms.: 149,060	Thes. AP WE
INDEPENDENCE								
KMO 1947	1510 1,000-D	Craig Siegfried 310 N. Osage Clifton 9815		Wayne J. Hatchett, gm & pmm Don Angel, cm	Mark Foster, pd & nd Robert Atkinson, ce	Bill Hardt, pdm Jim Dallas, fd Eva Thompson, wd	Pop.: 2,500,000	AP G
JEFFERSON CITY								
KLK 1953	950 5,000-D	Empire Bcstrg. Co. 410 E. Capitol 6-3191		Jack Adams, sm Dean Leupke, pd	Ted Porter, ce W. R. Wills, nd	Charles Stookey, fd		
KWOS 1937	1240 250	Capital Bcstrg. Co. 210 Monroe St. 6-3137	MBS, KBS Sears & Ayer	L. R. Goshorn, p Catherine Roer, gm, cm & pmm	Ewald A. Richter, sls. d Ralph L. Rose, pd	Leroy S. Hackmann, ce	Pop.: 200,000 Rad. Hms.: 60,000	Thes. AP
~KWOS-FM 1948	Ch. 253 (A) 98.5mc 9.2kw							Thes. AP Col.
JOPLIN								
KFSB 1948	1310 5,000-D 1,000-N- DA-N	Four States Bcstrs. Inc. 1025 Main 1310 Meeker	Harry Easley, p W. H. Clark, vp, gm & cm	Ed Johnson, pd & pmm Ralfph Meador, ce	Jim Randall, nd Don Cross, sd Leonard Brown, fd	Pop.: 500,000 Rad. Hms.: 119,000 Ret. Sis.: \$250,000,000	Wld. UP G
KSWM 1946	1230 250	Air Time Inc. 1928 W. 13th St. 7280	CBS Rambeau	Austin A. Harrison, p, gm & cm	Ronald Robson, pd & sd	Robert Brown, ce Kenneth Crowe, nd	Pop.: 249,200 Rad. Hms.: 72,500 Ret. Sis.: \$192,000,000 UP G
WMBH 1934	1450 250	Joplin Bcstrg. Co. 6th & Main St. 330	MBS Sears & Ayer	D. J. Poynor, o, p & gm M. E. Dunn, cm	Golda Shaunce, pd Jack P. Langford, ce Lee George, nd	Lou Boda, sd Maxine DeVaney, wd	Pop.: 231,750 Rad. Hms.: 85,000 Ret. Sis.: \$135,000,000 Pop.: 650,000 Rad. Hms.: 217,000 Ret. Sis.: \$375,000,000	Thes. AP Col. Thes. AP Col.
~WMBH-FM 1948	Ch. 241 (B) 96.1mc 70kw							
KANSAS CITY								
KCKN 1925	1340 250	(See Kansas City, Kan., listing)						

Data corrected to Dec. 10, 1953. If executives or services for FM are same as AM affiliate names are not repeated. Market Data supplied by stations. FM's in italic. *—Non-Commercial Station. CP—Construction Permit issued. D—Day. DA-N—Directional Antenna, night only. DA-I—Directional Antenna, same pattern day and night. DA-2—Directional Antenna, different pattern day and night. L—Limited Time with Dominant Station. LS—Local Sunset. N—Night. SA—Special Authorization. SH—Specified Hours. ST—Share Time. Complete key to abbreviations, page 6.

Bull's Eye!

KFAL

FULTON MISSOURI

DAYTIME
SINGLE RATE

TELEPHONE 1400-1401

1000 WATTS
900 KILOCYCLES

**ONE
STATION**
covering
The Rich 4-City

**"Central Mo" Market—Plus the Big 30
County 0.5 Millivolt Primary Area**

- ☆ 186,323 RADIO FAMILIES *
- ☆ \$462,359,000 RETAIL SALES **
- ☆ \$698,285,000 CONSUMER SPENDABLE INCOME ***

* 1953 Sales Management Survey of Buying Power
** SRDS Consumer Markets, 1951-52
*** SRDS Consumer Markets, 1953

BOONVILLE

KWRT 1370 William R. Tedrick William R. Tedrick, p Audrey M. Tedrick, Edna Deskin, wd Pop.: 168,000
 1953 1,000-D #5 Ralph B. Henry, cm & Ted J. Porter, ce, nd Ray Steele, pdm Rad. Hms.: 42,000
 Ret. Sis.: \$125,000.000

CAPE GIRARDEAU

KFVS 960 Hirsch Bcstg. Co. MBS Oscar C. Hirsch, p & Ralph L. Hirsch, cm Dorothy March, pd
 1925 1,000-D 324 Broadway Pearson gm 5-5511 UP
 KFVS-TV 500-N- DA-N
 KGMO 1220 KGMO Radio- KBS William C. Brandt, p, William M. Bryan, ce Robert Schultz, sd Pop.: 102,574
 1952 250-D Television Inc. pd & nd & fd Jim King, sd
 KGMO-TV P. O. Box 63 Richard C. Brandt, gm Edith Snyder, wd Ret. Sis.: \$150,000.000
 5-8228

CARTHAGE

KDMO 1490 Carthage Bcstg. KBS, L. C. McKenney, Leon Crocker, pd George Province, ce Pop.: 188,012
 1947 250 Co. 1201 East Magic, ptrn., gm & fd Robert Young, pmm & Jim King, sd Rad. Hms.: 42,321
 1201 East Chestnut Circle Edith Snyder, wd Edith Snyder, wd Ret. Sis.: \$150,000.000
 2848

CARUTHERSVILLE

KCRV 1370 Pemiscot Bcstg. J. E. Taylor, p Ed Dyer, cm O. V. Bennet, ce Wid., Thes.
 1950 1,000-D Co. 106 W. 3d St. Harry Moreland, pd Jim Brasfield, nd UP
 985 985 Chuck Givens, sd G

CHARLESTON

KCHR 1350 South Mo. Bcstg. KBS Kermit Barker, co-o, Charles W. Hobbs, James L. Byrd III, pd Pop.: 185,824
 1953 500-D Co. 4451 Continental gm, cm & ce co-o Ret. Hms.: 33,000
 Ret. Sis.: \$98,863.000

CHILLICOTHE

KCHI 1010 Cecil W. Roberts KBS Cecil W. Roberts, p Jerry Wilson, cm Donald P. O'Brian, ce
 1950 250-D Farmington, Mo. Best, Howard G. Rion, gm Dick Irving, pmm Virginia Bates, wd UP
 710 Conwell G

CLAYTON

*KFUO 850 The Lutheran Herman H. E. F. Schoenleber, d Larry N. Strahan, Assoc.
 1924 5,000 Church—Mo. Hohenstein, D.D., d of music office m UP
 *KFUO-TV L-KOA Synod The Rev. Elmer J. Knoernschild, pd A. H. Wiese, ce WE
 210 N. Broadway St. Louis, Mo. Chestnut 8001
 KXLW (See St. Louis listing)

CLINTON

KDKD 1280 Clinton Bcstg. KBS David M. Segal, p Don Montgomery, pd Jim Gammon, nd, fd Wid.
 1951 1,000-D Co. Devney Lee E. Baker, gm Dean Clayton, ce & sd UP
 P. O. Box 113 233 Joe Potts, cm & pmm Jerry Moomaw, wd Col.

COLUMBIA

KFRU 1400 KFRU Inc. ABC H. J. Waters Jr., p Felix J. Le Grand, cm Shirley Bauderer, pd Pop.: 115,000 L-W, Wid.
 1925 250 Hwy. 40 at 63 Mahlon R. Aldridge, gm, pmm & sd Robert Haigh, ce AP
 4141 Shirley Mason, wd GE

CONCORDIA

KFRM 550 Midland Bcstg. CBS Arthur B. Church, p Harold W. Storm, John Farmer, nd L-W
 1947 5,000-D Co. Free & George J. Higgins, vp Same Molen, sd AP, UP
 DA-D KMBC Bldg. K.C. Peters & mgng. d Ray Moler, ce Phil Evans, fd RCA
 Harrison 2650 Arthur B. Church Jr., adm. asst. J. Noland Franz, adm. Bea Johnson, wd
 Roderick B. Cupp, pd asst. & comp.

FARMINGTON

KREI 800 Cecil W. Roberts KBS Cecil W. Roberts, p Roy Brewington, cm William Westbrook, ce
 1947 1,000-D 710 Best Earl Whitener, gm UP
 G

FESTUS

KJCF 1010 Jefferson County KBS Donald M. Donze, p & Russell Seals Jr., ce Pop.: 1,000,000
 1951 250-D Radio & Television Co. gm RCA
 P. O. Box 192 North Mill St. Yellowstone UP
 7-3810

FLAT RIVER

KFMO 1240 Lead Belt Bcstg. MBS Oscar C. Hirsch, p Lynn Bohs, pd Gilbert Collins, ce Pop.: 66,722
 1947 250 Co. 1000 Pearson James F. Collins, gm, Virginia Collins, pmm & wd UP
 cm, nd & sd Col.

A "Regular"

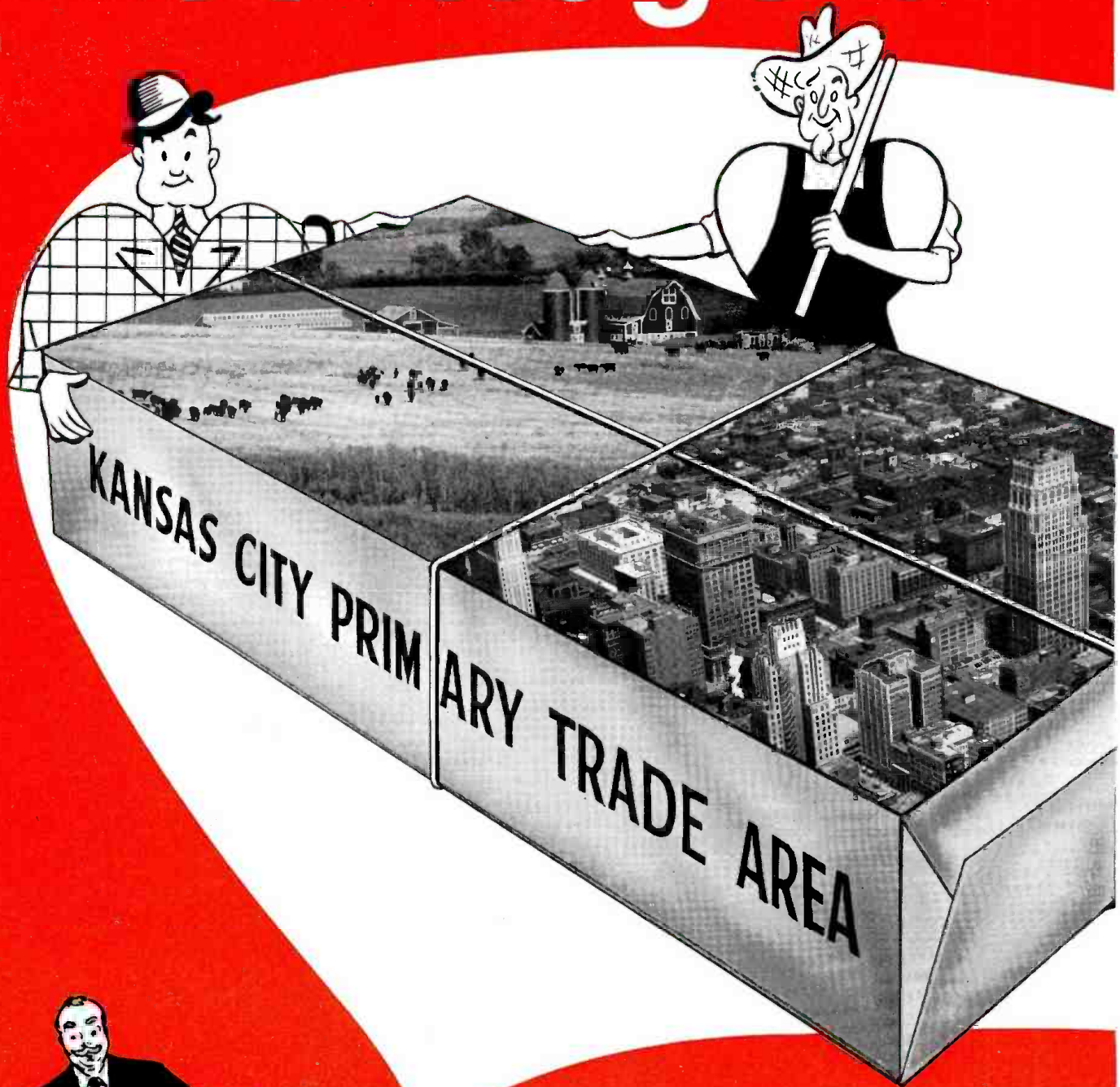

The **KMBC**
of KANSAS CITY
CBS RADIO FOR THE

in St. Louis



it's

FOR SPORTS

.....

CARDINALS BASEBALL
ST. LOUIS U. BASKETBALL
NOTRE DAME FOOTBALL

KXOK

FOR MUSIC

.....

ST. LOUIS BALLROOM
THE STEEPLECHASER
SONG AND DANCE PARADE

KXOK

FOR PERSONALITIES ..

.....

BRUCE BARRINGTON
ED BONNER
HARRY FENDER
MARTHA LANE
FRANCE LAUX

KXOK

and for NEWS

An average of 20 newscasts daily, prepared by the KXOK News Room,
Associated Press and United Press.

Phone your KXOK or John Blair Rep • ST. LOUIS' ABC STATION • 12th and DELMAR, CH 6000
630 KC—5000 WATTS

MISSOURI

City Call Letters Established TV Affiliate	Chan. or Freq. Power	Licensee Headquarters Telephone	Network Represent- ative	Executive Abbreviations Owner o; Pres. p; Exec. up evp; Gen. Mgr. gm; Sta. Mgr. sm; Coml. Mgr. cm; Sales Mgr. slm; Prog. Dir. pd; Chief Eng. ce; Prom. Mgr. pmm; Prod. Mgr. pdm; News, Farm, Sports or Women's Dir. nd, fd, sd, wd.	Market Data For Primary Area (Supplied by station)	Library, News Serv. Transmitter
---	----------------------------	---------------------------------------	--------------------------------	--	---	---------------------------------------

KANSAS CITY (Continued)

MISSOURI

City Call Letters Established TV Affiliate	Chan. or Freq. Power	Licensee Headquarters Telephone	Network Represent- ative	Executive Abbreviations Owner o; Pres. p; Exec. up evp; Gen. Mgr. gm; Sta. Mgr. sm; Coml. Mgr. cm; Sales Mgr. slm; Prog. Dir. pd; Chief Eng. ce; Prom. Mgr. pmm; Prod. Mgr. pdm; News, Farm, Sports or Women's Dir. nd, fd, sd, wd.	Market Data For Primary Area (Supplied by station)	Library, News Serv. Transmitter
---	----------------------------	---------------------------------------	--------------------------------	--	---	---------------------------------------

ROLLA

KTTR 1947	1490 250	"Show-Me" Bcstg. Co.	KBS	Luther W. Martin, cm & nd	Wilson C. Burkhead, nd	Chuck Cunningham, nd	Pop.: 45,000	
--------------	-------------	-------------------------	-----	------------------------------	---------------------------	-------------------------	--------------	--

MISSOURI

MONTANA

City Call Letters Established TV Affiliate	Chan. or Freq. Power	Licensee Headquarters Telephone	Network Represent- ative	Executive Abbreviations Owner o; Pres. p; Exec. up evp; Gen. Mgr. gm; Sta. Mgr. sm; Coml. Mgr. cm; Sales Mgr. slm; Prog. Dir. pd; Chief Eng. ce; Prom. Mgr. pmm; Prod. Mgr. pdm; News, Farm, Sports or Women's Dir. nd, fd, sd, wd.	Market Data For Primary Area (Supplied by station)	Library, News Serv. Transmitter
---	----------------------------	---------------------------------------	--------------------------------	--	---	---------------------------------------

SHELBY

KIYI 1947	1230 250 CP: 1240 250	Tri County Radio Corp. N. Marias Ave. 5541	MBS, KBS Inter- mountain Knoedel, Cooke	John Lyon, p & gm Frank Krshka, cm, pd & sd	George Potter, ce & nd Bob Buckner, fd	Georgia Knickerbocker, wd	Pop.: 25,084 Rad. Hms.: 8,111 Ret. Sis.: \$27,944,000	UP WE
--------------	--------------------------------	---	---	---	--	------------------------------	---	----------

SIDNEY

KGCX 1926	1480 5,000-DA-1	E. E. Krebsbach 109 S. Central Sidney 408	MBS, Great Northern Bestg. Lawson	E. E. Krebsbach p & gm E. Clair Krebsbach, cm	O. H. Halvorson, ce Jim Backlin, nd	Fay Crush, fd Don Cole, sd	Pop.: 60,000 Rad. Hms.: 15,000	Cap. UP RCA
--------------	--------------------	---	---	--	--	-------------------------------	-----------------------------------	-------------------

NEBRASKA

MARKET DATA BY COUNTIES

County	Population 1950	Radio Families 1953	Retail Sales 1952(000)	Food Sales 1952(000)	Drug Sales 1952(000)	Automobile Ownership 1952	County	Population 1950	Radio Families 1953	Retail Sales 1952(000)	Food Sales 1952(000)	Drug Sales 1952(000)	Automobile Ownership 1952
Adams	28,855	9,020	\$44,486	\$6,788	\$1,356	15,324	Keya Paha	2,160	460	1,156	411	21	1,140
Antelope	11,624	3,570	13,226	2,329	244	6,238	Kimball	4,283	1,240	6,922	1,299	176	3,659
Arthur	803		259	73		491	Knox	14,820	4,320	17,252	2,678	484	7,491
Banner	1,325	400	29	9		1,336	Lancaster	119,742	38,570	147,356	24,726	5,114	53,868
Blaine	1,203		790	110		742	Lincoln	27,380	8,650	39,077	8,688	1,036	15,615
Boone	10,721	3,190	10,250	1,656	16	5,393	Logan	1,357	580	630	186	16	856
Box Butte	12,279	3,680	18,631	3,712	335	6,811	Loup	1,348	400	672	120	19	797
Boyd	4,911	950	4,955	1,037	99	2,527	McPherson	825		276	51		12,407
Brown	5,164	1,410	8,861	1,528	177	2,872	Madison	24,338	7,230	41,520	6,793	764	501
Buffalo	25,134	8,040	35,586	6,512	943	13,465	Merrick	8,812	2,830	11,173	1,624	258	5,118
Burt	11,536	3,530	13,170	2,910	355	6,352	Morrill	8,263	2,160	8,993	1,852	307	4,858
Butler	11,432	3,580	9,561	1,890	266	6,642	Nance	6,512	1,960	5,776	1,032	129	3,471
Cass	16,361	5,120	13,813	3,066	437	8,681	Nemaha	10,973	3,300	8,817	2,007	157	5,256
Cedar	13,843	3,810	12,860	2,324	405	6,730	Nuckolls	9,609	2,810	10,867	2,366	314	5,885
Chase	5,176	1,550	7,939	1,462	153	3,330	Otoe	17,056	5,360	18,301	3,499	481	10,682
Cherry	8,397	2,510	12,275	1,786	266	4,904	Pawnee	6,744	2,130	4,429	877	116	3,611
Cheyenne	12,081	4,000	17,870	1,266	458	9,666	Perkins	4,809	1,350	5,844	1,123	148	3,277
Clay	8,700	2,910	6,530	214	142	5,743	Phelps	9,048	2,920	14,977	3,181	339	6,360
Colfax	10,010	3,220	17,048	1,355	279	5,889	Pierce	9,405	2,930	10,081	1,356	226	5,243
Cuming	12,994	3,740	16,778	2,525	378	7,133	Platte	19,910	5,720	27,275	4,805	634	10,944
Dakota	19,170	5,360	18,747	4,031	598	10,343	Folk	8,044	2,440	9,357	1,718	346	5,032
Custer	10,401	3,010	12,220	2,937	315	5,137	Red Willow	12,977	4,100	22,254	3,978	518	7,029
Dawes	9,708	2,760	12,745	2,738	272	5,309	Richardson	16,888	5,420	20,689	3,891	434	8,373
Dawson	19,393	6,110	35,847	5,620	826	12,556	Rock	3,026	950	3,689	586	20	1,798
Deuel	3,330	990	6,034	852	148	2,994	Saline	14,046	4,690	14,061	2,900	317	8,664
Dixon	9,129	2,850	8,629	1,639	196	4,473	Sarpy	15,693	4,580	15,601	1,698	246	9,118
Dodge	26,265	8,670	42,119	8,230	781	15,250	Saunders	16,823	5,450	16,498	4,181	336	10,116
Douglas	281,020	86,710	393,049	79,966	13,137	108,405	Scotts Bluff	33,939	10,040	48,454	9,613	1,142	20,567
Dundy	4,354	1,230	7,139	1,024	51	2,947	Seward	13,155	4,100	12,568	2,967	373	7,825
Fillmore	9,610	3,070	7,038	1,875	306	6,618	Sheridan	9,539	2,700	11,640	2,415	314	5,449
Franklin	7,096	2,300	8,472	1,887	189	3,988	Sherman	6,421	1,790	4,312	1,112	43	3,260
Frontier	5,282	1,430	3,319	509	39	3,070	Sioux	3,124	930	1,778	409	23	2,079
Furnas	9,385	3,180	11,506	2,574	340	5,140	Stanton	6,387	1,870	4,379	934	108	3,702
Gage	28,052	8,540	28,901	6,093	1,005	14,387	Thayer	10,563	3,420	10,328	2,218	290	6,498
Garden	4,114	1,140	3,775	1,018	112	2,621	Thomas	1,206	670	673	171	16	717
Garfield	2,912	850	3,487	628	44	1,601	Thurston	8,590	2,210	7,446	1,111	201	3,769
Gosper	2,734	790	2,121	275	42	1,868	Valley	7,252	2,180	7,130	1,920	203	4,195
Grant	1,057	190	950	260	13	781	Washington	11,511	3,520	11,171	2,867	206	7,163
Greeley	5,575	1,490	5,442	1,015	210	2,610	Wayne	10,129	2,870	10,847	1,852	162	5,404
Hall	32,186	10,280	47,040	9,570	1,163	19,186	Webster	7,395	2,310	6,853	1,511	192	4,236
Hamilton	8,778	2,850	7,823	1,799	149	4,348	York	1,526	440	1,220	123	16	864
Harlan	7,189	2,100	7,489	1,731	140	4,019	York	14,346	4,520	16,361	2,949	406	8,695
Hayes	2,404	780	568	26		1,486							
Hitchcock	5,867	1,830	5,653	855	194	3,730							
Holt	14,859	4,230	17,049	3,126	356	7,622							
Hooker	1,061		1,715	85	15	766							
Howard	7,226	2,190	6,187	1,323	141	4,237							
Jefferson	13,623	4,160	15,073	2,939	391	7,722							
Johnson	7,251	2,340	7,896	1,534	214	4,052							
Kearney	6,409	1,960	10,149	2,568	212	4,348							
Keith	7,449	2,290	11,749	1,795	227	4,718							
Total							1,325,510	406,330	\$1,642,701	\$317,930	\$44,999	619,693	

1 See Keith County 2 See Thomas County. 3 Hooker included in Grant County figures. 4 See Grant County. 5 Arthur included in Keith County figure. 6 McPherson included in Logan County figure. 7 See Logan.

Note: Population 1950 Census; radio families Standard Audit & Measurement Services Inc.; food, drug and retail sales, copyright 1953, Sales Management; further reproduction unlicensed; automobiles supplied by state.

DIRECTORY OF AM AND FM STATIONS

ALLIANCE KCOW 1949	1400 250	Sandhills Bcstrg. Corp. P. O. Box 391 1300	KBS McGillvra	Hans Jaegers, p Gene Ackerley, gm	Erv Jensen, pd George Vogel, ce & sd	Bob Fell, nd Wyletta Mounts, wd	Wld. UP G
BEATRICE KWBE 1949	1450 250	Blue Valley Bcstrg. Co. P. O. Box 567 1245	MBS, Nebraska	Merle G. Jones, p Gordon C. (Bud) Pentz, gm William R. Boyce, slm	Larry Pribyl, pd Marge McGavren, prod. sup. Earl McWilliams, ce	Jim Robinson, news ed. Jerry Granter, sd	Pop.: 138,400 Rad. Hms.: 40,260 Thes., Cole AP WE

GRAND ISLAND

KMMJ 1925	750 1,000 L-WSB	Town & Farm Co. Division at Cedar 703	ABC H-R Reprs.	Don Searle, p Bill Martin, vp & gm Rex Lathen, vp & reg. slm	Ed Meyer, pd Quint McCredie, pmm U. L. Lynch, ce	George Kister, nd & fd Nay Deines, sd Helen Clark, wd		Thes. AP Col.
KRGI 1953	1430 1,000-DA-N	Grand Island Bcstg. Co. 315 South Locust 5181	Sears & Ayer	Robert L. Lester, p Wick Heath, gm	Ray Kozak, cm, pd, & pmm	Don Campbell, ce Lloyd Oliver, fd Alan Stanley, sd	Pop.: 502,000 Rad. Hms.: 150,200 Ret. Sis.: \$581,915,000 AP G

HASTINGS

KHAS 1940	1230 250	Neb. Bcstg. Co. Tribune Bldg. 2-5101	MBS, KBS Gill- Perna	Fred A. Seaton, p James Pickett, gm Raymond Bartlett, cm	Lloyd Thomas, pd, pmm, nd & fd	Duane Allison, ce Bob Morey, sd		Thes. INS RCA
--------------	-------------	--	----------------------------	--	-----------------------------------	------------------------------------	--	---------------------

KEARNEY

KGFW 1930	1340 250	Central Neb. Bcstg. Corp. Federal Annex Bldg. 2-3541	MBS, KBS Holman	John W. Yeager Jr., p & gm Lyle Richardson, cm & sd	Bob Riedy, pd Howard Harrington, ce	Don Sherrill, nd Duane Jensen, fd Esther Sanders, wd	Rad. Hms.: 47,500 Ret. Sis.: \$100,000,000	Wid. UP Col.
--------------	-------------	--	--------------------	--	---	--	---	--------------------

LEXINGTON

KRVN 1950	1010 25,000-D DA	Neb. Rural Radio Inc. 104 West 8th St. 716	Raymer	Jay Person, p Max Brown, gm Dan Bellus, cm & asst. m	G. W. Embree, pd R. J. Bitner, ce Stan Matske, nd	Mike Meyer, fd Jim Price, sd Kay Wilkins, wd		St. AP RCA
--------------	------------------------	---	--------	---	---	--	--	------------------

LINCOLN

KFOR 1924	1240 250	Cornbelt Bcstg. Corp. 48th & Vine 2-6965	ABC, Nebraska Net. Raymer	James Stuart, p & o George T. Bastian, evp Richard W. Chapin, cm	Av Bondarin, pd Ruth Thone, pmm Charles W. Winkler, ce	Ken Wayman, nd Ken Greenwood, sp Hazel Stebbins, wd	Pop.: 329,300 Rad. Hms.: 95,350 Ret. Sis.: \$335,831,000	St., Cap. AP
KLMS 1949	1480 1,000-DA-2	Lincoln Bcstg. Corp. 130 North 16th St. 2-7579	KBS McGillvra	Howard A. Shuman, p J. Russell Joynt, gm	Frank Stubbs, sm Perry Douthit, nd	Carolyn Smith, wd	Pop.: 292,497 Rad. Hms.: 124,750 Ret. Sis.: \$443,136,000	Assoc. UP RCA
KOLN 1947	1400 250	Cornhusker Radio & Tv 40th & W 2-7218	MBS, Nebraska Weed	John E. Fetzer, p Harold E. Anderson, gm Otis H. Seidler, cm	William E. Lucas, pd Emroy Williamson, pmm Raymond Taylor, ce	By Krasne, nd William Morris, fd Bud Shaner, sd Elsie Sanderson, wd	Pop.: 252,400 Rad. Hms.: 78,700 Ret. Sis.: \$254,097,000	Wid. AP WE

McCOOK

KBRL 1947	1450 250	McCook Bcstg. Co. 1450	MBS McGillvra	LeRoy W. Lenwell, p, gm & ce Gil Mitchell, pd	Frank Hamilton, nd Bob Morris, sd	Roseanna S. Stearns, wd	Pop.: 60,000 Rad. Hms.: 15,012 Ret. Sis.: \$48,000,000 AP G
--------------	-------------	------------------------------	------------------	---	--------------------------------------	----------------------------	--	------------------

NORFOLK

WJAG 1922	780 1,000 L-WBBM	Norfolk Daily News 20	Walker	E. F. Huse, p R. E. Thomas, gm Vernon Stedry, cm Glen Hixson, pd	Evans Meier, pmm Frank Wiedenbach, ce M. M. Lee, office m	Wayne Wells, nd & fd Jerry Clark, sd Mary Moore, wd	Pop.: 426,520 Rad. Hms.: 125,680 Ret. Sis.: \$416,696,000	St. AP G
--------------	------------------------	-----------------------------	--------	---	---	---	---	----------------

NORTH PLATTE

KNBR 1952	970 1,000-D DA	John Townsend Box 778 3528	Indie	John Townsend, o Joe Stavis, gm	Mel Krehbiel, cm Jim Rufus, pd	Buford Eaves, ce Phyllis Becker, nd	Pop.: 200,000 Rad. Hms.: 45,000	Thes., SES. UP WE
KODY 1930	1240 250	Radio Station KODY 1521 West 12th St. 382	NBC, KBS Meeker	John Alexander, p & gm Joseph A. diNatale, loc. slm & sd	William A. Wood, pd Jerry Wing, pmm H. Jay Blakesley, ce	Charles H. Craig, nd Edwin H. Launer, fd Vaunia Burbank, wd	Pop.: 220,000 Rad. Hms.: 73,000 Ret. Sis.: \$280,000,000	L-W, Wid. AP

OMAHA

KBON 1942	1490 250	Inland Bcstg. Co. World Ins. Bldg. Jackson 8282	MBS Pearson	Paul R. Fry, p & gm Ernest Priesman, cm James Harker, pd	Richard E. Weina, ce Emory H. Dahlgard, secy.-treas. & bus. m	Dick McCann, nd Ed Morgan, sd Mayme M. Allison, wd	Pop.: 562,000 Rad. Hms.: 139,000 Ret. Sis.: \$573,000,000	Thes. AP WE
KFAB 1924	1110 50,000-DA-N	KFAB Bcstg. Co. 620 Farnam Bldg. Jackson 3420	CBS Free & Peters	Victor L. Toft, p Harry Burke, gm Harold Soderlund, cm	Lyell Bremser, pd & sd Don Shoemaker, pmm	Art Stewart, trans. enrg. Carl Uharik, nd William Macdonald, fd	Pop.: 1,400,000 Rad. Hms.: 409,830 Ret. Sis.: \$1,562,000,000	L-W, SES. AP WH
KOIL 1925	1290 5,000-DA-N	Central States Bcstg. Co. 511 S. 17th St. Jackson 7626	ABC Raymer	Max Brown, gm Mary Schroeder, asst. & pd	Bob Bitner, ce Steve Shepard, sd	Stan Matzke, fd Belle West, wd	Pop.: 985,300 Rad. Hms.: 280,560 Ret. Sis.: \$1,092,836,000	St., Cap. AP, INS RCA

NEBRASKA

City	Call Letters Established	Chan. or Freq. Power	Licensee Headquarters Telephone	Network Representative	Owner o; Pres. p; Exec. vp evp; Gen. Mgr. gm; Sta. Mgr. sm; Coml. Mgr. cm; Sales Mgr. slm; Prog. Dir. pd; Chief Eng. ce; Prom. Mgr. pmm; Prod. Mgr. pdm; News, Farm, Sports or Women's Dir. nd, fd, sd, wd.	Executive Abbreviations	Market Data For Primary Area (Supplied by station)	Library, News Serv. Transmitter	
OMAHA—(Continued)									
KOWH	1922	660 500-D	Mid-Continent Bcstg. Co. Kilpatrick Bldg. Atlantic 2228	Bolling	Robert H. Storz, p Todd Storz, vp & gm Virgil Sharpe, cm & pd	Dale Moudy, ce Jack Sandler, sd Lee Berg, nd	James Milliken, fd Shirley White, wd	Pop.: 800,000 Rad. Hms.: 500,000	L-W AP, UP, INS RCA
WOW	1923	590 5,000	Meredith Inc. Insurance Bldg. Webster 3400	NBC Blair	Fred Bohlen, chmn. of bd. E. T. Meredith Jr., p Payson Hall, vp Frank Fogarty, gm Lyle DeMoss, asst. gm	Bill Wiseman, natl. slm Ken Quaife, loc. reg. slm Ray Olson, pd Merrill Workhoven, pdm	William J. Kotera, ce Keith Royer, pmm James McGaffin, nd Jack Payne, sd Mal Hansen, fd Connie Cook, wd	Rad. Hms.: 389,809	St.. Wid. SES. UP RCA
SCOTTSBLUFF									
KNEB	1948	960 1,000-LS 500-N-DA-2	Platte Valley Bcstg. Co. Golden Rule Bldg. 1620	MBS, Inter-mountain Holman	John R. Jirdon, p Russ M. Stewart, gm Byron R. Joachim, cm	Duke Whitfield, pd Leslie A. Proctor, ce	Jim Kithcart, nd & sd Fred Waigren, fd		Cap.. L-W AP GE
KOLT	1930	1320 5,000-D 1,000-N-DA-2	The Hilliard Co. 1517½ Broadway 856	CBS Gill-Perna	L. L. Hilliard, p & gm T. A. Kehl, cm A. W. Taylor, pd & sd	Walter Amen, pmm H. A. Morrison, ce W. G. Walter, studio m	W. Joseph Brennan, nd R. C. Ingwerson, fd Doris Berry, wd	Pop.: 100,321 Rad. Hms.: 24,872 Ret. Sls.: \$129,000,000 UP G
SIDNEY									
KSID	1952	1340 250	Sidney Bcstg. Co. Legion Park 5503	ABC, KBS, Wyoming Cowboy McGilvra	W. C. Grove, p & ce Max Young, gm & cm Edith Sanks, pd	Chet Allan, pmm Gene Leinemann, nd	Glen Gilbert, sd Lois Hamm, wd	Pop.: 107,016 Rad. Hms.: 29,727 Ret. Sls.: \$133,131,000 UP

Data corrected to Dec. 10, 1953. If executives or services for FM are same as AM affiliate names are not repeated. Market Data supplied by stations. FM's in italic. *—Non-Commercial Station. CP—Construction Permit issued. D—Day. DA-N—Directional Antenna, night only. DA-1—Directional Antenna, same pattern day and night. DA-2—Directional Antenna, different pattern day and night. L—Limited Time with Dominant Station. LS—Local Sunset. N—Night. SA—Special Authorization. SH—Specified Hours. ST—Share Time. Complete key to abbreviations, page 6.

NEVADA

MARKET DATA BY COUNTIES

County	Population 1950	Radio Families 1953	Retail Sales 1952(000)	Food Sales 1952(000)	Drug Sales 1952(000)	Passenger Cars 1953	County	Population 1950	Radio Families 1953	Retail Sales 1952(000)	Food Sales 1952(000)	Drug Sales 1952(000)	Passenger Cars 1953
Churchill	6,161	1,690	\$ 9,238	\$ 1,295	\$ 105	2,707	Ormsby	4,172	1,150	5,267	1,421	355	1,656
Clark	48,289	18,220	80,176	17,288	2,794	29,586	Pershing	3,103	870	3,813	712	53	1,259
Douglas	2,029	480	2,270	320	127	1,386	Storey	671	250	429	133	940	240
Elko	11,654	3,100	15,144	3,046	568	4,194	Washoe	50,205	18,370	90,137	15,539	5,986	23,205
Esmeralda	614	170	152	31	37	153	White Pine	9,425	2,420	9,997	2,628	427	3,726
Eureka	896	*	855	457	37	283	Total	160,083	52,760	\$238,691	\$49,260	\$11,104	94,178
Humboldt	4,838	1,210	6,581	1,671	102	1,702	* See Lander. ** Eureka included in Lander County figures.						
Lander	1,850	**670	1,672	381	84	535	Note: Population 1950 Census; radio families Standard Audit & Measurement Services Inc.; food, drug and retail sales, copyright 1953, Sales Management; further reproduction uncensored; automobiles supplied by state.						
Lincoln	3,837	900	2,472	738	153	1,361							
Lyon	3,679	820	3,284	1,002	112	2,442							
Mineral	5,560	2,000	4,349	1,680	120	3,092							
Nye	3,101	820	2,855	1,098	81	1,766							



First Place . . . For Better Than 2 YEARS!

35.4%
AVERAGE HOOPER

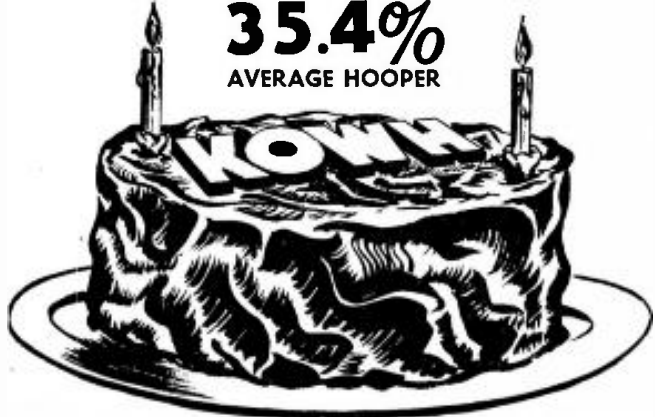

It's a "Happy Hooper" for KOWH advertisers—especially when the Hooper is an average for a 26-month period from October, 1951, to November, 1953. "It takes calls to get results," and KOWH consistently carries your sales message to more people in the Omaha, Council Bluffs area!

- Largest total audience of any Omaha Station, 8 A.M. to 6 P.M. Monday through Saturday! (Hooper, Oct., 1951, thru Nov., 1953)
- Largest share of audience, of any independent station in all America! (Hooper, November, 1953)



O M A H A

"America's Most Listened-to Independent Station"

General Manager, Todd Storz; Represented Nationally By The **STORZ BROS. CO.**



ALWAYS THE SAME

...today, tomorrow
and tomorrow

Stable as the alphabet! Go out today and buy any product of any good manufacturer's brand . . . ask for the same thing tomorrow, or weeks from now . . . match 'em up, and they're uniformly good, or *better*.

This uniformity is no accident. Every manufacturer works hard at it because he knows that only *unfailing goodness* will keep you buying his product. So he's mighty sure never to let quality slip. If he changes his product at all, you can bet it's a change for the better.

This goes for everything from a bobby pin to an automobile — just another reason for staying with your favorite brands for years and years.

For news of the goods that are always good, read the ads in this magazine.

BRAND NAMES FOUNDATION
INCORPORATED

A NON-PROFIT EDUCATIONAL FOUNDATION
37 WEST 57 STREET, NEW YORK 19, N. Y.



WANT UNIFORMITY? PATRONIZE THE DEALER WHO PROVIDES YOUR FAVORITE BRANDS

MISSOURI

City	Call Letters Established TV Affiliate	Chan. or Freq. Power	Licensee Headquarters Telephone	Network Represent- ative	Owner o; Pres. p; Exec. vp evp; Gen. Mgr. gm; Sta. Mgr. sm; Coml. Mgr. cm; Sales Mgr. slm; Prog. Dir. pd; Chief Eng. ce; Prom. Mgr. pmm; Prod. Mgr. pdm; News, Farm, Sports or Women's Dir. nd, fd, sd, wd.	Executive Abbreviations	Market Data For Primary Area (Supplied by station)	Library, News Serv. Transmitter	
ROLLA									
	KTRR 1947	1490 250	"Show-Me" Bcstr. Co. P. O. Box 567 380	KBS	Luther W. Martin, co-o, gm & nd Martin M. Mitchum, co-o & ce	Wilson C. Burkhead, co-o, pmm & fd Marianne Stephens, pd	Chuck Cunningham, sd Roxie M. Rhodes, wd	Pop.: 45,000 Rad. Hms.: 7,300 Ret. Sis.: \$18,200,000 Wid. AP
SALEM									
	KSMO 1953	1340 250	"Show-Me" Bcstr. Co. P. O. Box 71	KBS	Luther W. Martin, co-o & gm Martin M. Mitchum, co-o & ce	Wilson C. Burkhead, co-o & pmm Mel Lee, sm & nd Patsy Whittaker, pd	Ken Wilkins ch. opr. & sd Joe Parker, fd Donna Sullinger, wd	Pop.: 25,000 Rad. Hms.: 4,600 Ret. Sis.: \$9,000,000	
SEDALIA									
	KDRO 1939 KDRO-TV	1490 250	Milton J. Hinlein 2100 W. Broadway 4004	MBS Forjoe	Milton J. Hinlein, p Herbert W. Brandes, gm	James F. Glenn, cm & sd Bob Harvey, pd	Bob Younger, nd Nola Witte, wd	Pop.: 207,726 Rad. Hms.: 43,965 UP RCA
	(CP)	1050 1,000-D	Yates Bcstr. Co. 702 Rich St. Slater, Mo.						
SIKESTON									
	KSIM 1948	1400 250	Sikeston Community Bcstr. Co. Inc. Hwy. 60 W 1	Richard Watkins, gm & cm			Pop.: 65,000 Rad. Hms.: 21,000 AP Col.
STE. GENEVIEVE									
	KSGM 1947	980 500-DA-1	Donze Enterprises Inc 410 Merchant St. 580	KBS	Elmo L. Donze, p, gm, cm, pmm & pd	Murel L. Rose, ce Jim Schott, fd	Betty J. Donze, wd	 UP Col.
ST. JOSEPH									
	KFEQ 1923 KFEQ-TV	680 5,000-DA-2	KFEQ Inc. 8th St. & Frederick Ave. 3-2528	MBS Headley- Reed	Barton Pitts, p & gm J. Ted Branson, cm E. Carleton Schirmer, pd	J. Wesley Koch, ce Ralph E. Combes, nd Robert L. Horstman, sd	Harold J. Schmitz, fd Norma R. Todd, wd	Pop.: 583,900 Rad. Hms.: 179,200 Ret. Sis.: \$495,889,000	Wid. AP Col.
	KRES 1946	1550 5,000-DA-N	Missouri Valley Bcstr. Co. Inc. 7th & Edmond 4-6346 Pearson	Basil L. Kaufmann, p John W. Powell, gm	H. B. Greene, ce Gerry Henson, pdm	Frank Smith, news ed. Earl Hickerson, sd	Pop.: 517,600 Rad. Hms.: 375,190 Ret. Sis.: \$438,250,000	Thes. AP G
ST. LOUIS									
	KMOX 1925	1120 50,000	Columbia Bcstr. System 401 S. 12th Blvd. Central 8240	CBS	Gene Wilkey, gm Robert Hyland, cm Mark Russell, pd	Foster H. Brown, pmm Harry Harvey, ce Rex Davis, nd	Bob Burnes, sd Ted Mangner, fd	Pop.: 3,116,300 Rad. Hms.: 904,550 Ret. Sis.: \$3,071,757,000	Assoc. AP, UP WH
	KSD 1922 KSD-TV	550 5,000-DA-N	The Pulitzer Pub. Co. 1111 Olive St. Main 1111	NBC NBC Spot Sales	Joseph Pulitzer, p George M. Burbach, gm Arthur Casey, slm William A. Knight, cm James D. Neiswander, slm	Harold Grams, pd David Pasternak, pmm J. E. Risk, co-ce Dick J. Kasten, asst. m Tony Glenn, pd Edward B. Bench Jr., ce	Pete Yarger, co-ce Edward W. Hamlin, personnel d	 AP, UP RCA
	KSTL 1948	690 1,000-D CP: 10,000-D DA-D	Radio St. Louis, 8 N. Seventh St. Main 0800	Robert T. Convey, p & co Ray E. Dady, vp V. E. Carmichael, vp John W. Tinnea, asst. sta. d & pd	Fred J. Mueller, merc. m & pmm N. J. Zehr, ce Russell C. Kaiser, prog. coordinator	Dolores J. Ryan, pmm Robert J. Sheehan, nd Dave Dixon, sd		Cap. UP Ray.
	KWK 1927	1380 5,000-DA-N	KWK Inc. 12th & Cole Sts. Main 9100	MBS Katz	Robert T. Convey, p & co Ray E. Dady, vp V. E. Carmichael, vp John W. Tinnea, asst. sta. d & pd	Fred J. Mueller, merc. m & pmm N. J. Zehr, ce Russell C. Kaiser, prog. coordinator	John Traxler, pdm Grace Beck, traffic m Jack Griffin, nd	Pop.: 2,149,508 Rad. Hms.: 640,913 Ret. Sis.: \$2,245,051,000 AP Reuters WE
	KXLW 1947	1320 1,000-D	St. Louis County Bcstr. Co. 2735 Bomparte Sterling 4805 Pearson	John W. Kluge, p Les Ware, gm	Ed Pape, cm Norb Moore, pd	Art Roberts, pmm		L-W AP G
	KXOK 1938	630 5,000 DA-2	KXOK Inc. 12th & Delmar Chestnut 6000	ABC Blair	E. M. Roberts, p C. L. Thomas, gm V. N. Springgate, cm Elmer Muschany, pd	Arthur F. Rekart, ce	Bruce Barrington, asst. m & nd France Laux, sd Martha Lane, wd	Pop.: 3,713,314 Rad. Hms.: 1,121,059 Ret. Sis.: \$3,353,562,000	St. AP, UP WE
	WEW 1921	770 1,000-D	St. Louis Univ. 3642 Lindell Blvd. Franklin 5665 Gill- Perna	Rev. Paul C. Reinert, S.J., p George A. Volz, gm Ray Karpowicz, cm	Lambert Kaiman, pd Charles C. Casey, ce Roy May, nd	Ed Macauley, sd Charley Stookey, fd Louise Munsch, wd	Pop.: 3,243,400 Rad. Hms.: 946,660 Ret. Sis.: \$3,075,382,000	Assoc. UP
	WIL 1922 WIL-TV	1430 5,000-DA-2	Missouri Bcstr. Corp. Chase Hotel Rosedale 6200 Young	L. A. Benson, p, gm & ce R. M. Hetherington, vp in chg. sis.	N. M. Paqliara, natl. slm Edw. M. Galloway, pd Le Chapman, pmm	John Carr, nd Harry Caray, sd Marilyn Rohan, wd	Pop.: 2,150,476 Rad. Hms.: 622,871 Ret. Sis.: \$2,104,174,000	L-W AP G
SPRINGFIELD									
	KGBX 1926	1260 5,000-DA-N	Springfield Bcstr. 605 Boonville 4-2822	NBC Holling- bery	T. W. Duvall, p Keith G. Wells, gm & cm Fran Uhls, pd	Dudley Morris, pmm Richard Bowman, ce Betty Gilmer, bus. office m	Richard Stracke, nd Jerry Davis, sd Don Sylvester, fd Sherlu Walpole, wd	Pop.: 169,490 Rad. Hms.: 161,685 AP
	KICK 1949	1340 250	Kickapoo Prairie Bcstr. Co. 610 College St. 4-1561	MBS McGillvra	Floyd W. Jones, p L. C. McKenney, gm Welcome Stanton, asst. m & pd	Doris Henderson, pmm & wd Charles Grayston, ce	Richard Hairline, nd Bob Lee, sd	Pop.: 144,074 Rad. Hms.: 45,461 Ret. Sis.: \$124,436,000	St. UP G
	KTTS 1942 KTTS-TV	1400 250	Independent Bcstr. Co. P. O. Box 1716 2-7474	CBS Sears & Ayer	J. H. G. Cooper, p G. Pearson Ward, gm & pmm	Wendel Smith, pd William F. Curry, ce	Bill Bowers, nd Jerry Sweaney, sd	Pop.: 245,700 Rad. Hms.: 74,580 Ret. Sis.: \$220,327,000	Wid. AP RCA
	KTTS-FM 1948	Ch. 234 (B) 94.7mc 11.3kw						Pop.: 267,471	
	KWTO 1933	560 5,000-D 1,000-N DA-N	Ozark Bcstr. Co. Inc. 606 St. Louis St. 2-4422	ABC Pearson	Ralph D. Foster, p & gm Leslie L. Kennon, vp & asst. m Raymond M. Keltner, slm	Joe Slattery, pd Bill Bailey, pmm Fritz Bauer, ce George Earle, continuity ed.	Vern Hawkins, nd & sd Loyd Evans, fd Dorothy McDonald, wd	Pop.: 1,411,299 Rad. Hms.: 424,684 Ret. Sis.: \$1,732,530,000	L-W UP RCA

Data corrected to Dec. 10, 1953. If executives or services for FM are same as AM affiliate names are not repeated. Market Data supplied by stations. FM's in italic. *—Non-Commercial Station. CP—Construction Permit issued. D—Day. DA-N—Directional Antenna, night only. DA-I—Directional Antenna, same pattern day and night. DA-2—Directional Antenna, different pattern day and night. L—Limited Time with Dominant Station. LS—Local Sunset. N—Night. SA—Special Authorization. SH—Specified Hours. ST—Share Time. Complete key to abbreviations, page 6.

1,800,260 radio homes!

5,950,100 population!

\$5,839,548,000 annual retail sales!

\$9,398,092,000 effective buying income!

... it's the **BIGGEST** block of
SALES POTENTIAL offered by
any station in the nation's
9th **LARGEST** market . . . and
it's all yours when you use

KSD

THE ST. LOUIS POST-DISPATCH RADIO STATION

... with the **LARGEST** daytime
half-millivolt coverage area of
any radio station in **ST. LOUIS**



5000 WATTS ON 550 KC DAY AND NIGHT

NBC NETWORK • National Advertising Representative: NBC SPOT SALES

MISSOURI

City	Call Letters	Chan. or Freq.	Licenses Headquarters Telephone	Network Representative	Executive Abbreviations Owner o; Pres. p; Exec. vp evp; Gen. Mgr. gm; Sta. Mgr. sm; Coml. Mgr. cm; Sales Mgr. sim; Prog. Dir. pd; Chief Eng. ce; Prom. Mgr. pmm; Prod. Mgr. pdm; News, Farm, Sports or Women's Dir. nd, fd, sd, wd.	Market Data For Primary Area (Supplied by station)	Library, News Serv. Transmitter
THAYER							
KALM	1290		Robert Neathery	Robert Neathery, p		
1953	1,000-D		N. Hgwy. 63			
WARRENSBURG							
KOKO	1450		Clinton Bcstr.	KBS	David M. Segal, p	Lee E. Baker, gm	Lonnie Licata, pd
1953	250		Co. Inc. P. O. Box 395		C. L. Parks, cm	
WARRENTON							
KWRE	730		W. T. Zimmerman	KBS	W. T. Zimmerman, o	Leo Waters, cm	Murray Phillips, nd
1949	500-D		Warrenton 398	Continental	m, gm & pd	Bob Roberts, ce & fd	Merie Zimmerman, wd
							Pop.: 2,000,000 Rad. Hms.: 650,000 Ret. Sls.: \$1,000,000,000
WEST PLAINS							
KWPM	1450		Robert F. Neathery	KBS	Robert F. Neathery, p	John Billingsley, pd	A. Stricklen, sd
1947	250		Abe Taylor Blvd. 700	gm & ce	Orville Barton, nd	
KWPM-FM	Ch. 247 (B)						
1951	97.3mc 3kw				Fritze Williams Dixon, cm		
							Pop.: 45,000
							St. AP G St. AP RCA

MONTANA

MARKET DATA BY COUNTIES

County	Population 1950	Radio Families 1953	Retail Sales 1952(000)	Food Sales 1952(000)	Drug Sales 1952(000)	Passenger Cars 1953	County	Population 1950	Radio Families 1953	Retail Sales 1952(000)	Food Sales 1952(000)	Drug Sales 1952(000)	Passenger Cars 1953
Beaverhead	6,671	2,230	\$ 10,270	\$ 1,997	\$ 162	2,034	Park	11,999	*4,020	16,629	3,687	491	4,134
Big Horn	9,824	2,350	8,974	2,539	206	2,267	Petroleum	1,026	280	627	223	17	289
Blaine	8,516	2,300	6,976	1,603	124	1,877	Phillips	6,334	1,960	6,532	1,331	157	1,802
Broadwater	2,922	850	2,861	647	20	874	Pondera	6,392	1,710	9,488	1,355	262	2,311
Carbon	10,241	3,210	7,840	1,765	241	2,683	Powder River	2,693	970	1,219	325	20	697
Carter	2,798	640	1,968	444	24	624	Powell	6,301	1,740	5,099	1,591	59	2,090
Cascade	53,027	17,880	75,802	15,454	1,464	16,250	Prairie	2,377	770	2,354	561	20	753
Chouteau	6,974	2,230	9,607	1,724	26	2,527	Ravalli	13,101	4,250	10,888	2,635	278	3,493
Custer	12,661	4,280	22,310	3,408	626	3,982	Richland	10,366	3,090	15,663	3,162	369	2,992
Daniels	3,946	1,090	5,436	1,321	172	1,337	Roosevelt	9,590	2,780	16,329	2,834	435	2,963
Dawson	9,092	2,850	14,833	2,253	214	3,387	Rosebud	6,370	1,540	5,510	1,317	159	1,498
Deer Lodge	16,553	4,680	12,091	3,896	178	4,868	Sanders	6,983	2,180	4,321	1,054	157	1,840
Fallon	3,660	960	5,578	1,349	48	1,133	Sheridan	6,674	1,720	9,827	2,007	209	2,174
Fergus	14,015	4,440	17,957	3,950	430	4,267	Silver Bow	48,422	16,890	57,926	15,907	1,283	14,582
Flathead	31,495	10,450	42,105	8,776	1,106	9,680	Stillwater	5,416	1,640	4,939	934	212	1,653
Gallatin	21,902	6,840	27,835	5,527	532	6,891	Sweet Grass	3,621	1,030	4,858	852	25	1,098
Garfield	2,172	720	1,824	610	21	528	Teton	7,232	2,200	10,073	1,657	289	2,386
Glacier	9,645	2,510	11,609	2,807	292	2,381	Toole	6,867	1,920	8,979	1,649	196	2,295
Golden Valley	1,337	400	561	141	39	422	Treasure	1,402	360	1,500	248	38	386
Granite	2,773	930	2,854	788	61	805	Valley	11,353	3,310	10,791	2,166	306	3,154
Hill	14,285	4,400	16,954	3,777	46	4,446	Wheatland	3,197	1,070	3,842	781	21	1,062
Jefferson	4,014	940	2,581	647	93	1,051	Wilboux	1,907	390	1,883	642	20	598
Judith Basin	3,200	850	3,125	542	41	1,188	Yellowstone	55,875	19,530	81,834	15,103	2,274	20,245
Lake	13,835	4,130	11,475	2,934	288	3,404	Yellowstone Nat'l Park	58	**
Lewis & Clark	24,540	8,160	30,295	7,205	730	7,771							
Liberty	2,180	490	2,808	445	21	863							
Lincoln	8,693	2,620	6,855	2,363	209	2,673							
McCone	3,258	870	2,610	461	26	1,121							
Madison	5,998	1,810	3,662	797	148	1,517							
Meagher	2,079	780	1,356	194	17	637							
Mineral	2,081	570	1,884	458	40	826							
Missoula	35,493	11,400	42,336	9,563	1,616	11,357							
Musselshell	5,408	1,840	5,377	1,362	166	1,487							

Total 591,024 186,050 \$711,320 \$153,858 \$16,714 282,578
 * Yellowstone Nat'l Park included in Park County figure.
 ** See Park County.
 Note: Population 1950 Census; radio families Standard Audit & Measurement Services Inc.; food, drug and retail sales, copyright 1953, Sales Management; further reproduction withheld; automobiles supplied by state

DIRECTORY OF AM AND FM STATIONS

ANACONDA							
KANA	1230	Anacnda Bcstr.	A. J. Mosby, p & gm	Helen M. Ryan, pd	T. K. Ryan, sd		L-W
1946	250-D	Co. 136	Gill-Prms E. G. Rinn, cm & ce	A. L. Stewart, ce	John Dziak, nd		UP Ray.
BILLINGS							
KBMY	1240	Billings Bcstr.	MBS,	Rockwood Brown,	Warren Marshall, cm	T. A. Hildebrand, ce	Pop.: 88,600
1946	250	Co. Box 2124 3-3838	Inter- mountain Avery- Knodel	mngng. ptrn. Ken Nybo, gm	Charles G. du Bois, pd & nd	Bob McCann, sd Kay Hines, wd	Cap., Assoc. Rad. Hms.: 28,160 Ret. Sls.: \$107,110,000
KGHL	790	Northwestern	NBC.	Walter E. Schott, p	V. Braunberger, pd	Jeff Kitchii, ce	
1928	5,000-DA-N	Industries Inc. Fifth & N. Broadway 2-2222	Great West- ern Katz	Ed Yocum, gm & cm	Marian Murphy, pmm	Maury White, sd Gertrude Nyberg, wd	
KOOK	970	The Montana	CBS	C. L. Crist, p	Ed Peirs, sd	Vic Miller, pmm	Pop.: 189,420
1951	5,000-DA-N	Network Box 1498 9-5970	Headley- Reed	V. V. Clark, gm Lloyd Larsen, cm	Grant French, ce Cliff Ewing, pd	Don Holen, nd Voss Darby, fd	Thes. AP Rad. Hms.: 47,355 Ret. Sls.: \$167,524,000

Data corrected to Dec. 10, 1953. If executives or services for FM are same as AM affiliate names are not repeated. Market Data supplied by stations.
 FM's in italic. *—Non-Commercial Station. CP—Construction Permit issued. D—Day. DA-N—Directional Antenna, night only. DA-I—Directional Antenna, same pattern day and night. DA-2—Directional Antenna, different pattern day and night. L—Limited Time with Dominant Station. LS—Local Sunset. N—Night. SA—Special Authorization. SH—Specified Hours. ST—Share Time. Complete key to abbreviations, page 6.

BOZEMAN

KBMN 1950	1230 250	Penn Engineering Co. 2105	Gill-Perna	G. Norman Penwell, principal stockholder	Dan Snyder, gm & cm Ed Kolman, ce	Erin Sweeney, nd Larry Binder, sd	Pop.: 48,914 Ret. Sis.: \$47,942,000	Assoc. UP WE
KXLQ 1939	1450 250	KREB Bestrs. P. O. Box 345 1420	NBC, Z- Bar Net. Walker	E. B. Craney, p Ernest A. Neath, gm	Ernest Seccomb, cm Beverley Coulston, pd	Jack Provis, ce		L-W AP, UP RCA

BUTTE

KBOW 1946	1490 250	Copper City Radio Co. 720 Yale Ave. 7429	CBS Cooke	Frank Reardon, p & gm	Bill Carroll, gen. slm Art Collins, pd	Kay McNabb, traffic m Helen Reardon, wd	Pop.: 64,979 Rad. Hms.: 31,323 Ret. Sis.: \$79,883,000	
KOPR 1948 KOPR-TV	550 1,000-DA-N	Copper Bestg. Co. Finlen Hotel 6546	ABC, MBS, Inter- mountain Avery- Knodel	Frank C. Carman, p Ed Cooney, gm	George Chance, cm James Harrold, pd	John Gort, ce		Wid. UP G
KXLF 1929 KXLF-TV	1370 5,000	KGIR, Inc. 2-2344	NBC, Z- Bar Net., Pacific Northwest Walker Moore	E. B. Craney, p Arne E. Anzjon, gm & cm	Paul Hatton, pd & nd Vern Totten, pmm	W. J. Provis, ce	Pop.: 90,732 Rad. Hms.: 27,200 Ret. Sis.: \$107,689,000	Mac., St. AP, UP Hilliard

GLENDAVE

KXGN 1948	1400 250	Lewis Wiles Moore Box 200 122		Lewis Wiles Moore, o Daniel C. Palen, gm	Donald J. Powers, ce Robert Johnson, sd	Alice Lexa, wd		Cap. UP Col.
--------------	-------------	--	--	---	--	----------------	--	--------------------

GREAT FALLS

KFBB 1922 KFBB-TV	1310 5,000-DA-N	Buttrey Broadcast Inc. P. O. Box 1139 4377	CBS Weed	J. P. Wilkins, p & gm W. C. Blanchette, cm	Ray Kelley, pd	Wilbur Myhre, ce		Wid. UP WE
KMON 1948 KMON-TV	560 5,000-DA-N	Mont. Farmer Bestg. Corp. Tribune Bldg. 4382	ABC, MBS, Inter- mountain Avery- Knodel	Lester Cole, p Robert H. Warner, gm	Frank Kaull, cm Mel Hallock, pd & nd	Herb Hunter, sd	Pop.: 400,000 Rad. Hms.: 96,000	L-W AP RCA
KXLK 1947	1400 250	Great Falls Bestg. Co. P. O. Box 2072 2-2453	NBC, Z- Bar Net., Pacific Northwest, Great Western Walker	Barclay Craighead, p T. L. Frayling, gm & cm	Eugene Kukkola, pd & ce	Juanita Loucks, pmm		UP G

HAVRE

KOJM 1947	610 1,000 DA-2	North Mont. Bestg. Co. P. O. Box 70 1096	MBS, KBS, Inter- mountain Avery- Knodel Cooke	O. R. Rubie, p Charlotte H. Brader, gm	Lyle Leeds, cm, nd & sd Jas. Saenger, pd & fd	Stan G. Stephens, pmm George H. Bauer, ce		Cap. UP WE
--------------	----------------------	---	--	--	--	---	--	------------------

HELENA

KCAP 1949	1340 250	Lewis & Clark Bestg. Corp. 1705 Jerome Pl. 4030	MBS, KBS, Inter- mountain Avery- Knodel	Dr. James M. Flinn, p K. O. MacPherson, gm	Charles Sullivan, cm Pat Lee, pd	Dean Mack, ce		Assoc. UP WE
KXLJ 1937	1240 250	The Peoples Forum of the Air Inc. 1306 11th Ave. 1240	NBC, Z- Bar, XL Stations Walker, Moore	A. T. Hibbard, p Barclay Craighead, gm	Gene Hogan, pd Glenn Brese, ce	Harris Jensen, nd George Wenstrum, sd	Pop.: 35,000 Rad. Hms.: 12,830 Ret. Sis.: \$51,896,000	AP, UP RCA

KALISPELL

KGEZ 1927	600 1,000-DA-2	Donald C. Treloar 7 Main St. 4331	MBS, Inter- mountain	Don Treloar, p, gm & cm Norm Fisher, pd	Dick Vick, pmm, nd & sd	Glen Millhouse, fd Jean Fitzwater, wd	Pop.: 110,000 Rad. Hms.: 33,000 Ret. Sis.: \$68,500,000	St., Wid. UP Col.
--------------	-------------------	---	-------------------------------------	---	----------------------------	--	---	-------------------------

LEWISTOWN

KXLO 1947	1230 250	W. G. Kelly East Main St. 1210	MBS, Inter- mountain	W. G. Kelly, o	Marlin T. Obie, gm	David L. Sather, ce	Pop.: 25,000 Rad. Hms.: 8,000 Ret. Sis.: \$13,500,000	Wid. UP WE
--------------	-------------	--------------------------------------	----------------------------	----------------	--------------------	---------------------	---	------------------

LIBBY

KLCB 1950	1230 250	Lincoln Co. Broadcasters Hafferman Shopping Center 410		Oliver G. Coburn, p William F. Hafferman, gm & nd	Pauline B. White, pd Jimmie L. Laughlin, ce & fd	Don Powell, sd Mrs. M. E. Schermerhorn, wd	Pop.: 8,000 Rad. Hms.: 5,200	Mac., SES. UP
--------------	-------------	---	--	---	--	--	---------------------------------	---------------------------

LIVINGSTON

KPRK 1947	1340 250	Yellowstone Amusement Co. Box 691 1000	MBS, Inter- mountain Avery- Knodel	P. B. McAdam, p & gm Jack Hinman, cm	Jim Edmonds, pd & fd Dewey Webb, pmm & sd	Duke Long, ce Nikki Kolence, nd & wd	Pop.: 21,540 Rad. Hms.: 42,045 Ret. Sis.: \$14,500,800	Wid. UP G
--------------	-------------	---	--	--	--	--	--	-----------------

MILES CITY

KRJF 1941	1340 250	Star Printing Co. Box 1015 1340	KBS, MBS, Inter- mountain Avery- Knodel	Ian A. Elliot, gm Fred B. Hunnes, cm Earl L. Dahlstrom, pd Norval B. Davis, pmm	Donald E. Kern, pdm Phillip F. Hilt, ce Annette Smith, traffic d	F. Hunnes Davis, fd Tom Biedrzycki, sd Dorothy Dahlstrom, wd	Pop.: 40,100 Rad. Hms.: 10,969 Ret. Sis.: \$46,756,000	L-W UP RCA
--------------	-------------	--	---	--	---	---	--	------------------

MISSOULA

KGVO 1931 KGVO-TV	1290 5,000 DA-1	Mosby's Inc. Radio Central Bldg. 127 E. Main 2-2155	CBS Gill- Perna	A. J. Mosby, p & gm Earl L. Christensen, cm Don Bradley, pd & pmm	Leo Stewart, ce Don Weston, nd & sd	Bob Peters, fd Barbara Corcoran, wd	Pop.: 118,304 Rad. Hms.: 35,920 Ret. Sis.: \$112,649,000	
	1450 250	Western Mont. Assoc. Box 1503 4-4114	NBC, Pacific Northwest, Z-Bar Net. Walker	Pat M. Goodover, p & gm R. J. Gillis, cm	W. F. Strothman, pd Fred Cunningham, pmm	Rick Lee, ce John Campbell, sd		AP, UP RCA

GRAND ISLAND

KMMJ 1925	750 1,000 L-WSB	Town & Farm Co. Division at Cedar 703	ABC H-R Reps.	Don Searle, p Bill Martin, vp & gm Rex Lathen, vp & reg. slm	Ed Meyer, pd Quint McCredie, pmm U. L. Lynch, ce	George Kister, nd & fd Nay Deines, sd Helen Clark, wd		Thes. AP Col.
KRGI 1953	1430 1,000-DA-N	Grand Island Bcstg. Co. 315 South Locust 5181	Sears & Ayer	Robert L. Lester, p Wick Heath, gm	Ray Kozak, cm, pd, & pmm	Don Campbell, ce Lloyd Oliver, fd Alan Stanley, sd	Pop.: 502,000 Rad. Hms.: 150,200 Ret. Sis.: \$581,915,000 AP G

HASTINGS

KHAS 1940	1230 250	Neb. Bcstg. Co. Tribune Bldg. 2-5101	MBS, KBS Gill- Perna	Fred A. Seaton, p James Pickett, gm Raymond Bartlett, cm	Lloyd Thomas, pd, pmm, nd & fd	Duane Allison, ce Bob Morey, sd		Thes. INS RCA
--------------	-------------	--	----------------------------	--	-----------------------------------	------------------------------------	--	---------------------

KEARNEY

KGFW 1930	1340 250	Central Neb. Bcstg. Corp. Federal Annex Bldg. 2-3541	MBS, KBS Holman	John W. Yeager Jr., p & gm Lyle Richardson, cm & sd	Bob Riedy, pd Howard Harrington, ce	Don Sherrill, nd Duane Jensen, fd Esther Sanders, wd	Rad. Hms.: 47,500 Ret. Sis.: \$100,000,000	Wld. UP Col.
--------------	-------------	--	--------------------	--	---	--	---	--------------------

LEXINGTON

KRVN 1950	1010 25,000-D DA	Neb. Rural Radio Inc. 104 West 8th St. 716 Raymer	Jay Person, p Max Brown, gm Dan Bellus, cm & asst. m	G. W. Embree, pd R. J. Bitner, ce Stan Matske, nd	Mike Meyer, fd Jim Price, sd Kay Wilkins, wd		St. AP RCA
--------------	------------------------	---	-----------------	---	---	--	--	------------------

LINCOLN

KFOR 1924 KFOR-TV	1240 250	Cornbelt Bcstg. Corp. 48th & Vine 2-6965	ABC, Nebraska Net. Raymer	James Stuart, p & o George T. Bastian, evp Richard W. Chapin, cm	Av Bondarin, pd Ruth Thone, pmm Charles W. Winkler, ce	Ken Wayman, nd Ken Greenwood, sp Hazel Stebbins, wd	Pop.: 329,300 Rad. Hms.: 95,350 Ret. Sis.: \$335,831,000	St., Cap. AP
KLMS 1949	1480 1,000-DA-2	Lincoln Bcstg. Corp. 130 North 16th St. 2-7579	KBS McGillvra	Howard A. Shuman, p J. Russell Joynt, gm	Frank Stubbs, sm Perry Douthit, nd	Carolyn Smith, wd	Pop.: 292,497 Rad. Hms.: 124,750 Ret. Sis.: \$443,136,000	Assoc. UP RCA
KOLN 1947 KOLN-TV	1400 250	Cornhusker Radio & Tv 40th & W 2-7218	MBS, Nebraska Weed	John E. Fetzer, p Harold E. Anderson, gm Otis H. Segler, cm	William E. Lucas, pd Emroy Williamson, pmm Raymond Taylor, ce	By Krasne, nd William Morris, fd Bud Shaner, sd Elsie Sanderson, wd	Pop.: 252,400 Rad. Hms.: 78,700 Ret. Sis.: \$254,097,000	Wld. AP WE

McCOOK

KBRL 1947	1450 250	McCook Bcstg. Co. 1450	MBS McGillvra	LeRoy W. Lenwell, p, gm & ce Gil Mitchell, pd	Frank Hamilton, nd Bob Morris, sd	Roseanna S. Stearns, wd	Pop.: 60,000 Rad. Hms.: 15,012 Ret. Sis.: \$48,000,000 AP G
--------------	-------------	------------------------------	------------------	---	--------------------------------------	----------------------------	--	------------------

NORFOLK

WJAG 1922	780 1,000 L-WBBM	Norfolk Daily News 20 Walker	E. F. Huse, p R. E. Thomas, gm Vernon Stedry, cm Glen Hixson, pd	Evans Meier, pmm Frank Wiedenbach, ce M. M. Lee, office m	Wayne Wells, nd & fd Jerry Clark, sd Mary Moore, wd	Pop.: 426,520 Rad. Hms.: 125,680 Ret. Sis.: \$416,696,000	St. AP G
--------------	------------------------	-----------------------------	-----------------	---	---	---	---	----------------

NORTH PLATTE

KNBR 1952	970 1,000-D DA	John Townsend Box 778 3528 Indie	John Townsend, o Joe Stavis, gm	Mel Krehbiel, cm Jim Rufus, pd	Buford Eaves, ce Phyllis Becker, nd	Pop.: 200,000 Rad. Hms.: 45,000	Thes., SES, UP WE
KODY 1930	1240 250	Radio Station KODY 1521 West 12th St. 382	NBC, KBS Meeker	John Alexander, p & gm Joseph A. diNatale, loc. slm & sd	William A. Wood, pd Jerry Wing, pmm H. Jay Blakesley, ce	Charles H. Craig, nd Edwin H. Launer, fd Vaunia Burbank, wd	Pop.: 220,000 Rad. Hms.: 73,000 Ret. Sis.: \$280,000,000	L-W, Wld. AP

OMAHA

KBON 1942	1490 250	Inland Bcstg. Co. World Ins. Bldg. Jackson 8282	MBS Pearson	Paul R. Fry, p & gm Ernest Priesman, cm James Harker, pd	Richard E. Welna, ce Emory H. Dahlgard, secy.-treas. & bus. m	Dick McCann, nd Ed Morgan, sd Mayme M. Allison, wd	Pop.: 562,000 Rad. Hms.: 139,000 Ret. Sis.: \$573,000,000	Thes. AP WE
KFAB 1924	1110 50,000-DA-N	KFAB Bcstg. Co. 620 Farnham Bldg. Jackson 3420	CBS Free & Peters	Victor L. Toft, p Harry Burke, gm Harold Soderlund, cm	Lyell Bremser, pd & sd Don Shoemaker, pmm	Art Stewart, trans. enrg. Carl Uhlarik, nd William Macdonald, fd	Pop.: 1,400,000 Rad. Hms.: 409,830 Ret. Sis.: \$1,562,000,000	L-W, SES, AP WH
KOIL 1925	1290 5,000-DA-N	Central States Bcstg. Co. 511 S. 17th St. Jackson 7626	ABC Raymer	Max Brown, gm Gary Schroeder, asst. & pd	Bob Bitner, ce Steve Shepard, sd	Stan Matzke, fd Belle West, wd	Pop.: 985,300 Rad. Hms.: 260,560 Ret. Sis.: \$1,092,836,000	St., Cap. AP, INS RCA

NEBRASKA

City	Call Letters	Chan. or Freq. Power	Licensee Headquarters Telephone	Network Representative	Owner o; Pres. p; Exec. up evp; Gen. Mgr. gm; Sta. Mgr. sm; Coml. Mgr. cm; Sales Mgr. slm; Prog. Dir. pd; Chief Eng. ce; Prom. Mgr. pmm; Prod. Mgr. pdm; News, Farm, Sports or Women's Dir. nd, fd, sd, wd.	Executive Abbreviations	Market Data For Primary Area (Supplied by station)	Library, News Serv. Transmitter	
OMAHA—(Continued)									
KOWH	1922	660 500-D	Mid-Continent Bcstg. Co. Kilpatrick Bldg. Atlantic 2228	Bolling	Robert H. Storz, p Todd Storz, vp & gm Virgil Sharpe, cm & pd	Dale Moudy, ce Jack Sandler, sd Lee Berg, nd	James Milliken, fd Shirley White, wd	Pop.: 600,000 Rad. Hms.: 500,000	L-W AP, UP INS RCA
WOW	1923	590 5,000	Meredith Inc. Insurance Bldg. Webster 3400	NBC Blair	Fred Bohlen, chmn. of bd. E. T. Meredith Jr., p Payson Hall, vp Frank Fogarty, gm Lyle DeMoss, asst. gm	Bill Wiseman, natl. slm Ken Quaife, loc. reg. slm Ray Olson, pd Merrill Workhoven, pdm	William J. Kotera, ce Keith Royer, pmm James McGaffin, nd Jack Payne, sd Mal Hansen, fd Connie Cook, wd	Rad. Hms.: 389,809	St., Wid., SES, UP RCA
SCOTTSBLUFF									
KNEB	1948	960 1,000-LS 500-N-DA-2	Platte Valley Bcstg. Corp. Golden Rule Bldg.	MBS, Inter-mountain Holman	John R. Jirdon, p Russ M. Stewart, gm Byron R. Joachim, cm	Duke Whitfield, pd Leslie A. Proctor, ce	Jim Kithcart, nd & sd Fred Walgren, fd		Cap., L-W AP GE
KOLT	1930	1320 5,000-D 1,000-N-DA-2	The Hilliard Co. 1517 1/2 Broadway 858	CBS Gill-Perna	L. L. Hilliard, p & gm T. A. Kehl, cm A. W. Taylor, pd & sd	Walter Amen, pmm H. A. Morrison, ce W. G. Walter, studio m	W. Joseph Brennan, nd R. C. Ingwerson, fd Doris Berry, wd	Pop.: 100,321 Rad. Hms.: 24,672 Ret. Sl.: \$129,000,000	UP G
SIDNEY									
KSID	1952	1340 250	Sidney Bcstg. Co. LeKion Park 5503	ABC, KBS, Wyoming Cowboy McGilvra	W. C. Grove, p & ce Max Young, gm & cm Edith Sanks, pd	Chet Allan, pmm Gene Leinemann, nd	Glen Gilbert, sd Lois Hamm, wd	Pop.: 107,018 Rad. Hms.: 29,727 Ret. Sl.: \$133,131,000	UP

Data corrected to Dec. 10, 1953. If executives or services for FM are same as AM affiliate names are not repeated. Market Data supplied by stations. FM's in *italic*. *—Non-Commercial Station. CP—Construction Permit issued. D—Day. DA-N—Directional Antenna, night only. DA-I—Directional Antenna, same pattern day and night. DA-2—Directional Antenna, different pattern day and night. L—Limited Time with Dominant Station. LS—Local Sunset. N—Night. SA—Special Authorization. SH—Specified Hours. ST—Share Time. Complete key to abbreviations, page 6.

NEVADA

MARKET DATA BY COUNTIES

County	Population 1950	Radio Families 1953	Retail Sales 1952(000)	Food Sales 1952(000)	Drug Sales 1952(000)	Passenger Cars 1953	County	Population 1950	Radio Families 1953	Retail Sales 1952(000)	Food Sales 1952(000)	Drug Sales 1952(000)	Passenger Cars 1953
Churchill	6,161	1,690	\$ 9,238	\$ 1,295	\$ 105	2,707	Ormsby	4,172	1,150	5,267	1,421	355	1,656
Clark	48,289	18,220	80,176	17,288	2,794	29,588	Pershing	3,103	870	3,813	712	53	1,259
Douglas	2,029	480	2,270	320	127	1,386	Storey	671	250	429	133		240
Elko	11,654	3,100	15,144	3,046	568	4,194	Washoe	50,205	18,370	90,137	15,539	5,986	23,205
Esmeralda	614	170	152	31		153	White Pine	9,425	2,420	9,997	2,628	427	3,726
Eureka	896		855	457		37	Total	160,083	52,760	\$238,691	\$49,260	\$11,104	94,178
Humboldt	4,838	1,210	6,581	1,671	102	1,702	* See Lander. ** Eureka included in Lander County figures.						
Lander	1,850	*670	1,672	381	84	535	Note: Population 1950 Census; radio families Standard Audit & Measurement Services Inc.; food, drug and retail sales, copyright 1953, Sales Management; further reproduction unlicensed; automobiles supplied by state.						
Lincoln	3,837	900	2,472	738	153	1,361							
Lyon	3,679	820	3,284	1,002	112	2,442							
Mineral	5,560	2,000	4,349	1,680	120	3,092							
Nye	3,101	820	2,855	1,098	81	1,766							



First Place . . . For Better Than 2 YEARS!

35.4%
AVERAGE HOOPER

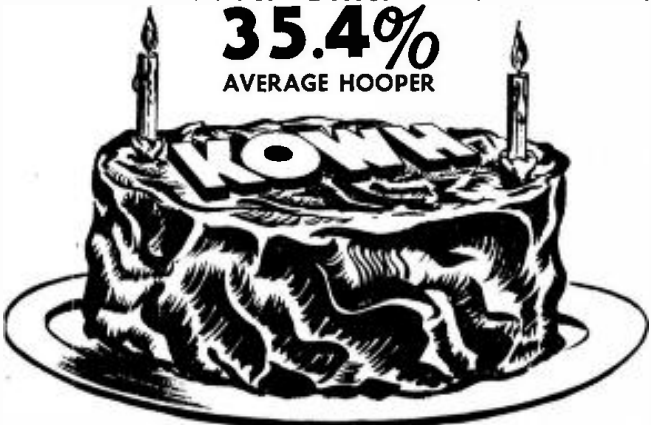

It's a "Happy Hooper" for KOWH advertisers—especially when the Hooper is an average for a 26-month period from October, 1951, to November, 1953. "It takes calls to get results," and KOWH consistently carries your sales message to more people in the Omaha, Council Bluffs area!

- Largest total audience of any Omaha Station, 8 A.M. to 6 P.M. Monday through Saturday! (Hooper, Oct., 1951, thru Nov., 1953)
- Largest share of audience, of any independent station in all America! (Hooper, November, 1953)



Kowh
OMAHA

"America's Most Listened-to Independent Station"

General Manager, Todd Storz; Represented Nationally By The [unclear] CO.

NEVADA

ELKO									
KELK 1948	1240 250	Elko Bcstg. Co. P. O. Box 790 260	MBS, Inter- mountain Avery- Knodel	Chris Sheerin, p John J. Gammick, gm, cm & pmm	Bob Vizina, pd Roy L. Gallagher, ce	Lynn Burns, sd Viola Lynch, traffic d			UP Ray.
ELY									
KELY 1950	1230 250	White Pine Bcstg. Co. P. O. Box 1088 2077		David I. Hansen, co-o Dale V. Bradley, co-o	Frank R. Bradley, nd	E. C. Chamberlain, fd			Wid. INS Col.
HENDERSON									
KBMI (CP)	1400 250	Moritz Zenoff							
LAS VEGAS									
KENO 1940	1460 1,000-DA-N	Nevada Bcstg. Co. The Strip 1400	ABC Grant	Maxwell Kelch, p & gm Tom Magowan, cm	Ken O'Connell, pd & pmm Ralph O. Dow, ce	Ed Oncken, nd Jim Blaine, sd Faith Bristol, wd	Pop.: 55,000 Rad. Hms.: 15,000 Ret. Sis.: \$60,000,000		INS Col.
KENO-FM 1947	Ch. 280 (A) 103.9mc 36kw								
KLAS 1947	1230 250	Las Vegas Bcstg. Inc. Wilbur Clark's Desert Inn 4646	CBS Weed	Fred Stoye, p Tom Ivory, gm Carl Greene, natl. cm Vill Pursel, loc. cm	Jim Hart, pd & nd Flo Brummel, pmm Bill Dawson, ce	Geneva Call, traffic m Chuck Hull, sd Judie Allen, wd	Pop.: 101,300 Rad. Hms.: 30,515 Ret. Sis.: \$87,396,180		St. UP GE
KORK 1951	1340 250	Vegas Valley Bcstg. Co. Hotel Thunderbird 6500	NBC Holling- bery	David McKay, p & gm Roland B. Valle, sm & cm	Robert Baker, pd Bernadine Young, pmm	William W. Binford, ce Tom Lee, sd	Pop.: 63,750 Rad. Hms.: 21,000 Ret. Sis.: \$80,176,000		UP WE
KRAM 1946	920 1,000-D 500-N DA-N	Boulder City Bcstg. Co. P. O. Box 1712 920	MBS, Don Lee, Inter- mountain Avery- Knodel	Truman B. Hinkle, gm Lester Seiffer, cm Martin Black, pd & sd	Pat Healy, pmm & fd Fred Young, ce	Rae Patton, continuity d & wd E. Jansen, nd	Pop.: 63,000 Rad. Hms.: 22,000		Wid. UP Col.
RENO									
KATO 1946	1340 250	Sierra Bcstg. Co. Box 2231 2-4501	MBS Walker	R. L. Stoddard, p & gm	Robert S. Hughes, cm Al Glass, ce	Betty Stoddard, wd	Pop.: 75,000 Rad. Hms.: 21,000 Ret. Sis.: \$90,000,000		Mae, UP GE
KOH 1928	630 5,000-LS 1,000-N- DA-N	McClatchy Bcstg. Co. of Nevada 143 Stevenson St. 3-5106	NBC Raymer	Eleanor McClatchy, p Hugh Kees, m	Bruce Branson, pd Wesley Craig, ce	George Umbenhaur, nd Charles Harris, fd			Cap. UP
KOLO 1946	920 1,000-DA-1	Reno Bcstg. Co. 33 Sierra St. 2-4516	CBS Holling- bery	David McKay, p H. G. Wells, gm Howard Doyle Jr., cm	Dave Niles, pd & nd Gene McKenna, pmm Merle Peterson, ce	Noble Crew, fd Shirley Priess, wd	Pop.: 125,000 Rad. Hms.: 45,000 Ret. Sis.: \$130,000,000		UP UP
KWRN 1947	1230 250	KWRN Inc. Box 76 3-6156	ABC Grant	Franz J. Roblschon, p & gm	W. Leroy Swecker, cm Walter Rees, ce	Don Mitchell, sd Fran Conrad, wd	Pop.: 56,600 Rad. Hms.: 17,690		UP RCA
KNEV(FM) 1953	Ch. 238 (B) 95.3mc 10.5kw	Everett B. Cobb 538 S. Virginia St. 2-5175		Everett G. Cobb, o Jerry Cobb, gm	Wallie Warren, cm John Tellisma, pd	Arthur Seymour, ce			

NEW HAMPSHIRE

MARKET DATA BY COUNTIES

County	Population 1950	Radio Families 1953	Retail Sales 1952(000)	Food Sales 1952(000)	Drug Sales 1952(000)	Automobile Ownership 1952	County	Population 1950	Radio Families 1953	Retail Sales 1952(000)	Food Sales 1952(000)	Drug Sales 1952(000)	Automobile Ownership 1952
Belknap	25,632	7,980	\$ 34,394	\$ 10,529	\$ 870	7,116	Strafford	51,567	14,600	51,068	15,915	1,718	12,384
Carroll	15,868	4,690	16,780	5,942	500	4,980	Sullivan	26,447	7,670	31,884	8,915	626	7,370
Cheshire	38,811	11,500	34,217	11,898	924	10,497	Total	533,242	154,450	\$553,277	\$172,864	\$14,844	181,497
Cos	35,932	9,610	31,849	10,624	870	8,127	Note: Population 1950 Census; radio families Standard Audit & Measurement Services Inc.; food, drug and retail sales, copyright 1953, Sales Management; further reproduction unlicensed; automobiles supplied by state.						
Grafton	47,823	13,080	50,134	14,416	1,878	12,217							
Hillsborough	156,987	46,500	174,405	54,539	3,702	35,989							
Merrimack	63,022	17,470	58,176	16,315	1,987	15,834							
Rockingham	70,059	21,350	70,360	23,771	1,769	20,809							

DIRECTORY OF AM AND FM STATIONS

BERLIN									
WMOU 1946	1230 250	White Mts. Bcstg. Co. 40 Main St. 1797	KBS Kettell- Carter, Radio Reps.	John W. Guider, p Jock MacKenzie, gm, pd & sd	Herschel M. Howe, ce Bob Holland, nd	Myrtle Anderson, wd			L-W AP Ray.
WMOU-FM 1953	Ch. 279 103.7mc 10kw								
CLAREMONT									
WTSV 1948	1230 250	Grandview Inc. 155 Front St. Manchester, N.H. 4-4075		William J. Barkley, p	W. J. Rust Jr., gm	Fred C. Stearns Jr. sm & cm			
WTSV-FM 1948	Ch. 291 106.1mc 4.8kw								

NEW HAMPSHIRE

City	Call Letters Established TV Affiliate	Chan. or Freq. Power	Licensee Headquarters Telephone	Network Represent- ative	Owner o; Pres. p; Exec. op evp; cm; Sales Mgr. sm; Prog. Dir. pd; Chief Eng. ce; Prom. Mgr. pmm; Prod. Mgr. pdm; News, Farm, Sports or Women's Dir. nd, fd, sd, wd.	Executive Abbreviations	Market Data For Primary Area (Supplied by station)	Library, News Serv. Transmitter	
CONCORD									
	WKXL 1946	1450 250	Capitol Bcstg. Co. 110 N. Main St. 4180	CBS Kettell- Carter, Young	Morris Silver, p Thomas F. Frank, gm cm & pd	Robert Wright, ce Donald Tibbets, sd	George Ross, fd Vera K. Tovey, wd	Pop.: 63,500 Rad. Hms.: 17,290 Ret. Sis.: \$71,558,000 AP RCA
HANOVER									
	WTSL 1949	1400 250	WTSL Inc. 4-4075	ABC Granite State Webb, Borgatti	William J. Barkley, p Ralph Gottlieb, gm Henry E. Lewis, sm & cm	Malcomb Morse, pd Al Davis, ce	Helen Ward, wd	
KEENE									
	WKNE 1928 WKNE-TV	1230 5,000-DA-1	WKNE Corp. 17 Dunbar St. 2080	CBS Yankee Meeker, Kettell- Carter	Joseph K. Close, p Frank B. Estes, gm & cm Edward B. Sawyer, pd	Ernest T. Robarge, ce Helen R. Paige, office m Palmer Payne, nd	Donald H. Roberts, sd Stacey Cole, fd Ruth Wade, wd		Wld. AP WH
LACONIA									
	WLNH 1921	1340 250	Northern Bcstg. Corp. 653 Main St. 2300	ABC, KBS Grant, Kettell- Carter	Genevieve Wingate, p Arthur Rothafel, vp & gm	Sydney Clarke, cm Irving Kaizer, pd	Walter Avery, ce	Pop.: 35,000 Rad. Hms.: 8,200 AP G
MANCHESTER									
	WFEA 1932	1370 5,000 DA-1	N. H. Bcstg. Inc. 286 Franklin St. 5-5491	CBS Young, Kettell- Carter	Morris Silver, p	Francis J. Finning, pd	Reginald A. B. Schow, ce		L-W AP RCA
	WKBR 1946	1240 250	Granite State Bcstg. Co. 155 Front St. 4-4075		William J. Barkley, p Ralph Gottlieb, gm	Warren H. Journay, sm	Saul Gross, cm		
	WKBR-FM 1947	Ch. 261 (A) 101.1mc 1kw							
	WMUR 1941 WMUR-TV	610 5,000-D 1,000-N- DA-2	The Radio Voice of N. H. Inc. 1819 Elm St. Manchester 5-5788	CBS Yankee Weed	Francis P. Murphy, p Hervey Carter, gm Gordon Moore, cm Bernie Mack, pd & pmm	Vincent Chandler, ce Tom Power, nd Gerry Henderson, sd	Gus Bernier, fd Esther Ayer, wd	Rad. Hms.: 135,000 Ret. Sis.: \$448,000,000	Wld. UP RCA
NASHUA									
	WOTW 1947	900 1,000-D	Nashua Bcstg. Corp. Lund Road 5000 Walker, Bannan	Arthur A. Newcomb, p & gm Harrison Q. Bauman, cm Aldo Cretarolo, pd & fd	Ed Lecius, pmm, nd & sd Harry H. Handfield, ce	Madaleine M. Hallisey, asst. treas. Nancy J. Taylor, wd	Pop.: 1,459,400 Rad. Hms.: 421,000 Ret. Sis.: \$1,283,770,000	Wld. UP Ray.
	WOTW-FM 1947	Ch. 292 (A) 106.3mc 1kw							
PORTSMOUTH									
	WHEB 1932	750 1,000 L-WSB	WHEB Inc. N. H. Natl. Bank Bldg. 4080	MBS Walker	Charles M. Dale, o, p, cm & pmm	Thomas M. Dale, gm Lucien Dumont, pd	Anthony Vaccaro, senior engr.	Pop.: 1,349,631 Rad. Hms.: 335,346	Wld. AP Col.
ROCHESTER									
	WVNH 1946	930 1,000-D	Strafford Bcstg. Corp. Route 16 1400	Granite State Webb, Borgatti	A. J. Malin, p & gm Howard B. Martin, sm M. Chester Ball, cm	Allan Jasper, pd & fd Frank De Falco, ce	Frank Dixon, nd Martha Mallory, wd	Pop.: 215,164 Rad. Hms.: 63,600 Ret. Sis.: \$194,316,000 UP Col.

Data corrected to Dec. 10, 1953. If executives or services for FM are same as AM affiliate names are not repeated. Market Data supplied by stations. FM's in *italics*. *—Non-Commercial Station. CP—Construction Permit issued. D—Day. DA-N—Directional Antenna, night only. DA-I—Directional Antenna, same pattern day and night. DA-2—Directional Antenna, different pattern day and night. L—Limited Time with Dominant Station. LS—Local Sunset. N—Night. SA—Special Authorization. SH—Specified Hours. ST—Share Time. Complete key to abbreviations, page 6.

**REACH
NEW HAMPSHIRE'S
LARGEST
AUDIENCE
WITH ...**

*The
State
Station*

★ Regularly reaches a DAYTIME audience of 42,537 radio families—in 8 of the 10 N. H. Counties.

★ Regularly reaches a NIGHTTIME audience of 32,894 radio families—in 5 of the 10 N. H. Counties.

★ 50.5% more families DAYTIME and 35.7% more families NIGHTTIME than any other New Hampshire station (1952 SAMS).

75% of the New Hampshire household are within the WMUR coverage area and do 77% of all the buying done in the state.

**STATE OF NEW HAMPSHIRE
Market Data***

Total Families 161,000

Urban, 100,000 — Rural non-farm, 38,000 — Rural farm, 23,000
Radio ownership 98.3%

Total Food Stores	(Approximately) 2100
Total Food Sales	" \$173 Million
Total Drug Stores	(Approximately) 230
Total Drug Sales	" 17 Million
Total Gen. Mdse. Stores	(Approximately) 315
Total Gen. Mdse. Sales	" 37 Million
Total Apparel Stores	(Approximately) 585
Total Apparel Sales	" 37 Million
Total Home Furnishing Stores	(Approximately) 505
Total Home Furnishing Sales	" 30 Million
Total Filling Stations	(Approximately) 860
Total Filling Station Sales	" 32 Million

Total Annual Retail Sales (approximately) \$560 Million

*Based upon the SRDS Market Data Book 1952-1953.

610 KC

BASIC ABC

MANCHESTER

NEW HAMPSHIRE

The Radio Voice of New Hampshire, Inc. ★ Represented nationally by WEED & CO.

WJLK FACT SHEET FOR SPONSORS!

- 1** "WJLK has More Listeners than any other radio station heard in its area."
- 2** "WJLK has Largest Average Radio Audience of all radio stations heard in this area."
- 3** "Nine out of Ten families in this area listen to WJLK; Five out of Ten Regularly."
- 4** "WJLK reaches 137,000 persons and reaches 77,000 Four or More Days Each Week."
- 5** Facts established by ADVERTEST RESEARCH through 11,369 interviews in 1953.

Local Hourly News
Fine Public Service

WJLK

Asbury Park,
New Jersey

Radio Voice of the
Asbury Park Press

THE ONLY RADIO STATION IN THE GROWING NORTH JERSEY SHORE AREA

NEW JERSEY

MARKET DATA BY COUNTIES

County	Population 1950	Radio Families 1953	Retail Sales 1952(000)	Food Sales 1952(000)	Drug Sales 1952(000)	Automobile Ownership 1952	County	Population 1950	Radio Families 1953	Retail Sales 1952(000)	Food Sales 1952(000)	Drug Sales 1952(000)	Automobile Ownership 1952
Atlantic	132,399	42,210	\$ 212,874	\$ 54,444	\$ 6,641	42,933	Morris	164,371	49,250	179,840	58,511	4,445	64,176
Bergen	539,139	176,180	527,966	180,575	13,367	217,813	Ocean	55,622	20,140	109,781	30,323	2,822	28,788
Burlington	135,910	36,860	120,157	36,095	2,758	46,795	Passaic	337,093	106,950	446,212	113,789	8,590	122,928
Camden	300,743	91,710	321,058	95,778	6,849	105,037	Salem	48,508	15,090	48,890	14,160	1,053	21,152
Cape May	37,131	12,670	61,961	19,353	1,334	16,883	Somerset	99,052	29,350	104,223	31,293	2,345	40,108
Cumberland	88,597	27,170	108,097	29,184	2,047	42,416	Sussex	34,423	10,600	38,453	11,629	600	17,403
Essex	905,949	273,020	1,198,218	312,713	31,677	315,076	Union	398,138	123,260	472,975	142,495	11,595	164,172
Gloucester	91,727	28,640	76,229	23,682	1,906	35,456	Warren	54,374	16,840	55,304	15,141	688	24,290
Hudson	647,437	196,610	603,904	202,135	15,914	166,056	Total	4,835,329	1,485,630	\$5,656,555	\$1,642,662	\$136,866	1,746,068
Hunterdon	42,736	13,470	52,102	12,696	920	21,526	Note: Population 1950 Census; radio families Standard Audit & Measurement Services Inc.; food, drug and retail sales, copyright 1953, Sales Management; further reproduction unlicensed; automobiles supplied by state.						
Mercer	229,781	64,260	302,804	74,875	6,292	78,895							
Middlesex	264,872	79,360	298,062	90,422	6,507	88,302							
Monmouth	225,327	71,980	317,445	92,169	8,316	98,742							

DIRECTORY OF AM AND FM STATIONS

ALPINE														
WFMN (FM) 1943	Ch. 226 (B)	Edwin H. Armstrong	Dr. Edwin H. Armstrong, o											
	93.1mc	Armstrong												
	6kw	Closter 5-1088												
ASBURY PARK														
WJLK 1926	1310 250	Asbury Park Press Inc. Press Plaza 2-3000	Wayne D. McMurray, p	MarKaret Curtis, cm & wd	Frank Huber, pd	Thomas Birkhead, nd	Frank L. Wilgus, sd	Pop.: 150,592	Rad. Hms.: 45,222	Ret. Sis.: \$300,000,000	Assoc. AP RCA			
WJLK-FM 1947	Ch. 252 (A)	94.3mc 1kw	Everett Rudloff, sm	Charles F. Hill, pd									Assoc. AP GE	
ATLANTIC CITY														
WFGP 1942	1450 250	Neptune Bcstg. Corp. Steel Pier	CBS Pearson	Fred Weber, p	Russell Truex, cm	Edward Davis, pd	Jessie Morris, pmm	Earl Godfrey, ce	Blair Thron, o pers. d					UP RCA
WMID 1947	1340	Mid-Atlantic Bcstg. Co. Senator Hotel 4-1340	ABC, MBS ForJoe	Richard Endicott, p	David H. Freedman, g & cm	Vincent Lindner, pd	Stan Howard Dixon, n & fd	Ralph Glenn, sd	Mildred Freeland, wd					Assoc. AP RCA
WOND 1950		(See Pleasantville, N. J. listing)												

In Atlantic City

WOND
now has the
largest share
of audience in
Atlantic County
(Advertest, Aug. 1953)

The
WONDERful
MUSIC STATION

Brings Sensational Results

John Struckell, General Manager

... Seashore Radio at its Best ...

NEWS EVERY HOUR

GOOD

MUSIC AND SPORTS

NEW JERSEY

City Call Letters Established TV Affiliate	Chan. or Freq. Power	Licenses Headquarters Telephone	Network Represent- ative	Executive Abbreviations Owner o; Pres. p; Exec. up evp; Gen. Mgr. gm; Sta. Mgr. sm; Coml. Mgr. cm; Sales Mgr. slm; Prog. Dir. pd; Chief Eng. ce; Prom. Mgr. pmm; Prod. Mgr. pdm; News, Farm, Sports or Women's Dir. nd, fd, sd, wd.	Market Data For Primary Area (Supplied by station)	Library, News Serv. Transmitter	
BRIDGETON							
WSNJ 1937	1240 250	Eastern States Bcstg. Corp. Carl's Corner 2930	Good Music Clark	Russell S. Henderson, p Paul Alger, evp & gm	Joseph A. McCulley Jr., pd Al Simms, pmm	Edward Bold, ce Don Hart, nd & fd Jerry Aiden, sd Louise Henderson, wd	Pop.: 141,000 Thes. UP Rad. Hms.: 38,770 Ret. Sis.: \$143,803,000 RCA
WSNJ-FM 1946	Ch. 299 (B) 98.9mc 9kw						Pop.: 5,000,000 Rad. Hms.: 500,000 Ret. Sis.: \$4,795,068,000
CAMDEN							
WCAM 1926	1310 250	City of Camden City Hall Emerson 5-5600	Willard C. Schriver, d John Cleary, gm & cm	Jack LaMar, pd John Zander, ce Lou Elliott, nd	Sam Scott, sd Theresa Skolski, wd	Pop.: 2,762,635 St. UP Rad. Hms.: 749,567 Ret. Sis.: \$2,843,380,000 RCA
WKDN 1948	800 1,000-D	S. J. Bcstg. Co. 2881 Mt. Ephraim State Ave. Emerson 5-7200	Garden State Keller	Ranulf Compton, p Gordon Giffen, gm	Harvey Husten, pd Robert S. Houston, ce	Robert Ross, nd	Pop.: 2,634,011 Assoc. Rad. Hms.: 720,780 Ret. Sis.: \$2,870,330 AP Ray.
MILLVILLE							
WMLV (CP)	1440 1,000-D DA	Union Lake Bcstrs. Inc. c/o Harry Daly 613 15th St., N.W. Washington, D. C.					
MORRISTOWN							
WMTR 1948	1250 1,000-D	Morristown Bcstg. Corp. P. O. Box 345 Park Square Mo. 4-5700	ABC	George S. Croy, p Kenneth A. Croy, gm Henry A. Behre, cm Bob Vesel, pd	Rudolph C. Prow, ce Merrill S. Morris, nd & fd	Ned Ehlers, sd Mary Bradley, wd	Assoc. AP Ray.
NEWARK							
WAAT 1926	970 5,000-D	Bremer Bcstg. Corp. 1020 Broad St. Mitchell 2-6400	New Jersey State Net. Weed	Irving R. Rosenhaus, p & gm Edmund S. Lennon, vp & sls. d Frank V. Bremer, enrg. vp	George Green, pd Lou Frankel, prom. d Edward Reeves, engr. in charge of am opers.	Robert B. Macdougall, pub. rel. d Herb Green, nd Fred Sayles, sd	Pop.: 3,977,350 Rad. Hms.: 1,195,600 Ret. Sis.: \$4,341,577,750 AP Col.
WAAT-FM 1947	Ch. 234 (A) 94.7mc 13.5kw						Assoc., SES. AP Col.

Data corrected to Dec. 10, 1953. If executives or services for FM are same as AM affiliate names are not repeated. Market Data supplied by stations. FM's in *italic*. *—Non-Commercial Station. CP—Construction Permit issued. D—Day. DA—Day. DA-N—Directional Antenna, night only. DA-1—Directional Antenna, same pattern day and night. DA-2—Directional Antenna, different pattern day and night. L—Limited Time with Dominant Station. LS—Local Sunset. N—Night. SA—Special Authorization. SH—Specified Hours. ST—Share Time. Complete key to abbreviations, page 6.

WNJR IS THE ONLY ALL NEGRO STATION

IN AMERICA'S LARGEST NEGRO MARKET



- Complete Negro programming every minute day and night
- All big name Negro talent
- Complete merchandising service
- Two special women's programs daily
- Negro Sports show nightly
- 11 of the nation's top Negro disc jockeys
- Covering All New York, Brooklyn and New Jersey

New Jersey and New York's

NEGRO Station

5000 WATTS 1430 KC

NEWARK

WNJR

NEW JERSEY

WHBI 1922	1280 2,500-D 1,000-N ST-WOV	May Radio Bcstg. 100 Shipman St. Mitchell 2-7354	James L. Shearer, p William A. Masi, gm	Marie E. Masi, pd Harold Michaels, ce	Thelma Taylor, wd	Pop.: 21,996,000 Rad. Hms.: 3,500,000 WE
WNJR 1947	1430 5,000-DA-N	Rollins Bcstg. Co. Route 22 Market 3-2700	Albert R. Lantheart, gm				St. UP RCA
WYNJ 1948	620 5,000-DA-2	Newark Bcstg. Corp. 91 Halsey St. Mitchell 3-7600	Edward W. Scudder Jr., p	Harry D. Goodwin, gm Ivon B. Newman, cm Steven Van Gluck, pd	James R. Ryall, pmm Peter Testan, ce		Wid. UP Fed.
NEW BRUNSWICK							
WCTC 1946	1450 250	Chanticleer Bcstg. Co. 385 George St. Charter 7-1450	James L. Howe, p Robert L. Williams, gm	James M. Vogdes Jr., cm Barbara M. Bauer, pd	Victor Takach, ce Anthony V. Marano, nd	Pop.: 371,000 Rad. Hms.: 98,120 Ret. Sls.: \$359,585,000	Wid. AP RCA
WCTC-FM 1948	Ch. 252 (A) 98.3mc 1kw						L-W AP Col.
NEWTON							
WNNJ 1953	1360 500-D	Sussex County Bcstrs. Andover Township	William Fairclough, gm	Simon Geller, cm & ce	Robert Mensel, pd & pmm	Pop.: 35,000 Rad. Hms.: 9,787 Ret. Sls.: \$48,453,000	
PATERSON							
WPAT 1941	930 5,000-DA-2	N. J. Bcstg. Co. 66 Hamilton St. Armory 4-3400	D. J. Wright, gm Charles W. Parker, bus. m	Charles Scully, opers. d	Earl Lucas, ce		L-W Assoc., Thes., SES, AP, UP Fed.
PLEASANTVILLE							
WOND 1950	1400 250	Pioneer Bcstrs. Inc. Old Turnpike 3971	Charles E. Rupp, p John G. Struckell, gm & pd Lawrence Carle, pmm	Milton C. Thurlow, Jr., ce George Lewis, nd Tom McCarthy, sd	Ned French, fd Peggy Jayne Lucca, wd	Pop.: 140,034 Rad. Hms.: 45,170	St. Thes. AP GE
TRENTON							
WBUD 1947	1260 1,000-DA-1	Morrisville Bcstg. 108-14 N. Broad St. 4-7191	Verna S. Hardin, p Richard M. Hardin, gm	William Garry, cm W. F. Hildenbrand, pd W. A. Brewer, ce	Nan Rednor, pmm & wd Chas. Fairchild, nd Bus Saidt, sd		Wid. AP G
WTNJ 1923	1300 250-D	WOAX Inc. 416 Bellevue Ave. Trenton 3-4281	William R. DeFreitas, p Erling C. Olsen, treas. Leonard H. Levitt, gm Jerome P. McCarthy, m	Charles Green, pd Nicholas Delasandro, ce Ralph Ridge, sd Paul Fireman, ce	Pearl Stevens, wd	Pop.: 233,200 Rad. Hms.: 58,120 Ret. Sls.: \$285,291,000	
WTOA(FM) 1949	Ch. 248 (B) 97.5mc 14.5kw	Mercer Bcstg. Co. 553 Ingham Ave. 5-8541			Don Clifton, sd		Assoc., St. UP GE
WTTM 1942 WTTM-TV	920 1,000-DA-1	Peoples Bcstg. NBC, Corp. Garden State 541 E. State St. 5-8515 Forjoe	Murray Lincoln, p Herbert E. Evans, vp Fred L. Bernstein, gm Gerhard Joseph, comp. Harry Barnam, loc. slm	Wesley Hopkins, pd & fd Fred E. Walker, pmm Chester Sunderland, co-ce	Theodore Kilmer, co-ce Arnold Snyder, nd & sp. events d Fulton Arnold, sd Bea Kirby, wd	Pop.: 1,060,250 Rad. Hms.: 295,205 Ret. Sls.: \$1,176,493,000	Thes. AP RCA
VINELAND							
WWEZ 1946	1360 1,000-DA-N	Community Bcstg. Service 633 Wood St. Vineland 7-1360	Joseph M. Bullock, p Fred M. Wood, gm, pmm & fd	John Serra, cm Dorothy H. Carlson, pd	Saul Aitzman, ce Milt Stevens, sd	Pop.: 269,200 Rad. Hms.: 78,400 Ret. Sls.: \$249,940,000	Wid. UP Col.
WILDWOOD							
WCMC 1951	1230 100	Francis J. Matrangola Spicer & Susquehanna 2-7751	Francis J. Matrangola, o & gm George M. Hart, cm & pd	Carlton S. Owen, ce Charles V. Mathis, nd	Nick Virgillo, sd Margaret Murphy, wd	Pop.: 133,585 Rad. Hms.: 38,254	Cap. AP G
ZAREPHATH							
*WAWZ 1931	1380 5,000-DA-2 ST-WBNX	Pillar of Fire Inc. Bound Brook 9-0102	Arthur K. White, p & gm	Donald J. Wolfram, pd	Nathaniel L. Wilson, ce	
*WAWZ-FM (CP)	Ch. 256(B) 99.1mc 4.8kw						

YOU CAN'T COVER CENTRAL NEW JERSEY WITHOUT WCTC!

REACHING 371,000 PEOPLE* IN A 359 MILLION & DOLLAR MARKET*

STRONG LOCAL NEWS

NEW BRUNSWICK, NEW JERSEY
(*1952-3 Consumer Markets)

WCTC

LISTENABLE MUSIC

"Mighty Mike"

PHONE CHARTER 7-1450

MARKET DATA BY COUNTIES

County	Population 1950	Radio Families 1953	Retail Sales 1952(000)	Food Sales 1952(000)	Drug Sales 1952(000)	Automobile Ownership 1953	County	Population 1950	Radio Families 1953	Retail Sales 1952(000)	Food Sales 1952(000)	Drug Sales 1952(000)	Automobile Ownership 1953
Bernalillo	145,673	43,750	\$179,020	\$ 38,021	\$ 5,437	60,029	Quay	13,971	3,860	18,266	3,950	804	5,724
Catron	3,533	650	1,264	523		1,052	Rio Arriba	24,997	4,210	8,889	2,687	307	4,653
Chaves	40,605	11,830	50,146	10,019	1,630	18,178	Roosevelt	16,409	4,640	16,433	3,652	681	6,417
Colfax	18,761	3,830	15,118	2,995	437	5,673	Sandoval	12,438	1,550	2,591	610	80	9,339
Curry	23,351	7,360	31,874	5,584	924	11,190	San Juan	18,292	2,840	10,901	1,689	360	5,073
De Baca	3,464	910	4,372	711	181	977	San Miguel	26,512	4,610	14,684	3,938	527	2,624
Dona Ana	39,557	9,250	30,906	7,022	789	10,553	Santa Fe	38,153	9,230	40,628	7,507	1,789	20,352
Eddy	40,640	12,280	50,385	12,138	2,075	19,490	Sierra	7,186	2,240	7,479	1,711	381	6,972
Grant	21,649	5,460	19,832	4,539	564	8,040	Socorro	9,670	2,020	4,684	1,022	221	2,683
Guadalupe	6,772	1,180	4,581	1,441	190	2,425	Taos	17,146	2,320	6,729	2,331	247	2,966
Harding	3,013	480	1,850	186	52	1,160	Torrance	8,012	1,530	4,196	774	140	2,402
Hidalgo	5,095	1,150	5,624	895	85	2,188	Union	7,372	1,880	7,647	1,494	163	4,158
Lea	30,717	9,660	42,525	8,046	1,070	23,461	Valencia	22,461	4,390	12,712	3,078	518	8,111
Lincoln	7,409	1,540	5,191	1,211	171	2,826	Total	681,187	168,830	\$644,927	\$139,765	\$21,740	271,848
Los Alamos	10,476	3,470	6,272	2,982	956	3,970	Note: Population 1950 Census; radio families Standard Audit & Measurement Services Inc.; food, drug and retail sales, copyright 1953, Sales Management; further reproduction unlicensed; automobiles supplied by state.						
Luna	8,753	2,210	8,857	2,279	241	3,893							
McKinley	27,451	3,550	18,941	3,208	259	6,401							
Mora	8,720	1,280	1,959	517	87	1,274							
Otero	14,909	3,670	10,368	3,005	414	5,771							

DIRECTORY OF AM AND FM STATIONS

City	Call Letters	Chan. or Freq.	Power	Licensee Headquarters Telephone	Network Representative	Owner o; Pres. p; Exec. vp; Gen. Mgr. gm; Sta. Mgr. sm; Coml. Mgr. cm; Sales Mgr. sim; Prog. Dir. pd; Chief Eng. ce; Prom. Mgr. pmm; Prod. Mgr. pdm; News, Farm, Sports or Women's Dir. nd, fd, sd, wd.	Executive Abbreviations	Market Data For Primary Area (Supplied by station)	Library, News Serv. Transmitter	
ALAMOGORDO										
KALG	1230	250	1950	William Wayne Phelps Box 268 211	MBS, KBS, Inter-mountain	William Wayne Phelps, p, gm & nd	Bob Hoffman, cm, pmm & sd	Ron Johnson, pd Harry Albers, ce Charmin Harris, wd	Pop.: 36,000 Rad. Hms.: 9,280 Ret. Sis.: \$14,000,000	Thes. UP G
ALBUQUERQUE										
KABQ	1340	250	1947	KABQ Bcstg. Co. 317 Broadway N. E. 3-1744	MBS, Inter-mountain R. O'Connell	Helen A. Price, p Bert Arnold, vp, gm & cm Don Husted, pd	John Morrison, ce Lowell Christison, nd	Gene Osborn, sd Pat Connolly, wd	Pop.: 153,800 Rad. Hms.: 41,610 Ret. Sis.: \$141,940,000	Thes. AP G
KDEF	1280	1,000-D	1953	Frank Quinn 506 2d NW 3-7813	Frank Quinn, p & gm Lee Govan, cm	Jerry Nesler, pd Bill Prevetti, pmm	Bob Easley, ce	Pop.: 190,000	
KGGM	610	5,000-DA-N	1927	N. Mex. Bcstg. Co. 1414 Coal Ave. S. W. 3-4543	CBS Weed	A. R. Hebenstreit, p & gm J. Graff, cm	Vergie Abeyta, traffic m & wd Bob Van Driel, pmm	Leonard Dodds, ce Dick Colman, nd	Pop.: 579,000 Rad. Hms.: 76,495 Ret. Sis.: \$320,000,000	Wld. AP, UP RCA
KOAT	1240	250	1946	Alvarado Bcstg. Co. 122 7/2 Tulane Dr. SE 5-7501	ABC Rambeau	Herbert Wimberly, p A. M. Cadwell, vp & gm Richard Gregory, cm	Kenneth Ferril, pd & sd Donald Delaney, ce	William H. Carman, sup. e Phil Eakins, sd Virginia Sears, wd		Assoc., L-W UP Ray
KOB	770	50,000-D	1920	Albuquerque Bcstg. Co. 234 5th St. S.W. 3-4411	NBC Branham	Wayne Coy, p & gm J. I. Meyerson, sm Rolf S. Nielsen, cm Michael Dillon, pd	Bill Mickel, pmm George S. Johnson, ce Lanita Leaverton, traffic m	Tom Doyle, nd & fd Charles Teas, sd	Pop.: 1,091,300 Rad. Hms.: 257,100 Ret. Sis.: \$956,567,000	SES. AP, INS RCA
KOB-TV	25,000-N									
ARTESIA										
KSVF	990	1,000-D	1946	Artesia Bcstg. Co. Box 38 1450 S. Roselawn 650	MBS, KBS, Inter-mountain	Martin Yates III, p David M. Button, gm, pd & pmm	Ronald Austin, ce	Bryce Howard, fd Bill Keys, sd	 UP G
CARLSBAD										
KAVE	1240	250	1936	Carlsbad Bcstg. Corp. 601 North St. 5-4101	CBS, Southwest Taylor	Val Lawrence, p Norman Loose, gm Richard Doyle, cm	Al Pitcaithley, pd Harland Nifong, ce	Frank Sheperd, nd Robert Barnett, sd	Pop.: 48,000 Rad. Hms.: 11,500 AP G
KPBM	740	1,000-D	1950	Coronado Bcstg. Co. Inc. 313 W. Mermod 5-5373 McGilvra	Maurice F. McEvoy, p & gm	Darrell A. Swayze, cm, pd, pmm & nd	Vic Daley, ce Bill West, sd	Pop.: 75,000 Rad. Hms.: 20,000	L-W AP G
CLAYTON										
KLMX	1450	250	1949	Ari-Ne-Mex Bcstg. Co. Box 7 616 Best	Arthur Jernigan, p Franklin E. Vale, gm, nd & fd	Henry J. Pruet, cm, pd & sd	Robert D. Waters, ce Beatrice Gove, wd	Pop.: 10,000 Rad. Hms.: 1,800 Ret. Sis.: \$33,000,000	Thes. UP G
CLOVIS										
KCLV	1240	250	1952	New Tex Bcstg. Inc. Box 866 4401	ABC Pearson	Odis L. Echois, p Harry Van Slycke, gm & nd	Evelyn Ganter, cm Phil Nickle, pd Lounel Winton, pmm	Clayton Fuchs, ce Roy Forbes, sd	Pop.: 45,000 Rad. Hms.: 42,000 Ret. Sis.: \$32,000,000	Cap UP G
KICA	980	1,000-DA-N	1933	Hugh DeWitt Landis 520 Pile St. 5511	MBS Holman	Hugh DeWitt Landis, o & gm C. O. Kendrick, cm	Harold B. Cook, pd M. S. O'Dell Jr., ce Dale Wood, nd & sd	Junaita Goodman, wd Boe Cook, fd	Pop.: 120,333 Rad. Hms.: 39,370 Ret. Sis.: \$146,289,000	Assoc., Wld. AP RCA
DEMING										
KOTS (CP)	1230	250-D		Luna County Bcstg. Co.						
FARMINGTON										
KVBC	1240	250	1951	Valley Bcstg. Co. 604 S. Miller Ave. 789	KBS	Marvin Bowles, o & gm	J. N. Montgomery, cm	Gene Pearsall, pd	Pop.: 42,000 Rad. Hms.: 36,000	L-W UP RCA
GALLUP										
KGAK	1230	250	1946	Thunderbird Bcstg. Co. East of Gallup 1300	KBS McGilvra	Merle H. Tucker, p & gm	G. H. McKinnon, cm	Robert E. Adamson, ce & nd Herb Schultz, sd		L-W UP

Data corrected to Dec. 10, 1953. If executives or services for FM are same as AM affiliate names are not repeated. Market Data supplied by stations. FM's in italic. *—Non-Commercial Station. CP—Construction Permit issued. D—Day. DA-N—Directional Antenna, night only. DA-1—Directional Antenna, same pattern day and night. DA-2—Directional Antenna, different pattern day and night. L—Limited Time with Dominant Station. LS—Local Sunset. N—Night. SA—Special Authorization. SH—Specified Hours. ST—Share Time. Complete key to abbreviations, page 6.

MARKET DATA BY COUNTIES

County	Population 1950	Radio Families 1953	Retail Sales 1952(000)	Food Sales 1952(000)	Drug Sales 1952(000)	Automobile Ownership 1952	County	Population 1950	Radio Families 1953	Retail Sales 1952(000)	Food Sales 1952(000)	Drug Sales 1952(000)	Automobile Ownership 1952
Ontario	60,172	17,300	70,155	17,505	1,300	24,964	Suffolk	276,129	79,170	330,776	103,332	7,595	147,622
Orange	152,255	44,840	199,491	55,190	4,736	59,240	Sullivan	40,731	12,600	79,222	25,526	2,225	21,372
Orleans	29,832	9,270	32,938	9,133	685	13,590	Tioga	30,166	9,260	31,246	8,557	525	11,760
Oswego	77,181	22,710	75,415	22,046	2,052	28,611	Tompkins	59,122	16,840	66,618	16,814	1,415	21,559
Osage	50,763	15,750	61,494	16,148	1,370	20,939	Ulster	92,621	28,760	113,914	35,643	2,228	38,838
Putnam	20,307	6,330	29,766	9,123	594	12,012	Warren	39,205	11,720	68,595	16,424	1,586	16,132
Queens	1,550,849	498,480	1,559,531	558,477	35,526	120,112	Washington	47,144	13,290	40,649	13,370	1,202	17,314
Rensselaer	132,607	40,170	146,051	40,496	2,853	44,728	Wayne	57,323	17,520	61,539	14,402	1,286	26,176
Richmond	181,555	54,090	171,883	68,810	4,433	33,244	Westchester	625,816	185,720	781,775	252,872	19,919	234,611
Rockland	89,276	23,200	80,430	28,247	2,094	33,244	Wyoming	32,822	9,350	34,135	7,425	660	12,561
St. Lawrence	98,897	26,240	99,322	28,471	2,413	33,646	Yates	17,615	5,540	26,625	10,403	467	7,891
Saratoga	74,869	22,760	77,738	22,381	1,799	26,657	Total	14,830,192	4,547,440	\$18,196,751	\$5,507,666	\$434,090	3,980,527
Schenectady	142,497	46,580	186,339	48,592	4,426	57,417	Note: Population 1950 Census; radio families Standard Audit & Measurement Services Inc.; food, drug and retail sales, copyright 1953. Sales Management; further reproduction unlicensed; automobiles supplied by state.						
Schoharie	22,703	6,760	26,486	6,312	390	10,023							
Schoyler	14,182	4,330	15,730	3,509	305	6,050							
Seneca	29,253	7,710	24,456	6,775	633	11,996							
Steuben	91,439	26,910	97,382	26,405	2,211	33,265							

DIRECTORY OF AM AND FM STATIONS

City	Call Letters	Chan. or Freq.	Licensee Headquarters Telephone	Network Representative	Owner	Executive	Abbreviations	Market Data For Primary Area (Supplied by station)	Library, News Serv. Transmitter
ALBANY									
WABY	1400	250	Eastern N.Y. Bcstg. Co. 80 Braintree St. 2-3353	Rambeau	David Kyle, p Edward L. Trudeau, gm	Alix Blake, cm & pmm Toni Brady, pd & wd Bill Pope, nd & sd	Tom Stapleton, ce		UP Col.
WOKO	1460	5,000 DA-N	Gov. Dongan Bcstg. Corp. 138 State St. 3-6638	Union McGillvra	Jim Healey, o & gm Eugene J. FitzPatrick, sm	Frank Panny, pd & nd Jim Sherwood, pmm Al Sardi, ce	Paul Dennis, fd Johnny Lawrence, sd Mona Smith, wd	Pop.: 776,000 Rad. Hms.: 234,600 Ret. Sls.: \$912,800,000	AP Col.
WPTR	1540	50,000-DA-1	Patron Bcstg. Co. Ten Eyck Hotel 87 State St. 5-3345	MBS Weed	J. Myer Schine, p Stephen R. Rintoul, gm	George Wetmore, asst. gm Thomas Mitchel, cm	Walter J. Maxwell, pmm W. Russell David, ce		Wld., SES., Assoc. AP, INS GE
WROW	590	5,000-D	Hudson Valley Bcstg. Co. Inc. 112 State St. 3-2225	MBS Bolling	Dr. John J. Quinlan, p Harry L. Goldman, gm	Harry Littler, cm & pmm Johnny Lee, sm Charles Heister, ce	Arnold Freedman, nd & fd Tom Ryan, sd Elaine Drooz, wd		Thes. UP RCA
ALLEGANEY									
WHDL			(See Olean, N. Y. listing)						
AMSTERDAM									
WCSS	1490	250	Community Service Bcstg. Co. Upper Locust Ave. 4000		Alphonse DiMezza, p	Walter T. Gaines, vp, gm, cm, pd, pmm, nd, fd, sd & wd	Barry Frank, ce	Pop.: 350,000 Rad. Hms.: 88,000 Ret. Sls.: \$304,473,000	Wld. UP Col.
AUBURN									
WMBO	1340	250	WMBO Inc. 141 Genesee St. 2-3511	MBS Clark	William O. Dapping, p Frederick L. Keese, gm Charles D. Osborne, p	Robert B. Morgan, pd	Herbert House, ce	Pop.: 104,000 Rad. Hms.: 32,380	Wld., SES., AP RCA
WMBO-FM	Ch. 241 (B)	96.1mc	18kw						

Data corrected to Dec. 10, 1953. If executives or services for FM are same as AM affiliate names are not repeated. Market Data supplied by stations. FM's in italic. *—Non-Commercial Station. CP—Construction Permit issued. D—Day. DA-N—Directional Antenna, night only. DA-1—Directional Antenna, same pattern day and night. DA-2—Directional Antenna, different pattern day and night. L—Limited Time with Dominant Station. LS—Local Sunset. N—Night. SA—Special Authorization. SH—Specified Hours. ST—Share Time. Complete key to abbreviations, page 6.

AN UNBEATABLE COMBINATION!

MBS NETWORK + 50,000 WATTS

IN THE 31st MARKET

WPTR ALBANY, NEW YORK SELLS ALBANY-TROY-SCHENECTADY PLUS UPSTATE, N. Y.

BATAVIA

WBTA 1490 Batavia Bcstg. MBS E. R. Gamble, p & gm Jim Fagan, pmm & Jim Gerrety, ce Pop.: 149,000 Wld., L-W
1941 250 218 E. Main St. Charles Snow, cm & sd Jan Davidson, wd Rad. Hms.: 96% AP
715 pd Fred Callandar, ce RCA

BAY SHORE

WRBS(FM) Ch. 290 (B) Great South Bay George E. Klein Jr., Paul E. Seidel, ce Wilhelmina Klein. Pop.: 336,014 L-W
(CP) 105.9mc Bcstg. Co. p & gm Alan Smith, nd mus. librarian Rad. Hms.: 53,024 AP
20kw Islip, Long Island Ret. Sis.: \$507,452,000 GE
Islip 3-4453R

BINGHAMTON

WENE 1430 Ottaway Stations ABC James H. Ottaway, p Norman F. Flynn, slm Sheldon W. Weyland, ce Pop.: 310,000 Assoc.
1947 5,000-DA-1 Inc. Radio-TV F. H. Brinkley, mgng. d Leonard Hathaway, pdm & sd Harold Hancock, news UP
909 E. Main St. Reprs. Stephen W. Ryder, sm ed. & farm ed. Rad. Hms.: 84,130 G
5-3351

WINR 680 Southern Tier NBC Donald W. Kramer, p H. R. Nicholson, slm Adelbert A. Kelley, ce L-W
1946 1,000-D Radio Service Hollingbery George J. O'Connor, gm Charles Bishara, pd & pmm Jan Costley, nd UP
500-N-DA-2 Court House Square 4-4318 Bob Cullings, sd Col.

WKOP 1360 The Binghamton MBS Andrew Jarema, p & Wally Buman, pd & fd Frank Dolan, nd & sd Pop.: 186,700 Wld.
1947 1,000-D Bcstg. Inc. Headley-Reed Thomas Riley, cm Charles Hallinan, ce Ceceila Roland, wd Rad. Hms.: 51,900 AP
500-N-DA-N 2-3437 Ray. Ret. Sis.: \$216,141,000

WKOP-FM Ch. 237 (A) 95.3mc 0.42kw (CP)

WNBF 1290 Clark Assoc. Inc. CBS Cecil D. Mastin, gm John L. Turner, pmm E. W. Farneti, comp. Pop.: 321,930 Thes.
1927 5,000-DA-N 40 Wall St. Bolling Stanley N. Heslop, slm Louveur H. Stantz, ce Bill Pryor, sd Rad. Hms.: 89,163 UP
WNBF-TV 3-7311 Edward M. Scala, pd Ret. Sis.: \$355,135,000 WH

BRISTOL CENTER

WRRE(FM) Ch. 238 (B) Northeast Radio Rural C. L. Dickinson, p H. Stilwell Brown, gm Thomas Humphrey, ce Assoc.
1948 95.1mc 308 State St. Knodel Donald K. deNeuf, gm Merrill Knapp, pd Itasca 4-6357 UP
5.3kw GE

BROOKLYN

*WBBR 1330 Watchtower Bible & Tract Society Inc. N. H. Knorr, p A. M. Cora, pd & nd J. Held, fd Assoc.
1924 5,000-DA-1 ST-WEVD & WHAZ 124 Columbia Heights Verda Hauenstein, wd R. H. Leffler, ce Main 5-1240 INS
& WHAZ RCA

BUFFALO

WBEN 930 WBEN Inc. NBC Edward H. Butler, p C. E. Daly, cm Gene Brook, pdm Thes., L-W
1930 5,000-DA-N Mohawk 0930 Christal A. H. Kirchhofer, vp Carl Erickson, pd Richard Burke, nd AP, UP, INS
WBEN-TV C. Robert Thompson, gm Joseph A. Haefner, pmm Joe Wesp, fd RCA
Frank W. Kelly, sm Ralph J. Kingsley, ce Ralph Hubbell, sd Sally Work, wd

WBEN-FM Ch. 293 (B) 106.5mc 105kw 1946

WBNY 1400 Roy L. Albertson Young Roy L. Albertson Sr., Carl J. Spavento, cm William Miles, nd
1935 250 485 Main St. Mohawk 1400 Roy L. Albertson Jr., Henry C. Brach, pd Thomas L. Vines, ce Eugene Korzelius, sd Helen Ketzler, wd

WBNY-FM Ch. 225 (B) 92.9mc 48kw 1948

WEBR 970 WEBR Inc. MBS William J. Conners Bill Schweitzer, pd & Dave Leopold, asst. Pop.: 1,022,968 Assoc.
1924 5,000-DA-1 Lincoln 7133 Katz III, p Frank Ridgeway, ce Gene Barry, nd Gene Korzelius, sd AP, UP, INS
Charley Bailey, sd WE

WGR 550 WGR Bcstg. Corp. CBS Leo J. Fitzpatrick Karl B. Hoffman, evp Robert J. Striel, pd
1922 5,000-DA-N 1800 Rand Bldg. Free & Peters chmp. of bd. Nat Cohen, vp & cm Roswell H. McPherson, pmm UP
Washington 3100 Peters GE

Wld., RCA, Cap., St.
.....
GE

WINNER, BINGHAMTON, N.Y.

WINNER

SELLING 381,000 CUSTOMERS IN SOUTHERN NEW YORK AND NORTHERN PENNSYLVANIA, WHO COUNT ON WINR FOR ENTERTAINMENT, NEWS AND SPORTS!

1,000 WATTS ON 680!

GEORGE P. HOLLINGBERY, NATIONAL REPRESENTATIVES

NEW YORK

City	Call Letters Established TV Affiliate	Chan. or Freq. Power	Licensee Headquarters Telephone	Network Represent- ative	Owner o; Pres. p; Exec. up evp; Gen. Mgr. gm; Sta. Mgr. sm; Coml. Mgr. cm; Sales Mgr. slm; Prog. Dir. pd; Chief Eng. ce; Prom. Mgr. pmm; Prod. Mgr. pdm; News, Farm, Sports or Women's Dir. nd, fd, sd, wd.	Executive Abbreviations	Market Data For Primary Area (Supplied by station)	Library, News Serv. Transmitter	
BUFFALO—(Continued)									
	WKBW 1925	1520 50,000-DA-1	WKBW Inc. 1430 Main St. Grant 5101	ABC. Rural Avery- Knodel	Clinton H. Churchill, p & gm Alfred E. Anscombe, sm	James L. McGrath, pd D. Ireland, pmm Leroy Fiedler, ce Hugh Shannon, nd	Wally Wagener, fd Stan Barron, sd Kay B. Cooke, wd	Pop.: 1,000,000 Rad. Hms.: 365,000	Wld. UP WH
	WWOL 1947	1120 1,000-D	Greater Erie Bcstg. 315 Main St. Mohawk 1200 ForJae	Leon Wyszatycki, p Ted Wyszatycki, gm Jack Greenfield, cm & pmm	Fred Klestine, pd & nd Walter Williams Jr., ce	Guy King, sd Trudy Peoples, wd		UP, INS GE AP, UP Col.
	WWOL-FM 1948	Ch. 291 (B) 104.1mc 7.7kw							
	WXRA 1948	1080 1,000-D	Western N. Y. Bcstg. Co. Box 85 Amherst 1160 (WXRA, Am Affiliate) Rambeau	Edwin R. Sanders, ptrn. Thaddeus Poddzielak, ptrn., gm & cm	James J. Frieling, pd Bradley D. Steiger, pmm	Roger W. Fleming, ce Jack McLean, nd Chuck Burr, sd	Rad. Hms.: 465,370 Ret. Sis.: \$1,487,750,000	Assoc. UP AP, UP Col.
	WXRC(FM) 1949	Ch. 277 (B) 103.3mc 4.6kw							
CHEEKTOWAGA									
	WNIA (CP)	1230 250	Niagara Bcstg. System c/o Gordon P. Brown WSAY Rochester, N. Y. Monroe 7710 (Rochester)	Federal Walker	Gordon P. Brown, p gm & ce			Pop.: 1,089,230 Rad. Hms.: 328,600 Ret. Sis.: \$1,307,748,000	
CHERRY VALLEY									
	WRRC(FM) 1948	Ch. 270 (B) 101.9mc 5.4kw	Northeast Radio Corp. 306 E. State St. Ithaca, N. Y. Ithaca 4-6357	Rural Avery- Knodel	C. L. Dickinson, p Donald K. deNeuf, gm	H. Stihwell Brown, cm Merrill Knapp, pd	Thomas Humphrey, ce		Assoc. UP GE
CORNING									
	WCBA 1948	1350 1,000-D	Corning, Wellsboro Bcstg. Caton Rd. 6-8442 McGillvra	Paul L. Carpenter, p Paul E. Carpenter Jr., gm	Robert G. Walters, asst. m Gerry Wells, pd	Charles Charnesky, ce John Johnston, sd Elaine Lawrence, wd		Wld. UP G
	WCLI 1950	1450 250	Radio Corning Inc. 114 Walnut St. 6-4651	ABC Meeker	Gordon M. Jenkins, co-o, p, gm & cm	George P. Droelle Jr., co-o, secy.-treas., sm, pd & sd Frank Saia, ce	Richard Tobias, nd Robert Shaddock, fd Joan Purcell, wd	Pop.: 139,700 Rad. Hms.: 42,690 Ret. Sis.: \$170,000,000	St. AP G
	WCLI-FM 1947	Ch. 291 (B) 106.1mc 4.2kw						Pop.: 444,795 Rad. Hms.: 45,690 Ret. Sis.: \$172,000,000	Thes. AP GE
CORTLAND									
	WKRT 1947	920 1,000-D 500-N-DA-N	Radio Cortland 27 N. Main St. 2990 Gill-Perna	Leighton A. Hope, p	William L. Thompson, gm	William A. Barron, ce		L-W, St. UP GE
	WKRT-FM 1947	Ch. 260 (B) 99.9mc 14kw							
DE RUYTER									
	WRRD(FM) 1948	Ch. 286 (B) 105.1mc 5.3kw	Northeast Radio Corp. 308 E. State Ithaca, N. Y. 4-6357	Rural Avery- Knodel	C. L. Dickinson, p D. K. deNeuf, gm	H. S. Brown, cm M. N. Knapp, pd	T. R. Humphrey, ce	 GE
DUNKIRK									
	WFCE 1949	1410 500-DA-2	Dunkirk Bcstg. Corp. 316 Main St. 7756 Walker	Alois A. Schmidt, p & gm Bernard F. Goodrich, cm	Earle A. Hamrick, pd & nd James T. Grace, ce	Roger M. Waite, secy. Van C. Miller, fd & sd Jane-Ellyn Ames, wd	Pop.: 148,000 Rad. Hms.: 42,140 Ret. Sis.: \$154,420,000	L-W, St. UP Ray.
ELMIRA									
	WELM 1947	1400 250	Radio Elmira Inc. 222 E. Market St. 3-5626	ABC, CBS, Rural Meeker	John S. Riggs, p Keith W. Horton, sls. vp & co-m	Phil Cameron, bcstg. vp & co-m William Griffiths, pd & sd	Arthur French, ce Gordon M. Ridenour, nd Ethel Parker, wd	Pop.: 98,900 Rad. Hms.: 29,200 Ret. Sis.: \$104,890,000	Thes. AP Ray
	WENY 1939 WECT(TV)	1230 250	Elmira Star- Gazette Inc. Mark Twain Hotel 5181	MBS, NBC Everett- McKinney	Dale L. Taylor, gm Bill Pope, cm Ted Hodge, pd	Ellis E. Erdman, pmm Thurlow A. Greene, ce	Stanley Hayes, pub. service d Wes Kimble, sd Edna Bartlett, wd	Pop.: 316,000 Rad. Hms.: 84,700 Ret. Sis.: \$315,514,000	L-W AP RCA
ENDICOTT									
	WENE 1947		(See Binghamton, N. Y. listing)						
FREERPORT									
	WGBB 1924	1240 100	Harry H. Carman 44 S. Grove St. 9-1400	Harry H. Carman, p, gm & ce Murray C. Evans, cm	Ada Cheesman, pd Herbert Clock, pmm	John Frogge, nd Byron Englander, sd		L-W AP Col.
FULTON									
	WOSC 1949	1300 1,000-D	Cassill Radio Hotel Pontiac Oswego, N. Y. 3088	KBS Devney	A. L. Richardson, p, gm & pmm	J. S. Burgess, cm, pd & sd	Robt. Blair, ce		Thes. UP GE
GENEVA									
	WGVA 1947	1240 250	Star Bcstg. Co. 87 Seneca St. 6691	ABC Cooke	Maurice R. Foreman, p Thomas L. Brown, vp & gm	Ernest F. Oliver, sm Alexander Lamutis, pd & nd	R. Carleton Greene, ce & secy. James Ludwig, sd	Pop.: 112,224 Rad. Hms.: 34,961	L-W AP Col.
GLENS FALLS									
	WWSC 1946	1450 250	Great Northern Radio Inc. 13 Warren St. 2-6518	ABC Rambeau	Louis P. Brown, p Martin Karik, gm & cm	Carl Mattison, pd & asst. m Kent Jones, pmm Henry Worthing, ce	E. V. Wiley, nd Earl Sharland, sd Margot Gram, wd	Pop.: 46,700 Rad. Hms.: 16,980 Ret. Sis.: \$63,220,000	Thes. AP G

Data corrected to Dec. 10, 1953. If executives or services for FM are same as AM affiliate names are not repeated. Market Data supplied by stations. FM's in *italics*. *—Non-Commercial Station. CP—Construction Permit issued. D—Day, DA—Directional Antenna, night only. DA-1—Directional Antenna, same pattern day and night. DA-2—Directional Antenna, different pattern day and night. L—Limited Time with Dominant Station. LS—Local Sunset. N—Night. SA—Special Authorization. SH—Specified Hours. ST—Share Time. Complete key to abbreviations, page 6.

SATURATION

**GIVES YOU
ALL
THE AUDIENCE**

IN BUFFALO and WESTERN NEW YORK



SO Pitch your sales message at ALL hours

... NOT once a week; NOT five times a week ...

BUT 26 TIMES A WEEK!

SELLS YOUR PRODUCT
WKBW
offers alert advertisers
SATURATION!

The most successful advertising technique is "Telling your sales story to as many people, as many times as you can, within the limits of a sound budget." This is the WKBW SATURATION FORMULA which is bringing increased sales results for WKBW advertisers; and we have the renewals to prove it. Call Avery-Knodel or WKBW.

SELLS YOUR PRODUCT
WKBW
offers you **MORE THAN TWICE**
AS MANY LISTENERS
FOR YOUR DOLLAR!

No matter what your yardstick is for buying radio time ... Nielsen ... Pulse ... coverage maps ... or special local surveys, you'll find a WKBW SATURATION CAMPAIGN gives you **MORE THAN TWICE AS MANY LISTENERS** for your advertising dollar. That's why your sales results will be **MORE THAN TWICE AS GOOD!** For details on this and other WKBW saturation campaigns call Avery-Knodel or WKBW.

WKBW
BUFFALO'S MOST POWERFUL STATION

50,000 WATTS
AVERY-KNODEL, INC.
National Representatives

BASIC ABC
CLINTON H. CHURCHILL
Founder, President
and General Manager

NEW YORK

City	Call Letters Established TV Affiliate	Chan. or Freq. Power	Licensee Headquarters Telephone	Network Represent- ative	Owner o; Pres. p; Exec. up evp; Gen. Mgr. gm; Sta. Mgr. sm; Coml. Mgr. cm; Sales Mgr. sim; Prog. Dir. pd; Chief Eng. ce; Prom. Mgr. pmm; Prod. Mgr. pdm; News, Farm, Sports or Women's Dir. nd, fd, sd, wd.	Executive Abbreviations	Market Data For Primary Area (Supplied by station)	Library, News Serv. Transmitter
GLOVERSVILLE								
WENT 1944	1340 250	Sacandaga Bcstg. Corp. 8 W. Fulton St. 4-7175	CBS Gill-Perna	George Bissell, p Jas. L. Brownell Jr. gm, cm, sim. fd & sd	Lloyd Howell, pd Peter R. Dreyer, pmm Richard J. Stewart, ce	Dick Ryall, nd Ruth Robertson, wd	Pop.: 96,800 Rad. Hms.: 28,950 Ret. Sls.: \$83,310,000	Thes. UP Col.
HEMPSTEAD								
WHLI 1947	1100 250-D	FM Bcstg. Corp. 245 Baldwin Rd. 2-8000 Rambeau	Paul Godofsky, p & gm Joseph A. Lenn, cm Jerry Carr. pd & nd	M. N. Godofsky, pmm & wd Frank E. Knaack, ce	George Ball, pub. rel. d, sp events d & sd Howard Campbell, fd Roger Wayne, mus. d	Pop.: 2,304,000 Rad. Hms.: 658,000 Ret. Sls.: \$2,071,000,000	Wid., Thes., Assoc. UP Col., RCA Thes., Wid., Assoc. UP Fed.
WHLI-FM 1947	Ch. 252 (A) 98.3mc 1kw							
HORNELL								
WLEA 1951	1480 1,000-D	Hornell Bcstg. Corp. Landman Bldg. 1420	MBS, KBS Gill-Perna	Charles D. Henderson, p & gm	G. W. Stidstone, ce & sm Fran Nettleton, nd	Don Jones, fd Wally Oliver, sd Roberta, wd	Pop.: 158,200 Rad. Hms.: 48,490 Ret. Sls.: \$136,250,000	Cap. UP
WWHG 1949	1320 1,000-D	W. H. Greenhow Co. 85 Canisteo St. 2000 McGillvra	Louis G. Buisch, p Donald J. Curran, sm & fd	Sheff Davis, cm Howard Huff, ce	Ed Murphy, nd & sd Marion Gale, wd	Pop.: 155,100 Rad. Hms.: 47,550 Ret. Sls.: \$21,000,000	Thes., Wid., AP GE
WWHG-FM 1946	Ch. 287 (B) 105.3mc 8.3kw							
HUDSON								
WHUC 1947	1230 250	Colgren Bcstg. Co. Box 804 8-3341	KBS, Union McGillvra	John F. Kearney, co-o, gm & nd Robert P. Strakos, co-o & cm	James P. Cranna, pd Jennie W. Weaver, pmm Charles Weiler, ce	Burt Files, fd Lou Pierrò, sd Dorothy Curtis, wd	Pop.: 75,000 Rad. Hms.: 28,000 Ret. Sls.: \$70,000,000	Wid., UP Col.
HUNTINGTON								
WGSM 1951	740 1,000-D DA	Huntington Montauk Bcstg. Co. 379 New York Ave. Huntington 4-8740	Edward J. Fitzgerald, co, gm & cm Don Daily, pd	Don Machechlan, pmm Wm. Naramore, ce Estelle Sammis, nd	Dave Rosehill, fd Jane Hendry, wd	Pop.: 3,000,000 Rad. Hms.: 900,000 Ret. Sls.: \$3,000,000,000	Wid., Thes., UP G
ITHACA								
WHCU 1921	870 1,000-D	Cornell U. Savings Bank Bldg 4-6301	CBS	Michael R. Hanna, gm Earl S. Cobey, cm Joseph A. Short, pd	Sam Woodside, pmm, nd & sd	True McLean, ce Gertrude Grover, wd	Pop.: 439,500 Rad. Hms.: 125,230 Ret. Sls.: \$462,631,000	Assoc. UP Ray.
WHCU-TV 1947	Ch. 247 (B) 97.3mc 40kw							Assoc. AP WE
WRRR(FM) 1953	Ch. 279 (B) 103.7mc 5.6kw	Northeast Radio Corp. 308 E. State St. 4-6357	Rural Avery- Knodel	C. L. Dickinson, p Donald K. deNeuf, gm	H. Stilwell Brown, cm Merrill Knapp, pd	Thomas Humphrey, ce		Assoc. UP GE
JAMESTOWN								
WJOC 1947	1340 250	Air Waves Inc. 415 W. Fourth St. 5-108	MBS, KBS Gill-Perna	Harold P. Kane, p & gm Richard F. Rose, cm William M. Winn, pd	Burton O. Waterman, ce Peter Hansson, nd	Ned McGrath, fd Jerry Lawson, sd Beverly Benson, wd	Pop.: 173,100 Rad. Hms.: 57,200 Ret. Sls.: \$191,300,000	AP WE
WJTN 1924	1240 250	James Bcstg. Co. Hotel Jamestown Bldg. 7-151	ABC Venard	Jay E. Mason, p Simon Goldman, gm & pmm J. Carl Willems, cm	George Pfeeger, pd Harold J. Kratzert, ce Jess Price, nd	Robert S. Webster, fd Max Robinson, sd Connie Samuelson, sd	Pop.: 179,700 Rad. Hms.: 55,400 Ret. Sls.: \$226,207,000	Assoc. Mac. UP G
WJTN-FM 1947	Ch. 227 (B) 93.3mc 9.5kw						Pop.: 305,300 Rad. Hms.: 85,200 Ret. Sls.: \$343,290,000	
JOHNSTOWN								
WENT		(See Gloversville, N. Y., listing)						
KENMORE								
WXRA		(See Buffalo listing)						
KINGSTON								
WKNY 1939	1490 250	Kingston Bcstg. Corp. 601 Broadway 4500	MBS Meeker	Joseph K. Close, p Robert M. Peebles, vp. gm & cm Ernest Ward, pd	Richard McCarthy, pmm & sd Carl Egoif, ce	Robert Brownink, nd Pete Gates, fd Dorothy A. Narel, wd	Pop.: 103,900 Rad. Hms.: 31,100 Ret. Sls.: \$105,100,000	Wid., UP RCA
LIBERTY								
WVOS 1947	1240 250	Sullivan County Bcstg. Corp. 1680	KBS	Seymour D. Lubin, p & gm	Harry G. Borwick, cm	Robert Gessner, ce	Pop.: 65,000 Rad. Hms.: 62,400 Ret. Sls.: \$40,000,000	UP WE
LITTLE FALLS								
WLFFH 1952	1230 250	Rock City Bcstrs. S. 2d St. 654	MBS McGillvra	Arthur Feldman, p Robert Feldman, vp James M. Bryant, gm & cm	Tersia Bilek, pd, pmm & wd Henry Darco, ce	Dick Waffle, nd Dan Tucker, fd Harry Feldman, sd	Pop.: 83,220 Rad. Hms.: 65,284 Ret. Sls.: \$62,088,000 AP WE
LOCKPORT								
WUSJ 1949	1340 250	Union Sun & Journal 320 Michigan St. 3-5944 Gill-Perna	Egbert D. Corson, p John R. Gelzer, gm Joseph Pinna, cm	Tom Jolls, pd & fd Richard Weatherbee, ce	Howard Hartzell, nd Jack Murphy, sd Joan O'Connor, wd		Wid., AP GE
MALONE								
WICY 1947	1490 250	No. Country Bcstg. Co. Radio Center 187	MBS	Mitchell C. Tackley, p & gm Alice M. Tackley, cm	John Flynn, pd, nd & sd Donald J. Paye, pmm	Pauline Smith, wd	Pop.: 15,000 Rad. Hms.: 6,500	Cap. UP G

Data corrected to Dec. 10, 1953. If executives or services for FM are same as AM affiliate names are not repeated. Market Data supplied by stations. FM's in italic. *—Non-Commercial Station. CP—Construction Permit issued. D—Day. DA-N—Directional Antenna, night only. DA-I—Directional Antenna, same pattern day and night. DA-2—Directional Antenna, different pattern day and night. L—Limited Time with Dominant Station. LS—Local Sunset. N—Night. SA—Special Authorization. SH—Specified Hours. ST—Share Time. Complete key to abbreviations, page 6.

NORWICH

WCHN 1953	970 500-D	Radio Norwich Inc. 14 S. Broad St. 4-2218	William J. Hall, p, gm & pd G. R. Perkins, cm & pmm	William M. Bush, ce Ray Whitlock, nd Wes Adams, fd	Paul Dohl, sd Eve Dennehy, wd	Pop.: 119,780 Rad. Hms.: 117,385 Ret. Sis.: \$190,000,000	UP G
--------------	--------------	--	-------	--	--	----------------------------------	---	---------

OGDENSBURG

WSLB 1940	1400 250	St. Lawrence Bcstg. Corp. 2315 Knox St. 500	MBS	J. R. Brandy, p H. J. Frank, gm Hal Gilman, pd	Ellsworth Hall, ce Dave Snyder, nd	Frank Mason, sd Flo Beach Rowe, wd UP RCA
WSLB-FM 1948	Ch. 291 (B) 106.1mc 13.7kw						

OLEAN

WHDL 1929	1450 250	WHDL Inc. 3219 W. State Rd. 4149	ABC Everett- McKinney	John R. Henzel, p & gm James F. Hastings, gen. slm	Donald W. Merriman, asst. m, pd & sd Jean L. Smith, pmm & Pub. service d	Parker H. Vincent, ce George Questa, nd Robert C. Norman, fd Donald McLean, wd	Ret. Sis.: \$208,971,000	Assoc. AP Col. WH
WHDL-FM 1949	Ch. 239 (B) 95.7mc 43kw							

ONEONTA

WDOS 1947	1400 250	Ottaway Stations Inc. 104 Chestnut St. 2470	MBS Radio-Tv Reps.	James H. Ottaway, p Francis H. Brinkley, mgng. d	Harold E. Graves, sm Howard Atwell, pd Wiley Bates, ce	Lee Hickling, nd Esther Walling, wd	Pop.: 72,973 Rad. Hms.: 20,333 Ret. Sis.: \$82,000,471	Assoc. UP GE
--------------	-------------	--	--------------------------	--	--	--	--	--------------------

OYSTER BAY

WKBS 1948	1520 250	Key Bcstg. System Inc. 6-2500	Lee Hollingsworth, p, gm & ce W. W. Giles, cm	Lucinda Hollings- worth, pd Tom Hollingsworth, pmm	Sue Hollingsworth, secy.-treas.	Pop.: 2,600,000 Rad. Hms.: 1,000,000	Mac. UP G
--------------	-------------	-------------------------------------	-------	---	---	------------------------------------	---	-----------------

PATCHOGUE

WALK 1952	1370 500-D	Suffolk Bcstg. Corp. P. O. Box 230 408	Nils E. Seærdahl, p & gm W. K. Macy Jr., vp	Jack Ellsworth, pd George Chandler, ce	Hal Fischer, nd Linda Wiman, wd Assoc., CaD. AP G	
WALK-FM 1952	Ch. 278 (B) 97.5mc 15kw							
WPAC 1951	1580 250-D	Patchogue Bcstg. Co. Inc. 2 E. Main St. 3-4600	Lee Morrison, p & gm Stan Allan, sm Herbert Morrison, cm & opers. m	Don Lombardy, pmm Morton Morrison, ce Bob Holmes, nd	Dick Hodkin, fd Marion Tappe, wd	Pop.: 60,000 Rad. Hms.: 12,000 Ret. Sis.: \$150,000,000	RCA Wid. UP G

PEEKSKILL

WLNA 1948	1420 1,000-D	Highland Bcstg. Corp. Box 188 7-2454	Peter C. Houskeeper, p & ce	Irving E. Cottrell, gm Francis V. Lough, cm	Sam D'onofrio, nd & sd Katherine Britt, wd	Pop.: 211,900 Rad. Hms.: 89,800 Ret. Sis.: \$237,300,000	Wid., SES. UP Ray.
--------------	-----------------	---	-------	--------------------------------	--	--	--	-----------------------------

PLATTSBURG

WEAV 1935	960 1,000-DA-2	Plattsburg Bcstg. Corp. 153 Margaret St. 1600	ABC Gill-Perna	George F. Bissell, p & gm Jack Charles, cm	Raymond Turner, pd Laurence Lapanne, ce	James Roddy, nd John Clute, fd	Pop.: 153,500 Rad. Hms.: 34,100 Ret. Sis.: \$142,400,000	L-W UP Col.
WIRY 1950	1340 250	Clinton County Bcstg. Co. 301 Cornelia St. 2800	MBS, KBS Grant	Joel H. Scheier, p, gm & cm Betty Kraus, pd & wd	Martin Mannix, pmm & nd Jack Nazak, ce	Chet Bosworth, fd Bird Berdan, sd	Pop.: 150,000 Rad. Hms.: 17,500 Ret. Sis.: \$66,000,000	Assoc. AP G

PORT JERVIS

WDLG 1953	1490 100	Port Jervis Bcstg. Co. Horn Rd. 3-3311 Cooke	William H. Ware, p Ernest C. Winkler, gm	Oscar Wein, cm Henry Schwartz, pd	Herbert Stein, ce	Pop.: 20,000	
--------------	-------------	---	----------------	---	--------------------------------------	-------------------	--------------	--

1000 W **WEAV** 960 KC

250 W **WENT** 1340 KC

PLATTSBURG, N. Y.

SELLS THE RICH CHAMPLAIN VALLEY INCLUDING RICH CLINTON, ESSEX AND FRANKLIN COUNTIES

** a fast growing, fertile market for your product's sales*

** a natural test market*

Retail Sales Almost Tripled in 10 Years

GLOVERSVILLE-JOHNSTOWN, N. Y.

The 'Local' and 'Most Popular' Station

THROUGHOUT RICH FULTON AND MONTGOMERY COUNTIES

Consistently WENT has dominated the listening in Gloversville-Johnstown and throughout the surrounding area.

Throughout the week, far more families in the Gloversville-Johnstown area listen to WENT. To sell more of your product, your sales messages must be heard by the largest audiences available . . . that makes WENT a natural for your sales messages beamed to the prosperous families throughout this rich, 2-county market.

WENT means consistently high listenership, and best results for WENT advertisers. WENT can sell the rich Gloversville-Johnstown area for you.

WEAV

ABC
PLATTSBURG,
NEW YORK

GILL-KEEFE & PERNA, INC.
National Representative

CBS
GLOVERSVILLE,
JOHNSTOWN

WENT

NEW YORK

City Call Letters Established TV Affiliate	Chan. or Freq. Power	Licensee Headquarters Telephone	Network Represent- ative	Owner; Pres. p; Exec. vp evp; Gen. Mgr. gm; Sta. Mgr. sm; Coml. Mgr. cm; Sales Mgr. slm; Prog. Dir. pd; Chief Eng. ce; Prom. Mgr. pmm; Prod. Mgr. pdm; News, Farm, Sports or Women's Dir. nd, fd, sd, wd.	Executive Abbreviations	Market Data For Primary Area (Supplied by station)	Library, News Serv. Transmitter	
POUGHKEEPSIE								
WEOK 1949 WEOK-TV	1390 1,000-D	Mid-Hudson Bcstrs. Inc. 385 Main St. 8300	Everett- McKinney	Arthur J. Barry Jr. p & gm Frank Breslin, cm & pd	John Burke, ce Jack Cutler, nd & sd	Wm. Sutherland, fd Betty Perl, wd	Pop.: 372,868 Rad. Hms.: 93,217 Ret. Sis.: \$586,000,000	Thes. UP RCA
WKIP 1940	1450 250	Dutchess County Bcstg. Corp. P. O. Box 889 6800	ABC	George W. Bingham, p Mabel S. Meurer, secy.-treas.	Richard A. Dwellley, cm John J. Kuhn, pd, pmm, nd & sd	Marvin S. Seimes, ce Ruth-Ann Dreyer, wd	Pop.: 100,000 Rad. Hms.: 25,000 Ret. Sis.: \$150,000,000	Assoc. AP RCA
WRRH (FM) 1948	Ch. 284 (B) 104.7mc 2.3kw	Northeast Radio Corp. 306 East State Ithaca, N. Y. Ithaca 4-6357	Rural Avery- Knodel	C. L. Dickinson, p Donald K. deNeuf, gm	H. Stillwell Brown, cm Merrill Knapp, pd	Thomas Humphrey, ce		Assoc. UP GE
ROCHESTER								
WBBF 1947 WCBF(TV)	950 1,000-DA-2	WARC Inc. Sheraton Hotel Hamilton 8920	MBS Cooke	Thomas L. Brown, p & gm Lloyd B. Gibson, cm	Nick Nickson, pd & nd Claude Johnstone, pmm	Vincent Lopopolo, ce Jerry Flynn, sd Pat Sumberg, wd		
WHAM 1922 WHAM-TV	1180 50,000	Stromberg- Carlson Co. 201 Humboldt St. Culver 7240	NBC Holling- bery	William A. Fay, gm J. W. Kennedy Jr., gen. slm	Charles W. Siverson, pd Arthur W. Kelly, slm K. G. Gardner, ce	David E. Kessler, nd George Haefner, fd Bob Turner, sd	Pop.: 1,161,000 Rad. Hms.: 337,000 Ret. Sis.: \$1,172,254,000	Wid. UP WH
WHFM (FM) 1939	Ch. 255 (B) 98.9mc 20kw	(WHAM, Am Affiliate)						
WHEC 1925 WHEC-TV	1460 5,000-DA-N	WHEC Inc. 40 Franklin St. Baker 6740	CBS Everett- McKinney	Frank E. Gannett, p Clarence Wheeler, evp C. Glover De Laney, gm	Lemoine C. Wheeler, cm William J. Adams, pd Bernard C. O'Brien, ce	L. H. MacMillan, asst. gm & sd Warren Doremus, nd Pauline Gaffney, wd		SES AP WE
WRNY 1947 WRNY-TV WRNY-FM 1948	680 250-D Ch. 250 (B) 97.9mc 7.4kw	Rochester Bcstg. 191 East Ave. Hamilton 9775	Stars National	Stanley J. Bachman, p Jack Shefrin, gm	Leo J. Halpin, ce Fred Bethel, pd			AP Ray. GE
WSAY 1936	1370 1,000-DA-1 CP: 5,000- DA-N	Federal Bcstg. System, Inc. 328 E. Main St. Baker 4870	Walker	Gordon P. Brown, p & gm	John Hill, sta. d & pd			INS RCA
WVET 1947 WVET-TV	1280 5,000-DA-N	Veterans Bcstg. Co. 17 Clinton Ave. S. Hamilton 4820	ABC Bolling	Ervin F. Lyke, p & gm Arthur Murrellwright, gen. slm & pmm	Elmer Walz, radio slm Paul C. Louthier, pd Ray F. Jobes, ce	F. Chase Taylor, opers. m David Roberts, nd Jack Buck, sd	Pop.: 800,000 Rad. Hms.: 300,000	Assoc. UP Col.
ROME								
WKAL 1946 WKTV(TV)	1450 250	Copper City Bcstg. Corp. Capitol Theatre Bldg. 3616	MBS Rambeau	Myron J. Kallet, p Charles A. King, gm Joseph C. Trela, cm Louis A. Barille, pd	Frank Roberts, pmm James Delaney, ce Malcom Alama, nd	Pat Esposito, fd Phil Tosti, sd Diane Mullin, wd	Pop.: 259,300 Rad. Hms.: 65,000 Ret. Sis.: \$284,951,000	L-W AP RCA
SARANAC LAKE								
WNBZ 1927	1450 250	Upstate Bcstg. 88 Main St. 1320	ABC Rambeau	Jacques DeMattos, p & gm Thomas Day, evp	Jeanne DeMattos, cm & secy.-treas. H. Berwind Williams, ce	Spinney Blair, nd & wd John Garwood, sd	Pop.: 35,000 Rad. Hms.: 10,180 Ret. Sis.: \$40,300,000	L-W AP RCA
SARATOGA SPRINGS								
WSPN (CP)	900 250-D	Spa Bcstrs. Inc. 71 West Ave. Slate Hill Middletown 94-2661						

Data corrected to Dec. 10, 1953. If executives or services for FM are same as AM affiliate names are not repeated. Market Data supplied by stations. FM's in *italics*. *—Non-Commercial Station. CP—Construction Permit issued. D—Day. DA-N—Directional Antenna, night only. DA-1—Directional Antenna, same pattern day and night. DA-2—Directional Antenna, different pattern day and night. L—Limited Time with Dominant Station. LS—Local Sunset. N—Night. SA—Special Authorization. SH—Specified Hours. ST—Share Time. Complete key to abbreviations, page 6.



WRNY

★ 680 on your dial 97.9 FM

ROCHESTER, NEW YORK

Jack Shefrin
General Manager

Fred Bethel
Program Director

A BACHMAN ENTERPRISE

THE BEST IN MUSIC

AM – All Day Long
FM – All Evening Long

5 MUSIC LIBRARIES

1. Thesaurus
2. Standard
3. Associated
4. Sesac
5. Capitol

Nationally Represented By
STARS NATIONAL, INC.

Why WQXR is more than a radio station to 600,000 families

It's because WQXR means something very special and personal to its listeners.



It's because WQXR provides New York's *only* consistent source of good music. It's because WQXR's listeners tune to it as a *station*, not just for a special program.

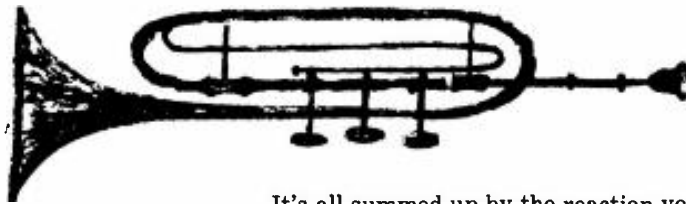

It's all summed up by the reaction you get whenever you mention WQXR: "Oh, that's my *favorite* station!"

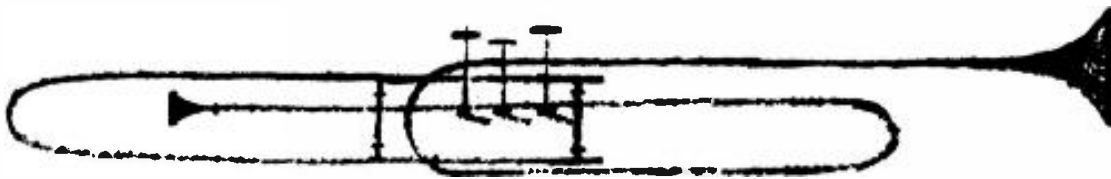

This very personal listener loyalty brings very generous results to WQXR advertisers. This year nearly 300 of them have found out how the nation's No. 1 good music station in the nation's No. 1 market pays off in more sales for them.

Let us tell you more.

AM WQXR FM

The Radio Station of The New York Times

"Always the Best in Music"

229 West 43 Street • New York 36, N. Y. • LA 4-1100

NEW YORK

City Call Letters Established Tv Affiliate	Chan. or Freq. Power	Licensee Headquarters Telephone	Network Representative	Executive Abbreviations Owner o; Pres. p; Exec. vp evp; Gen. Mgr. gm; Sta. Mgr. sm; Coml. Mgr. cm; Sales Mgr. slm; Prog. Dir. pd; Chief Eng. cc; Prom. Mgr. pmm; Prod. Mgr. pdm; News, Farm, Sports or Women's Dir. nd, fd, sd, wd.	Market Data For Primary Area (Supplied by station)	Library, News Serv. Transmitter		
NEW YORK (Cont'd)								
*WNYC 1924	830 1,000-DA-2 L-WCCO	City of New York 2500 Municipal Bldg. Whitehall 3-3600	Seymour N. Siegel, d John De Prosdo, exec. officer Bernard R. Buck, pd	Norman J. Seaman, radio pmm asst. Monroe Benton, publ. d	William Pitkin, ce Cy Freed, nd Peter Gravina, wd	Pop.: 8,000,000 Rad. Hms.: 2,000,000	SES. AP, UP
WNYC-FM 1943	Ch. 230 (B) 93.9mc, 18kw						Pop.: 12,517,858	SES. AP, UP WE
WOR 1922 WOR-TV	710 50,000	General Teleradio Inc. 1440 Broadway Longacre 4-8000	MBS H-R Reprs.	Thomas F. O'Neil, p Gordon Gray, vp & gm Robert Mayo, sls d William Crawford, slm	Florence Menkin, pd Robert Hoffman, re- search m Robert, pmm	Richard Jackson, publ. m Charles Singer, ce George Brown, nd	Pop.: 24,578,100 Rad. Hms.: 7,131,950 Ret. Slis.: \$28,122,000,000	Assoc. AP, UP WE
WOR-FM 1941	Ch. 254 (B) 98.7mc 3.4kw							GE
WOV 1926	1280 5,000 DA-1 ST-WHEI	Wodaam Corp. 730 Fifth Ave. Circle 5-7979	Pearson	Richard E. O'Dea, p Ralph N. Weil, gm & evp Arnold Hartley, vp & pd	Joseph N. Curl, cm Carroll B. Forbes, pmm	Emile Hill, ce Ruth Thompson, publ. d Thomas B. Moran, nd		St., Mac. AP
WQXR 1936	1560 10,000	Interstate Bestf. 229 W. 43d St. Lackawanna 4-1100 Raymer	Arthur Hays Sulzberger, p Elliott M. Sanger, evp Norman S. McGee, vp in charge of sls.	Eleanor N. Sanger, pd Mary Rice Anderson, pmm Louis J. Kleinklaus, ce	Abram Chasins, mus. d Eleanor P. Hurley, press info, d	Pop.: 12,000,000 Rad. Hms.: 3,600,000 Ret. Slis.: \$10,000,000,000	Assoc., SES.
WQXR-FM 1939	Ch. 242 (B) 96.3mc, 11kw							
WWRL 1926	1600 5,000-DA-1	Long Island Bestf. Corp. 41-30 58th St. Woodside, N. Y. Defender 5-1600	William H. Reuman, p Edith Dick, gm Selvin Donneson, cm & pmm	Fred Barr, pd & nd Benton R. Bartlett, ce Joseph Loskar, chief studio tech.	Jacko Maxwell, sd Alma John, wd	Pop.: 8,000,000 Rad. Hms.: 2,494,700 Ret. Slis.: \$9,830,830,000	Assoc. AP WE
WWRL-FM 1953	Ch. 286 (B) 105.1mc, 20kw							
NIAGARA FALLS								
WHLD 1940	1270 5,000-D DA	The Niagara Falls Gazette Hotel Niagara 8421	MBS Reed	Earl C. Hull, gm Richard G. Robbins, cm Edward Joseph, pd	Robert J. Wilson, ce Raymond J. Sweeney, nd	George Campbell, sd Shirley Arch, wd	Pop.: 1,184,230 Rad. Hms.: 301,758 Ret. Slis.: \$1,027,228,000	Assoc., Wld., St. UP Ray.
WHLD-FM 1946	Ch. 253 (B) 98.5mc 46kw		Rural					
WJLJ 1947	1440 1,000-D	John J. Laux 129 Main St. 5796	Pearson	John J. Laux, o Tom W. Talbot, gm cm & pmm	Helen Tubbs, pd & wd Gus Czaplak, ce	Jim Thompson, nd & sd Art Young, fd	Pop.: 1,212,900 Rad. Hms.: 335,850 Ret. Slis.: \$1,407,320,000	UP G

Data corrected to Dec. 10, 1953. If executives or services for FM are same as AM affiliate names are not repeated. Market Data supplied by stations. FM's in italic. *—Non-Commercial Station. CP—Construction Permit issued. D—Day. DA—N—Directional Antenna, night only. DA-1—Directional Antenna, same pattern day and night. DA-2—Directional Antenna, different pattern day and night. L—Limited Time with Dominant Station. LS—Local Sunset. N—Night. SA—Special Authorization. SH—Specified Hours. ST—Share Time. Complete key to abbreviations, page 6.

WLIB

1190 ON THE DIAL
WALTER WHITE SHOW
NATIONALLY SYNDICATED
GREATER N.Y. NEGRO POPULATION
1,012,883 - U.S. CENSUS

THE ONLY STATION IN NEW YORK WITH STUDIOS IN HARLEM. MORE NEGRO LISTENERS IN THE MORNING THAN ANY OTHER N. Y. STATION - Pulse

1190 ON THE DIAL
ALSO SERVING 700,000 ENGLISH-SPEAKING JEWISH FAMILIES... COST 7½ CENTS PER 1000 LISTENERS - PULSE

COMING!
POWERFUL NEW TRANSMITTER ON AIR JANUARY 15, 1954

PROGRAM
DAILY NEGRO BLOC
(6:30 a.m. to 12 noon)
FEATURING
COMMUNITY NEWS
SPECIAL EVENTS
SPIRITUALS—JAZZ
RHYTHM—BLUES
ANGLO-JEWISH TIME
(4 to 6 p.m. daily)

STARRING
LLOYD WILLIAMS
PHIL GORDON
"Harlem Serenade" "Appointment With Rhythm"
LARRY FULLER
BUDDY BOWSER
"Gospel Train" "Harlem Frolics"

STARRING
THE BOWSERS
BUDDY & SARA LOU
NEWS
Charles Campbell
Walter White

207 EAST 30th STREET, NEW YORK 16, N. Y. OREGON 9-2720

MASSENA

WMSA 1945	1340 250	The Brockway Co. Central Bldg. 990	ABC Weed	John B. Johnson, p Louis Saiff Jr., gm	Thomas R. McHugh, s & cm James H. Nash, pd	Michael Tarkulich, ce Dan Burgess, fd	Assoc. UP Tem.
WMSA-FM 1948	Ch. 287 (B) 105.3mc 13kw						RCA

MIDDLETOWN

WALL 1942	1340 250	Community Bcstg. Corp. 62 North St. 3119 Radio-TV Promotion Syndicate	James M. Patt, p, gm & cm Jerry Wax, pd	Charles Lissner, ce Albert Larson Jr., nd Harold Shively, fd	Joe Ryan, sd Betty Siers, wd	Pop.: 111,962 Rad. Hms.: 40,000 Ret. Sls.: \$137,713,000	Thes. AP G
--------------	-------------	---	--	---	--	---------------------------------	--	------------------

NEWBURGH

WGNY 1933	1220 1,000-D	Orange County Bcstg. Corp. 161 Broadway 4600	George W. Bingham, p Joseph W. Rake, cm John J. Kuhn, pd Marvin S. Seimes, ce	Mabel S. Meurer, secy-treas. Wm. Forrest, nd	Harold Lane, sd Margaret L. Schramm, wd	Pop.: 200,000 Rad. Hms.: 50,000 Ret. Sls.: \$200,000,000	
--------------	-----------------	---	----------------	--	--	---	--	--

NEW ROCHELLE

WNRC 1953	1480 500-D	Radio New Rochelle Inc. 411 Fifth Ave. 6-0800	James A. Iodice, p. gm & cm	Ken Johnston, pd Mort Morrison, ce	Joe Therrien, sd Don R. Iodice, pmm Mark Brooks, nd	Pop.: 1,000,000 Rad. Hms.: 500,000	
WNRC-FM 1953	Ch. 228 (A) 93.5mc 1kw						 AP Rel.

NEW YORK

WABC 1921 WABC-TV	770 50,000	American Bcstg. Paramount Theatres Inc. 30 Rockefeller Plaza Susquehanna 7-5000	ABC Petry	Robert E. Kintner (ABC), p Ted Oberfelder, vp Michael A. Renault, cm	Myrtle Tower, pd Willis Parsons, pmm John Bourcier, ce	William Whitehouse, sd Thomas Velotta, nd Phil Alampi, fd	 AP, INS RCA
WABC-FM 1948	Ch. 238 (B) 95.5mc 1.5kw							GE
WABF(FM) 1942	Ch. 253 (B) 99.5mc 18kw	Metropolitan Bcstg. & Television Inc. 645 Madison Ave. Templeton 8-5400		Ira A. Hirschmann, p	Sherman S. Lawrence, gm			
WBNX 1927	1380 5,000 DA-1 ST-WAWZ	WBNX Bcstg. Co. Inc. 260 E. 161st St. Melrose 5-0333 King	A. L. Haskell, p Wm. I. Moore, vp & gm	Edward Betchley, asst. cm	Frank Johnson, co-pd Edward Ervin, co-pd	Pop.: 11,861,240 Rad. Hms.: 3,178,430	SES. AP WE
WCBS 1924 WCBS-TV	880 50,000	Columbia Bcstg. System 485 Madison Ave. Plaza 1-2345	CBS, CBS Radio Spot Sales	Frank Stanton, p (CBS) Carl S. Ward, gm Henry Untermyer, slm	Sam Slate, pd Don Foley, pmm Davidson Vorhes, ce Mike Campbell, sls. service m	Ernie Hartman, asst. pd Dick Stahlberger, asst. pmm D. Gordon Graham, pub. affairs d	Pop.: 15,358,200 Rad. Hms.: 4,480,240 Ret. Sls.: \$18,251,116,100	Cap. AP, UP, INS Fed.
WCBS-FM 1941	Ch. 266 (B) 101.1mc 1.5kw							AP, UP, INS WH
WEVD 1927	1330 5,000-DA-2 ST-WBRR, WHAZ	Debs Memorial Radio Fund Inc. 117 W. 48th St. Plaza 7-0880	A. Held, p Henry Greenfield, gm & cm	George Field, pd	Charles W. Brown, ce	 AP RCA
WEVD-FM 1951	Ch. 250 (B) 97.9mc 20kw							

WHY ADVERTISERS
RENEW CONTRACTS with



1330 K.C. 5000 WATTS
97.9 20 K.W.

For more than twenty years some of the foremost national and local advertisers have renewed their contracts with WEVD to reach the Jewish population of the New York Metropolitan area.

Here they find an amazing market of vast buying power represented by more than 600,000 families with a population exceeding 3,000,000.

To this adult listening audience WEVD's selected cultural, educational and entertainment features in Jewish and in English are an eager "must" on the dial.

Through the years advertisers have proved the loyalty of WEVD's unique audience . . . it stays tuned to WEVD . . . it responds

quickly to quality . . . it has the money to buy.

That is the ONLY reason why advertisers renew their WEVD contracts year after year.

Advertisers who wish to cover the Metropolitan New York area need the voice of WEVD.

Send for your copy of the Roster of Distinguished WHO's WHO Among WEVD SPONSORS.

HENRY GREENFIELD, MANAGING DIRECTOR
WEVD 117-119 West 46th Street, New York 36, N.Y.

All Programs are Broadcast on AM and FM Simultaneously

NEW YORK

City	Call Letters Established	Chan. or Freq. Power	Licenses Headquarters Telephone	Network Representative	Executive Abbreviations	Market Data For Primary Area (Supplied by station)	Library, News Serv. Transmitter	
NEW YORK—(Continued)								
WGHF(FM)	1946	Ch. 270 (B) 101.9mc 10.3kw	WGHF Inc. 10 E. 40th St. Lexington 2-4927	W. G. H. Finch, p Gordon Myers, gm & cm	Delmar Neutzman, pd Veikko K. West, ce	SES. UP WE	
WHOM	1930	1480 5,000-DA-2	Atlantic Bcstg. Corp. 136 W. 52d St. Circle 6-3900	Fortune Pope, p Charles Baltin, vp & cm	Ralph Costantino, pd George Steiger, ce UP WE	
WHOM-FM	1930	Ch. 222 (B) 92.3mc 11kw	Assoc. GE	
WINS	1926	1010 50,000 LA-1	Gotham Bcst. Corp. 28 W. 44th St. Bryant 9-6000	J. Elroy McCaw, p John D. Keating, vp Harry Kirwan, cm Robert Crlar, pd	Joseph G. Besch, pmm Paul Von Kunitz, ce William Rohn, slm	Charles Hall, nd Jack Lightcap, sd Josephine Halpin, wd	Pop.: 16,000,000 Rad. Hms.: 4,000,000 SES, Assoc. UP, INS Cros.
WLIB	1942	1190 1,000-D L-WOWO	New Bcstg. Co. 207 E. 30 St. Oregon 9-2720	Forjoe	Morris S. Novik, p Harry Novik, gm William Travis, cm	Nat Rudick, pd Mitchell Jablons, pmm, nd & sd	John Bubbers, ce Sara Lou Harris, wd	Pop.: 12,575,000 Rad. Hms.: 12,000,000 Ret. Sls.: \$14,040,000,000 RCA
WMCA	1925	570 5,000-DA-1	WMCA Inc. 1657 Broadway Circle 6-2200	AM Sales	Nathan Straus, p M. M. Fleischl, gm John J. McSweeney, slm	Leon Goldstein, pd & nd Patricia Bolton, pmm	James McCafferty, ce Ruth Hurd, office m Helen Straus, educ. d	Rad. Hms.: 4,637,531 Wld. AP RCA
WMGM	1922	1050 50,000 DA-1	Marcus Loew Booking Agency 711 Fifth Ave. Murray Hill 8-1000	Radio Reprs.	Bertram Lebharr Jr., d Frank Roehrenbeck, gm	Arthur M. Tolchin, slm Raymond Katz, pd	Jo Ranson, pub. d Paul Fuelling, ce Nat Asch, sd	Pop.: 17,871,283 Rad. Hms.: 4,874,236 Ret. Sls.: \$21,165,332,165 AP, UP WE
WMGM-FM	1942	Ch. 262 (B) 100.3mc 18kw
WNBC	1922	660 50,000-DA-1	National Bcstg. Co. 30 Rockefeller Plaza Circle 7-8300	NBC Spot	Sylvester L. Weaver (NBC), p Robert W. Sarnoff, evp (NBC) Hamilton Shea, gm Ernest de la Ossa, sm	Stephen White, pd Robert Leber, slm John Huribut, pmm	Gerald Sellar, ce Phil Dean, Pub. d William Berns, nd	Thes. AP, UP, INS RCA
WNBC-FM	1944	Ch. 246 (B) 97.1mc 1.1kw
WNEW	1934	1130 50,000-D 10,000-N-DA-N CP: 50,000 DA-N	WNEW Inc. 565 Fifth Ave. Plaza 3-3300	Blair	William Cherry, p Bernice Judis, evp & gm Ira M. Herbert, vp & sls. d William Kaland, pd Kenneth Klein, pmm	Max Weiner, ce John Jaeger, asst. gm Alan E. Brandt, publ. d & sp, events d Burton Lambert, asst. to sls. d	Claire Himmel, research d Roy Ross, mus. d Milton B. Kaye, pdm Milton Robertson, continuity d WH

Data corrected to Dec. 10, 1953. If executives or services for FM are same as AM affiliate names are not repeated. Market Data supplied by stations. FM's in italic. *—Non-Commercial Station. CP—Construction Permit issued. D—Day. DA-N—Directional Antenna, night only. DA-i—Directional Antenna, same pattern day and night. DA-2—Directional Antenna, different pattern day and night. L—Limited Time with Dominant Station. LS—Local Sunset. N—Night. SA—Special Authorization. SH—Specified Hours. ST—Share Time. Complete key to abbreviations, page 6.

ARE YOU MISSING 5 MILLION?

YOU ARE IF YOU OVERLOOK THE WHOM FAMILY

For Twenty-three years, WHOM has devoted its time and effort to serving the foreign language and negro groups in New York. Today, many of the over FIVE MILLION Italian, Spanish, Polish, German and Negro citizens look to WHOM as a friend who has known how to speak to them "in their own language", providing the type of entertainment most popular to each group. That is why WHOM influence in these homes can mean so much to your sales figures.

★ **NEGRO**

Four hours of swing and chatter every day

★ **ITALIAN**

Two Hours a Day and Nine Hours Every Sunday.

★ **POLISH**

Three hours a day-Monday thru Saturday

★ **GERMAN**

One and a half hours daily and three hours on Sunday

and NOW . . . 8 Hours a Day of SPANISH PROGRAMS

For details on each language write or call:

WHOM

136 West 52 St. New York 19, N. Y.
Telephone—CIRCLE 6-3900



DON'T BE FOOLED



ABOUT ROCHESTER

IN ROCHESTER Pulse surveys and rates the 427 weekly quarter-hour periods that WHEC is on the air. Here's the latest score:

	STATION WHEC	STATION B	STATION C	STATION D	STATION E	STATION F
FIRSTS.....	274	112	6	0	0	0
TIES.....	34	34	2	0	0	0

★ WHEC carries ALL of the "top ten" daytime shows!

BUY WHERE THEY'RE LISTENING: -

Station on till sunset only

WHEC has consistently led in Rochester audience ratings since they were first inaugurated in 1943.

Material in this advertisement is from the latest Pulse report before closing.



WHEC

MEMBER GANNETT RADIO GROUP

of Rochester

NEW YORK
5,000 WATTS

Representatives: EVERETT-McKINNEY, Inc. New York, Chicago, LEE F. O'CONNELL CO., Los Angeles, San Francisco

City	Call Letters	Chan. or Freq.	Licensee Headquarters Telephone	Network Representative	Owner or Pres. p; Exec. vp evp; Gen. Mgr. gm; Sta. Mgr. sm; Coml. Mgr. cm; Sales Mgr. slm; Prog. Dir. pd; Chief Eng. ce; Prom. Mgr. pmm; Prod. Mgr. pdm; News, Farm, Sports or Women's Dir. nd, fd, sd, wd.	Executive Abbreviations	Market Data For Primary Area (Supplied by station)	Library, News Serv. Transmitter
SCHENECTADY								
WGNY	1922	810 50,000	General Electric Co. 1 River Rd. 7-2261	NBC Rural Christal	Chester H. Lang, GE Pub. rel. vp Robert B. Hanna Jr., best. sta. dept. m Raymond W. Weipott, opers. m R. B. Tufts, finance m Robert F. Reid, sim	J. Q. Cobb, pmm & publ. m Albert G. Zink, prog. m Willard J. Purcell, enrg. m A. O. Coggeshall, mus. librarian J. Q. Connolly, traffic sup.	L. J. Christman, news ed. Don Tuttle, fd Bob Bender, sd Martha Brooks, wd B. S. Krause, prod. sup.	Wld., The. AP, UP GE
WGFM(FM)	1940	Ch. 258 (B) 99.5mc 6kw	(WGNY, Am Affiliate)					
WSNY	1942	1240 250	Western Gateway Bcstg. Corp. Plaza Theatre 3-3622	Winslow Leighton, p. pd & pmm	Thomas Seeley, slm Irving Beck, ce	Stephen Fitz, sd Thomas Ryan, nd	L-W, SES. AP G
SYRACUSE								
WAGE	1941	620 5,000-D 1,000-N- DA-N	WAGE Inc. 511 Loew Bldg. 2-0277	ABC, Rural Venard	Frank G. Revolt, p L. N. Parmetier, ce George D. Drisko, cm	Donald F. Langham, ce Joe Cumiskey, nd & fd	Albert Meltzer, sd Ione Tracy, wd	Pop.: 1,012,720 Rad. Hms.: 186,000 Ret. Sis.: \$663,160,020
WFBL	1922	1390 5,000 DA-N	Onondage Radio Bcstg. Corp. 433 S. Warren St. 2-1147	CBS Free & Peters	Oscar F. Soule, p Samuel Woodworth, gm Charles F. Phillips, cm	Robert Weir, merc. m Robert E. Soule, pmm Lennox F. Wylie, slm Ray Owens, nd	Bob Holmes, fd Bill Thorpe, sd R. Dunn, wd	Pop.: 169,100 Rad. Hms.: 167,120 Ret. Sis.: \$685,556,000
WNDR	1947	1260 5,000-DA-N	Syracuse Bcstg. Corp. 306 S. Salina St. 2-6101	Franklin H. Small, vp & cm			
WOLF	1940	1490 250	Civic Bcstg. Corp. Kirkpatrick & Van Rennsaeler 2-7211 Walker	T. S. Marshall, p, gm & cm Hamilton M. Woodie, pd, pmm & nd	Donald Muir, ce Charles Shaw, fd	Rec Parton, sd Pat Marshall, wd	Pop.: 220,067 Rad. Hms.: 65,000 Ret. Sis.: \$257,906,000

Data corrected to Dec. 10, 1953. If executives or services for FM are same as AM affiliate names are not repeated. Market Data supplied by stations. FM's in *italics*. *—Non-Commercial Station. CP—Construction Permit issued. D—Day. DA-N—Directional Antenna, night only. DA-1—Directional Antenna, same pattern day and night. DA-2—Directional Antenna, different pattern day and night. L—Limited Time with Dominant Station. LS—Local Sunset. N—Night. SA—Special Authorization. SH—Specified Hours. ST—Share Time. Complete key to abbreviations, page 6.

WTRY in 1953, as seen by PULSE, Inc.

KEY
Metropolitan District as defined by Bureau of the Census—density of population of least 100 per sq. mile.
Metropolitan Area as defined by Bureau of the Census on whole-county basis.
Density belt-up area as revealed by aerial photographs of 1945 and later.
City of 25,000 population or more.
City of 12,500 population.
Incorporated City or Village of 1,000 or more population.

SCORE FOR 72 QUARTER HOURS

WTRY wins	42
Station "B"	24
Station "C"	2
Tied	4

WTRY Audience Increase Over 1952

Night-Time	Daytime
26%	12%

High Tune-In All Day

WTRY Share

8 P.M. 23.4	31%
8 A.M. 22.0	32%

WTRY—CBS—5000 WATTS

ALBANY • TROY • SCHENECTADY

Represented by Headley-Reed Co.



WGY-Land is Vacationland AND RADIO GOES WHERE VACATIONERS GO

From the first winter snow until the Spring thaw, winter sports fans from all over the country flock to upper New York State and New England. As in the summer WGY-Land again becomes vacationland for millions of people. From Lake Placid to the Catskills, from the Finger Lakes to the Green Mountains, wherever people ski or sled or skate, WGY reaches an increased audience all through the winter season.



WGY A GENERAL ELECTRIC STATION, SCHENECTADY, NEW YORK
Represented Nationally by Henry I. Christal Company
NEW YORK—BOSTON—CHICAGO—DETROIT—SAN FRANCISCO

NEW YORK

City Call Letters Established TV Affiliate	Chan. or Freq. Power	Licensee Headquarters Telephone	Network Represent- ative	Owner o; Pres. p; Exec. vp evp; Gen. Mgr. gm; Sta. Mgr. sm; Coml. Mgr. cm; Sales Mgr. slm; Prog. Dir. pd; Chief Eng. ce; Prom. Mgr. pmm; Prod. Mgr. pdm; News, Farm, Sports or Women's Dir. nd, fd, sd, wd.	Executive Abbreviations	Market Data For Primary Area (Supplied by station)	Library, News Serv. Transmitter	
SYRACUSE—(Cont'd)								
WSYR 1926 WSYR-TV	570 5,000-DA-2	Central N. Y. Bcstg. Corp. 224 Harrison St. 3-7111	NBC Headley- Reed	E. R. Vadeboncoeur, p & gm W. V. Rothrum, vp Thomas McCollum, pmm	A. G. Belle Isle, vp D. V. Johnson, asst. treas. A. I. Marshal, secy. & slm	W. R. Alford, cm Fred Hillegas, nd Deacon Doubleday, fd Bill Martin, sd Ruth Hardke, wd	Pop.: 1,404,900 Rad. Hms.: 537,110 Ret. Sis.: \$1,553,042	L-W UP RCA
WSYR-FM 1946	Ch. 233 (B) 94.5mc 10kw					Pop.: 425,000 Rad. Hms.: 100,000		
TROY								
WFLY(FM) 1945	Ch. 222 (B) 92.3mc 5.4kw	Troy Record Co. Hotel Troy Ashley 2-7700	Rural Radio Gill-Perna	Frank L. York, o & gm Robert C. Goodrich, sm Livingston W. Houston, p Hiram D. Harris, gm	Russell B. Wilde, cm Don G. Girard, pd	Karl H. Schabinger, ce	Pop.: 550,000 Rad. Hms.: 200,000	Assoc. AP GE
*WHAZ 1922	1330 1,000 ST-WBBR & WEVD	Rensselaer Polytechnic Institute 110 8th St. Ashley 2-3000	A. Olga Niles, pd & sd Carl J. Kunz Jr., ce & nd	Mary M. McKeever, wd	Pop.: 927,700 Rad. Hms.: 309,650 Ret. Sis.: \$879,500,000
WTRY 1940 WTRI(TV)	980 5,000-DA-1	Troy Bcstg. Co. Inc. 92 Fourth St. Ashley 4-1100	CBS Headley- Reed, Bannon	H. C. Wilder, p W. W. Carter Jr., gm E. M. Sieghel, cm	R. S. English, pd J. F. Baker Jr., pmm A. H. Chismark, ce	John J. Givney, nd Roy Shudt, sd Joyce Donovan, wd	Pop.: 927,700 Rad. Hms.: 309,650 Ret. Sis.: \$879,500,000	Cap. UP RCA
UTICA								
WGAT 1947	1310 1,000-D 500-N DA-N	Central Bcstg. Co. Box 464 2-9231 Meeker	J. Eric Williams, p John C. Davies, gm William Routh, ce	Barry Ritenour, nd C. D. Williams, fd Nick Dardano, sd	Martha Windecker, wd	Pop.: 350,000 Rad. Hms.: 74,560 Ret. Sis.: \$185,000,000 AP G
WIBX 1925	950 5,000-DA-1	WIBX Inc. First Bank Bldg. 2-2101	CBS Colton, Clark, Bannon	Margaret Bowen Stevens, p & gm Elliott Stewart, sm & evp Nathan W. Cook, pmm	John T. Dowdell, ce Frederick C. Bowen, merc. m Betty Cushing Griffin, pdm & educ. d	Edwin Slusarczyk, fd Ralph Allinger, sd Ellen T. Burt, wd	Pop.: 501,200 Rad. Hms.: 150,000 Ret. Sis.: \$525,000,000	Wid. UP Ray.
WIBX-FM 1946	Ch. 245 (B) 96.9mc 9kw							GE
WKAL 1946 WKTV(TV)	1450 250	(See Rome listing)						
WRUN 1948	1150 5,000-D 1,000-N DA-2	Rome Sentinel Co. 136 N. James St. 4-2245	ABC, Rural Avery- Knodel	Bradley C. Barnard, p Fritz S. Updike, gm Richard A. Clark, sm Edward N. Stemmler, pd	Mardi Barnard, pmm George S. Woods, co-ce	Carroll F. Henry, co-ce John Davis, nd Nick Stemmler, fd & sd	Pop.: 271,900 Rad. Hms.: 83,600 Ret. Sis.: \$308,056,000	Assoc. AP RCA
WRUN-FM 1949	Ch. 289 (B) 105.7mc 4.3kw							
WALTON								
WDLA 1951	1270 1,000-D	Delaware County Bcstg. Corp. 1270	Rural Rambeau	E. Ogden Bush, p Michael J. Cuneen, vp, gm & cm	James T. Kirwan, pd & nd Robert Devine, ce	Richard Hoyt, fd Betty Moore, wd	Pop.: 104,900 Rad. Hms.: 30,100 Ret. Sis.: \$119,900,000 UP
WATERTOWN								
WATN 1941	1240 250	Watertown Bcstg. Corp. Trust Co. Bldg. 2424	MBS Devney	G. H. Righter, p, gm, cm, pd, pmm & fd Donald Schryver, co-ce	Frederick Sprague, co-ce Donald Hopkins, sd			St., Assoc. AP RCA
WWNY 1941 WWNY-TV	790 1,000-DA-N	The Brockway Co. Hotel Woodruff 4120	CBS Weed	John B. Johnson, p Louis Saiff Jr., gm & cm	Earl R. Kelly, sm James W. Higgins, asst. sm	Maynard B. Davis, ce		Wid., Assoc. UP RCA
WWNY-FM 1948	Ch. 263 (B) 100.5mc 15.4kw							

Data corrected to Dec. 10, 1953. If executives or services for FM are same as AM affiliate names are not repeated. Market Data supplied by stations. FM's in *italic*. *—Non-Commercial Station. CP—Construction Permit issued. D—Day. DA—Day. DA-N—Directional Antenna, night only. DA-1—Directional Antenna, same pattern day and night. DA-2—Directional Antenna, different pattern day and night. L—Limited Time with Dominant Station. LS—Local Sunset. N—Night. SA—Special Authorization. SH—Specified Hours. ST—Share Time. Complete key to abbreviations, page 6.

WWRL NEW YORK

NEW YORK'S No. 1 STATION FOR AMERICA'S No. 1 NEGRO MARKET

*Powerfully Selling America's Greatest Market
at the Lowest Cost. Tops in New York for*

**SPANISH, GERMAN, Czechoslovakian, Greek, Hungarian,
Lithuanian, Ukranian, Syrian, Russian, Polish**

5,000 WATTS

Defender 5-1600

1



"This is the Deacon Speakin' "

By all odds the top farm-program personality in Central New York, Bob Doubleday, the RFD Deacon, mixes wisdom and wit to hold the enthusiasm of his huge farm audience. City slickers listen, too. Participating, Monday through Saturday,

5 to 7 a.m.

2



WSYR Timekeeper, Elliott Gove

Central New York's most popular timekeeper on Central New York's top-rated local morning program. At least five years' continuous sponsorship by more than half of the present sponsors. Participating, Monday through Saturday,

7:05-9:15 a.m.

3



Jim Deline and the Gang

After 16 years, the Jim Deline show is still the top radio variety show of Central New York. Sponsors' sales figures prove it. Participating, Monday through Saturday,

9:15-9:55 a.m.
(Also 1:00-2:00 p.m.)

Reasons Why Morning Radio PAYS OFF for WSYR Advertisers

Any way you want to look at it — Nielsen, SAMS, Pulse —
WSYR is **FIRST** in rich Central New York

WSYR ACUSE
570 KC

Write, Wire, Phone or Ask Headley-Reed

**WSYR-AM-FM-TV — the Only Complete Broadcast Institution
in Central New York. NBC Affiliate**

NORTH CAROLINA

City	Call Letters Established TV Affiliate	Chan. or Freq. Power	Licensee Headquarters Telephone	Network Represent- ative	Owner o; Pres. p; Exec. up evp; Gen. Mgr. gm; Sta. Mgr. sm; Coml. Mgr. cm; Sales Mgr. slm; Prog. Dir. pd; Chief Eng. ce; Prom. Mgr. pmm; Prod. Mgr. pdm; News, Farm, Sports or Women's Dir. nd, fd, sd, wd.	Executive Abbreviations	Market Data For Primary Area (Supplied by station)	Library, News Serv. Transmitt.	
GOLDSBORO									
	WFMC 1951	730 1,030-D	Southern Radio & Television Corp. Box 655 Truck Lane 117	KBS	Hayden Stuart, p Charles S. Carter, gm, pd. nd & sd	Carroll J. Chambers, cm Henry M. Harrison Jr., pmm & fd	William W. Bridges, ce Elsie S. Rogers, traffic d & wd	Pop.: 773,731 Rad. Hms.: 152,116 Ret. Sls.: \$450,000,000 UP WE
	WGBR 1938	1150 1,000-DA-2	Eastern Carolina Bcstg. Co. P. O. Box 1924 3730	ABC	A. T. Hawkins, p Vassie G. Belkcum, gm N. L. Royster, cm & fd (WGBR, Am Affiliate)	Doyle Satterthwaite, pd & nd	Daniel B. Trueblood, ce Jack Lee, sd		Assoc. AP REL.
	WEQR(FM) 1946	Ch. 227 (B) 93.3mc 35kw							
GREENSBORO									
	WBIG 1926	1470 5,000	N. C. Bcstg. Co. Inr. O. Henry Hotel 2-6125	CBS Holling- bery	Allen Wannamaker, gm & pmm Bill Mitchell, cm	Dan Griffin, pd William H. Malone, ce Elli Neal, nd	Add Penfield, sd Joe Tew, fd Anna Sears, wd	Pop.: 1,125,000 Rad. Hms.: 196,000 Ret. Sls.: \$375,000,000	Wld., Thes. AP RCA
	WCOG 1948 WCOG-TV	1320 1,000-DA-1	Inter-City Adv. Co. 314 S. Greene St. 3-6925	ABC Bolling	George W. Dowdy, p Gilbert M. Hutchison, gm Jack Rimmer, cm	Norm Gero, pd Doris Reardon, wd	Joseph L. Lamb Jr., ce Mart Taylor, fd	Pop.: 1,024,375 Rad. Hms.: 234,147 Ret. Sls.: \$768,654,450	UP Ray.
	WGBG 1942	1400 250	Greensboro Bcstg. Co. Inc. P. O. Box 2280 3-3631	MBS Burn- Smith	Ralph M. Lambeth, p & gm B. George Barber Jr., cm	H. Marie Craven, pd & wd Earl O. Sullivan, pmm Fred S. Smith, ce	Bob Jones, nd Fletcher Smith, sd Bob Montgomery, fd	 UP G
	WPET (CP)	950 500-D	Wayne M. Nelson	Wayne M. Nelson, p, gm & cm	Leoma Showmar, pd	E. M. Stanton Jr., ce		
GREENVILLE									
	WGTC 1940 WNCT(TV)	1590 5,000-D 1,000-N- DA-N	Carolina Bcstg. Co. Inc. P. O. Box 898 6181	MBS, Tobacco Radio Net. Pearson	Earl Westbrook, p A. Hartwell Campbell, gm	John G. Clark Jr., cm & pmm Bill Burwell, pd Hank Tribley, ce	Jane Marion, traffic m Bob Dupree, nd Larry Carr, sd Tom Moore, fd	Pop.: 95,000 Rad. Hms.: 28,600 Ret. Sls.: \$77,400,000	Wld., Assoc., Thes. Cap. UP
HENDERSON									
	WHNC 1945	890 1,000-D	Henderson Radio Corp. Norlina Rd. 7136 (WHNC, Am Affiliate)	MBS	Nathan Frank, p, gm, cm & pmm Tommy Powell, pd James Mayo, ce	Dr. Clave Frank, vp Margaret H. Frank, secy.	Robert Harrison, nd & sd Bab Harrison, fd Virginia Frank, wd		Thes., L-W AP WE Wld., L-W, Thes. AP WH
	WHNC-FM 1948	Ch. 223 (B) 92.5mc 9kw							
HENDERSONVILLE									
	WHKP 1946 WHKP-TV (CP)	1450 250	Radio Henderson- ville Inc. Chimney Rock Rd. 9061	ABC, KBS Cooke	Beverly M. Middleton, p	Kermit Edney, gm Robert Smith, fd & cm	Charles Renfrow, ce & sd	Pop.: 31,000 Rad. Hms.: 7,800 Ret. Sls.: \$19,116,000	Mac. AP G
HICKORY									
	WHKY 1939	1290 5,000-D 1,000-N DA-N	Catawba Valley Bcstg. Co. 415 1st Ave., N.W. 2294	ABC Walker	Carl V. Cline, p Edmund S. Long, gm James W. Batts, cm	Stowe "Sunny" Hoyle, pd Thomas E. Long, ce Dr. H. D. Henry, nd	C. D. Sigmon, fd Mrs. Lanthe Campbell, wd	Pop.: 375,952 Rad. Hms.: 97,525 Ret. Sls.: \$189,567,000	Wld. UP Col., WE
	WIRC 1948	630 1,000-D	Foothills Bcstg. Inc. P. O. Box 484 Annex 2124 Pearson	Edmond H. Smith Jr., p, secy.-treas. & gm Lee Douglas, cm Mattie Padgett, pd	Mrs. Cecile Bost, pmm Elmer Troutman, ce & asst. m	Margaret A. Smith, nd & wd Bill Wootten, sd Archie Deal, fd	Pop.: 460,121 Rad. Hms.: 114,866 Ret. Sls.: \$321,693,050	L-W AP Col.
HIGH POINT									
	WHPE 1947	1070 1,000-D	High Point Enterprise 305-7 N. Main St. 3466	KBS	R. B. Terry, co-o D. A. Rawley, co-o Walter F. Hester, cm	Morrison Combs, nd & fd	Yancey Cecil, ce Nick Lawrence, pd Bill Hackney, sd		Assoc., Wld. AP G
	WHPE-FM 1947	Ch. 238 (B) 95.5mc 37kw						 GE
	WMFR 1935	1230 250	Radio Station WMFR Inc. 164 S. Main St. 4593	ABC Burn- Smith	Frank S. Lambeth, p & gm Frank Smith, cm	Max Meeks, pd, nd & fd Gerald D. Sullivan, asst. & pmm	Robert P. Boyd, ce Bill Smith, sd	Pop.: 51,700 Rad. Hms.: 12,660 Ret. Sls.: \$53,800,000	L-W UP G
	WMFR-FM 1946	Ch. 258 (B) 99.5mc 38kw							L-W UP REL.
	WNOS 1953	1590 1,000-D	North State Bcstg. Co. P. O. Box 1448 8900 United Bcstg.	William H. Currie, p & gm	Clayton Steele, cm Harold Craven, pd	J. M. Stewart, ce Ronald Martin, nd	Pop.: 490,000	
	WNOS-FM 1946	Ch. 262 (B) 100.3mc 3.2kw							
JACKSONVILLE									
	WJNC 1945	1240 250	Lester L. Gould Box E 7707	MBS, Tobacco Radio Net.	Lester L. Gould, p & gm Rodric L. Jones, cm	Dorothy R. Gould, pd & wd Myron Zabner, pmm & nd	Rod O. Dorsey, ce Dick Bove, sd Jim Allgood, fd	Pop.: 100,000 Rad. Hms.: 19,000 Ret. Sls.: \$40,000,000	Wld. AP G
	WLAS (CP)	910 1,000-D	Seaboard Bcstg. Corp.					
KANNAPOLIS									
	WGTL 1947	870 1,000-D	Fred H. Whitley Inc. Cannon Blvd. 8700	Fred H. Whitley, p & gm	Foy Hinson, ce			L-W, Wld. UP Ray.
KINGS MOUNTAIN									
	WKMT 1953	1220 500-D	Southern Radiocasting Co. Box 822 999 Dora- Clayton	John C. Greene Jr., ptrn., gm & pd R. H. Whitesides, ptrn. J. K. Willis Jr., cm	Helen R. Greene, pmm George E. Webb, ce Alan Browning, Jr., pdm. nd & sd	Bill Pack, fd Barbara McLain, wd	Pop.: 350,000 Ret. Sls.: \$120,000,000	

Data corrected to Dec. 10, 1953. If executives or services for FM are same as AM affiliate names are not repeated. Market Data supplied by stations. FM's in *italics*. *—Non-Commercial Station. CP—Construction Permit issued. D—Day, DA—Directional Antenna, night only. DA-1—Directional Antenna, same pattern day and night. DA-2—Directional Antenna, different pattern day and night. L—Limited Time with Dominant Station. LS—Local Sunset. N—Night. SA—Special Authorization. SH—Specified Hours. ST—Share Time. Complete key to abbreviations, page 6.

criteria in the carolinas



46% at 9:00 A.M. for BOB BEAN and "What's Cookin'".



40% in the afternoon for JIMMY PATTERSON, "By Jimminy".



PHIL AGRESTA'S "Carolina News" has 59%.



DOUG MAYES gets to 62% Saturdays with "Farm Market Reporter".



45% gather daily at ARTHUR SMITH'S "Corner Store".



"Anything Goes" for 49% on Monday nights with GIL STAMPER.

35% for JEANNE ALEXANDER and "Jeanne's Journal" Saturday AM's.



GRADY COLE... for 22 years "Mr. Radio" in the South with a 52% share of audience.



LEWIS MARTIN'S HPL packs a 39% in the afternoon and a 52% by "Starlite Salute".

CLYDE McLEAN'S NEWS has 57% of the 6:00 P.M. traffic.



Many on the street and 51% at home for FLETCHER AUSTIN'S "Streetman".

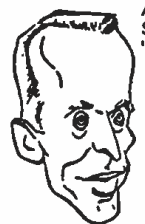

A 61% share for ALAN NEWCOMB'S Sunday evening "Evensong".

BOB RAIFORD'S "Robert D." race platters attract 38%.

Late in the evening FRED KIRBY'S "Hill-billy Star Time" reaches 55%.



JACK KNELL whose newscasts command 62% of the available ears at 12:35 P.M.



Meet WBT's criteria, each with his own individual "take" of the audience, according to The Pulse, Inc., March 1953... from 35% to 62% shares of audience, each personality leading all other competition.

Each of WBT's Pulse-powerful personalities is a criterion of excellence in nearly 400,000 North Carolina and South Carolina radio homes. Creating a daily diversity of broadcast banter, information, syncopation and public service, they couple their individual personalities with the 31-year personality of WBT's 50,000 watts—to provide unmatched coverage and penetration in the Carolinas market.

WBT
CHARLOTTE, N. C.

JEFFERSON STANDARD BROADCASTING COMPANY

Represented Nationally by CBS Radio Spot Sales

NORTH CAROLINA

City	Call Letters Established TV Affiliate	Chan. or Freq. Power	Licensee Headquarters Telephone	Network Represent- ative	Owner o; Pres. p; Exec. up evp; Gen. Mgr. gm; Sta. Mgr. sm; Coml. Mgr. cm; Sales Mgr. slm; Prog. Dir. pd; Chief Eng. ce; Prom. Mgr. pmm; Prod. Mgr. pdm; News, Farm, Sports or Women's Dir. nd, fd, sd, wd.	Executive Abbreviations	Market Data For Primary Area (Supplied by station)	Library, News Serv. Transmitter
DUNN								
WCKB 1946	780 1,000-D	N. C. Central Bcstrs. 3133	KBS	L. A. Tart Sr., p A. Lincoln Faulk, gm Carl E. Lamm, cm	E. L. Burwell, pd John Ciccone, pmm Joseph Kotlas, ce	Hershell Barbour, nd Bob Caudle, sd & fd Allene Mintz, wd	Pop.: 943,802 Rad. Hms.: 125,892 Ret. Sls.: \$528,241,000	L-W UP G
DURHAM								
WDNC 1934	620 5,000-D 1,000-N- DA-2	Durham Radio Corp. 138½ E. Chapel Hill St. 6155	CBS Raymer	C. C. Council, p J. Frank Jarman, gm & pmm C. James Woodhouse, cm & sd	E. R. Higgins Jr., pd & nd Sue Germino, office m	George W. Bartlett, ce John Watts, fd Frances Jarman, wd	Pop.: 1,439,243 Rad. Hms.: 337,896 Ret. Sls.: \$988,691,000	Assoc. UP WE
WDNC-FM 1948	Ch. 286 (B) 105.1mc 36kw							
WSRC (CP)	1410 1,000-D	Southern Radiocasting Co. Box 641 Rock Hill, S.C.						
WSSB 1948	1490 250	Public Information Corp. P.O. Box 1168 6910	MBS McGillvra	Thomas B. Sawyer, p William R. Kirby, gm	Charles M. Cook, pd & fd Edward Norman, ce	David Welborne, sd Leslie Carroll, wd		Caps. INS WE
WTIK 1946	1310 1,000-D 500-N- DA-N	Durham Bcstg. Enterprises Inc. 205½ W. Main St. 6-0904	ABC Tobacco Radio Net. Headley- Reed	Harmon L. Duncan, p & co-o Virginia D. Duncan, asst. secy. J. Floud Fletcher, gm & co-o	Mildred M. Fletcher, asst. treas. Mike Thompson, cm Ed J. Coles, pd, pmm, nd & sd A. A. White, ce	Jewel B. Lovette, traffic d William P. Weathers, fd Jane Bullock, wd	Pop.: 285,000 Rad. Hms.: 73,076 Ret. Sls.: \$422,858,000	Cap., Wld. AP RCA
ELIZABETH CITY								
WCNC 1939	1240 250	Albermarle Bcstg. Co. E. Colonial Ave. 4370		Jos. A. Gill, p			
WGAI 1947	560 1,000-D 500-N-DA-2	WGAI Radio Co. Inc. Kramer Bldg. 4371	C. Alden Baker, p & gm Ray Jones Jr., cm & sd	Don Owens, pmm G. F. Williams, ce	Gene Marshall, nd & fd	Pop.: 300,000 Rad. Hms.: 130,000 AP Ray.
ELKIN								
WIFM 1949	1540 250-D	James B. Childress 1141 Elk Spur St. 739	MBS Continental	James B. Childress, p, gm & cm	Claude White, pd	Terry Bane, ce	Pop.: 75,000	L-W UP Ray.
WIFM-FM 1950	Ch. 265 (A) 100.9mc 0.35kw							
FAIRMONT								
WFMO 1953	860 1,000-D	Carolinas Bcstg. Corp. P. O. Box 125 4781	Cutlar Moore, p Allen N. Vause, gm Billy Hodges, cm	Ray Godwin, pd & nd Joseph F. Milazzo, ce	Jerry Farmer, sd & fd Andre Mincey, wd	Pop.: 438,700 Rad. Hms.: 90,100 Ret. Sls.: \$241,371,000	
FAYETTEVILLE								
WFAI 1948	1230 250	Rollins Bcstg. Inc. P. O. Box 659 2-8131	CBS	John W. Rollins, chmn. of bd. O. Wayne Rollins, p	James H. Mayes Jr., gm & pd	Winifred Stevenson, pmm Robert Money, ce	Pop.: 106,400 Rad. Hms.: 24,100 Ret. Sls.: \$73,100,000	Thes. AP Ray.
WFLB 1948	1490 250	Fayetteville Bcstrs. Inc. P. O. Box 512 2-7136	ABC Burn- Smith	L. W. Allen, gm W. D. Bailey, cm	W. B. Belche, pmm Richard Madson, ce	John Paras, sd	Pop.: 226,358 Rad. Hms.: 41,638 Ret. Sls.: \$178,436,900	Wld. AP RCA
WFNC 1940	1390 5,000-D 1,000-N- DA-2	Cape Fear Bcstg. Co. 114½ Anderson St. 2-4948	MBS, Tobacco Radio Net. Walker	Victor W. Dawson, gm Tom Harrell, cm	Mack Stamps, pd Bill Jennings, pmm	Jack Ikner, ce Vestal Taylor, nd & fd	Pop.: 250,000 Rad. Hms.: 225,000 Ret. Sls.: \$200,000,000 UP WH
WFNC-FM 1947	Ch. 251 (B) 98.1mc 14kw						Pop.: 400,000 Rad. Hms.: 85,000 Ret. Sls.: \$200,000,000 UP GE
FOREST CITY								
WBBO 1947	780 1,000-D	Rutherford County Radio Co. Route 2 3205	Ed M. Anderson, p & gm Fred Blanton, cm	Jane Smith, pd, pmm & wd Merton Iwerks, ce	Lee Kanipe, nd & fd Billy Martin, sd	Pop.: 1,275,000 Ret. Sls.: \$955,984,000	Thes. AP
WBBO-FM 1948	Ch. 227 (B) 93.3mc 1.5kw							RCA AP REL.
FUQUAY-VARINA								
WFGV 1949	1460 1,000-D	Radio Station WFGV 333	KBS Continental	J. M. Stephenson, p Robert E. Stephenson, gm Rupert Weathers, cm	Walter M. Pearson, pd & nd Harry D. Stephenson, ce	Don Stephenson, sd Earl Roberts, fd Frances Wood, wd	Pop.: 352,760 Rad. Hms.: 90,500 Ret. Sls.: \$264,070,000 UP G
GASTONIA								
WGNC 1939	1450 250	Catherine T. McSwain 8501	ABC Continental	Catherine T. McSwain, p	Pat McSwain, gm F. C. Abernethy, cm	Fred Gray, pd W. C. Groves, ce		L-W UP Ray. L-W UP RCA
WGNC-FM 1948	Ch. 270 (B) 101.9mc 11.1kw							
WLTC 1948	1370 1,000-D	Gastonia Bcstg. Service Inc. Box 1010 5-1280	KBS Clark	James B. Petty, p, gm & pd	B. C. Morrow, cm Don Voigt, ce & fd	Naomi Edens, wd	Pop.: 2,000,000 Rad. Hms.: 500,000	Wld. UP Ray.

Data corrected to Dec. 10, 1953. If executives or services for FM are same as AM affiliate names are not repeated. Market Data supplied by stations. FM's in italic. *—Non-Commercial Station. CP—Construction Permit issued. D—Day. DA—Directional Antenna, night only. DA-1—Directional Antenna, same pattern day and night. DA-2—Directional Antenna, different pattern day and night. L—Limited Time with Dominant Station. LS—Local Sunset. N—Night. SA—Special Authorization. SH—Specified Hours. ST—Share Time. Complete key to abbreviations, page 6.

NORTH CAROLINA

ASHEVILLE

WISE 1939	1310 5,000-D	Radio Station WISE Inc. 100 College St. 3-5381	NBC Bolling	Harold Thoms, p & gm Loyd Leonard, cm Dick Harshaw, pd	M. S. Thoms, pmm John Randolph, ce	Art Borgerson, nd Ed Storey, fd	Pop.: 58,230 Rad. Hms.: 14,500 AP Col.
WLOS 1947	1380 5,000-D	Skyway Bcstg. Co. P. O. Box 2389 Battery Park Hotel 2-2431	ABC, MBS Venard	Charles B. Britt, evp Charles E. Newcomb, sm	George Roesler, cm R. Fred Brown, Jr., pd, nd & sd	Charles Sumner, ce Jim Mills, fd Sunny Daye, wd		Wld. UP RCA
WLOS-FM 1947	Ch. 282 (B) 104.3mc 9.2kw							
WSKY 1947	1230 250	Radio Asheville Inc. 12 Church St. 3-4451	Rambeau	Zeb Lee, p, gm & sd Hal Edwards, cm	James W. Young, pmm	William Clements, ce Harry Varner, fd	Pop.: 190,000 Rad. Hms.: 45,000 Ret. Slis.: \$175,000,000 AP Ray.
WWNC 1927	570 5,000-DA-N	Asheville Citizen- Times Pub Co. 14 O'Henry Ave. 5611	CBS H-R Reprs.	Roger Peace, ch. Charles Peace, p J. Kelley Sisk, vp Cecil B. Hoskins, gm & pmm James A. Hagan, cm	William F. Melia, pd & nd William H. Hamrick, ce	Jack Clements, news ed. Burwell Smith, fd Charlie Shepherd, sd Ellen Callahan, wd	Pop.: 362,900 Rad. Hms.: 85,300 Ret. Slis.: \$233,644,000	Assoc. AP, UP RCA

BOONE

WATA 1950	1450 250	Wilkes Bcstg. Co. 467	Doris B. Brown, p Roland B. Potter, gen. slm	Ralph Tugman, cm Dwight Larick, pd & nd	Ben Mast, pmm & sd Boyd Daugherty, ce	 AP RCA
--------------	-------------	-----------------------------	-------	--	---	--	--	--------------------

BREVARD

WPNF 1950	1240 250	Pisgah Bcstg. Co. Inc. 3-2611	NBC	Ed M. Anderson, p Jack Hammette, gm & cm	John Dellinger, pd, pmm & nd William Pascall, ce	John Anderson, exec. d Julian Glazener, fd Frances Walker, wd	Pop.: 35,000 Rad. Hms.: 7,500 Ret. Slis.: \$15,500,000 AP G
--------------	-------------	-------------------------------------	--------------	--	--	---	--	------------------

BURLINGTON

WBBB 1941	920 5,000-D	Alamance Bcstg. Co. 318 S. Main St. 6-6376	MBS, KBS, McGillvra	E. Z. Jones, gm & nd Robert Ray, cm Ed Brooks, pd & fd	Roy Springer, pmm Berry Tysor, ce	Louis Ferguson, comp. Jos. Sansone, sd Doris Rickard, wd		Assoc. AP G
WBBB-FM 1947	Ch. 267 (B) 101.1mc 4kw							Assoc. AP Ret.
WFNS 1946	1150 1,000-D	Burlington Graham Bcstg. Co. 113 W. Andrews St. 4261	L. E. Neese, p G. C. Starnes, gm Wally Mack, cm	Frank Candelario, pd & nd Ella Harper, pmm	Charles D. Chandler, ce Phil Peterson, sd & fd	Pop.: 500,000 Rad. Hms.: 136,550 Ret. Slis.: \$500,000,000	Wld. UP WE
WFNS-FM 1949	Ch. 230 (B) 93.9mc 2.8kw							Wld. UP WH

CHAPEL HILL

WCHL 1953	1360 1,000-D	Village Bcstg. Co. Box 388 9-2261	Roland McClamroch, Jr., p & gm Harold L. Nall, cm	C. Scott Jarrett, pd & nd Fritz Thurston, ce	R. B. Boyd, sd Mary Neil White, wd	Pop.: 377,443 Rad. Hms.: 75,488	L-W, SES. AP Col.
--------------	-----------------	---	-------	---	--	---------------------------------------	------------------------------------	-------------------------

CHARLOTTE

WAYS 1942	610 5,000-D	Inter-City Adv. Co. 3229 South Blvd. 3-7173	ABC Bolling	G. W. Dowdy, p James P. Poston, gm & cm	John William McKeel, nd Donald Matney, pmm & fd	B. C. Stewart, ce Bob Brown, sd Gladys Lavitan, wd	Pop.: 1,300,000 Rad. Hms.: 242,040 Ret. Slis.: \$790,925,000	L-W, SES. UP Col.
WBT 1922	1110 50,000-DA-N	Jefferson Std. Bcstg. Co. Wilder Bldg. 3-8833	CBS CBS Radio Sales	Joseph M. Bryan, p Charles H. Crutch- field, ex. vp & gm Kenneth Tredwell, asst vp (programs) J. Robert Covington, asst. vp (sls. & prom.)	Wally Jorgenson, gen. slm Virgil Evans, Carolina slm C. K. Spicer, bus. m. Bill Melson, acting pd	Nelson Benton, prom. sup. Thomas Howard, d of enrgg. Jack Knell, nd Lee Kirby, sd Grady Cole, fd Jeanne Alexander, wd	Pop.: 1,617,200 Rad. Hms.: 377,070 Ret. Slis.: \$1,140,490,000	Assoc. Wld. AP, UP RCA
WGIV 1947	1600 1,000-D	Charlotte Radio & Tv Corp. P. O. Box 58 2-6669	Francis M. Fitzgerald, p & gm Ray W. Ervin, cm Charles Friar, pd	John G. Surratt, pmm S. K. Lineberger, Jr., ce Julian Barber, nd	Eric Dehlin, sd Henry Poole, fd Hatty Fleming, wd	Pop.: 425,056 Rad. Hms.: 121,445	Cap. AP GE
WIST 1951	930 5,000-D	Bcstg. Co. of the South 204 Liberty Life Bldg. 6-3511	MBS Free & Peters	B. Calhoun Hipp, p G. Richard Shafto, vp & gm	Guy Vaughan Jr., mgng. d Fred Vinroot, pd & pmm	John N. Parker Jr., ce Pete Williams, nd & sd Vivian Buratti, wd	Pop.: 1,100,000 Rad. Hms.: 98,000	Thes. AP G
WSOC 1933	1240 250	Radio Station WSOC Inc. 1925 N. Tryon St. 2-7138	NBC H-R Reprs.	E. J. Gluck, p & gm Bomar Lowrance, cm Armand Bodie, pd & sd	Chas. Marshall, pmm L. L. Caudle Jr., ce	Fred Dixon, nd & fd June Sawyer, wd	Pop.: 853,200 Rad. Hms.: 853,246 Ret. Slis.: \$190,270,000 AP RCA
WSOC-FM 1947	Ch. 278 (B) 103.5mc 38kw							

CLINGMAN'S PEAK

WMIT(FM) 1942	Ch. 295 (B) 106.9mc 325kw	Mount Mitchell Bcstg. Inc. P. O. Box 546 6-7561		W. O. Nisbet Jr., p Wallace E. Stone, gm & pd J. R. H. Wilson, cm	J. L. McFarland, ce Conrad Phillips, pdm	Betsy Scarboro, traffic m		St. AP GE
------------------	---------------------------------	--	--	--	---	------------------------------	--	-----------------

CLINTON

WRRZ 1947	880 1,000-D	Radio Station WRRZ Inc. Butler Bldg. 2354		W. R. Roberson Sr., p				
--------------	----------------	--	--	-----------------------	--	--	--	--

CONCORD

WEGO 1943	1410 1,000-D	Cabarrus Bcstg. P. O. Box 527 2-6000		A. W. Huckle, p Elizabeth G. Huckle, gm	Howard McCurry, cm & pd	Kenneth R. Kennedy, ce	 AP
--------------	-----------------	---	--	---	----------------------------	---------------------------	--	----------------------

NORTH CAROLINA

KINSTON

WELS 1950	1010 1,000-D	Farmers Bcstg. Service Inc. 1400 W. Vernon Ave. 5151	KBS Devney	E. L. Scott, p Jack P. Hankins, gm	Harry Doggette, pd Ed Landry, ce	Peggy Kyle, wd	Pop.: 285,800 Rad. Hms.: 62,300 Ret. Sis.: \$175,850,000	Cap. UP Col.
WFTC 1937	960 5,000-D 1,000-N- DA-N	Kinston Bcstg. 204 E. King St. 4111	ABC, CBS Burn- Smith	William S. Page, p & gm J. Harold Vester, cm	Carl B. Caudill Jr., pmm David E. Hardison, ce	Tom Johnson, nd & sd Herman Civils, fd Jean Warwick, wd	Pop.: 460,500 Rad. Hms.: 103,300 Ret. Sis.: \$283,900,000	L-W UP Ray.
WISP 1953	1230 100	E. J. Schuffman Oasis Bldg. 6161	MBS	E. J. Schuffman, p, gm & pmm J. L. Moseley, cm	Robert E. Mongold, pd & nd S. Bruce Petteway, ce	Ted Work, sd Alice Aycock, wd	Pop.: 70,000 Rad. Hms.: 13,000 Ret. Sis.: \$47,000,000	

LAURINBURG

WEWO 1947	1080 1,000-D	Scotland Bcstg. State Bank Bldg. 770	KBS	Edwin Pate, p J. R. Dalrymple Jr., gm & fd	Bill Hogan, cm & sd C. W. Hogan, pd Dick Brown, pmm	Truman Brock, ce W. S. Brown, nd Rita Ryte, wd	Pop.: 295,500 Rad. Hms.: 60,450 Ret. Sis.: \$169,338,000	Thes. AP, UP Ray.
WEWO-FM 1951	Ch. 243 (B) 96.5mc 9.2kw						Pop.: 300,000 Ret. Sis.: \$170,000,000	WH

LEAKSVILLE

WLOE 1946	1490 250	WLOE Inc. Boulevard St. 701	MBS, KBS	Douglas L. Craddock, p, gm, cm & pmm Madeline Smart, pd	Eldred Winn, ce Carl Webb, nd & fd	Warren Wilson, sd Virginia Hudgins, wd	Pop.: 150,000 Rad. Hms.: 40,000	Wld. AP RCA GE
WLOE-FM 1949	Ch. 224 (A) 92.7mc 0.82kw							

LENOIR

WJRI 1947	1340 250	John P. Rabb 107 W. Ave. 4-5361	MBS, KBS Tobacco	John P. Rabb, o & gm F. Kent Atwater, cm	K. Rabb, pd & wd James B. Hemphill, ce	Max Culp, fd Mack Huntley, sd		L-W UP WE
--------------	-------------	---------------------------------------	---------------------	---	---	----------------------------------	--	-----------------

LEXINGTON

WBUY 1946	1450 250	Davidson County Bcstg. Co. P. O. Box 359 2716	KBS Continental	Omar G. Hilton, ptr. Greeley N. Hilton, ptr. & cm	John T. Cashion, sm	James Odom, pd Fred L. Honeycutt, ce	Pop.: 62,000 Rad. Hms.: 14,500 Ret. Sis.: \$41,000,000	St. AP G
WBUY-FM 1949	Ch. 232 (A) 94.3mc 0.3kw							Thes.

LINCOLNTON

WLON 1953	1270 500-D	Lincoln County Bcstg. Co. Startown Rd. 5-2359 Southern Radio Produc- tions	J. A. Pothill, p Earl Holder, vp, gm & pd	Jack Brown, cm	Dennis Long, ce	Pop.: 25,000 Rad. Hms.: 6,000	
--------------	---------------	--	--	---	----------------	-----------------	----------------------------------	--

LUMBERTON

WTSB 1946	1340 250	Robeson Bcstg. 112 W. 5th St. 6056	MBS Continental	Jack Pait, p James MacNeil, gm & sd	Marv Stuart, pd, nd & fd	Eddie Howell, ce Lillian Smith, wd	Pop.: 130,000 Rad. Hms.: 95,000 Ret. Sis.: \$65,000,000	Wld. AP WE
--------------	-------------	--	--------------------	---	-----------------------------	---------------------------------------	---	------------------

MARION

WBRM 1949	1250 1,000-D	Lake City Bcstg. 13½ W. Court St. 7221	W. P. Erwin, p & gm J. C. Pleasant, cm	J. L. Reynolds Jr., pd, pmm & sd Hubert C. Martin, ce	Jessie Reynolds, nd & wd Ted Powers, fd		Thes. UP G
--------------	-----------------	--	----------------	---	---	---	--	------------------

MAYODAN

WFMB(FM) 1949	Ch. 228 (A) 93.5mc 0.38kw	Mayo Bcstg. Corp. Madison 312	Southern	L. B. Shelton, p	L. E. Rish, gm & ce		 UP G
------------------	---------------------------------	-------------------------------------	----------	------------------	---------------------	--	--	------------------

MONROE

WMAP 1947	1060 250-D	Union Bcstg. Corp. P. O. Box 382 1060	KBS Continental	D. E. Marable, p, gm, & fd J. A. Laney, sm & sd	Frank Funderburk, pd William Dexter Ben- ton, bus. m	R. I. Smith, ce Frances Long, nd & wd	 UP G
--------------	---------------	--	--------------------	---	--	--	--	------------------

MOORESVILLE

WHIP 1950	1350 1,000-D	Wayne M. Nelson 3-4301	Wayne M. Nelson, p, gm & cm	Leoma Showmar, pd	E. M. Stanton Jr., ce		Cap. UP WE
--------------	-----------------	---------------------------	----------------	--------------------------------	-------------------	-----------------------	--	------------------

MOREHEAD CITY

WMBL 1947	740 1,000-D	Carteret Bcstg. Co. Inc. P. O. Box 432 6-3188 McGillvra	Grover C. Munden, p & gm James Q. Wallace, cm	Ray Cummins, pd, ce. sd & wd	Charles Markey, pmm Walt Niemi, nd & fd	Pop.: 131,900 Rad. Hms.: 24,880 Ret. Sis.: \$66,739,000	Wld. UP WE
--------------	----------------	--	--------------------	---	---------------------------------	--	---	------------------

MORGANTON

WMNC 1947	1490 250	Nathan J. Cooper Box 698 1100	NBC	Nathan J. Cooper, p	Frank A. Ballew, cm & ce	Madelyn Y. Patton, pd	Pop.: 45,000 Rad. Hms.: 10,230 Ret. Sis.: \$20,621,500 AP Ray.
--------------	-------------	-------------------------------------	--------------	---------------------	-----------------------------	-----------------------	--	---------------------

MOUNT AIRY

WPAQ 1948	740 1,000-D	Ralph D. Epperson Springs Rd. 1400	KBS Clark	Ralph D. Epperson, p & gm Lucy E. Bowman, cm Olive P. Epperson, pd	Bill Belton, pmm Harry A. Epperson Jr., ce Tom Stewart, nd	Joe Johnson, sd Niel M. Smith, fd Mary Lee Westmore- land, wd	Pop.: 180,000 AP Col.
WSYD 1952	1240 250	Mt. Airy Bcstrs. Inc. P. O. Box 209 Mt. Airy 581	MBS	Robert Hennis Epper- son, p, gm & ce Mrs. Erastus F. Poore, secy. & cm	James E. Harrelson, pd, pmm & sd	Mrs. Harvey Hiatt, asst. pd & wd	Pop.: 49,778 Rad. Hms.: 10,885 Col.

NEW BERN

WHIT 1943	1450 250	Harmon L. Duncan Box 551 New Bern 4450	MBS. Tobacco Radio Net. Pearson	Harmon L. Duncan, p Ray D. Williams, gm & cm	George Nelson, pd, pmm, nd & sd	Stuart Hall, ce Paul Cox, fd	Pop.: 49,400 Rad. Hms.: 16,900 Ret. Sis.: \$32,829,000	L-W UP
WOOW 1953	1490 250	Craven Bcstg. Co. Glenburnie Gar- dens 3311	L. T. Grantham, co-o L. H. Wetherington, co-o Lester L. Williams, gm	James C. Clark, cm Roy Williamson, pd Billy Haire, ce	Daniel Moss, news ed & nd Charles DeWitt, sd Larry Brown, sd	Pop.: 285,313 Rad. Hms.: 55,194 Ret. Sis.: \$8,000,000	

NORTH CAROLINA

City	Call Letters Established TV Affiliate	Chan. or Freq. Power	Licensee Headquarters Telephone	Network Represent- ative	Owner o; Pres. p; Exec. up evp; Gen. Mgr. gm; Sta. Mgr. sm; Coml. Mgr. cm; Sales Mgr. slm; Prog. Dir. pd; Chief Eng. ce; Prom. Mgr. pmm; Prod. Mgr. pdm; News, Farm, Sports or Women's Dir. nd, fd, sd, wd.	Executive Abbreviations	Market Data For Primary Area (Supplied by station)	Library, News Serv. Transmitter
NEWTON								
WNNC	1948	1230 250	Southern Radiocasting P. O. Box 148 930	John C. Greene Jr., ptrn., gm & cm R. H. Whitesides, ptrn.	Jonas Bridges, pd & nd Helen R. Greene, pmm George Webb, ce	Red Kirk, fd Pat Barnes, wd	Pop.: 105,000 SES. UP Ray.
NORTH WILKESBORO								
WKBC	1947	810 1,000-D	Wilkes Bcstg. Co. Radio Bldg. 633	KBS	(Mrs.) Doris B. Brown, gm, pd & fd	Roland B. Potter, cm & pmm Claude Raney, nd & sd	Walter Harrold, ce Anne Martin, wd	Thes. AP Col.
OXFORD								
WOXF	1949	1340 250	Oxford Bcstg. Corp. P. O. Box 1111 4167	Charles Allen, p James F. Flanagan, gm George A. Corkum, cm, pd & nd	Robert Smith, pmm Howard Harrell, ce Pat Flanagan, sd	Hart Curl, fd Doris Dickerson, wd	Pop.: 60,000 Rad. Hms.: 23,500 Cap. UP Ray.
RALEIGH								
WNAO	1948	850 10,000-D	Sir Walter Television Co. 219 S. McDowell 2-0321	ABC Avery- Knodel	John English, p Charles Baskerville, gm	Lee Parker, cm Byron Davidson, pd Peter Miller, ce	Hal Stanley, nd Jimmy Simpson, sd Clay Williams, fd	Wid. UP RCA
WNAO-TV	1949	Ch. 241 (B) 96.1mc 29.5kw						
WPTF	1924	880 50,000-DA-N	WPTF Radio Co. Insurance Bldg. 8311	NBC Free & Peters	S. B. Coley, ch. Richard H. Mason, p & gm Graham B. Poyner, vp & asst. gm R. W. Youngsteadt, slm	H. Taylor Vaden, pmm Henry Hulick Jr., ce	J. Edgar Kirk, nd Jim Reid, sd Bill Jackson, fd Harriet Pressly, wd	Pop.: 2,185,000 Rad. Hms.: 504,300 Ret. Sls.: \$1,451,016,000 L-W AP, UP WH Thes.
WPTF-FM	1949	Ch. 234 (B) 94.7mc 15kw						
WRAL	1939	1240 250	Capitol Bcstg. Co. Inc. 130 S. Salisbury St. 6411	MBS, Tobacco Radio Net. ForJoe	A. J. Fletcher, p Fred Fletcher, gm Fletcher Turner Jr., cm	George Hall, pd James Thomas, pmm Virgil D. Duncan, ce	William Armstrong, nd Ray Reeve, sd	Pop.: 136,450 Rad. Hms.: 33,370 Ret. Sls.: \$141,570,000 AP WE
WRAL-FM	1946	Ch. 268 (B) 101.5mc 54kw						Pop.: 1,139,942 Rad. Hms.: 231,312 Ret. Sls.: \$571,009,000 REL.
REIDSVILLE								
WFRC	1947	1600 1,000-DA-N	Piedmont- Carolina Bcstg. 116½ Gilmer St. 4361	ABC, KBS	H. T. Williams, p Steve Woodson, gm Forrest Bedell, cm & sd	A. W. Nelson, pd S. E. Sexton, ce	J. F. Womack, secy.- treas.	Pop.: 492,185 Rad. Hms.: 81,379 Ret. Sls.: \$357,218,000 Thes. AP Ray.
WREV	1950	1220 250-D	Reidsville Bcstg. Co. Inc. Danville Hwy. 7051	Universal Continental	William M. Oliver, p, gm, cm & fd	Katy P. Oliver, pd	William M. Oliver Jr., ce, nd, sd & wd	Pop.: 101,500 Rad. Hms.: 18,907 Ret. Sls.: \$40,955,000 St. UP G Fed.
WREV-FM	1948	Ch. 271 (B) 102.1mc 1.6kw						
ROANOKE RAPIDS								
WCBT	1939	1230 250	WCBT Inc. 251 Roanoke Ave. 7-2545	MBS, KBS Continental	J. W. Crew Jr., p & gm Jerry Elliott, sm, nd, sd, fd & wd	Don Collins, slm Dick Phillips, pd	Ed McLeod, ce	Pop.: 51,820 Rad. Hms.: 9,648 Ret. Sls.: \$35,000,000 L-W, SES. UP WE
WKFM(FM)	1949	Ch. 254 (B) 98.5mc 10kw		(WCBT, Am Affiliate)				Wid. REL.
ROCKINGHAM								
WAYN	1948	900 1,000-D	Radio Station WAYN Inc. 4041	Wayne M. Nelson, p & gm	William E. Henley, ce	William Futterer, cm	Cap. UP
ROCKY MOUNT								
WCEC	1947	810 1,000-D	Eastern Carolina Electronics 115 N. Church 2-3108	KBS Gold Leaf Bcstg., Tobacco Radio Net. Pearson	Josh Horne, p Mel Warner, gm & pmm Ray Thompson, cm	Ray Wilkinson, pd & nd Grover Taylor, ce	Wayne Jackson, sd Tal Pollard, fd Bunny Tucker, wd	Pop.: 645,728 Rad. Hms.: 461,469 Ret. Sls.: \$524,412,000 Assoc. AP Col.
WFMA(FM)	1947	Ch. 264 (B) 100.7mc 33kw		(WCEC, Am Affiliate)				Pop.: 1,045,728 Rad. Hms.: 302,143 Ret. Sls.: \$724,412,000 Fed.
WEED	1933	1390 1,000-DA-2	W. Avera Wynne Box 752 2-6149	ABC Burn- Smith	W. Avera Wynne, p & gm	Rainey Horner, cm Eunice Snipes, pd	Clay McBride, pmm Joe Morris, ce	Pop.: 639,500 Rad. Hms.: 133,900 Ret. Sls.: \$336,440,000 Thes. AP Ray.
WEED-FM	1949	Ch. 221 (A) 92.1mc 0.27kw						
ROXBORO								
WRXO	1949	1430 1,000-D	Roxboro Bcstg. P. O. Box 130 6013	Harold S. Taylor, p, gm & cm	John Mauti, pd & asst. m	Lloyd Perkins, ce UP WE
SALISBURY								
WSAT	1948	1280 1,000-DA-N	Mid-Carolina Bcstg. Co. 278	ABC McGillvra	C. H. Wentz, p Harry L. Welch, secy.- treas. & gm	Elbert L. Sherman, ce, asst. m & vp	Gales M. Adkins, nd & Grady E. Cole Jr., fd	Pop.: 250,000 Rad. Hms.: 56,680 Ret. Sls.: \$54,000,000 Wid. UP G
WSTP	1939	1490 250	Piedmont Bcstg. Center Theatre Bldg. 2121	MBS Burn- Smith	Bryce P. Beard, p Russell McIntire, gm & pd	Katherine Murphy, cm & pmm Carl B. Watson, ce Gene Dorton, secy.- treas.	James Turner, nd & sd Hal Frazier, fd Peggy Shaver, wd	Pop.: 76,200 Rad. Hms.: 17,983 Ret. Sls.: \$54,000,000 AP WE
WSTP-FM	1947	Ch. 293 (B) 106.5mc 2.9 kw						Pop.: 310,000 Rad. Hms.: 72,238 Ret. Sls.: \$54,000,000 AP REL.
SANFORD								
WEYE	1952	1290 1,000-D	Lee Bcstg. Corp. 519 Cross St. 1289	Waldo W. Primm, o & gm	W. M. Primm, pd & sd	Clint Long, nd	Assoc. SES. AP G

Data corrected to Dec. 10, 1953. If executives or services for FM are same as AM affiliate names are not repeated. Market Data supplied by stations. FM's in italic. *—Non-Commercial Station. CP—Construction Permit issued. D—Day. DA-N—Directional Antenna, night only. DA-1—Directional Antenna, same pattern day and night. DA-2—Directional Antenna, different pattern day and night. L—Limited Time with Dominant Station. LS—Local Sunset. N—Night. SA—Special Authorization. SH—Specified Hours. ST—Share Time. Complete key to abbreviations, page 6.

NORTH CAROLINA

—WSNS(FM) 1946	Ch. 276 (A) 103.1mc 0.33kw	Sanford Bcstg. Co.								
WWGP 1946	1050 1,000-D	Sandhills Bcstg. P. O. Box 651 860	KBS	J. R. McIver, p W. E. Horner, secy.- treas.	Harry C. Barfield, gm & pmm Del Carty, cm, pd & sd	Ed O. Kopriver, ce Les Williams, nd & fd Effie Covert, wd				Wid. UP G
—WWGP-FM 1950	Ch. 228 (A) 105.5mc 0.49kw									
SHELBY										
WOHS 1948	730 250-D	Western Carolina Radio Corp. P. O. Box 1401 6313	MBS, KBS	Robert M. Wallace, p & gm Max P. Butler, cm & pmm	Hugh Dover, pd & fd Edwin A. Patterson, ce	Don McLain, nd & sd	Pop.: 245,000 Rad. Hms.: 50,450			SES. UP Ray.
—WOHS-FM 1948	Ch. 241 (B) 96.1mc 2.6kw									
SILER CITY										
WNCA 1952	1570 1,000-D	Chatham Bcstg. P. O. Box 212 818	W. Wren, p	H. Tom Morris, gm & cm	W. B. Medlin, ce	Pop.: 49,471 Rad. Hms.: 16,150 Ret. Sis.: \$25,000,000		L-W, SES. UP Col.	
SMITHFIELD										
WMPM 1950	1270 1,000-D	Selma Smithfield Bcstg. Co. Buffalo Rd. 2434	J. Fred Horton, ptrn. J. S. Townsend, gm, ptrn. & ce	Charles I. Parrish, cm Bill Kirby, pd & fd	John A. Wall, nd & sd Mozelle Phillips, wd	Pop.: 961,130 Rad. Hms.: 203,106 Ret. Sis.: \$540,523,000			Cap. UP G
SOUTHERN PINES										
WEEB 1947	990 1,000-D	Sandhill Community Bcstrs. Inc. 113 N. E. Broad St. 2-2942	MBS	J. S. Younts, p & gm J. A. Warren, cm Melvin Kushner, ce	Charles Clapp, nd E. H. Garrison, fd	Emily M. Scheipers, wd				Assoc. AP G
STATESVILLE										
WSIC 1947	1400 250	Statesville Bcstg. Co. Inc. P. O. Box 1189 9078	MBS Southern Radio Produ- ctions	Chas. D. Melton, gm & cm	Tom Lawrence, pd & sd	T. Ken Abernathy, ce	Pop.: 75,000 Rad. Hms.: 74,000			Wid. AP Tem.
—WSIC-FM 1949	Ch. 289 (B) 105.7mc 2.7kw								 REL
TARBORO										
WCPS 1946	760 1,000-D	Coastal Plains Bcstg. Co. Inc. Edgecombe Bank Bldg. 2191 Dora- Clayton	V. E. Fountain, p J. T. Snowden Jr., gm & pmm J. P. McNair, cm	Ben F. Mayo, pd G. Lee Hodges, ce Tom Shields, nd	Lewis Heilbronner, sd John H. Price, fd Sybil D. Spain, wd	Pop.: 350,000 Rad. Hms.: 102,000 Ret. Sis.: \$235,323,000			Wid. AP Ray.
—WCPS-FM 1952	Ch. 282 (B) 104.3mc 10kw									Thes. WH
THOMASVILLE										
WTNC 1947	790 1,000-D	Thomasville Bcstg. Co. P. O. Box 750 2701 Continental	George W. Lyles Sr., p Harold Harrison, gm, cm, pd & pmm	James McAden, ce Joe Long, nd	David Cockman, sd Nell Fouts, wd				SES. UP G
—WTNC-FM 1949	Ch. 252 (A) 98.3mc 0.45kw									PCA
WADESBORO										
WADE 1923	1210 1,000-D	R. P. & R. A. Lyon 620	KBS Walker	R. P. Lyon, p James A. Ballard, gm Willard P. Billingsley, sm & nd	Peggy L. Mitchell, pd W. A. Kiker, pmm Kenneth Read, ce	Frank Martin, sd William Benoit, fd Patsy Lee, wd	Pop.: 912,340 Rad. Hms.: 191,918 Ret. Sis.: \$638,593,000			Cap. UP G
WALLACE										
WLSE 1953	1400 250	Duplin Bcstg. Co. P. O. Box 449 8611	MBS KBS	Harry Kramer, p Lester L. Gould, gm	Howard N. Fisher, sm cm, pd, pmm & sd Walter Tabler, ce & nd	Chuck Wagner, fd Edith Fisher, wd	Pop.: 46,000 Rad. Hms.: 10,200			
WASHINGTON										
WHED 1948	1340 250	Beaufort Bcstg. Co. Inc. U. S. Highway 17 S. 278	KBS Continental	Lee B. Wynne, p William R. Abeyounis, gm	Charlie Yates, pd John Wilroy, ce	Sandy Pfouts, sd Lillie Jackson, wd				L-W Ray.
WRRF 1942	930 5,000-D 1,000-N- DA-N	Tar Heel Bcstg. System Inc. Bank of Washington Bldg. 403	ABC Walker	W. R. Roberson Jr., p T. H. Patterson, gm William Abeyounis, cm	Merrill Daniels, pd Bob West, pmm & sd L. E. Hiland, ce	Dick Stokes, nd Gene Hodges, fd	Pop.: 678,564 Rad. Hms.: 107,040		 AP WE
WAYNESVILLE										
WHCC 1947	1400 250	Radio Station WHCC P. O. Box 180 Glendale 6-4661	MBS, KBS	Kenneth D. Fry, p & gm	Margaret F. Fry, vp treas.	Frank Wilbur, ce	Pop.: 58,000 Rad. Hms.: 20,000 Ret. Sis.: \$30,000,000			L-W Ray.
WHITEVILLE										
WENC 1946	1240 250	Whiteville Bcstg. Co. Inc. P. O. Box 700 2133	MBS Clark	J. A. Maulsby Sr., p Ward A. Coleman, gm Jerry Honeycutt, cm	Steve Hart, ce		Pop.: 160,000			LW, Thes. AP Ray.
WILLIAMSTON										
WIAM 1951	900 1,000-D	East Carolina Bcstg. Co. 115 E. Main St. 2457	Charles M. Gaylord, co-o, gm & cm William H. Ferrior Jr., co-o, sm, pd & sd	James L. McFarland, ce Tommy Lloyd, asst. pd & nd	William B. Humble, reg. sls. rep. Mattie Lou Roberson, wd	Pop.: 225,000 Rad. Hms.: 65,000 Ret. Sis.: \$123,460,000			L-W UP G

NORTH CAROLINA

City	Call Letters Established TV Affiliate	Chan. or Freq. Power	Licensee Headquarters Telephone	Network Represent- ative	Owner o; Pres. p; Exec. vp evp; Gen. Mgr. gm; Sta. Mgr. sm; Coml. Mgr. cm; Sales Mgr. slm; Prog. Dir. pd; Chief Eng. ce; Prom. Mgr. pmm; Prod. Mgr. pdm; News, Farm, Sports or Women's Dir. nd, fd, sd, wd.	Executive Abbreviations	Market Data For Primary Area (Supplied by station)	Library. News Serv. Transmitter
WILMINGTON								
WGNI	1946	1340 250	New Hanover Bcstrg. 211 N. 2d St. 2-2493	MBS. Tobacco Net. Pearson	J. S. Brody, p Allen B. Jones, gm A. V. Thompson, cm	Paul Parker, pd & nd Lou Essick, pmm & sd A. L. Madeley, ce	Betty Killian, fd Arlene Collier, wd	Thes. UP WE
WMFD	1935	630 1,000-DA-2	Richard A. Dunlea P. O. Box 696 4840	ABC Burn- Smith	R. A. Dunlea, p & gm Claud O'Shields, cm	R. A. Dunlea Jr., pd E. L. Herring Jr., ce	Paul Jennewein, nd Clint Long, sd	Pop.: 158,000 Rad. Hms.: 72,000 UP RCA Wld.
WMFD-FM	1949	Ch. 242 (B) 96.3mc 11.5kw						
WILSON								
WGTM	1937	590 5,000-DA-2	Watson Industries Inc. Herring Ave. Ext. 2188	CBS Walker	P. T. Watson, p Henry Sullivan, gm Bill Bunn, pd	Ernie Pate, ce Al Mosely, office m	Clint Faris, sd Bill Glover, fd	Pop.: 1,233,068 Rad. Hms.: 220,371 Ret. Sls.: \$600,000,000 Thes. UP Ray.
WVOT	1948	1420 1,000-D 500-N-DA-N	Wilson Radio Co. Inc. Wilson 5157	MBS	H. W. Anderson, p H. W. Severance, gm P. O. Barnes, cm	Joel Lawhon, pd & sd Lynda Thomas, pmm Dan Williams, ce	Bill Stuckey, sd Wally Williams, fd	Pop.: 380,000 Rad. Hms.: 76,000 Ret. Sls.: \$267,092,000 AP RCA
WINSTON-SALEM								
WAAA	1950	980 1,000-D	Community Bcstrg. Service P. O. Box 3119, Hshy. 311 E. 2-4121 Forloe	Roger Page Jr., p Gene Sink, gm & pmm	Tom Buckley, cm Larry Williams, pd	Fred Bennett, ce Doris Page, secy.-treas.	Ret. Sls.: \$85,830,000
WAIR	1937	1340 250	WAIR Bcstrg. Co. Pepper Bldg. 2-1133	ABC Walker	George Walker, p & gm Jack Weldon, sm Wallace Voigt, cm & nd	Frances Denny, pd Lawrence Patrick, pmm	Lee King, ce John O'Neil, sd Marion Cason, wd	Pop.: 390,700 Rad. Hms.: 91,030 Ret. Sls.: \$250,043,000 Pop.: 1,451,000 Ret. Sls.: \$1,250,000,000 Wld., Cap. AP WE RCA
WAIR-FM	1947	Ch. 226 (B) 93.1mc 34kw						
WSJS	1930	600 5,000-DA-2	Piedmont Pub. Co. 419-421 N. Spruce St. 5-2311	NBC Headley- Reed	Gordon Gray, p Harold Essex, gm & vp Harry B. Shaw, slm	Johnny Comas, prog. m Leon Lasley, ce Phil Hedrick, opers. m	F. O. Carver, nd Max Ulrich, sd Harvey Dinkins, fd	Pop.: 1,301,214 Rad. Hms.: 294,417 Ret. Sls.: \$1,015,415,000 Assoc. UP WE
WSJS-TV								
WTOB	1947	1380 5,000-D 1,000-N- DA-N	Winston-Salem Bcstrg. Co. Inc. 300 S. Stratford 3-4353	CBS. MBS H-R Reps.	James W. Coan, p John G. Johnson, gm Charles W. Brunt, cm Owen Spann, pd & sd	Avery Van Etten, pmm & wd Hassell Bailey, ce	Robert St. Lawrence, nd Johnny Miller, fd Fred L. Honeycutt, ce	Pop.: 670,000 Rad. Hms.: 168,000 Ret. Sls.: \$545,600,000 Thes. AP G
WTOB-TV								

Data collected to Dec. 10, 1953. If executives or services for FM are same as AM affiliate names are not repeated. Market Data supplied by stations. FM's in *italic*. *—Non-Commercial Station. CP—Construction Permit issued. D—Day. DA-N—Directional Antenna, night only. DA-1—Directional Antenna, same pattern day and night. DA-2—Directional Antenna, different pattern day and night. L—Limited Time with Dominant Station. LS—Local Sunset. N—Night. SA—Special Authorization. SH—Specified Hours. ST—Share Time. Complete key to abbreviations, page 6.

NORTH CAROLINA'S WSJS DELIVERS

A 15-COUNTY MARKET
with
\$625,075,000* RETAIL SALES

* Sales Management 1953 Survey of Buying Power

**MORE VALUE FOR YOUR ADVERTISING DOLLAR
ON RADIO - - - AND TV, TOO**

600 Kilocycles **AM- WSJS -TV** Channel 12

NBC
Affiliate

The Journal Sentinel Station
WINSTON-SALEM

Represented by
HEADLEY-REED CO.

MARKET DATA BY COUNTIES

County	Population 1950	Radio Families 1953	Retail Sales 1952(000)	Food Sales 1952(000)	Drug Sales 1952(000)	Automobile Ownership 1952	County	Population 1950	Radio Families 1953	Retail Sales 1952(000)	Food Sales 1952(000)	Drug Sales 1952(000)	Automobile Ownership 1952
Adams	4,910	1,180	\$ 6,855	\$ 1,370	\$ 105	2,640	Morton	19,295	4,550	20,542	3,696	467	7,847
Barnes	16,884	4,420	17,791	3,308	320	8,001	Mountrail	9,418	2,510	9,755	1,629	274	5,305
Benson	10,875	2,410	5,168	1,272	95	4,324	Nelson	8,090	1,870	9,669	1,255	203	3,855
Billings	1,777	470	130	51		776	Oliver	3,091	580	978	293	38	1,137
Bottineau	12,140	3,090	10,097	1,871	253	5,957	Pembina	13,990	3,410	13,543	2,419	204	6,813
Bowman	4,001	970	6,342	1,377	205	2,449	Pierce	8,326	2,020	7,655	1,274	86	3,779
Burke	6,621	1,810	5,353	1,306	154	3,352	Ramsey	14,373	3,550	18,989	2,925	331	6,453
Burleigh	25,673	6,700	40,038	5,020	1,137	11,595	Ransom	8,876	2,270	8,682	1,425	156	4,126
Cass	58,877	15,910	89,819	11,020	2,712	25,023	Renville	5,405	1,460	5,680	1,543	93	2,764
Cavaller	11,840	2,820	9,413	1,537	165	5,164	Richland	19,865	5,170	23,271	3,276	392	9,056
Dickey	9,121	2,380	10,466	1,567	280	4,161	Rolette	11,102	2,060	6,335	1,333	163	3,478
Divide	5,967	1,450	5,664	871	132	3,599	Sargente	7,616	1,840	4,332	987	38	3,413
Dunn	7,212	1,650	5,144	974	102	3,051	Sheridan	5,253	1,270	3,514	546	85	2,359
Eddy	5,372	1,270	5,570	846	135	2,408	Sioux	3,696	610	1,238	510	33	1,027
Emmons	9,715	1,970	8,805	1,699	47	3,831	Slope	2,315	490	442	155		1,247
Foster	5,337	1,460	7,091	1,303	86	2,673	Stark	16,137	3,830	23,033	3,041	567	7,218
Golden Valley	3,499	980	4,900	950	89	2,058	Steele	5,145	1,280	4,042	850	86	2,860
Grand Forks	39,443	10,320	56,450	8,019	1,052	15,216	Stutsman	24,158	5,660	28,314	4,208	599	10,336
Grant	7,114	1,630	5,425	977	187	3,200	Towner	6,360	1,450	5,824	1,110	126	3,273
Griggs	5,460	1,380	5,548	765	87	2,620	Trall	11,359	2,930	12,217	2,029	205	5,983
Hettinger	7,100	1,750	10,783	1,706	191	3,826	Walsh	18,859	4,490	20,116	2,732	383	9,009
Kidder	6,168	1,420	4,467	957	87	2,487	Ward	34,782	9,690	55,118	8,680	1,564	15,396
LaMoure	9,498	2,350	10,307	1,733	178	4,704	Wells	10,417	2,650	9,951	1,708	188	4,862
Logan	6,357	1,350	5,306	682	44	2,747	Williams	16,442	5,500	25,675	4,212	416	9,900
McHenry	12,556	3,090	10,736	2,659	218	5,903	Total	619,636	155,810	\$707,194	\$115,329	\$15,662	285,128
McIntosh	7,590	1,730	9,832	1,858	105	3,395	Note: Population 1950 Census; radio families Standard Audit & Measurement Services Inc.; food, drug and retail sales, copyright 1953, Sales Management; further reproduction unlicensed; automobiles supplied by state.						
McKenzie	6,849	1,840	5,064	1,015	130	3,741							
McLean	18,824	4,870	18,094	4,914	500	8,893							
Mercer	8,686	2,000	7,621	1,866	171	3,934							

DIRECTORY OF AM AND FM STATIONS

BISMARCK

KFYR 1925 KFYR-TV	550 5,000-DA-N	Meyer Bcstg. Co. 202½ 4th St. 468	NBC Northwest Blair	Mrs. P. J. Meyers, p F. E. Fitzsimonds, gm	R. W. MacLeod, cm Cal Culver, pd Ivar Nelson, ce	Jack Swenson, nd & pmm Doug Anderson, sd Larry Kindie, fd	Pop.: 1,300,000 Rad. Hms.: 3*3,000 Ret. Sls.: \$1,500,000,000	Thes. UP RCA
-------------------------	-------------------	---	---------------------------	---	--	--	---	--------------------

DEVILS LAKE

KDLR 1925	1240 250	KDLR Inc. 1025 3d St. 1090	MBS, KBS. Great Northern Lawson	Bert Wick, p & gm Paul R. Lange, cm Wilbur Clemenson, pd	Norman Buckner, pmm & sd Richard Moritz, ce	Hildur Marie Wick, treas. Lois J. Lange, secy. John Patterson, nd	Pop.: 81,000 Rad. Hms.: 19,850 Ret. Sls.: \$65,000,000	SES., Wld. UP WE
--------------	-------------	----------------------------------	--	--	---	--	--	------------------------

A "book"
that explains
time-buying and its
effect on
advertising and
public acceptance
and opinion

BROADCASTING • TELECASTING
is the one journal that gives you the most
reliable, most complete news of radio, tele-
vision and the allied arts. If you are new
to radio/tv, or if you plan to enter the field
—don't take chances on a buck-slip copy—
start your own subscription today. Read
the latest radio/tv news while it is still news.
Annual subscription \$7.00. *



1735 DeSales Street, N.W., Washington 6, D. C.

*BROADCASTING and TELECASTING Yearbooks may be ordered
as part of a year's subscription at the additional cost of \$2.00 per
copy. Apart from a subscription Yearbooks are \$5.00 each.



DO YOU KNOW THESE FACTS ABOUT WDAY?

WDAY Covers the Nation's Third-Best County in Retail Sales Per Capita*! (\$5579 vs national average of \$3584.)

WDAY Covers America's 73rd Wholesale Market! (Fargo ranks higher in wholesale

sales than many larger cities such as Camden, N. J. and Wilkes-Barre, Pa.)

Fargo's Effective Buying Income Per Family is \$6343, As Against the National Average of \$5086!

WDAY dominates this big market — is a 17-to-1 choice over the next station, according to a survey made by students of North Dakota Agricultural College, among radio listeners in 23 counties around Fargo!

In three of the last four years, WDAY was the top-rated Hooper station on NBC — in one of those years was actually the top-rated Hooper station in the entire nation!

Yes, and these are only *part* of our amazing story. Let your Free & Peters Colonel give you *all* the facts.

*Cass County is third-best among all U. S. counties of 50,000 or over population.

WDAY

FARGO, N. D.

NBC • 5000 WATTS • 970 KILOCYCLES



FREE & PETERS, INC., Exclusive National Representatives

MARKET DATA BY COUNTIES (Continued)

County	Population 1950	Radio Families 1953	Retail Sales 1952(000)	Food Sales 1952(000)	Drug Sales 1952(000)	Automobile Ownership 1952	County	Population 1950	Radio Families 1953	Retail Sales 1952(000)	Food Sales 1952(000)	Drug Sales 1952(000)	Automobile Ownership 1952
Sandusky	46,114	14,130	50,814	11,841	1,011	24,151	Washington	44,407	12,830	35,660	9,021	778	18,617
Scioto	82,910	23,800	72,215	19,106	1,810	27,542	Wayne	58,716	16,130	67,131	13,645	1,433	26,839
Seneca	52,978	15,450	55,608	12,841	1,315	25,885	Williams	26,202	8,230	29,008	6,767	582	14,339
Shelby	28,488	8,220	29,300	8,195	631	14,422	Wood	59,605	17,020	53,151	14,761	1,233	28,643
Stark	283,194	84,020	323,480	82,361	7,570	116,734	Wyandot	19,785	5,870	17,221	3,983	400	10,448
Summit	410,032	125,220	485,875	129,012	13,038	172,263	Total	7,946,627	2,375,590	\$8,970,090	\$2,284,987	\$246,148	3,021,633
Trumbull	158,915	46,110	151,263	43,915	3,282	68,253	Note: Population 1950 Census; radio families Standard Audit & Measurement Services Inc.; food, drug and retail sales, copyright 1953, Sales Management; further reproduction unlicensed; automobiles supplied by state.						
Tuscarawas	70,320	20,790	67,636	18,653	1,707	31,056							
Union	20,687	6,030	17,047	3,404	353	10,424							
Van Wert	26,971	8,520	30,410	7,326	565	13,962							
Vinton	10,759	2,570	4,132	1,754	72	3,635							
Warren	38,505	11,160	34,528	8,680	750	18,356							

DIRECTORY OF AM AND FM STATIONS

City	Call Letters	Chan. or Freq. Power	Established	Tv Affiliate	Licensee Headquarters Telephone	Network Representative	Owner o; Pres. p; Exec. vp evp; cm; Sals Mgr. slm; Prog. Dir. pd; Chief Eng. ce; Prom. Mgr. pmm; Prod. Mgr. pdm; News, Farm, Sports or Women's Dir. nd, fd, sd, wd.	Executive Abbreviations	Market Data For Primary Area (Supplied by station)	Library, News Serv. Transmitter	
AKRON											
	WADC	1350	1925		Allen T. Simmons WADC Bldg. JE 5-6165	CBS Holling- bery	Allen T. Simmons, o & Harold Hageman, pd, nd & fd Robert B. Wilson, asst. m	M. H. Bevan, traffic m & pdm C. S. Williams, slm & Doc Williams, sd Nina Magno, wd Arnold Bock, ce		Wld., St. UP Col.	
	WAKR	1590	1940		Summit Radio First National Tower Hemlock 4-6151	ABC Weed	S. Bernard Berk, p & gm Roger G. Berk, vp & sm	O. Keith Baldwin, cm A. R. Cooper, pd & pmm	Irwin L. Knopp, ce Torey Southwick, fd Bob Wylie, sd	Pop.: 1,252,390 Rad. Hms.: 347,731	Assoc. UP RCA
	WAKR-FM	Ch. 248 (B)	1947								
	WCUE	1150	1950		Akron Bestg. 41 S. Main St. Franklin 7114	Forjoe	Tim Elliot, p & gm Jack Maurer, sm Jack Clifton, pd	Jean Elliot, pmm & wd George V. Paul, ce	Kenneth Halterman, nd George Dunlevy, sd	Pop.: 2,500,000 Rad. Hms.: 750,000 Ret. Sls.: \$2,500,000,000	Assoc. UP GE
	WHKK	640	1945		The WHKK Bestg. Co. 51 W. State St. Blackstone 7101	MBS Bolling	J. B. Maurer, co-m P. R. Herbert, co-m Bruce Blake, pd	Henry Neiderkoffer, ce Max Plaucher, nd Dick Howard, fd	Bill Pierson, sd Lucille McClaren, wd	Pop.: 2,700,000 Rad. Hms.: 786,000	Thes. AP Cont.
	ALJANCE										
	WFAH	1310	1953		The Review Pub. 2720 S. Union 1-5345	Standard Net. Rambeau	D. A. Peterson, gm Frank LaBarba, cm R. A. Gates, pd	Gene Peterman, ce Bud Stone, nd	Tony Gates, fd Ed Kraehling, sd	Pop.: 1,103,000 Rad. Hms.: 309,717 Ret. Sls.: \$1,179,617,000	
	WFAH-FM	Ch. 269 (A)	1947								

Data corrected to Dec. 10, 1953. If executives or services for FM are same as AM affiliate names are not repeated. Market Data supplied by stations. FM's in italic. *—Non-Commercial Station. CP—Construction Permit issued. D—Day. DA—Day. DA-N—Directional Antenna, night only. DA-1—Directional Antenna, same pattern day and night. DA-2—Directional Antenna, different pattern day and night. L—Limited Time with Dominant Station. LS—Local Sunset. N—Night. SA—Special Authorization. SH—Specified Hours. ST—Share Time. Complete key to abbreviations, page 6.

Wcue... the station that's **FIRST** with Akron retailers

A current monitor report shows that more retailers use WCUE than any other Akron Station. These retailers can check results directly, and they find they get more direct sales for their advertising dollar on WCUE. Take a tip from the advertisers who are close enough to know. Contact WCUE soon. Independent and outstanding.



Wcue

See your FORJOE man for details

ASHLAND WATG 1950	1340 250	Ashland Bcstg. Co. Ashland-Mansfield Rd. 2-1573	MBS McGillvra	Robert S. Burke, p Eugene E. Mills, gm & cm Richard Leidy, pd	Don Holzapfel, sm & pmm Richard Matthes, ce Don Coffman, fd	Wayne Byers, sd Cathy Donges, wd	Pop.: 120,000 Rad. Hms.: 35,000 Ret. Sls.: \$150,000,000	Thes. AP RCA
WATG-FM 1947	Ch. 267 (B) 101.3mc 10.2kw							
ASHTABULA WICA 1937 WICA-TV	970 5,000-D 1,000-N DA-2	WICA Inc. 32-126	McGillvra	D. C. Rowley, p John Colin, gm Donald Fasset, cm John Strasen, pd	George Murray, office Frank Bernato, ce Charles Mandrake, asst. pd	Ralston Smith, nd Andy Holecko, sd Macklin Grove, fd Patricia Sharp, wd		Wld. UP RCA
WICA-FM 1949	Ch. 279 (B) 103.7mc 40kw						 REL.
ATHENS WATH 1950	1540 1,000-D	A. H. Kovlan & J. D. Sinyard Box 502 3-1360 Con- tinenta	A. H. Kovlan, co-o, gm & ce	J. D. Sinyard, co-o, cm & pmm Ted Covert, pd & fd	Jerry Boles, nd Robert Carano, sd	Pop.: 110,000 Rad. Hms.: 27,000 Ret. Sls.: \$90,000,000	
BELLAIRE WTRF 1947 WTRF-TV	1290 1,000-D	Tri-City Bcstg. Co. Woodmont Bellaire 1515	MBS Holling- bery	Thomas M. Bloch, p Robert W. Ferguson, vp & gm H. Needham Smith, cm	Franklin R. Curtis, pd William Greaver, pmm Howard L. Dauben- mejer Jr., ce	George Diab, nd & sd Paul Howard, fd Joanne Dunn, wd	Pop.: 350,000 Rad. Hms.: 340,000 Ret. Sls.: \$225,000,000	Assoc. AP GE
WTRF-FM 1947	Ch. 263 (B) 100.5mc 20kw						Pop.: 400,000 Rad. Hms.: 75,000	
BELLEFONTAINE WOHP 1952	1390 500-D	Lake Erie Radio & Tv Corp. 6681	KBS	Ted Nelson, p Pat Shannon, vp & nd	Frank Cummins, gm & sd Chester Terry, ce	Joe Smith, fd Nina Lewis, wd	Pop.: 40,000 Rad. Hms.: 21,000	AP G
BOWLING GREEN WWBG (CP)	730 750-D DA	Howard A. Ward Kell Lumber & Supplies Co.						
CAMBRIDGE WILE 1948	1270 1,000-D	Land O'Lakes Bcstg. Corp. 917 Beatty Ave. 4-5605	KBS	H. D. McClelland, p Howard A. Donahoe, evp	Bruce Meighen, sls. d & pmm Albert G. Engel, ce & fd	David C. Lorimer, pd & nd Don Evans, sd Thelma Granitsas, wd		Wld. AP Ray.
CANTON WAND 1947	900 500-D	P. C. Wilson 106 High Ave., N.W. 6-8396 Best	P. C. Wilson, o Fred Coukart, gm Frank Grosjean, cm	James Wilson, pd Robert Van Dyke, ce	Woody May, nd Ralph Pidcock, sd	Pop.: 750,000 Rad. Hms.: 225,000 Ret. Sls.: \$1,000,000,000	Cap., St. AP GE
WCMW 1946	1060 1,000-D	Stark Bcstg. Corp. Hills & Dales Rd., NW 5-9475 McGillvra	S. L. Huffman, p Clark L. Dozer, sm Jack R. Hale, cm	Gene Dillon, pd, nd, fd & sd	Jane Thomas, pmm & wd William Waechter, ce	Pop.: 1,063,352 Rad. Hms.: 257,862 Ret. Sls.: \$719,558,000	Wld., Thes. AP RCA
WHBC 1925	1480 5,000-DA-N	Ohio Bcstg. Co. 550 S. Market Ave. 6-7166	ABC Venard	Roy D. Moore, p G. Gordon Strong, gm Eugene Carr, radio d Robert C. Fehlman, m Paul E. Gilmor, cm	Robert Breen, pd Kenneth Silker, ce Wilbur Jameson, trans. sup.	Charles Pickens, mus. d Al Frances, nd Bob Krahlung, fd Jim Muzzy, sd Carol Adams, wd	Pop.: 1,412,000 Rad. Hms.: 328,000	
WHBC-FM 1948	Ch. 231 (B) 94.1mc 15kw							
CHILLICOTHE WBEX 1947	1490 250	Shawnee Bcstg. Co. 27 E. 2nd St. 3-2244	ABC Buckeye Grant	John Halliday, p Truman A. Morris, gm	Wm. R. Mnich, sm & cm James Eldridge, pd, pmm & nd	Henry Dornhuber, ce Dave Achor, sd & fd	Pop.: 64,000 Rad. Hms.: 14,000 Ret. Sls.: \$2,325,918,100 AP WE
CINCINNATI WCIN 1953 WCIN-TV	1480 1,000-D DA	Robert W. Rounsaville Mulberry 7600 Forjoe, Dora- Clayton	Robert W. Rounsaville, o William Wagner, m & cm	Larry Dean Faulkner, pd & nd Ralph Johnson, pmm Joseph McCormack, ce	Paul B. Cram, tech. d Charles Scruggs, fd Charles Gordon, sd Odessa Monrow, wd		
WCKY 1929	1530 50,000-DA-N	L. B. Wilson Inc. Hotel Sheraton Gibson Cherry 6565 Welstead	L. B. Wilson, p & gm C. H. Topmiller, evp & ce Geo. H. Moore, loc. slm Jeanette Heinze, traffic m	Bob Fleming, pmm Arthur D. Gillette, studio tech. sup. Norman Ponte, trans. sup.	Paul Sommerkamp, sd Vee James, wd John Murphy, nd Marty Roberts, fd	Ret. Sls.: \$1,035,997,000	Assoc., St. INS GE

CLEVELAND'S
ONLY
NEWS STATION
ON THE AIR
24 HOURS DAILY
'ROUND THE CLOCK

WSRS

LOCAL NEWS
EVERY SIXTY
MINUTES ON
THE HALF HOUR
'ROUND THE CLOCK
DAY AND NIGHT

"The All-American Family Station"

AWARDED 1st PLACE* FOR OUTSTANDING NEWS PROGRAMS!

*AFTRA AWARDS

NAT'L. REP. FORJOE & CO.

City	Call Letters	Chan. or Freq. Power	Licensee Headquarters Telephone	Network Representative	Owner or Pres. p; Exec. vp evp; Gen. Mgr. sm; Sta. Mgr. sm; Coml. Mgr. cm; Sales Mgr. slm; Prog. Dir. pd; Chief Eng. ce; Prom. Mgr. pmm; Prod. Mgr. pdm; News, Farm, Sports or Women's Dir. nd, fd, sd, wd.	Executive Abbreviations	Market Data For Primary Area (Supplied by station)	Library, News Serv. Transmitter	
	WCPO	1230	Scripps-Howard Radio Inc.	MBS Branham	Jack R. Howard, p M. C. Watters, vp & gm	Glenn Clark Miller, cm Earl Corbett, pd Richard Zavon, pmm	Paul Adams, ce Robert Otto, nd Waite Hoyt, sd	L-W UP WE	
	WCPO-TV	250	2345 Symmes St. Capitol 0777						
	WCPO-FM	Ch. 285 (A)							
	1949	105.1mc 12.5kw							
	WKRC	550	Radio Cincinnati Inc.	CBS Katz	Hulbert Taft Jr., p David G. Taft, evp Kenneth W. Church, vp & natl. cm Hubbard Hood, loc. cm	Byron Taggart, pd Lila Lambert, pmm Wilford H. Kennedy, ce	Tom McCarthy, nd & fd E. J. Kennedy Jr., sd Barbara Cameron, wd	Rad. Hms.: 482,000 L-W AP WE	
	WKRC-TV	5,000-D 1,000-N-DA-1	Hotel Alms Woodburn 0550						
	WKRC-FM	Ch. 270 (B)							
	1947	101.9mc 15.5kw							
	WLW	700	Crosley Bcstg. Corp.	MBS, NBC	Jas. D. Shouse, chmn. of bd. Robert E. Dunville, p & gm Ward Quaal, vp H. M. Smith, vp, ch. sis.	Carlos Franco, gen. slm. Chester Herman, pd Frederic Gregg, dir. client sv. dept. K. T. Murphy, vp & treas.	R. J. Rockwell, vp, ch. eng. Gilbert Kingsbury, vp, ch. pub. rel. Terry Flynn, nd Robert Miller, fd	Pop.: 11,769,000 Rad. Hms.: 3,313,660 Ret. Sls.: \$11,114,445,000 Thes. UP, INS Cros.	
	1922	50,000	140 W. 9th St. Cherry 1822						
	WLWT (TV)								
	WSAI	1360	Gordon Bcstg. St.	ABC Avery-Knodel	Sherwood R. Gordon, p & gm Tom Thuman, cm	Charles Black, pd Vonne Monsell, pmm Jonas Heiser, ce	Bill Robbins, nd Dick Baker, sd Marilu Case, wd	Pop.: 2,314,464 Rad. Hms.: 693,412 Ret. Sls.: \$2,338,561,000 L-W WE	
	1923	5,000-DA-N	115 East Fourth St. Main 1068						
CLEVELAND									
	WDOK	1260	Civic Bcstrs. Inc. Everett-McKinney	R. Morris Pierce, p & gm Fred Wolf, cm & asst. to p	Ralph Quay, pd & asst. m Clifford Ormiston, ce	Walter Kay, nd Joe Mayer, sd	Pop.: 1,604,285 Rad. Hms.: 494,128 Ret. Sls.: \$2,927,652,000 Wld. SES. UP, INS RCA	
	1950	5,000-DA-2	1515 Euclid Ave. Florida 1-1834						
	WERE	1300	Cleveland Bcstg. Inc. Venard	Ray T. Miller, p Richard M. Klaus, gm Richard C. Ar buckle, cm	Ed Stevens, pd & pmm Harry Dennis, ce	Jerry Bowman, nd Ellen Marshall, wd	Pop.: 1,763,918 Rad. Hms.: 536,000 Ret. Sls.: \$2,004,071,000 Wld. AP, INS RCA	
	1949	5,000-DA-1	1501 Euclid Ave. Bulky Bldg. Superior 1-9600						
	WERE-TV								
	WERE-FM	Ch. 253 (B)							
	1948	98.5mc 20kw							
	WGAR	1220	Peoples Bcstg. Corp.	CBS Christal, Radio Times Sales Ltd.	Herbert Evans, p Carl E. George, gm John B. Garfield, cm Reginald P. Merridew, pd Julius Glass, pmm Robert A. Fox, ce	Gertrude Hunkin, personnel d Robert C. Smith, pub. rel. d Lloyd C. Wingard, studio sup.	Donald McCollister, trans. sup. Charles Day, nd William McColgan, sd Meg Zahrt, wd	Pop.: 4,517,900 Rad. Hms.: 1,312,320 Ret. Sls.: \$4,666,614,000 Wld. UP, INS RCA	
	1930	50,000-DA-1	Hotel Statler PR 1-0200						
	WGAR-FM	Ch. 258 (B)							
	1952	92.5mc 31kw							
	WHK	1420	United Bcstg. Co.	MBS Headley-Reed	Sterling E. Graham, p Kenneth K. Hackathorn, gm William K. Brusman, cm	C. M. Hunter, pd John Wyman, pmm Ralph DeLany, ce James Aubele, pdm	John Pluntze, nd Paul Wilhelm, publ. d William Gannon, sd Eleanor Hanson, wd AP WH	
	1921	5,000-DA-N	5000 Euclid Ave. Express 1-5000						
	WHK-FM	Ch. 264 (B)							
	1947	100.7mc 11.5kw							
	WJMO	1540	Friendly Bcstg. Co.	United	Richard Eaton, p	Paul Nakel, sm Leonard Adams, cm	C. C. Courtney, ce	L-W UP Ray.	
	1947	1,000-D	2157 Euclid Ave. Superior 1-4424						
	WJW	850	WJW Inc.	ABC H-R Reps.	William M. O'Neil, p William Lemmon, gm & evp H. W. Waddell, sis. vp	P. W. Lawrence, treas. Gerald G. Roberts, engrg. vp Bruce MacDonald, pd	Florence Roth, pmm Thomas Carson, nd James Graner, sd Jane Stevens, wd	Pop.: 3,238,000 Rad. Hms.: 961,710 Ret. Sls.: \$1,646,265,000 Assoc. UP WE	
	1943	5,000-DA-1	1375 Euclid Ave. Superior 1-0101						
	WJW-FM	Ch. 281 (B)							
	1948	104.1mc 19kw							

Data corrected to Dec. 10, 1953. If executives or services for FM are same as AM affiliate names are not repeated. Market Data supplied by stations. FM's in *italics*. N—Non-Commercial Station. CP—Construction Permit issued. D—Day. DA-N—Directional Antenna, night only. DA-I—Directional Antenna, same pattern day and night. DA-2—Directional Antenna, different pattern day and night. L—Limited Time with Dominant Station. LS—Local Sunset. N—Night. SA—Special Authorization. SH—Specified Hours. ST—Share Time. Complete key to abbreviations, page 6.



GETTING INTO EASTERN OHIO

PLUS WESTERN PENNSYLVANIA AND WEST VIRGINIA

RADIO HOMES IS A PUSHOVER WITH WHEELING, W. VA.

WWVA

50,000 WATTS

CBS RADIO

ATTRACTIVE PROGRAMMING, PRODUCTIVE SELLING 24 HOURS EVERY DAY

Serving the Industrial Heart of America
Represented by JOHN BLAIR & CO.



National Sales Offices:

TOM HARKER, 118 E. 57th St. New York 22



SOUND SALES PLANNING INCLUDES

WSAI

*The
NEW SOUND
in
Cincinnati!*

NATIONAL REPRESENTATIVE: AVERY-KNODEL, INC.

Write, phone or wire for
**MORE SOUND REASONS TO BUY THE
5000 SELLING WATTS OF WSAI**
The New Sound in Cincinnati!

New Sound ENTERTAINMENT...

from big-time music to local news and homemaker views . . . supplemented by the widest variety of A B C attractions. Smart advertisers are profiting from our happy new balance of audience-pulling entertainment.

New Sound SHOWMANSHIP...

sparked by the fresh new ideas of the Gordon Broadcasting Company, salesmanship is the keynote of our showmanship . . . every personality in our talent shop is a showman . . . ready to sell for you!

New Sound MERCHANDISING..

"follow thru" at point-of-sale means more profit for you. Our complete merchandising planning department is at your service . . . to show you how to make more money out of radio!

SHERWOOD R. GORDON
President and General Manager

OHIO

City	Call Letters	Chan. or Freq. Power	Licensee Headquarters Telephone	Network Representative	Owner; Pres. p; Exec. cm; Sales Mgr. slm; Prod. Mgr. pdm; News, Farm, Sports or Women's Dir. nd, fd, sd, wd.	Executive Abbreviations	Gen. Mgr. gm; Sta. Mgr. sm; Coml. Mgr. cm; Sales Mgr. slm; Prog. Dir. pd; Chief Eng. ce; Prom. Mgr. pmm; Mgr. m; News, Farm, Sports or Women's Dir. nd, fd, sd, wd.	Market Data For Primary Area (Supplied by station)	Library, News Serv. Transmitter
CLEVELAND—(Contd)									
WTAM	1100		National Bcstg. Co. Inc.	NBC	Sylvester L. Weaver Jr., p (NBC)	Charles F. Hutaff, adv. prom. & mrchdsng. d	S. E. Leonard, engr. in chg.	Pop.: 2,500,000	Thes. AP, UP
1923	50,000		815 Superior Ave.	NBC Spot Sales	Robert W. Sarnoff, evp (NBC)	Brooke Taylor, pd	Edward R. Wallace, n & sp. events d	Rad. Hms.: 1,000,000	RCA
WNBK(TV)			Cherry 1-0942		Lloyd E. Yoder, gm	Clement G. Scerback, pmm	Tom Manning, sd	Ret. Sl.: \$2,000,000,000	
WTAM-FM	Ch. 289 (B)				William P. Dix Jr., slm				
1948	105.7mc								
CLEVELAND HEIGHTS									
WSRS	1490		WSRS Inc.	Tri-State	S. R. Sague, p & pd	Robert Leedham, ce	Bob Engel, nd	Pop.: 1,500,000	L-W
1947	250		2156 Lee Rd.	ForJoe	J. D. Kelly, sm	G. P. Bickford, secy.	Danny Landau, sd	Rad. Hms.: 500,000	AP
WSRS	Ch. 237 (A)		Erievlew 1-2005		W. L. Dougherty, cm				RCA
1947	95.3mc, 1kw								SES, INS
COLUMBUS									
WBNS	1460		Radioho Inc.	CBS	Richard A. Borel, gm	Jim Verian, pmm	Bill Zipf, fd	Pop.: 1,288,000	AP
1924	5,000-D		33 N. High St.	Blair	W. I. Orr, cm	Lester H. Nafzger, ce	Bill Corley, sd	Rad. Hms.: 368,000	AP
WBNS-TV	1,000-N-DA-N		Adams 9265		Geer Parkinson, pd	Chet Long, nd	Fern Sharp, wd	Ret. Sl.: \$1,500,000,000	AP
WCOL	1230		Air Trails Inc.	ABC	Charles Sawyer, p	John Q. Doty, cm	Mary Hart, pmm & wd	Pop.: 522,984	Wid.
1922	250		E. Broad at Young St.	H-R Repts.	J. Pattison Williams, evp	Myles R. Foland Jr., pd	Harold E. Beard, ce	Rad. Hms.: 155,310	UP
WCOL-FM	Ch. 222 (A)		Main 4581		Charles Reeder, sm		Walter Furniss, nd	Ret. Sl.: \$558,175,000	AP
1949	92.3mc								WH
WHKC	610		United Bcstg. Co.	MBS	Sterling Graham, p	John B. Moses, pd	Budd Sweeney, nd & sd	Pop.: 2,691,200	L-W
1921	5,000		22 East Gay St.	Raymer	Carl M. Everson, gm	William C. Minor, ce	George Zels, fd	Rad. Hms.: 784,480	UP, INS
	DA-N		Adams 1101		Harry H. Hoessly, cm & pmm		Ann Duffy, wd	Ret. Sl.: \$2,754,504,000	RCA
*WOSU	820		Oh'o State U.	NAEB	Howard L. Bevis, p	William H. Ewing, prog. sup.	Larry Sarbaugh, fd		Thes.
1922	5,000		University 3148	Robert C. Higgy, d & ce	William Wilcox, pmm	Frank Stevens, sd		UP
WOSU-TV	L-WFAA		ext. 711			G. R. Holsinger, nd	Cleora Ewalt, wd		RCA
WBAP									
WVKO	1580		Sky Way Bcstg. Corp.	Buckeye, Standard	Col. Gustav Hirsch, p	Janet Clark, pmm & wd	John Terry, nd	Pop.: 778,000	Assoc., Cap.
1951	1,000-D		274 S. 3d St.	ForJoe	Bert Charles, gm & pd	J. W. Hammett, ce	Bob Howard, sd	Rad. Hms.: 221,000	UP
WVKO-FM	Ch. 234 (B)		Main 5247		Charles Wm. Arthurs, slm			Ret. Sl.: \$832,000,000	WE
1948	94.7mc 52kw								
COSHOCTON									
WTNS	1560		Coshocton Bcstg.	Bruce Wallace, p & gm	Robert Barrick, pmm	Bill DuBois, fd	Pop.: 100,000	Thes.
1947	1,000-D		114 N. 6th St.	James T. Sigman, cm	Elmer Moravecky, ce	Joellen Irwin, wd	Rad. Hms.: 27,377	UP
			1560		Stanley C. Robinson, pd, nd & sd			Ret. Sl.: \$122,000,000	Ray.
DAYTON									
WHIO	1290		Miami Valley Bcstg. Corp.	CBS	James M. Cox Jr., p	Wade H. Alley, pd	Fred Brophy, nd		St.
1935	5,000-DA-N		45 S. Ludlow St.	Hollingbery	Robert H. Moody, gm	Charles E. Gay, pmm	Louis Emrn, sd		AP, UP, INS
WHIO-TV			Adams 2281		Walter E. Wolaver, cm	Ernest L. Adams, ce	Madeline Wise, wd		WE
WHIO-FM	Ch. 256 (B)								
1946	99.1mc								
	19kw								

Data corrected to Dec. 10, 1953. If executives or services for FM are same as AM affiliate names are not repeated. Market Data supplied by stations. FM's in italic. *—Non-Commercial Station. CP—Construction Permit issued. D—Day. DA—Directional Antenna, night only. DA-1—Directional Antenna, same pattern day and night. DA-2—Directional Antenna, different pattern day and night. L—Limited Time with Dominant Station. LS—Local Sunset. N—Night. SA—Special Authorization. SH—Specified Hours. ST—Share Time. Complete key to abbreviations, page 6.

WBNS radio reports:

MOST LISTENERS . . . WHERE MOST IS SPENT

Now we can PROVE WBNS Radio not only has more listeners than all other local stations combined, IT HAS THESE LISTENERS WHERE MOST DOLLARS ARE SPENT!

Each year, WBNS sponsors the Fall Festival . . . it's our own "pulse" which shows us where our listeners are. WBNS personalities offer inexpensive premium giveaways for ten days. This year we heard from 13,317 listeners, an increase of 20% over last year.

And the pattern shows . . . 11,006 replies from

More than ever . . .

. . . When Central Ohio is your market

. . . WBNS Radio is a must.

Franklin County alone. Eighty-two per cent of the returns came from the big spending area in Central Ohio, where retail sales far exceed the surrounding counties.

This proves our year-long pitch: WBNS sells action, not acres . . . WBNS sells quality listenership, not just quantity. We have more listeners than all other local stations combined, and we've got them where MOST MONEY IS SPENT!

CBS for CENTRAL OHIO



YOUNGSTOWN, OHIO

WFMJ

YOUNGSTOWN, OHIO

PRODUCES RESULTS

NBC
affiliate with
planned music
programming;
Local & world news
19 times daily;
Sports, scores
5 times daily



Call
Headley-Reed Co.
for testimonial
letters, success
stories and
availabilities

WFMJ

YOUNGSTOWN, OHIO . . . 101 W. Boardman St.

Phone
RI. 3-4121

THE
NBC
AFFILIATE
SERVING
OHIO'S 3rd
MARKET

OHIO

City	Call Letters	Chan. or Freq.	Licensee Headquarters Telephone	Network Representative	Owner; Pres. p; Exec. up evp; Gen. Mgr. gm; Sta. Mgr. sm; Coml. Mgr. cm; Sales Mgr. slm; Prog. Dir. pd; Chief Eng. ce; Prom. Mgr. pmm; Prod. Mgr. pdm; News, Farm, Sports or Women's Dir. nd, fd, sd, wd.	Executive Abbreviations	Market Data For Primary Area (Supplied by station)	Library, News Serv. Transmitter
DAYTON (Cont'd)								
WING 1924	1410 5,000 DA-N	Great Trails Bcstg. Corp. 121 N. Main Hemlock 3773	ABC, Air Trails H-R Reps.	Charles Sawyer, p & co John Pattison Williams, evp	Adna H. Karns, gm James Venable, pmm Howard Ryan, ce Jack Zeigen, nd	Bill Kehl, sd Betty Ann Horstman, wd	Pop.: 968,050 Rad. Hms.: 287,481 Ret. Slis.: \$475,000,000,000	Wid. AP Col.
WONE 1949 WIFE(TV)	980 5,000-DA-2	Skyland Bcstg. Corp. 380 W. First St. Michigan 6501	Headley-Reed	Ronald B. Woodyard, p, gm & pmm Louis G. Froelich, gm	Ranny Daly, pd Stanley A. Beck, ce	C. J. Thornquest, natl. slm		Cap. AP RCA
DEFIANCE								
WONW 1948	1280 500-DA-N	Tri-State Bcstg. Inc. U. S. Route 24 3-2226	Devney	R. W. Crowell, p Glenn R. Thayer, vp & gm	Paul R. Murphy, pd	William Dommer, sd		Assoc. AP G
DOVER								
WJER 1951	1450 250	Dover Bcstg. Co. Inc. 210 Boulevard 4-2126	KBS Best	Agnes Jane Reeves Greer, p W. B. Steis, gm John Needs, cm	Bob Valliquette, pd Don Graff, ce Rex Ridenour, nd	Bill Burton, fd Jim Wendling, sd Joye Beal, wd	Pop.: 75,000 Rad. Hms.: 22,000 Ret. Slis.: \$60,107,000	Wid. UP Col.
EAST LIVERPOOL								
WLIO 1948	1570 1,000-D	Pottery Bcstg. Co. 6th & Walnut Main 5190	KBS Schepp-Reiner	Paul Bron Saliner, p, gm & pmm Van Lane, cm, pd & sd	George Kelly, ce Frances Ledman, continuity d	Dale Smith, nd Slim Young, fd Bette Martin, wd	Pop.: 225,000 Rad. Hms.: 110,000	
WOHI 1949	1490 250	East Liverpool Bcstg. Corp. 516 Market St. P. O. Box 156	ABC Standard	Richard V. Beatty, p Robert E. Metcalfe, gm, pd & fd	George T. Farrall, cm William Siebenthal, ce Connie Buck, nd	James Lowery, sd Mary Jane Ready, wd		
ELYRIA-LORAIN								
WEOL 1948	930 1,000-DA-2	Elyria-Lorain Bcstg. Corp. Eyria Saving & Trust Bldg. 2255	Walker	Roy W. Ammel, p Alex Buchan, gm & cm Joseph L. Fredericks, pd	Ronald A. Barrett, pmm Wm. Albrecht, ce Douglas Lillico, pdm	Les Clark, nd Chas. Coles, fd Jess Stevens, sd Dorothy Dunbar, wd	Pop.: 200,000 Rad. Hms.: 57,000 Ret. Slis.: \$202,400,000	Wid. UP RCA
WEOL-FM 1948	Ch. 297 (B) 107.3mc 15kw							
FINDLAY								
WFIN 1941	1330 1,000-D	Findlay Pub. Co. 500 1/2 S. Main St. 1330	McGillvra	R. L. Heminger, p Harold H. Heminger, gm & cm	Jack E. Douglas, pd Allen P. Dudley, pmm	Edward Smith, ce		Thes. AP, UP, INS Col.
WFIN-FM 1948	Ch. 263 (B) 100.5mc 8.2kw							
FOSTORIA								
WFOB 1952	1430 1,000-DA-2	Seneca Radio Corp. P. O. Box 589 5666	KBS	Andrew Emerine, p Melvin L. Murray, gm, secy. & sd	Roger V. Wise, cm Robert G. Kuhn, pd, nd & fd	Farrel F. Elsea, ce		Cap., SES. UP RCA
WFOB-FM 1946	Ch. 244 (A) 96.7mc 1kw							Wid. GE
FREMONT								
WFRO 1949	900 500-D	Wolfe Bcstg. Co. 905 W. State St. Federal 2-3951	Best	Robert F. Wolfe, p R. C. Force, mgng. d & cm	Frank Swartz, pd Allen Kaubel, ce	Arthur Smith, nd & sd Earl Hurst, fd	Pop.: 1,066,703 Rad. Hms.: 261,012 Ret. Slis.: \$1,231,149,000	Thes. INS Ray
WFRO-FM 1946	Ch. 257 (A) 99.3mc 1kw							St. UP GE
GALLIPOLIS								
WJEH 1950	990 250-D	Ohio Valley on the Air Inc. Box 244 1160	KBS	John E. Halliday, p Truman A. Morris, gm Marianne B. Campbell, sm	William M. Watterson Jr., pd K. W. Robinson, pmm Edgar Atkins, ce	Melba Thornton, nd Dick Wells, fd Jim Brannon, sd Eleanore Fuller, wd	Pop.: 104,900 Rad. Hms.: 27,960 Ret. Slis.: \$71,586,000	Cap. UP G
HAMILTON								
WMOH 1944	1450 250	Fort Hamilton Bcstg. Co. 2d National Bank Bldg. 4-6543	Grant	Robert J. Briede, p Robert L. Odson, gm Raymond Motley, cm & sd	Norman Keller, pd Don J. Meeks, pub. rel. Gerard Cain, ce	Kenneth Maloney, nd George Wilson, fd Milly Soule, wd	Pop.: 1,424,946 Rad. Hms.: 339,664 Ret. Slis.: \$110,000,000	L-W UP Col.
WMOH-FM 1948	Ch. 278 (A) 103.5mc 8.7kw							
IRONTON								
WIRO 1951	1230 250	Iron City Bcstg. Co. Radio Plaza 280	MBS McGillvra	Ted Nelson, p C. E. McElroy, gm & cm	Jay Brushart, pd, pmm, nd & sd C. A. Baker, ce	W. P. Shannon, vp Bill Trowbridge, fd Donna Secrist, wd	Pop.: 110,000 Ret. Slis.: \$75,000,000	AP G
JACKSON								
WLMJ 1953	1280 1,000-D	WLMJ Inc. 850	KBS	Frances D. Moore, p Truman A. Morris, gm Don Hughes, sm & pd	Hank Dornhuber, ce Art Farrar, nd	Harold Adkins, fd Bill MacDonald, sd Donna Secrist, wd	Pop.: 65,723 Rad. Hms.: 22,000 Ret. Slis.: \$50,500,000	
LANCASTER								
WHOK 1948	1320 500-D	Hocking Valley Bcstg. Corp. N. Memorial Dr. 4500	McGillvra	Dr. Nelson R. Embrey, p & gm James Tidd, sm & pd	Roy Stinglery, pmm & sd Ron Johnson, nd	Roy McCollum, fd Eleanor Blazer, wd	Pop.: 178,828 Rad. Hms.: 44,707 Ret. Slis.: \$33,965,000	Thes. UP G
LIMA								
WIMA 1948 WIMA-TV	1150 1,000-DA-N	N. W. Ohio Bcstg. Corp. 223 N. Main St. 3-2660	ABC Weed	G. E. Hamilton, p R. W. Mack, gm C. B. Heller, cm	Easter Straker, pd & wd Robert McDermott, pmm & fd	Albert Smith, ce Tom Wade, nd Bill Frink, sd	Pop.: 700,000 Rad. Hms.: 190,000 Ret. Slis.: \$550,000,000	AP RCA
WIMA-FM 1948	Ch. 271 (B) 102.1mc 15.5kw							AP WH

Data corrected to Dec. 10, 1953. If executives or services for FM are same as AM affiliate names are not repeated. Market Data supplied by stations. FM's in italic. *—Non-Commercial Station. CP—Construction Permit issued. D—Day. DA—Day. DA-N—Directional Antenna, night only. DA-1—Directional Antenna, same pattern day and night. DA-2—Directional Antenna, different pattern day and night. L—Limited Time with Dominant Station. LS—Local Sunset. N—Night. SA—Special Authorization. SH—Specified Hours. ST—Share Time. Complete key to abbreviations, page 6.

WLOK 1936 WLOK-TV	1240 250	WLOK Inc. 1424 Rice Ave. 6-3411	NBC H-R Reps	L. A. Pixley, p R. O. Runnerstrom, evp Perry Beaumont, asst. gm	Lawrence Webb, natl. sim. John U. Voorhees, loc. slm William Huffman, pd	Margaret Miller, pmm Darrel Hunter, ce Joe Rex, nd Tom Hamlin, sd Marian Fletcher, wd	Pop.: 235,545 Rad. Hms.: 67,298 Ret. Sis.: \$236,912,000	Wld. UP RCA
MANSFIELD								
WMAN 1939	1400 250	Richland Inc. Ohio Theatre Bldg. 4235	ABC Venard	Mrs. M. F. Rubin, co J. M. O'Hara, p, gm & cm Robert A. James, pd	Carl C. Kindt, pmm William E. Morrison, ce Richard Kline, nd	Richard Drury, sd Pres Roper, fd Billie Worden, wd	Pop.: 138,000 Rad. Hms.: 32,820 Ret. Sis.: \$80,000,000	L-W AP RCA
MARIETTA								
WMOA 1946	1490 250	Wm. G. Wells Hotel Lafayette, 1890	MBS McGillvra	W. G. Wells, p R. Sanford Guyer, gm & cm	Thomas Butscher, pd & pmm Charles Clark, ce Dick Marion, nd	Gene Bowen, fd Dave Pyles, sd Paula Carr, wd	Pop.: 100,000 Rad. Hms.: 38,000	UP Col.
MARION								
WMRN 1940	1490 250	The Marion Bcstg. Co. P. O. 518 2-6666	ABC	Robert T. Mason, p & gm Arthur L. Martin, cm	Robert T. Mason Jr., pmm F. Joseph Peters, ce Joe Ionne, nd	Charley Might, fd Ed Paulin, sd Madge Cooper, wd	Pop.: 250,000 Rad. Hms.: 55,000 Ret. Sis.: \$200,000,000	Thes. UP RCA
WMRN-FM 1953	Ch. 295 (B) 106.9mc 25kw						Pop.: 875,000	
MIDDLETOWN								
WPFB 1947	910 1,000-D 100-N	Paul F. Braden Central Ave. 2-3625	Paul F. Braden, p, natl. com. slm. George D. Lummis, pd Ray W. Iglehart, pmm	Laurace H. Beckwith, ce Thomas P. Hogan, asst. m	Dan Humphreys, nd Homer Tingle, fd Warren Johnson, sd Fern Troutvine, wd	Pop.: 2,000,000 Rad. Hms.: 500,000	L-W AP
MT. VERNON								
WMVO 1953	1300 500-D-DA	The Mt. Vernon Bcstg. Coshocton Rd., Box 390 2-0946	Buckeye, Standard	Dr. Charles Tramont, p Mrs. Charles M. Zelko- witz, gm, cm & wd	Charles M. Zelkowitz, secy-treas. George Bennett, pd & sd	Eugene Phillips, ce Charles Kilkenny, nd & fd	Pop.: 13,000 Rad. Hms.: 98% Ret. Sis.: \$24,400,000	
WMVO-FM 1951	Ch. 229 (B) 93.7mc 3.2kw							
NEWARK								
WCLT 1949	1430 500-D	Advocate Printing Co. 27 W. Main St.	Buckeye, Standard Meeker	Frank W. Spencer, p Thomas A. Rogers, gm Robert H. Pricer, cm	John Fisher, pd Ben Windle, ce	Ned Stout, n & fd Ken Mack, sd		Thes. AP G
WCLT-FM 1947	Ch. 262 (B) 100.3mc 8.5kw	4007					 GE



Take a Big Bite...

Here's one garden spot where you'll be in—not out—if you eat the apple. Our 7-county garden is prosperous, diversified, growing—filled with new industries and quarter-of-a-million people with money to spend. And our radio station now beams more power than ever over this rich North Central Ohio Market. In addition we've added FM to give you the best value ever in this Midwest seller's paradise.



W M R N AM and FM

ABC in MARION, OHIO

OHIO

City	Call Letters Established TV Affiliate	Chan. or Freq. Power	Licensee Headquarters Telephone	Network Represent- ative	Owner o; Pres. p; Exec. vp evp; cm; Sales Mgr. slm; Prog. Dir. pd; Chief Eng. ce; Prom. Mgr. pmm; Prod. Mgr. pdm; News, Farm, Sports or Women's Dir. nd, fd, sd, wd.	Executive Abbreviations Gen. Mgr. gm; Sta. Mgr. sm; Coml. Mgr. James Londot, fd	Market Data For Primary Area (Supplied by station)	Library, News Serv. Transmitter
PIQUA								
WPTW 1947	1570 250-D	Miami County Bcstg. Co. Inc. 1625 W. Covington Ave. 1420	Richard E. Hunt, p. gm & cm Robert C. Bubb, pd. sm & pmm	Dallas Davis, ce Bill Fox, nd & fd Bill Mills, sd	Minabelle Hutchins, wd	Pop.: 400,000 Rad. Hms.: 105,380 Ret. Slis.: \$277,000,000	Wld., AP Col.
PORTSMOUTH								
WNXT 1951	1260 1,000-DA-1	Portsmouth Bcstg. Co. Masonic Bldg. P. O. Box 1228 2-1961	ABC Everett- McKinney	Marshall Rosene, p. gm & cm Phil Phillips, pd & pmm	Russell Newman, ce Roger Gannem, nd Geo. Wood, fd	Jack Hurst, sd Lucile Graham, wd	Pop.: 150,000 Rad. Hms.: 30,000 Ret. Slis.: \$75,000,000	St. UP Ray.
WPAY 1935	1400 250	The Scioto Bcstg. Co. 1009 Gallia St. 3-2111	CBS Venard	Roy D. Moore, p Eugene Carr, vp Gerald F. Boyd, m	O. T. Dresbach, office m Edward G. Sheridan Jr., pd	Marvin M. Reed, pmm Maurice L. Myers, ce Frank Balmert, nd Bill Green, sd		Assoc. AP RCA
WPAY-FM 1948	Ch. 281 (B) 104.1mc 7kw							
SANDUSKY								
WLEC 1947	1450 250	Lake Erie Bcstg. Cleveland Rd. & Huntington Ave. 5170	MBS Holman	Jay E. Wagner Jr., p, gm & sd Ralph S. Silver Jr., cm Robert Hanners, pd	Kathryn D. Heiser, pmm Jay Leibach, ce Louis E. Mahla, asst. m	Ray Sherman, nd James Londot, fd Nancy Lake, wd	Pop.: 250,000 Rad. Hms.: 247,500 Ret. Slis.: \$944,547	Wld., Thes. UP RCA
SPRINGFIELD								
WIZE 1940	1340 250	Radio Voice of Springfield, Inc. 117 W. High St. 3-4955	ABC H-R Repts	Charles Sawyer, p John Pattison Wil- liams, evp Adna H. Karns, vp & gm	Virginia Bennett, m John McEnaney, pd & pmm	Victor Bushong, ce Fred Weber, nd, fd & sd Alice Bahan, wd	Pop.: 252,100 Rad. Hms.: 73,856 Ret. Slis.: \$271,206,000	Wld. AP RCA
WJEL 1947	1600 500-D	Champion City Bcstg. 120 S. Limestone 3-4676 McGillvra	Geo. R. Walker, p, nd & fd Robt. L. Yontz, gm	Lucile Collins, pd Myron Maddex, ce	Vinc Shannon, sd Joan Warren, wd	Pop.: 762,000 Rad. Hms.: 239,800 Ret. Slis.: \$890,000,000	Thes. INS RCA
WWSO 1947	1210 250-D	Radio Springfield, Chamber of Commerce Bldg. 3-6488 Gill- Perna	Bradley Kincaid, p R. K. Wood, gm & cm Ford Rush Jr., pd	Vernon B. Yeich, ce Von Crabill, nd & sd	H. Norman Geron, fd Jean Adams, wd	Pop.: 730,000 Rad. Hms.: 185,000 Ret. Slis.: \$800,000,000 AP Col.
STEUBENVILLE								
WSTV 1940	1340 250-D	WSTV Inc. Exchange Realty Bldg. Atlantic 2-6265	MBS Avery- Knodel	John J. Laux, gm & cm Joseph M. Troesch, asst. gm Harry W. Birrell Jr., pd	Charles Shepherd, ce Scott McMurray, nd	Francis Taylor, fd 'Red' Donley, sd	Pop.: 295,778 Rad. Hms.: 80,926 Ret. Slis.: \$288,688,000	Wld. UP WE
WSTV-FM 1947	Ch. 278 103.5mc 2kw						Pop.: 2,839,942 Rad. Hms.: 755,981 Ret. Slis.: \$2,877,231,000	
TOLEDO								
WOHO (CP)	1470 1,000 DA-2	The Midwestern Bcstg. Co.		Russell Gohring, vp & gm				
WSPD 1921	1370 5,000-DA-N	Storer Bcstg. Co. 136 Huron St. Adams 3175	NBC Katz	George B. Storer, p Allen L. Haid, gm & vp	Westford Shannon, cm Emerson Kimble, pd William Ashworth, merc. d	William Stringfellow, ce Jim Uebelhart, nd	Pop.: 625,000 Rad. Hms.: 182,630 Ret. Slis.: \$723,133,000	L-W UP, INS WE
WSPD-FM 1947	Ch. 264 (B) 101.5mc 20kw						 RCA
WTOD 1946	1560 1,000-D	Unity Corp. 515 Madison Ave. Garfield 5551	ForJoe	Edward Lamb, p Sunne Miller, gm & pmm Edward Boissy, cm	Richard Rice, pd & nd Robert Sowers, ce	A. Mulberry, fd Orris Tabner, sd Barbara Baker, wd	Pop.: 800,000 Rad. Hms.: 269,000 Ret. Slis.: \$1,005,026,000	L-W AP Ray.
WTRT(FM) 1946	Ch. 260 (B) 99.9mc 10kw	(WTOD, Am Affiliate)						
WTOL 1938	1230 250	Community Bcstg. Co. Bell Bldg. Adams 3291	ABC Raymer	Frazier Reams, p Thomas S. Bretherton, gm	R. H. Edsall, slm Robert Krieghoff, pd	Harold Holmes, ce Doug Tabner, sd		St. AP, UP WE
WTOL-FM 1949	Ch. 284 (B) 104.7mc 1.3kw							
WARREN								
WHHH 1941	1440 5,000-DA-2	The Warren Tribune Radio Station Inc. 108 Main St. 2212-9	MBS Rambeau	Helen Hart Hurlbert, p Carl J. Raymond, gm, cm & pd	Peter W. Mesner, pmm Robert E. Hardy, ce	George Raymer, nd Danny Shaver, sd		Assoc., SES, AP RCA
WASHINGTON								
WCHO 1952	1250 500-D	Court House Bcstg. Co. P. O. Box 268 5-6211	KBS	W. N. NunGesser, p Leon Lloyd, gm & cm Carl Egbert, ce	Ronald W. Arnold, pdm	Perse Harlow, nd Bob Terhune, fd	Pop.: 150,000 Rad. Hms.: 35,000 Ret. Slis.: \$50,000,000	Thes., SES, AP
WAVERLY								
WPKO (CP)	1380 1,000-D DA-1	Hi Kinco Bcstrs.		Donald E. Kinker, co- o, gm & ce Alice Hively, co-o	Warren W. Cooper, co-o, & cm		Pop.: 75,000 Rad. Hms.: 25,000	
WELLSTON								
WKOV 1952	1570 250-D	Stephen Kovalan P. O. Box 190 546	Stephen Kovalan, p Parks Robinson, gm, ce & nd	Kenneth Williams, cm & fd	John E. Wilson, pd & sd Betty Walker, wd	Pop.: 30,000 Rad. Hms.: 18,000 Ret. Slis.: \$39,000,000 UP Tem.
WOOSTER								
WWST 1947	960 1,000-D	Wooster Republican Printing Co. 760	Buckeye	Raymond E. Dix, p Edwin B. Evans, gm Quentin W. Welty, cm	Robert E. Heeter, pd & nd Burton L. Bowman, ce	Harold Edwards, fd Roy Bates, sd		Wld., Cap., AP RCA
WWST-FM 1947	Ch. 283 (B) 104.5mc 13kw							
WORTHINGTON								
WRFD 1947	880 5,000-D	Peoples Bcstg. Corp. Franklin 2-5342 Clark	Herbert E. Evans, vp & gm Joseph D. Bradshaw, sm & cm	Robert M. Geis, pd Phil Sheridan, pmm Harold Schaaf, ce Bill Arthurs, nd	Jim Chapman, fd Dave Collins, sd Mary Lou Pfeiffer, wd		Thes. AP RCA

Data corrected to Dec. 10, 1953. If executives or services for FM are same as AM affiliate names are not repeated. Market Data supplied by stations. FM's in italic. *—Non-Commercial Station. CP—Construction Permit issued. D—Day. DA—Day. DA-N—Directional Antenna, night only. DA-1—Directional Antenna, same pattern day and night. DA-2—Directional Antenna, different pattern day and night. L—Limited Time with Dominant Station. LS—Local Sunset. N—Night. SA—Special Authorization. SH—Specified Hours. ST—Share Time. Complete key to abbreviations, page 6.

Toledo's "Billion Dollar Market"

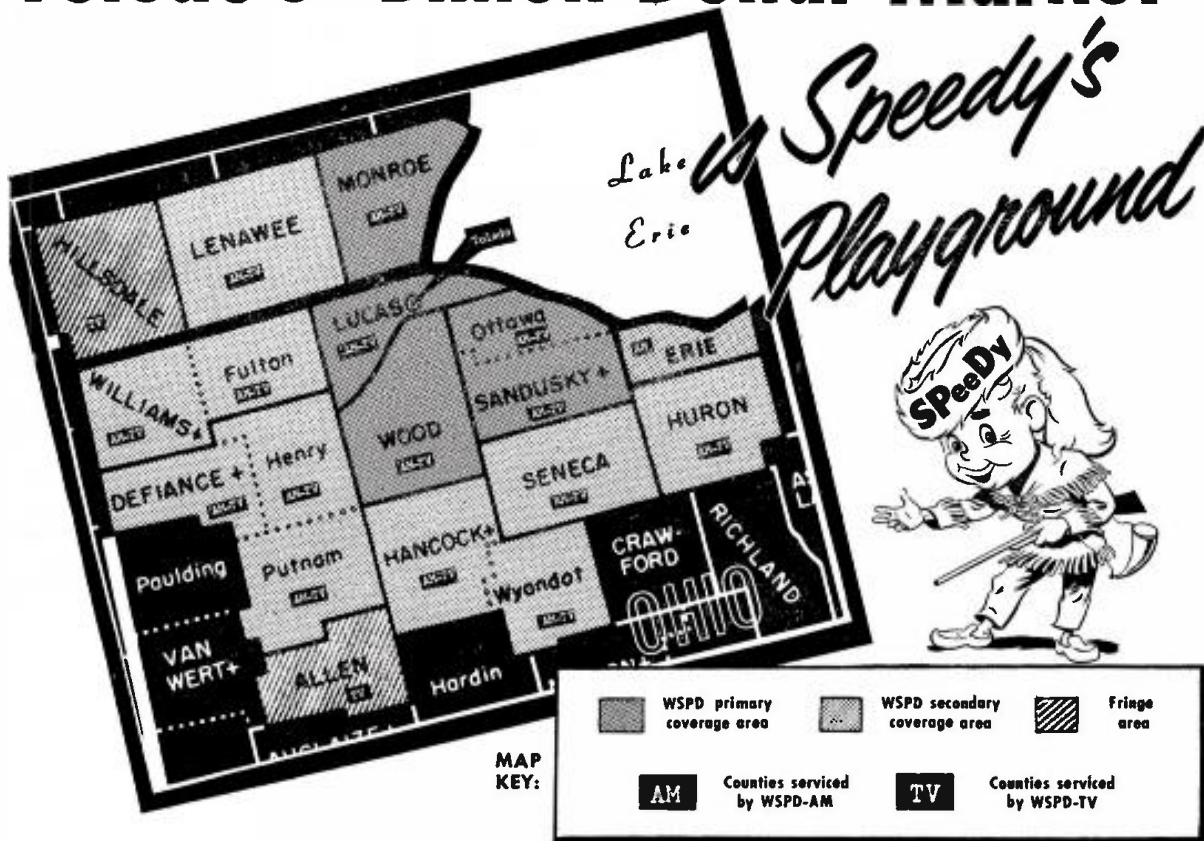

The area covered by WSPD (Radio and/or Television) encompasses 18 counties; 3 in Michigan and 15 in Northwestern Ohio.

Population 1,161,200
 Families 348,000
 Radio Homes 339,060
 Percent tuned to WSPD-AM
 Daytime 56.8%
 Nighttime 48.6%
 Television Homes 276,229
 Percent tuned to WSPD-TV
 Daytime 78%
 Nighttime 91.5%

EFFECTIVE BUYING POWER
 Total—\$1,896,407,000
 Per Capita \$1,633
 Per Family \$5,449

RETAIL SALES
 Total \$1,310,208,000
 Per Family \$3,764
 Spent For:
 Food \$321,211,000
 Gen. Mdse. \$128,461,000
 Furniture & Household—\$67,725,000
 Automotive \$251,294,000
 Drug \$35,282,000

Toledo's Metropolitan Area ranks high in the nation's 200 largest areas—

Toledo ranks 36th in total retail sales
 Toledo ranks 36th in food store sales
 Toledo ranks 35th in gen. mdse. store sales
 Toledo ranks 48th in apparel store sales
 Toledo ranks 38th in home furnishing sales
 Toledo ranks 31st in automotive store sales
 Toledo ranks 33rd in filling station sales
 Toledo ranks 50th in building material and hardware store sales.
 Toledo ranks 36th in drug store sales

SPeeDy daily entertains the people whose buying habits account for Toledo's high rating.

Authority for above listening and market information:

Sales Management's Survey of Buying Power,
 Standard Rate & Data Consumer Markets
 Nielsen Coverage Service
 Television Magazine

WSPD **AM-TV**
 TOLEDO, OHIO

Storer Broadcasting Company
 TOM HARKER NAT. SALES DIR., 116 E. 57th STREET, NEW YORK

Represented Nationally
 by KATZ

OHIO

City	Call Letters Established Tv Affiliate	Chan. or Freq. Power	Licensee Headquarters Telephone	Network Representative	Owner or Pres. p; Exec. cm; Sales Mgr. slm; Prod. Mgr. pdm;	Executive Abbreviations Exec. vp eyp; Gen. Mgr. gm; Sta. Mgr. sm; Coml. Mgr. cm; Chief Eng. ce; Prom. Mgr. pmm;	Market Data For Primary Area (Supplied by station)	Library, News Serv. Transmitter
YOUNGSTOWN								
	WBBW 1949	1240 250	Mahoning Valley Bestg. Corp. Warner Theatre Rt 4-4421	ABC, Standard Forjoe	John Cherpack Jr., p & ce	Gene Trace, vp, gm & cm Anthony Ross, pd	Pop.: 550,000 Rad. Hms.: 209,790 Ret. Sis.: \$565,948,000	Assoc., L-W AP RCA
	WFMJ 1939 WFMJ-TV	1390 5,000-DA-N	The WFMJ Bestg. Co. 101 W. Boardman St. Riverside 3-4121	NBC Headley-Reed	William F. Maag Jr., p & gm Leonard E. Nasman, cm & pmm	Ronald W. Richards, pd Frank A. Dierlinger, ce Robert C. Locke, asst. prog. m	Pop.: 542,600 Rad. Hms.: 199,590	AP, UP RCA
	WFMJ-FM 1953	Ch. 285 (B) 105.1mc 50kw						Thes.
	WKBN 1926 WKBN-TV	570 5,000-DA-N	WKBN Bestg. Corp. 3930 Sunset Blvd. Sterling 2-1145	CBS Raymer	W. P. Williamson Jr., p & gm J. L. Bowden, sta. d Don Brice, pd & pmm	Jim Smith, pub. rel. d B. T. Wilkens, ce Gene Starn, nd	Pop.: 750,200 Rad. Hms.: 182,840 Ret. Sis.: \$776,629,000	Wld., L-W AP, UP RCA
	WKBN-FM 1947	Ch. 255 (B) 98.9mc 25kw						
ZANESVILLE								
	WHIZ 1924 WHIZ-TV	1240 250	Southeastern Ohio Bestg. System Inc. North 5th St. 2-5431	NBC Pearson	Clay Littick, p Vernon A. Nolte, gm Nate Milder, natl. reg. cm	Robert Hodous, loc. cm Allan Land, pd Bob Crommwell, pmm William A. Hunt, ce	Pop.: 100,000 Rad. Hms.: 23,000 Ret. Sis.: \$100,000,000	AP, UP WE

Data corrected to Dec. 10, 1953. If executives or services for FM are same as AM affiliate names are not repeated. Market Data supplied by stations. FM's in *italics*. *—Non-Commercial Station. CP—Construction Permit issued. D—Day. DA-N—Directional Antenna, night only. DA-1—Directional Antenna, same pattern day and night. DA-2—Directional Antenna, different pattern day and night. L—Limited Time with Dominant Station. LS—Local Sunset. N—Night. SA—Special Authorization. SH—Specified Hours. ST—Share Time. Complete key to abbreviations, page 6.

OKLAHOMA

MARKET DATA BY COUNTIES

County	Population 1950	Radio Families 1953	Retail Sales 1952(000)	Food Sales 1952(000)	Drug Sales 1952(000)	Automobile Ownership 1952	County	Population 1950	Radio Families 1953	Retail Sales 1952(000)	Food Sales 1952(000)	Drug Sales 1952(000)	Automobile Ownership 1952
Adair	14,918	3,560	\$ 5,098	\$ 1,484	\$ 275	2,335	Greer	11,749	3,260	9,587	2,926	326	3,173
Alfalfa	10,699	3,200	10,330	2,590	574	3,634	Harmon	8,079	2,220	8,752	1,833	294	2,237
Atoka	14,259	3,500	6,456	1,997	63	2,036	Harper	5,977	1,740	7,106	1,396	274	2,286
Beaver	7,411	1,956	6,045	1,400	70	2,331	Haskell	13,313	2,990	5,335	1,054	85	2,065
Beckham	21,627	6,710	26,598	6,281	79	7,550	Hughes	20,664	5,350	13,782	3,924	477	4,176
Blaine	15,049	4,140	14,214	3,234	500	4,433	Jackson	20,082	5,920	23,154	4,954	694	6,333
Bryan	28,999	7,690	21,115	5,118	492	6,782	Jefferson	11,122	2,980	7,969	2,117	295	3,005
Caddo	34,913	9,420	28,338	7,099	984	8,979	Johnston	10,608	2,620	3,299	1,419	168	1,629
Canadian	25,644	7,340	22,829	5,344	836	8,199	Kay	48,892	15,670	51,589	12,339	2,339	18,884
Carter	35,455	10,620	35,541	8,554	1,431	11,517	Kingfisher	12,860	3,830	16,674	3,103	583	4,193
Cherokee	18,989	4,370	8,161	2,648	301	3,046	Kiowa	18,926	5,490	20,530	4,110	871	5,966
Choctaw	20,405	4,930	11,398	4,039	322	2,970	Latimer	9,690	2,240	3,265	1,008	104	1,331
Cimarron	4,589	1,310	6,912	1,274	72	1,467	LeFlore	35,276	8,890	16,106	4,725	428	6,332
Cleveland	41,443	11,010	30,336	8,796	1,548	10,816	Lincoln	22,102	6,010	18,265	5,013	507	6,223
Coal	8,056	1,730	2,852	982	48	1,304	Logan	22,170	6,420	16,777	4,165	561	6,182
Comanche	55,165	15,990	65,122	13,495	1,740	17,006	Love	7,721	1,790	3,534	1,122	139	1,579
Cotton	10,180	2,790	7,852	1,663	210	2,882	McCain	14,681	3,950	9,085	2,762	385	3,515
Craig	18,263	4,550	10,217	2,212	421	4,231	McCurtain	31,588	7,270	15,326	5,741	464	4,099
Creek	43,143	12,200	30,251	7,991	1,020	11,928	McIntosh	17,829	4,060	8,248	2,254	272	2,639
Custer	21,097	6,110	25,747	5,350	891	6,698	Major	10,279	3,000	8,342	1,684	180	3,319
Delaware	14,734	3,630	3,387	1,134	118	2,960	Marshall	8,177	2,100	4,416	1,277	181	1,965
Dewey	8,789	2,390	6,161	1,556	277	2,347	Mayes	19,743	5,190	10,668	2,785	291	4,364
Ellis	7,326	2,180	5,762	1,451	169	2,040	Murray	10,775	3,080	7,948	1,274	293	3,199
Garfield	52,820	16,640	68,649	11,323	2,544	17,249	Muskogee	65,573	18,340	50,440	11,304	2,200	15,173
Garvin	29,500	8,300	29,272	6,774	930	7,863	Noble	12,156	3,580	11,722	2,715	279	3,873
Grady	34,872	9,920	30,193	6,857	1,067	9,405	Nowata	12,734	3,580	7,170	1,738	188	4,068
Grant	10,461	3,000	8,050	1,930	355	3,854	Okfuskee	16,948	4,060	8,355	2,153	245	3,064

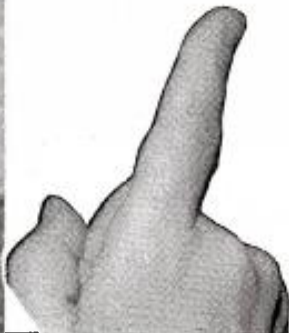

Compare the Rate — Compare the Weight

Check the Hooper Ratings and take a look at the Nielsen Coverage. WBBW has the weight in Mahoning County—the weight that gets the advertising message to the lion's share of this market. Check S R D S for the rate—the lowest cost per thousand homes. Yes, you compare the rate, compare the weight in Youngstown. You'll buy W B B W.

ABC IN YOUNGSTOWN, OHIO

WBBW

BUY THE BIG FIVE...

BUY WKBN

1. MAJOR MARKET

Youngstown, Ohio is the 30th U. S. market*

Population:

5-county primary coverage area	750,200
11-county nighttime primary-secondary	1,179,600
13-county daytime primary-secondary	1,227,400

*Source: 1950 U. S. Census, Metropolitan Areas
 Population Source: Copr. 1953 Sales Management Survey of Buying Power, further reproduction not licensed

2. BLANKETING COVERAGE

Daytime—Listeners: 182,804 radio families
 Nighttime—Listeners: 144,876 radio families

Source: 1952 report by Standard Audit & Measurement Services, Inc.

3. HIGHEST HOOPERS

WKBN has more listeners than the other two Youngstown stations combined.

Morning 42.4 Afternoon 44.0 Evening 48.1

Source: Report of C. E. Hooper, Inc. for Youngstown, Ohio,
 Fall-Winter 1952-53

4. MOST EXPERIENCE

Over 27 years of successful broadcasting give WKBN a wealth of program experience.

5. STRONG POWER

5,000 watts day and night at a favorable frequency of 570 kc.



Buy the leader in Youngstown, Ohio! Buy "Radio Youngstown," the Pioneer Station! You'll reach more people in more counties year after year with CBS and strong local programming

... All on WKBN

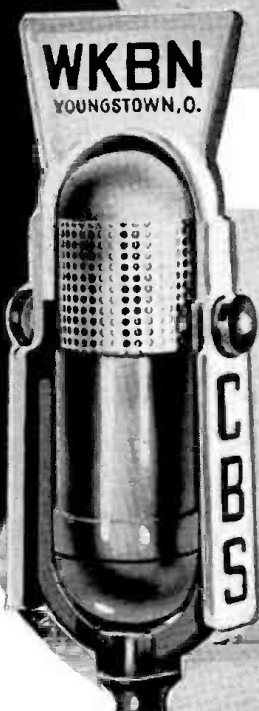

WKBN
 AM AND FM
 YOUNGSTOWN, OHIO
 3930 Sunset Blvd.

Represented Nationally by Paul H. Raymer Co.

MARKET DATA BY COUNTIES (Continued)

County	Population 1950	Radio Families 1953	Retail Sales 1952(000)	Food Sales 1952(000)	Drug Sales 1952(000)	Automobile Ownership 1952	County	Population 1950	Radio Families 1953	Retail Sales 1952(000)	Food Sales 1952(000)	Drug Sales 1952(000)	Automobile Ownership 1952
Oklahoma	325,352	108,670	411,220	78,916	14,948	118,281	Stephens	34,071	10,440	42,927	10,966	1,358	12,416
Okmulgee	44,561	12,410	32,740	8,847	998	11,036	Texas	14,235	4,440	25,589	5,081	993	5,137
Osage	33,071	9,330	17,856	4,971	681	10,098	Tillman	17,598	4,930	20,423	4,705	724	5,114
Ottawa	32,218	9,350	27,950	7,685	896	10,995	Tulsa	251,686	82,380	332,401	69,818	10,650	94,691
Pawnee	13,616	3,930	8,561	2,456	349	4,270	Wagoner	16,741	4,090	8,245	2,353	352	2,946
Payne	46,430	13,360	37,845	9,764	1,193	12,393	Washington	32,880	10,480	36,621	9,021	1,479	11,482
Pittsburg	41,031	10,710	34,111	8,960	1,224	9,534	Washita	17,657	4,910	12,476	2,571	433	4,761
Pontotoc	30,875	8,670	30,592	6,205	891	8,200	Woods	14,526	4,430	18,536	2,996	614	4,910
Pottawatomie	43,517	12,300	40,467	8,630	1,672	13,500	Woodward	14,383	3,900	15,135	3,417	580	4,537
Pushmataha	12,001	2,910	5,302	1,932	186	1,378	Total	2,233,351	648,380	\$2,105,954	\$475,538	\$73,167	891,473
Roger Mills	7,395	1,980	3,172	780	73	1,635	Note: Population 1950 Census; radio families Standard Audit & Measurement Services Inc.; food, drug and retail sales, copyright 1953, Sales Management; further reproduction unlicensed; automobiles supplied by state.						
Rogers	19,532	5,440	11,817	3,318	383	5,120							
Seminole	40,672	10,080	31,446	7,195	1,254	10,141							
Sequoyah	19,773	4,490	5,873	1,680	207	3,169							

DIRECTORY OF AM AND FM STATIONS

City	Call Letters Established	Chan. or Freq. Power	Licensee Headquarters Telephone	Network Representative	Owner o; Pres. p; Exec. vp evp; Gen. Mgr. sm; Sta. Mgr. sm; Coml. Mgr. cm; Sales Mgr. sm; Prog. Dir. pd; Chief Eng. ce; Prom. Mgr. pmm; Prod. Mgr. pdm; News, Farm, Sports or Women's Dir. nd, fd, sd, wd.	Executive Abbreviations	Market Data For Primary Area (Supplied by station)	Library, News Serv., Transmitter	
ADA									
KADA	1934	1230 250	KADA Bcstg. Inc. P. O. Box 642 12	ABC, KBS, Oklahoma Venard	Dr. C. C. Morris, p Bill Hoover, vp & gm Brown Morris, secy-treas. & sm	Naydine Mullinax, pd Vinita Archer, pmm George Miller Jr., ce & nd	Pop.: 165,437 Rad. Hms.: 20,680 Ret. Sis.: \$115,448,000	St. AP G	
ALTUS									
KWHW	1947	1450 250	Altus Bcstg. Co. Box 551 1405	MBS Best	Frank W. Wimberly, p & gm	Ernest Baucum, ce Rita Matthews, wd	Pop.: 32,000 Rad. Hms.: 14,700 Ret. Sis.: \$34,000,000 AP Ray.	
ANADARKO									
KADO (CP)		1750 500-D	Caddo Bcstg. Co.						
ARDMORE									
KVSO	1935	1240 250	John F. Easley Ardmore Bldg. 3030	Oklahoma Net. Venard	John F. Easley, p Albert Riesen, gm	Dolly Dutton, pd Gaey Varnell, pmm	Wm. E. Kolb, ce Wm. McGalliard, fd	Wld., SES. AP Cal.	
BARTLESVILLE									
KWON	1941	1400 250	Bartlesville Bcstg. Dewey Rd. 1400	MBS	J. Fred Case, p & gm	John Collins, cm Cecil Tanner, ce	 AP WE	
BLACKWELL									
KBWL	1953	1580 250-D	Star Bcstg. Co. Main & Bridge Sts. 308	Best	W. J. Britton, p Lloyd J. Woodell, gm & fd	Robert E. Lewis, cm Charles W. Hobbs, ce	John Carrick, nd & sd	Pop.: 109,000 Rad. Hms.: 32,209 Ret. Sis.: \$50,000,000	Thes. AP G
CHICKASHA									
KWCO	1946	1560 1,000-D 250-N-DA-N	Washita Valley Bcstg. Co. KWCO Bldg. 2898	MBS, KBS	Phil Jackson, co-o & gm	Hoyt Caldwell, cm Lorine Null, pd	Neal Allen, ce Gene Cunningham, fd	Pop.: 109,000 Rad. Hms.: 31,000 Ret. Sis.: \$37,000,000 AP G
CLINTON									
KWOE	1949	1320 1,000-D	W. Okla. Bcstg. Co. Box 558 617	Best	V. M. Preston, gm Leo Tremblay, cm	Lew Preston, pd & pmm Hubert Gaston, ce	Evelyn Preston, traffic Lewis Pierce, nd Marlow Preston, sd	Pop.: 208,000 Rad. Hms.: 59,425 Ret. Sis.: \$112,000,000	SES. UP Ray.
CUSHING									
KWHP	1953	1600 1,000-D	William Howard Payne P. O. Box 791 922	Best	William Howard Payne, o & gm George S. Lanham, sm & nd	James Kirkpatrick, cm Jim Waites, pd & sd Lo Rena H. Payne, pmm & wd	Charles F. Hebard, ce Lou S. Allard, fd	Pop.: 832,917 Rad. Hms.: 364,270 Ret. Sis.: \$925,734,000	Thes. AP G
DUNCAN									
KRHD	1947	1350 250-D 100-N	Duncan Bcstg. Co. Box 1192 1350	MBS, KBS Best	R. H. Drewry, p Bill Brubaker, gm, sd & fd	Lester Agee, cm & ce John Moen, pd Tommy Richards, pmm	Ruth Taylor, traffic m Bob Jackson, nd Anita Ensey, wd	Pop.: 52,000 Rad. Hms.: 10,440	Wld. UP WE
DURANT									
KSEO	1947	750 250-D	Democrat Printing Co. Democrat Bldg. 2200	R. F. Story, co-o Bennett Story, co-o	Leroy W. Moses, gm & cm	Leonard Brown, ce		St. AP GE
ELK CITY									
KASA	1932	1240 250	Southwest Bcstg. Co. 1500 Randall St. 730	MBS, KBS Best	Lonnie G. Preston, p, gm & fd Charles Cross, cm	Alice Howenstine, pd & wd F. E. Mayhew, pmm & nd	Robert Hemphill, ce	Pop.: 353,741 Rad. Hms.: 97,982 UP Ray.
ENID									
KCRC	1931	1390 1,000 DA-1	Enid Radiophone Broadway Tower Bldg. 447	ABC, Oklahoma Net. Venard	Milton B. Garber, p Guy B. Farnsworth, gm	H. P. Hale, cm Byron Napier, pd Murray D. Coleman, ce	Cecil Hill, nd Bill Orum, sd Ella Mae Hyde, wd	Pop.: 74,217 Rad. Hms.: 23,000 Ret. Sis.: \$82,833,000	L-W AP Col.
KGWA	1950	960 1,000 DA-1	Public Bcstg. Service Inc. 115 1/2 E. Broadway 4230	MBS, Grass Roots Net. Pearson	George E. Failling, p H. J. Godschalk, gm Tom Belcher, cm & pmm	Lorraine Canster, pd William Teitzel Jr., ce	Dick White, sd Blaine Smith, fd		St. UP G
FREDERICK									
KTAT	1948	1570 250-D	Frederick Bcstg. Co. Main & Grand 1010	KBS Best	J. Dan Jones Jr., ptnr., co-o, co-m, ce & nd	Ron W. Wheeler Jr., ptnr., co-o, co-m & sd Evelyn D. Jones, cm	Mary Wheeler, pd & wd Herman Vosburgh, fd	Pop.: 198,000 Rad. Hms.: 48,000 Ret. Sis.: \$8,000,000	Cap. UP G
GUYMON									
KGYN	1948	1220 1,000-D	Plains Bcstg. Co. P. O. Box 38 888	Best	T. M. Raburn Jr., p & m	Edward J. Slater, cm Herbert L. Noyes, ce	Ernetine Williamson, wd	Pop.: 68,638 Rad. Hms.: 19,500 Ret. Sis.: \$84,000,000	Thes., Wld. UP Ray.
HOBART									
KTJS	1947	1420 250-D	T. J. Shriner 315 E. 11th St. 1070	KBS	T. J. Shriner, p, gm, ce & nd	Herb J. Carnahan, pd & sd	Mary Jo Shriner, pmm & wd Tom Morris, fd	Pop.: 36,485 Rad. Hms.: 10,550 AP G
HOLDENVILLE									
KWSH			(See Weowoka, Okla., listing)						

Data corrected to Dec. 10, 1953. If executives or services for FM are same as AM affiliate names are not repeated. Market Data supplied by stations. FM's in *italics*. *—Non-Commercial Station. CP—Construction Permit issued. D—Day. DA—Day. DA-1—Directional Antenna, night only. DA-2—Directional Antenna, same pattern day and night. DA-3—Directional Antenna, different pattern day and night. L—Limited Time with Dominant Station. LS—Local Sunset. N—Night. SA—Special Authorization. SH—Specified Hours. ST—Share Time. Complete key to abbreviations, page 6.

the 21ST market

1ST in
drug outlets
in Oklahoma

One Sales contact, one
contract, one bill and
one promotion report.

RETAIL DRUG OUTLETS IN HOME COUNTIES

101
86
53
60
22
129
78

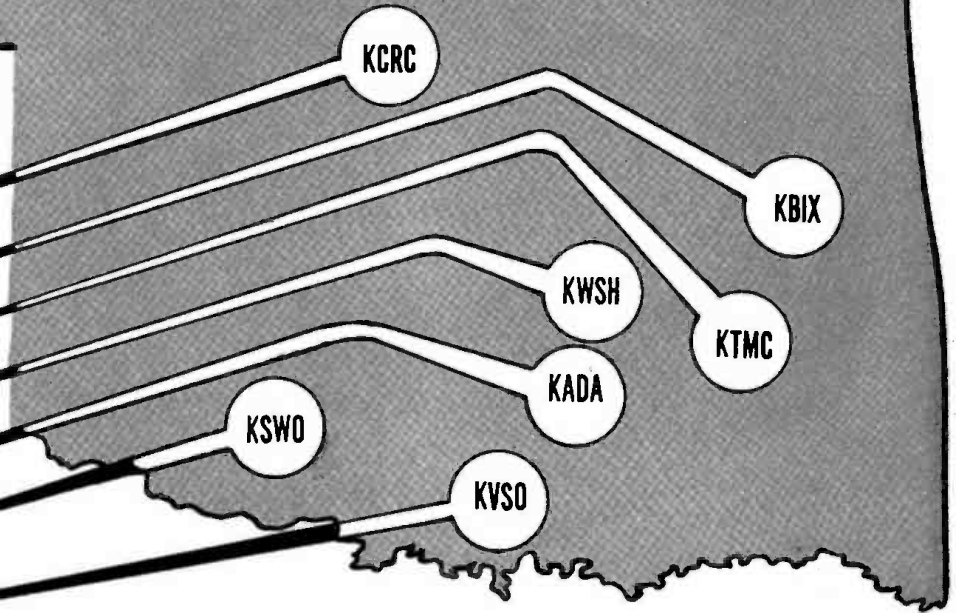

529*

THAT'S 50% MORE
DRUG STORES THAN
THERE ARE IN
CINCINNATI, OHIO

EXCLUSIVE

IN MERCHANDISING THESE
OUTLETS

Oklahoma Network stations offer complete and guaranteed unified merchandising of these 529 drug stores.

The Oklahoma Network stations offer in one package with one invoice at one price with a generous group discount a primary market in Oklahoma whose population and retail sales are greater than those of the 21st Standard Metropolitan area.

OKLAHOMA NETWORK

KBIX, Muskogee; KCRC, Enid; KADA, Ada; KWSH, Tri-Cities; KSWO, Lawton; KTMC, McAlester, KVSQ, Ardmore

ASK
VENARD, INC.
FOR FURTHER DETAILS

* from the 1952-53
Consumer Markets

OKLAHOMA

City Call Letters Established TV Affiliate	Chan. or Freq. Power	Licensee Headquarters Telephone	Network Represent- ative	Owner o; Pres. p; Exec. vp evp; Gen. Mgr. gm; Sta. Mgr. sm; Coml. Mgr. cm; Sales Mgr. slm; Prog. Dir. pd; Chief Eng. ce; Prom. Mgr. pmm; Prod. Mgr. pdm; News, Farm, Sports or Women's Dir. nd, fd, sd, wd.	Executive Abbreviations	Market Data For Primary Area (Supplied by station)	Library, News Serv. Transmitter
HUGO							
KIHN 1948	1340 250	Little Dixie Bcstg. Co. P. O. Box 248 1140	George L. Malone, p James Gerity Jr., p	Billie Van Hoose, pd Dalton E. Jones, ce		SES. AP G
IDABEL							
KBEL 1953	1240 250	Idabel Bcstg. Co. Box 1072 892	Winston O. Ward, p & gm	J. P. Stanley, cm Lee Mars, pd & nd Cliff Taylor, ce Amy Norwood, wd		
LAWTON							
KSWO 1941 KSWO-TV	1380 1,000-DA-2	Okla. Quality Bcstg. Co. 406½ D Ave. 1380	ABC, Oklahoma Net. Venard	R. H. Drewry, p Leo Morris, gm Lyle Gaston, pd Lodell Goochey, pmm	Bill Buford, ce Frank Boardman, bus. m Bill McReynolds, nd	Leonard Morton, sd Al Green, fd Bennie Schreffler, wd	Pop.: 37,000 Rad. Hms.: 10,432 L-W UP WE
McALESTER							
KNED 1950	1150 1,000-D 500-N-DA-N	Pittsburg County Bcstg. Co. P. O. Box 73 Aldridge Hotel 1460	Grass Roots Net. Pearson	Ray VanHooser, p & gm Phil Reed, cm	Mary Jo Lawson, pd Dexter Ferry, ce Larry Kraft, nd & fd	Joe Pate, sd Lena Hopkins, wd	Pop.: 124,524 Rad. Hms.: 28,500 Cap. Thes. UP G
KTMC 1946	1400 250	McAlester Bcstg. Co. Earle Hotel 2411	ABC Venard	Bob Baggett, gm Walter E. Freeman, pd	Harold Duncan, ce Bill Skeith, sd	Geraldne Jones, wd	Pop.: 225,000 Rad. Hms.: 60,000 Ret. Sls.: \$79,342,000 AP G
MIAMI							
KGLC 1948	910 1,000 DA-1	Miami Bcstg. Co. Box 511 3303	KBS Young	Kenyon Brown, p Charles Unger Jr., gm Jack Evans, cm	Louis Stone, ce Frank J. Lynch, sta. sup.	Russ Martin, sd Opal Wright, wd	Pop.: 739,000 Rad. Hms.: 231,500 AP WE
MUSKOGEE							
KBIX 1936	1490 250	Okla. Press Pub. Co. Wall St. Murray 2-1331	ABC, Oklahoma Net. Venard	Tarns Bixby Jr., p Wally Weber, gm George Lanham, cm	Howard Whiteley, pd & sd	Eugene O. Edwards, ce Joe Hasler, nd	Pop.: 196,176 Rad. Hms.: 50,210 Ret. Sls.: \$112,000,000 Thes. UP
KMUS 1948	1380 1,000-D 500-N-DA-N	Eastern Okla. Bcstg. Corp. 412½ Court Murry 2-3341 Pearson	R. M. Mountcastle, p Jimmie Barry, vp, gm & cm	George Overton, pd & nd Paul Weatherbee, pmm	James E. Keitel, ce Bill Mercer, sd Nancy Howard, wd	Pop.: 258,000 Rad. Hms.: 58,600 Wid., St. UP G
KMUS-FM 1947	Ch. 208 (B) 101.5mc 8.75kw			W. J. Rae, p		 WE
NORMAN							
KNOR 1949	1400 250	Cleveland County Bcstg. Co. P. O. Box 542 474 Best	Tol Dickenson, p William S. Morgan, ptrn.	James B. Logan, cm Gene Stansberry, pd Gene Morris, ce	June Morgan, traffic m Clyde Davis, nd Jim Hughes, sd	Rad. Hms.: 10,760 Wid. UP Col.
WNAD 1920	640 1,000-D	U. of Okla. 900	John W. Dunn, gm Hugh M. Mix, pd & sd	Mima Smethers, pmm Remy M. Perot, ce	Glen Kezer, nd WE
OKLAHOMA CITY							
KBYE 1947	890 1,000-D	State Bcstg. Co. 108 NW 9th Forest 5-2323 Airwaves Assoc.	A. Earl Cullum Jr., p Frank J. Lynch, vp & gm	F. F. Lynch, pd, nd & sd	Charles Shaeffer, ce Martha Knott, wd	
KLPR 1947 KMPT (TV)	1140 1,000-D	Okla. City Bcstg. Co. 128 W. Commerce Central 2-1341	Byrne Ross, p, gm & cm Kathleen Burkett, pd & wd	Grant Ladd, pmm & nd Jacob A. Davis, ce	L. H. Bengston, sd Betty York, fd AP Ray.
KOCY 1922	1340 250	Plaza Court Bcstg. Co. Plaza Court Bldg. Fo. 5-4333	MBS, Grass Roots Net. Pearson	Matthew H. Bone- brake, p & gm	George Collisson, m Lou Marquiss, pd	J. S. Merryman, ce Bob Murphy, sd	Pop.: 620,000 Ret. Sls.: \$552,600,000 St. AP Col.
KOMA 1927 KWTV (TV)	1520 50,000-DA-N	KOMA Inc. 66 Hiway at N.E. 73d St. Victor 3-6641	CBS Avery- Knodel	John Toole Griffin, p Edgar T. Bell, gm Ben H. Holmes, asst. m	M. Fuller, pd Montez Naden, pmm M. W. Thomas, ce	Bruce Palmer, nd Doris Dale, wd	Pop.: 1,443,000 Rad. Hms.: 370,000 Ret. Sls.: \$1,300,000,000 L-W, St. UP WE
KTOK 1927	1000 5,000	KTOK Inc. 1800 W. Main Forest 5-8353	ABC, Oklahoma Net. Venard	Wendell Mayes, p John Hopkins, gm	Dick Kirchner, pd Cliff Easum, ce	Harold Phillips, nd Bill Bailey, sd	Wid., Thes. AP, UP WE
KTOW 1947	800 250-D	Sooner Bcstg. Co. 3300 Liberty Bank Bldg. Central 2-6367 Rambeau	Ralph M. Ball, p Rex M. Lester Jr., gm Eddie Peak, cm	Bill Bryan, pd, nd & sd Woodrow W. Zachritz, pmm	Fred Lindsey, ce Sally Carter, wd	Pop.: 895,600 Rad. Hms.: 263,910 Ret. Sls.: \$821,768,000 GE
WKY 1920 WKY-TV	930 5,000 DA-N	WKY Radiophone Co. 500 E. Britton Ave. Trinity 8-2161	NBC Katz	E. K. Gaylord, p P. A. Sugg, sm Hoyte Andres, asst. sm Eugene B. Dodson, adm. asst. & night opers. m	Robert E. Chapman, cm Paul O. Brawner, prog. m Wally Kinnan, pub. rel. m	H. J. Lovell, ce Dallas Wyant, research m & pmm Grant Foster, nd Sandy Saunders, fd Prissy Thomas, pub. service d & wd	Pop.: 1,713,600 Rad. Hms.: 503,090 Ret. Sls.: \$1,639,871,000 St. AP, UP RCA

Data corrected to Dec. 10, 1953. If executives or services for FM are same as AM affiliate names are not repeated. Market Data supplied by stations. FM's in *italic*. *—Non-Commercial Station. CP—Construction Permit issued. D—Day. DA-N—Directional Antenna, night only. DA-I—Directional Antenna, same pattern day and night. DA-2—Directional Antenna, different pattern day and night. L—Limited Time with Dominant Station. LS—Local Sunset. N—Night. SA—Special Authorization. SH—Specified Hours. ST—Share Time. Complete key to abbreviations, page 6.

WKY Radio

thoroughly saturates one important southwestern market. It is powered and programmed exclusively for Oklahoma--you need not buy waste circulation.



Remember, when planning an advertising schedule for Oklahoma that WKY, the third oldest radio station in the nation, serves more Oklahoma homes and covers more Oklahoma buying power from Oklahoma's largest city . . . than any other station!

The 58 Oklahoma counties in WKY's Daytime Nielsen Coverage Area contain

- 73% OF OKLAHOMA'S RETAIL SALES
- 71% OF OKLAHOMA'S FOOD STORE SALES
- 74% OF OKLAHOMA'S DRUG STORE SALES
- 74% OF OKLAHOMA'S AUTOMOTIVE SALES
- 88% OF OKLAHOMA'S GROSS FARM INCOME

(Source: 1952 NCS Report and 1953 Sales Management Survey of Buying Power.)

WKY

Radio Oklahoma City, Okla.

930 KC 5000 W NBC

Owned and operated by The Oklahoma Publishing Company: The Daily Oklahoman — Oklahoma City Times — The Farmer-Stockman — WKY-TV . . . Represented by KATZ AGENCY

OKLAHOMA

City Call Letters Established TV Affiliate	Chan. or Freq. Power	Licensee Headquarters Telephone	Network Represent- ative	Owner o; Pres. p; Exec. up evp; Gen. Mgr. gm; Sta. Mgr. sm; Coml. Mgr. cm; Sales Mgr. slm; Prog. Dir. pd; Chief Eng. ce; Prom. Mgr. pmm; Prod. Mgr. pdm; News, Farm, Sports or Women's Dir. nd, fd, sd, wd.	Executive Abbreviations	Market Data For Primary Area (Supplied by station)	Library, News Serv. Transmitter	
OKMULGEE								
KHBG 1937	1240 250	Okmulgee Bcstg. Corp. Times Bldg. 3646	MBS, Eastern Oklahoma Pearson	Donald W. Reynolds, p Weldon Stamps, gm	John R. Trotter, sm Gladys Le Grand, pd	John Brennerman, ce AP G	
PAULS VALLEY								
KVLH 1947	1470 250-D	KVLH Bcstg. Co. Box 610 1470	KBS Best	James T. Jackson, p Phil Crenshaw, gm	Jim Gray, cm & fd George Rountree, ce	Bill Sullins, nd & sd	Pop.: 117,996 Rad. Hms.: 29,499 Ret. Sis.: \$110,231,000	Cap. UP Col.
PONCA CITY								
WBBZ 1926	1230 250	Ponca City Pub. Co. 1601 E. Oklahoma Rogers 5-6807	MBS Pearson	Clyde E. Muchmore, ptnr. Garth B. Muchmore, ptnr.	Allan W. Muchmore, ptnr. Cy Casper, gm Larry Nolan, cm Bill Maugans, pd, pmm & nd	George S. Black, ce Maureen McBride, wd Bill Platt, sd Don Putnam, fd	Pop.: 287,572 Rad. Hms.: 109,937	Wid. AP G
POTEAU								
KLCO (CP)	1280 1,000-D	Le Flore Bcstg. Co.	R. B. Bell, co-o	Bernice Bell co-o			
PRYOR								
KOLS 1950	1570 250-D	Lakes Area Bcstg. Co. 5th & S. Mill Sts. 1263	KBS, Eastern Oklahoma Net. Continental	L. L. Gaffaney, co. gm, ce & nd	Mrs. L. L. Gaffaney, cm	Merle Caldwell, pd Glenn Chapman, pmm	Pop.: 155,000 Rad. Hms.: 43,000 Ret. Sis.: \$80,000,000	SES. AP G
SEMINOLE								
KWSH		(See Wewoka, Okla., listing)						
SHAWNEE								
KGFF 1930	1450 250	KGFF Bcstg. Co. Inc. Hotel Aldridge 4390	MBS	Oscar S. Stauffer, p Ross Porter, vp Wilford C. Dickson, gm, pmm & secy.- treas.	Fred Davis, cm & sd Jeral C. Ziegler, pd, nd & wd	Earl R. Ward, ce Bill Bates, fd	Rad. Hms.: 28,300 Ret. Sis.: \$94,932,000	Wid. AP Col.
STILLWATER								
KSPI 1947	780 250-D	Stillwater Pub. Co. P. O. Box 231 311	MBS, Oklahoma Aggie	L. F. Bellatti, gm	James R. Bellatti, pd Paul McCollom, ce	Jim Wells, fd		St. UP WE
KSPI-FM 1947	Ch. 230 (B) 93.9mc 3.9kw							
TULSA								
KAKC 1946	970 1,000-LS 500-N-DA-2	Public Radio Corp. Amer. Airlines Bldg. 4-2401	MBS Walker	S. E. Avey, p & treas. James L. Neal, vp & gm James B. Wheeler, slm	L. B. Kirk, pd M. M. Donley, ce Jack Moore, pmm Frank Ross, sd	Shirley, wd Ron Greene, nd Charles Eills, continuity d AP Col.	
KFMJ 1947	1050 1,000-D	Fred Jones Bcstg. 13th & Boston 5-5555 Bolling	Fred Jones, p Lawson Taylor, gm Jack Betz, cm	C. Jenkins, pd Howard Hamilton, ce Jay Jones, nd	Hillis Bell, sd Ed Dumit, fd Marie Power, wd	Pop.: 896,000 Rad. Hms.: 242,000 UP WE
KOME 1938	1300 5,000-D 1,000-N-DA-2	Oil Capitol Sales 8th & Main 3-4121 Gill- Perna	John E. Brown Jr., p Clinton Fowler, evp	C. W. Grim Jr., gm, cm & pd Roy Brown, ce	Lee Grim, wd Tony George, sd		Wid. AP WE
KRMG 1949	740 50,000-D 25,000-N- DA-2	Western Bcstg. Co. 311 S. Denver 54-4291	ABC Blair	Harrington Wimberly, p Frank S. Kane, gm & cm	Keith Bretz, pd William H. Bradley, ce	Glenn Condon, nd Mack Creager, sd	Pop.: 2,850,300 Rad. Hms.: 763,170	Cap. AP RCA
KTUL 1934	1430 5,000-DA-N	Tulsa Bcstg. Co. 1850 S. Boulder 2-3191	CBS Avery- Knodel	John Griffin, p L. A. Blust Jr., vp & gm William D. Swanson, slm Karl Janssen, pd	George L. Ketcham, gen. pmm Robert E. Snider, ce Ruben Cohen, contin- uity d	Bob Wortley, mus. d Jack Morris, nd Jack Charvat, sd Elizabeth Dikeman, wd	Pop.: 855,500 Rad. Hms.: 215,590 Ret. Sis.: \$728,743,000	Wid. UP WE

Data corrected to Dec. 10, 1953. If executives or services for FM are same as AM affiliate names are not repeated. Market Data supplied by stations. FM's in italic. *—Non-Commercial Station. CP—Construction Permit issued. D—Day. DA-N—Directional Antenna, night only. DA-1—Directional Antenna, same pattern day and night. DA-2—Directional Antenna, different pattern day and night. L—Limited Time with Dominant Station. LS—Local Sunset. N—Night. SA—Special Authorization. SH—Specified Hours. ST—Share Time. Complete key to abbreviations, page 6.

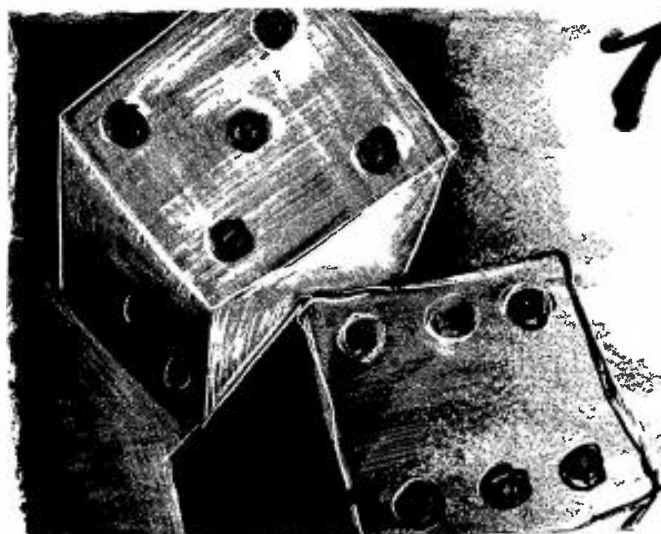

*7 or 11
you can't lose*

... on having your own personal subscription to BROADCASTING • TELECASTING. Whether it be \$7.00 (52 weekly issues) or \$11.00 for issues, Yearbooks and all supplements published during the year ... here's an investment that pays dividends every week. Subscribe today! BROADCASTING • TELECASTING, 1735 DeSales Street, N.W., Washington 6, D. C.

"OPEN SESAME" IN TWO RICH MARKETS



Tap the vast wealth
of **EASTERN OKLAHOMA**
Plus—the **RICH TRADE**
AREA of Western Arkansas

AMPLE COVERAGE
Without **WASTE!**

POPULATION	
KTUL	855,500
KFPW	248,200
TOTAL RETAIL SALES	
KTUL	\$728,743,000
KFPW	\$201,674,000
NET EFFECTIVE BUYING INCOME	
KTUL	\$740,890,000
KFPW	\$240,986,000
RADIO HOMES	
KTUL	215,590
KFPW	62,320

KTUL
TULSA

KFPW
FT. SMITH

KTUL-KFPW

TULSA FORT SMITH
The "HAPPY MEDIUM" Stations

• ONE NETWORK -- CBS RADIO • ONE REPRESENTATIVE -- AVERY-KNODEL, INC.

Earn greater discounts by using BOTH stations

L. A. (Bud) Blust
Vice-President-General Manager



Affiliated with
KOMA, Oklahoma City, Okla.

OKLAHOMA

City Call Letters Established TV Affiliate	Chan. or Freq. Power	Licensee Headquarters Telephone	Network Represent- ative	Owner; Pres. p; Exec. vp evp; Gen. Mgr. gm; Sta. Mgr. sm; Coml. Mgr. cm; Sales Mgr. slm; Prog. Dir. pd; Chief Eng. ce; Prom. Mgr. pmm; Prod. Mgr. pdm; News, Farm, Sports or Women's Dir. nd, fd, sd, wd.	Executive Abbreviations	Market Data For Primary Area (Supplied by station)	Library, News Serv. Transmitter
TULSA—(Continued)							
KVOO 1925	1170 50,000-DA-N	Southwestern Sls. Corp. Philtower Bldg. 2-3281	NBC Petry	W. G. Skelly, p C. A. O'Donovan, treas. W. B. Way, gm	Gustav K. Brandborg, cm & asst. gm Sam Schneider, pd & Ed	W. T. McClarin, pmm John Bushnell, ce Ken Miller, nd Hal O'Halloran, sd	Pop.: 1,680,000 St. Wid. Rad. Hms.: 477,130 UP, INS Ret. Sls.: \$1,668,658,000 WE
WEWOKA							
KWSH 1948	1260 1,000-DA-2	Tri-City Bcstg. Co. Inc. Box 1260 1260	ABC, KBS, Oklahoma Net, Venard	Dr. C. C. Morris, p Bill Hoover, gm Pat Murphy, sm	Roy Judge, cm Romane Balles, pmm & wd	Warren W. Abbott, ce Jay Harmon, sd	Pop.: 60,000 St. Rad. Hms.: 52,000 AP Ret. Sls.: \$45,000,000 Col.
WOODWARD							
KSIW 1947	1450 250	Woodward Bcstg. Co. 22d & Cedar Sts. 1450	MBS, KBS Best	Edward A. Ryan, p & gm	Lenora Woods Ryan, pd	George L. Archer, ce	Pop.: 40,000 Cap., Thes. Rad. Hms.: 39,200 AP WE

OREGON

MARKET DATA BY COUNTIES

County	Population 1950	Radio Families 1953	Retail Sales 1952(000)	Food Sales 1952(000)	Drug Sales 1952(000)	Automobile Ownership 1952	County	Population 1950	Radio Families 1953	Retail Sales 1952(000)	Food Sales 1952(000)	Drug Sales 1952(000)	Automobile Ownership 1952
Baker	16,175	4,920	\$ 16,793	\$ 3,679	\$ 482	7,821	Linn	54,317	18,260	79,209	19,135	1,457	26,870
Benton	31,570	9,620	29,602	6,737	582	12,391	Malheur	23,223	6,470	32,383	4,666	795	10,972
Clackamas	86,716	29,450	65,688	17,682	1,885	36,739	Marion	101,104	30,870	124,090	25,427	2,948	45,950
Clatsop	30,776	11,800	38,861	11,162	810	13,451	Morrow	4,783	1,330	5,606	1,267	75	3,086
Columbia	22,967	7,050	18,894	6,903	445	10,330	Multnomah	471,537	164,740	757,945	165,509	15,709	204,963
Coos	42,285	13,700	57,585	14,955	1,253	23,557	Polk	26,317	8,240	18,946	5,444	471	11,026
Crook	8,991	2,680	8,995	2,646	278	4,866	Sherman	2,271	680	2,505	482	33	1,700
Curry	6,048	2,190	6,020	1,948	169	4,791	Tillamook	18,606	6,080	22,470	6,469	678	9,751
Deschutes	21,812	6,970	37,463	7,900	806	10,602	Umatilla	41,703	13,830	52,072	11,560	1,642	25,331
Douglas	54,549	18,390	72,522	21,426	1,769	30,813	Union	17,962	5,630	20,201	4,373	721	9,133
Gilliam	2,817	960	3,861	524	87	1,855	Wallowa	7,264	2,110	7,182	1,768	269	4,046
Grant	8,329	2,420	8,297	1,871	204	4,483	Wasco	15,552	5,450	24,718	4,718	589	8,456
Harney	6,113	1,750	8,179	1,701	73	3,411	Washington	61,269	20,940	54,197	15,981	1,247	28,649
Hood River	12,740	3,870	14,391	4,008	297	6,703	Wheeler	3,313	1,020	1,659	273	31	1,609
Jackson	58,510	20,320	83,633	20,027	1,958	31,989	Yamhill	33,484	10,510	37,503	8,988	846	16,885
Jefferson	5,536	2,010	6,669	1,259	107	3,163	Total	1,521,341	507,050	\$2,003,176	\$469,203	\$45,466	711,982
Josephine	26,542	9,190	39,541	9,735	1,087	14,778	Note: Population 1950 Census; radio families Standard Audit & Measurement Services Inc.; food, drug and retail sales, copyright 1953, Sales Management; further reproduction unlicensed; automobiles supplied by state.						
Klamath	42,150	12,740	59,521	12,879	1,557	21,441							
Lake	6,649	1,900	10,041	2,045	423	4,031							
Lane	125,776	41,560	151,007	36,271	3,262	62,993							
Lincoln	21,308	7,400	24,927	7,765	421	10,275							

DIRECTORY OF AM AND FM STATIONS

ALBANY													
KWIL 1941	790 1,000 DA-2	Central Willamette Bcstg. Co. Queen & Elm Sts. 1234	MBS, Don Lee Wm. Ayers, Moore & Lund	R. R. Cronise, p Chet Wheeler, gm John Birrel, cm Robert Cornell, Corvallis m	Dewey Rand, Lebanon m LeRoy Jolley, pd Mal Waltham, pmm Warren Stoffer, asst. gm	Ken McCoy, nd Herb Davidson, ce & pd Hal Byer, sd Joanne Forbes, wd	Pop.: 150,000 Rad. Hms.: 40,000 Ret. Sls.: \$240,000,000	Wid. UP RCA					
KWIL-FM 1947	Ch. 269 (A) 101.7mc .7kw												
ASHLAND													
KWIN 1946	1400 250	Rogue Valley Bcstg. Co. 1180 Helman St. 2-4381	MBS, Don Lee	W. D. Miller, o H. Richard Magulre, p	Alan K. Abner, gm & cm	Jack Heald, ce Don Paillette, sd	Pop.: 80,000						
ASTORIA													
KAST 1938	1370 1,000-DA-N	Astoria Bcstg. Co. 1008 Taylor Ave. 95	MBS, KBS, Don Lee	Robert B. Chessman, p Robert D. Holmes, gm Irving M. Steinbeck, cm	Mary Ristola, pd & wd Jay Bruce Whitwell, ce pd	Herman Robison, nd & fd Warren Grimberg, sd	Pop.: 75,000 Rad. Hms.: 24,000 Ret. Sls.: \$34,000,000	St. AP Ray.					
KVAS 1950	1230 250	William Ohlmann, receiver for KVAS Inc. 612 Commercial St. 41	Tracy Moore	William Ohlmann, re- ceiver			Pop.: 50,000 Rad. Hms.: 12,000 Ret. Sls.: \$55,000,000	Wid. UP GE					
BAKER													
KBKR 1939	1490 250	Inland Radio Inc. 2030 Auburn Ave. 140	Oregon Trail Moore & Lund	Kenneth B. Lockwood, gm & cm	Kenneth F. Holden, pd & sd Richard R. Eardley, pmm & nd	Charles E. Harland, ce Lloyd McFee, fd Grace Baer, wd		UP RCA					
BEND													
KBND 1938	1110 1,000 DA-N	Central Oregon Bcstg. Co. Coble Bldg. 848	MBS, Don Lee Grant	Frank H. Loggan, p, gm & pmm Douglas Gaines, cm	Kessler Cannon, pd, asst. m & fd	Robert Dickinson, ce Jack Thornton, nd	Pop.: 43,808 Rad. Hms.: 11,840 Ret. Sls.: \$54,127,000	Wid. UP RCA					
COOS BAY													
KOOS 1928	1230 250	KOOS Inc. Hall Bldg. Congress 7-2121	MBS, Don Lee Moore & Lund	Sheldon F. Sackett, p Fred F. Chitty, gm Phil Waters, sm	John Tasnady, pd, nd, sd & pmm Nathan Olson, ce	Lucy Johnson, office m Fay Crabtree, traffic m Patsy Barkwell, wd		AP, UP RCA					
COQUILLE													
KWRO 1949	1450 250	KWRO Inc. Roxy Bldg. 3961		William E. Walsh, p	Lynn C. Thomas, gm & nd	Sid Roach, sd	Pop.: 42,285 Rad. Hms.: 13,400 Ret. Sls.: \$45,413,000	Cole, Cap. Assoc. AP					

Data corrected to Dec. 10, 1953. If executives or services for FM are same as AM affiliate names are not repeated. Market Data supplied by stations. FM's in *italics*. *—Non-Commercial Station. CP—Construction Permit issued. D—Day. DA-N—Directional Antenna, night only. DA-I—Directional Antenna, same pattern day and night. DA-2—Directional Antenna, different pattern day and night. L—Limited Time with Dominant Station. LS—Local Sunset. N—Night. SA—Special Authorization. SH—Specified Hours. ST—Share Time. Complete key to abbreviations, page 6.

KVOO

reaches

MORE *Homes*

MORE *Spendable Income*

Than any other Oklahoma Station

Yes, KVOO *does* reach more homes and more spendable income than any other Oklahoma radio station!

There's proof of this fact in every survey made by Nielsen, the recognized authority in radio measurement. Spendable income figures are provided by Standard Rate and Data, United States Census figures and any other accepted source you may wish to employ.

KVOO, located in the Northeast section of Oklahoma (the richest, most productive in minerals, dairying, number of highly paid white collar workers, air transportation, manufacturing and rate of growth of manufacturing—to mention a few) serves additional counties in Kansas, Missouri, and Arkansas with 50-100% coverage, and,

According to Rand McNally, the Tulsa Market Area includes all of these KVOO counties.

Thus it is evident that KVOO reaches *more homes* and *more spendable* income than any other Oklahoma radio station.

KVOO is located in Oklahoma's No. 1 market.

KVOO is your best buy to reach the *most people*, the *most spendable* income at the *lowest cost* per family.

See your nearest Edward Petry & Company office for detailed factual data on KVOO and this No. 1 market for time availabilities.

KVOO
TULSA

OKLAHOMA'S GREATEST STATION

Covering

OKLAHOMA'S NO.1. MARKET

RADIO STATION KVOO

NBC AFFILIATE

EDWARD PETRY AND CO., INC. NATIONAL REPRESENTATIVES

50,000 WATTS

OKLAHOMA'S GREATEST STATION

TULSA, OKLA.

OREGON

City	Call Letters Established Tv Affiliate	Chan. or Freq. Power	Licensee Headquarters Telephone	Network Represent- ative	Owner o; Pres. p; Exec. up evp; Gen. Mgr. gm; Sta. Mgr. sm; Coml. Mgr. cm; Sales Mgr. slm; Prog. Dir. pd; Chief Eng. ce; Prom. Mgr. pmm; Prod. Mgr. pdm; News, Farm, Sports or Women's Dir. nd, fd, sd, wd.	Executive Abbreviations	Market Data For Primary Area (Supplied by station)	Library, News Serv. Transmitter
CORVALLIS								
*KOAC 1922	550 5,000-DA-2	Oregon State College 3-4351	NAEB	James M. Morris, prog. m & sd	Grant S. Feikert, ce Bob Hinz, nd	Arnold Ebert, fd Gladys Chambers, wd	Pop.: 1,000,000 Rad. Hms.: 325,000 UP WE
KCOV (CP)	1240 250	Mid-Land Bcstg. Co. 1202 Equitable Bldg. Portland, Ore.	J. C. Haley, p Loyal H. Vickers, gm & pmm	John H. Gallant, cm Ted Carlson, pd & nd William Martin, ce	Rusel Adams, fd Hal Wehmeir, sd Metlyn Shaw, wd	Pop.: 105,310 Rad. Hms.: 31,103 Ret. Sls.: \$56,000,000	Cap. AP G
KRUL 1947	1340 250	Pacific States Radio Co. 1221 S. 15th 3-3322	McGillvra	W. Gordon Allen, p Anthony Maucione, gm Jack Vaughn, pd	Walter Dodd, pmm, nd & fd Bob Kennedy, ce	John Truhan, exec. dir. Wendel Ray, sd	Pop.: 30,000 Rad. Hms.: 7,500 Ret. Sls.: \$11,000,000	
COTTAGE GROVE								
KSGA 1953	1400 250	Coast Fork Broad Co. 1285	Oregon Beaver Net.	V. B. Kenworthy, p Paul E. Walden, sm Lawrence Beaudoin, cm	George Pence, pd Monte DeVon, pmm	Bruce Elliott, ce Ramona Stroh, wd		Mac. UP RCA
THE DALLES								
KODL 1940	1230 250-D 100-N	Western Radio Corp. KODL Bldg. 2300	ABC	E. L. Kincaid, p & gm Paul N. Plank, cm & fd	Laura Plank, pd & wd Clare Mattingly, asst. m & nd	Norville Packard, ce		Cap., SES. UP Col.
EUGENE								
KASH 1947	1600 1,000-DA-N	Radio Air Ways, Inc. Day Island Rd. 5-3357	ABC Cooke	Alton F. Baker, p L. W. Trommlitz, gm Herb Michael, cm	Robert Fulton, pd & pmm Calvert Applegate, ce	Jack J. Craig, nd Earl Britton, fd Ken Warren, sd	Pop.: 220,200 Rad. Hms.: 67,375 Ret. Sls.: \$151,007,000	St. UP G
KERG 1949	1280 1,000-DA-N	Guard Pub. Co. P. O. Box 506 5-4304	CBS Weed	Lee Bishop, p & gm Virgil Parker, cm & sd	Harry Kirk, pd Bob Davis, pmm	Darrell Burns, merc. m Dolph James, nd	Pop.: 150,000 Rad. Hms.: 42,800 Ret. Sls.: \$100,000,000	Wid. UP
KORE 1926	1450 250	Lane Bcstg. Co. 2598 Willamette St. 4-4214	MBS Everett- McKinney, Moore & Lund	Gordon Allen, o & cm John Truhan, ce		UP Col.
KRGA (CP)	1050 1,000-D	Oregon Beaver Net.	C. O. Fisher, p & gm E. W. Karl, cm Reg Roos, pd & pmm	George Hathaway, ce Jack Billings, nd	Woody Slater, sd Mimi Houglum, wd	Pop.: 254,000 Rad. Hms.: 101,750 Ret. Sls.: \$330,208,000	L-W AP RCA
KUGN-FM 1948	Ch. 256 (B) 99.1mc, .38kw	KUGN Inc. P. O. Box 112 4-6216	NBC Meeker					

Data corrected to Dec. 10, 1953. If executives or services for FM are same as AM affiliate names are not repeated. Market Data supplied by stations. FM's in italic. *—Non-Commercial Station. CP—Construction Permit issued. D—Day. DA-N—Directional Antenna, night only. DA-1—Directional Antenna, same pattern day and night. DA-2—Directional Antenna, different pattern day and night. L—Limited Time with Dominant Station. LS—Local Sunset. N—Night. SA—Special Authorization. SH—Specified Hours. ST—Share Time. Complete key to abbreviations, page 6.

KUGN

National Broadcasting Co.

EUGENE

Now reaching over
one million listeners —
more than 63% of
Oregon's population.

590 KC

5000 Watts Day
1000 Watts Night

Now reaching Western
Oregon with 5000 Watts
on 590 kcs. —

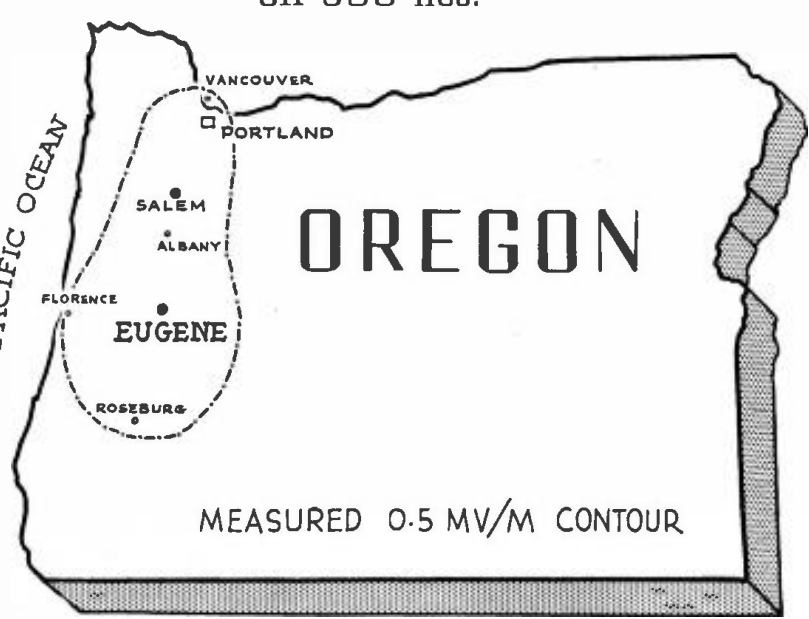

OREGON

MEASURED 0.5 MV/M CONTOUR

Represented Nationally by Robert Meeker Associates

FOREST GROVE

KRWC 1950	1370 250-D	Irving V. Schmidtke P. O. Box 245 6091	Wm. A. Ayers, Moore & Lund	Irving V. Schmidtke, o, gm & ce	Allen Hoffard, cm, pd, pmm & nd Charles Tucker, fd	James Forsythe, sd Eleanor Schmidtke, wd	Pop.: 60,000 Rad. Hms.: 20,540 Ret. Sls.: \$60,000,000	St., SES, AP Ray.
--------------	---------------	--	-------------------------------	------------------------------------	--	---	--	-------------------------

GRANTS PASS

KUIN 1939 KBES(TV)	1340 250	Southern Oregon Bcstg. Co. Redwood Hwy. 4477	MBS, Don Lee Grant	A. E. Voorhies, p Edward A. Malone, m Myron Ball, cm	Dave Allen, pd N. L. Williams, ce	Chris Hansen, nd Lee Boner, fd		Wld., Mac, AP WE
*KGPO(FM) 1947	Ch. 245 (A) 96.9mc 3.1kw	(KUIN, Am Affiliate)						

HOOD RIVER

KIHR 1950	1340 250	C. H. Fisher Box 207 8561 Keating	C. H. Fisher, o & gm	Don M. McCutcheon, sm, cm, pd, nd & sd	James H. Platz, ce Lenore Merritt, wd	Pop.: 35,000 Rad. Hms.: 7,700	L-W AP Ray.
--------------	-------------	---------------------------------	------------------	----------------------	---	--	----------------------------------	-------------------

KLAMATH FALLS

KFJI 1923	1150 5,000-D 1,000-N- DA-N	KFJI Bcstrs. Inc. 327 Main St. 2-2551	MBS, Don Lee Grant, Moore & Lund	W. D. Miller, p Dick Maguire, gm	Bob McVay, cm, pd & sd Shirley Ware, pmm	Wayne Loerke, ce Dale Cooper, pd John Barton, nd Nadine Robertson, wd	Pop.: 100,000 Rad. Hms.: 32,403 Ret. Sls.: \$59,521,000	Thes., Wld., UP Col.
KFLW 1946	1450 250	Herald Pub. Co. of Klamath Falls P. O. Box 941 8115	ABC, CBS Everett- McKinney	Frank Jenkins, p Bud Chandler, gm Aaron Boe, cm	Charlie McFarlan, prod. sup.	Edith Pieruccini, pmm & traffic m Bill Grimes, ce	Pop.: 50,000 Rad. Hms.: 15,000 Ret. Sls.: \$64,000,000	St. AP G

LA GRANDE

KLBM 1938	1450 250	Inland Radio Inc. Old Oregon Trail Hwy. 2201	Oregon Trail Net. Moore & Lund	Kenneth L. Lillard, gm & cm	Judy Holman, pd	Leonard J. Serdar, ce	 UP RCA
--------------	-------------	---	--------------------------------------	--------------------------------	-----------------	-----------------------	--	--------------------

LEBANON

KGAL 1950	920 1,000-DA-1	Linn Co. Bcstg. Co. 8631	Oregon Beaver Net.	Gordon Allen, p John Truhan, gm Don Wellman, cm	Keith Samples, pd & nd George Lichtenthaler, pmm	Daniel Bridges, ce Evelyn Bridges, traffic m & wd Clare Peck, fd & sd & reg. sls. m.	Pop.: 300,000 Rad. Hms.: 75,000 Ret. Sls.: \$850,000,000	L-W AP G
--------------	-------------------	--------------------------------	-----------------------------------	---	---	--	--	----------------

McMINNVILLE

KMCM 1949	1260 1,000 DA-N	Yamhill Bcstrs. P. O. Box 207 3811	KBS	Jack B. Bladine, p Glasco P. Branson, gm, cm & pmm	Les Cunningham, pd Jack Adkins, ce	Dave Riggs, sd	Pop.: 33,410 Rad. Hms.: 10,340 Ret. Sls.: \$35,000,000	L-W AP WE
--------------	-----------------------	--	--------------	--	---------------------------------------	----------------	--	-----------------

MEDFORD

KMED 1922	1440 5,000-D 1,000-N	Radio Medford Inc. P. O. Box 1306 2-4000	NBC Meeker, Moore & Lund	Vernon J. Robinson, p Jennings Pierce, gm Ray Johnson, asst. m & ce	Bill Hansen, cm Russ Jamison, pd & nd Norm Oberst, pmm	Paul Alexander, fd Clara Daniels, wd	Pop.: 69,000 Rad. Hms.: 17,000 Ret. Sls.: \$83,600,000	Thes., Mac, UP RCA
KYJC 1947	1230 250	Medford Printing Barnett Rd. 2-5277	ABC, CBS Grant	Robert W. Ruhl, p Jimmy Dunlevy, gm & pmm	Tom MacLeod, cm & sd John Ahern, pd & nd	Dick Woods, ce Monte Morris, fd	Pop.: 60,000 Rad. Hms.: 58,000 Ret. Sls.: \$72,116,000 UP RCA

NEWPORT

KNPT 1948	1310 1,000-DA-N	Yaquina Radio P. O. Box 276 Newport 560 Keating, Wm. Ayres	Thomas R. Becker, p, gm & ce Dan Kirch, cm & sd	Ed Warmoth, pd, pmm & nd	Amos Bierly, fd Mo Dixon, wd	Pop.: 35,000 Rad. Hms.: 11,800 Ret. Sls.: \$24,927,000	Wld., AP Col.
--------------	--------------------	---	--------------------------------	---	-----------------------------	---------------------------------	--	---------------------

NORTH BEND

KFIR 1951	1340 250	Bay Bcstg. Co. P. O. Box 905 Skyline 9-7351	CBS, Beaver Bcstg. Grant, Keating	Josephine Edwards, p Glenn Nickell, gm	William Kraus, cm & sd	Arthur Schuldt, ce Kieth Gebers, nd	Pop.: 40,000 Rad. Hms.: 13,700 Ret. Sls.: \$57,585,000	St. AP G
--------------	-------------	---	---	---	---------------------------	--	--	----------------

ONTARIO

KSRV 1946	1380 1000 DA-N	Inland Radio Inc. Box 540 212	Oregon Trail Net. Moore & Lund	Gordon L. Capps, gm & cm	Jay Sherlock, pd Charles E. Harland, ce Pat Wilkins, nd	Robert Humphreys, fd Jim Hayden, sd Marie Bailey, wd	Pop.: 159,667 Rad. Hms.: 47,899 Ret. Sls.: \$167,511,000	Wld., St., UP WE
--------------	----------------------	-------------------------------------	--------------------------------------	-----------------------------	---	--	--	------------------------

OREGON CITY

KGON 1947	1230 250	Clackamas Bcstrs. Box 391 Oregon City 5249 Meeker	Dr. John H. Fitzgib- bon, p Irwin S. Adams, gm, cm & pmm	Sonora B. Hoffman, pd Edward G. Saxe, ce	Philip George, asst. ce Frank Faro, nd H. I. Jackson, sd	Pop.: 739,400 Rad. Hms.: 242,580	Assoc., Wld., AP G
--------------	-------------	--	-----------------	---	---	--	-------------------------------------	--------------------------

PENDLETON

KWRC 1941	1240 250	Western Radio Box 178 1425	ABC Moore & Lund	V. B. Kenworthy, p Lea Phillips, gm, cm & sd	Denman Dayton, pd Jack Webb, pmm Douglas Whipple, ce	John Cameron, nd Doris Forsman, wd	Pop.: 70,100 Rad. Hms.: 97.15% Ret. Sls.: \$60,745,000 UP RCA
--------------	-------------	----------------------------------	---------------------	--	--	---------------------------------------	--	--------------------

PORTLAND

*KBPS 1923	1450 250	Benson Poly. School 546 N. E. 12th Ave. Fillmore 5469	Patricia L. Green, m & pd	Charles Weagant, ce			
KEX 1926	1190 50,000-DA-1	Westinghouse Bcstg. Co. 1230 SW Main Capital 1881	ABC Free & Peters	Chris J. Witting, p Joseph E. Baudino, evp J. B. Conley, sm R. H. Prigmore, slm Mel Bailey, pd Charles L. Burrow, pmm	T. T. Ely, ce John A. Erwin, tech. sup. Joseph E. Patterson, tech. sup.	Bob Thomas, nd Ivan Jones, fd Bob Blackburn, sd Kay West, wd	Pop.: 1,520,400 Rad. Hms.: 486,100 Ret. Sls.: \$1,809,216,000	Assoc. UP, INS WE
KEX-FM 1946	56.4kw 92.5mc Ch. 221 (B)							

OREGON

City	Call Letters Established	Chan. or Freq. Power	Licensee Headquarters Telephone	Network Representative	Owner or Pres. p; Exec. up evp; Gen. Mgr. gm; Sta. Mgr. sm; Coml. Mgr. cm; Sales Mgr. slm; Prog. Dir. pd; Chief Eng. ce; Prom. Mgr. pmm; Prod. Mgr. pdm; News, Farm, Sports or Women's Dir. nd, fd, sd, wd.	Executive Abbreviations	Market Data For Primary Area (Supplied by station)	Library, News Serv. Transmitter	
PORTLAND—(Continued)									
KGW	1922	620 5,000-DA-1	Pioneer Bcstrs. Inc. 1320 S. W. Broadway Beacon 6364	NBC Northwest Petry	H. Quenton Cox, p & sm S. I. Newhouse Jr., gm J. N. Wassan, cm	D. F. Whitman, pd Earl E. Peterson, ce	T. D. Rishworth, educ. d & pub. affairs d R. F. Franklin, pdm Paul Rask, sd	Pop.: 1,192,545 Rad. Hms.: 350,255 Ret. Sls.: \$1,621,443,000	L-W, Wid. AP, INS Ray.
KGW-FM	1953	Ch. 262 (B) 100.3mc 57kw	Atwater 0343						GE
KLIQ	1948	1290 1,000-D	Mercury Bcstg. Co. 3908 N. E. Sandy Blvd. Webster 1290		Gordon E. Bambricks, p, gm, pd				
KOIN	1925	970 5,000-DA-N	Mount Hood Radio & Tv Bcstg. Corp. P. O. Box 1031 Atwater 3333	CBS Avery-Knodel	Ted R. Gamble, p C. Howard Lane, vp Harry H. Buckendahl, gm	John L. Palmer, natl. adv. m Willard Mears, pd George Wann, pmm	L. S. Bookwalter, enrg. d Lester Halpin, nd Luke L. Roberts, fd Johnny Carpenter, sd	Thes., Wid. AP, INS	
KOIN-FM	1948	Ch. 266 (B) 101.1mc 48.6kw							
KPAM	1951	1410 1,000-D	Oregon Bcstrs. Ltd. P. O. Box 1230 Atwater 0106		S. M. Goard, p & gm Deal O. Wilkins, cm	D. Duclow, pd C. K. Dickson, ce	L. M. Marcus, nd	Pop.: 750,000 Rad. Hms.: 200,000	Assoc., Wid. AP WE
KPFM(FM)	1946	Ch. 246 (B) 97.1mc 3.3kw	(KPAM, Am Affiliatz)						
KPDQ	1947	800 1,000-D	John W. Davis Ltd. 1008 SW 6th Capitol 9209	Webb	John W. Davis, p & gm Dave Jack, cm	Wink Guthrie, pd	Bob Beattie, ce		Assoc. AP Ray.
KPOJ	1932	1230 5,000-DA-1	KPOJ Inc. 1019 SW 10th Ave. Broadway 3484	MBS Don Lee Blair	Wm. W. Knight, p R. M. Brown, gm Robt. C. LaBonte, cm Jack Moys, pd	Robt. Whitely, pmm Richard R. Pooley, ce Verne Mueller, nd	Alvin D. Bauer, fd Chas. LaFranchise, sd Alma Robinson, wd	Pop.: 867,410 Rad. Hms.: 302,410 Ret. Sls.: \$826,706,000	Thes. UP
KPOJ-FM	1948	Ch. 254 (B) 98.7mc 44kw							Thes. UP WE

Data corrected to Dec. 10, 1953. If executives or services for FM are same as AM, affiliate names are not repeated. Market Data supplied by stations. FM's in *italics*. —Non-Commercial Station. CP—Construction Permit issued. D—Day. DA-N—Directional Antenna, night only. DA-1—Directional Antenna, same pattern day and night. DA-2—Directional Antenna, different pattern day and night. L—Limited Time with Dominant Station. LS—Local Sunset. N—Night. SA—Special Authorization. SH—Specified Hours. ST—Share Time. Complete key to abbreviations, page 6.

Newsweek

**PACIFIC NORTHWEST:
Empire in the Making**

You're
SO RIGHT!

When your figures show that
NO LONGER does a Portland buy
SELL Oregon

RADIO *Willamette-Land*

IS MORE LISTENED TO—
SELLS BETTER THRU
"IN THE MARKET"
PENETRATION

Address:
SALES MANAGER
OREGON BEAVER NETWORK
P.O. BOX 768
SALEM, OREGON

**IT'S
IMPACT!**

IN OREGON ON THE
"GA" GOOD
ADVERTISING
—ALLEN
STATIONS

* PRONOUNCED WIL-LAM-ETTE-LAND

THE TIME BUYER WHO SAW 'DOUBLE' IN OREGON

**OREGON IS
PORTLAND
PLUS
Willamette-Land
WHERE**

1/2 million Oregonians spend
THREE QUARTER BILLION DOLLARS

OREGON

KWJJ 1925	1080 14,000 DA-2	Rodney F. Johnson 1011 SW 6th Ave.	Burn- Smith	Rodney F. Johnson, p & gm	Ben T. Crosby, cm & pmm Jerry Speerstra, pd	Les Windes, ce Charles A. Larsen, comp.	Pop.: 764,000 Rad. Hms.: 263,000 Ret. Sls.: \$1,000,000,000 UP WH
KXL 1926	750 10,000 L-WSB DA-1	KKL Bcstrs. Inc. Box 5886 Evergreen 1-6558	Walker	H. S. Jacobson, p, gm & cm	George Anthony, pd & pmm Len Garrett, ce	Chuck Foster, nd Ben Buisman, fd	Pop.: 445,260 Rad. Hms.: 413,010 Ret. Sls.: \$1,249,964	Assoc. AP, UP RCA
PRINEVILLE								
KRCO 1950	690 1,000-D	Radio Central Oregon inv. P. O. Box 188 6239	Grant, Best, Keating	N. A. Miksche, co-o, p, & gm Collin R. Matheny, co-o, vp, cm & ce	Elsie Stover, pd & wd Les McKay, sd		Pop.: 10,000 Rad. Hms.: 27,982	Thes. UP Col.
REDMOND								
KJUN 1952	1240 250	Juniper Bcstrs. P. O. Box 1240 234	ABC McGillvra	Harold Singleton, p Iris Rice Helliwell, gm & sd	Jack Luetjen, cm & pmm Don Gay, pd & ce Gene Stranahan, bus. m	Don Nelson, nd & fd Pat Riggs, wd	Pop.: 40,052 Rad. Hms.: 12,631 Ret. Sls.: \$51,000,000	
ROSEBURG								
KRNR 1935	1490 330	News-Review 134 N. Jackson P. O. Box 123 3-5551	CBS Grant	Frank Jenkins, p Leroy Hiatt, gm	Warren Ward, cm Lyle Fenner, pd & fd	Max Dick, ce Bob Grant, nd & sd	Pop.: 45,000 Rad. Hms.: 15,000 Ret. Sls.: \$52,600,000	St. AP G
KRXL 1950	1240 250	Umpqua Bcstrs. 1640 Medford St. 3-4464	MBS. Don Lee Art Moore	Donn W. Radabaugh, p Iris Rice Helliwell, gm Lon D. Hunt, cm	Del McKay, pd Carol Kerr, pmm & wd Leo Reetz, ce	Joe Haystead, nd Frank Purdy, sd	Pop.: 60,000 Rad. Hms.: 16,390 Ret. Sls.: \$60,000,000	L-W, Wld. UP G
SALEM								
KGAE 1951	1430 1,000-D	KGAE P. O. Box 768 3-7121	Oregon Beaver Net.	Gordon Allen, p Robert Bruce, gm Glenn Smyth, cm	Earl Headrick, natl. slm Jean McLean, pd & nd Andy Anderson, pmm	John Truhan, ce Betty Bangert, traffic m	Pop.: 400,000 Rad. Hms.: 100,000 Ret. Sls.: \$1,000,000,000 AP WE
KSLM 1934	1390 1,000	Oregon Radio Inc. 3-4831	MBS. Don Lee Everrett- McKinney	Glenn McCormick, p Dave Hoss, sm & cm	Ester Konantz, pd Glyde Carlton, ce	Glenda Lou, wd	Pop.: 280,000 Rad. Hms.: 91,600 Ret. Sls.: \$6,200,000	Wld. UP GE
SPRINGFIELD								
KRGA (CP) KTVF (TV)	1050 1,000-D	(See Eugene, Ore. listing)		W. Gordon Allen				
TILLAMOOK								
KTIL 1947	1590 250	Tillamook Bcstg. Box 227 1122	KBS Continental	F. H. Guyton, p Tom Hoover, gm, cm, pa, pmm, nd & sd	Larry Bruner, ce Carl Karpstein, fd & wd		Pop.: 22,000 Rad. Hms.: 6,080 Ret. Sls.: \$16,000,000 AP WE
WEST SALEM								
KOCO 1947	1490 250	Loring Schmidt 1426 Edgewater 3-3108	Rambeau	Loring Schmidt, p & gm Seth D. Smith, cm	Carl Ritchie, pd Robt. Suing, ce Ray Loter, nd	Chuck Boice, sd Delores Gotfried, wd	Pop.: 175,000 Rad. Hms.: 40,000 Ret. Sls.: \$180,500,000	Assoc., Cap. UP RCA

PENNSYLVANIA

MARKET DATA BY COUNTIES

County	Population 1950	Radio Families 1953	Retail Sales 1952(000)	Food Sales 1952(000)	Drug Sales 1952(000)	Automobile Ownership 1952	County	Population 1950	Radio Families 1953	Retail Sales 1952(000)	Food Sales 1952(000)	Drug Sales 1952(000)	Automobile Ownership 1952
Adams	44,197	12,140	\$ 46,588	\$ 10,302	\$ 899	50,329	Lawrence	105,120	29,730	106,604	30,496	2,301	
Allegheny	1,515,237	429,430	1,854,243	522,525	5,328	734	Lebanon	81,683	24,840	83,962	19,824	1,564	
Armstrong	80,842	21,950	68,811	18,671	1,719	4,792	Lehigh	198,207	57,120	235,744	51,480	4,071	
Beaver	175,192	48,760	178,556	56,836	4,792	358	Luzerne	392,241	104,190	361,526	99,769	7,001	
Bedford	40,775	10,530	29,765	7,485	358	5,336	Lycoming	101,249	30,180	105,831	30,341	2,539	
Berks	255,740	74,220	275,142	64,817	5,336	2,715	McKean	56,607	16,480	57,417	16,317	1,513	
Blair	139,514	39,410	130,712	41,367	2,715	887	Mercer	111,954	31,430	126,851	32,811	3,174	
Bradford	51,722	14,590	45,066	11,134	1,885	3,011	Mifflin	43,691	11,800	40,256	11,420	1,054	
Bucks	144,620	44,490	142,846	40,978	2,854	1,985	Monroe	33,773	9,820	40,981	9,863	873	
Butler	97,320	27,040	92,963	23,567	1,985	67	Montgomery	353,068	99,300	372,966	112,062	10,635	
Cambria	209,541	53,460	178,228	50,430	3,011	880	Montour	16,001	3,510	8,714	2,515	313	
Cameron	7,023	1,800	7,725	2,416	67	1,487	Northampton	185,243	51,900	214,535	66,235	5,163	
Carbon	57,558	15,580	45,905	16,287	880	4,368	Northumberland	117,115	32,470	107,630	30,957	2,803	
Centre	65,922	16,230	55,453	14,676	1,487	734	Perry	24,872	6,780	19,246	5,138	284	
Chester	159,141	41,560	155,175	40,190	4,368	9,792	Philadelphia	2,071,605	597,450	2,510,301	584,150	64,187	
Clarion	38,344	10,140	37,604	9,792	1,418	596	Pike	8,425	2,910	7,346	2,327	74	
Clearfield	65,937	22,680	77,185	22,569	1,418	983	Potter	18,810	4,660	15,538	4,077	199	
Clinton	36,352	10,200	32,377	9,533	596	1,731	Schuylkill	200,577	53,390	159,083	47,750	3,288	
Columbia	53,460	15,500	52,481	14,247	983	2,508	Snyder	22,912	5,890	15,825	3,675	226	
Crawford	78,948	22,820	89,025	21,649	1,731	810	Somerset	81,813	21,060	67,831	17,964	1,075	
Cumberland	94,457	28,130	94,847	24,716	2,508	790	Sullivan	6,745	1,700	5,011	1,783	39	
Dauphin	197,784	58,390	244,170	54,598	810	5,710	Susquehanna	31,970	8,480	24,055	7,638	245	
Delaware	414,234	122,410	374,711	114,088	13,660	3,478	Tioga	35,474	10,190	31,385	7,290	495	
Elk	34,503	9,170	24,190	8,917	790	3,478	Union	23,150	5,560	15,061	3,892	360	
Erle	219,368	64,380	283,570	73,888	5,710	2,329	Venango	65,328	17,770	58,119	16,763	1,207	
Fayette	189,809	49,560	171,529	45,887	3,478	29	Warren	42,598	11,700	52,611	11,291	816	
Forest	4,944	1,320	2,718	1,009	29	1,640	Washington	209,628	57,270	195,960	57,899	4,899	
Franklin	75,927	20,750	80,599	18,593	1,640	89	Wayne	28,478	7,740	27,186	6,733	420	
Fulton	10,387	2,590	5,471	1,171	89	1,345	Westmoreland	313,179	85,610	314,861	94,610	6,845	
Greene	45,394	11,670	29,162	9,221	571	85	Wyoming	16,766	4,600	16,353	4,096	161	
Huntingdon	40,872	10,710	29,042	8,234	343	5,110	York	202,737	60,590	216,431	55,272	3,653	
Indiana	77,106	20,110	67,572	16,882	1,345								
Jefferson	49,147	13,610	42,029	12,648	840								
Juniata	15,243	4,030	13,084	2,329	85								
Lackawanna	257,396	70,210	232,817	68,035	5,040								
Lancaster	234,717	63,640	263,381	550,826	5,110								
Total	8,013,492	2,949,280	\$11,169,820	\$2,961,446	\$267,654	3,266,830							

Note: Population 1950 Census; radio families Standard Audit & Measurement Services Inc.; food, drug and retail sales, copyright 1953, Sales Management; further reproduction unlicensed; automobiles supplied by state.

DIRECTORY OF AM AND FM STATIONS

WAEB 1948	790 500-D 1,000-N- DA-N	WAEB Inc. Center Sq. Hemlock 4-9364	Holling- bery	Howard Wasserman, p & gm P. Robert Ackley, cm	Lorraine Heiser, pmm William Gottshall, ce John Mraz, natl. slm	Bert Barer, nd Bob Harnish, sd Joan Amant, wd	Pop.: 450,000 Rad. Hms.: 160,000 UP WE
WFMZ(FM) 1947	Ch. 264 (B) 100.7mc 20kw	Penn-Allen Bcstg. Co. 1524 Linden St. Hemlock 3-7521		Raymond F. Kohn, p & gm	Horace W. Gross, cm Daniel Houck, ce	Maribelle J. Kohn, traffic m	Pop.: 852,200 Rad. Hms.: 232,740 Ret. Sls.: \$895,008,500	Assoc., SES. Col.
WHOL 1948	1230 250	Allentown Bcstg. Corp. Colorado & Poplar Sts. Hemlock 4-4801	CBS Meeker	Charles G. Helwig, p Victor C. Diehm, vp James F. Chambers, m & pd	Alfred F. Wilcox, pmm Gerald B. Werst, ce	Syd Paul, nd & sd Ruth Miller, wd	Pop.: 350,000 Rad. Hms.: 125,000	Thes. UP GE
WKAP 1947	1320 1,000-DA-N	WKAP Inc. P. O. Box 689 Hemlock 3-3166	Weed	N. Joe Rahall, p Oggie Davies, gm & cm	Marshall S. Cleaver, pd C. Frank Cordaro, ce Alan D. Raber, nd & sd	Paul Galgon, fd Gladys Hersh, wd	Pop.: 1,400,000 Rad. Hms.: 386,000 Ret. Sls.: \$1,280,000,000	Assoc. AP G

PENNSYLVANIA

City	Call Letters Established Tv Affiliate	Chan. or Freq. Power	Licensee Headquarters Telephone	Network Represent- ative	Owner o; Pres. p; Exec. up evp; Gen. Mgr. gm; Sta. Mgr. sm; Coml. Mgr. ce; Sales Mgr. stm; Prog. Dir. pd; Chief Eng. ce; Prom. Mgr. pmm; Prod. Mgr. pdm; News, Farm, Sports or Women's Dir. nd, fd, sd, wd.	Executive Abbreviations	Market Data For Primary Area (Supplied by station)	Library, News Serv. Transmitter
ALLENTOWN (Cont'd)								
WSAN	1923	1470 5,000-DA-N	Lehigh Valley Bcstg. Co. 39 N. Tenth St. Hemlock 4-9511	NBC Headley- Reed	B. Bryan Musselman, co & gm Olivia M. Barnes, cm	George Y. Snyder, pd Reuel H. Musselman, ce	John Van Sant, sd Kay Allen, wd	Wid. AP WE
WSAN-FM	1947	Ch. 260 (B) 99.9mc 8kw						
ALTOONA								
WFBG	1924	1340 250	Gable Bcstg. Co. Gable Arcade 6467	NBC, Quaker H-R Rep.	George P. Gable, p Jack Snyder, mngng. d	James Gates, cm, pd & nd George Burgoon, ce	Eugene Hammil, fd Josephine Cooney, wd	Wid. AP WE
WRTA	1947	1240 250	Thompson Bcstg. Co. 1421 12th Ave. 6646	ABC, MBS Meeker	Roy F. Thompson, p & gm William S. Clear, cm, sm, pmm & sd	Dorothy M. Thompson, pd George Shaffer, ce	S. Carlton Ayers, nd G. Hamill, fd Marge Griffith, wd	Pop.: 582,581 Rad. Hms.: 155,653 Ret. Sls.: \$493,873,000
WVAM	1948	1430 1,000-DA-2	General Bcstg. Corp. 2727 W. Albert Dr. Altoon 8127	CBS, Quaker Weed	George Gartland, co E. S. Leopold, p Will Ketner, m, pd & fd	Will Union, cm & pmm Bernard Bopp, ce Jean Lindemann, traffic m & wd	John Riley, nd Paul Melanson, sd	Pop.: 220,000 Rad. Hms.: 49,750 Ret. Sls.: \$63,272,000
WVAM-FM	(CP)	Ch. 261 (B) 100.1mc 4kw						Pop.: 250,000 Rad. Hms.: 90,000 Ret. Sls.: \$63,272,000
APOLLO								
WAVL	1947	910 1,000-D	Tri-Borough Bcstg. Co. 4th St. & Penna. Ave. 72-32921	Bennett	Cecil F. Clifton, co-o & gm	Andrew J. West, co-o & cm H. Edgar Smith, ce	Silas West, pd Carrey Bentley, nd	L-W, Cole, SES. UP G
BARNESBORO								
WNCC	1950	950 500-D	North Cambria Bcstrs. Inc. 803 Maple Ave. Barnesboro 1010	KBS, Quaker	Harris G. Breth, p W. J. Thomas, gm	William Rathall, m & pd Dyle Miller, ce	Joanne Tibbett, office m Mildred Tatters, wd	Pop.: 112,000 Rad. Hms.: 40,000 Ret. Sls.: \$150,000,000
BEAVER FALLS								
WBVP	1948	1230 250	WBVP Inc. 1216 7th Ave. Beaver Falls 4100		Frank R. Smith, p & gm Thomas B. Price, cm & vp	Charles Onderka, treas. Lillian M. Smith, secy. Charles H. Wilson, pd Jean E. Biggard, pmm Frank W. Schaefer, ce	Ernest P. Kline, nd Chuck Wilson, sd Gertrude B. Trobe, wd	Pop.: 178,000 Rad. Hms.: 54,000 Ret. Sls.: \$163,332,000
BETHLEHEM								
WGPA	1947	1100 250-D	The Bethlehems' Globe Pub. Co. 428 Brodhead Ave. University 6-8074	Quaker	Rolland L. Adams, p Arthur C. McCracken, sm	Frank R. Collie, cm & pmm Stefan George, pd	Edwin L. Rybak, ce John Daday, sd	Pop.: 437,824 Rad. Hms.: 137,800 Ret. Sls.: \$441,987,700
WGPA-FM	1947	Ch. 236 (B) 95.1mc 10kw						Cap., The. UP RCA
BLOOMSBURG								
WCNR	1947	930 1,000-D	Columbia- Montour Bcstg. Corp. 38 W. Main St. 1700	Quaker	Ed Darlington, gm & cm	Robert Fulton, ce	Vera Grove, wd Max Williamson, nd Paul Niesley, pd Kay Myers, sd	Pop.: 3,000,000 Rad. Hms.: 2,800,000
WHLM	1948	690 1,000-D- DA CP 550 500 DA-2	Harry L. Magee Hotel Magee 1800		Harry L. Magee, p Robert R. Williams, gm Pat Campbell, cm	James K. Stock, pd & sd Ray Calabrese, pmm Anthony Hogg, ce	Ted Jones, nd Walt Lewis, fd Gloria Michaels, wd	AP Ray.
BRADDOCK								
WLOA	1945	1550 1,000-D	Matta Bcstg. Co. 1233 Braddock Ave. Electric 1-1100		William G. Matta, p & gm Robert F. Pleunik, cm & nd	George C. Matta, pd Elmer L. Heess, ce	Dan Wagner, sd Ann Popovich, wd	Pop.: 1,890,000 Rad. Hms.: 44,750 Ret. Sls.: \$2,528,200,000
BRADFORD								
WESB	1947	1490 250	Radio Station WESB 43 Main St. 3173	MBS Burn- Smith	Joseph M. Cleary, gm, pmm & nd Frederick Tascone, cm	Lloyd P. Gordon, pd Dean W. Merry, ce Jack C. Laffin, sd	L. P. Gordon, fd Gertrude Curley, wd	Pop.: 59,400 Rad. Hms.: 13,750 Ret. Sls.: \$56,682,000
BUTLER								
WBUT	1949	1580 500-D CP: 1050 250-D	J. Patrick Beacom P.O. Box 1048 75-778	Gill-Perna	J. Patrick Beacom, p Kenneth E. White, gm & cm	Rick Hanna, pd Gerald D. Coleman, ce	Dick Kutan, sd Paula Dugan, wd	Pop.: 3,900,000 Rad. Hms.: 985,000 Ret. Sls.: \$4,000,000,000
WBUT-FM	1949	Ch. 249 (A) 97.7mc 0.72kw						WH
WISR	1941	680 250-D	Butler Bcstg. Co. Inc. 357 N. Main St. 74-701	KBS, Tri-State,	Joel W. Rosenblum, p Robert L. Kaufman, gm & nd George E. McGary, cm	Warren E. Ihlenfeld, pd & sd Michael S. Salamon, pmm	Paul F. Rex, ce John Turrell, fd Margo Pitts, wd	Pop.: 750,000 Rad. Hms.: 210,000 Ret. Sls.: \$500,000,000
CARBONDALE								
WC DL	1950	1230 250	Carbondale Bcstg. Co. Inc. 127 Salem Rd. 1230	KBS, Quaker Cooke	William H. Ware, p John R. Kreiger, gm Frank T. Bailey, cm	Edward J. Hughes, pd Robert G. Adams, tech. advisor	Walter F. Rude, ce Paul Elbrecht, sd	Pop.: 272,000 Rad. Hms.: 77,600 Ret. Sls.: \$238,900,000
CARLISLE								
WHYL	1952	960 1,000-D	Richard Field Lewis Jr. P. O. Box 345 Mount Holly Pike Carlisle 1785	Quaker	Richard Field Lewis Jr., p Winslow T. Porter, gm & cm	Clinton H. Morse, pd Jack Simmons, ce	Peggy Jane Goodyear, loc. nd Irwin W. Galt, fd	Pop.: 629,951 Rad. Hms.: 171,964 Ret. Sls.: \$631,584,000
CHAMBERSBURG								
WCHA	1946	800 1,000-D	Chambersburg Bcstg. Co. Craft Press Bldg. 1110	Forjoe	John S. Booth, vp Earl P. Strine, sm & cm	Sam A. Taylor, pd & nd Bob Harrison, pmm James A. McCurdy, ce	Jack Konode, fd Peter E. Farrell, sd Margaret Leete, wd	Pop.: 206,692 Rad. Hms.: 47,335
WCHA-FM	1948	Ch. 240 (A) 95.9mc .7kw						St., The. AP GE

Data corrected to Dec. 10, 1953. If executives or services for FM are same as AM affiliate names are not repeated. Market Data supplied by stations. FM's in italic. *—Non-Commercial Station. CP—Construction Permit issued. D—Day. DA—Directional Antenna, night only. DA-1—Directional Antenna, same pattern day and night. DA-2—Directional Antenna, different pattern day and night. L—Limited Time with Dominant Station. LS—Local Sunset. N—Night. SA—Special Authorization. SH—Specified Hours. ST—Share Time. Complete key to abbreviations, page 6.

CHARLEROI

WESA 1947	940 250-D	Monongahela Valley Bcstg. P. O. Box 584 Charleroi 3-6551 Rambeau	Dr. A. S. Sickman, p bd. of d Charles R. DuVall, gm George D. Galley, pd	Silvio Garafalo, ce	William Richards, nd & sd Shirley McDonald, wd			Thes. AP Ray.
--------------	--------------	---	------------------	---	---------------------	--	--	--	---------------------

CHESTER

WPWA 1947	1590 1,000-DA-N	Lou Poller 3500 Edgenont Ave. Chester 4-4321	ForJoe	Lou Poller, p Howard Weiss, gm Cy Swingle, cm Jeff Scott, pd, sd & nd	Harry Simington, ce Frances Johanssen, pmm & traffic m	Marian Pedlow, wd	Pop.: 150,000		St. AP Col.
--------------	--------------------	---	-----------------	---	--	-------------------	---------------	--	-------------------

WVCH 1948	740 250-D	James M. Tisdale Wolf Bldg. Market Sq. Chester 2-8861 Webb	James M. Tisdale, o. gm, cm & ce	Robert A. Hibbert, pd Frank Wayne, nd & fd	Don Baron, sd Carolyn Sphar, wd	Pop.: 2,000,000 Rad. Hms.: 490,000 Ret. Sis.: \$85,000,000 UP RCA	
--------------	--------------	--	---------------	-------------------------------------	---	------------------------------------	--	--------------------	--

CLEARFIELD

WCPA 1947	900 1,000-D	Clearfield Bcstrs. 215 Church St. Clearfield 5-5541	Quaker	W. K. Ulerich, p W. J. Thomas, gm & pmm	Llewellyn Duck, ce Joseph Milsop, m & pd Margaret Nemeth, asst. m	W. O. Mitchell, fd Janet Cowdrick, wd	Pop.: 101,000 Rad. Hms.: 24,000 Ret. Sis.: \$71,000,000	Thes., Assoc. UP G	
--------------	----------------	---	-----------------	---	--	--	---	--------------------------	--

COATESVILLE

WCOJ 1949	1420 1,000-D	Chester County Bcstg. Co. 703 E. Chestnut St. 2100	Quaker Webb	William S. Halpern, p & gm Richard Scully Jr., vp	Donald Kimes, cm & pmm Louis N. Seltzer, secy. & ce	George Thurston, nd Eloise Dannenhower, wd	Pop.: 160,000 Rad. Hms.: 40,000 Ret. Sis.: \$150,000,000	SES. UP G	
--------------	-----------------	--	----------------	---	--	--	--	-----------------	--

CONNELLSVILLE

WCVI 1947	1340 250	Connellsville Bcstrs. Inc. 128 W. Crawford 2700		Raymond Gallardi, p	Jack Craddock, gm & sd	Joseph Speeney, pd Paul Queer, ce			Wld., Ses. UP G
--------------	-------------	--	--	---------------------	---------------------------	--------------------------------------	--	--	-----------------------

COUDERSPORT

WFRM 1953	600 500-D	Farm & Home Bcstg Co. 9 N. Main St. 611	C. H. Simpson, p John A. Fay, vp & gm George A. Clark, slm	Dean L. Close, opers. m David W. Hammond, cm Maurice Sherman, ce	Walter Taylor, nd Gibby Hoffman, sd Pete Brennehan, fd Shirley Roche, wd	Pop.: 191,000 Rad. Hms.: 85,750 Ret. Sis.: \$266,623,000		
--------------	--------------	--	----------------	--	--	---	--	--	--

DOYLESTOWN

WBUX 1948	1570 250-D	Charles M. Meredith Hart Bldg. 220	KBS, Quaker Indie	Charles M. Meredith, p William A. Lynch, gm & cm	Robert Fretz, pd, nd & sd Richard A. Alliger, pmm	R. Robert Wright, ce Nonnie Crawford, wd	Pop.: 200,000 Rad. Hms.: 75,000		Wld. AP GE
--------------	---------------	---	-------------------------	--	--	---	------------------------------------	--	------------------

DU BOIS

WCED 1941	1230 250	Tri County Bcstg. Co. 80 N. Park Pl. 1700	CBS McGillvra	H. T. Gray, p J. S. Gray, gm & nd George Williams, cm & pd	Ken Johnston, pmm Bernard Guerwich, ce Marv Bloom, sd Mat Stevens, fd	Betty Lee, wd	Pop.: 200,000 Rad. Hms.: 45,000 Ret. Sis.: \$40,000,000		SES. UP RCA
--------------	-------------	--	------------------	---	--	---------------	---	--	-------------------

WCED-FM Ch. 271 (B)
1948 102.1mc
9.5kw

EASTON

WEEX (CP) WGLV (TV) WEEX(FM) 1948	1230 250 Ch. 252 (A) 98.3mc 1kw	Eastern Bcstg. Co. Easton Pub. Co. 8155 Headley- Reed NBC Meeker	J. L. Stackhouse, p Richard Hubbell, asst. to p Clair R. McCollough, sta. exec. Theodore W. Pierce, sm	Nelson S. Rounsley, bus. m	Charles McKee, pd Charles R. Thon, ce	Pop.: 206,120 Rad. Hms.: 49,980 Ret. Sis.: \$353,908,000		Assoc. AP RCA
---	---	---	--	--	-------------------------------	--	--	--	---------------------

WEST 1936	1400 250	Associated Bcstrs. Inc. 518 Northampton 6131		J. Robert Gullick, gen. slm	Eugene Bethman, pd J. E. Mathiot, tech. d				Wld. UP
--------------	-------------	---	--	--------------------------------	--	--	--	--	---------------------

WEST-FM Ch. 300 (B)
1948 107.9mc
11kw

EMPORIUM

WBTL (CP) WEMR (CP)	980 500-D 1340 100	Bucktail Bcstg. Corp. Kenneth H. Renne- nekamp 513-15 Berger Bldg. Pittsburgh, Pa. Atlantic 1-1385	KBS, Quaker	Kenneth H. Renne- kamp, p & gm Catherine McLaughlin, cm Mary Freed, pd	David McElhatten, ce				
------------------------------	-----------------------------	---	-------------------------	--	----------------------	--	--	--	--

ERIE WERC 1941	1260 5,000-DA-2	Presque Isle Bcstg. Co. 121 W. 10th St. 4-6387	NBC, Quaker Weed	Jacob A. Young, p B. Walker Sennett, vp Arthur M. Ingram, gm Robert Yochim, cm	J. Jacob Young, pd & pmm Kenneth L. Hestor, ce	Jay Young, sd Jim Dewart, nd Ralph Wheeler, fd	Pop.: 259,874 Rad. Hms.: 95,000 Ret. Sis.: \$283,570,000 UP RCA	
----------------------	--------------------	---	------------------------	---	--	--	--	--------------------	--

WERC-FM Ch. 260 (B)
1950 99.9mc
9.7kw

W E R C

ERIE PENNSYLVANIA'S LEADING REGIONAL STATION

GIVES YOU OUTSTANDING MERCHANDISING



Pluses

BUS CARDS

TAXI POSTERS

DIRECT MAIL

POINT OF SALE POSTERS

THEATER SCREEN PROMOTION

Represented by
WEED & CO.

PENNSYLVANIA

City Call Letters Established TV Affiliate	Chan. or Freq. Power	Licensee Headquarters Telephone	Network Represent- ative	Owner o; Pres. p; Exec. vp evp; cm; Sales Mgr. sm; Prog. Dir. pd; Prod. Mgr. pdm; News, Farm, Sports or Women's Dir. nd, fd, sd, wd.	Executive Abbreviations Gen. Mgr. gm; Sta. Mgr. sm; Coml. Mgr. ce; Chief Eng. ce; Prom. Mgr. pmin;	Market Data For Primary Area (Supplied by station)	Library, News Serv. Transmitter
WIKK 1949	1330 5,000-DA-2	Community Service Bcstg. 1021 State St. 23-248	ABC H-R Reps.	Edward Lamb, p Charles R. Kinney, gm William George, cm	James Hurley, pd & sd Jack Shumaker, pmm	Pop.: 225,000 Rad. Hms.: 65,000 Ret. Sis.: \$360,000,000	Wid. AP Col.
WJET 1951	1570 250-D	JET Bcstg. Co. 18th & Ash 4-6013	ForJoe	Myron Jones, p & gm Lou Skelly, cm Kay Pfadt, pd	William Fleckenstein, ce	Pop.: 200,000 Rad. Hms.: 67,000 Ret. Sis.: \$283,573,000	SES AP G
WLEU 1933	1450 250	Commodore Perry Bcstg. Service Inc. 212 Commerce Bldg. 22-129	MBS, KBS, Quaker Young	Owen K. Murphy, p Philip B. Hirsch, gm James D. Brownyard, cm	Robert Eaton, pd William Sebenick, ce Jim Carrington, nd & sd	Pop.: 250,000 Rad. Hms.: 62,500	AP RCA
WLEU-FM 1948	Ch. 250 (B) 97.9mc 7.8kw						
FARRELL WFAW (CP)	1470 500-D	Sanford A. Schaftiz					
GETTYSBURG WGCT 1950	1450 250	Times & News Pub. Co. P. O. Box 28 850	KBS, Quaker	Murray L. Goldsbor- ough Jr., gm & cm	C. W. Baker III, pd. Lester Blair, ce	Pop.: 50,000 Rad. Hms.: 12,500 Ret. Sis.: \$41,000,000	Wid. AP GE
GREENSBURG WHJB 1934	620 1,000-D 500-N DA-2	Pittsburgh Radio Supply House 128 N. Penn. Ave. 3740		George J. Podeyn, gm Glenn Grayson, pd & nd	Lyle Allen, ce Gene Tiberio, sd	Pop.: 25,450 Rad. Hms.: 8,600	L-W UP WE
GROVE CITY *WSAJ 1921	1340 100-SH	Grove City College 763		Dr. Weir C. Ketter, p	Dale O. Smock, ce	 GE
HANOVER WHVR 1949	1280 1,000-D 500-N DA-N	Radio Hanover Inc. Hanover 3831	MBS, Quaker	John D. Bare, p, gm & cm	Ned Rutledge, pd Ed John, pmm		Wid. UP RCA
HARRISBURG WCMB 1948 WCMB-TV	1460 5,000 DA-2	Rossmoyne Corp. 228 Court St. 4-3005	MBS Cooke	Edgar T. Shepard Jr., p Ed K. Smith, gm & vp Rudolf O. Marcoux, cm	John Archer, pd J. Howard Bair, ce Pete Wambach, nd	Pop.: 870,250 Rad. Hms.: 208,287 Ret. Sis.: \$796,646,000	

Data corrected to Dec. 10, 1953. If executives or services for FM are same as AM affiliate names are not repeated. Market Data supplied by stations. FM's in italic. *—Non-Commercial Station. CP—Construction Permit issued. D—Day. DA—Day. DA-N—Directional Antenna, night only. DA-1—Directional Antenna, same pattern day and night. DA-2—Directional Antenna, different pattern day and night. L—Limited Time with Dominant Station. LS—Local Sunset. N—Night. SA—Special Authorization. SH—Specified Hours. ST—Share Time. Complete key to abbreviations, page 6.

WCMB means BUSINESS in HARRISBURG



1 162% increase in National Spot sales first ten months of 1953 over same period 1952. Proof that national advertisers are getting wise to what local admen have known for a long time. That WCMB means BUSINESS in Harrisburg.

2 WCMB's 5000 watt power covers ALL of Harrisburg. Not just the city itself, but also the 69% (more than 200,000) who LIVE OUTSIDE the city but BUY INSIDE the city.

3 WCMB's POWER, PROGRAMS, PROMOTION . . . get the kind of ACTION you can measure in RESULTS rather than by slide-rule technique.



Mutual Broadcasting System

1460 KC • 5000 WATTS
24 HOURS DAILY

WCMB

LEMOYNE-HARRISBURG, PA.
Represented by-DONALD COOKE, Inc.

Erie

PENNSYLVANIA'S THIRD CITY

**WHERE
HISTORY
HAS BEEN
MADE**

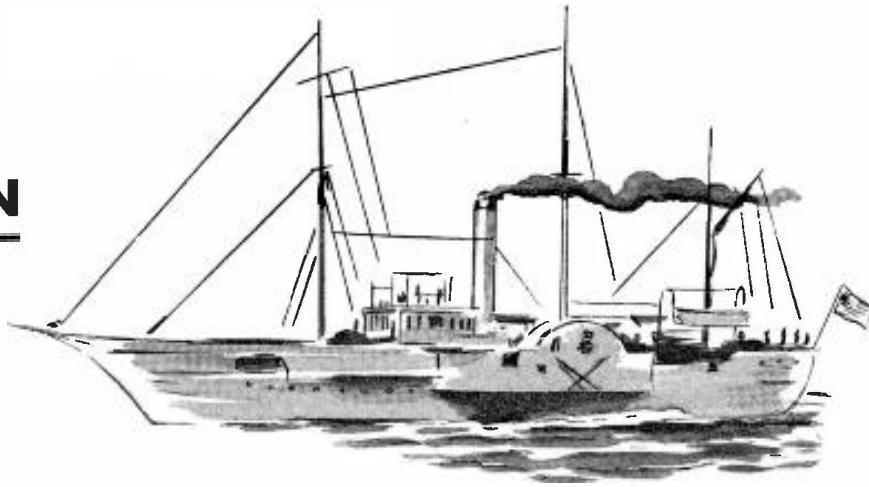

THE WOLVERINE

The first ironclad warship ever built—
launched at Erie in 1843.

**WHERE
HISTORY
IS BEING
MADE** *by the BIG THREE...*

WICU TV

Better than 99% set saturation—
tops in Public Service programming
—and the best from all four net-
works. WICU gives Erie folks an
outlet that's bound to create sales.

WIKK AM

Erie's first 5000 watt station with
top Pulse ratings all day long and
local advertisers soon find out that
WIKK is a "must buy."

the ERIE DISPATCH

Erie's oldest Daily and Sunday
newspaper with AP news service,
plus all the top features that make
it Erie's daily reading habit.

NATIONAL STANDING OF THIS MARKET

CITY	COUNTY	
97th	97th	per capita effective buying power
75th	29th	total retail sales per family
64th	89th	food sales
81st	88th	general merchandise sales
SOURCE - SALES MANAGEMENT - SURVEY OF BUYING POWER 1953		

- RADIO
- TV
- NEWSPAPER



EDWARD LAMB Enterprises INC.

HOME OFFICE—500 EDWARD LAMB BLDG., TOLEDO, OHIO WASHINGTON OFFICE 1177 NATIONAL PRESS BLDG.

WICU-TV—Erie, Pa.
Edward Petry & Co., Inc.

WIKK-AM—Erie, Pa.
H.-R. Co.

WTOD—Toledo, Ohio
Forjoe

WHOO—Orlando, Florida
Avery-Knode

WMAC-TV—Massillon, Ohio
Edward Petry & Co., Inc.

The Erie Dispatch—Erie, Pa.
Reynolds-Fitzgerald

PENNSYLVANIA

City	Call Letters	Chan. or Freq. Power	Licensee Headquarters Telephone	Network Representative	Owner o; Pres. p; Exec. cm; Sales Mgr. sim; Prog. Dir. pd; Chief Eng. ce; Prod. Mgr. pdm; News, Farm, Sports or Women's Dir. nd, id, sd, wd.	Executive Abbreviations	Market Data For Primary Area (Supplied by station)	Library, News Serv. Transmitter
HARRISBURG—(Continued)								
WHGB	1945	1400 250	Kendrick Bcstg. Co. Inc. 112 Market St. 4-4988	ABC, Quaker Weed	Herbert Kendrick, p. gm & cm Jack Hooper, pd & sd	Red McCarthy, pmm William O. Kuntz, ce Lewis Doolittle, nd	Pop.: 175,000 Rad. Hms.: 45,000	Cap. AP RCA
WHP	1924	580 5,000-DA-N	WHP Inc. 216 Locust St. 4-3211	CBS Bolling	A. K. Redmond, gm & cm Dick Redmond, pd	E. Daniel Leibensperger, ce Beatrice Potteiger, pmm	John Price, nd George Wirt, fd Ed Gundaker, sd	St. Assoc. AP, UP Ray, WH
WHP-FM	1946	Ch. 247 (B) 97.3mc 3.5kw						
WKBO	1922	1230 250	Keystone Bcstg. Corp. 31 N. 2d St. 4-0191	NBC Meeker	Clair R. McCollough, sta. exec. Henry M. Traugh, sm	J. Robert Gulick, gen. sim	S. D. Eberly, pd J. E. Mathiot, tech. d	Wld. UP
HAZLETON								
WAZL	1932	1490 250	Hazleton Bcstg. Hazleton Natl. Bank Bldg. Gladstone 4-3538	MBS, NBC Raymer	Victor C. Diehm, p & gm Thomas A. Tito, cm Bill Graham, pd & sd	Betty Mulligan, pmm Elwood C. Tito, ce Kathryn Kahler, asst. to gm	Pop.: 271,927 Rad. Hms.: 67,982 Ret. Sls.: \$399,972,000	Wld. AP WE
WAZL-TV								
WAZL-FM	1947	Ch. 250 (B) 97.9mc 7.8kw					Pop.: 498,330 Rad. Hms.: 124,582	
HOMESTEAD								
WHOD	1948	860 250-D	Steel City Bcstg. 105 E. 8th Ave. Homestead 1-0172	For Joe	Roy Ferree, gm Leonard Walk, sm	Sid J. Dickler, pmm James Herbert, ce	Mal Goode, nd	Pop.: 2,400,000 Rad. Hms.: 602,000 UP WE
HUNTINGDON								
WHUN	1947	1150 1,000-D	The Joseph F. Biddle Pub. Co. 400 Washington St. 1291	KBS Indie	John H. Biddle, p William E. Germann, gm	Darleen Grove, pd E. A. Craig, ce	Donald Stuller, nd R. S. Clark, fd	Pop.: 37,086 Ret. Sls.: \$31,661,570 Wld., L-W, SES. UP G
INDIANA								
WDAD	1945	1450 250	WDAD Inc. 673 Philadelphia St. Indiana 5-5511	CBS, KBS	W. K. Ulerich, p W. J. Thomas, gm Jonas Termin, cm & sm	Clifford Porter, pd Charles Rutledge, pmm Stanley Graziadio, ce	W. Hoehner, nd Rogers Wood, sd William Cochrane, fd	Pop.: 100,000 Rad. Hms.: 23,000 Ret. Sls.: \$30,000,000 UP WE

Data corrected to Dec. 10, 1953. If executives or services for FM are same as AM affiliate names are not repeated. Market Data supplied by stations. FM's in italic. *—Non-Commercial Station. CP—Construction Permit issued. D—Day. DA-N—Directional Antenna, night only. DA-1—Directional Antenna, same pattern day and night. DA-2—Directional Antenna, different pattern day and night. L—Limited Time with Dominant Station. LS—Local Sunset. N—Night. SA—Special Authorization. SH—Specified Hours. ST—Share Time. Complete key to abbreviations, page 6.

HATS OFF TO WHP!



Yes, hats off to this great Harrisburg, Pa., station whose 5000 powerful watts consistently and profitably shower the top quality market of the Keystone State with purse-opening CBS shows. For WHP lies deep in the heart of rich Dauphin County, an area whose retail sales alone are more than 92% of the national average! And WHP has developed a delightful habit of walking away with top audience ratings. Want to make money and build greater prestige for your product or service in Harrisburg, Pa.? Want to saturate the top quality market of the great Keystone State? Then, it's WHP. Just write, wire or phone BOLLING, N. Y. for all the startling facts.

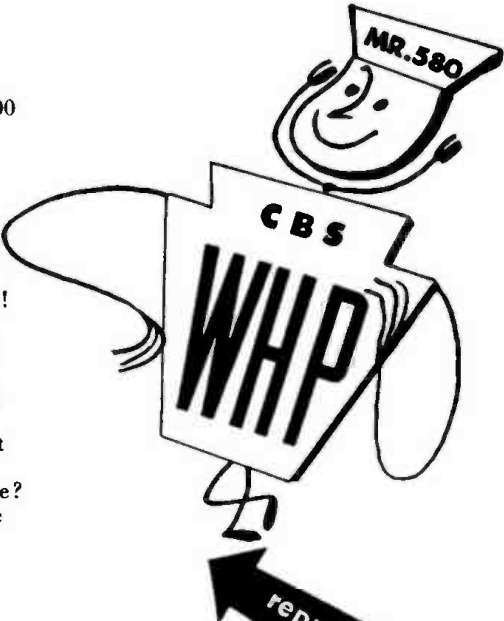



WHP
CBS RADIO NETWORK HARRISBURG, PA. 5000 WATTS. 580 KC

THE KEY STATION OF THE KEYSTONE STATE

represented by BOLLING

JOHNSTOWN

WARD 1946	1490 250	Central Bcstg. Co. Porch Bldg. 81-216	CBS, Quaker Weed	Paul Short, p George D. Gartland, gm	Robert R. Nelson, sm Joseph E. Smith, pd Millard C. Coleman, ce Frank C. Jordan, nd	Bernie Shedlock, fd Joe Cavanaugh, sd Alma Cramer, wd		Wld. UP WE
WARD-FM 1948	Ch. 221 (A) 92.1mc 0.285kw							
WCRO 1947	1230 250	Century Bcstg. Corp. Fort Stanwix Hotel 9-1187	ABC, MBS, Quaker Radio- Television Reps.	John J. Keel, p Stewart W. Phillips, gm, vp & cm	Jane Smith, asst. to m & wd Earl Castine, ce	Bill Walton, nd Frank Toal, sd	Pop.: 282,000 Rad. Hms.: 58,350 Ret. Sis.: \$260,075,000	INS WE
WJAC 1925 WJAC-TV	1400 250	WJAC Inc. WJAC Bldg. 329 Main St. 4-1267	NBC, Quaker Young	Walter W. Krebs, p John P. Foster, sm	Park Claycomb, cm Ron Stephenson, nd	Ted Burn, pmm Theodore Campbell, ce		L-W AP RCA
WJAC-FM 1948	Ch. 238 (B) 95.5mc 8.3kw							

KITTANNING

WACB 1948	1380 1,000-D	Armstrong Co. Bcstg. Corp. 325 Market St. 43-1381		J. E. Moore, p E. J. Hirschberg, gm Albert Dame, cm Chuck Moyer, pd	Joseph Pelletier, ce Clyde Cranmer, sm Ben Bowser, nd, fd & sd	Shirley Stull, wd		Thes. AP WE
--------------	-----------------	--	--	--	---	-------------------	--	-------------------

LANCASTER

WGAL 1922	1490 250	WGAL Inc. 8 W. King St. 5251	NBC Meeker	Clair R. McCollough, p Maynard W. Thomas, sm	J. Robert Gulick, gen. slm	Kenneth L. Kreider, pd J. E. Mathiot, tech. d		Wld. UP
WGAL-TV								
WGAL-FM 1944	Ch. 267 (B) 101.3mc 3.8kw							
WLAN 1946	1390 1,000-DA-N	Peoples Bcstg. Co. 252 N. Queen St. 7261	ABC, Quaker Headley- Reed	Frank A. Altdoerffer, p, gm & ce S. M. Altdoerffer, vp J. Stanley Baker, cm	Ted Pollack, pd & sd Bernie DePaul, pmm Karl Scheying, nd	Col. Arthur J. Burks, fd Dorothy Stevens, wd	Pop.: 250,000 Rad. Hms.: 101,830 Ret. Sis.: \$255,334,000	L-W, Cap. AP RCA
WLAN-FM 1947	Ch. 245 (B) 96.9mc 6.7kw							L-W, Cap. AP GE

LANSFORD

WLSH 1952	1410 1,000-D	Miners Bcstg. Service Inc. Box D 1440	Quaker Everett- McKinney	Jospeh L. Maguire, p John W. Angst, sm Joseph C. Lendvay, cm	Bud Angst, pd Milton W. Seltzer, ce Joe O'Grady, fd	Ed Fisher, sd Art Semigran, nd Sylvia White, wd	Pop.: 220,947 Rad. Hms.: 58,061 Ret. Sis.: \$197,119,700	
--------------	-----------------	--	--------------------------------	--	---	---	--	--

LATROBE

WAKU 1951	1570 250-D	Clearfield Bcstrs. Inc. 202 Depot St. 2348	KBS	W. K. Ulerich, p W. J. Thomas, gm Warren A. Koerbel, cm & pd	Bernard Guidos, ce Colleene Frichtel, office m & wd	Jack Gunning, nd Joe Pasquall, fd	Pop.: 54,000 Rad. Hms.: 15,000 Ret. Sis.: \$50,000,000	Thes., Wld. AP G
--------------	---------------	---	--------------	---	---	--------------------------------------	--	------------------------

LEBANON

WLBR 1946 WLBR-TV	1270 1,000-DA-N	Lebanon Bcstg. Co. Central Bldg. 8th & Cumberland Sts. 2-7651 Burn- Smith	H. Raymond Stadium, cont., gm & cm Henry H. Homan, pd & nd	Julian F. Skinnell, opers, m M. Leonard Savage, ce Howard P. Van Vorrhis, sd	Mildred S. Fortna, office sup. Ruth Sklar, d of copy Hyland White, fd Mary Ellen Kurtz, wd	Pop.: 1,000,000 Rad. Hms.: 300,000 Ret. Sis.: \$1,000,000,000	Assoc., Wld. AP RCA
WLBR-FM 1948	Ch. 261 (B) 100.1mc 0.72kw							Wld. UP RCA

LEWISTOWN

WKVA 1949	920 1,000-D	Central Penn. Bcstg. Co. 19 S. Wayne St. 6771	ABC, Quaker, Penn- Harrish Radio Net, Gill-Perna	Robert L. Wilson, p, gm & cm Lynn H. Bloom, pd & fd	Reed E. Gray, pmm & nd Robert C. Steltzer, ce	Robert E. Hyle, sd Vera Snook, wd	Pop.: 55,000 Rad. Hms.: 15,000 UP G
WMRF 1941 WMRF-TV	1490 250	Lewistown Bcstg. Co. 5 W. Market 6757	NBC, Quaker Burn- Smith	J. S. Woods, p T. W. Metzger, gm Ralph Parker, cm	James Keyes, pd & pmm Kenneth Callahan, ce	Dale Smith, sd Rita McCoy, wd		St. UP WE
WLTN(FM) 1947	Ch. 250 (B) 97.9mc 2.25kw	(WMRF, Am Affiliate)						

LOCK HAVEN

WBPZ 1946	1230 250	Lock Haven Bcstg. Co. 132½ E. Main St. 4038	MBS Quaker McGillvra	Donald C. Welch, p Harris Lipez, gm & cm	Dave King, asst. m, pd pmm & nd Kenneth Caum, ce	John McCool, fd June Kohr, wd	Pop.: 225,000 Rad Hms.: 85,000	L-W, Wld. AP Ray.
--------------	-------------	--	----------------------------	---	--	----------------------------------	-----------------------------------	-------------------------

McKEESPORT

WEDO 1946	810 1,000-D	Trl City Bcstg. Co. 547 5th Ave. 4-7167 Rambeau	Edward J. Hirshberg, p Robert E. Badger, m Russel R. Weiskircher, asst. m	Mike Lee, pd & sd Ray Lehman, d of mus. Wilkes Hurley, ce	Al MacDowell, nd Ray J. Maffel, con- tinuity d & fd Lucy L. Jones, wd		Thes. AP Ray.
WMCK 1947	1380 1,000-DA-N	Mon-Yough Bcstg. Co. McGillvra	Robert M. Cox, p Gene Kline, gm & cm Pat Haley, asst. m	Sam Vidnovic, pd & sd Charles W. White, ce	Lester Sullivan, nd Sally Mossman, wd	Pop.: 55,000 Rad. Hms.: 451,109 Ret. Sis.: \$1,601,448,000	Wld., L-W UP Ray. Fed.
WMCK-FM 1947	Ch. 285 (A) 104.9mc 0.5mc							Wld., L-W UP Fed.

PENNSYLVANIA

City Call Letters Established TV Affiliate	Chan. or Freq. Power	Licensee Headquarters Telephone	Network Represent- ative	Owner o; Pres. p; Exec. up evp; Gen. Mgr. gm; Sta. Mgr. sm; Coml. Mgr. cm; Sales Mgr. slm; Prog. Dir. pd; Chief Eng. ce; Prom. Mgr. pmm; Prod. Mgr. pdm; News, Farm, Sports or Women's Dir. nd, fd, sd, wd.	Executive Abbreviations	Market Data For Primary Area (Supplied by station)	Library, News Serv. Transmitter
MEADVILLE							
WMGW 1947	1490 250	Meadville Bcstg. Service Inc. 1st Natl. Bank Bldg. 46-723	ABC	H. C. Winslow, p Robert Trace, gm & sd	Douglas Rose, cm James Strickler, pd	Jack Harvey, ce Pop.: 76,000 Rad. Hms.: 23,000 Ret. Sis.: \$82,003,000	Wid. UP GE
WMGW-FM 1948	Ch. 262 (B) 100.3mc 10kw						Wid. UP WH
MEYERSDALE							
WMDL (CP)	560 500-D	WJAC Inc.					
MONTROSE							
WPFL 1953	1250 1,000-D	Montrose Bcstg. Lake & Locust St. 397	W. Douglas Roe, p Loren F. Bridges, gm Chas. Hallinan, ce	Henry W. Felton, nd Worth Warner, sd	Norman Dale, fd Pearl Greenwood, wd Pop.: 175,000 AP G
NANTICOKE							
WHWL 1947	730 1,000-D	Radio Anthracite Inc. 38 E. Main St. 1332 ForJoe	Henry W. Lark, p W. T. Jones Evans, gm	Thomas Hilburt, slm Livingston Clewell, pd & sd	Joseph Berrish, chf op	Cap. UP Ray.
NEW CASTLE							
WKST 1938 WKST-TV	1280 1,000-DA-N	WKST Inc. Cathedral Bldg. Oliver 4-5501	MBS. Quaker Everett- McKinney	S. W. Townsend, p Art Graham, sm & cm Harry Reith, pd & sd	Allen Croy, pmm & nd Donald Dout, ce	Al Francis, fd Ruth Ray, wd Rad. Hms.: 211,536 Ret. Sis.: \$780,658,000	Wid. UP RCA
NEW KENSINGTON							
WKPA 1940	1150 250-D	Allegheny Kiski Bcstg. Co. 810 Fifth Ave. Edison 7-3588 Continental	Edward J. Kroen, gm & sd	Mel Goldberg, cm W. W. Neely, ce	Michael Felack, nd Toni Lee, wd L-W Mac. SES., Col. UP RCA	
NORRISTOWN							
WNAR 1946	1110 500-D	Norristown Bcstg. Co. Inc. 115 W. Main St. Norristown 8-7600	N. Joe Rahall, p Ogden R. Davies, gm John M. Banzhoff, sm	Buddy Brode, pd & sd Julius Kosik, ce C. Frank Cordaro, tech. sup.	James M. Nellany, nd Dolores Wisler, wd Pop.: 3,760,000 Rad. Hms.: 1,052,000 Ret. Sis.: \$3,894,000,000	SES. AP G
OIL CITY							
WKRZ 1946	1340 250	WKRZ Inc. 201 Fair Bldg. 4-1260	MBS	Kenneth E. Renne- kamp, p & gm Catherine L. Mc- Laughlin, cm	Ruth Siembedia, pd Glenn Henderson, pmm & fd David McEl- hatten, ce	James Hester, nd Edward Vandenberg, sd Betty Lesco, wd	Wid. UP RCA
PHILADELPHIA							
KYW 1922 WPTZ(TV)	1060 50,000-DA-1	Westinghouse Bcstg. Co. Inc. 1619 Walnut St. Locust 4-3700	NBC Free & Peters	Chris J. Witting, p Joseph E. Baudino, evp Franklin A. Tooke, gm Robert H. Teter, slm	Gordon Davis, prog. m Paul I. Woodland, pmm I. N. Eney, ce	James Gantz, nd Bill Givens, fd Herb Carneal, sd Ruth Wells, wd Pop.: 6,161,600 Rad. Hms.: 1,732,727 Ret. Sis.: \$6,616,583,000	St., Thes. UP, INS WH
WCAU 1922 WCAU-TV	1210 53,000	WCAU Inc. City Line & Monument Ave. Greenwood 7-8300	CBS CBS Radio Spot Sales	Donald W. Thorn- burgh, gm Joseph T. Connolly, pd & vp	Robert N. Pryor, pmm & vp John G. Leitch, engrg. vp	Joseph L. Tinney, evp John S. deRussy, slm Charles Shaw, nd Amox Kirby, fd Bill Campbell, sd Pop.: 4,372,600 Rad. Hms.: 1,229,600 Ret. Sis.: \$4,795,585,000	L-W AP, UP
WCAU-FM 1941	Ch. 251 (B) 98.1mc 11kw						Assoc. INS GE
WDAS 1924	1400 250	Max M. Leon Inc. 223 Arch St. Market 7-8484 ForJoe	Max M. Leon, p Robert A. Klein, gm & cm	Fred H. Greene, pd Len Allen, merc. in & pmm Frank Unterberger, ce	M. Leonard Matt, asst. gm & nd John Mahan, sd Bernice Thompson, wd Pop.: 3,500,000 Rad. Hms.: 1,000,000 AP RCA
WFIL 1922 WFIL-TV	560 5,000-DA-2	Triangle Publications Inc. 46th & Market St. Evergreen 2-4700	ABC, Quaker Katz	Walter H. Annenberg, p Roger W. Clipp, gm Kenneth W. Stowman, gen. slm	Felix Meyer, pd Joe Zimmermann, pmm Henry Rhea, chief opers. eng.	Charles Harrison, news & special events d Howard Jones, fd Tom Moorehead, sd Mary Jones, wd Pop.: 7,407,400 Rad. Hms.: 2,104,178 Ret. Sis.: \$8,224,100,000	Wid. UP RCA
WFIL-FM 1941	Ch. 271 (B) 102.1mc 10kw						
WFLN(FM) 1949	Ch. 238 (B) 95.7mc 20 kw	Franklin Bcstg. Co. 8200 Ridge Ave. Ivyridge 2-6000	Lawrence M. C. Smith, p Raymond S. Green, evp & gm	William M. Davison, slm	Harry W. Dallison, ce Pop.: 3,844,960 Rad. Hms.: 572,756 UP Col.
WHAT 1929	1340 250	Independence Bcstg. Co. 1505 Walnut St. Rittenhouse 6-2058 Indie	William A. Banks, p & cm Dolly Banks, gm	Cal Milner, pd & nd Len Stevens, pmm Charles Lehmann, ce	Jerry Gaines, sd Mary Mason, wd Pop.: 4,000,000 AP RCA
WHAT-FM 1950	Ch. 243 (B) 96.5mc 20kw						
WIBG 1925 WIBG-TV	990 10,000-DA-2	Seaboard Radio Bcstg. Corp. 1425 Walnut St. Rittenhouse 6-2300 Radio-TV Reps	Paul F. Harron, p Joseph Lang, vp Edward D. Clery, gm & cm	Douglas Arthur, pd Rupe Werling, pmm & pdm John H. Henninger, tech. d	George Hooper, ce Ray Walton, nd Bob Knox, fd Bosh Pritchard, sd Pop.: 4,000,000 UP WE
WIBG-FM 1948	Ch. 231 (B) 94.1mc 20kw						

Data corrected to Dec. 10, 1953. If executives or services for FM are same as AM affiliate names are not repeated. Market Data supplied by stations. FM's in italic. *—Non-Commercial Station. CP—Construction Permit issued. D—Day. DA-N—Directional Antenna, night only. DA-1—Directional Antenna, same pattern day and night. DA-2—Directional Antenna, different pattern day and night. L—Limited Time with Dominant Station. LS—Local Sunset. N—Night. SA—Special Authorization. SH—Specified Hours. ST—Share Time. Complete key to abbreviations, page 6.

This is WFIL-adelphia

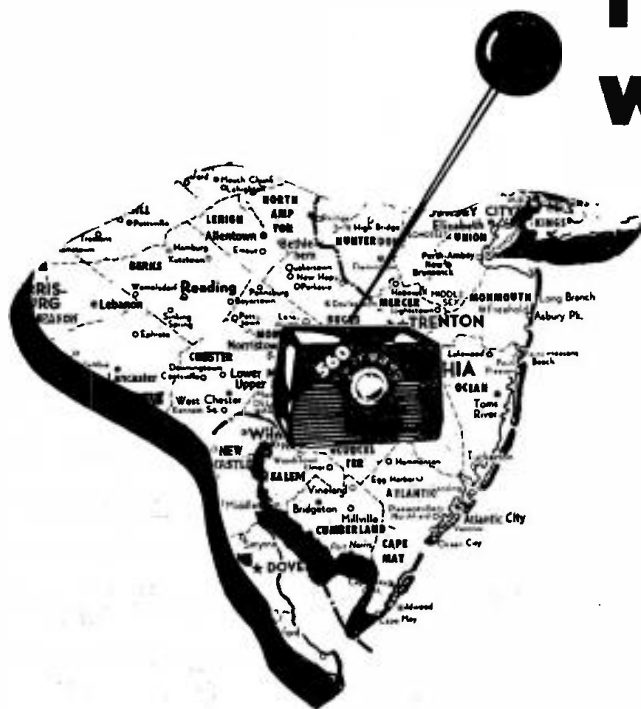

**almost TWICE THE
SIZE of the Philadelphia
Retail Trading Zone.**

**37 big-sales counties in
Pennsylvania... New Jersey...
Delaware... New York.**

**THERE IS NO GREATER ONE-
MEDIUM COVERAGE OF THIS
IMPORTANT FOUR-STATE
AREA THAN WFIL-RADIO.**

**WFIL gives RADIO COVERAGE
greater SALES IMPORTANCE through**

PROGRAMMING

... geared for public preference

PROMOTION

... well planned, aggressive, effective

MERCHANDISING

... most complete and concrete service in this area

**THAT'S WHY PHILADELPHIA ADVERTISERS —
WHO LIVE IN AND KNOW THE MARKET BEST —
PLACE MORE SPOT ADVERTISING ON WFIL
THAN ANY OTHER STATION.**

The Philadelphia Inquirer Station

WFIL

ABC AFFILIATE • Represented by JOHN BLAIR & COMPANY

PENNSYLVANIA

City	Call Letters Established TV Affiliate	Chan. or Freq. Power	Licensee Headquarters Telephone	Network Represent- ative	Executive Abbreviations Owner o; Pres. p; Exec. up evp; Gen. Mgr. gm; Sta. Mgr. sm; Coml. Mgr. cm; Sales Mgr. slm; Prog. Dir. pd; Chief Eng. ce; Prom. Mgr. pmm; Prod. Mgr. pdm; News, Farm, Sports or Women's Dir. nd, fd, sd, wd.	Market Data For Primary Area (Supplied by station)	Library, News Serv. Transmitter		
	WIP 1922 WIP-TV	610 5,000-DA-1	Penna. Bcstg. Co. 35 S. 9th St. Walnut 2-6800	MBS Petry	Benedict Gimbel Jr., p & gm Ralf Brent, vp & sls. d Clyde Spitzner, loc. cm Murray Arnold, pd	Edward Wallis, pmm Sam Ettinger, nd Jim Leaming, sd Mary Biddle, wd	Pop.: 7,372,639 Rad. Hms.: 2,024,282	Wid. AP, UP WE	
	WIP-FM 1942	Ch. 227 (B) 93.3mc 20kw							
	WJMJ 1948	1540 1,000-D	Patrick J. Stanton 2043 Locust St. Locust 4-2300	McGillivra	Patrick J. Stanton, o & m Charles Stahl, cm	Michael Deegan, pd Josephine Oris, pmm Alec F. Iles, ce	Douglas Henson, nd & sd Ruth Chilton, wd	Pop.: 2,500,000 Rad. Hms.: 500,000 Ret. Sis.: \$200,000,000	SES. AP RCA
	WPEN 1929	950 5,000-DA-N	Wm. Penn Bcstg. Co. 2212 Walnut St. Locust 4-6000	Gill-Perna	William H. Sylk, p Wm. B. Caskey, gm Erwin Rosner, loc. slm	Samuel Elber, pmm & pd Charles W. Burtis, ce	Matt Guokas, sd Pat Page, wd	Rad. Hms.: 1,500,000	Assoc. AP, UP WH
	WPEN-FM 1942	Ch. 275 (B) 102.9mc 20kw							
	WTEL 1925	860 250-D	Foulkrod Radio Engrg. Co. 4312 N. Broad St. Davenport 4-4310	Indie	E. Douglass Hibbs, p & pd	Henry N. Cocker, gm John Field, ce	Theodora Kay, wd	
PITTSBURGH									
	KDKA 1920	1020 50,000	Westinghouse Bcstg. Co. Inc. Grant Bldg. Grant 1-4200	NBC Free & Peters	Chris J. Witting, p Joseph E. Baudino, evp L. R. Rawlins, gm John Still, cm	Robert E. White, prog. m David N. Lewis, pmm	T. C. Kenney, ce Homer Martz, fd	Pop.: 7,000,000 Rad. Hms.: 2,228,000 Ret. Sis.: \$87,397,845,000	Thes. AP, UP WH
	KDKA-FM 1942	Ch. 225 (B) 92.9mc 9kw							
	KQV 1919	1410 5,000-DA-2	Allegheny Bcstg. Corp. 800 Chamber of Commerce Bldg. Atlantic 1-9100	CBS Weed	Gunnar O. Wiig, evp James Murray, gm Chris Salmon, slm	John D. Gibbs, pd Owen Simon, pmm James Schultz, ce	Jack Henry, nd Pie Traynor, sd	Pop.: 2,098,728 Rad. Hms.: 604,265	L-W, Wid. UP WE
	WCAE 1922	1250 5,000-DA-N	WCAE Inc. Carlton House 550 Grant St. Atlantic 1-6900 (See Homestead, Pa. listing)	ABC Katz	Leonard Kapner, p & gm R. Clifton Daniel, sm Carl M. Dozer, cm	Alan Trench, asst. slm William Thieiman, pmm	James Greenwood, ce Richard McCarthy, nd Gloria Abdou, wd	Pop.: 2,345,280 Rad. Hms.: 800,000 Ret. Sis.: \$2,619,928,000 INS RCA
	WHOD 1921	1320 5,000-DA-N	Pittsburgh Radio Supply House 411 7th Ave. Grant 1-4860	MBS Holling- bery	H. K. Brennen, p & gm John H. Buchheit, cm William E. Babcock, pd	Caley Augustine, pmm Walter W. McCoy, ce	Herbert O. Morrison, nd Jane Ellen Ball, wd	Pop.: 3,060,317 Rad. Hms.: 787,417 Ret. Sis.: \$2,847,991,000	L-W UP WE
	WJAS-FM 1948	Ch. 259 (B) 99.7mc 24kw							

Data corrected to Dec. 10, 1953. If executives or services for FM are same as AM affiliate names are not repeated. Market Data supplied by stations. FM's in *italics*. *—Non-Commercial Station. CP—Construction Permit issued. D—Day. DA—Day. DA-N—Directional Antenna, night only. DA-1—Directional Antenna, same pattern day and night. DA-2—Directional Antenna, different pattern day and night. L—Limited Time with Dominant Station. LS—Local Sunset. N—Night. SA—Special Authorization. SH—Specified Hours. ST—Share Time. Complete key to abbreviations, page 6.

how do you measure a radio station?

Our advertisers measure by results!
That's why more advertisers use WIP than any other Philadelphia network radio station, to sell their products and services.

National Representatives
EDWARD PETRY & CO., INC.

WIP

610 KC

PHILADELPHIA 7, PA.

P H I L A D E L P H I A ' S P I O N E E R V O I C E

PENNSYLVANIA

WKJF(FM) 1948 WKJF-TV	Ch. 229 (B) 93.7mc 40kw	Mrs. A. J. R. Greer 1715 Grandview Hubbard 1-2626	Agnes J. Reeves Greer, p F. G. Raese, gm	Herbert A. Waters, cm Ralph Wiethorn, pd Peter E. Pappas, ce	Estelle Jones, traffic m Mrs. F. G. Raese, office m	Pop.: 2,918,969 Rad. Hms.: 438,849	Wid., L-W UP WE	
WPGH 1947	1080 1,000-D	Pittsburgh Bcstg. Co. 220 N. Highland Ave. Emerson 1-5000	George M. Harton, p	Howard L. Lazarus, gm	Ralph L. Ketterer, ce		L-W AP	
WPIT 1947	730 1,000-D	WPIT Inc. 213 Smithfield St. Atlantic 1-1900	John J. Laux, p Don Ioset, vp, gm & cm	Clifford Charles, pd & pmm	Michael Komichak, ce	Pop.: 3,673,634 Rad. Hms.: 804,470 Ret. Sis.: \$2,897,928,000 UP G	
WWSW 1932	970 5,000-DA-2	WWSW Inc. Hotel Sheraton Grant 1-5200	O. M. Schloss, p & gm Ben W. Muros, cm	Harold Goldstein, pmm Henry Kaiser, ce	Ray Schneider, nd Joe Tucker, sd	Pop.: 2,438,500 Rad. Hms.: 630,382 UP WH Fed.	
WWSW-FM 1941	Ch. 233 (B) 94.5mc, 20kw							
PITTSTON									
WPTS 1953	1540 1,000-D	Midway Bcstg. Co. Inc. Newrose Bldg. OL 4-3388	Angelo W. Fiorani, ptrn. & gm Rose F. Fiorani, ptrn. R. E. Florey, cm	Ruth Goodman, pd R. M. Gallagher, pmm John P. McGoldrick, ce	Frank Silva, sm & sd Joseph Tipton, nd Eleanor Fagnotti, wd	Pop.: 992,241 Rad. Hms.: 174,400 Ret. Sis.: \$259,294,000		
POTTSTOWN									
WPAZ 1951	1370 1,000-D	Pottstown Bcstg. 247 High St. 5000	Quaker Indie	Herbert Scott, p & gm Clifford Chafey, slm William Gregory, pd	Bud Bentz, pmm Ralph Melton, ce Richard Wentzel, nd	Perry Samuels, sd Thelma Mellon, wd	Pop.: 300,000 Rad. Hms.: 99,000 Ret. Sis.: \$33,000,000	Thes. UP G	
POTTSVILLE									
WPAM 1947	1450 250	Miners Bcstg. Service Inc. P. O. Box 629 5050	MBS, Quaker Everett- McKinney	Joseph L. Maguire, p Lou H. Murray, gm Frank L. Tamulonis, cm	Horace Richards, pd Milton Seltzer, ce Ray Mulligan, nd	John Samm, sd Romaine Scott, wd	Pop.: 228,331 Rad. Hms.: 54,621 Ret. Sis.: \$103,083,000	Assoc. UP G	
WPAM-FM 1947	Ch. 238 (B) 95.5mc 5.1kw						Pop.: 1,771,968 Rad. Hms.: 442,992	RCA	
WPPA 1946	1360 1,000-D 500-N-DA-N	Pottsville Bcstg. 9 S. Second St. 4744	A. V. Tidmore, p & gm Ralph L. Price, cm Edward A. Romance, pd & sd	James B. Thompson, pmm & nd	William P. Tidmore, Vivian Price, wd	Pop.: 260,000 Rad. Hms.: 70,000 Ret. Sis.: \$187,000,000 AP WE	
WPPA-FM 1946	Ch. 270 (B) 101.9mc 2.3kw			Georgine Yanavage, pd	Walter F. Jones, cm		Pop.: 555,000 Rad. Hms.: 130,000	RCA	
PUNXSUTAWNEY									
WPME 1953	1540 1,000-D	Punxsutawney Bcstg. Co. 103 N. Gilpin St. 1221	Sheridan W. Pruett, p Charles M. Erhard Jr., vp & gm	Michael A. Catanzarito, cm Joseph A. Pelletier, ce C. Robert Shaw, pd	Tom Cooper, nd Dale Morley, fd Robert Walker, sd Eleanor Garnow, wd	Pop.: 100,000 Rad. Hms.: 30,000		
WPXY 1953	1300 1,000-D	Jefferson Bcstg. 110 N. Findley 2080	MBS McGillvra	C. H. Simpson, p Richard W. Bower, gm, cm & nd	Jim Crummy, pd Kenneth H. Bowers, ce	Al Salerno, sd	Pop.: 125,000 Rad. Hms.: 35,000 Ret. Sis.: \$12,000,000		
READING									
WEEU 1932 WEEU-TV	850 1,000 DA-N	Hawley Bcstg. Co. 433 Penn St. 6-7335	ABC Quaker Headley- Reed	Hawley Quier, p Thomas E. Martin, evp & gm K. Richard Creitz, asst. m & cm	George Carroll, pd & fd Jeanne Thompson, pmm David J. Miller Jr., tech. oper. d	Harold E. Schearer, asst. tech. oper. d Robert Newman, nd Ed Cammarota, sd Nan L. Heckman, wd	Pop.: 257,300 Rad. Hms.: 73,480 Ret. Sis.: \$269,873,000	Assoc. UP RCA	
WHUM 1946 WHUM-TV	1240 250	Eastern Radio Corp. Berkshire Hotel 4-4805	CBS H-R Reps.	Humboldt J. Greig, p & gm Dick Paisley, cm & pmm	Alan Lane, pd Louis E. Littlejohn, ce Johnny Deegan, nd	Sam Black, fd Jack Ryan, sd Kathy Sheetz, wd	Pop.: 339,700 Rad. Hms.: 98,700 Ret. Sis.: \$362,000,000 AP Ray.	
WRW 1922	1340 250	Reading Bcstg. 19 N. 5th St. 7173	NBC Meeker	Clair R. McCollough, sta. exec. Frank J. Voss, sm	J. Robert Gulick, gen. slm	Saul Miller, pd J. E. Mathiot, tech. d		Wid. UP	
RED LION									
WGCB 1950	1440 1,000-D	John M. Norris P. O. Box 88 3-3471	John M. Norris, p & gm	Vincent Freeman, cm Stanley Deppen, pmm	Geary Russell, ce		Cap., SES. UP G	



**GETTING INTO
WESTERN PENNSYLVANIA**

PLUS EASTERN OHIO AND WEST VIRGINIA

RADIO HOMES IS A PUSHOVER WITH

WWVA WHEELING, W. VA.
50,000 WATTS
CBS RADIO

**ATTRACTIVE PROGRAMMING, PRODUCTIVE
SELLING 24 HOURS EVERY DAY**



Serving the Industrial Heart of America
Represented by **JOHN BLAIR & CO**



National Sales Offices:
TOM HARKER, 118 E. 57th St. New York 22

PENNSYLVANIA

City Call Letters Established TV Affiliate	Chan. or Freq. Power	Licensee Headquarters Telephone	Network Represent- ative	Owner o; Pres. p; Exec. up evp; Gen. Mgr. gm; Sta. Mgr. sm; Coml. Mgr. cm; Sales Mgr. slm; Prog. Dir. pd; Chief Eng. ce; Prom. Mgr. pmm; Prod. Mgr. pdm; News, Farm, Sports or Women's Dir. nd, fd, sd, wd.	Executive Abbreviations	Market Data For Primary Area (Supplied by station)	Library, News Serv. Transmitter	
ST. MARYS								
WKBI 1950	1400 250	Elk-Cameron Bcstg. Co. 41 Erie Ave. 4-2821	MBS. KBS, Quaker	C. H. Simpson, gm R. H. Knouse, slm John A. Fay, pd	Gilbert H. Wogan, ce Arnold Kuhn, fd Herbert Martin, news ed	Bess Kallas, office m Gibby Hoffman, sd Becky Smith, wd	Pop.: 45,000 Rad. Hms.: 14,500 Ret. Slis.: \$30,000,000	St. AP G
SAYRE								
WATS 1950	960 1,000-D	Susquehanna Valley Bcstg. 110 N. Elmer Turner 2-2401 Indie	Thompson K. Cassel, o Walter D. Knowles, gm William J. Miller, pd	Benjamin A. Franklin, ce Charles L. Snyder, nd	Garry Miller, sd Jean S. Larkin, wd	Pop.: 465,600 Rad. Hms.: 130,500 Ret. Slis.: \$511,500,000	Thes., Wld. AP Ray.
SCRANTON								
WARM 1953 WARM-TV	590 5,000-DA-2	Union Bcstg. Co. Bowman Bldg. 4-1148	ABC Holling- bery	Martin F. Memolo, p William W. Scranton, vp William M. Dawson, gm	Sam M. Fiegenbaum, slm Joe Salsburg, pd Donald S. Preven, pmm	Roswell Parker, ce John Von Bergen, nd Dave Griffiths, sd Lynn Forman, wd	Pop.: 1,088,800 Rad. Hms.: 285,185 Ret. Slis.: \$935,850,000	Thes. UP GE
WGBI 1925 WGBI-TV	910 1,000-D 500-N	Scranton Bcstrs. Inc. 1000 Wyoming Ave. 2-0296	CBS Blair	Mrs. M. E. Megargee, p Mrs. Douglas Holcomb, vp George D. Coleman, gm, cm & pmm	Frank Monaghan, pd R. E. McDowell, sm K. R. Cooke, ce	Thomas Powell, nd Ralph White, sd	Pop.: 764,900 Rad. Hms.: 220,620 Ret. Slis.: \$713,815,000	Wld. AP RCA
WGBI-FM 1949	Ch. 267 (B) 101.3mc 1.8kw							
WIEK (CP)	1400 250	Scranton Radio Corp.						
WQAN 1950	630 500-D	E. J. & Elizabeth Lynett 149 Penn Ave. Diamond 2-9151 Bolling	Cecil Woodland, gm Frank McCaffrey, cm Hugh Connor, pd Bill Pierce, pmm	Guy Rauer, ce Robert Flanagan, merc. d	Warren Jones, nd Jack Gulnan, sd Tony Martell, wd	Pop.: 783,902 Rad. Hms.: 209,166	Assoc., St. AP, UP RCA
WEJL(FM) 1948	Ch. 298 (B) 107.3mc 1.8kw	(WQAN, Am Affiliate)						L-W
WSCR 1947	1320 1,000-D 500-N-DA-N	Lackawanna Valley Bcstg. 116 Adams Ave. Diamond 7-3388	NBC Headley- Reed	David M. Baltimore, p. gm & cm Barry Sherman, sm, pmm & sd	Willard Shymski, ce Bob McHale, nd	Jess Landenberger, fd Betty Jackman, wd	Pop.: 374,500 Rad. Hms.: 82,880	L-W AP Ray.
SHAMOKIN								
WISL 1948	1480 1,000-DA-N	Radio Anthracite Rock & Sunbury Sts. 8-6831	MBS ForJoe	Henry W. Lark, p Chas. R. Petrie, gm	Dick Owen, pd	Ray Willard, ce	Pop.: 259,800 Rad. Hms.: 71,540 Ret. Slis.: \$161,194,000	L-W AP RCA
SHARON								
WPIC 1938	790 1,000-D	Sharon Herald Bcstg. Co. P. O. Box 541 4113 Young	John Fahnline Jr., p & gm	Marc McCulloch, pd Evelyn Keller, publ. d	A. C. Heck, ce Harold Smith, pdm	Pop.: 1,589,904 Rad. Hms.: 455,950 Ret. Slis.: \$1,660,070,000	Wld., Assoc. UP WE
WPIC-FM 1947	Ch. 275 (B) 102.9mc 26kw							
SOMERSET								
WVSC 1951	990 250-D	Somerset Bcstg. Co. P. O. Box 231 Somerset 4186	KBS Indie	Theodore H. Oppe- gard, gm & cm Elwood S. Thompson, pd	Carl R. Lee, ce & sm Ted Chandler, nd & fd	Bob French, sd Jannet Murry, wd	Pop.: 83,946 Rad. Hms.: 21,888 Ret. Slis.: \$67,831,000	St. UP G
STATE COLLEGE								
WMAJ 1945	1450 250	Centre Bcstrs. Inc. P. O. Box 888 4959	MBS, KBS	W. K. Ulerich, co-o R. J. Kennard, co-o M. J. Bernstein, sm & sd	Miriam Krebs, cm & wd Walter J. Morris, pd	Douglas Beman, ce Roger Clinton, nd		Wld. AP
STROUDSBURG								
WVPO 1948	840 250-D	Pocono Bcstg. Inc. 578 Main St. 1102 Radio Reps.	James H. Ottaway, p Chester S. Miller, sm Francis H. Brinkley, mgng. d	Joseph Webster, pd & nd Ernest R. Transue, ce	John Meunier, fd Joseph Whalen, sd	Pop.: 90,000 Rad. Hms.: 24,000	Assoc. UP Col.
SUNBURY								
WKOK 1933	1240 250	Sunbury Bcstg. Corp. 1150 N. Front St. 1325	CBS. Quaker, William Penn	H. H. Haddon, p Basse A. Beck, secy.- treas. Homer R. Smith, gm	C. Donald Walther, cm Michael J. Kane, pd & sd	Malcolm L. Arter, pmm & nd John W. Keller Jr., ce Ethel Riegel, wd	Pop.: 220,800 Rad. Hms.: 47,890 Ret. Slis.: \$139,758,000 AP Col.
WKOK-FM 1947	Ch. 231 (B) 94.1mc 4.4kw							
UNIONTOWN								
WBMS 1937	590 1,000-DA-N	Fayette Bcstg. Corp. Fayette National Bank Bldg. 8-3900	CBS Meeker	Joseph C. Burwell, p James Gismond, gm, pmm & sd	Frederick J. David, cm Charles H. Under- wood, pd	William J. Henzly, ce Rex Carter, fd Hester W. Risk, wd		Thes. UP Col.
WARREN								
WNAE 1946	1310 1,000-D	Northern Allegheny Bcstg. Co. First Natl. Bank Bldg. 3032	David Potter, p & gm James Potter, cm	LeRoy Schneck, pd Homer Haines, ce	Herb Harris, nd Frank Fillis, sd	Pop.: 85,000	Thes. AP Ray.
WRRN(FM) 1948	Ch. 222 (B) 92.3mc 2.2kw	(WNAE, Am Affiliate)						
WASHINGTON								
WJPA 1942	1450 250	Wash. Bcstg. Co. Geo. Wash. Hotel Bldg. 4870	MBS McGillvra	A. Boyd Siegel, mgng. d John L. Merdian, gm	Peter Stanton, cm & sd G. Robert Johnson, pd	Chris E. Langhurst, ce Lynn Carter, wd	Pop.: 2,323,506 Rad. Hms.: 610,000 Ret. Slis.: \$200,000,000	Wld. UP
WJPA-FM 1949	Ch. 282 (B) 104.3mc 4.0kw							

Data corrected to Dec. 10, 1953. If executives or services for FM are same as AM affiliate names are not repeated. Market Data supplied by stations. FM's in italic. *—Non-Commercial Station. CP—Construction Permit issued. D—Day. DA—Day. DA-N—Directional Antenna, night only. DA-1—Directional Antenna, same pattern day and night. DA-2—Directional Antenna, different pattern day and night. L—Limited Time with Dominant Station. LS—Local Sunset. N—Night. SA—Special Authorization. SH—Specified Hours. ST—Share Time. Complete key to abbreviations, page 6.

PENNSYLVANIA

WAYNESBORO

WAYZ 1953	1380 1,000-D	Richard Field Lewis Jr. 21 W. Main St. 1900	Richard Field Lewis Jr., p	Sam Hanshaw, gm & cm	John Geiger, pd Fred Brabandt, ce	Pop.: 262,000 Rad. Hms.: 67,100 Ret. Sis.: \$295,600,000
--------------	-----------------	--	-------------------------------	-------------------------	--------------------------------------	--

WILKES-BARRE

WBAX 1922	1240 250	Anna Stenger 85 W. Union St. Valley 3-0196	MBS Burn- Smith	Anna Stenger, p John H. Stenger, gm	Edward Kuzma, pd Milan Krupa, ce	Jim Hutchison, fd Bob Whitehead, sd	Pop.: 291,800 Rad. Hms.: 75,600	Assoc. UP Col.
WBRE 1924 WBRE-TV	1340 250	Louis G. Baltimore 82 S. Franklin St. Valley 3-3101	NBC Headley- Reed	Louis G. Baltimore, p David M. Baltimore, gm & cm	Franklin D. Coslett, pd Bill Connelly, nd	Charles Sakoski Sr., ce Jim McCarthy, sd Rory Miles, wd	Pop.: 375,000 Rad. Hms.: 104,000 Ret. Sis.: \$375,000,000	Wid. AP RCA
- WBRE-FM 1947	Ch. 253 (B) 98.5mc 2.3kw							L-W
WILK 1947 WILK-TV	980 5,000-D 1,000-N- DA-N	Wyo. Valley Bcstg. Co. 88 N. Franklin St. Valley 4-4666	ABC. Quaker Avery- Knodel	Mitchell Jenkins, p Roy E. Morgan, evp Thomas P. Shelburne, treas.	Luther Strittmatter, cm Tom Bigler, pd & nd Dorothy Albee, pmm	Theodore French, ce Jim Hutchinson, fd Chuck Whitier, sd Libby Brennan, wd	Pop.: 735,000 Rad. Hms.: 257,982	L-W, Thes. AP WH

WILLIAMSPORT

WLYC 1951	1050 1,000-D	Lycoming Bcstg. Co. 331 Pine St. 2-4876	KBS. Quaker, Penn- Harris Net.	John T. Keliher, p W. Richard Carlson, gm, cm & nd	Vern Hester, pd & pmm Norman Briggs, ce	Hank Anders, fd Norah Carlson, wd	Pop.: 1,056,600 Rad. Hms.: 184,520 Ret. Sis.: \$477,641,000	Thes. AP G
- WLYC-FM 1949	Ch. 286 (B) 105.1mc 3.2kw							
WRAK 1930 WRAK-TV	1400 250	WRAK Inc. 244 W. 4th St. 2-6116	NBC Everett- McKinney	George E. Joy, p & gm J. Wright Mackey, cm Leon Kelly, pd	Everett Rubendall, pmm Glenn Sherman, ce Jennie L. Straw, treas.	Irving A. Berndt Jr., sd Joan Krimm, wd	Pop.: 100,903 Rad. Hms.: 37,500	Assoc. AP RCA
- WRAK-FM 1947	Ch. 262 (B) 100.3mc 3.2kw							
WWPA 1949	1340 250 CP: 1330 5,000-D 1,000-N DA-2	Williamsport Radio Bcstg. Assoc. Inc. 330 Government Pl. 7119	CBS Burn- Smith	Harry J. W. Kiessling, p Woodrow W. Ott, gm & cm	Louis C. Cate, pd Philip D. Lane, sls. ser. m Carl Steinbacher, ce	Gordon Thomas, nd John Martin, fd Bill Gardner, sd Gertrude Madden, wd	Pop.: 170,000 Rad. Hms.: 42,000 Ret. Sis.: \$117,000,000	Wid. UP RCA

YORK

WNOW 1948 WNOW-TV	1250 1,000-D	Broadcast Div., Helm Coal Co. 25 S. Duke St. 6-2911	KBS. Penn- Harris Net.	Lowell W. Williams, gm John O. Border, cm H. E. Daugherty, pd	Edwin L. Jay, pmm Glenn M. Winter, ce Albert Gladding, nd	James Wetzel, fd Charles Rawlinson, sd Joan Gneiser, wd	Pop.: 205,400 Rad. Hms.: 63,280 Ret. Sis.: \$201,916,000	Wid. AP RCA
- WNOW-FM 1948	Ch. 289 (B) 105.7mc 30kw							
WORK 1932	1350 5,000-D 1,000-N DA-N	York Bcstg. Co. 13 S. Beaver St. 6829	NBC Meeker	Clair R. McCollough, sta. exec.	Clare I. Miller, sm J. Robert Gulick, gen. slm	Glenn M. Brillhart, pd J. E. Mathiot, tech. d	Pop.: 350,000 Rad. Hms.: 25,000	Thes. UP
- WRZE(FM) 1948	Ch. 253 (B) 98.5mc 8kw	White Rose Bcstg. Co. 31 E. King St. 8-2873		C. M. Gitt, p M. B. Rebert, gm	E. S. Cannon, cm Stephen West, pd	Clark E. Wise, ce		Cap. AP RCA
WSBA 1942 WSBA-TV	910 1,000-DA-2	Susquehanna Bcstg. Co. 53 N. Duke St. 8-2676	ABC. Quaker Radio-TV Reps.	Louis J. Appell Jr., p Clarence L. Doty, vp & gm Philip K. Eberly, cm & pmm	Robert Shipley, pd Llewellyn Jones, ce Jean Farlow, traffic m Otis B. Morse, nd	Herman Stebbins, fd Ethel Grey, wd		Wid. AP RCA

RHODE ISLAND

MARKET DATA BY COUNTIES

County	Population 1950	Radio Families 1953	Retail Sales 1952(000)	Food Sales 1952(000)	Drug Sales 1952(000)	Automobile Ownership 1952	County	Population 1950	Radio Families 1953	Retail Sales 1952(000)	Food Sales 1952(000)	Drug Sales 1952(000)	Automobile Ownership 1952
Bristol	29,079	8,400	\$ 20,676	\$ 7,456	\$ 812		Providence	574,973	170,280	641,535	166,380	21,196	
Kent	77,763	24,380	68,337	21,037	2,028		Washington	48,542	13,580	45,103	14,715	1,608	
Newport	61,539	16,470	57,078	21,785	2,173		Total	615,299	233,110	\$832,729	\$233,373	\$27,817	270,983

Note: Population 1950 Census; radio families Standard Audit & Measurement Services Inc.; food, drug and retail sales, copyright 1953, Sales Management; further reproduction uncensored; automobiles supplied by state.

DIRECTORY OF AM AND FM STATIONS

NEWPORT

WADK 1948	1540 1,000-D	Aquidneck Bcstg. Corp. Reservoir Ave. Middletown, R. I. 4873	KBS Devney	Milton E. Mitler, o, p & gm	Joseph Britto, ce	Lill March, wd	Pop.: 236,914 Rad. Hms.: 74,781 Ret. Sis.: \$189,683,000	Wid. AP G
--------------	-----------------	--	---------------	--------------------------------	-------------------	----------------	--	-----------------

PAWTUCKET

WPAW 1950	550 1,000-D	Roger Williams Bcstg. Co. Inc. 34 N. Union Pawtucket 5-9000	KBS Rambeau	Dominick A. Hysko, p Allen Jones, gm	James F. M. Keough, cm Graham Richards, pd	James Bonney, ce China Valles, nd & sd	Pop.: 305,800 Rad. Hms.: 91,750 Ret. Sis.: \$262,800,000	Mac. UP G
--------------	----------------	---	----------------	---	--	---	--	-----------------

RHODE ISLAND

City	Call Letters Established	Chan. or Freq. Power	Licenses Headquarters Telephone	Network Representative	Owner or Pres. p; Exec. up evp; Gen. Mgr. gm; Sta. Mgr. sm; Coml. Mgr. cm; Sales Mgr. sim; Prog. Dir. pd; Chief Eng. ce; Prom. Mgr. pmm; Prod. Mgr. pdm; News, Farm, Sports or Women's Dir. nd, fd, sd, wd.	Executive Abbreviations	Market Data For Primary Area (Supplied by station)	Library, News Serv. Transmitter	
PROVIDENCE									
WEAN	1922	790 5,000-DA-2	Yankee Div. of General Teleradio Crown Hotel Temple 1-0800	MBS, Yankee H-R Reprs.	William S. O'Neill, p Mowry Lowe, gm	Tod Williams, asst. m & pmm Noel Breault, cm Nancy E. Hogan, pd	Pop.: 1,125,000 Rad. Hms.: 325,500 Ret. Sis.: \$1,038,000,000	Assoc. AP WE	
WHIM	1947	1110 1,000-D	Intercity Bcstg. 144 Westminster St. Union 1-4211	Relay Net. Headley-Read, Kettell-Carter	Robert T. Engles, p, co & gm Gus Parmet, cm & sd	C. George Taylor, pd & pmm Carroll Philbrook, ce Bruce Williamson, nd	Rad. Hms.: 202,000 AP Col.	
WICE	1947	1290 500-D	Narragansett Bay Bcstg. 1111 N. Main St. Jackson 1-6565	Rambeau	Louis Arthur Raymond Pieri, p Sumner Pearl, gm & pd	James F. Keough, cm George P. Duffy, pmm & sd Oliver R. Adams, ce John Crohan, nd	Pop.: 632,500 Rad. Hms.: 196,600 Ret. Sis.: \$735,430 UP WE	
WJAR	1922	920 5,000-DA-2	The Outlet Co. 176 Weybosset St. Gaspee 1-8251	NBC, New England Weed, Bannan ABC	George O. Griffith, vp & treas. John J. Boyle, gm	David J. Shurtleff, cm M. Southern Abbott, radio ops. m Thomas J. C. Prior, ce	Pop.: 1,103,100 Rad. Hms.: 367,700	Wid. AP WE	
WPJB	1941	1420 5,000 DA-1	Providence Journal Co. 75 Fountain St. Dexter 1-0600	ABC Borkatti	George P. Metcalf, p H. William Koster, gm Don Morton, pd	Arthur E. Lathrop Jr., pmm George W. Sharpe, ce	Harry V. McKenna, nd Sue Bailey Reid, wd		
WPJB-FM	1948	Ch. 286 (B) 105.1mc 20kw							
WPRO	1924	830 5,000-DA-N	Cherry & Webb Bcstg. Co. WPRO Bldg. 24 Mason St. Plantations 1-9776	CBS Blair	William S. Cherry Jr., p	Arnold F. Schoen Jr., gm Kenneth M. Curto, cm	John A. Owen Jr., pd John V. Ferri, ce	Thes. AP, UP RCA	
WPRO-FM	1948	Ch. 222 (B) 92.3mc 20kw					 WE	
WRIB	1947	1220 1,000-D	R. I. Bcstg. Co. Narragansett Hotel Union 1-4512	Forjoe	Frank Rao, p Nicholas Ruggieri, gm	Edward McBride, cm Don Rogers, pd	Frederick Weiss, ce Fabian Hume, nd	Pop.: 1,000,000 Rad. Hms.: 329,433 Ret. Sis.: \$737,795,000	Assoc. UP GE
WESTERLY									
WERI	1949	1230 250	Radio Westerly 34 Main St. Westerly 2263	ABC Walker, Bannan	Richard G. Moore, p Warren M. Greenwood, gm	A. W. Warren Jr., pd, nd, sd & fd	Anibal Martins, ce Jean Sicilian, wd	Pop.: 76,000 Rad. Hms.: 20,070	L-W UP Ray.
WOONSOCKET									
WNRI (CP)		1380 1,000-D	Friendly Bcstg. Co. 1 Social St. 5100		Raymond A. Mailloux, gm	Jack A. Salera, pd	Roger A. Nault, exec. secy.		WE
WWON	1946	1240 250	Woonsocket Bcstg. Co. 99 Main St. Woonsocket 1240	MBS, Yankee Borkatti	Millicent Palmer, p Mitchell F. Stanley, gm	Eugene A. Mailloux, Eugene C. Rousseau, pd	Harold K. Belknap, ce Eugene P. O'Neill, nd & sd Aurora Graziani, wd	Wid. AP Col.	
WWON-FM	1949	Ch. 288 (A) 105.5mc 39kw							

Data corrected to Dec. 10, 1953. If executives or services for FM are same as AM affiliate names are not repeated. Market Data supplied by stations. FM's in *italics*. Non-Commercial Station. CP—Construction Permit issued. D—Day. DA—Directional Antenna, night only. DA-1—Directional Antenna, same pattern day and night. DA-2—Directional Antenna, different pattern day and night. L—Limited Time with Dominant Station. LS—Local Sunset. N—Night. SA—Special Authorization. SH—Specified Hours. ST—Share Time. Complete key to abbreviations, page 6.

SOUTH CAROLINA

MARKET DATA BY COUNTIES

County	Population 1950	Radio Families 1953	Retail Sales 1952(000)	Food Sales 1952(000)	Drug Sales 1952(000)	Automobile Ownership 1953	County	Population 1950	Radio Families 1953	Retail Sales 1952(000)	Food Sales 1952(000)	Drug Sales 1952(000)	Automobile Ownership 1953
Abbeville	22,456	4,960	\$ 11,852	\$ 3,668	414	6,350	Chester	32,597	7,220	20,703	6,791	541	8,161
Aiken	53,137	16,680	31,907	10,206	692	34,927	Chesterfield	36,236	7,170	20,133	4,453	616	10,075
Allendale	11,773	2,730	5,170	1,609	168	3,717	Clarendon	32,215	5,330	10,681	2,705	307	6,159
Anderson	90,664	22,070	66,981	16,507	1,851	31,056	Colleton	28,242	5,820	14,939	2,896	615	7,636
Bamberg	17,533	3,560	9,348	2,056	240	4,875	Darlington	50,016	10,930	32,652	8,876	784	14,452
Barnwell	17,266	4,330	7,837	2,058	259	11,163	Dillon	30,930	5,870	16,415	4,370	433	7,324
Beaufort	26,993	5,180	13,025	3,702	284	6,597	Dorchester	22,601	5,010	11,209	3,595	397	6,285
Berkeley	30,251	5,170	8,889	3,186	130	6,029	Edgefield	16,591	3,340	7,815	2,181	247	5,132
Calhoun	14,753	2,720	4,539	1,332	141	3,594	Fairfield	21,780	4,060	8,849	2,255	252	5,046
Charleston	164,856	40,090	144,172	38,686	4,510	45,043	Florence	79,710	17,000	65,075	15,423	1,488	21,917
Cherokee	34,992	7,840	18,320	5,283	461	9,573	Georgetown	31,762	6,370	19,512	5,996	635	7,294

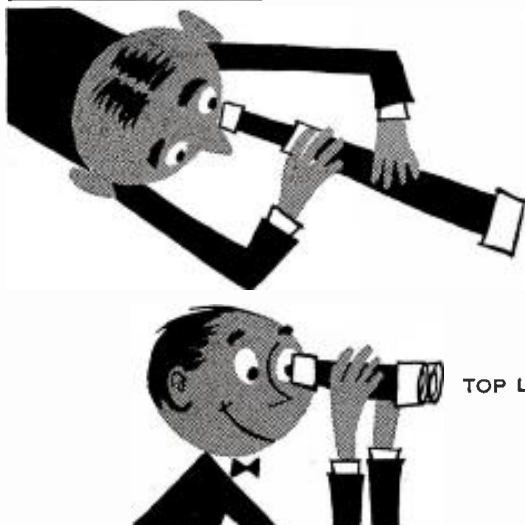

ANYWAY YOU LOOK AT IT - IN PROVIDENCE IT'S
TOP LOCAL AUDIENCE + TOP TALENTS = RESULTS

DIAL 1110



PROVIDENCE

REPRESENTED BY HEADLEY-REED

COVERAGE

5000 watts (full time) on 630 kc, blanketing NEW ENGLAND'S SECOND LARGEST MARKET, and also covering the rich Fall River - New Bedford, Mass., marketing area with a signal greater than 2 mv.

AUDIENCE

An "active" audience responsive to a rich variety of TOP-RATED local and CBS-Radio programs — RESULT-FUL programs consistently hitting the mark of PRIMARY listening attention. Listeners who LISTEN are buyers who BUY!

*to reach the
most buyers...*

BUY BASIC...



WPRO AM
& FM

PROVIDENCE · 630 KC · 5000 W

IN NEW ENGLAND

MORE PEOPLE LISTEN

TO WPRO THAN ANY

OTHER RHODE ISLAND

STATION.

Represented by John BLAIR & COMPANY

SOUTH CAROLINA

MARKET DATA BY COUNTIES—(Continued)

County	Population 1950	Radio Families 1953	Retail Sales 1952(000)	Food Sales 1952(000)	Drug Sales 1952(000)	Automobile Ownership 1953	County	Population 1950	Radio Families 1953	Retail Sales 1952(000)	Food Sales 1952(000)	Drug Sales 1952(000)	Automobile Ownership 1953
Greenville	168,152	44,650	169,577	36,971	4,955	63,557	Orangeburg	68,726	13,660	38,095	9,578	1,118	19,214
Greenwood	41,828	10,220	38,958	9,457	1,349	14,466	Pickens	40,058	9,520	211,513	7,018	727	13,422
Hampton	18,027	3,700	8,077	2,006	260	5,098	Richland	142,565	37,530	165,756	31,397	5,180	54,697
Horry	59,820	12,250	37,632	8,397	1,358	16,028	Saluda	15,924	3,370	5,637	1,210	140	5,013
Jasper	10,995	2,110	5,714	1,308	106	2,876	Spartanburg	150,349	37,080	132,379	31,058	3,125	46,116
Kershaw	32,287	6,530	17,368	5,269	474	9,458	Sumter	57,634	12,080	36,845	9,456	1,057	15,658
Lancaster	37,071	8,410	26,720	7,146	731	10,471	Union	31,334	7,010	17,450	5,463	632	7,399
Laurens	46,974	10,560	26,446	7,525	752	13,151	Williamsburg	43,807	7,200	19,682	5,075	416	8,822
Lee	23,173	4,000	7,238	2,258	280	5,078	York	71,596	16,720	60,409	16,385	1,513	20,476
Lexington	44,279	10,930	23,148	8,171	686	17,818	Total	2,117,027	483,220	\$1,493,035	\$374,948	\$42,778	686,270
McCormick	9,577	1,760	3,379	980	78	7,833	Note: Population 1950 Census; radio families Standard Audit & Measurement Services Inc.; food, drug and retail sales, copyright 1953, Sales Management; further reproduction unlicensed; automobiles supplied by state.						
Marion	35,110	6,800	20,661	4,807	738	7,601							
Marlboro	31,768	6,620	16,763	4,682	437	2,256							
Newberry	31,771	7,570	22,722	6,242	739	10,286							
Oconee	39,050	8,590	20,843	5,195	464	11,225							

DIRECTORY OF AM AND FM STATIONS

City	Call Letters Established	Chan. or Freq. Power	Licensee Headquarters Telephone	Network Representative	Owner or Pres. d; Exec. up evp; cm; Sales Mgr. slim; Prog. Dir. pd; Chief Eng. ce; Prom. Mgr. pmm; Prod. Mgr. pdm; News, Farm, Sports or Women's Dir. nd, fd, sd, wd.	Executive Abbreviations	Market Data For Primary Area (Supplied by station)	Library, News Serv. Transmitter
ABBEVILLE								
WCKI (CP)	1580	1,000-D	Abbeville Bcstg. Co.					
AIKEN								
WAKN 1952	990	1,000-D	Aiken Electronics Adv. Corp. P. O. Box 811 7-4242		B. T. Whitmire, p W. Randall Davidson, gm	Ted Wilds, cm Danny McClure, pmm	Pop.: 385,000 Rad. Hms.: 100,000 Ret. Sls.: \$325,200,000	Cap. AP G
WAKN-TV								
ANDERSON								
WAIM 1935	1230	250	Wilton E. Hall 1 Martin St. 3800	CBS, Palmetto Burn-Smith	Wilton E. Hall, o Glenn P. Warnock, gm	G. Paul Browne, cm & Marshall Gaillard, pd & nd	Pop.: 91,600 Rad. Hms.: 21,800 Ret. Sls.: \$57,560,000	Wid. INS WE
WAIM-TV								
WCAC(FM) 1947	Ch. 266 (B) 101.1mc 41kw		(WAIM, Am Affiliate)				Pop.: 411,000 Rad. Hms.: 99,020 Ret. Sls.: \$291,055,000	L-W
WANS								
WANS 1949	1280	1,000-DA-N	Carolina Bcstrs. P. O. Box 211 3262	MBS Devney, Southern Radio Reps.	C. R. Johnson Sr., p Robert E. Liverance, gm	Robert S. Fant, cm Carroll S. Lee pd	Pop.: 262,000 Rad. Hms.: 226,000 Ret. Sls.: \$139,517,000	St. UP WE
BARNWELL								
WBAB 1953	740	250-D	Blue Ridge Bcstg. Co. Inc. Jackson St. Ext. 3507	Southern Radio Rep.	J. A. Gallimore, p Joe Wilder, cm & sm	Frank Harmon, asst. m, pd & nd	Pop.: 100,000 Rad. Hms.: 30,000 Ret. Sls.: \$70,000,000	Thes. UP G
BEAUFORT								
WBEU (CP)	960	1,000-D	Beaufort Bcstg. Co.		Louis M. Neale Jr., p & gm		Pop.: 360,000 Rad. Hms.: 82,492 Ret. Sls.: \$172,000,000	
BENNETTSVILLE								
WBSC 1946	1550	10,000-D 5,000-N-DA-N	Bennettsville Bcstg. Co. Box 639 1081	MBS McGillvra	John Orvin, o Malcolm A. Young, gm	John D. McIntyre, cm Neil Terrell, pd, pmm, nd, sd & fd	Pop.: 251,900 Rad. Hms.: 25,880 Ret. Sls.: \$65,600,000	AP G
BISHOPVILLE								
WAGS (CP)	1380	1,000-D	Lee County Bcstg. Co.		Howard L. Ginsberg, ptr.	A. R. Godshall, ptr.	Pop.: 96,906 Ret. Sls.: \$85,258,000	
CAMDEN								
WACA 1948	1590	1,000-D	Camden Bcstg. Corp. 80		H. S. Bowden, p Tom Richards, gm & pmm	Charles Ballard, cm & fd	Pop.: 82,000 Rad. Hms.: 18,000 Ret. Sls.: \$33,000,000	Wid. UP G
WACA-TV								
CHARLESTON								
WCSC 1930	1390	5,000-DA-N	WCSC Inc. Francis Marion Hotel 2-7811	CBS Free & Peters	John M. Rivers, p & gm Roland Weeks, cm	Robert Tambllyn, pd Alma D. Davis, pmm Wilbur Albee, ce	Pop.: 520,000 Rad. Hms.: 151,600 Ret. Sls.: \$375,000,000	Wid. UP WH
WCSC-TV								
WCSC-FM 1948	Ch. 245 (B) 96.9mc. 36kw						Pop.: 788,000 Rad. Hms.: 243,000 Ret. Sls.: \$475,000,000	REL

Data corrected to Dec. 10, 1953. If executives or services for FM are same as AM affiliate names are not repeated. Market Data supplied by stations. FM's in italic. *—Non-Commercial Station. CP—Construction Permit issued. D—Day. DA—Directional Antenna, night only. DA-1—Directional Antenna, same pattern day and night. DA-2—Directional Antenna, different pattern day and night. L—Limited Time with Dominant Station. LS—Local Sunset. N—Night. SA—Special Authorization. SH—Specified Hours. ST—Share Time. Complete key to abbreviations, page 6.

23 YEARS

OF SUCCESSFUL

SALES STORIES

RADIO

WCSC

TELEVISION

After just 6 months of operation has 192 clients with outstanding success stories, showing measurable advertising results

FOR BEST ADVERTISING RESULTS

IN CHARLESTON, S. C.

WCSC-Radio WCSC-TV

REPRESENTED NATIONALLY BY FREE AND PETERS

SOUTH CAROLINA

WHAN 1946	1340 250	Charleston Bcstg. Co. 152 Market St. 3-1643	ABC Headley-Reed	S. Lewis Johnson, p E. Harold Keown, gm George R. Connor, cm	William P. Birchfield, ce Jack McKee, nd Chuck Lansford, sd	Jim Bigelow, fd Marjorie Swistak, wd		Cap. UP RCA
WPAL 1947	730 1,000-D	Palmetto Bcstrs. Inc. 149 Wentworth St. 3-6428 Forejoe, Dora- Clayton	George G. Weiss, p Laurens P. Moore, gm Robert T. Chrystie, cm, pmm & sd	Louise B. Withrock, pd Gunnar E. Sundeen Jr., ce	Johnie M. Ingold, fd	Pop.: 500,000 Rad. Hms.: 90,000 Col.
WTMA 1939	1250 5,000-D 1,000-N- DA-N	Atlantic Coast Bcstg. 133 Church St. 2-2961	NBC Hollin- bery	Edward Manigault, p Douglass M. Bradham, gm	Grange S. Cuthbert Jr., cm Newton S. Smyth, pd U. Gordon Knight, ce	Tom Bender, sd Robert S. Truere, nd Jack Leland, fd		Assoc. AP WH
WTMA-FM 1945	Ch. 236 (B) 95.1mc 15kw							RCA
WUSN 1948	1450 250	Southern Bcstg. Co. Inc. P. O. Box 154 2-2652	MBS	J. Drayton Hasite, gm & cm				
CHERAW WCRC 1953	1420 500-D	Chesterfield Bcstg. Co. Inc. Cheraw 7500 Sherman	Dr. R. D. Baxley, p D. A. Baxley, gm & cm R. G. Meishelmer, vp	Frank Martin, pd, nd & sd W. L. Hipp, ce	Bill Benoise, fd Rose Caudie, wd	Pop.: 49,888 Rad. Hms.: 8,100 Ret. Sls.: \$20,133,000	
CHESTER WGCD 1948	1490 250	Craig Bcstg. Co. 128 Main St. 2171	MBS McGillvra	Morgan J. Craig, p & George P. Cobb, gm & cm	Ila Mae Sawyer, pd & wd	James Kennedy, nd & sd	Pop.: 50,000 Rad. Hms.: 94% Ret. Sls.: \$32,000,000	Wid. AP GE
COLUMBIA WCOS 1939 WCOS-TV WCOS-FM 1950	1400 250	Radio Columbia Cornell Arms Apt. Bldg. 2-2177	ABC Headley- Reed	Charles W. Pittman, p & gm Law Epps, natl. cm	Bill Mims, loc, cm John Ropp, pd, pmm & nd	Robert Lambert, ce Ken Baldwin, sd Barbara Spencer, wd	Pop.: 250,000 Rad. Hms.: 60,000 Ret. Sls.: \$200,000,000	Wid. AP RCA
WIS 1939 WIS-TV	560 5,000-DA-N	The Bcstg. Co. of the South 1111 Bull St. 3-6431	NBC Free & Peters	B. Calhoun Hipp, p G. Richard Shafto, gm J. Dudley Saumentig, mgng. d	Frank Harden, pd James D. Poag Jr., pmm Herbert G. Eldson Jr., ce	W. Miller Montgom- ery, slm Ray Stanfield, nd & sd John Evans, fd Kay Collins, wd	Pop.: 952,900 Rad. Hms.: 262,950 Ret. Sls.: \$579,139,000	Thes. UP WE
WIS-FM 1948	Ch. 233 (B) 94.5mc 1.3kw							SES. AP
WMSC 1945	1320 1,000-DA-N	WMSC Radio 1127 Lady St. 2-8659	CBS H-R Reprs.	C. Wallace Martin, p & gm	Charles Wickenberg Jr., pd & nd	C. Ed. Stone Jr., ce Ruth Gottlieb, wd	Pop.: 179,000 Rad. Hms.: 43,350 Ret. Sls.: \$170,000,000	Assoc., L-W UP Col.
WNOK 1953 WNOK-TV	1230 250	Palmetto Radio Corp. 1811 Main St. 3-9401 Raymer	W. Croft Jennings, p H. Moody McElveen Jr., gm W. C. Bochman, cm	David M. Campbell, pd & nd H. Patricia Conder, pmm	Donald E. Willoughby, ce Bob Fulton, sd	Pop.: 200,000 Rad. Hms.: 40,000 Ret. Sls.: \$193,443,000 AP RCA
CONWAY WLAT 1945	1490 250	Coastal Bcstg. Co. P. O. Box 497 340	MBS McGillvra					
DARLINGTON WDAL (CP)	1350 500-D	Darlington Bcstg. Co.						
DILLON WDSC 1946	800 1,000-D	Border Bcstg. Co. Box 231 470	ABC Gill- Perna, Dora- Clayton	Joseph Martin, p, gm & pmm Adelaide Monroe, cm	Lee Lumpkin, pd & nd Ray Allen, ce	Jim Murff, asst. m & sd Dorothy Flemming, wd	Pop.: 500,000 Rad. Hms.: 32,150 Ret. Sls.: \$212,154,000	Thes. UP G
WDSC-FM 1951	Ch. 226 (B) 92.9mc 8.8kw							RCA
EASLEY WELP 1951	1360 1,000-D	Pickens County Bcstg. Co. Box 522 9388	KBS, Palmetto Indie	Cleatus Brazzell, p & gm David L. Sherrill, pd & nd	Henry O. McDonald Jr., ce Charles C. Smith, nd	Hal Smith, sd Betty McDonald, wd	Pop.: 206,908 Rad. Hms.: 51,473 Ret. Sls.: \$149,415,000 UP RCA
FLORENCE WJMX 1947	970 5,000-D 1,000-N- DA-N	Atlantic Bcstg. Co. U. S. 52 P. O. Box 1211 6351	ABC Walker, Dora- Clayton	Paul H. Benson Jr., gm, cm, pd & pmm	Frank A. Jenne, ce E. T. Melton Jr., nd & fd	Dave Thomas, sd	Pop.: 350,000 Rad. Hms.: 62,940 Ret. Sls.: \$170,000,000	Thes. UP WH
WOLS 1937	1230 250	Florence Bcstg. Co. 151 S. Dargan St. 3271	KBS	Melvin Purvis, p A. P. Skinner, gm & cm	Don Gray, pd	W. A. Pritchett, ce	Pop.: 248,705 Rad. Hms.: 62,176 Ret. Sls.: \$158,804,000	SES. UP
GAFFNEY WFGN 1948	1570 250-D	Cherokee Radio Co. Inc. P. O. Box 759 4795	A. Ray Godshall, p Morton E. Green, gm, cm & nd	Billy Gibbons, pd & sd V. Gertz, pmm	J. E. Parker, ce & fd Bettye Blake, wd	Pop.: 34,000 Rad. Hms.: 33,500 Ret. Sls.: \$18,000,000	L-W UP Ray.
GEORGETOWN WGTV 1949	1400 250	Georgetown Bcstg. Co. Inc. 216 S. Fraser St. 3-3421	MBS	J. B. Delzell, p & gm Al Wester, cm	M. A. Delzell, pd	A. D. Nix, ce	 Ray.
GREENVILLE WAKE 1950 WAKE-FM 1947	1440 5,000 DA-2 Ch. 235 (B) 94.9mc 3.94kw	Piedmont Bcstg. Co.	CBS Pearson	V. D. Ramseur, p James F. McDonough, gm & pd	John Westbrook, slm Horace A. Morris, ce	Jerry Mosteller, sd Inez Anders, traffic m & pmm Elmer Snodgrass, fd	Pop.: 200,000 Rad. Hms.: 32,726 Ret. Sls.: \$160,000,000	Assoc. UP Col.

SOUTH CAROLINA

City Call Letters Established TV Affiliate	Chan. or Freq. Power	Licensee Headquarters Telephone	Network Represent- ative	Owner o; Pres. p; Exec. vp evp; Gen. Mgr. gm; Sta. Mgr. sm; Coml. Mgr. cm; Sales Mgr. slm; Prog. Dir. pd; Chief Eng. ce; Prom. Mgr. pmm; Prod. Mgr. pdm; News, Farm, Sports or Women's Dir. nd, fd, sd, wd.	Executive Abbreviations	Market Data For Primary Area (Supplied by station)	Library, News Serv. Transmitter
GREENVILLE—(Continued)							
WESC 1947	660 5,000-D	Greenville Bcstg. Co. 1 College St. 2-8241	Rambeau. Dora- Clayton	Mrs. James G. Meade. p Buddy E. Starcher. gm	J. Davenport, asst. m Ralph A. Petti Jr., pd & nd Felton B. Bailey, ce	W. A. Mullinax, sd Wayne Davis, fd Christie Meade, wd	Pop.: 1,000,000 Ret. Slis.: \$707,968,000 L-W AP G
WESC-FM 1947	Ch. 223 (B) 92.5mc 12.5kw						Pop.: 250,000
WFBC 1933 WFBC-TV	1330 5,000-DA-N	WMRC Inc. Poinsett Hotel Bldg. 5-8525	NBC Avery- Knodel	R. A. Jolley Sr., p Kenneth Beachboard, gm & cm William T. Arrington, pd	Keener R. Garrett, pmm Wilson C. Wearn, ce Burton Anderson, trans. sup	Claude Freeman, nd Bob Shelley, sd Dr. Paul Fisher, fd Lidie Walters, wd	Pop.: 940,235 Rad. Hms.: 162,400 Ret. Slis.: \$553,285,000 Thes. UP WH
WFBC-FM 1948	Ch. 229 (B) 93.7mc 8.7kw						AP RCA
WMUU 1949	1260 1,000-D	Bob Jones U. 2-8711	Continental	Dr. Bob Jones Jr., p R. K. Johnson, gm Jim Ryerson, sm Glen Schunk, cm	Paul Schultz, pdm Virginia Patterson, pmm Paul Mathew, ce	Elmer Rumminger, nd Fred Aftman, sd Jack Buttram, fd Velma Eubanks, wd	AP, INS Col.
GREENWOOD							
WCBS 1941 WCBS-TV	1450 250	Greenco Inc. P. O. Box 868 4300	NBC Clark	Douglas Featherstone, p Dan Crosland, gm	Ralph Norman, cm David A. Moss, pd, pmm & sd	Charles M. Sparks, ce Jean Tribble, traffic m Hoke Smith May, nd	Pop.: 78,200 Rad. Hms.: 18,850 Ret. Slis.: \$48,950,000 Thes., Assoc. AP RCA
WCBS-FM 1948	Ch. 239 (B) 95.7mc 8.6kw						Pop.: 782,000 Rad. Hms.: 186,300 Ret. Slis.: \$506,200,000 Wtd. WH
WGSW 1953	1350 1,000-D	Radio Greenwood Inc. Edward Arms Bldg. 9-7372	MBS Indie	W. C. Woodall Jr., p C. H. Grider, gm Vernon C. McCarthy, cm & sd	Olyn L. Gee, sm & pd Eddie Rose, ce Earle Brodie Jr., nd	Ed Smith, fd Ann Holtzclaw, wd	Pop.: 150,000 Rad. Hms.: 65,000 Ret. Slis.: \$800,000,000 UP G
GREER							
WEAB 1949	800 250-D	Greer Bcstg. Co. P. O. Box 151 1057 & 1058	KBS	Edd A. Burch, co-o, gm & cm W. Ryan Frier, co-o	Betty Beers, pd & wd J. E. Cole, ce	Vernon Fox, news ed Perry Clinton, fd & sd	L-W UP G
HARTSVILLE							
WHSC 1946	1450 250	Hartsville Bcstg. Co. Inc. 1306 College Ave. 1450	MBS, KBS	Charles H. Campbell, p Raymond Caddell, gm & nd	George Brandon, cm Earl Caton, pd & fd Donald A. Brien, ce	Billy Bone, sd Eleanor Williamson, wd	Pop.: 48,190 Rad. Hms.: 10,044 Ret. Slis.: \$28,000,000 Cap. AP Ray.

Data corrected to Dec. 10, 1953. If executives or services for FM are same as AM affiliate names are not repeated. Market Data supplied by stations. FM's in italic. *—Non-Commercial Station. CP—Construction Permit issued. D—Day. DA-N—Directional Antenna, night only. DA-1—Directional Antenna, same pattern day and night. DA-2—Directional Antenna, different pattern day and night. L—Limited Time with Dominant Station. LS—Local Sunset. N—Night. SA—Special Authorization. SH—Specified Hours. ST—Share Time. Complete key to abbreviations, page 6.

WFBC WMRC

Greenville, South Carolina

we're together now!

Effective Nov. 15, 1953, Greenville's two 5,000 watt radio stations, WFBC and WMRC, long the largest and leading broadcasting facilities in South Carolina's top market area, have formed a merger. The resources and personnel of both stations are now combined in the ownership and operation of one strong radio station —

WFBC AM 1330 KC 5000 Watts
FM 93.7 MC 8700 Watts

NBC AFFILIATE Represented by Avery-Knodel, Inc.
Studios Poinsett Hotel, Greenville, S. C.

— and South Carolina's newest, most powerful VHF television station

WFBC-TV CHANNEL 4
Maximum Power
1204 ft. Antenna
NBC AFFILIATE

19 E. North St., Greenville, S. C.
Represented by WEED Television Corp.



You are cordially invited to contact the Stations or the Representatives for rates, market data, and other information.

SOUTH CAROLINA

KINGSTREE

WDKD 1949	1300 1,000-D	Palmetto Bcstg. Co. Kingstree 5761	E. G. Robinson Jr., co-o & gm M. L. Few, co-o	Arnold Graham, cm Carroll Godwin, pd, pmm & nd	Dan Owen, ce Glenn French, sd & fd Margaret Sullivan, wd	Pop.: 1,237,916 Rad. Hms.: 201,054 Ret. Sls.: \$504,963,000	Wld. AP G
--------------	-----------------	--	-------	---	--	--	---	-----------------

LAKE CITY

WJOT 1953	1260 1,000-D	Lake Bcstg. Corp. 10 S. Acline Ave. 7631	James Olin Tice Jr., p J. O. Tice Sr., gm Wofford McCutcheon, cm	Ralph Bramlett, pd & sd Ed Hinton, pmm Walter Turner, ce	Ben Boyer, nd Marlon Fowler, fd Ann Bramlett, wd	Pop.: 90,000 Rad. Hms.: 28,000 Ret. Sls.: \$46,000,000	
--------------	-----------------	--	-------	---	---	--	--	--

LANCASTER

WLCM 1951	1380 1,000-D	Royal Bcstg. Co. 103 S. Catawba St. 2051	C. K. Connelly Jr., p William G. Coble, gm, cm & nd	Jo Ann McManus, pd & wd Allen Hill, pmm, sd & fd	Robert J. Shikenjan- ski, ce	Pop.: 300,000 Rad. Hms.: 270,000	Wld., Thes. AP Col.
--------------	-----------------	---	-------	---	---	---------------------------------	-------------------------------------	---------------------------

LAURENS

WLBG 1948	860 250-D	WLBG Inc. P. O. Box 642 2-2331	KBS, Palmetto	J. C. Todd, p Richards Todd, gm & cm	Carroll Sexton, pd & fd	Jack H. Taylor, ce Betty J. Bishop, wd		Wld. UP Ray.
--------------	--------------	--------------------------------------	---------------------------	--	----------------------------	---	--	--------------------

MULLINS

WJAY 1946	1280 1,000-D	Mullins & Marlon Bcstg. Co. Box 41 Mullins 3901	KBS	William G. Smith, p James F. Ramsey, gm, cm, nd & fd	Kenneth Gasque, pd Dwight Snyder, pmm & sd	George Magera, ce Annie L. Sawyer, wd	Pop.: 73,494 Rad. Hms.: 14,957	L-W UP Ray.
--------------	-----------------	--	--------------	--	--	--	-----------------------------------	-------------------

MYRTLE BEACH

WMRA 1948	1450 250	Elizabeth Evans Ocean Forest Hotel 5061		Elizabeth Evans, p & gm S. W. Monroe, cm	Crosby Brunson, pd W. C. Evans, ce Tom Garner, pmm & sd	Sam Zack, nd Tom Lee, fd Betty Dale, wd	 UP G
--------------	-------------	--	--	--	--	---	--	------------------

NEWBERRY

WKDK 1946	1240 250	Newberry Bcstg. Co. 11 Radio Dr. P. O. Box 211 143	MBS, KBS	James F. Coggins, p & gm Marcia Coggins, vp & wd	Emory Bedenbaugh, cm Joe Morris, pd, pmm & fd	Ray Gilliam, ce Jimmie Coggins, nd & sd		Thes. AP Ray.
--------------	-------------	---	-------------------	---	--	---	--	---------------------

ORANGEBURG

WDIX 1946	1450 250 CP: 1150 5,000-D 500-N DA-2	WRNO Inc. Oranburg 1420	ABC, MBS, KBS James Ayers	Charles S. Henerey, p Frank B. Best, gm N. M. Matthews, cm & sd	Joe Phillips, pd & fd Gus Browning, ce Frank B. Best Jr., asst. m	James A. Davis, nd Betty Hydrick, wd	Pop.: 100,000	
WTND 1948	920 1,000-D	WTND Inc. No. 1 Memorial Plaza 1600 Clark, Dora- Clayton	J. I. Sims, p & gm Ed Paulling, cm	L. Richard Rhame, pd & nd Larry Styles, co-ce	Perry Herrington, co-ce Earl Bricklemeyer, sd	Pop.: 279,595 Rad. Hms.: 78,558 Ret. Sls.: \$192,929,000	Wld. UP RCA
WORG(FM) 1952	Ch. 274 (B) 102.7mc 15.5kw	(WTND, Am Affiliate)					Pop.: 362,480 Rad. Hms.: 80,590 Ret. Sls.: \$238,941,000	GE

ROCK HILL

WRHI 1944	1340 250	York County Bcstg. Co. Rock Hill Natl. Bank Bldg. 2085	MBS McGillvra	James S. Beaty Jr., co-o, gm & ce William C. Beaty, co-o, sm & pd	Harper S. Gault, co-o, cm, pmm & fd	Connie R. Morton, sd	Pop.: 102,000	Wld. AP RCA
WRHI-FM 1949	Ch. 248 (B) 97.3mc 9.4kw						 GE
WTYC 1949	1150 1,000-D	Tri-County Bcstg. Co. Robert Marshall Bldg. 3175 Indie	T. Laman Simmons, p Marshall T. Pack, gm Jack Whitley, cm	George Webb, pd & sd Bonnie Harrill, pmm Robert Bolin, ce & fd	Ray Ursillo, nd Barbara Mills, wd		

SENECA

WSNW 1949	1150 1,000-D	Blue Ridge Bcstg. Co. Seneca 8234	KBS	J. A. Gallimore, p & gm Chet Munson, cm	Virginia F. Gallimore, pd & wd Elizabeth Brock, pmm	Herbert Hosea, ce Herschel Wisebram, nd & sd	Pop.: 250,000	L-W, Wld. UP G
WSNW-FM 1953	Ch. 251 (B) 98.1mc 6.5kw							RCA

SPARTANBURG

WJAN 1953	1400 250	Spartanburg Bcstg. Co. 101 Schuyler Bldg. 3-1400	ABC, MBS	W. Ennis Brav, o & gm Charles B. Goodyear, cm	Bob R. Way, pd	James L. Tate, ce	Pop.: 200,349 Ret. Sls.: \$125,763,000 AP
WORD 1940	910 1,000	The Spartan Radiocasting Co. 291 E. Main St. 3-2711	NBC Holling- bery	Walter J. Brown, p J. W. Kirkpatrick, gm John C. Carrington, cm	Oles C. Womick, pd & fd Dick Sanders, pmm & nd	Clyde J. Burdette, ce William E. Goodrich, sd Helen Beeley, wd	Pop.: 385,989 Rad. Hms.: 84,091 Ret. Sls.: \$289,414,000	Thes. AP G
WDXY (FM) 1948	Ch. 263 (B) 100.5mc 9.2kw	(WORD, Am Affiliate)					Pop.: 231,700 Rad. Hms.: 71,960 Ret. Sls.: \$182,909,000	RCA WH

SOUTH CAROLINA

City Call Letters Established TV Affiliate	Chan. or Freq. Power	Licensee Headquarters Telephone	Network Represent- ative	Owner o; Pres. p; Exec. up evp; Gen. Mgr. gm; Sta. Mgr. sm; Coml. Mgr. cm; Sales Mgr. slm; Prog. Dir. pd; Chief Eng. ce; Prom. Mgr. pmm; Prod. Mgr. pdm; News, Farm, Sports or Women's Dir. nd, fd, sd, wd.	Executive Abbreviations	Market Data For Primary Area (Supplied by station)	Library, News Serv. Transmitter	
SPARTANBURG—(Continued)								
WSPA 1930	950 5,000 DA-N	The Bcstg. Co. of the South 224 E. Main St. 3-3621	CBS Blair. Cummins	Roger A. Shaffer, mgng. d Ross Holmes, cm	Ed McGrath, pd & sd Jane Dalton, pmm & wd	Harold R. Beckhoit, ce Tom J. Fleming, nd Cliff Gray, fd	Pop.: 498,200 Rad. Hms.: 128,600 Ret. Sls.: \$387,621,000	St. UP WE
WSPA-FM 1946	Ch. 255 (B) 98.9mc 4.85kw						 GE
SUMTER								
WFIG 1940	1340 250	Radio Station WFIG Inc. Radio Center Bldg. 1340	MBS McGillvra	F. B. Creech, p T. Doug Youngblood, gm	Fulton B. Creech Jr., cm Paul T. Reidy, pd Don P. Lee, pmm	Richard L. Elam, ce John Sherman, nd T. O. Bowen, fd Lois Roberts, wd		Wld. AP RCA
WSSC 1953	1240 100	Radio Sumter E. Calhoun Ext. 1498	ABC Southern Radio	J. A. Gallimore, p Ed Damron, gm Hiram Bray, cm	Ann Davidson, pd Harry Fowler, pmm Leon Webb, ce & fd	Bob Jacobs, nd Tony James, sd Lillian Davis, wd	Pop.: 190,000	
UNION								
WBCU 1949	1460 1,000-DA-N	Bcstg. Co. of Union 210 E. Main St. 1200	MBS, KBS Palmetto	Edward L. B. Osborne, p & gm	Noel Belue, pd & fd Thomas Weathers, ce	Bill Stribling, nd & sd	Pop.: 32,000	Thes. UP RCA
WALTERBORO								
WALD 1947	1490 250	Walterboro Bcstg. Co. Box 12 6262	MBS	R. M. Jefferies, p Louis M. Neale Jr., gm	Lanny Layton, cm & sd Peggy Ballentine, pd Cary Poole, pmm	Ralph Keogh, ce John Seigler, nd	Pop.: 28,000 Rad. Hms.: 7,159 Ret. Sls.: \$13,000,000	Wld. AP Ray.
WALD-FM 1952	Ch. 292 (A) 106.3mc 0.59kw						Pop.: 43,000 Rad. Hms.: 10,187 Ret. Sls.: \$20,123,000	GE

Data corrected to Dec. 10, 1953. If executives or services for FM are same as AM affiliate names are not repeated. Market Data supplied by stations.
 FM's in italic. *—Non-Commercial Station. CP—Construction Permit issued. D—Day. DA-N—Directional Antenna, night only. DA-1—Directional Antenna, same pattern day and night. DA-2—Directional Antenna, different pattern day and night. L—Limited Time with Dominant Station. LS—Local Sunset. N—Night. SA—Special Authorization. SH—Specified Hours. ST—Share Time. Complete key to abbreviations, page 6.

WSPA Has The Strongest Pulsebeat In The Carolina-Piedmont (SPARTANBURG-GREENVILLE) Area!

This past November 1953 . . . The Pulse, Inc., completed a comprehensive survey of who's-listening-to-what-and-when in these seven representative counties in part of our WSPA area . . . Cherokee, Greenville, Laurens, Spartanburg and Union in South Carolina—Polk and Rutherford in North Carolina.

Here's What It Proved

- From 6:00 A. M. to 12:00 Noon**
WSPA enjoys more than THREE TIMES the audience of the next highest of the seven stations reported in the seven counties surveyed!
- From 12:00 Noon to 6:00 P. M.**
WSPA enjoys more than THREE TIMES the audience of the next highest station!
- From 6:00 P. M. to 8:00 P. M.**
WSPA enjoys nearly FOUR TIMES the audience of the next highest station!

Here's Why!

In this prosperous, populous Carolina-Piedmont (Spartanburg-Greenville) Area... WSPA is tops in Showmanship because — in addition to the great CBS shows — our program is spiced with our own popular WSPA personalities and interspersed with accurate and frequent local, national and international news coverage. That's what keeps WSPA on top in audience preference!



And...Can We Sell!

Just call any John Blair man! He'll gladly give you all the details and figures pertinent to our huckstering ability in this rich, ready-to-buy, 17-county market.

Represented By **Harry E. Cummings**
John Blair & Co. *Southeastern Representative*

**First CBS Radio Station For
The Spartanburg-Greenville Market**

Roger A. Shaffer **Ross Holmes**
Managing Director *Sales Manager*



WSPA
5,000 WATTS 950 KC
South Carolina's Oldest Station
SPARTANBURG, S. C.

MARKET DATA BY COUNTIES

County	Population 1950	Radio Families 1953	Retail Sales 1952(000)	Food Sales 1952(000)	Drug Sales 1952(000)	Passenger Cars 1952	County	Population 1950	Radio Families 1953	Retail Sales 1952(000)	Food Sales 1952(000)	Drug Sales 1952(000)	Passenger Cars 1952
Armstrong	52	*					Lake	11,792	3,210	11,735	1,942	203	4,177
Aurora	5,020	1,350	\$ 3,399	\$ 491	\$ 125	1,670	Lawrence	16,648	4,950	13,003	3,406	586	5,096
Beadle	21,082	6,340	26,721	5,273	574	7,341	Lincoln	12,767	3,730	12,829	2,511	275	4,657
Bennett	3,396	700	2,889	551	48	1,095	Lyman	4,572	1,140	3,147	692	39	1,409
Bon Homme	9,440	2,680	10,178	1,306	286	3,496	McCook	8,828	2,370	7,422	983	165	3,067
Brookings	17,851	5,110	17,626	3,925	395	6,094	McPherson	7,071	1,760	6,607	967	47	2,224
Brown	32,817	9,690	54,658	8,776	1,181	10,609	Marshall	7,835	2,020	7,142	1,315	127	2,404
Brule	6,076	1,740	8,330	2,084	275	2,145	Meade	11,516	2,780	7,555	2,157	151	2,869
Buffalo	1,615	370	166	115		368	Mellette	3,046	760	1,181	236	22	785
Butte	8,161	2,390	11,283	2,085	291	2,856	Miner	6,268	1,750	5,871	993	225	2,102
Campbell	4,046	950	2,045	594	23	1,251	Minnehaha	70,910	22,060	95,261	16,725	2,804	25,188
Charles Mix	15,558	4,210	15,063	3,299	424	4,455	Moody	9,252	2,580	5,610	1,066	130	3,149
Clark	8,369	2,450	7,281	1,182	186	2,907	Pennington	34,053	10,930	49,588	7,142	1,532	14,066
Clay	10,993	3,140	7,809	1,529	279	3,537	Perkins	6,776	1,830	5,135	1,638	62	1,976
Codington	18,994	5,560	28,496	3,967	480	6,719	Potter	4,688	1,340	7,564	1,326	207	1,608
Corson	6,168	1,360	3,307	755	37	1,403	Roberts	14,929	3,720	11,185	1,770	214	4,561
Custer	5,517	1,460	3,665	980	34	1,740	Sanborn	5,142	1,460	4,340	1,025	45	1,745
Davison	16,522	4,970	30,436	3,760	676	5,779	Shannon	5,669	880	518	235	18	806
Day	12,294	3,240	12,969	2,173	282	3,928	Spink	12,204	3,310	12,329	2,231	299	3,610
Deuel	7,689	1,950	4,466	1,081	59	2,586	Stanley	2,055	460	893	260		710
Dewey	4,916	**1,130	3,451	875	135	1,060	Sully	800	2,940	580	580	23	948
Douglas	5,636	1,250	3,630	772	140	1,913	Todd	4,758	940	646	272		903
Edmunds	7,275	1,790	6,662	776	79	2,130	Tripp	9,139	2,300	12,195	1,926	180	3,007
Fall River	10,439	2,670	8,876	2,147	492	3,670	Turner	12,100	3,610	11,470	2,502	331	4,571
Faulk	4,752	1,460	4,726	795	44	1,626	Union	10,792	3,240	9,331	1,488	416	3,889
Grant	10,233	2,720	7,819	1,721	176	3,508	Walworth	7,648	2,170	11,471	1,941	298	2,413
Gregory	8,556	2,390	6,725	1,336	174	2,728	Washabaugh	1,551	****	156	46		293
Haakon	3,167	780	4,400	818	183	1,104	Yankton	16,804	4,210	20,431	3,328	332	5,612
Hamlin	7,058	2,010	6,113	877	46	2,338	Ziebach	2,606	610	1,552	420	23	611
Hand	7,149	1,850	8,163	1,275	355	2,369							
Hanson	4,896	1,260	1,895	508	32	1,527							
Harding	2,289	750	1,404	398	25	696							
Hughes	8,111	2,220	11,660	2,430	303	2,809							
Hutchinson	11,423	3,140	11,795	1,770	252	3,966							
Hyde	2,811	760	3,476	611	43	930							
Jackson	1,788	***690	2,600	430	53	559							
Jerauld	4,476	1,270	3,765	887	129	1,544							
Jones	2,281	780	2,768	308	21	777							
Kingsbury	9,962	2,820	10,949	2,020	207	3,645							

Total 17,806 182,320 \$707,945 \$125,802 \$17,298 299,909
 Note: Population 1950 Census; radio families Standard Audit & Measurement Services Inc.; food, drug and retail sales, copyright 1953, Sales Management; further reproduction unlicensed; automobiles supplied by state.
 * Armstrong County was officially combined with Dewey County in the elections of 1952. ** Armstrong included in Dewey County figure. *** Washabaugh included in Jackson County figure. **** See Jackson.

DIRECTORY OF AM AND FM STATIONS

ABERDEEN

KABR 1952	1220 250-D	Aberdeen Bcstg. Service Highway 281 No. 2686 Lawson	Delbert T. Hunt, p. gm, cm & ce	Eddie Weeks, pd. pmm & nd	Jaron Zastrow, sd	Pop.: 106,786	St. UP Col.
KSDN 1948	930 1,000-DA-N	Aberdeen News Co. 12 3d Ave., S.E. 4573	ABC Weed	Henry J. Schmitt, p. Byron J. McElligott, gm & pmm	Russa Osborne, cm F. C. Pieplow, pd & nd George Crocker, ce	Bill Rittman, fd Dick Doyle, sd Helen Holgate, wd	Pop.: 264,000 Rad. Hms.: 70,000 Ret. Sis.: \$250,000,000 AP WE

DEADWOOD

KDSJ 1947	980 1,000-DA-N	Heart of the Black Hills Station 745 Main 186	MBS, Upper Midwest Holman	John Daniels, co-o Eli Daniels, co-o, gm & ce	Harry Daniels, co-o & cm	Bonnie Laughlin, pd	Rad. Hms.: 20,000	Wid., UP Ray.
--------------	-------------------	--	---------------------------------	--	--------------------------	---------------------	-------------------	---------------------

HURON

KJIV 1947	1340 250	James Valley Bcstg. Co. 1726 Dakota St. 765	NBC, KBS	Max F. Staley, p & gm Dwight Coursey, cm, pmm & nd	Dale Larson, pd Lydell J. Smith, ce	Bill Tredway, sd Rita Engel, wd	Pop.: 135,000 Rad. Hms.: 37,300 Ret. Sis.: \$152,452,000	Thes. AP Col.
--------------	-------------	--	-------------------	---	--	------------------------------------	--	---------------------

MITCHELL

KORN 1947	1490 250	Mitchell Bcstg. Assoc. 217-219 N. Main St. 621	MBS	Ray Eppel, p, gm, & pd M'nroe Johnson, cm & pmm	John Doherty, ce	Gary Altman, nd Monk Johnson, sd Irv Boyd, fd		L-W UP WE
--------------	-------------	---	-----	--	------------------	---	--	-----------------

PIERRE

KGFX 1927	630 200-D	Estate of Dana McNeil 203 West Summit Ave. 2351	Upper Midwest Lawson	Ida A. McNeil, gm, cm, pd, pmm & nd			 UP RCA
--------------	--------------	--	-------------------------	-------------------------------------	--	--	--	--------------------

RAPID CITY

KOTA 1936	1380 5,000-DA-N	Black Hills Bcstg. Co. 1819 W. St. Joe St. 2000	CBS Headley-Reed, Bulmer & Johnson	Robert J. Dean, p Abner H. George, gm W. F. McCracken, slm Harley Hanson, pd & sd	Jack A. Crowley, pmm Robert Musfeldt, ce John Simpson, mus. d Stewart Steele, nd	Gene Taylor, fd Polly Weedman, wd	Pop.: 108,000 Rad. Hms.: 35,490	Wid., Cap. UP RCA
— KOZY(FM) 1949	Ch. 232 (B) 94.7mc 25kw	(KOTA, AM Affiliate)						
KRSD 1953	1340 250	Heart of the Black Hills Station 816 Kansas City St. 6050	MBS, Inter-mountain	John Daniels, p Eli Daniels, gm & ce Stan Lieberman, cm	Truman Walrod, pd, pmm & nd	Faith Walrod, cont. m	Pop.: 40,000 Rad. Hms.: 10,500 UP

SOUTH DAKOTA

Table with columns: City, Call Letters, Chan. or Freq., Licensee, Network, Owner, Executives, Executive Abbreviations, Market Data, Library. Lists stations for Sioux Falls, Vermillion, Watertown, and Yankton.

Data corrected to Dec. 10, 1953. If executives or services for FM are same as AM affiliate names are not repeated. Market Data supplied by stations. FM's in italic. *—Non-Commercial Station. CP—Construction Permit issued. D—Day. DA-N—Directional Antenna, night only. DA-L—Directional Antenna, same pattern day and night. DA-2—Directional Antenna, different pattern day and night. L—Limited Time with Dominant Station. LS—Local Sunset. N—Night. SA—Special Authorization. SH—Specified Hours. ST—Share Time. Complete key to abbreviations, page 6.

TENNESSEE

MARKET DATA BY COUNTIES

Table with columns: County, Population 1950, Radio Families 1953, Retail Sales, Food Sales, Drug Sales, Automobile Ownership 1951. Lists market data for various Tennessee counties and a total for the state.

Station Break

Our local and regional billings are up over last year, which was the biggest in our history, and the rate of national spot renewals is the highest ever. Audience mail is up 45% over last year (commercial mail, plus 12.2%; sustaining, plus 657.9%). Total audience mail averages 7911 per week. Distribution of mail: 446 counties in eleven states. A breakdown of our SAMS survey shows that every time we open our mike there are 202,801 families listening to Big Aggie at home (not counted: car, truck, portable, and business listening; or 248 counties outside the SAMS area, from which we receive mail).

Unblushing brag: WNAX-570 is the outstanding buy of the nation.

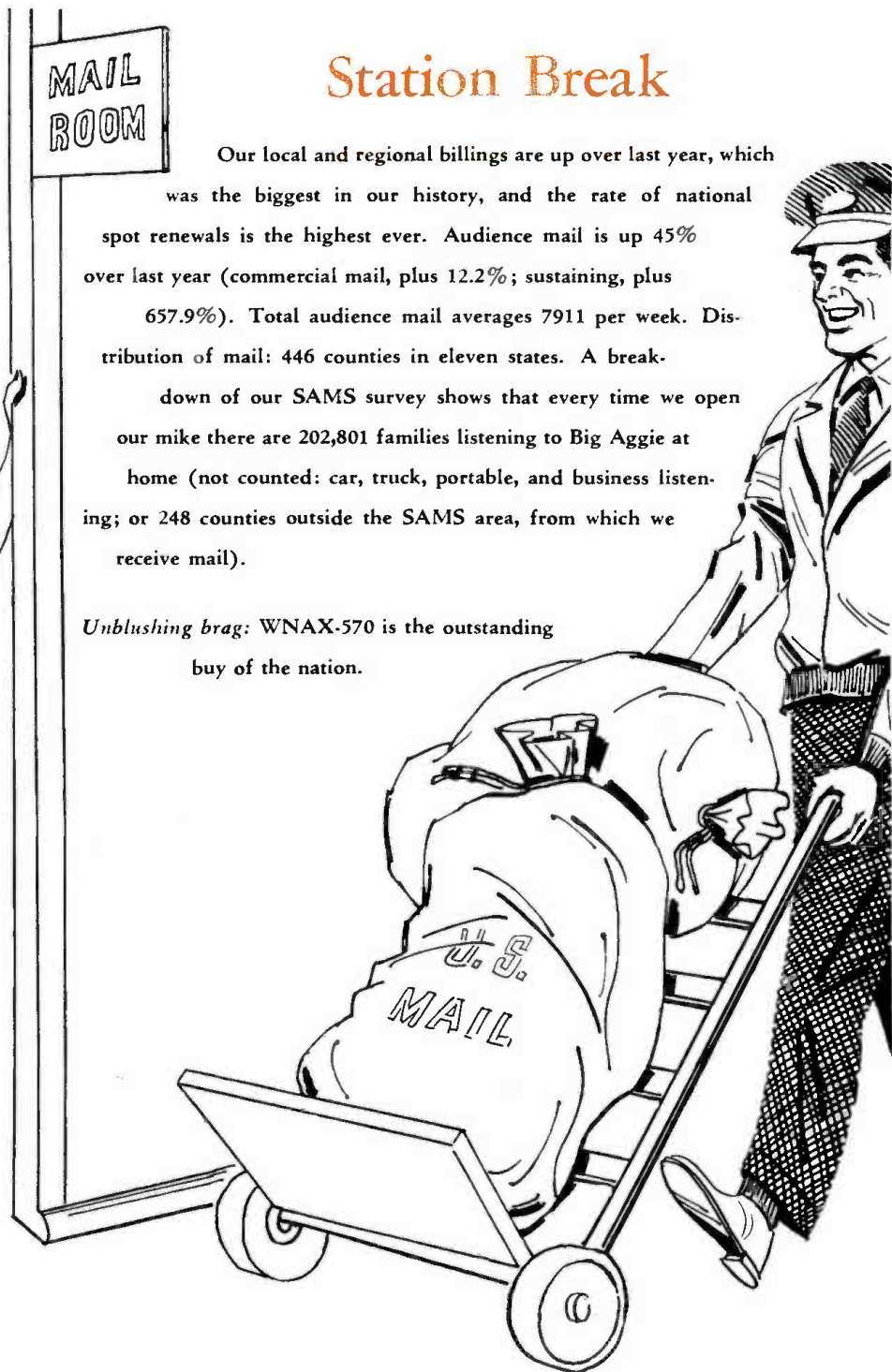
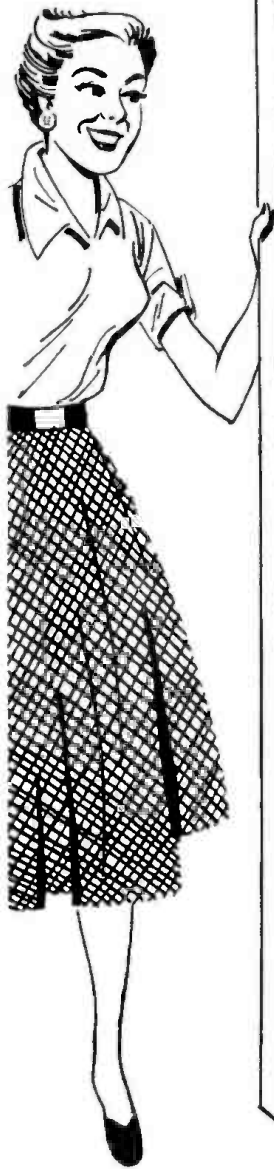

WNAX-570 **Yankton-Sioux City**

*A Cowles Station
Represented Nationally by
The Katz Agency
CBS Radio*

TENNESSEE

DIRECTORY OF AM AND FM STATIONS

City	Call Letters Established TV Affiliate	Chan. or Freq. Power	Licensee Headquarters Telephone	Network Represent- ative	Owner o; Pres. p; Exec. vp evp; cm; Sales Mgr. sm; Prog. Dir. pd; Prod. Mgr. pdm; News, Farm, Sports or Women's Dir. nd, fd, sd, wd.	Executive Abbreviations Gen. Mgr. gm; Sta. Mgr. sm; Coml. Mgr. Mgr. cm; Chief Exec. ce; Prom. Mgr. pmm; Chief Eng. ce; Chief of Station, ce	Market Data For Primary Area (Supplied by station)	Library, News Serv. Transmitter
ATHENS								
WLAR	1946	1450 250	Athens Bcstg. Co. North Jackson St. 1450	MBS	Lowell F. Arterburn, o & chief exec. Buel J. Charles, gm	Leonard M. Dawson, cm & pmm	Max Robinette, pd & nd J. W. Turner, ce	Pop.: 100,000 Rad. Hms.: 20,000 Thes. UP WE
BRISTOL								
WOPI	1929	1490 250	Radiophone Bcstg. Station 310 State St. South 3730	NBC, Tennessee Net. Burn- Smith	W. A. Wilson Sr., p & gm James C. Wilson, cm	Rocky Stone, pd & sd Wm. A. Wilson Jr. pmm George Guertin, ce	Harold Henley, nd Jerry Donovan, fd Judy Weston, wd	Pop.: 109,000 Rad. Hms.: 34,000 Ret. Sis.: \$116,031,726 L-W AP RCA
WOPI-FM	1946	Ch. 245 (B) 96.6mc 10kw						Pop.: 70,000 Rad. Hms.: 25,000 Ret. Sis.: \$90,000,000
WCYB			(See Bristol, Va., listing)					
WFHG			(See Bristol, Va., listing)					
CHATTANOOGA								
WAGC	1946	1450 250	Tennessee Valley Bcstg. Co. Hotel Patten 7-1128	MBS Walker	Vann Campbell, gm Cliff Bowers, cm Bill Giddens, pd	George McMurtrie, ce Gus Chamberlain, nd	Harry Thornton, sd Madelaine White, wd	Pop.: 120,000 Rad. Hms.: 80,000 Ret. Sis.: \$198,936,000 L-W AP Col.
WAPO	1936	1150 5,000-D 1,000-N- DA-N	WAPO Bcstg. Serv. Inc. Read House 6-6141	ABC Avery- Knodel	R. G. Patterson, o, p & gm Helen Patterson, vp	Frances Harley, pd B. B. Barnes, ce Nelson Krepps, pmm	Bernard Brown, nd J. D. Clett, fd Steve Conrad, sd	Thes. AP
WAPO-FM	1946	Ch. 256 (B) 99.1mc, 60kw						
WDEF	1941	1370 5,000-DA-N	WDEF Bcstg. Co. 420 Volunteer Bldg. 6-5664	NBC Branham	Carter M. Parham, p Ken Flenniken, gm & cm	Morris Quave, pd Warren Herring, pmm B. C. Baker, ce	Jim Garner, nd Les Ruthven, sd	Cap. UP RCA
WDOB	1925	1310 5,000-DA-N	WDOB Bcstg. Hamilton Nat'l Bank Bldg. 6-5117	CBS Raymer	Earl W. Winger, p & gm Norman A. Thomas, vp & cm	Frank Hubbs, pd Byron Bush, pmm J. E. Walker, ce	John Gray, nd Lee Sheridan, sd Anne Henderson, wd	Wld., St. UP Fed.
WDOB-FM	1949	Ch. 243 (B) 96.5mc, 42kw						
WDXB	1948	1490 250	WDXB Inc. Dome Bldg. 6-1114 Forjoe	Joseph Bloom, co-o David E. Cohen, co-o Byron E. Fincher, gm	Luther Wilson, cm Gaylord McPherson, pd	Everett E. East, ce Herschel Nation, sd	Pop.: 230,000 Rad. Hms.: 57,500 Ret. Sis.: \$350,000,000 AP Ray.
WMFS	1951	1260 1,000-D	WMFS Inc. 215 W. 9th St. 6-4146 Pearson	B. F. J. Timm, p & gm Dale Smith, cm Fred Webb, pd	Glenn Channels, ce Stanley H. Strickland, tech. d.	Evelyn Cato, wd	
CLARKSVILLE								
WDXN	(CP)	540 250-D	Clarksville Bcstg. Co.				
WJZM	1941	1400 250	Campbell & Sheftall 411 Madison St. 6414	MBS, KBS	E. T. Campbell, p & gm J. P. Sheftall, cm	Clay Cline, pd, pmm & fd John Bailey, ce	Dave Muhlstein, nd Earl Walton, sd	Cap. AP RCA
CLEVELAND								
WBAC	1945	1340 250	Robert W. Rounsaville Central Ave. 62	MBS Dora- Clayton	Robert W. Rounsaville, o Thad F. Fitch, gm John Fulton, mgng. dir.	Bland Sells, cm Paul Kirksey, pd & nd Bettye Trimm, wd	Bill Stuart, ce Mike Dodd, fd UP RCA Rad. Hms.: 28,000
COLUMBIA								
WKRM	1946	1340 250	Middle Tennessee Bcstg. Co. P. O. Box 71 1340	MBS, KBS Indie	R. M. McKay Jr., p, gm & cm Al Knott, pd & fd	Mel Dugger, pmm Cameron McKay, ce William Fraser, nd	Shelton Fowler, sd Bettie Pogue, wd	Pop.: 40,100 Rad. Hms.: 11,320 Ret. Sis.: \$31,123,000 Wld. AP RCA
COOKEVILLE								
WHUB	1940	1400 250	WHUB Inc. 315 E. Spring 789	CBS Continental	M. L. Medley, p, gm & cm Joe Mabry, sm & nd	Stacey Mott, pmm Claude W. Haston, ce Tom Harris, fd	Ed Legarske, sd Emogene Stevenson, wd	Pop.: 80,000 Rad. Hms.: 20,000 Ret. Sis.: \$35,000,000
CROSSVILLE								
WAEW	1953	1340 100	WAEW Inc 10th & School Sts. 334	Arthur Wilkerson, p & gm		 UP Gates
WAEW-FM	(CP)	Ch. 246 (B) 97.1mc, 9kw						
DICKSON								
(CP)	1260 1,000-D		Joe M. Macke					
DYERSBURG								
WDSG	1946	1450 250	State Gazette Bcstg. Co. Inc. Box 58 77	MBS, Mid-South	Frank Armstrong, gm Wendell Vaughan, cm	Bill Ward, pd	David Ross, ce	Pop.: 300,000 Rad. Hms.: 26,400 Wld. AP RCA
ELIZABETHTON								
WBEJ	1946	1240 250	Elizabethton Bcstg. Co. Elk Ave. 2-1241	MBS	Robert W. Rounsaville, o Frazier Cochrane, m John Fulton, mgng. d	Terry Sams, nd Frank Ryan, cm Bill Hale, pd & sd M. C. Bowers Jr., ce	Paul B. Cram, tech. d. B. J. Sams, fd Ruth Ritchie, wd UP Ray.
FAYETTEVILLE								
WEKR	1948	1240 250	Fayetteville Bcstg. Co. P. O. Box 625 1240	MBS	John R. Crowder, ptrn. James Porter Clark, ptrn.	James W. Tate, gm Teddy Barnes, pd Joe W. Loving, pmm	Ernest J. Tucker, ce Charles W. Shewry, nd	Pop.: 25,543 Rad. Hms.: 6,980 Ret. Sis.: \$14,000,000 Thes. AP Ray.
FRANKLIN								
WAGG	1953	950 1,000-D	Williamson County Bcstg. Mallory Rd. 982 Best	William R. Ormes, p & gm	A. B. Thomas, cm Bob Holland, pd	Ralph Emery, pmm Ellis F. Jones Jr., ce	Pop.: 596,724 Rad. Hms.: 145,922 Ret. Sis.: \$525,712,000
GALLATIN								
WHN	1948	1010 1,000-D	Sumner Co. Bcstg. P. O. Box 811 1010	KBS	A. B. Perkins, p J. B. Thomas, gm & pd Chas. W. Brewer, cm	Lee Raines Jr., ce & sd	Hugh Jarrett, nd	Pop.: 1,141,787 Rad. Hms.: 226,352 UP WE

Data corrected to Dec. 10, 1953. If executives or services for FM are same as AM affiliate names are not repeated. Market Data supplied by stations. FM's in italic. *—Non-Commercial Station. CP—Construction Permit issued. D—Day. DA-N—Directional Antenna, night only. DA-1—Directional Antenna, same pattern day and night. DA-2—Directional Antenna, different pattern day and night. L—Limited Time with Dominant Station. LS—Local Sunset. N—Night. SA—Special Authorization. SH—Specified Hours. ST—Share Time. Complete key to abbreviations, page 6.

GREENEVILLE

WGRV 1340 Radio Greenville MBS Paul O. Metcalfe, p & Hugh Pickel, cm Laile Hampton, ce Pop.: 40,000 Cap.
1946 250 Inc. Depot St. gm Bill Moore, pd Ray.
4147

HARRIMAN

WBHT 1230 Harriman Bcstg. MBS F. L. Crowder, p & gm Walter Scarbrough, cm Carl Williams, pd Wid.
1946 250 Co. Continental & pmm Reggie Honey, ce UP
G
WBHT-FM Ch. 237 (A) 55.3mc, .8kw

HUMBOLDT

WIRJ 740 Gibson Bcstg. Co. KBS, J. Frank Warmath, p Carroll Wilson, cm Gerald Hicks, ce Pop.: 68,035 Thes.
1949 250-D 210 N. 22d Ave. Mid-South Howard E. Byrum, gm Bill Carter, pd Rad. Hms.: 21,560 UP
740 Ret. Sis.: \$30,000,000 Col.

JACKSON

WDXI 1310 Dixie Bcstg. Co. MBS, KBS Aaron B. Robinson, p Larry Crenshaw, pd Dave O'Brien, nd Pop.: 653,000 Cap.
1948 5,000-D Williams Bldg. Dixie William H. Winsett, Leonard Fielding, Tom Williams, fd Rad. Hms.: 189,200 UP
WDXI-TV 1,000-N- Burn-Smith, pmm Lance Russell, sd Ret. Sis.: \$396,400,000 Ray.
DA-N Dora Clayton James Thomas, ce Dora Warr, wd

WTJS 1390 Sun Pub. Co. ABC, Albert A. Stone, vp & Leslie R. Brooks Jr., Robert M. Gordon, ce Rad. Hms.: 100,490 Wid.,
1931 1,000-DA-N 104 W. Baltimore Mid-South gm asst. m Vince Tapler, nd & sd Thes.
7-3316 Branham Frank S. Proctor, m Douglas Maxwell, studio d Peggy McKinnie, wd AP
RCA

WTJS-FM Ch. 264 (B) 100.7mc, 50kw
1947

JOHNSON CITY

WETB 790 Press Inc. U. G. Jones, ce Bill Miller, sd Pop.: 382,700 Wid.
1947 1,000-D Main St. City McGillvra (Mrs.) Sam Johnson, (Mrs.) Pat Jagers, wd Rad. Hms.: 100,000 AP
Ray.

WJHL 910 WJHL Inc. W. H. Lancaster Sr., p W. K. Matthews, pmm Mike Blancard, nd Pop.: 636,958 L-W
1938 5,000-D 145 W. Main St. Pearson O. K. Garland, ce Raymond Rossen, fd Rad. Hms.: 140,000 AP, UP
WJHL-TV 1,000-N- 2780 gm Tom Lyons, sd Margaret Shurtz, wd Ret. Sis.: \$403,911,000 RCA
DA-N William Shell, pd Mary Nell Sharp, traffic m

WJHL-FM Ch. 264 (B) 100.7mc 3.1kw
1948

KINGSPORT

WKIN 1320 WKIN Inc. Cy N. Bahakel, p James Hammond, ce Lottie Ferguson, Pop.: 150,000 Cap.
1951 1,000-D 338 E. Center St. L. J. Tackett, gm Charles Foster, sd traffic m Rad. Hms.: 50,000 AP
Ret. Sis.: \$46,000,000 Col.

WKPT 1400 Kingsport Bcstg. NBC C. P. Edwards Jr., p Martin Karant, pd & Thomas Phillips, ce Pop.: 107,138 Thes., Wid.
1940 250 Co. 222 Commerce St. Burn-Smith, nd Howard Long, evp Ike Upchurch, fd Rad. Hms.: 26,849 AP
Circle 5-4161 Paul L. Overbay, gm James E. Davis, pmm Richard Ellis, sd Ret. Sis.: \$46,262,945 WE

WKPT-FM Ch. 253 (B) 98.5mc, 10kw
1948

Pop.: 462,223 RCA
Ret. Sis.: \$331,221,000

KNOXVILLE

WBIR 1240 Radio Station ABC John P. Hart, p, gm Ted W. Brosseau, pmm Jack F. Joyner, sd Thes.
1941 250 WBIR Bolling & cm J. Rex Horton, ce Ellie Morton, wd UP
618 S. Gay 4-3321 Neal W. Branch, pd & nd RCA

WBIR-FM Ch. 227 (B) 93.3mc, 2.85kw
1949

WIVK 860 Dick Bcstg. Co. James M. Dick, co-o Marilyn M. Dick, co-o

WKGN 1340 Clarence Beaman MBS Clarence Beaman Jr., John Ward, pd & sd Emil V. Anderson, nd Pop.: 435,200 L-W
1947 250 Jr. Park Nat'l Bank o & gm Milton L. Jones, ce Rad. Hms.: 117,620 RCA
Bldg. 4-0766 J. Horton Davis, cm

WKXV 900 Knoxville Ra-Tel Roy S. Carr, p Thomas W. Gamble, vp Ben Akerman, secy.-
1953 1,000-D Inc. treas.

WNOX 990 Scripps-Howard CBS Jack R. Howard, p Charles McMahon, pd Joe Long, nd St.
1921 10,000-DA-N Radio Inc. Branham R. B. Westergaard, gm Walter Corning, pmm Cliff Allen, fd UP
110 S. Gay St. 3-3171 O. L. Smith, cm Ray Evans, ce Bill Jay, sd WE

WROL 620 Mountcastle NBC Paul Mountcastle, p J. H. Reese, pd Raleigh Powell, nd Pop.: 1,273,400 Wid.
1927 5,000-DA-2 Bcstg. Co. Knodel W. H. Linebaugh, gm H. W. Hudson, pmm Art Metzler, sd Rad. Hms.: 207,831 UP
WROL-TV 612 Gay St., S.W. & cm F. M. Andrews, ce Mary Walker, wd Ret. Sis.: \$808,678,000 RCA
2-7111

LaFOLLETTE

WLAF 1450 LaFollette Bcstg. c/o William L. Phillip Kemper, ce
(CP) 100 Co. Sharp Jr.

LAWRENCEBURG

WDXE 1370 Lawrenceburg MBS, Aaron B. Robinson, p Ken Marston, pd Phillip Kemper, ce SES.
1951 1,000-D Bcstg. Co. KBS George K. Eubanks, gm Bud Sawyer, pmm Wid.
4462 Dixie Vol-State Burn-Smith UP
Smith GE

LEBANON

WCOR 900 Lebanon Bcstg. KBS Theo. F. Ezell Jr., p & Jack Hendrickson, pd G. Paul Crowder, Pop.: 498,300
1949 250-D 106½ S. Cumber- & sd William Johnston, ce Lance Beard, nd & fd Rad. Hms.: 120,790 AP
land St. 1540 cm & pmm Ret. Sis.: \$451,923,000 Ray.

TENNESSEE

City	Call Letters Established TV Affiliate	Chan. or Freq. Power	Licensee Headquarters Telephone	Network Represent- ative	Owner o; Pres. p; Exec. up evp; Gen. Mgr. gm; Sta. Mgr. sm; Coml. Mgr. cm; Sales Mgr. sim; Prog. Dir. pd; Chief Eng. ce; Prom. Mgr. pmm; Prod. Mgr. pdm; News, Farm, Sports or Women's Dir. nd, fd, sd, wd	Executive Abbreviations	Market Data For Primary Area (Supplied by station)	Library, News Serv. Transmitter	
LENOIR CITY									
	WLIL 1950	730 1,000-D	WLIL Inc. Broadway at Grand 1095	Arthur Wilkerson, p & Thomas Tuck, cm gm			SES. UP G	
	WLIL-FM 1950	Ch. 262 (B) 100.3mc 8.8kw							
LEWISBURG									
	WJFM 1947	1490 250	Estate of James J. Murray Box 20 780	MBS, KBS	Louis D. Lingner, gm J. E. Sowell, ce	Perry Gillum, nd Wynona Clark, wd	Pop.: 25,547 Rad. Hms.: 8,518 Ret. Sis.: \$15,000,000 AP Col.	
LEXINGTON									
	WDXL (CP)	1490 250	Lexington Bcstg. Co.						
MARYVILLE									
	WGAP 1947	1400 250	Aluminum Cities Bcstg. Co. Blount Natl. Bank Bldg. 2490	KBS	Frank H. Corbett, ptrn. & gm Harry C. Weaver, ptrn.	Horace McGill, cm Ken Kribbs, pd & nd Mark Murphy, ce Fran King, wd	Pop.: 55,000 Rad. Hms.: 15,000 Ret. Sis.: \$40,000,000	Thes. AP Ray.	
McKENZIE									
	WHDM (CP)	1440 250-D	The Tri-County Bcstg. Co.	Michael R. Freeland, p				
McMINNVILLE									
	WMMT 1947	1230 250	McMinnville Bcstg. Co. N. Chancery St. 401	MBS	Sam J. Albritton, p Royce E. Richards, gm Charles Kuhn, cm	Roy Crocker, pd & sd Chris Alexander, pmm Hubert Beasley, ce	Joe Matyas, nd H. V. Massey, fd Anne Glassner, wd	Pop.: 65,000 Rad. Hms.: 14,000 Ret. Sis.: \$45,000,000	
MEMPHIS									
	KWEM 1947	990 1,000-D	KWEM Inc.						
	WCBR 1952	1480 1,000-D CP:730 250-D	Chickasaw Bcstg. Co. 1924 Exchange Bldg. 5-7545 Gill-Perna	Charles T. DeVois, gm Ben L. Enochs, ce				
	WDIA 1947	1070 50,000-D 5,000-N- DA-2	Bluff City Bcstg. Corp. 2074 Union Ave. Box 5125 36-2703 Pearson, Dora- Clayton	John R. Pepper, p Bert Ferguson, gm Harold F. Walker, cm	Don Kern, pmm & sd Henry N. Fones, ce David James, prod. d	Marie Wathen, nd Ernest Brazzle, fd Christine Spindel, wd	Pop.: 2,095,589 Rad. Hms.: 1,994,000	UP G
	WHBQ 1925 WHBQ-TV	580 5,000-D 1,000-N- DA-2	Harding College Hotel Chisca 8-6868	MBS Blair	Dr. George S. Benson, p John H. Cleghorn, gm Tom Ragland, loc. slm Frank B. Willis, natl. slm	L. O. Dobson, gen. sls d Lee N. McEachern, pd Hugh Murphy, pmm & fd	Welton M. Roy, ce W. O. Beeman, bus. m Gene Roper, nd & sd Barbara Walker Hum- mel, wd	Pop.: 4,000,000 Rad. Hms.: 450,000 Ret. Sis.: \$2,308,755,000	Assoc. UP RCA

Data corrected to Dec. 10, 1953. If executives or services for FM are same as AM affiliate names are not repeated. Market Data supplied by stations. FM's in *italics*. N—Non-Commercial Station. CP—Construction Permit issued. D—Day. DA-N—Directional Antenna, night only. DA-1—Directional Antenna, same pattern day and night. DA-2—Directional Antenna, different pattern day and night. L—Limited Time with Dominant Station. LS—Local Sunset. N—Night. SA—Special Authorization. SH—Specified Hours. ST—Share Time. Complete key to abbreviations, page 6.



from Lenoir City, Tennessee

WLIL — WLIL-FM

THE ARTHUR WILKERSON LUMBER COMPANY STATIONS

MAILING ADDRESS:

Wilkerson Building

Lenoir City, Tenn.

WLIL Lenoir City, Tenn., 1,000 Watts, 730 AM 100.3 FM

WAEW AM-FM Crossville, Tenn.

WLIK Newport, Tenn. 1,000 Watts 1270

WJHM 1946	1340 250	Mid South Bcstg. Co. 433 Sterick Bldg. 37-4422 Venard	Prentiss Furlow, p C. K. Beaver, gm	Allan Avery, cm Jay Black, pd, nd & sd	William Marsh, ce UP RCA
WMC 1923 WMCT(TV)	790 5,000-DA-N	Memphis Publ. Co. Goodwyn Institute Bldg. P.O. Box 311 8-7464 (WMC, Am affiliate)	NBC Branham	H. W. Slavick, gm Richard Voorhis, cm Otto Roush, pd	Walter E. Frase, pmm Charles Sullivan, sd E. C. Frase Jr., ce	Robert Pigue, nd Walter Durham, fd Olivia Brown, wd	Pop.: 3,681,500 Rad. Hms.: 1,010,000 Ret. Sls.: \$2,269,052,000 Thes., L-W UP RCA
WMC(FM) 1947	Ch. 259 (B) 99.7mc 260kw						
WMPS 1925	680 10,000-D 5,000-N- DA-N	WMPS Inc. Radio Center 5-2663	ABC Radio-TV Reps.	H. R. Krelstein, p & gm George B. Faulder, sm	W. E. Crump, pd F. B. Roper, pmm J. G. Deaderick, ce	Tys Terwey, nd Bob Neal, fd Dick Cook, sd	Pop.: 3,001,600 Rad. Hms.: 740,000 UP RCA
WREC 1922	600 5,000-DA-2	Hoyt B. Wooten WREC Bcstg. Service Hotel Peabody Bldg. 5-1313	CBS Katz	Hoyt B. Wooten, o. p & gm	Hollis R. Wooten, cm Roy Wooten, pd	Wilson Raney, ce Russ Hodge, nd & sd Kitty Kelly, wd	SES., Wld. L-W UP
MORRISTOWN							
WCRK 1947	1450 250	Cherokee Bcstg. Corp. Radio Center 1450	MBS Holman	Herbert S. Walters, p Howell Ashford Jr., gm	John Redwine, cm John Frank McCrary, pd	James R. Redden, ce Hugh Cate, nd	Pop.: 50,000 Rad. Hms.: 12,500 Ret. Sls.: \$24,000,000 L-W AP RCA
MURFREESBORO							
WGNS 1946	1450 250	WGNS Inc. Box 456 1450	KBS Holman	Cecil Elrod Jr., p & gm Bill Barry, cm John D. Hood, pd	Ruth Howell, pmm Paul Howell, ce Dick Hocker, nd	David Moore, fd Ray Duffy, sd Helene Ewing, wd	Pop.: 44,000 Rad. Hms.: 11,000 LW, Wld. AP, UP RCA
WMTS 1953	860 250-D	Murfreesboro Bcstg. Co. 122 NW Broad	Arthur D. Smith Jr., p Virgil Trimm, gm	Charles Snoddy, cm Jim Edwards, pd, nd & fd	Eugene Covington, ce UP
NASHVILLE							
WKDA 1947	1240 250	Capitol Bcstg. Co. First American Natl. Bank Bldg. 4-0511 Bolling	A. G. Beaman, ptrn. T. B. Baker Jr., ptrn. & gm	Ruth C. Holly, asst. to m John M. Savage, cm	A. G. Kenngott Jr., pd Oscar C. Griffin Jr., ce	Cap., St. AP Col.
WLAC 1926 WLAC-TV	1510 50,000-DA-N	WLAC Inc. Third Natl. Bank Bldg. 6-0161	CBS Katz	F. C. Sowell, gm E. G. Blackman, cm Paul Oliphant, pd	Frank Gonzales, pmm F. D. Binns, ce Jack Drake, nd	Herman Grizzard, sd Mary Manning, wd	Pop.: 1,066,183 Rad. Hms.: 278,660 Ret. Sls.: \$802,489,000 Thes. UP WE

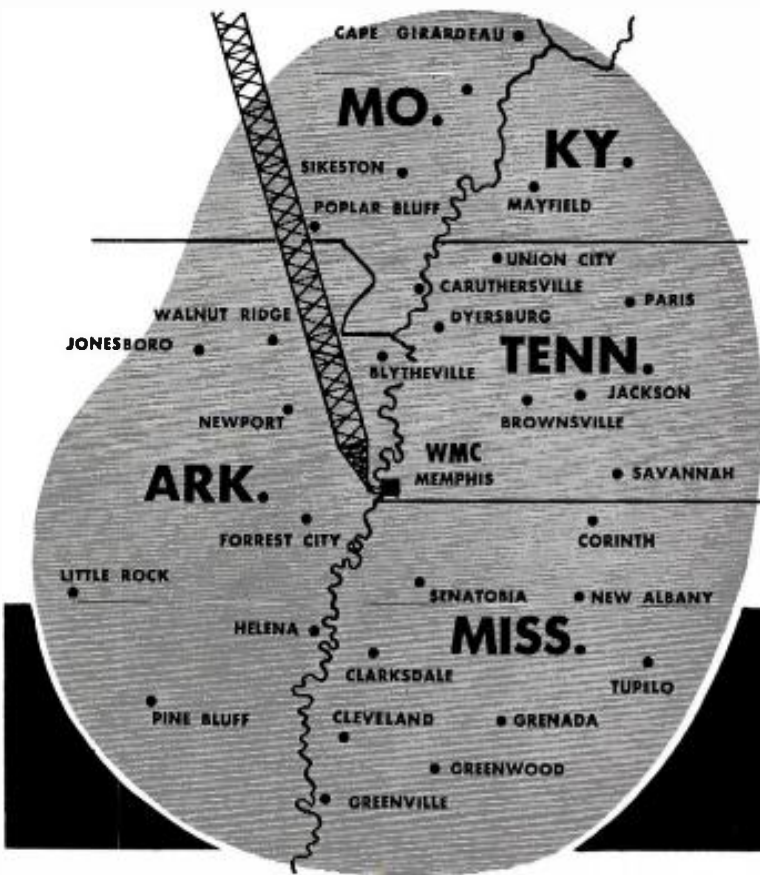

*there's a new look in Memphis radio
to make listening better than ever*

**It's WMC's new
half-wave radio tower
producing 65% more efficiency**

*over the typical quarter-wave
antennas operated by other stations
in Memphis*

WMC MEMPHIS
NBC — 5000 Watts — 790 K. C.

National representatives, The Branham Company
WMCF 260 KW Simultaneously Duplicating AM Schedule
WMCT First TV Station in Memphis and the Mid-South
Owned and Operated by The Commercial Appeal

FM day and night. Now 300,000 watts effective power, serving exclusively from Memphis over 70,000 FM sets in the Mid-South area with clear, high fidelity reception.

The station that "sets the standard" for finer radio reception in the Mid-South.

TENNESSEE

City Call Letters Established TV Affiliate	Chan. or Freq. Power	Licensee Headquarters Telephone	Network Represent- ative	Owner o; Pres. p; Exec. up evp; cm; Sales Mgr. sm; Prog. Dir. pd; Prod. Mgr. pdm; News, Farm, Sports or Women's Dir. nd, fd, sd, wd.	Executive Abbreviations Gen. Mgr. gm; Sta. Mgr. sm; Coml. Mgr. cm; Chief Eng. ce; Prom. Mgr. pmm; News, Farm, Sports or Women's Dir. nd, fd, sd, wd.	Market Data For Primary Area (Supplied by station)	Library, News Serv. Transmitter	
NASHVILLE—(Cont'd)								
WMAK 1948	1300 5,000-DA-N	Volunteer State Bcstg. Co. Inc. Maxwell House Hotel 4-3411	MBS Radio Reps.	Frank W. Mayborn, p Frank M. Farris, vp & treas. Robert E. Cooper, gm Dean Dunham, pd	Clarence L. Waggoner, gmm Charles W. Stokely, ce	Ruth W. Clinard, asst. m Bob Larimer, nd George B. Kelley, sd UP WE	
WNAH 1949	1380 1,000-D	Hermitage Bcstg. Corp. James Robertson Hotel 4-7611	KBS Continental	Van T. Irwin Jr., p, gm & sd Herman Rippey, cm	Donn C. McInturff, pd Webber Parrish, pmm Howard Woodard, ce	Earl Edwards, nd Donn Clark, wd	Pop.: 501,608 Rad. Hms.: 128,715 Ret. Sls.: \$459,828,000	St. UP G
WSIX 1927 WSIX-TV	980 5,000-DA-N	WSIX Bcstg. Station Nashville Trust Bldg. 5-5431	ABC Holling- bery	Louis R. Draughon, o & gm	E. S. Tanner, cm & pmm	Jack M. Simpson, pd Charles R. Duke, ce Wld. AP Col.	
WSM 1925 WSM-TV	650 50,000	WSM Inc. 301 Seventh Ave. N. 6-7181	NBC Petry	John H. DeWitt Jr., p Irving Waugh, exec. asst. & cm Jack Stapp, pd	William R. McDaniel, pub. rel. d George Reynolds, vp & tech. d	Harold Baker, nd John McDonald, fd Dick Shively, sd Marjorie Cooney, wd Thes. AP, UP, INS	
WSOK 1951	1470 1,000-D	Nashville Bcstg. 400 Davidson St. 42-0489 Forjoe, Doris Clayton	H. C. Young Jr., p, gm & pd	Norman Stewart, cm & pmm Arthur Viaches, ce	Louise Fletcher, wd	Pop.: 445,000 Rad. Hms.: 123,250 Ret. Sls.: \$435,025,000 Col.
WSOK-FM (CP)	Ch. 290 (B) 105.9mc, 3.1kw					 G	
NEWPORT								
WLIK (CP)	1270 1,000-D	Arthur Wilkerson Lumber Co.						
OAK RIDGE								
WATO 1948	1490 250	WATO Inc. Municipal Market Bldg. 5-3535	MBS	Ross Charles, evp & gm Samuel P. Thrower Jr., cm	Thearon O. Atkins, pd & sd Harold Tompkins, ce	Genevieve M. Long, office m William F. Hoopes, nd	Pop.: 32,000 Rad. Hms.: 9,800	
WOKE 1951	1290 1,000-D CP: 1,000-D 500-N DA-N	Air Mart Corp. P. O. Box 391 5-1333	KBS Continental	Harry C. Weaver, p & gm O. E. O'Bleness, cm	William E. Sorrell, pd Henry McDonald, ce	Joe Buchanan, nd & fd	Pop.: 300,000 Rad. Hms.: 65,000 Ret. Sls.: \$250,000,000 AP G
PARIS								
WTPR 1947	710 250-D	Paris Bcstg. Co. Davis Bldg. 1790	MBS, KBS, Dixie Burn- Smith	Aaron B. Robinson, p J. M. Cecil, gm	B. C. Kilgore, cm William R. Balch, pd	William Hamby, pmm Don Somerville, ce	Pop.: 480,000 Rad. Hms.: 114,990 Ret. Sls.: \$230,000,000	Wld. AP G

Data corrected to Dec. 10, 1953. If executives or services for FM are same as AM affiliate names are not repeated. Market Data supplied by stations. FM's in italic. *—Non-Commercial Station. CP—Construction Permit issued. D—Day. DA-N—Directional Antenna, night only. DA-1—Directional Antenna, same pattern day and night. DA-2—Directional Antenna, different pattern day and night. L—Limited Time with Dominant Station. LS—Local Sunset. N—Night. SA—Special Authorization. Sli—Specified Hours. ST—Share Time. Complete key to abbreviations, page 8.

We Have the EAR of Southern Kentucky and Middle Tennessee Folks

LOTS, and LOTS and LOTS of Them!

And they are YOURS . . . to talk with, and sell to, through WSIX's solid 5000-watt, 980 on-the-dial coverage . . . the kind that delivers REGULAR messages. WSIX's primary signal covers an area containing 175,350 radio homes in the compact market of Middle Tennessee and Southern Kentucky . . . at such low cost we think you will be surprised when you check it.

WSIX

5000 W. 980 KC.
NASHVILLE, TENNESSEE

ABC NETWORK

Ask **GEORGE P. HOLLINGBERY COMPANY** for information.
NEW YORK • CHICAGO • ATLANTA • LOS ANGELES • SAN FRANCISCO

P.S.: We have the **EYE** of these folks, too . . . through **WSIX-TV** . . . which began telecasting in November, 1953, on Channel 8.



Music is Big Business

in Nashville . . . and

W S M

has made it so.

Where is Music City, U. S. A. today?

In the 20s—it was New York, pouring out Broadway tunes.

In the 30s—it was Hollywood, grinding out cinema musicals.

In the 40s—it was neck-and-neck between New York and Hollywood as the twin music capitals of America.

But today, the musical center of gravity has shifted to Nashville, Tennessee—the modern Music City, U. S. A.—thanks to Station WSM's formidable, unequaled talent pool.

You needn't take our word for it; we admit to a flair for colorful tall tales. So we'll spare you the typical Tin Pan Valley exaggeration, and refer you instead to a few conservative, highly respected journals whose reputation for impaling stark facts is unquestioned.

- Farm and Ranch** "It is a well known fact that the balance of power in the present day music industry has shifted from New York and Hollywood to Nashville, Tenn."
- Nation's Business** "What brought this music into great popularity nationally, and now internationally, was . . . Station WSM. It's country music glamour boys are as big—sometimes bigger—in record sales and juke box popularity as Bing Crosby or Frank Sinatra . . ."
- Collier's** "Nashville is the focal point . . . For years this form of show business flourished apart from the Hollywood-New York axis, but recently the balance has been suddenly and violently disrupted. The Nashville muse has won the entire nation . . . if the rest of the radio industry is in the doldrums, WSM has more business than it can handle . . ."
- Pathfinder** "Not all the gold in the South is in the vaults at Fort Knox. A sizeable chunk of it is found in Radio Station WSM, Nashville, Tennessee, capital of folk music . . . The reason is Grand Ole Opry, owned outright by WSM, the showcase of American folk music . . . All the major record companies do a land-office business in Nashville."
- Coronet** "Events occurring today in Nashville comprise a sociological phenomenon. 'Will it ever stop growing?' the newly-rich song publishers, record firms and performers keep asking."
- American** "This year income (is) prophesied to reach \$35 million. The top country singers, expected to gross at least \$7,500,000 from records, personal appearances, radio, and sheet music sales . . . give thanks to Radio Station WSM, a powerful clear-channeler which blankets 30-odd states."
- New York Times Magazine** "There's a revolution brewing in the music business . . . (and) the center of this activity is Nashville, home of the fabulous radio program called Grand Ole Opry."

[Similar reports have appeared in Time, Look, Billboard, Variety, Redbook, Wall Street Journal, Newsweek, Saturday Evening Post, and many other publications.]

TENNESSEE

City	Call Letters Established	Chan. or Freq. Power	Licenses Head-quarters Telephone	Network Representative	Owner o; Pres. p; Exec. up evp; Gen. Mgr. gm; Sta. Mgr. sm; Coml. Mgr. cm; Sales Mgr. sim; Prog. Dir. pd; Chief Eng. ce; Prom. Mgr. pmm; Prod. Mgr. pdm; News, Farm, Sports or Women's Dir. nd, fd, sd, wd.	Executive Abbreviations	Market Data For Primary Area (Supplied by station)	Library, News Serv. Transmitter
PULASKI								
WKSR 1947	1420 1,000-DA-N	Richland Bcstg. Co. Jones Bldg. 1066	ABC Clarke	John R. Stephens, p & gm Mrs. John R. Stephens, cm	George Martin, pd Corky Hoover, pmm, sd & nd Noble G. Morgan, ce	Helen Abernathy, news ed. Terrell Jackson, fd Allene Williams, wd	Pop.: 70,000 Rad. Hms.: 16,000	Wid., SES, UP G
SHELBYVILLE								
WHAL 1946	1400 250	Shelbyville Bcstg. Co. East Side Square 1400	MBS Tenn. Valley	Charles Christian, vp, gm, cm & sd	Joyce Dixon, pmm & wd Tim Marsh, ce	Lewis Penuel, nd Dan Smith, fd		UP Ray.
SOUTH PITTSBURG								
WEPC (CP) 1953	910 500-D	Marion Co. Bcstg. Service						
SPARTA								
WSMT 1953	1050 1,000-D	Sparta Bcstg. Co. Inc. Box O 3751	Sam J. Albritton, p B. L. Upchurch, gm	Van L. Slack, cm & sd William Round Jr., pd	I. D. Byars, ce Gladys G. England, wd	Pop.: 60,000 Rad. Hms.: 15,000	
SPRINGFIELD								
WDBL 1950	1430 1,000-D	Springfield Bcstg. Co. Glenn Bldg. 1287	KBS	Walter A. Duke, gm Howard M. Peters, cm, pmm & sd	Eugene Locke, pd Anna A. Duke, ce & wd	Frank Rossiter, nd Charles Blankinship, fd	Pop.: 124,663 Rad. Hms.: 30,069	Wid. UP Col.
TULLAHOMA								
WJIG 1947	740 250-D	WJIG Bcstg. West End Dr. 2607	Col. Raymond L. Prescott Jr., o	Wallace Beecham, m William Dunn, ce	Mary C. Prescott, office m & wd		Wid. UP G
UNION CITY								
WENK 1946	1240 250	Union City Bcstg. Co. 1240	MBS, KBB, Dixie Burn-Smith	Aaron B. Robinson, p Louis C. Wrather, gm	Edwin A. Kallenberg, cm	Charles Holland, ce Lou Wrather, sd	Pop.: 29,100 Rad. Hms.: 8,219 Ret. Sls.: \$19,619,000	Wid. UP WE
WINCHESTER								
WCDT 1948	1340 250	Arthurs D. Smith Jr. P. O. Box 1103 2201	MBS	Arthur D. Smith Jr., o & gm Harry W. Sullivan, cm	Hank Murray, pd, fd & sd	James F. Spencer, ce Mildred Crawford, wd	Pop.: 54,000 Rad. Hms.: 12,000	UP Ray.

Data corrected to Dec. 10, 1953. If executives or services for FM are same as AM affiliate names are not repeated. Market Data supplied by stations. FM's in *italic*. *N*—Non-Commercial Station. *CP*—Construction Permit issued. *D*—Day. *DA-N*—Directional Antenna, night only. *DA-I*—Directional Antenna, same pattern day and night. *DA-2*—Directional Antenna, different pattern day and night. *L*—Limited Time with Dominant Station. *LS*—Local Sunset. *N*—Night. *SA*—Special Authorization. *SH*—Specified Hours. *ST*—Share Time. Complete key to abbreviations, page 6.

TEXAS

MARKET DATA BY COUNTIES

County	Population 1950	Radio Families 1953	Retail Sales 1952(000)	Food Sales 1952(000)	Drug Sales 1952(000)	Automobile Ownership 1953	County	Population 1950	Radio Families 1953	Retail Sales 1952(000)	Food Sales 1952(000)	Drug Sales 1952(000)	Automobile Ownership 1953
Anderson	31,875	8,390	\$ 23,237	\$ 7,400	\$ 703	10,923	Dawson	19,113	5,360	27,066	6,017	799	9,264
Andrews	5,002	2,090	5,244	1,907	154	3,706	Deaf Smith	9,111	2,840	14,902	3,577	399	6,784
Angelina	36,032	10,150	35,770	8,989	1,136	14,254	Delta	2,330	6,390	1,917	75	3,003	
Arañas	4,232	1,090	3,478	1,297	237	2,180	Denton	41,365	11,470	40,285	9,588	1,498	18,228
Archer	6,816	1,910	3,338	1,278	143	3,727	De Witt	22,973	6,020	27,441	6,680	706	10,945
Armstrong	2,215	690	1,407	289	28	717	Dickens	7,177	1,989	7,582	1,659	196	3,360
Atascosa	20,048	14,770	13,064	3,189	331	7,386	Dimmit	10,654	1,870	5,986	1,785	162	3,303
Austin	14,663	4,050	14,713	3,368	288	6,817	Donnan	6,216	1,750	6,233	1,556	222	3,095
Bailey	7,592	2,020	9,776	2,483	335	3,701	Duval	15,643	2,910	7,832	2,919	370	4,812
Bandera	4,410	1,220	4,524	1,611	190	2,649	Eastland	23,942	7,390	29,153	7,997	878	11,650
Bastrop	19,622	4,880	13,046	4,349	874	6,687	Ector	42,102	15,460	65,735	16,442	2,038	35,336
Baylor	6,875	2,110	8,030	1,697	73	3,730	Edwards	2,908	690	1,542	613	59	1,051
Bee	18,174	4,330	16,612	3,920	575	6,517	Ellis	45,645	12,540	40,060	12,397	1,218	18,059
Bell	73,824	20,410	64,842	16,324	2,233	29,825	El Paso	194,968	50,630	220,628	48,562	7,885	68,462
Bexar	500,460	128,970	529,236	122,177	16,820	189,068	Erath	18,434	5,840	18,057	3,325	503	8,356
Blanco	3,780	1,260	3,802	1,334	2,278	Falls	26,724	6,610	23,609	5,784	605	9,313
Borden	11,106	3,440	9,753	2,386	451	6,195	Fannin	31,253	8,930	19,469	6,355	784	10,297
Bosque	61,966	18,000	52,348	14,552	1,832	23,475	Fayette	24,176	6,240	23,002	4,697	693	10,182
Brazoria	46,549	13,820	57,341	16,965	1,747	26,783	Fisher	11,023	2,810	7,931	2,269	310	4,137
Brazos	39,390	10,040	39,371	9,281	1,283	13,578	Floyd	10,535	3,110	12,001	2,674	367	6,244
Brewster	7,309	1,710	7,170	1,830	297	2,859	Foard	4,216	1,100	4,056	833	66	1,937
Briscoe	3,528	860	3,252	854	70	1,935	Fort Bend	31,056	7,040	31,657	6,190	470	14,727
Brooks	9,195	2,170	11,254	2,870	344	2,887	Franklin	15,696	4,740	3,655	704	67	2,142
Brown	28,607	8,860	27,665	6,800	1,271	12,633	Freestone	10,357	3,830	9,597	2,739	396	5,159
Burleson	13,000	2,950	8,284	2,774	222	4,025	Frio	10,357	2,180	7,705	2,267	191	3,316
Burnet	10,356	2,930	6,836	1,412	238	4,337	Gaines	8,909	2,290	12,477	2,553	373	6,009
Caldwell	19,350	4,690	18,232	3,783	411	8,503	Galveston	113,066	34,670	150,341	35,190	5,854	43,666
Calhoun	9,222	2,570	9,007	2,514	211	4,522	Garza	6,281	1,710	6,151	1,523	153	3,051
Callahan	9,087	2,590	5,103	1,957	254	4,703	Gillespie	10,820	3,250	12,349	2,672	227	5,490
Cameron	125,170	28,510	123,679	28,392	3,066	36,618	Glasscock	1,089	377	53	31	793	
Camp	8,740	2,310	5,236	1,736	60	3,158	Goliad	6,219	1,310	4,431	1,131	63	2,211
Carson	6,852	1,960	6,791	1,420	282	4,652	Gonzales	21,164	4,980	34,175	6,072	391	7,927
Cass	26,732	6,200	18,818	3,447	549	8,294	Gray	24,728	7,630	37,215	8,686	1,780	15,545
Castro	5,417	1,570	5,282	1,135	61	3,412	Grayson	70,467	21,130	70,856	18,978	2,238	29,136
Chambers	7,871	1,990	6,322	1,773	65	4,792	Gregg	61,258	17,450	96,052	17,036	2,369	33,041
Cherokee	38,694	9,270	28,088	8,516	960	12,158	Grimes	15,135	3,550	10,988	3,420	308	5,238
Childress	12,123	3,550	16,223	4,042	355	6,426	Guadalupe	25,392	6,450	23,464	6,283	483	10,322
Clay	9,896	2,860	6,409	1,750	218	4,671	Hale	28,211	8,540	53,168	10,110	1,940	17,296
Cochran	5,328	1,630	7,862	2,031	165	3,032	Hall	10,930	2,860	13,339	3,390	641	4,641
Coke	4,945	1,100	3,125	943	83	2,313	Hamilton	10,680	3,180	10,561	3,985	309	5,616
Coleman	15,903	4,470	15,020	3,345	528	7,721	Hansford	4,202	1,180	6,359	1,003	327	3,342
Collin	41,682	12,130	32,408	9,672	891	17,974	Hardeman	10,212	3,030	9,131	2,317	297	4,018
Collingsworth	9,139	2,240	9,705	2,283	310	4,057	Hardin	19,535	5,310	13,654	3,890	371	7,520
Colorado	17,576	4,820	24,926	5,266	416	8,548	Harris	806,701	259,570	1,138,535	277,101	34,930	364,337
Comal	16,357	4,700	21,045	4,460	553	9,076	Harrison	47,745	11,440	35,953	9,588	868	13,828
Comanche	15,516	4,550	14,205	3,208	653	6,372	Hartley	1,913	530	515	305	28	1,491
Concho	5,078	1,450	4,474	930	86	2,386	Haskell	13,736	3,630	10,329	2,424	442	5,798
Cooke	22,146	6,230	24,132	5,467	830	11,636	Hays	17,840	4,240	13,701	4,185	519	8,251
Correll	16,284	4,730	9,782	3,067	278	9,039	Hemphill	4,123	1,250	4,716	1,084	63	2,267
Cottle	6,099	1,790	6,747	1,791	206	2,691	Henderson	23,405	5,820	17,539	3,846	439	8,735
Crane	3,965	1,240	3,940	694	73	2,575	Hidalgo	160,446	33,330	132,466	32,614	4,000	43,212
Crockett	3,981	1,070	4,812	1,164	178	2,234	Hill	31,282	8,900	25,497	6,463	746	13,239
Crosby	9,582	2,570	10,551	2,950	249	5,186	Hockley	20,407	6,000	29,130	7,920	1,003	11,482
Culberson	1,825	**	2,504	509	57	1,201	Hood	8,287	1,510	4,892	4,892	805	2,834
Dallam	7,640	2,240	13,337	3,012	519	4,240	Hopkins	23,490	6,650	14,718	3,228	552	8,747
Dallas	614,799	202,520	970,415	184,627	31,914	279,963	Houston	22,825	5,430	14,580	3,701	385	6,747
							Howard	26,722	7,540	35,731	7,562	1,035	15,122
							Hudspeth	4,298	*1,370	2,344	608	97	1,113
							Hunt	42,731	12,330	38,209	9,965	1,155	17,075

* McMullen included in Atascosa County figure.
 * See Dawson.
 * King is included in Cottle County figures. ** See Hudspeth County.

* See Sterling.
 * Culberson is included in Hudspeth County figures.

County	Population 1950	Radio Families 1953	Retail Sales 1952(000)	Food Sales 1952(000)	Drug Sales 1952(000)	Automobile Ownership 1953	County	Population 1950	Radio Families 1953	Retail Sales 1952(000)	Food Sales 1952(000)	Drug Sales 1952(000)	Automobile Ownership 1953
Hutchinson	31,580	10,220	39,951	11,180	1,771	17,981	Rains	4,266	1,040	1,723	442	68	1,969
Irion	1,590	440	1,086	307	65	1,048	Randall	13,774	4,940	11,910	2,186	383	9,078
Jack	7,755	2,180	6,560	1,807	258	3,997	Beagan	3,127	850	5,840	1,523	281	2,638
Jackson	12,916	3,430	10,508	2,965	379	6,274	Real	2,479	650	1,336	487	67	1,193
Jasper	20,049	4,810	20,858	5,169	639	6,884	Red River	21,851	5,550	12,032	3,775	457	6,004
Jeff Davis	2,090	440	879	310	65	725	Reeves	11,745	'03,160	16,456	4,536	388	7,121
Jefferson	195,083	59,040	258,117	59,446	8,187	83,015	Refugio	10,113	2,500	8,446	2,557	403	4,585
Jim Hogg	5,389	1,220	3,503	907	144	2,190	Roberts	1,031	300	745	124	49	838
Jim Wells	27,991	6,530	30,055	7,165	1,043	11,318	Robertson	19,908	4,650	14,782	4,579	534	6,704
Johnson	31,390	9,640	27,815	7,472	836	14,983	Rockwall	6,156	1,550	4,525	1,554	127	5,048
Jones	22,147	6,410	25,740	6,337	688	10,399	Runnels	16,771	4,840	15,237	3,871	438	9,312
Karnes	17,139	3,610	16,690	3,839	396	6,699	Sabine	42,348	10,720	30,323	7,398	904	16,807
Kaufman	31,170	7,530	25,104	6,184	650	11,720	San Augustine	8,568	1,870	3,266	1,127	87	2,472
Kendall	5,423	1,560	5,942	1,501	222	3,415	San Jacinto	8,837	1,790	5,263	1,749	243	2,920
Kenny	632		82	83		260	San Patricio	7,172	1,400	1,917	796	67	1,506
Kerr	2,249	570	1,180	412	58	1,066	San Saba	35,842	8,050	26,313	7,269	893	13,553
Kerr	14,022	4,190	18,977	3,980	482	8,070	Schleicher	8,666	2,420	8,706	2,079	226	3,731
Kimble	4,619	1,160	3,922	1,083	128	2,771	Shackelford	2,852	690	2,968	712	69	1,843
King	870		211	72		405	Shelby	22,779	7,280	35,845	5,275	794	12,412
Kinney	2,668	520	1,394	285	58	774	Sherman	5,001	1,360	4,926	1,050	198	3,169
Kleberg	21,991	5,560	22,565	6,974	528	7,591	Smith	23,479	5,970	14,082	3,762	514	7,731
Knox	10,082	2,840	8,752	2,402	421	4,351	Somervell	74,701	20,510	80,793	16,161	2,807	28,218
Lamar	43,033	11,960	38,070	9,197	1,391	13,732	Starr	2,542	750	1,938	549	69	1,498
Lamb	20,015	5,500	25,498	6,839	385	11,048	Stephens	13,948	2,340	6,745	2,895	330	3,593
Lampasas	9,929	2,940	10,422	1,838	286	5,036	Sterling	10,597	3,250	13,961	3,428	420	5,796
LaSalle	7,485	1,800	5,416	712	37	2,512	Stonewall	1,282	266	1,560	453	53	901
Lavaca	22,159	5,820	12,369	4,728	236	9,060	Sutton	3,679	920	2,029	628	69	1,741
Lee	10,144	2,500	8,912	2,022	188	4,078	Swisher	3,746	870	4,376	1,100	176	2,024
Leon	12,024	2,930	5,497	1,897	230	3,690	Tarrant	8,249	2,320	11,490	2,248	502	6,360
Liberty	26,729	6,900	30,612	8,366	816	12,744	Taylor	361,253	118,630	574,468	108,641	17,808	177,657
Limestone	25,251	6,320	15,832	4,853	658	9,403	Taylor	63,370	19,410	92,904	16,631	2,637	30,327
Lipscomb	3,658	1,040	6,504	1,351	288	2,546	Terrill	3,169	870	2,869	635	63	1,339
Live Oak	9,054	1,910	6,895	1,639	194	3,362	Terry	13,107	3,650	19,552	4,008	647	8,150
Llano	5,377	1,780	6,241	1,482	213	2,796	Throckmorton	3,618	980	3,012	825	135	1,830
Loving	227	47	147	49		228	Titus	17,302	4,770	14,520	4,386	362	6,605
Lubbock	101,048	32,840	178,066	27,633	6,647	51,030	Tom Green	58,929	17,990	78,063	15,831	2,371	28,941
Lynn	11,030	2,840	9,131	2,126	329	6,283	Travis	160,980	43,980	182,914	38,800	7,294	59,767
McCulloch	11,701	3,220	12,218	2,783	336	3,572	Trinity	10,040	2,500	9,010	2,593	189	3,253
McLennan	130,194	37,960	152,925	34,223	4,161	2,663	Tyler	11,292	2,780	9,184	1,925	239	4,159
McMullen	1,187	289	107	72	54	4,237	Upshur	20,822	5,230	12,824	3,311	377	7,923
Madison	7,996	1,980	6,975	1,598	198	2,340	Upton	5,307	1,580	1,580	1,307	268	4,300
Marion	10,172	2,290	5,335	1,596	196	9,836	Uvalde	16,015	4,150	18,589	4,196	626	7,670
Martin	5,941	1,300	2,707	734	82	3,176	Val Verde	16,635	3,590	15,982	3,528	483	5,831
Mason	4,945	1,610	3,896	899	184	5,755	Van Zandt	22,593	6,160	13,909	3,439	469	9,589
Matagorda	21,559	5,740	26,934	6,653	894	48,166	Victoria	31,241	8,720	37,497	8,554	635	16,199
Maverick	12,292	2,340	14,712	4,282	581	770	Walker	20,163	4,300	14,626	4,031	494	5,568
Medina	17,013	4,090	12,209	2,471	334	7,672	Waller	11,961	2,680	10,291	1,939	283	4,814
Menard	4,175	1,120	4,959	885	67	1,895	Ward	13,346	3,900	14,943	3,702	511	7,178
Midland	25,785	9,480	38,056	7,969	1,787	21,612	Washington	20,542	5,030	16,714	3,957	438	7,613
Milam	23,565	5,840	21,186	5,873	738	10,078	Webb	56,141	11,440	53,919	12,712	1,809	13,360
Mills	5,999	1,750	4,326	866	98	2,698	Wharton	36,077	9,080	37,843	8,856	849	15,865
Mitchell	14,357	3,900	12,847	3,422	327	6,360	Wheeler	10,317	2,690	12,692	2,943	470	5,073
Montague	17,070	4,880	16,983	3,795	525	8,530	Wichita	98,493	27,420	131,178	25,230	4,315	50,598
Montgomery	24,504	6,370	19,974	5,184	837	9,992	Willbarger	20,552	5,750	24,492	5,479	740	9,798
Moore	13,349	4,970	18,021	5,736	541	7,294	Willacy	20,920	'14,570	23,232	7,370	520	6,211
Morris	9,433	2,510	5,629	2,053	258	3,750	Williamson	38,853	10,310	35,765	8,755	955	16,699
Motley	3,963	1,130	4,554	1,238	158	1,830	Willamson	14,672	3,190	9,024	1,250	355	7,888
Nacogdoches	30,326	7,590	22,518	6,794	877	10,194	Winkler	10,064	3,200	11,613	3,436	494	6,523
Navarro	39,916	10,870	34,141	10,050	974	14,536	Wise	16,141	4,700	12,356	3,744	290	7,426
Newton	10,832	2,320	3,978	1,753	115	2,849	Wood	21,308	5,750	19,715	4,159	576	9,171
Nolan	19,808	5,800	25,911	5,594	6,810	10,417	Yoakum	4,339	1,030	2,339	926	98	2,922
Nueces	165,471	46,380	205,096	46,046	6,211	71,588	Young	16,810	5,030	19,883	3,944	562	9,302
Ochiltree	6,024	1,840	13,608	3,346	621	4,239	Zapata	4,405	780	1,365	649	48	988
Orange	1,872	390	1,595	155	33	1,192	Zavala	11,201	2,000	7,805	1,495	249	3,354
Oldham	40,567	12,930	44,220	15,230	1,303	16,245							
Palo Pinto	17,154	5,580	16,741	4,140	551	9,463							
Panola	19,250	4,530	14,845	3,199	440	5,836							
Parker	21,528	6,840	20,202	4,206	382	11,179							
Parmer	5,787	1,770	5,590	1,291	146	3,773							
Pecos	9,939	2,380	10,932	2,321	392	5,103							
Polk	16,194	3,840	11,178	3,477	358	5,353							
Potter	73,366	24,130	160,743	27,469	5,541	42,973							
Presidio	7,354	1,310	6,686	1,525	240	2,538							
Total	7,711,194	2,182,270	\$8,925,203	\$2,038,556	\$283,783	3,155,337							

* See Willacy. † See Cottle. * See Reeves. * See Alascosa.

¹⁰ Loving is included in Reeves County figure.
¹¹ Glasscock is included in Sterling County figure.
¹² Kenedy is included in Willacy County figure.

Note: Population 1950 Census; radio families Standard Audit & Measurement Services Inc.; food, drug and retail sales, copyright 1953, Sales Management; further reproduction unlicensed; automobiles supplied by state.

DIRECTORY OF AM AND FM STATIONS

ABILENE

KRBC 1936	1470 5,000-D 1,000-N- DA-N	Reporter Bestg. Co.	ABC, Tex. State	Dale Ackers, p Lewis J. Ackers, vp	Howard Barrett, gm Bro Mingus, cm & pd Bob Nash, pmm Troy Mallon, ce	Dub Bowlius, nd Virgil Terry, sd Harry Holt, d Dorothy Imholz, wd	Pop.: 533,210 Rad. Hms.: 160,313 Ret. Sis.: \$847,589,000	Assoc. AP Col.
KWKC 1946	1340 250	Citizens Bestg. Co. 2500 Butternut 3-2545	MBS Venard	W. P. Wright, p A. C. Etter, gm & pmm Tyler Stewart, cm	Leonard L. Johnson, pd & nd	Forrest Tipton, ce Melba White, wd		Wid. AP, UP WE

ALICE

KBKI 1947	1070 1,006-DA-N	Alice Bestg. Co. P. O. Box 731 4-4324	MBS Pearson	E. G. Lloyd Jr., p A. C. Lloyd Jr., gm Robert I. Grimes, cm	Jaye Allyn Frye, pd Gloria Sanchez, pmm Charles M. Boyd, ce	Ernest L. Mickey, nd Charles W. Farkas, sd Irma Salas, wd	Pop.: 338,100 Rad. Hms.: 84,240 Ret. Sis.: \$326,320,000	Wid. AP Col.
--------------	--------------------	---	----------------	---	---	---	--	-----------------

ALPINE

KVLF 1947	1240 250	Big Bend Bcstrs. 2144	MBS, KBS, Southwest Net., Cactus State Best	Jack Hawkins, p Gene Hendryx, gm & cm	Bill Height, pd & Sherman Newsom, ce	Bill Williams, ranch d LaDelle Kelley, wd	Pop.: 25,000	UP G
--------------	-------------	--------------------------	--	--	---	--	--------------	---------

TEXAS

City	Call Letters Established TV Affiliate	Chan. or Freq. Power	Licensee Headquarters Telephone	Network Represent- ative	Owner o; Pres. p; Exec. vp evp; Gen. Mgr. gm; Sta. Mgr. sm; Coml. Mgr. cm; Sales Mgr. slm; Prog. Dir. pd; Chief Eng. ce; Prom. Mgr. pmm; Prod. Mgr. pdm; News, Farm, Sports or Women's Dir. nd, fd, sd, wd.	Executive Abbreviations	Market Data For Primary Area (Supplied by station)	Library, News Serv. Transmitter
AMARILLO								
KAMQ 1947	1010 1,000-D 500-N-DA-N	Top of Texas Bcstg. Co. 1301 Polk St. 2-6543	MBS Forioe	R. D. Houck, co-o & gm Hoyt Houck, co-o B. M. Houck, co-o	Jess Richardson, cm & sd Webster Smith, pd Johnny Hathcock, pmm	Stewart Parsons, ce Bill Johns, nd Smokey Joe Barnes, fd	 AP Ray.
KFDA 1939 KFDA-TV	1440 5,000-D 1,000-N- DA-N	Amarillo Bcstg. Co. Broadway at Cherry Ave. 4-5343	ABC Branham	Wendell Mayes, p Stan Wilson, gm	Ed Moore, cm B. W. Spiller, ce	Bill Johns, nd	Pop.: 494,500 Rad. Hms.: 32,727 Ret. Sis.: \$2,112,070	Wid. UP RCA
KGNC 1922 KGNC-TV	710 10,000-DA-2	Plains Radio Bcstg. Box 751 4-4601	NBC, Tex. Quality Net. Katz	B. E. Walker, p Tom Kritzer, gm Bob Watson, sm & pd Dave Scribner, loc. sim	Marianne Johnson, pmm W. H. Torrey, ce Calvin Handy, bus. m	Wes Izzard, nd Hank Brown, sd J. Garland Smith, fd	Pop.: 969,732 Rad. Hms.: 269,370 Ret. Sis.: \$1,407,000	L-W, Cole AP, UP RCA
KLYN 1949 KLYN-TV	940 1,000 DA-1	Plains Empire Bcstg. Co. 1014 W. 7th St. 2-6773	CBS Blair	R. G. Hughes, o Howard Roberson, gm & cm	Gene Fennimore, ce Mae Dorsey, publ. d Kelly West, nd	John Heetland, sd Alma Thomas, wd		ST UP
ATHENS								
KBUD 1948	1410 250-D	Henderson Co. Bcstg. Co. Box 309 2277	KBS	J. B. McNutt Jr., co-o, gm & ce	Merl Saxon, co-o		Pop.: 30,000 Rad. Hms.: 12,282 UP G
ATLANTA								
KALT 1950	900 1,000-D	Ark-La-Tex Bcstg. Co. 900 Best	Herman H. Wommack Jr., p David A. Wommack, gm	Alvis N. Dowd, cm William R. Bentley, pd	James Waites, ce Jeane Wommack, wd	Pop.: 329,070 Rad. Hms.: 91,912	Cap. UP Col.
AUSTIN								
KNOW 1927	1490 250	Pioneer Bcstg. Co. Capital Natl. Bank Bldg. 2-6213	ABC, Tex. State Pearson	Wendell Mayes, p Louis Cook, gm	M. H. Coleman, cm Frank Bissett, pd & sd	J. E. Lewis, ce Warren Beaman, nd	Pop.: 260,000 Rad. Hms.: 67,000	St. AP
KTBC 1939 KTBC-TV	590 5,000-D 1,000-N- DA-N	Texas Bcstg. Corp. P. O. Box 717 2-2424	CBS Taylor	Claudia T. Johnson, p J. C. Kellam, gm O. P. Bobbitt, sim	Richard Pryor, pd Harry Voelker, pmm Ben Hearn, ce	Paul Bolton, nd Barbara Robinson, wd	Pop.: 610,500 Rad. Hms.: 119,646	Wid. UP WH
KTXN 1949	1370 1,000-D	Radio Station KTXN 1211 E. 6th 7-4476 Nat'l. Time Sales, Oakes	Ed C. James Sr., p Frank Stewart, gm & cm Lilla Guzman, pd	Larry Jones, pmm Paul Lindhorn, ce	Roberto V. Villanueva, nd Margarita Munoz, wd		Thes.
KVET 1946	1300 1,000 DA-N	Austin Bcstg. Co. 113 W. 8th St. 8-8521	MBS Forjoe	John B. Connally, p Willard Deason, gm Charles Howell, cm	H. W. Dunlop, asst. m Dave Smith, pd & nd Willis Morter, ce	Glenn Brown, sd Linda Lee, wd	Pop.: 650,000	L-W UP WE
BALLINGER								
KRUN 1947	1400 250	Runnels County Bcstrs. Box 351 3151	KBS Best, Melville	Walter G. Russell, p Robert F. McGarvey, gm, cm, pd, pmm, nd, sd & fd	W. C. Kelley, ce		Pop.: 16,700 Rad. Hms.: 5,000 Ret. Sis.: \$16,000,000 AP G
BAY CITY								
KIOX 1947	1270 1,000 DA-N	Bay City Bcstg. Co. 4642	MBS, KBS Best	J. G. Long, o Vernon L. Townsend, gm	Boyd Porter Jr., cm Sam Sitterle, pd & ce	Sie Schneider, pmm & wd Dan Keough, sd	Rad. Hms.: 25,000 Ret. Sis.: \$18,131,000	Wid. UP WE
BAYTOWN								
KRCT 1947	650 250-D	Bay Bcstg. Co. Box 629 8251	KBS	W. D. Christmas, p & co-o	Dudley Sharp, co-o J. H. Touchstone, gm & cm	C. W. Zorn, pd Gus Grebe, sd M. J. Tavary, ce	Pop.: 1,119,800 Rad. Hms.: 327,240 AP Col.
KREL 1947	1360 1,000-DA-2	Tri-Cities Bcstg. Co. P. O. Box 419 8211	Robert Matherne, p Patt McDonald, gm Don Lilly, cm	Jay Shepherd, pd Les Scott, pmm Mack Malpee, ce	Gus Grebe, sd Art. Bacca, nd Johnella Boynton, wd		Wid. UP G
KREL-FM 1949	Ch. 220 (A) 92.1mc 0.82kw							GE

Data corrected to Dec. 10, 1953. If executives or services for FM are same as AM affiliate names are not repeated. Market Data supplied by stations. FM's in *italic*. *—Non-Commercial Station. CP—Construction Permit issued. D—Day. DA-N—Directional Antenna, night only. DA-1—Directional Antenna, same pattern day and night. DA-2—Directional Antenna, different pattern day and night. L—Limited Time with Dominant Station. LS—Local Sunset. N—Night. SA—Special Authorization. SH—Specified Hours. ST—Share Time. Complete key to abbreviations, page 6.

Yours for East Texas Sales

KFRO — 1370

ABC Network
AP News
TSN Network

1000
WATTS
FULL TIME

JAMES R. CURTIS, PRESIDENT

Longview, Texas

"SEE THE AMARILLO MARKET BY PLANE?"

Man, you need a Canberra jet!"

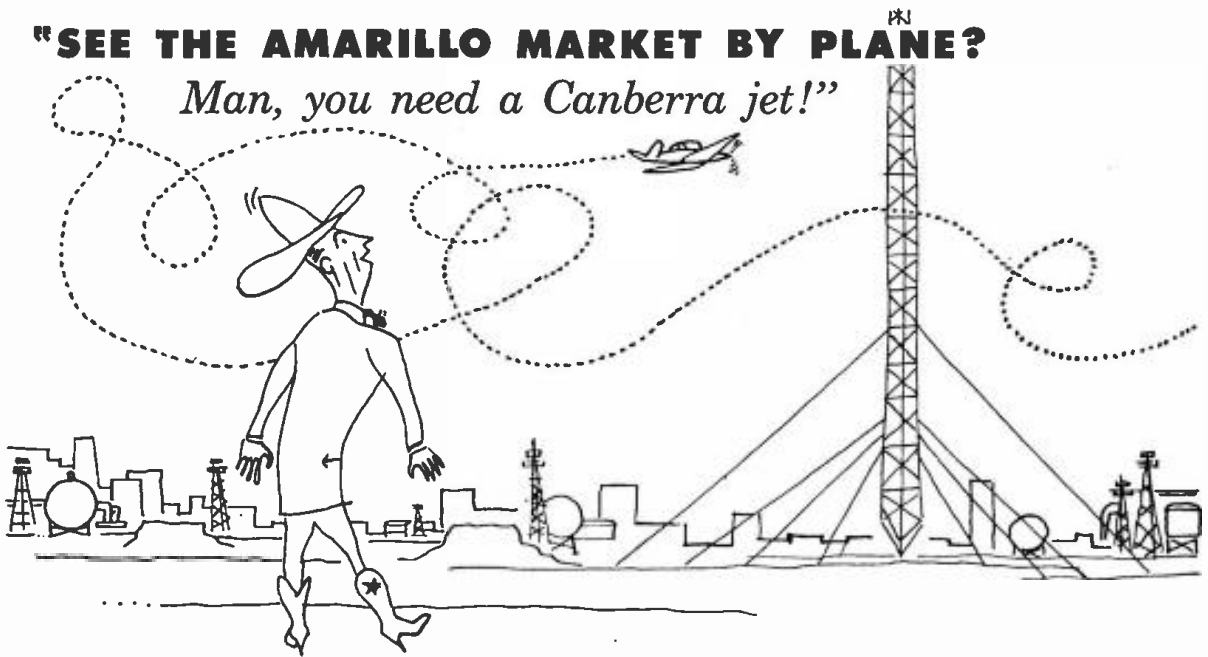

A dude from our agency wanted to see the Amarillo market. We showed him part of it from a Beechcraft Bonanza. A jet would have been more appropriate for thorough coverage, but the BB was handy—and it flies on Texas Panhandle gasoline. These are his notes; footnotes ours.

"Buzzed big ditch.¹ Roosted in trees. Climbed above Panhandle, headed for a town. Guide said easier to count cattle from plane than horse; must use special technique; like reading proof 20 paces. Town was Pampa, complete with new Celanese plastic plant.² What think of next, plant of plastic; what guide said tho. Across hiway, big gun barrel factory.³ Up road, boys with Erector sets.⁴ Turned nw, over vast oil refinery.⁵ Another town, with kids fooling around space ships.⁶ Guide pointed out three carbon black plants with huge smokestacks, one not working.⁷ South, over scattered dozen lonesome structures.⁸ Thin cloud across horizon; closed in on zinc smelter,⁹ smoking like man in cigarette commercial. Passed old ordnance plant, guide said now used to mfg. anhydrous ammonia and nitric acid. This great boon to farmers—fertilizer you can get down wind of! Back above Amarillo; over acres of railroad yards and roundhouse; over KGNC's antennas.¹⁰ Panhandle big place, all buildings new. People great—speak to stranger on street."

¹Palo Duro Canyon, recreation spot. ²Raw natural gas becomes plastic bases here. ³Cabot Carbon's; pump units for oil wells also made here. ⁴The Texas Panhandle oil and gas field, with 8400 oil and 3500 gas wells (world's greatest gas production; world's only helium plant). ⁵Town of Phillips—entire pop. of 5,200 Phillips Oil personnel. ⁶Town of Borger, with butadiene plant; looks like something from another world. ⁷Wrong; working fine. New supersonic stack so efficient it's almost smokeless. 75-80% of world's carbon black (for tires, phones, ink, etc.) from Panhandle. ⁸Natural gas pumping stations, on pipelines supplying 27 states. ⁹The American Zinc Smelter, located near Dumas because of low gas rate. ¹⁰Whence, powered with 10,000 watts, our signal reaches 78 Texas, Colorado, Oklahoma, New Mexico and Kansas counties with gross cash farm income of \$925,000,000. See Katz for further information.



NBC and DuMONT AFFILIATE

AM: 10,000 watts, 710 kc. TV: Channel 4. Represented nationally by the Katz Agency

TEXAS

City Call Letters Established TV Affiliate	Chan. or Freq. Power	Licensee Headquarters Telephone	Network Represent- ative	Executive Abbreviations Owner o; Pres. p; Exec. vp evp; Gen. Mgr. gm; Sta. Mgr. sm; Coml. Mgr. cm; Sales Mgr. sim; Prog. Dir. pd; Chief Eng. ce; Prom. Mgr. pmm; Prod. Mgr. pdm; News, Farm, Sports or Women's Dir. nd, fd, sd, wd.	Market Data For Primary Area (Supplied by station)	Library, News Serv. Transmitter		
BEAUMONT								
KFDM 1924	560 5,000 DA-N	Beaumont Bcstg. Corp. 1420 Calder Ave. 2-7758	ABC Free & Peters	D. A. Cannan, p C. B. Locke, gm & cm	Dave Russell, pd, nd & sd H. F. Caldwell, pmm	Harold Bartlett, ce Richard McAdoo, fd	Pop.: 930,050 Rad. Hms.: 243,000 Ret. Sis.: \$776,902,000	L-W UP RCA
KJIM 1947	1380 1,000-D	KPBX Bcstg., Inc. 2295 Calder Ave. 2-0201	Texas Quality ForJoe	Joe B. Carrigan, trustee Les Ryder, sm, cm & pmm	Virginia W. Ryder, pd & wd Fred Reiner, ce	Ray Gordon, nd Joe Munroe, sd		Cap. AP G
KRIC 1938	1450 250	The Enterprise Co. 380 Walnut St. 4-3311 Branham	E. C. Davis, vp Charles G. Baskerville, gm	Gordon Clark, pd Jack Easterwood, ce	Ed Dittert, sd		Wld. AP RCA
KRIC-FM 1948	Ch. 258 (B) 99.5mc 14kw							
KTRM 1947	990 1,000 DA-1	KTRM Inc. 230 Orleans St. 2-8478 Young, Airwaves Assoc.	Jack Nell, p & nd Joseph S. Trum, gm Bill R. McRae, cm	Roy D. Shotts, pd Ben F. Hughes, ce Tommy O'Brien, sd	Charlie Schmucker, fd Virginia Moon, wd	Pop.: 576,800 Rad. Hms.: 115,150 UP G
BEEVILLE								
KIBL 1949	1490 250	Bee Bcstg. Co. P. O. Box 650 1490	John D. Rossi, ptrn. & gm V. L. Rossi, ptrn. Fred Strong, cm	James V. Rossi, asst. m Bill Bennett, pd James L. Egbert, ce	Gerald Mueller, nd & sd Paul Russell, fd	Pop.: 149,400 Rad. Hms.: 36,980 Ret. Sis.: \$148,223,000	Thes., Wld. AP Ray.
BIG SPRING								
KBST 1936	1490 250	Big Spring Bcstg. Co. 702 Johnson St. 4-6391	ABC, Tex. State Pearson. Assoc. Radio Stations	William J. Wallace, p & gm William L. Cox, cm	J. N. Young Jr., pd & pmm Andrew M. Jones, ce John West, nd	Larry Sanville, sd Bruce Frazier, fd Dorothy Henderson, wd	Pop.: 82,367 Rad. Hms.: 26,570 Ret. Sis.: \$91,862,000	St. AP WE
KTXC 1949	1400 100	Big State Bcstg. Corp. City Park 4-4201	MBS, KBS Best. Melville	V. T. Anderson, p & gm			Pop.: 93,200 Ret. Sis.: \$91,862,000	Wld. UP G
BONHAM								
KFYN 1948	1420 250-D	Bonham Pub. Co. Center St. 915	Clark Bass, gm Leon Patrick, cm	Faye Thornton, pd	Clifton G. Tomlinson, ce		Wld. UP Col.
BORGER								
KHUZ 1947	1490 250	Radio Station KHUZ Inc. Box 110 1600	MBS	R. G. Hughes, p Jack Roberts, m & pd H. W. Blymiller, co-cm	Louis W. Roberts, co-cm Jack Roberts, pd	H. E. Kreiger, ce Jake Saxton, nd & sd Janet Parker, wd	Pop.: 40,000 Rad. Hms.: 20,000 Ret. Sis.: \$45,000,000	Wld., SES. UP Ray.

Data corrected to Dec. 10, 1953. If executives or services for FM are same as AM affiliate names are not repeated. Market Data supplied by stations. FM's in italic. —Non-Commercial Station. CP—Construction Permit issued. D—Day. DA-N—Directional Antenna, night only. DA-1—Directional Antenna, same pattern day and night. DA-2—Directional Antenna, different pattern day and night. L—Limited Time with Dominant Station. LS—Local Sunset. N—Night. SA—Special Authorization. SH—Specified Hours. ST—Share Time. Complete key to abbreviations, page 6.

YOURS IN ONE THROW!

BEAUMONT, PORT ARTHUR, ORANGE, and fabulous SABINE AREA

KFDM

STUDIOS IN BEAUMONT

A real market-coverage bargain! Because — seldom do you find such territorially-important and economically-active cities so close together (all within a radius of less than 20 miles) . . . PLUS — such wide diversification in sources of buyer-income. All the strategic industries shown below — in a compact area of 24 counties — mean **STEADY PAYROLLS**, strong demand, robust sales-performance. Some of the largest refineries and chemical plants in the nation are located in this area. Sell this market with KFDM's complete and concentrated coverage.

Concentrate on this Strong, Diversified-Income Market!

OIL
 SHIPPING, SHIP BUILDING
 CHEMICALS
 LUMBER
 RICE
 CATTLE

5000 watts • 560 kilocycles

AFFILIATED WITH
American Broadcasting Company
Represented by
FREE & PETERS

★ *930,050—Combined Population, including 12 Counties in Texas and 12 Parishes in Louisiana

★ \$776,902,000 — Retail Sales

★ \$1,125,803,000 — Net Effective Buying Income

*Figures compiled by Sales Management for 1953 Survey of Buying Power

BRADY									
KNEL 1935	1490 250	G. L. Burns 7777 Best	G. L. Burns, o & gm J. S. Sloane, cm, pmm & nd	Gene Burns, pd Cecil Nellin, ce Pearly Samuelson, sd	J. W. Halcomb, fd Mary Kirklain, wd	Pop.: 123,527 Rad. Hms.: 24,150 AP	
BRECKENRIDGE									
KSTB 1947	1430 1,000-D	Stephens County Bcstg. Co. Miller Bldg. 1430	KBS Best Melville	R. W. Chapman, p & gm	R. E. Smith, ce	Sid Foster, cm, pd, sd, nd		L-W AP G	
BRENHAM									
KWHI 1947	1280 1,000-D	Tom S. Whitehead Sr. 108½ Main 3655	Tom S. Whitehead Sr. o & gm	J. C. Price, cm Don Dickson Jr., ce	Tommie Blake, sd		Wld., SES, UP G	
BROWNFIELD									
KTFY 1949	1300 1,000-D	Terry County Bcstg. Co. P. O. Drawer 1032 2111	KBS	Mike A. Barrett, o, gm & cm	J. Richard Aker, pd & nd	E. Crawford Taylor, sd Ivan Andersen, ce & fd	Pop.: 186,100 Rad. Hms.: 46,525 Ret. Sis.: \$246,117,000	Wld., St., Cap, UP G	
BROWNSVILLE									
KBOR 1948	1600 1,000-DA-2	Brownsville Bcstg. Co. P. O. Box 472 2-5677	ABC Best	Minor J. Wilson, gm & pd	Vance C. Wilson, cm Willis A. Wilson, ce	Manny Wright, nd & sd Connie Green, wd	Pop.: 350,000 Rad. Hms.: 66,000 Ret. Sis.: \$250,000,000	Thes., Wld. AP	
XEO 1946	970 1,000	Mrs. Candelaria S. Gonzalez Sondock Bldg. Suite 110 6-6620	RCN Oakes, Nat'l. Times Sales, Stewart	Mrs. Candelaria S. Gonzalez, o	Robert N. Pinkerton, gm	Jane Pinkerton, cm Severo Garza, ce		
BROWNWOOD									
KBWD 1941	1380 1,000-D 500-N	Brown County Bcstg. Co. 800 Hawkins St. 2401	MBS, Texas State Net. Pearson	Wendell Mayes, p & gm	Joe B. Foster, cm Wendell Mayes Jr., pd	Barbara Taylor, pmm A. W. Stewart, ce	Pop.: 121,453 Rad. Hms.: 35,921 Ret. Sis.: \$118,756,000 AP RCA	
KEAN 1953	1240 100	Lyman Brown Enterprises							
BRYAN									
KORA 1947	1240 250	Bryan Bcstg. Co. 604 Varisco Bldg. 3-1240	MBS Best	David C. Jones Jr., o & gm Mike Mistovich, cm, pmm & sd	James W. Robertson, ce Ruth Reid, traffic m	Charles Evans II, nd & fd	Pop.: 214,971 Rad. Hms.: 38,483 Ret. Sis.: \$139,085,000 Col.	
CENTER									
KDET 1949	930 1,000-D	Center Bcstg. Co. 250 Austin St. 1189	KBS Best	Tom E. Foster, co-o & gm Tolbert Foster, co-o & pd	Harlan E. Riley, ce Jack Bell, sd	John Mossberg, fd	Pop.: 225,000 Rad. Hms.: 52,000 Ret. Sis.: \$105,000,000	Assoc., UP Col.	
CHILDRESS									
KCTK 1947	1510 250-D	Golden West Bcstg. Co. 217½ Main St. 1085	MBS Best	R. M. Hagan, ptrn. & p	George D. Cowan, ptrn. & gm LeRoy Carter, pd & sd	Nelle Carter, pmm William V. Queen, ce	Pop.: 66,923 Rad. Hms.: 17,420 Ret. Sis.: \$62,734,000 AP Ray.	
CLARKSVILLE									
KCAR (CP)	1350 500-D	Texo Bcstg. Co. c/o The Clarksville Times 96							
CLEBURNE									
KCLE 1947	1120 250-D	Marti Inc. 915 N. Main 5-6643 Best	George W. Marti, p & John Marti, cm	D'Voe Lee, pd Walter Lacy, ce	Monroe Coston, sd Dolores Farris, wd	Pop.: 50,000 Rad. Hms.: 17,000 Ret. Sis.: \$37,000,000 AP	
-KCLE-FM 1949	Ch. 232 (A) 94.3mc 0.32kw						Pop.: 40,000 Rad. Hms.: 13,500 Ret. Sis.: \$31,900,000 AP Com.	
CLEVELAND									
KVLB (CP)	1410 500 DA-2	H. C. Bailes P. O. Box 843 692	H. C. Bailes, o & gm Claude C. McAdams, pd	A. W. Strong, ce				
COLEMAN									
KSTA 1947	1,000 250-D	Coleman County Bcstg. Co. P. O. Box 432 8406	KBS	H. H. Jackson, p Floyd Shelton, gm, nd & fd	Paul Johnson, cm Charley Scott, pd & sd	J. D. Larson, ce Joann Harriss, wd	Pop.: 165,872 Rad. Hms.: 43,224 Ret. Sis.: \$87,683,800	SES, UP Col.	
COLLEGE STATION									
WTAW 1922	1150 1,000-D	A & M College of Tex. 6-6724	KBS	R. Henderson Shuffler, in chg. of sta. Richard L. Webb, sm	Elsie Patranella, cm John M. Scogin, pd Jerry D. Merryman, ce	Charles Parker, sd Dick Hickerson, fd	Pop.: 351,568 Rad. Hms.: 129,470 Col.	
COLORADO CITY									
KVMC 1951	1320 500-D	John & Eldon Mahon Box 990 1320	KBS Best	John B. Mahon, co-o Eldon B. Mahon, co-o	Charles A. Diegel, gm Porter A. Richardson, ce	Myrla Humphreys, wd	Pop.: 101,122 Rad. Hms.: 10,000 Ret. Sis.: \$75,694,000	Thes., Cap, AP RCA	
COMMERCE									
..... (CP)	1450 250	Memorial Bcstg. Co.							
CONROE									
KMCO 1951	900 500-D-DA	Montgomery County Bcstg. Co. 324½ N. Main St. 1130	Reagan Smith, p James C. Dorrell, sm David L. Oglesby, sm Hal H. Coley, pd & nd	James O. McCorquodale, pmm & sd John W. Neathery Jr., ce	Ed Williams, fd Mary McCoy, wd	Pop.: 80,000	St., Thes., UP Col.	

TEXAS

City	Call Letters Established TV Affiliate	Chan. or Freq. Power	Licensee Headquarters Telephone	Network Represent- ative	Owner o; Pres. p; Exec. up evp; Gen. Mgr. gm; Sta. Mgr. sm; Coml. Mgr. cm; Sales Mgr. slm; Prog. Dir. pd; Chief Eng. ce; Prom. Mgr. pmm; Prod. Mgr. pdm; News, Farm, Sports or Women's Dir. nd, id, sd, wd.	Executive Abbreviations	Market Data For Primary Area (Supplied by station)	Library, News Serv. Transmitter
CORPUS CHRISTI								
KCCT (CP)	1150 1,000-D DA	International Radio Co. 403 S. Staples St. 2-6263	Aroldo O. Lerma, ptrn. Gabriel Lozano, ptrn.	Hector de Pena, ptrn. Dr. Hector P. Garcia, ptrn.	Dr. J. A. Garcia, ptrn.	Pop.: 1,120,868 Rad. Hms.: 294,960	
KEYS 1941	1440 1,000-D 500-N DA-N	Nueces Bcstg. Co. Centre Theatre Bldg. 2-7411	CBS Taylor	Aubrey Jackson, gm Allan Dale, cm. pd & pmm	Harold Griffith, ce Paul Young, nd Joseph Keith, sd	Bart Boyd, fd Ruth Delmar Sullivan, wd	Pop.: 399,705 Rad. Hms.: 88,323	Wid. UP Col.
KRIS 1937	1360 1,000	Gulf Coast Bcstg. Co. P. O. Box 840 4-6354	NBC, Tex. Quality Net. Free & Peters	T. Frank Smith, p & gm W. M. Elkner, cm Charles Nethery, pd	Bill Crowds, pmm Don Morris, ce Hugh Gray, nd Bill Field, sd	Jack Lozier, fd Marjorie Hazelwood, wd	Pop.: 378,700 Pop.: 82,840 Ret. Sls.: \$374,838,000	St. AP Col.
KSDK 1947	1230 250	Corpus Christi Bcstg. Co. Show Room Bldg. 2-9242	ABC, Tex. State Net. Forjoe	Vann M. Kennedy, p & gm Charles R. Manning, cm	Eugene Looper, pd Forrest Moore, pmm W. K. Bridges, ce	J. K. Wright, nd Mary L. Kennedy, wd		
KUNO 1950	1400 250	KUNO Inc. Box 4286 4-5203	MBS Everett- McKinney	L. C. Smith, p & gm Herb Garrett, cm	H. E. Barrera, pd	J. H. Mayberry, ce	 UP Col.
KWBU 1944	1030 50,000-D	General Baptist Convention of Texas White-Plaza Hotel 4-5258 Branham	Carr P. Collins, p Harry H. Hayes, gm & cm	George A. Wilcox, pd & sd	Nestor Cuesta Jr., ce Liz Bailey, wd	 AP
CORSICANA								
KAND 1937	1340 250	Alto, Inc. State Nat'l. Bank Bldg. 2486	Branham	Luther A. Johnson Jr. p & gm	Perry Taylor, vp & pd			Wid., Thes. UP Col.
CROCKETT								
KIVY 1950	1570 250-D CP: 1290 500-D	Pioneer Bcstg. Co. Box 670 222	KBS	James H. Gibbs, o. m, pd, pmm & nd	Bill Carter, cm & ce Bob Hazlett, sd	Mabel Arledge, wd	Pop.: 38,815 Rad. Hms.: 7,635 Ret. Sls.: \$18,740,000	L-W UP G
CUERO								
KCFH 1949	1600 500-D	A. M. Respondek 5-3430 Best	A. M. Respondek, p & gm	Frank Notzon, cm Robbie Neil, wd		Pop.: 100,100 Rad. Hms.: 7,000	
DALHART								
KXIT 1948	1410 500-D	Dalrad Associates P. O. Box 1350 740	KBS Best	Ed Bishop, p	Ken Bishop, gm	Bill Smith, ce		Wid. UP G
DALLAS								
KGKO 1953	1480 1,000-D 500-N-DA-1	Lakewood Bcstg. Co. Cliff Tower Hotel Westbrook 7594 McGillvra	Leonard Coe, gm Bill Morgan, cm	Bud Vincent, pd Henry Steele, pmm	Henderson Rogers, ce	 UP G
KIXL 1947	1040 1,000-D	Variety Bcstg. Co. Inc. 1401 S. Akard St. Riverside 4521	Good Music Bcstrs. Assoc. Pearson	Lee Segall, p Thomas W. Massey, gm Charles F. Payne, asst. m	Martin Gudenberg, mus. d Bob Tripp, ce	Shirley J. Harris, traffic m Don Robinson, nd Mrs. Tim Healy, wd	Pop.: 1,558,724 Rad. Hms.: 364,200 Cap. Mac. Ret. Sls.: \$1,824,754,000	Wid., St. Assoc. Thes., Assoc. AP WE
KIXL-FM 1947	Ch. 283 (B) 104.5mc 34kw							
KLIF 1947	1190 5,000-D 1,000-N- DA-N	Trinity Bcstg. Corp. 2104 Jackson St. Randolf 7121 H-R Reps.	B. R. McLendon, p Gordon B. McLendon, exec. d & sd	Bill Weaver, gm Hal Bokke, pd & nd	Les Vaughn, pdm Glenn Callison, ce	Pop.: 1,823,300 Rad. Hms.: 499,540 Ret. Sls.: \$2,027,081,000 UP WE, Ray.
KRLD 1926	1080 50,000-DA-N	KRLD Radio Corp. Herald Sq. Randolph 6811	CBS Branham	John W. Runyon, chmn. of bd. Clyde W. Rembert, p & gm J. W. Crocker, asst. gm William A. Roberts, asst. gm in chg of sis.	Ted Parrino, pd A. J. Putman, pmm B. B. Honeycutt, ce A. H. Plumlee, traffic m H. W. Giersdorf, mus. librarian	Paul James, record librarian Jay Hogan, nd Ves. Box, sd A. B. Jolley, fd		
KRLD-FM 1948	Ch. 223 (B) 92.5mc 40kw							SES., St., Thes. INS, UP GE
KSKY 1941	660 1,000-D	Sky Bcstg. Service 2927 Maple Randolph 6193	A. L. Chilton, p R. G. Terrill, gm & pmm	R. L. Kanatzar, cm Leonard Holland, pd, nd, sd & fd	Morris M. Ming, ce Mrs. L. H. Chilton, wd	Pop.: 2,050,806 Rad. Hms.: 474,510 UP RCA

Data corrected to Dec. 10, 1953. If executives or services for FM are same as AM affiliate names are not repeated. Market Data supplied by stations.
 FM's in italic. *—Non-Commercial Station. CP—Construction Permit issued. D—Day. DA-N—Directional Antenna, night only. DA-I—Directional Antenna, same pattern day and night. DA-2—Directional Antenna, different pattern day and night. L—Limited Time with Dominant Station. LS—Local Sunset. N—Night. SA—Special Authorization. SH—Specified Hours. ST—Share Time. Complete key to abbreviations, page 6.

A Lesson to Remember

Yes.. 68 Secondary Radio Stations dot the map within KRLD's 0.5 Mv line...an impossible number for most advertisers to cover the area. But then, fortunately they don't have to... They can saturate it completely at one low cost, with one great 50,000 watt station, KRLD.

30.8% of All Radio Homes in the Great State of Texas are regular listeners to

KRLD, DALLAS

Exclusive outlet for CBS Network Programs in the Southwest's Largest Market

DALLAS and FORT WORTH

SAMS Report,
Spring 1952

1-68

DOWN IN TEXAS!

PRIMARY AREA OVERLAPS ADEQUATELY, BUT NOT EXCESSIVELY, OTHER SURROUNDING MAJOR MARKET STATIONS.

"THE MAKE SENSE BUY"

NO WASTE COST



KRLD

Dallas

THE BIGGEST BUY IN THE BIGGEST MARKET IN THE BIGGEST STATE

Owners and Operators of
KRLD-TV Maximum Power Station
100,000 Watts Video and 50,000 Watts Audio

The TIMES HERALD Stations The BRANHAM COMPANY, Exclusive Representative

JOHN W. RUNYON, Chairman of the Board
CLYDE W. REMBERT, President

TEXAS

City	Call Letters Established TV Affiliate	Chan. or Freq. Power	Licensee Headquarters Telephone	Network Represent- ative	Owner o; Pres. p; Exec. up evp; Gen. Mgr. gm; Sta. Mgr. sm; Coml. Mgr. cm; Sales Mgr. slm; Prog. Dir. pd; Chief Eng. ce; Prom. Mgr. pmm; Prod. Mgr. pdm; News, Farm, Sports or Women's Dir. nd, fd, sd, wd.	Executive Abbreviations	Market Data For Primary Area (Supplied by station)	Library, News Serv. Transmitter	
DALLAS--(Cont'd)									
WFAA	1922	820 50,000	A. H. Belo Corp. 1122 Jackson St. Riverside 9831	ABC, NBC, Texas Quality	E. M. Ted Dealey, p Alex Keese, gm George K. Utley, cm Karl Lambert, pd & asst. m	Wynona Portwood, pmm Wm. C. Ellis, ce Sid Pietzsch, nd	Murray Cox, fd Ralph Widman, sd Carolyn Coker, wd	L-W AP, UP RCA	
WFAA-TV		570 5,000-DA-2 SH-WBAP		Net. Petry					
WRR	1920	1310 5,000-DA-N	City of Dallas, Tex. Municipal Radio Bldg. Tenison 6101	MBS, Texas State Net. Blair	Durward J. Tucker, mgng. d & ce Pete Teddlie, sls. coordinator Richard Workman, pd	Charles Frauman, cont. sup. Jack Caruth, co-trans. sup. John G. Owen, co-trans. sup.	Taylor Branch, nd Eddie Hill, sd Al Jones, fd Maxine Koelling, wd	Pop.: 2,061,564 Rad. Hms.: 620,150 Ret. Slis.: \$4,075,863,000	Assoc. AP WE
WRR-FM	1948	Ch. 266 (B) 101.1mc 68kw					Pop.: 2,061,564 Rad. Hms.: 124,030 Ret. Slis.: \$4,075,863,000	Col.	
DEL RIO									
KDLK	1945	1230 250	Del Rio Bcstg. P. O. Box 1162 1745	KBS	Don R. Howard, gm & sd	Edward L. Williams, pd & nd	Pat Jeter, ce Mrs. H. K. Fawcett, wd	St. UP G	
DENISON									
KDSX	1948	950 500-DA-2	L. L. Hendrick & B. V. Hammond P. O. Box 263 3400 (See Sherman, Tex. Listing)	B. V. Hammond, co-o & co-cm L. L. Hendrick, co-o & co-cm	Allen Hundley Jr., m, pd, pmm & nd Joseph D. Knight, ce	John Clift, sd Nick Owen, fd Elsie Boyd, wd	Pop.: 201,600 Rad. Hms.: 65,800 Ret. Slis.: \$160,500,000	L-W AP Ray.
KRRV									
DENTON									
KDNT	1938	1440 1,000-D 500-N-DA-N	Harwell V. Shepard Radio Center Central 4144	Harwell V. Shepard, o		Pop.: 1,250,000	Thes. UP	
KDNT-FM	1947	Ch. 292 (A) 106.3mc 0.76kw							
DUMAS									
KDDD	1948	800 250-D	North Plains Bcstg. Corp. P. O. Box 337 2-5000 Best	Ken Duke, p & gm Al Tremble, cm, pmm & nd	Bill Lask, pd George Pepin, ce	Bill Cunningham, sd Jerry Duke, wd	Pop.: 150,000 Rad. Hms.: 39,000 Ret. Slis.: \$130,000,000	St. AP G
EAGLE PASS									
XEMU		580 5,000-D 250-N	Radio Station XEMU P. O. Box 196 Eagle Pass	Natl. Time Sales	(Located in Piedras Negros, Coah., Mex.)				
EASTLAND									
KERC	1953	1590 500-D	Tri-Cities Bcstg. Co. of Eastland Co.						
EDINBURG									
KURV	1947	710 250-D	KURV Inc. P. O. Box 480 3-2777	KBS ForJoe	Rogers Kelley, p Albert C. Ryan, gm, secy. & sd	Don Mallory, pd, nd & fd Irvan D. Williams, ce	Elizabeth Collier, office m	Pop.: 149,985 Rad. Hms.: 35,000 Ret. Slis.: \$198,000,000	Mac. UP Ray.
EL CAMPO									
KULP	1948	1390 500-D	Wharton County Bcstg. Co. P. O. Box 1390 1390	L. T. Culp Krueger, p Bob Hathaway, m William L. Burnell, cm	Jerry Werlla, pd & nd William Reading Jr., pmm & sd	Joe H. Miller, ce S. R. Hermansen, fd Helen Miller, wd	Pop.: 250,000 Rad. Hms.: 8,500 Ret. Slis.: \$180,000,000	L-W UP Col.
EL PASO									
KELP	1947	920 1,000-D	Trinity Bcstg. Corp. 4530 Delta St. 3-3658 Everett- McKinney	B. R. McLendon, p Joe Roddy Jr., gm & cm	David Pringle, pd David L. Mott, ce	Al Cobb, nd UP Ray.	
KEPO	1948	890 10,000-DA-2	KEPO Inc. 2419 N. Piedras St. 5-2731	ABC Avery- Knodel	Miller C. Robertson, p Willard L. Kline, sm & sls. d	Arthur B. Davis, pd & E. L. Gemoets, ce Charles J. Amador, nd	Jack McElrath, sd Charles J. Amador, rd Darlene Chaffee, wd	Pop.: 335,000 Rad. Hms.: 68,000 Ret. Slis.: \$270,000,000	L-W, St. UP RCA

Data corrected to Dec. 10, 1953. If executives or services for FM are same as AM affiliate names are not repeated. Market Data supplied by stations. FM's in italic. *—Non-Commercial Station. CP—Construction Permit issued. D—Day. DA-N—Directional Antenna, night only. DA-1—Directional Antenna, same pattern day and night. DA-2—Directional Antenna, different pattern day and night. L—Limited Time with Dominant Station. LS—Local Sunset. N—Night. SA—Special Authorization. SH—Specified Hours. ST—Share Time. Complete key to abbreviations, page 6.

Stations are assigned fulltime, but divide time between two channels; NBC rides 820 kc clear channel, ABC rides 570 kc regional channel. When WFAA operates on clear channel, WBAP operates on regional and vice versa. Both channels are for combined coverage of Dallas-Ft. Worth market areas.

BROADCASTING • TELECASTING

is Privileged to Publish

More Texas Radio and Television Station Advertising

Than all other Journals Combined



Go BIG GAME HUNTING in Texas...

You'll bag the limit, sure as shootin', when you aim your sales story at the Southwest's largest, richest market with a sure-fire WFAA formulated program or adjacency. The Petry company will gladly provide a guide.

WFAA-820 MARKET based on 25% 700% coverage, SAMS Spring, 1952 Report **WFAA-570 MARKET**

Population	4,288,700	Population	2,303,500
Families	1,263,200	Families	685,900
Effective Buying Income	\$5,386,771,000	Effective Buying Income	\$3,167,857,000
Retail Sales	4,438,038,000	Retail Sales	2,547,677,000
Food Sales	996,408,000	Food Sales	558,514,000
General Merchandise	610,899,000	General Merchandise	412,762,000
Furniture, Household, Radio.	223,263,000	Furniture, Household, Radio	125,106,000
Automotive Sales	971,442,000	Automotive Sales	510,777,000
Drug Sales	140,546,000	Drug Sales	81,008,000

(Sales Management, May 10, 1953)



ALEX KEESE, Station Manager
EDWARD PETRY & COMPANY • National Representatives

RADIO SERVICE OF THE DALLAS MORNING NEWS

City	Call Letters	Chan. or Freq. Power	Licensee Headquarters Telephone	Network Representative	Executive Abbreviations	Market Data For Primary Area (Supplied by station)	Library, News Serv. Transmitter
EL PASO—(Cont'd)							
KROD	600		El Paso Times Inc.	CBS.	Dorrance D. Roderick, chmn. of bd.		Cap. AP
KROD-TV	5,000-DA-N		2201 Wyoming St. 2-6551	Southwest Branham	Val Lawrence, p, gm & cm		AP RCA
KSET	1340		Rio Grande Bestg. Co. Inc. 904 Magoffin 326-93	MBS.	Fred Hervey, p		Cap. AP
KSET	250			Inter-mountain McGillvra	George R. Thady, gm		AP RCA
KTSM	1380		Tri State Bestg. 801 N. Oregon 2-5423	NBC	Karl O. Wyler, p & gm		Pop.: 528,000
KTSM-TV	1,000-D			Holling-bery	Roy T. Chapman, vp & cm		Rad. Hms.: 52,000
XEJ	970		Pedro Meneses H. P. O. Box 442	Natl. Time Sls.	Pedro H. Meneses, p		Ret. Sls.: \$280,103,000
XEJ-TV	10,000-D		Juarez 111	Oakes	M. D. Heredia, gm		Pop.: 617,000
					Blanca-Rosa Meneses, cm		Rad. Hms.: 122,962
					Roberto Soto, pd		Ret. Sls.: \$569,431,000
					Ramon Hurtado, pmm		
					Jose Luis DeLira, ce		
					Froylan Rascon, nd		
					Francisco Herrera, sd		
					Gilberto Nathal, fd		
					Dora Portillo, wd		
FALFURRIAS							
KBLP	1280		Ben L. Parker				
(CP)	500-D						
FLOYDADA							
KFLD	900		W. Tex. Bcstrs. Ralls Hwy. 900	KBS	Ed Holmes, p		Pop.: 270,000
1950	250-D			Continental	Wayne Robison, gm, cm, pmm & fd		Rad. Hms.: 225,000
							Ret. Sls.: \$291,500,000
FT. STOCKTON							
KFST	860		Ft. Stockton Bestg. Co. 860				
(CP)	250-D						
FT. WORTH							
KCNC	870		Blue Bonnet Bestg. Corp. P. O. Box 629		J. H. Speck, p & gm		Pop.: 1,700,000
1947	250-D		Fortune 7175		Herman Clark, cm		Rad. Hms.: 560,000
							UP Ray.
KCUL	1540		East West Bcstrg. 3607 Camp Bowie		Jas. G. Ulmer, p & gm		Pop.: 980,000
1949	5,000-D		Sunset 6555	Burn-Smith	Hewel Jones, cm		Rad. Hms.: 263,000
	1,000-N-DA-2				Dan Allison, pd & nd		Ret. Sls.: \$810,000,000
KFJZ	1270		Tarrant Bestg. 1201 W. Lancaster	MBS.	Gene L. Cagle, p & gm		
1936	5,000-DA-1		Edison 3473	Texas Blair	Charles B. Jordan, vp & asst. m		Assoc. AP WE
					D. C. Hornburg, secy-treas.		
					John Flood Jr., p		
					Joe W. Evans, gm & cm		
KWBC	970		Associated Bcstrs. Inc. 806 Taylor	Rambeau	Jerry Hahn, pd & sd		Pop.: 300,000
1946	1,000-D		Fortune 8262				Rad. Hms.: 294,000
							Ret. Sls.: \$3,500,000
KXOL	1360		Ft. Worth Bestg. 3004 W. Lancaster	Forjoe	Earle Fletcher, p & gm		Pop.: 1,139,950
1947	1,000-DA-N		Edison 1448		Jerry Hahn, pd & sd		UP Ray.
WBAP	820		Carter Publications	ABC, NBC, Tex.	Amon G. Carter, chmn.		Pop.: 1,928,700
1922	50,000		3906 Barnett St.	Quality	Ed Lally, pd		Rad. Hms.: 97.6%
WBAP-TV	570		Lockwood 1981	Lone Star	Howard Fisher, pmm		Ret. Sls.: \$2,267,311,000
	5,000-DA-2			Free & Peters	R. C. Stinson, ce		Assoc., Wid. Cole AP RCA
	ST-WFAA				James A. Byron, nd		
WBAP-FM	Ch. 263 (B)						
1949	100.5mc 50kw						

* Stations are assigned fulltime, but divide time between two channels: NBC rides 820 kc clear channel, ABC rides 570 kc regional channel. When WFAA operates on clear channel, WBAP operates on regional and vice versa. Both channels are for combined coverage of Dallas-Ft. Worth market areas.

EL PASO -

A bright spot in the Southwest

KROD -

A bright spot in El Paso

COVERAGE
24 County El Paso Trade Territory
plus 3 additional counties

GROWTH
488,244 Population,
38.8% increase since 1940

RADIO HOMES
119,650

AUTOMOTIVE SALES - \$101,201,000

FOOD SALES
\$120,633,000

Affiliated With KROD-TV • VHF 4
and the EL PASO TIMES



LOOK AT THIS
E. P. *

- Newspaper Ads. and Publicity
- 24 Sheet Posters
- Merchandising - Dealer Calls
- Courtesy Announcements
- Texas - Size Post Cards
- P.O.P. Displays
- Sales Meetings
- Promotion Reports

CBS RADIO NETWORK IN EL PASO

KROD

600 KC 5,000 WATTS

Represented Nationally By THE BRANHAM COMPANY "Let A Branham Man Help You"

*Effective Promotion



You Go First Class

WITH

WBAP's

GREATER COVERAGE

TREMENDOUS MARKET

FINER FACILITIES

SUPER PROGRAMMING



MASTER CONTROL



STUDIO D

WBAP-820 MARKET

Population	4,288,700
Families	1,263,200
Effective Buying Income	\$5,386,771,000
Retail Sales	4,438,038,000
Food Sales	996,408,000
General Merchandise	610,899,000
Furniture, Household, Radio	223,263,000
Automotive Sales	971,442,000
Drug Sales	140,546,000

WBAP-570 MARKET

Population	2,303,500
Families	685,900
Effective Buying Income	\$3,167,857,000
Retail Sales	2,547,677,000
Food Sales	558,514,000
General Merchandise	412,762,000
Furniture, Household, Radio	125,106,000
Automotive Sales	510,777,000
Drug Sales	81,008,000

SAMS Spring, 1952 Report (Sales Management, May 10, 1953)

\$3 billion market in the Fort Worth-Dallas area alone!
 Finest facilities in the South—six studios, control room for each, individual acoustical designs and a master control room for studio or network switches are just some of the features.

All the outstanding programs from ABC and NBC.
 Write WBAP direct, or see your Free and Peters man.



AM

★ 820 ★

50,000 WATTS

STAR-TELEGRAM STATIONS

ABC

AMON CARTER
Chairman

AMON CARTER, JR
President

HAROLD HOUGH
Director

WBAP

FM

★ 570 ★

5,000 WATTS

FORT WORTH, TEXAS

NBC

GEORGE CRANSTON
Manager

ROY BACUS
Commercial Manager

TEXAS

City	Call Letters Established TV Affiliate	Chan. or Freq. Power	Licensee Headquarters Telephone	Network Represent- ative	Owner o; Pres. p; Exec. up evp; Gen. Mgr. gm; Sta. Mgr. sm; Coml. Mgr. cm; Sales Mgr. slm; Prog. Dir. pd; Chief Eng. ce; Prom. Mgr. pmm; Prod. Mgr. pdm; News, Farm, Sports or Women's Dir. nd, fd, sd, wd.	Executive Abbreviations	Market Data For Primary Area (Supplied by station)	Library, News Serv. Transmitter	
FREDERICKSBURG									
	KNAF 1947	1340 250	Gillespie Bcstg. Co. Box #347 311	MBS. KBS	Arthur Stehling, p Norbert A. Fritz, gm. cm & ce	Walter Fuhrmann, fd Alene Fritz, wd	Pop.: 21,000 Rad. Hms.: 3,500 AP G	
FREEMONT									
	KBRZ 1952	1460 500-D	Brazosport Bcstg. Co. Box 1077 3-2655	Kelly Bell, p Rex Bodoin, gm Jack Howard, cm	Will Coker, pd & nd Charles Dunaway, pmm & sd	Pop.: 75,000 Rad. Hms.: 87% Ret. Sis.: \$57,341,000	Wid. AP WE	
GAINESVILLE									
	KGAF 1947	1580 250-D	Gainesville Bcstg. Co. Inc. 204 E. California St. 834	KBS Melville	Joe M. Leonard Sr., p & gm Earl Leonard, cm & nd	Frank Fancher, pd & sd Cordell Martin, ce	Pop.: 140,000 Rad. Hms.: 40,000	Cap. AP Ray.	
GALVESTON									
	KGBC 1947	1540 1,000-D 250-N DA-N	Galveston Bcstg. Co. 815 Marine Lindale Addn. 3-5352 Pearson	James W. Bradner Jr., o & gm Roger Beane, asst. gm & pd	Orland O. Dodson Jr., cm & pmm Ken Gilmore, ce Alec Gifford, nd	Pop.: 751,964 Rad. Hms.: 182,991 Ret. Sis.: \$140,110,000 AP Ray.	
	KLUF 1922	1400 250	KLUF Bcstg. Co. Haden Bldg. 5-6676 Rambeau	George Roy Clough, p & gm Lee D. Clough, vp, ce & nd	Braden E. Clough, asst. to p, cm & pd	Helen D. Clough, treas.	Wid. UP RCA	
	KLUF-FM 1948	Ch. 295 (B) 98.7mc 3kw							
GLADEWATER									
	KSLJ 1949	1430 1,000-D	Gladewater Bcstg. Co. T. W. Lee Bldg. 2181	Best	C. A. Lee, p Douglas Reeh, gm & sd Tom Perryman, cm & fd	Thomas Reeh, pd & nd Paul Rogers, pmm	Lloyd Johnson, ce Rebecca Russell, wd	Cap. AP G	
GONZALES									
	KCTI 1947	1450 250	Gonzales Bcstg. Co. P. O. Box 158 770	KBS Grand, Cooke	Frank Wilson Jr., ptrn., cm & ce	Lawrence M. Walshak, ptrn. & gm	David Walshak, nd & sd Barbara Hausler, wd	Pop.: 115,000 Rad. Hms.: 31,382 Ret. Sis.: \$70,000,000	SES. AP
GRAHAM									
	KSWA 1948	1330 500-D	Southwestair Inc. P. O. Box 1050 1200 & 1330		Clay E. Thompson Jr., H. V. Newsom, gm, cm, nd & ce	Eugene Turner, pd & sd D. J. Chandler, fd	Alethea M. Albright, wd UP	
GREENVILLE									
	KGVL 1948	1400 250	Truett Kimzey P. O. Box 1015 2066	MBS. KBS, Tex. Net. Pearson	Truett Kimzey, p & gm Leo Hackney, gm Paul D. Robinson, asst. m	James D. Jones, pd & Pat Martin, ce Stafford E. Davis, ce	Bill Rust, sd Jackie Taylor, wd	Pop.: 50,000 Rad. Hms.: 35,000 Ret. Sis.: \$31,234,000 AP
HAMILTON									
	KCLW 1948 KANG(TV)	900 250-D	Hamilton Bcstg. Co. 500	KBS	Clyde Weatherby, p J. H. Smith, gm	All Scott, cm & pd	Carl Kennelly, ce	Thes. UP Col.	
HARLINGEN									
	KGBT 1941 KGBT-TV	1530 50,000-D 10,000-N- DA-N	Harbenito Bcstg. Co. 1519 W. Harrison St. 2200	CBS Pearson	McHenry Tichenor, p & gm I. S. Roberts, natl. & reg. cm	Bob Burton, pd Pat Davis, pmm Harold Jones, ce	Jerry Fisher, nd Jim Lang, fd Mary Helen Guerra, wd	Pop.: 358,000 Rad. Hms.: 68,000	Assoc., ST. UP WE
HENDERSON									
	KGRI 1947	1000 250-D	Henderson Bcstg. Corp. Box 311 4528 Best	Roy B. Cannon, p W. C. Crawford, gm, cm & pmm	John T. Cauley, pd, nd & sd John M. Bolln, ce	Wesley Dean, fd JoAnne Kirkland, wd	Pop.: 175,000 Rad. Hms.: 68,000	Wid., SES. UP WE
HEREFORD									
	KPAN 1948	860 250-D	Marshall Formby Box 868 860 Best	Marshall Formby, o Clint Formby, gm	Tom Hulsey, cm Dennis Surber, ce	Kathleen Cayler, nd Louise Kalka, wd	Pop.: 224,940 Rad. Hms.: 56,446	Thes. UP RCA
HILLSBORO									
	KHBR 1948	1560 250-D	Hill County Bcstg. Co. 594		Ray J. Williams, p				
HOUSTON									
	KATL 1947	1590 5,000-DA-N	Texas Bcstrs. Inc. 412 Main St. Preston 3108 McGillivra	William Harry Talbot, p	King Howard Robin- son, gm & cm Webb Hunt, pd	Betty Mirau, pmm Ed Martin, ce Harry Grier, nd	Pop.: 1,165,000 Rad. Hms.: 356,000 Ret. Sis.: \$1,281,000,000	L-W UP G
	KCOH 1948	1430 1,000-D	Call of Houston Inc. 1 Main St. Charter 1888 Clark	William A. Smith, chmn. of bd. Robert C. Meeker, p & gm	Walter L. Rubens, asst. m & cm Vernon Chambers, pd & sd	Harrol Tillman, nd Harold Weinzal, ce Hatti Holmes, wd	Pop.: 352,584 Rad. Hms.: 114,086 Ret. Sis.: \$621,216,295	Assoc., Wid. UP G
	KLBS 1948	610 5,000 DA-2	Howard Bcstg. Co. Milby Hotel Preston 1161 Everett- McKinney	Howard W. Davis, p Howard L. Burris, vp Glenn Douglas, gm	Bill Pelham, asst. m Bill Stewart, pd	Glenn Cook, ce	Pop.: 2,250,000 Rad. Hms.: 250,000 Ret. Sis.: \$1,000,000,000	Wid. UP WH
	KNUZ 1948 KNUZ-TV	1230 250	Veteran Bcstg. P. O. Box 2135 Keystone 2581 Forjoe	Max H. Jacobs, p David H. Morris, gm Bill Lightfoot, cm	Ken Grant, pd George Johnson, pmm O. C. Crossland, ce	Bill Crawford, nd Jack Lee, sd	Pop.: 1,103,000 Rad. Hms.: 338,000	L-W UP G
	KPRC 1925 KPRC-TV	950 5,000-DA-N	The Houston Post Co. Box 1234 Madison 9271	NBC, Tex. Quality Net. Petry	W. P. Hobby, p Jack Harriss, vp & gm Jack McGraw, cm	Francis Sullivan, pd Kirt Harriss, pmm Harvey Wheeler, ce	Pat Flaherty, nd Bruce Layer, sd Bill McDougall, fd	Pop.: 1,490,400 Rad. Hms.: 698,080 Ret. Sis.: \$1,943,914,000	Thes. AP RCA
	KPRC-FM 1946	Ch. 275 (B) 102.9mc 57kw						Pop.: 1,423,000 Rad. Hms.: 458,040	

Data corrected to Dec. 10, 1953. If executives or services for FM are same as AM affiliate names are not repeated. Market Data supplied by stations. FM's in italic. *—Non-Commercial Station. CP—Construction Permit issued. D—Day. DA-N—Directional Antenna, night only. DA-1—Directional Antenna, same pattern day and night. DA-2—Directional Antenna, different pattern day and night. L—Limited Time with Dominant Station. LS—Local Sunset. N—Night. SA—Special Authorization. SH—Specified Hours. ST—Share Time. Complete key to abbreviations, page 6.

Only the Best STAYS First

In Houston, the South's FIRST market, KPRC continues conclusively FIRST. For 28 years, KPRC has shown top results because of leadership in popular live local programs . . . top local news coverage . . . audience rating . . . cost per thousand . . . coverage . . . network affiliation.

Behind these facts stand a sound organization of top personnel, hustling audience promotion and merchandising, plus public acceptance and prestige built up throughout the years.

FIRST by FIRST, and all combined, KPRC is the best buy in the Gulf Coast area. Call Edward Petry & Co., or write us direct for availabilities.

KPRC

HOUSTON

First

- FIRST** in Circulation
- FIRST** in News
- FIRST** in Ratings
- FIRST** in Local Talent
- FIRST** in Live Shows
- FIRST** in Merchandising and Promotion
- FIRST** in Public Service
- FIRST** in Physical Equipment

NBC and TQN on the Gulf Coast

JACK HARRIS

Vice President and General Manager

Nationally Represented by

EDWARD PETRY & CO.

TEXAS

City Call Letters Established TV Affiliate	Chan. or Freq. Power	Licensee Headquarters Telephone	Network Represent- ative	Owner o; Pres. p; Exec. vp evp; Gen. Mgr. gm; Sta. Mgr. sm; Coml. Mgr. cm; Sales Mgr. slm; Prog. Dir. pd; Chief Eng. ce; Prom. Mgr. pmm; Prod. Mgr. pdm; News, Farm, Sports or Women's Dir. nd, fd, sd, wd.	Executive Abbreviations	Market Data For Primary Area (Supplied by station)	Library, News Serv. Transmitter
HOUSTON—(Cont'd)							
KTHT 1944	790 5,000-DA-2	Texas Radio Corp., P. O. Box 3011 Keystone 5535	MBS, Texas Net. H-R Reprs.	Robert Straus, p Bill Bennett, vp, gm & cm Tim Osborne, pd	Lauri Schutt, pmm O. B. Johnson, ce Ted Nabors, pub. rel. d & fd	Ray Conaway, nd Loel Passe, sd Katie Houston, wd	Pop.: 2,150,000 Rad. Hms.: 485,000 UP G
KTRH 1930	740 50,000-DA-1	KTRH Bcstg. Co Rice Hotel Preston 4361	CBS, Texas Bcstg., Texas State Net. Blair	B. F. Orr, p Ray Herndon, m Ray Bright, slm	Tom Jacobs, pd Helen Bender, prom. d Tom Hiner, tech. d	Lew Lowry, prod. d Bob Hart, nd George Roesner, fd Wld. AP, UP, INS RCA
KTRH-FM 1947	Ch. 266 (B) 101.1mc 29.5kw						SES.
KXYZ 1941	1320 5,000	Shamrock Bcstg. Co. Gulf Bldg. Capitol 6151	ABC Free & Peters	Glenn H. McCarthy, p Fred Nahas, evp & gm Ted Hills, sm & cm Kenneth Bagwell, pd Alice Pugh, pmm Gerald R. Chinski, ce	Kenneth Duran, pdm Thomas Cavanagh, asst. cm Tharon Teage, bus. m	Roland Baker, nd Guy Savage, sd Tim Nolan, fd Joy Mladenka, wd	Pop.: 1,200,000 Rad. Hms.: 362,000 St. Cap. UP RCA
KXYZ-TV	DA-N						
HUNTSVILLE							
KSAM 1938	1490 250	Huntsville Bcstg. Co. Box 312 30	MBS, KBS	M. B. Cauthen, p Ted Lott, gm & nd	Roy Greer, cm, pd & pmm	Jack Nichols, ce Wesley Sherrill, fd	Pop.: 34,000 Rad. Hms.: 6,300 Ret. Sis.: \$113,523,000 Cap. SES. AP G
JACKSONVILLE							
KEBE 1948	1400 250	Billy Averitte Laurie Box 1071 2211	KBS	Billy Averitte Laurie, p, gm & ce Mrs. B. A. Laurie, pd, pmm & office m	Jerry D. Spencer, cm Sam Albright, nd & sd	C. Metz Heald, fd Emo Laurie, wd	Pop.: 73,000 Rad. Hms.: 16,000 Ret. Sis.: \$7,936,000 L-W AP
JASPER							
KTXJ 1948	1240 250 CP: 1350 1,000-D	Jasper Bcstg. Co. Texas Theatre Bldg. 580		Joe L. Fisher, p Farrell M. Brooks, o & m			
JUNCTION							
KMBL 1951	1450 250	Kimble Co. Bcstg. Co. 70					
KERMIT							
KERB 1950	600 1,000-D-DA-1	Radio Station KERB Inc. 112 Hghwy. 302 3481	G. H. Cook, p H. J. Porter, evp & gm J. E. Stanton, cm	Ray Boyd Kilman, pd & sd	Bobby Shackelford, ce Chas. E. McFarland, nd	Pop.: 193,648 Rad. Hms.: 67,150 Ret. Sis.: \$335,750,000 Thes. SES. UP Ray.
KERRVILLE							
KERV 1948	1230 250	Kerrville Bcstg. Co. P. O. Box 791 900 Best	W. Scott Schreiner, p William G. Field, gm & nd	Carol Woodard, pd Clyde Jones, ce Don Renavet, sd	Guy Powell, fd Virginia Ward, wd	Pop.: 52,000 Rad. Hms.: 10,021 Ret. Sis.: \$48,524,000 Cap. AP Ray.
KILGORE							
KOCA 1936	1240 250	Radio Station KOCA Inc. Box 989 2001	KBS	Roy G. Terry, p H. A. Degner, gm Wayne Douglas, cm & sd	John Andrews, pd & nd Britt Lamb, ce	Ray Beasley, fd Shirley Rae, wd	Pop.: 250,000 Rad. Hms.: 102,000 Ret. Sis.: \$89,241,242 AP Col.
KINGSVILLE							
KINE 1948	1330 1,000-D	Radio Station KINE Inc. 205 E. King St. 2-2822 Best	James H. Clement, p Ben A. Glusing, gm	Eston R. Pace, sm, cm & pmm	Jerry Fullerton, pd R. T. Whitaker, ce Cap. UP Ray.
LAMESA							
KPET 1947	690 250	Lamesa Bcstg. Co. Box 30 2404	KBS	R. O. Parker, co Bob Bradbury, gm & nd	Clayton Barkhurst, cm Geneva Crutcher, pd	Roland Ouelette, ce Bob Harris, sd	Pop.: 96,811 Rad. Hms.: 24,178 Ret. Sis.: \$118,096,000 Wld. AP G
LAMPASAS							
KCYL 1952	1450 250	Lampasas Bcstg. Co. 1000 Best	V. Dean Turner, p, gm & cm Albert Mason Jr., pd, ce & sd	James E. Nugent, secy. Lester Pitts, nd Harrison Stevens, fd	Warahidine Wheeler, wd	Pop.: 50,000 Rad. Hms.: 3,987 Ret. Sis.: \$25,053,000
LAREDO							
KVOZ 1952	1490 250	Border Bcstrs. Inc. P. O. Box 1498 3-4396	MBS, KBS, Texas Coast Net. Pearson	E. J. Harpole, p Burney Jones, m	Robert Oden, cm Evelyn Jones, pd	Frank Manuel, ce	Pop.: 59,000 Rad. Hms.: 11,474 Ret. Sis.: \$42,768,000 UP RCA
LEVELLAND							
KLVT 1949	1230 250	Forrest Weimhold Farm-Market Hghwy. 1030 Melville	Forrest Weimhold, p Victor King, gm Bobby Garrison, cm	James Bouthinghouse, pd & nd Gilbert W. Patschke, ce	Gerald H. Sanders, sd Artie Forehand, fd Mildred Hopkins, wd	Pop.: 200,000 Rad. Hms.: 55,000 Ret. Sis.: \$275,000,000 Wld., Thes. AP RCA
LITTLEFIELD							
KVOW 1947	1490 250	Southwestern Bcstrs. Box 192 400	KBS	J. C. Rothwell, p & pmm J. B. McShan, gm & cm	Othell Whitson, pd & wd Wilton Highfill, ce	Archie Gray, nd Lloyd Spencer, sd Emil Macha, fd	Pop.: 153,909 Rad. Hms.: 51,203 Ret. Sis.: \$162,000,000 SES. AP G

Data corrected to Dec. 10, 1953. If executives or services for FM are same as AM affiliate names are not repeated. Market Data supplied by stations. FM's in italic. *—Non-Commercial Station. CP—Construction Permit issued. D—Day. DA-N—Directional Antenna, night only. DA-1—Directional Antenna, same pattern day and night. DA-2—Directional Antenna, different pattern day and night. L—Limited Time with Dominant Station. LS—Local Sunset. N—Night. SA—Special Authorization. SH—Specified Hours. ST—Share Time. Complete key to abbreviations, page 6.

LONE STAR

KLST 1300 Lone Star Bcstg. c/o Pierce P.
(CP) 500-D Co. Brooks
Nat'l. Bankers
Life Ins. Corp.
Dallas

LONGVIEW

KFRO 1370 Voice of Longview ABC, KBS, James R. Curtis, p John Allen, cm Howard Kuhn, pd Pop.: 142,200 L-W
1935 1,000-DA-N Curtis Bldg. Tex. State Cooke AP
411 Ret. Sis.: \$149,630,000 RCA

KLTI 1280 LeTourneau R. G. LeTourneau, p Allen E. Vinson, cm Kenneth Maxwell, ce Pop.: 174,400 St., Cap.
1948 1,000-D Radio Corp. Arthur L. Greene, gm Ruby Cooper, pd Jack Brush, nd Rad. Hms.: 43,800 UP
P. O. Box 1866 4331 Ret. Sis.: \$96,052,000 Ray.

KLTI-FM Ch. 290 (B) Assoc., St.
1948 105.9mc UP
9.8kw GE

LUBBOCK

KCBD 1590 Caprock Bcstg. NBS, Tex. Joe H. Bryant, p & gm Jack Tippit, pmm Choc Hutcheson, nd & Pop.: 250,600 Wld., Assoc.
1947 1,000 Co. Quality George Tarter, cm Frank Lee, ce sd Rad. Hms.: 72,133 AP
KCBD-TV DA-2 5600 Avenue A Net. John Devine, pd Robert L. Snyder, bus. m Ret. Sis.: \$343,248,000 WE

KDAV 580 Western Bcstg. D. P. Pinkston, p, gm Tom Moss, continuity Corwin Riddell, nd Pop.: 500,000
1953 500-D- Co. & cm d Tom Moss Jr., sd Rad. Hms.: 170,000
DA Box 1319 W. J. Duncan, pd Dorothy Kissinger, traffic m

KDUB 1340 Texas Telecasting W. D. Rogers Jr., p. Corwin Riddell, nd Pop.: 500,000
(CP) 250 Inc. 7400 College Ave. 5-9388 Ret. Sis.: 170,000

KFYO 790 Plains Radio ABC W. B. Walker, p Leon E. Harris, cm & Dan Tarpley, nd Pop.: 648,100 Cap., St.,
1927 5,000-D Bcstg. Katz Parker F. Prouty, vp pmm Jack Dale, sd Rad. Hms.: 174,155 The.
KFYO-TV 1,000-N- 914 Ave. J Gordon Thompson, gm Robert Nash, pd Jack Creel, fd Ret. Sis.: \$784,404,000 AP, UP
DA-2 5-5567 W. S. Bledsoe, ce Peggy Bell, wd RCA

KSEL 950 Lubbock Bcstg. MBS Walter G. Russell, co Wes Youngblood, pd & H. I. Kiefer, nd Pop.: 370,000 L-W
1946 1,000-D Co. Rambeau M. M. Rochester, gm & sd E. J. Watkins, fd Rad. Hms.: 105,230 AP
500-N- Box 1524 pmm Roger V. Hively, ce Ret. Sis.: \$479,048,000 Col.
DA-N 3-0484 W. H. Kyle, cm

KVSP 1460 Hub Bcstg. Co. Wayne D. Tibbs Jr., gm Randall Abernathy, Charles Ferry, nd & pd
1953 500-D 52nd & Magnolia Indie. James G. Jarrett, asst. m Don Edwards, ce
4-1460 G. Grant Hal Ragan, cm

LUFKIN

KRBA 1340 Darrell E. Yates ABC, KBS Darrell E. Yates, o. Thomas Lubke, pmm Woodrow Behannon, L-W, Cole
1938 250 P. O. Box 755 Continental gm & cm Ambrose Maxim, ce sd Morris Blades, fd UP
3-6661 Virginia Fenley, pd & Lewis Sundquist, nd Col.

KFYO

Lubbock, Texas

790 KC

5,000-Day

1,000-Night

ABC

**LUBBOCK'S TOP STATION
AND BEST BUY BECAUSE . . .**

- 27 years of making friends—and sales
- Strongest voice on the South Plains of Texas
- Covers retail trading area of 174,155 Radio Homes
- Selected most often by local and national advertisers
- Favorite of the economically—potent farm audience
- Listeners' choice in high ranked per-capita income market
- Most complete news coverage: AP-UP-Lubbock
Avalanche-Journal

Represented By *The Katz Agency, Inc.*

TEXAS

City	Call Letters Established TV Affiliate	Chan. or Freq. Power	Licensee Headquarters Telephone	Network Represent- ative	Owner o; Pres. p; Exec. vp evp; Gen. Mgr. gm; Sta. Mgr. sm; Coml. Mgr. cm; Sales Mgr. sm; Prog. Dir. pd; Chief Eng. ce; Prom. Mgr. pmm; Prod. Mgr. pdm; News. Farm. Sports or Women's Dir. nd, fd, sd, wd.	Executive Abbreviations	Market Data For Primary Area (Supplied by station)	Library, News Serv. Transmitter	
LUFKIN—(Cont'd)									
KTRN 1947	1420	1,000-DA-N	Forest Capital Bcstg. Co. P. O. Box 701 3-7771	MBS, Tex. State Net. Venard	R. W. Wortham Jr., p Richman G. Lewin, gm Murphy Martin, cm	Royce Christenson, pd Carl King, pmm Fred Clinton Hill, ce	Roger Sizoo, nd & sd Hampton Keathley, fd Laverne Jones, wd	Pop.: 95,500 Rad. Hms.: 26,000 Ret. Sis.: \$97,000,000	Wid. AP Ray.
MARLIN									
KMLW 1953	1010	250-D	Falls County Public Service P. O. Box 335 6-2551	Hugh M. McBeath, gm & ce	Duane W. Ramsey, cm Jerry S. Hughes, pd & nd	Pop.: 275,901 AP G	
MARSHALL									
KMHT 1947	1450	250	Marshall Bcstg. Co. 109 W. Rusk St. 5-7826	MBS, Tex. State Net.	Earle Fletcher, p Myrl Stein, gm	John Strength Jr., cm George Warwick, pd	R. L. Clay, ce	Pop.: 45,000 Rad. Hms.: 12,250 Ret. Sis.: \$35,953,000	L-W AP Col.
McALLEN									
KRIO 1947	910	1,000-DA-1	Frontier Bcstg. Co. Inc. P. O. Box 1551 6-5454	ABC, Tex. State Net. Weed	Gene L. Cagle, p Charles B. Jordan, vp George C. Breeding Jr., gm	Normand Mann, pd William H. Meiners, ce	"Chuck" McKasson, nd & fd Dick Richmond, sd	Pop.: 23,000 Rad. Hms.: 68% Ret. Sis.: \$29,717,000 AP WE
XEOR 1950	1390	1,000	Mrs. Candelaria S. Gonzalez Nassar Bldg. 6-8112	RCN Natl. Time Sis., Oakes, Stewart	Mrs. Candelaria S. Gonzalez, o Robert N. Pinkerton, gm	Jane Pinkerton, cm	Severo Garza, ce		
McCAMEY									
KCMR (CP)	1450	250	Sprayberry Bcstg. Co.	Jack W. Hawkins, p	Gene Hendryx, gm		Pop.: 32,000 Rad. Hms.: 8,600 Ret. Sis.: \$18,000,000	
McKINNEY									
KMAE 1947	1600	1,000-D	McKinney Air Enterprises Inc. 218 E. Va. St. 2-2651	George W. Smith Jr., p, gm & ce	Melvin Belew, cm & pmm Denise Smith, pd & wd	C. W. Rampy, nd H. D. Mouzon, sd	Pop.: 1,500,000 Rad. Hms.: 377,401 Ret. Sis.: \$1,590,637	L-W, Wid. AP
MIDLAND									
KCRS 1935	550	5,000-D 1,000-N- DA-2	Clarence Scharbauer Jr., & Ruth Scharbauer P. O. Box 1072 2-4393	ABC, Tex. State Net. Pearson	Clarence Scharbauer Jr., co-o Ruth Scharbauer, co-o Wallace R. Jackson, gm	Eleanor McDonald, cm Dean Baker, pd & pmm	Tom Yates, ce John Drummond, nd Bob Byron, sd	Pop.: 600,000 Rad. Hms.: 9,460 Ret. Sis.: \$38,056,000	Thes. UP Ray.
KJBC 1950	1150	1,000-D	Jack Cecil 1½ SE Center of Midland 4-5152	KBS	Jack Cecil, o, gm & ce Naomi Boswell, cm	Keith Ward, pd Roth Burr, pmm	Eleanor Rich, wd	Pop.: 115,000	Wid., St. UP Ray.
MINERAL WELLS									
KORC 1946	1140	250-D	J. Elroy McCaw 608 N. Oak 319 & 203	Best	J. Elroy McCaw, o Harry Riley, cm & sd	Ada Moore, pd Ed Roberts, ce	Ollie Carriker, nd Thelma Doss, wd	 AP Ray.
MONAHANS									
KVKM 1947	1340	250	Monahans Bcstrs. Inc. P. O. Box 1118 438 & 439	MBS, KBS. Cactus Southwest Best	(Mrs.) Doris D. King, p J. Ross Rucker, gm, nd & fd	Joe Collins, cm & pmm John Rosenberger, ce	Don Bassman, sd Edith Bray, wd		Wid. G UP
MT. PLEASANT									
KIMP 1948	980	1,000-D	Mt. Pleasant Bcstg. Co. Box 990 4-4726	Winston O. Ward, p & gm	Ruby Stanley, pd & wd Brad Redfearn, ce	Chas. W. Monk, sd Rusty Reynolds, fd	Pop.: 188,203 Rad. Hms.: 26,965 Ret. Sis.: \$27,500,000	L-W AP G
NACOGDOCHES									
KOSF 1947	1230	250	Kelly Bell P. O. Box 8 4-4633	ABC	Kelly Bell, p J. C. Stallings, gm R. C. Atherton, cm	Lyn Bentley, pd Frank Murray, ce	Ed Rice, nd Billie Stallings, wd	Pop.: 80,000	Wid. UP Col.
KSFA 1947	860	1,000-D	Nacogdoches Bcstg. Co. Inc. 2107 North St. 4-3723	W. C. Fouts, p, co, gm, pmm, cm, merc. m & fd	Sara Jane Moon, pd & wd T. C. Dobbs, ce	J. W. Mitchell, nd Max Neel, sd	Pop.: 187,867 Rad. Hms.: 49,500 Ret. Sis.: \$144,234,000	Thes. AP G
NEW BRAUNFELS									
KGNB 1950	1420	1,000-D	Comal Bcstg. Co. Inc. 184 S. Castwell 1612	KBS Schepps- Reiner	F. T. Wilson, vp, gm, cm & pmm	H. L. Edwards, pd & nd	Bob Stewart, ce Arlon Moeller, sd	Pop.: 829,216 Rad. Hms.: 240,970 Ret. Sis.: \$700,000,000	Thes. AP RCA
ODESSA									
KECK 1947	920	1,000-D 500-N DA-N	Ector County Bcstg. Co. 120 W. 3d 6-5791 Forjoe	Ben Medow, o & gm Sol Scherman, cm Roy A. Eisner, pd & pmm	Dave Williams, ce T. A. Rollins, nd Bill Edwards, sd	Dan Kalenak, fd Jean Robertson, wd		St. AP Ray.
KOSA 1947	1230	250	Odessa Bcstg. Co. 115 W. 6th St. 6-4301	CBS, Southwest Taylor	Cecil L. Trigg, p & gm Jay H. Mehaffey, cm John Vacca, prog. m	Ed Costello, pmm, nd & sd	James Simpson, ce Virginia Heflin, wd	Pop.: 286,300 Rad. Hms.: 80,000 Ret. Sis.: \$330,122,000	Cap. AP RCA
KRIG 1946	1410	1,000-DA-N	Oil Center Bcstg. Co. Crane Hwy. 6-6871	MBS, KBS, Cactus State Net. Best	R. O. Canon, p Jack Hawkins, gm & vp Marguerite Larue, sm	Cliff Allen, cm Gerry Grainger, pd & nd	Barney Hubbs, pmm Jody Singleton, ce Jane Pemberton, wd	Pop.: 205,620 Rad. Hms.: 58,000 Ret. Sis.: \$100,000,000	Wid. UP WE
ORANGE									
KOGT 1948	1600	1,000-DA-N	Sabine Area Bcstg. Co. Lucas Bldg. 8-9336	KBS Best	M. L. Jacobs, p Ed Lovelace, gm & evp	Frank Dusenbury, cm Dean Durham, pd, ce & sd	Walter Wagner, nd	Pop.: 35,100 Rad. Hms.: 5,662 Ret. Sis.: \$27,493,000	Assoc. UP Col.

Data corrected to Dec. 10, 1953. If executives or services for FM are same as AM affiliate names are not repeated. Market Data supplied by stations. FM's in italic. *—Non-Commercial Station. CP—Construction Permit issued. D—Day. DA-N—Directional Antenna, night only. DA-1—Directional Antenna, same pattern day and night. DA-2—Directional Antenna, different pattern day and night. L—Limited Time with Dominant Station. LS—Local Sunset. N—Night. SA—Special Authorization. SH—Specified Hours. ST—Share Time. Complete key to abbreviations, page 6.

PALESTINE

KNET 1450 Palestine Bcstg. B. A. Laurie, p & gm Don Norton, pd & sd Betty Staines, wd Pop.: 115,000 SES.
1936 250 Corp. KBS Marvin Crain, cm, nd George Tubb, ce Rad. Hms.: 45,000 UP
Hotel O'Neil Ray.
8686 & fd

PAMPA

KPAT 1230 J. C. Daniels KBS J. C. Daniels, p Elbert Goodnight, pd Harry Kelly, fd Pop.: 254,550 Cap., St.
1951 250 Ent. Pearson Ed Murphree, gm & ce John Ross, nd Helene Madeva, wd Rad. Hms.: 64,557 UP, INS
4-2551 cm & pmm John Ross Babcock, Al Goodnight, sd Ret. Sis.: \$323,239,000 G

KPDN 1340 Top O' Texas MBS Warren Hasse, co-o & Kay L. Fancher, cm Henry S. Gordon, nd Pop.: 150,000 Wld.
1936 250 Bcstg. Co. sd Gene Smith, ce Billie Pulliam, wd Rad. Hms.: 40,000 AP
Hughes Bldg. Coy Palmer, co-o Ret. Sis.: \$209,778,000 G
4-7461

PARIS

KFTV 1250 Lamar Bcstg. Co. D. W. Brawner, p Dallas Turner, pd & Travis Fodge, ce Pop.: 793,129 SES.
1950 500-D Inc. Jimmy Hendrix, gm, pd & pmm Ret. Sis.: 147,384 UP
210 First Natl. Bank Bldg. cm, nd & sd Ret. Sis.: \$93,981,642 Col.

KPLT 1490 North Star Bcstg. ABC, Tex. Fred Kincaid, p & gm Ruby Riley, pmm Lloyd Neal, fd Pop.: 496,300
1953 250 Co. Inc. State Net. Boyd Kelley, vp Paul Daniels, ce Ann Marshall, wd Rad. Hms.: 142,010 AP
Hwy. 24 Pearson Robert Prichard, cm & Lewis Seibert, secy.- Ret. Sis.: \$377,078,000 RCA
3-3311 William Davis, pd & nd

PASADENA

KLVL 1480 Felix H. Morales Oakes Felix H. Morales, o & Victor Lara Ortegon. Maria Del Carmen Press News
1950 1,000-D CP: 1,000-D Bank Bldg. gm pd & nd Aleman, wd Col.
500-N- Grand 21-361 Vicente Marquez, cm Eugene C. McNailey, ce

PECOS

KIUN 1400 Jack Hawkins & MBS, KBS, Jack W. Hawkins, David Martin, sm, cm Harry Boehnemann, ce Pop.: 37,000
1935 250 Barney Hubbs Cactus, ptrn. & gm Jim Lundquist, sd Jim Lundquist, sd UP
318 S. Cedar St. Southwest Barney Hubbs, ptrn. & Jack James, pd Louise Hawkins, wd Ret. Sis.: \$27,000,000 RCA
999 Net. Best

PERRYTON

KEYE 1400 Great Plains MBS Irvin R. Buchanan, G. K. Rupprecht, pmm Mrs. Irvin R. Pop.: 15,000 L-W, Cap.
1948 250 Bcstg. Co. gm, cm & fd Kenneth Roller, pd, nd Coy Thompson, ce Buchanan, wd Rad. Hms.: 4,000 AP
5771 & sd

PLAINVIEW

KVOP 1400 KVOP Inc. MBS, KBS W. J. Harpole, p Harold Henegar, cm Tut Tawwater, pmm
1944 250 1100 W. 24th Kermit Ashby, gm Doug Sewell, pd Hugh Smith, ce AP
4-2771 RCA

PLEASANTON

KBOP 1380 Ben L. Parker Ben L. Parker, o & gm Neal S. Merritt, pd & Mona Parker, ce & wd Pop.: 1,000,000 Wld., SES.
1951 1,000-D P. O. Box 247 Best A. Terrell, cm & fd nd Rad. Hms.: 250,000 INS
4871 G

PORT ARTHUR

KOLE 1340 Port Arthur Socs Vratiss, ptrn, gm, Neal S. Merritt, pd & Mona Parker, ce & wd Pop.: 1,000,000 Wld., SES.
1947 250 Bcstg. Co. ce & sd nd Rad. Hms.: 250,000 INS
P. O. Box 1126 2-9436 G

KPAC 1250 Port Arthur MBS J. W. Williams, p Gordon Baxter Jr., cm Lester Ledet, sd Pop.: 482,250 St.
1934 5,000-D College Pearson college bd. of trustees Corinne Enos, pd Letha Lee Capland, wd Rad. Hms.: 102,853
1,000-N- Dr. 1515 Lakeshore Marjorie R. Vickers, gm Glenn Newberry, pmm Ret. Sis.: \$407,814,000 RCA
5-7458 George Crouchet Jr., slm

QUANAH

KOLJ 1150 Orville L. Jenkins KBS Orville L. Jenkins, Bob Stabler, slm & Richard Newton, nd Pop.: 351,804
1951 500-D P. O. Box 566 o & gm & co-pd co-pd J. R. Chism, sd Rad. Hms.: 316,623 AP
654 ce Richard O. Dormier, Kay Dunn, wd Ret. Sis.: \$387,867,000 G

ROSENBERG

KFRD 980 Ft. Bend Bcstg. Mart Cole, p Frank Wood, ce Bill Sloan, nd & fd Pop.: 1,243,496 L-W
1948 1,000-D Co. Jim Hairgrove, gm & sd Ret. Sis.: 350,033 UP
Northfield 2-3776 Ret. Sis.: \$1,500,870,000 G

SAN ANGELO

KGKL 980 Angelo Bcstg.- ABC, Tex. Lewis O. Seibert, p Franklin Rainey, pd & William Poteet, ce Pop.: 239,714
1928 5,000-D Telecasting Inc. State Net. gm & pmm nd Bob Milburn, sd Rad. Hms.: 60,080 AP
1,000-N- P. O. Box 850 Pearson Mark Cooper, cm Ret. Sis.: \$249,211,000 RCA
DA-N

KTXL 1340 Westex Bcstg. Co. A. D. Rust, p Jean Dobbins, traffic d Jerry Blair, pmm Wld.
1947 250 Inc. Venard Robt. L. McClellan, gm & wd John Line, fd John Line, fd UP
KTXL-TV 1901 W. Beauregard 7183 Walton A. Foster, cm & nd Robert Benson, ce Marcus Oquin, sd Ret. Sis.: \$229,800,000 WE

SAN ANTONIO

KCOR 1350 KCOR Inc. R. A. Cortez Sr., p Elroy Placer, pd Roger Frias, nd Pop.: 687,622 Mac.
1946 5,000-D KCOR Bldg. R. O'Connel W. P. Smythe, vp R. A. Cortez Jr., pmm Fred Romero, fd & sd Lydia De Garay, wd UP
1,000-N- Cathedral 2-1301 K. R. Hyman, gm Marvin Fiedler, ce Ret. Sis.:
DA-2 Wm. Lamar, cm

KEXX 1250 Manuel D. Leal Manuel D. Leal, o & Fidel Cuellar, pd J. Pepino, fd
1953 500-D 403 N. Flores St. McGilivra gm Charles Harris, ce O. Leal, wd
Garfield 6373 M. Davila, cm J. Barrios, nd Col.

KGBS 680 San Antonio CBS, Tex. George B. Storer, p Bill Joekel, cm Jim Wiggins, sd AP
1926 50,000-D Television Co. State, Tex. George B. Storer Jr.. Art Forrest, pmm Bill Shonette, fd
10,000-N- Milam Bldg. Bcstg. Tex. Bill Jackson, ce Monette Shaw, wd WH
DA-N Fannin 3126 Blair Bill Michaels, sm Ford Mitchell, nd

KITE 930 Radio KITE Inc. Charles W. Balthrope, p Kelly Wofford, cm John Siercovich, ce Pop.: 800,000 L-W
1947 1,000-D Tower Pearson Alex Cole, sm Stanley Nelson, pd Coit Butler, nd Rad. Hms.: 213,860 AP, UP
Fannin 0335 Ret. Sis.: \$2,229,800,000 Col.

KITE-FM Ch. 247 (B)
1951 97.3mc INS
8.3kw GE

TEXAS

City	Call Letters Established TV Affiliate	Chan. or Freq. Power	Licensee Headquarters Telephone	Network Represent- ative	Owner o; Pres. p; Exec. vp evp; Gen. Mgr. gm; Sta. Mgr. sm; Coml. Mgr. cm; Sales Mgr. slm; Prog. Dir. pd; Chief Eng. ce; Prom. Mgr. pmm; Prod. Mgr. pdm; News, Farm, Sports or Women's Dir. nd, fd, sd, wd.	Executive Abbreviations	Market Data For Primary Area (Supplied by station)	Library, News Serv. Transmitter
SAN ANTONIO—(Cont'd)								
	KIWW 1949	1540 250-D	Good Neighbor Bcstg. Co. 518 W. Houston Fannin 5254 Natl. Time Slis., Grant	Joe Olivares, p Felipe Cantu, cm & pd	L. E. Richards, ce & sm	Ann Lincoln, wd Pop.: 300,000 Rad. Hms.: 75,000 UP Col.
	KMAC 1926	630 5,000-DA-2	Howard W. Davis KMAC Bldg. Belmont 3-6211	MBS, Tex. State Net. Walker (KMAC, Am Affiliate)	Howard W. Davis, p gm & cm	Tony Bessan, pd & pmm Alfred Knight, ce	Ted Johnson, nd & sd Charlie Walker, fd WE GE
	KISS(FM) 1946	Ch. 258 (B) 99.5mc 12.7kw						
	KONO 1927	860 5,000-D 1,000-N- DA-N	Mission Bcstg. Co. Inc. 317 Arden Grove Fannin 5171 Forjoe	Eugene J. Roth, p James M. Brown, gm Jack Roth, asst. m	Bob A. Roth, cm & pmm Robert F. Jenkins, pd	George W. Ing, ce Ray Hunt, nd Blake McCreless, fd	Pop.: 1,709,000 Rad. Hms.: 435,110 Cap. AP RCA
	KONO-FM 1948	Ch. 225 (B) 92.9mc, 4.4kw						
	KTSA 1928	550 5,000-DA-N	Sunshine Bcstg. Co. Ave. E at Third St. Garfield 1251	ABC Free & Peters	Frank B. Huntress Jr., p Charles D. Lutz, gm, cm & pmm	Harold H. Carr, pd W. G. Egerton, ce John W. Scott, nd	Gayle Hayes, sd John Rasco, nd Leona Bender, wd	Assoc., Mac. AP, UP GE
	KTSA-FM 1949	Ch. 268 (B) 101.5mc 15kw						
	WOAI 1922 WOAI-TV	1200 50,000	Southland Industries Inc. 1031 Navarro St. Garfield 4221	NBC, Tex. Quality Net. Petry	Hugh A. L. Halff, p James M. Gaines, vp & gm Rex Preis, cm	Perry W. Dickey, pd Morton E. Grossman, pmm	Charles L. Jeffers, ce Henry Howell, nd Bill McReynolds, fd	Pop.: 1,195,600 Rad. Hms.: 1,151,060 Ret. Slis.: \$2,500,000,000 Wid. AP UP INS RCA
SAN MARCOS								
	KCONY 1948	1470 250-D	Central Bcstg. P. O. Box 32 888 Best	Edward C. James, p Tom C. Fleet, gm, nd & sd	Princess J. Fleet, cm Fred Cook, Lockhart d Alfonso Aranda, Spanish m	Burt Johnson, fd Ernie Wood, ce Inez Patton, wd	Pop.: 60,000 Rad. Hms.: 17,000 Ret. Slis.: \$32,000,000 L-W Col.
SEMINOLE								
	KSML (CP)	1250 1,000-D	Marshall Formby KPAN Hereford, Tex.					
SEQUIN								
	KWED 1948	1580 1,000-D	Sequin Bcstg. Co. 200 S. Camp St. 1580 Best	Garfield Kiel, p & gm Stan McKenzie, sm, cm, pmm & fd	Henry Lehnhoff, pd & nd Louie Sowders, ce	John Traeger, sd Faye Chessher, wd	Pop.: 843,600 Rad. Hms.: 146,330 Ret. Slis.: \$580,986,000 UP WE
SEYMOUR								
	KSEY 1950	1230 100	W. C. Moss Jr. Box 1191 2525	KBS	W. C. Moss Jr., p, gm & cm	Elizabeth Lynn Moss, pd & wd Hal Fees, pmm	Luke M. Stripling, ce, sd & fd Perry Nelson, nd	Pop.: 36,774 Rad. Hms.: 9,689 Ret. Slis.: \$31,201,424 L-W AP G
SHAMROCK								
	KEVA 1949	1580 250-D	Shamrock Tex. Bcstg. Co. P. O. Box 21 620	KBS Best	James D. Abbott, gm	Robert J. Beller, cm & ce	Joyce Abbott, pd WE
SHERMAN								
	KRRV 1936	910 1,000-DA-1	Red River Valley Bcstg. Corp. P. O. Box 665 Sherman 201	MBS, Tex. State Pearson	T. B. Lanford, co Tom E. Spellman, gm George Myers, cm (Sherman)	R. W. Tamplen, cm (Denison) Earl Ellington, pd & nd	Don Traphagen, pmm Tom John, ce Dorothy Cox, wd	Assoc. UP WE
	KTAN 1947	1500 250-D	Howard L. Burris Box 661 2910	KBS Best	Howard L. Burris, co William A. Jaco, gm	James T. Shelton, asst. m, ce, nd & fd	Walter Vaughan Jr., pd & sd	Pop.: 81,000 Rad. Hms.: 21,810 Ret. Slis.: \$52,534,000 AP Ray.
SINTON								
	KSPC (CP)	1590 1,000-D	San Patricio Bcstg. Co. Hwy. 181	Tom C. Fleet, p & gm Princess J. Fleet, cm	Ernest C. Wood, ce & pd	Edward Winton, pmm	Wid. AP G
SNYDER								
	KSNY 1949	1450 250	Snyder Bcstg. Co. Box 1468 3-5451	MBS	J. T. Hughes, p & gm Wendell Mayes Sr., vp	Mel Z. Gilbert, cm & pmm Zeb Williams, pd & nd	Jim Pllant, ce J. M. Kayser, sd Dorette Stell, wd	Pop.: 46,940 Rad. Hms.: 17,030 Ret. Slis.: \$34,569,000 L-W UP RCA
STAMFORD								
	KDWT 1947	1400 250	David W. Ratliff 1400	MBS, KBS	Dave Ratliff, p, gm & pmm George Morey, cm & sd	Billy Gray, pd Erick Henske, ce Alan Secan, nd	Billy Watson, fd Glenna Giles, wd	Pop.: 80,296 Rad. Hms.: 28,432 Ret. Slis.: \$51,084,000 AP WE
STEPHENVILLE								
	KSTV 1947	1510 250-D	Stephenville Bcstg. Co. Box 102 L-3141	KBS	Galen O. Gilbert, p, gm & fd	Jack Reeves, cm & nd Jim Farr, pd	John Dyer, pmm & sd Floyd Jeter, ce	Pop.: 50,000 Rad. Hms.: 16,100 Ret. Slis.: \$22,000,000 St. UP
SULPHUR SPRINGS								
	KSST 1947	1230 250	Hopkins County Bcstg. Co. Radio Rd. 1230	MBS, KBS	W. E. Bradford, p, gm & ce	Clovis Plinion, cm & pmm Lona Long, pd & wd	Margaret Thomas, nd Tom Brubaker, fd & sd	Pop.: 100,000 Rad. Hms.: 26,600 AP G
SWEETWATER								
	KXOX 1939	1240 250	Radio & News Inc. P. O. Box 570 4655	MBS, KBS Best	J. S. McBeath, p J. Harley Hubbard, gm	Elwood Fritsch, cm	J. T. Allen, ce	Rad. Hms.: 46,530 UP RCA
TAYLOR								
	KTAE 1948	1260 1,000-D	KTAE Inc. 121 E. 2d St. 1260	G. G. Conoley, p & gm John M. Wehby, cm	Fred S. Switzer, pd & nd	Karine Gilstrap, pmm Gordon Rainey, ce	Pop.: 300,000 Wid. UP Ray.
TEMPLE								
	KTEM 1936	1400 250	Bell Bcstg. Co. 17 S. 3d St. 3-5252	MBS	Frank W. Mayborn, p Burton Bishop, gm	Ralph Weedon, sm John O'Brien, pd	Curtis Casey, ce	Thes. UP RCA
	KTEM-FM 1948	Ch. 298 (B) 107.5mc, 1.9kw						

Data corrected to Dec. 10, 1953. If executives or services for FM are same as A.M. affiliate names are not repeated. Market Data supplied by stations. FM's in *italics*. *—Non-Commercial Station. CP—Construction Permit issued. D—Day. DA—Day. DA-N—Directional Antenna, night only. DA-1—Directional Antenna, same pattern day and night. DA-2—Directional Antenna, different pattern day and night. L—Limited Time with Dominant Station. LS—Local Sunset. N—Night. SA—Special Authorization. SH—Specified Hours. ST—Share Time. Complete key to abbreviations, page 6.

THE MUST MARKET *in the great Southwest*



SAN ANTONIO . . .
 more than
1/2 MILLION PEOPLE
RETAIL SALES . . .
 more than
1/2 BILLION DOLLARS



SOUTH TEXAS . . .
 nearly
1 1/2 MILLION PEOPLE
RETAIL SALES . . .
 more than
1 1/2 BILLION DOLLARS



WOAI COVERAGE . . .
 more than
2 1/2 MILLION PEOPLE
RETAIL SALES . . .
 nearly
2 1/2 BILLION DOLLARS

THE MUST STATION

in the great Southwest

**THE MOST POWERFUL ADVERTISING INFLUENCE
 IN THE SOUTHWEST**

NBC
 AFFILIATE
TQN

Represented Nationally by
EDWARD PETRY & COMPANY, INC.
 New York — Chicago — Los Angeles — St. Louis
 Dallas — San Francisco — Detroit



TEXAS

City	Call Letters Established TV Affiliate	Chan. or Freq. Power	Licensee Headquarters Telephone	Network Represent- ative	Executive Abbreviations Owner o; Pres. p; Exec. vp evp; Gen. Mgr. gm; Sta. Mgr. sm; Coml. Mgr. cm; Sales Mgr. sm; Prog. Dir. pd; Chief Eng. ce; Prom. Mgr. pm; Prod. Mgr. pdm; News, Farm, Sports or Women's Dir. nd, fd, sd, wd.	Market Data For Primary Area (Supplied by station)	Library, News Serv. Transmitter	
TERRELL								
KTER 1950	1570 250-D	Terrell Bcstg. Corp. Walnut & State 44497	Paul A. Wnorowski, p. co & gm Bill Collins, cm & pmm	Dean Tiller, pd Martin Pitte, ce & fd	R. J. Smith, sd Ruby Johnson, wd	Pop.: 58,000 Rad. Hms.: 15,000	Thes., SES. UP G
TEXARKANA								
KCMC 1932	1230 250	KCMC Inc. 315 Pine St. 3-6151	ABC, Tex. State Net. Venard	Frank O. Myers, gm	Harvey Robertson, ce		Pop.: 223,200 Rad. Hms.: 62,800 Ret. Sls.: \$145,127,000	L-W, Assoc. AP WE
KCMC-TV KCMC-FM 1945	Ch. 251 (B) 98.1mc 40kw							
KOSY 1951	790 1,000-D 500-N-DA-N	Gateway Bcstg. Wadley Bldg. 22-3771	MBS. Razorback Pearson	Dr. W. Decker Smith, ptnr. A. L. Davis, ptnr.	Tom Dillahunty, gm Herman Cecil, cm Bill Mitchell, pd	Chas. Mathis Jr. ce Walt Richardson, sd Carol Nethery, wd	Pop.: 375,000 Rad. Hms.: 90,000	Thes., Cap. AP G
KTFS 1946	1400 250	KTFS Inc. 4325 N. Stateline 3-5123	KBS. Cotton Belt Devney, Melville	David M. Segal, gm Floyd Bell, bus. m Les Eugene, prog. m, sta. d & fd	John Harmon Craw- ford, ce	Lonnie Licata, nd George Dobson, sd	Pop.: 330,722 Rad. Hms.: 31,290 Ret. Sls.: \$84,000,000	Wid. UP Col.
TEXAS CITY								
KT LW 1948	920 1,000-D	J. G. Long Showboat Theater Bldg. 5-4418	KBS Best	J. G. Long, p Joe J. Brown, gm, cm & sd	Guy Popham Jr. pd, pmm & nd	John Surovik, ce	Pop.: 30,000	Thes. UP G
TULIA								
(CP)	1260 1,000-D	Tulia Bcstg. Co.						
TYLER								
KGKB 1930	1490 250	Lucille Ross Lansing 115 S. College 2-3874	MBS Pearson	Lucille Ross Lansing, p Gerry Lansing, gm & nd William Peart, cm	Edwin Smith, pd Sam Matthews, pmm Hudson Collins, ce	John Lenox, sd Ben Browning, fd Bonnie Lenox, wd	Pop.: 74,701 Rad. Hms.: 22,360 Ret. Sls.: \$72,150,000	Wid. AP RCA
KTBB 1947	600 500-D 1,000-N- DA-N	Blackstone Bcstg. Blackstone Hotel 4-7278	ABC, Tex. State Net. Venard	Mrs. C. N. Clyde, p M. E. Danbom, gm Oneil F. Inman, cm	Don Jackson Tausch, pd David Bothwell, pmm R. A. Wileman, ce	Al Mann, nd & sd Bob Murdoch, fd Valdia House, wd	Pop.: 345,000 Rad. Hms.: 87,100 Ret. Sls.: \$329,000,000	L-W UP WE
UVALDE								
KVOU 1947	1400 250	E. J. & W. J. Harpole Box 758 717	MBS	Edward J. Harpole, gm Bob Hicks, sm & nd	Joe Watson Jr. cm fd & sd Neil Gilligan, pd	Walter Herbort, ce Sally Adams, wd	Pop.: 47,525 Rad. Hms.: 10,382 Ret. Sls.: \$40,773,000 UP G
VERMON								
KVWC 1939	1490 250	N. Western Bcstg. 1813½ Wilbarger 2-6221	MBS Clark	James E. Doyle, p, co. gm & cm	James Risner, pd	George Hampton, ce		

Data corrected to Dec. 10, 1953. If executives or services for FM are same as AM affiliate names are not repeated. Market Data supplied by stations. FM's in italic. *—Non-Commercial Station. CP—Construction Permit issued. D—Day. DA-N—Directional Antenna, night only. DA-1—Directional Antenna, same pattern day and night. DA-2—Directional Antenna, different pattern day and night. L—Limited Time with Dominant Station. LS—Local Sunset. N—Night. SA—Special Authorization. SH—Specified Hours. ST—Share Time. Complete key to abbreviations, page 6.

KWFT
WICHITA FALLS, TEX.
620 KC
5,000 WATTS

KLYN
AMARILLO, TEX.
940 KC
1,000 WATTS

TWO TOP CBS STATIONS
TWO BIG SOUTHWEST MARKETS
ONE LOW COMBINATION

WHEN you're making out that schedule for the Southwest don't overlook this sales-winning pair of CBS stations. For availabilities and rates, write, phone or wire our representatives.

NATIONAL REPRESENTATIVES JOHN BLAIR & CO.

Texas Listens...

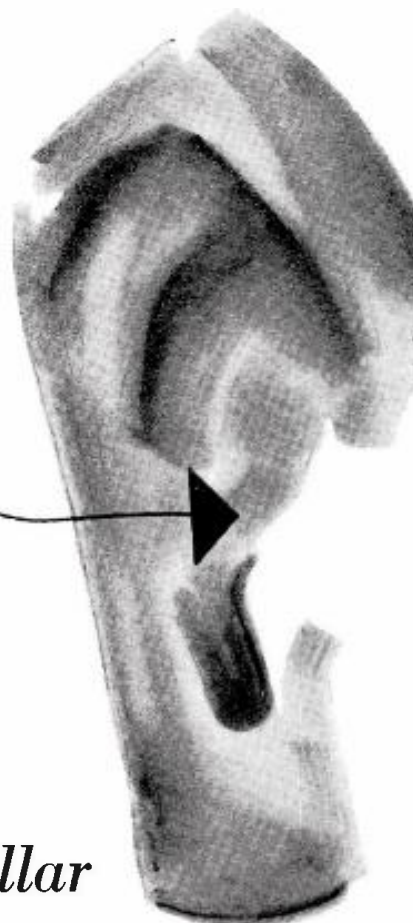

as Texas Quality
Network

*delivers more homes-per-dollar
in the richest
Texas markets*

★ *In the cities* ★ *On the farms* ★ *En route in autos*

Coverage that blankets Texas... that reaches out into Oklahoma, Arkansas, New Mexico and Louisiana... to give the most economical coverage possible. Reaching over 1½ million families daytime...over 2 million families nighttime...TQN delivers most listeners for fewest dollars.

Here is your market of over 2 million families...spending over \$7,600,000 in retail sales, with over \$9,700,000 in effective buying income. Business is good in the booming Southwest...best for advertisers on TQN.

-----NBC affiliated stations-----

WFAA

820-570 Dallas

WBAP

820-570 Fort Worth

KPRC

950 Houston

WOAI

1200 San Antonio

KCBD

1590 Lubbock



KRVG KGNC

1290 Weslaco

710 Amarillo

KRIS

1360 Corpus Christi

Contact any

station or their representative for availabilities
FREE & PETERS • THE KATZ AGENCY, INC.
EDWARD PETRY & CO. • RAYMER & CO.

TEXAS

City Call Letters Established TV Affiliate	Chan. or Freq. Power	Licensee Headquarters Telephone	Network Represent- ative	Owner o; Pres. p; Exec. up evp; Gen. Mgr. gm; Sta. Mgr. sm; Coml. Mgr. cm; Sales Mgr. slm; Prog. Dir. pd; Chief Eng. ce; Prom. Mgr. pmm; Prod. Mgr. pdm; News, Farm. Sports or Women's Dir. nd, fd, sd, wd.	Executive Abbreviations	Market Data For Primary Area (Supplied by station)	Library, News Serv. Transmitter
VICTORIA							
KNAL 1949 KNAL-TV	1410 500-DA-N	Victoria Bcstg. Co. Box 642 1410	Best	A. B. Alkek, p James A. Traber, gm Warren Dentler, cm & nd	Bob Smith, pd Bob Nance, pmm Doug Smith, ce Jean Wilson, traffic m	Paul Rogers, fd Jimmy Traber, sd Vina Burris, wd	Thes., Cap. SES. UP Col.
KVIC 1939	1340 250	KVIC Bcstg. Co. P. O. Box 725 1106	MBS	John G. Long, p Wm. C. Burks, gm & cm	Bill Jackson, pd, nd & sd Hans Felix, pmm	Victor Boldt, ce Cliff Berkman, fd Sue Stone, wd	Pop.: 210,000 Rad. Hms.: 50,000 Ret. Sls.: \$245,000,000
WACO							
KWTX 1946	1230 250	KWTX Bcstg. Co. 46th & Bosque 3-331	MBS Everett- McKinney	M. N. Bostick, gm J. M. Brinegar, cm Chuck Hinkle, pd	William Moore, ce Harry L. Gillam, pmm Bob Martin, nd	Johnny Watkins, fd Marvel Russel, wd Frank Fallon, sd Curtis B. Matties, traffic d	Wid. AP
WACO 1922	1460 1,000-DA-N	Texas State Net. P. O. Box 3066 Westview Station 2-6571	ABC, Tex. State Net. Weed	R. Lee Glasgow, gm Dan Hayslett, cm Doug Rains, pd & sd	Jesse Dove, ce Edwin George, nd	Clark Bolt, fd Mary Holliday, wd	Pop.: 450,000 Rad. Hms.: 149,600 Ret. Sls.: \$152,925,000
WESLACO							
KRGV 1927 KRGV-TV	1290 5,000-DA-N	Taylor Radio & Tv Corp. 201 Border 375	NBC. Tex. Quality Net. Taylor	O. L. Taylor, p Byron W. Ogle, gm Allan Page, cm	James D. Cook, pd Maxine Bertling, pmm O. Lewis Hartwig, ce	Bob McDonald, nd, fd & sd Sallye Jones, wd	Pop.: 360,300 Rad. Hms.: 75,730 Ret. Sls.: \$286,322,000
WICHITA FALLS							
KFDX 1948 KFDX-TV	990 10,000-D 1,000-N- DA-2	Wichtex Radio & Tv Co. City Nat'l. Bldg. 2-8668	ABC Taylor	Darold A. Cannan, p Howard H. Fry, vp Mott M. Johnson, gm Raymond Dorsey, cm	Charles Howard, pd Wm. P. Hood, pmm John Adams, ce Don Owen, nd	"Chuck" Mizner, fd James Baker, sd Dorothy Dooley, wd	Pop.: 812,548 Rad. Hms.: 184,670 Ret. Sls.: \$923,350,000
KTRN 1949	1290 5,000-D 1,000-N- DA-N	Texoma Bcstg. Co. 917½ Scott 2-5214	MBS Pearson	Boyd Kelley, p & gm Bob Cain, cm Bill Edgar, pd & pmm	Bob Harmon, ce Mike Carpenter, nd	Glen Shelton, fd Jack Britton, sd	Pop.: 200,000 AP Col.
KWFT 1939 KWFT-TV	620 5,000-DA-N	Rowley-Brown Bcstg. Co. P. O. Box 420 3-4181	CBS, Tex. State Net. Blair	Kenyon Brown, p Charles E. Clough, gm & cm	Blaine Cornwell, pd A. L. Pierce, pmm Herbert T. Wiley, ce	Hugh Shaw, nd Sid Grayson, sd Gerry Wright, wd	Pop.: 3,435,000 Rad. Hms.: 907,000 L-W UP RCA

UTAH

MARKET DATA BY COUNTIES

County	Population 1950	Radio Families 1953	Retail Sales 1952(000)	Food Sales 1952(000)	Drug Sales 1952(000)	Automobile Ownership 1952	County	Population 1950	Radio Families 1953	Retail Sales 1952(000)	Food Sales 1952(000)	Drug Sales 1952(000)	Automobile Ownership 1952
Beaver	4,856	1,150	\$ 3,931	\$ 742	\$ 161	Sevier	12,072	3,230	14,995	2,083	283
Box Elder	19,734	5,230	22,850	3,915	408	Summit	6,745	1,760	4,655	1,189	140
Cache	33,536	9,080	35,910	6,262	1,049	Tooele	14,636	5,030	13,967	3,906	586
Carbon	24,901	6,690	27,323	5,636	532	Utah	10,300	***2,500	10,288	1,140	305
Daggett	364	*	101	48	Utah	81,912	22,100	80,730	18,428	2,156
Davis	30,867	9,430	27,187	9,021	673	Wasatch	5,574	1,380	6,052	790	89
Duchesne	6,134	1,890	8,027	1,528	81	Washington	9,838	2,470	8,549	1,471	186
Emery	6,304	1,410	2,565	390	64	Wayne	2,205	****	1,137	148	31
Garfield	4,151	840	2,425	276	36	Weber	83,319	25,580	101,870	22,313	3,081
Grand	1,903	450	1,019	390	23	Total	688,862	196,230	\$752,707	\$157,866	\$21,973	273,313
Iron	9,642	2,560	15,321	2,484	437	* See Uintah. ** Wayne is included in Piute County figure. *** Daggett is included in Uintah County figure. **** See Piute.						
Jaub	5,981	1,550	6,118	1,482	166	Note: Population 1950 Census; radio families Standard Audit & Measurement Services Inc.; food, drug and retail sales, copyright 1953, Sales Management; further reproduction unlicensed; automobiles supplied by state.						
Kane	2,299	570	1,760	140	58							
Millard	9,387	2,310	9,901	1,046	255							
Morgan	2,519	590	2,590	266	68							
Piute	1,911	**880	598	96							
Rich	1,673	500	966	307							
Salt Lake	274,895	82,600	329,406	70,194	10,746							
San Juan	5,315	710	1,676	322							
Sanpete	13,891	3,740	10,790	1,853	379							

DIRECTORY OF AM AND FM STATIONS

BRIGHAM								
KBUH 1948	800 250-D	Revella M. Bone 948 W. Forrest Rd. 948	KBS	Revella M. Bone, p Wade M. Ebeling, gm, cm & fd	Mei Richardson, pd, nd & sd	Sam Stephens, ce	Pop.: 100,000 Rad. Hms.: 25,000 Ret. Sls.: \$100,000,000	Wid. UP GE
CEDAR CITY								
KSUB 1937	590 1,000-DA-N	Southern Utah Bcstg. Co. Hotel El Escalante 590	CBS CBS Radio Spot Sales	Ivor Sharp, p Arthur L. Higbee, gm & pmm Walter V. Lowe, cm	E. Mauray Payne, pd & fd Richard N. Gunn, ce	Robert L. Heyborne, asst. m & nd Edwin L. Peterson, sd	Pop.: 79,000 Rad. Hms.: 20,240 Ret. Sls.: \$81,453,000	Wid. UP GE

Data corrected to Dec. 10, 1953. If executives or services for FM are same as AM affiliate names are not repeated. Market Data supplied by stations. FM's in *italics*. *—Non-Commercial Station. CP—Construction Permit issued. D—Day. DA-N—Directional Antenna, night only. DA—Directional Antenna, same pattern day and night. DA-2—Directional Antenna, different pattern day and night. L—Limited Time with Dominant Station. LS—Local Sunset. N—Night. SA—Special Authorization. SH—Specified Hours. ST—Share Time. Complete key to abbreviations, page 6.

LOGAN							
KVNU 1938	610 1,000-DA-N	Cache Valley Bcstg. Co. P. O. Box 264 1400	MBS, KBS, Inter- mountain Avery- Knodel	Herschel Bullen, p & d Reed Bullen, gm, secy- treas., d, pmm & fd	W. W. Kirland, cm Morgan White, pd W. L. Jones, ce	Lloyd Mecham, nd Phil Sorensen, sd Maye Meservey, wd	Wid. UP Col.
MURRAY							
KMUR 1948	1230 250	Oral J. Wilkinson 4646 S. State Murray 1380	Biddick	Oral J. Wilkenson, o Howard W. Pingree, gm	Ted Rogers, cm & nd Mitzil Bailey, pd, asst. m & wd	Ervin Green, ce	L-W UP G
OGDEN							
KLO 1925	1430 5,000-DA-1	Interstate Bcstg. Corp. Ben Lomond Hotel 4-5721	MBS, Inter- mountain Avery- Knodel	A. L. Glassmann, co Collin W. Lowder, m W. Kimball Ward, cm	Len Allen, pd Robert V. Beadles, ce	Augie Navarro, sd Paula McCune, wd	Wid. UP
KOPP 1947	730 1,000-D	KOPP Inc. W. 12th St. 3-3124	KBS	G. Stanley Brewer, p Kink Harmon, gm & sd	Larry Stepe, pd Wayne A. Moss, ce Walter A. Phillips, pmm	Warren Angwin, fd Verlene Steepe, wd	L-W
KVOG 1948	1490 250	United Bcstg. Co. 1438 Gibbson Ave. 2-7535	Tri City Net. Webb, Biddick	Arch G. Webb, p & gm	D. B. Affleck, cm, nd & fd	Jay Livingood, pd & sd James M. Condrey, ce	Pop.: 135,000 Rad. Hms.: 35,000 Ret. Sis.: \$85,000,000 Cap. AP WE
PRICE							
KOAL 1936	1230 250	Eastern Utah Bcstg. Co. P. O. Box 591 Price 200	MBS, KBS, Inter- mountain Avery- Knodel	Jack Richards, p & gm	Carl P. Wolfrom, cm, pd & pmm	Leo E. Reid, ce UP
PROVO							
KCSU 1947	1400 250	Central Utah Bcstg. Co. P. O. Box 550 2802	ABC Rocky Mt. Holling- bery, Webb	Frank A. Van Wagenen, co-o, p & cm	Harold E. Van Wagenen, co-o, gm pd & pmm Dallin H. Oaks, ce	Robert Chambers, nd & fd Lee Brooks, sd JoAnn Moody, wd	Pop.: 88,000 Rad. Hms.: 8,212 Ret. Sis.: \$80,730,000 UP

when people listen people buy! . . .



KSL Radio listeners buy and buy because they are pre-sold by such expert salesmen as Rolfe Peterson and Leonard Friendly. The entire family tunes

THE ROLFE PETERSON SHOW, 7:15 a.m. to 7:45 a.m. Monday thru Saturday, and the LATE ROLFE PETERSON, 10:15 p.m. to 11 p.m. Monday thru Friday.

Wives in the home and husbands on the road listen faithfully for FRIENDLY TIME at 8 a.m. and FRIENDLY AT THE HAMMOND. 2:05 p.m. to 2:30 p.m. Monday thru Friday.

And don't overlook this sales-effective gal: Housewives by the thousands dial MARGARET MASTERS' KITCHEN, Monday thru Friday, at 8:45 a.m., for new cooking ideas and recipes.

KSL Radio has many other "Personality Shows" with large and loyal audiences. Contact your nearest CBS Radio Spot Salesman today to find the right show for you.

... AND KSL RADIO HAS OVER 1 1/4* MILLION REGULAR LISTENERS



SALT LAKE CITY, UTAH
CBS Radio Network • 50,000 Watts
Represented by CBS Radio Spot Sales

* Source: Nielsen Coverage Service—1952

UTAH

City	Call Letters	Chan. or Freq.	Licensee Headquarters Telephone	Network Representative	Executive Abbreviations	Market Data For Primary Area (Supplied by station)	Library, News Serv. Transmitter		
PROVO—(Cont'd)									
KEYY	1450	250	Mid-Utah Bcstg. 307 S. 16th West 4060	KBS	D. Spencer Grow, p George R. Turpin, vp	Edwin A. Niehay, sm S. Garn. Carter, cm	Hal Parkes, pd Ron Baillie, ce	Pop.: 81,912 Rad. Hrms.: 20,159 Ret. Sis.: \$77,348,000	Thes.
KOVO	960	5,000-D	KOVO Bcstg. Co. 108 W. Center 1680	MBS, Inter-mountain	Clifton A. Tolboe, p Arch L. Madsen, gm L. H. Curtis, cm James Lawrence, pd & sd	William Barth, pmm Lowell Killpack, ce Byron Jensen, mus. d	Wayne Carle, nd Athen Mendenhall, fd Donna Gosar, wd	Pop.: 410,000 Rad. Hrms.: 102,000 Ret. Sis.: \$151,000,000	Wid. UP RCA
KOVO-TV	1,000-N-DA-N			Avery-Knodel					
RICHFIELD									
KSVC	980	1,000-DA-N	Sevier Valley Bcstg. Co. 980 Tower Lane 620	Inter-mountain Avery-Knodel	Homer Bandley, p Frank Peacock, gm Art Tucker, cm	Hal Edwards, pd Ralph Ross, ce R. Harvey Dastrup, fd	George Staples, sd	Pop.: 54,671 Rad. Hrms.: 16,340 Ret. Sis.: \$42,483,000	Wid. UP
SALT LAKE CITY									
KALL	910	1,000-DA-1	Salt Lake City Bcstg. Co. 146 S. Main St. 4-3561	MBS, Inter-mountain Avery-Knodel	George C. Hatch, p Thomas H. Anderson, gm & cm Kay Richins, pd	Florien W. Wineriter, pmm W. D'Orr Cozzens, ce Jim Petersen, nd	Stanley Farnsworth, fd Mal Wyman, sd Gordon Owen, wd	Pop.: 274,209 Rad. Hrms.: 81,490 Ret. Sis.: \$322,800,000 AP
KDYL	1320	5,000-DA-1	Intermountain Bcstg. & Television Corp. 143 S. Main 5-2991	NBC, Great Western Blair	G. Bennett Larson, p & gm John N. Baldwin, vp George A. Provol, opers. m	Douglas R. Clawson, cm Alvin G. Pack, pd, fd & sd	Del Leeson, pmm Allen Gunderson, ce Jack Goodman, nd Reva Beck Bosone, wd	Pop.: 527,000 Rad. Hrms.: 144,890 Ret. Sis.: \$481,918,000	Assoc., Thes. UP RCA
KDYL-FM	Ch. 254 (B)	98.7mc 1.2kw						Pop.: 735,100 Rad. Hrms.: 179,300 Ret. Sis.: \$676,607,000	
KNAK	1280	1,000-D 500-N	Granite District Radio Bcstg. Co. 1042 S. 6th West 4-3685	Forjoe	Howard D. Johnson, p Lee Walker, gm, cm & pmm Wayne Logan, pd	Jack Jeppson, ce	Ruth Bryant, wd	Pop.: 200,000 Ret. Sis.: \$513,113,000	
KSL	1160	50,000	Radio Service Corp. of Utah 10 S. Main St. 5-4641	CBS, Bonneville CBS Radio Spot Sales	Ivor Sharp, evp Eugene M. Halliday, radio vp Frank B. McLatchy, gen. sim	Paul S. Dixon, natl. spot sim Joseph A. Kjar, pd A. Wayne Baker, pmm	Vincent E. Clayton, ce Rulon Bradley, nd Elvon W. Orme, fd ElDean Bennett, sd	Pop.: 967,900 Rad. Hrms.: 256,340 Ret. Sis.: \$1,017,062,000	Wid. AP, UP WE
KSL-FM	Ch. 262 (B)	100.3mc 5.9kw							SES. Col.
KUTA	570	5,000-DA-1	Utah Bcstg. & Tv Co. 179 Moton Ave. 22-2505	ABC, Rocky Mt. Hollingbery	Frank C. Carman, p & gm Allan Thomas, cm & pmm	Ray Fadel, pd & sm Wendell Bell, ce Hal Zogg, nd	Hal Collipriest, fd Ted Elders, sd Ginny Barlow, wd	Pop.: 667,055 Rad. Hrms.: 167,000 Ret. Sis.: \$650,000,000	
KUTV (TV)	97.1mc 23.5kw								
KUTF (FM) (CP)	Ch. 246 (B)								
VERNAL									
KJAM	1340	250	Uintah Bcstg. Co. 120 E. Main 494	KBS	James C. Wallentine, p L. E. Walker, gm	Grant E. Parry, cm & pmm Buck Fulmore, pd	Wallace D. Raker, ce & sd Sam Price, nd & fd Lee Walker, wd	Pop.: 48,000 Rad. Hrms.: 12,000 Ret. Sis.: \$50,000,000 UP

VERMONT

MARKET DATA BY COUNTIES

County	Population 1950	Radio Families 1953	Retail Sales 1952(000)	Food Sales 1952(000)	Drug Sales 1952(000)	Automobile Ownership 1952	County	Population 1950	Radio Families 1953	Retail Sales 1952(000)	Food Sales 1952(000)	Drug Sales 1952(000)	Automobile Ownership 1952
Addison	19,442	4,910	\$ 16,205	\$ 4,733	\$ 365		Rutland	45,905	12,790	54,828	14,484	1,008	
Bennington	24,115	7,090	25,946	7,796	543		Washington	42,870	11,590	43,556	12,693	820	
Caledonia	24,049	6,780	26,906	6,353	508		Windham	28,749	8,040	32,170	9,104	703	
Chittenden	62,570	17,105	74,105	19,832	1,543		Windsor	40,885	11,760	42,337	11,571	892	
Essex	6,257	1,710	3,364	1,754	81								
Franklin	29,894	8,040	31,292	9,589	655		Total	377,747	102,930	\$396,984	\$108,864	\$8,182	125,875
Grand Isle	3,406	770	2,134	893			Note: Population 1950 Census; radio families Standard Audit & Measurement Services Inc.; food, drug and retail sales, copyright 1953, Sales Management; further reproduction unlicensed; automobiles supplied by state.						
Lamoille	11,388	2,830	9,541	3,096	294								
Orange	17,027	4,530	14,144	2,983	372								
Orleans	21,190	5,510	20,456	4,183	398								

DIRECTORY OF AM AND FM STATIONS

BENNINGTON								
WBTV	1370	Catamount Bcstrs. Inc. Harwood Hill 6321	McGillvra	J. Gordon Keyworth, co & treas.	Benjamin A. Hubley, sm	Pop.: 48,000 Rad. Hrms.: 12,000 Ret. Sis.: \$50,000,000 UP	
BRATTLEBORO								
WTSA	1450	Granite State Bcstg. Corp. P. O. Box 819 1700	ABC, Granite State Rambeau, Bannan	Theodore Feinstein, p & o Phillips G. Terhune, gm & cm	Loren C. Smith, pd, nd & sd William Bigwood, pmm	Edward Somes, ce & fd Clara Antonetti, wd	Pop.: 26,650 Rad. Hrms.: 9,430 Ret. Sis.: \$31,320,000 Col.
BURLINGTON								
WCAX	620	WCAX Bcstg. Corp. 135 Main St. 3-3437	CBS Weed	C. P. Hasbrook, p & gm J. D. Swan, m & pmm	Louis J. Rocke, pd & fd James Tierney, ce	John A. Sullivan, nd Tony Adams, sd Carol King, wd	Pop.: 431,200 Rad. Hrms.: 109,990 Ret. Sis.: \$428,878,000	Wid. UP G
WJOY	1230	Vermont Bcstg. Co. 633 Main St. 4-5774	ABC Rambeau, Bannan	David W. Howe, p A. E. Spokes, sm & cm	Richard H. Burt, pd & pmm Donald Wheatley, ce	Frank Balch, sd Wynne Casey, wd	Pop.: 104,050 Rad. Hrms.: 27,420 Ret. Sis.: \$103,300,000	Thes. AP RCA

Data corrected to Dec. 10, 1953. If executives or services for FM are same as AM affiliate names are not repeated. Market Data supplied by stations. FM's in italic. *—Non-Commercial Station. CP—Construction Permit issued. D—Day. DA-N—Directional Antenna, night only. DA-1—Directional Antenna, same pattern day and night. DA-2—Directional Antenna, different pattern day and night. L—Limited Time with Dominant Station. LS—Local Sunset. N—Night. SA—Special Authorization. SH—Specified Hours. ST—Share Time. Complete key to abbreviations, page 6.

VERMONT

MONTPELIER

WSKI 1947	1240 250	Montpelier-Barre Bcstg. Co. Union Mutual Bldg. 1740	ABC Grant	Charles W. Grinnell, p, co-o, gm, cm & nd	Robert J. Bannon, pd Gerald Marcot, ce	Eliot Page, sd Martha Corker, wd	Pop.: 25,000 Rad. Hms.: 13,500 AP Col.
--------------	-------------	---	--------------	--	---	-------------------------------------	-----------------------------------	---------------------

NEWPORT

WIKE 1953	1490 250	Memphremagog Bcstg. Co. Farrant St. Box 586 832	North Country Stations McGillvra, Kettell- Carter	E. Dean Finney, p & gm	Donald A. Thurston, cm, pd & ce Donald J. Barry, nd	Helen K. Bowman, wd Morgan M. Brown, sd	Pop.: 126,600 Rad. Hms.: 32,400 Ret. Sis.: \$103,150,000	Wld. UP G
--------------	-------------	--	--	---------------------------	---	--	--	-----------------

RUTLAND

WHWB 1948	1,000 1,000-D	Central Vt. Bcstg. Corp. 24 1/2 Center St. Prospect 3-3200 Kettell- Carter	Vena M. Bates, p, co-o, gm, cm & pmm Martin J. Delliveneri, vp	Charles I. Bates, co & treas. Shirley Neilson, pd & wd	Kenneth Pockett, ce Tom Kibbe, nd Frank McCormack, sd	Pop.: 156,000 Rad. Hms.: 70,100 Ret. Sis.: \$275,000,000	Cap. AP Ray.
WSYB 1930	1380 1,000-DA-N	Phillip Weiss 35 Washington St. 1247	MBS, Yankee McGillvra	P. Weiss, p	J. H. Weiss, gm			

ST. ALBANS

WWSR 1941	1420 1,000-D	Vermont Radio Corp. 75 No. Main St. 1390	Walker	Lloyd E. Squier, p & gm Richard W. Hill, cm	Raymond Turner, pd & pmm Theodore Bolsvert, ce C. Stuart Perry, nd	Robert Leavitt, sd Cecile Fahl, wd & traffic m		Wld. UP C
--------------	-----------------	--	--------	---	---	--	--	-----------------

ST. JOHNSBURY

WTWN 1949	1340 250	Twin State Bcstrs. Inc. Box 662 Pioneer 8-2344	North Country Stations McGillvra, Kettell- Carter	E. Dean Finney, p, co & gm R. M. Adams, asst. m	Guy Austin, pd & ce Elby Stevens, nd	George Paterson, sd Marjorie Dow, wd	Pop.: 26,200 Rad. Hms.: 9,000 Ret. Sis.: \$30,000,000	Wld., Thes. UP Ray.
--------------	-------------	--	--	---	---	---	---	------------------------------

SPRINGFIELD

WNIX (CP)	1480 1,000-D	Conn. Valley Bcstg. Co.						
--------------	-----------------	-------------------------	--	--	--	--	--	--

WATERBURY

WDEV 1931	550 1,000-DA-N	Lloyd E. Squier 9 Stowe St. 4-7321	MBS, Yankee Walker, Bannan	Lloyd E. Squier, p Craig S. Parker, pd	Warren C. Chase, ce Thomas Dodd, nd	Harold M. Grout, fd Polly Jenkins, wd	Pop.: 275,000 Rad. Hms.: 74,280 Ret. Sis.: \$250,748,000 UP G
--------------	-------------------	--	-------------------------------------	---	--	--	--	------------------

VIRGINIA

MARKET DATA BY COUNTIES

County	Population 1950	Radio Families 1953	Retail Sales 1952(000)	Food Sales 1952(000)	Drug Sales 1952(000)	Automobile Ownership 1952	County	Population 1950	Radio Families 1953	Retail Sales 1952(000)	Food Sales 1952(000)	Drug Sales 1952(000)	Automobile Ownership 1952
Accomack	33,832	8,820	\$ 27,847	\$ 7,777	\$ 543	1,776	Grayson	21,379	5,150	16,150	2,297		315
Albemarle	26,662	12,350	54,769	11,731	1,776	1,776	Greene	4,745	900	1,174	525		
Alleghany	23,139	7,310	26,180	5,951	934	66	Greensville	16,319	3,250	12,888	2,889		438
Amelia	7,908	1,390	3,107	348	66	66	Halifax	41,442	8,150	22,113	4,853		733
Amherst	20,332	3,790	4,642	2,641	66	66	Hanover	21,985	5,090	9,458	2,927		110
Appomattox	8,764	1,720	3,925	648	61	61	Henrico	57,340	80,230	387,807	82,289		13,810
Arlington	136,449	65,210	256,372	80,484	14,182	1,838	Henry	31,219	11,360	41,435	9,601		857
Augusta	34,154	16,230	55,255	13,068	987	64	Highland	4,069	830	983	329		
Bath	6,296	1,480	3,181	987	64	64	Isle of Wight	14,906	3,190	9,402	2,281		191
Bedford	29,627	6,490	12,489	3,375	72	72	James City	6,317	2,470	12,394	2,904		41
Bland	6,436	1,260	1,999	363	45	45	King and Queen	6,299	1,140	1,874	1,003		
Botetourt	15,766	3,670	4,948	2,128	133	133	King George	6,710	1,670	2,168	1,019		
Brunswick	20,136	3,770	11,343	1,899	160	160	King William	7,589	1,640	7,474	2,357		31
Buchanan	35,746	6,620	15,181	2,525	69	69	Lancaster	8,640	2,020	7,485	1,724		167
Buckingham	12,288	2,270	4,470	900	40	40	Lee	36,106	7,260	12,462	2,259		329
Campbell	28,877	19,250	84,380	16,937	3,253	3,253	Louden	21,147	4,760	16,481	4,748		496
Caroline	12,471	2,330	6,203	2,174	69	69	Louisa	12,826	2,670	6,363	1,808		129
Carroll	26,695	6,170	7,068	1,708	32	32	Lunenburg	14,116	3,090	8,929	1,825		225
Charles City	4,676	740	699	539	82	82	Madison	8,273	1,750	2,351	949		32
Charlotte	14,057	2,730	4,603	923	213	213	Mathews	7,148	1,720	4,332	970		71
Chesterfield	40,400	12,310	11,017	4,128	192	192	Mecklenburg	33,497	6,860	24,950	5,218		484
Clarke	7,074	1,720	4,058	1,309	29	29	Middlesex	6,715	1,590	4,431	622		74
Craig	3,452	830	1,255	253	68	68	Montgomery	29,780	9,440	35,278	8,361		1,149
Culpeper	13,242	2,970	13,582	2,344	311	311	Nansemond	25,238	8,820	31,988	7,081		1,159
Cumberland	7,252	1,370	1,454	291	106	106	Nelson	14,042	2,730	4,088	1,379		36
Dickenson	23,393	4,330	8,155	1,632	1,862	1,862	New Kent	3,995	860	2,066	934		
Dinwiddie	18,839	12,060	50,611	12,178	70	70	Norfolk	99,937	116,000	434,563	108,604		14,634
Elizabeth City	55,028	1,300	5,364	1,413	1,366	1,366	Northampton	17,300	4,080	12,213	4,020		266
Essex	6,530	28,620	44,023	15,257	407	407	Northumberland	10,012	2,310	4,857	954		67
Fairfax	98,557	4,590	18,173	4,040	76	76	Notoway	15,479	3,910	14,451	3,128		582
Fauquier	21,248	2,520	4,649	783	71	71	Orange	12,755	2,810	11,324	2,031		379
Floyd	11,351	1,610	2,663	1,200	301	301	Page	15,152	3,600	9,178	1,879		276
Fluvanna	7,121	5,070	11,731	2,023	1,236	1,236	Patrick	15,642	3,190	4,897	1,186		37
Franklin	24,560	8,690	40,755	8,172	603	603	Pittsylvania	66,096	23,180	85,368	19,715		2,514
Frederick	17,537	4,500	17,172	4,494	74	74	Powhatan	5,556	1,020	2,563	443		
Giles	18,956	2,560	7,175	1,448			Prince Edward	15,398	3,230	12,519	2,163		450
Gloucester	10,343	1,460	2,256	1,109			Prince George	19,679	6,290	16,391	5,151		548
Goochland	8,934						Prince William	22,612	4,790	17,372	4,280		580

YOU'RE IN GOOD COMPANY ON WJOY

MR.
TIME
BUYER

Join this impressive list of Na-
tional Advertisers using WJOY
during the Fall-Winter season

AMAZO
ANACIN
BORDEN'S
CHASE & SANBORN
SHELL OIL CO.
MAXWELL HOUSE COFFEE

HOOD'S MILK & ICE CREAM
FORD
NARRAGANSETT
SCHAEFER BEER
SUGAR JETS
AND OTHERS

BURLINGTON MARKET HAS NO TV . . .

For Full Details Check With William G. Rambeau Company

ABC

WJOY
BURLINGTON, VERMONT

DIAL
1230

MARKET DATA BY COUNTIES

County	Population 1950	Radio Families 1953	Retail Sales 1952(000)	Food Sales 1952(000)	Drug Sales 1952(000)	Automobile Ownership 1952	County	Population 1950	Radio Families 1953	Retail Sales 1952(000)	Food Sales 1952(000)	Drug Sales 1952(000)	Automobile Ownership 1952
Princess Anne	42,277	11,070	29,058	9,947	994		Sussex	12,785	2,410	8,802	1,862	201	
Pulaski	27,758	6,760	18,472	4,954	627		Tazewell	47,512	10,530	35,559	8,294	884	
Rappahannock	6,112	1,270	1,337	175			Warren	14,801	3,970	15,256	4,140	516	
Richmond	6,189	1,290	4,344	768	31		Warwick	33,876					
Roanoke	41,486	36,590	157,964	36,992	4,452		Washington	37,536	12,340	46,256	9,462	1,465	
Rockbridge	23,359	6,470	19,390	5,096	1,320		Westmoreland	10,148	2,210	7,950	1,392	229	
Rockingham	35,079	11,410	44,128	5,083	1,012		Wise	56,336	12,170	45,696	10,192	1,075	
Russell	26,818	5,440	12,721	1,731	122		Wythe	23,327	5,280	20,004	3,865	443	
Scott	27,640	5,940	7,195	1,297	174		York	11,750	2,890	3,563	1,368	72	
Shenandoah	21,169	5,410	15,961	3,677	343		Total	3,318,680	828,510	\$2,868,538	\$693,655	\$82,802	1,034,011
Smyth	30,187	6,450	18,941	3,598	622		Note: Population 1950 Census; radio families Standard Audit & Measurement Services Inc.; food, drug and retail sales, copyright 1953, Sales Management; further reproduction unlicensed; automobiles supplied by state.						
Southampton	26,522	5,310	15,591	4,205	487								
Spotsylvania	11,920	5,780	32,523	6,691	954								
Stafford	11,902	2,820	3,543	1,920	40								
Surry	6,220	1,330	2,101	430	65								

DIRECTORY OF AM AND FM STATIONS

City	Call Letters	Chan. or Freq. Power	Licensee Headquarters Telephone	Network Representative	Owner o; Pres. p; Exec. up evp; Gen. Mgr. gm; Sta. Mgr. sm; Coml. Mgr. cm; Sales Mgr. slm; Prog. Dir. pd; Chief Eng. ce; Prom. Mgr. pmm; Prod. Mgr. pdm; News, Farm, Sports or Women's Dir. nd, fd, sd, wd.	Executive Abbreviations	Market Data For Primary Area (Supplied by station)	Library, News Serv. Transmitter
ALEXANDRIA								
	WPIK 1945	730 1,000-D	Potomac Bcstg. Co. Virginia Theatre Bldg. Overlook 3-3000	Metro-politan Webb	Carl L. Lindberg, p Arthur Kellar, cm	Dick Lawrence, pmm Bill Johnson, nd	Bob Roth, sd Barbara Power, wd Pop.: 2,000,000 AP G
ARLINGTON								
	WARL 1947	780 1,000-D	Northern Virginia Bcstrs. Inc. 5232 Lee Hwy. Jackson 7-7800	Lou Poller, p Cy Blumenthal, gm George Crump, cm	Ray Armand, pd & nd Millicent Vaunn, pmm & wd	Steve Hart, ce Connie B. Gay, fd Sam Brown, sd Pop.: 2,000,000 Rad. Hms.: 1,800,000 UP G
	WARL-FM 1951	Ch. 286 (B) 105.1mc 2.05kw	Harold H. Thoms, p George E. Oleson, gm & cm	John Cooley, pd & nd Buddy Kling, pmm William Beresford, ce	Nat Allbright, sd Jeanne DeRamus, wd Pop.: 3,315,000 Rad. Hms.: 479,000 Ret. Sis.: \$3,763,000 AP Col.
	WEAM 1947	1390 5,000-DA-1	Arlington-Fairfax Bcstg. Inc. 2030 N. 18th St. Jackson 7-7100
BEDFORD								
	WBLT 1950	1490 250	Bedford Bcstg. Corp. Box 406 8245	MBS Indie	A. P. Marsh Jr., p gm & fd R. A. Owen, cm & pmm	R. A. Scott, pd & nd W. A. Banton, ce James E. Synan, bus. m & sd	John P. Laughlin, traffic m Pop.: 30,000 Rad. Hms.: 6,570 Ret. Sis.: \$15,000,000	Thes. AP G
BIG STONE GAP								
	WLSB 1953	1220 1,000-D	Gap Bcstg. Co. 960	W. H. Wren Jr., p gm & cm W. R. Holland Jr., pd & nd	James E. True Jr., pmm Andrew R. McMaster, ce	Ruth Jensen, co-wd Kathy Kirk, co-wd Pop.: 200,000 Rad. Hms.: 45,000 Ret. Sis.: \$50,000,000
BLACKSTONE								
	WKLV 1947	1490 250	Blackstone Bcstg. Corp. Community Bldg. 478	MBS. KBS Colton	Harris L. Umstead, p & gm	Cosby A. Draper Jr., pd & ce	Pop.: 60,000 Rad. Hms.: 15,000 Ret. Sis.: \$24,000,000	L-W AP G
BRISTOL								
	WCYB 1946	690 10,000-D	Appalachian Bcstg. P. O. Box 3560 North 3560 Gill-Perna	Robt. H. Smith, p & gm J. Fey Rogers, vp & slm	James D. Thomas, pd Russell V. Robinson, ce Walter Crockett, nd	Frank Raymond, fd Ed Cowell, sd Alice F. Friberg, wd Pop.: 1,099,500 Rad. Hms.: 222,570 Ret. Sis.: \$546,208,000	Wid., Assoc. Cole, Ap. UP, Ray.
	WFHG 1947	980 1,000-DA-N	Bristol Bcstg. Co. Valley Dr. N-3620 (See Bristol, Tenn. listing)	MBS	W. C. Nininger, p & gm	Jack Martin, cm, nd & sd David Pursklove, pd	John Hughlett Jr., ce Verlin Mays, fd Pop.: 202,754 Rad. Hms.: 44,576	Thes. UP G
	WOPI							

Data corrected to Dec. 10, 1953. If executives or services for FM are same as AM affiliate names are not repeated. Market Data supplied by stations. FM's in italic. *—Non-Commercial Station. CP—Construction Permit issued. D—Day. DA-N—Directional Antenna, night only. DA-1—Directional Antenna, same pattern day and night. DA-2—Directional Antenna, different pattern day and night. L—Limited Time with Dominant Station. LS—Local Sunset. N—Night. SA—Special Authorization. SH—Specified Hours. ST—Share Time. Complete key to abbreviations, page 6.

BRISTOL, VA.-TENN.

10,000 WATTS WCYB 690 KILOCYCLES

Gets Results for the Tri-Cities Market

Bristol, Va.-Tenn, JohnsonCity, Tenn., Kingsport, Tenn.

Top POWER Top FREQUENCY Top PROGRAMS Top FEATURES Top PERSONALITIES

GIL-PERNA, INC. National Representatives

ask them for the Top story in the Virginia-Tennessee Market

CHARLOTTESVILLE

WCHV 1933 WCHV-TV	1240 250	Barham & Barham Rose Hill Dr. 2-5121	ABC Clark	Charles Barham, Jr., co Robert C. Walker, gm & cm	R. G. Sketchley, pd Charles Smith, pmm Walter Gray, ce William C. Gentry, continuity d	Norman Kelsey, fd Cris Cramer, sd Nancy Knight, wd	Pop.: 97,400 Rad. Hms.: 28,700 Ret. Sis.: \$79,300,000	AP Ray.
WINA 1949	1280 1,000-D	Charlottesville Bestg. Corp. 4th at E. Main St. 2-6177	MBS, KBS	Donald G. Heyne, p & gm Thomas M. Behrendt. cm	Edward M. Desmond, pd, nd & fd Hilda N. Schroetter, pmm Lawrence Kennedy, ce	Chas. W. Freeman, opers. m Ray Rushton, sd Barbara Brown, wd	Pop.: 37,000 Rad. Hms.: 35,000 Ret. Sis.: \$75,000,000	St. UP Ray.

CLIFTON FORGE

WCFV 1950	1230 250	Clifton Forge Bestg. Co. Fairview Hts. 2147	MBS	Cletus H. Lawler, p ce E. T. Nicely, treas.	Grover K. Fulk, gm & ce Larry L. Cooper, cm & pd	Barbara A. Johnson, secy.		St. AP WE
--------------	-------------	--	--------------	---	---	------------------------------	--	-----------------

COVINGTON

WKEY 1941	1340 250	Earl M. Key 217 W. Main St. 8351	ABC Devney	Earl M. Key, co & gm Kenneth Bryant, cm, pmm & sd	John Lee Davis, pd & nd	Everett G. Hemenway, ce	Pop.: 55,000 Rad. Hms.: 20,000	Thes. UP WE
--------------	-------------	--	---------------	---	----------------------------	----------------------------	-----------------------------------	-------------------

CREWE

WSVS 1947	800 1,000-D	Southern Va. Bestg. Corp. 800 Melody Lane 7811	C. S. Willis, p John E. Sadler, gm	Freeman H. Stewart, cm Frank Watkins, pd	C. E. Wilson, ce Don Greene, nd & sd	Pop.: 182,045	Wld. AP Ray.
WSVS-FM 1949	Ch. 284 (B) 104.7mc 14kw							

CULPEPER

WCVA 1949	1490 250	Culpeper Bestg. Corp. Hendricks Ave. 8338	MBS, KBS Indie	Ira C. Hopkins, p John T. Rogers, gm & cm	Woody Powell, pd, pmm, asst. m & nd Walter Wilkerson, ce	Marvin Bates, fd Jim Stover, sd Ann W. Rogers, wd	Pop.: 35,000 Rad. Hms.: 10,000 Ret. Sis.: \$31,750,220	St. UP G
--------------	-------------	--	-------------------	---	--	---	--	----------------

DANVILLE

WBTV 1930 WBTV-TV	1330 5,000-D 1,000-N- DA-N	Piedmont Bestg. Corp. 710 Grove St. 2350	ABC Holling- bery	L. N. Dibrell, p Edward G. Gardner, vp & gm John Holland III, cm	Milton N. Adams, pd Lyle C. Motley, ce Bill Sandefur, prod. d Leon Smith, nd	Charles Slate, fd George Reading, sd Betty Smith, wd	Pop.: 309,100 Rad. Hms.: 64,130 Ret. Sis.: \$205,737,000	Wld. AP RCA
WBTV-FM 1947	Ch. 250 (B) 97.9mc 3.89kw						Pop.: 939,000 Ret. Sis.: \$796,393,000	Wld. AP Fed.
WDVA 1947	1250 5,000-D 1,000-N- DA-N	Va.-Car. Bestg. Corp. American Natl. Bank Bldg. 5300	MBS Burn- Smith	John D. Pruitt, p Emerson J. Pryor, gm & vp Stover J. Morris Jr., cm	Dick Campbell, pd Ralph Hess Jr., pmm Howard Clendenon, ce Charles Craig, nd	Frank Raymond, fd Earl Stogner, sd Mill Willeford, wd	Pop.: 276,150 Rad. Hms.: 68,540 Ret. Sis.: \$212,270,400	Assoc. UP Col.

EMPORIA

WEVA 1952	1400 250	Stone Bestg. Corp. Florida & Washington Sts. 2133	KBS	M. E. Stone, p & gm A. L. Drew, sm, pd, pmm, nd & fd	Sally J. Whitlock, cm Elton Short, ce	George Lee, sd Virginia Gay, wd	Pop.: 35,000 Rad. Hms.: 9,000 Ret. Sis.: \$16,000,000	Thes. AP G
WEVA-FM 1952	Ch. 261 (A) 100.1mc 0.79kw						Pop.: 313,000 Rad. Hms.: 26,110 Ret. Sis.: \$128,000,000	

FALLS CHURCH

WFAX 1948	1220 500-D	Lamar A. Newcomb P. O. Box L Jefferson 2-0900	KBS Metro- politan	Lamar A. Newcomb, p, gm & cm Genevieve Main, pd	Richard Fanning, ce Warren Orre, pmm & nd	Lee Barbash, sd Dorine Barbash, wd	 UP G
--------------	---------------	--	--------------------------	---	---	---------------------------------------	--	------------------

FARMVILLE

WFLO 1947	870 1,000-D	Mrs. Carla B. Keys 118 W. 3d St. 870 Clark	Carla B. Keys, p John D. Wilson, gm & nd	John C. Calhoun, pd & sd Charles K. Chrismon, ce	Bill Reid, fd Garnette Jamerson, wd	Pop.: 100,190 Rad. Hms.: 14,512	Cap., Thes. UP Ray.
--------------	----------------	---	----------------	--	---	---	------------------------------------	---------------------------

FREDERICKSBURG

WFVA 1939	1230 250	Fredericksburg Bestg. Corp. 707 Princess Anne St. 1261	ABC, KBS	Richard F. Lewis Jr., evp	Walter F. Harris Jr., m		 UP WE
--------------	-------------	--	-------------------	------------------------------	----------------------------	--	--	-------------------

FRONT ROYAL

WFTR 1948	1450 250	Sky-Park Bestg. Corp. Box 192 750	MBS	Edward H. Stokes, p Kenneth Gordon, gm & cm	Tom Gibson, pd & nd Claude Jones, ce	Drayton Norcom, wd	Pop.: 22,000 Rad. Hms.: 4,470 UP WE
--------------	-------------	--	--------------	---	---	--------------------	----------------------------------	-------------------

GALAX

WEOB 1947	1400 250	Carroll- Grayson Bestg. Corp. Poplar Knob Rd. 2921	MBS, KBS Indie	Robert V. Morris, p Joe P. Crockett, gm Brice J. Parks, cm	Muriel M. Bell, pd & wd Jewell E. Cullop, pmm	Edward W. Boyer, ce & fd David A. Lehman, nd & sd	Rad. Hms.: 24,745 AP Ray.
--------------	-------------	--	-------------------	--	---	--	-------------------	---------------------

GRUNDY

WNRG (CP)	1250 1,000-D	Va.-Ky. Bestg. Co.						
--------------	-----------------	--------------------	--	--	--	--	--	--

HAMPTON

WVEC 1948 WVEC-TV	1490 250	Peninsula Bestg. Corp. Commonwealth Blvd. 6332	NBC Rambeau	Thomas P. Chisman, p Harrol A. Brauer Jr., vp & gm Charles L. Coker Jr., cm	L. W. Kilewer, opers. m Bob Drill, pd Georgia McCarty, pmm	William C. King Jr., ce Lewis T. Jester, nd Art Brock, sd	Pop.: 614,000 Rad. Hms.: 165,400 Ret. Sis.: \$571,000,000	Assoc. AP Ray.
-------------------------	-------------	--	----------------	---	--	--	---	----------------------

HARRISONBURG

WSVA 1935 WSVA-TV	550 1,000-DA-N CP: 5,000-D 1,000-N DA-N	Shenandoah Valley Bestg. Corp. Rawley Pike 4-4431	NBC Devney	Frederick L. Allman, p & gm Robert B. Harrington, cm & pmm	Richard H. Johnson, pd & sd Warren L. Braun, ce Harold A. Wright, bus. m	Charles R. McGinley, nd Homer Quann, fd Virginia Lindamood, wd	Pop.: 349,340 Rad. Hms.: 85,580 Ret. Sis.: \$294,095,000	Wld. UP RCA
WSVA-FM 1945	Ch. 264 (B) 100.7mc 7.2kw							

VIRGINIA

City	Call Letters Established TV Affiliate	Chan. or Freq. Power	Licenses Headquarters Telephone	Network Represent- ative	Owner o; Pres. p; Exec. up evp; Gen. Mgr. gm; Sta. Mgr. sm; Coml. Mgr. cm; Sales Mgr. slm; Prog. Dir. pd; Chief Eng. ce; Prom. Mgr. pmm; Prod. Mgr. pdm; News, Farm, Sports or Women's Dir. nd, fd, sd, wd.	Executive Abbreviations	Market Data For Primary Area (Supplied by station)	Library, News Serv. Transmitter
HOPEWELL								
WHAP 1949	1340 250	HoPewell Bcstg. P. O. Box 821 801	Mort Hendrickson, p & gm Vivian E. Hendrickson, vp & pd	Nancy Johnson, cm & pmm	Steve Wulchin, ce & nd Nancy Fowler, wd	Pop.: 150,000 Ret. Sis.: \$81,000,000	Thes. UP G
LEXINGTON								
WREL 1948	1450 250	Rockbridge Bcstg. Corp. 6000	NBC, KBS Cooke	Marshall L. Wilmer, p Milton B. Henson, gm & cm	Andrew P. Peterson, pd & sd James I. Bray Jr., ce	Jane P. Snider, office m Bob Bradford, nd	Pop.: 50,000 Rad. Hms.: 15,000 Ret. Sis.: \$40,000,000	Thes. AP G
LYNCHBURG								
WLVA 1930 WLVA-TV	590 1,000-DA-2	Lynchburg Bcstg. Corp. 925 Church St. 2-1242	ABC Holling- bery	Edward A. Allen, p Philip P. Allen, gm & vp John P. Read Jr., secy.-treas.	Joseph F. Wright Jr., cm Warren Uttal, pd & pmm	John T. Orth, ce Wayne Tyler, nd & sd Eric Lund, fd Betty Baldwin, wd	Pop.: 249,000 Rad. Hms.: 58,010	L-W AP RCA
WLVA-FM 1946	Ch. 248 (B) 97.5mc 3.7kw						Pop.: 500,000 Rad. Hms.: 75,000	L-W AP GE
WWOD 1947	1390 5,000-D 1,000-N- DA-N	Old Dominion Bcstg. Corp. P. O. Box 918 2-3441	MBS Walker	D. H. Dillard, p Charles R. Maillot, gm R. E. Gooch, cm	Forest J. Pinkerton, ce Joyce Fore, secy.- treas.	Wynn Alby, sd Betty Richardson, wd	Pop.: 159,000 Rad. Hms.: 34,745 Ret. Sis.: \$116,568,000	Wid., Thes. AP, UP Ray.
WWOD-FM 1948	Ch. 261 (A) 100.1mc 0.94kw							
MARION								
WMEV 1953 WMEV-TV	1010 1,000-D	Mt. Empire Bcstg. Corp. Park Blvd. 3-9001	ABC, KBS Cooke	Robert C. Wolfenden, evp, gm & cm Leon Beville, secy.- treas. Bob Wolfenden, pmm	Mrs. Robert C. Wolfenden, pd F. M. White Jr., ce Bryan McMurry, nd & fd	George Mizelle, sd Stella D. Wolfenden, wd	Pop.: 370,925 Rad. Hms.: 79,603 Ret. Sis.: \$187,500,850	Wid. AP WE
MARTINSVILLE								
WMVA 1941	1450 250	Martinsville Bcstg. Co. Chatham Hgts. 2152	NBC, KBS	S. S. Walker, p Judge Kennon C. Whittle, vp Maynard E. Dillaber, gm & nd Charles F. Adams, cm & pmm	Barbara Zimmerman, pd, secy.-treas. & wd B. Edward Boyer, ce	Paul E. Zimmerman, sd	Pop.: 76,207 Rad. Hms.: 17,289 Ret. Sis.: \$42,631,925 AP
WMVA-FM 1950	Ch. 242 (B) 96.3mc 2.7kw						Pop.: 753,400 Rad. Hms.: 221,128 Ret. Sis.: \$657,103,000 AP Rel.
MOUNT JACKSON								
WSIG (CP)	790 1,000-D	Richard Field Lewis Jr.						
NARROWS								
WNRV 1953	990 1,000-D	Giles Bcstg. Co. 2211	H. J. Romanus, p H. Tom Hicks, gm	R. J. Torquato, cm Albert A. Rich, pd	Washington Elitchko, ce	Pop.: 73,365 Rad. Hms.: 22,450 Ret. Sis.: \$58,893,000	
NEWPORT NEWS								
WGH 1928	1310 5,000-DA-1	Hampton Rds. Bcstg. Corp. 739 Boush St. 2-7031	ABC Free & Peters	Edward E. Bishop, vp & gm W. R. Van Buren Jr., asst. treas.	Clyde F. Meades, cm Amert Dail, pd William Rhyne, pmm Alois Braun Jr., ce	G. Edward Travis, nd William Diehl, sd	Pop.: 600,000 Rad. Hms.: 180,900 Ret. Sis.: \$371,574,000	Assoc. AP RCA
WGH-FM 1947	Ch. 243 (B) 96.5mc 36kw							
WHYU 1947 WACH(TV)	1270 1,000-D	Eastern Bcstg. Corp. 114 24th St. 3-1631	KBS Webb	John Doley, p Frederic F. Clair, gm & ce	Etoyse Patterson, cm & fd Thomas O. Bradshaw Jr., pd, pmm & nd	Ted Tatar, sd Mary Lou Adams, wd	Pop.: 688,058 Rad. Hms.: 166,685 Ret. Sis.: \$690,770,000	Cap. UP G
NORFOLK								
WCAV 1947	850 1,000-DA-2	Cavalier Bcstg. Corp. Helena Bldg. 2-3266	MBS Indie	Pauline Light, p William M. Manrov, gm & cm Jack Lynn, pd & nd	Sanford Willis, ce Erik Paige, sd	Kay Basnight, wd		Cap. UP WE
WNOR 1949	1230 250	Norfolk Bcstg. Corp. 1019 Boissevain Ave. 2-7071 Walker	Louis H. Peterson, p Earl Harper, gm & cm	Bill Montgomery, pd & pmm	Howard Sheets, ce Josh Barry, sd		L-W AP G
WRAP 1952	1050 1,000-D	Rollins Bcstg., Inc. 300 Portlock Bldg. 4-8307 Pearson	John W. Rollins, p O. Wayne Rollins, vp	Robert Lyons, gm & cm	Oliver Allen, pd Glen Frazier, ce	Pop.: 733,000 Rad. Hms.: 195,300 Ret. Sis.: \$630,000,000 AP
WRVC (FM) 1948	Ch. 273 (B) 102.5mc 8.7kw	Larus & Bros. 2712 Colley Ave. 4-1100	CBS Radio Sales	John B. Tansey, pd	S. T. Terry Jr., ce			
WTAR 1923 WTAR-TV	790 5,000 DA-N	WTAR Radio Corp. 720 Boush St. 5-6711	CBS	Campbell Arnoux, p & gm John C. Pepper, opers. m	Robert Lambe, gen. slm Jack Black, slm William Johnson, pd	Robert Davis, pmm Richard L. Lindell, ce Mildred Alexander, wd		St. AP RCA
WTAR-FM 1947	Ch. 247 (B) 97.3mc 50kw							
NORTON								
WNVA 1946	1450 250	Blanfox Radio Co. Inc. Harlan, Ky.	MBS, KBS	R. B. Helms, p Jack T. Helms, gm & pmm	Wally Douglass, cm & pd Gene Tommerdahl, ce & sd	Jack Darnell, nd Warren Jarvis, fd	Pop.: 84,854 Rad. Hms.: 20,776 Ret. Sis.: \$25,000,000	Wid. AP Tem.
ORANGE								
WJMA 1949	1340 250	James Madison Bcstg. Corp. Box 271 7263	MBS	Welford A. Sherman Jr., p Alfred W. Walthall, gm, cm & fd	James E. Simmons, pd, nd & sd	Charles E. Brown, ce Ann G. Butler, wd	Pop.: 55,000 Rad. Hms.: 30,000 Ret. Sis.: \$46,110,000	SES. UP G
PEARISBURG								
WNRN 1953		(See Narrows, Va. listing)						

Data corrected to Dec. 10, 1953. If executives or services for FM are same as AM affiliate names are not repeated. Market Data supplied by stations. FM's in italic. *—Non-Commercial Station. CP—Construction Permit issued. D—Day. DA-N—Directional Antenna, night only. DA-1—Directional Antenna, same pattern day and night. DA-2—Directional Antenna, different pattern day and night. L—Limited Time with Dominant Station. LS—Local Sunset. N—Night. SA—Special Authorization. SH—Specified Hours. ST—Share Time. Complete key to abbreviations, page 6.

PETERSBURG

WSSV 1945	1240 250	Southside Va. Bcstg. Corp. 112 West Tabb St. Regent 3-4567	MBS, KBS	Louis H. Peterson, p Raymond L. Moss, gm Edgar L. von Nordeck, cm	Nellie W. Andrews, pd Eleanor Schenk, pmm Donald W. Hall, ce & sd	Lyle C. Bradley, nd Fred J. Herman, fd Katherine M. Nunnally, wd	Pop.: 175,000 Rad. Hms.: 33,000 Ret. Sis.: \$45,120,000	Cap. AP
--------------	-------------	---	-------------------	--	--	---	---	---------------------

PORTSMOUTH

WAVY 1943	1350 5,000-DA-2	Portsmouth Radio Corp. Professional Bldg. 7-3488	NBC Burn- Smith	Hunter C. Phelan, p. Carl Burkland, vp & gm Howard Stanley, cm & pmm Raymond Rich, pd Luther Horris, ce	Jim Woods, sd Alice Brewer White, wd		Rad. Hms.: 240,000	
WLOW 1946 WTOV (TV)	1400 250	Commonwealth Bcstg. Corp. 21st & Manteo 4-5678 Forjoe	Robert E. Wasdon, evp & gm John Gilmore, cm	Art Ross, pd Tom Matthews. pmm	Jack Siegel, tech. d & secy.-treas.	Pop.: 567,000 Rad. Hms.: 161,000 UP Col.

PULASKI

WPUV 1946	1230 250	Southwest Bcstg. Corp. P. O. Box 351 3-3931	NBC Sears & Ayer	Mason C. Deaver Jr., p & gm Mrs. Mason C. Deaver, Jr., vp	Larry Schoenfeld, cm John A. Columbus, ce Bob Kent, nd Dale Gallmore, fd	Bill Flint, sd Carl Shuffebrager, bus. m		Wld. AP Col.
--------------	-------------	--	------------------------	--	---	--	--	--------------------

RADFORD

WRAD 1950	1340 250	Rollins Bcstg. Inc. P. O. Box 1007 2461 Pearson	John W. Rollins, p Wayne Rollins, vp Wendell H. Siler, gm & cm	Lee Mills, ce, asst. m & pd Ben Johnson, pmm	Leslie Esqate, wd	Pop.: 70,000 Rad. Hms.: 18,850 Ret. Sis.: \$29,750,000	Thes. AP G
--------------	-------------	--	------------------	---	--	-------------------	--	------------------

RICHLANDS

WRIC 1951	1050 1,000-D CP: 540 1,000-D	Clinch Valley Bcstg. Corp. Box 218 450	KBS	Max Minton Blakemore, gm & ce	Joe J. Webb, cm, pmm & sd	Lindy Mack Seamon, pd	Pop.: 89,000 Rad. Hms.: 21,000 Ret. Sis.: \$26,000,000	Thes., SES. AP G
--------------	---------------------------------------	---	--------------	----------------------------------	------------------------------	--------------------------	--	------------------------

RICHMOND

WANT 1951	990 1,000-D	United Bcstg. Co. of Va. 513 E. Main St. 3-8368 Oakes	Richard Eaton, p Richard C. Scheele, gm & cm	Michael Novelle, pd William Gibbon, pmm Silas Bell, ce	Wilbur Lewis, nd Tom Mitchell, sd	Pop.: 245,182 G
*WBBL 1924	1480 5,000-DA-2- SH	Grace Covenant Presbyterian Church 1627 Monument Ave.						
WLEE 1945	1480 5,000-DA-2	Lee Bcstg. Corp. Broad-Grace Arcade 3-6741	MBS Forjoe	Thomas G. Tinsley Jr., p Irvin G. Abeloff, gm & cm	George McGuigan, ce Lud Stebling, nd	Joe Mason, sd Mrs. Betsy Slon, wd		L-W AP WE
WLEE-FM 1948	Ch. 275 (B) 102.9mc 21.5kw							

WANT RESULTS

Use **WANT** A UBC Station

RICHMOND'S LEADING INDEPENDENT, 1,000 Watts 990 KC
Average Daily Mail Count: 800 letters

65 new leads for TV sales for one advertiser in 10 days.
1000 pairs of nylons sold for a leading Richmond Department store with FIVE spots on WANT
More new advertisers in 1953 than other Richmond station.

WANT WANT!

Ask: BC Remedy, Stanback, Royal Crown, Richbrau, Rem, Pinex, Sulfur 8, Manishe-witz, Scotts Emulsion, Sinclair, Musterole, 666, Lydia Pinkham, S.S.S., 4-Way Cold Tablets, Apex.

WANT MORE CALL WANT COLLECT 38368 Richmond, Va.

VIRGINIA

City	Call Letters Established TV Affiliate	Chan. or Freq. Power	Licensee Headquarters Telephone	Network Represent- ative	Executive Abbreviations Owner o; Pres. p; Exec. vp evp; Gen. Mgr. gm; Sta. Mgr. sm; Coml. Mgr. cm; Sales Mgr. slm; Prog. Dir. pd; Chief Eng. ce; Prom. Mgr. pmm; Prod. Mgr. pdm; News, Farm, Sports or Women's Dir. nd, fd, sd, wd.	Market Data For Primary Area (Supplied by station)	Library, News Serv. Transmitter		
RICHMOND—(Cont'd)									
	WMBG 1926 WTVR(TV)	1380 5,000-DA-N	Havens & Martin Inc. 3301 W. Broad St. 5-8611	NBC Bolling	Wilbur M. Havens, p & gm Walter A. Bowry Jr., cm & pmm	John V. Shand, pd, nd & fd James W. Kyle, ce Bob Grove, sd	Rad. Hms.: 127,710 Ret. Sis.: \$353,931,000	UP RCA	
	WCOB(FM) 1946	Ch. 251 (B) 98.1mc 34kw	(WMBG, Am Affiliate)				Pop.: 446,885 Rad. Hms.: 121,324 Ret. Sis.: \$353,931,000		
	WRNL 1937	910 5,000-DA-N	Richmond Newspapers Inc. 111 N. 4th St. Richmond 3-3436	ABC Petry	D. Tennant Bryan, p E. S. Whitlock, m Joseph H. Sierer, slm	Howard Hamrick, pd & sd Grace Brauer, pmm	E. V. Wolstenholme Jr., ce Ira Hull, fd Polly Daffron, wd	St., Thes. AP WE	
	WRNL-FM 1949	Ch. 271 (B) 102.1mc 50kw							
	WRVA 1925	1140 50,000 DA-1	Larus & Bros. Co. Hotel Richmond 3-6633	CBS CBS Radio Spot Sales	C. T. Lucy, gm Barron Howard, bus. m	S. S. Carey, prog. serv. m J. L. Stone Jr., pmm D. C. Woods, ce	W. R. Bishop, pub. rel. m George Passage, nd & sd	L-W, Wid. UP WE	
	WRVB (FM) 1950	Ch. 233 (B) 94.5mc 25kw	(WRVA, Am Affiliate)						
	WXGI 1947	950 1,000-D	Radio Virginia Inc. 100 W. Franklin St. 7-4684 Indie	Douglas H. Robertson, p	David M. Wilburn, gm & cm	Paul Kness, ce Newton Thomas, sd	Pop.: 600,000 Rad. Hms.: 127,820 AP WE	
ROANOKE									
	WDBJ 1924	960 5,000-DA-N	Times-World Corp. 124 W. Kirk Ave. 8131	CBS Free & Peters	J. P. Fishburn, p Ray P. Jordan, gm John W. Harkrader, cm	Paul E. Reynolds, pd Joe B. Grant, prom. d J. E. Newman, ce	Charles A. Ballou, prod. d John W. Eure, nd Don F. Murray, sd	Pop.: 410,900 Rad. Hms.: 94,720 Ret. Sis.: \$651,078,000	Wid. AP, UP RCA
	WDBJ-FM 1948	Ch. 235 (B) 94.9mc 41kw							
	WRIS 1953	1410 5,000-D	Roanoke Independent Bcstrs. Inc. Pythian Bldg. 2-3131	Cy N. Bahakel, p Frank Tirico, m	Lorraine Lancaster, office m Herman Reavis, pd	Coleman Austin, pmm John Strong, ce		

Data corrected to Dec. 10, 1953. If executives or services for FM are same as AM affiliate names are not repeated. Market Data supplied by stations. FM's in italic. *—Non-Commercial Station. CP—Construction Permit issued. D—Day. DA-N—Directional Antenna, night only. DA-1—Directional Antenna, same pattern day and night. DA-2—Directional Antenna, different pattern day and night. L—Limited Time with Dominant Station. LS—Local Sunset. N—Night. SA—Special Authorization. SH—Specified Hours. ST—Share Time. Complete key to abbreviations, page 6.

RADIO RESULTS FORMULA FOR ROANOKE

USE

WDBJ's weekly SAMS-1952 audience is 124% greater than the second station's; on a 3-or-more days basis 192% greater. WDBJ's weekly night-time audience is 94% greater, and for 3-or-more days 125% greater.

The cost difference? WDBJ rates average less than 20% more.

Whether you have a staple or luxury commodity, consider ROANOKE's excellent INCOME DISTRIBUTION — its superior TEST-MARKET rating.

Compare as you like — then call Free & Peters!

WDBJ Established 1924
CBS Since 1929 **ROANOKE, VA.**
AM - 5000 watts - 960 kc. — FM - 41,000 watts - 94.9 mc.

28 YEARS



IN



WITH



FOR

VIRGINIA



WRVA

An institution, according to Mr. Webster, is "that which is established."

In the truest sense of the word, then, WRVA is a Virginia institution. For since its beginning nearly three decades ago, WRVA has been firmly and continually established in the Old Dominion . . . in its constantly growing culture, commerce and industry.

Its 50,000-watt voice is heard as that of a friend throughout the commonwealth . . . a voice that will speak well for your products, your services.

50,000 WATTS • RICHMOND

VIRGINIA

City	Call Letters Established TV Affiliate	Chan. or Freq. Power	Licensee Headquarters Telephone	Network Represent- ative	Owner o; Pres. p; Exec. vp evp; Gen. Mgr. gm; Sta. Mgr. sm; Coml. Mgr. cm; Sales Mgr. sim; Prog. Dir. pd; Chief Eng. ce; Prom. Mgr. pmm; Prod. Mgr. pnm: News, Farm, Sports or Women's Dir. nd, fd, sd, wd.	Executive Abbreviations	Market Data For Primary Area (Supplied by station)	Library, News Serv. Transmitter	
ROANOKE (Cont'd)									
	WROV 1946	1240 250	Radio Roanoke Inc. 600 Mt. Trust Bldg. 3-4444	ABC, MBS Burn- Smith	Leo F. Henebry, p Frank E. Koehler, gm & cm	Lee Garrett, pd James W. Robertson, ce		L-W UP WE	
	WROV-FM 1948	Ch. 279 (B) 103.7mc 2.3kw							
	WLSL 1940	610 1,000	Shenandoah Life Stations Inc. 301 1st St., SW 9227	NBC Avery- Knodel	Paul C. Buford, p James H. Moore, evp Horace Fitzpatrick, asst. & cm	Melvin L. Linkous, pd F. L. Corstaphney, pmm	J. P. Briggs, ce Glenwood Howell, fd	Pop.: 874,000 L-W, Thes., Rad. Hms.: 80,000 Assoc. Ret. Sls.: \$633,190,000 AP RCA	
	WLSL-TV 1947	Ch. 256 (B) 99.1mc 10.6kw							
SOUTH BOSTON									
	WHLF 1947	1400 250	Halifax Bcstg. Co. Webster St. 2-9988	ABC, KBS	John L. Cole Jr., o, m & cm	Ella L. Poindexter, pd, pmm & wd	Arthur A. Moran Jr., ce Roy Marsh, nd	Pop.: 300,000 Rad. Hms.: 10,000 Ret. Sls.: \$40,000,000	Wld. AP G
SOUTH HILL									
	WJWS 1953	1370 1,000-D	Mecklenburg Bcstg. Corp. Box 669 230		John W. Shultz, p & gm	Phil Hedrick, vp & ce Ruth M. Schultz, secy.-treas.	W. Brown Hofer, cm		
STAUNTON									
	WAFC (CP)	900 1,000-D	American Home Bcstg. Co. P. O. Box 396		Willard F. Ganoe, p	Lloyd Gochenour, gm & pd			
	WTON 1946	1400 250	Charles P. Blackley Morrison Bldg. 5-5555	ABC	Charles P. Blackley, p & gm	Charles E. Seebeck, cm & pmm	Fulton A. King, pd Rex C. Houser, ce	Pop.: 75,000 Assoc., Thes. Rad. Hms.: 19,200 AP Ret. Sls.: \$62,000,000 WE	
SUFFOLK									
	WLPM 1940	1450 250	Suffolk Bcstg. Corp. Radio Bldg. 2394	ABC, KBS	Fred L. Hart, p & gm Earl Hundley, cm, nd & sd	Lee Williams, pmm .. Veryl W. Rupp, ce	L. E. Pettyjohn, fd	Thes. AP Col.	
WARSAW									
	WNNT 1949	690 250-D	Northern Neck & Tidewater Bcstg. Co. 690	KBS	Grayson Headley, p & gm Ruth R. Rouzie, cm	Ken Lueck, pd, ce, nd & fd Pat Parker, pmm, asst. cm & wd	Georgia Ferlazzo, adm. asst. Don Moyer, sd	Pop.: 135,000 Rad. Hms.: 120,000 Ret. Sls.: \$149,000,000	UP G
WAYNESBORO									
	WAYB 1947	1490 250	Waynesboro Bcstg. Corp. 526 W. Main St. 6066	MBS	Judson T. Phillips, p N. Wilbur Kidd, gm & cm	Albert C. Schmick, pd Donald D. Curtis, ce	Al Charles, sd Helen M. Huffman, wd	L-W AP	
WINCHESTER									
	WINC 1941	1400 250	Richard Field Lewis Jr. Drawer 605 4855	ABC, KBS	Richard Field Lewis Jr., p, gm & cm	John Carl Moran, pd & nd James Holder, pmm	Philip B. Whitney, ce Marion Park., wd	Pop.: 153,000 Rad. Hms.: 37,200 Ret. Sls.: \$110,000,000	Assoc. UP WE
	WRFL(FM) 1946	Ch. 223 (B) 92.5mc 13.4kw	(WINC, Am Affiliate)					Pop.: 2,150,225 Rad. Hms.: 120,000 Ret. Sls.: \$1,350,000,000	St. UP Fed.
WYTHEVILLE									
	WYVE 1949	1280 1,000-D	Wythe County Bcstg. Co. P. O. Box 534 840	MBS, KBS	Dr. A. M. Gates, co	Arthur M. Gates Jr., gm & cm	Jack Fleming, ce	Pop.: 200,000 Rad. Hms.: 52,000 L-W, Cap. Ret. Sls.: \$1,500,000	UP G

Data corrected to Dec. 10, 1953. If executives or services for FM are same as AM affiliate names are not repeated. Market Data supplied by stations. FM's in *italics*. *—Non-Commercial Station. CP—Construction Permit issued. D—Day. DA-N—Directional Antenna, night only. DA-1—Directional Antenna, same pattern day and night. DA-2—Directional Antenna, different pattern day and night. L—Limited Time with Dominant Station. LS—Local Sunset. N—Night. SA—Special Authorization. SH—Specified Hours. ST—Share Time. Complete key to abbreviations, page 6.

.....

WROV

AM FM

ABC MBS

Mountain Trust Building

Roanoke Virginia

}

..... a long list of satisfied
clients who have used WROV
in Roanoke year after year
will testify to the "result
getting" ability of this efficient,
economical radio station

MARKET DATA BY COUNTIES

County	Population 1950	Radio Families 1953	Retail Sales 1952(000)	Food Sales 1952(000)	Drug Sales 1952(000)	Automobile Ownership 1952	County	Population 1950	Radio Families 1953	Retail Sales 1952(000)	Food Sales 1952(000)	Drug Sales 1952(000)	Automobile Ownership 1952
Adams	6,584	2,090	\$ 11,749	\$ 1,727	\$ 229	4,672	Mason	15,022	4,980	14,064	4,094	169	7,136
Asotin	10,878	3,610	5,486	2,009	87	5,013	Okanogan	29,131	8,570	22,086	6,176	794	13,184
Benton	51,370	19,990	62,146	17,424	3,374	22,961	Pacific	16,558	5,470	16,796	5,251	368	7,629
Chelan	39,301	12,490	68,556	16,647	2,332	20,407	Pend Oreille	7,413	2,130	4,566	1,501	214	3,173
Clallam	26,396	8,300	34,815	10,137	793	12,841	Pierce	275,876	86,560	273,392	68,093	7,422	101,972
Clark	85,307	29,660	78,948	22,117	2,013	39,924	San Juan	3,245	3,510	2,422	697	40	1,442
Columbia	4,860	1,570	4,743	1,074	71	3,050	Skagit	43,273	1,160	60,373	15,359	1,196	21,577
Cowlitz	53,369	17,010	63,831	14,727	1,658	25,030	Skamania	4,788	1,570	1,935	945	35	2,131
Douglas	10,817	3,240	6,421	1,537	44	5,517	Snohomish	111,580	37,010	116,886	31,053	2,663	50,351
Ferry	4,095	1,000	1,254	466	32	1,380	Spokane	221,561	73,150	279,221	56,772	8,242	96,259
Franklin	13,563	4,910	27,772	6,226	968	10,513	Stevens	18,580	5,180	13,976	3,439	359	8,418
Garfield	3,204	890	3,887	432	116	2,150	Thurston	44,884	14,870	48,748	12,488	1,159	14,644
Grant	24,346	7,550	19,312	5,760	594	11,873	Wahkiakum	3,835	1,060	1,753	709	32	1,490
Grays Harbor	53,644	16,790	68,841	17,595	1,587	24,170	Walla Walla	40,135	12,410	52,611	10,289	1,533	18,093
Island	11,079	3,810	7,764	2,487	210	5,253	Whatcom	66,733	21,440	77,134	16,533	1,733	29,457
Jefferson	11,618	3,500	8,945	3,183	121	4,334	Whitman	32,469	9,230	35,394	8,012	1,259	14,705
King	732,982	252,080	914,238	208,810	26,308	298,068	Yakima	135,723	42,140	156,966	36,899	4,293	62,029
Kitsap	75,724	26,400	81,385	25,225	2,930	33,171	Total	2,378,963	781,900	\$2,755,132	\$661,202	\$77,374	988,849
Kittitas	22,235	6,450	28,875	6,847	591	10,149	Note: Population 1950 Census; radio families Standard Audit & Measurement Services Inc.; food, drug and retail sales, copyright 1953, Sales Management; further reproduction unlicensed; automobiles supplied by state.						
Klickitat	12,049	3,680	10,382	2,738	258	6,604							
Lewis	43,755	13,720	51,547	11,998	1,207	21,287							
Lincoln	10,970	3,180	15,912	2,686	360	7,292							

DIRECTORY OF AM AND FM STATIONS

ABERDEEN

KBKW 1948	1450 250	KBKW Inc. KBKW Bldg. 1015	ABC Forjoe	Archie Taft Jr., p L. H. Davis court, gm Francis White, pd	Jack Fleming, ce Erma Fulton, traffic m	Don Bullock, nd, fd & sd Vernona Keaton, wd	Pop.: 60,000 Rad. Hms.: 18,000 Ret. Sls.: \$90,000,000	Assoc. Wld. AP Col.
KXRO 1928	1320 1,000-DA-N	KXRO Inc. 207½ E. Market St. 4098	MBS, Don Lee Clark, Art Moore	Harry R. Spence, p Fred G. Goddard, gm Roy Johnson, cm	Phillip M. Wacker, pd Stanley Craft, pmm, nd & sd	Philip S. True, ce Heston Wyrick, fd Vivian Pinckney, wd	Pop.: 69,661 Rad. Hms.: 21,677 Ret. Sls.: \$592,590,000 UP Ray.

BELLINGHAM

KPUG 1948	1170 1,000-DA-1	KPUG Inc. P. O. Box 655 6-200	MBS, KBS, Evergreen, Don Lee Clark Moore & Lund	Jessica L. Longston, p Jim Hamstreet, gm Alex DeSchweinitz, cm	Jeanne Smith, pd & wd Dick Rapp, pmm Donald Pinney, ce John DiMeo, nd	Dick Thompson, fd Mal Alberts, sd	Pop.: 169,848 Rad. Hms.: 43,127 Ret. Sls.: \$150,163,000	L-W UP WE
KVOS 1927 KVOS-TV	790 1,000-DA-1	KVOS Inc. 1321 Commercial 790	ABC Forjoe	Rogan Jones, p Jack Clarke, gm Glen Beebe, cm Dave Mintz, pd	Mel McKee, pmm Ernest Harper, ce Fred Elsethagen, natl. slm	Bert Jackson, nd Hal Reeves, fd Haines Fay, sd Elaine Horn, wd	Pop.: 152,300 Rad. Hms.: 49,300 Ret. Sls.: \$182,508,000	Wld., Mac. UP WE

BREMERTON

KBRO 1947	1490 250	Bremerton Bcstg. Co. St. A Box 1803 7-3995	Bruce Bartley, o Loren B. Stone, gm Gil Jacobsen, slm	Al Stewart, pd & fd Bill Dore, ce	Jack Rogers, nd Linc Perry, sd	Pop.: 82,200 Rad. Hms.: 26,450 Ret. Sls.: \$81,385,000	St. AP WE
KGIB 1950	1540 1,000-D	Kitsap G. I. Bcstrs. Inc. 124 N. Callow St. 7-3757

CENTRALIA-CHEHALIS

KELA 1937	1470 1,000	Central Bcstg. Corp. P. O. Box 720 6-3321	MBS, KBS, Don Lee Clarke, O'Connell Moore & Lund, Western Radio	Elroy McCaw, p Mabel A. Gwinn, secy.-treas.	Joe Chytil, gm & cm Joe Clement, pd William Tilton, pmm Lloyd Hannah, ce	Robert Cleland, nd, fd & sd Polly O'Conner, wd	Pop.: 78,000 Rad. Hms.: 17,500	Wld. UP RCA
--------------	---------------	--	--	---	---	--	-----------------------------------	-------------------

CHEHALIS

KGLM (CP)	1420 1,000-D	J. W. Kendall 1200 Cascade Bldg. Portland, Ore.	Mid-State Bcstg. Co.
--------------	-----------------	--	-------------------------	-------	-------	-------	-------	-------

COLFAX

KCLX 1951	1450 250	Whitman County Bcstrs. Box 710 780	KBS	E. Pournell, p & gm Ross Pellerin, cm & pmm	Ruth Pournelle, pd & wd	David L. Dodd, ce Bob Curtis, sd	Pop.: 60,000 Rad. Hms.: 97.2%	SES. AP RCA
--------------	-------------	---	--------------	---	----------------------------	-------------------------------------	----------------------------------	-------------------

EDMONDS

KEDM (CP)	630 1,000-D	King's Inc. Seattle Emerson 1617	A. B. Martin, p	Pop.: 1,000,000
--------------	----------------	--	-------	-----------------	-------	-------	-----------------	-------

ELLENSBURG

KXLE 1946	1240 250	Central Wash. Broad Inc. Box 600 2-1488 McGillvra	Goodwin Chase Jr., p Joe Kendall, gm	Bill Chase, pd Bill Hanning, ce	Ron Forsell, nd & sd Phil Parker, fd	Pop.: 24,000 Rad. Hms.: 6,630 Ret. Sls.: \$23,800,000 UP RCA
--------------	-------------	--	--------------------	---	------------------------------------	---	---	--------------------

EPRHATA

KULE 1949	730 250-D	Columbia Basin Bcstg. Co. Box 548 4-3730	R. E. Billingsley, p Bob Moore, gm Bob Osland, cm & sd	Dorothy McCue, pd & wd Len Brown, mus. lib.	Bill McCoy, ce Jack Yearout, nd & fd	Pop.: 35,000 Rad. Hms.: 10,000 RCA
--------------	--------------	---	-------	--	---	---	-----------------------------------	-----------------------

EVERETT

KRKO 1920	1380 1,000-DA-N	Everett Bcstg. Co. Inc. P. O. 916 Cedar 1144	MBS, Don Lee McGillvra, Moore & Lund	William R. Taft, p & gm Dave Foley, ce	Warren Johnson, slm Nancy Spaeth, traffic & copy d	Shirley Bartholomew, nd Lloyd Rodstrom, sd	Pop.: 142,431 GE
--------------	--------------------	---	--	--	--	--	---------------	----------------------

WASHINGTON

City	Call Letters Established TV Affiliate	Chan. or Freq. Power	Licensee Headquarters Telephone	Network Represent- ative	Owner o; Pres. p; Exec. up evp; Gen. Mgr. gm; Sta. Mgr. sm; Coml. Mgr. cm; Sales Mgr. slm; Prog. Dir. pd; Chief Eng. ce; Prom. Mgr. pmm; Prod. Mgr. pdm; News, Farm, Sports or Women's Dir. nd, fd, sd, wd.	Executive Abbreviations	Market Data For Primary Area (Supplied by station)	Library, News Serv. Transmitter
GRAND COULEE								
KFDR 1950	1400 250	Columbia River Bcstrs. Inc. P. O. Box 395 140	KBS Moore & Lund	J. W. England, p & gm	Robert Anderson, pd	John Louden, ce	 UP
KELSO								
KLOG 1949	1490 250	Northwest Public Service Inc. P. O. Box 90 4900 Wm. Ayers, Feltis	Roscoe A. Day Jr., p John Carlson, gm	Lowell Gibson, pd & fd	Bill Vance, ce Warren Kemper, sd	Pop.: 75,000 Rad. Hms.: 97.9% Ret. Sis.: \$76,000,000 UP Ray.
KENNEWICK								
KWIE 1949	610 1,000-DA-N	KWIE Inc. 11 S. Cascade 6861	CBS Meeker, Moore & Lund	Harold A. Clark, p & gm C. J. McCredie, cm & ce	Marvin E. Johnston, pd & pmm Ben Weaver, nd	Holly Bishop, fd Jack Quinn, sd Mar Jean Matthews, wd	Pop.: 215,000 Rad. Hms.: 68.000 Ret. Sis.: \$380,140,000	Assoc. UP Col.
KIRKLAND								
KRKL 1948	1050 250-D	Eastside Bcstg. Co. Civic Center 22-1201 Continental	Lamar N. Ostrander, co-o W. O. Chamness, co-o	George A. Wilson, gm John G. Joachims, cm Rosanne, Coyle Lomen, pd	Robt. H. Waldron, ce Marguerite Warburton, wd	Pop.: 750,000 Rad. Hms.: 312,000 Ret. Sis.: \$1,000,000,000	CaD. Ray.
LONGVIEW								
KWLK 1938	1400 250	Twin City Bcstg. Corp. Natl. Bank of Commerce Bldg. 1500	MBS, Don Lee Grant	C. O. Chatterton, p Bob L. Moran, gm & nd	Ellen P. Hammond, pd Ralph I. Brown, ce	Frantzel Corman, wd		Wid. UP RCA
MOSES LAKE								
KSEM 1947	1450 250	KSEM Inc. P. O. Box 276 234	KBS Cooke, Moore	Jessica L. Longston, p Alan O. Miller, gm James Schroeder, cm	Roland Hooper, pd Earl Bayne, ce		Pop.: 25,000 Rad. Hms.: 9,000	Wid. UP WE
MOUNT VERNON								
KBRC 1946	1430 500-DA-N	Beckley Radio Co. P. O. Box 240 8955 Moore & Lund	Leo H. Beckley, p & gm Don Usher, cm	Tom Haveman, pd, pmm. nd & sd John Price, ce	Frank Snyder, fd Delores Healey, wd	Pop.: 69,100 Rad. Hms.: 21,168 Ret. Sis.: \$75,559,000	Wid. UP WE
OLYMPIA								
KGY 1922	1240 250	Tom Olsen Rockway-Leland Bldg. 6636	MBS, KBS, Don Lee	Tom Olsen, p & gm Elmer J. Holmberg, cm & pmm	Don Jones, pd & sd C. A. Roark, ce	Bob Cummings, nd Donna Murdock, wd	Pop.: 55,000 Rad. Hms.: 18,000	Wid., SES. UP WE
OMAK								
KOMW 1947	680 1,000-D	KOMW Inc. Box 151 00	R. L. McNett, p Dean C. Nichols, gm Grover D. Allen, cm	Mary Jane Robbins, pd Stan Pennington, nd	Burt A. Cast, sd Margaret Dunlap, wd		L-W AP WE
PASCO								
KALE 1950	(See Richland, Wash. listing)							
KPKW 1945	1340 250	Western Radio Corp. Chase & "A" Sts. 3337	ABC	V. Barney Kenworthy, p Wm. Hunt, sm & cm	Walter Mott, pd & nd Don Hays, pmm Robt. Rockne, ce	Della Perrault, wd William White, sd	Pop.: 80,000	Cap. UP
PORT ANGELES								
KONP 1945	1450 250	Radio Pacific Inc. 313 W. 1st St. 4200	KBS Keating	C. N. Webster, p & gm	Keith E. Patterson, sm James Frits, cm	Frederick Fields, ce	Pop.: 90,000 Rad. Hms.: 25,000	Wid. UP WE
PULLMAN								
KOFE 1950	1150 1,000-D	J. Ronald Bayton & Maynard F. Hicks P. O. Box 356 1-5251	J. Ronald Bayton, co-o, gm, pd & fd Maynard F. Hicks, co-o	John R. Puckett, cm Mrs. B. J. Bayton, pmm, ce & wd	Pearl Hall, record lib. Robert D. Adkins, nd Steven M. Buck, sd	Pop.: 130,000 Rad. Hms.: 34,000	L-W UP G
*KWSC 1922	1250 5,000 ST-KTW	State College of Wash. 9021	C. Clement French, p Allen Miller, gm Burt Harrison, pd & nd R. C. Norris, pdm	Robert E. Baird, ce Hugh A. Rundell, sp. events d	Dwight Fairbanks, fd Cal Watson, sd		Assoc., St., Wid. AP, UP GE
PUYALLUP								
KPUY 1951	1450 250	Puyallup Valley Bcstg. Co. Linden Dr. 5-7711	KBS	Merrill E. Mael, gm & cm	Pete Hansen, pmm & sd	George Yeager, ce Goldie Hendry, wd	Pop.: 250,000	Assoc. UP G
RAYMOND								
KAPA 1950	1340 250	Pacific Bcstg. Corp. Box 626 1010	Evergreen Clark, McGavren, Moore & Lund	Joe Chytil, p Hugh MacPherson, gm & cm	Stan Witter, pd, pmm & nd	Robert McNamara, ce	Pop.: 16,600 Rad. Hms.: 5,700 Ret. Sis.: \$16,000,000 AP RCA
RENTON								
KLAN 1950	1230 250	Interlake Bcstg. Corp. P. O. Box 449 7th North & Park Ave. Renton 5-3424 Forloe	Ralph J. Sanders, p George A. Edgar, pd	Frank C. Cook, ce	Rosemary Taylor, traffic m		Wid. UP RCA
RICHLAND								
KALE 1950	960 1,000-DA-N	KALE Inc. Box 367 4-3180 Clark	Robert S. McCaw, p L. G. Dix, gm, cm & pmm	Joseph Muench, pd & ce Wayne Kilmer, nd	Jerry Colkitt, sd Mary Ellen Boyd, wd	Pop.: 100,000 Rad. Hms.: 20,000 UP GE
KALE-FM 1950	Ch. 280 (A) 103.9mc 0.58kw						Pop.: 100,000 Rad. Hms.: 98,000	L-W Ray.

Data corrected to Dec. 10, 1953. If executives or services for FM are same as AM affiliate names are not repeated. Market Data supplied by stations. FM's in italic. *—Non-Commercial Station. CP—Construction Permit issued. D—Day. DA-N—Directional Antenna, night only. DA-I—Directional Antenna, same pattern day and night. DA-2—Directional Antenna, different pattern day and night. L—Limited Time with Dominant Station. LS—Local Sunset. N—Night. SA—Special Authorization. SH—Specified Hours. ST—Share Time. Complete key to abbreviations, page 6.

SEATTLE										
KAYO 1926	1150 5,000-D 1,000-N	Washington Telecaster Inc. 2939 4th Ave. So. Ellet 2480	Clark	Jessica Longston, p Robert E. Pollock, gm Ted Bell, asst. m	Rodney McArdle, cm Ben Harkins, pd & pmm	Tad Jones, ce J. R. Engler, nd & sd Mary Talcott, wd	Pop.: 1,700,000 Rad. Hms.: 365,000 Ret. Sls.: \$960,000,000	L-W AP RCA		
KING 1927 KING-TV	1090 50,000-DA-1	King Bcstg. Co. 320 Aurora Mutual 3555	ABC Blair	Mrs. A. Scott Bullitt, p Henry B. Owen, evp Otto P. Brandt, gm John Eichhorn, cm Frederick von Hofen, slm Earl F. Reilly Jr., pd	Melvin A. Anderson, pmm Arthur A. Shultz, ce James L. Middle- brooks, eng. d	Robt. E. Priebe, asst. to gm Bob Ryan, nd Bill O'Mara, sd Beth Leonard, wd	Pop.: 1,600,200 Rad. Hms.: 502,940 Ret. Sls.: \$1,777,350,000	UP GE		
KING-FM 1947	Ch. 251 (B) 98.1mc 15kw						Pop.: 1,290,400 Rad. Hms.: 402,740 Ret. Sls.: \$1,717,464,000	RCA		
KIRO 1929	710 50,000- DA-N	Queen City Bcstg. Co. 1530 Queen Anne Ave. Alder 9800	CBS	Saul Haas, p J. Archie Morton, exec. asst. to p. Lincoln W. Miller, asst. to p John Piper, natl. slm	William Tucker, cm Carroll Foster, pd Bill Ellison, pmm James B. Hatfield, ce	John King, community rel. Don Courtney, sd Helen Kimball, wd	Pop.: 1,600,200 Rad. Hms.: 510,480 Ret. Sls.: \$1,777,349,000	Thes. UP RCA		
KISW(FM) 1950	Ch. 260 (B) 99.9mc 2.1kw	Ellwood W. Lippincott 9201 Roosevelt Way Plaza 6255		Ellwood W. Lippincott, p, gm & ce	Peter Tommie, cm	Carolee Waite, pd	Pop.: 750,000 Rad. Hms.: 30,000	Wid. Ray.		
KJR 1922	950 5,000-DA-N	Mt. Rainier Radio & Tv Bcstg. Corp. 7th Floor. Skinner Bldg. Elliott 5890	Avery- Knodel	Theodore R. Gamble, p Maitland Jordan, vp & gm	Homer Pope, pd Donald M. Anderson, ce	Warren Durham, asst. m Ann Sterling, wd	Pop.: 1,600,200 Rad. Hms.: 510,480 Ret. Sls.: \$1,777,349,000	Wid. UP RCA		
KLAN		(See Renton listing)								
KLOQ (CP)	1590 5,000-D	W. Gordon Allen 260 Hansen Salem		W. Gordon Allen, p & gm	John Truhan, ce					
KOL 1925	1300 5,000-DA-1	Seattle Bcstg. Co. 100 W. Florida Main 2312	Bolling	Archie Taft Sr., p Archie Taft Jr., gm Gil Bond, slm	Bill Simpdson, asst. m Bob Harris, pd	Perry Lind, ce Rod Belcher, nd & sd	Pop.: 1,439,011 Rad. Hms.: 447,111 Ret. Sls.: \$1,135,470,000	Wid. UP RCA		
KOMO 1926 KOMO-TV	1,000 50,000-DA-N	Fisher's Blend Station Inc. 100 4th Ave. No. Seneca 6000	NBC Holling- bery	O. W. Fisher, p W. W. Warren, vp & gm	Ray Baker, vp & cm Fred Patterson, pd King Mitchell, slm	F. J. Brott engrg. d Biss Moshier, fd Katherine Wise, wd	Pop.: 1,540,686 Rad. Hms.: 504,120 Ret. Sls.: \$1,659,479,000	L-W, Assoc. UP RCA		
KTW 1920	1250 1,000 ST: KWSC	First Presby- terian Church of Seattle 7th Ave. & Spring St. Mutual 1250		James S. Ross, gm & ce	Don Bevilacqua, cm	A. G. Atworth Jr., pd, pmm & nd	Pop.: 750,000			

the friendly station

KIRO

listened to more often—in more places—by more people
than any other Pacific Northwest radio station

CBS 50,000 WATTS 710 kc

SEATTLE, WASHINGTON

WASHINGTON

City	Call Letters Established TV Affiliate	Chan. or Freq. Power	Licensee Headquarters Telephone	Network Represent- ative	Owner o; Pres. p; Exec. cm; Sales Mgr. slm; Prod. Mgr. pdm; News, Farm, Sports or Women's Dir. nd, fd, sd, wd.	Executive Abbreviations Exec. op evp; Gen. Mgr. gm; Sta. Mgr. sm; Coml. Mgr. cm; Prom. Mgr. pmm; Chief Eng. ce; News, Farm, Sports or Women's Dir. nd, fd, sd, wd.	Market Data For Primary Area (Supplied by station)	Library, News Serv. Transmitter	
SEATTLE—(Cont'd)									
KVI	1928	570 5,000	Puget Sound Bcstg. Co. Inc. Camlin Hotel 1619 9th Ave. Seneca 4848	MBS H-R Reps.	Laura M. Doern- becher, co	Vernice Irwin, p & gm Earl T. Irwin, cm	Harry Long, pd & nd D. M. McDonough, ce	Pop.: 1,403,393 Rad. Hms.: 540,230 Ret. Sls.: \$1,940,345,000 AP WE
KXA	1926	770 1,000-D L-WABC	KXA Inc. 320 2d Ave. W. Alder 8600 Rambeau	Cassius Gates, ch. Wesley I. Dumm, p Hugh A. Smoth, vp & gm	John W. Mowbray, cm John H. Dubuque, pd & cm	Robert J. Ackerley, nd	Pop.: 903,574 Rad. Hms.: 251,435 AP
SPOKANE									
KGA	1926	1510 50,000-DA-N	Bankers Life & Casualty Radio Central Bldg. MA-5383	ABC Clark	John MacArthur, p Kenneth Yeend, gm Irving N. Prell, cm	Rod Klise, pd Bernie Boardman, ce	John Fahey, nd Edna Storms, wd UP RCA	
KHQ	1922 KHQ-TV	590 5,000	KHQ Inc. Radio Central Bldg. MA-5131	NBC Katz	R. O. Dunning, p & gm Chas. E. Lohnes, cm M. O. Fritsch, asst. secy.-treas.	Dick Gordon, pd Birney Blair, pmm A. G. Sparling, ce Pat Cullen, nd	Glenn Lorang, fd Mary Frances Huffman, wd	Pop.: 883,000 Rad. Hms.: 272,000 Ret. Sls.: \$872,773,000	Wid. AP Col.
KNEW	1947	790 5,000 DA-2	Inland Empire Bcstg. Co. Sprague & Wall Riverside 8035	MBS, Don Lee Weed	Burl C. Hagadone, p & gm C. E. Rodell, sm & cm	Paul Crain, pd & pmm Vincent L. Hoffart, ce Robert Briley, nd	Kenneth Hutcheson, fd James McAdam, sd Lucille Petretees, wd	Pop.: 500,000 Ret. Sls.: \$500,000,000	Wid. AP
KREM	1947	970 5,000-D 1,000-N- DA-N	Louis Wasmer South 4103 Regal Keystone 0466 Bolling	Louis Wasmer, p Robert H. Temple, gm	Ed Mosley, pd Wm. Patterson, ce	Dick Hoover, nd Jack Hatch, sd	Pop.: 295,261 Rad. Hms.: 89,350 Ret. Sls.: \$348,591,000	Assoc. AP RCA
KREM-FM (CP)		Ch. 225 (B) 92.9mc 5kw							
KSPQ	1922	1340 250	D. Gene Williams & Delbert Bertholf Realty Bldg. Riverside 8033	D. Gene Williams, co-o, gm & cm Delbert Bertholf, co-o, pmm & fd	Edward Antosyn, ce Bob Concie, nd	Bob Fleming, sd Irmgard Buerger, wd	Pop.: 234,525 Rad. Hms.: 78,917 Ret. Sls.: \$227,939,000 UP
KXLY	1922 KXLY-TV	920 5,000	Symons Bcstg. Co. 315 W. Sprague Madison 1218	CBS Pacific Northwest Walker	Richard E. Jones, p Geo. Morgan, m & cm Gene Roth, pd Bob Moore, pmm	Geo. Langford, ce Ernie Jergenson, fd Knowles Robertson, nd	Marty Koschman, sd Adrain Scott, wd	Pop.: 893,178 Rad. Hms.: 229,020 Ret. Sls.: \$1,000,000,000	Mac., St. UP
SUNNYSIDE									
KREW	1950	1230 250	Cole E. Wylie Outlook Rd. 7-2277 Forjoe	Cole E. Wylie, p Don G. Bennett, gm Clifford Nelson, cm	Jean Runyon, pd John Berg, ce Fulton Travis, nd & fd	Allen Bell, sd Lynn Brown, wd AP RCA	
TACOMA									
KMO	1928 KMO-TV	1360 5,000	KMO Inc. 914 1/2 Broadway Fulton 1581 Branham	Carl E. Haymond, p Jerry Geehan, gm R. T. McKenzie, cm Richard D. Weeks, pd	Gene Dryden, pmm John L. Boor, ce Paul F. Benton, secy.- treas.	Dan Seymour, nd R. H. Robertson, sd	Pop.: 1,166,500 Rad. Hms.: 1,143,170 Ret. Sls.: \$1,324,622,000	St., Thes. UP G
KTAC	1942	850 1,000-DA-N	Tacoma Bcstrs. Inc. P. O. Box 1522 Broadway 2241	Evergreen McGillvra, Moore	H. J. Quilliam, p Ted R. Knightlinger, gm & pd	Don Hopkins, cm Jim Faber, co-nd Dick Velo, ce	Murray Morgan, co-nd Clay Huntington, sd Lovee Mills, wd Wid. UP WE	
KTNT	1952 KTNT-TV	1400 250	Tribune Pub. Co. South 11th & Grant Sts. Fulton 2561 Weed	Frank S. Baker, p Len Higgins, gm	John Upham, cm Gless Connoy, pd & nd	Max Bice, ce Gail Clark, wd	Pop.: 264,290 Rad. Hms.: 88,000	Assoc., L-W AP Col.
KTNT-FM	1948	Ch. 247 (B) 97.3mc 10.2kw						Pop.: 840,309 Rad. Hms.: 88,000	Assoc. AP, UP GE
VANCOUVER									
KHFS	(CP)	1150 1,000-D	Western Bcstg. Co.					
KVAN	1939 KVAN-TV	910 1,000-DA-2	Vancouver Radio Corp. 707 Main St. TW7323	Evergreen Bolling	Sheldon F. Sackett, p Fred F. Chitty, gm Walter P. Rossmann, cm & pmm	George W. Conner, pd Leo Erickson, ce George Hopkins, nd & sd	Clarence Hecox, fd Fern Hayes, wd	Pop.: 945,625 Rad. Hms.: 300,000 Ret. Sls.: \$956,778,000 UP, AP Ray.
WALLA WALLA									
KTEL	1946	1490 250	Walla Walla Bcstg. Co. Book Nook Bldg. 4103	ABC Grant, Keating	Jack Keating, p & gm Harold C. Singleton, vp Donald W. Harris, cm	Wayne E. Murphy, pd, pmm & nd Bevin Roth, ce	Mrs. L. Bussard, fd & wd Vern Kinsinger, sd	Pop.: 86,900 Rad. Hms.: 24,759 Ret. Sls.: \$55,324,000	Wid. AP WE
KUJ	1928	1420 5,000-DA-N	KUJ Inc. 55 E. Main St. 1230	MBS, Don Lee Weed, Moore & Lund	H. E. Studebaker, p & gm Don Wike, sm, cm & sd	John Sherman, pd & nd M. L. MacLafferty, ce	LaVerne Russell, fd Denise Hart, wd	Pop.: 200,000 Rad. Hms.: 53,000 Ret. Sls.: \$230,000,000	Thes., Assoc. UP RCA
WENATCHEE									
KPQ	1929	560 5,000-DA-N	Wescoast Bcstg. Co. 2d & Columbia 2757	ABC, NBC Forjoe	Rogan Jones, p James W. Wallace, vp & gm Pat O'Halloran, cm & pmm	Emerson Elder, pd George Frese, ce Dorothy Lee, traffic m & wd	Paul Pugh, nd Tom Templeton, fd Bill Denton, sd	Pop.: 135,000 Rad. Hms.: 42,000 Ret. Sls.: \$116,355,000	Wid., Assoc. UP WE
KWNW	1948	1340 250	Wenatchee Bcstrs. Box 1510 2468	MBS McGillvra, Moore & Lund	Stuart S. Mavs, co-o & gm	Mark A. Sorley, co-o & cm	Carol Gaines, pd Warren Brown, ce	Pop.: 35,000	
YAKIMA									
KIMA	1944 KIMA-TV	1460 5,000 DA-N	Cascade Bcstg. Co. Inc. P. O. Box 702 6104	CBS Weed	A. W. Talbot, p Frank E. Mitchell, vp, treas. & radio m Thomas C. Bostic, gm	W. B. Hansen, cm James W. Nolan Jr., nd Helen Turnell, pmm	J. Barry Watkinson, ce A. J. Knievel, nd John G. Stenkamp, sd Maryalice Hines, wd	Pop.: 283,000 Rad. Hms.: 84,700 Ret. Sls.: \$260,095,000	Assoc. AP WE
KIT	1929 KIT-TV	1280 5,000-D 1,000-N	KIT Inc. 414 1/2 E. Yakima Ave. 8115	ABC, NBC Branham	Carl E. Haymond, p James A. Murphy, vp & gm	Jack H. Goetz, cm & fd Vern Sawyer, pd H. B. Murphy, ce	Peder N. Wick, nd & fd Ray Litzinger, sd Catherine May, wd	Pop.: 160,500 Rad. Hms.: 54,600 Ret. Sls.: \$210,000,000	Cap. UP G
KYAK	1947	1390 1,000-D 500-N-DA-N	Yakima Bcstg. Corp. P. O. Box 172 2-7143	MBS Clark, L. O'Con- nell	R. S. McCaw, p W. W. Boone, gm Leroy T. Desilet, cm & sd	Gerald Webb, pd D. E. Gardner, ce Wey Simpson, nd	R. J. Passage, fd Helen Ruth Hoffman, wd	Pop.: 172,000 Rad. Hms.: 42,400 Ret. Sls.: \$138,159,630	Wid. UP RCA

Data corrected to Dec. 10, 1953. If executives or services for FM are same as AM affiliate names are not repeated. Market Data supplied by stations. FM's in *italics*. *—Non-Commercial Station. CP—Construction Permit issued. D—Day. DA-N—Directional Antenna, night only. DA-1—Directional Antenna, same pattern day and night. DA-2—Directional Antenna, different pattern day and night. L—Limited Time with Dominant Station. LS—Local Sunset. N—Night. SA—Special Authorization. SH—Specified Hours. ST—Share Time. Complete key to abbreviations, page 6.

LOGAN--(Cont'd)

WVOW 1952	1290 5,000-D 1,000-N DA-2	The Logan Bcstg. Corp. Bus Terminal Bldg. 2356	McGillvra	Chauncey M. Browning, p Henry V. Diefenbach, gm & cm	Audie Albright, pd & wd Lila Abrahams, pmm	Lew J. Frye, ce Bob Gaynor, nd Mike Wynn, sd	Pop.: 750,000 Rad. Hms.: 150,000	L-W UP
MARTINSBURG								
WEPM 1946	1340 250	Martinsburg Bcstg. Co. Box 874 5252	MBS, KBS McGillvra	C. Leslie Golliday, ptrn. & gm	C. M. Zinn, ptrn. Eunice J. Schneider, pd & wd	Clinton Lewis, ce John Floyd, nd & sd		Wid. AP G
WEPM-FM 1948	Ch. 232 (A) 94.3mc 0.80kw							
MATEWAN								
WHJC 1951	1360 1,000-D	Three States Bcstg. Co. Matewan 4771	KBS	Fred Morningstar, p Fred A. Staples, gm & sd	Leonard Dykema, ce Jack Collette, nd	Helen Pickering, wd	Pop.: 832,917 Rad. Hms.: 164,270 Ret. Sls.: \$385,737,000 UP G
MONTGOMERY								
WMON 1946	1340 250	Fayette Assoc. Inc. 1028 1st Ave. Hillside 2-2191	MBS	Arnold M. Vickers, p Andrew W. Vickers, gm, cm, pd & pmm	J. C. Craver, ce Jim Franklin, nd	Carl McAfee, sd Ann Elliott, wd	Pop.: 90,570 Rad. Hms.: 17,040 Ret. Sls.: \$43,000,000	Wid. AP Col.
MORGANTOWN								
WAJR 1940	1230 250	W. Va. Radio Corp. 446 Spruce 9488	MBS	Agnes J. Reeves Greer, p John W. Johns, gm	George J. Shean, cm Numa Fabre Jr., pd	Jack Fleming, pmm Al Novak, ce		Wid. UP RCA
WAJR-FM 1947	Ch. 257 (A) 99.3mc 1kw						Pop.: 69,680 Rad. Hms.: 15,613 Ret. Sls.: \$53,378,800	WE
MOUNDSVILLE								
WMOD 1950	1370 1,000-D	Robert W. Munn P. O. Box 308 Moundsville 1730	KBS. W. Va. Net.	Robert W. Munn, p John T. Taylor, gm & pmm	Leonard W. Zinck, cm George Wright, pd	James William Jones, ce Patrick J. Gaughan, sd	 UP
NEW MARINSVILLE								
WETZ 1953	1330 1,000-D	Magnolia Bcstg. Co. 3rd St. Ext. 1000	ABC Gill-Perna	J. Patrick Beacom, p Owen Deitz Jr., gm Nelson Parks, cm & pmm	Larry Deitz, pd Eugene Vinson, ce	Connstance Osborn, wd		

From Plug-in Sets to Color TV



Drawn for BROADCASTING • TELECASTING by Glenn R. Bernhardt

"When radio came out we waited for plug-in sets, when plug-in sets came out we waited for superheterodyne, when they came out we waited for fm, then he decided to wait for television. Now he's decided to wait for color tv!"

Throughout 23 years, BROADCASTING • TELECASTING has increasingly earned the loyalty of the thousands who read it. A keen editorial awareness of radio's problems and potentials has evoked, from broadcaster, advertiser and advertising agency alike, a confidence rarely accorded any trade publication. B•T has diligently championed the growth and welfare of every desirable advance in the whole, vast phenomenon of radio/tv broadcasting.

WEST VIRGINIA

City Call Letters Established TV Affiliate	Chan. or Freq. Power	Licensee Headquarters Telephone	Network Represent- ative	Owner o; Pres. p; Exec. v; e; Gen. Mgr. gm; Sta. Mgr. sm; Coml. Mgr. cm; Sales Mgr. slm; Prog. Dir. pd; Chief Eng. ce; Prom. Mgr. pmm; Prod. Mgr. pdm; News, Farm, Sports or Women's Dir. nd, fd, sd, wd.	Executive Abbreviations	Market Data For Primary Area (Supplied by station)	Library, News Serv. Transmitter	
OAK HILL								
WOAY 1947	860 10,000-D	Robert R. Thomas Jr. Oak Hill 651	Robert R. Thomas Jr. p & gm	Curtis Horton, ce Doug Ford, nd	Chuck Balding, sd & fd	Pop.: 425,000 Rad. Hms.: 230,000 Ret. Sls.: \$500,000,000	Cap., Thes. AP Col.
WOAY-FM 1948	Ch. 231 (B) 94.1mc 29kw						Pop.: 300,000 Rad. Hms.: 100,000 Ret. Sls.: \$300,000,000	
PARKERSBURG								
WCEF (CP) WCOM 1947	1050 250-D 1230 250	Clarence E. Franklin Parkersburg Bcstg. Co. 317 Ninth St. 7-4491 ABC McGillvra	Joseph M. Handian, p Aud N. Archer, gm, cm & pmm H. B. Kenny, loc. slm	William E. Collins, pd & ce			Wid. AP WE
WPAR 1935	1450 250	Ohio Valley Bcstg. Corp. 211½ 5th St. 75-475	CBS Branham	Austin V. Wood, p George H. Clinton, evp, gm & cm Sherman Grimm, pd, nd & fd	Hazel N. Mercer, pmm V. G. Brooks, ce Laurence V. Murphy, sls. pmm	J. Marshall McCarty, sd Sonia E. Wilson, wd	Pop.: 123,000 Rad. Hms.: 36,510 Ret. Sls.: \$98,044,000	Thes. UP Col.
WPAR-FM 1948	Ch. 293 (B) 106.5mc 8.9kw						Pop.: 210,000 Rad. Hms.: 60,400 Ret. Sls.: \$141,000,000	WH
PINEVILLE								
WWYO 1949	970 1,000-D	Wyoming Bcstg. Co. Box 184 2711	R. D. Bailey, p E. D. Hawley, gm & cm J. H. Frye, pd	Al Dougherty, pmm & sd William D. Stone, ce Jack K. Shipman, evp & treas.	William T. Lively, secy. Jack D. Mullens, nd Alberta Wyatt, fd Elaine Taylor, wd		L-W UP Col.
PRINCETON								
WLOH 1947	1490 250	Mt. Bcstg. Service Box 1011 Lilly Grove 2151	ABC, W. Va. Net.	E. E. Bailey, p Melvin F. Barnett, gm	James M. Angel, cm Paul Osburn, pd	Betty Tabor, pmm Earl Graham, ce		L-W UP WE
RONCEVERTE								
WRON 1947	1400 250	Blake Bcstg. Co. Shanklin Bldg. 300	NBC McGillvra	William E. Blake, p & gm	Ralph Shupe, cm, nd & fd Hugh Ike Shott III, ce	Gary Dent, sd Gladys Livesay, wd		L-W AP
WEIRTON								
WEIR 1950	1430 1,000 DA-2	Tri State Bcstg. Co. Professional Bldg. Weirton 2814	Industrial Rambeau	Thomas Millsop, p E. J. Hirshberg, gm Robert E. Badger, sm	Marshall Fatkin, pd James Mark, ce Harry Cochran, nd	Bill Dowling, sd Margaret Cattell, wd	Pop.: 167,300 Rad. Hms.: 44,480 Ret. Sls.: \$111,005,000	Thes., Assoc. AP WE
WELCH								
WBRW 1940	1340 250	McDowell Service Co. 10 Riverside Dr. 818	MBS, KBS	Joseph G. Hunt, p Paul Wm. Marlowe, gm & cm	Willis Seaman, ce Michael Silagi Jr., office m		Pop.: 176,658 Rad. Hms.: 40,500 Ret. Sls.: \$220,115,000	Thes. AP G
WELC 1950	1150 1,000-D	Pocahontas Bcstg. Co. Box 1032 Welch 1150 McGillvra	Sam Sidote, p D. C. Bradberry, secy.-treas.	John J. Villani, acting m, nd & sd Les Brech, cm J. Cullod, pd & pmm Howard R. King, ce	Jack Schammell, asst. sd George Branch, mus. librarian		Cap. UP G
WESTON								
WHAW 1948	1450 250	Lewis Service Corp. Harrison Ave. Box 431 1555	MBS, KBS, W. Va. Cooke	Harold McWhorter, p George Yazell, gm & cm	Don McWhorter, pd James E. McEwuen, ce Robert J. Conley, nd	Charles Ballard, sd Jo Durham, wd	Pop.: 105,000 Rad. Hms.: 31,000 Ret. Sls.: \$110,000,000	Assoc. UP G
WHEELING								
WHLL 1949	1600 5,000-D	Wheeling Bcstg. Co. Box 989 Wheeling 6700 Gill-Perna	Kenneth H. Forney, gm	Paul N. Miles, cm	James O. Smith, pd		Cap. UP G
WKWK 1941 WTRF (TV)	1400 250	Community Bcstg. Inc. 16th & Market Sts. Wheeling 5320	ABC Weed	John B. Reynolds, p & gm Elsie M. Cook, cm	Dale Schussler, pd, nd & sd Deen Brooks, pmm	Fred Baker, ce Evelyn Haden, wd	 UP RCA
WKWK-FM 1948	Ch. 247 (B) 97.3mc 16kw							

Data corrected to Dec. 10, 1953. If executives or services for FM are same as AM affiliate names are not repeated. Market Data supplied by stations. FM's in italic. *—Non-Commercial Station. CP—Construction Permit issued. D—Day. DA-N—Directional Antenna, night only. DA-1—Directional Antenna, same pattern day and night. DA-2—Directional Antenna, different pattern day and night. L—Limited Time with Dominant Station. LS—Local Sunset. N—Night. SA—Special Authorization. SH—Specified Hours. ST—Share Time. Complete key to abbreviations, page 6.

MARKET DATA BY COUNTIES

Table with columns: County, Population 1950, Radio Families 1953, Retail Sales 1952(000), Food Sales 1952(000), Drug Sales 1952(000), Passenger Cars 1952, and County, Population 1950, Radio Families 1953, Retail Sales 1952(000), Food Sales 1952(000), Drug Sales 1952(000), Passenger Cars 1952. Includes a total row and a note at the bottom.

DIRECTORY OF AM AND FM STATIONS

BECKLEY

Table listing AM and FM radio stations in Beckley, including call letters, frequency, power, and station details.

BLUEFIELD

Table listing AM and FM radio stations in Bluefield, including call letters, frequency, power, and station details.

CHARLESTON

Table listing AM and FM radio stations in Charleston, including call letters, frequency, power, and station details.

CLARKSBURG

Table listing AM and FM radio stations in Clarksburg, including call letters, frequency, power, and station details.

ELKINS

Table listing AM and FM radio stations in Elkins, including call letters, frequency, power, and station details.

WEST VIRGINIA

City	Call Letters Established TV Affiliate	Chan. or Freq. Power	Licensee Headquarters Telephone	Network Represent- ative	Owner o; Pres. p; Exec. up evp; Gen. Mgr. gm; Sta. Mgr. sm; Coml. Mgr. cm; Sales Mgr. slm; Prog. Dir. pd; Chief Eng. ce; Prom. Mgr. pmm; Prod. Mgr. pdm; News, Farm, Sports or Women's Dir. nd, fd, sd, wd.	Executive Abbreviations	Market Data For Primary Area (Supplied by station)	Library, News Serv. Transmitter
FAIRMONT								
WMMN 1928	920 5,000-DA-N	Peoples Bestg. Corp. 208 Adams St. 3100	CBS	Herbert Evans, p A. G. Ferrise, gm Frank J. Lee, asst. m & sd	Fran Lauzau, pd & fd Bob Leonard, pmm Harry Jackson, ce	Marv Boone, nd Helen Bidkel, wd	Pop.: 489,700 Rad. Hms.: 90,000 Ret. Sis.: \$274,291,000	St. UP
WVVW 1947 WJPB-TV	1490 250	Fairmont Bestg. Co. Radio-TV Centre Bldg. Fairmont 5000	ABC Gill-Perna	J. Patrick Beacom, p Robert M. Drummond, gm, vp & nd	R. E. Radcliff, cm Robert F. Mitchell, pd J. F. Watkins, pmm	Richard McBride, ce Harry Riley, sd Emily May Peed, wd	Pop.: 221,101 Rad. Hms.: 41,665 Ret. Sis.: \$201,109,000	Wid. AP G
WJPB (FM) 1949	Ch. 222 (B) 93.3mc 2.8kw	(WVVW, Am Affiliate)		Frank Watkins, cm Robert Hall, pd	Sheldon Loner, ce	Caroline Schroöder, mus. d	Pop.: 297,000 Rad. Hms.: 66,000 Ret. Sis.: \$341,600,000 WE
HUNTINGTON								
WHTN 1947	800 1,000-D	Greater Huntington Radio Corp. 1112½ 4th Ave. 3-3453 Indie	S. J. Hyman, vp & treas. John S. Phillips, gm & cm George Hutchinson, pd	Harold F. Sturm, ce Frances Reynolds, traffic m John Simpson, pub. service d	Dorothy Jeanne Schroöder, wd Karl Broadley, nd Ken Jones, sd	Pop.: 412,400 Rad. Hms.: 107,390 Ret. Sis.: \$267,980,000	Thes. UP RCA
WHTN-FM 1947	Ch. 263 (B) 100.5mc 53kw 1450 250							
WPLH 1946		Huntington Bestg. Corp. 1105 4th Ave. 3-3421	MBS Walker	F. J. Evans, p & gm Curtis Clark, cm Naseeb Tweel, pd	Charles Oppenheimer, pmm Alvin Jayne, ce	Bill Austin, nd Jim Thacker, sd	Pop.: 140,000 Rad. Hms.: 43,000	Cap. AP WE
WSAZ 1923 WSAZ-TV	930 5,000-D 1,000-N- DA-N	WSAZ Inc. 201 9th St. 3-8401	ABC Katz	Col. J. H. Long, p L. H. Rogers, gm C. T. Garten, sm Bos Johnson, pd Charles Dinkins, pmm	L. E. Kilpatrick, ce George Andrick, loc. slm Nick Basso, nd	Jack Bradley, sd W. D. Click, fd Mary E. Kercheval, wd	Pop.: 1,126,800 Rad. Hms.: 252,936 Ret. Sis.: \$789,613,000	L-W AP Col.
KEYSER								
WKYR 1953	1270 1,000-D	Potomac St. Bestg. Co. Radio Plaza 2-0741	KBS McGillvra	Glacus Merrill, p S. C. Bevins, gm	John J. Smith, pd & fd	Frank Aonett Swisher, ce Louise Westman, wd	Pop.: 98,053 Rad. Hms.: 51,496 Ret. Sis.: \$58,941,000	
LOGAN								
WLOG 1940	1230 250	Clarence H. Frey & Robt. O. Greever 445 Stratton St. 540	MBS	Clarence H. Frey, ptnr. & gm Robt. O. Greever, ptnr. & gm	Odetta Vickers, cm Lucille Gallion, pd Brooks Sweeney, pmm L. J. Frye, ce	Audie Albright, nd Mike Wynn, sd Linda Lane, wd		Wid. UP WE
WLOG-FM 1949	Ch. 277 (B) 103.3mc 2.7kw							

Data corrected to Dec. 10, 1953. If executives or services for FM are same as AM affiliate names are not repeated. Market Data supplied by stations. FM's in *italic*. *—Non-Commercial Station. CP—Construction Permit issued. D—Day. DA-N—Directional Antenna, night only. DA-1—Directional Antenna, same pattern day and night. DA-2—Directional Antenna, different pattern day and night. L—Limited Time with Dominant Station. LS—Local Sunset. N—Night. SA—Special Authorization. SH—Specified Hours. ST—Share Time. Complete key to abbreviations, page 6.

30 YEARS OF CONTINUOUS BROADCASTING

West Virginia's first station
in West Virginia's largest city . . . Huntington . . .
radio station WSAZ—930 on the dial—now
located in new-modern studios. . .
For information on this rich market
contact C. Tom Garten, Manager.

MARKET DATA

DAYTIME

Population	931,800
Families	238,800
Radio Homes	235,020
Effective Buying Income	\$978,361,000
Retail Sales	\$609,170,000
Food Sales	\$156,007,000
Drug Sales	\$14,186,000
General Merchandise..	\$86,964,000
Farm Income	\$66,887,000
Total Farms	51,665
Farm Radio Homes	55,670

**BMB
COVERAGE
AREA**

FIGURES FROM
SALES MANAGEMENT
"SURVEY OF
BUYING POWER"
1953 and
CONSUMER-MARKETS
1953



Represented Nationally by:
The KATZ AGENCY, Inc.

ABC NETWORK

RADIO STATION

WSAZ



ME USE RADIO IN OAK HILL, W. VA.?

YES, YOU, IF 21¢ PER-THOUSAND-

FAMILIES IS YOUR KIND OF BUY!

26-time rate

STATION COVERAGE DETAIL BY NCS AREAS

Total Radio Homes in Area	STATE NCS Area County	No. of Counties	DAYTIME						
			4-Week Cum.		Weekly		Average Day		
			NCS Circ.	%*	NCS Circ.	%*	NCS Circ.	%*	
	WEST VIRGINIA								
20,370	FAYETTE	1	18,490	90	18,220	89	10,150	49	
18,190	GREENBRIER	3	15,490	85	15,130	83	6,720	36	
	MONROE								
	SUMMERS								
66,940	KANAWHA	1	10,310	15	7,180	10	4,410	06	
14,570	LEWIS	4	3,110	21	2,280	15	1,680	11	
	BRAXTON								
	DODDRIDGE								
	GILMER								
18,260	LOGAN	1	2,780	15	1,960	10	1,020	05	
19,440	MERCER	1	8,000	41	6,480	33	3,990	20	
14,290	NICHOLAS	3	11,450	80	11,080	77	6,420	46	
	CLAY								
	WEBSTER								
23,930	RALEIGH	1	20,220	84	19,410	81	8,540	35	
12,290	ROANE	4	2,720	22	1,990	16	1,460	11	
	CALHOUN								
	JACKSON								
	WIRT								
16,750	WYOMING	2	9,630	57	8,610	51	6,730	40	
	BOONE								
225,030	10 TOTAL	21	102,200		92,540		51,320		

*= % of Radio Homes in Area

If you look it up, you'll find that West Virginia ranks 31st among the 48 States. Also that Oak Hill (population, 4600) ranks 18th among West Virginia's cities. Hardly top-drawer stuff! But if you're interested in *radio listeners*, please consider this: NCS credits us with 102,200 daytime families in 21 counties — all yours for a comfortable \$21.60 per quarter-hour!

We'd love to tell you more about WOAY, including some rather amazing facts about our national business. Address Robert R. Thomas, Jr., Manager, at:

WOAY

OAK HILL, WEST VIRGINIA

10,000 Watts AM
20,000 Watts FM

WEST VIRGINIA

City	Call Letters Established	Chan. or Power	Licenses Headquarters Telephone	Network Representative	Owner o; Pres. p; Exec. up exp; Gen. Mgr. gm; Sta. Mgr. sm; Coml. Mgr. cm; Sales Mgr. slm; Prog. Dir. pd; Chief Eng. ce; Prom. Mgr. pmm; Prod. Mgr. pdm; News, Farm, Sports or Women's Dir. nd, fd, sd, wd.	Executive Abbreviations	Market Data For Primary Area (Supplied by station)	Library, News Serv. Transmitter	
WHEELING—(Cont'd)									
WWVA	1926	1170 50,000-DA-N	Storer Bcstg. Co. Hawley Bldg. Wheeling 5383	CBS Blair	George B. Storer, p Paul J. Miller, mgng, d Andrew F. Hofmann, cm	Paul A. Myers, pd Howard W. Meagle, pmm Edwin L. Keim, ce	Ken Reed, nd Low Clawson, sd Pete Stenger, fd	Pop.: 5,902,847 Rad. Hrms.: 1,527,300 UP RCA
WWVA-FM	1947	Ch. 254 (B) 98.7mc, 7.4kw							L-W AP
WILLIAMSON									
WBTH	1939	1400 250	Williamson Bcstg. MBS 5½ E. 2d Ave. 1241		Clarence Lovitch, co-o Alice Shein, co-o, gm & cm	John T. Blair Jr., pd	Robert W. Bullio, ce	Pop.: 60,000 Rad. Hrms.: 12,620 Ret. Sis.: \$37,519,000	Thes. UP Col.

WISCONSIN

MARKET DATA BY COUNTIES

County	Population 1950	Radio Families 1953	Retail Sales 1952(000)	Food Sales 1952(000)	Drug Sales 1952(000)	Automobile Ownership 1953	County	Population 1950	Radio Families 1953	Retail Sales 1952(000)	Food Sales 1952(000)	Drug Sales 1952(000)	Automobile Ownership 1953
Adams	7,906	2,320	\$ 5,309	\$ 1,020	\$ 69	3,330	Marquette	5,839	2,580	7,761	1,497	121	3,877
Ashland	19,461	5,200	22,057	5,746	503	6,056	Millwaukee	871,047	260,930	1,142,562	271,329	30,138	287,552
Baton	34,703	9,840	46,010	8,022	1,042	13,647	Monroe	31,378	8,140	24,525	5,474	596	11,254
Bayfield	13,760	3,726	4,230	1,845	222	4,820	Oconto	26,238	6,930	22,793	4,218	258	9,648
Brown	98,314	27,440	114,251	24,158	2,929	37,225	Oneida	20,648	6,080	25,642	7,242	701	8,389
Buffalo	14,719	4,170	10,114	1,695	242	5,540	Outagamie	81,722	23,240	96,833	20,379	1,978	30,506
Burnett	10,236	2,820	7,521	1,728	156	3,858	Ozaukee	23,361	7,010	27,217	5,748	543	11,106
Calumet	18,840	5,150	21,409	3,548	342	7,655	Peplin	7,462	1,900	7,571	1,748	67	2,858
Chippewa	42,839	11,140	45,454	7,735	800	14,804	Pierce	21,448	5,970	20,735	5,208	424	8,367
Clark	32,459	8,776	32,328	5,027	597	12,584	Polk	24,944	7,160	27,810	5,325	757	9,989
Columbia	34,023	10,180	44,130	8,139	969	15,560	Portage	34,858	8,840	30,858	7,342	806	12,291
Crawford	17,652	4,680	13,974	3,433	289	6,019	Price	16,344	4,410	14,956	2,763	276	5,946
Dane	189,357	48,960	206,258	41,873	7,549	66,625	Racine	109,585	33,300	144,780	37,432	3,976	42,714
Dodge	57,611	16,400	52,923	11,900	997	22,712	Richland	19,245	5,230	22,197	4,715	494	7,141
Door	20,870	6,200	23,118	5,494	543	9,546	Rock	92,778	28,590	120,932	29,768	2,927	38,066
Douglas	46,715	13,660	49,194	14,145	1,264	14,283	Rusk	16,790	4,370	15,697	3,128	237	5,777
Dunn	27,341	7,410	26,062	5,059	499	10,355	St. Croix	25,905	7,440	27,058	4,984	499	10,205
Eau Claire	54,187	16,040	61,911	13,887	1,803	19,682	Sauk	38,120	11,210	43,410	9,282	1,019	16,199
Florence	3,756	1,150	2,413	850	28	1,456	Sawyer	10,323	2,780	9,507	2,063	318	3,872
Fond du lac	67,829	19,480	82,722	16,786	2,324	27,050	Shawano	35,249	9,210	28,687	6,371	483	12,987
Forest	9,437	2,030	6,597	1,397	157	3,154	Sheboygan	80,631	24,430	90,350	19,112	1,858	30,565
Grant	41,460	11,770	46,353	8,479	839	16,985	Taylor	18,456	4,530	14,150	2,396	217	6,612
Green	24,172	7,210	36,204	9,132	988	11,405	Trempealeau	23,730	6,360	21,517	3,762	353	9,365
Green Lake	14,749	4,430	20,340	3,927	283	6,878	Vernon	27,908	7,620	25,369	5,939	602	10,461
Iowa	19,610	5,440	15,506	3,477	300	8,111	Vilas	9,363	2,740	12,152	3,638	67	4,319
Iron	8,714	2,400	7,482	2,427	62	3,044	Walworth	41,584	13,200	56,132	12,283	1,455	19,906
Jackson	16,073	4,530	14,572	2,302	216	6,190	Washburn	11,665	3,070	11,492	3,413	404	4,080
Jefferson	43,069	12,890	53,409	11,876	1,018	18,895	Washington	33,902	9,970	42,219	9,024	658	15,167
Juneau	18,930	5,030	19,053	4,347	387	7,045	Waukesha	85,901	25,840	84,706	23,228	2,064	38,661
Kenosha	75,238	23,960	92,131	24,957	2,314	30,257	Waupaca	35,056	10,100	47,110	8,710	906	14,705
Kewaunee	17,366	4,570	15,645	2,462	252	7,042	Wauwasha	13,920	4,010	14,186	2,248	183	6,090
La Crosse	87,597	19,800	83,213	20,523	1,732	24,721	Winnebago	91,103	27,310	105,644	27,689	2,451	33,015
Lafayette	18,137	5,030	18,602	3,806	255	7,879	Wood	50,500	14,110	57,406	13,418	1,095	19,124
Langlade	21,975	5,760	24,961	5,914	368	7,786							
Lincoln	22,235	6,220	25,242	6,652	662	8,370							
Manitowoc	67,159	19,440	74,727	18,634	1,097	25,849							
Marathon	80,337	21,760	86,378	17,004	1,501	30,316							
Marinette	35,748	9,950	33,510	9,014	619	12,624							

Total 3,434,575 994,960 \$3,291,222 \$909,314 \$95,140 1,249,265
 Note: Population 1950 Census; radio families Standard Audit & Measurement Services Inc.; food, drug and retail sales, copyright 1953, Sales Management; further reproduction unlicensed; automobiles supplied by state.

DIRECTORY OF AM AND FM STATIONS

ANTIGO	900 1948	250-D	Antigo Bcstg. Co. 3-4124	Wis. Net.	Artemas F. Berner, p & gm	Robert E. Fowler, ce			Thes. UP G
APPLETON	1570 1952	1,000-D	Bartell Bcstrs. Balliet Hotel 4-2609	Gerald A. Bartell, p Rex Munger, pd	Connie Forster, office m	L. A. Bauernfeind, ce	Pop.: 400,000 Rad. Hrms.: 399,500
WBHY	1230 1925	250	WBHY Inc. 600 S. Lawe St. 3-6839	MBS, Upper Midwest. Wis. Net. Meeker	Earl H. Huth, gm & cm Grec McElrone, pd Don Love, pmm	George Merkl, ce Dewey Gill, copy chief John Flynn, nd	Clyoc Downing, fd Bob Lloyd, sd Marion Torgerson, wd	 Wid. AP RCA

Data corrected to Dec. 10, 1953. If executives or services for FM are same as AM affiliate names are not repeated. Market Data supplied by stations. FM's in italic. *Non-Commercial Station. CP—Construction Permit issued. D—Day. DA-N—Directional Antenna, night only. DA-1—Directional Antenna, same pattern day and night. DA-2—Directional Antenna, different pattern day and night. L—Limited Time with Dominant Station. LS—Local Sunset. N—Night. SA—Special Authorization. SH—Specified Hours. ST—Share Time. Complete key to abbreviations, page 6.



GETTING INTO WEST VIRGINIA

PLUS EASTERN OHIO AND WESTERN PENNSYLVANIA

RADIO HOMES IS A PUSHOVER WITH
WWVA WHEELING, W. VA.

50,000 WATTS
CBS RADIO

ATTRACTIVE PROGRAMMING, PRODUCTIVE
SELLING 24 HOURS EVERY DAY



Serving the Industrial Heart of America
Represented by JOHN BLAIR & CO.

National Sales Offices:

TOM HARKER, 118 E. 57th St. New York 22



ASHLAND

WATW 1940	1400 250	Upper Mich.-Wis. Bcstg. Co. Northern State Bank 1680	MBS, KBS, Wis. Net. Walker	William L. Johnson, p Todd Hogan, m, cm & sd	Mary Jean Anno, pd & wd	Arnold Peterson, pmm, nd & fd Otto Link, ce	Pop.: 21,880 Rad. Hms.: 6,550 Ret. Sls.: \$23,820,000	Thes. G
--------------	-------------	--	----------------------------------	--	----------------------------	---	---	---------------------

AUBURNDALE

*WLBL 1922	930 5,000-D	Wisc. State Radio Council Radio Hall, Madison Madison 5-2988		H. B. McCarty, gm	Wm. G. Harley, pd	Robert W. Hanson, ce		
---------------	----------------	--	--	-------------------	-------------------	----------------------	--	--

BEAVER DAM

WBEV 1951	1430 1,000-D	Beaver Dam Bcstg. Co. Inc. Radio Park 4444	William E. Walker, p Charles R. Dickoff, vp & gm William R. Walker, vp & cm	Alistar Alexander, ce Joseph D. Mackin, secy.-treas.	Ray Pepoon, fd Redd Hall, sd Doris Bilke, wd		Thes. UP WE
--------------	-----------------	---	-------	---	--	--	--	-------------------

BELOIT

WBEL 1948	1380 5,000-D- DA	Beloit Bcstrs. Inc. 335 W. Gran College 1380 Holman	Lloyd Burlingham, p L. O. Fitzgibbons, gm Warren A. Anderson, asst. m & pmm	Joe Moen, cm Rex Rucker, pd & nd Leo Wilson, ce	Bob Scholz, fd Roger Burns, sd Christie Thomsen, wd	Pop.: 550,000 Ret. Sls.: \$350,000,000	Thes. AP G
WGEZ 1948	1490 250	Sidney H. Bliss Hotel Hilton College 6024	MBS, Wis. Net. Clark	Sidney H. Bliss, co Robert J. Bodden, gm	Eugene Steinhorst, cm Stanley Holmes, ce	Al Vinson, nd Tom Anderson, sd	Pop.: 175,000 Rad. Hms.: 78,000	Wid. AP WE

EAU CLAIRE

WBIZ 1947	1490 250	WBIZ Inc. 609 Cameron St. 5111	MBS McGillvra	J. J. Conroy, p Stan Torgerson, gm & sd Prevost Coulter, cm	Dean Osmundson, pd & nd Don Roering, ce	Paul Albrecht, fd Pat Hartel, wd	Pop.: 110,000 Rad. Hms.: 28,000 UP RCA
WEAU 1937	790 5,000-DA-N	Central Bcstg. Co. 2415 S. Hastings Way 6149	NBC, Arrow- head Holling- bery	W. C. Bridges, p H. S. Hyett, gm Robert E. Nelson, cm	T. D. Jorgenson, ce Al Henry, nd	Jim Hill, fd Joe Tharton, sd	Pop.: 746,124 Rad. Hms.: 10,134 Ret. Sls.: \$289,100,000	L-W., Wid. UP
WEAU-FM 1947	Ch. 231 (B) 84.1mc 60kw							
WRFW 1948	1050 1,000-D	Chippewa Valley Radio & TV Corp. Rudolph Rd. 2-1629 Forjoe	Thomas K. Werner, p & pd Jack Kelly, gm & nd	R. K. Werner, cm Wm. Hill, ce Willard Hamm, fd	Ralph Gooding, sd Elly Kelly, wd	Pop.: 214,000 Rad. Hms.: 55,449 Ret. Sls.: \$180,600,000	Cap. AP G

FOND DU LAC

KFIZ 1922	1450 250	KFIZ Bcstg. Co. 18 W. 13th St. 356	MBS, Wis. Net. Holman	A. H. Lange, p Emery Martin, evp Lynn N. Fairbanks, gm & cm	Lucille A. Fairbanks, pd & wd	Joe Goeser, traffic m & sd Wendell S. Meyers, ce	Pop.: 60,258 Rad. Hms.: 49,940	Wid. UP RCA
--------------	-------------	--	-----------------------------	--	----------------------------------	--	-----------------------------------	-------------------

GREEN BAY

WBAY 1922	1360 5,000 DA-N	Norbertine Fathers Bellin Bldg. Adams 1	CBS Weed	Rev. M. J. Beemster, mgng. d Haydn R. Evans, gm	Rodger Mueller, pd Lee Stinson, pmm W. E. Stangel, ce	Craighton Knau, fd Clair Stone, sd	 AP RCA
WDUZ 1947	1400 250	Green Bay Bcstg. Co. 225 N. Adams St. Howard 6300	ABC Pearson	Ben A. Laird, p & gm Robert A. Vandersteen, cm	Jack Kessenich, pd Don Arthur, sm & sd Leo Westerman, ce	Robert Brice, nd Joyce Sant Amour, wd		L-W., Wid. UP G
WJPG 1947	1440 1,000-D 500-N-DA-2	Green Bay Newspaper Co. P. O. Box 629 Hemlock 5-7575	MBS, Wis. Net. McGillvra	V. I. Minahan, p John M. Walter, gm Glenn R. Holznecht, cm	Jack Stelling, pd William McCarthy, pmm Elmo Reed, ce	James Bartelt, nd Les Sturmer, fd Tony Flynn, sd Mary Ann Bartelt, wd	Pop.: 200,000 Rad. Hms.: 50,000	St., Thes. AP RCA

HARTFORD

WTKM 1951	1540 500-D	Kettle-Moraine Bcstg. Co. RR #1 61		Walter Zastrow, p & gm Don Zastrow, sm & fd	Ron Fleissner, cm Redd Hall, pd & sd Herbert Jordan, ce	Jim Bichler, nd Donna Erdman, wd		SES. UP
--------------	---------------	---	--	---	---	-------------------------------------	--	---------------------

COMING SOON — CHANNEL 11

COVERING

A potential half million TV families in the rich Green Bay- Fox River Valley Area,
as well as Upper and Lower Peninsulas of Michigan.

for details, write:

J. D. Mackin, c/o Radio Station WMAM, Marinette, Wis.

WISCONSIN

City Call Letters Established TV Affiliate	Chan. or Freq. Power	Licensee Headquarters Telephone	Network Represent- ative	Owner o; Pres. p; Exec. <i>vp</i> evp; Gen. Mgr. gm; Sta. Mgr. sm; Coml. Mgr. cm; Sales Mgr. slm; Prog. Dir. pd; Chief Eng. ce; Prom. Mgr. pmm; Prod. Mgr. pdm; News, Farm, Sports or Women's Dir. nd, fd, sd, wd.	Executive Abbreviations	For Primary Market Data Area (Supplied by station)	Library, News Serv. Transmitter	
JANESVILLE								
WCLO 1930	1230 250	Southern Wis. Radio Inc. 200 E. Milwaukee St. 3316	MBS, Wis. Net. Clark	Sidney H. Bliss, p Vern W. Williams, sm & nd	Bill Bessire, cm Ralph Schroeder, pd & pmm	Wayne Clay, ce Don Boyd, sd	Pop.: 186,000 Rad. Hms.: 50,192 Ret. Sis.: \$197,837,000	Wid. AP RCA
WCLO-FM 1947	Ch. 260 (B) 99.9mc 15.5kw							
KENOSHA								
WLIP 1947	1050 250-D	William L. Lipman 625 57th St. 6162 Everett- McKinney	William L. Lipman, gm Hugh L. Gately, sm Steve Kelley, prog. sup.	Jerry Golden, pd Cass Lubinski, ce Ardith Simons, office m	V. Taylor, nd Irene Buri Nelson, wd		Wid. AP Ray.
LA CROSSE								
WKBH 1923	1410 5,000-DA-N	WKBH Inc. 409 Main St. 2-4678	NBC Taylor	Howard Dahl, p & gm Berneice Callaway, pd Howard Nestingen, pmm	Al Leeman, ce Leonard Andersen, pdm	Marion Brancato, nd		Wid. AP RCA
WKTY 1948	580 1,000 DA-1	La Crosse Bcstg. Co. 112 N. 4th 2-6042	ABC Everett- McKinney	Verl Bratton, evp, gm & cm John Bondeson, pd & pmm	George W. Egli, ce Richard L. Hansen, nd	Charlie Kearns, sd	Pop.: 707,100 Rad. Hms.: 192,500 Ret. Sis.: \$689,028,000	Thes. UP
WLCX 1947	1490 250	Bermac Radio Inc. State Bank Bldg. 44521	MBS, Upper Midwest McGillvra	James J. Conroy, p Milo G. Knutson, sm Roy Nicholson, cm Rosemary Castor, pd	Loren Kassera, pmm Phil Uehling, ce & sd Robert Mikkalson, nd	Catherine Guillaume, fd Clifford Lue, wd	Pop.: 102,715 Ret. Sis.: \$70,000,000 UP Col.
LADYSMITH								
WLDY 1948	1340 250	Flambeau Bcstg. Co. W. Lake Ave. 584	KBS, Clark, Upper Midwest	Charles H. Nelson, p A. T. Shields, gm & cm Joseph Dahlvig, pd	Corinne Kopp, pmm J. E. Evans, ce & sd Steve Evans, mus. d & nd	Ed Sirek, fd Wm. Harley, pd Lillian Klake, wd	Pop.: 134,100 Rad. Hms.: 33,535 Ret. Sis.: \$63,302,000 UP GE

Data corrected to Dec. 10, 1953. If executives or services for FM are same as AM affiliate names are not repeated. Market Data supplied by stations, FM's in italic. *—Non-Commercial Station. CP—Construction Permit issued. D—Day. DA-N—Directional Antenna, night only. DA-1—Directional Antenna, same pattern day and night. DA-2—Directional Antenna, different pattern day and night. L—Limited Time with Dominant Station. LS—Local Sunset. N—Night. SA—Special Authorization. SH—Specified Hours. ST—Share Time. Complete key to abbreviations, page 6.



**EXCLUSIVE TWIN CITY—NETWORK—FULLTIME OUTLETS
SERVING 360,000 PEOPLE
PROOF OF EFFECTIVENESS
Is Volume Patronage at Card Rates**

**263 Area advertisers on long term contracts.
72 regional and network clients.**

Radio listings and consistent newspaper advertising promotion in the
Janesville Daily Gazette ABC circulation 21,333 and the Beloit Daily News
ABC circulation 19,241.

*Write for Market Data and Combination rates
Vern Williams Executive Office Janesville, Wis.*



MADISON

*WHA 1922 WHA-TV	970 5,000-D	U. of Wis. Radio Hall 5-2988	Wis. Net.	H. B. McCarty, gm William G. Harley, pd H. A. Engel, pmm	John Stiehl, ce Roy Vogelmann, nd Maurice White, fd	Lou Landman, sd Aline Hazard, wd UP WH
WIBA 1925	1310 5,000-DA-N	Badger Bcstg. Co. 3800 Regent St. 3-5311	NBC Avery- Knodel	William T. Evjue, p Kenneth F. Schmitt, gm Howard A. Johnson, bus. m	Robert N. Dick, pd Fern Noreen, pmm Norman Hahn, ce	Jack Newman, nd Frank Mayfield, fd Fred Gage, sd	Thes. AP WE
WIBA-FM 1948	Ch. 268 (B) 101.5mc 45kw						
WISC 1948	1480 1,000-DA-1	Radio Wis. Inc. Commercial State Bank Bldg. 7-2588	ABC, MBS, Arrow- head Holling- bery	Ralph M. Immell, p Ralph O'Connor, gm Richard Nickeson, cm Beverly White, pd	Le Roy Wesner, pdm W. M. Greely, ce Cliff Conahan, nd	Henry Buslee, fd Don Schmill, sd Barbara Lane, wd	Pop.: 225,000 Rad. Hms.: 75,000 Ret. Sis.: \$261,000,000
WISC-FM 1948	Ch. 251 (B) 98.1mc 1kw						GE
WKOW 1948 WKOW-TV	1070 10,000-D 5,000-N- DA-2	Monona Bcstg. Co. 215 W. Washington Ave. 7-2261	CBS Headley- Reed	Stewart Watson, p Michael Henry, gm Paul Enright, sm Mrs. Lu Baitinger, pd	Robert Wickham, engrg. sup. Hale Blakely, engrg. sup.	Jack Davis, co-nd Ray Streeter, co-nd RoY Gumtow, fd Pat Hernon, sd Luella Mortenson, wd	Pop.: 650,000 Rad. Hms.: 250,000 Ret. Sis.: \$600,000,000 Cap. UP RCA
WMFM(FM) 1948	Ch. 281 (B) 104.1mc 7.5kw	Earl W. Fessler 2047 Winnebago St. 4-2847 Continental	Earl W. Fessler, p, gm & ce	Wilburt E. Leppien, cm	Audrey Powers, pd Bill McMahon, nd	Pop.: 100,000 Rad. Hms.: 97% London Col.
MANITOWOC							
WOMT 1926	1240 250	Francis M. Kadow Radio Bldg. 5015	MBS, Wis. Net. Holman	Francis M. Kadow, p & gm G. H. Todd, cm	George Erdman, pd & nd L. J. Splitt, pmm	Hubert Willis, ce Les Mangin, sd Donna Wodak, wd	Pop.: 300,000 Rad. Hms.: 69,000 Ret. Sis.: \$350,000,000 Wid. UP
WWOC 1952	980 1,000-D	Manitowoc Bcstg. Co. P. O. Box 101 7763	McGillvra	Edward Allen Jr., ptrn. & gm	Edward W. Jacker, ptrn. & ce	Fritz Van Duyse, sd	Thes. AP RCA

WISCONSIN'S
BRIGHTEST SPOT . . .

MADISON

HIGH
INCOME
FAMILIES

IN DENSITY OF
WIBA
COVERAGE

IN
LOW COST
COVERAGE

For complete market
and station data, write
WIBA, Radio Park,
Madison 5, Wis.

NBC IN MADISON
AM **WIBA** FM

28th Anniversary Year

NATIONAL REPRESENTATIVE: Avery-Knodel, Inc.

dominated by
WIBA listening!

WIBA has more listeners in Metropolitan
Dane County among families listening 6 or 7
days or nights per week than all other
Madison stations combined! For better results
at lowest cost per family always use WIBA.

A Rich
RADIO AUDIENCE



	Daytime Listening Data		
	Dane Cty.	City of Madison	16 Cty. SAMS
Radio homes . . .	48,120	27,310	183,660
Weekly Audi- ence, Families . . .	40,834 85%	22,471 82%	83,975
6-7 Days, Nights Families	29,758 62%	15,211 56%	53,942

WISCONSIN

City	Call Letters	Chan. or Freq. Power	Licensee Headquarters Telephone	Network Representative	Owner o; Pres. p; Exec. up evp; Gen. Mgr. gm; Sta. Mgr. sm; Coml. Mgr. cm; Sales Mgr. sm; Prog. Dir. pd; Chief Eng. ce; Prom. Mgr. pmm; Prod. Mgr. pdm; News, Farm, Sports or Women's Dir. nd, fd, sd, wd.	Executive Abbreviations	Market Data For Primary Area (Supplied by station)	Library, News Serv. Transmitter
MARINETTE								
WMAM	1939	570 250-D	M & M Bcstg. Co. Inc. Radio Park 2-6831	NBC Clark	William E. Walker, p Joseph D. Mackin, gm Howard L. Emich, cm Patrick Kehoe, pd	Edward Maxwell, pmm Allster Alexander, ce Bob Macaulay, nd	John Bell, fd Bill Liegols, sd Ruthe Mensing, wd	Pop.: 200,000 UP RCA
MARSHFIELD								
WDLB	1947	1450 250	Dairyland's Bcstg. Serv. Inc. 1710 N. Central Ave. 1450	KBS	Lloyd L. Felker, p Robert W. Behling, gm Roger D. Thomsen, cm	Howard Sturtz Jr., pd Ronald Smith, pmm Gerald Boos, ce Jack Thornton, cont. d	Doris Langjahr, wd Don Nanning, nd Dean Lybeck, fd Russ Schallow, sd	Pop.: 100,000 Rad. Hms.: 33,300 Ret. Sls.: \$50,580,000 SES., Cap. Thes. UP Ray.
WDLB-FM	1948	Ch. 280 (A) 103.9mc .25kw						GE
MEDFORD								
WIGM	1941	1490 250	M & N Bctg. Co. 255	MBS, KBS Continental	Charles H. Nelson, p & gm Paul Alman, cm	Richard J. Johnson, pd Raymond Bohnert, ce	Harold R. Murphy, secy.-treas. Marlene Metz, nd	SES. UP RCA
MENOMONIE								
WMNE	1951	1360 500-D	Menomonie Bcstg. Co. 603 1/2 Broadway 1156	KBS Lawson	Dr. Wendell Hansen, p, gm & cm Douglas Weikley, pd & pmm	Everette Lindgren Bruce Swedien, nd & sd	Howard Kuhn, fd Margaret Burg, wd	Pop.: 105,000 Rad. Hms.: 32,000 Ret. Sls.: \$175,000,000 L-W UP
MERRILL								
WLIN(FM)	1947	Ch. 264 (B) 100.7mc 9.35kw	(WOSA Wausau, Am Affiliate)					
MILWAUKEE								
WCAN	1948	1250 5,000-DA-2	Midwest Bcstg. Co. 723 N. 3d St. Broadway 6-2154 Taylor	Lou Poller, p & gm Mort Rosenman, pd Kal Ross, adm. asst. & ops. d	Walter Wesley, ce Roger Mohr, sd	Alex Rosenman, N. Y. rep.	Pop.: 1,428,890 Rad. Hms.: 437,213 Ret. Sls.: \$1,714,881,000 UP Col.
WEMP	1935	1340 250	Wis. Net. Bcstg. Co. 710 N. Plankinton Ave. Broadway 1-7722	Headley-Reed	A. M. Spheeris, p Hugh K. Boice Jr., gm John Gagliano, cm	Thomas Shanahan, pd Lou Riepenhoff, pmm Roland Paske, ce Donald O'Connor, nd	Earl Gillespie, sd Mary Lou Lenken, cont. d & wd	Pop.: 1,500,000 Rad. Hms.: 98% UP RCA
WEMP-FM	1948	Ch. 227 (B) 93.3mc 50kw 380						Pop.: 1,750,000
WFOX	1946	250-D	Wis. Bcstg. System Inc. 208 E. Wis. Ave. Broadway 2-1272 Clark	Charles J. Lanphier, p, gm, cm & pmm Charles A. LaForce, pd	George Dodge, ce Viola E. Wilson, comp.	Art Jones, nd Neil K. Searles, sd	Pop.: 1,000,000 Rad. Hms.: 300,000 Ret. Sls.: \$3,000,000,000 AP WE

Data corrected to Dec. 10, 1953. If executives or services for FM are same as AM affiliate names are not repeated. Market Data supplied by stations. FM's in italic. *—Non-Commercial Station. CP—Construction Permit issued. D—Day, DA-N—Directional Antenna, night only. DA-1—Directional Antenna, same pattern day and night. DA-2—Directional Antenna, different pattern day and night. L—Limited Time with Dominant Station. LS—Local Sunset. N—Night. SA—Special Authorization. SH—Specified Hours. ST—Share Time. Complete key to abbreviations, page 6.

THE NBC AFFILIATE WITH THE **BIG WALLOP!**

Affiliated with Channel 11 — on the air soon!

NBC AFFILIATE

WMAM

J. D. Mackin, General Manager

MARINETTE
WISCONSIN

MENOMINEE
MICHIGAN

Represented Nationally by George W. Clark*, Inc.

WISCONSIN

WISN 1922	1150 5,000-DA-1	Hearst Corp. 540 N. Plankinton Ave. Division 2-3000	CBS Katz	D. L. Provost, vp Harry D. Peck, vp & gm Joseph Sergio, bus. m Richard E. Shireman, cm	Leslie F. Biebl, pd J. D. Hill, pmm Donald A. Weller, ce John Saxe, nd	Frances X. Haggerty, fd Jack Raymond, sd Mary Ann Lemay, wd	Pop.: 2,471,900 Rad. Hms.: 685,090	Wld. UP, INS RCA	
WMIL 1947	1290 1,000-D	Cream City Bcstg. Co. 2625 W. Wis. Ave. West 3-1290	Gene Posner, p Jerome Sill, gm	Arthur Vogel, pd	Gino Monaco, ce	Pop.: 1,200,000 Rad. Hms.: 356,000 Ret. Sis.: \$1,355,991,000	SES., Cole UP Col.	
WOKY 1950 WOKY-TV	920 1,000-DA-1	Bartell Bcstrs. Inc. 704 W. Wis. Ave. Broadway 1-8428	ABC Pearson	Gerald A. Bartell, p Melvin Bartell, gm	Joseph Wolfman, cm	Ralph E. Evans, ce			
WTMJ 1927 WTMJ-TV	620 5,000-DA-N	The Journal Co. 720 E. Capitol Dr. Broadway 1-6000	NBC Christal	Walter J. Damm, vp & gm R. G. Winnie, asst. gm George Comte, sm Neale V. Bakke, slm George Nicoud, asst. m Frank Bignell, prog. m	Phillip B. Laeser, engrg. m Bruce Wallace, pub. serv. m Jack Drueger, nd Bob Heiss, sd	Hig Murray, fd Esther Hottin, wd Maurice Kipen, mus. d William Hebal, ce Wendell Palmer, cont. m		SES. AP WE	
MONROE									
WEKZ 1953	1260 500-D	Green County Bcstg. Co. Monroe 1260	Kenneth Stuart, p Grant A. Ritter, gm, cm & fd	Stan Neuberger, pd Joseph Urban, pmm Rex Eyler, ce	Charles Booth, nd George McKeown, sd Dorothy Kundert, wd	Pop.: 97,837 Rad. Hms.: 27,700 Ret. Sis.: \$71,250,000	Cap. AP	
NEENAH-MENASHA									
WNAM 1947 WNAM-TV	1280 1,000-DA-N	Neenah-Menasha Bcstg. Town of Neenah 2-6471 Clark	Don C. Wirth, vp & gm W. C. Porsow, sm	Ted Moore, pd & sd Harry Hill, ce	Peq Spoor, wd	Pop.: 385,000 Rad. Hms.: 103,900 Ret. Sis.: \$363,055,000 UP	
OSHKOSH									
WOSH 1941 WOSH-TV	1490 250	Oshkosh Bcstg. Co. 1235 Bowen St. Stanley 4580	ABC Pearson	William Johns Jr., gm Robert J. Flynn, radio m	Noel Franzen, pd Donald Zuehlhe, ce Harry Rand, nd	L. Williams, fd William McDonald, sd Jessie Willer, wd	Pop.: 290,800,000 Rad. Hms.: 74,326 Ret. Sis.: \$317,300,000	Cap. UP RCA	
PARK FALLS									
WFFP 1953	1450 100	M & N Bcstg. Co. Inc. 262	KBS Continental	Charles H. Nelson, p & gm Albert J. Michela, sm	Paul Olson, pd Raymond Bohnert, ce Lois Hickey, nd	Richard Seehafer, sd Beverly Pinkerton, wd	Pop.: 23,152		
PORTAGE									
WFDR 1952	1350 1,000-D	Portage Bcstg. Co. Box 142 1200	William T. Comstock, p John Haerle, gm	Berwyn Ableman, cm & sd Keith Pettack, pd	Garth N. Bowker, ce & fd Jerry Bellman, nd	Pop.: 65,000 Rad. Hms.: 15,000	Cap. UP Col.	
POYNETTE									
WIBU 1925	1240 250	Wm. C. Forrest Poynette 98	KBS, Wisc. Net.	Wm. C. Forrest, p, g & cm	Sarah Forrest, pd	L. Stanley Sadler, ce		St. SES. UP	
WWCF (FM) 1947	Ch. 235 (B) 94.9mc 37kw							Col.	
PRAIRIE DU CHIEN									
WPRE 1952	1280 500-D	Prairie Bcstg. Co. P. O. Box 36 637	W. C. Schlaugat Jr., gm Thomas Multerer, cm & sd	Jack Hassebrook, pd & nd Willis Schultz, ce	Jerry Key, fd Mary Ellen, wd	 UP G	
RACINE									
WRAC 1950	1460 500-D	WRAC Inc. Arcade Bldg. 2-1627 Sears & Ayer	James S. Allen, p Bob Martin, gm, cm. pd & sd	Dick Fitzgerald, pmm Ray Doane, ce	Jake Erdmann, nd Julie Ruetz, wd	Pop.: 1,285,500 Rad. Hms.: 364,180 Ret. Sis.: \$1,740,316,000 UP GE	
WRJN 1926	1400 250	Racine Bcstg. Corp. American Bank Bldg. 4-3311	ABC, Wis. Net. Walker	Harry R. LePoidevin, gm Harold Newcomb, sm Jerry Nelson, cm	Lyman Merens, pd & nd Milly French, pmm	Lee DeChant, ce William Gumm, sd Larry Kaye, wd	Pop.: 114,000 Rad. Hms.: 32,000 Ret. Sis.: \$144,780,000 AP RCA	
WRJN-FM 1948	Ch. 264 (B) 100.7mc 15kw								
REEDSBURG									
WRDB 1953	1400 250	William C. Forrest P. O. Box 207 Reedsburg 400	Wis. Net.	William C. Forrest, o Wallace M. Morton, gm & ce William Christenson, cm	Charles Faulkner, pd Theresa Liezel, pmm Margurite Wacholz, nd & wd	Gordon Locke, sd Harry Dobson, fd	Pop.: 89,690 Rad. Hms.: 27,000 Ret. Sis.: \$86,700,000 RCA	

TWO

SOUTHEASTERN WISCONSIN

clear channel

WISCONSIN'S 4

IN THE KENOSHA MARKET AREA

WILLIAM L. LIPMAN
Owner & Gen. Mgr.



MARKETS

plus **NORTHERN ILLINOIS**

coverage in

th LARGEST CITY

LOTS OF COVERAGE AT LITTLE COST

only ONE station
Everett-McKinney, Inc., Nat'l. Rep.

HUGH L. GATELY
Station Mgr.

WISCONSIN

City Call Letters Established TV Affiliate	Chan. or Freq. Power	Licensee Headquarters Telephone	Network Represent- ative	Owner o; Pres. p; Exec. up evp; Gen. Mgr. gm; Sta. Mgr. sm; Coml. Mgr. cm; Sales Mgr. slm; Prog. Dir. pd; Chief Eng. ce; Prom. Mgr. pmm; Prod. Mgr. pdm; News, Farm, Sports or Women's Dir. nd, fd, sd, wd.	Executive Abbreviations	Market Data For Primary Area (Supplied by station)	Library, News Serv. Transmitter
RHINELANDER							
WOBT 1947	1240 250	Oneida Bcstg. Co. Highway 8-East 1240	MBS, Wisc., Upper Midwest McGillvra	James Cleary, p Bruce G. Beichl, gm & pmm	Robert Frye, cm John Wadd, pd & nd Charles Marvin, ce	Clyde Downing, fd Betty Reich, wd Madeline Jewell, wd	Wld. UP G
RICE LAKE							
WJMC 1938	1240 250	WJMC Inc. Rt. 2 550	MBS, Arrow- head, Northwest Wis. Net. Holling- bery Bulmer & Johnson	Walter C. Bridges, p Russell J. Brown, gm Arthur A. Stolk, cm	Carl N. Klaus, pd & sd George Palo, pmm Robert P. Kolsky, ce	Richard Johnson, nd Betty Reich, wd Dick Swiler, fd	Pop.: 38,742 Rad. Hms.: 8,570 SES., Wld. UP RCA
WJMC-FM 1947	Ch. 242 (B) 96.3mc 9.3kw						
RICHLAND CENTER							
WRCO 1949	1450 250	Richland Bcstg. Corp. P. O. Box 192 20	Arthur Overgaard, p Thomas R. Kelley, gm, cm, pd & pmm	Peter Athanas, ce Joseph Koelsch, nd Ed Mueller, co-sd	Bob Kane, co-sd Orlie Baker, fd Jean Jensen, wd	Pop.: 58,000 Thes., L-W, SES. UP RCA
SHAWANO							
WTCH 1948	960 1,000-DA-N	Shawano Co. Leader Pub. Co. 107-113 E. Green Bay St. 666 Lawson	Jeanne Donald, gm	Ray Gruetzmacher, sm		Cap. UP
SHEBOYGAN							
WHBL 1924	1330 1,000-D 250-N	WHBL Inc. Box 27 4844	ABC, Wis. Net.	Charles E. Broughton, p	Ben F. Hovel, gm John D. Harvey, cm	Glenn James, pd Herbert Mayer, ce	Pop.: 293,500 Rad. Hms.: 81,430 Ret. Sls.: \$319,644,000 Pop.: 295,000 Rad. Hms.: 81,000 Ret. Sls.: \$319,644,000 Assoc. AP RCA Wld. RCA
WHBL-FM 1948	Ch. 262 (B) 100.3mc 15kw						
SPARTA							
WKLJ 1951	990 250-D	Sparta-Tomah Bcstg. Co. 124 S. Water St. 3307	KBS Midwest	Jon F. Lohmer, p & gm	Orion Samuelson, pd Warner Stenslund, ce	John D. Rice, nd Andy Karsen, sd	Pop.: 160,000 Rad. Hms.: 32,000 SES., Assoc. UP G
STEVENS POINT							
WSPT 1948	1010 250-D	Stevens Point Bcstg. Co. 414½ Main St. 2744 Holman	William F. Johns Sr., p A. L. Mayer, gm	Peter Barnard, cm Jerry Bartosz, pd & nd	Robert Tellekson, ce David Silverman, sd Tom Lund, fd	Pop.: 187,211 Rad. Hms.: 82,404 SES. UP G
STURGEON BAY							
WDOR 1951	910 500-D	Door County Bcstg. Co. Inc. 15th & Utah Sturgeon Bay 593	Wis. Net.	Edward D. Allen Jr., p, gm & fd William O. Warnkey, cm	Dolores Allen, pd & wd	Joseph Genovese, ce & Vernille Haen, nd	Pop.: 122,000 Thes. AP Ray.
WOKW 1951	1050 250-D	Door County Radio Co. P. O. Box 538 1050	KBS	Chandler F. Harris, p Herbert H. Graefe, gm	Jack Schaefer, pd Robert Egeland, ce	Ilo Schultz, office m James Robertson, sd	Pop.: 10,000 UP G
SUPERIOR							
WDSM 1939	710 5,000-DA-N	WDSM Inc. 921 Tower Ave. 2-7234	ABC, MBS Free & Peters	Rodney A. Quick, gm Robert Rich, cm Lew Martin, pd	Carol Zimmerman, pmm Melvin Lasky, ce	James Payton, nd Dennis Murphy, sd	Pop.: 350,000 Rad. Hms.: 148,950 Ret. Sls.: \$489,167,000 St. UP RCA
WDSM-TV							
TWO RIVERS							
WTRW 1951	1590 1,000-D	Two Rivers Bcstg. 1817 Washington St. 324	Wendel Hansen, p Howard J. Luebke, gm	Stanley Greene, cm	Kerm Stevens, pd & nd Elmer Johnson, ce Woody Stangel, sd	Pop.: 55,000 Rad. Hms.: 20,625 Cap. UP G
WATERTOWN							
WTTN 1950	1580 250-D	Watertown Radio Inc. 104 W. Main St. 2215	KBS	Carl V. Kolata, p & gm	Clifford Scott, cm Arnold Kaine, pd	Harold Winkenwerder, ce Wayne Simon, nd	Pop.: 125,000 Rad. Hms.: 23,540 Ret. Sls.: \$1,098,508 Thes. UP G
WAUKESHA							
WAUX 1947	1510 250-D	Waukesha Bcstg. Co. 319 W. Main St. 6636	KBS Holman	Norman E. Schley, p Mig Figl, gm Charles E. Williams, cm	Don Froehlich, pd Adin Randall, ce	Bill Roberts, nd	Pop.: 300,000 Thes. AP G
WAUSAU							
WHVF 1953	1230 250	Lakeland Bcstg. Corp. 1110 Wausau Ave. 2-1188	Hilding V. Foreen, p & ce	R. J. Topinka, gm, pd & sd	Edward Przybylski, cm O. M. Leverton, fd	Pop.: 190,000 Rad. Hms.: 60,125 Ret. Sls.: \$113,000,000 Cap., St., Cole AP, UP Col.
WOSA 1948	550 5,000-DA-2	Alvin E. O'Konski Wausau 1444	MBS Rambeau	Alvin E. O'Konski, p & fd Harold Ladin, gm Danworth Turner, cm Jack Larkin, pd	Leon Gabriel, pmm Chris Zercher, ce Miriam Semling, bus. m	Steve Markstrom, nd Charles Summers, sd Carol Greene, wd	
WSAU 1937	1400 250	WSAU Inc. 714 5th St. 6521	NBC, Wis. Net. Meeker	John R. Tomek, p O. Charles Lemke, vp Richard D. Dudley, gm	James W. Frey, cm George Bundner, pd & pmm Roland W. Richardts, ce	Don DeByle, nd & sd Marv Nellis, fd Louise Gohdes, wd	Pop.: 191,485 Rad. Hms.: 60,330 Ret. Sls.: \$173,000,000 Thes. AP GE
WEST BEND							
WBKV 1950	1470 500-D	West Bend Bcstg. Co. P. O. Box 59 1640 Upper Midwest	Carl Rohde, p August C. Berkholtz, secy-treas. Paul J. Mueller, cm	Roy Ambrose, pd, pmm & fd Paul J. Ripple, ce	Nancy Dymale, nd Bob Becker, sd Anne Kleckhafer, wd	Thes. UP G
WISCONSIN RAPIDS							
WFHR 1940	1340 250	William F. Huffman Radio Inc. 143 W. Grand Ave. 1340	MBS, Wis. Net. Devney	Louise F. Huffman, p George T. Frechette, vp, gm & pmm	L. J. Zurawski, cm James Tighe, pd & nd Gordon Miller, ce	Ed Hanson, sd Arnie Strobe, fd Bernardine Speltz, wd	Pop.: 125,000 Rad. Hms.: 30,000 Ret. Sls.: \$110,000,000 Wld. AP Col.
WFHR-FM 1948	Ch. 277 (B) 103.3mc 2.1kw						

Data corrected to Dec. 10, 1953. If executives or services for FM are same as AM affiliate names are not repeated. Market Data supplied by stations. FM's in italic. *—Non-Commercial Station. CP—Construction Permit issued. D—Day. DA-N—Directional Antenna, night only. DA-1—Directional Antenna, same pattern day and night. DA-2—Directional Antenna, different pattern day and night. L—Limited Time with Dominant Station. LS—Local Sunset. N—Night. SA—Special Authorization. SH—Specified Hours. ST—Share Time. Complete key to abbreviations, page 6.

MARKET DATA BY COUNTIES

County	Population 1950	Radio Families 1953	Retail Sales 1952(000)	Food Sales 1952(000)	Drug Sales 1952(000)	Automobile Ownership 1952	County	Population 1950	Radio Families 1953	Retail Sales 1952(000)	Food Sales 1952(000)	Drug Sales 1952(000)	Automobile Ownership 1952
Albany	19,055	5,690	\$ 22,771	\$ 5,425	\$ 504		Sheridan	20,185	6,270	28,350	6,628	843	
Big Horn	13,176	3,530	13,356	2,861	550		Sublette	2,461	620	2,418	385	162	
Campbell	4,839	1,520	7,803	1,420	248		Sweetwater	22,017	6,200	30,333	5,998	891	
Carbon	15,742	4,620	18,549	3,753	590		Teton	2,593	750	4,831	927	58	
Converse	5,933	1,680	7,738	1,628	211		Uinta	7,331	1,770	9,954	1,950	237	
Crook	4,738	1,290	4,997	1,093	116		Washakie	7,252	1,940	12,927	2,575	343	
Freemont	19,580	5,530	26,055	5,657	860		Weston	6,733	2,110	7,445	1,663	350	
Goshen	12,634	3,540	18,261	3,370	430		Yellowstone						
Hot Springs	5,250	1,700	8,205	2,155	391		National Park	353	**	2,618	46	
Johnson	4,707	1,310	6,073	1,408	122		Total	76,866	85,970	\$413,239	\$63,782	\$12,039	290,529
Laramie	47,662	14,210	65,215	13,565	1,793		* Yellowstone Nat'l Park is included in Park County figure. ** See Park County.						
Lincoln	9,023	2,330	9,934	2,299	325		Note: Population 1950 Census; radio families Standard Audit & Measurement Services Inc.; food, drug and retail sales, copyright 1953, Sales Management; further reproduction unlicensed; automobiles supplied by state.						
Natrona	31,437	10,630	58,879	9,068	1,579								
Niobrara	4,701	1,300	7,003	1,061	153								
Park	15,182	*4,980	28,980	6,468	834								
Platte	7,925	2,250	10,764	2,379	449								

DIRECTORY OF AM AND FM STATIONS

CASPER													
KSPR 1930	1470	Donald Lewis	MBS, Inter-mountain	Donald Lewis	Marcus R. Nichols, pd	Jim Thompson, sd	Pop.: 55,000	Wld.					
KSPR-TV	1,000	Hathaway Box 930 3-5777	Sears & Ayer	Hathaway, p & gm	John Cheatham, ce	Jean Ann Dunn, wd	Rad. Hms.: 18,500	UP					
				Frederic W. Hufsmith, cm	Donn Driscoll, nd		Ret. Sls.: \$115,000,000	RCA					
KVOC 1946	1230	KVOC Bestg. Co. Box 2090 2-4511	ABC, Wyo. Cowboy McGillvra	Duane W. Simons, co-o, p & ce	I. E. Shahan, co-o, & cm	Warren Carlson, nd Mrs. W. H. Hileman, wd	Pop.: 41,000	Thes. AP					
	250			William F. Shutts, co-o & gm	Jim Baker, pd		Rad. Hms.: 13,229	G					
							Ret. Sls.: \$66,617,000						
CHEYENNE													
KFBC 1940	1240	Frontier Bestg. Co. 2923 E. Lincolnway 4-4461	ABC, Wyo. Cowboy McGillvra	William C. Grove, p & gm	D. W. Young, pmm	Larry Birleffi, sd	Pop.: 60,000	St. UP					
KFBC-TV	250			C. P. Cahill, cm	Robt. Pfannenschmid, ce	Margaret O'Brien, wd	Rad. Hms.: 15,000	RCA					
				Mae Sunada, pd	Kirk Knox, nd		Ret. Sls.: \$67,000,000						
KVWO 1952	1370	Great West Co. KVWO Bldg. 3000 W. Lincolnway 2-6433	MBS, Inter-mountain Avery-Knodel	William T. Kemp, p	Eugene Gelhaar, pd	Dick Long, pd	Pop.: 238,000	L-W AP					
	1,000-D			Bill Harrell, vp, gm & sd	Peter Dunne, pmm	Bruce Madsen, fd	Rad. Hms.: 63,000	G					
				Ruth Dorr, cm	Bert Godfrey, ce	Lois Lee, wd							
CODY													
KODI 1947	1400	Absaroka Bestg. Co. 1134 13th 444	ABC, Wyo. Cowboy McGillvra	Milward L. Simpson, p	Shubert Fendrich, pd & continuity d	Florence Salzar, nd & wd	Pop.: 5,000	Wld. AP					
	250			Charles Shaw, gm	Hal Bowen, ce	Gabby Barrus, sd	Rad. Hms.: 1,380	RCA					
				C. Owen Allen, sm									

... specify **KUWO**
MUTUAL

CHEYENNE'S POWER-FUL STATION

selling NORTHERN COLORADO
WESTERN NEBRASKA
and WONDERFUL WYOMING

KVWO

P. O. BOX 926—3000 W. LINCOLNWAY—PHONE 2-6433

BILL KEMP • BILL HARRELL CHEYENNE, WYOMING

Nationally represented by

Avery-Knodel, Inc.

NEW YORK
608 Fifth Avenue
Judson 6-5536

CHICAGO
75 E. Walker Drive
Andover 3-4710

SAN FRANCISCO
235 Montgomery Street,
Yukon 2-3877

ATLANTA
41 Marietta Street, N. W.,
Cypress 7545

LOS ANGELES
6399 Wilshire Blvd.
Tucker 2435

DALLAS
1915 Elm Street
Sterling 1558

Regional Representative: KENNETH E. PALMER & CO., 1554 California, Alpine 6450, Denver, Colorado

The Most Popular Programs in Cheyenne

WYOMING

City Call Letters Established TV Affiliate	Chan. or Freq. Power	Licensee Headquarters Telephone	Network Represent- ative	Owner o; Pres. p; Exec. op evp; Gen. Mgr. gm; Sta. Mgr. sm; Coml. Mgr. cm; Sales Mgr. slm; Prog. Dir. pd; Chief Eng. ce; Prom. Mgr. pmm; Prod. Mgr. pdm; News, Farm, Sports or Women's Dir. nd, fd, sd, wd.	Executive Abbreviations	Market Data For Primary Area (Supplied by station)	Library, News Serv. Transmitter	
EVANSTON								
KLUK 1953	1240 250	Advertising Enterprises Ltd. P. O. Box 198 700	MBS, KBS, Inter- mountain Avery- Knodel	Edwin L. Bullis, o&gm	Bob Collins, pd C. W. Brokaw, ce	Lee Rex, sd Shauna Eyre, wd	Thes. UP G	
LANDER								
KOVE 1948	1230 250 CP: 1330 1,000-DA-N	E. J. Breece Box 436 488	MBS, KBS, Inter- mountain Continental	Edward J. Breece, p Jack L. Breece, gm & pd	Dorothy L. Reed, cm Louise York, pmm Gary Fehlauer, ce	Marty Murphy, nd W. J. Luzmoor, sd Dorothy Scott, wd	Pop.: 22,420 Rad. Hms.: 5,900 Ret. Slis.: \$26,055,000 UP Col.
LARAMIE								
KOWB 1948	1340 250	Snowy Range Bcstg. Co. Inc. P. O. Box 972 4888	ABC, Wyo. Cowboy McGillvra	F. O. Rice, p C. S. Mohr, gm & cm L. O. Smith, pd, asst. m & ce	J. C. Steele, pmm & sd Ehtel Beagle, nd	Chuck Nichols, fd Kay Shelton, wd	Pop.: 15,500 Rad. Hms.: 4,650 Ret. Slis.: \$21,000,000 AP Col.
NEWCASTLE								
KASL 1953	1240 250	Newcastle Bcstg. Co. Newcastle 700	ABC, Wyo. Cowboy	Joe Aimonetto, p	Floyd L. Sparks, gm	C. E. Warford, ce	Pop.: 20,000 Rad. Hms.: 5,250 Ret. Slis.: \$21,124,000	
POWELL								
KPOW 1941	1260 5,000-D 1,000-N- DA-N	Albert J. Meyer Elder Bldg. 222	MBS, KBS, Inter- mountain Avery- Knodel	Albert J. Meyer, gm, ce & sup.	Agnes Fields, pd	Bink Meyer, sd	Pop.: 125,000 Rad. Hms.: 33,000	Assoc. Cole UP G
RAWLINS								
KRAL 1947	1240 250	Rawlins Bcstg. Co. W. Rawlins 1003	ABC, Wyo. McGillvra Cowboy	Tracy McCracken, p Jack C. Vagner, gm, cm & pmm	Anita Phisterer, pd Robert S. Williams, ce	Gene McMillen, nd Wanda Daley, wd	Pop.: 25,000 Rad. Hms.: 4,200 AP RCA
RIVERTON								
KWRL 1948	1450 250	Joseph P. Ernst Radio Station KWRL 789	ABC, Wyo. Cowboy McGillvra	Joseph P. Ernst, p Cleo Berry, gm, pd, pmm & wd	Bud Moore, cm & fd Mr. Lennert, ce	Bob Thorpe, nd & sd	Pop.: 20,000 Rad. Hms.: 5,500 Ret. Slis.: \$20,000,000 AP Col.
ROCK SPRINGS								
KVRS 1938	1360 1,000-D 500-DA-N	Wyoming Bcstg. Co. P. O. Box 1067 93	MBS, KBS, Inter- mountain Avery- Knodel	D. G. Richardson, p D. A. Fisher, gm & sd Laurel Mosbey, cm & fd	Imogene Parr, pd Rolland Dubois, nd & fd Jerri Fisher, wd	Dave Wood, ce	Pop.: 25,000 Rad. Hms.: 7,000	St. AP Col.
SHERIDAN								
KWYO 1934	1410 1,000-D 500-N	Bighorn Bcstg. Co. 21 N. Main 601	MBS, Inter- mountain Avery- Knodel	Jim Carroll, p & gm Don Tannehill, cm	Bob Wilson, pd & nd Bob Crosthwaite, ce	Jim Spracklin, sd	Pop.: 50,000 Rad. Hms.: 13,660	L-W UP RCA
TORRINGTON								
KGOS 1950	1490 250	Joseph Ernst Box 271 567	ABC, Wyo. Cowboy McGillvra	J. P. Ernst, p Alice Granke, gm & cm	Lester R. Rash, ce Bob Verdon, sd	Helen Olson, nd Evelyn Foster, wd	Pop.: 50,000 Rad. Hms.: 32,000 UP Col.
WORLAND								
KWOR 1946	1490 250	Joseph P. Ernst Radio Station KWOR 733	ABC, Wyo. Cowboy McGillvra	Joseph P. Ernst, p. pmm, nd & fd Mildred V. Ernst, gm, cm & wd	Karl V. Kertson, pd Joe C. Henry, ce	Charles Harkins, sd	Pop.: 7,000 Rad. Hms.: 1,800 Ret. Slis.: \$10,000,000 AP Col.

ALASKA

DIRECTORY OF AM AND FM STATIONS

ANCHORAGE

KBYR 1948	1240 250	Aleutian Bcstrs. P. O. Box 1980 3-4433						
KENI 1948	550 5,000	Midnight Sun Bcstg. Co. Box 879 2-0301	ABC, MBS, NBC, Don Lee	Mrs. Robert Kinsey, p Alvin O. Bramstedt, gm Claire O. Banks, sm William Stewart, cm Hal Knutson, pd	Phyllis Bock, pmm Raiph E. Walker, ce Gilbert A. Wellington, natl. slm James C. Fletcher, eastern slm	Walter Welch, nd William Murray, sd Ed Baldwin, fd Ruth Briggs, wd William Duck, ce	Pop.: 60,000 Rad. Hms.: 15,000	Assoc. AP, UP RCA
KFQD 1924	600 5,000	William J. Wagner 830 Securities Bldg. Seattle Seneca 6333	CBS, Alaska Bcstg. Alaska Radio Sales, Scott	William J. Wagner, p & gm George Ernst, sm	Don Kopf, cm Gerald Mathis, pd John Funk, pmm	Bob Lowrie, nd Gayle Bailey, wd	Pop.: 70,000 Rad. Hms.: 30,830	L-W AP RCA

FAIRBANKS

KFAR 1939	660 10,000	Midnight Sun Bcstg. Co. Box 910 2125	ABC, NBC, MBS, Don Lee Wellington Fletcher	Mrs. Robert Kinsey, p Alvin O. Bramstedt, gm	Robert Wells, cm Richard Greuel, pd Vay Greuel, pmm & nd Richard Shoup, ce	Don McCune, sd Merlyn Lage, wd	Pop.: 25,000 Rad. Hms.: 7,000 AP, UP RCA
KFRB 1948	790 5,000	William J. Wagner 830 Securities Bldg. Seattle Seneca 6333	CBS, Alaska Bcstg. Alaska Radio Sales, Scott	William J. Wagner, p & gm Jack Hauser, sm	Henry Whitson, cm Dale Haviland, pd John Funk, pmm	Murray Durham, ce Doug Haviland, nd Lorraine Tomme, wd	Pop.: 40,000 Rad. Hms.: 24,060	L-W AP RCA

Data corrected to Dec. 10, 1953. If executives or services for FM are same as AM affiliate names are not repeated. Market Data supplied by stations. FM's in italic. *—Non-Commercial Station. CP—Construction Permit issued. D—Day. DA—Day. DA-N—Directional Antenna, night only. DA-I—Directional Antenna, same pattern day and night. DA-2—Directional Antenna, different pattern day and night. L—Limited Time with Dominant Station. LS—Local Sunset. N—Night. SA—Special Authorization. SH—Specified Hours. ST—Share Time. Complete key to abbreviations, page 6.

ALASKA

JUNEAU

KINY 1935	1290 5,000	William J. Wagner 830 Securities Bldg. Seattle Seneca 6333	CBS, Alaska Bcstg. Alaska Radio Sales, Scott	William J. Wagner, p & gm James B. Lawson, sm	Richard L. Peter, pd & nd Helen Calman, wd	Gordon Burnett, ce John Funk, pmm JolYon Boynton, sd	Pop.: 31,600 Rad. Hms.: 21,780	L-W AP
KJNO 1952	630 1,000-D 500-N	Aurora Bcstrs. Inc. 123 3d St. 508	ABC, MBS, NBC, Wellington Fletcher	Austin Cooley, p Delmer L. Day, gm Joe Man'nan, cm	Ralph Seeley, pd Norma Weeks, pmm & wd	RoYal O'Reilly, ce Steve Brody, nd & sd	Pop.: 9,500 Rad. Hms.: 3,000 Ret. Sls.: \$3,000,000	Assoc. AP RCA

KETCHIKAN

KABI 1952	580 1,000-D 500-N	Aurora Bcstrs. Inc. Box 1459 211 Heckman Bldg. 3124	ABC, MBS, NBC, Wellington, Fletcher	Austin Cooley, p Jack D. Ellison, gm	John C. Gunn, cm Tom Sawyer, pd	Dick Nicholas, ce Patricia North, wd	Pop.: 10,000	Assoc. AP RCA
KTKN 1942	930 1,000	William J. Wagner 830 Securities Bldg. Seattle Seneca 6333	CBS, Alaska Bcstg. Alaska Radio Sales, Scott	William J. Wagner, p & gm Bob Mehan, sm	Thelma Alden, pd & wd John Funk, pmm	Jim Kemp, ce Roall Erickson, nd E. L. Vanderward, sd	Pop.: 25,000 Rad. Hms.: 19,600	L-W AP Col.

SEWARD

KIBH 1948	1340 250	William J. Wagner 830 Securities Bldg. Seattle Seneca 6333	CBS, Alaska Bcstg. Alaska Radio Sales, Scott	William J. Wagner, p & gm Joel Buffington, sm	Allen Hendricks, pd & nd	John Funk, pmm David Hassinger, ce	Pop.: 12,000 Rad. Hms.: 6,620	L-W AP RCA
---------------------	-------------	--	--	---	-----------------------------	---------------------------------------	----------------------------------	------------------

SITKA

KIFW 1949	1230 250	Wm. J. Wagner 830 Securities Bldg. Seattle Seneca 6333	CBS, Alaska Bcstg. Alaska Radio Sales, Scott	Wm. J. Wagner, p & gm	Harry Lanz, sm John Funk, pmm	De Wayne Sharp, ce	Pop.: 6,000 Rad. Hms.: 3,110	
---------------------	-------------	--	--	--------------------------	----------------------------------	--------------------	---------------------------------	--

GUAM

DIRECTORY OF AM STATION

AGANA KUAM (CP)	610 1,000	Radio Guam P. O. Box 68 Young	Harry M. Engel Jr., p, gm & cm	Richard Stanton, pd Wally George, pmm	Donald Brown, ce	Pop.: 85,000 Rad. Hms.: 25,000 Ret. Sls.: \$75,000,000	
-------------------------------------	--------------	----------------------------	----------------	-----------------------------------	--	------------------	--	--

HAWAII

DIRECTORY OF AM AND FM STATIONS

HILO KHBC 1936	970 1,000	Hawaiian Bcstg. System Ltd. P. O. Box 1476 4616	CBS, Hawaiian Free & Peters	J. Howard Worrall, p C. Richard Evans, vp & gm	C. T. Thrumston, sm Roger H. Coryell, pd Harold L. Marques, ce	Wayne L. Collins, nd Frank Valenti, sd Amy C. Izumi, wd	Pop.: 40,000 Rad. Hms.: 6,000	
KILA 1951	850 1,000	Island Bcstg. Co. Box 1595 5-4913	MBS, Inter- Island Holling- bery	J. Elroy McCaw, co-o John Keating, co-o	James E. Jaeger, gm	Rikio Doi, ce	Pop.: 40,000 Rad. Hms.: 9,000 Ret. Sls.: \$41,495,963 UP Col.
KIPA 1947	1110 1,000	Big Island Bcstg. Co., Ltd. 140 Iaiii St. 2177		A. H. Green, p & m				
HONOLULU KAIM(FM) (CP)	Ch. 238 (B) 95.5mc 6kw	Christian Bcstg. Assn. 1136 12th Ave. 724-005	Theis Reynertson, p Cornelius Keur, gm	Charles R. Palmquist Jr., sm & cm	Edward C. Shane, ce Mary Yuen, traffic m	Pop.: 500,000 Rad. Hms.: 100,000	SES, UP WE
KGMB 1930 KGMB-TV	590 5,000	Hawaiian Bcstg. System Ltd. P. O. Box 561 Honolulu 9-0914	CBS Free & Peters	J. Howard Worrall, p K. C. Wong, treas. C. Richard Evans, gm Wayne Kearl, asst. gm in chg. of sls.	Arthur B. Hansen, pd Faye Johnson, pmm Dan Hunter, ce Melvin B. Wright, merc. m	Wayne Collins, nd Frank Valenti, sd Maed Carson, wd	Pop.: 500,000 Rad. Hms.: 110,044 Ret. Sls.: \$521,189,496	St. UP RCA
KGU 1922	760 2,500 L-WJR	Advertiser Pub. Co. South & Kapiolani Blvd. 5-2977	NBC, All Island NBC Spot Sls.	Lorriin P. Thurston, p William O. Paine, gm Lee D. Hirshland, asst. m & pmm	George C. Mansfield, cm Sakae Kimata, ce George Dubie, traffic m	Joe Rose, co-sd Gene Good, co-sd Jo Biehl, wd	Pop.: 450,000 Rad. Hms.: 122,000	Thes. UP
KHON 1946	1380 5,000	Aloha Bcstg. Co. Ltd. P. O. Box 1380 9-5295	Aloha Grant	R. M. Fitkin, p Ira G. Mercer, sm & ce Hal Lewis, cm	Wright Esser, pd Buck Buchwack, pmm John D. Allison, nat'l. sls. d	John J. Jordan, nd Frank Valenti, sd Claire Justice, wd		L-W, Cap, UP RCA
KHTL(FM) (CP)	Ch. 222 92.3mc 6kw	Henry T. Lee 2998 Pacific Hghts.						
KIKI 1951	880 250 CP-810 1,000	KIKI Ltd. P. O. Box 692 6-3456 Rambeau	Royal V. Howard, p & ce	William B. Meyers, vp Robert W. Denison, gm & cm	Edward Anderson, pd & nd	Pop.: 400,000 Rad. Hms.: 192,000	L-W AP GE
KPOA 1946	630 5,000	Island Bcstg. Co. 575 Kamoku St. 9-5326	MBS, Inter- Island Holling- bery	John D. Keating, co-o J. Elroy McCaw, co-o Fin Hollinger, gm & cm	Suzanne Snell, pd Robert Lang, ce Herbert Markall, nd	Carlos Rivas, sd Barbara Bishop, wd	Pop.: 400,000 Rad. Hms.: 120,000 Ret. Sls.: \$500,000,000 UP WE
KULA 1947 KULA-TV	690 10,000	Pacific Frontier Bcstg. Co. Ltd. P. O. Box 1479 3-2121	ABC Young	Herbert L. Pettey, p Jack A. Burnett, gm Hugh Ben LaRue, gen. sim	Ted Scott, d of opers. Paul Yamamoto, pmm Ronald Miyahira, ce	Gordon Burke, nd & sd Nancy Aea, wd	Pop.: 500,000 Rad. Hms.: 119,000 Ret. Sls.: \$445,000,000 UP RCA

HAWAII

City	Call Letters	Chan. or Freq. Power	Licensee Headquarters Telephone	Network Representative	Owner o; Pres. p; Exec. vp evp; Gen. Mgr. gm; Sta. Mgr. sm; Coml. Mgr. cm; Sales Mgr. slm; Prog. Dir. pd; Chief Eng. ce; Prom. Mgr. pmm; Prod. Mgr. pdm; News, Farm, Sports or Women's Dir. nd, fd, sd, wd.	Executive Abbreviations	Market Data For Primary Area (Supplied by station)	Library, News Serv. Transmitter	
KANEHOE, OAHU									
KANI	1150	1,000-DA-1	Windward Bcstg. Co. Ltd. P. O. Box 227 243882	Judge Calvin C. McGregor, p	J. Robert Jensen, vp & gm Leonard E. Grothe, ce Merrill K. Riley, fd	Pop.: 31,000 Rad. Hms.: 8,000		
LIHUE, KAUAI									
KTOH	1490	250	Garden Island Pub. Co. 361	NBC, All Island NBC Spot Sls.	Charles J. Fern, p Martin H. Sabastian Jr., m & sd	Raymond Sasaki, pd Katashi Nose, ce	Pop.: 29,000 Rad. Hms.: 7,600 Ret. Sls.: \$23,000,000		
WAILUKU, MAUI									
KMVI	550	1,000	Maui Pub. Co. Ltd. Box 374 Wailuku 981	NBC, Inter-Island	J. Walter Cameron, p Ezra J. Crane, gm	Richard E. Mawson, sm Frank Kovacic, cm	Richard E. Mawson, pd Neil Arveschoug, ce	Pop.: 48,000 Rad. Hms.: 10,000 Ret. Sls.: \$34,000,000	St. PN RCA
WAIPAHU									
KAHU	920	1,000	Rural Bcstg. Co. Ltd. P. O. Box 1007 Honolulu 41-2835 Devney	Timothy Wee, p Harry En Chu, gm	Curtis L. Butler, sm & nd Robert Pearson, ce	Pop.: 300,000 Rad. Hms.: 78,000 Ret. Sls.: \$315,000,000		

PUERTO RICO

DIRECTORY OF AM AND FM STATIONS

AGUADILLA									
WABA	1240	250	Ledo. Hector Reichard P. O. Box 188 242	Ledo. Hector Reichard, p F. Bonnet Velez, gm	Wilfredo Almodovar, cm Ricardo Vega, pd Antolin Jimenez, ce	Pop.: 245,000 Rad. Hms.: 60,000	
ARECIBO									
WCMN	1280	1,000	Caribbean Bcstg. Corp. 1 Toribio Pagan 589	Kresto Denia, Cadena Azul	Aristides Santoni, p Nabal Barreto, gm Francisco Lopez Oronoz, cm	Digna Olivero Pabon, pd & wd Jose Soler, ce	Juan Lopez Montano, pd Hector Perez Cardona, sd	Pop.: 75,000 Rad. Hms.: 5,000 Ret. Sls.: \$72,000,000 Ray.
BAYAMON									
WENA	1580	250	Bayamon Bcstg. Corp. Box 157 161	Dr. A. Diaz Atilas, p	D. Diaz Alejandro, gm	Pop.: 80,000		
CAGUAS									
WJFR	1240	250	Jorama Fer-Radio Corp. 17 Gautier Benitez St. 3240	José M. Fernandez, p & gm	Manuel Iglesias, cm & pdm José M. Carriles, ce			
WRIA	1450	250	Inter American Radio Corp. Caguas 678					
WVJP	1110	250	Borinquen Bcstg. Co. P. O. Box 207 789					
FAJARDO									
WMDD	1490	250	Madrado & Diaz P. O. Box 187 132					
GUAYAMA									
WXRF	1590	1,000	Rafael Fuster Hostos No. 42 243	Rafael Fuster, p Charles Cordero, gm & cm	Jose Colon Melendez, pd Julius Conesa, ce	 G	
MAYAGUEZ									
WAEL	1400	250	Mario Acosta 12 Iglesia St. 799	Mario Acosta, o, gm, cm & pmm Angel Ramos, pd Jesus M. Aviles Brunet, ce	Secundino Minguela, nd Gabriel Castro, sd Berta De Tamayo, wd		
WKJB	710	1,000-D 500-N	Jose A. Bechara Jr. Minerva St. 54 983					
WORA	1150	1,000	Radio Americas Corp. Box 43 1150	Blue Net. Melchor & Guzman	Alfredo R. De Arellano Jr., p Reinaldo M. Dupont, asst. m, cm & nd	Blanca L. De Martinez, pd & wd Francisco Ortiz, pmm	Santiago Rodriguez, ce Santiago Llorens, sd GE	
WPRA	990	10,000-DA-1	WPRA Inc. Box 869 869	Andres Camara, p, gm & fd Virginia Di Cristina, cm	Esteban Rosado Baez, pd & nd Pedro Ojeda, pmm Jose A. Jimenez, ce	Santiago Llorens, sd Carmen Elbia Camara, wd	Pop.: 724,942 Rad. Hms.: 45,061 Ret. Sls.: \$49,290,722	
WTL	1300	1,000	Mayaguez Radio Corp. Post & Palmer Sts. 1290	Alberto Sanabria, p Patricio R. Fermainti, gm Gilbert Mamary, cm	Francis Feliu, pd Gabriel Castro, pmm & sd	Rafael R. Santiago, ce Yayi Mamary, wd G	
PONCE									
WISO	1260	1,000	South P. R. Bcstg. Corp. Box 2023 137	Luis E. Freyre, p, gm, ce & sd Jimmy Montanez, cm	Angel Ramos, pd & pmm	Milton Cott Quinones, pd Nilda P. Gonzalez, wd	Pop.: 160,000 Rad. Hms.: 100,000 Col.
WPAB	550	5,000-D 1,000-N	Portorican American Bcstg. Co. Inc. 164 Villa St. 783	A. Gimenez-Aguayo, p & gm	Radames Mayoral, cm	Eliseo Borrero, pd Pedro E. Conesa, ce	Pop.: 650,000 AP RCA
WPRP	910	5,000-DA-1	Voice of Puerto Rico Inc. Salud St. Corner to Guadalupe 1752	Blue Net. Melchor & Guzman	Alfredo Ramirez de Arellano, p	Roberto Muniz, gm Antonio Miro, cm	Luis A. Diaz, pd Julio M. Conesa, ce	Pop.: 600,000 Rad. Hms.: 60,000 Ret. Sls.: \$50,000,000 UP G

Data corrected to Dec. 10, 1953. If executives or services for FM are same as AM affiliate names are not repeated. Market Data supplied by stations. FM's in italic. *—Non-Commercial Station. CP—Construction Permit issued. D—Day. DA-N—Directional Antenna, night only. DA-1—Directional Antenna, same pattern day and night. DA-2—Directional Antenna, different pattern day and night. L—Limited Time with Dominant Station. LS—Local Sunset. N—Night. SA—Special Authorization. SH—Specified Hours. ST—Share Time. Complete key to abbreviations, page 6.

RIO PIEDRAS

WRIO 1949	1320 1,000	The Master Bcstg. Corp. P. O. Box 335, Hato Rey 1096	Isidro Quinones Vidal, p Julio Morales Ortiz, vp. gm & ce	Jose R. Camacho Rabelo, cm Diego Acevedo, pd	Manuel Rivera Morales, pmm	Pop.: 980,000 Rad. Hms.: 250,000 Ret. Sls.: \$102,000,000
WWWW 1949	1520 250	Frank A. Gandia P. O. Box 935 1098		Frank A. Ganda, o			

SAN JUAN

WAPA 1947 WAPA-TV	680 10,000	Jose Ramon Quinones 357 Ponce de Leon Ave. 3-3000	ABC, MBS	Jose Ramon Quinones, D Ary R. Moll, gm	Segismundo Quinones, cm Jose E. Franco, pd & asst. gm	Jose Arzuaga, ce J. Arnaldo Meyners, nd Pedro Vazquez, sd Guillermo Atilas, fd Delia Q. Arnaldo Meyners, wd	Pop.: 250,000 Rad. Hms.: 80,000	Thes. UP RCA
WITA 1948	1400 250 CP: 1140 500	Electronic Enterprises Inc. Box 2692 2-4756 Inter- national News- paper Reps.	Antonio Ayuso Valdivieso, p Hector Cintron Ayuso, vp	Jose M. Perez, gm Jose L. Nunez, cm Antonio Davila Collazo, pd	Luis Prado Martorell, ce Pedro J. Burgos, nd Munez Monge, sd Julie Ledee, wd	Pop.: 400,000 Rad. Hms.: 79,323	
WFOA (CP) WKAQ 1922 WKAQ-TV	1400 250 580 5,000	Continental Bcstg. Corp. El Mundo Bcstg. Corp. P. O. Box 9007 2-2023 CBS Inter- American Pub.	Angel Ramos, p Ventura Lamas Jr., cm	Esther Pales, pd & wd Rafael J. Acosta, trans. eng.	A. P. del Valle, studios eng. Turin Lamas, sd	Pop.: 500,000 Rad. Hms.: 80,000	Assoc. UP RCA
WKVM 1951	1070 25,000-D 5,000-N CP: 810 25,000-DA-1	American Colonial Bcstg. 1090 Ponce de Leon Ave. 3-0840	Ralph Perez Perry, p			
WNEL 1934	860 5,000-DA-1 CP: 850 10,000 DA-1	WNEL Inc. 960 Ponce de Leon Ave.						
WIAC 1947	740 10,000 DA-1	Radio Station WIAC Box 4504 2-0014	Cadena Azul Melchor Guzman	Tomas Muniz, secy. & gm Nestor Muniz, cm Roberto Perez Navarro, pd	Carmen Rosa Vidal, pmm Jose L. Milan, ce	Juan Maldonado, nd Jose R. Diaz, sd	Pop.: 500,000 Rad. Hms.: 250,000	
SANTURCE								
*WIPR 1949	940 10,000-DA-1	Department of Education Munoz Rivera Park 2-3218	Mariano Villarronga, p Jose A. Buitrago, sta. d Francisco Arrivi, pd	Pedro Luis Jimenez, ce Ismael Delgado, nd Carlos Gonzales, fd	Jose Seda, sd Catin Ballesteros, wd		Wld. WH

VIRGIN ISLANDS

DIRECTORY OF AM STATIONS

CHARLOTTE AMALIE (St. Thomas)

WIVI 1952	1230 250	Radio American West Indies						
WSTA 1950	1340 250	William N. Greer P. O. Box 538 489 Young	William N. Greer, p. gm & ce Nellie Greer, cm	Ron de Lugo, pd Seth Larrabee, pmm & nd	Anselmo Kuntz, sd Donna Allen, wd	Pop.: 34,000 Rad. Hms.: 5,200	L-W

DIRECTORY OF BROADCASTING STATIONS IN CANADA

ALBERTA

CALGARY

CFAC, began 1922, 960 kc, 5,000 w-DA-N. Calgary Bcstg. Co., 1000 Greyhound Bldg.; ph. 6-1036; CBC, Trans-Canada, net.; All-Canada Radio Facilities, Weed, repr. Exec.: John D. Southam, p; A. M. Cairns, m; D. H. Hartford, cm; George Brown, pdm; Dick Tregillus, prom. d; E. C. Connor, ce; A. D. Pattersen, office m; Larry Heywood, nd; Joe Marks, sd; Don McLean, fd; Brenda Cordwell, wd. Lib. Wld., Thes. Assoc.: news ser. PN, PUB, CP. Market Data For Primary Area: Pop.: 351,400; Rad. Hms.: 94,260; Ret. Sls.: \$313,123,000.

CFCN, began 1922, 1060 kc, 10,000 w-DA-N. The Voice of the Prairies Inc. Toronto General Trust Bldg.; ph. 2-1161; CBC, net.; Radio Reps., Young repr.; Exec.: H. G. Love, p & gm; E. H. McGuire, cm; Jas. A. Love, pd; G. L. Carter, pmm; R. W. Lamb, ce; Ross Henry, fd; Henry Viney, sd; Dora Dibney, ws. Lib., St., L-W, Cap.; news ser., PN, PUB, CP.

CKXL, began 1950, 1140 kc, 1,000 w-DA-N. The Albertan Bcstg. Co., 210 9th Ave. W.; ph. 6-3026; Stovin, repr.; Exec.: C. E. Chesher, p; F. R. Shaw, gm; B. D. Alloway, cm; J. R. Stewart, pd; R. L. Craig, ce; Guy Vaughan, nd; Ken Foss, sd. News Ser., CP, BUP; trans., RCA.

EDMONTON

CBX, began 1948, 1010 kc, 50,000 w. CBC, Macdonald Hotel; CBC, net. Exec.: J. A. Ouimet (CBC), gm; W. E. Powell (CBC), cm; Dane E. Cameron, m; Ron C. Fraser (CBC), press info. ser. d; D. C. McArthur (CBC), nd; Gordon W. Oliver (CBC), engr. d; A. K. Morrow (CBC), fd. News ser., BUP, CP, R.

CFRN, began 1934, 1260 kc, 5,000 w. Sunwapta Bcstg. Ltd., 109 CRP Bldg.; ph. 2-2101; CBC Dominion, net.; Radio Reps. Young, Oakes, repr. Exec.: G. R. A. Rice, p & gm; A. J. Hopps, cm; George A. Duffield, pd; Isabel McDonald, pmm; Frank Makepeace, ce; D. Atkinson, secy.-treas.; Laurie Graham, nd; Al Shaver, sd; Eve Henderson, wd. Lib. L-W; news ser. BUP; trans. RCA. Market Data For Primary Area: Pop.: 517,500; Rad. Hms.: 122,975; Ret. Sls.: \$360,176,000.

CHFA, began 1949, 680 kc, 5,000 w. Radio Edmonton Limitee, 10012 109 St.; ph. 4-2157; Reneud, repr. Exec.: Dr. O. L. Beauchemin, p; Leo Remillard, gm & cm; Robert Guy, ce; Tharcis Forestier, nd; Geralde Lachance, sd; Jacques Mayroll, fd; Liliane Chatein, wd. News ser. UP; trans. RCA.

CJCA, began 1922, 930 kc, 5,000 w. Edmonton Bcstg. Co., 452 Birks Bldg.; ph. 4-4131; CBC, Trans-Canada, net.; Weed, repr. Exec.: Gerry Gaetz, m; Rolfe Barnes, asst. m; Joe McKenzie, cm; Dalt Elton, pdm; Win Sutton, pmm; Frank Hollingworth, ce; Russ Sheppard, nd; Walt Rutherford, sd; Don Clayton, fd; Shirley Higginson, wd. Lib. Thes., St.; news ser. PN, BUP; trans. Marc. Market Data For Primary Area: Pop.: 525,000; Rad. Hms.: 132,000; Ret. Sls.: \$489,587,000.

CJCA (FM), began 1949, Ch. 258 (A), 99.5 mc, 0.2 kw.
*CKUA, began 1927, 580 kc, 1,000 w. U. of Alberta, Provincial Bldg.; ph. 2-5161; Exec.: J. G. Langdon, gm; J. W. Hagerman, pd; William Pinko, ce; Earl Olson, nd; Art Ward, sd; Everett McCrimmon, fd; Virginia Lee Hardy, wd. Lib. Assoc.: news ser. PN, BUP; trans. RCA.

GRAND PRAIRIE

CFGP, began 1937, 1050, kc, 1,000 w. Northern Bcstg. Corp., 9910 99th St.; ph. 2311; CBC, Trans-Canada, net.; All-Canada Radio Facilities Ltd., Weed, reprs. Exec.: John Thomson, p; A. J. Balfour, gm; John Soars, cm; John Wilson, pd & nd; Gene Ross, pmm; James De Roaldes, ce; Phil Floyd, sd; Ken Dunstan, fd; Lillian Bowes, wd. Lib. Wld.; news ser. PN; trans. Marc. Market Data For Primary Area: Pop.: 91,000; Rad. Hms.: 33,000.

LETHBRIDGE

CJOC, began 1926, 1220 kc, 5,000 w-DA-N. Lethbridge Bcstg. Ltd., 1015 3d Ave. S; ph. 3161; CBC, Trans-Canada, nets.; All-Canada Radio Facilities Ltd., Weed, reprs. Exec.: H. R. Carson, p; Norman Botterill, gm; Joe Budd, cm; Robert Reagh, pd; Fran Hushagen, pmm; Douglas Card, ce; Ed Conville, continuity ed; Bill Skelton, nd; Frank Bird, sd; Omar Broughton, fd; Mary Conville, wd. Lib. Assoc., L-W, Thes.; news ser., BUP, CP, PN; trans., Marc. Market Data For Primary Area: Pop.: 140,900 Rad. Hms.: 41,480; Ret. Sls.: \$195,347,400.

CBC

NETWORKS...

English and French

make Canada

... ONE BIG RADIO MARKET

The three CBC Networks . . . Dominion, Trans-Canada and French . . . provide flexible, economical coverage and give the penetration and sales results that make CBC network radio a most attractive advertising buy.

Two coast-to-coast CBC networks . . . Trans-Canada and Dominion . . . serve *English-speaking* Canadians, bringing listeners the best in music, drama, comedy, sports, news, information and public service programs.

The CBC French Network provides a separate program service designed especially to meet the tastes and interests of *French-speaking* Canadians . . . not only in the Province of Quebec but also to those in Northern Ontario and the Prairies through the westward extension of the network to French language stations across Canada.

In the development and production of Canadian Talent Programs . . . French and English . . . the CBC is glad to extend its fullest assistance to advertising agencies and their clients.

COMMERCIAL DIVISION

354 Jarvis St., Toronto 5

Ontario.

1425 Dorchester St. W., Montreal 25

Quebec.



ALBERTA

Sequence of information and abbreviations same as in U.S. Am and Fm Station Directory.

MEDICINE HAT

CHAT, began 1946, 1270 kc, 1,000 kw. Monarch Bcstg. Co., 520 1st St.; ph. 2821; CBC Dominion, net.; All-Canada Radio Facilities Ltd., Weed, reprs. Exec.: J. H. Yuill, p; R. J. Buss, gm; Orv Kope, cm; Ken Lapp, pd; Eva Weiler, pmm; Ian Carson, ce; Lorne Thompson, nd; Lloyd Colthrop, sd; Eleanor MacDougall, wd. News ser. PN, BUP; trans. RCA. Market Data For Primary Area: Pop.: 70,000; Rad. Hms.: 18,000; Ret. Sls.: \$38,000,000.

RED DEER

CKRD, began 1949, 850 kc, 1,000 kw. Central Alberta Bcstg. Co., Foster Block; ph. 2083; CBC Dominion, net.; Radio Reps. Ltd., Young, reprs. Exec.: Gordon S. Henry, p & gm; Ned B. Corrigan, cm; John D. Barton, pd; Jim Younie, pmm & nd; Ken L. Martin, ce; Ron Henry, sd; Ruby Enno, wd. Lib. Cap.; news ser. BUP; trans. G. Market Data For Primary Area: Pop.: 159,900; Rad. Hms.: 42,500; Ret. Sls.: \$140,953,000.

BRITISH COLUMBIA**CHILLIWACK**

CHWK, began 1927, 1270 kc, 1,000 w. Fraser Valley Bcstrs. Ltd., 50 Yale Rd. E; ph. Chilliwack 7511; CBC Dominion, net.; All-Canada Radio Facilities Ltd., Weed, reprs. Exec.: C. C. Wells, p; Jack Pilling, mgng. d & ce; W. G. Teeze, cm; J. M. MacLachlan, pdm; Margaret Cormack, pmm; Gordon Rose, nd; Alex Moir, sd & fd. Lib. Cole; news ser. BUP; trans. GE. Market Data For Primary Area: Pop.: 53,000; Rad. Hms.: 17,100.

DAWSON CREEK

CJDC, began 1947, 1350 kc, 1,000 kw. Radio Station CJDC, Ltd., 102d Ave.; ph. 216, CBC Trans-Canada, net.; Radio Reps. Ltd., Cooke, reprs. Exec.: W. B. Michaud, p; Lewis R. Roskin, gm; Mike Laverne, pd; Margaret Patterson, pmm; William Gordon, ce; Ron Dixon, nd; Roy Darling, sd; Hazel Velander, fd; Marj Jamison, wd. Lib. Assoc.; news ser. PN; trans. Marc. Market Data For Primary Area: Pop.: 85,000; Rad. Hms.: 22,000; Ret. Sls.: \$56,000,000.

KAMLOOPS

CFJC, began 1927, 910 kc, 1,000 w. Ian G. Clark Ltd., 310 St. Paul St.; ph. 1021; CBC, net.; All-Canada Radio Facilities, Weed, reprs. Exec.: Ian G. Clark, gm; R. J. Innes, cm; Walter Harwood, pd; Pat Marini, pmm & wd; Fred Webber, ce; Ralph Field, sd. Market Data For Primary Area: Pop.: 40,000; Rad. Hms.: 10,000; Ret. Sls.: \$24,000,000.

KELOWNA

CKOV, began 1931, 630 kc, 1,000 w. Okangon Bcstrs. Ltd., Box 1481; ph. Kelowna 3331; CBC, net.; All-Canada Radio Facilities, Weed, reprs. Exec.: J. W. B. Browne, p; J. H. Browne, gm; Dennis Reid, cm & sd; Freda Woodhouse, pd & pmm; J. Fred Weber, ce; Bob Hall, nd; Hugh Caley, fd; Gwyneth Harvey, wd. Lib. Thes., L-W; news ser. PN; trans. NE. Market Data For Primary Area: Pop.: 75,000; Rad. Hms.: 37,000.

NANAIMO

CHUB, began 1949, 1570 kc, 1,000 w-DA-N. Standard Bcstg. Co. Ltd., Malaspina Hotel; ph. 2630; Stephens & Townsend, Natl. Bcstg. Sls., Hunt, Cooke, reprs. Exec.: C. J. Rudd, m; Sheila Hassell, natl. sls. d & pmm; Tom Koch, pd; Ross MacIntyre, ce; Larry Thomas, nd & sd. Lib. St., Wld.; news ser. PN, R; trans. GE. Market Data For Primary Area: Pop.: 700,000.

NELSON

CKLN, began 1939, 1240 kc, 250 w. News Pub. Co., P.O. Box 250, 266 Baker St.; ph. 19; CBC Trans-Canada, net.; Stovin, Young, reprs. Exec.: Major R. Green, p & ce; Alan R. Ramsden, gm, cm, pd, pmm, ce & nd; Earl Warren, sd; Dorothy Bay, News ser. PN; trans. RCA. Market Data For Primary Area: Pop.: 10,000; Rad. Hms.: 1,970; Ret. Sls.: \$17,044,000.

NEW WESTMINSTER

CKNW, began 1944, 1320 kc, 1,000 w-DA-N. Internat'l. Bcstg. Co., 227 Columbia St.; ph. New Westminster 3000; Natl. Bcstg. Sls., Forjoe, reprs. Exec.: William Rea Jr., p & gm; Phil Baldwin, asst. m; Hal Davis, pd; Stan Buchanan, pmm; Clare Purvis, ce; Rosalie Slater, office m; MacIntosh Macdonald, sls, sup.; Bill Hughes, natl. sls. d; Jim Cox, nd & sd. Lib. Assoc., St., Cole; news ser. PN, BUP; trans. RCA. Market Data For Primary Area: Pop.: 725,000; Rad. Hms.: 250,000; Ret. Sls.: \$1,000,000,000.

PENTICTON

CKOK, began 1948, 800 kc, 1,000-D, 500-N kw. CKOK Ltd., 125 Nanaimo St.; ph. 2800; CBC Dominion, net.; Cooke, Mulvihill, Hunt, reprs. Exec.: Maurice P. Finnerty, p & gm; Roy G. Chapman, sm; Russ Richardson, pd; Dick France, ce; Bjorn Bjornson, nd; Dave Roegoel, sd; Ed Britten, fd; Pat Hanlon, wd. Lib. St.; news ser. PN; trans. GE. Market Data For Primary Area: Pop.: 35,222; Rad. Hms.: 10,200; Ret. Sls.: \$25,000,000.

PORT ALBERNI

CJAV, began 1946, 1240 kc, 250 w. CJAV Ltd., 735 3d Ave. N; ph. Port Alberni 603; Stephens & Townsend, Natl. Bcst. Sls., Hunt, Cooke, reprs. Exec.: Kenneth Hutcheson, gm; J. Geoffrey Holmes, cm; Thomas A. Rannie, pd; Harold Law, traffic m; Ross McIntyre, ce; Lyall B. Feltham, nd; James A. Robson, sd. Lib. Cole, Cap., L-W; news ser. AP, PN, R; trans. WE. Market Data For Primary Area: Pop.: 15,000; Rad. Hms.: 11,190.

Data corrected to Dec. 10, 1953. If executives or services for FM are same as AM affiliate names are not repeated. Market Data supplied by stations. FM's in bold face. *—Non-Commercial Station. CP—Construction Permit issued. D—Day. DA-N—Directional Antenna, night only. DA-1—Directional Antenna, same pattern day and night. DA-2—Directional Antenna, different pattern day and night. L—Limited Time with Dominant Station. LS—Local Sunset. N—Night. SA—Special Authorization. SH—Specified Hours. ST—Share Time. Complete key to abbreviations, page 6.

BRITISH COLUMBIA

Sequence of information and abbreviations same as in U.S. Am and Fm Station Directory.

PRINCE GEORGE

CKPG, began 1946, 550 kc, 250 w. Radio Station CKPG Ltd., 1220 6th Ave.; ph. 140; CBC Trans-Canada, net.; All-Canada Radio Facilities Ltd., Weed, reprs. Exec.: F. H. Elphicke, p; Cecil G. Elphicke, gm; Jack E. Carbutt, cm; Chuck Cawdell, pd, nd & sd; Dawson Stewart, pmm & traffic m; George Parkins, ce; Don Eccleston, librarian. Trans. NE. Market Data For Primary Area: Pop.: 25,000; Rad. Hms.: 11,650.

PRINCE RUPERT

CFPR, began 1938, 1240 kc, 250 w. Canadian Bcstg. Corp., 336 2d Ave. w; ph. 863; CBC Trans-Canada, net. Exec.: William C. Hankinson, sm; H. W. Paulson, cm; Noel Stone, prog. prod.; C. H. Insulander, sup. oper. Market Data For Primary Area: Pop.: 12,000.

TRAIL

CJAT, began 1932, 610 kc, 1,000 w. Kootenay Bcstg. Co., 815 Victoria St.; ph. 1840; CBC, net.; All-Canada Radio Facilities, Weed, reprs. Exec.: A. S. Mawdsley, p; John W. Loader, gm; Lorne V. McLeod, cm; Joseph P. Kobluk, pd; Vivvian Swanson, prom. d; John D. Hepburn, ce; James M. Bogyo, nd. Lib. Assoc.; news ser. PN; trans. RCA.

VANCOUVER

CBU, began 1936, 610 kc, 1,000 w. CBC, 701 Hornby St.; ph. Marine 6121 CBC, net. Exec.: J. A. Ouimet (CBC), gm; W. E. Powell (CBC), cm; Kenneth Caple, rep.; Ron C. Fraser (CBC), press info. & ser. d; Gordon W. Olive (CBC), engrg. d; D. C. McArthur (CBC), nd; A. K. Morrow (CBC), fd. News ser. BUP, R, CP.

CJOR, began 1926, 600 kc, 5,000 w-DA-1. CJOR Ltd., 846 Howe St.; ph. Marine 6464; CBC Dominion, net.; Stovin, Young, reprs. Exec.: G. C. Chandler, p; F. W. H. Wellwood, exec. asst.; D. E. Laws, cm; W. H. Knox, pmm; A. H. Chandler, ce; Jack Webster, nd. Lib. Thes., Mac.; news ser. UP, PN, BUP, NE. Market Data For Primary Area: Pop.: 875,900; Rad. Hms.: 265,900.

CKMO, began 1922, 1410 kc, 1,000 w-DA-N; BC Bcstg. System, 812 Robson St.; ph. Marine 1271; Renaud, Cooke, reprs. Exec. Mrs. R. J. Sproff, p; Mrs. K. M. Willis, mgng. d; R. Fortune, pd; D. Rogers, ce; Clare Copland, slm; Roy Jacques, nd; Norm Griffin, pd. Lib. SES., Assoc.; news ser. BUP; trans. RCA.

CKWX, began 1923, 980 kc, 5,000 w-DA-1. Western Bcstg. Co., 543 Seymour St.; ph. Tatlow 5131; MBS, net.; All-Canada Radio Facilities, Weed, reprs. Exec.: A. Holstead, p; F. H. Elphicke, vp & gm; S. G. Ross, asst. m; J. Sayers, cm; Laurie Irving, pdm; John Ansell, prog. m; Ken Hughes, pmm; Charles Smith, ce; Clare Copeland, retail slm; Bert Cannings, nd; Norm Griffin, fd; Nina Anthony, wd. News ser. PN, BUP; trans. RCA. Market Data For Primary Area: Pop.: 864,241; Rad. Hms.: 270,075; Ret. Sls.: \$1,070,845,000.

VERNON

CJIB, began 1947, 940 kc, 1,000 w. Interior Bcstrs. Ltd., 3330 Barnard Ave. W; ph. 3900; CBC Dominion, net.; Radio Reps., Cooke, reprs. Exec.: A. G. Seabrook, gm; L. S. Scott, cm; Don McGibbon, pd; David Lilwall, pmm; Loren Merriman, ce; Don Warner, sd; Nyra Groves, wd. Lib. Assoc.; news ser. PN; trans. RCA. Market Data For Primary Area: Pop.: 32,000; Rad. Hms.: 2,250; Ret. Sls.: \$13,649,000.

VICTORIA

CJVI, began 1940, 900 kc, 1,000 w-DA-2. Island Bcstg. Co., 817 Fort St.; ph. Beacon 8221; CBC, net.; All-Canada Radio Facilities Ltd., Weed, reprs. Exec.: H. R. Carson, p; William M. Guild, m; Cam Perry, asst. m; Lee Hallberg, cm; Vern Groves, pdm; Jim Crawford, pmm; Joe Sommers, ce; Bruce Lowther, nd; Ted Reynolds, sd; Shirley Shea, wd. Lib. Thes.; news ser. PN; trans. RCA. Market Data For Primary Area: Pop.: 165,900; Rad. Hms.: 48,730; Ret. Sls.: \$168,028,000.

CKDA, began 1950, 1340 kc, 250 w. David M. Armstrong, 1450 Douglas St.; ph. Garden 9311; Radio Reps. Ltd., Forjoe, reprs. Exec.: David M. Armstrong, p, gm & pmm; Gordon M. Reid, cm; David G. Hill, pdm; C. Edward Farey, pd; Ruby Masters, chief acct.; Norman E. Bergquist, ce; Andrew Stephen, nd; Keith MacKenzie, sd; Kay Knights, wd. Lib. St.; news ser. BUP; trans. GE. Market Data For Primary Area: Pop.: 140,000; Rad. Hms.: 35,000.

MANITOBA**BRANDON**

CKX, began 1928, 1150 kc, 1,000 w. Western Manitoba Bcstrs. Ltd., City Hall Sq.; ph. 4532; CBC, net.; John B. Craig, p & gm; E. D. Holland, cm; Eric Davies, pdm; A. W. Olson, pmm; E. Humphrey Davies, ce; Ken Milton, sd. Lib. Wld., Thes.; news ser. PN; trans. NE. Market Data For Primary Area: Pop.: 100,000; Rad. Hms.: 30,000; Ret. Sls.: \$90,000,000.

DAUPHIN

CKDM, began 1951, 1230 kc, 250 w. Dauphin Bcstg. Co. Ltd.; ph. 22; Radio Reps., Young, reprs. Exec.: Dr. M. Potoski, p; David M. Hughes, gm; Ralph D. Bagley, cm & sd; Jack M. Henderson, pd; Gordon Shave, ce; Lee Sage, nd; Bob Dale, fd; Mary McGregor, wd. Lib. Thes.; news ser. PN; trans. GE.

FLIN FLON

CFAR, began 1937, 590 kc, 1,000 w. Arctic Radio Corp., 75 Callinan St.; ph. 4422; CBC Trans-Canada, net.; Stovin, Young, reprs. Exec.: C. H. Whitney, gm; M. Cambrell, cm; E. Smallwood, pd & nd; J. Wardle, sd; D. Simpson, wd. News ser. PN. Market Data For Primary Area: Pop.: 30,000; Rad. Hms.: 8,500.

ST. BONIFACE

CKSB, began 1946, 1250 kc, 1,000 w-DA-1. Radio St. Boniface Ltée., 607 Langevin St.; ph. 20-4865; CBC, net.; McGillvra, repr. Exec.: C. E. Champagne, p; Roland Couture, gm & cm; Denis Belair, pd & pmm; Yves Savignac, ce; Norbert Prefontaine, nd; E. Bohemier, sd. Lib. Assoc.; news ser. BUP; trans. WE. Market Data For Primary Area: Pop.: 400,000; Rad. Hms.: 100,000.

WINNIPEG

CBW, began 1948, 990 kc, 50,000 w. CBC, 541 Portage Ave.; ph. 74-2541; CBC Trans-Canada, net. Exec.: J. A. Ouimet, (CBC) gm; J. N. Mogridge, sm; W. E. Powell, (CBC) cm; J. R. Finlay, reg. rep.; R. Horley, cm; D. E. Cameron, pd; C. E. L'Ami, pmm; R. O. Cahoon, ce; H. N. Cowan, nd; George Kent, sd; R. G. Knowles, fd.

CJOB, began 1946, 1340 kc, 250 w. Blick Bcstg. Ltd., 10th Floor, Lindsay Bldg.; ph. 926-374; Cooke, Broadcast Reps., reprs. Exec.: J. O. Blick, p & mgng, d; A. J. Messner, cm; George C. Davies, pdm; H. J. Gibson, pmm; R. V. Durie, ce; F. M. Sprague, office m; A. S. Bready, nd; George McCloy, sd. Lib. Assoc., St., L-W, Thes., Wld.; news ser. CP, BUP; trans. NE.

CJOB-FM, began 1948, Ch. 276, 103.1mc, 0.25kw.

CKRC, began 1934, 630 kc, 5,000 w-DA-N. Trans-Canada Communications. Free Press Bldg., 300 Carlton St.; ph. 922-266; CBC, net.; All-Canada Radio Facilities Ltd., Weed, reprs. Exec.: V. Sifton, p; W. A. Speers, gm; B. M. Pirie, cm; J. Hill, pd; F. M. Desourdy, pmm; A. W. Hooper, ce; J. Couper, loc. slm; Ev Dutton, nd; Maurice Smith, sd. Lib. L-W, St.; news ser. PN, BUP; trans. RCA.

CKY, began 1950, 580 kc, 5,000 w-DA-2. Bcstg. Station CKY, 432 Main St.; ph. 931-531; Stovin, Cooke, reprs. Exec.: Lloyd E. Moffat, p; A. R. MacKenzie, gm; W. E. Collier, cm; Jack Stewart, pd; Andy Malowanchuk, ce; C. F. Hawkins, loc. slm.; John McManus, nd; Jack Wells, sd; Wendy Warren, wd. Lib. Cap., Assoc., SES.; news ser. BUP, CP; trans. NE. Market Data For Primary Area: Pop.: 977,173; Ret. Sls.: \$690,250,102.

CAMPBELLTON

CKNB, began 1939, 950 kc, 1,000 w-DA-N. Restigouche Bcstg. Co. Ltd., 110 Water St.; ph. 8; CBC, net.; Hardy, Weed, reprs. Exec.: Dr. Charles Houde, mgng, d; J. W. Mac Donald, p; C. S. Chapman, sm; R. D. Richards, pd; L. P. Paquet, ce; W. H. Harper, pdm. News ser. PN; trans. NE. Market Data For Primary Area: Pop.: 200,000; Rad. Hms.: 51,250.

EDMUNDSTON

CJEM, began 1944, 570 kc, 1,000 w. Edmundston Radio Ltd., 91 Canada Rd.; ph. 880; CBC, net.; Stovin, Young, reprs. Exec.: Georges Michaud, p; Maurice Lacasse, m; Georges Guerrette, cm; Reynald Teasdale, pd, nd & sd; Yvon Roy, ce; Bob Beaulieu, chief ann. Lib. SES.; news ser. PN; trans. WE. Market Data For Primary Area: Pop.: 40,000.

FREDERICTON

CFNB, began 1923, 550 kc, 5,000 w-DA-N. James S. Neill & Sons Ltd., York St.; ph. 5501; Trans-Canada, net.; Weed, All-Canada Radio Facilities Ltd., reprs. Exec.: D. Malcolm Neill, gm; H. L. McFee, slm & pmm; Jack T. H. Fenety, pd; Glenn D. Love, ce. Lib. Thes., news ser. BUP; Radio Press; trans. Marc. Market Data For Primary Area: Pop.: 195,100; Rad. Hms.: 46,040; Ret. Sls.: \$78,937,000.

MONCTON

CKCW, began 1934, 1220 kc, 10,000 w. Moncton Bcstg. Ltd., Knights of Pythias Bldg.; ph. 9111; CBC, net.; Young, Stovin, reprs. Exec.: F. A. Lynds, p & gm; T. H. Tonner, cm; C. R. Tabor, pd; Robert Reid, pmm; Arnold Brewster, ce; William Hutton, nd; Earl Ross, sd; Jim Coulter, fd; Joan Nelson, wd. Lib. Wld.; news ser. BUP, Radio Press; trans. RCA. Market Data For Primary Area: Pop.: 156,000; Rad. Hms.: 35,000; Ret. Sls.: \$90,125,000.

NEWCASTLE

CKMR, began 1949, 1340 kc, 250 w. Miramichi Bcstg. Co. Ltd., Newcastle; ph. 690; CBC, Trans-Canada, net.; Renaud, repr. Exec.: L. W. Fleitt, p; R. J. Wallace, gm, cm & ce; F. Haining, pd & sd; D. Leeman, pmm; Paul Hansen, nd; Norma Weldon, wd. Market Data For Primary Area: Pop.: 48,000.

SACKVILLE

CBA, began 1939, 1070 kc, 50,000 w. Canadian Bcstg. Corp., 100 Sackville St., Halifax, N. S.; ph. 3-6188; CBC, net.; Exec.: J. A. Ouimet (CBC), gm; W. E. S. Briggs, rep.; S. R. Kennedy, sm; L. D. Brown, press & info rep.; L. A. Canning, chief oper. (Halifax); H. M. Smith, reg. engr. (Maritimes); M. Mac Donald, senior news ed.; Murray Creed, farm commentator. News ser. CP, BUP, R.

Coverage

LONDON CITY AREA *

No. of homes - - - - 35,300

No. of radio homes - - - 34,380

CFPL coverage

Daytime - 97% of radio homes

Night - 94% of radio homes

GREATER LONDON *

(London and Middlesex County)

No. of homes - - - - 47,100

No. of radio homes - - - 44,910

CFPL coverage:

Daytime - 92% of radio homes

Night - 85% of radio homes

Plus

Coverage in 7 additional Counties *

	Daytime	Night
Bruce	14%	11%
Elgin	62%	55%
Huron	62%	47%
Lambton	32%	17%
Norfolk	25%	13%
Oxford	48%	37%
Perth	53%	45%

in a major market

PRODUCTION QUALITY

Network standards - RCA studio equipment and transmitters - 980 kc., 5000 watts D/N, directional, pattern change at night - 1 K standby-emergency power generator - Studios incorporate approved specifications of CBC, with improvements - Turntables, 78 and 33 1/2 - Magnecorder studio tape recording, playback equipment; also portable model for remotes - Presto disc recording equipment - Telephone tape recording unit - Complete tech lab - Top flight personnel - Performance record high.

PROGRAM STRUCTURE

Basic affiliate CBC Dominion Network - Local shows meet network standards, add strong community flavor (some fed to network) - Programs specialized at audience favored times; day-by-day continuity ensures thru'-the-week penetration - Library: 78's, Lang-Worth, Standard and WORLD - Continuity staff - CFPL - FM both satellite and separate. Operating Schedule - 6:00 a.m. to 1:00 a.m. Mon. thru' Fri.; 6:00 a.m. to 2:00 a.m. Sat.; 8:30 a.m. to 1:00 a.m. Sun.

PROMOTION - MERCHANDISING

Program promotion thru' radio, daily newspaper, weekly newspaper - Staff co-operation on special merchandising plans - Data, as requested, on market, distribution, competition, test possibilities, etc.

IN U.S.A., CONTACT WEED & COMPANY; IN CANADA, ALL-CANADA RADIO FACILITIES.

980 CFPL LONDON - CANADA

* BBM SURVEY 1952

NEW BRUNSWICK

ST. JOHN

CFBC, began 1946, 930 kc, 5,000 w-DA-N. Fundy Bcstg. Co. Ltd., 68 Carleton St.; ph. 2-3301; CBC, net.; Natl. Bcst. Sls., Hunt, Weed, reprs. Exec.: Dr. A. M. A. McLean, p; R. T. Bowman, m & fd; C. F. Bedford, slm; W. H. Tonner, pd; R. J. Gallagher, pmm; Harold M. Stout, ce; D. A. Armstrong, pdm; W. N. Lovatt, nd; Gord Smith, sd; Margaret E. Williams, wd. Lib. St.: news ser. BUP, Radio Press; trans. RCA. Market Data For Primary Area: Pop.: 217,800; Rad. Hms.: 55,510; Ret. Sls.: \$126,013,000.

CHSJ, began 1934, 1150 kc, 5,000 w DA-N. New Brunswick Bcstg. Co. Ltd., 14 Church St.; ph. 3-3304; Exec.: George A. Cromwell, gm. News ser. PN; trans. NE.

CHSJ-FM, began 1947, Ch. 263, 100.5mc, 0.32kw.

NEWFOUNDLAND

CORNER BROOK

CBY, began 1949, 790 kc, 1,000 w. CBC; CBC, net.; Exec.: J. A. Ouimet (CBC), gm; William F. Galgay, reg. rep.; W. E. Powell (CBC), cm; C. V. Hierlihy, sm; E. D. Long (CBC), wd; Ron C. Fraser (CBC), press & info. ser. d; Gordon W. Olive (CBC), engrg. d; D. C. McArthur (CBC), nd; A. K. Morrow (CBC), fd. News ser. CP, BUP, R.

GANDER

CBG, began 1949, 1450 kc, 250 w. CBC; CBC, net.; Exec.: J. A. Ouimet (CBC), gm; William F. Galgay, reg. rep.; W. E. Powell (CBC), cm; A. W. Barrett, sm; Ron C. Fraser (CBC) press & info. ser. d; Gordon W. Olive, engrg. d; D. C. McArthur (CBC), nd; A. K. Morrow (CBC), fd; E. D. Long (CBC), wd. News ser. CP, BUP, R.

GOOSE BAY

*CGB, 1350 kc, 250 w. Royal Canadian Air Force.

GRAND FALLS

CBT, began 1949, 1350 kc, 1,000 w. CBC; CBC, net.; Exec.: J. A. Ouimet (CBC), gm; William F. Galgay, reg. rep.; W. E. Powell (CBC), cm; J. J. Grace, act. sm; A. K. Morrow (CBC), fd; Gordon W. Olive, engrg. d; Ron C. Fraser (CBC), press & info. ser. d; D. C. McArthur (CBC), nd. News ser. CP, BUP, R.

NEWFOUNDLAND

HARMON FIELD

*VOHF, began 1945, 1490 kc, 50 w. U. S. Air Force.

ST. JOHNS

CBN, began 1949, 640 kc, 10,000 w. CBC; CBC, net.; Exec.: J. A. Ouimet (CBC) gm; William F. Galgay, reg. rep.; W. E. Powell (CBC), cm; Gordon W. Olive (CBC), engrg. d; Ron C. Fraser (CBC), press & info. ser. d; D. C. McArthur (CBC), nd; A. K. Morrow (CBC), fd. News ser. CP, BUP, R.

CJON, began 1951, 930 kc, 5,000 w. Newfoundland Bcstg. Co., Prince of Wales St.; ph. 7106; Weed, All-Canada Radio, reprs. Exec.: Geoff Stirling, p & gm; Art Harnett, cm; Don Jamieson, pd; Jack Baird, pmm; O. Hierhily, ce; Bren Walsh, nd; J. MacDonald, sd; J. White, fd; Mrs. McKay, wd. News ser. CP, PN; trans. Marc. Market Data For Primary Area: Pop.: 292,000; Rad. Hms.: 60,000; Ret. Sls.: \$200,000,000.

VOAR, began 1931, 1230 kc, 100 w-D. Radio Station VOAR, Box 574, 106 Freshwater Rd.; ph. 6760; Exec.: Philip Moores, p, gm & cm; Walter O. Comm, pd & nd; Emerson Hillock, pmm; George Rabbits, ce; Doris E. Moores, wd. Market Data For Primary Area: Pop.: 150,000.

VOCM, began 1936, 590 kc, 1,000 w. Colonial Bcstg. System Ltd., McBrides Hill; ph. 3148; Young, Stovin, reprs. Exec.: J. L. Butler, p & gm; M. Shulman, cm; J. M. Murdoch, pd; Denys Ferry, pmm; W. B. Williams, ce; John Holmes, nd; Jim Brown, sd; Sylvia Wigh, wd. Lib. Wld., Thes.; news ser. CP, PN; trans. RCA. Market Data For Primary Area: Pop.: 150,000; Rad. Hms.: 46,000. *VOCM, 700 kc, 500 w-SH. Wesley Radio Board, Patrick St.

NORTHWEST TERRITORY

HAY RIVER

CFHR, (CP), 1490 kc, 100 w.

NORMAN WELLS

CFNW, (CP), 1240 kc, 100 w.

YELLOW KNIFE

*CFYP, began 1949, 1450 kc, 150 w. Dept. of Natl. Defense; ph. 94. Exec.: Rev. Judson Stude, chmn. of bd.; Gordon Betts, pd.



IN A VAST COUNTRY with wide "skip-distances" between major markets, All-Canada offers you the most economical, most effective method of reaching the consumer at home through a select group of key Canadian stations.

THE "ALL-CANADA" FAMILY OF RADIO STATIONS

ONTARIO

CJSH-FM Hamilton
CKOC Hamilton
CJCS Stratford
CKSO Sudbury
CFRB Toronto
CFPL London
CKLW Windsor

MARITIMES

CFCY Charlottetown
CFNB Fredericton
CHNS Halifax
CJCB Sydney
CJLS Yarmouth

BRITISH COLUMBIA

CHWK Chilliwack
CFJC Kamloops
CKOV Kelowna
CKPG Prince George
CJAT Trail
CKWX Vancouver
CJVI Victoria

QUEBEC

CFCF Montreal

SASKATCHEWAN

CKBI Prince Albert
CKCK Regina

ALBERTA

CFAC Calgary
CJCA Edmonton
CFGP Grande Prairie
CJOC Lethbridge
CHAT Medicine Hat

MANITOBA

CKRC Winnipeg

NEWFOUNDLAND

CJON St. John's

ALL-CANADA RADIO FACILITIES *Limited*

VANCOUVER • CALGARY • WINNIPEG • TORONTO • MONTREAL

Sequence of information and abbreviations same as in U.S. Am and Fm Station Directory.

ANTIGONISH

CJFX, began 1943, 580 kc, 5,000 w. Atlantic Bcstrs. Ltd., St. Ninian St.; ph. 580; CBC, net.; Mulvihill, Young, reprs. Exec.: J. Clyde Nunn, gm; Ralph Rick-otts, cm; Charles O'Brien, pd; Bruce Refuse, pmm; Gordon MacDougall, ce; Bill MacKinnon, nd; Al Graham, sd. Lib. L-W; news ser. PN.

BRIDGEWATER

CKBW, began 1947, 1000 kc, 1,000 w. Acadia Bcstg. Co. Ltd., 399 King St.; ph. 444; CBC Trans-Canada, net.; Radio Reprs., Cooke, reprs. Exec.: John F. Hirtle, gm; James A. MacLeod, cm; Max Ramey, pd; Douglas B. Hirtle, ce; Lester L. Rogers, slm. Lib. Assoc.; news ser. PN; trans. RCA. Market Data For Primary Area: Pop.: 60,000; Rad. Hms.: 14,850.

HALIFAX

CBH, began 1947, 1330 kc, 100 w. CBC, 100 Sackville St.; ph. 3-6188; CBC Trans-Canada, net.; Exec.: W. E. S. Briggs, reg. rep.; S. R. Kennedy, sm; L. D. Brown, press & info. rep.; L. A. Canning (Halifax), chief oper.; H. M. Smith, reg. engr. (Maritimes); M. MacDonald, senior news ed.; Murray Craed, farm commentator. News ser. BUP, CP, R. Market Data For Primary Area: Pop.: 133,000.

CHNS, began 1926, 960 kc, 5,000 w-DA-N. Maritime Bcstg. Co., P.O. Box 400; ph. 3-8318; CBC, net.; All-Canada Radio Facilities Ltd., Weed, reprs. Exec.: Graham W. Dennis, p; Gerald J. Redmond, gm; Douglas A. Grant, cm; John Funston, prog. m; Arthur W. Greig, ce. Lib. Thes., L-W; news ser. PN, BUP; trans. NE. Market Data For Primary Area: Pop.: 402,000; Rad. Hms.: 80,000; Ret. Sls.: \$291,000,000.

CHNS-FM, began 1949, Ch. 241, 96.1mc, 0.25kw. Lib. L-W; Thes.; news ser. BUP, CP; trans. RCA.

CJCH, began 1944, 920 kc, 5,000 w-DA-N. Chronicle Co. Ltd., 741 Robie St.; ph. 5-5443; Mulvihill, Young, reprs. Exec.: B. Pearson McCurdy, mgng. d; E. Finlay MacDonald, gm; Clair L. Chambers, slm; Baz Russell, prog. sup.; William E. Fulton, pdm; A. Reginald MacWilliams, ce; Howard E. Gerard, bus. m; Sydney C. Pilkington, continuity m; Len Chapple, nd; Pat Connolly, sd; (Mrs.) Abbie Lane, wd. Lib. Wld., Assoc.; news ser. PN; trans. NE. Market Data For Primary Area: Pop.: 381,000; Rad. Hms.: 79,270; Ret. Sls.: \$229,648,000.

KENTVILLE

CKEN, began 1948, 1490 kc, 250 w. Evangeline Bcstg. Co. Ltd., Radio Centre; ph. 2111; Alexander, repr. Exec.: George Wilson, p; J. A. C. Lewis, gm; E. J. Macmillan, cm; W. A. Bishop, pd & nd; B. M. Butler-Gray, pmm; A. M. Bishop, ce; C. R. Huggins, sd; Diana Bishop, wd. Lib. L-W; news ser. PN; trans. GE. Market Data For Primary Area: Pop.: 55,900; Rad. Hms.: 13,120; Ret. Sls.: \$29,992,000.

SYDNEY

CBI, began 1948, 1570 kc, 1,000 w. CBC, P.O. Box 700; ph. 4495; CBC Trans-Canada, net.; CBC, Commercial Division, repr. Exec.: Barry MacDonald, m; G. R. Oulton, sup. oper. News ser. BUP, CP, R.

CJCB, began 1929, 1270 kc, 5,000 w-D, 1,000 w-N. Cape Breton Bcstrs. Ltd., Radio Bldg.; ph. 5596; CBC, net.; All-Canada, Weed, reprs. Exec.: J. W. Nathanson, p & gm; R. M. Burchell, cm; C. R. Huggins, sd; L. W. Taylor, pmm; A. Vernon, ce; R. E. Bennett, nd; D. MacIsaac, sd; Ann Terry, wd. Lib. Thes., L-W; news ser. PN; Trans. Marc.

CJCB-FM, began 1948, Ch. 235, 94.9mc, 0.25kw.

TRURO

CKCL, began 1947, 1400 kc, 250 w. Colchester Bcstg. Co. Ltd., 7 Pleasant St.; ph. 491; Renaud, repr. Exec.: J. A. Manning, p & gm; George B. Moore, cm & pmm; Lloyd Cavanagh, pd & fd; E. S. Bernasconi, ce; Ray Chaisson, nd; Win Langille, sd. Lib. Assoc.; news ser. BUP; trans. NE. Market Data For Primary Area: Pop.: 55,000; Rad. Hms.: 14,000; Ret. Sls.: \$16,500,000.

WINDSOR

CFAB, began 1946, 1450 kc, 250 w. Evangeline Bcstg. Co. Ltd., Radio Centre; ph. 2111; Alexander, repr. Exec.: George Wilson, p; J. A. C. Lewis, gm; E. J. Macmillan, cm; W. A. Bishop, pd & nd; B. M. Butler-Gray, pmm; A. M. Bishop, ce; C. R. Huggins, sd; Diana Bishop, wd. Lib. L-W; news ser. PN; trans. NE. Market Data For Primary Area: Pop.: 55,900; Rad. Hms.: 13,120; Ret. Sls.: \$29,992,000.

YARMOUTH

CJLS, began 1934, 1340 kc, 250 w. Gateway Bcstg. Co. Ltd., 222 Main St.; ph. 500; CBC, net.; All-Canada Radio Facilities Ltd., Weed, reprs. Exec.: Donald L. Smith, p, gm, cm & ce; William Singer, pmm; Denny J. Comeau, nd & sd; Gene Alton, fd & wd. News ser. CP; trans. NE.

ONTARIO

BARRIE

CKBB, began 1949, 1230 kc, 250 w. Ralph T. Snelgrove, 26 Elizabeth St.; ph. 5585. Exec.: Ralph T. Snelgrove, p & gm. News ser. AP; trans. RCA

BELLEVILLE

CJBQ, began 1946, 1230 kc, 250 w. A. McLean Haig, Box 153; ph. 3200; CBC, net.; Young, Stovin, reprs. Exec.: A. McLean Haig, p; W. H. Stovin, m; J. H. MacDonald, loc. adv. m; C. Hannah, pd; F. C. Murray, pmm & asst. m; J. B. Buchanan, ce; P. Flagler, Trenton m & fd; Pat Bennett, nd; Jack Devine, sd. Lib. Wld., Thes.; news ser. PN; trans. WE. Market Data For Primary Area: Pop.: 145,253; Rad. Hms.: 22,100; Ret. Sls.: \$101,143,000.

Data corrected to Dec. 10, 1953. If executives or services for FM are same as AM, FM's in bold face. *—Non-Commercial Station, CP—Construction Permit issued, same pattern day and night. DA-2—Directional Antenna, different pattern day and night. L—Limited Time with Dominant Station. LS—Local Sunset. N—Night. SA—Special Authorization. SH—Specified Hours. ST—Share Time. Complete key to abbreviations, page 6.

Sequence of information and abbreviations same as in U.S. Am and Fm Station Directory.

BRAMPTON

CFJB, began 1953.

BRANTFORD

CKPC, began 1923, 1380 kc, 1,000 DA-N. Telephone City Bcstg. Ltd., CKPC; ph. 3-2664; CBC Dominion, net.; Alexander, repr. Exec.: Florence M. Buchanan, p; Hugh Bremner, m; Richard Buchanan, pd; Jack Wilkinson, pmm; Don Williamson, ce; Eileen Taylor, traffic; Al Chandler, nd; Arnold Anderson, sd; Mike Warren, fd; Marion George, wd. Lib. Wld., Cap.; news ser. BUP; trans. NE. Market Data For Primary Area: Pop.: 43,000

BROCKVILLE

CFJR, began 1943, 1450 kc, 250 w. Jack R. Radford, 17 King St. W.; ph. 4628; CBC, net.; Stovin, Young, reprs. Exec.: Jack R. Radford, p, gm, cm & nd; Thomas Statham, pd, asst., pmm & sd; Sidney Penstone, ce; Ethel Radford, treas.; Edgar Clow, fd; Norine Kelly, wd. News ser. BUP; trans. RCA. Market Data For Primary Area: Rad. Hms.: 20,000.

CHATHAM

CFCO, began 1926, 630 kc, 1,000 w-DA-N. John Beardall, P.O. Box 277; ph. 2626; CBC Dominion, net. Exec.: John Beardall, o & gm; P. A. Kirkey, coml. d & pmm; Gordon D. Brooks, pd, ce & personnel m; Eunice Gardiner, nd, fd & wd. Lib. L-W, Cole; news ser. BUP; trans. NE. Market Data For Primary Area: Pop.: 595,300; Rad. Hms.: 168,600; Ret. Sls.: \$475,063,000.

CORNWALL

CKSF, began 1945, 1230 kc, 250 w. Daily Standard Freeholder, 36 Pitt St.; ph. Cornwall 4800; CBC, net.; Stovin, McGillvra, reprs. Exec.: Howard Fleming, p; Fred H. Pemberton, gm; Carl Fisher, prod. d & sd; Mahlon Clark, ce; Patrick Lyndon, nd; Jack Reid, wd. Lib. Thes.; news ser. PN; trans. Marc. Market Data For Primary Area: Pop.: 86,000; Rad. Hms.: 18,770; Ret. Sls.: \$46,114,150.

CKSF-FM, began 1945, Ch. 284, 104.3mc, 0.6kw.

EASTVIEW

CKGO, began 1953, 1240 kc, 250 w.

FORT FRANCES

CKFI, began 1944, 800 kc, 1,000 w-D, 500 w-N. Bcstg. Station CKFI Ltd., 242 Scott St.; ph. 200; CBC Dominion, KBS, nets.; Alexander Bcstg. Reprs.; reprs. Exec.: J. C. McLaren, p, gm & nd; W. H. McLellan, cm; Gordon McBride, pd & sd; Victor Price, pmm; Richard Endseth, ce; Charles Renaud, fd & wd. News ser. PN; trans. NE. Market Data For Primary Area: Pop.: 300,000; Rad. Hms.: 75,000; Ret. Sls.: \$284,704,000.

FORT WILLIAM

CKPR, began 1931, 580 kc, 1,000 w. CKPR, Radio Hall; ph. 3-3477; CBC, net.; Young, Radio Reprs., Stovin, All-Canada, reprs. Exec.: H. F. Dougall, p; G. D. Jeffrey, cm; J. P. Friesen, pd & nd; J. Masters, pmm & fd; W. T. Ross, ce; Chuck McManus, sd; Pauline Chorniuk, wd. Lib. Thes.; news ser. PN; trans. RCA. Market Data For Primary Area: Pop.: 120,000; Rad. Hms.: 25,000.

CKPR-FM, began 1950, Ch. 232 (A), 94.3mc, 0.25kw.

GUELPH

CJOY, began 1948, 1450 kc, 250 w. CJOY Ltd., Bond Bldg.; ph. 5500; Cooke, Radio Reprs., reprs. Exec.: Wallace Slatter, p, pmm & sm; Frederick Metcalf, secy-treas. & vp; Donald LeBlanc, pd & fd; Jack Milligan, ce; Allan Hodge, nd; Hugh Bowman, sd; Doris Mack, wd. Lib. Assoc., L-W; news ser. PN; trans. RCA. Market Data For Primary Area: Pop.: 157,600; Rad. Hms.: 40,500; Ret. Sls.: 125,000,000.

HAMILTON

CHML began 1927, [tv affiliate CHCH [TV]], 900 kc, 5,000 w-DA-N. Maple Leaf Bcstg. Co. Ltd., 848 Main St. E.; ph. 9-2411; CBC Dominion, net.; Stephens & Townsend, Hunt, Natl. Bcst. Sls., Young, reprs. Exec.: Kenneth D. Soble, p; Tom Darling, gm; W. D. Whitaker, cm; Russell Eastcott, prog. m; Stafford Habberfield, pmm; Hugh Potter, ce; Burnett Gillispe, news ed. & fd; Norman Marshall, sd; Jane Gray, wd. Lib. Assoc., St.; news ser. PN; trans. RCA. Market Data For Primary Area: Pop.: 3,030,100; Rad. Hms.: 2,829,100; Ret. Sls.: \$783,909,000.

CJSH (FM), began 1949, [tv affiliate CHCH [TV]] Ch. 275, 102.9mc, 9.2kw. Hamilton Spectator, 163 Jackson St. W.; ph. 2-1121; Exec.: St. Clair Balfour, p; Anthony Thomas, gm; Hugh D. Potter, ce; trans. GE. Market Data For Primary Area: Pop.: 2,000,000.

CKOC began 1922, 1150 kc, 5,000 w. Wentworth Radio Bcstg. Co. Ltd., 32 John St. N.; ph. 7-4483; CBC Trans-Canada, net.; All-Canada Radio Facilities Ltd., Weed, reprs. Exec.: H. R. Carson, p; W. T. Cranston, gm; Lloyd A. Westmoreland, cm; J. Lyman Potts, asst. m; Mary Alice Hill, pmm; Leslie Horton, ce; Graham Emslie, nd; Perc Allen, sd; Joan Pritchard, wd. Lib. Wld., Thes.; news ser. PN, BUP; trans. Marc. Market Data For Primary Area: Pop.: 2,215,044; Rad. Hms.: 616,712; Ret. Sls.: \$2,435,945,000.

KENORA

CJRL, began 1938, 1220 kc, 1,000 w. C. W. Johnson, Johnson Block; ph. 6212; CBC, net.; Stovin, Cooke, reprs. Exec.: C. W. Johnson, gm; W. J. Young, cm; J. Thom, pdm; G. Balcaen, pmm; J. Edwards, ce; Donn Kirton, nd & sd. Lib. Thes.; news ser. CP, trans. NE. Market Data For Primary Area: Pop.: 39,600; Rad. Hms.: 9,520; Ret. Sls.: \$21,817,000.

KINGSTON

*CFRC, 1490 kc, 100 w. Queen's U., Fleming Hall.

CKWS, began 1942, 960 kc, 5,000 w. The Brookland Co. Ltd., King St.; ph. 4405; CBC Trans-Canada, net. Natl. Bcst. Sls., repr. Exec.: Senator W. R. Davies, p; R. Hofstetter, gm; E. Jones, cm; W. Luxton, pd; B. Cobb, ce. Lib. L-W, Thes.; news ser. PN; trans. RCA. Market Data For Primary Area: Pop.: 248,000.

CKWS-FM, began 1947, Ch. 242, 96.3mc, 0.25kw.

KIRKLAND LAKE

CJKL, began 1934, 560 kc, 5,000 w-D, 500 w-N-DA-N. Northern Bcstg. Co., Woolworth Bldg., Government Rd.; ph. 27; CBC, net.; Natl. Bcst. Sls., Cooke, reprs. Exec.: R. H. Thompson, p; J. M. Davidson, gm; Jack Weatherwax, cm; Jesse French, pd; William Binney, pmm; Cy L. Spence, ce; G. W. Burnett, m; M. Morrison, nd & sd; R. Nelson, fd; Mary Rachich, wd. Lib. L-W, Thes.; news ser. PN; trans. RCA. Market Data For Primary Area: Pop.: 120,000; Rad. Hms.: 35,000.

CJKL-FM, began 1948, Ch. 229, 93.7mc, 0.25kw. Market Data For Primary Area: Pop.: 100,000; Rad. Hms.: 8,000.

KITCHENER

CKCR, began 1929, 1490 kc, 250 w. K-W Bcstg. Co. Ltd., 125 King St. W; ph. 3-3628. CBC, net.; Renaud, Young, reprs. Exec.: G. Liddle, p; Etta G. Mitchell, vp; James C. Mitchell, cm; Stu Monroe, pd; Bill Moyer, pmm; Bill Marchand, ce; Dick Austin, nd; E. Hubble, wd. Lib. Assoc.; news ser. PN; trans. RCA.

CKCR-FM, began 1948, Ch. 244, 96.7mc, 0.35kw.

LONDON

CFPL, began 1933, [tv affiliate CFPL-TV], 980 kc, 5,000 w. London Free Press Printing Co., Free Press Bldg.; ph. 2-5201; CBC, net.; All-Canada Radio Facilities, Weed, reprs. Exec.: Walter J. Blackburn, mgng. d; Murray T. Brown, sm; Douglas C. Trowell, cm; Robert A. Reinhart, pd; John F. Harty, pmm; Glenn L. Robitaille, ce; John N. Illman, pdm; Alex J. Kelman, traffic m; John Trethewey, nd; Ken Ellis, sd; Roy Jewell, fd; Mary Ashwell, wd. Lib. L-W, Wld.; news ser. PN; trans. RCA.

NIAGARA FALLS

CHVC, began 1947, 1600 kc, 5,000 w-DA-N. Radio Station CHVC Ltd., Rainbow Bridge; ph. 4110; Alexander, Cooke, reprs. Exec.: B. Howard Bedford, p; R. H. Hamilton, adv. m.; A. W. Blakely, prod. d; L. H. Rooke, ce; Janet Hague, acct.; Jack Burghardt, asst. sls & prod. d; Bob Vanstone, Welland Branch m; George McLean, nd; Lance Browne, sd; Ruth Chantrey, wd. Lib. Thes.; news ser. BUP, trans. WE. Market Data For Primary Area: Pop.: 128,703; Rad. Hms.: 35,765; Ret Sls.: \$131,153,000.

NORTH BAY

CFCH, began 1931, 600 kc, 1,000 w. Northern Bcstg. Co. Ltd., Fraser St. & First Ave.; ph. 2400; CBC Trans-Canada, net.; Exec.: Roy H. Thompson, p [Northern Bcstg. Co. Ltd.]; Keith Packer, gm; Bill King, cm; Gord Shale, ce; Clarence Houston, pmm; Jack Barnaby, ce; Jay Glover, nd; Ted Fielder, sd; John Size, fd. News ser. PN; trans. RCA.

CFCH-FM, began 1949, Ch. 292, 10.63mc, 0.25kw.

ORILLIA

CFOR, began 1945, 1570 kc, 1,000 w. Gordon E. Smith, 101 Misissaga St. E; ph. 3511; CBC, net.; Stovin, repr. Exec.: Gordon E. Smith, p & gm; Alex Gilmour, cm; Pete McGarvey, pd & fd; Russ Waters, pmm; George Slinn, ce; Ed Richardson, bus. m; Bob Douglas, nd; Grant Forsythe, sd; Nora North, wd. Lib. Cole, Wld., Assoc.; news ser. BUP; trans. RCA. Market Data For Primary Area: Pop.: 160,000; Rad. Hms.: 40,720.

OSHAWA

CKLB, began 1950, 1240 kc, 250 w. Lakeland Bcstg. Co., 16 Centre St.; ph. 3-3415; Alexander, McGillvra, reprs. Exec.: A. H. Collins, p; Gordon G. Garrison, cm; John Wacko, pd; Paul Summerville, pmm & sd; Bill Marchand, ce; Burt McCollum, nd; Shane Rimmer, fd; Jan Harris, wd. Lib. Wld., L-W; news ser. CP; trans. RCA.

OTTAWA

CBO, began 1924, 910 kc, 1,000 w. CBC, Chateau Laurier, ph. 2-1151. CBC, net.; Exec.: J. A. Ouimet [CBC], gm; W. E. Powell [CBC], cm; C. P. Wright, sm; Ron C. Fraser [CBC], press & info. ser. d; D. C. McArthur [CBC], nd; Gordon W. Olive [CBC], engrg. d; A. K. Morrow [CBC], fd. News ser. CP, BUP, R.

CBO-FM, began 1948, Ch. 277, 103.3mc, 0.38kw.

CFRA, began 1947, 560 kc, 5,000 w-DA-1. Radio Station CFRA, Catherine St.; ph. 3-6241; Weed, repr. Exec.: Frank Ryan, p, gm & fd; George Gowling, cm; Tom Foley, pd & sd; Nan Nicholson, pmm; Harold Peerenboom, ce; Campbell McDonald, nd; Joan Baxter, wd. Lib. Cap., Wld., St.; news ser. BUP; trans. G. Market Data For Primary Area: Pop.: 500,000; Rad. Hms.: 128,000.

CRFA-FM, began 1948, Ch. 230, 93.8mc, 0.25kw.

CKOY, began 1949, 1310 kw, 5,000 w-D, 1,000 w-N-DA-N. CKOY Ltd., 272 Somerset St. W; ph. 2-2641; CBC, net.; Natl. Bcst. Sls., Cooke, reprs. Exec.: D. K. MacTavish, p; Dan V. Carr, gm; Jack Thompson, cm; Keith Sterling, pd; Allen Chrysler, pmm; Ken Puttock, ce; Jack Alexander, nd; Jack Daly, sd; Pat Kenny, wd. Lib. Thes., Cap., Assoc.; news ser. PN, BUP; trans. RCA. Market Data For Primary Area: Pop.: 500,000; Rad Hms.: 100,000; Ret. Sls.: \$210,000,000.

OWEN SOUND

CFOS, began 1940, 1470 kc, 1,000 w. Grey & Bruce Bcstg. Co. Ltd., 270 9th St. E; CBC, net.; Exec.: M. Howard Fleming, p; W. N. Hawkins, gm, R. Tomlinson, cm; E. Smith, pd; B. Masters, pmm; R. Turnpenny, ce; Aubrey Wice, nd; Bill Dane, sd; Bill McGee, sd; Lawrence Phillips, fd; Isabel Doyle, wd; Melba Croft, wd. Lib. Wld.; news ser. PN, trans. RCA.

PEMBROKE

CHOW, began 1942, 1350 kc, 1,000 w-DA-N. The Ottawa Valley Bcstg. Co. Ltd., 197 Albert St.; ph. 1350; CBC Dominion net.; Stovin, Young, reprs. Exec.: E. Gordon Archibald, p & gm; Ramsey F. Garrow, cm; Gregory Ponpore, pd; W. Edwin Schmidt, ce; Bill Kay, sd; Judy Hayes, wd. Lib. Thes., SES.; news ser. BUP, trans. RCA. Market Data For Primary Area: Pop.: 76,376; Rad. Hms.: 16,060; Ret. Sls.: \$32,000,000.

PETERBOROUGH

CHEX, began 1942, 1430 kc, 1,000 w-DA-N. Brookland Co. Ltd., Examiner Bldg.; ph. 2-0451; Natl. Bcst. Sls., Cooke, reprs. Exec.: R. A. Davis, p; J. M. Davidson, gm; D. R. Lawrie, sm; G. Grady, cm; W. Straitton, pd & nd; D. Scanlan, pmm; B. Crump, ce; George Ludgate, sd; Stan Williams, fd; Ruth Panter, wd. Lib. St., L-W; news ser. PN; trans. RCA. Market Data For Primary Area: Pop.: 109,681; Rad. Hms.: 27,000; Ret. Sls.: \$42,570,000.

CHEX-FM, began 1949 Ch. 268, 101.1mc, 0.25kw.

PORT ARTHUR

CFPA, began 1944, 1230 kc, 250 w. Ralph H. Parker Ltd., Public Utilities Bldg.; ph. 5-7651; CBC, net.; Weed, Alexander, Bcst. Reprs., reprs. Exec.: Ralph H. Parker, p & gm; R. P. MacGowan, cm. Lib. St., L-W; news ser. PN; trans. RCA. Market Data For Primary Area: Pop.: 75,000; Rad. Hms.: 16,810.

ST. CATHARINES

CKTB, began 1933, 620 kc, 1,000 w. Niagara District Bcstg. Co., 12 Yates St.; ph. Mutual 5-7351; CBC, net.; Mulvihill, McGillvra, reprs. Exec.: W. B. C. Burgoyne, p; Mary C. Burgoyne, mgng. d; Vince A. Lococo, cm; Jack Dawson, pd; Cliff Wingrove, m; Bill Allen, ce; John Morrisson, nd; Rex Stimers, sd; Elde Flintoff, wd. Lib. St.; news ser. PN; trans. RCA. Market Data For Primary Area: Pop.: 214,900; Rad. Hms.: 57,040; Ret. Sls.: \$205,-227,000.

CKTB-FM, began 1949, Ch. 249, 97.7mc, 0.25kw.

ST. THOMAS

CHLO, began 1948, 680 kc, 1,000 w. Radio Station CHLO Ltd., 133 Curtis St.; ph. 3696; CBC Trans-Canada net.; Stephens & Towndrow, Radio Reprs., Cooke, reprs. Exec.: E. M. Warwick, ce; G. C. Nichols, p; F. A. Bestall, gm; D. O. Cole, slm [St. Thomas] & pmm; K. Deas, slm [London]; P. K. Dickens, pd; G. J. Barber, ce; Glenn Bricklin, pdm; Robert Evans, nd & fd; Cam Church, sd; John Fox, wd. Lib. L-W; news ser. PN; trans. NE. Market Data For Primary Area: 165,000; Rad. Hms.: 65,000.

SARNIA

CHOK, began 1946, 1070 kc, 5,000 w-D, 1,000 w-N-DA-N. Sarnia Bcstg. Co. Ltd., 148 1/2 N. Front St.; ph. Digby 1121; CBC Trans-Canada, net.; Mulvihill, Cooke, reprs. Exec.: Claude R. Irvine, p & gm; Karl E. Monk, sm; Arthur O'Hagan, cm; Phil Clayton, prog. m; Frank Stalley, prog. d & nd; Robert F. Cooke, ce & sd; Charles Doering, fd; Elaine MacDonald, wd. Lib. L-W; news ser. PN; trans. RCA. Market Data For Primary Area: Pop.: 35,100; Rad. Hms.: 10,350.

CHOK-FM, began 1949, Ch. 263, 97.5mc, 0.25kw.

SAULT STE. MARIE

CJIC, began 1934, 1490 kc, 250 w. J. G. Hyland, P.O. Box 218, Algoma 3-1121. CBC, net.; McGillvra, Alexander, reprs.; Exec.: J. G. Hyland, p & gm.; E. G. Vance, cm; J. B. Scully, pd & pmm; D. N. Irwin, ce; Lionel McAuley, nd; John Mislán, sd; Helen Johnston, wd. Lib. Wld.; news ser. PN; trans. RCA.

CJIC-FM, began 1949, Ch. 263, 100.5mc, 0.25kw.

STRATFORD

CJCS, began 1924, 1240 kc, 250 w. Frank M. Squires, 125 Ontario St.; ph. 1675; CBC Dominion, net.; All-Canada Radio Facilities Ltd., Weed, reprs. Exec.: Frank M. Squires, p; Stan E. Tapley, gm & cm; Alex L. Smith, pd & nd; John E. Phillips, pmm; John Grigg, ce; Charles Trethewey, acct.; Bill Inkol, sd; Lloyd Robertson, fd; Norman Jary, wd. Lib. Wld.; news ser. BUP; trans. G. Market Data For Primary Area: Pop.: 82,196; Rad. Hms.: 21,963; Ret. Sls.: \$46,136,000.

SUDBURY

CHNO, began 1947, 1440 kc, 1,000 w-DA-1. Sudbury Bcstg. Co. Ltd., 166 Elm W; ph. 6-6416; CBC, net.; Renaud, Young, reprs. Exec.: F. B. Ricard, p & gm; Rene Riel, cm; Wilf Davidson, pd & nd; Peter Scott, pmm; Henry Albert, ce; Bob McDevitt, sd; C. E. Fortin, fd. Lib. Assoc.; news ser. PN; trans. RCA. Market Data For Primary Area: Pop.: 80,000; Rad. Hms.: 20,000; Ret. Sls.: \$88,141,000.

CKSO, began 1935, [tv affiliate CKSO-TV], 790 kc, 5,000 w. CKSO Radio Ltd., 21 Elgin St. N; ph. 7-7505; CBC, net.; All-Canada Radio Facilities Ltd., Weed, reprs. Exec.: George M. Miller, p; W. J. Woodill, gm; Ken Dobson, cm; Basil Scully, pd; Jim Purvis, pmm; James McRea, ce; Don Martz, sd; Trudy Manchester, wd. Lib. Thes.; news ser. PN; trans. Marc.

TIMMINS

CFCL, began 1951, 580 kc, 1,000 w. J. Conrad Lavigne, 175 3d Ave.; ph. 577; French, net.; Renaud, repr. Exec.: J. Conrad Lavigne, p; Rene Barrette, gm & pmm; Larry Smith, cm; Jean DeVilliers, pd & sd; Roch Demers, ce; Albert Aube, chief ann. & nd; Robert Millette, fd; Madeleine Fournier, wd. Lib. SES.; news ser. BUP; trans. G. Market Data For Primary Area: Pop.: 100,000.

Sequence of information and abbreviations same as in U.S. Am and Fm Station Directory.

CKGB, began 1933, 680 kc, 5,000 w-DA-N. Northern Bcstg. Co., Thompson Bldg.; ph. 1500; CBC, net.; Natl. Bcstg. Sls., Cooke, reprs. Exec.: R. H. Thomson, p; Jack Davidson, gm; Jack Pollie, sm; Wally Rewegan, cm; William Nadeau, pd; Gerry Hall, pmm; Ernest Mott, ce. Lib. L-W; news ser. PN; trans. RCA. Market Data For Primary Area: Pop.: 101,968; Rad. Hms.: 6,000; Ret. Sls.: \$34,527,000.

CKGB-FM, began 1948, Ch. 233 (A), 94.5mc, 0.25kw.

TORONTO

CBL, began 1927, [tv affiliate CBLT[TV]], 740 kc, 50,000 w. CBC, 354 Karvis St.; ph. Midway 5481; CBC, net.; Exec.: J. A. Ouimet (CBC), gm; W. E. Powell (CBC), cm; E. L. Bushnell, pd (gan); Ron C. Fraser (CBC), press & info. ser. d; Harry J. Boyle, pd; Gordon W. Olive (CBC), engrg. d; D. C. McArthur (CBC), nd. News ser. CP, BUP, R.

CBL-FM, Ch. 256, 99.1mc, 5.58kw.

CFRB, began 1927, 1010 kc, 50,000 w. Rogers Radio Bcstg., 37 Bloor St. W; ph. Princess 5711; CBS, net.; All-Canada Radio Facilities, Young, reprs. Exec.: Harry Sedgwick, p; Lloyd Moore, gm; Waldo Holden, cm; Wes McKnight, pd & sd; Ken Marsden, pmm; Clive Eastwood, ce; Rex Frost, fd. Lib. Wld., Thes.; news ser. BUP, CP; trans. RCA. Market Data For Primary Area: Pop.: 2,000,000; Rad. Hms.: 639,000.

CHUM, began 1945, 1050 kc, 1,000 w. York Bcstrs., 225 Mutual St.; ph. Empire 4-4271. McGillvra, Alexander, reprs. Exec.: John H. O'Part, p; Robert L. Lee, gm; John Pritchard, cm; Leigh Lee, pd; Phil Stone, pmm & sd; George Jones, ce; Larry Martin, nd; Wendy Paige, wd. News ser. PN, BUP; trans. NE.

CJBC, began 1936, 860 kc, 50,000 w. CBC, 345 Jarvis St. ph. Midway 5481. CBC, net.; Stovin, repr. Exec.: J. A. Ouimet (CBC), gm; Ron C. Fraser (CBC), press & info. ser. d; Gordon W. Olive (CBC), engrg. d; H. G. Walker, m; W. E. Powell (CBC), cm; Bob McGall, pd; E. L. Bushnell, pd. News ser. PN, BUP, R.

CKEY, began 1944, 580 kc, 5,000 w-D, 1,000 N-DA-2, Toronto Bcstg. Co., 444 University Ave.; ph. Empire 8-3881; Natl. Bcst. Sls., Cooke, reprs. Exec.: Jack Kent Cooke, p; Hal E. Cooke, gm; Jack Turrall, cm; D. W. Inslay, pd; G. Nault, pmm; Al Taylor, ce; E. H. Houston, mus. d & pdm; E. Guest, personnel d; Kendrick Crossley, traffic m; Angus McLellan, nd; Joe Crysdale, sd; Mona Gould, wd. Lib. Wld., Assoc., L-W. St.; news ser. AP, PN, BUP; trans. Marc.

CKFH, began 1951, 1400 kc, 250 w-DA-1. Foster Hewitt Bcstg. Ltd., 1 Grenville St.; ph. Midway 0921; Radio Reprs., Weed, reprs. Exec.: Foster W. Hewitt, p; Howard C. Caine, gm; Keith Davey, natl. slm.; C. A. Clark, loc. slm.; D. R. Pugh, pd; Frank Somerville, pmm; Gerald A. Wilson, ce; [Mrs.] Reforde Craig, traffic m; William Falkner, nd; Bill Hewitt, sd. Lib. Thes.; news ser. PN, BUP; trans. RCA. Market Data For Primary Area: Pop.: 1,250,000; Rad. Hms.: 350,000; Ret. Sls.: \$2,476,425,000.

WINDSOR

CBE, began 1950, 1550 kc, 10,000 w. CBC, Security Bldg. CBC, net. Exec.: J. A. Ouimet (CBC), gm; Ron C. Fraser (CBC), press & info. ser. d; W. E. Powell (CBC), cm; M. L. Poole, sm; Gordon W. Olive (CBC), engrg. d; D. C. McArthur (CBC), nd; A. K. Morrow (CBC), fd. News ser. CP, BUP, R. CKLW, began 1932, 800 kc, 50,000 w-DA-1. Western Ontario Bcstg. Co. Ltd., Canada Trust Bldg.; ph. Clearwater 4-1155; MBS, net.; Young, All-Canada Radio Facilities, reprs. Exec.: J. E. Campeau, p & gm; E. W. Wardell, cm; S. C. Ritchie, pd; A. R. Gloster, pmm; W. J. Carter, ce; C. E. Gunn, asst. slm; W. H. Gaffield, treas.; B. H. Chick, continuity d; M. R. Pratt, traffic m; E. M. Saunders, d of pub. rel.; Austin Grant, nd; Art Laing, sd; Myrtle Labbitt, wd; Mary Morgan, wd. News ser. INS., BUP; Lib. Wld., Thes.; trans. RCA. Market Data For Primary Area: Pop.: 10,573,080; Rad. Hms.: 2,949,486; Ret. Sls.: 7.914%.

CKLW-FM, began 1947, Ch. 230, 93.9mc, 0.25kw.

WINGHAM

CKNX, began 1926, 920 kc, 1,000 w-DA-N. Radio Station CKNX Ltd., Josephine St.; ph. 158; CBC Dominion, net.; Alexander, Young, reprs. Exec.: W. T. Cruickshank, p & gm; J. J. Cruickshank, sm; G. W. Cruickshank, asst. m; Vin Dittmer, pmm; Scott Reid, ce; John A. Strong, nd; Tom Raftery, sd; Bob Carbert, fd; Margaret Brophy, wd. Lib. Thes.; news ser. BUP; trans. RCA.

WOODSTOCK

CKOX, began 1947, 1340 kc, 250 w. Oxford Bcstg. Ltd., Box 100; ph. 2400; Renaud, repr. Exec.: M. J. Werry, p & gm; Geoffrey Lewis, cm; William Holmes, pd & sd; Gordon Ballantyne, ce; Alice Munro, wd. Lib. Wld., L-W; news ser. BUP; trans. RCA. Market Data For Primary Area: Pop.: 60,000; Rad. Hms.: 15,500.

PRINCE EDWARD ISLAND

CHARLOTTETOWN

CFCY, began 1924, 630 kc, 5,000 w-DA-N. Island Radio Bcstg. Co. Ltd, 85 Kent St.; ph. 7347; CBC Dominion, Maritime, nets.; All-Canada Radio Facilities Ltd., Weed, reprs. Exec.: Lt. Col. K. S. Rogers, p; R. F. Large, sm & natl. sls.; C. E. MacArthur, loc. sls.; W. A. MacMillan, prog. traffic sup.; M. E. Large, prom. sup.; A. L. Finley, tech. sup.; A. S. Dickson, nd; L. McAuley, sd; Ches Cooper, fd; Jane Weldon, wd. Lib. Assoc.; news ser. PN; trans. GE. Market Data For Primary Area: Pop.: 500,000; Rad. Hms.: 150,000; Ret. Sls.: \$260,000,000.

SUMMERSIDE

CJRW, began 1948, 1240 kc, 250 w. Gulf Bcstg. Co. Ltd., Water St.; ph. 2201; Radio Reprs., Ltd., repr. Exec.: J. K. Curran, p; R. C. Schurman, gm, cm & sd; A. A. Nicholson, asst. gm & fd; P. R. Turner, pd; L. Huestis, pmm; H. Huestis, ce; D. D. Dewar, wd. Market Data For Primary Area: Pop.: 100,000; Rad. Hms.: 26,000.

Data corrected to Dec. 10, 1953. If executives or services for FM are same as AM affiliate names are not repeated. Market Data supplied by stations. FM's in bold face. *—Non-Commercial Station. CP—Construction Permit issued. D—Day, DA—N—Directional Antenna, night only. DA-1—Directional Antenna, same pattern day and night. DA-2—Directional Antenna, different pattern day and night. L—Limited Time with Dominant Station. LS—Local Sunset. N—Night. SA—Special Authorization. SH—Specified Hours. ST—Share Time. Complete key to abbreviations, page 6.

Sequence of information and abbreviations same as in U.S. Am and Fm Station Directory.

AMOS

CHAD, began 1942, 1340 kc, 250. Northern Radio, 70 Gamble W; ph. 1400; CBC, French, net.; Renaud, repr. Exec.: David Armand Gourd, p & gm; Andrew Stuparick, pd; John Senecal, ce; Jacques Tremblay, sd. News ser. BUP; trans. NE. Market Data For Primary Area: Pop.: 130,000.

CHICOUTIMI

CBJ, began 1933, 1580 kc, 10,000 w-DA-1. CBC, 286a rue Racine; ph. 155. CBC, net.; Exec.: J. A. Ouimet (CBC), gm; W. E. Powell (CBC), cm; Marcel Ouimet, d; Ron C. Fraser (CBC), press & info. ser. d; V. Fortin, sm; Gordon W. Olive (CBC), engrg. d; J. Saint-Georges, sup., press & info. News ser. CP, BUP, R.

GRANBY

CHEF, began 1945, 1450 kc, 250 w. Granby Bcstg. Co. Ltd., 7 Johnson St.; ph. 353.

HULL

CKCH, began 1933, 970 kc, 1,000 w-DA-1. CKCH Bcstg. Co., 121 Notre-Dame St.; ph. Province 7-2771; CBC, net.; Renaud, McGillvra, reprs. Exec.: Jean-Paul Lemire, gm; Henry W. Allard, cm; Yvon Dufour, pd & pmm; J. L. Champagne, ce; Lionel Duval, nd; Roger LeGER, sd; Jean Fontaine, fd; Simone Lanctot, wd. Lib. SES.; news ser. BUP; trans. Marc. Market Data For Primary Area: Pop.: 380,000; Rad. Hms.: 95,000; Ret. Sls.: \$351,439,000.

JONQUIERE

CKRS, began 1947, 590 kc, 1,000 w-DA-1. Radio Saguenay Ltée., 359 St. Dominique St.; ph. 2-3551; Trans-Quebec, net.; Hardy, Young, reprs. Exec.: Tom Burham, gm; Raymond Maynard, cm; Gerard Lemieux, ce; Maurice Simard, acct.; Lionel Tremblay, nd; Jean Martin, sd; Rose-Alma Asselin-Boivin, wd. News ser. BUP; trans. G. Market Data For Primary Area: Pop.: 211,200; Rad. Hms.: 31,780; Ret. Sls.: \$95,711,000.

LA SARRÉ

CKLS, began 1950, 1240 kc, 250 w. Radio LaSarre Inc., 70 Gamble W; ph. 1400; CBC, French, net.; Renaud, repr. Exec.: David Armand Gourd, p & gm; Andrew Stuparick, pd & nd; John Senecal, ce; Jacques Tremblay, sd. Market Data For Primary Area: Pop.: 130,000.

MATANE

CKBL, began 1949, 1250 kc, 1,000 w-DA-1. La Cie de Radiofusion, 144 St. Jerome Ave.; ph. 355.

MONTREAL

CBF, began 1937 [tv affiliate CBFT[TV]], 690 kc, 50,000 w. CBC, P.O. Box 6000; ph. University 6-2571; CBC, ABC, MBS, NBC, nets.; CBC, repr. Exec.: Jean Saint-Georges, m; Maurice Valiquette, cm; Gerard Lamarche, pd; Robert Elie, pmm; Joseph Marcotte, ce; J. M. Bailly, sd; Armand Berube, fd; Louise Simard, wd. Lib. CP; news ser. BUP; trans. R.

CBM-FM, began 1945, Ch. 236, 95.1mc, 10kw. Market Data For Primary Area: Pop.: 1,500,000; Rad. Hms.: 500,000.

CBM, began 1933 [tv affiliate CBMT[TV]], 940 kc, 50,000 w. CBC, P.O. Box 6000; ph. University 6-2571; ABC, MBS, NBC, CBS, Trans-Canada, nets.; CBC, repr. Exec.: Jean Saint-Georges, m; Maurice Valiquette, cm; Donald E. McGill, pd; Robert Elie, pmm; Joseph Marcotte, cm; R. Bourbonnais, nd; Margaret Howes, sd & wd; A. E. Miller, fd. Lib. CP; news ser. BUP; trans. R.

CBM-FM, began 1945, Ch. 299 (A), 100.7mc, 5kw.

CFCF, began 1919, 600 kc, 5,000 w-DA-N. Canadian Marconi Co., 4824 Cote des Neiges Rd.; ph. Exdale 1184; ABC, CBC Dominion, nets.; Weed, All-Canada Radio Facilities Ltd., reprs. Exec.: W. Victor George, bcastg. m; J. Allan Hammond, sm; T. J. Quigley, cm; J. Howlett, pd; W. Garnett, pmm; J. Creighton Douglas, ce; M. Wood, prod. sup.; E. Gee, librarian; David Rogers, nd; Keith Dancy, sd; Jean McKinnon, wd. Lib. St.; news ser. RP, BUP; trans. Marc. Market Data For Primary Area: Pop.: 1,500,000; Rad. Hms.: 325,000.

CFCF-FM, began 1947, Ch. 293 (A), 106.5mc, 7.5kw.

CHLP, began 1933, 1410 kc, 1,000 w-DA-1. La Patrie Pub. Co. Ltd., Sun Life Bldg.; ph. University 6-6611; Alexander, McGillvra, reprs. Exec.: P. R. DuTremblay, p & gm; Flavius M. Daniel, cm, pd & pmm; Alphonse Cloutier, ce; Fernand E. Bergevin, asst. m; Armand Goulet, nd; Real Giguere, sd. Lib. Assoc.; news ser. PN, BUP; trans. GE. Market Data For Primary Area: Pop.: 2,512,747; Rad. Hms.: 574,030; Ret. Sls.: \$3,000,000,000.

CJAD, began 1945, 800 kc, 10,000 w-DA-1. CJAD Ltd., 1191 Mountain St.; ph. University 6-6821; CBC, net.; Radio Time Sls. Ltd., Young, reprs. Exec.: J. Arthur Dupont, p & gm; James A. Tapp, sm; R. L. Laurin, cm & pmm; H. T. McCurdy, pd; Maurice Rousseau, ce; C. W. McGibbon, d of sta. rel.; Hamilton Grant, news ed.; Grace Bartholomew, women's commentator. Lib. L-W., Assoc., Cap., Thes., Wld.; news ser. PN, BUP; trans. WH. Market Data For Primary Area: Pop.: 2,156,600; Rad. Hms.: 513,330.

CJMS, began 1953, 1280 kc, 5,000 w.

CKAC, began 1922, 730 kc, 10,000 w. La Compagnie De Publications de la Presse Ltd., 980 St. Catherine W; ph. University 6-7301. Renaud, repr.; Exec.: Hon. Senator P. R. DuTremblay, p; Phil Lalonde, gm; Georges Bourassa, cm; Ferdinand Biondi, pd; Leonard Spencer, ce; Paul Boudreau, nd; Michel Normandin, sd; Rejane DesRameaux, wd.

NEW CARLISLE

CHNC, began 1933, 610 kc, 5,000 w-DA-2. Gaspesia Radio Bcstg. Co., New Carlisle; ph. 64; CBC, net.; Hardy, Young, reprs. Exec.: Dr. Charles E. Dumont, p; Dr. Charles H. Houde, gm; Viateur Bernard, cm; Gordon S. Coleman, ce; Raoul St-Julien, nd & sd. News ser. BUP; trans. NE.

QUEBEC

CBV, began 1939, 980 kc, 1,000 w. CBC, Palais Montcalm; ph. 5-8155. CBC, net.; Exec.: J. A. Ouimet (CBC), gm; W. E. Powell (CBC), cm; Marcel Ouimet, d; Ron C. Fraser (CBC), press & info. ser. d; Guy Dumais, sm; Gordon W. Olive (CBC), engrg d; J. Saint-Georges, sup., press & info. CHRC, began 1926, 800 kc, 5,000 w. CHRC Limitee, 39 St. John St.; ph. 2-8177; Radio Groupe. Trans-Quebec Limitee, nets.; Young, Hardy, reprs. Exec.: Herve Baribeau, p; Henri Lepage, gm; Aurele Pelletier, cm; Magella Alain, pd & pmm; Arsene Nadeau, ce; Guy Rondeau, nd; Maurice Descarreaux, sd; Lucien Sevigny, fd. News ser. UP, PN, BUP; trans. Marc.

CHRC-FM, began 1949, Ch. 251, 98.1mc, 0.59kw.

CJQC, began 1949, 1340 kc, 250 w. Goodwill Bcstrs. of Quebec Inc., 405 Blvd. Hamel; ph. Murray 3-4931; CBC Trans-Canada, net.; Radio & Tv Sls., Young, reprs. Exec.: G. Howard Wert, p (Goodwill Bcstrs. of Quebec Inc.); G. M. Macdonald, gm; Benoit Nadeau, slm; Ed Thomson, chief ann.; Mary Hamilton, prom. d; Mark Mullins, ce; Ray Orchard, nd; Bob Martin, sd; Ursula Delaney, wd. Market Data For Primary Area: Pop.: 250,000; Rad. Hms.: 54,130; Ret. Sls.: \$200,000,000.

CKCV, began 1926, 1280 kc, 1,000 w. CKCV Limitee, 142 St. John St.; ph. 2-1585; CBC, French Radio Associates, nets.; Weed, Renaud, reprs. Exec.: Gaston Pratte, p; Paul Lepage, gm & cm; Marcel Leboeuf, pd; Normand Maltais, pmm; Albert Duberger, ce; Marie-Paule Vachon, asst. m & wd; Roger Bruneau, nd & fd; Rene Collard, sd. News ser. PN; trans. Marc. Market Data For Primary Area: Pop.: 695,900; Rad. Hms.: 128,450; Ret. Sls.: \$316,110.

RIMOUSKI

CJBR, began 1937, 900 kc, 5,000 w-DA-N. Central Pub. Service Corp., 1 St. John St.; ph. 2217; CBC, net.; Stovin, Young, reprs. Exec.: Jacques Brillant, p; Andre Lecomte, gm; Rosario Levesque, cm; Francois Raymond, pd; Guy Ross, pmm; F. C. Doak, ce; Jean Tetreau, nd; Bernard Langlois. Lib. SES., St.; news ser. PN; trans. NE. Market Data For Primary Area: Rad. Hms.: 74,310. — CJBR-FM, began 1947, Ch. 266, 101.5mc, 1kw. trans. WE.

RIVIERE DU LOUP

CJFP, began 1947, 1400 kc, 250 w. Radio-Termiscouata, 322 Lafontaine St.; ph. 2727. CBC, net.; Exec.: Armand Belle, p. News ser. BUP; trans. RCA.

ROBERVAL

CHRL, began 1949, 1340 kc, 250 w. Radio Roberval Inc., Hotel Maison Blanche; ph. 450. Renaud, repr.; Exec.: George Gagnon, p; Lionel Morin, gm; Eric Gagnon, cm; Normand Gagnon, pd; Raymond Lacomte, ce; Lise Brulanger, wd. News ser. BUP; trans. G.

ROUYN

CKRN, began 1939, 1400 kc, 250 w. Northern Radio, 70 Gamble W; ph. 1400; CBC, French, net.; Renaud, repr. Exec.: David Armand Gourd, p & gm; Andrew Stuparick, pd & nd; John Senecal, ce; Jacques Tremblay, sd. News ser. BUP; trans. G. Market Data For Primary Area: Pop.: 130,000.

STE. ANNE DE LA POCATIERE

CHGB, began 1938, 570 kc, 1,000 w-DA-N. G. Thomas Desjardins, Main St.; ph. 101.

SHAWINIGAN FALLS

CKSM, began 1951, 1220 kc, 1,000 w. Shawinigan Falls Bcstg. Co. Ltd., City Hall Bldg.; ph. 4494; Renaud, Weed, reprs. Exec.: Allan Rogerson, p, gm & pmm; Fernand Cyr, cm; Gaston Tessier, pd; Ernest Brunelle, ce; Phil Fisette, nd; C. Blain, sd; R. Dupuis, fd; Marie Rogerson, wd. Lib. Thes.; news ser. BUP; trans. GE. Market Data For Primary Area: Pop.: 200,000; Rad. Hms.: 24,695; Ret. Sls.: \$82,367,000.

SHERBROOKE

CHLT, began 1937, 900 kc, 1,000 w. La Tribune Limitee, 221 Dufferin St.; ph. 3-2525; CBC, net.; Hardy, Young, reprs. Exec.: Hon. Jacob Nicol, p; Alphee Gauthier, gm; J. L. Gauthier, cm; R. Caron, pd; J. Tremblay, pmm; R. Paquette, ce. Lib. Thes., SES., news ser. CP; trans. Marc. CKTS, began 1946, 1240 kc, 250 w-DA-1. CKTS, 221 Dufferin St.; ph. 3-2525. CBC, net.; Young, repr.; Exec.: Hon. Chas. B. Howard, p; Alphee Gauthier, gm; Jean-Louis Gauthier, cm; Rene Caron, pd; Romeo Paquette, ce; Jos. Walters, nd; J. P. Lassonde, sd; Mary Hill, wd. Lib. L-W; news ser. CP; trans. Marc.

SOREL

CJJO, began 1945, 1320 kc, 1,000 w. Radio Richelieu Ltd., 70 du Roi St.; ph. 3318; French Radio Assoc. Ltd., net.; Radio & Tv Sls. Inc., repr. Exec.: J. Arthur Villeneuve, p; Maurice Boulianne, m; Claude Rochon, pd; Lorenzo Brouillard, pmm; Joseph Cardin, ce; Henri Olivier, vp & treas.; Simon Boisvert, nd; Gaston Auclair, sd; Lilliane Motha, wd. News ser. BUP; trans. G. Market Data For Primary Area: Pop.: 129,900; Rad. Hms.: 25,570.

CANADA is boom country

... want a share? Just speak up!

THE Canadian is listening for you at his radio. He's listening in Alberta, where the oil's coming up richer and thicker than ever. In Saskatchewan, where uranium, oil and bumper crops are swelling the coffers. In Labrador, on top a new wealth of iron ore. In Quebec and Ontario, where heavy industry keeps getting heavier and light industry expands by leaps and bounds.

The Canadian is listening in every city, town and village . . . to a voice he already knows and trusts, the voice of his local radio station. The wife is listening—the youngsters, too. Millions upon millions of Canadians, with more money than ever to spend . . . and wanting to know what to spend it on.

Speak up. You'll be heard in 95% of all the homes in Canada . . . in the language familiar to each home, English or French. You'll be heard in the best of company—the big network shows *plus* the friendly entertainment, news and services that only local radio can provide for its community.

Local radio in Canada is welcome, intimate, persuasive. It's

everywhere, in a country where only 38% of the population lives in cities of 30,000 or over. It combines penetration, effectiveness and economy as no other advertising medium in Canada can. That's hard fact.

Purchasing power is booming. Canadians spent 10½ billion dollars in 1951, just in the retail stores . . . over 11½ billion dollars in 1952. And the Canadian buys more U.S. goods than any country other than your own. With cash—the stuff that's straining every billfold in the nation.

Want a share? Canada is waiting by the radio. Just speak up.

“In Canada you sell 'em when you tell 'em!”

• A message from the 120 member stations of the Canadian Association of Radio and Television Broadcasters whose voices are invited into over 3 million Canadian homes every day.

Canadian Association of Radio and Television Broadcasters

108 Sparks St., Ottawa 4, Canada

373 Church St., Toronto 5, Ontario

Sequence of information and abbreviations same as in U.S. Am and Fm Station Directory.

THREE RIVERS

CHLN, began 1937, 550 kc, 1,000 w-DA-1. Radio Three Rivers Inc., 522 Bonaventure St.; ph. 4-3556; Renaud, Young, reprs. Exec.: Honore Dansereau, p; Leon Trepanier, gm; Maurice Dansereau, cm; Andre Cartier, pd; Antoine Desroches, pmm & nd; Oric Lefebvre, ce; Leo Benoit, continuity d; Del Dugre, sd; Andre Dupuis, fd; Jacqueline Morin, wd. Lib. SES.; news ser. PN; trans. Marc. Market Data For Primary Area: Pop.: 250,000; Rad. Hms.: 60,000; Ret. Sls.: \$105,841,000.
CKTR, began 1953, 1350 kc, 5,000 w.

VAL D'OR

CKVD, began 1940, 1230 kc, 250 w. Northern Radio, 70 Gamble W; ph. 1400; CBC, French, net.; Renaud, repr. Exec.: David Armand Gourd, p & gm; Andrew Stuparick, pd & nd; John Senecal, ce; Jacques Tremblay, sd. News ser. BUP; trans. G. Market Data For Primary Area: Pop.: 130,000.

VERDUN

CKVL, began 1946, 980 kc, 1,000 w-DA-1. Jack Tietolman, 213 Gordon Ave.; ph. Pontiac 6-2311; Radio & Tv Sls., Cooke, reprs. Exec.: Jack Tietolman, p; Corey Thomson, gm; Judah Tietolman, cm; Marcel Provost, pd; Lucien St-Amand, pmm; J. C. Charlebois, ce; M. R. Carabine, comp.; Marcel Beauregard, nd; Roland Bayeur, sd; Gaston Voyer, fd; Pierrette Champoux, wd. News ser. BUP, CP; trans. Col.

VICTORIAVILLE

..... (CP), 1380 kc, 1,000 w-DA-N. Pierre Brisson.

SASKATCHEWAN

GRAVELBOURG

CFRG, began 1952, 1230 kc, 250. Radio-Gravelbourg Ltee., Gravelbourg; ph. 155; CBC, French, net.; Renaud, repr. Exec.: Dr. Rosario Morin, M.D., p; Dumont Lepage, gm, cm & pd; Leon Kendergi, pmm & nd; Marc Riou, ce; Guy Pariseau, sd & fd; Madeleine Grenier, wd. Lib. BUP; news ser. NE. Market Data For Primary Area: Pop.: 250,000; Rad. Hms.: 40,000; Ret. Sls.: \$34,917,742.

MOOSE JAW

CHAB, began 1922, 800 kc, 5,000 w-DA-N. Radio Station CHAB Ltd., 127 Main St. N.; ph. 6464; CBC Dominion, net.; Stovin, Weed, reprs. Exec.: W. L. Davis, p; Sid Boyling, gm; Nev Skingle, cm; Bob Giles, pd; Merv Pickford, ce; Jack Johnson, bus. m; Earl Barnholden, nd; Paul Hack, sd. Lib. L-W; news ser. BUP; trans. Marc. Market Data For Primary Area: Pop.: 201,995; Rad. Hms.: 66,010.

NORTH BATTLEFORD

CJNB, began 1947, 1460 kc, 1,000 w. Northwestern Bcstg. Co., 66 E. 1st Ave.; ph. 2744. Exec.: Hume Lethbridge, gm; Tommy Nelson, pd; Clint Nicholl, ce; Eldon Elliott, sd. Lib. Assoc.; news ser. BUP.

Data corrected to Dec. 10, 1953. If executives or services for FM are same as AM affiliate names are not repeated. Market Data supplied by stations. FM's in bold face. *—Non-Commercial Station. CP—Construction Permit issued. D—Day. DA-N—Directional Antenna, night only. DA-I—Directional Antenna, same pattern day and night. DA-2—Directional Antenna, different pattern day and night. L—Local with Dominant Station. LS—Local Sunset. N—Night. SA—Special Authorization. SH—Specified Hours. ST—Share Time. Complete key to abbreviations, page 6.

Sequence of information and abbreviations same as in U.S. Am and Fm Station Directory.

PRINCE ALBERT

CKBI, began 1932, 900 kc, 5,000 w. Central Bcstg. Co., Sanderson Block; ph. 2621; CBC Dominion, net.; All-Canada Radio Facilities, Weed, reprs. Exec.: E. A. (Eddie) Rawlinson, gm; G. (Gerry) Prest; J. J. (Jack) Cannon, pd; Jerry Johnson, pmm; T. (Tom) VanNess, ce; F. F. Frank Rawlinson, asst. m; Fran Church, nd; Nick Roche, sd; K. Tremaine, fd; Marion Sherman, wd. Lib. Thes.: news ser. PN; trans. NE. Market Data For Primary Area: Pop.: 185,240; Rad. Hms.: 49,310.

REGINA

CKCK, began 1922 (tv affiliate CKCK-TV), 620 kc, 5,000 w-DA-N. Trans-Canada Communications, 1853 Hamilton St.; ph. 8525; CBC, net.; Weed, All-Canada. reprs. Exec.: Victor Sifton, p; Harold Crittenden, gm; Roy Malone, cm; Jim Grisenthwaite, pdm; Allan Edwardson, pmm; Ernest A. Strong, ce; Don Dawson, asst. m; Jim McLeod, nd; Lloyd Saunders, sd. Lib. Wld.; news ser. PN, BUP; trans. RCA. Market Data For Primary Area: Pop.: 459,521; Rad. Hms.: 134,690; Ret. Sls.: \$495,197,000.
CKRM, began 1926, 980 kc, 5,000 w-DA-N. Western Communications Ltd., 1819 Cornwall St.; ph. 7631; CBC Dominion, net.; Young, Radio Reprs., reprs. Exec.: Dr. E. A. McCusker, p; Don Oaks, gm; Harry Dane, cm; Robert Hill, pd; William Rees, pmm; William MacDonald, ce; A. J. Smith, exec. asst.; (Miss) W. Dufty, office m; Art Kinnard, nd & fd; John Esaw, sd.

SASKATOON

CFNS, began 1953, 1170 kc, 1,000 w-DA-1, Radio-Prairies-Nord Ltee., 1902 Broadway Ave.; ph. 9-3766; CBC, net.; Renaud, repr. Exec.: Father J. A. Beaulac, p; Theodore Prefontaine, gm & cm; Fernand Ippersiel, pd & fd; E. Bourassa, pmm, asst. m & sd; E. O. Drouin, ce; R. Bonvalet, nd; Therese Masson, wd. News ser. BUP; trans. NE. Market Data For Primary Area: Pop.: 75,000; Rad. Hms.: 25,000; Ret. Sls.: \$10,000,000.
CFQC, began 1923, 600 kc, 5,000 w-DA-N. A. A. Murphy & Sons Ltd., 212-216 1st Ave. N.; ph. 7917; CBC Dominion, net.; Radio Reprs., Young, Oakes, reprs. Exec.: A. A. Murphy, p; Vernon Dallin, gm; G. Blair Nelson, cm; Roy Currie, pd; Edna Kinloch, pmm; Lyn Hoskin, ce; A. E. Marshall, acct. & office m; Godfrey Hudson, nd. Lib. Assoc., L-W, St.; news ser. PN, BUP; trans. Marc. Market Data For Primary Area: Pop.: 450,000; Rad. Hms.: 138,330.
CKOM, began 1939, 540 kc, 50,000 w. Radio Station CKOM, Empire Hotel; ph. 2-1271. Stovin, Weed, reprs.; Exec.: Robert A. Hosie, p & gm; Murray D. Dyck, cm; Gordon E. Walburn, pd; William Forst, ce; J. L. McManus, nd; A. Henderson, sd; F. H. Gayner, wd. Lib. Thes., Cap.; news ser. BUP; trans. GE.

WATROUS

CBK, began 1939, 540 kc, 50,000 w. CBC, 541 Portage Ave., Winnipeg; ph. 74-2541; CBC, net. Exec.: J. A. Ouimet (CBC), gm; W. E. Powell (CBC), cm; R. Horley, sls. rep.; D. E. Cameron, pd; C. E. L'Ami, pmm; R. D. Cahoon, ce; J. N. Moogridge, sm; H. N. Cowan, nd; R. G. Knowles, fd; George Kent, sd. News ser. BUP, CP, R.

YORKTON

CJGX, began 1927, 940 kc, 1,000 w. Yorkton Bcstg. Co. Ltd., Smith Block; ph. 2258; CBC Dominion, net.; Stovin, Young, reprs. Exec.: Dawson Richardson, p; J. M. Shortreed, gm; G. G. Gallagher, cm; J. C. Goodman, pd & pmm; H. F. McRae, ce; M. G. Phillips, nd; W. A. Western, sd. Lib. L-W; news ser. PN; trans. Marc. Market Data For Primary Area: Pop.: 283,000; Rad.

STATE ASSOCIATIONS OF RADIO AND TELEVISION BROADCASTERS

Alabama Broadcasters Association

P. O. Box 477, University, Ala. Founded in 1946; meetings in March and October; elections in March; number of members 69. Officers: Malcolm Street, WHMA Anniston, president; J. Dige Bishop, WCTA Andalusia, vice president; Dick Biddle, WOWL Florence, secretary-treasurer.

Arizona Broadcasters Association

P. O. Box 2671, Phoenix, Arizona. Founded in 1952; meetings in January; elections in January; number of members 21. Officers: Albert D. Johnson, KOY Phoenix, president; Carl Morris, KSUN Bisbee, vice president; Frank P. Redfield, KIFN Phoenix, secretary-treasurer; Richard O. Lewis, KTAR Phoenix, legislative chairman.

Arkansas Broadcasters Association

P. O. Box 550, Little Rock, Arkansas. Founded in 1946; meetings in Spring and Fall; elections in Spring; number of members 37. Officers: W. V. Hutt, KLRA Little Rock, president; W. N. McKinney, KELD El Dorado, vice president; R. W. "Ted" Woods, KOST Osceola, secretary-treasurer; Jay P. Beard, KBTM Jonesboro, legislative chairman.

California State Radio and Television Broadcasters Association, Inc.

T. W. Patterson Bldg., Fresno, Calif. Founded in 1947; meetings in November (and on special call); elections in November. number of members 97. Officers: Arthur Westlund, KRE Berkeley, president; William J. Beaton, KWKW Pasadena, vice president; Paul R. Bartlett, KFRE Fresno, secretary-treasurer; C. L. McCarthy, KROY Sacramento, legislative chairman.

Colorado Broadcasters Association

c/o President or Secretary. Founded in 1950; meetings semi annual; elections in March; number of members 34. Officers: Russell Shaffer, KBOL Boulder, president; Vir N. James, KVRH Salida, vice president; Joseph Rohrer, KRDO Colorado Springs, secretary-treasurer; Robert Ellis, KGHF Pueblo, legislative chairman.

Florida Association of Broadcasters

c/o President or Secretary. Founded in 1936; meetings in May or June and November; elections in May or June; number of members 76. Officers: L. Herschel Graves, WTAL Tallahassee, president; John B. Browning, WSPB Sarasota, vice president; Thomas S. Gilchrist, WTMC Ocala, vice president; A. B. Letson, WCNH Quincy, secretary-treasurer.

Georgia Association of Broadcasters

c/o President or Secretary. Founded in 1935; meetings first weekend after Labor Day and Winter; elections by mail following Winter meeting; number of members 56. Officers: S. J. Carswell, WSTL Thomaston, president; E. F. MacLeod, WBML Macon, vice president; Glen Jackson, WAGA Atlanta, secretary-treasurer; Ben Chatfield, WMAZ Macon, legislative chairman.

Hawaiian Association of Radio and Television Broadcasters

P. O. Box 1380, Honolulu, T. H. Founded in 1952; meetings on call; elections in May; number of members 18. Officers: Fin Hollinger, KP OA Honolulu, president; Ez Crane, KMVI Waiuku, vice president; Ira Mercer, KHON Honolulu, secretary-treasurer.

Idaho Broadcasters Association

Box 31, Pocatello, Idaho. Founded in 1951, meetings in Spring and Fall; elections in Fall; number of members 21. Officers: Edward P. Hurt, KRID Nampa, president; Donald A. Thomas, KRCL Lewiston, vice president; Florence M. Gardner, KTFI Twin Falls, secretary-treasurer; Walter E. Wagstaff, KIDO Boise, legislative chairman.

Illinois Broadcasters Association

c/o President or Secretary-Treasurer. Founded in 1948; meetings in February and October; elections in February; number of members 65. Officers: Robert J. Burow, WDAN Danville, president; Harold L. Dewing, WCVS Springfield, vice president; R. Karl Baker, WLOS Jacksonville, secretary-treasurer; Ray Livesay, WLBH Mattoon, legislative chairman.

Indiana Broadcasters Association, Inc.

Box 89, Washington, Ind. Founded in 1944; meetings four times a year; elections in March; number of members 49. Officers: Dee O. Coe, WWCA Gary, president; Farrell Rippetoe, WBOW Terre Haute, vice president (AM); E. D. Ogborne, WCFTW New Castle, vice president (FM); Harry Bitner Jr., WFBM-TV Indianapolis, vice president (TV); Robert E. Williams, WFML Washington, secretary-treasurer; Robert D. Enoch, WXLW Indianapolis, assistant secretary; Ronnie Householder, WJVA South Bend, assistant treasurer; C. Bruce McConnell, WISH Indianapolis, legislative chairman.

Iowa Broadcasters Association

c/o President. Founded in 1951; meetings annually; elections annually; number of members 35. Officers: Ben Sanders, KICD Spencer, president; Ken Gor-

don, KDTH Dubuque, vice president; W. W. Woods, WHO Des Moines, secretary-treasurer; Herbert Orth, KGLO Mason City, director.

Kansas Association of Radio Broadcasters

KSAL Salina, Kansas. Founded in 1951; meetings in April or May; elections in April or May; number of members 37. Officers: Ray V. Jensen, KSAL Salina, president; Fred Conger, WREN Topeka, vice president; Grover Cobb, KVG B Great Bend, secretary-treasurer; Wendell Elliot, KGNO Dodge City, legislative chairman.

Kentucky Broadcasters Association

c/o Hugh O. Potter, Secy.-Treas., P. O. 536, Owensboro. Founded in October 1945; meetings in October and June; elections in October; number of members 38. Officers: Mike Layman, WSPC Somerset, president; Sam Livingston, WKYB Paducah, first vice president; Gilmore Nunn, WLAP Lexington, second vice president; Hugh O. Potter, WOMI Owensboro, secretary-treasurer; J. W. Betts, WFTM Maysville, legislative chairman.

Louisiana Association of Broadcasters

P. O. Box 4218, Shreveport, Louisiana. Founded in 1945; meetings in June and November; elections in November; number of members 42. Officers: Willard Cobb, KALB Alexandria, president; Frank Ford Jr., KENT Shreveport, vice president; Jerry Hamm, KANE New Iberia, secretary-treasurer.

Maine Radio & Tv Broadcasters Association

c/o WPOR Portland, Maine. Founded in 1947; meetings in October; elections in October; number of members 15. Officers: Harold H. Meyer, WPOR Portland, president; Harold Glidden, WAGM Presque Isle, vice president; Francis H. Farnham, WGAN Portland, secretary-treasurer; Frank S. Hoy, WLAM Lewiston, legislative chairman.

Maryland-D. C. Radio and Television Broadcasters Association

c/o President or Secretary-Treasurer. Founded in 1951; meetings in June and November; elections in November; number of members 29. Officers: Charles E. Smith, WTOB Cumberland, Md., president; Joseph L. Brechner, WGAY Silver Spring, Md., vice president; Les Peard, WBAL Baltimore, secretary-treasurer.

Michigan Association of Broadcasters

c/o WILS Lansing 30, Michigan. Founded in 1948; meetings in June and November; elections in November; number of members 68. Officers: W. A. Pomeroy, WILS Lansing, president; W. J. Edwards, WKXN Saginaw, vice president; Gayle Grubb, WJBK Detroit, secretary-treasurer; Walter Patterson, WKMH Jackson, legislative chairman.

Minnesota Association of Broadcasters

WDGY-Nicollet Hotel, Minneapolis. Founded in 1946; meetings in September; elections in September; number of members 30. Officers: C. T. Hagman, WDGY Minneapolis, president; Lee L. Whiting, KEYD Minneapolis, vice president; Manny Marget, KVOX Moorehead, secretary-treasurer; C. T. Hagman, WDGY Minneapolis, legislative chairman.

Mississippi Broadcasters Association

c/o President or Secretary-Treasurer. Founded in 1942; meetings in March or April; elections in March or April; number of members 46. Officers: C. F. Wright, Jr., WFOR Hattiesburg, president; Bob Evans, WLEO Tupelo, vice president; Granville Walters, WAML Laurel, secretary-treasurer; Fred Beard, WJDX Jackson, legislative chairman.

Missouri Broadcasters Association

P. O. Box 1716 S.S.S. Springfield, Mo. Founded in 1948; meetings in April and August; elections in August; number of members 47. Officers: G. Pearson Ward, KTTS Springfield, president; Robert Neathery, KWPM Alton, vice president; Catherine Roer, KWOS Jefferson City, secretary-treasurer; Bruce Barrington, KKOK St. Louis, legislative chairman.

Montana Radio Stations Inc.

P. O. Box 2124, KBMY Billings, Montana. Founded in 1949; meetings 2nd week in January; elections 2nd week in January; number of members 25. Officers: Ken Nybo, KBMY Billings, president; Ian Elliot, KRJF Miles City, vice president; Norm Penwell, KBMN Bozeman, secretary-treasurer; Paul MacAdam, KPRK Livingston, legislative chairman.

Nebraska Broadcasting Association

c/o WJAG Norfolk, Nebraska. Founded in 1934; meetings May 1st; elections May 1st; number of members 28. Officers: R. E. Thomas, WJAG Norfolk, president; L. L. Hilliard, KOLT Scottsbluff, vice president; Gene Ackerley, KCOW Alliance, secretary-treasurer.

Nevada State Broadcasters Association

KOLO, P. O. Box 821, Reno, Nevada. Founded in 1945; meetings as called; elections early; number of members 12. Officers: H. G. Wells, KOLO Reno, president; Fred Stoye, KLAS Las Vegas, vice president; Bob Stoddard, KATO Reno, secretary-treasurer; H. G. Wells, KOLO Reno, legislative chairman.

New Jersey Broadcasters Association

WSNJ Bridgeton, New Jersey. Founded in 1947; meetings 2nd week in May and 2nd week in October; elections 2nd week in October; number of members 17. Officers: Exeret Rudloff, WJLK Asbury Park, president; Jerry McCarthy, WTOA Trenton, secretary-treasurer; Gordon Giffin, WKDN Camden, vice president; Fred Bernstein, WTTM Trenton, legislative chairman.

New Mexico Broadcasters Association

759 Cerrillos Road, Santa Fe, New Mexico. Founded in 1952; meetings in September and April; elections in April; number of members 18. Officers: Ivan R. Head, KVSV Santa Fe, president; E. N. Thwaites, KRTN Raton, vice president; Lydia S. Sleppy, KOBE Las Cruces, secretary-treasurer; W. E. Whitmore, Jr., KEMN Portales, legislative chairman.

North Carolina Association of Broadcasters Inc.

Founded in 1932; meetings in June and October; elections in October; number of members 95. Officers: James McVell, WTSB Lumberton, president; William S. Page, WFTC Kinston, vice president; J. T. Snowden, WCPS Tarboro, secretary-treasurer.

North Dakota Broadcasters Association

KNOX Grand Forks, N. D. Founded in 1953; meetings 2nd week in October; elections 2nd week in October; number of members 14. Officers: F. E. Fitzsimmonds, KFVR Bismarck, president; Elmer Hanson, KNOX Grand Forks, vice president; John Cooley, KLPN Minot, legislative chairman.

Ohio Association of Radio and Television Broadcasters

44 E. Broad Street, Columbus, Ohio. Founded in 1951; meetings in April and October; elections in April; number of members 68. Officers: Adna Karns, WING Dayton, president; Robert Ferguson, WTRF Bellaire, vice president; L. A. Pixley, WLOK-AM-TV Lima, secretary-treasurer; Adna Karns, WING Dayton, legislative chairman.

Oklahoma Association of Broadcasters

P. O. Box 588, Ponca City, Oklahoma. Founded in 1948; meetings in January; elections in January; number of members 36. Officers: Cy Casper, WBBZ Ponca City, president; J. J. Bernard, KOMA Oklahoma City, vice president; Guy Farnsworth, KCRG Enid, secretary-treasurer; Bill Hoover, KADA Ada, legislative chairman.

Oregon State Broadcasters Association

R. E. Summers, Manager, Journalism Bldg., Univ. of Oregon, Eugene, Oregon. Founded in 1940; meetings semi-annually; elections annually; number of members 48. Officers: S. W. McCready, KUGN Eugene, president; Paul Walden, KODL The Dalles, vice president; Joe Schertler, KEX Portland, secretary-treasurer; R. M. Brown, KPOJ Portland, legislative chairman.

Pennsylvania Association of Broadcasters

WCPA, 215 Church Street, Clearfield, Pa. Founded in 1922; meetings in May; elections in May; number of members 108. Officers: W. J. Thomas, WCPA Clearfield, president; Frank Altdorfer, WLAN Lancaster, vice president; James F. Murray, KQV Pittsburgh, vice president; Joseph T. Connolly, WCAU Phila., secretary; James F. Murray, KQV Pittsburgh, treasurer; Roy E. Morgan, WILK Wilkes-Barre, legislative chairman.

Puerto Rican Association of Broadcasters

Box 4504, San Juan, Puerto Rico. Founded in 1947; meetings second Monday of each month; elections second Wednesday of July; number of members 19. Officers: Alfonso Gimenez Aguayo, WPAW Ponce, president; Tomas Muniz Souffron, WIAC Santurce, vice president; Frederico E. Virella, WVJP Caguas, secretary; Gustavo Dias, WENA Bayamon, treasurer.

Rhode Island Radio & Television Broadcasters Association

c/o WEAN, Crown Hotel, Providence, R. I. Founded in 1935; meetings in June; elections in June; number of members 12. Officers: Mowry Lowe, WEAN Providence, president; Mitchell Stanley, WWON Woonsocket, vice president; Norman Gittelson, WJAR-TV Providence, secretary-treasurer.

South Carolina Radio and Television Broadcasters Association

Sec's Office, Box 30, Sumter, S. C. Founded in 1947; meetings in January; elections in January; number of members 38. Officers: Walter J. Brown, WORD Spartanburg, president; James F. Coggins, WKDK New Berry, vice president; T. Doug Youngblood, WFTG Sumter, secretary-treasurer; H. Moody McElveen, WNOK Columbia, legislative chairman.

Southern California Broadcasters Assn.

6047 Hollywood Blvd., Hollywood 28. Officers: Frank Burke Jr., KFVD Los Angeles, president; Norman Ostby, KHJ Los Angeles, vice president; Thelma Kirchner, KGFJ Hollywood, secretary-treasurer; Norman Nelson, managing director.

South Dakota Broadcasters Association

Secretary, KUSD Vermillion, S. D. Founded in 1947; meetings in Spring; elections in Spring; number of members 14. Officers: Max Staley, KJIV Huron, president; Ross Case, KWAT Watertown, vice president; Keith Nighbert, KUSD Vermillion, secretary-treasurer; Mort Henkin, KSOO Sioux Falls, legislative chairman.

Tennessee Association of Broadcasters

407 Chamber of Commerce Building, Nashville, Tenn. Founded in 1948; meetings in November or December and May or June; elections in November or December; number of members 46. Officers: Earl Winger, WDDO Chattanooga, president; John Hart, WBIR Knoxville, vice president; Mrs. Drue Smith, WAO Chattanooga, secretary-treasurer; F. C. Sowell, WLAC Nashville, legislative chairman.

Texas Association of Broadcasters

KTRE Lufkin, Texas. Founded in 1951; meetings in Spring and Fall; elections in September; number of members 112. Officers: Willard Deason, KVET Austin, president; Louis R. Cook, KNOW Austin, vice president; Richard Lewin, KTRE Lufkin, secretary-treasurer.

Utah Broadcasters Association

P. O. Box 99, Provo, Utah. Founded in 1951; meetings in January and June; elections in January; number of members 19. Officers: Arch L. Madsen, KOVO Provo, president; Reed Bullen, KLO Ogden, vice president; George Hatch, KVNUN Logan, vice president; Arch Webb, KVOG Ogden, secretary-treasurer; Oral Wilkinson, KMUR Murray, legislative chairman.

Virginia Association of Broadcasters

c/o WCYB Bristol, Va. Founded in 1947; meetings in May or June; elections in May or June; number of members 42. Officers: Robert H. Smith, WCYB Bristol, president; Frank Koehler, WROV Roanoke, vice president; Charles Maillett, WWOD Lynchburg, secretary-treasurer; C. T. Lucy, WRVA Richmond, legislative committee.

Washington State Association of Broadcasters

Carl Downing, Manager, Legislative Bldg., Olympia, Washington. Founded in 1935; meetings in March & September; elections in March; number of members 44. Officers: Leo Beckley, KBRC Mount Vernon, president; Loren Stone, KBRO Bremerton, vice president; Allen Miller, KWSC Pullman, secretary-treasurer.

West Virginia Broadcasters Association

c/o Secretary. Founded in 1948; meetings in Spring and Fall; elections in Spring; number of members 34. Officers: Alice Shein, WBTH Williamson, president; Paul A. Myers, WVVA Wheeling, vice president; John S. Phillips, WHTN Huntington, secretary-treasurer; Harry Brawley, WCHS Charleston, legislative chairman.

Wisconsin Broadcasters Association

225 N. Adams Street, Green Bay, Wisconsin. Founded in 1928; meetings first Tuesday in October; elections first Tuesday in October; number of members 46. Officers: Harry D. Peck, WISN Milwaukee; William E. Walker, WMAM Marinette, vice president; Verl Bratton, WKTY La Crosse, secretary; Mig Figl, WAUX Waukesha, treasurer.

Station Authorizations

FOR comparative purposes, here is the status of commercial broadcast station authorizations at FCC on Dec. 31 of 1951, 1952 and 1953:

	AM		FM	
	1951	1952	1951	1952
Total authorized	2,408	2,524	2,636	650
Total on the air	2,331	2,391	2,521	637
Licensed (all on the air)	2,300	2,371	2,500	564
Construction permits on the air	31	20	21	73
Construction permits not on the air	77	133	115	13
Construction permits	108	153	136	86
Total applications pending	988	943	863	215
Total applications in hearing	220	162	127	7
Requests for new stations	102	251	172	2
Request to change existing facilities	205	190	149	16
Deletion of licensed stations during year	12	11	6	40
Deletion of construction permits during year	17	12	20	35
				10
				16

RADIO PROGRAM PRODUCTION & TRANSCRIPTION SERVICES

Including Recording, Talent and Script Writing Firms
For Tv Film and Television Production see Telecasting Yearbook

A

JOHN ADASKIN PRODUCTIONS
314-15 67 Yonge St., Toronto, Ont., Canada. Tel.: Empire 4-8286; John Adaskin, owner.
Services: Program production, syndicated transcriptions, package programs.

AFFILIATED ARTISTS REPRESENTATIVES
20 E. 53rd St., New York 22, N. Y., Tel.: Plaza 4-1862; Lee Wallace, partner.
Services: Package shows, talent.
Hollywood-8778 Sunset Blvd., Tel.: Crestview 6-4652; Louis Artigue.

AFFILIATED PROGRAM SERVICE INC.
535 5th Ave., New York 17, N. Y., Tel.: Murray Hill 7-1881; Paul F. Adler, president.
Services: Syndicated transcriptions, scripts.

AIR FEATURES INC.
347 Madison Ave., New York 17, N. Y., Tel.: Murray Hill 9-5900; I. S. Becker, president.
Services: Program production, package programs.

ALTON ALEXANDER RADIO-TELEVISION PRODUCTIONS
825 W. 187th St., New York 33, N. Y., Tel.: Lorraine 8-3100; Lottie Ritter, manager.
Services: Recording, scripts, package programs, production.

ALLIED RECORD MFG. CO.
1041 N. Las Palmas Ave., Hollywood 38, Calif., Tel.: Hollywood 9-5107; D. K. Broadhead, president.
Services: Recording, program production, package programs.
New York 19-619 W. 54th St., Tel.: Judson 2-3791; K. R. Smith, manager.
Washington 5-1121 Vermont Ave., N. W.; Tel.: District 7-5162; W. S. Adams.

AMERICAN FOUNDATION FOR THE BLIND INC.
15 W. 16th St., New York 11, N. Y., Tel.: Watkins 4-0420; Dr. Gregor Ziemer, public education director.
Services: Series of 13 radio shows dealing with blindness, available to stations.

AMERICAN INSTITUTE OF FOOD PRODUCTS INC.
608 5th Ave., New York 20, N. Y., Tel.: Judson 6-7600; Robert A. Bories, general manager.
Services: Production, scripts, talent for food merchandising.

AMERICAN JEWISH BROADCASTING CO., INC.
150 Broadway, New York 38, N. Y., Tel.: Worth 2-3322; Herman Younglieb, manager.
Services: Jewish programs.

AMERICANA RADIO & TELEVISION PRODUCTIONS
9313 W. Parkhill Dr. Washington 14, D. C.; Tel.: Oliver 2-7915; Frank X. Green, general manager.
Services: Recording, program production, package programs.

ARIZONA RECORDING PRODUCTIONS
834 N. 7th Ave., Phoenix, Ariz., Tel.: Alpine 2-2016; Raymond A. Boley, owner and manager.
Services: Recording, program production, scripts, talent.

ARTISTS RECORDING STUDIOS
15 W. 10th St., Kansas City 6, Mo., Tel.: Harrison 8109; Bill L. Godden, owner-engineer.
Services: Recording, syndicated transcriptions, scripts, package programs, talent.

ASSOCIATED BROADCAST ADVERTISING CO.
1001 N. Western Ave., Los Angeles 38; Tel.: Hollywood 5-0580; Edwin T. Porter, Gertrude T. Porter, partners.
Services: Program packagers, producers.

ASSOCIATED BROADCASTING CO.
1139 Bay St., Toronto, Ont., Canada, Tel.: Princess 1111; Gordon Allen, director, broadcast & tv division.
Services: Program production, scripts.

THE ASSOCIATED PRESS
50 Rockefeller Plaza, New York 20, N. Y., Tel.: Plaza 7-1111; Frank J. Starzel, general manager.
Services: World-wide news service delivered by 24-hour teletype circuit. 150 branch offices located throughout the U. S. and abroad.

ASSOCIATED PROGRAM SERVICE (DIV. OF MUZAK CORP.)
237 W. 54th St., New York 19, N. Y., Tel.: Plaza 7-7700; Edward Hochhauser Jr., vice president-general manager.
Services: Recording (transcribed libraries of music for radio stations), distributor for transcribed programs available to national networks only.
New York 3-229 4th Ave., Tel.: Orchard 4-7400; Edward Hochhauser Jr., vice president-general manager.

AUDIO-MASTER CORP.
17 E. 45th St., New York 17, N. Y., Tel.: Oxford 7-0725; Herbert Rosen, president.
Services: Recording.

AUDIO-VIDEO RECORDING CO. INC.
730 5th Ave., New York 19, N. Y., Tel.: Plaza 7-3091; Charles Rynd, president.
Services: Recording.

A-V TAPE LIBRARIES INC.
730 5th Ave., New York 19, N. Y., Tel.: Plaza 7-3091; Charles Rynd, president.
Services: Recording, program production.

V. S. BECKER PRODUCTIONS
562 5th Ave., New York 36, N. Y., Tel.: Judson 2-1040; Viola S. Becker, owner.
Services: Recording, program production, scripts, package programs, talent.

BELTONE RECORDING CORP.
4 W. 31st St., New York City, Tel.: Oxford 5-1055; Leslie C. Cahan, president.
Services: Recording.

GEORGE R. BENTEL AGENCY
5617 Hollywood Blvd., Hollywood 28, Calif., Tel.: Hollywood 7-8608; Carl Coolidge, director.
Services: Scripts.

BERMAN & BETTENBENDER
410 S. Michigan Ave., Chicago 5, Ill., Tel.: Wash 2-7488; Bernard S. Berman, partner.
Services: Program production, scripts, package programs, talent.

WALTER BIDDICK CO.
1151 S. Broadway, Los Angeles 15, Calif., Tel.: Richmond 6184; Guy Biddick, manager.
Services: Recording, program production, syndicated transcriptions, package programs.

BOYD ENTERPRISES
Box 1844, Fort Worth, Texas, Tel.: Wa 2429; Harvey R. Boyd, owner-manager.
Services: Recording, program production, scripts, package programs, talent.

BROADCAST PRODUCTIONS INC.
350 Madison, Detroit 26, Mich., Tel.: Woodward 5-0909; Lois Michels, president, and J. Hall Smith, production manager.
Services: Program production, scripts, package programs, talent, spot announcements, promotion service.

BROADCASTING & FILM COMMISSION OF THE NATIONAL COUNCIL OF CHURCHES.
220 5th Ave., New York 1, N. Y., Tel.: Oregon 9-2968; Ben E. Wilbur, radio director.
Services: Program production.
Hollywood 26-5746 Sunset Blvd., Tel.: Hillside 7464; George Heimrich, radio-tv director.

BROADCASTING PROGRAM SERVICE
17 E. 45th St., New York 17, N. Y., Tel.: Oxford 7-0725; Herbert Rosen, president.
Services: Program production, syndicated transcriptions, package programs.

AL BUFFINGTON PRODUCTIONS
6711 Sunset Blvd., Hollywood 28, Calif., Tel.: Hollywood 9-8387; Al Buffington, president.
Services: Recording, program production, package programs, scripts, syndicated transcriptions.

EDWARD A. BYRON PRODUCTIONS CO.
8 E. 52d St., New York 22, N. Y., Tel.: Plaza 3-6930; Edward A. Byron, president.
Services: Package programs.

B

BARRY, ENRIGHT & FRIENDLY INC.
667 Madison Ave., New York City, Tel.: Templeton 2-8600; Dan Enright, partner and vice president.
Services: Program production, package programs.

GERALD BARTELL ASSOC.
710 N. Plankton Ave., Milwaukee 3, Wis., Tel.: Broadway 1-8428; Gerald A. Bartell, president.
Services: Syndicated transcriptions.

BASCH RADIO & TELEVISION PRODUCTIONS
17 E. 45th St., New York 17, N. Y., Tel.: Murray Hill 2-8877; Charles J. Basch Jr., partner.
Services: Recording, program production, syndicated transcriptions, scripts, package programs.

IRENE BEASLEY RADIO PRODUCTION SERVICE
501 Madison Ave., New York 22, N. Y., Tel.: Plaza 3-8940; Irene Beasley, owner.
Services: Program production, package programs.

C

S. W. CALDWELL LTD.
447 Jarvis St., Toronto 5, Ontario, Canada, Tel.: Kingsdale 2103; Spence W. Caldwell, president.
Services: Recording, program production, syndicated transcriptions, scripts, package programs, talent.

Before You Contract For Any Transcription Library . . .

You Owe it to Yourself & Your Listeners to Get The Facts About APS.

1. APS is the only transcription library which has had the courage to recognize important economic and programming changes in the broadcasting industry and do something realistically constructive about it.
2. APS is the industry's only all high-fidelity full basic transcription library service.
3. APS is the only transcription library actively managed and operated by broadcasters.
4. APS is the only transcription library produced, planned and engineered with the famous exclusive MUZAK knowhow.
5. APS is budget priced.

There's much more to the APS story. Write, phone or wire—we'll be pleased to tell it to you—we'd be proud to have the privilege of serving you and your listeners.

* **Attention: Telecasters** *
* **& TV Applicants** *
* APS exclusively distributors of the *
* world famous Encyclopedia Britannica *
* Films. EB Films can help you satisfy *
* your public service requirements and *
* attract viewers & clients too. Better *
* contact us right away for details. *



* **Another APS Exclusive.** *
* Telecasters: The same APS TV production *
* Music Transcription Library *
* you've heard so much about is yours *
* for just \$19.50 per month. More TV *
* station: subscribe to APS than any *
* other TV transcription service. If you *
* want the best, you want APS. *



**20 YEARS
OF
RECORD
SERVICE**

PROCESSING

Better in dozens of ways,
because of scientific
testing at every step.

PRESSING

Proved better by hundreds
of satisfied clients all
over the world.

TAPE DUPLICATION

Guaranteed broadcast
quality—now used in
broadcasts everywhere.

SHIPPING

Allied's cross checking
controls assure on-time
delivery under any
circumstance.



**ALLIED RECORD
MANUFACTURING COMPANY**

**619 W. 54th STREET
NEW YORK, NEW YORK**

**1041 N. LAS PALMAS
HOLLYWOOD, CALIFORNIA**

SPOT SALES SOAR FOR STATIONS!

UP TO **75** SPOTS
PER WEEK *SOLD* IN
"HOUR OF STARS"

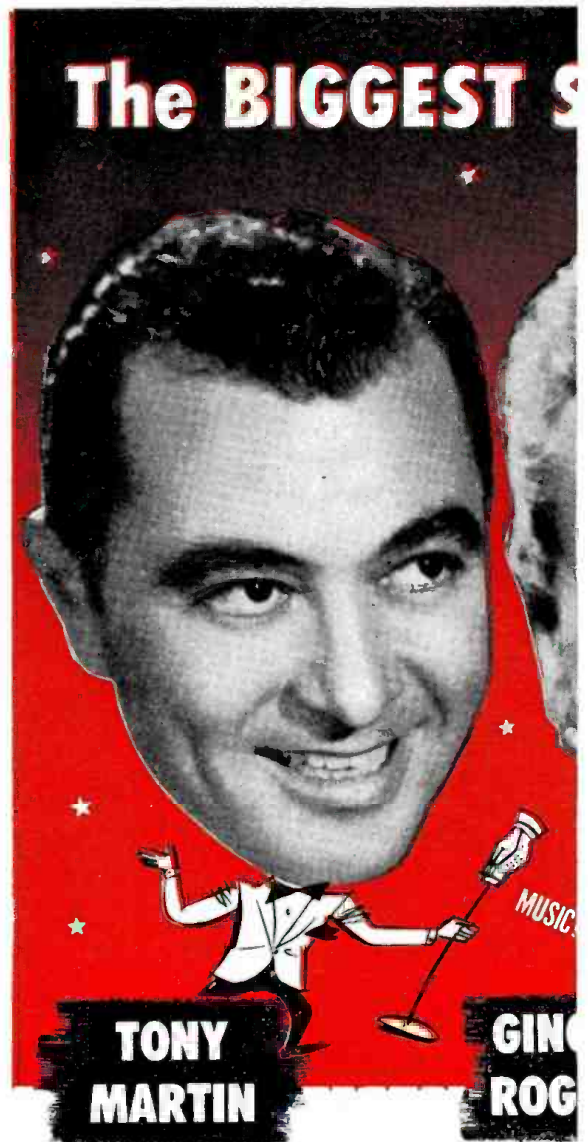

**TONY
MARTIN**

**GINO
ROG**

SELL-OUTS! COMPLETE SELL-OUTS IN NO TIME AT ALL!
LOOK AT THESE STATION SELL-OUTS!

ZIV'S

WSAI CINCINNATI, OHIO
"HOUR OF STARS" . . .

SOLD OUT!

75 SPOTS WEEKLY ON FIRST AUDITIONS
TO THESE ALERT ADVERTISERS . . .

- ALBERS SUPER MARKET
- JUMBO PEANUT BUTTER
- PEPSI-COLA
- HOTPOINT APPLIANCES (dealer)
- BAVARIAN BREWING CO.
- MR. MUSTARD
- WORTHMORE SOUP
- DORSEL'S FLOUR

All 8 Sponsors New to WSAI

KLMR LAMAR, COLORADO
"HOUR OF STARS" . . .

SOLD OUT!

75 SPOTS WEEKLY TO THIS
GREAT GROUP OF SPONSORS . . .

- FLORA REXALL STORE
- MILNE INSURANCE CO.
- LAMAR LIGHT & POWER CO.
- PEERY ELECTRIC
- POWER'S FIRESTONE STORE
- CUT RATE GROCERY & MARKET
- DON WESTFALL CREDIT BUREAU
- MAIN CAFE
- MORANS HARDWARE STORE

Hour of Stars Creates New Business!

WDOV DOVER, DELAWARE
"HOUR OF STARS" . . .

SOLD OUT!

75 SPOTS WEEKLY TO THIS
GREAT GROUP OF ALERT SPONSORS . . .

- EMANUEL'S (ladies' ready to wear)
- DOVER HARDWARE
- PHILCO DEALER
- VOGUE SHOE SHOP
- DANNEMANS' (Mill Remnants)
- NAP & SPENCE (Furniture)
- SANDERS JEWELER
- WESTERN AUTO STORE
- GENERAL ELECTRIC DEALERS
- HUBER BREAD

Hour of Stars Brings New Profits!

Now... The **LOWEST** Price... in History!

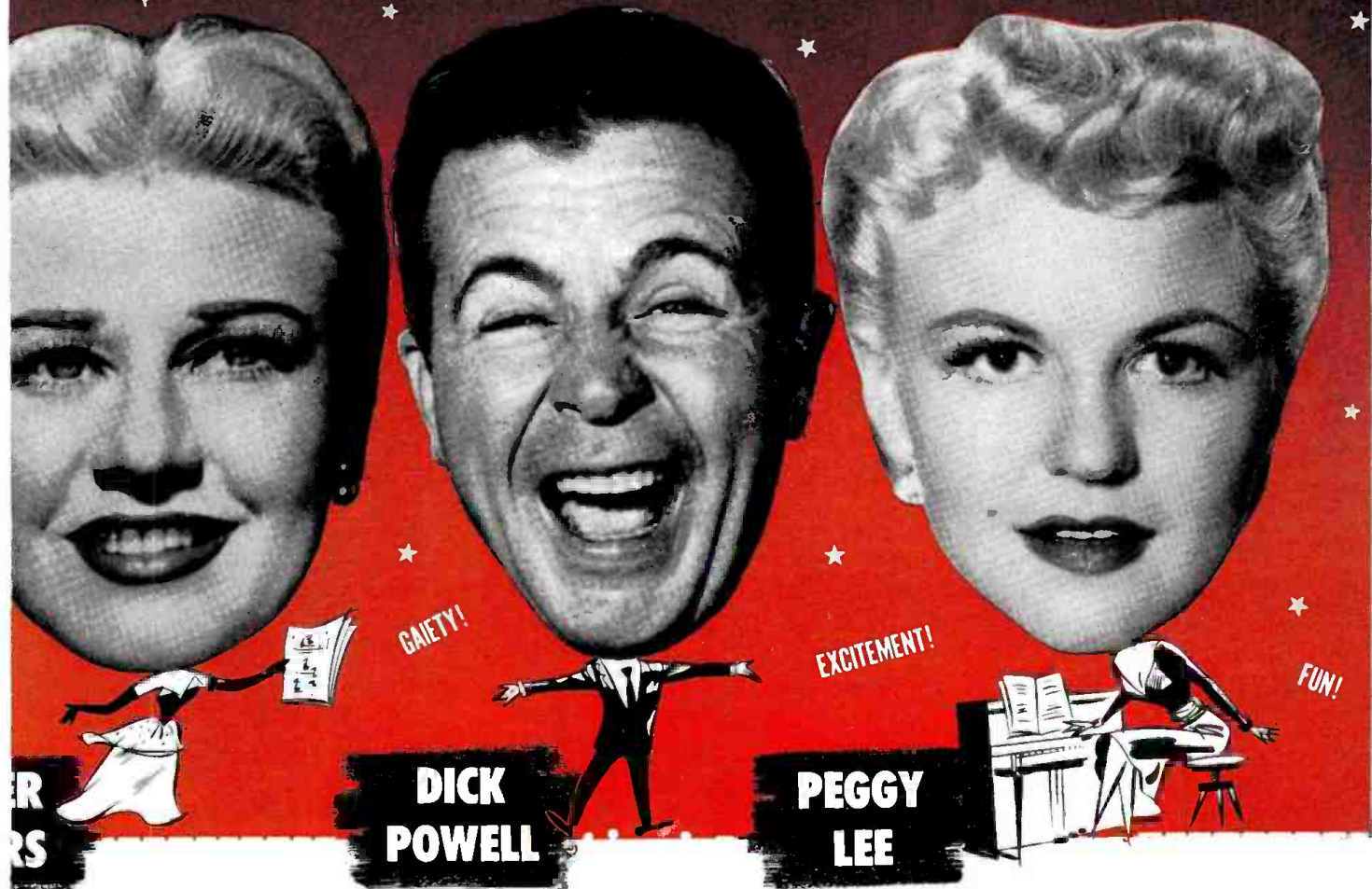

"HOUR OF STARS"

PULLING SPONSORS AND PROFITS FOR STATIONS IN OVER 300 MARKETS!

*BE SURE YOUR MARKET, YOUR STATION IS IN THE MONEY
WRITE, WIRE OR PHONE*

- KRESGE 5 & 10
- GENERAL MILLS FLOUR
- COLGATES VEL
- MAXWELL HOUSE COFFEE
- PERTUSSIN
- FLETCHER'S CASTORIA
- ZENITH TV
- 7-UP BOTTLING CO.
- FORD DEALER
- PONTIAC DEALER
- DODGE DEALER
- B-C HEADACHE POWDER
- HOOVER APPLIANCE DISTRIBUTORS
- BABBITT CLEANER
- NATIONAL PREMIUM BEER
- GENERAL ELECTRIC DEALERS

NATIONAL ADVERTISERS LIKE THESE:

ARE BUYING PARTICIPATION IN "THE HOUR OF STARS" ON FINE STATIONS LIKE THESE:

- WING, Dayton, Ohio
- WSAZ, Huntington, W. Va.
- KSD, St. Louis, Mo.
- WFAA, Dallas-Ft. Worth
- WKOY, Bluefield, W. Va.
- WSPD, Toledo, Ohio
- WHOO, Orlando, Fla.
- WMC, Memphis, Tenn.
- WSDC, Marine City, Mich.
- KXYZ, Houston, Texas



PROGRAM PRODUCTION SERVICES

CAPITAL FILM SERVICE

224 Abbott Road, East Lansing, Mich., Tel.: 8-3544; J. R. Hunter, owner.
Services: Recording, program production, syndicated transcriptions, scripts, package programs, talent.

CAPITOL RECORDS DISTRIBUTING CORP.

Executive Offices: 1507 N. Vine St., Hollywood 28, Calif.

(Studio Recording Services; Sales Div.) 5515 Melrose Ave., Hollywood 38, Calif., Tel.: Hollywood 3-7114; Walter S. Heebner, general manager; Gene J. Becker, western sales representative; John Seely, production manager.
Services: Recording for records and tv, mastering, processing and pressing, full library of production music (Q series).

New York 36—151 W. 46th St., Tel.: Columbus 5-4758; Herbert I. Sachs, eastern sales representative; William H. Fowler, acting general manager; Glenn Wallichs, president.

PHILLIPS CARLIN

2214 RKO Bldg., 1270 6th Ave., New York 20, N. Y., Tel.: Judson 6-5534; Phil Carlin.
Services: New York representative for out-of-town advertising agencies.

CATHOLIC BROADCASTING SERVICE

P. O. Box 16, Long Island City 3, N. Y., Tel.: Astoria 8-2474; M. E. O'Brien, president.
Services: Recording, program production, transcriptions.

CAVALIER PRODUCTIONS

Box 215, 800 Franklin St., Garden City, N. Y., Tel.: Garden City 7-7110; Dr. Joseph Levit, president.
Services: Program production, package programs, talent.

New York 19—1164 Avenue of the Americas, Tel.: Circle 7-8466; Phillip St. Clair, technical director.

HU CHAIN ASSOC.

40 E. 40th St., New York 16, N. Y., Tel.: Murray Hill 5-7220; Hubert V. Chain, owner.
Services: Program production, scripts, package programs.

THE BRUCE CHAPMAN CO.

55 W. 42d St., New York 36, N. Y., Tel.: Wisconsin 7-9244; Bruce Chapman, president.
Services: Program production, package programs.
Paris 2—20 rue de Gramont, Tel.: Richelieu 8004; Dan Morley, manager.
London W. 1—22 Davies St., Tel.: Mayfair 1037; Frank Byers, manager.
Berlin-Schoneberg, Germany—9-10 am Park, Tel. 71-64-69; Rolfe Brede, manager.

CHESHIRE & ASSOC. INC.

6533 Hollywood Blvd., Hollywood 28, Tel.: Hollywood 2-6048; Bob Reichenbach, general manager.
Services: Program production, syndicated transcriptions, package programs, talent.

CHICAGO TRIBUNE-NEW YORK NEWS SYNDICATE INC.

220 E. 42d St., New York 17, N. Y., Tel.: Murray Hill 2-1234; Mollie Slott, manager.
Services: Newspaper features adaptable to broadcasting.

FRANK CHRISTL & ASSOC.

521 N. LaCienega Blvd., Los Angeles 48, Calif., Tel.: Crestview 1-6452; Frank Christl, owner.
Services: Program production, package programs.

ARTHUR B. CHURCH PRODUCTIONS

222 W. 11th St., Kansas City 5, Mo., Tel.: Harrison 2650; George E. Halley, manager syndicated features.
Services: Program production, syndicated transcriptions.

COASTAL RECORDING CO. INC.

136 W. 52d St., New York 19, N. Y., Tel.: Circle 6-3900; Arthur Shaer, managing director.
Services: Radio transcription service for advertising agencies.

COLE CORP.

823 S. Wabash Ave., Chicago 5, Ill., Tel.: Harrison 7-7461; M. M. Cole, president.
Services: Transcription library.

TED COLLINS CORP.

500 5th Ave., New York 36, N. Y., Tel.: Chickerling 4-5036; Ted Collins, manager.
Services: Production, talent.

HARRISON COLSON ASSOC.

3846 Meredith, Dallas, Tex.; Tel. Federal 6065, Randolph 6811; H. D. Colson, owner.
Services: Recording, program production, syndicated transcriptions, talent.

COLUMBIA ARTISTS MANAGEMENT INC.

113 W. 57th St., New York 19, N. Y., Tel.: Circle 7-6900; Humphrey Doulens, director, radio-tv. Services: Talent booking.
Los Angeles—714 Auditorium Bldg., 427 W. 5th St., Tel.: Madison 6-2327; David Ferguson, Pacific Coast manager.

Chicago—Wrigley Bldg., Tel.: Delaware 7-6622; Herbert Fox, midwestern sales manager.

COLUMBIA TRANSCRIPTIONS

(Div. of Columbia Records)
799 7th Ave., New York 19, N. Y., Tel.: Circle 5-7300; Gilbert McKean, general manager.
Services: Recording (disc and tape), program production, scripts, package programs, talent, commercial and industrial records, Microgroove records, special products.
Chicago 11—410 Michigan Ave., Tel.: Whitehall 4-6000; Girard D. Ellis, manager.
Los Angeles—8723 Alden Dr., Tel.: Crestview 8-1034; William A. Wheeler, manager.

COMMODORE PRODUCTIONS & ARTISTS INC.

971 N. La Cienega Blvd., Hollywood 46, Calif.; Tel.: Crestview 4-2023; Walter White Jr., president.
Services: Program production, syndicated transcriptions, scripts, package programs, talent.

THE COMPO CO. LTD.

2377 Remembrance St., Lachine, Quebec, Tel.: Nelson 5-1993; R. A. Chislett, general manager.
Services: Recording.
Toronto, Ont.—Apex Records Ltd., 670 Richmond St. W., Tel.: Empire 6-5825; George Offer, manager.

FRANK COOPER ASSOCIATES

521 5th Ave., New York 17, N. Y., Tel.: Vanderbilt 6-5661; Sy Fischer, manager.
Services: Talent, production, personal management, writers' agent.
Hollywood 28—6277 Selma Ave., Tel.: Hollywood 4-7258; Frank Cooper, owner.

LOUIS G. COWAN INC.

575 Madison Ave., New York 52, N. Y., Tel.: Plaza 9-3700; Louis G. Cowan, president.
Services: Program production, package programs.
Chicago 3—8 S. Michigan Ave., Tel.: Randolph 6-2022; John Lewellen, vice president.

LEIGH CROSBY

1651 Cosmo St., Hollywood 28, Calif., Tel.: Hollywood 7-5165; Leigh Crosby.
Services: Program production.

CROSBY BROADCASTING CORP. (WLW)

Crosley Square, Cincinnati 2, Ohio, Tel.: Cherry 1822; R. E. Dunville, president-general manager.
Services: Talent, merchandising facilities.

New York 20—630 5th Ave., Tel.: Circle 6-1616; Bernard Musnik.
Chicago 1—360 N. Michigan Ave., Tel.: State 2-6693; Harry Albrecht.
Hollywood 28—6381 Hollywood Blvd., Tel.: Hollywood 9-5408; Tracy Moore.
San Francisco—Tel.: Exbrook 2-8033; Tracy Moore, Jerry Moore.
Atlanta 3—15 Forsythe Ave. S. W., Tel.: Cypress 6676; George Moore Jr.

D

HENRY H. DAGAND

Royalton Hotel, 44 W. 44th St., New York, N. Y.

DAMON RECORDING STUDIOS INC.

117 W. 14th St., Kansas City 6, Mo., Tel.: Victor 2585; Vic Damon, president.
Services: Recording.

RONALD DAWSON ASSOC.

545 5th Ave., New York 17, N. Y., Tel.: Murray Hill 7-6865; Ronald Dawson, owner.
Services: Program production, scripts, package programs.

GORDON M. DAY PRODUCTIONS

108 E. 30th St., New York 16, N. Y., Tel.: Oregon 9-3595; Gordon M. Day.
Services: Recording, program production, scripts.

D. C. PRODUCTIONS

408 Seward Square, S. E. (P. O. Box 1), Washington, D. C., Tel.: Lincoln 7-5109; Dale Crowley, manager.
Services: Syndicated transcriptions, package programs.

DECCA RECORDS INC.

50 W. 57th St., New York 19, N. Y., Tel.: Columbus 5-2300; Edward R. Strauss, manager, special service.
Services: Records, transcriptions, studios available.

De FRENES CO.

1909 Buttonwood St., Philadelphia 30, Pa., Tel.: Rittenhouse 6-1686; Joseph De Frenes, president.

Services: Transcriptions, program production. (Equipped with facilities for sound stage, disc recorders, etc.)

JERRY DEVINE PRODUCTIONS

6331 Hollywood Blvd., Hollywood 28, Calif., Tel.: Hollywood 2-1228; Jerry Devine, producer.
Services: Program production, scripts, package programs, talent.

WILLIAM B. DOLPH RADIO PRODUCTIONS

910 17th St., NW., Washington 6, D. C., Tel.: District 7-2717; William B. Dolph, partner.
Services: Program production, talent.

DOMINION BROADCASTING CO.

4 Albert St., Toronto, Ontario, Canada, Tel.: Empire 3-3383 Hal B. Williams, manager.
Services: Recording, program production, syndicated transcriptions, scripts, package programs, talent.

SHERMAN H. DRYER PRODUCTIONS

667 Madison Ave., New York 21, N. Y., Tel.: Templeton 8-7827 Sherman H. Dryer, president.
Services: Program production, syndicated transcriptions, package programs.

HARRY S. DUBE

10 Rockefeller Plaza, New York 20, N. Y., Tel.: Columbus 5-7035; J. Knight, general manager.
Services: Recording, program production, syndicated transcriptions, scripts, package programs, talent.

E

ECCLES RECORDING

6233 Hollywood Blvd., Hollywood 28, Calif., Tel.: Hollywood 4-8351; Bob Newman, president.
Services: Recording, program production, scripts, package programs.

CHARLES ECKART CO.

4880 Santa Monica Blvd., Los Angeles 29, Calif., Tel.: Olympia 2901 Charles G. Eckart, general manager.
Services: Phonograph record matrices.

RALPH EDWARDS PRODUCTIONS

1635 N. Cherokee Ave., Hollywood 28; Tel.: Hollywood 3-8121; Ralph Edwards, president.
Services: Package programs.

ELECTRO-VOX RECORDING STUDIOS

5546 Melrose Ave., Hollywood 38, Calif., Tel.: Hollywood 5-2189; Bert B. Gottschalk, owner and manager.
Services: Recording.

W. M. ELLSWORTH

159 E. Chicago Ave., Chicago, Ill., Tel.: Mohawk 4-7050; W. M. Ellsworth, owner.
Services: Program production, package programs, talent.

EMPIRE BROADCASTING CORP.

480 Lexington Ave., New York 17, N. Y., Tel.: Plaza 9-4500; Helen D. Kelleher, president.
Services: Recording, program production, scripts, package programs, talent.

ENDORSEMENTS INC.

500 5th Ave., New York 36, N. Y.; Tel. Chickerling 4-7257; Jules Alberti, president.
Services: Secures endorsements by celebrities of manufacturers' products.
Hollywood 46—9172 Sunset Blvd., Tel.: Crestview 6-1272; Stella March, manager.
Also offices in Chicago, London, Paris.

LYLE KENYON ENGEL

1 East 42d St., N. Y. 17, Murray Hill 2-8322.
Services: Music exploitation.

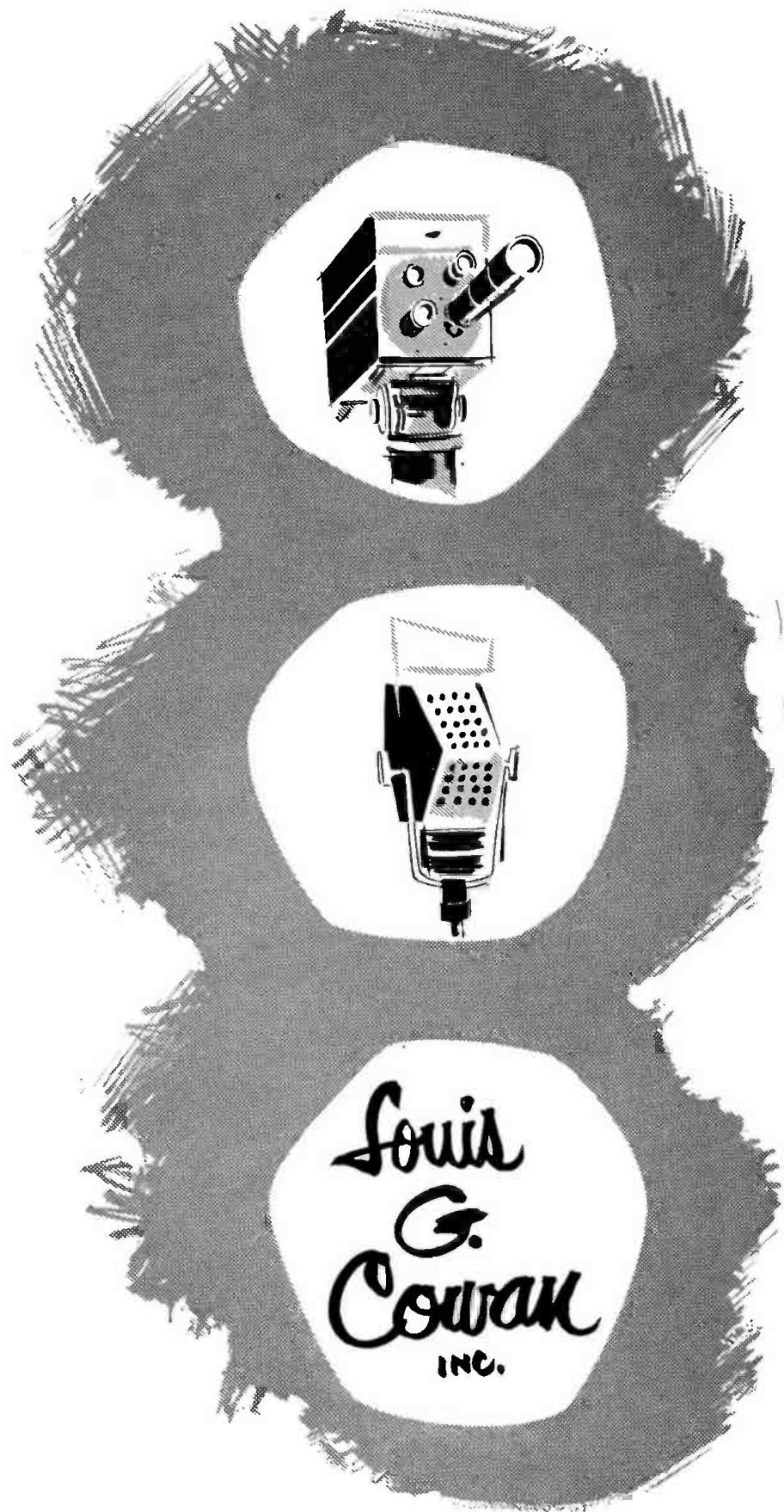

NEW YORK 575 Madison Avenue, New York 22, N. Y. PLaza 9-3700

CHICAGO 8 S. Michigan Avenue, Chicago 3, Ill. RAndolph 6-2022

PROGRAM PRODUCTION SERVICES

DAVID ETELSON & ASSOC.

858 N. LaSalle St., Chicago 43, Ill., Tel.: Whitehall 4-5460; David Eitelson, senior partner. Services: Recording, program production, scripts, package programs, talent.

F

FADIMAN ASSOCIATES LTD.

1501 Broadway, New York 36, N. Y., Tel.: Lackawanna 4-3544; Edwin Fadiman, manager. Services: Production, package shows.

FAMILY THEATRE INC.

7201 Sunset Blvd., Hollywood 46, Calif., Tel.: Hollywood 2-1317; Rev. Patrick Peyton, C. S. C., executive producer. Services: Program production. Albany 3-432; Western Ave., Tel.: 2-4111; Rev. Joseph Quinn, C. S. C.

FAMOUS ARTISTS CORP.

9441 Wilshire Blvd., Beverly Hills, Calif., Tel.: Crestview 1-5222; Thomas F. Greenhow, radio-tv department.

Services: Package programs, talent. New York City—610 5th Ave., Tel.: Circle 7-6200; Charles Abramson.

NEWTON L. FAUSEY

605 N. Michigan Ave., Chicago 11, Ill., Tel.: Whitehall 4-3844; Newton L. Fausey, owner. Services: Personal management, tax accounting.

FEATURE BUREAU

152 W. 42d St., New York 36, N. Y., Tel.: Wisconsin 7-9715; Bert Nevins, managing editor. Services: Scripts (for women's commentators).

FEATURE PRODUCTIONS

1440 N. State Pkwy., Chicago 10, Ill., Tel.: Michigan 2-8015; Chuck Acree, managing director. Services: Package programs.

HERMAN FIALKOFF AGENCY

1560 Broadway, New York 36, N. Y., Tel.: Judson 2-4037-8-9; Herman Fialkoff, owner. Services: Talent, package programs. North Hollywood—5809 Troost Ave.; Harry A. Gourfain.

FILM ASSOC. INC.

440 E. Schantz Ave., Dayton 9, Ohio, Tel.: Walnut 2164; Edward R. Lang, general manager. Services: Recording, talent.

FILM NETWORK

30 Rockefeller Plaza, New York 20 N. Y., Tel.: Judson 2-3026; West Hooker, president. Services: Package programs, program production, talent.

New York—853 7th Ave., Tel.: Judson 2-3026; G. Van Patten, general manager.

FILM RECORDERS

1515 N. Western Ave., Los Angeles 27, Calif., Tel.: Hollywood 9-3163; William Redlin, assistant manager. Services: Full film recording, dubbing, mixing.

FRIEDA FISHBEIN

11 W. 42d St., New York 36, N. Y., Tel.: Longacre 5-1379; Frieda Fishbein, owner. Services: Scripts (authors' representative).

FLANKAY & JACKSON

(See Harry Smith Recording Studios)

FLYING A. PRODUCTIONS

6926 Sunset Blvd., Hollywood 28, Calif., Tel.: Hollywood 9-3611; Leslie Clucas, president of radio division.

Services: Package programs.

GEORGE F. FOLEY INC.

625 Madison Ave., New York, N. Y., Tel.: Plaza 1-1860; George F. Foley, president. Services: Package programs, talent representative, production consultant.

FORTUNE RECORDING LABS

11629 Linwood, Detroit 6, Mich., Tel.: Townsend 7-3077; Dorothy S. Brown. Services: Recording, syndicated transcriptions, scripts, talent.

FREMANTLE OVERSEAS RADIO INC.

365 Madison Ave., New York 17; Tel.: Murray Hill 7-4344; Paul Talbot, President.

FULTON RECORDING CO.

80 W. 40th St., New York 18, N. Y., Tel.: Lackawanna 4-7187; Thomas E. Farrell, general manager. Services: Recording, program production, package programs.

ALLEN A. FUNT PRODUCTIONS

100 Central Park S., New York 19, N. Y., Tel.: Judson 6-5227; Allen A. Funt, president. Services: Production.

G

GAINSBOROUGH ASSOC. INC.

207 E. 30th St., New York 16, N. Y., Tel.: Oregon 9-2720; Mitchell Jablons, president. Services: Program production, scripts, package programs, talent.

Hollywood—6615 Padre Terrace, Tel.: Granite 6930; M. A. Boyd.

GALE AGENCY INC.

48 W. 48th St., New York 19, N. Y., Tel.: Plaza 7-7100; Tim Gale, president. Services: Talent.

GALE INC.

48 W. 48th St., New York 19, N. Y., Tel.: Plaza 7-7100; Moe Gale, president. Services: Management, package programs.

GBA-GALLUCCI BROS. & ASSOC.

727 Meriden Rd., Waterbury, Conn.; Tel. 3-5272; Joe Gallucci, president; N. T. Gallucci, general manager.

Services: Program production, scripts, package programs, talent. Denver—P. O. Box 1224; N. T. Gallucci, general manager.

GAMBLE RECORDING STUDIO

(Formerly Gamble Hinged Music Co.) 228 S. Wabash Ave., Chicago 4, Ill., Tel.: Harrison 7-1364; Richard Hervieux, manager. Services: Recording.

AL GARRY PRODUCTIONS

48 W. 48th St., New York 19, N. Y., Tel.: Riverside 9-5055; Al Garry, owner. Services: Package programs.

GENERAL ARTISTS CORP.

1270 6th Ave., New York 20, N. Y., Tel.: Circle 7-7550; Thomas G. Rockwell, president.

Services: Talent, package programs, recording and talent sales, program productions, syndicated transcriptions.

Beverly Hills, Calif.—9650 Santa Monica Blvd., Tel.: Crestview 1-8101; Henry Miller.

Chicago—9 S. Michigan Ave., Suite 310, Tel.: State 2-6288; Pat Lombard. Cincinnati—1502 Carew Tower, Tel.: Main 1197; Frank Hanshaw.

Dallas—1511 Bryan St., Tel.: Riverside 3665; Phil Brown.

GENNETT RECORDS

P. O. Box 38, Foulke Station, Richmond, Ind., Tel.: 2-4445; R. T. Conner, owner-manager. Services: Producer of sound effect records.

Los Angeles 15—6321 W. 78th St.; Harry Gennett Jr.

New York 36—15 W. 47th St., Tel.: Plaza 7-0695; Charles Michelson.

MITCHELL GERTZ AGENCY

240 S. Beverly Dr., Beverly Hills, Calif., Tel.: Crestview 4-5491; Mitchell Gertz, owner. Services: Scripts, talent.

JOHN GIBBS AGENCY INC.

30 Rockefeller Plaza, New York 20, N. Y., Tel.: Plaza 7-5959; John Gibbs, president.

Services: Program production and packages, scripts, talent.

Hollywood—6253 Hollywood Blvd., Tel.: Hollywood 9-5377; Leonard Reeg.

GRACE GIBSON RADIO PRODUCTIONS OF HOLLYWOOD

6533 Hollywood Blvd., Hollywood 28, Calif., Tel.: Hollywood 9-4580; Bob Reichenbach, general manager.

Services: Program production, syndicated transcriptions, scripts, package programs.

HAROLD GINGRICH PRODUCTIONS

333 N. Michigan Ave., Chicago 1, Ill., Tel.: Franklin 2-1022; Harold R. Gingrich.

Services: Syndicated transcriptions, scripts, package programs.

NAT C. GOLDSTONE AGENCY

9121 Sunset Blvd., Los Angeles 46, Calif., Tel.: Crestview 6-1071; Nat C. Goldstone, owner; Milton Rosner, radio-tv department head.

Services: Program production, scripts, package programs, talent.

HARRY S. GOODMAN PRODUCTIONS

19 E. 53d St., New York 22, Tel.: Plaza 5-6131; Harry S. Goodman, owner-manager.

Services: Syndicated transcriptions, package programs, program production, scripts, talent.

Hollywood 28—6533 Hollywood Blvd., Tel.: Hollywood 9-4580; Bob Reichenbach, manager.

Toronto—447 Jarvis St., Tel.: Kingsdale 2103; Spence Caldwell, manager.

GOODSON-TODMAN PRODUCTIONS

41 E. 57th St., New York 22, N. Y., Tel.: Plaza 1-0600; W. S. Todman, Mark Goodson, partners.

Services: Program production and packages, scripts.

GOTHAM RECORDING CORP.

2 W. 46th St., New York 36, N. Y., Tel.: Judson 6-5577; Herbert M. Moss, president.

Services: Radio transcription recording studios, writing and production staff available.

GREEN ASSOC.

520 N. Michigan Ave., Chicago 11, Ill., Tel.: Whitehall 4-0818; Lewis G. Green, general manager.

Services: Recording, program production, syndicated transcriptions, scripts, package programs.

BEN GREENE FILM PRODUCTIONS

48 W. 48th St., New York 19, N. Y., Tel.: Plaza 7-3858; Ben Greene, owner.

Services: Recording, program production.

JOHN GUEDEL PRODUCTIONS

8321 Beverly Blvd., Los Angeles 48, Calif., Tel.: York 6291; John Guedel, Art Linkletter, partners.

Services: Program production, package programs.

Pacific Palisades (Calif.)—1055 Galloway St.; Tel.: Exbrook 4-4567; Dick Pettit.

Sherman Oaks (Calif.)—15418 Sutton St., Tel.: State 9-2676; Martin Hill.

H

HERMAN HACK PRODUCTIONS

535 N. Laurel Ave., Los Angeles 48, Calif., Tel.: Walnut 2068; Herman Hack, owner.

Services: Program production, package programs.

SYLVIA HAHLO THEATRICAL AGENCY

113 W. 57th St., New York 19, N. Y., Tel.: Judson 6-2731; Sylvia Hahlo, owner. Services: Talent.

WENDELL HALL MUSIC MAKER PRODUCTIONS

4355 N. Paulina St., Chicago 13, Ill., Tel.: Grace-land 2-6418; Wendell Hall, owner.

Services: Package programs, talent.

MITCHELL J. HAMILBURG AGENCY

8776 Sunset Blvd., Hollywood 46, Calif., Tel.: Crestview 5-4171; Mitchell J. Hamilburg, owner.

Services: Program production, scripts, package programs, talent.

LAURENCE HAMMOND PRODUCTIONS INC.

455 E. 51st St., New York 22, N. Y., Tel.: Plaza 9-2210; Laurence Hammond, president.

Services: Recording, program production, syndicated transcriptions, scripts, package programs.

MARK HANNA

654 Madison Ave., New York 21, N. Y., Tel.: Templeton 8-8730; Mark Hanna, owner.

Services: Talent.

HARRIS & STEELE

50 W. 67th St., New York 23, N. Y., Tel.: Endicott 2-9555; Helen Steele, manager.

Services: Production, talent.

HARTLEY PRODUCTIONS INC.

20 W. 47th St., New York 36, N. Y., Tel.: Judson 2-3960; Irving Hartley, president.

Services: Recording.

SAM HAYES PRODUCTIONS

6000 Sunset Blvd., Hollywood 28, Calif., Tel.: Hollywood 3-1515; Sam Hayes, president and general manager; Hazel Thornton, secretary.

Services: Program production, package programs.

GEORGE HEID PRODUCTIONS

William Penn Hotel, Pittsburgh 30, Pa., Tel.: Grant 1-3696; George Heid, president.

Services: Package programs, program production, recording, syndicated transcriptions, scripts, talent, air checks service.

HORACE HEIDT PRODUCTIONS

14155 Magnolia Blvd., Van Nuys, Calif., Tel.: State 4-8211; Horace Heidt, producer-director.

Services: Program production, scripts, package programs, talent.

WALTER HERZBRUN AGENCY
8820 Sunset Blvd., Los Angeles 46, Calif., Tel.:
Crestview 6-4157; Walter Herzbrun, owner.
Services: Talent.

HISPANO BROADCASTING CO.
3549 E. 1st St., Los Angeles 63, Calif., Tel.:
Angelus 3-6005; Tony Sein, manager.
Services: Recording, program production, syndi-
cated transcriptions, scripts, package programs,
talent.

HOLLYWOOD CENTRAL RECORDING STUDIOS
1538 Cahuenga Blvd., Hollywood 28, Calif., Tel.:
Hollywood 3-2131; Boris Radoff, proprietor.
Services: Recording, package programs.

MARY HOWARD RECORDINGS
37 E. 49th St., New York 17, N. Y., Tel.: Plaza
8-2910; Mary Howard, owner.
Services: Recording.

HOWARD RADIO-TV PRODUCTIONS
123 W. Chestnut St., Chicago 10, Ill., Tel.: Michi-
can 2-0128; Bernard Howard, owner.
Services: Recording, program production, scripts,
package programs, consultant.

RICHARD W. HUBBELL & ASSOC.
1300 Knox Ave., Fords Township, Easton, Pa.;
Tel.: 3-8493; R. W. Hubbell, chairman.
Services: Agent for foreign syndicated trans-
criptions.
New York City—120 Broadway, Tel.: Barclay
7-7760; Gilbert Parker.
London—11a Montpelier St., S. W. 7, Tel.: Ken-
sington 6250; Derick Williams.
Sherman Oaks (Calif.)—4825 Katherine Ave.;
Philip Booth.

HULLINGER PRODUCTIONS
5200 Kilgine St., N. W., Washington 16, D. C.,
Tel.: Woodley 6-9487; Edwin Ware Hullinger,
president.
Services: Recording, scripts.

IND-O-PRO RECORDING
475 5th Ave., New York 17; Murray Hill 3-1093;
Lawrence H. Lafer, executive vice president.
Services: Recording, program production, syndi-
cated transcriptions, scripts, package programs,
press conferences.

INTER-CALIFORNIA BROADCASTING SYSTEM
253 S. Broadway, Los Angeles 12, Calif., Tel.:
Mutual 2759; G. F. Moran, general manager.
Services: Recording, program production, syndi-
cated transcriptions, package programs (Span-
ish radio advertising agency).

INTERNATIONAL MONITORING SERVICE
1103 North Rd., Belmont, Calif., Tel.: Lytlet
3-4728; Edgar W. Parmenter, general manager.
Services: Recording (international shortwave
monitoring and recording of am broadcasts),
contract research, development and special
manufacturing of electronic equipment.
Los Angeles—12215 Victoria, Tel.: Exbrook 7-4272;
J. M. Dill.

Venice, Calif.—5404 Centinella, Tel.: Exbrook
7-6713; L. D. Skonnord.

Grand Fords (N. D.)—1025 Lanard Ave., Tel.:
23016; R. W. Jagd.

Gardnerville, Nev.—P. O. Box 8; A. C. Stewart.

CHARLES IRVING PRODUCTIONS
24 Beekman Place, New York City, Tel.: Eldo-
rado 5-0389; Charles Irving, owner.
Services: Program productions and package
shows (live and transcribed), scripts.

LOU IRWIN INC.
9165 Sunset Blvd., Hollywood 46, Calif., Tel.:
Crestview 1-7131; Lou Irwin, president.

Services: Recording, program production, syndi-
cated transcriptions, scripts, package programs,
talent.

New York 18—48 W. 48th St., Tel.: Plaza 7-1880;
Allen Whitehead, secretary.

J

FREDERICK JACKY PRODUCTIONS
520 N. Michigan Ave., Room 1622, Chicago 11,
Ill., Tel.: Delaware 7-3262; Frederick Jacky,
owner.

Services: Program production, syndicated trans-
criptions, scripts, package programs, talent.

JAFFE AGENCY INC.
8553 Sunset Blvd., Hollywood 46, Calif., Tel.:
Crestview 6-6121; Sam Jaffe, president; Mary
Baker, West Coast radio-tv head.

Services: Program production, scripts, package
programs, talent.

New York—Talent Assoc., 41 E. 50th St.; Tel.:
Plaza 3-1030.

JEWELL RADIO AND TELEVISION PRODUCTIONS
185 N. Wabash Ave., Chicago 1, Ill., Tel.: Finan-
cial 6-4474; James E. Jewell, president.

Services: Recording, program production, syndi-
cated transcriptions, scripts, package pro-
grams, talent.

Detroit 26—3062 Penobscot Bldg., Tel.: Woodward
3-0617; W. Ralph Jewell, vice president.

K

KAGRAN CORP.
4 W. 58th St., New York 19, N. Y., Tel.: Murray
Hill 8-0585; Martin Stone, president.
Services: Program production, package pro-
grams.

ESTELLA H. KARN
49 W. 45th St., New York City, Tel.: Luxemburg
2-2170; Estella H. Karn, manager-producer.

KAIE DEEL
1697 Broadway, New York 19, N. Y., Tel.: Colum-
bus 5-3623; Kaie Deel, director.
Services: Scripts, talent consultants for unusual
cultures.

KMBC-KFRM ARTIST BUREAU
KMBC Bldg., 11th & Central, Kansas City 5,
Mo., Tel.: Harrison 2650; James E. McConnell.
Services: Furnishes radio artists.

L

LANG-WORTH DISTRIBUTING CORP.
113 W. 57th St., New York 19; Tel.: 6-5700; John
D. Langlois, general manager.

Services: Recording, program production, syndi-
cated transcriptions.
San Francisco—21 Grand View Ave.; Tel.: Mis-
sion 8-3766; Hugh S. Allen Jr.

LANG-WORTH FEATURE PROGRAMS INC.
113 W. 57th St., New York 19, Tel.: Judson 6-5700;
John D. Langlois, general manager.
Services: Recording, program production.
San Francisco—21 Grand View Ave., Tel.: Mis-
sion 8-3766; Hugh S. Allen Jr.

Toronto, Ont.—447 Jarvis St.; Kingsdale 2103; S.
W. Caldwell.

LANG-WORTH PUBLICATIONS INC.
113 W. 57th St., New York 19; Tel.: Judson
6-5700; C. O. Langlois Jr., general manager.
Services: Program production, syndicated trans-
criptions.

Hollywood 46—6327 Santa Monica Blvd.; Tel.:
Hollywood 4-4687.

Toronto, Ont.—447 Jarvis St.; Tel.: Kingsdale
2103; S. W. Caldwell.

LARRABEE ASSOC. ADV.
1415 K St. N.W., Washington 5, D. C., Tel.:
Metropolitan 8-1171; Jean Senter, radio-tv
director.

Services: Recording, program production, scripts,
package programs.

HERBERT S. LAUFMAN
646 N. Michigan Ave., Chicago 11, Ill., Tel.:
Whitehall 4-2370; Herbert S. Laufman.
Services: Program production, package pro-
grams, scripts.
New York—15 E. 86th St.; R. Claver.

LES LEAR PRODUCTIONS
Hotel Sherman, Chicago, Ill., Tel.: Franklin 2-7840;
Les Lear, manager.
Services: Talent, production.

W. BIGGIE LEVIN AGENCY
612 N. Michigan Ave., Chicago 11, Ill., Tel.:
Superior 7-0506; W. G. T. Hyer, production
director.
Services: Program production, package pro-
grams, talent, scripts.

JACK LEWIS THEATRICAL ENTERPRISES
1564 Broadway, New York 36, N. Y., Tel.: Plaza
7-0412; Lou Harold, general manager; Henry
Jorgensen, associate.
Services: Production, talent, scripts.

LESTER LEWIS ASSOC.
11 E. 48th St., New York 17, N. Y., Tel.: Plaza
3-5083; Lester Lewis.
Services: Program production, scripts, package
programs, talent.

LEWIS & CLARK INC.
218 S. Wabash Ave., Chicago 13, Ill., Tel.: We
9-6434; Herschell G. Lewis, president.
Services: Recording program production, scripts,
package programs, talent.

LICHTIG-ENGLANDER
(See Roy Mack & Lou Levine Agency)

LIFETONE TRANSCRIPTIONS
#3 Gilbert Court, Peoria 5, Ill., Tel.: 2-9443;
Norris John Buechele, president.
Services: Recording, syndicated transcriptions,
package programs.

JACK LLOYD & ASSOC.
4119 Los Feliz Blvd., Los Angeles 27, Calif., Tel.:
Olympia 1214; Jack Lloyd, executive director.
Services: Recording, program production, syndi-
cated transcriptions, scripts, package pro-
grams, talent.

BOB LOEWI PRODUCTIONS INC.
255A E. 49th St., New York 17, N. Y., Tel.:
Plaza 5-0958; Bob Loewi, president.
Services: Package programs, program produc-
tion.

ROBERT LONGENECKER
8428 Melrose Pl., Los Angeles 46, Calif., Tel.:
Webster 1-2267; Robert Longenecker, president.
Services: Program production, scripts, package
programs, talent.

PHILLIPS H. LORD INC.
501 Madison Ave., New York 22, N. Y., Tel.:
Plaza 5-2211; Phillips H. Lord, president.
Services: Package programs.

LORD & THOMAS PRODUCTIONS INC.
7427 1/2 Hollywood Blvd., Hollywood 46; Tel.: Hol-
lywood 9-8484; John Cole Annis, president;
Shirley Thomas, vice president; Ruby Annis,
secretary.
Services: Program packaging.

M

C. P. MacGREGOR CO.
729 S. Western Ave., Los Angeles 5, Calif., Tel.:
Dunkirk 4-4191; George R. Jones, general sales
manager.
Services: Recording, program production, syndi-
cated transcriptions, scripts, package pro-
grams, talent.

ROY MACK & LOU LEVINE AGENCY
(Formerly Lichtig-Englander)
9128 Sunset Blvd., Hollywood 46, Calif., Tel.:
Crestview 1-2141; Roy Mack and Lou Levine,
partners.
Services: Program production, package programs,
talent.

MARSHALL-HEISTER PRODUCTIONS INC.
521 5th Ave., New York 17, N. Y., Tel.: Murray
Hill 7-2722; Anthony W. Marshall, president.
Services: Program production, scripts, package
programs; also consultant.

ARNOLD MARQUIS PRODUCTIONS INC.
717 N. La Cienega Blvd., Hollywood 46; Tel.:
Crestview 6-8798; Arnold Marquis, president.
Services: Program packaging, production.

MASTERTON, REDDY & NELSON
10 E. 49th St., New York 17; Plaza 9-1120; John
Masterton, John Reddy, John Nelson, part-
ners.
Services: Package programs.

MASTERTONE RECORDING STUDIOS INC.
709 8th Ave., New York 36; Tel. Circle 7-7732;
Anthony Anglieri, president; Sidney Feldman,
chief engineer.
Services: Recording, program production, scripts.

MBS RECORDING STUDIO (Midwest Broadcast-
ing School)
(Formerly Gamble Recording Studio and Gamble
Hinged Music Co.)
228 S. Wabash Ave., Chicago 4; Tel.: Harrison
7-1364; Fred Robbins.
Services: Rentals, recordings, transcriptions.

MCA ARTISTS LTD.
598 Madison Ave., New York City, Tel.: Plaza
9-7500.

Services: Package programs, talent.
Beverly Hills (Calif.)—9370 Santa Monica, Tel.:
Crestview 6-2001; Mickey Rockford.
Chicago—430 N. Michigan Ave., Tel.: Delaware
7-1100; Raoul Kent, manager.

San Francisco—105 Montgomery St., Tel.: Ex-
brook 2-8922.
Dallas—2102 Ekard St., Tel.: Central 1448; Eddie
Greene.

Cleveland—Union Commerce Bldg., Tel.: Cherry
1-6610; De Arv Barton.
Detroit—1612 Book Tower, Tel.: Woodward
2-2604.

Boston—45 Newbury St., Tel.: Copley 7-5830.
Minneapolis—Northwestern Bank Bldg., Tel.:
Lincoln 7863; Charles Richter.

RALPH S. McFEELY CO.
Hartman Theatre Bldg., Columbus 15, Ohio, Tel.:
Adams 4116; Ralph S. McFeely.
Services: Syndicated transcriptions.

ALEXANDER McQUEEN & ASSOC.
5222 N. Lakewood Ave., Chicago 40, Ill., Tel.:
Ravenswood 8-9010; Alexander McQueen, man-
ager.
Services: Program production, talent.

MELOTONE RECORDING STUDIO
25 Central Park West, New York 23, N. Y., Tel.:
Circle 6-1366; Mera M. Weinstock, director.
Services: Recording.

METRO ARTIST BUREAU
730 5th Ave., New York 19, N. Y., Tel.: Circle
6-8471; T. M. Nelson, director.
Services: Program production, scripts, package
programs, talent.

**METRO-GOLDWYN-MAYER RADIO ATTRAC-
TIONS**
711 5th Ave., New York 22, N. Y., Tel.: Murray
Hill 8-1000; Bertram Lebar Jr., director.

Services: Recording, program production, syndi-
cated transcriptions.

METROPOLITAN STUDIOS FOR RECORDING
1697 Broadway, New York 19, N. Y., Tel.: Circle
7-3428; Leo Kahn, president.
Services: Recording, transcriptions, production,
air checks.

CHARLES MICHELSON INC.
15 W. 47th St., New York 36, N. Y., Tel.: Plaza
7-0695; Charles Michelson, president.

Services: Syndicated transcriptions.
Hollywood 28—6533 Hollywood Blvd., Tel.: Hol-
lywood 9-4580; Bob Reichenbach.

Chicago 1—360 N. Michigan Ave., Tel.: Franklin
2-8067; Ray Linton.

MICHELSON & STERNBERG INC.
15 W. 47th St., New York 36, N. Y., Tel.: Plaza
7-1269; Aaron Michelson, president.
Services: ETs and sound effect records for ex-
port.

J. W. MILLER CO.
Sturbridge, Mass., Tel.: Dickens 7-3336; James
W. Miller, president.

Services: Program production, package pro-
grams, sales promotion.

MOLE & LEE INC.
105 W. 55th St., New York 19, N. Y., Tel.: Circle
6-0006; John Mole, president.
Services: Package shows.

IN 1954...

RCA's *Thesaurus* will

to more sales!

because Thesaurus gives you planned programming — and sales aids such as —

Big-name talent in complete shows . . .
Exclusive singing Jingle-Library . . . Special feature program signatures . . .
Tailored sound effects for sponsor identification . . . Sales-clinching audition discs . . . Sponsor-selling brochures . . .
Exclusive Monthly Marketing Bulletin . . . Sponsor success stories!

to more profits!

because Thesaurus cuts operating costs!

Only with Thesaurus do you get so many exclusive services that save valuable staff time and reduce your sales expense: Big weekly continuity service . . . Specially prepared marketing research . . . Time and money-saving sales packages that produce peak sales with minimum time and minimum effort on your part!

to more listeners!

because Thesaurus gives you top shows, popular big names and plenty of promotion aids!

You can build audiences faster . . . and keep them . . . with these popular, big-name Thesaurus shows. Plenty of the kind of promotion you need to sell — mats, photos, press releases, tune-in announcements — to keep folks in your area talking about . . . and tuning in . . . your station!

Only with Thesaurus do you get so many exclusive door openers!

1 BASIC LIBRARY OF BIG-NAME SHOWS:

Look at that Thesaurus talent roster! Not just big names . . . but big-name shows complete with full continuity, open-end for local announcements. The basic library has a minimum of 52 new musical selections added each month!

2 EXCLUSIVE MARKETING BULLETIN:

Here's a really thrifty way to save staff research time. Marketing Bulletin gives you the latest information on what are the "hot items" for the coming month . . . what to promote, who is your likeliest prospect. And, it's exclusive with Thesaurus!

3 EXCLUSIVE JINGL-LIBRARY:

The world's largest collection of singing jingles! More than 1800 jingles, for every kind of product, for every situation . . . something to hit the mark with every prospect. Open-end for local tie-in.

4 CONTINUITY SERVICE:

Every week you get expertly written continuity for 31 different shows. In addition the library includes production aids such as voice tracks, theme music, tie-ins, cross-plugs, sound effects . . . plus signatures for sports, news and feature programs.

5 SALES TOOLS:

Thesaurus provides you with sales aids — sponsor-selling brochures, sales-clinching audition discs, testimonials, case histories, success stories, publicity and promotion kits, advertising assistance . . . the works!

No other Library offers all these features

And no other service opens doors to more profits, more sponsors and more listeners the way Thesaurus does. Get in touch with a Thesaurus representative today for all the profitable details.

RCA's Thesaurus . . . the library that pays its own way!



Radio Corporation of America RCA Victor Division

630 Fifth Avenue, New York 20, N. Y.
Judson 2-5011
445 N. Lake Shore Drive, Chicago 11, Ill.
Whitehall 4-3530
1016 N. Sycamore Ave., Hollywood 38, Calif.
Hollywood 4-5171
522 Forsyth Bldg., Atlanta 3, Ga.
LAmar 7703
1907 McKinney Ave., Dallas 1, Tex.
Riverside 1371

TMKS®

open more doors for you!

The Hour of Charm



Phil Spitalny's All-Girl Orchestra and Choir — featuring Evelyn and her Magic Violin . . . half-hour show — once a week.

THIS IS YOUR TALENT LIST WITH THE SAURUS . . .

The Sammy Kaye Show
The Hour of Charm
The Wayne King Serenade
Music by Roth
Music Hall Varieties
Concert Hall of the Air
Men Behind the Melody
Norman Cloutier

"DATE IN HOLLYWOOD"



Starring Eddie Fisher and Gloria de Haven with Hugo Winterhalter and his Orchestra . . . quarter-hour show — twice weekly.

SONS OF THE PIONEERS



An all-star, quarter-hour musical round-up of Western and Cowboy music at its best . . . five times weekly.

The Freddy Martin Show
Date in Hollywood
Sons of the Pioneers
The Tex Beneke Show
Hank Snow
Music of Manhattan
Church in the Wildwood
Fran Warren Sings
A Festival of Waltzes
The Singing Americans
Vincent Lopez
Music in March Time

The Sammy Kaye Show

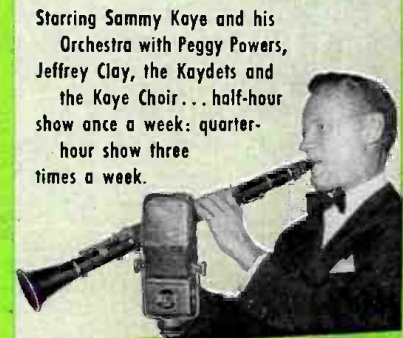

Starring Sammy Kaye and his Orchestra with Peggy Powers, Jeffrey Clay, the Kaydets and the Kaye Choir . . . half-hour show once a week; quarter-hour show three times a week.

"the FREDDY MARTIN Show"



Freddy Martin and his Orchestra with Merv Griffin, Murray Arnold and the Martin Men . . . quarter-hour show — twice weekly.

I Hear the Southland Singing
Music to Dream By
Slim Bryant and his Wildcats
Here's June Christy Organairs
Old New Orleans
Claude Thornhill
Artie Shaw
Ray McKinley
Jumpin' Jacks

The WAYNE KING Serenade

The "Waltz King" and his Orchestra with Harry Hall, Gloria Van, Jacqueline James and the Wayne King Chorus . . . half-hour show — once a week.

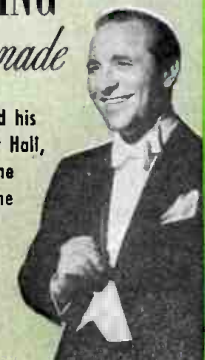

PROGRAM PRODUCTION SERVICES

MONARCH PROGRAM LIBRARY INC.

615 Kirtledge Bldg., 511 16th St., Denver 2 Col.; Tel.: Alpine 4038; Noel Jordan, president; Garrett M. Etheridge, vice president, manager. Services: Production of packages and spot announcements, syndicated transcriptions, scripts, talent.

MONOGRAM-CHICAGO

75 E. Wacker Dr., Chicago 1, Ill., Tel.: Andover 3-7169; William K. Ermeling, president. Services: Program production, package programs.

CARLTON E. MORSE ENTERPRISES INC.

1500 Vine St., Hollywood 28, Calif., Tel.: Hollywood 9-6161; Carlton E. Morse, president. Services: Recording, program production, scripts, package programs.

MORTON RADIO PRODUCTIONS INC.

64 E. Lake St., Chicago 1, Ill., Tel.: Central 6-4144; Morton Jacobson president. Services: Syndicated transcriptions, package programs.

HERBERT M. MOSS PRODUCTIONS

2 W. 46th St., New York 36, N. Y., Tel.: Judson 6-5577; Herbert M. Moss. Services: Recording, program production, package programs.

MUSIC PROMOTIONS INC.

1 E. 42d St., New York 17, N. Y., Tel.: Murray Hill 2-8322; Lyle Kenyon Engel, president. Services: Music promotion packages for radio shows.

N

NBC RADIO RECORDING DIVISION

30 Rockefeller Plaza, New York 20, N. Y., Tel.: Circle 7-8300; Henry P. Hayes, manager. Services: Recording, program production, scripts, package programs, talent.

Chicago 54—Merchandise Mart; Superior 7-8300; M. P. Eisenmenger, manager. Washington (D. C.)—Sheraton Park Hotel; Adams 4-5400.

Hollywood 28—Sunset & Vine Sts.; Hollywood 9-6161; A. M. Woolley, manager.

NATIONAL PRODUCTIONS

1001 Connecticut Ave., N. W., Washington, D. C., Tel.: Sterling 3-2222; Robert L. Friend. Services: Recording, program production, scripts, package programs, talent.

NATIONAL RESEARCH BUREAU INC.

415 N. Dearborn St., Chicago 10, Ill., Tel.: Superior 7-5080; Frank P. Kendall, executive vice president.

Services: Syndicated transcriptions, scripts, idea services for stations.

Burlington (Iowa)—NRB Bldg., Tel.: 5528.

NATIONAL RETAIL RADIO SPOTS INC.

6331 Hollywood Blvd., Hollywood 28, Calif., Tel.: Hollywood 9-1989; Phillip B. Singer, sales director; Jack Ross, production director. Services: Syndicated transcriptions, package programs, program production.

NATIONAL SAFETY COUNCIL

425 N. Michigan Ave., Chicago 11, Ill., Tel.: Whitehall 4-4800; Dan Thompson, radio-tv director.

Services: Free safety spot transcriptions, scripts, package programs.

NATIONWIDE ASSOC.

P. O. Box 58, Garland, Tex., Tel.: 3-9235; Charles H. Edwards, president. Services: Recording, program production, syndicated transcriptions, scripts, package programs, talent.

Dallas—4215 Gaston, Tel.: Victor 1341; Larry Gianneschi, executive vice president.

GEORGE R. NELSON INC. (Advertising Agency)

208 State St., Schenectady, N. Y., Tel.: Schenectady 4-4135; Robert S. Cragin, radio director. Service: Transcription production.

TED NELSON ASSOC.

730 5th Ave., New York 19, N. Y., Tel.: Circle 6-8470; Ted Nelson, director. Services: Program production, scripts, package programs, talent.

NELSON PRODUCTIONS INC.

341 Madison Ave., New York 17, N. Y., Tel.: Murray Hill 6-5862; Raymond E. Nelson, president. Services: Recording, program production, scripts, package programs.

NETHERLANDS INFORMATION SERVICE

10 Rockefeller Plaza, New York 20, N. Y., Tel.: Columbus 5-6216; Mrs. Ann Buurman. Services: Recording, scripts (for women commentators), interview service, regular series programs.

San Francisco—988 Mills Bldg., Tel.: Exbrook 2-7948; Mrs. Julie G. Lynch.

Holland (Mich.)—Netherlands Museum, Tel.: Holland 3174; Willard C. Wichers.

NEWSREEL SERVICE

5 Centre Market Pl., New York 13, N. Y., Tel.: Canal 6-3284; Howard V. Smythe, production manager.

Services: Tape recording, program production.

OLIVER W. NICOLL PRODUCTIONS

37 W. 46th St., New York 36; Tel.: Judson 2-5130; Oliver W. Nicoll, executive director; Sandra Munsell, associate director.

Services: Program production, syndicated transcriptions, scripts, package programs, talent, consultation.

NOCTURNE PRODUCTIONS

88 Diamond Bridge Ave., Hawthorne, N. J., Tel.: Hawthorne 7-2523; Jack Hartley.

Services: Recording, package programs.

NOLA STUDIOS INC.

1657 Broadway, New York 19, N. Y., Tel.: Plaza 7-4870; V. Thomas Nola, vice president.

Service: Recording

New York 19—Steinway Hall, 113 W. 57th St., Tel.: Judson 6-0040.

JOHN NORMAN PRODUCTIONS

2704 Sackett, Houston 6, Texas, Tel.: Lynchburg 7336; John Norman, general manager.

Services: Program production, syndicated transcriptions, scripts, package programs, talent, consultant.

MEYER B. NORTH

1564 Broadway, New York 36, N. Y., Tel.: Plaza 7-3445; Meyer B. North, owner.

Service: Talent representative.

NORTHWESTERN RECORDING INC.

411 S. W. 13th Ave., Portland 5, Ore.; Tel.: Beacon 2411; Robert M. Lindahl and Sheldon Goldstein.

Service: Recording

O

JOHN J. O'CONNOR

1697 Broadway, New York 19, N. Y., Tel.: Circle 5-4920; John O'Connor, owner.

Service: Talent

LILIAN OKUN INC.

2 W. 67th St., New York 23, N. Y., Tel.: Trafalgar 7-8916; Lilian Okun, president.

Services: Program production, scripts, package programs (children, teen-age).

ORSATTI & CO. INC.

300 S. Beverly Dr., Beverly Hills, Calif., Tel.: Crestview 6-6241; Victor M. Orsatti, president.

Services: Program production, scripts, package programs, talent.

FRANK OXARART PRODUCTIONS

6223 Selma, Hollywood 28, Calif., Tel.: Hollywood 9-1171; Frank Oxarart.

Services: Program production, scripts, package programs.

P

PACKAGED PROGRAMS INC.

634 Penn Ave., Pittsburgh 22, Pa., Tel.: Grant 1-4756; M. E. Fierst, general manager.

Services: Recording, program production, syndicated transcriptions, scripts, package programs.

PALMETTO BROADCASTING SYSTEM

1 Martin St., Anderson, S. C., Tel.: 3802; Glenn P. Warnock, general manager.

Services: Recording, program production, package programs.

Atlanta, Ga.—405 Mortgage Guarantee Bldg.; Clayton J. Cosse.

New York—19 W. 44th St.; C. Stanley Bailey.

PETERSON RADIO PRODUCTIONS

1457 Broadway, New York 36, N. Y., Tel.: Wisconsin 7-0069; Donald Peterson, owner.

Services: Recording, program production (religious, economic).

PHILBIN-BERGMANN PRODUCTIONS

350 5th Ave., New York 1, N. Y., Tel.: Longacre 5-3200; Robert Bergmann, production head.

Services: Program production, package programs.

POLISH BELLS RADIO PROGRAM (STATION WBNX NEW YORK)

260 E. 161st St., New York 51, N. Y., Tel.: Melrose 8-0333; T. W. Ochrymowicz, director.

Services: Recording, program production, scripts, package programs, talent.

Hicksville (N. Y.)—Plainview RD1, Tel.: 3-0187.

POLISH BROADCASTING BUREAU

820 Fillmore Ave., Buffalo 12, N. Y., Tel.: Cleveland 6876; Joseph F. Mikolajczak, director.

Service: Program production (Polish)

POLISH PROGRAM SERVICE

PO Box 485, Passaic, N. J.; W. J. Maycher, president.

Services: Taped Polish-language radio programs, commercials translated on tape.

LELAND POWERS SCHOOL INC.

31 Evans Way, Boston 15, Mass., Tel.: Aspinwall 7-2900; Haven M. Powers, principal. Service: Talent.

GEORGE LOGAN PRICE

20828 Pacific Coast Hwy., Malibu, Calif., Tel.: Globe 6-2135; G. L. Price, president.

Services: Program production, syndicated transcriptions, scripts, package programs, talent.

PROCKTER PRODUCTIONS INC.

221 W. 57th St., New York 19, N. Y., Tel.: Judson 6-6800; Bernard J. Prockter, president.

Services: Package programs.

R

RADIO CENTER

1203 S. Main St., Los Angeles 13, Calif., Tel.: Prospect 9232; Al Nazareth, owner.

Services: Recording, program production, scripts, package programs (Armenian, Turkish programs).

RADIO EVENTS INC.

535 5th Ave., New York City, Tel.: Murray Hill 7-1668; Julienne Dupuy, manager.

Services: Production, scripts, talent.

RADIO FEATURES OF AMERICA

37 W. 47th St., New York 36; Tel.: Judson 2-5130; Oliver W. Nicoll, executive director; Sandra Munsell, associate director.

Services: Program production, syndicated transcriptions, scripts, package programs, talent, consultation.

New York 22—RFA Production Unit, Hotel New Weston, Madison Ave. at 49th St.; Tel.: Plaza 3-4800; John Henry Macdonell, managing director.

THE RADIO & FILM COMMISSION OF THE METHODIST CHURCH

1908 Grand Ave., Nashville 4, Tenn., Tel.: 42-4335; Howard Ellis, radio director.

Services: Package programs (Upper Room Radio Parish, devotional guide).

RADIO LUXEMBOURG

22 Rue Bayard, Paris 8, France; J. du Closel.

Services: Recording, program production, scripts, package programs, talent.

New York—17 E. 42d St., Tel.: Murray Hill 2-0810; Guy Bolam, executive agent U.S.A.

London, Eng.—38 Hertford St.; G. Clement Cave, general manager.

Brussels, Belg.—66 Rue de la Limite; J. C. Henriot, general manager.

RADIO PRODUCTION SERVICE

501 Madison Ave., New York 22, N. Y., Tel.: Plaza 3-8940; Irene Beasley, owner.

Services: Package programs (live and transcribed).

RADIO PROGRAMME PRODUCERS

1440 St. Catherine St., West, Montreal, Quebec, Tel.: University 6-8751; Paul L'Anglais, president.

Services: Program production, package programs.

RADIO PROVIDENCE PRODUCTIONS INC.

10 Paterson St., Providence 6, R. I., Tel.: Plantations 1-6784; Frank Jones, president.

Services: Program production, scripts, syndicated transcriptions.

RADIO RECORDERS

7000 Santa Monica Blvd., Hollywood 38, Calif., Tel.: Hollywood 3-3282; J. Joseph Sameth, vice president in charge of sales.

Services: Recording.

RADIO RECORDING STUDIOS

1244 Carmen Ave., Chicago 40, Ill., Tel.: Edgewater 4-6461; Myron Bachman, owner.

Services: Recording (air checks).

RADIO RESULTS

8641 S. Escanaba Ave., Chicago 17, Ill., Tel.: South Chicago 8-5374; George Jarovoski, manager.

Services: Foreign language broadcasting.

RADIO SCRIPT SERVICES

218 N. Duke St., Lancaster, Pa., Tel.: Lancaster 3-4337; Mrs. Dorothy S. Brown, owner-director.

Services: Scripts (seasonal shows).

RADIO-TELEVISION ARTS ACADEMY

3819 Wilshire Blvd., Los Angeles 5, Calif., Tel.: Dunkirk 8-1323; Doria Balli, director.

Services: Program production, scripts, talent.

RADIOVISION INTERNACIONAL

Room 907, 630 5th Ave., New York 20; Tel.: Lehigh 4-8315; Alastair Kyle, president; George P. Asker, vice president.

Services: Transcribed radio programs in Spanish and English, scripts in Spanish, transcription library with Spanish continuity, weekly hit record package, LP records.

Mexico D. F., Mexico—Morelos 58; Ignacio Carral y Izaca, manager; Juan Resendex Picasso, assistant manager.

RADIOZARK ENTERPRISES INC.

606 Saint Louis St. Springfield 2, Mo.; Tel.: 2-4422; E. E. Siman Jr., John B. Mahaffey, vice presidents.

Services: Recording, program production, syndicated transcriptions, scripts, package programs, talent.

Chicago 1—75 E. Wacker Dr., Tel.: Andover 3-7169; William K. Ermeling, manager.

DOROTHY N. RAISON AGENCY

5304 Clinton Ave., Los Angeles 4, Calif., Tel.: Hollywood 4-0426, Dorothy N. Raison, manager. Services: Scripts.

RAM PRODUCTIONS

661 West End Ave., New York 25, N. Y., Tel.: Monument 2-5111; E. F. Lindner, director.

Services: Recording, program production, syndicated transcriptions, package programs, talent.

RAY & BERGER

1471 N. Tamarind Ave., Hollywood 28, Calif., Tel.: Hollywood 3-8648, 2-4202; Howard Ray and Jack Berger, partners.

Services: Syndicated prizes, formats for giveaway shows.

RCA VICTOR CO. LTD.

Royal York Hotel Toronto, Ontario, Canada, Tel.: Empire 3-3443.

Services: Recording, syndicated transcriptions, package programs.

Montreal—1001 Lenoir St., Tel.: Wellington 7551; E. Traynor.

RCA VICTOR DIVISION

(RCA Victor Record Dept.)

630 5th Ave., New York 20, N. Y. Tel.: Judson 2-5011; Emanuel Sacks, vice president.

RCA Victor Custom Record Div.—James P. Davis, manager; Ben Selvin, artist and repertoire manager; Frank O'Donnell, advertising and promotion manager.

Custom Record Sales Section—D. J. Finn, manager; A. E. Hindle, Chicago manager; Richard C. Bucholz, Hollywood manager; Richard E. Bylandt, New York manager of orders and service; Ralph C. Williams, New York sales representative; Marjorie B. Tahaney, New York sales representative; James R. Cunnison, New York sales representative (transcriptions); Geoffrey B. Bennett, Chicago sales representative.

Services: Recording, processing, pressing, transcriptions, slidefilms and promotion records, shipping and handling.

RCA Recorded Program Services—A. B. Sambrook, manager; William F. Reilly, Central sales manager (Chicago); William C. Gartland, Western sales representative (Hollywood); George Field, Northeastern sales representative (New York); Wallace D. Cochran, Southeastern sales representative (Atlanta); Hugh Grauel, Central sales representative (Chicago); Robert Fender, Southwestern sales representative (Dallas); Charles Broderick, manager of sales service; Donald D. Axt, manager of commercial research.

Services: Thesaurus (musical program service), RCA syndicated programs (recorded dramatic, variety, musical shows), tv film libraries and syndicated programs.

Studios and Regional Offices—630 5th Ave., New York 20, N. Y., Tel.: Judson 2-5011; 445 N. Lake Shore Dr., Chicago 11, Ill., Tel.: Whitehall 4-3530; 1016 N. Sycamore Ave., Hollywood 38, Calif., Tel.: Hollywood 4-5171; 522 Forsyth Bldg., Atlanta 3, Ga., Tel.: Walnut 5948; 1907-11 McKinney Ave., Dallas, Texas. Tel.: Riverside 1371.

REC-ART RECORDING STUDIOS

1203 S. Main St., Los Angeles 15, Calif.; Tel.: Prospect 9232. Al Nazareth, owner.

Services: Recording, program production.

REEVES SOUND STUDIOS INC.

304 E. 44th St., New York 17, N. Y., Tel.: Oregon 9-3550; Chester L. Stewart, vice president-general manager.

Services: Recording.

RELIGIOUS NEWS SERVICE

381 4th Ave., New York, N. Y., Tel.: Murray Hill 4-1463; Louis Minsky, managing editor.

Services: Scripts (weekly religious series).

REPUBLIC RADIO & TELEVISION FEATURES

64 E. Lake St., Chicago 1, Ill., Tel.: State 2-0460; Capico Kapps, president.

Services: Recording, program production, syndicated transcriptions, scripts, package programs, talent.

ROBBINS BROS.

67 W. 44th St., New York 36, N. Y., Tel.: Murray Hill 7-2033; Fred Robbins, president.

Services: Artists booking.

ROBINSON RECORDING LABS

#35 S. 9th St. Philadelphia 7, Pa., Tel.: Walnut 2-6800; W. R. Robinson, owner.

Services: Recording.

ROCKHILL PRODUCTIONS INC.

18 E. 50th St., New York 22, N. Y., Tel.: Plaza 9-7979; Stanley J. Wolf, president.

Services: Recording, program production, syndicated transcriptions, package programs, live and transcribed productions.

RICHARD H. ROFFMAN ASSOC.

675 West End Ave., New York, N. Y., Tel.: Riverside 9-3647; Richard H. Roffman, president.

Services: Program production, scripts, package programs, talent. Merchandise for giveaways, guests for programs.

ROLAB STUDIOS & PHOTO-SCIENCE LABS

Sandy Hook, Conn., Tel.: Garden 6-2466; Henry Roger, owner-director.

Services: Recording, program production (sponsorship).

ROSS-DANZIG PRODUCTIONS

6331 Hollywood Blvd., Hollywood 28, Calif.; Tel.: Hollywood 5-1085; Frank K. Danzig, Bart Ross, partners.

Services: Program packaging, production.

ALLEN ROTH RADIO PRODUCTIONS

48 W. 48th St., New York 19, N. Y., Tel.: Plaza 7-1162; Allen Roth, manager.

Services: Talent, production, recording.

ROYAL RECORDING CO.

601 Ashby Ave., Berkeley 10, Calif., Tel.: Ashberry 3-3453; Don Hambly, manager.

Services: Recording, program production.

ART RUSH INC.

1418 N. Highland Ave., Hollywood 28, Calif., Tel.: Hollywood 4-5161; W. Arthur Rush, president-owner.

Services: Package programs, talent (artist management), recording, program production.

JACK RUSSELL & ASSOC.

203 N. Wabash Ave., Chicago 1, Ill., Tel.: State 2-2818; Jack Russell, president.

Services: Scripts, talent, program production.

5

BARNARD L. SACKETT PRODUCTIONS

Empire Bldg., Philadelphia 7; Tel.: Kingsley 5-6063; Barnard L. Sackett, manager.

Services: Program production, scripts, package programs, talent.

PAUL BRON SALINER RADIO ADVERTISING

7054 S. Western Ave. Chicago 36, Ill., Tel.: Walbrook 5-0129; Paul Bron Saliner, president.

Services: Program production, package programs, talent.

SAM SAMUELS

1564 Broadway, New York 36, N. Y., Tel.: Judson 6-9012; Sam Samuels.

Services: Package programs, talent.

JAMES L. SAPHIER AGENCY INC.

9538 Brighton Way, Beverly Hills, Calif., Tel.: Crestview 1-7231; James L. Saphier, president.

Services: Program production, package programs, talent.

New York 17—6 E. 45th St., Tel.: Murray Hill 7-8370; James A. Schulke.

WALTER SCHWIMMER PRODUCTIONS INC.

75 E. Wacker Dr., Chicago 1, Ill., Tel.: Franklin 2-4392; Walter Schwimmer, president.

Services: Syndicated transcriptions, package programs, program production, scripts.

New York 17—16 E. 41st St., Tel.: Lexington 2-1791; Jack Arden, N. Y. manager.

SELS PRODUCTIONS

1906 N. Lietz Ave., Burbank, Calif., Tel.: Charleston 0-8668; Len Segall, general manager.

Services: Program production, scripts, talent. Los Angeles 35—1458 S. Shenandoah St., Tel.: Crestview 6-2426; Bob Clamage, manager.

Chicago—6705 N. Seeley Ave., Tel.: Hollycourt 5-9254; Dore Lewis, representative.

STANDARD'S 20th YEAR!

Stronger than ever with

2 GREAT SERVICES

The New Standard
"Own Your Own"
Transcription
Library

Buy your own selective transcription service outright at reasonable rates on terms as low as \$50. a month. Ask for complete information.

Standard's Super Sound
Effects Library

The most complete library of high fidelity sound effects available anywhere. Over 1000 sound effects recorded from life and pressed on vinyl. The number one choice of broadcasters, telecasters, theatres, and schools the world over. Send for free cross-indexed catalog.

STANDARD RADIO TRANSCRIPTION SERVICES, INC., 360 N. Michigan Ave., Chicago—State 2-5322

SESAC INC.

475 5th Ave., New York 17, N. Y., Tel.: Murray Hill 5-5365; Robert S. Stone, production manager. Services: Syndicated transcriptions, scripts, package programs, program production.

SHOW/STOPPERS

P. O. Box 210, Grand Central Station, New York 17; Tel.: Mamaroneck 9-3349; Robert J. Clarkson, owner-producer. Services: Scripts, package programs.

WAYNE STEFFNER PRODUCTIONS INC.

6223 Selma St., Hollywood 28; Tel.: Hollywood 3-4173; Wayne Steffner, president. Services: Program production, package programs.

EDWARD SLOMAN PRODUCTIONS

17520 Stretto Way, Pacific Palisades, Calif., Tel.: Exbrook 5-8558; Edward Sloman, manager. Services: Syndicated transcriptions.

HARRY SMITH RECORDING STUDIOS INC.

43 W. 48th St., New York 36, N. Y., Tel.: Judson 6-2893; Harry Smith, president. Services: Recording.

JOSEPH I. SONNENREICH

143 W. 103rd St., New York 11, N. Y., Tel.: Monument 3-7138; Joseph I. Sonnenreich, president. Services: Program production, package programs.

SOUNDAC PRODUCTIONS INC.

704 Elmwood Ave., Buffalo 22, N. Y., Tel.: Summer 6262; Robert D. Buchanan, president. Services: Program production, scripts, recordings, syndicated transcriptions, package programs.

THE SOUVAINE COMPANY

119 W. 57th St., New York, N. Y., Tel.: Circle 6-6100; Henry Souvaine, general partner. Services: Package programs and productions.

SIGMUND SPAETH

400 E. 58th St., New York 22, N. Y., Tel.: Plaza 8-0879; Sigmund Spaeth, president. Services: Program production, syndicated transcriptions, scripts, package programs, talent.

SPEAK-O-PHONE RECORDING & EQUIPMENT

CO.
23 W. 60th St., New York 23, N. Y., Tel.: Columbus 5-1350; R. L. Austin, owner. Services: Recording.

SPEEDY-Q SOUND EFFECTS

P. O. Box 38, Foulke Station, Richmond, Ind., Tel.: 2-3871; H. Gennett Jr., owner-manager. Services: Sound effect records. New York 36—15 W. 47th St., Tel.: Plaza 7-0695. Toronto 1—80 Richmond St., West, Tel.: Empire 6-7691.

STANDARD RADIO TRANSCRIPTION SERVICES INC.

360 N. Michigan Ave., Chicago 1; Tel.: State 2-5322; Milton M. Blink, president; Gus Hagenak, vice president. Services: Transcription library, sound effects.

WILBUR STARK-JERRY LAYTON

4 W. 58th St., New York 19, N. Y., Tel.: Plaza 3-1742; Wilbur Stark, president; Jerry Layton, vice president. Services: Package programs.

STEMPEL-OLENICK AGENCY

717 N. LaCienega Blvd., Los Angeles 46, Calif., Tel.: Crestview 1-7141; Frank Stempel, Julian H. Olenick, co-partners. Services: Talent.

IRV STOLL CO., INC.

2350 Buhl Bldg., Detroit 26, Mich., Tel.: Woodward 3-0465; Irv Stoll, president. Services: Program production, syndicated transcriptions, package programs.

BOB STRUBLE & ASSOC. INC.

735 N. Vine St., Hollywood 38, Calif., Tel.: Hollywood 4-0249; Robert B. Struble, president. Services: Recording, advertising counseling.

STUDIO & ARTISTS RECORDERS

6087 Sunset Blvd., Hollywood 28, Calif., Tel.: Hollywood 4-8241; Lewis Finston, manager. Services: Recording.

H. N. SWANSON INC.

8523 Sunset Blvd., West Hollywood 46, Calif., Tel.: Crestview 1-5115; Edgar Carier, manager. Services: Scripts, literary talent, package programs.

SYNCRO SOUND EFFECTS

P. O. Box 38, Foulke Station, Richmond, Ind., Tel.: 2-4445; R. T. Conner, owner and manager. Services: Recorded sound effects.

T

HAL TATE PRODUCTIONS

192 N. Clark St., Chicago 1, Ill., Tel.: Financial 6-5450; Hal Tate, president. Services: Syndicated transcriptions, program production, packages. Toronto—150 Simcoe St., Simcoe House, Tel.: Plaza 8727 (S. W. Caldwell Ltd.)

TBC RECORDING CO.

11 Trinity Square, Toronto, Ont.; Tel.: Empire 8-3881; W. H. McAlpine, manager. Service: Recording.

TECHNISONIC STUDIOS

1201 S. Brentwood Blvd., St. Louis 17, Mo., Tel.: Parkview 1055; Charles E. Harrison, president. Services: Recording and processing, program production.

TELEMOUNT PICTURES INC.

P. O. Box 4555, Los Angeles 24, Calif.; Henry B. Donovan, president; John Chesely, secretary-treasurer. Services: Package programs.

TEL RA PRODUCTIONS

1518 Walnut St., Philadelphia 2, Pa., Tel.: Kingsley 5-8540; W. Wallace Orr, president. Services: Recording, program production, scripts, package programs, talent.

TELEVISION & RADIO FEATURES OF AMERICA

37 W. 46th St., New York 36; Tel.: Judson 2-5130; Oliver W. Nicoll, executive director; Sandra Munsell, associate director. Services: Program production, syndicated transcriptions, scripts, package programs, talent. New York 22—Production Unit, Hotel New Weston, Madison Ave. at 49th St.; Tel.: Plaza 3-4800; John Henry Macdonnell, managing director.

L. S. TOOGOOD RECORDING CO.

221 N. LaSalle St., Chicago 1, Ill., Tel.: Central 6-5275; L. S. Toogood, owner. Services: Recording.

TOWERS OF LONDON (CAN.) LTD.

314-15, 67 Yonge St., Toronto, Ontario, Canada, Tel.: Empire 4-9296; John Adaskin, general manager. Services: Syndicated transcriptions.

TRANS-AMERICAN BROADCASTING & TELEVISION CORP.

1 E. 54th St., New York 22, N. Y., Tel.: Plaza 5-9800; John L. Clark, president. Services: Package programs, program production.

TRANSCRIBED RADIO SHOWS

2 W. 47th St., New York 36, N. Y., Tel.: Judson 2-3530; M. E. Moore, president. Services: Program production, syndicated transcriptions, scripts, package programs.

TRANSCRIPTION SALES INC.

117 W. High St., Springfield, Ohio, Tel.: 2-4974; Bess Deck, office manager. Services: Recording, program production, syndicated transcriptions, scripts, package programs, talent.

GEORGE R. TURPIN & ASSOC.

P. O. Box 802, Fort Worth 1, Texas, Tel.: Fortune 7453; George R. Turpin, general manager. Services: Regional sales campaigns and giveaway shows for radio stations.

For Dramatic Sound Effects Records . . . use

MAJOR RECORDS

Over 500 realistic sound effects

“From a Cat’s Meow to a Lion’s Roar . . . a Pistol Shot to a World War”

Send for catalog by

MAJOR RECORDS

Distributed by

THOMAS J. VALENTINO, Inc.

150 West 46th St. New York 36, N. Y.



A Repertory of Distinction .

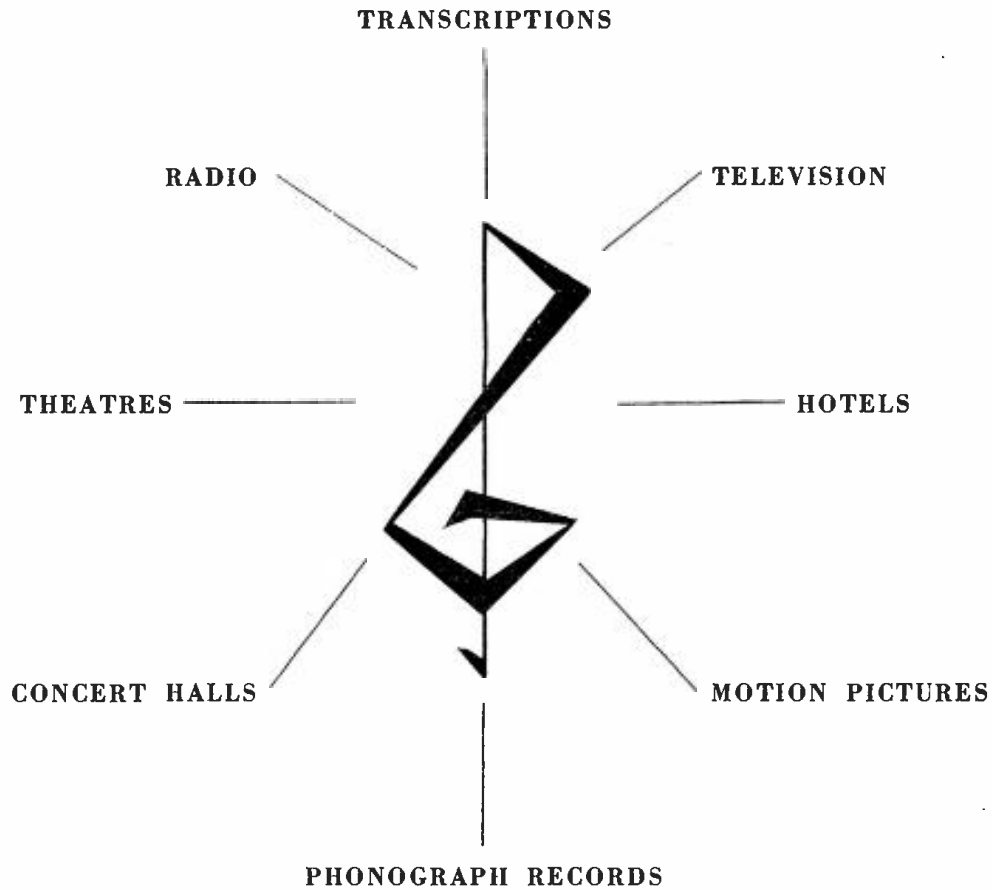

An Outstanding Transcribed Library

SESAC INC.
475 Fifth Avenue
New York 17, N.Y.

Serving The Entertainment Industry Since 1931

**FROM STATION
AFTER STATION
COMES THE WORD...**

\$8388
ANNUAL NET FROM "YOU WIN"
REPORTS
WBML
MACON, GEORGIA
12 participating advertisers
six days weekly include
Philco TV, Sherwin-Williams
Paints, Necchi. 13 weeks' re-
turn, more than cost of en-
tire Service for year.

\$6500
ANNUAL NET FROM "YOU WIN"
SAYS
KDON
SALINAS, CALIFORNIA
52-week contract with 9 ad-
vertisers Monday thru Fri-
day. Income more than 3 1/2
times cost of entire Service
for year.

\$3744
ANNUAL REVENUE FROM "YOU W
SAYS
KBTM
JONESBORO, ARKANSAS
Six participating advertisers.
Quarter-hour Monday thru
Friday. Annual take more
than double cost of entire
Service for year.

\$8580
ANNUAL NET WITH "YOU WIN"
SAYS
WJPS
EVANSVILLE, INDIANA
52-week contract Monday
thru Friday, with Royal Super
Foods of Evansville. In just
13 weeks this one series
pays for the entire World
Service for over a year.

PROFITS *Zoom!*

Local radio's stronger, sturdier, healthier than ever! The proof is in the profits . . .
LOOK HOW THESE WORLD AFFILIATES ARE MAKING MONEY, *BIG* MONEY WITH JUST ONE WORLD SHOW

\$6240
ANNUAL NET FROM "YOU WIN"
SAYS
WJBO
BATON ROUGE, LA.
4 participating advertisers,
42 participating announce-
ments, each Monday thru
Friday, netting in only 13
weeks more than the cost of
a year's complete Service.

\$6000
ANNUAL NET "YOU WIN"
PREDICTS
KTUL
TULSA, OKLAHOMA
Sponsored exclusively by
Tulsa Retail Grocers, quarter
hour, Monday thru Friday.
Revenue for year covers more
than 3 times the cost of the
entire World Service for year.

LISTENERS BY THE THOUSANDS SIGN THIS PLEDGE TO LISTEN TO THEIR FAVORITE WORLD-AFFILIATE STATION

One station reports 5000 listeners sign up every week. Another reports more than 3000 signatures a week. Another reports 10,000 in six weeks.

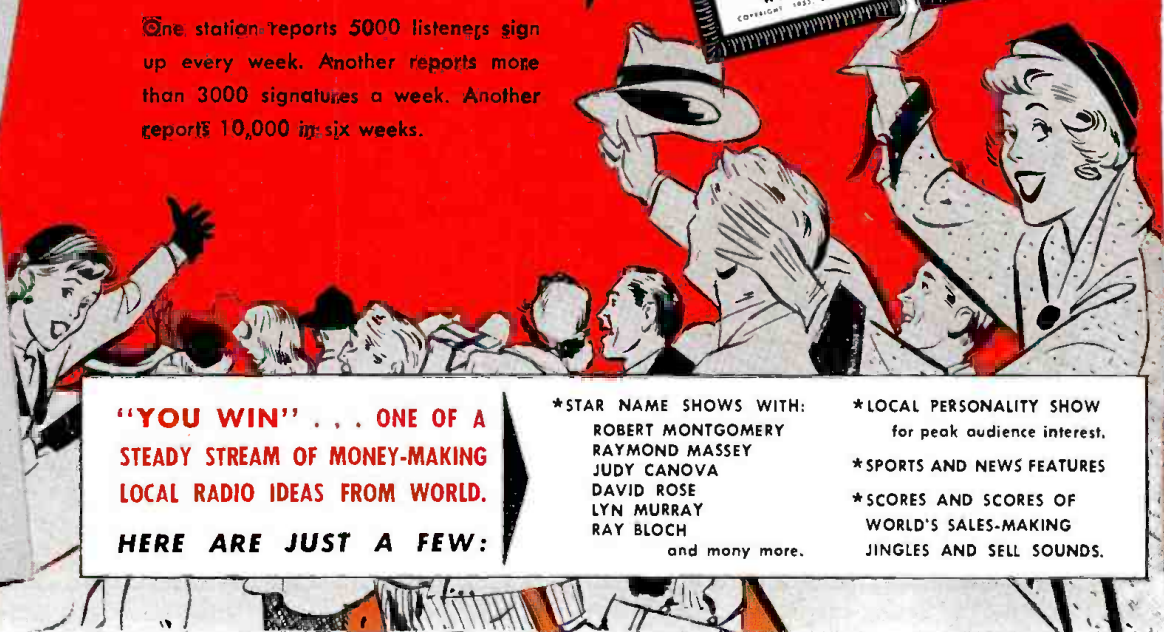

"YOU WIN" . . . ONE OF A STEADY STREAM OF MONEY-MAKING LOCAL RADIO IDEAS FROM WORLD. HERE ARE JUST A FEW:

- *STAR NAME SHOWS WITH:
ROBERT MONTGOMERY
RAYMOND MASSEY
JUDY CANOVA
DAVID ROSE
LYN MURRAY
RAY BLOCH
and many more.
- *LOCAL PERSONALITY SHOW for peak audience interest.
- *SPORTS AND NEWS FEATURES
- *SCORES AND SCORES OF WORLD'S SALES-MAKING JINGLES AND SELL SOUNDS.

\$7113.64
ANNUAL NET FROM "YOU WIN"
PROJECTED BY
WGET
GETTYSBURG, PA.
42 spot participations
weekly. Income for 13 weeks
already more than cost of
entire World Service for year.

\$7800
ANNUAL NET FROM "YOU WIN"
FOR
KWBW
HUTCHINSON, KANSAS
8 participating advertisers
including Admiral Radio &
Television. Net for 13 weeks
more than covers cost of en-
tire Service for year.

\$3276
ANNUAL NET FROM "YOU WIN"
PROJECTED BY
KRHD
DUNCAN, OKLAHOMA
20 participating advertisers
including Philco, Sinclair,
MacGregor, Rexall, Texaco,
Westinghouse Appliances.
Profit in 26 weeks more than
pays cost of entire Service
for year.

\$5200
ANNUAL NET FROM "YOU WIN"
SAYS
WHLM
BLOOMSBURG, PA.
8 participating advertisers
including Standard Plumb-
ing, Pittsburgh Inter-Lock
Tile. Annual revenue pro-
jects to more than 3 times
annual cost of entire Service.

\$4056
ANNUAL NET PROFIT TO
COME FROM "YOU WIN"
SAYS
KROX
CROOKSTON, MINN.
52-week contracts with 18
participating advertisers.
Profit is more than 2½ times
cost of entire Service for
year.

\$3120
ANNUAL NET FROM "YOU WIN"
FOR
KYOU
GREELEY, COLORADO
Ten participating advertisers
including Coco-Cola. Pro-
jected revenue amounts to
twice the cost of the entire
Service for one year.

CANADA, TOO, IN
ON "YOU WIN" MONEY!
Home Provisioners Limited of
Canada sponsors "You Win"
profitably on
CFAC, CALGARY
CJCA, EDMONTON
CJOC, LETHBRIDGE
CHAT, MEDICINE HAT

GO WITH WORLD!

You Win!

BIG NATIONAL ADVERTISERS SPONSOR "YOU WIN"

- Westinghouse Appliances
- Coco-Cola
- Necchi
- Sherwin-Williams Paints
- Philco TV
- Pittsburgh Inter-Lock Tile
- Standard Plumbing
- Admiral Radio & Television
- Texaco Gas & Oil
- Rexall Drug Products
- MacGregor Sports Wear
- Sinclair Gas & Oil
- Gruen
- Bulova
- Dodge Motors
- Canada Dry

The EXCITING, EXCLUSIVE, NEW half-hour telephone quiz series!

Just one of hundreds of the profit-making World features!



WORLD
SALES AND
PROGRAM SERVICE
WORLD BROADCASTING SYSTEM, INC.
488 Madison Avenue, New York 22, New York
INCINNATI An Affiliate of The Frederic W. Ziv Company HOLLYWOOD

CANADIAN REPRESENTATIVES . . . ALL-CANADA RADIO, FACILITIES LIMITED, VICTORY BUILDING, TORONTO

Clip and
Mail NOW!

WORLD BROADCASTING SYSTEM, INC.
488 Madison Avenue
New York 22, N. Y.

Please rush all the facts on your money-making program and sales service. No obligation.

STATION MANAGER _____
RADIO STATION _____
STREET ADDRESS _____
CITY _____ ZONE _____ STATE _____

PROGRAM PRODUCTION SERVICES

U

GEORGE ULLMAN AGENCY
8978 Sunset Blvd., Hollywood 48, Calif., Tel.: Crestview 4-5238; George Ullman, owner.
Services: Scripts, package programs, talent.

UNITED FILM & RECORDING STUDIOS INC.
301 E. Erie St., Chicago 1, Ill., Tel.: Superior 7-9114; William L. Klein, president-executive producer.
Services: Recording, program production, package programs.

UNITED SOUND SYSTEMS
5840 Second Ave., Detroit 2, Mich., Tel.: Trinity 1-2570; James V. Siracuse, owner.
Services: Recording, syndicated transcriptions.

UNIVERSAL BROADCASTING SYSTEM
17 E. 48th St., New York 17, Tel.: Plaza 5-1127; Lincoln A. Mayo, general manager.
Services: Program production, syndicated transcriptions.

UNIVERSAL RADIO PRODUCTIONS
105 N. 5th St., Phoenix, Ariz., Tel.: Alpine 2-9536; John Perica Jr., manager.
Services: Program production, scripts, package programs.

UNIVERSAL RECORDERS INC.
6757 Hollywood Blvd., Hollywood 28, Calif., Tel.: Hollywood 9-8282; Roger Le Font, general manager.
Services: Recording, program production, syndicated transcriptions, package programs, scripts, talent.

UNIVERSAL RECORDING CORP.
111 E. Ontario St., Chicago 11, Ill., Tel.: Michigan 2-6465; Milton T. Putnam, president.
Service: Recording.

UNUSUAL FEATURES SYNDICATE
333 N. Michigan Ave., Chicago 1, Ill., Tel.: Ravenswood 8-0780; Dean Schaefer, owner.
Services: Program production, syndicated transcriptions, scripts, package programs.

UPPER ROOM RADIO PARISH
1908 Grand Ave., Nashville 5, Tenn.; Tel.: 7-7300; Harold L. Hermann, public relations director.
Services: Religious syndicated transcriptions

U. S. RECORDING CO.
1121 Vermont Ave., N. W., Washington 5, D. C., Tel.: Lincoln 3-2705; Joseph Tait, general manager.
Services: Recording, program production, package programs, talent.

V

THOMAS J. VALENTINO INC.
150 W. 46th St., New York 36, N. Y., Tel.: Circle 6-4675; T. J. Valentino, president.
Services: Recording, transcriptions, package programs, master pressing transcriptions and commercial phonograph records.

VIDICAM PICTURES CORP.
240 E. 39th St., New York 17, N. Y., Tel.: Murray Hill 6-3310; Alfred Justin.
Services: Recording.

CHICK VINCENT CO.
509 Madison Ave., New York 22, N. Y., Tel.: Eldorado 5-0734; Chick Vincent, director-producer.
Services: Recording, program production, syndicated transcriptions, package programs.

OWEN VINSON & CO.
803 19th St., (P. O. Box 111), Santa Monica, Calif., Tel.: Exbrook 5-1305; Owen Vinson, owner.
Services: Program production, scripts, package programs.

J. FRANKLYN VIOLA
152 W. 42d St., New York 36, N. Y., Tel.: Chickering 4-3254; J. Franklyn Viola, president.
Services: Recording, production, English and foreign language shows.

VOELER PRODUCTIONS INC.
1052 Carol Dr., Hollywood 46, Calif., Tel.: Crestview 4-6253; Will H. Voeller, president.
Services: Program production, syndicated transcriptions, package programs.

Washington 7, D. C.—3409 Fulton St., N. W.; Tel.: Kellogg 7-1968; George Hughes, vice president.

VONNA PRODUCTIONS INC.
1040 N. Las Palmas Ave., Hollywood 28, Calif., Tel.: Hollywood 4-0841; Eddison von Ottenfeld, president.
Services: Recording, program productions, talent, syndicated transcriptions, scripts, package programs.

New York—419 W. 54th St., Tel.: Judson 2-3791; Peter M. Rogers.

Washington (D. C.)—1121 Vermont Ave., N. W.; Wynn Adams.

W

RADIO STATION WAIM
1 Martin St., Anderson, S. C., Tel.: 3800-01; Glenn P. Warnock, general manager.
Services: Syndicated transcriptions.

WEINHOLD INC.
(Div. of Columbia Artists Management)
113 W. 57th St., New York 19, N. Y., Tel.: Circle 7-6900.
Services: Musical artists' management.

RUPE WERLING
Hidden Haven, Chalfont, Pa., Tel.: Lexington 707; Rupe Werling.
Services: Program production, scripts.

WESTERN RECORDERS
6000 Sunset Blvd., Hollywood 28, Calif., Tel.: Hollywood 3-6811; H. Dixon McCoy, owner.
Services: Recording.

RADIO STATION WFAA
1122 Jackson St. Dallas 2, Texas, Tel.: Riverside 9631; Alex Keese, manager.
Services: Recording.

Z

WIEDERHOLD RECORDING STUDIO
404 Norton Bldg., Louisville 2, Ky., Tel.: Jackson 7808; George Wiederhold, owner.
Services: Recording, program production, scripts, talent.

WLS ARTIST BUREAU
1230 Washington Blvd., Chicago 7, Ill., Tel.: Monroe 8-9700; George Ferguson, manager.
Services: Package programs, talent (represents WLS Chicago artists).

RADIO STATION WOKY
704 W. Wisconsin, Milwaukee 3, Wis.; Tel.: Broadway 1-8428; Mel Bartell, station manager.
Service: Recording.

WOLF ASSOC. INC.
420 Madison Ave., New York 17, N. Y., Tel.: Plaza 5-2050; Edward Wolf, president.
Services: Program production, package programs.

WOR ENTERTAINMENT BUREAU
1440 Broadway, New York 18, N. Y., Tel.: Longacre 4-8000; Nat M. Abramson, manager.
Services: Club dates and cruises, etc.

WOR RECORDING STUDIOS
1440 Broadway, New York 18, N. Y., Tel.: Longacre 4-8000; John B. Hayes, manager.
Services: Recording (disc and tape), program production, talent.

WORLD BROADCASTING SYSTEM INC.
489 Madison Ave., New York 22, N. Y., Tel.: Murray Hill 8-4700; Robert W. Friedheim, vice president; Pierre Weis, general manager.
Services: Recording, syndicated transcriptions, transcribed library service.
Cincinnati 6—1529 Madison Rd., Tel.: Plaza 1323; Leo Gutman, advertising director.
Los Angeles 4—5255 Clinton St., Tel.: Hollywood 3-1521; Herbert Gordon, vice president for radio production.

WYNN WRIGHT ASSOC.
17 W. 57th St., New York 19, N. Y., Tel.: Plaza 3-4417; Charles Granow, manager.
Services: Package programs.

WRIGHT-SONOVOX INC.
6331 Hollywood Blvd., Hollywood 28, Calif., Tel.: Hollywood 9-3614; John T. Abbott, general manager.
Service: Recording.

WRITERAFTER AGENCY
5555 Hollywood Blvd., Hollywood 28; Tel.: Hollywood 7-8608; Carl Coolidge, director.
Service: Scripts, package programs.

FREDERIC W. ZIV CO.
1529 Madison Rd., Cincinnati 6, Ohio, Tel.: Plaza 1323; Frederic W. Ziv, president.
Services: Syndicated transcriptions.
New York 22—488 Madison Ave., Tel.: Murray Hill 8-4700; John L. Sinn, executive vice president.
Los Angeles—5255 Clinton St., Tel.: Hollywood 3-5121; N. L. Rogers, western division manager.

PRODUCTION OF CIVILIAN RADIO SETS — 1922 THROUGH 1953

(Compiled for the 1954 BROADCASTING YEARBOOK by O H. Caldwell, Editor of 'Tele-Tech & Electronic Industries')

Year	Total Civilian Radio Sets Manufactured		Total Receiving Tubes*		Automobile Sets Manufactured		Total Radio Reception Equipment Value	Auto Sets In Use	Homes with Radio Sets	Total Radio Sets in U. S.	At Close of Year	
	Number	Retail Value	Number	Retail Value	Number	Retail Value						
1922	100,000	\$ 5,000,000	1,000,000	\$ 6,000,000	\$ 60,000,000	260,000	400,000	1922	
1923	550,000	30,000,000	4,500,000	12,000,000	151,000,000	1,000,000	1,100,000	1923	
1924	1,500,000	100,000,000	12,000,000	36,000,000	358,000,000	2,500,000	3,000,000	1924	
1925	2,000,000	185,000,000	20,000,000	48,000,000	430,000,000	3,500,000	4,000,000	1925	
1926	1,750,000	200,000,000	30,000,000	58,000,000	506,000,000	5,000,000	5,700,000	1926	
1927	1,350,000	168,000,000	41,200,000	67,300,000	425,600,000	6,500,000	7,000,000	1927	
1928	3,281,000	400,000,000	50,200,000	110,250,000	690,350,000	7,500,000	8,500,000	1928	
1929	4,428,000	600,000,000	69,000,000	172,500,000	842,548,000	9,000,000	10,500,000	1929	
1930	3,827,000	300,000,000	52,000,000	118,800,000	34,000	\$ 3,000,000	496,432,000	12,048,762	13,000,000	1930
1931	3,420,000	225,000,000	53,000,000	69,550,000	108,000	5,940,000	300,000,000	100,000	14,000,000	15,000,000	1931	
1932	3,000,000	140,000,000	44,300,000	48,730,000	143,000	7,150,000	200,000,000	250,000	16,809,562	18,000,000	1932	
1933	3,806,000	180,500,000	59,000,000	49,000,000	724,000	28,538,000	300,000,000	500,000	20,402,369	22,000,000	1933	
1934	4,084,000	214,500,000	58,000,000	36,600,000	780,000	28,000,000	350,000,000	1,250,000	21,456,000	26,000,000	1934	
1935	6,026,800	330,192,480	71,000,000	50,000,000	1,125,000	54,562,500	370,000,000	2,000,000	22,869,000	30,500,000	1935	
1936	8,248,000	450,000,000	98,000,000	69,000,000	1,412,000	69,188,000	500,000,000	3,500,000	24,800,000	33,000,000	1936	
1937	8,084,780	450,000,000	91,000,000	85,000,000	1,750,000	87,500,000	537,000,000	5,000,000	26,668,500	37,800,000	1937	
1938	6,000,000	210,000,000	75,000,000	93,000,000	800,000	32,000,000	350,000,000	6,000,000	28,000,000	40,800,000	1938	
1939	10,500,000	354,000,000	91,000,000	114,000,000	1,200,000	48,000,000	375,000,000	6,500,000	28,700,000	45,300,000	1939	
1940	11,890,000	450,000,000	115,000,000	115,000,000	1,700,000	60,000,000	584,000,000	7,500,000	29,200,000	51,000,000	1940	
1941	13,000,000	480,000,000	130,000,000	143,000,000	2,000,000	70,000,000	610,000,000	8,750,000	29,700,000	56,000,000	1941	
1942	4,400,000	154,000,000	87,700,000	94,000,000	350,000	12,250,000	360,000,000	9,000,000	30,800,000	59,340,000	1942	
1943	17,000,000	19,000,000	75,000,000	8,000,000	32,000,000	58,000,000	1943	
1944	22,000,000	25,000,000	85,000,000	7,000,000	33,000,000	57,000,000	1944	
1945	500,000	20,000,000	30,000,000	35,000,000	105,000,000	6,000,000	34,000,000	58,000,000	1945	
1946	14,000,000	700,000,000	190,000,000	200,000,000	1,200,000	72,000,000	900,000,000	7,000,000	35,000,000	60,000,000	1946	
1947	17,000,000	800,000,000	220,000,000	260,000,000	2,500,000	150,000,000	1,100,000,000	9,000,000	37,000,000	66,000,000	1947	
1948	16,000,000	700,000,000	200,000,000	230,000,000	2,800,000	200,000,000	950,000,000	11,000,000	40,000,000	74,000,000	1948	
1949	10,000,000	500,000,000	200,000,000	350,000,000	3,500,000	240,000,000	1,500,000,000	14,000,000	42,000,000	81,000,000	1949	
1950	14,600,000	721,000,000	385,000,000	644,000,000	4,780,000	248,000,000	2,800,000,000	17,000,000	45,000,000	90,000,000	1950	
1951	13,000,000	605,000,000	490,000,000	840,000,000	4,450,000	236,000,000	3,000,000,000	20,000,000	45,650,000	107,250,000	1951	
1952	10,000,000	500,000,000	330,000,000	740,000,000	2,500,000	135,000,000	3,300,000,000	25,000,000	48,000,000	114,000,000	1952	
1953	13,400,000	536,000,000	410,000,000	920,000,000	4,800,000	250,000,000	3,600,000,000	28,000,000	48,000,000	120,500,000	1953	

*Total tubes include those used in tv. Replacements accounted for about 25% in 1952.
 *Figures for sets include value of tubes in receivers. In recent years (except 1942 to 1946), replacement tubes have run 25% to 40% of total tube sales. All figures are at retail value.
 Note: WFB ordered (April, 1942) all civilian radio-set production stopped and factories converted to war production. Reconversion to civilian-radio production began August, 1945.

ADVERTISING AGENCIES HANDLING RADIO ACCOUNTS

N Network, S Spot, R Regional

A

ACCURATE ADV. AGENCY INC.
9 W. 60th St., New York 23
Tel.: Circle 7-3885

A. D. ADAMS ADVERTISING
277 Broadway
Tel.: Rector 2-6980

Radio Dept.: A. D. Adams, owner.
AD FRIED ADVERTISING AGENCY
318 15th St., Oakland 12, Calif.
Tel.: Higate 4-6580

Radio Dept.: Ad Fried, radio director, owner, producer; Phyllis Rose, timebuyer, producer; Elaine Fried, musical director, librarian, producer; Gerhard Jacobi, art & production director, producer.

Radio Accounts: American Upholstering Co. (R-S); Bell Smoked Fish Co. (Tara Bell Brand) (S); Cohran & Celli Chevrolet Dealers (R); Commercial Sales Co. (R); Davi Miracle Foam; Betty Elizabeth Shampoo; Henry deLugach Real Estate (R); Morwear Paint Co. (Morwear Brands); Fidelity Roof Co. (R); Rhodes & Jamieson Ltd. (R); Buy-Rite Truck & Equipment Co. (S); The Quiet Hour (N); Lou Winston Co.; Smith Bros. "Mac" compound (R); Oakland Police & Firemen; Oakland Light Opera Assn. (R); Lo-Fare Cab Co. (R); Fox West Coast Theatres; Bower-Smith Co.; Duplex Dean Plan Services (S); Elemen Supreme Formula (vitamins) (N-S); Grimshaw Nurseries (S); Western Gem Co. (S); Dicks Home Furnishers (R); Agalite Bronson Co. (S); Mica-Seal Waterproofing (S); Lake Merrit Hotel; Roto Rooter of Bay Area.

ADVERTISING ENGINEERS CORP.
448 S. Hill St., Los Angeles 13
Tel.: Mutual 5039

Radio Dept.: Feed Bear.

ADVERTISING INC.
1523-31 Central Nat'l Bank Bldg., Richmond 19
Tel.: 3-2809, 3-2800

Radio Dept.: J. Lynn Miller, A. G. Timewell
Richmond 19—416 E. Main St. Tel.: 3-5687.
Radio Accounts: Virginia Electric & Power Co.; Commonwealth Motors Inc.; Virginia Hospital Service Assn.; Virginia Dairy Co.

THE AITKIN-KYNETT CO.
1400 S. Penn Square, Philadelphia 2
Tel.: Rittenhouse 6-7810

Radio Dept.: Paul B. Phillips, radio director; Barclay Hallowell, Sydney Thayer, timebuyers.

R. H. ALBER COMPANY
439 N. Larchmont Blvd., Los Angeles 4
Tel.: Hollywood 9-8273

Radio Dept.: Pauline Hagen, executive vice president and Fred Allen, account executive.
Radio Accounts: Gospel Broadcasting Assn. (N-S); Unity School of Christianity (S).

DON ALLEN & ASSOC.
409 S. W. 13th Ave., Portland 3, Ore.
Tel.: Capitol 9445

Radio Dept.: Everett A. Mitchell, radio director; Don Allen, Irv Walsh, Rolland Gabel, account executives.

Radio Accounts: Benjamin Franklin Fed. Savings & Loan; Windolph Pontiac Co.; Wolf Radio & Electric.

ALLEN & REYNOLDS
1300 Woodmen of the World Bldg., Omaha 2
Tel.: Atlantic 4445

Radio Dept.: Milt Stephan, partner, director of radio; Don B. Amsden and John F. Keiner, assistant directors; Alice Helker, secretary to radio; Helen Prince and Edith M. Holland, copywriters.

Radio Accounts: Carpenter Oil Co.; Federal Land Bank; Northrop-Jones; Omaha Public Power Dist.; P. F. Petersen Baking Co.; Tekseed Hybrid Co.; U. S. Nat'l Bank; Walnut Grove Products; T. H. Maenner Real Estate; Fairmont Foods (institutional div.); Peter Pan Bakery Inc.; Petersen Baking Co.; Bryon Reed Co.; Evans Laundry; Merchants Biscuit Co.; Sides Conditioned Air Co.; Woodman Accident Ins.; Omaha Clearing House Assoc.

ALLIED ADVERTISING AGENCIES INC.
187 S. Vermont Ave., Los Angeles 4
Tel.: Dunkirk 7-7331

Radio Dept.: Dick Gardner, radio director; W. F. Gardner, Milton Hoffman, Stuart Heine-mann.

Radio Accounts: Dr. F. E. Campbell; Pridham Davis; Fisher's Compression Seal; Paradise Theatre; Podolor Motors; Harold A. Sparling; West Pico Furniture; Standard Motor Rebuilders; Stylart Card Co.; United Sporting Goods; Angelus Funeral Home; Arden Farms Co.; Gold's Furniture-Appliances.

ALLIED ADV. AGENCY INC.
100 Boylston St., Boston 16
Tel.: Hubbard 2-4100

Radio Dept.: Howard Shamban; Marc F. Shamban.

Radio Accounts: Beacon Wax (N-S).
ALTMARI ADV. AGENCY INC.
20 Vesey St., New York 7

Tel.: Digby 9-1510
Radio Dept.: Michael Altomari, radio director, timebuyer, account executive.
Radio Accounts: Rainbow Greeting Cards, Manhattan Greeting Cards.

ANDERSON & CAIRNS
488 Madison Ave., New York 22
Tel.: Murray Hill 6-5800

Radio Dept.: Victor Seydel, radio director and chief timebuyer; Jean Simpson, asst. director and timebuyer.

Radio Accounts: Rootes Motors; Nat'l Home Furnishings Show; Thom McAn; Baldwin Piano; Martinson's Coffee; Rye-King.

ANTHRACITE ADVERTISING AGENCY
415 Scranton Times Bldg., Scranton 3, Pa.
Tel.: Diamond 7-9328

Radio Dept.: Lawrence L. Russoniello; I. L. Dalley, timebuyer.

Radio Accounts: Parodi Cigars Inc.; Williams Baking Co.; Simplex Stoker; Moore-Ford.

ARBE AGENCY INC.
Advertising Arts Bldg., Wabash at Brown, Terre Haute, Ind.

Tel.: Crawford 3563
Radio Dept.: W. L. Smith.
JOHN FALKNER ARNOLD & CO. INC.
160 N. 15th St., Philadelphia 9

Tel.: Kingsley 5-8500
ARNOLD & CO. INC.
282 Washington St., Boston 8

Tel.: Richmond 2-1220
Radio Dept.: Arnold Z. Rosoff, Harold Glickman.

Radio Accounts: Foremaid Bra Co.; Roloff's Rest Co.; Colonial Pro. Co.; Equipment Distributors; Mass. Stove Co.; Old Monastery Wines.

ART-COPY ADVERTISING AGENCY
11 Hill St., Newark 2, N. J.
Tel.: Market 2-7115

Radio Dept.: Seymour Steinhardt, radio director & timebuyer; Martin Steinhardt, account executive.

Radio Accounts: Walter Thornton; Pomona Hosiery; Parts Unlimited Stores.

ASSOCIATED ADV. AGENCY INC.
812 First Nat'l Bank Bldg., Cincinnati 2
Tel.: Main 2811

Radio Dept.: S. Malcolm Levy, president; I. C. Levy, secretary-treasurer; W. Wilson Lang, vice president in charge of radio; J. G. Mauplin, radio director; Templeton Briggs, executive vice president.

ASSOCIATED BROADCAST ADVERTISING CO.
1001 N. Western Ave., Los Angeles 38
Tel.: Hollywood 5-0580

Radio Dept.: Edwin T. Porter, Gertrude T. Porter, partners.

Radio Accounts: Kankups; Avalon Catering; Beverly Termite Control; Moss Fabric & Draperies; Summerland Auction House; Figueroa Water & Heater Exchange; True-Drum Brake Shop; Beverly Motors; Carl's Paints; Roy Brummer Enterprises; W. T. Wills Machinery Co.; Whiting Mead Lumber Co.

ATHERTON ADV. AGENCY
8455 Melrose Pl., Los Angeles 46
Tel.: Webster 3-8488

Radio Dept.: Herbert H. Wixson, radio director and timebuyer.

Radio Accounts: Pacific Citrus Products Co.; Acousticon Hearing Aid.

ATHERTON & CURRIER INC.
420 Lexington Ave., New York 17
Tel.: Lexington 2-8795

Radio Dept.: John P. Atherton, radio director; W. T. Tieman, timebuyer.

Toronto—100 Adelaide W. Tel.: Empire 3-5148.
William E. McDonald, manager.

Radio Accounts: Eno-Scott & Bowne; Potter Drug & Chemical.

AUBREY, FINLAY, MARLEY & HODGSON, INC.
230 N. Michigan Ave., Chicago 1
Tel.: Financial 6-1600

Radio Dept.: Gene Fromherz, director of media; Richard Fachheimer, Robert Marley, Earl Hodgson, Leonard Krick, vice presidents; J. T. Aubrey, board chairman; J. J. Finlay, president.

Radio Accounts: Williamson Candy Co. (S); Pay-U Labs.; H & H Cleaner Co.; International Harvester Co. (S).

N. W. AYER & SON INC.
30 Rockefeller Plaza, New York 20
Tel.: Circle 6-0200

Radio Dept.: James E. Hanna, vice president for radio; Thomas J. McDermott, radio plans;

Thomas H. Calhoun, programming; John M. Caldwell, copy chief; G. D. Gudebrod, film; Robert A. Mortenson, sports broadcasting;

Harry L. Smith Jr., radio research; James A. MacDonald, radio traffic; Elga Gamba, billing; Charles M. Wilds, timebuying; Paul F. Kizenberger, Richard S. Bunbury, Helen Hartwig, William P. Crossdale, Joan Rutman, Elaine Sloat, timebuyers.

Hollywood 28—714 Taft Bldg., Tel.: Hollywood 3-4871; Glenhall Taylor, director.

Chicago 3—135 S. LaSalle St.; Tel.: Randolph 6-3458; Roderick Mitchell, director.

Detroit 26—4170 Penobscot Bldg.; Tel.: Woodward 5-3322; James Robertson, director.

Radio Accounts: Atlantic Refining Co.; B. C. Remedy Co.; Reuben H. Donnelley; Gordon Baking Co.; Hawalian Pineapple Co.; Hill Bros. Coffee; Charles E. Hires Co.; Howard D. Johnson Co.; Ill. Bell Tel. Co.; Michigan Bell Tel. Co.; Sheffield Farms Milk Co.; United Air Lines; Regal Shoes Inc.; Chesapeake & Potomac Tel. Co.; Bell Tel. System; Electric Co. Adv. Program; Chesnut Farms; Kiwi Polish Co.; Seabrook Farms Co.

AYLIN ADV. AGENCY
522 Waugh Dr., Houston 19, Tex.
Tel.: Lynchburg 3788

AYRES & ASSOC. INC.
1325 N St., Lincoln, Neb.
Tel.: 2-6928

Radio Dept.: Harry H. Packard, radio director; Warren M. Swanson, W. J. Ayres, William Oliver, account executives; Arthur F. White, timebuyer.

Radio Accounts: Steckley Hybrid Corn Co.; Inter-State Nurseries; Cushman Motor Works; Driftmeyer Pub. Co.; Habco Mfg. Co.; Smith Baking Co.; Danner Mills Inc.; Hill Hatcheries; Hill-Fairchild Feed Co.; Dursorb Co.; Amtel Productions; Dwarries Corp.; Permo Mfg. Co.; Lincoln Service & Supply Co.; House of Bauer.

AZRAEL ADV. AGENCY
1000 N. Charles St., Baltimore 1
Tel.: Lexington 7575

B

BADGER & BROWNING & HERSEY INC.
(See Badger & Browning & Farcher)

630 8th Ave., New York 20
Tel.: Circle 3-719

Radio Dept.: Jack Wilcher, radio director.
BADGER & BROWNING & FARCHER
(see Badger & Browning & Hersey, parent agency)

75 Federal St., Boston
Tel.: Liberty 2-3364

Radio Dept.: Jack Wilcher, radio director.
FREDERICK E. BAKER & ASSOC.
Vance Bldg., Seattle 1, Wash.

Tel.: Elliott 0957
Radio Dept.: Peter Lyman, radio director; Patricia Olson, timebuyer.

Radio Accounts: Boeing Airplane Co.; Alaska Steamship Co.; Seattle Chevrolet Dealers; The Bon Marche; Riach Oldsmobile.

LYNN BAKER INC.
745 5th Ave., New York 22
Tel.: Murray Hill 8-3505

Radio Dept.: Mary Bentley, media director; Mary Burak, Lewis Happ, timebuyers; Donald Cutler, E. Sherman Pratt, A. J. Hilton, account executives.

BALDWIN, BOWERS & STRACHAN INC.
374 Delaware Ave., Buffalo 2, N. Y.
Tel.: Madison 6020

Radio Dept.: Everett L. Thompson, radio director; Joseph H. Radder, Leon A. McNamara Jr., Malcolm L. Barney, Catharine D. Walsh, copywriters and producers; Nora L. Cuff, Helen Sengbusch, Elorie Boll.

BALL & DAVIDSON INC.
1030 Speer Blvd., Denver 4
Tel.: Main 1291

Radio Dept.: Carl A. Salstrand, president; Billy D. Prescott, vice president.

Radio Accounts: Bowman Biscuit Co.; The Morey Mercantile Co.; Hugh M. Woods Co.; Howry-Berg Inc.

BARLOW ADV. AGENCY INC.
742 James St., Syracuse, N. Y.
Tel.: 9-8644

Radio Dept.: B. J. Stapleton, radio director; Harry J. Accurso, assistant; J. R. Coleman, H. H. Goodhart, G. F. Swartz, E. R. Crawford, R. K. McCabe; F. B. Thompkins, account executives.

Radio Accounts: Lincoln Bank; C. A. Durr Pkg. Co.; Dairylea; General Electric; Procino & Rossi; Will & Baumer.

BARNES-CHASE CO.
530 S. Broadway, San Diego 1
Tel.: Franklin 7771

Los Angeles 5—3450 Wilshire Blvd.; Tel.: Dunkirk 4-1193

Radio Accounts: Sunset Oil Co.; Biltmore Hotel.
BARNES ADVERTISING AGENCY
312 E. Wisconsin Ave., Milwaukee 2
Tel.: Broadway 6-2393

Radio Dept.: John Barnes, John Barnes III, E. R. Wholihan, Kenneth J. Goelzer, all account executives; Pat Ann Klopatek, radio director; Gilbert Goetz, timebuyer.

Radio Accounts: Marshall & Isley Bank; Roundy's Inc.; Wisconsin Ice & Coal; Interstate Bakeries; Williams Chemical; Marquette U.; Kingsbury Breweries; Otto L. Kuehn Co.; Wisconsin Auto Racing Assn.; J. J. Jones Co.; Super Seal.

AGENCIES

TED BATES & CO.
630 5th Ave., New York 20
Tel.: Judson 6-0600
Radio Dept.: James C. Douglass, radio director;
John Doherty, business manager; Vincent
Rowe, new program director; Jay Clark,
Allan Dingwall Jr., Edward Brown, pro-
ducers; Ned Midgley, timebuying manager;
Christopher Lynch, MacDonald Dunbar, Wil-
liam J. Kennedy, Al Petcavage, Frank Mc-
Cann, Jack McCarthy, Michael James, Win
Kirchert, timebuyers.

Hollywood 28-1680 N. Vine St.; Tel.: Hollywood
9-2161; R. Austin Peterson, partner in charge
of radio; Frank O'Connor, Henry Saz, pro-
ducers.

Radio Accounts: Colgate-Peet Co.; Continental
Baking Co.; Brown & Williamson Tobacco
Corp.; American Home Foods Products;
Carter Products; Minute Maid Corp.; Stand-
ard Brands Inc.; Pillsbury Mills Inc.; Ana-
hrist Co.; American Sugar Refining Co.; Can-
trell-Cochrane Corp.; CBS-Columbia Inc.;
Grocery Store Products.

**BATTEN, BARTON, DURSTINE & OSBORN
INC.**
383 Madison Ave., New York 17
Tel.: Eldorado 5-5800
Radio Dept.: Arthur Pryor Jr., vice president in
charge; James Bealle, in charge of new
program developments; Carol P. Newton,
vice president, chairman of radio plans board;
Arthur Bellaire, head, radio copy; Fred Bar-
rett, vice president in charge of media; Frank
Silvernail, radio network operations; Tucker
Scott, coordinator; Elenore Scanlan, Fred
Stoutland, Robert Tatum, George Polk, time-
buying supervision; Hope Martinez, Mary
Ellis, Ted Wallower, Richard McKeever,
timebuyers; Jim Brown, promotion-public-
ity.

Boston 16-1220 Statler Office Bldg.; Tel.: Hub-
bard 2-0430; F. W. Hatch, vice president.

Buffalo 3-3 Rand Bldg.; Tel.: Cleveland 7915;
Alan M. Ward, vice president.

Chicago 11-919 N. Michigan Ave.; Tel.: Superior
9-7200; H. H. Haupt, vice president.

Cleveland 13-Terminal Tower; Tel.: Tower
1-7270; E. E. Haring, vice president.

Detroit 26-1856 Penobscot Bldg.; Tel.: Wood-
ward 5-0320; R. E. Anderson, vice president.

Hollywood 28-1680 N. Vine St.; Tel.: Hollywood
9-7337; Wayne Tiss, vice president.

Los Angeles 48-6563 Wilshire Blvd.; Tel.: Web-
ster 1-1234; A. W. Neally, vice president.

Minneapolis 2-N. W. Bank Bldg.; Tel.: Lincoln
8401; J. C. Cornelius, executive vice pres-
ident.

Pittsburgh 19-Grant Bldg.; Tel.: Grant 1-8060;
L. D. Hansen, vice president.

San Francisco 4-Russ Bldg.; Tel.: Sutter
1-2232; John G. Motheral, vice president.

Radio Accounts (all network): American To-
bacco Co.; Cream of Wheat; DeSoto Div.,
Chrysler Corp.; George A. Hormel & Co.;
Murine; Rexall Drug Co., Consolidated Cos-
metics; Thomas Nelson & Sons.

BAY PATH ADVERTISING INC.
9 Elm St., Southbridge, Mass.
Tel.: Southbridge 4-8161
Radio Dept.: Maurice L. LaReau, timebuyer &
account executive.

BEAL TELEVISION AGENCY
220 St. James Place, Brooklyn 38, N. Y.
Radio Dept.: Joseph C. Beal.

BEAN ADV. AGENCY
136 N. Delaware St., Indianapolis 4
Tel.: Franklin 4248
Radio Dept.: Harold Bean, timebuyer, account
executive.

Radio Accounts: L. S. Ayres & Co.; Indiana
Tempered Air Inc.; Central Supply Co.; An-
nual Custom Auto Show.

BEAUMONT, HELLER & SPERLING INC.
6th & Walnut Sts., Reading, Pa.
Tel.: 5-4311
Radio Dept.: Dorothea Hassler, radio director.
Radio Accounts: Bowers Battery Co.; Maier's
Bakery; Ontalamee Orchards; St. Lawrence
Dairy Co.; Crystal Rock Bottling Co.; Will-
son Sun Glasses.

HERBERT S. BENJAMIN ASSOCIATES INC.
234 Main St., Baton Rouge, La.
Tel.: 3-2847
Radio Dept.: Allen R. Brent, Lee Herzberg Jr.,
vice presidents.

BENNETT, WALTHER & MENADIER INC.
69 Newbury St., Boston 16
Tel.: Kenmore 6-3820-1-2
Radio Dept.: Mrs. Elizabeth D. Parsons, media
director.

BENTON & BOWLES INC.
444 Madison Ave., New York 22
Tel.: Murray Hill 8-1100
Radio Dept.: L. T. Steele, administrative vice
president; Tom McDermott, vice president in
charge of radio programming; William E.
Schneider, business manager; Cecilia Mul-
rooney, asst. to the business manager; Paul
Roberts, director of radio production; Oliver
Barbour, Maximilian Bryer, Douglas Burch,
Ralph Starr Butler Jr., Carl Eastman,
Charles Fisher, Arthur Richards, Wilfred S.
Roberts, Irwin Segelstein, Elizabeth Shay,
Donald Wallace, Lawrence White, directors.

Hollywood 28-6253 Hollywood Blvd., Tel.: Hol-
lywood 4-9141; Al Kaye, vice president in
charge of West Coast operations; Murray
Eolen, program director; Mary Edith Stahl,
office manager.

Radio Accounts: American Express Co. (Travel-
ers Cheques, Money Orders); Assn. of

American Railroads; Benson & Hedges (Par-
liament Cigarettes); Best Foods Inc. (Helli-
man's and E. F. Mayonnaise, Salad Oil,
French Dressing, Old Homestead, French
Dressing and Sandwich Spread, Nucoa Mar-
garine, H-O Quick Oats, H-O Enriched Cream
Farina, Presto Cake Flour); Brewing Corp.
of America (Carling's Red Cap Ale); Con-
tinental Oil Co. (Conoco Petroleum Pro-
ducts); Crosley Div. AVCO Mfg. Corp. (Shelva-
dor Refrigerators, Shelvador Freezers, Electric
Ranges, Automatic Washers and Dryers,
Complete Electric Kitchens, Sinks, Food
Waste Disposers, Dishwashers, Water Heaters,
Room Air Conditioners); Diamond Crystal
Salt Co.; Diamond Match Co. (Toilet Tissues,
Waxed Paper, Matches (book & box); French
Government Tourist Office; General Foods
Corp. (Maxwell House Coffee, Instant Max-
well House Soluble Coffee, Yuban Coffee,
Bliss Coffee, Post's 40% Bran Flakes, Post's
Sugar Crisp, Post-Tens, Post's Raisin Bran,
Post's Individual Treats, Baker's Chocolate
Products, Log Cabin Syrup, Gaiens Dog
Food, Certo, Sure-Jell, Maxwell House Tea);
M&R Dietetic Lab. Inc., Food Products Div.;
Norwich Pharmaceutical Co. (Pepto-Bismol, Un-
guentine, Norwich Aspirin); Pepperell Mfg.
Co. (Sheets, Blankets); Procter & Gamble
Co. (Ivory Snow, Tide, Fluffo, Prel Sham-
poo, Camay, Zest, Pert).

BERMINGHAM, CASTLEMAN & PIERCE INC.
136 E. 78th St., New York 16
Tel.: Lexington 2-7550
Radio Dept.: John H. McNeil, radio director;
James G. Walker and Herbert Lorentzen,
account executives.

Radio Accounts: Griffin Mfg. Co. (S); Pilgrim
Laundry; Dif Corp. (S); Wilson Co.; J. B.
Williams Co. (S).

TED BERNSTEIN ASSOCIATES
51 Madison Ave., New York 10
Tel.: Murray Hill 5-3730
Radio Dept.: Sylvester J. Bernstein, timebuyer
and radio director.

BOB BETTS ADVERTISING
1st Nat'l Bank Bldg., Denver 2
Tel.: Main 6782
Radio Dept.: John F. Connors, radio director
and timebuyer.

Radio Accounts: Frontier Refining Co.; Maple-
crest Turkey Farms Inc.; Carlson-Frink Co.;
Denver Dairy Council; Stone Hall Co.; Delta
Canning Co.; Green Thumb Peat Moss; Alba
Dairy; Nevada Dairy.

BEN BEZOFF & CO.
220 Majestic Bldg., Denver 2
Tel.: Alpine 2300

LEE S. BIESPIEL ADV.
605 N. Michigan Ave., Chicago 11
Tel.: Delaware 7-4190
Radio Dept.: Lee S. Biespiel, A. C. Norton.
Radio Accounts: Burton Mfg. Co. (S); She-
ler Mfg. Co. (S).

RALPH BING ADVERTISING
306 Frederick Bldg., Cleveland 15, Ohio
Tel.: Superior 1-2773
Radio Dept.: Ralph S. Bing, radio director;
Nancy Shattenfeld, account executive; Thom-
as Friedman.

Radio Accounts: Al Strat Grotto Circus; Blaus-
hild Motors; Ace Cigarette Service; Blaus-
hild's Chrysler-Plymouth Hq.; A. D. Pelunis
DeSoto; Meisel Mercury; Democrat Hdq.

BIOW CO. INC.
640 5th Ave., New York 19
Tel.: Plaza 9-1717
Radio Dept.: Roy Winsor, vice president in
charge of radio; J. E. Kucera, head time-
buyer; Henry White, manager of radio dept.
Hollywood 28-1606 N. Argyle; Tel.: Hollywood
3-2377; Edward Feldman, Mary Morris, radio
directors.

San Francisco 3-703 Market St., Tel.: Garfield
4854.

BLAINE-THOMPSON CO. INC.
234 W. 44th St., New York 36
Tel.: Longacre 4-0800
Radio Dept.: Franklin Hobbs, director; Ingram
Ash, timebuyer.
Radio Accounts: Warner Bros. Motion Pictures;
Joe Lowe Corp.

FRANK L. BLUMBERG AGENCY
800 Cathedral St., Baltimore 1
Tel.: Mulberry 6672
Radio Dept.: Horace J. Elias, radio director.
Radio Accounts: Kress Farm Dairy; Annapolis
Dairy; Park Circle Motor Co.; Herman's
Dept. Store; American TV Service.

FRED BOCK ADV. CO.
Second Nat'l Bldg., Akron 8
Tel.: Portage 4616
Radio Dept.: John Simpson, radio director; Fred
Bock, Pearl Fairall.
Radio Accounts: Home Food Stores; Betsy Ross
Coffee; Souvenir Beer; M&B Fruit Juices;
Vickers Trailers; Evans Savings; Bissler
Furniture; City Bakery; Dettling Seeds; Ohio
Edison Co.

BILL BONSBIE ADV. AGENCY
1717 E. Colfax Ave., Denver 6
Tel.: Florida 4418
Radio Dept.: William F. Angelos Jr., radio direc-
tor; Jay Tallant, Victor Boccard, account ex-
ecutives.

Radio Accounts: Chemical Corp. of Col.; A. D.
Jones & Co.; McCollum-Law Corp.; Bay
Petroleum Co.; Irrigation Systems Inc.

BOTSFORD, CONSTANTINE & GARDNER
115 Southwest Fourth Ave., Portland 4, Ore.
Tel.: Atwater 9541
Seattle 4-Central Bldg. Tel.: Eliot 3523.
New York 1-5122 Empire State Bldg. Tel.: Bry-
ant 9-4845.
San Francisco 5-625 Market St. Tel.: Exbrook
2-7565.

LEO P. BOTT JR. ADV.
64 E. Jackson Bldg., Chicago 4.
Tel.: Harrison 7-9187
Radio Dept.: M. Donald Foran, timebuyer.

LEO BOULETTE AGENCY
303 N. Main St., Three Rivers, Mich.
Tel.: 3-4155

BOURNE ASSOC. INC.
60 E. 42d St., New York 17
Tel.: Vanderbilt 6-1423
Radio Dept.: Victor Arden, radio director.

STANLEY G. BOYNTON & SON
159 Pierce St., Birmingham, Mich.
Tel.: Jordan 4-5888 (Birmingham); Midwest
4-2346 (Detroit).
Radio Dept.: S. G. Boynton, president and ac-
count executive; S. G. Boynton Jr., vice
president, account executive and timebuyer;
S. M. Boynton, traffic and production man-
ager; A. E. Kennedy, continuity.

BOZELL & JACOBS INC.
510 Electric Bldg., Omaha 2
Tel.: Jackson 8030
Radio Dept.: Morris Jacobs, president; F. C.
Miller, executive vice president.
Chicago-205 N. LaSalle St.; Tel.: Central 6-0870;
Philip Rouda, vice president, radio director;
Gertrude Ruskov, timebuyer; Anthony
Jacobs, writer-producer.
Indianapolis 2-1812 N. Meridian; Tel.: Wabash
4524.
Seattle 4-2123 Smith Tower; Tel.: Main 0145.
New York 38-2 W. 45th St.; Tel.: Murrayhill
7-6210.
Minneapolis-625 Second Ave.; Tel.: Main 4527.
Shreveport, La.-324 Fairfield Bldg.; Tel.: 3-6124.
Hollywood 28-6711 Sunset Blvd.; Tel.: Holly-
wood 5-3083; Archie Jacobs, manager.
Houston 2-703 United Gas Bldg.; Tel.: Fairfax
4108.
Dallas 1-813 Thomas Bldg.; Tel.: Randolph
5428.
Washington 5-711 14th St.; Tel.: Sterling 3-2406.
Kansas City-1016 Baltimore Bldg.
Radio Accounts: Leaf Brands; Pollyanna Town
& Country (S); Postal Finance Corp.; North-
western Telephone Co.; District Nat'l Bank;
Central Nat'l Bank; Coronet Sales Club;
Augusta Bedding Co.; Central Illinois Electric
& Gas Co.; Serta Co.; Pfaff Sewing Machine
Co.

ARTHUR BRAITSCHE ADV.
15 Westminster St., Providence 3.
Tel.: Dexter 1-5313
Radio Dept.: Arthur Braitsch, director; John
A. Lorimer, timebuyer; Frances Goodwin,
secretary.
Radio Accounts: Baird-North, Inc.; Roger Wil-
liams Savings; Weynosset Markets; Strand
Theatre; Sally's Fur Studio; Hospital Trust
Co.; Palladium Ballroom; Goggin Motors;
G. H. Walker; Ojaco Paint; Mule Batteries.

MICHAEL BRAND ASSOC.
8820 Sunset Blvd., Hollywood 46
Tel.: Crestview 6-2991
Radio Dept.: Michael Brand, radio director.

J. CARSON BRANTLEY ADV. AGENCY
Owen Building Salisbury, N. C.
Tel.: 900
Radio Dept.: J. Carson Brantley, radio director;
June C. Brantley, assistant radio director.
Radio Accounts: Duke Power Co. (S); Owen
Drug Co.; Carolina Beverage Corp.; Isen-
hour Brick & Tile Co.

BREIG ASSOC.
1715 Walnut St., Philadelphia 3
Tel.: Rittenhouse 6-3836

BRENNAN ADV. AGENCY
1414 W. Clay, Houston 19
Tel.: Madison 2311
Radio Dept.: Hazel Reed, director

BRUCE B. BREWER & CO.
900 Walnut St., Kansas City 6, Mo.
Tel.: Harrison 4890
Radio Dept.: Jack Kirwan, radio director and
account executive.
Minneapolis 2-400 Foshay Tower; Tel.: Atlantic
7314; Charles R. Strotz, manager; Loy M.
Booton and Warren Michael, account ex-
ecutives.
Radio Accounts: Fautless Starch Co. (N-S);
Katz Drug Co. (S); Nutrena Mills (S); Ocoma
Foods Co. (S); Lan-O-Sheen Inc. (S); Min-
neapolis Brewing Co. (S).

BRINDLEY-ROTH INC.
131 Lafayette W., Detroit 26
Tel.: Woodward 1-8295

BRISACHER, WHEELER & STAFF
1680 Bush St., San Francisco 9
Tel.: Prospect 6-2600
Radio Dept.: Richard I. Clark, media director;
Mary Elizabeth Loeber, radio timebuyer;
John Butler, radio producer.

New York 1-350 5th Ave. Tel.: Bryant 9-5600.
Darrell McGain, timebuyer.

Radio Accounts—Pictsweet Food; Van Camp Sea Food; Richmond-Chase; Pacific Intermountain Express; Sacramento Milk Council; Parkmerced Towers; San Francisco Examiner; Wilson & George Meyer; Bay View Federal Savings & Loan; Langendorf United Bakeries Inc.

B-P-I ADVERTISING
350 Madison St., Detroit 26
Tel.: Woodward 5-0909
Radio Dept.: Mary Lee Lippincott, radio director; Lois M. Michels, timebuyer; Lucilla Mack, Patricia Howe, Adele Hager, account executives.

BROADCAST ADVERTISING INC.
8 Newbury St., Boston 18
Tel.: Kenmore 6-0854
Radio Dept.: J. E. Murley, director and account executive; J. J. Manning, timebuyer; F. P. Russell, account executive; E. P. Gieringer, production manager.

BROADCAST ADV.
170 S. Beverly Dr., Beverly Hills, Calif.
Tel.: Bradshaw 2-4840
Radio Dept.: Van C. Newkirk, radio director; Betty Lester, timebuyer; John G. Fryer, account executive.

Radio Accounts: Bible Institute (N-S); Haven of Rest (N-S); The Church of the Open Door; King's Ambassador Broadcast; Messianic Hour; Through the Bible; Morning Chap'l Hour, Caravan to Cannan (N-S); World Vision Inc. (N); World's Greatest Book Quiz.

BROADCAST SERVICE INC.
4601 Gordon Ave., Madison, Wis.
Tel.: 4-5929
Radio Dept.: Richard S. Nickeson, manager; Virginia Green, timebuyer; Lynn Griffy, account executive.

Radio Accounts: Ace of Clubs; C. W. Anderes Co.; Badger Office Supply; C & P Shopping Center; Crescent Clothing; Refrigeration Equipment; Rentschler Floral.

BROOKE, SMITH, FRENCH & DORRANCE INC.
8469 E. Jefferson Ave., Detroit 14
Tel.: Valley 2-9700
Radio Dept.: Hugh Hole, radio director; James P. Danaher, assistant director.

New York 17-52 Vanderbilt Ave. Tel.: Murray Hill 6-1800; Jay Berry, assistant radio director.

Radio Accounts: Gobel Brewing Co.; Hudson Motor Car Co.; Mullins Mfg. Corp. (Youngstown Kitchens); Chamberlin Corp. of America.

BROOKS ADV. AGENCY
416 W. 8th St., Los Angeles 14
Tel.: Trinity 0558
Radio Dept.: Jean Shay, timebuyer, copywriter.
Radio Accounts: Bekins Van & Storage; Western-Holly Ranges.

D. P. BROTHER & CO.
3044 Grand Blvd., Detroit 2
Tel.: Trinity 2-8750
Radio Dept.: Carl Georgi Jr., vice president, timebuyer; Ralph E. Bachman, timebuyer; Kenneth G. Manuel, vice president and radio director; Melvius G. Furney, R. V. Pollock, assistant radio directors.

New York 19-720 Fifth Ave. Tel.: Columbus 5-1004
Radio Accounts: Oldsmobile Div. (N-S), including Guide Lamp, A. C. Spark Plug, Saginaw Steering Gear divisions.

BURTON BROWNE ADV.
619 N. Michigan Ave., Chicago 11
Tel.: Superior 7-7700
Radio Dept.: Burton Browne, president; James Cody, account executive.

FRANKLIN BRUCK ADV. CORP.
1270 Sixth Ave., New York 20
Tel.: Circle 7-7660
Radio Dept.: D. Davidow, director of radio; C. J. Gavin, timebuyer; Franklin Bruck, M. J. Kleinfeld, M. Heineman, H. Gold, account executives.

Los Angeles 4-532 N. Cherokee. Tel.: Hollywood 3-1153. Howard Blake, manager.

Radio Accounts: Sitroux Inc.; Coty Inc.; Fashion Frocks Inc.; Claridge Foods Inc.; Hi-V Co.; North American Accident Ins. Co.; Pines Publications; Yonkers Trotting Assn.; Old Country Trotting Assn.; Russeks, Fifth Ave. Inc., All S.

BUCHANAN & CO. INC.
1501 Broadway, New York 36
Tel.: Bryant 9-7900
Radio Dept.: Nat Strom, radio director; William Dasher, executive vice president; John McEvoy, William Boley, account executives.

Los Angeles 48-451 N. LaCienega Blvd. Tel.: Crestview 5-5293; Charles Coleman, vice president.

San Francisco 4-155 Montgomery St. Tel.: Yukon 6-2927; Ray Randall, vice president.

Radio Accounts—Reynolds Metals Co. (N); Dictograph Prod. Co. (N-S); United Paramount

Theatres (S); Eskimo Pie Corp. (S); Western Airlines (S); Wilbur Clark Desert Inn; Tide-water Associated Oil Co.; Paramount Pictures.

BUCHANAN-THOMAS ADV. CO.
410-412 S. 19th St., Omaha 2
Tel.: Atlantic 2125
Radio Dept.: Adam Reinemund, radio director; Gene Cuddeback, assistant director.

THE BUCHEN CO.
400 W. Madison St., Chicago 6
Tel.: Randolph 8-9305
Radio Dept.: Robert Long, radio director; Martin Fritz, C. W. Fisher, timebuyers; Mary Jane Carry, assistant department manager; John Cole, writer-producer.

Radio Accounts: Club Aluminum Products (N); Fairbanks, Morse & Co. (S); Oliver Corp. (S); Michigan Nat'l Bank; Harnischfeger Corp. (S); L. P. Gas (S).

FRANK BULL & CO.
1239 North Highland Ave., Los Angeles 38
Tel.: Hollywood 5-4194
Radio Dept.: Mel R. Roach, account executive; Rudy Perkal, radio director; Jane T. Darden, timebuyer.

THE BULLARD AGENCY
219 Court St., Port Huron, Mich.
Tel.: Yukon 5-8755
Radio Dept.: Rockwood Bullard.
Radio Accounts: Hein Franck Sons Inc.; Alma Trailer Co.

G. NORMAN BURK INC.
223 4th Ave., Pittsburgh 22
Tel.: Grant 1-6316
Radio Dept.: G. Norman Burk, account executive, director; Dolores E. McCarthy, timebuyer; Robert L. Forsythe, Kenneth Hoel, account executives.

Radio Accounts: Houlaheh Motor Co.; D. J. Kennedy Co.; Meadow Gold Dairies; Midtown Motors Inc.; National Coffee; Standard Floor Co.; United Vacuum Stores; Weitershausen Agency.

LEO BURNETT CO. INC.
360 N. Michigan Ave., Chicago 1
Tel.: Central 6-5959
Radio Dept.: William Weddell, vice president in charge of broadcasting; David Dole, broadcasting operations manager; Lee Bland, program and production director; Glen Heisch, program manager.

New York 22-677 5th Ave. Tel.: Murray Hill 8-9480; W. McIlvain, broadcasting manager.
Hollywood 28-1680 N. Vine St. Tel.: Hollywood 4-7374; W. Williams, broadcasting manager; Gordon Minter, film production supervisor.

Radio Accounts: Brown Shoe Co. (S); Comstock Canning Corp. (S); Dean Milk Co. (S); Globe Mills (S); Green Giant Co. (N-S); Hoover Co. (S); Kellogg Co. (N-S); Chas. Pfizer & Co. (S); Mars Inc. (N); Pillsbury Mills Inc. (N-S); Pure Oil Co. (S); Santa Fe Railway (S); Toni Corp. (N); Procter & Gamble (Lava Soap) (N).

DYER & BOWMAN ADVERTISING AGENCY
68 S. Sixth St., Columbus 15
Tel.: Main 3276
Radio Dept.: John D. Metzger, radio director; Martha Sullivan, radio production manager; Charles Krause, copy director; account executives, Prentiss W. Brown, S. N. Hallock, Willis F. Munro Jr., Reginald Testament, Gus Bowman Sr., Herbert Byer, Matthew McCormick, Herbert Wise, Nick Popa.

Radio Accounts: Ashland Oil & Refining Co.; Buckeye Foods; City National Bank; Styron-Beggs Co.; August Wagner Breweries; Abel Corp.; Columbus Transit Co.; Ohio Fuel Gas Co.; F & R Lazarus Co.; Marzetti's Salad Oils.

BYRUM ADVERTISING AGENCY
924 Broadway, Denver 3, Col.
Tel.: Tabor 7745
Radio Dept.: R. H. Byrum, owner & timebuyer.
Radio Accounts: Denver Gospel Center; Western Seed Co.; Radio Gospel Fellowship.

C

CAHBAT-GILL ADVERTISING AGENCY
194 N. Church St., Tucson, Ariz.
Tel.: 2-6382
Radio Dept.: Sue Plummer, radio director & time buyer. Ernest Cabat, timebuyer.

Radio Accounts: Pioneer Paint; Southern Ariz. Bank & Trust Co.; Burger Sq.; Prell's Broadway Village Drug; Western Hills.

HAROLD CABOT & CO. INC.
136 Federal St., Boston 10
Tel.: Hancock 6-7600
Radio Dept.: Kay Chille, media director; William E. Ganick, Edward F. Chase, James I. Summers, account executives.

Radio Accounts: Boston Consolidated Gas Co.; Boston & Maine E. R.; Boston & Maine Transportation Co.; H. P. Hood & Sons; New England Electric System; New England Telephone & Telegraph Co.; S. S. Pierce Co.; Red Coach Grille.

CAHN-MILLER INC.
510 St. Paul Place, Baltimore 2
Tel.: Saratoga 7-4466
Radio Dept.: Louis J. Fedar Jr., vice president.
Radio Accounts: Eutaw Savings Bank; Fidelity Trust Co.; Jarman Motors; Fraternity Federal Savings & Loan Assn.; Hirsberg Paint Co.; Styleplus Clothes.

CALDWELL, LARKIN & CO. INC.
Merchants Bank Bldg., Indianapolis 4
Tel.: Market 6501

CALKINS & HOLDEN, CARLOCK, McCLINTON & SMITH INC.
247 Park Ave., New York 17
Tel.: Plaza 5-6900
Radio Dept.: Henry F. Hull, radio director.
Chicago 1-383 N. Michigan Ave.; Tel.: Randolph 6-3831; Phillip M. White, manager; Wayne J. Fickinger.

Los Angeles 36-712 S. Curson Ave. Tel.: York 5145; Harry W. Witt, manager.

Radio Accounts: Stokeley-Van Camp Inc. (N); Prudential Insurance Co. of America (N); Marshall Field & Co.; A. S. Harrison Co. (R); Oakite Products Inc. (R); Marcalus Mfg. Co.

J. M. CAMP & CO.
104 Savings & Loan Bldg., Wheaton, Ill.
Tel.: Wheaton 8-4485
Radio Dept.: John M. Camp, owner and timebuyer; Lois Devries, timebuyer; Clarence Benware, account executive.

Radio Accounts: Radio Bible Class (N-S); Young People's Church of the Air (N); Tabor College, Mennonite Hour, Pacific Garden Mission, Christian Amendment Movement, Rock of Ages, Back to The Bible, Moody Church, all S.

CAMPBELL-EWALD CO.
General Motors Bldg., Detroit 2
Tel.: Trinity 2-6200
Radio Dept.: Winslow H. Case, vice president for radio; Joseph J. Hartigan, vice president, media director; H. G. Little, president, account executive.

New York 22-1 E. 57th St. Tel.: Murray Hill 8-3190; Donald E. Benkhart, radio department business manager, account executive; Frank W. Townshend, vice president, manager of New York office.

Chicago 1-230 N. Michigan Ave. Tel.: Central 6-1946; Earl W. Clements, vice president.
Los Angeles 15-714 W. Olympic Blvd. Tel.: Richmond 6204; R. C. Francis, vice president.
San Francisco 4-235 Montgomery St. Tel.: Sutter 1-8736; T. M. Johnston, vice president.
Atlanta 3-45 Edgewood Ave. Tel.: Lamar 3858; C. G. Thom, manager.

Hollywood 28-1680 N. Vine St. Tel.: Hollywood 5-4136; W. H. Case, manager.

CAMPBELL-MITHUN INC.
1370 Northwestern Bank Bldg., Minneapolis 2
Tel.: Lincoln 8824
Radio Dept.: Arthur H. Lund, director; John Cole, timebuyer; Paul Ewing, Rita Arm-

Hey!
MR. TIMEBUYER!



... **STAY SANE LONGER**
by remembering to contact the responsive **BUYING** millions in Southern California through the powerful voice of

KEVD
LOS ANGELES

Represented Nationally by
Joseph Hershey McGillvra, Inc.
New York - Chicago - San Francisco

strong, assistant timebuyers; E. P. Andrews, radio production.
 Chicago—1024 Palmolive Bldg. Tel.: Delaware 7-7553. Minnie Kaplan, timebuyer; Bob Noel, radio production.
 Radio Accounts: Gold Seal (S); Griggs, Cooper (S); Theodore Hamm Brewing (N-S); Land O'Lakes Creameries (S); Northern States Power (S); Our Own Hardware (S); Northwestern Nat'l Bank (S); F. H. Peavy Co. (S); Great Northern R. R. (S) Pillsbury—Ballard (OvenReady-N-S) (Obelisk-S) (Feeds & Soy Div.-S); Zinsmaster Baking Co. (S); Malt-o-Meal Co. (S); American Dairy Assn. (N); Charmin Paper Mills (S); The Larsen Co. (S).
THE CAPLES CO.
 225 E. Erie St., Chicago 11
 Tel.: Superior 7-6016
 Radio Dept.: W. E. Gibson, space buyer; D. J. Bowers, vice president.
 New York 17—535 Fifth Ave. Tel.: Murray Hill 7-3577. S. R. Carlin, radio director; H. F. Meyer, vice president.
 Omaha 2—1504 Dodge St. Tel.: Jackson 7795. L. M. Branch, vice president, J. D. Farris, account executive.
 Los Angeles 5—301 S. Kingsley Dr. Tel.: Dunkirk 7-4255. R. R. Rullman, vice president.
 Radio Accounts: C&NW Railway; Union Pacific Railroad.
CARNEY ADVERTISING AGENCY INC.
 238 W. Wisconsin Ave., Milwaukee 3
 Tel.: Broadway 2-3008
 Radio Dept.: William G. Carney.
 Los Angeles—3757 Wilshire Blvd. Tel.: Dunkirk 2-2301.
CARTER ADV. AGENCY INC.
 912 Baltimore Ave., Kansas City 5, Mo.
 Tel.: Harrison 1356
CAYTON INC.
 9 E. 40th St., New York 16
 Tel.: Lexington 2-1711
 Radio Dept.: William D'Arcy Cayton, account executive; Allan Black, radio director, account executive; Donna Quigley, assistant radio director; Jane E. Nickum and Bea Bader, timebuyers.
 Radio Accounts: Miracle Adhesive Corp. (S); Virginia Metal Products Corp. (S); Young America Films (S).
CECIL & PRESBREY INC.
 247 Park Ave., New York 17
 Tel.: Murray Hill 8-1234
 Radio Dept.: J. Frank Gilday, vice president and radio director; W. C. Patterson, assistant director of radio and executive producer; Harry Farnas, vice president and media director; Herbert Gruber, Charlotte Corbett, Jane Smathers, timebuyers; Leonard Tarcher, account executive and timebuyer.
 Cincinnati—1814 Union Central Bldg.; Tel.: Garfield 5178; R. W. Lowander.
 Radio Accounts: Block Drug (N-S); Electric Auto Lite (N); Nestle Co. (S); Oyster Shell Products Corp. (S); Redtop Brewing Co. (S); Sylvania Electric Products Inc. (S); Union Dime Savings Bank (S); McCormick & Co. (S); Benrus Watch Co. (S); Mennen Co. (S); Seeman Bros. Inc. (S).
W. CRAIG CHAMBERS INC.
 513 Second Ave., Pittsburgh 19
 Tel.: Atlantic 1-4028
 Radio Dept.: W. Craig Chambers, president.
 Radio Accounts: Clearfield Furs; First Federal Savings & Loan Assn.; Marlane Bridal Shop; Potter McCune Co.; Morrison-McCluan; Peters Packing Co.
CHARLES J. CHARNEY ASSOC.
 1819 Broadway, New York 23
 Tel.: Plaza 7-0955
 Radio Dept.: Alvin George, radio director; Charles J. Charney, timebuyer & account executive.
JAMES THOMAS CHIRURG CO.
 414 Park Square Bldg., Boston 16
 Tel.: Hancock 6-7010
 Radio Dept.: Edward B. Pope, media director.
 New York 17—1612 Chanin Bldg., Tel.: Murray Hill 7-5040; R. D. Stuart, vice president.
C. P. CLARK INC.
 James Robertson Hotel, Nashville 3
 Tel.: 6-4179
 Radio Dept.: D. G. Goodwin, account executive and timebuyer; Sara Nolan, copy director; Donald R. Taylor, production manager.
 Radio Accounts: First National Bank.
COE ADVERTISING AGENCY
 307 Townsend St., Syracuse 2, N. Y.
 Tel.: 4-2197.
 Radio Dept.: Smith S. Binning, radio director; William T. Cowie, account executive.
 Radio Accounts: Tedesco Inc.; E. M. O'Donnell Distributors; Grunder & Sons; Jeans Beans Co.; Fairway Packing; Parker Upholstering; Men's Shop in Hotel; Syracuse; Altman & Greene; Park Branch; Typewriter Store; E. W. Edwards & Son; Haberle Congress Brewing; Broome Distributing; Central City Business Institute; E. P. Collins Paint Co.; Dibble's Inn; Rudolph Bros.; Sundure Paint Co.; Town Talk Dairies; Vanderhoof Roofing; Wm. H. Kearney Inc.; Illingworth-Bailey; H. C. Poad Inc.; Westinghouse Electric Supply.
ARNOLD COHAN CORP.
 460 W. 34th St., New York 1
 Tel.: Wisconsin 7-4700
 Radio Dept.: Arnold Cohan, director; Michael Gargiulo, production supervisor; Marvin Haas, copy chief.

HARRY B. COHEN ADVERTISING CO. INC.
 1 East 57th Street, New York 22
 Tel.: Murray Hill 8-3030
 Radio Dept.: Peter Finney, vice president, radio production; Mary Dunlavey, chief timebuyer, media director; Arthur Harrison, timebuyer; account executives: Harry B. Cohen, president; Edward Aleshire, executive vice president; Harry B. Cohen Jr., secretary.
 Radio Accounts: Grove Labs; Chattanooga Medicine Co.; B. T. Babbitt Inc.; Lydia E. Pinkham Medicine Co.; West End Brewing Co.; House of Westmore (Westmore Cosmetics); Lewal Industries Inc. (Instant Dip).
I. T. COHEN ADVERTISING INC.
 1322 New York Ave., N. W., Washington 5, D. C.
 Tel.: Sterling 3-3333
 Radio Dept.: Elizabeth Doyle, radio director; Reuben Cohen, Sidney E. Wolfe, account executives.
RUSSELL C. COMER CO.
 15 W. 10th St., Kansas City 5, Mo.
 Tel.: Harrison 3964
 Radio Dept.: Jon Yost, radio director; Mrs. E. W. Collier, media director.
COMPTON ADV. INC.
 630 5th Ave., New York 20
 Tel.: Circle 6-2800
 Radio Dept.: Lewis H. Titterton, production vice president; Marjorie Irwin, business manager; Floyd Holm, associate director of radio; Henry Clochessy, chief timebuyer.
 Chicago 4—Suite 2142, 141 W. Jackson Blvd.; Tel.: Harrison 7-6933; Lawrence D. Holmberg, vice president, branch manager; Beverly Rowine, radio director.
 Cincinnati 2—Room 720-22, 525 Walnut St.; Tel.: Parkway 6961.
 Hollywood 28—8253 Hollywood Blvd.; Tel.: Hollywood 9-8107; James J. Seaborne, manager.
 Milwaukee 3—744 N. 4th St., Tel.: Broadway 1-9475; Richard Davis, manager.
 Radio Accounts: Procter & Gamble Co. (N-S); Socony Vacuum Oil Co. (S); Standard Brands Inc. (S); M. K. Goetz, Brewing Co. (S); Personal Products Corp. (S); Goodyear Tire & Rubber Co. (S); Campbell Soup Co. (N-S); Whitehall Pharmaceutical Co. (N-S); Kelly-Springfield Tire Co. (S).
THOMAS F. CONROY INC.
 1101 Majestic Bldg., San Antonio 5
 Tel.: Garfield 3456
CO-ORDINATED ADVERTISING CORP.
 9 E. 38th St., New York 16
 Tel.: Murray Hill 9-1440
 Radio Dept.: Lester Wolf, executive producer; Arthur Peltz, director of radio.
 Radio Accounts: Sunrise Food Stores; Pioneer Food Stores; General Baking Co.; Baker Importing Co.; Frederick Lowenfels & Son.
COWAN & DENGLE INC.
 527 5th Ave., New York 17
 Tel.: Murray Hill 2-0940
 Radio Dept.: Thomas H. Moore Jr., radio director.
 Radio Accounts: Vermont Industries of America Inc.; American Agricultural Chemical Co.; Charles P. Rogers Co.; Raytheon Mfg. Co.
CRAIG & WEBSTER ADV. AGENCY
 22 Park Place, Lubbock, Tex.
 Tel.: 2-2314
 Radio Dept.: Rex Webster, account executive.
JOHN GILBERT CRAIG ADV. INC.
 913 Washington St., Wilmington 99, Del.
 Tel.: 5-6185
 Radio Dept.: J. Gorman Walsh, executive vice president; Kathleen A. Walsh, secretary, treasurer and account executive; William H. Gordy, Donald B. Madden, account executives.
 Radio Accounts: Joseph Bancroft & Sons Co.; Brosius & Smedley Co.; H. P. Cannon & Son; Delaware Coach Co.; Delaware Power & Light Co.; Diamond Ice & Coal Co.; Equitable Security Trust Co.; Greenhill Dairies.
THE CRAMER-KRASSETT CO.
 733 N. Van Buren St., Milwaukee 2
 Tel.: Broadway 6-3500
 Radio Dept.: Roger LeGrand, radio director; Loretta Mahar, timebuyer; Ken Hegard, John Pritchard, account executives.
 Radio Accounts: Aitorfer Bros. Co.; Blue Cross; First Federal Savings; Humphrey Chevrolet Co.; Plankinton Packing Co.; Schroeder Hotel System; Ed Schuster & Co.; A. O. Smith Corp.; Wisconsin Telephone Co.
CROOK ADV. AGENCY
 Southwestern Life Bldg., Dallas 1
 Tel.: Riverside 1175
SAMUEL CROOK CO., INC.
 28 W. 44th St., New York 36
 Tel.: Bryant 9-2588
 Radio Dept.: William Dollison, media director.
CUMMINGS, BRAND & McPHERSON ADV.
 409 Gas-Electric Bldg., Rockford, Ill.
 Tel.: 2-0677
CUNNINGHAM & WALSH INC.
 260 Madison Ave., New York 16
 Tel.: Murray Hill 3-4900
 Radio Dept.: General Accounts—John R. Sheehan, Radio director; David P. Lewis, assistant; William White, timebuyer; Liggett & Myers—Norman G. Gort, radio director; Moulton Sawin.
 Hollywood 46—8420 Sunset Blvd.; Tel.: Hollywood 7-6131, William J. Peterson, West Coast manager.
 Radio Accounts: Liggett & Myers Tobacco Co. (N-S); Narragansett Brewing Co. (R-S); Northwest Airlines (S); Colgate-Palmolive-Bet. Co. (S); Italian Line (S); The News (S); Pan American Coffee Bureau (S); Sunshine Biscuits Inc. (S).

DANCER-FITZGERALD-SAMPLE INC.
 (see Dancer-Fitzgerald-McDougal Inc. divi-114 Sansome St., San Francisco 4
 Tel.: Douglas 2-5107
 Radio Dept.: Alvin Kagaber, vice president, director.
 New York—347 Madison Ave., New York 17
 Tel.: Oregon 9-0600
 Chicago 1—221 N. La Salle St.; Tel.: Financial 6-4700; Joe Sample, radio head.
 Hollywood 28—1680 N. Vine St.; Tel.: Hollywood 2-3256; Mr. Kabaker, radio vice president.
 Toronto 1—Dancer-Fitzgerald-Sample (Canada) Ltd. 6 King St., E.; Tel.: Empire 3-2851.
LEONARD DAVIS ADVERTISING
 107 Front St., Worcester 8, Mass.
 Tel.: 7-3617
 Radio Dept.: Leonard Davis, radio director; Marion Davis, timebuyer.
 Radio Accounts: Park Theatre; Reck's Fur Shop; Lubin Clothing; W. T. Grant Co.; (Worcester, Fitchburg, Leominster); R & R Plumbing Supply; Grand View Market; World Pants Co.; Narcus Bros.; Fortin's Market.
ROBERT J. DENNIS ADV. AGENCY INC.
 4584 York Blvd., Los Angeles 41
 Tel.: Albany 2367
 Radio Dept.: Robert F. Dennis.
THE DES AGENCY
 1107 Edwin Lane, Chattanooga, Tenn.
 Radio Dept.: Dale Smith, president and account executive; Elaine Smith, vice president and timebuyer.
 Radio Accounts: (handles per inquiry advertising), "I Shall Not Want"; Redi-Cut dresses; Abraham Lincoln color book; Doc R. C. Anderson, horoscope; K. Costonie; other p. i. accounts.
DEVEREUX & CO. INC.
 266 Genesee St., Utica 2, N. Y.
 Tel.: 3-8295
DIENER & DORSKIND INC.
 147 W. 42nd St., New York 36
 Tel.: Bryant 9-8300
 Radio Dept.: Leo Greenland, director; Harry Pollack, account executive; Larry Seymoure, timebuyer.
DOHERTY, CLIFFORD, STEERS & SHENFIELD INC.
 350 5th Ave., New York 1
 Tel.: Bryant 9-0445
 Radio Dept.: Chester MacCracken, radio director; Frank Dennis, head, commercial writing; account executives: Joel F. Jacobs, Harry M. Ireland, Arthur Menadier, Robert Prentice, Ronald C. Bradley, Robert Hayes; Donald H. Quinn, timebuyer.
 Radio accounts: Bristol-Myers Co. (N-S); The Borden Co. (N-S); Pharmaco Inc. (S).
RALPH L. DOMBROWER CO. INC.
 11 E. Franklin St., Richmond 19
 Tel.: 3-111-3
 Radio Dept.: T. Michaux Moody, talent buyer; Malcolm B. Dombrower, transcription buyer.
 Washington, D. C.—Woodward Bldg.; Tel.: Republic 7-1420; Philip Rosenfeld, manager.
 Radio Accounts: Etichson Hat Co. Inc.; Chesterfield Hat Corp.; Central Nat'l Bank; Thos. C. Slaughter Co.; Bone Dry Fertilizer Co.
DONAHUE & COE INC.
 1270 6th Ave., New York 20
 Tel.: Columbus 5-2772
 Radio Dept.: A. Carl Rigrod, radio director; Evelyn Jones, timebuyer; Charles Patrick, Jack Rosenthal, Oliver A. Kingsbury, Latham Owens, James Ryan, account executives; A. B. Churchill.
 Radio Accounts: River Brand Rice; N. Y. World Telegram & Sun; N. Y. Herald Tribune; Metro-Goldwyn-Mayer; Loew's Theatres Inc.; Republic Pictures; Atlantic Ale & Beer; Brandt Theatres; Monarch Wine Co. (all S.).
W. B. DONNER & CO.
 505 Washington Blvd. Bldg., Detroit 26
 Tel.: Woodward 5-7400
 Radio Dept.: Charles F. Rosen, radio director; Julian A. Grazer, Felix Hower, account executives; Ellen Huser, timebuyer.
 Chicago—Tel.: Dearborn 2-4676; Marvin H. Frank.
 Milwaukee—Tel.: West 3-9315; D. P. MacRae.
 Radio Accounts: Speedway Petroleum Corp.; Feigenson Bros. Co.; Altes Brewing Co.; Hub Appliance Stores; American Savings & Loan Assn.; Richards Drive In Cafeterias; D. W. G. Cigar Corp.; Argo Oil Corp.; Stark Hickey.
DOREMUS & COMPANY
 120 Broadway, New York 5
 Tel.: Worth 4-0700
 Radio Dept.: Edwin R. Rooney Jr., radio director.
 Boston 9—53 State St., Tel.: Lafayette 3-0770. Charles W. Morse, vice president.
 Philadelphia 2—1518 Walnut St. Tel.; Penny-packer 5-4477, Howard York, vice president.
 Chicago 4—208 S. LaSalle St. Tel.: Central 6-9132, Charles C. Greene, vice president.
 San Francisco 8—425 Bush St. Tel.: Yukon 2-4080, Ronald Brindley, vice president.
 Radio Accounts: Kidder, Peabody & Co.; Union Trust Co.; Troy Savings Bank; Calvin Bullock; Wellington Fund; Provident Trust; Penington Colkert; Methodist Radio Soc. of Pa. & N. J.; Seilers Inc.; Estabrook & Co.; R. L. Day & Co.; Boston 5-Cent Savings Bank; Boston Federal Savings & Loan Assn.; Automatic Heating Corp. of America; Diamond Match Co. Pastene Wine & Spirits; American School; Lawn Savings & Loan Assn.; Paul Savings & Loan Assn.; Crocker Nat'l Bank.

JOHN C. DOWD INC.
 (also see Dowd, Redfield & Johnstone Inc., affiliated agency)
 212 Park Sq. Bldg., Boston 16
 Tel.: Hubbard 2-8050
 Radio Dept.: Joseph L. Tully, radio director; Charles M. Bucklin, timebuyer; account executives, Lawrence E. Duane, Robert E. Bouquet, Ernest W. Gross, Gerald D. Roscoe, David R. Lutkins, Edgar R. Emery, E. D. Parent.
 Radio Accounts: Albany Carpet Cleaning Co.; Boston Edison Co.; Boston Globe; Cott Beverage Corp.; Cott Bottling Co.; First Nat'l Stores Inc.; Martin L. Hall Co.; Harvard Brewing Co.; Megowen-Educator Food Co.; House of Old Molineaux; National Co.; Northeast Airlines Inc.; Paine Furniture Co.; Pepsinic Seltzer Inc.; Workingmen's Co-operative Bank.
DOWD, REDFIELD & JOHNSTONE INC.
 (see John C. Dowd Inc.)
 501 Madison Ave., New York 22
 Tel.: Murray Hill 8-1275
 Radio Dept.: Wallace H. Lancton, radio director; Jean M. Gilbon, assistant; Edmund F. Johnstone, A. B. Crampton, Robert I. Angelus, Gene McMasters, Michael van Dore, account executives.
 Radio Accounts: Block Drug Co. (S); Albert Ehlers Inc. (S); Cott Beverage Co. (S); Bristol-Myers Co. (N-S); Dormin Inc. (S); Guardian Chemical Corp. (S).
DUNDES & FRANK INC.
 64 W. 48th St., New York 19
 Tel.: Plaza 7-0750
 Radio Dept.: Ben Frank, radio director.
ROY S. DURSTINE INC.
 730 Fifth Ave., New York
 Tel.: Circle 6-1400
 Radio Dept.: Maria Cayaras, timebuyer; Hubert Wilke, radio producer, director; John Malone, account executive.
 Los Angeles-3440 Wilshire Blvd.; Tel.: Dunkirk 8-3411; William D. Sloan, manager; David W. White, radio director.
 San Francisco-156 Montgomery St.; Tel.: Yukon 6-6917.

E

EASTBURN & SIEGEL
 623 Spring St. N. W., Atlanta
 Tel.: Vernon 4707
 Radio Dept.: Mel Finkel.
ADAM EBY ADVERTISING
 336 Andrews Bldg., Buffalo 2, N. Y.
 Tel.: Madison 2921
 Radio Dept.: Alfred Osborne, account executive.
 Radio Accounts: Chip Steak Co.; Stamford Park Race Track; S. R. Gerber Sausage Co. Inc.; Dewey Michaels Promotions; Ford Dealers of Erie County; Sportsmen's & Boat Show.
ELLINGTON & CO. INC.
 535 5th Ave., New York 17
 Tel.: Murray Hill 7-4300
 Radio Dept.: Hall James, vice president in charge of radio; Dan Kane, business manager, timebuyer; Howard Doyle, radio copy chief; Doris Lustgarten, radio continuity; Kay Woelfel, radio production assistant.
 Radio Accounts: Cities Service Gas & Oil (N); McKesson & Robbins (S); Bayuk Cigars (S); Cadbury Fry Candy (S).
EMERY ADV. CORP.
 2 N. Ave. East, Baltimore 2
 Tel.: Vernon 3731
ROBERT J. ENDERS ADV. INC.
 1001 Connecticut Ave. N. W., Washington 6
 Tel.: Sterling 3-2222
 Radio Dept.: Margot Phillips, radio director; Mary Griffin Jr., copy chief; Anne Merriman, timebuyer; William F. Fitzgerald, Robert L. Friends, Hal Rosen, John Swallow, Rudy Vallee, Howard A. Enders, Robert J. Enders, Eric Smith, account executives.
 Hollywood-6611 Santa Monica Blvd.; Tel.: Hillside 6118; John Swallow, manager.
 New York-270 Park Ave.; Tel.: Plaza 5-4952.
ENTERPRISE ADV. AGENCY INC.
 432 Aliso St., Los Angeles 12
 Tel.: Madison 9-1477
 Radio Dept.: Sander Heyman, president; Donald E. Fawcett, radio manager, Irvin Ashkenazy, copy chief.
 Radio Accounts: Maier Beer.
ALVIN EPSTEIN ADV.
 1407 G St., N. W., Washington 5
 Tel.: Sterling 3-8850
 Radio Dept.: Toni Pearson, radio director, timebuyer; Jean Senter, Juanita Summers, copywriters; Frank Boucher, sales promotion; Jackie Ganz, research; Ruth Grace; Jerome Horwitz, account executives.
 Radio Accounts: Dalton's Finance; Clean-Rite Appl.; Crown Credit Co.; Dailey's Clothiers; Certified TV Service; Louis Bernheimer Theatres; Valley Forge Beer; U. S. Storage Co.; Thompson's Honor Dairy; Thomas Circle Radio & TV Co.; Best Theatres; San Bar Restaurant; Shaw & Shaw jewelers; Sears, Roebuck & Co.; Eli Rubin Co.; Quality Music; Nat'l Pipe & Tobacco Co.; R. Mars Contract Co.; Lloyd's of Connecticut Ave.; Herson's 8 & 9; Gentler Furs; Famous Appliances; Dynamic Music; Dynamic Electronics; Greber Bros. Appliance Distributors.

ERWIN, WASEY & CO. INC.
 420 Lexington Ave., New York 17
 Tel.: Lexington 2-8700
 Radio Dept.: Keith B. Shaffer, radio director; Harold Davis, timebuyer; Dorman Ingraham, Jack Sperzel, Julian Snyder, Walter Holt, William Tirell, account executives.
 Los Angeles 36-5045 Wilshire Blvd.; Tel.: Webster 1-1211; Robert L. Redd, radio director.
 Chicago 1-230 N. Michigan Ave.; Tel.: Randolph 6-4952; L. R. Northrup.
 Minneapolis 2-Rand Tower; Tel.: Atlantic 1233; Mac Martin.
 Oklahoma City 2-First Nat'l Bank; Tel. 7-5429; Harold Halsell.
 Toronto, Canada-1170 Bay St.; Tel.: Randolph 5187; Ralph L. Lawson.
 Montreal, Canada-1121 St. Catherine St.; Tel.: Plateau 9146; Charles Sheppard.
 Radio Accounts: Barbasol Co.; Musterole Co.; Dulany & Son; Consolidated Cigar Corp.; Texas Co.; Zonite Products Corp.; Seeck & Kade Inc.; all S.
BENJAMIN ESHLEMAN CO.
 1522 Locust St., Philadelphia 2
 Tel.: Kingsley 5-2590
WILLIAM ESTY CO. INC.
 100 E. 42d St., New York 17
 Tel.: Oxford 7-1600
 Radio Dept.: Wendell Adams, director; Arline A. Lunny, producer; Harry Martin, business manager; Richard C. Grahl, spot timebuyer.
 Radio Accounts-R. J. Reynolds Tobacco Co. (N-S); Colgate-Palmolive-Peet Co. (N-S); Coca-Cola Bottling Co. (S); Nat'l Carbon Co. (S).
EVANS & ASSOC. ADV.
 9th Floor, Dan Waggoner Bldg., Fort Worth 2, Tex.
EVERLING ASSOCIATES
 1015 Chestnut St., Philadelphia 7
 Tel.: Market 7-2617
 Radio Dept.: Alice L. Mooney, timebuyer & account executive; Frank J. Corkery, account executive.
EXPORT ADV. AGENCY
 919 N. Michigan Ave., Chicago 11
 Tel.: Superior 7-3875
FACTOR-BREYER INC.
 607 S. Hobart Blvd., Los Angeles 5
 Tel.: Dunkirk 8-8111
 Radio Dept.: Bob Carter, radio director; Jean Kelly, copy department; Ted H. Factor, Donald A. Breyer, Stanley Pfaum, account executives; Bernice Levitas, timebuyer.
 Radio Accounts: Farmers Insurance; Mission Pak; Union Mortgage Co.; J. N. Ceazan Co.; Sav-On Drug Stores; Necchi Sewing Machine; Globe Bottling Co.; LeRoy's Jewelers; Sportsmen's Show; Zeeman Clothing Co.; Clyde Beatty Circus; Ringling Bros. Circus.

F

MIKE FADELL ADV. AGENCY
 525 Northwestern Bank Bldg., Minneapolis 2
 Tel.: Atlantic 3416
FEIGENBAUM & WERDEN ADV. AGENCY
 1922 Spruce St., Philadelphia 3
 Tel.: Locust 4-1536
 Radio Dept.: Stanley Goldstein, radio director; David Wermen, Leonard Shore, account executives.
 Radio Accounts: Arrow Store; Old Export Beer; Federal Savings Assns.; Hardwick & Magee; Royalist Cigars; Fox Weis Furs; Booth Bottling; Gaby Suntan; Kasser Distillers; Ke-muzit Home Products.
COURTLAND D. FERGUSON INC.
 315 Nat'l Press Bldg., Washington 4
 Tel.: National 8-7713
 Radio Dept.: George F. Ely Jr., radio director; Dar Shopoff, Stanley Olsen, account executives; Mrs. Nan Hannum, timebuyer.
 New York-45 Rockefeller Plaza. Tel.: Plaza 7-2411. Phil Jackson, manager.
 Richmond-Southern States Bldg.; Tel.: 7-0788. Richard Nall, manager.
LAWRENCE FERTIG & CO. INC.
 149 Madison Ave., New York 16
 Tel.: Murray Hill 9-7100
 Radio Dept.: Joseph Mintzer, radio director and timebuyer.
FIRST UNITED BROADCASTERS
 201 N. Wells St., Chicago 2
 Tel.: Randolph 6-7800
 Radio Dept.: Hugh Rager, managing director; Maryellen Convery, timebuyer.
M. M. FISHER ASSOCIATES
 134 N. LaSalle St., Chicago 2
 Tel.: Central 6-1610
 Radio Dept.: Jack L. Fisher Sr., owner, account executive; Jack L. (Bud) Fisher Jr., co-owner, account executive.
 Radio Accounts: Bell Savings & Loan Assn.; Central Democratic Committee of Cook Cty.; Tam O'Shanter Country Club (gol.); United Artists Corp.; Universal-International Picture Corp.; National Foundation for Infantile Paralysis; Monroe Theatre; Goodman Furniture; Lowebeo Inc. (Wilsolve); Morae Pharmaceutical Co. (Insombutal); Tv Time Popcorn.

FITZGERALD ADV. AGENCY
 Lee Circle Bldg., New Orleans 13
 Tel.: Tulane 3131
 Radio Dept.: Aubrey Williams, radio director; Marie O'Meara, timebuyer.
 Radio Accounts: Wesson Oil & Snowdrift Sales Co. (N); Jackson-Brewing Co. (N); Pan-Am Southern Corp.; Alabama-Georgia Syrup Co.; Blue Plate Foods; Godchaux Sugars Inc.; H. G. Hill Stores Inc.; La. State Rice Milling Co.; La. Power & Light Co.; Jet Dog Food Co., all S.
FLACK ADV. AGENCY INC.
 Hills Bldg., Syracuse 2, N. Y.
 Tel.: 2-3129
RICHARD A. FOLEY ADV. AGENCY INC.
 1528 Walnut St., Philadelphia 2
 Tel.: Kingsley 5-1560
 Radio Dept.: Frank Knight, radio director; Lester Harmon, assistant; Alice Mooney, timebuyer.
 Radio Accounts: Baltimore & Ohio R. R. (S); Abbotts Milk, Ice Cream; Delaware Park Race Track; Beneficial Saving Fund; Burks Pork Products; Silvo Silver Polish; Kliz Dog Candy; French's Bird Seed; Freihofer's Bread; Mrs. Smith's Pies.
FOOD RESEARCH & ADVERTISING
 159 E. Chicago Ave., Chicago 11
 Tel.: Superior 7-6664
 Radio Dept.: Norman E. Kraff, president, media director; J. J. Smythe, radio director.
 Radio Accounts: Macaroni Products Inc.; Jordan Carpet Co.; Chef Michele Foods; Adjustable Steel Post Corp.; Cubette Processors; Guard Graphite Oil Co.
FOOTE, CONE & BELDING
 247 Park Ave., New York 17
 Tel.: Murray Hill 8-5000
 Radio Dept.: Roger Pryor, radio vice president; Thomas M. McDonnell, program development director.
 Chicago 11-155 E. Superior St.; Tel.: Superior 7-4800; Robert Hussey, vice president, media director; Harry Dieter, radio business manager; Genevieve Lemper, timebuyer.
 Los Angeles 17-Statler Center, 900 Wilshire Blvd.; Tel.: Madison 9-3611; George Weaver, media director; Lydia R. Hatton, timebuyer.
 San Francisco 4-235 Montgomery St.; Tel.: Sutter 1-2355; T. Lew A. Jones, media director; Robert Esfeldt, assistant media director.
 Hollywood 28-900 Wilshire Blvd.; Tel.: Madison 9-3611; Edmund L. Cashman, vice president; George Weaver, director of plans; Kenneth V. Moore, media director; Lydia V. Hatton, timebuyer.
 Houston 2-510 Taft; (mail) P. O. Box 4223, Houston 14; Tel.: Justin 5461; Grace Spanhel, timebuyer; Stephen R. Wilhelm, vice president, general manager.
 Portland 4, Ore.-644 Pacific Bldg.; Tel.: Broadway 3732; Leith F. Abbott, manager.
 Montreal 2-925 Dominion Sq. Bldg., 1010 St. Catherine St. W.; Tel.: University 6-8591; Harry K. Hutchins, manager.
 London W. 1-27 Hill St.; Tel.: Mayfair 9181; Brian F. Maccabe, managing director.
 Radio Accounts-General Foods; Liebmann Breweries; New York Central; Lever Bros.; Armour & Co.; Frigidaire Div. General Motors; Hall Bros.; Toni Co.; Internat'l Cellulose Products; Acme Brewing; Bullocks; Hoffman Radio; Hughes Aircraft; Lockheed; Purex Corp. Ltd.; Security-First National Bank; Sunkist Growers; Union Oil; Westgate-Sun Harbor; Paper Mate Pen; Pepsodent (Shield Toothpaste); RKO Theatres.
FORT & CO.
 416 Providence Rd., Charlotte 1, N. C.
 Tel.: 4-7122
 Radio Dept.: John L. Fort.
ALBERT FRANK-GUENTHER LAW INC.
 131 Cedar St., New York 6
 Tel.: Cortlandt 7-5060
 Radio Dept.: Robert W. Day, vice president.
 Boston 9-10 Post Office Sq.; Tel.: Hancock 6-5900
 Chicago 2-1 N. LaSalle St.; Tel.: Dearborn 2-6424; R. W. Dawson, George H. Knott, vice presidents.
 Philadelphia 2-Packard Bldg.; Tel.: Rittenhouse 6-3915
 San Francisco 8-246 Bush St.; Tel.: Yukon 6-4641.
 Washington-1510 19th Street N.W.; Tel.: Columbia 5-4888
 Radio Accounts-Kiplinger Washington Agency Inc.; Bache & Co. (S); United Business Service (S); Western Union Telegraph (S).
JONES FRANKEL CO.
 180 N. Wabash Ave., Chicago 1
 Tel.: Dearborn 2-5745
 Radio Dept.: Lew Sanders, radio director; A. G. Gaines, J. B. Frankel (president) account executives.
FREDERICK-CLINTON CO. INC.
 545 5th Ave., New York 17
 Tel.: Murray Hill 2-7433
 Radio Dept.: Harold Rieff, executive vice president.
 Radio Accounts: Adler Shoes for Men (S); Vim Electric Co. (S); Chock Full O'Nuts.
CURT FREIBERGER & CO.
 1439 Court Place, Denver 2
 Tel.: Alpine 2048
 Radio Dept.: Curt Freiberger, account executive and timebuyer; Steve Demarest, copy chief.

1899—1954

55 Years Publishing

FACTS!

*marshalled to do
Your bidding—*

Modern business and Sales Management depends for its vigor upon accurately marshalled FACTS—conclusive Facts—ready for instant reference.

There are approximately 20,000 complete business data items in the McKITTRICK DIRECTORY OF ADVERTISERS—Geographical Section and Classified Section respectively. Items that yield all the essential FACTS about National Advertisers—their Products, Trade Names, Executive Personnel, Appropriations, Media, When Lists are made up, Distribution, etc.

Sales problems are always changing and maximum Spot-Sales can be obtained through

- * *FACTS that help increase the time spent with prospects.*
- * *FACTS that help make calls more profitable.*
- * *FACTS that reveal additional opportunities in the territory.*

Why not plan your Sales and Promotional campaigns on the basis of these determinable FACTS?

Why not send for further information as to the cost and other essential details concerning this directory and Service?

GEORGE MCKITTRICK & COMPANY

108 Fulton Street

New York 38, N. Y.

AGENCIES

OAKLEIGH R. FRENCH & ASSOC.
4235 Lindell Blvd., St. Louis 8
Tel.: Newstead 0037

FRENCH & PRESTON INC.
1 E. 43d St., New York 17
Tel.: Murray Hill 7-8550
Radio Dept.: Mildred Gannon, radio director; James P. Selvage, Ted Price, John Sharp, Preston Selvage Jr., account executives.
Washington—1730 I St. N.W.; Tel.: Republic 7-4041; Samuel Bledsoe, manager.
Radio Accounts: Grand Union Co. (S); Francis I DuPont & Co. (S); Minwax (S); Teddy's The House of Sea Food (S); Nat'l Republican Senatorial Committee (N-S); Gray Mfg. Co. (N).

AD FRIED AGENCY
(see "A" listing)

FRIEND-REISS-McGLONE
221 W. 57th St., New York 19
Tel.: Plaza 7-8030
Radio Dept.: Edward Ratner, radio director.
Radio Accounts: Merkin Paints, Grayson-Robinson; Liqui-Moly; Sweet-Orr; S. Klein; Lafayette Radio; St. Mary's Coats; Grossett & Dunlap.

HARRY M. FROST CO. INC.
260 Tremont St., Boston 16
Tel.: Liberty 2-0813

FULLER & SMITH & ROSS INC.
71 Vanderbilt Ave., New York 17
Tel.: Murray Hill 6-5600
Radio Dept.: A. E. Duram, radio director; Peter Cardozo, creative copy supervisor; Byron McKinney, radio production supervisor; Bernard G. Rasmussen.
Cleveland 15—1501 Euclid Ave., Tel.: Cherry 1-6700; David Adam.
Chicago 3—105 W. Adams St.; Tel.: Andover 3-5041; E. J. Laussen, vice president and manager; C. W. Billingsley, manager of media dept.
Radio Accounts—Owens-Corning Fiberglas (N); Keystone Steel & Wire Co. (N); Bryant Heater Div. (S); Burkhardt Brewing Co. (S); Commercial Solvents Corp. (S); Hercules Powder Co. (S); Linen Thread Co. (S); Mellon Nat'l Bank (S); Pennzoll Co. (S); Aluminum Co. of America; Nat'l Better Business Bureau; Westinghouse.

G

GARDNER ADVERTISING CO.
915 Olive St., St. Louis 1
Tel.: Central 3200
Radio Dept.: William D. Fisher, vice president, director; Al Chance, production manager; May Kohler, Marshall Smith, production supervisors; Jay Kacin, assistant director; Champ Humphrey, vice president, media research; John Naylor, radio media director; Phil Archer, Grace McMullan, Earl Hotze, timebuyers; Don Cole, promotion director; Jo Mueller, radio traffic.
New York 20—9 Rockefeller Plaza. Tel.: Columbus 5-2000. Roland Martini, vice president in charge, radio director; James Marshutz, assistant.
Radio Accounts: Pet Milk (N-S); Barton Mfg. Co. (S); Lion Oil Co. (S); Grove Labs. (S); Ralston Cereals (N-S); First Nat'l Bank; Independent Packing Co.; Monsanto Chemical Co.; Union Electric Co.

SIDNEY GARFIELD & ASSOC.
45 Second St., San Francisco 5
Tel.: Exbrook 2-3420
Radio Dept.: Harold M. Walker, vice president, radio director; Audrey Wagenknect, time-buyer.
Radio Accounts: Kay Jewelers; No Doz Awakeners; Vano Products; Rough Rider Slacks; Pacific Veg. Oil; Trader Scott; Shut-Eye.

NEWSOM W. GAY ADV.
Gulf States Bldg., Dallas 1
Tel.: Prospect 7300

GEARE-MARSTON INC.
SE corner 22d & Locust Sts., Philadelphia 3
Tel.: Locust 4-0530

GEMMER ASSOC. INC.
208 Strauss Bldg., Fort Wayne 2, Ind.
Tel.: Anthony 1157
Radio Dept.: Duane A. Zimmerman, radio director.
Radio Account: Bluffton Grocery Co.; Eskay Dairy; Hargas-Mills Candy Shops; I. M. O. Distributors; North American Van Lines; Wayne Candies; Jim Kelley Motors; Fort Wayne Packard Sales Inc.; Nyenhuis Hatcheries.

HENRY GERSTENKORN, Advertising-Merchandising Agency
4840 Wilshire Blvd., Los Angeles 5.
Tel.: Webster 1-1586
Henry Gerstenkorn, owner; A. W. Stowe, copy chief.

GEYER ADVERTISING INC.
745 Fifth Ave., New York 22
Tel.: Plaza 1-3300
Radio Dept.: Ralph Robertson, vice president; George Wolf, director of radio; Betty Powell and Carol Sleeper, timebuyers.
Dayton 2—931 Third Nat'l Bank Bldg.; Tel.: Fulton 4145; E. G. Frost, manager.

Detroit 32—14250 Plymouth Rd.; Tel.: Webster 3-5520; Walker R. Graham, Ralph L. Wolfe, co-managers.

Los Angeles—1680 N. Vine St.; Tel.: Hollywood 7-6114; Wright Nodine, vice president & account executive, in charge; Faith Vent, timebuyer.

GIBBONS ADVERTISING AGENCY
802 Daniel Bldg., Tulsa 3
Tel.: 4-2444
Radio Dept.: J. Burr Gibbons, president; John B. Gibbons, vice president; Mercedes Freiday, radio director.

Radio Accounts: Nat'l Bank of Tulsa; Stanley's Funeral Service; State Federal Savings & Loan Assn.; Wortz Biscuit Co.; Tom P. McDermott Inc.; Sand Springs Turkey Farms; Tulsa Cabinet Shop; Community Loan & Investment Co.; Prayson Candies Co.; Comet Moving & Storage Co.

GILLHAM ADV. AGENCY
Continental Bank Bldg., Salt Lake City
Tel.: 4-5516
Radio Dept.: Heber G. Wolsey, radio director; Larch Cody, assistant director.

Radio Accounts: Cloverleaf Dairy; Colville Ice Cream Co.; Fisher Brewing Co.; Freed Motor; Ogden First Federal Savings; Petty Motor; Purty Biscuit Co.; Royal Baking Co.; Sego Milk Products; Streater Chevrolet Co.; Union Pacific Railroad; Utah Oil Refining Co.; Utah Power & Light; First Federal.

BERT S. GITTINS ADV.
739 N. Broadway, Milwaukee 2
Tel.: Broadway 6-5948
Radio Dept.: Gerald L. Seaman, radio director; LaVerne T. Laustsen, Paul D. Seabrook, account executives.

Radio Accounts: Allis-Chalmers Mfg. Co. (Tractor Div.) (N); William F. Renk & Sons; Wisconsin Bankers Assn.

GLASSER-CALLEY INC.
301 S. Harvard Blvd., Los Angeles 5
Tel.: Dunkirk 4-2141
Radio Dept.: G. F. Glasser and Hal Rorke.
Radio Accounts: L. B. Labs; Bluhli Foods Inc.; Huggins-Young Coffee Co.

WM. GLAZER ADV. AGENCY
707 United Office Bldg., Cleveland 13
Tel.: Main 1-0816
Radio Dept.: W. J. Gabriel Jr.; Mollie G. Rodie.
Radio Accounts: Foodtown Super Markets; Mary Lee Candies; Anchor Rubber Products; Blue Water Fillets.

GLENN ADV. INC.
First Life Bldg., Fort Worth 2, Tex.
Tel.: Fannin 4476
Radio Dept.: Ray K. Glenn, president; John H. Stewart, executive vice president; Robert L. Rogers, account executive.

Dallas 1—1915 Elm St.; Tel.: Riverside 6886; Ward M. Wilcox, vice president; William Cunningham Jr., Lewis Purnell.

Los Angeles 48—6399 Wilshire Blvd.; Tel.: Webster 39-369; George D. Winkler.

Radio Accounts: Waples-Platter Co.; The Firtio Co.; Bewley Mills; Texas Dry Concrete Co.; Ft. Worth Nat'l Bank; Republic Nat'l Bank; Gerhardt Chili Powder Co.; Serval Drug Stores; Texas Industries.

GLENN-JORDAN-STOETZAL INC.
307 N. Michigan Ave., Chicago 1
Tel.: State 2-8927
Radio Dept.: John C. Whitley, media director, timebuyer; R. Rozema, account executive.

Radio Accounts: Back to God Hour (Christian Reformed Church) (N-S).

GLEW ADVERTISING AGENCY
211 N. Lafayette Ave., Grand Rapids 3, Mich.
Tel.: 9-4052
Radio Dept.: Francis K. Glew.

GODOY & CROSS ADV. AGENCY
Prado 51, Havana, Cuba
Tel.: A-1941
Radio Dept.: Enrique Marrero, radio director; Sarah Cross, radio producer; Domingo Martinez, radio producer; Cuqui Ponce de Leon.

Radio Accounts: Cia. Nacional de Alimentos (Nestle-Libby); RCA Victor; Warner Hudnut (N); Cia. Pepsi-Cola de Cuba; Standard Brands; Ford; Squibb; Mentholatum; Mennen; U. S. Rubber Co.; Selecciones del Reader's Digest; Mahatma Rice; Cigarros Royal; Del Gas; Kellogg's Co.; Swift & Co.; Lanman & Kemp Barclay Co. of Cuba; Cia Godoy Sayán; Bauer & Black; Ekco; Pyrex; Kleenex (all S).

GOODKIND, JOICE & MORGAN INC.
919 N. Michigan Ave., Chicago 11
Tel.: Superior 7-6747
Radio Dept.: Florence Neighbors, media director and timebuyer; Clyde Joice, president; H. P. Roberts, executive vice president; Henry Nathan, vice president.

KENT GOODMAN ADV.
6047 Hollywood Blvd., Hollywood 28
Tel.: Gladstone 7168
Radio Dept.: Kent Goodman, radio director; Helen Neschime, timebuyer; Joan Chapman & Larry Goodman, account executives.

Radio Accounts: Transmission Exchange Co.; DuBont Motors; Crenshaw Car Center; Mist-Master.

PHIL GORDON AGENCY INC.
23 E. Jackson Blvd., Chicago 4
Tel.: Harrison 7-2103
Radio Dept.: V. Daniel Smith, president; Philip W. Abrams, vice president; Ruth Sacks Pollock, secretary; Roy Rutkoff, account executive; Clark Davis, radio director.

GOTHAM ADVERTISING CO.
2 W. 46th St., New York 36
Tel.: Judson 2-2880
Radio Dept.: Arthur A. Kron.

CLARENCE M. GOTSCH & ASSOC.
57 E. Jackson Blvd., Chicago 4
Tel.: Wabash 2-9352
Radio Dept.: Clarence M. Gotsch.

GRANT ADV. INC.
919 N. Michigan Ave., Chicago 11
Tel.: Superior 7-6500
Radio Dept.: Donald E. Tompkins, radio director; Jane Baker, assistant; Fred Norman, assistant media director; Tee V. Watson, radio media timebuyer; W. R. Watson, H. A. Jones, L. R. McIntosh, K. Browning, Hill Blackett Jr., account executives.

Dallas 1—1313 Gulf States Bldg.; Tel.: Prospect 8121; Thomas Murphy.

Detroit 26—2450 Guardian Bldg.; Tel.: Woodward 3-9400; Edward Grace.

Hollywood 28—1680 N. Vine; Tel.: Hollywood 9-5371; P. L. Bradley, vice president; John Gaunt, radio-tv director.

Washington 6—1741 DeSales St.; Tel.: Sterling 3-1467; J. Holt.

Miami 32—Langford Bldg.; Tel.: Miami 3-0773; John Dey.

New York 21—655 Madison Ave.; Tel.: Templeton 8-9393; Hugh C. R. Vogel.

Portland, Ore.—American Bank Bldg.; Tel.: Capitol 9609; John Glesy.

San Francisco—593 Market St.; Tel.: Douglas 2-0369; Jack Early.

Other offices in Bogota, Colombia; Bombay, India; Buenos Aires, Argentina; Calcutta, India; Cape Town, S. Africa; Caracas, Venezuela; Havana, Cuba; Hong Kong, China; Johannesburg, S. Africa; Karachi, Pakistan; London, England; Madras, India; Manila, P. I.; Mexico City, Mexico; Montreal, Quebec, Canada; New Delhi, India; Panama, R. de Panama; Rio de Janeiro, Brazil; Santiago de Chile; Sao Paulo, Brazil; Toronto, Ont., Canada.

Radio Accounts: Dodge Div. of Chrysler Corp. (N-S); J. A. Folger & Co. (S); Oelrich & Berry (S); Farmcrest Bakeries (S); Nat'l Airlines (N-S); Florists Telegraph Delivery Assn. (N-S); Excell Labs. (S); Dad's Root Beer; Donald Duck Ice Cream; Pinafore Chicken; Old Man's Syrup.

GRAY & ROGERS
12 S. 12th St., Philadelphia 7
Tel.: Walnut 2-4808
Radio Dept.: Edmund H. Rogers, partner in charge of radio; Walter M. Erickson, radio director; John Sumner, assistant.

Radio Accounts: Bell Telephone Co. of Pa.; Diamond State Telephone Co.; Associated Hospital Service of Philadelphia; M. A. Hanna Co.; Chevrolet Dealers Assoc.; Phila. Zone Planning Assoc.; Phila. Saving Fund Society; Lee Tire & Rubber Co.

GREGORY-HOUSE INC.
2157 Euclid Ave., Cleveland 15
Tel.: Main 1-7922
Radio Dept.: Bromley House, radio director; Mrs. Marion Reeves, timebuyer; Honor Gregory, account executive.

Radio Accounts: Grocery chain; appliance distributor, meat packer, real estate broker, bakery and insurance company.

Los Angeles—P. O. Box 8504; Tel.: Hollywood 5-6483; Jay Faggen.

Terre Haute—522 Ohio St.; Tel.: Crawford 8048; Myra Jancó.

GREY ADV. AGENCY INC.
166 W. 33d St., New York 1
Tel.: Oxford 5-2000
Radio Dept.: Alfred L. Hollender, vice president, radio director; Sidney T. Hertz, business manager of radio department; Joel Spector, radio production manager; George Feld, production assistant; Helen Wilbur, Warren Stewart, Robert Burke, timebuyers.

Radio Accounts: Kirsch Beverages (S); Coronet Magazine (S); Krueger Beer; Saraka; Mennen Baby Products; Quinsana.

GRIFFITH-McCARTHY INC.
602 Times Bldg., St. Petersburg 1, Fla.
Tel.: 7-4311
Tampa—206 S. Franklin St.; Tel.: 2-9644; R. E. McCarthy, manager and radio director.

Radio Dept.: Donald P. Griffith, radio director.

Radio Accounts: Borden's Dairy Products (S); First Federal Savings & Loan Assn.; Pioneer Tire Co.; Hendry Lumber Co.

JULIAN GROSS ADV. AGENCY INC.
11 Asylum St., Hartford 3, Conn.
Tel.: 7-7179

GRUBB & PETERSEN ADV. AGENCY
111 N. Market St., Champaign, Ill.
Tel.: 6-3766

GUNTHER, BROWN & BERNE INC.
1418 Enquirer Bldg., Cincinnati 2
Tel.: Garfield 4244
Dayton—3 E. 2d St.; Tel.: Hemlock 7411.

GUILD, BASCOM & BONFIGLI INC.
130 Kearney St., San Francisco 8
Tel.: Yukon 2-6040
Radio Dept.: Fred Graesser, radio director; Rod MacDonald, media director.

Radio Accounts: Rosefield Pkg. Co.; Good Foods Inc.; Roman Meal Co.; Gravem-Inglis Baking Co.; Golden State Co.; Gurley-Lord Co.; Girard's.

LAWRENCE C. GUMBINNER ADV. AGENCY INC.
655 Madison Ave., New York 21
Tel.: Templeton 8-1717
Radio Dept.: Paul Gumbinner, director; Anita Wasserman, assistant timebuyer.

Radio Accounts: ChapStick Co. (S); Messing Bakeries Inc. (S); A Schonnbrunn & Co. Inc.; Good Grooming Products (S); Alfred Dunhill of London (S); Bercut-Richards Co. (S).

H

WM. J. HACKENBERG ADVERTISING
206 Main St., Wheeling, W. Va.
Tel.: Wheeling 6983
Radio Dept.: Wm. J. Hackenberg.

Radio Accounts: Cooney-Bentz Co.; Posins Jewellers; Alexander & Co.; Colvig.

HERBERT SUMMERS HALL ADV.
30 N. LaSalle St., Chicago 2
Tel.: State 2-0670
Radio Dept.: Herb Hall, radio director.

Radio Accounts: Mah Chena Corp.; NuTrishus Products Corp.; Daymel Co.; S. Shore Lincoln-Mercury; Wood-Davis Co.

JOHN L. HALPIN ADVERTISING
207 State St., Schenectady 5, N. Y.
Tel.: 2-0492
Radio Dept.: John L. Halpin, copy; M. G. Halpin, timebuyer.

Radio Accounts: Airport Rug & Carpet Co.; Schenectady Rug & Carpet Store; Mohawk Nat'l Bank; Cobleskill Agricultural Society; Mineola Rug & Carpet Co.; Alvord Glove Co.; IUE-CIO Local 301.

HAMMER CO.
171 Church St., Hartford 3, Conn.
Tel.: 7-0183
New York—1819 Broadway; Tel.: Plaza 7-0955; S. Charney, director.

Radio Dept.: M. H. Hammer, radio buyer; Vincent Caronne, radio director; Herbert Sherman, account executive.

Radio Accounts: Berklene Corp. (N-S); Shelton Tack Co. (S); Conm Coil Corp. (S); Munising Co. (N-S); Deaborn Corp. (S); The Pantasote Co. (S); Ruth Wallace Recordings (S).

HANLY, HICKS & MONTGOMERY INC.
500 Fifth Ave., New York 36
Tel.: Longacre 5-5000
Radio Dept.: H. E. Lehman.

HANSON & RIDLON ASSOC.
212 Essex St., Boston
Tel.: Hancock 6-4924
Radio Dept.: J. A. Riddlon, timebuyer & radio director.

Radio Accounts: Touraine Paints; H. F. Staples & Co.

HARRINGTON-RICHARDS
(see Fletcher D. Richards)
256 Sutter St., San Francisco 8
Tel.: Exbrook 2-6025
Radio Dept.: Virginia Miller, timebuyer; A. E. Smith, account executive.

R. T. HARRIS ADVERTISING AGENCY INC.
1400 Walker Bank Bldg., Salt Lake City 1
Tel.: 3-8815
Radio Dept.: R. T. Harris, president; Keith Montague, vice president; Robert L. Love, account executive; Afton L. Langton, timebuyer.

HART-CONWAY CO. INC.
45 Exchange St., Rochester 14, N. Y.
Tel.: Locust 3520
Radio Dept.: H. Lyman Hart, Harold E. Kennedy, John P. Street, Joseph P. Brown, E. Ward Phillips, John M. Nixon, account executives.

Radio Accounts: Blue Boy Dairy; F. Cappellino & Sons; Crescent-Puritan Laundry; Genesee Valley Trust Co.; Genesee-Monroe Racing Assn.; Haxton Foods Inc.; Levis Music Store; Qualtop Beverages Inc.; Roseland Park; Security Trust Co.; Siefert & Sons; Sears, Roebuck & Co.; Standard Brewing Co.; Hallman Chevrolet Co.; Franklin Chemical Co.; Kemp Equipment Co.; Sheraton Hotel; W. C. Zink Inc.

GEORGE H. HARTMAN CO.
307 N. Michigan Ave., Chicago 1
Tel.: State 2-0055
Radio Dept.: Thomas Kivlan, vice president for broadcasting; Charles Golling, radio director; John T. Holloway, David Cory, account executives.

Radio Accounts: Chicago Show Printing Co.; Hartz Mountain Products; Nash-Underwood Inc.; Nelson Bros.; P. A. Starck Plano Co.; Vermont Marble Co.; Lanahan Co.; United Biscuit Co. (Lakeside, Manchester and Sawyer Divs.)

HARVEY-MASSENGALE CO. INC.
Walton Bldg., Atlanta 3
Tel.: Walnut 9117
Durham, N. C.—Snow Bldg.; Tel.: J-8451

HEINTZ & CO. INC.
611 Wilshire Blvd., Los Angeles 17
Tel.: Michigan 6061
Radio Dept.: June Morgan, account executive, radio director, timebuyer; account executives, Herbert R. Dickow, Robert P. Heintz, Carl M. Heintz Jr., Charles M. Pickering.

Radio Accounts: Knudsen Creamery Co.; Dempsey-Tegeier & Co.; Standard Federal Savings and Loan Assn.; 4 Seasons Inc.; Sterling Electric Motors Inc.; Pig 'n' Whistle; Kebo Products.

AGENCIES

the Voice
of the
Oil Country



KBMX

Coalinga, Fresno County, California

... has an audience with money ... and an audience that spends money ... a steady flow from all or part of nine counties ... (ask for our mail map) ...

A strike of close to \$500,000,000.00 "brought-in" by the KBM—Xtra rich market since November, 1950. No wild-cattling here ... oil evaluated (in 1950) at \$105,048,377 and (1950's) natural gas production—\$14,133,554; agriculture — \$325,579,150 (in 1951).

Alone, the city of Coalinga—population 5,520 (1950), averages annually, in retail sales, nearly \$10,000,000.00 and the approximate trade area is 20,000 ...

KBM—X marks the spot—in this rich market, with its assurance of consistently responsive listeners ...

KBMX
FRESNO COUNTY
ABULOUS FRESNO COUNTY

- PAUL LYNN HELLER ADV. INC.**
911 13th St., N. W., Washington 5
Tel.: National 8-7638
Radio Dept.: Paul Lynn Heller, Jerome F. Horwitz, r.
- HENDERSON ADVERTISING AGENCY INC.**
9 W. McBea Ave., Greenville, S. C.
Tel.: 3-8381
Radio Dept.: James M. Henderson, Howard K. McIntyre, account executives; Betty McCowan, timebuyer.
Radio Accounts: Texize Chemicals; Edisto Dairies; South Carolina Marketing Commission.
- HENRI HURST & McDONALD INC.**
121 W. Wacker Drive, Chicago 1
Tel.: Franklin 2-9180
Radio Dept.: J. S. Keck, radio director; Lee Randon, film director; Mrs. Laura Hall, timebuyer.
Radio Accounts: Milnot Co.; Perma Starch Inc.; Skelly Oil Co.; Ready-to-Bake Foods Inc.; A. O. Smith Corp.
- AL HERR ADV. AGENCY INC.**
225 E. Michigan St., Milwaukee 2
Tel.: Broadway 2-8040
Radio Dept.: Al Herr, John Rock, account executives; Elton Koclan, radio director; Ruth Walter, timebuyer.
- C. J. HERRICK ASSOC.**
132 W. 43d St., New York 18
Tel.: Lackawanna 4-9310
Radio Dept.: Elaine Samuels, radio director, timebuyer; Clarence J. Herrick, account executive; Neil R. Herrick, assistant timebuyer.
Radio Accounts: Wave Crest Gardens; Lake Panamoka; Jane Engel; Carbona Products.
- HEVENOR ADV. AGENCY INC.**
11 N. Pearl St., Albany 7, N. Y.
Tel.: 5-1586
Radio Dept.: Horace L. Hevenor, president; Edward T. Loveday, vice president, account executive; Lois E. Stephenson, radio director.
- HEWITT, OGLVY, BENSON, MATHER**
575 Madison Ave., New York
Tel.: Murray Hill 8-6100
Radio Dept.: Howard Connell, vice president in charge of radio; Frank Brandt, manager of radio; Rex Coston, traffic; Ann Janowicz, Matt Kane, timebuyers.
London, England—Roger Lloyd.
Radio Accounts: Good Luck Margarine; Lever Bros.; Helena Rubenstein.
- HICKS & GREIST INC.**
Graybar Bldg., New York 17
Tel.: Murray Hill 3-9135
Radio Dept.: Peter A. Krug, radio director; J. A. Drake, S. R. Huntley, C. V. Skoog, account executives.
Radio Accounts: Lewyt Corp. (S); Louis L. Libby Foods (S); Waring Products Corp. (S); Sapolin Paints (S); Dixie Cup Co. (S); Home Decorators (S); Serval Inc. (S).
Los Angeles 5-3450 Wilshire Blvd.; Tel.: Dunkirk 5-1721; Peyton Carrol, manager.
- IVAN HILL INC.**
49 East Superior St., Chicago 11
Tel.: Superior 7-3116
Radio Dept.: Elinor Fahrenholz, radio director.
Radio Accounts: Thomas J. Webb Co. (S).
- HILTON & RIGGIO**
4 W. 58th St., New York 19
Tel.: Murray Hill 8-4224
Radio Dept.: Peter Hilton, president; Louis J. Riggio, vice president and treasurer; James Williamson, Jack Kirk, vice presidents; Vincent De Luca, media director; L. S. Hendrickson, secretary; Daniel Lozeaux, art director; Ralph Kidd, production manager; account executives: Mr. Riggio, Williamson, Kirk, Maurice Odquist, Joseph P. Quin Jr. and John G. Wright.
Hollywood 22-1680 Vine St.; Tel.: Hollywood 2-8343; Robert L. Nourse Jr., vice president in charge; West Coast operations; Doris Morgan, office manager.
- HIRSON-GARFIELD INC.**
745 5th Ave., New York 22
Tel.: Murray Hill 8-8900
Radio Dept.: Sylvan Taplinger, director; Robert Loeb, production, timebuyer; Eleanor Yotka, timebuyer; George Sugar, research, account executive.
Boston 16—Park Square Bldg.; Tel.: Liberty 2-0488; Herbert Stern, director.
Miami 32, Fla.—210 Roper Bldg.; Tel.: Miami 3-0793, Jules Kase.
Radio Accounts: Adam Hat Stores; U. S. Time Corp.; Finlay Straus; B. G. Phillips; Cocilana Cough Drops; Key Corp.
- HIXSON & JORGENSEN INC.**
2001 Beverly Blvd., Los Angeles 4
Tel.: Dunkirk 8-3121
Radio Dept.: H. D. Walsh, radio director; Harriett M. Weigand, radio timebuyer; account executives Tyler Macdonald, Russell M. Lockwood, Lewis K. Woodward, Donald P. Parmalee, Ross Sawyer, Gordon Gumpertz, William E. Betts.
Radio Accounts: Beaute Vues Corp. (Nutri-Tonic Permanent) (S); Challenger Cream & Butter Assn. (S); Affiliated Gas Equipment Inc. (Day & Night Division and Payne Furnace Division) (S); Kierulff & Co.; Local Loan Co.; Omega Shoe Polish; Richfield Oil Corp. (N); Santa Fe Vintage Co.; Simple Simon Frozen Pies; White Rock Bottlers Co. (Welchade) (S); Voit Rubber Corp.; Wilson & Co.
- HOEFER, DIETERICH & BROWN INC.**
405 Sansome St., San Francisco 11
Tel.: Yukon 2-0575
Radio Dept.: James A. Brown, John H. Hoefer, account executives; Wallace C. Riddell Jr., radio copy; Geneva Hawkins, timebuyer.
Radio Accounts: George W. Caswell Co. (N); Crystal Cream & Butter Co. (S); Heidelberg Brewing Co. (S); Santa Rosa Shoe Co. Inc. (N); Marshall Steel Co. (S).
- HOFFMAN & YORK INC.**
808 N. 3rd St., Milwaukee 3
Tel.: Broadway 6-6510
Radio Dept.: Joel Kursel, account executive; Joseph F. Mulvanny, timebuyer.
Radio Accounts: Gettelman Brewing Corp.; Milwaukee Gas Light Co.; Sawyer Elscuit Co. (Wis. division); Shaler Co.; Chevrolet Dealer of Greater Milwaukee; Milwaukee Board of Realtors; L. J. Mueller Furnace Co.
- WILLIAM F. HOLLAND AGENCY**
Holland Bldg., Cincinnati 19
Tel.: Capitol 1252
Radio Dept.: William F. Holland, owner and buyer.
- HOLST & CUMMINGS & MYERS**
1307 Kapiolani Blvd., Honolulu, T. H.
Tel.: 95291
Radio Dept.: Jim Wahl, director and vice president; Alexa Cogswell, assistant director.
San Francisco 5-215 Market St. Tel.: Yukon 65957
Radio Accounts: Bank of Hawaii; Castle & Cooke Ltd.; Theo H. Davies & Co. Ltd.; Hawaii Employers Council; Hawaii Statehood Commission; Hawaii Visitors Bureau; Hawaiian Airlines; Hawaiian Electric Co. Ltd.; Hawaiian Sugar Planters Assn.; Hawaiian Tuna Packers; Kodak Hawaii; Lewers & Cooke; Liberty House; Matson Navigation Co.; Pineapple Co. of Hawaii; Von Hamm-Young Co. Ltd.; Tont Co.; Lever Bros. Co.; Borden Co.; Electric Auto-Lite Co.; Lambert Prophylactic; Heinz; Norwich Pharmacal; Honolulu Motors; American Hawaiian Motors
- HOME SAVINGS BANK**
11 N. Pearl St., Albany 7
Tel.: 4-4105
Radio Dept.: Lester H. Carson, assistant vice president.
Radio Accounts: WPTR.
- HONIG-COOPER CO.**
333 Montgomery St., San Francisco 4
Tel.: Exbrook 2-7004
Radio Dept.: John W. Davis, radio director; Gall Myers, Shirley Lang, assistants.
Seattle, Wash.—455 Skinner Bldg.
Tel.: Main 6435.
- HOOT ADVERTISING AGENCY**
15 E. 40th St., New York 16
Tel.: Murray Hill 6-3714
Radio Dept.: Dexter Halle; Marlana Lautman, Harold Olson, James Campbell.
Radio Accounts: Mogen David Products; Mermaid Brands (sea foods); Snow Kist Frozen Foods; Seeco Industries.
- HOUC & CO. OF FLORIDA INC.**
1234 Alfred I. duPont Bldg., Miami 32
Tel.: 82-1475
Radio Dept.: Robert G. Venn, vice president; radio director; Marie C. Power, timebuyer.
W. Arthur Fielden, account executive; Marguerite G. Brown, timebuyer.
- CHARLES W. HOYT CO. INC.**
380 Madison Ave., New York 17
Tel.: Murray Hill 2-2000
Radio Dept.: William Philip Smith, director of radio; Thomas Lee Jr., John Farris, assistants; D. H. Humm, radio timebuyer.
Hartford 3, Conn.—15 Lewis St. Tel.: 3-6066.
- Radio Accounts: Charles Gulden Inc.; Mail Pouch Tobacco; Montecello Drug Co.; KLM Royal Dutch Airlines; Arnold Bakers Inc.; Kirkman Soap Products; N. Y. & New England Apple Institute; Switzerland Cheese Assn.; Lehn & Fink Products Corp.**
- THE HUBBELL ADV. AGENCY INC.**
1900 Euclid Ave., Cleveland 15
Tel.: Cherry 1-0212
Radio Dept.: Frank Hubbell, timebuyer; Inez Wallace, account executive; V. D. Lidyard, director.
Radio Accounts: Jacob Laub Baking Co.; Montana Flour Mills Co.; Ward Products Div. (Gabriel Co.); Gabriel Co.
- CHRISTY HUMBUG ADV. AGENCY**
742 N. Forest, Webster Groves 19, Mo.
Tel.: Republic 8223
Radio Dept.: Vera C. Humbug.
- H. B. HUMPHREY, ALLEY & RICHARDS INC.**
370 Lexington Ave., New York
Tel.: Lexington 2-3020
Boston—1235 Statler Bldg.; Tel.: Liberty 2-6100.
- HUMPHREY, PRENTKE & ASSOC.**
11406 Euclid Ave., Cleveland 6, Ohio
Tel.: Randolph 1-4582
Radio Dept.: Herbert E. Prentke, radio director.
- HURLEY ADVERTISING CO.**
214 Securities Bldg., Des Moines 9
Tel.: 4-6289
Radio Dept.: J. E. Hurley, director.
Radio Accounts: Ungles Baking Co.; Donald Duck Bread; Duncan Hines Bread; Peanut Corp. of America; Rislone; Lally's Potato Chips; Iowa Fibre Products; Chevrolet Dealers of Iowa; Boesen the Florist; Paul Manning Chevrolet; Van Dyck Lennox Furnace.

HUTCHINS ADV. CO. INC.
42 East Ave., Rochester 4, N. Y.
Tel.: Hamilton 1160
Radio Dept.: H. Pierson Mapes, James H. Burton, William F. Lacey, vice presidents; Frank M. Hutchins, president; Margaret Nugent, Elizabeth Eggleton, Margaret H. Carl, John P. McCarthy, vice president, all account executives.
Philadelphia 40—3701 N. Broad St.; Tel.: Baldwin 3-6200; John R. Maxwell, vice president.
New York 19—16-18 W. 46th St.; Tel.: Plaza 7-8526; Mr. Mapes, Mr. Burton.
Toronto 4—1244 Dufferin St.; Tel.: Kenwood 2737; William A. Bounsall.
Radio Accounts: Philco Corp.; Aeolian American; Lincoln Rochester Trust Co.; Hub Oil Co.; Scrantom's; Projansky Inc.; Schuler's Potato Chips; E. E. Bausch.

IDAHO ADVERTISING AGENCY
906½ Jefferson St., Boise, Idaho
Radio Dept.: B. R. Joy, timebuyer; E. F. Casebeer, owner.
Radio Accounts: Music Center; City Dye Works; Idaho Motor Transport Assn.; Idaho Coal Dealers; Boise-Winnemucca Stages Inc.

JACKSON & CO.
62 Worth St., New York 13
Tel.: Worth 4-7005
Radio Dept.: John Yeagain, radio director, timebuyer.
Radio Accounts: Pequot Mills (S-N); J. W. Valentine Co.; Hayward Hosiery Co. (S-N).

TEVIE JACOBS ADV. AGENCY
401 Morris Plan Bldg., Indianapolis 4
Tel.: Imperial 9189
Radio Dept.: Delores Perrault, radio director.
Radio Accounts: Morris Plan; Barrett's; Capital Paper Co.; Worcel Traller Sales; J. C. Hirschman Co., Southside Furniture Co.

RAY C. JENKINS ADV. AGENCY
1240 Builders Exchange, Minneapolis 2, Minn.
Tel.: Main 4421
Radio Dept.: Ray C. Jenkins, radio director; account executives E. M. Grundy, E. R. Warren, Donald MacRae, D. W. Ittner.
Radio Accounts: Marquette Nat'l Bank; Western Oil & Fuel Co.; Murray's Inc.; M. A. Gedney Co.; Midtown Motors Inc.; Minnesota Bankers; Motor Sales Inc.

JESSOP ADV. CO. INC.
First Nat'l Tower, Akron 8
Tel.: Franklin 2169

DUANE JONES CO. INC.
570 Lexington Ave., New York 22
Tel.: Plaza 3-4848
Radio Dept.: Duane Jones, president; Elward Breset, assistant to president; William Tarr, account executive; Betty Nasse, timebuyer.
Radio Accounts: Nat'l Selected Products (S); Protam Sales Co. (N-S); Fillex Co. (N-S); Wayplex Co. (N-S); Save-By-Mail (N-S); Package Products Co. (S).

RALPH H. JONES CO.
3100 Carew Tower, Cincinnati 2
Tel.: Garfield 2300
Radio Dept.: Kathryn M. Hardig, radio director; Ann Smith, assistant radio director; Rita Kennedy and Eula Reggin, timebuyers.
New York 36—390 5th Ave.; Tel.: Plaza 7-4600.

JONES & BRAKELEY
150 Nassau St., New York 38
Tel.: Beekman 3-1912
Radio Dept.: Henry T. Rockwell, president and radio director; Marie C. Power, timebuyer.
Radio Accounts: Bethlehem Steel Co.

JONES & JONES ADV. AGENCY
525 Leonhardt Bldg., Oklahoma City 2
Tel.: Regent 6-3226
Radio Dept.: Henry C. Jones.

JORDAN CO.
2404 W. 7th St., Los Angeles 5
Tel.: Dunkirk 2-2248
Radio Dept.: Walter C. Hughes Jr., media director.
Radio Accounts: Armstrong Nurseries; Downey Fertilizer Co.; R. C. Wlan Enterprises.

KAL, EHRlich & MERRICK ADV. INC.
Star Bldg., Washington 4
Tel.: Executive 3-3700
Radio Dept.: Alvin Q. Ehrlich, vice president in charge of radio; David Thomas, radio director; Nella Manes, timebuyer; Philip Berne, Forest R. Entwisle, Alexander Charles, William Mullett, William Roberts, Joseph Weinstein, account executives.

THE KAPPS CO.
64 East Lake St., Chicago 1
Tel.: State 2-0460
Radio Dept.: Capico Kapps, Joseph Kapps, Albert Kapps, D. Dally.
Radio Accounts: Public Service Stores; Martin Oil Co.; Davidson's Baking Co.; Langendorff Clothing Co.; Southeast Radio Stores; Ford Hopkins Drugs; North Park Sales; Archer Motors; Petroleum Sales & Construction Co.; Wellmade Mattress Co.; Lynn Stewart Distributing Co.; Interstate Co.

KASTOR, FARRELL, CHESLEY & CLIFFORD INC.
400 Madison Ave., New York 17
Tel.: Plaza 1-1400
Radio Dept.: Harry B. Walsh, radio director; Nancy E. Booth, assistant; Jack B. Peters, timebuyer.
Radio Accounts: Charles Antell Inc. (S-N); Community Television (S); Block Drug (S-N); White Diet Bread (S); Ar. Winarick Inc. (S); Pierce's Proprietaries (S); Stoppers Inc. (S); Hickok Mfg. Co. (S); Plough Inc. (S).

H. W. KASTOR & SONS ADV. CO.
75 E. Wacker Drive, Chicago 1
Tel.: Central 6-5331
Radio Dept.: James H. West, radio director; Walter Kniffin, timebuyer; Marvin Harms, John T. Urice and Herman Kastor, all vice presidents.
Radio Accounts: International Milling Co.; Procter & Gamble Co.; Campana Co. and Union Starch & Refining Co.

JOSEPH KATZ CO.
10 W. Chase St., Baltimore 1
Tel.: Lexington 1500
Radio Dept.: Joseph Katz, president; John T. McHugh, vice president, media; Robert G. Swan, vice president, radio; C. M. Harrison, vice president-treasurer; Morton L. Salan, radio production.
New York 22—488 Madison Ave.; Tel.: Murray Hill 8-1223; Perry Schofield, N. C. Wildman, vice presidents; Beth Black, media director; Richard Katz, radio production.
Radio Accounts: American Oil Co.; Block Drug Co.; Md. Pharmaceutical Co.; Globe Brewing Co.; Madera Bonded Wine & Liquor Co.; Cellowax Co.; S. & N. Katz, Jewelers; Pompeian Olive Oil Corp.

HENRY J. KAUFMAN & ASSOC.
1419 H St. N.W., Washington 5
Tel.: District 7-7400
Radio Dept.: Jeffrey A. Abel, radio director and timebuyer; Robert S. Maurer, radio creative director; Alvin Sarra, E. Charles Mueller, account executives.

KAUFMAN-STROUSE ADV.
419 N. Charles St., Baltimore 1
Tel.: Saratoga 2414
Radio Dept.: Renee Davis, all media; Myron Subotnik, production.

KEELOR & STITES CO.
3001 Carew Tower, Cincinnati 2
Tel.: Parkway 1310
Radio Dept.: Arthur A. Radkey, radio director.
EDWARD S. KELLOGG CO.
603 S. Rampart Blvd., Los Angeles 5
Radio Dept.: Edward S. Kellogg, president; Wally Seidler, radio director

KELLY, ZAHNRDT & KELLY INC.
2343 Hampton Ave., St. Louis 10
Tel.: Hilland 2684
Radio Dept.: Virgil A. Kelly, radio director; Walter W. Zahndt, timebuyer; William H. Thomson, Robert Kelly, account executives.
Radio Accounts: Sterling Pen Co.; Joseph A. Mrazek Moving & Storage; Newberry Radio Co.

KENYON & ECKHARDT INC.
247 Park Ave., New York 17
Tel.: Murray Hill 8-3700
Radio Dept.: Wickcliffe W. Crider, vice president in charge of radio; Clinton Wheeler, Jack Babb, Alfred Tennyson, Blake Johnson, production supervisors; Joseph Braun, vice president in charge of media; Phillip Kenny, chief timebuyer; Lucy Kerwin, Thomas Visconti, Robert Erath.

Hollywood 28—Equitable Bldg.; Tel.: Hollywood 3-2101.
Chicago 3—620 Market St.; Tel.: Randolph 6-6470.
Detroit 28—Penobscot Bldg.; Tel.: Woodward 5-0300.

Atlanta 5—805 Peachtree St., N. E.; Tel.: Vernon 0194.
San Francisco 4—Crocker Bldg.; Tel.: Yukon 2-3070.
Toronto 1—80 King St., W.; Tel.: Empire 3-8314.
Radio Accounts: American Maize Products Co.; Beech-Nut Packing Co.; Ford Motor Co. (Institutional); General Electric Co. (air conditioning); Hudnut Sales Co.; Lincoln-Mercury Div.; Ford Motor Co.; Lincoln-Mercury Dealers; National Brewing Co.; Mennen Co.; Pepperidge Farm; Welch Grape Juice Co.; Wesson Oil & Snowdrift Sales Co.

KETCHUM, MacLEOD & GROVE INC.
411 Seventh Ave., Pittsburgh 19
Tel.: Court 1-5100
Radio Dept.: Lansing Lindquist, radio director; Edgar J. Donaldson, John D. Held, Melvin Johnston, assistants.
Cleveland 14, Ohio—1221 Nat'l City Bank Bldg.; Tel.: Superior 1-7327.
Washington 6, D. C.—1627 K Street.
Harrisburg, Pa.—State Street Bldg.
Richmond 19—Central Nat'l Bank Bldg.
Buffalo 3, N. Y.—Brisbane Bldg.
Radio Accounts: Braun Baking; Buffalo Chevrolet Dealers; Harrisburg, Maryland, Pittsburgh, Virginia Chevrolet Dealers; Colonial Trust Co.; Dairyman's Cooperative Sales Assn.; Hospital Service Assn.; Jones & Laughlin Steel Corp.; Mrs. Light & Heat Co.; Natural Gas Co.; Peoples Natural Gas Co.; Reymer & Bros. Inc.; Rieck Dairy Co.; Thorofare Markets.

KIESEWETTER ASSOC. INC.
9 E. 40th St., New York 16
Tel.: Lexington 2-0023
Radio Dept.: Horace Hagedorn, radio director, vice president; Sam S. Baker, vice president; E. Thompson, timebuyer; E. G. Chase, account executive.
Radio Accounts: V. La Rosa & Sons; Standard Labs.; Rollfast Bicycles; Abraham & Straus; Courtley Ltd.; Stern's Nurseries; Medaglia d'Oro Coffee.

KILLINGSWORTH CO. INC.
8743 Sunset Blvd., Hollywood 46
Tel.: Crestview 1-5275
Radio Dept.: James C. Killingsworth.
New York 16—The Penthouse, 77 Park Ave.; Tel.: Murray Hill 4-0788; Sidney Saxe.
Radio Accounts: North American Airlines; Stratosphere Products.

ABBOTT KIMBALL CO. INC.
250 Park Ave., New York 17
Tel.: Plaza 3-9600
Radio Dept.: Miriam Traeger, director of radio and timebuyer; Elizabeth Prouditt, research; Alice White, publicity; Rita McNamara, George Bowen, Lawrence W. Radice, Jay E. Perine, account executives.
San Francisco 4—155 Sansome St. Tel.: Exbrook 2-6275.
(Abbott Kimball Co. of Calif. Inc.)
Los Angeles 5—638 S. Van Ness at Wilshire Blvd. Tel.: Dunkirk 7-7305; Abbott Kimball, president; Robert W. Boone, vice president.
Chicago—520 N. Michigan Ave. Tel.: Michigan 2-0300; George Enzinger, executive vice-president.
Radio Accounts: Drake America Corp. (Roundtree's chocolates); Flrth Carpet Co.; Holland Herring Fisheries Inc.; Hathaway Mfg. Co. (curtain fabrics).

KIRCHER, HELTON & COLLETT INC.
1900 Hulman Bldg., Dayton 2
Tel.: Fulton 5161
Radio Dept.: Ralph W. Kaufman, radio director.

PHILIP KLEIN ADV. INC.
226 South 16th St., Philadelphia 2
Tel.: Pennypacker 5-7696
Radio Dept.: Edward Felbin, radio director.
Radio Accounts: Buten's Paint Stores; Paper-Mate Pens; 7-Up Bottling.

NAT M. KOLKER ADV. AGENCY
Empire Bldg., Philadelphia 7
Tel.: Kingsley 6-1320

M. R. KOPMEYER CO. INC.
Realty Bldg., Louisville 2, Ky.
Tel.: Wa 3357

KRONSTADT ADVERTISING AGENCY
711 14th St. N.W., Washington 5
Tel.: Republic 7-0272
Radio Dept.: Henry L. Kronstadt, account executive; Mary Lou Tardio, radio production director.

Radio Accounts: Mazor; L. Frank Co.; Harris & Ewing; Capitol Fur Shop; Joseph De Young; Louis & Dan Brown; Ace Van & Storage; Alperstein's; Ernest Burk; Chase Photographers; Rich's Shoes; Latt's Tie Bar.

KUDNER AGENCY INC.
575 Madison Ave., New York 22
Tel.: Murray Hill 8-6700
Radio Dept.: Myron P. Kirk, vice president, executive radio director; Frank Harting, assistant radio director; Albert W. Reibling, general manager of radio; John P. Marsich, John Murphy, timebuyers; G. Johnstone, L. Dean, C. Rohrabough, E. Owens, K. Tuttle, A. Corrigan, Lloyd Deelaney, account executives.
Detroit 2—New Center Bldg.; Tel.: Madison 5315; Martin Rice, Richard Farricker, vice presidents.
San Francisco 5—681 Market St.; Tel.: Garfield 1-5433; J. Hornell.
Washington—Albee Bldg.; Tel.: National 8-5506; F. Getty.

Radio Accounts: Texas Co. (N-S); General Motors (N-S); U. S. Tobacco (N-S); Buick (N-S); Goodyear Tires (N); Colliers (S); Texas Co.; Schick (N-S).

KUTTNER & KUTTNER INC.
646 N. Michigan Ave., Chicago 11
Tel.: Superior 7-7940
Radio Dept.: Milton J. Klee, Harold E. Kuttner, Chester D. Kuttner, account executives; S. S. Korshak, account executive, radio director; Stanley C. Kuttner, timebuyer.
New York 19—130 W. 57th St., Tel.: Judson 6-2358.
Radio Accounts: Douglas Lumber Co.; Sampson Co.; Franks Dept. Store; Shainberg Dept. Store.

LAHR ADV. AGENCY INC.
915 N. Pennsylvania St., Indianapolis 4
Tel.: Plaza 5328
Radio Dept.: Account executives Fred W. Lahr, George S. Madden, Bernard Howard.

Direct From Paris

RDF

**THE FRENCH BROADCASTING SYSTEM (RDF)
BRINGS YOU FREE OF CHARGE A REGULAR
TRANSCRIBED SERVICE**

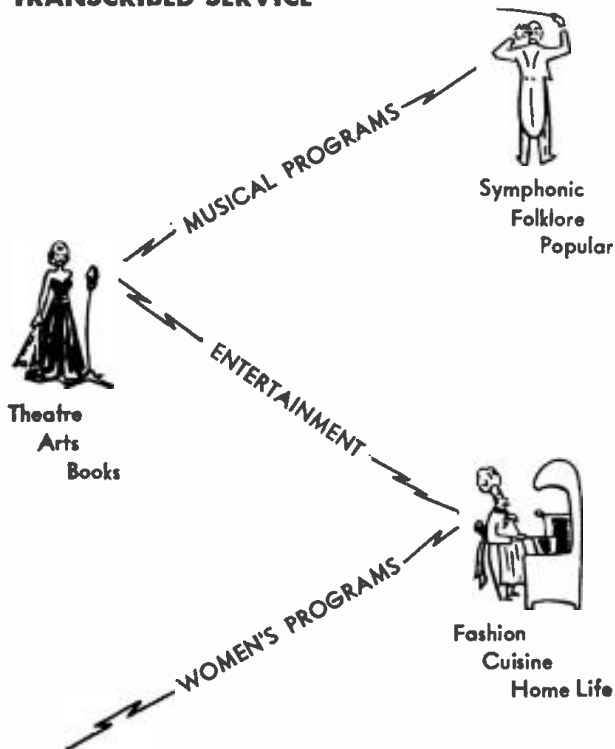

**BY SPECIAL SHORTWAVE FEED
ON-THE-SPOT NEWS • INTERVIEWS • REPORTS**

The French Broadcasting System

PIERRE CRENESSE—*Director in North America*

972 Fifth Avenue • New York 21, N. Y. • REgent 4-1501

AGENCIES

LAKE-SPIRO-SHURMAN INC.
Radio Center Bldg., Memphis 3
Tel.: 5-1571
Radio Dept.: Mrs. Lucille Simmons, radio manager; Robert F. Keefe, radio promotion manager.

Radio Accounts: Plough Sales Corp.; Liberty Petroleum Co.; Pantage Drug Stores; Union Planters Nat'l Bank Kelley-Clarke Co.

LAMB & KEEN INC.
1616 Walnut St., Philadelphia 3
Tel.: Kingsley 6-3500

LAMBERT & FEASLEY INC.
60 E. 42d St., New York 17
Tel.: Murray Hill 7-8980
Radio Dept.: Frank W. Mace, vice president & general manager; Joseph Burland, media director; John Bates, radio director; William Hinman, timebuyer.

LANG, FISHER & STASHOWER INC.
1010 Euclid Ave., Cleveland 15
Tel.: Main 1-8579

RAYMOND I. LANG ADV.
450 Grant Ave., San Francisco 8
Tel.: Yukon 2-5028
Radio Dept.: Marilyn Johnston, timebuyer; Raymond I. Lang, account executive.

Radio Accounts: Lanal Restaurant.

LANNAN & SANDERS ADVERTISING INC.
Fidelity Bldg., Dallas
Tel.: Prospect 1583
Radio Dept.: Robert E. Stuart, radio director; W. Don Fryers, production manager.
Hollywood 28-1522 N. LaBrea; Tel.: Hollywood 8-1681. G. S. Lannan, executive vice president.

Radio Accounts: Continental Trailways Bus System; Transcontinental Bus System Inc., Dixie Lines, Central Lines, Southern Lines Inc., Western Lines, Panhandle Lines, Pacific Lines, Rocky Mountain Div., Santa Fe System.

C. J. LaROCHE & CO. INC.
247 Park Ave., New York 17
Tel.: Plaza 5-7711
Radio Dept.: Stuart Ludlum, radio director; Sally Mansfield, chief timebuyer.

Radio Accounts: Necco (S); Mackintosh, Lovel & Covell (S); Walt Disney (S)

LAVENSON BUREAU OF ADVERTISING
12 S. 12th St., Philadelphia 7
Tel.: Market 7-6767
Radio Dept.: Harry A. Egbert, radio director.
Radio Accounts: Mrs. Schlorer's Inc.; Fleck Co.

GEORGE M. LAWS ADVERTISING AGENCY
1119 S. Hope St., Los Angeles 15
Tel.: Prospect 7761
Radio Dept.: George M. Laws, owner.
Radio Accounts: Sentinel TV; Christopher Candies; Boys Markets.

CARL LAWSON ADV. CO.
4722 Broadway, Kansas City 12
Tel.: Jefferson 5155
Radio Dept.: Account executives John Lawson, Wayne H. Ross, Michael Swift, George E. Hicks; Mrs. Dorothy Mosley, timebuyer.
Eureka Springs, Ark.—11 Howell Ave.; Tel.: 6751; Ned Bailey, manager.

Radio Accounts: Kitty Clover Potato Chip Co.; Curry Real Estate Co.; Faultless Laundry.

AL PAUL LEFTON CO. INC.
1617 Pennsylvania Blvd., Philadelphia 3
Tel.: Rittenhouse 6-1500
New York 17—521 5th Ave.; Tel.: Vanderbilt 8-4340.
Chicago 11—435 N. Michigan Ave.; Tel.: Superior 7-9511.

LENNEN & NEWELL INC.
17 E. 45th St., New York 17
Tel.: Murray Hill 2-5400
Radio Dept.: Nicholas E. Keesely, senior vice president in charge of radio; Francis C. Barton, vice president and general manager of radio; Anthony J. Pan, vice president in charge of radio; George Kern, director of broadcast media; Frank A. Daniel, radio business manager; James S. Ennis, radio coordinator; Fred D. Kilian, program development; producers Charles T. Harrell, Herbert K. Horton, Ted Huston, George G. Tompkins; timebuyers William D. Smith, chief timebuyer, Richard H. Eyman, Jean Jaffee, John R. Widholm; George E. Caron, radio traffic chief; Eva Bain, radio promotion.

Beverly Hills, Calif.—308 N. Rodeo Dr. 1; Tel.: Crestview 1-7221; Benjamin R. Potts, vice president-general manager; Frank Woodruff, radio director.

Detroit 26—1710 Book Tower; Tel.: Woodworth 2-7812; John L. McQuigg, executive vice president in charge.

Milwaukee—231 W. Wisconsin Ave.; Tel.: Broadway 1-6890; James T. Kelley, manager.

Radio Accounts: Colgate-Palmolive Co. (Lustre-Creme Shampoo, Lustre Hairdressing, Home Hair coloring, Home Permanent) (N-S); Lehn & Fink Products Corp. (Lysol Disinfectant) (S); P. Lorillard Co. (Old Gold cigarettes, Embassy, Briggs pipe mixture, Muriel cigars, Headline cigars) (N-S); Tide Water Associated Oil Co. (Tydol gasoline, Veedol motor oil, Federal tires) (S); Joseph Schlitz Brewing Co. (S); The Emerson Drug Co. of Baltimore (Bromo-Seltzer) (N-S); Dorothy Gray Ltd. (S).

LEVY ADV. AGENCY
850 Broad St., Newark 2, N. J.
Tel.: Mitchell 2-0433

TED LEVY ADV. AGENCY
811 Cooper Bldg., Denver 2
Tel.: Main 7133

LEWIN, WILLIAMS & SAYLOR INC.
40 E. 49th St., New York
Tel.: Murray Hill 8-6200
Radio Dept.: A. W. Lewin, president; S. M. Weiss, executive vice president; William R. Seth, vice president in charge of radio; Mary Steffensen, timebuyer; Edward L. Bailey, copy chief; A. Raymond Hopper, Jean Zenlowitz, radio writers; Gerald Gould, Wray D. Kennedy, account executives.
Newark 2, N. J.—11 Commerce St.; Tel.: Market 3-3200; L. Newsteder, Richard Gulick, account executives.

Radio Accounts: G. N. Coughlan; Odell Co. (Trol); Costa's Ice Cream; Carl Fischer Inc.; Dale Dance Studios; Norman M. Morris Corp. (Omega Watch) (S); Harris-Upham.

LEWIS & GILMAN INC.
1528 Walnut St., Philadelphia 2
Tel.: Pennypacker 5-9900

LILLER, NEAL & BATTLE
810 Walton Bldg., Atlanta 3
Tel.: Cypress 6521

Radio Dept.: Sarah Williams, media director; W. W. Neal, C. K. Liller, partners & account executives; Howard Axelburg, G. L. Watts, J. K. Otley Jr., account executives; A. L. Sharp, copy chief, public relations.
Columbia, S. C.—408 Palmetto Bldg.; Tel.: 4-4458; Caldwell Writhers, radio director.
New York 22—40 E. 51st St.; Tel.: Eldorado 5-3771; Robert Kane.
Radio Accounts: Armour Fertilizer Works; Brock Candy Co. (S); Colonial Stores Inc.; H. W. Lay & Co. (S); Nat'l NuGrape Co. (S); Georgia Peanut Co.; Puritan Mills Inc.

LINDSEY & CO. INC.
10 N. 4th St., Richmond 19, Va.
Tel.: 7-3065

W. E. LONG CO.
188 W. Randolph St., Chicago 1
Tel.: Randolph 6-4606

Radio Dept.: Edward C. Fritz Jr., radio director; David Hays, assistant radio director; Suzanne Simpson, radio talent buyer.
Radio Accounts: Amrhein's Bakery; Carpenter Baking Co.; Cotton's Holsum Bakers; Cotton Baking Co.; Cotton Bros. Baking Co.; Dietzen's Bakery; Rluhrer Bakeries; Fuchs Baking Co.; Gase Baking Co.; Haller's Eagle Bakery; Heath's Holsum Bakery; Phoenix Bakery Inc.; Holsum (baking companies in Ft. Wayne, Ind.; Harlingen, Lubbock, Tex.; Roswell, Carlsbad, N. M.; Tampa, Fla.; Visalia, Calif.); Jamestown Baking Co.; Lee Baking Co. (Victoria, Corpus Christi, Tex.); McLaughlin Bakeries (Decatur, Montgomery, Birmingham, Ala.); Master Baking Co.; W. G. Shipley Baking Co.; Betsy Ross Bakery; Brown's Bakery; Butter Krust Baking Co.; Cross Baking Co.; Fisher Baking Co.; Glusti Baking Co.; Gunzenhauser Bakery Inc.; Alfred Nickles Bakery; Old Homestead Bread Co.; Sally Ann Baking Co.; Williams Baking Co.

T. ROBLEY LOUITT INC.
58 Weybosset St., Providence 3
Tel.: Jackson 1-5858

LOWE & HALL ADVERTISING
600 News Bldg., Greenville, S. C.
Tel.: 5-7489
Radio Dept.: Elliott H. Hall Jr., Sidney L. Lowe, account executives.
Radio Accounts: Mackeye Mortuary; S. C. Hospital Service Plan (Blue Cross); Balentine Packing Co.; Greenville News-Piedmont; WFCB-TV; Harper Bros. Inc.

EARLE LUDGIN & CO.
121 W. Wacker Drive, Chicago 1
Tel.: Andover 3-1888
Radio Dept.: Jane Daly, radio director; Ruth Babick, Kay Morgan, timebuyers; Montgomery N. McKinney, Vincent R. Bliss, account executives.
Radio Accounts: Best Foods Inc.; Jules Montener Inc. (Stopette, Finesse, Poof; Rit Products Corp.); W. F. McLaughlin & Co.

LYNN-FIELDHOUSE ADV. AGENCY
15 S. Franklin St., Wilkes-Barre, Pa.
Tel.: 2-7182
Radio Dept.: W. B. Pritchard, radio director, timebuyer.
New York 17—51 E. 42d St.; Tel.: Murray Hill 2-4048.
Radio Accounts: Wise Potato Chips; Jack's Tasty Snack Corp.; Quinlan Pretzel Co.; Purvin Dairy Co.; Zion Biscuit Co.; Planters Edible Oil Co.

W. D. LYON CO.
303 2nd Ave., S.E., Cedar Rapids, Ia.
Tel.: 4-2451
Radio Dept.: Robert H. Schubert, radio director; R. P. Ames, timebuyer.
Sioux City—Orpheum Electric Bldg.; Tel.: 5-4428. Don Carlos, manager.
Radio Accounts: Barron Supply, Crescent Elec.; Kent Feeds; Potosi Brewing; Collins Radio; Peterson Furr.; Hometown Dairies; Cownie Williges; Johnson Biscuit; Tolerton-Warfield, all S.

M

MacFARLAND AVEYARD & CO.
333 N. Michigan Ave., Chicago 1
Tel.: Randolph 6-9360

Radio Dept.: James C. McDonough, radio director; Kay Lloyd, assistant radio director; A. B. Dicus, David W. Stotter; Robert Blackburn, account executives; A. S. Trude Jr., media director.
Radio Accounts: Drewrys Ltd., U.S.A. Inc.; The Hallcrafters Co.; Stewart-Warner Corp.'s Alemite Division; Foulds Macaroni & Spaghettil.

MacGRUDER, BAKEWELL, KOSTKA INC.
1866 California St., Denver
Tel.: Alpine 1477

Radio Dept.: Jack Hull, radio director; Sally Black, timebuyer; George Bakewell, Revill Fox, Louise Hewlet, account executives.
Radio Accounts: Adolph Coors Co.; Citizen's Savings Bank; Denver Federal Savings & Loan Assn.; Denver Tramway Corp.; Empire Savings & Bldg. Loan Assn.; Fairmount Cemetery Assn.; Fontius Shoe Co.; First Nat'l Bank; International Trust Co.

MacLAUGHLIN ADVERTISING AGENCY
601 Ellicott Sq., Buffalo 3
Tel.: Mohawk 5703

Radio Dept.: Frederick R. MacLaughlin, radio director; J. Andrea Connaroe, timebuyer and account executive.
Radio Accounts: Genesee Co. Agriculture Society; C. V. Ortner & Son; J. Allen Bentley; F. C. Ortner Dist. Co.; Guy Smith Hardware; Knights Templar St. of N. Y.

MacMANUS, JOHN & ADAMS INC.
Long Lake Rd. & Woodward, Bloomfield Hills, Mich.
Tel.: Midwest 6-1000

Radio Dept.: Charles N. Campbell, William A. Bushaw, timebuyers.
Los Angeles 48—6399 Wilshire Blvd.; Tel.: Webster 3-9569.
New York 22—444 Madison Ave.; Tel.: Plaza 9-3221; Henry C. Fownes Jr.
Radio Accounts: Pontiac Motors (S); Ferry Morse Seed (N); Cadillac Mtrs. Div. (S); Dow Chemical (S).

MacWILKINS, COLE & WEBER
Corbett Bldg., Portland 4, Ore.
Tel.: Broadway 6401
Seattle 1—Republic Bldg.; Tel.: Elliott 7377.

MAHOOL ADVERTISING
914 N. Charles St., Baltimore 1
Tel.: Plaza 2-3616

Radio Dept.: Account executives Katherine H. Mahool, Robert D. Myers, Robert S. Nyburg.
Radio Accounts: Oil Heat Assn. of Md.; Savings Bank of Baltimore; Metropolitan Savings Bank; Edmondson Village Merchants Assn.; Clayton Shop; Parkington Merchants Assn.; K. Katz & Sons.

MALCOLM-HOWARD ADV. AGENCY
203 N. Wabash Ave., Chicago 1
Tel.: Andover 3-0022

Radio Dept.: Evelyn Burke, timebuyer; Max Holland, Ray Freedman, Hal Barkun.
Radio Accounts: Ambrosia Brewing Co.; Fohrman Motors; Holland; Mages Sporting Goods; Rubins; World Wide Chinchilla Ranch.

W. H. MALE LTD.
1674 Kona St., Honolulu 14
Tel.: 9-1178

Radio Dept.: L. Cunningham, radio director, timebuyer; account executives H. V. Beazlie, Maurice Myers, Earl Goris.
Radio Accounts: City Mill Co.; Dairymen's Assn.; Dutch Boy Paint; Hawaii Brewing Corp.; Love's Biscuit & Bread; Motor Supply; Pacific Chemical & Fertilizer; Pacific Insurance Co.; Pet Milk; Schuman Carriage Co.; Territorial Motors; TPA Aloha Airline; Koss-Sherry Ltd.; Republican Party of Hawaii; Schenley International (through McCann-Erickson, New York); Skymaster Reservations.

DAVID MALKIEL ADV. AGENCY
172 Newbury St., Boston 16
Tel.: Copley 7-5980

LLOYD MANSFIELD CO. INC.
110 Pearl St., Buffalo 2, N. Y.
Tel.: Washington 2762

MARFREE ADV. CORP.
105 W. 40th St., New York 18
Tel.: Longacre 4-7190
Radio Dept.: Harry A. Friedenber, Barnett Friedenber, timebuyers.
Radio Accounts: Bankers Life & Casualty Co.; D-Con Co.; French Masters Inc.; Harris Chemical Co.; House of Goddard; James R. Barnett Co.; Junex Products Co. Inc.; Lobex Products Co.; Parker Pharmaceutical Co.; R & F Co. Inc.

HARWOOD MARTIN ADVERTISING
2519 Connecticut Ave. N. W., Washington 8
Tel.: Adams 2-1161

Radio Dept.: Harlot Stern, radio director; Jean Art, timebuyer; Mildred Martin, Margo Phillips, account executives.
Radio Accounts: American Wholesalers; Arcade-Sunshine; Beckers; Clement's Bakery; Hahn Shoe Stores; The Hecht Co.; Master Auto Body; P. J. Nee Co.; Leo Rocca Inc.; Tuerke's; Washington Gas Light Co.; Woodward & Lothrop; Blair's TV & Appliances; Suit Shop; Palace Laundry.

MARSCHALK & PRATT INC.
535 Fifth Ave., New York 17
Tel.: Vanderbilt 6-2022

Radio Dept.: Curt A. Peterson, director of radio; Eugene Cogan, Cameron Higgins, timebuyers; account executives, Robert Haydon Jones, Samuel L. Meulendyke.
Radio Accounts: Esso Standard Oil Co.; International Nickel Co. Inc.

MASON-RELKIN CO.
46 West 57th St., New York 19
Tel.: Circle 5-7010
Radio Dept.: Roger B. Reiklin.

J. M. MATHES INC.
260 Madison Ave., New York 16
Tel.: Lexington 2-7450

Radio Dept.: Read Hamilton Wight, radio director; Richard S. Jackson, assistant; Edna Cathcart, timebuyer; Patricia A. Hartnett, assistant timebuyer.
Radio Accounts: Canada Dry Inc. (S); Pyrofax Gas (S); Northam Warren Corp. (S); The Pure Food Co. Inc. (S).

MATHISSON & ASSOC. INC.
411 E. Mason St., Milwaukee 2
Tel.: Broadway 6-4090

Radio Dept.: Jack Severson, radio director and timebuyer; Edward G. Ball, Hugo Bauch, Paul Wurga, Joe Manning, account executives.

Los Angeles—1127 Wilshire Blvd.; Tel.: Long Beach 7-2061; Chas. Smith, manager.
New York—1005 International Bldg.; Tel.: 7-2061. Ed Hinkle, manager.

Radio Accounts: Miller Brewing Co. (N-S); Clark Super 100 Gasoline (Petco Corp. Division) (S).

JOSEPH MAXFIELD CO.
87 Weybosset St., Providence 3
Tel.: Gaspee 1-4456

Radio Dept.: Joseph M. Finkle, timebuyer; Archie M. Finkle, radio director.

MAXON INC.
2761 E. Jefferson Ave., Detroit 7
Tel.: Loraine 7-5710

New York 22—12 E. 53d St.; Tel.: Plaza 9-7676.
Chicago 11—644 N. Rush St.; Tel.: Whitehall 4-1676; Thomas P. Maguire, radio business manager.

Radio Accounts: General Electric Co.; Hotpoint Co.; Gillette Co.; Packard Motor Co.

THE MAYERS CO. INC.
2301 W. Third St., Los Angeles 57
Tel.: Dunkirk 8-2111

Radio Dept.: Don Johnson, Larry Lewin, account executives; Bob Hoehn, radio, time and production.

Radio Accounts: Sears Roebuck & Co.; Bandini Fertilizers; Glendale Federal Savings & Loan; D. R. Bleock, optometrist; Kermin Food Prod. Co.; Penzoil Co.

CHARLES H. MAYNE CO.
8487-B Melrose Place, Los Angeles 46
Tel.: Webster 3-8261
Radio Dept.: Eugene P. Ramsay.

MAYS & CO.
412 W. 6th St., Los Angeles 14
Tel.: Trinity 8534

Radio Dept.: Kay Abner, timebuyer; Rich Fowler, radio director; Roderick A. Mays, account executive and owner.
Radio Accounts: Barker Bros.; General Electric Appl.; Four Friendly Dealers; Philco.

MCCANN-ERICKSON INC.
50 Rockefeller Plaza, New York 20
Tel.: Judson 6-3400

Radio Dept.: Alfred J. Scalpone, vice president, director of radio; Hendrik Booraem, vice president for new programs; Ralph B. Koser, vice president, radio commercials; Dorothy B. McCann, vice president, executive producer; A. Edward Sutherland, radio production director; Clifford C. Lubkert, radio service manager; Thaddeus S. Kelly, radio timebuyer manager.
Boston 16—200 Berkeley St.; Tel.: Liberty 2-7382; Watson M. Gordon, vice president and manager.

Cincinnati 2—707 Terrace Plaza Bldg.; Tel.: Garfield 4524; Royal M. Alderman, vice president and manager.

Cleveland 14—829 Euclid Ave.; Tel.: Cherry 1-3490; Robert Dailey, vice president.
Detroit 26—647 Griswold St.; Tel.: Woodward 2-9792; Paul Holder, vice president and manager.

Chicago 4—318 S. Michigan Ave.; Tel.: Webster 9-3701; Sidney A. Wells, vice president and manager.

San Francisco 4—114 Sansome St.; Tel.: Douglas 2-5560; H. Q. Hawes, senior vice president, manager of Western operations.

Los Angeles 17—612 S. Flower St.; Tel.: Mutual 1181; Burt Cochran, vice president and manager.

Hollywood 28—6331 Hollywood Blvd.; Tel.: Hollywood 4-8288; J. Neil Reagan, vice president and manager.

Portland 4, Ore.—310 Pub. Service Bldg.; Tel.: Atwater 4305; Willard E. Wilson, manager.

Radio Accounts: American Trust (S); American Safety Razor (N-S); Calif. Pkg. Corp. (S); Calif. Spray Chemical (S); Calif. Wine Assn. (S); Chesebrough Mfg. (N); Chrysler Sales Div. (S); Chrysler Corp. (S); Columbia Records (S); Gruen Watch (N); W. P. Fuller & Co. (S); Lucky Lager Brewing Co. (S); Mfrs. Trust Co. (S); Nat'l Biscuit Co. (N-S); Ohio Bell Telephone (N); Pacific Power & Light (S); Pepsodent Div. Lever Bros. (N-S); Portland Gas & Coke (S); S.O.S. Co. (N-S); So. Calif. Gas (S); So. Counties Gas (S); Standard Oil of Indiana (S); Standard Oil of Ohio (N-S); Swift & Co. (N-S); Lelsy Brewing Co. (S); Richman Bros. (S); Westinghouse Electric Supply Co. of St. Louis (S); Esso Standard Oil Co. (S); Allied Van Lines Inc. (S); Gray Drug Stores Inc. (S); Lehn & Fink Products Corp. (S); Milk Foundation Inc. (S); Pharmacrast Corp. (S); Seeck & Kade Inc. (S); Stegmaier Brewing Co. (S).

MCCARTY CO.
1206 Maple Ave., Los Angeles 15.
Tel.: Prospect 7011
Radio Dept.: Herb Brown, radio director.
San Francisco—116 New Montgomery; Tel.: Sutter 1-8224
Chicago—20 East Huron St.; Tel.: Superior 7-1847; Harry L. Bauer, manager.

MCCORMICK CO.
217 E. 7th Ave., Amarillo, Tex.
Tel.: 6-5333
Radio Dept.: Lawrence Patton, G. Don Curphey, account executives.
Radio Accounts: Shamrock Oil & Gas Corp.; First Nat'l Bank of Amarillo; Ted Lokey Oil Co.; Service & Supply; West Texas Distributing Co.

WALTER MCCREERY INC.
9344 Wilshire Blvd., Beverly Hills, Calif.
Tel.: Crestview 5-5333
Radio Dept.: Howard Flynn, radio director; Virginia White, timebuyer; account executives Walter McCreery, Marvin Briggs, John Gillingham, Richard Berggren, Robert Svensson.
Radio Accounts: Normalaids Co.; Ice Follies; Los Angeles County Council; American Legion; Murphy Oldsmobile; Harris & Frank; Riverside Rancho; Hull Hotels; Pan Pacific Aud.; Fad Nylons.

FORD C. McELLAGOT & ASSOC.
742 S. Hill St., Los Angeles 14
Tel.: Vandyke 4653
Radio Dept.: Ford C. McElligot

McKEE & ALBRIGHT INC.
1809 Walnut St., Philadelphia 3
Tel.: Locust 7-4737

Radio Dept.: J. A. McFadden, vice president; E. R. Walmsley, timebuyer.

Radio Accounts: Breyers Ice Cream; Phila. & Reading Coal & Iron Co.; Caloric Stove Corp.; Fels & Co.; Western Maryland Dairy.

J. WALTER McLEAN ADVERTISING
601 Chronicle Bldg., Spokane 1
Tel.: Temple 2509

Radio Dept.: J. Walter McLean.

MELDRUM & FEWSMITH INC.
1220 Huron Rd., Cleveland 15
Tel.: Cherry 1-3510

Radio Dept.: Richard Fansler, radio director; M. C. Taylor, media director; Charles J. Lonsdale, Robert G. Henry.

Birmingham, Mich.—135 N. Woodward Ave.; Tel.: Midwest 4-9800; W. H. Stone, vice president.

New York 17—342 Madison Ave.; Tel.: Murray Hill 7-1171; K. R. Frazine, radio director.

Radio Accounts: Apex Electrical Mfg. Co., Glidden Co.; Seiberling Rubber Co.; Willard Storage Battery Co.; Republic Steel Corp.; all S.

ARTHUR MEYERHOFF & CO.
410 N. Michigan Ave., Chicago 11
Tel.: Delaware 7-7860

Radio Dept.: B. J. Green, radio director; George Rich, account executive; Stuart L. Novy, assistant radio director; Kay Knight, timebuyer; Bobbie Francis, asst. timebuyer.

Radio Accounts: E. J. Brach & Sons (S); Chicago Nat'l League Ball Club; Chicago Transit Authority; Evans Fur Co.; Ill. Meat Co.; Myzon Inc. (S); Patricia Stevens Inc.; Perfect Plus Hosiery Mills Inc.; Marie Kruse Nurseries (S); Wm. Wrigley Jr. Co. (N-S); Clark's Super Gas; Wisconsin & Michigan Steamship Lines; Milwaukee Elec. Rwy. & Transport Co.; Towne-Talk; Schaafer Co.; Chicago-Metropolitan Mutual Assurance Co.; Catalina Island Steamship Co.; IBEW Local 1031; I. J. Grass Noodle Co.; Jackson Mutual Life Ins. Co.; Louis Milani Foods; Milwaukee & Suburban Transport Corp.; Grant Tool; De Mert & Dougherty; Ade-o-Matic.

C. L. MILLER CO. INC.
521 Fifth Ave., New York 17
Tel.: Murray Hill 2-1010

Radio Dept.: G. V. Carhart, radio director; Rita Driscoll, timebuyer.

Chicago 1—333 N. Michigan Ave. Tel.: Central 6-1640. I. M. Tuteur.

Radio Accounts: Corn Products Sales; Circle Line Sight Seeing Yachts.

J. W. MILLER CO.
76 Broad St., Gullford, Conn.
Tel.: Glendale 3-2748

DAN B. MINER CO.
304 S. Kingley Drive, Los Angeles 5
Tel.: Dunkirk 8-3301

Radio Dept.: Hildred Sanders, vice president in charge; Arthur E. Trask, associate radio director; Kay Ostrander, timebuyer; Garth Hintz, assistant to vice president.

Radio Accounts: Interstate Bakeries Corp. (N-S); Butay Products; Forest Lawn Co.; Thrifty Drug Stores; Freeman Frozen Foods; Kerr Glass; Georgia Peat of California; Sues, Young & Brown.

MOGGE-PRIVETT INC.
712 S. Curson Ave., Los Angeles 36
Tel.: York 7243

Radio Dept.: Jane Leider, media director.

EMIL MOGUL CO.
250 W. 57 St., New York 19
Tel.: Judson 2-5200

Radio Dept.: Lewis S. Wechsler, radio director; Lynn Diamond, timebuyer.

Radio Accounts Barley's Clothes; Canadian Fur Corp.; Gem Packing; National Shoes; Ronzoni Macaroni Co.; Rayco Auto Seat Covers; Berolio Import Co.; all S; Knomark Mfg. Co. (N).

MOREY, HUMM & JOHNSTONE INC.
350 Fifth Ave., New York 1
Tel.: Longacre 4-2240

Radio Dept.: W. L. Wernicke, radio director; Joe Davis assistant; K. S. Shanahan, timebuyer; June McConnell, assistant to timebuyer; account executives S. F. Ellsworth, L. B. Van Doren.

New York 1—9 Rockefeller Plaza; Tel.: Plaza 7-8060.

Radio Accounts: Sinclair Refining Co. (S); Richfield Oil Corp. of N. Y. (S).

RAYMOND R. MORGAN CO.
6233 Hollywood Blvd., Hollywood 28
Tel.: Hempstead 3-4194

Radio Dept.: Raymond R. Morgan, president; Robert C. Temple, executive vice president; James C. Morgan, vice president for radio; Terri Brady, timebuyer; Jack Kerr, Porter F. Anderson, account executives.

San Francisco 11—260 California St.; Tel.: Douglas 2-6073; Porter F. Anderson.

Chicago 11—Goodkind, Joice & Morgan Inc.; Palmolive Bldg.; Tel.: Superior 7-6746; Harlow P. Roberts, Clyde M. Joice.

Radio Accounts: White King Soap Co. (N); Folger Coffee Co. (N); Planters Nut & Chocolate Co. (N); Victory Packing Co. (R); Nehi Beverages (R-S).

MORSE INTERNATIONAL INC.
122 E. 42d St., New York 17
Tel.: Oxford 7-2100

Radio Dept.: C. C. Slaybaugh, radio director.
Radio Accounts: Vick Chemical Co. (N-S); A. D. McKelvy Co. (S); The Sofskin Co. (S).

MOSS ASSOC.
415 Lexington Ave., New York 17
Tel.: Murray Hill 7-7377

Radio Dept.: Ely Landau, radio director.

MOTTL & SITEMAN ADVERTISING AGENCY
6399 Wilshire Blvd., Los Angeles 46
Tel.: Webster 8-6288

Radio Dept.: Charles Mottl, Irvin Siteman, partners; Elva Pascoe, media director.

C. WENDELL MUENCH & CO.
75 E. Wacker Dr., Chicago 1
Tel.: Financial 6-3481

Radio Dept.: Victor Fabian, timebuyer; Weldon O. Yocum, account executive.

Radio Accounts: Fox DeLuxe Foods; Iowa Soap Co.; Maurer-Neuer Corp.; Neuhoff Bros.; Pavelka Bros.; Miracloth Corp.

IRVIN MYERSON AGENCY
330 S. Wells St., Chicago 6
Tel.: Harrison 7-6828

Radio Dept.: Irvin Meyerson
Radio Accounts: Wine Corp. of America (N).

N

NEALE ADVERTISING ASSOC.
448 S. Hill St., Los Angeles 13
Tel.: Michigan 2149

Radio Dept.: Ted Neale Jr.
Radio Accounts: Quality Television Corp.; E. W. Reynolds Co.

NEEDHAM & GROHMANN INC.
30 Rockefeller Plaza, New York 20
Tel.: Circle 5-6200

Radio Dept.: Harry C. Ledingham, media director, timebuyer; account executives John M. Handley, vice president, and John M. Keil.
Radio Accounts: Waldorf-Astoria Hotel.

want to
sell?
your Ideas your Products?

IN EUROPE?

reach more people at less cost through
THE WORLD'S TWO MOST
POWERFUL COMMERCIAL STATIONS

"RADIO LUXEMBOURG 1"

232 k/cs 150,000 watts
plus 50,000 watt short wave "bonus"
—for all European languages—

"RADIO LUXEMBOURG 2"

1439 k/cs 150,000 watts
—for English-language programs—

EXCLUSIVE REPRESENTATIVE U. S. A.

GUY BOLAM,

AMERICAN SALES AND SERVICING AGENCY

17 E. 42nd Street

Murray Hill 2-0810

NEEDHAM, LOUIS & BRORBY INC.
135 S. LaSalle St., Chicago 3
Tel.: State 2-5151
Radio Dept.: James G. Cominos, vice president, director of radio; Alan Wallace, vice president for programming; Otto R. Stadelman, vice president, media director; Arnold Johnson, director of radio facilities; Pat Brouwer, Don DeCarlo, timebuyers.
Hollywood 28—1680 N. Vine St.; Tel.: Hollywood 2-2991; Frank Pittman, vice president, manager.
New York 20—730 Fifth Ave.; Rockefeller Center; Tel.: Plaza 7-0333; Richard L. Eastland, vice president, manager.
Toronto 5—880 Bay St.; Tel.: Randolph 5530 & 8613; John A. Willoughby, vice president, managing director.
Radio Accounts: Derby Foods Inc. (N-S); Phenix Foods Co. (S); Household Finance Corp. (R-S); Kraft Foods (Parkey) (N-S); Quaker Oats (S); Wilson & Co. (N); S. C. Johnson & Son Inc. (N-S); Morton Salt Co. (S); Wieboldt Stores Inc. (S); State Farm Ins. Co. (N); Monsanto Chemical (All detergent) (S); People's Gas Light & Coke Co. (S).
GEORGE R. NELSON INC.
206 State St., Schenectady, N. Y.
Tel.: 4-4135
Radio Dept.: George R. Nelson, president, treasurer; Helen C. Nelson, vice president; Alice Pach, secretary; Robert S. Cragin, radio director, copy chief; Michael Danyla Jr., assistant copy chief; Anne F. Pratt, timebuyer; Pearl Veeder, copy writer.
Radio Accounts: William W. Lee & Co.; Saratoga Assn. (racing); Sterling Furniture Mart.
NEWMAN, LYNDE & ASSOC. INC.
1628 San Marco Blvd., Jacksonville 7, Fla.
Tel.: 98-9721
Radio Dept.: Hunter Lynde, David E. Robeson, John A. Bunker, Ron G. Sercombe.
KELSO NORMAN ADV.
222 Kearney St., San Francisco 8
Tel.: Douglas 2-3942

O

R. T. O'CONNELL CO.
420 Madison Ave., New York 17
Tel.: Plaza 3-5412
Radio Dept.: R. T. O'Connell
Radio Accounts: Pomatex Co.; Central Paint & Varnish Works Inc.
OHIO ADV. AGENCY INC.
2300 Payne Ave., Cleveland 14
Tel.: Superior 1-7070
Radio Dept.: Mel Tenenbaum, radio director; Burt Schildhouse, copy writer; Samuel L. Abrams, account executive.
Radio Accounts: Lyon Tailoring Co.; Jalovec Motors; Packard Cleveland; Ascot Park Racetrack; Cranwood Racetrack; Thistle-down Racetrack; Ohio State Fair.
OLIAN & BRONNER INC.
35 E. Wacker Dr., Chicago 1
Tel.: State 2-3381
Radio Dept.: Irwin A. Olian, president, account executive; Kay Kennelly, radio timebuyer, media director; Miriam Orr, traffic production (radio); M. H. Bronner, Robert Ross, Bob Singer, Jules Draznin, Ed Sonnenschein, account executives.
Radio Accounts: Atlas Brewing Co.; Beltone Hearing Aid Co.; Chicago Engineers for Television; Nu-Enamel Paint Co.; Schoenhofen-Edelweiss Co.; Special Foods Co.; Union Liquor Co.; Niagara Mfg. & Dist. Co.; New Process (Holsom Bread); Continental Products; General Rug Co.; National Business & Property Exchange; Pope Chemical Co.; Lo-beck's Products.
OLIAN ADVERTISING CO.
411 N. 7th St., St. Louis 1
Tel.: Central 8380
Radio Dept.: Mrs. Alice McDonough, radio director; James Spencer, Albert Maescher Jr., account executives; Peggy Leonhardt, radio production.
Radio Accounts: Bardenheir Wine Co. (S); Sayman Products Co. (S); Pevely Dairy Co.; Dixie Mills Co.; St. Louis Federal Savings & Loan Assn.; Weber Chevrolet.
OLMSTED & FOLEY
1200 Second Ave., Minneapolis 3
Tel.: Atlantic 8166
Radio Dept.: Warren T. Way, timebuyer.
Radio Accounts: Marshall-Wells; Regan Bros. Bakery; Rochester Dairy; Owatonna Canning Co.; Russell-Miller Milling Co.; Northland Milk Co.; Clover Leaf Creamery Co.; Northwest K-F Motors; Page & Hill Homes; Salisbury Co.; Hotel Leamington.
O'NEIL, LARSON & MCMAHON
230 N. Michigan Ave., Chicago 1
Tel.: Andover 3-4470
Radio Dept.: Walter Zivi, executive vice president; William R. Cline, radio director, timebuyer.
New York—290 Madison Ave.; Tel.: Murray Hill 3-8930; E. D. Silba.
Toronto—67 Yonge St.; Tel.: Empire 6-5641.
THE E. A. OPPENHEIM CO.
1200 Michigan Theatre Bldg., Detroit 26
Tel.: Woodward 1-6765
Radio Dept.: Richard Farrell, director.
Radio Accounts: Bill Brown; Barlum Hotel; Donovan Bldg.; Edward's Nash; Flat Rock Speedway; Kimco Industries; Miller Modern-

ization; Pringle Furniture Co.; H. A. Powell Studios.
ROBERT W. ORR & ASSOC. INC.
4 W. 58th St., New York 19
Tel.: Plaza 9-8050
Radio Dept.: Louis L. Ergman, radio director; Eleanor Accles, timebuyer.
Los Angeles 46—9130 Sunset Blvd.; Tel.: Crestview 5-0104; Richard Diggs.
Radio Accounts: Andrew Jergens Co. (N); Clairol Inc. (S); Resort Airlines (S).
MERRITT OWENS ADV. AGENCY INC.
365 New Brotherhood Bldg., Kansas City 1, Kan.
Tel.: Drexel 7250
Radio Dept.: Merritt Owens, Earl Allvine, R. Grant Neds, account executives and timebuyers.
Radio Accounts: Joe M. O'fill Motor Co.; Home Federal Savings & Loan; Kelley-Williams Motor Co.; Pyramid Life Insurance Co.; Chevrolet Dealers Assoc.; Joe Strick Nash; Davidson Bros. Motor Co.; Kansas Business Magazine.

P

PACIFIC NATIONAL ADV. AGENCY
2124 Fourth Ave., Seattle 1
Tel.: Elliot 1401
Radio Dept.: Trevor Evans, radio director; Gertrude M. Nyman, timebuyer.
Portland 4, Ore.—715 Cascade Bldg.; Tel.: Capitol 1021, Milton Foland.
Spokane 8—606 Chronicle Bldg. Tel.: Madison 4371, Martin Boss
PARIS & PEARL
370 Lexington Ave., New York 17
Tel.: Murray Hill 9-2424
Radio Dept.: H. L. Mooney, media and research director; Weymouth Symmes.
Radio Accounts: Excelsior Quick Frozen Foods; Great A & P Tea Co.; West Disinfectant Co.; J. Colonna Bros.
PATCH & CURTIS
437 E. Broadway, Long Beach 2, Calif.
Tel.: 6-1259
Radio Dept.: John Curtis, Gene Curtis, Lee Arbutnot, accounts executives.
Radio Accounts: Harrod Diagnostic Offices; California Chiropractic Assn.; L. S. Whaley; Wilton Hotel; St. Catherine Hotel.
PATTEN & ASSOCIATES
8741 Sunset Blvd., Hollywood 46
Tel.: Bradshaw 28143
Radio Dept.: William V. Patten, president and account executive; Elizabeth Cody, media director.
Radio Accounts: Famous Four Ford Dealers.
PEARSON ADV. AGENCY INC.
250 Park Ave., New York 17
Tel.: Murray Hill 8-3055
Radio Accounts: The Dime Savings Bank of Brooklyn; National Home Owners Assn. Inc.
PECK ADV. AGENCY INC.
400 Madison Ave., New York 17
Tel.: Plaza 3-0900
Radio Dept.: S. S. Schweitzer, radio director.
Radio Accounts: Howard Clothes; Old Dutch Coffee; Industrial Bank of Commerce; Francis H. Liggett (Premier Foods), all S.
PERRY-BROWN INC.
2831 Vernon Place, Cincinnati 19
Tel.: Plaza 8200
Radio Dept.: Edward J. Doran, radio director, timebuyer.
Radio Accounts: Willson Dairy; political; miscellaneous.
J. R. PERSHALL CO.
105 W. Adams St., Chicago
Tel.: Franklin 2-8440
Radio Dept.: George B. Bogart, vice president; Grace D. Rauworth, media manager.
New York 23—1861 Broadway; Tel.: Plaza 3-7440; Francis E. O'Neill.
Radio Accounts: State Street Council (S); Packard Motor Car Co. (S).
THE PHILLIPS-RAMSEY CO.
604 First Nat'l Bank Bldg., San Diego 1
Tel.: Main 8-5121
Radio Dept.: Orva Huff, radio director; Robert L. Phillips, media director; Robert F. Lewis, Tom Ables, C. C. Ramsey, account executives.
JOSEPH J. PINKUS ADV.
318 Market St., Newark 2, N. J.
Tel.: Mitchell 2-5475
Radio Dept.: Joseph J. Pinkus, timebuyer.
Radio Accounts: Perfume Import Co.; American Healthaids Co.; Radio-Offers Co.; Christmas, hillbilly, pop records, hymns.
PLATT, ZACHARY & SUTTON INC.
7 E. 44th St., New York 17
Tel.: Murray Hill 7-3240
Radio Dept.: William S. Walker, vice president; Thomas O'Donnell, secretary, media director; Guy Wallace, vice president; George Zachary, radio director; Stephen Price, assistant; Thomas O'Donnell, timebuyer.
Boston 16—31 Providence St.; Tel.: Kenmore 6-3103.
Radio Accounts: Gambarelli & Davitto Wines & Vineyard; Squirrel Brand & Co.; Oxo Ltd.
POLLYEA ADVERTISING
670 Cherry St., Terre Haute, Ind.
Tel.: Crawford 6707
Radio Dept.: Marie Pershing, radio director, timebuyer.
Radio Accounts: Hulman & Co.; K. C. Fords; F. W. Cook Co.

POSNER-ZABIN ADVERTISING
95 Madison Ave., New York 16
Tel.: Murray Hill 9-2672
Radio Dept.: James B. Zabin.
Radio Accounts: Bilt-Rite Baby Carriage Co. (S), others.
R. J. POTTS-CALKINS & HOLDEN
215 W. Pershing Rd., Kansas City 8
Tel.: Grand 3775
Radio Dept.: William J. Brewer, radio director.
POTTS-TURNBULL ADV. CO.
912 Baltimore Ave., Kansas City 6
Tel.: Victor 9400
POWELL-GRANT ADV. INC.
1166 Fenobscot Bldg., Deroit 26
Tel.: Woodward 1-4321
Radio Dept.: Robert H. Powell, account executive, timebuyer; Bill Gayek, account executive; Charles Schiappacasse, assistant radio director.
Radio Accounts: Charlie's Nash; Detroit City Ice & Fuel; Dorman's Cafe Lounge; Highland Park Motors; Jefferson Lincoln Mercury; Hillcrest Country Club; Kay-Way-Kales Kramer; Military Inn; Kirby Corp.; Thiele Constr.; Miller Boat & Motor Co.; Plymouth Dealers; McDonald Trailer Sales; Motor City Speedway; Louis Rose Co.; Park Motor Sales.
JOHN O. POWERS CO.
110 William St., New York 38
Tel.: Worth 4-7361
Radio Dept.: Robert W. Powers, treasurer.
PRATER ADV. AGENCY INC.
705 Chestnut St., St. Louis 1
Tel.: Garfield 6490
Radio Dept.: George L. Prater, president and account executive; Grant L. Calvert, vice president and account executive; Barbara Block, radio director.
Radio Accounts: Falls City Brewing Co. (S).
PRESBA, FELLERS & PRESBA INC.
360 N. Michigan Ave., Chicago 1
Tel.: Central 6-7683
Radio Dept.: Mark M. Smith; Grant Smith, timebuyer.
Radio Accounts: Beltone Hearing Service; Book House for Children; Flex-O-Glass Inc.; Keeley Brewing Co.; Olson Rug Co.; Stix Dental Products.
PROEBSTING, TAYLOR INC.
100 E. Ohio St., Chicago 11
Tel.: White Hall 4-1051
Radio Dept.: K. August, Earl C. Collings, account executives; Stephanie M. Seeder, timebuyer.
Radio Accounts: American Extension School of Law & Elmer Wheeler Training Institute; Hooker Glass & Paint Mfg. Co.
PROFILE ADV.
73 B St., Manchester, N. H.
Tel.: 4-4991

R

RADIO ADV. CORP. OF AMERICA
128 Mallory Ave., Jersey City 5
Tel.: Henderson 4-2332
Radio Dept.: Paul Apello, radio director; B. E. Geise, Michael A. Fiore, timebuyers; Andrew Bryant, C. D. Murphy, S. P. Brown, account executives; Murray Chaban, comptroller.
Radio Accounts: Korex Diet Gum; Watchung Lake; Specialty Sales Co.; Grand Central Autos; Stage Coach Inn; AFCC Sales Corp.; S. Wolff & Co.; Greeting Card Co. (N-S); China Clipper; Dent-Re-Par Inc.; David Schamroth Co.; Montecarlo Inn; Leslie Toy Co.; Glassarent Mfg. Co.; The Ward-Stilson Co.; Children's Times; Alexander Beverages; New School for Modern Music; Rev. Rittenhouse; Coast-to-Coast Vendors; Aronda Chemical Co.; Harvey Industries Ltd.; Visi-Disc Record Co.
FRED M. RANDALL CO.
3314 Book Tower, Detroit 26
Tel.: Woodward 1-4662
Radio Dept.: Charles E. Foerster, timebuyer; Hugh R. Mack Jr., radio director; account executives, R. D. Hughes, Hal G. Trump.
THE RANDALL CO.
75 Pearl St., Hartford 3, Conn.
Tel.: 7-1179
Radio Dept.: Mrs. Florence Grady, radio director; Robert Berger, art director.
Radio Accounts: General Electric Supply; Hartford Gas Co.; Hoffman Wallpaper Co.; New England Laundry Co.; Savitt Jewelers; Wachtel's Dept. Store; Ellin & Levin; State Line Potato Chip.
RAY-HIRSCH CO. INC.
37 W. 57th St., New York 19
Tel.: Murray Hill 8-3515
Radio Dept.: Murray Hirsch.
KNOX REEVES ADV. INC.
600 First Nat'l-Soo Line Bldg., Minneapolis 2
Tel.: Bridgeport 7701
Radio Dept.: R. E. Neff, radio director; William S. Shepherd, radio program director; Coy Bender, timebuyer.
Radio Accounts: General Mills Inc. (N-S); Pacific Gamble Robinson Co. (S); Midland Nat'l Bank; Art Instruction Inc.; Soo Line Railroad (S).

One of
Los Angeles'
MORE IMPORTANT

Radio
Stations

KOWL

Reaching and Selling:

• The NEGRO Market
(350,000)—

Joe Adams (d. j.)

"Sharing Secrets" (women's
program)

News (Negro appeal)

• The MEXICAN &
MEXICAN AMERICAN
Market (400,000)—

"Chico" (Latin flavor d.j.)
Mrs. Elena Salinas (Spanish
language family program)

News (Spanish)

• PLUS Jewish and eight other
language markets



1580kc.

NOW 10,000 WATTS!

(See Santa Monica listing)

REINCKE, MEYER & FINN INC.
520 N. Michigan Ave., Chicago 11
Tel.: Whitehall 4-7440
Radio Dept.: John A. Priebe, media director.
Radio Accounts: Anderson Co.; Chicago Bur-
lington & Quincy; Ontario Hearing Aids;
John R. Thompson restaurants; American
Chain & Cable Corp.

EMIL REINHARDT ADV. AGENCY
1738 Franklin St., Oakland 12, Calif.
Tel.: Templebar 2-2408
Radio Dept.: William Dalley, radio director;
James Resor, timebuyer and account ex-
ecutive.

Radio Accounts: San Francisco Brewing Corp.
(N-S); Central Bank; Old Home Bakers;
Golden Brands; Walter N. Boysen Co.; Gold-
en Crust Bakers; Kilpatrick's Bakery, all
spot.

FLETCHER D. RICHARDS INC.
(see Harrington-Richards, division)
10 Rockefeller Plaza, New York 20
Tel.: Judson 6-5400

Radio Dept.: E. A. Elliott, vice president for
media; Edwin S. Reynolds, radio director;
Claire Lorenz, coordinator of program infor-
mation; J. M. Kelly, radio timebuyer; S. J.
Frolick, radio commercials director; Robert S.
Colodzin, in charge of radio production; Wil-
liam L. Russell, in charge of radio copy;
John Nolan, radio copy production assistant;
Barbara M. Kiefer, radio traffic coordinator.
Chicago 1—221 N. LaSalle St.; Tel.: Financial
6-5885.

San Francisco 8—256 Sutter St.; Tel.: Exbrook
2-6025.

Los Angeles 36—5816 Wilshire Blvd.; Tel.: Web-
ster 3-5577.

Radio Accounts: Canadian Nat'l. Railways (S);
Durham-Enders Razor Corp. (S); Eastern
Air Lines (S); Peter Fox Brewing Co. (S);
United States Rubber Co. (S); Squirt Bever-
age Co. (S); Avoset Co. (S).

M. EVANS RICHMOND AGENCY
127 S. 22d St., Philadelphia 3
Tel.: Locust 7-1674
Boston 16—230 Boylston St.; Tel.: Common-
wealth 6-4491.
Hollywood—Yucca Vine Bldg.; Tel.: Hempstead
3517.

RICKARD & CO. INC.
11 E. 36th St., New York 16
Tel.: Murray Hill 6-4870
Radio Accounts: Oakite Products Inc.

RINGER & ASSOCIATES INC.
3142 Wilshire Blvd., Los Angeles 5
Tel.: Dunkirk 7-8131

DAN RIVKIN AGENCY
1418 Walnut St., Philadelphia 2
Tel.: Pennypacker 5-5766
Radio Accounts: Ford Optical; John Kohler
Clothing; Shulte Optical Co.; Spiro's Ap-
parel; Stanley's Corrective Shoes; Moskin
Clothes.

MARSHALL ROBERTSON ADVERTISING
AGENCY
509 Railway Exchange Bldg., Denver 2
Tel.: Keystone 6269
Radio Dept.: Margaret Pierson, director; Mar-
shall Robertson. Mary Robertson, partners,
account executives; John Eby, Walter Kranz,
R. Wendell McWilliams, James Briggs, ac-
count executives.

Radio Accounts: Miller Super Markets; Elitch
Gardens; Frumess Jewelry Co.; Cottrell
Clothing Co.; Grayson Apparel Co.; Wolf-
berg Theatres; Weicker Transfer & Storage
Co.; O'Meara Motor Co.; First Nat'l Bank of
Englewood; Republic Drug Co.; Elcar Fence
Co.

ELWOOD J. ROBINSON & CO.
1111 Wilshire Blvd., Los Angeles 17
Tel.: Mutual 6293

Radio Dept.: Talbot Johns, radio director; Rob-
ert C. Neuman, media director; Elwood J.
Robinson, John W. Haynes, account execu-
tives.

Radio Accounts: Loma Linda Food Co.; Pioneer
Savings & Loan Assn.; California Federal
Savings & Loan Assn.; Lincoln Savings &
Loan Assn.; Cinch Products Inc.; Wilco Co.;
Pasadena Savings & Loan; Western Federal
Savings & Loan Assn.; Republic Federal
Savings & Loan Assn.

ROCHE, WILLIAMS & CLEARY INC.
135 S. La Salle St., Chicago 3
Tel.: Randolph 6-9760

Radio Dept.: P. R. Stewart, radio director; N. J.
Cavanagh, timebuyer.

Radio Accounts: The Studebaker Corp. (N-S);
Chl.-Milwaukee-St. Paul & Pac. R. R. Co.
(S); Hardware Mutual Casualty Co. (S);
John Pahl Products Co. (S); Stewart and
Ashby Coffee Co. (S); Deepfreeze Appliance
Div. Motor Products Corp. (N-S); National
Toilet Co. (S).

ROCKLIN, IRVING & ASSOC.
32 W. Randolph St., Chicago 1
Tel.: Randolph 6-2324

Radio Dept.: I. Rocklin, director and timebuyer;
Ira Segall, Marjorie Lovinger, Gerald Addis,
account executives.

Radio Accounts: Walton Motors; Union Life Ins.
Co. (S); Chicago Furniture Mart; Kay-Den
Beauty Salon; Roxy Rug; Bailey's; Bala-
ban's.

IRVING ROSEN ADVERTISING
230 Fifth Ave., New York 1
Tel.: Oregon 9-1926
Radio Dept.: Irving Rosen, timebuyer; E.
Wayne, production.

ROSS ADV. AGENCY
4053 Lindell Blvd., St. Louis 8
Tel.: Lucas 1322
Los Angeles 4—184 S. Alvarado St.; Tel.: Dun-
kirk 7-2148.
So. Nyack, N. Y.—156 Piedmont Ave.; Tel.:
7-2506.
Kansas City 6, Mo.—823 Walnut St.; Tel.: Balti-
more 6730.

CHARLES ROSS ADV. AGENCY
1418 N. Highland Ave., Hollywood 28
Tel.: Hollywood 2-1184

CHARLES L. RUMRILL & CO. INC.
339 East Ave., Rochester, N. Y.
Radio Dept.: Alan Brown, radio director.

LOWE RUNKLE CO.
1305 Liberty Bank Bldg., Oklahoma City 2
Tel.: Regent 6-3521

Radio Dept.: Maury Ferguson, radio director;
Howard Neumann, Harold Kranz, Roger
Fishny, timebuyers and account executives.
Radio Accounts: Cain's Coffee Co. (S); Liberty
Nat'l Bank & Trust; Local Federal Savings
& Loan Assn.; Arkansas City Flour Mills;
Dulaney; Simpson Auto Co.; Hirsch-Swan.

RUTHRAUFF & RYAN INC.
405 Lexington Ave., New York 17
Tel.: Murray Hill 6-6400

Radio Dept.: Tom Slater, vice president, direc-
tor; Grant Y. Flynn, network timebuyer;
Daniel M. Gordon, media director; Henry
Frankel, talent buyer.

Chicago 1—360 N. Michigan Ave.; Tel.: Finan-
cial 6-1833; R. W. Metzger, vice president,
radio director.

Los Angeles 5—3440 Wilshire Blvd.; Tel.: Dun-
kirk 8-0571; John Welsler, vice president and
Pacific Coast manager.

Hollywood 28—6920 Sunset Blvd.; Tel.: Holly-
wood 9-3811; William Burch, radio director.

Detroit 2—7430 2d Blvd.; Tel.: Trinity 4-2200;
Tod Reed, vice president, manager.

Cincinnati 2—Carew Tower; Tel.: Main 2413;
John L. Magro, manager.

St. Louis 1—611 Olive St.; Tel.: Main 0127; Oscar
A. Zahner, senior vice president, manager.

Dallas 1—505 N. Ervay St.; Tel.: Victor 4-4986;
Roger Bacon, manager.

Houston 2—Gulf Oil Bldg.; Tel.: Charter 4-1741;
W. Van A. Combs, manager.

Seattle 1—Northern Life Tower; Tel.: Elliott
1572; Francis G. Mullins, vice president,
manager.

San Francisco 4—235 Montgomery St.; Tel.: Ex-
brook 4616; John L. Harvey, vice president,
manager, account executive.

Toronto 1—Toronto St.; Tel.: Plaza 1515; Gor-
don Ralston, manager.

LEWIS EDWIN RYAN
726 Jackson Place N.W., Washington 6
Tel.: Republic 7-7606

Radio Dept.: William J. Green, director of radio;
John F. Hardie, William R. Doores, Marshall
Hurt, Donald Dixon, Murray Platok, account
executives.

MAXWELL SACKHEIM & CO. INC.
670 5th Ave., New York 19
Tel.: Plaza 8-2086

Radio Dept.: Rae E. Elbrock, radio timebuyer;
Jose Di Donato, radio director.

Radio Accounts: Jackson & Perkins (N-S);
Around the World Shoppers' Club; Chilton
Greeting Cards; Facts on File, all S.

ST. GEORGES & KEYES INC.
250 Park Ave., New York 17
Tel.: Plaza 5-1180

Radio Dept.: James J. Freeman, media director;
William O'Brien.

Radio Accounts: Davison Chemical Corp. (S).

WALKER SAUSSY ADVERTISING
823 Perdido St., New Orleans 12
Tel.: Magnolia 3218

Radio Dept.: Charles Bloom II, P. J. Stakelum
Jr., Dorothea Schlesinger, Joseph C. Shields
Jr., Moise Bloch.

Radio Accounts: American Brewing Co.; Wm.
B. Rely Co. Inc.; Elmer Candy Co.; Petrol-
ene Gas Co.; J. T. Gibbons Inc.; Fulton
Bag & Cotton Milk; Henderson Sugar Re-
finery; Holsum Bakeries Inc.

FRANK B. SAWDON INC. ADV.
480 Lexington Ave., New York 17
Tel.: Plaza 5-2516

Radio Dept.: Jerry Bess, radio director in charge
of timebuying.

Chicago 1—75 E. Wacker Dr.; Tel.: Dearborn
2-0826; Tom Mannos.

Radio Accounts: Robert Hall Clothes; Abelson's
Inc. Jewelry.

THE SAXTON AGENCY
312 E. Wisconsin Ave., Milwaukee 2
Tel.: Broadway 6-2142
Radio Dept.: H. Ellis Saxton, radio director;
Eunice Grobe, timebuyer.

SCHIEDLER, BECK & WERNER INC.
487 Park Ave., New York 22
Tel.: Murray Hill 8-8886
Radio Dept.: Vera Brennan, radio director;
Anne Small, Sally Reynolds, Nina Flynn,
timebuyers.
Radio Accounts: Manhattan Soap Co. (N); C. F.
Mueller Co.; G. F. Heublein & Bro. Inc.;
Int'l Salt Co.; McIlhenny Co.; Economics
Labs, all S.

SCHOENFELD, HUBER & GREEN LTD.
520 N. Michigan Ave., Chicago 11
Tel.: Whitehall 4-0818
Radio Dept.: Lewis G. Green, radio director;
Merritt R. Schoenfeld, account executive;
Miriam R. Orr, timebuyer.

SCHOLTS ADV. SERVICE
1201 W. Fourth St., Los Angeles 17
Tel.: Michigan 2396
Radio Dept.: Cory Simmons, radio director.
(Also Rhoades & Davis, same address)

SCHWIMMER & SCOTT INC.
75 E. Wacker Dr., Chicago 1
Tel.: Dearborn 2-1815
Radio Dept.: Robert Knapp, radio director;
Evelyn Vanderploeg, timebuyer; account executives,
R. J. Scott, C. H. Lillienfeld, Fred
Vosse, Ed Guy, Ed Arlis.

Radio Accounts: Boyer Internat'l Labs. Inc.;
Chicago Stadium Corp.; Citrus Products Co.;
Helberg's Diamond Shops Inc.; Nat'l Tea
Co.; ReaLemon Puritan Co.; Red Dot Foods
Inc.; Salerno-Megowan Biscuit Co.; Spiegel
Inc.; Walgreen Co.; Hawthorne-Mellody
Farms Dairy; F & F Labs.

SCOTT'S AGENCY INC.
11 Pemberton Sq., Boston 8
Tel.: Capital 7-2422
Radio Dept.: Edith M. Ripley.

RUSSEL M. SEEDS CO. INC.
919 N. Michigan Ave., Chicago 11
Tel.: Whitehall 3-2133
Radio Dept.: Russell B. Young, vice president
in charge of radio; Merle Myers, timebuyer;
Freeman Keyes, president; George Aayard,
executive vice president; Harry Maus, Harry
Goldsmith, vice presidents; Fred Wilson,
James Withereil, account executives.

Hollywood 46-7324 Santa Monica Blvd.; Tel.:
Hollywood 9-1103; Lou Place, vice president.
Radio Accounts: Brown & Williamson Tobacco
Co.; LeBlanc Corp.; King Midas Flour; Pinex
Co.; Shaeffer Pen Co.; Elgin American-
Illinois Watch Case Co.

ROSCOE W. SEGAR ADVERTISING
2125 N. E. 48th Ave., Portland 13, Ore.
Tel.: Trinity 3445
Radio Dept.: D. D. Segar, timebuyer and radio
director.

Radio Accounts: Niklas & Son; G. B. Wallace
Co.

SHACKLEFORD ADV. AGENCY
120 1/2 San Fernando Rd., Los Angeles 31
Tel.: Capitol 2-1192
Radio Dept.: J. H. Shackelford, owner.
Radio Accounts: Pacific Lends.

SHAFFER, BRENNAN, MARGULIS ADV. CO.
4 N. 8th St., St. Louis 1
Tel.: Main 2579

THE LEONARD SHANE AGENCY
104 S. Vermont Ave., Los Angeles 4
Tel.: Dunkirk 3-3215
Radio Dept.: Leonard Shane, president; William
T. Crago, radio director, timebuyer; J. M.
Lench, assistant radio director, timebuyer.

RALPH SHARP ADV. INC.
2300 Guardian Bldg., Detroit 26
Tel.: Woodward 2-8070
Radio Dept.: Art Seely, radio director; Lloyd
Raddell, media director.

JOHN W. SHAW ADVERTISING
716 N. Rush St., Chicago 11
Tel.: Mohawk 4-6322
Radio Dept.: John W. Shaw, president; Sylvia
Slive, timebuyer; David E. Guerrant, vice
president, account executive.

Radio Accounts: Armour & Co. (N); Drum-
mond Packing Co.

SHERMAN & MARQUETTE INC.
919 No. Michigan Ave., Chicago 11
Tel.: Delaware 7-8000
Radio Dept.: Louis E. Tilden, radio director;
Clifford E. Bolard, timebuyer.
New York 20-10 Rockefeller Plaza; Tel.: Plaza
7-6400; John Crandall, director of media;
Jan Gilbert, timebuyer.

CHARLES SILVER & CO.
737 N. Michigan Ave., Chicago 11
Tel.: Superior 7-6625
Radio Dept.: Ben Solomon, radio director, ac-
count executive; Charles Silver, account ex-
ecutive.

Radio Accounts: Rival Dog Food (S); Elam
Mills (S).

SIMMONDS & SIMMONDS INC.
201 N. Wells St., Chicago 6
Tel.: Andover 3-6645

Radio Dept.: Stephanie M. Seeder, media direc-
tor; Kenneth R. Willert, radio department.
St. Louis 1-611 Olive St.; Georgia X, Tobias,
media director.

Dallas-512 Fidelity Bldg.; P. J. Crandall, ac-
count executive.
Ft. Worth-506 Neil P. Anderson Bldg.; George
A. Addington, vice president.
Memphis-61 Madison Bldg.; Maurice Marshall,
vice president.
Radio Accounts-Sanford Webb Motor Co.; Uni-
versal Mills.

SIMON & GWYNN
622 Commerce Title Bldg., Memphis
Tel.: 5-2404
Radio Dept.: H. N. Gwynn, partner; W. E. Dav-
idson Jr. timebuyer.
Nashville-930 Stahlman Bldg.; Tel.: 5-8909;
G. K. Leckie, manager.
Radio Accounts: American Snuff Co.; American
Tea & Coffee; The Hum-Ko Co.; Robilio &
Cuneo; Rigo Chemical; Grocery Products Co.

SIMONS-MICHELSON CO.
1126 Lafayette Bldg., Detroit 26
Tel.: Woodward 3-3000
Radio Dept.: R. N. Hughes, radio director;
Cynthia J. Waites, Evelyn J. Keller, Leon-
ard M. Simons, Lawrence J. Michelson,
Marion Stein.

Radio Accounts: Cunningham's Drug Stores;
Detroit Free Press; Dossin's Food Products;
E & B Brewing Co.; General Electric Sup-
ply Co.; Gerson's Jewelers; Guardian Sav-
ings & Loan; Keoplinger's Bakery (R);
King Paint Roller Co.; Krun-Chee Potato
Chips; Lasky Furniture; Leo Adler Co.;
Marshall Drug Co.; Mohawk Lumber Co.;
Sealy Mattress Co.; People's Outfitting Co.;
Velvet Peanut Products Inc. (R); Wrigley's
Supermarkets.

RAYMOND L. SINES & ASSOC.
291 Geary St., San Francisco
Tel.: Sutter 1-8137
Radio Dept.: Beth Norman, timebuyer.

LEONARD M. SIVE & ASSOC. INC.
22 W. 7th St., Cincinnati 2
Tel.: Garfield 3000
Radio Dept.: Robert G. Grannen, radio director.

SMITH & GANZ INC. ADVERTISING
6642 Sunset Blvd., Hollywood 28
Tel.: Hollywood 9-8234
Radio Dept.: Charles B. Ganz, president; Byron
Niemann, radio director; Caila Hunt, time-
buyer; account executives, Mr. Ganz, Har-
old Dreyfus, William R. Hoffman, Frederic
B. Vanderhurst.

Radio Accounts: Fred J. Jeckell (R); Ideal
Mortgage Co. (S); Lutheran Bible Institute
(R); Pacific Institute of Nursing (S); Peita
Furs (S); Ransom Insurance Agency (N);
John S. Reed (S); Walter Wellman (R);
Steve's Motor Exchange (R); Top's Music
Enterprises (NS); J. B. Finch Furniture
(R); Growth Corp. (R).

SMITH, TAYLOR & JENKINS INC.
223 Fourth Ave., Pittsburgh 22
Tel.: Atlantic 1-9312
Radio Dept.: Les Sterne, radio director; Ron
Taylor, Bob Quaid, Bill Sutherland, account
executives.

Radio Accounts: Pgh Brewing; Pgh Prov. &
Packing; Sealy Mattress; Dad's Root Beer;
Otto Milk; Motaloy Dist. Inc., all S.

STAAKE & SCHOONMAKER CO.
808 Kalamazoo Bldg., Kalamazoo, Mich.
Tel.: 3-1678
Radio Dept.: Carl B. Schoonmaker, John G.
Eldredge.

Radio Accounts: First Nat'l Bank.
CHARLES N. STAHL ADV. AGENCY
6671 Sunset Blvd., Hollywood 28
Tel.: Hollywood 2-7344
Radio Dept.: Charles N. Stahl, radio director;
Kay Dunlap, timebuyer.
San Francisco-Stahl-Casey Advertising, 208
Sheldon Bldg.; Tel.: Exbrook 2-4713; John
J. Casey.

Radio Accounts: Dr. Beauchamp (R); Culver
City New Car Dealers; Martin Motors.

STANLEY ADV. AGENCY INC.
1009 Francis Palms Bldg., Detroit 19
Tel.: Woodward 5-6155
Radio Dept.: Stanley Altschuler, manager; Leon-
ard Kotowski, account executive; Barbara
Fisher, timebuyer.

BARTON A. STEBBINS
1250 Wilshire Blvd., Los Angeles 17
Tel.: Trinity 8821
Radio Dept.: E. C. Bloodworth, radio director;
Nat Jeffras, account executive; A. W. Gudel-
man, timebuyer, account executive.
Radio Accounts: Signal Oil Co.; Certified Gro-
cers of Calif.; Brewster's Food Supplement;
Sleep-Eze.

STEINER, TOWERS, DOBRIN & KAUS
221 W. 57th St., New York 19
Tel.: Circle 6-0912
Radio Dept.: Jack Steiner, Frank Kaus.
Radio Accounts: Robert Shoe Repair; Maisel
State Name Restaurants; Senator Hotel; Ir-
ving Streits Food Products; Plesser Inc.

STERLING ADV. AGENCY INC.
535 8th Ave., New York 17
Tel.: Murray Hill 7-3400
Radio Dept.: Myron L. Broun, radio director.

STOCKTON-WEST-BURKHART INC.
1300 First Nat'l Bank Bldg., Cincinnati 2
Tel.: Dunbar 5600
Radio Dept.: Ranald S. West, vice president,
director of radio, copy; Robert A. McDowell,
vice president and director of media; James
A. Gray, radio timebuyer.
New York 22-501 Madison Ave. Tel.: Eldorado
5-1041.

Radio Accounts-Cincinnati Gas & Electric Co.;
Ohio Oil; Hudepohl Brewing Co. (S); Cen-
tral Trust Co.; Fulham Bros. Inc. (S); The
Gibson Wine Co. (S); The Cincinnati &
Suburban Bell Telephone Co.; The U. S.
Shoe Corp.

STOCKWELL & MARCUSE
Industrial Bank Bldg., Detroit 26
Tel.: Woodward 1-4484
STODEL ADV. CO.
5611 Melrose Ave., Hollywood 38
Tel.: Hollywood 9-7163

Radio Dept.: Edward C. Stodel, radio head;
Clifford Levine, radio timebuyer; Jacqueline
Hopkins, traffic and assistant timebuyer;
Mort Goodman, Robert F. Anderson, account
executives.

Radio Accounts: Eastern Columbia; Universal
International; Warner Bros. Film Corp.; Fox
West Coast Theatres; Nic-L-Silver Battery
Co.; United Paramount Theatres; Barr Mfg.
Co.; Ransom Motors; all S.

GLENNE JORDAN STOETZEL INC.
307 N. Michigan Ave., Chicago 1
Tel.: State 2-8927

Radio Dept.: George McGivern; Ralph Rozema,
account executive.
Radio Accounts: Christian Reformed Church
(Back to God) (N-S).

STORM & KLEIN INC.
331 Madison Ave., New York 17
Tel.: Murray Hill 7-4460

Radio Dept.: Allston E. Storm, president and
secretary; Edward Klein, executive vice
president, treasurer; Harry Chapperon, vice
president, research director; Arthur J. Klein,
timebuyer; Frederick Widlicka, art director.
Radio Accounts: The Tintex Co. (tints and
dyes); Park & Tilford (cosmetics, perfumes
and eye makeup) and John Harvey & Sons
Ltd. (ports and sherries); all S.

STREET & FINNEY INC.
76 9th Ave., New York 11
Tel.: Watkins 4-8510

Radio Dept.: Helen A. Thomas, radio timebuy-
er; Howard Miller, program director; Robert
Finney, Warren E. Faxon, William G. Johns-
ton, account executives.

Radio Accounts: Chattanooga Medicine Co. (Car-
dulo); Colgate-Palmolive (Florient Aerosol
air deodorant); Eastco Inc. (Espotabs); Fos-
ter Milburn Co. (Doan's Pills); G. T. Fulford
Ltd. (Baby's Own tablets, cough syrup, Dr.
William's Pink pills); Kress & Owen (glyco-
thymoline); Merrick Medicine Co. (Percy
medicine); all S.

*YOU CAN REACH
over 400,000*

*Spanish - American
LISTENERS*

IN

METROPOLITAN

LOS ANGELES

for as little as

\$46.80 per 6-day week

MANY OF THE FIRMS USING OUR
SPANISH-LANGUAGE PROGRAMS
HAVE BEEN ON KWKW and KWKW-
FM FOR OVER 10 YEARS.

KWKW

PASADENA-LOS ANGELES

N. Y. Representative
Richard O'Connell

KXLA
10,000 W-on-1110

21
HOURS OF
WESTERN
MUSIC
A-DAY

PRODUCES
ELEVENTH
STRAIGHT
TOP
YEAR

IN THE
BIG
LOS ANGELES
MARKET
The Western
Music Station
Must be Included
IN

GET WITH-IT
KXLA
Loyal K. King, Pres.-Mgr.

AGENCIES

STROMBERGER, LAVENE, MCKENZIE
800 S. Lafayette Park Place, Los Angeles 57
Tel.: Dunkirk 5-2211
Radio Dept.: George G. Anthony, media director;
T. L. Stromberger, Norval LaVene, Donald F. McKenzie, Jack J. Leener, A. Hays Busch, account executives.
Radio Accounts: General Petroleum.
BOB STRUBLE & ASSOC.
735 N. Vine St., Hollywood 38
Tel.: Hollywood 4-0249
Radio Dept.: R. B. Struble, radio director; Len McLean, timebuyer; Bruce Bailey, music director; Hank Caldwell, Jack Large, Karen Struble, account executives.
Radio Accounts: Empire Home Improvement Co.; Foundation Films Corp.; Customers Club; Scientific Dog Foods; Fade Control.
CHARLES R. STUART ADV.
625 Market St., San Francisco 5
Tel.: Douglas 2-2438
Radio Dept.: Janet Lindsay, media director; Fred M. Parke, account executive.
Radio Accounts: Bank of America (N).
DANIEL F. SULLIVAN CO.
216 Tremont St., Boston 16
Tel.: Hancock 6-7643
SULLIVAN, STAUFFER, COLWELL & BAYLES INC.
437 5th Ave., New York 16
Tel.: Oregon 9-2500
Radio Dept.: Philip H. Cohen, vice president for radio; Francis Minehan, vice president for media; John McCorklee, Jean Carroll, Stephen Suren, timebuyers; Frank J. Reed, radio business manager.
Hollywood 28—6253 Hollywood Blvd.; Tel.: Hillside 2119; J. J. Van-Nostrand, vice president for radio.
SUPERIOR ADVERTISING INC.
300 Fort Wayne Bank Bldg., Fort Worth 2
Tel.: Anthony 6131
Radio Accounts; McMillen Feed Mills.
SUTHERLAND-ABBOTT
234 Clarendon St., Boston 16
Tel.: Kenmore 6-1472
Radio Dept.: Thomas R. Covey Jr., radio director; Evelyn Victor, assistant.
Radio Accounts: Blue Cross-Blue Shield; Foss Vanilla; Burreled Sunlight Paint; Corcoran Shoe Co.
SWAFFORD & CO., ADV.
307 S. Robertson Blvd., Beverly Hills, Calif.
Tel.: Bradshaw 2-2784
Radio Dept.: Sherman Mulle, vice president and account executive; Edin Bulow, media director.
Radio Accounts: Apple Valley Inn; Apple Valley Building & Development Co.; Arrowhead Springs Hotel; Bel Air Hotel.
SYKES ADV. INC.
1101 Fifth Ave., Pittsburgh 19
Tel.: Grant 1-6120
Radio Dept.: R. W. Cooper, T. E. Morgan, M. Roberts.

T

TAGGART & YOUNG
7364 Beverly Blvd., Los Angeles 36
Tel.: Webster 3-8108
Radio Dept.: Ray Lewis, radio director.
Radio Accounts: Parklabrea; Tom Ray Pontiac Co.
TATHAM-LAIRD INC.
64 E. Jackson Blvd., Chicago 4
Tel.: Harrison 7-3700
Radio Dept.: George A. Bolas, radio director; Paul Schlesinger, Joseph Perry, James Madison, radio managers.
New York 22—595 Madison Ave.; Tel.: Plaza 3-7057; H. Lawrence Holcomb, William Vance, radio supervisors.
Radio Accounts: The Toni Co. (N); Geo. Wiedemann Brewing Co. (S).
GEORGE TAYLOR ADV. AGENCY
420 Market St., San Francisco 11
Tel.: Garfield 1-6812
Radio Dept.: George Taylor, Carl Christopher, timebuyers and account executives.
Radio Accounts: J. E. French Co.; Hoberg's; Exposition Grotto; Henry Doelger; Panelli's; Mel's Drive-In; Paoli's; Frank Edward Co.
TECH AD AGENCY INC.
1004 E. Jefferson Ave., Detroit 7
Tel.: Woodward 2-7367
Radio Dept.: M. M. Winthrop, radio director; V. L. Marcinak, Patricia Moore, buyers.
Radio Accounts: Paul-Reed Inc., Michigan Bean Shippers Assn. (both S).
J. WALTER THOMPSON CO.
420 Lexington Ave., New York 17
Tel.: Murray Hill 3-2000
Radio Dept.: Stanley Resor, president; John U. Reber, vice president; Robert Ballin, vice president; Richard de Rochemont, James O. Luce, Anne C. Wright, Jayne M. Shannon, timebuyers; Virginia Spragle, H. Bart McHugh Jr., talent buyers.
Chicago 11—410 N. Michigan Ave.; Tel.: Superior 7-0303; George C. Reeves, manager.
Detroit 26—535 Griswold St.; Tel.: Woodward 2-6890; Norman H. Strouse, manager, vice president.
Los Angeles 48—6399 Wilshire Blvd.; Tel.: Webster 3-7201; Thomas Cooper, Cornwall Jackson, vice presidents.
San Francisco 4—320 California St.; Tel.: Garfield 1-3510; Fred Fidler, vice president, manager.

Lakeland, Fla.—712 Marble Arcade Bldg.; Tel.: 2-4571; John Forshey, manager.
Coral Gables, Fla.—220 Miracle Mile; Tel.: Miami 83-5487; Frank W. Linder, manager.
Washington, D. C.—1737 DeSales St. N.W.; National 8-6140; Loy Baxter, manager (also 22 foreign offices).
Radio Accounts: Credit Union National Assn.; Florida Citrus Commission; Johns-Manville Corp.; Kraft Foods Co.; Lever Brothers Co.; The Quaker Oats Co.; Radio Corporation of America; Swift & Co. (all N); Libby, McNeill & Libby (R); P. Ballantine & Sons; Bowman Dairy Co.; Ford Dealer Advertising Assn.; Ford Motor Co., Ford Div.; Indiana Bell Telephone Co.; Mentholatum Co.; Northern Trust Co.; Pacific Mills; Pan American-Grace Airways; Pan American World Airways System; Penick & Ford, Ltd. Inc.; Safeway Stores Inc.; Shell Chemical Co.; Shell Oil Co.; Southeastern Trailways Bus System; Southwest Airways; Truscon Lab.; Ward Baking Co.; J. B. Williams Co.; Yellow Taxi Cab Co. of Los Angeles (all S).
ARTHUR TOWELL INC.
505 Insurance Bldg., Madison 1, Wis.
Tel.: 6-2688
Radio Dept.: Philip M. Davies, radio director.
TOWN CRIER AGENCY INC.
305 Wickham Bldg., Council Bluffs, Iowa.
Tel.: 7768
Radio Dept.: D. H. Filbert, radio director; William Belcher, Norman Filbert Jr., account executives.
Radio Accounts: Roberts Dairy Co.; Broadway Cleaners; Continental Keller; Soft Water Service; State Savings Bank; Emarines Printers; Playland Park.
TRACY, KENT & CO. INC.
515 Madison Ave., New York 22
Tel.: Eldorado 5-4404
Radio Dept.: Philip A. Baecker, radio director; Frank S. Kent, William Irwin Tracy, Hudson Budd, account executives.
Radio Accounts: H. C. Brill Co. Inc.; Grinstead Bros. Inc.; J. W. Beardsley's Sons; Dellwood Dairy Co.; Packers Tar Soap Inc.; Charles & Co. Inc.
TRACY-LOCKE CO. INC.
2501 Cedar Springs Rd., Dallas 1
Tel.: Sterling 4741
Radio Dept.: Phillip L. McHugh, radio director; Tena Cummings, assistant radio director.
Houston 2—711 Main St.; Tel.: Charter 5467; Clay W. Stephenson Jr., account executive; Tom Daly, timebuyer.
Radio Accounts: Adieta Co.; Mrs. Baird's Bakeries; Borden Co.; Burrus Mills Inc.; Comet Rice; Duncan Coffee Co.; Imperial Sugar Co.; Bene E. Keith; Ireland's; Reserve Life.
TURNER ADV. AGENCY
101 E. Ontario St., Chicago 11
Tel.: Michigan 2-6426
Radio Dept.: John K. Turner, J. Gordon Turner, account executives.
Radio Accounts: O-Cedar Corp. (N); Berry Bros. Inc. (S).

U

C. J. ULRICH & ASSOC.
3253 Irving Park Rd., Chicago 18
Tel.: Juniper 8-6545
Radio Dept.: C. J. Ulrich.

V

VANSANT, DUGDALE & CO.
15 E. Fayette St., Baltimore 2
Tel.: Lexington 9-5400
Radio Dept.: Robert V. Walsh, radio director; Rita G. Eastman, radio copy, production, timebuying; Marilyn Bauer, timebuyer; R. E. Daiger, C. M. Buchanan, H. G. Erck, Nicholas Vansant, D. J. Loden, E. E. Cooke Jr., account executives.
Radio Accounts: Anchor Post Products; The Crosse & Blackwell Co.; Equitable Trust Co.; Gibbs & Co.; Schluderberg-Kurde Co.; Sherwood Bros. Inc.; Globe Brewing Co.; Keystone Marconi Mfg. Co.; Laco Products Inc.; Weaver Bros. & Interstate; Hals Brewing Co.
CARLO VINTI ADV.
431 Fifth Ave., New York 16
Tel.: Murray Hill 9-8476
Radio Dept.: Carlo Vinti, owner, Joseph Vinti, account executive; Beatrice Messina, secretary.
San Francisco, Philadelphia and Chicago branch offices.

W

GEOFFREY WADE ADV.
20 N. Wacker Dr., Chicago 6
Tel.: State 2-7369
Radio Dept.: Paul McCluer, general manager; Louis J. Nelson, media director; Jack Farnell, radio director; D. S. Williams, timebuyer.
Hollywood 28—8381 Hollywood Blvd.; Tel.: Hollywood 7-7457; R. E. Dwyer, manager; Forrest F. Owen Jr., radio director; Snowden Hunt Jr., media director.
Radio Accounts: Miles Labs. (N-S); Aireloom Bedding Co. (S); Colonial Dames (S); Durham Chemical Co. (S); Miles California Co. (N-S).

LOUIS E. WADE INC.
204 Paramount Bldg., Fort Wayne 2
Tel.: Anthony 6282
Radio Dept.: Richard Katt, radio director; Richard Katt and Edward P. Wade, account executives.

Radio Accounts: Patterson-Fletcher Co.; Meyers Drug Co.; Wolf Bedding Co.; American Coal & Supply Co.; Gillie's Seat Cover Co.

WADSWORTH & WALKER INC.
517 Gerona Ave., Coral Gables 46, Fla.
(Mail: PO Box 486, Coconut Grove, Fla.)
Tel.: Miami 67-3686
Radio Dept.: Ralph K. Wadsworth, president.
New York 17—369 Lexington Ave.; Tel.: Murray Hill 5-6100.

HUGH WAGENSEL & ASSOC.
Talbot Bldg., Dayton 2
Tel.: Hemlock 5542

WALKER & DOWNING GENERAL AGENCY
532 Oliver Bldg., Pittsburgh 34
Tel.: Grant 1-1900
Radio Dept.: Robert Stevens, radio director; William O. Burge, Frank A. Orr, assistant directors.

WALLACE-FERRY-HANLY CO.
400 W. Madison St., Chicago 6
Tel.: Franklin 2-6440
Radio Dept.: J. T. Ainsley, radio director.
Radio Accounts: Campana Sales Co. (N).

WARWICK & LEGLER INC.
230 Park Ave., New York 17
Tel.: Murray Hill 4-5800
Radio Dept.: William P. Warwick, radio director; Joe Gratz, Robert Steen, assistants; Joseph J. Hudack, Jerry Moliese, timebuyers.

Los Angeles 5—2405 W. 8th St.; Tel.: Dunkirk 3-1141; Cecil Underwood, radio director; Joy Mallicoat, Hugh McTernan, media.

Radio Accounts: Ex-Lax Inc. (N-S); Hoffman Beverage Co. (N-S); Larus & Bro. Co. (S); Los Angeles Brewing Co. (N-S); Kingan & Co. (N-S); Pabst Sales Co. (S); Ben-Hur Products Inc. (N-S); H. J. Caruso (N-S).

WATTS, PAYNE-ADV. INC.
900 S. Maine St., Tulsa 3
Tel.: 3-8108
Radio Dept.: Don Mitchell, radio director; account executives Don Dyer, Benton Ferguson, R. C. Keefe, Joe Jillson, Jack Stewart.
Dallas—Fidelity Bldg. Tel.: Riverside 5201. Marie Callahan, Burke Gilliam, account executives.

Radio Accounts: Oklahoma Tire & Supply Co.; United Federal Savings & Loan; Mid-West Chevrolet; Bell Oil & Gas Co.; Burt's Ice Cream; Ozark Nurseries; Hanna Lumber Co.; Watt Plumbing Supply; Pepsi Cola; First Nat'l Bank & Trust; Mayo Hotel; Brookside State Bank; Palace Office Supply; El Wino Soft Drinks; Com'l Nat'l Bank; Surgeons-Lotion Co.; Fort Worth Macaroni; Chick Sticks; Bell Cleaners; Cuellar Foods.

WAXELBAUM ADV. CO.
10 E. 43rd St., New York 17.
Tel.: Murray Hill 2-7398
Radio Dept.: Ben Waxelbaum, owner.

WEAVER-GARDNER INC.
405 Oppenheim Bldg., St. Paul 1
Tel.: Garfield 4715
Radio Dept.: Luther Weaver, radio director; Don Gardner, account executive.

THE ARMAND S. WEILL CO.
170 Franklin St., Buffalo 2
Tel.: Washington 6250
Toronto 2, Ont., Canada—225 Mutual St.; Tel.: Empire 35112

MILTON WEINBERG ADV. CO.
3508 Wilshire Blvd., Los Angeles 5
Tel.: Dunkirk 3-4134
Radio Dept.: William H. Krauch, radio director, account executive; Selma Solmann, media director; Florie Field, timebuyer.

WILLIAM H. WEINTRAUB & CO. INC.
488 Madison Ave., New York 22
Tel.: Plaza 1-0900
Radio Dept.: Harry Trenner, vice president in charge of radio; Lester Blumenthal, business manager; Joan Stark, chief timebuyer.
New York—49 E. 53d St.; Tel.: Plaza 1-0900.
Radio Accounts: Blatz Brewing Co.; Revlon Products Corp.; Kaiser-Willys Sales Div. of Willys Motors; Kaiser Henry J.

WEISS & GELLER INC.
400 N. Michigan Ave., Chicago 11
Tel.: Delaware 7-1124
Radio Dept.: Marvin L. Mann, vice president, radio director; Jack Bard, media analyst, timebuyer; Irving D. Auspitz, creative director; Don Paul Nathanson, vice president, account supervisor; Eugene W. Cooper, Byron Bonnheim, account executives.

New York 17—400 Madison Ave.; Tel.: Plaza 4-4070; Bruce M. Dodge, radio production director; Frank P. Higgins, assistant.

Radio Accounts: Toni Co. Div. Gillette Co. (N-S); Wine Corp. of America (N-S); Terre Haute Brewing Co. (S); Wyler Soups (S); Collese Inn Foods (S).

WELSH-HOLLANDER ADV.
350 S. Alvarado St., Los Angeles 57
Tel.: Dunkirk 9-1171
Radio Dept.: Henry W. Welsh, A. M. Hollander.

WENDT ADV. AGENCY
618 Strain Bldg., Great Falls, Mont.
Tel.: 4-4842
Radio Dept.: W. E. Wendt and Z. H. Schroeder, partners.

Radio Accounts: Great Falls Breweries; Jersey Gold Foods; Montana Bank; Montana Flour Mills.

WERTHEIM ADV. ASSOC.
11 W. 42d St., New York 36
Tel.: Wisconsin 7-5978

WESLEY ASSOC.
247 Park Ave., New York 17
Tel.: Eldorado 5-2880
Radio Dept.: J. D. Knap Jr., media director; C. O. Sloane, account executive.

Radio Accounts: Shulton Inc.; Winston Inc.; Paradise Prod.; Lipstae.

WEST-MARQUIS INC.
1220 Wilshire Blvd., Los Angeles 17
Tel.: Madison 9-2214
Radio Dept.: Hazel S. Beaver, media manager.
San Francisco 3—785 Market St.; Tel.: Garfield 1-1716; Harold H. Marquis, vice president.
Portland 5, Ore.—333 American Bank Bldg.; Tel.: Broadway 7373; Richard K. Stanton, vice president.

Seattle 4—1473 Dexter Horton Bldg.; Tel.: Mutual 1068; Wells R. Wiley, vice president.

Long Beach 12, Calif.—602 Pacific Ave.; Tel.: 7-5171; Jack Horner, manager.
(Fashion Arts Div.)

Los Angeles 5—2404 W. 7th St.; Tel.: Dunkirk 4-4348; Charles B. Smith, manager.

Radio Accounts: Norris-Thermador Corp.; Northrop Aircraft Inc.; J. W. Robinson Co.; Pacific Northern Airlines Inc.; Wilbur-Ellis Co.; Calif. Farm Bureau Federation; Niagara Equipment Co.; Atlas Heating & Ventilating Co.; M. E. Bernstein Co.; Gallagher Motors Inc.

WESTERN ADV. AGENCY INC.
4840 Wilshire Blvd., Los Angeles 5
Tel.: Webster 1-1588
Radio Dept.: Edmund Lytle, radio-TV director; Claire Koren, chief timebuyer; account executives George Balsam, Ray Banks, Mark Fuller, John Moore, Ken Snee, Paul Wickman.

Radio Accounts: Voice of Prophecy (N-S); Ontra Cafeterias; Overseas Div. of Gen. Conference of SDA; Gowland Creations; Drayer-Hansen; Librascope; Pierpoint Landing.

WESTHEIMER & BLOCK
315 N. 7th St., St. Louis 1
Tel.: Garfield 4080
Radio Dept.: Rita Forrester, media director; James H. Stobie, account executive.

Radio Accounts: Centivire Brewing Corp.; Peter Eckrich & Sons; Bonnee Frozen Foods; Sears, Roebuck & Co.

TOM WESTWOOD ADV. AGENCY
105 East Lexington, Glendale 6, Calif.
Tel.: Chapman 5-5051
Radio Dept.: Elba Herriott, timebuyer.
Radio Accounts: Voice of China (S); So. Calif. Lutheran Hour (S).

WARD WHELOCK CO.
Lincoln-Liberty Bldg., Philadelphia 7
Tel.: Rittenhouse 6-7500
New York 22—444 Madison Ave.; Tel.: Plaza 3-7120
Hollywood 28—6277 Selma Ave.; Tel.: Hollywood 4-9221; Maggie Wallace.

WHITE ADV. AGENCY
19 W. 10th St., Tulsa, Okla.
Tel.: 2-5194
Radio Dept.: Marguerite Cunningham, radio director; Pete White, Bruce D. Hall, Jack Gill, account executives.

Oklahoma City—415 Commerce Exchange Bldg., Tel.: Regent 6-8282; Stephen Olesluk, manager.

Hollywood 28—6351 Selma; Tel.: Hollywood 3-5694; Betty Newell, manager.

Radio Accounts: Healing Waters Inc.; Allied Paint Co.; Doenges Motors; Associated Grocers; Arthur Murray; KCEB-TV Tulsa.

THOMAS C. WILSON ADV. AGENCY
33 E. Truckee River Lane, Reno, Nev.
Tel.: 2701
Radio Dept.: Pamela Holden, radio timebuyer.
Radio Accounts: Harold's Club; Bonanza Airlines; Chism Ice Cream Co.; First Nat'l Bank of Nevada; Reno Brewing Co.

WINIUS-BRANDON CO.
1706 Olive St., St. Louis 3
Tel.: Chestnut 6380
Radio Dept.: Vernon L. Morelock, vice president and radio director; Rosalie A. Pietuch, assistant radio director; William L. Sanborn, treasurer, account executive.

Radio Accounts: Deep Rock Oil Corp.; American Packing Co.; Boatmen's Bank; Katy Railroad; Emerson Electric Mfg. Co.; Miller Chemical Co.

WOLFE-JICKLING-CONKEY INC.
327 John R. St., Detroit 26
Tel.: Woodward 1-1885

WOODARD & VOSS INC.
24 James St., Albany 7, N. Y.
Tel.: 3-1243

WORTMAN, BARTON & SPOHN INC.
345 Madison Ave., New York 17
Tel.: Murray Hill 4-5920
Radio Dept.: Elbert B. M. Wortman, radio director; Hortense Essler, radio timebuyer.
Radio Accounts: Nat'l Paper Products Co.; Allied Group Assoc.

Y

YAMBERT-PROCHNOW INC.
6630 Sunset Blvd., Hollywood 28
Tel.: Hollywood 3-8143
Radio Dept.: Ralph Yambert, president; Norine Freeman, media director.
Radio Accounts: Gallengamps; Burl Berry; Bowie Pies.

YOUNG & RUBICAM INC.
285 Madison Ave., New York
Tel.: Murray Hill 9-5000
Radio Dept.: Nat Wolff, vice president, director of radio dept.; Dan Seymour, vice president for programming; George Gribbin, vice president for commercials; Rodney Erickson, account planning and supervision; David Y. Bradshaw, director of operations; A. V. B. Geoghegan, vice president and media director; Peter Levathes, vice president, special assignments.

Los Angeles, Hollywood—6253 Hollywood Blvd.; Tel.: Hollywood 9-2731; Walter Bunker, vice president, director of radio division.

Chicago—333 N. Michigan Ave.; Tel.: Financial 6-0750; William Wilson, radio department manager.

London, England—285 Regent St. W. 1; Tel.: Regent 0211-5; Dan Ingman, radio department manager.

Mexico City—Ave. Juarez 117; Tel.: 10-49-00; Ary Moll, director of radio department.

Toronto—Bank of Nova Scotia Bldg.; Tel.: Empire 3-5035; William Byles, supervisor of radio department.

Montreal—1120 University Tower Bldg.; Tel.: University 6-8941; Mr. Byles.

Radio Accounts: Thomas J. Lipton Inc.; General Foods Corp.; Cannon Mills, Inc.; P. Lorillard Co.; Cudahy Packing Co.; American Home Foods Inc.; Procter & Gamble Co.; Metropolitan Life Insurance Co.; International Harvester Co.; Sanitized Division of Cluett Peabody & Co., Inc., all (N). Local and spots: Borden Co.; American Bakeries Co.; Bristol Myers Co.; Drackett Co.; Drake Bakeries Inc.; Duffy-Mott Co., Inc.; General Cigar Co.; Gulf Oil Corp.; Hunt Foods Inc.; Johnson & Johnson; Lifesavers Corp.; Mission Bell Wineries; Northern Paper Mills; Personal Products Corp.; Petri Wine Co.; Simmons Co.; Singer Sewing Machine Co.; Time Inc.

Z

ZIMMER, KELLER & CALVERT INC.
28 Adams Ave., W., Detroit 21
Tel.: Woodward 1-9151
Radio Dept.: A. H. Ritter, radio director; C. D. Vortman, timebuyer; John McManus, John Buzby, Richard Long.
Radio Accounts: General Mills (Formula Feed Div.); Stroh Brewery Co.; Farmers & Manufacturers Beet Sugar Assn.

**FACTS PROVE.....
.....SALES IMPROVE!**

When you CONCENTRATE
your sales message to a

**Guaranteed-Responsive
Audience!!!**

These EXCLUSIVE
SAN FRANCISCO MARKETS

1. **NEGRO** - Over 7 hours of
Programs Daily
Exclusive in Nation's 6th
Negro Income Market

2. **FOREIGN** Language
ITALIAN-SPANISH-GREEK
CHINESE-YIDDISH

Phone—Wire—Write—
For Rates—Additional Information

KSAN 1355 Market St.
Phone: Market 1-8171

look to **ALLIED**
for everything in
ELECTRONIC SUPPLIES
for TV and Radio
Broadcast Stations



new home of **ALLIED RADIO**

one complete
dependable source
for everything
in electronics

world's largest stocks of electronic supplies

Simplify and speed your purchasing of electronic supplies and equipment—send your orders to **ALLIED**, the reliable one-supply-source for *all* of your electronic needs. Look to us for quick, efficient shipment from the world's largest stocks of special-purpose electron tubes, test instruments, high-fidelity audio equipment, recorders and supplies, electronic parts and accessories—complete lines of quality apparatus.

Our expert Broadcast and Industrial supply service saves you time, effort and money.

**we specialize in tube supply
for TV and Radio Broadcast application**
IMMEDIATE DELIVERY FROM STOCK
ON ALL TYPES IN ALL LEADING MAKES

the 268-page 1954 BUYING GUIDE

Send for the latest **ALLIED** Catalog—complete, up-to-date guide to the world's largest stocks of Electronic Supplies. It's invaluable to key station personnel. **FREE** copies for members of your organization are available on request.



**FREE
SEND
FOR IT**

ALLIED RADIO
100 N. Western Ave., Chicago 80, Ill.
HAYmarket 1-6800

AM & FM EQUIPMENT MANUFACTURERS

- Ace Engineering & Machine Co., Inc.**
Philadelphia 40, Pa., 3644 N. Lawrence St.; Frances M. Fay, Sec'y.-Treas.
Tel: Regent 9-1019
Los Angeles, Calif., 6907½ Melrose Ave., C. R. Fetty, Mgr.; Tel: Webster 3-7276
Products: Shielded enclosures
- Acme Electric Corp.**
Cuba, N. Y.; Louis S. Danko, Sls. Mgr., Spec. Prds.; Tel: Cuba 4
Products: Transformers
- Ader Communications, Labs.**
New Rochelle, N. Y., 1 Le Fevre Lane; Harold L. Danson, Sls. Mgr.
Products: Special audio console work; receiver mfr. for commercial use
- Advance Electronics Co., Inc.**
Passaic, N. J., 451 Highland Ave., Paul Yu, Mgr.; Tel: Prescott 7-4270
Products: Continuously variable delay and step variable delay lines, phase meter, vectorlyzer
- Advance Recording Products Co.**
Long Island City 1, N. Y.; 36-12 34th St., I. H. Goldman, Mgr.; Tel.: Stillwell 4-7837
Products: Recording discs
- Allen-Bradley Co.**
Milwaukee 4, Wis., 136 W. Greenfield Ave.; D. S. W. Kelly, Mgr.; Tel: Orchard 1-2000
Boston 34, Mass., 24 Brighton Ave.; C. M. McCoohe, Mgr.; Tel: Stadium 2-0203
Buffalo 3, N. Y., 41 N. Division St.; E. F. Sigmond, Mgr.; Tel: Cleveland 7636
Chicago 10, Ill., 445 N. LaSalle St.; John McC. Price, Mgr.; Tel: Whitehall 4-1670
Cincinnati 2, Ohio, 2331 Reading Rd.; W. L. Jaeckel, Mgr.; Tel: University 4445
Cleveland 3, Ohio, 4312 Carnegie Ave.; R. J. Roy, Mgr.; Tel: Express 1-2519
Dayton 3, Ohio, 2240 E. Third St.; Jerome F. Hohelsel, Mgr.; Tel: Kenmore 2828
Detroit 14, Mich., 11100 E. Warren Ave.; J. D. Petersen, Mgr.; Valley 1-8100
East Orange, N. J., 350 Main St.; O. C. Stark, Mgr.; Tel: Orange 2-9683-4
Flint, Mich., Genesee Bank Bldg.; Charles H. Hawks, Mgr.; Tel: 2-9341
Indianapolis, Ind., 1491 N. Harding St.; R. C. Norris, Mgr.; Tel: Atlantic 1491
New York 17, N. Y., 155 E. 44th St.; A. W. Paul, Mgr.; Tel: Murray Hill 2-6070
Philadelphia, Pa., 235 Fairfield Ave.; G. F. Pain, Mgr.; Tel: Flanders 2-6000
Pittsburgh 16, Pa., 2721 W. Liberty Ave.; H. C. Thornberry, Mgr.; Tel: Fieldbrook 1-2822
Rockford, Ill., 1013 Broadway; J. K. McKnight, Mgr.; Tel: 5-8795
St. Louis 6, Mo., 904 N. Grand Blvd.; G. W. Schalchlin, Mgr.; Tel: Lucas 1901
Springfield, Mass., 172 Chestnut St.; W. L. Plate, Mgr.; Tel: Springfield 2-3430
Syracuse 3, N. Y., 820 E. Water St.; Chester H. Hitchcock, Mgr.; Tel: 76-2141
York, Pa., 653 W. Market St.; Fred Krsek, Mgr.; Tel: 82-239
Products: Fixed and adjustable resistors; ceramic capacitors, ferrite parts
- Allied Radio Corp.**
Chicago 80, Ill., 100 N. Western Ave.; Leo Brook, Indus. & Brdest. Sls. Mgr.; Tel: Haymarket 1-6800
Products: Station equipment and supplies for immediate shipment. Audio equipment, amplifiers, condensers, C.A.A. approved tower light control, Daven attenuators, equalizers, disc and tape recording equipment, resistors, patch panels and cords, pickups and turntables, public address systems, receivers, microphones, noise and distortion measuring equipment, test equipment, transformers, transcription players
- Allied Recording Products Co.**
Long Island City 1, N. Y., 32-32 Greenpoint Ave.; J. Strauss, Pres.; Tel: Stillwell 4-2318
Products: Recording blanks and machines
- Altec Lansing Corp.**
Beverly Hills, Calif., 9356 Santa Monica Blvd.; A. A. Ward, V.P.; Tel: Crestview 5-5101
New York 13, N. Y., 161 Sixth Ave.; H. S. Morris, Prds. Sls. Mgr.; Tel: Algonquin 5-3636
Products: am-fm—Speech input consoles and amplifiers, microphones, limiter amplifiers, monitoring loudspeakers, public address and sound reinforcement systems for studios
- American Electrical Heater Co.**
Detroit 2, Mich., 6110 Cass Ave.; Richard G. Ellis, Gen. Sls. Mgr.; Tel: Trinity 5-2505
Products: Soldering irons, electric temperature regulating stand
- American Elite, Inc.**
New York 19, N. Y., 1775 Broadway; Michael Von Mandel, Pres.; Tel: Plaza 7-7276, 7253
Products: Receivers, microphones
- American Microphone Co.**
Pasadena 1, Calif., 370 S. Fair Oaks Ave.; G. N. Christensen, Sls. Mgr.
Products: Microphones, accessories
- American Television & Radio Co.**
St. Paul 1, Minn., 300 E. 4th St.; Albert A. Goffstein, Gen. Mgr.; Tel: Cedar 3791
Products: Inverters, battery eliminators, vibrators
- American Volume Control Corp.**
New York 6, N. Y., 115 Liberty St.; Dave Parkhurst, Mgr.; Tel: Beekman 3-0224-25
Products: Volume controls, potentiometers, resistance cords
- Amperex Electronic Corp.**
Hicksville, L. I., N. Y., 230 Duffy Ave.; Sam Norris, Pres.; Tel: Hicksville 3-6200
Products: Power and transmitting tubes, rectifiers, thyatron, magnetrons, uhf and special purpose tubes
- Amperite Co., Inc.**
New York 12, N. Y., 561 Broadway; S. Ruttenberg, Gen. Mgr.; Tel: Canal 6-1446
Products: fm-Microphones (ribbon, dynamics)
- Ampex Corp.**
Redwood City, Calif., 934 Charter St.; Harrison Johnston, Gen. Sls. Mgr.; Tel: Emerson 8-1471
Atlanta, Ga., 252A North Ave., N.W.; R. A. Miner, Mgr.; Tel: Atwood 8402
Chicago, Ill., 111 E. Ontario St.; E. L. Koller, Mgr.; Tel: Michigan 2-2083
College Park, Md., 7338 Baltimore Ave.; Robert Sackman, Mgr.; Tel: Appleton 7-9276
New York, N. Y., 405 Lexington Ave.; Phillip N. Gundy, Mgr.; Tel: Murray Hill 4-4437
San Francisco, Calif., 100 Bush St.; Jack Hauser, Mgr.; Tel: Yukon 6-5654
Products: Magnetic recording, reproducing and duplicating equipment
- Amplifier Corp. of America**
New York 13, 396-8 Broadway; Sidney Karr, Mgr.; Tel: Digby 9-1890
Products: Battery-operated portable and standard AC magnetic tape recorders



the finest tape recorders for broadcast use

For uses where utmost reliability, "perfect" fidelity and accuracy of timing are of prime importance, Ampex Tape Recorders are universally preferred. America's four major broadcasting networks, the country's leading phonograph record manufacturers and various important musical organizations are among those whose usage has established Ampex as the world's standard of excellence in sound recording.

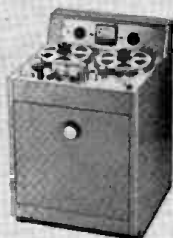

Series 300 console



Series 350 table top console on base



Series 400 single case portable



Model 450 console on base

SERIES 300

These, the finest of the Ampex line, are the machines used where speaking or musical performances justify the best recordings it is possible to make. Because of their supreme reliability, the 300 Series machines are used by major radio networks to originate, delay and rebroadcast important radio shows. Record manufacturers use the Series 300 for master recordings because of their high signal-to-noise ratio and low flutter and wow.

SERIES 350

Newest of Ampex's general purpose audio recorders, the 350 has a 30° slant on the top-plate. This puts reels, editing knobs and all controls within easier reach of the operator. Tape editing is faster and less tedious. A three motor tape transport (also used on the higher priced Model 300) provides excellent tape control and utmost reliability of operation. The Series 350 is unusually accessible for servicing.

SERIES 400

The Series 400 was the first tape recorder to bring the Ampex standard of performance within reach of smaller radio stations, schools, conservatories, high fidelity enthusiasts and semi-professional users. The 400 Series portables are the lightest of the Ampex models and consequently the best suited for professional quality recordings on location.

MODEL 450

For background music, automatic broadcasting and TV test patterns, the Model 450 Continuous Tape Reproducer provides up to 8 hours of continuous unrepeated program. The Model 450 uses 14-inch NARTB reels with double track pre-recorded tapes. Starting, stopping, reversing and program repeating are controlled automatically with no attention from a standby operator.

TAPE DUPLICATOR

Designed to make duplicate tapes at minimum labor cost, the Ampex Tape Duplicator makes from 1 to 10* duplicates simultaneously and employs a time-saving speedup. Double track tapes are made in one pass. Fidelity is high (see specifications). Duplicates of any standard tape speed can be made from masters of any standard speed.

*User has the option of buying from 1 to 10 slaves to operate from one master unit.

* SPECIFICATIONS

	Series 300	Series 350	Series 400	Model 450	Tape Duplicator
Frequency response (Tape speeds shown are not all available in all models)	15 in./sec. — 30 to 15,000 cps. within ± 2 db 7½ in./sec. — 40 to 15,000 cps. within ± 4 db	40 to 15,000 cps. within ± 2 db	40 to 10,000 cps. within ± 2 db	3¾ in./sec. — 50 to 7,500 cps. within ± 2 db	
Signal-to-noise ratio (by NARTB Standards)	Over 60 db	Over 55 db	Over 55 db	Over 50 db	Over 45 db
Flutter and wow	Well under 0.1% rms. at 15 in./sec.	Well under 0.2% rms. at 15 in./sec.	Well under 0.2% rms. at 15 in./sec.	Well under 0.4% rms. at 3¾ in./sec.	Ampex Data Bull. 3-3-1
Available mounting	Console, rack and portable				Unmounted

* Full specifications are given in bulletins on each individual series or model.

Write for further information to Dept. D-1498R



AMPEX CORPORATION
934 Charter Street • Redwood City, California
Branch offices: New York, Chicago, Atlanta, San Francisco and College Park, Maryland (Washington, D. C. area)

Andrew Corporation
Chicago 19, Ill., 363 E. 75th St.; Robert P. Lamons, Sls. Mgr.; Tel: Triangle 4-4400
Cambridge, Mass., 93 Westgate Ave.; Karl E. Sterne, Mgr.; Tel: University 4-391
Monrovia, Calif., 525 Ranchito Rd.; Joseph F. Moynihan, Mgr.; Tel: Elliott 8-4045
Ridgewood, N. J., 200 E. Ridgewood Ave.; Robert C. Bickel, Mgr.; Tel: Ridgewood 6-9181
Whitby, Ont., Can., P. O. Box 971; John W. McLeod, Mgr.; Tel: Whitby 329
Products: Transmission lines and accessories, dehydrators, antenna tuning and phasing equipment, phase sampling equipment, current sampling equipment, phase monitor, tower lighting equipment. fm: Transmission lines and accessories, multi-V transmitting antenna, harmonic filters

Atlas Sound Corp.
Brooklyn 18, N. Y., 1449 39th St.; R. C. Reinhardt, Gen. Sls. Mgr.; Tel: Gedney 8-5500
Products: Microphone support and boom stands; microphone adaptors and fittings

Audio Devices, Inc.
New York 22, N. Y., 444 Madison Ave.; Bryce Haynes, V. P.; Tel: Plaza 3-0973
Chicago 30, Ill., 6124 Milwaukee Ave.; B. N. Freifeld, Mgr.; Tel: New Castle 1-9580
Hollywood 46, Calif., 1006 N. Fairfax Ave.; Alan H. Bodge, Mgr.; Tel: Hollywood 9-8902
Products: Recording discs, recording, playback points; magnetic recording tape

Audio Instrument Co., Inc.
New York 11, N. Y., 133 W. 14th St.; C. J. LeBel, Pres.; Tel: Oregon 5-7820
Chicago 39, Ill., 4949 W. Diversey Ave.; Loren F. Green, Mgr.
Kansas City 14, Mo., P. O. Box 8467; Eugene Shapiro, Mgr.
Los Angeles 18, Calif., 2331 W. Wash. Blvd.; Lee H. Owens, Mgr.
Toronto 18, Ont., Can., 2914 Bloor St. W.; Alex L. Clark, Mgr.
Products: Reverberation unit (magnetic tape); intermodulation meter; acoustic reverberation test equipment

Audio-Master Corp.
New York 17, N. Y., 17 E. 45th St.; Herbert Rosen, Mgr.; Tel: Oxford 7-0725
Products: Transcription players, tape recorders, mastertape

Audio & Video Products Corp.
New York 19, N. Y., 730 Fifth Ave.; Robert D. Winston, Mgr.; Tel: Plaza 7-3091
Washington 1, D. C., 100 Indiana Ave.; Herman Norwood, Jr., Mgr.; Tel: Republic 7-8566
Products: Magnetic tape recorders and complete line accessories; amplifiers, speakers, variable equalizers, hi and lo pass variable filters, tape duplicating service and music library pre-recorded on tape

Berlant Associates
Los Angeles 16, Calif., 4917 W. Jefferson Blvd.; Harlan Thompson, Sls. Mgr.; Tel: Republic 1-2141
Products: Magnetic tape recorders; four-channel mixers

Bishop Mfg. Corp.
Cedar Grove, N. J., 10 Canfield Rd.; John J. Connors, Exe. V. P.; Tel: Vernon 9-2373
Products: Electrical insulating tapes

Blaw-Knox Equipment Div.
BlawKnox, Pa.; A. H. Jackson, Sls. Mgr., Tower Dept.; Tel: Sterling 1-2700
Birmingham 3, Ala., Brown-Marx Bldg.; W. E. Balliet, Mgr.; Tel: Birmingham 9-7661
Chicago 3, Ill., Peoples Gas Bldg.; J. C. McQuide, Mgr.; Tel: Harrison 7-7633
New York 17, N. Y., 405 Lexington Ave.; W. F. Simmons, Mgr.; Tel: Vanderbilt 6-0661
Philadelphia 3, Pa., Suburban Sta. Bldg.; W. F. Simmons, Mgr.; Tel: Rittenhouse 6-1681
San Francisco 5, Calif., Monadnock Bldg.; J. P. Cullen, Mgr.; Tel: Yukon 2-1569
Washington 5, D. C., Wire Bldg.; Marvin Marcus, Mgr.; Tel: Republic 7-3142
Products: Self-support and guide towers

Brach Mfg. Corp.
Newark 3, N. J., 200 Central Ave.; Ira Kamen, V. P. chrg. Sls.; Tel: Humboldt 2-1500
Products: Master antenna systems, antennas-amplifiers

The William Brand & Co., Inc.
Willimantic, Conn., North & Valley Sts.; R. H. Robinson, Mgr.; Tel: Willimantic 3-1861
Chicago, Ill., 1313 W. Randolph St.; E. W. Brinson, Mgr.; Tel: Seeley 8-0345
Products: Insulating materials

Broadcast Equipment Specialties Corp.
Richmond Hill 19, N. Y., 135-01 Liberty Ave.; A. C. Travis, Jr., Pres.; Tel: Republic 9-9020
Products: Walkie tape recorder

Burgess Battery Co.
Freeport, Ill.; L. H. Harriss, Mgr.; Tel: Main 3300
Products: Dry batteries, flashlights

Califone Corp.
Hollywood 38, Calif., 1041 N. Sycamore Ave.; Robert G. Metzner, Pres.; Tel: Hollywood 2-2353
Products: Portable transcription players, high fidelity magnetic tape recorders

Cambridge Thermionic Corp. (Cambridge Crystal Div.)
Cambridge 38, Mass., 445 Concord Ave.; Clarence Cheney, Crystal Engr.; Tel: Trowbridge 6-2800
Products: Frequency check service

Canadian Marconi Co.
Montreal 16, Que., Can., 2442 Trenton Ave.; J. H. Martin, Sls. Supv. Brd. & TV Trans. Sls.; Tel: Atlantic 9441
Halifax, Nova Scotia, 572 Barrington St.; D. J. Murphy, Mgr.
St. John's Nfld., 3 Prescott St.; W. A. Brown, Mgr.
Toronto, Ont., 830 Bayview Ave.; S. Slinger, Mgr.
Vancouver, B. C., 550 Burrard St.; J. S. Baxter, Mgr.
Products: Transmitter, studio equipment, turntables, remote control equipment, transmitting and receiving tubes. fm: Turnstile antennas, transmitters. Facsimile: Transmitters, recorders

Cannon Electric Co.
Los Angeles 31, Calif., 3209 Humboldt St.; Floyd Cate, Sls. Engr.; Tel: Capitol 5-1251
East Haven 12, Conn., 191 Kimberly Ave.; Clarke Quackenbush, Mgr.; Tel: Hobart 7-6329
Toronto, Ont., Can., 2451 Danforth Ave.; Colin Legge, Mgr.
Products: XL and audio connectors

Cardinal Corp.
Louisville, Ohio, P. O. Box 72; John F. Grinnan, Mgr.
Products: Record storage racks

Carrier Corporation
Syracuse 1, N. Y., 300 S. Geddes St.; C. V. Fenn, Mgr.; Tel: Syracuse 76-9911
Atlanta 3, 300 Ivy St., N. E.; M. H. Darby, Mgr.; Tel: Cypress 7621
Boston 14, N. Station Office Bldg.; W. H. Wetherell, Mgr.; Tel: Richmond 2-0772-3-4
Chicago 54, Merchandise Mart Plaza; W. S. Bodinus, Mgr.; Tel: Whitehall 4-3441
Dallas 1, 710 N. Harwood St.; H. C. Hoffman, Mgr.; Tel: Riverside 4475
Denver 2, 1718 California St.; H. C. Kugeler, Mgr.; Tel: Acoma 2561
Jacksonville, Fla., 1011 Hendricks Ave.; N. W. Rathbun, Mgr.; Tel: 9-9781
Kansas City 6, Mo., Riss Bldg.; G. H. Stoffer, Mgr.; Tel: Angelus 4622
Los Angeles 22, 5330 Harbor St.; W. L. Yerkes, Mgr.; Tel: Angelus 3-7161
New York 17, 385 Madison Ave.; H. Peacock, Mgr.; Tel: Plaza 9-5000
Philadelphia 7, P.S.F.S. Bldg.; L. M. Church, Mgr.; Tel: Market 7-7100
Toronto 14, Canada, 857 The Queensway; E. F. Pope, Mgr.; Tel: Rodney 2305
Washington 5, D. C., Investment Bldg.; L. E. Mighell, Mgr.; Tel: Executive 5540
Products: Air conditioning and refrigeration equipment for studio. Includes room air conditioners, packaged equipment from 2 to 20 h.p. and equipment for built-up systems to maximum studio.

Centralab, A Div. of Globe-Union, Inc.
Milwaukee 1, Wis., 900 E. Keefe Ave.; Walter Peek, Mech. Elec. Prds. Sls. Mgr.; Tel: Woodruff 2-9200
Chicago 39, Ill., 5359 W. Fullerton; F. L. Tiegs, Mgr.; Tel: Berkshire 7-0129
Toronto 12, Ont., Can., 804 Mt. Pleasant Rd.; P. J. Heenan, Mgr.; Tel: Hudson 1-2291
Products: Variable resistors (composition and wire-wound); ceramic capacitors; selector switches; printed electronic circuits; ceramic insulators; ceramic piezoelectric crystals

Cinema Engineering Co. (Div. Aerovox Corp.)
Burbank, Calif., 1100 Chestnut St.; James L. Fouch, Gen. Mgr.; Tel: Rockwell 9-2381
Products: Audio attenuators, speech input consoles, audio equalizers, wave filters

Clarkstan Corp.
See Pacific Transducer Co.

Classophone, Inc.
New York, 42-08 Vernon Blvd.; Augusta S. Spector, Mgr.; Tel: Stillwell 6-1370
Products: Phonograph record holders

Clebar Watch Agency
New York 21, N. Y., 521 Fifth Ave.; Leonard S. Naurison, Sls. Mgr.; Tel: Murray Hill 2-3890
Products: Stop watches

Collins Radio Co.
Cedar Rapids, Iowa, 855 35th St., N.E.; R. H. Hollister, Brd. Sls. Mgr.; Tel: 3-0281
Burbank, Calif., 2700 W. Olive Ave.; J. D. Phelan, Mgr.; Tel: Charleston 0-5224
Dallas 2, Texas, 1930 Hi-Line Dr.; J. G. Flynn, Jr., Mgr.; Tel: Prospect 5151
New York 36, N. Y., 11 W 42nd St.; W. A. Schrader, Mgr.; Tel: Longacre 4-3930
Products: Speech equipment, control-room consoles, remote amplifiers, transmitters, accessories. fm, Antennas, speech equipment, accessories

CBS-Hytron, A Div. of CBS, Inc.
Danvers, Mass., 100 Endicott St.; John Q. Adams, Mgr.; Tel: Danvers 2360
Chicago, Ill., 5637 W. Diversey Ave.; W. Brock, Mgr.; Tel: National 2-1425-6-7
Newark, N. J., 32 Green St.; L. Niemann, Mgr.; Tel: Market 3-5832
Products: Recording, transmitting tubes

CALIFONE

Portable Playbacks

Studio performance plus portability plus popular prices add up to give you a playback to meet your most exacting demands. CALIFONEs have been chosen by over 50% of all radio stations, hundreds of advertising agencies, as well as professional musicians and vocalists everywhere. All Califone Playbacks have 3 speeds for playing 7-16" recordings.

CUSTOM IMPERIAL 400

The choice for executive offices where both highest quality performance and affluent appearance are important. From its precision-made pickup to its Jim Lansing Signature speaker, the Custom Imperial 400 offers the absolute ultimate in tonal fidelity sumptuously housed in silver gray case with chrome trim.

SPECIFICATIONS

- Studio type heavy duty turntable
- Separate bass and treble controls
- Professional variable reluctance cartridge
- World's finest extended range speaker



CUSTOM IMPERIAL 400

\$169.50 Net



MODEL 10P2

\$89.50 Net

MODEL 10P2

Our newest model, engineered to give you professional high fidelity by means of its variable reluctance cartridge. The 8-inch full range speaker, heavy duty turntable, wide range amplifier, and separate treble and bass controls offer outstanding musical quality.

MODEL 6U (not shown)

The ideal transcription player for budget-minded organizations, since its low price enables each salesman to be equipped with his own playback. Famous for its portability and fine performance.

\$69.95 Net.

WRITE FOR CATALOGUE DEPT. B54

CALIFONE CORPORATION

1041 N. Sycamore Avenue, Hollywood 38, Calif.

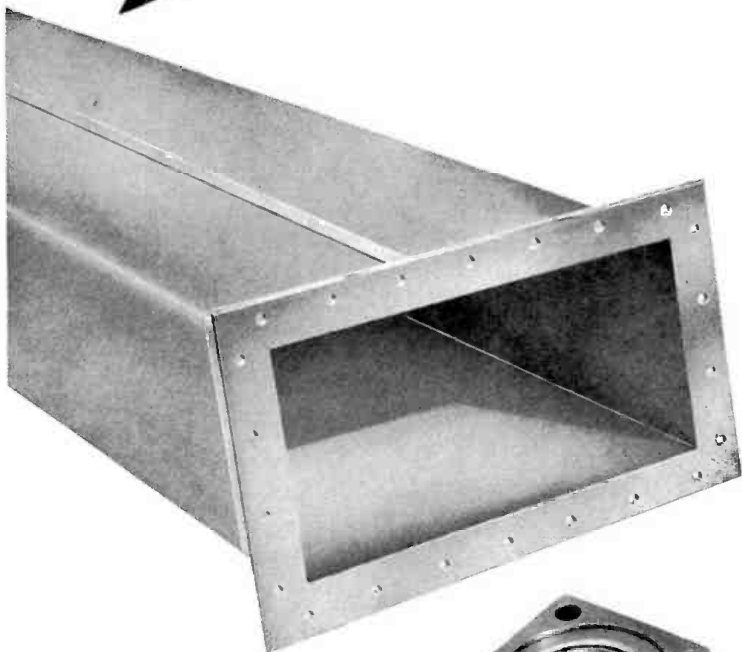

VHF

TV Transmission Line

UHF

TV Transmission Line
Waveguide

The oldest in the field—still a pioneer—designing, engineering and producing transmission lines for the ever advancing needs of the industry. Aided by the industry's finest research, Andrew's vast experience in solving transmission problems has produced the most advanced TV transmission line and waveguide available today.

For complete electrical and mechanical specifications, request Bulletin 81. The special Andrew Nomographs in this Bulletin permit direct graphical computation of efficiency of 10 to 2000 foot runs of line.

Andrew
CORPORATION

363 EAST 75TH STREET, CHICAGO 19

ANTENNA SPECIALISTS

ANDREW Type Number	Size	Impedance	Insulator Bead Material
TRANSMISSION LINE FOR VHF-TV			
451	1 1/4"	51.5 ohms	steatite
551-4	1 3/8"	51.5 ohms	Teflon*
452	3 1/2"	51.5 ohms	steatite
552-1	3 3/8"	51.5 ohms	Teflon*
T-453	6 1/8"	51.5 ohms	steatite
TRANSMISSION LINE FOR UHF-TV			
561	1 1/2"	50.0 ohms	Teflon*
562	3 1/8"	50.0 ohms	Teflon*
563	6 1/8"	75.0 ohms	Teflon*
WAVEGUIDE FOR UHF-TV			
565	Copper clad steel 7 1/2" x 15" rectangular cross-section, RTMA designation WR-1500, 10 foot section		
564	Copper clad steel waveguide WR-1150, 11 1/2" x 5 3/4" inside dimensions, 10 foot section		

*trademark for DuPont tetrafluoroethylene

TRANSMISSION LINES FOR AM-FM-TV-MICROWAVE • ANTENNAS • DIRECTIONAL ANTENNA EQUIPMENT • ANTENNA TUNING UNITS • TOWER LIGHTING EQUIPMENT

for
**TOWER and
ANTENNA**
erection
that's best

call on...



For your new TV or radio station, entrust the important job of tower and antenna installation to a firm with a proven record!

* **Experience** — has erected hundreds of AM, FM, TV, microwave towers coast-to-coast.

* **Equipment**—adequate for every job, properly manned by highly trained and skilled workmen.

Get full facts by writing, phoning or wiring Stan Bernstein, President and General Manager. Your inquiry will receive prompt and full attention.

FREE brochure sent on request.

ELECTRICAL TOWER SERVICE, INC.
P. O. Box 1285 • Peoria, Ill. • Ph. 3-9848

- Commercial Radio-Sound Corp.**
New York 18, N. Y., 652 First Ave.; Arthur W. Schneider, Gen. Mgr.; Tel: Oregon 9-0400
Products: Sound effects machine, speech input, rack and console wiring, audition equipment, jack cleaning tool
- Communications Co., Inc.**
Coral Gables, Fla., P. O. Drawer 6250; R. E. Graham, Mgr.; Tel: 4-0846
Products: hf and vhf base station equipment. Mobile equipment for airport vehicles. Control tower equipment. fm: vhf base station, mobile equipment
- Communication Products Co., Inc.**
Marlboro, N. J.; J. L. Bernard, Jr., Mgr.; Tel: Freehold 8-1880
Products: Coaxial transmission lines, dehydrators, switches, lacquer, coaxial antennas
- L. L. Constantin & Co.**
Lodi, N. J., Rt. 46 & Franklin Ave.; Stephen C. Taber, Sls. Mgr.; Tel: Prescott 7-0223
Products: Crystal holders, connector plugs, glass to metal seals, all types; vacuum coating equipment
- Continental Electronics Mfg. Co.**
Dallas 17, Texas, 4212 S. Buckner Blvd.; W. M. Witty, Mgr.; Tel: Evergreen 1137
Products: Broadcast transmitters, 250 watt through 50 kilowatt. Antenna phasing equipment and associated apparatus. Transmitter remote control equipment
- Crouse-Hinds Co.**
Syracuse 1, N. Y.; A. H. Clarke, Comm. V. P., Illumination, Mgr.; Tel: 74-1011
Birmingham 3, Ala., Watts Bldg.; M. J. Booth, Mgr.; Tel: 7-4232
Boston 10, Mass., 80 Federal St.; G. V. Miller, Mgr.; Tel: Liberty 2-9881
Chicago 6, Ill., 600 W. Jackson Blvd.; W. L. Johnson, Mgr.; Tel: Franklin 2-5917
Detroit 2, Mich., Gen. Motors Bldg.; G. G. Snyder, Mgr.; Tel: Trinity 5-4355
Houston 4, Texas, 2801 San Jacinto St.; G. G. Griffin, Mgr.; Tel: Charter 3464
Los Angeles 15, Calif., 714 W. Olympic Blvd.; H. L. White, Mgr.; Tel: Prospect 3189
New York 7, N. Y., 11 Park Pl.; C. H. Gurney, Mgr.; Tel: Cortland 7-0750
Pittsburgh 22, Pa., Empire Bldg.; J. J. Bangert, Mgr.; Tel: Grant 1-6882
St. Louis 8, Mo., 3732 Wash. Blvd.; J. A. Webb, Mgr.; Tel: Newsted 5555
Tulsa 3, Okla., 17 W. 10th St.; E. N. Jolliff, Mgr.; Tel: 4-7107
Washington 5, D. C., 1511 K St., N.W.; H. L. Guiney, Mgr.; Tel: Republic 7-2033
Products: Aircraft obstruction lighting equipment for towers; flashing beacons, obstruction marker lights, flashing switches, photoelectric controls
- The Daven Co.**
Newark 4, N. J., 191 Central Ave.; Edward L. Grayson, Sls. Mgr.; Tel: Mitchell 2-6555
Products: Precision wire wound resistors, attenuators, rotary switches, potentiometers, transmission measuring sets, decade resistance boxes, attenuation networks
- Daystrom Electric Corp.**
Poughkeepsie, N. Y.; Frank Randall, Dir. Sls.; Tel: Poughkeepsie 10000
Chicago, Ill., 221 N. LaSalle St.; H. H. Hanlon, Mgr.; Tel: State 2-8648
Products: Tape recorders
- Detroit Diesel Engine Div. (General Motors Corp.)**
Detroit 28, Mich., 13400 W. Outer Dr.; Tel: Kenwood 1-7100
Products: Standby generator sets
- DeWald Radio Mfg. Corp.**
Long Island City 1, N. Y., 35-15 37th Ave.; L. N. Weiss, Mgr.; Tel: Stillwell 4-9334
Products: Receivers
- M. Ducommun Co.**
New York 36, N. Y., 580 Fifth Ave.; A. G. Stepchuk, Mgr.; Tel: Plaza 7-2540
Products: Stop watches; program, studio timers; service and repair
- Allen B. Dumont Labs., Inc.**
Clifton, N. J., 1500 Main Ave.; Fred M. Link, Dir. Optns.; Mulberry 4-7400
New York, Empire State Bldg.; Walter Roche; Murray Hill 8-2800
Products: Mobile communications equipment
- DX Radio Products Co.**
Chicago 47, 2300-10 W. Armitage Ave.; Frank J. Hajek, Sls. Mgr.; Armitage 6-3740
Products: Horizontal transformers, coils, crystals
- Eastern Air Devices, Inc.**
Brooklyn 17, 585 Dean St.; E. Janse, Mgr.; Tel: Sterling 3-3406
Products: Sub-fractional horsepower motors and blowers
- Eastern Mike-Stand Co.**
Brooklyn 12, N. Y., 56 Christopher Ave.; S. Sherman, Mgr.; Tel: Dicken 2-3538
Products: Microphone stands
- Ectro, Inc.**
Delaware 1, Ohio, 425 S. Sandusky St.; R. Stahl, Pres.; Tel: 3-1201
Products: Mobile tape recorder; battery charger for tape recorder
- Eidson Electronic Co.**
Temple, Texas, 1902 N. 3rd St.; Merrill Eidson, Mgr.; Tel: 3-3901
Products: Quartz crystals; station frequency measuring service
- Eitel-McCullough, Inc.**
San Bruno, Calif., 798 San Mateo Ave.; O. H. Brown Dir. Field Engr.; Tel: Juno 8-1212
Products: Transmitting type vacuum tubes including tubes for RF and audio driver stages, final amplifiers and modulators; STL services. Air cooled and water cooled triodes, tetrodes and pentodes; vacuum capacitors and vacuum switches; contact finger stock; air system tube sockets; tube connectors
- Electows Supply Co.**
Madison, Wis., 405 Broom St.; Louis Glass, Mgr.
Products: Towers
- Elco Corp.**
Philadelphia 40, Pa., 190 W. Glenwood Ave.; Leo Kagan, Sls. Mgr.; Tel: Garfield 6-6620
Products: Varicon connectors; sockets, transistor, printed circuit, 14 and 20-pin relay, turret, crystal, plus special and custom designed. fm: Tube shields, binding posts; strap nuts
- Electrical Tower Service, Inc.**
Peoria 2, Ill., 206 S. Washington St.; Stanley Bernstein, Pres.; Tel: 3-9848
Products: Erect towers; microwave systems
- Electro-Voice, Inc.**
Buchanan, Mich., Carroll & Cecil Sts.; Webster F. Soules, Mgr.; Tel: Buchanan 1000
Garden City, L. I., N. Y., 205 Kilburn Rd.; Phillip C. Erhorn, Mgr.; Tel: Garden City 7-10087
Products: Microphones, monitoring loudspeakers, loudspeaker enclosures
- The Elmor Co.**
Chicago 2, Ill., 29 E. Madison St.; H. Weiner, Mgr.; Tel: Central 6-9672
Products: Stop watches, timers, chronographs
- Emerson Radio and Phonograph Corp.**
New York 11, 111 Eighth Ave.; David Hopkins, Mgr.; Tel: Oregon 5-7000
Products: Receivers
- Emsco Mfg. Co.**
Houston 1, Texas, P. O. Box 1289; Leo A. Doering, Mgr. Struct, Sls.; Tel: Milby 3361
Products: Towers



*For Equipment
above and beyond
the usual standards*

Continental Electronics

MANUFACTURING COMPANY

4212 S. BUCKNER BLVD.

DALLAS 17, TEXAS

PHONE EVergreen 1137

ACROSS THE NATION...

Graybar service is always nearby

**OFFICES AND WAREHOUSES
IN OVER 110 PRINCIPAL CITIES**

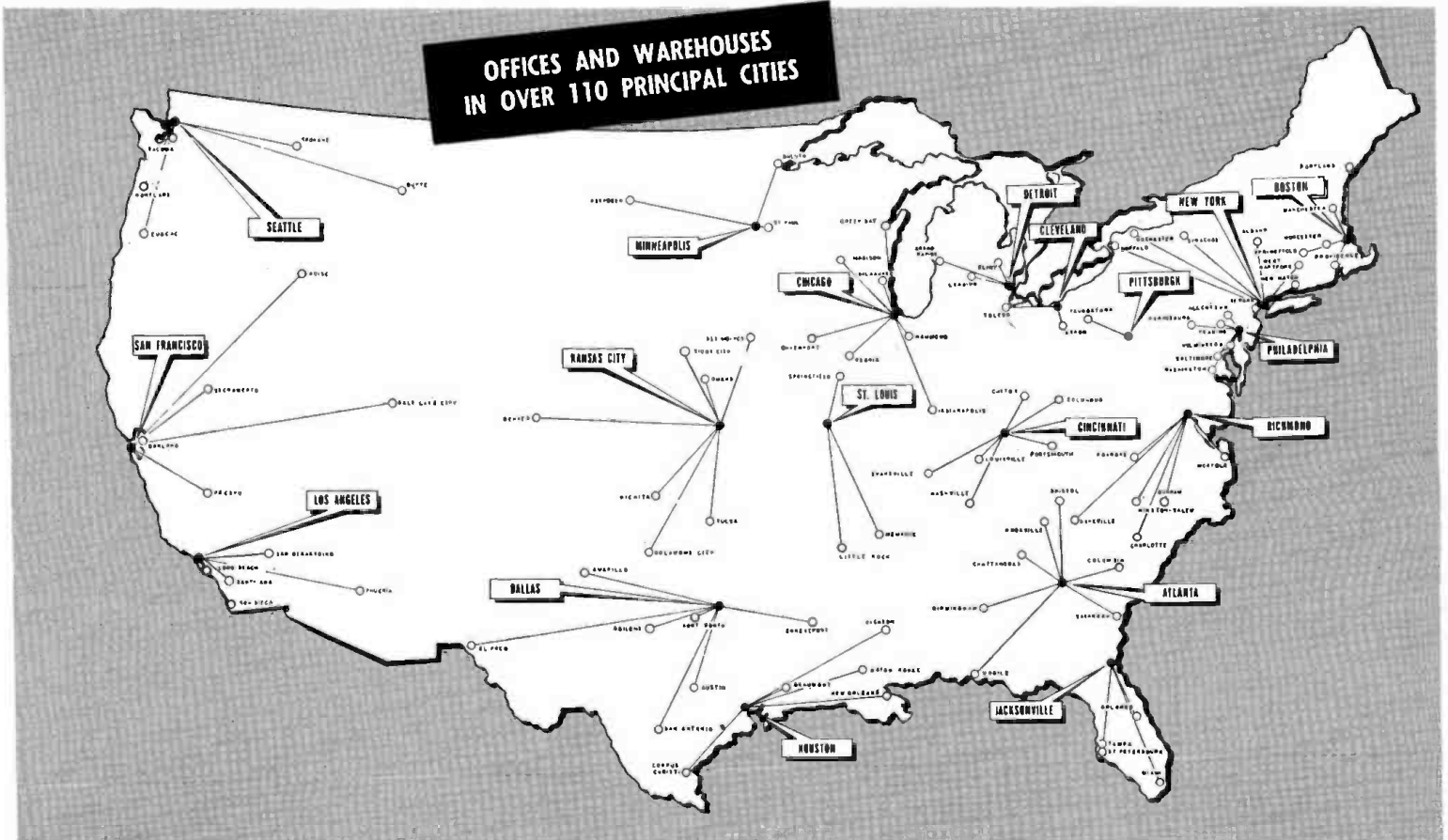

WASHINGTON, D. C.
W. C. COTHRON
Executive 3-0022



SEATTLE
D. I. Craig
Mutual 0123



SAN FRANCISCO
K. G. Morrison
Market 1-5131



ST. LOUIS
J. P. Lenkerd
Newstead 4700



RICHMOND
E. C. Toms
Richmond 7-3491



PITTSBURGH
R. F. Grossett
Allegheny 1-4100



PHILADELPHIA
J. W. Crockett
Walnut 2-5405



OMAHA
L. J. O'Connell
Atlantic 5740



NEW YORK
R. W. Griffiths
Exeter 2-2000

Call Graybar first for assistance on any phase of AM — or TV — station construction, expansion or modernization. Graybar can supply the products of over 600 of the nation's leading manufacturers — more than 100,000 different electrical items, ranging from transmitter and antenna to lighting equipment and cable. So if it's electrical, our office nearest you will fill your order promptly

and efficiently. Graybar service is available from any of the Graybar offices and warehouses shown above.

For technical help in AM or TV equipment selection, consult the Graybar Broadcasting Specialist who serves your area — you'll find his intimate knowledge of broadcasting problems invaluable in planning your facilities. Check above for his name and location. 401

**EVERYTHING ELECTRICAL
to keep you on the air...**

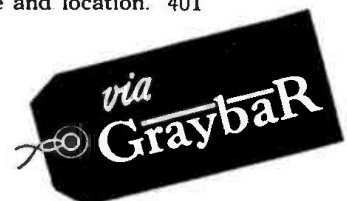

GRAYBAR ELECTRIC CO., INC. • Executive offices: Graybar Building • 420 Lexington Ave., New York 17, N. Y.

AM & FM EQUIPMENT



ATLANTA
John Kluttz
Cypress 1751



BOSTON
J. P. Lynch
Kenmore 6-4567



CINCINNATI
W. H. Hansher
Main 0600



CHICAGO
E. H. Taylor
Conal 6-4100



CLEVELAND
A. C. Schwager
Cherry 1-1360



DALLAS
C. C. Ross
Randolph 6452



DETROIT
A. E. Byers
Temple 1-5500



HOUSTON
R. T. Asbury
Atwood 4571



KANSAS CITY, MO.
R. B. Uhrig
Baltimore 1644



JACKSONVILLE
W. C. Winfree
Jacksonville 6-7611



LITTLE ROCK
W. E. Kunkel
Little Rock 5-1246



MINNEAPOLIS
L. S. Sellner
Geneva 1621



LOS ANGELES
R. B. Thompson
Angelus 3-7282

A few of Our Leading Supplier-Manufacturers

Altec Lansing • Ampex • Berndt-Bach • Bishop • Blaw-Knox • Cannon • Century Lighting • Communication Products • Continental Electronics • Crouse-Hinds • Daven • Fairchild • Federal Telecommunications Laboratories • General Electric • General Radio • Houston-Fearless • Hubbell • Karp Metal • Kliegl • James Knights • Machlett • Meletron • Minnesota Mining • Mole-Richardson • Plastic Wire & Cable • Presto • Prodelin • Rok-O-Kut • Sarvis • Simplex • Thomas & Betts • Tung-Sol • Webster • Western Electric • Zoomar

Everything Electrical for Broadcasting-Televasting

Amplifiers • Antennas • Consoles • Frequency and Modulation Monitors, Test Equipment • Loudspeakers and Accessories • Microphones and Accessories • Recorders and Accessories • Speech Input Equipment • Towers • Tower and Studio Lighting Equipment • Transmission Line and Accessories • Transmitters, AM and TV • Tubes • Turntables, Reproducers, and Accessories • TV Cameras and Film Equipment • Video and Audio Monitors • Wiring Supplies and Devices.

Engineering Associates
Dayton 9, Ohio, 434 Patterson Rd.; Charles C. Littel, Jr., Mgr.; Tel: Walnut 1662

Products: Laboratory and test equipment: military surplus (rebuilt), etc. Microwave test equipment—receivers, etc., aircraft communications

Espey Mfg. Co., Inc.
New York 21, 528 E. 72nd St.; William W. Jablon, Mgr.; Tel: Trafalgar 9-7000
Chicago 44, 5707 W. Lake St.; R. E. Stemm, Mgr.; Tel: CO 1-1566
Dallas 1, 505 N. Ervay St.; J. E. Smith, Mgr.; Tel: RA 2966
Philadelphia, 1622 68th Ave.; Herman Lewis, Mgr.
Portland 5, Ore., 917 S. W. Oak St.; Don H. Burcham, Mgr.

Products: Receivers, tuners, amplifiers, power supplies

Fairchild Recording Equipment Corp.
Whitestone, N. Y., 154th & 7th Ave.; Jay H. Quinn, Mgr.; Tel: Independence 3-2100

Products: Sound recorders (disc and magnetic tape)

Federal Telephone and Radio Corp.
Clifton, N. J., 100 Kingsland Rd.; R. S. Terry, Mgr.; Tel: Nutley 2-3600
Wash. 6, D. C., 1025 Conn. Ave., N.W.; E. J. Girard, Mgr.; Tel: Executive 3-1697

Products: Transmitting tubes, microwave radio relay links and carrier systems, HF cable, field intensity meters, radar, miniature and standard selenium rectifier stacks, battery chargers and power supplies

C. H. Fisher & Son
Portland 13, Ore., 6100 N. E. Columbia Blvd.; C. H. Fisher, Mgr.; Tel: Trinity 7303

Products: Towers, vertical radiators, erecting, lighting, painting and ground systems

Freed Transformer Co., Inc.
Brooklyn 27, N. Y., 1718 Weirfield St.; Tel: Evergreen 6-1300

Products: Transformers

Gates Radio Co.
Quincy, Ill., 123 Hampshire St.; L. J. Cervone, Gen. Sls. Mgr.; Tel: Main 8202
Atlanta, Ga., 13th & Spring Sts.; Howard Decker, Mgr. Tel: Elgin 0389
Houston, Texas, 2700 Polk Ave.; Joe Woods, Mgr.; Tel: Atwood 8536
Los Angeles, Calif., 7501 Sunset Blvd.; Robert Kuhl, Mgr.; Tel: Hollywood 2-6351
New York, N. Y., 51 E 42nd St.; John Haerle, Mgr.; Tel: Murray Hill 7-7971
Washington, D. C., Warner Bldg.; O. J. McReynolds, Mgr.; Tel: Metropolitan 8-0522

Products: Broadcast transmitters and complete station equipment; transmitter control consoles, audio consoles, audio amplifiers, patch panels, racks, custom-built audio consoles, audio preset master controls, turntables, recording equipment, microphones, towers, transmission line. fm: Transmitters, studio equipment, antennas, coaxial cable

General Electric Co.
Syracuse 1, N. Y., Electronics Park; P. L. Chamberlain, Gen. Mgr.; Tel: 76-4411
Atlanta 3, Ga., Red Rock Bldg.; T. F. Bost, Jr., Mgr.; Tel: Cypress 2581
Boston 15, Mass., 963 Commonwealth Ave.; A. F. Wild, Mgr.; Tel: Hubbard 2-1800
Chicago 54, Ill., Merchandise Mart; G. E. Webster, Mgr.; Tel: Whitehall 4-3915
Cincinnati 2, Ohio, 215 W. Third St.; John Wall, Mgr.; Tel: Main 5022
Cleveland 2, Ohio, Williamson Bldg.; G. F. Oberrender, Jr., Mgr.; Tel: Superior 1-8822

Dallas, Texas, 3200 Maple Ave.; J. H. Douglas, Mgr.; Tel: Prospect 4296
Houston, Texas, 1100 E. Holcombe Blvd.; H. W. Granberry, Mgr.; Tel: Justin 0657

Los Angeles, Calif., 3460 Wilshire Blvd.; F. R. Walker, Mgr.; Tel: Dunkirk 5-2391
New York 22, N. Y., 570 Lexington Ave.; C. J. Simon, Mgr.; Tel: Plaza 1-1311
Philadelphia 2, Pa., 1405 Locust St.; J. W. I. Cody, Mgr.; Tel: Pennypacker 5-9000

St. Louis 8, Mo., 4227 Lindell Blvd.; W. R. Chapin, Mgr.; Lucas 8873
San Francisco 6, Calif., 235 Montgomery St.; C. T. Haist, Jr., Mgr.; Tel: Douglas 2-3740

Syracuse 1, N. Y., OCS Bldg.; W. G. Broughton, Mgr.; Tel: 2-3308
Washington 5, D. C., 777 14th St., N.W.; J. H. Painter, Mgr.; Tel: Executive 3-3600

Products: Audio consoles, amplifiers—limiting, portable and complete line for program monitoring and transcription use, both plug-in and rack mounted. Audio accessories—turntable tone arms, equalizers and pickup heads, patch cords and jacks. Rack cabinets, power and audio boards; cable, microphone and audio; speakers

General Instrument Corp.
Elizabeth 3, N. J., 829 Newark Ave.; E. A. Freed, Sls. Mgr.; Tel: Elizabeth 3-4400
Chicago, Ill., 3147 Logan Sq.; B. V. K. French, Mgr.; Tel: Albany 2-6468
Chicopee, Mass., P. O. Box 330; B. F. Valiere, Mgr.; Tel: Springfield 3-6621
Danielson, Conn., Connecticut Mills Ave.; R. L. Klabin, Mgr.; Tel: Prescott 4-9614
Joliet, Ill., 1301 Herkimer St.; E. Lyons, Mgr.; Tel: Joliet 3-9341

Products: Variable air capacitors

General Radio Co.
Cambridge 39, Mass., 275 Mass. Ave.; Myron T. Smith, Mgr.; Tel: Trowbridge 6-4400

Chicago 5, 920 S. Mich. Ave.; Kipling Adams, Mgr.; Tel: Wabash 2-3820
Los Angeles 38, 1000 N. Seward St.; Frederick Ireland, Mgr.; Tel: Hollywood 9-6201

New York 6, 90 West St.; William R. Thurston, Mgr.; Tel: Worth 2-5837
Products: Station frequency, modulation monitors, distortion and noise meters, test oscillators, signal generators, vacuum tube voltmeters, impedance measuring equipment. fm—Same plus coaxial elements, measuring equipment

Graphic Systems
New York 36, N. Y., 55 W. 42nd St.; Hines Hatchett, Mgr.; Tel: Wisconsin 7-8444
Products: Boardmaster visual traffic control system; graphic printed forms

Graybar Electric Co., Inc.
New York 17, N. Y., 420 Lexington Ave.; J. W. LaMarque, Gen. Comm. Sls. Mgr.; Tel: Lexington 2-4000

Atlanta 1, Ga., 333 North Ave., N.W.; J. Kluttz, Mgr.; Tel: Cypress 1751
Boston 16, Mass., 287 Columbus Ave.; J. P. Lynch, Mgr.; Tel: Kenmore 6-4567

Chicago 80, Ill., 850 W. Jackson Blvd.; E. H. Taylor, Mgr.; Tel: Canal 6-4100
Cincinnati 14, Ohio, 115-129 W. McMicken Ave.; W. H. Hansher, Mgr.; Tel: Main 0600

Cleveland 14, Ohio, 1010 Rockwell Ave.; A. C. Schwager, Mgr.; Tel: Cherry 1-1360

Dallas 1, Texas, 717 Latimer St.; C. C. Ross, Mgr.; Tel: Randolph 6452

Detroit 1, Mich., 55 W. Canfield Ave.; A. E. Byers, Mgr.; Tel: Temple 1-5500

Houston 3, Texas, 1702 Cullen Blvd.; R. T. Asbury, Mgr.; Tel: Atwood 4571

Jacksonville 1, Fla., 12th & Main Sts.; W. C. Winfree, Mgr.; Tel: Jacksonville 6-7611

Kansas City 8, Mo., 1644 Baltimore Ave.; R. B. Uhrig, Mgr.; Tel: Baltimore 1644

Long Island City 1, N. Y., 21-15 Bridge Plaza, N.; R. W. Griffiths, Mgr.; Tel: Exeter 2-2000

Los Angeles 54, Calif., 210 Anderson St.; R. B. Thompson, Mgr.; Tel: Angelus 3-7282

Minneapolis 15, Minn., 824 S. Fourth St.; L. S. Sellner, Mgr.; Tel: Geneva 1621

New York 17, N. Y., 420 Lexington Ave.; G. I. Jones, Electronic Sls.; Tel: Lexington 2-4000

Philadelphia 7, Pa., 910 Cherry St.; J. W. Crockett, Mgr.; Tel: Walnut 2-5405

Pittsburgh 12, Pa., 900 Ridge Ave.; R. F. Grossett, Mgr.; Tel: Allegheny 1-4100

- Richmond 19, Va., 10 S. Sixth St.; E. C. Toms, Mgr.; Tel: Richmond 7-3491
San Francisco 1, Calif., 1750 Alameda St.; K. G. Morrison, Mgr.; Tel: Market 1-5131
- Seattle 4, Wash., King & Occidental Sts.; D. I. Craig, Mgr.; Tel: Mutual 0123
St. Louis 3, Mo., 2642 Wash. Ave.; J. P. Lenkerd, Mgr.; Tel: Newstead 4700
Products: Transmitters, antennae, antenna towers, transmission line products, phase monitors, antenna phasing equipment, transmitter and studio measuring equipment, speech input equipment, speech input amplifiers and accessories, microphones and accessories, transcription turntables and pickups, loudspeakers, power supplies, meters, electron tubes, relays, keys, condensers, jacks, mountings, thermistors, varistors, sound measuring equipment, public utilities, radio-telephone equipment, motor generators, emergency power plants and associated apparatus, tape recorders and reproducers, mobile, vehicle and railroad radio-telephone equipment
- Gray Research & Development Co., Inc.
Manchester, Conn., 858 Hilliard St.; Chester B. Hayes, Gen. Sls. Mgr.; Tel: Mitchell 9-4506
New York, N. Y., 521 Fifth Ave.; Richard R. Otto, Mgr.; Murray Hill 7-4590
Products: Transcription arms and audio equalizers, sound effects consoles, switching units
- Great American Industries, Inc.
Bedford, Va.; R. T. Dunlap, Jr., Sls. Mgr.
Products: Facsimile: Rubatex-closed cellular rubber
- Grinnan Fixture Co.
Minerva, Ohio, R. D. #3; John F. Grinnan, Owner
Products: Cabinets for storing records, tape, transcriptions, etc.
- Guardian Electric Mfg. Co.
Chicago 12, Ill., 1821 W. Walnut St.; Robert Heine, Mgr.; Tel: Chesapeake 3-1100
Cleveland 15, Ohio, Caxton Bldg.; J. Burkell, Mgr.; Tel: Superior 1-8644
Dallas 1, Texas, 1330 N. Industrial Blvd.; J. McKinney, Mgr.; Tel: Sterling 1997
New York 11, N. Y., 160 Fifth Ave.; C. Chilson, Mgr.; Tel: Chelsea 2-9063
Philadelphia 24, Pa., 2158 Friendship; W. Wehrheim, Mgr.; Tel: Devonshire 2-1389
San Francisco 2, Calif., 530 Gough St.; L. Logan, Mgr.; Tel: Hemlock 1-5127
Products: Component parts only—interchangeable coil and contacts for relays, radio relays, switches, solenoids
- The Hallcrafters Co.
Chicago 24, Ill., 4401 W. Fifth Ave.; W. J. Halligan, Jr.; Tel: Van Buren 6-6300
Products: am: Receivers, tuners, amplifiers, fm: Receivers: portable and low powered industrial two-way radio telephone
- F. Sumner Hall, Inc.
Amityville, N. Y., 500 Old Sunrise Hwy.; F. Sumner Hall, Pres.; Tel: Amityville 4-6060
Products: Jack panels, jacks, patch cords, plugs, replacement cords, microphone call letter plates and accessories, record labels
- J. M. Hamilton & Co.
Gastonia, N. C., Box 2432; J. M. Hamilton, Owner; Tel: 4-2115
Products: Tower erection
- Hammarlund Mfg. Co., Inc.
New York 1, N. Y., 460 W. 34th St.; Robert B. Moon, Gen. Sls. Mgr.; Tel: Longacre 5-1300
Chicago 11, Ill., 605 N. Mich. Ave.; Ray Ramon, Mgr.; Tel: Delaware 7-6456
Products: Communications, receivers, transmitter and receiver equipment for remotely controlling operations of broadcast transmitters from control studios. (Supervisory control and telemetering of remote broadcast transmitters). Variable capacitors, including those for vhf and uhf operations.
- Harvey Radio Co., Inc.
New York 18, 103 W. 43rd St.; Harvey E. Sampson, Mgr.; Tel: Luxemburg 2-1500
Products: Electronic distributors of broadcast supplies, tape recorders, tubes, batteries, test equipment, audio systems, radio parts
- Hepner Mfg. Co.
Round Lake, Ill., Box 1207; Ray Cuny, Sls. Mgr.; Round Lake 6-2161
Products: EM-FM speakers; flyback transformers. FM focusing devices, ion traps; ferrite rod antennas, centering devices; magnetic door catches
- Hewlett-Packard Co.
Palo Alto, Calif., 395 Page Mill Rd.; W. Noel Eldred, Sls. Mgr.; Tel: Davenport 5-4451
Products: Monitor, audio signal generator, distortion analyzer, vacuum tube voltmeter and test oscillator
- Hogan Labs, Inc.
New York 14, N. Y., 155 Perry St.; Elliott Crooks V. P.; Tel: Chelsea 2-7855
Products: Facsimile equipment for broadcast via fm and inter-studio or inter-office communication
- Harvey Hubbell, Inc.
Bridgeport 2, State St. & Bostwick Ave.; H. Long, Mgr.; Tel: Bridgeport 5-3151
Chicago 7, 37 S. Sangamon St.; R. L. Renaud, Mgr.; Tel: Monroe 6-3737
Los Angeles 12, 103 N. Santa Fe Ave.; A. M. McMillan, Mgr.; Tel: Mutual 7226
New York 7, 11 Park Pl.; Michael Plombo, Mgr.; Tel: Barclay 7-2657
San Francisco, 542 Natoma St., Grover A. Andersen, Mgr.; Tel: Underhill 1-5030
Products: Self locking connectors
- Hughes & Phillips, Inc.
Burbank, Calif., 3300 N. San Fernando Blvd.; M. S. Phillips, Pres.; Tel: Rockwell 9-1104
New York 17, N. Y., 60 E. 42nd St.; H. J. Geist, Mgr.; Tel: Murray Hill 7-1550
Products: am, fm: Tower lighting equipment; beacons, obstruction lights, flashers, photoelectric controls, junction boxes, lamp failure indicators and complete tower lighting kits
- Hycor Co., Inc.
North Hollywood, Calif., 11423 Vanowen St.; Kenneth Eckardt, Mgr.; Tel: Sunset 3-3860
Products: Attenuator controls, fixed attenuators, sound effects filters, variable equalizers, low and high pass audio filters
- IDECO Div., Dresser-Stacey Co.
Columbus 8, Ohio, 875 Mich. Ave.; Joseph M. Hogan, Gen. Sls. Mgr.; Tel: University 2123
Los Angeles 44, Calif., 8909 S. Vermont Ave.; K. H. Brust, Mgr.; Tel: Pleasant 84194
Products: Towers, insulated steel buildings
- Insuline Corp. America
Long Island City 1, N. Y., 3602 35th Ave.; B. L. Cahn, V. P.; Tel: Astoria 8-3738
Chicago, Ill., 6518 W. North Ave.; Leroy W. Beier, Mgr.
Products: Receiving aerials, aerial installation equipment, servicing and testing tools, mechanical components: switches, jacks, plugs, connectors, sockets, dials
- Jennings Radio Mfg. Corp.
San Jose, Calif., 970 McLaughlin Ave.; Calvin K. Townsend, V. P.; Tel: Cypress 2-4025
Products: Vacuum fixed capacitors, vacuum variable capacitors and vacuum switches
- Jensen Mfg. Co.
Chicago 38, Ill., 6601 S. Laramie Ave.; Charles A. Hansen, Sls. Mgr.; Tel: Portsmouth 7-7600
Boston 61, Mass., 148 Needham St.; Tim Coakley, Mgr.; Tel: Decatur 2-4800
Columbus 15, Ohio, 150 E. Broad St.; William McFadden, Mgr.; Tel: Main 3368
Denver 3, Colo., 446 Broadway; Ronald G. Bowen, Mgr.; Tel: Sherman 2501
Kansas City 2, Mo., Porter Bldg.; J. O. Schmitz, Jr., Mgr.; Tel: Logan 9824
Los Angeles 15, Calif., 1148 S. Grand Ave.; George S. Tivy, Mgr.; Tel: Richmond 7-7553
Minneapolis 1, Minn., 6110 Excelsior Blvd.; Fred B. Hill, Mgr.; Tel: Main 8353
New York 10, N. Y., 220 E. 23rd St.; Adolph Friedman, Mgr.; Tel: Lexington 2-0375
Oakland 20, Calif., 1401 Middle Harbor Rd.; Philip Belchamber, Mgr.; Tel: Glencourt 1-4460
Phoenix, Ariz., 240 S. First Ave.; H. George Sheffer, Mgr.; Tel: Alpine 8-7893
Rochester 10, N. Y., 3 Juniper St.; William Richter, Mgr.; Tel: Culver 7635
Seattle, 4310 Roosevelt Way; Burt C. Porter, Mgr.; Tel: Melrose 6828
Silver Spring, Md., 8416 Georgia Ave.; Morris F. Taylor, Mgr.; Tel: Juniper 9-4002
Products: Loudspeakers, networks, level controls and enclosures for loudspeakers for use for monitoring and similar purposes.
- Johns-Manville Corp.
New York 16, N. Y.; 22 E. 40th St.; Paul J. Washburn, Mgr.; Tel: Lexington 2-7600
Boston 18, Mass., 100 Newbury St.; J. A. Chambers, Mgr.; Tel: Copley 7-6500
Chicago 54, Ill.; Merchandise Mart Plaza; A. A. Purvis, Mgr.; Tel: Delaware 7-1144
Cleveland 15, Ohio; 45 Prospect Ave., N.W.; E. E. Clapsadel, Mgr.; Tel: Main 1-5151
New York 16, N. Y.; 270 Madison Ave.; E. A. Scherr, Mgr.; Tel: Lexington 2-7600
Philadelphia 3, Pa.; 1617 Penna. Blvd.; S. A. Peterson, Mgr.; Tel: Rittenhouse 6-7850
St. Louis 1, Mo.; 1000 Market St.; P. D. Lee, Mgr.; Tel: Central 3940
San Francisco 5, Calif.; 116 New Montgomery St.; G. E. Harrington, Mgr.; Tel: Douglas 2-4353
Products: Acoustical treatment for studios
- E. F. Johnson Co.
Waseca, Minn.; 206 Second Ave., S.W.; E. T. Herbig, Jr., Gen. Sls. Mgr.; Tel: 990
Products: R. F. contactors; inductors; pressure, air variable and fixed capacitors
- Kaar Engineering Corp.
Palo Alto, Calif., 2995 Middlefield Rd.; Norman C. Helwig, Mgr.; Tel: Davenport 3-9001
Products: fm-Mobile communication transmitters, receivers
- Kahle Engineering Co.
North Bergen, N. J., 1307 Seventh St.; James B. Lindsay, Mgr.; Tel: Union 7-6500
Products: Equipment and methods for production of electronic tubes, incandescent lamps and related devices and special machinery
- Kay Electric Co.
Pine Brook, N. J., 14 Maple Ave.; L. A. Garten, Sls. Mgr.; Tel: Caldwell 6-4000
Products: Wide range and low frequency sweeping oscillators; random noise generators; vibration and speech analyzing equipment; radar measuring and microwave test equipment
- Kline Iron & Metal Co.
Columbia, S. C., P. O. Box 1013; B. H. Kline, Gen. Mgr.; Tel: 4-0301
Products: Towers
- Lambda Electronics Corp.
Corona 68, N. Y., 103-02 Northern Blvd.; D. C. Warren, Sls. Mgr.; Tel: Twining 8-9400
Products: Power supplies
- Langevin Mfg. Corp.
New York 23, N. Y., 37 W. 65th St.; F. K. Hankinson, Mgr.; Tel: Endicott 2-7200
Products: Audio frequency amplifiers, transformers, powers supplies, accessories
- James B. Lansing Sound, Inc.
Los Angeles 39, Calif., 2439 Fletcher Dr.; William H. Thomas, Pres.; Tel: Normandy 33218
Products: High fidelity loudspeakers; divided network loudspeaker systems, high frequency drivers, acoustic lens
- The LaPointe-Plascomold Corp.
Rockville, Conn., 155 W. Main St.; Fred A. Hess, Mgr.; Tel: Rockville 5-3351
Products: Receiving antennas, towers, lightning arresters; antenna accessories; boosters, antenna divider networks
- Lapp Insulator Co., Inc. (Radio Specialties Div.)
Le Roy, N. Y., 319 Gilbert St.; Sumner P. Lapp, Sls. Mgr.; Tel: Le Roy 385
Products: Antenna insulators, gas-filled condensers, special porcelain
- Leach Relay Co.
Los Angeles 3, Calif., 5915 Avalon Blvd.; R. B. Hutton, Sls. Mgr.; Tel: Adams 8221
Products: Relays for broadcast equipment
- Lehigh Structural Steel Co.
New York 4, N. Y., 17 Battery Pl.; J. F. Neary, Sls. Mgr. Radio & Export Div.; Tel: Whitehall 4-1424
Products: am; Towers—vertical radiators, towers for micro-wave use. fm; facsimile: Supporting towers
- Lewis & Kaufman, Ltd.
Los Gatos, Calif., P. O. Box 337; Jack Kaufman, Sls. Mgr.; Tel: El Gato 4-3540
Products: Transmitting type vacuum tubes for RF and audio driver stages, modulators and final amplifiers. Triodes, tetrodes, pentodes, high vacuum rectifiers and special purpose tubes
- John E. Lingo & Son, Inc.
Camden 5, N. J., 2814 Buren Ave.; John E. Lingo, Pres.; Tel: Woodlawn 4-0487
Products: Tubular steel vertical radiators: vhf antennas and supporting towers. fm: Antennas and supporting towers. Facsimile: Supporting poles

QUALITY IN MINIATURE!

Langevin PLUG-IN

AMPLIFIERS and POWER SUPPLIES

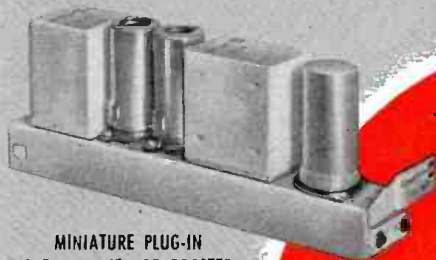

MINIATURE PLUG-IN PRE-AMPLIFIER OR BOOSTER AMPLIFIER TYPE 5116

Miniature plug-in two stage, low noise pre-amplifier or booster amplifier. The smallest high performance amplifier of its type that exceeds FCC requirements. Small size, excellent design and plug-in features make type 5116 ideal for installation in consoles and equipment racks. Push button metering facilities and gold plated plugs are standard at no extra cost.

Langevin-engineered to **IMPROVE PERFORMANCE!**

Miniature-designed to **SAVE PANEL SPACE!**

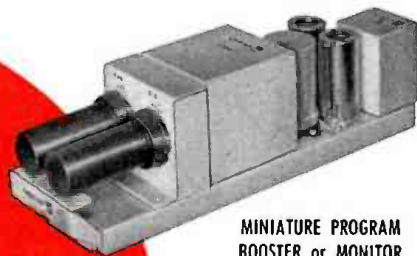

MINIATURE PROGRAM BOOSTER or MONITOR AMPLIFIER TYPE 5117

A plug-in two stage, push-pull, fixed gain audio amplifier. The most compact amplifier available for this service. Outstanding quality recommends type 5117 for applications requiring outstanding performance and maximum availability. Push button metering facilities and gold plated plugs are standard at no extra cost.

-for Radio and Television Broadcast, Recording Studios and Sound Systems

AVAILABLE IMMEDIATELY FROM STOCK

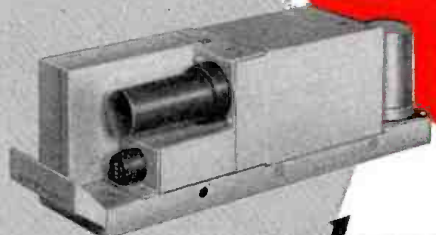

PLUG-IN POWER SUPPLY TYPE 5208

A miniaturized power supply of extremely compact design. Built of highest quality component parts throughout, type 5208 is designed for continuous service. Capable of supplying power for 10 Type 5116 pre-amplifiers or lesser combinations of types 5116 and 5117. Overall length 10 1/4"; width 2 3/8"; height 3".



PLUG-IN POWER SUPPLY TYPE 5206

Designed for use with Langevin Miniature Amplifiers. Provides AC for amplifier filaments and well filtered DC for amplifier plate. One unit provides adequate power to operate up to 22 Type 5116 Amplifiers or lesser combinations of Types 5116 and 5117 with separately fused filament and plate supplies.

Langevin

-the name synonymous with quality in audio equipment and components since 1923

NEW! File Catalog for broadcast engineers and sound technicians available without obligation. Request your copy today—just call or write, on company letterhead, to:

LANGEVIN MANUFACTURING CORPORATION
37 WEST 65TH STREET, NEW YORK 23, N. Y.

A SUBSIDIARY OF THE W. L. MAXSON CORPORATION



EXPORT DISTRIBUTORS: INTERNATIONAL STANDARD ELECTRIC CORPORATION, 50 CHURCH ST., NEW YORK CITY



Which
Magnecorder
best fits
your needs?

the **PROFESSIONAL TAPE RECORDER**

Voyager

The first one-case professional recorder for remotes — rugged, light, reliable. Complete with line level amplifier. Other units available with 10 watts of audio.

Standard Magnecorder

PT63-AH recorder includes a 3-head assembly for monitoring directly from the tape. PT7-P amplifier provides high level mixing of three channels.

MagneCordette

A professional Magnecorder enclosed in smart blond, mahogany, or black lacquer cabinet. Also offered as the new Portable MagneCordette — a complete record-playback-P.A. system in a single carrying case.

New Magnecord M-80

Watch for the brilliant new Magnecord M-80 at your dealer's — the finest tape recorder ever built for the price. Features push-button controls, slot loading, 15 kc response at 7½ ips!

PT6-VAH
\$524.00

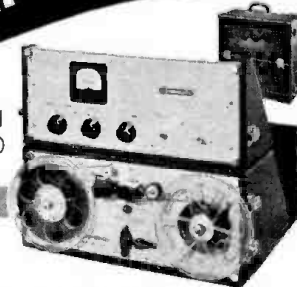

PT63-AH
PT7-P
\$894.00
complete

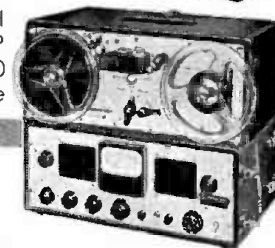

PT6-GAH
\$449.00

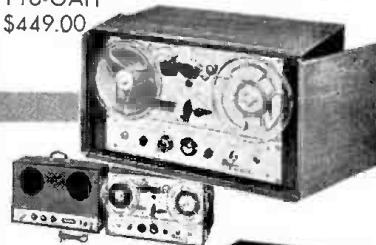

Portable
MagneCordette
\$549.00



M-80
from
\$1185.00

Look under "recorders" in the
phone book for your dealer's name

Magnecord INC.

225 WEST OHIO ST., CHICAGO 10, ILL., DEPT. BY-54

Machlett Labs., Inc.
Springdale, Conn., 1063 Hope St.; H. J. Hoffman, V. P., Power Tube Sls.; Tel: Stamford 4-5781
Products: Broadcast tubes

Magnecord, Inc.
Chicago 10, Ill., 225 W. Ohio St.; John W. Hines, Sls. Dir.; Tel: Whitehall 4-1889
Products: Professional magnetic tape recorders—reproducers

Majestic Radio & Television (Div. of Wilcox-Gay Corp.)
Brooklyn 1, N. Y., 79 Washington St.; Maurice Raphael, V. P.; Tel: Ulster 2-6000
Charlotte, Mich.; L. M. Sandwick, V. P.; Tel: Charlotte 485
Chicago 10, Ill., 743 N. LaSalle St.; R. E. Jenkins, Mgr.; Tel: Whitehall 4-0077
Los Angeles, Calif., 2772 W. Olympic Blvd.; B. R. Ross, Mgr.; Tel: Dunkirk 1783
Products: Magnetic tape recorders; tape and disc recorders; magnetic tape, disc blanks; cutting and playback needles; receivers; spectrum analyzers; inter-communication equipment. Facsimile: Converters

Major Electronics Co.
Brooklyn 6, N. Y., 42-44 Meserole St.; Murray Schrier; Evergreen 8-5230-1
Products: Phonographs, record players, record changers

Measurements Corp.
Boonton, N. J.; Nelson C. Doland, Jr., Mgr.; Tel: Boonton 8-2131
Products: Test equipment—Standard signal, pulse, square wave generators; uhf radio noise and field strength, megohm meters; peak voltmeters, R.F. attenuators, crystal calibrators; intermodulation, megacycle meter; inductance, capacitance bridges, vacuum tube voltmeters, special test instruments. fm signal generators. Special precision components: Condensers, coils and resistors

Merit Coil & Transformer Corp.
Chicago 40, 4427 N. Clark St.; W. J. Barron, Mgr.; Tel: Longbeach 1-6311
Products: Audio and power transformers; reactors

Milo Radio & Electronics Corp.
New York 7, 200 Greenwich St.; M. Putterman, Mgr.; Tel: Beekman 3-2980
Products: Wholesale, standard brand radio-electronic equipment

Minnesota Mining & Mfg. Co.
St. Paul 6, Minn., 900 Fauquier Ave.; Paul W. Jansen, Sls. Mgr., Magnetic Prdts. Sls.; Tel: Cedar 3071
Atlanta 3, Ga., 732 Ashby St., N.W.; G. S. Miles, Mgr.; Tel: Elgin 4401
Buffalo 6, N. Y., P. O. Box 2012; J. J. McDonald, Mgr.; Tel: Bailey 5214
Chicago 8, Ill., 1500 S. Western Ave.; A. J. Forss, Mgr.; Tel: Monroe 6-6126
Cincinnati 2, Ohio, c/o Terminal Warehouse, 47 Central Ave.; J. J. O'Brien, Mgr.; Tel: Parkway 5700-01-02
Cleveland 11, Ohio, 12430 Elmwood Ave.; A. D. Steele, Mgr.; Tel: Boulevard 2-5200
Dallas 2, Tex., 1221 Dragon St.; S. P. Van Arsdall, Mgr.; Tel: Riverside 6256
Denver, Col., 1639 Blake St.; J. T. Donahue, Mgr.; Tel: Alpine 2066
Detroit 13, Mich., 8825 Grinnel Ave.; A. D. Steele, Mgr.; Tel: WA 5-6700
Grand Rapids 4, Mich., 815 Monroe Ave.; A. J. Forss, Mgr.; Tel: Glendale 6-8577
High Point 3, N. C., 1501 S. Main St.; G. S. Miles, Mgr.; Tel: 3496
Hollywood 36, Calif., 446 N. LaBrea Ave.; M. D. Benson, Mgr.; Tel: Webster 1-1289
Los Angeles 54, Calif., 6411 Randolph St.; M. D. Benson, Mgr.; Tel: Underhill 0-1241
Newton Center 59, Mass., 1330 Centre St.; E. F. Gregg, Mgr.; Tel: Decatur 2-9810
Philadelphia 8, Pa., 401 N. Broad St.; C. M. Jacobson, Mgr.; Tel: Lombard 3-2900
Pittsburgh 19, Pa., Plaza Bldg.; C. M. Jacobson, Mgr.; Tel: Atlantic 1-2075
Ridgefield, N. J., 700 Grand Ave.; J. J. McDonald, Mgr.; Tel: Morsemerse 6-6700
St. Louis 8, Mo., 3700 Forest Park Blvd.; S. P. Van Arsdall, Mgr.; Tel: Lucas 5289
St. Paul 1, Minn., 367 Grove St.; J. T. Donahue, Mgr.; Tel: Cedar 3071
San Francisco 10, Calif., 450 Alabama St.; J. T. Evans, Mgr.; Tel: Underhill 3-4480
Seattle 4, Wash., 1242 Sixth Ave. S.; J. T. Evans, Mgr.; Tel: Seneca 4554
Products: Magnetic tape, film and associated accessories

Moody Machine Products Co., Inc.
Providence 5, R. I., 42 Dudley St.; J. N. Moody, Treas.; Tel: Gaspee 1-3317
Products: Precision small tools

Mycalex Corp. of America
Clifton, N. J., 125 Clifton Blvd.; J. H. DuBois, V. P., Engr.; Tel: Prescott 9-8866
New York, N. Y., 30 Rockefeller Plaza; Jerome Taishoff, Pres.; Tel: Columbus 5-5989
Products: Glass-bonded mica: high temperature, high frequency, low loss insulation; machinable and injection molded grades for tuners, microphones and other components; miniature, sub-miniature, uhf, transistor, and printed circuit tube sockets; hermetic seals; telemetering equipment; terminal boards

Nassau Research & Development Associates, Inc. (subsidiary of Peerless Instrument Co., Inc.)
Mineola, N. Y., 66 Main St.; William A. Bourke, V. P.; Tel: Garden City 3-3570
Products: fm microwave components, systems, instruments and test equipment for microwave links

National Co., Inc.
Malden 48, Mass., 61 Sherman St.; C. G. Barker, Distrib. Mgr.; Tel: Malden 2-7950
Products: Receivers

Newark Electric Co.
Chicago 6, Ill., 223 W. Madison St.; Sam Poncher, Mgr.; Tel: State 2-2950
Products: All types broadcasting equipment

Newcomb Audio Products Co.
Hollywood 36, Calif., 6824 Lexington Ave.; Robert Newcomb, Mgr.; Tel: Hollywood 9-5391
Products: Receivers, public address systems, transcription players, phonographs, amplifiers, phonograph amplifiers

Otto K. Olesen Co.
Hollywood 28, 1534 N. Cahuenga Blvd.; Otto K. Olesen, Mgr.; Tel: Gladstone 5194
Products: Studio lighting equipment, lighting control equipment, dimmer and lighting control consoles, microphone booms

ORRadio Industries
Opelika, Ala., T-120 Marvyn Rd.; J. Herbert Orr, Mgr.; Tel: 1123
Products: Magnetic sound recording, splicing, program divider tape; leader stock and accessory items for sound recording tape

Oxford Electric Corp.
Chicago 15, Ill., 3911 S. Mich. Ave.; Hugo Sundberg, V. P.-Sls. Mgr.; Tel: 5-6161
Products: Speakers, audio transformers, dial lamps

Pacific Transducer Corp.
Los Angeles 64, Calif., 11921 W. Pico Blvd.; R. S. Clarke, Mgr.; Tel: Arizona 9-6129
Products: Audio sweep frequency generators (am and fm) and transcriptions, records, wide range reproducers, playback stylus, tone arms, equalizers, audio transformers, needle force gauges

Packard-Bell Co.
Los Angeles 64, Calif., 12333 W. Olympic Blvd.; Kenneth R. Johnson, Gen. Sls. Mgr.; Tel: Arizona 76721; Bradshaw 2-2171
Products: Receivers

Panoramic Radio Products, Inc.
Mt. Vernon, N. Y., 10 S. 2nd Ave.; Bernard Schlessel, V. P.; Tel: Mount Vernon 4-3970
Products: Panalyzer and Panadaptor for examining fm deviations, side band spill over, harmonic and inter-modulation distortion. Sonic analyzer and sonic response indicator: used for harmonic and inter-modulation distortion analysis of audio frequencies. Later provides visual inspection of response characteristics of amplifiers, speakers, microphone, filter and other audio networks

The Pentron Corp.
Chicago 16, 221 E. Cullerton; Irving Rossman, Mgr.; Tel: Victory 2-7234
Products: Multi-speed tape recorders, tape players, electronic mixer, am tuner, foot control, reel adapters, tape transport mechanism, telephone pickups, external speakers

Permoflux Corp.
Chicago 39, Ill., 4900 W. Grand Ave.; Russell S. Fenton, V. P.-Gen. Sls. Mgr.; Tel: Berkshire 7-3200
Glendale 5, Calif., San Fernando Rd.; John Mutschler, Mgr.; Tel: Chatnam 4-5133
Lansing, Ont., Can., 45 Sheppard, Ave., E., Peter Posnikoff., Mgr.
Products: High fidelity headphones, speakers and speaker enclosures

Philco Corp. Government & Industrial Div.
Philadelphia 44, Pa., 4700 Wissahickon Ave.; George A. Hagerty, Industrial Sls. Mgr.; Tennessee 9-4000
Beverly Hills, Calif., 260 S. Beverly Dr.; Marshall A. Williams; Crestview 5-4486
Chicago 11, Ill., 666 Lake Shore Dr.; Robert A. MacDonald; Whitehall 4-5750
Dallas 1, Texas, Southland Life Bldg.; Richard A. Fay; Prospect 8657
Dayton 2, Ohio, Talbot Bldg.; Lewis Kendall; Michigan 6578
Philadelphia 44, Pa., 4700 Wissahickon Ave.; John W. Mullen; Tennessee 9-4000
San Francisco 4, Calif., Russ Bldg.; Lewis J. Boss; Sutter 1-6262
Washington 6, D. C., 744 Jackson Pl., N.W.; Charles M. Volkland; Executive 3-1500
L'Etang La Ville (Seine et Oise), France, 4 Rue De Saint Nom; Fred F. Bartlett; Mansard 5822
Products: Microwave for broadcast STL use; program channel multiplex equipment

Pilot Radio Corp.
Long Island City 1, N. Y., 37-06 36th St.; James I. Benjamin, Sls. Mgr.; Tel: Stillwell 4-5455
Products: Tuners, amplifiers, preamplifiers

Potter & Brumfield
Princeton, Ind.; R. T. Brengle, Dir. Sls.; Tel: 1596
Camden 3, N. J., Stevens Bldg.; G. R. North, Mgr.; Tel: Woodlawn 6-1800
Chicago 44, Ill., 5967 W. Madison St.; J. J. Bierhaus, Mgr.; Tel: Columbus 1-1928
Washington 5, D. C., Bond Bldg.; D. J. Fagge, Mgr.; Tel: Executive 3-7457
Products: Relays

Precision Apparatus Co., Inc.
Elmhurst, L. I., N. Y., 92-27 Horace Harding Blvd.; J. M. Kirshbaum, V. P. Charge Sls.; Tel: Havemeyer 9-6262
Products: Electronic test and measuring instruments

Precision Piezo Service
Baton Rouge 10, La., 427 Mayflower St.; C. E. Pearce, Mgr.; Tel: 2-5359
Products: Quartz crystals, holders, ovens

Presto Recording Corp.
Paramus, N. J., P. O. Box 500; Thomas B. Aldrich, Sls. Mgr.; Tel: Diamond 3-0700
Buffalo 1, N. Y., Ellicott Sq. Bldg.; Robert W. Mitcher, Mgr.; Tel: Garrison 2-0233
Chicago, Ill., 220 Kedzie St., Evanston, Ill.; Warren Cozzens, Mgr.; Tel: Davis 8-4800
Clayton, Mo., 135 N. Central Ave.; Lee Maynard, Mgr.; Tel: Delmar 3723
Cleveland, Ohio, 1836 Euclid Ave.; Ernest P. Scott, Mgr.; Tel: Main 1565
Dallas, Tex., 505 N. Ervar St.; J. Earl Smith, Mgr.; Tel: C-2966
Detroit, Mich., 17636 Edinborough Rd.; R. A. Adams, Mgr.; Tel: Vermont 8-1344
Los Angeles, Calif., 2331 W. Wash. Blvd.; Lee Owens, Mgr.; Tel: Republic 0203
New York, N. Y., 7 E. 48th St.; Thomas Aye, Mgr.; Tel: Eldorado 5-8021
San Francisco, Calif., 312 7th St.; William J. Purdy, Mgr.; Tel: Underhill 3-4321
Seattle, Wash., 2601 First Ave.; Lloyd Marsh, Mgr.; Tel: Main 8782
Silver Spring, Md., 8614 Georgia Ave.; Morris F. Taylor, Mgr.; Tel: Shepherd 4002
Products: Disc recording, transcription; tape recording, transcription equipment, amplifiers, equalizers, blank recording discs

Radex Corp.
Chicago 14, 2076 Elston Ave.; R. R. Cook, Mgr.; Tel: Armitage 6-6900
Products: Impedance matching bridge, audio oscillator, blowers

Radio Corporation of America, RCA Victor Div., Engineering Products Dept., Broadcast Equipment Sales
Camden 2, N. J., Front & Cooper Sts.; Edwin C. Tracy, Mgr., Sales Sec., Broad. Marketg. Div.; Tel: Woodlawn 3-8000, Ext. PC-2456
Atlanta 3, Ga., Forsyth Bldg.; Tel: Lamar 7703
Boston 18, Mass., John Hancock Bldg.; Tel: Hubbard 2-1700
Chicago 11, Ill., 866 N. Lake Shore Dr.; Tel: Delaware 7-0700
Cleveland 15, Ohio, Keith Bldg.; Tel: Cherry 1-3450
Dallas 1, Tex., 1907-II McKinney Ave.; Tel: Riverside 1371-2-3
Hollywood 28, Calif., 1580 N. Vine St.; Tel: Hollywood 9-2154
Kansas City 6, Mo., Dierks Bldg.; Tel: Harrison 6480-1-2
New York 20, N. Y., 36 W. 49th St.; Tel: Circle 6-4030
San Francisco 3, Calif., 1355 Market St.; Tel: Hemlock 1-8300
Products: Complete line broadcast audio equipment; transmitters; antennas and test measuring equipment

RCA Victor Co., Ltd.
Montreal, Que., 1001 Lenoir St.; H. S. Walker, Mgr., Brd. & TV Sta. Eqp. Div.; Tel: Wellington 7551
Calgary, Alta., 1210 11th Ave.; H. C. Thompson, Mgr.; Tel: 42766
Halifax, N. S., 99 Brunswick St.; C. C. Bowers, Mgr.; Tel: 36186
Toronto, Ont., 1450 Castlefield; K. G. Chisholm, Mgr.; Tel: Murray 7311
Vancouver, B. C., Grandview Hwy. at Rupert St.; R. A. Marsh, Mgr.; Tel: Dexter 6800
Winnipeg, 626 St. James St., N.; H. C. Ramsey, Mgr.; Tel: 720481
Products: Transmitters, transmitter accessories, transcription turntable equipment, microphone accessories, monitoring and test equipment, transmitting tubes, speech input equipment, acetate recording blanks, amplifier equipment, recording equipment, microphones, faradon condensers, facsimile equipment, fm transmitters, antenna phasing equipment, engineering services, loudspeakers, transmission line accessories, crystals and crystal holders, receivers

Radio Engineering Labs., Inc.
Long Island City 1, N. Y., 36-40 37th St.; Frank A. Gunther, V. P.; Tel: Stillwell 6-2100
Products: Studio transmitter and mobile transmitter links; fm same plus tuners and crystal control receiver for relay purposes

For equipment plans

J. A. (JULES) RENHARD
2250 First Ave. South
Seattle 4, Washington
Telephone: Maine 8350

W. G. (WOODY) EBERHART
666 N. Lake Shore Drive
Chicago 11, Illinois
Telephone: Delaware 7-0700

R. J. (DICK) NEWMAN
1355 Market Street
San Francisco 3, California
Telephone: Hemlock 1-8300

C. A. (CHET) WALLACH
P.O. Box 6616
3300 E. 43rd Ave.
Denver, Colorado
Telephone: Acoma 8-8963

W. B. (WALT) VARNUM
340 Dierks Building
1006 Grand Avenue
Kansas City 6, Missouri
Telephone: Harrison 6480

E. (JACK) FROST
1560 North Vine Street
Hollywood 28, California
Telephone: Hollywood 7-2154

J. F. (JOHN) PALMOQUIST
1907-11 McKinney Ave.
Dallas 1, Texas
Telephone: Riverside 1371

J. N. (JIM) BARCLAY
1907-11 McKinney Avenue
Dallas 1, Texas
Telephone: (Dallas) Riverside 1371
(Austin) Austin 2-5055

RCA

RADIO CORPORATION of AMERICA
ENGINEERING PRODUCTS DEPARTMENT
CAMDEN, N. J.

see your nearest RCA broadcast representative

F. A. (TIM) TIMBERLAKE
666 N. Lakeshore Drive
Chicago 11, Illinois
Telephone: Delaware 7-0700

J. H. (JIM) KEACHIE
718 Keith Building
Cleveland 15, Ohio
Telephone: Cherry 1-3450

J. R. (JOE) SIMS
36 West 49th Street
New York 20, New York
Telephone: Circle 6-4030

R. S. (BOB) EMCH
718 Keith Building
Cleveland 15, Ohio
Telephone: Cherry 1-3450

D. S. (DAVE) NEWBORG
718 Keith Building
Cleveland 15, Ohio
Telephone: Cherry 1-3450

J. L. (JESS) NICKELS
666 N. Lake Shore Drive
Chicago 11, Illinois
Telephone: Delaware 7-0700

J. E. (ED) HILL
John Hancock Building
200 Berkeley Street
Boston 16, Mass.
Telephone: Hubbard 2-1700

A. (AL) JOSEPHSEN
36 W. 49th Street
New York 20, New York
Telephone: Circle 6-4030

J. F. (FRANK) INGELS
340 Dierks Building
1006 Grand Avenue
Kansas City 6, Missouri
Telephone: Harrison 6480

E. S. (ED) CLAMMER
Front and Cooper Streets
Camden, N. J.
Telephone: Woodlawn 3-8000

D. (DAVE) BAIN
1625 "K" Street, N.W.
Washington, D. C.
Telephone: District 7-1260

W. D. (WILEY) WENGER
1907-11 McKinney Avenue
Dallas 1, Texas
Telephone: Riverside 1371

P. G. (PG) WALTERS
522 Forsyth Building
Atlanta 3, Georgia
Telephone: Lamar 7703

P. (PAUL) BERGQUIST
1625 "K" Street, N.W.
Washington, D. C.
Telephone: District 7-1260

J. W. (JOHN) HILLEGAS
522 Forsyth Building
Atlanta 3, Georgia
Telephone: Lamar 7703

A. M. (ADRON) MILLER
666 N. Lake Shore Drive
Chicago 11, Illinois
Telephone: Delaware 7-0700

J. M. (JOE) WALTERS
522 Forsyth Building
Atlanta 3, Georgia
Telephone: Lamar 7703

Radio-Music Corp.
 Port Chester, N. Y. (Byram, Conn.), 84 S. Water St.; Lionel B. Cornwell, Mgr.;
 Tel: Byram River 6-8620
 Products: Transcription reproducers, turntables, amplifiers; special filter
 networks and transformers

The Radion Corp.
 Chicago 14, Ill., 1130 W. Wisconsin Ave.; R. N. Leonard, Pres.; Tel: Mohawk
 4-4617
 Products: Antennae; lightning arrestor

Rangertone, Inc.
 Newark 4, N. J., 73 Winthrop St.; Richard H. Ranger, Mgr.; Tel: Humboldt
 5-2550
 Products: High fidelity magnetic tape recorders and editing equipment

Raytheon Mfg. Co.
 Waltham, Mass., 138 River St.; L. A. Rooney, Mgr., Comm. Eqp. Sls.; Tel:
 Waltham 5-5860
 Chicago, Ill., 5016 W. Madison St.; G. J. Zipf, Mgr.; Tel: Esterbrook 9-3277
 Cleveland, Ohio, 3076 W. 117th St.; H. L. Herndon, Mgr.; Tel: Winton 1-7005
 New Orleans, La., 4032 Thalia; W. J. Monroe, Mgr.; Tel: Canal 7611
 New York, N. Y., 19 Rector St.; D. B. Whittemore, Mgr.; Tel: Whitehall 3-4980

San Francisco, 49 California St.; E. J. Rome, Mgr.; Tel: Sutter 1-0475
 Seattle, Wash., 3224 Western Ave.; R. W. Mackay, Mgr.; Tel: Alder 4895
 Wilmington, Del., 114 West B. St.; J. L. Lovett, Mgr.; Tel: Terminal 4-8575
 Products: Microwave relay links

Recoton Corp.
 New York 11, 147 W. 22nd St.; Jack Karns, Mgr.; Tel: Oregon 5-7868-69
 Products: Playback phonograph needles, cutting styli, cartridges, recording
 blanks, magnetic recording tape

Reeves Soundcraft Corp.
 New York 22, N. Y., 10 E. 52 St.; Frank B. Rogers, V. P.; Tel: Plaza 9-2644
 Products: Magnetic recording tape; recording discs, styli

Rek-O-Kut Co.
 Long Island City, N. Y., 38-01 Queens Blvd.; George Silber, Sls. Mgr.; Tel:
 Stillwell 4-7062
 Products: Disc recording equipment; transcription turntables

Remler Co., Ltd.
 San Francisco 10, Calif., 2101 Bryant St.; H. N. Eierman, Indus. Sls. Mgr.;
 Tel: Valencia 4-3435
 Products: Ruggedized dynamic microphones for field service; induction field
 announcing equipment



SELF WINDING CLOCKS

Automatically Synchronized

by WESTERN UNION

for TV and RADIO stations

- **AUTOMATICALLY SYNCHRONIZED**—by WESTERN UNION with Naval Observatory Time Signal or Master Clock.
- **SELF CONTAINED POWER**—Power failures, voltage drops, or frequency changes cannot affect accuracy.
- **INDIVIDUAL CLOCKS OR A CLOCK SYSTEM**—can be synchronized. With SELF WINDING, you and your audience know every clock is RIGHT on time —ALL the time!
- **MANUAL SYNCHRONIZER**—Available, if desired.

SELF WINDING CLOCK CO., INC.
 203 Willoughby Ave., Brooklyn 5, N. Y.

Please send FREE details on SELF WINDING clocks for TV and RADIO.

Name

Company

Street

City..... Zone..... State.....

SELF WINDING CLOCK COMPANY, INC.

Manufacturers of Standard and Specially Designed Clocks and Clock Systems for more than 65 Years

203 Willoughby Ave., Brooklyn 5, N. Y.

THIS IS WHAT RUST MEANS BY A COMPLETE REMOTE CONTROL SYSTEM



Illustrated on this page are what *we* consider to be the basic elements of a remote control system for the RCA 250 K or L transmitter. For other transmitters, different groups of elements will apply. Note that Rust not only supplies standard transmitter, control and pre-amplifier units (right) but also units for each of the functions in the table below. These units are especially designed for *your* transmitter. Each Rust system includes a complete interconnection diagram tailored to *your* equipment and *your* requirements. When you buy Rust you have everything you need . . . nothing else to buy; no units to fabricate.

What will you get for your money?

Don't be fooled by talk of "low price" remote control systems. Check and compare before you buy any system. Find out how much a *complete* installation will cost . . . what additional parts you will have to buy or make. Does it fulfill all your requirements?

Rust considers the system illustrated on this page to be the *minimum* to do a satisfactory job. It will provide the following control and metering functions:

CONTROL

Tower Lights
Filament "on-off" Reset filament, line and modulator overload breakers.
Plate "on-off" Reset plate and P.A. overload breakers.
P.A. Tuning
Power Output

METERING

Lighting Current
Filament Line Volts
Plate Voltage
Plate Current
Antenna Current



. . . and provides for addition of other control and metering functions when and if desired.

Of special interest is the especially designed RCA Actuator (A) which "hooks up" directly with the RCA 250 K or L front panel controls. Like other Rust Systems, it provides for resetting of manual overload breakers (so that you need not send a man to the transmitter location in the event of overload).

Let Rust quote you on a *complete* remote control system designed for *your* transmitter. You'll find an unbeatable value. Write, wire or phone.



the rust industrial company, inc.

608 WILLOW STREET

MANCHESTER, N. H.

- Rissi Electronic Supply Co.**
Detroit 1, Mich., 1112 W. Warren Ave.; V. A. Wilton, Mgr.; Tel: Temple 2-5611
Grand Rapids 3, Mich., 505 Jefferson Ave. S.E.; Norman MacPhail, Mgr.; Tel:
Grand Rapids 9-4611
Products: Tape, disc recording equipment, power tubes, allied equipment
- Rust Industrial Co., Inc.**
Manchester, New Hampshire, 608 Willow St.; W. F. Rust, Jr., Pres.; Tel:
Manchester 3-3596
Products: Packaged remote control equipment; remote control components;
rotary and linear actuator assemblies, RF monitor preamplifiers, etc.;
failure alarms
- Paul Schafer Custom Engineering**
Los Angeles 39, Calif., 2279 Allesandro St.; Paul C. Schafer, Owner-Manager;
Tel: Normandy 2-2161
Products: Remote control system for remote operation of unattended trans-
mitters
- Schulmerich Electronics, Inc.**
Sellersville, Pa., Carillon Hill; H. L. Conover, Mgr.; Tel: Sellersville 2323-24
Products: Carillon bells, Schumetric radio bells, carillon bell record-
ings
- Schumaker Construction Co.**
Michigan City, Ind., E. Mich. St. at Warnke Rd.; K. F. Schumaker, Mgr.; Tel:
3-3218
Products: Erectors towers, antennas and coaxial cable
- Hermion Hosmer Scott, Inc.**
Cambridge 39, Mass., 385 Putnam Ave.; V. H. Pomper, Asst. Gen. Mgr.; Tel:
Kirkland 7-0646
Chicago 10, Ill., 13 W. Hubbard St.; Robert Karet, Mgr.; Tel: Whitehall 4-6345
Los Angeles 15, Calif., 1244 S. Grand Ave.; Henry Feldman, Mgr.; Tel: Prospect
8803
Philadelphia 19, Pa., 7135 Germantown Ave.; Harry Estersohn, Mgr.; Tel:
Wissahickon 7-1816
Products: Dynaural noise suppressors, equalizer-preamplifiers, audio am-
plifiers, sound level meters, sound analyzers
- Scully Machine Co.**
Bridgeport 8, Conn., 62 Walter St. L. J. Scully, Owner; Tel: Bridgeport 4-5300
Products: Disc recording machine
- Self Winding Clock Co., Inc.**
Brooklyn 5, N. Y., 207 Willoughby Ave.; Harvey S. Wellman, Asst. Sls. Mgr.;
Tel: Main 2-6300
Products: Sweep seconds, dry cell battery operated self winding clocks con-
taining connections for receiving automatic synchronizing pulses from
Western Union lines or manual synchronized pulses from control kit
- Servo Corp. of America**
New Hyde Park, N. Y., 20-20 Jericho Turnpike; J. H. Lasley, Sls. Supv.; Tel:
Fieldstone 7-2810
Boston, Mass., 270 Commonwealth; R. MacVeety, Mgr.; Tel: Kenmore 6-1800
New York, N. Y., 103 Lafayette St., G. D. Sullivan, Mgr.; Tel: Digby 9-1240
Syracuse, N. Y., Statewater Bldg.; W. T. Doolittle, Jr., Mgr.; Tel: Syracuse
2-6253
Upper Darby, Pa., 222 Longlane; M. E. Gerry, Mgr.; Tel: Flanders 2-2044
Washington, D. C., 2017 S St., N.W.; M. Brimberg, Mgr.; Tel: Decatur 2-8000
Products: Direction finders, spectrum and signal generators, sub-audio pre-
amplifiers, test and analysis equipment, infrared radiation instrumentation
and material and equipment to customer specification
- Shallcross Mfg. Co.**
Collingdale, Pa., Jackson & Pusey Aves.; John S. Shallcross, Pres.; Tel: Far-
ragut 9-5100
Products: Fixed and step type audio attenuators, key-type attenuation boxes,
precision wirewound resistors, wirewound power resistors, precision rotary
selector switches, portable db meter for gain or loss measurements on 600
ohm lines
- Shure Brothers, Inc.**
Chicago 49, Ill., 225 W. Huron St.; Ray Ward, Mgr.; Tel: Delaware 7-4550
Products: Microphones; wireless microphone system
- Sierra Electronic Corp.**
San Carlos, Calif., 1050 Brittan Ave.; W. Feldscher, Mgr.; Tel: Lytell 3-2104
Products: Frequency voltmeters, wave analyzer, bridging transformer, wide
band R. F. transformers (high power), Low frequency directional couplers,
fm: Directional couplers, reflection coefficient meter
- Skyllne Tower Co.**
Chicago 29, Ill., 2436 W. 59th St.; Walter E. Smith, Mgr.; Tel: Walbrook 5-1288
Products: Self-supporting and uniform cross section guyed towers
- Small Motors, Inc.**
Chicago 14, Ill., 2076 Elston Ave.; R. R. Cook, Pres.; Tel: Armitage 6-6900
Products: Blowers
- Rawdon Smith Associates**
Washington 7, D. C., 2217 M St.; Dr. F. Rawdon Smith, Partner; Tel: District
7-1970
Products: Magnetic tape duplication equipment
- Sound Apparatus Co.**
Stirling, N. J.; Arthur W. Nieman, Mgr.; Tel: Millington 7-0600
Products: Graphic recorders
- Sonic Recording Products, Inc.**
Freeport, N. Y., 58 Mill Rd.; A. Snyder, Sls. Mgr.; Tel: Freeport 8-3610
Products: Instantaneous professional recording blanks
- Sonocraft Corp.**
New York 36, N. Y., 115-17 W. 45th St.; Harold H. Oppenheimer, Mgr.; Tel:
Judson 2-1750
Products: Sound and recording equipment; microphones, speakers, tuners,
amplifiers, recording tapes, blank disc, etc.
- South River Metal Prods Co., Inc.**
South River, N. J., 377-379 Turnpike; Martin L. Roth, Sls. Mgr.; Tel: South
River 6-2330
Products: Contract manufacturing of stampings to manufacturers specifica-
tions
- The SoundScriber Corp.**
New Haven 4, Conn., 146 Munson St.; J. J. McKeon, Sls. Prom.-Adv. Mgr.; Tel:
State 7-2125
Products: Plastic disc dictating and recording equipment; magnetic tape
recorders
- Speak-O-Phone Recording & Equipment Co.**
New York 23, N. Y., 23 W. 60th St.; R. L. Austin, Owner; Tel: Columbus 5-1350
Products: Disc recorders; tape-disc recorders
- Stainless, Inc.**
North Wales, Pa., Third & Montgomery Sts., John F. Guzewicz, Mgr.; Tel:
North Wales 874
New York 7, 50 Church St.; Henry J. Guzewicz, Mgr.; Tel: Digby 9-4379
Phoenix, Ariz., 5711 N. 14th Pl.; Frank Cooke, Mgr.; Tel: Phoenix 3-7235
Products: Self-supporting, Rhomic array, guyed and micro wave towers.
Antenna masts. fm: Self-supporting and guyed towers
- The Stancil-Hoffman Corp.**
Hollywood 38, Calif., 921 N. Highland Ave.; William V. Stancil, Pres.; Tel:
Hollywood 4-7461
Chattanooga, Tenn., Signal Mountain; W. B. Taylor, Mgr.; Tel: 88-2487
Evanston, Ill., 220 Kedzie St.; Warren Cozzens, Mgr.; Tel: Davis 8-4800
Honolulu, T. H., 1545 S. Beretania; T. Y. Takase, Mgr.; Tel: 9-3769
New York 17, N. Y., 60 E. 42nd St.; Henry J. Geist, Mgr.; Tel: Murray Hill
7-1550
Toronto 5, Can., 447 Jarvis St.; S. W. Caldwell, Mgr.; Tel: Em. 6-8727
Products: Magnetic tape; battery operated recorder and synchronous and
interlock motors
- Standard Electronics Corp. (A Subsidiary of Claude Neon, Inc.)**
Newark 5, N. J., 285 Emmet St.; W. H. Zillger, V. P.; Tel: Bigelow 3-5540,
3-4444-5-6
Birmingham, Ala., 2463 Fairway Dr.; Jimmy Evans, Mgr.; Tel: Birmingham
2-6223
Chicago, Ill., 6728 S. Halsted, Robert R. Howard, Mgr., Tel: Wentworth 5-5182
Washington, D. C., 6624 32nd Pl, N.W.; Jim Campbell, Mgr.; Tel: Woodley 6-1954
Products: Transmitters; associated equipment
- Standard Piezo Co.**
Carlisle, Pa., P. O. Box 278; Albert B. Myers, Sls. Mgr.; Tel: Carlisle 1495
Products: Quartz crystals
- Sylvania Electric Products, Inc.**
New York 19, N. Y., 1740 Broadway; R. A. Penfield, Adv. Mgr., radio & tv
tube div.; Tel: Judson 6-2424
Warren, Pa., 12 Second Ave.; P. M. Pritchard, Mgr.; Tel: Warren 3220
Products: Receivers, tubes, special electronic devices, electronic components,
tungsten and chemicals for electronics
- Technicraft Labs., Inc.**
Thomaston, Conn., Thomaston-Waterbury Rd.; George R. Houk, Mgr.; Tel:
Atlas 3-4315
Products: Passive relay for use with 7000 mc/s equipment
- Techonology Instrument Corp.**
Acton, Mass., 531 Main St.; H. L. Gray, Asst. Mgr., Sls. Engr.; Tel: Actor 3-7711
Products: Phase, Z-angle meters, AF and RF: wide band decade ampli-
fiers; RF oscillators; phase standards, complex plane analyzer, precision
potentiometer noise testers; wire-wound linear and non-linear precision
potentiometers.
- Tektronix, Inc.**
Portland 7, Ore., P. O. Box 831; W. K. Dallas, Sls. Mgr.; Tel: Cypress 2-2611
Baltimore 14, Md., 8118 Harford Rd.; Fred J. Hart, Mgr.; Tel: Boulevard 2600
Bronxville 8, N. Y., 49 Pondfield Rd.; George Edens, Mgr.; Tel: Bronxville
2-3266
Newtonville 60, Mass., 18 Austin St.; Jack E. Day, Mgr.; Tel: Lasell 7-2212
Philadelphia 38, Pa., 7709 Ogontz Ave.; F. K. Frost, Mgr.; Tel: Waverly 4-5678
Products: Cathode-ray oscilloscopes; wide-band and low-level amplifiers;
square-wave, time-mark, constant-level signal and special pulse and wave-
form generators
- Teletronics Laboratory, Inc.**
Westbury, L. I., N. Y., 54 Kinkel St.; R. S. Marston, Pres.; Tel: Westbury 7-1027
Products: Audio oscillators; special electronic equipment of all types
- Terminal Radio Corp.**
New York 7, 85 Cortlandt St.; William Filler, Mgr.; Tel: Worth 4-3311
Products: Audio equipment for broadcast stations. Portable tape recorders,
broadcast station recording and playback equipment. Test equipment.
Microphones, radio parts and equipment
- The Thomas & Betts Co.**
Elizabeth 1, N. J., 36 Butler St.; E. C. Hewitt, Mgr.; Tel: Elizabeth 4-4321
Atlanta, Ga., Candler Bldg.; Fred M. Shepard, Mgr.
Bellair, Texas, P. O. Box 53; John Humber, Mgr.
Boston, Mass., 10 High St.; Stephen A. Imhof, Mgr.
Chicago, Ill., 411 S. Sangamon St.; E. C. Moses Jr., Mgr.
Cleveland, Ohio, 1900 Euclid Ave.; Wyman Elliot, Mgr.
Ft. Lauderdale, Fla., P. O. Box 1516; Philip J. Webb, Mgr.
Los Angeles, 459 E. Fourth St.; Karl G. Kempf, Mgr.
New York, N. Y., 15 Park Pl.; A. C. Biddulph, Mgr.; Tel: Barclay 7-8644
Philadelphia, Pa., 1015 Chestnut St.; Donald Wildauer, Mgr.
Products: Pressure wire connectors; grounding seath connectors (solderless)
- Tower Construction Co.**
Sioux City, Ia., 1923 Geneva St.; M. M. Lasensky, Owner; Tel: 5-7653
Washington, D. C., 2002 P St., N.W.; Frank J. Little, Mgr.; Tel: Adams 4-6447
Products: Towers, microwave passive reflectors and tower erection
- Tower Engineering & Construction Co., Inc.**
Houston 3, Tex., 2930 Pease Ave.; Ben S. Foss, Jr., Mgr.; Tel: Central 7378
Products: Tower erectors
- Tower Sales & Erecting Co.**
Portland 13, Ore., 6100 N. E. Columbia Blvd.; C. H. Fisher, Pres. & Mgr.;
Tel: Trinity 7303
Products: Towers, vertical radiators, erecting, lighting, painting and ground
systems
- Trans-Lux Corp.**
New York 20, N. Y., 1270 Sixth Ave.; A. Giles, V. P.; Tel: Circle 7-4970
Products: Traveling message signs
- Transmitter Equipment Mfg. Co., Inc.**
New York 14, 345 Hudson St.; Morton B. Kahn, Mgr.; Tel: Watkins 4-1550
Products: Transmitting, receiving equipment for ground, mobile, airborne,
specialized services; radar test equipment and electronic training devices
- Truscon Steel Div., Republic Steel Corp.**
Youngstown 1, Ohio, Albert St.; George F. Bateson, Mgr. Sls., Steel Joint &
Tower Prds.; Tel: Riverside 6-7211
Boston 27, Mass. (South), 307 Dorchester Ave.; C. H. Watt, Mgr.; Tel: South
Boston 8-2420-21-22
Buffalo 3, N. Y., Rand Bldg.; R. A. Bohling, Mgr.; Tel: Madison 5767-9
Chicago 6, Ill., 201 N. Wells St.; W. D. George, Mgr.; Tel: Franklin 2-4600
Cleveland 15, Ohio, Hanna Bldg. Annex; L. F. Stormont, Mgr.; Tel: Superior
1-9010
Dallas 1, Tex., 2900 Routh St.; H. T. Swanson, Mgr.; Tel: Logan 8527
Kansas City 6, Mo., 1012 Baltimore Ave.; A. A. Raymond, Mgr.; Tel: Harrison
3673
Los Angeles 22, Calif., P. O. Box 6788, E. Los Angeles Branch; N. J. Cavaller,
Mgr.; Tel: Underhill 0-1375
Minneapolis 2, Minn., Baker Bldg.; John W. Davies, Mgr.; Tel: Main 5537
New York, N. Y., 48-18 Northern Blvd.; C. D. Loveland, Mgr.; Tel: Astoria
4-2410
Omaha 2, Neb., Insurance Bldg., J. R. Rippey, Mgr.; Tel: Harney 7353
Portland 12, Ore., 2139 N. Kerby Ave.; C. W. Anderson, Mgr.; Tel: Trinity 1153
St. Louis 3, Mo., Shell Bldg.; W. H. Hogeland, Mgr.; Tel: Central 0146
San Francisco 5, Calif., 16 Beale St.; Hal Waller, Mgr.; Tel: Yukon 2-4680
Washington 5, D. C., Investment Bldg.; F. W. Youry, Mgr.; Tel: District 7-0883
Products: Self-supporting and guyed towers for am, fm and microwave.
Copper mesh ground screen

WBRW KMUS WLSI **WMAZ-TV** WTOB CMCU WFMO **WHBQ-TV** WJBS WJCD WREB **WWOR-TV** KWWL
KCEB-TV WGIG WLYC WRAD **WKLO-TV** WLON WHBS WOZK **WREX-TV** WCOJ WGET WQAM
WCRE WCRB WIDE WMBL WIRY KIKI WWOC WLEA WLMJ WSMT WDOV WPEM WERC WOBL **KCJB-TV**
WKBV WAMI WKCT WBIS **KVEC-TV** WTOB WPRO WCAM **WKNB-TV** KJCK WEAT KCJB WGAF WSOK
WCHW WHAW **WOC-TV** WGRY WKBR WFUL **WGEM-TV** WHOM WGYV WPLI **WJHP-TV** WINZ WC
WPEL WHBO WGVM WNOE WRAC WGNR WBUD KWOC WSLM WGBS WAZL WMIK WEOK WGTA **CMQ** WNI
WARD-TV WMMB WGLS KAGH **WHIZ-TV** WHIL WRAY WLTR **WLOK-TV** WZOB WARA WBRY WPA
KRG1 WOBS WIRC WYVE CMBC WRIC WMGR WNNJ WJMC WDSC WRHI WKRT WBLT WEIM WAWZ KMA
WKNX WKOY WOLS **WJMC-TV** WJIV WAWZ **CKCR-TV** WICE WKID WWWR **WVEC-TV** WTVB WT
WOHO WPOR WARN KCOH WIRJ WTPR WHYN WABM WLEA WLMJ WIKE WKRT WHSY KLMX WCDL WILK
WKIK WMMB WGLS KAGH WRHC **WCOC-TV** WRAY WKBV WAMI **KOLN-TV** WKXY WDSM WTOB WPR
WTAC-TV WIRJ WTPR
KOLN KDDD WCVA WJMA
WGEA **WOOD-TV** WSFL
WPME WSPD WWHG WW
WPAW WNEB WKLY **KCC**
WRIS WPPA WNAV WDOK
WIVK KBON KXLW WPAW
WPAG **WKNX-TV** WREB
WOZK WGSW WBRM WCC
WSMT WDOV WPEM WERC
WJMJ KPAN KJCK WEAT KCJB WGAF WSOK WTCW WKIK WMMB WGLS KAGH WRHC KUKI WHIL WRA
VNOK-TV WGYV WPLI WCLD **WEEU-TV** WOHP WPOR WARN **WERC-TV** WTPR WHYN WABM **WHP-TV**
WGBS **KCJB-TV** WEOK WGTA KBOP **WPAG-TV** KOLN KDDD WCVA **WBRC-TV** WATH KSOO WDI
WLTR WKLO WJAY WZOB WARA WBRY WPAC WMOU WGEA KXIT WFEC WSFL WELC WWBZ WKMH WTU
WDOS WRHI WKRT **WJMC-TV** WAWZ KMAK WTVB **WBAY-TV** WWHG WWWF KCIM **KCSJ-TV** W
WICE WKID WWWR WFMD WOND KCIM KRYN WDOR WPAW WNEB WKLY KNEX WKVA WOKO KCRE WC
VHUM-TV WIKE WKRT WHSY **WTAP-TV** WILK KNBR WRIS **KTSM-TV** WDOK WPBB WTVB **KHOL-TV**
WAMI **WCOC-TV** WKXY WDSM WTOB **WJIM-TV** WIVK KBON KXLW **WATR-TV** KLWN WOAP WE
KMUS WLSI WNNT WEBK WTOB CMCU WFMO KLAS WPAG WJBS WJCD WREB KBTA WIOD KWWL WABM
KTRY WGIG WLYC **WMTV-TV** WPAZ WLON WHBS **WTAP-TV** WBRM WCOJ WGET WQAM WKS
WCRB WIDE WMBL WIRY KIKI WWOC WKMH WRAP WSMT WDOV WPEM WERC **WKNA-TV** WINZ WC
WLBR-TV KBON KXLW WPAW **WMRC-TV** WOAP WCAM WJMJ **WCOS-TV** WEAT KCJB WGAF **WMBR-TV**
W WHAW **KCCC-TV** WGRY WKBR WFUL **KVEC-TV** WHOM WGYV WPLI **KRDO-TV** WINZ WOHP WS
WHBO WGVM WNOE WRAC WGNR WBUD KWBR WSLM WGBS WAZL WMIK WEOK WGTA KBOP WND
KDDD WCVA WJMA **WCOV-TV** KSOO WDBF WCAR **WKNA-TV** WJAY WZOB WARA **WBAY-TV** WJ
WOBS WIRC WYVE CMBC WRIC WMGR WNNJ WJMC WDSC WRHI WKRT WBLT WEIM WAWZ KMAK W
CKCR-TV WOLS WOSC WABG **WVEC-TV** WATH WLOK WICE **WKNY-TV** WFMD WOND WELC **WSVA-TV**
WEEC WSEL WELC **WKNY-TV** KBBA WIKE WKRT WHSY **WVSI-TV** WILK KNRR



STAINLESS • INC.
NORTH WALES, PA.

Partial List of Proud Owners of Our Towers

Phone, write or wire today, for full information



Westinghouse supplies reliable, economical transmission for WNEW

Radio Station WNEW, New York, broadcasts with a Westinghouse 50 KW AM Transmitter. This transmitter gives proved performance with both initial and long-range savings . . . assured by the finest line-up of 50 KW transmitter features available today.

Maximum reliability . . . minimum maintenance

The total tube complement numbers only twenty. To cut tube inventory and maintenance, only seven different types of tubes are used. To save floor space and installation costs, the Westinghouse 50 KW has been designed in compact cubicles . . . smaller, lighter than previous 50 KW designs. And since all components are of the dry air-cooled type, there is no need for a fireproof vault.

Tube cost per hour is the lowest on record

Thoriated tungsten filaments in Westinghouse driver and high power tubes save many kilowatts of filament power. And, as shown by a recent field check, power amplifier tubes in Westinghouse 50 KW Transmitters have racked up more than half a million hours of service without a single failure. Twenty of these tubes have been going continuously for from 15,000 to 48,500 hours, with no end in sight.

You profit from the years of experience and research that go into the development of Westinghouse broadcast equipment. For full information, call your Westinghouse representative or write: Westinghouse Electric Corporation, Electronics Division, Communications Section, 2519 Wilkens Ave., Baltimore 3, Md.

Station WNEW operates non-directional daytime and directional at night with two towers, both top-loaded. Set-up includes elevated ground screen.

Mr. Max Weiner, Chief Engineer of Station WNEW, at the Westinghouse 50 KW Transmitter. In background is the Westinghouse 10 KW Standby Transmitter. Audio, monitoring and measuring equipment at far right.



YOU CAN BE SURE...IF IT'S

Westinghouse

J-02273

a complete



THE WHOLE JOB *Wrapped Up*

From coast to coast you will find installations where TOWER'S "Package" service is paying off. We manufacture the tower and erect it—handle your job from the planning stage on through complete maintenance service.

A NEW HEAVY DUTY 600 FT. TV TOWER

Guyed type . . . heavy legs and braces designed for 100 MPH wind and one-half inch ice load . . . hot dipped galvanized or shop coat of primer undercoat . . . supports all types of television antennas and coaxial feed line or wave guide . . . complete erection by experienced crews.

MICROWAVE TOWERS AND REFLECTORS



TOWER is a pioneer in Microwave towers and Microwave reflectors. We are manufacturers of famous Microwave passive reflectors used by the U. S. Government, Bell Telephone System and leading manufacturers. TOWER reflectors are used widely by TV stations to direct microwave signal from studio to transmitter. We invite you to check with our satisfied customers.

Tops in Towers

TOWER

Construction Co.
SIoux CITY, IOWA

- The Turner Co.**
Cedar Rapids, Iowa, 909 17th St., N. E.; H. M. Murdock, Sls. Mgr.; Tel: 83144.
Products: Microphones.
- United States Motors Corp.**
Oshkosh, Wis., 430 Nebraska; Louis Shriber II, Mgr.; Tel: Blackhawk 9100.
Products: Standby power plants.
- U. S. Recording Co.**
Washington 5, D. C., 1121 Vermont Ave., N. W.; Eugene Rosen, Sls. Mgr.; Tel: Lincoln 3-2705
Products: Panacoustic line of electronic products, audio control consoles, salesmen's and educational AC-DC playbacks, complete line recording studio broadcast, intercommunication and sound equipment. fm Amplifiers and installation.
- United Tower Co.**
Petersburg, Va., Union Trust Bldg.; John J. Hoke, Mgr.; Tel: 3347
Products: Guyed-typed and self-supporting towers
- Universal General Corp.**
New York 13, 324 Canal St.; Morris Greenberg, Mgr.; Tel: Walker 5-9642
Products: Radio, amplifier kits
- University Loudspeakers, Inc.**
White Plains, N. Y., 80 S. Kensico Ave.; Lawrence J. Epstein, Sls. Mgr.; Tel: White Plains 6-7700
Products: am-fm—Loudspeakers, high fidelity, monitor
- Joseph Vasconcellos, Inc.**
Long Island City, N. Y., 27-22 Jackson Ave.; Joseph Vasconcellos, Pres.; Tel: Stillwell 4-8356
Burbank, Calif., 3816 W. Magnolia Blvd.; Michael Fusco, Mgr.; Tel: Rockwell 9-3026
Products: Studio equipment. Microphone boom dollies, turntables
- Vulcan Tower Co.**
Birmingham 1, Ala., P. O. Box 2467; W. J. Brennan, Partner; Tel: 54-4441, 57-3390
Washington, D. C., 3738 Kanawha St., N. W.; W. E. Benns, Jr., Partner; Tel: Emerson 2-8071
Products: Towers
- Wallach & Associates**
Cleveland 18, Ohio, 1532 Hillcrest Rd.; Arthur Wallach, Sls. Mgr.; Tel: Yellowstone 2-2353
Products: Allmetal sectional and double door discabinets for filing, protecting recordings and transcriptions. Allmetal sectional and double door tape recording reels cabinets
- The Ward Products Corp. Div. of The Gabriel Co.**
Cleveland 3, 1523 E. 45th St.; M. R. Friedberg, Mgr.; Tel: Express 1-3300
Jersey City, N. J., One Exchange Pl.; Adolph Schwartz, Mgr.; Tel: Kingswood 4855
Kansas City, Mo., 406 W. 34th St.; R. W. Farris, Mgr.; Tel: Logan 7495
Pasadena, Calif., 40 S. Los Robles; G. S. Marshall, Mgr.; Tel: Sycamore 5-2022
Philadelphia, Pa., 121 N. Broad St.; Ken Randall, Mgr.; Tel: Locust 4-2151
Products: am—Auto, home antennas, two-way communication antennas for remote units. fm—Mobile communication antennas, point-to-point antennas, remote unit antennas
- J. C. Warren Corp.**
Freeport, N. Y., 21 Hanse Ave.; R. C. Jackson, Exe. Asst. to Pres.; Tel: Freeport 8-4441
Products: Magnetic tape recorders and allied equipment
- West Coast Electronics Co.**
Los Angeles 16, 5873 W. Jefferson Blvd.; Samuel D. Dorris, Sls. Eng.; Tel: Texas 0-7211
Products: Amplifiers, uhf, vhf, fixed and mobile, dipole; fm. ground plane; communications systems, radio-teletype, vehicular fm-am; recorders, magnetic tape
- Westinghouse Electric Corp.**
Baltimore 3, Md., 2519 Wilkens Ave.; C. W. Miller, Mgr.; Tel: Edmondson 6-2300
Atlanta 2, 1299 Northside Dr., N. W.; A. W. Rose, Mgr.; Tel: Atwood 1642
Boston 10, 10 High St.; E. S. Mielke; Tel: Liberty 2-0600
Chicago 54, Mdse Mart Plaza; W. E. Berkey, Mgr.; Tel: Whitehall 4-3860
Cleveland 13, 1370 Ontario St.; H. N. Runkle; Tel: Cherry 1-7600
New York 5, 40 Wall St.; A. T. Lattauzeo; Tel: Whitehall 3-4321
Philadelphia 4, 3001 Walnut St.; P. F. Buckler; Tel: Evergreen 2-1200
St. Louis 1, 411 N. Seventh St.; A. F. Buck, Mgr.; Tel: Central 1120
San Francisco 8, 410 Bush St.; S. H. Harrison, Mgr.; Tel: Exbrook 2-5353
Products: Amplitude and frequency modulated transmitters (5, 10 and 50 kw am; 1, 3, 10, 50 kw fm) standard transmitter consoles, antenna phasing and tuning equipment transmitting tubes, instruments, meters, relays studio and tower lighting equipment transformers, capacitors, circuit breakers, regulators, precipitrons and switchgear
- Weston Electrical Instrument Corp.**
Newark 5, N. J., 614 Frelinghuysen Ave.; E. T. Higgons, Mgr.; Tel: Bigelow 3-4700
Chicago 6, 205 W. Wacker Dr.; C. G. Miller, Mgr.; Tel: Franklin 2-4656
New York 7, 50 Church St.; W. J. Healey, Mgr.; Tel: Worth 4-3510
Washington 11, D. C., 6230 Third St., N. W.; L. F. Parachini, Mgr.; Tel: Tuckerman 2414
Products: am, fm—Insulation, circuit testers; vacuum tube voltmeters; tube checkers; electronic test equipment; VU and DB meters; panel instruments
- Wilcox-Gay Corp.**
Charlotte, Mich.; L. M. Sandwick, V. P. & Sls. Mgr.; Tel: Charlotte 485
Brooklyn 1, N. Y., 79 Washington St.; Maurice Raphael, V. P.; Tel: Ulster 2-6000
Chicago 10, Ill., 743 N. LaSalle St.; R. E. Jenkins, Mgr.; Tel: Whitehall 4-0077
Los Angeles, Calif., 2772 W. Olympic Blvd.; B. R. Ross, Mgr.; Tel: Dunkirk 1783
Products: Magnetic tape recorders; tape and disc recorders; magnetic tape, disc blanks; cutting and playback needles; receivers; spectrum analyzers; inter-communication equipment. fm: Converters
- Wincharger Corp.**
Sioux City 2, East 7th at Division; V. V. Holmes, Mgr. Antenna Tower Dept.; Tel: 2-1844
Products: Insulated vertical guyed towers. fm—Non-insulated guyed support towers for antennas
- Wind Turbine Co.**
West Chester, Pa., East Market St. & Pa. R. R.; R. W. Weeks, Pres., Tel: West Chester 3110
Products: Supply, installation guyed towers; micro-wave relay towers; ground systems; transmission lines
- Wright Zimmerman, Inc.**
New Brighton, Minn., 330 Fifth Ave.; Joseph D. Zimmerman, Pres.; Tel: Nestor 8877
Products: Loudspeakers, under pillow speaker and relays
- Zenith Radio Corp.**
Chicago 39, 6001 W. Dickens Ave.; H. J. Hector, Mgr.; Tel: Berkshire 7-7500
New York 1, 527 W. 34th St.; W. W. Boyne, Mgr.; Tel: Longacre 4-6800
Products: Table radios, portables, clock radios, table and console radio-phonographs
- Zephyr Products Co.**
New York 35, 129 E. 124th St.; Irving London, Mgr.; Tel: SA 2-1800
Products: Recording discs, wire recording spools, needles, accessories

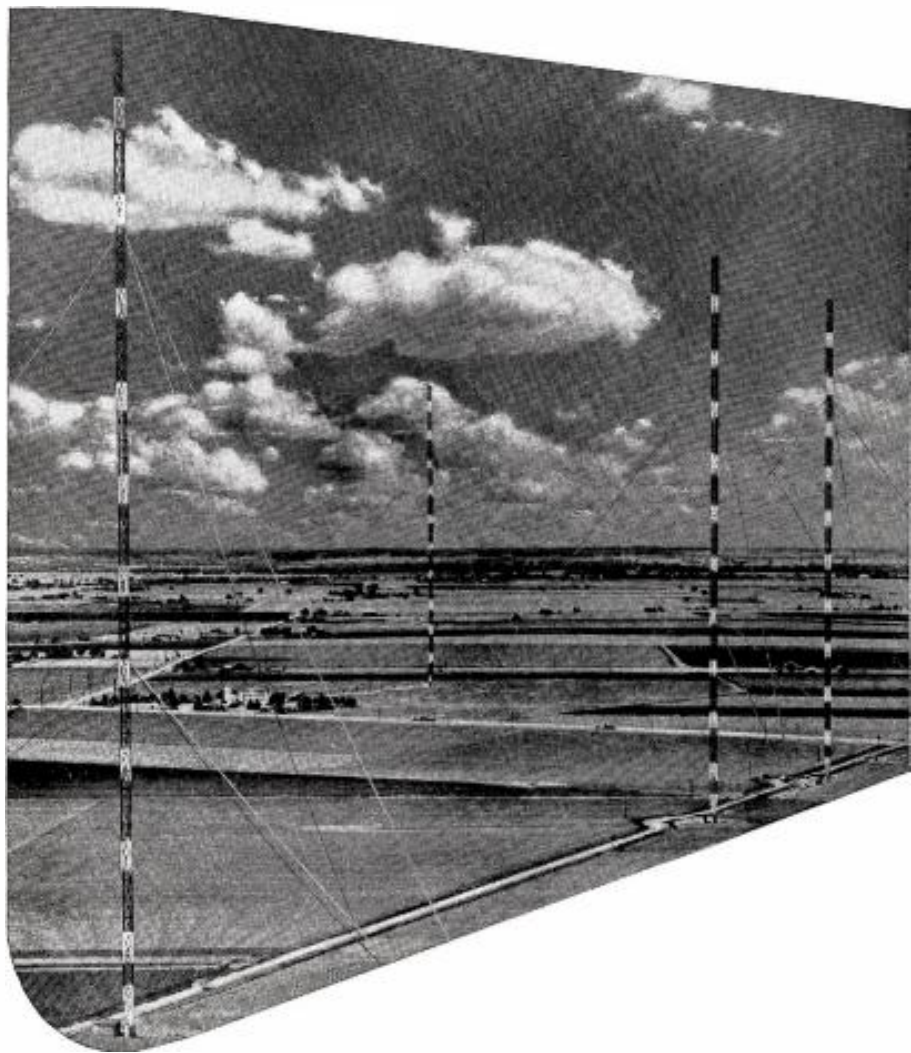

Symbol of Communications the World Over...

● Truscon's radio tower experience is world-wide. Truscon engineers have designed and built many hundreds of towers which now stand strong and tall—serving the communications needs of peoples everywhere. Truscon towers today are performing dependably in all types of topography... exposed to all extremes of wind and weather.

Truscon manufacturing facilities are modern and efficient—geared to production of guyed and self-supporting towers... tall or small... tapered or uniform in cross-section... for AM, FM, TV, and Microwave transmission.

Your own tower program can benefit from this world-wide experience. Truscon engineers are equipped to help you achieve maximum tower performance... whatever the location... whatever the weather. Your phone call or letter to any Truscon district office, or to "tower headquarters" in Youngstown, will help get your tower program started as soon as possible.



TRUSCON® a name you can build on

TRUSCON STEEL DIVISION
REPUBLIC STEEL CORPORATION
 1074 ALBERT STREET • YOUNGSTOWN 1, OHIO

CALL *Federal* FOR TUBES

For dependable transmitting and industrial power—it's *Federal*—outstanding for solid-rock ruggedness, long operating life and efficient performance—proven by years of service in hundreds of applications.

Federal quality and Federal workmanship are based on design, engineering and manufacturing experience dating from the birth of the industry.

Whatever your power requirements... for broadcasting or industry... Federal has a tube type of superior quality... to serve your needs dependably and economically.

Remember to "Call Federal for TUBES!"... you'll get *more* per tube dollar... and you'll get prompt delivery of your order.



F-134

Used in high power broadcasting and industrial service up to 22 Mc.



**F-6366
F-6367**

Used in 3 and 6 KW industrial heating applications.



F-5918

Used in light power communications and industrial service. 100 kilowatts of plate modulated power available up to 22 Mc.

Condensed Technical Data Covering the Complete Line of FEDERAL TRANSMITTING AND INDUSTRIAL TYPE VACUUM TUBES

Type	Description	Coating	Max Plate Dissipation	Max. A	Max. Plate Input	Max DC Plate Volt	Max. Freq. Per Max. Ratings	filament Voltage
F-3X2500A3	HF Triode	A	2.5 KW	20	8 KW	4,000	110 MC	7.5
F-3X2500F3	HF Triode	A	2.5	20	8	4,000	110	7.5
F-7C23	Pulse Triode	A	1.2	25		17,000		11.0
F-7C25	HF Triode	A	2.5	25	5.6	4,500	50	11
F-7C26	HF Triode	A	1	17	3	3,000	150	9.0
F-8C25	AF Triode	A	5	6	10	5,000		7
F-9C23	RF Triode	W	25	32	30	15,000	20	22
F-9C28	AF Triode	W	40	4.75	100	15,000		7.5
F-9C29	AF Triode	A	20	4.75	30	15,000		7.5
F-9C30	RF Triode	W	40	42	120	15,000	20	7.5
F-9C31	RF Triode	A	20	42	100	15,000	20	7.5
F-110X	RF Triode	W	25	40	30	20,000	3	28
F-124-A	RF Triode	W	40	42	135	20,000	20	13.6
F-124-R	RF Triode	A	20	42	100	20,000	20	13.6
F-125-A	AF Triode	W	40	4.75	100	15,000	20	13.6
F-127-A	RF Triode	A	0.2	38	0.95	3,000	30	10
F-128-A	RF Triode	A	0.6	36	3	3,500	30	11
F-129-B	RF Triode	W	7.5	26	18	12,000	30	18
F-129-R	RF Triode	A	5	26	18	12,000	30	18
F-132-A	AF Triode	A	0.6	10	1.8	3,500		11
F-134	RF Triode	W	150	21	450	20,000	22	25
F-212E	RF Triode	A	0.275	16	0.7	2,000	4.5	14
F-220CA/320BA	RF Triode	A	5	40	22.5	15,000	4	21.5
F-220C/320B	RF Triode	W	10	40	22.5	15,000	4	21.5
F-347-A	RF Triode	W	25	40	50	20,000	4	20
F-343-A	RF Triode	W	10	40	36	18,000	4	21.5
F-343-AA	RF Triode	A	5	40	20	18,000	4	21.5
F-631	RF Triode	W	25	40	50	20,000	3	28
F-862-A	RF Triode	W	100	45	200	20,000	1.6	33
F-891	RF Triode	W	6	8.5	18	12,000	1.6	11/22
F-891-R	RF Triode	A	4	8.5	15	10,000	1.6	11/22
F-892-A	RF Triode	W	10	50	30	15,000	1.6	11/22
F-892-R	RF Triode	A	4	50	18	10,000	1.6	11/22
F-898-A	RF Triode	W	100	45	200	20,000	1.6	18.5
F-5604	HF Triode	A	10	20	32.5	12,500	22.5	11
F-5604-R	HF Triode	W	10	50	30	15,000	1.6	22
F-5619	HF Triode	W	20	20	32.5	12,500	22.5	11
F-5658	RF Triode	W	20	20.5	60	10,500	25	12
F-5666	HF Triode	W	12.5	21	20	10,000	22.5	11
F-5667	RF Triode	A	7.5	21	20	10,000	22.5	11.0
F-5668	RF Triode	W	20	50	28	14,000	5	22
F-5669	RF Triode	A	10	50	28	14,000	5	22
F-5680	HF Triode	A	2.5	25	12	6,000	20	13.0
F-5771	RF Triode	W	22.5	20	60	12,500	25	7.5
F-5874	AF Triode	W	7.5	6	15	8,000		7
F-5917	HF Triode	W	5	20	8	4,000	110	7.5
F-5918	RF Triode	W	70	37	300	17,500	22	11
F-5919	RF Triode	A	35	37	175	17,500	22	11
F-6096	HF Triode	A	2.5	25	12	6,000	30	13.0
F-6099	HF Triode	W	4	25	12	6,000	30	13
F-6179	AF Triode	W	50	4.75	120	15,000		27.2
F-6366	HF Triode	A	3	25	7	5,500	30	11
F-6367	HF Triode	A	3	25	12	6,200	30	13
F-6399	HF Triode	W	6	25	9	6,200	30	11

Federal also manufactures vacuum tubes for Rectifying and for Special Purpose

CALL THESE TELEPHONE NUMBERS for *Federal* SERVICE—

DAYTIME CALLS TO FACTORY, CLIFTON, N. J.
J. E. Shipco
NUTley 2-3600, Ext. 449

NIGHT, SATURDAY, SUNDAY, HOLIDAYS
Call NUTley 2-3621—if no answer,
call W. N. Weber, GREGory 3-0737



"Federal always has made better tubes"

Federal Telephone and Radio Company

VACUUM TUBE DEPARTMENT 100 KINGSLAND ROAD, CLIFTON, N. J.

In Canada: Federal Electric Manufacturing Company, Ltd., Montreal, P. Q.
Export Distributors: International Standard Electric Corp., 67 Broad St., N. Y.

FCC RULES AND REGULATIONS FOR BROADCAST SERVICES

Selected Sections as Amended to Jan. 1, 1954. Compiled With the Cooperation of Pike & Fischer Inc., publishers of Pike & Fischer Radio Regulation.

Allocations and Definitions

IN AM RULES' . . .

§3.1 *Standard broadcast station.*—The term "standard broadcast station" means a station licensed for the transmission of radio-telephone emissions primarily intended to be received by the general public and operated on a channel in the band 535-1605 kilocycles, inclusive.

§3.2 *Standard broadcast band.*—The term "standard broadcast band" means the band of frequencies extending from 535-1605 kilocycles.

§3.3 *Standard broadcast channel.*—The term "standard broadcast channel" means the band of frequencies occupied by the carrier and two side bands of a broadcast signal with the carrier frequency at the center. Channels shall be designated by their assigned carrier frequencies. The 107 carrier frequencies assigned to standard broadcast stations shall begin at 540 kilocycles and be in successive steps of 10 kilocycles.

§3.4 *Dominant station.*—The term "dominant station" means a class I station, as hereinafter defined, operating on a clear channel.

§3.5 *Secondary station.*—The term "secondary station" means any station except a class I station operating on a clear channel.

§3.6 *Daytime.*—The term "daytime" means that period of time between local sunrise and local sunset.

§3.7 *Nighttime.*—The term "nighttime" means that period of time between local sunset and 12 midnight local standard time.

§3.8 *Sunrise and sunset.*—The term "sunrise and sunset" means for each particular location and during any particular month, the time of sunrise and sunset as specified in the instrument of authorization.

§3.9 *Broadcast day.*—The term "broadcast day" means that period of time between local sunrise and 12 midnight local standard time.

§3.10 *Experimental period.*—The term "experimental period" means that time between 12 midnight and local sunrise. This period may be used for experimental purposes in testing and maintaining apparatus by the licensee of any standard broadcast station on its assigned frequency and with its authorized power, provided no interference is caused to other stations maintaining a regular operating schedule within such period. No station licensed for "daytime" or "specified hours" of operation may broadcast any regular or scheduled program during this period.

§3.11 *Service areas.*—(a) The term "primary service area" of a broadcast station means the area in which the ground wave is not subject to objectionable interference or objectionable fading.

(b) The term "secondary service area" of a broadcast station means the area served by the sky wave and not subject to objectionable interference. The signal is subject to intermittent variations in intensity.

(c) The term "intermittent service area" of a broadcast station means the area receiving service from the ground wave but beyond the primary service area and subject to some interference and fading.

§3.12 *Portable transmitter.*—The term "portable transmitter" means a transmitter so constructed that it may be moved about conveniently from place to place, and is in fact so moved about from time to time, but not ordinarily used while in motion. In the standard broadcast band, such a transmitter is used in making field intensity measurements for locating a transmitter site for a standard broadcast station. A portable broadcast station will not be licensed in the standard broadcast band for regular transmission of programs intended to be received by the public.

§3.13 *Auxiliary transmitter.*—The term "auxiliary transmitter" means a transmitter maintained only for transmitting the regular programs of a station in case of failure of the main transmitter.

Allocations—(Am)

§3.21 *Three classes of standard broadcast channels.*—(a) *Clear Channel:* A "clear channel" is one on which the dominant station or stations render service over wide areas and which are cleared of objectionable interference within their primary service areas and over all or a substantial portion of their secondary service areas.

(b) *Regional channel:* A "regional channel" is one on which several stations may operate with powers not in excess of 5 kilowatts. The primary service area of a station operating on any such channel may

INDEX TO SECTIONS

Allocations and Definitions	419
Censorship	429
Facsimile	424
Indecent Language	429
License Renewals	426
Lotteries	428
Multiple Ownership	420
Network Affiliation	424
Operating Schedules	422
Operator Requirements	422
Political Broadcast	428
Rebroadcasts	428
Recordings and Transcriptions	426
Reports to Be Filed	424
Revocations; Modifications, Suspensions	428
Sponsored Programs	426
Station Identification	426
Studio Location	422
Transfers and Assignments	429

(EDITOR'S NOTE: For convenience, rules for am and fm have been consolidated under the above general headings.)

be limited, as a consequence of interference, to a given field intensity contour.

(c) *Local channel:* A "local channel" is one on which several stations may operate with powers not in excess of 250 watts. The primary service area of a station operating on any such channel may be limited, as a consequence of interference, to a given field intensity contour.

§3.22 *Classes and power of standard broadcast stations.*—(a) *Class I station:* A "class I station" is a dominant station operating on a clear channel and designed to render primary and secondary service over an extended area and at relatively long distances. Its primary service area is free from objectionable interference from other stations on the same and adjacent channels and its secondary service area free from interference except from stations on the adjacent channel, and from stations on the same channel in accordance with the channel designation in section 3.25 or in accordance with the Engineering Standards of Allocation. The operating power shall be not less than 10 kilowatts nor more than 50 kilowatts. (Also see section 3.25 (a) for further power limitation.)

(b) *Class II station:* A "class II station" is a secondary station which operates on a clear channel (see section 3.25) and is designed to render service over a primary service area which is limited by and subject to such interference as may be received from class I stations. A station of this class shall operate with power not less than 0.25 kilowatt nor more than 50 kilowatts. Whenever necessary, a class II station shall use a directional antenna or other means to avoid interferences with class I stations and with other class II stations, in accordance with the Engineering Standards of Allocation.

[EDITOR'S NOTE: Since 1945 the FCC has been considering various changes in the Clear Channel assignments, including the question of daytime sky-wave. As of Jan. 1 this policy was still pending an FCC decision.]

(c) *Class III station:* A "class III station" is a station which operates on a regional channel and is designed to render service primarily to a metropol-

itan district² and the rural area contiguous thereto. Class III stations are subdivided into two classes:

(1) *Class III-A station:* A "class III-A station" is a class III station which operates with power not less than 1 kilowatt nor more than 5 kilowatts, and the service area of which is subject to interference in accordance with Engineering Standards of Allocation.

(2) *Class III-B station:* A "class III-B station" is a class III station which operates with a power not less than 0.5 kilowatt and not more than 1 kilowatt night and 5 kilowatts daytime, and the service area of which is subject to interference in accordance with the Engineering Standards of Allocation.

(d) *Class IV station:* A "class IV station" is a station operating on a local channel and designed to render service primarily to a city or town and the suburban and rural areas contiguous thereto. The power of a station of this class shall not be less than 0.1 kilowatt nor more than 0.25 kilowatt, and its service area is subject to interference in accordance with the Engineering Standards of Allocation.

§3.23 *Time of operation of the several classes of stations.*—The several classes of standard broadcast stations may be licensed to operate in accordance with the following:

(a) "Unlimited time" permits operation without a maximum limit as to time.

(b) "Limited time" is applicable to class II (secondary stations) operating on a clear channel only. It permits operation of the secondary station during daytime, and until local sunset if located west of the dominant station on the channel, or if located east thereof, until sunset at the dominant station; and in addition during night hours, if any, not used by the dominant station or stations on the channel.

(c) "Daytime" permits operation during the hours between average monthly local sunrise and average monthly local sunset. Daytime stations operating on local channels may, upon notification to the Commission and the engineer in charge of the district in which they are located, operate at hours beyond those specified in their license.

(d) "Sharing time" permits operation during hours which are so restricted by the station license as to require a division of time with one or more other stations using the same channel.

(e) "Specified hours" means that the exact operating hours are specified in the license. (The minimum hours that any station shall operate are specified in section 3.71.) Specified hours stations operating on local channels except those sharing time with other stations may, upon notification to the Commission and the engineer in charge of the district in which they are located, operate at hours beyond those specified in their license.

§3.24 *Broadcast facilities—showing required.*—An authorization for a new standard broadcast station or increase in facilities of an existing station* will be issued only after a satisfactory showing has been made in regard to the following, among others:

(a) That the proposed assignment will tend to affect a fair, efficient, and equitable distribution of radio service among the several states and communities.

(b) That objectionable interference will not be caused to existing stations or that if interference will be caused the need for the proposed service outweighs the need for the service which will be lost by reason of such interferences. That the proposed station will not suffer interference to such an extent that its service would be reduced to an unsatisfactory degree. (For determining objectionable interference, see Engineering Standards of Allocation and Field Intensity Measurements in Allocation.)

(c) That the applicant is financially qualified to construct and operate the proposed station.*

(d) That the applicant is legally qualified. That the applicant (or the person or persons in control of an applicant corporation or other organization) is of good character and possesses other qualifications sufficient to provide a satisfactory public service.

(e) That the technical equipment proposed, the location of the transmitter, and other technical phases of operation comply with the regulations governing the same, and the requirements of good engineering practice. (See technical regulations herein and Locations of Transmitters of Standard Broadcast Stations.)

(f) That the facilities sought are subject to assignment as requested under existing international agreements and the Rules and Regulations of the Commission.

(g) That the population within the 1 v/m contour does not exceed 1.0 percent of the population within the 25 mv/m contour, provided, however, that where the number of persons within the 1 v/m contour is 300 or less the provisions of this subparagraph are not applicable.

(h) That the public interest, convenience, and necessity will be served through the operation under the proposed assignment.

§3.25 *Clear Channels: Class I and II stations.*—The frequencies in the following tabulations are designated as clear channels and assigned for use by the classes of stations given:

(a) To each of the channels below there will be assigned one class I station and there may be assigned one or more class II stations operating limited time or daytime only: 640, 650, 660, 670, 700, 720, 750, 760, 770, 780, 820, 830, 840, 870, 880, 890, 1020, 1040, 1100, 1120, 1160, 1180, 1200, and 1210 kilocycles. The power of the class I stations on these channels shall not be less than 50 kilowatts.

(b) To each of the channels below there may be assigned class I and class II stations: 680, 710, 810, 850, 940, 1000, 1030, 1060, 1070, 1080, 1090, 1110, 1130, 1140, 1170, 1190, 1500, 1510, 1520, 1530, 1550, and 1560 kilocycles.

(c) For class II stations which will not deliver over 5 microvolts per meter ground wave or 25 microvolts per meter 10 per cent time sky wave at any point on Canadian border and provided that such stations operating nighttime (i.e., sunset to sunrise at the location of the class II station) are located not less than 650 miles from the nearest Canadian border: 540, 690, 740, 860, 990, 1010,* and 1580 kilocycles.

(d) In continental United States, for class II stations which operate daytime only with power not in excess of 1 kilowatt and which will not deliver over 5 microvolts per meter groundwave at any point on the Mexican border, and in Alaska, Hawaii, Puerto Rico, and the Virgin Islands, for class II stations which will not deliver over 5 microvolts per meter groundwave or 25 microvolts per meter 10 per cent time skywave at any point on the said border: 730, 800, 900, 1050*, 1220* and 1570 kilocycles.

(e) For class II stations which will deliver not over 5 microvolts per meter ground wave or 25 microvolts per meter 10 per cent time sky wave at any point of land in the Bahama Islands, and provided that such stations operating nighttime (i.e., sunset to sunrise at the location of the class II station) are located not less than 650 miles from the nearest point of land in the Bahama Islands: 1540 kilocycles.

§3.26 *Regional channels: Classes III-A and III-B stations.*—The following frequencies are designated as regional channels and are assigned for use by class III-A and III-B stations*: 550, 560,* 570,* 580, 590,* 600, 610, 620, 630,* 790, 910, 820, 930, 950, 960, 970, 980,* 1100, 1250, 1270,* 1280, 1290, 1300, 1310, 1320, 1330, 1350, 1360, 1370, 1380, 1390, 1410, 1420, 1430, 1440, 1460, 1470, 1480, 1590, and 1600 kilocycles.

§3.27 *Local channels: Class IV stations.*—The following frequencies are designated as local channels and are assigned for use by class IV stations: 1230, 1240, 1340, 1400, 1450, and 1490 kilocycles.

§3.28 *Assignment of stations to channels.*—(a) The individual assignments of stations to channels which may cause interference to other United States sta-

tions only shall be made in accordance with the standards of good engineering practice prescribed and published from time to time by the Commission for the respective classes of stations involved. (For determining objectionable interference see "Engineering Standards of Allocation" and "Field Intensity Measurements in Allocation," Section C.)

(b) In all cases where an individual station assignment may cause interference with or may involve a channel assigned for priority of use by a station in another North American country, the classifications, allocation requirements and engineering standards set forth in the North American Regional Broadcasting Agreement shall be observed.*

§3.29 *Class IV stations on regional channels.*—No license will be granted for the operation of a Class IV station on a regional channel, provided, however, that: (1) Class IV stations presently authorized to operate on regional channels will not be required to change frequency or power but will not be protected against interference from Class III stations and that (2) applications for Class IV assignments on regional channels which were on file prior to December 18, 1952 may be granted on condition that interference will not be caused to any Class III station* and that the Class IV station will be subject to such interference as it may receive from Class III stations.

* The assignment of a Class IV station to a regional channel normally is not considered as making the best usage of the assignment and will be made only when it is shown among other things that

- (1) There are no other transmission facilities in the town or towns in the proposed service area.
- (2) There is no local channel assignment available for that area.
- (3) Adequate economic support is not available for a Class III station.
- (4) It is not practical from an engineering point of view to establish a Class III station and it would not prevent the establishment of any Class III station on that channel or an adjacent channel.

IN FM RULES . . .

§3.201. *Numerical designation of fm broadcast channels.*—For convenience, the frequencies available for fm broadcasting (including those assigned to non-commercial educational broadcasting) are given numerical designations which are shown in the table below:

[EDITOR'S NOTE: The band is 88-108 mc. Non-commercial educational fm occupies 88-92 mc. Class A commercial channels are shown in 3.203(b), below. The rest are Class B.]

§3.202 *Areas of the United States.*—For the purpose of allocation the United States is divided into two areas. The first area—Area I—includes southern New Hampshire; all of Massachusetts, Rhode Island, and Connecticut; southeastern New York as far north as Albany-Troy-Schenectady; all of New Jersey, Delaware, and the District of Columbia; Maryland as far west as Hagerstown; and eastern Pennsylvania as far west as Harrisburg. The second area—Area II—comprehends the remainder of the United States not included in Area I.

§3.203 *Class A Stations.*—(a) A class A station is a station which operates on a class A channel and is designed to render service primarily to a community or to a city or town other than the principal city of an area, and the surrounding rural area. The coverage of a Class A station shall be not more than the equivalent¹³ of 1 kilowatt effective radiated power and antenna height of 250 feet above average terrain, as determined by the methods prescribed in the Standards of Good Engineering Practice Concerning fm Broadcast Stations. A Class A station will not be licensed with more than 1 kilowatt effective radiated power. The power rating of the transmitter used for a Class A station shall be not less than 250 watts nor more than 1 kilowatt. The signal intensity requirements of Section 2 of the Standards of Good Engineering Practice Concerning fm Broadcast Stations shall determine the minimum coverage of a Class A Station. Class A station will normally be protected to the 1 mv/m contour; however, assignments will be made in a manner to insure, insofar as possible, a maximum of service to all listeners, whether urban or rural, giving consideration to the minimum signal capable of providing service.

(b) The following frequencies, except as provided in paragraph (c) of this section, are designated as Class A channels and are assigned for use by Class A stations:

Pre-frequency	Channel	Pre-frequency	Channel	Pre-frequency	Channel
92.1	221	96.7	244	102.3	272
92.7	224	97.7	249	103.1	276
93.5	228	98.3	252	103.9	280
94.3	232	99.3	257	104.9	285
95.3	237	100.1	261	105.5	288
95.9	240	100.9	265	106.3	292
		101.7	269	107.1	296

These channels are available for assignment (1) in cities which are not the central city or cities of a metropolitan district, and (2) in central cities of metropolitan districts which have fewer than six Class B stations.

(c) In the Territory of Hawaii, the frequency band 98-108 mc is allocated for nonbroadcast use. The frequencies 98.1 through 107 mc, inclusive. (Channels 251 through 300 inclusive) will not be assigned in the Territory of Hawaii for use by fm broadcast stations.

§3.204 *Class B Stations.*—(a) A class B station is a station which operates on a class B channel and is

designed to render service primarily to a metropolitan district or principal city and the surrounding rural area, or to rural areas removed from large centers of population. The service area of a class B station will not be protected beyond the 1 mv/m contour; however, class B assignments will be made in a manner to insure, insofar as possible, a maximum of service to all listeners, whether urban or rural, giving consideration to the minimum signal capable of providing service. Standard power ratings of transmitters used for class B stations shall be 1 kw or greater. The signal intensity requirements of Section 2 of the Standards of Good Engineering Practice Concerning fm Broadcast Stations shall determine the minimum coverage of a class B station. In the following sub-sections, antenna height above average terrain and effective radiated power are to be determined by the methods prescribed in the Standards of Good Engineering Practice Concerning fm Broadcast Stations.

(1) The coverage of a Class B station in Area I shall be not more than the equivalent¹³ of 20 kilowatts effective radiated power and antenna height of 500 feet above average terrain.¹³ A class B station in Area I will not be licensed with an effective radiated power greater than 20 kilowatts.

(2) The coverage of a Class B station in Area II shall normally be not more than the equivalent¹³ of 20 kilowatts effective radiated power and antenna height of 500 feet above average terrain.¹³ The use of greater power and antenna height will be encouraged in those portions of Area II where such use would not result in undue interference to stations already authorized or to probable assignments insofar as can be determined at the time of the grant. In such case, the power, antenna height, and area will be determined on the merits of each application with particular attention being given to rural areas which would not otherwise receive service.

(b) The following frequencies are designated as Class B channels and are assigned for use by Class B stations.

[EDITOR'S NOTE: Class B channels are those channels between 92 mc and 108 mc which are not designated as Class A channels in 3.203(b).]

(c) In the Territory of Hawaii the frequency band 98-108 mc is allocated for nonbroadcast use. The frequencies 98.1 through 107 mc inclusive. (Channels 251 through 300 inclusive) will not be assigned in the Territory of Hawaii for use by fm broadcast stations.

Multiple Ownership

IN AM RULES . . .

§3.35 *Multiple ownership.*—No license for a standard broadcast station shall be granted to any party (including all parties under common control¹⁴) if

(1) such party directly or indirectly owns, operates or controls another standard broadcast station, a substantial portion of whose primary service area would receive primary service from the station in question, except upon a showing that public interest, convenience and necessity will be served through such multiple ownership situation; or

(2) such party, or any stockholder, officer or director of such party, directly or indirectly owns, operates, controls, or has any interest in, or is an officer or director of any other standard broadcast station if the grant of such license would result in a concentration of control of standard broadcasting in a manner inconsistent with public interest, convenience, or necessity. In determining whether there is such a concentration of control, consideration will be given to the facts of each case with particular reference to such factors as the size, extent and location of areas served, the number of people served, classes of station involved and the extent of other competitive service to the areas in question. The Commission, however, will in any event consider that there would be such a concentration of control contrary to the public interest, convenience or necessity for any party or any of its stockholders, officers or directors to have a direct or indirect interest in, or be stockholders, officers, or directors of, more than seven standard broadcast stations.¹⁵

IN FM RULES . . .

§3.240 *Multiple ownership.*—No license for an FM broadcast station shall be granted to any party (including all parties under common control¹⁴) if

(1) such party directly or indirectly owns, operates, or controls another FM broadcast station which serves substantially the same service area; or

(2) such party, or any stockholder, officer or director of such party, directly or indirectly owns, operates, controls, or has any interest in, or is an officer or director of any other FM broadcast station if the grant of such license would result in a concentration of control of FM broadcasting in a manner inconsistent with public interest, convenience, or necessity. In determining whether there is such a concentration of control, consideration will be given to the facts of each case with particular reference to such factors as the size, extent and location of areas served, the number of people served, classes of stations involved, and the extent of other competitive service to the areas in question. The Commission, however, will in any event consider that there would be such a concentration of control contrary to the public interest, convenience or necessity for any party or any of its stockholders, officers or directors to have a direct or indirect interest in, or be stockholders, officers, or directors of, more than seven FM broadcast stations.¹⁵

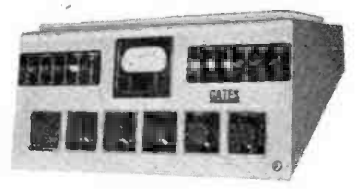
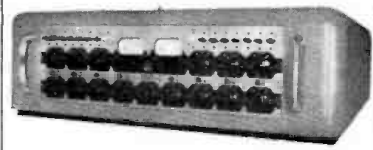
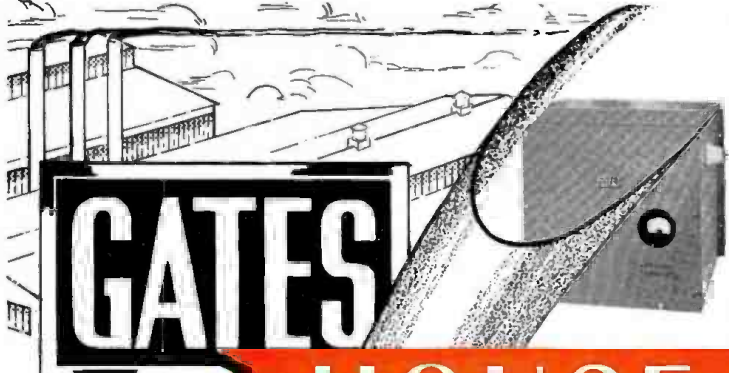

HOUSE of SERVICE for Broadcasters

Wherever you are — Gates is your house of Service! — Direct stock carrying branches at Atlanta, Houston, Los Angeles and Quincy, Illinois, plus district sales offices in Washington and New York. Add to this, twelve highly competent field sales engineers traveling the nation, the many field offices of the Canadian Marconi Company and the around-the-world operations of our international division. For broadcasting equipment — wherever you are — Gates is *your house of service*.

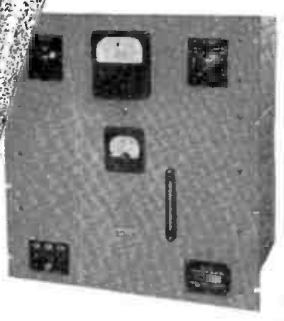

A NOTE ON YOUR LETTERHEAD WILL BRING ANY OR ALL OF THESE GATES CATALOGS TO YOU SPEEDILY.

GATES RADIO COMPANY QUINCY, ILL., U.S.A.

- | | | |
|---------------------|---------------------|--------------------------|
| Quincy, Illinois | Main 8202 | Gates Radio Company |
| Atlanta, Ga. | Elgin 0369 | Gates Radio Company |
| Houston, Texas | Atwood 8536 | Gates Radio Company |
| Los Angeles, Calif. | Hollywood 2-6351 | Gates Radio Company |
| Montreal, Quebec | Atlantic 9441 | Canadian Marconi Company |
| New York (domestic) | Murray Hill 7-7971 | Gates Radio Company |
| New York (overseas) | Murray Hill 9-0200 | Gates Radio Company |
| Washington, D. C. | Metropolitan 8-0522 | Gates Radio Company |

Studio Location; Originations

IN AM RULES . . .

§3.30 *Station location and program origination.*—(a) Except as provided in subsection (b) below, each standard broadcast station will be licensed to serve primarily a particular city, town, or other political subdivision which will be specified in the station license and the station will be considered to be located in such place. Unless licensed as a synchronous amplifier transmitter, each station shall maintain a studio, which will be known as the main studio, in the place where the station is located, provided that the main studio may be located at the transmitter site whether or not the transmitter site is in the place where the station is located. A majority (computed on the basis of duration and not number) of a station's programs or in the case of a station affiliated with a network two-thirds of such station's non-network program whichever is smaller, shall originate from the main studio or from other studios or remote points situated in the place where the station is located.

(b) Stations will be licensed to serve more than one city, town, or other political subdivision only where a satisfactory showing is made that such place meets all the requirements of the Rules and Standards of Good Engineering Practice with respect to the location of main studios; that the station can and will originate a substantial number of local live programs from each such place; and that the requirements as to origination of programs contained in subsection (a) above would place an unreasonable burden on the station if it were licensed to serve only one city, town, or other political subdivision. A station licensed to serve more than one place shall be considered to be located in and shall maintain main studios in each such place. With respect to such station the requirements as to origination of programs contained in subsection (a) above shall be satisfied by the origination of programs from any or all of the main studios or from other studios and remote points situated in any or all of the places in which the main studios are located.

(c) The transmitter of each standard broadcast station shall be so located that primary service is delivered to the borough or city in which the main studio is located in accordance with the Standards of Good Engineering Practice, prescribed by the Commission.

§3.31 *Authority to move main studio.*—The licensee of a standard broadcast station shall not move its main studio outside the borders of the borough of city, State, district, Territory, or possession in which it is located without first making written application¹⁴ to the Commission for authority to so move, and securing written permission for such removal. The licensee shall promptly notify the Commission of any other change in location of the main studio.

IN FM RULES . . .

§3.205—[EDITOR'S NOTE: In substance the same as §3.30, above, except that subsection (c) reads as follows:

"The transmitter of each fm broadcast station shall be so located that satisfactory service is delivered to the city where the main studio is located in accordance with the Standards of Good Engineering Practice Governing Fm Broadcast Stations: Provided, however, upon special showing of need, authorization may be granted to locate the transmitter so that adequate service is not rendered to this city, but in no event shall this city be beyond the 50 uv/m contour."]

Operating Schedules

FOR AM STATIONS

§3.71 *Minimum operating schedule.*—Except Sundays, the licensee of each standard broadcast station shall maintain a minimum operating schedule of two-thirds of the total hours, that it is authorized to operate between 6 a.m. and 6 p.m., local standard time, and two-thirds of the total hours it is authorized to operate between 6 p.m. and midnight, local standard time, except that in an emergency when, due to causes beyond the control of the licensee, it becomes impossible to continue operating, the station may cease operation for a period of not to ex-

ceed 10 days, provided that the Commission and the inspector in charge shall be notified in writing immediately after the emergency develops.

§3.72 *Operation during experimental period.*—The licensee of each standard broadcast station shall operate or refrain from operating its station during the experimental period as directed by the Commission in order to facilitate frequency measurement or for the determination of interference. (Stations involved in the after-midnight frequency monitoring programs are notified of their operating and silent schedule.)

§3.73 *Specified hours.*—If the license of a station specifies the hours of operation, the schedule so specified shall be adhered to except as provided in sections 3.71 and 3.72.

§3.76 *Local standard time; license provisions.*—The time of operation of any broadcast station which does not share time with other stations on the same channel shall be understood to have reference to local standard time unless modification of such license with respect to hours of operation is authorized by the Commission. [EDITOR'S NOTE: See "Time: Time Changes," below.]

§3.79 *License to specify sunrise and sunset hours.*—If the licensee of a broadcast station is required to commence or cease operation, or to change the mode of operation of the station at the times of sunrise and sunset at any particular location, the controlling times for each month of the year are set forth in the station's instrument of authorization. Uniform sunrise and sunset times are specified for all of the days of each month, based upon the actual times of sunrise and sunset for the fifteenth day of that month adjusted to the nearest quarter hour. In accordance with a standardized procedure described therein, actual sunrise and sunset times are derived by interpolation in the tables of the 1946 American Nautical Almanac, issued by the Nautical Almanac Office of the United States Naval Observatory.

§3.80 *Secondary station; filing of operating schedule.*—The licensee of a secondary station authorized to operate limited time and which may resume operation at the time the dominant station (or stations) on the same channel ceases operation shall, with each application for renewal of license, file in triplicate a copy of its regular operating schedule, bearing a signed notation by the licensee of the dominant station of its objection or lack of objection thereto. Upon approval of such operating schedule, the Commission will affix its file mark and return one copy to the licensee authorized to operate limited time, which shall be posted with the station license and considered as a part thereof. Departure from said operating schedule will be permitted only in accordance with the procedure set forth in section 3.77.

§3.81 *Secondary station; failure to reach agreement.*—If the licensee of a secondary station authorized to operate limited time and a dominant station on a channel are unable to agree upon a definite time for resumption of operation by the station authorized limited time, the Commission shall be so notified by the licensee of the station authorized limited time. After receipt of such statement the Commission will designate for hearing the applications of both stations for renewal of license, and pending the hearing the schedule previously adhered to shall remain in full force and effect.

§3.82 *Departure from schedule; material violation.*—In all cases where a station licensee is required to prepare and file an operating schedule, any deviation or departure from such schedule, except as herein authorized, shall be considered as a violation of a material term of the license.

Time: Time Changes

§3.83 *Local standard time.*—All references herein to standard time or local standard time refer to local standard time as determined and fixed by the Interstate Commerce Commission.

§3.84 *Daylight saving time.*—If local time is changed from standard time to daylight saving time at the location of all stations sharing time on the same channel, the hours of operation of all such stations on that channel shall be understood to refer to daylight saving time, and not standard time, as long as daylight saving time is observed at such location. This provision shall govern when the time is changed by provision of law or general observance of daylight saving time by the various communities, and when the time of operation of such stations is specified in the license or is mutually agreed upon by the licensees; *Provided, however,* That when the license specifies average time of sunrise and sunset, local standard time shall be observed. In no event shall a station licensed for daytime only operate on regular schedule prior to local sunrise, or shall a station licensed for greater daytime power than nighttime power or for a different radiation pattern for daytime operation than

for nighttime operation operate with the daytime power or radiation pattern prior to local sunrise.

§3.85 *Changes in time; agreement between licensees.*—Where the local time is not changed from standard time to daylight saving time at the location of all stations sharing time on the same channel, the hours of operation of such stations shall be understood to have reference to standard time, and not daylight saving time, unless said licensees mutually agree upon a new schedule which shall be effective only while daylight saving time is observed at the location of some of these stations.

Pre-Sunrise Operation

§3.87 *Program transmission prior to local sunrise.*—(a) The provisions of sections 3.6 3.8, 3.9, 3.10, 3.23, 3.79 and 3.84 shall not prevent the transmission of programs between four o'clock a.m., local standard time, and local sunrise of standard broadcast stations with their authorized daytime facilities. *Provided,* That the provisions of this rule shall not extend to:

(1) Stations regularly sharing time during daytime hours either under licenses pursuant to which time-sharing agreements have been entered into or licenses specifying hours of operation, unless time-sharing agreements have been reached covering such operation prior to local sunrise. Sections 3.74, 3.77, and 3.78 of these rules shall be applicable to such agreements.

(2) Any class II station causing interference¹⁵ by use of its daytime facilities within the 0.5 mv/m 50% sky wave contour of any class I station either of the United States or of any country party to the North American Regional Broadcasting Agreement, except (a) where the class I station is located east of the class II station, in which case operation may begin at local sunrise at the class I station; (b) where an agreement has been reached with the class I station to begin operation prior to local sunrise.

(3) Operation by use of its daytime facilities of any class II station on any class I-A channel not assigned to the United States under the North American Regional Broadcasting Agreement.

(b) Any station operating during such hours receiving notice from the Commission that undue interference is caused shall refrain from such operation during such hours pending further notice from the Commission.

(c) Nothing contained in outstanding instruments of authorization for such stations shall prohibit such operation except as herein provided.

(d) The period 4 a.m. to 6 a.m., local standard time, shall not be included in determining compliance with section 3.71 of these rules.

FOR FM STATIONS . . .

§3.281 *Time of Operation.*—All fm broadcast stations will be licensed for unlimited time operation. Until further notice a minimum of 6 hours per day of operation will be required, which shall consist of 3 hours during the period of 6 a.m. to 6 p.m., local standard time, and 3 hours during the period of 6 p.m. to midnight, local standard time. In an emergency, however, when due to causes beyond the control of the licensee, it becomes impossible to continue operation, the station may cease operation for a period not to exceed 10 days, provided that the Commission and the engineer in charge of the radio district in which the station is located shall be notified in writing immediately after the emergency develops.

§3.282 *Experimental Operation.*—The period between 1:00 a.m. and 6:00 a.m., local standard time, may be used for experimental purposes in testing and maintaining apparatus by the licensee of any fm broadcast station on its assigned frequency and not in excess of its authorized power, without specific authorization by the Commission.

Operator Requirements

IN AM RULES . . .

§3.165 *Operator Requirements.*—(a) One or more radio operators holding a valid radiotelephone first-class operator license, except as provided below, shall be in actual charge of the transmitting apparatus and shall be on duty either at the transmitter location or remote control point.

(b) A station which is authorized for non-directional operation with power of 10 kilowatts or less may be operated by persons holding commercial radio operator license of any class, except an aircraft radiotelephone operator authorization or a temporary limited radiotelegraph second-class operator license, when the equipment is so designed that the stability of the frequency is maintained by the transmitter itself within the limits of tolerance specified, and none of the operations, except those specified below, necessary to be performed during the course of normal operation may cause off-frequency operation or result in any unauthorized radiation.¹⁶ Adjustments of transmitting equipment by such operators, except when under the immediate supervision of a radiotelephone first-class operator, shall be limited to the following: (1) Those necessary to commence or terminate transmitter emissions as a routine matter. (2) Those external adjustments that may be required as a result of variations of primary power supply. (3) Those external adjustments which may be necessary to insure modulation within the limits required. (4) Those adjustments necessary to effect any change in operating power which may be required by the station's in-

Through 40 years of leadership in sound control

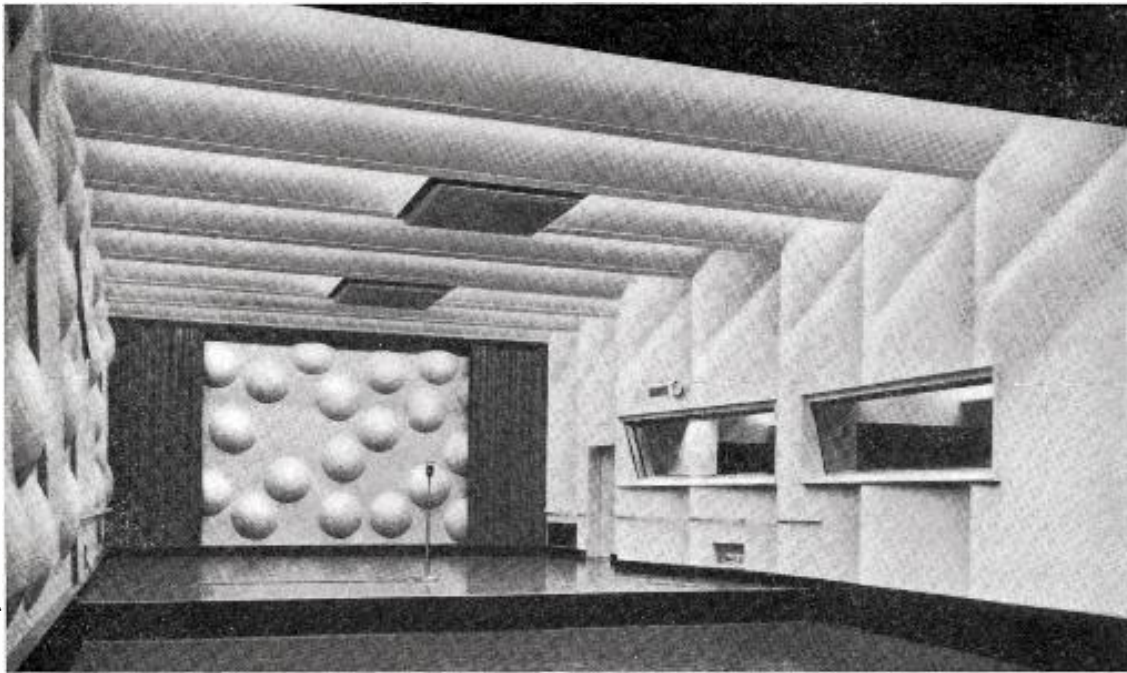

Johns-Manville acoustical materials and the J-M sound isolation principle combine to provide maximum fidelity in this broadcasting studio

Johns-Manville can effectively serve you in solving your acoustical problems

ARCHITECTS, Engineers and Acoustical Consultants look to Johns-Manville, the pioneer in sound control, for reliable technical assistance . . . and depend on J-M acoustical materials, installed under responsible J-M supervision, for maximum acoustical efficiency and service.

Among the materials developed by Johns-Manville are Transite* a perforated asbestos-cement fac-

ing backed with a sound-absorbing element for commercial installations, or a special sound-absorbing element for use in broadcasting and television studios; Sanacoustic*, a demountable, perforated metal unit backed with a non-combustible sound-absorbing element; Permasonic*, a textured noncombustible unit that combines unusual beauty with high acoustical efficiency; and Fibre-

tone*, a low-cost drilled fibreboard which is available with a flame-resistant finish.

Johns-Manville acoustical engineers and technical resources are available to help you solve any sound control problem.

For complete information write to Johns-Manville, Box 158, New York 16, N. Y. In Canada, write 199 Bay St., Toronto 1, Ontario.

*Reg. U.S. Pat. Off.

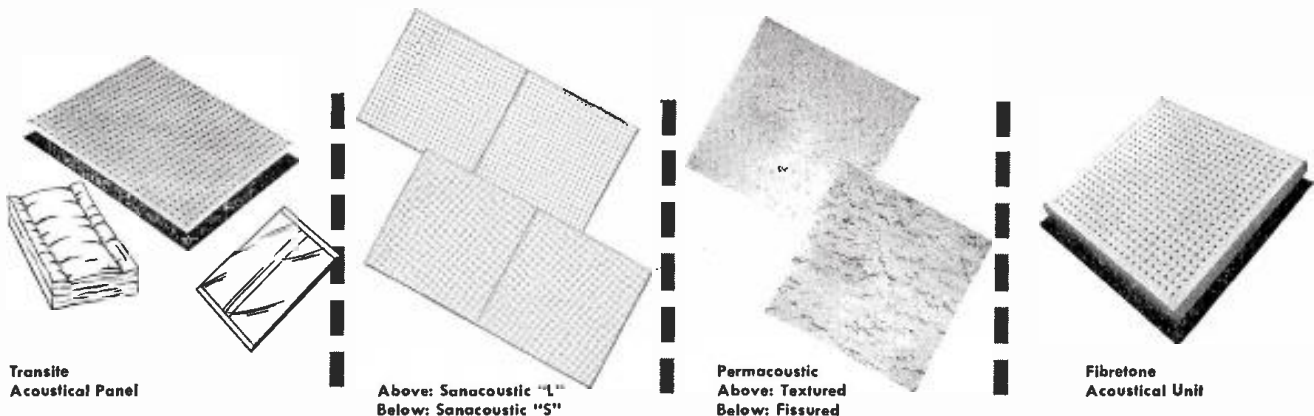

Transite Acoustical Panel

Above: Sanacoustic "L"
Below: Sanacoustic "S"

Permasonic
Above: Textured
Below: Fissured

Fibretone Acoustical Unit



Johns-Manville

strument of authorization. Should the transmitting apparatus be observed to be operating in a manner inconsistent with the station's instrument of authorization and none of the above adjustments are effective in bringing it into proper operation, a person holding other than a radiotelephone first-class operator license and not acting under the immediate supervision of radiotelephone first-class operator, shall be required to terminate the station's emissions.

(c) The licensee of a station which is operated by one or more operators holding other than a radiotelephone first-class operator license shall have one or more operators holding a radiotelephone first-class operator license in regular full-time employment at the station whose primary duties shall be to effect and insure the proper functioning of the transmitting equipment. In the event that the licensee also operates an fm broadcast station in the same community, a regular fulltime radiotelephone firstclass operator or operators employed in connection with the standard broadcast station may concurrently be employed to satisfy the requirements of § 3.265(c) or 3.565(c); Provided, that the duties of such operator or operators concerning the fm broadcast transmitting equipment shall in no wise interfere with the proper performance of his duties with respect to the standard broadcast transmitter.

(d) The licensed operator on duty and in charge of a standard broadcast transmitter may, at the discretion of the licensee, be employed for other duties or for the operation of another radio station or stations in accordance with the class of operator's license which he holds and the rules and regulations governing such other stations; Provided, however, that such duties shall in no wise interfere with the proper operation of the standard broadcast transmitter.

IN FM RULES . . .

§3.265 Operator requirements.
[EDITOR'S NOTE: Substantially the same as Sec. 3.165.]

Facsimile

§3.266 Facsimile broadcasting and multiplex transmission.—(a) fm broadcast stations may transmit simplex facsimile in accordance with transmission standards set forth in the Standards of Good Engineering Practice Concerning fm Broadcast Stations during periods not devoted to fm aural broadcasting. Such transmissions may not exceed one hour during the period between 7 a.m. and midnight (no limit for the hours between midnight and 7 a.m.) and may not be counted toward the minimum operation required by Sec. 3.261. The Commission shall be notified by the licensee of the fm broadcast station of its intent to transmit such facsimile.

(b) fm broadcast stations may, upon securing authorization from the Commission, transmit multiplex facsimile in accordance with transmission standards set forth in the Standards of Good Engineering Practice Concerning fm Broadcast Stations; Provided that the transmission of such facsimile does not reduce the quality of aural programs simultaneously transmitted by the licensee below that required by the Standards of Good Engineering Practice Concerning fm Broadcast Stations and that no degradation of such aural programs will result from such facsimile transmissions when received on fm receivers not equipped with filter or other additional equipment.

Network Affiliation

IN AM RULES . . .

§3.101 Exclusive affiliation of station.—No license shall be granted to a standard broadcast station having any contract, arrangement, or understanding, expressed or implied, with a network organization²⁸ under which the station is prevented or hindered from, or penalized for, broadcasting the programs of any other network organization.

§3.102 Territorial exclusivity.—No license shall be granted to a standard broadcast station having any contract, arrangement, or understanding, express or implied, with a network organization which prevents or hinders another station serving substantially the same area from broadcasting the network's programs not taken by the former station, or which prevents or hinders another station serving a substantially different area from broadcasting any program of the network organization. This section shall not be construed to prohibit any contract, arrangement, or understanding between a station and a network organization pursuant to which the station is granted the first call in its primary service area upon the programs of the network organization.

§3.103 Term of affiliation.—No license shall be granted to a standard broadcast station having any contract, arrangement, or understanding, express or implied, with a network organization which provides, by original term, provisions for renewal, or otherwise for the affiliation of the station with the network organization for a period longer than two years; Provided, That a contract, arrangement, or understanding for a period up to two years, may be entered into within six months prior to the commencement of such period.

§3.104 Option time.—No license shall be granted to a standard broadcast station which options²⁹ for network programs any time subject to call on less

than 56 days' notice, or more time than a total of three hours³⁰ within each of four segments of the broadcast day, as herein described. The broadcast day is divided into 4 segments as follows: 8:00 a.m. to 1:00 p.m.; 1:00 p.m. to 6:00 p.m.; 6:00 p.m. to 11:00 p.m.; 11:00 p.m. to 8:00 a.m.³¹ Such options may not be exclusive as against other network organizations and may not prevent or hinder the station from optioning or selling any or all of the time covered by the option, or other time, to other network organizations.

§3.105 Right to reject programs.—No license shall be granted to a standard broadcast station having any contract, arrangement, or understanding, express or implied, with a network organization which (a), with respect to programs offered pursuant to an affiliation contract, prevents or hinders the station from rejecting or refusing network programs which the station reasonably believes to be unsatisfactory or unsuitable; or which (b), with respect to network programs so offered or already contracted for, prevents the station from rejecting or refusing any program which, in its opinion, is contrary to the public interest, or from substituting a program of outstanding local or national importance.

§3.106 Network ownership of stations.—No license shall be granted to a network organization, or to any person directly or indirectly controlled by or under common control³² with a network organization, for more than one standard broadcast station where one of the stations covers substantially the service area of the other station, or for any standard broadcast station in any locality where the existing standard broadcast stations are so few or of such unequal desirability (in terms of coverage, power, frequency, or other related matters) that competition would be substantially restrained by such licensing.

§3.107 Dual network operation.—No license shall be issued to a standard broadcast station affiliated with a network organization which maintains more than one network. Provided, That this section shall not be applicable if such networks are not operated simultaneously, or if there is no substantial overlap in the territory served by the group of stations comprising each such network.

§3.108 Control by networks of station rates.—No license shall be granted to a standard broadcast station having any contract, arrangement, or understanding, express or implied, with a network organization under which the station is prevented or hindered from, or penalized for, fixing or altering its rates for the sale of broadcast time for other than the network's programs.

IN FM RULES . . .

§3.231-3.238, inclusive—
[EDITOR'S NOTE: Same as §3.101-3.108, above, with the following exceptions: (1) references are to fm rather than standard stations and networks; and (2) the section on "Network Ownership of Stations" is changed to read as follows:

§3.236 Network ownership of stations.—No license shall be granted to a network organization, or to any person directly or indirectly controlled by or under common control³² of a network organization, for an fm broadcast station in any locality where the existing fm broadcast stations are so few or of such unequal desirability in terms of coverage, power, frequency, or other related matters) that competition would be substantially restrained by such licensing.]

Reports to be Filed ²⁸

ALL BROADCAST STATIONS . . .

§1.341 Financial report, broadcast licensees and permittees.—(a) Each licensee of a broadcast station (standard, fm, television, or international) and each permittee of a broadcast station engaged in interim operation shall file with the Commission on or before April 1 of each year on Form 324, together with supporting schedules, a balance sheet showing its financial condition as of December 31 of the preceding calendar year and an income statement for said calendar year.

§1.342 Filing of contracts, broadcast licensees and permittees.—Each licensee or permittee of a standard, fm, television, or international broadcast station shall file with the Commission within 30 days of execution thereof copies of the following contracts, instruments and documents, together with amendments, supplements and cancellations. The term "contract" as used herein includes any contract, express or implied, oral or written. The substance of oral contracts shall be reported in writing:

(a) Contracts relating to network service. This provision does not require the filing of transcription agreements, or contracts for the supplying of film for television stations which do not specify option time, contracts granting the right to broadcast music such as ASCAP, BMI or SESAC agreements. Transcription agreements or contracts for the supplying of film for television stations which do specify option time must be filed.

(b) Contracts, instruments or documents relating to the present or future ownership or control of the licensee or permittee, or of the licensee's or permittee's stock, rights or interests therein, or relating to changes in such ownership or control. All contracts, instruments and documents exempted from the requirements of §1.343 of the rules are similarly exempted here. The term "stock" includes any interest in legal or beneficial, right or privilege in connection with stock. The terms "officers" and

"directors" include the comparable officials of unincorporated associations. This provision is limited to the following:

- (1) Articles of partnership, association and incorporation and changes in such instruments.
 - (2) Bylaws and any instruments affecting changes in such bylaws.
 - (3) Any agreement, document or instrument affecting directly or indirectly, the ownership or voting rights of the licensee's or permittee's stock, (common or preferred, voting or non-voting stock) such as (i) agreements for transfer of stock, (ii) instruments for the issuance of new stock, (iii) or agreements for the acquisition of licensee's or permittee's stock by the issuing licensee or permittee corporation. Options to purchase stock, pledges, trusts agreements, and other executory agreements are required to be filed.
 - (4) Proxies with respect to the licensee's or permittee's stock running for a period in excess of one year; and all proxies, whether or not running for a period of one year, given without full and detailed instructions binding the recipient to act in a specified manner. With respect to the latter proxies given without full and detailed instructions, a statement showing the number of such proxies, by whom given and received, and the percentage of outstanding stock represented by each proxy shall be submitted by the licensee or permittee within 30 days after the stockholders' meeting in which the stock covered by such proxies has been voted; provided, however, that when the permittee or licensee is a corporation having more than 50 stockholders, such complete information need be filed only with respect to proxies given by stockholders who are officers or directors or who have one percent or more of the corporation's stock. In cases where the permittee or licensee is a corporation having more than 50 stockholders and the stockholders giving the proxies are neither officers or directors nor hold one percent or more of the corporation's stock, the only information required to be filed is the name of any person voting one percent or more of the stock by proxy, the number of shares voted by proxy by such person, and the total number of shares voted at the particular stockholders' meeting in which the aforesaid shares were voted by proxy.
 - (5) Mortgage or loan agreements containing provisions restricting the licensee's or permittee's freedom of operation, such as those specifying or limiting the amount of dividends payable, the purchase of new equipment, the maintenance of current assets, etc.
 - (6) Any agreement reflecting a change in the officers, directors, or stockholders of a corporation other than the licensee or permittee having an interest, direct or indirect, in the licensee or permittee as specified by §1.343 of the rules.
- (c) Contracts relating to the sale of broadcast time to "time brokers" for resale.
- (d) Contracts relating to functional music operations such as "storecasting," "transitcasting," "background music," and similar services. This provision does not require the filing of contracts granting functional music licensees or permittees the right to broadcast copyright music.
- (e) Time sales contracts with the same sponsor for 4 or more hours per day, unless the length of the events broadcast pursuant to the contract is not under control of the station, such as athletic contests, musical programs and special events.
- (f) Contracts relating to the utilization in a management capacity of any person other than an officer, director, or regular employee of the licensee or permittee station, and management contracts with any persons, whether or not officers, directors, or regular employees which provide for both a percentage of profits and a sharing in losses. With the above exceptions, this provision does not require the filing of agreements with persons regularly employed as general or station managers or salesmen, contracts with program managers or program personnel, contracts with chief engineers or other engineering personnel, contracts with consulting radio engineers, attorneys, or accountants, contracts with performers, contracts with station representatives, contracts with labor unions, or any similar agreements. It does require the filing of management consultant agreements with independent contractors.
- §1.343 Ownership reports, broadcast licensees and permittees.—(a) The licensee or permittee of each broadcast station (standard, fm, television, and international) shall file an ownership report (FCC Form 323) at the time the application for renewal of station license is required to be filed by Sec. 1.320(a) of the rules, giving the following information as of the date of filing:
- (1) In the case of an individual, the name of such individual.
 - (2) In the case of a partnership, the names of the partners and the interests of each partner.³³
 - (3) In the case of a corporation or association: (i) Capitalization, with a description of the classes and voting power of stock authorized and the shares of each class issued and outstanding; (ii) the name, residence, citizenship, and stockholdings of officers and directors, and stockholders; (iii) full information

Save TV OFF-THE-AIR TIME WITH G-E 5-STAR TUBES!

They're specially designed and built for **RELIABILITY**.



Scores of extra quality steps in design, manufacturing, and testing, combine to give you 5-Star Receiving Tubes—real high-reliability types you can count on. Ask for these tubes in new equipment! Install them as replacements, and your transmitter downtime will drop off sharply. Chart below shows fourteen G-E 5-Star types that you will find especially useful.



EXAMPLE: heater failures are virtually eliminated by a cataphoresis coating process on bends that assures even, unbroken insulation... by baking the coating in 1700 C heat... by using heavy-gage heater wire.



EXAMPLE: short-circuit incidence is reduced by carefully inspecting tube parts with microscopes. Grids are micrometer-gaged. Every 5-Star Tube receives these check-ups... and many more like them.

PROTOTYPE	5-STAR TUBE	DESCRIPTION	ELECTRICAL DIFFERENCES															
5Y3-GT	GL-6087	Full-wave rectifier	5Y3-GT has coated filament; GL-6087, coated unipotential cathode... 5Y3-GT has 60 v tube voltage drop; GL-6087, 50 v drop (both at 125 ma per plate).															
6AC7	GL-6134	Sharp-cutoff r-f pentode	None															
6AK5	GL-5654	Sharp-cutoff r-f pentode	None															
6AL5	GL-5726	Twin diode	None															
6AQ5	GL-6005	Beam power amplifier	None															
6AS6	GL-5725	Dual-control sharp-cutoff r-f pentode	None															
6AU6	GL-6136	Sharp-cutoff r-f pentode	None															
6BA6	GL-5749	Remote-cutoff r-f pentode	None															
6C4	GL-6135	Medium-mu triode	6C4 heater current is 0.150 amp; GL-6135, 0.175 amp.															
6X4	GL-6202	Full-wave rectifier	<table border="0"> <tr> <td></td> <td>6X4</td> <td>GL-6202</td> </tr> <tr> <td>Max peak current</td> <td>210 ma</td> <td>200 ma</td> </tr> <tr> <td>Max d-c output current</td> <td>70 ma</td> <td>50 ma</td> </tr> <tr> <td>Tube voltage drop</td> <td>22 v at 70 ma</td> <td>22 v at 50 ma</td> </tr> <tr> <td></td> <td>per plate</td> <td>per plate</td> </tr> </table>		6X4	GL-6202	Max peak current	210 ma	200 ma	Max d-c output current	70 ma	50 ma	Tube voltage drop	22 v at 70 ma	22 v at 50 ma		per plate	per plate
	6X4	GL-6202																
Max peak current	210 ma	200 ma																
Max d-c output current	70 ma	50 ma																
Tube voltage drop	22 v at 70 ma	22 v at 50 ma																
	per plate	per plate																
12AT7	GL-6201	H-f high-mu twin triode	None															
12AU7	GL-5814-A	Medium-mu twin triode	12AU7 heater current is 0.150 amp per section; GL-5814-A, 0.175 amp per section.															
12AY7	GL-6072	Low-noise high-mu twin triode	12AY7 heater current is 0.150 amp per section; GL-6072, 0.175 amp per section.															
12AX7	GL-5751	High-mu twin triode	12AX7 heater current is 0.150 amp per section; GL-5751, 0.175 amp per section... 12AX7 amplification factor is 100; GL-5751, 70.															

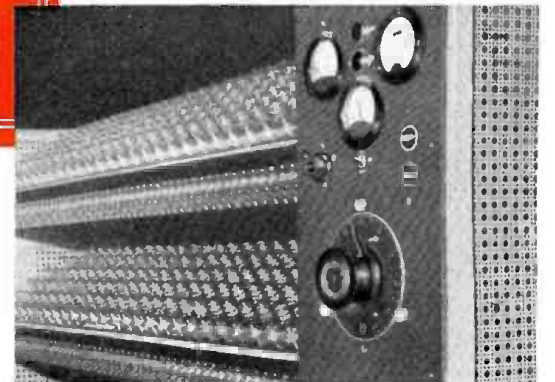

EXAMPLE: a 46-hour "burn-in" under Class A conditions is given every G-E 5-Star Tube. This (1) helps to prevent early life failures, (2) assures uniform, stable electrical performance when tube is installed.

● Your local G-E tube distributor is the man for you to see for 5-Star Tubes. He also carries a full line of standard G-E receiving types, glass, metal, and miniature, and is your best source for power tubes and rectifiers. Your General Electric distributor makes fast deliveries right to your door. He knows broadcast needs, and how to meet them with ample tube stocks and efficient service. Keep in touch with him! *General Electric Company, Tube Department, Schenectady 5, New York.*

GENERAL ELECTRIC



166-1C2

with respect to the interest and identity of any person whether or not a stockholder of record, having any interest, direct or indirect, in the licensee or any of its stock.

FOR EXAMPLE:

- (a) Where A is the beneficial owner or votes stock held by B, the same information should be furnished for A as is required for B.
- (b) Where X corporation controls the licensee, or holds 25% or more of the stock of the licensee, the same information should be furnished with respect to X corporation (its capitalization, officers, directors, and stockholders and the amount of stock in X held by each) as is required in the case of the licensee, together with full information as to the identity and citizenship of the person authorized to vote licensee's stock.
- (c) The same information should be furnished as to Y corporation if it controls X corporation or holds 25% or more of the stock of X, and as to Z corporation if it controls Y corporation or holds 25% or more of the stock of Y and so on back to natural persons.
- (d) Full information as to family relationship or business association between two or more officials and/or stockholders.
- (e) In the case of all licensees (i) a list of all contracts still in effect required to be filed with the Commission by Section 1.342 showing the date of execution and expiration of each contract; (ii) any interest which the licensee may have in any other broadcast station.

(b) A supplemental ownership report (FCC Form 323) shall be filed by each licensee or permittee within 30 days after any change occurs in the information required by the ownership report (the application or construction permit in the case of a permittee who has not filed an ownership report) from that previously reported. Such report shall include without limitation:

- (1) Any change in capitalization or organization.
- (2) Any change in officers or directors or in operating personnel determining program policy.
- (3) Any transaction affecting the ownership, direct or indirect, or voting rights of licensee's or permittee's stock, such as (i) a transfer of stock (ii) issuance of new stock or disposition of treasury stock, (iii) acquisition of licensee's or permittee's stock by the issuing corporation.
- (4) Any change in the officers, directors or stockholders of a corporation other than the licensee or permittee such as X, Y or Z Corporation described in the example above; provided, however, that in the case of a change in the officers, directors or stockholders of a corporation other than the licensee or permittee (such as X, Y, or Z Corporation described in the example above), such change need not be reported in the supplemental report unless that corporation directly or indirectly owns 25% or more of the voting stock in the licensee or permittee.²³

(c) Exceptions. Where information is required under paragraphs (a) or (b) of this section with respect to a corporation having more than 50 stockholders, such information need be filed only with respect to stockholders who are officers or directors of the corporation, or of other stockholders who have 1% or more of the stock of the corporation.

§1.344 Definitions of terms used in Section 1.341-1.343.—As used in Sections 1.341-1.343:

- (a) "Stock" shall include any interest, legal or beneficial in, or right or privilege in connection with stock.
- (b) "Officer" or "director" shall include the comparable officials in unincorporated associations.
- (c) "Contract" shall include any agreement (including, without limitation, an option, trust, or pledge) or any modification thereof, express or implied, oral or written.

License Renewals

GENERAL . . .

§1.320 Application for renewal of license; broadcast and nonbroadcast.—(a) Unless otherwise directed by the Commission, each application for renewal of license of a standard broadcast, fm broadcast, non-commercial educational fm broadcast, and television broadcast station and an auxiliary broadcast station (remote pickup broadcast, broadcast STL, television pickup, television STL and television inter-city relay) shall be filed at least 90 days prior to the expiration date of the license sought to be renewed; and each application for renewal of license of a nonbroadcast station shall be filed at least 60²⁴ days prior to the expiration date of the license sought to be renewed. No application for renewal of license of a broadcast station²⁵ will be considered unless there is on file with the Commission the information currently required by Sections 1.341-1.344, in reference to which by date and file number shall be included in the application.

(b) Whenever the Commission regards an application for a renewal of license as essential to the proper conduct of a hearing or investigation, and specifically directs that it be filed by a certain date, such application shall be filed within the time thus specified. If the licensee fails to file such application within the prescribed time, the hearing or investiga-

tion shall proceed as if such renewal application had been received.

(c) The following application forms should be used: [EDITOR'S NOTE: There follows a list of forms to be used in filing for license renewals.]

IN AM RULES . . .

§3.34 Normal license period.—(a) All standard broadcast station licenses will be issued for a normal license period of three years. Licenses will be issued to expire at the hour of 3:00 a.m., Eastern Standard Time, in accordance with the following schedule, and at three-year intervals thereafter:

[EDITOR'S NOTE: Expiration dates for licenses began Aug. 1, 1951 for stations in Delaware and Pennsylvania, are listed chronologically thereafter for stations in groups of other states down to June 1, 1954 for stations in New Jersey and New York.]

IN FM RULES . . .

Commercial Stations

§3.128 Normal license period.—(a) All fm broadcast station licenses will be issued for a normal license period of three years. Licenses will be issued to expire at the hour of 3:00 a.m., Eastern Standard Time, in accordance with the following schedule and at three-year intervals thereafter:

[EDITOR'S NOTE: Expiration dates for licenses began Aug. 1, 1951 for stations in Delaware and Pennsylvania, are listed chronologically thereafter for stations in groups of other states down to June 1, 1954 for stations in New Jersey and New York.]

Station Identification

IN AM RULES . . .

§3.187 Station identification.—(a) A licensee of a standard broadcast station shall make station identification announcement (call letters and location) at the beginning and ending of each time of operation and during operation (1) on the hour and (2) either on the half hour or at the quarter hour following the hour and at the quarter hour preceding the next hour: Provided,

(b) Such identification announcement need not be made on the hour when to make such announcement would interrupt a single consecutive speech, play, religious service, symphony concert, operatic production or forum of longer duration than 30 minutes. In such cases the identification announcement shall be made at the beginning of the program, at the first interruption of the entertainment continuity, and at the conclusion of the program.

(c) Such identification announcement need not be made on the half hour or quarter hours when to make such an announcement would interrupt a single consecutive speech, play, religious service, symphony concert or operatic production. In such cases an identification announcement shall be made at the first interruption of the entertainment continuity and at the conclusion of the program. Provided, That an announcement within 5 minutes of the times specified in subdivision (2) or paragraph (a) of this section will satisfy the requirements of identification announcements.

(d) In the case of variety show programs, baseball game broadcasts, or similar programs of longer duration than 30 minutes, the identification announcement shall be made within 5 minutes of the hour and of the times specified in subdivision (2) of paragraph (a) of this section.

(e) In the case of all other programs the identification announcement shall be made within 2 minutes of the hour and of the times specified in subdivision (2) of paragraph (a) of this section.

(f) In making the identification announcement the call letters shall be given only on the channel of the station identified thereby, except as otherwise provided in §3.287 of the Commission's Rules Governing fm Broadcast Stations.

IN FM RULES . . .

§3.287 Station identification.—(a) A licensee of an fm broadcast station shall make separate station identification announcement (call letters and location) for such station. Provided, however, that if the same licensee operates an fm radio broadcasting station and a standard broadcast station and simultaneously broadcasts the same programs over the facilities of both such stations, station identification announcements may be made jointly for both stations for periods of such simultaneous operation. If the call letters of the fm station do not clearly reveal that it is an fm station, the joint announcement shall state that one of the stations is an fm station. Station identification announcement shall be made at the beginning and ending of each time of operation and during operation (1) on the hour and (2) either on the half hour or at the quarter hour following the hour and at the quarter hour preceding the next hour: Provided:

[EDITOR'S NOTE: Remainder is identical with paragraphs (b), (c), (d), (e), and (f) of §3.187 above.]

Sponsored Programs

(Announcement of)

IN AM RULES . . .

§3.189 Sponsored programs, announcement of.—(a) In the case of each program for the broadcasting of which money, services, or other valuable consideration is either directly or indirectly paid or promised to, or charged or received by, any radio broadcast station, the station broadcasting such program shall make, or cause to be made, an appropriate announcement that the program is sponsored, paid for, or furnished, either in whole or in part.

(b) In the case of any political program or any program involving the discussion of public controversial issues for which any records, transcriptions, talent, scripts, or other material or services of any kind are furnished, either directly or indirectly, to a station as an inducement to the broadcasting of such program, an announcement shall be made both at the beginning and conclusion of such program on which such material or services are used that such records, transcriptions, talent, scripts, or other material or services have been furnished to such station in connection with the broadcasting of such program: Provided, however, That only one such announcement need be made in the case of any such program of five minutes' duration or less, which announcement may be made either at the beginning or the conclusion of the program.

(c) The announcement required by this section shall fully and fairly disclose the true identity of the person or persons by whom or in whose behalf such payment is made or promised, or from whom or in whose behalf such services or other valuable consideration is received, or by whom the material or services referred to in subsection (b) hereof are furnished. Where an agent or other person contracts or otherwise makes arrangements with a station on behalf of another, and such fact is known to the station, the announcement shall disclose the identity of the person or persons in whose behalf such agent is acting instead of the name of such agent.

(d) In the case of any program, other than a program advertising commercial products or services, which is sponsored, paid for or furnished, either in whole or in part, or for which material or services referred to in subsection (b) hereof are furnished, by a corporation, committee, association or other unincorporated group, the announcement required by this section shall disclose the name of such corporation, committee, association or other unincorporated group. In each such case the station shall require that a list of the chief executive officers or members of the executive committee or of the board of directors of the corporation, committee, association or other unincorporated group shall be made available for public inspection at one of the radio stations carrying the program.

(e) In the case of programs advertising commercial products or services, an announcement stating the sponsor's corporate or trade name or the name of the sponsor's product, shall be deemed sufficient for the purposes of this section and only one such announcement need be made at any time during the course of the program.

IN FM RULES . . .

§3.289. [Editor's Note: Identical with §3.189 above.]

[EDITOR'S NOTE: In a statement issued in 1950, the FCC warned that the sponsor or his product must be identified by a distinctive name and not by one merely descriptive of the type of business or product. The following are acceptable, the Commission said: "Henry Smith offers you. . ." or "Smith Stove Co. offers you. . ." or Ajax Pens bring you. . ." The following are not acceptable: "Write to the Comb Man. . ." or "Send your money to Nylons, Box— . . ." or "This program is sponsored by your Sink Man. . ."]

Recordings and Transcriptions

(Identification of)

IN AM RULES . . .

§3.188 Mechanical records.—Each program broadcast which consists in whole or in part of one or more mechanical reproductions shall be announced in the manner and to the extent set out below.

(a) Each such program of longer duration than 30 minutes, consisting in whole or in part of one or more mechanical reproductions, shall be identified by appropriate announcement at the beginning of the program, at each 30-minute interval and at the conclusion of the program: Provided, however, that the identifying announcement at each 30-minute interval is not required in case of a mechanical reproduction consisting of a continuous uninterrupted speech, play, religious service, symphony concert or operatic production of longer than 30 minutes.

(b) Each such program of a longer duration than 5 minutes and not in excess of 30 minutes, consisting in whole or in part of one or more mechanical reproductions, shall be identified by an appropriate announcement at the beginning and end of the program.

(c) Each such program of five minutes or less, consisting in whole or in part of mechanical reproductions shall be identified by appropriate announcement immediately preceding the use thereof: Provided, however, that each such program of one minute or less need not be announced as such.

(d) In case a mechanical reproduction is used for background music, sound effects, station identification, program identification (theme music of short duration) or identification of the sponsorship of the

Have you seen and
tried the newest
PRESTO
EQUIPMENT?

Here is a sampling of the complete Presto line of precision disc and tape recording and reproducing equipment specifically designed for ease of operation and professional results.



**PRESTO PRECISION-ENGINEERED
"UNITIZED" TAPE RECORDER RC-11**

Presto's newest, most revolutionary tape recorder, the RC-11 is available in console (as shown) or for rack mounting. Has self-contained capstan drive with dual-speed motor plus two torque motors. Tape speed of 7½" and 15" per sec. with complete push-button operation. Takes reels up to 10½".



**PRESTO RELIABLE LONG-PLAYING
TAPE REPRODUCER PB-17**

Automatically reversible for continuous playback of background music. Frequency response uniform from 50 to 8,000 cps (±2 db). Tape speed: 3¾" per sec. Reels up to 14" dia. (4,800' of tape) with dual track. Mechanism will re-cycle or stop after 8-hours of play.

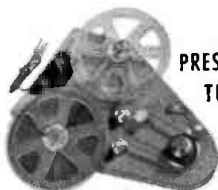

**PRESTO HIGH-QUALITY
TURNTABLE-DRIVEN
TAPE PLAYBACK
UNIT TL-10**

Powered by mounting on any standard 16" turntable. Equalized output of playback head can be fed directly into high-quality preamplifier, such as standard broadcast speech input equipment. Capstan for 7½" and 15" per sec. when table turns at 78 rpm. Ideal for low-cost, high-fidelity tape playback.



**PRESTO PRECISION FIELD
TAPE AMPLIFIER 900 A-3**

Here is the proper high quality, wide range amplifier to match Presto Tape Transport mechanisms RC-7 and RC-11. Separate power supply eliminates noise. Three microphone input, low distortion. 900 A-1 amplifier identical except for single input transformer.

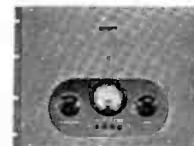

**PRESTO 92-B
RECORDING
AMPLIFIER
FOR VERTICAL
RACK MOUNTING**

Has low internal output impedance, high degree of feed-back and its response is virtually unaffected by changes in load. Holds distortion to minimum. 60-watt output ample for transient peaks. Push-button selector for recording characteristics. Vertical chassis with removable front panel for instant inspection or servicing.



**PRESTO 90-B
RECORDING
CONSOLE
FOR PORTABLE
OR FIXED USE**

The widely used 90-B features a 3-microphone mixer, input and output controls, has several fixed characteristics as well as variable high and low frequency controls, and V.U. meter. Switching and connectors for double turntable. Highest professional standard materials and workmanship... over-all performance equal to finest high-fidelity studio equipment.



**PRESTO
HIGH-PRECISION
STUDIO CONSOLE
RECORDER
8 D-G**

Unusually flexible in operation and easy to control. Cuts finest instantaneous and master recordings, with choice of seven different feed pitches, plus 250 lpi microgroove in each direction. Direct gear drive at 33⅓ and 76.26 rpm, either speed selected by double-throw switch. Transmission unit is simple, very rugged, and extremely accurate.



**PRESTO 16" TURNTABLE
10-B FOR RADIO STATIONS
AND RECORDING STUDIOS**

An improvement on the long popular model 10-A. Capable of continuous operation by non-technical personnel. Inexpensive and simple to service. Operates at 33⅓, 78 and 45 rpm. With its 3-speed mechanism, the Presto 10-B is an extremely accurate rim-driven table. Available as chassis only or in console cabinet.



**PRESTO PORTABLE,
HIGHLY ACCURATE
PROFESSIONAL-TYPE
RECORDER 6-N**

A fine, high-quality recorder for portable or stationary operation, whose dependability has made it a 15-year favorite here and abroad. Especially designed for professional users. Presto 1-D cutting head supplied. Equipped with precision overhead mechanism including spiraling feedscrew. May be equipped for microgroove recording at extra cost.



PRESTO RECORDING CORPORATION
PARAMUS, NEW JERSEY

Export Division: 25 Warren Street, New York 7, N. Y.
Canadian Division: Walter P. Downs, Ltd., Dominion Square Bldg., Montreal

WORLD'S LARGEST MANUFACTURER OF PRECISION RECORDING EQUIPMENT AND DISCS

program proper, no announcement of the mechanical reproduction is required.

(e) The exact form of identifying announcement is not prescribed, but the language shall be clear and in terms commonly used and understood. A licensee shall not attempt affirmatively to create the impression that any program being broadcast by mechanical reproduction consists of live talent.

IN FM RULES . . .

§3.288—[Editor's NOTE: Identical with §3.188, above.]

Political Broadcasts

FOR AM AND FM²³

§3.190 Definitions.—(a) A "legally qualified candidate" means any person who has publicly announced that he is a candidate for nomination by a convention of a political party or for nomination or election in a primary, special, or general election, municipal, county, state or national, and who meets the qualifications prescribed by the applicable laws to hold the office for which he is a candidate, so that he may be voted for by the electorate directly or by means of delegates or electors, whichever.

(1) has qualified for a place on the ballot or (2) is eligible under the applicable law to be voted by sticker, by writing in his name on the ballot, or other method, and (1) has been duly nominated by a political party which is commonly known and regarded as such, or (2) makes a substantial showing that he is a *bona fide* candidate for nomination or office, as the case may be.

(b) General requirements.—No station licensee is required to permit the use of its facilities by any legally qualified candidate for public office, but if any licensee shall permit any such candidate to use its facilities, it shall afford equal opportunities to all other such candidates for that office to use such facilities. Provided, That such licensee shall have no power of censorship over the material broadcast by any such candidate.

(c) Rates and practices.—The rates, if any, charged all such candidates for the same office shall be uniform and shall not be rebated by any means, directly or indirectly; no licensee shall make any discrimination in charges, practices, regulations, facilities, or services for or in connection with the service rendered pursuant to these rules, or make or give any preference to any candidate for public office or subject any such candidate to any prejudice or disadvantage; nor shall any licensee make any contract or other agreement which shall have the effect of permitting any legally qualified candidate for any public office to broadcast to the exclusion of other legally qualified candidates for the same public office.

(d) Records; inspections.—Every licensee shall keep and permit public inspection of a complete record of all requests for broadcast time made by or on behalf of candidates for public office, together with an appropriate notation showing the disposition made by the licensee of such requests, and the charges made, if any, if request is granted.

Rebroadcasts

IN AM RULES . . .

§3.191 Rebroadcast.—(a) The term "rebroadcast" means reception by radio of the program²⁴ of a radio station, and the simultaneous or subsequent retransmission of such program by a broadcast station.²⁴

(b) The licensee of a standard broadcast station may, without further authority of the Commission, rebroadcast the program of a United States standard or high frequency broadcast station, provided the Commission is notified of the call letters of each station rebroadcast and the licensee certifies that express authority has been received from the licensee of the station originating the program.²⁵

(c) (1) The licensee of a standard broadcast station located within a state or the District of Columbia may, without further authority of the Commission, rebroadcast on a noncommercial basis a noncommercial program of a United States international broadcast station.

(2) The licensee of a standard broadcast station located in any territory or insular possession of the United States may, without further authority of the Commission, rebroadcast any program of a United States international broadcast station.

(3) In the case of any rebroadcast under the provisions of this paragraph (c), the Commission shall be notified of the call letters of each station whose programs are rebroadcast and the licensee shall certify that express authority has been received from the licensee of the station originating the program.

(d) No licensee of a standard or high frequency broadcast station shall rebroadcast the program of any other class of United States radio station without written authority having first been obtained from the Commission upon application accompanied by written consent or certification of consent of the licensee of the station originating the program.²⁶

(e) In case of a program rebroadcast by several standard broadcast stations, such as a chain rebroadcast, the person legally responsible for distributing the program or the network facilities may obtain the necessary authorization for the entire rebroadcast both from the Commission and from the person or licensee of the station originating the program.

Attention is directed to section 325(b) of the Communications Act of 1934, which reads as follows:

No person shall be permitted to locate, use, or maintain a radio broadcast studio or other place or apparatus from which or whereby sound waves are converted into electrical energy, or mechanical or physical reproduction of sound waves produced, and caused to be transmitted or delivered to a radio station in a foreign country for the purpose of being

broadcast from any radio station there, having a power output of sufficient intensity, and/or being so located geographically that its emissions may be received consistently in the United States, without first obtaining a permit from the Commission upon proper application therefor.²⁷

IN FM RULES . . .

§3.291—[Editor's NOTE: Identical in terms with §3.191, above, with two exceptions: Paragraph (e) of §3.191 is deleted in §3.291, and Paragraph (b) relates to rebroadcasts of programs of U.S. "standard, FM or noncommercial educational" stations.]

Revocations, Modifications, Suspensions

OF STATION LICENSES (ALL CLASSES)

§1.401 Notice of violations.—Any licensee who appears to have violated any provision of the Communications Act of 1934 or of the Rules and Regulations of the Federal Communications Commission, shall be served with a notice calling the facts to his attention and requesting a statement concerning the matter. Within three days from receipt of such notice or such other period as may be specified, the licensee shall send a written answer direct to the office of the Commission originating the official notice. If an answer cannot be sent nor an acknowledgment made within such three-day period by reason of illness or other unavoidable circumstances, acknowledgment and answer shall be made at the earliest practicable date with a satisfactory explanation of the delay. The answer to each notice shall be complete in itself and shall not be abbreviated by reference to other communications or answers to other notices. If the notice relates to violations that may be due to the physical or electrical characteristics of transmitting apparatus, the answer shall state fully what steps, if any, have been taken to prevent future violations, and if any new apparatus is to be installed, the date such apparatus was ordered, the name of the manufacturer, and promised date of delivery. If the installation of such apparatus requires a construction permit, the file number of the application shall be given, or if a file number has not been assigned by the Commission such identification shall be given as will permit ready identification thereof. If the notice of violation relates to lack of attention to or improper operation of the transmitter, the name and license number of the operator in charge shall be given.

§1.402 Revocation of station licenses and construction permits and issuance of cease and desist orders.

(a) Whenever it appears that a station license or construction permit should be revoked for any of the reasons set forth in Section 312(a) of the Communications Act of 1934, as amended, or a cease and desist order should be issued for any of the reasons specified in Section 312(b) of the Act, the Commission will issue an order directing the licensee, permittee or person to show cause why an order of revocation or a cease and desist order, as the case may be, should not be issued.

(b) Any order to show cause issued in accordance with subsection (a) of this Section will contain a statement of the matters with respect to which the Commission is inquiring and will call upon the licensee or permittee or person to appear before the Commission at a time and place stated in the order, but in no event less than thirty (30) days before the receipt of such order, and give evidence upon the matter specified therein; except that where safety of life or property is involved, the Commission may provide in the order for a shorter period.

(c) In order to avail himself of the opportunity to appear before the Commission at the time and place stated in the show cause order to give evidence upon the matter specified therein, the licensee, permittee or person, in person or by his attorney, shall within 30 days of the receipt of the order, or such shorter period as may be specified therein if the safety of life or property is involved, file with the Commission, in triplicate, a written appearance stating that he will appear and present evidence on the matter specified in the order.

(d) Hearings on the matters specified in the order to show cause and the practice and procedure in connection therewith shall accord with the provisions of subparts F and G of this Part, except that in all such hearings the burden of proceeding with the introduction of evidence and burden of proof shall be upon the Commission, and except that the Commission may, where the circumstances of the proceeding require expedition, specify in the show cause order, or authorize the hearing examiner to specify by subsequent order, times within which the initial decision in such proceedings shall become effective, within which exceptions to such initial decision or replies thereto may be filed, and within which parties may file notice of intent to seek and participate in oral argument, less than those specified in §§ 1.853 and 1.854 of the Rules.

(e) If the licensee, permittee or person does not desire to appear before the Commission and give evidence upon the matter specified in the show cause order, he shall, within 30 days of the receipt of the order, or such shorter period as may be specified therein if the safety of life or property is involved, file with the Commission, in triplicate, a written waiver of hearing. Such waiver, which shall include the name of the licensee, permittee or person to whom the show cause order was addressed, the call letters of his station, if any, and the Docket Number of the proceeding, may be accompanied by a statement of reasons why the licensee, permittee or person believes that an order of revocation or a cease and desist order, as the case may be, should not be issued.

(f) If the licensee, permittee or person fails timely to respond to an order to show cause or fails to appear at a hearing, such failure will be deemed a waiver of hearing.

(g) If the licensee, permittee or person waives a hearing in accordance with the provisions of sub-

section (e) of this Section and fails to submit a statement therewith showing why he believes an order of revocation or a cease and desist order should not be issued, or if he is deemed to waive a hearing in accordance with the provisions of subsection (f) of this Section, the allegations specified in the order to show cause will be deemed to be admitted and a decision will be issued by the Commission invoking the sanction specified in the order to show cause. If a hearing is waived pursuant to subsection (e) of this Section but a written statement as to why an order of revocation or cease and desist order should not be issued is submitted, the Commission will, on the basis of the facts before it as supplemented by such written statement, issue a decision stating its reasons for invoking the sanction specified in the order to show cause or for dismissing the proceeding, as the case may be; Provided, that where the written statement contains factual allegations contrary to those upon which the show cause order was based the Commission may call upon the submitting party to furnish additional information under oath, or, if necessary, designate the proceeding for oral hearing. The decisions of the Commission referred to in this subsection shall have the same effect as an initial decision and the procedure to be followed thereafter shall be the same as in the case of an initial decision issued in the course of the regular hearing procedure.

(h) Any order of revocation or cease and desist order issued pursuant to this Section shall include a statement of the findings and the grounds and reasons therefor and specify the effective date of the order, and shall be served on said licensee, permittee or person.

§1.403 Modification of licenses.—Whenever it appears that public interest, convenience, and necessity would be served, or the provisions of the Communications Act, or if any treaty ratified by the United States will be more fully complied with, by the modification of any radio station construction permit or license, the Bureau of Law and Engineering after conferring with the other bureaus prepare a report and other necessary papers which are presented to the Commission for action. If the Commission concludes that proceedings should be instituted, an order will be issued to show cause why such construction permit or license should not be modified. Such order to show cause shall contain a statement of the grounds and reasons for such proposed modification, and shall specify wherein the said construction permit or license is required to be modified. It shall require the licensee against whom it is desired to appear at a place and time therein named to show cause why the proposed modification should not be made and the order of modification issued. If the licensee against whom the order to show cause is directed does not appear at the time and the place provided in said order, a final order of modification shall issue forthwith.

OF OPERATOR LICENSES . . .

§1.404 Suspension of operator licenses.—Whenever it appears that grounds exist for suspension of an operator license, as provided in Section 303 (m) of the Act, the Chief of the Safety and Special Radio Services Bureau, with respect to amateur operator licenses, or the Chief of the Field Engineering and Monitoring Bureau, with respect to commercial operator licenses, pursuant to authority delegated by the Commission, issues an order suspending the operator license. No order of suspension of any operator's license shall take effect until 15 days' notice in writing thereof, stating the cause for the proposed suspension, has been given to the operator licensee, who may make written application to the Commission at any time within said 15 days for a hearing upon such order. The notice to the operator licensee shall not be effective until actually received by him, and from that time he shall have 15 days in which to mail the said application. In the event that physical conditions prevent mailing of the application before the expiration of the 15-day period, the application shall then be mailed as soon as possible thereafter, accompanied by a satisfactory explanation of the delay. Upon receipt by the Commission of such application for hearing, said order of suspension shall be designated for hearing by the Chief, Safety and Special Radio Services Bureau or the Chief, Field Engineering and Monitoring Bureau, as the case may be, pursuant to authority delegated by the Commission, and said order of suspension shall be held in abeyance until the conclusion of the hearing, which shall be conducted under such rules as the Commission shall deem appropriate. Upon the conclusion of said hearing, the Commission may affirm, modify, or revoke said order of suspension. If the license is ordered suspended, the operator shall send his operator license to the office of the Commission in Washington, D. C., on or before the effective date of the order, or, if the effective date has passed at the time notice is received, the license shall be sent to the Commission forthwith.

Lotteries

FOR ALL STATIONS . . .

§3.192²⁸ Lotteries and Give-Away Programs.—(a) An application for construction permit, license, renewal of license, or any other authorization for the operation of a broadcast station, will not be granted where the applicant proposes to follow or continue to follow a policy or practice of broadcasting or permitting "the broadcasting of any advertisement of or information concerning any lottery, gift enterprise, or similar scheme, offering prizes dependent in whole or in part upon lot or chance or any list of the prizes drawn or awarded by means of any such lottery, gift enterprise, or scheme, whether said list contains any part or all of such prizes." (See U.S.C. §1304.)

(b) The determination whether a particular program comes within the provisions of subsection (a) depends on the facts of each case. However, the Commission will in any event consider that a pro-

FCC RULES

gram comes within the provisions of subsection (a) if in connection with such program a prize consisting of money or thing of value is awarded to any person whose selection is dependent in whole or in part upon lot or chance, if as a condition of winning or competing for such prize:

(1) such winner or winners are required to furnish any money or thing of value or are required to have in their possession any product sold, manufactured, furnished or distributed by a sponsor of a program broadcast on the station in question; or

(2) such winner or winners are required to be listening to or viewing the program in question on a radio or television receiver; or

(3) such winner or winners are required to answer correctly a question, the answer to which is given on a program broadcast over the station in question or where aid to answering the question correctly is given on a program broadcast over the station in question. For the purposes of this provision the broadcasting of the question to be answered over the radio station on a previous program will be considered as an aid in answering the question correctly; or

(4) such winner or winners are required to answer the phone in a prescribed manner or with a prescribed phrase, or are required to write a letter in a prescribed manner or containing a prescribed phrase, if the prescribed manner of answering the phone or writing the letter or the prescribed phrase to be used over the phone or in the letter (or an aid in ascertaining the prescribed phrase or the prescribed manner of answering the phone or writing the letter) is, or has been, broadcast over the station in question.

§1304 (of U. S. Criminal Code) *Broadcasting Lottery Information*.—Whoever broadcasts by means of any radio station for which a license is required by any law of the U. S., or whoever, operating any such station, knowingly permits the broadcasting of any advertisement of or information concerning any lottery, gift enterprise, or similar scheme, offering prizes dependent in whole or in part upon lot or chance, or any list of the prizes drawn or awarded by means of any such lottery, gift enterprise or scheme, whether said list contains any part or all of such prizes, shall be fined not more than \$1,000 or imprisoned not more than one year, or both.

Each day's broadcasting shall constitute a separate offense.

Censorship

FOR ALL STATIONS . . .

§326 (of Communications Act).—Nothing in this Act shall be understood to give the Commission the power of censorship over the radio communications or signals transmitted by any radio station, and no regulation or condition shall be promulgated or fixed by the Commission which shall interfere with the right of free speech by means of radio communication.

Indecent Language

§1464 (of U. S. Criminal Code) *Broadcasting Obscene Language*.—Whoever utters any obscene, indecent, or profane language by means of radio communication shall be fined not more than \$10,000 or imprisoned not more than two years, or both.

Transfers and Assignments

VOLUNTARY . . .

§1.321 *Application for voluntary assignment or transfer of control; broadcast*.—(a) Applications for consent to the assignment of construction permit or license for an am, fm, television or other broadcast station or for consent to the transfer of control of a corporation holding such a construction permit or license shall be filed with the Commission on FCC Form No. 314 (Assignment of License), FCC Form No. 315 (Transfer of Control), or FCC Form No. 316 (Short Form). Such applications shall be filed with the Commission at least 60 days prior to contemplated effective date of assignment or transfer of control.

(b) *Pro forma* assignment or transfer applications shall be filed on FCC Form 316. Such cases are defined as cases in which:

(1) There is an assignment from an individual or individuals (including partnerships) to a corporation owned and controlled by such individuals or partnerships without any substantial change in their relative interests;

(2) There is an assignment from a corporation to its individual stockholders without effecting any substantial change in the disposition of their interests;

(3) There is an assignment or transfer by which certain partners or stockholders retire but no new ones are brought in, provided that the interest transferred is not a controlling one;

(4) There is corporate reorganization which involves no substantial change in the beneficial ownership of the corporation;

(5) There is an involuntary transfer to an executor, administrator or other court appointed officer caused by death or legal disability except that this form does not cover assignments (or transfers) from the executor, administrator or other court appointed officers to the ultimate beneficiary;

(6) There is an assignment or transfer from a corporation to a wholly owned subsidiary thereof or vice versa, or where there is an assignment from a corporation to a corporation owned or controlled by

LEHIGH VERTICAL RADIATORS

Are Dependable,
Durable, And
Include Years
of Experience
in Designing
and
Fabricating
Antennas

Lehigh 340 Foot
Self-Supporting
Vertical Radiator
at
Radio Station
WNEW
Kearney, N. J.

CONSULT
RADIO DIVISION
LEHIGH STRUCTURAL STEEL CO.

17 BATTERY PLACE

NEW YORK 4, N. Y.

Offices in Principal Cities

PLANT AT ALLENTOWN, PA.



Collins 21E/M Broadcast Transmitters — The new Collins 5 kilowatt 21E and 10 kilowatt 21M AM broadcast transmitters give you superior performance from 550 kilocycles to 18 megacycles. Modern components and circuitry provide lower initial cost, minimum maintenance, minimum operating costs and maximum dependability.

Collins 12Z light weight, four-channel remote amplifier is ready to go anywhere at any time. It operates from the ac lines and features automatic instantaneous change-over to self-contained batteries when AC power fails.

Collins 212Y remote amplifier combines small size and light-weight with high fidelity. Its simple construction, installation, and operation make it ideal for non-technical personnel. Low cost of the 212Y suggests its permanent installation at points where pickups are made regularly. For example, it can be inconspicuously installed in a church or auditorium and turned on and off by the speaker at beginning and end of program.

Collins 212U remote amplifier. Easy to operate. Quickly set up. Reliable. It combines a 212Y described above with a 60H mixer to provide a convenient two-channel remote set-up.



you
name it...



Collins 212A speech input console. With facilities for auditioning or rehearsing, cueing and broadcasting simultaneously from any combination of two studios, an announce booth, a control room microphone, two turn-tables, and any two of nine remote lines. Two program amplifiers are included, making it possible to feed two independent programs at once. Or by operating the line reversal switch it provides an emergency amplifier for normal use. A novel rotating arrangement allows the console to be lifted forward and upward for access to the underside of the chassis without requiring additional space or interrupting operation. The 212A can be placed against a wall without sacrificing accessibility. Carefully engineered, expertly constructed throughout.



Collins 212B speech input console. Has the same outstanding features of construction and operation as the 212A. The only difference — smaller size, with fewer amplifiers and functional facilities. Unit amplifiers are individually mounted on airplane type shockmounts. The high fidelity 212B fills the needs of the smaller station, and is ideal for single studio control in larger stations. Facilities are provided for one program channel and an additional channel which functions with the self-contained monitor amplifier. The single program channel exactly duplicates one of the two channels in the 212A. Seven independent input channels are provided, including pre-amplified channels for four microphones and two transcription reproducers, and a high level input for any one of nine remote lines. High level transcription inputs can be supplied.

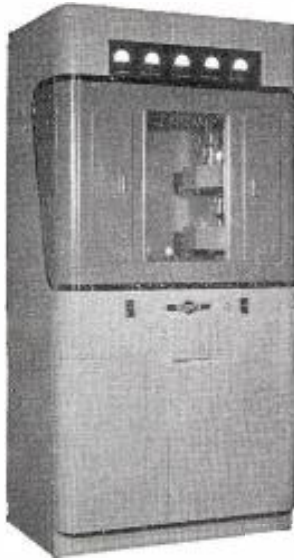

(Left) **Collins 300J** 250/100 watt AM broadcast transmitter.

(Right) **Collins 20V** 1000/500 watt AM broadcast transmitter — rear, open view.

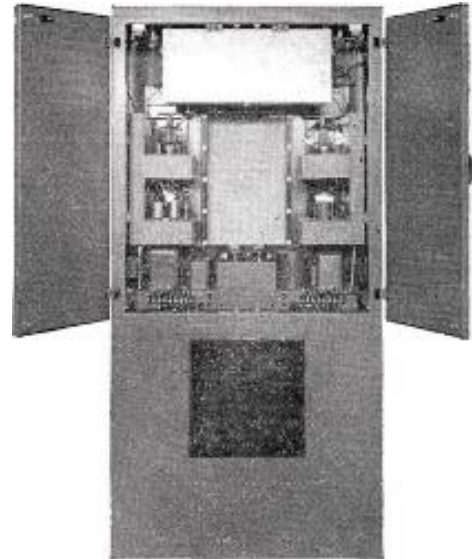

Like all of Collins modern transmitters, the 250 watt 300J and the 1000 watt 20V feature simplified trouble-free circuitry, and the latest high-gain tetrode tubes. The advanced engineering features of Collins transmitters spell economy and many years of continuous trouble-free operation.

Collins has it...

Everything for the modern broadcasting station from console to antenna tip

And when it's Collins, you know it's the best . . . in *engineering, performance, and styling*. This is no idle boast. Take engineering for example. In Collins transmitters, great simplification has been achieved in the circuits associated with the modulator and power amplifier stages through the use of high gain, long lived tetrodes. The result: these efficient tubes also permit the use of low drain, low cost tubes in the driver stages. Troublesome crystal ovens are eliminated entirely with frequency control

through new super stability crystals.

You get the benefits of advanced engineering in all Collins broadcast equipment — transmitters, in powers of 250 watts to 10 kilowatts, speech input consoles, remote amplifiers, rack mounted speech equipment, test and control equipment, custom designed audio equipment, transducers, and accessories for every need.

Get a Collins estimate before you buy. Get the best in modern broadcasting equipment. Contact your nearest Collins office, today.

MODERN BROADCASTING EQUIPMENT BY

COLLINS RADIO COMPANY

Cedar Rapids, Iowa

11 W. 42nd St.
NEW YORK 36

1930 Hi-Line Drive
DALLAS 2

2700 W. Olive Ave.
BURBANK

Dogwood Road, Fountain City
KNOXVILLE



the assignor stockholders without substantial change in their interests;

(7) There is an assignment of less than a controlling interest in a partnership.

EDITOR'S NOTE: In a statement issued by the FCC in 1948, licensees were warned that no transfers of station control are permitted until after Commission approval. The FCC also asked that licensees who are in doubt whether a transfer application is necessary bring ownership changes to the attention of the Commission to determine whether they are changes in control before consummating the transaction.]

INVOLUNTARY TRANSFERS AND ASSIGNMENTS

§1.323 Application for involuntary assignment or transfer of control; broadcast and nonbroadcast.— In the event of the death or legal disability of a permittee or licensee, or a member of a partnership, or a person directly or indirectly in control of a corporation, which is a permittee or licensee:

(a) the Commission shall be notified in writing promptly of the occurrence of such death or legal disability, and

(b) within thirty days after the occurrence of such death or legal disability (except in the case of a ship or amateur station), application shall be filed for consent to involuntary assignment of such permit or license or for involuntary transfer of control of such corporation to a person or entity legally qualified to succeed to the foregoing interests under the laws of the place having jurisdiction over the estate involved. The procedure and forms to be followed are the same as those specified in Sections 1.321 and 1.322. In the case of ship and amateur stations, involuntary assignment of licenses will not be made; such licenses shall be surrendered for cancellation upon the death or legal disability of the licensee.

Other definitions which may pertain to standard broadcast stations are included in sections 2.1 and 2.102 and the Communications Act of 1934, as amended.

The term "metropolitan district" as used in this paragraph is not limited in accordance with the definition given by the Bureau of the Census but includes any principal center of population in any area.

Formal applications required. See Standards of Good Engineering Practice, for number.

See money required to Construct and Complete Electrical Tests of Stations of Different Classes and Powers.

A station on 1010 kilocycles shall also protect a class I-B station at Havana, Cuba.

See North American Regional Broadcasting Agreement for use of this channel by a station in New York (Appendix I, Table IV.)

See Agreement with Mexico for further use of this channel.

See section 3.29 in regard to assigning class IV stations to regional channels.

See North American Regional Broadcasting Agreement for special provisions concerning the assigning of Class II stations in other countries of North America to these regional channels. Such stations shall be protected from interference in accordance with Appendix II, Table I, of said Agreement.

Pending action with respect to ratification and entry into force of the North American Regional Broadcasting Agreement, Washington, 1950 (referred to herein as NARBA), no assignment for a standard broadcast station will be made which would be inconsistent with the terms of that Agreement. (Remainder of footnote describes procedures to carry this out, also states that no assignments will be made conflicting with a duly notified station in nations not signatory to NARBA, i.e., Mexico and Haiti.)

In some of the territory contiguous to area 1, the demand for frequencies requires that applications be given careful study and consideration to insure an equitable distribution of facilities throughout the region. This region includes the remainder of Maryland, Pennsylvania, and New York (except the northeastern corner) not included in area 1; Virginia, West Virginia, North Carolina, South Carolina, Ohio and Indiana; southern Michigan as far north as Saginaw; eastern Illinois as far west as Rockford-Decatur; and southeastern Wisconsin as far north as Sheboygan. Other regions may be added as required.

For the purpose of determining equivalent coverage, the 1 mv/m contour should be used.

In the determination of appropriate coverage, consideration should be given to population distribution, terrain, service from other FM stations, trade area and other economic factors. Among the recognized trade area authorities are the following: J. Walter Thompson (Retail Shopping Areas), Hearst Magazines, Inc. (Consumer Trading Areas), Rand McNally Map Co. (Trading Areas) and Hagstrom Map Co. (Four Color Retail Trading Area Map).

The word "control" as used herein, is not limited to majority stock ownership but includes actual working control in whatever manner exercised.

In applying the foregoing provisions to the stockholders of a corporation which has more than 50 voting stockholders, only those stockholders need be considered who are officers or directors or who directly or indirectly own 1% or more of the outstanding voting stock.

Formal application required (Form 301).

As determined by the Standards of Good Engineering Practice Governing Standard Broadcast Stations and the North American Regional Broadcasting Agreement.

A person holding any class of radio operator license or permit who is authorized thereunder to perform limited operation of a standard broadcast station may, when a Conelrad Radio Alert

is called, make adjustments necessary to effect operation on a Conelrad authorization; Provided, that the station's full-time radiotelephone first-class operator shall have previously instructed such person in the adjustments to the transmitter which are necessary to accomplish Conelrad operation.

The term "network organization" as used herein includes national and regional network organizations. See Chapter VII, J, of Report on Chain Broadcasting.

As used in this section, an option is any contract, arrangement, or understanding, express or implied, between a station and a network organization which prevents or hinders the station from scheduling programs before the network agrees to utilize the time during which such programs are scheduled, or which requires the station to clear time already scheduled when the network organization seeks to utilize the time.

All time options permitted under this section must be for specified clock hours, expressed in terms of any time system set forth in the contract agreed upon by the station and network organization. Shifts from daylight saving to standard time or vice versa may or may not shift the specified hours correspondingly as agreed by the station and network organization.

These segments are to be determined for each station in terms of local time at the location of the station but may remain constant throughout the year regardless of shifts from standard to daylight saving time or vice versa.

Effective date of this section with respect to any station may be extended from time to time in order to permit the orderly disposition of properties; and it shall be suspended indefinitely with respect to regional network organizations.

The word "control" as used herein, is not limited to full control but includes such a measure of control as would substantially affect the availability of the station to other networks.

See footnote 24, above.

EDITOR'S NOTE: Regarding reports filed in compliance with these sections, §2.06(c) provides, in part: "The information filed under §1.341 and network and transcription contracts filed pursuant to §1.342 shall not be open to public inspection."

Any change in partners or in their rights will require prior consent of the Commission upon an application for consent to assignment of license.

Before any change is made in the organization, capitalization, officers, directors, or stockholders of a corporation other than licensee or permittee, which results in a change in the control of the licensee or permittee, prior Commission consent must be received under Sec. 310 (b) of the Communications Act.

The 60-day requirement does not apply to Amateurs.

This requirement does not apply to noncommercial educational fm broadcast stations.

During the annual periods in which Daylight Saving Time will be effective, the requirements of this section are waived with respect to network programs transcribed and rebroadcast one hour later because of the time differential resulting from the adoption of Daylight Saving Time in some areas, this waiver being applicable whether the off-the-line recording is made by the network itself at one of its key stations or by an individual station, but only when the off-the-line recording is for broadcast one hour later by those stations which operate on standard time. Furthermore, each station which broadcasts network programs one hour later in accordance with this waiver shall make an appropriate announcement at least once each day between the hours of 10 a.m. and 10 p.m., stating that some or all of the network programs which are broadcast by that station are delayed broadcasts by means of transcription, and indicating whether the transcriptions have been made by the network or the individual station. A network organization or individual station taking advantage of this waiver should so advise the Commission.

Sec. 3.190, reprinted here, is from am rules. In fm it is 3.290.

As used in Sec. 3.191, program includes any complete program or part thereof, or any signals if other than A-3 emission.

In case a program is transmitted from its point of origin to a broadcast station entirely by telephone facilities in which a section of such transmission is by radio, the broadcasting of this program is not considered a rebroadcast.

The notice and certification of consent shall be given within three (3) days of any single rebroadcast, but in case of the regular practice of rebroadcasting certain programs of a standard broadcast station several times during a license period, notice and certification of consent shall be given for the ensuing license period with the application for renewal of license, or at the beginning of such rebroadcast practice if begun during a license period.

The broadcasting of a program relayed by a remote pickup broadcast station (Sec. 4.401) is not considered a rebroadcast.

Informal application may be employed.

By Order No. 82, dated and effective June 24, 1941, until further order of the Commission, Section 3.191 (d) is suspended only insofar as it requires prior written authority of the Commission for the rebroadcasting of programs originated for that express purpose by U. S. Government radio stations.

Formal application required. See Standards of Good Engineering Practice for form number.

Effective date of the lottery rules was postponed by FCC until current court tests of their legality have been completed. The same is true of §3.292 (fm) which is identical to §3.192, reprinted here.

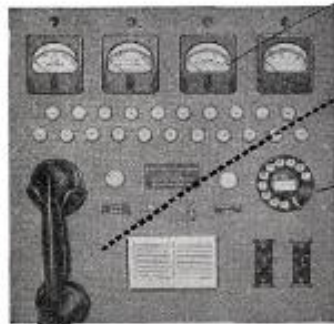

LINE UP THESE FEATURES — COMPARE THE COST

- the finest
- remote control
- system available ...
- positive control
- 20 metering circuits
- 40 control circuits

SCHAFFER REMOTE CONTROL SYSTEM

satisfied customers coast to coast
one year guarantee

two weeks delivery

complete — ready to install \$1570

Paul Schaffer Custom Engineering

2272 ALLESANDRO STREET
LOS ANGELES 39, CALIFORNIA
NO 2-2161

NON-COMMERCIAL EDUCATIONAL FM BROADCAST STATIONS

November 20, 1953

* Indicates construction permit only

City	Call	Licensee	Frequency	Effective Radiated Power	City	Call	Licensee	Frequency	Effective Radiated Power
ALABAMA					MINNESOTA				
Tuscaloosa	WUOA	U. of Alabama	91.7 mc	4.8 kw	St. Paul	WNOV	Northwest Vocational Institute	89.1 mc	10 w
ARIZONA					MISSISSIPPI				
Phoenix	KFCA	Phoenix College	88.5 mc	10 w	Meridian	WMMI	Meridian Municipal Junior College	88.1 mc	10 w
CALIFORNIA					MISSOURI				
Berkeley		Pacifica Foundation	89.3 mc	150 w	St. Louis	KSLH	Board of Education	91.5 mc	12.5 kw
Long Beach	KLON	U. of Southern California	91.5 mc	2.9 kw	NEW JERSEY				
Los Angeles	KUSC	Oceanside-Carlsbad Union High School District	89.7 mc	10 w	Newark	WBGO	Board of Education	88.3 mc	20 kw
Oceanside	KOEN	San Bernardino Valley Union Junior College District	91.9 mc	77 w	South Orange	WSOU	Seton Hall College	89.5 mc	2 kw
San Bernardino	KVCR*	San Diego Unified School District	88.3 mc	375 w	NEW MEXICO				
San Diego	KSDS	San Francisco Unified School District	91.7 mc	1.25 kw	Albuquerque	KANW	Board of Education	89.1 mc	350 w
San Francisco	KALW	San Mateo Junior College	90.9 mc	10 w	NEW YORK				
San Mateo	KCSM	U. of Santa Clara	90.1 mc	530 w	Brooklyn, NYC	WNYE	Board of Education	91.5 mc	20 kw
Santa Clara	KSCU*	Santa Monica School Board	89.9 mc	460 w	Floral Park	WSHS	Sewanhaka High School	90.3 mc	350 w
Santa Monica	KCRW	College of the Pacific	91.3 mc	3.4 kw	Ithaca	WITJ	Ithaca College	91.7 mc	10 w
Stockton	KCVN				New York	WFUV	Fordham U.	90.7 mc	3.5 kw
COLORADO					Springville	WSPE	Board of Education Central School District No. 1 of towns of Concord, Sardinia and Collins (Erie County) and Ashford, Yorkshire and East Otto (Cattaraugus County)	88.1 mc	10 w
Colorado Spgs.	KRCC	Colorado College	91.3 mc	10 w*	NORTH CAROLINA				
FLORIDA					Syracuse	WAER	Syracuse U.	88.1 mc	730 w
Lakeland	WFSI	Florida Southern College	88.1 mc	10 w	OHIO				
Miami	WTHS	Lindsey Hopkins Vocational School, Dade County Board of Public Instruction	91.7 mc	400 w	Athens	WOUI	Ohio U.	91.5 mc	10 w
Tallahassee	WFSU-FM*	Florida State U.	91.5 mc	10 w	Bowling Green	WBGU	Bowling Green State U.	88.1 mc	10 w
Tampa	WTUN	U. of Tampa	88.9 mc	770 w	Cleveland	WBOE	Board of Education	90.3 mc	10 kw
Winter Park	WPRK	Rollins College	91.5 mc	10 w	Columbus	WOSU-FM	Ohio State U.	89.7 mc	14 kw
GEORGIA					Delaware	WDLN	Ohio Wesleyan U.	91.1 mc	10 w
Atlanta	WABE	Board of Education	90.1 mc	4.8 kw	Kent	WKSU-FM	Kent State U.	88.1 mc	10 w
HAWAII					Oxford	WMUB	Miami U.	88.1 mc	10 w
Honolulu	KVOK	Kamehameha Schools	88.1 mc	10 w	Toledo	WTDS	Board of Education	91.3 mc	730 w
ILLINOIS					OKLAHOMA				
Chicago	WBEZ	Board of Education	91.5 mc	16 kw	Norman	WNAD-FM	State U. of Oklahoma	90.9 mc	7 kw
Elgin	WEPS	Board of Education Union School District No. 46	88.1 mc	10 w	Oklahoma City	KOKH	Board of Education	88.9 mc	7.6 kw
Evanston	WNUR	Northwestern University	89.3 mc	10 w	Shawnee	KBGC	Oklahoma Baptist U.	89.9 mc	10 w
Urbana	WIUC	U. of Illinois	91.7 mc	100 w	Tulsa	KWGS	U. of Tulsa	90.5 mc	1.1 kw
INDIANA					OREGON				
Evansville	WEVC	Evansville College	91.5 mc	1.9 kw	Eugene	KWAX	State U. of Higher Education	88.1 mc	10 w
Gary	WGVE*	School City of Gary	88.1 mc	10 w	Eugene	KRVM	School District No. 4, Lane County	89.3 mc*	400 w
Greencastle	WGRE	DePauw U.	91.7 mc	10 w	Oretech	KTEC	Oregon Technical Institute	88.1 mc	10 w
Huntington	WVSH	School City of Huntington	91.9 mc	10 w	PENNSYLVANIA				
Indianapolis	WAJC	Butler U.	91.9 mc	700 w	Havertown	WHHS	Haverford Township Senior High School	89.3 mc	10 w
Muncie	WWHI	Wilson Junior High School	91.5 mc	10 w	Philadelphia	WPWT	Philadelphia Wireless Technical Institute	91.7 mc	125 w
New Albany	WNAS	School City of New Albany	88.1 mc	10 w	Philadelphia	WRTI-FM	Temple U.	90.1 mc	10 w
New Castle	WYSN	New Castle Henry Township Schools	91.1 mc	10 w	Pittsburgh	WDUQ	Duquesne U.	91.7 mc	2.75 kw
Wabash	WSKS	School City of Wabash	91.3 mc	10 w	Scranton	WUSV	U. of Scranton	89.9 mc	10 w
IOWA					State College	WDFM*	Pennsylvania State College	91.1 mc	860 w
Ames	WOI-FM	Iowa State College of Agriculture and Mechanical Arts	90.1 mc	15.5 kw	RHODE ISLAND				
Des Moines	KDPS	Independent School District	88.1 mc	1.5 kw	Providence	WPPTL	Providence Bible Institute	91.5 mc	3.2 kw
Iowa City	KSUI	State U. of Iowa	91.7 mc	17.5 kw	SOUTH CAROLINA				
Waverly	KWAR	Wartburg Normal College	89.1 mc	10 w	Columbia	WUSC-FM	Extension Division, U. of South Carolina	89.9 mc	10 w
KANSAS					TENNESSEE				
Emporia	KSTE	Kansas State Teachers College	88.7 mc	350 w	Knoxville	WKCS	Fulton High School	91.1 mc	310 w
Lawrence	KANU	U. of Kansas	91.5 mc	35 kw	Knoxville	WUOT	U. of Tennessee	91.9 mc	3.4 kw
Manhattan	KSDB-FM	Kansas State College	88.1 mc	10 w	TEXAS				
Ottawa	KTJO-FM	Ottawa U.	88.1 mc	10 w	Abilene	KACC-FM	Abilene Christian College	91.9 mc	160 w
Wichita	KMUW	Municipal U. of Wichita	89.1 mc	10 w	Dallas	KSMU-FM	Southern Methodist U.	89.3 mc	10 w
KENTUCKY					Dallas	KVTT	Texas Trade School	91.7 mc	780 w
Lexington	WBKY	U. of Kentucky	91.3 mc	2.3 kw	El Paso	KVOF-FM	Texas Western College of U. of Texas	88.5 mc	10 w
Louisville	WFPL	Free Public Library	89.3 mc	150 w	Houston	KUHF	U. of Houston	91.3 mc	9.6 kw
Louisville	WFPK*	Free Public Library	91.9 mc	10 kw	Elainview	KHBL	Wayland Baptist College	88.1 mc	10 w
Louisville	WSDX	Southern Baptist Theological Seminary	90.3 mc	10 w	UTAH				
LOUISIANA					Ephraim	KEPH	Snow Branch Junior College	88.9 mc	10 w
Baton Rouge	WLSU	Louisiana State U.	91.7 mc	1.8 kw	Logan	KVSC	Utah State Agricultural College	88.1 mc	10 w
New Orleans	WBEH	P. G. Beauregard School	89.3 mc	10 w	WASHINGTON				
MARYLAND					Seattle	KUOW	U. of Washington	90.5 mc	3.4 kw
Baltimore	WBJC	Baltimore Junior College	88.1 mc	125 w	Tacoma	KTOY	Tacoma School District 10	91.7 mc	3.5 kw
MASSACHUSETTS					WISCONSIN				
Amherst	WMUA	U. of Massachusetts	91.1 mc	10 w	Chilton	WHKW	State Radio Council	89.3 mc	51 kw
Boston	WBUR	Boston U.	90.9 mc	20 kw	Colfax	WHWC	State Radio Council	88.3 mc	50 kw
Boston	WERS	Emerson College	88.9 mc	18 kw*	Delafield	WHAD	State Radio Council	90.7 mc	52 kw
Boston	WGBH	WGBH Educational Foundation	89.7 mc	16 kw	Highland	WHSA	State Radio Council	89.9 mc	50 kw
Springfield	WEDK*	School Committee of Springfield	91.7 mc	10 w	Holeman	WHLA	State Radio Council	90.3 mc	39 kw
MICHIGAN					Iowa County	WHHI	State Radio Council	91.3 mc	50 kw
Ann Arbor	WUOM	U. of Michigan	91.7 mc	44 kw	Madison	WHA-FM	State Radio Council	87.7 mc	22kw*
Detroit	WDTR	Board of Education	90.9 mc	2 kw	Wausau	WHRM	State Radio Council	91.9 mc	114 kw
East Lansing	WKAR-FM	Michigan State College	90.5 mc	9.7 kw					
Highland Park	WHPR	School District of City of Highland Park	88.1 mc	10 w					
Kalamazoo	WMCR	Western Michigan College of Education	91.1 mc	400 w					

HOW TO APPLY FOR A BROADCAST STATION LICENSE

Pertaining to Am, Fm, Television and Related Services

Any qualified citizen, firm, or group may apply to the Federal Communications Commission for authority to construct a commercial standard (am), frequency modulation (fm), or television (tv) broadcast station.

Licensing of these facilities is prescribed by the Communications Act of 1934, as amended, which sets up certain basic requirements. In general, applicants must satisfy the Commission that they are legally, technically and financially qualified, and that operation of the proposed station would serve the public convenience, interest or necessity. The Communications Act also recognizes broadcasting as a competitive industry and invests the Commission with the responsibility of allocating facilities so as to provide a fair, efficient, and equitable distribution of radio service.

The licensing procedure is detailed in Part 1 of the Commission's "Rules Relating to Practice and Procedure," while station operation is covered by Part 3, "Rules Governing Radio Broadcast Services," and, in the case of am and fm, "Standards of Good Engineering Practice."

Following is a summary of the consecutive steps required in applying for authorization to build and operate a commercial broadcast station. The application procedure is substantially the same whether the facility sought is for am, fm, or tv broadcast.

Selecting a Frequency

Standard (am) broadcast stations operate on "local," "regional," or "clear" channels. Local stations are of 100 to 250 watts power and serve smaller communities; station of 500 watts to 5 kilowatts power cover larger centers of population and surrounding areas; stations of 10 to 50 kilowatt maximum power are for large area coverage, particularly at night.

To determine whether an am frequency is available for assignment in a particular area, it is necessary for the applicant to have a frequency search made by a competent engineer. The Commission's engineering personnel cannot undertake to make such studies for prospective applicants.

An applicant for a commercial fm station must specify a frequency available to the area to be served. The Commission has tentatively allocated geographic blocks of frequencies to accommodate Class A stations (community) and Class B stations (metropolitan and rural) throughout the United States. The demand for fm stations has not yet exceeded the supply of available frequencies. (The Noncommercial Educational FM Broadcast Service is a separate category with its own rules.)

An applicant for a new television station must request a channel assigned in the Table of Assignments to the community involved. However, a channel assigned to any community listed in the table can be requested for operation in any unlisted community within 15 miles of the listed community. Commercial tv stations are authorized for unlimited hours of operation and are of a single class with minimum power determined by the size of the principal city and maximum power dependent on antenna height and allocation zone. Channels are reserved for noncommercial educational tv operation.

Applying for a Construction Permit

Once a prospective licensee has decided upon the type of station he wishes to apply for, the next step is to make application for a construction permit. (Under the Communications Act, no license shall be issued for a station prior to the construction of the station unless a permit for such construction has been granted by the Commission.) This applica-

CONCERNING FCC RULES & REGULATIONS

"How to apply for a Broadcast Station License" is a comprehensive and concise statement prepared by the FCC Office of Reports & Information, which explains in layman's language the procedures involved in making application for the various types of broadcast licenses.

Published in easy reference form, starting on page 419, are excerpts of the FCC Rules & Regulations most frequently used. Further information concerning rules and regulations may be obtained at the Office of the Secretary, FCC, New Post Office Bldg, Washington 25, D. C.

tion must be in writing on a form supplied by the Commission (Form 301, "Application for Authority to Construct a New Broadcast Station or Make Changes in an Existing Broadcast Station," which covers am, fm and tv broadcast). This form requires information about the citizenship and character of the applicant, as well as his financial, technical, and other qualifications to construct and operate a station, plus details about the transmitting apparatus to be used, and the proposed new service. Triplicate copies are required, one of which must be executed under oath or affirmation.

Application Processing

Applications are reviewed in their engineering, legal, and financial aspects by the Broadcast Bureau, which makes recommendations to the Commission.

Applications are, in general, processed in the order in which accepted for filing. There is a Temporary Processing Procedure for tv applications which, starting July 1, 1952, gives priority to places now without tv service, to communities with uhf assignments only, and to noncommercial educational tv applications.

If, upon examination of an application, the Commission determines that there are no engineering conflicts, that the applicant is qualified, and that all other requirements are met, the application is granted without hearing and a construction permit is issued.

Any grant made by the Commission without a hearing is subject to protest within a period of 30 days, during which the protesting party may request a hearing. Within 15 days thereafter the Commission must determine whether the objection merits a hearing.

The law requires that, in general, final decision on noncontested applications be rendered within three months from the date of the original filing, and within six months from the conclusion of a hearing in those cases which go through a hearing.

Hearings

Where it appears that an application violates provisions of the Commission's rules and regulations; that interference would be caused to another am or fm broadcast station; or that the minimum separation requirements for tv stations, are not met; or if other serious questions of a technical, legal, or financial character are involved, a hearing usually is required before a final decision on the application can be made. Often a hearing is necessary because two or more applicants seek to use the same frequency or immediately adjacent frequencies with such a proximity of stations that excessive interference would result. In such instances, the

Commission is compelled by law to accord a hearing to the competing applicants and to make a comparative judgment as to which, if either, should be granted.

If unable to grant an application, the Commission is required to notify the applicant and other known parties of interest as to the reason. The applicant usually is given 30 days in which to reply. After that, if the Commission is still unable to make a grant, a hearing is ordered.

In designating an application for hearing, the Commission gives public notice of the issues for the information of the applicant and other parties who may be concerned. The hearing notice generally allows the applicant a period of 30 days or more in which to prepare. Even after being designated for hearing, an applicant may sometimes find it possible to satisfy the issues by amending his application, especially if the apparent deficiencies are of an engineering nature.

All competing applications for the same facility are required to be on file at least 30 days before the start of the scheduled hearing. Broadcast hearings start with a conference for the purpose of working out stipulations of fact so as to reduce the hearing to bare essentials.

Hearings are customarily conducted by an examiner. The hearing examiner has authority to administer oaths, examine witnesses and rule upon the admission of evidence.

Within 20 days after the close of a record by the hearing examiner, each party and the Chief of the Broadcast Bureau of the Commission has the privilege of filing proposed findings of fact and conclusions in support of their contentions. After review of the evidence and statements, the hearing examiner issues an initial decision.

In the event he wishes to contest the initial decision, the applicant or any other interested party has 20 days from the date on which the initial decision was announced to file exceptions and to request oral arguments before the Commission. In all cases heard by the examiner, the Commission will hear oral argument on request of either party. After oral argument, the Commission may adopt, modify, or reverse the hearing examiner's initial decision. Within 30 days thereafter, any party involved may petition for rehearing.

If no exceptions are filed, and the Commission does not initiate a review of the hearing examiner's initial decision, the latter becomes effective 40 days after the issuance of the initial decision, unless otherwise ordered by the Commission.

Construction Permit

When and if an application meets statutory and other requirements, it is granted and a construction permit is issued. A maximum of 60 days from date of grant is provided in which construction shall begin, and a maximum of 6 months thereafter as the time for completion (or 8 months in all). Application to modify a broadcast construction authorization, or to make changes in an existing station, or to modify a license, is made on the same form (301) used in seeking initial construction authorization. If the permittee is unable to build his station within the time specified, he can apply for extension of time on Form 701 ("Application for Additional Time to Construct a Radio Station"), giving the reasons. Upon completion of construction the permittee can engage in equipment tests.

Licenses

The final step is to apply for the actual license. All applicants for broadcast license are required to fill out Form 302 ("Application for New Broadcast Station License"). Applicants must show compliance with all terms, conditions, and obligations set forth in the original application and the construction permit. After applying for a license and receiving authority from the Commission, the holder of a construction permit can conduct program tests. A station license is then issued if no new clause or circumstance has come to the attention of the Commission that would make operation of the station contrary to public interest.

Am and fm broadcast stations are licensed for the statutory limit of three years; tv stations for one year. Applications for renewal of license are made on Form 303 ("Application for Renewal of Broadcast Station License").

Forms for Other Purposes

If the holder of a construction permit or license desires to assign the same to someone else, he makes application on Form 314 ("Application for Consent to Assignment of Radio Broadcast Station Construction Permit or License").

Should the permittee or the licensee wish to transfer corporate control, he applies on Form 315 ("Application for Consent to Transfer Control of Corporation Holding Radio Broadcast Station Construction Permit or License").

In certain cases a permittee or licensee can apply for a transfer of corporate control or an assignment of license by using Form 316 ("Application for Assignment or Transfer—Short Form"). This form may only be used when the transfer or assignment is pro forma or technical in nature, i.e., where no substantial changes in interest occur.

RADIO & TV PRODUCTION IN 1953

	Television	Radio Home Sets	Radio Portables	Radio Auto	Radio Clock	Total Radio
January	719,234	361,921	93,962	447,667	189,592	1,093,142
February	730,597	402,742	87,711	491,062	210,924	1,192,439
March (5 wks)	810,112	442,101	177,656	654,367	275,079	1,549,203
April	567,878	286,974	201,476	483,092	198,394	1,158,936
May	481,936	278,156	204,065	497,379	129,391	1,108,991
June (5 wks)	524,479	287,724	239,189	505,774	131,144	1,163,831
July	316,289	172,197	78,434	336,208	87,620	674,459
August	603,760	299,939	145,460	376,937	169,301	991,637
September (5 wks)	770,085	529,427	147,355	357,326	182,417	1,216,525
October	680,433	370,178	135,009	358,076	189,230	1,052,493
November*	561,480	464,974	127,947	297,296	171,780	1,061,997
December** (5 wks)	550,000	500,000	125,000	300,000	100,000	1,025,000
	7,316,283	4,396,333	1,763,264	5,105,184	2,023,872	13,288,653

Source: Radio-Electronics-Television Manufacturers Association

* Preliminary

** Estimated

U. S. AM BROADCASTING STATIONS BY FREQUENCIES

(Licensed or Authorized by FCC as of January 1, 1954)

* CP granted for increase in power. † Construction permit for new station. ‡ Special authorization for power or frequency. CP—Construction permit for frequency. L—Limited time; operates night hours only when dominant station is not operating. DA—Directional antenna. D—Daytime operation. LS—Local sunset. N—Night. U—Unlimited time. SH—Specified hours. Class of Station shown in parentheses.

Call Letters	City	Power in Watts	Call Letters	City	Power in Watts	Call Letters	City	Power in Watts	Call Letters	City	Power in Watts
KFMB	San Diego, Calif. (II)	DA-5,000	KUTA	Salt Lake City, Utah (III-A)	DA-5,000	WIOD	Miami, Fla. (III-A)	DA-5,000	WESC	Greenville, S. C. (II)	D-5,000
†WDXN	Clarksville, Tenn. (II)	D-250	KVI	Seattle, Wash. (III-A)	5,000	WCEH	Hawkinsville, Ga. (III)	D-500	KSKY	Dallas, Tex. (II)	D-1,000
WRIC	Richland, Va. (II)	D-1,000	WMAM	Marinette, Wis. (IV)	LS-250	KDAL	Duluth, Minn. (III-A)	DA-N-5,000	†KFAR	Fairbanks, Alaska (III-A)	10,000
(CP from 1050 kc)									(Also see 610 kc)		
550 KC. REGIONAL											
KOY	Phoenix, Ariz. (III-A)	LS-5,000	WTUS	Tuskegee, Ala. (III)	D-500	WDAF	Kansas City, Mo. (III-A)	5,000	WMAQ	Chicago, Ill. (I-A)	50,000
KAFY	Bakersfield, Cal.	DA-1,000	KCNA	Tucson, Ariz. (III)	LS-5,000	KOJM	Havre, Mont. (III)	DA-1,000	680 KC. CLEAR		
KFMB	San Diego, Cal. (III-B)	DA-1,000	KMJJ	Fresno, Cal. (III-A)	5,000	WMUR	Manchester, N. H. (III-B)	LS-5,000	KNBC	San Francisco, Cal. (I-B)	50,000
(CP for 540 kc)			WDBO	Orlando, Fla. (III-A)	DA-N-5,000	KGGM	Albuquerque, N. M. (III-A)	DA-N-5,000	WPIN	St. Petersburg, Fla. (II)	D-1,000
WGGA	Gainesville, Ga. (III)	LS-5,000	WGAC	Augusta, Ga. (III-B)	LS-5,000	WAYS	Charlotte, N. C. (III-B)	LS-5,000	WCTI	Corbin, Ky. (II)	DA-N-1,000
KFRM	Kansas City, Mo. (III)	DA-N-500	KFXD	Nampa, Ida. (III-B)	DA-N-1,000	WHKC	Columbus, O. (III-A)	DA-N-5,000	WCBM	Baltimore, Md. (II)	LS-10,000
†KXSD	St. Louis, Mo. (III-A)	DA-N-5,000	WILL	Urbana, Ill. (III-B)	DA-N-5,000	WIP	Philadelphia, Pa. (III-A)	DA-5,000	WNAC	Boston, Mass. (II)	DA-50,000
KOPR	Butte, Mont. (III-B)	DA-N-1,000	KSAC	Manhattan, Kan. (III-B)	LS-5,000	KLBS	Houston, Tex. (III-A)	DA-5,000	WDBC	Escanaba, Mich.	DA-1,000
WGR	Buffalo, N. Y. (III-A)	DA-N-5,000	WIBW	Topeka, Kan. (III-A)	DA-N-5,000	KVNU	Logan, Utah (III-B)	DA-N-1,000	KFEQ	St. Joseph, Mo. (II)	DA-5,000
KFYR	Bismarck, N. D. (III-A)	DA-N-5,000	KALB	Alexandria, La. (III-B)	LS-5,000	WSLS	Roanoke, Va. (III-B)	DA-1,000	WINR	Binghamton, N. Y.	LS-1,000
†WKRC	Cincinnati, O. (III-B)	LS-5,000	WTAG	Worcester, Mass. (III-A)	DA-5,000	KWIE	Kennewick, Wash. (III)	DA-N-1,000	WRNY	Rochester, N. Y. (II)	D-250
KOAC	Corvallis, Ore. (III-A)	DA-5,000	WHP	Harrisburg, Pa. (III-A)	DA-N-5,000	†KUAM	Agana, Guam (III)	1,000	WPTF	Raleigh, N. C. (II)	DA-N-50,000
WHLM	Bloomington, Pa. (III)	DA-500	KDAV	Lubbock, Tex. (III)	DA-D-500	KFAR	Fairbanks, Alaska (III-A)	5,000	WISR	Butler, Pa. (II)	D-250
WPAW	Pawtucket, R. I. (III)	D-1,000	WCHS	Charleston, W. Va. (III-A)	DA-N-5,000	†KXSD	St. Louis, Mo. (III-A)	DA-N-5,000	WMPS	Memphis, Tenn. (II)	LS-10,000
KCRS	Midland, Tex. (III-B)	DA-U-N-1,000	WKTU	La Crosse, Wis. (III-B)	DA-1,000	WAGA	Atlanta, Ga. (III-A)	DA-N-5,000	KGBS	San Antonio, Tex. (II)	LS-50,000
KTSA	San Antonio, Tex. (III-A)	DA-N-5,000	KABI	Ketchikan, Alaska (III)	LS-1,000	KID	Idaho Falls, Ida. (III)	LS-5,000	WAPA	San Juan, P. R. (II)	10,000
WDEV	Waterbury, Vt. (III-B)	DA-1,000	WKAQ	San Juan, P. R. (III-A)	5,000	WVNL	Lexington, Ky. (III-B)	DA-1,000	690 KC. (Canadian) CLEAR		
WSVA	Harrisonburg, Va. (III)	DA-N-1,000	WRAG	Carrollton, Ala.	D-1,000	WVNY	Newark, N. J. (III-A)	DA-5,000	WVOK	Birmingham, Ala. (II)	DA-D-50,000
WOSA	Wausau, Wis.	DA-5,000	KBHS	Hot Springs, Ark. (III)	D-1,000	WAGE	Syracuse, N. Y. (III-B)	LS-5,000	KGPH	Flagstaff, Ariz. (II)	LS-1,000
KENI	Anchorage, Alaska (III-A)	5,000	KFXM	San Bernardino, Cal. (III-B)	DA-1,000	WJDX	Jackson, Miss. (III-B)	DA-N-1,000	KEVT	Tucson, Ariz. (II)	D-250
KMVI	Wailuku, T. H. (III-A)	1,000	KCSJ	Pueblo, Colo. (III-B)	DA-N-1,000	WVNJ	Newark, N. J. (III-A)	DA-5,000	KKBA	Benton, Ark. (II)	D-250
WPAB	Ponce, P. R. (III)	LS-1,000	WDLF	Panama City, Fla. (III-B)	DA-N-1,000	WAGF	Wilmington, N. C. (III-B)	DA-1,000	KGGF	Coffeyville, Kan. (II)	LS-10,000
550 KC. REGIONAL											
WOOF	Dothan, Ala. (III)	D-5,000	WAGA	Atlanta, Ga. (III-A)	DA-N-5,000	WGW	Portland, Ore. (III-A)	DA-5,000	WWEZ	New Orleans, La. (II)	DA-5,000
KYUM	Yuma, Ariz. (III-B)	DA-N-1,000	KID	Idaho Falls, Ida. (III)	LS-5,000	WHJB	Greensburg, Pa. (III-B)	LS-1,000	KSTL	St. Louis, Mo. (II)	D-1,000
KSFO	San Francisco, Cal. (III-A)	LS-5,000	WVLK	Lexington, Ky. (III-B)	DA-1,000	WROL	Knoxville, Tenn. (III-A)	DA-U-N-500	†KRCO	Prineville, Ore.	D-1,000
KLZ	Denver, Colo. (III-A)	DA-5,000	WEEI	Boston, Mass. (III-A)	DA-5,000	KWFT	Wichita Falls, Tex. (III-A)	DA-5,000	WHLM	Bloomington, Pa. (II)	DA-D-1,000
WQAM	Miami, Fla. (III-A)	LS-5,000	WKZO	Kalamazoo, Mich. (III-A)	DA-N-5,000	WCAX	Burlington, Vt. (III-A)	DA-5,000	KEPO	El Paso, Tex. (II)	DA-10,000
WIND	Chicago, Ill. (III-A)	DA-5,000	WOW	Omaha, Neb. (III-A)	5,000	WVNY	Newark, N. J. (III-A)	DA-5,000	KPET	Lamesa, Tex. (II)	250
WMIK	Middlesboro, Ky. (III)	D-500	WROW	Albany, N. Y. (III-B)	LS-5,000	WVNY	Newark, N. J. (III-A)	DA-5,000	KSCV	Richfield, Utah (II)	D-1,000
WGAN	Portland, Me. (III-A)	DA-5,000	WGTU	Wilson, N. C. (III-A)	DA-5,000	WVNY	Newark, N. J. (III-A)	DA-5,000	WCVB	Bristol, Va. (II)	D-10,000
WHYN	Springfield, Mass. (III-B)	DA-1,000	WGTU	Wilson, N. C. (III-A)	DA-5,000	WVNY	Newark, N. J. (III-A)	DA-5,000	WNNT	Warsaw, Va. (II)	D-250
KWTO	Springfield, Mo. (III-B)	LS-5,000	WGTU	Wilson, N. C. (III-A)	DA-5,000	WVNY	Newark, N. J. (III-A)	DA-5,000	KULA	Honolulu, T. H. (II)	10,000
KMON	Great Falls, Mont. (III-A)	DA-N-1,000	WGTU	Wilson, N. C. (III-A)	DA-5,000	WVNY	Newark, N. J. (III-A)	DA-5,000	700 KC. CLEAR		
WGAI	Elizabeth City, N. C. (III-A)	LS-1,000	WGTU	Wilson, N. C. (III-A)	DA-5,000	WVNY	Newark, N. J. (III-A)	DA-5,000	WLW	Cincinnati, O. (I-A)	50,000
†WMDL	Meyersdale, Pa. (III)	D-500	WGTU	Wilson, N. C. (III-A)	DA-5,000	WVNY	Newark, N. J. (III-A)	DA-5,000	710 KC. CLEAR		
WFIL	Philadelphia, Pa. (III-A)	DA-5,000	WGTU	Wilson, N. C. (III-A)	DA-5,000	WVNY	Newark, N. J. (III-A)	DA-5,000	WKRG	Mobile, Ala. (II)	LS-1,000
WIS	Columbia, S. C. (III-A)	DA-N-5,000	WGTU	Wilson, N. C. (III-A)	DA-5,000	WVNY	Newark, N. J. (III-A)	DA-5,000	KMPC	Los Angeles, Cal. (II)	LS-50,000
WHBQ	Memphis, Tenn. (III-B)	LS-5,000	WGTU	Wilson, N. C. (III-A)	DA-5,000	WVNY	Newark, N. J. (III-A)	DA-5,000	WGBS	Miami, Fla. (II)	LS-50,000
KFDM	Beaumont, Tex. (III-A)	DA-U-N-1,000	WGTU	Wilson, N. C. (III-A)	DA-5,000	WVNY	Newark, N. J. (III-A)	DA-5,000	WROM	Rome, Ga. (II)	DA-U-N-10,000
KPQ	Wenatchee, Wash. (III-A)	DA-N-5,000	WGTU	Wilson, N. C. (III-A)	DA-5,000	WVNY	Newark, N. J. (III-A)	DA-5,000	KTBS	Shreveport, La. (II)	LS-10,000
WJLS	Beckley, W. Va. (III-B)	LS-5,000	WGTU	Wilson, N. C. (III-A)	DA-5,000	WVNY	Newark, N. J. (III-A)	DA-5,000	WHB	Kansas City, Mo. (II)	DA-U-N-5,000
570 KC. REGIONAL											
WGWD	Gadsden, Ala. (III)	D-1,000	WGTU	Wilson, N. C. (III-A)	DA-5,000	WVNY	Newark, N. J. (III-A)	DA-5,000	WOR	New York, N. Y. (I-B)	DA-50,000
KCNO	Alturas, Cal. (III)	D-1,000	WGTU	Wilson, N. C. (III-A)	DA-5,000	WVNY	Newark, N. J. (III-A)	DA-5,000	WTPR	Paris, Tenn. (II)	D-250
KLAC	Los Angeles, Cal. (III-A)	LS-5,000	WGTU	Wilson, N. C. (III-A)	DA-5,000	WVNY	Newark, N. J. (III-A)	DA-5,000	KGNC	Amarillo, Tex. (II)	DA-10,000
WGMS	Washington, D. C. (III)	D-1,000	WGTU	Wilson, N. C. (III-A)	DA-5,000	WVNY	Newark, N. J. (III-A)	DA-5,000	KURV	Edinburg, Tex. (II)	D-250
WACL	Waycross, Ga.	D-1,000	WGTU	Wilson, N. C. (III-A)	DA-5,000	WVNY	Newark, N. J. (III-A)	DA-5,000	KIRO	Seattle, Wash. (I-B)	DA-N-50,000
WKYB	Paducah, Ky.	LS-1,000	WGTU	Wilson, N. C. (III-A)	DA-5,000	WVNY	Newark, N. J. (III-A)	DA-5,000	WDSM	Superior, Wis. (II)	DA-N-5,000
WVMI	Biloxi, Miss. (II)	D-1,000	WGTU	Wilson, N. C. (III-A)	DA-5,000	WVNY	Newark, N. J. (III-A)	DA-5,000	WKJB	Mayaguez, P. R. (II)	LS-1,000
WMCA	New York, N. Y. (III-A)	DA-5,000	WGTU	Wilson, N. C. (III-A)	DA-5,000	WVNY	Newark, N. J. (III-A)	DA-5,000	720 KC. CLEAR		
WSYR	Syracuse, N. Y. (III-A)	DA-5,000	WGTU	Wilson, N. C. (III-A)	DA-5,000	WVNY	Newark, N. J. (III-A)	DA-5,000	WGN	Chicago, Ill. (I-A)	50,000
WWNC	Asheville, N. C. (III-A)	DA-5,000	WGTU	Wilson, N. C. (III-A)	DA-5,000	WVNY	Newark, N. J. (III-A)	DA-5,000	730 KC. (Mexican) CLEAR		
WKBN	Youngstown, O. (III-A)	DA-N-5,000	WGTU	Wilson, N. C. (III-A)	DA-5,000	WVNY	Newark, N. J. (III-A)	DA-5,000	WJMW	Athens, Ala. (II)	D-500
WNAX	Yankton, S. D. (III-A)	DA-N-5,000	WGTU	Wilson, N. C. (III-A)	DA-5,000	WVNY	Newark, N. J. (III-A)	DA-5,000	WKTG	Thomasville, Ga. (II)	D-1,000
WFAA	Dallas, Tex. (III-A)	DA-5,000	WGTU	Wilson, N. C. (III-A)	DA-5,000	WVNY	Newark, N. J. (III-A)	DA-5,000	KGWB	Goodland, Kan. (II)	D-1,000
WBAP	Ft. Worth, Tex. (III-A)	DA-5,000	WGTU	Wilson, N. C. (III-A)	DA-5,000	WVNY	Newark, N. J. (III-A)	DA-5,000	WFMW	Madisonville, Ky. (II)	D-250
(See 820 kc)			WGTU	Wilson, N. C. (III-A)	DA-5,000	WVNY	Newark, N. J. (III-A)	DA-5,000	WMTG	Vanceville, Ky. (II)	D-1,000
(See 820 kc)			WGTU	Wilson, N. C. (III-A)	DA-5,000	WVNY	Newark, N. J. (III-A)	DA-5,000	KTRY	Bastrop, La. (II)	D-250
(See 820 kc)			WGTU	Wilson, N. C. (III-A)	DA-5,000	WVNY	Newark, N. J. (III-A)	DA-5,000	WARB	Covington, La. (II)	D-250
(See 820 kc)			WGTU	Wilson, N. C. (III-A)	DA-5,000	WVNY	Newark, N. J. (III-A)	DA-5,000	WACE	Chicopee, Mass. (II)	D-1,000
(See 820 kc)			WGTU	Wilson, N. C. (III-A)	DA-5,000	WVNY	Newark, N. J. (III-A)	DA-5,000	WVNY	Worthington, Minn. (II)	D-1,000
580 KC. REGIONAL											
WTUS	Tuskegee, Ala. (III)	D-500	WGTU	Wilson, N. C. (III-A)	DA-5,000	WVNY	Newark, N. J. (III-A)	DA-5,000	WVNY	Worthington, Minn. (II)	D-1,000
KCNA	Tucson, Ariz. (III)	LS-5,000	WGTU	Wilson, N. C. (III-A)	DA-5,000	WVNY	Newark, N. J. (III-A)	DA-5,000	WVNY	Worthington, Minn. (II)	D-1,000
KMJJ	Fresno, Cal. (III-A)	5,000	WGTU	Wilson, N. C. (III-A)	DA-5,000	WVNY	Newark, N. J. (III-A)	DA-5,000	WVNY	Worthington, Minn. (II)	D-1,000
WDBO	Orlando, Fla. (III-A)	DA-N-5,000	WGTU	Wilson, N. C. (III-A)	DA-5,000	WVNY	Newark, N. J. (III-A)	DA-5,000	WVNY	Worthington, Minn. (II)	D-1,000
WGAC	Augusta, Ga. (III-B)	LS-5,000	WGTU	Wilson, N. C. (III-A)	DA-5,000	WVNY	Newark, N. J. (III-A)	DA-5,000	WVNY	Worthington, Minn. (II)	D-1,000
KFXD	Nampa, Ida. (III-B)	DA-N-1,000	WGTU	Wilson, N. C. (III-A)	DA-5,000	WVNY	Newark, N. J. (III-A)	DA-5,000	WVNY	Worthington, Minn. (II)	D-1,000
WILL	Urbana, Ill. (III-B)	DA-N-5,000	WGTU	Wilson, N. C. (III-A)	DA-5,000	WVNY	Newark, N. J. (III-A)	DA-5,000	WVNY	Worthington, Minn. (II)	D-1,000
KSAC	Manhattan, Kan. (III-B)	LS-5,000	WGTU	Wilson, N. C. (III-A)	DA-5,000	WVNY	Newark, N. J. (III-A)	DA-5,000	WVNY	Worthington, Minn. (II)	D-1,000
WIBW	Topeka, Kan. (III-A)	DA-N-5,000	WGTU	Wilson, N. C. (III-A)	DA-5,000	WVNY	Newark, N. J. (III-A)	DA-5,000	WVNY	Worthington, Minn. (II)	D-1,000
KALB	Alexandria, La. (III-B)	LS-5,000	WGTU	Wilson, N. C. (III-A)	DA-5,000	WVNY	Newark, N. J. (III-A)	DA-5,000	WVNY	Worthington, Minn. (II)	D-1,000
WTAG	Worcester, Mass. (III-A)	DA-5,000	WGTU	Wilson, N. C. (III-A)	DA-5,000	WVNY	Newark, N. J. (III-A)	DA-5,000	WVNY	Worthington, Minn. (II)	D-1,000
WHP	Harrisburg, Pa. (III-A)	DA-N-5,000	WGTU	Wilson, N. C. (III-A)	DA-5,000	WVNY	Newark, N. J. (III-A)	DA-5,000	WVNY	Worthington, Minn. (II)	D-1,000
KDAV	Lubbock, Tex. (III)	DA-D-500	WGTU	Wilson, N. C. (III-A)	DA-5,000	WVNY	Newark, N. J. (III-A)	DA-5,000	WVNY	Worthington, Minn. (II)	D-1,000
WCHS	Charleston, W. Va. (III-A)	DA-N-5,000	WGTU	Wilson, N. C. (III-A)	DA-5,000	WVNY	Newark, N. J. (III-A)	DA-5,000	WVNY	Worthington, Minn. (II)	D-1,000
WKTU	La Crosse, Wis. (III-B)	DA-1,000	WGTU	Wilson, N. C. (III-A)	DA-5,000	WVNY	Newark, N. J. (III-A)	DA-5,000	WVNY	Worthington, Minn. (II)	D-1,000
KABI	Ketchikan, Alaska (III)	LS-1,000	WGTU	Wilson, N. C. (III-A)	DA-5,000	WVNY	Newark, N. J. (III-A)	DA-5,000	WVNY	Worthington, Minn. (II)	D-1,000
WKAQ	San Juan, P. R. (III-A)	5,000	WGTU	Wilson, N. C. (III-A)	DA-5,000	WVNY	Newark, N. J. (III-A)	DA-5,000	WVNY	Worthington, Minn. (II)	D-1,000
590 KC. REGIONAL											
WRAG	Carrollton, Ala.	D-1,000	WGTU								

STATIONS BY FREQUENCIES

Call Letters	City	Power in Watts	Call Letters	City	Power in Watts	Call Letters	City	Power in Watts	Call Letters	City	Power in Watts
740 KC. (Canadian) CLEAR			WJAT	Swainsboro, Ga. (II)	D-1,000	870 KC. CLEAR			KFNH	Shenandoah, Ia. (III-B)	LS-1,000
†WBAM	Montgomery, Ala. (II)	DA-D-50,000	KXIC	Iowa City, Ia. (II)	DA-D-1,000	KIEV	Glendale, Cal. (II)	D-250			N-500
KBIG	Avalon, Cal. (II)	DA-D-10,000	WRUS	Russellville, Ky. (II)	D-1,000	WWL	New Orleans, La. (I-A)	DA-50,000	WTCW	Whitesburg, Ky. (III)	D-1,000
KCBS	San Francisco (II)	DA-50,000	WBOK	New Orleans, La. (II)		WKAR	E. Lansing, Mich. (II)	D-5,000	†WVXY	Bogalusa, La. (III)	D-1,000
WORZ	Orlando, Fla. (II)	DA-1,000				WHCU	Ithaca, N. Y. (II)	LS-1,000	KDEL	Faribault, Minn. (III-B)	DA-1,000
		*LS-5,000	WCCM	Lawrence, Mass. (II)	D-1,000	WGTL	Kannapolis, N. C. (II)	D-1,000	KWAD	Wadena, Minn. (III-B)	DA-1,000
KLER	Lewiston, Ida. (II)	D-250	KREI	Farmington, Mo. (II)	D-1,000	KCBC	Farmville, Va. (II)	D-250	KRAM	Las Vegas, Nev. (III-B)	DA-N-1,000
WVUN	Olney, Ill. (II)	D-250	WKDN	Camden, N. J. (II)	D-1,000						LS-1,000
KBOE	Oskaloosa, Ia. (II)	D-250	KTOW	Oklahoma City, Okla. (II)		880 KC. CLEAR			KOLO	Reno, Nev. (III-B)	DA-1,000
WNOP	Newport, Ky. (II)	DA-D-1,000	KPDQ	Portland, Ore. (II)	D-250	WRZZ	New York, N. Y. (I-A)	50,000	WTTM	Trenton, N.J. (III-B)	DA-1,000
WTAO	Cambridge, Mass. (II)	D-250	WCHA	Chambersburg, Pa. (II)	D-1,000	WRFD	Worthington, O. (II)	D-5,000	WKRT	Cortland, N.Y. (III-B)	LS-1,000
KPBM	Carlsbad, N. M. (II)	D-1,000	WDSC	Dillon, S. C. (II)	D-1,000	890 KC. CLEAR			WBBB	Burlington, N. C. (III)	DA-N-500
WGSM	Huntington, N. Y. (II)	D-1,000	WEAB	Greer, S. C. (II)	D-250	WENR	Chicago, Ill. (I-A)	50,000	WGAL	Lebanon, Ore. (III)	D-5,000
WMBL	Morehead City, N. C. (II)	D-1,000	KDDD	Dumas, Tex. (II)	D-250	WLS	Chicago, Ill. (I-A)	50,000	KGAL	Lebanon, Ore. (III)	D-1,000
		D-1,000	KBUH	Brigham City, Utah (II)	D-250	WHNC	Henderson, N. C. (II)	D-1,000	WKVA	Lewistown, Pa. (III)	D-1,000
WPAQ	Mt. Airy, N. C. (II)	D-1,000	WSVS	Crewe, Va. (II)	D-1,000	KBYE	Oklahoma City, Okla. (II)	D-1,000	WJAR	Providence, R. I. (III-A)	DA-5,000
KRMG	Tulsa, Okla. (II)	LS-5,000	WHTN	Huntington, W. Va. (II)	D-1,000	900 KC. (Mexican) CLEAR			WTND	Orangeburg, S.C. (III)	D-1,000
		DA-U-N-25,000				WLBS	Birmingham, Ala. (II)	D-1,000	KELP	El Paso, Tex. (III)	D-1,000
WVCH	Chester, Pa. (II)	D-250	810 KC. CLEAR			WZOK	Ozark, Ala. (II)	D-1,000	KECK	Odessa, Tex. (III)	LS-1,000
WEAW	Barnwell, S. C. (II)	D-250	KGO	San Francisco, Cal. (I-B)	DA-50,000	KBIF	Sanger, Cal. (II)	D-1,000	KTLW	Texas City, Tex. (III)	D-1,000
WIRJ	Humboldt, Tenn. (II)	D-250	WASL	Annapolis, Md. (II)	D-250	WJWL	Georgetown, Del.	D-1,000	KXLY	Spokane, Wash. (III-A)	5,000
WJIG	Tullahoma, Tenn. (II)	D-250	KCMO	Kansas City, Mo. (II)	LS-50,000	WSWN	Belle Glade, Fla. (II)	D-1,000	WMMN	Fairmont, W. Va. (III-A)	DA-N-5,000
KTRH	Houston, Tex. (II)	DA-50,000	WGY	Schenectady, N. Y. (I-B)	50,000	WMOP	Ocala, Fla. (II)	D-1,000	WOKY	Milwaukee, Wis. (III)	DA-1,000
WIAC	Santurce, P. R. (II)	DA-10,000	WKBC	N. Wilkesboro, N. C. (II)	D-1,000	WCGA	Calhoun, Ga. (II)	D-1,000	KAHU	Waipahu, T. H. (III)	1,000
750 KC. CLEAR			WCEC	Rocky Mount, N. C. (II)	D-1,000	WJVV	Savannah, Ga. (II)	D-1,000	930 KC. REGIONAL		
WSB	Atlanta, Ga. (I-A)	50,000	WEDO	McKeesport, Pa. (II)	D-1,000	WKYW	Louisville, Ky. (II)	D-1,000	WETO	Gadsden, Ala. (III)	D-1,000
WBMD	Baltimore, Md. (II)	D-1,000	KIKI	Honolulu, T. H. (II)	1,000	WPIV	Pikeville, Ky. (II)	D-1,000	KHJ	Los Angeles, Cal. (III-A)	DA-5,000
KMMJ	Grand Island, Neb. (II)	LS-1,000	WKVM	San Juan, P. R.	DA-25,000	KREH	Oakdale, La. (II)	D-250	KIUP	Durango, Colo. (III)	DA-N-1,000
		N-L-1,000			(CP from 1070 kc)	WATC	Gaylord, Mich. (II)	D-1,000	WKSB	Milford, Del. (III)	DA-D-500
WHEB	Portsmouth, N. H. (II)	LS-1,000	WAIT	Chicago, Ill. (II)	LS-5,000	KTIS	Minneapolis, Minn. (II)	D-1,000	WJAX	Jacksonville, Fla. (III-A)	DA-N-5,000
		N-L-1,000			N-L-5,000	KFAL	Fulton, Mo.	D-1,000	KSEI	Pocatello, Ida. (III-A)	DA-N-5,000
KSEO	Durant, Okla. (II)	D-250	WCBBD	Chicago, Ill. (II)	D-5,000	KJSK	Columbus, Neb. (II)	D-1,000	WTAD	Quincy, Ill. (III-B)	LS-5,000
KXL	Portland, Ore. (II)	LS-10,000	WKYK	Evansville, Ind. (II)	D-250	WOTW	Nashua, N. H. (II)	D-1,000	WKCT	Bowling Green, Ky. (III)	LS-1,000
		DA-L-N-L-10,000	WOSU	Columbus, O. (II)	LS-5,000	†WSPN	Saratoga Springs, N. Y. (II)	D-250	WFMD	Frederick, Md. (III-B)	DA-N-1,000
WPDX	Clarksburg, W. Va. (II)	D-1,000	WFAA	Dallas, Tex. (I-A)	50,000	WAYN	Rockingham, N. C. (II)	D-1,000	WREB	Holyoke, Mass.	D-500
760 KC. CLEAR			WBAP	Fort Worth, Tex. (I-A)	50,000	WIAM	Williamston, N. C. (II)	D-1,000	WBCK	Battle Creek, Mich. (III-B)	DA-1,000
WJR	Detroit, Mich. (II)	50,000			(See 570 kc)	WAND	Canton, O. (II)	D-500	WSLI	Jackson, Miss. (III-A)	DA-N-5,000
WCPS	Tarboro, N. C. (I-A)	D-1,000	WCBT	Chicago, Ill. (II)	D-5,000	WFRO	Fremont, O. (II)	DA-1,000	KWOC	Poplar Bluff, Mo. (III)	LS-1,000
KGU	Honolulu, T. H. (II)	LS-2,500	WOSU	Columbus, O. (II)	LS-5,000	WPCA	Clearfield, Pa. (II)	D-1,000	WVNH	Rochester, N. H. (III)	D-1,000
		N-L-2,500	WFAA	Dallas, Tex. (I-A)	50,000	WKXV	Knoxville, Tenn. (II)	D-1,000	WPAT	Paterson, N.J. (III-A)	DA-N-5,000
770 KC. CLEAR			WBAP	Fort Worth, Tex. (I-A)	50,000	WCBR	Lebanon, Tenn. (II)	D-250	WBNB	Buffalo, N. Y. (III-A)	DA-N-5,000
KUOM	Minneapolis, Minn. (II)	D-5,000			(See 570 kc)	KALT	Atlanta, Tex. (II)	D-1,000	WIST	Charlotte, N. C. (III)	LS-5,000
WCAL	Northfield, Minn. (II)	D-5,000	WCCO	Minneapolis, Minn. (I-A)	50,000	KMCO	Conroe, Tex. (II)	DA-D-500	WRRF	Washington, N.C. (III)	LS-5,000
WEW	St. Louis, Mo. (II)	D-1,000	KBOA	Kennett, Mo. (II)	D-1,000	KFLD	Floydada, Tex. (II)	D-250	WEOL	Elyria, O. (III-B)	DA-1,000
†KOB	Albuquerque, N. M. (II)	LS-50,000	WNYC	New York, N. Y. (II)	LS-1,000	KCLW	Hamilton, Tex. (II)	D-250	WKY	Oklahoma City, Okla. (III-A)	DA-N-5,000
		N-25,000			DA-L-N-L-1,000	†WATK	Staunton, Va. (II)	D-1,000	KGAL	Lebanon, Ore. (III)	D-1,000
WABC	New York, N. Y. (I-A)	50,000	830 KC. CLEAR			WATC	Antigo, Wis. (II)	D-250	WCNR	Bloomington, Pa. (III)	D-1,000
KXA	Seattle, Wash. (II)	LS-1,000	WCCO	Minneapolis, Minn. (I-A)	50,000	†WGLT	Linnet, Ala. (III)	D-500	KSDN	Aberdeen, S. D. (III-B)	DA-N-1,000
		N-L-1,000	KBOA	Kennett, Mo. (II)	D-1,000	KPHO	Phoenix, Ariz. (III-A)	DA-N-5,000	KDET	Center, Tex. (III)	D-1,000
780 KC. CLEAR			WNYC	New York, N. Y. (II)	LS-1,000	KPFO	Phoenix, Ariz. (III-A)	DA-N-5,000	KITE	San Antonio, Tex. (III)	D-1,000
WBBM	Chicago, Ill. (I-A)	50,000	WCBT	Chicago, Ill. (II)	D-5,000	KLX	Oakland, Cal. (III-A)	DA-5,000	WSAZ	Huntington, W. Va. (III-B)	LS-5,000
WJAG	Norfolk, Neb. (II)	LS-1,000	WKYK	Evansville, Ind. (II)	D-250	KPOF	Denver, Colo. (III-A)	LS-5,000	WLBL	Stevens Point, Wis. (III)	D-5,000
		N-L-1,000	WOSU	Columbus, O. (II)	LS-5,000	WHAY	New Britain, Conn. (III-A)	DA-5,000	KTKN	Ketchikan, Alaska (III-A)	1,000
WCKB	Dunn, N. C. (II)	D-1,000	WFAA	Dallas, Tex. (I-A)	50,000	WGAF	Valdosta, Ga. (III-A)	DA-N-5,000	940 KC. (Mexican & Canadian) CLEAR		
WBBO	Forest City, N. C. (II)	D-1,000	WBAP	Fort Worth, Tex. (I-A)	50,000	WSUI	Iowa City, Ia. (III-A)	DA-5,000	KFRE	Fresno, Cal. (II)	DA-50,000
KSPI	Stillwater, Okla. (II)	D-250			(See 570 kc)	WLCS	Baton Rouge, La. (III)	DA-1,000	WINZ	Hollywood, Fla. (II)	LS-50,000
WARL	Arlington, Va. (II)	D-1,000	WHDH	Boston, Mass. (II)	DA-50,000	WABI	Bangor, Me. (III-A)	DA-N-5,000			DA-U-N-10,000
790 KC. CLEAR			WKBZ	Muskegon, Mich. (II)	DA-1,000	WFDF	Flint, Mich. (III-B)	DA-1,000	WMAZ	Macon, Ga. (II)	DA-10,000
KOSY	Texarkana, Ark. (III)	LS-1,000	KFUO	Clayton, Mo. (II)	LS-5,000	WCCO	Meridian, Miss. (III-A)	LS-5,000	WMX	Mt. Vernon, Ill. (II)	D-1,000
		DA-N-500	WNAO	Raleigh, N. C. (II)	LS-10,000	KBIM	Roswell, N. Mex. (III)	D-1,000	KIOA	Des Moines, Ia. (II)	LS-10,000
KABC	Los Angeles, Cal. (III-A)	DA-N-5,000	WJW	Cleveland, O. (II)	DA-5,000	†WLAS	Jacksonville, N. C. (III)	D-1,000	WTPS	New Orleans, La. (II)	LS-1,000
WLBE	Leesburg, Fla. (III-B)	DA-1,000	WEUW	Reading, Pa. (II)	DA-N-1,000	KCTB	Minot, N. D. (III)	DA-N-1,000	WESA	Charleroi, Pa. (II)	D-250
WQXI	Atlanta, Ga. (III)	LS-5,000	WCAV	Norfolk, Va. (II)	DA-1,000	WPPB	Middletown, O. (III)	LS-1,000	KLYN	Amarillo, Tex. (II)	DA-1,000
WGRA	Cairo, Ga. (III)	D-1,000	KTAC	Tacoma, Wash. (II)	DA-N-1,000	GLGC	Miami, Okla. (III-B)	DA-1,000	WIPR	Rio Piedras, P.R. (II)	DA-10,000
KXXX	Colby, Kan. (III)	D-5,000	KILA	Hilo, T. H. (II)	1,000	WAVL	Apollo, Pa. (III)	D-1,000	950 KC. REGIONAL		
WGRC	Louisville, Ky. (III-B)	LS-5,000	WNEL	San Juan, P. R. (II)	DA-10,000	WGBI	Scranton, Pa. (III-B)	LS-1,000	WRMA	Montgomery, Ala. (III)	D-1,000
		DA-U-N-1,000			(CP from 860 kc)	WJHL	Johnson City, Tenn. (III-A)	LS-5,000	KXJK	Forest City, Ark. (III)	D-1,000
WSGW	Saginaw, Mich. (III-B)	DA-1,000	860 KC. (Canadian) CLEAR			†WPEG	S. Pittsburg, Tenn. (III)	D-500	KFSA	Ft. Smith, Ark. (III-B)	LS-1,000
KGHL	Billings, Mont. (III-A)	DA-N-5,000	WAMI	Opp, Ala. (II)	D-1,000	KRIO	McAllen, Tex. (III-B)	DA-1,000	KFEL	Denver, Colo. (III-A)	DA-5,000
WVNY	Watertown, N. Y. (III-B)	DA-N-1,000	KIFN	Phoenix, Ariz. (II)	D-1,000	KRRV	Sherman, Tex. (III-B)	DA-1,000	WLOF	Orlando, Fla. (III-A)	DA-N-5,000
WTNC	Thomasville, N. C. (III)	D-1,000	KOSE	Osceola, Ark. (II)	D-1,000	KALL	Salt Lake City, Utah (III-B)	DA-1,000	WGTA	Summerville, Ga. (III)	D-1,000
KFGO	Fargo, N. D. (III-A)	DA-N-5,000	KWRF	Warren, Ark. (II)	D-250	WRNL	Richmond, Va. (III-A)	DA-N-5,000	WGOV	Valdosta, Ga. (III-A)	LS-5,000
KWIL	Albany, Ore. (III)	DA-1,000	KTRB	Modesto, Cal. (II)	LS-10,000	KVAN	Vancouver, Wash. (III-B)	DA-1,000			DA-U-N-1,000
WAEB	Allentown, Pa. (III-B)	LS-500	WKKO	Cocoa, Fla. (II)	DA-U-N-1,000	WDOR	Sturgeon Bay, Wis. (III)	D-500	WESA	Charleroi, Pa. (II)	D-250
WPIC	Sharon, Pa. (III)	DA-U-N-1,000	WERD	Atlanta, Ga. (II)	D-250	WFRP	Ponce, P. R. (III-A)	DA-5,000	KLYN	Amarillo, Tex. (II)	DA-1,000
WEAN	Providence, R. I. (III-A)	D-1,000	WDMG	Douglas, Ga. (II)	D-1,000	920 KC. REGIONAL			WIPR	Rio Piedras, P.R. (II)	DA-10,000
WETB	Johnson City, Tenn. (III)	DA-5,000	KWPC	Muscatine, Ia. (II)	D-250	WVWR	Russellville, Ala. (III)	D-1,000	930 KC. REGIONAL		
WMC	Memphis, Tenn. (III-A)	DA-N-5,000	KOAM	Pittsburg, Kans. (II)	LS-10,000	KARK	Little Rock, Ark. (III-A)	DA-N-5,000	WRMA	Montgomery, Ala. (III)	D-1,000
KTHT	Houston, Tex. (III-A)	DA-5,000	WSON	Henderson, Ky. (II)	D-500	†.....	Coachella, Calif. (III)	D-1,000	KXJK	Forest City, Ark. (III)	D-1,000
KFYO	Lubbock, Tex. (III)	LS-5,000	WNAW	North Adams, Mass. (II)	D-250	KVEC	San Luis Obispo, Cal. (III-B)	LS-1,000	KFSA	Ft. Smith, Ark. (III-B)	LS-1,000
†WSIG	Mt. Jackson, Va. (III)	D-1,000	KNUJ	New Ulm, Minn. (II)	D-1,000				KFEL	Denver, Colo. (III-A)	DA-5,000
WTAR	Norfolk, Va. (III-A)	DA-N-5,000	WFMO	Fairmont, N. C. (II)	D-1,000				WLOF	Orlando, Fla. (III-A)	DA-N-5,000
KVOS	Bellingham, Wash. (III-B)	DA-1,000	WHOD	Homestead, Pa. (II)	D-250				WGTA	Summerville, Ga. (III)	D-1,000
KNEW	Spokane, Wash. (III)	DA-5,000	WTEL	Philadelphia, Pa. (II)	D-250				WGOV	Valdosta, Ga. (III-A)	LS-5,000
WEAU	Eau Claire, Wis. (III-A)	DA-N-1,000	WLBG	Laurens, S. C. (II)	D-250						DA-U-N-1,000
KFRB	Fairbanks, Alaska (III)	5,000	WMTS	Knoxville, Tenn. (II)	D-1,000				KDSH	Boise, Ida. (III-A)	DA-N-5,000
800 KC. (Mexican) CLEAR			†KFST	Ft. Stockton, Tex. (II)	D-250				KOEL	Chicago, Ill. (III)	D-1,000
WHOS	Decatur, Ala. (II)	D-1,000	KPAN	Hereford, Tex. (II)	D-250				KJRG	Newton, Kans. (III)	D-500
WMGY	Montgomery, Ala. (II)	D-1,000	KSFA	Nacogdoches, Tex. (II)	D-1,000						
KVOM	Morrilton, Ark. (III)	D-250	KONO	San Antonio, Tex. (II)	LS-5,000						
WLAD	Danbury, Conn. (II)	D-250			DA-N-1,000						
WMBM	Miami Beach, Fla. (II)	D-1,000									

STATIONS BY FREQUENCIES

Call Letters	City	Power in Watts	Call Letters	City	Power in Watts	Call Letters	City	Power in Watts	Call Letters	City	Power in Watts
WORL	Boston, Mass. (III)	D-5,000	KREM	Spokane, Wash. (III)	DA-N-1,000	KMLW	Marlin, Tex.	D-250	WBAL	Baltimore, Md. (I-B)	DA-N-50,000
WWJ	Detroit, Mich. (III-A)	DA-N-5,000			*LS-5,000	WMEV	Marion, Va. (II)	D-1,000	WBMS	Boston, Mass. (II)	D-1,000
†KLIK	Jefferson City, Mo. (III)	D-5,000			*DA-N-1,000	WSFT	Stevens Point, Wis. (II)	D-250	WMUS	Muskegon, Mich. (II)	D-1,000
WBBF	Rochester, N. Y. (III-B)	DA-1,000	WWYO	Pineville, W. Va. (III)	D-1,000			1020 KC. CLEAR	KING	Seattle, Wash. (II)	DA-50,000
WIBX	Utica, N. Y. (III-A)	DA-5,000	WHA	Madison, Wis. (III)	D-5,000			LS-5,000			
†WPET	Greensboro, N. C. (III)	D-500	KHBC	Hilo, T. H. (III-A)	1,000			N-L-5,000			
WNCC	Barnesboro, Pa. (III)	D-500						D-1,000			
WPEN	Philadelphia, Pa. (III-A)	DA-N-5,000						D-1,000			
WSPA	Spartanburg, S. C. (III-A)	DA-N-5,000						50,000			
KWAT	Watertown, S. D. (III-B)	DA-N-1,000	WKLF	Clanton, Ala. (III)	D-1,000			1030 KC. CLEAR	KJBS	San Francisco, Cal. (II)	LS-1,000
WAGG	Franklin, Tenn. (III)	DA-N-1,000	KFWB	Los Angeles, Cal. (III-A)	5,000			D-250			
KDSX	Denison, Tex. (III)	DA-500	WRC	Washington, D. C. (III-A)	DA-N-5,000			1,000			
KPRC	Houston, Tex. (III-A)	DA-N-5,000						*50,000			
KSEL	Lubbock, Tex. (III-B)	LS-1,000	WKLY	Hartwell, Ga. (III)	D-1,000			D-50,000			
WXGI	Richmond, Va. (III)	D-1,000	WITY	Danville, Ill. (III)	DA-1,000			1,000			
KJR	Seattle, Wash. (III-A)	DA-N-5,000	KCLJ	Shreveport, La. (III)	D-5,000			D-50,000			
WKNA	Charleston, W. Va. (III-B)	LS-5,000	WCAP	Lowell, Mass. (III)	D-1,000			D-50,000			
		DA-U-N-1,000	WPBC	Minneapolis, Minn. (III)	D-1,000						
	960 KC. REGIONAL		†WABL	Columbia, Miss. (III)	D-1,000			1040 KC. CLEAR			
WBRC	Birmingham, Ala. (III-A)	DA-N-5,000	KMBC	Kansas City, Mo. (III)	D-500			WHO	Des Moines, Iowa (I-A)	50,000	
WMOZ	Mobile, Ala. (III)	D-1,000						KIXL	Dallas, Tex. (II)	D-1,000	
KOOL	Phoenix, Ariz. (III-A)	DA-N-5,000	KSGM	Ste. Genevieve, Mo. (III)	DA-N-5,000						
KROW	Oakland, Cal. (III-A)	D-5,000									
†KAVR	Victorville, Cal. (III)	D-5,000	KICA	Clovis, N. M. (III)	DA-N-1,000						
WELI	New Haven, Conn. (III-B)	DA-N-1,000	WTRY	Troy, N. Y. (III-A)	DA-5,000						
WRFC	Athens, Ga. (III)	LS-1,000	WAAA	Winston-Salem, N. C. (III)	D-1,000						
WSBT	South Bend, Ind. (III-A)	DA-5,000									
KMA	Shenandoah, Ia. (III-A)	DA-N-5,000	WONE	Dayton, O. (III-A)	DA-5,000						
WPRT	Prestonsburg, Ky. (III)	D-1,000	†WBTL	Emporium, Pa. (III)	D-500						
KROF	Abbeville, La. (III)	D-1,000	WLK	Wilkes-Barre, Pa. (III)	LS-5,000						
WBOC	Salisbury, Md. (III-B)	DA-N-1,000									
WHAK	Rogers City, Mich. (III)	D-5,000	KDSJ	Deadwood, S. D. (III)	DA-N-1,000						
KLTF	Little Falls, Minn. (III)	D-500									
WABG	Greenwood, Miss. (III)	LS-1,000	WSIX	Nashville, Tenn. (III-A)	DA-N-5,000						
KFVS	Cape Girardeau, Mo. (III-B)	DA-N-5,000	KFRD	Rosenberg, Tex. (III)	D-1,000						
KNEB	Scottsbluff, Neb. (III)	DA-N-1,000	KSVG	Richfield, Utah (III)	DA-N-1,000						
WEAV	Plattsburg, N. Y. (III-B)	DA-1,000	WFHG	Bristol, Va. (III)	DA-N-1,000						
WFTC	Kinston, N. C. (III)	LS-5,000	WFOC	Manitowoc, Wis. (III)	D-1,000						
WWST	Wooster, O. (III)	D-1,000									
KGWA	Enid, Okla. (III-B)	DA-1,000									
WHYL	Carlisle, Pa. (III)	D-1,000									
WATS	Sayre, Pa. (III)	D-1,000									
WBEU	Beaufort, S. C. (III)	D-1,000									
KIMP	Mt. Pleasant, Tex. (III)	D-1,000									
KGKL	San Angelo, Tex. (III-B)	LS-5,000									
KOVO	Provo, Utah (III-B)	LS-5,000									
WDBJ	Roanoke, Va. (III-A)	DA-N-1,000									
KALE	Richmond, Wash. (III)	DA-N-1,000									
WTCH	Shawano, Wis. (III)	DA-N-1,000									
	970 KC. REGIONAL										
WERH	Hamilton, Ala. (III)	D-5,000									
KNEA	Jonesboro, Ark. (III)	D-1,000									
KBS	Bakersfield, Cal. (III)	DA-1,000									
KBOC	Modesto, Cal. (III)	DA-1,000									
WFLA	Tampa, Fla. (III-A)	DA-N-5,000									
WGLS	Decatur, Ga. (III)	D-1,000									
WVOP	Vidalia, Ga. (III)	D-1,000									
WMAY	Springfield, Ill. (III)	LS-1,000									
WAVE	Louisville, Ky. (III-A)	DA-U-N-500									
KSYL	Alexandria, La. (III-B)	DA-N-1,000									
WCSH	Portland, Me. (III-A)	DA-N-5,000									
WKHM	Jackson, Mich. (III)	DA-1,000									
KOOK	Billings, Mont. (III-A)	DA-N-5,000									
KNBR	North Platte, Neb. (III)	DA-D-1,000									
WAAT	Newark, N. J. (III-B)	LS-5,000									
WEBR	Buffalo, N. Y. (III-A)	DA-5,000									
WCNN	Norwich, N. Y. (III)	D-500									
WRCS	Ahoscie, N. C. (III)	D-1,000									
WDAY	Fargo, N. D. (III-A)	DA-N-5,000									
WICA	Ashtabula, O. (III-B)	LS-5,000									
KAKC	Tulsa, Okla. (III-B)	LS-1,000									
KOIN	Portland, Ore. (III-A)	DA-U-N-500									
WWSW	Pittsburgh, Pa. (III-A)	DA-N-5,000									
WJMX	Florence, S. C. (III)	LS-5,000									
KWBC	Ft. Worth, Tex. (III)	D-1,000									
	BROADCASTING • TELECASTING										

STATIONS BY FREQUENCIES

Call Letters	City	Power in Watts	Call Letters	City	Power in Watts	Call Letters	City	Power in Watts	Call Letters	City	Power in Watts			
KPAC	Port Arthur, Tex. (III-B)	LS-5,000	KTLN	Denver, Colo. (III)	DA-5,000	KVOR	Colorado Springs, Colo. (III-A)	1,000	WWHG	Hornell, N. Y. (III)	D-1,000			
KEXX	San Antonio, Tex. (III)	D-500	WIPC	Lake Wales, Fla.	D-1,000	WMTM	Moultrie, Ga. (III)	D-1,000	WCOG	Greensboro, N. C. (III-B)	DA-1,000			
KSML	Seminole, Tex. (III)	D-1,000	WIBB	Macon, Ga. (III)	D-1,000	WIMO	Winder, Ga. (III)	D-1,000	WHOK	Lancaster, O. (III)	D-500			
WDVA	Danville, Va. (III-B)	LS-5,000	WMRO	Aurora, Ill. (IV)	D-250	WTAQ	La Grange, Ill. (III)	D-500	KWOB	Clinton, Okla. (III)	D-1,000			
†WNRG	Grundy, Va. (III)	DA-N-1,000	WGFB	Evansville, Ind. (III-B)	LS-5,000	WFRX	West Frankfort, Ill. (III)	D-1,000	WASP	Pittsburgh, Pa. (III-A)	DA-N-1,000			
KWSC	Pullman, Wash. (III-A)	5,000	KSOK	Arkansas City, Kan. (III)	DA-N-1,000	KGLO	Mason City, Ia. (III-A)	DA-N-5,000	WSCR	Scranton, Pa.	DA-N-5,000			
KTW	Seattle, Wash. (III-A)	1,000	WLSU	New Orleans, La. (III-A)	DA-5,000	WLEX	Lexington, Ky. (III-B)	DA-N-1,000	WMSC	Columbia, S. C. (III-A)	DA-N-1,000			
WCAN	Milwaukee, Wis. (III-A)	DA-5,000	WDSU	New Orleans, La. (III-A)	DA-5,000	WIBR	Baton Rouge, La. (III)	DA-1,000	KELO	Sioux Falls, S. D. (III-A)	DA-N-5,000			
1260 KC. REGIONAL														
WCRT	Birmingham, Ala. (III)	D-1,000	WEIM	Fitchburg, Mass. (III)	DA-N-1,000	WFBR	Baltimore, Md. (III-A)	DA-5,000	KWKM	Kingsport, Tenn. (III)	D-1,000			
KGIL	San Fernando, Cal. (III-B)	DA-1,000	WFYC	Alma, Mich. (III)	D-1,000	WJDA	Quincy, Mass. (III)	D-1,000	KVMC	Colorado City, Tex.	D-500			
KYA	San Francisco, Cal. (III-A)	LS-5,000	WTCN	Minneapolis, Minn. (III-A)	LS-5,000	WOOD	Grand Rapids, Mich. (III-A)	DA-N-5,000	KXYZ	Houston, Tex. (III-A)	DA-N-5,000			
KFTM	Ft. Morgan, Colo. (III)	D-500	KDKD	Clinton, Mo. (III)	D-1,000	WRBC	Jackson, Miss. (III-A)	LS-5,000	KDYL	Salt Lake City, Utah (III-A)	DA-5,000			
KUBC	Montrose, Colo. (III)	LS-1,000	KCNI	Broken Bow, Nebr. (III)	D-1,000	KMMO	Marshall, Mo. (III)	D-1,000	KXRO	Aberdeen, Wash. (III-B)	DA-N-1,000			
WAVZ	New Haven, Conn. (III)	D-1,000	WHBI	Newark, N. J. (III-B)	LS-2,500	WOTJ	Trenton, N. J. (IV)	D-250	WRIO	Rio Piedras, P. R. (III)	1,000			
WWDC	Washington, D. C. (III-A)	DA-5,000	KDEF	Albuquerque, N. M. (III)	N-1,000	WOSC	Fulton, N. Y. (III-A)	D-1,000	1330 KC. REGIONAL					
WFTW	Ft. Walton, Fla. (III)	D-1,000	WVOV	New York, N. Y. (III-A)	D-1,000	WREB	Cleveland, O. (III-A)	DA-5,000	WROS	Scottsboro, Ala. (III)	D-1,000			
WWPF	Palatka, Fla. (III)	DA-N-500	WVET	Rochester, N. Y. (III-A)	DA-N-5,000	WTFB	Mt. Vernon, O. (III)	DA-D-500	KFCF	Los Angeles, Cal. (III-A)	DA-N-5,000			
WTJH	East Point, Ga. (III)	D-5,000	WSAT	Salisbury, N. C. (III)	DA-N-1,000	WTPX	Punxsutawney, Pa. (III)	D-1,000	WARN	Ft. Pierce, Fla. (II)	D-1,000			
WFBM	Indianapolis, Ind. (III-A)	DA-N-5,000	WONW	Defiance, O. (III)	DA-N-500	WDKD	Kingstree, S. C. (III)	D-1,000	†WMEN	Tallahassee, Fla. (III)	D-1,000			
KFGQ	Boone, Ia. (IV)	D-250	WOLM	Jackson, O. (III)	D-1,000	WMAK	Nashville, Tenn. (III-A)	DA-N-5,000	WEAW	Evanston, Ill. (III)	DA-D-500			
KWHK	Hutchinson, Kan. (III)	LS-1,000	KLCO	Poteau, Okla. (III)	D-1,000	KVET	Austin, Tex. (III-B)	DA-N-1,000	WRRR	Rockford, Ill. (III)	DA-D-1,000			
WXOK	Baton Rouge, La. (II)	D-1,000	KERG	Eugene, Ore. (III-B)	DA-N-1,000	KTFY	Brownfield, Tex. (III)	D-1,000	WJPS	Evansville, Ind. (III-B)	LS-5,000			
WVDA	Boston, Mass. (III-A)	DA-N-5,000	WHVR	Hanover, Pa. (III)	LS-1,000	†KLST	Lone Star, Tex. (III)	D-500	KWWL	Waterloo, Ia. (III-B)	LS-5,000			
KROX	Crookston, Minn. (III)	LS-1,000	WKST	New Castle, Pa. (III-A)	DA-N-1,000	KOL	Seattle, Wash. (III-A)	DA-5,000	KFH	Wichita, Kan. (III-A)	DA-U-N-1,000			
KDUZ	Hutchinson, Minn. (III)	D-1,000	WANS	Anderson, S. C. (III)	DA-N-1,000	WITL	Mayaguez, P. R. (III)	1,000	KVQL	Lafayette, La. (III)	DA-N-5,000			
WGVW	Greenville, Miss. (III)	D-1,000	WJAY	Mullins, S. C. (III)	DA-N-1,000	WHEP	Foley, Ala. (III)	D-1,000	WASA	Havre de Grace, Md. (III)	D-1,000			
KGBX	Springfield, Mo. (III-A)	DA-N-5,000	KWHI	Brenham, Tex. (III)	D-1,000	WJAM	Marion, Ala. (III)	D-1,000	WCRB	Waltham, Mass. (III)	D-1,000			
WBUD	Trenton, N. J. (III)	DA-1,000	KLTI	Longview, Tex. (III)	D-1,000	KTYL	Mesa, Ariz. (III)	LS-1,000	WBBC	Flint, Mich. (III-A)	DA-1,000			
KVSF	Santa Fe, N. M. (III-A)	1,000	KNAK	Salt Lake City, Utah	LS-1,000	KWBR	Oakland, Cal. (III-A)	1,000	WLWL	Minneapolis, Minn. (III-A)	DA-5,000			
WNRD	Syracuse, N. Y. (III-A)	DA-N-5,000	WINA	Charlottesville, Va. (III)	D-1,000	KTKR	Taft, Cal. (III)	D-500	WJPR	Greenville, Miss.	LS-1,000			
WGWR	Asheboro, N. C. (III)	DA-N-5,000	WYVE	Wytheville, Va. (III)	D-1,000	KFKA	Greely, Colo. (III-B)	DA-N-1,000	WBBR	Brooklyn, N. Y. (III-A)	DA-5,000			
WDOK	Cleveland, O. (III-A)	DA-5,000	KIT	Yakima, Wash. (III-A)	LS-5,000	†WBRO	Waynesboro, Ga. (III)	D-1,000	WEVD	New York, N. Y. (III-A)	DA-5,000			
WNXT	Portsmouth, O.	LS-5,000	WNAM	Neanah, Wis. (III)	DA-N-1,000	KLIX	Twin Falls, Ida. (III)	DA-1,000	WHAZ	Troy, N. Y. (III-A)	1,000			
KWSH	Seminole, Okla. (III)	DA-1,000	WPRE	Prairie du Chien, Wis. (III)	D-500	WISH	Indianapolis, Ind. (III-B)	LS-5,000	WFAN	Findlay, O. (III)	D-1,000			
KMCM	McMinnville, Ore. (III-A)	DA-N-1,000	WCMN	Arecibo, P. R. (III-A)	1,000	KOKX	Keokuk, Ia. (III)	DA-U-N-500	KPOJ	Portland, Ore. (III-A)	DA-5,000			
WERC	Erie, Pa. (III-B)	DA-5,000	WCPD	1290 KC. REGIONAL		WORC	Worcester, Mass. (III-B)	DA-1,000	WIKK	Erie, Pa. (III-A)	DA-5,000			
WMUU	Greenville, S. C. (III)	D-1,000	WMLA	Sylacauga, Ala. (III)	D-1,000	WKMV	Dearborn, Mich. (III-B)	DA-1,000	WWPA	Williamsport, Pa. (III)	LS-5,000			
WJOT	Lake City, S. C. (III)	D-1,000	WVMS	Tucson, Ariz. (III-A)	1,000	KFSB	Joplin, Mo. (III-B)	DA-U-N-1,000	(CP from 1340 kc)					
WMFS	Chattanooga, Tenn. (III)	D-1,000	KDMA	El Dorado, Ark.	D-1,000	KFBB	Great Falls, Mont. (III-A)	DA-N-5,000	WFBC	Greenville, S. C. (III-A)	DA-N-5,000			
†.....	Dickson, Tenn. (III)	D-1,000	KUOA	Siloam Springs, Ark. (III)	D-500	WJLK	Asbury Park, N. J. (IV)	250	KSWA	Graham, Tex. (III)	D-500			
KBLP	Falfurrias, Tex. (III)	D-500	KHSL	Chico, Cal. (III-A)	DA-N-5,000	WVAM	Camden, N. J. (IV)	250	KKNE	Kingsville, Tex. (III)	D-1,000			
KTAE	Taylor, Tex. (III)	D-1,000	KITO	San Bernardino, Cal. (III-A)	DA-5,000	WGAT	Utica, N. Y. (III-B)	LS-1,000	WBTM	Danville, Va. (III-B)	LS-5,000			
†.....	Tulla, Tex. (III)	D-1,000	WCCC	Hartford, Conn. (III)	D-500	WISE	Asheville, N. C. (III)	LS-5,000	WETZ	New Martinsville, W. Va. (III)	D-1,000			
WEKZ	Monroe, Wis. (III)	D-500	WTUC	Wilmington, Del. (III)	D-500	WTK	Durham, N. C. (III-B)	LS-1,000	WHBL	Sheboygan, Wis. (III-B)	LS-1,000			
KPOW	Powell, Wyo. (III-B)	LS-5,000	WTRM	Ocala, Fla. (III-B)	DA-N-1,000	WTOC	Savannah, Ga. (III-A)	DA-N-5,000	WKOVE	Lander, Wyo. (III)	DA-N-1,000			
WISO	Ponce, P. R. (III)	1,000	WIRK	W. Palm Beach, Fla. (III-B)	LS-5,000	WJAX	Jacksonville, Fla. (III-A)	DA-N-5,000	(CP from 1230 kc)					
1270 KC. REGIONAL														
WGSV	Guntersville, Ala. (III)	D-1,000	WTOC	Savannah, Ga. (III-A)	DA-N-5,000	KNOX	Grand Forks, N. D. (III)	DA-N-5,000	WCTA	Andalusia, Ala. (IV)	250			
KRCH	Hot Springs, Ark. (III)	D-1,000	WJRL	Peoria, Ill. (III-A)	DA-5,000	WFAH	Alliance, O. (III)	DA-D-1,000	WKUL	Cullman, Ala. (IV)	250			
KCOK	Tulare, Cal. (III-B)	DA-N-1,000	KJEF	Jennings, La. (III)	D-500	KNPT	Newport, Ore. (III)	DA-N-1,000	WJOF	Florence, Ala. (IV)	250			
WTAL	Tallahassee, Fla. (III-A)	DA-N-5,000	†WHRG	Houghton Lake, Mich. (III)	D-1,000	WNAE	Warren, Pa. (III)	D-1,000	WGWC	Selma, Ala. (IV)	250			
WGBA	Columbus, Ga. (III)	D-1,000	WBLE	Batesville, Miss. (III)	D-1,000	WDOB	Chattanooga, Tenn. (III-A)	DA-N-5,000	WFBF	Sylacauga, Ala. (IV)	250			
KTPI	Twin Falls, Ida. (III-A)	LS-5,000	KGVM	Thayer, Mo. (III)	D-1,000	WDXI	Jackson, Tenn. (III-B)	LS-5,000	KCLS	Flagstaff, Ariz. (IV)	250			
WHBF	Rock Island, Ill. (III-A)	DA-N-5,000	KALM	Missoula, Mont. (III-A)	DA-5,000	WRR	Dallas, Tex. (III-A)	DA-N-5,000	KRUX	Glendale, Ariz. (IV)	250			
WWCA	Gary, Ind. (III-B)	DA-1,000	KOIL	Omaha, Neb. (III-A)	DA-N-5,000	WGH	Newport News, Va. (III-A)	DA-5,000	KNOG	Nogales, Ariz. (IV)	250			
KSCB	Liberal, Kan. (III)	D-1,000	WKNE	Keene, N. H. (III-A)	DA-5,000	WIBA	Madison, Wis. (III-A)	DA-N-5,000	KBAH	Batesville, Ark. (IV)	250			
WAIN	Columbia, Ky.	D-1,000	WNBK	Binghamton, N. Y. (III-A)	DA-N-5,000	1320 KC. REGIONAL			KAGH	Crossett, Ark. (IV)	250			
WFUL	Fulton, Ky. (III)	D-1,000	WHKY	Hickory, N. C. (III-B)	LS-5,000	WAGF	Dothan, Ala. (III-B)	DA-N-1,000	KWFC	Hot Springs, Ark. (IV)	250			
†.....	Alexandria, La. (III)	D-500	WEYB	Sanford, N. C. (III)	D-1,000	WEZB	Homewood, Ala. (III)	D-1,000	KBRS	Springdale, Ark. (IV)	250			
WSPR	Springfield, Mass. (III-B)	DA-1,000	WTRF	Bellaire, O. (III)	D-1,000	KWHN	Ft. Smith, Ark. (III-A)	DA-N-5,000	KMAK	Fresno, Cal. (IV)	250			
WXVZ	Detroit, Mich. (III-A)	DA-N-5,000	WHIO	Dayton, O. (III-A)	DA-N-5,000	KRLW	Walnut Ridge, Ark.	D-1,000	KAVL	Lancaster, Cal. (IV)	250			
WLSM	Louisville, Miss. (III)	D-1,000	KLIQ	Portland, Ore. (III)	D-1,000	KCRA	Sacramento, Cal. (III-B)	LS-5,000	KWSD	Mt. Shasta, Cal. (IV)	250			
WHLD	Niagara Falls, N. Y. (III)	DA-D-5,000	WICE	Providence, R. I. (III)	D-500	WAGF	Dothan, Ala. (III-B)	DA-N-1,000	KSPF	Needles, Cal. (IV)	250			
WDLA	Walton, N. Y. (III)	D-1,000	WOKB	Oak Ridge, Tenn. (III)	D-1,000	WEZB	Homewood, Ala. (III)	D-1,000	KMOR	Oroville, Cal. (IV)	250			
WLON	Lincolnton, N. C. (III)	D-500	KIVY	Crockett, Tex. (III)	D-500	KWHN	Ft. Smith, Ark. (III-A)	DA-N-5,000	KATY	San Luis Obispo, Cal. (IV)	250			
WMPM	Smithfield, N. C. (III)	D-1,000	KRGV	Weslaco, Tex. (III-A)	DA-N-5,000	WATR	Waterbury, Conn. (III-B)	DA-1,000	KIST	Santa Barbara, Cal. (IV)	250			
KGCU	Mandan, N. D. (III-B)	LS-1,000	KTRN	Wichita Falls, Tex. (III-B)	LS-5,000	WHWD	Hollywood, Fla.	D-500	KHUB	Watsonville, Cal. (IV)	250			
WILE	Cambridge, O. (III)	D-1,000	WVOW	Logan, W. Va. (III-B)	LS-5,000	WJHP	Jacksonville, Fla. (III-A)	DA-N-5,000	KMYR	Denver, Colo. (IV)	250			
WLBK	Lebanon, Pa. (III)	DA-N-1,000	WMIL	Milwaukee, Wis. (III)	D-1,000	WRHT	Griffin, Ga. (III)	D-1,000	KGLN	Glenwood Springs, Colo. (IV)	250			
KIHO	Sioux Falls, S. D. (III-B)	DA-1,000	KINY	Juneau, Alaska (III)	5,000	WKAN	Kankakee, Ill. (III)	D-1,000	KLMR	Lamar, Colo. (IV)	250			
†WLJK	Newport, Tenn. (III)	D-1,000	1300 KC. REGIONAL			WAGF	Dothan, Ala. (III-B)	DA-N-1,000	KVRH	Salida, Colo. (IV)	250			
KIOX	Bay City, Tenn. (III-B)	DA-N-1,000	WFMH	Cullman, Ala. (III)	D-1,000	WEZB	Homewood, Ala. (III)	D-1,000	WNHC	New Haven, Conn. (IV)	250			
KFJZ	Ft. Worth, Tex. (III-A)	DA-5,000	†WTLS	Tallassee, Ala. (III)	D-1,000	KWHN	Ft. Smith, Ark. (III-A)	DA-N-5,000	WVOC	Washington, D. C. (IV)	250			
WHYU	Newport News, Va. (III)	D-1,000	KWCB	Searcy, Ark. (III)	D-1,000	KRLW	Walnut Ridge, Ark.	D-1,000	WTAN	Clearwater, Fla. (IV)	250			
WKYR	Keyser, W. Va. (III)	D-1,000	KROP	Brawley, Cal. (III-B)	LS-1,000	WATR	Waterbury, Conn. (III-B)	DA-1,000	WRD	Daytona Beach, Fla. (IV)	250			
1280 KC. REGIONAL												WWSR	Lake City, Fla. (IV)	250
WPID	Piedmont, Ala. (III)	D-1,000	KYNO	Fresno, Cal. (III-B)	DA-1,000	WHWD	Hollywood, Fla.	D-500	WTYS	Marianna, Fla. (IV)	250			
WNPT	Newscastle, Ala. (III)	D-1,000	KWKW	Pasadena, Cal. (III-B)	DA-N-1,000	WJHP	Jacksonville, Fla. (III-A)	DA-N-5,000	WVPG	Palm Beach, Fla. (IV)	250			
KNEB	Newburyport, Ark. (III)	D-1,000	WFBM	Birmingham, Ala. (III)	D-1,000	WRHT	Griffin, Ga. (III)	D-1,000	WJCM	Sebring, Fla. (IV)	250			
KFOX	Long Beach, Cal. (III-A)	1,000	†WTRF	Bellaire, O. (III)	D-1,000	WKAN	Kankakee, Ill. (III)	D-1,000	WGAU	Athens, Ga. (IV)	250			
KXOB	Stockton, Cal. (III-B)	DA-N-1,000	KWCB	Searcy, Ark. (III)	D-1,000	KLWN	Lawrence, Kan. (III)	D-500	WBEA	Atlanta, Ga. (IV)	250			
												WBBQ	Augusta, Ga. (IV)	250
												WGAA	Cedartown, Ga. (IV)	250
												WDAK	Columbus, Ga. (IV)	250
												WMLT	Dublin, Ga. (IV)	250
												WVGS	Tifton, Ga. (IV)	250
												KPST	Preston, Ida. (IV)	250
												WSOX	Decatur, Ill. (IV)	250
												WJFP	Herrin, Ill. (IV)	250
												WJOL	Joliet, Ill. (IV)	250
												WBIV	Bedford, Ind. (IV)	250
												WTRC	Elkhart, Ind. (IV)	250

STATIONS BY FREQUENCIES

Call Letters	City	Power in Watts	Call Letters	City	Power in Watts	Call Letters	City	Power in Watts	Call Letters	City	Power in Watts
WLBC	Muncie, Ind. (IV)	250	1350 KC. REGIONAL			WDOB	Canton, Miss. (III)	D-500	KULP	El Campo, Tex. (III)	D-500
KROS	Clinton, Ia. (IV)	250	WGAD	Gadsden, Ala. (III-B)	LS-5,000	KWRT	Boonville, Mo. (III)	D-1,000	WEAM	Arlington, Va. (III-A)	DA-5000
KLIL	Estherville, Ia. (IV)	250			DA-N-1,000	KCRV	Caruthersville, Mo.	D-1,000	WWOD	Lynchburg, Va. (III-B)	LS-5,000
KCKN	Kansas City, Kan. (IV)	250	KCSB	San Bernardino, Cal. (III-B)	DA-N-500	KXLF	Butte, Mont. (III-A)	5,000			DA-N-1,000
KSEK	Pittsburg, Kan. (IV)	250	KSRO	Santa Rosa, Cal. (III-B)	DA-N-500	WFEA	Manchester, N. H. (III-A)	DA-5,000	KYAK	Yakima, Wash. (III)	LS-1,000
WCMI	Ashland, Ky. (IV)	250	KGHF	Pueblo, Colo. (III-B)	LS-5,000	WALK	Patchogue, N. Y. (III)	D-500			DA-N-500
WKIC	Hazard, Ky. (IV)	250	WNSL	Norwalk, Conn. (III-B)	DA-N-500	WSAY	Rochester, N. Y. (III-A)	DA-1,000			
WNBS	Murray, Ky. (IV)	250	WPCT	Putnam, Conn. (III)	D-500			*DA-N-5,000			1400 KC. LOCAL
WEKY	Richmond, Ky. (IV)	250	KRLC	Lewiston, Ida. (III-B)	DA-N-1,000	WLTC	Gastonia, N. C. (III)	D-1,000	WMSL	Decatur, Ala. (IV)	250
KRMD	Shreveport, La. (IV)	250	WEEK	Peoria, Ill. (III-B)	DA-1,000	WSPD	Toledo, O. (III-A)	DA-N-5,000	WXAL	Demopolis, Ala. (IV)	250
WFAU	Augusta, Me. (IV)	250	WIOU	Kokomo, Ind. (III-B)	DA-1,000	KAST	Astoria, Ore. (III-B)	DA-N-1,000	WFPA	Fort Payne, Ala. (IV)	250
WABM	Houlton, Me. (IV)	250	KRNT	Des Moines, Ia. (III-A)	DA-N-5,000	WPAZ	Pottstown, Pa. (III)	DA-1,000	WGYV	Greenville, Ala. (IV)	250
WGAW	Gardner, Mass. (IV)	250	KMAN	Manhattan, Kan. (III)	D-500	WDEF	Chatanooga, Tenn. (III-A)	DA-N-5,000	WJLD	Homewood, Ala. (IV)	250
WNBH	New Bedford, Mass. (IV)	250	WLOU	Louisville, Ky. (III)	D-1,000	WDXE	Lawrenceburg, Tenn. (III)	D-1,000	WJHO	Opelika, Ala. (IV)	250
WBRK	Pittsfield, Mass. (IV)	250	WSMB	New Orleans, La. (III-A)	DA-N-5,000	KTXN	Austin, Tex. (III)	D-1,000	KCLF	Clifton, Ariz. (IV)	250
WLAV	Grand Rapids, Mich. (IV)	250	KCHR	Charleston, Mo. (III)	D-500	KFRO	Longview, Tex. (III-B)	DA-N-1,000	KTUC	Tucson, Ariz. (IV)	250
WMTE	Marquette, Mich. (IV)	250	WCBA	Corning, N. Y. (III)	D-1,000	WBTV	Bennington, Vt. (III)	D-500	KYMA	Yuma, Ariz. (IV)	250
WMAW	Menominee, Mich. (IV)	100	WHPP	Mooreville, N. C.	D-1,000	WJWS	South Hill, Va. (III)	D-1,000	KELD	El Dorado, Ark. (IV)	250
WMBN	Potoskey, Mich. (IV)	250	WADC	Akron, O. (III-A)	DA-5,000	WMOD	Moundsville, W. Va. (III)	D-1,000	KCLA	Pine Bluff, Ark. (IV)	250
WEXL	Royal Oak, Mich. (IV)	250	KRHD	Duncan, Okla. (IV)	LS-250	KVVO	Cheyenne, Wyo. (III)	D-1,000	KRE	Berkeley, Cal. (IV)	250
WEVE	Evleeth, Minn. (IV)	250	WORK	York, Pa. (III-B)	LS-5,000				KCRE	Crecent City, Cal. (IV)	250
KVOX	Moorhead, Minn. (IV)	250	1WDAL	Darlington, S. C. (III)	D-500				KKREO	Indio, Cal. (IV)	250
KROC	Rochester, Minn. (IV)	250	WJW	Greenwood, S. C. (III)	D-1,000				KKSP	Santa Maria, Cal. (IV)	250
KWLM	Willmar, Minn. (IV)	250	KCAE	Clarksville, Tex. (III)	D-500				KSP	Santa Paula, Cal. (IV)	250
WTMB	Brookhaven, Miss. (IV)	250	KTXJ	Jasper, Tex. (III)	D-1,000				KUKI	Ukiah, Cal. (IV)	250
WCBI	Columbus, Miss. (IV)	250			(CP for 1240 kc)				KONG	Visalia, Cal. (IV)	250
WKOZ	Kosciusko, Miss. (IV)	250	KCOR	San Antonio, Tex. (III-B)	LS-5,000				KRLN	Canon City, Colo. (IV)	SH-250
WAML	Laurel, Miss. (IV)	250	WAVY	Portsmouth, Va.	DA-5,000				KNBZ	La Junta, Colo. (IV)	250
KXEO	Mexico, Mo. (IV)	250	WPDR	Portage, Wis. (III)	D-1,000				WICH	Norwich, Conn. (IV)	250
KWOC	Poplar Bluff, Mo. (IV)	250			1360 KC. REGIONAL				WSTC	Stamford, Conn. (IV)	250
	(CP for 930 kc)		WAL	Darlington, S. C. (III)	D-500	WELR	Roanoke, Ala. (III)	D-1,000	WFLL	Ft. Lauderdale, Fla. (IV)	250
KSMO	Salem, Mo. (IV)	250	KCAE	Clarksville, Tex. (III)	D-500	KCLS	Flagstaff, Ariz. (III)	D-5,000	WFRP	Ft. Pierce, Fla. (IV)	250
KICK	Springfield, Mo. (IV)	250	KTXJ	Jasper, Tex. (III)	D-1,000	KFFA	Helena, Ark. (III-B)	DA-N-1,000	WVHC	Wachonville, Fla. (IV)	250
KCAF	Helena, Mont. (IV)	250			(CP for 1240 kc)				WPFC	Panama City, Fla. (IV)	250
KPRK	Livingston, Mont. (IV)	250	KCOR	San Antonio, Tex. (III-B)	LS-5,000				WTRR	Sanford, Fla. (IV)	250
KRFJ	Miles City, Mont. (IV)	250	WAVY	Portsmouth, Va.	DA-5,000	WATL	Atlanta, Ga. (III-A)	DA-N-5,000	WWSG	Elberton, Ga. (IV)	250
KFGT	Fremont, Neb. (IV)	100	WPDR	Portage, Wis. (III)	D-1,000	WKJG	Ft. Wayne, Ind. (III-A)	DA-5,000	WVNE	Macon, Ga. (IV)	250
KGFV	Kearney, Neb. (IV)	250			1360 KC. REGIONAL				WVGA	Moultrie, Ga. (IV)	250
KSID	Sidney, Nebr. (IV)	250	WELR	Roanoke, Ala. (III)	D-1,000	KCMC	Carroll, Ia. (III)	DA-1,000	WCOH	Newman, Ga. (IV)	250
KORK	Las Vegas, Nev. (IV)	250	KCLS	Flagstaff, Ariz. (III)	D-5,000	WTTH	Port Huron, Mich. (III-B)	DA-1,000	WDRK	Savannah, Ga. (IV)	250
KATO	Reno, Nev. (IV)	250	KFFA	Helena, Ark. (III-B)	DA-N-1,000	WNLA	Indianola, Miss. (III)	D-500	WKRP	Idaho Falls, Ida. (IV)	250
WLNH	Laconia, N. H. (IV)	250	KMOD	Modesto, Cal. (III-B)	DA-N-1,000	WTUP	Tupelo, Miss. (III)	D-1,000	KRPL	Mocksville, N. C. (IV)	250
WMLD	Atlanta, Ga. (IV)	250	KGB	San Diego, Cal. (III-A)	1,000	KUDL	Kansas City, Mo. (III)	D-1,000	KSPT	Sandpoint, Ida. (IV)	250
KVER	Albuquerque, N. M. (IV)	250	WDRG	Hartford, Conn. (III-A)	DA-5,000	KWK	St. Louis, Mo. (III-A)	DA-N-5,000	WDWS	Champaign, Ill. (IV)	250
KSIL	Silver City, N. M. (IV)	250	WOBS	Jacksonville, Fla. (III)	DA-5,000				WGIL	Galesburg, Ill. (IV)	250
WMBO	Auburn, N. Y. (IV)	250	WKAT	Miami Beach, Fla. (III-B)	LS-5,000				WEOA	Evansville, Ind. (IV)	250
WENT	Gloversville, N. Y. (IV)	250			LS-5,000				WBAT	Marion, Ind.	250
WJOC	Jamestown, N. Y. (IV)	250	WLBK	DeKaib, Ill. (III)	D-500				KCOG	Centerville, Ia. (IV)	100
WUSJ	Lockport, N. Y. (IV)	250	WVMC	Mt. Carmel, Ill. (III)	D-500				KKFD	Ft. Dodge, Ia. (IV)	250
WMSA	Massena, N. Y. (IV)	250	KXGI	Fort Madison, Ia. (III)	D-500				KTSW	Emporia, Kan. (IV)	250
WALL	Middletown, N. Y. (IV)	250	KSCJ	Sioux City, Ia. (III-A)	DA-N-5,000				KAYS	Hays, Kan. (IV)	250
WPLT	Plattsburg, N. Y. (IV)	250			DA-N-5,000				WIEL	Elizabethtown, Ky. (IV)	250
WRIJ	Watkins, N. C. (IV)	250	KBTO	Eldorado, Kan. (III)	D-500				WIHL	Hammond, La. (IV)	250
WTSB	Lumberton, N. C. (IV)	250	1KDBE	Mansfield, La. (III)	D-1,000				WLA	Lake Charles, La. (IV)	250
WOXF	Oxford, N. C. (IV)	250	KVM	New Iberia, La. (III)	D-1,000				WRDO	Augusta, Me. (IV)	250
WHED	Washington, N. C. (IV)	250	WLYN	Lynn, Mass. (III)	D-1,000				WIDE	Biddeford, Me. (IV)	250
WGNI	Wilmington, N. C. (IV)	250	WKMI	Kalamazoo, Mich. (III-B)	DA-N-1,000				WWIN	Baltimore, Md. (IV)	250
WAIR	Winston-Salem, N. C. (IV)	250	KDLM	Devils Lake, Minn. (III)	D-1,000				WALE	Fall River, Mass. (IV)	250
WATG	Ashland, O. (IV)	250	WNNJ	Newton, N. J. (III)	D-500				WLLH	Lowell, Mass. (IV)	250
WIZE	Springfield, O. (IV)	250	WWBZ	Vineland, N. J. (III-B)	DA-N-1,000				WLLM	Northampton, Mass. (IV)	250
WSTV	Wesleyville, O. (IV)	250	WKOP	Binghamton, N. Y. (III)	LS-1,000				WELL	Barle Creek, Mich. (IV)	250
KIHN	Hugo, Okla. (IV)	250	WCHL	Chapel Hill, N. C. (III)	DA-N-500				WJLB	Detroit, Mich. (IV)	250
KOCY	Oklahoma City, Okla. (IV)	250	WSAI	Cincinnati, O. (III-A)	DA-N-5,000				WVDF	Houghton, Mich. (IV)	250
KRUL	Corvallis, Ore. (IV)	250	WMCK	McKeesport, Pa. (III-B)	DA-N-5,000				WSAM	Saginaw, Mich. (IV)	250
KUIN	Grants Pass, Ore. (IV)	250	WPPA	Pottsville, Pa. (III-B)	LS-1,000				WTMC	Traverse City, Mich. (IV)	250
KIHR	Hood River, Ore. (IV)	250	WELP	Easley, S. C. (III)	DA-N-1,000				KLIZ	Brainerd, Minn. (IV)	250
KFIR	North Bend, Ore. (IV)	250	WLCM	Lancaster, S. C. (III)	D-1,000				KMHL	Marshall, Minn. (IV)	250
WFEG	Altoona, Pa. (IV)	250	WNAH	Nashville, Tenn. (III)	D-1,000				WMIN	St. Paul, Minn. (IV)	250
WCVI	Connellsville, Pa. (IV)	250	KREL	Baytown, Tex. (III-B)	DA-1,000				WVLB	Virginia, Minn. (IV)	250
WFEMR	Emporium, Pa. (IV)	100	KRIS	Corpus Christi, Tex. (III-A)	1,000				WVBE	Booneville, Miss. (IV)	250
WSAJ	Grove City, Pa. (IV)	SH-100	KXOL	Ft. Worth, Tex. (III-B)	DA-N-1,000				WVNB	Booneville, Miss. (IV)	250
WKRZ	Oil City, Pa. (IV)	250	KMO	Tacoma, Wash. (III-A)	5,000				WVNS	Grenada, Miss. (IV)	250
WHAT	Philadelphia, Pa. (IV)	250	WHJG	Matewan, W. Va.	D-1,000				WFOR	Hattiesburg, Miss. (IV)	250
WRAW	Reading, Pa. (IV)	250	WBAY	Green Bay, Wis. (III-A)	DA-N-5,000				WJQS	Jackson, Miss. (IV)	250
WBRE	Wilkes-Barre, Pa. (IV)	250	WMNE	Menomonie, Wis. (III)	D-500				WVBC	Macon, Miss. (IV)	250
WWPA	Williamsport, Pa. (IV)	250	KVRS	Rock Springs, Wyo. (III-B)	LS-1,000				KFRU	Columbia, Mo. (IV)	250
	(CP for 1330 kc)				DA-N-500				KSIM	Sikeston, Mo. (IV)	250
WHAN	Charleston, S. C. (IV)	250	WELM	Lufkin, Tex. (IV)	250				KTKS	Springfield, Mo. (IV)	250
WRHI	Rock Hill, S. C. (IV)	250	KRBA	Monahan, Tex. (IV)	250				KKGJ	Kendrick, Mont. (IV)	250
WFIG	Sumter, S. C. (IV)	250	KPKM	Monahan, Tex. (IV)	250				KKXK	Great Falls, Mont. (IV)	250
KIJV	Huron, S. D. (IV)	250	KPDN	Pampa, Tex. (IV)	250				KCOW	Alliance, Neb. (IV)	250
KRSD	Rapid City, S. D. (IV)	250	KOLE	Port Arthur, Tex. (IV)	250				KOLN	Lincoln, Neb. (IV)	250
WBAC	Cleveland, Tenn. (IV)	250	KTXL	San Angelo, Tex. (IV)	250				1KBM	Henderson, Nev. (IV)	250
WKRM	Columbia, Tenn. (IV)	250	KVIC	Victoria, Tex. (IV)	250				WTSL	Hanover, N. H. (IV)	250
WAEW	Crossville, Tenn. (IV)	100			Price, Utah (IV)				WOND	Pleasantville, N. J. (IV)	250
WGVY	Greenville, Tenn. (IV)	250	KJAM	Vernal, Utah (IV)	250				KGFL	Roswell, N. M. (IV)	250
WKGW	Knoxville, Tenn. (IV)	250	WTRW	St. Johnsbury, Vt. (IV)	250				KTRC	Santa Fe, N. M. (IV)	250
WHHM	Memphis, Tenn. (IV)	250	WKEX	Covington, Va. (IV)	250				KCHS	Truth or Consequences, N. M. (IV)	250
WCDT	Winchester, Tenn. (IV)	250	WHFA	Hopewell, Va. (IV)	250				KTNM	Tucumcari, N. M. (IV)	250
KWKC	Abilene, Tex. (IV)	250	WMA	Orange, Va. (IV)	250				WBYB	Albany, N. Y. (IV)	250
KAND	Corsicana, Tex. (IV)	250	WRAD	Radford, Va. (IV)	250				WBNY	Buffalo, N. Y. (IV)	250
KSET	El Paso, Tex. (IV)	250	WPKV	Paico, Wash. (IV)	250				WELM	Elmira, N. Y. (IV)	250
KNAF	Fredericksburg, Tex. (IV)	250	KAPA	Raymond, Wash. (IV)	250				WVSL	Ogdenburg, N. Y. (IV)	250
KDUB	Lubbock, Tex. (IV)	250	KSPO	Spokane, Wash. (IV)	250				WDOS	Oneonta, N. Y. (IV)	250
KRBA	Lufkin, Tex. (IV)	250	KWNW	Wenatchee, Wash. (IV)	250				WVGB	Greensboro, N. C. (IV)	250
KPKM	Monahan, Tex. (IV)	250	WHAR	Clarksville, W. Va. (IV)	250				WVSC	Statesville, N. C. (IV)	250
KPDN	Pampa, Tex. (IV)	250	WEPM	Martinsburg, W. Va. (IV)	250				WVSE	Wallace, N. C. (IV)	250
KOLE	Port Arthur, Tex. (IV)	250	WMON	Montgomery, W. Va. (IV)	250				WVBC	Waynesville, N. C. (IV)	250
KTXL	San Angelo, Tex. (IV)	250	WBRW	Weich, W. Va. (IV)	250				KNOX	Grand Forks, N. D. (IV)	250
KVIC	Victoria, Tex. (IV)	250	WLDY	Lady'sburg, Wis. (IV)	250					(CP for 1310kc)	
	Price, Utah (IV)	250	WEMP	Milwaukee, Wis.							

STATIONS BY FREQUENCIES

Call Letters	City	Power in Watts	Call Letters	City	Power in Watts	Call Letters	City	Power in Watts	Call Letters	City	Power in Watts
KCNV	San Marcos, Tex. (IV)	D-250	WTXL	W. Springfield, Mass. (IV)	250				KOLS	Pryor, Okla. (II)	D-250
KELA	Centralia, Wash. (III-A)	1,000	WABJ	Adrian, Mich. (IV)	250		1510 KC. CLEAR		KRWC	Forest Grove, Ore. (II)	D-250
WBKV	West Bend, Wis. (III)	D-500		(CP from 1500 kc)		KOCS	Ontario, Cal. (II)	D-250	WBUX	Doylston, Pa. (II)	D-250
KSPR	Casper, Wyo. (III-B)	1,000	WJBK	Detroit, Mich. (IV)	250	KTIM	San Rafael, Cal. (II)	D-1,000	WJET	Erie, Pa. (II)	D-250
	1480 KC. REGIONAL			(CP for 1500 kc)		WKAI	Macomb, Ill. (II)	D-250	WAKU	Latrobe, Pa. (II)	D-250
WABB	Mobile, Ala. (III-A)	DA-N-5,000	WESK	Escanaba, Mich. (IV)	250	WMEX	Boston, Mass. (II)	DA-5,000	WFGN	Gaffney, S. C. (II)	D-250
KGLU	Safford, Ariz. (III-A)	1,000	WMDN	Midland, Mich. (IV)	250	WMRP	Flint, Mich. (II)	D-250	KIVY	Crockett, Tex. (II)	D-250
KIEM	Eureka, Cal. (III-A)	DA-5,000	KXRA	Alexandria, Minn. (IV)	250	KIMO	Independence, Mo. (II)	D-1,000		(CP for 1250 kc)	
KYOS	Merced, Cal. (III-A)	DA-N-5,000	KBZY	Grand Rapids, Minn. (IV)	250	WLAC	Nashville, Tenn. (I-B)	DA-N-50,000	KTER	Terrell, Tex. (II)	D-250
	(CP for 1250 kc)		WLOX	Biloxi, Miss. (IV)	250				WAPL	Appleton, Wis. (II)	D-500
KVOE	Santa Ana, Cal. (III-B)	DA-1,000	WCLD	Cleveland, Miss. (IV)	250	KCTX	Childress, Tex. (II)	D-250			
	(CP for 1250 kc)		WLAU	Laurel, Miss. (IV)	250	KSTV	Stephenville, Tex. (II)	D-250		1580 KC. (Canadian) CLEAR	
WRDW	Augusta, Ga. (III-A)	DA-N-5,000	WHOC	Philadelphia, Miss. (IV)	250	KGA	Spokane, Wash. (I-B)	DA-N-50,000	WATM	Atmore, Ala. (II)	D-250
	(CP for 1250 kc)		WEL0	Tupelo, Miss. (IV)	250				KOWL	Santa Monica, Cal. (II)	D-5,000
WTHI	Terre Haute, Ind. (III-B)	DA-1,000	WVIM	Vicksburg, Miss. (IV)	250	WAUX	Waukesha, Wis. (II)	D-250			
	(CP for 1250 kc)		KDMO	Carthage, Mo. (IV)	250		1520 KC. CLEAR		WBRD	Ft. Lauderdale, Fla. (II)	D-250
WRSW	Warsaw, Ind. (III)	DA-500	KTTR	Rolla, Mo. (IV)	250						
↑KLEE	Ottumwa, Ia. (III)	D-500	KDRO	Sedalia, Mo. (IV)	250	WHOW	Clinton, Ill. (II)	D-1,000	WDQN	Duquoin, Ill. (II)	D-250
KANS	Wichita, Kan. (III-B)	LS-5,000	KBOW	Butte, Mont. (IV)	250	KSIB	Creston, Ia. (II)	D-1,000	WKID	Urbana, Ill. (II)	D-250
	(CP for 1250 kc)		KBON	Omaha, Neb. (IV)	250	WKBW	Buffalo, N. Y. (I-B)	DA-50,000	WCNE	Connersville, Ind. (II)	D-250
↑----	Shreveport, La. (III)	D-1,000	KWEW	Hobbs, N. M. (IV)	250	WKBS	Oyster Bay, L. I., N. Y. (II)	D-250	WJVA	South Bend, Ind. (II)	D-250
	(CP for 1250 kc)		KRSN	Los Alamos, N. M. (IV)	250	KOMA	Oklahoma City (I-B)	DA-N-50,000	KCHA	Charles City, Ia. (II)	D-250
WSAR	Fall River, Mass. (III-A)	DA-5,000	KRTN	Raton, N. M. (IV)	250				KFMA	Davenport, Ia. (II)	D-250
	(CP for 1250 kc)		WCSS	Amsterdam, N. Y. (IV)	250	WWW	Rio Piedras, P. R. (II)	250	WPKY	Princeton, Ky. (II)	D-250
KAUS	Austin, Minn. (III-B)	DA-1,000	WBTA	Batavia, N. Y. (IV)	250		1530 KC. CLEAR		KLOU	Lake Charles, La. (II)	DA-1,000
KGCK	Sidney, Mont. (III-A)	DA-5,000	WKNY	Kingston, N. Y. (IV)	250	KFBK	Sacramento, Cal. (I-B)	DA-50,000	↑WPGC	Morningside, Md. (II)	D-250
KLMS	Lincoln, Neb. (III-B)	DA-1,000	WICV	Malone, N. Y. (IV)	250				WFGM	Fitchburg, Mass. (II)	D-1,000
WLEA	Hornell, N. Y. (III)	D-1,000	WDLC	Port Jervis, N. Y. (IV)	100	WCKY	Cincinnati, O. (I-B)	DA-50,000	WGLC	Centerville, Miss. (II)	D-250
WHOM	New York, N. Y. (III-A)	DA-5,000	WOLF	Syracuse, N. Y. (IV)	250	KGFT	Harlingen, Tex. (II)	LS-50,000	WPMP	Pascagoula, Miss. (II)	D-250
	(CP for 1250 kc)		WSSB	Durham, N. C. (IV)	250				KNPM	Maryville, Mo. (II)	D-250
WHBC	Canton, O. (III-A)	DA-N-5,000	WFLB	Fayetteville, N. C. (IV)	250		1540 KC. (Bahama Island) CLEAR		WPAC	Patchogue, N. Y. (II)	D-250
WCIN	Cincinnati, O. (III)	DA-D-1,000	WLOE	Leaksville, N. C. (IV)	250	KPOL	Los Angeles, Cal. (II)	D-10,000	WVKO	Columbus, O. (II)	DA-D-1,000
WISL	Shamokin, Pa. (III-B)	DA-N-1,000	WMNC	Morgantown, N. C. (IV)	250	WKXY	Sarasota, Fla. (II)	D-1,000	KBWL	Blackwell, Okla. (II)	D-250
	(CP for 1250 kc)		WOOW	New Bern, N. C. (IV)	250	↑WCLB	Camilla, Ga. (II)	D-250	WBUT	Butler, Pa. (II)	D-500
WCBR	Memphis, Tenn. (III)	D-1,000	WSTP	Salisbury, N. C. (IV)	250	WSMI	Litchfield, Ill. (II)	D-1,000		(CP for 1050 kc)	
KGKO	Dallas, Tex. (III)	LS-1,000	↑KNOC	Hettinger, N. D. (IV)	250	WBNL	Boonville, Ind. (II)	D-250	↑WCKI	Abbeville, S. C. (II)	D-1,000
	(CP for 1250 kc)		KOVV	Valley City, N. D. (IV)	250	WLOI	La Porte, Ind. (II)	DA-N-50,000	KGAF	Gainesville, Tex. (II)	D-250
KLVL	Pasadena, Tex.	D-1,000	WBEX	Chillicothe, O. (IV)	250	KXEL	Waterloo, Ia. (II)	DA-N-50,000	KWED	Seguin, Tex. (II)	D-1,000
	(CP for 1250 kc)		WSRS	Cleveland Hts., O. (IV)	250	KNEX	McPherson, Kan. (II)	D-250	KEVA	Shamrock, Tex. (II)	D-250
↑WNIX	Springfield, Vt. (III)	D-1,000	WOHI	East Liverpool, O. (IV)	250	KLKC	Parsons, Kan. (II)	D-250	WTTN	Watertown, Wis.	D-250
WBEL	Richmond, Va. (III)	SH-DA-5,000	WMOA	Marietta, O. (IV)	250	WDON	Wheaton, Md. (II)	D-250			
WLEE	Richmond, Va. (III-A)	DA-5,000	WMRN	Marion, O. (IV)	250	WALM	Albion, Mich. (II)	D-250		1590 KC. REGIONAL	
WISC	Madison, Wis. (III-B)	DA-1,000	KBKX	Muskogee, Okla. (IV)	250	WLEW	Bad Axe, Mich. (II)	D-250	KSJO	San Jose, Cal. (III-B)	LS-1,000
	(CP for 1250 kc)		KBKR	Baker, Ore. (IV)	250	↑WHER	Columbus, Miss. (II)	DA-10,000			
1490 KC. LOCAL			KRNR	Roseburg, Ore. (IV)	250	WPRR	Albany, N. Y. (II)	DA-50,000	KVVC	Ventura, Cal. (III-B)	DA-1,000
↑WAN	Anniston, Ala. (IV)	250	KOCO	West Salem, Ore. (IV)	250	WIFM	Elkin, N. C. (II)	D-250	WBRV	Waterbury, Conn. (III-A)	DA-5,000
WAJF	Decatur, Ala. (IV)	250	WESB	Bradford, Pa. (IV)	250	WATH	Athens, O. (II)	D-1,000	WBEB	Tampa, Fla. (III)	D-1,000
WRLD	Lanett, Ala. (IV)	250	WAZL	Hazelton, Pa. (IV)	250	WJMO	Cleveland, O. (II)	D-1,000	WALB	Albany, Ga. (III-A)	DA-N-1,000
WHBB	Selma, Ala. (IV)	250	WARD	Johnstown, Pa. (IV)	250	WJMP	Philadelphia, Pa. (II)	D-1,000	↑WFLA	Lafayette, Ga. (III)	D-5,000
WTBF	Troy, Ala. (IV)	250	WGAL	Lancaster, Pa. (IV)	250	WPTS	Pittsboro, Pa. (II)	D-1,000	WNNP	Evanston, Ill. (III)	D-1,000
KYCA	Prescott, Ariz. (IV)	250	WMRF	Lewistown, Pa. (IV)	250	WPME	Punkstunawney, Pa.	D-1,000	WTVF	Peoria, Ill. (III-B)	DA-1,000
KTKR	Tucson, Ariz. (IV)	250	WMGW	Meadville, Pa. (IV)	250	WADK	Newport, R. I. (II)	D-1,000	WXLW	Indianapolis, Ind. (III)	D-1,000
KXAR	Hope, Ark. (IV)	250	WGCD	Chester, S. C. (IV)	250	KCUL	Fort Worth, Tex. (II)	LS-5,000	KWBG	Boone, Ia.	LS-1,000
KTLO	Mt. Home, Ark. (IV)	250	WLAT	Conway, S. C. (IV)	250						
KDRS	Paragould, Ark. (IV)	250	WAKE	Greenville, S. C. (IV)	250	KGBC	Galveston, Tex. (II)	LS-1,000			
KOTN	Pine Bluff, Ark. (IV)	250	WALD	Walterboro, S. C. (IV)	250	KIWW	San Antonio, Tex.	D-250	KVGB	Great Bend, Kan. (III-A)	DA-N-5,000
KXRT	Russellville, Ark. (IV)	250	KORN	Mitchell, S. D. (IV)	250	WTKM	Hartford, Wis. (II)	D-500			
KPAS	Banning, Cal. (IV)	250	WOPF	Bristol, Tenn. (IV)	250		1500 KC. (Mexican) CLEAR		WLNK	Lebanon, Ky. (III)	D-500
KBLA	Burbank, Cal. (IV)	250	WDXB	Chattanooga, Tenn. (IV)	250	WBHS	Huntsville, Ala. (II)	LS-5,000	WTVB	Coldwater, Mich. (III)	LS-5,000
KICO	Calexico, Cal. (IV)	250	WJMJ	Lewisburg, Tenn. (IV)	250	KEAR	San Mateo, Cal. (II)	DA-N-1,000	WDVG	Marine City, Mich. (III)	DA-D-1,000
KAFP	Petaluma, Cal. (IV)	250	↑WDXL	Lexington, Tenn. (IV)	250				WVNO	St. Paul, Minn.	D-5,000
KBLF	Red Bluff, Cal. (IV)	250	WATO	Oak Ridge, Tenn. (IV)	250	KENT	Shreveport, La. (II)	LS-1,000	KPRS	Kansas City, Mo. (III)	D-1,000
KDB	Santa Barbara, Cal. (IV)	250	KNOW	Austin, Tex. (IV)	250	WBSC	Bennettsville, S. C. (II)	LS-10,000	WGTC	Greenville, N. C. (III)	LS-5,000
KSYC	Yreka, Cal. (IV)	250	KIBL	Beeville, Tex. (IV)	250						
KBOL	Boulder, Colo. (IV)	250	KBST	Big Spring, Tex. (IV)	250	WHPA	Chester, Pa. (III)	DA-N-1,000	WAC	Camden, S. C. (III)	D-1,000
↑KSLV	Monte Vista, Colo. (IV)	250	KRUZ	Borger, Tex. (IV)	250	KERC	Eastland, Tex. (III)	D-500	KATL	Houston, Tex. (III-A)	DA-N-5,000
WNLC	New London, Conn. (IV)	250	WBRD	Brady, Tex. (IV)	250	KATL	Houston, Tex. (III-A)	DA-N-5,000	KCBP	Libbuck, Tex. (III-B)	DA-1,000
WTOR	Torrington, Conn. (IV)	250	KSAM	Huntsville, Tex. (IV)	250	KCBP	Sinton, Tex. (III)	DA-D-1,000	↑KSPC	Sinton, Tex. (III)	DA-D-1,000
WTRL	Bradenton, Fla. (IV)	250	KVOZ	Laredo, Tex. (IV)	250	KQLO	Seattle, Wash. (III)	D-5,000	WTRW	Two Rivers, Wis. (III)	D-1,000
WJBS	Deland, Fla. (IV)	250	KVOW	Littlefield, Tex. (IV)	250	WXR	Guayama, P. R. (III-A)	1,000			
WEAT	Lake Worth, Fla. (IV)	250	KPLT	Paris, Tex. (IV)	250						
	(CP for 850 kc)		KGKB	Tyler, Tex. (IV)	250		1600 KC. REGIONAL				
↑WAHR	Miami, Fla. (IV)	100	KVVC	Vernon, Tex. (IV)	250	WAPX	Montgomery, Ala. (III-A)	DA-N-1,000	KGST	Fresno, Cal. (III)	D-1,000
↑WPJV	Vero Beach, Fla. (IV)	100	KVOG	Ogden, Utah (IV)	250				KPMO	Pomona, Cal. (III-B)	500
WSIR	Winter Haven, Fla. (IV)	250	WKNE	Newport, Vt. (IV)	250	KUBA	Yuba City, Cal. (III-B)	LS-1,000			
WMGR	Bainbridge, Ga. (IV)	250	WBET	Bedford, Va. (IV)	250				WKWF	Key West, Fla. (III-B)	500
WMOG	Brunswick, Ga. (IV)	250	WKLV	Blackstone, Va. (IV)	250	WQXR	New York, N. Y. (II)	10,000	WABR	Winter Park, Fla. (III)	D-1,000
WJMJ	Cordele, Ga. (IV)	250	WCVA	Culpepper, Va. (IV)	250	WTOS	Toledo, O. (II)	D-1,000	WBTO	Linton, Ind. (II)	D-500
↑WMRE	Monroe, Ga. (IV)	250	WVEC	Hampton, Va. (IV)	250	WKCO	Chickasha, Okla. (II)	DA-N-250	WBRI	Cedar Rapids, Ia. (III-A)	DA-N-5,000
WWNS	Statesboro, Ga. (IV)	250	WAYB	Waynesboro, Va. (IV)	250						
KBLI	Blackfoot, Ida. (IV)	250	KBRO	Bremerton, Wash. (IV)	250	KHBR	Hillsboro, Tex. (II)	D-250	WINX	Rockville, Md. (III)	D-1,000
KCID	Caldwell, Ida. (IV)	250	KELS	Kelso, Wash. (IV)	250	WENA	Bayamon, P. R. (II)	250	WVOM	Brookline, Mass. (III-A)	DA-5,000
WKRO	Cairo, Ill. (IV)	250	KTEL	Walla Walla, Wash. (IV)	250		1570 KC. (Mexican) CLEAR				
WDAN	Danville, Ill. (IV)	250	WGKV	Charleston, W. Va. (IV)	250	WCRL	Oneonta, Ala. (II)	D-250	WJKO	Springfield, Mass. (III)	DA-D-5,000
WTM	E. St. Louis, Ill. (IV)	250	WVUV	Fairmont, W. Va. (IV)	250	KCVR	Lodi, Cal. (II)	D-1,000			
WOPA	Oak Park, Ill. (IV)	250	WLOH	Princeton, W. Va. (IV)	250	WPLA	Plant City, Fla. (II)	D-250	WHRV	Ann Arbor, Mich. (III-A)	DA-1,000
WKBV	Richmond, Ind. (IV)	250	WGEZ	Beloit, Wis. (IV)	250	WOKZ	Alton, Ill. (II)	D-1,000			
WHOT	South Bend, Ind. (IV)	250	WLXZ	La Crosse, Wis. (IV)	250	WFRL	Freeport, Ill. (II)	D-1,000	WKNK	Muskegon, Mich. (III-A)	DA-1,000
KBUR	Burlington, Iowa (IV)	250	WIGM	Medford, Wis. (IV)	250	WFRP	Frankfort, Ind. (II)	D-250	WWRL	New York, N. Y. (III-A)	DA-N-5,000
WBQB	Dubuque, Iowa (IV)	250	WOSH	Oshkosh, Wis. (IV)	250	WLRP	New Albany, Ind. (II)	D-1,000			
KRIB	Mason City, Iowa (IV)	250	KGOS	Torrington, Wyo. (IV)	250	KFAD	Fairfield, Ia. (II)	D-250	WGIV	Charlotte, N. C. (III-A)	DA-5,000
KTOP	Topeka, Kan. (IV)	250	KWOR	World, Wyo. (IV)	250	KJFJ	Webster City, Ia. (II)	D-250	WFR	Reidsville, N. C. (III-A)	D-1,000
WPCF	Cumberland, Ky. (IV)	250	KTOH	Lihue, T. H. (IV)	250	KWSK	Pratt, Kan. (II)	D-250	WJEL	Springfield, O. (III)	D-1,000
WFKY	Frankfort, Ky. (IV)	250	WMDD	Fajardo, P. R. (IV)	250	WPTX	Lexington Park, Md. (II)	D-1,000	KWHF	Cushing, Okla. (III)	D-1,000
WKAY	Glasgow, Ky. (IV)	250		1500 KC. CLEAR					KASH	Eugene, Ore. (III-B)	DA-N-1,000
WOMI	Owensboro, Ky. (IV)	250									

* Construction permit for new station.
N—Night power.

DIRECTORY OF CANADIAN STATIONS BY FREQUENCIES

Licensed or Authorized by the Canadian Department of Transport as of January 1, 1954

D—Day power.
DA—Directional antenna.

Call Letters	Location	Power in Watts	Call Letters	Location	Power in Watts	Call Letters	Location	Power in Watts	Call Letters	Location	Power in Watts	Call Letters	Location	Power in Watts
CBK	540 KILOCYCLES Watrous, Sask.	50,000	CBF	690 KILOCYCLES Montreal, Que.	50,000	CKNB	Campbellton, N. B. (DA)	1,000	CKSF	Cornwall, Ont.	250	CHOV	Pembroke, Ont.	
CFNB	550 KILOCYCLES Fredericton, N. B.		CKVM	700 KILOCYCLES Ville Marie, Que.		CFAC	960 KILOCYCLES Calgary, Alta.		CJFB	Belleville, Ont.	250	CJDC	Dawson Creek, B. C.	1,000-DA
CHLN	5,000-DA-N Three Rivers, Que.		CKAC	730 KILOCYCLES Montreal, Que.	10,000-D 5,000-N	CHNS	5,000-DA-N Halifax, N. S.		CFYV	Dawson, Y. T.	100	CBT	Grand Falls, Nfld.	1,000
CKPG	1,000-DA-2 Prince George, B. C.	250	CBL	740 KILOCYCLES Toronto, Ont.	50,000	CKWS	5,000-DA-N Kingston, Ont. (DA)	5,000	CHWK	Chilliwack, B. C.	250	CKTR	Three Rivers, Que.	1,000-DA-1
CJKL	560 KILOCYCLES Kirkland Lake, Ont.		CKSO	790 KILOCYCLES Sudbury, Ont.		CKCH	970 KILOCYCLES Hull, Que.	1,000-DA	CKDM	Dauphin, Man.	250	CKPC	1380 KILOCYCLES Branford, Ont.	
CFRA	5,000-DA-1 Ottawa, Ont.		CBY	740 KILOCYCLES Corner Brook, Nfld.	1,000	CKRM	980 KILOCYCLES Regina, Sask.		CKVD	Val d'Or, Que.	250	CFDA	Victoriaville, Que.	1,000-DA-N
CJEM	570 KILOCYCLES Edmonton, N. B.		CJAD	800 KILOCYCLES Montreal, Que.	10,000-DA	CKVW	990 KILOCYCLES Winnipeg, Man.	50,000	CKBB	Barrie, Ont.	250	CKLC	Kingston, Ont.	1,000-DA-1
CJFX	580 KILOCYCLES Antigonish, N. S. (DA)	5,000	CHAB	Moose Jaw, Sask.	5,000-DA	CKVL	1000 KILOCYCLES London, Que.	1,000-DA	CKLD	Thetford Mines, Que.	250	CKLN	1400 KILOCYCLES Truro, N. S.	250
CKUA	Edmonton, Alta.	1,000	CKLW	Windsor, Ont.	50,000-DA-2	CBW	990 KILOCYCLES Winnipeg, Man.	50,000	CFPR	Prince Rupert, B. C.	250	CKRN	Rouyn, Que.	250
CKPR	Fort William, Ont.	1,000	CKRC	Quebec, Que.	5,000-DA	CKBW	1000 KILOCYCLES Bridgewater, N. S.	1,000-DA-N	CJCS	Stratford, Ont.	250	CJFP	Riviere du Loup, Que.	250
CKEY	Toronto, Ont. (DA)	5,000-D	CKOK	Penticton, B. C.	1,000-D	CKBX	1010 KILOCYCLES Edmonton, Alta.	50,000-DA	CJCT	Sherbrooke, Que.	250	CKFH	Toronto, Ont.	250
CKY	Winnipeg, Man.	1,000-N-DA-2	CKFI	Fort Francis, Ont.	500-N	CFRB	Toronto, Ont.	50,000-DA-2	CJAV	Port Alberni, B. C.	250	*.....	Ville St. Georges, Que.	250
CFCL	Timmins, Ont.	5,000-DA	VOWR	St. John's, Nfld.	1,000	CHUM	1050 KILOCYCLES Toronto, Ont.	1,000-D	CJRW	Summerside, P. E. I.	250	CKMO	1410 KILOCYCLES Vancouver, B. C.	1,000
CFAR	590 KILOCYCLES Flin Flon, Man.	1,000	CKRD	850 KILOCYCLES Red Deer, Alta.	1,000-DA-N	CFGP	1050 KILOCYCLES Grande Prairie, Alta.	1,000	CKLS	La Sarre, Que.	250	CHLP	Montreal, Que.	1,000-DA
VOCM	St. John's, Nfld.	1,000	CJBC	860 KILOCYCLES Toronto, Ont.	50,000	CFCN	1060 KILOCYCLES Calgary, Alta.	10,000-DA-N	CKGO	Eastview, Ont.	250-DA-1	CKOM	1420 KILOCYCLES Saskatoon, Sask.	5,000-DA-N
CKRS	Jonquiere, Que.	1,000-DA-1	CJVI	900 KILOCYCLES Victoria, B. C.	1,000-DA	CBA	1070 KILOCYCLES Sackville, N. B.	50,000	CKSB	St. Boniface, Man. (DA)	1,000	CHEX	1430 KILOCYCLES Peterborough, Ont.	1,000-DA
CJOR	600 KILOCYCLES Vancouver, B. C. (DA)	5,000	CJBR	910 KILOCYCLES Rimouski, Que.	5,000-DA-N	CHOK	1070 KILOCYCLES Sarnia, Ont.	5,000-D	CKBL	Matane, Que.	1,000-DA-1	CFJR	1450 KILOCYCLES Brockville, Ont.	250
CFQC	Saskatoon, Sask.	5,000-DA-N	CHML	Hamilton, Ont.	5,000-DA-N	CHED	1080 KILOCYCLES Edmonton, Alta.	1,000-DA-1	CHAT	Medicine Hat, Alta.	1,000-N	CFBM	Brockton, Man.	100
CFCH	610 KILOCYCLES North Bay, Ont.	1,000-DA	CKBI	Prince Albert, Sask.	5,000-DA-2	CFJB	1090 KILOCYCLES Brampton, Ont.	250-D	CFGT	St. Joseph d'Alma, Que.	1,000-DA-N	CFBF	Granby, Que.	250
CJAT	Trail, B. C.	1,000	CHLT	Sherbrooke, Que.	1,000-DA-N	CFJC	1130 KILOCYCLES Vancouver, B. C.	5,000	CKCV	1280 KILOCYCLES Quebec, Que.	1,000-DA-N	CFAB	Windsor, N. S.	250
CHNC	620 KILOCYCLES Regina, Sask.	5,000-DA-N	CHNO	Sudbury, Ont.	1,000	CKXL	1140 KILOCYCLES Calgary, Alta.	1,000-DA-N	CJMS	1310 KILOCYCLES Montreal, Que.	5,000-DA-1	CFOR	Orillia, Ont.	250
CKCK	St. Catharines, Ont.	1,000-DA	CBO	Ottawa, Ont.	5,000	CKXK	1150 KILOCYCLES Brandon, Man.	1,000	CKOY	1310 KILOCYCLES Ottawa, Ont.	5,000-D	CJOY	Guayn, Ont.	250
CKTB	630 KILOCYCLES Charlottetown, P. E. I.	5,000-DA-N	CKNX	930 KILOCYCLES Edmonton, Alta.	5,000-DA-N	CKOC	1150 KILOCYCLES Hamilton, Ont.	5,000-DA	CKNW	1320 KILOCYCLES New Westminster, B. C.	1,000-DA-N	CBG	Gander, Nfld.	250
CFCO	Chatham, Ont.	1,000-DA	CJCA	940 KILOCYCLES Montreal, Que.	50,000	CHSJ	1220 KILOCYCLES Kenora, Ont.	1,000	CJSO	1330 KILOCYCLES Sorel, Que.	1,000-DA-N	*.....	Chicoutimi, Que.	250
CKOV	Kelowna, B. C.	1,000	CFCB	940 KILOCYCLES St. John's, Nfld.	5,000-DA	CJRL	1220 KILOCYCLES Moncton, N. B.	1,000	CKBH	1330 KILOCYCLES Halifax, N. S.	100	CJNB	1460 KILOCYCLES North Battleford, Sask.	1,000
CKRC	Winnipeg, Man.	5,000-DA-N	CJON	940 KILOCYCLES Montreal, Que.	50,000	CKCW	1220 KILOCYCLES Moncton, N. B.	1,000	CKSO	1340 KILOCYCLES Amos, Que.	250	CFOS	1470 KILOCYCLES Owen Sound, Ont.	1,000-DA-N
CBN	640 KILOCYCLES St. John's, Nfld.	10,000	CBM	940 KILOCYCLES Montreal, Que.	50,000	CJOC	1220 KILOCYCLES Lethbridge, Alta.	5,000-DA-N	CHAD	1340 KILOCYCLES Amos, Que.	250	CKCR	1490 KILOCYCLES Kitchener, Ont.	250
CKGB	680 KILOCYCLES Timmins, Ont.	5,000-DA-N	CJGX	940 KILOCYCLES Montreal, Que.	50,000	CKSM	1230 KILOCYCLES Shawinigan Falls, Que.	1,000	CJLS	1340 KILOCYCLES Yarmouth, N. S.	250	CFRC	Kingston, Ont.	100
CHLO	St. Thomas, Ont.	1,000-DA	CJIB	940 KILOCYCLES Montreal, Que.	50,000	CFPA	1230 KILOCYCLES Port Arthur, Ont.	250	CJOB	1340 KILOCYCLES Winnipeg, Man.	250	CJIC	1490 KILOCYCLES Sault Ste. Marie, Ont.	250
CHFA	Edmonton, Alta.	5,000-DA	CHBD	950 KILOCYCLES Saskatoon, Sask.	1,000				CKOX	1340 KILOCYCLES Woodstock, Ont.	250	CKEN	1500 KILOCYCLES Kentville, N. S.	250

FREQUENCY ALLOCATIONS FOR EUROPEAN BROADCASTING STATIONS

LONG WAVES (150 to 285 kc)

Station	Frequency (kc)	Power (kw)
Tromsø (Norway)	155	10
Brasov (Romania)	150	150
Allouis (France)	164	450
Moscow I (USSR)	173	500
Reykjavik (Iceland)	182	100
Lulea (Sweden)		10
Ankara (Turkey)		120
Motala (Sweden)	191	200
Droitwich (G. B.) (or Ottringham)	200	400
Kiev I, Ukraine (USSR)	209	150
Oslo (Norway)	218	200
Warsaw I (Poland)	227	200
Leningrad I (USSR)	236	100
Kalundborg (Denmark)	245	150
Lahti (Finland)	254	200
Moscow II (USSR)	263	150
Ceskoslovensko (Czechoslovakia)	272	200
Minsk (USSR)	281	100

INTERMEDIATE

(415-490 kc and 510-525 kc)

Ostersund (Sweden)*	420	10
Oulu (Finland)*	453	10
Hamar (Norway)*	520	1

MEDIUM WAVES (525 to 1605 kc)

Beromunster (Switzerland)	529	150
Budapest I (Hungary)	539	135
Oukha, Finno-Carelia (USSR)	548	20
Simferopol, Russia (USSR)	548	100
Cairo II (Egypt)	557	20

[As agreed upon by European Broadcasting Convention at Copenhagen in 1948 and now in effect. Nations not signing pact: United States (occupying power in Germany), Austria, Spain, Sweden, Turkey, Egypt, Syria and Iceland. Most nations had reservations based on unsatisfactory frequencies for individual operations. Many stations are not operating on their assigned channels, according to monitoring reports].

Station	Frequency (kc)	Power (kw)
Helsinki (Finland)*	100	100
Monte Ceneri (Switzerland)	50	50
Athlone I (Ireland)	566	100
Catania (Italy)		5
Palermo (Italy)		10
Riga, Latvia (USSR)	575	100
Vienna I (Austria)	584	120
Sofia II (Bulgaria)*	593	60
Sundsvall (Sweden)*		150
Lyon (France)	602	150
Eidar (Iceland)	611	5
Rabat I (Morocco)		120
Petrozavodsk, Finno-Carelia (USSR)		100
Sarajevo (Yugoslavia)		60
Brussels I (Belgium)	620	150
Moscow III, Russia (USSR)		872
Moalaty (Turkey)		50
Vigra (Norway)	629	50
Tunis II (Tunisia)*		120
Prague I (Czechoslovakia)	638	150
Burhead (Great Britain)	647	15
Droitwich (Great Britain)		120
Stagshaw (Great Britain)		15
Westerglen (Great Britain)		15
Kharkov, Ukraine (USSR)	656	20
Bolzano (Italy)		80
Florence I (Italy)		80
Naples I (Italy)		80
Turin I (Italy)		45
Murmansk, Russia (USSR)	665	100
Vilnius, Lithuania (USSR)	665	100
Marseilles (France)	674	100
Bodo (Norway)		10

Station	Frequency (kc)	Power (kw)
Rostov-on-Don, Russia (USSR)		100
Belgrade I (Yugoslavia)	683	150
Nicosia (Cyprus)	692	10
Moorside Edge (Great Britain)		150
Banska-Bystrica (Czechoslovakia)	701	100
Czechoslovakia sync. network		5
Rabat II (Morocco)		120
Finnmark (Norway)		20
Limoges (France)	710	150
Stalino, Ukraine (USSR)		150
Lisbon (Portugal)	719	120
Damascus I (Syria)		50
Athens (Greece)	728	100
Akureyri (Iceland)	737	1
Jerusalem I (Palestine)		20
Gliwice (Poland)		50
Seville (Spain)		50
Hilversum I (Netherlands)	746	120
Kuopio (Finland)	755	20
Lisbon (Portugal)		50
Timisoara (Rumania)*		50
Sottens (Switzerland)	764	150
Cairo I (Egypt)	773	50
Stockholm (Sweden)*		150
Kiev II, Ukraine (USSR)	782	100
Soviet troops in Germany		70
Rennes (France)	791	150
Salonika (Greece)		50

Station	Frequency (kc)	Power (kw)
Leningrad II, Russia (USSR)	800	100
Burhead (Great Britain)		800
Dundee (Great Britain)		5
Redmoose (Great Britain)		20
Westerglen (Great Britain)		100
Skopje (Yugoslavia)		135
Foznan (Poland)		818
Sofia I (Bulgaria)		827
Nancy (France)		836
Beirut I (Lebanon)		20
Rome I (Italy)		845
Bucharest (Rumania)		854
Paris I (France)		863
Moscow III, Russia (USSR)		872
Aberystwyth (Great Britain)		881
Penmon (Great Britain)		20
Washford (Great Britain)*		150
Wrexham (Great Britain)		5
Cetinge (Yugoslavia)		20
Algiers I (Algeria)*		890
Bergen (Norway)		20
Kristiansand (Norway)		20
Trondheim (Norway)		20
Dnepropetrovsk, Ukraine (USSR)		20
Milan I (Italy)		899
London (Great Britain)		908
Ljubljana (Yugoslavia)		917
Brussels II (Belgium)		926
Lwow, Ukraine (USSR)		935
Toulouse (France)		944
Voronezh, Russia (USSR)		20
Morava (Czechoslovakia)		953
Turku (Finland)*		962
Tunis I (Tunisia)*		120
British Zone (Germany)		971
Izmir (Turkey)		50
Kalinin, Russia (USSR)		20
Smolensk, Russia (USSR)		20
Algiers II (Algeria)*		980
Goteborg (Sweden)*		150

EUROPEAN STATIONS

Station	Fre- quen- cy	Pow- er kw	Station	Fre- quen- cy	Pow- er kw	Station	Fre- quen- cy	Pow- er kw	Station	Fre- quen- cy	Pow- er kw
Rovaniemi (Finland)	939	10	Dundee (Great Britain)		5	Madrid I (Spain)	1,385	100	Nice (France)		75
American Zone (Germany)	70	10	Lisnagarvey (Great Britain)		10	Kaunas, Lithuania (USSR)	150	5	Turi, Estonia (USSR)		20
Beirut II (Lebanon)	20	10	Londonderry (Great Britain)		51	Dornbirn (Austria)	1,394	5	Portuguese sync. network	1,562	5
Kishinev, Moldavia (USSR)	998	100	Moorside Edge (Great Britain)		8	Graz (Austria)	15	5	Swedish sync. network		20
Hilversum II (Netherlands)	1,007	120	Plymouth (Great Britain)		2	Innsbruck (Austria)		5	Swiss sync. network		5
Aleppo I (Syria)	1,016	150	Redmoss (Great Britain)		2	Linz (Austria)		5	USSR Zone (Germany)	1,570	70
Istanbul (Turkey)	1,025	100	Redruth (Great Britain)		2	Rhodes (Greece)		5	Spanish sync. network		5
Graz-Dobl (Austria)		10	Stagshaw (Great Britain)		10	Swedish sync. network		20	Sfax II (Tunisia)		5
Jerusalem II (Palestine)		20	Westerglen (Great Britain)		50	Bayonne (France)	1,403	20	Italian sync. network	1,578	10
Turlin II (Italy)	1,034	10	British troops in Germany		70	Lille (France)		20	Fredrikstad (Norway)		10
Lisbon (Portugal)		40	Azores (Portugal)		2	Paris (France)		10	British Zone (Germany)	1,586	70
Tallinn, Estonia (USSR)		100	Kursk, Russia (USSR)		20	Quimper (France)		20	Spanish sync. network		5
USSR Zone (Germany)	1,043	70	Str Zagora (Bulgaria)	1,223	20	Montpellier (France)		10	International common frequency†	1,594	
Kalamata (Greece)		5	Barcelona (Spain)		20	Nice (France)		20	U. S. Zone (Germany)	1,602	70
Agadir I (Morocco)		5	Falun (Sweden)		100	French troops in Germany		25	Norwegian sync. network		2
Marrakesh (Morocco)		20	Budejovice (Czechoslovakia)	1,232	5	Komotini (Greece)		5	Portuguese sync. network		5
Ujda I (Morocco)		20	Cechy-Zapad (Czechoslovakia)		25	Baranovichi, Byelorussia (USSR)		20			
Harland Point (Great Britain)	1,052	10	Morava-Vychod (Czechoslovakia)		25	Banja Luka (Yugoslavia)	1,412	20	¹ DA protecting S.W.		
Start Point (Great Britain)**	150	150	Prague II (Czechoslovakia)		100	Bitolja (Yugoslavia)		20	² DA protecting S.W.		
Tripoli (Libya)**		50	Vaasa (Finland)	1,241	50	Maribor (Yugoslavia)		20	³ DA protecting S.		
Jassi (Rumania)		10	Bayonne (France)		20	Pristina (Yugoslavia)		20	⁴ DA protecting Switzerland.		
Focani (Rumania)		5	Clermont-Ferrand (France)		20	Rijeka (Yugoslavia)		20	⁵ DA. Apparent power towards Swe- den 10 kw.		
Eastern Denmark	1,061	60	Corse (France)		10	Split (Yugoslavia)		60	⁶ DA. Apparent power towards Bul- garia 20 kw.		
Cagliari (Italy)		15	Grenoble (France)		20	Sarrebruck (Germany: French Zone)	1,421	20	⁷ DA protecting Norway.		
Lisbon (Portugal)		15	Le Havre (France)		20	Sfax I (Tunisia)		5	⁸ Power to be reduced to 20 kw if DA protecting Portugal is not used.		
Paris II (France)	1,070	100	Montbéliard (France)		20	Chernikov, Ukraine (USSR)		5	⁹ DA. Apparent power towards Egypt 20 kw.		
Krasnodar, Russia (USSR)		20	Nice (France)		20	Argyrokastrò (Albania)	1,430	5	¹⁰ DA. Apparent power towards Yu- goslavia 150 kw.		
Breslau (Poland)	1,079	50	Quimper (France)		20	Western Denmark		70	¹¹ DA protecting Norway.		
Korca (Albania)	1,088	10	Tiraspol, Moldavia (USSR)		5	Copenhagen (Denmark)		10	¹² DA protecting Finland.		
Shkodra (Albania)		10	Lower Egypt	1,250	5	Madrid II (Spain)		50	¹³ DA protecting Sweden.		
Droitwich (Great Britain)		150	Nyiregyhaza (Hungary)		10	Luxembourg	1,439	150	¹⁴ DA protecting Algeria.		
Norwich (Great Britain)		150	Zalaegerzeg (Hungary)**		20	Ancona (Italy)	1,448	25	¹⁵ DA protecting Libya.		
Bratislava (Czechoslovakia)	1,097	150	Athlone (Ireland)		20	Florence II (Italy)		3	¹⁶ DA protecting Great Britain.		
Czechoslovakia sync. network		5	Le Havre (France)	1,259	50	Genoa II (Italy)		3	¹⁷ DA protecting Ireland.		
Moghilev, Byelorussia (USSR)	1,106	100	Belgrade II (Yugoslavia)	1,288	135	Milan II (Italy)		50	¹⁸ Shared by: Albania, Austria, Bel- gium, Cyprus, Czechoslovakia, Den- mark, Finland, France, Germany, British Zone, Gibraltar, Great Britain, Greece, Hungary, Ireland, Italy, Lithu- ania, Malta, Morocco, Norway, Poland, Portugal, Rumania, Russia, San Marino, Spain, Syria, Trieste, Tripoli, Tunisia, Ukraine, and Yugoslavia. Vatican City is permitted to use this frequency with a power of 5 kw until receivers cover- ing 1.529 kc are more generally in use.		
Bari I (Italy)	1,115	50	Lille (France)	1,277	150	Naples II (Italy)		5	¹⁹ Belfast (5kw); Bournemouth (2); Brighton (5); Bristol (2); Cardiff (2); Dundee (2); Edinburgh (5); Exeter (5); Fareham (2); Glasgow (5); Hull (5); Leeds (5); Liverpool (5); London (20); Manchester (2); Middlesbrough (2); Newcastle-on-Tyne (5); Plymouth (5); Preston (2); Redmoss (2); Redruth (2); Sheffield (2).		
Bologna I (Italy)		50	Kosice (Czechoslovakia)	1,286	100	Venice II (Italy)		5	²⁰ Shared by: Andorra; Austria; Bel- gium; Bulgaria; Ceylon; Czechoslo- vakia; Denmark; Finland; France; Great Britain; Greece; Ireland; Latvia; Madeira Is. Morocco (Tangier); Nor- way; Netherlands; Poland; Portugal; Spain; Switzerland; Syria; Trieste; Yu- goslavia.		
S. Remo (Italy)		5	Radio Catolica (Portugal)		20	Portuguese sync. network		20			
Norwegian sync. network		5	Otringham (Great Britain)	1,295	150	Swedish sync. network		20			
Brussels III (Belgium)	1,124	20	Constantine II (Algeria)	1,304	20	Bartley (Great Britain)	1,457	60			
Varna (Bulgaria)		20	Oran II (Algeria)		40	Clevedon (Great Britain)		60			
Viborg, Russia (USSR)		20	Danzig (Poland)		50	Craslow (Rumania)	1,466	120			
Zagreb (Yugoslavia)	1,133	135	Stavanger (Norway)	1,313	100	Monte-Carlo (Monaco)		2			
Constantine I (Algeria)	1,142	20	Ouhgorod, Ukraine (USSR)	1,322	100	Norwegian sync. network		2			
Oran I (Algeria)		40	Genoa I (Italy)	1,331	50	Vienna II (Austria)	1,475	30			
Kaliningrad, Russia (USSR)		20	Messina (Italy)		25	Salzburg (Austria)		20			
Carlisle (Great Britain)	1,151	5	Pescara (Italy)		25	Klagenfurt (Austria)		20			
Lisnagarvey (Great Britain)		100	Rome II (Italy)		50	International common frequency*	1,484				
Londonderry (Great Britain)		5	Venice (Italy)		25	French sync. network	1,493	60			
Stagshaw (Great Britain)		100	Alexandria (Egypt)	1,340	5	Gomel, Byelorussia (USSR)		20			
Bala Mare (Rumania)		20	Crowborough or Stagshaw (Great Britain)		150	Cracow (Poland)	1,502	50			
Clug (Rumania)		5	Budapest (Hungary)		5	Warsaw II (Poland)		10			
Oradea (Rumania)		5	Magyarovar (Hungary)		5	Zaragoza (Spain)		50			
Strasbourg I (France)	1,160	150	Miskolc (Hungary)		5	Brussels IV (Belgium)	1,511	20			
Odessa, Ukraine (USSR)	1,169	150	Pecs (Hungary)		5	Chania (Greece)		5			
Horby (Sweden)	1,178	100	Corse (France)	1,349	10	Jihlava (Czechoslovakia)	1,520	5			
Budapest II (Hungary)	1,187	135	Marseilles (France)		50	Ostrava (Czechoslovakia)		5			
French Zone (Germany)	1,196	70	Nantes (France)		30	Pilzen (Czechoslovakia)		30			
Kerkya (Greece)		15	Toulouse (France)		50	Corunna (Spain)		20			
Agadir II (Morocco)		20	KAPA Raymond, Wash.	1400	250	Funchal (Madeira Is.)	1,529	20			
Marrakesh II (Morocco)		20	KAPK Minden, La.	1240	100	Swedish sync. network		20			
Ujda II (Morocco)		20	KARE Atchison, Kan.	1470	1,000	Vatican City		100			
Bordeaux (France)	1,205	100	KARK Little Rock, Ark.	920	5,000	French Zone (Germany)	1,538	70			
Haifa (Palestine)		5	KARM Fresno, Cal.	1430	5,000	Spanish sync. network	1,546	5			
Lublin (Poland)		10	KASA Elk City, Okla.	1240	250	British sync. network†	1,546	5			
Ayr (Great Britain)	1,214	5	KASH Eugene, Ore.	1600	1,000	Vinnitza, Ukraine (USSR)		5			
London (Great Britain)		60	KASI Ames, Ia.	1430	D-1,000	Germany: U. S. Forces	1,554	70			
Burghhead (Great Britain)		20	KASL Newcastle, Wyo.	1240	250						
			KASM Albany, Minn.	1150	D-500						
			KAST Astoria, Ore.	1370	1,000						
			KATE Albert Lea, Minn.	1450	250						
			KATL Houston, Tex.	1590	5,000						
			KATO Reno, Nev.	1340	250						
			KATY San Luis Obispo, Cal.	1340	250						
			KAUS Austin, Minn.	1480	1,000						

DIRECTORY OF AM BROADCASTING STATIONS BY CALL LETTERS

* Construction permit for power or frequency change

† Construction permit for new station

‡ Special service authorization

Call Letters	City	Fre- quency in KC	Power in Watts	Call Letters	City	Fre- quency in KC	Power in Watts	Call Letters	City	Fre- quency in KC	Power in Watts
KAAA	Red Wing, Minn.	1250	D-1,000	KAMD	Camden, Ark.	1450	250	KAVE	Carlsbad, N. M.	1240	250
KABC	Los Angeles, Cal.	790	5,000	KAMQ	Amarillo, Tex.	1010	LS-1,000	KAVL	Lancaster, Cal.	1340	250
			N-10,000				N-500	*KAVR	Victorville, Cal.	960	D-5,000
KABI	Ketchikan, Alaska	580	LS-1,000	KANA	Anaconda, Mont.	1230	250	KAWT	Douglas, Ariz.	1450	250
			N-500	KAND	Corsicana, Tex.	1340	250	KAYL	Storm Lake, Ia.	990	D-250
KABQ	Albuquerque, N. M.	1340	250	KANE	New Iberia, La.	1240	250	KAYO	Seattle, Wash.	1150	LS-5,000
KABR	Aberdeen, S. D.	1220	D-250	*KANI	Kaneohe, Oahu, T. H.	1150	1,000	KAYS	Hays, Kans.	1400	250
KADA	Ada, Okla.	1230	250	KANS	Wichita, Kans.	1480	LS-5,000	KBAR	Burling, Ida.	1230	250
*KADQ	Anadarko, Okla.	1250	D-500				N-1,000	KBBA	Benton, Ark.	690	D-250
KAFP	Petaluma, Cal.	1490	250					KBEL	Idabel, Okla.	1240	250
KAFY	Bakersfield, Cal.	550	1,000	KAOK	Lake Charles, La.	1400	250	KBHS	Hot Springs, Ark.	590	D-1,000
KAGH	Crossett, Ark.	1340	250	KAPL	Raymond, Wash.	1340	250	KBIF	Sanger, Cal.	900	D-1,000
KAGR	Yuba City, Cal.	1450	100	KAPK	Minden, La.	1240	100	KBIG	Santa Catalina, Cal.	740	D-10,000
KAHU	Waipahu, T. H.	920	1,000	KARE	Atchison, Kan.	1470	1,000	KBIM	Roswell, N. M.	910	D-1,000
KAKC	Tulsa, Okla.	970	LS-1,000	KARK	Little Rock, Ark.	920	5,000	KBIS	Bakersfield, Cal.	970	1,000
			N-500	KARM	Fresno, Cal.	1430	5,000	KBKX	Muskogee, Okla.	1490	250
KAKE	Wichita, Kans.	1240	250	KASA	Elk City, Okla.	1240	250	KBZ	Ottumwa, Ia.	1240	250
KALB	Alexandria, La.	580	LS-5,000	KASH	Eugene, Ore.	1600	1,000	KBKJ	Alice, Tex.	1070	1,000
			N-1,000	KASI	Ames, Ia.	1430	D-1,000	KBKR	Baker, Ore.	1490	250
KALE	Richland, Wash.	960	1,000	KASL	Newcastle, Wyo.	1240	250	KKBR	Aberdeen, Wash.	1450	250
KALG	Alamogordo, N. M.	1230	250	KASM	Albany, Minn.	1150	D-500	KBLA	Burbank, Cal.	1490	250
			N-1,000	KAST	Astoria, Ore.	1370	1,000	KBLB	Red Bluff, Cal.	1490	250
KALI	Pasadena, Cal.	1430	D-1,000	KATE	Albert Lea, Minn.	1450	250	KBLI	Blackfoot, Idaho	1490	250
			*D-5,000					KBLT	Hot Springs, Ark.	1470	D-1,000
KALL	Salt Lake City, Utah	910	1,000	KATL	Houston, Tex.	1590	5,000	KBLP	Falfrunias, Tex.	1260	D-500
KALM	Thayer, Mo.	1290	D-1,000	KATO	Reno, Nev.	1340	250	*KBMI	Henderson, Nev.	1400	250
KALT	Atlanta, Tex.	900	D-1,000	KATY	San Luis Obispo, Cal.	1340	250				

AM CALL LETTERS

Call Letters	City	Frequency in KC	Power in Watts	Call Letters	City	Frequency in KC	Power in Watts	Call Letters	City	Frequency in KC	Power in Watts	Call Letters	City	Frequency in KC	Power in Watts
KBUC	Corona, Cal.	1370	LS-1,000	KDKA	Pittsburgh, Pa.	1020	50,000	KFKA	Greeley, Colo.	1310	1,000	KGNO	Dodge City, Kan.	1370	LS-5,000
KBUD	Athens, Tex.	1410	N-500	KDKD	Clinton, Mo.	1280	D-1,000	KFKU	Lawrence, Kans.	1250	5,000	KGO	S. Francisco, Cal.	810	50,000
KBUH	Brigham City, Utah	800	D-250	KDLA	DeRidder, La.	1010	D-1,000	KFLD	Floydada, Tex.	900	D-250	KGON	Oregon City, Ore.	1230	250
KBUN	Bemidji, Minn.	1450	250	KDLK	Del Rio, Tex.	1230	250	KFLW	Klamath Falls, Ore.	1450	250	KGOS	Torrington, Wyo.	1490	250
KBUR	Burlington, Ia.	1490	250	KDLM	Detroit Lakes, Minn.	1360	D-1,000	KFMA	Davenport, Iowa	1580	D-250	KGPH	Flagstaff, Ariz.	690	LS-1,000
KBWD	Brownwood, Tex.	1380	LS-1,000	KDLR	Devils Lake, N. D.	1240	250	KFMB	San Diego, Cal.	550	1,000	KGRI	Fayetteville, Ark.	1450	250
			N-500	KDMA	Montevideo, Minn.	1450	100	KFMJ	Tulsa, Okla.	1050	D-1,000	KHBB	Henderson, Tex.	1000	D-250
KBWL	Blackwell, Okla.	1580	D-250	KDMO	Carthage, Mo.	1490	250	KFMO	Flat River, Mo.	1240	250	KHBC	Malvern, Ark.	1380	D-1,000
KBYE	Oklahoma City, Okla.	890	D-1,000	KDMS	El Dorado, Ark.	1290	D-1,000	KFNF	Shenandoah, Ia.	920	LS-1,000	KHBT	Fresno, Cal.	1600	D-1,000
KBYR	Anchorage, Alaska	1240	250	KDNT	Denton, Tex.	1440	LS-1,000	KFOR	Lincoln, Nebr.	1240	250	KHCV	Honolulu, T. H.	760	LS-2,500
KBZY	Grand Rapids, Minn.	1490	250	KDON	Salinas, Cal.	1460	5,000	KFPD	Long Beach, Cal.	1280	1,000	KHCU	Honolulu, T. H.	760	LS-2,500
KCAL	Redlands, Cal.	1340	D-1,000	KDRO	Sedalia, Mo.	1490	250	KFPW	Fort Smith, Ark.	1230	250	KHCV	Greenville, Tex.	1400	250
KCAP	Helena, Mont.	1410	250	KDRS	Paragould, Ark.	1490	250	KFRB	Anchorage, Alaska	600	5,000	KCVG	Missoula, Mont.	1230	5,000
KCAR	Clarksville, Tex.	1350	D-500	KDSH	Boise, Idaho	950	5,000	KFRB	Fairbanks, Alaska	610	5,000	KCWG	Portland, Ore.	620	5,000
KCB	Des Moines, Ia.	1390	1,000	KDSJ	Deadwood, S. D.	980	1,000	KFRD	Rosenberg, Tex.	980	D-1,000	KCYA	Enid, Okla.	960	1,000
KCB	Lubbock, Tex.	1590	1,000	KDSX	Denison, Tex.	950	500	KFRE	Fresno, Cal.	940	50,000	KGY	Olympia, Wash.	1240	250
KCBQ	San Diego, Cal.	1170	LS-5,000	KDTH	Dubuque, Ia.	1370	1,000	KFRM	Kansas City, Mo.	550	D-5,000	KGYN	Guymon, Okla.	1220	D-1,000
			N-1,000	KDUB	Lubbock, Tex.	1340	250	KFRO	Longview, Tex.	1370	1,000	KGYV	Vallejo, Cal.	1190	D-250
KCBS	San Francisco, Cal.	740	50,000	KDUZ	Hutchison, Minn.	1260	D-1,000	KFRU	Columbia, Mo.	1400	250	KHAS	Hastings, Neb.	1230	250
KCC	Corpus Christi, Tex.	1150	D-1,000	KDWL	Stamford, Tex.	1400	250	KFSA	Ft. Smith, Ark.	950	LS-1,000	KHBB	Hilo, T. H.	970	1,000
KCFH	Cuero, Tex.	1600	D-500	KDYL	Salt Lake City, Utah	1320	5,000	KFSB	Joplin, Mo.	1310	LS-5,000	KHBC	Okmulgee, Okla.	1240	250
KCHA	Charles City, Ia.	1580	D-250	KDZA	Pueblo, Colo.	1230	250	KFSC	Denver, Colo.	1220	D-1,000	KHBT	Hillsboro, Tex.	1580	D-250
KCHE	Cherokee, Ia.	1440	D-500	KEAN	Brownwood, Tex.	1240	100	KFSG	San Diego, Cal.	600	5,000	KHCV	Honolulu, T. H.	760	D-1,000
KCHI	Chillicothe, Mo.	1010	D-250	KEAR	San Mateo, Cal.	1550	1,000	KFST	L. Angeles, Cal.	1150	LS-2,500	KHCV	Honolulu, T. H.	760	D-1,000
KCHJ	Delano, Cal.	1010	D-1,000	KEBE	Jacksonville, Tex.	1400	250	KFTM	Ft. Stockton, Tex.	860	D-250	KHCV	Honolulu, T. H.	760	5,000
KCHR	Charleston, Mo.	1350	D-500	KECC	Pittsburg, Cal.	990	1,000	KFTV	Paris, Texas	1250	D-500	KHCV	Honolulu, T. H.	760	5,000
KCHS	Truth or Consequences, N. M.	1400	250	KECK	Odessa, Tex.	920	LS-1,000	KFUD	Las Vegas, N. M.	1230	250	KHCV	Honolulu, T. H.	760	5,000
KCID	Caldwell, Idaho	1490	250	KEED	Edmonds, Wash.	630	D-1,000	KFUV	Clayton, Mo.	850	LS-5,000	KHCV	Honolulu, T. H.	760	5,000
KCIJ	Shreveport, La.	980	D-5,000	KEEN	San Jose, Cal.	1370	1,000	KFV	L. Angeles, Cal.	1020	L-N-5,000	KHCV	Honolulu, T. H.	760	5,000
KCI	Homma, Ia.	1490	250	KEEP	Twin Falls, Idaho	1450	250	KFV	L. Angeles, Cal.	1020	L-N-5,000	KHCV	Honolulu, T. H.	760	5,000
KCI	Carroll, Ia.	1380	1,000	KELA	Centralia, Wash.	1470	1,000	KFV	L. Angeles, Cal.	1020	L-N-5,000	KHCV	Honolulu, T. H.	760	5,000
KCI	Minot, N. D.	910	1,000	KELD	El Dorado, Ark.	1400	250	KFV	L. Angeles, Cal.	1020	L-N-5,000	KHCV	Honolulu, T. H.	760	5,000
KCKN	Kansas City, Kans.	1340	250	KELK	Elko, Nev.	1240	250	KFV	L. Angeles, Cal.	1020	L-N-5,000	KHCV	Honolulu, T. H.	760	5,000
KCKY	Coolidge, Ariz.	1150	1,000	KELQ	Sioux Falls, S. D.	1320	5,000	KFWB	L. Angeles, Cal.	980	5,000	KHCV	Honolulu, T. H.	760	5,000
KCLA	Pine Bluff, Ark.	1400	250	KELP	El Paso, Tex.	920	D-1,000	KFXD	Nampa, Ida.	580	5,000	KHCV	Honolulu, T. H.	760	5,000
KCLE	Cleburne, Tex.	1120	D-250	KELY	Ely, Nev.	1230	250	KFXJ	Grand Jct., Colo.	920	LS-1,000	KHCV	Honolulu, T. H.	760	5,000
KCLF	Clifton, Ariz.	1400	250	KENA	Mena, Ark.	1450	250	KFXM	San Bernardino, Cal.	590	D-250	KHCV	Honolulu, T. H.	760	5,000
KCLO	Leavenworth, Kans.	1410	D-500	KENI	Anchorage, Alaska	550	5,000	KFY	Bonham, Tex.	1420	D-250	KHCV	Honolulu, T. H.	760	5,000
KCLS	Flagstaff, Ariz.	1360	D-5,000	KENM	Portales, N. M.	1450	250	KFY	Lubbock, Tex.	790	LS-5,000	KHCV	Honolulu, T. H.	760	5,000
KCLV	Clovis, N. M.	1240	250	KENO	Las Vegas, Nev.	1460	1,000	KFY	Lubbock, Tex.	790	LS-5,000	KHCV	Honolulu, T. H.	760	5,000
KCLW	Hamilton, Tex.	900	D-250	KENT	Shreveport, La.	1550	LS-1,000	KFY	Lubbock, Tex.	790	LS-5,000	KHCV	Honolulu, T. H.	760	5,000
KCLX	Colfax, Wash.	1450	250	KEPO	El Paso, Tex.	690	10,000	KFY	Lubbock, Tex.	790	LS-5,000	KHCV	Honolulu, T. H.	760	5,000
KCLM	Carroll, Ia.	1490	250	KEQB	Kermit, Tex.	600	D-1,000	KFY	Lubbock, Tex.	790	LS-5,000	KHCV	Honolulu, T. H.	760	5,000
KCLN	Carroll, Ia.	1490	250	KERC	Eastland, Tex.	1590	D-500	KFY	Lubbock, Tex.	790	LS-5,000	KHCV	Honolulu, T. H.	760	5,000
KCLP	Carroll, Ia.	1490	250	KERG	Eugene, Ore.	1280	1,000	KFY	Lubbock, Tex.	790	LS-5,000	KHCV	Honolulu, T. H.	760	5,000
KCLQ	Carroll, Ia.	1490	250	KERN	Bakersfield, Cal.	1410	1,000	KFY	Lubbock, Tex.	790	LS-5,000	KHCV	Honolulu, T. H.	760	5,000
KCLR	Carroll, Ia.	1490	250	KERO	Bakersfield, Cal.	1230	250	KFY	Lubbock, Tex.	790	LS-5,000	KHCV	Honolulu, T. H.	760	5,000
KCLS	Carroll, Ia.	1490	250	KERV	Kerrville, Tex.	1230	250	KFY	Lubbock, Tex.	790	LS-5,000	KHCV	Honolulu, T. H.	760	5,000
KCLT	Carroll, Ia.	1490	250	KEUN	Euclid, La.	1490	250	KFY	Lubbock, Tex.	790	LS-5,000	KHCV	Honolulu, T. H.	760	5,000
KCLU	Carroll, Ia.	1490	250	KEVA	Shamrock, Tex.	1580	D-250	KFY	Lubbock, Tex.	790	LS-5,000	KHCV	Honolulu, T. H.	760	5,000
KCLV	Carroll, Ia.	1490	250	KEVT	Tucson, Ariz.	690	D-250	KFY	Lubbock, Tex.	790	LS-5,000	KHCV	Honolulu, T. H.	760	5,000
KCLW	Carroll, Ia.	1490	250	KEWA	Portland, Ore.	1190	50,000	KFY	Lubbock, Tex.	790	LS-5,000	KHCV	Honolulu, T. H.	760	5,000
KCLX	Carroll, Ia.	1490	250	KEXO	Grand Junction, Colo.	1230	250	KFY	Lubbock, Tex.	790	LS-5,000	KHCV	Honolulu, T. H.	760	5,000
KCLY	Carroll, Ia.	1490	250	KEXX	San Antonio, Texas	1250	D-500	KFY	Lubbock, Tex.	790	LS-5,000	KHCV	Honolulu, T. H.	760	5,000
KCLZ	Carroll, Ia.	1490	250	KEYD	Minneapolis, Minn.	1440	D-5,000	KFY	Lubbock, Tex.	790	LS-5,000	KHCV	Honolulu, T. H.	760	5,000
KCL	Carroll, Ia.	1490	250	KEYE	Perryton, Tex.	1400	250	KFY	Lubbock, Tex.	790	LS-5,000	KHCV	Honolulu, T. H.	760	5,000
KCL	Carroll, Ia.	1490	250	KEYS	Corpus Christi, Tex.	1440	LS-1,000	KFY	Lubbock, Tex.	790	LS-5,000	KHCV	Honolulu, T. H.	760	5,000
KCL	Carroll, Ia.	1490	250	KEYY	Provo, Utah	1450	250	KFY	Lubbock, Tex.	790	LS-5,000	KHCV	Honolulu, T. H.	760	5,000
KCL	Carroll, Ia.	1490	250	KFAB	Omaha, Neb.	1110	50,000	KFY	Lubbock, Tex.	790	LS-5,000	KHCV	Honolulu, T. H.	760	5,000
KCL	Carroll, Ia.	1490	250	KFAC	Los Angeles, Cal.	1330	5,000	KFY	Lubbock, Tex.	790	LS-5,000	KHCV	Honolulu, T. H.	760	5,000
KCL	Carroll, Ia.	1490	250	KFAD	Fairfield, Ia.	1570	D-250	KFY	Lubbock, Tex.	790	LS-5,000	KHCV	Honolulu, T. H.	760	5,000
KCL	Carroll, Ia.	1490	250	KFA	Fulton, Mo.	900	D-1,000	KFY	Lubbock, Tex.	790	LS-5,000	KHCV	Honolulu, T. H.	760	5,000
KCL	Carroll, Ia.	1490	250	KFAL	Fargo, N. D.	790	5,000	KFY	Lubbock, Tex.	790	LS-5,000	KHCV	Honolulu, T. H.	760	5,000
KCL	Carroll, Ia.	1490	250	KFAM	St. Cloud, Minn.	1450	250	KFY	Lubbock, Tex.	790	LS-5,000	KHCV	Honolulu, T. H.	760	5,000
KCL	Carroll, Ia.	1490	250	KFAR	Fairbanks, Alaska	610	5,000	KFY	Lubbock, Tex.	790	LS-5,000	KHCV	Honolulu, T. H.	760	5,000
KCL	Carroll, Ia.	1490	250	KFB	Great Falls, Mont.	1310	5,000	KFY	Lubbock, Tex.	790	LS-5,000	KHCV	Honolulu, T. H.	760	5,000
KCL	Carroll, Ia.	1490	250	KFBB	Great Falls, Mont.	1310	5,000	KFY	Lubbock, Tex.	790	LS-5,000	KHCV	Honolulu, T. H.	760	5,000
KCL	Carroll, Ia.	1490	250	KFBC	Cheyenne, Wyo.	1240	250	KFY	Lubbock, Tex.	790	LS-5,000	KHCV	Honolulu, T. H.	760	5,000
KCL	Carroll, Ia.	1490	250	KFBI	Wichita, Kans.	1070	LS-10,000	KFY	Lubbock, Tex.	790	LS-5,000	KHCV	Honolulu, T. H.	760	5,000
KCL	Carroll, Ia.	1490	250	KFB	Sacramento, Cal.	1530	50,000	KFY	Lubbock, Tex.	790	LS-5,000	KHCV	Honolulu, T. H.	760	5,000
KCL	Carroll, Ia.	1490	250	KFDA	Amarillo, Tex.	1440	LS-5,000	KFY	Lubbock, Tex.	790	LS-5,000	KHCV	Honolulu, T. H.	760	5,000
KCL	Carroll, Ia.	1490	250	KFDM	Beaumont, Tex.	560	5,000	KFY	Lubbock, Tex.	790	LS-5,000	KHCV	Honolulu, T. H.	760	5,000
KCL	Carroll, Ia.	1490	250	KFDR	Grand Coulee, Wash.	1400	250	KFY	Lubbock, Tex.	790	LS-5,000	KHCV	Honolulu, T. H.	760	5,000
KCL	Carroll, Ia.	1490	250	KFDX	Wichita Falls, Tex.	990	LS-10,000	KFY	Lubbock, Tex.	790	LS-5,000	KHCV	Honolulu, T. H.	760	5,000
KCL	Carroll, Ia.	1490	250	KFE	Denver, Colo.	950	5,000	KFY	Lubbock, Tex.	790	LS-5,000	KHCV	Honolulu, T. H.	760	5,000
KCL	Carroll, Ia.	1490	250	KFEQ											

AM CALL LETTERS

Call Letters	City	Power in Watts	Call Letters	City	Power in Watts	Call Letters	City	Power in Watts	Call Letters	City	Power in Watts
KJR	Seattle, Wash.	950	KNED	McAlester, Okla.	1150	KPAL	Palm Springs, Cal.	1450	KROY	Sacramento, Cal.	1240
KJRG	Newton, Kan.	950	KNEL	Brady, Tex.	1490	KPAM	Portland, Ore.	1410	KRPL	Moscow, Ida.	1400
KJRL	Pocatello, Idaho	1240	KNEM	Nevada, Mo.	1240	KPAN	Hereford, Tex.	860	KRRV	Sherman, Tex.	910
KJSK	Columbus, Neb.	900	KNET	Palestine, Tex.	1450	KPAT	Banning, Cal.	1490	KRSD	Rapid City, S. D.	1340
KJUN	Redmond, Ore.	1240	KNEX	Spokane, Wash.	790	KPBD	Parpa, Tex.	1340	KRSN	Los Alamos, N. M.	1490
KLAC	Los Angeles, Cal.	570	KNEX	McPherson, Kans.	1540	KPDQ	Portland, Ore.	800	KRTN	Raton, N. M.	1490
KLAN	Renton, Wash.	1230	KNGS	Hanford, Cal.	620	KPEL	Lamesa, Tex.	690	KRUN	Bullier, Tex.	1400
KLAS	Las Vegas, Nev.	1230	KNIM	Maryville, Mo.	1580	KPHO	Phoenix, Ariz.	910	KRUX	Ruston, La.	1490
KLBM	La Grande, Ore.	1450	KNOE	Monroe, La.	1390	KPIG	Cedar Rapids, Iowa	1450	KRWV	Glendale, Ariz.	1340
KLBS	Houston, Tex.	610	KNOG	Nogales, Ariz.	1340	KPKW	Pasco, Wash.	1340	KRWG	Forest Grove, Ore.	1570
KLCB	Libby, Mont.	1220	KNOR	Norman, Okla.	1400	KPLC	Lake Charles, La.	1470	KRXK	Ore.	1570
KLCN	Blytheville, Ark.	910	KNOW	Austin, Tex.	1490	KPLN	Camden, Ark.	1370	KRXL	Rexburg, Ida.	1230
KLCO	Poteau, Okla.	1280	KNOX	Grand Forks, N. D.	1400	KPLT	Paris, Tex.	1490	KSAC	Roseburg, Ore.	1240
KLEA	Livingston, N. M.	1050	KNPT	Newport, Ore.	1310	KPMC	Bakersfield, Cal.	1560	KSAL	Salinas, Kans.	1150
KLEB	Ottumwa, Ia.	1490	KNJU	New Ulm, Minn.	850	KPMO	Pomona, Cal.	1600	KSAM	Huntsville, Tex.	1490
KLEE	Lewiston, Ida.	740	KNKZ	Houston, Tex.	1230	KPOA	Honolulu, T. H.	630	KSAN	S. Francisco, Cal.	1450
KLER	Lafayette, La.	1420	KNWS	Waterloo, Iowa	1090	KPOC	Pocahontas, Ark.	1420	KSBW	Salinas, Cal.	1380
KLFY	Lafayette, La.	1420	KNX	Los Angeles, Cal.	1070	KPOF	Denver, Colo.	910	KSCB	Liberal, Kans.	1270
KLIC	Monroe, La.	1230	KOA	Denver, Colo.	850	KPOJ	Portland, Ore.	1330	KSCJ	Sioux City, Ia.	1360
KLIF	Dallas, Tex.	1190	KOAC	Corvallis, Ore.	550	KPOL	Los Angeles, Cal.	1540	KSCO	Santa Cruz, Cal.	1080
KLIK	Jefferson City, Mo.	950	KOAL	Price, Utah	1230	KPOO	San Francisco, Cal.	1010	KSD	Searcy, Ark.	1450
KLIL	Estherville, Ia.	1340	KOAM	Pittsburg, Kan.	860	KPOW	Powell, Wyo.	1260	KSDN	St. Louis, Mo.	550
KLII	Portland, Ore.	1290	KOAT	Albuquerque, N. M.	1240	KPPC	Pasadena, Cal.	1240	KSDO	Aberdeen, S. D.	930
KLIR	Denver, Colo.	990	KOBE	Albuquerque, N. M.	1030	KPPQ	Wash. Wenatchee,	560	KSEI	Pocatello, Ida.	930
KLIX	Twin Falls, Ida.	1310	KOBF	Las Cruces, N. M.	1450	KPRC	Houston, Tex.	950	KSEK	Pittsburg, Kans.	1340
KLKZ	Brainerd, Minn.	1400	KOBK	Owatonna, Minn.	1390	KPRR	Livingston, Mont.	1340	KSEL	Lubbock, Tex.	950
KLKC	Parsons, Kan.	1540	KOCA	Wet. Kilgore, Tex.	1240	KPRL	Paso Robles, Cal.	1230	KSEM	Moses Lake, Wash.	1450
KLMO	Longmont, Colo.	1050	KOCG	Salem, Ore.	1490	KPRO	Riverside, Cal.	1440	KSET	Durant, Okla.	750
KLMR	Lamar, Colo.	1340	KOCS	Ontario, Cal.	1510	KPRS	Kansas City, Mo.	1590	KSEY	El Paso, Tex.	1340
KLMS	Lincoln, Neb.	1480	KOCY	Okla. City, Okla.	1340	KPST	Preston, Idaho	1340	KSFA	Nacogdoches, Tex.	860
KLMX	Clayton, N.M.	1450	KODI	Cody, Wyo.	1400	KPUG	Bellingham, Wash.	1170	KSFE	Needles, Cal.	1340
KLO	Ogden, Utah	1430	KODL	The Dalles, Ore.	1230	KPUY	Puyallup, Wash.	1450	KSFO	S. Francisco, Cal.	560
KLOG	Kelso, Wash.	1490	KODY	N. Platte, Neb.	1240	KQV	Pittsburgh, Pa.	1410	KSGA	Cottage Grove, Ore.	1400
KLOK	San Jose, Cal.	1170	KOEL	Oelwein, Ia.	950	KRAI	Craig, Colo.	1230	KSGM	Ste. Genevieve, Mo.	980
KLQ	Seattle, Wash.	1590	KOFE	Pullman, Wash.	1150	KRAL	Rawlins, Wyo.	1240	KSIB	Creston, Iowa	1520
KLOU	Lake Charles, La.	1580	KOFO	Ottawa, Kans.	1220	KRAM	Las Vegas, Nev.	920	KSID	Sidney, Neb.	1340
KLPM	Minot, N. D.	1390	KOG	Orange, Tex.	1600	KRBA	Lufkin, Tex.	1340	KSIG	Crowley, Ia.	1450
KLPR	Oklahoma City	1140	KOH	Reno, Nev.	630	KRBC	Abilene, Tex.	1470	KSIJ	Gladewater, Tex.	1430
KLRA	Little Rock, Ark.	1010	KOIL	Omaha, Neb.	1290	KRCH	Hot Springs, Ark.	1270	KSIL	Silver City, N. M.	1340
KLST	Lone Star, Tex.	1300	KOIN	Portland, Ore.	970	KRCO	Prineville, Ore.	690	KSIM	Sikeston, Mo.	1400
KLTF	Little Falls, Minn.	960	KOJM	Havre, Mont.	610	KRCT	Baytown, Tex.	850	KSKS	Sedalia, Mo.	1050
KLTI	Longview, Tex.	1280	KOKO	Warrensburg, Mo.	1450	KRDO	Colorado Springs, Colo.	1240	KSIW	Woodward, Okla.	1450
KLUF	Galveston, Tex.	1400	KOKX	Keokuk, Iowa	1310	KRDU	Dinuba, Cal.	1240	KSIX	Corpus Christi, Tex.	1230
KLUK	Evanston, Wyo.	1240	KOL	Seattle, Wash.	1300	KRE	Berkeley, Cal.	1400	KSJB	Jamestown, N. D.	600
KLVC	Leadville, Colo.	1230	KOLD	Yuma, Ariz.	1240	KREH	Oakdale, La.	900	KSJO	San Jose, Cal.	1590
KLVL	Pasadena, Tex.	1480	KOLE	Port Arthur, Tex.	1340	KREI	Farmington, Mo.	800	KSKY	Dallas, Tex.	660
KLVT	Levelland, Tex.	1230	KOLJ	Quanah, Tex.	1150	KREM	Spokane, Wash.	970	KSL	Salt Lake City, Utah	1180
KLWN	Lawrence, Kan.	1320	KOLN	Lincoln, Neb.	1400	KREO	Indio, Cal.	1400	KSLM	Salem, Ore.	1390
KLWT	Lebanon, Mo.	1230	KOLO	Reno, Nev.	920	KRES	St. Joseph, Mo.	1550	KSLP	Opelousas, La.	1230
KLX	Oakland, Cal.	910	KOLS	Pryor, Okla.	1570	KREW	Sunnyside, Wash.	1230	KSLV	Monte Vista, Colo.	1490
KLXN	Amarillo, Tex.	940	KOLT	Scottsbluff, Neb.	1320	KRGA	Springfield, Ore.	1050	KSMA	Santa Maria, Cal.	1240
KLZ	Denver, Colo.	560	KOMA	Okla. City, Okla.	1520	KRGI	Grand Island, Neb.	1430	KSML	Seminole, Tex.	1250
KMA	Shenandoah, Ia.	960	KOME	Tulsa, Okla.	1300	KRGV	Weslaco, Tex.	1290	KSMN	Mason City, Ia.	1010
KMAK	S. Antonio, Tex.	630	KOMW	Seattle, Wash.	1000	KRHD	Duncan, Okla.	1350	KSMO	Salem, Mo.	1340
KMAE	McKinney, Tex.	1600	KONG	Omaha, Wash.	680	KRIB	Mason City, Ia.	1490	KSNY	Nynder, Tex.	1450
KMAK	Fresno, Cal.	1340	KONO	Visalia, Cal.	1400	KRIC	Beaumont, Tex.	1450	KSO	Des Moines, Ia.	1460
KMAN	Manhattan, Kan.	1350	KONP	San Antonio, Tex.	860	KRIS	Corpus Christi, Tex.	1360	KSOA	Arkansas City, Kans.	1280
KMB	Kansas City, Mo.	980	KOOK	Port Angeles, Wash.	1450	KRIS	McAllen, Tex.	910	KSPA	Santa Paula, Cal.	1400
KMBL	Junction, Tex.	1450	KOOL	Billings, Mont.	970	KRIZ	Phoenix, Ariz.	1230	KSPC	Sinton, Tex.	1590
KMBY	Monterey, Cal.	1240	KOOS	Phoenix, Ariz.	960	KRJF	Miles City, Mont.	1340	KSPK	Stillwater, Okla.	780
KMCM	McMinnville, Ore.	1260	KOPO	Coos Bay, Ore.	1230	KRKD	Los Angeles, Cal.	1150	KSPR	Spokane, Wash.	1340
KMCO	Conroe, Tex.	900	KOPP	Tucson, Ariz.	1450	KRKL	Kirkland, Wash.	1050	KSRO	Casper, Wyo.	1470
KMED	Medford, Ore.	1440	KOPR	Ogden, Utah	730	KRKO	Everett, Wash.	1380	KSRT	Sandpoint, Ida.	1400
KMHL	Marshall, Minn.	1400	KORA	Butte, Mont.	550	KRKC	Lewiston, Ida.	1350	KSRV	Santa Rosa, Cal.	1350
KMHT	Marshall, Tex.	1450	KORC	Bryan, Tex.	1240	KRKL	Dallas, Tex.	1080	KSSS	Ontario, Ore.	1380
KMJ	Fresno, Cal.	580	KORE	Mineral Wells, Tex.	1140	KRKN	Canon City, Colo.	1400	KST	Sulphur Spring, Tex.	1230
KMLB	Monroe, La.	1440	KORL	Eugene, Ore.	1450	KRKR	Walnut Ridge, Ark.	1320	KSTA	Coleman, Tex.	1000
KMLV	Marlin, Tex.	1010	KORK	Las Vegas, Nev.	1340	KRKS	Shreveport, La.	1340	KSTB	Breckenridge, Tex.	1430
KMMJ	Grand Island, Neb.	750	KORN	Las Vegas, Nev.	1340	KRKT	Tulsa, Okla.	740	KSTL	St. Louis, Mo.	690
KMMO	Marshall, Mo.	1300	KOSA	Mitchell, S. D.	1490	KRKR	Des Moines, Ia.	1350	KSTN	Stockton, Cal.	1420
KMO	Tacoma, Wash.	1360	KOSE	Odessa, Ark.	860	KRKR	Rochester, Minn.	1340	KSTP	St. Paul, Minn.	1500
KMOD	Modesto, Cal.	1360	KOSF	Oscagea, Ark.	860	KRKR	El Paso, Tex.	600	KSTT	Davenport, Ia.	1170
KMON	Great Falls, Mont.	560	KOSV	Nacogdoches, Tex.	1230	KRKR	Abilene, La.	960	KSTV	Stephenville, Tex.	1510
KMOR	Oroville, Cal.	1340	KOVB	Texarkana, Ark.	790	KRKR	Sonora, Cal.	1450	KSUB	Cedar City, Utah	590
KMOX	St. Louis, Mo.	1120	KOVL	Laramie, Wyo.	1340	KRKR	Brawley, Cal.	1300	KSUM	Susanville, Cal.	1240
KMP	Los Angeles, Cal.	710	KOVS	Provo, Utah	980	KRKR	El Paso, Tex.	600	KSUN	Fairmont, Minn.	1370
KMPK	Los Angeles, Cal.	710	KOVT	Laramie, Wyo.	1340	KRKR	Sonora, Cal.	1450	KSUP	Bisbee, Ariz.	1230
KMUR	Morgan City, La.	1430	KOVC	Valley City, N. D.	1490	KRKR	Brawley, Cal.	1300	KSVK	Richfield, Utah	690
KMUT	Murray, Utah	1230	KOVS	Lander, Wyo.	1230	KRKR	El Paso, Tex.	600	KSVV	Artesia, N. M.	980
KMUS	Muskogee, Okla.	1360	KOVB	Provo, Utah	980	KRKR	Sonora, Cal.	1450	KSWA	Graham, Tex.	1330
KMVI	Wailuku, T. H.	550	KOVL	Provo, Utah	980	KRKR	Brawley, Cal.	1300	KSWI	Council Bluffs, Iowa	1560
KMYC	Marysville, Cal.	1410	KOVS	Provo, Utah	980	KRKR	El Paso, Tex.	600	KSWM	Joplin, Mo.	1230
KMYR	Denver, Colo.	1340	KOVS	Provo, Utah	980	KRKR	Sonora, Cal.	1450	KSWO	Lawton, Okla.	1380
KNAF	Fredericksburg, Tex.	1340	KOVS	Provo, Utah	980	KRKR	Brawley, Cal.	1300	KSWV	Roswell, N. M.	1230
KNAK	Salt Lake City, Utah	1280	KOVS	Provo, Utah	980	KRKR	El Paso, Tex.	600	KSWW	Roswell, N. M.	1230
KNAL	Victoria, Tex.	1410	KOVS	Provo, Utah	980	KRKR	Sonora, Cal.	1450	KSWX	Roswell, N. M.	1230
KNBC	San Francisco, Cal.	680	KOVS	Provo, Utah	980	KRKR	El Paso, Tex.	600			
KNBR	N. Platte, Neb.	970	KOVS	Provo, Utah	980	KRKR	Sonora, Cal.	1450			
KNBY	Newport, Ark.	1280	KOVS	Provo, Utah	980	KRKR	Brawley, Cal.	1300			
KNCK	Concordia, Kan.	1390	KOVS	Provo, Utah	980	KRKR	El Paso, Tex.	600			
KNCM	Moberly, Mo.	1230	KOVS	Provo, Utah	980	KRKR	Sonora, Cal.	1450			
KNOC	Hettinger, N. D.	1490	KOVS	Provo, Utah	980	KRKR	Brawley, Cal.	1300			
KNEA	Jonesboro, Ark.	970	KOVS	Provo, Utah	980	KRKR	El Paso, Tex.	600			
KNEB	Scottsbluff, Neb.	960	KOVS	Provo, Utah	980	KRKR	Sonora, Cal.	1450			

AM CALL LETTERS

Call Letters	City	Freq- ency in KC	Power in Watts	Call Letters	City	Freq- ency in KC	Power in Watts	Call Letters	City	Freq- ency in KC	Power in Watts	Call Letters	City	Freq- ency in KC	Power in Watts
KSYX	Yreka, Cal.	1490	250	KVCV	Redding, Cal.	600	1,000	KWOC	Poplar Bluff, Mo.	930	LS-1,000	WABZ	Albermarle, N. C.	1010	D-1,000
KSYL	Alexandria, La.	970	1,000	KVCE	San Luis Obispo, Cal.	920	LS-1,000	KWOW	Clinton, Okla.	1320	D-1,000	WACA	Camden, S. C.	1590	D-1,000
KTAC	Tacoma, Wash.	850	1,000	KVEN	Ventura, Cal.	1450	N-500	KWON	Battlesville, Okla.	1400	250	WACB	Kittanning, Pa.	1380	D-1,000
KTAE	Taylor, Tex.	1280	D-1,000	KVET	Austin, Tex.	1300	1,000	KWRF	Warren, Ark.	860	D-250	WACE	Chicopee, Mass.	730	D-1,000
KTAN	Sherman, Tex.	1500	D-250	KVFD	Ft. Dodge, Iowa	1400	250	KWRL	Riverton, Wyo.	1450	250	WACL	Waycross, Ga.	570	D-1,000
KTAR	Phoenix, Ariz.	830	5,000	KVGB	Great Bend, Kans.	1590	5,000	KWRO	Worland, Wyo.	1490	250	WACO	Waco, Tex.	1460	1,000
KTAT	Frederick, Okla.	1570	D-250	KVI	Seattle, Wash.	570	5,000	KWOS	Jefferson City, Mo.	1240	250	WACR	Columbus, Miss.	1050	D-250
KTBB	Tyler, Tex.	600	LS-500	KVIC	Victoria, Tex.	1340	250	KWPC	Muscataine, Ia.	860	D-250	WADC	Akron, O.	1350	5,000
KTBC	Austin, Tex.	590	LS-5,000	KVIM	New Iberia, La.	1360	D-1,000	KWPM	West Plains, Mo.	1450	250	WADE	Wadesboro, N. C.	1210	D-1,000
KTBS	Shreveport, La.	710	LS-10,000	KVKM	Monahans, Tex.	1340	250	KWRC	Pendleton, Ore.	1240	250	WADK	Newport, R. I.	1540	D-1,000
KTEL	Walla Walla, Wash.	1490	250	KVLM	Cleveland, Tex.	1410	500	KWRE	Warrenton, Mo.	730	D-500	WAEB	Allentown, Pa.	790	LS-500
KTEM	Temple, Tex.	1400	250	KVLC	Little Rock, Ark.	1050	D-1,000	KWRR	Warren, Ark.	860	D-250	WAGB	Chattanooga, Tenn.	1450	250
KTER	Terrell, Tex.	1570	D-250	KVLF	Alpine, Tex.	1240	250	KWRL	Riverton, Wyo.	1450	250	WAGE	Syracuse, N. Y.	620	LS-5,000
KTFI	Twin Falls, Ida.	1270	LS-5,000	KVLH	Pauls Valley, Okla.	1470	D-250	KWRN	Reno, Nev.	1231	250	WAGF	Dothan, Ala.	1320	1,000
KTFS	Texasarkana, Tex.	1400	250	KVMA	Magnolia, Ark.	630	D-1,000	KWRO	Coquille, Ore.	1450	250	WAGG	Franklin, Tenn.	950	D-1,000
KTFY	Brownfield, Tex.	1300	D-1,000	KVMC	Colorado City, Tex.	1320	D-500	KWRT	Boonville, Mo.	1370	D-1,000	WAGM	Presque Isle, Me.	1450	250
KTHS	Hot Springs, Ark.	1090	LS-10,000	KVNC	Winslow, Ariz.	1010	LS-1,000	KWSC	Pullman, Wash.	1250	5,000	WAGS	Bishopville, S. C.	1380	D-1,000
KTHT	Houston, Tex.	790	D-500	KVNI	Coeur d'Alene, Ida.	1240	250	KWSD	San Shasta, Cal.	1340	250	WAGT	Staunton, Va.	900	D-1,000
KTIB	Thibodaux, La.	630	D-500	KVNU	LoKan, Utah	610	1,000	KWSH	Seminole, Okla.	1260	1,000	WAGA	Atlanta, Ga.	590	5,000
KTIL	Tillamook, Ore.	1590	250	KVOA	Tucson, Ariz.	1290	1,000	KWSK	Pratt, Kans.	1570	D-250	WAGC	Chatanooga, Tenn.	1450	250
KTIM	San Rafael, Cal.	1510	D-1,000	KVOB	Casper, Wyo.	1230	250	KWST	Wasco, Cal.	1050	D-1,000	WAGD	Syracuse, N. Y.	620	LS-5,000
KTIP	Porterville, Cal.	1450	250	KVOD	Denver, Colo.	630	5,000	KWTO	Springfield, Mo.	560	N-1,000	WAGE	Syracuse, N. Y.	620	LS-5,000
KTIS	Minneapolis, Minn.	900	D-1,000	KVOE	Santa Ana, Cal.	1480	1,000	KWXX	Sheridan, Wyo.	1410	LS-1,000	WAGF	Dothan, Ala.	1320	1,000
KTJS	Hobart, Okla.	1420	D-250	KVOG	Ogden, Utah	1490	250	KXAA	Seattle, Wash.	770	LS-1,000	WAGG	Franklin, Tenn.	950	D-1,000
KTKN	Ketchikan, Alaska	930	1,000	KVOL	Lafayette, La.	1330	1,000	KXAB	Hope, Ark.	1490	D-250	WAGM	Presque Isle, Me.	1450	250
KTKR	Taft, Cal.	1310	D-500	KVON	Morrilton, Ark.	1440	D-500	KXAR	Hope, Ark.	1490	D-250	WAGS	Bishopville, S. C.	1380	D-1,000
KTKT	Tucson, Ariz.	1490	250	KVOP	Plains, Okla.	1170	50,000	KXEL	Waterloo, Ia.	1540	50,000	WAGT	Staunton, Va.	900	D-1,000
KTLN	Denver, Colo.	1150	D-1,000	KVOP	Plainsview, Tex.	1400	250	KXEO	Mexico, Mo.	1340	250	WAIM	Anderson, S. C.	1230	250
KTLO	Mt. Home, Ark.	1490	250	KVOR	Colorado Springs, Colo.	1300	1,000	KXGI	Ft. Madison, Ia.	1350	D-500	WAIN	Columbia, Ky.	1270	D-1,000
KTLL	Texas City, Tex.	920	D-1,000	KVOS	Bellingham, Wash.	790	1,000	KXGN	Glendive, Mont.	1400	250	WAIR	Winston-Salem, N. C.	1340	250
KTMS	McAlester, Okla.	1400	250	KVOU	Uvalde, Tex.	1400	250	KXIC	Iowa City, Ia.	800	D-1,000	WAIT	Chicago, Ill.	820	LS-5,000
KTMC	Santa Barbara, Cal.	1250	1,000	KVOV	Littfield, Tex.	1490	250	KXIT	Dalhart, Tex.	1410	D-500	WAJF	Decatur, Ala.	1490	250
KTNM	Tucumcari, N. M.	1400	250	KVOX	Moorehead, Minn.	1340	250	KXJK	Forrest City, Ark.	950	D-1,000	WAJR	Morgantown, W. Va.	1230	250
KTNT	Tacoma, Wash.	1400	250	KVOZ	Laredo, Tex.	1490	250	KXLA	Portland, Ore.	750	LS-10,000	WAKE	Greenville, S. C.	1490	250
KTOE	Mankato, Minn.	1420	LS-5,000	KVPI	Ville Platte, La.	1050	D-250	KXLB	Ellensburg, Wash.	1240	250	WAKN	Alken, S. C.	990	D-1,000
KTOH	Lihue, T. H. Okla.	1490	5,000	KVRC	Arkadelphia, Ark.	1240	250	KXLE	Butte, Mont.	1370	5,000	WAKR	Akron, O.	1590	5,000
KTOP	Topeka, Kans.	1490	250	KVRH	Rock Springs, Wyo.	1360	LS-1,000	KXLF	Butte, Mont.	1370	5,000	WAKU	Latrobe, Pa.	1570	D-250
KTOW	Okla. Okla.	800	D-250	KVRS	Rock Springs, Wyo.	1360	LS-1,000	KXLG	Helena, Mont.	1240	250	WALA	Mobile, Ala.	1410	5,000
KTRB	Modesto, Cal.	860	LS-10,000	KVSA	McGehee, Ark.	1220	D-1,000	KXLI	Great Falls, Mont.	1400	250	WALB	Albany, Ga.	1590	1,000
KTRC	Santa Fe, N. M.	1400	250	KVSF	Santa Fe, N. M.	1260	1,000	KXLM	Missoula, Mont.	1450	250	WALD	Waterboro, S. C.	1490	250
KTRF	Lufkin, Tex.	1420	1,000	KVSM	San Mateo, Cal.	1050	D-1,000	KXLO	Lewiston, Mont.	1230	250	WALE	Fall River, Mass.	1400	250
KTRH	Thief River Falls, Minn.	1230	250	KVSO	Ardmore, Okla.	1240	250	KXLP	Bozeman, Mont.	1450	250	WALK	Patchoque, N. Y.	1370	D-500
KTRI	Houston, Tex.	740	50,000	KVSP	Lubbock, Tex.	1460	D-500	KXLR	N. Little Rock, Ark.	1150	LS-5,000	WALL	Middletown, N. Y.	1340	250
KTRM	Beaumont, Tex.	990	1,000	KVVC	Vernon, Tex.	1490	250	KXLW	Clayton, Mo.	1320	D-1,000	WALM	Albion, Mich.	1540	D-250
KTRN	Wichita Falls, Tex.	1290	LS-5,000	KVVO	Cheyenne, Wyo.	1370	D-1,000	KXLY	Spokane, Wash.	920	5,000	WALT	Tampa, Fla.	1110	D-1,000
KTRY	Bastrop, La.	730	D-250	KVWA	Wadena, Minn.	920	1,000	KXO	El Centro, Cal.	1230	250	WAMI	Op. Ala.	880	D-1,000
KTSA	San Antonio, Tex.	550	5,000	KWAL	Wallace, Ida.	620	1,000	KXOA	Sacramento, Cal.	1470	1,000	WAML	Laurel, Miss.	1340	250
KTSM	El Paso, Tex.	1380	LS-1,000	KWAT	Watertown, S. D.	950	1,000	KXOB	Stockton, Cal.	1280	1,000	WAMS	Wilmington, Del.	1380	1,000
KTSS	Emporia, Kans.	1400	250	KWB	Wichita, Kans.	1410	1,000	KXOC	Chico, Cal.	1150	5,000	WANA	Anniston, Ala.	1490	250
KTSS	Springfield, Mo.	1400	250	KWBE	Ft. Worth, Tex.	970	D-1,000	KXOK	St. Louis, Mo.	630	5,000	WAND	Canton, Ohio	900	D-500
KTUC	Tucson, Ariz.	1400	250	KWBG	Boone, Ia.	1590	LS-1,000	KXOL	Ft. Worth, Tex.	1360	1,000	WANE	Ft. Wayne, Ind.	1450	250
KTUL	Tulsa, Okla.	1430	5,000	KWBM	Williston, N. D.	1450	N-500	KXOX	Sweetwater, Tex.	1240	250	WANN	Annapolis, Md.	1190	D-1,000
KTUR	Turlock, Cal.	1390	1,000	KWBW	Hutchinson, Kan.	1030	D-50,000	KXRA	Alexandria, Minn.	1490	250	WANS	Anderson, S. C.	1280	1,000
KTW	Seattle, Wash.	1250	1,000	KWBX	Corpus Christi, Tex.	1030	D-50,000	KXRJ	Russellville, Ark.	1490	250	WANT	Richmond, Va.	990	D-1,000
KTXX	Big Spring, Tex.	1400	100	KWBW	Hutchinson, Kan.	1030	D-50,000	KXRO	Aberdeen, Wash.	1320	1,000	WAPA	San Juan, P. R.	680	10,000
KTXY	Jasper, Tex.	1240	250	KWCB	Searcy, Ark.	1300	D-1,000	KXRX	San Jose, Cal.	1500	1,000	WAPF	McCumb, Miss.	1010	D-1,000
KTXL	San Angelo, Tex.	1340	D-1,000	KWCJ	Natchitoches, La.	1450	250	KXSA	San Francisco, Cal.	1260	LS-5,000	WAPI	Birmingham, Ala.	1070	LS-10,000
KTXN	Austin, Tex.	1370	D-1,000	KWDM	De Moines, Ia.	1150	1,000	KXSC	Monterey, Cal.	630	1,000	WAPL	Appleton, Wis.	1570	D-1,000
KTYL	Mesa, Ariz.	1310	LS-1,000	KWED	Seguin, Tex.	1580	D-1,000	KXST	Colby, Kans.	790	D-5,000	WAPO	Chattanooga, Tenn.	1150	LS-5,000
KUAM	Agana, Guam	610	1,000	KWEI	Weiser, Idaho	1240	250	KXU	Houston, Tex.	1320	5,000	WAPX	Montgomery, Ala.	1600	1,000
KUBA	Yuba City, Cal.	1600	LS-1,000	KWEM	Memphis, Tenn.	990	D-1,000	KY	San Francisco, Cal.	1260	LS-5,000	WARA	Attleboro, Mass.	1320	1,000
KUBC	Montrose, Colo.	1260	LS-1,000	KKEW	Hobbs, N. M.	1490	250	KYAC	Yakima, Wash.	1390	LS-1,000	WARB	Wilmington, La.	730	D-250
KUDL	Kansas City, Mo.	1380	D-1,000	KKFC	Hot Springs, Ark.	1340	250	KYCA	Prescott, Ariz.	1490	250	WARD	Johnstown, Pa.	1490	250
KUGN	Eugene, Ore.	590	5,000	KKFT	Wichita Falls, Tex.	620	5,000	KYCF	Medford, Ore.	1230	250	WARE	Ware, Mass.	1250	D-1,000
KUIN	Grants Pass, Ore.	1340	250	KKWB	Wichita Falls, Tex.	620	5,000	KYMA	Yuma, Ariz.	1400	250	WARK	Hagerstown, Md.	1490	250
KUJ	Walla Walla, Wash.	1420	5,000	KKWG	Stockton, Cal.	1230	250	KYNO	Fresno, Cal.	1300	1,000	WARM	Warrenton, Pa.	780	D-1,000
KUKI	Ukiah, Cal.	1400	250	KKWH	Hutchinson, Kan.	1260	LS-1,000	KYOS	Blythe, Cal.	1450	250	WASN	Warrenton, Pa.	780	D-1,000
KULA	Honolulu, T. H.	690	10,000	KKWI	Wichita Falls, Tex.	620	5,000	KYPS	Merced, Cal.	1480	5,000	WASP	Fort Pierce, Fla.	1330	D-1,000
KULE	Ephrata, Wash.	730	D-250	KKWL	Albany, Ore.	1240	250	KYSA	Greeley, Colo.	1450	250	WASA	Havre de Grace, Md.	1330	D-1,000
KULP	El Campo, Tex.	1390	D-500	KKWM	Wichita Falls, Tex.	620	5,000	KYSC	Yuma, Ariz.	360	1,000	WASK	Lafayette, Ind.	1450	250
KUNO	Corpus Christi, Tex.	1400	250	KKWN	Wichita Falls, Tex.	620	5,000	KYSD	Mankato, Minn.	1230	250	WASL	Annapolis, Md.	810	D-250
KUOA	Siloam Springs, Ark.	1290	D-5,000	KKWX	Wichita Falls, Tex.	620	5,000	KYSM	Yuma, Ariz.	360	1,000	WATA	Boone, N. C.	1450	250
KUOM	Minneapolis, Minn.	770	D-5,000	KKXX	Wichita Falls, Tex.	620	5,000	KYSN	Yuma, Ariz.	360	1,000	WATC	Gaylord, Mich.	900	D-1,000
KURV	Edinburg, Tex.	710	D-250	KKXY	Wichita Falls, Tex.	620	5,000	KYUW	Philadelphia, Pa.	1060	50,000	WATG	Ashland, O.	1340	250
KUSD	Vermillion, S. D.	690	D-1,000	KKYZ	Wichita Falls, Tex.	620	5,000	KYWA	Winston-Salem, N. C.	980	D-1,000	WATH	Athens, O.	1540	D-1,000
KUTA	Salt Lake City, Utah	570	5,000	KKZZ	Wichita Falls, Tex.	620	5,000	KYWB	Worcester, Mass.	1440	5,000	WATK	Antigo, Wis.	900	D-250
KVAN	Vancouver, Wash.	910	1,000	KL	Wichita Falls, Tex.	620	5,000	KYWC	Merced, Cal.	1480	5,000	WATL	Atlanta, Ga.	1380	5,000
KVAS	Astoria, Ore.	1230	250	KL	Wichita Falls, Tex.	620	5,000	KYWD	Merced, Cal.	1480	5,000	WATM	Attmore, Ala.	1580	D-250
KVBC	Farmingington, N. M.	1240	250	KL	Wichita Falls, Tex.	620	5,000	KYWE	Greeley, Colo.	1450	250	WATN	Watertown, N. Y.	1240	250
KVCC	Victoria, Tex.	1340	250	KL	Wichita Falls, Tex.	620	5,000	KYWF	Merced, Cal.	1480	5,000	WATO	Oak Ridge, Tenn.	1490	250
KVCE	San Luis Obispo, Cal.	920	LS-1,000	KL	Wichita Falls, Tex.	620	5,000	KYWG	Merced, Cal.	1480	5,000	WATR	Waterbury, Conn.	1320	1,000
KVEN	Ventura, Cal.	1450	N-500	KL	Wichita Falls, Tex.	620	5,000	KYWH	Merced, Cal.	1480	5,000	WATS	Sayre, Pa.	960	D-1,000
KVET	Austin, Tex.	1300	1,000	KL	Wichita Falls, Tex.	620	5,000	KYWI	Merced, Cal.	1480	5,000	WATT	Cadillac, Mich.	1240	250
KVFD	Ft. Dodge, Iowa	1400	250	KL	Wichita Falls, Tex.	620	5,000	KYWK	Merced, Cal.	1480	5,000	WATW	Ashland, Wis.	1400	250
KVGB	Great Bend, Kans.	1590	5,000	KL											

AM CALL LETTERS

Call Letters	City	Frequency in KC	Power in Watts	Call Letters	City	Frequency in KC	Power in Watts	Call Letters	City	Frequency in KC	Power in Watts	Call Letters	City	Frequency in KC	Power in Watts
WAWZ	Zarephath, N. J.	1380	5,000	WBUX	Lexington, N. C.	1450	250	WCRB	Waltham, Mass.	1330	D-1,000	WEAT	Lake Worth, Fla.	1490	250
WAYB	Waynesboro, Va.	1490	250	WBVP	Beaver Falls, Pa.	1230	250	WCRE	Cheraw, S. C.	1420	D-500				
†WAYM	Waynesboro, Miss.	980	D-250	WBYS	Canton, Ill.	1560	D-250	WCRI	Scottsboro, Ala.	1050	D-250		*W. Palm Beach, Fla.		*1,000
WAYN	Rockingham, N. C.	900	D-1,000	WBZ	Boston, Mass.	1030	50,000	WCRK	Morristown, Tenn.	1450	250	WEAU	Eau Claire, Wis.	790	5,000
WAYS	Charlotte, N. C.	610	LS-5,000	WBZA	Springfield, Mass.	1030	1,000	WCRL	Oneonta, Ala.	1570	D-250	WEAV	Plattsburg, N. Y.	960	1,000
WAYX	Waycross, Ga.	1230	N-1,000	WCAE	Pittsburgh, Pa.	1250	5,000	WCRO	Johnstown, Pa.	1230	250	WEAW	Evanston, Ill.	1330	D-500
WAYZ	Waynesboro, Pa.	1380	D-1,000	WCAL	Northfield, Minn.	770	D-5,000	WCRS	Greenwood, S. C.	1450	250	WECB	Duluth, Minn.	1320	5,000
WAZF	Yazoo City, Miss.	1230	250	WCAM	Camden, N. J.	1310	250	WCRT	Birmingham, Ala.	1260	D-1,000	WEBJ	Brewton, Fla.	1240	250
WAZL	Hazleton, Pa.	1490	250	WCAN	Milwaukee, Wis.	1250	5,000	WCRW	Chicago, Ill.	1240	100	WEBK	Tampa, Fla.	1590	D-1,000
WBAA	Lafayette, Ind.	920	LS-5,000	WCAO	Baltimore, Md.	600	5,000	WCSC	Charleston, S. C.	1390	5,000	WEBQ	Harrisburg, Ill.	1240	250
WBAC	Cleveland, Tenn.	1340	250	WCAP	Lowell, Mass.	980	D-1,000	WCSS	Portland, Me.	970	5,000	WEBR	Buffalo, N. Y.	970	5,000
WBAL	Baltimore, Md.	1090	50,000	WCAR	Pontiac, Mich.	1130	D-1,000	WCSS	Columbus, Ind.	1010	D-250	WEDC	Chicago, Ill.	1240	250
WBAM	Montgomery, Ala.	740	D-50,000		*Detroit		*LS-50,000		Amsterdam, N. Y.	1490	250	WEDO	McKeesport, Pa.	810	D-1,000
WBAP	Ft. Worth, Tex.	570	5,000	WCAU	Philadelphia, Pa.	1210	50,000			1490	250	WEDR	Birmingham, Ala.	1220	D-1,000
WBAR	Bartow, Fla.	1460	D-1,000	WCAV	Norfolk, Va.	850	1,000	WCTA	Andalusia, Ala.	1340	250	WEEB	Southern Pines, N. C.	990	D-1,000
WBAT	Marion, Ind.	1400	250	WCAW	Charleston, W. Va.	1400	250	WCTC	New Brunswick, N. J.	1450	250	WEED	Rocky Mount, N. C.	1390	1,000
WBAW	Barnwell, S. C.	740	D-250	WCAZ	Burlington, Vt.	620	5,000	WCTT	Corbin, Ky.	680	1,000	WEEL	Boston, Mass.	590	5,000
WBAX	Wilkes-Barre, Pa.	1240	250	WCBZ	Carthage, Ill.	990	D-1,000	WCUE	Akron, O.	1150	D-1,000	WEFK	Peoria, Ill.	1350	1,000
WBAY	Green Bay, Wis.	1380	5,000	WCBF	Corning, N. Y.	1350	D-1,000	WCUM	Cumberland, Md.	1490	250	WEWU	Reading, Pa.	850	1,000
WBBB	Burlington, N. C.	920	D-5,000	WCBG	Anderson, Ind.	1470	D-1,000	WCVA	Charleston, W. Va.	1490	250	WEXX	Easton, Pa.	1230	250
WBBC	Flint, Mich.	1330	1,000	WCBH	Chicago, Ill.	820	SH-5,000	WCVI	Culpeper, Va.	1490	250	WFOG	Concord, N. C.	1410	D-1,000
WBFB	Rochester, N. Y.	950	1,000	WCBJ	Chicago, Ill.	820	SH-5,000	WCVM	Palmer, Pa.	1340	250	WFOH	Fitchburg, Mass.	1280	1,000
WBFL	Richmond, Va.	1480	SH-5,000	WCBK	Baltimore, Md.	680	LS-10,000	WCWB	Baltimore, Md.	680	LS-10,000	WFKR	Fayetteville, Tenn.	1240	250
WBMM	Chicago, Ill.	780	50,000	WCBR	Memphis, Tenn.	1480	D-1,000	WCWB	Baltimore, Md.	680	LS-10,000	WFKY	Richmond, Ky.	1340	250
WBBO	Forest City, N. C.	780	D-1,000	WCBS	New York, N. Y.	880	50,000	WCWT	Roanoke Rapids, N. C.	1230	250	WFKZ	Monroe, Wis.	1260	D-500
WBBS	Augusta, Ga.	1340	250	WCCT	Hartford, Conn.	1290	D-500	WCW	Hartford, Conn.	1290	D-500	WFLC	Welch, W. Va.	1150	D-1,000
WBBS	Brooklyn, N. Y.	1330	5,000	WCDC	Lawrence, Mass.	800	D-1,000	WCW	Lawrence, Mass.	800	D-1,000	WFLM	New Haven, Conn.	960	1,000
WBBS	Youngstown, O.	1240	250	WCDF	Minneapolis, Minn.	830	50,000	WCW	Minneapolis, Minn.	830	50,000	WFLN	Battle Creek, Mich.	1400	250
WBBS	Ponca City, Okla.	1230	250	WCDF	Savannah, Ga.	1450	250	WCW	Savannah, Ga.	1450	250	WFLM	Elmira, N. Y.	1400	250
WBCK	Battle Creek, Mich.	930	1,000	WCDF	Carbondale, Pa.	1230	250	WCW	Carbondale, Pa.	1230	250	WFLM	Tupelo, Miss.	1490	250
WBDM	Bessemer, Ala.	1450	LS-1,000	WCDF	Winchester, Tenn.	1340	250	WCW	Winchester, Tenn.	1340	250	WFLM	Easley, S. C.	1360	D-1,000
WBDC	Union, S. C.	1450	1,000	WCDF	Rocky Mt., N. C.	810	D-1,000	WCW	Rocky Mt., N. C.	810	D-1,000	WFLM	Roanoke, Ala.	1360	D-1,000
WBDC	Pittsfield, Mass.	1490	250	WCDF	Du Bois, Pa.	1230	250	WCW	Du Bois, Pa.	1230	250	WFLM	Kinston, N. C.	1010	D-1,000
WBEJ	Elizabethton, Tenn.	1240	250	WCDF	Parkersburg, W. Va.	1050	D-250	WCW	Parkersburg, W. Va.	1050	D-250	WFLM	Milwaukee, Wis.	1340	250
WBEL	Beloit, Wis.	1380	D-1,000	WCDF	Hawkinsville, Ga.	610	D-500	WCW	Hawkinsville, Ga.	610	D-500	WFLM	Emporium, Pa.	1340	100
WBEN	Buffalo, N. Y.	930	5,000	WCDF	Cambridge, Md.	1240	100	WCW	Cambridge, Md.	1240	100	WFLM	Bayamon, P. R.	1560	250
WBET	Brockton, Mass.	1480	1,000	WCDF	Mt. Pleasant, Mich.	1150	LS-1,000	WCW	Mt. Pleasant, Mich.	1150	LS-1,000	WFLM	Whiteville, N. C.	1240	250
†WBFB	Beaufort, S. C.	960	D-1,000	WCDF	Chicago, Ill.	1000	50,000	WCW	Chicago, Ill.	1000	50,000	WFLM	Endicott, N. Y.	1430	5,000
WBFB	Beaver Dam, Wis.	1430	D-1,000	WCDF	Clifton Forge, Va.	1230	250	WCW	Clifton Forge, Va.	1230	250	WFLM	Tenn.	1240	250
WBFB	Chillicothe, O.	1490	250	WCDF	Chambersburg, Pa.	800	D-1,000	WCW	Chambersburg, Pa.	800	D-1,000	WFLM	Chicago, Ill.	890	50,000
WBFB	Atlanta, Ga.	1340	250	WCDF	Chapel Hill, N. C.	1360	D-1,000	WCW	Chapel Hill, N. C.	1360	D-1,000	WFLM	Gloversville, N. Y.	1340	250
WBFB	Jesup, Ga.	1370	D-1,000	WCDF	Norwich, N. Y.	970	D-500	WCW	Norwich, N. Y.	970	D-500	WFLM	Elmira, N. Y.	1230	250
WBFB	Fitzgerald, Ga.	1240	250	WCDF	Washington Court House, Ohio	1250	D-500	WCW	Washington Court House, Ohio	1250	D-500	WFLM	Evansville, Ind.	1400	250
WBFB	Cartersville, Ga.	1450	250	WCDF	Charleston, N. C.	1250	5,000	WCW	Charleston, N. C.	1250	5,000	WFLM	Poughkeepsie, N. Y.	1390	D-1,000
WBFB	Huntsville, Ala.	1230	250	WCDF	Charlotteville, Va.	1240	250	WCW	Charlotteville, Va.	1240	250	WFLM	Elvira, O.	930	1,000
WBFB	Greensboro, N. C.	1470	5,000	WCDF	Charlottesville, Va.	1240	250	WCW	Charlottesville, Va.	1240	250	WFLM	W. Va.	1390	D-1,000
WBFB	Booneville, Miss.	1400	250	WCDF	Carbondale, Ill.	1020	D-1,000	WCW	Carbondale, Ill.	1020	D-1,000	WFLM	Tenn.	910	D-500
WBFB	Knoxville, Tenn.	1240	250	WCDF	Cincinnati, O.	1480	D-1,000	WCW	Cincinnati, O.	1480	D-1,000	WFLM	Martinsburg, W. Va.	1340	250
WBFB	Bristol, Conn.	1440	D-500	WCDF	Columbia, Miss.	1450	250	WCW	Columbia, Miss.	1450	250	WFLM	Erie, Pa.	1260	5,000
WBFB	Bedford, Ind.	1340	250	WCDF	Dunn, N. C.	780	D-1,000	WCW	Dunn, N. C.	780	D-1,000	WFLM	Atlanta, Ga.	860	D-1,000
WBFB	Eau Claire, Wis.	1400	250	WCDF	Abbeville, S. C.	1580	D-1,000	WCW	Abbeville, S. C.	1580	D-1,000	WFLM	Cleveland, O.	1360	5,000
WBFB	West Bend, Wis.	1470	D-500	WCDF	Cincinnati, O.	1540	50,000	WCW	Cincinnati, O.	1540	50,000	WFLM	Hamilton, Ala.	970	D-5,000
WBFB	Batesville, Miss.	1290	D-1,000	WCDF	Camilla, Ga.	1540	D-250	WCW	Camilla, Ga.	1540	D-250	WFLM	Wesley, Fla.	1230	250
WBFB	Dalton, Ga.	1230	250	WCDF	Cleveland, Miss.	1490	250	WCW	Cleveland, Miss.	1490	250	WFLM	Charleroi, Pa.	940	D-250
WBFB	Clarksburg, W. Va.	1400	250	WCDF	Corning, N. Y.	1450	250	WCW	Corning, N. Y.	1450	250	WFLM	Bradford, Pa.	1490	250
WBFB	Bedford, Va.	1490	250	WCDF	Janesville, Wis.	1230	250	WCW	Janesville, Wis.	1230	250	WFLM	Greenville, S. C.	660	D-5,000
WBFB	Baltimore, Md.	750	D-1,000	WCDF	Newark, O.	1430	D-500	WCW	Newark, O.	1430	D-500	WFLM	Escanaba, Mich.	1490	250
WBFB	Macon, Ga.	1240	250	WCDF	Cornith, Miss.	1230	250	WCW	Cornith, Miss.	1230	250	WFLM	Easton, Pa.	1400	250
WBFB	Boston, Mass.	1090	D-1,000	WCDF	Harrisburg, Pa.	1460	5,000	WCW	Harrisburg, Pa.	1460	5,000	WFLM	Salem, Mass.	1230	250
WBFB	Boonville, Ind.	1460	D-250	WCDF	Lemoyne, Pa.	1480	250	WCW	Lemoyne, Pa.	1480	250	WFLM	Johnson City, Tenn.	790	D-1,000
WBFB	Columbus, Ohio	1540	LS-5,000	WCDF	Wilwood, N. J.	100	250	WCW	Wilwood, N. J.	100	250	WFLM	Gadsden, Ala.	930	D-1,000
WBFB	New York, N. Y.	1380	N-1,000	WCDF	Ashland, Ky.	1340	250	WCW	Ashland, Ky.	1340	250	WFLM	New Martinsville, W. Va.	1330	D-1,000
WBFB	Buffalo, N. Y.	1400	250	WCDF	Arcadio, P. R.	1280	1,000	WCW	Arcadio, P. R.	1280	1,000	WFLM	Emporia, Va.	1400	250
WBFB	Galax, Va.	1400	250	WCDF	Canton, Ohio	1060	D-1,000	WCW	Canton, Ohio	1060	D-1,000	WFLM	New York, N. Y.	1330	5,000
WBFB	Salisbury, Md.	960	1,000	WCDF	Ottawa, Ill.	1430	D-500	WCW	Ottawa, Ill.	1430	D-500	WFLM	Eveleth, Minn.	1340	250
WBFB	New Orleans, La.	800	D-1,000	WCDF	Connersville, Ind.	1580	D-250	WCW	Connersville, Ind.	1580	D-250	WFLM	St. Louis, Mo.	770	D-1,000
WBFB	Terre Haute, Ind.	1230	250	WCDF	Elizabeth City, N. C.	1240	250	WCW	Elizabeth City, N. C.	1240	250	WFLM	Laurinburg, N. C.	1080	D-1,000
†WBFB	Tarpon Springs, Fla.	1470	D-5,000	WCDF	Quincy, Fla.	1230	250	WCW	Quincy, Fla.	1230	250	WFLM	Sanford, N. C.	1290	D-1,000
WBFB	Birmingham, Ala.	960	5,000	WCDF	Bloomburg, Pa.	930	D-1,000	WCW	Bloomburg, Pa.	930	D-1,000	WFLM	Homewood, Ala.	1320	D-1,000
WBFB	Ft. Lauderdale, Fla.	1580	D-250	WCDF	Centralla, Ill.	1210	D-1,000	WCW	Centralla, Ill.	1210	D-1,000	WFLM	Dallas, Tex.	570	5,000
WBFB	Wilkes-Barre, Pa.	1340	250	WCDF	Crestview, Fla.	1010	D-1,000	WCW	Crestview, Fla.	1010	D-1,000	WFLM	Alliance, O.	820	50,000
WBFB	Pittsfield, Mass.	1340	250	WCDF	Middletown, Conn.	1150	D-500	WCW	Middletown, Conn.	1150	D-500	WFLM	Fayetteville, N. C.	1310	D-1,000
WBFB	Marion, N. C.	1250	D-1,000	WCDF	Pensacola, Fla.	1370	5,000	WCW	Pensacola, Fla.	1370	5,000	WFLM	White Plains, N. Y.	1230	250
WBFB	Big Rapids, Mich.	1460	D-500	WCDF	Meridian, Miss.	910	LS-5,000	WCW	Meridian, Miss.	910	LS-5,000	WFLM	Augusta, Me.	1340	250
†WBFB	Waynesboro, Ga.	1310	D-1,000	WCDF	Greensboro, N. C.	1320	1,000</								

AM CALL LETTERS

Call Letters	City	Frequency in KC	Power in Watts	Call Letters	City	Frequency in KC	Power in Watts	Call Letters	City	Frequency in KC	Power in Watts	Call Letters	City	Frequency in KC	Power in Watts
WFIW	Fairfield, Ill.	1390	D-500	WGRA	Cairo, Ga.	790	D-1,000	WHLI	Hempstead, N. Y.	1100	D-250	WIND	Chicago, Ill.	560	5,000
WFKY	Frankfort, Ky.	1490	250	WGRG	Louisville, Ky.	790	LS-5,000	WHLL	Wheeling, W. Va.	1600	D-5,000	WION	Dayton, Ohio	1410	5,000
WFLA	Tampa, Fla.	970	5,000				N-1,000	WHLM	Bloomington, Pa.	890	D-1,000	WINK	Ft. Myers, Fla.	1240	250
WFLB	Fayetteville, N. C.	1490	2,500	WGRD	Grand Rapids, Mich.	1410	D-1,000	WHLN	Harlan, Ky.	1230	250	WINR	Winnetka, Ill.	1240	250
WFLO	Farmville, Va.	870	D-1,000	WGRM	Greenwood, Miss.	1240	250	WHMA	Anniston, Ala.	1450	250				
WFNLW	Hodgensville, Ky.	1320	D-1,000	WGRV	Greenville, Tenn.	1340	250	WHMP	Northampton, Mass.	1400	250	WINS	New York, N. Y.	1010	50,000
WFMC	Goldboro, N. C.	730	D-1,000	WGRT	Gary, Ind.	1370	D-500	WHOD	Homestead, Pa.	860	D-250	WINX	Rockville, Md.	1600	D-1,000
WFMD	Frederick, Md.	930	1,000	WGSM	Huntington, N. Y.	740	D-1,000	WHOL	Lancaster, O.	1320	D-500	WINZ	Hollywood, Fla.	940	1,000
WFMH	Cullman, Ala.	1300	D-1,000	†WGSN	Mobile, Ala.	960	D-1,000	WHOO	Orlando, Fla.	990	LS-10,000				
WFMI	Youngstown, O.	1390	5,000	WGST	Atlanta, Ga.	920	LS-5,000	WHOP	Hopkinsville, Ky.	1230	250	WIOD	Miami, Fla.	610	5,000
WFMO	Fairmont, N. C.	860	D-1,000	WGSV	Gunthersville, Ala.	1270	D-1,000	WHOT	Decatur, Ala.	800	D-1,000	WIOU	Indianapolis, Ind.	1350	1,000
WFMC	Madisonville, Ky.	730	D-250	WGSW	Greenwood, S. C.	1350	D-1,000	WHPR	Indianapolis, Ind.	1490	250	WIP	Philadelphia, Pa.	610	5,000
WFNC	Fayetteville, N. C.	1390	LS-5,000	WGTA	Summerville, Ga.	950	D-1,000	WHRE	Richmond, Va.	1490	250	WIPC	Lake Wales, Fla.	1280	D-1,000
WFNS	Burlington, N. C.	1150	D-1,000	WGTC	Greenville, N. C.	1590	LS-5,000	WHRS	Richmond, Va.	1490	250	WIPR	Santurce, P. R.	940	10,000
WFOB	Fostoria, O.	1430	1,000	WGTH	Hartford, Conn.	1410	5,000	WHSA	Harrisburg, Pa.	580	5,000	WIRA	Ft. Pierce, Fla.	1400	250
WFOG	Marletta, Ga.	1230	250	WGTI	Kannapolis, N. C.	870	D-1,000	WHSE	Hickory, N. C.	630	D-1,000	WIRE	Indianapolis, Ind.	1430	5,000
WFOR	Hattiesburg, Miss.	1400	250	WGTN	Georgetown, S. C.	1400	250	WHSH	Hartsville, S. C.	1450	250	WIRJ	Humboldt, Tenn.	740	D-250
WFOX	Milwaukee, Wis.	880	D-250	WGUY	Bangor, Maine	1230	250	WHST	Tallahassee, Fla.	1230	250	WIRK	W. Palm Beach, Fla.	1290	LS-5,000
WFOY	St. Augustine, Fla.	1240	250	WGVV	Geneva, N. Y.	1240	250	WHUB	Cookeville, Tenn.	1400	250				
WFPA	Fort Payne, Ala.	1400	250	WGVW	Greenville, Miss.	1260	D-1,000	WHUC	Hudson, N. Y.	1230	250	WISL	Shamokin, Pa.	1480	1,000
WFPG	Atlantic City, N. J.	1450	250	WGWG	Selma, Ala.	1340	250	WHUD	Hudson, N. Y.	1230	250	WISN	Milwaukee, Wis.	1150	5,000
WFPM	Ft. Valley, Ga.	1150	D-1,000	WGDW	Gadsden, Ala.	570	D-1,000	WHUM	Reading, Pa.	1240	250	WISP	Ponca, P. R.	1280	1,000
WFRD	Reidsville, N. C.	1600	1,000	WGWV	Asheboro, N. C.	1260	D-1,000	WHUN	Huntingdon, Pa.	1400	250	WISR	Butler, N. C.	690	100
WFRM	Freeport, Ill.	1570	D-1,000	WGWY	Waynesville, N. Y.	810	50,000	WHV	Hanover, Pa.	1280	LS-1,000	WIST	Charlotte, N. C.	930	LS-5,000
WFRM	Coudersport, Pa.	600	D-500	WGYV	Greenville, Ala.	1400	250	WHV	Hanover, Pa.	1280	LS-1,000				
WFRG	Fremont, O.	900	D-500	WHA	Madison, Wis.	970	D-5,000	WHWB	Rutland, Vt.	1000	D-1,000	WITV	Christiansted, St. Croix, V. I.	1230	250
WFRP	Savannah, Ga.	1230	250	WHAI	Greenfield, Mass.	1240	250	WHWD	Hollywood, Fla.	1320	D-500	WIX	Wixom, Mich.	1280	D-1,000
WFRX	W. Frankfort, Ill.	1300	D-1,000	WHAK	Rogers City, Mich.	960	D-5,000	WHWI	Waukegan, Ill.	920	D-1,000	WJAC	Johnstown, Pa.	1400	250
WFTC	Kinston, N. C.	980	LS-5,000	WHAL	Shelbyville, Tenn.	1400	250	WHWR	Hanover, Pa.	1280	LS-1,000	WJAG	Norfolk, Nebr.	780	LS-1,000
WFTL	Fort Lauderdale, Fla.	1400	250	WHAM	Rochester, N. Y.	1180	50,000	WHWS	Huntsville, Ala.	1550	LS-5,000	WJAM	Marion, Ala.	1310	D-1,000
WFTM	Maysville, Ky.	1240	250	WHAN	Charleston, S. C.	1340	250	WHY	Newport News, Va.	1270	D-1,000	WJAN	Spartanburg, S. C.	1400	250
WFTS	Front Royal, Va.	1450	250	WHAP	Hopewell, Va.	1340	250	WHX	Hickory, N. C.	630	D-1,000	WJAR	Providence, R. I.	920	5,000
†WFTW	Walton, Fla.	1260	D-1,000	WHAR	Clarksburg, W. Va.	1340	250	WHY	Newport News, Va.	1270	D-1,000	WJAT	Pittsburgh, Pa.	1320	5,000
WFUL	Fulton, Ky.	1270	D-1,000	WHAS	Louisville, Ky.	840	50,000	WHY	Newport News, Va.	1270	D-1,000	WJAX	Swainsboro, Ga.	800	D-1,000
WFUN	Huntsville, Ala.	1450	250	WHAT	Philadelphia, Pa.	1340	250	WHY	Newport News, Va.	1270	D-1,000	WJAY	Jacksonville, Fla.	930	5,000
WFUR	Grand Rapids, Mich.	1570	D-1,000	WHAV	Haverhill, Mass.	1480	250	WHY	Newport News, Va.	1270	D-1,000	WJAZ	Albany, Ga.	1050	D-250
WFVA	Fredericksburg, Va.	1230	250	WHAW	Weston, W. Va.	1450	250	WHY	Newport News, Va.	1270	D-1,000	WJBB	Haleyville, Ala.	1230	250
WFGV	Fuquay Springs, N. C.	1460	D-1,000	WHAY	New Britain, Conn.	910	5,000	WHY	Newport News, Va.	1270	D-1,000	WJBC	Bloomington, Ill.	1230	250
WFGY	Alma, Mich.	1280	D-1,000	WHAZ	Troy, N. Y.	1330	1,000	WHY	Newport News, Va.	1270	D-1,000	WJBF	Augusta, Ga.	1230	250
WGAA	Cedarhurst, Ga.	580	LS-5,000	WHB	Kansas City, Mo.	710	LS-10,000	WHY	Newport News, Va.	1270	D-1,000	WJBF	Detroit, Mich.	1490	250
WGAC	Augusta, Ga.	580	LS-5,000	WHBB	Selma, Ala.	1490	250	WHY	Newport News, Va.	1270	D-1,000	WJBF	Detroit, Mich.	1490	250
WGAD	Gadsden, Ala.	1350	LS-5,000	WHBC	Canton, Ohio	1480	5,000	WHY	Newport News, Va.	1270	D-1,000	WJBF	Detroit, Mich.	1490	250
WGAF	Valdosta, Ga.	910	N-1,000	WHBF	Rock Island, Ill.	1270	5,000	WHY	Newport News, Va.	1270	D-1,000	WJBF	Detroit, Mich.	1490	250
WGAI	Eliz. City, N. C.	560	LS-1,000	WHBI	Newark, N. J.	1280	LS-2,500	WHY	Newport News, Va.	1270	D-1,000	WJBF	Detroit, Mich.	1490	250
WGAL	Lancaster, Pa.	1490	N-500	WHBL	Sheboygan, Wis.	1330	LS-1,000	WHY	Newport News, Va.	1270	D-1,000	WJBF	Detroit, Mich.	1490	250
WGAN	Portland, Me.	580	5,000	WHBO	Sulphur Springs, Fla.	1050	D-250	WHY	Newport News, Va.	1270	D-1,000	WJBF	Detroit, Mich.	1490	250
WGAP	Maryville, Tenn.	1400	250	WHBQ	Memphis, Tenn.	560	LS-5,000	WHY	Newport News, Va.	1270	D-1,000	WJBF	Detroit, Mich.	1490	250
WGAR	Cleveland, O.	1220	50,000	WHBS	Huntsville, Ala.	1550	LS-5,000	WHY	Newport News, Va.	1270	D-1,000	WJBF	Detroit, Mich.	1490	250
WGAT	Utica, N. Y.	1310	LS-1,000	WHBT	Harriman, Tenn.	1230	N-250	WHY	Newport News, Va.	1270	D-1,000	WJBF	Detroit, Mich.	1490	250
WGAU	Athens, Ga.	1340	250	WHBU	Anderson, Ind.	1240	250	WHY	Newport News, Va.	1270	D-1,000	WJBF	Detroit, Mich.	1490	250
WGAU	Gardner, Mass.	1340	250	WHBY	Appleton, Wis.	1230	250	WHY	Newport News, Va.	1270	D-1,000	WJBF	Detroit, Mich.	1490	250
WGAU	Silver Spring, Md.	1050	D-1,000	WHCC	Waynesville, N. C.	1400	250	WHY	Newport News, Va.	1270	D-1,000	WJBF	Detroit, Mich.	1490	250
WGBA	Columbus, Ga.	1270	D-1,000	WHCC	Waynesville, N. C.	1400	250	WHY	Newport News, Va.	1270	D-1,000	WJBF	Detroit, Mich.	1490	250
WGBB	Freeport, N. Y.	1240	100	WHCC	Waynesville, N. C.	1400	250	WHY	Newport News, Va.	1270	D-1,000	WJBF	Detroit, Mich.	1490	250
WGBF	Evansville, Ind.	1280	LS-5,000	WHCC	Waynesville, N. C.	1400	250	WHY	Newport News, Va.	1270	D-1,000	WJBF	Detroit, Mich.	1490	250
WGBF	Evansville, Ind.	1280	LS-5,000	WHCC	Waynesville, N. C.	1400	250	WHY	Newport News, Va.	1270	D-1,000	WJBF	Detroit, Mich.	1490	250
WGBG	Greensboro, N. C.	1400	250	WHCC	Waynesville, N. C.	1400	250	WHY	Newport News, Va.	1270	D-1,000	WJBF	Detroit, Mich.	1490	250
WGBI	Scranton, Pa.	910	LS-1,000	WHCC	Waynesville, N. C.	1400	250	WHY	Newport News, Va.	1270	D-1,000	WJBF	Detroit, Mich.	1490	250
WGBR	Goldboro, N. C.	1150	N-500	WHCC	Waynesville, N. C.	1400	250	WHY	Newport News, Va.	1270	D-1,000	WJBF	Detroit, Mich.	1490	250
WGBS	Miami, Fla.	710	LS-5,000	WHCC	Waynesville, N. C.	1400	250	WHY	Newport News, Va.	1270	D-1,000	WJBF	Detroit, Mich.	1490	250
WGBS	Miami, Fla.	710	LS-5,000	WHCC	Waynesville, N. C.	1400	250	WHY	Newport News, Va.	1270	D-1,000	WJBF	Detroit, Mich.	1490	250
WGBS	Miami, Fla.	710	LS-5,000	WHCC	Waynesville, N. C.	1400	250	WHY	Newport News, Va.	1270	D-1,000	WJBF	Detroit, Mich.	1490	250
WGBS	Miami, Fla.	710	LS-5,000	WHCC	Waynesville, N. C.	1400	250	WHY	Newport News, Va.	1270	D-1,000	WJBF	Detroit, Mich.	1490	250
WGBS	Miami, Fla.	710	LS-5,000	WHCC	Waynesville, N. C.	1400	250	WHY	Newport News, Va.	1270	D-1,000	WJBF	Detroit, Mich.	1490	250
WGBS	Miami, Fla.	710	LS-5,000	WHCC	Waynesville, N. C.	1400	250	WHY	Newport News, Va.	1270	D-1,000	WJBF	Detroit, Mich.	1490	250
WGBS	Miami, Fla.	710	LS-5,000	WHCC	Waynesville, N. C.	1400	250	WHY	Newport News, Va.	1270	D-1,000	WJBF	Detroit, Mich.	1490	250
WGBS	Miami, Fla.	710	LS-5,000	WHCC	Waynesville, N. C.	1400	250	WHY	Newport News, Va.	1270	D-1,000	WJBF	Detroit, Mich.	1490	250
WGBS	Miami, Fla.	710	LS-5,000	WHCC	Waynesville, N. C.	1400	250	WHY	Newport News, Va.	1270	D-1,000	WJBF	Detroit, Mich.	1490	250
WGBS	Miami, Fla.	710	LS-5,000	WHCC	Waynesville, N. C.	1400	250	WHY	Newport News, Va.	1270	D-1,000	WJBF	Detroit, Mich.	1490	250
WGBS	Miami, Fla.	710	LS-5,000	WHCC	Waynesville, N. C.	1400	250	WHY	Newport News, Va.	1270	D-1,000	WJBF	Detroit, Mich.	1490	250
WGBS	Miami, Fla.	710	LS-5,000	WHCC	Waynesville, N. C.	1400	250	WHY	Newport News, Va.	1270	D-1,000	WJBF	Detroit, Mich.	1490	250
WGBS	Miami, Fla.	710	LS-5,000	WHCC	Waynesville, N. C.	1400	250	WHY	Newport News, Va.	1270	D-1,000	WJBF	Detroit, Mich.	1490	250
WGBS	Miami, Fla.	710	LS-5,000	WHCC	Waynesville, N. C.	1400	250	WHY	Newport News, Va.	1270	D-1,000	WJBF	Detroit, Mich.	1490	250
WGBS	Miami, Fla.	710	LS-5,000	WHCC	Waynesville, N. C.	1400	250	WHY	Newport News, Va.	1270	D-1,000	WJBF	Detroit, Mich.	1490	250
WGBS	Miami, Fla.	710	LS-5,000	WHCC	Waynesville, N. C.</										

AM CALL LETTERS

Call Letters	City	Freq- ency in KC	Power in Watts	Call Letters	City	Freq- ency in KC	Power in Watts	Call Letters	City	Freq- ency in KC	Power in Watts	Call Letters	City	Freq- ency in KC	Power in Watts
WJKO	Springfield, Mass.	1600	D-5,000	WKMF	Flint, Mich.	1470	1,000	WLEX	Lexington, Ky.	1300	1,000	WMIN	St. Paul, Minn.	1400	250
WJLB	Detroit, Mich.	1400	250	WKMH	Dearborn, Mich.	1310	LS-5,000	WLEF	Lafayette, Ga.	1590	D-5,000	WMIQ	Iron Mt., Mich.	1450	250
WJLD	Bessemer, Ala.	1400	250	WKMI	Kalamazoo, Mich.	1360	1,000	WLFH	Little Falls, N. Y.	1230	250	WMIS	Natchez, Miss.	1240	250
WJLK	Asbury Park, N. J.	1310	250	WKMT	Kings Mountain, N. C.	1220	D-500	WLIB	New York, N. Y.	1190	LS-1,000	WMIX	Mt. Vernon, Ill.	940	D-1,000
WJLS	Beckley, W. Va.	550	LS-5,000	WKNA	Charleston, W. Va.	950	LS-5,000	WLIL	Lenoir City, Tenn.	730	D-1,000	WMJM	Cordele, Ga.	1490	250
WJMA	Orange, Va.	1340	250	WKNB	New Britain, Conn.	840	D-1,000	WLIO	E. Liverpool, O.	1570	D-1,000	WMLS	Sylacauga, Ala.	1290	D-1,000
WJMB	Brookhaven, Miss.	1340	250	WKNE	Keene, N. H.	1290	5,000	WLIP	Kenosha, Wis.	1050	D-250	WMLT	Dublin, Ga.	1340	250
WJMC	Rice Lake, Wis.	1240	250	WKNK	Muskegon, Mich.	1600	5,000	WLHJ	Lowell, Mass.	1400	250	WMLV	Milville, N. J.	1440	D-1,000
WJMD	Philadelphia, Pa.	1540	D-1,000	WKNX	Kingsport, Tenn.	1400	250	WLNJ	Jackson, Ohio	1280	D-1,000	WMMB	Melbourne, Fla.	1240	250
WJMO	Cleveland, Ohio	1540	D-1,000	WKNY	Saginaw, Mich.	1210	D-1,000	WLNK	Peekskill, N. Y.	1420	D-1,000	WMMN	Fairmont, W. Va.	920	5,000
WJMR	New Orleans, La.	990	D-250	WKOK	Kingston, N. Y.	1490	250	WLOA	Eraddock, Pa.	1550	250	WMMT	McMinville, Tenn.	1230	250
WJMS	Ironwood, Mich.	630	D-500	WKOP	Binghamton, N. Y.	1360	LS-1,000	WLOH	Laconia, N. H.	1340	250	WMMW	Meriden, Conn.	1470	D-1,000
WJMW	Athens, Ala.	730	D-1,000	WKOV	Wellston, O.	1570	D-250	WLOG	Logan, W. Va.	1230	250	WMNB	N. Adams, Mass.	1230	250
WJMX	Florence, S. C.	970	LS-5,000	WKOW	Madison, Wis.	1070	LS-10,000	WLOI	La Porte, Ind.	1540	D-250	WMNC	Morganston, N. C.	1490	250
WJNC	Jacksonville, N. C.	1240	250	WKPA	New Kensington, Pa.	1150	D-250	WLOK	Lincoln, Minn.	1330	5,000	WMNE	Menomonia, Wis.	1360	D-500
WJNO	N. Palm Beach, Fla.	1230	250	WKPT	Kingsport, Tenn.	1400	250	WLOL	Minneapolis, Minn.	1330	5,000	WMOA	Marietta, O.	1490	250
WJOB	Hammond, Ind.	1230	250	WKRC	Cincinnati, Ohio	550	LS-5,000	WLOR	Orlando, Fla.	950	5,000	WMOB	Wood Mount, W. Va.	1370	D-1,000
WJOC	New York, N. Y.	1340	250	WKRG	Mobile, Ala.	710	LS-1,000	WLOS	Asheville, N. C.	1380	LS-5,000	WMOG	Brunswick, Ga.	1490	250
WJOI	Florence, Ala.	1340	250	WKRR	Columbia, Tenn.	1340	250	WLPA	Lima, O.	1240	250	WMOH	Hamilton, O.	1450	250
WJOL	Joliet, Ill.	1340	250	WKRT	Cortland, N. Y.	920	LS-1,000	WLPH	Portsmouth, Va.	1400	250	WMOK	Metropolis, Ill.	920	D-500
WJON	St. Cloud, Minn.	1240	250	WKRZ	Oil City, Pa.	1340	250	WLPI	Pikeville, Ky.	900	D-1,000	WMON	Montgomery, W. Va.	1340	250
WJOT	Lake City, S. C.	1260	D-1,000	WKSB	Milford, Del.	930	D-500	WLPM	Portsmouth, Va.	1400	250	WMPA	Aberdeen, Miss.	1240	250
WJOY	Burlington, Vt.	1230	250	WKSC	Fulaski, Tenn.	1420	1,000	WLPO	La Porte, Ind.	1540	D-250	WMPB	Lapeer, Mich.	1230	SH-250
WJPA	Washington, Pa.	1450	250	WKST	New Castle, Pa.	1280	1,000	WLPN	Lincoln, N. C.	1270	D-500	WMPM	Smithfield, N. C.	1270	D-1,000
WJPD	Ishpeming, Mich.	1240	250	WKTG	Thomasville, Ga.	730	D-1,000	WLPR	New Albany, N. Y.	1570	D-1,000	WMPN	Memphis, Tenn.	680	LS-10,000
WJPF	Herrin, Ill.	1340	250	WKTM	Mayfield, Ky.	1050	1,000	WLS	Chicago, Ill.	890	50,000	WMRA	Myrtle Beach, S. C.	1450	250
WJPG	Green Bay, Wis.	1440	LS-1,000	WKTY	La Crosse, Wis.	580	1,000	WLSD	Big Stone Gap, Va.	1220	D-1,000	WMRC	Greenville, S. C.	1440	5,000
WJPR	Greenville, Miss.	1330	LS-1,000	WKUL	Cullman, Ala.	1340	250	WLSE	Wallace, N. C.	1400	250	WMRE	Weston, Ga.	1490	250
WJPS	Evansville, Ind.	1330	LS-5,000	WKVM	San Juan, P. R.	920	LS-25,000	WLSH	Lansford, Pa.	1410	D-1,000	WMRF	Lawrenceville, Ga.	1490	250
WJQS	Jackson, Miss.	1400	N-1,000	WKWA	Lewistown, Pa.	1070	D-1,000	WLSP	Lynchburg, Va.	590	50,000	WMRN	Marion, O.	1490	250
WJRB	Detroit, Mich.	760	50,000	WKWB	Wheeling, W. Va.	1400	250	WLSM	Louisville, Miss.	1270	D-1,000	WMRO	Aurora, Ill.	1280	D-250
WJRD	Tuscaloosa, Ala.	1150	LS-5,000	WKXC	Concord, N. H.	1450	250	WLST	Louisville, Miss.	1270	D-1,000	WMRP	Flint, Mich.	1510	D-250
WJRI	Lenoir, N. C.	1340	250	WKXX	Knoxville, Tenn.	900	D-1,000	WLVA	Valdosta, Ga.	1370	D-1,000	WMRY	New Orleans, La.	600	D-500
WJTN	Jamestown, N. Y.	1240	250	WKXY	Sarasota, Fla.	1540	D-1,000	WLWB	Washington, D. C.	630	5,000	WMSA	Massena, N. Y.	1340	250
WJVA	South Bend, Ind.	1580	D-250	WKYB	Paducah, Ky.	570	LS-1,000	WLWC	Washington, D. C.	630	5,000	WMSB	Columbia, S. C.	1320	1,000
WJVB	Jacksonville Beach, Fla.	1010	D-1,000	WKYK	Oklahoma City, Okla.	930	5,000	WLWD	Danbury, Conn.	800	D-250	WMSD	Decatur, Ala.	1400	250
WJW	Cleveland, Ohio	850	5,000	WKYL	Lakeland, Fla.	1430	1,000	WLWE	Leesburg, Fla.	790	1,000	WMSL	Cedar Rapids, Ia.	600	5,000
WJWL	Georgetown, Del.	900	D-1,000	WKYM	Louisville, Ky.	900	D-1,000	WLWF	La Follette, Tenn.	1450	100	WMT	Van Cleve, Ky.	730	D-1,000
WJWS	South Hill, Va.	1370	D-1,000	WKZO	Kalamazoo, Mich.	590	5,000	WLWG	Wilmington, N. C.	1230	D-1,000	WMTA	Manistee, Mich.	1340	250
WJXN	Jackson, Miss.	1450	250	WLAC	Nashville, Tenn.	1510	50,000	WLWH	Wilmington, N. C.	1230	D-1,000	WMTB	Moultrie, Ga.	1300	D-1,000
WJZM	Clarksville, Tenn.	1400	250	WLAD	Danbury, Conn.	800	D-250	WLWI	Wilmington, N. C.	1230	D-1,000	WMTD	Morrilton, Miss.	1250	D-1,000
WKAB	Mobile, Ala.	840	D-1,000	WLAF	La Follette, Tenn.	1450	100	WLWJ	Wilmington, N. C.	1230	D-1,000	WMTM	Morrilton, Miss.	1250	D-1,000
WKAL	Macon, Ill.	1510	D-250	WLAG	LaGrange, Ga.	1240	250	WLWK	Wilmington, N. C.	1230	D-1,000	WMTN	Morrilton, Miss.	1250	D-1,000
WKAM	Rome, N. Y.	1450	D-250	WLBK	De Kalb, Ill.	1360	D-500	WLBW	Auburn, Wis.	930	D-5,000	WMTU	Morrilton, Miss.	1250	D-1,000
WKAN	Kankakee, Ill.	1320	D-1,000	WLBL	Lebanon, Ky.	1590	D-500	WLBX	Lebanon, Pa.	1270	1,000	WMTV	Morrilton, Miss.	1250	D-1,000
WKAP	Allentown, Pa.	1320	1,000	WLBZ	Lebanon, Pa.	1270	1,000	WLBY	Birmingham, Ala.	900	D-1,000	WMTW	Morrilton, Miss.	1250	D-1,000
WKAQ	San Juan, P. R.	580	5,000	WLCA	Lancaster, Pa.	1390	1,000	WLCC	Campbellsville, Ky.	1450	250	WMTX	Morrilton, Miss.	1250	D-1,000
WKB	E. Lansing, Mich.	870	D-5,000	WLCE	Lawrence, Miss.	1490	250	WLCD	Lancaster, S. C.	1360	D-1,000	WMTY	Morrilton, Miss.	1250	D-1,000
WKAT	Miami Beach, Fla.	1360	LS-5,000	WLCH	Chattanooga, Tenn.	1320	D-1,000	WLCS	Baton Rouge, La.	910	1,000	WMTZ	Morrilton, Miss.	1250	D-1,000
WKAY	Glasgow, Ky.	1490	250	WLCL	Clarks Summit, Pa.	1340	1,000	WLCO	Lafayette, La.	1010	D-1,000	WNA	Wilmington, N. C.	1230	D-1,000
WKBC	N. Wilkesboro, N. C.	810	D-1,000	WLDA	Ladysmith, Wis.	1340	250	WLCP	Clarks Summit, Pa.	1340	1,000	WNAA	Warren, Pa.	1310	D-1,000
WKBH	N. C. Wilkesboro, N. C.	810	D-1,000	WLDB	Dubuque, Ia.	1340	250	WLCS	Baton Rouge, La.	910	1,000	WNAE	Grenada, Miss.	1400	250
WKBI	St. Marys, Pa.	1400	250	WLDE	Leesburg, Fla.	790	1,000	WLDA	Ladysmith, Wis.	1340	250	WNAF	Nashville, Tenn.	1360	D-1,000
WKBN	Youngstown, O.	570	5,000	WLDF	Ladysmith, Wis.	1340	250	WLDB	Dubuque, Ia.	1340	250	WNAH	Nashville, Tenn.	1360	D-1,000
WKBO	Harrisburg, Pa.	1230	250	WLDF	Ladysmith, Wis.	1340	250	WLDB	Dubuque, Ia.	1340	250	WNAI	Nashville, Tenn.	1360	D-1,000
WKBR	Manchester, N. H.	1240	D-250	WLDF	Ladysmith, Wis.	1340	250	WLDB	Dubuque, Ia.	1340	250	WNAJ	Nashville, Tenn.	1360	D-1,000
WKBS	Oyster Bay, N. Y.	1520	D-250	WLDF	Ladysmith, Wis.	1340	250	WLDB	Dubuque, Ia.	1340	250	WNAK	Nashville, Tenn.	1360	D-1,000
WKBV	Richmond, Ind.	1490	250	WLDF	Ladysmith, Wis.	1340	250	WLDB	Dubuque, Ia.	1340	250	WNAF	Nashville, Tenn.	1360	D-1,000
WKBW	Buffalo, N. Y.	1520	50,000	WLDF	Ladysmith, Wis.	1340	250	WLDB	Dubuque, Ia.	1340	250	WNAH	Nashville, Tenn.	1360	D-1,000
WKBY	Buffalo, N. Y.	1520	50,000	WLDF	Ladysmith, Wis.	1340	250	WLDB	Dubuque, Ia.	1340	250	WNAI	Nashville, Tenn.	1360	D-1,000
WKCB	Muskegon, Mich.	850	1,000	WLDF	Ladysmith, Wis.	1340	250	WLDB	Dubuque, Ia.	1340	250	WNAJ	Nashville, Tenn.	1360	D-1,000
WKCT	Bowling Green, Ky.	930	LS-1,000	WLDF	Ladysmith, Wis.	1340	250	WLDB	Dubuque, Ia.	1340	250	WNAK	Nashville, Tenn.	1360	D-1,000
WKDA	Nashville, Tenn.	1240	250	WLDF	Ladysmith, Wis.	1340	250	WLDB	Dubuque, Ia.	1340	250	WNAF	Nashville, Tenn.	1360	D-1,000
WKDK	Newberry, S. C.	1240	250	WLDF	Ladysmith, Wis.	1340	250	WLDB	Dubuque, Ia.	1340	250	WNAH	Nashville, Tenn.	1360	D-1,000
WKDN	Camden, N. J.	800	D-1,000	WLDF	Ladysmith, Wis.	1340	250	WLDB	Dubuque, Ia.	1340	250	WNAI	Nashville, Tenn.	1360	D-1,000
WKEL	Keweenaw, Ill.	1450	100	WLDF	Ladysmith, Wis.	1340	250	WLDB	Dubuque, Ia.	1340	250	WNAJ	Nashville, Tenn.	1360	D-1,000
WKEM	Griffin, Ga.	1450	250	WLDF	Ladysmith, Wis.	1340	250	WLDB	Dubuque, Ia.	1340	250	WNAK	Nashville, Tenn.	1360	D-1,000
WKEU	Covington, Va.	1340	250	WLDF	Ladysmith, Wis.	1340	250	WLDB	Dubuque, Ia.	1340	250	WNAF	Nashville, Tenn.	1360	D-1,000
WKEY	Covington, Va.	1340	250	WLDF	Ladysmith, Wis.	1340	250	WLDB	Dubuque, Ia.	1340	250	WNAH	Nashville, Tenn.	1360	D-1,000
WKGN	Knoxville, Tenn.	1340	250	WLDF	Ladysmith, Wis.	1340	250	WLDB	Dubuque, Ia.	1340	250	WNAI	Nashville, Tenn.	1360	D-1,000
WKHM	Jackson, Mich.	970	1,000	WLDF	Ladysmith, Wis.	1340	250	WLDB	Dubuque, Ia.	1340	250	WNAJ	Nashville, Tenn.	1360	D-1,000
WKIC	Hazard, Ky.	1340	250	WLDF	Ladysmith, Wis.	1340	250	WLDB	Dubuque, Ia.	1340	250	WNAK	Nashville, Tenn.	1360	D-1,000
WKID	Urbana, Ill.	1580	D-250	WLDF	Ladysmith, Wis.	1340	250	WLDB	Dubuque, Ia.	1340	250	WNAF	Nashville, Tenn.	1360	D-1,000
WKIK	Leonardtown, Md.	1370	D-1,000	WLDF	Ladysmith, Wis.	1340	250	WLDB	Dubuque, Ia.	1340</					

AM CALL LETTERS

Call Letters	City	Freq- uency in KC	Power in Watts	Call Letters	City	Freq- uency in KC	Power in Watts	Call Letters	City	Freq- uency in KC	Power in Watts	Call Letters	City	Freq- uency in KC	Power in Watts
WNNJ	Newton, N. J.	1380	D-500	WPCT	Putnam, Conn.	1350	D-500	WRNL	Richmond, Va.	910	5,000	WSRS	Cleveland		
WNNT	Warsaw, Va.	690	D-250	WPDQ	Jacksonville, Fla.	600	5,000	WRNY	Richmond, N. C.	910	D-250	WSSE	Hghts., O.	1490	250
WNOR	New Orleans, La.	1060	LS-50,000 N-5,000	WPDF	Portage, Wis.	1350	D-1,000	WROB	West Point, Miss.	1450	250	WSSC	Durham, N. C.	1490	250
WNOK	Columbia, S. C.	1230	250	WPDFX	Clarksburg, W. Va.	750	D-1,000	WROD	Daytona Beach, Fla.	1340	250	WSSO	Sumter, S. C.	1240	100
WNOP	Newport, Ky.	740	D-1,000	WPEL	Montrose, Pa.	1250	D-1,000	WROK	Rockford, Ill.	1440	LS-1,000	WSSV	Starkville, Miss.	1230	250
WNOR	Norfolk, Va.	1230	250	WPEN	Philadelphia, Pa.	950	5,000	WROL	Knoxville, Tenn.	620	5,000	WSTA	Petersburg, Va.	1240	250
WNOS	High Point, N. C.	1590	D-1,000	WPEO	Peoria, Ill.	1020	D-1,000	WROM	Rome, Ga.	710	D-1,000	WSTC	Charlotte Amalie, St. Thomas, V. I.	1340	250
WNOW	York, Pa.	1250	D-1,000	WPEP	Taunton, Mass.	1570	D-1,000	WRON	Ronceverte, Rome, Ga.	1400	250	WSTN	Stamford, Conn.	1400	250
WNOX	Knoxville, Tenn.	890	10,000	WPET	Greensboro, N. C.	950	D-500	WROS	Scottsboro, Ala.	1330	D-1,000	WSTR	Salisbury, N. C.	1490	D-1,000
WNPT	Tuscaloosa, Ala.	1280	D-1,000	WPFV	Middletown, O.	910	LS-1,000	WROV	Roanoke, Va.	1240	250	WSTV	Sturgis, Mich.	1460	D-500
WNRC	New Rochelle, N. Y.	1460	D-500	WPFH	Paris, Ky.	1240	250	WROW	Albany, N. Y.	590	LS-5,000	WSUI	Stuebenville, Ohio	1340	250
WNRR	Grundy, Va.	1250	D-1,000	WPFK	Park Falls, Wis.	1450	100	WROX	Clarksdale, Miss.	1450	250	WSUN	Iowa City, Iowa	910	5,000
WNRI	Woonsocket, R. I.	1380	D-1,000	WPGC	Morningside, Md.	1580	D-250	WROY	Carmi, Ill.	1480	D-1,000	WSVA	St. Petersburg, Fla.	620	5,000
WNRV	Narrows, Va.	990	D-1,000	WPGH	Pittsburgh, Pa.	1080	D-1,000	WRR	Dallas, Tex.	1310	5,000	WSVA	Harrisonburg, Va.	550	1,000
WNTM	Vero Beach, Fla.	1370	D-1,000	WPGI	Portland, Ind.	1440	D-500	WRRF	Washington, N. C.	930	LS-5,000	WSVA	Harrisonburg, Va.	550	1,000
WNVV	Norton, Va.	1450	250	WPGM	Sharon, Pa.	790	D-1,000	WRRZ	Rockford, Ill.	1330	D-1,000	WSVS	Crewe, Va.	800	D-1,000
WNXT	Portsmouth, O.	1280	1,000	WPGN	Piedmont, Ala.	1280	D-1,000	WRZA	Clinton, N. C.	880	D-1,000	WSWN	Belle Glade, Fla.	900	D-1,000
WNYC	New York, N. Y.	830	LS-5,000 *N-1,000 L-N-1,000	WPKA	Alexandria, Va.	730	D-1,000	WRWB	Warsaw, Ind.	1480	500	WSYB	Rutland, Vt.	1380	1,000
WOAI	San Antonio, Tex.	1200	50,000	WPKB	St. Petersburg, Fla.	680	D-1,000	WRWA	Altoona, Pa.	1240	250	WSYD	Mt. Airy, N. C.	1240	250
WOAP	Owosso, Mich.	1080	D-250	WPKC	Pittsburgh, Pa.	1080	D-1,000	WRWB	Altoona, Pa.	1240	250	WSYR	Syracuse, N. Y.	570	5,000
WOAY	Oak Hill, W. Va.	860	D-10,000	WPKD	Portland, Me.	1490	LS-1,000	WRWB	Altoona, Pa.	1240	250	WTAC	Flint, Mich.	600	LS-1,000
WOB	Jacksonville, Fla.	1360	D-1,000	WPKL	Pottsville, Pa.	1360	LS-1,000	WRWB	Altoona, Pa.	1240	250	WTAD	Quincy, Ill.	930	LS-5,000
WOBT	Rhineland, Wis.	1240	250	WPKM	Huntington, W. Va.	1450	250	WRWB	Altoona, Pa.	1240	250	WTAD	Quincy, Ill.	930	LS-5,000
WOC	Davenport, Ia.	1420	5,000	WPKN	Punxsutawney, Pa.	1540	D-1,000	WRWB	Altoona, Pa.	1240	250	WTAG	Worcester, Mass.	580	5,000
WOCB	W. Yarmouth, Mass.	1240	250	WPKO	Pasagoula, Miss.	1580	D-250	WRWB	Altoona, Pa.	1240	250	WTAL	Tallahassee, Fla.	1270	5,000
WOHI	East Liverpool, Ohio	1490	250	WPKP	Brevard, N. C.	1240	250	WSAJ	Cincinnati, O.	1360	5,000	WTAM	Cleveland, Ohio	1100	50,000
WOHO	Toledo, O.	1470	1,000	WPKQ	Phenix City, Ala.	1460	1,000	WSAL	Logansport, Ind.	1230	250	WTAN	Clearwater, Fla.	1340	250
WOHP	Bellefontaine, O.	1390	D-500	WPKR	Pontiac, Mich.	1460	500	WSAM	Saginaw, Mich.	1400	250	WTAO	Cambridge, Mass.	740	D-250
WOHS	Shelby, N. C.	730	D-250	WPKS	Portland, Me.	1490	500	WSAN	Allentown, Pa.	1470	5,000	WTAO	Cambridge, Mass.	740	D-250
WOI	Ames, Iowa	640	D-5,000	WPKT	Pottsville, Pa.	1360	LS-1,000	WSAR	Fall River, Mass.	1480	5,000	WTAR	La Grange, Ill.	1300	D-500
WOK	Oak Ridge, Tenn.	1290	D-1,000	WPKU	Pottsville, Pa.	1360	LS-1,000	WSAT	Salisbury, N. C.	1280	1,000	WTAR	Norfolk, Va.	790	5,000
WOKV	Albany, N. Y.	1460	*N-1,000 *LS-5,000	WPKV	Pottsville, Pa.	1360	LS-1,000	WSAU	Wausau, Wis.	1400	250	WTAW	College Station, Tex.	1150	D-1,000
WOKW	Sturgeon Bay, Wis.	1050	D-250	WPKW	Prattville, Ala.	1460	1,000	WSAV	Savannah, Ga.	630	5,000	WTBW	Troy, Ala.	1490	250
WOKY	Milwaukee, Wis.	920	1,000	WPKX	Prattville, Ala.	1460	1,000	WSAX	Rochester, N. Y.	1370	D-500	WTBW	Cumberland, Md.	1450	250
WOKZ	Alton, Ill.	1570	D-1,000	WPKY	Prattville, Ala.	1460	1,000	WSAZ	Huntington, W. Va.	930	LS-5,000	WTBW	Cumberland, Md.	1450	250
WOL	Washington, D. C.	1450	250	WPKZ	Prattville, Ala.	1460	1,000	WSB	Atlanta, Ga.	750	N-1,000	WTBW	Cumberland, Md.	1450	250
WOLF	Syracuse, N. Y.	1490	250	WPKA	Prestonburg, Ky.	960	D-1,000	WSBA	York, Pa.	910	1,000	WTBW	Cumberland, Md.	1450	250
WOLS	Florence, S. C.	1230	250	WPKB	Perry, Fla.	1220	D-250	WSBB	New Smyrna Beach, Fla.	1230	250	WTBW	Cumberland, Md.	1450	250
WOMI	Owensboro, Ky.	1490	250	WPKC	Raleigh, N. C.	880	50,000	WSBC	Chicago, Ill.	1240	250	WTBW	Cumberland, Md.	1450	250
WOMT	Manitowoc, Wis.	1240	250	WPKD	Albany, N. Y.	1540	50,000	WSBT	South Bend, Ind.	960	5,000	WTBW	Cumberland, Md.	1450	250
WOND	Pleasantville, N. J.	1400	250	WPKL	Piqua, Ohio	1570	D-250	WSCR	Scranton, Pa.	1320	LS-1,000	WTBW	Cumberland, Md.	1450	250
WONE	Dayton, O.	980	5,000	WPKM	Lexington Park, Md.	1570	D-1,000	WSDR	Sterling, Ill.	1240	100	WTBW	Cumberland, Md.	1450	250
WONN	Lakeland, Fla.	1230	250	WPKN	Lexington Park, Md.	1570	D-1,000	WSFA	Montgomery, Ala.	1440	LS-5,000	WTBW	Cumberland, Md.	1450	250
WONW	Defiance, O.	1280	500	WPKO	Lexington Park, Md.	1570	D-1,000	WSFC	Somerset, Ky.	1240	250	WTBW	Cumberland, Md.	1450	250
WOOD	Grand Rapids, Mich.	1300	5,000	WPKP	Lexington Park, Md.	1570	D-1,000	WSFT	Thomaston, Ga.	1220	D-250	WTBW	Cumberland, Md.	1450	250
WOOF	Dothan, Ala.	560	D-5,000	WPKQ	Lexington Park, Md.	1570	D-1,000	WSGC	Elberton, Ga.	1400	250	WTBW	Cumberland, Md.	1450	250
WOOK	Washington, D. C.	1340	250	WPKR	Lexington Park, Md.	1570	D-1,000	WSGN	Birmingham, Ala.	610	LS-5,000	WTBW	Cumberland, Md.	1450	250
WOOW	New Bern, N. C.	1490	250	WPKS	Lexington Park, Md.	1570	D-1,000	WSGW	Saginaw, Mich.	790	N-1,000	WTBW	Cumberland, Md.	1450	250
WOPA	Oak Park, Ill.	1490	250	WPKT	Lexington Park, Md.	1570	D-1,000	WSHB	Stillwater, Minn.	1220	D-250	WTBW	Cumberland, Md.	1450	250
WOPI	Bristol, Tenn.	1490	250	WPKU	Lexington Park, Md.	1570	D-1,000	WSIC	Statesville, N. C.	1400	250	WTBW	Cumberland, Md.	1450	250
WOR	New York, N. Y.	710	50,000	WPKV	Lexington Park, Md.	1570	D-1,000	WSID	Essex-Baltimore, Md.	1010	D-1,000	WTBW	Cumberland, Md.	1450	250
WORA	Mayaguez, P. R.	1150	1,000	WPKW	Lexington Park, Md.	1570	D-1,000	WSIG	Mount Jackson, Va.	790	D-1,000	WTBW	Cumberland, Md.	1450	250
WORC	Worcester, Mass.	1310	1,000	WPKX	Lexington Park, Md.	1570	D-1,000	WSIP	Paintsville, Ky.	1490	250	WTBW	Cumberland, Md.	1450	250
WORD	Spartanburg, S. C.	910	1,000	WPKY	Lexington Park, Md.	1570	D-1,000	WSIR	Winter Haven, Fla.	1490	250	WTBW	Cumberland, Md.	1450	250
WORK	York, Pa.	1350	LS-5,000	WPKZ	Lexington Park, Md.	1570	D-1,000	WSIV	Pekin, Ill.	1140	D-1,000	WTBW	Cumberland, Md.	1450	250
WORL	Boston, Mass.	950	D-5,000	WRAC	Racine, Wis.	1460	D-500	WSIX	Nashville, Tenn.	980	5,000	WTBW	Cumberland, Md.	1450	250
WORX	Madison, Ind.	1440	D-500	WRAD	Radford, Va.	1340	250	WSJS	Winston-Salem, N. C.	600	5,000	WTBW	Cumberland, Md.	1450	250
WORZ	Orlando, Fla.	740	*LS-5,000 *N-1,000	WRAG	Carrollton, Ala.	590	D-1,000	WSKB	McComb, Miss.	1250	LS-5,000	WTBW	Cumberland, Md.	1450	250
WOSA	Wausau, Wis.	550	5,000	WRAL	Williamsport, Pa.	1400	250	WSKI	Montpelier, Vt.	1240	250	WTBW	Cumberland, Md.	1450	250
WOSC	Fulton, N. Y.	1300	D-1,000	WRAP	Raleigh, N. C.	1240	250	WSKY	Asheville, N. C.	1230	250	WTBW	Cumberland, Md.	1450	250
WOSH	Oshkosh, Wis.	1490	250	WRAP	Raleigh, N. C.	1240	250	WSLB	Ogdensburg, N. Y.	1400	250	WTBW	Cumberland, Md.	1450	250
WOSU	Columbus, Ohio	820	LS-5,000	WRAP	Raleigh, N. C.	1240	250	WSLI	Jackson, Miss.	990	5,000	WTBW	Cumberland, Md.	1450	250
WOTW	Nashua, N. H.	900	D-1,000	WRAP	Raleigh, N. C.	1240	250	WSLM	Salem, Ind.	1220	D-250	WTBW	Cumberland, Md.	1450	250
WOW	New York, N. Y.	1280	5,000	WRAP	Raleigh, N. C.	1240	250	WSLS	Roanoke, Va.	610	1,000	WTBW	Cumberland, Md.	1450	250
WOW	Omaha, Neb.	590	5,000	WRAP	Raleigh, N. C.	1240	250	WSM	Nashville, Tenn.	650	50,000	WTBW	Cumberland, Md.	1450	250
WOWL	Florence, Ala.	1240	250	WRAP	Raleigh, N. C.	1240	250	WSMB	New Orleans, La.	1550	5,000	WTBW	Cumberland, Md.	1450	250
WOWO	Ft. Wayne, Ind.	1190	10,000	WRAP	Raleigh, N. C.	1240	250	WSMT	Litchfield, Ill.	1500	D-1,000	WTBW	Cumberland, Md.	1450	250
WOXF	Oxford, N. C.	1340	250	WRAP	Raleigh, N. C.	1240	250	WSMT	Sparta, Tenn.	1050	D-1,000	WTBW	Cumberland, Md.	1450	250
WOZK	Ozark, Ala.	900	D-1,000	WRAP	Raleigh, N. C.	1240	250	WSNJ	Bridgeton, N. J.	1240	250	WTBW	Cumberland, Md.	1450	250
WPAA	Mayaguez, P. R.	1190	250	WRAP	Raleigh, N. C.	1240	250	WSNW	Seneca, S. C.	1150	D-1,000	WTBW	Cumberland, Md.	1450	250
WPAB	Ponce, P. R.	550	LS-5,000	WRAP	Raleigh, N. C.	1240	250	WSNY	Schenectady, N. Y.	1240	250	WTBW	Cumberland, Md.	1450	250
WPAC	Patchogue, N. Y.	1580	D-250	WRAP	Raleigh, N. C.	1240	250	WSOC	Charlotte, N. C.	1240	250	WTBW	Cumberland, Md.	1450	250
WPAD	Paducah, Ky.	1450	250	WRAP	Raleigh, N. C.	1240	250	WSOK	Nashville, Tenn.	1470	D-1,000	WTBW	Cumberland, Md.	1450	250
WPAG	Ann Arbor, Mich.	1050	D-1,000	WRAP	Raleigh, N. C.	1240	250	WSOJ	Henderson, Ky.	860	D-500	WTBW	Cumberland, Md.	1450	250
WPAL															

AM CALL LETTERS

Call Letters	City	Power in Watts	Call Letters	City	Power in Watts	Call Letters	City	Power in Watts	Call Letters	City	Power in Watts				
WTHH	Port Huron, Mich.	1380	WVAM	Altoona, Pa.	1430	1,000	WWBZ	Vineland, N. J.	1360	1,000	WWPF	Palatka, Fla.	800		
WTTM	Trenton, N. J.	920	1,000	WVCG	Coral Gables, Fla.	1070	D-1,000	WWC	Gary, Ind.	1270	1,000	*1260	D-250		
WTTN	Watertown, Wis.	1580	D-250	WVCH	Chester, Pa.	740	D-250	WWCO	Waterbury, Conn.	1240	250	WWPG	Palm Beach, Fla.	1340	250
WTTR	Westminster, Md.	1470	D-1,000	WVDA	Boston, Mass.	1260	5,000	WWDC	Washington, D. C.	1260	5,000	WWRL	New York, N. Y.	1600	5,000
WTTS	Bloomington, Ind.	1370	LS-5,000	WVEC	Hampton, Va.	1490	250	WWEE	New Orleans, La.	690	5,000	WWSC	Glens Falls, N. Y.	1450	250
WTUP	Tupelo, Miss.	1380	N-500	WVJP	Caguas, P. R.	1110	250	WWGP	Sanford, N. C.	1050	D-1,000	WWSO	Springfield, O.	1210	D-250
WTUS	Tuskegee, Ala.	580	D-500	WVJS	Owensboro, Ky.	1420	1,000	WWGS	Tifton, Ga.	1340	250	WWSR	St. Albans, Vt.	1420	D-1,000
WTUX	Wilmington, Del.	1290	D-500	WVKO	Columbus, O.	1580	D-1,000	WWHG	Hornell, N. Y.	1320	D-1,000	WWST	Woooster, Ohio	960	D-1,000
WTVB	Coldwater, Mich.	1590	LS-5,000	WVLK	Lexington, Ky.	590	1,000	WWIN	Baltimore, Md.	1400	250	WWSW	Pittsburgh, Pa.	970	5,000
WTVH	Peoria, Ill.	1590	1,000	WVLN	Olney, Ill.	740	D-250	WWJ	Detroit, Mich.	950	5,000	WWVA	Wheeling, W. Va.	1170	50,000
WTVL	Waterville, Me.	1490	250	WVMT	Mt. Carmel, Ill.	1360	D-500	WWNC	Asheville, N. C.	570	5,000	WWVF	Fayette, Ala.	990	D-1,000
WTWA	Thomson, Ga.	1240	250	WVNI	Biloxi, Miss.	570	D-1,000	WWNH	Rochester, N. H.	930	D-1,000	WWWR	Russellville, Ala.	920	D-1,000
WTWN	St. Johnsbury, Vt.	1340	250	WVOK	Birmingham, Ala.	690	D-50,000	WWNR	Beckley, W. Va.	620	LS-1,000	WWWRI	Piedras, P. R.	1520	250
WTXL	W. Springfield, Mass.	1490	250	WVOW	Logan, W. Va.	1290	LS-5,000	WWNS	Statesboro, Ga.	1490	250	WXXL	Pineville, W. Va.	970	D-1,000
WTYC	Rock Hill, S. C.	1150	D-1,000	WVPA	Stroudsburg, Pa.	840	D-250	WWNY	Watertown, N. Y.	790	1,000	WXXY	Demopolis, Ala.	1400	250
WTVS	Marianna, Fla.	1340	250	WVSC	Somerset, Pa.	890	D-250	WWOC	Manitowoc, Wis.	980	D-1,000	WXXZ	Richmond, Va.	950	D-1,000
WUVA	Eufaula, Ala.	1240	250	WVW	Fairmont, W. Va.	1490	250	WWOD	Wyandoch, Va.	1390	LS-5,000	WXXL	Indianapolis, Ind.	1590	D-1,000
WUSJ	Lockport, N. Y.	1340	250	WVWG	Bowling Green, Ohio	730	D-250	WWOL	Buffalo, N. Y.	1120	D-1,000	WXK	Baton Rouge, La.	1260	D-1,000
WUSN	Charleston, S. C.	1450	250	WVWV	Fairmont, W. Va.	1490	250	WWON	Woonsocket, R. I.	1240	250	WXRA	Kenmore, N. Y.	1080	D-1,000
WUST	Bethesda, Md.	1120	D-250	WVWG	Bowling Green, Ohio	730	D-250	WWPA	Williamsport, Pa.	1340	250	WXRF	Guayama, P. R.	1590	1,000
										*1330	*LS-5,000	WKYZ	Detroit, Mich.	1270	5,000
										*N-1,000	250	WYVE	Wytheville, Va.	1280	D-1,000
												WZIP	Covington, Ky.	1050	D-250
												WZOB	Fort Payne, Ala.	1250	D-1,000

DIRECTORY OF CANADIAN STATIONS BY CALL LETTERS

CBA.....Sackville, N. B.	CFJC.....Kamloops, B. C.	CHOV.....Pembroke, Ont.	CJOR.....Vancouver, B. C.	CKNB.....Campbellton, N.B.
CBE.....Windsor, Ont.	CFJR.....Brockville, Ont.	CHRC.....Quebec, Que.	CJOY.....Guelph, Ont.	CKNW.....New Westminster, B. C.
CBF.....Montreal, Que.	CFNB.....Fredericton, N. B.	CHRL.....Roberval, Que.	CJRL.....Kenora, Ont.	
CBG.....Gander, Nfld.	CFOR.....Orillia, Ont.	CHSJ.....St. John, N. B.	CJRW.....Summerside, P.E.I.	CKNX.....Wingham, Ont.
CBH.....Halifax, N. S.	CFOS.....Owen Sound, Ont.	CHUB.....Nanaimo, B. C.	CJSO.....Sorel, Que.	CKOC.....Hamilton, Ont.
CBI.....Sydney, N. S.	CFPA.....Port Arthur, Ont.	CHUM.....Toronto, Ont.	CJVI.....Victoria, B. C.	CKOK.....Penticton, B. C.
CBJ.....Chicoutimi, Que.	CFPR.....Prince Rupert, B. C.	CHVC.....Niagara Falls, Ont.	CKAC.....Montreal, Que.	CKOM.....Saskatoon, Sask.
CBK.....Wetmore, Sask.	CFPL.....London, Ont.	CHWK.....Chilliwack, B. C.	CKBB.....Barrie, Ont.	CKOV.....Kelowna, B. C.
CBL.....Toronto, Ont.	CFQC.....Saskatoon, Sask.	CJAD.....Montreal, Que.	CKBI.....Prince Albert, Sask.	CKOX.....Woodstock, Ont.
CBM.....Montreal, Que.	CFRA.....Ottawa, Ont.	CJAT.....Trail, B. C.	CKBL.....Matane, Que.	CKOY.....Ottawa, Ont.
CBN.....St. John's, Nfld.	CFRB.....Toronto, Ont.	CJAV.....Port Alberno, B. C.	CKBW.....Bridgewater, N. S.	CKPC.....Brantford, Ont.
CBO.....Ottawa, Ont.	CFRC.....Kingston, Ont.	CJBC.....Toronto, Ont.	CKCH.....Hull, Que.	CKPG.....Prince George, B. C.
CBU.....Vancouver, B. C.	CFRG.....Gravelbourg, Sask.	CJBQ.....Belleville, Ont.	CKCK.....Regina, Sask.	CKPR.....Fort William, Ont.
CBT.....Grand Falls, Nfld.	CFRN.....Edmonton, Alta.	CJBR.....Rimouski, Que.	CKCL.....Truro, N. S.	CKRC.....Winnipeg, Man.
CBV.....Quebec, Que.	CFYK.....Yellowknife, N.W.T.	CJCA.....Edmonton, Alta.	CKCR.....Kitchener, Ont.	CKRD.....Red Deer, Alta.
CBW.....Winnipeg, Man.	CFYT.....Dawson, Y. T.	CJCB.....Sydney, N. S.	CKCV.....Quebec, Que.	CKRM.....Regina, Sask.
CBX.....Edmonton, Alta.	CHAB.....Moos Jaw, Sask.	CJCH.....Halifax, N. S.	CKCW.....Moncton, N. B.	CKRN.....Rouyn, Que.
CBY.....Corner Brook, Nfld.	CHAD.....Amos, Que.	CJCS.....Stratford, Ont.	CKDA.....Victoria, B. C.	CKRS.....Jonquiere, Que.
CBZ.....Windsor, N. S.	CHAK.....Akiavik, N.W.T.	CJCC.....Dawson Creek, B. C.	CKDM.....Dauphin, Man.	CKSB.....St. Boniface, Man.
CFAC.....Calgary, Alta.	CHAT.....Medicine Hat, Alta.	CJEM.....Edmundston, N. B.	CKEC.....New Glasgow, N.S.	CKSF.....Cornwall, Ont.
CFAR.....Flin Flon, Man.	CHED.....Saskatoon, Sask.	CJFP.....Riviere du Loup, Que.	CKEN.....Kentville, N. S.	CKSO.....Sudbury, Ont.
CFBC.....St. John, N. B.	CHED.....Edmonton, Alta.		CKEY.....Toronto, Ont.	CKTB.....St. Catharines, Ont.
CFBM.....Brochet, Man.	CHEF.....Granby, Que.	CJFX.....Antigonish, N. S.	CKFH.....Toronto, Ont.	CKTR.....Three Rivers, Que.
CFCF.....Montreal, Que.	CHEX.....Peterborough, Ont.	CJGX.....Yorkton, Sask.	CKFI.....Fort Francis, Ont.	CKTS.....Sherbrooke, Que.
CFCH.....North Bay, Ont.	CHFA.....Edmonton, Alta.	CJIB.....Vernon, B. C.	CKGB.....Timmins, Ont.	CKUA.....Edmonton, Alta.
CFCL.....Timmins, Ont.	CHGB.....St. Anne de la Pocatiere, Que.	CJIC.....Sault Ste. Marie, Ont.	CKGO.....Eastview, Ont.	CKVD.....Val d'Or, Que.
CFCN.....Calgary, Alta.	CHLN.....Three Rivers, Que.	CJKL.....Kirkland Lake, Ont.	CKLB.....Oshawa, Ont.	CKVL.....Verdun, Que.
CFCO.....Chatham, Ont.	CHLO.....St. Thomas, Ont.	CJLS.....Yarmouth, N. S.	CKLC.....Kingston, Ont.	CKVM.....Ville Marie, Que.
CFCY.....Chattanooga, P.E.I.	CHLP.....Montreal, Que.	CJMS.....Montreal, Que.	CKLD.....Thetford Mines, Ont.	CKWS.....Kingston, Ont.
CFDA.....Victoria, B. C.	CHLT.....Sherbrooke, Que.	CJNB.....North Battleford, Sask.	CKLN.....Nelson, B. C.	CKWX.....Vancouver, B. C.
CFDP.....Grand Prairie, Alta.	CHML.....Hamilton, Ont.	CJNT.....Quebec, Que.	CKLS.....La Sarre, Que.	CKX.....Brandon, Man.
CFGT.....St. Joseph d'Alma, Que.	CHNC.....New Carlisle, Que.	CJOB.....Winnipeg, Man.	CKLW.....Windsor, Ont.	CKXL.....Calgary, Alta.
CFHR.....Hay River, N.W.T.	CHNO.....Sudbury, Ont.	CJOC.....Lethbridge, Alta.	CKMO.....Vancouver, B. C.	CKY.....Winnipeg, Man.
CFJB.....Brampton, Ont.	CHNS.....Halifax, N. S.	CJON.....St. John's, Nfld.	CKMR.....Newcastle, N. B.	VOAR.....St. John's, Nfld.
	CHOK.....Sarnia, Ont.			VOCM.....St. John's, Nfld.
				VOWR.....St. John's, Nfld.

DIRECTORY OF FM STATIONS BY CALL LETTERS

† Construction Permit

Call Letters	Location	Frequency Mcs.	Chan- nel No.	Call Letters	Location	Frequency Mcs.	Chan- nel No.	Call Letters	Location	Frequency Mcs.	Chan- nel No.
KAIM	Honolulu, T. H.	95.5	238	KFGQ-FM	Boone, Iowa	99.3	257	KMUS-FM	Muskogee, Okla.	101.5	268
KALB-FM	Alexandria, La.	96.9	245	KFH-FM	Wichita, Kan.	100.3	262	KMYC-FM	Marysville, Calif.	99.9	260
KALE-FM	Pasco, Wash.	103.9	280	†KFML	Golden, Colo.	98.5	253	KNBC-FM	San Francisco, Calif.	99.7	259
KARM-FM	Fresno, Calif.	101.9	270	KFMV	Fort Dodge, Iowa	102.7	274	†KNEV	Reno, Nev.	95.5	238
KAYL-FM	Storm Lake, Iowa	101.5	268	KFOX-FM	Long Beach, Calif.	102.3	272	KNOB	Long Beach, Calif.	103.1	276
KBEE	Modesto, Calif.	103.3	277	KFPW-FM	Fort Smith, Ark.	94.9	235	KNX-FM	Los Angeles, Calif.	93.1	226
KBOA-FM	Kennett, Mo.	98.9	255	KFSA-FM	Fort Smith, Ark.	101.1	236	KOA-FM	Denver, Colo.	95.7	239
KBTM-FM	Jonesboro, Ark.	101.9	270	KFSO-FM	San Diego, Calif.	94.1	231	KOIN-FM	Portland, Ore.	101.1	266
KCBH	Los Angeles, Calif.	98.7	254	KFDU-FM	Clayton, Mo.	99.1	256	KOKX-FM	Keokuk, Iowa	102.7	274
KCBS-FM	San Francisco, Calif.	98.9	255	KFWB-FM	Hollywood, Calif.	94.7	234	KONO-FM	San Antonio, Tex.	92.9	235
KCHR-FM	Charleston, Mo.	101.7	269	KGLO-FM	Mason City, Iowa	101.1	268	KOZY	Rapid City, S. D.	94.7	234
KCLX-FM	Cleburne, Tex.	94.3	232	KGO-FM	San Francisco, Calif.	106.1	291	KPFA	Berkeley, Calif.	94.1	231
KCMO-FM	Texarkana, Tex.	98.1	251	KGPO	Grants Pass, Ore.	96.9	245	KPFM	Portland, Ore.	97.1	246
KCMC-FM	Kansas City, Mo.	94.9	235	KGW-FM	Portland, Ore.	100.3	262	KPOC-FM	Pocahontas, Ark.	97.7	249
KCMS	Manitou Springs, Colo.	104.9	285	KHJ-FM	Los Angeles, Calif.	101.1	266	KPOJ-FM	Portland, Ore.	98.7	254
KCRA-FM	Sacramento, Calif.	96.1	241	†KIND-FM	Independence, Kan.	93.5	228	KPRC-FM	Houston, Tex.	102.9	275
KDFC	San Francisco, Calif.	102.1	271	KING-FM	Seattle, Wash.	98.1	251	KRE-FM	Berkeley, Calif.	102.9	275
KDKA-FM	Pittsburgh, Pa.	92.9	225	KIRO-FM	Seattle, Wash.	100.7	264	KRED	Eureka, Calif.	96.3	242
KDNT-FM	Denton, Tex.	106.3	292	KISS	San Antonio, Tex.	99.5	258	KREL-FM	Baytown, Tex.	92.1	221
KDYL-FM	Salt Lake City, Utah	98.7	254	KISW	Seattle, Wash.	99.9	260	†KREM-FM	Spokane, Wash.	92.9	225
KBCA-FM	Los Angeles, Calif.	95.5	238	KITE-FM	San Antonio, Tex.	97.3	247	KRFM	Fresno, Calif.	93.7	229
KEDO	Ontario, Calif.	93.5	228	KIXI-FM	Dallas, Tex.	104.5	283	KRIC-FM	Rapid City, S. D.	99.5	258
KENO-FM	Las Vegas, Nev.	103.9	280	KLCN-FM	Blytheville, Ark.	96.1	241	KRKD-FM	Los Angeles, Calif.	96.3	242
KERN-FM	Bakersfield, Calif.	94.1	231	KLTI-FM	Longview, Tex.	105.9	290	KRLD-FM	Dallas, Tex.	92.5	223
KEX-FM	Portland, Ore.	92.3	222	KLUF-FM	Galveston, Tex.	98.7	254	KRMD-FM	Shreveport, La.	101.1	266
KFAC-FM	Los Angeles, Calif.	104.3	282	KLX-FM	Oakland, Calif.	101.3	267	KRNT-FM	Des Moines, Iowa	104.5	283
KFAM-FM	St. Cloud, Minn.	104.7	284	KLZ-FM	Denver, Colo.	94.1	231	KRON-FM	San Francisco, Calif.	96.5	243
KFBK-FM	Sacramento, Calif.	96.9	245	KMAR	Bakersfield, Calif.	92.5	223	KROS-FM	Clinton, Iowa	96.1	241
KFEL-FM	Denver, Col.	97.3	247	KMJ-FM	Fresno, Calif.	97.9	250	KRXX-FM	Rexburg, Ore.	93.7	229
				KMLB-FM	Monroe, La.	104.1	281	KSBR	San Bruno, Calif.	100.5	263

FM CALL LETTERS

Call Letters	Location	Frequency Mcs.	Channel No.
KSCJ-FM	Sioux City, Iowa	94.9	235
KSEI-FM	Pocatello, Idaho	96.5	243
KSJL-FM	San Jose, Calif.	97.3	237
KSL-FM	Salt Lake City, Utah	100.3	262
KSO-FM	Des Moines, Iowa	97.3	247
KSPI-FM	Stillwater, Okla.	93.9	230
KRSRT	Beverly Hills, Calif.	93.9	230
KTBS-FM	Shreveport, La.	96.5	243
KTEM-FM	Tempe, Tex.	107.5	298
KTFI-FM	Twin Falls, Idaho	99.7	259
KTIS-FM	Minneapolis, Minn.	98.5	253
KTNT	Tacoma, Wash.	97.3	247
KTRB-FM	Modesto, Calif.	104.1	281
KTRH-FM	Houston, Tex.	101.1	266
KTSA-FM	San Antonio, Tex.	101.5	289
KTTS-FM	Springfield, Mo.	94.7	234
KTYL-FM	Mesa, Ariz.	104.7	284
KUGN-FM	Eugene, Ore.	99.1	256
KUOA-FM	Siloam Springs, Ark.	105.7	289
KUTE	Glendale, Calif.	101.9	270
↑KUTE	Salt Lake City, Utah	97.1	246
KVME	Merced, Calif.	97.5	248
KVOE-FM	Santa Ana, Calif.	96.7	244
KVOL-FM	Lafayette, La.	96.1	241
KVRE	Redding, Calif.	103.9	280
KWFT-FM	Wichita Falls, Tex.	99.9	260
KWLF-FM	Albany, Ore.	101.7	269
KWKH-FM	Shreveport, La.	94.5	233
KWKW-FM	Pasadena, Calif.	98.3	252
KWNO-FM	Winona, Minn.	97.5	248
KWOC-FM	Poplar Bluff, Mo.	94.5	283
KWOS-FM	Jefferson City, Mo.	98.5	253
KWPC-FM	Muscatine, Iowa	99.7	259
KWPM-FM	Wes Plains, Mo.	97.3	247
KKKX-FM	San Francisco, Calif.	104.3	287
KKOA-FM	Sacramento, Calif.	107.9	300
KYSM-FM	Mankato, Minn.	103.5	278
WAAF-FM	Chicago, Ill.	93.9	230
WAAT-FM	Newark, N. J.	94.7	234
WABF-FM	Mobile, Ala.	102.1	271
WABC-FM	New York, N. Y.	95.5	238
WABF	New York, N. Y.	99.5	258
WADF-FM	Wadesboro, N. C.	95.9	240
WAEW-FM	Crossville, Tenn.	97.1	246
WAFB-FM	Baton Rouge, La.	104.3	282
WAFM	Birmingham, Ala.	99.5	258
WAGA-FM	Atlanta, Ga.	103.3	277
WAIR-FM	Winston-Salem, N. C.	93.1	226
WAJR-FM	Morgantown, W. Va.	99.3	257
WAKR-FM	Akron, O.	97.5	248
WALD-FM	Walterboro, S. C.	106.3	292
WALK-FM	Patchogue, N. Y.	97.5	246
WAPF-FM	McComb, Miss.	100.1	261
WAPQ-FM	Chattanooga, Tenn.	92.1	248
WARD-FM	Johntown, Pa.	93.1	221
WARL-FM	Arlington, Va.	105.1	286
WASH	Washington, D. C.	97.1	246
WATG-FM	Ashland, O.	101.3	267
WATL-FM	Atlanta, Ga.	97.5	248
WAUG-FM	Augusta, Ga.	105.7	289
WAVU-FM	Albertville, Ala.	105.1	286
WAWZ-FM	Zarephath, N. J.	99.1	256
WAZL-FM	Hazlet, Pa.	97.9	250
WBAF-FM	Fort Worth, Tex.	100.5	263
WBBA-FM	Burlington, N. C.	101.1	266
WBBI-FM	Chicago, Ill.	96.3	242
WBBO-FM	Forest City, N. C.	93.3	227
WBBS	Crawfordsville, Ind.	106.3	292
WBBC-FM	Bay City, Mich.	96.1	241
WBEN-FM	Pittsfield, Mass.	94.3	232
WBEN-FM	Buffalo, N. Y.	106.5	293
WBET-FM	Brockton, Mass.	97.7	249
WBGE-FM	Atlanta, Ga.	95.5	238
WBIB	New Haven, Conn.	100.7	264
WBIR-FM	Knoxville, Tenn.	93.3	227
WBNY-FM	Buffalo, N. Y.	92.9	225
WBOW-FM	Terre Haute, Ind.	101.1	266
WBRE-FM	Wilkes-Barre, Pa.	98.5	253
WBRI	Detroit, Mich.	97.9	250
WBRL	Baton Rouge, La.	98.1	251
WBSM-FM	New Bedford, Mass.	97.3	247
WBTF-FM	Danville, Va.	97.9	250
WBTV-FM	Lexington, N. C.	94.3	232
WBWZ	Bradbury Hts., Md.	95.5	238
WBYS-FM	Canton, Ill.	100.9	265
WBZ-FM	Boston, Mass.	92.9	225
WBZA-FM	Springfield, Mass.	97.1	246
WCAC	Anderson, S. C.	101.1	266
WCAC-FM	Baltimore, Md.	102.7	274
WCAR-FM	Pontiac, Mich.	99.5	258
WCAU-FM	Philadelphia, Pa.	98.1	251
WCBS-FM	New York, N. Y.	101.1	266
WCED-FM	Dubois, Pa.	102.1	271
WCFM	Washington, D. C.	99.5	258
WCHA-FM	Chambersburg, Pa.	95.9	240
WCHI	Chicago Heights, Ill.	95.9	240
WCIL-FM	Corning, N. Y.	106.1	291
WCLO-FM	Janesville, Wis.	99.9	260
WCMT-FM	Newark, O.	100.3	262
WCMI-FM	Ashland, Ky.	93.7	229
WCNB-FM	Connersville, Ind.	103.3	282
WCNT-FM	Centralia, Ill.	98.5	243
WCOD	Richmond, Va.	98.1	251
WCOH-FM	Newnan, Ga.	96.7	244
WCOL-FM	Columbus, O.	92.3	222
WCOP-FM	Boston, Mass.	100.7	284
WCOS-FM	Columbia, S. C.	97.9	250
WCOU-FM	Lewiston, Me.	93.9	230
WCOV-FM	Montgomery, Ala.	94.5	233
WCPO-FM	Cincinnati, O.	105.1	286
WCPS-FM	Tarboro, N. C.	104.3	282
WCRS-FM	Greenwood, S. C.	95.7	239
WCSC-FM	Charleston, S. C.	96.9	245
WCTA-FM	Andalusia, Ala.	98.1	251
WCTC-FM	New Brunswick, N. J.	98.3	252
WCTW	New Castle, Ind.	102.5	273
WCUM-FM	Cumberland, Md.	102.9	275
WCDAE-FM	Tampa, Fla.	100.7	264
WDBI-FM	Roanoke, Va.	94.9	235
WDBO-FM	Orlando, Fla.	92.3	222
WDBQ-FM	Dubuque, Iowa	103.3	277

Call Letters	Location	Frequency Mcs.	Channel No.
WDEL-FM	Wilmington, Del.	93.7	229
WDET-FM	Detroit, Mich.	101.9	270
WDLB-FM	Marshfield, Wis.	103.9	280
WDLI-FM	Fanama City, Fla.	98.9	255
WDNC-FM	Durham, N. C.	105.1	286
WDOD-FM	Chattanooga, Tenn.	96.5	243
WDRC-FM	Hartford, Conn.	93.7	229
WDSC-FM	Dillon, S. C.	92.9	225
WDSU-FM	New Orleans, La.	105.3	287
WDUN-FM	Gainesville, Ga.	103.9	280
WDWD-FM	Dawson, Ga.	101.1	266
WDWS-FM	Champaign, Ill.	97.5	248
WDXY	Spartanburg, S. C.	100.5	263
WEAU-FM	Eau Claire, Wis.	94.1	231
WEAW-FM	Evanston, Ill.	105.1	286
WEBC-FM	Duluth, Minn.	92.3	222
WEBQ-FM	Harrisburg, Ill.	99.9	260
WEED-FM	Rocky Mount, N. C.	92.1	221
WEEL-FM	Boston, Mass.	103.3	277
WEEX-FM	Easton, Pa.	98.3	252
WEFM	Chicago, Ill.	99.5	258
WEHS	Chicago, Ill.	97.9	250
WEJL	Scranton, Pa.	107.3	297
WEMP-FM	Milwaukee, Wis.	97.3	227
WENR-FM	Chicago, Ill.	94.7	234
WEOL-FM	Elyria, O.	107.3	297
WEPM-FM	Martinsburg, W. Va.	94.3	232
WEQR	Goldensboro, N. C.	93.3	227
WERC-FM	Erie, Pa.	99.9	260
WERE-FM	Cleveland, O.	98.5	253
WESC-FM	Greenville, S. C.	92.5	223
WEST-FM	Easton, Pa.	107.9	300
WEVA-FM	Emporia, Va.	100.1	261
WEVD-FM	New York, N. Y.	97.9	280
WEWO-FM	Laurinburg, S. C.	96.5	243
WFAH-FM	Alliance, O.	101.7	269
WFAN	Washington, D. C.	100.3	262
WFAS-FM	White Plains, N. Y.	103.9	280
WFBC-FM	Greenville, S. C.	93.7	229
WFBE	Flint, Mich.	95.1	236
WFHR-FM	Wisconsin Rapids, Wis.	103.3	277
WFIL-FM	Philadelphia, Pa.	102.1	271
WFIN-FM	Firmly, O.	103.5	263
WFJI	Bloomington, Ind.	103.7	279
WFJL	Chicago, Ill.	93.1	226
WFLA-FM	Tampa, Fla.	93.3	227
WFLN	Philadelphia, Pa.	95.7	239
WFLY	Troy, N. Y.	92.3	222
WFMA	Rocky Mount, N. C.	100.7	264
WFMB	Mayodan, N. C.	93.5	228
WFMB	Chicago, Ill.	100.3	262
WFMH-FM	Cullman, Ala.	101.1	266
WFMJ-FM	Youngstown, O.	105.1	286
WFML	Washington, Ind.	106.5	290
WFMN	Alpine, N. J.	93.1	226
WFMR	New Bedford, Mass.	98.1	251
WFMT	Chicago, Ill.	98.7	254
WFMW-FM	Madisonville, Ky.	93.9	230
WFMY	Greensboro, N. C.	97.3	247
WFMY	Allentown, Pa.	100.7	264
WFNC-FM	Fayetteville, N. C.	98.1	251
WFNS-FM	Burlington, N. C.	93.9	230
WFOW-FM	Toledo, O.	94.7	244
WFRO-FM	Fremont, O.	99.3	257
WFUL-FM	Fulton, Ky.	104.9	285
WFUM	Flint, Mich.	107.1	296
WGAL-FM	Lancaster, Pa.	101.3	267
WGAR-FM	Cleveland, O.	99.5	258
WGAU-FM	Athens, Ga.	99.5	258
WGBI-FM	Scranton, Pa.	101.3	267
WGBS-FM	Miami, Fla.	96.3	242
WGCM-FM	Gulfport, Miss.	101.5	268
WGEM-FM	Quincy, Ill.	105.1	286
WGFM	Schenectady, N. Y.	99.5	258
WGH-FM	Newport News, Va.	96.5	243
WGHF	New York, N. Y.	101.9	270
WGKV-FM	Charleston, W. Va.	98.5	253
WGMS-FM	Washington, D. C.	103.5	278
WGNC-FM	Gastonia, N. C.	101.9	270
WGPA-FM	Bethlehem, Pa.	95.1	236
WGST-FM	Atlanta, Ga.	97.3	247
WGT-FM	Buffalo, N. C.	93.1	226
WGW-FM	Asheboro, N. C.	92.3	222
WHA1-FM	Greenfield, Mass.	98.3	252
WHA2-FM	Philadelphia, Pa.	98.5	243
WHBC-FM	Canton, O.	94.1	231
WHBF-FM	Rock Island, Ill.	98.9	255
WHBL-FM	Sheboygan, Wis.	100.3	262
WHBS-FM	Huntsville, Ala.	95.1	236
WHBT-FM	Harriman, Tenn.	95.3	237
WHCU-FM	Ithaca, N. Y.	97.3	247
WHDH-FM	Boston, Mass.	94.5	233
WHDL-FM	Allegany, N. Y.	95.7	239
WHFB-FM	Benton Harbor, Mich.	99.9	260
WHFM	Rochester, N. Y.	98.9	255
WHIO-FM	Dayton, O.	99.1	256
WHK-FM	Cleveland, O.	100.7	264
WHLD-FM	Niagara Falls, N. Y.	98.5	253
WHLI-FM	Hempstead, L. I., N. Y.	98.3	252
WHMA-FM	Anniston, Ala.	100.5	263
WHNC-FM	Henderson, N. C.	92.5	223
WHO-FM	Des Moines, Iowa	100.3	262
WHOM-FM	New York, N. Y.	92.3	222
WHOO-FM	Orlando, Fla.	96.5	243
WHOP-FM	Hopkinsville, Ky.	98.7	254
WHOS-FM	Decatur, Ala.	92.5	223
WHP-FM	Harrisburg, Pa.	97.3	247
WHPE-FM	High Point, N. C.	95.5	238
WHTB-FM	Talladega, Ala.	97.1	246
WHTN-FM	Huntington, W. Va.	100.5	263
WHYN-FM	Holyoke, Mass.	93.1	226
WIBA-FM	Madison, Wis.	101.5	268
WIBG-FM	Philadelphia, Pa.	94.1	231
WIBX-FM	Utica, N. Y.	96.9	245
WICA-FM	Ashtabula, O.	103.7	279
WIFM-FM	Alkin, N. C.	100.9	265
WIKY-FM	Evansville, Ind.	104.1	281
WIMA-FM	Lima, O.	102.1	271



**CKNW
ANNOUNCES
15% RATE
INCREASE**

With an audience gain of more than 20% in the last 12 months, CKNW announces a 15% rate increase effective July 1, 1954.

**CKNW
TOP DOG
ON THE
PACIFIC COAST**

FM CALL LETTERS

Call Letters	Location	Frequency Mcs.	Channel No.
WIMS-FM	Michigan City, Ind.	83.5	228
WJNL	Lebanon, Ind.	107.1	298
WIOD-FM	Miami, Fla.	97.3	247
WIP-FM	Philadelphia, Pa.	93.3	227
WIS-FM	Columbia, S. C.	94.5	233
WISC-FM	Madison, Wis.	98.1	251
WITR-FM	Baltimore, Md.	104.3	282
WIVY-FM	Jacksonville, Fla.	93.7	229
WJAC-FM	Johnstown, Pa.	95.5	238
WJAS-FM	Pittsburgh, Pa.	99.7	256
WJAT-FM	Swainsboro, Ga.	101.7	269
WJAX-FM	Jacksonville, Fla.	95.1	236
WJBC-FM	Bloomington, Ill.	101.5	268
WJBB-FM	Detroit, Mich.	93.1	226
WJBY-FM	Gadsden, Ala.	103.7	279
WJDX-FM	Jackson, Miss.	102.9	275
WJEF-FM	Grand Rapids, Mich.	93.7	229
WJEE-FM	Hagerstown, Md.	104.7	284
WJHL-FM	Johnson City, Tenn.	100.7	264
WJHP-FM	Jacksonville, Fla.	96.9	245
WJIZ	Hampton, Ind.	92.3	222
WJKO-FM	Springfield, Mass.	101.9	270
WJLK-FM	Asbury Park, N. J.	94.3	232
WJLN	Birmingham, Ala.	104.7	284
WJLS-FM	Beckley, W. Va.	99.5	258
WJMC-FM	Rice Lake, Wis.	96.3	242
WJOI-FM	Florence, Ala.	98.3	252
WJPA-FM	Washington, Pa.	104.3	282
WJPB	Fairmont, W. Va.	92.3	222
WJR-FM	Detroit, Mich.	96.3	242
WJTN-FM	Jamestown, N. Y.	93.3	227
WJW-FM	Cleveland, O.	104.1	281
WKAT-FM	Miami Beach, Fla.	93.1	226
WKBN-FM	Youngstown, Ohio	98.9	255
WKBR-FM	Manchester, N. H.	100.1	261
WKBZ-FM	Muskegon, Mich.	98.9	255
WKBU-FM	Griffin, Ga.	102.1	271
WKCF	Roanoke Rapids, N. C.	98.5	253
WKLG-FM	Pittsburgh, Pa.	93.7	229
WKLJ-FM	Ft. Wayne, Ind.	106.1	291
WKLK-FM	Clanton, Ala.	100.9	265
WKMH-FM	Dearborn, Mich.	100.3	262
WKNA-FM	Charleston, W. Va.	97.5	248
WKOK-FM	Sunbury, Pa.	94.1	231
WKOP-FM	Binghamton, N. Y.	95.3	237
WKPT-FM	Kingsport, Tenn.	98.5	253
WKRC-FM	Cincinnati, O.	101.9	270
WKRG-FM	Mobile, Ala.	98.9	259
WKRT-FM	Cortland, N. Y.	99.9	260
WKWK-FM	Wheeling, W. Va.	97.3	247
WKYB-FM	Paducah, Ky.	93.3	227
WLAG-FM	LaGrange, Ga.	104.1	281
WLAN-FM	Lancaster, Pa.	96.9	245
WLAP-FM	Lexington, Ky.	94.5	233
WLAV-FM	Grand Rapids, Mich.	96.9	245
WLBB-FM	Mattoon, Ill.	96.9	245
WLBF-FM	Bowling Green, Ky.	101.1	266
WLBK-FM	Lebanon, Pa.	100.1	261
WLCS-FM	Baton Rouge, La.	101.1	266
WLDM	Detroit, Mich.	95.5	238
WLDS-FM	Jacksonville, Ill.	100.5	263
WLET-FM	Richmond, Va.	102.9	275
WLEU-FM	Toccoa, Ga.	106.1	291
WLEU-FM	erie, Pa.	97.9	250
WLEY	Elmwood Park, Ill.	107.1	296
WLLH	Lenoir City, Tenn.	100.3	262
WLLN-FM	Merrill, Wis.	100.7	264
WLLH-FM	Lowell, Mass.	99.5	258
WLOG-FM	Leaksville, N. C.	92.7	224
WLOG-FM	Logan, W. Va.	103.3	277
WLOS-FM	Asheville, N. C.	104.3	282
WLRD	Miami Beach, Fla.	93.9	230
WLTV	Lewistown, Pa.	97.9	250
WLVA-FM	Lynchburg, Va.	97.5	248
WLVC-FM	Williamsport, Pa.	105.1	266
WLYN-FM	Lynn, Mass.	105.5	268
WMA-FM	Washington, D. C.	107.3	279
WMAQ-FM	Chicago, Ill.	101.1	266
WMAS-FM	Springfield, Mass.	94.7	234
WMBD-FM	Macon, Ga.	99.1	256
WMBD-FM	Peoria, Ill.	92.5	223
WMBH-FM	Jonlin, Mo.	96.1	241
WMBH-FM	Auburn, N. Y.	96.1	241
WMBR-FM	Jacksonville, Fla.	96.1	241
WMCF	Memphis, Tenn.	97.7	259
WMCK-FM	Mckeesport, Pa.	104.9	285
WMFD-FM	Wilmington, N. C.	96.3	242

Call Letters	Location	Frequency Mcs.	Channel No.
WMFM	Madison, Wis.	104.1	281
WMFR-FM	High Point, N. C.	99.5	258
WMGM-FM	New York, N. Y.	100.3	282
WMGW-FM	Meadville, Pa.	100.3	282
WMIN-FM	St. Paul, Minn.	99.5	258
WMIT	Clingman's Peak, N. C.	106.9	295
WMIX-FM	Mt. Vernon, Ill.	94.1	231
WMLL	Evansville, Ind.	94.5	233
WMLN	Mt. Clemens, Mich.	106.3	282
WMMW-FM	Hamilton, Conn.	95.7	239
WMOU-FM	Hamilton, O.	105.5	278
WMOU-FM	Berlin, N. H.	103.7	279
WMRC-FM	Greenville, S. C.	94.9	235
WMRI	Marion, Ind.	106.9	295
WMRN-FM	Marion, O.	106.9	295
WMSA-FM	Massena, N. Y.	105.3	287
WMUN	Muncie, Ind.	104.1	281
WMVA-FM	Martinsville, Va.	96.3	242
WMVO	Mount Vernon, O.	93.7	229
WMW-FM	Boston, Mass.	98.5	253
WNAO-FM	Raleigh, N. C.	96.1	241
WNAV-FM	Annapolis, Md.	99.1	256
WNBC-FM	New York, N. Y.	97.1	246
WNBD-FM	Daytona Beach, Fla.	94.5	233
WNEX-FM	Macon, Ga.	96.9	245
WNHC-FM	New Haven, Conn.	99.1	256
WNOS-FM	High Point, N. C.	100.3	262
WNOW-FM	York, Pa.	105.7	289
WNPC-FM	New Rochelle, N. Y.	93.5	228
WNYC-FM	New York, N. Y.	93.9	230
WOAY-FM	Oak Hill, W. Va.	94.1	231
WOC-FM	Davenport, Iowa	103.7	279
WOCB-FM	West Yarmouth, Mass.	94.3	232
WOHS-FM	Sheily, N. C.	96.1	241
WOLF-FM	Washington, D. C.	98.7	254
WOMC	Royal Oak, Mich.	104.3	282
WOMI-FM	Owensboro, Ky.	92.5	223
WOP-FM	Oak Park, Ill.	102.3	274
WOPF-FM	Bristol, Tenn.	96.9	245
WOR-FM	New York, N. Y.	98.7	254
WORG-FM	Orangeburg, S. C.	102.7	274
WORX	Madison, Ind.	96.7	244
WORZ-FM	Orlando, Fla.	100.3	282
WOTW-FM	Nashua, N. H.	106.3	292
WPAD-FM	Paducah, Ky.	96.9	245
WPAM-FM	Pottsville, Pa.	95.5	238
WPAR-FM	Parkersburg, W. Va.	106.5	293
WPAY-FM	Portsmouth, O.	104.1	281
WPDX-FM	Clarksburg, W. Va.	95.1	236
WPEN-FM	Philadelphia, Pa.	102.9	275
WPIC-FM	Sharon, Pa.	102.9	275
WPJB-FM	Providence, R. I.	105.1	286
WPPA-FM	Pottsville, Pa.	101.9	270
WPRO-FM	Providence, R. I.	92.3	222
WPRS-FM	Paris, Ill.	98.3	252
WPTF-FM	Raleigh, N. C.	94.7	234
WQAM-FM	Miami, Fla.	94.9	235
WQXR-FM	New York, N. Y.	96.3	242
WRAC-FM	Williamsport, Pa.	100.3	282
WRAL-FM	Raleigh, N. C.	101.5	268
WRBL-FM	Columbus, Ga.	93.3	227
WRBS	Bay Shore, N. Y.	105.9	290
WRCC-FM	Washington, D. C.	93.9	230
WRCM	New Orleans, La.	97.1	246
WRDV-FM	Reidsville, N. C.	102.1	271
WRFL	Winston-Salem, N. C.	92.5	223
WRFB	Hickory, Miss.	97.9	250
WRFS-FM	Alexander City, Ala.	106.1	291
WRGA-FM	Rome, Ga.	106.5	293
WRHI-FM	Rock Hill, S. C.	98.3	252
WRJN-FM	Racine, Wis.	100.7	264
WRLD-FM	Lanett, Ala.	102.9	275
WRNL-FM	Richmond, Va.	102.1	271
WRNY-FM	Rochester, N. Y.	97.9	250
WROK-FM	Rockford, Ill.	97.5	248
WROY-FM	Roanoke, Va.	103.7	279
WROW-FM	Albany, N. Y.	93.9	230
WROY-FM	Carmi, Ill.	97.3	247
WRR-FM	Dallas, Tex.	101.1	266
WRRR	Ithaca, N. Y.	103.7	279
WRRR	Cherry Valley, N. Y.	101.9	270
WRRD	De Ruyter, N. Y.	105.1	286
WRRE	S. Bristol, N. Y.	95.1	236
WRRH	Poughkeepsie, N. Y.	104.7	284
WRRH	Watersford, N. Y.	107.7	292
WRRN	Warren, Pa.	92.3	222
WRSW-FM	Warsaw, Ind.	107.3	297

Call Letters	Location	Frequency Mcs.	Channel No.
WRUF-FM	Gainesville, Fla.	104.1	281
WRUN-FM	Utica, N. Y.	105.7	289
WRVB	Richmond, Va.	94.5	233
WRVC	Norfolk, Va.	102.5	273
WRZE	York, Pa.	98.5	253
WSAM-FM	Saginaw, Mich.	98.1	251
WSAN-FM	Allentown, Pa.	99.9	260
WSAV-FM	Savannah, Ga.	100.3	262
WSB-FM	Atlanta, Ga.	98.5	253
WSB-FM	Chicago, Ill.	104.3	285
WSEL	Birmingham, Ala.	93.7	229
WSGN-FM	Statesville, N. C.	105.7	289
WSIC-FM	Ogdensburg, N. Y.	106.1	291
WSLS-FM	Roanoke, Va.	99.1	256
WSNJ-FM	Bridgeton, N. J.	98.9	255
WSNS	Sanford, N. C.	103.1	276
WSNW-FM	Seneca, S. C.	98.1	251
WSOC-FM	Charlotte, N. C.	103.5	278
WSOK-FM	Nashville, Tenn.	103.9	290
WSQN-FM	Henderson, Ky.	99.5	258
WSOY-FM	Decatur, Ill.	102.1	271
WSPA-FM	Spartanburg, S. C.	98.9	255
WSPD-FM	Toledo, O.	101.5	268
WSRK	Shelbyville, Ind.	101.3	267
WSRS-FM	Cleveland Heights, O.	95.3	237
WSTC-FM	Stamford, Conn.	96.7	244
WSTP-FM	Salisbury, N. C.	106.5	293
WSTR-FM	Sturgis, Mich.	103.1	276
WSTV-FM	Stuebenville, O.	103.5	278
WSSA-FM	Harrisonburg, Va.	100.7	264
WSSV-FM	Crews, Va.	104.7	284
WSYR-FM	Syracuse, N. Y.	94.5	233
WTAD-FM	Quincy, Ill.	99.5	258
WTAG-FM	Worcester, Mass.	96.1	241
WTAL-FM	Tallahassee, Fla.	103.9	280
WTAM-FM	Cleveland, O.	105.7	289
WTAR-FM	Norfolk, Va.	97.3	247
WTAX-FM	Springfield, Ill.	103.7	279
WTBC-FM	Tuscaloosa, Ala.	95.7	239
WTGN-FM	Minneapolis, Minn.	97.1	246
WTHI-FM	Terre Haute, Ind.	99.9	260
WTIC-FM	Hartford, Conn.	96.5	243
WTJS-FM	Jackson, Tenn.	100.7	264
WTMA-FM	Charleston, S. C.	95.1	236
WTNC-FM	Thomasville, N. C.	98.3	252
WTOA	Trenton, N. J.	97.5	248
WTOC-FM	Savannah, Ga.	97.3	247
WTOL-FM	Toledo, O.	104.7	284
WTOP-FM	Washington, D. C.	96.3	242
WTRC-FM	Elkhart, Ind.	100.7	264
WTRF-FM	Bellaire, O.	100.5	263
WTRT	Toledo, O.	99.9	260
WTSP-FM	St. Petersburg, Fla.	102.5	273
WTSV-FM	Claremont, N. H.	105.1	291
WTVB-FM	Coldwater, Mich.	98.3	252
WUST-FM	Bethesda, Md.	106.3	292
WVAM-FM	Allentown, Pa.	100.1	261
WVJS-FM	Owensboro, Ky.	96.1	241
WVKO-FM	Columbus, O.	94.7	234
WVLLN-FM	Oney, Ill.	92.9	225
WVVC	Greenfield, Wis.	94.9	235
WVDC-FM	Washington, D. C.	101.1	266
WVGP-FM	Sanford, N. C.	105.5	288
WVHG-FM	Hornell, N. Y.	105.3	287
WVJ-FM	Detroit, Mich.	97.1	246
WVWMT	New Orleans, La.	95.7	239
WVNY-FM	Watertown, N. Y.	100.5	263
WVOD-FM	Lynchburg, Va.	100.1	261
WVOL-FM	Buffalo, N. Y.	104.1	281
WVON-FM	Woonsocket, R. I.	105.5	288
WVPP-FM	Miami, Fla.	101.5	268
WVPP-FM	Palm Beach, Fla.	97.9	250
WVWRL-FM	New York, N. Y.	105.1	286
WVST-FM	Wooster, O.	104.5	283
WVSW-FM	Pittsburgh, Pa.	94.5	233
WVVA-FM	Wheeling, W. Va.	98.7	254
WVWB-FM	Jasper, Ala.	102.5	273
WXHR	Cambridge, Mass.	96.9	245
WXRC	Buffalo, N. Y.	103.3	277
WXYZ-FM	Detroit, Mich.	101.1	266

BROADCAST STATIONS IDENTIFIED WITH NEWSPAPER OWNERSHIP

The following tabulation, showing newspaper ownership or affiliation of am and fm broadcast stations in the United States, Hawaii and Alaska, is based on information procured from the operating companies or from official sources. Minority interests are indicated where the information was available. In many instances stations and newspapers are owned by the same interests but operations are entirely separated. (For tv stations with newspaper ownership, see Telecasting Yearbook.)

ALABAMA

WRFS, WRFS-FM, Alexander City—Licensed to Piedmont Service Corp., Publisher of Alexander City Outlook is minority stockholder.
 WHMA, WHMA-FM, Anniston—Licensed to Anniston Bestg. Co. Harry M. Ayers, owner of Anniston Star, principal stockholders.

WAPI, WAFM(FM), Birmingham—Licensed to the Birmingham News Co., publisher of Birmingham News. Birmingham News Co. also owns all capital stock of The Huntsville Times Co., licensee of WHBS and WHBS-FM, Huntsville, Ala.; and publisher of Huntsville Times.
 WEEB, Brewton—Licensed to Brewton Broadcasting Co., under same ownership as Brewton Standard.
 WHOS, Decatur—Licensed to Northern Alabama Broadcasting Co. Barrett C. Shelton, 50% owner, publisher of Decatur Daily.
 WGEA, Geneva—Licensed to Geneva County Reaper, weekly publication.
 WHBS, WHBS-FM, Huntsville—Licensed to Huntsville Times Co., Inc., publisher of Huntsville Times. See also WSGN Birmingham.
 WRLD, WRLD-FM, Lanett—Licensed to Valley Broadcasting Co. President J. C. Henderson is publisher or substantial owner of Lanett Valley Times-News, Alexander City Outlook, Dadeville Record.
 WABB, WABB-FM, Mobile—Licensed to Mobile

Press Register Inc., publishers of Mobile Press Register.
 WMFC, Monroeville—Licensed to Monroe Broadcasting Co. William M. Stewart and James H. Faulkner, majority stockholder, publishers of weekly Monroe Journal and South Alabamian. Mr. Faulkner is also publisher of weekly Baldwin Times.
 WSFA, Montgomery—Licensed to Montgomery Broadcasting Co. Inc.; one-fourth interest owned individually by R. F. Hudson, publisher of Montgomery Advertiser.
 WHITE, Talladega—Licensed to Voice of Talladega Inc., 80% owned by Talladega News Pub. Co., publisher of weekly Talladega News.

ARIZONA

KGAN, Kingman—Licensed to J. James Glancy, publisher of Mohave County Miner.

ARKANSAS

KFSA, KFSA-FM, Fort Smith—Licensed to Southwestern Publishing Co. (Fort Smith

Times Record and Southwest American). Donald W. Reynolds, owner, also owns *Bartlesville (Okla.) Examiner and Enterprise*, *Okmulgee (Okla.) Times and Democrat* (KHBG), *Las Vegas (Nev.) Review Journal*, *Boulder City (Nev.) Journal*. See also KBRS Springdale, Ark.: KHBG Okmulgee, Okla.

KXAR, Hope—Licensed to the Hope Broadcasting Co. A. H. Washburn, principal owner, is publisher of *Hope Star*.

KLRA, Little Rock—Licensed to Arkansas Broadcasting Co. which is controlled by Gazette Publishing Co., publishers of *Arkansas Gazette*.

KTHS, Little Rock—Licensed to Radio Broadcasting Inc., chief owners identified with the Times Publishing Co. Inc., publishers of *Shreveport (La.) Times* and parent company of International Bcstg. Corp. (KWKH). Same ownership as *Monroe (La.) World and News-Star*.

KWCB, Searcy—Licensed to White County Broadcasting Co. Inc. Minority stockholder M. P. Jones Jr. is publisher of *Searcy Citizen*.

KBRS, Springdale—Licensed to Southwestern Publishing Co. President is Donald W. Reynolds (See KFSA Ft. Smith).

CALIFORNIA

KERN, KERN-FM, Bakersfield—Licensed to McClatchy Broadcasting Co.; same ownership as *Sacramento Bee*, *Fresno Bee*, *Modesto Bee* (McClatchy Newspapers). Also: KMJ Fresno, KBEE(FM) Modesto, KFBK Sacramento, KWG Stockton; KOH Reno.

KXO, El Centro—Licensed to Valradio Inc., 19% of which is owned by Imperial Valley Publishing Co. (El Centro *Morning Post*, *Imperial Valley Press*, *Brawley Daily News*); 61% is owned by Paul and Edith Jenkins, and 20% by Mr. and Mrs. Harry Hovey.

KMJ, KMJ-FM, Fresno—Licensed to McClatchy Broadcasting Co. (See KERN Bakersfield.)

KNGS, Hanford—Licensed to Earl J. Fenston, publisher of *Hanford Journal and Sentinel*. See also KSJV Sanger, Calif.

KLAC, Los Angeles—Licensed to KMTR Radio Corp., owned by Dorothy Schiff, publisher *New York Post*.

KNGS, Hanford—Licensed to Hanford Bcstg. Co. Earl J. Fenston is president of licensee and of Hanford Pub. Co., publisher of the *Hanford Journal and Sentinel*.

KBEE(FM), Modesto—Licensed to McClatchy Broadcasting Co. (See KERN, Bakersfield.)

KVON, Napa—Licensed to Napa Broadcasting Co., owned by Luther E. Gibson, publisher of *Vallejo (Calif.) Times-Herald and News-Chronicle*.

KLX, KLX-FM, Oakland—Licensed to Tribune Building Co.; affiliated with *Oakland Tribune*.

KROW, Oakland—Licensed to KROW Inc., owned by Sheldon F. Sackett, chief owner of KVAN, Vancouver, Wash., owner of KOOS, Coos Bay, Ore., publisher of *Coos Bay Times*.

KOCS, KEDO(FM), Ontario—Licensed to Daily Report Co., same ownership as *Ontario-Upland Report*.

KFBK, KFBK-FM, Sacramento—Licensed to McClatchy Broadcasting Co. (See KERN Bakersfield.)

KRON-FM, San Francisco—Licensed to Chronicle Publishing Co., publisher of *San Francisco Chronicle*.

KSJO, KSJO-FM, San Jose—Licensed to Santa Clara Broadcasting Co. President Patrick H. Peabody is publisher *Gilroy Dispatch*, *Los Gatos Daily Times*.

KTIM, San Rafael—Licensed to Marin Broadcasting Co., owned by *San Rafael Independent-Journal*.

KTMS, Santa Barbara—Licensed to News-Press Publishing Co., publisher of *Santa Barbara News-Press* (T. M. Storke, publisher, owns 51% of common stock). See KCOY, Santa Maria.

KSCO, Santa Cruz—Licensed to Radio Santa Cruz; Fred D. McPherson Jr., publisher of *Santa Cruz Sentinel News*, is a partner.

KCOY, Santa Maria—Licensed to News Press Publishing Co. See KTMS Santa Barbara.

KOWL, Santa Monica—Licensed to KOWL Bcstg. Co., 37% owned by Robert E. McClure and 25% by J. D. and R. D. Funk who own controlling interest in *Santa Monica Outlook*.

KSRO, Santa Rosa—Licensed to Finley Broadcasting Co. Ruth W. Finley, president, is affiliated with *Santa Rosa Press-Democrat*. Operated independently of newspaper.

KWG, Stockton—Licensed to McClatchy Broadcasting Co. (See KERN Bakersfield.)

KHUB, Watsonville—Licensed to Patrick H. Peabody, who has 35% interest in *Los Gatos (Calif.) Times*, 40% interest in *Gilroy (Calif.) Dispatch*.

COLORADO

KLMR, Lamar—Licensed to Southeast Colorado Broadcasting Co., Inc. Fred M. Betz, one-seventh owner, owns *Lamar Daily News*.

CONNECTICUT

WHTT, Hartford—Licensed to the Hartford Times Inc., publisher of *Hartford Times*; 80.84% of stock owned by the Gannett Newspapers. See WHEC Rochester, N. Y.

WCNX, Middletown—Licensed to Middlesex Broadcasting Co. Middletown Press Publishing Co. (*Middletown Press*) owns 50%.

WICH, Norwich—Licensed to Eastern Connecticut Broadcasting Co. Stockholders Harrison C. Noyes and Clifford C. Oat are co-publishers of *Norwich Bulletin and Record*.

WSTC, WSTC-FM, Stamford—Licensed to Western Connecticut Broadcasting Co. Kingsley Gillespie, publisher of *Stamford Advocate*, is president.

WBRY, Waterbury—Licensed to the American-Republican Inc., publisher of *Waterbury Republican and American*.

DELAWARE

WDEL, WDEL-FM, Wilmington—Licensed to WDEL Inc. Operated independently. Ownership affiliated with Steinman & Steinman Inc. (See WGAL Lancaster, Pa.)

DISTRICT OF COLUMBIA

WMAL, WMAL-FM, Washington—Licensed to Evening Star Broadcasting Co., subsidiary of *Washington Star*.

WTOP, WTOP-FM, Washington—Licensed to WTOP Inc. 55% owned by *Washington Post* (45% owned by CBS). See also WMBR Jacksonville, Fla.

FLORIDA

WNDB, WNDB-FM, Daytona Beach—Licensed to the News-Journal Corp., publisher of *Daytona Beach Journal and News*.

WFTL, Ft. Lauderdale—Licensed to Tri-County Bcstg. Co., 78.5% owned by Gore Pub. Co., publishers of *Ft. Lauderdale News*.

WJHP, WJHP-FM, Jacksonville—Licensed to Jacksonville Journal Co., publisher of *Jacksonville Journal*. See WCOA Pensacola.

WTHR-AM-FM, Jacksonville—Licensed to Washington Post Co., publisher of *Washington (D.C.) Post*. See WTOP-AM-FM Washington, D.C.

WIOD, WIOD-FM, Miami—Licensed to Isle of Dreams Broadcasting Corp., stock owned by Miami News Inc., publisher of *Miami News*. See WHIO Dayton, O., and WSB Atlanta, Ga.

WQAM, WQAM-FM, Miami—Licensed to Miami Broadcasting Co., owned by Miami Herald Publishing Co., publisher of *Miami Herald* (Knight Newspapers). See WIND Chicago.

WGBS, WGBS-FM, Miami—Licensed to Storer Broadcasting Co. George B. Storer, president, is also president of Florida Sun Publishing Co., publisher of *Miami Beach Florida Sun*.

WTMC, Ocala—Licensed to Ocala Broadcasting Co. Inc.; affiliate of *Ocala Star-Banner* (Perry Newspapers). See WCOA Pensacola.

WHOO, WHOO-FM, Orlando—Licensed to WHOO Inc. Owned by Edward Lamb Enterprises. Mr. Lamb owns WTOD and WTKT(FM) Toledo, WIKK Erie, Pa. (*Erie Dispatch*).

WDLF, WDLF-FM, Panama City—Licensed to Panama City Bcstg. Co. Same ownership as *Panama City News-Herald*. See WCOA Pensacola.

WCOA, Pensacola—Licensed to WCOA Inc. John H. Perry estate is publisher of following Florida newspapers: *Pensacola Journal and News*, *Deland Sun-News*, *Jacksonville Journal* (WJHP), *Ocala Star-Banner* (WTMC), *Panama City News-Herald* (WDLF), *Palm Beach News*, as well as a number of weekly newspapers. Mr. Perry also publishes the *Frankfort (Ky.) State Journal* and is chairman of board of Western Newspaper Union, newspaper syndicate. See also WJHP Jacksonville, WTMC Ocala, WDLF Panama City.

WTSP, WTSP-FM, St. Petersburg—Licensed to Pinellas Broadcasting Co., 99% of stock owned by Nelson Poynter, publisher of *St. Petersburg Times*.

WJCM, Sebring—Licensed to Clearfield Broadcasters Inc. Same ownership as *Clearfield (Pa.) Progress*. See also WCPA Clearfield, WAKU, Latrobe, and WDAW Indiana, all Pa.

WDAE, WDAE-FM, Tampa—Licensed to Tampa Times Co., publisher of *Tampa Times*.

WFLA, WFLA-FM, Tampa—Licensed to Tribune Co., publisher of *Tampa Tribune*.

GEORGIA

WALB, Albany—Licensed to Herald Publishing Co., publisher of *Albany Herald*.

WGAA, WGAA-FM, Athens—Licensed to J. K. Patrick & Co. Stockholder E. B. Braswell is editor of the *Athens Banner-Herald*.

WAGA, WAGA-FM Atlanta—See WGBS Miami, Fla.

WSB, WSB-FM, Atlanta—Licensed to Atlanta Newspapers Inc., publisher of *Atlanta Journal and Constitution* (chief owner, J. M. Cox Jr., see also WIOD Miami and WHIO Dayton, O.)

WBHF, Cartersville—Licensed to W. R. Frier, owner of weekly *Bartow Herald*.

WGBA, WGBA-FM, Columbus—Licensed to Georgia-Alabama Broadcasting Corp. Same ownership as *Columbus Enquirer and Ledger* and *Bradenton (Fla.) Herald*.

WGLS, Decatur—Licensed to DeKalb Broadcasting Co. Ownership has one-sixth interest in *DeKalb New Era*.

WGGA, Gainesville—Licensed to Blue Ridge Broadcasting Co. Charles Smithgall, publisher *Gainesville Daily Times*, is president and majority stockholder. See also WRGA, Rome, Ga.

WKLY, Hartwell—Licensed to Louie L. Morris, partner in weekly *Hartwell Sun*.

WLFA, Lafayette—Licensed to Radio Dixie, owned by J. A. Gallimore, publisher of weekly *Seneca (S. C.) Journal*. See WSNW Seneca and WSSC Sumter, S. C.

WLAG, WLAG-FM, La Grange—Licensed to La Grange Broadcasting Co. 33 1/4% of stock owned by Roy C. Swank, publisher of *La Grange News*.

WNEK, WNEK-FM, Macon—Licensed to Macon Broadcasting Co.; 16% held by the *Telegraph Publishing Co.*, publisher of *Macon Telegraph and News*.

WMVG, Milledgeville—Licensed to Jere N. Moore, editor, weekly *Union-Recorder*.

WLAQ, Rome—Licensed to News Publishing Co., publisher of *Rome News-Tribune*.

WRGA-AM-FM, Rome—Licensed to Rome Bcstg. Corp. Controlling stockholder Charles Smithgall, owner of *Gainesville (Ga.) Daily Times*. See also WGGG Gainesville, Ga.

WSFT, Thomaston—Licensed to the Thomaston Broadcasting Co. J. B. Hardy, S. J. Carswell, co-owners, weekly *Thomaston Times and Free-Press*, owns 40% of station.

WVOP, Vidalia—Licensed to Vidalia Broadcasting Co. R. E. Ledford, 50% owner, is publisher of weekly *Vidalia Advance*.

WAYX, Waycross—Licensed to Jack Williams, publisher, *Waycross Journal-Herald*.

IDAHO

KBIO, Burley—Licensed to KBIO Inc. Owned 86% by Jessica L. Longston, publisher of bi-weekly *Burley Bulletin and St. Helens (Ore.) Sentinel*. See also KPUG Bellingham, KSEM, Moses Lake, and KAYO Seattle, Wash.

KVNI, Coeur d'Alene—Licensed to Coeur d'Alene Bcstg. Co., 40% owned by Burl C. Hagadone, 40% by Scripps Newspapers Inc., and 20% by Harry Henke Jr. Mr. Hagadone is 45% owner and publisher and Scripps Newspapers is 45% owner of *Coeur d'Alene Press*. Mr. Hagadone is 50% owner and publisher and Scripps Newspapers is 50% owner of *North Idaho Press*, *Wallace-Kellogg, Idaho*, *Scripps Newspapers* also publishes *Provo (Utah) Herald*, *Logan (Utah) Herald Journal*, *Pocatello Idaho State Journal*, *Kalispell (Mont.) Daily Interlake*, and *The Dalles (Ore.) Chronicle*. See also KNEW Spokane, Wash., and KJRL Pocatello, Ida.

KIFI, Idaho Falls—Licensed to Eastern Idaho Bcstg. & Tele. Co. *Idaho Falls Post-Register* is part owner (see KWIK Pocatello).

KJRL, Pocatello—Licensed to Radio & Television Bcstg. Co. of Idaho, 24% owned by Burl Hagadone, 24% by Scripps Newspapers Inc., and 8% by Harry Henke Jr. Scripps Newspapers publishes (*Pocatello Idaho State Journal*, for newspapers holdings of Mr. Hagadone and other holdings of Scripps Newspapers, see KVNI Coeur d'Alene, Ida.

KWIK, Pocatello—Licensed to Eastern Idaho Broadcasting and Television Co. *Idaho Falls Post-Register* is part owner. See KIFI Idaho Falls.

ILLINOIS

WAVA, Ava—Licensed to Ava Broadcasting Co. Leonard M. Johnson, 50% owner, is publisher of weekly *Ava Citizen*.

WJBC, WJBC-FM, Bloomington—Licensed to Bloomington Broadcasting Corp., affiliated with *Daily Pantagraph Co.*, publisher of *Bloomington Pantagraph*.

WDWS, WDWS-FM, Champaign—Licensed to The Champaign News-Gazette Inc., publisher of *Champaign News-Gazette*.

WAAF, WAAF-FM, Chicago—Licensed to Corn Belt Publishers Inc. (*Drivers Journal* division).

WGN, Chicago—Licensed to WGN Inc., 100% subsidiary of the *Tribune Co.*, publisher of *Chicago Tribune*.

WIND, Chicago—Licensed to the W.I.N.D. Inc. Knight Newspapers own 27.1% (*Chicago Daily News*, *Detroit Free Press*, *Akron Beacon Journal* (WAKR), *Miami Herald* (WQAM)).

WFMF(FM), Chicago—Licensed to WFMF Inc., owned by Field Enterprises Inc., controlled by Marshall Field, publisher, *Chicago Sun-Times*.

WLS, Chicago—Licensed to Agricultural Broadcasting Co.; 100% of stock owned by Frairie Farmer Publishing Co., publisher of *Prairie Farmer*, bi-weekly.

WDAN, Danville—Licensed to Northwestern Publishing Co., publisher of *Danville Commercial-News* (Gannett Newspapers). See WHEC Rochester, N. Y.

WSOY, WSOY-FM, Decatur—Licensed to Illinois Broadcasting Co., 100% of stock owned by Decatur Newspapers Inc., publisher of *Decatur Herald and Review*; same ownership as *Champaign-Urbana (Ill.) Evening Courier* and others.

WCRA, Effingham—Licensed to the Effingham Bcstg. Co. Some stockholders also hold stock in *Effingham News*. See also WRMN Elgin, Ill., and KOBE Las Cruces, N. M.

WMRN, Elgin—Licensed to Elgin Bcstg. Co. Ownership identified with *Effingham News*, and *Pekin Times*, both Illinois. See also WCRA Effingham, Ill., and KOBE Las Cruces, N. M.

WGIL, Galesburg—Licensed to Galesburg Broadcasting Co.; controlled by Galesburg Printing & Publishing Co., publisher of *Galesburg Register-Mail*.

WLDS, Jacksonville—Licensed to Jacksonville Radio & Television Bcstg. Corp., 90% owned by Jacksonville Journal and Courier Co., publisher of *Jacksonville Journal and Courier*.

WKAN, Kankakee—Licensed to the Kankakee Daily Journal Co., publisher, Kankakee Daily Journal.

WLPO, La Salle—Licensed to La Salle County Broadcasting Corp., 100% owned by Peter Miller, publisher of La Salle News-Tribune.

WMBD, WMBD-FM, Peoria—Licensed to Peoria Broadcasting Co., majority ownership identified with ownership of Peoria Journal.

WGEM, WQDI(FM), Quincy—Licensed to Quincy Bcstg. Co., affiliated with Quincy Herald Whip.

WTAD, WTAD-FM, Quincy—Licensed to Lee Broadcasting Inc., affiliated with KGLO Mason City, Ia.

WHBF, WHBF-FM, Rock Island—Licensed to Rock Island Broadcasting Co.; majority stockholders own all stock of Rock Island Argus.

WROK, WROK-FM, Rockford—Licensed to Rockford Broadcasters Inc. Same ownership as Rockford Star and Register-Republic.

WKRS, Waukegan—Licensed to News-Sun Broadcasting Corp., subsidiary of the Waukegan News-Sun.

WFRX, West Frankfort—Licensed to Pyramid Radio Broadcasting & Television Co. 20% of stock owned by E. J. Paxton, vice president of Paducah Newspapers. See WKYB Paducah, Ky.

INDIANA

WCNB, WCNB-FM, Connersville—Licensed to News Examiner Co., publisher of Connersville News-Examiner.

WTRC, Elkhart—Licensed to Truth Publishing Co. Inc., publisher of Elkhart Truth.

WGL, Ft. Wayne—Licensed to News Sentinel Broadcasting Co. which is owned by News Publishing Co. (Fort Wayne News-Sentinel).

WIRE, Indianapolis—Licensed to Indianapolis Bcstg. Inc. 100% owned by Central Newspapers Inc. (Eugene C. Pulliam, 54% owner.) Central Newspapers Inc. owns Vincennes (Ind.) Sun-Commercial (WAOV) and Huntington Herald-Press. Central Newspapers Inc. also owns majority stock of Indianapolis Newspapers Inc. (Indianapolis Star and News). Indianapolis Newspapers Inc. owns majority stock in Muncie Newspapers Inc. (Muncie Star and Press). Central Newspapers Inc. also owns minority stock of Phoenix (Ariz.) Republic and Gazette. Mr. Pulliam is also an officer and director of each of the above-mentioned newspapers.

WIOU, Kokomo—Licensed to North Central Broadcasting Corp. President Richard Blackledge also president of Kokomo Tribune.

WMRI(FM), Marion—Licensed to Chronicle Publishing Co., Inc., publisher of Marion Leader-Tribune and Chronicle.

WCTW(FM), New Castle—Licensed to Courier-Times Inc., publisher of New Castle Courier-Times.

WSRK(FM), Shelbyville—Licensed to Shelbyville Radio Inc. Stockholders have interest in Shelbyville News. (Application pending before FCC for assignment of license.)

WSBT, South Bend—Licensed to the South Bend Tribune.

WAOV, Vincennes—Licensed to Vincennes Sun Co., publisher of Vincennes Sun-Commercial. Vincennes Sun Co. is owned by Central Newspapers Inc. (Eugene C. Pulliam, 54% owner.) Central Newspapers Inc. also owns Huntington Herald-Press, and owns majority stock of Indianapolis Newspapers Inc. (Indianapolis Star and News—WIRE.) Indianapolis Newspapers Inc. owns majority stock of Muncie Newspapers Inc. (Muncie Star and Press.) Central Newspapers Inc. also owns minority stock of Phoenix (Ariz.) Republic and Gazette. Mr. Pulliam is also an officer and director of each of the above mentioned newspapers.

WRSW, WRSW-FM, Warsaw—Licensed to Reub Williams & Sons Inc., publisher of Warsaw Times-Union.

WFML(FM), Washington—Licensed to Washington Radio Inc., majority interest held by owner of Washington (Ind.) Herald.

IOWA

KASI, Ames—Licensed to Ames Broadcasting Co. President W. S. Rupe and Hollis Nordyke, stockholders, own stock in Ames Tribune.

KWBG, Boone—Licensed to Boone Broadcasting Co. Stockholders Harold A. and Mary Garvey control Boone News-Republican.

KBUR, Burlington—Licensed to Burlington Bcstg. Co., owned by John P. and Sidney Harris, owners of Burlington Hawkeye Gazette (for other newspaper holdings, see KIUL Garden City, Kan.).

KCRG, KCRK(FM), Cedar Rapids—Licensed to Cedar Rapids Tv Co., 30% owned by Cedar Rapids Gazette.

KCOG, Centerville—Licensed to Centerville Broadcasting Co. President Robert K. Beck controls Centerville Iowegian.

KSWI, Council Bluffs—Licensed to the Nonpareil Broadcasting Co., affiliated with the Nonpareil Co., publisher of the Council Bluffs Nonpareil.

KRNT, KRNT-FM, Des Moines—Licensed to Cowles Broadcasting Co., subsidiary of the Register & Tribune Co., publisher of Des Moines Register and Tribune; also publisher of Minneapolis Tribune and Star and Look Magazine. See WNAX Yankton, S. D.

KDTH, Dubuque—Licensed to Dubuque Telegraph-Herald.

KFVB, Marshalltown—Licensed to Marshall Electric Co. owned by the Marshalltown Times Republican.

KGLO, KGLO-FM, Mason City—Licensed to Lee Radio Inc., affiliated with ownership to WTAD, Quincy Ill. Lee P. Loomis, president, also publisher of Mason City Globe-Gazette.

KSCJ, KSCJ-FM, Sioux City—Licensed to the Perkins Brothers Co. William R. Perkins, president, also is president-publisher of Sioux City Journal and Journal-Tribune.

KTRI, Sioux City—Licensed to Sloux City Broadcasting Co., whose owners have interests in the Sloux City Journal-Tribune.

KANSAS

KSOK, Arkansas City—Licensed to KSOK Broadcasting Co. Beneficial owner of stock is Stauffer Publications Inc., publisher of Arkansas City Traveler, Pittsburg (Kans.) Headlight and Sun (KSEK), Shawnee (Okla.) News and Star (KGFF), Grand Island (Neb.) Independent, Maryville (Mo.) Forum-Topeka (Kans.) State Journal, Nevada (Mo.) Mail, York (Neb.) News-Times, Santa Maria (Calif.) Times, Pauls Valley (Okla.) Democrat, Independence (Mo.) Examiner. See also KSEK Pittsburg, Kans., and KGFF Shawnee, Okla.

KGFF, Coffeyville—Licensed to Midwest Broadcasting Co. Same majority ownership as Coffeyville Journal. See KHAS, Hastings, Neb.

KGNO, Dodge City—Licensed to Dodge City Broadcasting Co. Inc. President J. C. Denious and other stockholders also own Dodge City Globe.

KIUL, Garden City—Licensed to KIUL Inc., owned by John P. and Sidney Harris, owners of Garden City Telegram, Hutchinson News-Herald, Ottawa Herald, Chanute Tribune, Salina Journal (KSAL), all Kansas, and Burlington (Iowa) Hawkeye-Gazette (KBUR).

KVGB, Great Bend—Licensed to KVGB Inc. Same ownership as Great Bend Tribune and Russell (Kans.) News.

KAYS, Hays—Licensed to KAYS Inc., principally owned by Hays News.

KCKN, Kansas City—Licensed to The KCKN Broadcasting Co., controlled by Capper Publications Inc., publisher of Kansas City Kansas and Topeka Capital (WIBW).

KMAN, Manhattan—Licensed to Manhattan Broadcasting Co. Same ownership as Manhattan-Mercury-Chronicle. See KHAS, Hastings, Neb.

KNEK, McPherson—Licensed to K. R. Krehbiel, publisher of McPherson Republican.

KLKC, Parsons—Licensed to Community Broadcasting Co. President Clyde M. Reed Jr. is publisher of Parsons Sun.

KSEK, Pittsburg—Licensed to the KSEK Broadcasting Co., owned by Stauffer Publications; also see KSOK Arkansas City, Kan., and KGFF Shawnee, Okla.

KSAL, Salina—Licensed to KSAL Inc., owned by John P. and Sidney Harris, owners of Salina Journal (for other newspaper holdings, see KIUL Garden City, Kan.).

WIBW, Topeka—Licensed to Topeka Broadcasting Assn. Inc., controlled by Capper Publications Inc., publisher of Topeka Capital, Kansas City (Kans.) Kansan. See KCKN, Kansas City, Kan.).

KFBI, Wichita—Licensed to KFBI Inc., 24% owned by John P. and Sidney Harris (for newspaper holdings, see KIUL Garden City, Kan.).

KFH, KFHF, Wichita—Licensed to Radio Station KFHF Co.; 50% of stock owned by Wichita Eagle Inc., publisher of Wichita Eagle.

KWBB, Wichita—Licensed to Wichita Beacon Broadcasting Co. Minority stockholders are owners of Beacon Publishing Co., publisher of Wichita Beacon.

KENTUCKY

WCMI, WCMI-FM, Ashland—Licensed to Ashland Bcstg. Co. 70% owned by Charles Sawyer, publisher of Lancaster (Ohio) Eagle-Gazette and Waverly (Ohio) News. See also WCOL Columbus, WIZE Springfield and WING Dayton, all Ohio.

WKCT, Bowling Green—Licensed to Daily News Broadcasting Co., controlled by Park City News.

WCNL, Central City—Licensed to Central City-Greenville Broadcasting Co. Owners L. L. and A. E. Stone and R. G. Utley also own weekly Central City Messenger and Times-Argus.

WTP, Corbin—Licensed to Corbin Times-Tribune Inc. Publisher Corbin Tribune and Times and 50% owner of Harlan (Ky.) Enterprise.

WFUL, Fulton—Licensed to Ken-Tenn Broadcasting Corp. Robert Paul Westpheling Jr. and wife own 4% of station, publish weekly Fulton News.

WKIC, Hazard—Licensed to BMG Broadcasting Co., which owns 75% of Herald Publishing Co. (Hazard Herald).

WHAS, Louisville—Licensed to WHAS Inc., subsidiary of Courier-Journal & Louisville Times Co., publisher of Louisville Courier-Journal and Louisville Times.

WFMW, WFMW-FM, Madisonville—Licensed to Messenger Broadcasting Co., owned 50% by Madisonville Messenger.

WMIK, Middlesboro—Licensed to Cumberland Gap Broadcasting Co. Some stockholders also own stock in Middlesboro News.

WOMI, WOMI-FM, Owensboro—Licensed to Owensboro Broadcasting Co., stock owned by principal stockholders of Owensboro Publishing Co., publisher of Owensboro Messenger and Inquirer.

WKYB, WKYB-FM, Paducah—Licensed to WKYB Inc. Interlocking ownership with Paducah Newspapers Inc., publisher of Paducah Sun-Democrat.

WLSI, Pikeville—Licensed to Cumberland Pub. Co., publisher of Pikeville News.

WTCW, Whitesburg—Granted to Ky.-Va. Bcstg. Corp. Mark Webb, Jr., one-third owner, is advertising manager of Pikeville (Ky.) News.

LOUISIANA

KTRY, Bastrop—Licensed to Morehouse Broadcasting Co. President Nathan Bolton is publisher of weekly Bastrop Clarion and Enterprise.

WJBO, WBRL(FM), Baton Rouge—Licensed to Baton Rouge Broadcasting Co. Inc.; same ownership as Baton Rouge Advocate and State-Times.

KSIG, Crowley—Licensed to the Acadia Broadcasting Co. Owner Max Thomas is publisher Crowley Signal and weekly Acadian. (See KJEF Jennings.)

KJEF, Jennings—Licensed to Jennings Broadcasting Co. President Max Thomas owns Crowley Signal and weekly Acadian.

KVOL, KVOL-FM, Lafayette—Licensed to Evangeline Broadcasting Co. Inc.; 50% of stock owned by Lafayette Advertiser.

WTPS, New Orleans—Licensed to Times Picaune Publishing Co., publisher of New Orleans Times-Picaune and States.

KRUS, Ruston—Licensed to C. E. Faulk Jr., publisher Ruston Leader.

KWKH, KWKH-FM, Shreveport—Licensed to International Broadcasting Corp.; 100% of stock owned by Times Publishing Co. Ltd., publisher of Shreveport Times; same ownership as Monroe (La.) World and News-Star (See also KTMS Little Rock, Ark.)

MAINE

WGUY, WGUY-FM, Bangor—Licensed to the Guy Gannett Bcstg. Services, owned by Guy Gannett Publishing Co., owner of Portland Press Herald and Express; Kennebec Journal, Augusta; and Waterville Sentinel.

WGAN, Portland—Licensed to Guy Gannett Broadcasting Services; See WGUY Bangor.

WRUM, Rumford—Licensed to Rumford Pub. Co., publisher of Rumford Times.

MARYLAND

WBAL, Baltimore—Licensed to Hearst Corp. Hearst newspapers are Baltimore News-Post, New York Journal-American and Mirror, Albany (N. Y.) Times-Union, Boston Record and American, Pittsburgh Sun-Telegraph (WCAE), Chicago Herald-American, Milwaukee Sentinel (WISN), Detroit Times, San Francisco Examiner and Call-Bulletin, Los Angeles Examiner and Herald-Express, San Antonio Light, Seattle Post-Intelligencer. See also WCAE Pittsburgh, WISN Milwaukee.

MASSACHUSETTS

WHDH, WHDH-FM, Boston—Licensed to Matheson Radio Co., owned by Boston Herald-Traveler Corp., publisher Boston Herald and Traveler.

WLAW, WLAW-FM, Boston-Lawrence—Licensed to Hildreth & Rogers Co. under same ownership as Eagle-Tribune Publishing Co. publisher of Lawrence Eagle and Tribune.

WBET, WBET-FM, Brockton—Licensed to Enterprise Pub. Co., publisher, Brockton Enterprise & Times.

WSAR, Fall River—Licensed to Fall River Broadcasting Co., owned by Fall River Herald News Publishing Co., publisher of Fall River Herald News.

WHAU, Haverhill—Licensed to Haverhill Gazette Co., publisher of Haverhill Gazette.

WHYN, WHYN-FM, Holyoke—Licensed to Hampden Hampshire Corp.; all stock of station owned by owners of Holyoke Transcript-Telegram and Northampton (Mass.) Hampshire Gazette.

WNBH, WFBM(FM), New Bedford—Licensed to E. Anthony & Sons Inc., publisher of New Bedford Standard Times and Hyannis (Mass.) Cape Cod Standard-Times.

WBEC, WBEC-FM, Pittsfield—Licensed to Western Mass. Broadcasting Co., owned by Berkshire Eagle.

WPPE, Taunton—Licensed to Silver City Broadcasting Corp. J. Milton Hammond, part owner and general manager, owns the Catholic Observer magazine in Pittsborough and several newspapers in Pittsborough area.

WOCB, WOCB-FM, West Yarmouth—Licensed to E. Anthony & Sons Inc., see WNBH New Bedford.

WTAG, WTAG-FM, Worcester—Licensed to WTAG Inc., affiliated with Worcester Telegram Publishing Co. Inc., publisher of Worcester Telegram and Gazette.

MICHIGAN

NEW, Albion—Licensed to Calhoun Bcstg. Co., James C. Biedent, 25% stockholder, is half-owner of Albion Recorder; James Moses, 25%, is publisher of Marshall (Mich.) Chronicle; George W. and George T. Campbell, 16.8% and 16.4% stockholders, are part owners of Owosso (Mich.) Argus-Press

WELL, Battle Creek—Licensed to Federated Publications Inc., publisher of Battle Creek Enquirer & News, Grand Rapids Herald and Lansing State Journal.

WHFB, WHFB-FM, Benton Harbor—Licensed to Palladium Pub. Co., publisher of Benton Harbor News-Palladium, St. Joseph (Mich.) Herald-Press.

WJBK, WJBK-FM, Detroit—See WGBS, Miami, Fla.

WJLB, WBRI(FM), Detroit—Licensed to Booth Radio & Television Stations Inc. Mr. J. L. Booth personally owns a 3% stock interest in Booth Newspapers Inc. (Grand Rapids Press, Flint Journal, Muskegon Chronicle, Kalamazoo Gazette, Saginaw News, Bay City Times, Jackson Citizen-Patriot, Ann Arbor News.) See WBCB Flint and WSGW Saginaw.

WWJ, WWJ-FM, Detroit—Licensed to Evening News Association, publisher of Detroit News.

WDBC, Escanaba—Licensed to Delta Broadcasting Co. The J. P. Norton estate, 45% owner, also controls the Escanaba Press.

WBBC, Flint—Licensed to Booth Radio and Television Stations Inc. J. L. Booth, owner, personally has stock in Booth Newspaper Inc. See WJLB Detroit.

WMIQ, Iron Mountain—Licensed to the Iron Mountain-Kingsford Bcstg. Co. President Frank J. Russell is publisher of Iron Mountain News.

WDMJ, Marquette—Licensed to Lake Superior Broadcasting Co. Inc., wholly owned by the Mining Journal Co. Ltd., publisher Marquette Mining Journal.

WMDN, Midland—Licensed to Rich Publishing House Inc., publisher of Midland News.

WMLN(FM), Mt. Clemens—Licensed to Macomb Publishing Co., publisher of Mt. Clemens Monitor Leader, South Macomb News and Flyer.

WOAP, Owosso—Licensed to Owosso Bcstg. Co., subsidiary of Argus Press Co., publisher of Owosso Argus Press.

WSGW, Saginaw—Licensed to Booth Radio & Television Stations Inc. (See WJLB Detroit.)

WSOO, Sault Ste. Marie—Licensed to Hiawathaland Broadcasting Co. George A. Osborn, publisher of Sault Ste. Marie News, owns 30%.

MINNESOTA

WEBC, WEBC-FM, Duluth—Licensed to Head of the Lakes Broadcasting Co., 32% of stock owned by Evening Telegram Co., Superior, Wis., publisher of Superior Telegram; 22% by Northwest Paper Co., 20% by Moran, Murphy, president of Evening Telegram Co., 10% by W. C. Bridges, manager of WEBC. Mr. Murphy is also interested in WMFG Hibbing, Minn.; WHLB Virginia, Minn.; WISC Madison; WEAU Eau Claire, Wis.; KVOL Lafayette, La., and the Manitowoc (Wis.) Herald-Times, Chippewa Falls (Wis.) Herald-Telegram, Two Rivers (Wis.) Reporter, Virginia (Minn.) Mesabi News and Range Facts, Los Angeles (Calif.) Eagle Rock News-Herald and Highland Park News-Herald, and Lafayette (La.) Daily Advertiser.

WMFG, Hibbing—Licensed to Head of the Lakes Bcstg. Co. See WEBC, Duluth.

WCCO, Minneapolis—Licensed to Midwest Radio-Television Inc., 53% owned by Mid Continent Radio-Television Inc. and 47% owned by CBS. Mid Continent is 50% owned by Northwest Publications Co. (Ridder interests), and 50% by Minnesota Tribune Co. Ridder interests own St. Paul Pioneer-Press and Dispatch, Duluth News-Tribune and Herald (WDSM Superior, Wis.), New York Staats-Zeitung and Herald, New York Journal of Commerce, Aberdeen (S. D.) American and News (KSDN), Grand Forks (N. D.) Herald (KJLO), San Jose (Calif.) Mercury and News, Long Beach (Calif.) Independent and Press-Telegram, minority interest in Seattle Times. See also WDSM Superior, Wis.; KSDN Aberdeen, S. D.; KJLO Grand Forks, N. D. and WEMP Milwaukee, Wis.

KNUJ, New Urm—Licensed to KNUJ Inc., affiliated with New Urm Journal.

KFAM, KFAM-FM, St. Cloud—Licensed to Times Publishing Co., publisher of St. Cloud Times.

WHLB, Virginia—Licensed to Head of the Lakes Broadcasting Co.; see WEBC, Duluth.

KWNO, KWNO-FM, Winona—Licensed to Winona Radio Service, owned by M. H. White, publisher of Winona Republican-Herald.

MISSISSIPPI

WBIP, Booneville—Licensed to Booneville Broadcasting Co. E. O. Roden, sole owner, controls weekly Walker County Times and Booneville Independent.

WJMB, Brookhaven—Licensed to Brookhaven Broadcasting Co. Stockholder Dalton Brady is editor of Brookhaven Leader Times.

WROX, Clarksdale—Licensed to Birney Imes Jr., owner of Columbus (Miss.) Commercial Dispatch. See WCBI Columbus, Miss.

WCJU, Columbia—Licensed to Lester Williams, editor and publisher of weekly Columbian Progress.

WACR, Columbus—Licensed to Mississippi Bcstg. Co., owned by Withers Gavin, publisher of weekly Meridian Record and Clark County Tribune (Quitman, Miss.). See also WCOG Meridian, WMBC Macon and WJQS Jackson, all Miss.

WCBI, Columbus—Licensed to Birney Imes Jr., owner of Columbus Commercial Dispatch. See also WELO Tupelo; WROX Clarksdale; WNAG Grenada; WMOX Meridian, all Miss.

WVAC, Grenada—Licensed to Birney Imes Jr., owner of Columbus (Miss.) Commercial Dispatch. See WCBI Columbus, Miss.

WJQS, Jackson—Licensed to Mississippi Bcstg. Co., owned by Withers Gavin, publisher of weekly Meridian Record and Clark County Tribune (Quitman, Miss.). See also WCOG Meridian, WACR Columbus, and WMBC Macon, all Miss.

WMBC, Macon—Licensed to Mississippi Bcstg. Co., owned by Withers Gavin, publisher of weekly Meridian Record and Clark County Tribune (Quitman, Miss.). See also WCOG Meridian, WACR Columbus and WJQS Jackson, all Miss.

WCOG, Meridian—Licensed to Mississippi Bcstg. Co., owned by Withers Gavin, publisher of weekly Meridian Record and Clark County Tribune (Quitman, Miss.). See also WACR Columbus, WMBC Macon and WJQS Jackson, all Miss.

WVOX, WMOX-FM, Meridian—Licensed to Birney Imes Jr., owner of Columbus (Miss.) Commercial Dispatch. See WCBI, Columbus, Miss.

WELO, Tupelo—Licensed to Tupelo Broadcasting Co., owned by Birney Imes Jr., owner of Columbus (Miss.) Commercial Dispatch. See WCBI Columbus, Miss.

WQBC, Vicksburg—Licensed to Delta Broadcasting Co. Inc. President L. P. Cashman is publisher of the Vicksburg Herald and Post.

MISSOURI

KFRU, Columbia—Licensed to KFRU Inc.; controlled by H. J. Walters Jr., publisher of Columbia Tribune.

KIMO, Independence—Licensed to the Blue Valley Co. Craig Siegfried, general manager and 25% owner, owns the Independence News.

KWOS, KWOS-FM, Jefferson City—Licensed to the Capital Broadcasting Co. Mrs. R. C. Goshorn, president, is also president of the News Tribune Co., publisher of Jefferson City Capital News and Post-Tribune.

KCKN, Kansas City—Licensed to the KCKN Broadcasting Co. Owned by Capper Publications Inc., publishers of the Kansas City Kansas and the Topeka Daily Capital. See WBW Topeka, Kans.

WDAF, Kansas City—Licensed to The Kansas City Star Co., publisher of Kansas City Star and Times.

KGBX, Springfield—Licensed to Springfield Broadcasting Co.; owned 98% by Springfield Newspapers Inc., publisher of Springfield News and Leader-Press.

KFEQ, St. Joseph—Licensed to KFEQ Inc.; 43% of stock owned by the News Corp., publisher of the St. Joseph News-Press and Gazette.

KSD, St. Louis—Licensed to Pulitzer Publishing Co., publisher of St. Louis Post-Dispatch.

KWK, St. Louis—Licensed to KWK Inc. St. Louis Globe-Democrat is minority stockholder.

MONTANA

KMON, Great Falls—Licensed to the Montana Farmer Broadcasting Corp., affiliated with Montana Farmer Stockman, semi-monthly farm journal, and Great Falls Tribune and 40% owned by Ogden (Utah) Standard-Examiner.

KRJJ, Miles City—Licensed to Star Printing Co., publisher of Miles City Star.

NEBRASKA

KFGT, Fremont—Licensed to Walker Radio Inc., affiliated with Fremont Guide Tribune.

KHAS, Hastings—Licensed to Nebraska Broadcasting Co. Owned by Fred A. and Richard M. Seaton, publishers of Hastings Tribune, Manhattan (Kans.) Mercury-Chronicle (KMAN), Coffeyville (Kans.) Journal (KGGF), Winfield (Kans.) Courier, Alliance (Neb.) Times-Herald, Deadwood (S. D.) Pioneer-Times, Lead (S. D.) Call, Sheridan (Wyo.) Press and the magazine Western Farm Life (Denver).

WJAG, Norfolk—Licensed to Huse Pub. Co., publisher of the Norfolk News.

KFAB, Omaha—Licensed to KFAB Broadcasting Co., 50% of stock owned by Sidles Co., 25% of stock owned by Lincoln Nebraska State Journal; 25% of stock owned by Lincoln Star.

WOW, Omaha—Licensed to Meredith WOW Inc., owned by Meredith Publishing So., publisher of Better Homes & Gardens and Successful Farming.

NEVADA

KELK, Elko—Licensed to Elko Broadcasting Co. Chris H. Sheerin, 50% owner Elko Free Press is president and 17.66% owner of station.

KBMI, Henderson—Licensed to Moritz Zenoff, publisher of weekly Henderson Home News and Boulder City (Nev.) News.

KOH, Reno—Licensed to McClatchy Broadcasting Co. of Nevada. Same ownership as Sacramento Bee, Fresno Bee, Modesto Bee, all in California (McClatchy Newspapers). See KERN Bakersfield, Calif.

NEW JERSEY

WJLK, WJLK(FM), Asbury Park—Licensed to Asbury Park Press Inc., publisher of Asbury Park Press.

WFPG, WFPG-FM, Atlantic City—Licensed to Neptune Broadcasting Corp., affiliated with Atlantic City Reporter.

WVNJ, WVNJ-FM, Newark—Licensed to Evening News Publishing Co. (Newark News).

WPAT, Paterson—Licensed to North Jersey Broadcasting Co. 90% owned by Passaic News.

WTOA(FM), Trenton—Licensed to the Mercer Broadcasting Co. Owned by Trenton Times Corp., publisher of Trenton Times.

NEW MEXICO

KOB, Albuquerque—Licensed to Albuquerque Broadcasting Co., 50% owned by Time Inc. (Time, Life, Fortune, etc.) and 50% by Wayne Coy. See also KDYL Salt Lake City, Utah.

KOBE, Las Cruces—Licensed to Mesilla Valley Bcstg. Co. Minority stockholders F. F. and J. T. McNaughton are identified with the ownership of Effingham News and Pekin Times, both Illinois. See also WCRA Effingham and WMRN Elgin, both Illinois.

NEW YORK

WMBO, WMBO-FM, Auburn—Licensed to Auburn Publishing Co., publisher of Auburn Citizen-Advertiser.

WBEN, WBEN-FM, Buffalo—Licensed to WBEN, Inc.; stock owned by same ownership as Buffalo News.

WEBR, Buffalo—Licensed to WEBR Inc. Owned by Buffalo Courier-Express.

WALK, WALK-FM, Patchogue—Licensed to Suffolk Broadcasting Co. Owned by Julia Dick Macy, who also has controlling interest in Suffolk Consolidated Press, publisher of weekly newspapers in Long Island.

WENY, Elmira—Licensed to Elmira Star-Gazette Inc., publisher of Elmira Star-Gazette and Advertiser (Gannett Newspapers). See WHEC Rochester, N. Y.

WENE, Endicott-Binghamton—Licensed to Ottaway Stations Inc. Major stockholder James H. Ottaway is president-publisher and controlling stockholder of Endicott Bulletin and Oneonta (N. Y.) Star (WDOs) Plattsburgh (N. Y.) Press-Republican and Stroudsburg (Pa.) Record (WVPO). See also WDOs Oneonta, N. Y., and WVPO Stroudsburg, Pa.

WWSG, Glens Falls—Licensed to Great Northern Radio Inc., 50% owned by Glens Falls Post Co., publisher of Glens Falls Post-Star and Times.

WVOS, Liberty—Licensed to Sullivan County Broadcasting Corp. President S. D. Lubin and Commercial Manager H. G. Borwick, stockholders, own Sullivan Evening News and Liberty News.

WUSJ, Lockport—Licensed to Lockport Union Sun and Journal Inc., publisher of Lockport Union Sun & Journal.

WMSA, WMSA-FM, Massena—Licensed to the Brockway Co., owned and operated by the Watertown (N. Y.) Times. See WWNY Watertown, N. Y.

WEVD, New York—Licensed to Debs Memorial Radio Fund Inc.; among cooperative backers are directors of the Jewish Forward; the newspaper company itself has no interest or control.

WHOM, New York—Licensed to Atlantic Broadcasting Co., subsidiary of Il Progresso Italo Americano.

WOV, New York—Licensed to Wodaam Corp.; Richard E. O'Dea, majority stockholder, is director and stockholder of the Paterson (N. J.) Call.

WQXR, WQXR-FM, New York—Licensed to the Interstate Broadcasting Co., subsidiary of New York Times.

WHLD, WHLD-FM, Niagara Falls—Licensed to Niagara Falls Gazette Publishing Co., publisher of Niagara Falls Gazette.

WHDL, WHDL-FM, Olean—Licensed to WHDL, Inc., 100% of stock owned by Olean Times-Herald Corp., publisher of Olean Times-Herald. Minority interest owned by Gannett Newspapers. See WHEC Rochester, N. Y.

WDOs, Oneonta—Licensed to Ottaway Stations Inc. Major stockholder James H. Ottaway is present-publisher and controlling stockholder of Empire Newspapers Inc., publisher of Oneonta Star and Endicott (N. Y.) Bulletin (WENE). See also WENE Endicott, N. Y., and WVPO Stroudsburg, Pa.

WHEC, Rochester—Licensed to WHEC Inc., 86% of stock owned by the Gannett Co. Inc., publisher of Rochester Times-Union and Democrat & Chronicle (Gannett Newspapers). Other Gannett newspapers are Albany Knickerbocker News, Utica Observer-Dispatch and Press, Newburgh News, Beacon News, Ithaca Journal, Olean Times-Herald (minority) (WHDL), Ogdensburg Journal, Malone Telegram, Saratoga Springs Saratogan, Massena Observer, Elmira Star-Gazette and Advertiser (WENY), Binghamton Press, all in New York; Hartford

NEWSPAPER OWNERSHIP

(Conn.) Times (WHTT), Plainfield (N. J.) Courier-News, Danville (Ill.) Commercial News (WDAI).

WSYR, WSYR-FM, Syracuse—Licensed to Central New York Broadcasting Corp. Same ownership (S. I. Newhouse) as Syracuse Post-Standard and Herald-Journal, Newark Star-Ledger, Jersey City Journal, Long Island Press and Star Journal, Harrisburg (Pa.) Patriot News (WHP), Staten Island (N. Y.) Advance, Portland Oregonian (50% owner of KOIN), WFLY (FM), Troy—Licensed to the Troy Record Co., publisher of Troy Record and Times-Record.

WRUN, WRUN-FM, Utica—Licensed to Rome Sentinel Co., publisher of Rome (N. Y.) Sentinel.

WWNY, WWNY-FM, Watertown—Licensed to the Brockway Co., owned and operated by the Watertown Times. See WMSA Massena.

WFAS, WFAS-FM, White Plains—Licensed to Westchester Broadcasting Corp. J. Noel Macy and Valentine E. Macy Jr., co-owners, publishers of White Plains Reporter Dispatch, Yonkers Herald-Statesman, Tarrytown News, Port Chester Item, Ossining Citizen-Register, Mt. Vernon Argus, New Rochelle Standard-Star Mamaroneck Times, all in New York.

NORTH CAROLINA

WGWR, WGWR-FM, Asheville—Licensed to the Asheville Broadcasting Co., owners including Roy Cox, publisher Asheville Courier Tribune, a semi-weekly newspaper.

WWNC, Asheville—Licensed to Asheville Citizen-Times Co., publisher of the Asheville Citizen-Times. See also WFBC Greenville, S. C.

WPNF, Brevard—Licensed to Pisgah Broadcasting Co., same newspaper ownership association as WBBO Forest City, below.

WEGO, Concord—Licensed to Cabarrus Broadcasting Co. Same ownership as Concord Tribune.

WDNC, WDNC-FM, Durham—Licensed to the Durham Radio Corp.; 100% owned by the Durham Herald Co., publisher Durham Herald and Sun.

WBBO, WBBO-FM, Forest City—Licensed to Rutherford County Radio Co., Inc., stockholders affiliated with following weekly newspapers: Forest City Courier, Spindale Sun. See WPNF Brevard.

WGBR, WGBR-FM, Goldsboro—Licensed to East Carolina Broadcasting Co. Talbot Patrick, 7 1/2% owner, is publisher of Goldsboro News-Argus and Rock Hill (S. C.) Herald.

WHKY, Hickory—Licensed to Catawba Valley Broadcasting Co.; stockholders include Lester C. Gifford, publisher of Hickory Record.

WHPE, WHPE-FM, High Point—Licensed to High Point Enterprise Inc., publisher of High Point Enterprise.

WNAO, WNAO-FM, Raleigh—Licensed to Sir Walter Television Co., 14.2% owned by News & Observer Pub. Co. (Raleigh News & Observer).

WCEC, WFMA (FM), Rocky Mount—Licensed to Eastern Carolina Electronics Inc., affiliated with Rocky Mount Telegram.

WREV, WREV-FM, Reidsville—Licensed to Reidsville Broadcasting Co. W. M. and W. M. Oliver Jr., owners, also own stock in Reidsville Review.

WSTP, WSTP-FM, Salisbury—Licensed to Piedmont Broadcasting Co.; 37% of stock owned by Salisbury Post and Post stockholders.

WSJS, WSJS-FM, Winston-Salem—Licensed to Piedmont Publishing Co., publisher of Winston-Salem Journal and Twin City Sentinel.

NORTH DAKOTA

WDAY, Fargo—Licensed to WDAY Inc.; 44.44% of stock owned by stockholders of Forum Publishing Co., publisher of Fargo Forum.

KILO, Grand Forks—Licensed to Grand Forks Herald Inc., publisher of Grand Forks Herald which is 60% owned by Ridder Publications. See WCCO Minneapolis.

OHIO

WAKR, WAKR-FM, Akron—Licensed to Summit Radio Corp., and 45% owned by the Akron Beacon-Journal (Knight Newspapers). See WIND Chicago.

WFAH, WFAH-FM, Alliance—Licensed to the Review Pub. Co., publisher of Alliance Review.

WICA, WICA-FM, Ashtabula—Licensed to WICA Inc. Same ownership as Ashtabula Star-Beacon, Geneva Free Press, Painesville Telegraph, Conneaut News-Herald, all Ohio.

WTRF, WTRF-FM, Bellaire—Licensed to Tri-City Broadcasting Co. Albert & Gordon Dix together own 30% interest in station, and also have interest in Martins Ferry Times, Bellaire Leader and Wooster Record.

WHBC, WHBC-FM, Canton—Licensed to Ohio Broadcasting Co., subsidiary of Brush-Moore Newspapers Inc., publisher of Canton Repository, Steubenville Herald-Star, Marion Star, East Liverpool Review, Portsmouth Times (WPAY) and Salem News, all in Ohio; Salsbury (Md.) Times.

WCPO, WCPO-FM, Cincinnati—Licensed to Scripps-Howard Radio Inc.; 100% owned by E. W. Scripps Co., chief stockholders in Scripps-Howard Newspapers, publisher of Cincinnati Post, New York World-Telegram & Sun, Cleveland Press (WEWS), Pittsburgh Press, Columbus Citizen, San Francisco News, Wash-

ington News, Indianapolis Times, Knoxville News-Sentinel (WNOX), Memphis Commercial Appeal and Press-Scimitar (WMC), Birmingham Post-Herald, Houston Press, Forth Worth Press, El Paso Herald-Post, Albuquerque Tribune, Covington (Ky.) Post, Denver Rocky Mountain News, Evansville (Ind.) Press. See WNOX Knoxville, Tenn. and WMC Memphis, Tenn.

WKRC, WKRC-FM, Cincinnati—Licensed to Radio Cincinnati, Inc., subsidiary of the Cincinnati Times-Star Co., publisher of Cincinnati Times-Star.

WHK, WHK-FM, Cleveland—Licensed to United Broadcasting Co., controlling interest owned by Forest City Publishing Co., publisher of the Cleveland Plain Dealer and News. See WKBN Youngstown, WHKC Columbus.

WBNS, Columbus—Licensed to RadiOhio, Inc. Same ownership (Edgar T. Wolfe) as Columbus Dispatch and Ohio State Journal.

WHKC, WHKC-FM, Columbus—Licensed to United Broadcasting Co.; controlling interest owned by The Forest City Publishing Co., publisher of the Cleveland Plain Dealer and News. See WHK Cleveland, and WKBN Youngstown.

WTNS, Coshocton—Licensed to Coshocton Broadcasting Co. Bob, Bill and Bruce Wallace control both licensee and Coshocton Tribune.

WCOL, Columbus—Licensed to Air Trails Inc., owned by Charles Sawyer, publisher of Lancaster (Ohio) Eagle-Gazette and Waverly (O.) News (weekly). See WIZE Springfield and WING Dayton, Ohio, and WCMJ Ashland, Ky.

WHIO, WHIO-FM, Dayton—Licensed to Miami Valley Broadcasting Corp.; same ownership as Dayton News and Journal Herald, Springfield (O.) News and Sun, Miami News (WIOD) and Atlanta Journal and Constitution (WSB) (James M. Cox).

WING, Dayton—Licensed to Great Trails Broadcasting Corp., owned by Charles Sawyer, publisher of Lancaster Eagle-Gazette and Waverly (O.) News (weekly). See WIZE Springfield and WCOL Columbus, Ohio, and WCMJ Ashland, Ky.

WJER, Dover—Licensed to Dover Broadcasting Co. Inc. See WAJR Morgantown and WDNE Elkins, W. Va.

WFIN, WFIN-FM, Findlay—Licensed to Findlay Publishing Co., publisher of Findlay Republican Courier.

WCLT, WCLT-FM, Newark—Licensed to the Advocate Printing Co., publisher of Newark Advocate and American Tribune.

WPAY, WPAY-FM, Portsmouth—Licensed to The Scioto Broadcasting Co.; 100% owned by Brush-Moore Newspapers Inc., publisher of Portsmouth Times Canton Repository, Steubenville Herald-Star, Marion Star, East Liverpool Review, Salem News (all in Ohio); and Salsbury Times, Maryland. See WHBC Canton.

WIZE, Springfield—Licensed to Radio Voice of Springfield Inc., controlled by Charles Sawyer, publisher of Lancaster (Ohio) Eagle-Gazette and Waverly (O.) News (weekly). See WING Dayton and WCOL Columbus, Ohio, and WCMJ Ashland Ky.

WSPD, WSPD-FM, Toledo—See WGBS Miami, Fla.

WTOD, WTRT (FM), Toledo—Licensed to Unity Corp. Inc. Edward Lamb, president, is publisher Erie (Pa.) Dispatch (WIKK) and owns WHOO-AM-FM Orlando, Fla.

WHHH, Warren—Licensed to Warren Tribune Radio Station Inc., owned by Tribune Co., publisher of Warren Tribune-Chronic.

WWST, WWST-FM, Wooster—Licensed to Wooster Republican Printing Co., publisher of the Wooster Record.

WFMJ, WFMJ-FM, Youngstown—Licensed to WFMJ Broadcasting Co. President William F. Maag Jr. is publisher of Youngstown Vindicator.

WKBN, WKBN-FM, Youngstown—Licensed to WKBN Broadcasting Corp., Forest City Publishing Co. (Cleveland Plain Dealer and News) owns 40%. See WHK Cleveland WHKC Columbus.

WHIZ, Zanesville—Licensed to Southeastern Ohio Broadcasting System Inc., majority of stock owned by Zanesville Pub. Co., publisher of Zanesville Times-Recorder and Signal.

OKLAHOMA

KWHW, Altus—Licensed to Altus Broadcasting Co., 50% owned by Altus Times-Democrat. See also KRMG Tulsa, Okla.

KVSO, Ardmore—Licensed to John F. Easley, owner of Ardmore Ardmoreite.

KSEO, Durant—Licensed to Democrat Printing Co., publisher Durant Democrat, Durant Weekly News.

KCRC, Enid—Licensed to Enid Radiophone Co.; all stock owned by same interests owning Enid Publishing Co., publisher of Enid News and Eagle.

KBIX, Muskogee—Licensed to Oklahoma Press Publishing Co., publisher of Muskogee Phoenix and Times-Democrat.

WKY, Oklahoma City—Licensed to WKY Radiophone Co.; same stock owners as Oklahoma Publishing Co., publisher of Oklahoma

City Oklahoman and Times, Farmer-Stockman. KHBG, Okmulgee—Licensed to Okmulgee Broadcasting Corp., subsidiary of Okmulgee Times. See also KFSA Fort Smith, Ark.

WBBZ, Ponca City—Licensed to Ponca City Publishing Co., publisher of the Ponca City News.

KGFF, Shawnee—Licensed to KGFF Broadcasting Co. Inc. Controlling stock interest (94%) owned by Stauffer Publications Inc. See KSOK Arkansas City, Ark.

KSPI, KSPI-FM, Stillwater—Licensed to Stillwater Pub. Co., publisher Stillwater News-Press.

KRMG, Tulsa—Licensed to Western Broadcasting Co., owned by Harrington Wimberly and family, owners of Altus (Okla.) Times-Democrat. See KWHW Altus, Okla.

OREGON

KWIL, KWIL-FM, Albany—Licensed to Central Willamette Broadcasting Co.; all stock owned by W. L. Jackson Estate and R. R. Cronise, co-publishers of Albany Democrat-Herald.

KAST, Astoria—Licensed to Astoria Broadcasting Co., ownership affiliated with Astoria Astorian Budget.

KOOS, Coos Bay—Licensed to KOOS Inc. Sheldon F. Sackett, owner, is publisher of Coos Bay Times. See KROW Oakland, Calif.

KERG, Eugene—Licensed to Guard Publishing Co., publisher of Eugene Register-Guard.

KUIN, KGPO (FM), Grants Pass—Licensed to Southern Oregon Bcstg Co., 50% owned by Pres. A. E. Voorhies, of Grants Pass Courier.

KFLW, Klamath Falls—Licensed to Herald Pub. Co., publisher Klamath Falls Herald & News. See KRNR Roseburg.

KMCM, McMinnville—Licensed to Yamhill Broadcasters Inc. Same ownership as McMinnville News-Register.

KYJC, Medford—Licensed to the Medford Printing Co., publisher Medford Mail Tribune. See KRNR Roseburg.

KOIN, Portland—Licensed to Mt. Hood Radio & Television Bcstg. Corp., 50% owned by S. I. Newhouse Jr. and wife (Portland Oregonian). For other Newhouse newspapers see WSYR Syracuse, N. Y.

KPOJ, KPOJ-FM, Portland—Licensed to KPOJ Inc.; stock owned by Portland Oregon Journal.

KRNR, Roseburg—Licensed to The News-Review Co., publisher of Roseburg News-Review, Southern Oregon Publishing Co., which controls the licensee, also owns Kalmath Falls Herald & News (KFLW) and 20% interest in Medford Mail Tribune (KYJC).

PENNSYLVANIA

WGPA, WGPA-FM, Bethlehem—Licensed to Bethlehem Globe Pub. Co., publisher Bethlehem Globe Times.

WCNR, Bloomsburg—Licensed to Columbia-Montour Broadcasting Corp., affiliated with the Bloomsburg Press.

WCFA, Clearfield—Licensed to Clearfield Broadcasters Inc., wholly owned by publishers of Clearfield Progress. See also WAKU Latrobe, WAD Indiana, both Pa., and WJCM Sebring, Fla.

WBUX, Doylestown—Licensed to Charles M. Meredith, publisher Quakertown Free Press.

WCED, WCED-FM, DuBois—Licensed to the Tri-County Bcstg. Co. Inc., affiliated with the DuBois Courier Express. See WILK Wilkes-Barre.

WEEK (FM), Easton—Licensed to the Easton Pub. Co., publisher of the Easton Express.

WEST, WEST-FM, Easton—Licensed to Associated Broadcasters Inc. Operated independently. Ownership affiliated with Steinman & Steinman Inc. See WGAL Lancaster.

WBTL, Emporium—Licensed to Bucktail Bcstg. Corp., 8% owned by James P. Klees, president, weekly Emporium Press-Independent.

WIKK, Erie—Licensed to Community Service Broadcasting Co. Owned by Dispatch Inc., publisher of Erie Dispatch. Edward Lamb also owner of WTOD and WTRT (FM), Toledo, O., and WHOC and WHOC-FM Orlando, Fla.

WHGB, Harrisburg—Licensed to Kendrick Bcstg. Co. Half-owned by Triangle Publications Inc., publisher of Philadelphia Inquirer and Seventeen magazine and licensee of WFIL-AM-FM Philadelphia.

WHP, WHP-FM, Harrisburg—Licensed to WHP Inc. Same ownership as Harrisburg Patriot-News (Newhouse). For other Newhouse newspapers see WSYR Syracuse, N. Y.

WBBO, Harrisburg—Licensed to Keystone Broadcasting Corp. Operated independently. Ownership affiliated with Steinman & Steinman Inc. See WGAL Lancaster.

WHUN, Huntingdon—Licensed to Joseph F. Biddle Pub. Co., publisher Huntingdon News.

WDAD, Indiana—Licensed to WDAD Inc., owned by Clearfield Broadcasters Inc. (Clearfield (Pa.) Progress). See also WCFA Clearfield and WAKU Latrobe, both Pa., and WJCM Sebring, Fla.

WJAC, WJAC-FM, Johnstown—Licensed to WJAC Inc.; 100% owned by Johnstown Tribune Publishing Co., publisher of Johnstown Tribune-Democrat.

WGAL, WGAL-FM, Lancaster—Licensed to WGAL Inc. Operated independently. Ownership affiliated with Steinman & Steinman Inc., publisher of Lancaster Intelligencer Journal and New Era.

WAKU, Latrobe—Licensed to Clearfield Broadcasters Inc. Same ownership as Clearfield (Pa.) Progress. See also WCFA Clearfield, WAD Indiana, both in Pa., and WJCM Sebring, Fla.

WMRF, WLTN(FM), Lewistown—Licensed to Lewistown Broadcasting Co.; 25% of stock owned by the Sentinel Co., publisher of Lewistown Sentinel.

WCAU, WCAU-FM, Philadelphia—Licensed to WCAU Inc., owned by Philadelphia Bulletin.

WFIL, WFIL-FM, Philadelphia—Licensed to Triangle Publications Inc., publisher Philadelphia Inquirer. See also WHGB Harrisburg, Pa.

WCAE, WCAE-FM, Pittsburgh — Licensed to WCAE Inc., owned by Hearst Publishing Co., publisher of Pittsburgh Sun-Telegraph. For other Hearst newspapers see WBAL Baltimore.

WKJF(FM), Pittsburgh—Licensed to Agnes Jane Greer, who is stockholder in West Virginia Pub. Co., publisher of Morgantown Post and Dominion News, New Martinsville Wetzel Republican. See also WAJR Morgantown, W. Va.; WJER Dover, Ohio; WDNE Elkins, W. Va.

WWSW, WWSW-FM, Pittsburgh — Licensed to WWSW Inc. Owned by the Pittsburgh Post-Gazette.

WEEU, Reading—Licensed to the Hawley Broadcasting Co., affiliated with Reading Eagle Times.

WRWA, Reading — Licensed to the Reading Broadcasting Co. Operated independently. Ownership affiliated with Steinman & Steinman Inc. See WGAL Lancaster.

WQAN, WQAN-FM, Scranton—Licensed to the Scranton Times.

WPIC, WPIC-FM, Sharon—Licensed to Sharon Herald Broadcasting Corp. One stockholder holds stock in Sharon Herald Publishing Co., publisher of Sharon Herald.

WVPO, Stroudsburg—Licensed to Pocono Broadcasting Inc., James H. Ottaway, majority stockholder, is also president-publisher of Stroudsburg Record. See also WENE Endicott-Binghamton, N. Y., and WDOS Oneonta, N. Y.

WKOK, WKOK-FM, Sunbury—Licensed to Sunbury Broadcasting Corp., majority ownership identified with Sunbury Item.

WRAK, WRAK-FM, Williamsport—Licensed to WRAK Inc., 66½% owned by Williamsport Sun-Gazette.

WWPA, Williamsport—Licensed to Williamsport Radio Broadcasting Associates Inc. Harry J. W. Kiessling, Grit Publishing Co. executive, is president and owns 32%.

WILK, Wilkes-Barre — Licensed to Wyoming Valley Broadcasting Co. Stockholders in station also own interests in Dubois Courier-Express and Butler Eagle. See WCED DuBois.

WORK, York—Licensed to York Broadcasting Co. Operated independently. Ownership affiliated with Steinman & Steinman Inc. See WGAL Lancaster.

RHODE ISLAND

WPJB, WPJB-FM, Providence — Licensed to Providence Journal Co., publisher of the Providence Journal-Bulletin.

WWON, WWON-FM, Woonsocket—Licensed to Woonsocket Broadcasting Co., whose principals include stockholders of Woonsocket Call.

SOUTH CAROLINA

WAIM, WCAC(FM), Anderson — Licensed to Wilton E. Hall, owner of Anderson Independent and Mail.

WTMA, WTMA-FM, Charleston — Licensed to Atlantic Coast Broadcasting Co.; affiliated with Charleston News & Courier and Post.

WFBC-AM-FM, Greenville—Licensed to WMRC Inc., 39% owned by Greenville News-Piedmont Co., publisher of Greenville News and Piedmont. See also WWNC Asheville, N. C.

WEAB, Greer—Licensed to Greer Bcstr. Co. Partner E. A. Burch is publisher of the weekly Greer Citizen.

WTND, Orangeburg—Licensed to the WTND Inc. Owned by Sims Publishing Co., publisher of Orangeburg Times & Democrat.

WSNW, Seneca—Licensed to Blue Ridge Broadcasting Co., owned by J. A. Gallimore and wife, publishers of weekly Seneca Journal, and Waihalla (S. C.) Keowee Courier.

WSSC, Sumter—Licensed to Radio Sumter, owned by J. A. Gallimore and wife, publisher of weekly Seneca (S. C.) Journal. See WSNW Seneca, S. C. and WLPA Lafayette, Ga.

SOUTH DAKOTA

KSDN, Aberdeen—Licensed to Aberdeen News Co., publishers of the American News (identified with Ridder Publications). For other Ridder newspapers see WCCO Minneapolis.

WNAX, Yankton—Licensed to Cowles Broadcasting Co. See KRNT, Des Moines.

TENNESSEE

WLAR, Athens—Licensed to Athens Broadcasting Co., owned by Lowell F. Arterburn, publisher Athens Post-Athenian.

WDSG, Dyersburg—Licensed to State Gazette Broadcasting Co., owned by Dyersburg State Gazette.

WTJS, WTJS-FM, Jackson—Licensed to Sun Publishing Co. Inc., publisher of Jackson Sun.

WETB, Johnson City—Licensed to the East Tennessee Broadcasting Co., ownership interlocks with Press Inc., publishers of Johnson City Press-Chronicle.

WKPT, WKPT-FM, Kingsport — Licensed to Kingsport Broadcasting Co. Identified with ownership of Kingsport Times-News.

WNOX, Knoxville—Licensed to Scripps-Howard Radio Inc., subsidiary of Scripps-Howard Newspapers (Knoxville News-Sentinel). See WCPO, Cincinnati.

WMC, WMC(FM), Memphis — Licensed to Memphis Publishing Co., publisher of Memphis Commercial Appeal a Scripps-Howard newspaper. See WCPO, Cincinnati.

WMAK, Nashville—Licensed to the Volunteer State Broadcasting Co., Frank Mayborn, president of the Temple Telegram, and the Sherman News, is 75% owner, and president.

WHAL, Shelbyville — Licensed to Shelbyville Broadcasting Co. Same owners as Bedford County News.

TEXAS

KBKI, Alice—Licensed to Alice Broadcasting Co. President E. G. Lloyd Jr. is stockholder of Alice News.

KVLF, Alpine—Licensed to Big Bend Broadcasters, 40% owned by Barney Hubbs owner of semi-weekly Pecos (Tex.) Enterprise. See KIUN Pecos, KRIG Odessa, KCMR McCamey, Tex.

KFDA, KFDA-FM, Amarillo — Licensed to Amarillo Bcstg. Co. C. C. Woodson, 25% stockholder, is owner-publisher of Brownwood Bulletin, Lamesa Reporter, Del Rio News-Herald, Wazachachie Light, all Texas, and Miami (Okla.) News-Record.

KGNC, Amarillo—Licensed to Plains Broadcasting Co. 80% of stock owned by Globe News Publishing Co. Inc., publisher of Amarillo News and Globe Times. Same interests also control Lubbock Avalanche and Journal. See KFYO Lubbock.

KREL, KREL-FM, Baytown—Licensed to Tri-Cities Broadcasting Co. President Robert Matherne is stockholder in Baytown Sun.

KRIC, KRIC-FM, Beaumont—Licensed to Enterprise Co., publishers Beaumont Enterprise and Journal.

KBST, Big Spring—Licensed to Big Spring Bcstg. Co., 20% owned by Robert Whipkey, publisher Big Spring Herald.

KFYN, Bonham—Licensed to Bonham Publishing Co., publisher of Bonham Favorite.

KCAR, Clarksville—Licensed to Texo Broadcasting Co. Reagan Hurt, 33½% owner, publisher of weekly Clarksville Times.

KMCO, Conroe—Licensed to Montgomery County Broadcasting Co. Stockholder D. C. Norton owns weekly Conroe Courier.

KRLD, KRLD-FM, Dallas—Licensed to KRLD Radio Corp.; subsidiary of Times Herald Printing Co., publishers Dallas Times-Herald.

WFAA, Dallas—Licensed to A. H. Belo Corp., publisher of the Dallas News.

KROD, El Paso — Licensed to the Roderick Broadcasting Corp., Dorrance D. Roderick, president is also majority stockholder of El Paso Times.

WBAP, WBAP-FM, Fort Worth—Licensed to Carter Publications Inc., publisher of Fort Worth Star-Telegram.

KGAF, Gainesville — Licensed to Gainesville Broadcasting Corp. President Joe M. Leonard is part owner of Gainesville Register.

KATL, Houston—Licensed to Texas Broadcasters Inc. Affiliated with Houston Press (no interlocking ownership).

KPRC, KPRC-FM, Houston—Licensed to Houston Post Co., publisher of Houston Post.

KTRH, KTRH-FM, Houston—Licensed to KTRH Broadcasting Co., subsidiary of Houston Chronicle Pub. Co., publisher of Houston Chronicle.

KPET, Lamesa—Licensed to R. O. Parker, R. A. Woodson and W. J. Beckham, Mr. Woodson, 37% owner, is half-owner of Lamesa Reporter and 5% owner of Brownwood Bulletin.

KLVT, Levelland—Licensed to Herald Broadcasting Co. Forrest Weimhold owner, also owns Levelland News-Sun and Hockley County Herald (Levelland).

KFYO, Lubbock — Licensed to Plains Radio Broadcasting Co. Same interests publish Lubbock Avalanche and Journal. See KGNC Amarillo.

KSEL, Lubbock—Licensed to News Inc., publisher of a chain of weekly newspapers in Texas suburban communities.

KCMR, McCamey — Licensed to Sprayberry Bcstg. Co., 40% owned by Barney Hubbs, owner of semi-weekly Pecos (Tex.) Enterprise.

KGNB, New Braunfels—Licensed to Comal Broadcasting Co. Charles W. Scruggs, president and 40% stockholder, owns New Braunfels Herald.

KRIG, Odessa—Licensed to Oil Center Broadcasting Co., part owned (25%) by Barney Hubbs, chief owner of semi-weekly Pecos (Tex.) Enterprise. See KIUN Pecos, KVLF Alpine, KCMR McCamey, Tex.

KIUN, Pecos—Licensed to Jack W. Hawkins and Barney H. Hubbs, Mr. Hubbs is chief owner of semi-weekly Pecos (Tex.) Enterprise. See KRIG Odessa, KVLF Alpine, KCMR McCamey, Tex.

KTSA, KTSA-FM, San Antonio — Licensed to Sunshine Broadcasting Co., owned by San Antonio Express and News.

KEVA, Shamrock—Licensed to Shamrock Broadcasting Co. Albert Cooper, 20% stockholder of station, owns 52% of weekly Shamrock Texan and Wheeler Times.

KKXO, Sweetwater—Licensed to Radio & News Inc. Owned by J. S. McBeath, owner of Sweetwater Reporter.

KTEM, KTEM-FM, Temple—Licensed to Bell Broadcasting Co. Frank W. Mayborn, president and 85% owner, also president and 95% owner of Bell Pub. Co., publisher of Temple Telegram.

KCMC, KCMC-FM, Texarkana — Licensed to KCMC Inc., identified with ownership of Texarkana Gazette and News.

KVWC, Vernon — Licensed to Northwestern Broadcasting Co. R. H. Nichols, 49% owner, is president and editor of Vernon Record.

KTBB, Tyler—Licensed to Blackstone Broadcasting Co. whose principal owners are also principal owners of Tyler Courier-Times and Telegraph.

KTRN, Wichita Falls—Licensed to Texoma Broadcasting Co. Owned 50% by Times Publishing Co., publisher of Wichita Falls Record-News and Times.

UTAH

KLO, Ogden—Licensed by Interstate Broadcasting Corp.; 62% owned by A. L. Glasman, publisher of Ogden Standard-Examiner.

KALL, Salt Lake City—Licensed to Salt Lake City Broadcasting Co., 28% owned by Mrs. Wilda Gene Hatch, who is 12.5% stockholder in Ogden Standard-Examiner. Owned by Telegram Pub. Co., publisher of Salt Lake Tribune Publishing Co., publisher of Salt Lake City Tribune and Telegram.

KDYL, KDYL-FM, Salt Lake City—Licensed to Intermountain Bcstg. & Tv Corp., owned 80% by Time Inc. (Time, Life, Fortune and Architectural Forum), and 20% by G. Bennett Larson.

VIRGINIA

WPIK, Alexandria—Licensed to Potomac Broadcasting Corp. C. C. Carlin Jr., publisher of the Alexandria Gazette, is stockholder.

WDVA, Danville—Licensed to Virginia-Carolina Broadcasting Co. Publisher of Danville Register is stockholder.

WGH, WGH-FM, Newport News—Licensed to Hampton Roads Broadcasting Corp.; 75% of stock owned by Daily Press Inc., publisher of Newport News Press and Times-Herald; 25% by Edward E. Bishop.

WTAR, WTAR-FM, Norfolk—Licensed to WTAR Radio Corp.; subsidiary of Norfolk Newspapers Inc., publisher of Norfolk Virginian-Pilot and Ledger-Dispatch.

WRNL, WRNL-FM, Richmond — Licensed to Richmond Newspapers, Inc., publisher of Richmond Times-Dispatch and News Leader.

WDBJ, WDBJ-FM, Roanoke—Licensed to Times-World Corp., publisher of Roanoke Times and World-News.

WASHINGTON

KPUG, Bellingham—Licensed to KPUG Inc., owned 50% by Jessica L. Longston, publisher of bi-weekly Burley (Ida.) Bulletin and St. Helens (Ore.) Sentinel Mist. See KBIO, Burley, Ida., KAYO Seattle, and KSEM Moses Lake, Wash.

KWLK, KWLK-FM, Longview — Licensed to Twin City Broadcasting Corp.; 72% of stock owned by Longview Pub. Co., publisher of Longview News.

KSEM, Moses Lake—Licensed to KSEM Inc., owned 56% by Jessica L. Longston, publisher of bi-weekly Burley (Ida.) Bulletin and St. Helens (Ore.) Sentinel Mist. See KBIO, Burley, Ida.; KPUG Bellingham and KAYO Seattle, Wash.

KONP, Port Angeles—Licensed to Radio Pacific, Inc., subsidiary of Port Angeles News.

KAYO (formerly KRSC), Seattle—Licensed to Washington Telecasters Inc., 52% owned by Jessica L. Longston, publisher of bi-weekly Burley (Ida.) Bulletin and St. Helens (Ore.) Sentinel Mist. See KPUG Bellingham, KSEM Moses Lake, both Wash., and KBIO Burley, Ida.

KHQ, Spokane—Licensed to KHQ Inc. Same ownership as Spokane Chronicle.

KNEW, Spokane—Licensed to Inland Empire Bcstg. Co., 40% owned by Burl C. Hagadone, 40% by Scripps Newspapers Inc., and 20% by Harry Henke Jr. For Mr. Hagadone's and Scripps Newspapers' newspaper interests, see KVIN Coeur d'Alene, Ida.

KTNT, KTNT-FM, Tacoma—Licensed to the Tribune Publishing Co., publisher of Tacoma News-Tribune.

KVAN, Vancouver—Licensed to KVAN Inc., controlled by Sheldon F. Sackett, publisher of Coos Bay Times, 95% owner of KOOS, Coos Bay, and 90% of KROW Oakland, Calif.

WEST VIRGINIA

WHIS, Bluefield—Licensed to Daily Telegraph Printing Co., publisher of Bluefield Telegraph and Sunset News.

WBLK, Clarksburg—Licensed to Ohio Valley Bcstr. Corp., owned by News Pub. Co., publisher of Wheeling (W. Va.) Intelligencer and News-Register and other W. Va. newspapers. See WPAR Parkersburg, W. Va.

WDNE, Elkins—Licensed to West Virginia Radio Corp. (See WAJR Morgantown, W. Va., WJER Dover, Ohio.)

NEWSPAPER OWNERSHIP

WVWV, WJPB(FM), Fairmont — Licensed to Fairmont Broadcasting Co. J. Patrick Beacom, owner, publishes *Mannington* (W. Va.) *Times*.

WSAZ, Huntington—Licensed to WSAZ Inc., 89% of stock owned by Huntington Publishing Co., publisher of *Huntington Herald-Dispatch* and *Advertiser*.

WLOG, WLOG-FM, Logan—Licensed to Clarence H. Frey, publisher of the *Logan Banner*, and Robert O. Greever, partners.

WAJR, WAJR-FM, Morgantown — Licensed to West Virginia Radio Corp. Mrs. A. J. R. Greer, president, owns stock in West Virginia Publishing Co., publishers of *Morgantown Post* and *Dominion News*; *New Martinsville Wetzel Republican*. (See *WJER* Dover, Ohio; *WDNE* Elkins, W. Va., and *WKJF(FM)* Pittsburgh, Pa.)

WPAR, WPAR-FM, Parkersburg—Licensed to Ohio Valley Broadcasting Corp., owned by News Publishing Co., publishers of the *Intelligencer* and *News-Register*, Wheeling, and other W. Va. newspapers. See *WBLK* Clarksburg, W. Va.

WBRW, Welch—Licensed to McDowell Service Co.; ownership includes W. R. Keyser, 25 shares, editor *Welch Daily News*; Clarence H. Frey, 25 shares, publisher, *Logan Banner*.

WVVA, WVVA-FM, Wheeling — See *WGBS*, Miami, Fla.

WISCONSIN

WATK, Antigo—Licensed to Antigo Broadcasting Co. Artemas F. Berner, 90% owner, is co-publisher of weekly *Antigo Journal*.

WGEZ, Beloit—Licensed to Beloit Broadcasting Co., owned by Sidney H. Bliss and family, owners of *Janesville* (Wis.) *Gazette*. See *WCLO* Janesville, Wis.

WEAU, WEAU-FM, Eau Claire—Licensed to Central Broadcasting Co.; 25% of stock owned by Eau Claire Press Co., publisher of *Eau Claire Telegram* and *Leader*; 54½% owned by Morgan Murphy (and wife), publisher of *Superior Telegram*. See *WEBC* Duluth, Minn.

KFIZ, Fond du Lac—Licensed to KFIZ Broadcasting Co. Same owners as *Fond du Lac Commonwealth Reporter*.

WJPG, Green Bay—Licensed to the Green Bay Newspaper Co., publisher of *Green Bay Press Gazette*.

WCLO, WCLO-FM, Janesville — Licensed to Southern Wisconsin Radio Inc., subsidiary of *Gazette Printing Co.*, publisher of *Janesville Gazette*. See also *WGEZ*, Beloit, Wis.

WKTY, LaCrosse—Licensed to LaCrosse Broadcasting Co., affiliated with *LaCrosse Tribune*.

WIBA, WIBA-FM, Madison—Licensed to Badger Broadcasting Co., Inc.; 86¾% owned by the *Capital Times* Co., publisher of *Madison Capital Times*. Other stockholders and directors include officers of the Wisconsin State Journal Publishing Co., publishers of the *Wisconsin State Journal* (Lee Syndicate). See *KGLO*, Mason City, Ia.

WISC, WISC-FM, Madison—Licensed to Radio Wisconsin Inc. controlled by Morgan Murphy, publisher of *Superior* (Wis.) *Telegram*. See *WEBC* Duluth, Minn.

WIGM, Medford—Licensed to M & N Bcstg. Co. Stockholders Harold R. Murphy and Harvey J. Kitz own *Northshore Publishing Co.*, publisher of *Weekly Shorewood Herald* and *Whitefish Bay Herald*, Wis.

WEMP, WEMP-FM, Milwaukee—Licensed to Milwaukee Broadcasting Co. Owned 26.6% by Mid Continent Radio-Television Inc. Mid Continent is 50% owned by Northwest Publications Co. (Ridder interests.) For other Ridder newspapers, see *WCCO* Minneapolis.

WISN, Milwaukee—Licensed to Hearst Corp. Affiliated with *Milwaukee Sentinel*. For other Hearst newspapers see *WBAL* Baltimore, Md.

WTMJ, Milwaukee—Licensed to The Journal Co., publisher of *Milwaukee Journal*.

WPDR, Portage—Licensed to Portage Bcstg. Co. W. T. Comstock, president and 92% stockholder, is general manager and majority stockholder of *Comstock Pub. Co.*, publisher of *Portage Register & Democrat*.

WRJN, WRJN-FM, Racine—Licensed to Racine Broadcasting Corp. Same ownership as *Racine Journal-Times*.

WTCH, Shawano—Licensed to Shawano County Leader Pub. Co., publisher of *Shawano Leader*.

WHBL, WHBL-FM, Sheboygan — Licensed to WHBL Inc. Press Publishing Co., publisher of *Sheboygan Press*, owns 100% of preferred stock.

WOKW, Sturgeon Bay—Licensed to Door County Radio Co. President Chandler F. Harris is publisher of weekly *Door County Advocate*.

WDSM, Superior—Licensed to WDSM Inc., which is owned by Northwest Publications (Ridder Publications Inc.). Affiliated with *Duluth Herald* and *News-Tribune*. For other Ridder publications see *WCCO*, Minneapolis, Minn.

WFHR, WFHR-FM, Wisconsin Rapids—Licensed to Wm. F. Huffman Radio Inc. Mrs. Huffman is principal owner Wisconsin Rapids Tribune Co., publishers *Wisconsin Rapids Tribune*.

WYOMING

KVOC, Casper—Licensed to KVOC Broadcasting Co. Affiliated through stockholders with *Casper Tribune-Herald*.

KFBC, Cheyenne—Licensed to Frontier Bcstg. Co.; 33% owned by Cheyenne Newspapers Inc., publisher of the *Wyoming Eagle* and *State Tribune*.

KOVE, Lander—Licensed to Edward J. Breece, publisher of semi-weekly *Wyoming State Journal*.

KRAL, Rawlins—Licensed to Rawlins Broadcasting Co., affiliated with *Rawlins Times*.

ALASKA

KENI, Anchorage—Licensed to Midnight Sun Bcstg. Co. See *KFAR*.

KFAR, Fairbanks—Licensed to Midnight Sun Broadcasting Co., controlled by the estate of the late A. E. Lathrop, also publisher of the *Fairbanks News-Miner*.

HAWAII

KHBC, Hilo—Licensed to Hawaiian Broadcasting System Ltd. See *KGMB* Honolulu.

KGMB, Honolulu—Licensed to Hawaiian Broadcasting System Ltd.; 24.25% of stock owned by *Honolulu Star-Bulletin*.

KGU, Honolulu—Licensed to Advertiser Publishing Co. Ltd., publisher of *Honolulu Advertiser*.

KTOH, Lihue—Licensed to Garden Island Publishing Co. Ltd., publisher of *Garden Island* (weekly).

KMVI, Wailuku, Maui—Licensed to Maui Publishing Co., Ltd., publisher of *Maui News*.

PUERTO RICO

WKAQ, San Juan—Licensed to El Mundo Bcstg. Co. Same ownership as *El Mundo*.

CANADIAN BROADCASTING CORPORATION EXECUTIVES

BOARD OF GOVERNORS: A. Davidson Duntun, Ottawa, Ont., Chairman; Rene Morin, Montreal, Que., Vice-Chairman; Dean Adrien Pouliot, Quebec, P.Q.; Professor J. A. Corry, Kingston, Ont.; Dr. G. Douglas Steel, Charlottetown, P.E.I.; W. H. Phillips, Ottawa, Ont.; Frederick J. Crawford, Toronto, Ont.; Jesse P. Tripp, Oxbow, Sask.; Mrs. Mary E. Farr, Victoria, B.C.; Gordon A. Winter, St. John's, Nfld.; Roy J. Fry, Winnipeg, Man.

OTTAWA: Victoria Bldg., 140 Wellington St., Ottawa, Ont., P.O. Box 806, Ottawa, Ont. J. A. Oulmet, General Manager; E. L. Bushnell, Assistant General Manager, and Co-ordinator of Television; G. W. Richardson, Executive Assistant; F. W. Savignac, Executive Assistant; L. J. D. C. McArthur, Executive Assistant; Charles Jennings, Director of Programs; Marcel Oulmet, Assistant Director of Programs; J. P. Gilmore, Assistant to Co-ordinator of Television; A. G. Walker, Director of Network Co-ordination; H. M. Palmer, Program Organizer TV Network; George Young, Director of Station Relations and Broadcast Regulations; W. E. Powell, Commercial Manager; R. C. Fraser, Director of Press and Information Services; G. W. Richardson, Director of Engineering; N. M. Morrison, Supervisor of Talks and Public Affairs; A. K. Morrow, Supervisor of Farm and Fisheries Broadcasts; H. Bramah, Treasurer; S. Schnobb, Assistant to Treasurer; W. R. Mortimer, Supervisor of Expenditures; R. E. Keddy, Secretary to Board of Governors; V. F. Segee, Editor, Staff Magazine "RADIO"; M. Carter, Director of Personnel and Administrative Services; C. E. Stiles, Assistant to Director, Personnel and Administrative Services; K. M. Kelly, Supervisor of Personnel and Welfare; G. G. Dupre, Supervisor of Central Registries; J. P. Maisonneuve, Administrative Assistant; V. A. Nagle, Administrative Assistant; J. A. Lapointe, Industrial Relations Officer.

QUEBEC REGION: Radio Canada Bldg., 1425 Dorchester St., West, Montreal, P.Q., P.O. Box 6000, Montreal, R. P. Landry, Director for the Province of Quebec; Gaston Quessy, Assistant to the Director for the Province of Quebec; Aurele Seguin, Program Director for the Province of Quebec; J. Saint-George, Director of Sound Broadcasting (Montreal); D. G. McKinstry, Chief Architect; J. E. Hayes, Chief Engineer; W. A. Nichols, Assistant Chief Engineer; H. Audet, Quebec Regional Engineer; N. R. Olding, Operations Engineer; J. Carlisle, Plant Engineer; R. E. Santo, Transmission and Develop-

ment Engineer; E. C. Stewart, Co-ordinator of Engineering Projects and Services; M. D. Peterkin, Purchasing Agent; G. G. Yull, Supervisor of Stores; Robert Elle, Supervisor of Press and Information (French); R. Charbonneau, Editor *CBC Times* (French); B. Lafleur, Supervisor of Talks and Public Affairs (French); A. Berube, Supervisor of Farm and Fisheries Broadcasts (French); R. David, Supervisor of School Broadcasts (French); D. E. McGill, Program Director (CBM Montreal); G. Lamarche, Program Director (CBF Montreal); Maurice Vaillette, Commercial Manager (French); M. Goudault, Supervisor of Station Relations; Aurele Seguin, Director of Television, Montreal.

ONTARIO REGION: 354 Jarvis St., Toronto 5, Ont. Ira Dilworth, Director for Ontario; W. K. Moyer, Administrative Assistant to Director for Ontario; H. J. Boyle, Regional Program Director for Ontario; H. Z. Palmer, Supervisor of Program Production; R. S. Lambert, Supervisor of School Broadcasts; W. H. Hogg, Chief News Editor; W. H. Brodie, Supervisor of Broadcast Language; W. J. Dunlop, Supervisor of International Exchange and Institutional Broadcasts; E. W. Jackson, Traffic Manager; A. E. Powley, Supervisor of Outside Broadcasts; H. E. S. Hamilton, Supervising Engineer (Network); D. J. Van Bommel, Manager of Personnel and Administration Services; W. R. Johnston, Assistant Commercial Manager; W. H. Clark, Senior Sales Representative; W. G. Carpenter, Sales Representative; J. Kennedy, Sales Representative (Television); Miss Anne Bergin, Supervisor of Commercial Acceptance and Production; J. Crawford, Assistant Sales Representative; Arthur Barr, Sales and Commercial Traffic; H. F. Chevrier, CBC Statistician; R. S. Bryden, Assistant to the Director, Press and Information Services; T. C. Fairley, Editor *CBC Times* (Eastern); W. C. Walls, Press and Information Representative; E. S. Coatsworth, Press and Information Representative (tv); J. G. Murphy, Supervisor of Publicity; Geoffrey Gordon, Manager, Information Bureau; Miss Marjorie C. Beaton, Reference Librarian; Walter Anderson, Supervisor of Program Clearance; R. W. McGill, Director of Radio (Toronto); E. Misenar, Supervisor of Music Library and Copyright Clearance; H. R. Hilliard, Ontario Regional Engineer; M. L. Poole, Manager (CBE Windsor, Ont.) Security Bldg., Windsor, Ont.; C. P. Wright, Director, (CBO and CBOT Ottawa, Ont.) Chateau Laurier Hotel, Ottawa, Ont.; Fergus Mutrie, Director of Television, Toronto.

PRAIRIE REGION: 541 Portage Avenue West, Winnipeg, Man., P. O. Box 160, Winnipeg, Man. J. R. Finlay, Regional Representative; D. E. Cameron, Regional Program Director; J. N. Mordridge, Station Manager (CBK-CBW Watrous, Sask., and Winnipeg, Man.); R. D. Cahoon, Regional Engineer; R. L. Horley, Sales Representative; D. Claringbull, Station Manager, (CBX Edmonton) MacDonald Hotel, Edmonton, Alberta); C. E. L'Ami, Press and Information Representative.

BRITISH COLUMBIA REGION: 701 Hornby St., Vancouver, B. C. Kenneth Caple, B. C. Regional Representative; J. D. Nixon, Regional Program Director; F. B. C. Hilton, Regional Engineer; H. W. Faulson, Sales Representative; W. G. Clark, Press and Information Representative; Peter McDonald, Director of Television; W. C. Hankinson, Manager, (CFPR Prince Rupert) 336 2nd Avenue West, Prince Rupert, B.C.

MARITIME REGION: United Services Bldg., 100 Sackville St., Halifax, N. S., P.O. Box 175, Halifax, N.S. W. E. S. Briggs, Maritime Regional Representative; S. R. Kennedy, Regional Program Director, and Station Manager (CBH Halifax, N.S.); H. M. Smith, Regional Engineer (CBC Sackville, N.B.); L. B. MacDonald, Station Manager (CBI Sydney, N.S.); Lyal Brown, Press and Information Representative.

NEWFOUNDLAND REGION: St. John's, Nfld., P.O. Box E5372, St. John's, Nfld. Wm. Galgay, Regional Representative; E. D. Witherstone, Area Engineer.

CBC INTERNATIONAL SERVICE: Radio Canada Bldg., 1425 Dorchester Street West, Montreal, Que., P.O. Box 6000, Montreal, P.Q. J. Desy, Director General, International Service; C. R. DeLafield, Assistant Director General of the International Service.

CBC OVERSEAS OFFICE: c/o BBC, 200 Oxford St., London W.1, England; Andrew G. Cowan, European Representative; Matthew Halton, European Correspondent.

NEW YORK OFFICE: Canadian Broadcasting Corp., c/o United Nations, New York City, N.Y., U.S.A. Margaret Fielder.

CONSULTING RADIO ENGINEERS

GEORGE P. ADAIR—George P. Adair Engineering Co., 1610 I St., N.W., Washington 6, D. C. Tel.: Executive 1230, 5851. Associate engineers: Robert E. Ritch, Charles W. Bumgardner.

ADLER COMMUNICATIONS LABS.—1 LeFevre Lane, New Rochelle, N. Y. Tel.: New Rochelle 6-1620. Ben Adler. Staff: Harry Adler, Harold L. Danson, Alfred Strogoff, Leland J. Burnett Jr., Harold W. Kaye, Louis Katz.

BEN ADLER—Adler Communications Labs., 1 LeFevre Lane, New Rochelle, N. Y. Tel.: New Rochelle 6-1620.

HARRY ADLER—Adler Communications Labs., 1 LeFevre Lane, New Rochelle, N. Y. Tel.: New Rochelle 6-1620.

LLOYD R. AMOO—3709 Carpenter Ave., Des Moines, Iowa. Tel.: 7-9272.

W. E. ANTONY—Post Office Box 1387, Shreveport 92, La. Tel.: 2-8711. Partner: O. S. Droke. Associate: E. S. Gunning.

STUART L. BAILEY—Jansky & Bailey Inc., 1339 Wisconsin Ave., N.W., Washington 7, D. C. Tel.: Adams 4-2414.

LEE E. BAKER—Consulting Radio Engineer 286-28 Landers Bldg., Springfield 4, Mo. Tel.: 2-1951.

ROBERT E. BALUTA—Frank H. McIntosh, Wyatt Bldg., 777 14th St., N.W., Washington 5, D. C. Tel.: Metropolitan 8-4477.

WILLIS C. BEECHER—Kear & Kennedy, 1302 18th St., N.W., Washington 6, D. C. Tel.: Hudson 3-9000.

GEORGE P. BEGUE—Jansky & Bailey Inc., 1339 Wisconsin Ave., N.W., Washington 7, D. C. Tel.: 4-2414.

STANTON D. BENNETT—3437 36th Ave., West, Seattle 99, Wash. Tel.: Garfield 2451.

PAUL BENNEWITZ—Walter J. Stiles, 115 W. Drachman, Tucson, Ariz., (KOPO-TV). Tel.: 4-2511.

WILLIAM E. BENNS JR.—3738 Kanawha St., N.W., Washington, D. C. Tel.: Emerson 2-8071, Box 1447, Montgomery, Ala. Tel.: 2-3851.

ERGE BERGEN—Commercial Radio Equipment Co., 1319 F St., N.W., Washington 4, D. C. Tel.: District 7-1319.

BERNARD ASSOCIATES — 5010 Sunset Blvd., Hollywood 27, Calif. Tel.: Normandy 2-6715.

JAMES R. BIRD—P.O. Box 1032, Oroville, Calif. Tel.: 1340.

A. R. BITTER—A. R. Bitter Consulting Radio Engineer, 3106 Algonquin Pkwy., Toledo 6, Ohio. Tel.: Kingswood 5159.

RALPH J. BITZER—Fred O. Grimwood & Co., 2025-26 Railway Exchange Bldg., St. Louis 1, Mo. Tel.: Chestnut 4977.

MARVIN BLUMBERG—A. D. Ring & Assoc., 342 Munsey Bldg., Washington 4, D. C. Tel.: Republic 7-2347.

RUSSELL L. BOARDMAN—Page, Creutz, Garrison & Waldschmitt, 710 14th St., N.W., Washington 5, D. C. Tel.: Executive 3-5670.

DAVID F. BOWMAN—Weldon & Carr, 1001 Connecticut Ave., N.W., Washington 6, D. C. Tel.: Sterling 3-2550.

CHARLES L. BRADY—Frank H. McIntosh, Wyatt Bldg., 777 14th St., N.W., Washington 5, D. C. Tel.: Metropolitan 8-4477.

DAVID F. BRITTLE JR.—Page, Creutz, Garrison & Waldschmitt, 710 14th St., N.W., Washington 5, D. C. Tel.: Executive 3-5670.

BROWN DUNCAN & PORTER INC.—P.O. Box 9296, Raleigh, N. C.

CHARLES W. BUMGARDNER—George P. Adair Engineering Co., 1610 I St., N.W., Washington 6, D. C. Tel.: Executive 3-1230.

LELAND J. BURNETT JR.—Adler Communications Labs., 1 LeFevre Lane, New Rochelle, N. Y. Tel.: New Rochelle 6-1620.

RALPH E. CANNON—A. D. Ring & Assoc., 342 Munsey Bldg., Washington 4, D. C. Tel.: Republic 7-2347.

LESTER H. CARR—Weldon & Carr, 1001 Connecticut Ave., N.W., Washington 6, D. C. Tel.: Sterling 3-2550.

JOHN M. CARTER—Jansky & Bailey Inc., 1339 Wisconsin Ave., N.W., Washington 7, D. C. Tel.: Adams 4-2414.

JULES COHEN—Vandivere, Cohen & Wearn, 1420 New York Ave., N.W., Washington 5, D. C. Tel.: National 8-2698.

JULIUS COHEN—George C. Davis, 504 Munsey Bldg., Washington 4, D. C. Tel.: Sterling 3-0111.

JOE W. COLLIER—George C. Davis, 504 Munsey Bldg., Washington 4, D. C. Tel.: Sterling 3-0111.

WILLIAM H. COLLINS—Page, Creutz, Garrison & Waldschmitt, 710 14th St., N.W., Washington 5, D. C. Tel.: Executive 3-5670.

COMMERCIAL RADIO EQUIPMENT CO.—1319 F St., N.W., Washington 4, D. C. Tel.: District 7-1319. General Manager: Everett L. Dillard. Engineering Manager: Edward F. Lorentz. Associate Engineers: Charles C. Worsley, Serge Bergen. Midwest Office: P.O. Box 7037, Kansas City, Mo. Tel.: Jackson 5302. Allocation Engineering: Robert Wolfskill.

ROBIN COMPTON—George C. Davis, 504 Munsey Bldg., Washington 4, D. C. Tel.: Sterling 3-0111.

SIDNEY CORDERMAN — Frank H. McIntosh, Wyatt Bldg., 777 14th St., N.W., Washington 5, D. C. Tel.: Metropolitan 8-4477.

CRAVEN, LOHNES & CULVER—1242 Munsey Bldg., Washington 4, D. C. Tel.: District 7-8215.

T. A. M. Craven, George M. Lohnes, Ronald H. Culver.

T. A. M. Craven—Craven, Lohnes & Culver, 1242 Munsey Bldg., Washington 4, D. C. Tel.: District 7-8215.

JOHN CREUTZ—Page, Creutz, Garrison & Waldschmitt, 710 14th St., N.W., Washington 5, D. C. Tel.: Executive 3-5670.

ELLIOTT CROOKS—Hogan Laboratories, Inc., 155 Perry St., New York 14, N. Y. Tel.: Chelsea 2-7855.

MURRAY G. CROSBY—Crosby Laboratories Inc., Box 233, Robbins Lane, Hicksville, L. I., New York. Tel.: Hicksville 3-3191.

JAMES R. CROY—Frank H. McIntosh, Wyatt Bldg., 777 14th St., N.W., Washington 5, D. C. Tel.: Metropolitan 8-4477.

A. EARL CULLUM JR.—Consulting Radio Engineers, Highland Park Village, Dallas 5, Texas. Tel.: Justin 5108. Partners: D. A. Peterson, T. A. Wright Jr., C. M. Daniell. Associate Engineers: J. G. Rountree, K. B. Landress.

RONALD H. CULVER—Craven Lohnes & Culver, 1242 Munsey Bldg., Washington 4, D. C. Tel.: District 7-8215.

ELIZABETH L. DAHLBERG—Frank H. McIntosh, Wyatt Bldg., 777 14th St., N.W., Washington 5, D. C. Tel.: Metropolitan 8-4477.

C. M. DANIELL—A. Earl Cullum Jr., Village Branch Post Office, Box 8026, Dallas 5, Texas. Tel.: Justin 6108.

HAROLD L. DANSON—Adler Communications Labs., 1 LeFevre Lane, New Rochelle, N. Y. Tel.: New Rochelle 6-1620.

DAVID & BARBEAU—Schenectady, N. Y. Partners: W. Russell David Sr., Ernest A. Barbeau.

GEORGE C. DAVIS—Consulting Radio Engineers, 504 Munsey Bldg., Washington 4, D. C. Tel.: Sterling 3-0111. Associates: Joe W. Collier, Julius Cohen, Ralph Dippell, Walter L. Davis, Robin Compton.

WALTER L. DAVIS—George C. Davis, 504 Munsey Bldg., Washington 4, D. C. Tel.: Sterling 3-0111.

EDWARD W. DEETERS—William L. Foss Inc., 927 15th St., N.W., Washington, D. C. Tel.: Republic 7-3883.

WILLIAM T. DICKINSON—Jansky & Bailey, Inc., 1339 Wisconsin Ave., N.W., Washington 7, D. C. Tel.: Adams 4-2414.

EVERETT L. DILLARD — Commercial Radio Equipment Co., 1319 F St., N.W., Washington 4, D. C. Tel.: District 7-1319.

RALPH E. DIPPPELL JR.—George C. Davis, 504 Munsey Bldg., Washington 4, D. C. Tel.: Sterling 3-0111.

DIXIE SERVICE CO.—P.O. Box 1435, Anniston, Ala. Tel.: 5011-J. Raymond C. Watson Jr.

RAYMOND DORDAL—A. D. Ring & Assoc., 342 Munsey Bldg., Washington 4, D. C. Tel.: Republic 7-2347.

O. S. DROKE—Post Office Box 1387, Shreveport 92, La. Tel.: 2-8711. Partner: W. E. Antony. Associate: E. S. Gunning.

R. S. DUNCAN—James C. McNary, National Press Bldg., Washington 4, D. C. Tel.: District 7-1205.

VIGOR L. DUNCAN—Brown, Duncan & Porter Inc., P.O. Box 9296, Raleigh, N. C. Tel.: 8892.

L. J. N. DUTREIL—L. J. N. Dutreil & Assoc., 204 Hometown Ave., New Orleans 24, La. Tel.: Audubon 3525, 0917.

A. JAMES EBEL — Consulting Engineer, 212 South Jefferson St., Peoria 2, Ill. Tel.: 6-0711.

JOHN P. EGBERT—Page, Creutz, Garrison & Waldschmitt, 710 14th St., N.W., Washington 5, D. C. Tel.: Executive 3-5670.

DAWKINS ESPY — 10620 Wilshire Blvd., Los Angeles, Calif. Tel.: Arizona 8-8922.

PERRY W. ESTEN—Page, Creutz, Garrison & Waldschmitt, 710 14th St., N.W., Washington 5, D. C. Tel.: Executive 3-5670.

JOSEPH FORNO—Page, Creutz, Garrison & Waldschmitt, 710 14th St., N.W., Washington 5, D. C. Tel.: Executive 3-5670.

WILLIAM L. FOSS INC.—927 15th St., N.W., Washington 5, D. C. Tel.: Republic 7-3883. President: Edward W. Deeters.

THOMAS B. FRIEDMAN—2830 Van Aken Blvd., Cleveland 20, Ohio. Tel.: Skyline 1-8618.

MILLARD M. GARRISON—Page, Creutz, Garrison & Waldschmitt, 710 14th St., N.W., Washington 5, D. C. Tel.: Executive 3-5670.

GAUTNEY & JONES—1052 Warner Bldg., Washington 4, D. C. Tel.: National 8-7757.

D. W. GELLERUP—5437 North Santa Monica Blvd., Milwaukee 11, Wis. Tel.: Woodruff 2-5172.

JOHN D. GILBERT—Weldon & Carr, 1001 Connecticut Ave., N.W., Washington 6, D. C. Tel.: Sterling 3-2550.

THEODORE A. GILES—Fred O. Grimwood & Co., 2025-26 Railway Exchange Bldg., St. Louis 1, Mo. Tel.: Chestnut 4977.

PAUL F. GODLEY—Paul Godley Co., Great Notch, N. J. Tel.: Montclair 3-3000.

PAUL GODLEY CO.—Upper Montclair, N. J. Tel.: Montclair 3-3000. Offices & Laboratories: Great Notch, N. J. Associates: Paul F. Godley Jr., Carson W. Kaufman, J. G. Littlefield.

PAUL F. GODLEY JR.—Paul Godley Co., Great Notch, N. J. Tel.: Montclair 3-3000.

DR. ALFRED N. GOLDSMITH—597 Fifth Ave., New York 17, N. Y. Tel.: Plaza 3-4150.

CLAUDE M. GRAY—P.O. Box 602, Birmingham 1, Ala. Tel.: 2-3570.

FRED O. GRIMWOOD & CO.—2025-26 Railway Exchange Bldg., St. Louis 1, Mo. Tel.: Chestnut 4977. President: S. C. Grimwood, Vice President and Chief Engineer: Ralph J. Bitzer, Superintendent for Construction and Field Engineering: Theodore A. Giles.

S. C. GRIMWOOD—Fred O. Grimwood & Co., 2025-26 Railway Exchange Bldg., St. Louis 1, Mo. Tel.: Chestnut 4977.

ZIGMUND V. GROBOWSKI—Jansky & Bailey Inc., 1339 Wisconsin Ave., N.W., Washington 7, D. C. Tel.: Adams 4-2414.

E. S. GUNNING—W. E. Antony & O. S. Droke, P.O. Box 1387, Shreveport 92, La. Tel.: 2-8711.

A. C. HAGAMAN—Weldon & Carr, 1001 Connecticut Ave., N.W., Washington 6, D. C. Tel.: Sterling 3-2550.

ROBERT L. HAMMETT—230 Bankers Investment Bldg., San Francisco 2, Calif. Tel.: Sutter 1-7545.

HOWARD T. HEAD—A. D. Ring & Assoc., 342 Munsey Bldg., Washington 4, D. C. Tel.: Republic 7-2347.

JOHN B. HEFFELFINGER—815 East 83rd St., Kansas City 10, Mo. Tel.: Hilland 7010.

JOHN V. L. HOGAN—155 Perry St., New York 14, N. Y. Tel.: Chelsea 2-7855.

W. J. HOLEY—1146 Briarcliff Place, N.E., Atlanta, Ga. Tel.: Atwood 3328.

KENNETH M. HOLLINGSWORTH—Page, Creutz, Garrison & Waldschmitt, 710 14th St., N.W., Washington 5, D. C. Tel.: Executive 3-5670.

JAMES L. HOLIS—Page, Creutz, Garrison & Waldschmitt, 710 14th St., N.W., Washington 5, D. C. Tel.: Executive 3-5670.

G. PORTER HOUSTON—Page, Creutz, Garrison & Waldschmitt, 710 14th St., N.W., Washington 5, D. C. Tel.: Executive 3-5670.

GUY C. HUTCHESON—1100 W. Abrams St., P.O. Box 32, Arlington, Tex. Tel.: 4-8721.

EDWARD IANNELLI—5010 Sunset Blvd., Hollywood 27, Calif. Tel.: Normandy 2-6715.

EDWARD W. JACKER—Church Road, Elmhurst (suburban Chicago), Ill. Tel.: Elmhurst 3610.

JOHN J. JANSEN—Page, Creutz, Garrison & Waldschmitt, 710 14th St., N.W., Washington 5, D. C. Tel.: Executive 3-5670.

JANSKY & BAILEY—1339 Wisconsin Ave., N.W., Washington 7, D. C. Tel.: Adams 4-2414. C. M. Jansky Jr., Stuart L. Bailey, Engineers: Delmer C. Forts, Frank T. Mitchell Jr., Oscar W. B. Reed Jr., John J. Renner, William T. Dickinson, Neil G. Schairer, Raymond E. Rohrer, Zigmund V. Grobowski, Clarence H. Stewart II, George P. Begne, Casimir A. Zielsinski, William B. Valentine, John M. Carter, Nugent S. Sharp.

C. M. JANSKY JR.—Jansky & Bailey Inc., 1339 Wisconsin Ave., N.W., Washington 7, D. C. Tel.: Adams 4-2414.

RALPH W. JENSEN—Page, Creutz, Garrison & Waldschmitt, 710 14th St., N.W., Washington 5, D. C. Tel.: Executive 3-5670.

AM ■ TV
ENGINEERING

A COMPLETE SERVICE

- applications
- tv site selection
- am channel surveys
- hearing exhibits
- directional antenna design
- directional antenna proof-of-performance
- am-fm-tv (vhf and uhf) field intensity surveys
- CAA tower clearance
- studio design
- installation supervision
- equipment selection

DAWKINS ESPY

10620 Wilshire Blvd.
Los Angeles, California

■

Arizona 88922

LOUIS KATZ—Adler Communications Labs., 1 LeFevre Lane, New Rochelle, N. Y. Tel.: New Rochelle 6-1620.
 CARSON W. KAUFFMAN—Paul Godley Co., Great Notch, N. J. Tel.: Montclair 3-3000.
 HAROLD W. KAYE—Adler Communications Labs., 1 LeFevre Lane, New Rochelle, N. Y. Tel.: New Rochelle 6-1620.
 WALTER F. KEAN—1 Riverside Road, Riverside, Ill. Tel.: Riverside 7-2153. Associate: George Sklom.
 FRANK G. KEAR—Kear & Kennedy, 1302 18th St., N.W., Washington 6, D. C. Hudson 3-9000.
 KEAR & KENNEDY—1302 18th St., N.W., Washington 6, D. C. Tel.: Hudson 3-9000. Partners: Frank G. Kear, Robert L. Kennedy, Willis C. Beecher.
 JOHN J. KEEL—1121 East Capitol St., Washington 3, D. C. Tel.: Lincoln 4-5131.
 ROBERT L. KENNEDY—Kear & Kennedy, 1302 18th St., N.W., Washington 6, D. C. Tel.: Hudson 3-9000.
 STEPHEN W. KERSHNER—A. D. Ring & Assoc., 342 Munsey Bldg., Washington 4, D. C. Tel.: Republic 7-2347.
 J. GORDON KEYWORTH—Berkshire Drive, Williamstown, Mass. Tel.: 869.
 CARL L. KOWALSKI—Robert M. Silliman & Assoc., 1405 G St., N.W., Washington 5, D. C. Tel.: Republic 7-6646.
 AMBROSE W. KRAMER—Raymond M. Wilmoth, 1469 Church St., N.W., Washington 5, D. C. Tel.: Decatur 2-1231.
 K. B. LANDRESS—A. Earl Cullum Jr., Highland Park Village, Dallas, Texas. Justin 6108.
 J. G. LITTLEFIELD—Paul Godley Co., Great Notch, N. J. Tel.: Montclair 3-3000.
 GEORGE M. LOHNES—Craven Lohnes & Culver, 1242 Munsey Bldg., Washington 4, D. C. Tel.: District 7-8215.
 EDWARD F. LORENTZ—Commercial Radio Equipment Co., 1319 F St., N.W., Washington 4, D. C. Tel.: District 7-1319.
 HARRY R. LUBCKE—2443 Creston Way, Hollywood 28, Calif. Tel.: Hollywood 9-3286.
 RUSSELL P. MAY—711 14th St., N.W., Washington 5, D. C. Tel.: Republic 7-3984.
 WINFIELD SCOTT McCACHREN & ASSOC.—2404 Columbia Pike, Arlington 4, Va. Tel.: Jackson 8-9096.
 FRANK H. MCINTOSH—Wyatt Bldg., 777 14th St., N.W., Washington 5, D. C. Tel.: Metropolitan 8-4477. Associates: Robert E. Baluta, James R. Crox, Elizabeth L. Dahlberg, Charles L. Brady, JOHN H. McMAHON—Weldon & Carr, 1001 Connecticut Ave., N.W., Washington 6, D. C. Tel.: Sterling 3-2550.
 JAMES C. McNARY—National Press Bldg., Washington 4, D. C. Tel.: District 7-1205. R. S. Duncan, C. P. Horne, Bernard R. Segal.
 FRANK T. MITCHELL JR.—Jansky & Bailey Inc., 1339 Wisconsin Ave., N.W., Washington 7, D. C. Tel.: Adams 4-2414.

D. C. Tel.: Adams 4-2414.
 JOHN A. MOFFET—Robert M. Silliman & Assoc., 1405 G St., N.W., Washington 5, D. C. Tel.: Republic 7-6646.
 MONROE E. MOON—Raymond M. Wilmoth, 1469 Church St., N.W., Washington 5, D. C. Tel.: Decatur 2-1231.
 TOM G. MORRISSEY—5700 West 28th Ave., Denver 14, Col. Tel.: Belmont 3-5320.
 JOHN H. MULLANEY—2002 P St., N.W., Washington 6, D. C. Tel.: Adams 4-6393.
 ALBERT F. MURRAY—4707 Windom Place N.W., Washington 16, D. C. Tel.: Emerson 2-4841.
 KALEVI E. OITTINEN—Page, Creutz, Garrison & Waldschmitt, 710 14th St., N.W., Washington 5, D. C. Tel.: Executive 3-5670.
 PAGE, CREUTZ, GARRISON & WALDSCHMITT—710 14th St., N.W., Washington 5, D. C. Tel.: Executive 3-5670. Partners: Esterly C. Page, John Creutz, Millard M. Garrison, Joseph A. Waldschmitt. Associate: James L. Hollis. Staff Engineers: David F. Brittle Jr., John P. Egbert, John J. Jansen, Kalevi E. Oittinen, Glenn G. Peebles, David L. Steel Sr. Field Engineers: Russell L. Boardman, William H. Collins, Perry W. Esten, Joseph Forno, G. Fortes, Houston, Ralph W. Jensen, Delbert T. Rylander, Robert H. Sublett, J. Harold White, Paul D. Wickre, John L. Wildermuth.
 ESTERLY C. PAGE—Page, Creutz, Garrison & Waldschmitt, 710 14th St., N.W., Washington 5, D. C. Tel.: Executive 3-5670.
 MAURICE L. PAINCHAUD—Frank H. McIntosh, Wyatt Bldg., 777 14th St., N.W., Washington 5, D. C. Tel.: Metropolitan 8-4477.
 NORWOOD J. PATTERSON—Radio Engineering Co., 908 Kansas Ave., Topeka, Kan. Tel.: 3-1336. 1355 Market St., San Francisco, Calif. Tel.: Market 1-8171.
 GLENN G. PEEBLES—Page, Creutz, Garrison & Waldschmitt, 710 14th St., N.W., Washington 5, D. C. Tel.: Executive 3-5670.
 D. A. PETERSON—A. Earl Cullum Jr., Highland Park Village, Dallas, Tex. Tel.: Justin 6108.
 DELMER C. PORTS—Jansky & Bailey, Inc., 1339 Wisconsin Ave., N.W., Washington 7, D. C. Tel.: Adams 4-2414.
 RADIO ENGINEERING CO.—1355 Market St., San Francisco, Calif. Tel.: Market 1-8173. 908 Kansas Ave., Topeka, Kan. Tel.: 3-1336. Owner: Norwood J. Patterson.
 GARO W. RAY—Hilltop Drive, Stratford, Conn. Tel.: Bridgeport 7-2465.
 EDWARD A. RAY JR.—Weldon & Carr, 1001 Connecticut Ave., N.W., Washington 6, D. C. Tel.: Sterling 3-2550.
 OSCAR W. B. REED JR.—Jansky & Bailey Inc., 1339 Wisconsin Ave., N.W., Washington 7, D. C. Tel.: Adams 4-2414.
 JOHN J. RENNER—Jansky & Bailey Inc., 1339 Wisconsin Ave., N.W., Washington 7, D. C. Tel.: Adams 4-2414.
 WILLIAM E. RICHARDSON & ASSOC.—1935 S.W. Moss St., Portland 19, Ore. Tel.: Atwater 777. Cherry 4070.
 A. D. RING & Assoc.—342 Munsey Bldg., Washington 4, D. C. Tel.: Republic 7-2347. Andrew D. Ring, Associates: Howard T. Head, Stephen W. Kershner, Charles S. Wright, Ralph E. Cannon, Marvin Blumberg, Raymond Dordal.
 ANDREW D. RING—A. D. Ring & Assoc., 342 Munsey Bldg., Washington 4, D. C. Tel.: Republic 7-2347.
 ROBERT R. RITCH—George P. Adair Engineering Co., 1810 I St., N.W., Washington 6, D. C. Tel.: Executive 3-1230, 3-5831.
 RAYMOND E. ROHRER—Jansky & Bailey Inc., 1339 Wisconsin Ave., N.W., Washington 7, D. C. Tel.: Adams 4-2414.
 HAROLD B. ROTHROCK—530 S. Gay St., Knoxville, Tenn. Tel.: 5-2113.
 J. G. ROUNTREE—4515 Prentice, Dallas 6, Tex.
 DELBERT T. RYLANDER—Page, Creutz, Garrison & Waldschmitt, 710 14th St., N.W., Washington 5, D. C. Tel.: Executive 3-5670.
 MERL SAXON—622 Hoskins St., P.O. Box 575, Lufkin, Tex. Tel.: 3-4242, 3-9558.
 NEIL J. SCHAIRER—Jansky & Bailey Inc., 1339 Wisconsin Ave., N.W., Washington 7, D. C. Tel.: Adams 4-2414.
 BERNARD R. SEGAL—James C. McNary, National Press Bldg., Washington 4, D. C. Tel.: District 7-1205.
 NUGENT S. SHARP—Jansky & Bailey Inc., 1339 Wisconsin Ave., N.W., Washington 7, D. C. Tel.: Adams 4-2414.
 C. I. SHELKOFKY—104 Lee St., Montgomery, Ala. Tel.: 3-0520.
 ROBERT M. SILLIMAN & ASSOC.—1405 G St., N.W., Washington 5, D. C. Republic 7-6646. Associate: John A. Moffet. Staff: Carl L. Kowalski.
 HAROLD C. SINGLETON—4488 S.W. Council Crest Drive, Portland 1, Ore. Tel.: Beacon 1201, 6364.
 GEORGE SKLOM—Walter F. Kean, Riverside Road, Riverside, Ill. Tel.: Riverside 7-2153.
 LYNNE C. SMEEBY—1311 G St., N.W., Washington 5, D. C. Tel.: Executive 3-8073.
 CARL E. SMITH—4900 Euclid Ave., Cleveland 3, Ohio. Tel.: Henderson 2-3177.
 DAVID L. STEEL SR.—Page, Creutz, Garrison & Waldschmitt, 710 14th St., N.W., Washington 5, D. C. Tel.: Executive 3-5670.
 CLARENCE H. STEWART II—Jansky & Bailey Inc., 1339 Wisconsin Ave., N.W., Washington 7, D. C. Tel.: Adams 4-2414.
 WALTER J. STILES—115 W. Drachman, Tucson, Ariz., (KOPO-TV). Tel.: 4-2511. Associate: Paul Bennowitz.
 MAURICE J. STOUGHTON—Kear & Kennedy, 1302 18th St., N.W., Washington 6, D. C. Tel.: Hudson 3-9000.
 CHARLES E. STRAIN—Strain Engineering Service, 1216 Niles Ave., N.W., Atlanta, Georgia. Tel.: Belmont 5164.
 ALFRED STROGOFF—Adler Communications Labs., 1 LeFevre Lane, New Rochelle, N. Y.

Tel.: New Rochelle 6-1620.
 ROBERT H. SUBLETT—Page, Creutz, Garrison & Waldschmitt, 710 14th St., N.W., Washington 5, D. C. Tel.: Executive 3-5670.
 JAY E. TAPP—Radio Measurements Co., 2557 Atlantic Ave., Long Beach 8, Calif. Tel.: 4-2015.
 T & T RADIO MEASUREMENTS CO.—2557 Atlantic Ave., Long Beach 8, Calif. Tel.: 4-2015.
 A. E. TOWNE—Universal Research Labs., 2655 Van Ness Ave., San Francisco 9, Calif. Tel.: Prospect 5-5833.
 UNIVERSAL RESEARCH LABS.—A. E. Towne, 2655 Van Ness Ave., San Francisco 9, Calif. Tel.: Prospect 5-5833.
 WILLIAM B. VALENTINE—Jansky & Bailey Inc., 1339 Wisconsin Ave., N.W., Washington 7, D. C. Tel.: Adams 4-2414.
 EDGAR F. VANDIVERE JR.—Vandivere, Cohen & Wearn, 1420 New York Ave., N.W., Washington 5, D. C. Tel.: National 8-2698.
 VANDIVERE, COHEN & WEARN—1420 New York Ave., N.W., Washington 5, D. C. Tel.: National 8-2698. Edgar F. Vandivere Jr., Jules Cohen & Wilson C. Wearn.
 JOHN C. VOGTLE—Exton, Pa.
 JOSEPH A. WALDSCHMITT—Page, Creutz, Garrison & Waldschmitt, 710 14th St., N.W., Washington 5, D. C. Tel.: Executive 3-5670.
 RAYMOND C. WATSON JR.—Dixie Service Co., P.O. Box 1435, Anniston, Ala. Tel.: 5011-J.
 WILSON C. WEARN—Vandivere, Cohen & Wearn, 1420 New York Ave., N.W., Washington 5, D. C. Tel.: National 8-2698.
 WELDON & CARR—Lester H. Carr, 1001 Connecticut Ave., N.W., Washington 6, D. C. Tel.: Sterling 3-2550. James O. Weldon, 4212 S. Buckner Blvd., Dallas 10, Tex. Tel.: Evergreen 1137. Staff: David F. Bowman, John O. Gilbert, A. C. Hagaman, John H. McMahon, Homer A. Ray, JAMES O. WELDON—Weldon & Carr, 4212 S. Buckner Blvd., Dallas 10, Tex. Evergreen 1137.
 J. HAROLD WHITE—Page, Creutz, Garrison & Waldschmitt, 710 14th St., N.W., Washington 5, D. C. Tel.: Executive 3-5670.
 PAUL D. WICKRE—Page, Creutz, Garrison & Waldschmitt, 710 14th St., N.W., Washington 5, D. C. Tel.: Executive 3-5670.
 JOHN L. WILDERMUTH—Page, Creutz, Garrison & Waldschmitt, 710 14th St., N.W., Washington 5, D. C. Tel.: Executive 3-5670.
 MARTIN R. WILLIAMS—7401 E. 14 St., Indianapolis 19, Ind. Blackstone 0038, Market 3326.
 NATHAN WILLIAMS—20 Algoma Blvd., Oshkosh, Wis. Tel.: Blackhawk 22.
 RAYMOND M. WILMOTTE—1469 Church St., N.W., Washington 5, D. C. Tel.: Decatur 2-1231.
 AMBROSE W. KRAMER, Monroe E. Moon.
 ROBERT WOLFSKILL—Commercial Radio Monitoring Co., P.O. Box 7037, Kansas City, Mo. Tel.: Jackson 5302.
 CHARLES S. WORSLEY—Commercial Radio Equipment Co., 1319 F St., N.W., Washington 4, D. C. Tel.: District 7-1319.
 GRANT R. WRATHALL—Rio del Mar, Aptos, Calif. Tel.: 3352.
 CHARLES S. WRIGHT—A. D. Ring & Assoc., 342 Munsey Bldg., Washington 4, D. C. Tel.: Republic 7-2347.
 LOWELL R. WRIGHT—R.F.D. No. 2, Box 29, Herndon, Va. Tel.: 114-M.
 R. EARL CULLUM JR.—Earl Cullum Jr., Highland Park Village, Dallas 5, Tex. Justin 6108.
 CASIMIR A. ZIELINSKI—Jansky & Bailey Inc., 1339 Wisconsin Ave., N.W., Washington 7, D. C. Tel.: Adams 4-2424.

ACTIVE MEMBERS OF AFCCE

GEORGE P. ADAIR—George P. Adair.
 STUART L. BAILEY—Jansky & Bailey.
 WILLIAM E. BENNS JR.—William E. Benns Jr.
 LESTER H. CARR—Weldon & Carr.
 T. A. M. CRAVEN—Craven, Lohnes & Culver.
 JOHN CREUTZ—Page, Creutz, Garrison & Waldschmitt.
 A. EARL CULLUM JR.—A. Earl Cullum Jr.
 R. H. CULVER—Craven, Lohnes & Culver.
 GEORGE C. DAVIS—George C. Davis.
 EVERETT L. DILLARD—Commercial Radio Equipment Co.
 MILLARD M. GARRISON—Page, Creutz, Garrison & Waldschmitt.
 GEORGE E. GAUTNEY—George E. Gautney.
 GLENN D. GILLET—Glenn D. Gillett.
 PAUL F. GODLEY—Paul Godley Co.
 C. M. JANSKY JR.—Jansky & Bailey.
 FRANK G. KEAR—Kear & Kennedy.
 ROBERT E. L. KENNEDY—Kear & Kennedy.
 WORTHINGTON C. LENT—(On military duty).
 G. M. LOHNES—Craven, Lohnes & Culver.
 FRANK H. MCINTOSH—Frank H. McIntosh.
 JAMES C. McNARY—James C. McNary.
 RUSSELL P. MAY—Russell P. May.
 E. C. PAGE—Page, Creutz, Garrison & Waldschmitt.
 WILLIAM E. PLUMMER—(On gov't duty).
 A. D. RING—A. D. Ring & Assoc.
 ROBERT M. SILLIMAN—Robert M. Silliman.
 CARL E. SMITH—Carl E. Smith.
 JAMES O. WELDON—Weldon & Carr.
 R. M. WILMOTTE—Raymond M. Wilmoth.
 GRANT R. WRATHALL—Grant R. Wrathall. Associate: Members
 RODNEY D. CHIFF—Dulmor Labs.
 WILLIAM S. DUTTERA—NBC
 J. B. EPPERSON—Scripps-Howard Radio, Inc.
 RAYMOND F. GUY—National Broadcasting Co.
 ANDREW F. INGLIS—RCA
 EARL M. JOHNSON—MBS
 LOUIS E. LITTLEJOHN—Radio Station WHUM.
 WILLIAM B. LODGE—CBS
 FRANK L. MARX—American Broadcasting Co.
 GEORGE A. MAYORAL—General Electric Co.
 JOHN G. PRESTON—American Broadcasting Co.
 PHILIP F. SILING—RCA
 JAY W. WRIGHT—CBS

AM-TV
ENGINEERING

A COMPLETE SERVICE

- applications
- tv site selection
- am channel surveys
- hearing exhibits
- directional antenna design
- directional antenna proof-of-performance
- am-fm-tv (vhf and uhf) field intensity surveys
- CAA tower clearance
- studio design
- installation supervision
- equipment selection

DAWKINS ESPY

10620 Wilshire Blvd.

Los Angeles, California

Arizona 88922

RADIO HIGHLIGHTS OF 1953

Jan. 5—B-T survey lists 30 leading agencies in radio and tv billings. BBDO tops list with \$40 million, Young & Rubicam is second with \$36 million, Benton & Bowles is third with \$30 million.

Jan. 5—Frank White is elected president of NBC as Joseph H. McConnell quits to become president of Colgate-Palmolive-Peet.

Jan. 26—Radio time sales in 1952 are estimated at \$464 million in annual B-T analysis.

Feb. 2—KFMB-AM-TV San Diego sold for \$3.1 million by John A. Kennedy to J. D. Wrather Jr. and Helen M. Alvarez, owners of KOTV (TV) Tulsa. FCC approves \$2.4 million sale of WMBR-AM-FM-TV Jacksonville, Fla., by Ed Norton, Frank M. King and Glenn Marshall to The Washington Post, majority owner of WTOP-AM-FM-TV Washington, and the \$1.5 million sale of WLTV (TV) Atlanta (now WLWA (TV) by group of Atlanta businessmen to Crosley Broadcasting Corp.

Feb. 2—ABC establishes single rate, day and night, for its owned radio stations.

Feb. 16—FCC approves merger of ABC and United Paramount Theatres forming new company, American Broadcasting-Paramount Theatres Inc.

Feb. 23—Westinghouse Radio Stations Inc. buys WPTZ (TV) Philadelphia for \$8.5 million, highest price ever paid for tv station.

March 23—President Eisenhower appoints John C. Doerfer, chairman of Wisconsin Public Service Commission, to FCC, succeeding Eugene H. Merrill, Utah Democrat.

April 6—B-T roundup of baseball sponsorship plans estimates the 1953 season will represent

a \$35 million package for radio and television.

April 6—Time Inc. buys KDYL-AM-FM-TV Salt Lake City from Intermountain Broadcasting & Television Corp. for \$2.1 million.

April 13—Ed Norton and Thad Holt sell WAPI, WAFM (FM) and WAFM-TV Birmingham to Birmingham News Co. for \$2.4 million.

April 27—President names Rosel H. Hyde chairman of FCC.

May 4—Optimism sparks NARTB "Gold Rush" convention.

May 4—Official FCC figures show radio revenue in 1952 was \$473.1 million, up 5% from year before.

June 1—Brig. Gen. David Sarnoff, chairman of board of RCA-NBC, quells incipient tv affiliate uprising at special meeting of stations.

June 8—President Eisenhower ushers in new era for White House by appearing on specially staged simulcast, with technical counsel by advertising agencies including BBDO.

July 20—MBS proposes revolutionary affiliate "compensation" plan which would pay stations in programs for local sale rather than in money.

Aug. 3—Theodore C. Streibert, former president of WOR-AM-TV New York, becomes head of U. S. Information Agency.

Aug. 3—Frank White resigns as president of NBC; Brig. Gen. David Sarnoff adds NBC president duties to those as chairman of board of RCA-NBC.

Aug. 17—B-T analysis shows 110 million radio sets have been manufactured since World War II.

Sept. 28—At annual convention of Assn. of National Advertisers, members say they're getting more than their money's worth out of radio and television.

Oct. 5—Meredith Publishing Co. buys KCMO-AM-FM-TV Kansas City from Tom L. Evans and Lester E. Cox for \$2.5 million.

Oct. 12—President Eisenhower names Robert E. Lee, former G-man and House committee investigator, as FCC commissioner.

Oct. 26—Chris J. Witting becomes president of Westinghouse Radio Stations Inc. and Ted Bergmann is promoted to replace him as managing director of DuMont Television Network.

Nov. 9—MBS shelves its revolutionary affiliate compensation plan which paid stations in free programs rather than money.

Nov. 16—Thirty-three song writers sue NARTB, BMI and several broadcasting companies for \$150 million, charging conspiracy to keep all but BMI music off the air.

Nov. 23—William B. Ryan quits as Broadcast Advertising Bureau president in policy disagreement.

Nov. 23—Paul H. Raymer Co. acquires O. L. Taylor Co. assets and part of Taylor representation list.

Nov. 30—FCC amends multiple ownership rules to prevent anyone from holding interests in more than seven am, seven fm or five tv stations.

Dec. 28—B-T survey shows BBDO still leads other agencies in radio-tv billings with \$49.5 million, Young & Rubicam is second with \$49 million, J. Walter Thompson third with \$5 million.

MEMBERS OF THE FEDERAL COMMUNICATIONS BAR ASSOCIATIONS

A

Adams, Eva B., 409 Senate Office Bldg., Washington.

Adams, Mearle G., 231 S. LaSalle St., Chicago 4, Ill. Tel.: Financial 6-3762.

Affleck, Gordon Burt, 47 East So. Temple St., Salt Lake City, Utah.

Albertson, Fred W.—Dow, Lohnes & Albertson, 600 Munsey Bldg., Washington 4, D. C. Tel.: Sterling 3-1000.

Alter, William—Alter & Wadell, 1416 Alamo National Bldg., San Antonio, Tex. Tel.: Garfield 5136.

Altman, Norman S.—Krooth & Altman, 1025 Vermont Ave. N.W., Washington 5, D. C. Tel.: Executive 3-5691.

Anderson, Walter S., 130 North Broadway, Camden, N. J.

Ansberry, T. Peter—Martin, Ansberry & Henderson, Ring Bldg., Washington 6, D. C. Tel.: Executive 3-3812.

Arnold, Thurman—Arnold, Fortis & Porter, 1229 19th St. N.W., Washington 6, D. C. Tel.: Executive 3-7300.

B

Babler, Wayne E.—American Telephone & Telegraph Co., 195 Broadway, New York 7, N. Y. Tel.: Exchange 3-9800.

Bailey, Clyde S., Munsey Bldg., Washington 4, D. C.

Baker, Philip M., Woodward Bldg., Washington 5, D. C. Tel.: Republic 7-8040.

Baldwin, James W., 5501 Lincoln Road, Bethesda, Md.

Ball, Frederic J.—Pierson & Ball, Ring Bldg., Washington 6, D. C. Tel.: Republic 7-2566.

Barker, Robert W.—Wilkinson, Boyden, Cragun & Barker, 744 Jackson Place, N.W., Washington 6, D. C. Tel.: National 8-1114.

Barlow, Joel—Covington & Burling, 701 Union Trust Bldg., Washington 5, D. C. Tel.: Republic 7-5900.

Barnes, Maurice R.—Barnes & Neilson, 1329 E St. N.W., Washington 4, D. C. Tel.: Sterling 3-7670.

Baron, Theodore—Scharfeld, Jones & Baron, 752 National Press Bldg., Washington 4, D. C. Tel.: Sterling 3-4115.

Beall, Kirke M., First National Bldg., Pensacola, Fla.

Becker, A. Harry, 1118 Ring Bldg., Washington 6, D. C. Tel.: Executive 3-1228.

Becker, George O.—Ralph E. Becker, 1346 Connecticut Ave. N.W., Washington 6, D. C. Tel.: Columbia 5-7641.

Becker, Ralph E.—George O. Becker, 1346 Connecticut Ave. N.W., Washington 6, D. C. Tel.: Columbia 5-7641. Partners: Ralph E. Becker, George O. Becker, Herbert G. Bitz, Kenneth W. Moroney, Charles C. Kieffer.

Beebe, Raymond N., 815 Fifteenth St., N. W., Washington.

Beelar, Donald C.—Kirkland, Fleming, Green, Martin & Ellis, World Center Bldg., Washington 6, D. C. Tel.: Sterling 3-3200.

Belaval, Edgar S.—Dept. of Justice of Puerto Rico, Box 1902, San Juan, P. R.

Benavie, J. J.—RCA International Division, 30 Rockefeller Plaza, New York 20, N. Y. Tel.: Judson 6-3800.

Benson, Harvey S.—Benson & Davis, 306 Public Service Bldg., Portland 4, Ore. Tel.: Atwater 7481.

Bergson, Philip B.—Lyon, Wilner & Bergson, 700 Wyatt Bldg., Washington 5, D. C. Tel.: Metropolitan 8-8900.

Berk, S. Bernard, First Central Tower, Akron, Ohio.

Berkman, Jack N., 708 Sinclair Bldg., Steubenville, Ohio.

Beznor, Lee K., 808 N. Third St., Milwaukee, Wis.

Bickford, George P., 2600 Terminal Tower Bldg., Cleveland, Ohio.

Bingham, Herbert M.—Bingham, Collins, Porter & Kistler, 921 Tower Bldg., Washington 5, D. C. Tel.: District 7-2141.

Bitz, Herbert G.—Ralph E. Becker, 1346 Connecticut Ave. N.W., Washington 6, D. C. Tel.: Columbia 5-7641.

Bloch, Roger S., 77 W. Washington St., Chicago.

Blodgett, Harold E., 408 State St., Schenectady, N. Y.

Bluestein, Arthur S., 33 N. LaSalle St., Chicago.

Blum, William Jr., 1741 K St., N. W., Washington 5, D. C.

Blume, Jack P.—Fly, Shuebruk, Blume & Gaguine, 1001 Conn. Ave., Washington 6, D. C. Tel.: Metropolitan 8-6190.

Booth, Robert M. Jr.—Bingham, Collins, Porter & Kistler, 921 Tower Bldg., Washington 5, D. C. Tel.: District 7-2141.

Borut, Frank, 222 Broadway, New York.

Bradford, Lowell J.—Pierson & Ball, Ring Bldg., Washington 6, D. C. Tel.: Republic 7-2566.

Brady, John B., 701 Colorado Bldg., Washington 5, D. C. Tel.: National 8-4806.

Brauner, Julius F.—CBS, 485 Madison Ave., New York 22, N. Y. Tel.: Plaza 1-2345.

Breene, Samuel A.—Breene & Jobson, First National Bank Bldg., Oil City, Pa.

Brenner, Jacob—Pritchard & Brenner, 321 So. Beverly Dr., Beverly Hills, Calif. Tel.: Bradshaw 2-3103.

Britt, Henry M., 824 Central Ave., Hot Springs, Ark.

Bronson, William H.—Tucker, Bronson & Martin, 901 Commercial Bldg., Shreveport 24, La. Tel.: 5-7764.

Brooks, L'on—CBS, 1735 DeSales St., N. W., Washington 6, D. C. Tel.: Emerson 2-9300.

Brown, Darwin Charles—Ginsburg, Leventhal & Brown, 1632 K St. N. W., Washington 5, D. C. Tel.: Sterling 3-6781.

Brown, James Harvey, 109 Lawyer's Bldg., Hollywood 28, Calif. Tel.: Hollywood 4-9311.

Brown, Thad H. Jr.—NARTB, 1771 N St., N. W., Washington 6, D. C. Tel.: Emerson 2-9300.

Brown, Travis T.—Hayes & Hayes, 945 Munsey Bldg., Washington 4, D. C. Tel.: District 7-5376.

Bugay, Paul E., 700 District National Bldg., Washington.

Bunn, George—Arnold, Fortas & Porter, 1229 19th St., N. W., Washington 5, D. C. Tel.: Executive 3-7500.

Burke, Eugene L., 821 15th St., N. W., Washington 5, D. C. Tel.: Sterling 3-3717.

Burroughs, J. Edward—Cummings, Stanley, Truitt & Cross, 1625 K St. N. W., Washington 6, D. C. Tel.: District 7-0777.

Burt, William C.—Koteen & Burt, Wyatt Bldg., Washington 5, D. C. Tel.: Republic 7-5566.

Burnley, 614 W. Walnut St., Louisville, Ky.

Butman, Carl H., 892 Nat'l. Press Bldg., Washington 4, D. C. Tel.: National 8-7846.

C

Cahill, John T.—Cahill, Gordon, Zachry & Reindel, 63 Wall St., New York 5, N. Y. Tel.: Whitehall 4-7400.

Callister, Reed E., 650 S. Spring St., Los Angeles.

Cannfield, Austin F., 637 Woodward Bldg., Washington.

Canon, David H., 650 S. Spring St., Los Angeles.

Carr, John P.—Dow, Lohnes & Albertson, 600 Munsey Bldg., Washington 4, D. C. Tel.: Sterling 3-1000.

Carrigan, Joe B., Wichita Falls, Tex.

Carson, Byron G., 501 Tower Bldg., Washington.

Carter, Chauncey P. Jr.—Kirkland, Fleming, Green, Martin & Ellis, World Center Bldg., Washington 6, D. C. Tel.: Sterling 3-3200.

Case, Norman S., 605 Southern Bldg., 15th & H Sts., N. W., Washington 5, D. C. Tel.: National 8-1841.

Castellano, A. J., 10 Park Square Bldg., Morristown, N. J.

Chaffetz, Hammond E.—Kirkland, Fleming, Green, Martin & Ellis, World Center Bldg., Washington 6, D. C. Tel.: Sterling 3-3200.

Chopnick, Max, 9 East 46th St., New York.

Church, Abiah A.—NARTB 1771 N St., N. W., Washington 6, D. C. Tel.: Decatur 2-9300.

Clagett, John F., 1424 K St., N. W., Washington 5, D. C. Tel.: National 8-1774.

Clinton, John Hart—San Mateo Times, 145 Second Ave., San Mateo, Calif. Tel.: Diamond 3-1831.

Cohen, Harold D.—Pierson & Ball, Ring Bldg., Washington 6, D. C. Tel.: Republic 7-2566.

Cohen, Harold J.—Root, Ballantine, Harlan, Bushby & Palmer, 31 Nassau St., New York.

Cohen, Lester—Hogan & Hartson, 810 Colorado Bldg., Washington 5, D. C. Tel.: National 8-2006.

Cohen, Wallace M., 1822 Jefferson Place, Washington.

Cohn, Marcus—Cohn & Marks, Cafritz Bldg., 1625 Eye St., N. W., Washington 6, D. C. Tel.: Sterling 3-5880.

Coleman, James J., National Bank of Commerce Bldg., New Orleans, La.

Colin, Ralph F.—Rosenman, Goldmark, Colin & Kaye, 575 Madison Ave., New York 22, N. Y. Tel.: Murray Hill 8-7800.

Collins, Clayton Braswell, 1025 Vermont Ave., Washington.

Collins, Linton M.—Bingham, Collins, Porter & Kistler, Tower Bldg., Washington 5, D. C. Tel.: District 7-2141.

Collins, Wallace C. Jr., 3059 S. Buchanan St., Arlington, Va.

Colton, Herbert S., 1625 K St. N. W., Washington 6, D. C. Tel.: Republic 7-5062.

Compere, Thomas H.—Moser & Compere, 360 N. Michigan Ave., Chicago 1, Ill. Tel.: Randolph 6-8168.

Conrad, Edwin—Aberg, Bell, Blake & Conrad, 900 Gay Bldg., Madison 3, Wis. Tel.: 7-2531.

Cooley, Thomas M. III—Weaver & Glassie, 1210 Tower Bldg., Washington 5, D. C. Tel.: Sterling 3-4355.

Carver, Harvey L., 1245 Hurt Bldg., Atlanta, Ga.

Cordon, Alfred C. Jr.—Dow, Lohnes & Albertson, 600 Munsey Bldg., Washington 4, D. C. Tel.: Sterling 3-1000.

Correa, Rodolfo A.—Commercial Dept., RCA, 30 Rockefeller Plaza, New York 20, N. Y. Tel.: Columbus 5-5900.

Cottone, Benedict P.—Lucas & Thomas, 1025 Conn. Ave. N.W., Washington 6, D. C. Tel.: Sterling 3-2252.
 Courtney, Jeremiah, 908 20th St., N. W., Washington 6, D. C. Tel.: Sterling 3-5551.
 Cowgill, Harold G., 816 Connecticut Ave., Washington.
 Cragun, John W.—Wilkinson, Boyden, Cragun & Boyden, 74 Jackson Place, Washington 6, D. C. Tel.: National 8-1114.
 Cressy, Warren F.—Cressy, Bartram, Melvin & Sherwood, 300 Main St., Stamford, Conn.
 Crook, Omar L.—Wheat, May & Shannon, 520 Shoreham Bldg., Washington 5, D. C. Tel.: Republic 7-4123.
 Cutler, Charles R.—Kirkland, Fleming, Green, Martin & Ellis, World Center Bldg., Washington 6, D. C. Tel.: Sterling 3-3200.

D

Daly, Harry J. — Harry J. Daly, Metropolitan Bank Bldg., Washington 5, D. C. Tel.: 8-3260.
 Daubn, Meredith—Dow, Lohnes & Albertson, 600 Munsey Bldg., Washington 4, D. C. Tel.: Sterling 3-1000.
 David, Nathan H., 1625 K St., N. W., Washington 5, D. C. Tel.: Republic 7-2413.
 Davis, John Morgan, 1332 Lincoln Liberty Bldg., Philadelphia.
 Davis, Kenneth C., 402 Paulsen Bldg., Spokane, Wash.
 Davis, Philip R., 1 North LaSalle St., Chicago 2, Ill. Tel.: Franklin 2-6050.
 Dechert, Philip, Tloga and C Sts., Philadelphia.
 Delany, Frank J., 1317 F St., N. W., Washington 4, D. C. Tel.: Sterling 3-1234.
 de Grazia, Edward—Kirkland, Fleming, Green, Martin & Ellis, World Center Bldg., Washington 6, D. C. Tel.: Sterling 3-3200.
 Dempsey, William J.—Dempsey & Kopolovitz, 815 15th St., N. W., Washington 5, D. C. Tel.: Republic 7-6363.
 Detmar, Charles F. Jr.—Cahill, Gordon, Zachry & Reindel, 63 Wall St., New York 5, N. Y. Tel.: Whitehall 4-7400.
 Denslow, L. Alton—Denslow-Hartman, 531 Washington Bldg., Washington 5, D. C. Tel.: Republic 7-0727.
 Diamond, Milton—Poletti, Diamond, Freidin & Mackay, 598 Madison Ave., New York.
 Dixon, James A., 908 First National Bank Bldg., Miami, Fla.
 Dobin, Paul—Cohn & Marks, Cafritz Bldg., 1625 Eye St., N. W., Washington 6, D. C. Tel.: Sterling 3-5880.
 Donaldson, Ray S.—RTMA, 777 14th St. N. W., Washington 4, D. C.
 Doty, Dwight David—Haley, Doty & Schellenberg, 1735 De Sales St., N. W., Washington 6, D. C. Tel.: District 7-2724.
 Dow, Fayette B.—Dow, Lohnes & Albertson, Munsey Bldg., Washington 4, D. C. Tel.: Sterling 3-1000.
 Dowd, Thomas N.—Pierson & Ball, Ring Bldg., Washington 6, D. C. Tel.: Republic 7-2566.
 Drain, Dale D., 1422 F St., N. W., Washington 4, D. C.
 Driscoll, Hugh D., 4730 Burnet Ave., Sherman Oaks, Calif.
 Dunbar, Frank C., 3230 A.I.U. Bldg., Columbus, Ohio.
 Duvall, Charles F.—Fisher, Wayland, Duvall & Southmayd, 703 Perpetual Bldg., 1111 E St., N. W., Washington 4, D. C. Tel.: Republic 7-1450.
 Durka, William J.—Fly, Shuebruk, Blume & Gaguine, 30 Rockefeller Plaza, New York 20, N. Y. Tel.: Circle 7-3040.

E

Eagan, R. Russell—Kirkland, Fleming, Green, Martin & Ellis, World Center Bldg., Washington 6, D. C. Tel.: Sterling 3-3200.
 Eggman, Horace J. Jr., 400 First Federal Bldg., 435 Missouri Ave., East St. Louis, Ill. Tel.: Upton 3-0200.
 Egolf, Willard D., 6001 Brookside Drive, Chevy Chase 15, Md. Tel.: Oliver 2-1216.
 Elder, Omar Franklin Jr.—ABC, 7 West 66th St., New York 23, N. Y. Tel.: Susquehanna 7-5000.
 Emerson, Leonidas P. B.—McKenna & Wilkinson, 1735 DeSales St., N. W., Washington 6, D. C. Tel.: National 8-2931.
 Emerson, Walter L.—NBC, Merchandise Mart, Chicago 54, Ill. Tel.: Superior 7-8300.
 Emison, John Rabb, 500 Oliphant Bldg., Vincennes, Ind.
 Esterhal, John L., 8423 Pembroke Road, Philadelphia.
 Estes, Robert M.—General Electric, Electronics Park, Syracuse, N. Y. Tel.: Syracuse 76-4411.
 Etherton, Seddon L., 700 Michigan Bank Bldg., Detroit.
 Ervin, Thomas E.—NBC, 30 Rockefeller Plaza, New York 20, N. Y. Tel.: Circle 7-8300.
 Ewing, Samuel E.—RCA Victor Division, Camden, N. J. Tel.: Woodlawn 3-8000.

F

Falk, Edwin A.—Gale, Bernays, Falk & Eisner, 40 Wall St., New York. Tel.: Whitehall 4-1771.
 Falk, Edwin A.—Gale, Bernays & Eisner, 40 Wall St., New York. Tel.: Whitehall 4-1771.
 Fanelli, Joseph A., 729 15th St., N. W., Washington.
 Farris, Frank M. Jr., Third National Bank Bldg., Nashville 3, Tenn. Tel.: 4-3506.

Fay, William L., 333 W. State St., Jacksonville, Ill.
 Feen, A. Fearley, 119 So. Winoski Ave., Burlington, Vt.
 Fine, Joseph J.—Fine & Efurd, 556 Hurt Bldg., Atlanta, Ga.
 Fischer, Henry G.—Fischer, Willis & Panzer, 1735 De Sales St., N. W., Washington 6, D. C. Tel.: Sterling 3-3660.
 Fisher, Ben C.—Fisher, Wayland, Duvall, Southmayd, Warner Bldg., Washington 4, D. C. Tel.: Republic 7-8607.
 Fisher, Ben S.—Fisher, Wayland, Duvall & Southmayd, 703 Perpetual Bldg., 1111 E St., N. W., Washington 4, D. C. Tel.: Republic 7-1450.
 Flanagan, Frank A., 1319 F St., N. W., Washington 4, D. C.
 Fletcher, Arthur L., Munsey Bldg., Washington 4, D. C. Tel.: National 8-5398.
 Fletcher, Frank U.—Spearman & Roberson, Munsey Bldg., 1329 E St., N. W., Washington 4, D. C. Tel.: Metropolitan 8-0023.
 Fletcher, Stephen H.—The C & P Telephone Co., 725 13th St., N. W., Washington.
 Fly, James Lawrence—Fly, Shuebruk, Blume & Gaguine, 30 Rockefeller Plaza, New York 20, N. Y. Tel.: Circle 7-3043.
 Foote, Edward A.—Great Lakes Carbon Corp., 334 Bowen Bldg., Washington.
 Ford, Aaron L., 535 College St., Jackson, Miss. Tel.: 5-8647.
 Formby, Marshall C. Jr., Box 868, Hereford, Tex.
 Fortas, Abe—Arnold, Fortas & Porte, 1229 19th St., N. W., Washington 6, D. C. Tel.: Executive 3-7300.
 Freeman, Milton V.—Arnold, Fortis & Porter, 1229 19th St. N. W., Washington 6, D. C. Tel.: Executive 3-7300.
 Freret, Julian P.—Roberts & McInnis, 400 DeSales Bldg., Washington 6, D. C. Tel.: 8-0032.
 Fullerton, Hugh T., 802 Commonwealth Bldg., Washington.

G

Galane, Morton R.—Roberts & McInnis, 400 DeSales Bldg., Washington 6, D. C. Tel.: National 8-0032.
 Gallagher, James E. Jr., 1222 Real Estate Trust Bldg., Philadelphia.
 Gardner, Addison L. Jr., 231 South La Salle St., Chicago.
 Gassaway, William G.—The C & P Telephone Co., 725 13th St., N. W., Washington.
 Gaughan, Vincent M., Hotel Lafayette, Buffalo 3, N. Y. Tel.: Madison 6484.
 George, Arthur T., 140 New Montgomery St., San Francisco.
 George, Carl E.—WGAR Broadcasting Co., Hotel Statler, Cleveland 1, Ohio. Tel.: Prospect 1-0200.
 Gepson, John M.—American Telephone & Telegraph Co., 195 Broadway, New York 7, N. Y. Tel.: Exchange 3-9800.
 Gerber, Gustave A., 120 West 42nd St., New York 36, N. Y. Tel.: Wisconsin 7-3722.
 Gibbons, John F., 67 Broad St., New York.
 Glassie, Henry H.—Weaver & Glassie, 1210 Tower Bldg., Washington 5, D. C. Tel.: Sterling 3-4355.
 Goldfarb, Aaron, 515 City National Bank Bldg., Houston 2, Tex. Tel.: Central 7417.
 Goldstein, David, Electric Bldg., Asbury Park, N. J.
 Golub, William W.—Shearman & Sterling & Wright, 20 Exchange Place, New York.
 Goodman, E. M., 1404 West Wisconsin Ave., Stratford Hotel Bldg., Milwaukee, Wis.
 Goodrich, Pierre F., 712 Electric Bldg., Indianapolis, Ind.
 Goodwin, Francis M.—Wilkinson, Boyden, Cragun & Barker, 744 Jackson Pl., Washington 6, D. C. Tel.: National 8-1114.
 Goodwin, Bernard, 1501 Broadway, New York.
 Granik, Theodore R., 1627 K St., N. W., Washington.
 Greeley, James E.—Cahill, Gordon, Zachry & Reindel, Wire Bldg., 1000 Vermont Ave. N. W., Washington 5, D. C. Tel.: District 7-7480.
 Green, Harry, Seven Bridge Road, Little Silver, N. J. Tel.: Red Bank 6-5666.
 Green, William S.—Pierson & Ball, Ring Bldg., Washington 6, D. C. Tel.: Republic 7-2566.
 Greenbaum, Wolff & Ernst, 285 Madison Ave., New York 17, N. Y. Tel.: Murray Hill 5-1582.
 Griffith, Kelly E.—Kirkland, Fleming, Green, Martin & Ellis, World Center Bldg., Washington 6, D. C. Tel.: Sterling 3-3200.
 Guider, John W., Littleton, N. H. Tel.: Littleton 4-2824.

H

Haley, Andrew G., 1735 De Sales St., N. W., Washington 6, D. C. Tel.: District 7-2724.
 Hall, Charles M., 305 Broadway, New York.
 Hallen, Billie, 1280 Humbolt, Denver, Colo.
 Hamilton, Walton—Arnold, Fortis & Porter, 1229 19th St. N. W., Washington 6, D. C. Tel.: Executive 3-7300.
 Hamlyn, John J., Sacramento, Calif.
 Hancock, Parker D.—Hogan & Hartson, 810 Colorado Bldg., Washington 5, D. C. Tel.: National 8-2006.
 Hand, Frank P. Jr., Transportation Bldg., Washington 6, D. C. Tel.: National 8-6587.
 Hannon, William A., 21 West 10th St., Kansas City, Mo.

Harris, Abraham J.—Sher, Oppenheimer & Harris, Woodward Bldg., Washington 5, D. C. Tel.: Republic 7-3028.
 Harry, Lawrence W., 346 Glenmont Dr., Solano Beach, Calif. Tel.: Delmar 564-M.
 Hartman, John A., Jr., 67 Broad St., New York.
 Hawkins, Carl S.—Wilkinson, Boyden, Cragun & Barker, 744 Jackson Place, N. W., Washington 6, D. C. Tel.: National 8-1114.
 Hawkins, Edward R.—RCA Communications Inc., 66 Broad St., New York.
 Hawley, Edmund S., 195 Broadway, New York.
 Hayes, John C.—Hayes & Hayes, 945 Munsey Bldg., Washington 4, D. C. Tel.: District 7-5375.
 Hayes, Raymond Kyle—Hayes & Hayes, 309 Ninth St., North Wilkesboro, N. C.
 Heald, Robert L.—Welch, Mott & Morgan, 710 14th St., N. W., Washington 5, D. C. Tel.: Executive 3-4600.
 Hearne, John P., 1000 N. Cahuenga Blvd., Hollywood 38, Calif. Tel.: Hollywood 4-5231.
 Hedrick, F. Cleveland Jr., 1001 Connecticut Ave., N. W., Washington 6, D. C. Tel.: National 8-5923.
 Hennessey, Philip J. Jr.—Segal, Smith & Hennessey, 816 Connecticut Ave., Washington 6, D. C. Tel.: Republic 7-2701.
 Herman, A. M., 12th Floor, Electric Bldg., Fort Worth, Tex.
 Herriott, Irving, 120 South LaSalle St., Chicago.
 Hilmer, Lucien, 1009 DuPont Circle Bldg., Washington 6, D. C. Tel.: Adam 4-3226.
 Hilton, Henry M., 134 North LaSalle St., Chicago.
 Hirmon, George F.—Wheeler & Wheeler, 704 Southern Bldg., 15th & H Sts., N. W., Washington 5, D. C. Tel.: District 7-7117.
 Hodson, Robert E.—Pierson & Ball, Ring Bldg., Washington 6, D. C. Tel.: Republic 7-2566.
 Hogan, Robert G., 606 Stangenwald Blvd., Honolulu, T. H.
 Horton, Richard W.—Royal A. Stewart & Richard W. Horton, 131 West 2nd St., Reno, Nev. Tel.: 2-4508.
 Horton, Richard W., 2600 Tunlaw Road, N. W., Washington.
 Hosmer, John—Hosmer & Newberry, 202 Woodruff Bldg., Springfield, Mo. Tel.: 6-1171.
 Houston, Ray B.—Radiomarine Corp. of America, 75 Varick St., New York 13, N. Y. Tel.: Walker 5-3716.
 Howard, Benjamin C., 1845 Mathieson Bldg., Baltimore.
 Hurt, Wilson, 1275 Pontiac St., Denver, Colo.
 Hysmith, Logan Earl, Apt. 204, 2307 N. 11th St., Lee Gardens North, Arlington, Va.

I

Irwin, Ellis C., 914 Richards Bldg., New Orleans.
 Irwin, Robert L.—Dow, Lohnes & Albertson, 600 Munsey Bldg., Washington 4, D. C. Tel.: Sterling 3-1000.

J

Jacobs, Carl M., 23d Floor, Union Central Bldg., Cincinnati, Ohio.
 Jacobus, Gilbert C., 3801 N. 23d St., Arlington, Va.
 James, W. Ervin, 17 Molton St., Montgomery, Ala.
 Jameson, Guilford—Smith & Jameson, 1206 Walker Bldg., 734 15th St., N. W., Washington 5, D. C. Tel.: National 8-6232.
 Jansky, Maurice M.—Loucks, Zias, Young & Jansky, The American Bldg., Washington 4, D. C. Tel.: Sterling 3-4004.
 Jencks, Richard—CBS, 6121 Sunset Blvd., Hollywood, Calif.
 Jennes, Ernest W.—Covington & Burling, 701 Union Trust Bldg., Washington 5, D. C. Tel.: Republic 7-5900.
 Johnston, Everett D.—Roberts & McInnis, 400 DeSales Bldg., Washington 6, D. C. Tel.: National 8-0032.
 Jones, Clifford A., Friedman Bldg., Las Vegas, Nev.
 Jones, Robert F.—Scharfeld, Jones & Baron, 752 National Press Bldg., Washington 4, D. C. Tel.: Sterling 3-4115.
 Jorgensen, Norman E.—Krieger & Jorgensen, 514 Wyatt Bldg., Washington 5, D. C. Tel.: Executive 3-1635.

K

Kahn, Alexander, 175 East Broadway, New York.
 Karp, Joseph D., 321 West 44th St., New York.
 Kaye, Sydney M.—Rosenman, Goldmark, Colin & Kaye, 575 Madison Ave., New York 22, N. Y. Tel.: Murray Hill 8-7800.
 Keller, Joseph E.—Dow, Lohnes & Albertson, 600 Munsey Bldg., Washington 4, D. C. Tel.: Sterling 3-1000.
 Kellough, Robert W., 524 McBirney Bldg., Tulsa, Okla.
 Kenehan, Edward F.—RCA Victor Div., Camden, N. J.
 Kenkel, John B.—Miller & Schroeder, 218 Munsey Bldg., Washington 4, D. C. Tel.: Metropolitan 8-2193.
 Kennedy, James A., 67 Broad St., New York.
 Kessler, Sylvia D.—Cohn & Marks, Cafritz Bldg., 1625 Eye St., N. W., Washington 6, D. C. Tel.: Sterling 3-5880.

Kieffer, Charles C.—Ralph E. Becker, 1346 Connecticut Ave., N. W., Washington 6, D. C. Tel.: Columbia 5-7641.
 King, H. G. E., 719 Chattanooga Bank Bldg., Chattanooga, Tenn.
 Kistler, H. Donald—Bingham, Collins, Porter & Kistler, Tower Bldg., Washington 5, D. C. Tel.: District 7-2141.
 Knowles, Miles H., 801 Bowen Bldg., Washington.
 Kohlhaas, Vernon C.—Pierson & Ball, Ring Bldg., Washington 6, D. C. Tel.: Republic 7-2566.
 Kopietz, Frank M., 1326 National Bank Bldg., Detroit, Mich.
 Koplovitz, William C.—Dempsey & Koplovitz, 815 15th St., N. W., Washington 5, D. C. Tel.: Republic 7-6363.
 Koteen, Bernard—Koteen & Burt, Wyatt Bldg., Washington 5, D. C. Tel.: Republic 7-5566.
 Kramer, Milton—Schoene & Kramer, 1625 K St., N. W., Washington 6, D. C. Tel.: National 8-6926.
 Krieger, Seymour—Krieger & Jorgensen, 514 Wyatt Bldg., Washington 5, D. C. Tel.: Executive 3-1635.
 Krooth, David L.—Krooth & Altman, 1025 Vermont Ave., N. W., Washington 5, D. C. Tel.: Executive 3-5691.

L

LaBrum, J. Harry, 1507 Packard Bldg., Philadelphia.
 Ladner, Henry—Ballantine Laboratories Inc., Boonton, N. J.
 Lamb, Edward, Edison Bldg., Toledo, Ohio.
 Lambert, I. E., Wheeler Kelly Hagney Bldg., Wichita, Kans. Tel.: 2-3413.
 Landa, Alfons E., 815 15th St., N. W., Washington.
 Lavine, Richard A., 807 Guarantee Bldg., Hollywood, Calif.
 Landon, S. Whitney, 32 Avenue of the Americas, New York.
 Lawton, Samuel T., 7 S. Dearborn St., Chicago.
 Leahy, William E., Bowen Bldg., Washington.
 Leonard, Donald S.—Commissioner, Michigan State Police, East Lansing, Mich.
 Letterman, John B., 710 14th St., N. W., Washington 4, D. C.
 Levine, J. L., 518 Volunteer Bldg., Chattanooga, Tenn.
 Levinson, Louis, 14 Overhill Road, Cynwyd, Pa.
 Levy, Isaac D., 1622 Chestnut St., Philadelphia.
 Lewis, Ralph E., 650 S. Spring St., Los Angeles.
 Lippincott, Donald K.—Lippincott & Smith, 24 California St., San Francisco 11, Calif. Tel.: Yukon 8-4058.
 Lipkin, Max J., 1140 Jefferson Bldg., Peoria, Ill.
 Littlepage, James H.—Littlepage & Littlepage, Investment Bldg., Washington 5, D. C. Tel.: District 7-3723.
 Littlepage, John M.—Littlepage & Littlepage, Investment Bldg., Washington 5, D. C. Tel.: District 7-3723.
 Littlepage, Thomas P., Jr.—Littlepage & Littlepage, Investment Bldg., Washington 5, D. C. Tel.: District 7-3723.
 Lockwood, Corwin R., Jr.—Hogan & Hartwell, Colorado Bldg., Washington 5, D. C. Tel.: 8-2006.
 Lohnes, Horace L.—Dow, Lohnes & Albertson, 600 Munsey Bldg., Washington 4, D. C. Tel.: Sterling 3-1000.
 Lomerick, David L., Jr., P. O. Box 492, Rossville, Ga.
 Loucks, Philip G.—Loucks, Zias, Young & Jan-sky, The American Bldg., Washington 4, D. C. Tel.: Sterling 3-4004.
 London, John M.—Lyon, Wilner & Bergson, 700 Wyatt Bldg., Washington 5, D. C. Tel.: Metropolitan 8-6900.
 Lovett, Elliot C., 729 15th St., N. W., Washington 5, D. C. Tel.: Sterling 3-5168.
 Luxford, Ansel F.—Pehle, Lesser, Mann, Riemer & Luxford, 1616 K St., N. W., Washington 6, D. C. Tel.: Republic 7-7643.
 Lynch, Paul B.—NBC, 30 Rockefeller Plaza, New York.
 Lyon, R. B. H.—Lyon, Wilner & Bergson, 700 Wyatt Bldg., Washington 5, D. C. Tel.: Metropolitan 8-6900.
 Lyon, Richard K.—Lyon, Wilner & Bergson, 700 Wyatt Bldg., Washington 5, D. C. Tel.: Metropolitan 8-6900.

M

MacClain, George—Cohn & Marks, Cafritz Bldg., 1625 Eye St., N. W., Washington 6, D. C. Tel.: Sterling 3-5880.
 Madsen, Kenneth R.—Wilkinson, Boyden, Cragun & Barker, 744 Jackson Pl., Washington 6, N. W. Tel.: National 8-1114.
 Margraf, Gustav B.—NBC, 30 Rockefeller Plaza, New York.
 Marks, Leonard H.—Cohn & Marks, Cafritz Bldg., 1625 Eye St., N. W., Washington 6, D. C. Tel.: Sterling 3-5880.
 Martin, Harlan W., 203½ E. Main St., Jackson, Tex.
 Masters, Keith, 33 N. LaSalle St., Chicago.
 Mather, E. Everett, Jr., 1835 Arch St., Philadelphia.
 May, Philip S.—Crawford & May, 11 East Forsyth, Lynch Bldg., Jacksonville 2, Fla. Tel.: Jacksonville 6-4174.
 May, Robert E., Shoreham Bldg., Washington.
 Mayer, Henry, 19 West 44th St., New York.
 Mayer, J. Gerald—Mayer, Rigby & Seely, Wyatt Bldg., Washington 5, D. C. Tel.: Metropolitan 8-3662.

McAllister, William M.—McAllister, Duncan & Brophy, P. O. Box 226, Medford, Ore. Tel.: Medford 2-7124.
 McCabe, Thomas M.—McCabe, Gruber, Clure, Donovan & Crassweller, 700 Torrey Bldg., Duluth 2, Minn.
 McCauley, Raymond F., 959 8th Ave., New York.
 McConnell, John D., Village Court Bldg., Pinehurst, N. C.
 McCoy, John E.—Storer Bcstg. Co., 1005 Kane Concourse, Bay Harbor Island, Miami Beach, Fla.
 McDaniel, Gien—Lundgren, Lincoln, Peterson & McDaniel, 63 Wall St., New York 5, N. Y. Tel.: Whitehall 3-7380.
 McDonald, Joseph A.—NBC, 30 Rockefeller Plaza, New York 20, N. Y. Tel.: Circle 7-8300.
 McDonough, Francis X.—Dow, Lohnes & Albertson, 600 Munsey Bldg., Washington 4, D. C. Tel.: Sterling 3-1000.
 McDowell, James C.—Scharfeld, Jones & Baron, National Press Bldg., Washington 4, D. C. Tel.: Sterling 3-4115.
 McDowell, C. Blake, 2200 First National Tower, Akron 8, Ohio.
 McGovern, William—Arnold, Fortis & Porter, 1229 19th St., N. W., Washington 6, D. C. Tel.: Executive 3-7300.
 McInnis, Charles B.—Roberts & McInnis, DeSales Bldg., Washington 6, D. C. Tel.: National 8-0032.
 McKenna, James A., Jr.—McKenna & Wilkinson, 1735 DeSales St., N. W., Washington 6, D. C. Tel.: National 8-2931.
 McLeod, W. J., Jr., Jefferies Blvd. and Washington St., Waltherboro, S. C.
 Meurer, Raymond J., 1800 Mutual Bldg., Detroit 26, Mich.
 Meyer, Daniel W., 1776 Broadway, New York.
 Meyers, Milton H., 182 Grand St., Waterbury, Conn.
 Midlen, John H.—John H. Midlen, Munsey Bldg., Washington 4, D. C. Tel.: Metropolitan 8-6006.
 Miles, Clarence W., 1000 Mathieson Bldg., Baltimore 2, Md.
 Miller, Herbert J.—Kirkland, Fleming, Green, Martin & Ellis, World Center Bldg., Washington 6, D. C. Tel.: Sterling 3-3200.
 Miller, John Roberts—Sullivan & Cromwell, 48 Wall St., New York.
 Miller, Justin—NARTB, 1771 N. St., N. W., Washington 6, D. C. Tel.: Decatur 2-9300.
 Miller, Neville—Miller & Schroedler, 218 Munsey Bldg., Washington 4, D. C. Tel.: Metropolitan 8-2193.
 Miller, Reed—Arnold, Fortis & Porter, 1229 19th St., N. W., Washington 6, D. C. Tel.: Executive 3-7300.
 Miller, Samuel, 1025 Vermont Ave., Washington 5, D. C. Tel.: Sterling 3-5764.
 Mode, Douglas G., 705 Ring Bldg., Washington 6, D. C. Tel.: Sterling 3-5646.
 Montgomery, Mervyn R., 302 Clifton Ave., Clifton, N. J.
 Mooney, William E., Insurance Bldg., Omaha, Nebr.
 Morgan, Edward P.—Welch, Mott & Morgan, 710 14th St., N. W., Washington 4, D. C. Tel.: Executive 3-4600.
 Morgan, Gerald D., 412 Washington Bldg., Washington.
 Moroney, Kenneth W.—Ralph E. Becker, 1346 Connecticut Ave., N. W., Washington 6, D. C. Tel.: Columbia 5-7641.
 Moser, J. G., 807 Guarantee Bldg., Hollywood, Calif.
 Moser, John B.—Moser & Compere, 360 N. Michigan Ave., Chicago 1, Ill. Tel.: Randolph 6-8168.
 Mott, Harold E.—Welch, Mott & Morgan, 710 14th St., N. W., Washington 4, D. C. Tel.: Executive 3-4600.
 Mullin, Eugene F., Jr.—Charles S. Rhyne, 726 Jackson Pl., N. W., Washington 6, D. C. Tel.: District 7-1381.
 Munger, Alfred C., 1110 First National Bank Bldg., Omaha, Nebr.
 Murray, John M.—Wilkinson, Boyden, Cragun & Barker, 744 Jackson Place, N. W., Washington 6, D. C. Tel.: National 8-1114.
 Myse, Daryl A., 822 Connecticut Ave., N. W., Washington.

N

Naftalin, Alan—Koteen & Burt, Wyatt Bldg., Washington 5, D. C. Tel.: Republic 7-5565.
 Neu, James H., 117 West Garro St., Plymouth, Ind.
 Newton, Blake T., Jr., 725 13th St., N. W., Washington.
 Nields, John W.—Cahill, Gordon, Zachry & Reindel, 63 Wall St., New York 5, N. Y. Tel.: Whitehall 4-7400.
 Niner, Isidor, 366 Madison Ave., New York.
 North, Ernest E.—American Telephone & Telegraph Co., 32 Avenue of the Americas, New York 13, N. Y. Tel.: Exchange 3-9700.
 Norris, George Jr.—ABC, 30 Rockefeller Plaza, New York.

O

O'Brien Chilton, 1218 American National Bank Bldg., Beaumont, Tex.
 O'Brien, Seymour, 2400 Baltimore Trust Bldg., Baltimore.
 O'Bryan, Paul A.—Dow, Lohnes & Albertson, 600 Munsey Bldg., Washington 4, D. C. Tel.: Sterling 3-1000.

O'Callaghan, Robert Denis, 405 National Bank of Commerce Bldg., San Antonio, Tex.
 Ockershausen, Harry J.—Dempsey & Koplovitz, Bowen Bldg., Washington 5, D. C. Tel.: Republic 7-6363.
 O'Hara, Donald C.—Dow, Lohnes & Albertson, 600 Munsey Bldg., Washington 4, D. C. Tel.: Sterling 3-1000.
 O'Hare, Richard C., 1016 Investment Bldg., Washington.
 Oliver, Robert W.—Pogue & Neal, Southern Bldg., Washington 5, D. C. Tel.: Executive 3-0440.
 Olson, Eldon S.—Wheeler & Wheeler, 704 Southern Bldg., 15th & H Sts., N. W., Washington 5, D. C. Tel.: District 7-7117.
 Oppenheimer, Monroe—Sher, Oppenheimer & Harris, 1026 Woodward Bldg., Washington 5, D. C. Tel.: Republic 7-3028.
 Ortmann, Francis J.—Roberts & McInnis, 400 DeSales Bldg., Washington 6, D. C. Tel.: National 8-0032.

P

Pantzer, Kurt F., 1313 Merchants Bank Bldg., Indianapolis, Ind.
 Panzer, Irving R. M., Fischer, Willis & Panzer, 1735 De Sales St., N. W., Washington 6, D. C. Tel.: Sterling 3-3660.
 Patrick, Duke M.—Hogan & Hartson, 810 Colorado Bldg., Washington 5, D. C. Tel.: National 8-2006.
 Patterson, Perry S.—Kirkland, Fleming, Green, Martin & Ellis, World Center Bldg., Washington 6, D. C. Tel.: Sterling 3-3200.
 Pendleton, George C.—Cummings, Stanley, Truitt & Cross, 1625 K St., N. W., Washington 5, D. C. Tel.: District 7-0777.
 Pepper, Vincent A.—Welch, Mott & Morgan, 710 14th St., N. W., Washington 5, D. C. Tel.: Executive 3-4600.
 Peterson, Nad A.—Pierson & Ball, Ring Bldg., Washington 6, D. C. Tel.: Republic 7-2566.
 Petty, Don E.—McClellan, Salisbury, Petty & McClellan, 650 South Grand Ave., Los Angeles 17, Calif. Tel.: Michigan 6003.
 Peycke, Tracy J., Telephone Bldg., Omaha, Nebr.
 Phelps, Gerald L.—Dow, Lohnes & Albertson, 600 Munsey Bldg., Washington 4, D. C. Tel.: 3-1000.
 Pierson, W. Theodore—Pierson & Ball, Ring Bldg., Washington 6, D. C. Tel.: Republic 7-2566.
 Pilafian, James, 200 S. W. 2nd Ave., Miami 36, Fla. Tel.: 82-2773.
 Pischke, Vail W., 724 Ninth St., N. W., Washington.
 Plock, Richard H., 406-413 Tama Bldg., Burlington, Iowa.
 Plotkin, Harry M.—Arnold, Fortis & Porter, 1229 19th St., N. W., Washington 6, D. C. Tel.: Executive 3-7300.
 Pogue, L. Welch—Pogue & Neal, Southern Bldg., Washington 5, D. C. Tel.: Executive 3-0440.
 Porter, Frederick M.—RCA Communications Inc., 66 Broad St., New York.
 Porter, Paul A.—Arnold, Fortis & Porter, 1229 19th St., N. W., Washington 6, D. C. Tel.: Executive 3-7300.
 Porter, William A.—Bingham, Collins, Porter & Kistler, Tower Bldg., Washington 5, D. C. Tel.: District 7-2141.
 Posner, Gene, 710 North Plankenton Ave., Milwaukee, Wis.
 Powell, Garland W.—Station WRUF, Gainesville, Fla.
 Prescott, Ross K., 1430 Life of America Bldg., Dallas, Tex. Tel.: Prospect 2224.
 Price, Robert N.—Pierson & Ball, Ring Bldg., Washington 6, D. C. Tel.: Republic 7-2566.
 Price, T. Brooke—American Telephone & Telegraph Co., 195 Broadway, New York 7, N. Y. Tel.: Exchange 3-9800.
 Prichard, S. V. O.—Prichard & Brenner, 321 S. Beverly Dr., Beverly Hills, Calif. Tel.: Bradshaw 2-3103.
 Prince, D. F.—Prince, Taylor & Crampton, 815 15th St., N. W., Bowen Bldg., Washington 5, D. C. Tel.: Republic 7-8154.

Q

Quinones, Jose Ramon, 357 Ponce de Leon Ave., San Juan, P. R.
 Quinn, Frank B., 1415 Erie Bldg., Erie, Pa.
 Quisenberry, John T.—American Telephone & Telegraph, 195 Broadway, New York 7, N. Y. Tel.: Exchange 3-9800.

R

Randolph, John Peyton, 7413 New P. O. Bldg., Box 684, Washington.
 Rauth, Joseph L. Jr.—Rauth & Levy, 1631 K St., N. W., Washington 4, D. C. Tel.: Metro-7-7795.
 Rawlings, Wallace—Roberts & Black, 530 Judge Bldg., Salt Lake City 1, Utah. Tel.: 4-3566.
 Ray, John H., 195 Broadway, New York.
 Ream, Joseph H., 485 Madison Ave., New York.
 Reams, Frazier, 303 Bell Bldg., Toledo, Ohio.
 Redmond, William P., 610 South Broadway, Los Angeles.
 Rennkamp, Kenneth E., 513 Berger Bldg., Pittsburgh, Pa.
 Resnick, Leo, Occidental Bldg., Washington 5, D. C. Tel.: National 8-9320.

Rhyme, Brice W.—Charles S. Rhyme, 726 Jackson Pl., N. W., Washington 6, D. C. Tel.: District 7-1381.

Rhyme, Charles S.—Charles S. Rhyme, 726 Jackson Pl., N. W., Washington 6, D. C. Tel.: District 7-1381.

Richman, Milton, 1 Salem St., Malden, Mass.

Rigby, Scott G.—Mayer, Rigby & Seely, Wyatt Bldg., Washington 5, D. C. Tel.: Metropolitan 8-3662.

Rizzolo, Victor A., 17 Williams St., Newark, N. J.

Robb, Robert Roger—Bingham, Collins, Porter & Kistler, Tower Bldg., Washington 5, D. C. Tel.: District 7-2141.

Roberson, Frank—Spearman & Roberson, 1329 E St., N. W., Munsey Bldg., Washington 4, D. C. Tel.: Metropolitan 8-0023.

Roberts, Glenn D., 110 East Main St., Madison, Wis.

Roberts, William A.—Roberts & McInnis, 400 DeSales Bldg., Washington 6, D. C. Tel.: National 8-0032.

Robinson, Ray, Robinson-Montgomery Bldg., Merced, Calif.

Rogers, William—Arnold, Fortis & Porter, 1229 19th St., N. W., Washington 6, D. C. Tel.: Executive 3-7300.

Rollo, Reed T.—Kirkland, Fleming, Green, Martin & Ellis, World Center Bldg., Washington 6, D. C. Tel.: Sterling 3-3200.

Ronon, Gerald, 1222 Real Estate Trust Bldg., Philadelphia.

Rorer, Dwight E., 531 Washington Bldg., Washington 5, D. C. Tel.: Republic 7-0727.

Rosen, Leo—Greenbaum, Wolff & Ernst, 295 Madison Ave., New York.

Rosenbaum, Samuel R., 1828 Land Title Bldg., Philadelphia.

Rosenman, Samuel I.—Rosenman, Goldmark, Colin & Kaye, 575 Madison Ave., New York 22, N. Y. Tel.: Murray Hill 8-7800.

Rowell, Russell—Spearman & Roberson, 1329 E St., N. W., Washington 4, D. C. Tel.: Metropolitan 8-0023.

Russell, Percy H., Jr.—Kirkland, Fleming, Green, Martin & Ellis, World Center Bldg., Washington 6, D. C. Tel.: Sterling 3-3200.

Ryan, William, 122 West Washington Ave., Madison, Wis.

S

Sakowitz, Theodore J., 922 Seybold Bldg., Miami, Fla.

Salant, Richard S.—CBS, 485 Madison Ave., New York.

Salsbury, Franklin C., 1624 Eye St., N. W., Washington 6, D. C. Tel.: Sterling 3-9072.

Samuelson, Cyrus D., 271 Midland Ave., River Edge, N. J.

Sarpy, Leon—Chaffe, McCall, Bruns, Toler & Phillips, 724 Whitney Ave., New Orleans, La.

Scallan, Thomas K., 1260 Northwestern Bank Bldg., Minneapolis 2, Minn. Tel.: Lincoln 7571.

Schapiro, Maurice, 17 Academy St., Newark, N. J.

Scharfeld, Arthur W.—Scharfeld, Jones & Baron, 752 National Press Bldg., Washington 4, D. C. Tel.: Sterling 3-4115.

Schellenberg, Howard J., Jr.—Haley & Doty, 1735 DeSales St., N. W., Washington 6, D. C. Tel.: District 7-2724.

Schinder, C. E., 61 Kenyon Bldg., Louisville, Ky.

Schneiderman, Irwin—Cahill, Gordon, Zachry & Reindel, 83 Wall St., New York 5, N. Y. Tel.: Whitehall 4-7400.

Schoemer, John R., Jr., 220 East 42nd St., New York.

Schoene, Lester P.—Schoene & Kramer, 1625 K St., N. W., Washington 6, D. C. Tel.: National 8-6928.

Schroeder, Arthur H.—Miller & Schroeder, 218 Munsey Bldg., Washington 4, D. C. Tel.: Metropolitan 8-2193.

Seaks, Robert G.—Wheeler & Wheeler, 704 Southern Bldg., 15th & H Sts., N. W., Washington 5, D. C. Tel.: District 7-7117.

Seay, Temple W.—Dow, Lohnes & Albertson, 600 Munsey Bldg., Washington 4, D. C. Tel.: Sterling 3-1000.

Sealy, Hamilton F.—Mayer, Rigby & Seely, Wyatt Bldg., Washington 5, D. C. Tel.: Metropolitan 8-3662.

Segal, Paul M.—Segal, Smith & Hennessey, 816 Connecticut Ave., N. W., Washington 6, D. C. Tel.: Republic 7-2701.

Seward, P. W., 1101 Warner Bldg., Washington 4, D. C. Tel.: Republic 7-7944.

Shannon, Charles V., 520 Shoreham Bldg., Washington.

Shaw, Roscoe L., 2305 Telephone Bldg., St. Louis, Mo.

Sher, Robert E.—Sher, Oppenheimer & Harris, Woodward Bldg., Washington 5, D. C. Tel.: Republic 7-3028.

Shipley, Carl L., 982 National Press Bldg., Washington 4, D. C. Tel.: Sterling 3-1648.

Shuebruk, Peter—Fly, Shuebruk, Blume & Gagne, 30 Rockefeller Plaza, New York 20, N. Y. Tel.: Circle 7-3940.

Simon, Morton J., 1100 Morris Bldg., Philadelphia.

Sims, William P., Jr.—Dow, Lohnes & Albertson, 600 Munsey Bldg., Washington 4, D. C. Tel.: Sterling 3-1000.

Sirica, John J.—Hogan & Hartson, 810 Colorado Bldg., Washington 5, D. C. Tel.: National 8-2006.

Siskind, Max, 1025 Connecticut Ave., N. W., Washington 6, D. C. Tel.: Republic 7-1664.

Slaughter, Harrison T.—Pierson & Ball, Ring Bldg., Washington 6, D. C. Tel.: Republic 7-2566.

Smith, Andrew A., 1628 Candler Bldg., Atlanta, Ga.

Smith, Bernard B., 551 Fifth Ave., New York 17, N. Y. Tel.: Vanderbilt 6-0116.

Smith, Samuel B.—Lippincott & Smith, 24 California St., San Francisco 11, Calif. Tel.: Yukon 6-4058.

Smith, E. Stratford—Welch, Mott & Morgan, 710 14th St., N. W., Washington 5, D. C. Tel.: Executive 3-4600.

Smith, George S.—Segal, Smith & Hennessey, 816 Connecticut Ave., Washington 6, D. C. Tel.: Republic 7-2701.

Smith, Karl A.—Hogan & Hartson, 810 Colorado Bldg., Washington 5, D. C. Tel.: National 8-2006.

Smith, Quayle B.—Segal, Smith & Hennessey, 816 Connecticut Ave., N. W., Washington 6, D. C. Tel.: Republic 7-2701.

Smith, Samuel Burrows—Lippincott & Smith, 24 California St., San Francisco 11, Calif. Tel.: Yukon 6-4058.

Smith, Sidney V.—Mechlin, Marshall & Smith, Tower Bldg., Washington 5, D. C. Tel.: District 7-0016.

Smith, William P.—Smith & Jameson, 1206 Walker Bldg., 734 15th St., N. W., Washington 5, D. C. Tel.: District 7-1192.

Socolow, A. Walter, 580 Fifth Ave., New York 36, N. Y. Tel.: Plaza 7-2112.

Southmayd, John P.—Fisher, Wayland, Duvall & Southmayd, 703 Perpetual Bldg., 1111 E St., N. W., Washington 4, D. C. Tel.: Republic 7-1450.

Sovik, Laurence, University Bldg., Syracuse, N. Y.

Spawn, Coy U., Jr., 733 Bankers Mortgage Bldg., Houston 2, Tex.

Spearman, John C.—Spearman & Roberson, 1329 E St., N. W., Washington 4, D. C. Tel.: Metropolitan 8-0023.

Spearman, Paul D.—Spearman & Roberson, 1329 E St., N. W., Washington 4, D. C. Tel.: Metropolitan 8-0023.

Spears, Adrian A., Majestic Bldg., San Antonio, Tex.

Spiro, Jacob S., 51 Chambers St., New York.

Sprague, E. Stuart, 36 West 44th St., New York.

Stamler, Arthur—Scharfeld, Jones & Baron, 752 National Press Bldg., Washington 4, D. C. Tel.: Sterling 3-4115.

St. Clair, Orla, 130 Montgomery St., San Francisco, Calif.

Steen, J. W., 1625 K St., N. W., Washington 5, D. C.

Stein, Abe L., Warner Bldg., Washington 4, D. C. Tel.: Republic 7-7944.

Stevens, David S.—McKenna & Wilkinson, 1735 DeSales St., N. W., Washington 6, D. C. Tel.: National 8-2931.

Stollenwerck, Frank, 892 National Press Bldg., Washington 4, D. C. Tel.: National 8-7846.

Stone, Warren M.—Stone & Flick, 705-707 Warren Bank & Trust Bldg., Warren, Pa.

Stout, Clair L.—Dow, Lohnes & Albertson, 600 Munsey Bldg., Washington 4, D. C. Tel.: Sterling 3-1000.

Strauss, Samuel W., 300 Broadway, Camden, N. J.

Strong, George E., Washington Bldg., Washington 5, D. C. Tel.: National 8-2880.

Struck, William L., 512 Harries Bldg., Dayton 2, Ohio. Tel.: Adams 8171.

Stuart, Harold C.—Doerner, Rinehart, Stuart & Clammer, 1001 Connecticut Ave., N. W., Washington 6, D. C. Tel.: Sterling 3-1767.

Sullivan, Francis C., 1200 Alworth Bldg., Duluth, Minn.

Sutton, George O.—George O. Sutton, 1038 National Press Bldg., Washington 4, D. C. Tel.: National 8-7949.

Swezey, Robert D.—WDSU Broadcasting Corp., 520 Royal St., New Orleans 16, La. Tel.: Tulane 4371.

T

Taylor, Telford—Landis, Taylor & Scoll, 400 Madison Ave., New York. Tel.: Murray Hill 8-8990.

Taylor, Willis H. Jr.—Pennie, Edmonds, Morton & Barrows, 247 Park Ave., New York.

Thomson, William—George O. Sutton, 1038 National Press Bldg., Washington 4, D. C. Tel.: National 8-7949.

Torlow, Sherwood Jordan, 18 Tremont St., Boston, Mass.

Trendle, George W. Jr., 1854 National Bank Bldg., Detroit.

Tucker, John H.—Tucker, Bronson & Martin, 901 Commercial Bldg., Shreveport 24, La. Tel.: 5-7764.

Tuft, Leonard W.—RCA Communications Inc., 66 Broad St., New York.

Tuhy, Stephen Jr., 406 Albee Bldg., Washington 5, D. C. Tel.: Metropolitan 8-2004.

Tumulty, Joseph P. Jr., 1317 F St., N. W., Washington.

Turner, George B., 15 Broad St., New York.

Tyler, Lyon L. Jr.—Welch, Mott & Morgan, 710 14th St., N. W., Washington 5, D. C. Tel.: Executive 3-4600.

Tyler, Varro E., 109 South Ninth St., Nebraska City, Neb. Tel.: 480.

V

Van Allen, John W.—Wilcox & Van Allen, 1008 Liberty Bank Bldg., Buffalo 2, N. Y. Tel.: Washington 0095.

Van Orsdel, Ralph, 314 Sonora Drive, San Mateo, Calif.

Veve, Adolfo Garcia, Box 2655, San Juan, P. R.

Vieth, Duane—Arnold, Fortis & Porter, 1229 19th St., N. W., Washington 6, D. C. Tel.: Executive 3-7300.

W

Wald, Patricia M.—Arnold, Fortis & Porter, 1229 19th St., N. W., Washington 6, D. C. Tel.: Executive 3-7300.

Walker, Henry B., Old National Bank Bldg., Evansville, Ind.

Walker, Paul A., 401 Warner Bldg., Washington 4, D. C. Tel.: Metropolitan 8-1899.

Walker, Ralph L.—Pierson & Ball, Ring Bldg., Washington 6, D. C. Tel.: Republic 7-2566.

Wall, Thomas H.—Dow, Lohnes & Albertson, 600 Munsey Bldg., Washington 4, D. C. Tel.: Sterling 3-1000.

Wallace, Harold E., 530 Judge Bldg., Salt Lake City, Utah.

Walton, Frederick H. Jr.—Dempsey & Koplovitz, 938 Bowen Bldg., Washington 5, D. C. Tel.: Republic 7-6363.

Walter, Harry F., 916 Evans Bldg., 1420 New York Ave., Washington 5, D. C. Tel.: National 8-2150.

Wasilewski, Vincent T.—NARTE, 1771 N St., N. W., Washington 6, D. C. Tel.: Decatur 2-9300.

Waters, John H.—Western Union Telegraph Co., 60 Hudson St., New York.

Wayland, Charles V.—Fisher, Wayland, Duvall & Southmayd, 703 Perpetual Bldg., 1111 E St., N. W., Washington 4, D. C. Tel.: Republic 7-1450.

Weaver, Henry B. Jr.—Weaver & Glassie, 1210 Tower Bldg., Washington 5, D. C. Tel.: Sterling 3-4355.

Weber, Arthur W., 455 Spitzer Bldg., Toledo, Ohio.

Webster, Bethuel M., 15 Broad St., New York.

Welch, Francis X., 1038 Munsey Bldg., Washington 4, D. C.

Welch, Vincent B.—Welch, Mott & Morgan, 710 14th St., N. W., Washington 5, D. C. Tel.: Executive 3-4600.

Wendt, William—Western Union Telegraph Co., 60 Hudson St., New York.

Werner, Robert L.—RCA, 30 Rockefeller Plaza, New York 20, N. Y. Tel.: Columbus 5-5900.

Wheat, Carl L.—Wheat, May & Shannon, Shoreham Bldg., Washington 5, D. C. Tel.: Republic 7-4123.

Wheeler, Burton K.—Wheeler & Wheeler, 704 Southern Bldg., 15th & H Sts., N. W., Washington 5, D. C. Tel.: District 7-7117.

Wheeler, Edward K.—Wheeler & Wheeler, 704 Southern Bldg., 15th & H Sts., N. W., Washington 5, D. C. Tel.: District 7-7117.

Whissell, George B., 2305 Telegraph Bldg., St. Louis, Mo.

Whittenberg, Ralph K., Hilp Bldg., Reno, Nev.

Wildner, Gaston H. Jr., 211 Goodhue Bldg., Beaumont, Tex.

Wilkinson, Ernest L.—Wilkinson, Boyden, Cragan & Barker, 744 Jackson Place, Washington 6, D. C. Tel.: National 8-1114.

Wilkinson, Glen A.—Wilkinson, Royden, Cragan & Barker, 744 Jackson Place, Washington 6, D. C. Tel.: National 8-1114.

Wilkinson, Vernon L.—McKenna & Wilkinson, 1735 DeSales St., N. W., Washington 6, D. C. Tel.: National 8-2931.

Williams, A. Rea, 733 Investment Bldg., Washington.

Willis, John W.—Fischer, Willis & Panzer, 1735 DeSales St., N. W., Washington 6, D. C. Tel.: Sterling 3-3660.

Wilner, Morton H.—Lyon, Wilner & Bergson, 700 Wyatt Bldg., Washington 5, D. C. Tel.: Metropolitan 8-6900.

Wilson, James E.—Roberts & McInnis, 400 DeSales Bldg., Washington 6, D. C. Tel.: National 8-0032.

Wilson, Thomas W.—Dow, Lohnes & Albertson, 600 Munsey Bldg., Washington, D. C. Tel.: Sterling 3-1000.

Winter, Harrison L., 10 Light St., Baltimore.

Wisehart, Harold H.—Wisehart & Savage, 104-112 Professional Bldg., Clinton, Ohio.

Wolff, Sanford I.—Riskin & Wolff, 134 N. LaSalle St., Chicago.

Wood, Joseph G.—Schortemeier, Eby & Wood, 301 Circle Tower, Indianapolis, Ind.

Woods, Warren—Roberts & McInnis, 400 DeSales Bldg., Washington 6, D. C. Tel.: National 8-0032.

Wozencraft, Col. Frank H., 605 Southern Bldg., Washington 5, D. C. Tel.: Executive 3-5363.

Wrape, James W., Sterick Bldg., Memphis, Tenn.

Wright, J. Warren, 5504 Grove St., Chevy Chase, Md.

Wyatt, Wilson W.—Wyatt, Grafton & Grafton, 300 Marion E. Taylor Bldg., Louisville, Ky. Tel.: Amherst 1881.

Y

Yates, Carlyle E.—RCA Laboratories Div., David Sarnoff Research Center, Princeton, N. J. Tel.: Princeton 1-2500.

Young, Verne R.—Loocks, Zias, Young & Janisky, The American Bldg., Washington 4, D. C. Tel.: Sterling 3-4304.

REGIONAL RADIO NETWORKS OF THE UNITED STATES

ALASKA BROADCASTING SYSTEM—Comprising KFQD Anchorage; KFRB Fairbanks; KINY Juneau; KTKN Ketchikan; KIBH Seward; KIFW Sitka. Headquarters: 830 Securities Bldg., Seattle. Tel.: Seneca 6333. Wm. J. Wagner, owner and general manager. Represented nationally by Alaska Radio Sales.

ALOHA NETWORK—Comprising KIPA Hilo; KTOH Lihue; KHON Honolulu and KMVI Wailuku. Headquarters: P. O. Box 1380, Honolulu 42. Tel.: 9-5295. R. M. Fittkin, general manager. National sales, Jack Allison. Represented by W. S. Grant Co.

ARIZONA BROADCASTING SYSTEM—Comprising KTAR Phoenix; KVOA Tucson; KYUM Yuma; KGLU Safford; KWJB Globe; KYCA Prescott; KAWT Douglas. Executive officers: Dick Lewis, KTAR, manager; Bill Harvey, KTAR, commercial manager; Rol Laughner, KTAR, program manager; Ted Edwards, KTAR, promotion manager; John Snow, KTAR, news editor. Represented nationally by Paul H. Raymer Co.

ARIZONA NETWORK—Comprising KOY Phoenix; KTUC Tucson; KSUN Bisbee; KYMA Yuma; and KCLS Flagstaff. Available as a regional network. Executive officers: Albert Johnson, KOY; Lee Little, KTUC; Carl Morris, KSUN; Charles J. Saunders, KCLS; William L. Lindsey, KYMA. John L. Hogg, KOY, commercial manager. Represented nationally by John Blair & Co.

ARKANSAS NETWORK—Comprising KARK Little Rock and all other stations in the State of Arkansas. Two or more stations may be used; one or more outlets in cities with multiple stations. Costs are combined station time and line charge. General Office, 114 East Capitol St., Little Rock, Ark. T. K. Barton, general manager; A. C. Dowden, commercial manager.

ARROWHEAD NETWORK—Comprising WEBC Duluth, Minn.; WMFG Hibbing, Minn.; WHLB Virginia, Minn.; WEAU Eau Claire, Wis.; WJMC Rice Lake, Wis.; WISC Madison, Wis. Available as a hookup. Headquarters: WEBC Bldg., Duluth 2, Minn. Executive officers: Walter C. Bridges, WEBC, manager. Represented nationally by George P. Hollingsbery Co.

BROADCASTING CORP. OF AMERICA'S NETWORK—Comprising KPRO Riverside and San Bernardino; KROP Brawley and El Centro; KREO Indio; KYOR Blythe. Office: 3401 Russell St., Riverside. Richard T. Sampson, general manager.

PAUL BUNYAN NETWORK—Michigan regional network comprising WTCM Traverse City; WATT Cadillac; WATZ Alpena; WMBN Petoskey; WATC Gaylord. Headquarters: Paul Bunyan Bldg., Traverse City.

CALIFORNIA NORTHERN GROUP—KSYC Yreka; KBLF Red Bluff; KSUE Susanville. Jack A. Mitchell, KSYC, manager. West Coast Representative: Tracy Moore & Assoc.

COLUMBIA PACIFIC NETWORK—Comprising KNX Los Angeles; KCBS San Francisco; KFMB San Diego; KFRE Fresno; KGDM Stockton; KMBY Monterey; KROY Sacramento; KCMJ Palm Springs; KHUM Eureka; KERN Bakersfield; KHSJ Chico; KVCV Redding, all Calif.; KOIN Portland; KFR North Bend; KFLW Klamath Falls; KYJC Medford; KRNK Roseburg; KERG Eugene, all Ore. KIRO Seattle; KXLY Spokane; KWIE Kennewick, and KIMA Yakima, all Wash.; KDLO Reno, Nev. Headquarters: Columbia Square, Los Angeles; William D. Shaw, general manager.

COLUMBINE NETWORK—Comprising KMYR Denver; KYOU Greeley; KBOL Boulder; KCOL Fort Collins; KFTM Fort Morgan; all in Colorado. Business office and studio—Security Life Bldg., Denver 2, Colo. A. G. Meyer, general manager; E. E. Koepke, sales manager.

CONNECTICUT STATE NETWORK—Regional network comprising WSTC Stamford; WNAB Bridgeport; WHTT Hartford; WNBC New Haven; WNLG New London; WATW Waterbury; WTOR Torrington; WHAY New Britain. Headquarters: WHTT. C. Glover DeLaney, president.

DAIRYLAND NETWORK—Comprising WTCN Minneapolis-St. Paul; KATE Albert Lea; KWLM Willmar, and KWNO Winona. All in Minnesota. Headquarters: Box 393 Willmar, Minn. H. W. Linder, president.

—FCB MEMBERS—

Younger, Donald, Santa Cruz Theatre Bldg., Santa Cruz, Calif. Tel.: Santa Cruz 4700.
Yourd, Kenneth L.—CBS, 465 Madison Ave., New York.

Z

Zagon, Samuel S., 6263 Hollywood Blvd., Los Angeles.
Zeller, Robert G.—Cahill, Gordon, Zachry & Reindel, 83 Wall St., New York 5, N. Y. Tel.: Whitehall 4-7400.
Zias, Joseph F.—Loucks, Zias, Young & Jansky, The American Bldg., Washington 4, D. C. Tel.: Sterling 3-4004.
Zorbaugh, Geraldine B.—American Bcstg.—Paramount Theatres, Inc., 7 W. 66th St., New York 23, N. Y. Tel.: Susquehanna 7-5000.

DON LEE BROADCASTING SYSTEM—Comprising KHJ Los Angeles; KGB San Diego; KDB Santa Barbara; KFXM San Bernardino; KFRC San Francisco; KMYC Marysville; KYNO Fresno; KSBW Salinas-Monterey; KVEN Ventura; KCOK Tulare-Visalia; KXO El Centro; KAFY Bakersfield; KVCC San Luis Obispo; KPRL Paso Robles; KIEM Eureka; KXOC Chico; KYOS Merced; KXOA Sacramento; KXOB Stockton, all in California. KRXL Roseburg; KPOJ Portland; KFJI Klamath Falls; KORE Eugene; KBND Bend; KOOS Coos Bay; KWIL Albany; KAST Astoria; KUIN Grants Pass; KSLM Salem; KWIN Ashland, all in Oregon. KATO Reno, Nev. KVI Seattle-Tacoma; KYAK Yakima; KNEW Spokane; KXRO Aberdeen; KGY Olympia; KELA Centralia; KRKO Everett; KWLK Longview; KUJ Walla Walla; KPUG Bellingham; KWNW Wenatchee, all in Washington. KRLC Lewiston; KWAL Wallace-Kellogg. KVIN Coeur d'Alene, all in Idaho. Headquarters: Don Lee Bldg., 1313 N. Vine St., Hollywood 28, Calif.

FOREIGN LANGUAGE QUALITY NETWORK—Comprising stations WOV New York; WHAY New Haven; WJMJ Philadelphia; WSBG Chicago; WSRB Cleveland; WHOD Pittsburgh; KSN San Francisco; WACE Springfield, Mass.; WTEL Philadelphia, and KOWL Los Angeles. Headquarters: 110 Chapel St., New Haven. Telephone: Spruce 7-3611. Pat Stanton, general manager.

GUY GANNETT BROADCASTING SYSTEM—Comprising WGAN Portland and WGUY Bangor, Me. Headquarters: Gannett Bldg., Portland, Me.

GEORGIA ASSN. OF LOCAL STATIONS—Comprising WDEC Americus; WGAU Athens; WBBQ Augusta; WLBB Carrollton; WBHF Cartersville; WGAA Cedartown; WWMJ Cordele; WROC Covington; WBLJ Dalton; WMLT Dublin; WKEU Griffin; WFOM Marietta; WFRP Savannah; WWNS Statesboro; WWCZ Tifton; WLET Toccoa; WVOG Vidalia; WYWA Waynesboro; WLLD West Point; WMVG Milledgeville; WMAA Moultrie; WDWD Dawson; WBHB Fitzgerald; WDUW Gainesville; WSFT Thomaston; WKTG Thomasville; WBBB Macon; WGIG Brunswick. Tom Carr, sales director, Box 66, Atlanta.

GEORGIA MAJOR MARKET TRIO—Comprising WAGA Atlanta; WTOC Savannah; WMAZ Macon. Available individually and in group. National representatives: The Katz Agency Inc.

GRANITE STATE NETWORK—Comprising WKBR Manchester; WWNH Rochester; WTSV Claremont; WMOU Berlin, and WTSL Hanover, all in New Hampshire. Also WPSA Brattleboro, Vt., and WCAW Gardner, Mass. Headquarters: 155 Front St., Manchester. W. J. Barkley, president; W. R. Rust Jr., treasurer; Ralph Gotlieb, general manager; Warren H. Journey, commercial manager.

GREAT NORTHERN BCSTG. SYSTEM—Comprising KVOX Moorhead, Minn.; KGDE Fergus Falls, Minn.; KLPB Minot, N.D.; KGCU Mandan, N.D.; KOVC Valley City, N.D.; KDRL Devils Lake, N.D.; KGXC Sidney, Mont.; KNOX Grand Forks, N.D. Headquarters: 107 First Ave., N.W., Mandan, N.D. M. J. Reinert, secretary.

HOOVER NETWORK—Comprising WCNB Connersville; WCTW New Castle; WMRI Marion; WSRK Shelbyville; WFML Washington; WRSW Warsaw, all Indiana. Business office: Colonial Bldg., New Castle, Ind.

INTERMOUNTAIN NETWORK—Utah Group: KALL Salt Lake City; KLO Ogden; KOVO Provo; KOAL Price; KVVU Logan; KSCV Richfield. Idaho Group: KWIK Pocatello; KIFI Idaho Falls; KLIX Twin Falls; KFXD Nampa; KGEM Boise. Nevada Group: KELK Elko; KRAM Las Vegas; KELY Ely. Wyoming Group: KLUK Evanston; KVRB Rock Springs; KSP Casper; KWYO Sheridan; KPOW Powell; KOVE Lander; KWYO Cheyenne. Montana Group: KBMY Billings; KRJF Miles City; KOPR Butte; KPRK Livingston; KMOM Great Falls; KCAP Helena; KOJM Havre; KIYI Shelby; KXLO Lewistown; KGEZ Kalispell. Also KABQ Albuquerque, N.M., and KNEB Scottsbluff, Neb. Main office: 146 S. Main St., Salt Lake City. Officers: George C. Hatch, chairman; Lynn L. Meyer, president; Jack Paige, vice president; Thomas H. Anderson, manager; Kay Richins, manager, program operations; W. D'Ort Cozzens, director of engineering; Gordon Owen, director of homemaker's programs; Mal Wyman, sport director; Stan Farnsworth, farm director; James Petersen, news director; Earl Donaldson, music director.

LONG RADIO ENTERPRISES—Comprising KIOX Bay City; KVIC Victoria; and KTLW Texas City. All in Texas and available as a package group. J. G. Long, managing director, P. O. Box 1391, Bay City.

MAINE BROADCASTING SYSTEM—Comprising WCSI Portland; WLBZ Bangor; WRDO Augusta. Headquarters: 157 High St. c/o WCHS Portland 3, Me.

McCLATCHY BEELINE—Comprising KFBK, KFBK-FM Sacramento; KMJ and KMJ-FM Fresno; KWG Stockton; KERN and KERN-FM Bakersfield; KOH Reno, Nev. and KBEE (FM) Modesto. Headquarters: 21st & Q Sts., Sacramento, Calif. Eleanor McClatchy, president; Leo O. Ricketts, director of sales.

METROPOLITAN NETWORK—Comprising WPIK Alexandria and WFAK Falls Church in Virginia. WGAY Silver Spring and WUST Bethesda-Chevy Chase in Maryland. (All Washington, D. C. area.) Represented nationally by Richard O'Connell, New York.

MICHIGAN RADIO NETWORK—Comprising WXYZ Detroit (key station); WBCM Bay City; WTAC Flint; WJIM Lansing; WIBM Jackson; WELL Battle Creek; WLAV Grand Rapids; WSOO Sault Ste. Marie; WKCB Muskegon; WKLA Ludington; WGFJ Kalamazoo; WHRV Ann Arbor. Sold as a unit of ABC Network. Headquarters: Mutual Bldg., Detroit. Executives: James G. Riddell, president.

MID-SOUTH NETWORK—Comprising WCBI Columbus; WELO Tupelo; WMOX Meridian; WROX Clarksdale; WNAG Grenada; WROB West Point; all in Mississippi. Headquarters: WCBI Columbus. Bob McRaney, general manager.

MISSISSIPPI BROADCASTING CO. (Withers Gavin Stations)—Comprising WCOB Meridian; WJQS Jackson; WMBC Macon, and WACR Columbus, all in Mississippi.

NEW ENGLAND REGIONAL NETWORK—Special regional network of NBC-affiliated stations, comprising WTIC Hartford; WBZ Boston; WJAR Providence; WCSH Portland; WLEZ Bangor; WRDO Augusta. Me. Directors: Paul W. Morency, WTIC, chairman; Chris J. Witting, Westinghouse Bcstg. Co. Inc.; John J. Bcyle, WJAR; William E. Rines, WCSH. Operations Director: Mr. Morency. Represented nationally by Weed & Co.

NORTHWEST NETWORK—Comprising KSTP St. Paul; KROC Rochester, Minn.; KYSM Mankato, Minn.; KFAM St. Cloud, Minn.; WDAY Fargo, N.D.; KFRY Bismark, N.D. Headquarters and sales office: 315 University Ave., KSTP Minneapolis-St. Paul. Officials: Stanley E. Hubbard, general manager; Kenneth M. Hance, treasurer; Karl Plaim, sales manager.

OKLAHOMA NETWORK—Comprising KADA Ada; KCRC Enid; KBKX Muskogee; KVSQ Ardmore; KTMK McAlester; KSWO Lawton. Bill Hoover, president. KADA, Ada. Represented nationally by Venard Inc.

OREGON TRAIL NETWORK—Owned and operated by Inland Radio Inc. KSRV Ontario; KBKR Baker, and KLEB LaGrande. Lee W. Jacobs, general manager, Baker, Ore.

PALMETTO BROADCASTING SYSTEM—Basic group comprising WGAC Augusta; WBGE Atlanta, both in Georgia; WCOS Columbia and choice in Charleston, WJMX Florence; WBCU Spartanburg-Union; WAJM Anderson; WTCU Rock Hill and WTND Orangeburg, all in South Carolina; other affiliated stations, WRFC Athens; WKLY Hartwell and WGGG Gainesville, all in Georgia; WGGD Chester; WHSC Hartsville; WSNW Seneca; WKDK Newberry; WALD Walterboro; WDSC Dillon; WACA Camden and choice in Greenville, all in South Carolina. Executive offices: 1 Martin St., Anderson, S. C. Tel.: 3802. Officers: Wilton E. Hall, president; Jimmy Scribner, director; Glenn P. Warnock, general manager; G. P. Browne, national sales manager; John F. McCallum, regional sales. Representatives: national—Burn-Smith Co. Inc.; southern—Dora-Clayton Agency Inc.

QUAKER NETWORK—Pennsylvania regional hookup comprising WFIL Philadelphia; WEEV Reading; WAEB Allentown; WEST Easton; York; WAZL Hazleton; WLAN Lancaster; WBSA York; WAZL Hazleton; WLAN Lancaster; Harrisburg; WRKOK Suburb; WRAX Williamsport; WEEG Altoona; WARD Johnstown; WERC Erie; WCAE Pittsburgh; WKST New Castle; WKRZ Oil City. Operates as network or split as desired. Other cities available on order. Headquarters: WFIL Philadelphia. General Manager: Rofer W. Clipp; General Sales Manager: Kenneth W. Stowman.

RAZORBACK NETWORK—Comprising KLXR Little Rock and all other stations in Arkansas. Headquarters: 217 E. Third St., Little Rock. Tel.: 4-8928. Emil J. Pouzar, general manager.

REBEL NETWORK—Mississippi regional network comprising WJDX Jackson; WAML Laurel; WFOR Hattiesburg; WTOK Meridian; WCGM Gulfport. Frank Gerry, business manager.

RURAL RADIO NETWORK—Northeast Radio Corp. owns and operates FM stations WRRJ Wethersfield; WRRR Bristol Center; WRRR Ithaca; WRRD DeRuyter; WRRR Cherry Valley; WRRH Mt. Beacon, all New York. FM affiliates: WHLD-FM Niagara Falls; WMSA-FM Massena; WNNY-FM Watertown; WRUN-FM Utica-Rome; WHDL-FM Olean; WFLY (FM) Troy; all New York, and WQAN-FM Scranton, Pa. AM associated stations: WFLD Niagara Falls; WKWB Buffalo; WJTN Jamestown; WHAM Rochester; WACS Syracuse; WHCU Ithaca; WELM Elmira; WNEB Binghamton; WDLA Walton; WRUN Utica-Rome; WNNY Watertown; WMSA Massena; WGY Schenectady; WKIP Poughkeepsie; WGNV Newburgh, all New York, and WQAN Scranton, Pa. Headquarters: 306 E. State St., Ithaca, N. Y. Telephone: 4-6357. Officers: D. K. deNeuf, general manager; H. S. Brown, sales manager; T. R. Humphrey, chief engineer; M. N. Knapp, program director.

SOUTHERN MINNESOTA NETWORK—Comprising KYSM Mankato; KROC Rochester and KATE Albert Lea, all in Minnesota. Headquarters: Bulmer & Johnson Inc., 326 WCCO Building, 626 Second Ave. S., Minneapolis 2. Tel.: Lincoln 7017. Represented nationally by Robert Meeker.

STEINMAN STATIONS—Comprising WDEL Wilmington, Del.; WORK York, Pa.; WGAL Lancaster, Pa.; WRAW Reading, Pa.; WEST Easton, Pa.; WKBO Harrisburg, Pa. Represented nation-

REGIONAL NETWORKS

ally by Robert Meeker Assoc. Headquarters: WGAL Lancaster. General Manager: Clair R. McCollough.

TALL CORN NETWORK—An Iowa network comprising KPIG Cedar Rapids; KROS Clinton; KSIJ Creston; KNE Shenandoah; KDEC Decorah; KDTH Dubuque; KVFD Fort Dodge; KFJB Marshalltown; KWPC Muscatine; KWBG Boone; KICD Spencer; KRIB Mason City; KCMC Carroll; KOEL Oelwein; KBOE Oskaloosa, and KXIC Iowa City. Represented nationally by John E. Pearson Co.

TEXAS BROADCASTING SYSTEM (TBS)—Regional network comprising KRLD Dallas; KABC San Antonio and KTRH Houston. Headquarters: KRLD Herald Square, Dallas. Clyde W. Rembert, general manager.

TEXAS QUALITY NETWORK—Comprising WFAA Dallas; WOAI San Antonio; KPFC Houston; WBAP Ft. Worth; KRIS Corpus Christi; KCNC Amarillo; KRGV Weslaco, and KCBD Lubbock, all Texas. No national representative. Each station acts as sales agent for the other; national representative of any one station can supply information about all stations.

TEXAS STATE NETWORK—Regional network comprising KFJZ Fort Worth; WRR Dallas; KGBS San Antonio; KBST Big Spring; KGKL San Angelo; KWFT Wichita Falls; KRBC Abilene; KPLT Paris; KRRV Sherman; KCMC Texarkana; WACO Waco; KNOW Austin; KLYN Amarillo; KFRO Longview; KBWD Brownwood; KCRS Midland; KCVL Greenville; KTRH Houston; KRIO McAllen; KTBB Tyler; Gene L. Carle, president; Dale Drake, sales manager. Tel.: Edison 3473. Headquarters: 1201 W. Lancaster, Fort Worth 1.

TOBACCO NETWORK INC.—Eastern North Carolina regional network comprising WRAL Raleigh; WTKI Durham; WFNC Fayetteville; WGNW Wilmington; WCCE Rocky Mount; WGTC Greenville; WHIT New Bern; WGBR Goldsboro, WJNC Jacksonville. Headquarters: 710 Odd Fellows Bldg., Raleigh. Telephone: 8885. Represented nationally by John E. Pearson Co. Executives: Harmon Duncan, WTKI, president; Victor Dawson, WFNC, vice president; Lester Gould, WJNC, secretary-treasurer; K. C. Will-

son, executive vice president and general manager.

UNION BROADCASTING SYSTEM—Comprising WKRA Buffalo; WOKO Albany; WCSS Amsterdam; WENT Gloversville; WHUC Hudson; WKNY Kingston; WKIP Poughkeepsie; WDOS Oneonta; WKOP Binghamton; WELM Elmira; WGAT Utica; WICY Malone; WEAV Plattsburgh; all in New York. WBEC Pittsfield; WACE Chitticoque; WALE Fall River; WVOM Boston, all in Massachusetts; WSYB Rutland, Vt.; WJOY Burlington, Wt.; WWCO Waterbury, Conn.; WFAU Augusta, Me.; WKNE Keene, N.H. Headquarters: WOKO Albany, N. Y. Jim Healey, general manager.

UPPER MIDWEST BROADCASTING SYSTEM—Comprising KASM Albany, KXRA Alexandria; KBUN Bemidji; KLIZ Brainerd; KBMW Breckenridge; WKLK Cloquet; KROK Crookston; KDLM Detroit Lakes; WEVE Eveleth; KSUM Fairmont; KDHL Faribault; KGDE Ferris Falls; KBZY Grand Rapids; CKFI International Falls; KVOX Moorhead-Fargo; KNUJ New Ulm, and WSHB Stillwater, all Minnesota; KDLR Devils Lake; KVOX Fargo-Moorehead; KNOX Grand Forks; KGCU Mandan-Bismarck; KPLM Minot; KOVC Valley City, and KGCX Williston-Sidney, all North Dakota; KABR Aberdeen; KDSJ Deadwood; KIJV Huron; KORN Mitchell; KGFX Pierre; KISD Sioux Falls, and KWAT Watertown, all South Dakota; WHBY Appleton; WATW Ashland; WBIZ Eau Claire; WJPC Green Bay; WLXC La Crosse; WLDY Ladysmith; WIBU Madison-Poynette, WDLB Marshfield; WMNE Menomonie; WOSA Merrill; WPRD Portage; WPRE Prairie du Chien; WOPR Rhinelander; WRCO Rhinelander Center; WRJN Racine; WTCH Shawano; WSTP Stevens Point; WTRW Two Rivers; WBKV West Bend, and WFHR Wisconsin Rapids, all Wisconsin; WDBC Escanaba; WHDF Houghton; WIKB Iron River; WJMS Ironwood, and WJPD Ishpeming, all Michigan; KASI Ames; KJAN Atlantic; KCOG Centerville; KCHA Charles City; KSTT Davenport; KOKX Keokuk; KSMN Mason City; KAY, Storm Lake; and KJFW Walker City, all Iowa; KCBN Broken Bow; KJSK Columbus; KPFT Fremont; WJAG Norfolk, and KNEB Scottsbluff, all Nebraska;

WMRO Aurora; WCAZ Carthage, and WLBK DeKalb, all Illinois; KXGN Glendive and KGCC Sidney-Williston, both Montana. Headquarters: 1687 Northwestern Bank Bldg., Minneapolis. Orville F. Lawson, president.

WEST TEXAS PACKAGED STATIONS—Comprising KRBC Abilene; KBST Big Spring; KGKL San Angelo; KTRN Wichita Falls.

WISCONSIN NETWORK—Network comprising WHBY Appleton; KFIZ Fond du Lac; WCOJ Janesville; WIBU Poynette-Madison; WWCW Baraboo; WRJN Racine; WHBL Sheboygan; WFHR Wisconsin Rapids; WJPG Green Bay; WGEZ Beloit. Supplementary stations: WMAM Marinette; WEAU Eau Claire; WJMS Ironwood, Mich.; WATW Ashland; WECB Superior; WISN Milwaukee; WKBH La Crosse; WOSH Oshkosh; WJMC Rice Lake; WOBT Rhinelander; WATK Antigo; WRCO Richland Center; WSAU Wausau; WRDB Reedsburg; WIGM Medford; WFPF Park Falls; WLDY Ladysmith; WOSA-WLIN Merrill. Main office: Nash Block, Wisconsin Rapids, George T. Frechette, WFHR, managing director and secretary-treasurer.

YANKEE NETWORK—Division of General Tele-radio, Inc., comprising WNAC Boston-Lawrence, Mass.; WFAU Augusta, Me.; WIDE Biddeford, Me.; WICC Bridgeport, Conn.; WALE Fall River, Mass.; WJEM Pitchburg-Leominster, Mass.; WHAI Greenfield, Mass.; WONS Hartford, Conn.; WMAS Springfield, Mass.; WCOU Lewiston-Auburn, Me.; WLLH Lowell-Lawrence, Mass.; WNBH New Bedford, Mass.; WOCB Hyannis, Mass.; WNLN New London, Conn.; WBRK Pittsfield, Mass.; WPOR Portland, Me.; WBEH Portsmouth-Dover, N. H.; WEAN Providence, R. I.; WWON Woonsocket, R. I.; WSYB Rutland, Vt.; WWSR St. Albans, Vt.; WWCQ Waterbury, Conn.; WDEV Waterbury, Vt.; WAAB Worcester, Mass. Represented nationally by H-R Representatives, Inc., headquarters WNAC Boston. Executive vice-president and general manager, Linus Travers.

Z-BAR-NET—Comprising KXLF Butte; KXLJ Helena; KXJL Bozeman; KXKL Great Falls; KXLL Missoula, all in Montana. Available as a hookup. Managing Director: Ed Craney, KXLF.

SERVICES RELATED TO THE BUSINESS OF BROADCASTING

ASSOCIATIONS AND COMMITTEES

ACADEMY OF TELEVISION ARTS & SCIENCES—Hollywood Athletic Club Bldg., 6525 Sunset Blvd., Hollywood 28, Calif. Tel.: Hollywood 3-8942. Officers: Charlie Ruggles, president; Guy V. Thayer Jr., first vice president; Hal Hudson, second vice president; Robert Cummins, secretary; Ernest Felix, treasurer; Isabelle Pantone, recording secretary; Mildred Beach, secretary to treasurer; Robert Pelgram, corresponding secretary.

ADVERTISING ASSN. OF THE WEST—425 Bush St., San Francisco 8. Tel.: Garfield 1-6888. Officers: Robert R. Gros, Pacific Gas & Electric Co., president; Chas. W. Collier, executive vice president; Marie B. Carlton, office manager.

ADVERTISING COUNCIL—25 West 45th St., New York 36. Tel.: Judson 2-1520. Officers: Philip L. Graham, Washington Post, chairman; Louis N. Brockway, Leo Burnett, Stuart Peabody, vice chairmen; Frederic R. Gamble, secretary; Paul B. West, treasurer; Theodore S. Repplier, president; Allan M. Wilson, George P. Ludlum, vice presidents; Maxwell Fox, public relations director; Gordon C. Kinney, radio-TV director; Mrs. L. S. Schwartz, Chicago representative; Robert Coleson, Hollywood representative; Charles W. Collier, San Francisco representative. Washington office, 1209 18th St., N.W., Tel.: Sterling 3-9153. Chicago office, 203 North Wabash Ave., Tel.: Randolph 6-1753. Hollywood office, 1689 North Vine St., Tel.: Hollywood 7-7168. San Francisco office, 425 Bush St., Tel.: Garfield 1-6888.

ADVERTISING FEDERATION OF AMERICA—330 W. 42nd St., New York 36. Tel.: Bryant 9-0430. Officers: Robert M. Gray, chairman of the board; E. G. Borton, president.

ALLIED STATES ASSN. OF MOTION PICTURE EXHIBITORS—1346 Connecticut Ave., N. W., Washington 6, D. C. Tel.: Dupont 7-7400. Officers: Abram F. Myers, chairman of board and general counsel; Wilbur Snaper, president; John M. Wolfberg, secretary; Ben Marcus, treasurer; Stanley D. Kane, recording secretary.

AMERICAN ASSN. OF ADVERTISING AGENCIES—420 Lexington Ave., New York. Tel.: Lexington 2-7980. Officers: Earle Ludgin, Earle Ludgin & Co., chairman of the board; Frederic R. Gamble, president; William R. Baker Jr., Benton & Bowles, vice chairman; Winthrop Hoyt, Charles W. Hoyt Co., secretary-treasurer; Frank G. Silvermail, BBDO, chairman. Committee on Broadcast Media; Kenneth Godfrey, AAAA secretary to the committee; John F. Devine, J. Walter Thompson Co., chairman. Committee on Radio & Television Production; Richard L. Scheidker, AAAA secretary to the committee.

AMERICAN MARKETING ASSN.—1525 East 53d St., Chicago 15. Tel.: Museum 4-5267. Officers: Neil H. Borden, president; Allen K. Gaffers, Lawrence C. Lockley, Donald E. Megathlin, vice presidents; Ira D. Anderson, secretary; Charles W. Smith, treasurer. William C. Gordon Jr., executive director.

AMERICAN NEWSPAPER PUBLISHERS ASSN.—370 Lexington Ave., New York 17. Tel.: Murray Hill 5-2000. Officers: George C. Biggers, Atlanta Journal & Constitution, president; Richard W. Slocum, Philadelphia Bulletin, vice president; William Dwight, Holyoke Transcript-Telegram, secretary; W. L. Fanning, Westchester County Publishers, White Plains, N. Y., treasurer; Cranston Williams, general manager. Chicago office: 360 N. Michigan Ave., Chicago 1. Tel.: Franklin 2-3746. George N. Dale, manager.

AMERICAN RADIO RELAY LEAGUE—38 LaSalle Bld., West Hartford 7, Conn. Officers: Goodwin L. Dosland, president; F. E. Handy, vice president; Wayland M. Groves, vice president; D. H. Houghton, treasurer; A. L. Budlong, secretary.

AMERICAN WOMEN IN RADIO & TELEVISION, Grand Central Terminal Bldg., New York. Tel.: Murray Hill 9-8520. Officers: Doris Corwith, NBC, New York, president. Dorothy Fuller, WBET, Brockton, Mass. (East); Elizabeth E. Marshall, WBEZ, Chicago (Central); Alice Frisberg, WCYB, Bristol, Va. (South); Mollie Morse, KFMB, San Diego (West), vice presidents. Jane Dalton, WSPA, Spartanburg, S. C., secretary-treasurer. Betty Chapin, executive secretary.

ASSN. OF CANADIAN ADVERTISERS—Federal Bldg., Toronto 1. Tel.: Empire 3-8046. Officers: John O. Pitt, Canadian Fairbanks-Morse Co., president; Robert E. Day, executive vice president; R. E. Sewell, Coca-Cola Ltd., vice president, treasurer. Vice presidents: R. R. McIntosh, General Foods; M. M. Schneckenburger, House of Seagram; John M. Meldram, National Carbon. Athol McQuarrie, general manager; John A. M. Gaillee, secretary. Directors: T. M. Atkinson, Canadian Industries Ltd.; D. C. Bythell, Trans-Canada Air Lines; G. C. Clarke, Standard Brands; K. J. Farthing, Canadian Westinghouse Co.; T. G. Ferris, Household Finance Corp. of Canada; E. T. Gater, Sterling Drugs; Hugh E. Kent, Bromo-Seltzer Ltd.; J. J. McGill, Tuckett Ltd.; Armand Pambrum, Molson's Brewery; J. E. Potts, Pepsodent Div., Lever Bros.; H. T. Venning.

ASSN. OF FEDERAL COMMUNICATIONS CONSULTING ENGINEERS—Munsey Bldg., Washington 4, D. C. Tel.: District 7-8215. Frank G. Kear, president; Frank H. McIntosh, vice president; T. A. M. Craven, secretary; Everett L. Dillard, treasurer.

ASSN. OF NATIONAL ADVERTISERS Inc.—285 Madison Ave., New York 17. Tel.: Oregon 9-4940. Officers: Ben R. Donaldson, Ford Motor

Co., chairman of the board; Guy Berghoff, Pittsburgh Plate Glass Co., vice chairman; Paul E. West, president; Cy Norton, vice president; M. L. McElroy, vice president; Peter W. Allport, secretary.

BRAND NAMES FOUNDATION—37 West 57th St., New York 19. Tel.: Plaza 9-8425. Henry E. Abt, president; Nathan Keats, vice president.

BROADCAST ADVERTISING BUREAU—270 Park Ave., New York 17. Tel.: Murray Hill 8-4020. Kevin B. Sweeney, president.

BUREAU OF ADVERTISING, of American Newspaper Publishers Assn.—570 Lexington Ave., New York 22. Tel.: Plaza 9-6262. Stuart M. Chambers, chairman of the board.

CANADIAN ASSN. OF RADIO & TELEVISION BROADCASTERS—Main office 108 Sparks St., Ottawa. Tel.: 3-4036. Sales Branch—373 Jarvis St., West, Toronto, Ont. Tel.: Empire 4-8244. Officers: T. J. Allard, executive vice president; Flora Love, secretary-treasurer; Pat Freeman, sales manager; Samuel Rogers, C. C. copyright counsel; Guy Roberge, French language counsel; D. Malcolm Neill, Fredericton, chairman of the board. Board: F. H. Elphicke, Vancouver, president; E. Finlay Macdonald, Halifax, N. S., vice president; D. Malcolm Neill, Fredericton, N. B.; William Rea, New Westminster; Gerry Gaetz, Edmonton; H. A. Crittenden, Regina; John Craig, Brandon; J. E. Campeau, Windsor; F. B. Ricard, Sudbury; Wallace Slater, Guelph; Jack Davidson, Toronto; J. P. Lemire, Hull; J. A. Dupont, Montreal; Henry Lepage, Quebec City.

CLEAR CHANNEL BROADCASTING SERVICE—Shoreham Bldg., Washington, D. C. Tel.: Executive 3-0255. Officers: Hollis M. Seavey, director; Edwin W. Craig, WSM, Nashville, chairman; Harold Hough, WBAP, Fort Worth, treasurer; Reed T. Rollo, counsel; B. G. Rowley, secretary. Executive Committee: Edwin W. Craig, WSM; Victor A. Sholis, WHAS Louisville; Harold Hough, WBAP, Fort Worth; James Shouse, WLW Cincinnati; William Fay, WHAM Rochester.

DAYTIME BROADCASTERS ASSN.—17th & Broadway, Mattoon, Ill. Tel.: 6464. Officers: Kenneth Patterson, WSVI Pekin, Ill., president; Robert Harrison, KCRV Caruthersville, Mo., vice president; Ray Livesay, WLBH Mattoon, Ill., secretary-treasurer; Harry J. Daly, Washington, counsel; Fred O. Grimwood & Co., St. Louis, engineering consultant.

DIRECT MAIL ADVERTISING ASSN.—381 Fourth Ave., New York 16. Tel.: Murray Hill 3-1682. Officers: Lawrence G. Chait, Time Inc., president; Howard S. Mark, Robert Simpson Co., Toronto, Canadian vice president; Charles S. Downs, Abbott Labs., American vice president; Arthur W. Theiss, Minnesota Mutual Life Insurance Co., secretary; Herbert Buhrow, McGraw-Hill Book Co., treasurer; William B. Hen-

person, managing director; John K. Lord, assistant managing director.

ELECTRONICS MFRS. ASSN.—598 Madison Ave., New York 22. Tel.: Murray Hill 8-3200. David Wald, United Scientific Laboratories, president; Nathan Pinsky, Espey Mfg. Co., vice president; I. A. Mitchell, United Transformer Corp., vice president; Allan C. Bernstein, Adams Laboratories, secretary; Irving Golin University Loudspeakers, treasurer; Jesse Freidin, general counsel.

FAIR TV PRACTICES COMMITTEE—50 Broad St., New York City 4. Tel.: Digby 4-2923. Jerome W. Marks, chairman; James J. Mahoney, vice chairman. Opposes theatre TV and subscription TV.

FEDERAL COMMUNICATIONS BAR ASSN.—400 DeSales Bldg., Washington, D. C. Officers: Fred W. Albertson, president; Vincent B. Welch, first vice president; Percy H. Russell Jr., second vice president; Everett D. Johnston, secretary; Robert M. Booth Jr., treasurer. Executive Committee: Officers ex officio and Corwin R. Lockwood Jr., William J. Dempsey, Vernon L. Wilkinson, George O. Sutton, Leonard H. Marks, Stephen H. Fletcher, Delegate to American Bar Assn., Arthur W. Scharfeld.

FINANCIAL PUBLIC RELATIONS ASSN.—231 S. LaSalle St., Chicago 4. Tel.: State 2-5547. Preston E. Reed, executive vice president.

INSTITUTE FOR EDUCATION BY RADIO-TELEVISION—Ohio State U., Columbus 10, Ohio. Tel.: University 3148, Ext. 280. I. Keith Tyler, director; Tracey Phillips, secretary.

INSTITUTE OF RADIO ENGINEERS Inc.—1 E. 79th St., New York 21. Tel.: Regent 7-9600. Officers: W. R. Hewlett, president; Maurice J. H. Ponte, vice president; W. R. G. Baker, treasurer; Haraden Pratt, secretary; J. R. Pierce, editor.

JOINT TECHNICAL ADVISORY COMMITTEE—(Institute of Radio Engineers, Radio-Electronics-Television Mfrs. Assn.)—1 E. 79th St., New York 21. Officers: A. V. Loughren, chairman; Lloyd V. Berkner, vice chairman; Ralph Brown, Donald G. Fink, John V. Hogan, Dorman D. Israel, I. J. Kaar, Philip F. Siling, L. G. Cumming, non-member secretary.

NATIONAL APPLIANCE & RADIO-TV DEALERS ASSN.—1141 Merchandise Mart, Chicago 54. Tel.: Michigan 2-5505. Officers: Wallace Johnston, president; Vergal Bourland, H. B. Price Jr., P. S. Urner, vice presidents; Victor P. Joerndt, secretary; K. J. Stucky, treasurer; A. W. Bernsohn, managing director; J. A. Cobbey, general counsel.

NATIONAL ASSN. FOR BETTER RADIO & TELEVISION—882 Victoria Ave., Los Angeles 5. Tel.: Whitney 4245. Officers: Mrs. Clara S. Logan, president; Dr. Richard Atkinson, first vice president; Dr. Lee deForest, second vice president; Mrs. Victor Roberts, recording secretary; Gertrude M. Blackstock, treasurer; Mrs. A. Stanley Adams, corresponding secretary.

NATIONAL ASSN. OF EDUCATIONAL BROADCASTERS—2500 Municipal Bldg., New York City 7. Graydon Ausmus, president; Burton Paul, vice president; Frank Schooley, treasurer; Harry Skornia, executive director.

NATIONAL ASSN. OF MANUFACTURERS—14 W. 49th St., New York. Tel.: Circle 5-8600; 918 16th St., Washington 6, D. C. Tel.: Republic 7-3630. Officers: William J. Grede, Foundries Inc., chairman of the board; Charles R. Sligh Jr., president; Earl Bunting, managing director; Noel Sargent, secretary; Kenneth R. Miller, treasurer; Thon T. Tracher, vice president in charge of public relations; Richard R. Bennett, Washington public relations director; G. W. (Johnny) Johnstone, director, radio and television dept., public relations div.

NATIONAL ASSN. OF RADIO FARM DIRECTORS—Jack Jackson, KCMO-AM-TV Kansas City, president; Frank Atwood, WTIC Hartford, vice president; Merrill Langfitt, KMA Shenandoah, Ia., secretary-treasurer.

NATIONAL ASSN. OF RADIO & TELEVISION BROADCASTERS—171 N. St., NW, Washington 6, D. C. (See index for separate departmental listing.)

NATIONAL BETTER BUSINESS BUREAU—405 Lexington Ave., New York 17. Tel.: Murray Hill 6-3535. Officers: Charles W. Watts, chairman of the board; Warren C. Agry, vice chairman; Kenneth B. Wilson, president; Allan E. Backman, executive vice president.

NATIONAL COUNCIL OF THE CHURCHES OF CHRIST IN THE USA, Broadcasting & Film Commission—220 Fifth Ave., New York 1. Tel.: Oregon 9-2968. Officers: Ronald Bridges, executive director; Wesley B. Goodman, assistant executive director; Arthur W. Rhinow, business manager; Albert Crews, director of television; Ben E. Wilbur, director of radio; John Gunn, director of radio production; Wayne Williams, director of TV production; Arthur Austin, supervisor of special events; Charles H. Schmitz, broadcasting training director; Rachel Bowers, acting director of promotion; Hollywood Office: 5748 Sunset Blvd., Hollywood 28, Calif. Tel.: Hillside 7464. Oren W. Evans, director.

NATIONAL ELECTRICAL MFRS. ASSN.—155 E. 44th St., New York 17. Tel.: Murray Hill 2-1500. Officers: James H. Jewell, Westinghouse Electric Corp., president. Vice presidents: J. L. Busey, General Electric Co.; J. W. Corey, Reliance Electric & Engineering Co.; W. A. Elliott Co.; F. F. Lock, Allen-Bradley Co.; Hoyt P. Steele, Benjamin Electric Mfg. Co.; F. Metz, Okonite Co., treasurer; W. J. Donald, managing director.

NATIONAL EXHIBITORS THEATRE TELEVISION COMMITTEE — 1501 Broadway, New

York. Tel.: Chickering 4-1200. Simon H. Fabian, chairman; Philip F. Harlin, secretary-treasurer; Washington Office—Suite 518, 1625 I St., NW. Tel.: Sterling 3-5880; Marcus Cohn, general counsel.

NATIONAL RETAIL DRY GOODS ASSN.—100 W. 31st St., New York 1. Tel.: Chickering 4-8780. Officers: Wade G. McCargo, president; J. Gordon Dakins, executive vice president and treasurer; Howard P. Abrahams, manager, Sales Promotion Division. Office: 711 14th St., NW, Washington, D. C. Tel.: National 8-3680; John C. Hazen, manager.

NATIONAL TELEVISION FILM COUNCIL—1501 Broadway, New York 36. Officers: Arche Mayers, president; Sally Perle, vice president; William van Praag, secretary; Waldo Mayo, treasurer.

PROPRIETARY ASSN.—810 18th St., N. W., Washington 6, D. C. Tel.: National 8-1914. Officers: Dr. Frederick J. Cullen, Washington, D. C., executive vice president; E. T. T. Williams, Lambert Co., St. Louis, president; A. K. Barta, secretary-treasurer, Washington, D. C.

RADIO & TELEVISION COMMISSION OF THE SOUTHERN BAPTIST CONVENTION — 1585 Ponce de Leon Ave., N. E., Atlanta 6, Ga. Tel.: Cresent 6431. Rev. Paul M. Stevens, director.

RADIO & TELEVISION EXECUTIVES SOCIETY—420 Lexington Ave., New York 17. Tel.: Lexington 2-3888. Officers: James M. Gaines, president; George Shupert, first vice president; Robert Burton, second vice president; Claude Barrere, secretary; Joseph A. McDonald, treasurer. Board of Governors: Lester Gottlieb, G. W. Johnstone, Eugene Katz, Marvin Kirsch, Donald McCuire, Bruce Robertson, Elliot M. Sanger, Robert W. Sarnoff, Reggie Schuebel, Chris Witting, Elizabeth Clarkson, executive secretary.

RADIO-ELECTRONICS-TELEVISION MANUFACTURERS ASSN.—777 14th St., N. W., Washington 5, D. C. Tel.: National 8-3902. Officers: Glen McDaniel, president and general counsel; Robert C. Sprague, Sprague Electric Co., chairman of the board; James D. Secrest, executive vice president; Leslie F. Muter, C. O. treasurer. Vice president: Robert S. Alexander, Wells-Gardner & Co.; R. E. Carlson, Tung-Sol Electric Inc.; R. G. Zender, Lenz Electric Mfg. Co.; H. J. Hoffman, Machlett Labs.; Sidney Harman, Harman, Kardon. Headquarters Staff: Peter H. Cousins, special assistant to the executive vice president; William L. Reynolds, staff attorney; Albert Coumont, service coordinator; Charles Macching Jr., government relations officer; Tyler Nourse, editorial director; William F. E. Long, director of statistics.

RADIO PIONEERS—580 Fifth Ave., New York 36. Plaza 7-1800. Officers: Paul W. Morency, president; Arthur B. Church, 1st vice president; Raymond F. Guy, vice president; Victor C. Diehm, vice president; John F. Patt, secretary; Charles A. Wall, treasurer.

RADIO-TELEVISION GALLERIES OF CONGRESS—The Capitol, Washington, D. C. Tel.: National 8-3120. Senate: D. Harold McGrath, superintendent. House: Robert Menough, superintendent.

RADIO-TELEVISION CORRESPONDENTS ASSN.—Radio-Television Galleries, The Capitol, Washington, D. C. Tel.: National 8-3120. Officers: Rickness (NBC), chairman; William Costello (CBS), vice chairman; Joseph F. McCaffrey (MBS), secretary; Gunnar Back (ABC), treasurer; Julian Goodman (NBC), William Higginbotham (UP), Ann Corrick (Crosley), members at large. Martin Agronsky (ABC) is member exofficio.

RADIO-TELEVISION MFRS. ASSN. OF CANADA—159 Bay St., Toronto, Ont. Tel.: Empire 3-1531. A. B. Hunt, president; S. D. Brownlee, executive secretary; C. A. Pollock, vice president and chairman of Receiver Division; H. S. Dawson, vice president and chairman of Technical Products Division; J. N. Rutherford, vice president and chairman of Parts Division; E. Olsen, chairman, Engineering Committee; G. B. Elliott, chairman Service Committee.

RADIO-TELEVISION NEWS DIRECTORS ASSN.—James Byron, WBAP-AM-TV Fort Worth, president; Russ Van Dyke, KRNT Des Moines, vice president; Sheldon Peterson, KLZ Denver, treasurer; Robert Downey, WKAR Lansing (Michigan State College), executive secretary.

STATION REPRESENTATIVES ASSN.—101 Park Ave., New York 17. Tel.: Murray Hill 8-4141. Officers: John Blair, president; John E. Pearson, vice president; Adam J. Young Jr., secretary; Thomas F. Clark, treasurer; Joseph J. Weed, Joseph Timlin, George Brett, Russel Woodward, directors; T. F. Flanagan, managing director.

THEATRE NETWORK TELEVISION INC.—515 Madison Ave., New York 22. Tel.: Plaza 3-3464. Nathan L. Halpern, president.

THEATRE OWNERS OF AMERICA—1501 Broadway, New York 36. Tel.: Longacre 3-6238. Officers: Alfred Starr, president; Walter Reade Jr., executive vice president; Charles P. Skouras, chairman of the board; S. H. Fabian, treasurer; Albert M. Pickus, secretary; E. D. Martin; Pat McGee, John Rowley, Roy Cooper, Myron Blanker, vice presidents; Herman M. Levy, general counsel; Howard L. Bryant, administrative director; Dick Pitts, director of public relations.

ULTRA-HIGH FREQUENCY TV ASSN.—400 De Sales Bldg., Washington 6, D. C. Tel.: Metropolitan 8-0370. Officers: Lou Poller, WCAN-TV Milwaukee, president; Melvin A. Goldberg, acting executive secretary; William A. Roberts, general counsel; J. Bernard McDonnell, public relations.

UNITED NATIONS RADIO—Dept. of Public Information, United Nations, New York 17. Tel.:

Plaza 4-1234. Officers: Assistant Secretary General, Benjamin Cohen; Prin. Director, Tor Cleveland; Director, Radio Division, Peter Ayles; Chief of Production, W. Gibson Parker; Senior Broadcast Engineer, Arthur E. Barrett; Chief, Central Radio Services, Hugh Williams; Chief, English Language Service, Gerald Kean; Coordinator, U. S. Station Relations, Dorothy Lewis.

WESTERN ASSN. OF BROADCASTERS—c/o CJCA Edmonton, Gerry Gaetz, CJCA Edmonton, president; Director: William Rea CKNW New Westminster, B. C.; John Craig, CKX Brandon, Man.; F. H. Elphicke, CKWX Vancouver, B. C.; Sydney Boyling, CHAB Moosejaw, Sask.

COLLEGE NETWORK

INTERCOLLEGIATE BROADCASTING SYSTEM—3107 Westover Drive, S.E., Washington 20, D. C. Tel.: Ludlow 2-7210; 706 Sanders Ave., Schenectady 2, N. Y. Tel.: Schenectady 3-6028. Executive Officers: George Abraham, president; David W. Borst, operations manager; Richard H. Crompton, engineering director; Charles E. Rondabush, station relations manager; James R. Wylie, treasurer; Howard C. Hansen, program manager; Thomas M. Blaisdell, sales and public relations manager; Vail W. Pischke, general counsel.

COMMUNICATIONS CARRIERS

AMERICAN TELEPHONE & TELEGRAPH Co. (Long Lines Dept.)—32 Avenue of the Americas, New York 13. Tel.: Exchange 3-9700. Officers: H. T. Kingsworth, vice president; A. F. Jacobson, director of operations.

BELL TELEPHONE LABS.—463 West St., New York 14. Tel.: Chelsea 3-1000.

CANADIAN NATIONAL TELEGRAPHS—347 Bay St., Toronto 1, Ont. Tel.: Empire 8-6071. Officers: J. R. White, general manager; D. H. Hawley, chief of commercial operations; A. E. Allen, supervisor of broadcast services.

GLOBE WIRELESS Ltd.—141 Battery St., San Francisco, Calif. Tel.: Exbrook 2-6181. Officers: R. Stanley Dollar, president; R. H. Anderson, Walter F. Boatwright, J. D. Hopkins, William H. Phillips, R. Stanley Dollar Jr., vice presidents.

INTERNATIONAL TEL. & TEL. Corp.—87 Broad St., New York 4. Tel.: Bowling Green 9-3800. William H. Harrison, president and director.

MACKAY RADIO & TELEGRAPH CO. (AC&R)—87 Broad St., New York 4. Tel.: Bowling Green 9-3800. Officers: Adm. William F. Halsey, chairman of board; Ellery W. Stone, president; F. L. Henderson, executive vice president; J. A. Kennedy, vice president and general counsel; E. B. Tower, vice president and controller; L. N. Anderson, and C. R. McPherson, vice presidents; C. E. Scholz, vice president and chief engineer; E. H. Price, vice president, Marine Division; Robert D. Merrill, vice president, commercial department; J. T. Chatterton, (San Francisco), William Edgar Jr., (Paris), A. C. Jorkensen (Tankier), Gordon Kern (Stuttgart, Germany), and Leroy Spangenberg (New York), vice presidents; J. F. Gibbons, general attorney; J. C. Trimble, treasurer; R. M. Schibner, secretary.

PRESS WIRELESS Inc.—660 First Ave., New York 16. Tel.: Murray Hill 3-6103. William J. McCambridge, president and treasurer; Bernard P. E. Wolbarst, vice president; A. G. Greany, secretary; T. J. Reilly, assistant treasurer.

RCA COMMUNICATIONS—66 Broad St., New York 4. Tel.: Hanover 2-1811. Officers: Thompson H. Mitchell, president; Sidney Sparks, vice president, Commercial Activities; Profram and Photo Transmission Services, F. H. Goring, N. Y.; H. E. Austin, San Francisco.

WESTERN UNION TELEGRAPH Co.—60 Hudson St., New York 13. Tel.: Worth 2-7300. Officers: Walter P. Marshall, president; T. B. Gittings, public relations and sales vice president; H. P. Corwith, development and research vice president; S. M. Barr, plant and engineering vice president; J. Z. Millar, assistant vice president; F. B. Bramhall, transmission research engineer; W. B. Sullinger, radio research engineer; L. G. Pollard, electronics research engineer; W. H. Francis, director of applied engineering; A. J. Hanks, transmission engineer; A. W. Dickey, electronics applications engineer.

AMERICAN RADIO PUBLICATIONS Inc.—119A N. Washington St., Peoria 2, Ill. Tel.: 4-3282. Rex E. Howard, president; S. C. Zinser, treasurer; Olive M. Howard, secretary. (Civil Defense Manual.)

BLACKBURN HAMILTON Co.—Washington Bldg., Washington 5, D. C. Tel.: Sterling 3-4341. Tribune Tower, Chicago; Tel.: Delaware 7-2755. 235 Montgomery St., San Francisco 4; Tel.: Exbrook 2-5872. Media brokers. Partners: James W. Blackburn, Ray W. Hamilton, Lester M. Smith, William T. Stubblefield.

BOOZ, ALLEN & HAMILTON—135 South La Salle St., Chicago 3. Tel.: Financial 6-1900. New York: 285 Madison Ave., New York 17. Tel.: Oregon 9-1900. San Francisco: 235 Montgomery St., San Francisco 4. Tel.: Yukon 2-2490. Philadelphia: 1401 Walnut St., Philadelphia 2. Tel.: Locust 4-5555. Washington: 1625 Eye St., NW, Washington 6. Tel.: Executive 3-5212. Cleveland: 629 Euclid Ave., Cleveland 14. Tel.: Cherry 1-1800. Detroit: 3075 Penobscot Bldg., Detroit 26. Tel.: Woodward 1-1900. Minneapolis:

FREQUENCY MEASURING SERVICES

WILLIAM L. BURNETT RADIO LABORATORY—4814 Idaho St., San Diego 16, Calif. Tel.: Talbot 3-4903. William W. L. Burnett, engineer in charge.

CAMBRIDGE THERMIONIC CORP. (Cambridge Crystal Div.)—445 Concord Ave., Cambridge 38, Mass. Tel.: Trowbridge 6-2800. Clarence Cheney. **COMMERCIAL RADIO MONITORING CO.**—P. O. Box 7037, Kansas City 2, Tel.: Jackson 5302. Robert F. Wolfskill, manager; Walter H. Campbell, Wm. L. Blakeley and Walter V. Nitcher, associates.

L. J. N. du TREIL & ASSOC.—202 Homedale Ave., New Orleans 24. Tel.: Audubon 3525-0917.

EIDSON ELECTRONIC CO.—1902 N. Third St., Temple, Texas. Tel.: 3-3901. Merrill Eldson, owner-manager.

CLAUDE M. GRAY—P. O. Box 602, Birmingham, Ala. Tel.: 2-3570.

HUTTON MONITORING SERVICE—Rockwell and Westchester Aves., Catonsville 28, Md. Tel.: Ridgeway 7-9078. J. W. Hutton owner.

INTERNATIONAL MONITORING SERVICE—1103 N. Road, Belmont, Calif. Special representative—A. C. Stewart, 277 Fulton St., San Francisco.

PRECISION FREQUENCY SERVICE—1428 S. Flower St., Santa Ana, Calif. Tel.: Kimberly 2-2117. John R. Schick, engineer.

RCA COMMUNICATIONS INC.—86 Broad St., New York 4, Tel.: Hanover 2-1811. Officers: Thompson H. Mitchell, president; Sidney Sparks, vice president for commercial activities; Frank Flood, manager of special services. Branch: Riverhead, L. I., N. Y.; Tel.: 2290; E. C. Rundquist, manager. Branch: San Francisco, 28 Geary St. Tel.: Garfield 4200. H. E. Austin, vice president and manager.

SOUTHWEST FREQUENCY MEASUREMENTS—P. O. Box 4114, Austin, Tex. Tel.: 5-1678. Marion T. Hill, engineer in charge.

T & T RADIO MEASUREMENTS Co.—2557 Atlantic Ave., Long Beach 6, Calif. Tel.: Long Beach 4-2015.

VAN NOSTRAND RADIO ENGINEERING SERVICE—339 Leland Terrace NE, Atlanta 6, Ga. Tel.: Dearborn 4774.

MARTIN R. WILLIAMS—7401 E. 14th St., Indianapolis 19, Ind. Tel.: Blackstone 0388; Market 3326.

NATHAN WILLIAMS FREQUENCY MEASUREMENTS—20 Algoma Blvd., Oshkosh, Wis. Tel.: Blackhawk 22.

MUSIC LICENSING GROUPS

AMERICAN SOCIETY OF COMPOSERS, AUTHORS & PUBLISHERS' (ASCAP)—575 Madison Ave., New York 22. Officers: Otto A. Harbach, president; Oscar Hammerstein II, vice president; Paul Cunningham, secretary; Louis Bernstein, treasurer; A. Walter Kramer, assistant secretary; Donald Gray, assistant treasurer. **Board of Directors:** Stanley Adams, Fred E. Ahlert, Louis Bernstein, Saul H. Bourne, Gene Buck, Irving Caesar, Frank H. Connor, Paul Cunningham, Max Dreyfus, Bernard Goodwin, Donald Gray, Oscar Hammerstein II, Otto A. Harbach, John Tasker, Howard, A. Walter Kramer, Edgar Leslie, George W. Meyer, Jack Mills, Abe Olman, J. J. Robbins, Gustave Schirmer, Herman Starr, Deems Taylor, Jack Yellen.

BROADCAST MUSIC INC. (BMI)—580 Fifth Ave., New York 36. Tel.: Plaza 7-1800. Officers: Carl Haverlin, president; Sydney M. Kaye, vice president & general counsel. Charles A. Wall, vice president in charge of finance; Robert J. Burton, secretary and vice president in charge of publisher and writer relations; Jean Geiringer, vice president in charge of foreign relations; Roy Harlow, vice president in charge of station service; Glenn Dolberg, vice president in charge of station relations. **Directors:** Justin Miller, NARTB, chairman; Sydney M. Kaye, vice chairman; Herbert Akerberg, CBS; John Elmer, WCBM Baltimore; Carl Haverlin, BMI; William S. Hedges, NBC; Herbert Hollister, KEOL Boulder, Colo.; Leonard Kapner, WCAE Pittsburgh; Paul Morency, WTIC Hartford; J. Leonard Reinsch, WSB Atlanta; J. Harold Ryan, Storer Broadcasting Co.; James E. Wallen, MBS; Joseph E. Baudino, Westinghouse Radio Stations; Ray Diaz, ABC.

COMPOSERS, AUTHORS and PUBLISHERS ASSN. OF CANADA LTD.—182 St. George St., Toronto. Tel.: MI 8457. Sir Ernest MacMillan, president; W. S. Low, gen. mgr.

HARRY FOX—45 Rockefeller Plaza, New York 20. Tel.: Circle 6-3084. (Agent and trustee for international music publishers.)

MUSIC PUBLISHERS PROTECTIVE Assn.—45 Rockefeller Plaza, New York 20. Tel.: Circle 6-3084. Harry Fox, general manager; Walter G. Douglas, chairman of board.

NATIONAL ASSN. OF PERFORMING ARTISTS—630 Fifth Ave., New York 20. Tel.: Circle 7-8194. Fred Waring, president and chairman of the board; Alfred Rice, general counsel.

G. RICORDI & Co.—1270 Avenue of the Americas, New York 20. Tel.: Judson 2-5300. Franco Colonabo, managing director.

SESAC Inc.—475 Fifth Ave., New York 17. Tel.: Murray Hill 5-5365. Paul Heinecke, president; R. C. Heinecke, treasurer; E. S. Prager, assistant to president.

Northwestern Bank Bldg., Minneapolis 2. Tel.: Lincoln 1116. Los Angeles: 523 West Sixth St., Los Angeles 14. Tel.: Trinity 3215. **Partners:** James L. Allen, James C. Olson, Edward J. Burnell, John L. Burns, Sherrill A. Parsons, Stuart M. Campbell, Stanley M. Humphrey, Harry W. Knight, Stewart M. Lowry, William C. Eldridge, Arnold F. Emch, Joseph M. Kubert, Perry Adleman, Charles P. Bowen, Robert Wise, John W. Pocock, Robert M. Browning, George F. Hamson, Edwin L. Morris, Alfred J. Gagnon, Philip Donham, Lloyd E. Wilkinson, Lawrence L. Ellis, Ralph E. Smiley, F. Newton Parks, James A. Newman, Robert I. Hale, H. Ferris White, Clyde C. Sney, John P. Gallagher, William S. Powell, Ralph W. Jones, Watson Snyder, Thornton W. Sneed, Lester E. Burmeister, Richard S. MacKenzie, William F. Ackerman.

RUDY BRETZ—Croton-on-Hudson, N. Y. Tel.: Croton 1-3478. (Television consultant in programs, production and personnel; staff training.)

BROADCAST MANAGEMENT SERVICES Co. (agency)—17 E. 48th St., New York 17. Tel.: Plaza 5-1127. Officers: Edward C. Lobdell, president—licensee; R. G. Mann, executive director; A national employment service (for radio and television stations dealing exclusively in essential staff personnel.)

BROADCAST SERVICE BUREAU Inc.—1025 Vermont Ave., N. W., Washington 5, D. C. Tel.: National 8-7808. C. B. Collins, president. (Supplying rules and standards to radio and television stations.)

CARL H. BUTMAN—National Press Bldg., Washington, D. C. Tel.: National 8-7846. (Consultant on FCC procedural, regulatory and technical matters; applications supervised.)

REUBEN H. DONNELLEY Corp.—350 East 22d St., Chicago 16. Tel.: Victory 2-3232. Officers: Gaylord Donnelley, chairman of the board; David L. Harrington, president and chief executive officer; Curtiss E. Frank, executive vice president and general counsel; Albert M. Andersen, executive vice president; Harold P. Harper, J. A. Hope, Donald R. Arnold, vice presidents; Harry W. Warner, secretary-treasurer. (Services: Trade paper publishers, contest judging, premium mailing and packaging, classified telephone directory publishers, house-to-house distribution, store service direct mail advertising, mailing lists.)

LYLE KENYON ENGEL—1 East 42d., N. Y. 17. Tel.: Murray Hill 2-8322. (Music consultant for television.)

THE FAUGHT COMPANY Inc.—342 Madison Ave., New York 17. Tel.: Murray Hill 7-1171. Millard C. Faught, president.

NEWTON L. FAUSEY—605 N. Michigan Ave., Chicago 11. Tel.: Whitehall 4-3844. (Personal management and tax accounting.)

HUGH FELTIS & ASSOC.—Central Bldg., Seattle 4, Wash. Tel.: Elliott 4489. (Radio and tv management consultant.)

HOWARD S. FRAZIER—Bond Bldg., Washington 5, D. C. Tel.: National 8-2173. Howard S. Frazier. (Television and radio management consultants; broadcaster's executive placement service.)

MICHAEL R. HANNA—Savings Bank Bldg., Ithaca, N. Y. Tel.: 4-6301. (AM, FM, TV management consultant.)

HOOT ASSOCIATES—15 E. 40th St., New York 16. Tel.: Murray Hill 6-3714. (Personnel service for radio and tv stations.)

EDWARD T. INGLE—802 Ring Bldg., Washington, D. C. Tel.: Executive 3-3663.

ALLEN KANDER—1701 K St., Washington 6, D. C. Tel.: National 8-3233. Lincoln Bldg., New York 17. Tel.: Murray Hill 7-4242. (Radio and television station broker.)

A. LEWIS KING—551 Fifth Ave., New York 17. Tel.: Murray Hill 2-8276. (Television and broadcast advertising consultant.)

MCKINSEY & COMPANY—60 East 42d St., New York 17. Tel.: Murray Hill 7-3123. **Partners and principals:** Horace G. Crockett, Marvin Bower, Howard C. Adams, Philip S. Babb, Gordon G. Bowen, Gilbert H. Clee, Ewing W. Reilly, E. Everett Smith, J. Alex Smith, Arthur T. Casuso, Richard D. Elwell, Carl T. Hoffman, Paul Roberts. Office: 75 Federal St., Boston 10; Tel.: Hubbard 2-9626; Stanley L. Balmer. Office: 1625 I St., N.W., Washington 6; Tel.: Metropolitan 8-6888; John J. Corson. Office: 208 South La Salle St., Chicago 4; Tel.: Randolph 6-6980; Harrison A. Roddick. Office: 235 Montgomery St., San Francisco 4; Tel.: Garfield 1-3636; John G. Neukom, William H. Dennick. Office: 612 South Flower St., Los Angeles 17; Tel.: Madison 6-3201; Forrest Wallace.

GEORGE MCKITTRICK & Co.—108 Fulton St., New York 38. Tel.: Barclay 7-4929. Branch office: 185 N. Wabash St., Chicago 1. Tel.: State 2-8911. (Publishes McKittrick's Geographical and Classified Directory of Advertisers and Advertising Agency list.)

NATIONAL REGISTER PUBLISHING Co. Inc.—130 W. 42d St., New York 36. Tel.: Longacre 4-1710. Officers: R. W. Ferrell, president; C. H. Brown, general manager. Branch: 333 N. Michigan Ave., Chicago; Tel.: Randolph 6-5744; manager, A. J. Crane. (Publishes Standard Advertising Register services, listing national advertisers, agencies and their personnel.)

TED NELSON ASSOCIATES—730 Fifth Ave., New York 19. Tel.: Circle 6-8470. Owner: Ted Nelson. Radio directors: Richard Diamond, Perry Bruskin, Charles Duran. Account executive: Nathan Fields. (Radio consultants, radio packages, radio advertising agency.)

M. S. NOVIK—Room 500, 300 W. 23d St., New York 11. Tel.: Algonquin 5-4385. (Public service radio consultant.)

FRED A. PALMER Co.—6800 N. High, Worthington, Ohio. Tel.: Franklin 2-7346. Fred A. Palmer, president. (Radio management consultant.)

PIKE & FISCHER—Broadcasting, Telecasting Bldg., 1735 De Sales St., Washington 6, D. C. Publishers of Pike & Fischer Radio Regulation. Officers: Henry G. Fischer, president; John W. Willis, vice president; Irving R. M. Panzer, secretary-treasurer. (FCC rules, amendments, decisions, and related radio and television documentary service.)

RADIO & TELEVISION STATIONS SALES Inc.—611 Olive St., St. Louis. Patricia Ames, special agent. (Media brokers.)

WILLIAM J. SCRIPPS ASSOCIATES Inc.—1005 Kales Bldg., Detroit 26. Principals: William J. Scripps, Walter J. Duschinsky. (Telecommunications consultants; tax, economic, finance, insurance, market research services; foreign representation.)

HOWARD E. STARK—50 E. 58th St., New York 22. Tel.: Eldorado 5-0405. Associate: Vincent J. Manno. (Brokerage, financing newspapers, radio and television stations.)

TRADE-WAYS INC.—285 Madison Ave., New York. Tel.: Oregon 9-3070. William H. Lough, president and treasurer. (Marketing counselors specializing in sales training.)

GEORGE R. TURPIN & ASSOCIATES—P. O. Box 502, Forth Worth 1, Tex.: Fortune 7453. George R. Turpin, president. (Regional sales campaigns and giveaway shows for radio and TV stations.)

LOWELL R. WRIGHT—RFD No. 2, Box 29, Herndon, Va. Tel.: Herndon 114-M. (Consultant to radio and television industry on tower and aeronautical problems.)

CLIFFORD YEWDALE—154 W. 14th St., New York 1. Tel.: Chelsea 2-4843. Branches: 11 S. LaSalle St., Chicago. Tel.: Randolph 6-7575. Sharp Bldg., Lincoln 8, Neb. Tel.: 2-3135. (Accountant specializing in radio.)

Frequency Check Service

CAMBRIDGE THERMIONIC CORPORATION
CAMBRIDGE CRYSTAL DIVISION

445 CONCORD AVENUE

CAMBRIDGE 38, MASSACHUSETTS

CONTACT:

Clarence Cheney

FOR RATE INFORMATION

AT

Trowbridge 6-2800

PUBLIC RELATIONS AND PROMOTION SERVICES

JOHN B. ADAMS—872 National Press Bldg., Washington 4, D. C. Tel.: Metropolitan 8-4248.

DAVID O. ALBER ASSOCIATES Inc.—654 Madison Ave., New York 21. Tel.: Templeton 8-8300. Eugene Shefrin, vice president.

ARROW ASSOCIATES—Chamber of Commerce Bldg., Scranton, Pa. *Officers:* John E. McDonald, production director; Harold Murphy, technical director; Edgar A. Manley, publicity director; Bernard Blier, managing director.

BALDWIN & MERMEY—205 E. 42nd St., New York 17. Tel.: Murray Hill 4-4540. *Partners:* William H. Baldwin, Maurice Mermei.

BANNER & GREIF—18 E. 41st St., New York 17. Tel.: Murray Hill 6-8622. Jack Banner and Ed Greif, partners.

BENTLEY & LIVINGSTONE Inc.—220 S. State St., Chicago 4. Tel.: Webster 9-7439. George Livingstone, president; E. W. Welch, secretary-treasurer.

EDWARD L. BERNAYS—26 E. 64th St., New York 21. Tel.: Templeton 8-5000.

GEORGE BIDERMAN—82 Washington Pl., New York. Tel.: Algonquin 4-4878.

IVAN BLACK ASSOCIATES—400 Madison Ave., New York 17. Tel.: Plaza 5-4760.

H. A. BRUNO & ASSOC. Inc.—30 Rockefeller Plaza, New York. Tel.: Circle 6-8040. Harry Bruno, president; *Associates:* Russell Gudgeon, Hudson Phillips, Theon Wright, K. L. Harris, Abbott M. Geer.

CARL BYOIR & ASSOCIATES—10 E. 40th St., New York 16. Tel.: Murray Hill 6-3200. *Officers:* Carl Byoir, chairman of the board; Gerry Swinehart, president; George Hammond, executive vice president; Charles E. McVarish, vice president and director of publicity; Muriel Fox, radio and television director. *Offices:* Washington, D. C., National Press Bldg. Tel.: Sterling 3-6565; Lyle Youngstrom, vice president. Chicago, 33 N. LaSalle St., Tel.: Dearborn 2-6300; George Dye, vice president. Los Angeles, 727 W. Seventh St., Tel.: Trinity 6421; Joseph J. Aivin, vice president.

HARRY COLEMAN & CO.—684 N. Michigan Ave., Chicago 11. Tel.: Mohawk 4-3883. Harry M. Coleman, president.

COLL & FREEDMAN Inc.—49 W. 51st St., New York 19. Tel.: Plaza 3-9872. Principals: Fred Coll, Zac Freedman.

JAMES A. COWAN—20 Carlton, Toronto, Ont., Canada. Tel.: Empire 4-8561.

DINE & KALMUS—4 W. 58th St., New York. Tel.: Plaza 3-1370. *Partners:* Josef C. Dine, Allan H. Kalmus.

DIXON GAYER PUBLIC RELATIONS—120 Central Park South, New York 17. Tel.: Plaza 7-7150. Dixon Gayer, president; Edward Robert Brooks, associate.

EDWARD GOTTLIEB & ASSOCIATES—2 W. 45th St., New York 36. Tel.: Murray Hill 7-3050. Edward Gottlieb, president; J. Seegar Heavilin, vice president.

HAL K. HALPERN ASSOCIATES—15 E. 40th St., New York 16. Tel.: Murray Hill 6-3714. *Officers:* Hal K. Halpern, general manager; J. Lindsey Campbell, Helene Parker, associates. Hollywood—204 S. Beverly Drive, Beverly Hills. Tel.: Crestview 6-9892.

STEVE HANNAGAN ASSOCIATES—247 Park Ave., New York. Tel.: Plaza 5-2900. Associate: Jim Scanlan.

ROBERT S. KELLER, Inc.—72 Barow St., New

York 14. Tel.: Watkins 4-6599. Bob Keller, president; E. Benjamin Wright, secretary-treasurer.

EDWARD M. KIRBY—4620 Brandywine St., N. W., Washington, D. C. Tel.: Emerson 3-8527.

KRIEDT & MYERS—J. Clarence Myers, Gary Kriedt, 607 Market St., San Francisco 5. Tel.: Excubook 2-7443.

MARK LARKIN—83-15 Lefferts Blvd., Kew Gardens 15, N. Y. Tel.: Virginia 9-6340.

AUSTIN C. LESCARBOURA & STAFF—Croton-on-Hudson, N. Y. Tel.: Croton 1-3444. Austin C. Lescarboura, senior partner, account executive; Stanley A. Lescarboura, junior partner, account executive; Winifred Phillips, production.

PHILIP LESLY Co.—100 W. Monroe St., Chicago 3. Tel.: Central 6-7555. Philip Lesly, president. New York office, 424 Madison Ave. Tel.: Plaza 8-1525.

BERNARD L. LEWIS Inc.—Empire State Bldg., New York 1. Tel.: Longacre 5-3209. Bernard L. Lewis, president.

HAL LEYSHON & ASSOCIATES—292 Madison Ave., New York. Tel.: Murray Hill 5-0744.

HOWARD J. MCCOLLISTER Co.—66 Acacia Drive, Atherton, Calif. Tel.: Davenport 3-3061. Regional promotional sales campaigns for radio and television.

J. BERNARD McDONNELL—818 17th St., Washington 6, D. C., Tel.: Metropolitan 8-0370. J. Bernard McDonnell, Billie Dunkle, partners.

ARTHUR H. MILLER—39 E. 49th St., New York 17. Tel.: Eldorado 5-6092.

REG MITCHELL & ASSOCIATES—1004 National Press Bldg., Washington 4, D. C. Tel.: National 8-4457. Reginald P. Mitchell, director.

JACK PERLIS—310 West End Ave., New York 23. Tel.: Trafalgar 3-5284.

RA-TEL PROMOTION SERVICE—1019 Stanford Drive, Huntsville, Ala. (Promotion and publicity for radio and tv stations.)

RICHARD H. ROFFMAN—575 West End Ave., New York 25. Tel.: Riverside 9-3647. Richard H. Roffman, president. (Also law and public relations counsel.)

A. A. SCHECHTER ASSOC.—250 Park Ave., New York. Tel.: Plaza 3-6122.

SELVAGE, LEE & CHASE—One E. 43rd St., New York 17. Tel.: Murray Hill 7-8550. James P. Selvage, Morris M. Lee Jr., W. Howard Chase, partners. *Offices:* 221 N. LaSalle St., Chicago 1. Tel.: Franklin 2-4821. J. Handley Wright, Robert Wood. Cafritz Bldg., 1625 Eye St., N. W., Washington 6, D. C. Tel.: Republic 7-4040. S. B. Bledsoe.

BENJAMIN SONNENBERG—247 Park Ave., New York. Tel.: Plaza 5-2200.

PAT SWEENEY ASSOCIATES—400 Madison Ave., New York. Tel.: Plaza 3-4466.

SERVICES TO STATIONS

GANO F. CULWELL CORP.—6412 Orchard Ave., Bell, Calif. (Painting service to broadcasting industry.)

SURVEYS AND MARKET RESEARCH

ADVERTEST RESEARCH—90 Bayard St., New Brunswick, N. J. Tel.: Charter 7-1564. Directors: Seymour Smith, Richard Bruskin. Director of Agency Relations, Warren Rebell. Field Director, Alice Ashly. Office manager, Doris Denniston. (Measurement of radio and television audience habits and reactions. Publishers of monthly research studies, *The Television Audience of Today.*)

ADVERTISING RESEARCH FOUNDATION—11 West 42d St., New York. Tel.: Longacre 3-5100.

Officers: Henry M. Schachte, chairman of the board; Marion Harper, Jr., vice chairman of the board; Edgar Kobak, president; A. W. Lehman, managing director; Frederic R. Gamble, treasurer; Paul B. West, secretary; D. B. Lucas, technical director. *Directors:* John F. Apsey, Jr., Lowry H. Crites, B. B. Geyer, Earle Ludgin, F. B. Manchee, Fergus Mead, Paul Montgomery, Adrian Murphy, Vernon C. Myers, Charles A. Pooler, W. B. Potter, Edward P. Seymour, D. P. Smelser, John C. Sterling, H. M. Warren, Frank White and W. H. Wulfeck.

AMERICAN RESEARCH BUREAU—National Press Bldg., Washington 4, D. C. Tel.: National 8-0822. James W. Seiler, director. Los Angeles: 234 S. Garfield Ave., Monterey Park, Roger Cooper, manager, Tel.: Cumberland 3-3149. New York: 516 Fifth Ave., Jack L. Gross, manager, Tel.: Murray Hill 7-3787. (Radio and television audience measurement.)

AUDIT BUREAU OF CIRCULATIONS—123 N. Wacker Drive, Chicago 6. Tel.: Central 6-7894. James N. Shryock, executive vice president. Branch: 330 W. 42nd St., New York 18. Tel.: Longacre 3-2322; William F. Hoffmann, manager. (Newspaper and periodical circulation audit service.)

A.S. BENNETT-CY CHAIKIN Inc.—333 Madison Ave., N. Y. 17. Tel.: Murray Hill 9-0734. Cy Chaikin, president; A. S. Bennett, vice president, (Marketing, advertising, and media research and analysis.)

BUREAU OF BROADCAST MEASUREMENT—Federal Bldg., Toronto. Tel.: Empire 3-8046. *Officers:* Charles R. Vint, Colgate-Palmolive Ltd., Toronto, president; Athol McQuarrie, Assn. of Canadian Advertisers, treasurer; Horace N. Stovin, Horace N. Stovin & Co., Toronto, vice-president; Charles J. Follett, executive secretary of Bureau of Broadcast Measurement, Assn. of Canadian Advertisers, Toronto. *Directors:* William T. Cranston, CKOC Hamilton; G. C. Hammond, Cockfield, Brown & Co., Montreal; G. Frank Mills, Spitzer & Mills Ltd., Toronto; Walter E. Powell, Canadian Broadcasting Corp.; A. M. Sanderson, Whitehall Pharmacal (Canada) Ltd., Toronto; Lee Talley, Coca-Cola Ltd., Toronto; William E. Trimble, Baker Adv. Agency, Toronto.

WALTER P. BURN—17 Washington St., Middlebury, Vt. Tel.: 593. (Maps and coverage data.)

CANADIAN FACTS LTD.—146 Wellington St. West, Toronto, Ont. Tel.: Empire 4-6373. John F. Graydon, president; Lewis Gray, vice president; Mrs. M. Sims, director of personnel; George Severs, chief statistician. Branch Office: 1466 Drummond St., Montreal. Tel.: Plateau 1734. Frank Lyman, vice president.

ROBERT S. CONLAN ASSOCIATES—1715 Wyandotte St., Kansas City. Tel.: Victor 3038. John L. Guyant, president; Robert E. West, director of sales. (Local and national radio and television audience surveys, national rating service.)

CONTROLLED CIRCULATION AUDIT—420 Lexington Ave., New York. Tel.: Lexington 2-6380. *Officers:* Adin L. Davis, managing director; Richard S. Hayes, president; G. Kenneth Thornton, vice president; George W. N. Riddle, secretary; Arthur A. Kron, treasurer. (Auditing circulation of business publications.)

ELLIOTT-HAYNES Ltd.—515 Broadview, Toronto, Ont. Tel.: Gerard 1144. Walter E. Elliott, president; J. Myles Leckie, vice president; E. R. Comte, secretary-treasurer. Branch Offices: 1500 St. Catherine St. W., Montreal. Tel.: Willowbank 1913; 441 Seymour St., Vancouver, B. C.

EXECUTIVES RADIO-TV SERVICE—Larchmont, N. Y. Tel.: Larchmont 2-0833. James M. Boerst, owner and publisher. (Publishers of monthly Spot Radio Report, quarterly Factory

CALL-LETTER SPECIALTIES FOR RADIO & TELEVISION STATIONS

TIES AVAILABLE
any type
microphone
and name
plate insignia



\$2.50 each
\$24.00 per dozen

All popular
solid colors

MONEY-GETTING PROGRAM GIMMICKS AND IDEAS

BANNERS

Any size, Any shape—your own special design and insignia. Send us your sketch or artwork, and be sure to state size when writing for prices.

- LAPEL BUTTONS & PINS
- CAR PLATES
- AUTOMOBILE BUMPER STRIPS
- TIES
- T-SHIRTS
- ASH TRAYS
- THERMOMETERS
- CLOCKS
- DESK CALENDARS
- JEWELRY

NEW TRUNK LID PLATES
on and off in a jiffy!

\$1.50 each
\$15.00 per dozen



You Name it—We Have it! Satisfaction Guaranteed!

RA-TEL PROMOTION SERVICE • 1019 STANFORD DR., HUNTSVILLE, ALA.

[sponsored radio-TV network data], and semi-annual Time Buyers Register.)
GRAHAM RESEARCH SERVICE—424 Madison Ave., New York 17. Tel.: Plaza 3-4565. Director: J. E. Graham.
GUIDE-POST RESEARCH—213 Smithfield St., Pittsburgh 22, Pa. C. F. Ackenheil, director.
C. E. HOOPER Inc.—Executive offices, 10 E. 40th St., New York 16. Tel.: Lexington 2-3000. Officers: C. E. Hooper, president; Dorothy M. Behrens, Richard K. Doan, Nadine E. Miller, Bruce McEwen, Edythe F. Bull, vice presidents. Production office and plant: Dry Hill, Norwalk, Conn. Tel.: 8-0606.
RICHARD MANVILLE RESEARCH—230 Park Ave., New York 17. Tel.: Oregon 9-2435. (Consultants on advertising and marketing research. Radio, television market program and audience research; studies on effectiveness of commercials. Customer-per-dollar studies; radio and television contest and mail handling. Diary studies, etc.)
MARKET RESEARCH CORP. OF AMERICA (formerly Industrial Surveys Co.)—122 East 42 St., New York 17. Tel.: Oxford 7-3540. National Retail Food & Drug Audits and other continuing studies. Samuel G. Barton, president; C. C. Rogers and Stanley Womer, executive vice-presidents; John Rhodes, administrative vice-president; Arden Crawford, v.p. in charge of Client Service Division; Daniel Connell, v.p. in charge Eastern Service Operation. Chicago office: 425 N. Michigan Avenue (11). Tel.: Mohawk 4-4600. Palmer Waterbury, vice-president and client service branch manager; A. J. diPietro, vice-president in charge of production. San Francisco office: 2 Pine St. (11). Tel.: Sutter 1-2289. James D. North, vice-president in charge.
MARKET RESEARCH OF CLEVELAND—1220 Huron Rd., Cleveland. Tel.: Main 1-0166. Albert E. Strass, director. (Radio and television research for midwest stations, advertisers and agencies.)
MARKETSCOPE RESEARCH Co.—156 Washington St., Newark 2, N. J. Tel.: Mitchell 2-1753. Robert E. Spinner, executive director. (Market-scope Test-Town, consumer panel and store audits, continuous purchase diary in TV and non-TV homes, qualitative and quantitative radio and TV studies, national coverage.)
MEDIA RECORDS Inc.—63 Vesey St., New York 7. Tel.: Worth 4-0076. John Halpin, president; L. H. Collins, vice president. Offices: 174 E. Long St., Columbus 15, Ohio; Tel.: Main 7784; Frances Davis, manager. 173 W. Madison St., Chicago. Tel.: Andover 3-5683; Ladious Siwak, manager. 355 Stockton St., San Francisco 8. Tel.: Garfield 4989; E. J. Raleigh, Jr. manager.
MOFFETT RESEARCH Co.—6253 Hollywood Blvd., Hollywood 28. Tel.: Hollywood 3-5653. Jessie Locke Moffett, owner.

A. C. NIELSEN Co.—2101 Howard St., Chicago 45. Tel.: Hollycourt 5-4400. Officers: Arthur C. Nielsen, Sr., president; Arthur C. Nielsen Jr., Frederick K. Leisch, James P. Napier, Charlton G. Shaw, executive vice presidents. 500 Fifth Ave., New York 36. Tel.: Pennsylvania 6-2850. James O. Peckham, executive vice president. 215 Market St., San Francisco, Calif. Tel.: Yukon 2-1970. Franklin H. Graf, vice president. 109 St. Aldates, Oxford, England; Dr. Edward L. Lloyd, managing director. 2436 Yonge St., Toronto, Ontario, Canada; D. M. Prather, president. 35 Fisher St., Petersham, N. S. W., Sydney, Australia; Justin Power, director; 570 Heerengracht, Amsterdam. The Netherlands; J. B. Staniland, director. (Broadcast audience and station coverage measurement, marketing research.)
EDWARD J. NOONAN MARKET RESEARCH ORGANIZATION—157 Federal St., Boston 10. Tel.: Liberty 2-1870. Edward J. Noonan, director.
O'CONNOR SURVEY Co.—Vester Bldg., Knoxville. Tel.: 5-2272. Bernice M. O'Connor, director. (O'Connor Radio Audience Surveys.)
OFFICE OF RESEARCH Inc.—3470 Broadway, New York 31 and P. O. Box 666, Norwalk, Conn. Tel.: Audubon 6-7455. John G. Peatman, president and director; V. S. McGee, assistant director. (Radio and TV consultants and publishers of weekly surveys of network music.)
OPINION RESEARCH CORP.—44 Nassau St., Princeton, N. J. Tel.: 1-3800. Dr. Claude Robinson, president; Walter G. Barlow, Joseph C. Brincis, LeBaron Foster, M. Starr Northrop, LeRoy Purvis, Hugh Rusch, Dilman M. K. Smith, vice presidents.
ALFRED POLITZ RESEARCH INC.—270 Park Ave., New York 17. Tel.: Plaza 9-5200. Alfred Politz, president; Lester R. Frankel, technical director; Eva Klein, J. Stevens Stock, project coordinators; Jerome Greene, Robert Lindsey, Robert Weller, David F. Wolfe, project directors; Nathan Schiller, sampling director; Mildred Taylor, field director. (Marketing, advertising, product, opinion and media research.)
THE PSYCHOLOGICAL Corp.—522 Fifth Ave., New York 36. Tel.: Murray Hill 2-2145. Walter R. Miles, chairman of the board; George K. Bennett, president; Albert D. Freiberg, 1st vice president and director, Div. of Marketing & Social Research; Philip G. Corby, associate director; Charles L. Vaughn, assistant director. (Opinion polling, audience measurement, special surveys, advisory and consulting services.)
PUBLISHERS INFORMATION BUREAU Inc. (PIB)—271 Madison Ave., New York 16. Tel.: Murray Hill 5-2210. Frank Braucher, president; W. H. Mullen, secretary. Branch Office: c/o Leading National Advertisers, 21 E. Hubbard St., Chicago 11. Tel.: Whitehall 4-6533.

THE PULSE Inc.—15 W. 46th St., New York 36. Tel.: Judson 6-3316. Director: Dr. Sydney Roslow; David Klein, manager; Nellie Kelly, assistant director; Lawrence Rodow, associate director; George Sternberg, service manager; Robert Collins, director of client relations. (Radio, television, market research.)
RADIO REPORTS Inc.—200 E. 42nd St., New York 17. Tel.: Murray Hill 7-6638. Officers: Edward F. Loomis, president; Gorton V. Caruth, vice president; Simon Nathenson, vice-president and general manager; George W. Loomis, vice-president and secretary; David Fins, vice president and assistant treasurer; Carl Hirschfeld, midwest vice-president in charge of Chicago, Detroit and Cleveland. Branch offices: 5050 Joy Road, Detroit 4; 1550 E. 53rd St., Chicago; 11615 Cromwell Ave., Cleveland; 36 Springfield St., Wilbraham, Mass.; 2024 W. 6th St., Los Angeles 5; 519 6th St., N. W., Washington 1, D. C. 264 Arlington Ave., Berkeley, Calif.; 4811 Walnut St., Philadelphia 39, Pa. (Transcripts, digests and analyses of radio and TV news and comments, surveys of program content; monitoring of commercials in about 200 markets.)
RESEARCH CO. OF AMERICA—570 Fifth Avenue, New York 36. Tel.: Plaza 7-1865. Managing Director, A. Edwin Fein; director of research, Otis T. Wingo.
ELMO ROPER—30 Rockefeller Plaza, New York 20. Tel.: Plaza 7-4900. Associates: Carolyn Crusius, Louis Harris, Burns Roper, Robert Williams.
N. C. RORABAUGH Co.—347 Madison Ave., New York 17. Tel.: Murray Hill 6-2193. Publisher: N. Charles Rorabaugh. TV Editor: Stella Brauner. (Publishes quarterly Rorabaugh report on spot television advertising.)
SCHWERIN RESEARCH Corp.—1775 Broadway, New York 19. Tel.: Judson 2-4890. Horace S. Schwerin, president; Leonard Kudisch, executive vice president. (Radio, television, motion picture qualitative research and commercial studies.)
S-D SURVEYS Inc.—642 Fifth Ave., New York. Tel.: Plaza 7-2430. Officers: Arthur B. Dougall, president and treasurer; Carl H. Henrikson Jr., vice president and general manager; Carol A. Cruikshank, executive project director.
SOUTHWEST RESEARCH Inc.—4231 Normandy, Dallas 5. Tel.: Logan 2641. Officers: Mary H. Winters, president; Ira G. Corn Jr., vice president; Verna C. Brock, secretary-treasurer.
STANDARD AUDIT & MEASUREMENT SERVICES Inc.—89 Broad St., New York 4. Tel.: Whitehall 3-8390. Kenneth H. Baker, president; Owen Smith, vice president; Michael R. Notaro, treasurer; Edward Becker, secretary.
DANIEL STARCH & STAFF—Boston Post Road & Beach Ave., Mamaroneck, N. Y. Tel.: New York, Enterprise 6076.

GOVERNMENT AGENCIES DEALING WITH RADIO

(All Washington, D. C. addresses unless otherwise specified. • Complete FCC listing on page 30.)

EXECUTIVE OFFICE OF THE PRESIDENT

White House
 1600 Pennsylvania Ave., N. W.
 Tel.: National 8-1414

The White House Office: Assistant to the President, Sherman Adams. Deputy Assistant to the President, Maj. Gen. William B. Parsons (Congressional Liaison); Associate counsel to the President, Maxwell M. Rabb; C. D. Jackson, Administrative Assistants to the President, Robert Cutler, Gabriel Hauge, Bryce Harlow. Secretary to the President, Thomas E. Stephens. Press Secretary to the President, James C. Hagerty. Assistant Press Secretary to the President, Murray Snyder. Special Counsel to the President, Bernard M. Shanley.
 Office of Defense Mobilization, 17th & Pennsylvania Ave., N. W. Tel.: Executive 3-3300. Director, Arthur S. Fleming. Deputy Director, Victor A. Cooley. Asst. Director, (Telecommunications), William A. Porter. General Counsel, Charles H. Kendall. Public Information officer, Lee W. Schooler.

DEPT. OF STATE

21st and Virginia Ave., N. W.
 Tel.: REpublic 7-5600

Secretary: John Foster Dulles. Under Secretaries: Walter Bedell Smith, Donald Lourie (Administration).
 Assistant Secretary of State for Public Affairs: Carl W. McArdie. Chief, News Div.: Henry Suydam. Assistant Chief, Lincoln White.
 Transportation & Communications Office (Telecommunications): Chief, Francis Colt d'Wolf. Assistant Chiefs, John S. Cross, Cecil G. Harrison, T. H. E. Nesbitt, Arthur Lebel. Special Assistant to the Chief, Helen Kelly.

DEPT. OF JUSTICE

9th & Pennsylvania Ave., N. W.
 Tel.: REpublic 7-8200

Attorney General: Herbert Brownell Jr. Deputy Attorney General: William P. Rogers. Assistant Attorneys General: H. Brian Holland (Tax Div.), Stanley N. Barnes (Antitrust Div.), Warren Olney III (Criminal Div.)
 Office of Public Information: Director, G. Frederick Mullen. Assistant Director, Leo Cadison.

DEPT. OF HEALTH, EDUCATION & WELFARE

330 Independence Ave., S. W.
 Tel.: EXecutive 3-6300

Secretary: Oveta Culp Hobby. Undersecretary: Nelson A. Rockefeller.
 Office of Publications & Reports: Director, J. Stewart Hunter. Deputy Director, Harvey A. Bush. Press Officer, H. C. John Russell.
 Food Administration: Wallace Janssen (Information Officer).
 Office of Education: John Lloyd (Information Officer).
 Social Security Administration: William Galvin (Information Officer).
 Public Health Service: Mary Ross (Information Officer).
 Office of Vocational Rehabilitation: W. Oliver Kincannon (Information Officer).
 National Institutes of Health: Jack Fletcher (Information Officer).

DEPT. OF AGRICULTURE

14th St. & Independence Ave., S. W.
 Tel.: REpublic 7-4142

Secretary: Ezra Taft Benson.
 Office of Information: Director R. L. Webster. Deputy Director, James H. McCormick, Assistant Directors, Kenneth Gagen (radio-TV), Harold Lewis (press relations), TV Information Specialists, Alice Skelsey, Jules Renaud, Supervisor of Network Programming, Jack H. Towers. Director of Individual Station Relations, J. Don Looper.

U. S. INFORMATION AGENCY

1778 Pennsylvania Ave., N. W.
 Tel.: REpublic 7-5600

Director: Theodore C. Streibert. Deputy Director: Abbott Washburn. Special Assistants to the Director: Henry Loomis and John R. Kennedy. Congressional and Public Information Staff: Ben G. Crosby, Chief, Broadcasting Service (Voice of America); Leonard F. Erikson, Chief, Press Service; Harlan Logan, Chief, Motion Picture Service; Turner Shelton, acting Chief, Information Center Service; Richard A. Humphrey, acting Chief, Private Enterprise Cooperation Staff; John M. Begg, acting Chief.

FEDERAL TRADE COMMISSION

6th St. & Pennsylvania Ave., N. W.
 Tel.: EXecutive 3-6800

Members: Chairman, Edward F. Howrey. Lowell B. Mason, James M. Mead, Albert A. Carretta, John W. Gwyne.
 Bureau of Anti-Deceptive Practices: Daniel J. Murphy, director.
 Bureau of Industry Cooperation: James R. Horton, director.
 General Counsel: Earl W. Kintner.
 Executive Assistant for Public Affairs: Fitzhugh Green.
 Office of Public Information: Donald R. Moore, acting director.

FEDERAL CIVIL DEFENSE ADMINISTRATION

1930 Columbia Rd., N. W.
 Tel.: HUDson 3-5500

Administrator: Val Peterson.
 Warning & Communications Division: Director, William Talbot.
 Public Affairs Office: Director, John A. DeChant. Audio-Visual Division, Director, Stephen McCormick. Radio-TV Branch, Chief, Chester Spurgeon. Motion Picture Branch, Rodney Radford. News and Publications: Director, Wade McCoy.

ATOMIC ENERGY COMMISSION

1901 Constitution Ave., N. W.
 Tel.: STerling 3-8000

Chairman: Lewis L. Strauss.
 Division of Information Services: Director, Morse Salisbury. Chief, Public Information Service: Shelby Thompson. Radio-Visual Branch: Chief, Charter Heslep.

GENERAL SERVICES ADMINISTRATION

F St., between 18th & 19th Sts., N. W.
 Tel.: EXecutive 3-4900

Administrator: Edmund F. Mansure.
 Office of Public Information & Reports: Director, Herbert Plummer.

AGENCIES DEALING WITH RADIO

DEPT. OF COMMERCE
14th & Constitution Ave., N. W.
Tel.: STerling 3-9200

Secretary: Sinclair Weeks

Director of Office of Publications Management: Donald R. Burgess. Director of Public Information, Albert Leman. Deputy Director of Information, Henry Scharer. Chief, News Section, Harry Weiss.

Census Bureau (Tel.: LUdlow 4-3000): Director, Robert W. Burgess. Deputy Director, A. Ross Eckler. Assistant Directors, Howard C. Grieves, Dr. Conrad Tauber. Information Officer: A. W. Von Struwe. Information Specialist: Conrad Shamel.

National Bureau of Standards (Tel.: Emerson 2-4040): Director, A. V. Astin. Assistant to the Director (Director of Office of Scientific Publications), Hugh Odishaw. Director of Technical Reports (information office), William Tilley. Chief, Central Radio Propagation Labs., W. R. Brode. Acting Chief, Electronics Division, J. G. Reid Jr.

Civil Aeronautics Administration (Tel.: Sterling 3-9200): Administration, F. E. Lee. Chief, Airspace Utilization Branch, E. R. Mehring. Director, Office of Aviation Information, Ben Stern.

U. S. Weather Bureau (Tel.: Adams 2-3200) Chief, Radio-TV Unit, James C. Fidler.

DEPT. OF DEFENSE
Pentagon Bldg.
Tel.: LIberty 5-6700

Secretary: Charles Erwin Wilson. Deputy Secretary: Roger M. Kyes.

Office of Public Information: Director, C. Herschel Schooley. Deputy, Osgood Roberts. Assistant to the Director, Philip F. Hines.

Radio-TV Branch: Chief (acting), Maj. Clarke

Thornton (Army), Lt. Michael Marlow (Air Force). Chief, Radio Section, Charles W. Freudenthal, Lt. G. D. Miner Jr. (Navy).

Press Branch: Chief, Joseph F. Flynn. Deputy, Hunt Clement. Executive Assistants, Edward Cottrell (Army), Comdr. Benjamin Franklin (Navy), Lt. Col. Monclé Monks (Air Force), Col. John Gabbert (Marine Corps).

Dept. of the Air Force: Secretary, Harold E. Talbott. Office of Information Service—Director, Maj. Gen. Sory Smith; Executive Officer, Lt. Col. George Carter; Deputy Director, Brig. Gen. Arno H. Luehman; Communications Director, Brig Gen. Gordon A. Blake.

Dept. of the Army: Secretary, Robert Ten Broeck Stevens. Office of Public Information—Director, Maj. Gen. Gilman C. Mudgett. Radio-Television Branch—Chief, Lt. Col. Tom Matthews. Assistants, Maj. Thomas B. Clagett, 2d Lt. John A. Mortimer.

Dept. of the Navy: Secretary Robert B. Anderson. Office of Public Information—Chief, Rear Adm. Louis S. Parks; Deputy Chief, Capt. E. W. Parish; Special Deputy, Capt. Walter Karig; Director, Public Information Div., Comdr. Slade D. Cutter. News Branch—Director, Lt. Comdr. R. S. Froude. Radio-TV Branch—Director, Lt. Comdr. S. J. Wornom. Pictorial Branch—Director, Lt. Frank E. Coghlan.

Marine Corps (Arlington Annex, Navy Dept.): Division of Public Information—Acting Director, Col. Raymond F. Crist Jr. Radio-TV Branch—Chief, Maj. Theodore F. Curtis. Press Branch—Chief, Lt. Col. Robert Barry.

DEPT. OF TREASURY
(U. S. Savings Bond Division)
Tel.: EXecutive 3-6400

Secretary: George M. Humphrey.

National Director: Earl O. Shreve.

Advertising & Promotion Branch: Assistant National Director, Elihu E. Harris.

Advertising Section: Chief, Edmund J. Linehan (radio and television).

Public Information Section: Chief, John Koepf.

VETERANS ADMINISTRATION
Vermont Ave. & H St., N. W.
EXecutive 3-4120

Administrator: Harvey V. Higley.

Office of Public Information: Director, A. W. Woolford. Associate Director, Frank Hood. Assistant Director, Radio-TV Division, Bernard Posner. Assistant Director, News, Lawrence George.

DEPT. OF LABOR
14th & Constitution Ave., N. W.
Tel.: EXecutive 3-2420

Secretary: James P. Mitchell.

Office of Public Information: Director, Herbert Little. Assistant Director, John W. Leslie. Administrative Assistant, Mary Brown.

NATIONAL LABOR RELATIONS BOARD
815 Connecticut Ave., N. W.
REPublic 7-7500

Members: Chairman, Guy Farmer; Philip Ray Rodgers, Abe Murdock, Ivar H. Peterson (vacancy).

Office of Public Information: Director, Louis G. Silverberg. Associate Director, Jay E. Shanklin.

SECURITIES EXCHANGE COMMISSION
425 2d St. N. W.
Tel.: STerling 3-7600

Members: Chairman, Ralph H. Demmler; Paul R. Rowen, Clarence H. Adams, A. J. Goodwin Jr., J. Sinclair Armstrong.

Secretary of the Commission and Director of Information: Orville L. Dubois.

UNIONS AND LABOR GROUPS REPRESENTING RADIO EMPLOYEES

ACTORS EQUITY ASSN.* (AFL)—45 W. 47th St., New York, Tel.: Plaza 7-7660. Ralph Bellamy, pres.; Angus Duncan, exec. sec. **OTHER OFFICES**—6636 Hollywood Blvd., Hollywood 28, Calif. Tel.: Hudson 2-2334. Edd X. Russell, Los Angeles rep.

AMERICAN COMMUNICATIONS ASSN. (ACA) (Ind.)—5 Beekman St., New York, Tel.: Cortland 7-1374. Joseph Selly, pres., William Bender, vp. (Atlantic Branch).

AMERICAN FEDERATION OF LABOR (AFL)—Headquarters: 901 Massachusetts Ave., N.W., Washington, D. C. Tel.: National 8-3870. George Meany, pres.; Wm. F. Schnitzler, secy.-treas.

AMERICAN FEDERATION OF MUSICIANS (AFM) (AFL)—Headquarters, 570 Lexington Ave., New York, Tel.: Plaza 8-0600. James C. Petrillo, pres.; C. L. Bagley, vp.; Leo Cluesmann, secy.; Harry J. Steeper, treas. **CHICAGO LOCAL** 10: 175 W. Washington Blvd. Tel.: State 2-0063. James C. Petrillo, pres.; Edward Bankert, rec. secy. **NEW YORK LOCAL** 802: 570 Lexington Ave. Tel.: Plaza 8-0600. Al Manuti, pres.; Al Knopf, vp.; Charles R. Iucci, secy.; Hy Jaffe, treas.

AMERICAN FEDERATION OF MUSICIANS MUTUAL PROTECTIVE ASSN. LOCAL 47 (AFL)—817 N. Vine St., Hollywood 38, Calif. Tel.: Hudson 2-2161. John Te Groen, pres.; Phil Fischer, vp. & int'l. studio & tv film rep.

AMERICAN FEDERATION OF TELEVISION & RADIO ARTISTS (AFTRA)* (AFL)—15 W. 44th St., New York 36, N. Y. Tel.: Vanderbilt 6-1810. Knox Manning, chrmn.; Lawrence Tibbett, co-chrmn.; George Heller, nat'l. exec. secy. **OTHER OFFICES**: 6331 Hollywood Blvd., Hollywood 28, Calif. Tel.: Hillside 5125. Claude L. McCue, western rep. dir. 102 Hubbard St., Chicago, Tel.: Delaware 7-7017. Raymond A. Jones, central rep. dir.

AMERICAN GUILD OF MUSICAL ARTISTS* (AFL)—Headquarters: 276 W. 43rd St., New York, Tel.: Columbus 5-3687. Lawrence Tibbett, pres.; Hyman Faine, exec. secy. **OTHER OFFICES** 6636 Hollywood Blvd.; Hollywood 28, Calif. Tel.: Hudson 2-2334.

AMERICAN GUILD OF VARIETY ARTISTS* HEADQUARTERS AND EASTERN REGIONAL OFFICE (AFL)—1697 Broadway, New York, Tel.: Circle 6-7130. Jackie Bright, pres.; Georgie Price, first vp.; Jack Gwynne, sec. vp.; Joe Campo, third vp.; Rex Weber, treasurer; Peter Chan, recording secy.; Jack Irving, nat'l. admin. secy.; Dick Jones, eastern rep. dir. **MID-WEST REGIONAL OFFICE**—84 W. Randolph St., Chicago, Ill. Tel.: Central 6-5561 & 2. Ernie Fast, mid-west rep. dir. **WESTERN REGIONAL OFFICE**—6758 Hollywood Blvd., Hollywood, Calif. Tel.: Hillside 8281. Eddie Rio, western rep. dir.

AMERICAN NEWSPAPER GUILD (CIO)—99 University Pl., New York, Tel.: Oregon 7-1661. Joseph Collis, pres.; Ralph B. Nowak, exec. vp.; William Farson, secy.-treas.

ASSOCIATED ACTORS & ARTISTES OF AMERICA (AFL)—45 W. 47th St., New York, Tel.: Plaza 7-7660. Paul Dullzell, pres.

AUTHORS LEAGUE OF AMERICA (Ind.)

—Headquarters, 6 E. 39th St., New York, Tel.: Murray Hill 9-4950. Rex Stout, pres.; Luise Silcox, exec. secy.; Evelyn Burkey, asst. exec. secy.

BROADCAST-TELEVISION RECORDING ENGINEERS LOCAL 45 (IBEW) (AFL)—1584 Cross-Roads-of-the-World, Hollywood 28, Calif. Tel.: Hollywood 5-3129. Harold Stone, bus. mgr. **LOCAL** 202—450 Harrison St., San Francisco 5, Calif. Tel.: Yukon 2-6752. Jack Dunn, bus. mgr. **BUILDING SERVICE EMPLOYEES (AFL)**—1154 N. Western Ave., Hollywood 29, Calif. William Sundby, bus. mgr.

CHORUS EQUITY ASSN.* (AFL)—70 - 70th Ave., New York, Tel.: Circle 5-6054. Clarence Derwent, pres.; Paul Dullzell, chrmn. exec. comm.

COMMUNICATIONS WORKERS OF AMERICA (CWA) (CIO)—1808 Adams Mill Rd., Washington, Tel.: Hudson 3-9200. Joseph A. Beirne, pres.; A. B. Herrington, editor & pub. rel. dir.

CONGRESS OF INDUSTRIAL ORGANIZATIONS (CIO)—Headquarters: 718 Jackson Pl., N.W., Washington, Tel.: Executive 3-5581. Walter P. Reuther, pres.

DISTRIBUTING PROCESS & OFFICE WORKERS OF AMERICA (DIST. 65) (CIO)—13 Astor Pl., New York, Tel.: Oregon 2-5120. Jack Paley, acting pres.; Cleveland Robinson, secy.-treas.

INTERNATIONAL ALLIANCE OF THEATRICAL STAGE EMPLOYEES & MOVING PICTURE OPERATORS (IATSE) (AFL)—1270 6th Ave., New York, Tel.: Circle 5-4370. Richard Walsh, pres.; Harland Holmden, secy.-treas. **OTHER OFFICES**: 6636 Hollywood Blvd., Hollywood 28, Calif. Tel.: Gladstone 3117. 102 E. Hubbard St., Chicago, Tel.: Delaware 7-7017.

INTERNATIONAL BROTHERHOOD OF ELECTRICAL WORKERS (IBEW) (AFL)—1200 15th St., N.W., Washington 5, D. C. Tel.: Columbia 5-8040. Albert O. Hardy, dir. of radio, tv & recording div. **LOCAL** 45—1584 Cross-Roads-of-the-World, Hollywood 28, Tel.: Hollywood 5-3129. Harold Stone, bus. mgr. **LOCAL** 202—450 Harrison St., San Francisco, Tel.: Yukon 2-6752. John J. Dunn, bus. mgr. **LOCAL** 1212—11 West 42nd St., New York 36, Tel.: Pennsylvania 6-8216. Charles A. Calame, bus. mgr. **LOCAL** 1220—400 N. Michigan Ave., Chicago 11, Ill. Tel.: Superior 7-5244. H. Walter Thompson, pres.

NATIONAL ASSN. OF BROADCAST ENGINEERS & TECHNICIANS (NABET) (CIO)—INTERNATIONAL OFFICE: 80 E. Jackson, Chicago 4, Ill. Tel.: Wabash 2-2462. George Maher, exec. secy.; Bertha Treu, secy.-treas.; Louis J. Favara, nat'l. rep. **BUFFALO OFFICE**: 86 W. Chipewawa St., Mohawk 6028. Edward M. Lynch, nat'l. rep. **NEW YORK OFFICE**: 48 West 48th St., Tel.: Plaza 7-3065. G. Tyler Byrne, nat'l. rep.; Clifford L. Gorsuch, nat'l. rep. **SAN FRANCISCO OFFICE**: 451 O'Farrell St. Tel.: Ordway 3-8494. John R. McDonnell, pres. **HOLLYWOOD OFFICE**: 6223 Selma Ave. Tel.: Hollywood 4-9311. James H. Brown, nat'l. rep. **MONTREAL OFFICE**: 448 King's Hall Bldg., 1231 St. Catherine, West, Tel.: Plateau 5488. Adrien Gagné, nat'l. rep. **TORONTO OFFICE**: 519 Jarvis, Tel. Randolph 7343. Timothy J. O'Sullivan, nat'l. rep.

NATIONAL ASSN. OF BROADCAST UNIONS & GUILDS (NABUG) (Ind.)—37 W. 46th St., New York 36, N. Y. Tel.: Judson 2-5130. Oliver W. Nicoll, nat'l. chrmn. **OTHER OFFICES**—6331 Hollywood Blvd., Hollywood 28, Calif. Tel.: Hillside 5125. Claude L. McCue, chrmn. 341

Menomonee St., Chicago 11, Ill. Tel.: Delaware 7-7017. H. Walter Thompson, chmn.; Raymond A. Jones, secy.-treas.

OFFICE EMPLOYEES' INTERNATIONAL UNION LOCAL 174 (OEIU) (AFL)—7268½ Sunset Blvd., Hollywood 46, Tel.: Hollywood 7-9178. Leroy Patterson, local pres.; Max Krug, bus. rep.

PUBLICISTS GUILD (Ind.)—2700 N. Highland Ave., Hollywood 28, Calif. Tel.: Hollywood 3-6826. Walker Compton, pres.; Lloyd Ritchie, bus. mgr.; Adele Salem, exec. secy.

RADIO & TELEVISION DIRECTORS GUILD (RTDG) (AFL)—INTERNATIONAL OFFICE—114 East 52nd St., New York 22, Tel.: Plaza 9-0949. Franklin J. Schaffner, international pres.; Theodore Bliss, first vp.; Charles K. Dargan, sec. vp.; Ian Harrower, third vp.; Alan Fishburn, secy.; Andrew McCullough, treas., Newman H. Burnett, nat'l. exec. dir. **NEW YORK LOCAL**: 114 East 52d St. Tel.: Plaza 9-0875. Richard Schneider, pres.; Newman H. Burnett, exec. secy. **HOLLYWOOD LOCAL**: 1655 N. Cherokee Ave. Tel.: Hollywood 7-5866. Robert L. Robb, pres.; Elizabeth Gould, exec. secy. **CHICAGO LOCAL**: 1413 N. Dearborn, Tel.: Delaware 7-4867. Alan M. Fishburn, pres. **DETROIT LOCAL**: 1257 Penobscot Bldg. Tel.: Woodward 5-0061. Ian Harrower, pres.; Boaz Siegel, exec. secy. **WASHINGTON LOCAL**: Sheraton Park Hotel, Tel.: Adams 4-5400. Richard Borden, pres. **CLEVELAND LOCAL**: 13300 Second Ave., East Cleveland 12, Ohio. Charles K. Dargan, pres.

RADIO WRITERS GUILD (RWG)* (Ind.)**—Headquarters: 6 E. 23d St., New York, Tel.: Gramercy 7-9190. Philo Higley, pres.; Nelson Sykes, vp. eastern rep.; Ben Starr, vp. western rep. **OTHER OFFICES**: 1655 N. Cherokee Ave., Hollywood 28, Calif. Tel.: Gladstone 7128. Michael Davidson, exec. secy.; May Holhamer, exec. sec. **WBBM Chicago**, 400 N. Michigan Ave. Tel.: Whitehall 4-6000. Russ Bensley, vp. midwestern rep. [Note: Chicago chapter affiliated with NABET-CIO except for WBBM.]

SCREEN ACTORS GUILD (SAG)—Headquarters: 7046 Hollywood Blvd., Hollywood 28, Calif. Tel.: Hollywood 9-7311. Walter Pidgeon, pres.; John L. Dales, nat'l. exec. secy. **NEW YORK**: 67 W. 44th St., New York 36, N. Y. Tel.: Murray Hill 7-4623. Mrs. Florence Marston, eastern rep. **CHICAGO**: 102 E. Hubbard St. Tel.: Delaware 7-7017. Ray Jones, rep. **DETROIT**: 1257 Penobscot Bldg. Tel.: Woodward 2-2896. Boaz Siegel, rep. **SAN FRANCISCO**: 760 Market St. Tel.: Exbrook 2-6990. Charlotte Cohelan, rep. **BOSTON**: 11 Beacon St., Rm 624. Tel.: Richmond 2-0208. Robert M. Segal, rep. **CINCINNATI**: 1505 Fountain Sq. Bldg. Tel.: Dunbar 2121. Ben Gettler, rep. **CLEVELAND**: 513 Bulkeley Bldg. Tel.: Superior 11930. Ted Smoot, rep. **PITTSBURGH**: Frick Bldg. Tel.: Atlantic 1-2428. Donald B. Hirsch, rep.

SCREEN WRITERS GUILD (SWG) *—8782 Sunset Blvd., Los Angeles 46, Calif. Tel.: Crestview 5-1162. Richard Breen, pres.; Valentine Davies, 1st vp.; Ronald MacDougall, 2d vp.; David Dortort, secy.; Leonard Spigelgass, treas.**

UNITED SCENIC ARTISTS OF AMERICA (AFL)—54 W. Randolph St., Chicago 1. Tel.: Dearborn 2-2563. **LOCAL** 350, Chicago, same address. Herb Marlow, bus. rep. **LOCAL** 829, 234 W. 56th St., New York 19, Tel.: Circle 6-0823. Rudy Karnolt, bus. rep.

Awards and citations listed herewith were presented during 1953 and were not necessarily for that year.

MAJOR AWARDS AND CITATIONS—1953

duPont Awards*

WMT Cedar Rapids, Iowa

SPECIAL MENTIONS

Clifton Utley, NBC
Martin Agronsky, ABC
Erwin Canham, ABC
WDIA Memphis
WNAX Yankton, S. D.

* Made annually for "loyal service" by radio and tv stations and commentators "to the nation and the communities they serve". Administered by Washington & Lee U., Lexington, Va. Winners receive \$1,000 cash which, if they choose, they may donate to scholarship or fellowship. Awards established by widow of Alfred I. duPont with perpetual trust fund.

Freedoms Foundation Awards*

TOP AWARD

Robert Montgomery, *A Citizen Views the News*, sponsored by *Life* magazine on NBC.

HONOR MEDAL AWARDS

(National Series Broadcasts)

Ford Foundation Fund for Adult Education, *The People Act*, NBC.

Paul Harvey, news program, ABC.

World Broadcasting System, *Freedom Is Our Business: The People Choose* (syndicated).

Ziv Productions, *I Was a Communist for the FBI* (syndicated).

(National Single Broadcasts)

American Legion Auxiliary, *Mission for Mothers* (miscellaneous stations).

Earl Godwin, commentary on Oct. 18, 1952 on NBC.

The Hour of St. Francis, *The Congressman's Temptation* (miscellaneous stations).

(Local Series Broadcasts)

Bank of Douglas (Ariz.) *Sam Jones, American*, KOY Phoenix.

John J. Dixon, *What Price America*, WROK Rockford, Ill.

KPOJ Portland, Ore., *On the Record*.

Ohio Bell Telephone Co., *The Ohio Story*, WGAR Cleveland.

WCAU Philadelphia, *Seek the Kingdom*.

WDIA Memphis, *Brown America Speaks*.

WHAM Rochester, *Court of Public Opinion*.

(Local Single Broadcasts)

Albert Charles, *George Washington Memorial*, KEX Portland, Ore.

Radio Council of Chicago Public Schools, *Headlines from History*, WBEZ(FM) Chicago.

St. Michael's College, *The Knight and the Lady*, WJOY Burlington, Vt.

WBUR(FM) Boston, *Living Democracy*.

WCNR Bloomsburg, Pa., *Hour of Decision*.

WGN Chicago, *Citizen Jane Doe*.

WHAS Louisville, *The Story That Never Should Be Told*.

KOIN Portland, Ore., *Who Killed Dr. Drew?*

* These awards are for 1952 but announced in 1953.

National Headliners Awards

James Uebelhart, new director, WSPD Toledo.
Frank Bourgoitze, NBC
for consistently outstanding news broadcasting in 1952.

National Safety Council 1952 Public Interest Awards

RADIO WINNERS

CBL Toronto; CHUM Toronto; CJBC Toronto; KASI Ames, Iowa; KECK Odessa, Tex.; KELO Sioux Falls, S. D. KFAB Omaha; KFEL Denver; KFEQ St. Joseph, Mo.; KFH Wichita, Kan.; KING Seattle; KLON Long Beach, Calif.; KLRA Little Rock, Ark. KOIL Omaha; KOIN Portland, Ore.; KOMA Oklahoma City; KOMO Seattle; KONO San Antonio, Tex.; KOOL Phoenix; KPOJ Portland, Ore.; KQV Pittsburgh; KRHD Duncan, Okla.; KRNT Des Moines, Iowa; KSTN Stockton, Calif.; KTAC Tacoma, Wash.; KTFI Twin Falls, Idaho; KTLN Denver, Colo.; KTRM Beaumont, Tex.; KUBA Yuba City, Calif.; KVI Seattle; KYA San Francisco; KYNO Fresno, Calif.; KYW Philadelphia; WAYS Charlotte, N. C.; WAZL Hazelton, Pa.; WBNY-FM Buffalo; WBUD Trenton, N. J.; WCAE Pittsburgh; WCCM Lawrence, Mass.; WCSS Amsterdam, N. Y.; WDBO Orlando, Fla.; WDEF Chattanooga, Tenn.; WEEI Boston; WEEU Reading, Pa.; WFDF Flint, Mich.; WFTM Maysville, Ky.; WGAR Cleveland; WGH Norfolk, Va.; WHIM Providence, R. I.; WHWB Rutland, Vt.; WIBA Madison, Wis.; WIBX Utica, N. Y.; WISN Milwaukee; WJAG Norfolk, Neb.; WKAP Allentown, Pa.; WKNA Charleston, W. Va.; WMAQ Chicago; WMOA Marietta, Ohio; WMRN Marion, Ohio; WORZ Orlando, Fla.; WPEP Taunton, Mass.; WPRO Providence, R. I.; WRJN Racine, Wis.; WROL Knoxville, Tenn.; WRUF Gainesville, Fla.; WRUN Utica, N. Y.; WRVA Richmond, Va.; WSAV Savannah, Ga.; WSGW Saginaw, Mich.; WSMB-AM-FM New Orleans; WSTC Stamford, Conn.; WSYR Syracuse; WTIC Hartford; WTRI Memphis; *WUOT (FM) Knoxville; WWDC Washington; WWJ-FM Detroit; WWL New Orleans, and WWSW Pittsburgh.

Ohio State Awards*

* Several score awards and citations presented annually by the Institute for Education by Radio-Television, which meets under the auspices of Ohio State U. for educational, religious and other public service broadcasting.

George Foster Peabody Awards*

Martin Agronsky, ABC
for outstanding news coverage during 1952.

New York Philharmonic Symphony Orchestra, CBS

The Standard Symphony, NBC
double award for outstanding entertainment in music.

WIS Columbia, S. C.
for regional public service and promotion of international understanding.

* Established in 1940 in honor of the late George Foster Peabody by the board of regents of the U. of Georgia to be jointly administered by its Henry W. Grady School of Journalism and the NARTE.

Radio-Television News Directors Assn.

GOLD TROPHY

CFQC Saskatoon, Sask. for outstanding radio news operation.

KFMB San Diego for outstanding radio investigative reporting by Paul W. White, executive editor.

DISTINGUISHED ACHIEVEMENT CERTIFICATES

WCAU Philadelphia and WHO Des Moines.

Information on Awards

Following is partial list of addresses for obtaining information in connection with radio awards:

duPont—Write O. W. Riegel, curator, Alfred I. duPont Awards Foundation, Washington & Lee U., Lexington, Va.

Freedoms Foundation—Ken Wells, executive vice president, Freedoms Foundation Inc., Valley Forge, Pa. (deadline for nominations Nov. 20; announcement following February.)

NRDGA—Howard P. Abrahams, NRDGA, 100 W. 31st St. N. Y.

National Headliners' Club—Mal Dodson, Convention Hall, Atlantic City, N. J.

Ohio State—Keith Tyler, director, Institute for Education by Radio, Ohio State U., Columbus, Ohio.

George Foster Peabody—Dean John E. Drewry, Henry W. Grady School of Journalism, U. of Georgia, Athens, Ga. (Entries taken in January or later; awards in April.)

National Safety Council Public Interest Awards—National Safety Council, 425 N. Michigan Ave., Chicago 11, Ill.

Alfred P. Sloan Awards for Highway Safety—National Safety Council, 425 N. Michigan Ave., Chicago 11, Ill.

Sigma Delta Chi—Address Sigma Delta Chi Awards in Journalism, 35 E. Wacker Dr., Chicago, 1, Ill.

Radio-Television News Directors Awards—competition for annual awards is conducted by the radio-tv department of the Medill School of Journalism, Northwestern U., Evanston, Ill.

Sigma Delta Chi Awards In Journalism

RADIO (AND TV) REPORTING

Charles and Eugene Jones, NBC.

RADIO NEWSWRITING

Clifton Utley, WMAQ Chicago and NBC.

PUBLIC SERVICE IN RADIO JOURNALISM

WMT Cedar Rapids, Iowa.

Alfred P. Sloan Awards

RADIO NETWORK SUSTAINING PROGRAMS
MBS for "a splendid, all-year-round safety campaign".

LOCAL STATION, SUSTAINING PROGRAMS
WHIM Providence, R. I.

REGIONAL STATION, SUSTAINING
PROGRAMS
KING Seattle.

RADIO NETWORK COMMERCIAL PROGRAMS
Standard Oil Co. (Ind.) for "the variety, quality and effectiveness of its safety program in 27 cities".

LOCAL STATION, COMMERCIAL PROGRAMS
Dittman Motors, Reading, Pa., for its quarter-hour *Music for Motoring* on WEEU Reading.

REGIONAL STATION, COMMERCIAL PROGRAM

Preferred Insurance Exchange, Seattle, for *Could This Be You?* on KVI Seattle.

RADIO REFERENCE BOOKS AND PUBLICATIONS—1953

Editor's Note: As in previous years, this list includes material published during the current year. Unless otherwise noted, the place of publication is New York City. The word *Apply* is used to indicate published studies which may not be available. However, depository libraries for radio and television material have been established in more than a hundred city and university libraries. It is therefore recommended that a check be made in the one nearest you for the items listed and for others which it was not possible to include. Agnes Law, Librarian, CBS Reference Department, Editor.

ADVANCING JOURNALISM. Ed. by John E. Drewry. Athens, Ga. University of Georgia School of Journalism, 1953. pa. \$2.00, cloth \$3.00. This is the fifth in a series of bulletins, 1949-1953, sub-titled "Press, Radio, Television, Periodicals, Public Relations and Advertising as Seen Through Institutes and Special Occasions of the Henry W. Grady School of Journalism." Leaders in the various fields of mass communications have contributed chapters.

ALL ABOUT RADIO AND TELEVISION. By Jack Gould. Random House, 1953. 143p. \$1.95. The noted columnist of the *New York Times*, interested in radio from his youth, has written this book for juveniles but it is equally of interest to adults. Directions for building a "foxtrot radio" are given with specifications and good illustrations.

THE BLUE BOOK OF HOLLYWOOD MUSICALS. By Jack Burton. Watkins Glen, N. Y., Century House, 1953. 285p. \$5.00. Covering the 25 years of sound motion pictures, this third book in a trilogy lists films alphabetically in a chronological arrangement with four sub-divisions for straight musicals, feature films, westerns and full-length cartoons which embody songs.

BROADCASTING PROJECTS: RADIO AND TELEVISION. By Henry L. Ewbank and S. P. Lawton. Harper, 1953. 152p. \$2.50. This is a loose-leaf combination textbook and workbook for use in teaching the techniques of writing, producing and directing, copy editing, audience measurement and other projects involved in the business of broadcasting.

BROADCASTING'S INFLUENCES. By Harold E. Fellows. Washington (6). Nat. Assn. of Radio and Tv Broadcasters, 1953. 21p. *Apply*. A reprint of a talk by the President of the NARTB before its annual convention on the four major influences bearing upon the future of the broadcasting industry, including educational television.

BROADCASTING RELIGION BY THE EPISCOPAL CHURCH National Council, 281 Fourth Ave. (10). 34p. 50 cents. This is a supplement to a manual published by the Broadcasting and Film Commission of the Nat. Council of Churches of Christ in the USA in 1952. It includes hints for "clerical radio and television aspirants" as well as the usual handbook information on radio and television techniques for religious broadcasting.

(SEVEN) COPYRIGHT PROBLEMS ANALYZED. By Commerce Clearing House, 218 N. Michigan Ave. Chicago 1. 1952. 184p. \$3.00. This is the printed text of addresses by legal experts before the Copyright Institute of the Federal Bar Assn. of New York, New Jersey and Connecticut, Oct. 15-Dec. 10, 1951. Broadcasting problems are the subject of three lectures, designed to furnish a clearer understanding of copyright problems and their solution.

—(1953) **COPYRIGHT PROBLEMS ANALYZED.** By Commerce Clearing House, Chicago 1. 1953. 280p. \$6.75. One section of this volume includes contracts in the entertainment and literary fields.

DIMENSIONS OF RADIO AND TELEVISION. By the Research Dept. of the Nat. Assn. of Radio and TV Broadcasters. Washington (6). 8p. *Apply*. A revision of a combination of comparative statistics on sets, station operations and financial data.

DIRECTORY OF RADIO AND TV PERSONALITIES. 1952-53. By Radio Reports, Inc. 220 East 42d St. (17) 1953. 73p. \$15.00. An annual service with two supplements which lists personalities and program information for network and local programs in nine large cities and nearby areas.

FIELDS AND WAVES IN MODERN RADIO. By Simon Ramo and J. R. Whinnery. John Wiley, 1953. 578p. \$8.75. The second edition of a book originally published in 1944 by specialists connected with the GE Electronics Laboratories.

A FINANCIAL ANALYSIS OF 54 EDUCATIONAL STATIONS. By Raymond D. Cheydeur. Huntington, W. Va. Marshall College, 1953. 92p. paper. *Apply*. This is the first survey of budgets for radio stations connected with colleges and universities (one municipal station included), public schools, boards of education and other institutions, as a guide to administrators in planning for 1954.

HOW TO COVER, WRITE AND EDIT SPORTS. By Harry E. Heath, Jr. and Lou Gelfand. Ames, Iowa State College Press, 1951. 527p. \$5.00. The techniques involved in this highly specialized type of news coverage are treated in comprehensive chapters on writing sports for radio and television coverage of sports. It is intended for the practicing journalist as well as the student.

MICROWAVE THEORY AND TECHNIQUES. By H. J. Reich. Van Nostrand, 1953. 901p. \$12.50. Field theory through transmission lines, wave guides, radiation, microwave amplifiers and oscillators are some of the engineering aspects which are treated by experts.

MODERN RADIO ADVERTISING. By Charles Hull Wolfe. Funk & Wagnalls, 1953. 738p. \$7.50. First published in 1949, this second edition brings facts and figures up to date and includes an analysis of television advertising. It is a comprehensive treatment of all phases of radio advertising.

MODULATION THEORY. By Harold S. Black. Van Nostrand, 1953. 363p. \$8.75. One of the Bell Laboratories series, this book "treats the fundamentals of modulation theory, including modern theoretical and informational concepts of particular systems, for advanced students and practicing engineers."

MORE POWER FOR YOUR CHURCH. By W. A. Pleuthner. Farrar, Straus and Young, 1953. 408p. \$3.75. Dr. Norman Vincent Peale has written the introduction to this book which contains a 16-page chapter on radio and television as a promotional guide for various churches.

THE PEOPLE'S RIGHT TO KNOW. By Harold L. Cross. Columbia University Press, 1953. 405p. \$5.50. This is a report on the results of a study of freedom of information in the USA, primarily directed toward newspapermen, but equally of interest and applicable to the management of radio and television stations. It is a well-documented study by an expert in newspaper law.

PRESS, FILM, RADIO, TV. 1951. By UNESCO, Paris. 1951. Available from Columbia University Press, 1953. 583p. \$4.50. This is the final volume of Reports on the Facilities of Mass Communications begun in 1947 to determine the damage in war-devastated countries. These surveys were gradually extended to include all countries on their needs as well as available technical resources. Although nine countries are not included, this report covers basic figures and facts for 157 countries and territories.

PRINCIPLES OF TRANSISTOR CIRCUITS. Edited by Richard F. Shea. John Wiley, 1953. 535p. \$11.00. Research material on transistor circuits is presented by nine members of GE's Electronics Labs. In three parts, it covers low-frequency, high-frequency and large-signal, non-linear applications, as well as research of a general nature to represent the great majority of transistors.

RADIO AND TELEVISION. By Samuel Beckoff. Oxford Book Co., 1952. 92p. 40 cents. This paper-bound teaching aid for high schools is a study guide in fifteen units with test questions and projects aimed to develop a critical appraisal of commercial radio and television and their impact upon the student. The author is a teacher of English in a New York City high school.

RADIO AND TELEVISION ANNOUNCING. By Lyle D. Barnhart. Prentice-Hall, 1953. 292p. \$6.65. This is a combined text and drill book to prepare the reader for professional work in the field, by a member of the Radio and TV Department, School of Speech, Northwestern University.

A RADIO AND TELEVISION BIBLIOGRAPHY. Comp. by Burton Paulu. Urbana, Ill. Nat. Assn. of Educational Broadcasters, 1952. 129p. *Apply*. Part One is devoted to a classified list of books and magazine articles on the non-technical aspects of radio, published between Jan. 1, 1949 and June 30, 1952. It is a very useful compilation.

RADIO AND TELEVISION DRAMA. By Joseph Mickel. Exposition Press, 1953. 126p. \$3.00. A collection of plays for all groups which were given in "Workshop Productions" at the Lin-Rey School of Broadcasting, New Orleans.

RADIO AND TELEVISION RIGHTS. By Harry P. Warner. Albany, N. Y., Matthew Bender, 1953. 1276p. \$35.00. This loose-leaf manual on the law of copyright, trade-marks and unfair competition in the broadcasting industry is in four volumes. It covers the protection of program content, service marks, ideas and individual rights, with extensive chapters on the musicians union and the music publishing associations and includes a section on the Copyright Code.

RADIO AND TV TODAY IN SUCCESSFUL FARMING HOMES. Des Moines, Iowa (3) Meredith Pub. Co. 1714 Locust St. 1953. 34p. *Apply*. An audience study made by *Successful Farming*.

RADIO AND TELEVISION WORKSHOP MANUAL. By Sidney A. Diamond and D. M. Anderson. Prentice-Hall, 1952. 301p. \$4.50. For the beginning student, this is a loose-leaf textbook on the techniques of program script writing, editing, production and direction and allied activities. Sample scripts are included.

RADIO BROADCAST PRIMER. By the Federal Communications Commission, Washington, (25), The FCC. Nov. 1952. 22p. Free. A revised edition of a general information bulletin which traces broadcasting history, defines terms and procedures pertaining to AM and FM radio and television as well as educational broadcasting.

RADIO LISTENING PATTERNS. By the Katz Agency Data Service. Nov. 1953. 5p. mimeo'd. *Apply*. A survey made by Pulse Reports in Jan.-Feb. 1953 of 12 TV markets showing that nighttime listening exceeds early morning hours and the scope of listening beyond the living-room.

RADIO LISTENING PATTERNS. based on a Pulse Analysis of 18 Major Cities. By the Katz Agency, 488 Madison Ave. (22). 1953. *Apply*. A new audience measurement concept of total listeners per thousand radio homes based on sets in use and by listeners per set. The study was made in Jan.-Feb. 1952 in important TV markets and depicts the number of men, women, teenagers and children with total radio listening in 1000 homes on a daily and weekly basis.

THE RADIO MANUAL. By George E. Sterling and Robert B. Monroe. 4th ed. Van Nostrand, 1950. 899p. \$12.00. A standard, comprehensive reference book for the experienced engineer as well as the new radio operator. This revision includes the latest developments in the radio field, including new chapters on radio wave propagation and antennas. A chapter on tv by Dr. Thomas T. Goldsmith Jr. has been added.

RADIO'S PLACE IN THE DAILY LIFE OF THE AMERICAN PEOPLE. Henry I. Christal Co. Advertising, 270 Park Ave. (17) 1953. 14 (7) p. *Apply*. A study (in preparation) of people in TV areas who listen to the radio and where they listen.

RADIO PLAYS FROM HISTORY AND LITERATURE. By Walter A. Hackett. Boston, Baker, 1952. 100p. \$1.00.

RADIO—U. S. A. By the Nat. Assn. of Radio and Television Broadcasters. Washington (6) The Association, 1953. 28p. 25 cents. A booklet which is designed to acquaint the listener with the fascinating story of radio so that he may understand how it works in America.

SOUND TALK. By the Minnesota Mining and Mfg. Co., St. Paul, (6). 21p. loose-leaf. *Apply*. Technical and general information on magnetic tape recording by a leading supply company.

A STUDY OF FOUR MEDIA: Their accumulative and Repeat Audiences, conducted for LIFE, by Alfred Politz Research, Inc. Time, Inc. 1953. 176p. *Apply*. This audience penetration measurement includes leading weekly magazines, a bi-weekly and a monthly magazine, a newspaper supplement together with radio and TV shows.

A STUDY OF TV, RADIO AND COMIC BOOK EFFECTIVENESS among the School Children of Norwalk, Conn. By the Dell Pub. Co., 261 Fifth Ave. (16) 1953. 27p. (O.p.) A survey conducted by the Norwalk Board of Education in the elementary school classrooms for individual reactions to the impact of these media.

—Also a second study has been made for the school children of Poughkeepsie, N. Y. 1953.

SUBVERSIVE INFILTRATION OF RADIO, TELEVISION AND THE ENTERTAINMENT INDUSTRY. By the Committee on the Judiciary, U. S. Senate, Washington, U. S. Govt. print. off. 1952. A hearing before the sub-committee to investigate the administration of the internal security act and other internal security laws, in two parts. Part I reports the hearings held April through June and October 1951. Part II continues with those held from March thru May, 1952.

THE TEACHER TALKS ABOUT SOUND RECORDING. By Audio Devices, Inc. 444 Madison Ave. (22) 1953. 40p. *Apply*. This book describes the practical use of sound recording equipment in teaching processes.

TEACHING WITH RADIO, AUDIO RECORDING AND TELEVISION EQUIPMENT. By the Joint Committee on the Use of Communications in Education, Washington. Radio-TV Manufacturers Assn. 1953. 41p. *Apply*. Practical methods of teaching with modern equipment comprise this new brochure which supersedes three earlier studies by this committee on school sound systems.

TELEVISION AND RADIO IN AMERICAN LIFE. Ed. by H. L. Marx, Jr. H. W. Wilson, 1953. 198p. \$1.75. Experts have contributed thoughtful articles to this collection dealing with the impact of radio and TV on advertising, the home, education, recreation, politics and other phases of our society. Methods of regulation and a consideration for the future are included.

TRANSISTORS AND THEIR APPLICATIONS IN TV, RADIO AND ELECTRONICS. By Louis E. Garner, Jr. Indianapolis 15. Howard W. Sams Co. 1953. 100p. \$1.50. An authority in this new field provides a practical explanation of transistors for the technician on the theory, circuitry, installation, testing, and servicing aspects. An appendix provides a reference trade list.

TRANSMITTING WORLD NEWS. By Francis Williams. Paris UNESCO. Available from Columbia University Press, (27). 1953. 95p. \$1.00. This latest in the UNESCO series on Mass Communications is sub-titled: *A Study of Telecommunications and the Press*. It is well illustrated by the Netherlands Statistical Foundation and describes the physical set-up for world telecommunications, news agencies and other fields of mass communications. The author is a British journalist and broadcaster.

YOUR SLIP IS SHOWING. By Kermit Schafer. Grayson Press, 1953. \$2.00. Hilarious fluffs and boners made on TV and radio have been collected by a broadcast producer. It is illustrated with cartoons.

U. S. INFORMATION AGENCY, VOICE OF AMERICA BROADCASTS

U. S. INFORMATION AGENCY
 Headquarters: 1778 Pennsylvania Ave., N.W.,
 Tel.: Republic 7-8340

Director: Theodore C. Streibert

INTERNATIONAL BROADCASTING SERVICE
 New York Headquarters: * 251 W. 57th St., New
 York 19, N. Y. Tel.: Judson 6-2000

Washington Headquarters: 1778 Pennsylvania
 Ave., N.W. Tel.: Republic 7-8340, Extensions
 3634-3738

(For complete listing of executive personnel of
 the U. S. Information Agency, see U. S. Gov-
 ernment Agencies dealing with Broadcasting.)

**OFFICERS OF THE INTERNATIONAL BROAD-
 CASTING SERVICE**

Leonard F. Erikson, *Director of Broadcasting*
 Edward F. Lethen, Jr., *Deputy Director of
 Broadcasting*

Frank L. Seymour, *Controller*

John M. Vebber, *Program Manager*

Edgar T. Martin, *Chief Engineer*

Harold Wright, *Facilities Manager*

Allen W. Moore, *Washington Representative for
 the Director of Broadcasting*

John F. Hogan, *Washington Special Events*

VOICE OF AMERICA FACT SHEET

The work of the Voice of America, as part
 of the U. S. Information Agency, is, in the
 words of President Eisenhower, "to submit
 evidence to the peoples of other nations . . .
 that the objectives and policies of the United
 States are in harmony with and will advance
 their legitimate aspirations for freedom, pro-
 gress and peace." Equally VOA exposes Soviet
 imperialism and the fraud of international
 communism, while combatting their anti-
 American slanders and lies.

Radio is the fastest, most effective day-to-
 day medium for achieving these objectives; it
 speaks directly to people abroad, instantane-
 ously surmounting barriers of distance, cen-
 sorship, illiteracy, foreign exchange, paper
 shortages and tariffs.

More than 75 separate programs, ranging
 from 15 minutes to one hour amounting to
 28 1/4 programs hours and about 210,000 words,
 are broadcast daily in 34 language services as
 follows:

*EDITOR'S NOTE: Plans are to have all Voice
 functions housed in Washington, D. C., this year,
 possibly as early as June.

EUROPE

	hrs. mins.
Albanian	:30
Armenian*	:30
German to Austria	:30
Bulgarian**	1 :00
Czech and Slovak	1 :15
English	:30
Estonian***	:45
French	:15
Georgian*	:30
German to Germany	1 :00
Hungarian**	1 :15
Italian	:15
Latvian*	:30
Lithuanian***	:45
Rumanian	1 :30
Russian**	2 :30
Serbo-Croat	1 :00
Slovene	:15
Spanish	:30
Ukrainian*	1 :00
TOTAL TO ALL AREAS	17 :00

FAR EAST

	hrs. mins.
Amoy	:30
Burmese	:30
Cantonese	1 :00
Indonesian	:30
Japanese	:30
Korean	1 :15
Mandarin	2 :30
Russian*	:30
Thai	:30
Vietnamese	:30
TOTAL TO ALL AREAS	8 :15

NEAR EAST AND AFRICA

	hrs. mins.
Arabic	1 :00
Greek	:30
Persian	1 :00
Turkish	:30
TOTAL TO ALL AREAS	3 :00
TOTAL TO ALL AREAS	28 :15

*VOA broadcasts 7 hrs. daily to the USSR and
 Soviet-controlled areas in Russian, Ukrainian,
 Armenian, Georgian, Estonian, Latvian and
 Lithuanian. These programs, as well as those
 beamed to the satellites, are recorded at over-
 seas relay bases and repeated to counter
 Soviet jamming.

**Originate in part from Munich Program
 Center.

FACILITIES

VOA has a network of 82 transmitters of

which 30 are in the U. S. These latter are
 short-wave stations, ranging in power from
 25 kw to 200 kw and operated under contract
 to VOA by private broadcasting companies.
 Government-owned and controlled relay sta-
 tions are located at Colombo, Ceylon, Hono-
 lulu; Baguio and Manila in the Philippines,
 Munich, Okinawa, Salonika and Tangier. These
 installations, comprising short, medium and
 long-wave stations, including million-watt
 transmitters—the world's most powerful—at
 Baguio, Okinawa and Munich.

Relay facilities are also leased from BBC
 in England and from the government of
 Ceylon. Other relays or rebroadcasts are
 made through arrangement with local broad-
 casters of other countries.

VOA also has a floating broadcasting sta-
 tion, the U.S. Coast Guard Cutter *Courier*,
 which uses high powered medium wave and
 short-wave transmitters.

PROGRAM CONTENT

VOA programs consist of news, news anal-
 yses and features, which include political com-
 mentaries, press reviews, round-table discus-
 sions, documentaries, special events, and
 music. Although the breakdown varies from
 area to area, the program content in general
 is balanced as follows:

News: 37% Analyses and Features: 56%
 Music: 7%

About three-quarters of VOA's programs are
 directed to the Iron Curtain countries and
 Communist China. In addition to direct short-
 wave programming, VOA regularly furnishes
 U.S. Information offices throughout the world
 with transcribed programs, music recordings,
 script material and kinescopes for tv broad-
 casts. Programs are beamed to areas hav-
 ing a potential audience of over 400 million. The
 Broadcasting Service is responsible for the
 planning, execution and content of programs.
 Programs are written, produced, and broad-
 cast from studios in New York, Washington
 and Munich, Germany.

RADIO STATION REVENUE

DISTRIBUTION OF THE BROADCASTER'S EXPENSE DOLLAR—1952

Total Broadcast Expenses—100%; major items of operating cost shown as percentage of total sta-
 tion expenses, for each class of station income.

	EXPENSE DOLLAR—1952									
	Below \$50,000	\$50,000 to \$75,000	\$75,000 to \$100,000	\$100,000 to \$125,000	\$125,000 to \$150,000	\$150,000 to \$200,000	\$200,000 to \$350,000	\$350,000 to \$1,000,000	Over \$1,000,000	Total
Total Operating Expenses	100.00	100.00	100.00	100.00	100.00	100.00	100.00	100.00	100.00	100.00
Technical Expenses										
Salaries	14.30	14.12	12.38	12.66	12.33	11.27	12.18	14.08	13.42	12.95
Repairs	2.24	2.00	1.79	1.81	1.87	1.71	1.75	1.55	1.23	1.82
Other	1.48	2.36	1.92	2.19	1.64	1.94	2.41	2.54	2.36	2.29
Total	18.02	18.48	16.09	16.66	15.84	14.92	16.34	18.17	17.01	16.86
Program Expenses										
Salaries	13.48	16.76	17.52	15.77	16.67	16.42	17.00	16.63	12.63	15.82
Talent	1.41	1.33	2.14	2.88	2.27	3.97	3.52	7.37	16.95	6.73
Royalties	3.54	3.64	3.77	3.52	3.61	3.49	3.75	4.01	3.85	3.70
Transcriptions	3.33	3.27	1.97	1.67	2.19	1.53	1.23	1.16	.69	1.34
Wire Service	5.50	4.45	3.47	3.05	2.85	2.05	1.66	1.11	.85	1.74
News Service	2.02	1.12	.85	.74	1.10	.66	.53	1.13	.55	.81
Teletype Service82	.40	.63	.50	.40	.33	.20	.15	—	.23
Other	2.06	2.52	2.26	2.16	2.41	2.65	2.92	2.92	4.06	2.95
Total	32.66	33.49	32.61	30.29	31.50	31.10	30.81	33.89	39.08	33.32
Selling Expenses										
Salaries	5.81	9.14	9.52	12.61	12.39	11.66	11.14	8.64	6.48	9.70
Other	3.37	2.76	3.41	3.95	3.85	4.69	5.25	6.85	6.28	5.44
Total	9.18	11.90	12.93	16.56	16.04	16.35	16.39	15.29	12.76	15.14
General Admin. Expenses										
Salaries	18.72	13.87	16.82	15.13	15.84	15.02	13.89	11.31	9.55	12.88
Professional Services63	1.57	1.08	1.28	1.43	1.59	1.99	1.45	1.60	1.57
Insurance	1.05	.98	1.02	1.10	1.01	.97	.96	.91	.92	.96
Experimental Expenses	—	.18	.27	.23	.16	.59	.39	.30	.32	.34
Depreciation on Invest.	6.94	5.69	6.24	5.73	5.25	5.82	6.34	5.67	4.32	5.81
Rent87	1.42	1.97	1.60	1.70	1.85	1.88	2.97	3.50	2.44
Taxes	2.14	1.98	1.94	2.04	2.05	2.06	2.03	2.14	2.49	2.14
Losses on Notes, etc.	1.54	1.52	1.48	1.36	.83	1.00	.80	.27	.36	.68
Other	8.25	8.92	7.55	8.04	8.35	8.73	8.18	7.83	8.09	8.06
Total	40.14	36.13	38.37	36.49	36.62	37.63	36.46	32.65	31.15	34.68

LATIN AMERICAN BROADCASTING STATIONS

Frequencies and power listed in parentheses show assignments under the 1950 North American Regional Broadcasting Agreement, not yet ratified by the U. S.

Frequency	Call	City	Owner or Operator	Power	DA	Class	Frequency	Call	City	Owner or Operator	Power	DA	Class
BAHAMAS													
1540	ZNS	Nassau	Bahamas Government	5.0		I-A	1030	CMAC	San Cristobal	Guillermo Garcia Ovies	0.25 (0.25-D)		II
CUBA													
(540)	CMDQ	Victoria de las Tunas		(1.0)	(DA-N)	(II)	1040	CMJR	Camaguey	Radio S. A.	1.0 (5.0)	(DA)	II (II-E)
550	CMW	Havana	A. Gil y M. Troncoso	2.5 (10.0)	(DA)	III-A (I-C)	1050	CMHF	Santa Clara	Jose Fernandez Aleman	0.25		IV
560	CMKM	Holguin	Union Radio S. A.	5.0	(DA)	III-A	(1050)	CMHB	Sancti Spiritus	Manuel J. de Gongova	0.25		(II)
570	CMHI	Santa Clara	RHC Cadena Azul S. A.	(10.0)	(DA)	II (I-D)	1060	CMCX	Havana	Circuito Occidental de Radio S. A.	10.0-D (0.25-N)		II
(580)	CMJP	Ciego de Avila		(0.5-D) (0.25-N)		(III)	1070	CMJA	Camaguey	Rafael Valdes Jimenez	0.25		II
590	CMCY	Havana	RHC Cadena Azul S. A.	15.0 (25.0)	(DA)	II (I-D)	1070	CMKS	Camaguey	Union Radio S. A.	0.25		II
600	CMKV	Holguin	RHC Cadena Azul S. A.	1.0 (2.5)	(DA)	III	(1070)	CMAB	Pinar del Rio	(See 760 kc)	(5.0-D) (2.0-N)		(II)
630	CMQ	Havana	Cirquito CMQ S. A.	25.0	(DA)	III-E (I-D)	(1080)	CMJM	Ciego de Avila	(See 840 kc)	(0.5)		(II)
640	CMHQ	Santa Clara	Cirquito CMQ S. A.	15.0	(DA)	II (I-C)	1090	CMBS	Havana	Enrique Artalejo Fernandez	0.25-D 0.1-N		II
660	CMCU	Havana	Radio Garcia Serra S. A.	5.0-D 1.0-N	(DA)	II	CMHE	Enrucijada	Virgilio R. Diaz Quintanilla	0.25-D 0.1-N		II	
(670)	CMKP	Holguin	(Satellite CMBC Havana)	(1.0)	(DA)	(II-E)	1100	CMKW	Matanzas	Ramon A. de Zayas Lopez	0.5	(DA)	II
(680)	CMJE	Camaguey	(Satellite CMBC Havana)	(1.0)		(II)	(1110)	CMKI	Guantanamo	Union Radio S. A.	(0.25)		(II)
680	CMDE	Santiago de Cuba	(Synchronized with CMBC Camaguey)	1.0-D 0.5-N		II	1120	CMBY	Havana	Pages y Cia.	0.25 (0.25-D)		II (II-E)
CMHG	Santa Clara	(Synchronized with Camaguey)	1.0-D 0.5-N			II	1130	CMHM	Santa Clara	Cadena Oriental de Radio S. A.	1.0		II
690	CMBC	Guanabacoa	Radio Progreso S. A.	10.0 (50.0)	(DA)	II (I-C)	CMKH	Guantanamo	Luis Coronado Estrada	0.25		II	
720	CMHU	Cienfuegos	Modesto Vasquez Gonzales	0.25	(DA)	II	(1130)	CMHU	Cienfuegos	(See 720 kc)	(0.25)		(II)
730	CMKJ	Holguin	Circuito CMQ S. A.	5.0	(DA)	II	(1140)	CMKH	Guantanamo	(See 1130 kc)	(0.25)		(II)
(730)	CMCA	Havana	(See 1150 kc)	(10.0)	(DA)	(II)	1150	CMKA	Havana	Radio Publicidad Tropic S. A.	10.0		II (III-E)
740	CMCD	Havana	La Voz del Aire (See 730 kc)	10.0 (10.0)	(DA)	II (I-D)	CMDL	Holguin	Jones, Castrillon y Cia.	1.0-D 0.25-N	(L- KSL)	(II)	
(740)	CMKJ	Havana	(See 730 kc)	(10.0)	(DA)	II	(1160)	CMJK	Camaguey	Manuel Diaz Autran	0.25	(DA-N)	II
760	CMAB	Pinar del Rio	Simeon Ferro Martinez	5.0		II	1170	CMAR	Artemisa	Union Radio S. A.	1.0		II
CMJY	Ciego de Avila	Cadena Oriental de Radio S. A.	1.0		II	1190	CMJD	Ciego de Avila	Union Radio S. A.	0.25		III-B	
(760)	CMCD	Havana	(See 740 kc)	(10.0)	(DA)	(II-E)	CMK	Havana	Fausto Montiel	0.25		II	
770	CMKC	Santiago de Cuba	Radio Oriente S. A.	1.0		II	1210	CMHK	Cruces	Virgilio Villanueva Bravo	0.25		II
780	CMHB	Havana	Union Radio S. A.	0.25	(DA)	(II-E)	1220	CMKO	Holguin	Manuel Angulo Ferran	0.25		II
(780)	CMHD	Santa Clara	(See 890 kc)	(5.0)	(DA)	(II-E)	(1220)	CMHK	Cruces	(See 1210 kc)	(1.0)		(II)
790	CMCH	Havana	Radio Cadena Habana S. A.	10.0	(DA)	(III-E)	1230	CMCO	Havana	Edelberto Perez Rubio	0.25		IV
800	CMAW	Pinar del Rio	Pedro Redondo Fernandez	0.25		II	CMJX	Moron	Dr. Pablo Castellanos Caballero	0.25		IV	
CMKL	Santiago de Cuba	Cadena Oriental de Radio S. A.	2.0		II	1240	CMAD	Artemisa	Manuel Dominguez Motolongo	0.25		IV	
(800)	CMJY	Ciego de Avila	(See 760 kc)	(1.0)		(II)	CMGF	Matanzas	RHC Cadena Azul S. A.	0.25		IV	
810	CMHW	Santa Clara	RHC Cadena Azul S. A.	1.0-D 0.25-N (0.5-N)	(DA)	II	CMGW	Victoria de las Tunas	Humberto Anteres Pena	0.25		IV	
830	CMBZ	Havana	Manuel y Guillermo Salas	5.0-D 1.0-N (5.0)	(DA)	II (II-E)	(1240)	CMGW	Matanzas	(See 1100 kc)	(0.5)		(IV-E)
840	CMAN	Havana	RHC Cadena Azul S. A.	1.0		II	1250	CMHP	Cabaiguan	Borgos Enriquez	0.25		IV
CMJM	Havana	RHC Cadena Azul S. A.	0.5		II	CMKA	Guantanamo	Cadena Oriental de Radio S. A.	0.25		IV		
850	CMKU	Santiago de Cuba	Circuito CMQ S. A.	2.0		II	1260	CMCI	Havana	Cadena Oriental de Radio S. A.	5.0		III
(850)	CMJB	Camaguey	(See 880 kc)	(1.0)		(II)	1270	CMJC	Camaguey	Cadena Camaguey-ana de Radio	1.0		III-A
860	CMBL	Havana	Radio Cadena Suaritos	15.0 (25.0)	(DA)	II (I-C)	1280	CMHA	Sagua la Grande	Justiniano Valdes Aguado	0.25		II
880	CMJB	Camaguey	Union Radio S. A.	1.0		II	1290	CMCW	Havana	Gibb y Mario Lavin Dominguez	0.25		II (IV)
890	CMHD	Havana	Union Radio S. A.	1.0		II	CMDC	Holguin	Cadena Oriental de Radio S. A.	1.0		III-A	
900	CMKS	Guantanamo	Candido S. Von Suarez	0.25		II	(1290)	CMKC	Santiago de Cuba	(See 770 kc)	(1.0)		(III)
(900)	CMKU	Santiago de Cuba	(See 850 kc)	(2.0)		(II)	1300	CMAN	Pinar del Rio	(See 840 kc)	(1.0)		(III)
910	CMCF	Havana	J. Ulloa y Cia.	10.0	(DA)	III-B (III-E)	1300	CMJQ	Nuevitas	Juan Filgueras Cabaleiro	1.0		III
920	CMAQ	Havana	Circuito CMQ S. A.	1.0-D (1.0)		III-A (III)	1310	CMHO	Santa Clara	Org. Insular de Radio	1.0		III-A
CMJL	Havana	Circuito CMQ S. A.	5.0 (10.0)	(DA)		III-B (I-D)	(1320)	CMDA	Santiago de Cuba		(0.1)		(III)
930	CMKN	Santiago de Cuba	RHC Cadena Azul S. A.	1.0		III-A (III)	1330	CMCB	Havana	Radio Reloj S. A.	1.0		III-A
(930)	CMGF	Matanzas	(See 1240 kc)	(0.25)		(IV)	1340	CMJF	Camaguey	Radio Camaguey	1.0		II (IV-E)
950	CMBF	Havana	Radio Universal S. A.	5.0-D 1.0-N		I-B (I-D)	CMGU	Matanzas	Cadena Oriental de Radio S. A.	0.25		IV	
960	CMGN	Havana	RHC Cadena Azul S. A.	0.5		III-B (III)	(1340)	CMKY	Puerto Padre	(See 1350 kc)	(0.25)		(IV)
CMJN	Camaguey	RHC Cadena Azul S. A.	1.0 (2.0)		III-A (III)	1350	CMAL	Pinar del Rio	Radioccidente S. A.	(0.25)		(IV)	
970	CMKD	Holguin	Cadena Oriental de Radio	1.0		III-A (III)	CMHJ	Cienfuegos	Union Radio S. A.	0.25		IV	
(970)	CMHM	Santa Clara	(See 1130 kc)	(1.0)		(III)	CMKY	Puerto Padre	Pedro Zacca Cheda	1.0		IV	
980	CMCK	Havana	Cia. Radiodif. COCO y CMCK S. A.	5.0 (10.0)	(DA)	III-A (I-D)	1360	CMOX	Havana		0.25		IV
990	CMHT	Sancti Spiritus	Juan B. Santana Padron	1.0-D 0.25-N (0.25)		II	(1360)	CMDC	Santiago de Cuba	(See 1290 kc)	(1.0-D) (0.5-N)		(III)
(990)	CMAW	Pinar del Rio	(See 800 kc)	(0.25)		(II)	1370	CMJH	Ciego de Avila	Luis Marauri Mendoza	0.25 (0.5)		IV (III)
1000	CMJG	Camaguey	Cadena Oriental de Radio S. A.	1.0		II	1390	CMBX	Havana	Alberto Alvarez Ferrera	0.25 (0.5)		IV (III)
CMKW	Santiago de Cuba	Reloj del Aire S. A.	0.25		II	CMKX	Bayamo	Aistides Gervet Villafane	0.25 (0.5)		IV (III)		
1010	CMBQ	Havana	Radio Continental CMBQ S. A.	5.0-D 1.0-N		I-B	1400	CMGL	Matanzas	Cadena Oriental de Radio S. A.	0.25		IV
(1020)	CMHF	Camajuani	(See 1040 kc)	(0.1-D)		(II-E)	CMJI	Florida	Dr. Osvaldo Moran Artega	0.25		IV	
							CMKQ	San Luis		0.25		IV	
							CMKT	Holguin		0.5		III	
							CMHC	Santa Clara	(Assigned 1480 kc)	1.0-D 0.5-N		III	
							1410	CMHC	Santa Clara		0.25		IV
							1420	CMCQ	Havana	Andres Martinez	1.0		(III)

LATIN AMERICAN STATIONS

Fre- quen- cy-	Call	City	Owner or Operator	Power	DA	Class	Fre- quen- cy-	Call	City	Owner or Operator	Power	DA	Class	
1430	CMKZ	Palma Soriano	Maria Dominguez Dousseu	0.25		IV		XEHA	Ciudad Camar- go, Chih.	Hugo Pinera Limas	0.5-D		IV	
1440	CMJW	Camaguey	Andres Moran Cisneros	0.25		IV		XEMU	Piedras Negras, Coah.	Alfonso L. Bres.	0.25-N 5.0-D 0.25-N		IV	
(1440)	CMGM	Colon		(0.25)		(IV)	590	XEHQ	Hermosillo, Son.	Radio Hermosillo	1.0		III-B	
(1450)	CMHL	Sancti Spiritus		(0.25)		(IV)		XEPH	Mexico, D. F.	Cia. Mexico de Radiodif. S. A.	5.0		III-A	
1460	CMCM	Havana	Cia. Transradio Columbia S. A.	0.25		III		XERT	Reynosa, Tam.	Ignacio Magallon	5.0-D 0.25-N		IV	
	CMKQ	San Luis	Raul de Arms Trompeta	0.5		III-B		XEBB	Acapulco, Gro.		1.0		III-B	
1470	CMGE	Cardenas	Genaro Sabater Fox	0.5		IV	600	XEDN	Torreón, Coah.	Difusora del Norte S. A.	1.0		III-B	
	CMJO	Ciego de Avila	Bonifacio Idelfonso Morales	0.25		IV		XEZ	Merida, Yuc.	Jorge L. Palomeque	2.0		III-A	
1480	CMHX	Cienfuegos	Eugenio Perez Mena	0.25		(III)		(New)	Patzcuaro, Mich.		0.25-D		IV	
(1480)	CMHC	Santa Clara		(1.0-D) (0.5-N)		(III)	610	XEBX	Sabinas, Coah.	Radiodif. Coahuila S. A.	0.5		III-B	
1490	CMBG	Havana		0.25		IV		XEJA	Jalapa, Ver.		1.0-D 0.5-N		III-B	
	CMKG	Victoria de las Tunas	Ramon Espinosa Perez	0.25		IV		XELR	Veracruz, Ver.	Ignacio Navarro	0.1		IV	
1520	CMBD	Marianao	Luis Perez Garcia	0.25		II		XEUW	Uruapan, Michoa.		0.5		III-B	
	CMKT	Victoria de las Tunas	Alfr. O. Sanchez Moregon	1.0-D 0.25-N		II		XEWZ	Guanajuato, Gto.	Gonzalo Sanchez Gomez	0.25-D		IV	
1550	Havana		0.25		II		XEGS	Guasane, Sin.		5.0-D 0.75-N		III-B	
	Banes		0.25		II		620	XEBU	Chihuahua, Chih.	Roberto O. Steven- son	1.0-D 0.25-N		IV
1560	CMZ	Havana	Ministry of Education	5.0	(DA)	I-B		XEGH	Reynosa, Tam.		0.25-D		III	
	Guantanamo		0.25		II		XEGO	Progreso, Yuc.		5.0	DA	III-A	
	Banes	(Provisional operation)	0.25		II		XENK	Mexico, D. F.	Gral. Brig. P.A.F. Proal Pardo	5.0		III-A	
(1560)	Santa Clara		(10.0)	(DA)	(I-B)		XEEF	Santiago Ix- cuintla, Hay.		0.5-D 0.25-N		IV	
1560	CMHR	Sagua la Grande		0.25-D 0.1-N		II		(New)	Tepic, Nay.		0.5-D 0.25-N		IV	
(1570)	CMHR	Sagua la Grande (Assignment 1560 kc)		0.25-D 0.1-N		II		630	XEFB	Monterrey, N. L.	Emis. Inc. de Monterrey S. A.	5.0-D 1.0-N	DA-N	III-A
(1580)	CMJS	Ciego de Avila		(0.25-D)		(II)		XEFU	Cosamaloapan, Ver.		2.0-D 0.75-N		III-B	
1590	CMOA	Havana	Juan Fernandez Duran	0.25		II		XEJB	Guadalajara, Jal.	State Government	0.5		III-B	
	CMDF	Manzanillo		0.25		IV		XETS	Tapachula, Chis.	Napoleon Correa	0.5-D 0.25-N		IV	
(1590)	Holguin		(0.25)		(II)		650	XEZM	Zamora, Mich.	La Voz del Comer- cio de Zamora	1.0-D		II

DOMINICAN REPUBLIC

610	HI3J	San Pedro de Marconis		0.5		III		660	XEAY	Ciudad Delicia, Chih.		0.5-D		II
620	HI3T	Ciudad Trujillo	J. Arismendi Trujillo	10.0		I-C		XEBZ	Mexico, D. F.	Vocero Mexicano S. A.	0.5	DA-N	II	
790	HIL	Ciudad Trujillo	Joaquin C. Pellicer	0.5		III-B		670	XEGZ	Ciudad Lerdo, Dur.		0.25-D		II
820	HI9Z	Santiago	Luis F. Moscoso C.	1.0-D 0.1-N		III-B		680	XEFJ	Teztlutlan, Pue.		1.0-D	DA-N	II
	Ciudad Trujillo	Andres Cordero Puello	0.25		III-B		XELG	Leon, Gto.	Radio Impuls. del Centro S. A.	5.0		II	
1050	HI8B	Santiago		1.0		(II)		690	XEAC	Tijuana, B. C.	Jorge I. Rivera	5.0		I-B
(1050)	Barahona		(0.25)		(II)		XEN	Mexico, D. F.	Guillermo P. de Del Conde	5.0		II	
1220	HIN	Ciudad Trujillo	Partido Dominicano	0.25		IV		700	XEDV	Zapopan, Jal.		0.5-D		II
1230	HIL	Santiago	Joaquin C. Pellicer	0.25		IV		710	XEON	Tuxtla Gu- ierrez, Chia.	Enrique Valero Arambula	1.0		II
1240	HI9U	Puerto Plata	Luis A. Pelegrin	0.25		IV		730	XEX	Mexico, D. F.	Radio de Mexico S. A. de C. V.	500.0	DA	I-A
(1250)	HI4C	San Francisco de Macoris	Manuel R. Peralta	(1.0-D) (0.1-N)		(III- IV)		760	XECO	Zapopan, Jal.		0.5-D	DA-N	II
1310	HI3V	Bani	Manuel Bello Hijo	0.5		III		XENP	Mexico City		10.0		II	
(1330)	HI4B	Santiago	Abraham Vander- horst	0.5		III		770	XEHB	San Francisco del Oro, Chih.		0.5-D		II
1350	HIZ	Ciudad Trujillo	Frank Hatton	1.0		III-B		790	XEBI	Aguascalientes, Ags.	Pedro C. Rivas	1.0-D 0.25-N		IV
1360	HI5K	Barahona		0.25		III		XEFE	Nuevo Laredo, Tam.	Ruberto Villarreal	1.0-D 0.5-N		III-B	
1380	HI6T	Santiago		1.0-D		III		XENT	LaPaz, B. C.		2.0		III-A	
1400	HI3A	Santiago	Expedi Pou	0.25		IV		XEPA	Gomez Palacio, Dur.		0.25	DA	IV	
1400	HIT	Ciudad Trujillo	Francisco A. Sana- bia	0.2		IV		XERC	Mexico, D. F.	Radio Popular de Mexico	1.0		III-A	
1440	HI4F	San Francisco de Macoris		1.0-D 0.1-N		III- IV		800	XESU	Mexicali, B. C.		1.0-D		III
	San Cristobal		0.25		IV		XEAN	Ocotlan, Jal.	Radio Ocotlan S. de R. L.	0.25		II	
1490	HI2R	Ciudad Trujillo	Luis Alberti	0.25		IV		XEBE	Tijuana, B. C.		0.5-D		II	
	Ciudad Trujillo	Raf. F. Tavarez L.	0.2		IV		XELO	Ciudad Juarez, Chih.	Cia. Radio de Piedras Negras	150.0		I-A	

HAITI

1300	4VW	Port-au-Prince	Ricardo Widmaier	0.5				810	XEFW	Tampico, Tam.	Flores y Martinez	50.0-D 30.0-N	DA-N	II
1470	4VGM	Port-au-Prince	Frank C. Magloire	0.4-SH				XETA	Zitacuaro, Mich.		0.5-D		II	

JAMAICA

880	ZQI	Kingston	Jamaica Broad- casting Co.	0.5		II		820	XEJD	Cordoba, Ver.	J. Jac. Vda. de Zuniga	1.0-D		II
(1180)	Montego Bay		(5.0)		(II)		(New)	Fortin de la Flores, Ver.		1.0-D		III-B	

MEXICO

540	XEWA	S. Luis Potosi, S. L. P.	Cadena Radiodif. Mex. S. A.	150.0	DA-N	I-A	830	XELA	Mexico, D. F.	Radio Metropolitan S. A.	10.0-D 5.0-N	DA-N	II	
550	XEAF	Tala, Jal.		0.15		IV	840	XEBA	Guadalajara, Jal.	Jesus D. Gonzales	0.25-D		II	
	XEKL	Jalapa, Ver.	Carlos Ferraez Matos.	1.0-D 0.25-N		IV		XEGB	Coatzacoalcos, Ver.		0.25-D		II	
	XEPX	La Paz, B. C.		0.25		IV	860	XEDU	Durango, Dur.	Carlos C. Armas	1.0-D 0.5-N		II	
	XEQW	Merida, Yuc.		5.0	DA-N	III-A		XEMO	Tijuana, B. C.	Fernando Frederico Ferreira	5.0		II	
	XEUW	Uruapan, Mich.	Ignacio Navarro	0.3		IV		XEUN	Mexico, D. F.	Universidad Na- cional de Mexico	5.0		II	
560	XEAH	S. Rosalia, B. C.		0.1		IV		XENL	Monterrey, N. L.		5.0	DA-N	II	
	XEAK	Tecate, B. C.		0.25		IV	900	XEW	Mexico, D. F.	Cadena Radio- difusora S. A.	250.0		I-A	
	XEOP	Mexico, D. F.		1.0		III-B		910	XEAO	Mexicali, B. C.	Juan C. Chavez	0.25		IV
	XEPL	Ciudad Cuah- temoc, Chih.		0.5		III-B		XEMW	Monclova, Coah.		0.5-D		III-B	
570	XELQ	Morelia, Mich.	Francisco Laris Iturbide	1.0		III-B	920	XEBH	Hermosillo, Son.	Carlos Balderrama	5.0-D 1.0-N		III-B	
	XERR	Monterrey, N. L.		5.0-D 0.15-N		IV								
	XEAV	Guadalajara, Jal.	Manuel Lopez Diaz	25.0	DA	III-A								
	XEDZ	Cordoba, Ver.		1.0-D 0.45-N		III-B								

LATIN AMERICAN STATIONS

Frequency	Call	City	Owner or Operator	Power	DA	Class	Frequency	Call	City	Owner or Operator	Power	DA	Class
	XEBM	S. Luis Potosi, S. L. P.	Benjamin Briones	5.0-D 1.0-N		III-B	1190	XERP	Guadalajara, Jal.		10.0		I-B
	XEGK	Papantla, Ver.		0.25		II	1200	Orizaba, Ver.		5.0	DA-N	III-A
	XELT	Guadalajara, Jal.	Eduardo Reynoso Gonzalez	0.25		IV	1220	XEB	Mexico, D. F.	El Buen Tono S. A.	100.0		I-A
	XEMJ	Piedras Negras, Coah.	Jesus L. Elizondo	1.0-D 0.25-N		IV	1240	XEBN	Ciudad Delicias, Chih.		0.25		IV
	XEOK	Monterrey, N. L.	Carlos Roa Montes de Oca	0.5-D 0.25-N		IV		XEBQ	Empalme, Son.	Roberto Gonzalez Mata.	0.5-D 0.25-N		IV
	XEMD	Gomez Palacio, Dur.		0.1		IV		XECA	Tampico, Tam.		0.25		IV
	(New)	Culiacan, Sin.		5.0		III-A		XECE	Oaxaca, Oax.		0.25		IV
940	XEBF	Mexicali, B. C.		0.25-D		II		XECG	Nogales, Son.		0.25		IV
	XEQ	Mexico, D. F.	Radio Panamericana S. A.	150.0-D 50.0-N		I-B		XEFV	Reynosa, Tam.		1.0-D 0.25-N		IV
950	XEGM	Tijuana, B. C.	Gustavo Faist Fernandez	2.5-D 1.0-N	DA-N	III-A		XEGV	Ciudad Juarez, Chih.	Dario Cordo Rocha	0.25		IV
960	XEDF	Neuvo Laredo, Tam.	Rafael Tijerina Carranza	5.0-D 1.0-N		III-A		XEMQ	Apatzingan, Mich.		0.25		IV
	XEHK	Guadalajara, Jal.	Francisco E. Fregoso	0.25		IV		XERZ	Merida, Yuc.	Lazaro Achurra Suarez	1.0-D 0.25-N		IV
	XEOP	Hermosillo, Son.		0.5		III-B		XERZ	Leon, Gto.	Carlos Obregon	0.25		IV
	XEU	Veracruz, Ver.	Fernando Pazos Sosa	0.5		III-B		XES	Tampico, Tam.	Radio Televisora de Tampico	0.25		IV
	XENQ	Ciudad Lerdo, Dur.		0.1-D		IV		XETC	Torreón, Coah.		0.25		IV
	XEOS	Chetumal, Q. R.		0.5		III-B	1250	XEAT	Hidalgo del Parral, Chih.	Sucrs. de Jorge Perez	0.25		IV
970	XEJ	Ciudad Juarez, Chih.	Pedro Meneses Jr.	5.0		III-A		XEDK	Guadalajara, Jal.	Manuel Lopez Diaz	1.0		III-B
	XEK	Mexico, D. F.	Arturo Martinez	1.0-D 0.5-N		III-B		XEDL	Hermosillo, Son.	Eufemia Esquer de Vidal	0.5		III-B
	XELT	Guadalajara, Jal.	Eduardo Reynoso Gonzalez	0.25		III-B		XESJ	Saltillo, Coah.	Froylan Mier Narro	0.5		III-B
	XEO	Matamoros, Tam.	Can. Maria Gonzalez	1.0		III-B		XETF	Veracruz, Ver.	Sucrs. de Jose Rodr. Lopez	0.5		III-B
	XEVV	Villahermosa, Tab.		1.0-D 0.5-N		III-B	1260	XEBL	Culiacan, Sin.	Enrique Maxdm. Gomez Blanco	1.0-D 0.5-N		III-B
	XEHE	Irapuato, Gto.		1.0-D 0.1-N		III-B		XEDW	Minatitlan, Ver.	Sucrs. de Hector Silva Canto	0.25		IV
	(New)	Los Mochis, Sin.		5.0		III-A		XEL	Mexico, D. F.	Herdez S. A.	5.0-D 1.0-N		III-B
980	XEFQ	Cananea, Son.	Pedro L. Diaz	0.5		III-B		XEMF	Monclova, Coah.	Alfonso L. Bres.	0.25		IV
	XEHG	Navojoa, Son.		1.0-D 0.25-N		IV		XEPO	San Luis Potosi, S. L. P.	Alejandro Espinosa Pitman	0.25		IV
	XEJC	Cuernavaca, Mor.	Ed. Jimenez de la Cuesta	1.0		IV		XER	Linares, N. L.	Radio Linares S. A.	0.25		IV
	XETU	Tampico, Tam.	Impuls. Moderna del Radio S. A.	1.0		III-B	1270	XEAX	Oaxaca, Oax.	Delia Rodriguez de Marquez	0.5		III-B
	XEXT	Tepic, Nay.	State Government	1.0		III-A		XEAZ	Tijuana, B. C.	Fernando Sanchez Mayans	0.5		III-B
	XEPA	San Andres Tuxtla, Ver.		0.25		IV		XEFM	Leon, Gto.		0.1		IV
990	XECL	Mexicali, B. C.	Alfonso A. Lacarra	5.0		II		XEGL	Navajoa, Son.	Fausto M. Gomez	0.5		III-B
	XET	Monterrey, N. L.	El Pregonere del Norte	50.0-D 5.0-N		II		XEGW	Acambaro, Gto.		0.25		IV
	XEER	Ciudad Cuauhtemoc		0.5-D		II		XEME	Merida, Yuc.		0.5		III-B
1000	XEOY	Mexico, D. F.	Fomento de Radio S. A.	10.0		I-B		XEOH	Ciudad Camargo, Chih.		0.15		IV
1010	XEDX	El Sauzal, B. C.		0.25-D		II		XEZU	Zacapu, Mich.	Guillermo Calzada Cervantes	0.25		IV
	XEHL	Guadalajara, Jal.	Radiodif. de Occidente S. A.	10.0-D 5.0-N		II	1280	XEAG	Mazatlan, Sin.	Luz Maria Zuniga de Miguel	1.0		III-B
	XETX	Nuevo Casas Grandes, Chih.	Laureano Molinar Contreras	1.0-D 0.25-N		II		XEAW	Cordoba, Ver.	Jesus D. Gonzalez	5.0-D 0.5-N		III-B
	XEKD	Ciudad Acuma, Coah.		0.5-D 0.25-N		II		XEBW	Monterrey, N. L.	Radioemisora del Norte	1.0-D 0.6-N		III-B
1030	XEQR	Mexico, D. F.	Corp. Mexicana de Radio S. A.	50.0	DA-N	II		XEE	Chihuahua, Chih.	Radioemisora del Norte	1.0-D 0.6-N		III-B
1050	XED	Mexicali, B. C.	Carlos Blanco	5.0-D 1.0-N	DA-N	II		XEGJ	Durango, Dgo.	Jose Valenzuela	1.0-D 0.25-N		IV
	XEG	Monterrey, N. L.	La Voz de Norteamerica S. A.	100.0		I-A		XELK	Guadalajara, Jal.	Quirino Francisco Gonzalez	0.25		IV
1060	XEDP	Mexico, D. F.	Radio Gobernacion	50.0	DA-N	I-B		XERL	Zacatecas, Zac.	Macias y Acevedo	0.25		IV
1080	XEGY	Tehuacan, Puebla		1.0-D 0.5-N		II		XERL	Colima, Col.	J. Roberto Levy	0.25		IV
	XEUS	Villahermosa, Tab.		1.0	DA-N	IV		XESQ	San Miguel Allende, Gto.		0.1		IV
1090	XEHR	Pueblo, Pue.	Manuel R. Canale	0.25		II		XEUT	Colima		0.25		IV
	XELB	La Barca, Jal.	Ramon Alvarez Lopez	0.25-D		II	1290	XEAP	Ciudad Obregon, Son.	Emilio Manzanilla	0.1		IV
	XERB	Rosarito, B. C.	Interamericana de Radio S. A.	50.0	DA-N	I-B		XEDA	Obregon, Son.	Publ. Com. de Mexico S. A.	1.0		III-A
	XERG	Nuevo Laredo, Tam.	Reynoldo Garza Alvarez	2.5-D		II		XEIX	Mexico, D. F.		1.0		III-B
	XEOD	Boca del Rio, Ver.		0.5	DA-N	II		XEGA	Jiquilpan, Mich.		1.0-D 0.5		III-B
1100	XERL	Colima		1.0		II		XECQ	Tuxtla, Ver.	Radio Culiacan S. A.	1.0-D 0.5-N		III-B
1110	XEFL	Rio Bravo, Tam.		0.25-D		II		XEP	Culiacan, Sin.	Esteban Parra	0.5		III-B
	XEQB	Mexico, D. F.	Radio Central de Mexico	5.0	DA	II		XESF	Ciudad Juarez, Chih.	Jose Martinez Ramirez	0.5		III-B
1120	XETR	Ciudad Valles, S. L. P.	Tomas Oliva Banielos	1.0-D		II		XELE	Chih. Morelia, Mich.		1.0-D 0.15-N		IV
1130	XEFN	Uruapan, Mich.		0.25-D		II	1310	XEAL	Tampico		0.5		III-B
	XEJW	Jalapa, Ver.	Mariano Caraza	10.0	DA-N	II		XEBP	La Paz, B. C.	La Voz de la Laguna S. A.	10.0-D 0.25-N		IV
1140	XEFZ	Monterrey, N. L.		50.0	DA-N	I-B		XEC	Torreón, Coah.	Luis Enrique Enciso	0.25		IV
	XEXO	Nuevo Laredo, Tam.	Julio Santo Coy	50.0		I-B		XEFH	Tijuana, B. C.	Jesus Rodriguez Verdugo	1.0-D		III
1150	XEAD	Guadalajara, Jal.	Alejandro Diaz	0.125		IV		XEHV	Agua Prieta, Son.	Sucrs. de Juan A. Palavicini	1.0		III-A
	XEJO	Monterrey, N. L.		1.0-D		III		XEJE	Veracruz, Ver.	Difusoras de Occidente S. A.	0.25		IV
	XEJP	Mexico, D. F.	Radio America S. A.	10.0	DA-N	III-A		XEVH	Guadalajara, Jal.		0.25-D		IV
	XEJS	Hidalgo del Parral, Chih.	Alfonso Perez Porras	0.5		III-B	1320	XEAI	Valle Hermosa, Tam.		0.5		III-B
	XERY	Merida, Yuc.		0.5-D 0.35-N		III-B		XEAL	Mexico, D. F.	G. N. Medina y Loc. Ag. Ramos	0.5-D 0.25-N		III-B
	XESO	Ciudad Obregon, Son.		5.0-D 0.3-N		III-B		XEBP	Ciudad Jimenez, Chih.	Oscar Perez E.	0.5-D 0.25-N		III-B
1170	XECD	Puebla, Pue.	Roberto Canedo	0.35		II		XERJ	Mazatlan, Sin.		0.5-D 0.5-N		III-B
	XEFD	Rio Bravo, Tam.		2.0-D		II		XESR	Santa Rosalia, B. C.		0.5		III-B
	XEIV	Agascalientes, Agu.		0.5-D		II		XESY	Magdalena, Son.		0.2		IV
1180	XEFR	Mexico, D. F.		1.0-D 0.25-N		II		(New)	Montemorelos, N.L.		0.25-D 0.125-N		IV
	XEPK	Pachuca, Hgo.	Radio Publ. de Pachuca	1.0-D 0.25-N		II	1330	XEUI	Teapa, Tab.		0.5		III-B
				0.25-N		II		XEBO	Irapuato, Gto.	Alfonso Martinez	0.5		III-B
						II		XEEA	Salina Cruz, Oax.		0.5		III-B
						II		XEFC	Merida, Yuc.	Rafael Rivas Franco	0.5		III-B
						II	1340	XEKS	Saltillo, Coah.	Elfrain Lopez	0.1		IV
						II		XEAA	Mexicali, B. C.	Consuelo Tonnella King	0.25		IV

LATIN AMERICAN STATIONS

Fre- quen- cy-	Call	City	Owner or Operator	Power	DA	Class	Fre- quen- cy-	Call	City	Owner or Operator	Power	DA	Class
	XEBJ	Ciudad Victoria, Tam.	Fernando Elizalde	0.25		IV		XEFS	Cuernavaca, Mor.		0.25		IV
	XEBK	Nuevo Laredo, Tam.	Juan Manuel Cortes	0.1		IV		XEH	Monterrey, N. L.	Radio Tarnava S. de R. L.	1.0		III-A
	XECI	Acapulco, Gro.		0.25		IV		XEJC	Cuernavaca, Mor.	Miguel Angel T. Benitez	0.25		IV
	XECJ	Apatztingam, Mich.		0.25		IV		New	Matamoros, Tam.		0.25-D		IV
	XECK	Durango, Dgo.		0.25		IV		XEWE	Irapuato, Gto.	Felipe Gallardo	0.1		IV
	XECR	Morelia, Mich.		0.25-D		IV		XEWJ	Tehuacan, Pue.	Jaime Retif Del Morel	0.25		IV
	XEDH	Villa Acuna, Coah.	Oscar Gonzalez Galindo	0.25		IV		XEXX	Tijuana, B. C.	Jose J. Clark, Fern. Fed. Ferrei	2.0		III-A
	XEFA	Jalapa, Ver.	Adolfo Alvarez	0.25		IV		XETK	Pachuca, Hgo.		1.0-D		IV
	XEJK	Ciudad Delicias, Chih.	Amador Ronquillo Reza	0.25		IV		1430 XEBC	Ciudad Guzman, Jal.	Roberto Chavez Gonzalez	0.15-N		IV
	XELW	Guadalajara, Jal.	Salvador Galindo de la Torre	0.25		IV		XECZ	San Luis Potosi, S. L. P.	Radiodif. Mexicana	1.0		III-A
	XEMA	Fresnillo, Zac.	Jose Miguel Acevedo Moya	0.25		IV		XELL	Veracruz, Ver.	Carlos Ferraez Matos	5.0-D		IV
	XEMT	Matamoros, Tam.	Severo Garza Saenz	0.25		IV		XEOX	Ciudad Obregon, Son.	Felipe G. de Leon	0.25-N		III-B
	XEOM	Coatzacoalcos, Ver.	Daniel Schact Perez	1.0-D		IV		XERN	Nueva Rosita, Coah.		0.1		IV
	XEOX	Ciudad Obregon, Son.	Felipe G. de Leon	1.0-D		IV		XEHD	Ciudad Miguel Aleman, Tam.		2.0-D		IV
	XESL	San Luis Potosi, S. L. P.	Guadalupe Delgada Ramirez	0.5-N		IV		XENP	Salamanca, Gto.		0.15-N		IV
	XEUX	Tuxpan, Nay.	Salvador Hrena Benitez	0.25		IV		XEFI	Chihuahua, Chih.	Pregon. del Est. de Chih.	1.0		III-B
1350	XEQK	Mexico, D. F.	Guillermo Morales B.	1.0		III-A		XELZ	Mexico, D. F.	María Cardena de Zetina	5.0-D		III-A
	XETB	Torreón, Coah.	Radio Laguna S. A.	1.0-D		III-B		1450 XEAM	Matamoros, Tam.	Manuel L. Salinas	0.25		IV
	XETM	Naco, Son.	Jesus Manuel Franco	1.0		III-B		XECB	San Luis Rio Colorado, Son.	Carlos Elando	0.25		IV
1360	XEKF	Iguala, Gro.	Rafael Campos Marquina	1.0-D		III-B		XECM	Ciudad Mante, Tam.		0.25		IV
	XEUE	Tuxtla Gutierrez, Chi.		0.5-N		III-B		XECP	Ciudad Victoria, Tam.		0.1		IV
	XESA	Cuicatlan, Sin.	Pablos y Elizalde	0.5		III-B		XECT	Ojinaga, Chih.		0.25		IV
	XEY	Celaya, Gto.		1.0-D		IV		XEDJ	Magdalena, Son.	Jesus L. Rochin	0.1		IV
1370	XEA	Campeche, Camp.	Casanova Brito	1.0		III-B		XEDY	Merida, Yuc.		0.25		IV
	XEDG	Guadalajara, Jal.		0.5		III-B		XEFG	Tecuala, Nay.		0.125		IV
	XEHF	Nogales, Son.	Gaston Mascarenas	1.0		III-A		XEFY	Ensenada, B. C.		0.1		IV
	XEMR	Monterrey, N. L.	Enrique Serna Martinez	0.5		III-B		XEGC	Saguayo, Mich.	Alberto Barragan Degollado	0.25		IV
	XETO	Tampico, Tam.	Radio Tiempo S. de R. L. de C. V.	0.25		IV		XEGF	Culiacan, Sin.		0.25		IV
	XETQ	Orizaba, Ver.	Sucrs. de Francisco Campos H.	0.25		IV		XEJM	Monterrey, N. L.		0.25		IV
	XENU	Nuevo Laredo, Tam.		0.25-D		IV		XEJX	Queretaro, Qro.	Radio Emisora Queretaro	0.25		IV
	XERM	San Andres Tuxtla, Ver.		0.25-D		IV		XENA	Queretaro, Qro.	Ramon Rodriguez Familiar	1.0-D		IV
	XELF	Nueva Rosita, Coah.		0.1-N		IV		XEPP	Orizaba, Ver.	Radio Impulsora de Orizaba	0.25-N		IV
1380	XEMX	Mexico, D. F.	Publ. Com. de Mexico S. A.	1.0		III-B		XERK	Tepec, Nay.	Dario Mondragon	0.1		IV
	XERK	Tepec, Nay.	Dario Mondragon	0.5		III-B		XESZ	Zihustanejo, Gro.		0.25		IV
	XETZ	Villahermosa, Tab.		1.0-D		IV		XEXZ	Zacatecas, Zac.	Manuel Llamas Flex	0.25		IV
	XEKN	Monclova, Coah.		0.5		III-B		XEYZ	Aguascalientes, Ags.	Luis Chavez Calvillo	0.1		IV
	XEM	Chihuahua, Chih.	Pedro Meneses Jr.	0.5		III-B		1460 XEHX	Ciudad Obregon, Son.		0.25		IV
	XEOR	Reynosa, Tam.	Cond. S. Vda. de Gonzalez	1.0		III-B		XELX	Zitacuaro, Mich.		10.0	DA-N	III-A
	XERW	Leon, Gto.	Augustin Obregon Padilla	0.25		IV		XECA	Tampico, Tam.	Difusora Portena S. de R. L.	1.0		III-B
	XETK	Mazatlan, Sin.	Radio Emisoras de Occidente	0.5		III-B		XESH	Sabinas, Coah.		1.0-D		III-B
	XETL	Tuxpan, Ver.	Calixte Almazan	1.0		III-B		XETU	Tampico, Tam.	Impuls. Moderna del Radio	1.0		IV
	New	Tehuantepec, Oax.		2.5-D		III-B		XEXQ	San Luis Potosi, S. L. P.		0.25		IV
1400	XEAB	Santa Ana, Son.	Alfredo Marin Castro	0.35-N		IV		XEYQ	Ciudad Juarez, Chih.	Ysela Fern. Caball. de Yanez	1.0		III-B
	XEAJ	Navojoa, Son.		0.25		IV		XEUJ	Ciudad del Carmen, Cam.		0.25		IV
	XECN	Progreso, Yuc.		0.25		IV		1470 XEAU	Tijuana, B. C.	Manuel Acuna Varela	5.0		III-A
	XECS	Manzanillo, Col.		0.25		IV		XECU	Los Mochis, Sin.	Luis Perez Gomez	0.25		IV
	XEDE	Saltillo, Coah.	Enrique Martinez y Martinez	0.25		IV		XEHI	Ciudad Miguel Aleman, Tam.		0.5-D		IV
	XEDQ	San Andres Tuxtla, Ver.		0.25		IV		XESM	Mexico, D. F.	Salvador San Martin	5.0		III-A
	XEDU	Durango, Dgo.	Carlos C. Armas	0.25		IV		1480 XEAR	Monterrey, N. L.	Alfonso Flores Lopez	1.0-D		III-B
	XEI	Morelia, Mich.	Tiburcio Ponce	1.0-D		IV		XEFO	Poza Rica, Ver.		0.5-N		III-B
	XEJA	Jalapa, Ver.	Adolfo Alvarez	0.25-N		IV		XEGW	Acambaro, Gto.		0.5-N		IV
	XEJF	Nueva Rosita, Coah.		0.5-D		IV		XECA	Ciudad Ixtepec, Oax.		0.5-D		IV
	XEKJ	Acapulco, Gro.	Ramon Ortega Escobedo	1.0-D		IV		XEGW	Ciudad Ixtepec, Oax.		0.2-N		IV
	XEMH	Merida, Yuc.	Man. Aranjó Echeverria	0.25		IV		XEAQ	Ocambaro, Gto.	Manuel Rodriguez	5.0-D		III-B
	XEPF	Ensenada, B. C.	Luis Enrique Enciso	0.2		IV		1490 XECH	Agua Prieta, Son.		0.2		IV
	XEPO	San Luis Potosi, S. L. P.	Alejandro Espinosa Pitman	0.1		IV		XECV	Toluca, Mex.	Rodolfo Llamas	0.25		IV
	XERS	Gomez Palacio, Dgo.		0.25		IV		XECW	Guasave, Sin.		0.25		IV
	XESB	Santa Barbara, Chih.	Domingo Salayandia Najera	0.15		IV		XEDR	Veracruz, Ver.	Sucrs de Modesto Ortega.	0.5-D		IV
	XESP	San Pedro Tlaquepaque, Jal.	Hermínio Macias Alonso	0.25		IV		XEFF	Guaymas, Son.		0.25-N		IV
	XETO	Tampico, Tam.	Radio Tiempo S. de R. L. de C. V.	0.25		IV		XEGS	Matehuala, S. L. P.		0.25		IV
	XETX	N. Casas Grandes, Chih.	Laureano Molinar Contreras	0.25		IV		XEGT	Guassave, Sin.	Radio Guassave S. A.	0.25		IV
	XEWF	Cuautla, Mor.	Fernando Diaz Enriquez	0.1		IV		XEGU	Zamora, Mich.	Radio Zamora S. de R. L.	0.25		IV
	XEXB	Jalapa, Ver.		0.5-D		IV		XEGV	Huachuichingo, Puebla		0.25-D		III-B
1410	XEAS	Nuevo Laredo, Tam.	Jose Maria Villarreal	0.25		IV		XEJR	Hidalgo del Parral, Chih.		0.1		IV
	XEBS	Mexico, D. F.	Hispano Mexicano S. A.	1.0		III-B		XEMH	Merida, Yuc.	Alvaro Barquet Y.	0.25		IV
	XECF	Los Mochis, Sin.	Francisco Perez H.	1.0-D		III-B		XEOB	Torreón, Leon		0.25		IV
1420	XEDS	Mazatlan, Sin.	Alexjandro A. Schober	1.0-D		III-B		XERA	Chihuahua, Chih.	Red Nacional Radiomisoras S. A.	0.25		IV
	XEF	Ciudad Juarez, Chih.	Jose Carlos Amaya	0.5-N		III-B		XERO	Chihuahua, Chih.		0.25		IV
				5.0-D		III-B		XESW	Agascalientes, Ags.	Radio Hidrotermopolitana	0.25		IV
				0.5-N		III-B		XESM	Mexico, D. F.	Salvador San Martin	5.0		IV
				0.5-N		III-B		XEWG	Ciudad Juarez, Chih.	Carlos Mendez	0.25		IV
				0.5-N		III-B		XEXU	Saltillo, Coah.		0.1		IV
				0.5-N		III-B		XERH	Mexico, D. F.	"A.R.S.E." S. A.	20.0	DA-N	II
				0.5-N		III-B		XEUH	Villa Hermosa, Tab.		0.25		II

LATIN AMERICAN STATIONS

Fre- quen- cy-	Call	City	Owner or Operator	Power	DA	Class	Fre- quen- cy-	Call	City	Owner or Operator	Power	DA	Class
1510	XELN	San Andres Tuxtla, Ver.		1.0-D		IV		XEQZ	Ciudad Clauhemoc, Chih.		5.0-D		II
1520	XEDB	Tehuacan, Pue.		0.25		II		XERX	Salamanca, Gto.	Ernesto Bravo Vargas	2.0-N		II
	XEGD	Hidalgo del Parral, Chih.		1.0-D		III		New	Tonantzintla, Pue.		1.0-D		II
	XEHT	Huamantla, Tlax	Alf. Macias y Mario Pardo S.	0.25-D		II					0.25-N		II
	XEJX	Queretaro, Qro.	Radio Emsora Queretana	0.25-D		II	1570	XEDI	Queretaro, Que.		1.0-D		II
	XENA	Queretaro, Qro.	Ramon Rodriguez Familiar	1.0				XEGE	Mexicali, B. C.		1.0-D		II
1540	XENC	Celaya, Gto.	El Heraldo del Bajio	0.25		II		XERF	Villa Acuna, Coah.	Cia. Radiodif. de Coahuila S. A.	50.0		I-A
	XEQN	Hermosillo, Son.		5.0		II	1580	XEDM	Hermosillo, Son.	Cia Radio Pacifico	50.0		II
	XEBG	Tijuana, B. C.	Octavio B. Lelevier	1.0		II		XEGP	Morelia, Mich.		0.5-D		III-B
1550	XEML	Mexico, D. F.	Roberto Valeggi Esparza	2.0		II	1590	XEQQ	Monterrey, N. L.		5.0	DA-N	III-B
	XEXO	Nuevo Laredo, N. L.		50.0	DA-N	I-B		XEKT	Tecate, B. C.		1.0-D		III
	XEDC	Aguascalientes, Ags.		0.25		II		XEMC	Mexico, D. F.	Dol. G. Estrada de Ferreiro	5.0		III-A
1560	XEDD	Monterrey, N. L.		0.5-D		II	1600	XEAE	Villa Acuna, Coah.		5.0		III-A
								XEDO	Acapulco, Gro.	Heriberto Guizar Castro	0.5		1-B
								XELC	La Piedad, Mich.		5.0-D		III-A
											1.0-N		

INDEX TO ADVERTISERS IN 1954 BROADCASTING YEARBOOK-MARKETBOOK NUMBER

AGENCIES	GENERAL (Cont'd.)	NETWORKS-GROUPS (Cont'd.)
Batten, Barton, Durstine & Osborn, Inc.	Brand Names Foundation, Inc.	Storer Broadcasting Co.
McCann-Erickson, Inc.	Broadcast Music, Inc.	Texas Quality Network
	Cambridge Thermionic Corp.	United Broadcasting Co.
	Canadian Association of Radio and Television Broadcasters	Westinghouse Broadcasting Co., Inc.
EQUIPMENT	Louis G. Cowan, Inc.	
Allied Radio	Dawkins Espy	
Ampex Corp.	GBA Productions	NATIONAL REPRESENTATIVES
Andrew Corp.	George McKittrick & Co.	All-Canada Radio Facilities, Ltd.
Califone Corp.	RCA Recorded Program Services	Hil F. Best Co.
Collins Radio Co.	RA-TEL Promotion Service	The Branham Co.
Continental Electronics Mfg. Co.	SESAC, Inc.	Free & Peters, Inc.
Electrical Tower Service, Inc.	Standard Radio Transcription Services, inc.	NBC Spot Sales
Federal Telephone & Radio Corp.	United Press	H. N. Stovin & Co.
Gates Radio Ca.	Thomas J. Valentino, Inc.	
General Electric Tubes	World Broadcasting System, Inc.	STATIONS
Graybar Electric Co., Inc.	Frederic W. Ziv Co.	CKLW, Detroit
Hammarlund Mfg. Co., Inc.		KADA, Ada
Johns-Manville	NETWORKS-GROUPS	KANS, Wichita
Langevin Mfg. Corp.	ABC Radio Network	KARM, Fresno
Lehigh Structural Steel Co.	Canadian Broadcasting Corp.	KATE, Albert Lea
Magnecord, Inc.	CBS Radio Network	KBIC-TV, Los Angeles
ORRradio Industries, Inc.	The Fetzer Stations	KBID-TV, Fresno
Presto Recording Corp.	French Broadcasting System	KBIF, Fresno
RCA Engineering Products Dept.	The Georgia Trio	KBIG, Avalon
Radio Corporation of America	Keystone Broadcasting System, Inc.	KBIX, Muskogee
Rust Industrial Co., Inc.	Edward Lamb Enterprises, Inc.	KBMX, Coalinga
Paul Schafer Custom Engineering	Don Lee Broadcasting System	KCBD, Lubbock
Self Winding Clock Co., Inc.	The Linder Stations	KCMO, Kansas City, Mo.
Standard Electronics Corp.	Meredith Stations	KCRC, Enid
Stainless, Inc.	Mutual Broadcasting System	KDKA, Pittsburgh
Tower Construction Co.	NBC Western Radio Network	KDMA, Montevideo
Truscon Steel	Oklahoma Network	KGBS, San Antonio
Westinghouse Electric Corp.	Radio Luxembourg	KEX, Portland
	Rounsaville Radio Stations	KFAL, Fulton
	Southern Minnesota Network	KFDM, Beaumont
	Steinman Stations	KFMA, Davenport
		KFRO, Longview

(Continued on page 482)

INDEX TO ADVERTISERS

IN 1954 BROADCASTING YEARBOOK-MARKETBOOK NUMBER

STATIONS (Cont'd.)		STATIONS (Cont'd.)		STATIONS (Cont'd.)	
KFVD, Los Angeles	381	WCLO-WGEZ, Janesville-Beloit	342	WLIK, Newport	294
KFYO, Lubbock	313	WCMB, Harrisburg	272	WLIL, Lenoir City	294
KGAE, Salem	268	WCSC, Charleston	284	WLIP, Kenosha	345
KGAL, Lebanon	268	WCTC, New Brunswick	215	WLOU, Louisville	114
KGJF, Los Angeles	85	WCUE, Akron	246	WMAC-TV, Massillon	273
KGGF, Coffeyville	149	WCYS, Springfield, Ill	131	WMAL, Washington, D. C.	103
KGNC, Amarillo	301, 319	WCYB, Bristol	324	WMAM, Marinette	341, 344
KIEM, Eureka	52	WDAY, Fargo	245	WMAY, Springfield, Ill.	133
KIRO, Seattle	333	WDBJ, Roanoke	328	WMAZ, Macon	119
KMBC-KFRM, Kansas City, Mo.	198-199	WDBO, Orlando	109	WMBM, Miami Beach	114
KMHL, Marshall	192	WEAV-WENT, Plattsburg-Gloversville	227	WMC-WMCF-WMCT, Memphis	295
KOLN, Lincoln	183	WELI, New Haven	98	WMFJ, Daytona Beach	105
KOWH, Omaha	210	WELL, Battle Creek	176	WMGY, Montgomery	73
KOWL, Santa Monica	392	WEOA, Evansville	137, 181	WMRN, Marion	253
KPHO, Phoenix	66	WERC, Erie	271	WMT, Cedar Rapids	143
KPRC, Houston	311, 319	WERH, Hamilton, Ala.	71	WMUR, Manchester	212
KRGV, Weslaco	319	WEVD, New York	223	WNAX, Yankton	291
KRIS, Corpus Christi	319	WEXL, Royal Oak	187	WNEW, New York	7
KRLD, Dallas	305	WFAA, Dallas	307, 319	WNHC, New Haven	99
KROC, Rochester, Minn.	188	WFBC-WMRC, Greenville	286	WNJR, Newark	214
KROD, El Paso	308	WFBM, Indianapolis	137, 181	WOAI, San Antonio	317, 319
KROY, Sacramento	88	WFD, Flint	137, 181	WOAY, Oak Hill	339
KSAN, San Francisco	395	WFIL, Philadelphia	277	WOC, Davenport	141
KSD, St. Louis	205	WFLA, Tampa	111	WOND, Pleasantville	213
KSFO, San Francisco	80	WFMJ, Youngstown	251	WOOD, Grand Rapids	137, 181
KSGA, Redmond	268	WGBS, Miami	50-51	WOOK, Washington, D. C.	102
KSL, Salt Lake City	321	WGMS, Washington, D. C.	101	WOW, Omaha	66
KSO, Des Moines	145	WGN, Chicago	125	WOWL, Florence	70
KSWO, Lawton	259	WGY, Schenectady	231	WOWO, Fort Wayne	5, 169
KTMC, McAlester	259	WHAI, Greenfield	171	WPOR, Portland, Maine	165
KTOE, Mankato	192	WHAS, Louisville	157	WPRO, Providence	283
KTUL-KFPW, Tulsa-Fort Smith	263	WHB, Kansas City, Mo. . . Inside Back Cover		WPTR, Albany	218
KUGN, Eugene	266	WHBF, Rock Island	130	WPTZ, Philadelphia	5, 169
KVOO, Tulsa	265	WHEC, Rochester	229	WQXI, Atlanta	114
KVSO, Ardmore	259	WHEN, Syracuse	66	WQXR, New York	225
KVVO, Cheyenne	347	WHIM, Providence	54, 170, 282	WRHC, Jacksonville	107
KWFT-KLYN, Wichita Falls-Amarillo	318	WHLS, Port Huron	185	WRNY, Rochester	228
KWKW, Pasadena	393	WHO, Des Moines	147	WROK, Rockford	127
KWLM, Willmar	192	WHOM, New York	224	WROV, Roanoke	330
KWSH, Seminole	259	WHOO, Orlando	273	WRVA, Richmond	329
KXLA, Pasadena	394	WHP, Harrisburg	274	WSAI, Cincinnati	249
KXO, El Centro	83	WIBA, Madison	343	WSAZ, Huntington	336
KXOK, St. Louis	201	WIBW, Topeka	151	WSB, Atlanta	113
KYSM, Mankato	188	WICU-TV, Erie	273	WSID, Baltimore	166
KYW, Philadelphia	5, 169	WIKK, Erie	273	WSIX, Nashville	296
WACE, Springfield, Mass.	173	WINR, Binghamton	219	WSJS, Winston-Salem	242
WAEW, Crossville	294	WIOU, Kokomo	135	WSM, Nashville	297
WAGA, Atlanta	50-51, 115, 119	WIP, Philadelphia	278	WSOY, Decatur	126
WANT, Richmond	327	WIRE, Indianapolis	139	WSPA, Spartanburg	288
WAVE, Louisville	155	WJAX, Jacksonville	106	WSPD, Toledo	50-51, 255
WBAC, Cleveland, Tenn.	114	WJBK, Detroit	50-51	WRSR, Cleveland Heights	247
WBAP, Fort Worth	309, 319	WJBO, Baton Rouge	161	WSYR, Syracuse	233
WBBW, Youngstown	256	WJLK, Asbury Park	213	WTAX, Springfield, Ill.	132
WBEJ, Johnson City	114	WJOY, Burlington	323	WTIC, Hartford	97
WBNS, Columbus	250	WJR, Detroit	179	WTOC, Savannah	119
WBOC, Salisbury	167	WKBN, Youngstown	257	WTOD, Toledo	273
WBRC, Birmingham	50-51	WKBW, Buffalo	221	WTRY, Troy	230
WBT, Charlotte	237	WKY, Oklahoma City	261	WTTH, Port Huron	184
WBZ-WBZA-WBZ-TV, Boston	5, 169	WKZO-WJEF, Kalamazoo-Grand Rapids	183	WWJ, Detroit	175
WCCC, Hartford	96	WLAM, Lewiston	164	WWRL, New York	232
WCCO, Minneapolis	190	WLIB, New York	226	WWVA, Wheeling	50-51, 248, 279, 340
WCIN, Cincinnati	114			CFPL, London	354
				CKNW, New Westminster	453



"**D**edicated to pioneering and steadfast in our purpose to give America pre-eminence in communications, we shall continue our efforts to advance and to merit the faith and confidence the American people have in 'RCA' as an emblem of quality, dependability and progress."

Chairman of the Board

RADIO CORPORATION OF AMERICA

YOUR KANSAS CITY RADIO DOLLARS BUY MORE IN '54!

When you Swing to

WHB

710 KC • 10,000 WATTS • MBS NETWORK

Never before in Kansas City radio history has the advertising dollar bought a bigger or better audience! Programs have never been better . . . daytime ratings have never been higher . . . and the market (the nation's 17th richest) has never had more money to spend! Despite four-channel* television competition, your radio schedule on WHB *still* buys you more listeners per dollar!

WHB programming is tailor-made for the Kansas City area. *Larry Ray's* exclusive broadcasts of the Kansas City Blues baseball games, Big Seven football and Big Seven basketball give year-round sport coverage not matched by any medium! *Sandra Lea* today sells more WHB-advertised goods to homemakers than ever before and for 11 years has delivered a highly responsive woman's audience. "The Musical Clock," 23-year-old disc jockey show, has an ever-growing following of faithful morning listeners. Complete WHB news and weather service, inaugurated in 1936 by John Cameron Swayze, commands an area-wide audience that merits any advertiser's attention. "Neighborin' Time," with *Bruce Grant*, has a 23-year-old record as Kansas City's favorite farm hour . . . and its popularity grows with every broadcast! For the music minded, there's *Wayne Stitt's* all-afternoon d.j. show and *Roch Ulmer's* "Night Club of the Air."

These few random examples of WHB programming show why more and more advertisers are swinging to 710 on the radio dial. 1,399,541 Radio Sets (Nov. 30 KC Elec. Assn. est.)—plus WHB's outstanding merchandising cooperation—are two other reasons your radio dollars buy more in '54. Your Blair man can give you the complete picture on the WHB market. Contact him for details and availabilities.

*WHB-TV is on Channel 9 For complete Kansas City coverage, swing your television schedule to WHB-TV—Basic CBS Television Affiliate in a 349,529 TV set market. (Nov. 30 estimate of Kansas City Electrical Assn.)



FREE to advertisers and agency executives

Read SWING, the vest-pocket-sized magazine published monthly by WHB and WHB-TV.

Articles on marketing, merchandising, research excerpts from John Crosby's Radio and TV Column . . . pictures, jokes and cartoons. Ask for a copy on your company letterhead.



Don Davis, President
John T. Schilling, General Manager

WHB

710 K.C. 10,000 WATTS
MUTUAL NETWORK

KANSAS CITY'S
OLDEST
CALL LETTERS

Represented nationally by
JOHN BLAIR & CO. Represented Nationally by

WHB-TV

CHANNEL 9 BASIC CBS-TV
SHARING TIME WITH KMBC-TV Kansas City

TV
BLAIR
INC.