

Great Holiday Idea: New Book Coming November 1, 2011
See Review Inside

**A.R.C. - The National Publication For Buyers & Sellers
Of Old Radios & Related Items**

www.antiqueradio.com



THE HISTORY OF RADIO ON CD-ROM

Radio Era Archives produced the QST-VIEW series of CD's for the American Radio Relay League (ARRL) and over 1/2 million CD's have been sold. QST Magazine has been continuously published since 1915. We are now proud to announce that this small mountain of CD's (about 35) is now available exclusively from REA (All Sets) ! Every magazine published from 1915 to 1994, front cover to back cover, every article and column, all accessible with our database search engine.

QST-VIEW CD Edition truly captures the history of radio in 11 volumes. All CD's warranted to work on all Windows platforms from Windows 95 through XP. Each set is \$ 39.95 and we have all sets in stock. The sets are: 1915-1929, 1930-1939, 1940-1949, 1950-1959, 1960-1964, 1965-1969, 1970-1974, 1975-1979, 1980-1984, 1985-1989, 1990-1994. Each set of years is a self-contained set so you can operate one or all sets together. Now that large capacity hard drives are so inexpensive, the 36 CD's can be loaded on about 20Gb of hard disc space for instant searching and viewing without having to swap discs! Full information is provided with each purchase and QST-VIEW has on-line instructional help for operating the QST-VIEW browser!

EACH SET \$ 39.95 (specify the years)

ALL 11 SETS \$ 379

S&H USA for first set is \$ 5.00, add \$ 1.00 each set thereafter
S&H Export first set is \$ 15.00, add \$ 2.00 for each set thereafter

2009 1/2 PRICE SPECIAL (while supply lasts)

Don't forget, we have the entire John Rider's Perpetual Troubleshooters Manuals on a single DVD. All 23 Volumes of the Riders available at the click of a mouse! Over 120,000 different model radio schematics and related service information in an easy to use DVD. Thousands sold at \$ 199. **SPECIAL \$ 99 + \$ 6.00 S&H in the USA, add \$12 for worldwide delivery. Order Now while supply lasts !**

We now have a small mountain of vacuum tubes at very competitive prices - Thousands sold since our first posting of these tubes. All types including receiving and transmitting types. Tube price listings on the web:

<http://www.radioera.com/tubes.asp>

SCHMATIC DIAGRAM & MANUAL SERVICE

Over a Million schematics & 100,000 manuals and growing! Schematics and most manuals may be emailed instantly via the internet

Check the web - On-line antique radio flea market - Radios for sale - Antique radio museum - Zenith Trans-Oceanic museum - thousands of old catalogs, manuals, literature, information, how-to data, reference, auction price section and much-much more! Visit antique radios largest web address today!

RADIO ERA ARCHIVES

2043 Empire Central
Dallas, Texas 75235
Inquiries: 214-358-5195

OFFICE HOURS 10AM - 4PM DAILY M-F

Visit us on the Internet:
www.radioera.com

ANTIQUE RADIO CLASSIFIED

September 2011 • Volume 28 • Number 9

The National Publication for Buyers and Sellers of
Old Radios and Related Items - Published Monthly

www.antiqueradio.com

- | | | | |
|-----------|---|-----------|--|
| 3 | Publisher's Comments | 16 | Restoring a Western Electric Model 540-AW Speaker |
| 3 | On The Cover | 17 | Do You Know Your A.R.C. Subscriber Benefits? |
| 4 | A Look at the Philco Junior Scope Model 7019 | 20 | Photo Review |
| 8 | Getting Acquainted with the Southern California Antique Radio Society | 24 | Classified Advertisements |
| 12 | At Home with the Collector, Rich Lee from New York | 32 | Coming Radio Events |
| 15 | New Book Review: <i>Lee de Forest—King of Radio, Television, and Film</i>, by Mike Adams | 40 | Radio Clubs |

Antique Radio Classified (ISSN:8750-7471) is published monthly, 12 times per year, by Vintage Radio Publishing, LLC, PO Box 1558, Port Washington, NY 11050. Periodicals postage paid at Port Washington, NY, and additional mailing offices.

Annual subscription rates: U.S. - \$36.00 by Periodicals mail, \$48.00 by First Class mail; Canada - \$50.00; Mexico - \$60.00; other foreign countries - \$70.00. Web-Only - \$30.00. For multiple year rates see website.

© 2011 by Vintage Radio Publishing, LLC

POSTMASTER: Send address changes to
Antique Radio Classified, PO Box 1558,
Port Washington, NY 11050.

Printed in U.S.A.

PURPOSE - Antique Radio Classified is published for people involved in the radio collecting hobby. Its purpose is to stimulate growth of the hobby through the buying, selling and trading of radios and related items, and to provide a monthly forum for the interchange of ideas and information.

Publisher: Jon Kummer, **Editor:** Edith Lennon, **Publisher/Editor Emeritus:** John Terrey, **Founding Publisher/Editor:** Gary B. Schneider, **Contributing Editor:** John Terrey, **Contributing Writers & Consultants:** Mike Adams, Richard L. Arnold, Richard Begbie, Ray Birdliff, Norman Braithwaite, Ray Chase, Dave Crocker, Alan Douglas, Richard Foster, Jim Kreuzer, Phil MacArthur, Ron Ramirez, Gary Schneider, Daniel Schoo, Frank White.

CONTACTING ANTIQUE RADIO CLASSIFIED

All correspondence should be sent to:

A.R.C., PO Box 1558, Port Washington, NY 11050

Telephone: (866) 371-0512; Fax: (516) 883-1077

Email: ARC@antiqueradio.com

Web: www.antiqueradio.com

Your ads, renewals, letters, etc. can be handled faster and more efficiently if your name address and SUB# are written on each.

Unfortunately, A.R.C. is not staffed to answer all letters with questions about antique radios or requests for advice. However A.R.C. does solicit letters of interest from its readers and publishes them as space permits.

WEB. Antique Radio Classified issues are published on the web as PDF files for subscribers. Web-only subscriptions are available. One issue is available for viewing by all on the web as a sample.

ADVERTISING. Display and Classified advertising rates and artwork specifications are available on the web site.

PAYMENT. Please include full payment with your order or ad. A.R.C. does not carry accounts; all subscriptions, ads, etc. must be prepaid. Pay in U.S. funds. Checks drawn on a U.S. bank, money orders, VISA, MasterCard, American Express, Discover or PayPal. Make check out to "A.R.C." Subscriptions will be prorated to amount sent if amount is incorrect. *For your protection, no credit cards by e-mail; use our secure website instead.*

CHANGE OF ADDRESS. Please notify us in advance of a change of address. Send your new address, your old address, your SUB# and the effective date of the change.

PUBLISHING RIGHTS. Unless other arrangements are made:

(1) All received materials (ads, articles, letters, correspondence, email, photos, artwork, etc.) become the property of A.R.C., may be edited, combined with other material, published, and will not be returned. (2) For all received materials, A.R.C. is granted publishing and reprint rights in all forms of media including the monthly printed magazine, internet, etc. (3) Publication is subject to approval by A.R.C. and to time and space constraints.

MAILING OF ISSUES. U.S. subscribers can receive A.R.C. by First Class or Periodicals mail (Periodicals is the way most magazines are mailed). Mailing dates change each month.

DISCLAIMER. The publisher is not responsible for any buying and selling transactions incurred, or for any other use of the contents of this publication.

NOTICE. Subscription rates, frequency of publication, content, policies, size and ad details, and rates are subject to change at any time by A.R.C.

SUBSCRIBERS: All paid subscribers receive a FREE classified ad of up to 50 words in each issue.



Publisher's Comments

I always look forward to a new book or product for the antique and vintage radio community. This month we review the new book from Mike Adams, *Lee de Forest—King of Radio, Television, and Film*. Lee de Forest was an inventor and controversial figure through out his life. Mike Adams is no stranger to the radio community, having written numerous books, articles, as well as documentaries for PBS television.

"At Home with the Collector" this month looks at the collection of Rich Lee. Rich has been a collector and restorer for almost 20 years and has a collection of equipment that complements his tvintage home and his interest in the Art Deco period.

John Vuolo writes about the Philco model 7019 Junior Oscilloscope. This scope has a two-inch CRT and was first manufactured in 1946.

Have you ever wanted to restore a cone speaker? This month we feature a 1923 Western Electric model 540-AW cone speaker that had seen better days. Fortunately, there's a company that sells replacement cones. Without these replacement cones, many of these speakers would have ended up in landfills. Check out our step-by-step restoration.

Look forward next month to articles by Dave Crocker, record changer restoration, and auction results.

Magazine Delivery

There have been several complaints about the delivery date of A.R.C. I agree that we have to do better and we are working hard to rectify the issue. We are talking with the printer and the Post Office about how to speed up the delivery of the magazine.

New Editor

This month, we welcome Edith Lennon as the new editor of A.R.C. Edith comes to us as the former editor of *Popular Communications* magazine and has also held many other editorial positions at magazines in the radio and broadcast television industry. She holds the amateur callsign N2ZRW!

Edith will make an excellent addition to the staff and will be instrumental in making sure the magazine is delivered to the readers at the earliest possible date. Edith can be reached at editor@antiqueradio.com.

Attention All Clubs: Domestic and International

Please send us your 2012 meeting schedule as well as any changes to your contact listing. It's time for A.R.C. to set up its 2012 listings. We invite both Domestic and International clubs to submit to our "Coming Events" section.

Your Contributions Wanted!

As always, we'd like to request your input with photographs for the "Photo Review" as well as any articles that would be of interest to our readers.

Until next time, happy collecting and restorations!

Jon Kummer
Publisher

On The Cover

This month we feature the cover of the new Mike Adams book: *Lee de Forest—King of Radio, Television, and Film*.

TUBE TECHNOLOGY

A Look at the 2A3 Output Triode Tube

BY JOHN VUOLO

The 2A3 was one of the most popular tubes of the 1930s and was perhaps the most frequently used output triode of all time. Today it's used more exclusively in hi-fi products and is noted for offering exceptional linearity and sound quality. This medium-power, direct-heated triode was designed and introduced by RCA circa 1932 and was intended to be a double-power version of the popular 45 (1929). The 2A3 could produce up to 3.5 watts in single-ended mode, which was sufficient to power the new better-sounding, but relatively inefficient, moving coil speakers of that

time. For powerful applications, the 2A3 was often used in push-pull (sometimes paralleled) products like disk-cutting lathes, early jukeboxes, cinema amplifiers, and electric organs and pianos by Hammond, Wurlitzer, and the like.

TUBE EVOLUTION

The initial version of the 2A3 was a mono valve/plate construction with a modest 15-watt plate dissipation, but RCA introduced a more powerful bi-plate design in the later 1930s. Roughly speaking, the bi-plate 2A3 was two 45 triodes in a single

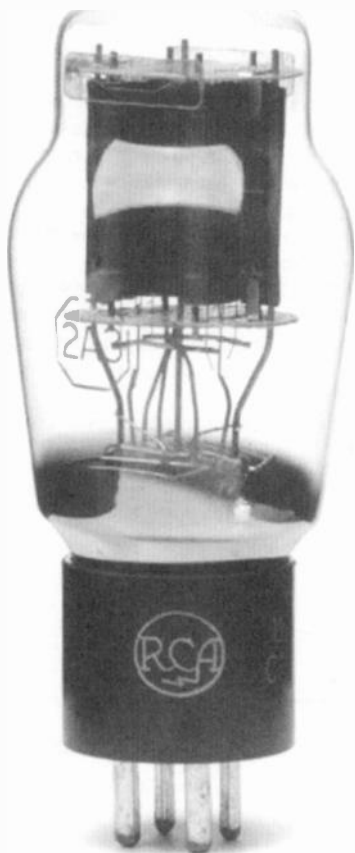

2A3 RCA



2A3 RCA National Union,
single plate 1930s

MORE GEAR FROM YESTERYEAR

A Look at the Philco Junior Scope Model 7019

BY JOHN VUOLO

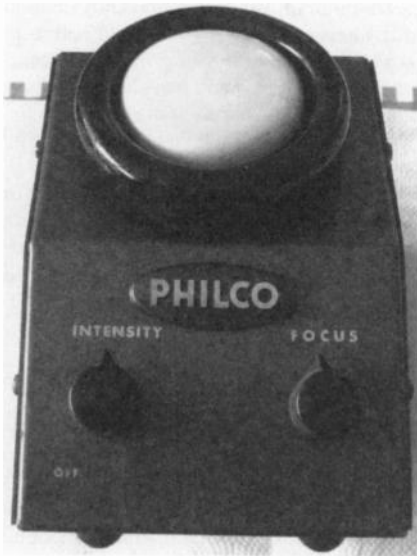

The Philco Junior Scope Model 7019 was designed to serve as a compact, portable, low-cost oscilloscope for the radio serviceman and the radio amateur experimenter, as well as to provide general portable use in the lab. Its small size and light weight (5 3/4 pounds) make it easy to move and set up near the equipment being analyzed.

The oscilloscope consists of three tubes and a 2-inch 2API CRT. I have also discovered that the Philco Junior Scope is identical to the Waterman "Pocket-Scope" Model S-10-A, but the Philco version is painted in brown. Since the circuitry is identical in the two products, if a schematic is needed for the Philco, you could simply refer to the Waterman's.

Here's the tube complement of the Philco 7019 scope:

CHARACTERISTICS OF THE
PHILCO Junior Scope

POWER SUPPLY

Rear 100-250 volt 50-60 cycles AC
Power consumption 50 watts at 115 volts @ typical

OPERATING DATA

Vertical Deflection Sensitivity	Horizontal Deflection Sensitivity	Sweeping, Horizontal and Vertical	Vertical Position	Vertical Magnification	Horizontal Magnification
1 V 1000/Div	1 V 1000/Div	-200 to 100,000 cycles	0 to 100,000 cycles	10 to 1000	10 to 1000
100 to 100,000 cycles	100 to 100,000 cycles	100 to 100,000 cycles	100 to 100,000 cycles	100 to 100,000 cycles	100 to 100,000 cycles

TUBE COMPLEMENT

PHILCO Junior Scope

*Small • Light • Rugged
GENERAL PURPOSE
OSCILLOSCOPE*

Only \$66.00

MODEL 7019

The Philco Model 7019 Junior Scope fits a need for a portable piece of test equipment in small size and light weight. The Model 7019 is a complete portable test oscilloscope with a newly designed cathode ray tube, vertical and horizontal amplifiers, and constant energy circuit, and constructed as the study of wave shapes, measurements of modulation percentages, peak-to-peak, phase shift, time, distortion, adjustment of under-amplitude and all radio receiving and transmitting equipment except very high frequency.

Top: Front view of Philco scope screen, power and intensity controls;
Bottom: Actual advertisement for the Philco scope



Photo of the actual CRT in scope

- 6AU6: Vertical Amplifier
- 6J6: Time base oscillator and horizontal amplifier
- 6X4: Rectifier
- 2API-A: Cathode Ray Tube (2-inch screen)

Circuit Description of the Philco Junior

U6, is used in the vertical amplifier circuit. The input amplitude is controlled by R100, the 500K-ohm potentiometer used on the GAIN control. When the control is turned to its maximum counterclockwise position, switch S101 is thrown to the position opposite that shown in the diagram, applying the input signal directly to the vertical plates of the cathode-ray tube.

When the GAIN control is turned to any clockwise position, switch S101 connects the output circuit of the amplifier through condenser C104 to the vertical plates. The small air-core inductance coil, L100, functions as a shunt peaking coil to improve the high-frequency response of the amplifier.

A small amount of the amplified voltage in the plate circuit appears across the 560-ohm resistor R104, which is connected to the "INT" terminal on the "FUNCTION"

switch, S103. This voltage is used for internal synchronization; thus, a small amount of energy is needed to synchronize the sweep and may, when desired, be taken from the amplified vertical input voltage instead of an external source.

The double triode tube, type 6J6, is used as a time base oscillator or as an amplifier for the horizontal input voltage, depending on the position of the "FUNCTION" switch, S103. The time base oscillator uses a multi-vibrator circuit incorporating both triode sections of the tube. The correct values of capacitance for each range are selected by the "RANGE" switch, S104. When the function switch is thrown to the "HOR" position, one section of the

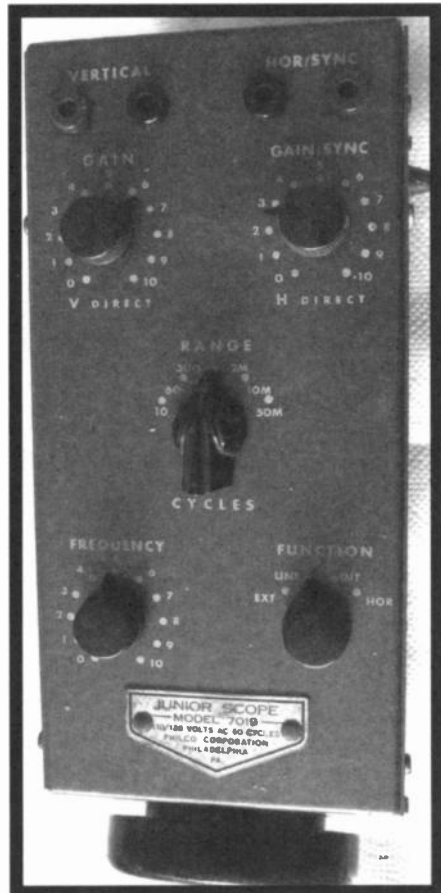

Top view of the Philco scope controls

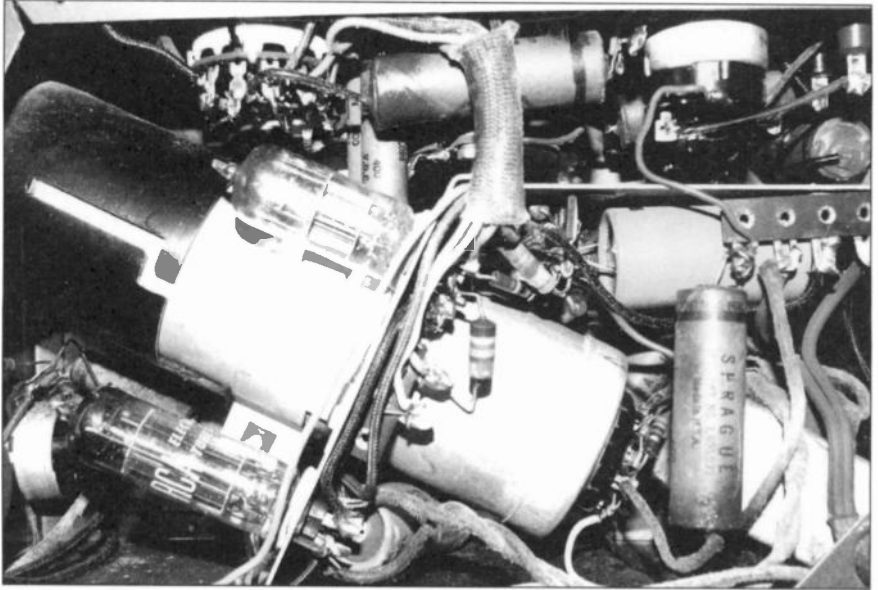

Inside view from left side of scope with cover off

6J6 tube is made inoperative by grounding the control grid circuit so the other tube section then becomes an amplifier for the horizontal input voltage.

The cathode ray tube, type 2A1-A, gets its adjustable negative bias from potentiometer R106 and is also the "INTENSITY" control and is combined with the AC power switch

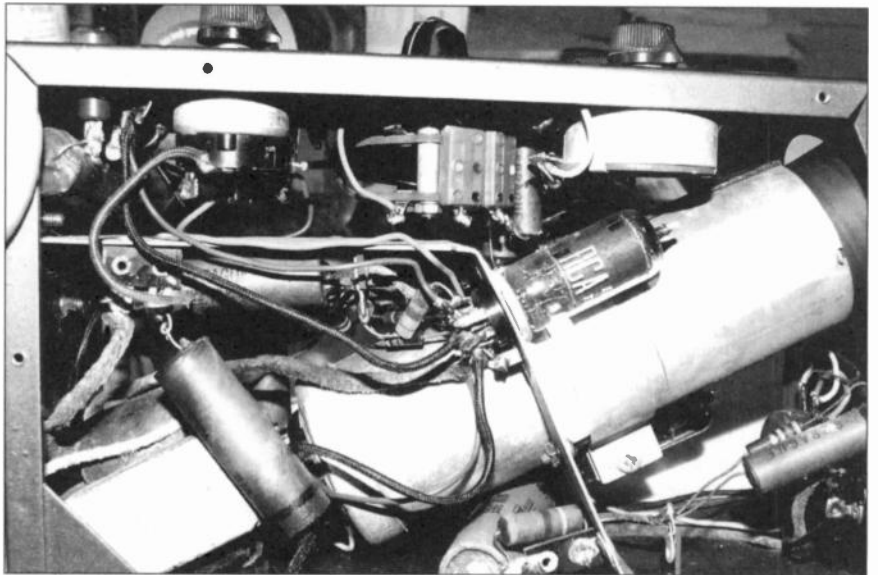

Inside view from right side of scope with cover off

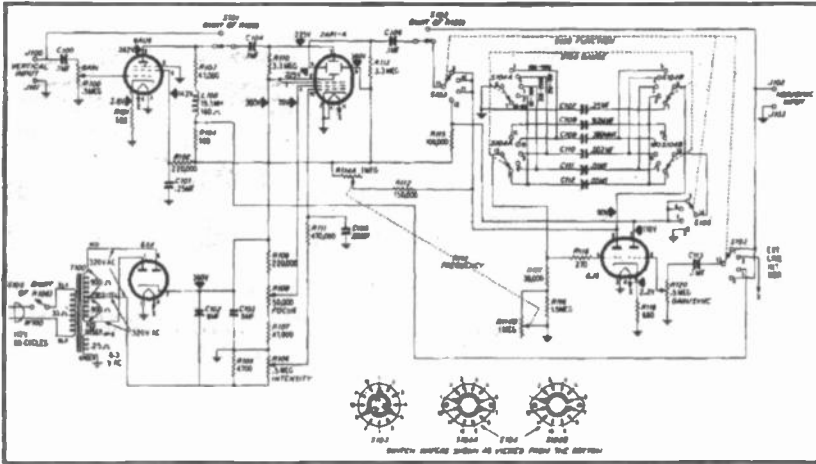

Figure 25. Complete Schematic

ACCESSORY DIVISION

PHILCO CORPORATION

PHILADELPHIA, PA.

Actual Philco schematic from the service manual

S100, which turns the scope on and off. The first anode voltage is taken from the variable arm of potentiometer R108, which forms a part of the voltage divider circuit across the output of the power supply. This potentiometer is used as the "FOCUS" control. The second anode voltage is taken from the positive output of the power supply.

The power supply for the scope is furnished by a transformer and the 6X4 tube operating as a rectifier along with two 8- μ F electrolytic capacitors.

Measuring History

I received the Philco Junior as a gift, and several photos of it, along with a copy of the schematic and of the original Philco advertisement (courtesy of www.myvintagetv.com), accompany this article.

As you can see from the photographs, I'm going to have to go through and replace all of the paper capacitors. I've tested the three tubes on my TV7/DU and they are just with-

in acceptable limits. I'll have to make up an adapter to test the 2AP1 on my Heathkit CRT tester/rejuvenator, but I believe it should be O.K. There are no burn marks on the screen and the CRT is still holding its vacuum. It will also need a new AC power cord. Once I remove the sub assembly from the cabinet I can give the scope a better cleaning and have easier access to all the components.

In 1946 this scope cost only \$66, and now it joins my collection. It is a piece of history just as the radios, amateur equipment, amplifiers, and televisions it was designed to be used on.

Reference

Philco 7019 Service Manual

John Vuolo has been working in the telecommunications industry for 34 years. He has been restoring and collecting antique radios, tube amplifiers and receivers, TVs, phonographs, and reel-to-reel machines for 40 years.

Contact John at jvuolo9603@aol.com.

MEET THE CLUB

Getting Acquainted with the Southern California Antique Radio Society (SCARS)

BY EDITH LENNON



In this Internet world, it's not easy to keep an antique radio club vibrant, but the Southern California Antique Radio Society (SCARS) has managed to do it with enviable results.

Established in San Diego in 1976 with a mere 30 people, today the club is one of the largest in the United States. Over the course of its 35-year history, it contributed greatly to

the vintage radio hobby and proudly counts among its members some of the best-known and influential collectors and writers, like Morgan McMahon and Floyd Paul. (The club recently reprinted Paul's Los Angeles Radio Manufacturing, The First Twenty Years and offers it on its website).

While it's seen some ups and downs in its membership roster, thanks in no small part to the effects of the Internet and eBay, today it boasts nearly 400 members. Impressive!



Field Day "Ambassadors" Barry Dagestino, Jerry Cantou, and Jim Ryan

There are just some things a local club offers that no search engine can ever provide.

A.R.C. recently had a chance to chat with SCARS club president, Barry Dagestino, who shared with us some of the club's secrets for success and plans for the future.

In Person

SCARS keeps its members connected by holding an event every other month, kicking off the year in February with a club auction and ending it with a two-day meet, its largest, in November. Day one of the November gathering buzzes with activities like a flea market swap meet, lunch, seminars, dinner with a special guest speaker, a club business election meeting for the upcoming year. Day two gives attendees another chance to snag a new treasure with a second swap meet and then to show off their finds over brunch, before breaking about midday.

Other events are usually one-day affairs, held on the third Saturday of the month, with the not-to-be-missed August auction serving as the biggest fundraiser of the year for the club. Well attended (dinners and seminars usually get about 50 people and auctions around 100), these meets are

a great chance to reconnect with old friends and make new ones and share your love of radio with friendly people.

SCARS promotes its events—and itself— through ads placed in local publications (and even larger, mass distribution ones for major gatherings), through its web-



John Gallesteth, Mary Curry and others at Mike Simpson's Midwest Radio Collection outing.



A crowd waits for last year's SCARS auction, held in Van Nuys, to begin.

site, by widespread flyer distribution, and intensive word of mouth. Members cover a wide geographic area to place the club's flyers and attractive membership forms in antique stores, electronics stores, the gatherings, flea markets and swap meets of related groups, as well as some larger events with general attendance, sometimes exhibiting themselves and serving as "ambassadors" of the antique radio collecting hobby.

For instance, this year SCARS was on hand in support of in the community outreach section of the Orange County Fair in Santa Ana, setting up and staffing a booth in conjunction with the Orange County Council of Amateur Radio Organizations. This exhibit, which highlighted a display of vintage radios, was so well-received by the public that it took the blue ribbon award as Number 1 participant in the Fair, a hugely popular exposition that attracts approximately one million people over a six-week period.

SCARS is also reaching out to the amateur radio community itself by attending ham gatherings. This past June the club set up a display at the American Radio Relay League's annual emergency preparedness event and social gathering, known as Field

Day, to answer questions about and promote interest in vintage radio.

In The Know

But even members who can't get together in person can stay plugged in through the club's quarterly publication, the SCARS Gazette. The hardcopy Gazette brings, straight to members' mailboxes, articles of human interest, technical topics, and event recaps, as well as want ad, of course.

To keep members up-to-date in between those quarterly issues, SCARS also recently launched a newsletter, called "Signals," which is sent out electronically but can also be mailed in hardcopy upon request. The club's website (www.antiqueradios.org), accessible to anyone, also lists a calendar, announcements, and links to a forum and club contacts.

Into The Future

Building on the strength of its long and productive history, SCARS is marching purposely forward. Dagestino says that club



Club member Don Jensen gives a presentation on Crosley radio development at the SCARS April Corona meet and auction.



PHILOSOPHY

SCARS is a non-profit organization. Its purpose is to preserve the legacy of wireless communication by encouraging the acquisition, preservation and exhibition of antique radio apparatus and publications, training in radio history and development.

SCARS provides social contacts through meetings held at various locations throughout Southern California. Funneered at those meetings are contests, swap sessions, sales talks by members and guests on subjects of interest to collectors.



MEMBERSHIP APPLICATION

Name _____
 Address _____
 City _____ State _____ Zip _____
 Phone: _____ e-Mail: _____
 Amateur Call Sign (if applicable): _____
 Collecting Interest: _____

Please indicate if you would be willing to help with the following club activities:

- Meetings Meeting Sites Presentations
 SCARS Gazette Articles Membership
 Meeting Site Auctions Swap Meets
 Club/Event Promotions Other

Are you a member of other Radio related Clubs or organizations? If so, Please List _____

Signature: _____ Date: _____

Mail form and check to:

MATT STEINER
 24803 PITCAIRN WAY
 TORRANCE, CA 90505-6614

SOUTHERN CALIFORNIA ANTIQUE RADIO SOCIETY

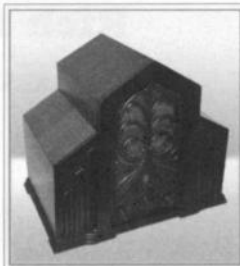

BE CURIOUS? JIM

Wonder what it would take to own, collect and restore antique radios? Like what you see, but just don't know where to begin?

SCARS - the Southern California Antique Radio Society, is an association of people just like you who enjoy the acquisition, preservation, and exhibition of these beautiful old radios. We have members with decades of experience who are ready and willing to share their knowledge with you. Join us as we explore the history and challenge of Antique Radios.



The attractive SCARS membership brochure helps spark interest in the club and makes signing up a breeze.



Jim Ryan admiring auction entry.

goals for the upcoming year and beyond include attracting new and younger members by instituting outreach programs in schools, creating tutorials and hands-on classes, and updating its website to provide even more useful information.

Plans are already underway, so keep an eye on this impressive group of like-minded people. Or, better yet, stop by at one of their gatherings and meet the club—their big November event is just around the corner.

Contact SCARS

Southern California Antique Radio Society (SCARS). Jim Garrett, 15621 Fox Hills St., Westminster, CA 92683. (714) 891-1689. wa6yos@juno.com. Pub: SCARS Gazette, quarterly. Dues: \$20. Website: www.antiqueradios.org

AT HOME WITH THE COLLECTOR

Rich Lee From New York's Hudson Valley Area

BY STAFF



At the work bench

This month, "At Home With The Collector" visits with Rich Lee, who lives in a wonderfully radio-filled home in the Hudson Valley area of New York. And it's not surprising since Rich has been collecting and restoring vintage radios, test equipment, communications receivers, and tube audio equipment since 1994.

Like many of us, his collection consists of all types of equipment. He has a great interest in the Art Deco period and many of his home furnishings, as well as his radios, reflect that era. Art Deco style, Machine Age and the

Industrial Designers of the 1930s—Vassos, Teague and Bel Geddes—have all contributed to his collection.

His serious collecting started during the six months he spent living in Philadelphia, Pennsylvania, frequenting the local flea markets and visiting the "ruins" of the Philco Manufacturing Co., located in Northwest Philadelphia at the junction of Tioga and Ontario Streets. During that time Rich saw an ad for an antique radio swap meet sponsored by the New Jersey Antique Radio Club. He was hooked!



The radio room

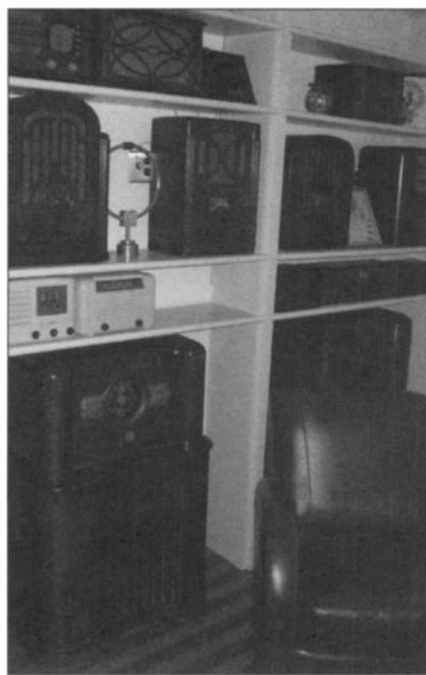

The "other" radio room

His collection complements his 1904 home. He has a room in the house known as the "radio room," decorated with pre-World War II radios. His basement "radio laboratory" is full of future projects in waiting. A tour of his garage, along with his vintage BMW motorcycle, led us to believe Rich will certainly be adding to his projects list. We suspect, as with all collectors, by Rich's third lifetime, his collection will be complete.

Rich is a recently retired electrical foreman with the International Brotherhood of Electrical Workers in New York City. He is president of the New Jersey Antique Radio Club (NJARC) and holds a membership in the Hudson Valley Antique Radio and Phonograph Society (HARPS), Delaware Valley Historical Radio Club (DVHRC), Antique Wireless Association (AWA), Greater New York Vintage Wireless Association, Connecticut Radio and Communications Club, and InFo Age.

Rich can be contacted by phone at 914-589-3751 or via email at president@njarc.org.



Supreme 189 signal generator

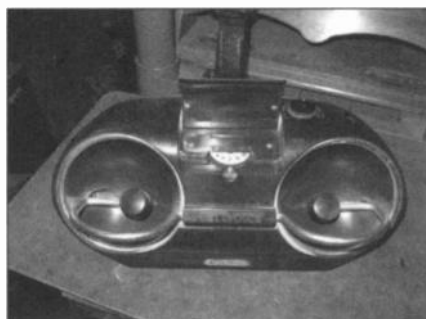

A Bell Voice transistor radio



Communications receivers



RCA advertising sign



A new method of tube storage



Battery set and wall decorations



Some table sets

A.R.C. BOOKSHELF

Lee de Forest—King of Radio, Television, and Film

by Mike Adams

BY STAFF

The life-long inventor Lee de Forest designed the three-element vacuum tube used between 1906 and 1916 as a detector, amplifier and oscillator of radio waves. Beginning in 1918 he began to develop a light valve, a device for writing and reading sound using light patterns. While he received many patents for his process, he was initially ignored by the film industry, to which his devices were ideally suited. To promote and demonstrate his process, de Forest made several hundred sound short films, renting space to show them, selling tickets, and publicizing them himself to gain an audiences for his invention. Lee de Forest officially brought sound to film in 1919.

Lee De Forest: King of Radio, Television, and Film is about both invention and early film making, examining de Forest's role as scientist as well as producer, director, and writer of the content. This book tells the story of de Forest's contribution in changing the history of film through the incorporation of sound. The text includes primary source historical material, U.S. patents and richly illustrated photos of de Forest's experiments. Readers will greatly benefit from an understanding of the transition from silent to audio motion pictures, the impact this had on the scientific community and the popular culture, and on the economics of the entertainment industry.

The book presents a broad and sweeping perspective on the inventing process and the life of de Forest. From his college days' fascination with the "speaking flame" and its application in physics and electricity, de Forest not only invented technology for the entertainment media but he also created its content and amassed its consumers. What becomes evident in this story is how the invention process really happens, how each new device builds on those prior to it, and how patents

are developed, granted and then challenged in a number of increasingly higher courts, where they are upheld or overturned as invalid by judges who may or may not fully understand the technology upon which they are ruling.

Lee de Forest, Yale doctorate and Oscar winner, gave voice to the radio and the motion picture. Yet by the 1930s, after the radio and the Talkies were regular features of American life, de Forest had seemingly lost everything. Why didn't he receive the recognition and acclaim he sought his entire life until years later, when in 1959, he was awarded an Oscar? Perhaps that's too big a question to answer with certainty, but reading *Lee de Forest, King of Radio, Television, and Film* gives a fascinating glimpse into the early role this brilliant man played in developing the mass entertainment media we enjoy today.

Springer Science & Business Media; Paperback, 501 pages, \$27.95; Expected Release Date: October 31, 2011. Pre-publication orders taken on the ARC website or by phone at 877-371-0512.

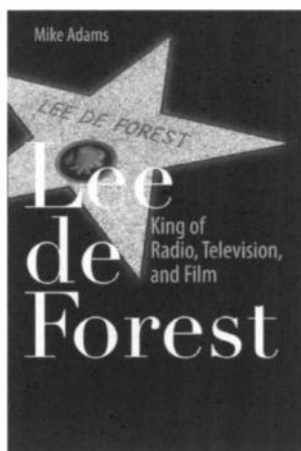

RESTORATION REPORT

Restoring A Western Electric 540-AW Speaker

BY JON KUMMER

Western Electric

No. 540-AW

LOUD SPEAKING TELEPHONE

A number of years before radio telephony had become a subject of interest to millions of people, the scientists of the laboratories of the American Telephone and Telegraph Company and the Western Electric Company had produced a loud speaking telephone of the horn type which gained an excellent reputation in certain applications to wire telephony.



THE No. 540-AW LOUD SPEAKING TELEPHONE

However, this type of loud speaking telephone has its limitations, in that a horn that would reproduce accurately the full range of the musical scale, particularly the low notes, would be too large for ordinary use. Scientific research into this problem has led to further developments and the Western Electric Company is now in a position to offer the No. 540-AW Loud Speaking Telephone which eliminates the use of a horn and gives a true reproduction of speech and music.

Western Electric
No. 540-AW
LOUD SPEAKING TELEPHONE

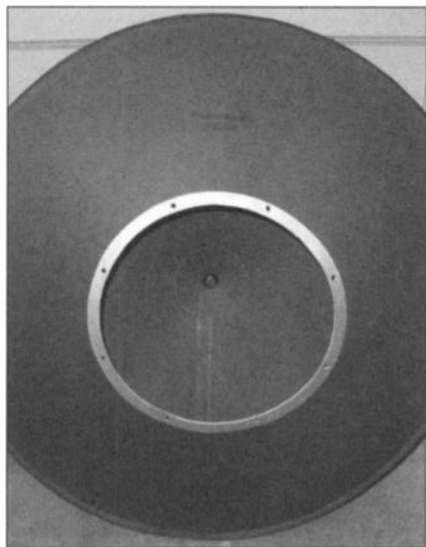

New speaker cone rear view

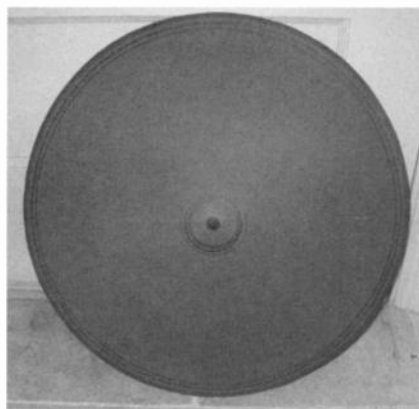

New speaker cone front view

I recently purchased a Western Electric model 540-AW cone speaker. As shown in the photos, both the cone and dust cover needed replacement.

The speaker was manufactured by Western Electric circa 1923–1924. It was named in Western Electric literature as the “Loud Speaking Telephone.” The speaker is 18 inches in diameter and sat on a metal base. Though it is light weight, there is a carrying handle on the back.

During this same period Western Electric made similar speakers, such as the model 560-AW with a 24-inch cone (one model with a metal base and one model for hanging on the wall), the 548-AW with a 36 inch cone, the 548-DW with a swivel wall bracket, and the 548-CW with a three-point wall bracket.¹

The Restoration

I found the parts needed from Buford and Jane Chidester. They sell a kit consisting of a cone, dust cover, and full instructions.²

First, I removed the driver access plate from the back of the speaker. It's fastened by five screws. The silk dust cover in my speaker was in poor shape, but if the cover in your speaker is good you can reuse it. I then removed the remains of the silk dust cover with a wire brush and glued the new silk cover to the wire mesh. The excess silk was cut off.

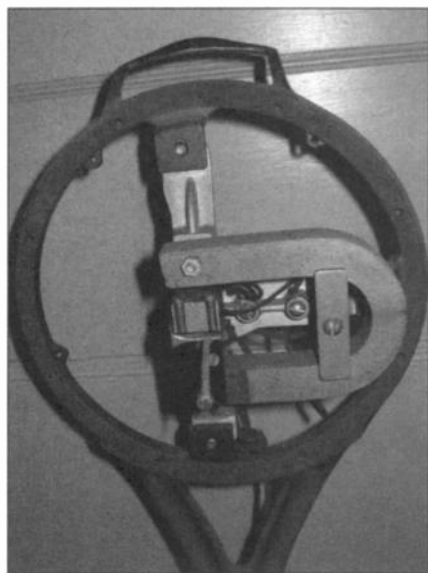

Driver and base with cone removed

To remove the cone you loosen the driver pin retaining screw and unscrew the eight retaining screws and the cone will come off. You should check the existing driver pin to make sure it's in good condition and is the correct length. You might have to replace the driver pin. Then install the new cone with the eight retaining screws and the driver pin retaining screw.

There are three screws securing the driver to the base. The driver may have to be aligned by loosening the three screws.

Finally, reinstall the driver access plate with the new silk dust cover using the three screws.

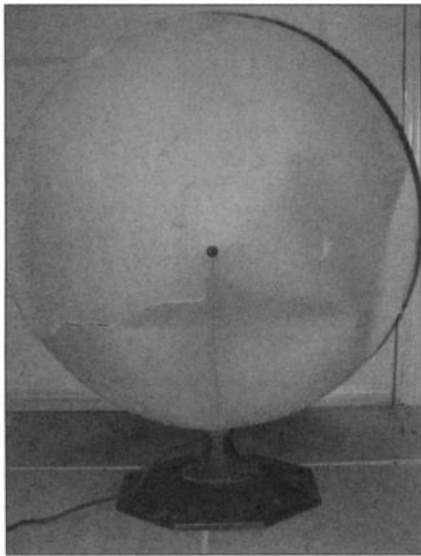

Speaker front prior to restoration

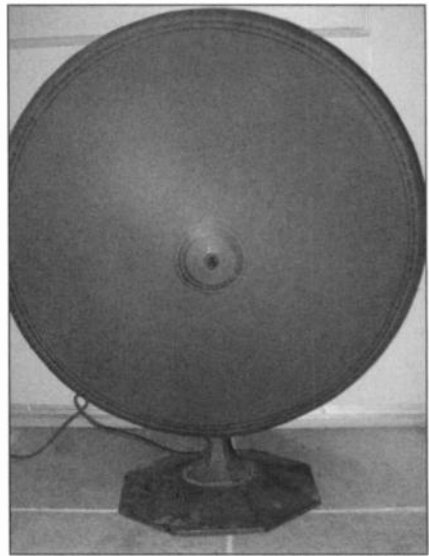

Speaker front after restoration



Speaker rear prior to restoration

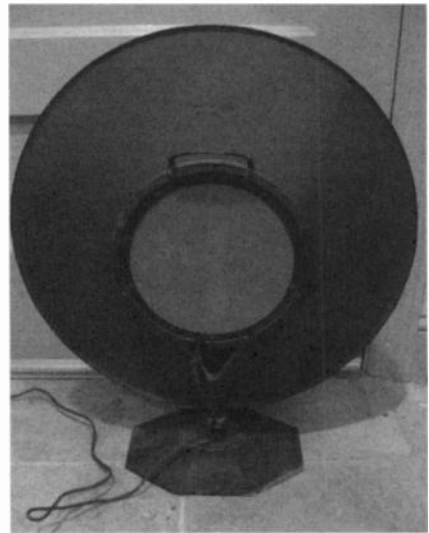

Speaker rear after restoration

Results

The entire restoration took less than an hour, except for the time required for the glue to dry. The speaker works fine and looks just like new. If you find one of these golden oldies at a swap meet or antique store, don't be scared off by a poor condition. This was an easy fix that made for an fun afternoon.

Footnotes

1. See the book *Classic Cones* by Buford and Jane Chidester.
2. Buford and Jane Chidester, 785 Locust St., Mount Wolf, PA 17347; (717) 266-4450; www.angelfire.com/pa/conespeaker.

DO YOU KNOW YOUR A.R.C. SUBSCRIBER BENEFITS?

Since becoming publisher I've asked many of our subscribers about the benefits that come with a subscription to *Antique Radio Classified*.

These have included both our print subscribers as well as our online edition subscribers. The only difference between the print and online subscribers is that the online subscribers pay a reduced subscription rate and don't receive the print magazine.

Many of the people I spoke with didn't know about our subscription benefits.

Let's take a look at them:

ABILITY TO LOOK AT THE MAGAZINE ONLINE

As a print or online subscriber you can look at the latest issue of the magazine online on our web site. This is the entire issue of the magazine and not an abbreviated edition. Subscribers can look at the last four issues of the magazine. Non-subscribers can look at earlier editions of the magazine at no cost.

One advantage of the online edition is that any photograph sent to us in color is posted in color!

ABILITY TO LOOK AT PAST AUCTION RESULTS

Almost every month we publish auction results in the magazine. Did you know that we have a database of the auction prices online on our web

site? Subscribers can look at the auction results and they are SEARCHABLE! If you want to see if a specific radio, piece of equipment, tube, magazine, etc. that has been sold, all you have to do is enter the item and see every time the item has been sold as well as the price, auction house, and date!

ABILITY TO LOOK AT ONLY THE CLASSIFIED ADS

Subscribers can also look only at the classified ads without downloading the entire magazine. This is very useful for readers who just want to read the classified ads. Readers with dial up Internet service will save a lot of downloading time.

FREE MONTHLY CLASSIFIED AD

Each month a paid subscriber is entitled to place a free classified ad in the magazine. The classified ad can be up to 50 words. Additional words are 10 cents each. Classified ads can be submitted by email, fax, or mail. Typewritten preferred to reduce possible errors. Name, address and telephone number count as 6 words. Full name and address are required in all classified ads.

Of course the most important benefit to the subscribers of *Antique Radio Classified* are the articles containing information that will help you in increasing your knowledge of our hobby.

HOW DO I ACCESS THESE BENEFITS?

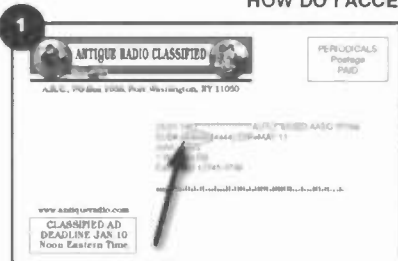

Your print subscriber user ID and password are on your mailing label. Online subscribers are emailed their user ID and password. Your user ID is the number after "SUB#" on your mailing label. Your password is the digits in brackets [xxx] after your "SUB#".

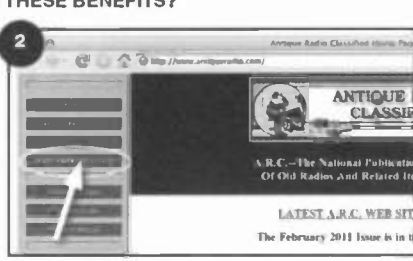

Go to A.R.C.'s home page www.antiqueradio.com and click on *Subscriber Only Page*.

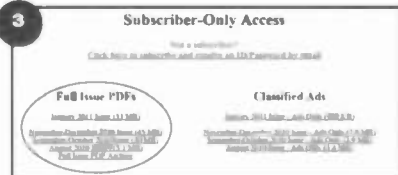

On the *Subscriber-Only Access* page you can click on the *Full Issue* you would like to view or click on the *Classified Ads* section from that issue.

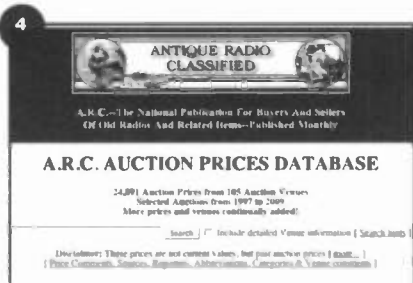

Or you can click on the *Auction Prices Data Base*. Just enter the item that you are researching.



PHOTO REVIEW



This column presents in pictorial form many of the more unusual radios, speakers, tubes, advertising, and other old radio-related items from our readers' collections. The photos are meant to help increase awareness of what's available in the radio collecting hobby. Send in any size photos from your collection. Photos must be sharp in detail, contain a single item, and preferably have a light-colored background. A short, descriptive paragraph **MUST** be included with each photo. Please note that receipt of photos is not acknowledged, publishing is not guaranteed, and photos are not returned.



Belmont model 6D111—This 6 tube radio was manufactured in 1946. Streamline shape with 6 pushbuttons. Ralph Brandes, Framingham, MA.

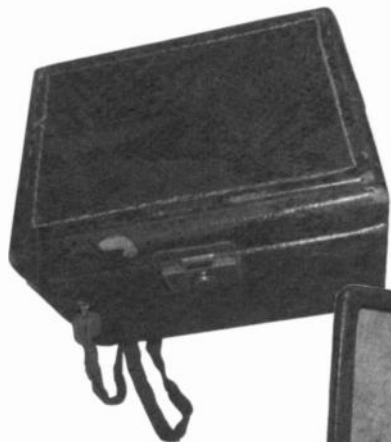

Jewel Portable Radio—Model number unknown. Made during late 1940s. Two knobs. Alligator-like covering. Cindie Morris, Indianapolis, IN



PHOTO REVIEW

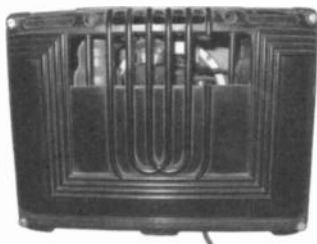

Emerson model BA199—Bakelite radio made in 1938. Comes with Bakelite back cover, 4 tubes, AC/DC. Alfred Dove, Sioux City, IA.



Zenith model 4F133—This is a 6 volt farm set. Receives the AM band. Manufactured in the late 1930s. Sue Artiste, Bayville, NY.

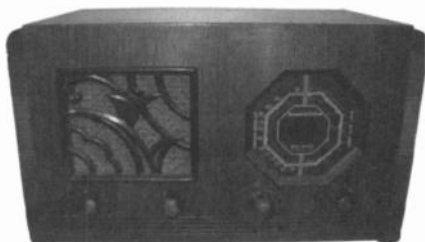

Stromberg Carlson model 225H—Octagonal dial radio covering the AM band. Made in 1937 with 6 tubes. Artie Schwartz, Phoenix, AZ



PHOTO REVIEW



Philco model 42-340T—Two tone wood table radio that covers AM and shortwave bands. Made in 1942 with 7 tubes. Dan Santos, Carlisle, PA

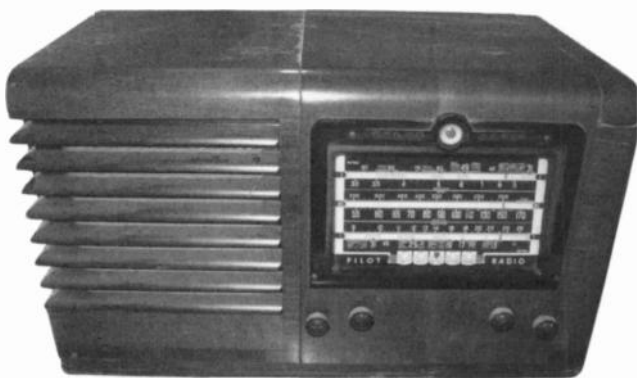
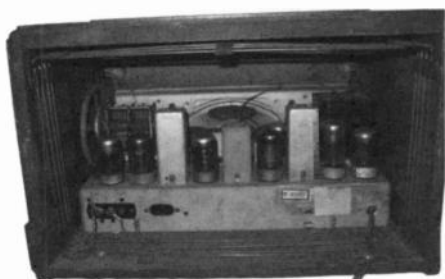

Pilot model 173—Manufactured in 1941. Large table top radio that covers 3 bands – AM and 2 short wave. John Hewlett, Little Rock, AR.



PHOTO REVIEW



Sentinel model 238-V—This is a rare radio that looks like a three-volume set of books. Made in 1941 and covers the AM band. Arnold West, Bellevue, WA



Bush Portable Radio—Model number unknown. This is an English transistor radio that works on a PP9 9 volt battery. Covers medium and longwave bands. Irwin Strongwater, Houston, TX



CLASSIFIED ADVERTISEMENTS



FOR SALE: 500 electronics and antique items, radios, telephones, magazines, books, tubes leica rare 1950 model. John Engl Sr., 5425 Tart Cherry Ln., Egg Harbor, WI 54209. (920) 743-3672. Call between 2pm & 9pm CST.

FOR SALE: FSOT, CMPD, FOR SALE OR TRADE, CONSIDER MERE PAPER DOLLARS!: Collins 75A1, nice, working; Collins 32V, nice, working; Collins 32V3, good, needs work; Four BC 348's, one with AC internal, one needs AC external, both working, two more untested; Western Electric GF12 transmitter, four coils, w/ Dynamotor, nice; RU17, six coils, remote, may be NOS--excellent!; Two BC 654, one working, w/ PE 103, 104, and nice spare; DU2, nice, working; Neat 18" copper/bronze marine RDF loop, \$45.00; T195, very nice; Sprague TO-4, nice, working, bright eye, \$75.00; Motorola 5A1 "cube", 1947 portable, nice and working, \$45.00; Drake TR7/PS7, both very nice, w/manual, working; BC 669 transceiver, w/power supply, nice, working; Two Aussie version HRO's, made by AWA, one power supply, one complete set of coil sets in coil box; Nice GRC 9 w/DY88, runs on 6/12 or 24 volts and cables; Drake R4C, excellent, w/all three crystal filters, also nice T4XC, AC4, MS 4; 16 mm Ezy thread sound projector, nice, working; Large RCA tube poster, orange sawtooth deco design, late 20's, newest tubes 226, 227, all the rest four prong; RCA atom clock from 50's, excellent, works. **ALWAYS BUYING:** Interesting early wire and tape recorders, disc cutters, broadcast and recording mics, tube pre-amps, compressors, early hi-fi. Cash or trade for any of above. Prefer pick-up on heavy items, but can ship. Ward Kremer K14JHA, 57262 Poppy Rd., South Bend, IN 46619. (574) 204-2877. E-mail: witzend99@comcast.net. Website: <http://www.radioattic.com/kremer>.

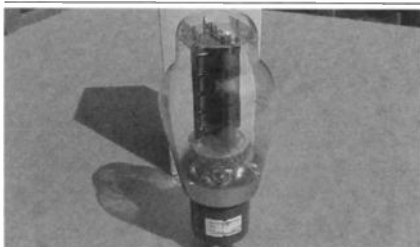

FOR SALE: Type 300-B tube. (China Mfg.), New in box. (75.00. Dave Crocker, 35 Santuit Pond Rd., #4B, Mashpee, Cape Cod, MA 02649. Tel. (508) 477-1578, before 9 p.m. please. Thanx.

the Radio Attic

**Ready to try the internet
for selling your old radios?**

The Radio Attic will display your antique radio ads, with photos, to a worldwide audience for one low fee until they sell.

Got test equipment, parts, or incomplete radios? Old Radio Classified has photo ads for these items.

ARC sellers, get a discount off the fees for your first group of ads!

Contact Steve Adams at
steve@radioattic.com
for more information

or visit
<http://radioattic.com>

<http://oldradioclassified.com>

FOR SALE: Simpson model 312 VTVM \$25; Hickok model 470 VTVM \$25. Good condition with test leads. Joe Whisnant, 1233 Newcastle Way, Maryville, TN 37803. (865) 977-9024.

FOR SALE: Grommes 510 receiver \$120; Grommes 512 receiver \$50; Bendix 626-A \$40; Dewald L-803 tuner \$35; Philco 40-120 wood \$25; Freshman Equaphase G1 \$40; Audiomatic turntable P-702 \$30; RCA RP-190-1, K274, 203 45 RPM \$25; Automatic CL-152 clock radio \$30; Grommers S-20 precision amplifier \$100; Knight tuner 8 tubes \$20. Paul Lisowski, 5603 E. 100 N., Knox, IN 46534. (574) 772-2021.

FOR SALE: 1934 Motorola S-10 Lazy Boy in Oriental cabinet. Remote with Tune-a-Light tube. Both radio and remote all original and working. Includes original 1934 Radio News full page article. Pictures available. \$500 plus shipping USA only. Richard Arnold P.O. Box 275, Lone Grove, OK 73443. (580) 657-3319. E-mail: Arnold@brightok.net.



WANTED: RCA 5T4 wood-case table radio and Philmore 1001C kit set. Contact me for e-mail picture if desired for identification. 5T4 was an export unit sold mainly in Europe before WWII. Dave Smith, k9uim, Box 81, Olney, ILL. 62450 618-843-6601 or k9uim@frontier.com.

WANTED: Old microphones, no CB or ham. Send photo and price to: Tom Keeton, 684 W. Crestline Ave., Littleton, CO 80120. (303) 797-8073.

WANTED: Motorola 68LIU pristine grey on/off volume knob, schematic, 1 to 4 power (AC) cords, any swivel handle Motorola cord OK. GE 7-2880B schematic, Tonemaster TM735 schematic. Larry Lamia, 2610 Ouachita Cir., Mena, AR 71953. (479) 394-3509.

WANTED: Data roll chart for Hickok tube tester # 533A and one wooden roller--will consider buying junker 533A to recover chart. I have a data roll chart for a 532-533-533DM-534-534A-534B-600 tube tester--dated 3/1/59--price TBD. Bryan Hodgson, 11 Fox Trot Ct., Sicklerville, NJ 08081. (609) 567-6248. E-mail: bhodgson1@comcast.net.

WANTED: Kodak Crystal set as well as others. Also looking for a timbertone horn and good brass base 01a, 200. Greg Michaels, 1285 South Rd., Scottsville, NY 14546. (585) 538-9341.

WANTED: Stoddard Aircraft Radio Company AN/PRM-1A OR NM-20A power supply (PP-472B or equivalent). Dean Gagnon, 965 Lake Rd., Milton, VT 05468. (802) 893-6692. E-mail: dean.gagnon@juno.com

WANTED: Climax "Ruby" radio and Trav-ler model 442 "Oval" radio. Joseph DiCaro 4155 Last-rada Hts., Mississauga, Ontario, Canada, L5C-3V1. (905) 848-7759. Email : decoradio@primus.ca

WANTED: A OSCILLATOR COIL FOR A GRUN-OW 450 OR A VINTAGE NOS SUBSTITUTE PART. Roger Fethkenher, 2410 Clay Ave., Spring-field, MO 65807. E-mail: roger647@gmail.com

WANTED: Kenwood TS-830S. Carter Elliott, 1460 Pinedale Rd. Charlottesville, VA 22901. (434) 566-8767. E-mail: celliott14@aol.com

WANTED: Airline 62-101 chassis & Spkr, Silver-tone 4464 chassis & spkr, Silvertone 4792 dial bezel & insert, Zenith 12S265 outer dial ring w/seconds. Breting 14 cover. Keith Park, 31 Barkwood Ln., Clifton Park, NY 12065. (518) 373-0417. E-mail: toptonch@nycap.rr.com

audioXpress

The Audio Technology Authority

Subscribe to
12 Great Issues of
Hands-on Audio...

BUILDING RESTORING MODIFYING

From vintage tubes to classic speaker designs and cutting-edge uses of today's technologies...find all of this and more in the pages of each monthly issue of *audioXpress*.

SUBSCRIBE TODAY!
Only \$50 for 12 monthly issues

To subscribe call 860-875-2199
or order online at
www.audioXpress.com



audioXpress

4 Park Street, Vernon, CT 06066 USA
P 860-875-2199 F 860-871-0411
email: custserv@audioXpress.com
www.audioXpress.com

CQ Amateur Radio



CQ is devoted entirely to the things that Hams care about. It's a fine blend of technical ideas and projects, news and reviews of new Ham products and operating information, written and edited by a group of people who are absolutely crazy about this hobby!

SUBSCRIBE TODAY!

	USA	VE/XE	FN
1 yr	\$36.95	\$ 49.95	\$ 61.95
2 yrs	\$66.95	\$ 92.95	\$116.95
3 yrs	\$96.95	\$135.95	\$171.95

Monthly issues include:

- * Hamfest/Special Event Listings
- * Hobby News
- * New Product Info/Reviews
- * Kit-Building & Projects
- * CQ WW Contests Info/Results and much, much more!

CQ Amateur Radio

25 Newbridge Rd, Hicksville, NY 11801

Phone 516-681-2922

www.cq-amateur-radio.com

FOR SALE: Scott in Wellington cabinet 7 knobs slide rule dial 2 eye tubes \$250; Scott 10 tube chassis & power supply 12" speaker w/ Scott musical resonator board has 7" round dial \$150; Grunow 500 T.S. chrome grille like new; Majestic model 461 T.S. chrome grille like new; Motorola T.S. like new working; RCA model 5T completely re-conditioned works great w/ guarantee \$250; Silvertone T.S. beautiful walnut cabinet; Hallicrafters Sky Champion shortwave communication receiver beautiful working; Hallicrafters S85 communication receiver working excellent; Musicaire 6 tube T.S. cherry wood cabinet airplane dial shortwave broadcast looks like new; Philco 38-10 label radio wood nice condition; Crosley model 48 book radio beautiful; Allied, Lafayette catalogs form 1920s to 1960s; many Radio Retailing, Radio Today magazines showing pictures of radios; many tubes - 2A3, 6L6, 45, 80, 01A, 71A, etc. very reasonable. See my ad from last month in A.R.C. Bill Kalcik, Meadowbrook Resort, 1533 River Rd., Wisconsin Dells, WI 53965. (608) 253-9855.

FOR SALE: Magazines \$1.00 each plus s/h. Antique Radio Classified, Electronics News, Electronic Servicing & Technology, Electronic Servicing, Electronic Technician & Dealer, Nuts & Volts, PR Photofact Index, PF Reporters, Poptronics, Popular Electronics, Radio & TV News, Radio TV Service & Dealer, 1969 Electronic Installation & Servicing, 1970 Electronic Installation & Servicing, Consumers Digest, Consumers Reports, Home Mechanics, Mechanics Illustrated, This Old House, Modern Electronics, Money, schematics, books, good used CRTs, yokes, horizontal output transformers, tubes pots, sockets, plugs, resistors, capacitors, motors, switches. Angelo J. Milardo, 201 English St., New Haven, CT 06513. (203) 624-1015.

FOR SALE: New in box at \$3 each: 1V4, 1V5, 1T4, 1R5, 1H5, 1N5, 6BA6, 6BE6, 6AT6, 6AV6, 6AU6, 12BA6, 12BE6, 12AV6, 12AT6, 12AV6, 12SA7, 12SK7, 12SQ7, 6SA5, 6SK7, 6SQ7, 25L6, 25Z5, and 25Z6. The following are new in box at \$5 each: 3Q4, 3S4, 3V4, 3Q5, 35W4, 35C5, 50C5, 35L6, 50L6. The following are used and test good: 80 \$8, 71A \$15, 6BQ5 \$8; 12AX7, 12AT7, 12AU7 \$2, 6SN7GT \$6, 6V6GT \$7, 271A \$30. Add \$5 for shipping or prepaid for orders over \$50. Call for more tubes. James Lopaz, 5467 S. 975 East #1, Ogden, UT 84405. (602) 373-4002.

FOR SALE: Triplett tube tester transformer T-23C-72 NIB \$16; Hallicrafters S39E repaired, good cabinet \$72. Ye Olde Radio Shoppe, 228 Beck Rd., Avon Lake, OH 44012. (440) 933-5668. Fax (440) 933-8864. E-mail: yeolderadioshippe@oh.rr.com.

FOR SALE: Huge Quantity, Tubes, Picture Tubes, Needles, Parts, Data, Radios, Phonographs, Televisions, Test Equipment. Sales support our self-funded museum. Ray Seppeler, Sunshine Radio Museum, 8 East Main St., Sodus, NY 14551. (315) 483-8451. Web www.sunshineradiomuseum.org/collector.



WANTED: (Photo above) RCA 143 tombstone. Mark Murphy, 931 Village Blvd., Ste. 905-381, West Palm Beach, FL 33409. (561) 801-1478 Email: markmmurphy@att.net.

WANTED: Do you have so many vacuum tubes you don't know what to do with them? Before you trash those tubes call me and I will try to find a home for them. Jeff Arndt, 4021 S. Parker Way, De Pere, WI 54115. (920) 323-6789.

WANTED: Output transformer for a late 40s Westinghouse console. 260 ohm center tapped with 6Y6 P-P tubes. Also, looking for a RCA Victor R28P chassis. Brad Winder, Box 160, Hay Lakes, Alberta, Canada T0B 1W0. (780) 878-2363. E-mail: rubcad58@hotmail.com.

WANTED: LOOKING TO BUY SHORTWAVE/HAM/CB RADIO COLLECTIONS. ANY CONDITION IN NY TRI STATE AREA. CASH PAID ASAP. Juan Remus KC2ZTE, 2 Springbriar Ln., Kings Park, NY 11754. (631) 697-5850. E-mail: stocpro47@yahoo.com

WANTED: Stereo/Hifi/Commercial Tube Gear, Amps/Speakers/Parts/etc., Guitars, Guitar amps/Pedals/Parts, Tube Testers and Audio Tubes. Sonny Goldson, 520 Pocahontas Dr., Fort Walton Beach, FL 32547. (850) 314-0321. E-mail: sonnysound@aol.com.

ANTIQUE ELECTRONIC SUPPLY

**NOS TUBES • RADIO BOOKS
CAPACITORS • GRILL CLOTH
AND MUCH MORE!**

tubesandmore.com • 480.820.5411

WANTED

**FISHER RADIO/PHONO CONSOLE
SERVICE MANUALS
OWNERS MANUALS
ADVERTISING MATERIALS**

1945 THROUGH 1972

Contact: Jon Kummer
ANTIQUERADIO CLASSIFIED
Web: www.antiquradio.com
Email: arc@antiquradio.com
Tel: (866) 371-0512

RADIO DAZE VINTAGE RADIO & ELECTRONICS

- Professional Repair Services: Classic Radios, Communications Receivers, Antique Automobile Radios, Vintage Audio Gear, Jukeboxes, Cabinet Refinishing
- Books • Capacitors Of All Kinds • Chassis-Aluminum/Steel
- Chokes • Cloth-Covered Solid/Stranded Wire • Decals • Dial Belts & Cord
- Dial Lamps & Sockets • Diodes • Enclosures • Fuses & Fuseholders
- Grillecloth • Hardware • Kits • Knobs • Potentiometers • Power Cord
- Power Plugs • Refinishing Supplies • Reproduction Dial Scales
- Resistors Of All Kinds • Service Supplies • Sockets • Soldering Items
- Speakers • Switches • Technical Data • Terminal Strips • Tools
- Transformers - Classic Audio, Power, Filament, Isolation, etc.

Radio Daze, LLC • 20 Assembly Drive, Suite 103 • Mendon, New York USA 14506
Inquiries: 585-624-1099 • e-mail: info@radiodaze.com • Web: www.radiodaze.com
U.S. Orders Toll-Free: Phone 877-OLDTUBE (877-653-8823) Fax 800-456-6494



FOR SALE: World Radio (Boston), dealer display. It is not a door stop! This cast metal display piece was issued to advertise the "World Radio" battery sets they were marketing in the 20's. "World Radio" is cast into the front of the base. It is about the size of the Atwater Kent ones used on the dealer's display cases. This one still has some gold plating on the sails. \$42. Dave Crocker, 35 Santuit Pond Rd., #4B, Mashpee, Cape Cod, MA 02649. Tel. (508) 477-1578, before 9 p.m. EST, please. Thanx.

FOR SALE: Nice hi-tube consoles; Midwest Eighteen, Emerson Fifteen, RCA Fifteen, Stromberg-Carlson Fifteen, Silvertone Fourteen, Zenith 9S262, 9S367 & 7S258 shuttentials, also 8S463's, 10S464's, & 10S567, 10S669 plus Belmont Oval Dial, Grunow Egg, Motorola Fliplid, Westinghouse Rising Sun, & many others. WANTED: Airite/Kadette Deskset and/or pen & clock. C.R. Nevins Museum of Radio, Ken Nevins, 406 Jipson St., Blissfield, MI 49228. (517) 486-3019 evenings. E-mail: <mailto:ken@kennevins.com> ken@kennevins.com

FOR SALE: Cartridge kits replace obsolete cartridges for RCA 45 players, Magnavox and others! Custom molded chassis mounting cones for RCA and V-M 45 players. Phono and tape recorder wheels, belts. Phono needles, cartridges, 45 adapters, centerposts for most brands. AC cords with plugs for record changers! Gary Stork, 47530 E. Meadowhill, Northville, MI 48167. (248) 478-0990. Visit www.thevoiceofmusic.com or email info@the-voiceofmusic.com.

FOR SALE: Original Heath manuals for all Heath-kits 1948-1991; All Riders Radio Manuals; Allied, Lafayette, Heathkit and other catalogs; all RCA tube and transistor manuals; all Popular Electronics, Electronics Illustrated, Radio-Electronics, Radio-Craft issues. WANTED: August 2001, July 2003 "73" Magazine; RadioShack Catalogs 1954, 1972, 1973. A.J. Bernard, P.O. Box 690098, Orlando, FL 32869. (407) 351-5536. E-mail: NI4Q@juno.com.

FOR SALE: Airline DC-6 battery set, Kennedy 66B chassis, AK 55C chassis, GE model 250 floptop with wet cell, Philco 42-355, Record players for: Spartan model 7-46, for Magnavox model 43 (CR-151, CPAR389), Girrard Model RC-80M. John Zima, 1360 Reed Rd., Churchville, NY 14428. (585) 293-3023.

FOR SALE: DeVry Institute Of Technology/Bell and Howell Schools*****4 books(9" x11" color blue)--describing oscilloscope operation*****4 books (9" x11" color brown)--describing construction of transistorized multimeter (includes multimeter(Incomplete))*****1 volume (9"x11"-brown) describing the DeVry Design Console-manual #9009A(includes Console).The following receivers:-Hammarlund BC-794-B(40 mhz)with power supply RA-74-C///Lafayette HA-52(FM)/// Part of RAK-7(15khz to 600khz) with home built power supply///Halicrafters S-27/// Harvey-Wells ATR-13///RCA Service Data--stack 17 inches tall--all 50's stuff-TV,radio,phonos,projectors--weight is 52 lbs///information please on a Radio Allocchio Bacchini /// I have tube testers(12)/// oscilloscopes(6)///Loewe-Opta Stereo Hi-Fi console(blond)///Battery Burgess #G6B60///CB Radio-4 vols 1970-1975///catalogs--HP T&M 1995--Radio Shack 1993/// Pictogram radio loudspeaker - base is in pieces, but transducer and horn (black) are in good shape \$40 plus s/h; 7 text books in Dutch - good shape \$30 plus s/h; 3 text books in German - poor condition but readable - 4" x 6" - one is from 1906 \$15 plus s/h; Proceeding of the IRE - 1924 through 1937 bound \$30 plus s/h; Reel-to-Reel: VOM (2), Pentron (2), RCA (1), state wants/// all items plus shipping(some items pickup only)located in Winslow in southern NJ. Bryan Hodgson, 11 Fox Trot Ct., Sicklerville, NJ 08081. (609) 567-6248. E-mail: bhodgson1@comcast.net.

Philco knobs, pushbuttons, and escutcheons!

1941 models 41-250, 255, 256, 280, 285, 287, 290, 296, and 610

1942 models 42-355, 355T, 380, 380X, 390, and 390X

For 1940 models:
 Translucent wine red pushbuttons, set of eight \$16.
For 1941 models: Escutcheon \$29.95, Knobs, set of four \$20, Pushbuttons, set of eight \$16 opaque brown. **For 1942 models:** Escutcheon with gold trim as per original \$32.95. Knobs, set of four \$20, Pushbuttons, set of nine \$31.50.
 Money order gets immediate shipment. Add \$5 s&h. California residents add 9.75% sales tax.



OLD TIME REPLICATIONS, 5744 Tobias Ave. Sherman Oaks, CA 91411. Phone 818-786-2500. Email olddimerep@aol.com. www.antiqueradioknobs.com

SERVICES: Repairs to vintage tube equipment including home receivers, phonographs, and auto radios. South Bay Radio, 7187 Lakeshore Rd., Cicero, NY 13039. (315) 699-7341.

SERVICES: All American table radio restoration specials: 5-tube \$49.99; 6-tube \$59.99. Other flat rate restorations for larger radios, car radios & TVs. Send E-mail, write, call, or visit my web sites for details. Dave's Antique Radio and TV Restorations, PO Box 285, Liverpool, NY 13088. E-mail: dave2@dreamscape.com or dave2@tubesandtransistorsandmore.com. Web sites: www.dreamscape.com/dave2/daves.htm or www.tubesandtransistorsandmore.com. (315) 944-0265.

SERVICES: Logan's TV & Radio Repair. Logan's has over 3,000 rare radio tubes for sale. We also repair old radios, through our repair and ship service. Please contact: George for further details at Logan's, Rear 526 Mt. Pleasant St., Greensburg, PA 15601. (724) 826-2163.

SERVICES: Since 1987 Sound Remedy has specialized in reconing vintage loudspeakers used in antique radios, automobiles, jukeboxes and musical instruments as well as stereo and high-power Pro speakers. Our repair work is meticulous and guaranteed. Contact Sound Remedy, 331 Virginia Ave, Collingswood, NJ 08108. (856) 869-0238. E-mail: soundremedy@aol.com.

SERVICES: Antique Radio of Iowa & vintage furniture restorations. All bands electronic chassis repair. Sorry, no foreign units or conversions. Speaker service wood & veneer cabinet restoration. Plasti/bakelite repair and painting. Vintage auto radio repair. Tybe hybrid, all transistor, 8 track, 1930s to 1960s. Check out my eBay Store: iowastuff46. PayPal and cashiers check welcome. 7 days a week. Don Nordboe, 3131 Avenue A, Council Bluffs, IA 51501. (712) 322-2255. E-mail: dnordboe@aol.com. Web: www.antiqueradioiowa.com

SERVICES: Repair of old radio, car radio, audio, stereo. Free estimate, reasonable cost. #1 Google "Vintage Hi-Fi repair". Mike Urban, 37 Elm St., Windsor, CT 06095. (203) 877-2409. Web: www.urban-antique-radio.com

SERVICES: Utah Reconing your full service speaker reconing and repair shop. Fast turn around specializing in antique radio speakers as well as a full service reconer. 22 years experience, reasonable prices, quick turn around. Matt Shelton, Utah Reconing, 7120 Camelot Way, West Jordan, UT 84084. (801) 694-0166. E-mail: redmatt2@juno.com.

SERVICES: Northern Arizona sales, service, and parts for tube radios, amplifiers, auto radios. Vintage Radio, 440 W. Palomino Dr., Chino Valley, AZ 86323 next to our Radio Shack store. (928) 636-5140. E-mail: info@azvintageradio.com. www.azvintageradio.com.

SERVICES: Radio repairs for the Rocky Mtn. Region. Also some radio instrument repairs. Only tube type radios and instruments. For Sale: Selection of refurbished radio and TV repair instruments including RCA, EICO, Heathkit, PACO, & etc. Rates and prices very reasonable. David Boyle, 1058 Colt Cir., Castle Rock, CO 80109. E-mail: djboylesr@msn.com.

Join the **AWA** ANTIQUE WIRELESS ASSOCIATION

THE ORIGINAL AND LARGEST HISTORICAL RADIO-COLLECTOR GROUP

- Publishes *AWA Journal* with:
 - Battery and AC receiver restoration
 - Vacuum-tube history and collecting
 - Old-time amateur-radio contests
 - Communications receivers
 - Free want-sell-swap ads
 - Early television
 - Horn loudspeakers
 - Reviews of current books
 - Keys and land-line telegraphy
 - News of U. S. and foreign clubs
 - Information on public radio museums.
- Maintains unique radio-TV museum.
- Produces the annual Rochester meet.
- Co sponsors local meets.
- Publishes the annual *AWA Review*.



Membership is only \$25 per year U.S.A. (\$30 per year elsewhere). Write to:

AWA Membership Director
PO Box 421, Bloomfield, NY 14469-0421
www.antiquewireless.org

ELECTRIC RADIO



Are you tired of plastic modern radios that you can't work on and are hard to understand? Are you looking for information on restoration of quality vintage receivers and transmitters? **Electric Radio** is the magazine for you! In print since May, 1989, we also have the largest vintage-only Ham classified section available. Please send \$1 for a sample copy to:
ER, PO Box 242, Bailey CO, 80421
720-924-0171 email: 1editor2@indra.com
WWW.ERMAG.COM



A.G. Tannenbaum

Electronic Service Data

2043 Empire Central
Dallas, Texas 75235
Phone 214-654-0033

STILL THE



FOR

*Service Data - 1920's - Present
Newly Expanded Library*

*Now selling tubes, equipment,
test equipment and much more!*

Browse our expanded web offerings at
<http://www.agtannenbaum.com>

The A.R.C. Book Store has over 55 books...

...on vintage and antique radios, radio manufacturers, tube audio, restoration, tube manuals, speakers, phonographs, crystal sets, ham products, telegraph keys, tube testers, military radio gear, and radio history.

Visit us today on the Web at www.antiqueradio.com and click on the "Marketplace" button.

Visit the A.R.C. Web Site!

The URL to access the A.R.C. Web site is:
www.antiqueradio.com

While visiting our site, you may send e-mail and orders for books, videos and subscriptions.

Let us know what you think about A.R.C. on the Web!

BOB'S ANTIQUE RADIOS & ELECTRONICS

SERVING THE VINTAGE RADIO COMMUNITY WITH QUALITY
AND LOW COST PRODUCTS FOR OVER 25 YEARS !!

*CAPACITORS		*ELECTROLYTICS	
630 VOLT AXIAL		160 VOLT AXIAL	
VALUE	PRICE/25	VALUE	PRICE/25
.001	\$6.00	10	\$13.00
.0022	6.15	22	16.00
.0033	6.20	33	21.00
.0047	6.25	47	24.00
.0068	6.35	100	30.00
.01	6.50	450 VOLT AXIAL	
.022	7.00	10	\$18.75
.047	7.50	22	28.00
.1	8.00	33	36.00
.22	15.00	47	45.00
.47	20.00	10-PACK	
1.	26.00	47	\$20.00
		100	28.00

FOR FURTHER INFO VISIT
RADIOANTIQUES.COM

\$1.75 FLAT RATE SHIPPING WITHIN THE USA

NO MINIMUM ORDER!

*STARTER KITS

(CAPACITOR, MOST COMMON)

*TWO STAGE FILTERS

*pilot lamps

*NEON LAMPS

*DIAL CORDS

BOB'S ANTIQUE RADIOS AND ELECTRONICS

111 EAST 29TH STREET
LAGRANGE PARK, IL 60526
PHONE: 1-708-352-0648
FAX: 1-708-362-0647

radiobob1@radioantiques.com

Radio Manufacturers of the 1920's

BY ALAN DOUGLAS

All 3
Volumes!

Order
Today!



"The definitive book on American broadcast receivers of the 1920s"

Volume 1: A-C Dayton - Adams Morgan - Air-Way - All-American Mohawk - American Bosch - Amrad - Amrad S-Tube - Apex - Atwater Kent - Bremer Tully - Browning-Drake - Clapp-Eastham - Crosley - Cutting & Washington - Day-Fan - DeForest - Eagle - ERLA - FADA - Federal - Ferguson. Federal - Ferguson. 225 Pages.

Volume 1: \$29.95

Volume 2: Freed-Eisemann - Eisemann - Freshman - Garod - Gilfillan - Grebe - Howard - Jones (Lester/Melco) - Jones (Jos.) - Kellogg - Kennedy - King - Kodel - Kolster - Leutz - Magnavox - Majestic - Marti - Metro - Klitzen/Michigan - Midwest - Mu-Rad - Murdock - Music Master - Neutrowound - Operadio - Ozarka - Pfanstiehl - Philco - Pilot - Priess. 266 Pages.

Volume 2: \$29.95

Volume 3: RCA - Scott - Silver-Marshall - Slagle - Sleeper - Sonora - Sparton - Splittorf - Steinite - Stewart-Warner - Stromberg-Carlson - Thermodyne - R.E. Thompson - Thorola - Tri-City - C. D. Tuska - Ware - Western Coil - Western Electric - Workrite - Zenith. 292 Pages.

Volume 3: \$29.95

Everything stocked and shipped promptly — Radio is our middle name.

**A.R.C., PO Box 1558, Port Washington, NY 11050 – Toll Free: (866) 371-0512
Fax: (516) 883-1077 – E-mail: ARC@antiqueradio.com – Web: www.antiqueradio.com**

U.S. orders \$3 for first book, \$1 per additional book (typical U.S. order will be received within 7 days, but allow 2-3 weeks). Most orders shipped by next business day. Send payment with order. New York residents add sales tax. Non-U.S. orders, contact us for shipping costs. For your protection, if using a credit card, use our secure website. Do not send credit card information via e-mail.





CALIFORNIA - October 1
CHRS SACRAMENTO CHAPTER
SWAP MEET

Turlock Fairgrounds 9:00am
 Info: www.californiahistoricalradio.com

ILLINOIS - October 2
ANTIQUE RADIO CLUB OF ILLINOIS
SWAP MEET

American Legion Hall
 7:00am to 11:00am
 Carol Stream, IL
 Info: clubinfo@antique-radios.org

NEW YORK - October 2
GREATER NEW YORK VINTAGE
WIRELESS ASSOCIATION
SWAP MEET & MEETING

Long Island, NY
 Seaford Train Station Parking Lot
 7 am - 11 am
 Info: Jim Koehler - (516) 623-0035
 Rich Lee - (914) 589-3751

OHIO - October 4
ANTIQUE RADIO COLLECTORS
OF OHIO MEETING

Dayton, OH - 2929 Hazelwood Ave. 7 pm
 Info: Karl Koogle - (937) 294-8960
karlkrad@gmail.com

ARKANSAS - October 6
ANTIQUE RADIO COLLECTORS CLUB
OF FORT SMITH MEETING

Fort Smith
 AR 1st Baptist Church 1400 Grand Ave.
 7:30pm - Info: Paul Tucker - (479) 782-8178

ARKANSAS - October 6
ANTIQUE RADIO COLLECTORS CLUB
OF FORT SMITH MEETING

Fort Smith
 AR 1st Baptist Church 1400 Grand Ave.
 7:30pm - Info: Paul Tucker - (479) 782-8178

OREGON - October 8
NORTHWEST VINTAGE RADIO SOCIETY
MEETING & TAILGATE SWAP

Aurora, OR - American Legion Hall
 21510 Main St. - 9:00am to 3:00pm
 Info: Mike McCrow (503) 730-4639
 E-mail: tranny53@frontier.com

TENNESSEE - October 8
NASHVILLE VINTAGE RADIO CLUB
FALL SWAP MEET AND AUCTION

Nashville, TN
 Associated Builders & Contractors Building
 1604 Elm Hill Pike - 7:00am to 12noon
 Walk-around Auction: 10:30am
 Info: Larry Chambers (615) 355-2005
 Kelton Trammell (615) 962-4310

OKLAHOMA - October 8
OKLAHOMA VINTAGE RADIO
COLLECTORS MEETING

Oklahoma City, OK
 3900 N.W. 63rd St
 Info: Jim Collings - (405) 755-4139
jrcradio@cox.net - www.okvrc.org

NEW MEXICO - October 9
NEW MEXICO RADIO COLLECTORS
CLUB MEET

Albuquerque, NM
 Kaseman Presh. Hospital
 8300 Constitution Ave. (W. of Wyoming)
 1:30 pm: Tailgate Swap Meet
 2 pm: Program, Show & Tell and Auction
 Info: Chuck Burch - (505) 286-9674
chuckBurch@aol.com
<http://members.aol.com>

GEORGIA - October 10
SOUTHEASTERN ANTIQUE
RADIO SOCIETY

MEETING WITH SHOW & TELL
 Norcross, GA
 Fire Mountain Rest. Jimmy Carter Blvd.
 6:30 pm Info: Rich Rodgers - (678) 591-3619
www.sarsradio.com

**MISSOURI - October 11
ANTIQUA RADIO COLL. & HIST. OF
GREATER ST. LOUIS MEETING**

Kirkwood, MO - Kirkwood Comm. Ctr
111 S. Geyer Rd., Room 201-A
7:30 pm Meeting, Show & Tell, Swap Table
Info: Joe Tauser - (314) 616-0745
joe@jtauser.com

**OHIO - October 11
SOCIETY FOR THE PRESERVATION
OF ANTIQUA RADIO KNOWLEDGE
(SPARK) MEETING**

Kettering, OH - Parkview Comm. Ctr
4100 Glenheath 7:30 pm
Info: Jeff Bothwell - (937) 854-7106

**OHIO - October 11
SOCIETY FOR THE PRESERVATION
OF ANTIQUA RADIO KNOWLEDGE
(SPARK) MEETING**

Kettering, OH - Parkview Comm. Ctr
4100 Glenheath 7:30 pm
Info: Dan Casey - (513) 265-8466
E-mail: dansradioland@gmail.com

**PENNSYLVANIA - October 11
DELAWARE VALLEY HIST. RADIO CLUB
MEETING - SWAP - AUCTION**

Telford, PA - Telford Community Building
Hamilton & Hamlin - 7:30 pm
Info: Delaware Valley Historic Radio Club
PO Box 5053, New Britain, PA 18901
www.dvhrc.info

**NORTH CAROLINA
October 11**

**EAST CAROLINA ANTIQUA RADIO
CLUB MEETING**
Greenville, NC - Sheppard Memorial Li-
brary
Meeting Room A, 530 Evans St. 7 pm
Info: Herman Schnur - (252) 752-2264

**ARKANSAS - October 13
ARKANSAS ANTIQUA
RADIO CLUB MEETING**

Call for location and directions 7 pm
Info: Tom Burgess - (501) 455-0773

**NEW JERSEY - October 14
NEW JERSEY ANTIQUA RADIO CLUB**

Princeton, NJ - Bowen Hall
70 Prospect Ave. - 7:30 pm
Info: Marv Beeferman (609) 693-9430
Rich Lee (914) 589-3751
E-mail: radiorich@prodigy.net
Join us on our live webcast: www.njarc.org

**TEXAS - October 15
VINTAGE RADIO & PHONOGRAPH
SOCIETY MEETING**

Irving, TX - Call for location
Info: George Potter - (972) 353-4862
vrps@sbcglobal.net - www.vrps.org

**OLD TECH
BOOKS
& THINGS**



What am I doing after A.R.C.? I now have time to sort through the dozens (probably 100s) of boxes of duplicate items in my collection... books, catalogs, manuals, pamphlets, horn speakers, radios... and offer them via my long-dormant business: Old Tech - Books & Things. Old Tech handles more than just radio-related items... included are vintage television, wireless, skiing, computers, musical synthesizers, and more. For details on what's for sale, visit:

www.oldtech.com

or contact:

John Terrey
Old Tech - Books & Things
P.O. Box 803, Carlisle, MA 01741
(978) 371-2231 — jvt@oldtech.com

For Sale
Theremin Cello and
Speaker (Repro-
ductions by Floyd
Engles)



Theremin Cello



Theremin Speaker

WEST VIRGINIA – October 15
MUSEUM OF RADIO & TECHNOLOGY
FALL TRADERS SHOW & AUCTION
Huntington, WV – 1640 Florence Ave.
Info: www.mrtwv.org

MARYLAND – October 16
MID-ATLANTIC ANTIQUE
RADIO CLUB RADIO FEST
Davidsonville, MD
Davidsonville Family Recreation Center
3789 Queen Anne Bridge Rd.
Gates open at 7:00am – Auction at 12:30pm
Info: Geoff Shearer - (703) 818-2686
www.maarc.org

TEXAS – October 16
TEXAS ANTIQUE RADIO
CLUB MEETING
VFW Hall, Schertz, TX
Info: Ed Engelken - EdEngel@gvtc.com
(830) 899-3864
www.gvtc.com/~edengel/TARC.htm

WASHINGTON – October 16
PUGET SOUND ANTIQUE
RADIO ASSN. MEETING
Seattle, WA – Seattle Scottish Rite Masonic Ctr.
1207 N. 152nd, Seattle, WA
10 am - 12 Noon: Tailgate Swap
12 Noon: Meeting, Program, Show & Tell
Info: Lynda Glaspey - (425) 478-3643
<http://www.eskimo.com/~hhagen/psara>

FLORIDA – October 17
JACKSONVILLE ANTIQUE
RADIO SOC. MEETING
Jacksonville, FL
Countryside Village Clubhouse
10960 Beach Blvd. 7:30 pm
Info: Sean Olin - (904) 386-8332
www.jarsradioclub.com

OHIO – October 19
CENTRAL OHIO ANTIQUE
RADIO ASSOCIATION
DeVry Institute of Tech.,
1350 Alum Creek Rd, I-70 Exit 103B
Columbus – 7:30am
Info: Barry Gould (614) 777-8534

OKLAHOMA – October 20
HEARTLAND ANTIQUE
RADIO ASSOCIATION
See web site for meeting
www.hlara.org

OHIO – October 19
CINCINNATI ANTIQUE RADIO SOCIETY
Fairfield Pavilion, 5251 Dixie Hwy.
Fairfield, OH 7:30 pm
Info: Bob Sands: 513-858-1755

NEW YORK – October 21
HUDSON VALLEY ANTIQUE RADIO
& PHONOGRAPH SOCIETY
Episcopal Church of Suffern
65 Washington Street 7pm to 9pm
Info: Dale Cranston (845) 357-1615

INDIANA – October 22
INDIANA HISTORICAL RADIO
SOCIETY FALL MEET
Greenfield Riley Park Shelter – 8pm
1 block north of US40 on Apple St
Swap meet, contest, silent auction
Info: Glen Fitch (765) 565-6911 or
Fred Prohl (812) 988-1761
www.indianahistoricalradio.org

TEXAS – October 22
HOUSTON VINTAGE RADIO
ASSOCIATION MEGA AUCTION
Bayland Park Community Center
6400 Bissonnet, Houston, TX
Info: Bill Werzner (713) 721-2242
www.hvra.org

NEW YORK – October 23
SCHENECTADY ANTIQUE RADIO CLUB
Schenectady Museum
& Planetarium, Knott Terrace
Flea Market- 1:30pm
Info: David Ellers (518) 326-6042 <http://dadellers.triod.com>

ALABAMA – October 24
ALABAMA HISTORICAL
RADIO SOCIETY MEETING
Birmingham, AL – Alabama Power Bldg.
1801 Abraham Woods Blvd. – 7:00 pm
Info: Dee Haynes – (205) 841-4630
www.alabamahistoricalradiosociety.org

KANSAS - October 29
MID AMERICA ANTIQUE RADIO CLUB
FALL AUCTION
Grandview, MO - 10:00am
Hickman Mills Community Church
Red Badge & Hillcrest
Info: Bob Lutz (913) 634-0816

MASSACHUSETTS
October 30
NEW ENGLAND ANTIQUE RADIO CLUB
SWAP MEET
Westford, MA - Westford Regency
219 Littleton Road (MA Route 110)
8:00am to 12noon - Free Admission
Info: Charlie Perkett (603) 898-4821
E-mail: cperkett@myfairpoint.net

OHIO - November 1
ANTIQUE RADIO COLLECTORS
OF OHIO MEETING
Dayton, OH - 2929 Hazelwood Ave. 7 pm
Info: Karl Koogle - (937) 294-8960
karlkrad@gmail.com

ARKANSAS - November 3
ANTIQUE RADIO COLLECTORS CLUB
OF FORT SMITH MEETING
Fort Smith
AR 1st Baptist Church 1400 Grand Ave.
7:30pm
Info: Paul Tucker - (479) 782-8178

CALIFORNIA - November 5
KRE Building
Berkeley, CA 9:00am
Info: www.californiahistoricalradio.com

NEW YORK - November 6
GREATER NEW YORK VINTAGE
WIRELESS ASSOCIATION
SWAP MEET & MEETING
Long Island, NY - Seaford Train Station Park-
ing Lot
7 am - 11 am
Info: Jim Koehler - (516) 623-0035
Rich Lee - (914) 589-3751
www.nyantiqueradio.org

MISSOURI - November 8
ANTIQUE RADIO COLL. & HIST. OF
GREATER ST. LOUIS MEETING
Kirkwood, MO - Kirkwood Comm. Ctr
111 S. Geyer Rd., Room 201-A
7:30 pm Meeting, Show & Tell, Swap Table
Info: Joe Tauser - (314) 616-0745
joe@jtauser.com

PENNSYLVANIA
November 8
DELAWARE VALLEY HIST. RADIO CLUB
MEETING - SWAP - AUCTION
Telford, PA - Telford Community Building
Hamilton & Hamlin 7:30 pm
Info: Delaware Valley Historic Radio Club
PO Box 5053, New Britain, PA 18901
www.dvhrc.info

NORTH CAROLINA
November 8
EAST CAROLINA ANTIQUE
RADIO CLUB MEETING
Greenville, NC - Sheppard Memorial Library
Meeting Room A, 530 Evans St. 7 pm
Info: Herman Schnur - (252) 752-2264

OHIO - November 8
SOCIETY FOR THE PRESERVATION
OF ANTIQUE RADIO KNOWLEDGE
(SPARK) MEETING KETTERING
OH - Parkview Comm. Ctr
4100 Glenheath 7:30 pm
Info: Jeff Bothwell - (937) 854-7106

ARKANSAS - November 10
ARKANSAS ANTIQUE
RADIO CLUB MEETING
Call for location and directions 7 pm
Info: Tom Burgess - (501) 455-0773

NEW JERSEY - November 11
NEW JERSEY ANTIQUE RADIO CLUB
Princeton, NJ - Bowen Hall
70 Prospect Ave. - 7:30 pm
Info: Marv Beeferman (609) 693-9430
Rich Lee (914) 589-3751
E-mail: radiorich@prodigy.net
Join us on our live webcast: www.njarc.org

OREGON - November 12
NORTHWEST VINTAGE RADIO SOCIETY
MEETING & TAILGATE SWAP
Oregon City, OR - Abernethy Grange Hall
15745 S. Harley Ave. Tailgate: 8:30 am - Meet-
ing: 10 am
Info: www.nwvrs.org

TEXAS - November 12
TEXAS ANTIQUE
RADIO CLUB MEETING
Railroad BBQ
Kyle, TX
Info: Ed Engelken - EdEngel@gvtc.com
(830) 899-3864
www.gvtc.com/~edengel/TARC.htm

COLORADO – November 13

**COLORADO RADIO
COLLECTORS MEETING**
Info: David Boyle - (303) 681-3258
www.radioace.com

NEW MEXICO – November 13

**MEXICO RADIO
COLLECTORS CLUB MEET**
Albuquerque, NM
Kaseman Presb. Hospital
8300 Constitution Ave. (W. of Wyoming)
1:30 pm: Tailgate Swap Meet
2 pm: Program, Show & Tell and Auction
Info: Chuck Burch - (505) 286-9674
chuckBurch@aol.com
<http://members.aol.com>

GEORGIA – November 14

**SOUTHEASTERN ANTIQUE
RADIO SOCIETY
MEETING WITH SHOW & TELL**
Norcross, GA - Fire Mountain Rest.
Jimmy Carter Blvd.
6:30 pm Info: Rich Rodgers - (678) 591-3619
www.sarsradio.com

OHIO – November 16
CINCINNATI ANTIQUE RADIO SOCIETY

Fairfield Pavilion, 5251 Dixie Hwy.
Fairfield, OH 7:30 pm
Info: Bob Sands: 513-858-1755

OHIO – November 16

**CENTRAL OHIO ANTIQUE
RADIO ASSOCIATION**
DeVry Institute of Tech.,
1350 Alum Creek Rd., I-70 Exit 103B
Columbus – 7:30am
Info: Barry Gould (614) 777-8534

OKLAHOMA – November 17

**HEARTLAND ANTIQUE
RADIO ASSOCIATION**
See web site for meeting
www.hlara.org

NEW YORK – November 18

**HUDSON VALLEY ANTIQUE
RADIO & PHONOGRAPH SOCIETY**
Episcopal Church of Suffern
65 Washington Street 7pm to 9pm
Info: Dale Cranston (845) 357-1615

**CALIFORNIA -
November 19-20**
**SOUTHERN CALIFORNIA ANTIQUE
RADIO SOCIETY (SCARS)
ANNUAL SWAP MEET**

Holiday Inn – Carlsbad By The Sea
starts at 7:00am
850 Palomar Airport Rd., Carlsbad, CA
Info: www.antiqueradios.org

**WASHINGTON -
November 20**

**PUGET SOUND ANTIQUE
RADIO ASSN. MEETING**
Seattle, WA - Shoreline Museum
Seattle, WA – Seattle Scottish Rite
Masonic Ctr.
1207 N. 152nd, Seattle, WA
10 am - 12 Noon: Tailgate Swap
12 Noon: Annual Radio Contest
Info: Lynda Glaspey - (425) 478-3643
<http://www.eskimo.com/~hhagen/psara>

**TEXAS –
November 18-20**
**VINTAGE RADIO &
PHONOGRAPH SOCIETY MEETING**

Annual VPRS Convention
Hampton Inn - Mesquite, TX
Info: George Potter - (972) 353-4862
vrps@sbcglobal.net - www.vrps.org

**MARYLAND –
November 20**

**MID-ATLANTIC ANTIQUE
RADIO CLUB MEETING**
Tailgating: 11:30 - Meeting: 1:30 pm
Info: Geoff Shearer - (703) 818-2686
www.maarc.org

**TENNESSEE –
November 20**
**MEMPHIS ANTIQUE
RADIO CLUB MEETING**

Memphis, TN
St. Timothy United Methodist Church -
4105 St. Elmo Ave. 2 pm
Info: Ray Eaton - (731) 989-7089
marcmemphis@gmail.com

FLORIDA – November 21

**JACKSONVILLE ANTIQUE
RADIO SOC. MEETING**
Jacksonville, FL
Countryside Village Clubhouse
10960 Beach Blvd. 7:30 pm
Info: Sean Olin - (904) 386-8332
www.jarsradioclub.com

NEW YORK – December 4

**GREATER NEW YORK VINTAGE
WIRELESS ASSOCIATION**
Swap Meet & Meeting
Long Island, NY - Seaford Train Station Park-
ing Lot
7 am - 11 am
Info: Jim Koehler - (516) 623-0035
Rich Lee - (914) 589-3751
www.nyantiqueradio.org

NEW YORK – November 27

**SCHENECTADY ANTIQUE RADIO
CLUB**
Schenectady Museum & Planetarium,
Knott Terrace
FLEA MARKET- 1:30PM
Info: David Ellers (518) 326-6042
<http://dadellers.triod.com>

OHIO – December 6
**ANTIQUERADIO COLLECTORS OF
OHIO MEETING**

Dayton, OH - 2929 Hazelwood Ave. 7 pm
Info: Karl Koogler - (937) 294-8960 karlkrad@gmail.com

ALABAMA – November 28

**ALABAMA HISTORICAL
RADIO SOCIETY MEETING**
Birmingham, AL – Alabama Power Bldg.
1801 Abraham Woods Blvd. – 7:00 pm
Info: Dee Haynes – (205) 841-4630
www.alabamahistoricalradiosociety.org

ARKANSAS – December 8
**ARKANSAS ANTIQUE RADIO CLUB
MEETING**

Call for location and directions 7 pm
Info: Tom Burgess - (501) 455-0773

ARKANSAS – December 1
**ANTIQUERADIO COLLECTORS CLUB
OF FORT SMITH MEETING**

Fort Smith
AR 1st Baptist Church 1400 Grand Ave.
7:30pm
Info: Paul Tucker t- (479) 782-8178

NEW JERSEY – December 9
NEW JERSEY ANTIQUE RADIO CLUB

Princeton, NJ – Bowen Hall
70 Prospect Ave. - 7:30 pm
Info: Marv Beeferman (609) 693-9430
Rich Lee (914) 589-3751
E-mail: radiatorich@prodigy.net
Join us on our live webcast: www.njarc.org

CONNECTICUT – December 3

**VINTAGE RADIO & COMMUNICA-
TIONS MUSEUM OF CT**
115 Pierson Ln, Windsor, CT
Swap Meet – 8:00am
Info: <http://www.vrcmct.org>

OREGON – December 10
**NORTHWEST VINTAGE RADIO SOCIETY
MEETING & TAILGATE SWAP**

Oregon City, OR - Abernethy Grange Hall
15745 S. Harley Ave. Tailgate: 8:30 am - Meet-
ing: 10 am
Info: www.nwvrs.org

FLORIDA – December 4
**JACKSONVILLE ANTIQUE RADIO
SOCIETY**

Annual Radio Sale and Swap Meet
Jacksonville, FL – Avonlea Antique Mall
8101 Phillips Hwy – 1pm to 5pm
Info: Sean Olin (904) 386-8332
www.jarsradioclub.com

NEW MEXICO – December 11
**NEW MEXICO RADIO COLLECTORS
CLUB MEET**

Albuquerque, NM - Kaseman Presb. Hospital
8300 Constitution Ave. (W. of Wyoming)
1:30 pm: Tailgate Swap Meet
2 pm: Program, Show & Tell and Auction
Info: Chuck Burch - (505) 286-9674
chuckBurch@aol.com <http://members.aol.com>

ILLINOIS - December 11
ANTIQUÉ RADIO CLUB OF ILLINOIS
SWAP MEET

American Legion Hall 7:00am to 11:00am
Carol Stream, IL

Info: clubinfo@antique-radios.org

WASHINGTON - December 11
PUGET SOUND ANTIQUÉ RADIO
ASSN. MEETING

Seattle, WA - Seattle Scottish Rite Masonic Ctr.
1207 N. 152nd, Seattle, WA

10 am - 12 Noon: Tailgate Swap

12 Noon: Meeting, Program, Show & Tell

Info: Lynda Glaspey - (425) 478-3643

<http://www.eskimo.com/~hhagen/psara>

GEORGIA - December 12
SOUTHEASTERN ANTIQUÉ RADIO
SOCIETY

Meeting with Show & Tell

Norcross, GA - Fire Mountain Rest. Jimmy
Carter Blvd.

6:30 pm Info: Rich Rodgers - (678) 591-3619

www.sarsradio.com

MISSOURI - December 13
ANTIQUÉ RADIO COLL. & HIST. OF
GREATER ST. LOUIS MEETING

Kirkwood, MO - Kirkwood Comm. Ctr

111 S. Geyer Rd., Room 201-A

7:30 pm Meeting, Show & Tell, Swap Table

Info: Joe Tauser - (314) 616-0745 joe@

jtauser.com

NORTH CAROLINA -
December 13

EAST CAROLINA ANTIQUÉ RADIO
CLUB MEETING

Greenville, NC - Sheppard Memorial Library

Meeting Room A, 530 Evans St. 7 pm

Info: Herman Schnur - (252) 752-2264

PENNSYLVANIA -
December 13
DELAWARE VALLEY HIST. RADIO CLUB
CHRISTMAS PARTY

Telford, PA - Telford Community Building
Hamilton & Hamlin 7:30 pm

Info: Delaware Valley Historic Radio Club

PO Box 5053, New Britain, PA 18901

www.dvhrc.info

OHIO - December 13
SOCIETY FOR THE PRESERVATION
OF ANTIQUÉ RADIO KNOWLEDGE

(SPARK) Meeting Kettering, OH - Parkview
Comm. Ctr

4100 Glenheath 7:30 pm

Info: Dan Casey (513) 265-8466 E-mail: dan-
sradioland@gmail.com

NEW YORK - December 16
HUDSON VALLEY ANTIQUÉ RADIO &
PHONOGRAPH SOCIETY

Episcopal Church of Suffern

65 Washington Street 7pm to 9pm

Info: Dale Cranston (845) 357-1615

MARYLAND - December 18
MID-ATLANTIC ANTIQUÉ RADIO
CLUB MEETING

Tailgating: 11:30 - Meeting: 1:30 pm

Info: Geoff Shearer - (703) 818-2686 www.maarc.org

OHIO - December 21
CINCINNATI ANTIQUÉ RADIO
SOCIETY

Fairfield Pavilion, 5251 Dixie Hwy.

Fairfield, OH 7:30 pm

Info: Bob Sands: 513-858-1755

OHIO - December 21
CENTRAL OHIO ANTIQUÉ RADIO
ASSOCIATION

DeVry Institute of Tech., 1350 Alum Creek

Rd, I-70 Exit 103B

Columbus - 7:30am

Info: Barry Gould (614) 777-8534

NEW YORK - December 25
SCHENECTADY ANTIQUÉ RADIO
CLUB

Schenectady Museum & Planetarium, Knott
Terrace

Flea Market- 1:30pm

Info: David Ellers (518) 326-6042 <http://dadellers.triod.com>

Changes, cancellations and errors do occur.
To avoid disappointment, verify place, date
and time especially for events which are
new to you.

CRYSTAL CLEAR

By Maurice L. Sievers

Volume 1

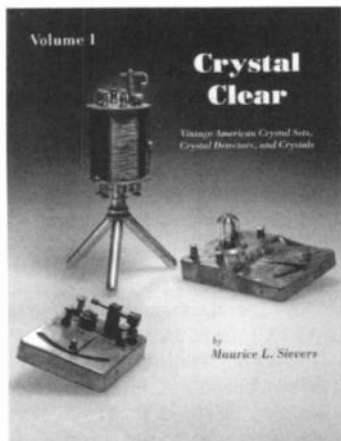

750 Illustrations – 570 Crystal Sets
341 Detectors – 207 Crystals
Perfect for the beginning collector!
Useful for the experienced too!

Crystal Clear is the most comprehensive reference for collectors, historians and anyone interested in early radio. In addition to the many excellent photos and reproductions of ads, *Crystal Clear* includes lists showing all sets by manufacturer, set name, selling price and date of manufacture. 8 1/2" x 11", 282 pages.

\$29.95 – Softcover

Volume 2

Crystal Clear, Vol. 2 supplements the first volume. It identifies an additional 172 crystal radio sets, 91 crystal detectors and 26 crystals by manufacturer, model, year produced, description and original selling price. Further research on many of the crystal sets covered in Volume 1. Detailed history on the Philmore Manufacturing Company and the Western Manufacturing Company. 8 1/2" x 11", 252 pages.

\$29.95 – Softcover

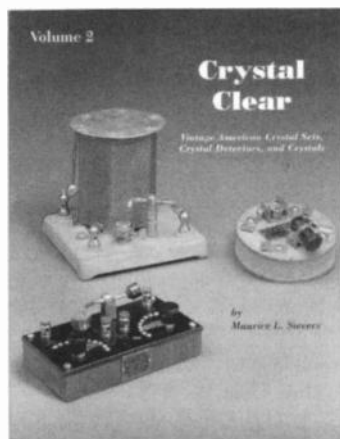

Everything stocked and shipped promptly — Radio is our middle name.

**A.R.C., PO Box 1558, Port Washington, NY 11050 – Toll Free: (866) 371-0512
Fax: (516) 883-1077 – E-mail: ARC@antiqueradio.com – Web: www.antiqueradio.com**



U.S. orders \$3 for first book, \$1 per additional book (typical U.S. order will be received within 7 days, but allow 2-3 weeks). Most orders shipped by next business day. Send payment with order. New York residents add sales tax. Non-U.S. orders, contact us for shipping costs. For your protection, if using a credit card, use our secure website. Do not send credit card information via e-mail.



MasterCard





CLUBS: Send antique radio club and meet information to A.R.C. for free listing here, as space permits. Sorry, we don't have room for hamfests. Always send a SASE when writing to clubs!

NATIONAL CLUB:

Antique Wireless Association (AWA). PO Box 421, Bloomfield, NY 14469. Pub: The AWA Journal, quarterly. Dues: \$25(U.S.A) \$30 (elsewhere). National annual conference and regional meets. Museum. www.antiquewireless.org. AWA World Convention: <http://awamuseum.org/>

REGIONAL CLUBS:

Alabama Historical Radio Society (AHRS). PO Box 131418, Birmingham, AL 35213. Pub: The Superflex, monthly. Dues: \$20. Meetings, Every Sat. morning and 4th Mon. evening each month but Dec., annual show/swap meet. Don Kresge Radio Museum, Lobby of the Alabama Power Bldg., 600 North 18th Street, Birmingham, AL 35203. Contact Dee Haynes (205) 841-4630. www.alabamahistoricalradiosociety.org.

Antique Radio Club of Illinois (ARCI). PO Box 1139, LaGrange Park, IL 60526. Art Bilski (630) 739-1060. Pubs: ARCI News, monthly and ARCI Update, periodically. Dues \$15. Annual August Radiofest and bimonthly swap meets. www.antique-radios.org. clubinfo@antique-radios.org

Antique Radio Collectors Club of Ft. Smith, Arkansas (ARCC). Paul Tucker 479-782-8178, 4700 N. "N" St., Fort Smith, AR 72904. Dues: \$10. Meets first Thursday of month.

Antique Radio Collectors & Historians (ARCH) of Greater St. Louis. Joe Tauser, joe@jtauser.com. Dues: \$12. Monthly newsletter and meetings, annual picnic/swap meet. www.archradioclub.com

Antique Radio Collectors of Ohio (ARCO). Karl Koogle, 2929 Hazelwood Ave., Dayton, OH 45419. E-mail: karlkrad@gmail.com

Arkansas Chapter/AWA. Arkansas Antique Radio Club (AARC). Tom Burgess, PO Box 191117, Little Rock, AR 72219. Dues: \$5.00. Monthly meets.

Arizona Antique Radio Club (AZARC). 1080 E. Pecos Rd., Suite 18, PMB 105, Chandler, AZ 85225-2426. Pub: The Arizona Antique Radio Club News, quarterly. Dues: \$20. Meetings, swap meets, Arizona Radio Round-up. www.azarc.org.

Buckeye Antique Radio and Phonograph Club (BARPC). Jon Jansma, 31051 Fox Hollow Dr., Pepper Pike, OH 44124. (216) 591-0121. Pub: Soundings, bimonthly. Dues: \$10.00. Monthly meetings in Akron, Spring and Fall auctions, April joint meeting with PARS.

California Historical Radio Society (CHRS). CHRS, PO Box 31659, San Francisco, CA 94131. CHRS Hotline: (415) 821-9800. Steve Kushman, 4233 25th St., San Francisco, CA 94114. Pubs: The Journal, quarterly; 20 Years of CHRS, Hints & Kinks, free with membership. Dues: \$20. 13 events per year. www.californiahistoricalradio.com

CHRS/Sacramento Chapter (CHRS). PO Box 162612, Sacramento, CA 95816-9998. Pub: The Announcer, quarterly. Dues: \$10. Special meets, monthly meetings. www.californiahistoricalradio.com

Carolinas Chapter/AWA (CC-AWA). Ron Lawrence, PO Box 3015, Matthews, NC 28106. Pub: Radio Daze, quarterly. Dues: \$10. Quarterly swapmeets. www.cc-awa.org

Central Ohio Antique Radio Association (COARA). Dave Poland, Westerville, OH (614) 890-5422. E-mail: dcp944@yahoo.com. Quarterly meetings in March, June, September, and December. January Cabin Fever & July Tailgate Meet. Dues: \$12. <http://coara.tripod.com/page2.html>

Cincinnati Antique Radio Society. (CARS) Bob White (513) 385-8291. Monthly mtgs.

ANTIQUe RADIO SWAP MEET

Sponsored by the New England Antique Radio Club

Sunday, October 30, 2011 – 8:00 AM to Noon

Inside the Westford Regency Inn's large ballroom

219 Littleton Road (MA Rte 110), Westford MA

Public Welcome • Free Parking • Food Concession inside

Buyer Admission is FREE for the entire show!!
Doors Open at 8:00 AM until 12 Noon Closing Time

Visit our website www.nearc.net for more information

— DIRECTIONS —

- Use I-90 (Mass Pike), I-290 (Worcester area), I-93 (NH), I-95 (ME & RI), MA Rte. 2, MA Rte. 3 or any local road to reach the section of I-495 located west of Lowell, MA.
- Take I-495 Exit 32. Head south following the "To Rte. 225" sign & go only 0.1 miles.
- At the traffic light by the two gas stations, turn right (westbound) onto Rte. 110.
- Follow Rte. 110-west for 0.4 miles. The Westford Regency will be on your right.
- Take the first Westford Regency driveway and follow it to the large parking lot.
- Enter the Regency using either of the two double-doors facing the parking lot.

Colorado Radio Collectors (CRC). David Boyle, 1058 Colt Cir., Castle Rock, CO 80109. (303) 681-3258. Newsletter "The Flash", bimonthly starting in Jan. Dues: \$12. Annual Spring Show & Fall BBQ/Auction. www.radioace.com

Cumberland Valley Radio Society (CVRS). HC-66 Box 1604, Barbourville, KY 40906. Weekly meetings, quarterly swap meets.

Delaware Valley Historic Radio Club (DVHRC). DVHRC PO Box 5053, New Britain, PA 18901. Pub: The Oscillator, monthly. Dues: \$20. Monthly meetings with swap meet in July. Sponsors twice-yearly Kutztown Radio Show (May and September.) Web site: www.dvhrc.info.

East Carolina Antique Radio Club (EC-ARC). Bill Engstrom, 218 Bent Creek Dr., Greenville, NC 27834.

Florida Antique Wireless Group (FAWG). c/o Radio Relics, 1987 Corporate Square, #151, Longwood, FL 32750. (407) 895-9075. E-mail: oldradio@cfl.rr.com.

Greater Boston Antique Radio Collectors (GBARC). c/o A.R.C., PO Box 2-W20, Carlisle, MA 01741. Informal org. Write to be put

on mailing list. Annual meet in Feb.

Greater New York Vintage Wireless Association (GNYVWA). Jim Koehler 516-623-0035, Rich Lee 914-589-3751. Swap meet first Sunday of the month at Seaford, NY Long Island Rail Road Parking Lot. Web site: www.nyantiqueradio.org

Heartland Antique Radio Association (HLARA). PO Box 52310, Tulsa, OK 74152. Dues \$15. See website for more info. www.hlara.org

Houston Vintage Radio Association (HVRA). PO Box 31276, Houston, TX 77231-1276. Membership info: Tom Burslem, tomburslem@yahoo.com. Pub: The Grid Leak, bi-monthly. Dues: \$20. Monthly meetings and auctions held 4th Saturday of each month. Web site: www.hvra.org

Hudson Valley Antique Radio and Phonograph Society-AWA (HARPS). meets third Friday of the month at the Episcopal Church of Suffern, 65 Washington St., Suffern, NY 10901. Info: Dale Cranston (845) 357-1615 dale.cranston@gmail.com

Indiana Historical Radio Society (IHRS). 245 N. Oakland Ave., Indianapolis, IN

46201-3360. Pub: IHRS Bulletin, quarterly. Dues: \$15 per year. Quarterly swap meets in various areas of state. www.indianahistoric-radio.org

Illinois Historical Radio Society (IHRS). Paul Johnston, 8592 N. Creek Rd., Roscoe, IL 61073.

Iowa Antique Radio Club and Historical Society (IARCHS). Doug Spyrison, President. E-mail: dougspyrison@mchsi.com. Pub: IARCHS Newsletter, quarterly. Dues: \$10. Annual Radiofest. www.iarchs.org

Jacksonville Antique Radio Society (JARS). Sean Olin (904) 386-8332, oldradios@bell-south.net. www.jarsradioclub.com

Long Island Radio and TV Historical Society (LIRTVHS). 43 Sayville Blvd., Sayville, NY 11782. Membership \$25 per year. E-mail: liwhs@gmail.com. Web site: www.lirtvhs.org

Memphis Antique Radio Club (MARC). President, Ray Eaton, 459 Second St., Henderson, TN 38340. E-mail: MARCMemphis@gmail.com.

Michigan Antique Radio Club (MARC). Don Colbert, MARC, membership@michiganantiqueradio.org. Pub: The Michigan Antique Radio Chronicle, quarterly. Dues: \$20. Annual Extravaganza and other quarterly meets. www.michiganantiqueradio.org

Mid-America Antique Radio Club (MAARC). Claude Chafin, 4223 E. 42nd St. Way, Independence, MO 64055. Pub: The Broadcaster, quarterly. Dues: \$15. Semi-annual auctions and swap meets. <http://sites.google.com/site/midamericaantiqueradioclub/>

Mid-Atlantic Antique Radio Club (MAARC). Geoff Shearer, 14408 Brookmere Dr., Centreville, VA 20120 (703) 818-2686. E-mail: gshearer2@verizon.net. Pub: Radio Age, monthly. Dues: \$20. Monthly meetings. www.maarc.org

Mid-South Antique Radio Collectors (MSARC). Terry Layman, 130 Saint Margaret Dr., Lexington, KY 40502. E-mail: layvinrad@insightbb.com. Meets last Saturday in April and October.

Military Radio Collectors Association (MRCA). Pete Hamersma, PO Box 467, Holderness, NH 03245. www.mrca.ar88.net

Military Radio Collector's Group (MRCG).

Lynn Fielding KE6JZD, PO Box 11322, Torrance, CA 90501-1322. lfielding@elcamino.edu. www.syzen.com/milradio/

Museum of Radio & Technology. 1640 Florence Ave., Huntington, WV 25701. www.mrtwv.org

Nashville Vintage Radio Club (NVRC). 514 E. Kings Rd., Smyrna, TN 37167. (615) 355-2005. Web: www.musiccityvintageradio.org

New England Antique Radio Club (NEARC). Info: (603) 898-4821. Charlie Perkett, 16 Sunset Rd., Salem, NH 03079-1704. Pub: NEARC Radio News, quarterly. Dues: \$12. Two swap meets/year in April and October. Web site: www.nearc.net

New Jersey Antique Radio Club (NJARC). Richard Lee - President (914) 589-3751 radiorich@prodigy.net. Membership: Marsha Simkin, 33 Lakeland Dr., Barnegat, NJ 08005. Meetings are the 2nd Friday of the month from 7pm to 10pm alternating between Info Age, 2201 Marconi Rd., Wall Township, NJ 07719 and Bowen Hall, Princeton University. Monthly newsletter "The Jersey Broadcaster". Dues \$20. 3 swap meets and 4 repair clinics a year. December holiday party. Info: www.njarc.org

New Mexico Radio Collectors Club (NMRCC). Contact Ron Monty - ronmonty@comcast.net. Pub: New Mexico Radio Collectors Club Newsletter, monthly. Dues: \$20. Annual Sale & Show and monthly meetings. <http://www.newmexicoradiocollectorsclub.com/>

Niagara Frontier Wireless Association (NFWA). Gary Parzy, 135 Autumnwood, Cheektowaga, NY 14227. Regional meets. Display at the Amherst Museum, Amherst, NY

Northland Antique Radio Club (NARC). PO Box 18362, Minneapolis, MN 55418. Pub: The NARC Newsletter, four/year. Dues: \$10. Four meets (including 2 swap meets) per year and Radio Daze event.

Northwest Vintage Radio Society (NWVRS). PO Box 82379, Portland, OR 97282-0379. Pub: The Call Letter, monthly. Dues: \$25 a year. Monthly meetings. <http://nwvrs.org>

Oklahoma Vintage Radio Collectors, OK City Chapter (OKVRC). Jim Collings, jrcradio@cox.net, PO Box 50625, Midwest City,

OK 73140-5625. Pub: OKVRC Broadcast News, monthly. Dues: \$15 per year. Monthly meetings, spring and fall swap meets. <http://www.okvrc.org>

Pittsburgh Antique Radio Society, Inc. (PARS). Chris Wells, 110 Fawn Valley Dr., McMurray, PA 15317. (724) 942-1113. Pub: The Pittsburgh Oscillator, quarterly. Dues: \$10. There are 8 meets a year including the April Tri State Radio Fest. www.pittantique-radios.org

Puget Sound Antique Radio Association (PSARA). PO Box 7567, Tacoma, WA 98417. Contact Linda Glaspey (425) 478-3643. Pub: The Horn of Plenty, monthly. Dues: \$25 per year. Monthly meetings & swap meets, Nov. show, & Aug. swap meet. www.eskimo.com/~hhagen/psara

Radio Enthusiasts of Puget Sound (REPS). REPS Membership, 17334 Densmore Ave. N, Shoreline, WA 98133. Pub: Air Check, 9 times a year. Dues: \$20 per year. Monthly meetings, annual Radio Showcase. www.reps-online.org

Radio History Society, Inc. (RHS). Radio & Television Museum, 2608 Mitchellville Rd., Bowie MD 20716. Rusty Wallace, Membership Chair. Quarterly publication: Dials and Channels. Dues: \$25 per year. E-mail: radiotvmuseum@verizon.net. www.radiohistory.org

Roanoke Antique Radio Enthusiasts (RARE). Frank G. Smith, WPXR-TV 38, 3819 Bloonsboro Rd., Lynchburg, VA 24503.

Schenectady Antique Radio Club (SARC). David Ellers, 60 111th Street, Troy, NY 12182. Pub: The Broadcaster. Dues: \$3. <http://dadellers.tripod.com/>

Society for the Preservation of Antique Radio Knowledge (SPARK). Dues: \$15. Annual Swap Meet, Monthly meeting, 7:30 pm Parkview Community Center, Kettering, OH. Contact: Dan Casey (513) 265-8466 E-mail: dansradioland@gmail.com. www.antiqueradios.com/spark

Society of Wireless Pioneers. PO Box 86, Geyserville, CA 95441. The World Wireless Beacon, quarterly; Register, bi-annually. Dues: \$15.

South Florida Antique Radio Collectors. Thomas Valenti, 2651 N.W. 19 Ave., Oakland Park, FL, 33311. Ph. (954) 662-3689.

Southeastern Antique Radio Society (SARS). Rich Rodgers, President, 113 Laurel Ridge Dr., Alpharetta, GA 30004. Pub: Newsletter, quarterly. Dues: \$16. Spring, Fall and Winter swap meets. Monthly dinner meetings, 2nd Monday of each month, in Norcross, GA. www.sarsradio.com

Southern California Antique Radio Society (SCARS). Jim Garrett, 15621 Fox Hills St., Westminster, CA 92683. (714) 891-1689. wabyos@juno.com. Pub: SCARS Gazette, quarterly. Dues: \$20. Web site: www.antique-radios.org

Southern Vintage Wireless Association (SVWA). Jim Makar, 8224 Bailey Cove Rd. SE, Apt. 9, Huntsville, AL 35802. Pub: SVWA Newsletter, 3/year. Dues: \$5. Three swap meets.

Texas Antique Radio Club (TARC). Ed Engelken, 680 Lake Forest, Canyon Lake, TX 78133. Pub: Lone Star Waveform, monthly. Monthly meetings. www.gvct.com/~edengel/TARC.htm

Texas Panhandle Vintage Radio Society (TPVRS). Eloy A. Heras, 4086 Business Park Dr., Amarillo, TX 79110. Dues: \$5. Quarterly meetings.

Tidewater Antique Radio and Phonograph Association (TARPA). Barry Callis, 3689 N. Landstown Rd., Virginia Beach, VA 23456. (757) 427-9667. E-mail: betty3689@aol.com. Meets last Tuesday of each month at the Mary Pretlow Library.

Vintage Radio & Communications Museum (VRCM). 115 Pierson Ln., Windsor, CT 06095. (860) 683-2903. www.vrcmct.org

Vintage Radio & Phonograph Society (VRPS). PO Box 165345, Irving, TX 75016. Pub: The Soundwaves is published quarterly. Dues: \$20.00 annually. Monthly meetings, swap meets, Spring auction, annual convention. More information at www.vrps.org

W. Va. Chapter, AWA (AWA-WVC). Geoff Bourne, 405 8th Ave., St. Albans, WV 25177. Newsletter, monthly. Dues: \$25.00 (includes museum membership). Quarterly meets, monthly meetings, classes.

Wisconsin Antique Radio Club, Inc. (WARCI). Bill Engaas, 18265 W. Thornapple Ln., New Berlin, WI 53146. Dues: \$15. www.warci.org

INTERNATIONAL CLUBS:

(A.R.C. would like to hear about other international antique radio clubs.)

Australia: Historical Radio Society of Australia (HRSA). Membership Secretary, PO Box 2283, Mt. Waverley, Victoria 3149, Australia. Pub: Radio Waves, quarterly. Dues: \$35 Australian. Monthly Meetings. <http://hrsa.asn.au>

Australia: Historical Wireless Society of South East Queensland (HWS of SEQ). Pub: Wireless Review, quarterly. Membership: membership@hws.org.au. Web Site: www.hws.org.au

Australia: North East Vintage Radio Club. Monthly meetings at Wangaratta T.A.F.E. electronic unit. Info: Noel Meagher, 62 3149; Ian Milne, 62 5153; Rodney Champness, 62 1454 (all Benalla numbers).

Australia: Australia Vintage Radio Society Inc. Monthly meetings, workshops, tech. assistance, etc. Bi-monthly newsletter. Overseas memberships are \$35pa + \$5 joining fee. AVRS Secretary, PO Box 3099, Syndal LPO, Victoria, Australia 3150. Web: www.avrs.org.au

Belgium: Belgische Radio Club. Francois Marschang, Kromvendreef 53, B-2900, Schoten, Belgium.

Belgium: Vlaamse Liefhebbers Van Der Historische Radiotechniek (VLHR). Rudi Sillen, Limberg 31, B-2230, Herselt, Belgium. Pub: Retro-Radio, quarterly. Dues: \$20.

Brazil: Antique Radios in Brazil. João Mello, PO Box 101, São Roque, Brazil 18130-000.

Canada: Canadian Vintage Radio Society (CVRS). CVRS, 10271 Algonquin Dr., Richmond, British Columbia V7A 3A5. membership@canadianvintageradio.com. Newsletter is available by print or email. See web site for dues. www.canadianvintageradio.com

Alberta Chapter/CVRS, Rick Williams, rich@canadianvintageradio.com. Secretary CVRS Alberta, 9611 142 St., Edmonton, Alberta T5N 2M8.

British Columbia Chapter/CVRS, Bill West-Sells, westsells@telus.net.

Manitoba Chapter/CVRS, volunteer needed, vactube@hotmail.com.

New Brunswick Chapter/CVRS, W.H. Gentleman, bill@canadianvintageradio.com. 17 Maple Cresc., Rothesay, New Brunswick E2E 2A4.

Newfoundland Chapter/CVRS, John Bray, john@canadianvintageradio.com.

Nova Scotia Chapter/CVRS, Brian McK-eigan, brian@canadianvintageradio.com. 4 Baird St., North Sydney, Nova Scotia B2A 2B3.

Ontario Chapter/CVRS, Paul Martin, paulmartin8@yahoo.com.

Saskatchewan Chapter/CVRS, Stan Marlin, smarlin@sasktel.net.

Yukon and NWT Chapter/CVRS, volunteer needed.

Canada: Society for the Preservation of Antique Radio in Canada (SPARC). Bruce C.E. Russell, 220-4411 Hastings St. E, Burnaby, British Columbia, Canada V5C 2K1. Pub: Periodic newsletters. Dues: \$12. Annual open house and show, periodic shows and displays, and museum. <http://www3.bc.sympatico.ca/radiomuseum/>

Canada, Ontario: London Vintage Radio Club (LVRC). Dave Cantelon, 42 Clematis Rd., North York, Ontario, Canada M2J 4X2. Pub: LVRC Newsletter "The Loudspeaker." bimonthly. Dues: \$15 Canadian. Six meetings yearly. www.lvrc.homestead.com/index.html

Canada, Ontario: Ottawa Vintage Radio Club (OVRC). Lea Barker, barker@ca.inter.net. Pub: OVRC. Monthly meetings. www.ovrc.org

Canada, Ontario: Ontario Vintage Radio Association (OVRA). Ted Catton. <http://www.ovra.ca/>

Canada, Quebec: Quebec Society for Vintage Radio Collectors (QSVRC). SQCRA, Daniel Labelle, 538 Judd, St-Eustache, Quebec, Canada J7R 4N8. Pub: Radiophilie Quebec, bimonthly. www.sqcrq.qc.ca

Czech Republic: Historicy Radioclub Ceskoslovensky (HRCS). Nadrazni 1394/53, CZ 589 01 Trest. Pub: Radiojournal, 3 per year. Meetings: 4 per year. Dues: 25 Euro/Year. Web: www.radiojournal.cz

England: British Vintage Wireless Society (BVWS). Mike Barker, Pound Cottage, Coate, Devizes, Wiltshire SN10 3LG, England. Pubs: BVWS Bulletin, quarterly; BVWS

Newsletter, five times/year. Dues: £25. Meetings and swap. www.bvws.org.uk

England: Eddystone User Group (EUG). Online only. Web Site: www.eddystoneusergroup.org.uk/

France: Association des Amis du Musée de l'Electro-Acoustique les Radiophiles Français (A.E.A.). Jean-Claude Montagné, President, 35 rue Salvador Allende, F92220, Bagneux, France. Pub: Bulletin of the A.E.A. Dues: \$46. <http://perso.wanadoo.fr/clubaea/index.htm>

France: Club Histoire et Collection Radio (CHCR). Chez Gilbert Gorin, 3 rue Capitaine H. Maizan, 80160 Plachy-Buyon, France. Pub: Telegraphie et Telephonie Sans Fil Electricite Ancienne, quarterly. Library. Annual May event in Riquewihir, Sept. Bar Le Duc event, meetings.

France: Radiofil. Jean-Paul Delattre, Secrétaire general, 2 Rue de la Clairiere, 54425, Pulnoy, France. Email: secretaire-general@radiofil.com. Pub: Radiofil Magazine, 6 issues/year. Dues: euro 39/year. <http://www.radiofil.com>

Germany: German Society of Wireless History. Prof. Otto Künzel, Belm Tannenhof 55, 7900 Ulm 10, Germany. Pub: Funkgeschichte, bimonthly.

Hungary: Hungarian Radio Collectors Club. Laszlo Koger, H-8900 Szekesfehervar Sajo U 9. Meetings twice a year, bi-monthly news.

Ireland: Irish Vintage Radio & Sound Society. Henry Moore, 9 Auburn Close, Killiney, Co. Dublin, Ireland. Quarterly newsletter. 26 weekly and six monthly meetings.

Israel: Antique Radio and Broadcasting Museum. Museum in Tel-Aviv. Bruno Pinto, 24 Remez St., #7, Tel-Aviv, Israel 62192

Italy: Associazione Italiana Radio d'Epoca (AIRE). Nerio Neri, President, Via de Pellicceria 23, 52100 Arezzo, Italy. Pub: Bollettino-Notiziario, bimonthly.

Japan: Antique Wireless Club (AWC). Noriyoshi Tezuka, JA1NTF, Secretary AWC, Telephone: +81-45-949-3195, Kagahara 1-24-6-115, Tsuzuki-ku, Yokohama 224-0055, Japan. Monthly meetings and newsletter. E-mail: n-tezuka@pop16.odn.ne.jp. Web site: <http://blog.goo.ne.jp/vrc-tezuka>

Netherlands: Nederlandse Vereniging voor de Historie van de Radio (NVHR). Paulus Potterstraat 19, 6814 KT Arnhem, Holland. www.nvhr.nl

New Zealand: New Zealand Vintage Radio Society (NZVRS). David Crozier, 154 Grey St. Onehunga, Auckland, New Zealand 1006. NZVRS Bulletin, quarterly, monthly meetings. Dues: \$15. www.nzvrs.pl.net

Norway: The Norwegian Radiohistoric Society. Mekanikerveien 32, N-0683 Oslo, Norway. Pub.: Hallo Hallo, quarterly. Dues: \$40. Regular meetings every Tuesday Auctions - a couple of times per year. www.nrhf.no/nrhf-eng.html

Romania: Pro Radio Antic. P-ta. Acad. Caius Iacob, Nr.4, Bl.R, Sc.A, Et.8, Ap.29; 310136 Arad, Romania. www.proradioantic.ro

Spain: Spanish Vintage Wireless Club (Asociacio Cultural Amicos de la Radio). Rei Jaume, 55, 08840 Cardedeu, Spain.

Sweden: The Radio History Society of West Sweden. Anders Carlssons, Gata 2, SE-417 55 Gothenburg, Sweden. Pub: Audionen. Amateur radio station: SK6RM. Museum: <http://www.radiomuseet.se>. E-mail: info@radiomuseet.se

Sweden: Sveriges Radio Historiska Forening (SRHF). Contact Johan van der Levin: johan@johansoldradians.se. Web site: www.radiohistoriska.se

Switzerland: Club der Radio-und Grammosammler (CRGS). Johannes M. Gutekunst, Lenzhardstrasse 22, 5102 Rapperswil, Switzerland. Quarterly newsletter. <http://www.crgs.ch/>

Tube Collectors Association. PO Box 636, Ashland, OR 97520 USA. Pub: Tube Collector, 6 times a year. Dues: \$20 per year to the US and Canada. See the web site for multiple year dues and foreign membership dues. www.tubecollectors.org

From Antique Radio Classified

(Copyright 2011 by Vintage Radio Publishing LLC.)

BUSINESS CARD ADS - \$53.00 FOR 3 MONTHS

Free Estimates
Hrs. - 9 AM - 5 PM EST
Tues. - Sat

Tel./Fax (800) 928-2828
E-mail: bob@oldradiodoc.com
www.oldradiodoc.com



ANTIQUE RADIO RESTORATION & REPAIR

1920 - 1980's

Buy & Sell

Reasonable Rates. Tubes, Professional
Overhauls, Cabinet Refinishing. Service
For All Antique Car, Table & Console
Radios, Communication Receivers &
Tube Amplifiers.

20 Gary School Road
Pomfret Center, CT 06256



BOB ESLINGER

ANTIQUE RADIOS

WANTED



DAVE CROCKER

35 Santuit Pond Rd. #4B

Mashpee, MA 02649

E-mail: rado-1@comcast.net

(508) 477-1578

URBAN ANTIQUE RADIO AND VINTAGE HI-FI

Mike Urban
Restoration and Sales

800-594-4359

www.urban-antiqueradio.com

Repro Dial Covers

<http://jmpalm.home.mindspring.com>

Mark Palmquist
Retro Radio Repair

5033 Arbor Lane

Lilburn, GA 30047

770-923-8929 \$18 ppd

Free mounting in your bezel

(add \$3.00 for Priority Mail Shipping)

jmpalm@mindspring.com

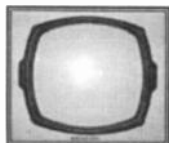

SOUND REMEDY

Loudspeaker Repair Service

www.soundremedyNJ.com • email: soundremedy@aol.com

Richard G. Stamer
Reliable-Prompt Guaranteed

331 Virginia Avenue
Collingswood, NJ 08108

Tel (856) 869-0238
Fax (856) 869-6880



ESTES AUCTIONS

Specializing in Vintage Radios
& Radio Appraisal Service
www.estesauctions.com

7404 Ryan Road
Medina, Ohio 44256

Phone: (330) 769-4992

Fax: (330) 769-4116

E-mail: estes.auctions@aol.com

WANTED PRE-1960 ELECTRICITY

MECHANICAL • X-RAY
TELEGRAPHY • TELEPHONE
PRE-1925
RADIO • WIRELESS
PRE-1960
TELEVISION

BOOKS • TUBES • ARTICLES
MAGAZINES • ALBUMS
CATALOGS • PHOTOFRA



NEW WIRELESS PIONEERS

1541 BRONSON RD

GRAND ISLAND, NY 14072

(716) 773-4999 • Fax (716) 773-5757

E-mail: wireless@pcc.net

www.marconi-wireless.com



Just Radios



Capacitors & Schematics for Tube Radios

David and Babylyn Canteion
6 Ferncrest Gate, Scarborough,
Ontario, Canada, M1W 1C2

www.justradios.com
justradios@yahoo.com
(416) 502-9128

ANTIQUE TELEPHONES

RADIOS • MICROPHONES • EDISON-VICTOR • EARLY FANS • TOYS
BARBER POLES • RESTORATION • REPAIR • BUY • SELL • TRADE

FIRE & POLICE
CALL BOXES

E-MAIL: AMPW@PACBELL.NET
WEBSITE: VINTAGEPHONE.COM

EKKHAART



PH/FAK (850) 571-8070

1128 E. CAMINO REAL

SAN CARLOS, CA 94070

(850) 831-1800

OPEN DAILY 10:00-6:00



WANTED FISHER RADIO/PHONO CONSOLE

SERVICE MANUALS • OWNERS MANUALS
ADVERTISING MATERIALS

1945 THROUGH 1972

Contact: Jon Kummer • Antique Radio Classified

Web: www.antiqueradio.com • Email: arc@antiqueradio.com

Tel: 866-371-0512

Play Things of Past

Vintage Radios, Tubes and Parts

Service early Radios, TV's,
Phonographs & Telephones

Play Things of Past
2324 Fawn Haven Dr.
Medina, Ohio 44256
330-558-0247 Work

Gary B. Schneider
gbptop@aol.com
www.oldradioparts.com
330-558-0208 Home



Buying radio tubes, parts, radio literature, telephone parts

PUT
YOUR BUSINESS CARD
HERE!

\$53 for 3 months - \$90 for 6
months

Don't have one? Send an extra \$7
and we will typeset one for you.

BUSINESS CARD ADS - \$53.00 FOR 3 MONTHS

BETA-TEK ANTIQUE RADIO SERVICE

- Quality Radio Repair & Restoration
- Prompt Service • Free Estimates
- Radios Bought & Sold

RAY BINTLIFF
2 Powder Horn Lane
Acton, MA 01720
978-263-7435
w1ry@msn.com



Great Northern Vintage Radios



Vintage Radio
Bought • Sold • Repaired
Knobs • Parts

Advertising • Antiques • Collectibles

Alan Jesperson
5200 Bloomington Ave. S.
Minneapolis, MN 55417

Tel: (612) 727-2489
Email: alanjesp@gmail.com
Web: www.gn4radios.com

Antique Electric Radios

Repair, Restore, Buy & Sell
Vintage table and console radios, phono, Hi-Fi
audio, auto radios, crank phonographs

Hear them play again!

John Hartman PO Box 201, Eaton, NH 03832
(603) 447-4821 E-mail: nm1h@hotmail.com
Sales web site: www.radioattic.com/nm1h

www.renovatedradios.com

specializing in rubber & plastic repros

grommets
washers
pushings
RF isolation
cushions
bumpers
feet



radio knobs
clock knobs
TV knobs
TV masks
pushbuttons
CDs
R/P rubber

Ed Schutz (586) 697-6153
5209 St. Richard Dr., Shelby Twp., MI 48316
blacksmith@renovatedradios.com

RADIO BOOKS WANTED

Always buying: Books, Magazines and Manuals.
Single items or collections. Call us toll free: 888-447-5037
We have a large selection of books on radio and related
technology for sale. Call us about our shop and catalogs or
visit our web site: <http://www.beqbooks.com>

BEQUAERT OLD BOOKS
P.O. BOX 775, FITZWILLIAM NH 03447
(603)-585-3448 info@beqbooks.com

Replica knobs and small parts

PUSHBUTTONS • ESCUTCHEONS • PLASTIC GRILLES

Larry Bordanara, Old Time Replications
5744 Tobias Ave., Sherman Oaks, CA 91411
Phone (818) 786-2500 • Fax (818) 909-0241
email: oldtimerep@aol.com
www.antiqueradioknobs.com

knobs



Vintage Electronics



Our Specialty - Phonograph
Cartridges/Needles



Phono / Tape Idlers - Rebuilt



Ed Crockett
128 Buccanier Drive
Hattiesburg, MS 39402
e-mail: phonoed@aol.com

(601) 264-4755
Monday - Friday
9am - 5pm CST Only
www.vintageelectronics.com



The Voice of Music®

V-M MANUFACTURED:

- Phono & Tape Service Parts
- Service and Owner's Manuals
- 45 Adapters and Accessories
- Component Record Changer Sales
- Changer Restoration Services

ALL BRANDS:

- Wheels, Needles/Cartridges and more!

V-M Audio Enthusiasts

37530 E Meadowhill, Northville, MI 48167 • (248) 478-0990
www.thevoiceofmusic.com • info@thevoiceofmusic.com • Gary Blank

ADAMS MANUFACTURING CO.

RADIO DIAL BELTS

To Fit All Radios

Visit our website
www.Adamsradio.com

RADIOS &
STRANGE
MISCELLANEA

IF YOU VISIT THE BRIMFIELD FLEA MARKET...
STOP BY FIRST!

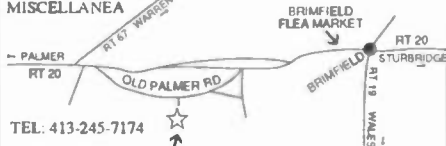

TEL: 413-245-7174

COUNTRY ROAD BARN - BERNIE SAMEK
OLD PALMER ROAD, BRIMFIELD, MASS.



WAVES L.L.C.

ANTIQUES
EARLY RADIOS
&
PHONOGRAPHS
BOUGHT • SOLD
RENTALS • REPAIRED

11-5 WED-SUN
MON & TUES BY APPOINTMENT

WEBSITE: WavesLLC.com

e-mail: WavesLLC@gmail.com

212-273-9816

201-461-7121 Fax

SHOWPLACE ANTIQUE CENTER 40 W. 25 ST. NY, NY 10010 # 107

PROPRIETORS Bruce and Charlotte Meyer

P
UT
YOUR BUSINESS CARD
HERE!

\$53 for 3 months - \$90 for 6
months

Don't have one? Send an extra \$7
and we will typeset one for you.



ANTIQUE RADIO CLASSIFIED BOOK STORE



Audio Amateur Power Amp Projects. This profusely illustrated handbook features 26 of the best articles on power amps published between 1970 and 1989 (mostly solid state). 205 pages, soft cover.....\$19.95.

Beginner's Guide to Reading Schematics, Traister & Lisk. Takes you step by step through every phase of understanding and using electronic circuit diagrams or schematics. 129 pages, soft cover.....\$15.95

Beginner's Guide to Tube Audio Design, Rozenblit. Explains what vacuum tubes do and how to use them for tube audio design. 134 pages, soft cover.....\$24.95

Classic Cones, Chidester. Pictorial reference & value guide for 1920s radio cone speakers. 100s of color photos. 2001. 122 pgs.....\$25.95

Collector's Guide to Antique Radios, 7th Edition, Stusser. Covers the 1920s to the 1950s. Plus 14 additional manufacturers. Over 10,000 models. 1,200 color photos, (15% more than the last edition). Updated 2007 pricing. 320 pgs.....\$24.95

The Collector's Guide to Novelty Radios, Bunis & Breed. Descriptions with prices. 600+ color photos. 1994. 224 pgs.....\$18.95

The Complete Price Guide to Antique Radios: Pre-War Consoles, Stein. Identifies, grades, values & pictures 3,500 models. Tube & band count information & variations. Resource section. 240 pgs.....\$29.95

The Complete Price Guide to Antique Radios: Sears Silverstone Catalogs 1930-1942, Stein. 1,000+ radios. Original advertising, options, specs & pricing. Full model cross reference matrix with tube & band counts, variations. 240 pgs.....\$34.95

Crystal Clear - Vintage American Crystal Sets, Crystal Detectors and Crystals, Sievers.
Vol. 1 - Comprehensive reference with 750 illustrations, 570 crystal sets, 341 detectors, 207 crystals, 282 pgs.....\$29.95
Vol. 2 - 479 all new & different illustrations, more crystal sets, detectors and crystals identified, 252 pgs.....\$29.95

Fixing Up Nice Old Radios, Romney. Written by a retired radio instructor, this book covers Ohm's law, through battery sets, superhets..... and communications receivers. 1990. 300+ figures, 185 pgs.....\$35.00

Flick of the Switch, McMahon. The classic photo reference guide for '30s - '50s radios. 1000+ photos. 263 pgs.....\$11.95

Genuine Plastic Radios of the Mid Century, Jupp & Oina. Colorful and collectible, mid-century table radio are examples of popular culture and industrial design. 439 color photos. 208 pgs.....\$39.95

Ham Price Guide, 2nd, Rippen. Prices for over 3,800 transceivers, receivers, tuners, transmitters, amplifiers, antennas and test equipment. Additional prices for books, tubes and catalogs. 1999. 81 pgs.....\$10.95

Healthkit, a Guide to Amateur Radio Products, 2nd Ed., Penson Updated and expanded documentation of Healthkit's amateur radio products and a history of the company. 328 pages.....\$32.95

The LP is Back. From the pages of Audio Amateur magazine and other sources, absolutely everything you need to get the most out of your vintage LPs or new audiophile quality pressings. 160 pages, soft cover.....\$7.95.

The Mechanics of TV, Yanczer. Explanation of mechanical tv, details for a working system. 170 pgs.....\$24.95

Old-Time Radios! Restoration and Repair, Carr. How to repair vacuum-tube and transistor radios. A self-paced training guide. 200 illustrations, 256 pgs.....\$19.95

Perera's Telegraph Collectors Guide, Perera. Basic info & reference material, 300 pictures, descriptions & current prices. 104 pgs.....\$19.95

Philo Condensers and More, Fourth Edition, Bintliff. Updated and expanded service data. 300 illustrations, 74 pgs.....\$14.95

Philo Radio: 1928-1942. 2nd Ed., Reamirez. A reference book on Philco. Show receivers and company history year-by-year. 464 color photo, 364 black & white photos and drawings. 160 pgs.....\$29.95

Practical Radio Repair, A Handbook for Radio Collectors, Bintliff Provides practical information on how to repair and restore vacuum tube radios and related electronic devices. More than 270 illustrations & tables. 140 pgs.....\$25.95

Radio Craft - 50 Years of Radio, (reprint), March 1938 issue of Radio Craft magazine. Numerous articles on the development of radio, then 50 years old, & on early radio pioneers. 144 pgs.....\$15.95

Radio Dial Belts, 2nd Ed., Bintliff. A guide to the selection and replacement of dial belts in radios from the 1930 & 1940s.....\$15.95

Radio Manufacturers of the 1920's, Douglas. 3 volumes.
Vol. 1: A-C Dayton thru Ferguson, 225 pgs.....\$29.95
Vol. 2: Freed-Eiseman thru Pries. 266 pgs.....\$29.95
Vol. 3: RCA thru Zenith. 292 pgs.....\$29.95

Radiola - The Golden Age of RCA, 1919-1929, Wenaas. Documents & pictures every radio receiver & the major accessories sold by RCA during the first decade. 700 color photos, 485 pgs.....Hardcover \$45.00

Radios by Hallicrafters, Dachis. From the 1930s until the 1980s Hallicrafters led the shortwave radio boom with innovative design and cutting edge technology. Over 1000 photos and 225 pages.....\$29.95

RCA Cunningham Radiotron Tube Manual RC-12. This is a nice reprint of the RCA Cunningham Radiotron Tube Manual RC-12. Originally published in 1934. 154 pages, soft cover.....\$16.95

S. Gensback Radio Encyclopedia (reprint). 1927 classic encyclopedia on radio. From "A" battery to Zirconium, with 1000s of entries in between. 100s of illustrations. 175 pgs.....\$9.95

Tickling the Crystal, Sanders. Comprehensive coverage of British crystal sets from the 1920s. 200+ B&W photos. 2001. 256 pgs.....\$64.95

Tickling the Crystal 2, Sanders. Domestic British Crystal Sets of the 1920s. 2004. 208 pgs.....\$64.95

Tickling the Crystal 4, Sanders. Next in a series on domestic British crystal sets. Many color photos in addition to B&W. Cumulative index to Vols. 1, 2, 3 & 4. 2008. 280 pgs.....\$64.95

The Tube Amp Book, Pittman. Deluxe edition revised. Already known as the bible of guitar tubes and guitar tube amps, The Tube Amp Book is now even better! This deluxe revised edition contains 40% new material. 416 pages, hard cover, CD ROM included.....\$39.95

Zenith Radio Corporation (reprint). The instructions for installation and operation for Models 39-39A Models 392-392A, and Electric Zenith Receivers. 3 schematics, 3 photos. 16 pgs.....\$4.50

Zenith The Early Years, 1919-1935, Cones, Bryant & Blankinship. Explains the Zenith story. Discover never published photos, documents and information. 300 photos and illustrations, 120 m color. 224 pages.....\$29.95

Zenith The Glory Years, 1936-1945, Cones, Bryant & Blankinship. Illustrated Catalog & Database, 520 B & W images, 182 pages.....\$29.95

Zenith The Glory Years, 1936-1945, Cones, Bryant & Blankinship. History and products, 180 color photos, 183 B & W photos. 256 pages.....\$34.95

The Zenith Tran-Oceanic, Bryant & Cones. The untold story of the Zenith Tran-Oceanic now in a newly revised and expanded edition. A wealth of never before published photos. 226 photos with price guide, 128 pages, soft cover.....\$34.95

Zenith Transistor Radios, Evolution of a Classic, Smith. A complete listing of all transistor radio models created by Zenith during the "Magic Years" from 1955-65. Color photos and price guide. 1998. 160 pgs.....\$29.95

**Everything stocked & shipped promptly
Radio is our middle name.**

A.R.C., PO Box 1558, Port Washington, NY 11050
Toll Free: (866) 371-0512 • Fax: (516) 883-1077
E-mail: ARC@antiqueradio.com
Web: www.antiqueradio.com

\$3.00 shipping & handling on all U.S. orders (typical U.S. order will be received within 7 days, but allow 2-3 weeks). Non-U.S. orders, write for shipping costs, or use credit card. Most orders shipped by next business day. If using credit card, include name on card, card number and expiration date. Send payment with order. New York residents must add sales tax.





★ HUGE 3-DAY AUCTION ★

Antique Phonographs, Radios, Music Boxes, Televisions, Juke Boxes, Etc.

To be held at 1025 S. Cochran Ave., Eaton County Fairgrounds, in Charlotte, Michigan on:

Auction - Thursday Nov. 17 @ 3:30 P.M. – Selling approximately 250 lots

Preview begins at 1:00 P.M. – Luncheon from 1:00 – 3:00 P.M.

Auction: Friday Nov. 18th & Saturday Nov. 19th @ 9:00 A.M. each day

A fantastic auction including large Estate collections, accumulations of rare, early and collectible machines of all types & lots more. We are in the beginning stages of assembling, photographing and cataloging items that will be sold, as well as still acquiring additional pieces from around the country and Canada. Call if you have questions or to be put on our list to receive our free catalog. Also go to our website at www.stantons-auctions.com for more information.

Rare early cylinder, disc and coin-operated phonographs, excellent and scarce music boxes including a Regina automatic changer, bell boxes, Reginaphones, etc., an excellent collection of antique radios including many rare Atwater Kent breadboards, Sparton Peach sleigh, Catalin, speakers, floor, the list goes on and on, a great collection of antique televisions including early mechanical, pre and post-war examples, table and floor and related items, many jukeboxes, a Cremona nickelodeon w/stained and leaded glass, and thousands of interesting and rare pieces from all fields. This is an excellent and diversified offering.

10% buyer's premium charged

Steven E. Stanton

517-852-0627 evenings or 517-331-8150 days

Founded in 1954 we are specialists in the field of automatic music machines. Call us to discuss your situation in total confidence.

Stanton's Auctioneers & Realtors

144 S. Main, P.O. Box 146

Vermontville, MI 49096

Phone: (517) 726-0181

Fax: (517) 726-0060

E-mail: stantonsauctions@sbcglobal.net

Website: www.stantons-auctions.com



Steven E. Stanton

(517) 331-8150 day/cellular
or (517) 852-0627 evenings



PRESORTED
FIRST CLASS MAIL
U.S. POSTAGE PAID
FARMINGDALE, NY 11735
PERMIT NO. 459

A.R.C., PO Box 1558, Port Washington, NY 11050

14/14 1415*****AUTO**MIXED AADC 117
SUB#=20441[3592] EXP=SEP 12
Lavern Velau
PO Box 143
Klemme IA 50449-0143



www.antiqueradio.com

CLASSIFIED AD
DEADLINE October 23
Noon Eastern Time