



ANTIQUE RADIO CLASSIFIED



VOLUME 17

APRIL 2000

NUMBER 4



A.R.C. — THE NATIONAL PUBLICATION FOR BUYERS AND SELLERS
OF OLD RADIOS AND RELATED ITEMS — PUBLISHED MONTHLY

ANTIQUE RADIO CLASSIFIED

Antique Radio Classified (ISSN:8750-7471) is published monthly, 12 times per year, by John V. Terrey, One River Road, P.O. Box 2, Carlisle, MA 01741. Periodicals postage paid at Carlisle, MA, and additional mailing offices. Telephone: (978) 371-0512, 8:30 AM to 5:00 PM ET weekdays; machine answers phone at other times.

Annual subscription rates within the U.S. are \$39.49 by Periodicals mail and \$57.95 by First Class mail.

Annual foreign rates. By air: Canada - \$61.00; Mexico - \$67.00; Other foreign countries - \$105.00. Surface mail: Canada - \$51.00; Other foreign countries - \$58.00. (Surface delivery to countries other than Canada may take two or more months and cannot be guaranteed.)

Two-year subscriptions are twice these rates and receive an extra month. Sample issues are available free on request.

© Copyright 2000 by John V. Terrey.

POSTMASTER: Send address changes to Antique Radio Classified, P.O. Box 2, Carlisle, MA 01741. Printed in U.S.A.

STAFF:

Publication and Editor: John V. Terrey
Production & Advertising Manager: Cindie Bryan
Office Manager: Tammy DeGray
Managing Editor: Dorothy Schecter
Publishing & Editorial Staff:
Malaika Brodeur, Dave Crocker, Bobby Lyman
Founding Publisher/Editor: Gary B. Schneider
Contributing Writers & Consultants: Mike Adams, Richard L. Arnold, Richard Begbie, Ray Bintliff, Ron Boucher, Paul J. Bourbin, Norman S. Braithwaite, Dave Crocker, Dick Desjarlais, Alan S. Douglas, Richard C. Foster, Fred Geer, Jim Kreuzer, Ron Ramirez, Henry Rogers, Ian L. Sanders, Gary B. Schneider, Daniel Schow, Frank R. White, Ralph Williams, Walter Worth

PURPOSE. Antique Radio Classified is published for people involved in the radio collecting hobby. Its purpose is to stimulate growth of the hobby through the buying, selling and trading of radios and related items, and to provide a monthly forum for the interchange of ideas and information.

CONTACTING ANTIQUE RADIO CLASSIFIED. All correspondence should be sent to:

A.R.C., P.O. Box 2, Carlisle, MA 01741.

Only UPS, Federal, etc. items to street address; One River Road.

Telephone: (978) 371-0512; Fax: (978) 371-7129

E-mail: ARC@antiqueradio.com - Web: www.antiqueradio.com

Please, no classified ads by telephone; thanks.

Your ads, renewals, letters, etc. can be handled faster and more efficiently if your name, address and SUB# are written on each.

Unfortunately, A.R.C. is not staffed to answer all letters with questions about antique radios or requests for advice. However, A.R.C. does solicit letters of interest to its readers and publishes them as space permits. (See "Publishing Rights" paragraph.)

GUARANTEE. You may cancel your subscription at any time and receive a pro rata refund for issues not yet mailed. If errors to ads are made by A.R.C., upon request a free correction will be run in the next available issue.

DISPLAY AND BUSINESS CARD ADS - DETAILS AND RATES

The deadline is the first of the month for display and business card ad artwork, payment and repeat requests.

Advertising is accepted only for early items related to radio, communication, etc. All items must be described fairly; reproductions, reprints and non-original items must be so identified. Advertisers must agree to respond promptly to inquiries and orders, to resolve problems promptly if the buyer is not satisfied, and to comply with a buyer's refund request on unaltered returned items.

Advertising must be prepaid, except as noted below; see "Payment" paragraph above for details. Late ads will be run only if space and time permit. Since artwork is reduced to 63% in the printing process, originals must be the artwork size listed below. Do not send in artwork on art board or send negatives. Ads should be typeset or typed neatly with a carbon ribbon, black ink (not pencil) on white. If used, reverse type must be limited to 25% of the ad. If you want us to prepare your ad, include the one-time cost below for A.R.C. to make up the ad.

Photos should be at an 85-line screen; otherwise, add \$16.00 per photo for screening. Do not cut or trim photos or glue photos to artwork; submit separately.

If you are confused by these requirements and terms, please

Page	ARTWORK SIZE (SEND IN THIS SIZE)		As Printed (size in magazine)	
	H x W (inches)		H x W (inches)	
Full	12 7/16 x 7 1/2		7 3/4 x 4 3/4	
1/2 H	5 1/4 x 7 1/2		3 5/16 x 4 3/4	
1/2 V	12 7/16 x 3 9/16		7 3/4 x 2 1/4	
1/4	5 1/4 x 3 9/16		3 5/16 x 2 1/4	
1/8	2 5/8 x 3 9/16		1 5/8 x 2 1/4	
Business Card (1st)	2 x 3 3/4		1 1/4 x 2 3/8	
Business Card (2nd...)	2 x 3 3/4		1 1/4 x 2 3/8	

* Full & 1/2 page. 6-mos.: 1/2 due with order; 1/2 due in 3 mos. ** Full & 1/2 page, 12-mos.: 1/2 due with order; 1/2 due at 3, 6 & 9 mos.

* For 6 and 12 month ads, no ad make-up charge if no change is made to ad for entire run.

PAYMENT. Please send in full payment with your order or ad. A.R.C. does not carry accounts; all subscriptions, ads, etc. must be prepaid (except for the 6 and 12 month display ads indicated below). Pay in U.S. funds. Checks drawn on a U.S. bank, money orders, VISA or MasterCard (\$10.00 min.) are preferred. Make check out to "A.R.C." U.S. stamps or cash are OK for small amounts. Canadian payers may send a Canadian check but specify U.S. funds. Subscriptions will be prorated to amount sent if amount is incorrect.

FAX & E-MAIL PROCEDURES/PAYMENT. Subscriptions, book orders, classified ads, display ads, etc. are welcome by fax or e-mail. Deadlines are the same as for ads received by mail. Please calculate the amount due. Payment by VISA or MasterCard is preferred if your order is over \$10. If under \$10, or if you prefer to send a check or money order, state the amount being sent and that the payment is in the mail. Do not send another copy of your ad with your payment; simply indicate that it is a fax or e-mail payment. If you want confirmation of our receipt of your fax, call immediately after sending your fax.

CHANGE OF ADDRESS. Please notify us 4 weeks in advance of a change of address. Send both your new and old addresses, and include your SUB# and effective date of your new address. Temporary address changes can be made also.

SUBMISSION OF MATERIAL. Antique Radio Classified welcomes and solicits information that pertains or relates to radio history or collecting. This may include articles, book reviews, photos, information on upcoming radio events, meetings, antique radio organizations, radio auctions, sources of old radio and restoration supplies, and other related and interesting material. All material submitted should be carefully researched, typed and accompanied by good photos, if appropriate. Computer disks are appreciated. Writing guidelines are available upon request.

PUBLISHING RIGHTS. Unless other arrangements are made: (1) All received materials (ads, articles, letters, correspondence, e-mail, photos, artwork, etc.) become the property of A.R.C. may be edited, combined with other material, published, and will not be returned. (2) For all received materials, A.R.C. is granted publishing and reprint rights in all forms of media including the monthly printed magazine, internet, etc. (3) Publication is subject to approval by A.R.C. and to time and space constraints.

MAILING OF ISSUES. U.S. subscribers can receive A.R.C. by First Class or Periodicals mail (Periodicals is the way most magazines are mailed). The mailing of First Class copies is staggered with faraway copies mailed before local copies. Non-U.S. copies are mailed on the first day. Periodicals copies are mailed on the last day. Mailing dates change each month, but mailing is usually completed by the 27th of the month. First Class copies usually are received by the 5th of the month; copies by Periodicals mail, by the 10th.

ETHICS. No person involved in the production of A.R.C. is to act on any information in the magazine until the first delivery day after local copies are mailed.

DISCLAIMER. The publisher is not responsible for any buying and selling transactions incurred, or for any other use of the contents of this publication.

Antique Radio Classified subscription rates, frequency of publication, content, policies, size and ad details, and rates are subject to change at any time by A.R.C.

contact A.R.C. before beginning to prepare your ad. We will be happy to advise you on your ad ideas, estimate how much the ad will cost, recommend an ad size, etc.

We assume that advertisers want all ads which are submitted to run without delay; therefore, we will run the ad and bill for any additional work required for the ad to meet these specifications. A late ad will run beginning with the next month. "Tear sheets" will be sent only for 1/8-page or larger ads and only if requested when the ad is submitted.

First business card per advertiser is at lower rate.
The 3-month rates represent about an 11% discount, the 6-month rates 23%, the 12-month rates 30%. Placement requests: add 15% but call first. Clubs: write for discount policy.

Cost for	Cost for	Cost for	Cost for	One Time
1-month	3-months	6-months	12-months	to Make up Ad
\$289.00	\$769.00	\$1,329.00*	\$2,325.00**	\$69.00†
146.00	389.00	675.00*	1,175.00**	37.00†
146.00	389.00	675.00*	1,175.00**	37.00†
74.00	197.00	342.00	595.00	19.00†
38.00	101.00	177.00	305.00	9.00†
not avail.	53.00	90.00	159.00	7.00†
not avail.	68.00	118.00	205.00	7.00†



ANTIQUE RADIO CLASSIFIED



EDITOR'S COMMENTS

Our April issue always calls for a bit of foolery, and the advertising cartoon on our cover seemed to fill the bill. Since the drawing is half of an ink blotter (see the other half on page 21), we began to wonder how many of you even remember ink blotters. They were standard equipment in the days of quill pens, inkwells (ah, those "Palmer Method" days!) and, later, fountain pens.

Sitting at his desk, the owner of this blotter was constantly reminded that his radio needed batteries — USLs, of course. Certainly the character on our cover is a foot-tapping, happy man with musical notes popping all around him, thanks to his being "on the right side" of battery choice. But, his sad counterpart on page 21 has been left without a USL battery and is steeped in static.

It's hard not to think of the hazard of having such an acid-filled, storage battery on the living room rug. The ladies of the times must have been relieved when battery eliminators became more available.

And since batteries are the theme of the moment, Robert Pinelli's article on rebuilding a portable radio battery fits right in. Rather than search for those hard-to-find B batteries, Robert decided to take the cases of the burnt-out batteries and install modern rechargeable batteries in them. Ray Bintliff adds some comments about rechargeable batteries and battery chargers.

Our lead article leaps a few decades ahead to the military equipment of World War II and beyond — Part 3 of Hank Brown's report on the activities of the Military Radio Collectors Group and some of their impressive equipment. Though some collectors showed interest in this field as early as the 1950s, the time appears to be right for the serious preservation of its history.

Home brews are another aspect of radio collecting that is not as heavily pursued as that of name brands. However, when something unique comes along, like the air-frame variometers in Bill Corkutt's home brew, we all pay attention. Bill's pleasure in restoring his find reminds us that sometimes a home brew can be much more than a bargain.

And Ray Bintliff's fascination with a seemingly ordi-

Oops — The Hazards of E-mail!

Radio Miscellanea in our March 2000 issue contained comments from an individual who had not given a postal address. Since we continue to use postal addresses in our magazine, we consulted our files and came up with the address of a subscriber of the same name. However, our subscriber, Mark Richardson, did not send the e-mail. We have apologized to Mark and have resolved in the future to verify the identity of all e-mail correspondents whose names might be published.

The marvel of e-mail is diminished by the confusion resulting from people failing to use even full names, let alone postal addresses. In general, e-mail encourages anonymity. To counter this trend, the signature feature on some e-mail programs can add your identification automatically. If people wish to be heard, they should be willing to identify themselves completely.

nary midget AC/DC set is another kind of nudge in the direction of not judging a book by its cover or a radio by its cabinet. An inquisitive engineer like Ray couldn't resist pursuing the answer to why this set has the unusual 5-pin socket on the rear apron of the chassis. You'll have to read the article to find out the result of his dogged search.

With each year, excitement over the Greater Boston Antique Radio Collector's Radio XXXI grows, and it has become *the* annual New England radio event. Such an event catches fire not just because of the display of interesting equipment but because of the people who make it all happen. This year we decided to set Dorothy Schecter, our managing editor, loose to interview folks around the hall. Her report shows how varied in age, gender, and specific radio interests the crowd is, and how this variety generates the excitement generally felt.

In addition to several interesting crystal sets, *Photo Review* depicts a rather unusual horn speaker. Also unusual is the Radiola III with its Balanced Amplifier mounted in a cabinet with a built-in horn speaker.

Radio Miscellanea contains an observation about an odd source of interference when testing old radios, along with a request for information concerning another area of radio not often addressed — auto radios. We also have received feedback on articles about Rider's, radios as furniture, and Multivalve radios. And we're always grateful for notes of praise about the magazine, our services, and our Web site.

The Internet. In general, the plan to put the classified ads up on the Web has been a success. About a week after the 10th, you can obtain the classified ad release date by checking the Web site. Hundreds of you have used our traditional Marketplace for several years now with great success. Adding the "secure" feature to this service is still proving difficult. We want it to be flawless before we release it, but you should see it soon.

Coming Radio Events. Among the nearly 50 meets scheduled for April are the Colorado Radio Collectors Club's Annual Show & Sale in Colorado; and "Spring Fever" in West Virginia, jointly held by the Museum of Radio & Technology and the Pittsburgh Antique Radio Society. For our South American collectors, Antique Radios in Brazil is holding a 4-day show consisting of a swap meet, sale, and auction in Sao Roque, Brazil.

Look for A.R.C. at both the New England Antique Radio Club Swap Meet in Nashua, New Hampshire, and at the National Vintage Communications Fair in Birmingham, England.

Happy Collecting!

John V. Terrey, Editor

ON THE COVER

Our cover is an example of humor in advertising in the 1920s. The drawing is the cartoon on the right half of an advertising ink blotter from your editor's collection and shown in full on page 21. USL batteries are the product being touted, and the slogans indicate that the Madison Ave. mindset was hard at work even then.

VINTAGE MILITARY EQUIPMENT

Collecting Military Equipment — Part 3 Plus a Preview of the MRGC 2000 Meet

BY HANK BROWN

A.R.C. has been following the MRGC annual meets for three years now, and each of Hank Brown's reports has attested to the growing interest in military equipment. Hank also includes much additional material on individual sets, and this Part 3 draws on that material. In fact, a Part 4 surely will be published in a later issue. These articles help to open up a special category of radio history and its jargon and to introduce us to a highly participatory aspect of radio collecting.

Past A.R.C. articles on World War II military equipment appeared in November '89, June '91, and November '94. Parts 1 and 2 of this series appeared in March '99 and August '99. (Editor)

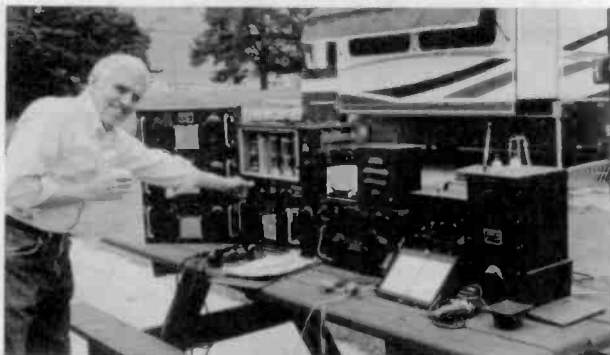

At last year's event, Andy Becker, NONVM, looks over the BC-191 and BC-312 set. This station was operational with dynamotors powered by batteries on the back of the bench.

The Military Radio Collectors Group (MRGC) will hold its fifth annual meet on Friday and Saturday, May 5-6, 2000, at the NCO Club in Camp San Luis Obispo, California. We hope to have something for everyone with the usual theme — Military Radio. That means anything from any time period and from any place in the world. Examples of last year's displays and operational stations are shown in accompanying photos.

FRIDAY EVENTS

The general program for Friday, May 5, 2000, includes field operations, setting up equipment and a 6-meter hidden transmitter hunt followed by a 6-meter DX distance test. A small FM transmitter with variable low

power operating on 51 MHz will be used as the hidden transmitter. The same transmitter will be used as a signal source for the 6-meter distance test.

Anything working on 51 MHz FM can be used to try for the best DX distance. Another BC-611/TBY shootout for best DX will be held as last year. Those results, unfortunately, were undecided due to equipment troubles.

Two BC-148 Army transceivers (on CW) from the 1930s period will be set up and operating on loop antennas. Anyone with an appropriate license can operate one of the sets and communicate with friends on the other set. There should also be a number of PRC-6, PRC-25, PRC-77 and helmet-type radios in operation.

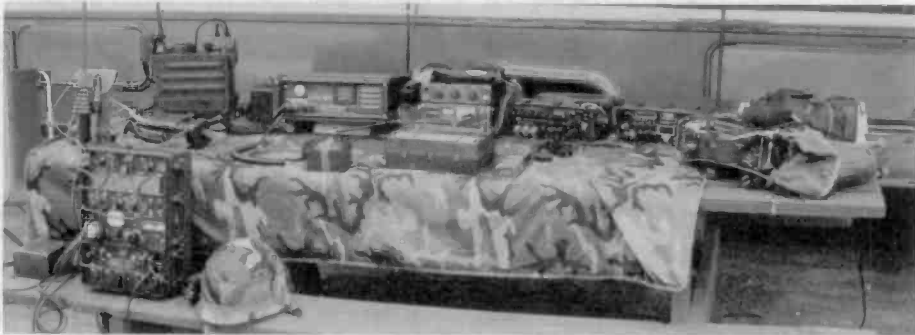

Last year, Cameron Ogan, WA6VVC, brought late model military gear, as well as the AN/GRC-9 on the left bench seat. Next to the GRC-9 is a helmet radio. On the table, left to right: PRC-77 VHF, RT-100 HF, FT-70 HF, SC-130 HF, MP-25 HF and PRC-1099 HF sets.

Several other sets will be up and running. For example, a T-368/R390 on 80-, 40- and 20-meter bands will be in operation. The 1942 GPW Jeep with AN/GRC-9 and RT-70 aboard will be operating again. A TBX is expected to be in operation. Late PRC-104, PRC-132, PRC-1099 and URC-87 gear will also be represented.

Both active and passive equipment displays will be set up inside the NCO Club, as in past years. Some of the active displays will be an ARN-30 aircraft navigation system, a Navy RU-18 receiver, an Army TG-7 page printer teletype machine, Navy RBM receivers and

(Continued on following page)

RADIO SET AN/GRC-7

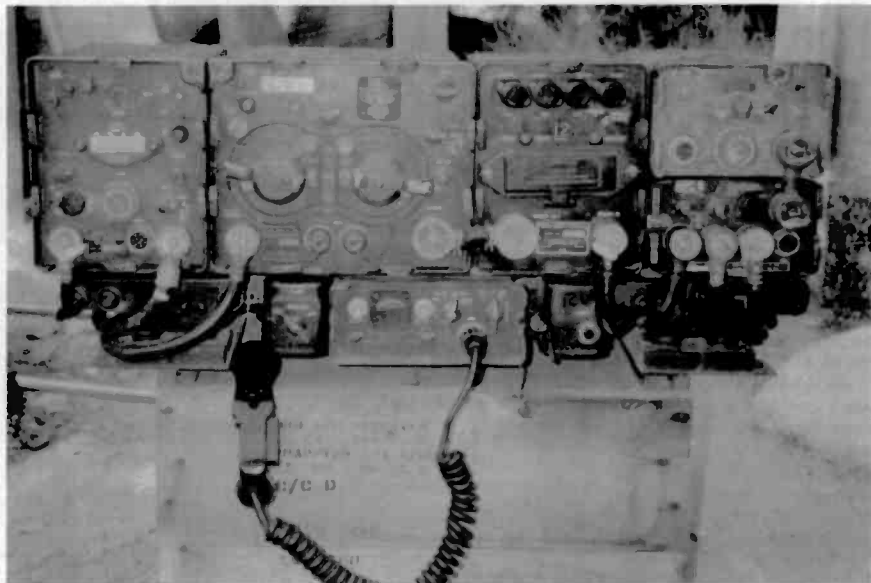

The auxiliary receiver is on the left of the rack with the main transmitter/receiver next. To the right of the transmitter is the main power supply with a short power cable near the bottom of the two units. On the right side of the rack is an RT-70 low power transmitter/receiver (top) and an AM-65 interphone and a 3-channel audio amplifier (bottom). The AM-65 also supplies power for the RT-70. Seven rack cables interconnect the units via a terminal board in the rack. The C-435/GRC control is installed in the bottom middle of the rack. This unit provides duplex and retransmission operation.

The AN/GRC-7 is one of several sets in a system, and specific nomenclature depends upon the frequency bands and equipment employed. The line runs from AN/GRC-3 to AN/GRC-8. The complete frequency range of all the sets is from 20 MHz to 58.4 MHz.

AN/GRC-7 frequency range is 38 to 58.4 MHz with an auxiliary receiver tuning from 38 to 55 MHz. There are two transmitter/receiver sets in addition to the auxiliary receiver.

This equipment is designed for short-range communications using FM. The units were installed in trucks, personnel carriers, weapons carriers, armored and other vehicles.

All of the equipment is mounted on a rack which provides interconnection between units, control of main power and power distribution. Primary power input is either 12 or 24 volts DC from batteries. Maximum current drain is about 20 amps from 12-volt sources.

Equipment used in the GRC-7 is the main transmitter/receiver with about 16 watts output and power supply PP-109/GR, the auxiliary re-

ceiver, R-110/GRC, a low power transmitter/receiver (RT-70/GRC) and an audio amplifier (AM-65/GRC). A small control unit (C-435/GRC) is used for duplex and repeater operation.

These radios were used by Army armored, artillery and infantry units in the mid-1950s.

An interesting feature of the equipment is the various modes that can be used. The two transmitter/receiver units can be used for simplex push-to-talk operation on different frequencies or can be set up to receive and transmit on different frequencies as a repeater. The set can be turned on and off and operated from a remote location over a telephone line.

Full duplex radio operation is possible with the appropriate frequencies selected. The AM-65 audio amplifier also has provision for 3-channel audio intercom work. Although it takes two men to move this set, it is a lot of fun to use.

(Reference: Army Technical Manual TM-11-284; Air Force Technical Order TO 16-30GRC-3-6.)

Army SCR-628 sets, as well as various backpack and hand-held sets.

A fun-filled Friday will wind down with pizza, salad, and soft drinks late Friday afternoon at the NCO Club.

SATURDAY EVENTS

Saturday at dawn the swap meet will start and run to about 9 A.M. You will find this to be one of the largest military-only swap meets in existence.

(Continued on page 9)

RADIO SET PRC-47

The main unit of this set is the RT-671 transmitter and receiver. The frequency range from 2.000 to 11.999 MHz is selected by three switches in 1 kHz steps.

The Marine Corps used these sets as did the Navy Seabees. The equipment is heavy and field transportable by three men. This set can be operated for several hours from 24V silver-zinc batteries or from a gasoline driven generator set operating at 115 VAC at 400 Hz.

An H-33/PT handset is used for upper sideband voice work while an H-70C headset and J-45 key are used in the CW mode. The transmitter has high and low power output settings for antenna lengths from 15 feet to 45 feet. Transmitter output on high power selection is 100 watts while low power selection is for 20 watts output.

The photograph shows the transmitter/receiver sitting on top of the portable transit case. Antennas, phones, mike, key, batteries and cables are carried in compartments in the case.

Cables to operate the equipment from 115 VAC at 400 Hz are included. The antenna is on top of the radio, and the ground radial system is to the left of the case.

When the set is installed in a vehicle, power is supplied by the onboard 24 Vdc vehicle system. The gear was usually used for longer distance communications.

Some owners and operators of this unit install a lower sideband (LSB) kit so the radio can be used on 75- and 40-meter Ham bands.

This identical receiver was probably used by mili-

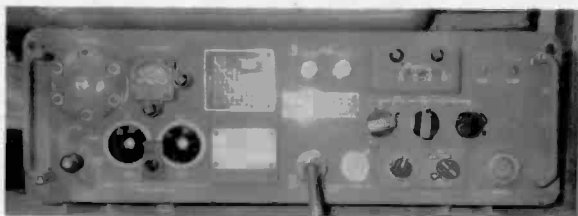

A close-up view of the AN/PRC-47 panel.



The AN/PRC-47 sitting on top of its carrying case, which also has provisions for storing accessories.

tary units right up until just a few years ago.

There were two PRC-47 units used in the field and camp grounds at the 1998 SLO MRCG meet with good results. Bob McChord, KF5PB, came down from Oregon and used a whip and 40 meter inverted V antenna. Dave Ross, KA6EPI, traveled from Rosburg, Washington, to use a whip on his PRC-47.

Collins Radio Company designed and built this set.

(Reference: TM 11-5820-509-12.)

RADIO SET SCR-300-A

The SCR-300-A, commonly called a walkie-talkie, is a small, lightweight (35 lb.) portable VHF radio set for troops in the field, which operates on dry batteries. These units were used in both World War II and the Korean War.

The top half of its case (CS-128-A) contains the BC-1000-A transmitter/receiver unit while the bottom half mounts the two dry batteries, Types BA-70 and BA-80.

The set uses a TS-15 handset and antennas AN-131-A and AN-130-A. Various accessories and components, such as bags, straps, batteries and other items, make up the complete SCR-300-A.

The 18-tube FM transmitter/receiver operates from 40 to 48 MHz. Its usable range is approximately 3 miles.

The August 1944 issue of *Radio News* has a short article on the production and testing of this unit. Photos show sets from production lines being heated to 145 degrees F to remove moisture. They are then tested.

Another photo shows sets being subjected to a temperature of 35 degrees F and then up to 149 F degrees. Again, the sets are tested for operation.

The equipment is also subjected to a 2-hour rain test. After the tests, the presence of 4 or 5 drops of water inside the case is cause for rejection.

(Reference: TM 11-242.)



A view of the SCR-300-A panel.



The SCR-300-A is shown with the antenna attached, the handset plugged into the set, and the battery box on the bottom. Carrying straps for backpack operation are attached.

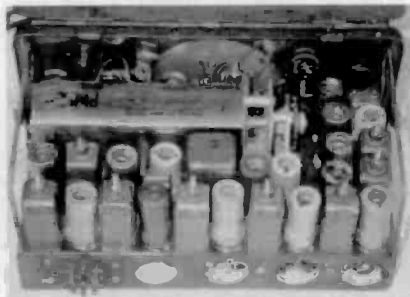

The SCR-300-A with cover removed showing interior components.

AN/GRC-109

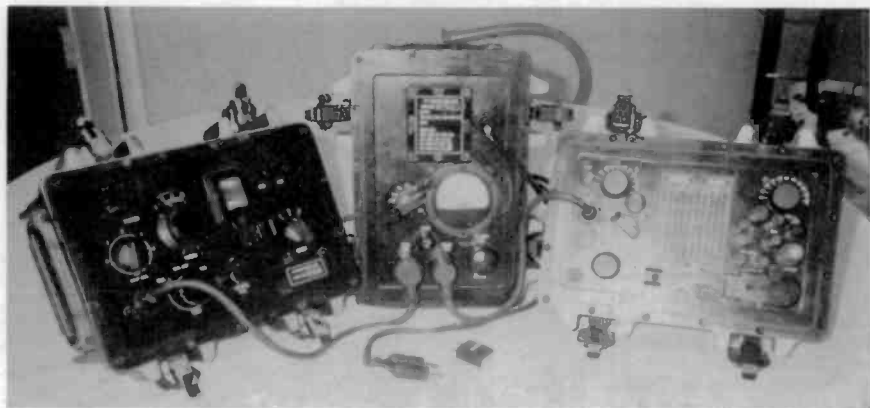

The AN/GRC-109 components, left to right: receiver, power supply for AC operation, and transmitter. An antenna and headphones would complete this installation. AC power can range from 40 to 400 cycles at voltages from 70 v to 240 v. Note the large, round, 2-pin power plug (as used in Europe) on the power cord in the photograph.

The AN/GRC-109 is a collection of units that make up a complete transmitter/receiver system. The units are small, rugged components and consist of the transmitter (T784-A), the receiver (R1004-A), and a power supply. Covers are fitted with gaskets to make the gear watertight. Small self-contained cables connect the units together for operation. This equipment dates from the 1970s and 1980s.

There are two choices for power units. One, the PP-2685A/GRC-109, operates from 75 to 260 VAC at 40 to 400 Hz, and a PP-2684A/GRC-109 which operates as above, but also from a 6 v storage battery. Current drawn from the battery is about 12 amps at full load. This later unit also charges 6-volt batteries at 3.75 amps when not transmitting or receiving.

In the field, a G-43 hand-cranked generator can be used for power. A voltage regulator, CN-690/GRC-109, is provided for field work when running from the G-43 only.

R1004A/GRC-109 is a small 3-band receiver tuning from 3 to 24 MHz. Output was usually to a set of headphones via binding posts on the front panel. Antenna and ground connections were also made to binding posts on the panel.

The receiver can be crystal controlled by plugging into the "Crystal Osc." socket located at the bottom center of the front panel.

The transmitter, T784A/GRC-109, is crystal controlled and operates on CW from 3 to 22 MHz with a crystal plugged into a socket on the front panel. The frequency range is covered in 4 bands, and a tuning chart is provided on the front panel. A key is also mounted on the front panel.

The transmitter uses crystals on the fundamental frequency or may double, triple or quadruple the crystal frequency. Lower output results from operating at 4 times the crystal frequency. Power output is about 10 to 15 watts depending on frequency.



The AN/GRC-109 power supply for 6 Vdc or AC operation. This unit is larger than the AC-only power supply. Note the AC cord and battery cables. This unit can operate from 6 Vdc input or can be used to charge a 6-volt battery when not operating the radio sets.



The AN/GRC-109 components with covers on, left to right: power supply, transmitter and receiver. The smaller AC-only power supply is shown at the center.

AN/GRC-109 (continued)

A wide variety of antennas can be loaded by the transmitter Pi output network. A wire anten-

na about 100 feet long is recommended for general use. Break-in is provided by grounding the receiver antenna when the transmitter key is down.

(Reference: TM 11-5820-474-14.)

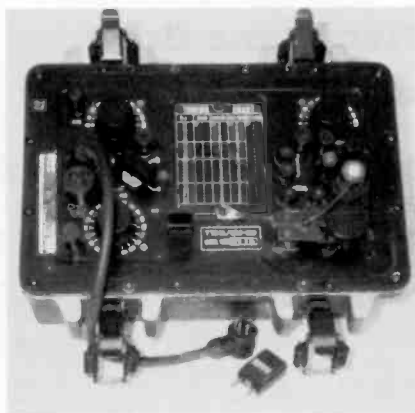

The T784A/GRC-109 transmitter has the controls and tuning chart on the front panel. The power cable extends from the front panel. A typical crystal is in front of the unit. A built-in key is mounted on the bottom right corner of the unit.

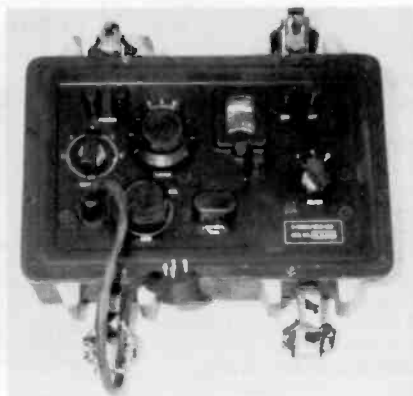

The R1004-A/GRC-109 receiver showing the power cable and crystal socket near the bottom center of the front panel.

Preliminary information indicates that among the offerings will be the following: RBC, RAS, BC-348, ARC-5, SCR-274-N, PRC-47, BC-611, PRC-9, RBL, ART-13, BC-639, and BC-AR-230, as well as assorted racks, plugs, coils, cables and other accessories and parts. There will also be a large number of military manuals to look over. Bring your gear and set it out for trade or sale.

On Saturday, the first speaker will be Ludwell Sibley with a presentation on World War II German and Japanese radios. Bart Lee follows Ludwell with Part II of his topic on World War II radio intercept. Cam Ogan will present an overview of late model tactical radios, which should answer many questions for a number of collectors who are getting into "Green Radio." Cam will have several sets in operation. Bjorn Forsberg will round out the program with an interesting presentation on the German Enigma code machine.

Lunch on Saturday, the ever popular Santa Maria style BBQ with chicken, meat, salad, beans, and all the trimmings, will be held just outside the rear of the NCO Club. Prepared by Dave Ragsdale and Art Plummer, this BBQ is always reasonably priced and delicious.

Also on Saturday, Jeanne Reed has prepared a trip to the Steinbeck home in Salinas for all the ladies. They will have lunch there and explore old Salinas. Please let us know if you plan to join the group.

Final meeting activities include a short report on preparations for this year's meet, costs involved,

announcing next year's dates, and selecting someone to host that event.

There are a number of convenient motels in nearby San Luis Obispo, as well as the Camp SLO RV Park next to the NCO Club. BOQ type rooms are also available on the Camp San Luis Obispo property. The area seems to be pretty active about this time of year so get your reservations and plans in early.

The MRCG is a group of volunteers with no elected officers. No dues are paid, and the group is supported by contributions at the event. Please feel free to join in and have some fun. We welcome your ideas, suggestions and participation. The only thing you need is an interest in Military Radio.

Contacts for this year's meet: Hank Brown, W6DJX, 4141 West L-2, Lancaster, CA 93536, (661) 943-2027, htbrown@earthlink.net; and Dennis DuVall, W7QHO, 1524 Princess Drive, Glendale, CA 91207, w7qho@aol.com.

Photo credits: Hank Brown

(Hank Brown, 4141 West L-2, Lancaster, CA 93536)

Hank Brown's interest in radio goes back to a childhood gift from his father of a Tom Swift book on adventures with wireless. Now retired from Hughes Aircraft, Hank's varied career includes working in broadcast stations and as a sailor on tankers and cargo ships, a stint in the Navy as a Second Radio Officer, and a hitch in the U.S. Army Signal Corps. He currently focuses on older tube-type radio gear.



HOME BREWING

Air-Frame Variometer Home Brew

BY BILL CORKUTT

Many collectors tend to ignore home brews, and then miss out on what may turn out to be not only a bargain but also something unique. Bill Corkutt's home brew indicates that the original owner combined unusual construction techniques and components. Be sure to note in this set the open, self-supporting air coils, which are usually wrapped on a form in conventional sets. Home brews sometimes seem like snapshots of history. (Editor)

Having been told "it's sold" in my telephone response to an ad in A.R.C., I naturally inquired if anything else was available. My correspondent revealed that he had just acquired a home brew which seemed within my budget and interests, and after some good-natured haggling, we agreed on a price and shipping. It is always exciting to unpack a home brew purchased on the basis of a few descriptive words. In this exchange, I was not disappointed.

The radio was an early 1920s, 3-tube receiver, featuring ceramic compression-type carbon rheostats, a variable, panel-controlled grid leak, and a celluloid enclosed variable capacitor — all indicative of early age. Figure 1 shows a front view. In addition it had three air-frame variometers of a type I had not seen before, shown in Figure 2. Each variometer consisted of two parallel, self-supporting, narrow coils with two similar coils rotating within. The radio was exceedingly dirty and had obviously been stored in a damp place, since all metal parts were coated with a uniform layer of black oxide.

TESTING AND CLEANING

I followed my usual procedure of testing the audio transformers and grid leak with an ohmmeter. To my surprise, both audios tested good, although the grid leak was open. After removing both audio transformers, I washed the entire radio in a tub of warm soapy water, rinsed it with a warm spray, and set it in the sun to dry. I would

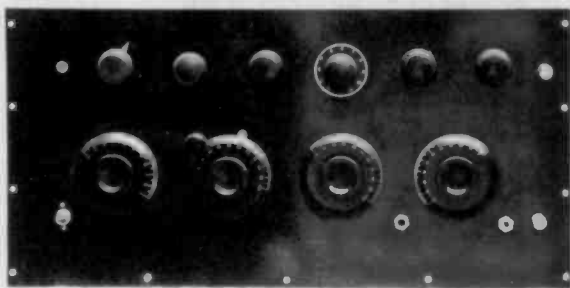

Figure 1. This front panel view of the home brew shows an impressive array of knobs and dials — more than enough to keep its operator busy. Knob and dial functions are described in the text.

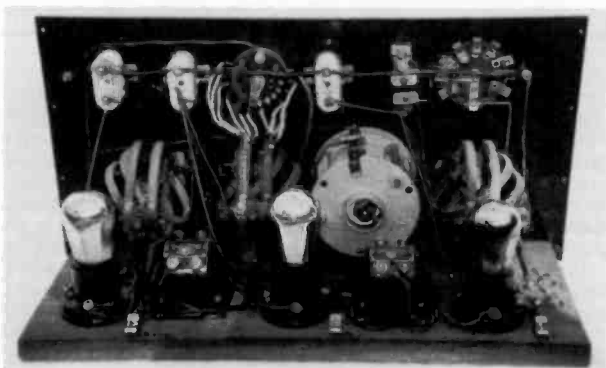

Figure 2. A rear view reveals the neat construction and layout, as well as the author's fine restoration.

not do this with an expensive commercially built radio, but it's a good first approach for particularly filthy sets. Before this bath, I always remove the transformers — audio and IF — since encased windings may not survive water logging.

RESTORING THE INTERIOR

After the initial cleaning, I removed each individual electrical contact point — screws, nuts, washer, wire — and sanded, scraped or filed off the oxide coating. This is often necessary as few solder joints were used on early home brews, and oxides do form between mechanical connections. This thorough cleaning also affords the opportunity to study the circuitry which proved to be that

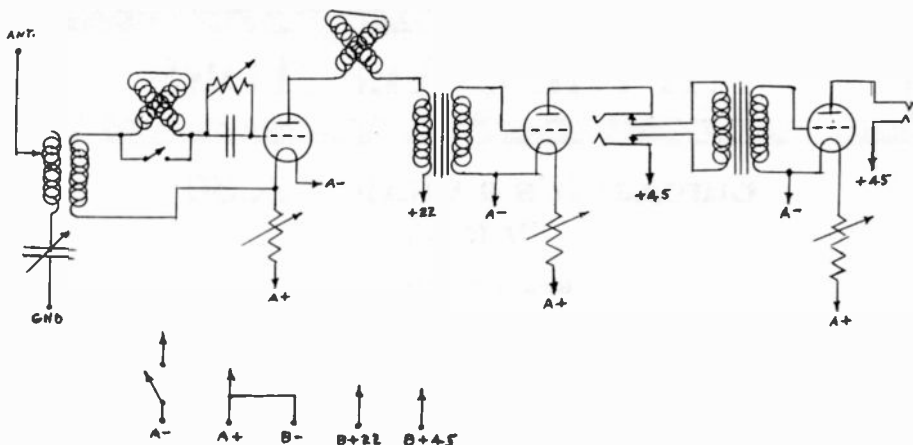

Figure 3. This schematic diagram depicts the circuitry of this 3-tube radio. The regeneration detector is followed by 2 stages of audio amplification.

of a 3-tube regenerative set using individual grid and plate variometers, a tapped variocoupler, and a large variable capacitor for antenna tuning. Figure 3 shows the radio's circuitry.

The variable capacitor is in the ground lead, presumably to inhibit hand capacity when tuning. A 2-position rotary switch shunts out the grid variometer to enable tuning to higher frequencies. Battery connections are via Fahnestock clips.

I remounted the audio transformers after cleaning the terminals. The variable grid leak consisted of a compression plate pressing onto a carbon surface. Unable to rejuvenate the carbon, I used a standard 2-megohm resistor and hid it beneath the grid capacitor. The celluloid cover of the variable capacitor had turned gray with age, and I decided to dispense with it.

The wiring was a mixture of tubing-insulated bus-bar and rubber-coated flexible copper. Both the tubing and rubber had become brittle over the years. I preserved as much of the original wire as possible, replaced some, and painted the tubing with model dope of appropriate color in an effort to prevent further decay.

I connected a regulated power supply (being careful to set the filament voltage at no more than 5 volts), attached the aerial and ground and speaker, and then inserted good 01-As. After I had fiddled with it a bit, the radio gradually came to life and received broadcast stations in the New York and New Jersey area with good volume and fidelity.

The plate and grid variometers, the variocoupler, the variocoupler tap-switch, and the tuning capacitor all interact while tuning, but after some practice, the best settings became apparent. Regeneration is smooth and reliable via the plate variometer. Shunting out the grid variometer allows reception up to 1300 kilocycles, a relatively high frequency in the early 1920s.

THE PANEL

The panel is well laid out and professional in appearance, indicating the set may have been a

kit. The variable capacitor is by Acme, the rheostats by Bradley, and the audio transformers by Rauland. No other markings are evident. Extra holes on the baseboard indicate some reworking by the original radio "experimenter."

Panel controls, as shown in Figure 1, are: top row, left to right, grid variometer shunt switch, variable grid leak, detector rheostat, 12-position variocoupler tap-switch, first audio rheostat, second audio rheostat. Bottom row controls are, left to right: grid variometer, antenna variable capacitor with vernier knob, variocoupler, plate variometer.

A standard push-pull, filament, on-off switch, two phone jacks, and two large brass screw-connectors for aerial and ground complete the panel. There are no panel markings.

I use TV contact cleaner and a stiff toothbrush to clean Bakelite knobs, especially the fine finger-grooves, a procedure that works well if the surface is not pitted. Household *Fantastic* cleaner and *Brasso* metal polish were used to complete the panel restoration.

The baseboard edge-holes and panel screw-holes indicate that a wrap-around wood cabinet had once existed. Since the panel is of an odd size (10 x 20 inches), a new cabinet would have to be fabricated. However, I prefer to let the "works" remain exposed to view. All in all, the set remains an interesting piece from an era when more radios were brewed at home than built in factories.

Consultant Credit: Wally Worth

(Bill Corkutt, 26 Hillside Ave., Monsey, NY 10952)

Bill Corkutt has been sporadically collecting old radios since he bought a junker 3-dialer at a Hamfest in 1993. His interest in radio dates back to the early 1950s when he served as an army radio operator during the Korean War. He holds a degree in electrical engineering and operates radio station WZ2I.

WITH THE COLLECTORS

Eureka! It's a Clarion TC30 Or is it?

BY RAY BINTLIFF

In this article, Ray Bintliff describes his efforts to identify a radio — a sort of radio genealogical search in which he discovers some interesting similarities to other 1930s sets. (Editor)

At first glance, the 4-tube 1930s AC/DC TRF radio shown in Figure 1 looks much like other "midget" radios produced during the mid-1930s. The cabinet style is similar to those used by a number of manufacturers and the layout is conventional — with two controls on each side of the center-mounted speaker. The tube complement consists of the following types: a 6D6 RF amplifier, a 6C6 detector, a 43 audio output, and a 12Z3 half-wave rectifier. Some similar sets used a Type 25Z5 tube as the rectifier. This radio and most others used a resistance line cord to drop the AC line voltage to the appropriate filament voltage.

Some radios of this ilk used a ballast tube instead of the resistance line cord.

OK then, what makes this radio different? As Figure 2 shows, there is a 5-pin tube socket located on the rear apron of the chassis. But for what purpose? A schematic diagram is glued to the bottom of the cabinet that declares the radio to be a Model 45 but there are no clues to the radio's maker or brand name. Further, the schematic diagram does not include the mysterious 5-pin tube socket which probably serves as an adapter socket.

MANUFACTURER SEARCH

My search of some collector's guidebooks produced some interesting results. Based upon appearance alone, a host of possible manufacturers were found. To narrow the search, I eliminated the major manufacturers on the assumption that a large company would have identified its radio in some fashion. There is no evidence that a decal, label or logo has been removed from the radio or cabinet. This decision reduced the list of possible brands to Auburn, Berkshire, Clarion, Climax, Colonial, Halson, Kadette, LeWol, Monarch, Pickwick and Premier.

Next, I searched some Rider volumes for radios that used the same tube complement and came up



Figure 1. This small 4-tube AC/DC TRF radio of the mid-1930s lacks a manufacturer's name.

with the following sets: Arvin 403, Clarion TC30, Climax 4-tube AC/DC, Detrola 403, DeWald 430, Federated Purchaser 53 and Howard A12. The schematic diagrams for these radios do not show a 5-pin socket, but then neither did the schematic for

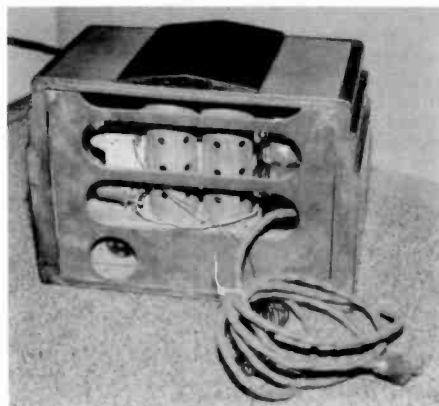

Figure 2. A rear view of the radio shows the adapter socket at the lower left.

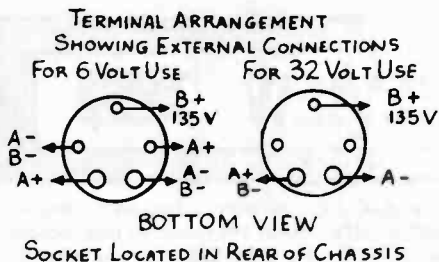

Figure 3. This adapter plug and socket hookup for the Howard Model AA-25 is typical of those found in my search.

my radio. So, I compared my radio's schematic to those in the Rider volumes and found a match with the Clarion TC30.

The Clarion schematic can be found in Rider Volume V under Transformer Corporation of America (TCA), page TCA 5-6. The schematic on the bottom of the cabinet differs from the Rider page only in that it does not carry the name or address of TCA and the model numbers are different. Thus, it seemed safe to conclude that the radio in question was manufactured by TCA.

TECHNICAL SEARCH

Once the manufacturer was identified, I returned to the Rider volumes to discover the purpose of that adapter socket. This time I looked for schematics that included an adapter socket and used the same or similar tube complement. The following radios were found: Allied F-9525, Autocrat 4LW, Howard AA-25, LeWol LW4, Radolek 10931 and 11910, Trav-Ler 50A and Warwick 419 and 420.

After I took a quick look at the schematics, the answer became clear — the adapter socket is used to operate the radio on voltages other than 110 volts. These radios are described below.

The Allied Model F-9525 uses a Type 25Z5 as a half-wave rectifier. The radio came with an adapter cord, a resistance line cord and a 6-pin plug that allowed operation on 110 volts DC or AC. According to Rider, other adapters were available "from the factory at a slight extra cost for operating this receiver on automobiles, 32-volt farm light plants, and 200- (sic) volt AC or DC." The Rider page also notes that "Cord for 110 volts or 220 volts heats moderately, as the cord contains resistance necessary for operation at these voltages."

This radio offers the most options for operation

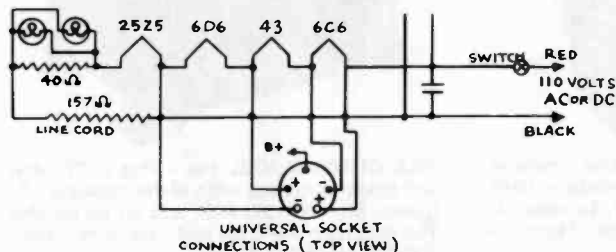

Figure 4. A partial schematic diagram of the Warwick models shows the filament to socket connections.

on power sources other than 115 volts. Its tube complement, consisting of Types 39/44 RF, 77 Detector, 43 Audio output and 25Z5 half-wave rectifier, bears little resemblance to the Clarion. But despite the difference in tube complement, the Allied radio's adapter socket is a useful clue regarding the purpose of the Clarion's socket.

The Autocrat Model 4LW uses a 7-contact adapter socket. The schematic diagram notes that 6-volt or 32-volt operation is possible but does not provide hook-up instructions. This radio is a bit different in that the 25Z5 is used as a voltage doubler.

The Howard Model AA-25 uses a Type 25Z5 as a half-wave rectifier and includes a 5-contact adapter socket. Figure 3 depicts the adapter arrangement for 6- and 32-volt operation. The radio's schematic diagram carries the notation "In all cases of 6- and 32-volt operation, replace the 43 tube with a 41 tube." While not specifically stated on the schematic, it is apparent that the choice of 6- or 32-volt operation applies to filament voltages only and that a separate B supply is also required. When the radio is operated on 6 or 32 volts, the filament of the 25Z5 is out of the circuit.

The LeWol Model LW4 also uses a 25Z5 as a half-wave rectifier, but the adapter socket accepts a 5-pin plug. The schematic diagram identifies the adapter socket as an "Auto socket" (as in automobile) and implies 6-volt operation only. Although unstated, it is obvious that the Type 43 tube would need to be replaced with a Type 41 to operate the radio's filament on 6 volts.

The Radolek Models 11910 and 10931, like the Howard, employ a 25Z5 as a half-wave rectifier and a 6-contact adapter socket. Hook-up information is not provided.

The schematic for the Trav-Ler Model 50 is identical to the Radolek schematic. This fact raises the question — did Radolek manufacture radios for Trav-Ler or vice versa?

The same question springs to mind after looking at the schematic for the Warwick Models 419 and 420. The adapter socket information is identical for the Howard and the Warwick models. And the schematics are identical, except that the Warwick models have a band switch for the broadcast and shortwave bands. A partial schematic for the Warwick models is shown in Figure 4. It depicts the connections between the adapter socket and the tube filaments.

Use of adapter sockets seems to have ended with the 1936 models. Perhaps the feature was not very popular and manufacturers were interested in keeping the costs down on these low-end radios.

(Ray Bintliff, 2 Powder Horn Ln., Acton, MA 01720)

Ray Bintliff, a frequent contributor to A.R.C., holds an Amateur Extra Class license. A retired engineer, he enjoys repairing and restoring pre-1945 radios and test equipment. In addition to Amateur Radio, his interests include electronic equipment design and audio reproduction.



PHOTO REVIEW



This column presents in pictorial form many of the more unusual radios, speakers, tubes, advertising, and other old radio-related items from our readers' collections. The photos are meant to help increase awareness of what's available in the radio collecting hobby. Send in any size photos from your collection. Photos must be sharp in detail, contain a single item, and preferably have a light-colored background. A short, descriptive paragraph **MUST** be included with each photo. Please note that receipt of photos is not acknowledged, publishing is not guaranteed, and photos are not returned.



JEROME HORN SPEAKER – This odd-looking speaker was sold by the Jerome Radio Corp. of Chicago in 1922. Incorporating a Baldwin driver at the rear of the spun aluminum horn, it is mounted on a walnut base. This same speaker was sold earlier that year as the Githens speaker by the Auto Parts Mfg. Co. of Detroit. (Dave Crocker – Mashpee, MA)

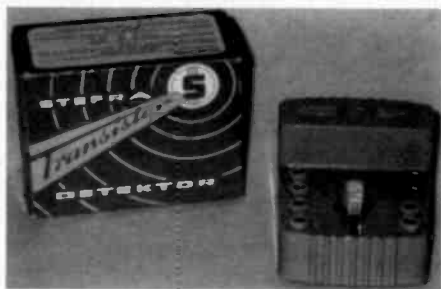

STEFRA TRANSISTOR DETECTOR – Built into a gray plastic case, this Austrian set was powered by a 3-volt battery. It still has its original box. (Erwin Macho – Vienna, Austria)



ABBIPHONE MODEL C.R.O. – This miniature catwhisker-type crystal set was made in 1923 by Abbey Industries, Ltd., of London. It measures only 2" x 2 1/2". (Jim Taylor – Bournemouth, England)



RCA VICTOR MODEL 110 – This 1933 cathedral operates on one each of the following tube types: 58, 2A7, 57, 2A5, and an 80 rectifier. The cabinet is 14 1/4" tall and 11 3/4" wide. (Wally Worth – Wollaston, MA)

PHOTO REVIEW



PHILCO MODEL 37-610 – This rare 6-tube receiver, sold in 1937, tunes both AM and short-wave bands. (*Wally Worth – Wollaston, MA*)

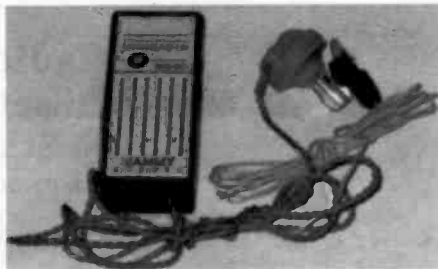

MAMMY MINIRADIO MG-20 – This germanium crystal radio is almost dwarfed alongside its headphone plug which is inserted into the ear. (*Erwin Macho – Vienna, Austria*)

CURRENT PINCUSHION RADIO – Shown to the left is a plastic germanium crystal radio, designed to be used as a pincushion, and styled as a world globe on a stand. The radio is in the base. On the right is a real pincushion of similar design. (*Harry Blesy – Hinsdale, IL*)

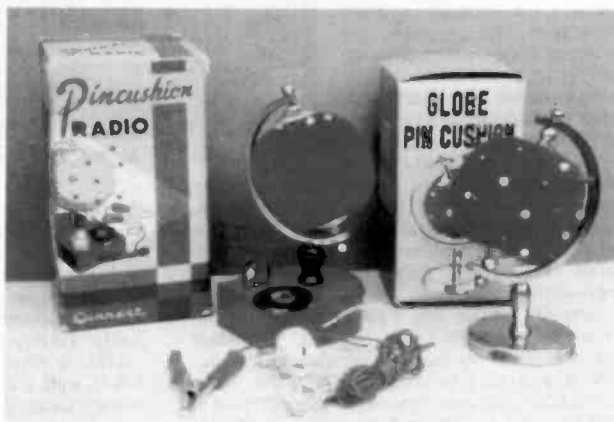

RCA RADIOLA III – This Radiola III is set in an original ACRE Deluxe cabinet, which includes the 2-tube RCA balanced amplifier and built-in speaker below. The radio operates on (4) Type WD-11 tubes, but could use Type UX-199 or Type 230 tubes with WD-11 adapters. When these substitute tubes are used, the knob at the bottom of the grille controls the filament current. (*Ross Mason – Mason City, IA*)



MEET REPORT

Radio XXXI Westford, Massachusetts — February 20, 2000 "Old Stuff is Cool"

REPORTED BY DOROTHY SCHECTER

Once again antique radio buffs gathered at what has become the New England regional radio show of the year — the Greater Boston Antique Radio Collectors' (GBARC) Radio XXXI. The event, which is managed by *Antique Radio Classified*, was held in the Westford Regency Hotel's 6,500 square foot Regency Ballroom, on Sunday, February 20, from 8 A.M. to 1 P.M. Despite the 2-day snowstorm that preceded the show, an eager crowd gathered early in anticipation.

As indicated by the name, this is the 31st GBARC show; the first, called "Radio East," was in June 1977. There's no doubt that the show continues to grow in size and quality. In fact, all 92 tables were sold two weeks ahead of time, and a second room was required to accommodate the overflow. Total attendance, including buyers and exhibitors, was 851, an impressive turnout.

One reason for this show's success is the extensive publicity handled by A.R.C. This effort includes 225 press releases to newspapers, museums, and radio, cable, and TV stations. More than 3,000 flyers were mailed to interested folks in New England, New York, New Jersey, and Pennsylvania. *Yankee Magazine* gave us a plug in its



Danny Wood of E. Marion, N. Y. reserved his favorite table early.

"Traveler's Journal," and even after the event, we made the front page of the *Westford Eagle* with two photos of action at the show. Besides publicity, the timing of the show works in its favor — a weekend, 1-day event means everyone can come, either for the weekend (41 rooms were booked) or just for the day.

What is most interesting about this day to the A.R.C. staff, many of whom are not collectors, is meeting the people who travel days ahead or before dawn to attend. Through correspondence, we feel we already know many of them, but now we can put

faces to the names. Still, we have to ask, "What is the special madness that draws them here?" The answers are as varied as the folks themselves, as I found out by talking to them in a round of the hall.

My hat with the feather boa may have taken them aback at first, but, in general, they were willing to share their enthusiasm for the show. And the hat confirmed the fact that, although I don't own a vintage radio, I was a genuine antique and would understand their passion.

Some folks were just curious about the event. Joe Kiebasti, for example, had read about it in a regional paper and brought 9-month old A.J. with him "to give Mom a morning off." He had an old shortwave radio at home and won-



Norm Hertz has the help of daughter Ashley in selling crystal sets and microphones.

dered if anyone at the meet could tell him something about its worth. So, not a collector *per se*, but who knows, after this exposure.

On the other hand, Bob Fuerderer and his wife of Keene, New Hampshire, who came to spend the weekend at the hotel to celebrate her birthday and have a mini-vacation, are serious collectors. He calls himself "an active addict" and says he "loves that magazine" (A.R.C., of course).

The Fuerderers joined Dave and Karen Sutherland — he is the president and treasurer of the New England Antique Radio Club in Nashua, N. H. — for a social evening the night before the meet. Obviously, the hotel offers reasonable rates and good facilities — an indoor pool (unfortunately closed for renovations this weekend), a health club, racquetball courts, and three restaurants — to make the stay enjoyable.

Back to the other end of the spectrum. Russ and Alexis Burgess came from Connecticut to look for



Ross & Bruce Phillips demonstrate their working Predicta TVs.

duly impressed by the enthusiastic crowds.

Pauline and Bill Morin of Topsham, Maine, came last year as spectators, but this year, their table displayed their primary interest — radio-related books. With their penchant for the literary, they say they love the articles in A.R.C. — good news for my department, I must say.

Perhaps the most striking thing about this event from the human standpoint is the number of children present who seemed genuinely interested. Our subtitle — "old stuff is cool" — is a quote from 12-year old Lauren Kopec, there with her father Tom from Amherst, Mass. Lauren also commented that looking at the old equipment made her think that "people have become a lot less creative." A savvy lass, to say the least. She and Dad were also most interested in books.

Nearby, Ashley Hertz, age 13, was tending her dad Norm Hertz's table. They've been coming to this meet for four years from Staten Island, New York, bringing crystal sets and microphones to sell. While I talked to them, they sold an AIWA crystal set for \$55. For them, this is a favorite meet because of the

(Continued on following page)



Pauline and Bill Morin of Topsham, Maine, displaying their radio-related books.

one particular radio only — a 1934 RCA 128 — just because he has fond memories of the one his grandmother had. Or there were the onlookers. Christy and Jon Avery came to see what her father, Ray Bintliff, an exhibitor and A.R.C. contributor, had been so excited about all these years. They were



Howard Edwards, left, and Ray Lumb, right, engage in some good old radio talk.



A.R.C.'s managing editor dressed for the occasion.

(Radio XXXI, continued)

"interesting people and the quality goods available."

Ann Marie and Binny Longobardi from North Haven, Connecticut, brought not one, but three children for the weekend. And everyone was looking for novelty transistor treasures. The littlest girl had already bought a Miss Piggy radio; the middle-sized girl, a computer radio; and the boy, a Bel Air. Mom is a Coca Cola collector. The consensus was that, in addition to the radio show, the hotel offers enough to interest the children, and it makes for a great weekend.

Young Jeffrey Small came with his father John "to humor Grandpa Charlie." But it sounded to me as if Jeffrey is a collector-in-the-making. He talked about his 1956 Zenith table model that he had bid on at a town hall auction. The only trouble was that the auctioneer didn't hear his bid, and someone else got the radio.

"It just wasn't fair," said Jeffrey. However, he prevailed. His dad convinced the buyer that he should sell the set to Jeffrey, who, incidentally, was able to describe some of its technical attributes.

Michael and Lisa Phelps were there with 7-month old Hannah. They just like to have consoles and table models that work around the house, and this was the perfect place to look.

Up from Philadelphia was one of the grown-up kids — Ross Phillips, who came to help his dad, Bruce Phillips, from Stratham, New Hampshire, with his full three tables. Both are avid collectors, Ross of Drexel plastics of the 1950s, and Bruce of



John DeLoria with a customer interested in one of his items for sale. John's wife Judy, who helps out at his table, can be seen in the background.

Catalins and the Predicta TVs — yes, the Predictas were working — that made an impressive display. Of course, in true radionik style, they also expressed interest in everything from early battery sets through transistors.

An interesting radio sideline showed up at Stuart and Hildy Altman's table. In 1990, they started to go to shows selling his Bakelite polish. Now this is the only show they attend, and business here is good — in an hour and a half, they sold all their stock.

One of few women collectors, Candace Savage from Plymouth, Mass., was there with David Pope. They are most interested in crystal sets and radios of the Soviet Union. His collection numbers 300-



Mike Katz shows some of the many variations of his grille cloth used in radio restoration.

400, while hers is around 100. They rate this show at the high end, right up there with Rochester. They sold more than ¾ of the equipment they had brought and said that the buyers here appreciate "better stuff."

Among the familiar faces was Richard Sharisky who has been collecting old vacuum tubes, battery sets and hi-fi equipment since 1988. He says that the rest of his family is "sane." The ubiquitous Steve Finberg was also there spreading the word via flyers about the local, immensely successful M.I.T. electronic flea market. Though Steve collects "absolutely everything," he says he has no time to sell anything.

Well known historian, author and collector Alan Douglas was among the buyers looking for "new toys." Alan has been doing just that since he was eight years old when his first radio came out of the trash. One of the great things about this show is the gathering of seasoned collectors along with newcomers, all seeking and sharing info about radio history.

No one I spoke with was more enthusiastic about the show than first-time vendor Len Provost from North Andover, Mass. He was happily ensconced in the overflow room where he wants to be next year. Len commented that he thinks people are sick of the Internet already because buyers can't see what they're getting.

"And why go to all the flea markets," he asked, "when you can find people here who know a lot and who are more focused?" Len's parting words were, "You run a very good show — I'll be back next year!"

That's what we're hoping — that the more than 800 who attended this year will spread the word to many more. We have the option of opening up more space at the hotel, so be sure to watch for word of Radio XXXII in February 2001. See you there — I'll be the one in the hat.

(Dorothy Schecter, c/o A.R.C., Box 2, Carlisle, MA 01741)



Rebuilding A Portable Radio Battery Mission Impossible?

BY ROBERT A. PINELLI

Bob Pinelli describes his project to rebuild the 67½-volt and 4½-volt batteries for his Emerson Model 560A portable radio using rechargeable batteries.

For those who prefer a less challenging approach, standard 67½-volt batteries still are available through mail order houses for \$20 to \$30, depending on the dimensions. 4½-volt military surplus batteries are available for \$5. (Editor)

I was extremely pleased when a friend of mine presented to me as a gift the Emerson Model 560A portable radio, shown in Figure 1. It is an AM-only, 4-tube, battery-operated receiver that was mass-produced and inexpensive in 1947. What was truly surprising to me was that the set was in mint condition right down to having the original batteries. Most collectors look for the more exotic and expensive makes, and this set certainly doesn't qualify in that category! Nevertheless, I considered it a worthwhile restoration project.

I have been a self-employed radio/TV repairman for 45 plus years, and in my early days, this type of set crossed my bench many times. It was with a sense of nostalgia and love of antique radios that I wanted to put this radio in operating condition. Before I could accomplish this, however, there were a number of challenging problems to be solved.

Problem 1: The batteries, of course, were completely dead, and I wondered if perhaps they had deteriorated over time. Fortunately, when the batteries were removed, they were not bulged or leaking electrolyte.

Problem 2: Do I try to get the same type of batteries somewhere or replace them with sub-

(Continued on following page)

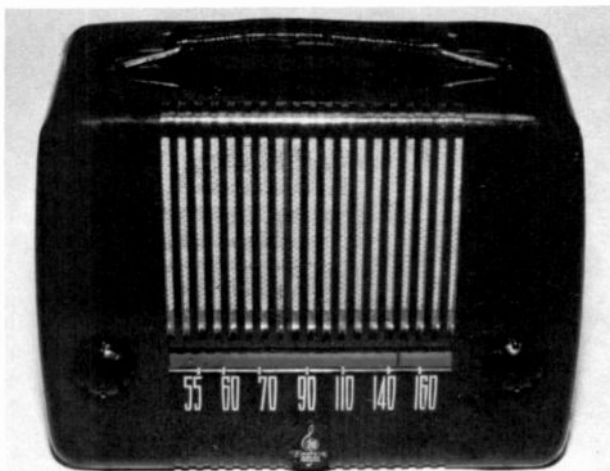

Figure 1. The maroon Emerson Model 560A portable radio.

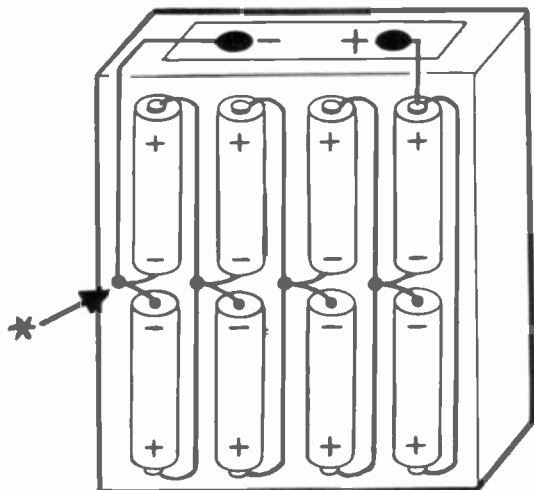

Figure 2. Pictorial diagram of the battery arrangement and wiring for the 4.8-volt A battery. It uses eight 1.2-volt nickel-cadmium, rechargeable C-size batteries wired in series-parallel. The negative ends of the batteries are soldered together using "Solder-Wick." A 0-30-volt, 3-amp regulated power supply is used to charge the A battery.

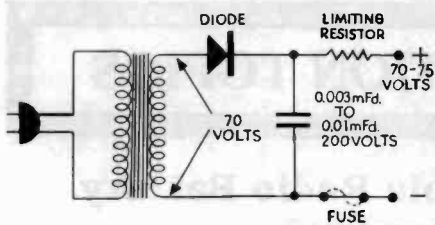

Figure 3. A basic schematic diagram for the 72-volt battery charger. We have added the limiting resistor to Pinelli's design. See the sidebar for additional information

(Rebuilding a Portable Radio Battery, continued)

stitutes? As far as I know, the 67½-volt B battery for this radio has not been manufactured for years. As for the 4½-volt A battery, I didn't think this would pose as difficult a problem.

While pondering the problem, I was struck with an idea. Since the cases of these batteries were in relatively good condition, why not try to install new batteries within cases of the original batteries? I opened the bottoms of both batteries and to my delight the contents slipped right out with no difficulty.

Problem 3: How do I get 67½ volts packed within the confines of a case measuring 4" x 3" x 1¼"? Solution: eight 9-volt batteries wired in series fit in perfectly and provide more than enough voltage. The 4½-volt case measuring 4" x 4" x 1¼" would not accept size D cells, but eight C cells also fit in perfectly. The wiring configuration consisted of groups of two C cells wired in parallel, and then the resulting four groups wired in series. Figure 2 shows how this was accomplished.

Problem 4: Do I install conventional carbon batteries, alkaline batteries or nickel-cadmium rechargeable batteries? Being a free spender, I decided on the very expensive nickel-cadmium route. Doing so, however, allows me to keep the original cases when they run down — all I would have to do is recharge them. I chose Panasonic brand batteries because I was told by my distributor that they had a 25 percent greater capacity.

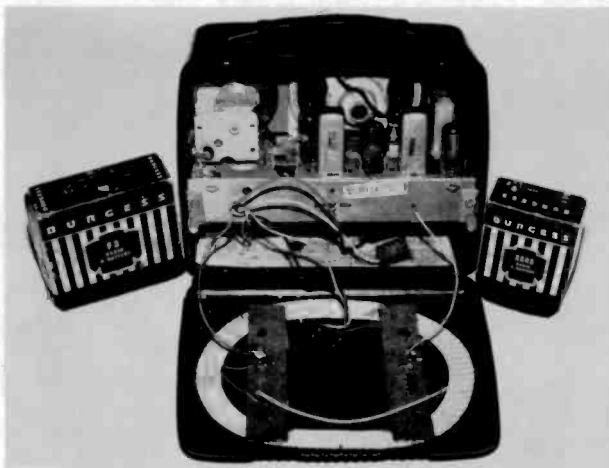

Figure 4. The Emerson Model 560A with rear cover open and batteries removed. On the right side is the Burgess No. XX45 67½-volt B battery converted to a 72-volt rechargeable. On the left side is the Burgess No. F3 4½-volt A battery converted to 4½-volt rechargeable.

Charging Batteries — Additional Comments

BY RAY BINTLIFF

Battery chargers were once rather simple devices, but that is no longer the case. With the introduction of the rechargeable nickel-cadmium and nickel-metal hydride types of batteries, battery chargers have become elaborate devices. Now battery chargers are available that can operate on fast charge and automatically detect the level of charge and switch to a trickle charge. Some can terminate fast charge if a battery's voltage does not peak within a preset period of time. Others offer thermal protection of the battery by means of a high temperature sensor and shutoff. In short, the design of battery charger can be daunting.

The simple battery chargers used by Pinelli do not have these features, but they work for him. However, for his 72-volt charger, A.R.C. recommends the addition of a current limiting resistor, 1.6 Kohms at 10 watts, and slow-blow fuse rated at ¼ A to protect the battery and charger. Some form of current limiting should also be used when using a bench supply to charge the 4.8-volt battery described in this article.

The intent of Pinelli's article is to provide an

example of how original batteries can be replaced with modern rechargeable batteries, not to provide complete details for building a battery charger. However, some comments regarding rechargeable batteries and battery chargers may be useful.

Nickel-cadmium batteries are relatively inexpensive, dependable, and readily available. They offer moderate tolerance to overcharging and, like other batteries, should not be short circuited.

Regarding charging current, a good rule is that the maximum fast charge current should not exceed 50 percent of its rated capacity. For example a nickel-cadmium rated at 125 mA, should not be subjected to a charging current in excess of about 60 mA. A trickle charge rate of 6 to 10 percent is recommended in some literature. The duration of the charge is also an important factor. Typical charging times are 6 to 8 hours, but the actual times vary depending on the battery, charger and charging current.

For readers that wish to pursue the subject further, the September 1994 issue of *QST* contains an excellent article "A Smart Charger for Nickel-Cadmium Batteries."

Problem 5: How do you charge a 72-volt battery? Solution: construct your own charger. I had on hand a transformer with a 70-volt secondary winding. Using the schematic in Figure 3, I found that it worked just fine.

Problem 6: Making a similar charger for the 4½-volt (or more precisely 4.8-volt in this case) battery proved to be much more difficult. Being neither an electronics engineer nor a designer, I thought that, if I got a common 6-volt transformer with a diode, filter capacitor, dropping resistor, and zener diode, I would be home free. No such luck. To my surprise, after charging the 4.8-volt battery for more than 20 hours, it would last only 4 or 5 minutes in the radio before running down! What I hadn't accounted for was exactly how much current was required to charge eight C cells. [The typical capacity for a rechargeable C cell is 1.2 AH.]

I decided I would have to pull out the heavy artillery — my 30-volt, 3-amp regulated power supply. I set the voltage output to 4.8 volts and the current output to 2 amps. Voila — success!

After charging for 18 hours, the battery was installed and has lasted for months now.

Problem Solved So now, after great trouble and expense to myself, I have a working vintage 1947 Emerson Model 560A portable, battery-operated radio. It is in mint condition no less, complete with original appearing, now rechargeable batteries, as shown in Figure 4. My wife and my non-electronically inclined friends think I am completely nuts for undertaking this project. They just don't get it.

(Robert Pinelli, 1 Lorraine Pl., Harrison, NY 10528)

Robert Pinelli's interest in radio and electronics as a teenager led to his opening of a repair shop with a partner in 1951 in the Bronx, N. Y. Though TV repair became their focus, his passion for antique radios never abated. His goal always is that the set be in perfect working order when he finishes the repair.

USL Radio Batteries Do Make a Big Difference

BY JOHN V. TERREY

USL Radio Batteries Do Make a Big Difference



Don't Get Left!
Be on the Right Side!

Don't Cuss
Just C Uss

We carry a full line
of USL
RADIO "A" and "B"
BATTERIES



Auto Electric Service Co.

61 Ameral St., Manchester, N. H.
Telephone 1006

The advertising ink blotter above, the basis for our cover this month, tells the story well. You could depend on a USL battery to power the filaments in your early 1920s radio.

Since AC-operated sets did not become common until the late 1920s, a radio during the early 1920s required a 6-volt, automobile-type, storage battery to light the tube filaments. Every several weeks, the battery was taken to the radio shop or garage to be recharged.

The cut on the right from a brochure for Cunningham Radio Co. of Kansas City, Missouri, further touts the features of the USL battery — long life, radio terminals, polished case, 75 ampere. The retail price was \$18.00 and the dealer's price was \$13.50.

(John V. Terrey, c/o A.R.C., P.O. Box 2, Carlisle, MA 01741)





RADIO MISCELLANEA

"Radio Miscellanea" includes items of general interest selected from A.R.C.'s incoming correspondence. "In The Marketplace" items are based on information submitted by the businesses themselves. "From The Internet" items are obtained from internet newsgroups and other internet resources. Submitted items should be verified for accuracy; items may be edited by A.R.C. for publication, and publication is not guaranteed. See the masthead for more details.

"Radios as Furniture" & "Multivalve"

Dear Editor:

The fine article "Radios as Furniture" by Gerry Schneider and his wish for a dining room table reminded me of my grandfather, Henry Gloomfritz. He once glued together four Bendix 646A end table radios and used them for a while in his dining room. Unfortunately, the guys in his poker group could not agree on a single program, so the resulting din of competing stations brought complaints from the neighbors, and he abandoned the idea. It was hard to sit at his table anyway because of all those legs!

Thanks for printing my Multivalve article, though the pictures for Figures 5 and 6 got transposed. A "final final" Compacton set that I developed using a regenerative circuit is the hottest one of all in terms of speaker volume.

Dick Parks, Oakton, VA

We try to be as accurate as possible in our articles, but sometimes errors occur. In this case, the photos were inadvertently transposed during layout. (Editor)

A.R.C. Service is Top Notch!

Dear Editor:

Just want to thank you for responding so fast to my request to replace a section of the February 2000 issue that had been misprinted. I was hoping only for the article on old capacitors, but I got the entire issue less than 72 hours after I notified you via e-mail. Now that is service! You only confirm my belief — A.R.C.'s standards of product and service are top notch!

John Lovering, Hampton, NH

80 Percent of Ads Sell

Dear Editor:

80 percent of my ads sell. Now that's a good average. Pocket money here and there helps — and now there's more room to move about in my house! Thanks.

R.G. Purcell, Cleveland, OH

Seeks Auto Radio Info

Dear Editor:

Thanks for the interesting articles on various radio subjects. Although I am not technically oriented, I enjoy reading about discovery and restoration. I have a B-L rectifier, Model 160 C4, auto radio filterpac, 115V-AC, 6V-DC, by B-L Electric Mfg. Co., St. Louis, Missouri. I think it was used to bench test auto radios.

My question is how is it used, and can I use it to run some old auto radios? It looks complete, but I have not cleaned it up from years of attic storage, and I hesitate to plug it in without knowing whether or not I could do some damage. I would appreciate any information your readers can give me. Keep up the good work.

Bill De Vries, Dixfield, ME

Broadcast Band Interference

Dear Editor:

I recently repaired an RCA Radiola 80. When I checked it out after it was back in the cabinet, I found howling and squealing on many stations across the dial. I was relieved when I turned off my portable fluorescent lamp and the interference stopped. The battery-powered multivibrator circuit for the fluorescent bulb had been generating many harmonics in the broadcast band and surely gave me a!

Harold Wright, Chancellor, AL

Yet Another Early Rider's

Dear Editor:

I read with interest Charles Kirsten's article "The Four Versions of Rider's Trouble Shooter's Manuals — Volume II" in the February 2000 A.R.C. I also have a number of the various versions of early Rider's Manuals and have found Kirsten's article quite enlightening.

I have yet another version of early Rider's. My variation differs, not in content, but in binding. I have Volumes I, II, and III combined into one large binder about eight inches thick! The binder is stamped, "Rider's Perpetual Trouble Shooter's Manuals I, II, III," so it must have come that way from Rider. The contents are identical to the late folio versions and are separated by tabbed, index pages. At one time, I also had Volumes IV, V, VI bound the same way. They are unwieldy to use, so I speculate that they were supplied to radio parts stores and distributors to be used on a reference/catalog rack similar to those found in auto parts stores.

I have more details if folks are interested.

Paul Joseph Bourbin, San Francisco, CA

Cabin Fever Fun

Dear Editor:

Just a short note of thanks for giving our winter Central Ohio Antique Radio Association (COARA) show "Cabin Fever" a little plug in your "Editor's Comments." We thank you for such consideration, as we are not one to the "biggies" among shows. But we are growing — we are up to about 42 dealer tables.

Barry Gould, Hilliard, OH

Web Link Success

Dear Editor:

Thank you for putting my CK722 Transistor Web page on your site. I am seeing two or three hits a day through your site with a total of five to ten hits a day.

Jack Ward, Brookline, MA

A.R.C. Kudos

Dear Editor:

A.R.C. is the best hobby magazine I have seen. Thanks. Keep up the good work.

Thomas Shelton, New Boston, NH

CLASSIFIED ADVERTISEMENTS



WANTED: Zenith Model 835, chrome-front tombstone. **FOR TRADE:** From Scott chassis, AK homebrew breadboard, AK82, RCA143, GEK-80, Detroitlaminare cathedral. Chris Hicks, 57 Jameson Hill Rd., Clinton Corners, NY 12514. (914) 266-4257

WANTED: Manual or schematic for Sargent 1939 Streamliner receiver. Harry Blesy, N9CQX, 9S740 Clarendon Hills Rd., Hinsdale, IL 60521. (630) 789-1793

WANTED: Bendix Model 853 and 953 radios. Radios need not work. Aaron Mall, 903 Dropleaf Ct., Baltimore, MD 21208. (410) 486-8813

WANTED: Plastic tabletops: RCA 9-X-561. Philco 53-563. Complete and crack-free only please. Glenn A. Weaver, PO Box 349, Valley Center, CA 92082. (760) 739-9840

WANTED: Schematic or manual for RCA 308B field intensity meter. Also need loop for bands 2 & 3. Need RCA Redbook for 1936. Art Zimmerla, 501 Thorngate Pl., Millersville, PA 17551. (717) 871-3293

WANTED: Microphones, bullet-shaped or rocket-shaped or space-age style, mostly 1940s. David Mednick, 10 Doe Dr., Wesley Hills, NY 10901-2302. (914) 354-5041. E-mail: davemed@acd-pc.com

WANTED: National NC46 speaker enclosure with or without speaker buy or trade. Tom Mooringham, N3LWJ, PO Box 487, Maugansville, MD 21767-0487. E-mail: lunarip@aol.com

WANTED: Collections, bulk and estate sales of radios, tubes, literature, advertising, etc. RadioDaze, LLC, 7 Assembly Dr., Mendon, NY 14506. (716) 624-9755. Fax: (716) 624-7857. E-mail: info@radiodaze.com. Web: http://www.radiodaze.com

WANTED: Hickok 6000A tube tester in good working condition. Bill Jewell, 3800 Ridgehaven Rd., Fort Worth, TX 76116. (817) 377-4664. E-mail: OldRadios@aol.com

WANTED: N.O.S. transistor radio repair parts. Larry Daniel, 1758 Chennault Cir., San Antonio, TX 78226. (210) 923-2634. E-mail: LDaniel102@aol.com

WANTED: Knobs and dial for Crosley #11-103W. **FOR SALE:** Allied 1970, 1971 catalogs, exc cond. - \$20. Stephen L. Bonino, 107 Georgetown Rd., Glassboro, NJ 08028. (856) 881-0244. E-mail: slbon@erots.com

WANTED: Dud Magnavox 01-A type tubes, dud Rainbow 01As, dud BB 01-As and WD-11s. Steve Wallace, 3707 Pricetown Rd., Fleetwood, PA 19522. (610) 944-7230. E-mail: kksk@epix.net

WANTED: Remler filament rheostat approx. 2 1/8 inches diameter. It has Remler printed on it. Grebe 4 inch tuning (has groove on back) dial. Grebe tube socket for CR-5. Bob Nicholson, 2745 S.W. Villa West Dr. #1308, Topeka, KS 66614-5236. E-mail: brnichxxxks@webtv.net

WANTED: Schematic diagram and service information on Pioneer stereo receiver Model SX-838. Will pay reasonable fee. Alva May, 6623 U.S. Hwy. 340, Shenandoah, VA 22849. (540) 652-8638

WANTED: Metal cabinets for RCA AR1300 and AA1400 sets. Frank Camenisch, 209 San Francisco Blvd., San Anselmo, CA 94960. (415) 453-9090

WANTED: Delco (Oldsmobile) auto radios: 982699 (700) (1951), 983336 (1956), 989002 (1957), 989171 (1959). Alan J. Kriss, 1872 Portsmouth Way, Union, NJ 07083. (908) 688-2092

.....
A.R.C. Advertising Policy
Sellers and Buyers, Please Note!
Advertising is accepted only for early items related to radio, communication, etc. All items must be described fairly; reproductions, reprints and not-original items must be so identified. Advertisers must agree to respond promptly to inquiries and orders, to resolve problems promptly if the buyer is not satisfied, and to comply with a buyer's refund request on unaltered returned items.
.....

WANTED: Grebe CR Series brown phenolic tube shell, and variable condenser. J113 rheostat. J.C. Woychowski, 81 Penn. Ave., Niantic, CT 06357. E-mail: jc.woy@snet.net

WANTED: Multiband Meissner receivers, dead or alive, advice. Henry Mohr, 1005 Wyoming, Allentown, PA 18103

WANTED: To buy: Several 7-inch, extra long play (XLP) records such as were used with the Chrysler Corp. Highway Hi-Fi. James Fred, 5355 S 275 W, Cutler, IN 46920

WANTED: Dud 50/UJ250/CX250 tubes, must be cosmetically OK. Craig Tipton, 3595 Call Rd., Perry, OH 44081. E-mail: tipton@mailbag.net

WANTED: Atwater Kent advertising lamp, without shade OK. Steve Dando, 4572 Mark Trl., Copley, OH 44321. (330) 666-7222

WANTED: Wood or metal, Victor Edison Columbia outside horns, cranks, reproducers, literature. Call me. Thanks. John Yanny, 153-19 75 Ave., Flushing, NY 11367-3016. (718) 268-6413. E-mail: johnnyvictrola@aol.com

WANTED: Sony TC788 manuals; band knob Panasonic RF1600 radio. **FOR SALE:** RCA Radiola 62 - \$400 pickup. Majestic speaker - \$50. Ray Barnes, 38 Woodmere Rd., Framingham, MA 01701. (508) 877-5232

WANTED: 220 and/or 440 volt relays and transformers to 120 volts, 60 cyc. H. Andreoni, c/o 250-D So. Lyon Ave., Hemet, CA 92543

FOR SALE: Zenith 7H820W – \$30. RCA U119 – \$25. Pilot T601 TV tuner – \$15. Jim Clifford, KE4DSP, 108 Bayfield Dr., Brandon, FL 33511. (813) 654-7531. E-mail: j.c.clifford@juno.com

FOR SALE: Heathkit IB-5281 resistance, capacitance, inductance bridge, excellent, with manual – \$45 plus shipping. Ralph Michelson, KG8FA, 4538 Golfview Dr., Brighton, MI 48116. (810) 225-9825

Classified Ad Deadline Noon

Apr. 10 for May 2000 Issue

May 10 for Jun. 2000 Issue

Boxed, Photo, & Display Ads - 1st

FOR SALE: Great Issue June 1922 Radio topics, very good condition – \$15 plus \$2 shipping. Fred Schultz, 1246 Lincolnway S, Ligonier, IN 46767. E-mail: ofradio@ligtel.com

FOR SALE: Radios, test equipment. Lists, mail or Internet. **WANTED:** Small black 0-100 tuning knobs. R. Allen, 399 Canterbury Tpke., Norwich, CT 06360. (860) 822-6096. Web: <http://www.99main.com/~allens>

FOR SALE: 45 and 50 tube adapters – \$16 and \$25 plus UPS, no circuit changes. James Sinwell, 511 Newport Dr., Greensburg, PA 15601. (724) 834-0763

FOR SALE: Sony 2R28 – \$25. Motorola 66L2 portable – \$15. Heathkit Q-Meter – \$40. Postage not included. Radiosale website <http://members.aol.com/dmradios/tube.html>. Donald M. Maurer, 29 S. 4th St., Lebanon, PA 17042. (717) 272-2481. E-mail: dmradios@aol.com

FOR SALE: B&K Model 1450 diagnostic oscilloscope – \$20. Knight Model KG-600C tube tester – \$20. Both working, in good shape, with manuals, cables, plus S&H. Irv Sanders, 242 Hunter Ln., Harrisburg, PA 17112. (717) 469-2185

TUBES WANTED

USED

NEW

2A3	\$12.00	6B4G	\$14.00
6B4G	8.00	6FQ7	2.00
6V6G	4.00	10/10Y	25.00
10	16.00	12BH7	4.00
45	14.00	12BH7 RCA	6.00
199	15.00	42	6.00
201A	8.00	45	30.00
226 gl	3.00	71A	14.00
227 gl	3.50	171A gl	25.00
280 gl	20.00	864	10.00

New tubes must be well known brands in complete boxes; all subject to inspection. Will refund shipping cost; write or fax for complete bid list.

ANTIQUÉ TRIODE

653 Commercial St., Box A2
Farnham, NY 14061
Fax 716-549-3823

FOR SALE: Clear plastic dial covers for Addison 2, Emerson 400, 520, Fada 1000, National 100, 200, 240D, Packard Bell 5FP, Zenith G500, 8G005 and (500) different ones – \$15 ea. includes postage or mounted in your bezel – \$22.50. Doyle Roberts, HC 63, Box 236-1, Clinton, AR 72031. (501) 745-6690. E-mail: drob@hypertech.net

FOR SALE: Quality reprint operator's manual for the following Zenith Trans-Oceanics. 7G605 – \$14 plus 75¢ first class U.S. postage. H500 black embossed leatherette stock cover paper, gold printing, (32) gloss pages, clear crisp pictures, includes a copy of original Zenith schematic, copy of station log card, "This Radio Belongs To" sticker – \$17 plus \$1 postage. G500, tan cover, and R600-R600L manuals and Zenith schematics, sticker, works well with all 600 Series, for – \$15 plus 75¢ postage. T-O 1000, full color cover, includes Zenith service manual for – \$16 plus 75¢ postage. 3000-1, full color cover, five languages, 42 pages, includes service manual for – \$17 plus \$1.21 postage. Royal 7000, full color cover, 104 pages includes service manual for – \$20 plus \$1.85 postage. Mike Koch, 17355 Golden Maple Ln., Yorba Linda, CA 92886. (714) 961-0261. E-mail: rkoch17355@aol.com

FOR SALE: Two AK audio transformers – \$8 ea. Johnson Messenger 323A CB – \$24. Vecore 12 v 4 amp power supply – \$15. Seven N.O.S. yokes for B&W televisions – \$25 or \$5 ea. Eight old telephone handsets with cradles or desk hanger boxes, one cradle contains ringer – \$87/all. Twelve radio earphones, various makes and prices. Photos of telephones or earphones are – 50¢ ea., refundable. Plus UPS. **WANTED:** Riders No. V. Will be gone til April 11. Thanks. D.W. McDonald, 1813 Main Ave., Clear Lake, IA 50428. (515) 357-2446

FOR SALE: American Bosch Model 505 (Bunis 1), star, pin stripe – \$75 + ship. Paul Harnetty, 4805 Parkmore Dr., Westerville, OH 43082. (614) 882-1979

the Radio Attic

Buy & Sell Your Old Radios Here!

.....
Advertise your radios on the Internet with full-color photographs. Your ad runs until your radio sells for one payment. We can scan your photos & crop to best show off your radio. We have other pages of interest for collectors, including featured articles, radio club events, and a "Who Knows This Radio?" page. Check us out!

the Radio Attic

P.O. Box 90

Moody, AL 35004

<http://www.radioattic.com>

e-mail: ads@radioattic.com

WANTED: Type E, F, G, H, J, AA, AB and AC coils and coil box for National HRO-50T1 receiver. Globe Chief, Globe Scout, Johnson Navigator or Ranger, Heath AT-1, DX-20, DX-35, DX-40 or similar transmitter. ARC-5 receiver with power supply. 1940s/1950s vintage earphones. Morgan Godwin, 166 W. 87th St., #901, New York, NY 10024-2901

**RATE FOR ADDITIONAL WORDS:
29¢ per word**

FIRST 20 WORDS FREE!

Cash or stamps OK for small amounts.

Your payment helps to keep A.R.C. healthy!

WANTED: E.H. Scott! E.H. Scott! E.H. Scott! Interested in Scott battery and AC sets, military, accessories, advertising, and literature. Check with us before selling your items we are very serious Scott collectors. Radio Daze, LLC, 7 Assembly Dr., Mendon, NY 14506. (716) 624-9755. Fax: (716) 624-7857. Web: <http://www.ehscott.com>

WANTED: I collect large/quality portable SW multiband radios esp. Philips D2999 and 1960s with SW books. Also still looking for front cover for my Sony CRF 330K. Thank you. Denis Burke, 308 Person St., PO Box 137, Runnells, IA 50237. (515) 966-2871. E-mail: zeenith@msn.com

WANTED: Chassis and good front panel for AK Model 30. Jack Ghery, 1753 Community Beach Rd., Odin, IL 62870. (618) 532-5548

WANTED: RCA 103 speaker, hard rubber coil covers for Bunnell relay, Telegraph parts. Michael Cutler, 2419 Ave. O, Galveston, TX 77550. (409) 763-0938

WANTED: Factory prerecorded open reel tapes. Classical, jazz, rock. Telefunken radios, microphones, speakers, etc. Rhode & Schwartz equipment Richard E. Brown, 455 Winchester Rd., Norfolk, CT 06058. (860) 542-0057

A. G. Tannenbaum

Electronic Service Data

PO Box 386, Ambler, PA 19002

Phone: (215) 540-8055

Fax: (215) 540-8327

THE



FOR

**Vintage Parts & Service Data
1920's - Present**

Credit Cards Welcome

**Browse our on-line catalog at
www.agtannenbaum.com**

WANTED: Unassembled or partly built Heathkits and Knight kits. Gene Peroni, Box 7164, St. Davids, PA 19087. (610) 293-2421

WANTED: Early auto radio, Ford-Philco Model 5, 6, 7, 8, 9, Zenith Model 462. Atwater Kent Model 424, 664. Motorola Model 6, 8. Write or fax: Nobuyuki Tanaka, 2-15-13 Taira-cho, Meguru-ku, Tokyo, Japan 152-0032 Fax: 81-3-5729-1729

WANTED: Western Electric 753, 728B, 713A. Will trade other Western Electric, Tannoy GRF. Frank Cooney, 3C Columbia Ave., Cranford, NJ 07016. (908) 272-0676. E-mail: fjc1z@worldnet.att.net

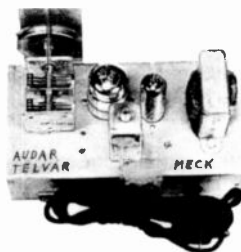

WANTED: This pictured FM tuner, which uses two or three tubes, made in the late 40s by Audar, Telvar, Meck, Knight and others. Richard Matiasek, 2212 S. 139th Ct. Apt. 3, Omaha, NE 68144. (402) 691-0852

WANTED: An IF transformer square can 1 1/4" x 1 1/4" for Philco 40-165, part #P-32-3210, or replacement. Dan Trombley, 54 Cherry St., Rutland, VT 05701. (802) 775-4104

WANTED: Zenith 6-D-525 chassis, knobs and dial escutcheon. Midwest AC-9 chassis and speaker. Mark Gutekunst, 2600 Martin Rd., Willow Grove, PA 19090 (215) 657-8958

CLOSING DOWN MY GRILLE CLOTH BUSINESS!

Clearance sale in progress, only 19 patterns still available (including some of the more popular ones).

Prices are 25-50% below original pricing. Stock up now while prices are so low and cloth is still available.

For a fax listing of prices and availability, write to me or fax your request to:
(212) 947-1148.

**Samples are still available -
Send 55¢ LSASE (4"x10")**

**MICHAEL KATZ
3987 DALEVIEW AVENUE
SEAFORD, NY 11783
(516) 781-6202 (EVENINGS/WK-ENDS)**

FOR SALE: RCA Cunningham Perpetual Troubleshooters manual, 1921-1930 radio schematics, 2,767 pages - \$125. Bill Rolf, 30131 Center Ridge, Westlake, OH 44145. (440) 871-4547

FOR SALE: Longines Symphonette cassette recorder, 1972, accessories, used, original packing - \$10 + shipping. Louis L. D'Antuono, 8802 Ridge Blvd., Brooklyn, NY 11209. (718) 748-9612, after 6 pm

One Month Free!

BONUS FOR EARLY RENEWALS

If you renew **before** the month shown on your mailing label (your expiration month), you will receive an extra month on your subscription: 13 months instead of 12! 26 months for an early 2-year renewal!

FOR SALE: Sencore FE20 field effect multimeter - \$45. Precision 10-15 counter top tube tester - \$70. John Osborne, 2 Lake St., Winthrop, ME 04364. (207) 377-2519

FOR SALE: Catalins: Fada, DeWald, Sonora, Emerson, at <http://www.catalinradio.homepage.com>. No calls please. J. Finkelstein, 63 Cedar Hill Ln., Media, PA 19063. E-mail: evanor@home.com

FOR SALE: New lists available in April. Radios 20-30-40-50-60s, work and don't work. Also lists transistors, novelty, books & magazines, miscellaneous instruments, etc. SASE (2) stamps each list. Robert J. Stone, 721 Fisk St., Piqua, OH 45356-3729

FOR SALE: AK 33, exc - \$140. Precision signal generator, zero Hz - 240 MHz - \$40. Used and N.O.S. vacuum tubes at very fair prices, typical 24A - \$2; 26 - \$4; 27 - \$2; 80 - \$4. Andrew Toross, 425 Old Country Rd., Orange, CT 06477. (203) 795-4523



RADIO DAZE



VINTAGE RADIO & ELECTRONICS

Sales • Service • Components • Supplies

We are dramatically expanding our charter!! Our goal is to become THE PREMIER source of components, products, services, supplies and information for the vintage electronics marketplace supporting both individual and business customers.

We are proud to be distributors for many fine companies including:

**Hammond Manufacturing • GC Electronics
Xicon Components • Howard Products**

Check us out BEFORE you place your next vintage electronics order. We WELCOME internet, phone and credit card orders!!!



Visit Our On-Line Catalog At:
www.radiodaze.com



MAIN OFFICES & RETAIL STORE
7 Assembly Drive, Mendon, New York 14506
Tel: 716-624-9755 Fax: 716-624-7857
email: info@radiodaze.com

Radio Daze, LLC - A Limited Liability Company

FORSALE: Preceptor tube tester made by Radiophone Inc. in Oakland, Calif., no meter, uses lights for tube condition, six Philco knobs used, tests 4-pin, like 01-A to a limited number of early octals, filament volts 1.5 to 30, gas test, chart for setup, hardwood case - \$80 OBO. Complete, clean and working well 1942-48 Chevrolet radio - \$125 OBO. Shipping extra. Still have 5+ list of for sale items for 33c LSASE or e-mail. Stan Lopes, KB6LGV, 1201-74 Monument Blvd., Concord, CA 94520. (925) 825-6865. E-mail: splopes@aol.com

FOR SALE: Tube and transistor radios. See my web site: <http://pws.prsev.net/usinet.hmaurer/mywp.htm>. Hank Maurer, 101 Sunset Ter., Scotts Valley, CA 95066. E-mail hmaurer@atglobal.net

FOR SALE: Grundig TR700 - \$30. Majestic 31, chassis 30 service manual - \$12. Rider's III w/index, fair - \$15. 3" stack of Motorola CB manuals, 1950s w/Shure CB microphone - \$20. Magnavox amplifier maintenance manuals AMP129-168 - \$10. 1944 War Dept. manuals for SCR radios - \$10. For Radar Electronic Fundamentals Technical manual - \$10. All plus postage. Charles G. Phillips, Jr., 8607 Rembrandt Cir., Newark, DE 19702. (302) 832-9592

FOR SALE: In Door County, Wisconsin or will ship: Plethora of antique, collectible radios; tombstones, cathedrals, foreign, military, transistors, novelties. Antique speakers. Multibands, recorders, televisions, transcriptions, tube hearing aids, hi-fis. Test equipment. Antique medical, law, aviation, other books. Polka, square dance recordings. Uniforms. For catalogs, send two-stamp LSASE to: John Enigl, Sr., K9HJL, 5425 Cherry Ln., Egg Harbor, WI 54209. (920) 743-3672

FOR SALE: Original black 1890s Western Union telegraph form with attached receipt - \$6 ppd. Herman Fothe, 5292 Tiffany Ann, West Palm Beach, FL 33417. (561) 688-2799

FOR SALE: Communications gear. Kenwood Communications receiver Model 300 - \$95. Lowe electronics communications receiver SRX100 - \$65. Knight transmitter Model T-150A - \$85. Heathkit monitor scope w/manual Model SB-610 - \$65. Central Electronics exciter 20A - \$90. Johnson Messenger Model 242-223 (tube) with mic - \$45. Hallicrafters CB-17 6 ch. - \$55. Norton Thompson, PO Box 422, Paonia, CO 81428. (970) 527-3017

FOR SALE: Radio Amateur's Handbook & License Manual, both - \$10. Receiving tube manual app. 1940 - \$5. Philco 38-12 chassis, complete working - \$25. Thomas Guastella, 1633 W. 11th St., Brooklyn, NY 11223. (718) 256-8367

10 BAND MINIATURE SHORTWAVE RADIOS!

Listen to the entire world! This unusual shortwave radio, 7 x 1 1/4 x 3/2 inches, is one of the smallest and most sensitive radios ever built. It has AM/FM/MV and 7 shortwave bands. It uses only two AA batteries or 3-volt adapter (not included). The cost including shipping and insurance is: Only \$35.00 per set N.I.B. E-mail: RGENT@AOL.COM.

Call 732-607-0299, Fax 732-679-8524.

Mail your check or money order to:

R.G.B. Enterprises, Dept. 71
P.O. Box 5367, Old Bridge, N.J. 08857, U.S.A.



Mid-Atlantic
Antique Radio Club

MAARC Proudly Announces:

RadioActivity 2000!

June 15-17, Beltsville, MD

Our best meet ever! Giant flea market and two great auctions!

*Sheraton College Park (same location as last year but hotel has new name)
4095 Powder Mill Rd. Beltsville, MD 20705
(301) 937-4422*

Between Washington and Baltimore, exit 29B off I-95, at the southwest corner of the interchange. Block of rooms available at \$82 single or double. Room reservation cutoff date: May 15 (Group MEK).

Huge flea market beginning at 1 p.m. Thursday. (Publicity to the general public will enhance sales.) Regular auction plus an outstanding estate auction, seminar on television, and radio restoration clinic. Large Old Equipment Contest, with rare and beautiful displays.

Pre-register and save. (No confirmation mailed.) Fee includes family.

- Registration postmarked on or before June 3: \$4
(At the door: \$8)
- Flea market parking spaces: \$10 each

Mail check made out to MAARC to:
Brian Belanger
5730 Avery Park Drive
Rockville, MD 20855-1738
Phone: (301) 258-0708
Fax: (301) 947-3338 E-mail:
bcbelanger@aol.com

For complete details including contest categories and meet agenda see April and May *Radio Age*, write to Brian Belanger, or see:
<http://www.maarc.org>

The Nole Estate Auction:

In addition to the regular MAARC auction on Saturday, the Radio History Society will auction the Len Nole estate collection on Friday night. 300+ fine radios to be sold — battery sets, cathedrals, tombstones, and more:

- AK breadboards, other AKs
- Early Crosleys
- Early Radiolas
- Midwest console
- Dozens of Plaskon, Bakelite and wood table models
- Early transistor radios, some in original boxes
- Test equipment & ham gear

For a partial listing, check the RHS website at
www.radiohistory.org

FOR SALE: Sentinel 312-P, SASE. Robert J. Stone, 721 Fisk St., Piqua, OH 45356-3729

FOR SALE: Antique radio schematics plus data still only - \$3 ppd. Joseph R. Forth, 321 Long Vue Acres, Wheeling, WV 26003. (304) 277-3154. E-mail: wa2tr@juno.com

FOR SALE: Atwater Kent brass binding posts and bases for breadboards - \$48 per dozen, \$30 per 1/2 dozen. Paul Thompson, 340 Old Mill Rd., #247, Santa Barbara, CA 93110. (805) 692-1941

FOR SALE: RCA Delco transistor year 60, 70, 80, new & 6 volts, 12 volts. Louis L. Veltre, 643A Sherwood Ct., Lakehurst, NJ 08733. (732) 657-7592

FOR SALE/TRADE: 1940s Emerson radio/phone - \$30. Silverstone 3026 - \$35. 1950 RCA 9X561 - \$45. 1952 RCA 1X51 - \$35. 1950 Sentinel 335P - \$35. Photofac Service for 51 & 53 TVs, both - \$5. Others. Thomas Guastella, 1633 W. 11th St., Brooklyn, NY 11223. (718) 256-8367

FOR SALE: Must move: Stromberg-Carlson TS-16-10M room TV, radio, phonos, original and beautiful - \$150 BO. Malcolm D. Burdick, W1NOO, 156 Station Rd., Hampton, CT 06247. (860) 455-9640, before 8:30

FOR SALE: GE 221 AM-SW wood table radio, needs repair & refinish - \$20. Donald Sochurek, W191, S7500 Richdorf Dr., Muskego, WI 53150. (262) 679-0212

FOR SALE: Pair Utah Celesta C8JC-2" round 2-way speakers, N.I.B. - \$40. Richard Zintek, 11954 U.S. 31, Grand Haven, MI 49417. (616) 842-2211

FOR SALE: Wurlitzer jukebox Model 851 amplifier (electronics restored), 15-inch speaker, control unit, works great. Gordon Wilson, 11108 50 Ave., Edmonton, Alberta, Canada T6H 0H9. (780) 434-6257. E-mail: wilsons@freenet.edmonton.ab.ca

FOR SALE: Professional equipment: Yamaha MX200-12, 12-channel stereo mixer - \$350. Otari MX 5050 stereo R-R tape recorder - \$300. McKay Dymek AM5, best AM tuner made - \$400. Charles Harper, 2000 Jackstown Rd., Paris, KY 40361. (606) 484-9393. E-mail: charper@kyk.net

FOR SALE: HQ 129X, nice condition, SX-28 rcvr needs mechanical repair, pick up. H.N. Felder, 7517 Granada Dr., Bethesda, MD 20817. E-mail: radiok3rpy@aol.com

**NOTICE TO ALL
CLASSIFIED ADVERTISERS!
OUR CLASSIFIED AD DEADLINE IS
12:00 NOON
ON THE 10th OF EACH MONTH**

FOR SALE: Vitamin Q and mica capacitors; ohmrite resistor cabinets; Monitoring Times and old CQ, QST magazines. Angelo Pallotta, W2TPW, 1367 D'Angelo Dr., N. Tonawanda, NY 14120. (716) 695-0329

FOR SALE: Johnson Viking II, good condition - \$150. **WANTED:** Drake T-4X & R-4C. Robert Braza, W1RMB, 34 Beverly Cir., Attleboro, MA 02703. (508) 222-5553

FOR SALE: Dud tubes, (7) Globe, (1) 216A ball tipped, (1) 71A tubular - \$22 prepaid. M.B. Gaskins, 227 Risen Ave., Campbellsville, KY 42718. (270) 465-3755

FOR SALE: Majestic 196 cathedral, needs regluing - \$275. AK 545 tombstone, needs regluing - \$125. AK 856 tombstone - \$225. Emerson U4A, with back, no cracks - \$175. Grunow 500 chrome tombstone - \$350. Grunow 640 tombstone - \$125. Naylor, Model Sterling Five, battery set, mint. Chris Hicks, 57 Jameson Hill Rd., Clinton Corners, NY 12514. (914) 266-4257

FOR SALE: Zenith Trans-Oceanic 1st production, tan leather L600L, mint condition - \$895. 3000-1, vg - \$175. Ted Demski, 5806 225 Pl. SW, Mountlake Terrace, WA 98043. Ph./fax: (425) 778-7100

VACUUM TUBES WANTED

(920) 208-0353

(All tubes are subject to testing and inspection)

WESTERN ELECTRIC:

VT-2 / 205A/B \$225 NOS, \$110 used
VT-25 \$50 NOS, \$25 used
VT-52 \$150 NOS, \$75 used
101D / 101F \$175 NOS, \$100 used (TB)
101D / 101F \$40 NOS (ST)
102D / 102F \$175 NOS, \$100 used (TB)
102D / 102F \$35 NOS (ST)
205D/E \$425 NOS, \$275 used (TB)
205F \$200 NOS, \$100 used
211A/D/E \$300 NOS, \$175 used
212A/D/E \$750 NOS, \$300 used
216A / 217A \$175 NOS, \$90 used
228A \$100 NOS, \$50 used
231D / 257A / 281A / 349A \$50 NOS
242A/B/C \$200 NOS, \$100 used
244A / 249A \$25 NOS
252A \$1100 NOS, \$650 used
261A \$150 NOS, \$75 used
262A Balloon / 275A \$90 NOS, \$50 used
262B \$40 NOS, \$15 used
264A/B/C \$30 NOS, \$15 used
274A / 274B \$210 NOS, \$110 used
274A / 274B \$250 NOS engraved base
276A \$100 NOS

300A / 300B \$850 NOS (engraved base)
300B \$550 NOS, \$275 used (1950-60's)
310A / 311A \$20 NOS, \$10 used
331A / 367A / 272A \$45 NOS
348A \$80 NOS, \$40 used
350B \$200 NOS, \$100 used
345A / 352A \$25 NOS, \$13 used
412A / 418A \$10 NOS
417A / 420A / 5755 \$10 NOS
421A / 422A \$35 NOS
347A / 437A \$75 NOS, \$38 used
US & EUROPEAN TUBES:
2A3 RCA \$42 NOS, \$20 used
2A3 Single-Plate \$175 NOS, \$100 used
10 Balloon \$70 NOS, \$35 used
10 Balloon "Meshplate" \$100 NOS

112A Balloon \$25 NOS, \$13 used
26/226 Balloon \$10 NOS, \$4 used
45/245 Balloon \$60 NOS, \$30 used
45 Balloon "Meshplate" \$110 NOS
50 Balloon \$200 NOS, \$110 used
50 Balloon "Meshplate" \$275 NOS
71A Balloon \$25 NOS, \$13 used
80/280 Balloon \$30 NOS, \$13 used
211 RCA / United \$110 NOS
800, 808 RCA \$40 NOS, \$20 used
845 RCA \$200 NOS, \$85 used
5691 Red Base \$18 NOS, \$10 used
5692 Red Base \$35 NOS, \$18 used
6550 Tungsol \$60 NOS (ST)
7189A US Brands \$10 NOS
7591A \$30 NOS, \$15 RCA used
6L6GC RCA Black Plate \$30 NOS
12AX7 Telefunken \$15 used
12AX7 RCA \$8 NOS
5AR4 Mullard \$35 NOS
EL34 Mullard \$60 NOS, \$30 used
EL37 Mullard \$60 NOS, \$30 used
KT66 Genalex / Mullard \$70 NOS
KT77 Gold Lion/GEC \$120 NOS
KT88 Gold Lion/GEC \$150 NOS

TUBE WORLD, Inc.

2712 Superior Ave.

Sheboygan, WI 53081

(920) 208-0353 Phone/Fax

Call, Fax, Write or Email for our
detailed "Want to Buy List"
Email: tekman@tubeworld.com

WANTED: For BC-654-A, copy TM-11-275, PE-104 PS, PE-103 dynamotor, other. Paul Wipperman, K1MTM, 17 Oliver St., West Bridgewater, MA 02379. (508) 583-7985

WANTED: Crosley 8-inch Electrodynamic speaker for Model 77 circa 1930. Also need knobs and phonograph for this model. Grebe M1-2, need cabinet and speaker. Alan Kalivas, 7 Anderson St., Peabody, MA 01960. (978) 535-8175



WANTED: Emerson Catalin radios. Nobody pays more than I. What an arrogant and inaccurate thing to say. I mean, like there isn't anyone wealthy enough, dumb enough, desperate enough – or any combination of the three – to pay even a dollar more than I would pay. I mean, c'mon, who am I trying to kid! Please write or call collect: Rain Buttignol, 214 State St., #7, Portsmouth, NH 03801. (603) 427-1384

WANTED: Top dollar paid for your excellent-to-mint Zenith 7000-2 Trans-O. Must be 2WMM70. Gerry Harmon, 10803 Chateau Hill, Austin, TX 78750. (512) 219-0072. E-mail: wharmon1@austin.rr.com

WANTED: 1930 Navy radios, manuals, CW-38412 tubes. Will even pick up! Top dollar! William Donzelli, 15 Gen. MacArthur Dr., Carmel, NY 10512. (914) 225-2547. E-mail: aw288@osfn.org

WANTED: Hey East Coast! Need 1952 Shaw TV. Also good Garrod 930TV back, knobs. Fred Ringwald, 2909-A Mesa Rd., Colorado Springs, CO 80904. (719) 635-8595. E-mail: fred.ringwald@wcom.com

SEND ALL A.R.C. MAIL TO
Antique Radio Classified
P.O. Box 2, Carlisle, MA 01741

WANTED: Magnavox Sportsman Model AW-24 allwave 7 transistor 2-band portable radio. Joe Bentrovato, 84 E. Munson Ave., Dover, NJ 07801. (973) 361-7392

WANTED: Base only for AK Mod L horn speaker. John J. Hoffmann, 154 E. Wall St., Algood, TN 38506. (931) 537-3853

WANTED: Repairable chassis for Crosley Mod 635, w/ without tubes. Ernest Bigler, 292 Cleveland Ave., Macon, GA 31204. E-mail: leroybigler@we3tv.net

WANTED: Tube sockets for Western Electric. WE 109A, or WE 121A. Dave Vaughn, 2640 N.W. Robinia, Portland, OR 97229. (503) 574-2825. E-mail: dbvon@involved.com



WANTED: Mills Studio juke box. Top price paid. John Ringle, III, PO Box 4, 8875 Sand Lake Rd., Harshaw, WI 54529. (715) 277-2011. Fax: (715) 277-4120

2nd ANNUAL KUTZTOWN RADIO MEET SATURDAY MAY 13

At the Renninger's Antique and Farmers Market on Noble Street in Kutztown PA, at 7:00 AM. 100+ spaces under pavilion plus unlimited uncovered spaces. No pre-registration, \$15/space. Camping available on site. Lodging at the Campus Inn (610) 683-8721, 1 mi. from meet. For questions contact Steve Wallace (610) 944-7230, kkk@epix.net, or Dan Dewald (610) 683-6848.

Follow map below and exit Rte. 222 or 78 at Rte. 7375/Kutztown. Proceed into Kutztown, take a right onto Main Street, then left at 1st light on to Noble Street. Renninger's is 1 mi. on right.

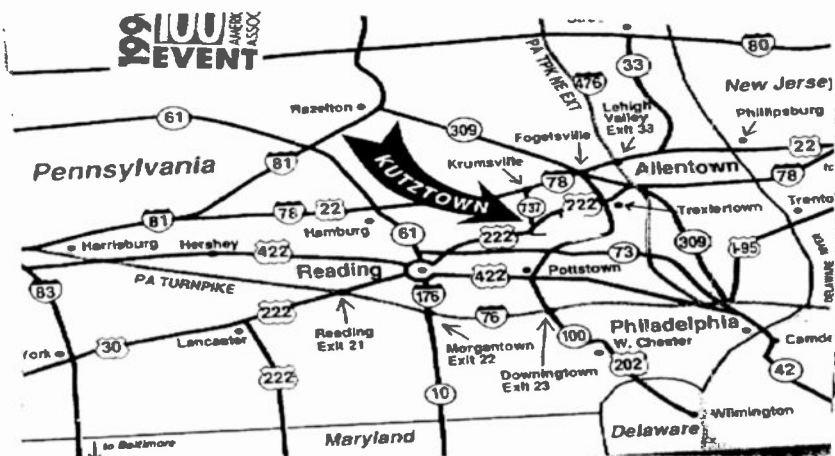

FOR SALE: Zenith 86005 Trans-Oceanic Clipper, parts radio - \$20. Philco cathedral 37-61, works great, good cond. - \$125. Packard car radio PA-393607 - \$30. Plus shipping. Dan Trombley, 54 Cherry St., Rutland, VT 05701. (802) 775-4104

FOR SALE: Grundig multiband tube radio, Model 3033/56, plays great, missing one knob - \$40. Joseph B. Kelber, 503 S. Scranton Ave., Scranton, KS 66537. (785) 793-2323. E-mail: ble17@juno.com

FOR SALE: Stand By, juvenile book, 1930, dust cover - \$25. Day-Fan Radio promotional button - \$35. Mike Grimes, K5MLG, 3805 Appomattox Cir., Plano, TX 75023. (972) 867-6373. E-mail: grimesm@flash.net

FOR SALE: Wersi-Voice tabletop Model WV-300 rotor-string-choir music sound unit (makes single musical instrument sound like small ensemble); adds vibrato, original cost \$396, price - \$99 + \$10 packing & UPS. Bob Eckert, 133 E. 7th St., Clifton, NJ 07011-1104. (973) 340-0579

FOR SALE: Fada 609, SASE. Robert J. Stone, 721 Fisk St., Piqua, OH 45356-3729

FOR SALE: Barzilay walnut stereo: w/(2) 15" speaker cabinets, Scott 296, Fisher FM 200B, Collaro phono, tambour doors. Francis H. Yonker, PE, W2IBH, 1229 Inverary Pl., State College, PA 16801. (814) 867-1400

FOR SALE: (600) receiving tubes in original boxes, cheap - trades? Star Trek frequency counter 5 Hz to 2.8 GHz, very sensitive - \$200 or trade for ? Bill Gerk, KD5EBF, 8061 U.S. Hwy. 49N, Hattiesburg, MS 39402. (601) 268-6059, lv. msg.

FOR SALE: Gernsback Official Radio Service Manual; NRI Service Manual Volume 1; Beitman Radio Diagrams, 1926-1938, 1939, 1940, 1942. Telmer Olson, W0YPT, PO Box 267, 304 West Iowa St., Monona, IA 52159. (319) 539-2315

FOR SALE: Sanyo R100P wristwatch/radio, N.I.B. with headphones - \$25 + ship. Leroy Marshall, 1178 Foxboro Ln., Bartlett, IL 60103. (630) 483-8833

FOR SALE: 1947-1950 console televisions - \$50 to \$100 ea. Call for details. Photos LSASE. PU only. Sam Mannino, PO Box 331, Villanova, PA 19085. (610) 353-6747

— WANTED —
PICTURES FOR PHOTO REVIEW OR TELEGRAPH REVIEW
PHOTOS MUST BE SHARP IN DETAIL
A SHORT DESCRIPTION IS A MUST!
SEE PHOTO REVIEW PAGES FOR ADDITIONAL INFORMATION

FOR SALE: Arvin 451T1 - \$60. See Website photo: <http://www.interestingoldjunk.com>. James J. McGrath, W2IOJ, 2 Centerville Ln., West Seneca, NY 14224-2124. (716) 675-0160. E-mail: w2ioj@interestingoldjunk.com

FOR SALE: Book: Audel Diesel Engine Manual - \$12.95 ppd. R.J. Eastwick, W2RJE, 400 N. Haddon Ave. Unit 109, Haddonfield, NJ 08033. (856) 429-2477

FOR SALE: Too many radios, books, parts, tubes. LSASE. **WANTED:** Chassis 21/Kennedy 30/32 (A.R.C. Sep. 1998, p. 9). W.F. Horn, 13110 Marsh Rd., Bealeton, VA 22712. E-mail: wehcoll@tidalwave.net

FOR SALE: Solid-state scopes, both dual trace, work good: HP 1707B, 75 MHz - \$150; Ballantine 1066S, 10 MHz - \$50. Rod Galloway, 2220 Woodbury Rd., Melbourne, FL 32935. (321) 254-0280. E-mail: rdgall@brevard.net

FOR SALE: Pancake transmitter and receiver - \$250. Also Amprobe multimeter Model AM-3E - \$120. Frank Waskiewicz, 143 Carlis Path, Deer Park, NY 11729. (516) 667-3269

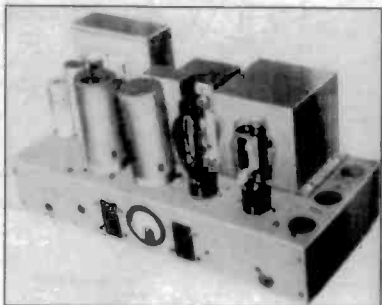
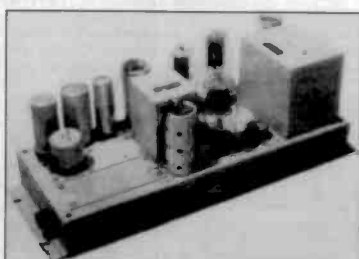
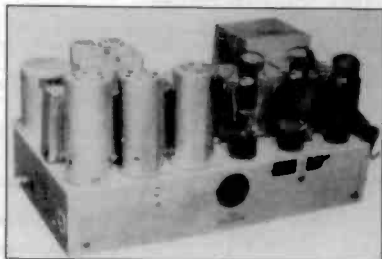

Always wanted Western Electric theatre amps, speakers, horns, drivers and tubes. Also seeking vintage tube equipment by Marantz, McIntosh and Tannoy. Thank you.

Chong Ong
10223 Valentino Dr. #7304
Oakton, VA 22124
Tel. (703) 255-3218
Fax (703) 255-3718
E-mail: ongkt88@erols.com

Radio Restoration Parts

Vacuum Tube Repair Wafers

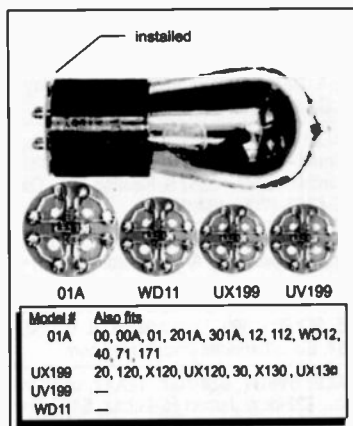

These tube repair wafers are solid-state devices for quick and easy repair of early vacuum tubes. The wafer is installed by simply sliding it over the tube pins and reinserting the tube into its socket. If the filament is intact, but there is little or no emission, the filament may be lit for best visual effect. However, the tube can be open filament.

No change in radio operating voltages is required. Any number of tubes may be repaired in a radio. If wafers are installed on all tubes, the B+ voltage may usually be reduced without sacrificing volume or sensitivity. Performance will vary between radio models.

\$10.00/each (\$7.50/ea. 3 or more)

Antique Radio Power Supply

The H15/ H16 power supplies operates most tube type battery radios from low cost batteries. The H15/H16 steps up the voltage from a 6V battery to provide 22.5V, 45V, and 90VDC for the "B" voltage requirements.

A very desirable feature of the H15/H16 is the method of switching power on and off. This function is provided by the switch on the radio. No radio modification required.

The "A" voltage required by the radio can be from "C" or "D" flashlight batteries or from a 6V gelled electrolyte battery when operating 5V tubes. When operating 1.5, 2, or 3V tubes the H15/H16 can be powered by 4 "C" or "D" flashlight batteries or from a 6V gelled electrolyte battery. The gelled electrolyte battery can operate both the H15/H16 and the 6V "A" supply for 5V tubes from one battery.

Order the H15 of parallel filaments or the H16 for series filaments.

The compact size, 4"X4"X3/4", allows the unit to be installed with batteries in the battery compartment of most radios.

H15 or H16: \$99.50. Accessories: "D" cell holders: \$6.00 per set. 6V 10AH battery \$31.00. Battery charger \$45.00. 1.5 - 90V socket \$9.50.



Active Antenna

Allows antique radios which were designed for a long wire outdoor antenna to operate on a 42" indoor whip antenna. Portable, operates from a 9 volt battery.

Only \$34.95

New Atwater Kent Breadboard Switch -

Only \$50

Order from: PTI, 7925 Mabelvale Cutoff, Mabelvale, AR 72103

Orders shipped UPS or Parcel Post, prepaid in continental U.S. Please allow 3 weeks for delivery.
Arkansas residents add 6.125% sales tax.



To Order: Call (501) 568-1995

FOR SALE: Philco console 41315. Motorola 65F21 console/phono. Crosley 02CP console/phono. Aircastle 1091 console. Magnavox 132B chairside w/phono. Pick-up only. A.A. Dubois, Jr., 67 Peggy Ann Rd., Queensbury, NY 12804. (518) 792-3130

**FAX NUMBER FOR
ANTIQUÉ RADIO CLASSIFIED
(978) 371-7129 – 24 hours a day
Ads – Subscriptions – Book Orders
See inside front cover for details**

FOR SALE: Supreme tube tester, Model 89D, with original 9 pages of data and instruction. Ray Miner, 1215 Ave. B, Ft. Madison, IA 52627. (319) 372-1271

FOR SALE: Batt. sets. Splitdorf Model R-500 with tubes, untested, w/tubes – \$195 + ship. Freshman Masterpiece 5-F-5 NT – \$150 + ship. Freshman 5-F-4, not tested – \$150 + ship. Kolster 6-D NT untested – \$150. Frank Vaillancourt, PO Box 726, Woodstock, VT 05091. (802) 457-3482

FOR SALE: Dial belt kits, dial lamps, cloth covered power cord, capacitors, Hammond transformers, GC Electronics supplies, refinishing products, etc., etc. Radio Daze, LLC, 7 Assembly Dr., Mendon, NY 14506. (716) 624-9755. Fax: (716) 624-7857. E-mail: info@radiodaze.com. Web: <http://www.radiodaze.com>

FOR SALE: (76) AR manuals, #19-241, (66) TSM manuals, #27-121 – \$5 ea. plus UPS. Lois Rasmusson, 1107 W. Jefferson St., Joliet, IL 60435. (815) 744-4565. E-mail: L.E.Rasmusson@juno.com

FOR SALE/TRADE: Collins KY-45/FRT-5, AN/ART-13. BC-348. Drake TR-4C. Heath HW-12, QF-1, EK-2. ARC/MD-7. E-list. Sam Timberlake, KF4TXQ, PO Box 161, Dadeville, AL 36853-0161. (256) 825-7305. E-mail: stimber@lakemartin.net

IT'S HERE!

The solution to poor reception on your A.M. radio. Designed to improve signal strength on portable and table model radios, our easy to use signal booster works great with any radio that has a built-in ferrite or air wound antenna. Needs no battery or A.C. power. Lifetime warranty.

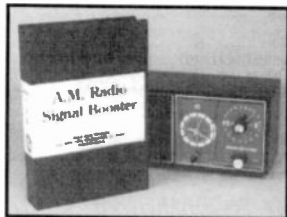

Model 1601 covers 530-1600 kHz – \$45.

Model 1701 covers 530-1700 kHz – \$54.

Please add \$6 S&H (U.S.)

Send payment with order. Money back (less S&H charge) if not satisfied with our product.



FALA ELECTRONICS

PO Box 1376, Milwaukee, WI 53201

FOR SALE: Zenith Trans-Oceanic D7000Y, looks great, has a name engraved on handle and has no map and charts in front cover, this is a good receiver – \$200 + shipping, will ship to U.S. only. Jim Montague, 907 S. Stanley Ln., Spokane, WA 99212. (509) 535-9576. E-mail: Montaguespokane@aol.com

FOR SALE: DeForest audion 445, checks good – \$55 ppd. U.S.A. Darrell Combs, 6587 Pacheco Way, Citrus Heights, CA 95610. (916) 969-0635

FOR SALE: AC & DC voltmeter by Amprobe, 0-750 volts, manual – \$10. Digital video stabilizer, with manual – \$15. Daniel Seidler, 10337 S. Keating Ave., Oaklawn, IL 60453-4753. (708) 424-2057

FOR SALE: Stromberg-Carlson rare Art Deco chairsides from my S-C collection: An extraordinary 231-R, half round glass top, near mint – \$950; and a 231-F, glass top butler table, excellent – \$850. Can be shipped. John England, PO Box 393, Lincolnshire, IL 60068. (847) 823-5287. E-mail: triodes@sprintmail.com

FOR SALE: 6V6GT, 6SN7GT, 12AX7, used tested – \$2.50 ea., \$22/doz. James R. Lopaz, 5467 S 975 E, Ogden, UT 84405. (801) 476-1470

FOR SALE: Philco TV, 17" Predicta, works, SASE. Robert J. Stone, 721 Fisk St., Piqua, OH 45356-3729

FOR SALE: Emerson 38, very nice, plays – \$125. Tubes N.I.B.: Western Electric 396A, (2) – \$5; 401A (3) – \$5; 403B (6) – \$7; 408A (3) – \$7; 5D21 (1) – \$30. Other tubes WL6146A – \$10; 4E27/8001 (3) – \$20; 5894 – \$35; 807 – \$9; 4-65 Eimac (4) – \$35; 4-125 (2) – \$60; VT25 – \$60; C3J – \$35; 2A3 – \$45; Silvertone 45 – \$45; RCA 280 – \$40; 71A – \$20; 46 – \$10; 6A3 – \$20; Amperex E80F – \$15; 6072 – \$9; 8156 – \$10; 928 – \$12; 2050 – \$10; 2051 – \$7; 7239 – \$20; 8106 – \$10; 8156 – \$10; 7868 (1) – \$25; 6072 – \$9; WE417 – \$20; Amp 6360A – \$9; ECLL800 (1) – \$30; 7199 – \$15; 80 – \$12; 12BH7 – \$9; 6AR5 – \$4; 6DJ8 – \$5; 6HS5 – \$5; 6HF5 – \$9. Many other new and used tubes, prices per tube. Tony Rinaldo, 308 Lenox Ave., Oneida, NY 13421. Phone/fax: (315) 363-3644

FOR SALE: Working novelty radios; milk carton – \$30; Australian Amcolor film box – \$30. Shipping extra. Steve Whited, 3637 W. 71st St., Indianapolis, IN 46268. (317) 298-9967

FOR SALE: Heathkit AJ1510A dig. FM tuner, works – \$25. H.H. Scott LT110 FM tuner, works – \$30. Revere T-2000 tape recorder, all orig. with manual, untested – \$25. Shipping extra. WANTED: Repairable chassis for Philco PT-44. Harold D. Wright, RR1 Box 259, Chancellor, AL 36316-9749. (334) 347-0393

CATALIN WANTED	WANTED RADIOS
	
TOP PRICES PAID!	
Michael Lawlor P.O. Box 179 Santa Barbara, CA 93102 (805) 682-2336	

WANTED: Excellent to mint pair of Altec 604E Super Duplex speakers with or without original home use cabinets (858A, 855A, 859A, 860A, 612A, 614A). Mike J. Ceklowsky, 8847 Olive Ranch Ln., Fair Oaks, CA 95628. (916) 962-2942

WANTED: Miniature tube coat pocket size radios. Mint or mangled. Oddball typewriters. I'll pay \$500-\$1,000 for over 75 primitive models, including incomplete, rusted basket cases. 25 year collector. Mike Brooks, 7335 Skyline, Oakland, CA 94611. (510) 339-1751. E-mail: minlwave@aol.com

FREE - 20 WORD AD EACH MONTH

To get your free 20 words,
include your SUB# with your Ad.
Additional words are 29¢ each.
Read Inside back cover for details.
MANY THANKS!!!!

WANTED: Electric tuning motor for Crosley 1217. Part # 45168. Thanks. Jack Sweeney, 321 Olympic Hgts., Dubuque, IA 52001. E-mail: mrradio@mwci.net

WANTED: WWII SCR299 base station radio and truck components to complete K51 vehicle restoration project. Need: T-50 mic, JB 69-A junction box, J-37 key, phone and speaker control panel, FT-162, FT178, FT388-A, FT389-A mountings, SW-199-A (start-stop) switch, CH-89 (seat) chest, CH-112A chest, DR-4 reel mounts, axle RL-27. Various cords: CD-562, 563, 564, 565, 566, 587, 652, CO-313, 314, 315, 316, TE-48 tool equipment, BC-610C back panel & shock mount, BC-614D top cover and shock mounts, lamp LM-27, EE-8 table side box, BC614D I.D. tag, mount for BC-721 (Gladder) frame FM-62-A spare tire, typewriter w/telegraphers keyboard, radio panel van left exterior side wooden storage box drawings... help! What do you have? Any information would be gratefully appreciated! Bill Miller, 5035 E. Wheatland Rd., Vincennes, IN 47591. (812) 882-2437 home, (812) 882-6690 work. Fax: (812) 886-0573

WANTED: Doron radios/products (Doron Bros. Electrical Co., Hamilton, Ohio). Joe Baker, 209 Maywood St., Blacksburg, VA 24060-1316. (540) 951-7748. E-mail: rok90@adelphia.net



WANTED: The above Pilot radio, will pay up to \$1,500 or trade. Call: Bill Moore, 1901 Spanish Oaks, Huntsville, AL 35803. (256) 885-0068. E-mail: bmoore2nd@aol.com

WANTED: Voice of Music parts, accessories, idlers, dealer items. Gary Stork, 37530 E. Meadowhill, Northville, MI 48167. (248) 478-0990. E-mail: gstork@concentric.net

WANTED: Record cutting machines, hi-fi tube amplifiers, limiters, automotive record players. I make records. Klm Gutzke, 7134 15th Ave. S, Minneapolis, MN 55423. (612) 869-4963. Fax: (612) 798-4169

WANTED: Offering \$40 for good Silver Marshall audio SM-220. Need case top for RCA Victor SW converter, SW-10. Can you help? Clyde Watson, 8311 Via de Sereno, Scottsdale, AZ 85258. (480) 948-6466. E-mail: clydelois@earthlink.net

WANTED: Complete band selector switch assembly for Hallicrafters S-85 schematic, Crosley tombstone 612. Ronald Nolen, PO Box 387, Clinton, TN 37717. (423) or (865) 457-4854

VACUUM TUBE VALLEY

Legendary Tube Audio Knowledge and Performance

The Ultimate Tube Audio Journal

- Detailed Audio Tube History and Listening Comparisons
- SE and PP Amp Projects and Kit Reviews
- Speaker Mods and Tests
- Vintage Hi-Fi History
- Interviews, DIY, Kits, Mods, Tube Lore and More!

All 12 Back Issues Available!

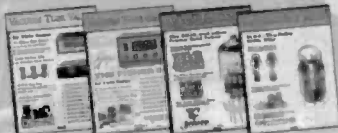

www.vacuumtube.com
tride@vacuumtube.com

Pro-Tube Shop

Mail Order & Online Parts & Tubes

- Ultra-Tone Silver Foil Paper in Oil Caps
"Rich, liquid and real - the best sounding caps"
 - Premium New & NOS tubes (Amperex, Mullard, RCA, Siemens, Sovtek, Svetlana, Telefunken)
 - ASUSA Kit Tube SE and PP Amps, Preamp Kits
Vintage US Tube Hi-Fi Components: Dyna, Fisher, Scott
 - Electro-Print Transformers, Illinois Capacitors, Hovland, D.H. Labs, Rebuild Kits and Supplies
- 24 Hour Order Line - AMEX, MC, VISA
Informative Catalog: \$3.00 US, \$5.00 Foreign

Subscription Rates: \$45/yr US First Class, \$36 3rd Class,
\$48 Canada, \$56 Europe, \$66 Asia and World (4 issues)

P.O. Box 1499 Lakeport, CA 95453
Phone: 707-263-5881 FAX 707-263-7648

FOR SALE: About (200) issues QST - \$2.50 ea. or \$200 for all + shipping. Frank Brewster, 2020 W. 5th, Baxter Springs, KS 66713. (316) 856-3220, eves.

FOR SALE: Tubes galore. Send SASE for new list AB. Telegraph instruments (list TG); test equipment (list TE). Special: 3-level rotary switch, 20 contacts per level - \$15. Amphenol and Cinch-Jones plugs, sockets and connectors. **WANTED:** 4-pin Amphenol plugs. Typetronics, Fred Schmidt, N4IT, PO Box 8873, Ft. Lauderdale, FL 33310-8873. (954) 583-1340. Fax: (954) 583-0777

HAS YOUR SUBSCRIPTION

EXPIRED?

It has if your mailing label reads
"EXP=APR00" or earlier.

Renew now!

*BONUS: Renew before
your "EXP" month and receive
13 issues per year instead of 12!*

Renewal rates are:

\$39.49 for Periodicals Mailing

\$57.95 for First-Class Mailing

(Two-year renewals are twice above rates.)

FOR SALE: RCA Nipper and Chipper stuffed dogs in doghouse - \$30 plus shipping. Alan Piorek, WB9RAD, 1050 N. Paulina St., Chicago, IL 60622. (773) 235-1523

FOR SALE: Silvertone 6256 portable, 4 tubes, 8 digital photos via e-mail - \$30 delivered. Tom Tetzlaff, 23 Nelson Dr., Silver Bay, MN 55614. (218) 226-4192. E-mail: catt@lakenet.com

THE TUBE SHOP

"Your one stop for new old-stock tubes"



Box 231160

Boston, MA 02123-1160

Phone: 617-369-0980

Fax: 617-262-0148

Fax: 617-353-1466

E-mail: tubeshop@quik.com

On the Web at:

www.thetubeshop.com

FORSALE: Channel Master broadband VHF distribution amplifier 7030. Sams Photofacts. Hickok color bar gen. 246. Ann Bichanich, Jay's, 15 W. Lake St., Chisholm, MN 55719. (218) 254-4421

FOR SALE: Atwater Kent 10A, 4560, vg - \$800. Larry Brososky, 15514 Windover Trl., Fort Wayne, IN 46845. (219) 637-5339

FOR SALE: Transistors. (53) excellent condition, all work, (47) are - \$10 or less. List SASE. Leo Woodbridge, 5130 Steeplechase Dr., Schnecksville, PA 18078

FOR SALE: Western Electric 100F amplifier, (loud speaker set), 11" x 7" x 5" wood case, 3 tubes - \$125. Bob Puttre, 637 Stratford Rd., Baldwin, NY 11510. (516) 223-9667

FOR SALE: Victor radio high boy R-52 in very good condition and works - \$480. Wayne Ader, 2023 S. Quanicassie Rd., Reese, MI 48757. (517) 868-4511

FORSALE: Radiola 25 complete with antenna, directory, and map excellent original - \$300 plus UPS. Claude Chafin, 4223 E. 42nd Way, Independence, MO 64055. (816) 478-4518. E-mail: n0fmo@email.msn.com

FOR SALE: National NC-57, SASE. Robert J. Stone, 721 Fisk St., Piqua, OH 45356-3729

FOR SALE: Radio Essentials, 1948 - \$9. Radio Communication, 1943, Nilson - \$11. Radio Fundamentals, 1945 - \$11. Rich Yoch, 22410 Bartlett Dr., Rocky River, OH 44116. Ph./fax: (440) 331-9206

FOR SALE: S-meter for Pierson Holt communications receiver - \$15 + postage. Henry Engstrom, KD6KWH, PO Box 5846, Santa Rosa, CA 95402. (707) 544-5179. E-mail: pacific@sonic.net

FOR SALE: (5) A.R.C.s Aug. (Bonzo pup issue) thru Dec. 1990 - \$20 includes postage. Bob Barr, 4477 S.E. Heartwood Trl., Stuart, FL 34997. (561) 283-4143

FOR SALE: Silver Marshall 1930s wood table model radio - \$65. (4) used good 6CA7/EL34 tubes; 17-inch TV magnifier; Boss/Roland VT1 voice transfer unit; BE 2100 broadcast cart machine, record and playback; four old broadcast equipment catalogs; N.O.S. 6L6, 6JE6 tubes; Lionel 1014 transformer; Aquatron Space Helmet, AF-8 trk, white. Charles Harper, 2000 Jackstown Rd., Paris, KY 40361. (606) 484-9393. E-mail: charper@kyk.net

FOR SALE: Zenith 705 table, missing (1) knob and back, otherwise complete, cabinet in good cond. but needs some cosmetics. Needs a good home. Ray Sanderford, 1580 Reh. Church Rd., Clarion, PA 16214-5936. (814) 764-5002

(818) 786-2500



Old Time Replications 5744 Tobias Ave., Van Nuys, CA 91411
CA Residents, please add 8.25% sales tax

INDIANA

Historical Radio Society



and

The Antique Wireless Association



Present the 29th Annual Regional Spring Radio Festival

Same great location as last year!!!

Signature Inn East, Indianapolis, IN, (317) 353-6966

June 9th & 10th, 2000

I-465 at East Washington Street, (US Rt. 40). When registering, inform them that you are attending the IHRS event so you will receive the special price of \$60.00 per night. We have a block of 32 rooms held for us until May 25. Get your reservations in now! There's a lot going on in the Indy area.

Friday, June 9

Registration	7:30 am
Flea Market	All day to 6 pm
Old Equipment Contest Room opens†	9 am
Co-ed Luncheon	12 noon
at the wonderful Laughner's Cafeteria on East Washington St. (Route 40) at 20 N. Franklin Rd. by I-465 (1/2 mi. from Signature.)	
Contest Judging (room closes to allow review and judging)	1:30 pm

Seminars:

Overcoming bonding problems in a Chrome-Plated Chassis (Scott AW23). Cabinetry restoration, esp. speaker grilles & veneer repair. Xfmr "repair" or replacement. EZ Philco block rebuild. Make that new condenser look like the original. Many other "Hints & Kinks". Seminars located in meeting Rm #2 on 2nd floor of the Signature Inn. 2:00 pm

Banquet & Entertainment:

- IHRS Annual Awards Banquet 5:45 pm at Laughner's. See "Banquet Details."
- Equipment contest awards 6:45 pm
- The "Charleston Chasers" 7 pm See "Details."

Saturday June 10

Event	Time
Registration	7:30 am
Bring in items for 2 auctions	8:45 am
<i>Items for the regular auction will be signed in at this point. Those bringing in material for the Donation auction should make sure it is not junk. Please do not abandon cabinets or chassis on the grounds.</i>	
Donation auction	10:30 am
Auction (please note there is a 10% fee involved)	11:15 am

Details: Banquet & Co-ed Luncheon: Entertainment for Co-ed luncheon to be announced the day of the event, or call for info. The "Charleston Chasers" will play music from the early period of radio at the Friday night banquet. They're great. Ask anyone who saw them last year.

† Contest categories:

Please register your entries.

1. Farm battery radios
2. Novelty Transistor radios
3. Indiana-made radios
4. Crystal sets
5. Open

We would like to have all contest entry items to remain on display until Saturday. Room will be locked after hours.

FEE SCHEDULE:

Registration - FREE. Vendor spaces/tables: Tent tables - \$15 Fri. only. Outdoor spaces - \$10 each both days. Please note that all spaces are numbered and assigned. Do not attempt to move in early. You might have to tear down and be moved. Reserve your spaces now. Mail deadline is June 3.

Contacts: Herman Gross (765) 459-8308, w9itt@juno.com or George Freeman (812) 265-6878. Send check for reserved spaces to: Dr. Michael Clark, Treasurer, IHRS, 6484 East 350 North, Franklin, IN 46131. (317) 738-4649

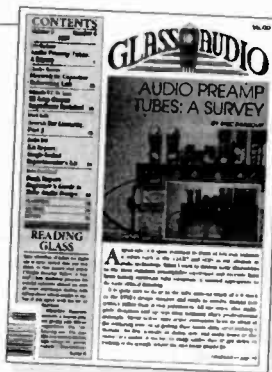

*Vacuum tubes
for Audio are back ...
and they sound better
than ever!*

Glass Audio brings together
yesterday's tubes and today's
improved components,
making smooth sound possible
for your audio again.

Ask for your first issue **FREE** to
examine, without obligation!

Glass Audio

PO Box 176, Dept. ARC8
Peterborough, NH 03458-0176 USA
Phone: 603-924-9464

Fax: 603-924-9467 Email: custserv@audioexpress.com

Visit our website at www.audioexpress.com

FOR SALE: New tubes 19, 27, 31, 36, 37, 43, 58 - \$5 ea. Plus shipping. I have 1,000s more. SASE for a free list. J. Arndt, 1215 Division St., Manitowoc, WI 54220-5734. (920) 684-8830

FOR SALE: Emerson 544. **WANTED:** Zenith MJ 1035. Hoover Noonan, Rt. 1, Box 187, Pineland, SC 29934. (843) 726-5762

FOR SALE: Lot about (28) chassis and (8) speakers, most have tubes, 1928 to 1948, great parts source - \$250. Richard Foster, Antique Radio Service, 12 Shawmut Ave., Cochituate, MA 01778. (800) 201-2635, 2-4 pm weekdays

**HAVE YOU MOVED? ARE YOU MOVING?
PLEASE NOTIFY US A.S.A.P.**

**SEND US YOUR...
OLD ADDRESS
NEW ADDRESS and
SUB #
MANY THANKS!!!!!!**

FOR SALE: Betamovie VCR tapes, some good, sell as re-recordable, clean - \$35 per (100) + shipping. Rudy G. Purcell, 4473 W. 136th St., Cleveland, OH 44135. (216) 251-6511

FOR SALE: Microphones: RCA BC Lavalier - \$10. Astatic 10M5 - \$10. Transformers, capacitors, publications. SASE list. Bill Riley, W7EXB, 863 W. 38th Ave., Eugene, OR 97405-2375

FOR SALE: N.O.S. capacitors; resistors, various values, bagged & marked - \$2.50 ea. pkg; 3 stack resistor cabinet, loaded with same - \$25. Maureen Martin, 1407 Memory Ln., Lutz, FL 33549. (813) 949-1835

FOR SALE: Tubes N.O.S. (100) assorted 2 to 20 volt - \$100. **WANTED:** Leica camera, lens. James Wright, 4307 Hwy. 166N, Maynard, AR 72444. (870) 647-2913

FOR SALE: Toshiba 2 band 8 transistor radio, Model 8TM-300SB still in original box - \$65. Harry Schesnuik, PO Box 2162, Newport, WA 99156. (509) 447-4630

FOR SALE: Vintage radio and electronic components. Transistors CK722, CK760, CK762, 2N107, 2N35, 2N170, 2N94, etc. Many N.O.S. tubes, Tungar bulbs, etc. Please, visit site at: www.electronic-projects.com. Mention this ad on your order and we'll give you 10% off your first purchase at the time of shipping. Helio Sakaya, 9925 N.W. 66th Manor, Parkland, FL 33076

FOR SALE: Good emission, pullout tubes: 12AU7 - \$2; 12AX7 - \$3; 12BH7 - \$4; reasonable quantities. Stan Marlin, Box 1035, Assiniboia, Saskatchewan, Canada S0H 0B0. (306) 642-3824. Fax: (306) 642-5381

FOR SALE: Dynakit ST-70 stereo amplifier, original, clean, works fine, with cage - \$299. Ben Deovlet, W6FDU, 933 Robin Ln., Campbell, CA 95008. (408) 374-9519. E-mail: w6fdu@aol.com

FOR SALE: Tubes from 0B2 to 9003 including 23A, WE 417A, 807, 811A, 832A, 866A, 872A, SASE for list. VC50 vacuum capacitor 55 mmf at 20 KV and Precise VTVM Model 907/9071 - Offers. **WANTED:** Osc. coil Meissner part no. 14-1073 or Emerson part no. 716005. E. F. Hayes, W0JFN, 3109 N. Douglas Ave., Loveland, CO 80538-2548

FOR SALE: GE 1946 #201, ivory - \$40. Emerson 1949 #587A, wood - \$40. List: LSASE to: Jacob, Box 9374, N. St. Paul, MN 55109. (651) 777-6791

WANTED: Deco thru earlier horns & radios. Oddball mechanical, electrical or brass scientific. Steve Erenberg, 23 Furnace Brook Dr., Cortlandt Manor, NY 10567. (212) 818-0100. (914) 739-1423. E-mail: erenberg@bestweb.net



WANTED: Air King Skyscraper radios, except for that unbearably ugly model with the third (tuning) eye at the top that bears better resemblance to a flounder than to the face of a building. Please write or call collect: Rain Buttignol, 214 State St., #7, Portsmouth, NH 03801. (603) 427-1384

WANTED: RP-6, RS-6 spy transceiver, parts, any plugs for Tektronix TM504 mainframe modular instrument, also need speaker and metal lid for Philco 65 (same ugly metal cabinet as #511!). Also need horn bells for Magnavox M4 and R3 horns, also innards for Bremer-Tully counter phase, and Norco 3 dial battery set, easy huh? Thanks. Jim Barratt, 26313 S.E. Leonard Rd., Camas, WA 98607

WANTED: AR1 speaker, any finish. Altec A333 mono amp. Fairchild Z60 black label mono amp. Pilot AA901 mono amp. U.S. N.O.S. 12AX7, large quantity OK. Walt Fleming, 182 Plain Hill Rd., Norwich, CT 06360. (860) 889-1957/1937. E-mail: wrlfleming@snet.net

WANTED: Interested in acquiring businesses that serve the vintage radio and electronics marketplace. Send information in strictest confidence to: Radio Daze, LLC, 7 Assembly Dr., Mendon, NY 14506. (716) 624-9755. Fax: (716) 624-7857. E-mail: info@radiodaze.com. Web: http://www.radiodaze.com

WANTED: Radio Boys: Flood Fighters, On Pacific, To Rescue, Lost Atlantis, Border Patrol, Air Patrol, Secret Service, Thousand Islands, Under Sea. Tubes wanted: Arcturus 15v #40, AC28, Sonora SO1, RA1; good emission only. John Swett, 8677 Usher Rd., Okmstead Twp., OH 44138. (440) 235-0361. E-mail: johnaswett@aol.com

WANTED: DeForest spherical Audion to restore early RJ4 detector. Need not function. Don Willoughby, 480 Distel Dr., Los Altos, CA 94022. (650) 948-9207. E-mail: donwillo@jps.net

WANTED: Trans-Oceanic Zenith radio; Model Royal 1000D, with chassis 9HT412Z only. William Johnson, 1142 Hillsdale, Pittsburgh, PA 15216

**PHONE NUMBER FOR
ANTIQUA RADIO CLASSIFIED
(978) 371-0512**

**Best time to call is weekdays:
9 am to 5 pm Eastern Time**

(Please no classified ads by phone. Thanks!)

WANTED: Ampex Model 6D2 tape deck with recording electronics. Also Viking FF-75 tape transport and recording electronics. Neil Koenig, 14108 Sylvan St., #1, Van Nuys, CA 91401. (818) 989-4137, please phone collect

WANTED: M.O.S. Delco car radio volume controls:
1218641, 1220961, 1221125, 7256188, 7264211,
7266193. Bill Van Pelt, 4401 S. Plateau Trl., Sioux Falls, SD 57106. (605) 362-7243

WANTED: Vogue picture records. Phonograph advertising items: original advertising from Edison, Victor, RCA Victor. Needle tins, advertising featuring Nipper. Record brushes and dusters. Pocket advertising mirrors. Dealer trade cards, lapel pins, buttons posters, puzzles, fans, Edison, Columbia, and any wax cylinder records. Phonograph toys. Toy wind-up phonographs. Thanks. Bernie Seiber, 714 Moreton Rd., Meadowbrook, PA 19046-1907. (215) 886-6124. Fax: (215) 638-2265. E-mail: phonoman-bernie@worldnet.att.net

WANTED: Additional tube chart for EICO tube tester Model 666. Gordon Busenius, 10336 44 St., Edmonton, Alberta, Canada T6A1V7. (780) 469-7566

BUY • SELL • TRADE

CATALIN RADIOS



I'll buy single pieces or
whole collections. Top prices paid.

RADIOART

Jim Meehan

P.O. Box 102 • Centerbrook, CT 06409

(860) 526-1762

E-mail: radioart@ntplx.net

The Electronics Collector

(Formerly Transistor Network)

Transistor, Tube, Novelty & Crystal Radios • Recorders • Hearing Aids • Calculators • Reviews • Repair & Restoration • More

Information • Articles • Classifieds

Subscribe Today!

\$24.95 U.S. (First Class) \$34.95 Canada (Air)

\$43.95 Other Countries (Air)

Subscribers get a free 50-word ad monthly.

The Electronics Collector

P.O. Box 43, Dept. C, Live Oak, FL 32064-0043

Free sample copy upon request

FOR SALE: Civil German WWII radios. **WANTED:** Bendix 526C in good condition. G. Faassen, Heideweg 1, 5953 T. L. Reuver, Holland. Fax: 0031-77-474-6683. E-mail: Rattekast@hetnet.nl

FOR SALE: Moving. No Lists. Rece/trans meters, std coil/thermo/hot wire before 1930. Ye Olde Meter Cellar, Leonard Cartwright, 879 Russet Dr., Sunnyvale, CA 94087. (408) 739-6025. E-mail: lencartwright@msn.com

FOR SALE: Original Zenith stock certificates - \$20 + \$2 postage. Barry S. Dagestino, 1040 S. Hidden Cyn Rd., Anaheim Hills, CA 92807. (714) 281-5190

FOR SALE: Service lit. & catalogs - \$5 ea. 1936 Kenyon Lab std. audio TV, 1943 Federal ref. data, Dec. 1908 & April 1911 Electrician & Mechanic, Silver Models 30 & 34, Kolster K22 to 28, 1935 The Electric Eye by ERY, 1941 Warner Photo Electric Control, Solovox Model K, 1938 Noise Reduction, Meissner 1st Ed., IF replacements, 1940 Centralab guide, 1936 Rider AVC, 1946 Cooper Supply, 1946 Dakota Electric, 1978 & 80 Burstein-Applebee, Sams Code practice 45 records. N.O.S. Wilcox-Gay Recordio discs, 2 albums of 6 plus (2) misc. packs - \$25/all. Joe Svihel, 17227 Co. Rd. 54, Avon, MN 56310. (320) 356-7601

FOR SALE/TRADE: Must sell! Offers! Radios, audio, ham, test, parts, tubes, more. SASE: free list. Joseph Bedlovics, PO Box 139, Stratford, CT 06615

FOR SALE/TRADE: New Sams transistor manuals #45-87. Consoles. Zenith, RCA, Stromberg-Carlson. **WANTED:** Arborphone, International Kadette. Nevins Museum of Radio, Ken Nevins, 406 Jipson St., Blissfield, MI 49228. (517) 486-3019, evenings please. E-mail: knevins@tc3net.com

FOR SALE: Visit www.78rpm.com for a full line of turntables, books, vintage records & cylinders. Nauck's Vintage Records, 6323 Inway Dr., Spring, TX 77389. E-mail: nauck@78rpm.com



Got Grille Cloth?

ZENITH Philco
Emerson

World's largest selection!

- ★ 12 Philco patterns Y2K compliant
- ★ 8 Zenith patterns
- ★ Majestic (Grigsby-Grunov)
- ★ German (Grundig, Telefunken, Nordmende)
- ★ Stromberg, GE, Westinghouse, Emerson
- ★ Plus many other generic patterns

Send \$3 for cloth sample sheets to:
John Okolowicz, N3VSR
624 Cedar Hill Rd.
Amler, PA 19002 

 or 

see them on the web @
www.grillecloth.com
email: john@grillecloth.com

FOR SALE: Clean plastic smoke grey dust cover: 20.5" x 13.5" x 3.5" - \$24 shipped. Leroy Marshall, 1178 Foxboro Ln., Bartlett, IL 60103. (630) 483-8833

FOR SALE: Several N.O.S. Astatic 81TB plug-in phono Cartridges with mounting - \$6 ea., shipping included. Gregg Humanic, 540 Wicklow Ln., Monroe, OH 45050. (513) 539-8926

— WANTED —

CLUB CONTACT INFORMATION. A.R.C. IS UPDATING ITS CLUB LIST. PLEASE SEND US NAME OF CONTACT PERSON, ADDRESS, DUES, RATES, ETC.

FOR SALE: Rollcharts for Hickok, EICO, Jackson tube testers - \$20 ppd. Joe Waskel, 26606 S. Peartree, Sunlakes, AZ 85248. (480) 895-1473

FOR SALE: Edison Std, "C" reproducer, repo horn, no lid - \$490. Edison Home B, "C" reproducer, 11 panel black horn, repo crane - \$675. Apex Super 5, case restored, btry set w/matching Apex horn spkr - \$395. Horn speakers: RCA UZ1325 - \$190; AK-L - \$185; Mussette - \$175; Magnavox R-3 - \$175; Radiola III - \$105; Radiola 3A - \$135; Radiola BA - \$110; West Aeriola Sr. - \$145. Zenith T-O's: 8GYQ - \$110; 6A40 - \$125. All plus shipping. Bruce Houser, 4600 Alabama St., #69, El Paso, TX 79930. (915) 562-5779. E-mail: rucbaj@aol.com

FOR SALE: RCA loudspeaker Model 100B good condition, no grille cloth. Lou Staton, 404 Pebblebrook Ave., Baton Rouge, LA 70815. (225) 273-5926

FOR SALE: Sams 1 thru 3075; Rider's 1 thru 17; (4) How It Works indexes - Make Offer. Joe Kelly, 2868 Jennifer Dr., Castro Valley, CA 94546. (510) 582-1621

FOR SALE: Telegraphy, wireless, radio, television books at: Second Hand Prose Bookshop, 8 Main St., Keyport, NJ 07735. Jerry Simkin, Bookseller, 10 Avalon Ln., Matawan, NJ 07747. (732) 583-5196

FOR SALE: Atwater Kent E speaker, Info/manual Hickok Teaching System. Guldo Montella, 2714 Charleston Dr., Plant City, FL 33565. (813) 752-7174

FOR SALE: 300+ antique radios, tubes, parts, test equipment, books, more. 30 page photolist - \$2. Radio Ranch, 10745, 255th Ave., NE, Belgrade, MN 56312

FOR SALE: Dual electrolytic capacitors. 50-30 mFd at 160 Vdc - \$3.75 ea. for 4 or more, includes P&H. Many other types in stock. Also new manufacture twist prong, stud mount, clamp mount, and octal based capacitors. Call or write for free flyers. DH Distributors, PO Box 48623, Wichita, KS 67201-8623. (888) 684-0050, v/f

WANTED

Amrad 3366 as shown. Also 3500-U and Jewel, and other pre-1926 Amrad sets & parts.



Andrew Mooradian,
5 Priscilla Lane
Winchester, Massachusetts
01890
tel. 781-729-1873 after 7 pm

TUBES WANTED



Electron Valve
431 NORTH CLEVELAND
MEMPHIS, TN 38104
Phone: 901-274-8823 • Fax: 901-274-0499
TOLL FREE: 1-888-909-8823
Email: cmagee@electron-valve.com



Western Electric

TB-Tennis Ball
 VT-2 / 205A/B S250 NOS, S125 used
 VT-52 S150 NOS, S80 used
101D / 101F (TB) \$185 NOS, \$100 used
 101D / 101F / 101L (ST) S35 NOS
 102D / 102F (TB) S180 NOS, S100 used
 102D / 102F (ST) S35 NOS
205D/E (TB) S445 NOS, S285 used
 211A/D/E S280 NOS, S150 used
 212A/D/E S750 NOS, S250 used
 231D S65 NOS, S30 used
 242A/B/C S300 NOS, S150 used
252A S1200 NOS, S700 used
 261A S155 NOS, S80 used
 262A/B S65 NOS, S35 used
274A / 274B S250 NOS, S180 used (Engraved Base)
 274A / 274B S200 NOS, S130 used
 275A S140 NOS, S65 used
300A \$900 NOS, S675 used
 300B S875 NOS, S525 used (Engraved Base)
 300B S565 NOS (1950's and 1960's printed base)
 310A / 310B S20 NOS, S12 used
 331A S45 NOS, S23 used
 348A / 349A S95 NOS, S45 used
 350B S210 NOS, S95 used
 417A / 420A / S755 S10 NOS
 421A / 422A S35 NOS, S15 used

TRIODES:
 2A3 RCA S44 NOS, S20 used
 2A3 (Single Plate) S180 NOS, S100 used
 10 Balloon S80 NOS, S35 used
 45/245 Balloon S65 NOS, S28 used
 50 Balloon S220 NOS, S120 used
 VT-52 S120 NOS, S60 used
 71A Balloon S28 NOS, S14 used
 80/280 Balloon S32 NOS, S20 used
 211 RCA / United S125 NOS
 845 S200 NOS, S95 used

PENTODES:
 6550 Tungol S65 NOS
 7591A S34 NOS, S18 used
 616GC RCA (Black-Plate) S40 NOS
 EL34 Mullard S80 NOS, S35 used
 EL37 Mullard S75 NOS, S35 used
 KT66 Genalex / Mullard S80 NOS
 KT77 Gold Lion S160 NOS, S90 used
 KT88 Gold Lion S185 NOS, S80 used

PREAMP / DRIVERS:
 S691 Red Base S18 NOS, S10 used
 S692 Red Base S34 NOS, S20 used
 65N7 Sylvania / RCA S6 NOS
 65L7 Sylvania / RCA S4 NOS
 12AX7 / ECC83 Telefunken S38 NOS, S15 used
 12AU7 / ECC82 Telefunken S34 NOS, S8 used
 12AT7 / ECC81 Telefunken S30 NOS, S6 used
 6B8CC Telefunken (Gold Pin) S40 NOS, S18 used
 EF86 / 6267 (GEC, Amperax, Tele) S20 NOS, S8 used
 Genalex Z-729 S20 NOS, S14 used
 Genalex Z-759 Gold Lion 12AX7 S100 NOS

Highest prices paid for NOS tubes in original boxes. If you have any other tubes that you think we might be interested in, please call.

We will meet or beat any written offer!

We would like to buy any of your Western Electric, H.M. Scott, Marantz, Fisher, or Dynaco amplifiers or preamplifiers.

Electron Valve is also seeking the following recording gear. If you have any of the following pieces or know anyone that does, please contact us.

MICROPHONES:

Neumann U-47
 Neumann U-67
 Neumann U-87
 Neumann KMB4
 Neumann M-49
 Neumann M-50 Omni
 RCA 44
 RCA 77
 Sony C-37A
 Telefunken ELAM 251



TUBES FOR MICROPHONES:

Telefunken VF-14 S600 NOS, S400 used
 Telefunken AC701K S120 NOS



OUTBOARD / RACK GEAR:

Fairchild 660 / 670 Compressor
 Neve 1066, 1073, 1081, 1272 Mix Pre / EQ
 Telefunken V72 / V76 Mix Pre
 Pultec EQ's
 BCA B66A Compressor
 IREI 1176 Compressor
 Urei LA2A Compressor

WE BID ON SMALL OR LARGE LOTS.

IF YOU HAVE ANY QUESTIONS OR IF YOU HAVE ANY OF THE ITEMS LISTED HERE, GIVE US A CALL!

FOR SALE: Early radio & collector tubes. See www.fathauer.com or write for catalog, e-mail fathauer@home.com. George H. Fathauer & Assoc., 688 W. First St. Ste. 4, Tempe, AZ 85281. (480) 968-7686

FOR SALE: Tonearm for transcription turntable (large records) Japanese from the 1950s, never used in original box, less cartridge - Best Offer over \$65. Maurer Television, 29 South 4th St., Lebanon, PA 17042. (717) 272-2481

IF YOUR EXPIRATION DATE IS APRIL OR BEFORE, RENEW TODAY! EARLY RENEWALS RECEIVE AN EXTRA ISSUE!

FOR SALE: Older type electronic parts and hardware. Free vintage flyer. Mail order since 1954. Bigelow Electronics, 186 East Jefferson, Bluffton, OH 45817-1343

FOR SALE: Still sorting 6,000 tubes. Have 112, 71As, 30s among others. 1/3 discount. Floyd A. Paul, 1545 Raymond Ave., Glendale, CA 91201. (818) 242-8961

FOR SALE: Rola cathedral dynamic power speaker Model 30, nice original cabinet - \$100. Ken Armstrong, Box 216, Storm Lake, IA 50588. (712) 732-3012

FOR SALE: All technical books in shop will be on sale in early April. Details? Rainy Day Books, PO Box 775, Fitzwilliam, NH 03447. (603) 585-3448. E-mail: info@rainybooks.com

FOR SALE: Many E.H. Scott chassis for sale, call for info. No lists. (15) E.H. Scott consoles for sale. Owner's and service manuals for most Scott radios - Call. **WANTED:** Cabinet for 25 tube Zenith Stratosphere, or complete rough set, will pick up. Alan Jerspenson, PO Box 17338, Minneapolis, MN 55417. (612) 727-2489, Tues.-Fri., 8 am-5 pm, Sat. 10-3. Fax: (612) 821-4821. E-mail: mte612@aol.com

FOR SALE: Zenith Trans-Oceanics, all original, complete & working, 100% cosmetically restored to showpiece condition. H-500 - \$275; R 600 - \$285; 8G005YT - \$295; 8G005Y - \$295; 6G601ML rare bomber on grille-alligator covered companion to 7G605 bomber - \$450. Frank J. Manzano, 82 Monhegan Ave., Oakland, NJ 07436. (201) 337-5263

FOR SALE: Zenith 8G005YT Trans-Oceanic, 4G800GY, small chip on side, 1920s horn driver parts, inquire. Several sets variable tuning caps by Pilot, Triangle, and Kellogg, 13 units, inquire. UTC O-14 transformers (2) N.I.B., Thordarson 6425 N.I.B., Philco 20 (restorable, needs 5 grille bars, solid, original otherwise, inquire), Bearcat 300 scanner (needs repaired), Sony hand-held cassette player/recorder TC-55 (heavy, well-made, w/ case), Sony 8-Track TC248D, Lafayette Micro 923 (small FM receiver, X-tal and tuneable), AMECO Code Course (lessons 3-10 on (4) 78-RPM records & AMECO Amateur Radio Q & A booklet 1973, Motorola instruction manual for FM two-way radios (30-60W RF Power, 152-174 MHz, 6/12VDC, Models T43AAD 1-5, T43GAD 1-5, T53AAD 1-4, and T53GAD 1-4, 1955 - \$20, Cleveland Institute of Electronics 12 lessons, 1967, DeForests Training, Inc. (25 lessons). Home Study Course (US Navy, 1951). The Radio Handbook (by editors of Radio 1939, hardcover, OK cond), Elements of Radio (Marcus, Marcus, hardcover), Radio Operators Q&A Manual (Kaufman, 6th Ed, 1963, hardcover), Fundamentals of Radio (Jordan, 1942, hardcover), Radio Handbook (16th edition, 1962, hardcover, Orr), Elementary Radio Servicing (Wellman, 1947), Understanding Radio (2nd Edition, Watson), Newark Electronics catalog 1971, Radio Amateur Licensing Manual 1975-ARRL, Everybody's Television and Radio Handbook. Weston 301 DC milliammeters (5) some N.I.B., Roller-Smith DC milliammeters (0-75/0) (5) N.I.B., Wacine 1555 Model AED (0-1.0DC mA) (9) N.I.B. Send want lists. Wilbur Gilroy, PO Box 459, Lake Winola, PA 18625. (570) 378-2508. E-mail: wilbrg@aol.com



Antique Electronic Supply wants your tubes!

NEW TUBES

300A WE	\$300.00	845	\$125.00	5692-Red (Red Base)	\$30.00	V201A	\$24.00
300B WE	\$350.00	211V74C	\$75.00	6SN7GT-B (Full base USA only)	\$4.00	171-A	\$20.00
Engraved base on above adds	\$50.00	6CD7/EM34	\$24.00	6900 (Bendix)	\$10.00	2B2	\$14.00
274A WE	\$175.00	EM35	\$20.00	12SX7GT	\$3.50	WD-11	\$70.00
274B WE	\$150.00	2A3	\$24.00	6JEC6/BL06	\$17.50	01A (ST)	\$15.00
275A WE	\$75.00	2A3 Single Plate	\$75.00	6L6/6AH6	\$25.00	30 (Must say 30)	\$5.00
310A/B WE	\$115.00	59B2 (Bendix)	\$10.00	6L6/6AH6	\$25.00	864	\$12.00
262A/B WE	\$50.00	SAR4GZ34 (European USA)	\$25.00	20LFB	\$27.50	6A8	\$4.00
348A WE	\$50.00	7668	\$16.00	6J58C	\$20.00	6A8G	\$5.00
417A WE	\$15.00	6A3	\$12.00	6K06	\$15.00	6A8G	\$5.00
420 WE	\$23.00	12AX7A-Tele (Smooth Plate)	\$30.00	6L6R6	\$12.00	83V	\$5.00
421A WE	\$15.00	12AX7A (Mullard)	\$30.00	6L6R6	\$12.00	6F6GT	\$5.00
437A WE	\$30.00	12AX7A (Amperex B B)	\$25.00	21J56A/23J56	\$8.00	6V4E280	\$2.00
412A WE	\$10.00	12AX7A (RCA)	\$15.00	21L6F	\$18.00	41-ST	\$3.00
6CA7 EL34-M (MULLARD)	\$40.00	12AT7	\$10.00	40K6A/PL519	\$3.00	5Y4G	\$2.50
68Q5 EL84	\$8.50	(Tele, Mullard Amperex B B)	\$4.00	6L6R6	\$5.00	6386	\$16.00
68Q5 EL84 (Tele Mullard Amperex B B)	\$12.00	12AT7 (RCA)	\$4.00	8950	\$35.00	6072-A	\$4.00
6V6GT	\$6.00	12AU7A	\$15.00	M-2057	\$50.00		
6550 (Tung-Sol)	\$40.00	(Tele, Mullard Amperex B B)	\$5.00	8908	\$36.00		
6L6GC (RCA Black Plate)	\$25.00	12AU7A (RCA)	\$12.50	42KN6	\$3.00		
7188A	\$12.50	6D8	\$12.50	31L06	\$7.00		
7027A	\$25.00	(Tele Mullard, Amperex B B)	\$8.00	6KN6	\$6.00		
7591A	\$32.00	7308GP (Gold Pin)	\$8.00	X201A/301A	\$15.00		
		7025 (Can have only 7025 on glass)	\$10.00				

B B - Bugle Boy
Tele - Telefunken

USED TUBES

300A WE	\$150.00	437A WE	\$15.00	2A3 Single Plate	\$50.00	6K06	\$8.50	V201A	\$12.00
300B WE	\$175.00	6CA7/EL34 (Mullard only)	\$20.00	6A3	\$5.00	6L6R6	\$7.00	171-A	\$10.00
Engraved base on 500 above adds	\$50.00	8417	\$10.00	6JEC6/BL06	\$6.00	21J56/23J56	\$4.00	2B2	\$12.00
275A WE	\$45.00	7591A	\$18.00	6L6/6AH6	\$14.00	8950	\$25.00	WD-11	\$36.00
310A/B WE	\$7.50	845	\$50.00	20LFB	\$14.00	M-2057	\$36.00	01A (ST)	\$6.00
421A WE	\$8.00	211V74C	\$15.50	6J58C	\$4.00	8908	\$17.50	30 (Must say 30)	\$3.00
		2A3	\$12.00	6K06	\$4.00	X201A/301A	\$7.50		

We need the following tubes. All must be well known brands (GE, RCA, Sylvania, Tung-Sol, Philips, etc. of U.S. or Western manufacture). New tubes must be in original boxes. All tubes subject to inspection. Ship by UPS (ground), we'll mail a check upon receipt and testing at prices shown plus your shipping charges. Call or fax for buying procedure and complete bid list. Call before sending more than 16 pieces of one type of tube.

CALL FOR OUR FREE 72 PAGE CATALOG!

6221 S. Maple Ave., Tempe, AZ 85283 (480) 820-5411 FAX (480) 820-4643 or (800) 708-6789
www.tubesandmore.com E-MAIL info@tubesandmore.com

WANTED: Stromberg-Carlson Model 228H, in working or restorable condition. RCA Service Notes Vol. I, 1923-37. Tom Seller, 1285 James St., Harrison, MI 48625. (517) 539-2570. E-mail: tbsel@webtv.net

WANTED: Heathkit GR-43A portable, looks like Zenith 3000-1. Martin Duling, 1231 Ivywood Dr., Springfield, IL 62704-4392. (217) 726-5153. E-mail: mduling@att.net

WANTED: Zenith T-O sold in Korea Xmas 1951, Model number unknown. Arvinet 40 40A. William H. Rector, 14616 Frances Cir., Omaha, NE 68144. (402) 334-1696

WANTED: Heathkit amateur radio license course #ER-3701B which includes a morse audio cassette tape. W. J. Klewchuk, PO Box 927, Wadena, Saskatchewan, Canada S0A 4J0. (306) 338-2264

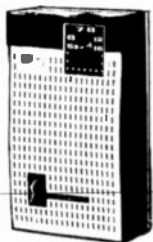

WANTED: Japanese transistor radios. Sony radios and display cases, signs. Fax or write: Tom Christopher, 45 Boway Rd., So. Salem, NY 10590. Fax: (914) 763-5936

WANTED: Schematic for Hitachi KH-1005C. Dwight Baker, 4137 E. 24th St., Des Moines, IA 50317. (515) 263-0278. E-mail: vtaudio@netzero.net

WANTED: Marconi test equipment, signal generators, RLC, Q-meters. Heathkit Q-meter. B. Turke, PO Box 222288, Hollywood, FL 33022. (954) 925-3670

WANTED: National Company emblems, escutcheons, National S-101 impedance coupler, NC-2-40D knobs. Don Barsema, 1458 Byron SE, Grand Rapids, MI 49506. (616) 451-9874. E-mail: DBARSEMA@prodigy.net

WANTED: Unbuilt radio and equipment kits: Allied, Heathkit, etc. Must be complete, including manual. Art Sabin, 315 Plymouth, Chicago, IL 60604. (312) 987-1441. E-mail: 7Sabin@jmls.edu

WANTED: Power cord for Sony open reel recorder Model 772. Also 2 power cords for Ampex amplifier speakers Model A620. Also seeking commercially recorded reel-to-reel tapes. Must be originals in original box, no dubs. Ralph Shomer, PO Box 657, Newark, NJ 07101-0657. E-mail: rshomer@aol.com

WANTED: Belmont 6D111 radio. For more information visit website: www.interestingoldjunk.com. James J. McGrath, W2IOJ, 2 Centerview Ln., West Seneca, NY 14224-2124. (716) 675-0160. E-mail: w2ioj@interestingoldjunk.com

CLASSIFIED AD NOTICE

Please check your ads carefully before sending them in. Once ads are received, it is not always possible to refund the amount sent, pull the ad or make changes.

WANTED: (2) Zenith chassis, speakers, knobs Model 8-S-154. Eddie Enrique, 1824 Wylie Dr., Modesto, CA 95355. (209) 576-8170

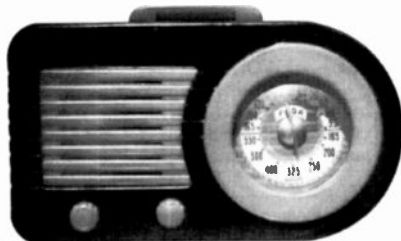

WANTED: Fada Catalin radios. Help! My entire collection spontaneously combusted during an interview with the "Enquirer." Replenish and repent ye sinners. Please write or call collect: Rain Buttignol, 214 State St., #7, Portsmouth, NH 03801. (603) 427-1384

WANTED: Sharp portable television sold in Vietnam Christmas 1968 Zenith 6G801 black silver. William Rector, 14616 Frances Cir., Omaha, NE 68144. (402) 334-1696

WANTED: Good 16EP4 pix tube or source where I can have mine rebuilt. John Phipps, 1412 Navaho Trail, St. Charles, MO 63304

A.R.C. BACK ISSUES

April '87 to current issue: Originals available 32 to 100 pages each.

Oct. '86 to Mar. '87: Reprints available Reprinted from original artwork; 28 to 32 pgs. ea. Quality & appearance same as an original copy.

June '84 to Sept. '86: Photocopies available Not original quality, useful for info.; 16 to 28 pages each.

Publication of *Antique Radio Classified* began in 1984 which had only five issues: June, Sept., Oct., Nov. & Dec. 1984. 1985 through current year have had 12 issues each.

\$5.00 each — Postpaid to U.S., Canada and Mexico.

Orders of 6 issues or more may take a 10% discount. Orders for a full calendar year may take a 50% discount. 15th Year Special: 60% discount on orders for a full calendar year. Foreign orders other than Canada and Mexico: \$8.00 each by air. Mass. residents, please add 5% sales tax.

A.R.C. UNCUT, UNFOLDED COVERS

June '91 to present - 9.25" x 12.5" - \$9.95 each Postpaid to U.S., Canada, & Mexico

Mass. residents, please add 5% sales tax.

A.R.C., P.O. Box 2, Carlisle MA 01741

Or Call (978) 371-0512

ARBE-III — Universal Battery Eliminator

\$149.95 Shipped USA

Contact:

Antique Radios Inc.

Box 6352, Jackson, MI 49204

www.beity.com/antiqueradiosinc

(517) 787-2985 or

Fax (517) 782-7422



FOR SALE: Zenith 6S152 nice, plays, 11S474, 6S632, Philco 52-940 white, swirled, plays, 50-921 chassis. Fisher 400 FM receiver and KM-60 Stratakit FM Wide-Band Multiplex Tuner. Pilot Stereo FM Multiplex tuner-amplifier Model 602A (clean, nice, working), B&K CRT tester/rejuvenators Models 400 & 445. Simpson Signal Generator Model 315 (large). Cross Country and ACME Battery Chargers (old, 6-volt each). Philco Auto Radio Yearbook 1946-47, Philco 1968-69 5-Year Electronic Service Parts Guide - \$15/both. Good 1L6 tube. Channel Master 6505, Decca P-902 45 rpm player, Jensen Dynamic Speaker Concert Model D-7 (good condition), Peerless speaker (similar to Jensen D-7 w/bad cone). Much more-send wants to: Wilbur Gilroy, PO Box 459, Lake Winola, PA 18625. (570) 378-2508. E-mail: wlbgr@aol.com

FREE - 20 WORD AD EACH MONTH

To get your free 20 words,
include your SUB# with your Ad.
Additional words are 29¢ each.
Read inside back cover for details.
MANY THANKS!!!!!!

FOR SALE: Vacuum tubes, all kinds. 62,000 on hand. Send want list & SASE for prompt response. Tom Ivas, 2932 W. 99th St., Evergreen Park, IL 60805. Ph./fax: (708) 423-0528. E-mail: tivas@xnet.com

FOR SALE: Tubes VT-4-C/211 - \$100; V70D - \$90; T55 - \$60; 3C24 - \$30; 813 - \$25; 829B/3E29 - \$10; 250TL - \$95; 100TH - \$40; 5949 - \$50. Plus shipping. Tony Rinaldo, 308 Lenox Ave., Oneida, NY 13421. Ph./fax: (315) 363-3644

FOR SALE: N.I.B. tubes, 70% AES prices: 50ST, 5692 (red), 5691 (red), 5693, 0A4G, 2C40, 6A5, 6B4, 6JB6A, 6BK4C, 2050/A, W-E 416B, 12AT7, 12AU7. Complete list, SASE. Chris Hicks, 57 Jameson Hill Rd., Clinton Corners, NY 12514. (914) 266-4257

Visit the A.R.C. Web Site!

The URL to access the A.R.C. Web site is:
<http://www.antiqueradio.com/>

Our site includes highlights from
current and recent issues:

- Editor's Comments
- Image of the Cover
- Feature Article
- Radio Miscellanea

- Plus:
- Photo Reviews
 - Book Reviews
 - Coming Radio Events
 - Complete Club Listing
 - List of Books For Sale
 - Subscription Information

While visiting our site, you may
send e-mail and orders for
books, videos and subscriptions.

Let us know what you think
about A.R.C. on the Web!

FOR SALE: Tele-tone portable television, 6", circa 1948 - \$195. Brown Hallicrafters TW 2000 - \$195. Zenith 5S320 - \$245. Stewart Warner 1231 mini cathedral, nice original - \$345. RCA 7T1 tombstone, near mint - \$325. Ding Dong School RCA 45 phono, crack and chip on back side - \$95. White painted Bakelite, excellent original paint, slight crack on bottom, clock mirror cracked - \$395. Westinghouse Plaskon WR 173L (Super Pee Wee), stress line on top - \$275. Tom Thumb portable, excellent condition - \$145. Zenith tombstone 7S28. Zenith 10S531 large table model. Rare Zenith console 9S369. 15S479 motor drive shutterdial. Stromberg-Carlsons: 231F mirror top chairside; 130H; 130R; 225H. Zenith 701 - \$135. Zenith 5S327 - \$325. Cathedrals: Zenith LH - \$395; Zenith 210 - \$395; Zenith 805 - \$425. To reference our Zenith models, order our 60 page 11 x 17 Zenith Brochure Book for - \$28.95 ppd. The Story Of Zenith: 1954 booklet Zenith reprinted 10 years ago - \$9 ppd. Most Trans-Oceanics available - Call. Many Fader's manuals available including 3, 17, 18, 20 - Call. Zenith consoles: Aviatix; 15S373; 15U270; 15U479; 12H689; 12S568; 12S569; 12S471; 12S370; 12S371; 12S265; 12S268; 12U159; 12U158; 12A58; 12A57; 980; 11S474; 10S470; 10S153; 10S155; 10S156; 10S160; 9S54; 9S55; 9S262; 9S264; 9S365; 9S367; 9S369; 8S154; 8S463 (5808); 8S359; 7S261 bookcase; 6S362; 7S363; 7S364; 775B; 755 and many others. Zenith chairside: 9S244; 9S344; 7S342; 7S340; 7S240; 6S239; 6S238; 6S203 phono; 6S241 bar radio. Zenith table models: 4K535; 5S126; 5S127; 5S319; 6S322; 6S528; 7S432. Cathedrals: LH; L; 210; 805; 6D029; 6D630; 7S323; 6S439; 6V27; 6S27; 6S128; 6S229; 8S443; 10S130; 12S445; 8S531; 288; 711; 807; and others. Others available: Stromberg, Philco, GE, RCA, Fada. We can and do ship consoles and we do it right. All radios unrestored electrically unless noted. Satisfaction guaranteed, highest quality assured. New free parts and supplies catalog. We offer complete chassis restoration service on all radios, including complete speaker repair - Call. Visiting Minneapolis? Visit our store at 5200 Bloomington Ave, 5 minutes from the airport. Visa, MC, Discover. Alan Jespersion, PO Box 17338, Minneapolis MN 55417. (612) 727 2489. Fax: (612) 821 4821, 8 am to 5 pm, Tues.-Fri., Sat 10-3. E-mail mte612@aol.com

FOR SALE: Type 30 tubes N.O.S. - \$6 each, good used - \$3. Type 6D6 RCA N.O.S. - \$2.50. Type 41 N.O.S. - \$4. See www.fathauer.com or write or e-mail for catalog of other collector and early radio tubes. George H. Fathauer & Assoc., 688 W. First St. Ste. 4, Tempe, AZ 85281. (480) 968-7686. E-mail: fathauer@home.com

Old Authors Bookshop

**Wireless Telegraphy Telephony Radio
Television Electricity**

Books and Literature
Bought and Sold

PO Box 403 Morrisburg ON Canada K0C 1X0
Tel (613) 543-3337 Fax (613) 543-2380
e-mail authors@mor-net.on.ca

Website <http://www.abebooks.com/home/oldauthors>

EXTRAVAGANZA '00

Hosted by the Michigan Antique Radio Club
July 6-9, 2000



Holiday Inn South Convention Center
6820 S. Cedar Street, Lansing, MI 48911
(517) 694-8123



Come join us for our 15th annual convention

CONVENTION THEME:

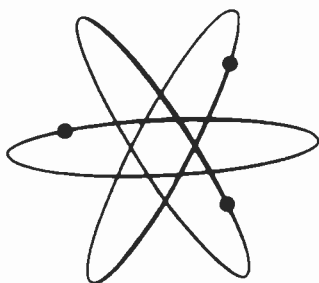

HIGHLIGHTS:

- HUGE 3-DAY OPEN AIR FLEA MARKET
- NOTE: FLEA MARKET STARTS FRIDAY!
- SAT. AUCTION WITH RICH ESTES
- HEATHKIT EXHIBIT
- EQUIPMENT CONTEST
- INFORMAL SOCIAL HOUR
- 4 INFORMATIVE PROGRAMS
- DAILY DRAWINGS

To mail check or to request a convention brochure, write: EXTRAVAGANZA '00, 3520 Okemos Rd. #6, Okemos, MI 48864. For additional information contact: Jim Clark @ (517) 349-7187 or E-mail: JC072651@AOL.COM, or check out the MARC Homepage at www.antiqueradios.com/marc

EXTRAVAGANZA '00 Registration

Note: Everyone attending EXTRAVAGANZA must register! The monies collected as a result of registration are a major source of revenue that help pay for this event. Your cooperation is appreciated.

Family Registration (All registrants must live at same address)		TOTAL
Current MARC member	\$ 12 →	\$
Non-MARC member	\$ 18* →	\$
Outdoor Flea Market sellers		
1st outside Flea Market space (\$20)	→	\$
Additional outside spaces <input type="text"/> # spaces x \$10 each	→	\$
8' table to rent <input type="text"/> # tables x \$10 each	→	\$
Under Tent Flea Market sellers		
8' table with 2 chairs <input type="text"/> # tables x \$20 each	→	\$
Make check out to MARC for this amount	TOTAL	\$

* Includes MARC membership from July-December 31, 2000.

FOR SALE: GE Model T-155B cocoa, BC, AC/DC, plastic condition, vg - \$40 plus S/H. Leroy Neal, 603 Butterworth Ave., Dyersburg, TN 38024. (901) 285-5120, after 8 pm CST

FOR SALE: Manual reprints: AK, Hallicrafters S-22, Majestic 52, Radiola III, 18, etc. Free list. Herman Gross, 1705 Gordon Dr., Kokomo, IN 46902. E-mail: w9itf@juno.com

FOR SALE: Test equipment from closed shop B & K 465 picture tube restorer 3 meters deluxe model - \$175. Heathkit picture tube restorer - \$95. Also 3 meters & Hickok 799 Model tube tester simplified quicker testing - \$190. B & K transistor analyzer - \$70. Eico VTVM, works - \$30. Precision 912 tube tester w/manuals - \$65. Add shipping to all. Offers considered. Maurer Television, 29 South 4th St., Lebanon, PA 17042. (717) 272-2481. E-mail: radiobks@aol.com

FOR SALE: Crosley Model F-110BK DC portable - \$25. Motorola TC 101 UHF converter - \$20. Jim Ligouri, 7 Sycamore Ct., Atkinson, NH 03811. (603) 362-5712. E-mail: Jjligouri@aol.com

FOR SALE: Henry Lyford 5 tube chassis, front panel, NT - \$20. Radiola 26, WT - \$475. Leonard Aquino, 2 Somerset Ln., Putnam Valley, NY 10579. (914) 528-6857

FOR SALE: Amplex Touradio, untested - \$40. Crosley 10-138 - \$70; 11-105U, very clean - \$100. Emersons: 349, Ingraham cabinet, one is - \$100; other is - \$85. 578A needs knobs - \$30. Philco 40-505 - \$30. Radiola 18, untested - \$50. Stewart-Warner 385, untested - \$125. Trav-Ler 5019, untested - \$20. Many more. Also regular and novelty transistor. LSASE for complete lists. State preference. Can furnish photos by e-mail or computer copies. H.B. McMahan, 313 W. Shaw, Tyler, TX 75701-3029. (903) 593 5433. E-mail: hbmc@juno.com

FOR SALE: Rare old bug, Electric Specialty Mfg Co., Cedar Rapids Iowa - \$60. Joe Duffin, 4 W. Central Ave., Moorestown, NJ 08057. (856) 778-1436

FOR SALE: (3) Hallicrafters S-41 Skyriider, g - \$90; SR10A, g - \$50; SX-104 vg - \$95. Silvertone 7124 T-O SW, 4 band, vg - \$100. Zenith 6G001Y, vg - \$100. Gilbert Simpson, 18 Beechwood Dr., Ansonia, CT 06401. (203) 734-4085

FOR SALE: Airline 62-646 hairline cracks top, back, good 6G5 - \$35. Used 5U4GB, 6U6GT - \$2. James S. Looney, Rt. 1 Box 54, Grundy, VA 24614. (540) 531-8677

FOR SALE: We have over 100 different highest quality repro knobs. New free parts and supplies catalog. New: high quality photocopies of both versions of the 25 tube Zenith Stratosphere owner's manuals - \$20. New design Zenith T-shirts and sweats, the pre-war Zenith neon window sign in electric green and orange; also the 1938 Zenith Robot Dial design, and another one with the original Zenith logo!; t-shirts, all sizes - \$14; sweats - \$22. Call for more info. Glass rods for your Zenith 5S317 - \$8 ea. Toothed drive belt for the Zenith 7000 - \$5 plus \$1.50 shipping. Rubber gasket for the dial glass for Zenith and other brands - \$3 per foot. Brass inserts for Zenith Trans-Oceanics and 1942 Zeniths - \$5 each; or 2 for - \$8. Also H500 and 600 knobs with inserts - \$15. We stock a large selection of quality repro grille cloth. Lucite dial lens 1942 Zeniths - \$16. Universal Dial Belt Kit - \$9.95 ppd. Complete speaker repair - Call. Visa, Discover, Mastercard. Alan Jesperson, PO Box 17338, Minneapolis, MN 55417. (612) 727-2489, 8 am-5 pm, Tues.-Fri., Sat. 10-3. Fax only: (612) 821-4821. E-mail: mte612@aol.com

**NOTICE TO ALL
CLASSIFIED ADVERTISERS!
OUR CLASSIFIED AD DEADLINE IS
12:00 NOON
ON THE 10th OF EACH MONTH**

FOR SALE: Emerson Ingraham #440 - \$165; Motorola 5X1 on chrome tubular base - \$125. RCA 68 RI AM/FM - \$65; RCA 66XI AM/SW - \$55; Zenith G-615 - \$40; RCA portable ivory w/metal Nipper logo - \$40; GE 401 white w/red knobs - \$45; Detrola Deco wood #146 rare - \$195; Trutone D2616 - \$40; RCA Bakelite record player & radio combo - \$75; RCA 45EY-2 45 record player Bakelite - \$65; Fada 209 - \$75; communication receivers: National NC173 w/manual - \$225; Hallicrafters S-15 Sky Challenger rare, all complete & original - \$195. Frank J. Manzano, 82 Monhegon Ave., Oakland, NJ 07436. (201) 337-5263

FOAM SURROUND REPLACEMENT KIT

Kit c/o two foam surrounds, shims, speaker cement and instructions.

8" kit = \$17.95 12" kit = \$21.95

10" kit = \$19.95 15" kit = \$24.95

plus \$4 S/H. N.J. add 6% sales tax

Sound Remedy

Loudspeaker Repair Service

331 Virginia Ave.
Collingswood, NJ 08108
(856) 869-0238
Fax (856) 869-6880

Need to find past articles in *A. R. C.* or the *OTB*?
Try the:

INDEX TO ANTIQUE RADIO CLASSIFIED

Covers 1984-99, by topic and author. Includes 1800+ photos, 1400+ tube radios, auctions, etc. Has 76 pages. \$15 postpaid anywhere.

INDEX TO AWA PUBLICATIONS

Covers *Old Timer's Bulletin*, *AWA Review*, and misc. publications from 1960 through Aug. 1999. Gives 7000+ citations, indexed by topic and author; has 73 pages. \$12 postpaid anywhere.

Still available:

Tube Lore

A Reference for Users and Collectors

186 pages of "stuff RCA never told you." \$19.95 ppd in North America or \$24.95 elsewhere.

Ludwell Sibley
102 McDonough Rd.
Gold Hill, OR 97525

Questions? We're on (541) 855-5207 or
tubelore@internetcds.com.

WANTED: Airline 62-351 cabinet, pointer and dia assy. for Emerson 539, cabinet for Garod 5A-2, (2) pushbuttons for Coronado 803, top handle and escutcheon for GE-S22, escutcheon for Philco 89. Tony LaMartina, 13325 W. Dahlia Dr., Boise, ID 83713. (208) 939-3769

**E-MAIL ADDRESS FOR
ANTIQUE RADIO CLASSIFIED
ARC@antiqueradio.com**

**Ads - Subscriptions - Book Orders
See inside front cover for details**

WANTED: Western Radio Model BN-1 transmitter/receiver. Must be vg and working. Rodger Skinner, 6431 N.W. 65th Ter., Pompano Beach, FL 33067. (954) 340-3110. E-mail: radiotv@cris.com

WANTED: I will pay extra high for Western Electric 596, 597, TA 4171, TA 7257. Vincent Gallo, 532 Laguardia Pl., #600, New York, NY 10012. (212) 274-0432

WANTED: RCA R11 or Westinghouse WR15 chassis, working or junker. Jim Elsbury, 106 6th NW, Nora Springs, IA 50458. (515) 749-2264

WANTED: Collector paying top dollar for Japanese transistor radios. Fax or write. Tom Christopher, 45 Boway, So. Salem, NY 10590. (914) 763-5936

WANTED: Old telegraph keys, sounders, relays & related equipment. Gerry Maira, 3 Jackson St., Silver Creek, NY 14136. (716) 934-3776. E-mail: gm@netsync.net

WANTED: 1920s headphones, headphone literature, phone plugs. Please include asking price. Bob Sukosky, 62 Strong St., Manchester, CT 06040. (860) 646-8857, 5 to 9:30 pm EST

WANTED: Who can help me with blank disks? Arnaud Vrand, Lauwestraat 67, B-8560, Belgium. Fax: 09 32 56 42 63 30. E-mail: arv@unicall.be

WANTED: B&W pix tubes: 16GP4, 8AP4, 8BP4, 7JP4, 3KP4. Any help greatly appreciated. Alvin Abramowitz, 11218 Liberty Rd., Owings Mills, MD 21117. (410) 496-1177

WANTED: To buy: Sterling R-517 tube tester or any parts or chassis from old unit. Help! Charles Kirsten, Radio Relics, 15556 Sandra Ln., Sylmar, CA 91342. (818) 364-0491



WANTED: Motorola Catalins #'s 50XC, 51X15, and 52, as complete or "parts" sets. I am a very serious collector seriously looking for serious stuff (leaving all kidding aside, of course!) Please write or call collect: Rain Buttignol, 214 Slate St., #7, Portsmouth, NH 03801. (603) 427-1384

WANTED: New old stock Sony radios ICF-S30W. Fred Haines, 132 Rural Ave., Lewisburg, PA 17837

WANTED: 1920-1930 vintage transmitter, will pay top dollar for a nice unit. E-mail description (and pic if you have them) to: H. David Meitzen, 12401 N. Shadow Lake Dr., Cypress, TX 77429. (713) 525-7546, call collect. E-mail: dmeltzen@pov.net

WANTED: Metal dial pointer for Zenith AM-FM table radio Model T825 or Y825. Stephen Price, 1351 Oliver Ave., Johnstown, PA 15909-1427. (814) 322-1841. E-mail: vinyltoCDR@aol.com

HIGHEST PRICES PAID FOR NEW and USED TUBES

WANTED!

*Western
Electric*

VT25/A VT52 101D/F 104D
205D/E/F 211A/D/E 212A/D/E
231D 239A 252A 262A/B
264A/B/C 274A/B 275A 300A/B
301A 310A/B 311A/B 347A
348A 349A 350B 412A
417A 421A 422A 437A

OTHER TUBES WANTED!

2A3 5AR4/GZ34 6BQ5/ELB4 6CA7/EL34
6DJ8/ECC88 6L6G/GC 6SN7GTB 6V6G/GT
10(GLOBE) 12AT7/ECC81 12AU7/ECC82
12AX7/ECC83 (Amperex/Mullard/RCA/Telefunken)
45(GLOBE) 50(ST & GLOBE) KT66 KT77 KT88
211 EF804S 845 5691 & 5692 (Red Base)
6267/EF86 6550 7025 7189 7199 7591/A, Etc.

IF YOU HAVE ANY OF THE TUBES LISTED IN THIS AD,
PLEASE Call, Fax or E-Mail DOM SINGERHOUSE

Call TOLL-FREE (Tel / Fax) **(888) 715-8823**

E-Mail singtube@frontnet.net

**SINGERHOUSE
OUND, LLC**

PO Box 321, New Richmond, Wisconsin 54017

Est. 1994

FOR SALE: Following A/O N/D Dewald M C800 A/FM 4 kn. - \$70. GE Mod 210 A/FM 2 kn. - \$50. Following woodrad/phono: RCA 77U @9 - \$55. GE Mod HJ618AC @9 - \$40. Zen. portable no. tan case canvas drop front - \$40. Chassis for RCA Victor console has horiz. slide dial w/spkr. 3 PC, S - \$40. Tube tester Hickok Mod 800 @10 - \$140. Mickey Mouse case, only, GE Mod C2418A wht, all you need is chassis & grille @9 - \$30. Bernie Samek, 113 Old Palmer Rd., Brimfield, MA 01010. (413) 245-7174. Fax: 0441

FOR SALE: Scopes 3 left Telequipment S-54 (div of Tektronix) 0-10 MHz with copy of manual - \$50. Con. U.S. only. Harry Pewowaruk, 1535 N. 8th Ave., St Cloud, MN 56303. (320) 252-9910. E-mail: HPewowaruk@aol.com

FOR SALE: MRL multiband crystal set, Radiola III/III-A support literature, WD-II substitute units. Free details, SASE, Dave Smith, Box 81, Olney, IL 62450. E-mail: k9uim@otbnet.com

SEND ALL A.R.C. MAIL TO
Antique Radio Classified
P.O. Box 2, Carlisle, MA 01741

FOR SALE: Gonsset G-66B & AC - \$150. National NC-183D & spkr - \$335; NC-46 & spkr - \$225; Miller receiver preamp - \$45. Richard Prester, 131 Ridge Rd., West Milford, NJ 07480. (973) 728-2454. E-mail: rprester@warwick.net

FOR SALE: Lunalit, only one known (Plate 612, Bunis & Breed's novelty radio guide) - \$300. Gerald Schneider, 3101 Blueford Rd., Kensington, MD 20895-2726. (301) 929-8593

FOR SALE: Airline 04BR729A, 6P.B wood table. Heath T.C. 2 tube tester. Knight KG652 sweep generator. 1942 Audels Blue Print Reading book. Ted Gasiorek, 201 Golden Ave., Briggsville, WI 53920. (608) 981-2051

FOR SALE/TRADE: Kenwood TS830S, spkr & manual, also Heathkit SB 220 & manual. I need Kenwood TL 922. A. Bruno, 24 Butternut Dr., New City, NY 10956. (914) 354-8899

FOR SALE: Motorola 5P33VW and Airline 64BR-1504B Bakelite, very good condition - \$40 ea. plus shipping. Michael Leopold, 788 Duxbury Ln., Bartlett, IL 60103. (630) 540-1282

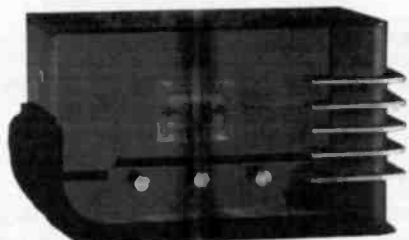

FOR SALE: 1936 Sparton Sleigh replica AM/FM radio, with stereo CD player. This unique and beautifully crafted cobalt blue mirrored glass table top radio is the true form of the 1930s Art Deco period. It has all the features and looks of the Moderne style. Including elaborate etching on the glass covered all wood cabinet, five chrome wraparound bars accentuating the design chrome control knobs. This stunning full-sized radio is fashioned by Crosley. A perfect accent piece for your home or office, a must addition to any radio collection. Model CR-38CD Crosley Sleigh - \$249.50 or CR38 AM/FM radio only - \$169.50 inc. S/H. To see these radios and over thirty other antique and classic collectable radios visit my web site: <http://www.radioattic.com/attics/martin.htm>. Ben Martin, 18334 Pepper St., Castro Valley, CA 94546-2319. (510) 582-6804, local phone or (800) 595-0191. E-mail: bensradios@aol.com

FOR SALE: Sams manuals auto radio tape recorder hi-fi stereo - \$3 each plus \$2 shipping. Maurer Television, 29 South 4th St., Lebanon, PA 17042. (717) 272-2481

FOR SALE: Dynaco SCA-35 - \$250. Dynaco SCA-50 - \$150. Dynaco AF-6 - \$125. Kenwood KD-1033 turntable - \$45. Doug Fox, 603 S. 12th Ave., St. Charles, IL 60174. (630) 584-5915. E-mail: dfoxradio@aol.com

FOR SALE: European radios: Grundig 4070/U stereo, 2 speakers BC/SW/SWII, FM stereo - \$150; Lowe Opta wood, hi-fi Fonovox Bella Type #05710 - \$125. Frank J. Manziano, 82 Monhegon Ave., Oakland, NJ 07436. (201) 337-5263

NEW QUALITY CAPACITORS:

Volt 630 Axial Leads

Part Number	Value (UF)	*Price/25	**Each
.001-630-AL	.001	\$ 6.00	24¢
.0047-630-AL	.0047	\$ 6.25	25¢
.0068-630-AL	.0068	\$ 6.35	25¢
.01-630-AL	.01	\$ 6.50	26¢
.022-630-AL	.022	\$ 7.00	28¢
.033-630-AL	.033	\$ 7.25	29¢
.047-630-AL	.047	\$ 7.50	30¢
.1-630-AL	.1	\$ 8.00	32¢
.22-630-AL	.22	\$ 15.00	60¢
.47-630-AL	.47	\$ 20.00	80¢

ELECTROLYTICS:

Volt 160 Axial Leads

22-160-AL	22	\$ 16.00	64¢
33-160-AL	33	\$ 21.00	84¢
47-160-AL	47	\$ 24.00	96¢

Volt 450 Axial Leads

10-450-AL	10	\$ 18.75	75¢
22-450-AL	22	\$ 28.00	\$1.12
47-450-AL	47	\$ 45.00	\$1.80
47-450-AL10	47	\$ 20.00 (per 10)	\$2.00
100-450-AL10	100 NEW	\$ 28.50 (per 10)	\$2.85

To order, Send Check or Money Order to:

BOB'S ANTIQUE RADIOS AND ELECTRONICS

111 East 29th Street La Grange Park, Illinois 60526

Telephone: (708) 352-0648 / Fax: (708) 352-0647

Visit radioantiques.com or e-mail: radiobob1@aol.com

Ask About Super Bulk Rates/Sorry No Credit Cards or C.O.D.'s

Shipping & Handling included in price. **Comparison price only.

*Sold in 25 piece lots - No Minimum Order

WANTED MICROPHONES
BROADCASTING EQUIPMENT
 Amplifiers, mixers, compressors, on-air lights. Mike flags, equalizers, literature, TV cameras. Disk, wire & tape recorders. 16" transcriptions. Turntables, arms, pickups, blank discs, speakers. Commercial, home & theater audio. Interesting, early or elaborate radio & TV sets. Buy & sell.

Robert Van Dyke, 2 Squires Ave., East Quogue NY 11942
 Tel. 516 728 9835 Fax. 516 723 3538 vandyke@hamptons.com

WANTED: Knightkit C-11 transceiver 1960 vintage, need not work but must be complete and dirt cheap. Al Cikas, 412 Radford Dr., Sherman, IL 62684. (217) 496-3150

WANTED: Collector tubes. We buy complete collections. Call, write or e-mail for bid list. George H. Fathauer & Assoc., 688 W. First St. Ste. 4, Tempe, AZ 85281. (480) 968-7686. E-mail: fathauer@home.com

VISIT A.R.C.'s WEB SITE
www.antiqueradio.com

Book Orders - Subscriptions - Articles and more!

WANTED: McIntosh: all tuners, whole systems, tube amps, cabinets, literature. Altec A333 amp, VOT systems. Pilot AA901 amp. Karlson factory 15" speaker cabinets, singles OK. Thorens TD 121 33 only turntable. Walt Fleming, 182 Plain Hill Rd., Norwich, CT 06360. (860) 889-1957. E-mail: wrlfleming@snet.net

WANTED: RCA 121, GE K64 or Westinghouse WR37 cathedral radio. Mark Hewitt, 6659 Tipperary Trl., Roscoe, IL 61073. (815) 623-8729

WANTED: It's the round one, excellent original working Wilcox-Gay A-17. Joseph Di Caro, 4155 Lastrada Hts., Mississauga, Ontario, Canada L5C 3V1. (905) 848-7759. E-mail: fox@globalserve.net

WANTED: Zenith Suncharger Royal 56 or 555 in black, Hallicrafters SX16 or SX17. Jim Choroszy, 764 E. Imperial Dr., Hartland, WI 53029. (262) 367-8367

WANTED: The juvenile fiction book, Young Wireless Operator With the Secret Service by Theiss. Robert Stapleford, 1800 S.W. Randolph Ave., Topeka, KS 66604-3158

WANTED: Antique brass microscopes. Scientific and medical apparatus. Optical and electrical. Allan Wissner, Box 102, Ardsley, NY 10502. (914) 693-4628. E-mail: wissner@bestweb.net

WANTED: Western Electric tubes. 205D/E(TB): N.O.S. \$450; used \$320. 262A: N.O.S. \$140; used \$80. 348A: N.O.S. \$100; used \$60. 239A: N.O.S. \$50; used \$30. 264C: N.O.S. \$50; used \$30. 300A: N.O.S. \$1,000. Jun Mizuno, 933 Portswood Cir., San Jose, CA 95120. Ph./fax: (408) 268-4016

WANTED: Need 3 German tubes for VE 301. REN 904 (A4110) RES 264 (L 416/D5/RGN 354). Richard Brill, PO Box 6367, Old Bridge, NJ 08857. (732) 607-0299. E-mail: rrgbent@aol.com

WANTED: Low or no emission tubes, need a few 01-A, 112 and 171 tubes. Cosmetically good with filament continuity. Paying \$2.50 each plus postage. Joe Waskel, 26606 S. Peartree, Sunlakes, AZ 85248. (480) 895-1473

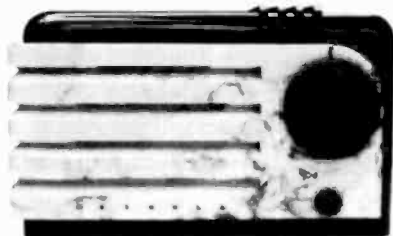

WANTED: More prewar plastics by Detrola, RCA, Kadette, Air King, et al. Take all my money before the relatives do. They are trying to hurry my already imminent demise. Please write or call collect. Rain Buttignol, 214 State St., #7, Portsmouth, NH 03801. (603) 427-1384

WANTED: Radiodyne radios, catalogs, promotional literature, and manuals made by Western Coil & Electrical Co. of Racine, Wis. Clem Krivich, 627 Monticello Dr., Racine, WI 53402. (262) 639-8395. E-mail: celkriv@wi.net

Our Customers Say It Best: "You've Gotta Have an AM-100!"

Whether you are a novice collector with one radio or a seasoned veteran with a roomful, curious visitors always ask the question: "Does it still work?" What better way to prove the point than with a live old-time radio broadcast. With the Comtronics AM-100, you can entertain friends with authentic on-the-air radio demonstrations!

Will it Work for Me? *You be the Judge:*

"Big-band music all the time from any of my radios"

"I can't live without one!"

"The little transmitter works like a champ...the bass response is remarkable!"

"As I'm writing this, I am enjoying vintage Count Basie on my RCA 816K"

This is the Genuine Article. Call Now and Enjoy the Music

Tusa Consulting Services
19 Augusta Drive, Covington, LA 70435
(504) 892-7348 (504) 892-2075 FAX



Make those old radios come alive with an AM-100, today

Price: \$199.50

Includes antenna, power supply and UPS delivery (48 States) 1-yr warranty, 30-day trial

FOR SALE: Radios and TE. Lists mail or internet.
WANTED: Black 0-100 tuning dials. R. Allen, 399 Canterbury Tpk., Norwich, CT 06360. (860) 822-6096.
Web: <http://www.99main.com/~allens>

FOR SALE: Zeniths T-600 vg - \$120. 5F166 console, vt - \$130 p.u. N.O.S. 3C23 - \$25 ea. Buzz Miller, 725 Mt. Rock Rd., Carlisle, PA 17013. (717) 776-3279. E-mail: buzzm@sprintmail.com

FOR SALE: 5BP1 crt in crate old (WWII). Peter Perrotti, 25 Francine Dr., Rochester, NY 14606. E-mail: pperr20393@aol.com

FOR SALE/TRADE: Westinghouse Refrigerator Model H-134, orig. ivory paint, some dings, great Bakelite, no chips, handle brass and knobs all orig. and nice, felt feet like new, Model & UL sticker on bottom, has been completely rebuilt and plays just fine - Best Offer. RCA Radiola 26, exc overall, has 6 UV-199, all RCA, all show tested 4-28, I've tested 5, have continuity, can't get 6th out of socket - Offers. RCA 74 Jr., baby 44 on midget stand, good orig. cosmetics, very nice grilles - \$400 OBO. Admiral Model 5-Y-22-AN, brown Bakelite AM/3-speed phono, very nice Deco looking, bottom is missing, sort of working, could use rebuild and TLC - \$75 OBO. Hallicrafters R-46 speaker, all orig., face nice, needs new felt on grille cloth, case could use good repainting. National solid copper 3 spoke grille, same as Hallicrafters, could use good repaint. General Radio strobe, Model 631-BL, fair, works. Tubes: four Philco 45s, all test 95+ on Hickock - \$100 for all four; two RCA 27s - \$7 ea., one Cunningham 41 - \$10; one National Union 41 - \$10; one Philco 42 - \$15, all shoulder type. Always looking for vintage mics and stands, early oddball tape and wire recorders; also Enigma machines, other WWII era spy stuff; and last, but certainly not least, still seeking Zenith Strat 1000, serious buyer, will pay the price. Ward Kremer, 5807 Papaya Dr., Ft. Pierce, FL 34982. Ph./fax: (561) 468-7732. E-mail: WKremer798@aol.com

FOR SALE: Philco 38-62 T.M. vg - \$75. RCA 3BX51 port. vg - \$25. Stromberg-Carlson 400H vg - \$50. Bob Fuerderer, Holly Farm, 813 Rte. 12A, Surry, NH 03431. (603) 352-3005

FOR SALE: Relays! 60s vintage Mil Spec N.O.S. Fax or e-mail me with your needs. Russell Hulme, 3609 Country Club Rd., Duncan, OK 73533. Fax: (580) 255-5439. E-mail: hulmetek@marlownet.net

FOR SALE/TRADE: Pristine Grebe CR13 receiver.
WANTED: Connecticut Tel. & Elect. headphones, working UV199 tubes, Conn. Tel & Elec. DR6 cabinet with label. Stu Mount, W2AO, 35 Grand St., Highland, NY 12528. (914) 691-7957

FOR SALE: Mississippi pumper (Breed-36) N.I.B., one hose - \$100 shipped. Arnold Hornstein, 1929 Windy Run Rd., Baltimore, MD 21228. (410) 744-0919

FOR SALE: Transistors T5 Philco pink & black. P785 GE Royal 200 Zenith - \$100 + shipping. David Cox, PO Box 415, Kiefer, OK 74041. (918) 321-5945

FOR SALE: Instrument amplifier Gibson Inc. Les Paul Jr. cosmetics good, not tested. Best Offer. James E. Inglett, 94 Leawood Dr., Midway AR 72651-9208. (870) 431-8430. E-mail: cen62047@centurytel.net

FOR SALE: Parts, tubes, books, two stamp SASE or E-mail for list. Wayne Letourneau, PO Box 62, Wannaska, MN 56761. E-mail: wbOcte@arrl.net

FOR SALE: 1936 RCA tombstone Model 5T, looks and plays good, photo on web site at <http://www.pcola.gulf.net/~d1don/> - \$110. Don Reinsma, 610 Nix Rd., Pensacola FL 32506-8333. (850) 455-7721. E-mail: d1don@pcola.gulf.net

FOR SALE: 1-37-84 Philco cat., complete W/T real nice not tested, but lights up etc. - \$145 + S/H. Carlos Gimenez, 15091 Shamrock Dr., Fort Meyers, FL 33912. (941) 482-0198

NORTHLAND ANTIQUE RADIO CLUB



AND

PAVEK Museum of Broadcasting

Proudly Announce

RADIO DAZE 2000 Sponsored by AWA

Friday, May 19th and Saturday, May 20th, 2000

- SPECIAL** — Special presentation by the Rochester Radio Theater Guild
FEATURES: — Old Radio Auction
— A visit to the Pavek Museum of Broadcasting

NARC

P.O. Box 18362 • Minneapolis, MN 55418

Don Hauff: 612-933-9070

E-mail: DHauff@isd.net

Comfort Inn

3000 Harbor Ln. (494 & 55) • Plymouth, MN

612-559-1222

MENTION "RADIO MEET" FOR SPECIAL RATES.

www.geocities.com/TelevisionCity/4544/

SWAP MEET/AUCTION/PROGRAMS/CONTEST/LUNCHEON

WANTED: Antique medical, scientific devices, fans, Deco clocks, radios, and horn phonographs. Richard Cane, 1333 N.W. 127th Dr., Sunrise, FL 33323. (954) 846-7116. E-mail: rbcane@sprynet.com

WANTED: Antenna transformer part no. 06619 for Philco Model 19 89 or junk chassis. Norman Reiss, 360 South St., West Deer Park, WI 54007. (715) 269-5473

WANTED: Addison A2 and Fada bullet Catalin radios. I'd like one of each to round out my collection. Thanks! Dave Springer, 1115 Brookfield Ln., Wausau, WI 54401. (715) 355-0271, before 9 pm CST

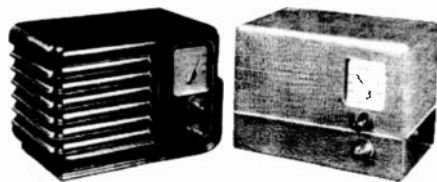

WANTED: One of these pictured FM tuner-converters, which uses two or three tubes, made in the late 40s, by Audar, Telvar, Meck, Knight and others. Richard Matiassek, 2212 S. 139th Ct. Apt. 3, Omaha, NE 68144. (402) 691-0852

WANTED: Sonora Sonnerette (France), Addison #2S (Canada) particularly bright yellow, blue, or swirled and speckled ones, Bendix 115, Philco 49-501, and a single ivory pushbutton for a Belmont 6D-111. Go ahead, make my day. Bruce Phillips, 127 Bunker Hill, Stratham, NH 03885. (603) 772-7516. E-mail: radioorphanage@prodigy.net

WANTED: Atwater Kent advertising lamp. Without shade OK. Steve Dando, 4572 Mark Trail, Copley, OH 44321. (330) 666-7222

WANTED: Wood cabinet for Zenith Model 6J257. Restorable condition. Tony Faust, 108 Knut St., Alexandria, MN 56308. (320) 763-6441

WANTED: Chassis for Henry Field Shenandoah Five radio. Ron Timperley, 1725 Mission Ct., Huron, SD 57350. (605) 352-4723. E-mail: ronkaytimp@basec.net

WANTED: Tube piano radio in green. Help me complete my collection! Thanks. Geoff Shearer, 14408 Brookmere Dr., Centerville, VA 20120. (703) 818-2686. E-mail: GShea90278@aol.com

WANTED: Tubes: 6851, 6852, 6854, 6877, also Telefunken 6211, Amperex 6463. Thomas Miller, PO Box 20138, London Terrace Station, New York, NY 10011 (212) 675-7704, evs

WANTED: Western Electric amplifiers 25A/B/C, 117A, speakers: 555, 597A, 713B, 728B, 754B. Acrosound TO350. Ming Yang, 1995 University Ave. #119, Berkeley, CA 94704. (925) 376-4220

WANTED: Merle Duston's Radio Library Vol. 1-5, 7, 8, 9-10. Will purchase originals or copies. Richard Dzick, 31572 Juniper Ln., Warren, MI 48093. (810) 268-4671. E-mail: n8mq@aol.com

Classified Ad Deadline Noon

Apr. 10 for May 2000 Issue

May 10 for Jun. 2000 Issue

Boxed, Photo, & Display Ads - 1st

WANTED: Western Electric amps, horn, spkr, x-fmr, wire, socket, caps, and data-sheet etc. 101, 102, 104, 205, 211, 212, 216, 217, 242, 252, 253, 262, 271, 274, 275, 276, 284, 300, 310, 339, 347, 348, 349, 350, VT2, VT25A, VT52. Others: KT66, 77, 88, RCA50/250/350, 845, Telefunken ECC81, 82, 83. Jun Mizuno, 933 Portwood Cir., San Jose, CA 95120. Ph./fax: (408) 268-4016. E-mail: jmizuno@usa.net

WANTED: Black plastic dial scale escutcheon for Philco 16B or others. James S. Fisher, R.R. 1 Box 861, Port Royal, PA 17082. E-mail: yrless@tricity.net

WANTED: Dial scale for RCA 10T, same as 9K/T, 10K, 13K, 15K, 5 band radio. Igor Golio. 17 Addison Dr., Fairfield, NJ 07004. (973) 463-4973

WANTED: Philco transformer 32-8899-1 T4 HVT for Model H3410L or chassis 10L42 U, 10L43. Philco cathedral Model 90 cabinet. Source for rebuilding phono cartridges. Frank D. Atwood, Nostalgia Radio Subdivision of Atwood TV & Radio Service, Inc., 117 E. Main St., Unit 1, Merrimac, MA 01860. (978) 346-8100. Fax: (978) 374-1030. E-mail: atwoodtv@110.net. Web: <http://www.110.net/~pr2858>

Join the

AWA

ANTIQUE WIRELESS ASSOCIATION

THE ORIGINAL AND LARGEST HISTORICAL RADIO-COLLECTOR GROUP

- Publishes *Old Timer's Bulletin* with:
 - Battery and AC receiver restoration
 - Vacuum-tube history and collecting
 - Old-time amateur-radio contests
 - Communications receivers
 - Free want-sell-swap ads
 - Early television
 - Horn loudspeakers
 - Reviews of current books
 - Keys and land-line telegraphy
 - News of U. S. and foreign clubs
 - Information on public radio museums.
- Maintains unique radio-TV museum.
- Produces the annual Rochester meet.
- Co-sponsors local meets.
- Publishes the annual *AWA Review*.



Membership is only \$15 per year (\$27 for two years, \$18 per year for overseas). Mail check to:

Antique Wireless Association, Inc.

Box E, Breesport, NY 14816

<http://www.antiquewireless.org>

PUETT ELECTRONICS

PO BX 180818 DALLAS TX 75218-0818 U.S.A.
IN OUR 27TH YEAR



88-PAGE CATALOG
\$5.00 POSTPAID IN U.S.A.
OVERSEAS AIR MAIL ADD \$3.00
\$5.00 DISCOUNT COUPON WITH CATALOG.
OVER 2,500 INSTRUCTION MANUALS,
AND OTHER PIECES OF LITERATURE!
TUBES, RADIO SHOWS, ETC.

VISIT OUR WEBSITE:
www.flash.net/~puett

Order These Popular Books From Antique Radio Classified

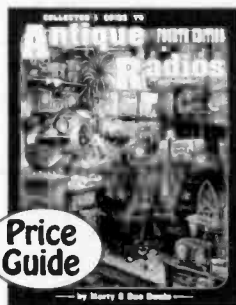

Price Guide

The Collector's Guide to Antique Radios 4th Edition by Marty & Sue Bunis. 8,500+ Battery & AC sets from the '20s to the '60s. Updated prices. Many new photos. 1996. Shipping Now. — **\$18.95**
Combined Ed., CD-ROM by Bunis & Kaczowka. Available Now. — **\$39.95**



Price Guide

The Collector's Guide to Transistor Radios 2nd Edition by Marty & Sue Bunis. This book will help you identify the most sought-after vintage transistor radios. Over 2,900 models, all with current prices. Includes radio club listing. 375 all new color photos, 320 pages. 1996. — **\$16.95**

NEW.....

The Collector's Guide to Antique Radios, Combined Ed., CD-ROM, Bunis & Kaczowka. Combines book editions 1-4. Over 9,000 models with pricing. 1,800 full color photos. Requires a web browser. Runs on both IBM & Mac. 1998. **\$39.95**

The Collector's Guide to Vintage Televisions, Durbal & Bubenheimer. Size of the screen, year of manufacture, cabinet composition, and current value for over 1,400 vintage TVs made from 1945-1960 and transistor TV sets through 1980. 200+ color photos. Price guide. 176 pgs. **\$15.95**

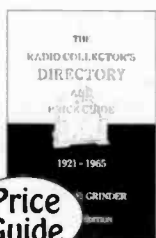

Price Guide

The Radio Collector's Directory and Price Guide, 1921-1965, 2nd Ed. by Robert Grinder. Over 20,000 radios by manufacturer, model number, year, etc. with prices. Radio history, cabinet style chapters. No photos, 264 pages. — **\$26.95**

Transistor Radios, A Collector's Encyclopedia and Price Guide by Robert Lane and David Lane. Identification guide to over 2,500 transistor and novelty radios. History and key to collecting chapters, 170 pages. — **\$19.95**

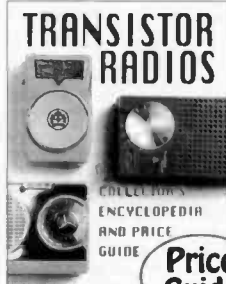

Price Guide

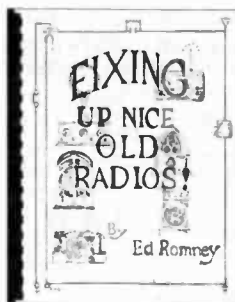

Fixing Up Nice Old Radios by Ed Romney. Written by a retired radio instructor. Plastic binding. 300+ figures, 185 pages. — **\$35.00**

Old Time Radios Restoration and Repair by Joseph J. Carr. A self-paced training guide. History, theory and practical operation of antique and classic radios. 200 illustrations, 256 pages. — **\$19.95**

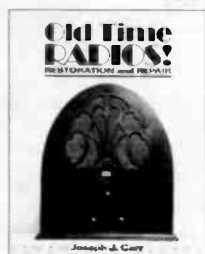

Everything stocked and shipped promptly - Radio is our middle name.

U.S. Orders - 16th Anniversary Special - free U.S. packing & book-rate shipping thru June 30, 2000. If using VISA or MasterCard, include name on card, card number and expiration date. Send payment with order. Mass. residents add 5% sales tax. Money back return policy. Softcover unless stated otherwise. Most orders shipped by next business day. Typical U.S. order will be received within 7 days, but allow 2-3 weeks. Foreign orders - write for shipping costs, or use credit card and specify air or surface (allow 2-3 months for surface shipping).



A.R.C., P.O. Box 2, Carlisle, MA 01741. Tel: (978) 371-0512

Fax: (978) 371-7129 - E-mail: ARC@antiqueradio.com - Web: www.antiqueradio.com



(Apr-00)

Order These Popular Books From Antique Radio Classified

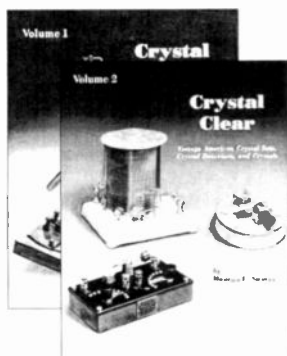

Crystal Clear Volume 1 and Crystal Clear Volume 2 by Sievers. *Comprehensive reference to crystal sets, crystal detectors, and crystals. Each volume contains different illustrations and information. Order by volume. — \$29.95*



Flick of the Switch by Morgan McMahon. *The classic photo reference guide for 1930s - 1950s radios. 1000+ photos of radios, 5" x 8", 263 pages. — \$11.95*

NEW.....

Radio Tubes and Boxes of the 1920s, Fathauer. *Pictorial presentation of radio tubes of the 20s, including packaging and advertising. 400+ color photos and illustrations. 105 pages. \$26.95*

A Pictorial History of Collins Amateur Radio Equipment, Miller. *The most complete story of Collins told in hundreds of photos and in the word: of the men who made it happen. 175 pages.... \$39.95*

Hams! We now have 8 ham books . See our full page ad



Guide to Old Radios, Pointers, Pictures, and Prices, 2nd Ed. by Johnson. *Introduction to radio collecting. Includes hundreds of photos and a price guide. 272 pages. — \$19.95*



Antique Radio Restoration Guide, 2nd Ed. by Johnson. *Beginner's introduction to troubleshooting and repairing AC table model radios. 145 pages. — \$14.95*

Price Guide



The Zenith Trans-Oceanic: The Royalty of Radios by Bryant and Cones. *Presents the fascinating story of the development and use of the Trans-Oceanic. Several photos, documents, ads, etc. 160 pages. — \$24.95*

Communications Receivers, 4th Ed. by Ray Moore. *Information on vacuum tube receivers by 66 manufacturers. 448 radios illustrated, 136 pages. — \$19.95*



16th Anniversary Special! Free U.S. shipping thru June 30, 2000!

U.S. Orders - 16th Anniversary Special - free U.S. packing & book-rate shipping thru June 30, 2000. If using VISA or MasterCard, include name on card, card number and expiration date. Send payment with order. Mass. residents add 5% sales tax. Money back return policy. Softcover unless stated otherwise. Most orders shipped by next business day. Typical U.S. order will be received within 7 days, but allow 2-3 weeks. Foreign orders - write for shipping costs, or use credit card and specify air or surface (allow 2-3 months for surface shipping).



A.R.C., P.O. Box 2, Carlisle, MA 01741. Tel: (978) 371-0512

Fax: (978) 371-7129 - E-mail: ARC@antiqueradio.com - Web: www.antiqueradio.com



(Apr-00)

FOR SALE: A great selection of over 800 books on radio, wireless, telegraphy, electricity, etc. Browse the Electro-Technology catalog on our web site at: <http://abebooks.com/home/oldauthors> or contact us at: Old Authors Bookshop, PO Box 1176, Ogdensburg, NY 13669. (613) 543-3337. E-mail: authors@mor-net.on.ca

FOR SALE/TRADE: Guild Stereodon square grand piano, new Sams transistor manuals #45-87. **WANTED:** Internationals, Kadettes. C. R. Nevins Museum of Radio, Ken Nevins, 406 Jipson St., Blissfield, MI 49228. (517) 486-3019, evenings please. E-mail: knevins@tc3net.com

FOR SALE: Mint Philco #70 cathedral - \$525. Mint Emerson Mickey #409 - \$2,300. Richard Bednarcik, 28 Steele Ave., Lincoln Park, NJ 07035. (973) 694-6374. E-mail: radiorich1@yahoo.com

FOR SALE: Zenith 6S361 spkr, black dial w/tuner, 3 wooden knobs - \$100. RCA 5-T chassis, recapped - \$65. Philco 116X chassis recapped - \$100. Drake TR4 SSB trcvr, 80, 40, 20, 15, 10 meter, p.s., spkr, no mike - \$200. Heathkit TC-2 tube tester - \$40. Waterman S-14A industrial scope - \$75. A.R.C. back issues '89-'99 - \$35/yr. Heathkit TS-2 TV alignment generator w/ manual - \$75. Knight r.f. generator Mod KG-686 - \$75. CRT testivator Mod 103 - \$20. Eico Mod 368 TV-FM sweep generator & marker - \$65. Zenith 10S567 chassis, 12" spkr, wavemagnet antenna - \$150. Stromberg-Carlson 420-H chassis, no spkr but checked, plays great, 3-band - \$50. Hundreds of Bakelite, wooden knobs for old radios; tubes & spkrs also. D&K's Antique Radios, 2767 Cottage Rd., Lafayette, IL 61449. E-mail: radios1@yahoo.com

FOR SALE: Philco 39-55 radio with mystery wireless remote, as found from original owner, needs restoration - \$250, pickup only. Kevin Kuehn, 1615 13 1/2 Ave., Barron, WI 54812. (715) 537-3225. E-mail: kjkuehn@chibardun.net

FOR SALE: Pro-microphones: RCA, WE and Shure, mint condition. Broadcast, recording and boom mikes all ribbed and cosmetically perfect. Other WE dynamic 618 type mikes also available. Bill Cook, PO Box 4390, Woodland Park, CO 80866. (719) 687-6357

FOR SALE: Volt Ohmmeter, U.S. Army I-166 with manual, test leads, and it works - \$50 plus S&H. Len Gardner, 458 Two Mile Creek Rd., Tonawanda, NY 14150. (716) 873-0447

FORSALE: (25) N.O.S. phono driver (3) 6G5, (1) 6AB5, (1) EM-34 eye tubes. William K. Seiler, 8819 South St. Rd. 135, Pekin, IN 47165

**WHAT IS YOUR PRICE?
1920'S TO 1930'S RADIO**

**COLLECTION WANTED
ESPECIALLY IF IT INCLUDES
A SELECTION OF BREADBOARDS
AND/OR UNUSUAL SPEAKERS.**

Will buy as is, where is.

Russell Ofria

**8432 Darby Ave., Northridge, CA 91325
818-989-5222 days, 818-701-8181 eves PST**

FOR SALE: VC50 vacuum cap. 55mmf 20kv, Precise VTVM Model 907 - Offers. Vacuum tube list, also parts list including old Stanwyck, Zenith, Meissner coils in orig. boxes. Harman Kardon AM/FM tuner Model ST360 - \$50. Shipping extra. SASE for lists. E.F. Hayes, W0JFN, 3109 N. Douglas Ave., Loveland, CO 80538-2548

FOR SALE: Electro-Voice 664 mike in original box, cord, manual, excellent - \$150 + postage. **WANTED:** Tube CB's. Charles Zafonte, N1FRX, RR3 Box 2075, Fort Kent, ME 04743. (207) 834-6273

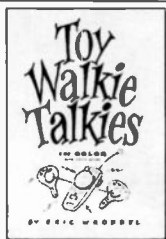

FOR SALE: Toy Walkie Talkies, brand new book featuring 73 of the all-time greatest walkie talkies. Amazing designs! All in full color, with model numbers, dates, notes and current prices - \$19.95 includes postage. A really fun book! Eric Wrobbel, Dept. A, 20802 Exhibit Ct., Woodland Hills, CA 91367. (818) 884-2282. E-mail: ewrobbel@aol.com

FOR SALE: Midwest Delux radio circa 1924, clean set - Best Offer. Military test gear. Paul Recupero, 265 Union St., Portsmouth, RI 02871-2209

FOR SALE: Scott 1510 chassis - \$80. Philco 38-10 chairside - \$275. Sears child phono - \$15. RCA IMBT6 portable - \$90. (3) miniature tubes #5977, 5639, & 6112 - \$12. Grunow 470 - \$140. Zenith H500 - \$150. Bendix 112 - \$30. Large 1 tube homebrew - \$50. Silvertone 8010 clock radio - \$35. Westinghouse H122A - \$40. Hallicrafters S-38B - \$35; Hallicrafters S-41G - \$35. Lear radio 6615 - \$40. Airline WG1636A - \$35. RCA K80 chassis - \$35. Thomas cathedral - \$25. RCA 45J2 phono - \$20; RCA 45J2 phono - \$12. Crosley 706 Showbox - \$60. Crosley Bandbox Jr. - \$40. Old Spartan RF amplifier - \$25. '69 Olds radio with Wonderbar - \$100. '55 or '56 Chev. radio with Wonderbar - \$125. Mitchell Airboy Sr. - \$15. Electric auto antenna - \$25. Tenna Tractor radio - \$20. (2) crystal radios - \$20. Oriental meter - \$8. National SW54 shortwave radio - \$45. Eico 950 bridge type tester - \$8. Walt Wrabek, Rt. 4 Box 370, Menahga, MN 56464. (218) 546-4623

FOR SALE: Antique Radio Classified 1990 to 1999. Ten years mint condition - \$100 plus UPS. Onerio Lou Sabeto, 1717 Burgess Rd., Cleveland, OH 44112. (216) 481-1036

FOR SALE: N.I.B. Bud No. CK-356, lo-coil kit, range 11-210 meters - \$150 ppd. Also N.I.B. LGB passenger train set w/trans Model 20301 - \$400 + \$35 shipping. John Nosbaum, W9BJP, 2743 Wilmette Ave., Wilmette, IL 60091. (847) 256-0547

FOR SALE: Clean, nice, complete: 1940s Zenith 5 tube table radio chassis - \$20; 1940s home brew audio amplifier, with 5 tubes, 4 transformers - \$30. Ellsworth O. Johnson, 364 S. Coeur Dalene St., Spokane, WA 99204-1063. (509) 838-2161. E-mail: eojohnsonw2@home.com

RADIO CRAZE

John Sakas P.O. Box 4124 So. Hackensack NJ 07606-4124
 Phone (201)794-0437 ~ Fax 24 Hours (201)794-8359
 visit our web site at <http://www.radiocraze.com>

WANTED

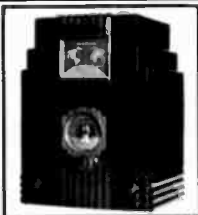

AIR KING SKYSCRAPERS

PAYING \$14,500.00+ for near mint condition red or blue
 \$10,000.00+ for green, lavender or yellow
 \$3000.00+ for black and \$2000.00+ for white or brown
ALSO WANTED ANY COLOR-ANY CONDITION
 COLLECTOR PAYING TOO MUCH, CALL ME LAST

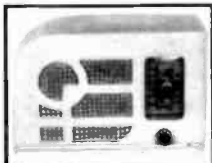

TOM THUMB CATALIN RADIOS WANTED

paying \$6,750.00+ for mint cond red, green, orchid, blue
 \$2,500.00+ for any mint condition one
ALSO WANTED ANY COLOR-ANY CONDITION

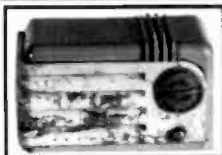

DETROLA PEE WEE & SUPER PEE WEE WANTED

paying \$600.00+ for mint cond black, white
 \$1,450.00+ for beabe, gray salt & pepper
 \$2000.00+ for red blue \$3500.00+ for green or lavender
ALSO WANTED ANY COLOR-ANY CONDITION

WANTED ANY CATALIN RADIO

ADDISON 2 MAROON & YELLOW \$900.00, YELLOW & RED \$2,750.00
 ARVIN 532 ANY COLOR \$2,500.00, BENDIX 526 GREEN & BLACK \$625.00,
 DeWALD A501, A502 BROWN \$375.00, YELLOW \$425.00, RED \$1,200.00
 EMERSON AU 190 & BT 245 YELLOW \$1,300.00, GREEN \$2,500.00,
 DARK RED \$2,700.00, BLUE \$6,850.00, BRIGHT RED \$11,000.00,
 ESPEY MIDGET, YOU NAME THE PRICE I WILL PAY IT!
 EMERSON BM258 YELLOW \$750.00, GREEN \$1,350.00, RED \$2,150.00, BLUE \$4,000.00
 EMERSON 564 BLACK \$500.00, GREEN \$1,150.00, RED \$1,650.00
 FADA L56, F55, 52, 5F50, 5F60, 136, 53X, YELLOW \$1,500.00, LT GREEN \$1,750.00
 MAROON & YELLOW \$2,200.00, YELLOW & BLUE \$2,500.00, YELLOW & RED \$3,100.00,
 EMERALD GREEN & YELLOW \$7,000.00, BLUE & YELLOW \$7,000.00,
 FADA 115, 116 & 1000 ALL YELLOW \$700.00, MAROON & YELLOW \$950.00,
 YELLOW & RED \$1,150.00, PEA GREEN \$1,300.00, BLUE & YELLOW \$2,550.00
 GAROD 6AUI MAROON \$675.00, YELLOW & RED 1,350.00,
 RED & YELLOW \$1,450.00, HALSON ANY COLOR \$1,500.00 TO \$5,000.00
 MOTOROLA 50XC ALL YELLOW \$1,750.00, BROWN & TORT \$2,750.00,
 RED & YELLOW \$6,000.00, GREEN & YELLOW \$6,250.00,
 MOTOROLA 52 YELLOW & TORT \$1,500.00, MAROON & YELLOW \$1,850.00,
 GREEN & YELLOW \$2,900.00,
 SONORA KM ANY COLOR \$1,600.00,
 SENTINEL 284 WAVEY GRILL YELLOW \$700.00, SAND 950.00,
 RED 1,450.00, BLUE 6,500.00
 SPARTON CLOISONNE ANY COLOR \$3,500.00 TO \$5,500.00, EMERSON 520 \$50.00

always buying any catalin or pre-war colored bakelite radios
 We will buy one piece or the entire collection.

"watch out there's a new guy in town"

WANTED

ADDISON 2 MAROON & YELLOW \$900.00, YELLOW & RED \$3,750.00
 ARVIN 532 ANY COLOR \$2,500.00,
 BENDIX 526 GREEN & BLACK \$625.00,
 DeWALD A501, A502 BROWN \$375.00,
 YELLOW \$425.00, RED \$1,200.00
 EMERSON AU 190 & BT 245 YELLOW \$1,300.00, GREEN \$2,500.00,
 DARK RED \$2,700.00, BLUE \$6,850.00,
 BRIGHT RED \$11,000.00,
ESPEY MIDGET, YOU NAME THE PRICE I WILL PAY IT!
 EMERSON BM258 YELLOW \$750.00, GREEN \$1,350.00, RED \$2,150.00, BLUE \$4,000.00
 EMERSON 564 BLACK \$500.00, GREEN \$1,150.00, RED \$1,650.00
 FADA L56, F55, 52, 5F50, 5F60, 136, 53X, YELLOW \$1,500.00, LT GREEN \$1,750.00
 MAROON & YELLOW \$2,200.00, YELLOW & BLUE \$2,500.00, YELLOW & RED \$3,100.00,
 EMERALD GREEN & YELLOW \$7,000.00, BLUE & YELLOW \$7,000.00,
 FADA 115, 116 & 1000 ALL YELLOW \$700.00, MAROON & YELLOW \$950.00,
 YELLOW & RED \$1,150.00, PEA GREEN \$1,300.00, BLUE & YELLOW \$2,550.00,
 GAROD 6AUI MAROON \$675.00, YELLOW & RED 1,350.00,
 RED & YELLOW \$1,450.00
 HALSON ANY COLOR \$1,500.00 TO \$5,000.00
 MOTOROLA 50XC ALL YELLOW \$1,750.00, BROWN & TORT \$2,750.00,
 RED & YELLOW \$6,000.00, GREEN & YELLOW \$6,250.00,
 MOTOROLA 52 YELLOW & TORT \$1,500.00, MAROON & YELLOW \$1,850.00,
 GREEN & YELLOW \$2,900.00,
 SONORA KM ANY COLOR \$1,600.00,
 SENTINEL 284 WAVEY GRILL YELLOW \$700.00, SAND 950.00,
 RED 1,450.00, BLUE 6,500.00
 SPARTON CLOISONNE ANY COLOR \$3,500.00 TO \$5,500.00,
 EMERSON 520 \$50.00

Collector's Guide to Antique Radios Combined Edition – CD-ROM

By Marty & Sue Bunis and George Kaczowka

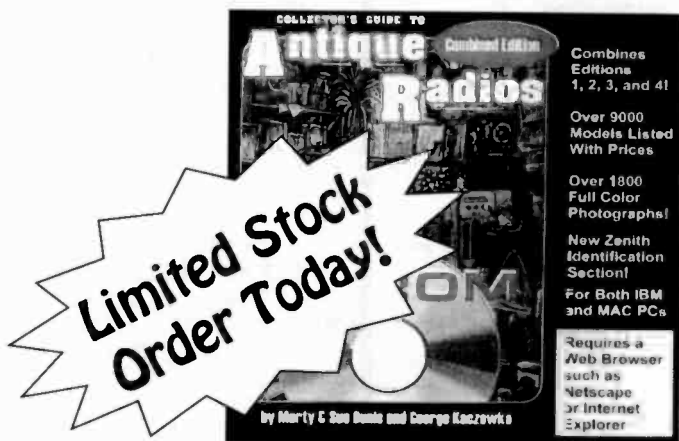

Combines Book Editions 1, 2, 3, and 4!
Over 9,000 Models with Pricing
1,800 Full Color Photographs
Model Number Index for All Manufacturers
Photo Index by Category

Runs on both IBM and Mac

Requires a Web Browser, such as Netscape Navigator or Internet Explorer

\$39.95

Everything stocked and shipped promptly – Radio is our middle name.

16th Anniversary Special! Free U.S. shipping thru June 30, 2000!

U.S. Orders - 16th Anniversary Special - free U.S. packing & book-rate shipping thru June 30, 2000. If using VISA or MasterCard, include name on card, card number and expiration date. Send payment with order. Mass. residents add 5% sales tax. Money back return policy. Softcover unless stated otherwise. Most orders shipped by next business day. Typical U.S. order will be received within 7 days, but allow 2-3 weeks. Foreign orders - write for shipping costs, or use credit card and specify air or surface (allow 2-3 months for surface shipping).



A.R.C., P.O. Box 2, Carlisle, MA 01741. Tel: (978) 371-0512

Fax: (978) 371-7129 – E-mail: ARC@antiqueradio.com – Web: www.antiqueradio.com



(Apr-00)

The Collector's Guide To Antique Radios - 4th Edition

By Marty & Sue Bunis



**Order
Today!**

8,500+ Battery & AC sets from the '20s - '60s
400+ color photographs
Updated prices
\$18.95 - Softcover

There are no transistor radios listed in the fourth edition. You will find them in
The Collector's Guide to Transistor Radios available from A.R.C. for \$16.95.

Everything stocked and shipped promptly - Radio is our middle name.

16th Anniversary Special! Free U.S. shipping thru June 30, 2000!

U.S. Orders - 16th Anniversary Special - free U.S. packing & book-rate shipping thru June 30, 2000. If using VISA or MasterCard, include name on card, card number and expiration date. Send payment with order. Mass. residents add 5% sales tax. Money back return policy. Softcover unless stated otherwise. Most orders shipped by next business day. Typical U.S. order will be received within 7 days, but allow 2-3 weeks. Foreign orders - write for shipping costs, or use credit card and specify air or surface (allow 2-3 months for surface shipping).



A.R.C., P.O. Box 2, Carlisle, MA 01741. Tel: (978) 371-0512

Fax: (978) 371-7129 - E-mail: ARC@antiqueradio.com - Web: www.antiqueradio.com



(Apr-00)

FOR SALE: Scott Marine #SLRM - \$175. Oscilloscope - \$175. RCA 9X571 mint - \$75. Crosley Sheraton cathedral - \$275. Ernest Odeneal, K5QJF, 2710 Lee St., Greenville, TX 75401. (903) 455-2113/455-5788. E-mail: odeneal@pulse.net

FOR SALE: The Country Belle Mod 556 radio, made by Guild, near mint, looks and works like new. Gordon Van Allen, 5822 Knollwood Dr., Ashtabula, OH 44004. Ph./fax: (440) 998-0723

FOR SALE: Vacuum tubes, new and used, auto vibrators, octal tube keyway replacement wafers, 6 - \$5. Radioparts, etc., send e-mail or postcard for eventual reply! **WANTED:** Tubes, horn speakers, Arcturus items S. Thanks! Bob Dobush, Arcturus Radio Supply, 126 S. Main, Wellington, OH 44090. (216) 227-0040. E-mail: bobtheatre@aol.com

FOR SALE: Moving and don't want to take it with me, radios, audio equipment, parts, test equipment, books, telegraph keys, etc. Please send LSASE for list for Frank Cuva Jr., c/o IBE Corp. 45-22 Pearson St., Long Island City, NY 11101

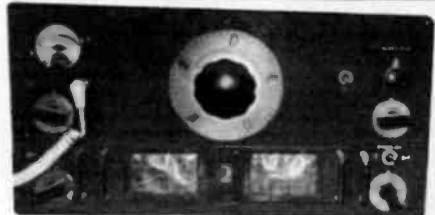

FOR SALE: Rare 1935 National HRO communications receiver. S-meter, doghouse power supply, four coils, and original manual, works perfect - \$750. Chris Cross, Box 94, McConnell, IL 61050

FOR SALE: National NC-188 receiver, good condition, works - \$125. Gott 630U amplifier, works - \$125; Gott preamp - \$25. Homemade amplifier. Copy of radio Craftsman C-550, has Dynaco A420 output. 5881's, works - \$150. Pair Scott 121C preamps, one has wood case - \$700. Eico HF-20 amplifier, good condition, works - \$100. Webster Electric 90 watt power amp, 6550's in output, works - \$150. Add UPS, call for details. Rick Weibezahl, 305 Belvidere Ave., Washington, NJ 07882. (908) 689-3276

FOR SALE: Motorola 77XM beautiful Art Deco ivory/gold trim wood cab. Spartan 557 very nice working - \$2,250. Philco Predictas 17" & 28" I have 13 left from last months sale. Crosley 63 TA wood table radio huge dial w/stars & stripes complete. 6D111 Belmont complete original. Emerson 7KW 228A in Ingraham cabinet works original hums. Crosley Pup General Motors cathedral 180MA all original wood knobs. Philco 1936 mantle radio complete - \$30. Quack medical device nice w/nickel plated controls weighs 9 lbs. Philco #20 cathedral needs cabinet repair, all orig w/brass dial escutcheon. Radio Servicemens caddy w/RCA decals - \$15. Hallicrafters S38A black hums all orig looks great. Traveler T201 works beautiful white cabinet w/pink grille all orig. Philco cath. 37-89 hums W.T. needs 6K7 cabinet repair. Bill Kalick, 3714 S. Lombard, Berwyn, IL 60402. (708) 788-9022, call after 9 pm CST

FOR SALE: Vintage loudspeakers, EV/Oxford/Utah/Quam. Send SASE list. Ed Crockett, 128 Buccaneer Dr., Hattiesburg, MS 39402. Fax: (601) 264-0226

FOR SALE: Bud Code Master, complete less key. Ken Lemke, 1452 Fall Creek Rd., Canisteo, NY 14823-9662. (607) 698-4938

FOR SALE: Atwater Kent Model 10 perfect - \$900. **WANTED:** Dial face for Hallicrafters SX62. Ray L. Mayeux, 520 Gladstone Blvd., Shreveport, LA 71104. (318) 868-1202

FOR SALE: Gates top level stereo limiter - \$150. Gates studioette 5X1 tube mixing console - \$250. Mark Schackow, 307 4th Ave., E, Lemmon, SD 57638. (605) 374-3424

FOR SALE: Hammarlund HQ110 w/clock - \$120. Cocoa Radio in box, Coke sign flashes w/music - \$95. Postal Junior Code Set, needs work - \$30. Belmont Mod 740, Sky Rover - \$100. GE Mod 100, circa 1946 - \$75. Zenith 5S-119, black dial, wood table radio - \$175. Zenith part radio, 4G903Y - \$20. Diawa RF speech processor, RF 400 - \$45. FSK 1000 by IRL - \$40. Coors Lite hat radio, N.I.B. - \$45. Classic Tunes microphone radio, N.I.B. - \$30. Motorola 65X11, with back, nice - \$85. Philco Model 66, tombstone - \$130. 15 transistor multi-band Westinghouse, Mod RPM 5020, AM/SW etc. - \$55. Hallicrafters S77A, works, no knobs - \$70. RCA 96T5, works - \$75. Stewart-Warner low boy cabinet only, nice with original grille cloth and escutcheon, probably Mod R-102A, B or E - \$75. Philco 37-610, parts - Call. Philco console, 40-180, chassis - \$15. American Bosch 610 - \$70. Firestone Air Chief, Model 7483-8 - \$60. Ward's Airline Mod 62-370 w/eye - \$100. RCA 86T1, BC/SW, part radio - \$50. Silvertone Model 8260 - \$50. Truetone D2026B - \$45. Emerson 595A - \$50. Arvin 35-86 - \$45. National NC57, part radio, no knobs - \$55. Truetone D1011, pushbutton - \$40. Hallicrafters S-40, S-77, SX-100 and SX-110 parts - Call. Have Trans-Oceanic parts. Workbench Guide to Practical Solid State - \$16. Radio/Phono Service Guide, 1957-59 - \$25. Simple Transistor Projects for Hobbyists and Students by Steckler, 1st ed. 1976 - \$20. Electronic Circuit Book 1 Project Construction, 1st ed. 1976, Mimms - \$12. Samm's Publication Eliminating Engine Interference by Lenk - \$12. (2) CB Radio, Leo Sands, excellent, 1976 - \$15. Understanding Electricity and Electronics, 446 pp. - \$23. Practical Electricity, Audel, 483 pp. - \$15. Electronic Communication, 801 pp. - \$15. Radio Handbook, 10th ed. - \$14. Fundamentals of Radio - \$20. Electronic Eng. Principals, 397 pp. - \$14. ARRL Antenna Handbook, 1956 - \$12. ARRL Antenna Handbook, 1994 ed. w/software disk - \$20. Messenger and Miller coils and IFs, also N.O.S. JFD dial belts - Call. Scott Mod 800B - \$250, pick up only. All of the above + S&H. Also, see ad in February A.R.C., page 60 and March ad, page 32 for reduced prices, call ore-mail. **WANTED:** Hallicrafters 5T Sky Buddy w/boy on dial face. S29 Sky Traveller or S39 Ranger. Also, need a small knob (not tuning knob) for Silvertone 1807. A volume knob for Zenith 6S119. And a complete Truetone D723, w/colorful dial. Ron Crowe, PO Box 117, Handley, WV 25102. (304) 442-8179. E-mail: rcrowe@wvutec.edu

FOR SALE: GE radio/phonograph RC 4679A in cherry. Also, Sonora crank phonograph parts. TCM, PO Box 363, Rotterdam Junction, NY 12150-0363

FOR SALE: Telefunken Model 5161W Jubilate - \$100. Western Union Telegraph Sounder, mfd. by J.H. Bunnell & Co. - \$85. Joel Camicia, 1811 N.E. 58th Ave., Portland, OR 97213-4103. (503) 287-7832

WANTED: In excellent condition: A batteries: Eveready #746 or Burgess #G3. B batteries: Eveready #482 or Burgess #M30 or Ray-O-Vac #202. Need 2 (A) types & 2 (B) types. Write to: Mike Hanke, PO Box 773, Wausau, WI 54402

WANTED: Base & driver for Citco (Canadian Independent Telephone Co.) horn speaker. Page 6 March A.R.C. Darrell Combs, 6587 Pacheco Way, Citrus Heights, CA 95610. (916) 969-0635

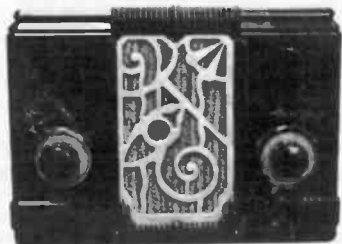

WANTED: Early (prewar II) plastic radios. I collect these objects of beauty to enhance my otherwise dull and uneventful life to which I am forever bound by my sad-but-true unworthiness and shortcomings: physical, emotional, and intellectual. Please write or call collect: Rain Buttignol, 214 State St., #7, Portsmouth, NH 03801. (603) 427-1384

WANTED: Schematic for Knight Star Roamer. Copy OK. Warren C. Sprague, 11855 Orlando Circle, Waynesboro, PA 17268. (717) 762-7283

WANTED: Buying Western Electric tubes, tubes 205D/E, N.O.S. tennis ball shape \$500; used \$340; 274A/B, N.O.S., engraved base \$265; used \$190. Tubes subject to inspection and testing. Call, write, fax or e-mail to: George Stagakis, 1714A 41st St., North Bergen, NJ 07047. (201) 867-9136. Fax: (201) 867-4044. E-mail: georgestv@aol.com

WANTED: RCA 9X571 largest gold louver. Philco 49-901 bottom half of case. Brian Kurre, 2222 Nodleigh Terr., Jarrettsville, MD 21084. (410) 692-0450

WANTED: Radio News May 1937, January 1944; Radio-Craft January, May 1940, August 1942. A.J. Bernard, PO Box 690098, Orlando, FL 32869-0098. (407) 351-5536. E-mail: ni4q@juno.com

WANTED: Zenith 25 tube Stratosphere or cabinet, any condition. Will trade from vast supply of fine radios or buy. Will pick up. Alan Jespersion, PO Box 17338, Minneapolis, MN 55417. (612) 727-2489. E-mail: mte612@aol.com

ANTIQUE TUBES

NEW Colorful Catalog of
Pre-Octal and Collector Tubes

for copy - e-mail: fathauer@home.com
or send request to:

George H. Fathauer & Assoc., LLC

688 W. First St., Ste.4, Tempe, AZ 85281

Phone: 480.968.7686 Fax: 480.921.9961

TUBE BID LIST AVAILABLE

WANTED: 1970s handheld LED calculators, all makes, models, especially HP (LED & LCD). Erik Hedegaard, 1084 Washington Ave., Pelham Manor, NY 10803. (914) 738-9422. E-mail: floete@aol.com

WANTED: Mallory Radio Service Encyclopedias, 4th/ed. (1941); 6th/ed. (1948); have others for trade. Gary A. Micanek, 226 Henry Ave., Manchester, MO 63011. (636) 227-7046. Email: micanek@aol.com

— WANTED —
**PICTURES FOR PHOTO REVIEW OR
TELEGRAPH REVIEW
PHOTOS MUST BE SHARP IN DETAIL
A SHORT DESCRIPTION IS A MUST!
SEE PHOTO REVIEW PAGES FOR
ADDITIONAL INFORMATION**

WANTED: SP600JX, SX73, BC342, BC348, HROs, Collins, Drake and etc. Masahiro Nada, 3-15-39 Nishishizu, Sakura, Chiba 285-0845 Japan. Fax: 011-81-43-487-1688. E-mail: nada@fsinet.or.jp

WANTED: Philco 89C '40, Admiral B, 29-G5. Ichiro Yamada, 10-21 Chiyodadai-cho, Kawachi, Nagano-shi, Osaka, Japan 586-0027. Ph/fax: 011-81-721-52-4695, mid/ev., local. E-mail: yamada1r@silver.ocn.ne.jp

WANTED: Awater Kent 10 breadboard, Model 4340 or Radiodyne, in excellent original condition. George Johnson, 1147 1/2 Camino San Acacio, Santa Fe, NM 87501. (505) 989-4490. E-mail: johnson@nytimes.com

WANTED: Escutcheon for Philco Model 20, dial for Philco Model 97, PN 275093. Fielding L. Grigsby, Jr. 1523 Towson Ave., Fort Smith, AR 72901. (501) 782-0111

WANTED: Beg, borrow or buy, test card for Tracor 599K receiver. Harry Weber, 4845 W. 107th St., Oak Lawn, IL 60453-5252

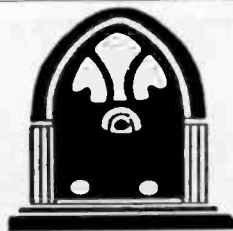

*Craig L. Graybar
Furniture Works Ltd.*

(414) 258-2390 or (888) 383-2390
SPECIALISTS IN RESTORING,
REPAIRING AND REPRODUCING
CLASSIC STYLED ANTIQUE TV,
RADIO & PHONOGRAPH CABINETS

Send us your plans or your project
via UPS for immediate price quotes



1535 S. 84th St.
West Allis, WI 53214



"We Turn Ideas Into Heirlooms"

FOR SALE: (2) R390A Hallicrafters SX110 SX100 parts radio. SX101A. SX108. SX76. S85. S120. S38. S20R. S19. SX24, 2 of them. SX130. Hammarlund SP400+PS. HQ180A+SP. HQ110. HQ100. HQ129 3 of them. HQ140. HQ145X. National FRG59. 240D+SP. NC300. NC46+SP. NC57. Scott 800BC+SP+PS. 6 more Scotts. FRG9600 VHF, UHF. Kenwood TS530S + AT230 + SP230. Heath Apache TX1 working. GR78 still in box. Knight R55. Knight R100A nice. Collins 51J project. Bearcat 9000 XLT scanner + phone converter. Some German wood & plastic Grundig working etc. & lots more. Call: Alan Carpenter, 6850 N. Camino De Fray Marcos, Tucson, AZ 85718. (520) 575-1960

FOR SALE: Rescued 1940(?) Zenith console chassis 8" x 13" 7 tube RP/BC/SW hook up, complete w/ faceplate, face glass on a half moon black face dial, Zenith dial pointer, 6 tone control tabs, push buttons, plastic control, knobs w/Z logo, speaker w/sound board and cloth and a cabinet light switch assembly, missing Zenith nameplate - \$85, includes shipping. Carl Falco, 392 Arcadia Dr., W. Islip, NY 11795. (631) 587-7099

FOR SALE: Airline Roamer - \$125. American Bosch: 35 cruiser - \$100; 38 - \$90; 205A - \$85; 331 - \$90; 610 - \$65; 605 - \$75; 808P - \$75. Atwater Kent: 20 - \$100; 20C - \$125. Arvin 722A - \$65. Brunswick, like Radiola 60 - \$100. Graybar 310 - \$125. Fada: 175 - \$110; 355 - \$100. Freed/Eisemann FE-15 - \$110. Crosley: Trirdyn - \$100; 52 - \$110. Kellogg 527 - \$130. Radiola: III - \$100; III-A - \$150. Philco: 610 chairside - \$100; 39-116 console - \$125. Steinite Duco - \$110. Stewart-Warner: 205 - \$110; 705 - \$110. Zenith: 10A console - \$175; 6D-116 - \$90. Stewart Warner 385 - \$110. Sonora RCU-208 - \$95. Splittdorf UR580 - \$110. Magnavox R3-B horn speaker - \$150. Radiola UZ-1325, horn - \$150. Western Electric 543, horn - \$130. J. Gary Cameron, 824 Andrews St., Southington, CT 06489. (860) 276-9200

FOR SALE: Regencys: TR1G, gray - \$365; TR4, black - \$250. Zenith Royals: 50, lt brown - \$30; 400, lt. brown - \$60; 500D, burgundy - \$82. Channel Masters: 6512, red - \$42; 6518A; black - \$27. Robert Morrison, 10238 117th Ln., Live Oak, FL 32060-6716. (904) 362-1521. E-mail: rrmorison@suwaneevalley.net

FOR SALE: Two high quality tape decks, Technics RS-631 and Sankyo STD-2000, both nice and clean - \$50 ea. plus shipping. Classic Radio & Television, 541 Riverside Dr. Box 61, Augusta, ME 04330. (207) 623-2059

FOR SALE: Optical and Electronic Research, Inc. 3D passport camera with flash, uses Polaroid film - \$75. Fisher 250TX receiver, solid state - \$125. Fisher 440-T receiver, solid state - \$125. H.H. Scott Model 99A, 1954, tube mono amp - \$125. RCA transistorized portable radio RGM-49E - \$30. RCA tube type portable radio, 1955, Mod 6-B-5B - \$30. About 125 Sams AR (auto radio) books - \$6 each. About 3,000 Sams Photofact folders, call for model lookup and available numbers - \$3 each. Garrard RC-88 Mk II record player w/base - \$65. Electronic Technical Circuit Digests, Mar. 1954 to Aug. 1961 - \$35. Grab bag special: hundreds of pounds of parts, mostly new, some in original packaging, including jacks, plugs, wires, cables, needles, lamps, controls, meters, relays, misc. hardware, and much more stuff, a generous 5 pound box, no 2 alike, for - \$10 ea. Zenith Trans-Oceanic Royal 3000 - \$75. Philco misc. service manuals 1960 & 1961 - \$20. All prices plus UPS. Bob Lynn, 26 E. Orchard St., Somerville, NJ 08876. (908) 685-9070

FOR SALE: Wavemagnet from Zenith 9S263 (chassis 5905) - \$15. Zenith SpaceCommand receiver w/motor and clicker - \$25. Plus UPS. **WANTED:** Cabinet (internal dimensions: 15" wide, 12" deep, 23" tall). For Zenith chassis 5905: wiring diagram, 3 knobs (not tuning ones), 6T5-G. Dick Friedman, 1502 Elmwood, Wimette, IL 60091. (847) 803-3050

CALL FOR OUR FREE 72 PAGE CATALOG!

ANTIQUE ELECTRONIC SUPPLY 1999 CATALOG
TUBES · PARTS · BOOKS · SUPPLIES



LOGO: 1999 CATALOG FAX: 800-820-4643 OR 800-706-6789

2001 SOUTH MAPLE AVE. TEMPE, AZ 85283

TUBES PARTS SUPPLIES

ANTIQUE ELECTRONIC SUPPLY
LIMITED PARTS DEPT.

your complete source for...

Tubes:

Over 3500 receiving, transmitting, audio and industrial types in stock, including many foreign and early types.

Transformers:

Hard to find power, filament, and output transformers as well as filter chokes for tube equipment. We feature HAMMOND performance transformers as well as many new old stock transformers.

Capacitors:

High voltage electrolytic and mylar capacitors, multi-section capacitors and more for tube circuits.

Parts:

Resistors, tube sockets, potentiometers, knobs, dial belt lamps, diodes, speakers, wire, phonograph needles and much more.

Literature:

Extensive selection of literature and books on antique radios, tubes, circuit diagrams, communication gear, and hi-fi equipment. Some items not available elsewhere!

Supplies:

Grill cloth, cabinet restoration supplies, batteries, chemicals, tools, test meters, kits and gifts.

6221 S. Maple Ave. · Tempe, AZ 85283 · (480) 820-5411 · FAX (480) 820-4643 or (800) 706-6789
www.tubesandmore.com · E-MAIL info@tubesandmore.com

Announcing a major new CD-Series



Collins Radio CD Technical Series

For decades Collins Radio equipment has been known as the Rolls-Royce of the communications equipment industry. Their equipment is highly sought by collectors throughout the world. The technical manuals are difficult and expensive to obtain. No longer, as this CD collection of 4 volumes contains every item of communication and amateur equipment that was manufactured from 1946 until 1980. The CD-Set that can be purchased as a group or singly. Every item of equipment including accessories is contained in this CD-Set. Where there were multiple editions of equipment manuals, we have provided multiple editions which cover early, middle, and late revisions to specific items of equipment manufactured. The set even contains all of the factory service notes for the major equipment items. A resource who's time has now arrived for the next millennium! Another major product of Radio Era Archives.

Volume 1 - Receivers

Volume 2 - Transmitters & Amplifiers

Volume 3 - Transceivers

Volume 4 - All accessories, etc.

Each Volume - \$ 75 Complete set of 4 - \$ 275 All + S&H

Requirements for use. PC, CD-Rom & Internet Browser

Other Radio Era CD-ROM Publications

Complete Riders Troubleshooters Manuals - highest resolution with database search

Complete set of Radio Boys books by Chapman on a single CD-ROM

QST - 80 years - 1915-1994 created for ARRL by Radio Era Archives

The Radiophile Series - 3 volumes

The Antique Radio Repair Series - 2 volumes

RCA Radiotron Handbook and HB-3 Tube Handbook CD's

Military R390-R390A/URR Technical CD-ROM

REA-Riders accurate index on CD-ROM

Sam's Dial Cord Series CD-ROM

Sam's Photofact Sets V1 & V2, (Sets 1-25 & 26-50)

Amos 'N Andy

and more on the way!

SCHEMATIC DIAGRAM & SERVICE MANUALS

Over 200,000 schematics available and thousands of radio manuals are now available. REA has digitized these into digital masters for fast & accurate reproduction. NOW WITH ELECTRONIC DELIVERY BY EMAIL - We have thousands of satisfied customers for our old radio publications

2043 Empire Central
Dallas, Texas 75235

Inquiries: 214-358-5195

Fax: 214-357-4693

Email: tsm@radioera.com

Hours: 9-5 M-F CST

We take all major credit cards

RADIO ERA ARCHIVES

Visit us on the Internet:

<http://www.radioera.com>

Announcing
A.R.C.'s Expanded Web Site Including
★ CLASSIFIED ADS ONLINE ★

www.antiqueradio.com

Look for your password
on each month's address label.

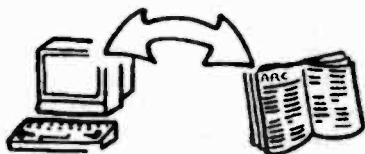

Try These New Features Online Now!

Searchable Classified Ads for Subscribers Only
Searchable Past Auction Prices

Coming Soon!

An Improved Searchable A.R.C. Marketplace

Updated Each Month

The Cover, On The Cover, Editor's Page
One or More Feature Articles (Web Editions)
Book Reviews, Radio Miscellanea
Coming Radio Events & Mark Your Calendar
Radio Club Listing (over 80 clubs, worldwide)
Links to Over 200 Related Web Sites

Archives on the A.R.C. Web Site

Nearly Four Years of Web Editions of A.R.C.

The A.R.C. Web Store

Subscribe and Renew
Order From Over 90 Books and Videos
Request a Free Sample Copy

Also on the A.R.C. Web Site

Frequently Asked Questions (FAQ) about A.R.C.
E-mail A.R.C. With Your Ads and Comments

A.R.C., P.O. Box 2, Carlisle, MA 01741. Tel: (978) 371-0512
Fax: (978) 371-7129 – E-mail: arc@antiqueradio.com – Web: www.antiqueradio.com

(Dec-99)

WANTED: Round brown Bakelite piece behind rheostats and switch on Atwater Kent 30. Eric Miller, PO Box 778, Linn, MO 65051. (573) 897-4121

WANTED: Marantz 2230B AM/FM dial scale and tuning meter or whole parts radio. Mark W. Hilliard, N3NBL, 921 South Edward St., Allentown, PA 18103. (610) 432-8089

RATE FOR ADDITIONAL WORDS:

29c per word

FIRST 20 WORDS FREE!

Cash or stamps OK for small amounts.

Your payment helps to keep A.R.C. healthy!

WANTED: Early plain style Pathé cone speaker, preferably with nickel frame. Kennedy 521 rheostats. Gary Carter, WA4IAM, 1405 Sherwood Dr., Reidsville, NC 27320. (336) 349-1991. E-mail: gcarter01@sprynet.com

WANTED: Manual for RCA 155-C oscilloscope. Magnetic pickup for 1937 Capehart. Bruce Mercer, 1226 S.E. Second St., Evansville, IN 47713. E-mail: maxbud12@sigecon.net

WANTED: Heathkit stereo amplifier Model AA-100. Don Hoover, 3060 N. Atlantic Ave., #106, Cocoa Beach, FL 32931. (407) 383-5352 days, (407) 783-4545, evenings

WANTED: Western Electric 594A driver \$5,000. Jun Mizuno, 933 Portwood Cir., San Jose, CA 95120. Ph./fax: (408) 268-4016

WANTED: Collins Radio Company Catalogs, promotional literature, manuals 1933-1983. Jim Stitzinger, 23800 Via Irapana, Valencia, CA 91355. 1-661-259-2011

WANTED: Paying \$1,500 for complete ZENITH TRANS-OCEANIC MILITARY R-520/URR in excellent and original condition, i.e. pages 84-85 The Zenith Trans-Oceanic - The Royalty of Radios. Kenneth F. Cerva, 3851 Harbor Hts. Dr., Largo, FL 33774-1209. (727) 584-6471

ELECTRON TUBES: Over 1 Million Tubes in Stock. Buy & Sell. Daily Electronics, 10914 NE 39th St. #B-6, Vancouver, WA 98682. 800-346-6667. 360-896-8856. 360-896-5476, fax

WANTED: Broadcast-type MICROPHONES. Early carbon, condenser, ribbons, etc. Cash or trade. James Steele, P.O. Box 620, Kingsland, GA 31548-0620. (912) 729-2242. E-mail: JSteele@k-bay106.com. Microphone collectors Internet site: <http://www.k-bay106.com/mics.htm>.

PHONO NEEDLES & CARTRIDGES (magnetic/ceramic). Over 500 cartridges and 5,000 needles. J. J. Papovich, 165 Trellis Ln., Sewell, NJ 08080. (856) 464-6741

WANTED: 12AP4 CRT. Any condition. TOP \$\$\$ PAID. Steve McVoy, 4350 Dublin Rd., Columbus, OH 43221. E-mail: smcvoy@columbus.rr.com

BOXED CLASSIFIED ADS WORK! This is a boxed classified ad. These ads can be run more than two months. See the inside back cover for details. Boxed ad deadline: the 1st of the month.

WANTED: Transformer for Philco 90 cathedral (p/n 5362) or junk chassis with good transformer. Gerry Hale, 538 Carner St., Richland, WA 99352. (509) 627-6319. E-mail: gd.hale@gte.net



WANTED: Symphony and Detrola Catalin radios. I am not a human being: I am a radio collector. God forbid! Pity me the lost soul that I am and fulfill my humble needs. Please write or call collect: Rain Buttignol, 214 State St., #7, Portsmouth, NH 03801. (603) 427-1384

WANTED: In quantities, common tube types 2050, 2051, or 502A. Bob Putnak, 1507 4th St., Monongahela, PA 15063. (724) 258-6236. E-mail: tubesound@home.com

WANTED: Buying European all make of radios! What you have? Richard Brill, PO Box 6367, Old Bridge, NJ 08857. (732) 607-0299. E-mail: rgbent@aol.com

WANTED: Radiola III or III-A Rheostat wiper arm, length 1 1/4 inch, shaft dia. 3/16 inch. Frank H. Gibson, 477 Laws Brook Rd., Concord, MA 01742-2022. (978) 369-5203. E-mail: hoot@fiam.net

WANTED: Two bone-colored plastic knobs for Zenith universal portable from 1940. Carl Steinberg, 5 Cannan Rd., Monsey, NY 10952. (914) 352-0701. E-mail: csteinberg@rflect.com

WANTED: Paying \$3,000 for green ZENITH TRANS-OCEANIC MILITARY JB600 in original excellent condition. Kenneth F. Cerva, 3851 Harbor Hts. Dr., Largo, FL 33774-1209. (727) 584-6471

Victrola Repair Service: Windup phonograph repairs, parts, springs, needles via U.P.S. Rod Lauman, 19 Cliff St., St. Johnsbury, VT 05819. (800) 239-4188, evess.

WANTED: Paying \$600 for Hallicrafters EC-6 Echophone commercial portable in excellent and original condition, i.e. page 147 Radios by Hallicrafters, 1st edition. Kenneth F. Cerva, 3851 Harbor Hts. Dr., Largo, FL 33774-1209. (727) 584-6471

WANTED: Vintage Electronic Music Synthesizers and modules by the following manufacturers, especially the listed models. **Aires** Modular, System III. **ARP** 2500. **Buchia** Modular, 100, 400. **E-mu** Modular. **EML Electrocomp** 100, 101, 200. **EMS** Synthi A, Synthi AKS, VCS3. **Korg** Modular PS-3100, PS-3200, PS-3300. **Moog** Theramin, Modular, Series 15, 35, 55. **Oberheim** SEM modules, 2-, 4- & 8-Voice Systems. **Paia** Modular 2700, 4700. **Roland** Modular Systems 100, 700. **Serge** Modulares, System 79. **Synton** Modular System. Call and surprise me; make my day! John V. Terrey, 498 Cross St., Carlisle, MA 01741. (978) 369-9770. Fax: (978) 371-7129

Looking for a Price Guide?

- The Collector's Guide to Antique Radios, 4th Ed., Bunis.** *This guide covers radios from 1920s to 1960s. Over 8,500 prices and many all new color photos are included.* \$18.95
- The Collector's Guide to Antique Radios, Combined Ed., CD-ROM, Bunis & Kaczowka.** *Combines book editions 1, 2, 3, and 4. Over 9,000 models with pricing. Model number index for all manufacturers, photo index by category. 1,800 full color photos. Requires a web browser. IBM & Mac.* \$39.95
- The Collector's Guide to Novelty Radios, Bunis & Breed.** *The source for novelty transistor radios in all shapes & sizes. Radios are described in detail with current prices. 600+ color photos. 224 pgs.* \$18.95
- The Collector's Guide to Novelty Radios, Book II, Bunis & Breed.** *All new 2nd volume. New radios are described with current prices. 600+ all new color photos. 208 pgs.* \$19.95
- The Collector's Guide to Transistor Radios, 2nd Ed., Bunis.** *Identifies the most sought-after vintage transistor radios. Over 2,900 models, 375 all new color photos, with current prices. 320 pgs.* \$16.95
- The Collector's Guide to Vintage Televisions, Durbal & Bubenheimer.** *Includes information about the size of the screen, year of manufacture, cabinet composition, and current value for over 1,400 vintage TVs made from 1945-1960 and transistor sets through 1980. 200+ color photos. 176 pgs. New.* \$15.95
- Genuine Plastic Radios of the Mid-Century, Jupp & Piña.** *Overview of plastic table radios with ads, vintage black & white photos. 439 color photos. 208 pgs. Hardcover.* \$39.95
- Ham Price Guide, 2nd, Eugene Rippen.** *Prices for over 3,800 transceivers, receivers, tuners, transmitters, amplifiers, antennas, test equipment, books, tubes and catalogs. Small print. 81 pgs. Softcover.* \$10.95
- The Radio Collector's Directory and Price Guide, 1921-1965, 2nd Ed., Grinder.** *Directory of over 20,000 radios by manufacturer, model number, year, etc., with prices. History, cabinet styles, vacuum tube development chapters. 500 pgs.* \$26.95
- Radios by Hallicrafters, 2nd Ed., Dachis.** *The most definitive book on the company. Over 1,000 photos (some color) on everything they made. Additional coverage & updated pricing. An invaluable tool for anyone interested in Hallicrafters. 225 pgs. New.* \$29.95
- The Talking Machine, Fabrizio and Paul.** *Contains over 550 photos of internal and external horn phonographs. The text and value guide, complemented with lots of visuals, make this book a must in your library. 256 pgs. Hardcover Only.* \$69.95
- Transistor Radios: 1954-1968, Smith.** *Over 1,000 transistor radios identified by manufacturer, marketing organization, type, and style. Color photos and price guide. 160 pgs.* \$29.95
- Transistor Radios, A Collector's Encyclopedia and Price Guide, Lane.** *Identification guide to over 2,500 transistor & novelty radios. History & key to collecting chapters. 170 pgs.* \$19.95
- Zenith The Early Years, 1919-1935, Bryant & Cones.** *Explains the Zenith story. Discover never published photos, documents and info. 300 photos & illustrations, 120 color. 224 pgs.* \$29.95
- Zenith Transistor Radios, Evolution of a Classic, Smith.** *A complete listing of all transistor radio models created by Zenith from 1955-65. Color photos and price guide. 160 pgs.* \$29.95

Everything stocked and shipped promptly – Radio is our middle name.

16th Anniversary Special! Free U.S. shipping thru June 30, 2000!

U.S. Orders - 16th Anniversary Special - free U.S. packing & book-rate shipping thru June 30, 2000. If using VISA or MasterCard, include name on card, card number and expiration date. Send payment with order. Mass. residents add 5% sales tax. Money back return policy. Softcover unless stated otherwise. Most orders shipped by next business day. Typical U.S. order will be received within 7 days, but allow 2-3 weeks. Foreign orders - write for shipping costs, or use credit card and specify air or surface (allow 2-3 months for surface shipping).



A.R.C., P.O. Box 2, Carlisle, MA 01741. Tel: (978) 371-0512

Fax: (978) 371-7129 – E-mail: ARC@antiqueradio.com – Web: www.antiqueradio.com



(Apr-00)

WANTED: Electron tubes, ball bearings, radio & aircraft receivers & transmitters, connectors, lamps, relays, switches breakers. Hy Ness Company, 709B Delair Rd., Cranbury, NJ 08512-4212. (609) 395-1116. Fax: (609) 395-1117

WANTED: Biddle measuring instruments. Wood electric wall clock. Westinghouse phase angle meter. Henry Weiland, 8946 West Grantosa Dr., Milwaukee, WI 53225. (414) 463-4681

WANTED: Clean, working, no damage RCA 2XF91 green, brown. Paying up to \$30. Greg Sheppard, W3FSP, 4402 Jupiter St., Rockville, MD 20853-3255. E-mail: moreradios@webtv.net

WANTED: Audio Engineering/Audio Magazine 1947-1965, and 1940s-1960s Japanese audio magazines. Randy Liebermann, 2820 Lee Oaks Pl. #102, Falls Church, VA 22046-7339. (703) 560-5790. E-mail: lunarcity@aol.com

WANTED: HP Audio Oscillator 204D & HP distortion analyzer 334. Manual for Orban 622b parametric eq. John Sampson, 75 Glenwood Dr., Leominster, MA 01453. (978) 537-0092. E-mail: sampsonj@massed.net

WANTED: Antenna for Priess radio. An early loop type. Jim Berg, 4261 Wilcox Rd. Box A, Northport, WA 99157. (509) 732-4047. E-mail: jimberg@webtv.net

WANTED: Antenna coil assembly for Zenith 8S154/129, part #S4419. Steve Hansman, 855 Arundel Dr. N., Arnold, MD 21012. (410) 974-0561. E-mail: Shans01a@aol.com

WANTED: Picture or knobs for Webster-Rauland W819, coils for RCA AR1145. Jiri Placek, 60 Applewood Ln., Boyertown, PA 19512. (610) 367-0861

WANTED: National Semiconductor Audio/Radio Handbook circa 1980. John Lomas, 253 Elm Ave., Glen Riddle, PA 19063-5739. Home: (610) 459-0186

WANTED: Battery farm sets, no junkers please. John Evans, 8511 Thompson Rd., Highlands, TX 77562. (281) 426-3952. E-mail: jevans35@juno.com

WANTED: Shadowgraph assy. for Philco 37-640, chassis Airline 62-101, dial for Zenith Porthole TV. Keith Park, 31 Barkwood Ln., Clifton Park, NY 12065. (518) 373-0417

**HAVE YOU MOVED? ARE YOU MOVING?
PLEASE NOTIFY US A.S.A.P.
SEND US YOUR...
OLD ADDRESS
NEW ADDRESS and
SUB #
MANY THANKS!!!!**

WANTED: Brunswick 11 chassis, Clarion 60 or 70 chassis, Crosley 50 case. Richard E. Jehlik, 14441 N. River Rd., Omaha, NE 68112. (402) 457-4604 after 9 pm. E-mail: rjehlik@creighton.edu

WANTED: Picture of Magnavox Type TRF 5 radio, Mod A #1392. Can I get supplies to rebuild old speakers? Harry MacMullan, 469A Garnet Mine Rd., Boothwyn, PA 19061. (610) 494-4196. E-mail: crystal11@usa.com

WANTED: Wood radios with chrome grilles, miniature cathedrals, and tiny 1930s wood sets. Jay Malkin, 1250 Galapago No. 206, Denver, CO 80204. (303) 623-6451

WANTED: For Marconiphone II w/peep hole: UV socket, bracket(?) interior/exterior jpegs. Ted Hutson, 11 1/2 Winthrop Ave., Beverly, MA 01915-4139. (978) 922-3405. E-mail: tedhutson@yahoo.com

WANTED: Marconi receivers and advertising. Will purchase or have many trade items. Barry A. Janov, 2454 Dempster St., Suite 416, Des Plaines, IL 60016. (847) 299-8999. E-mail: marconifon@aol.com

300+ STALLHOLDERS
will be exhibiting at the next

National Vintage Communications Fair

HALL 11 • NEC (Birmingham) • UK
• Sunday 30th April 2000 •
— 10.30am - 4pm —

Britain's **premier event** for buying
VINTAGE

RADIOS,
EARLY
TVs, and
GRAMS

etc. etc.



For further details/bookings:

NVCF, 13 Belmont Road, Exeter, Devon, ENGLAND

— Telephone (01392) 411565 —

Internet <http://www.angelfire.com/tx/sunpress/index.html>



BUY/SELL

TUBES

NEW & USED

SEND FOR OUR "WANT LIST"
OR
OUR **FREE CATALOG**

ELECTRON TUBE ENTERPRISES
P. O. BOX 8311
ESSEX, VT 05451-8311

TEL: 802-879-1844
FAX: 802-879-7764

EMAIL: etetubes@vbimail.champlain.edu

FOR SALE: Five volumes Beitman's Most-Often-Needed Television, 1956-60, 190 pp/each - \$25 + ship. John R. Tebeau, 2572 Oak Villa Rd. NE, Thomson, GA 30824. (706) 595-8211. E-mail: Tebeauj@aol.com

FOR SALE: N.O.S. flybacks & yokes by Merit, Thordarson, Stancor, Ram, etc. for pre-1970 TVs. Stock up with our half-price inventory reduction sale - \$6.50 each, \$25/5, \$40/10, plus shipping. Applies only to stock available. Several thousand in stock! Don't ask for Predictas, portholes or 7"ers. They're long gone. Mail list (use TV model #) with alternate #s to: Vintage TV & Radio, 3498 W. 105 St., Cleveland, OH 44111. E-mail: vintageradio@ameritech.net

FOR SALE: Zenith Golden Triangle to restore, shows well, bottom chip, missing knob, some pitting - \$50. David Rush, WB4FRE, 45 High Pond Ln., Bedminster, NJ 07921. (908) 234-0321

FOR SALE: Philco parts for Model 70 & 90 (no speakers). Atwater Kent Model 72 chassis and front panel - \$50. RCA 45 players How to Repair Technical manual - \$10. Idler wheels and all parts. RCA-Edison-Columbia-Victor Novelty List, LSASE 55c. Belmont Radio Model 6D111 (1946) - \$200. Bearcat Model BC 3 Scanner - \$15. Vacuum Tubes type 45n - \$50 each. Electronic Stock Certificates - \$10 and up, for List SASE 33c postage. Old type interstage transformers - \$25 each. Variometers, variocouplers, large variable capacitors. For list send SASE 33c postage. Cartridges and needles for all phonographs. Edison diamond disks for list SASE 33c postage. Homebrew Radio with 2-199 and 1-120 tubes, wood cabinet - \$75. Plus shipping on all items. J.J. Papovich, 165 Trellis Ln., Sewell, NJ 08080. (856) 464-6741. E-mail: jjpapo@juno.com

FOR SALE: Stromberg-Carlson radios Models 130-H - \$140. 1105 portable - \$40. RCA 118 - \$160. Grunow 580 - \$170. All working untested radios but very restorable. Stromberg-Carlson Models 250-L - \$250; and 420 - \$50. Call: Arnie Sanchez, 9615 Rockhurst, Houston, TX 77080. (713) 939-9221

CLASSIFIED AD NOTICE

Please check your ads carefully before sending them in. Once ads are received, it is not always possible to refund the amount sent, pull the ad or make changes.

SERVICES: Antique radio repair at reasonable prices. Work guaranteed. Midwest Antique Radio Service, 22164 Fleming Ave., Tomah, WI 54660. (608) 372-0716. E-mail: rhodesl@mwt.net. Web: <http://www.mwt.net/~rhodesl>

SERVICES: Decals and dial scales for antique radios. SASE for list. Rock-Sea Enterprises, PMB 241, 323-110 E. Matilija St., Ojai, CA 93023. (805) 646-7362. E-mail: dials@juno.com

SERVICES: Free schematics by e-mail www.joes.com/home/Radiorelic (capitol "R"). Zach Taylor, 1413 Broadway, Lincoln, IL 62656

SERVICES: Repair and restoration of antique radio and televisions, 2-week turnover, 40 yrs. experience, guaranteed work. Tom's Antique Radio & TV, 8 Howe Ln., Millbury, MA 01527. (508) 865-6293

SERVICES: Hand-wound plug in coils for SW-3s, Wasp, and Superwasp. Tony LeDoux, PO Box 74, Schoenchen, KS 67667. (785) 625-8669

SERVICES: Dial covers - \$15. Loose, mounted in your bezel - \$22.50. Doyle Roberts, HC 63, Box 236-1, Clinton, AR 72031. (501) 745-6690. E-mail: drob@hypertech.net

SERVICES: Rider/Sams schematics, 1920-1970 - \$3 ppd. Send make/model to: Richard A. Lerche, 1561 Bluebell Ct., Livermore, CA 94550. (925) 447-9365. E-mail: lerche@home.com

SERVICES: Hickok factory authorized contact person offering affordable, professional services, calibration and technical assistance. **FOR SALE:** Beautiful new master crafted, natural finish wood carrying cases for your Hickok tube testers. Hickok test equipment accessories. **WANTED:** Hickok test equipment. **MESSAGE:** Service that satisfies since 1943. Thanks for your continued support and patience. Wendell E. Hall, 3 Mockingbird Cir., Jeffersonville, IN 47130. Home phone: (812) 282-9709. Shop: (812) 256-2090. Fax: (419) 793-4036. E-mail: hickok@bellsouth.net. Please always include your phone, fax or e-mail with your communications

SERVICES: Radio schematics & service data, U.S. & Canadian models, 1920s to 1960s - \$2.50 plus #10 SASE. Steve Rosenfeld, PO Box 387, Ocean Gate, NJ 08740. (609) 597-2201. E-mail: srosenfeld@ems.att.com

AUCTION: 20 year collection of antique radios and related items. 40 vintage radios, including 1923 Howard, Tri City, Federal, Tuska, Freed-Eisemann, Atwater Kent, Crosley, Radiola 29, horn speakers, tubes, parts, test equipment and Red Gem cylinder phonograph, toy phono, new children's 78s, 1905 IBM 3' oak time clock and more related fine items. Carlson Auction Center 5 minutes North of Cambridge, Minn. on Hwy., No. 65, Grandy, Minn. (763) 689-4652. Sunday, April 9, 2000 at 12:00 noon. Doug Whitney, 1115 Robinson Dr., Coon Rapids, MN 55433

MESSAGE: Radios from the 30s, 40s & 50s, wood and Bakelite, table models & consoles, good prices & new sets all the time. Valerie & Seth Gardner, Brandywine River Antiques Market, 878 Baltimore Pike (Rte. 1), Chadds Ford, PA 19317. (610) 388-2000

MESSAGE: Thanks to the person from Allied Signal for the 51S1 manual from: John Eickhof, Box 258, Wendell, ID 83355

HELP: Collecting information on superregenerative FM broadcast band radios. All relevant information appreciated. Andrew Mitz, 4207 Ambler Dr., Kensington, MD 20895. (301) 897-5531. E-mail: arm@gnode.org. Web: www.somerset.net/arm/fm_only.html

HELP: Service literature for Cobra 142GTL, Sams CB219, good copy OK. Jim Gaudin, 134 Hawthorne Dr., Danville, VA 24541. (804) 791-2286. E-mail: jimg@goabco.com

HELP: Need small knob for GE Model K-50 cathedral. A. Eisenstein, 10815 Falstaff Rd., Sebastopol, CA 95472. (707) 829-7559

HELP: Attention all Coco III clubs. Need an alternative to DMP-105 printer since ribbon cartridge no longer made. Can get Epson printers here. D'arcy Brownrigg, 15 Old Chelsea Rd., Chelsea, Quebec, Canada J9B 1K9. (819) 827-0128



COMING RADIO EVENTS

AUSTRALIA - Apr. 1

HIST. RADIO SOC. OF AUSTRALIA
SYDNEY GROUP
SWAP MEET

Sydney - 2WS Carpark

Noon

Info: John McIlwaine - 02 4332 6008

Fax: 02 4333 7775

VIRGINIA - Apr. 5

TIDEWATER ANTIQUE RADIO ASSOC.
MEETING

Call for location & directions

7 pm

Info: Vic Johnston - (757) 825-0757, eves.

Scott Balderston - (757) 545-0449, eves.

CALIFORNIA - Apr. 1

CALIFORNIA HISTORICAL RADIO SOC.
SWAP MEET

Concord, CA - Solano Drive-In Theatre
Flea Market

8 am

Info: CHRS Hotline - (415) 821-9800

ARKANSAS - Apr. 6

ANTIQUA RADIO COLLECTORS CLUB
OF FORT SMITH
MEETING

Fort Smith, AR - St. Luke Lutheran Church
Waldron Road, at Free Ferry

7:30 pm

Info: Paul Tucker, 4700 N. "N" St.

Fort Smith, AR 72904 - (501) 782-8178

WASHINGTON - Apr. 1

RADIO ENTHUSIASTS OF PUGET SOUND
MEETING

Seattle, WA - Queen Anne Library
400 W. Garfield

2 pm

Info: REPS, 9936 N.E. 197th Street

Bothell, WA 98041 - (206) 488-9518

NEVADA - Apr. 6

NEVADAN ENTHUSIASTS FOR
ANTIQUA RADIOS
MEETING

Las Vegas, NV - Sunset Road Library
Corner of Green Valley Pkwy. & Sunset Rd.

7 pm

Info: Cort & Eileen Ancman - (702) 312-7110

ancman@juno.com

NEW YORK - Apr. 2

GREATER NEW YORK VINTAGE
WIRELESS ASSOCIATION
SWAP MEET

Lake Ronkonkoma, NY - 367 Hawkins Ave.

8 am-Noon

Info: Chris Lieppert - (516) 471-9526

Chris Bacon - (516) 821-7618

FRANCE - Apr. 8

CLUB HISTOIRE ET COLLECTION RADIO
MEETING

Metz - Metz-Born Exhibition Site

9:30 am

Info: M. LeClercq - 03 87.76.65.72

ONTARIO - Apr. 5

OTTAWA VINTAGE RADIO CLUB
FLEA MARKET - MEETING

Ottawa, Ont. - The Ottawa Citizen
Conference Room - 1101 Baxter Rd.

7 pm: Flea Market - 8 pm: Meeting

Theme: Ham Equipment

Presentation: Dayton Hamfest Video

Presenter/Host: Larry Wilcox

Info: OVRC - (613) 832-3097

KENTUCKY - Apr. 8

MID-SOUTH ANTIQUA RADIO COLLECTORS
SWAP MEET

Henderson, KY - Day's Inn Motel
2044 U.S. 41 North

Hotel: (800) 329-7466 (ph./fax)

Info: Jim Church - (812) 867-0721

MENTION A.R.C. WHEN CONTACTING CLUBS!

OKLAHOMA - Apr. 8

OKLA. VINTAGE RADIO COLLECTORS MEETING

Oklahoma City, OK - Oklahoma Station BBQ
Springdale Shopping Center, 4333 N.W. 50th

6 pm: Dinner

7 pm: Meeting

Info: Jim Collings - (405) 755-4139, after 6 pm
Mike Lapuzza - (405) 745-3394, after 7 pm

NEW ZEALAND - Apr. 9

NEW ZEALAND VINTAGE RADIO SOCIETY WELLINGTON MEETING

Wellington - Tireti Hall
Te Pene Ave., Titahi Bay

1 pm

Info: Bob Hatton, 40 Rose St.
Wadestown - 04-4728788

OREGON - Apr. 8

NORTHWEST VINTAGE RADIO SOCIETY MEETING

Oregon City, OR - Abernethy Grange Hall
15745 S. Harley Ave.

10 am

Info: Ed Charman, PO Box 82379
Portland, OR 97282-0379 - (503) 654-7387

GEORGIA - Apr. 10

SOUTHEASTERN ANTIQUE RADIO SOC. MEETING WITH SHOW & TELL

Norcross, GA - Picadilly Cafeteria
3400 Holcomb Bridge Road

6:30 pm

Topic: "G" "H" & "N" Radios

Info: Gordon Hunter - (770) 475-0713
SARS, PO Box 1055, Tucker, GA 30085-1055

PENNSYLVANIA - Apr. 8

PITTSBURGH ANTIQUE RADIO SOCIETY MEMBERSHIP MEETING

Brentwood, PA - Brentwood Presbyterian
Church Hall, 3725 Brownsville Rd.

10 am: Flea Market

Noon: Meeting

Presentation: Century of Recorded Sound
Info: Sev Dvorsky - (412) 344-6633

MISSOURI - Apr. 11

ANTIQUERADIO COLLECTORS & HISTORIANS OF GREATER ST. LOUIS MEETING

Kirkwood, MO - Kirkwood Community Center
111 S. Geyer Rd., Room 201-A

7:30 pm: Meeting

(earlier for conversation)

Show & Tell, Swap Table

Info: Derek Cohn, 8141 Stratford Dr.,
Clayton, MO 63105 - (314) 725-2333

AUSTRALIA - Apr. 9

HIST. RADIO SOC. OF AUSTRALIA NSW NORTH COAST GROUP MEETING

Call for Time & Location

Info: Ted Gill - 02 6653 2216

N. CAROLINA - Apr. 11

EAST CAROLINA ANTIQUE RADIO CLUB MEETING

Greenville, NC - Golden Corral Rest.
504 S.W. Greendale Blvd.

6:30 pm

Info: Bill Engstrom - (252) 355-8732
Herman Schnur - (252) 752-2264

NEW MEXICO - Apr. 9

NEW MEXICO RADIO COLLECTORS CLUB MEET

Albuquerque, NM - Anna Kaseman Hospital
8300 Constitution Ave. (W. of Wyoming)

1:30 pm: Tailgate Swap Meet

2 pm: Program - Zenith Radios,
Show & Tell and Auction

Info: Chuck Burch, 39 Chaco Loop, Sandia Park,
NM 87047 - (505) 286-9674 - ChuckBurch@aol.com

OHIO - Apr. 11

ANTIQUERADIO COLLECTORS OF OHIO MEETING

Kettering, OH - National City Bank Basement
4100 Far Hills Ave., at Stroop Rd.

7:30 pm

Topic: Early TVs

Info: John Heck - (937) 435-1571
ARCO, PO Box 292292, Kettering, OH 45429

SUBMISSION DEADLINE

5th OF MONTH

Please include date, time, place, directions,
event details & information/contact person.

Attend a radio event near you, learn,
meet others in the hobby, and perhaps
find an item or two for your collection!

MARK YOUR CALENDAR

- Apr. 1 - Australia, Sydney - HRSA Meeting
Apr. 1 - CA, Concord - CHRS Meeting
Apr. 1 - WA, Seattle - REPS Meeting
Apr. 2 - NY, Lake Ronkonkoma - GNYVWA Swap
Apr. 5 - Ontario, Ottawa - OVRC Flea Market/Mtg.
Apr. 5 - VA, TBA - TARA Meeting
Apr. 6 - AR, Fort Smith - ARCCFS Meeting
Apr. 6 - NV, Las Vegas - NEAR Meeting
Apr. 8 - France, Metz - CHCR Meeting
Apr. 8 - KY, Henderson - MSARC Swap Meet
Apr. 8 - OK, Oklahoma City - OKVRC Meeting
Apr. 8 - OR, Oregon City - NWVRS Meeting
Apr. 8 - PA, Brentwood - PARS Membership Meeting
Apr. 9 - Australia, NSW - HRSA Meeting
Apr. 9 - NM, Albuquerque - NMRCC Meet
Apr. 9 - New Zealand, Wellington - NZVRS Meet
Apr. 10 - GA, Norcross - SARS Meeting
Apr. 11 - MO, Kirkwood - ARCHGSL Meeting
Apr. 11 - NC, Greenville - ECARC Meeting
Apr. 11 - OH, Kettering - ARCO Meeting
Apr. 11 - PA, Telford - DVHRC Meet & Auction
Apr. 11 - TX, Houston - HVRA Meeting
Apr. 13 - AR, Little Rock - AARC Meeting
Apr. 14 - NJ, Freehold - NJARC Meeting
Apr. 15 - Australia, Melbourne - HRSA Swap Meet
Apr. 15 - CA, Corona - SCARS Meet
Apr. 15 - TX, Houston - HVRA Basic Elec. Seminar
Apr. 15 - TX, Irving - VRPS Meeting
Apr. 15 - WV, Huntington - PARS/MRAT Spring Fever
Apr. 15-16 - CO, Denver - CRCC Show & Sale
Apr. 16 - TX, Schertz - TARC Meeting
Apr. 16 - VA, Sully Station - MAARC Meeting
Apr. 16 - WA, Seattle - PSARA Meeting
Apr. 17 - New Zealand, Auckland - NZVRS Meeting
Apr. 18 - CA, Sacramento - CHRS-Sac. Meeting
Apr. 19 - OH, Cincinnati - CARS Meeting
Apr. 19 - OH, Columbus - COARA Meeting
Apr. 20 - Australia, Melbourne - HRSA Gen. Mtg.
Apr. 20 - NY, Goshen - HARPS Meeting
Apr. 22 - CA, San Francisco - CHRS Earth Day 2000
Apr. 22 - VA, Roanoke - RARE Spring Swap Meet
Apr. 24 - AL, Birmingham - ALHRS Meet
Apr. 25 - OH, Kettering - SPARK Meeting
Apr. 28-May 1 - Brazil, Sao Roque - Swap & Auction
Apr. 29 - NH, Nashua - NEARC Meet
Apr. 29 - TN, Nashville - MCVRPS Spring Swap Meet
Apr. 30 - IL, Elgin - ARCI Meeting
Apr. 30 - UK, Birmingham - NVCF Meet
May 3 - Ontario, Ottawa - OVRC Auction
May 3 - VA, TBA - TARA Meeting
May 4 - AR, Fort Smith - ARCCFS Meeting
May 4 - NV, Las Vegas - NEAR Meeting
May 5-6 - CA, San Luis Obispo - MRCG Meet
May 5-6 - TX, TBA - HVRA Auction
May 6 - CA, Los Altos Hills - CHRS Swap Meet/Auction
May 6 - WA, Seattle - REPS Meeting
May 7 - NY, Lake Ronkonkoma - GNYVWA Swap
May 8 - GA, Norcross - SARS Meeting
May 9 - MO, Kirkwood - ARCHGSL Meeting
May 9 - NC, Greenville - ECARC Meeting
May 9 - OH, Kettering - ARCO Meeting
May 9 - PA, Telford - DVHRC Meet & Auction
May 11 - AR, Little Rock - AARC Meeting
May 12 - NJ, Freehold - NJARC Meeting

MARK YOUR CALENDAR

(Continued from bottom left column)

- May 13 - CA, Valencia - SCARF Meet
May 13 - France, St. Ouen - CHCR Quarterly Meeting
May 13 - OK, Oklahoma City - OKVRC Meeting
May 13 - PA, Kutztown - 2nd Annual Radio Meet
May 13 - TX, Houston - HVRA Basic Elec. Seminar
May 19-20 - MN, Plymouth - Radio Daze 2000
May 19-21 - OH, Dayton - Hamvention
May 20 - AL, Decatur - SVWA Swap Meet
May 20 - NC, Spencer - CC-AWA Spring Swap Meet
May 20 - OR, Oregon City - NWVRS Meeting
May 20 - OR, TBA - NWVRS Spring Swap Meet
May 20 - TN, Memphis - MARC Spring Swap Meet
May 20 - TX, Kyle - TARC Meeting
May 21 - CO, Denver - CRC Meeting
May 21 - NJ, Wayne - WPAL Mech. Mus-c Extravaganza
May 28 - British Columbia - CVRS Meeting
May 28 - Manitoba - CVRS Spring Flea Market
† Jun. 9-10 - IN, Indianapolis - IHRS/AWA Spring Fling
Jun. 15-17 - MD, Beltsville - MAARC Radio Activity
Jun. 30-Jul. 1 - WA, Seattle - PEMCO/REPS Showcase
† Jul. 6-9 - MI, Lansing - MARC Extravaganza '00
Jul. 15 - NH, Nashua - NEARC Meet
Aug. 4-6 - IL, Elgin - ARCI Radiofest XIX
Aug. 19 - IN, Elkhart - IHRS Summer Meet
Aug. 26-27 - MA, Boxboro - Boxboro 2000 (ARRL)
Sep. 6-9 - NY, Rochester - AWA Meet
Oct. 14 - IN, Greenfield - IHRS Fall Meet
Oct. 21 - NH, Nashua - NEARC Meet

See expanded listing for many of these events

† = Changed Date

PENNSYLVANIA - Apr. 11

DELAWARE VALLEY HIST. RADIO CLUB MEETING - SWAP MEET - AUCTION

Telford, PA - Telford Community Bldg.
Hamilton & Hamlin

7:30 pm

Info: Bill Overbeck, PO Box 847,
Havertown, PA 19083

TEXAS - Apr. 11

HOUSTON VINTAGE RADIO ASSOC. MEETING - PROGRAM - AUCTION

Houston, TX - TBA

6:30 pm

Info: Bill Wertzner - (713) 721-2242
mingqi53@earthlink.net

ARKANSAS - Apr. 13

ARKANSAS ANTIQUE RADIO CLUB MEETING

Call for Location and Directions

7 pm

Info: Tom Burgess - (501) 455-0773
(Call to confirm details)

NEW JERSEY - Apr. 14

NEW JERSEY ANTIQUE RADIO CLUB MEETING

Freehold, NJ - Grace Lutheran Church
West Main St. & Park Ave. (Old Rt. 33)
7:30 pm

Info: Marv Beeferman - (609) 693-9430
Phil Vourtsis - (732) 446-2427

AUSTRALIA - Apr. 15

HIST. RADIO SOC. OF AUSTRALIA MELBOURNE GROUP - AUCTION

Glen Iris - St. Andrews Uniting Church Hall
253A Burke Rd.

Call for Time

Info: Warwick Woods - 03 9885 1030
www.woods@netspace.net.au

CALIFORNIA - Apr. 15

SO. CAL. ANTIQUE RADIO SOCIETY SWAP MEET & BRUNCH

Corona, CA - TB Scott's Seafood Landing & Kings Inn Best Western - 1084 Pomona Rd.

7 am-Noon

Info: John Gallisath - (909) 734-3411
commuters@msn.com

COLORADO - Apr. 15-16

COLORADO RADIO COLLECTORS CLUB ANNUAL SHOW & SALE

Denver, CO - Denver Coliseum Antique & Collectors Fair

Sat.: 9 am-4 pm

Sun.: 10 am-4 pm

Info: David Boyle - (303) 681-3258
djboyles@aol.com

TEXAS - Apr. 15

HOUSTON VINTAGE RADIO ASSOC. BASIC ELECTRONICS SEMINAR

Houston, TX - New Garden Rest.
11403 Chimney Rock Rd.

8 am: Breakfast

9 am-Noon: Seminar

Info: Bill Werzner - (713) 721-2242
mingqi53@earthlink.net

New Club Forming?

Let A.R.C. Help You Find New Members

Send your information to

arc@antiqueradio.com or fax: (978) 371-7129

Or mail to: PO Box 2, Carlisle, MA 01741

TEXAS - Apr. 15

VINTAGE RADIO & PHONO. SOCIETY MEETING

Irving, TX - Senter East Building
3 pm

Info: George Potter - (972) 353-4862
VRPS, PO Box 165345, Irving, TX 75016

W. VIRGINIA - Apr. 15

MUSEUM OF RADIO & TECHNOLOGY/ PITTSBURGH ANTIQUE RADIO SOCIETY SPRING FEVER

Huntington, WV - MRAT
1640 Florence Ave.

7 am-5 pm

Info: (304) 525-8890

TEXAS - Apr. 16

TEXAS ANTIQUE RADIO CLUB MEETING

Schertz, TX - VFW Hall
2:30 pm

Info: Jim Moffett, 218 Shannon Lee, San Antonio, TX 78216 - (210) 826-4938

VIRGINIA - Apr. 16

MID-ATLANTIC ANTIQUE RADIO CLUB MEETING - SWAP MEET - AUCTION

Sully Station, VA - Community Center
Sequoia Farms Dr.

2 pm

Info: Ed Lyon - (301) 293-1773
11301 Woodland Way, Myersville, MD 21773

WASHINGTON - Apr. 16

PUGET SOUND ANTIQUE RADIO ASSOCIATION - MEETING

Seattle, WA - Shoreline Museum
N. 175th & Linden Ave.

9 am-Noon: Tailgate Swap Meet

Noon: Meeting, Program, Show & Tell

Info: Pete Petersen - (425) 747-1323
PSARA - PO Box 2095, Snohomish, WA
98291-0125 - (360) 568-2698

NEW ZEALAND - Apr. 17

NEW ZEALAND VINTAGE RADIO SOCIETY AUCKLAND MEETING

Auckland - Horticultural Soc. Hall, Chamberlain
Park Golf Clubhouse, 990 Great North Rd.

7:30 pm

Info: Ian Sangster - ian.Sangster@airnz.co.nz

CALIFORNIA – Apr. 18

CALIF. HISTORICAL RADIO SOCIETY SACRAMENTO CHAPTER MEETING

Sacramento, CA – SMUD Building
Corner of Elkhorn & Don Julio
7 pm

Info: CHRS Hotline – (415) 821-9800

CALIFORNIA – Apr. 22

CALIFORNIA HISTORICAL RADIO SOC. EARTH DAY 2000

San Francisco, CA – Presidio
9 am

Info: CHRS Hotline – (415) 821-9800

OHIO – Apr. 19

CENTRAL OHIO ANTIQUE RADIO ASSOC. MEETING

Columbus, OH – DeVry Institute of Tech.
1350 Alum Creek Rd., I-70 Exit 103B
7:30 pm

Info: Barry Gould – (614) 777-8534
Chuck Davis – (614) 792-6237

VIRGINIA – Apr. 22

ROANOKE ANTIQUE RADIO ENTHUSIASTS SPRING SWAP MEET

Roanoke, VA – Elks Lodge
1147 Persinger Road
8 am

Maps: dhcook@rev.net
Info: Craig Smith – (540) 977-5424

OHIO – Apr. 19

CINCINNATI ANTIQUE RADIO SOCIETY MEETING

Norwood, OH – ITT Technical Institute
4750 Wesley Ave.

7:30 pm

Info: Kirk Webb – (513) 231-4557
2183 Springwheel Ln., Cincinnati, OH 45244

ALABAMA – Apr. 24

ALABAMA HISTORICAL RADIO SOCIETY MEETING

Birmingham, AL – Homewood Public Library
1721 Oxmoor Road

7 pm

Info: Julian Brook, PO Box 130307,
Birmingham, AL 35213 – (205) 879-1191

AUSTRALIA – Apr. 20

HIST. RADIO SOC. OF AUSTRALIA MELBOURNE GROUP GENERAL MEETING

Glen Iris – Gardiner Church of Christ Hall
Malvern Rd. cnr Scott Grove

7:30 pm

Theme: Radios With Nicknames
Info: Warwick Woods – 03 9885 1030
wwwoods@netspace.net.au

OHIO – Apr. 25

SOCIETY FOR PRESERVATION OF ANTIQUÉ RADIO KNOWLEDGE MEETING

Kettering, OH – Party Room at Cassano's
Pizza, 1700 E. Stroop Rd.

7:30 pm

Presentation: British Receiver Documentary
Show & Tell: Foreign Radios
Info: PO Box 292111, Kettering, OH 45429
E-mail: sparkinc@juno.com

NEW YORK – Apr. 20

HUDSON VALLEY ANTIQUE RADIO AND PHONO. SOCIETY MEETING

Goshen, NY – Catawag Fire House
7 pm-9 pm

Info: Peter DeAngelo – (914) 496-5130
(Call to confirm details)

BRAZIL – Apr. 28-May 1

ANTIQUÉ RADIOS IN BRAZIL SWAP MEET – SALE – AUCTION Sao Roque – TBA

Contact for Time & Location

Info: Joao Mello – PO Box 101, Sao Roque,
Brazil 18130-000 – old_radio@hotmail.com

A free* listing on these pages is available for each coming radio event. Sponsors should provide description of event, date, time, place, directions, & information/contact person. Since listings are on a "space available" basis, no guarantee of listing is made. *Submission deadline – 5th of month. *Club/museum/non-profit events are listed free; other events are obtained from advertisements placed elsewhere in A.R.C. Sorry, we don't have room for hamfests.*

NEW HAMPSHIRE - Apr. 29

NEW ENGLAND ANTIQUE RADIO CLUB SWAP MEET

Nashua, NH - Resurrection Center
Rt. 3 (Everett Turnpike) Exit 6
1 1/2 miles West on Rt. 130, 449 Broad St.
7:30-8 am - Real Early Admission
8-9 am - Early Admission
9 am-1 pm - General Admission
Over 100 tables - 50/50 Raffle - CATERED
Old Equipment Contest
Reservations required to sell
Info: Joe Coco - (617) 923-2665
PO Box 2382, Fitchburg, MA 01420

TENNESSEE - Apr. 29

MUSIC CITY VINTAGE RADIO & PHONO. SOC. SPRING SWAP MEET

Nashville, TN - Braid Electric Co. Parking Lot
299 Cowan St. (I-65 & I-24 North, Jefferson St. Exit)
7 am-Noon
10 am: Walking Auction
Info: Larry Chambers - (615) 833-2448

ILLINOIS - Apr. 30

ANTIQUE RADIO CLUB OF ILLINOIS SWAP MEET

Elgin, IL - Elgin Plaza Hotel
345 River Rd. (Soon to be Ramada Inn)
7 am-1 pm: West Parking Lot
Info: A.R.C.I., PO Box 1139, LaGrange Park,
IL 60526 - E-mail: arci31280@aol.com

UNITED KINGDOM - Apr. 30

NATIONAL VINTAGE COMMUNICATIONS FAIR
Birmingham, UK - NEC Hall 11 - 10:30 am-4 pm
300+ Exhibitors - Radio, TV, Phonograph, etc.
Info: NVCF, 13 Belmont Rd., Exeter, Devon, England
Ph: (01392) 411565 - sunpress@eurobell.co.uk

ONTARIO - May 3

OTTAWA VINTAGE RADIO CLUB AUCTION - FLEA MARKET - MEETING

Ottawa, Ont. - The Ottawa Citizen
Conference Room - 1101 Baxter Rd.
7 pm: Flea Market - 8 pm: Meeting
Theme: My Best Radio
Presentation: Old Time Radio
Info: OVRC - (613) 832-3097

Although non-members are welcome at all
events, joining may be required at some.
Admission is charged at some events.

VIRGINIA - May 3

TIDEWATER ANTIQUE RADIO ASSOC. MEETING

Call for location & directions
7 pm
Info: Vic Johnston - (757) 825-0757, eves.
Scott Balderston - (757) 549-0449, eves.

ARKANSAS - May 4

ANTIQUE RADIO COLLECTORS CLUB OF FORT SMITH MEETING

Fort Smith, AR - St. Luke Lutheran Church
Waldron Road, at Free Ferry
7:30 pm
Info: Paul Tucker, 4700 N. "N" St.
Fort Smith, AR 72904 - (501) 782-8178

NEVADA - May 4

NEVADAN ENTHUSIASTS FOR ANTIQUE RADIOS MEETING

Las Vegas, NV - Sunset Road Library
Corner of Green Valley Pkwy. & Sunset Rd.
7 pm
Info: Cort & Eileen Ancman - (702) 312-7110
ancman@juno.com

CALIFORNIA - May 5-6

MILITARY RADIO COLLECTORS GROUP 5TH ANNUAL MEET

San Luis Obispo, CA - NCO Club,
Camp San Luis Obispo
Fri.: Field Operations
Setting Up Equipment
6-Meter Hidden Transmitter Hunt
6-Meter Distance Test

Sat.: Dawn-9 am - Swap Meet
Presentations:

WWII German & Japanese Radios
WWII Radio Intercept,
Late Model Tactical Radios
German Enigma Code Machine
Info: Hank Brown, W6DJX
htbrown@earthlink.net - (661) 943-2027
4141 West L-2, Lancaster, CA 93536

TEXAS - May 5-6

HOUSTON VINTAGE RADIO ASSOC. AUCTION

Contact for Location & Time
Info: Bill Werzner - (713) 721-2242
mingqi53@earthlink.net

CALIFORNIA - May 6

CALIFORNIA HISTORICAL RADIO SOC. SWAP MEET/AUCTION

Los Altos Hills, CA - Foothill College, Lot "D"
8 am
Info: CHRIS Hotline - (415) 821-9800

N. CAROLINA - May 9

EAST CAROLINA ANTIQUE RADIO CLUB MEETING

Greenville, NC - Golden Corral Rest.
504 S.W. Greendale Blvd.
6:30 pm
Info: Bill Engstrom - (252) 355-8732
Herman Schnur - (252) 752-2264

WASHINGTON - May 6

RADIO ENTHUSIASTS OF PUGET SOUND MEETING

Seattle, WA - Queen Anne Library
400 W. Garfield
2 pm
Info: REPS, 9936 N.E. 197th Street
Bothell, WA 98041 - (206) 488-9518

OHIO - May 9

ANTIQUERADIO COLLECTORS OF OHIO MEETING

Kettering, OH - Party Room at Cassano's
Pizza, 1700 E. Stroop Rd.
7:30 pm
Topic: Emerson Radios
Info: John Heck - (937) 435-1571
ARCO, PO Box 292292, Kettering, OH 45429

NEW YORK - May 7

GREATER NEW YORK VINTAGE WIRELESS ASSOCIATION SWAP MEET

Lake Ronkonkoma, NY - 367 Hawkins Ave.
8 am-Noon
Info: Chris Lieppert - (516) 471-9526
Chris Bacon - (516) 821-7618

PENNSYLVANIA - May 9

DELAWARE VALLEY HISTORIC RADIO CLUB MEETING - SWAP MEET - AUCTION

Telford, PA - Telford Community Bldg.
Hamilton & Hamlin
7:30 pm
Info: Bill Overbeck, PO Box 847,
Havertown, PA 19063

GEORGIA - May 8

SOUTHEASTERN ANTIQUE RADIO SOC. MEETING WITH SHOW & TELL

Norcross, GA - Picadilly Cafeteria
3400 Holcomb Bridge Road
6:30 pm
Topic: "P" Radios

Info: Gordon Hunter - (770) 475-0713
SARS, PO Box 1055, Tucker, GA 30085-1055

ARKANSAS - May 11

ARKANSAS ANTIQUE RADIO CLUB MEETING

Call for Location and Directions
7 pm
Info: Tom Burgess - (501) 455-0773

MISSOURI - May 9

ANTIQUERADIO COLL. & HIST. OF GREATER ST. LOUIS MEETING

Kirkwood, MO - Kirkwood Community Center
111 S. Geyer Rd., Room 201-A
7:30 pm: Meeting (earlier for conversation)
Show & Tell, Swap Table
Info: Derek Cohn, 8141 Stratford Dr.,
Clayton, MO 63105 - (314) 725-2333

NEW JERSEY - May 12

NEW JERSEY ANTIQUE RADIO CLUB MEETING

Freehold, NJ - Grace Lutheran Church
West Main St. & Park Ave. (Old Rt. 33)
7 pm
Info: Marv Beeferman - (609) 693-9430
Phil Vourtsis - (732) 446-2427

Publicize Your Event

Submission Deadline: 5th of Month
Submit your listing to A.R.C.
arc@antiqueradio.com or fax: (978) 371-7129
Or mail to: PO Box 2, Carlisle, MA 01741

NOTE: The "Coming Radio Events" pages are tabulated from the best information available to A.R.C. However, changes, cancellations and errors do occur. To avoid disappointment, verify place, date and time especially for events which are new to you.

CALIFORNIA - May 13

SO. CAL. ANTIQUE RADIO FEST MEET

Valencia, CA - Valencia Travel Village
27961 Hwy. 126

6 am-11 am

Info: Jerry Simpson - (661) 251-7829
Phil Rheinschild - (805) 583-1121

FRANCE - May 13

CLUB HISTOIRE ET COLLECTION RADIO QUARTERLY MEETING

St. Ouen - Paul Bert Restaurant

Info: Gerald Koch - 0140127938, eves.

OKLAHOMA - May 13

OKLA. VINTAGE RADIO COLLECTORS MEETING

Oklahoma City, OK - Oklahoma Station BBQ
Springdale Shopping Center, 4333 N.W. 50th

6 pm: Dinner - 7 pm: Meeting

Info: Jim Collings - (405) 755-4139, after 6 pm

Mike Lapuzza - (405) 745-3394, after 7 pm

PENNSYLVANIA - May 13

2ND ANNUAL KUTZTOWN RADIO MEET

Kutztown, PA - Renninger's Antique and
Farmers Market, Noble Street

7 am

Hotel: Campus Inn - (610) 683-8721

Info: Steve Wallace - (610) 944-7230

kkks@epix.net

Dan Dewald - (610) 683-6848

TEXAS - May 13

HOUSTON VINTAGE RADIO ASSOC. BASIC ELECTRONICS SEMINAR

Houston, TX - New Garden Rest.
11403 Chimney Rock Rd.

8 am: Breakfast

9 am-Noon: Seminar

Info: Bill Werzner - (713) 721-2242

mingqi53@earthlink.net

Updating Club List

*Please send A.R.C. the name, address, etc.
of your club's contact person.*

Submission Deadline for May issue is April 5

MINNESOTA - May 19-20

NORTHLAND ANTIQUE RADIO CLUB PAVEK MUSEUM OF BROADCASTING RADIO DAZE 2000

Plymouth, MN - Comfort Inn, 3000 Harbor Ln.

Time: TBA

For Reservations: (612) 559-1222
Mention "Radio Meet"

Info: JimThompson - (612) 822-4000

RadioJim@worldnet.att.net

Kip Wallace - (612) 544-2547 - kipwallace@dl-inc.com

ALABAMA - May 20

SOUTHERN VINTAGE WIRELESS ASSOC. INDOOR/OUTDOOR RADIO SWAP MEET

Decatur, AL - Ninth St. Methodist Church
1227 6th Ave.

6 am-Noon

Info: Jim Makar - (256) 880-7924

sparkgap@juno.com

N. CAROLINA - May 20

CAROLINAS CHAPTER - AWA SPRING SWAP MEET

Spencer, NC - North Carolina Transportation
Museum "Spencer Shops"

Time TBA

Info: Ron Lawrence - (704) 289-1166

kc4yoy@trellis.net - www.CC-AWA.org

OREGON - May 20

NORTHWEST VINTAGE RADIO SOCIETY SWAP MEET

Callfor Location & Time

Info: Ed Charman, PO Box 82379

Portland, OR 97282-0379 - (503) 654-7387

TENNESSEE - May 20

MEMPHIS ANTIQUE RADIO CLUB SPRING SWAP MEET

Memphis, TN - St. Timothy
United Methodist Church, 4105 St. Elmo Ave.

7 am-11 am

Info: Ray Eaton - (901) 989-6942 or 989-7089

reaton@fhu.edu

TEXAS - May 20

TEXAS ANTIQUE RADIO CLUB MEETING

Kyle, TX - Railroad BBQ

10 am

Info: Jim Moffett, 218 Shannon Lee, San
Antonio, TX 78216 - (210) 826-4938

COLORADO - May 21

COLORADO RADIO COLLECTORS MEETING

Denver, CO - VecraBank Bldg.
1380 South Federal Ave.

1 pm

Info: Larry Weide - (303) 758-8382

NEW JERSEY - May 21

WAYNE POLICE ATHLETIC LEAGUE MECHANICAL MUSIC EXTRAVAGANZA

Wayne, NJ - I Pal Drive
Off Rt. 23, Exit Rt. 202/Lincoln Park
9 am-3 pm

Info: (973) 655-9730 - (973) 772-2741

BRITISH COLUMBIA - May 28

CANADIAN VINTAGE RADIO SOCIETY BRITISH COLUMBIA CHAPTER MEETING

Richmond, BC - Steveston Hotel
Info: Fred Tutt - (604) 275-2033

MANITOBA - May 28

CANADIAN VINTAGE RADIO SOCIETY SPRING FLEA MARKET

Winnipeg - CBC Bldg. Parking Lot
541 Portage Ave.
10 am

Info: Bob Murray - (204) 885-3045
rmurray@hsc.mb.ca

INDIANA - Jun. 9-10

INDIANA HISTORICAL RADIO SOCIETY 29TH ANNUAL REGIONAL SPRING FESTIVAL

Indianapolis, IN - Signature Inn East
East Washington St. at I-465

Fri.: 7:30 am - Registration

7:30 am-6 pm - Flea Market

9 am-1:30 pm - Old Equipment Contest Room

Noon - Coed Luncheon

2 pm - Seminars

5:45 pm - Annual Awards Banquet

6:45 pm - Equipment Contest Awards

Sat.: 7:30 am - Registration

10:30 am - Donation Auction

11:15 am - Auction

Hotel: (317) 353-6966

Info: George Freeman - (812) 265-6878
102 E. Main St., Madison, IN 47250

MENTION A.R.C.

WHEN CONTACTING CLUBS!

MARYLAND - Jun. 15-17

MD-MID-ANTIQUE ANTIQUE RADIO CLUB RADIOACTIVITY 2000

Beltsville, MD - Sheraton College Park
4095 Powder Mill Rd.

For hotel reservations: (301) 937-4422

Info: Brian Belanger - (301) 258-0708
5730 Avery Park Dr., Rockville, MD 20855-1738
bcbelanger@aol.com

RADIO CLUB LISTINGS

CLUBS: Send antique radio club and meet information to A.R.C. for free listing here, as space permits. Sorry, we don't have room for hamfests. Always send a SASE when writing to clubs!

NATIONAL CLUB

Antique Wireless Association (AWA). Box "E", Breesport, NY 14816. Pub: *The Old Timer's Bulletin (OTB)*, quarterly. Dues: \$15. National annual conference and regional meets. Museum.

REGIONAL CLUBS

Alabama Historical Radio Society (ALHRS). PO Box 26452, Birmingham, AL 35226. Julian Brook, PO Box 130307, Birmingham, AL 35213. Pub: *The Superflex*, monthly. Dues: \$20. Meetings 4th Mon. evening each month but Dec., annual show/swap meet. **Don Kresge Radio Museum**, Fairfield Civic Center, 6509 E.J. Oliver Blvd., Fairfield, AL.

Antique Radio Club of Illinois (ARCI). PO Box 1139, La Grange Park, IL 60526. Art Bilski, (630) 739-1060. Pubs: *ARCI News*, semiannually, and "ARCI Update," periodically. Dues: \$15. Annual August Radiofest and bimonthly swap meets.

Antique Radio Collectors Club of Ft. Smith, Arkansas (ARCCFSA). Paul Tucker, 4700 N. "N" St., Fort Smith, AR 72904. Dues: \$10. Monthly meetings, annual show.

Antique Radio Collectors & Historians (ARCH) of Greater St. Louis. Derek Cohn, 8141 Stratford Dr., Clayton, MO 63105-3707. Dues: \$12. Monthly newsletter and meetings, annual picnic/swap meet.

Antique Radio Collectors of Ohio (ARCO). John Heck, ARCO, PO Box 292292, Kettering, OH 45429. Pub: *The ARCO Code*, quarterly. Dues: \$10. Monthly meetings, August show & auction.

Arkansas Chapter/AWA. Arkansas Antique Radio Club (AARC). Tom Burgess, PO Box 191117, Little Rock, AR 72219. Dues: \$5. Monthly meets.

Arizona Antique Radio Club (AARC). Bill Lettow, 2025 E. LaJolla Dr., Tempe, AZ 85282-5910. Pub: *The Arizona Antique Radio Club News*, quarterly. Dues: \$18. Monthly meetings, swap meets, Arizona Radio Roundup.

Belleville Area Antique Radio Club (BAARC). Karl Stegman, 4 Cresthaven Dr., Belleville, IL 62221. Monthly newsletter. Dues: \$10. Monthly meetings.

Border Amateur Radio Club. Chris Roy, PO Box 372, Derby, VT 05829.

Buckeye Antique Radio and Phonograph Club (BARPC). Kevin Grimm, 1716 Chestnut Blvd.,

Cuyahoga Falls, OH 44223. Pub: *Soundings*, bi-monthly. Dues: \$10. Monthly meetings, public mail show, March swap meet with PARS.

California Historical Radio Society (CHRS). CHRS, PO Box 31659, San Francisco, CA 94131. CHRS Hotline: (415) 821-9800. Steve Kushman, 4233 25th St., San Francisco, CA 94114. Pubs: *The Journal*, quarterly; *20 Years of CHRS, Hints & Kinks*, free with membership. Dues: \$20. 13 events per yr.

CHRS/Sacramento Chapter. PO Box 162612, Sacramento, CA 95816-9998. Pub: *The Announcer*, quarterly. Dues: \$10. Special meets, monthly meetings.

Carolinas Chapter/AWA (CC-AWA). Ron Lawrence, PO Box 3015, Matthews, NC 28106.

Central Ohio Antique Radio Association (COARA). Barry Gould, 3782 Mill Stream Dr., Hilliard, OH 43026. Monthly meetings, January Cabin Fever swap meet. Dues: \$12.

Central Pa. Radio Collectors Club. Frank Hagenbuch, 1440 Lafayette Parkway, Williamsport, PA 17701, or Mike Heffner, 501 S. Market St., Muncy, PA 17756.

Cincinnati Antique Radio Society. Ted Lewis, 6 Indian Dr., Sardinia, OH 45171. Monthly meetings.

Collins Collectors Association (CCA). PO Box 10459, Phoenix, AZ 85064. Dues: \$20.

Colorado Radio Collectors (CRC). Robert Baumann, 1985 S. Cape Way, Lakewood, CO 80227. Pub: *The Flash!*, bimonthly. Dues: \$12. Monthly meetings/swap meets. April Show & Swap Meet and September Auction.

Delaware Valley Historic Radio Club (DVHRC). Bill Overbeck, Box 847, Havertown, PA 19083. Pub: *The Oscillator*, monthly. Dues: \$15. Monthly meetings with swap meets, quarterly tailgate swaps.

East Carolina Antique Radio Club. Bill Engstrom, 218 Bent Creek Dr., Greenville, NC 27834.

Florida Antique Wireless Group (FAWG). Paul Currie, Box 738, Chuluota, FL 32766. Pub: *FAWGorn News*, quarterly. Monthly tailgate swap meets, fall auction, & quarterly flea markets.

Greater Boston Antique Radio Collectors (GBARC). c/o A.R.C., PO Box 2-W20, Carlisle, MA 01741. (978) 371-0512. Informal org. Write to be put on mailing list. Annual meet in Feb.

Greater New York Vintage Wireless Association (GNYVWA). Chris Bacon, 52 Uranus Rd., Rocky Point, NY 11778. Pub: Meeting notices. Dues: \$4. Six meets/year and monthly meetings.

Houston Vintage Radio Association (HVRA). PO Box 31276, Houston, TX 77231-1276. Membership info: David Moore, 3213 Regal Oaks, Pearland, TX 77581. Pub: *The Grid Leak*, monthly. Dues: \$20. Monthly meetings and special regional events.

Hudson Valley Antique Radio and Phonograph Society-AWA (HARPS). PO Box 207, Campbell Hall, NY 10916. Peter DeAngelo, 25 County Route 51, Campbell Hall, NY 10916. Dues: \$15. Monthly meetings, annual Old Time Radio & Phono Show.

Indiana Historical Radio Society (IHRS). 245 N. Oakland Ave., Indianapolis, IN 46201-3360. Pub: *IHRS Bulletin*, quarterly. Dues: \$15/1 yr.; \$25/2 yrs. Quarterly swap meets in various areas of state.

International Antique Radio Club, World-Wide. Richard G. Brill, PO Box 5367, Old Bridge, NJ 08857. No dues.

Illinois Historical Radio Society (IHRS). Paul

Johnston, 8592 N. Creek Rd., Roscoe, IL 61073

Iowa Antique Radio Club and Historical Society (IARCHS). 790 Kane St., Dubuque, IA 52001. Pub: *IARCHS Newsletter*, quarterly. Dues: \$12. Annual Radiofest.

Louisiana & Gulf Coast Antique Radio Club. Phil Boydston, 750 Moore St., Baton Rouge, LA 70806.

Memphis Antique Radio Club (MARC). Mel Urban, 7190 Mimosa, Germantown, TN 38138. Pub: *Newsletter*, bimonthly. Dues: \$12. Monthly meetings and summer swap meet.

Michigan Antique Radio Club (MARC). Brenda Clark, MARC, Suite 100, 3520 Okemos Rd., #6, Okemos, MI 48864-5943. Pub: *The Michigan Antique Radio Chronicle*, quarterly. Dues: \$12. Annual Extravaganza and other quarterly meets.

Mid-America Antique Radio Club (MAARC). Gary Watkins, 8006 Greenwald, Belton, MO 64012. Pub: *The Broadcaster*, quarterly. Dues: \$12. Semi-annual auctions and swap meets.

Mid-Atlantic Antique Radio Club (MAARC). Barry Zimmerman, 5825 Woodwinds Cir., Frederick, MD 21703-7579. Pub: *Radio Age*, monthly. Dues: \$20. Monthly meetings.

Mid-South Antique Radio Collectors (MSARC). Joe Zahnen, 933 Venice Rd., Knoxville, TN 37923. Pub: *Old Radio Time's*, quarterly. Dues: \$10. Two meets per year.

Music City Vintage Radio Club & Phonograph Society. PO Box 22291, Nashville, TN 37202. Mary Evans, 713 Setfill Pl., Nashville, TN 37206. Pub: *Newsletter*, quarterly. Dues: \$15. Spring and fall swap meets.

Museum of Broadcast Communications. 78 E. Washington, Chicago, IL 60602. Dues: \$30.

Nebraska Antique Radio Collectors Club (NARCC). Steve Morton, 905 W. First, N. Platte, NE 69101. Pub: *Mountains 'N Plains* newsletter, 6/year. Dues: \$12. Monthly meetings Apr. to Oct. in W. Nebraska, annual auction in Kearney.

Nevadan Enthusiasts for Antique Radios (NEAR). Cort & Eileen Ancman, 1881 Capo San Vito Ave., Las Vegas, NV 89123. Monthly meetings.

New England Antique Radio Club (NEARC). Info: (617) 923-2665. Bob Andersen, PO Box 918, Melrose, MA 02176. Pub: *Escutcheon*, quarterly. Dues: \$10. Quarterly meets & auctions.

New Jersey Antique Radio Club (NJARC). Phil Vourtsis, 13 Cornell Pl., Manalapan, NJ 07726. Pubs: *New Jersey Antique Radio Club News*, quarterly; *The Jersey Broadcaster*, flyer. Dues: \$15. Monthly meetings, three swap meets/year.

New Mexico Radio Collectors Club (NMRCC). Charles Burch, 39 Chaco Loop, Sandia Park, NM 87047. Pub: *New Mexico Radio Collectors Club Newsletter*, quarterly. Dues: \$12. Annual Sale & Show and monthly meetings.

Niagara Frontier Wireless Association (NFWA). Gary Parzy, 135 Autumnwood, Cheektowaga, NY 14227. Pub: *NFWA Chronicle*, quarterly. Dues: \$9. Regional meets. Display at the Amherst Museum, Amherst, N. Y.

Northland Antique Radio Club (NARC). PO Box 18362, Minneapolis, MN 55418. Pub: *The NARC Newsletter*, four/year. Dues: \$10. Four meets (including 2 swap meets) per year and Radio Daze event.

Northwest Vintage Radio Society (NWVRS). PO Box 82379, Portland, OR 97282-0379. Pub: *The Call Letter*, monthly. Dues: \$15. Monthly meetings.

Oklahoma Vintage Radio Collectors Club (OKVRC). PO Box 50625, Midwest City, OK 73140-5625. Pub: *OKVRC Broadcast News*, monthly. Dues: \$12. Monthly meetings, spring and fall swap meets.

Pittsburgh Antique Radio Society, Inc. (PARS). Seth Ward, 83 Ruthfred Dr., Pittsburgh, PA 15241. Pub: *The Pittsburgh Oscillator*, quarterly. Dues: \$10. Quarterly meetings, Spring Fever, and March meet.

Puget Sound Antique Radio Association (PSARA). PO Box 2095, Snohomish, WA 98291-0125. Pub: *The Horn of Plenty*, monthly. Dues: \$20. Monthly meetings & swap meets, Nov. show, & Aug. swap meet.

Radio Enthusiasts of Puget Sound (REPS). Bill Davies, 14911 Linden N., Seattle, WA 98133. Pub: *Air Check*, quarterly newsletter. Dues: \$18 (\$22 first year). Monthly meetings, annual Radio Showcase.

Radio History Society, Inc. (RHS). Museum and library. Steve Snyderman, 4147 Lenox Dr., Fairfax, VA 22032. Dues: \$15 & up (various membership levels).

Roanoke Antique Radio Enthusiasts (RARE). Frank G. Smith, WPXR-TV 38, 3819 Bloomsboro Rd., Lynchburg, VA 24503.

E. H. Scott Historical Society, Inc. (EHSHS). 3712 N. Broadway #4450, Chicago, IL 60613. Pub: *Scott News*, quarterly. Dues: \$20. Manuals, parts and service, Scott Video.

Society for the Preservation of Antique Radio Knowledge (SPARK). PO Box 292111, Kettering, OH 45429. Pubs: *The Electronic Collector (TEC)*, quarterly; *SPARK Notes*, monthly. Dues: \$12. Monthly meetings, quarterly swap meets.

Society of Wireless Pioneers. PO Box 86, Geysrville, CA 95441. *The World Wireless Beacon*, quarterly; *Register*, bi-annually. Dues: \$15.

South Florida Antique Radio Collectors. Thomas Valenti, 1717 N. Bayshore Dr., Apt. #1549, Miami, FL 33132. Dues: \$25.

Southeastern Antique Radio Society (SARS). SARS, PO Box 1055, Tucker, GA 30085-1055. Pub: Newsletter, quarterly. Dues: \$12. Spring and fall swap meets. Monthly dinner meetings.

Southern California Antique Radio Fest (SCARF). c/o Jerry's Vintage Radio, 17665-1/4 Sierra Hwy., Canyon Country, CA 91351. Three swap meets a year — January, May and Sept.

Southern California Antique Radio Society (SCARS). Robert Schoenbeck, 9301 Texhoma Ave., Northridge, CA 91325-2330. Pub: *California Antique Radio Gazette*, quarterly. Dues: \$15. Quarterly meets in L.A. area and mini meets, two-day November meeting, annual auction.

Southern Vintage Wireless Association (SVWA). Earl Ridolphi, 2413 Old Briar Trail, Birmingham, AL 35226. Pub: *SVWA Newsletter*, 3/year. Dues: \$5. Three swap meets.

Texas Antique Radio Club (TARC). Jim Moffett, 218 Shannon Lee, San Antonio, TX 78216. Pub: *Lone Star Waveform*, monthly. Monthly meetings.

Tidewater Antique Radio Association (TARA). Vic Johnston, 7 Hillcrest Cir., Hampton, VA 23666

Tri-State Antique Radio Club. Close to N.Y.C., all of N.J., Ct., L.I., upstate N.Y. and Pa. Bob Masterson, Box 172, Valley Cottage, NY 10989. Swap meets and education.

Tube Collectors Association. PO Box 1181, Medford, OR 97501. Pub: *Tube Collector*, 6 times a

year. Dues: \$20.

Vintage Radio & Phonograph Society (VRPS). George Potter, PO Box 165345, Irving, TX 75016. Pubs: *The Reproducer*, quarterly. *Soundwaves*, monthly between the quarterly. Dues: \$13.50. Monthly meetings, spring auction, annual convention, summer swap meet.

W. Va. Chapter, AWA (AWA-WVC). Geoff Boume, 405 8th Ave., St. Albans, WV 25177. Newsletter, monthly. Dues: \$25 (includes museum membership). Quarterly meets, monthly meetings, classes.

Wisconsin Antique Radio Club (WARC). Dale Boyce, 10230 W. Greenwood Ter., Milwaukee, WI 53224-3716. Dues: \$12.

FOREIGN CLUB LISTINGS

(Dues, when listed, are for U.S. membership. A.R.C. would like to hear about other foreign antique radio clubs.)

Australia: Historical Radio Society of Australia (HRSA). Membership Secretary, PO Box 2283, Mt. Waverly, Victoria, 3149, Australia. Pub: *Radio Waves*, quarterly. Dues: \$35 Australian. Monthly Meetings.

Australia: North East Vintage Radio Club. Monthly meetings at Wangaratta T.A.F.E. electronic unit. Info: Noel Meagher, 62 3149; Ian Milne, 62 5153; Rodney Champness, 62 1454 (all Benalla numbers).

Belgium: Belgische Radio Club. Francois Marschang, Kromvendreef 53, B-2900, Schoten, Belgium.

Belgium: Vlaamse Liefhebbers Van De Historische Radiotechniek (VLHR). Rudi Sillen, Limberg 31, B-2230, Herselt, Belgium. Pub: *Retro-Radio*, quarterly. Dues: \$20.

Brazil: Antique Radios in Brazil. João Mello, PO Box 101, São Roque, Brazil 18130-000.

Canada: Canadian Vintage Radio Society (CVRS). CVRS, 4895 Mahood Dr., Richmond, British Columbia V7E 5C3. Pub: *Radio Waves*, bimonthly. Dues: \$17 U.S. (\$21 Canadian). Bimonthly meetings.

Alberta Chapter/CVRS, Rick Williams, Secretary CVRS Alberta, 9611 142 St., Edmonton, Alberta T5N 2M8. **British Columbia Chapter/CVRS,** Fred Tutt, 4895 Mahood Dr., Richmond, B.C. V7E 5C3.

Manitoba Chapter/CVRS, Bob Murray, 3216 Assiniboine Ave., Winnipeg, Manitoba R3K 0B1. **New Brunswick Chapter/CVRS,** W.H. Gentleman, 17 Maple Cres., Rothesay, New Brunswick E2E 2A4.

Newfoundland Chapter/CVRS, Tasker Squires, 11 Gulliver, St. John's, Newfoundland A1E 4K5. **Nova Scotia Chapter/CVRS,** Brian McKeigan, 4 Baird St., North Sydney, Nova Scotia B2A 2B3. **Ontario Chapter/CVRS,** Bill Beaton, 79 Meadowlands Dr., Nepean, Ontario K2G 2R9. **Saskatchewan Chapter/CVRS,** Roy Sawley, Box 174, Melfort, Saskatchewan S0E 1A0. **Yukon and NWT Chapter/CVRS,** Hoby Irwin, 21 Hyland Cres., Whitehorse, Yukon Y1A 4P6.

Canada: Range Land Collecting Club. Doug Hart, 912 7A St. S, Lethbridge, Alberta T1J 2J2.

Canada: Society for the Preservation of Antique Radio in Canada (SPARC). Bruce C.E. Russell, 220-4411 Hastings St. E, Burnaby, British Columbia, Canada V5C 2K1. Pub: Periodic newsletters. Dues: \$12. Annual open house and show, periodic shows and displays, and museum.

Canada, Ontario: London Vintage Radio Club (LVRC). Dave Cantelon, 42 Clematis Rd., North York, Ontario, Canada M2J 4X2. Pub: *LVRC Newsletter "The Loudspeaker,"* bimonthly. Dues: \$15 Canadian. Six meetings yearly.

Canada, Ontario: Ottawa Vintage Radio Club (OVRC). Box 84084, Pinecrest PO, Ottawa, Ontario K2C 3Z2. Pub: *OVRC*, quarterly newsletter. Dues: \$10. Monthly meetings.

Canada, Quebec: Quebec Society for Vintage Radio Collectors (QSVC). SQCRA, 224 Decelles, Brigham, Quebec, Canada J2K 4S5. Pub: *Radiophile Quebec*, bimonthly.

Czech Republic: Historicy Radioclub Ceskoslovensky (HRCS). Dr. F. Perina, Prika 3495, CZ 76000 Zlin, Czech Republic.

England: British Vintage Wireless Society (BVWS). Mike Barker, 23 Rosendale Rd., West Dulwich, London, SE21 805, UK. Pubs: *BVWS Bulletin*, quarterly; *BVWS Newsletter*, five times/year. Dues: £25. Meetings and swap meets.

England: Eddystone User Group (EUG). C/O Graeme Wormald, 15 Sabrina Dr., Bewdley, Worcestershire, DY12 2RJ, England. Pub: *EUG Newsletter*, 6 per year.

Finland: Radiohistorical Society of Finland. Jukka Heino, Viilarinkatu 5, FIN-87150, Kajaani, Finland. Pub: society magazine, quarterly. Meetings in October and March.

France: Association des Amis du Musée de l'Electro-Acoustique les Radiophiles Français (A.E.A.). Jean-Claude Montagné, President, 35 rue Salvador Allende, F92220, Bagneux, France. Pub: *Bulletin of the A.E.A.* Dues: \$46.

France: Club Histoire et Collection Radio (CHCR). Chez Gilbert Gorin, 3 rue Capitaine H. Maizan, 80160 Plachy-Buyon, France. Pub: *Telegraphie et Telephonie Sans Fil Electricite Ancienne*, quarterly. Library. Annual May event in Riquewihir, Sept. Bar Le Duc event, meetings.

France: Rétro-Phonia. 7 rue Binaud, 33300 Bordeaux, France.

Germany: German Society of Wireless History. Prof. Otto Künzel, Belm Tannenhof 55, 7900 Ulm 10, Germany. Pub: *Funkgeschichte*, bimonthly.

Hungary: Hungarian Radio Collectors Club: Laszlo Koger, H-8900 Szekesfehervar Sajo U 9. Meetings twice a year, bi-monthly news.

Holland: Nederlandse Vereniging voor de Historie van de Radio (NVHR). Paulus Potterstraat 19, 6814 KT Amhem, Holland.

Ireland: Irish Vintage Radio & Sound Society. Henry Moore, 9 Auburn Close, Killiney, Co. Dublin, Ireland. Quarterly newsletter. 26 weekly and six monthly meetings.

Israel: Antique Radio and Broadcasting Museum. Museum in Tel-Aviv. Bruno Pinto, 24 Remez St., #7, Tel-Aviv, Israel 62192

Italy: Associazione Italiana Radio d'Epoca (AIRE). Nerio Neri, President, Via de Pellicceria 23, 52100 Arezzo, Italy. Pub: *Bollettino-Notiziario*, bimonthly.

Japan: Antique Wireless Club (AWC). Noriyoshi Tezuka, JA1NTF, Secretary AWC, 1-11-2-403 Hiroo, Shibuyaku, Tokyo 150, Japan. Monthly meetings and newsletter.

New Zealand: New Zealand Vintage Radio Society (NZVRS). David Crozier, 154 Grey St. Onehunga, Auckland, New Zealand 1006. *NZVRS Bulletin*, quarterly, monthly meetings. Dues: \$15.

Norway: Norsk Radiohistorisk Forening (NRHF). Maridalsvn. 256, 0872 Oslo, Norway. Pub.: *Hallo Hallo*, quarterly. Dues: \$40. Regular meetings every Tuesday and first Saturday of each month.

Spain: Spanish Vintage Wireless Club (Asociacion Cultural Amicos de la Radio). Rei Jaume, 55, 08840 Cardedeu, Spain.

Sweden: The Radio-Historical Society in West-Sweden. Anders Carlssons, Gata 2, 417 55 Guteborg, Sweden. Pub: *Audionen*. Amateur radio station: SK6RM. Museum.

Switzerland: Club der Radio-und Grammosammler (CRGS). Claude Meylan, Muehlemastrasse 25, CH-6004 Luzern, Switzerland. Quarterly newsletter.

BUSINESS CARD ADS - \$53.00 FOR 3 MONTHS

ANTIQUE RADIOS



Specializing in
Horn Speakers WANTED

DAVE CROCKER

4B Beechwood Point Dr.,
Mashpee, MA 02649 (508) 477-1578

Crystal Radios
Reproductions • Kits • Parts
Send \$1 for catalog.

Refundable on first purchase over \$10.

RogRadCo

www.crystalrad.com

23110 Arlington
Dearborn, MI 48128

Phone:
313-277-2529

**PUT
YOUR BUSINESS CARD
HERE!**

**\$53 FOR 3 MONTHS - \$90 FOR 6 MONTHS
DON'T HAVE ONE? SEND AN EXTRA \$7 AND
WE WILL TYPESET ONE FOR YOU.**

Richard E. Desjarlais
(978) 486-9018

Antique Radios
Bought and Sold

DICK'S RADIO DAYS



Don't Trash - Get Cash!

P.O. Box 629, Littleton
Massachusetts 01460

Member: AWA NEARC

BUSINESS CARD ADS - \$53.00 FOR 3 MONTHS



ARBE-III Universal Battery Eliminator



Visit us on the web at
www.bcicy.com/antiqueradiosinc

David & Nancy Snow, PO Box 6352,
Jackson, MI 49204. (517) 787-2985

ANTIQUÉ RADIO REPAIR
Repair - Restore - Buy & Sell
Schematic Service
Radios \$2.⁹⁹, TVs \$4.⁹⁹

DAMASKE ELECTRONICS
574-W16834 Janesville Road
Muskego, WI 53150
Phone: (414) 679-0838



1298 SE 5th Avenue
PO Box 1939
Melrose, FL 32666
Phone: (352) 475-1950
Fax: (352) 475-1128

RADIO ELECTRIC SUPPLY

We Specialize In Receiving and Special Purpose Tubes

Buy and Sell

Don and Dorothy Gies

<http://www.vacuumtubes.net>
E-mail tubes@mindspring.com

FOR SALE: Just released, Flyer **200**.

For details send **2-stamp LSASE**
for 20-page flyer to:

Olde Tyme Radio Company
2445 Lyttonsville Road, Suite 317
Silver Spring, MD 20910

Fax/phone: (301) 587-5280
Fax anytime, phone 10 am-10 pm local time
E-mail: oldetymeradio@juno.com

TV's "F" FITTING???

Around 1950-1951, "F" fitting introduced by
some firm - preceded by smaller version than
today. Do you know who, when???. Help
please. Cooper, PO Box 330, Mangonui, Far
North, New Zealand or e-mail
Skyking@clear.net.nz

**SOUTHERN CALIFORNIA
GA RADIO SERVICE**
TUBE - TRANSISTOR - IC
SPECIALISTS IN COLLECTOR CAR RADIOS
CORVETTE - MUSTANG - T-BIRD & CLASSICS
PHONE/FAX 760-741-9660
140 N. ANDREASEN, ESCONDIDO, CA 92029

SPY EQUIPMENT WANTED!

- Code Machines
- Secret Radios
- Clandestine Weapons
- Secret Cameras
- OSS, SOE, CIA, KGB!
- I Buy or Trade!

Keith Melton

880 Jupiter Park Dr., Suite 5, Jupiter, FL 33458
(561) 743-1143 Days; Fax (561) 743-7504
E-mail: hkmlton@adelphia.net



"The Home of Mr. Herpy Herp"
Paul and Robin
phone 414 964 3392
fax 414 964 3393

PR NOVELTY
VACUUM TUBE SPECIALISTS
(New Old Stock and Used)
Juke Box Amplifier Rebuilding

PO Box 140 Milwaukee WI 53201
email prnovelty1@earthlink.net

www.prnovelty.com

Hear and compare 12 classic broadcast microphones
See their interior construction

CLASSIC MICROPHONES

from the **GOLDEN AGE OF RADIO**

Video Vol. I \$45.⁰⁰

Western Electric 618, 630, 633, 639
RCA 50A, 88A, 8K-1A, 44BX, 74B, 77C, D, DV, KB-2C, BK-5A

HIGHLAND LABORATORIES

7471 mont Street, #202, San Francisco, CA 94111

Tel: (415) 981-5010 Fax 981-5019



ESTES AUCTIONS

Specializing in Vintage Radios

7404 Ryan Rd
Medina, Ohio 44256

Buss Phone 330-769-4992
Fax 330-769-4116
Res Phone 330-769-3987

WANTED

PRE 1900
ELECTRICITY
MEDICAL • X-RAY
TELEGRAPHY • TELEPHONE
PRE 1925
RADIO • WIRELESS
PRE 1940
TELEVISION



**NEW WIRELESS
PIONEERS**
P O BOX 398
ELMA, NY 14059
716-681 3186
FAX 716-681-540

BOOKS • TUBES • ARTIFACTS
MAGAZINES • ALTOGRAPHS
CATALOGS • EPHEMERA

1930's to 1980's
**BUY
SELL
REPAIR**

William A. Burrows, N2WFR
709 Division Street
Gloucester City NJ 08030
Phone (856) 456-5998
Email wabr101@erots.com



BEC

Antique Radio Restoration & Repair
Quality Dependable Work Guaranteed

BUSINESS CARD ADS - \$53.00 FOR 3 MONTHS

TEST EQUIPMENT

BUY - SELL - TRADE

Parts - Manuals - Books

Boca Electro Magnetic Lab
22340 Greentree Circle
Boca Raton, FL 33433

(561) 750-8911

bocalab@bellsouth.net



Collector, Historian, Seeker of
Stromberg-Carlson Radio Apparatus

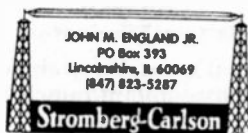

Entrepreneur: Art Moderne,
Streamline, Machine Age Design

40 Years Experience



Tom's Antique Radio & TV

REPAIRS & RESTORATION ON ALL
PRE-1960's - RADIOS & TV's
ANY MAKE OR MODEL



THOMAS ROMANO
8 HOWE LANE
MILLBURY, MA 01527
508-865-6293

Fine Quality Reproductions - Addition to Zenith - SASE for List

DECALS & DIAL SCALES

Rock-Sea Enterprises
PMB 241
323-110 E. Matilija St.
Ojai, CA 93023

Mike Tobin
(805) 646-7362
dials @juno.com
<http://members.aol.com/RockSeaEnt>



THE RADIO MAN

Buy-Sell-Trade
Antique Radios • Tubes • Parts

TEL: (972) 276-5458
FAX: (972) 272-1831

DICK MORGAN
RES: (972) 564-6464

P.O. BOX 461485
GARLAND, TX 75046-1485



Internet Sales
of Antique
Radios

Terry Williams

Toll-Free: (888) 339-4517
eFax: (603) 843-7903
eMail: info@radioage.com
Website: www.radioage.com

2751 Camino San Pablo
Del Mar, CA 92014

Proud
Member
ANA & NAPS

"The Early Soundman"

JOHN P. ANDOLINA JR.

Satisfaction
is
Guaranteed

**ANTIQUE
PHONOGRAPHS**



COLLECTOR & EXPERT IN RESTORATION
OF SPRING WOUND CYLINDER & DISC
PHONOGRAPHS. SUPPLIER OF NEEDLES,
MAIN SPRINGS, ORIGINAL & REPRODUCTION
PARTS.

Honest, Friendly
Advice

28 Glen Oaks Drive
Rochester, NY 14624
(716) 247-3058

Specialist in
Reproducer
Rebuilding

E-mail: rjysdmn@rochester.rr.com

40s-50s TV/FM Accessories

TV boosters, distribution amps and passives, UHF set-top converters, antenna rotors, data sheets/literature collected. Cash or swaps from extensive inventory. Cooper, PO Box 330, Mangonui, Far North, New Zealand or e-mail Skyking@clear.net.nz (U.S.A. ship to address)



john d. eckland

Vintage American & European Radio Repair
Expert HI FI Service • Custom Built Amplifiers
198A ADDISON AVENUE PALO ALTO, CALIFORNIA 94301
Dharsport 3-0101

All Tube Equipment Repaired



"The Fisher Doctor"
VINTAGE FISHER PRODUCTS
Bought • Sold • Traded • Repaired

Al Pugliese

718-948-7489

FisherDoc@aol.com

27 Daleham Street
Staten Island, NY 10308



Modern Radio Laboratories
Since 1932

Crystal Set and One Tube Radio Instructions. Exclusive source, printing and publishing of all MRL Handbooks & literature by Elmer G. Osterhoudt. Tested instructions and plans.

Catalog \$2.00 ppd.

MODERN RADIO LABS
P.O. Box 14902-T
Minneapolis, MN 55414-0902

**WANTED: Tube Hi-Fi Components
of the 1950's and 1960's**

Marantz - McIntosh - Western Electric
Brook - Leak - Quad - Tannoy - RCA - Altec
UTC - Fisher - Jensen - JBL - RCA - Hadley

Richard Sharisky

P.O. Box 521

Belmont, MA 02478

Tele: 617-484-5784

Fax: 617-484-5784

BUSINESS CARD ADS - \$53.00 FOR 3 MONTHS

BETA-TEK

ANTIQUÉ RADIO SERVICE

- Quality Repair & Restoration of Vacuum Tube Radios
- Free Estimates • Radios Bought & Sold • Battery Eliminators

RAY BINTLIFF, W1RY
2 Powder Horn Lane
Acton, MA 01720-2014
☎ 978-263-7435

e-mail: w1ry@msn.com



(708) 383-1649
BY APPOINTMENT

DO YOU HAVE
A PROBLEM RADIO?

THE OLD RADIO SHOP

SERVICE OF VACUUM TUBE ELECTRONIC S
SCHEMATIC DIAGRAM SERVICE
RESTORATION OR REPAIR • FREE ESTIMATES

405 ERIE ST
LAKE PARK, IL 60302

ED HUETHER



Vintage Electronics



Phono

Cartridges/Needles

Phone: Mon.-Fri.
SAM-5PM CST only

Center Post/Idlers

45 Adaptors

Fax Anytime

128 Buccaneer Drive Ed Crockett Phone (601) 264-4755
Hattiesburg, MS 39402 Fax (601) 264-0226

RADIO BOOKS WANTED

Always buying: Books, Magazines or Manuals.
We have a large selection of books on Radio and related
Technology. Call or write for our List of Catalogs or
Visit our web site: <http://www.rainybooks.com>

RAINY DAY BOOKS

P.O. BOX 775, FITZWILLIAM NH 03447
(603)-585-3448

ANTIQUÉ ELECTRONIC RESTORATION

35 Years Experience
Radios - Juke Boxes - Vintage TV's
Repair - Buy - Sell

Complete Restorations • Auto and Home • Prompt Service

COOPERS'S RADIO SERVICE

425 Court Street
Rockwell City, Iowa 50579



LARRY COOPER
712-297-7232

Old Time Replications

"TURN TO US WHEN YOU NEED KNOBS"
KNOBS • PUSHBUTTONS • ESCUTCHEONS
PLASTIC GRILLS • HANDLES

LARRY BORDONARO

5744 TOBIAS AVE VAN NUYS, CA 91411
PHONE (818) 786-2500 • FAX (818) 909-0241
E-MAIL: oldtimerep@aol.com

(856) 869-0238



SOUND REMEDY

Loudspeaker Repair Service

Richard G. Stamer
Reliable-Prompt-Guaranteed

331 Virginia Avenue
Collingswood, NJ 08108

PHILCO PREDICTAS WANTED:

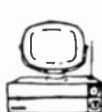

BUY • SELL • TRADE • RENT • RESTORE
APPRAISALS/LECTURES GIVEN

DAVID WEDDINGTON
(615) 890-7498

2702 Albany Ct.
Murfreesboro, TN 37129

RADIOGALLERY.COM

ANTIQUÉ RADIO, TRANSISTOR and WATCH SALES
"CLASSIC MODELS THAT WORK" / NEVER "as is" or "untested"

Big selection on the internet at: www.RadioGallery.com

Order On-Line... ALL MAJOR CREDIT CARDS WELCOME!

Scott Stambaugh

725 South 14th Street Lebanon, Pa. 17042

E-MAIL: Scott@RadioGallery.com

Free Estimates
Hrs - 9 AM - 5 PM EST
Tues - Sat

Tel / Fax (860) 928-2628
E-Mail: radioec@neca.com
<http://users.neca.com/radiodoc/>



ANTIQUÉ RADIO RESTORATION & REPAIR

1920 - 1960's

Buy & Sell

Reasonable Rates, Tubes, Professional
Overhauls, Cabinet Refinishing, Service
For All Antique Car, Table & Console
Radios, Communication Receivers &
Tube Amplifiers

20 Gary School Road
Pomfret Center, CT 06259

BOB ESLINGER

WANTED!

JAPANESE MILITARIA

any kind of WW-2 Japanese hardware - aircraft instruments
radios, optics.

Takashi Doi

Fax: 011-8145-301-8069

E-Mail: taka-doi@a2.ctktv.ne.jp

I-21-4 Minamidai, Seyaku, Yokohama, 246 Japan.



Cayce Vintage Sound Company

(803) 791-0733

Your complete source for

Leatherette.

"Black Stag" style leatherette stocked
Others available by special order

Scott McAuley
117 Sandy Lane
Cayce, S.C. 29033

LSASE for samples
cavisco@aol.com
Expert Vintage Electronic Repair

BUSINESS CARD ADS - \$53.00 FOR 3 MONTHS

Antique Radio & Television

Visit our shop in downtown New London
15 Green St., New London, CT 06320
www.tuberadiorepair.com

(860) 442-0233
William Morse

Mon.-Sat. 11 am to 7



871 River Rd
Eugene, OR 97404

Ken's "Antique" Electronics

We Buy • Sell • Repair
Antique Radios • Jukeboxes
Hi-fi Stereo • Auto Radios

"We Specialize In Tube Equipment"

541-485-8676
FAX 541-689-6316
Email kszenith@webtv.net

Great Northern Antiques

We Buy and Sell
Antiques-Collectibles-Advertising
and Vintage Radios

Alan Jespersen
5200 Bloomington Ave. S
(4 blocks west of Cedar Ave)
Minneapolis, MN 55417

TEL (612) 727-2489
FAX (612) 821-4821
E-Mail: mte612@aol.com

The Bavarian Radio Works

HOSS A. HOKSTRASSEN
(781) 447-6299
bavarianradio@mediasone.net



30 WALNUT ST.
WHITMAN, MA 02082

• GRUNDIG • SABA • TELEFUNKEN • NORDMENNKE • PHILIPS • SENSORS •
- SPECIALIZING IN REPAIR OF EUROPEAN RADIO SETS -

FRED GORDON

Fred's
OLD RADIO REPAIR • HOME • CAR

221 North Commerce
Corsicana, TX 75110

Bus 903-874-4531
Home 903-874-7147

Jackson Speaker Service

Expert Antique Loudspeaker
Repair And Reconing.
No Field Coil Repairs.

Service On Virtually Any Speaker Made Including
Stereo, P.A., And Antique Auto Speakers.

217 Crestbrook Dr. Owner
Jackson, Mich. 49203 Ron McGee
Ph. - (517) 789-6400, Ans 4th ring
Fax: (517) 788-6558

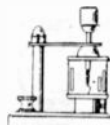

B. TURKE
P.O. Box 222288
Hollywood, FL 33022
(954) 925-3670
B.A. Turke, Ph.D.E.E.

CRYSTAL SETS

PARTS - PLANS - KITS - BOOKS
CATALOG \$2.00

Largest source of Vintage and New
Variable Air Condensers, Variometers,
Vario-Couplers, Tap Switches, Tap
Points, Galena and Germanium
Detectors, Detector Stands, Cat
Whiskers, Terminals, Sliders,
Headsets, Dial Knobs, Coil Forms,
Magnetic Wire, etc.



If you buy, sell or like jukeboxes you need
ALWAYS JUKIN'-THE MONTHLY JUKEBOX
MAGAZINE!! Subscribers in 25 countries,
ALWAYS JUKIN' LEADS THE WAY: Articles,
photos, show reports, ads, new products,
price guides, restoration tips, repairs-
everything you need to know about JUKE-
BOXES- the fastest appreciating collectible in
the world!!! Fun & a great investment.
Sample Copy, \$3. \$36 per year.
ALWAYS JUKIN', 1952 1st Ave. S, Ste. #6AR,
Seattle, WA 98134, (206) 652-4005.
Fax (206) 652-4007
Master/Visa OK

LOGANS RADIO SERVICE

724-837-5580

BUY • SELL • TRADE • WHEEL AND DEAL

N.O.S. BLACK/WHITE PICTURE TUBES
40's-70's

FOR SALE, CALL OR WRITE

SERVICE AND RESTORATION SINCE 1952

REAR 526 Mt. PLEASANT ST., GREENSBURG, PA 15601

Antique Radio & TV Repair

Repair & Restore of Vacuum Tube Electronics

Bill Christie, KB3DCS
2208 Persimmon Dr.
Coatesville, PA 19320
Ph: 610-486-6820

E-mail: christiew1@prodigy.net

I accept work from all states via UPS or USPS

Erstwhile Radio Brings You

Oldtime Radio Broadcasts on Cassettes

5,700+ Shows Available - Purchase By The Hour

Catalog is Only \$2.00 (P & H) - Send To:

Erstwhile Radio
P.O. Box 2284
Peabody, MA 01960-7284

Your Ticket To The Golden Age of Radio



WAVES
ANTIQUES
EARLY RADIOS
&
PHONOGRAPHS
BOUGHT • SOLD
RENTALS • REPAIRS

MON.-FRI. 12-6
SAT.-SUN. 10-6
FAX 201 481-7121
e-mail: c1waves@aol.com
www.wavesradio.com

110 W 25TH ST., NY, NY 10001 SURF 1008 212 989-9284
PROPRIETORS Bruce and Charlene Meyer

A Pictorial History of Collins Amateur Radio Equipment

By Jay H. Miller, KK5IM



**Early Gear, War and Recovery
History of SSB Development
The Full Story of the S-Line
Never Before Told Stories**

**100s of Original Photos - Many Full Color
Fully Indexed - 175 Pages**

\$39.95

Everything stocked and shipped promptly - Radio is our middle name.

16th Anniversary Special! Free U.S. shipping thru June 30, 2000!

U.S. Orders - 16th Anniversary Special - free U.S. packing & book-rate shipping thru June 30, 2000. If using VISA or MasterCard, include name on card, card number and expiration date. Send payment with order. Mass. residents add 5% sales tax. Money back return policy. Softcover unless stated otherwise. Most orders shipped by next business day. Typical U.S. order will be received within 7 days, but allow 2-3 weeks. Foreign orders - write for shipping costs, or use credit card and specify air or surface (allow 2-3 months for surface shipping).



A.R.C., P.O. Box 2, Carlisle, MA 01741. Tel: (978) 371-0512

Fax: (978) 371-7129 - E-mail: ARC@antiqueradio.com - Web: www.antiqueradio.com



(Apr-00)

Millennium Special

Back Issues — 60% Off — \$2.00 Each

Full Calendar Years

A sampling of articles and topics is listed below.

(12 issues in all years except 1984. All originals except for June 1984 through March 1987)

- | | | |
|------|--|------|
| 1984 | A.R.C.'s First Year. The June Sample Copy plus September-December. First Kreuzer's Value Guide,* Heathcote's Collectors' Corner, Crocker's Crosley Review,* With The Collectors* and Meet Reports.* (5 Issues. Photocopies; 16-20 pgs.) | \$10 |
| 1985 | First Photo Review,* Radio Novelties,* Collector Profile,* Telegraph Key Review,* Crystal Set Review* and Atwater Kent Breadboard Review.* Also Value Guide A-T, Penna Wireless, Marconi 106, WD-11. (Photocopies; 20-24 pgs.) | \$24 |
| 1986 | First Collecting British Crystal Sets.* Collectors' Corner, Value Guide S-Z, Horn Speaker Values, Speaker Review, Precision Ace, Quaker Oats Crystal Set, HQ-120X, First Issue Published by John Terrey. (Jan.-Sept. Photocopies; Oct.-Dec. reprints; 24-28 pgs.) | \$24 |
| 1987 | First full-color covers. First Foster's Restoration Topics,* Vintage Television.* Philco 38-3, EHScott 48-Tube Set, Marconi Multiple Tuner, Vacuum Tube Value Guide, Freed Eisemann, Crosley Pup, Fada Bullet, Vitus, Sparton Mirrored Radios. (Jan.-Mar. reprints; Apr.-Dec. originals; 32-36 pgs.) | \$24 |
| 1988 | First Old Tyme Radio Services Directory,* Jim Fred's Repairing AC Radios,* Vintage Test Equipment.* Also DuMont Clifton TV, Mechanical TV, Aerola Senior, A-K Model 20, Kennedy 220, Philco Predictas, Martian and Gem Crystal Sets. (40-60 pgs.) | \$24 |
| 1989 | Automatic Radio, Clapp-Eastham HR/HZ, Mechanical TV,* Western Electric 1920-1927, Radiola 44, Ace Radio Repair on June cover, Arvin & the Hopalong Radio, Magnavox TRF-5, A-K Crystal Set, A-K 9A, Philco Block Capacitors, Marconi 106D, Patterson PR-10, Oriole 7B. (52-68 pgs.) | \$24 |
| 1990 | First Radio Adventures.* Also California Earthquake, Transistor Radios, Cleaning Bakelite, EH Scott Telematic, Ekko Round Radios, Radiola Grand, Horn Speaker Survey, Atlantic Radio, GE 901 TV, Philco Block Capacitors, Tuska 224, RCA 816K, RCA Theremin. (68-92 pgs.) | \$24 |
| 1991 | First Collecting Foreign Sets,* Out-Of-Sight Radios, Philco 20, 90, Wilcox-Gay Recordio, A.R.C. Index '84-'90, Westinghouse RC-RA-DA-DR-RT-AR, Radio Stock Certificates, German Radios, Subminiature Tube Radios, Early Navy Radio Equipment, Gonset. (84-100 pgs. Index issue is 148 pgs.) | \$24 |
| 1992 | Vintage Microphones, Gonset, Early Navy Equipment, Superhets of the 20s,* The Neurodyne, Telmaco, Atlantic Radio, Vintage Hi-Fi, Battery Eliminators, Radio Fans, A-K 35, RCA 648PTK TV, Repairing IF Transformers, Paragon RA-10/DA-2, A-K 21, 33, WLW, 1991 Index. (88-100 pgs.) | \$24 |
| 1993 | Arvin Metal Radios, Repairing RCA Catacombs, Philco Armchair Radios, Kenrad Crystal Set, Transistor Radios, A-K 52, Philco Cabinet Design,* Webster Electric Co., Kyletron Electrostatic Speaker, Vintage Guitar Amp, Tower Cone Speakers, EH Scott Allwave, 1992 Index. (100-104 pgs.) | \$24 |
| 1994 | Radiola I, Radiola 60 series, Pot Metal, Fada Neurodyne, Clinton Mfg. Co., Kardon Radios, Philco Cabinet Designers, Palco, SCR-609 & 610, Philco Survey, Permeability Tuning, Weston, Regency TR-1, Charles Herold, Nipper, 1993 Index. (100-116 pgs.) | \$24 |
| 1995 | Zenith Trans-Oceanic, Steinway Capehart, Ken-Rad, Radio Shop J, Freshman Master Speaker, Broadcast Equipment, Philco Survey, Power Transformers, Tube Testers,* Radio Apparatus Co., L.E. Knott Apparatus Co., Ford Museum Auction in color, Ozarka, 1994 Index. (108-116 pgs.) | \$24 |
| 1996 | Communications Receivers, KDKA, Philco Designers, Radiola IV, WJZ, Art Deco Radios, Herold Microphone, Tuning Battery Sets, Paul Godley & Paragon, Soldering, Webb Microphone Collection, Mirrored Glass Radios, Samson Electric Co., Russian Red Star, Echophone EC-1. (100-116 pgs.) | \$24 |
| 1997 | Thompson Minuet, Marconi Archive Auction Saga, Frank Krantz, Emerson Multivalve Radios, De Forest Detectors & Tuners, Remote Control Radios, Ekko Stamps, Freshman Polydyne, Vintage Audio Recorders, Selenium Rectifiers, DeForest Reflex Sets, Early Zenith. (100-116 pgs.) | \$24 |
| 1998 | Sears Commentator, 300B Tube, Replica Nameplates, Australian Radios, WMAZ, Espey, Nipper, Early Wireless, Rider's Volume 1, Pilot Radio, Browning-Drake, Army-Navy Numbering System, Cortlandt Street Radio Row, Pooley Co., Transistor's Early History. (100-108 pgs.) | \$24 |
| 1999 | Reinartz Receiver, Cone Ship Speakers, The Internet, WebTV, Military Equipment, Krantz Estate Auction, Atwater Kent Time Capsule, Atwater Kent Radiodyne, RCA Radiolas for 1923/24, 15th Year Special Issue, Australian Pedal-Operated Radio, Early RCA TV, Battery Set Power Supplies. (100-108 pgs.) | \$24 |

* These articles continued for one or more years and some continue today.

Millennium Back Issue Special: U.S. Orders - Above prices include shipping. If using VISA or MasterCard, include name on card, card number and expiration date. Send payment with order. Money back return policy. Most orders shipped the same day received, but allow 2-4 weeks to receive order. Non-U.S. orders - write for shipping costs, or use VISA or MasterCard and specify air or surface (allow 2-3 months for surface shipping).



A.R.C., P.O. Box 2, Carlisle, MA 01741. Tel: (978) 371-0512

Fax: (978) 371-7129 - E-mail: ARC@antiqueradio.com - Web: www.antiqueradio.com



(Jan-00)

CRYSTAL CLEAR

By Maurice L. Sievers

Volume 1

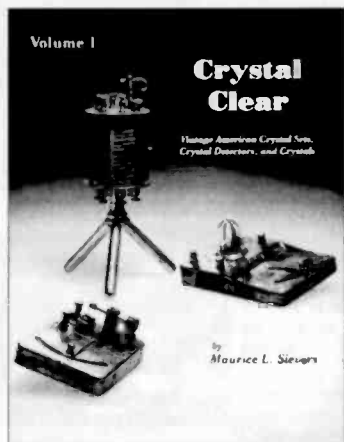

750 Illustrations – 570 Crystal Sets
341 Detectors – 207 Crystals
Perfect for the beginning collector!
Useful for the experienced too!

Crystal Clear is the most comprehensive reference for collectors, historians and anyone interested in early radio. In addition to the many excellent photos and reproductions of ads, *Crystal Clear* includes lists showing all sets by manufacturer, set name, selling price and date of manufacture. 8 1/2" x 11", 282 pages.

\$29.95 – Softcover

Volume 2

Crystal Clear, Vol. 2 supplements the first volume. It identifies an additional 172 crystal radio sets, 91 crystal detectors and 26 crystals by manufacturer, model, year produced, description and original selling price. Further research on many of the crystal sets covered in Volume 1. Detailed history on the Philmore Manufacturing Company and the Western Manufacturing Company. 8 1/2" x 11", 252 pages.

\$29.95 – Softcover



Everything stocked and shipped promptly – Radio is our middle name.

16th Anniversary Special! Free U.S. shipping thru June 30, 2000!

U.S. Orders - 16th Anniversary Special - free U.S. packing & book-rate shipping thru June 30, 2000. If using VISA or MasterCard, include name on card, card number and expiration date. Send payment with order. Mass. residents add 5% sales tax. Money back return policy. Softcover unless stated otherwise. Most orders shipped by next business day. Typical U.S. order will be received within 7 days, but allow 2-3 weeks. Foreign orders - write for shipping costs, or use credit card and specify air or surface (allow 2-3 months for surface shipping).



A.R.C., P.O. Box 2, Carlisle, MA 01741. Tel: (978) 371-0512

Fax: (978) 371-7129 – E-mail: ARC@antiqueradio.com – Web: www.antiqueradio.com



(A/R-00)

New Books for the Collector

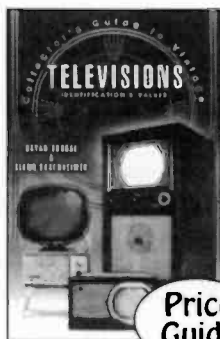

Price
Guide

Collector's Guide to Vintage Televisions by Bryan Durbal and Glenn Bubenheimer. Includes information about the size of the screen, year of manufacture, cabinet composition, and current value for over 1,400 vintage TVs from 1945-1960 and transistor sets through 1980. 200+ full color photos. 5 1/2" x 8 1/2", 176 pages. Softcover. NEW. — \$15.95

A Pictorial History of Collins Amateur Radio Equipment by Jay Miller. The most complete story of Collins. Told in hundreds of photos & in the words of the men who made it happen. NEW. — \$39.95

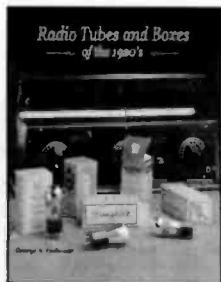

Price
Guide

Zenith Radio: The Early Years 1919-1935 by John Bryant and Harold Cones. The first of a planned 3-book series explains the Zenith story. Never published photos, documents, and information. 300 photos and illustrations, 120 in color. 8 1/2" x 11", 224 pages. Softcover. — \$29.95

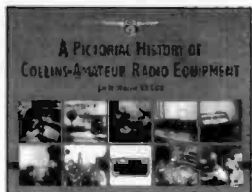

Price
Guide

Genuine Plastic Radios of the Mid-Century by Ken Jupp and Leslie Piña. Illustrates mid-century table radios made of plastic as examples of industrial design and pop-culture. Vintage B&W photos and advertisements. 439 color photos. 8 3/4" x 11 1/4", 208 pages. Hardcover. — \$39.95

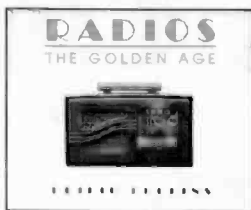

Radios: The Golden Age by Philip Collins. Colorful Catalin and Bakelite radios from the late 1930s to the early 1940s. Over 100 color photos. 10" x 8 1/4". 119 pages. Hardcover. — \$12.98



The Golden Age of Televisions by Philip Collins. An amazing collection of photos of these early machines that evoke a time when the television was more than merely a box or a screen: it was the center of every home. 10" x 8 1/2". Softcover. — \$15.95



Everything stocked and shipped promptly – Radio is our middle name.

16th Anniversary Special! Free U.S. shipping thru June 30, 2000!

U.S. Orders - 16th Anniversary Special - free U.S. packing & book-rate shipping thru June 30, 2000. If using VISA or MasterCard, include name on card, card number and expiration date. Send payment with order. Mass. residents add 5% sales tax. Money back return policy. Softcover unless stated otherwise. Most orders shipped by next business day. Typical U.S. order will be received within 7 days, but allow 2-3 weeks. Foreign orders - write for shipping costs, or use credit card and specify air or surface (allow 2-3 months for surface shipping).



A.R.C., P.O. Box 2, Carlisle, MA 01741. Tel: (978) 371-0512

Fax: (978) 371-7129 – E-mail: ARC@antiqueradio.com – Web: www.antiqueradio.com



(Apr-00)

Books About Tubes

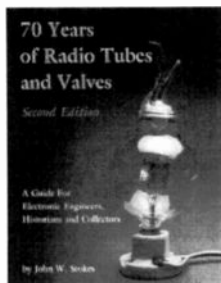

70 Years of Radio Tubes and Valves, 2nd Ed., Stokes. *The thermionic vacuum tube story from 1883 through 1960. New chapter on audio application tubes, more photos, magazine ads and a new index by tube number. 264 pgs. — \$29.95*

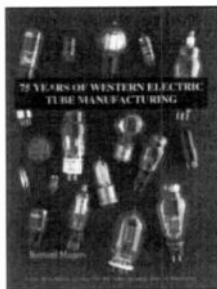

75 Years of Western Electric Tube Manufacturing, Magers. *A log book history. 750+ WE tubes. Illustrated. 133 pgs. — \$16.95*



Tube Lore, Sibley. *Trends in tube design, receiving and audio tubes, special-purpose and transmitting tubes, military types, tips on testing, repairing, adapting various tubes, auction prices from six major sales. 186 pgs. — \$19.95*



Radio Tubes and Boxes of the 1920s, Fathauer. *A pictorial presentation of radio tubes of the 20s, including packaging and advertising. Over 400 color photos and illustrations. 105 pgs. NEW — \$26.95*

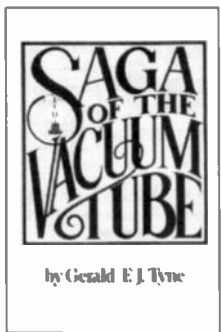

Saga of the Vacuum Tube, Tyne. *The development of vacuum tubes - 1880 to 1930. From Edison, Thomson and Fleming to DeForest, Philips, Siemens and many more. 100+ tube photos. 495 pgs. — \$18.95*



TubeData, Holm. *The most comprehensive list of vacuum tubes and data in an easy-to-use program for PCs. 27,000+ tubes, includes receiving and transmitting tubes. Lists function, manufacturer, technical data, & more. (3 1/2" disk). — \$39.95*

Everything stocked and shipped promptly - Radio is our middle name.

16th Anniversary Special! Free U.S. shipping thru June 30, 2000!

U.S. Orders - 16th Anniversary Special - free U.S. packing & book-rate shipping thru June 30, 2000. If using VISA or MasterCard, include name on card, card number and expiration date. Send payment with order. Mass. residents add 5% sales tax. Money back return policy. Softcover unless stated otherwise. Most orders shipped by next business day. Typical U.S. order will be received within 7 days, but allow 2-3 weeks. Foreign orders - write for shipping costs, or use credit card and specify air or surface (allow 2-3 months for surface shipping).



A.R.C., P.O. Box 2, Carlisle, MA 01741. Tel: (978) 371-0512

Fax: (978) 371-7129 - E-mail: ARC@antiqueradio.com - Web: www.antiqueradio.com



(Apr-00)

Amateur Radio Books



COMMUNICATIONS RECEIVERS



Communications Receivers 4th Edition by Raymond S. Moore. A comprehensive guide to 750, 1932 to 1981, vacuum tube receivers by 66 manufacturers. Three pages of military receivers. 448 radios pictured! Sharper, clearer photographs. 8 1/2" x 11", 136 pages. Softcover. — \$19.95

Heathkit, A Guide to the Amateur Radio Products by Chuck Penson. Documentation of ALL Heathkit's amateur products. 200+ sharp photos. Most products are pictured with a full-page description. 8 1/2" x 11", 256 pgs. Softcover. — \$24.95

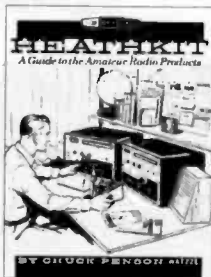

The Pocket Guide to Collins Amateur Radio Equipment 1946-1980 by Jay Miller. A pictorial guide to Collins equipment and accessories. 90+ sharp photographs. 3 1/2" x 7". 106 pages. Softcover. — \$19.95

Radios by Hallicrafters, 2nd Ed. by Chuck Dachis. This book includes over a thousand photographs (b/w & color) of radio receivers, transmitters, electronics accessories and advertising material. Technical descriptions are provided for every known Hallicrafters model, including dates of production, model numbers, accompanying pieces and original prices. This 2nd edition includes additional coverage of receivers and updated pricing. 8 1/2" x 11", 225 pages. Softcover. — \$29.95

Shortwave Receivers Past & Present Communications Receivers 1942-1997, 3rd Edition by Fred Osterman. This book is designed for the radio collector, the informed receiver buyer or anyone interested in the history and development of shortwave radios. Over 770 receivers from 98 manufacturers. 8 1/2" x 11", 473 pages. Softcover. — \$24.95

Ham Price Guide, 2nd by Eugene Rippen. Prices for over 3,800 transceivers, receivers, tuners, transmitters, amplifiers, antennas, test equipment, books, tubes and catalogs. Small print. 8 1/2" x 11", 81 pages. Softcover. — \$10.95

Tube Type Transmitter Guide by Eugene Rippen. Provides a wealth of information on transmitters and transceivers. Includes ancillary items such as linear amplifiers, converters, modulators and VFOs. Over 500 illustrations. 8 1/2" x 11", 145 pages. Softcover. — \$17.95

Transmitters, Exciters & Power Amplifiers 1930-1980 by Ray Moore. Pictorial and descriptive guide to amateur high frequency transmitters and amplifiers manufactured in the U.S.A. Over 500 photos. 8 1/2" x 11", 144 pages. Softcover. — \$21.95

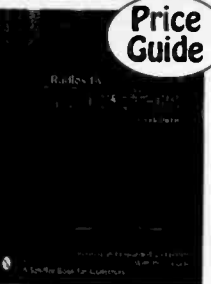

Ham Price Guide 2nd



TRANSMITTERS EXCITERS & POWER AMPLIFIERS 1930-1980

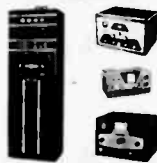

Everything stocked and shipped promptly – Radio is our middle name.

U.S. Orders - 16th Anniversary Special - free U.S. packing & book-rate shipping thru June 30, 2000. If using VISA or MasterCard, include name on card, card number and expiration date. Send payment with order. Mass. residents add 5% sales tax. Money back return policy. Softcover unless stated otherwise. Most orders shipped by next business day. Typical U.S. order will be received within 7 days, but allow 2-3 weeks. Foreign orders - write for shipping costs, or use credit card and specify air or surface (allow 2-3 months for surface shipping).



A.R.C., P.O. Box 2, Carlisle, MA 01741. Tel: (978) 371-0512

Fax: (978) 371-7129 – E-mail: ARC@antiqueradio.com – Web: www.antiqueradio.com



Transistor Radio Books



The Collector's Guide to Transistor Radios 2nd Edition by Marty & Sue Bunis. *This book will help you identify the most sought-after vintage transistor radios. Over 2,900 models listed, all with current prices. Includes radio club listing. 375 all new color photos. 5 1/2" x 8 1/2". 320 pgs. 1996. Softcover. - \$16.95*

Price Guide

Transistor Radios: 1954-1968 by Norman Smith. *Over 1,000 transistor radios identified by manufacturer, marketing organization, type, and style. 460+ color photographs and price guide. 8 1/2" x 11". 160 pgs. Softcover - \$29.95*



Price Guide



Transistor Radios, A Collector's Encyclopedia and Price Guide by David Lane & Robert Lane. *Identification & price guide to over 2,500 transistor and novelty radios. History & key to collecting chapters. 8 1/2" x 11". 170 pgs. Softcover. - \$19.95*

Price Guide

Collector's Guide to Novelty Radios by Marty Bunis & Robert Breed. *This book is the source for novelty transistor radios in all shapes and sizes. Radios are described in detail with current prices. Over 600 color photographs. 8 1/2" x 11". 224 pgs. Softcover - \$18.95*



Price Guide

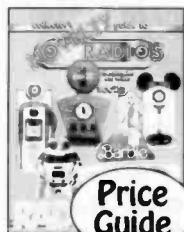

Collector's Guide to Novelty Radios, Book II by Marty Bunis & Robert Breed. *All new second volume takes up where the first book left off. New radios are described with current prices. Over 600 all new color photographs. 8 1/2" x 11". 208 pgs. Softcover - \$19.95*

Price Guide

Zenith Transistor Radios, Evolution of a Classic by Norman Smith. *A complete listing of all transistor radio models created by Zenith during the Magic Years from 1955-65. 200+ color photographs and price guide. 8 1/2" x 11". 160 pgs. Softcover - \$29.95*



Price Guide

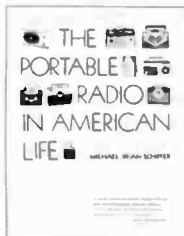

The Portable Radio in American Life by Michael Schiffer. *Approximately 50 pages on transistor radios, beginning with the Regency TR-1 through to the later sets made overseas. 450 photographs, 193 transistor radios pictured. 8 1/2" x 11". 259 pgs. Softcover - \$26.95 Hardcover - \$45.00*

Everything stocked and shipped promptly - Radio is our middle name.

16th Anniversary Special! Free U.S. shipping thru June 30, 2000!

U.S. Orders - 16th Anniversary Special - free U.S. packing & book-rate shipping thru June 30, 2000. If using VISA or MasterCard, include name on card, card number and expiration date. Send payment with order. Mass. residents add 5% sales tax. Money back return policy. Softcover unless stated otherwise. Most orders shipped by next business day. Typical U.S. order will be received within 7 days, but allow 2-3 weeks. Foreign orders - write for shipping costs, or use credit card and specify air or surface (allow 2-3 months for surface shipping).



A.R.C., P.O. Box 2, Carlisle, MA 01741. Tel: (978) 371-0512

Fax: (978) 371-7129 - E-mail: ARC@antiqueradio.com - Web: www.antiqueradio.com



(Apr-00)

Radio Manufacturers of the 1920's

BY ALAN DOUGLAS



"The definitive book on American broadcast receivers of the 1920s"

Volume 1: A-C Dayton - Adams Morgan - Air-Way - All-American Mohawk - American Bosch - Amrad - Amrad S-Tube - Apex - Atwater Kent - Bremer Tully - Browning-Drake - Clapp-Eastham - Crosley - Cutting & Washington - Day-Fan - DeForest - Eagle - ERLA - FADA - Federal - Ferguson. 225 Pages.

Volume 1: \$24.95 - Softcover Only

Volume 2: Freed-Eisemann - Eisemann - Freshman - Garod - Gilfillan - Grebe - Howard - Jones (Lester/Melco) - Jones (Jos.) - Kellogg - Kennedy - King - Kodel - Kolster - Leutz - Magnavox - Majestic - Marti - Metro - Klitzen/Michigan - Midwest - Mu-Rad - Murdock - Music Master - Neutrowound - Operadio - Ozarka - Pfanstiehl - Philco - Pilot - Priess. 266 Pages.

Volume 2: \$29.95 - Softcover Only

Volume 3: RCA - Scott - Silver-Marshall - Slagle - Sleeper - Sonora - Sparton - Splitdorf - Steinite - Stewart-Warner - Stromberg-Carlson - Thermodyne - R.E. Thompson - Thorola - Tri-City - C. D. Tuska - Ware - Western Coil - Western Electric - Workrite - Zenith. 292 Pages.

**Volume 3: \$29.95 - Softcover
\$39.95 - Hardcover**

Everything stocked and shipped promptly – Radio is our middle name.

16th Anniversary Special! Free U.S. shipping thru June 30, 2000!

U.S. Orders - 16th Anniversary Special - free U.S. packing & book-rate shipping thru June 30, 2000. If using VISA or MasterCard, include name on card, card number and expiration date. Send payment with order. Mass. residents add 5% sales tax. Money back return policy. Softcover unless stated otherwise. Most orders shipped by next business day. Typical U.S. order will be received within 7 days, but allow 2-3 weeks. Foreign orders - write for shipping costs, or use credit card and specify air or surface (allow 2-3 months for surface shipping).



A.R.C., P.O. Box 2, Carlisle, MA 01741. Tel: (978) 371-0512

Fax: (978) 371-7129 – E-mail: ARC@antiqueradio.com – Web: www.antiqueradio.com



(Apr-00)

Collector's Guide to Vintage Televisions

By Bryan Durbal and Glenn Bubenheimer



Identification & Price Guide
1,400 Vintage TV Sets from 1945-1960
Transistor TV Sets through 1980
200+ full color photographs
176 pages

\$15.95 - Softcover

Everything stocked and shipped promptly - Radio is our middle name.

16th Anniversary Special! Free U.S. shipping thru June 30, 2000!

U.S. Orders - 16th Anniversary Special - free U.S. packing & book-rate shipping thru June 30, 2000. If using VISA or MasterCard, include name on card, card number and expiration date. Send payment with order. Mass. residents add 5% sales tax. Money back return policy. Softcover unless stated otherwise. Most orders shipped by next business day. Typical U.S. order will be received within 7 days, but allow 2-3 weeks. Foreign orders - write for shipping costs, or use credit card and specify air or surface (allow 2-3 months for surface shipping).



A.R.C., P.O. Box 2, Carlisle, MA 01741. Tel: (978) 371-0512
Fax: (978) 371-7129 - E-mail: ARC@antiqueradio.com - Web: www.antiqueradio.com



(Apr-00)

Shortwave Receivers Past & Present Communications Receivers 1942-1997 3rd Edition

By Fred Osterman

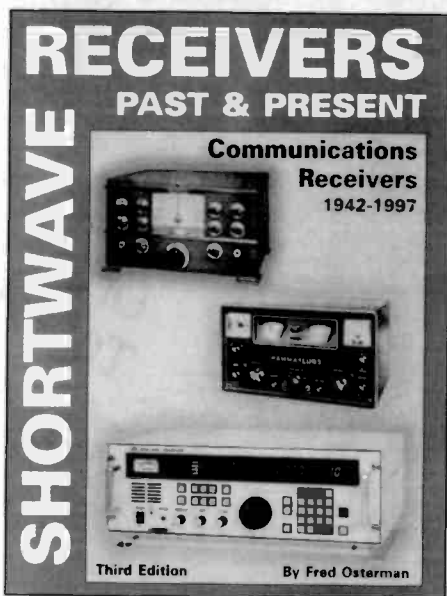

**840 Photographs — 473 Pages
Features Over 770 Receivers from
98 American and International Manufacturers**

NEW Edition

270 More Receivers!

28 More Manufacturers!

122 More Pages!

\$24.95 - Softcover

Everything stocked and shipped promptly – Radio is our middle name.

16th Anniversary Special! Free U.S. shipping thru June 30, 2000!

U.S. Orders - 16th Anniversary Special - free U.S. packing & book-rate shipping thru June 30, 2000. If using VISA or MasterCard, include name on card, card number and expiration date. Send payment with order. Mass. residents add 5% sales tax. Money back return policy. Softcover unless stated otherwise. Most orders shipped by next business day. Typical U.S. order will be received within 7 days, but allow 2-3 weeks. Foreign orders - write for shipping costs, or use credit card and specify air or surface (allow 2-3 months for surface shipping).



A.R.C., P.O. Box 2, Carlisle, MA 01741. Tel: (978) 371-0512

Fax: (978) 371-7129 – E-mail: ARC@antiqueradio.com – Web: www.antiqueradio.com



Radios

of the Baby Boom Era

Four Volumes Available — 2000 pages — From Sams' Archives
 1946 to 1960 — 274 Brands — 3494 Illustrations (B&W)
 6769 Models — Catalin, Bakelite, Wood, Transistor Radios & More

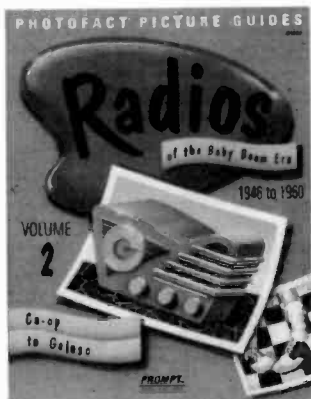

Vol.	Brands	Included
1	56	Admiral to Clearsonic
2	54	Co-op to Galeso
3	58	GE to Monitoradio
4	30	Motorola to RCA Victor
5	35	Realtone to Stratovox
6	35	Stromberg-Carlson to Zenith

All Vols. Out of Print. Limited stock available.
 Vols. 1 and 4 Out of Print & Unavailable.



1/2 Page for each illustrated radio including:

- Large illustration of the radio including knob functions
- Short description of the radio
- Number of tubes
- Power supply type (AC, Battery, etc.)
- Tuning range
- Manufacturer
- Sams Photofact Set number & year Photofact published.

Each Volume: \$16.95 – Softcover
 8 1/2" x 11" – Approx. 328 pages

ALSO

- Index by model number listing tubes in radio
- List of similar radio models indexed to pictured radio
- List of manufacturers and suppliers indicating their brand names
- Basic trouble-shooting hints

Everything stocked and shipped promptly – Radio is our middle name.

16th Anniversary Special! Free U.S. shipping thru June 30, 2000!

U.S. Orders - 16th Anniversary Special - free U.S. packing & book-rate shipping thru June 30, 2000. If using VISA or MasterCard, include name on card, card number and expiration date. Send payment with order. Mass. residents add 5% sales tax. Money back return policy. Softcover unless stated otherwise. Most orders shipped by next business day. Typical U.S. order will be received within 7 days, but allow 2-3 weeks. Foreign orders - write for shipping costs, or use credit card and specify air or surface (allow 2-3 months for surface shipping).



A.R.C., P.O. Box 2, Carlisle, MA 01741. Tel: (978) 371-0512

Fax: (978) 371-7129 – E-mail: ARC@antiqueradio.com – Web: www.antiqueradio.com



Zenith Transistor Radios Evolution of a Classic

By Norman Smith

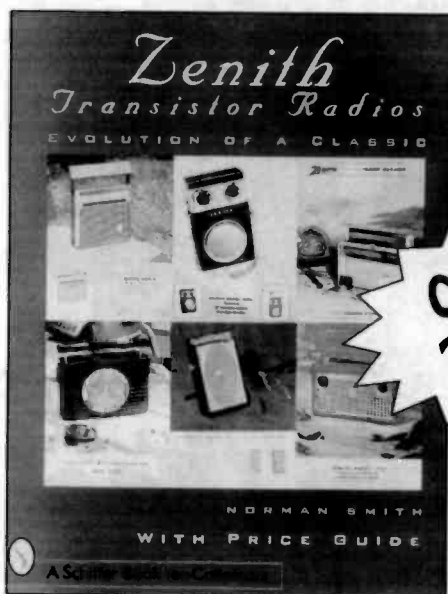

**Order
Today!**

**Includes all Zenith Transistor Radio Models
from 1955 through 1965**

200+ Color Photographs — Price Guide

**Photographs, Documents & Original Drawings
from Zenith Archives**

\$29.95 - Softcover

Everything stocked and shipped promptly – Radio is our middle name.

16th Anniversary Special! Free U.S. shipping thru June 30, 2000!

U.S. Orders - 16th Anniversary Special - free U.S. packing & book-rate shipping thru June 30, 2000. If using VISA or MasterCard, include name on card, card number and expiration date. Send payment with order. Mass. residents add 5% sales tax. Money back return policy. Softcover unless stated otherwise. Most orders shipped by next business day. Typical U.S. order will be received within 7 days, but allow 2-3 weeks. Foreign orders - write for shipping costs, or use credit card and specify air or surface (allow 2-3 months for surface shipping).



A.R.C., P.O. Box 2, Carlisle, MA 01741. Tel: (978) 371-0512

Fax: (978) 371-7129 – E-mail: ARC@antiqueradio.com – Web: www.antiqueradio.com



(Apr-00)

Transistor Radios: 1954-1968

By Norman Smith



**Over 1,000 Transistor Radios
460+ Color Photographs
Price Guide**

\$29.95 - Softcover

Everything stocked and shipped promptly – Radio is our middle name.

16th Anniversary Special! Free U.S. shipping thru June 30, 2000!

U.S. Orders - 16th Anniversary Special - free U.S. packing & book-rate shipping thru June 30, 2000. If using VISA or MasterCard, include name on card, card number and expiration date. Send payment with order. Mass. residents add 5% sales tax. Money back return policy. Softcover unless stated otherwise. Most orders shipped by next business day. Typical U.S. order will be received within 7 days, but allow 2-3 weeks. Foreign orders - write for shipping costs, or use credit card and specify air or surface (allow 2-3 months for surface shipping).



A.R.C., P.O. Box 2, Carlisle, MA 01741. Tel: (978) 371-0512

Fax: (978) 371-7129 – E-mail: ARC@antiqueradio.com – Web: www.antiqueradio.com



(Apr-00)

COLLECTOR BOOKS AVAILABLE FROM A.R.C.

BOOKS MARKED WITH "E" ARE THE MOST POPULAR AND ARE ESPECIALLY RECOMMENDED FOR NEW COLLECTORS!

- Antique Radio Restoration Guide, 2nd Ed., Johnson. *Beginner's introduction to troubleshooting and repairing AC table model radios.* 1992. 145 pgs. \$14.95
- The AWA Review. Vol. 6: Hawaiian Wireless, U.K. TV, SCR-RC-BC Dir., NYC Wireless, etc. Vol. 7: Poldhu xmitters, Navy equipment, Arc xmitters. Vol. 8: Keys, Federal Co., KFS-Federal-Mackay story, Nat'l Electrical Supply Co., Navy Electronics Dir., etc. Vol. 9: Marconi, The Int'l Contest for Radar, Magnetron Story, F. Lowenstein, Ham Licensing. Vol. 10: Atwater Kent, Race for Radiotelephone, Radio Central 75th Anniversary, The Heintz and Kaufman Radio, Collins Radio Co. Vol. 11: Scott Radio Products, National sliding coil receivers. Vol. 12: The Atwater Kent Radios. Vol. 6-8, ea. \$10.00; Vol. 9-11, ea. \$20.00; Vol. 12 \$34.00
- The Antique Radio Boys and the Garrulous Grebe, Dryer. *Adventure story written in the style of the '20s & '30s.* 51 pgs. \$4.95
- The Auto Radio, Matteson. *Info, photos & ads of the auto radio through the 1950s.* 316 pgs. (hardcover) \$34.95
- Audio! Audio!, Hill. *A comprehensive directory of classic audio amplifiers and control units. Details of over 850 models from nearly 150 British manufacturers from the 1940s to the 1970s. Signed and numbered.* 95 pgs. \$19.95
- Behind the Front Panel, Rutland. *Reviews radio circuits and radio history. Easy descriptions.* 25 pics. 158 pgs. \$18.95
- Blast from the Past, A Pictorial History of Radio's First 75 Years, Rhoades. *The performers, programs, & technology that made radio a part of everyday life. 100s of never-before-published photos* (hardcover) \$39.95
- Classic TVs, 2nd Printing, Wood. *Prevar to 1950s. Revised price guide.* 140+ color photos, repros of catalogs & ads. 86 pgs. \$18.95
- The Collector's Guide to Antique Radios, 4th Ed., Bunis. *This guide covers radios from 1920s to 1960s. Over 8,500 prices and many all new color photos are included.* 1996. \$18.95
- The Collector's Guide to Antique Radios, Combined Ed., CD-ROM, Bunis & Kaczowka. *Combines book editions 1, 2, 3, and 4. Over 9,000 Models with pricing. Model number index for all manufacturers, photo index by category.* 1,800 full color photos. Requires a web browser. IBM & Mac. 1998. \$39.95
- The Collector's Guide to Novelty Radios, Bunis & Breed. *Descriptions with prices.* 600+ color photos. 1994. 224 pgs. \$18.95
- The Collector's Guide to Novelty Radios, II, Bunis & Breed. *New radios & prices.* 600+ color photos. 1998. 208 pgs. \$19.95
- The Collector's Guide to Transistor Radios, 2nd Ed., Bunis. *Identifies the most sought-after vintage transistor radios. Includes club listing.* Over 2,900 models, 375 all new color photos, with current prices. 1996. 320 pgs. \$16.95
- The Collector's Guide to Vintage Televisions, Durbal & Bubeneimer. *Includes information about the size of the screen, year of manufacture, cabinet, and current value for over 1,400 vintage TVs.* 200+ color photos. 1999. 176 pgs. NEW \$15.95
- Communication Receivers, 4th Ed., Moore. *Information on 750, 1932 to 1981, vacuum tube receivers by 66 manufacturers.* 448 radios illustrated. 3 pages of military receivers. 136 pgs. \$19.95
- The Complete Talking Machine, 3rd Ed., Reiss. *A guide to antique phonographs. Revised price guide. Covers construction, cleaning and repairing of parts and cabinets.* Over 700 pictures. 249 pages \$29.95
- Crystal Clear - Vintage American Crystal Sets, Crystal Detectors and Crystals, Sievers. Vol. 1 - *Comprehensive reference with 750 illustrations, 570 crystal sets, 341 detectors, 207 crystals.* 282 pgs. \$29.95
Vol. 2 - *479 All new & different illustrations, more crystal sets, crystals and crystals identified.* 252 pgs. \$29.95
- Crystal Radio: History, Fundamentals, and Design, Kinzie. *Plus crystals for detectors.* 121 pgs. \$11.95
- Crystal Set Building and More, The Xtal Set Society. *Projects and information about crystal radios, mostly dealing with design and electronics issues.* Vols. 6 & 7 of the Xtal Set Society Newsletter. \$15.95
- The Crystal Set Handbook, Anderson. *Formulas for coil inductance, a procedure for measuring coil capacitance, circuit matching theory, & more.* Vol. 3 of the Xtal Set Society Newsletter. \$11.95
- Crystal Set Looper, a 3 Tuber and More, The Xtal Set Society. *Shortwave looper, AM/SW 3 tuber, antenna tuner/AM trap, and more.* Vol. 8 of the Xtal Set Society Newsletter. \$15.95
- Crystal Set Projects: 15 Radio Projects You Can Build, The Xtal Set Society. 160 pgs. \$14.95
- E.H. Scott Radio Collectors Guide, 1925-1946, Clark. *The reference for collectors of Scott radios, cabinets and accessories. Lists original prices of cabinets and accessories. Over 200 photos with descriptions.* 88 pgs. \$29.95
- 1940 E.H. Scott Catalog, King. *Quality reproduction of the custom built receivers. Includes radios & cabinet illustrations.* \$12.95
- Early Radio, In Marconi's Footsteps, Jensen. *Realistic description of Marconi's work and his surroundings. Early construction projects with diagrams. Color and B&W photographs.* 170 pgs. (hardcover only) \$39.95
- Evolution of the Audio Recorder, Van Praag. *Comprehensive guide to the audio recorder.* 1997, 518 pages. \$39.95
- Evolution of the Radio, L-W Books. *Radios pictured and priced, plus reproductions of catalog pages and ads.* Vol. 1 - *Eight-hundred + radios.* 1991. 227 pgs., 118 pgs. in color. \$22.95
Vol. 2 - *Totally different from volume one with new photos, etc.* 1993. 654 color photos. 226 pgs. \$24.95
- Fixing Up Nice Old Radios, Romney. *Written by a retired radio instructor, this book covers Ohm's law, through battery sets, superhets and communications receivers.* 1990. 300+ figures, 185 pgs. \$35.00
- Flick of the Switch, McMahon. *The classic photo reference guide for 30s - 50s radios.* 1000+ photos. 263 pgs. \$11.95
- Genuine Plastic Radios of the Mid-Century, Jupp & Piña. *Overview of plastic table radios with advertisements, vintage black & white photos.* 439 color photos. 208 pgs. (hardcover) \$39.95
- The Golden Age of Televisions, Collins. *Nice collection of photographs of these early machines* \$15.95
- Guide to Old Radios - Pointers, Pictures & Prices, 2nd Ed., Johnson. *Introduction to radio collecting. Includes hundreds of photos and a price guide.* 1995. 272 pgs. \$19.95
- Hake's Guide to TV Collectibles. *Price guide and photos for 1600 TV shows, comic books, etc.* 1990. 185 pgs. \$14.95
- Ham Price Guide, 2nd, Rippen. *Prices for over 3,800 transceivers, receivers, tuners, transmitters, amplifiers, antennas and test equipment. Additional prices for books, tubes and catalogs.* 1999. 81 pgs. NEW \$10.95
- Healthkit, A Guide to the Amateur Radio Products, Person. *Documentation of all Healthkit's amateur radio products, a complete history of the company.* 200+ sharp photos. 256 pgs. \$24.95
- Index to A.R.C., 1984-99, Sibley. *Index to articles in Antique Radio Classified from 1984 through 1999.* 76 pages. NEW \$15.00
- L. A. Radio Manufacturing, Paul. *Radio makers in L.A. from 1922-42. Echophone, Gilfillan & 10 others.* 88 pgs. \$11.90
- Supplement No. 1, Paul. *Coverage of additional manufacturers, people and sets.* 1993. 48 pgs. \$6.75
- Supplement No. 2, Paul. *Coverage of additional manufacturers, people and sets.* 1999. 54 pgs. \$10.90
- The Magnetic Cone Speaker Notebook, Paul. *250+ cone speakers from 120+ companies. Philcopy.* 1995. 58 pgs. \$11.90
- The Mechanics of TV, Yanczer. *Explanation of mechanical to, details for a working system.* 5 1/2" by 7 1/2", 170 pgs. \$24.95
- Most Often Needed 1926-38 Radio Diagrams and Servicing Information (reprint). *600+ diagrams for mostly AC radios from '26-'38.* 240 pgs. \$18.50
- Old Radio Sets, Hill. *The development of the radio in Britain from the late Victorian era until the late 60s.* 60 photos. 32 pgs. \$4.95
- Old Telephones, Emmerson. *The development of the telephone in Britain from 1878 thru the 80s.* 50 photos. 32 pgs. \$4.95
- Old Television, Emmerson. *The development of the television in Britain until the late 60s.* 50 photos. 32 pgs. \$4.95
- Old-Time Radios! Restoration and Repair, Carr. *How to repair vacuum-tube and transistor radios. A self-paced training guide.* 200 illustrations, 256 pgs. \$19.95
- Philco Condensers and More, Bintliff. *Detailed service data for Philco Bakelite block condensers, metal-cased condensers and tone controls. Pictorial guides show electrical connections and capacitor values.* 300+ illustrations. 68 pgs. NEW \$14.95
- Philco Radio: 1928-1942, Ramirez. *A reference book on Philco. Shows receivers and company history year-by-year.* 464 color photos, 364 black & white photos and drawings. 1993. 160 pgs. \$29.95
- Phono-Graphics: The Visual Paraphernalia of the Talking Machine, Schwartzman. 119 pgs. \$16.95

- A Pictorial History of Collins Amateur Radio Equipment.** Miller. *The most complete story of Collins. Told in hundreds of photos & in the words of the men who made it happen.* 1999. 175 pgs. **NEW \$39.95**
- The Pocket Guide to Collins Amateur Radio Equipment 1946-1980.** Miller. 90+ sharp photos. 3 1/2" x 7". 108 pgs. \$19.95
- Portable Radio In American Life.** Schiffer. *Traces the development of the portable radio and how it affected American culture and society.* 450 photos and drawings. 259 pgs. (hardcover: \$45.00) \$26.95
- RCA Radiolas, Radiotrons, and Accessories** (reprint). *Twenty-page booklet summarizing RCA's 1926 product line.* \$4.50
- Radio Art.** Hawes. *A chronological, illustrated history of the technical and stylistic progress of the radio. Mostly British, but American sets are featured as well.* 250 photos, 150 in color. 128 pgs. (hardcover only) **Low Price \$9.95**
- Radio Art Postcard Deck.** 30 full-color photographs from Hawes' book. \$7.50
- Radio Collector.** (Videotape, VHS). *The five-part Emmy-nominated PBS series combined on one 130-minute videotape.* \$29.95
- The Radio Collector's Directory and Price Guide, 1921-1965, 2nd Ed.,** Grinder. *Directory of over 20,000 radios by manufacturer, model no., year, etc. with prices. History, cabinet styles, vacuum tube development chapters.* 500 pgs. \$26.95
- The Radio Collector's Foto-Finder, Bintliff.** *An alphabetical index to illustrations in the four editions of the "Collector's Guide to Antique Radios" by Marty & Sue Burns.* 1997. 48 pgs. \$12.95
- Radio Collector's Guide,** McMahon. *Listing of 9,000+ radios made by some 1200 companies from 1921 to 1932. Gives manufacturer, year, model name and other info. No photos, 264 pgs.* \$11.95
- Radio Diagram Sourcebook,** Gray. *Valuable tool for identifying radios. Tubes used, replacement dial lamps, and I.F. frequency.* Reprint of *Sylvania's tube complement guide* is included listing almost 10,000 radios. 290 pgs. \$18.95
- Radio Horn Speaker Encyclopedia,** Paul. *Listing of horn speakers for 320+ manufacturers for the 1920s. Expanded info. on 10 companies.* 145+ photos, 80 pgs. \$15.90
- Radio Horn Speaker Notebook,** Rev. H. Paul. *The companion to the Encyclopedia. Over 450 horn picture ads are shown, over 325 manufacturers are identified. Photocopy. New Index.* 1995. 72 pgs. \$16.90
- Radio Manufacturers of the 1920's,** Douglas. 3 volumes. **Vol. 1: A-C Dayton thru Ferguson** (softcover only) \$24.95
Vol. 2: Freed-Eisemann thru Priess. 266 pgs. (softcover only) \$29.95
Vol. 3: RCA thru Zenith. 292 pgs. (hardcover: \$39.95) \$29.95
- Radio Tubes and Boxes of the 1920s,** Fathauer. *A pictorial presentation of radio tubes of the 20s, including packaging and advertising.* 400+ color photos and illustrations. 1999. 105 pgs. **NEW \$26.95**
- Radio/Radiol, 3rd Ed.,** Hill. *Comprehensive coverage of British radios from the 1920s-70s. This expanded edition includes the previous versions plus 75 new pages and 50 new illustrations. New transistor radio section.* (hardcover only) \$64.95
- Radios by Hallcrafters,** 2nd Ed., Dachs. *The most definitive book on radio on the company. Over 1,000 photos (some color) on everything they made. Additional coverage & updated pricing. An invaluable tool for anyone interested in Hallcrafters.* 225 pgs. \$29.95
- Radios of the Baby Boom Era.** *Pictures and info from Sams Photofacts.* 3,494 radios illustrated plus 3,275 additional radios listed. 274 brands. 1946-1960. 300+ pages per volume. **Vol. 1: Admiral - Crosmore** Vol. 2: **Co-op - Geloso** Vol. 3: **GE - Montoradio** Vol. 4: **Motrola - RCA** Vol. 5: **Realtone - Stratovox** Vol. 6: **Stromberg-Carlson - Zenith.** (1st Vol.) \$16.95
- Radios: The Golden Age,** Collins, (reprint). *Vintage table radios.* 100+ color photos. 119 pgs. \$12.98
- Rasco Radio Parts,** (reprint). *Catalog No. 18 summarizing 1928's product line.* 144 pgs. \$9.95
- Refinishing Old Furniture,** Wagoner. *Written by a furniture restoration instructor. A step-by-step guide to furniture (or radio) restoration, from removal of finishes right up to the final polish.* 178 pgs. \$14.95
- Saga of the Vacuum Tube,** Tyne. *The development of vacuum tubes - 1880 to 1930. From Edison, Thomson and Fleming to de Forest, Philips, Siemens and many more.* 100+ tube photos, 495 pgs. \$18.95
- Shortwave Receivers Past & Present,** Communications Receivers 1942-1997, 3rd Ed., Osterman. *For the radio collector, the informed receiver buyer or anyone interested in the history of shortwave radios.* 700+ receivers listed. 473 pgs. \$24.95
- S. Gernsback Radio Encyclopedia** (reprint). *1927 classic encyclopedia on radio. From "A" battery to Zirconium, with 1000s of entries in between.* 100s of illustrations. 175 pgs. \$9.95
- 70 Years of Radio Tubes and Valves,** 2nd Ed., Stokes. *The thermionic vacuum tube story from 1883 through 1960. New chapter on audio application tubes, more photos, magazine ads and a new index by tube number.* 264 pgs. \$29.95
- 75 Years of WE Tube Manufacturing,** Magers. *A log book history 750+ WE tubes. Illustrated.* 133 pgs. \$16.95
- The Talking Machine,** Fabrizio and Paul. *Over 550 photos of horn phonographs.* 256 pgs. (hardcover only) \$69.95
- Transistor Radios: 1954-1968,** Smith. *Over 1,000 transistor radios identified by manufacturer, marketing organization, type, and style. Color photos and price guide.* 1998. 160 pgs. \$29.95
- Transistor Radios, A Collector's Encyclopedia and Price Guide,** Lane. *Identification guide to over 2,500 transistor and novelty radios. History and key to collecting chapters.* 1994. 170 pgs. \$19.95
- Transmitters, Exciters and Power Amplifiers 1930 - 1980,** Moore. *Pictorial and descriptive guide to amateur high frequency transmitters and amplifiers manufactured in the U.S.A. Over 500 photos.* 144 pgs. \$21.95
- Tube Data,** Holm. *The most comprehensive list of vacuum tubes and data in an easy-to-use program for IBM compatibles.* 27,000+ tubes, includes receiving and transmitting tubes. Lists function, manufacturer, technical data, & more. (3 1/2" disk). \$39.95
- Tube Lore,** Sibley. *Trends in tube design, receiving and audio tubes, special-purpose and transmitting tubes, military types, tips on testing, repairing, adapting various tubes, auction prices from six major sales.* 186 pgs. \$19.95
- Tube Type Transmitters,** Rippen. *Provides a wealth of info on transmitters and transceivers. Includes ancillary items such as linear amplifiers, converters, modulators and VFOs.* Over 500 illustrations. 145 pgs. \$17.95
- The Weekend Refinisher,** Johnson. *A complete guide to stains and finishes and tips for setting up your own workshop. A handy furniture "first aid" kit for quick repairs.* Illustrated. 296 pgs. \$12.00
- Wireless Communication in the U.S.,** Mayes. *Early development of American radio operating companies. Alternators, coherers, stock promotions, unpublished letters, etc.* 160 illustrations. 240 pgs. \$29.95
- The Xtal Set Society Newsletter,** Anderson. *Complete set of the Society's newsletter. Order by volume. Vol. 1 & 2: 7/91 to 5/93. Field Strength Meter, FM Xtal Set, Xtal Sets & Wireless, the Lead Pencil Detector, The Universal Xtal Set, & more.* \$19.95
Vol. 4: 1/94 to 11/94 - Measuring Coil Capacitance, home-brew headphones and curve tracers, etc. **Vol. 5: AM Receiver Design, Marconi Type 107, Radio Outfit in a Headset, & more. Vol. 4-5 \$10.95**
- Zenith The Early Years, 1919-1935,** Bryant and Cones. *The 1st of a planned 3-book series. Explains the Zenith story. Discover never published photos, documents and info.* 300 photos and illustrations, 120 in color. 224 pgs. \$29.95
- Zenith Radio Corporation** (reprint). *The instructions for installation and operation for Models 39-39A Models 392-392A, and Electric Zenith Receivers.* 3 schematics, 3 photos, 7 1/2" by 5", 16 pgs. \$4.50
- The Zenith Trans-Oceanic: The Royalty of Radios,** Bryant and Cones. *Presents the fascinating story of the development and use of the Trans-Oceanic. Several photos, documents, ads, etc.* 160 pgs. \$24.95
- Zenith Transistor Radios, Evolution of a Classic,** Smith. *A complete listing of all transistor radio models created by Zenith during the "Magic Years" from 1955-65. Color photos and price guide.* 1998, 160 pgs. \$29.95

Everything stocked and shipped promptly - Radio is our middle name.

U.S. Orders - 16th Anniversary Special - free U.S. packing & book-rate shipping thru June 30, 2000. If using VISA or MasterCard, include name on card, card number and expiration date. Send payment with order. Mass. residents add 5% sales tax. Money back return policy. Softcover unless stated otherwise. Most orders shipped by next business day. Typical U.S. order will be received within 7 days, but allow 2-3 weeks. Foreign orders - write for shipping costs, or use credit card and specify air or surface (allow 2-3 months for surface shipping).



A.R.C., P.O. Box 2, Carlisle, MA 01741. Tel: (978) 371-0512

Fax: (978) 371-7129 — E-mail: ARC@antiqueradio.com — Web: www.antiqueradio.com



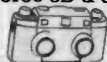

Repair man's TUBE Box—This holds about 200 radio and TV type vacuum tubes, and was used by a local repairman in the 1950s and 1960s. Should be handy for anyone! \$57

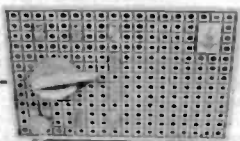

FOR SALE: Emerson 708 Series B. This gray plastic radio is 6-1/2" wide by 5-1/2" tall, has gold knob and trim, and the famous Emerson logo on the front. Excellent cosmetics and works—but you can hear a hum. Priced at only... \$28



FOR SALE: RCA 9-JY Phono. This brown bakelite 45-player has gold arm and turn table and looks great—the bakelite is not broken. This has a push button on the front and knob on the side. Untested electrically...\$41

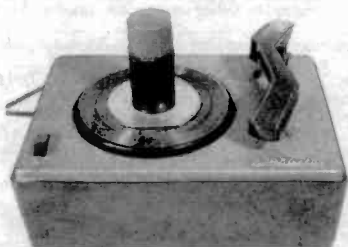

FOR SALE: RCA 45-J2 Phono. This brown bakelite 45-player has gold-tone upper half, in excellent cosmetics with no chips or cracks—but it's untested electrically...\$45

Please see our
TRANSISTOR Radios FOR SALE:
www.harryposter.com

FOR SALE: PEPSI Cap Novelty Transistor! This 6" diameter plastic radio is still new, packaged—from JSNY, #2852. A recent close-out, but this should make a great collectible! AM-FM radio in the familiar bottle cap shape with red, white and blue Pepsi Cola logo...\$15



FOR SALE: Emerson Model 849. This 6" wide gray radio has brass trim on the front and 2 knobs on the right side. Emerson's first all-transistor radio, excellent condition; no corrosion. Features 6 push-in transistors on a hand-wired chassis. I can get static only...\$99



FOR SALE:
Orion 8-transistor HiFi.

This 4-1/2" tall Japanese black and chrome transistor radio is in excellent condition with Civil Defense markings on the dial. Working condition, but it has a squeal...\$49



FOR SALE: Toshiba 6TP-385, 4-1/2" wide brown with white radio; CD marks on the dial. Excellent with normal wear, but 1/2" fracture on right side at the parting line. It uses tall black painted transistors and it does work...\$129

CLASSIFIED ADVERTISING POLICY

ONE FREE 20-WORD AD for subscribers in each issue; additional words are 29c each. See details below. Classified ads sent by mail, fax, e-mail or by any other method must be received (not just postmarked!) by **Noon Eastern Time** on the classified ad deadline date to guarantee inclusion in the current issue. Late ads are held for the following issue. Please enclose correct payment with all ads. Stamps or cash are OK for small amounts. (Canadian and other foreign advertisers, please see "Payment" on page 2 for methods.) "Free words" cannot be accumulated from month to month; free words must be requested when ad is submitted.

Faxed & e-mailed ads: Please see additional information on the inside front cover.

When including ads with other A.R.C. correspondence, write the ads on a separate piece of paper. Include SUB# with ad. Ads may be sent in advance; but, write each ad on a separate piece of paper and indicate the month (or successive two months) you want the ad to run.

To minimize our typing errors: Please write legibly. Use both capital and small letters. Do not use a dash between words. Carefully write the following numbers and letters (especially in model numbers) since some can look alike; for example 1, l and i (the number one, the capital i and the small L.) Also: 0, O, o, Q and D; r and n; 6, b and G; V, U, u, v and Y; A and R; 5, S and s; 2, Z and z. We try to correct spelling errors, so when using an uncommon word or manufacturer which we might mistake as a more common word or manufacturer, note it so that we do not "correct" it. Editor's annotations are in [brackets].

Advertising is accepted only for early items related to radio, communication, etc. All items must be described fairly; reproductions, reprints and not-original items must be so identified. Advertisers must agree to respond promptly to inquiries and orders, to resolve problems promptly if the buyer is not satisfied, and to comply with a buyer's refund request on unaltered returned items.

The publisher reserves the right to edit ads without notification to the advertiser and to reject ads for any reason. Names other than the advertiser will be edited out of ads. Ads with non-radio-related items will be returned or edited unless the non-radio-related items are for trade of radio-related items, or they are incidental to and appear at the end of an otherwise acceptable ad. The publisher is not responsible for errors due to illegibly written ads or for any other reason. See also Publishing Rights on page 2.

Clubs: Since club activities receive free coverage on the *Coming Radio Events* pages, the free 20 words may not be used for club activity ads. A discount on display advertising is available for clubs.

CLASSIFIED AD DETAILS

Deadline: NOON ET— 10th of the month!

Classified ads must have a standard heading such as **WANTED, FOR SALE, FOR TRADE, FOR SALE/TRADE, SERVICES, MESSAGE, HELP, AUCTION, MEET, etc.** This heading is the only bold or all-capitalized words allowed in the ad. Capitalize only manufacturer names, model names, etc. This standard ad format makes scanning the ads easier.

Before writing your ad, please look over the ads in a recent issue of A.R.C., and try to write your ad in the same style. Full name (or company name) and address is required in all classified ads; we will add it if you forget.

To encourage varied content of the ads, the same classified ad may be run only once per issue and for only two consecutive months. (To run an ad longer, use a boxed classified or display ad.)

Classified Ad Rates per Month

Subscribers:

First 20 words: **FREE***

29c per word for extra words over 20 **plus**

10c per word for a shaded ad (count all words including free words).

* Subscribers may take 20 free words on only **one** ad each month.

Non-Subscribers:

47c per word **plus**

10c per word for shaded ad.

Please do not forget to send in the extra 29c per word when your classified ad runs over the free 20 words; your payment will be appreciated, and it will help to keep A.R.C. healthy.

BOXED CLASSIFIED AD DETAILS

Deadline: 1st of the month!

Boxed classified ads can run unchanged for three months or more. No words are free. Ads may be shaded and may include bold and all-capitalized words freely. The ad need not begin with "For Sale," etc. Minimum run is 3 months, prepaid. Discount: 10% for 6 months; 20% for 12 months.

Boxed Classified Ad Rates per Month

Nonshaded ads:

40c per word for all words,* none free, **plus**

10c per word for each bold word **plus**

10c per word for each all-caps word.

Shaded Ads (All words are bold at no charge):

50c per word for all words* **plus**

10c per word for each all-caps word.

Non-Subscribers:

Add 20c per word to above costs.

*Three words can be bold-all-caps at no extra charge.

PHOTO & DRAWING DETAILS

Deadline: 1st of the month

for all ads with drawings or photos!

Drawings and photos are encouraged as the response to your ad is much larger and the reader knows better what you want or are selling. Send in your drawing or photograph, and A.R.C. will reduce it or enlarge it as needed.

Photo and Drawing Rates per Month

\$23.00 per month for each photo or drawing (If ad is canceled, this amount cannot always be refunded.)

CHANGES & CANCELLATIONS

Please check your ads carefully before sending them in. Once ads are received, it is not always possible to refund the amount sent, pull the ad or make changes.

IMPORTANT — COUNTING WORDS — IMPORTANT

The standard headings: **WANTED, FOR SALE, etc.**, count as **one word** each time used in an ad. **Name, address and (one) telephone number, count as 6 words**, regardless of length. Ham call letters and business name can be included in the 6 words and do not count extra. Full name (or company name) and address is required in all classified ads. Each additional word, abbreviation, model number or number group, extra telephone numbers, fax, e-mail, etc. count as one word each. Hyphenated words count as two words.

PERIODICALS

ANTIQUE RADIO CLASSIFIED

A.R.C., P.O. Box 2, CARLISLE, MA 01741
ADDRESS SERVICE REQUESTED

FOR ADC 780
EXP=JUN01

J*****ALL

K SUB#-27-777 [3630]

JOE W MCCLUGHAN

PO BOX 310465

NEW BRAUNFELS TX 78131

CLASSIFIED AD

DEADLINE APR. 10th

Noon Eastern Time